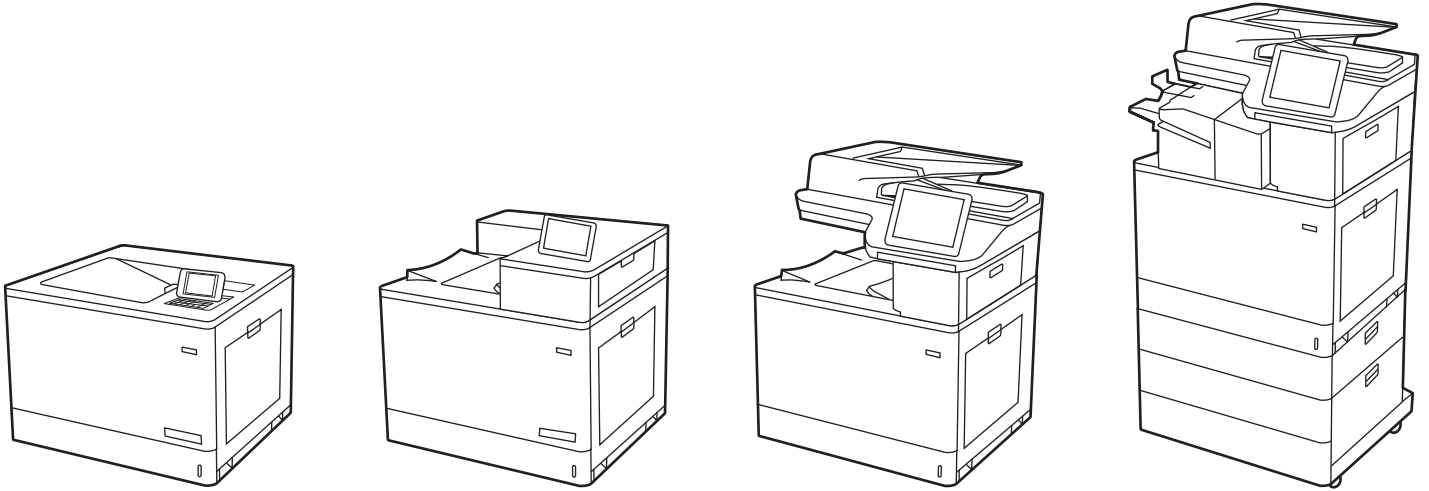




HP Color LaserJet Enterprise M751, M856
HP Color LaserJet Managed E75245, E85055
HP Color LaserJet Enterprise MFP M776

Service Manual: Repair



www.hp.com/videos/LaserJet
www.hp.com/support/colorljM751
www.hp.com/support/colorljM776MFP

www.hp.com/support/colorljM856
www.hp.com/support/colorljE75245
www.hp.com/support/colorljE85055



HP Color LaserJet Enterprise M751, M856, Managed E75245, E85055, and Enterprise MFP M776 - Service Manual: Repair

SUMMARY

This guide provides theory of operation, troubleshooting, and repair information.

Legal information

Copyright and License

© Copyright 2020 HP Development Company, L.P.

Reproduction, adaptation, or translation without prior written permission is prohibited, except as allowed under the copyright laws.

The information contained herein is subject to change without notice.

The only warranties for HP products and services are set forth in the express warranty statements accompanying such products and services. Nothing herein should be construed as constituting an additional warranty. HP shall not be liable for technical or editorial errors or omissions contained herein.

Edition 9, 4/2021

Revision history

View a list of document revisions.

The information contained herein is subject to change without notice. The only warranties for HP products and services are set forth in the express warranty statements accompanying such products and services. Nothing herein should be construed as constituting an additional warranty. HP shall not be liable for technical or editorial errors or omissions contained herein.

Table Revision history

Revision number	Revision date	Revision notes
9	3/31/2021	Added duplexing assembly part number to table 2-12 on page 2098
8	2/2021	Updated Part number for Control panel (M751/E75245) on page 78
7	12/2020	Added HP Color LaserJet Enterprise MFP M776 cable part numbers (FY21PR-4719). See Parts and diagrams: Discrete cables (M776) on page 2091 .
6	06/2020	Updated information in remove and replace topics for the inner finisher. <ul style="list-style-type: none"> Return belt assembly <p>Added note "After replacement, the following adjustments need to be performed." to procedures that require adjustments.</p> <p>Processing tray assembly</p> <p>Staple mount assembly</p> <ul style="list-style-type: none"> Added new image for reinstall tip to Staple mount assembly. <p>Removal and replacement: Inner finisher staple mount assembly (M776zs) on page 1783</p>
2	11/2019	Added repair topics for the M856/E85055/M776 models. <ul style="list-style-type: none"> Removal and replacement: Control panel (M776) on page 85 Removal and replacement: Document feeder reflector (M776) on page 96 Removal and replacement: Control panel (M856/E85055) on page 79 Removal and replacement: Top cover (M856/E85055) on page 149 Removal and replacement: Accessory upper cover (M856/E85055/M776dn/M776z) on page 155 Removal and replacement: Left upper front and rear covers (M751/E75245/M856/E85055/M776) on page 159 Removal and replacement: Reverse tray (M856/E85055/M776dn/M776z) on page 163 Removal and replacement: Document feeder (M776) on page 190
2	11/2019	Added repair topics for the M856/E85055/M776 models. <ul style="list-style-type: none"> Removal and replacement: Image scanner (M776) on page 195 Removal and replacement: Right upper cover (M776zs) on page 205 Removal and replacement: Right upper door (M776zs) on page 209 Removal and replacement: Right rear upper cover (M776zs) on page 222 Removal and replacement: Rear upper cover (M776zs) on page 226

Table Revision history (continued)

Revision number	Revision date	Revision notes
		<ul style="list-style-type: none"> • Removal and replacement: Main cover (M776zs) on page 230 • Removal and replacement: Front cover (M776zs) on page 234 •
2	11/2019	<p>Added repair topics for the M856/E85055/M776 models.</p> <ul style="list-style-type: none"> • Removal and replacement: Right front cover (M776zs) on page 236 • Removal and replacement: Delivery front cover (M776zs) on page 246 • Removal and replacement: Delivery cover (M776zs) on page 257 • Removal and replacement: Delivery rear cover (M776zs) on page 272 • Removal and replacement: Keyboard (M776z/M776zs) on page 292 • Removal and replacement: Scanner control board (M776) on page 299 • Removal and replacement: Wireless PCA (M856/E85055) on page 303 • Removal and replacement: Wireless PCA (M776) on page 309
2	11/2019	<p>Added repair topics for the M856/E85055/M776 models.</p> <ul style="list-style-type: none"> • Removal and replacement: Communication PCA (M776) on page 312 • Removal and replacement: Duplexing controller PCA (M856/E85055/M776) on page 317 • Removal and replacement: Low-voltage power supply fan (M856/E85055/M776) on page 1225 • Removal and replacement: Low-voltage power supply (LVPS) (M856/E85055/M776) on page 960 • Removal and replacement: Delivery assembly (M856/E85055) on page 341 • Removal and replacement: Toggle front assembly (M856/E85055/M776dn/M776z) on page 394 • Removal and replacement: Toggle rear assembly (M856/E85055/M776dn/M776z) on page 413 • Removal and replacement: Duplex reverse guide assembly (M856/E85055) on page 433
2	11/2019	<p>Added repair topics for the M856/E85055/M776 models.</p> <ul style="list-style-type: none"> • Removal and replacement: Delivery assembly (M776zs) on page 373 • Removal and replacement: Toggle front assembly (M776zs) on page 468 • Removal and replacement: Toggle rear assembly (M776zs) on page 483 • Removal and replacement: Fuser motor (M856/E85055/M776) on page 500 • Removal and replacement: Fuser drive assembly (M856/E85055/M776) on page 545 • Removal and replacement: Cartridge guide (M751/E75245/M856/E85055/M776) on page 570 • Removal and replacement: Cartridge rail assembly (M856/E85055/M776dn/M776z) on page 591

Table Revision history (continued)

Revision number	Revision date	Revision notes
		<ul style="list-style-type: none"> • Removal and replacement: Cartridge rail assembly (M776zs) on page 605
2	11/2019	<p>Added repair topics for the M856/E85055/M776 models.</p> <ul style="list-style-type: none"> • Removal and replacement: DT-cartridge rail assembly (M856/E85055/M776dn/M776z) on page 649 • Removal and replacement: DT-cartridge rail assembly (M776zs) on page 663 • Removal and replacement: Formatter (M856/E85055/M776) on page 707 • Removal and replacement: Formatter case (M856/E85055/M776) on page 713 • Removal and replacement: Memory PCA (M856/E85055/M776) on page 727 • Removal and replacement: Main connecting PCA (M856/E85055/M776) on page 748 • Removal and replacement: Controller fan (M856/E85055/M776) on page 763
2	11/2019	<p>Added repair topics for the M776zs inner finisher.</p> <ul style="list-style-type: none"> • Removal and replacement: Inner finisher components on page 1693
2	11/2019	<p>Added new procedures for the M751/E75245 models.</p> <ul style="list-style-type: none"> • Removal and replacement: Cartridge rail assembly (M751/E75245) on page 571 • Removal and replacement: DT-cartridge rail assembly (M751/E75245) on page 629
1	5/2019	HP Color LaserJet Enterprise M751/E75245 Repair Manual initial release.

Table of contents

1 Removal and replacement	1
Conventions used in this guide	1
HP service and support	1
Removal and replacement strategy	2
Introduction	2
Considerations during removal and replacement	3
Electrostatic discharge	4
Required tools	4
Fasteners used in this printer	5
Service approach	5
Before performing service	5
After performing service	6
Print quality test	6
Removal and replacement procedures	6
Customer self-repair (CSR) A parts and accessories	6
Field replaceable units (FRUs)	103
2 Parts and diagrams	2077
HP service and support	2077
Order parts by authorized service providers	2078
Ordering	2078
Orderable parts	2078
Supplies and accessories	2078
Customer self-repair kits	2081
HP service and support	2082
Assembly locations	2084
Printer front view (M751/E75245)	2084
Printer back view (M751/E75245)	2085
Printer front view (M856/E85055)	2085
Printer back view (M856/E85055)	2086
Printer front view (M776)	2087
Printer back view (M776)	2089
How to use the parts lists and diagrams	2089
Parts and diagrams: Document feeder and image scanner (M776)	2090
Parts and diagrams: Discrete cables (M776)	2091
Parts and diagrams: Printer components	2091
Parts and diagrams: Printer components (M751/E75245)	2092
Parts and diagrams: Printer components (M856/E85055/M776dn/M776z)	2107
Parts and diagrams: Printer components (M776zs)	2125
Parts and diagrams: Inner finisher components	2141
Parts and diagrams: Printer covers (Inner finisher)	2141
Parts and diagrams: Printer internal assemblies (inner finisher; 1 of 3)	2144
Parts and diagrams: Printer internal assemblies (inner finisher; 2 of 3)	2146
Parts and diagrams: Printer internal assemblies (inner finisher; 3 of 3)	2148
Parts and diagrams: 550-sheet tray components	2150
Parts and diagrams: 550-sheet tray covers	2150
Parts and diagrams: 550-sheet paper tray internal assemblies	2151
Parts and diagrams: 2x550-sheet tray components	2153
Parts and diagrams: 2x550-sheet tray covers	2153

Parts and diagrams: 2x550-sheet paper tray internal assemblies (1 of 2)	2154
Parts and diagrams: 2x550-sheet paper tray internal assemblies (2 of 2)	2156
Parts and diagrams: High-capacity input (HCI) tray components	2157
Parts and diagrams: High-capacity input (HCI) tray covers	2157
Parts and diagrams: High-capacity input (HCI) tray internal assemblies (1 of 2)	2158
Parts and diagrams: High-capacity input (HCI) tray internal assemblies (2 of 2)	2160
Alphabetical parts list	2162
HP service and support	2077
Order parts by authorized service providers	2078
Ordering	2078
Orderable parts.....	2078
Supplies and accessories	2078
Customer self-repair kits.....	2081
HP service and support	2082
Assembly locations	2084
Printer front view (M751/E75245).....	2084
Printer back view (M751/E75245).....	2085
Printer front view (M856/E85055).....	2085
Printer back view (M856/E85055).....	2086
Printer front view (M776).....	2087
Printer back view (M776)	2089
How to use the parts lists and diagrams.....	2089
Parts and diagrams: Document feeder and image scanner (M776).....	2090
Parts and diagrams: Discrete cables (M776)	2091
Parts and diagrams: Printer components	2091
Parts and diagrams: Printer components (M751/E75245).....	2092
Parts and diagrams: Printer components (M856/E85055/M776dn/M776z)	2107
Parts and diagrams: Printer components (M776zs).....	2125
Parts and diagrams: Inner finisher components.....	2141
Parts and diagrams: Printer covers (Inner finisher)	2141
Parts and diagrams: Printer internal assemblies (inner finisher; 1 of 3).....	2144
Parts and diagrams: Printer internal assemblies (inner finisher; 2 of 3).....	2146
Parts and diagrams: Printer internal assemblies (inner finisher; 3 of 3).....	2148
Parts and diagrams: 550-sheet tray components	2150
Parts and diagrams: 550-sheet tray covers	2150
Parts and diagrams: 550-sheet paper tray internal assemblies.....	2151
Parts and diagrams: 2x550-sheet tray components.....	2153
Parts and diagrams: 2x550-sheet tray covers	2153
Parts and diagrams: 2x550-sheet paper tray internal assemblies (1 of 2)	2154
Parts and diagrams: 2x550-sheet paper tray internal assemblies (2 of 2)	2156
Parts and diagrams: High-capacity input (HCI) tray components	2157
Parts and diagrams: High-capacity input (HCI) tray covers	2157
Parts and diagrams: High-capacity input (HCI) tray internal assemblies (1 of 2)	2158
Parts and diagrams: High-capacity input (HCI) tray internal assemblies (2 of 2)	2160
Numerical parts list.....	2169
HP service and support	2077
Order parts by authorized service providers	2078
Ordering	2078
Orderable parts.....	2078
Supplies and accessories	2078
Customer self-repair kits.....	2081
HP service and support	2082
Assembly locations	2084
Printer front view (M751/E75245).....	2084
Printer back view (M751/E75245).....	2085

Printer front view (M856/E85055).....	2085
Printer back view (M856/E85055).....	2086
Printer front view (M776).....	2087
Printer back view (M776).....	2089
How to use the parts lists and diagrams.....	2089
Parts and diagrams: Document feeder and image scanner (M776).....	2090
Parts and diagrams: Discrete cables (M776).....	2091
Parts and diagrams: Printer components.....	2091
Parts and diagrams: Printer components (M751/E75245).....	2092
Parts and diagrams: Printer components (M856/E85055/M776dn/M776z).....	2107
Parts and diagrams: Printer components (M776zs).....	2125
Parts and diagrams: Inner finisher components.....	2141
Parts and diagrams: Printer covers (Inner finisher).....	2141
Parts and diagrams: Printer internal assemblies (inner finisher; 1 of 3).....	2144
Parts and diagrams: Printer internal assemblies (inner finisher; 2 of 3).....	2146
Parts and diagrams: Printer internal assemblies (inner finisher; 3 of 3).....	2148
Parts and diagrams: 550-sheet tray components.....	2150
Parts and diagrams: 550-sheet tray covers.....	2150
Parts and diagrams: 550-sheet paper tray internal assemblies.....	2151
Parts and diagrams: 2x550-sheet tray components.....	2153
Parts and diagrams: 2x550-sheet tray covers.....	2153
Parts and diagrams: 2x550-sheet paper tray internal assemblies (1 of 2).....	2154
Parts and diagrams: 2x550-sheet paper tray internal assemblies (2 of 2).....	2156
Parts and diagrams: High-capacity input (HCI) tray components.....	2157
Parts and diagrams: High-capacity input (HCI) tray covers.....	2157
Parts and diagrams: High-capacity input (HCI) tray internal assemblies (1 of 2).....	2158
Parts and diagrams: High-capacity input (HCI) tray internal assemblies (2 of 2).....	2160
Index.....	2177

1 Removal and replacement

When servicing the printer, several items must be taken into account to ensure a successful repair and to avoid damage to the printer or injury. Learn about these considerations and find detailed instructions for removing and replacing printer parts.

Conventions used in this guide

Learn about the conventions used in this publication.



TIP: Tips provide helpful hints or shortcuts.



NOTE: Notes provide important information to explain a concept or to complete a task.



CAUTION: Cautions indicate procedures that you should follow to avoid losing data or damaging the product.



WARNING! Warnings alert you to specific procedures that you should follow to avoid personal injury, catastrophic loss of data, or extensive damage to the product.

HP service and support

Learn about HP access to additional service and support information.

Additional service and support for channel partners

Channel partners go to partner.hp.com, and then use the steps below to access the HP Web-based Interactive Search Engine (WISE).

[View a video of how to use the HP Partner First Portal to access WISE.](#)

Access WISE for Channel partners

1. Select [Services & Support](#) (near the top of the screen).
2. Under [Services Delivery](#), select [Technical Support](#).
3. Select [Technical Documentation](#).

Find information about the following topics

- Service manuals
- Service advisories
- Up-to-date control panel message (CPMD) troubleshooting
- Solutions for printer issues and emerging issues
- Remove and replace part instructions and videos
- Install and configure
- Printer specifications
- Warranty and regulatory information

Additional service and support for HP internal personnel

HP internal personnel, go to one of the following Web-based Interactive Search Engine (WISE) sites:

[View a video of how to access WISE for internal HP users.](#)

Americas (AMS)

- [WISE - English](#)
- [WISE - Spanish](#)
- [WISE - Portuguese](#)
- [WISE - French](#)

Asia Pacific / Japan (APJ)

- [WISE - English](#)
- [WISE - Japanese](#)
- [WISE - Korean](#)
- [WISE - Chinese \(simplified\)](#)
- [WISE - Chinese \(traditional\)](#)
- [WISE - Thai](#)

Europe / Middle East / Africa (EMEA)

- [WISE - English](#)

Additional technical support WISE videos

The videos below provide additional ways to access printer information using WISE.

[View a video of how to use WISE to find technical support videos \(model number search\).](#)

[View a video of how to use WISE to find technical support videos \(Product detail page \[PDP\] search\).](#)

Removal and replacement strategy

The printer uses a field repair strategy. Defective parts are diagnosed and replaced at the Field Replaceable Unit (FRU) assembly level. Follow basic safety precautions to avoid injury or printer damage. Learn about the tools required to service the printer and the types of fasteners used.

Introduction

Learn the overall process for troubleshooting failures and replacing parts, as well as items of note related to installing and tracking printer supplies

Repair normally begins by using the printer internal diagnostics and the following two-step process:

1. Isolate the problem to the major system (for example, the network, the server, or the printer).

2. Identify the cause of failures according to the troubleshooting section in the printer service manual, and follow the disassembly procedures to replace the defective parts or the consumable parts.

 **IMPORTANT:** See the separate control panel message document (CPMD) for this printer for control panel error message descriptions and solutions (also available online).

After locating a faulty part, the printer can usually be repaired at the assembly level by replacing the field replaceable unit (FRUs). HP does not support replacement of components on the printed circuit assemblies (PCAs).

The user replaces supplies (cartridges) as they are depleted. Additional instructions about other user-replaceable parts are provided in this section.

The printer tracks the amount of use on the customer-replaceable supplies by keeping a page count. The printer prompts the user to replace certain items when a supply is depleted or a specific number of pages have been printed.

Swapping supplies between products might be necessary in some test scenarios. However, this might cause a misrepresentation of supply life values, and is not recommended.


Considerations during removal and replacement

Understand the items to take into account when removing and replacing parts.

This chapter describes the FRUs.


Reinstalling FRUs is generally the reverse of removal. Notes are included to provide directions for difficult or critical replacement procedures.

HP does not support repairing individual subassemblies or troubleshooting at the PCA component level.

 **WARNING!** Never operate or service the printer with the protective cover removed from the laser scanner assembly. The reflected beam, although invisible, can cause damage to the eyes.


The sheet-metal parts can have sharp edges. Be careful when handling sheet-metal parts.

Turn the printer off, wait five seconds, and then remove the power cord before attempting to service the printer. **If this warning is not followed, severe injury can result as well as damage to the printer.** The power must be on for certain functional checks during troubleshooting. However, the power cord must be disconnected during parts removal. AC voltage is still present inside the printer when the power switch is in the off position. The power cord must be disconnected before servicing the printer.

 **CAUTION:** Incorrectly routed or loose wire harnesses or flat flexible cables (FFCs) might interfere with other internal components or assemblies and can be damaged, pinched, or frayed. Make sure that wire harnesses are correctly routed and retained when installing assemblies.


Do not bend or fold the FFCs during removal or installation.

Do not expose the toner cartridges or imaging drums to strong light even for a short time.


 **IMPORTANT:** When an assembly is removed that includes a rating plate, tag, or a printer code label, make sure to transfer the plate, tag, or code label to the replacement assembly.

Do not replace the formatter, DC controller, memory PCA (island of data), eMMC PCA, or hard-disk drive (HDD) simultaneously during a single printer servicing. Doing so might cause the printer to become unstable or inoperable.

When replacing the formatter, make sure that all accessories installed on the formatter, such as the fax PCA, hard disk drive, trusted platform module, and DIMM, are removed from the defective formatter and installed on the replacement formatter. Make sure that the formatter is a new service part that has not been installed in a different device.



 **NOTE:** During assembly removal and replacement, or if the printer is moved, remove the toner cartridges, the imaging drums, and the toner collection unit.

Toner is a non-poisonous substance composed of plastic and a small number of colored components. If toner gets on the skin or clothing, wipe it off with dry tissue paper and wash in cold water. Hot water sets toner and it might be difficult, or impossible, to remove. Toner easily breaks down vinyl materials, so avoid letting toner contact vinyl.

 **TIP:** Some figures might show assemblies removed or installed that have not yet been removed or installed at that specific step. However, the procedures are correct for this printer and the target assembly. Always thoroughly read the instructions that accompany each figure.

Electrostatic discharge

Learn how to protect sensitive parts against damage from electrostatic discharge.

 **CAUTION:**  Some parts are sensitive to electrostatic discharge (ESD). Look for the ESD reminder when removing printer parts. Always perform service work at an ESD-protected workstation or mat. If an ESD workstation or mat is not available, touch the sheet-metal chassis to provide a static ground before touching an ESD-sensitive assembly.

Protect the ESD-sensitive assemblies by placing them in ESD pouches when they are out of the printer.

Required tools

Find information about the tools required to remove and replace parts on the printer.

- #2 Phillips screwdriver with a magnetic tip
- Small, flat-blade screwdriver
- Needle-nose pliers
- ESD strap (if one is available)
- Penlight


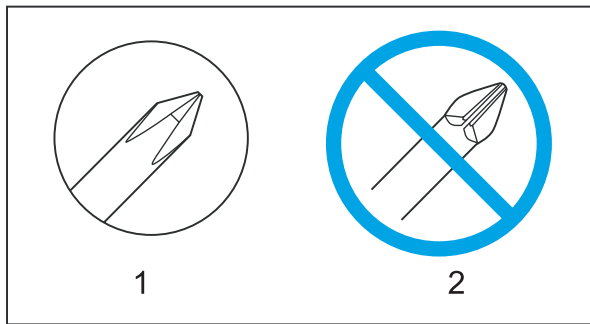
 **CAUTION:** Always use a #2 Phillips screwdriver (callout 1). Do not use a Pozidriv screwdriver (callout 2) or any motorized screwdriver. These can damage screws or screw threads.

Figure 1-1 Screwdrivers



Fasteners used in this printer

Learn about the different types of screws used in the printer and the importance of installing the correct type of screw in the correct location when replacing a part.

⚠ WARNING! Make sure that assemblies are replaced with the correct screw type. Using the incorrect screw (for example, substituting a long screw for the correct shorter screw) can cause damage to the printer or interfere with printer operation. Do not intermix screws that are removed from one assembly with the screws that are removed from another assembly.

📝 NOTE: To install a self-tapping screw, first turn it counterclockwise to align it with the existing thread pattern, and then carefully turn it clockwise to tighten. Do not overtighten. If a self-tapping screw hole becomes stripped, repair the screw hole or replace the affected assembly.

Always take note of the length, diameter, color, type, and location of each removed screw. Make sure that screws are installed in their original location during reinstallation.

Types of screws used in the printer

- Screw, BH M3x10
- Screw, D, M3x6
- Screw, D, M3x8
- Screw, Tapping, Truss Head, M4x10
- Screw, W/Washer
- Screw, W/Washer, M3x10
- Screw, W/Washer D, M3x8

Service approach

Follow these steps before and after performing service on the printer to prevent damage to the printer and ensure that the repair was successful.

Before performing service

Follow these steps before performing any type of service on the printer.

⚠ WARNING! Turn the printer off, wait five seconds, and then remove the power cord before attempting to service the printer. **If this warning is not followed, severe injury can result as well as damage to the printer.** The power must be on for certain functional checks during troubleshooting. However, the power cord must be disconnected during parts removal. AC voltage is still present inside the printer when the power switch is in the off position. The power cord must be disconnected before servicing the printer.

1. Turn the printer off using the power button.
2. Unplug the power cable and interface cable or cables.
3. Place the product on an ESD workstation or mat, or use an ESD strap (if one is available). If an ESD workstation, mat, or strap is not available, ground yourself by touching the sheet-metal chassis before touching an ESD-sensitive part.

4. Remove the toner cartridges and imaging drums. Place a sheet of paper over the imaging drums to protect them from excessive light exposure.
5. Remove all paper from the trays.
6. Remove the tray(s).

After performing service

Follow these steps after performing service on the printer.

1. Verify that you have completed the necessary reassembly steps.
2. Reinstall the tray(s).
3. Return all paper to the trays.
4. Reinstall the toner cartridges and imaging drums.
5. Plug in the power cable and interface cable or cables.
6. Turn the printer on using the power button.
7. Verify that the expected start-up sounds occur.

Print quality test

Ensure that the print quality is acceptable after performing printer repairs.

Use the printer internal print quality pages to help diagnose and solve print-quality problems. For more information, see the troubleshooting section in the service manual.



NOTE: To get further assistance in print quality troubleshooting, go to <http://www.hp.com/support/colorljM751>, <http://www.hp.com/support/colorljE75245>, <http://www.hp.com/support/colorljM856>, <http://www.hp.com/support/colorljE85055>, or <http://www.hp.com/support/colorljM776MFP>. Select **Troubleshooting**, select **Print**, and then select **Print Quality**.

Removal and replacement procedures

Learn how to remove and replace selected parts on the printer.

Customer self-repair (CSR) A parts and accessories

Customer self-repair (CSR) A parts are parts that a customer replaces without assistance from a field technician. These parts can be replaced without the use of any tools.

Install accessory: Internal USB ports (M751/E75245/M856/E85055/M776)

Learn how to install the internal USB ports accessory.

[View a video of how to install the internal USB ports.](#)

Mean time to repair: 10 minutes

Service level: CSR A

Before performing service

Turn the printer power off

- Disconnect the power cable.

⚠ WARNING! To avoid damage to the printer, turn the printer off, wait 30 seconds, and then remove the power cord before attempting to service the printer.

Use the table below to identify the correct part number for your printer. To order the part, go to www.hp.com/buy/parts.

Table 1-1 Part information

Part number	Part description
B5L28-67902	Internal USB ports

Required tools

- No special tools are required to remove or install this assembly.

After performing service

Turn the printer power on

- Connect the power cable.
- Use the power switch to turn the power on.

Post service test

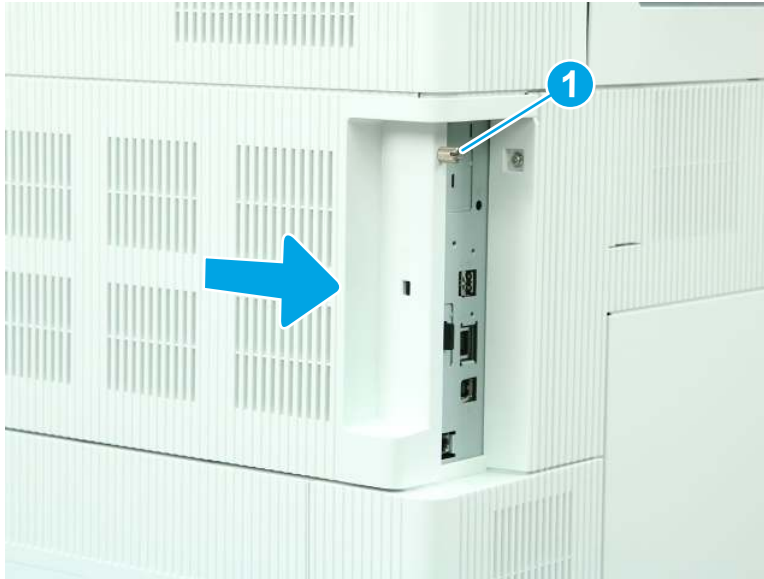
Make sure that the printer initializes to a **Ready** state.

Print a page to make sure that the printer is functioning correctly.

1. Remove the formatter cover.

- ▲ Loosen one thumbscrew (callout 1), and then slide the formatter cover (callout 2) away from the printer to remove it.

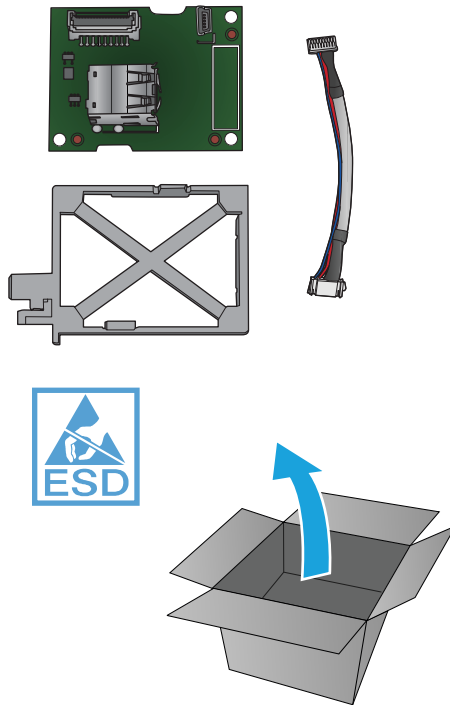
Figure 1-2 Remove the formatter cover



2. Unpack the accessory

- ▲ Remove the small PCA board, the PCA mounting cradle, and the shortest single cable (B5L45-60115) from the packaging.

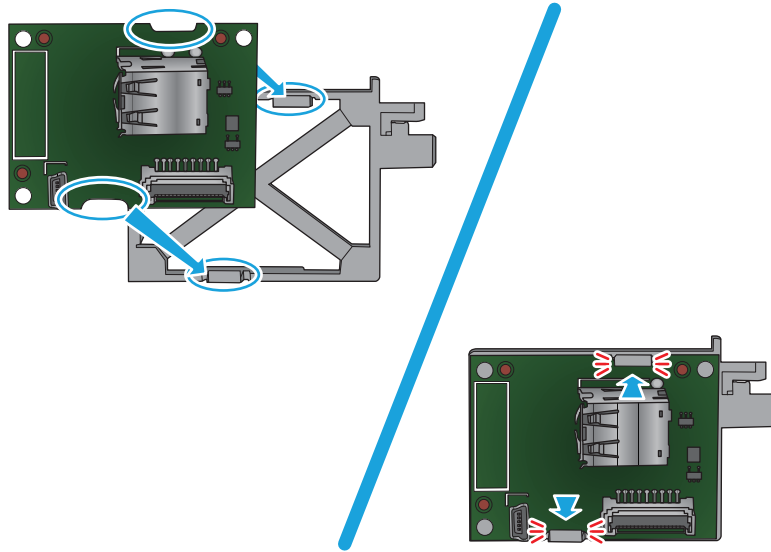
Figure 1-3 Unpack the components



3. Install the internal USB ports accessory.

- a. Position the notches on the internal USB ports PCA over the clips on the PCA holder, and then press down to attach the PCA to the holder. Make sure that the clips snap into place.

Figure 1-4 Attach the PCA to the cradle



- b. Connect the cable to the connector (callout 1) on the small PCA.


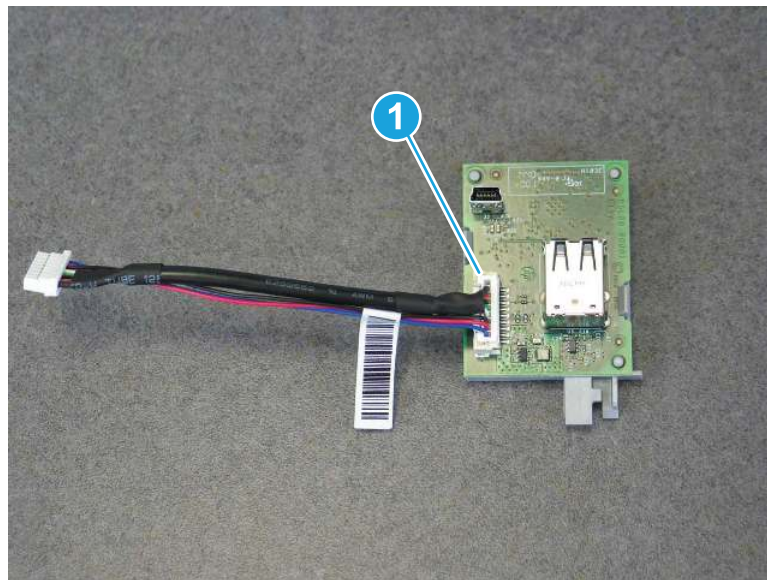
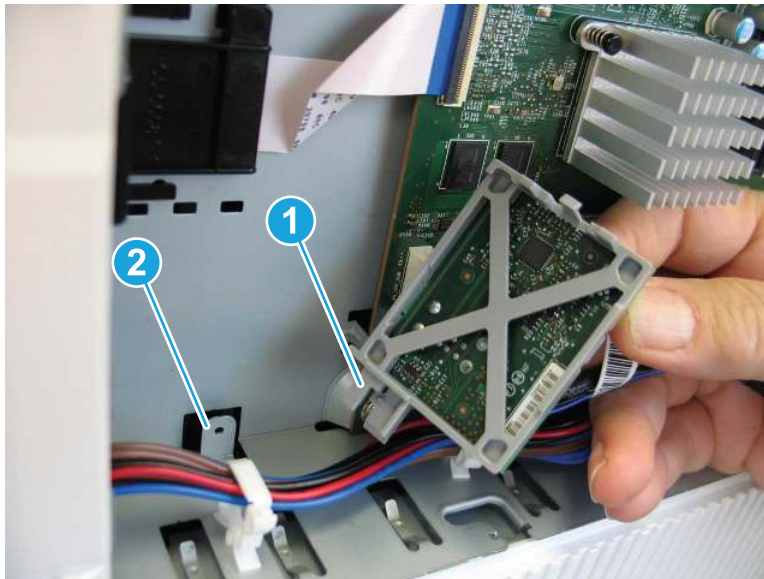
 **NOTE:** The connector on the cable is keyed. Make sure it is correctly installed.

Figure 1-5 Connect the cable to the PCA



- c. Position the slot (callout 1) on the end of the PCA bracket over the metal tab (callout 2) on the formatter case.

Figure 1-6 Position the slot over the tab



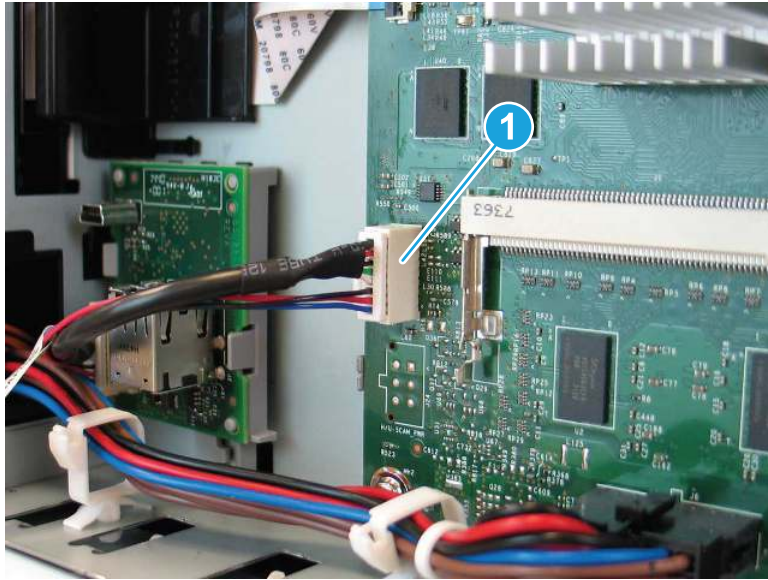
- d. Position the upper tabs on the PCA bracket into the slots in the formatter case. Press until the tabs snap into place.

Figure 1-7 Install the upper tabs



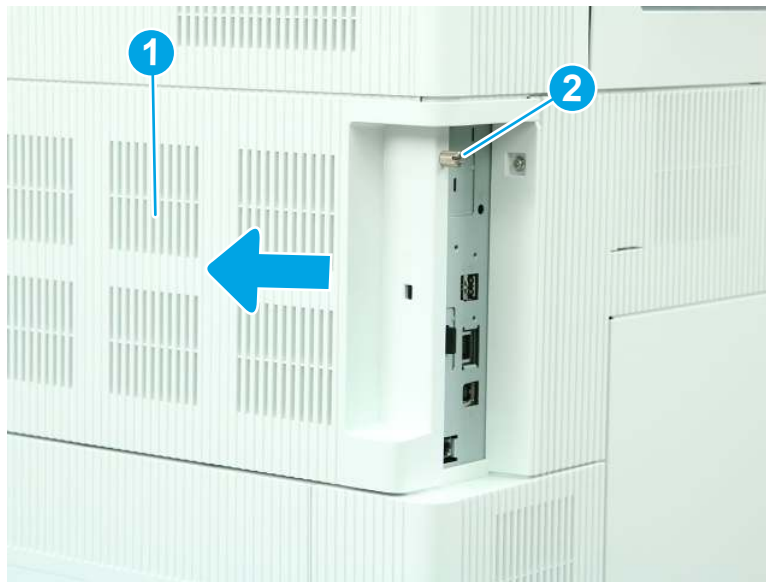
- e. Connect the cable to the connector (callout 1) on the formatter board.

Figure 1-8 Connect the cable to the formatter



4. Install the formatter cover.
 - ▲ Position the formatter cover (callout 1) on the printer, slide it toward the printer to install it, and then tighten one thumbscrew (callout 2).

Figure 1-9 Install the formatter cover



Removal and replacement: SODIMM (M751/E75245/M856/E85055/M776)

Learn how to remove and replace the SODIMM.

[View a video of how to remove and replace the SODIMM.](#)

Mean time to repair: 10 minutes

Service level: CSR A

Before performing service

Turn the printer power off

- Disconnect the power cable.

⚠ WARNING! To avoid damage to the printer, turn the printer off, wait 30 seconds, and then remove the power cord before attempting to service the printer.

Use the table below to identify the correct part number for your printer. To order the part, go to www.hp.com/buy/parts.

Table 1-2 Part information

Part number	Part description
E5K48-67902	HP 1GB DDR3 x32 144-pin 800MHz SODIMM
5851-6581	HP 2GB DDR3 x32 144-pin 800MHz SODIMM

Required tools

- No special tools are required to remove or install this assembly.

After performing service

Turn the printer power on

- Connect the power cable.
- Use the power switch to turn the power on.

Post service test

Make sure that the printer initializes to a **Ready** state.

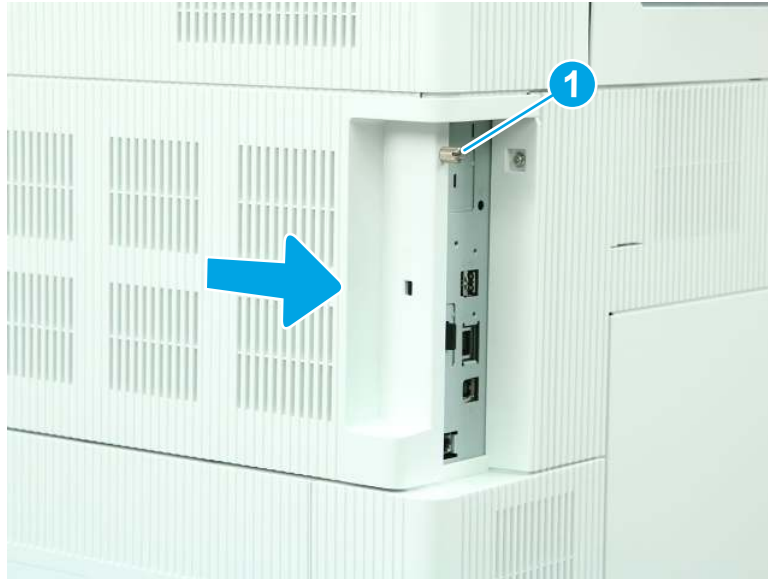
Print a page to make sure that the printer is functioning correctly.

Print a configuration page and verify that the memory section shows 1.5 GB.

1. Remove the formatter cover.

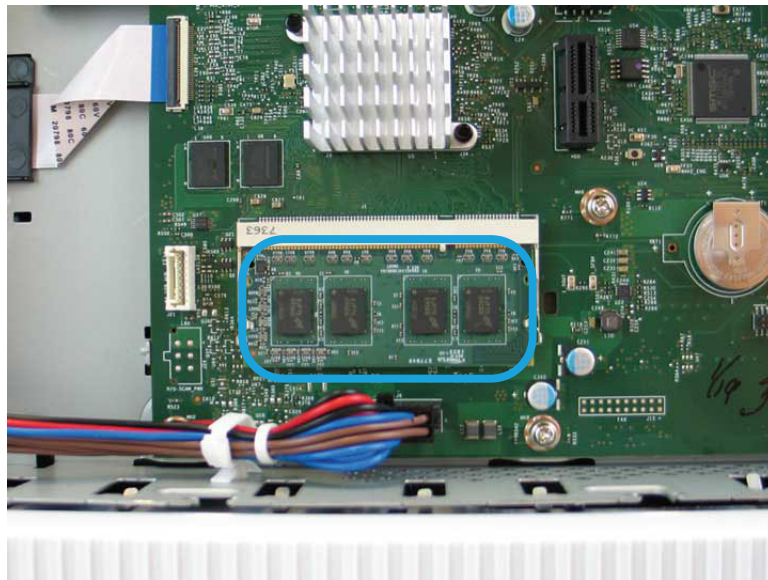
- ▲ Loosen one thumbscrew (callout 1), and then slide the formatter cover (callout 2) away from the printer to remove it.

Figure 1-10 Remove the formatter cover



- 2. Remove the SODIMM.
 - a. Locate the SODIMM on the formatter board.

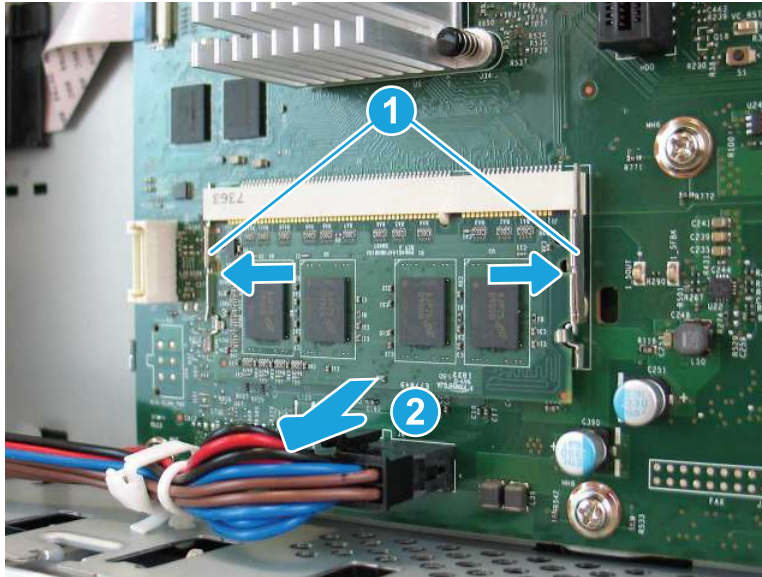
Figure 1-11 Locate the SODIMM



- b. Release two locking arms (callout 1), and then allow the lower edge of the SODIMM to pivot slightly upwards to free it from the holder (callout 2).

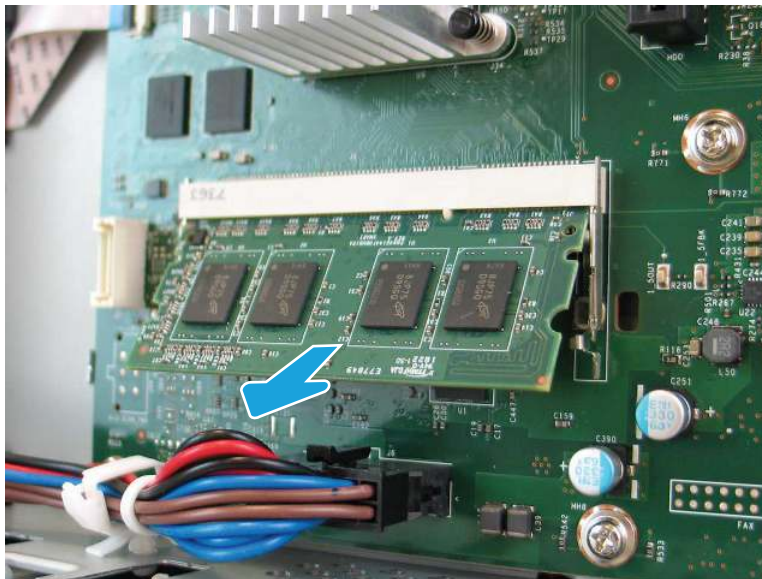
i

Figure 1-12 Release two locking arms



- c. Pull the SODIMM down and away from the holder to remove it.

Figure 1-13 Remove the SODIMM



- 3. Unpack the replacement assembly.
 - a. Dispose of the defective part.




NOTE: HP recommends responsible disposal of the defective part.


<http://www8.hp.com/us/en/hp-information/environment/product-recycling.html>

- b. Unpack the replacement part from the packaging.



CAUTION:  Some parts are sensitive to electrostatic discharge (ESD). Always perform service work at an ESD-protected workstation or mat. If an ESD workstation or mat is not available, touch the

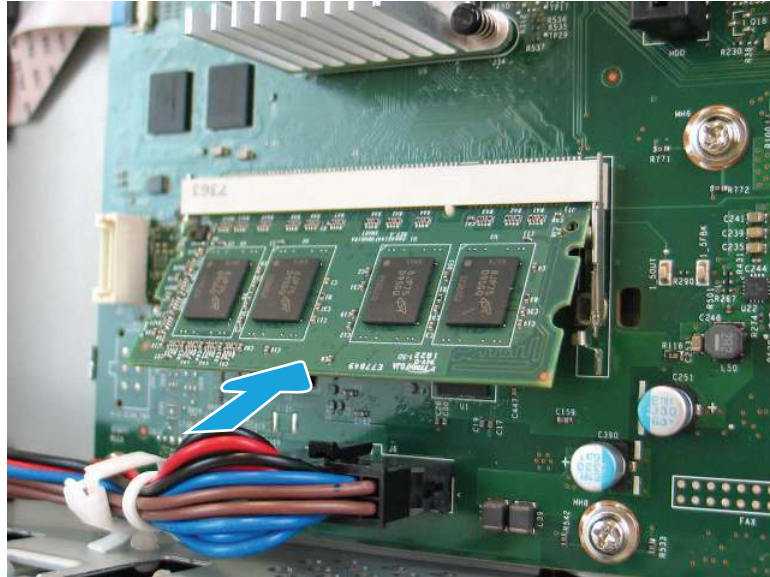
sheet-metal chassis to provide a static ground before touching an ESD-sensitive assembly. Protect the ESD-sensitive assemblies by placing them in ESD pouches when they are out of the printer.

 **IMPORTANT:** Make sure that all of the shipping materials (for example shipping tape) are removed from the replacement part prior to installation.

4. Install the SODIMM.
 - a. Insert the top edge of the SODIMM in the holder.

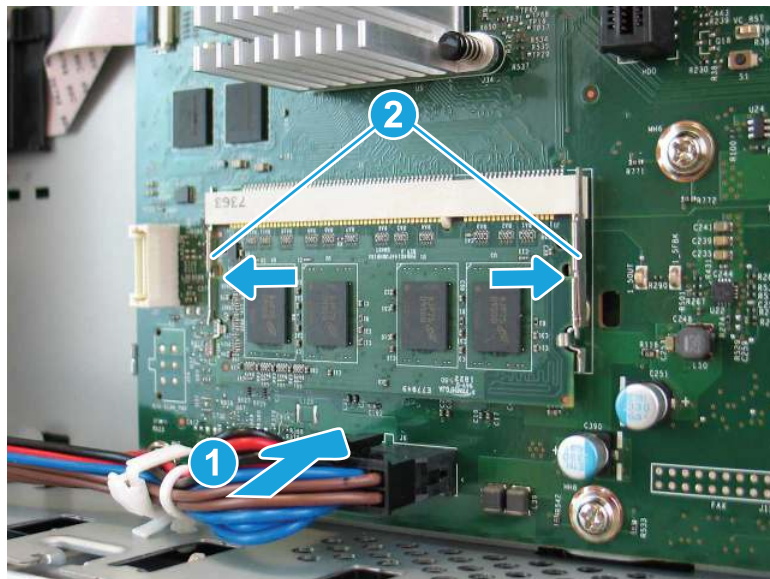
 **TIP:** The SODIMM is keyed and can only be inserted in the holder one way.

Figure 1-14 Insert the SODIMM



- b. Pivot the bottom edge of the SODIMM toward the holder (callout 1), and then make sure that the two locking arms snap into place (callout 2).

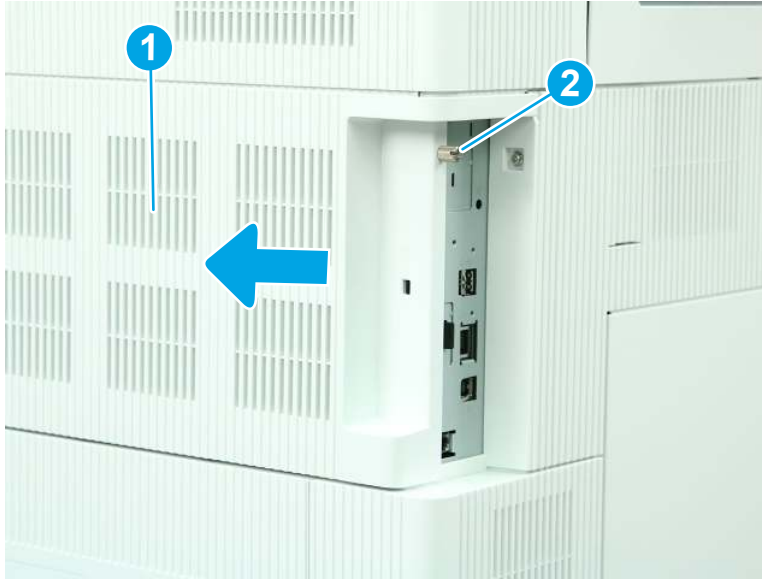
Figure 1-15 Install the DIMM



5. Install the formatter cover.

- ▲ Position the formatter cover (callout 1) on the printer, slide it toward the printer to install it, and then tighten one thumbscrew (callout 2).

Figure 1-16 Install the formatter cover



Removal and replacement: Hard disk drive (M751/E75245/M856/E85055/M776)

Learn how to remove and replace the hard disk drive (HDD).

[View a video of how to remove and replace the hard disk drive.](#)

Mean time to repair: 10 minutes

Service level: CSR A

Before performing service

Turn the printer power off

- Disconnect the power cable.

▲ **WARNING!** To avoid damage to the printer, turn the printer off, wait 30 seconds, and then remove the power cord before attempting to service the printer.

Use the table below to identify the correct part number for your printer. To order the part, go to www.hp.com/buy/parts.

Table 1-3 Part information

Part number	Part description
L41606-011	HDD, 500GB 5400RPM SED (Secure Encrypted Drive)
L42243-021	HDD, 500GB 5400RPM FIPS/CCC OPAL2 7MM (higher level of security than SED)
L42244-031	HDD, 500GB FIPS/CCC/TAA OPAL2 7MM (for use in US government contracts)

Required tools

- No special tools are required to remove or install this assembly.

After performing service

Turn the printer power on

- Connect the power cable.
- Use the power switch to turn the power on.

Post service test

Make sure that the printer initializes to a **Ready** state.

Print a page to make sure that the printer is functioning correctly.

1. Remove the formatter cover.
 - ▲ Loosen one thumbscrew (callout 1), and then slide the formatter cover (callout 2) away from the printer to remove it.

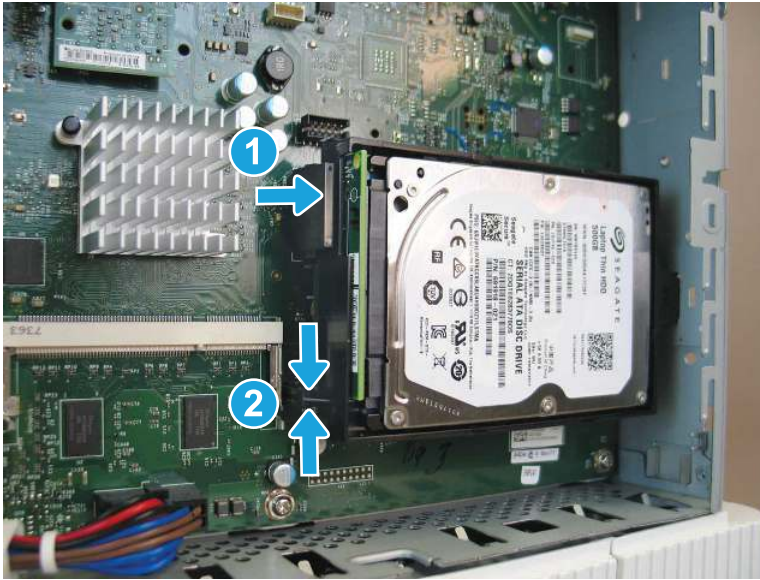
Figure 1-17 Remove the formatter cover



2. Remove the hard disk drive (HDD).

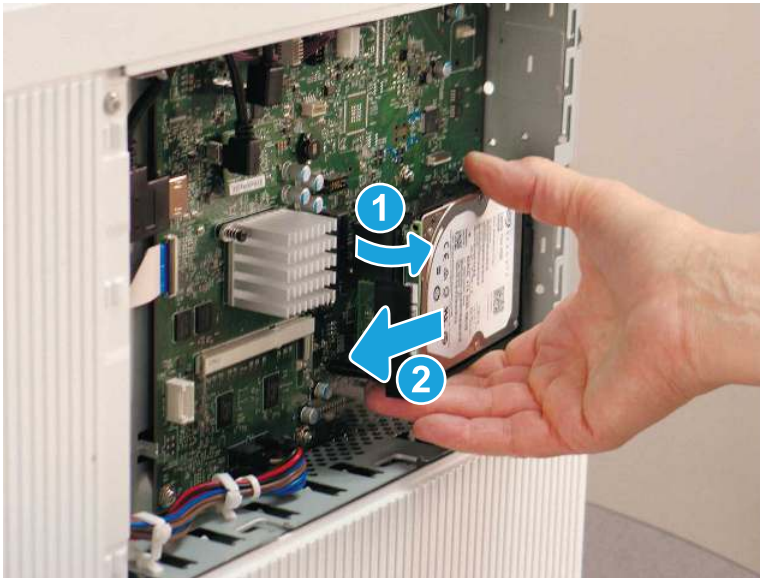
- a. Release the locking connector (callout 1), and then pinch the retainer (callout 2) to release it.

Figure 1-18 Release the HDD



- b. Raise the connector end of the HDD out and away from the formatter (callout 1), and then slide it to the left (callout 2) to remove it.

Figure 1-19 Remove the HDD




3. Unpack the replacement assembly.
 - a. Dispose of the defective part.




NOTE: HP recommends responsible disposal of the defective part.

<http://www8.hp.com/us/en/hp-information/environment/product-recycling.html>

- b. Unpack the replacement part from the packaging.

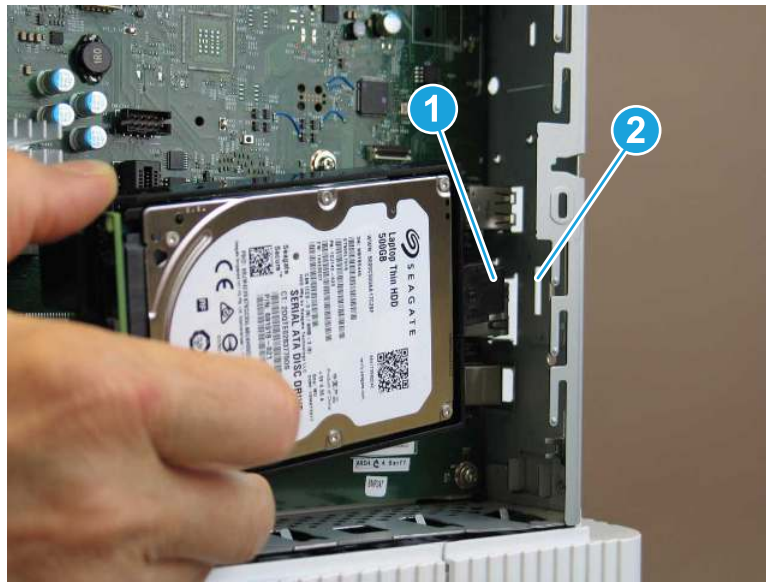
CAUTION:  Some parts are sensitive to electrostatic discharge (ESD). Always perform service work at an ESD-protected workstation or mat. If an ESD workstation or mat is not available, touch the sheet-metal chassis to provide a static ground before touching an ESD-sensitive assembly. Protect the ESD-sensitive assemblies by placing them in ESD pouches when they are out of the printer.

IMPORTANT:  Make sure that all of the shipping materials (for example shipping tape) are removed from the replacement part prior to installation.

4. Install the hard disk drive (HDD).

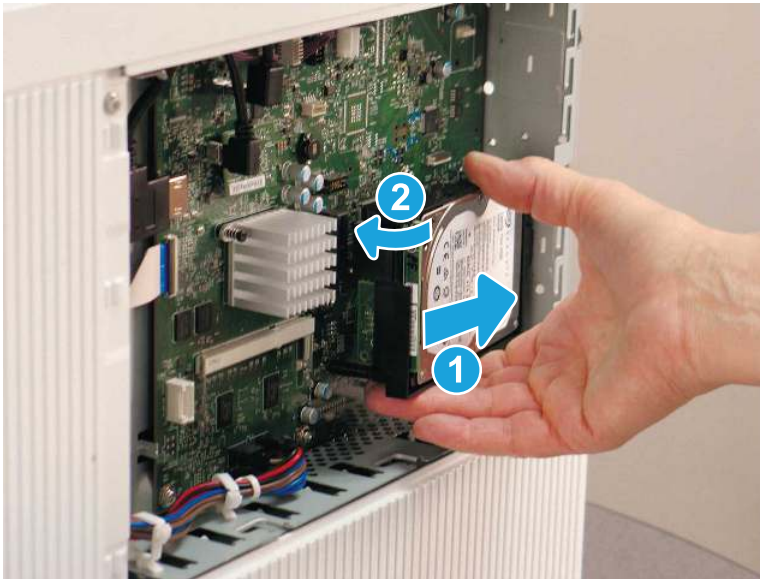
- a. Before proceeding, take note of the location of the tab (callout 1) on the end of the HDD that fits into the slot (callout 2) in the formatter case.

Figure 1-20 Locate the slot in the sheet metal



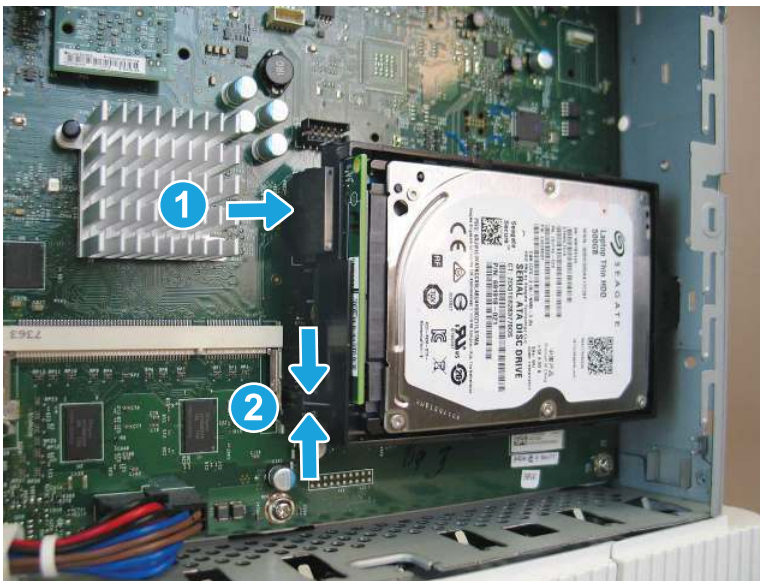
- b. Insert the HDD cradle mounting tab in the slot in the sheet metal, slide the HDD to the right (callout 1) to fully install the tab in the sheet metal, and then rotate the connector end (callout 2) of the HDD toward the formatter.

Figure 1-21 Install the HDD



- c. Make sure that the locking connector (callout 1) latches and that the standoff (callout 2) engages with the slot in the formatter (it might be necessary to pinch the retainer to engage it with the slot).

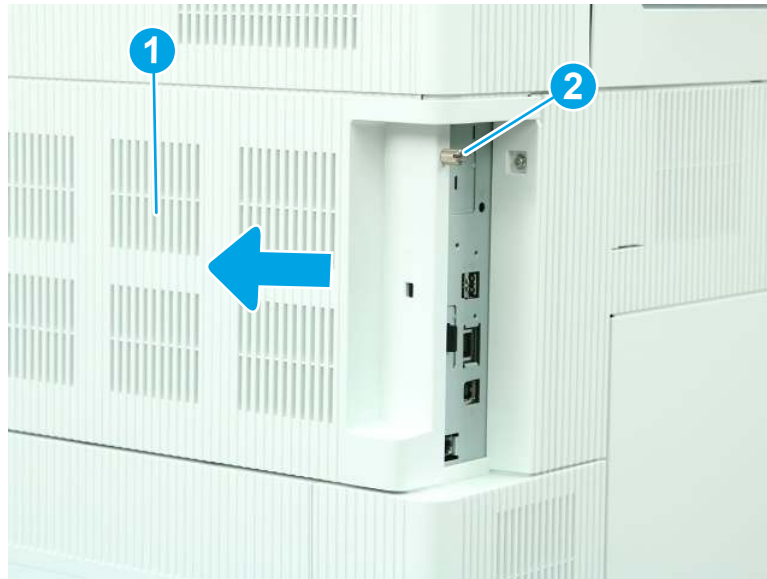
Figure 1-22 Check the HDD connector



5. Install the formatter cover.

- ▲ Position the formatter cover (callout 1) on the printer, slide it toward the printer to install it, and then tighten one thumbscrew (callout 2).

Figure 1-23 Install the formatter cover



- 6. Reverse the removal steps to install the assembly. Also use the following **special installation instructions**.

Reinstall the printer firmware

- a. Go to www.hp.com/go/futuresmart.
- b. Select **Upgrade now**.
- c. Find your Enterprise printer model.
- d. Select the link to open the firmware download page.
- e. Scroll down and expand **Firmware-FutureSmart 4**.
- f. Select **Download** next to the printer firmware entry.

🔧 **Reinstallation tip:** To view installation instructions, go to <http://www.hp.com/go/futuresmart>. Select **Upgrade now**, and then select **How to perform a firmware update**.

faa_

Removal and replacement: embedded Multi-Media Card (eMMC) (M751/E75245/M856/E85055)

Learn how to remove and replace the embedded Multi-Media Card (eMMC).

[View a video of how to remove and replace the embedded Multi-Media Card \(eMMC\).](#)

Mean time to repair: 10 minutes

Service level: CSR A

Before performing service

Turn the printer power off

- Disconnect the power cable.

⚠ WARNING! To avoid damage to the printer, turn the printer off, wait 30 seconds, and then remove the power cord before attempting to service the printer.

Use the table below to identify the correct part number for your printer. To order the part, go to www.hp.com/buy/parts.

Table 1-4 Part information

Part number	Part description
B5L32-60002	PC board - eMMC 16GB

Required tools

- No special tools are required to remove or install this assembly.

After performing service

Turn the printer power on

- Connect the power cable.
- Use the power switch to turn the power on.

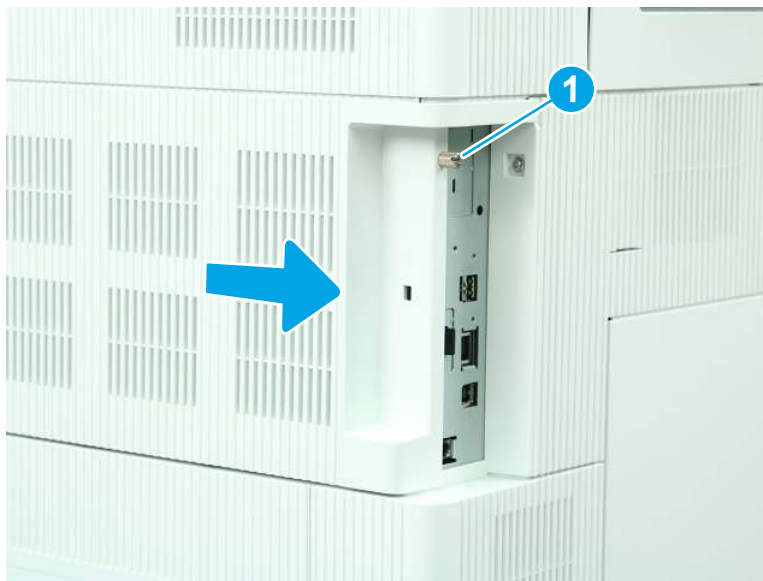
Post service test

Make sure that the printer initializes to a **Ready** state.

Print a page to make sure that the printer is functioning correctly.

1. Remove the formatter cover.
 - ▲ Loosen one thumbscrew (callout 1), and then slide the formatter cover (callout 2) away from the printer to remove it.

Figure 1-24 Remove the formatter cover



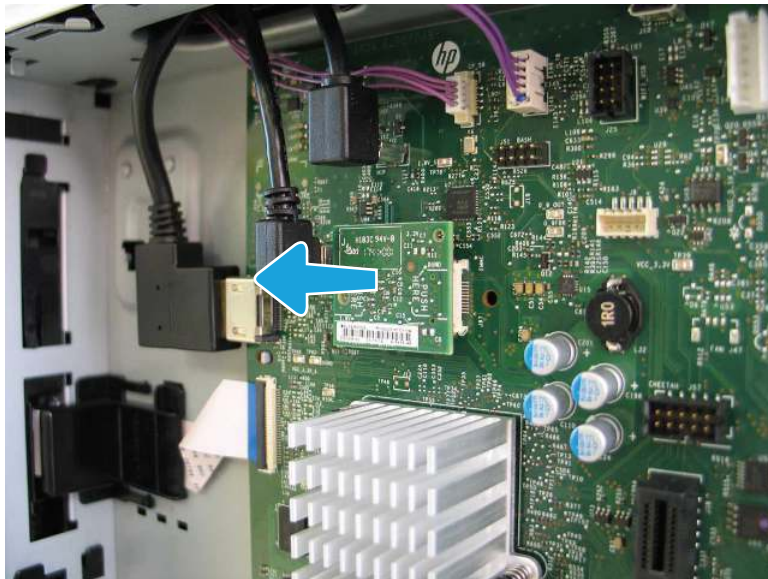
2. Remove the embedded Multi-Media Card (eMMC) (M751/E75245/M856/E85055).
 - a. Locate the embedded Multi-Media Card (eMMC) on the formatter board.

Figure 1-25 Locate the eMMC



- b. Lift the eMMC off of the formatter board to remove it.

Figure 1-26 Remove the eMMC




3. Unpack the replacement assembly.
 - a. Dispose of the defective part.




NOTE: HP recommends responsible disposal of the defective part.

<http://www8.hp.com/us/en/hp-information/environment/product-recycling.html>

- b. Unpack the replacement part from the packaging.

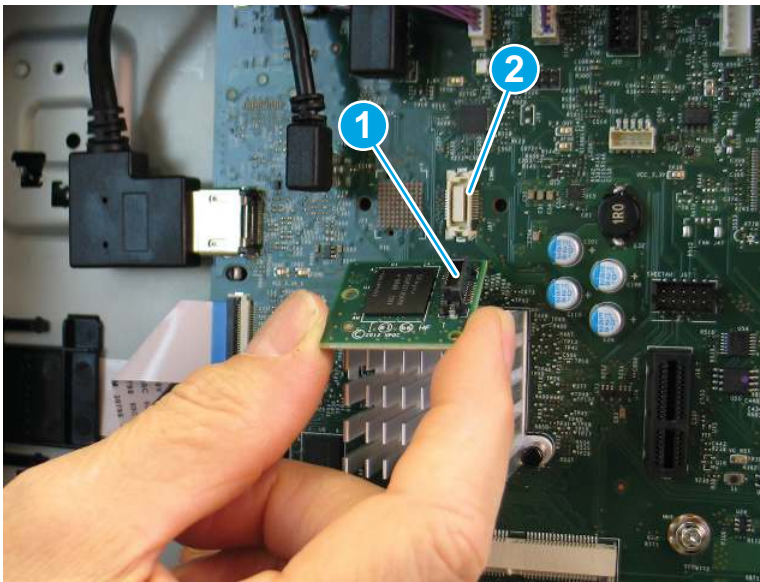
CAUTION:  Some parts are sensitive to electrostatic discharge (ESD). Always perform service work at an ESD-protected workstation or mat. If an ESD workstation or mat is not available, touch the sheet-metal chassis to provide a static ground before touching an ESD-sensitive assembly. Protect the ESD-sensitive assemblies by placing them in ESD pouches when they are out of the printer.

IMPORTANT:  Make sure that all of the shipping materials (for example shipping tape) are removed from the replacement part prior to installation.

4. Install the embedded Multi-Media Card (eMMC) (M751/E75245/M856/E85055).

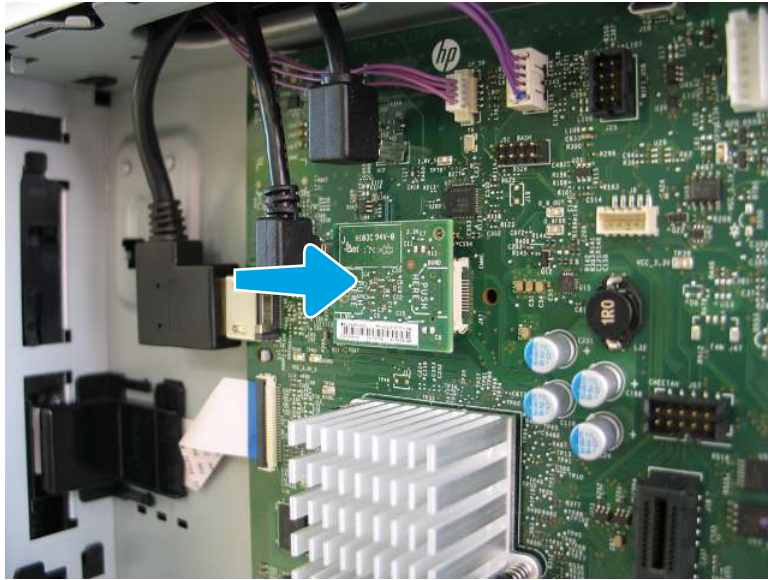
- a. Position the connector (callout 1) on the eMMC card into the connector (callout 2) on the formatter board.

Figure 1-27 Position the eMMC



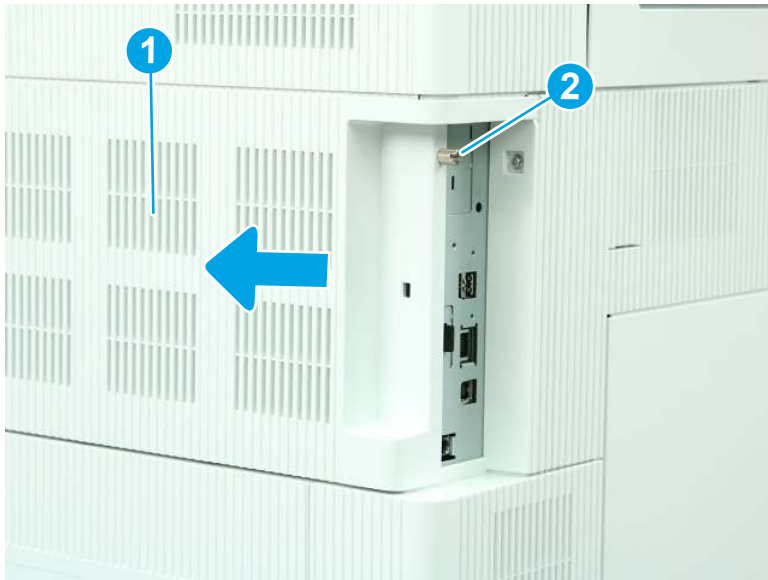
- b. Press the eMMC firmly onto the formatter board to install it.

Figure 1-28 Install the eMMC




5. Install the formatter cover.
 - ▲ Position the formatter cover (callout 1) on the printer, slide it toward the printer to install it, and then tighten one thumbscrew (callout 2).

Figure 1-29 Install the formatter cover



6. Reverse the removal steps to install the assembly. Also use the following **special installation instructions**.
Reinstall the printer firmware
 - a. Go to www.hp.com/go/futuresmart.
 - b. Select **Upgrade now**.
 - c. Find your Enterprise printer model.

- d. Select the link to open the firmware download page.
- e. Scroll down and expand **Firmware-FutureSmart 4**.
- f. Select **Download** next to the printer firmware entry.

 **Reinstallation tip:** To view installation instructions, go to <http://www.hp.com/go/futuresmart>. Select **Upgrade now**, and then select **How to perform a firmware update**.

faa_

Removal and replacement: Fax PCA (M776z/M776zs)

Learn how to remove and replace the fax PCA.

[View a video of how to remove and replace the fax PCA.](#)


Mean time to repair: 10 minutes

Service level: CSR A

Before performing service

Turn the printer power off

- Disconnect the power cable.

 **WARNING!** To avoid damage to the printer, turn the printer off, wait 30 seconds, and then remove the power cord before attempting to service the printer.

Use the table below to identify the correct part number for your printer. To order the part, go to www.hp.com/buy/parts.

Table 1-5 Part information

Part number	Part description
2EH31-67901	Fax PCA (most of the world)
F2A79-60002	Fax PCA (Bangladesh, Brunei, Cambodia, East Timor, Hong Kong, Indonesia, Korea, Laos, Malaysia, Maldives, Mongolia, Myanmar, Philippines, Singapore, Sri Lanka, Thailand, Vietnam)

Required tools

- No special tools are required to remove or install this assembly.

After performing service

Turn the printer power on

- Connect the power cable.
- Use the power switch to turn the power on.

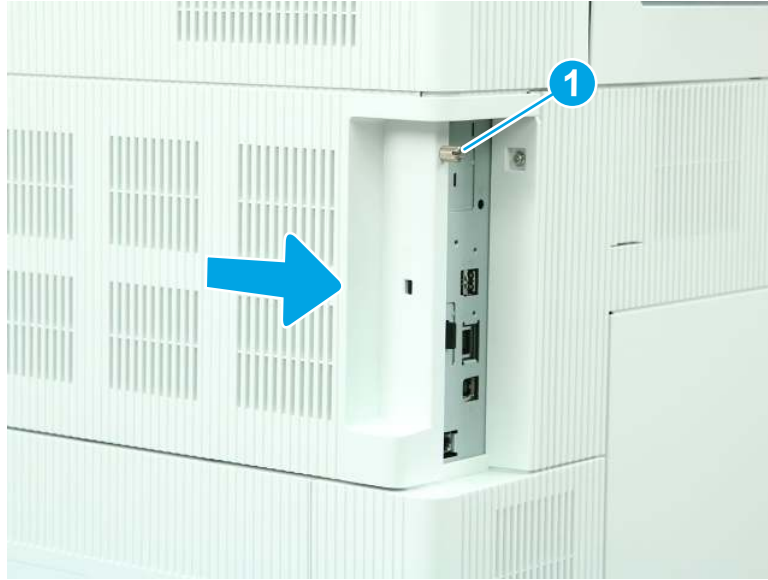
Post service test

Make sure that the printer initializes to a **Ready** state.

Make sure that the fax PCA is functioning correctly by sending a test fax.

1. Remove the formatter cover.
 - ▲ Loosen one thumbscrew (callout 1), and then slide the formatter cover (callout 2) away from the printer to remove it.

Figure 1-30 Remove the formatter cover



2. Remove the fax PCA (M776z/M776zs).
 - ▲ Rotate the fax PCA away from the formatter board to remove it.


Figure 1-31 Remove the fax PCA




3. Unpack the replacement assembly.
 - a. Dispose of the defective part.

 **NOTE:** HP recommends responsible disposal of the defective part.

- b. Unpack the replacement part from the packaging.

CAUTION:  Some parts are sensitive to electrostatic discharge (ESD). Always perform service work at an ESD-protected workstation or mat. If an ESD workstation or mat is not available, touch the sheet-metal chassis to provide a static ground before touching an ESD-sensitive assembly. Protect the ESD-sensitive assemblies by placing them in ESD pouches when they are out of the printer.

IMPORTANT:  Make sure that all of the shipping materials (for example shipping tape) are removed from the replacement part prior to installation.

4. Install the fax PCA (M776z/M776zs).

- a. Position the connector on the fax PCA (callout 1) into the opening (callout 2) in the formatter case.

Figure 1-32 Position the fax PCA



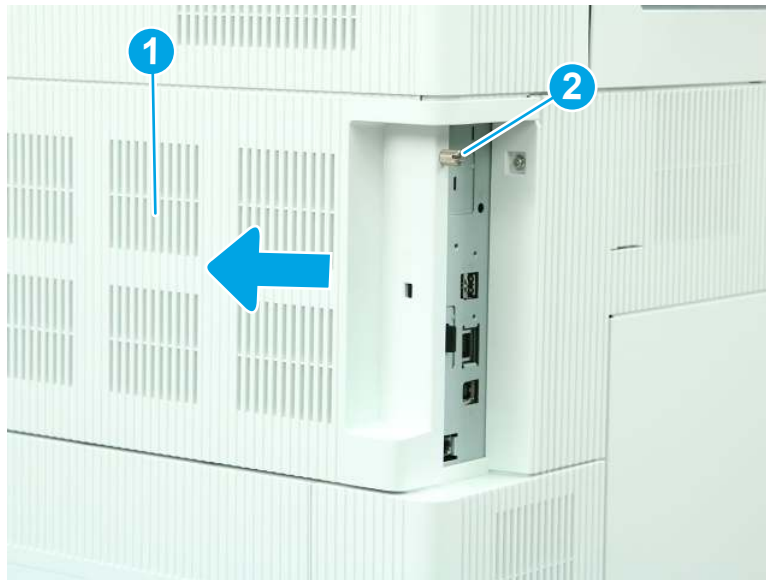
- b. Rotate the fax PCA toward the formatter board to install it .

Figure 1-33 Install the fax PCA



- 5. Install the formatter cover.
 - ▲ Position the formatter cover (callout 1) on the printer, slide it toward the printer to install it, and then tighten one thumbscrew (callout 2).

Figure 1-34 Install the formatter cover



Removal and replacement: Toner cartridge (M751/E75245/M856/E85055/M776)

Learn how to remove and replace the toner cartridge.

[View a video of how to remove and replace the toner cartridge.](#)

Mean time to repair: 2 minutes

Service level: CSR A

Before you begin

For the E75245 model, make sure that the toner cartridge has reached the **Very Low** point. If this point has not been reached, the toner cartridge cannot be removed from the printer.

Use the table below to identify the correct part number for your printer. To order the part, go to www.hp.com/buy/parts.

Table 1-6 Part information

Part number	Part description
W2000-67901	HP 658A Black Original LaserJet Toner Cartridge (M751)
W2001-67901	HP 658A Cyan Original LaserJet Toner Cartridge (M751)
W2002-67901	HP 658A Yellow Original LaserJet Toner Cartridge (M751)
W2003-67901	HP 658A Magenta Original LaserJet Toner Cartridge (M751)
W2000-67902	HP 658X High Yield Black Original LaserJet Toner Cartridge (M751)
W2001-67902	HP 658X High Yield Cyan Original LaserJet Toner Cartridge (M751)
W2002-67902	HP 658X High Yield Yellow Original LaserJet Toner Cartridge (M751)
W2003-67902	HP 658X High Yield Magenta Original LaserJet Toner Cartridge (M751)
5851-7901	HP 659A Black Original LaserJet Toner Cartridge (M856/M776)
5851-7902	HP 659A Cyan Original LaserJet Toner Cartridge (M856/M776)
5851-7903	HP 659A Yellow Original LaserJet Toner Cartridge (M856/M776)
5851-7904	HP 659A Magenta Original LaserJet Toner Cartridge (M856/M776)
5851-7905	HP 659X High Yield Black Original LaserJet Toner Cartridge (M856/M776)
5851-7906	HP 659X High Yield Cyan Original LaserJet Toner Cartridge (M856/M776)
5851-7907	HP 659X High Yield Yellow Original LaserJet Toner Cartridge (M856/M776)
5851-7908	HP 659X High Yield Magenta Original LaserJet Toner Cartridge (M856/M776)
W9020-67901	HP Black Managed LaserJet Toner Cartridge (E75245)
W9021-67901	HP Cyan Managed LaserJet Toner Cartridge (E75245)
W9022-67901	HP Yellow Managed LaserJet Toner Cartridge (E75245)
W9023-67901	HP Magenta Managed LaserJet Toner Cartridge (E75245)
5851-7897	HP Black Managed LaserJet Toner Cartridge (E85055)
5851-7898	HP Cyan Managed LaserJet Toner Cartridge (E85055)
5851-7899	HP Yellow Managed LaserJet Toner Cartridge (E85055)
5851-7900	HP Magenta Managed LaserJet Toner Cartridge (E85055)

Required tools

- No special tools are required to remove or install this assembly.

After performing service

There are no special instructions for after performing service.

Post service test

Make sure that the printer initializes to a **Ready** state.

Print a page to make sure that the printer is functioning correctly.

- ▲ Remove and replace a toner cartridge.

- a. Open the front door.

Figure 1-35 Open the front door



- b. Grasp the handle of the toner cartridge and pull out to remove it.

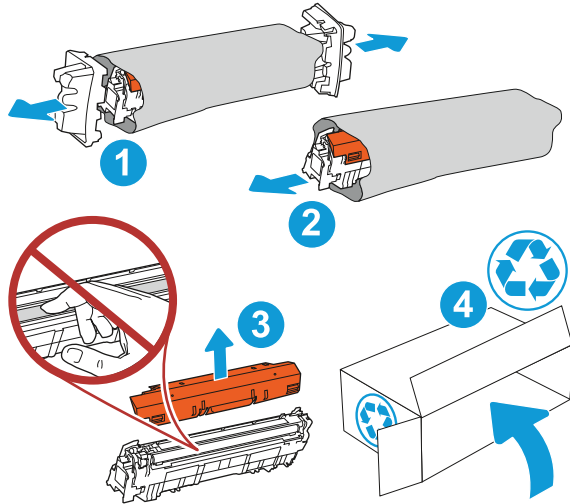
Figure 1-36 Remove the toner cartridge



- c. Remove the new toner cartridge from its packaging by removing the end caps, removing the cartridge from the plastic bag, and then removing the orange protective shield. Save all packaging for recycling the used toner cartridge.

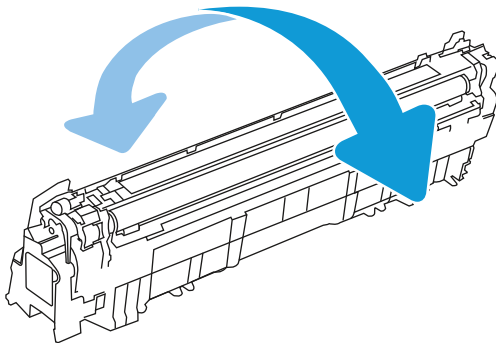
 **NOTE:** Do not touch the developer roller. Fingerprints on the developer roller can cause print-quality problems.

Figure 1-37 Unpack the new toner cartridge



- d. Hold both ends of the toner cartridge and rock it 5-6 times.

Figure 1-38 Rock the toner cartridge



- e. Support the toner cartridge underneath with one hand while holding the cartridge handle with the other. Align the toner cartridge with its slot on the shelf, and then insert the toner cartridge into the printer.

 **NOTE:** Do not touch the developer roller. Fingerprints on the developer roller can cause print-quality problems.

Figure 1-39 Install the toner cartridge



- f. Close the front door.

Figure 1-40 Close the front door



Removal and replacement: Imaging drum (M751/E75245/M856/E85055/M776)

Learn how to remove and replace the imaging drum.

[View a video of how to install the imaging drum.](#)

Mean time to repair: 2 minutes

Service level: CSR A

Before you begin

Use the table below to identify the correct part number for your printer. To order the part, go to www.hp.com/buy/parts.

Table 1-7 Part information

Part number	Part description
W2004-67901	HP 660A Original LaserJet Imaging Drum

Required tools

- No special tools are required to remove or install this assembly, unless the printer is a managed model with imaging drum locks installed.

After performing service

There are no special instructions for after performing service.

Post service test

Make sure that the printer initializes to a **Ready** state.

Print a page to make sure that the printer is functioning correctly.

- ▲ Remove and replace the imaging drum.
 - a. Open the front door.

Figure 1-41 Open the front door



- b. Rotate the blue lever in front of the imaging drum to the left.

Figure 1-42 Rotate the blue lever



- c. Grasp the handle of the imaging drum and pull out to remove it.

Figure 1-43 Remove the imaging drum

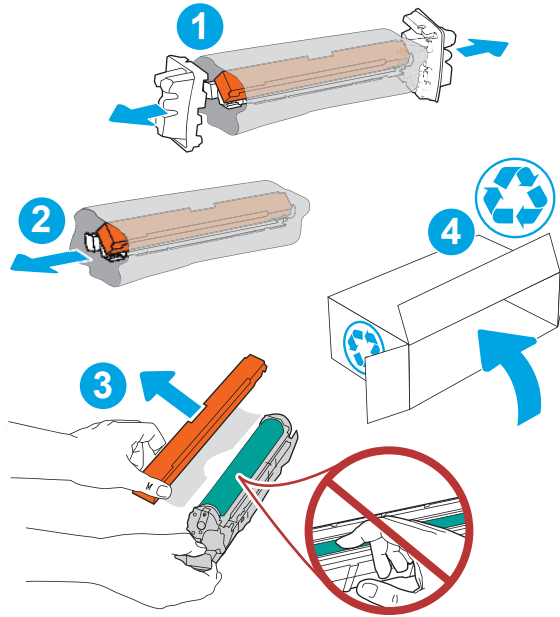


- d. Remove the new imaging drum from its packaging by removing the end caps, removing the imaging drum from the plastic bag, and then removing the orange protective shield. Save all packaging for recycling the imaging drum.



NOTE: Avoid touching the green imaging drum. Fingerprints on the imaging drum can cause print defects.

Figure 1-44 Remove the new imaging drum from its packaging



- e. Support the imaging drum underneath with one hand while holding the handle with the other. Align the imaging drum with its slot on the shelf, and then insert the imaging drum into the printer.


 **NOTE:** Avoid touching the green imaging drum. Fingerprints on the imaging drum can cause print defects.

Figure 1-45 Install the imaging drum



- f. Rotate the blue lever in front of the imaging drum to the right.

Figure 1-46 Rotate the blue lever



- g. Close the front door.

Figure 1-47 Close the front door



Removal and replacement: Tray 2 (M751/E75245/M856/E85055/M776)

Learn how to remove and replace Tray 2.

[View a video of how to remove and replace Tray 2.](#)

Mean time to repair: 2 minutes

Service level: CSR A

Before performing service

Remove any paper from the defective tray and set it aside for installation in the replacement tray.

Use the table below to identify the correct part number for your printer. To order the part, go to www.hp.com/buy/parts.

Table 1-8 Part information

Part number	Part description
RM2-1394-000CN	Cassette assembly

Required tools

- No special tools are required to remove or install this assembly.

After performing service

Install paper in the tray and adjust the paper guides.

Post service test

Make sure that the printer initializes to a **Ready** state.

Print a page to make sure that the printer is functioning correctly.

1. Remove Tray 2.
 - ▲ Pull Tray 2 away from the printer until it stops, and then lift up slightly to remove it.

Figure 1-48 Remove Tray 2



2. Unpack the replacement assembly.
 - a. Dispose of the defective part.




NOTE: HP recommends responsible disposal of the defective part.

<http://www8.hp.com/us/en/hp-information/environment/product-recycling.html>

If the printer is a managed model with tray locks installed, remove the locks before disposing of the defective tray.

- b. Unpack the replacement part from the packaging.

 **IMPORTANT:** Make sure that all of the shipping materials (for example shipping tape) are removed from the replacement part prior to installation.

Removal and replacement: Document feeder rollers (M776)

Learn how to remove and replace the document feeder pickup and separation rollers.

[View a video of how to remove and replace the document feeder pickup and separation rollers.](#)

Mean time to repair: 3 minutes

Service level: CSR A

Before performing service

Turn the printer power off

- Disconnect the power cable.

 **WARNING!** To avoid damage to the printer, turn the printer off, wait 30 seconds, and then remove the power cord before attempting to service the printer.

Use the table below to identify the correct part number for your printer. To order the part, go to www.hp.com/buy/parts.

Table 1-9 Part information

Part number	Part description
5851-7202	Document feeder roller kit

Required tools

- No special tools are required to remove or install this assembly.

After performing service

Turn the printer power on

- Connect the power cable.
- Use the power switch to turn the power on.

Post service test

Make sure that the printer initializes to a **Ready** state.

Copy a page from the image scanner and verify it is functioning correctly.

1. Remove the document feeder rollers.

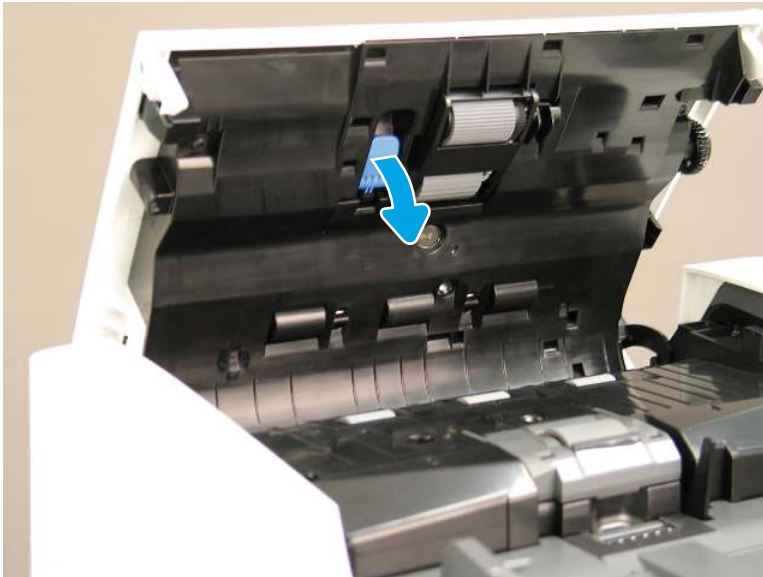
- a. Open the document feeder cover.

Figure 1-49 Open the document feeder cover



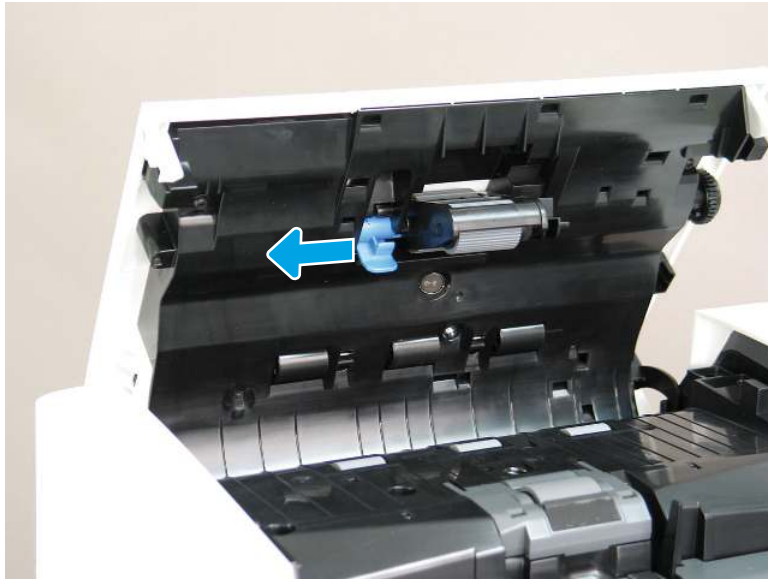
- b. Rotate the blue locking lever down.

Figure 1-50 Rotate the blue locking lever down



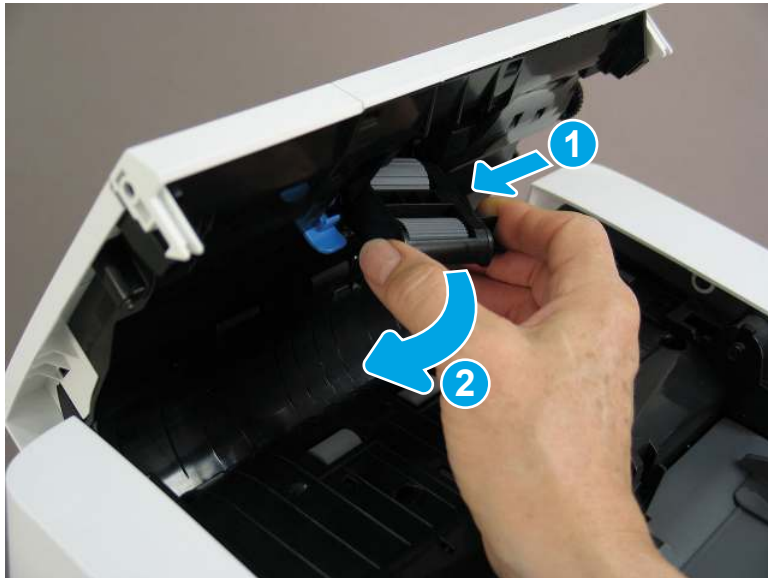
- c. Slide the locking lever toward the front of the printer.

Figure 1-51 Slide the locking lever toward the front of the printer



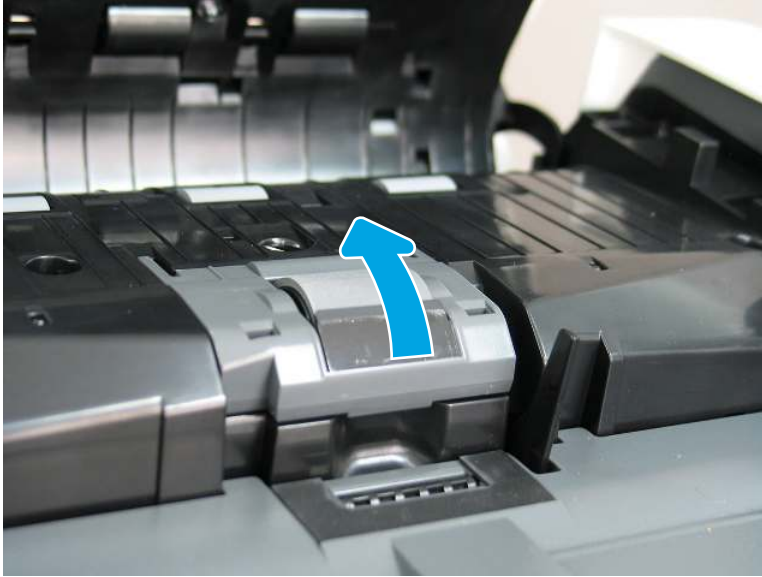
- d. Slide the roller to the left (callout 1), and then rotate it away from the document feeder to remove it (callout 2).

Figure 1-52 Remove the pickup roller



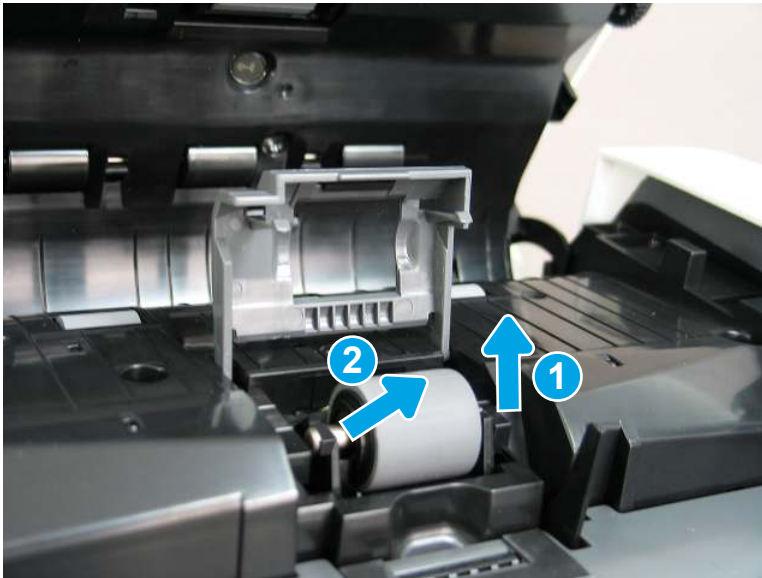
- e. Open the document feeder separation roller cover.

Figure 1-53 Open the document feeder separation roller cover



- f. Raise the right edge of the separation roller (callout 1), and then slide the roller to the right (callout 2) to remove it.

Figure 1-54 Remove the separation roller




2. Unpack the replacement assembly.
 - a. Dispose of the defective part.



NOTE: HP recommends responsible disposal of the defective part.

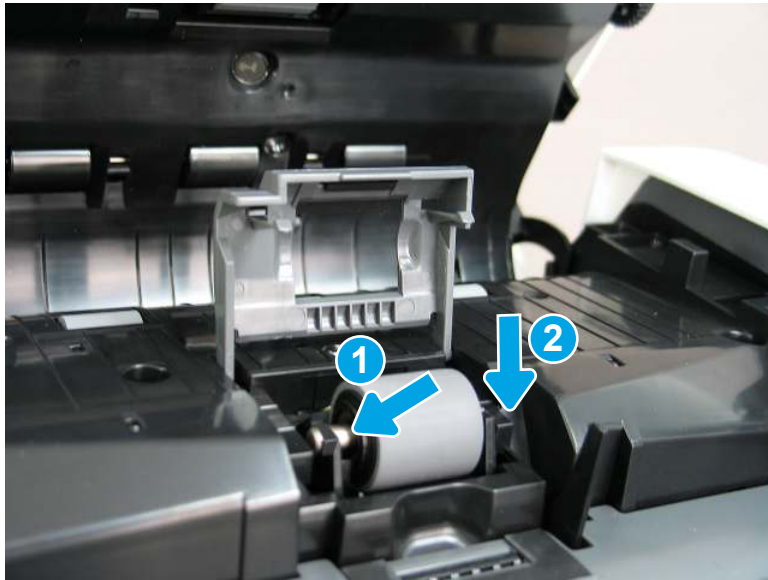
<http://www8.hp.com/us/en/hp-information/environment/product-recycling.html>

- b. Unpack the replacement part from the packaging.

 **IMPORTANT:** Make sure that all of the shipping materials (for example shipping tape) are removed from the replacement part prior to installation.

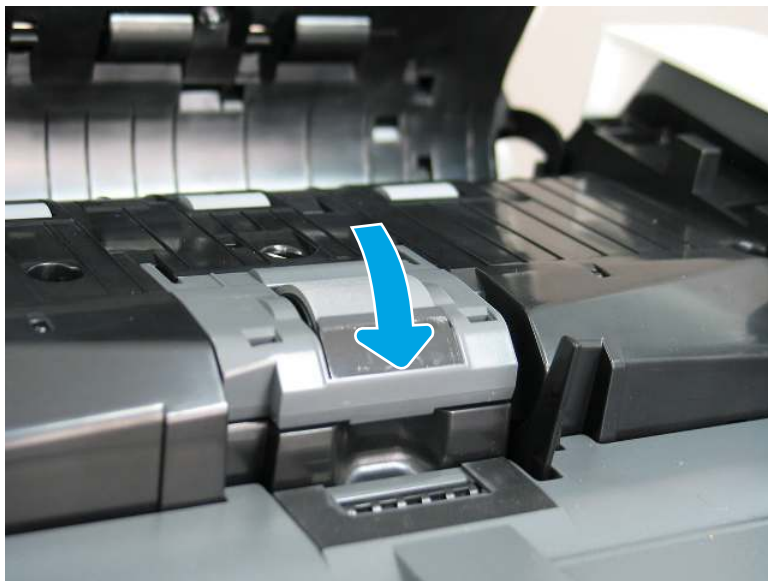
- 3. Install the document feeder rollers.
 - a. Install the left end of the replacement separation roller into the holder (callout 1), and then press the right side of the roller down (callout 2).

Figure 1-55 Install the separation roller



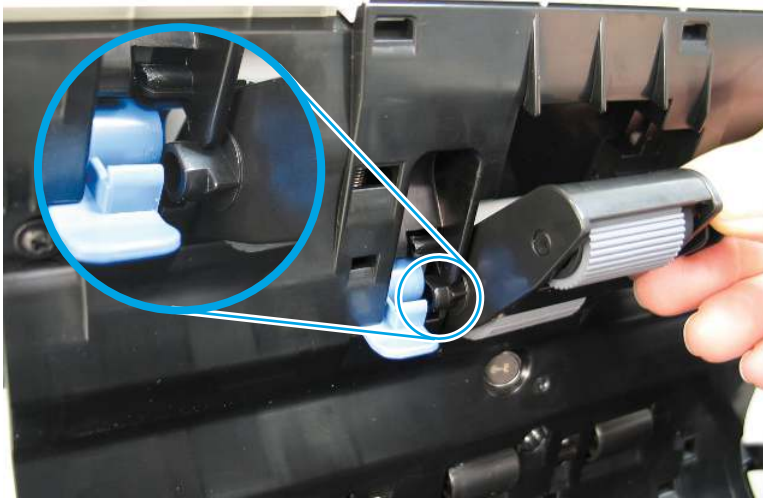
- b. Close the document feeder separation roller cover.

Figure 1-56 Close the document feeder separation roller cover



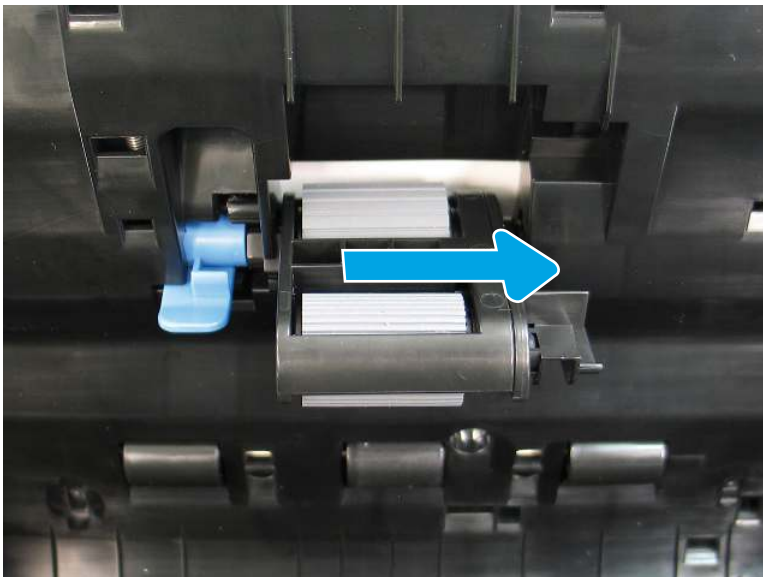
- c. Install the tab on the left end of the replacement pickup roller assembly into the slot in the document feeder.

Figure 1-57 Install the pickup roller



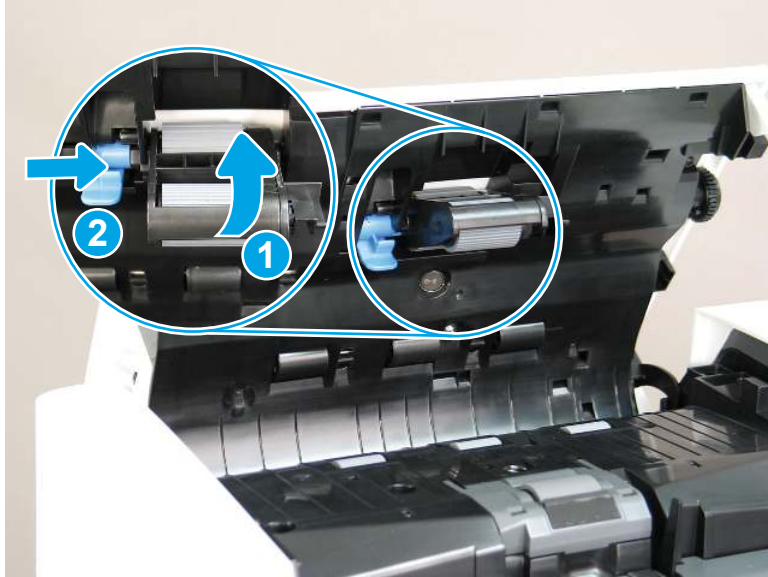
- d. Slide the pickup roller assembly toward the back of the printer.

Figure 1-58 Slide the pickup roller assembly



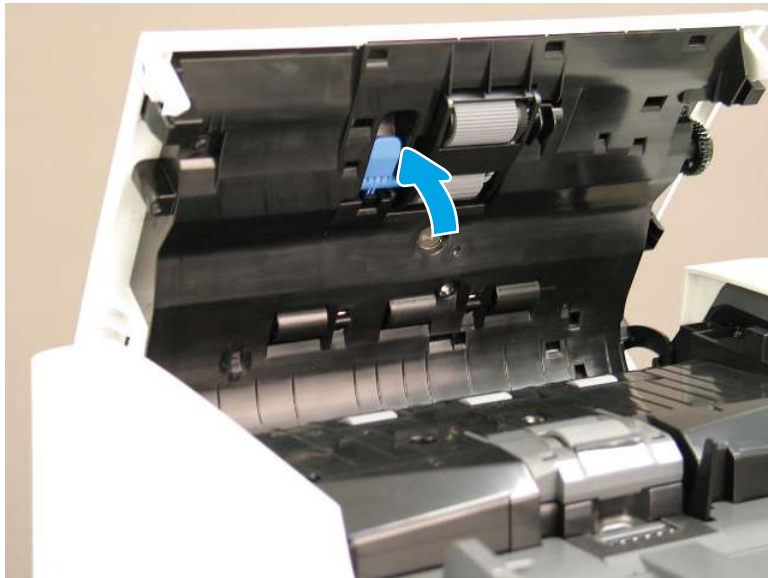
- e. Rotate the pickup roller assembly up into the holder (callout 1), and then slide the blue locking lever toward the back of the printer (callout 2).

Figure 1-59 Rotate and slide the roller assembly



- f. Rotate the blue locking lever up.

Figure 1-60 Rotate the blue locking lever up



- g. Close the document feeder cover.

Figure 1-61 Close the document feeder cover



- h. From the Home screen on the printer control panel, do the following:
 - i. Scroll to and touch the Settings button.
 - ii. Open the following menus:
 1. Manage Supplies
 2. Reset Supplies
 - iii. Select the Document Feeder Kit item.
 - iv. Select the Reset item to reset the firmware counter.

Removal and replacement: Tray 1 rollers (M751/E75245/M856/E85055/M776)

Learn how to remove and replace the Tray 1 pickup and separation rollers.

[View a video of how to remove and replace the Tray 1 pickup and separation rollers.](#)

Mean time to repair: 3 minutes

Service level: CSR A

Before performing service

Turn the printer power off

- Disconnect the power cable.

⚠ WARNING! To avoid damage to the printer, turn the printer off, wait 30 seconds, and then remove the power cord before attempting to service the printer.

Use the table below to identify the correct part number for your printer. To order the part, go to www.hp.com/buy/parts.

Table 1-10 Part information

Part number	Part description
RM2-1525-000CN	Tray 1 pickup and separation rollers

Required tools

- No special tools are required to remove or install this assembly.

After performing service

Turn the printer power on

- Connect the power cable.
- Use the power switch to turn the power on.

Post service test

Make sure that the printer initializes to a **Ready** state.

Print a page from Tray 1 to make sure that the printer is functioning correctly.

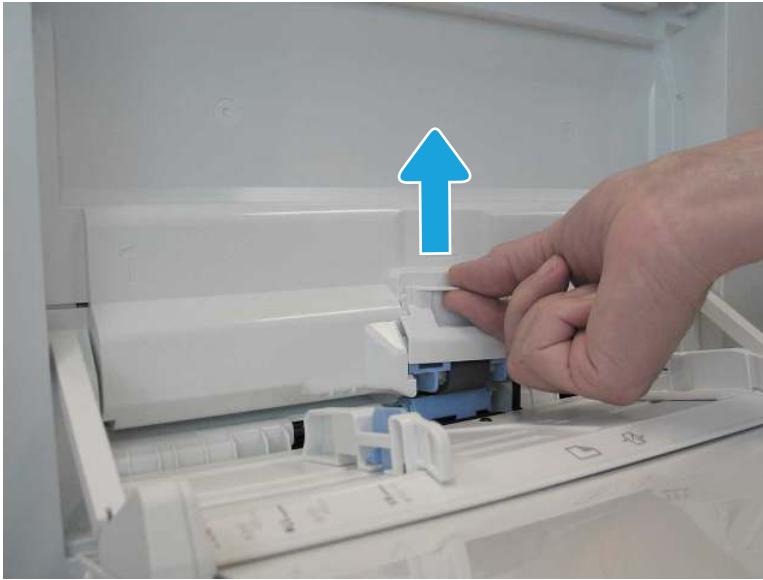
1. Remove the Tray 1 pickup roller.
 - a. Open Tray 1.

Figure 1-62 Open Tray 1



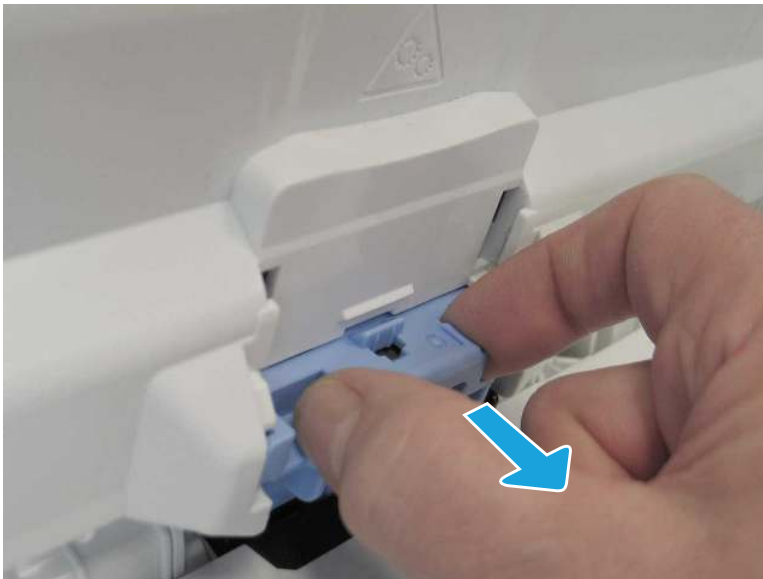
- b. Slide the pickup roller cover up to remove it.

Figure 1-63 Remove the pickup roller cover



- c. Slide the pickup roller away from the printer to remove it.

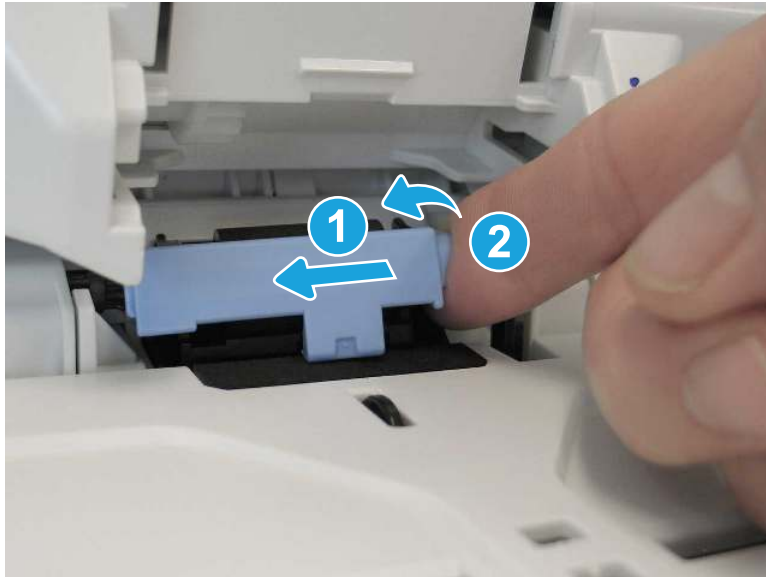
Figure 1-64 Remove the pickup roller



- 2. Remove the Tray 1 separation roller.

- ▲ Slide the separation roller to the left (callout 1), and then rotate the right side up (callout 2) to remove it.

Figure 1-65 Remove the separation roller



- 3. Unpack the replacement assembly.

- a. Dispose of the defective part.



NOTE: HP recommends responsible disposal of the defective part.

<http://www8.hp.com/us/en/hp-information/environment/product-recycling.html>

- b. Unpack the replacement part from the packaging.

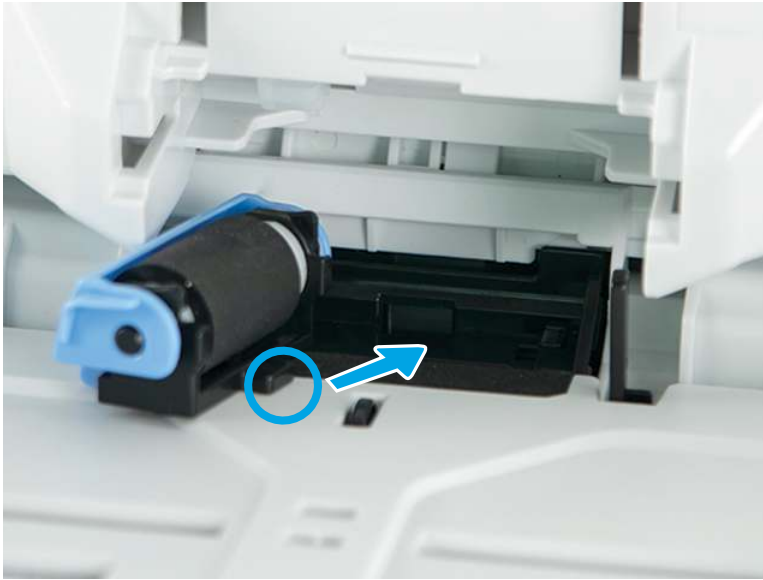


IMPORTANT: Make sure that all of the shipping materials (for example shipping tape) are removed from the replacement part prior to installation.

- 4. Install the Tray 1 separation roller.

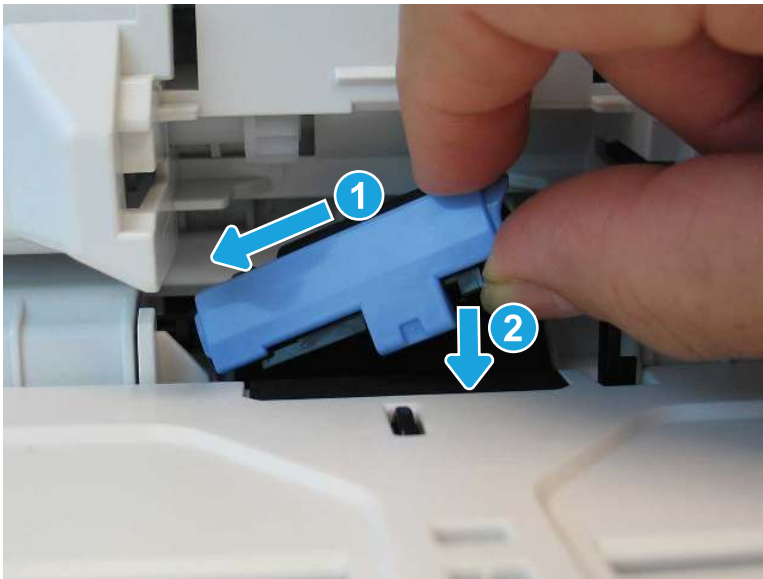
- a. When reinstalling the separation roller, note the tab on the roller that fits into the slot on the printer.

Figure 1-66 Note the tab on the roller



- b. Slide the roller assembly to the left (callout 1), and then lower it (callout 2) until it snaps into place.

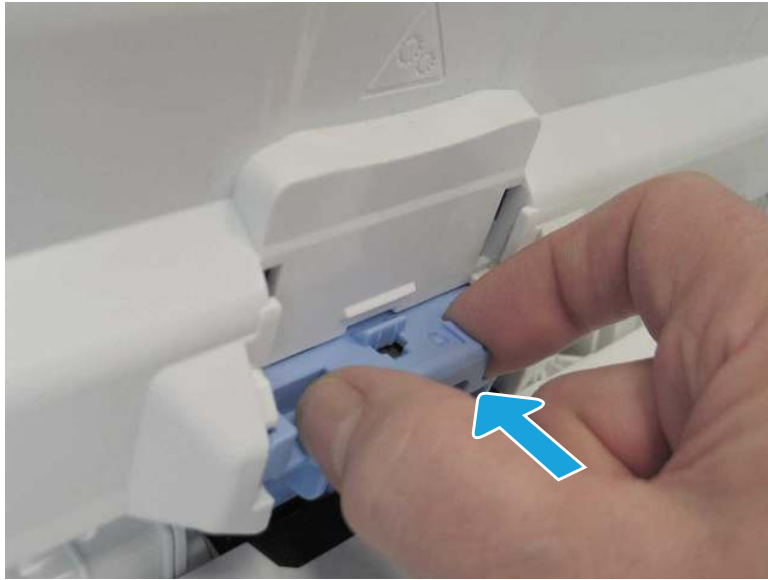
Figure 1-67 Install the separation roller



5. Install the Tray 1 pickup roller.

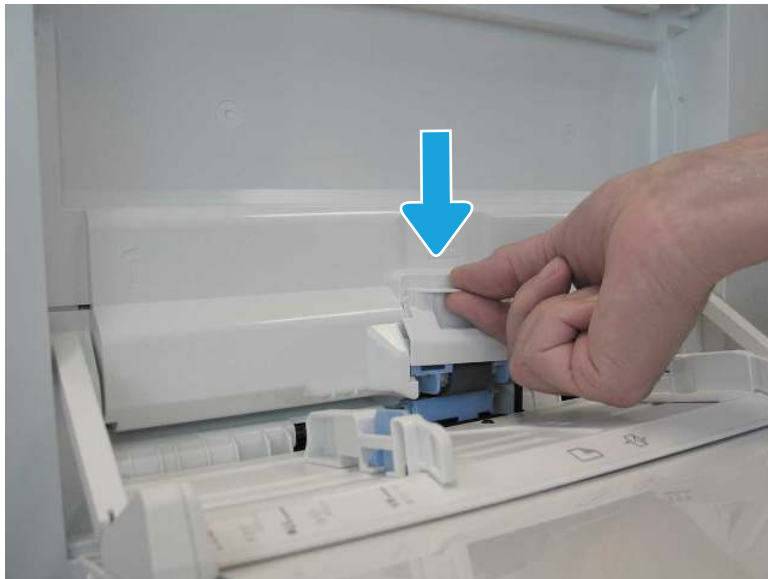
- a. Align the roller housing with the slots in the printer, and then slide the roller assembly into the printer.

Figure 1-68 Install the pickup roller



- b. Position the pickup roller cover on the printer, and then slide it down to install it.

Figure 1-69 Install the pickup roller cover



- c. Close Tray 1.

Figure 1-70 Close Tray 1



Removal and replacement: Tray 2 rollers (M751/E75245/M856/E85055/M776)

Learn how to remove and replace the Tray 2 pickup and separation rollers.

[View a video of how to remove and replace the Tray 2 pickup and separation rollers.](#)

Mean time to repair: 2 minutes

Service level: CSR A

Before performing service

Turn the printer power off

- Disconnect the power cable.

⚠ WARNING! To avoid damage to the printer, turn the printer off, wait 30 seconds, and then remove the power cord before attempting to service the printer.

Use the table below to identify the correct part number for your printer. To order the part, go to www.hp.com/buy/parts.

Table 1-11 Part information

Part number	Part description
RM2-1526-000CN	Tray 2-x pickup and separation rollers

Required tools

- No special tools are required to remove or install this assembly.

After performing service

Turn the printer power on

- Connect the power cable.
- Use the power switch to turn the power on.

Post service test

Make sure that the printer initializes to a **Ready** state.

Print a page from Tray 2 to make sure that the printer is functioning correctly.

1. Remove the Tray 2 separation roller.
 - a. Open Tray 2.

Figure 1-71 Open Tray 2



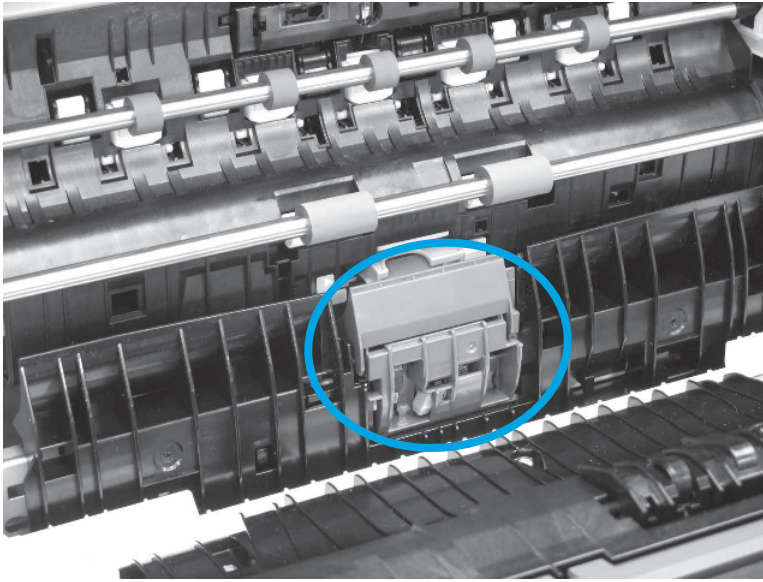
- b. Open the right door.

Figure 1-72 Open the right door



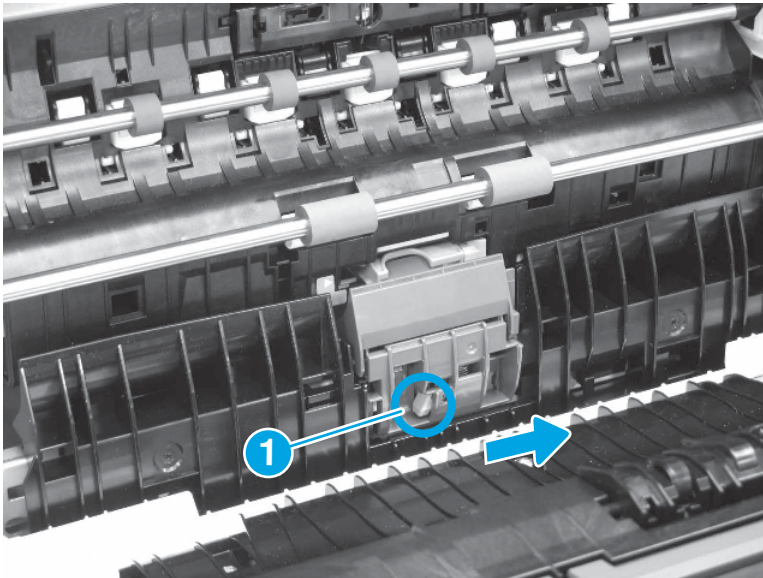
- c. Locate the separation roller assembly.

Figure 1-73 Locate the separation roller assembly



- d. Press the release button (callout 1), slide the assembly to the right, and then pull it away from the printer to remove it.

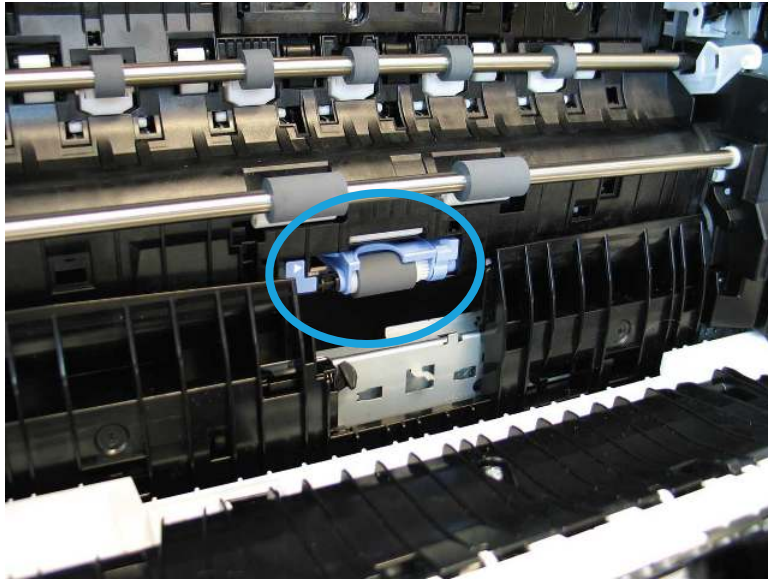
Figure 1-74 Remove the separation roller assembly



2. Remove the Tray 2 pickup roller.

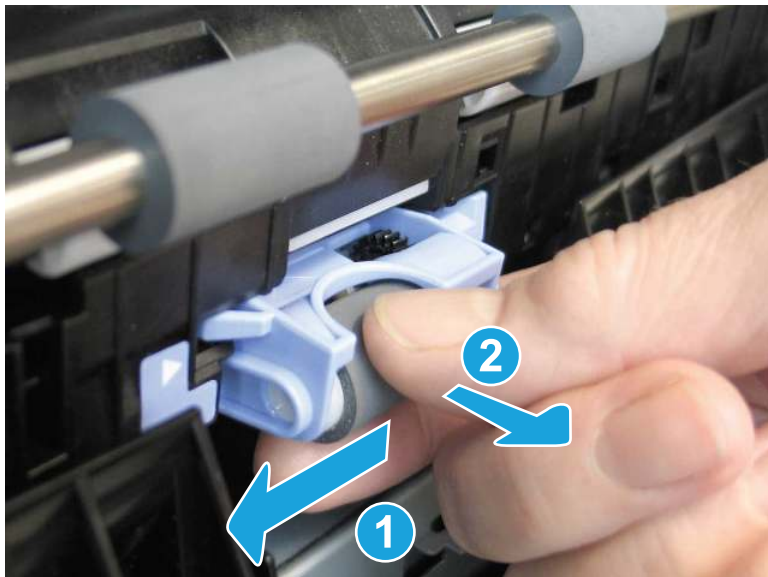
- a. Locate the pickup roller.

Figure 1-75 Locate the pickup roller



- b. Slide the pickup roller assembly to the left (callout 1), and then pull it away from the printer (callout 2) to remove it.

Figure 1-76 Remove the pickup roller



3. Unpack the replacement assembly.


- a. Dispose of the defective part.




NOTE: HP recommends responsible disposal of the defective part.

<http://www8.hp.com/us/en/hp-information/environment/product-recycling.html>

- b. Unpack the replacement part from the packaging.

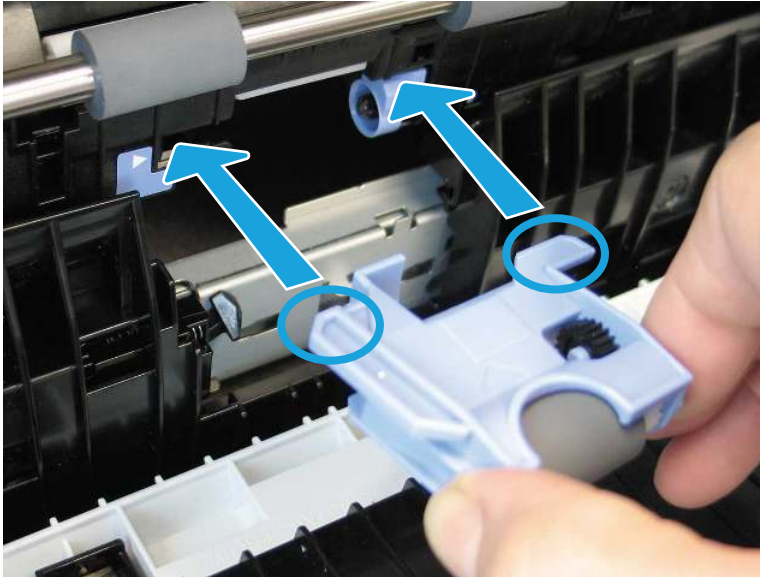
 **IMPORTANT:** Make sure that all of the shipping materials (for example shipping tape) are removed from the replacement part prior to installation.

4. Install the Tray 2 pickup roller.

 **NOTE:** Make sure that the tray is open before installing the roller.

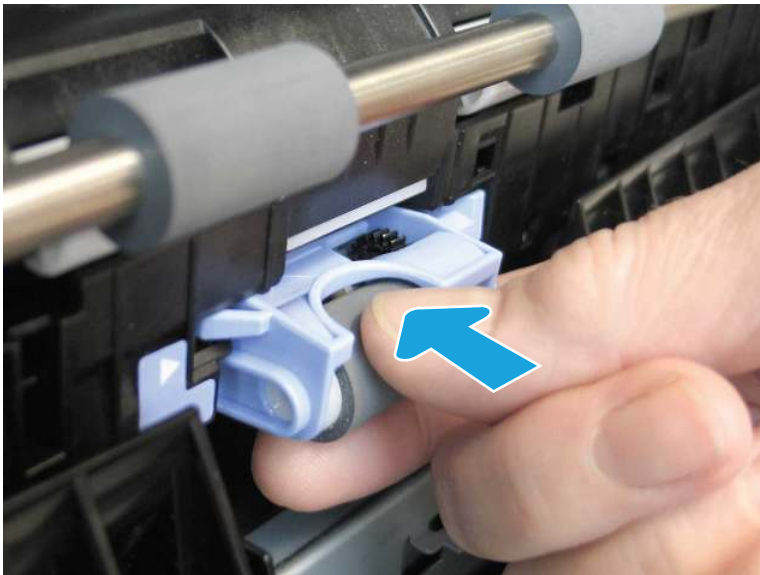
- a. Align the edges of the pickup roller assembly with the slots in the printer.

Figure 1-77 Position the pickup roller




- b. Slide the roller assembly into the printer until it stops.

Figure 1-78 Install the pickup roller

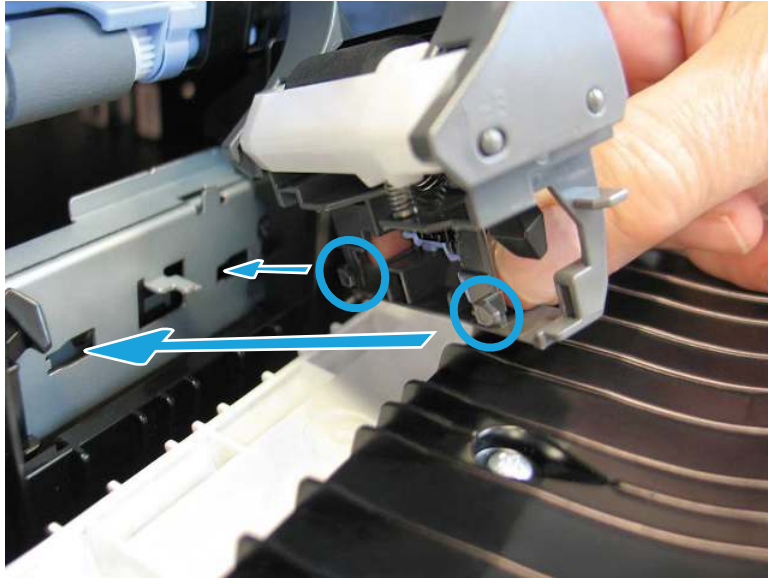


5. Install the Tray 2 separation roller assembly.

 **NOTE:** Make sure that the tray is open before installing the roller.

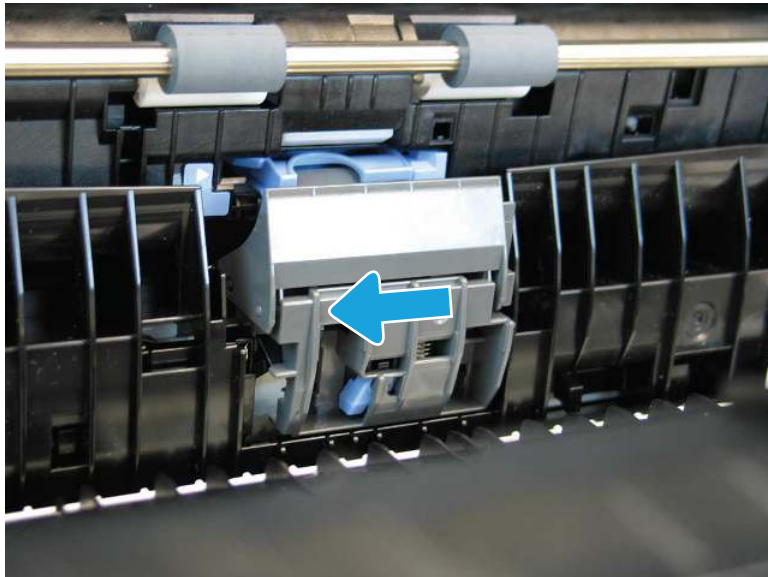
- a. Position the tabs on the separation roller assembly into the slots on the printer.

Figure 1-79 Position the separation roller assembly



- b. Slide the roller assembly to the left until it snaps into place.

Figure 1-80 Install the separation roller assembly



- c. Close the right door.


Figure 1-81 Close the right door



- d. Close Tray 2.

Figure 1-82 Close Tray 2



 **NOTE:** When closing the tray, if you feel resistance, verify that the roller was installed correctly. Do not force the tray closed.

Removal and replacement: Fuser (M751/E75245/M856/E85055/M776)

Learn how to remove and replace the fuser.

[View a video of how to remove and replace the fuser.](#)

Mean time to repair: 2 minutes

Service level: CSR A

Before performing service

Turn the printer power off

- Disconnect the power cable.

⚠ WARNING! To avoid damage to the printer, turn the printer off, wait 30 seconds, and then remove the power cord before attempting to service the printer.

Use the table below to identify the correct part number for your printer. To order the part, go to www.hp.com/buy/parts.

Table 1-12 Part information

Part number	Part description
3WT87-67901	HP LaserJet 110V fuser kit (M751/E75245)
3WT88-67901	HP LaserJet 220V fuser kit (M751/E75245)
4YL16-67901	HP LaserJet 110V fuser kit (M856/E85055/M776)
4YL17-67901	HP LaserJet 220V fuser kit (M856/E85055/M776)

Required tools

- No special tools are required to remove or install this assembly.

After performing service

Turn the printer power on

- Connect the power cable.
- Use the power switch to turn the power on.

Post service test

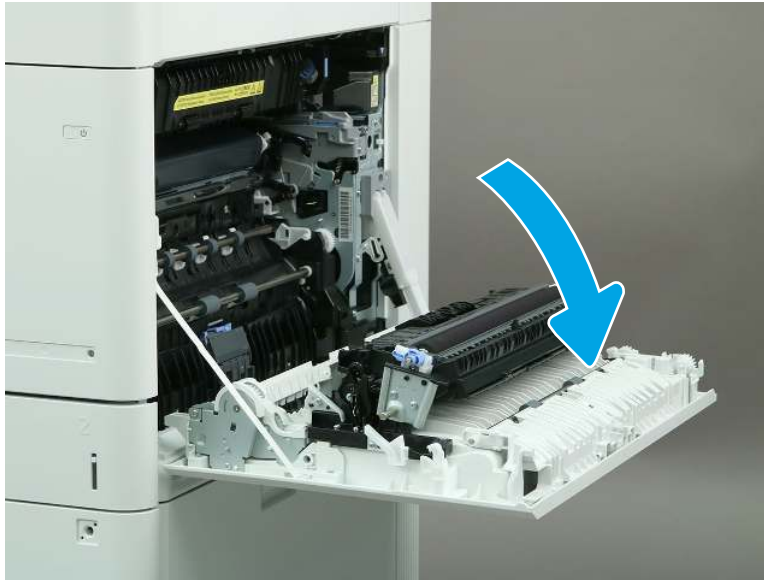
Make sure that the printer initializes to a **Ready** state.

Print a page to make sure that the printer is functioning correctly.

1. Remove the fuser.

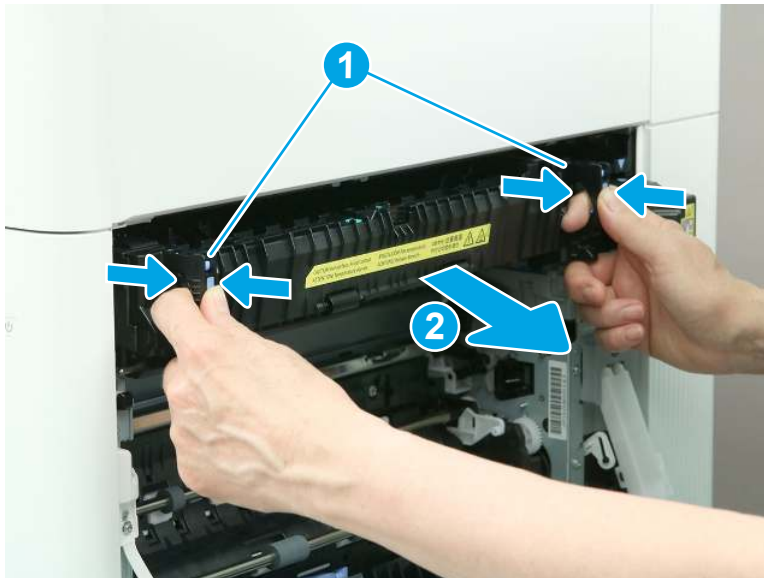
- a. Open the right door.

Figure 1-83 Open the right door



- b. Grasp the fuser handles, and then squeeze the release levers (callout 1). Lift up slightly, and then pull straight out to remove the fuser (callout 2).

Figure 1-84 Remove the fuser



2. Unpack the replacement assembly.


- a. Dispose of the defective part.



NOTE: HP recommends responsible disposal of the defective part.

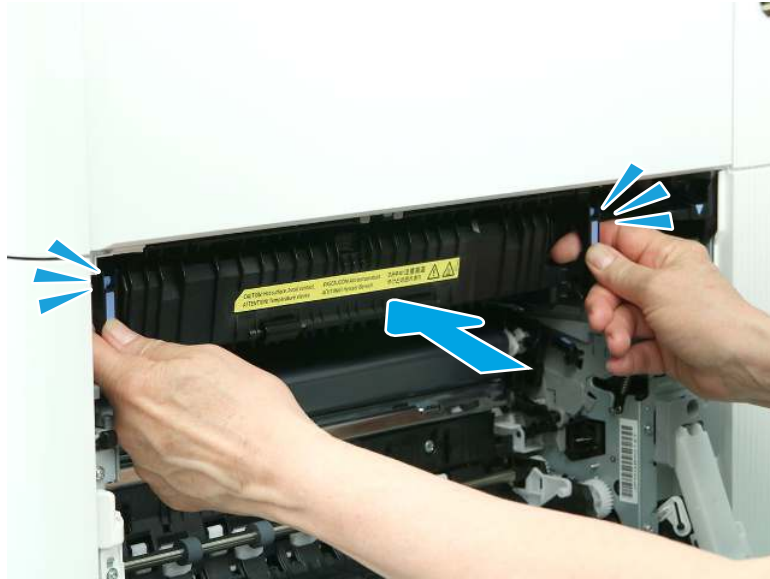
<http://www8.hp.com/us/en/hp-information/environment/product-recycling.html>

- b. Unpack the replacement part from the packaging.

 **IMPORTANT:** Make sure that all of the shipping materials (for example shipping tape) are removed from the replacement part prior to installation.

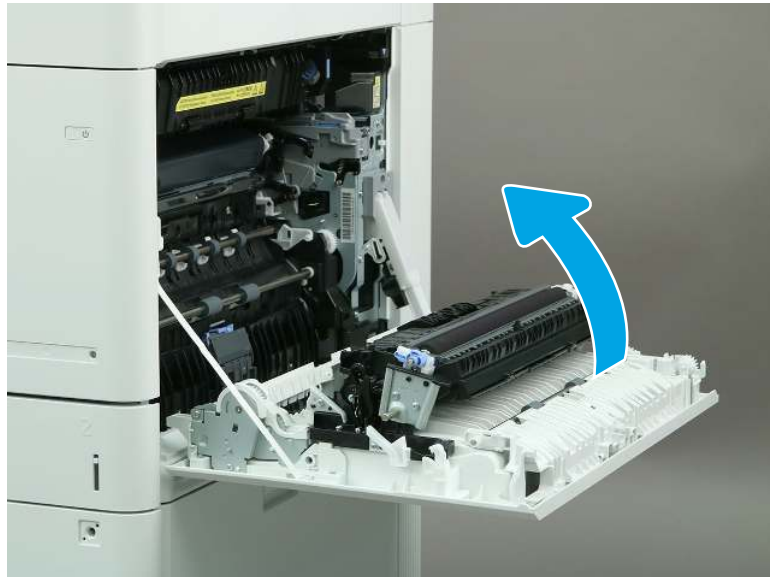
3. Install the fuser.
 - a. Install the fuser completely into the printer until it clicks into place.

Figure 1-85 Install the fuser



- b. Close the right door.

Figure 1-86 Close the right door



Removal and replacement: Intermediate transfer belt (ITB; M751/E75245/M856/E85055/M776)

Learn how to remove and replace the intermediate transfer belt (ITB).

[View a video of how to remove and replace the intermediate transfer belt.](#)

Mean time to repair: 2 minutes

Service level: CSR A

Before performing service

Turn the printer power off

- Disconnect the power cable.

⚠ WARNING! To avoid damage to the printer, turn the printer off, wait 30 seconds, and then remove the power cord before attempting to service the printer.

Use the table below to identify the correct part number for your printer. To order the part, go to www.hp.com/buy/parts.

Table 1-13 Part information

Part number	Part description
RM2-1504-000CN	Intermediate transfer belt

Required tools

- No special tools are required to remove or install this assembly.

After performing service

Turn the printer power on

- Connect the power cable.
- Use the power switch to turn the power on.

Post service test

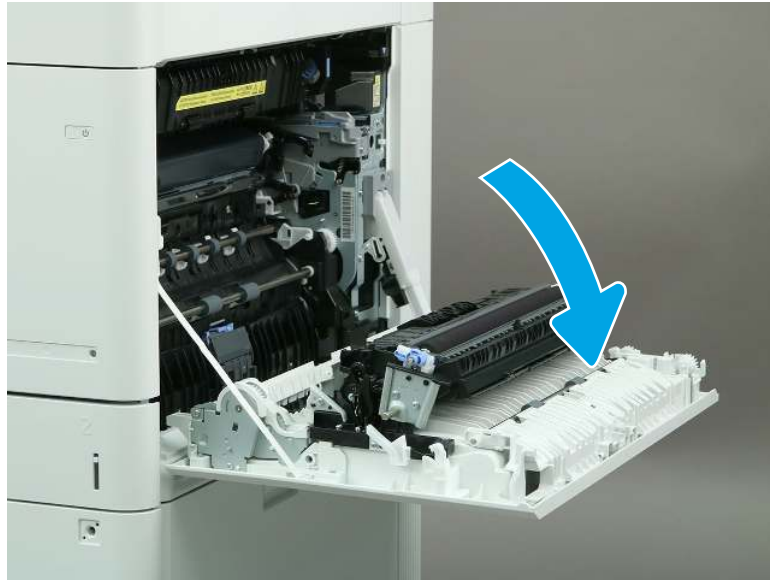
Make sure that the printer initializes to a **Ready** state.

Print a page to make sure that the printer is functioning correctly.

1. Remove the intermediate transfer belt (ITB).

- a. Open the right door.

Figure 1-87 Open the right door



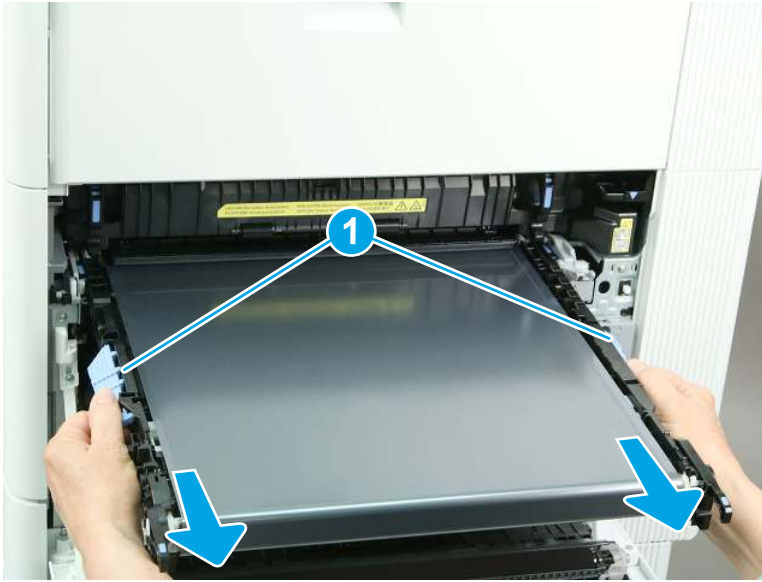
- b. Grasp the two blue handles on the ITB, and then pull the ITB partially out of the printer.

Figure 1-88 Partially remove the ITB



- c. Grasp the blue handles on the side of the ITB (callout 1), and then remove the ITB from the printer.

Figure 1-89 Remove the ITB



2. Unpack the replacement assembly.
 - a. Dispose of the defective part.



NOTE: HP recommends responsible disposal of the defective part.

<http://www8.hp.com/us/en/hp-information/environment/product-recycling.html>

- b. Unpack the replacement part from the packaging.



IMPORTANT: Make sure that all of the shipping materials (for example shipping tape) are removed from the replacement part prior to installation.

3. Install the ITB.

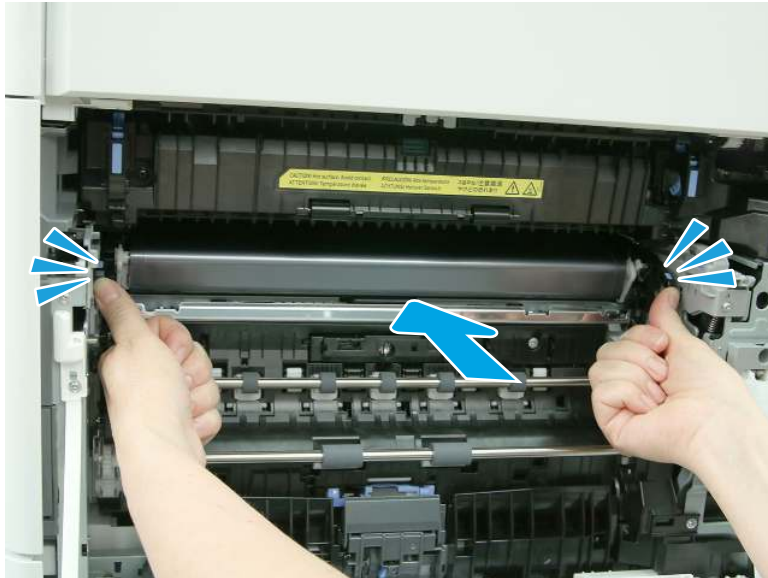
- a. Align the blue tabs on the ITB with the guides inside the printer, and then begin to carefully slide it into the printer.

Figure 1-90 Align the ITB



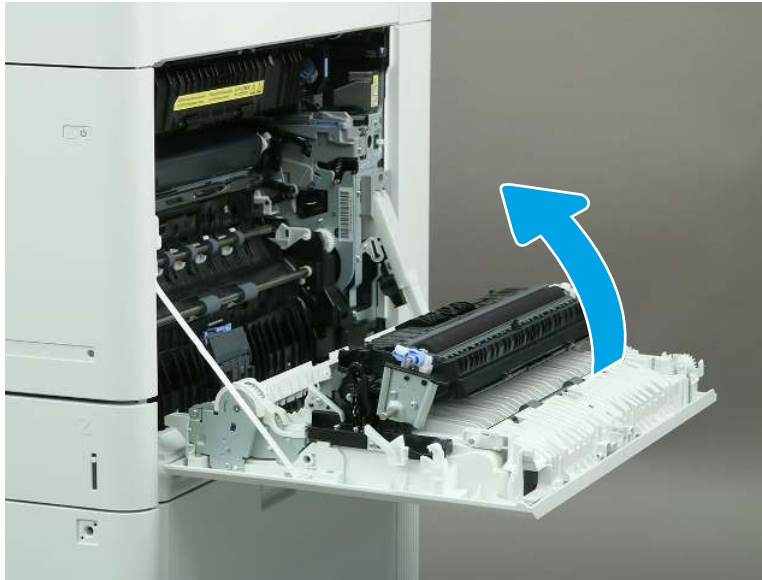
- b. Using the blue handles, continue to carefully slide the ITB into the printer until it snaps into place.

Figure 1-91 Install the ITB



- c. Close the right door.

Figure 1-92 Close the right door



Removal and replacement: Toner collection unit (TCU; M751/E75245/M856/E85055/M776)

Learn how to remove and replace the toner collection unit (TCU).

[View a video of how to remove and replace the toner collection unit.](#)

Mean time to repair: 1 minute

Service level: CSR A

Before performing service

Turn the printer power off

- Disconnect the power cable.

⚠ WARNING! To avoid damage to the printer, turn the printer off, wait 30 seconds, and then remove the power cord before attempting to service the printer.

Use the table below to identify the correct part number for your printer. To order the part, go to www.hp.com/buy/parts.

Table 1-14 Part information

Part number	Part description
3WT90-67901	Toner collection unit

Required tools

- No special tools are required to remove or install this assembly.

After performing service

Turn the printer power on

- Connect the power cable.
- Use the power switch to turn the power on.

Post service test

Make sure that the printer initializes to a **Ready** state.

Print a page to make sure that the printer is functioning correctly.

1. Remove the TCU.
 - a. Open the front door.

Figure 1-93 Open the front door



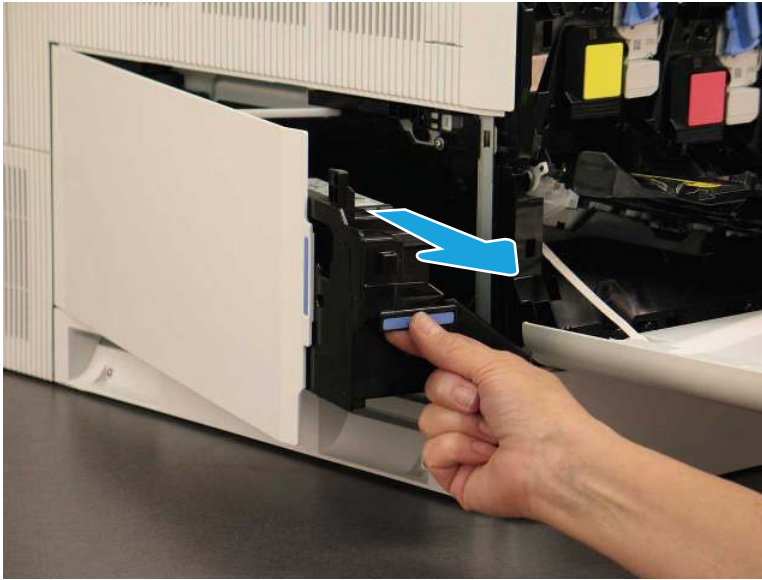
- b. Open the left door.

Figure 1-94 Open the left door



- c. Grasp the front of the TCU, and then remove it from the printer.

Figure 1-95 Remove the TCU



2. Unpack the replacement assembly.
 - a. Dispose of the defective part.



NOTE: HP recommends responsible disposal of the defective part.

<http://www8.hp.com/us/en/hp-information/environment/product-recycling.html>

- b. Unpack the replacement part from the packaging.

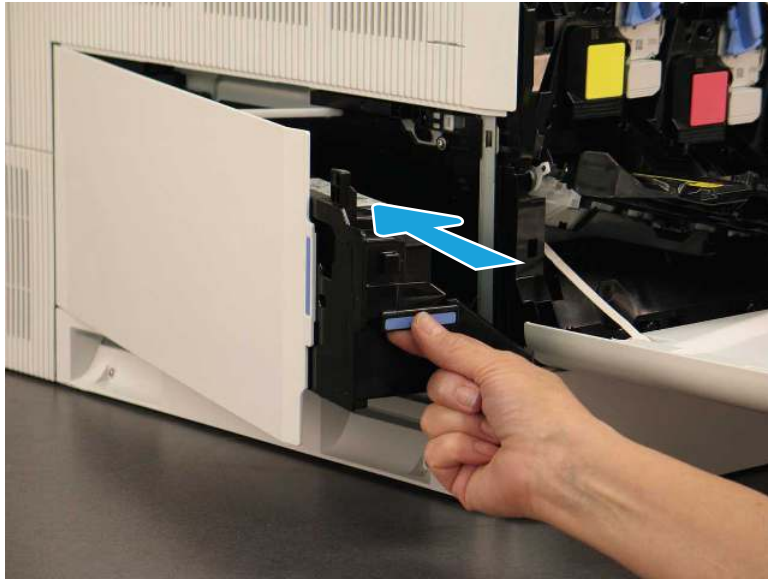


IMPORTANT: Make sure that all of the shipping materials (for example shipping tape) are removed from the replacement part prior to installation.

3. Install the TCU.

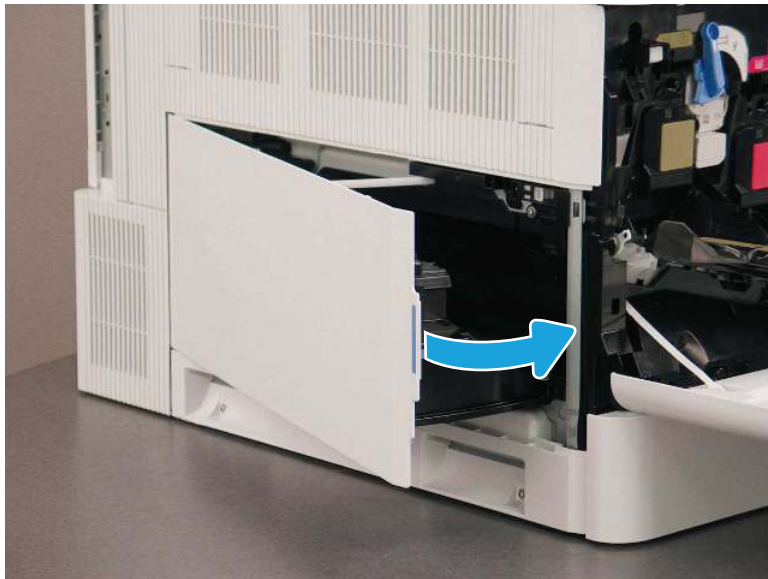
- a. Install the new TCU into the printer. Make sure that it is fully installed.

Figure 1-96 Install the TCU



- b. Close the left door.

Figure 1-97 Close the left door



- c. Close the front door.

Figure 1-98 Close the front door



Removal and replacement: Secondary transfer roller (M751/E75245/M856/E85055/M776)

Learn how to remove and replace the secondary transfer roller.

[View a video of how to remove and replace the secondary transfer roller.](#)

Mean time to repair: 2 minutes

Service level: CSR A

Before performing service

Turn the printer power off

- Disconnect the power cable.

⚠ WARNING! To avoid damage to the printer, turn the printer off, wait 30 seconds, and then remove the power cord before attempting to service the printer.

Use the table below to identify the correct part number for your printer. To order the part, go to www.hp.com/buy/parts.

Table 1-15 Part information

Part number	Part description
RM2-1399-010CN	Secondary transfer roller

Required tools

- No special tools are required to remove or install this assembly.

After performing service

Turn the printer power on

- Connect the power cable.
- Use the power switch to turn the power on.

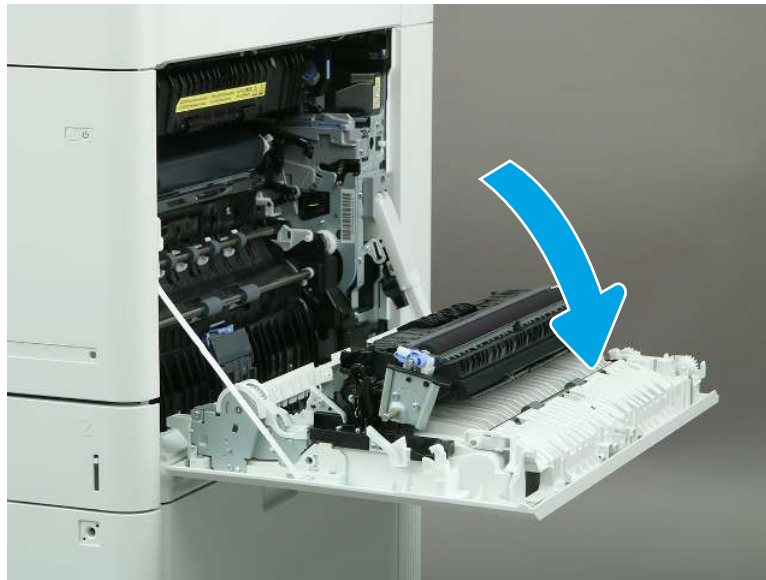
Post service test

Make sure that the printer initializes to a **Ready** state.

Print a page to make sure that the printer is functioning correctly.

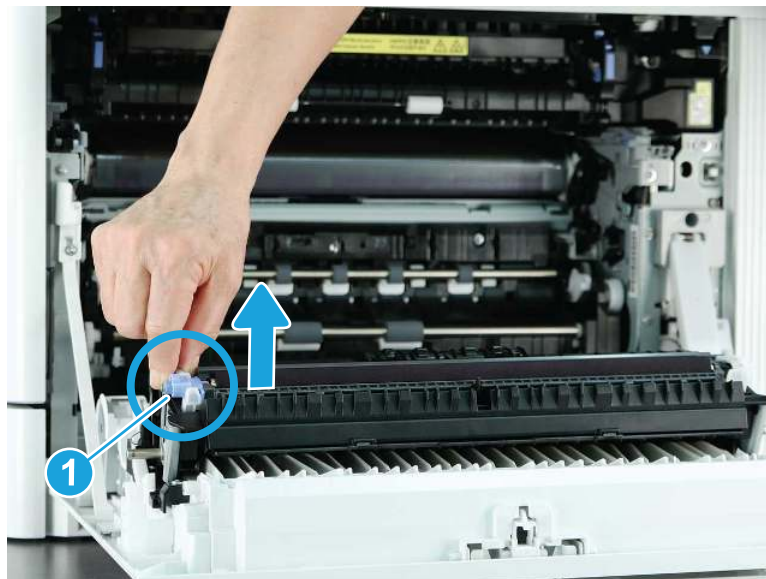
1. Remove the secondary transfer roller.
 - a. Open the right door.

Figure 1-99 Open the right door



- b. Release the latch (callout 1), and then lift the left side of the roller.

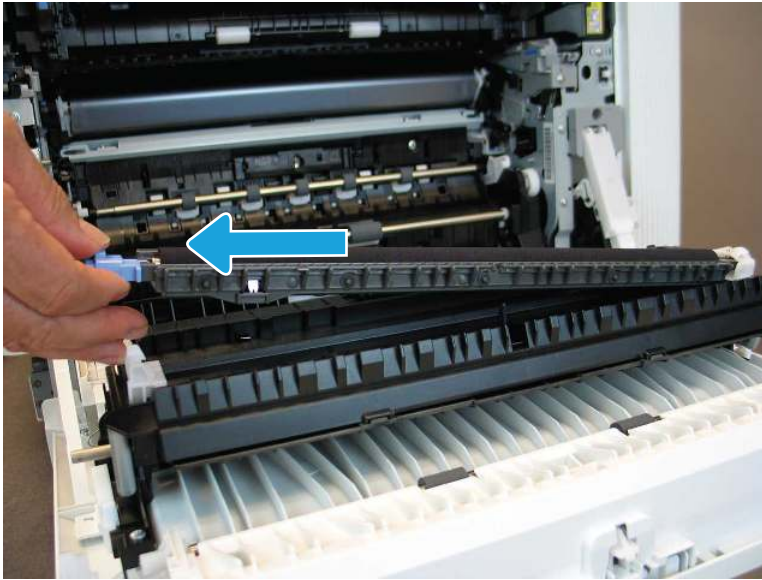
Figure 1-100 Release the transfer roller



- c. Slide the transfer roller to the left to remove it.

CAUTION: Do not touch the surface of the secondary transfer roller.

Figure 1-101 Remove the secondary transfer roller



2. Unpack the replacement assembly.

- a. Dispose of the defective part.

NOTE: HP recommends responsible disposal of the defective part.

<http://www8.hp.com/us/en/hp-information/environment/product-recycling.html>

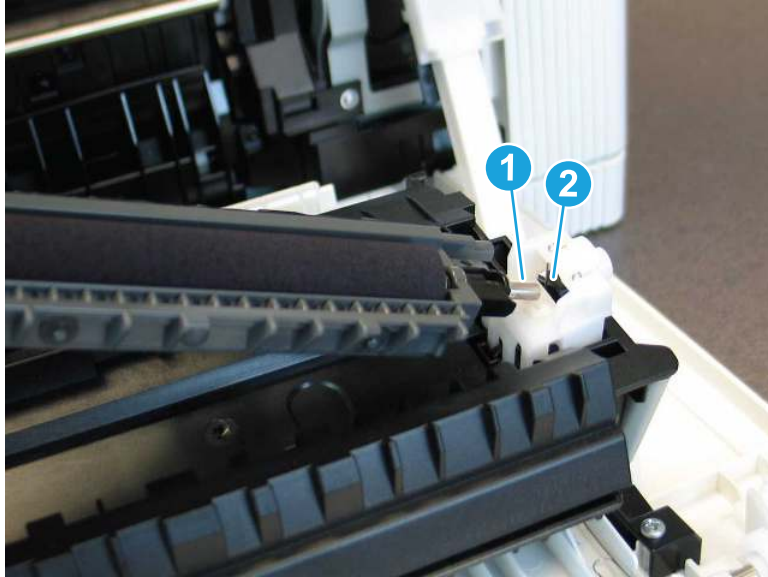
- b. Unpack the replacement part from the packaging.

IMPORTANT: Make sure that all of the shipping materials (for example shipping tape) are removed from the replacement part prior to installation.

3. Install the secondary transfer roller.

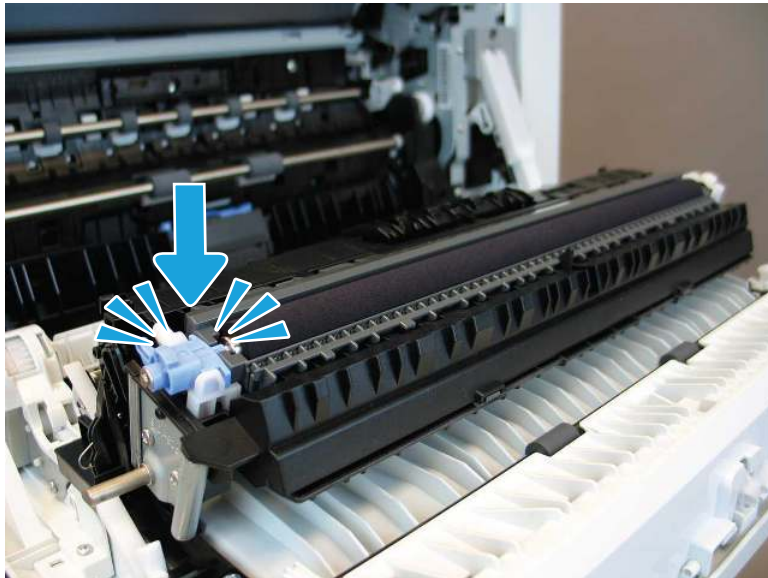
- a. Position the shaft (callout 1) on the secondary transfer roller into the opening (callout 2) in the right door.

Figure 1-102 Position the secondary transfer roller



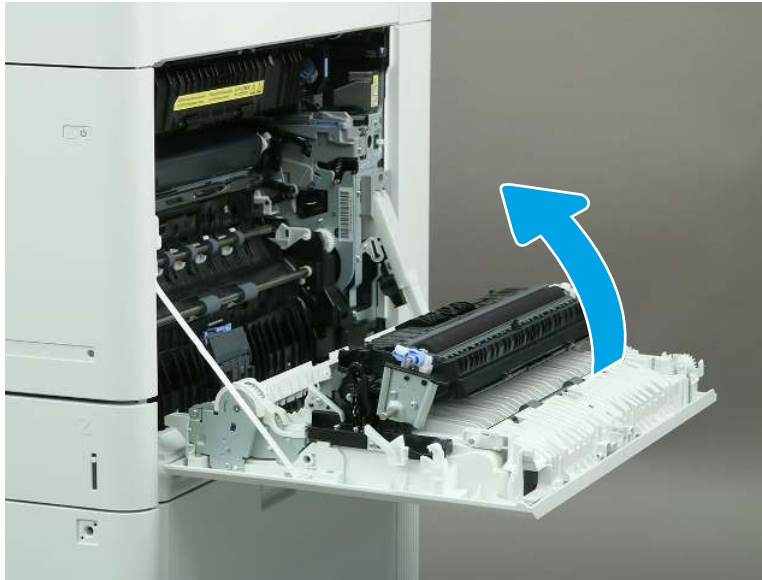
- b. Press the left edge of the secondary transfer roller down until it snaps into place.

Figure 1-103 Install the secondary transfer roller



- c. Close the right door.

Figure 1-104 Close the right door



Removal and replacement: Control panel (M751/E75245)

Learn how to remove and replace the control panel.

[View a video of how to remove and replace the control panel.](#)

Mean time to repair: 3 minutes

Service level: CSR A

Before performing service

Turn the printer power off

- Disconnect the power cable.

⚠ WARNING! To avoid damage to the printer, turn the printer off, wait 30 seconds, and then remove the power cord before attempting to service the printer.

Use the table below to identify the correct part number for your printer. To order the part, go to www.hp.com/buy/parts.

Table 1-16 Part information

Part number	Part description
RM2-1267-010CN	Control panel

Required tools

- #2 Phillips screwdriver with a magnetic tip
- Small, flat-blade screwdriver

After performing service

Turn the printer power on

- Connect the power cable.
- Use the power switch to turn the power on.

Post service test

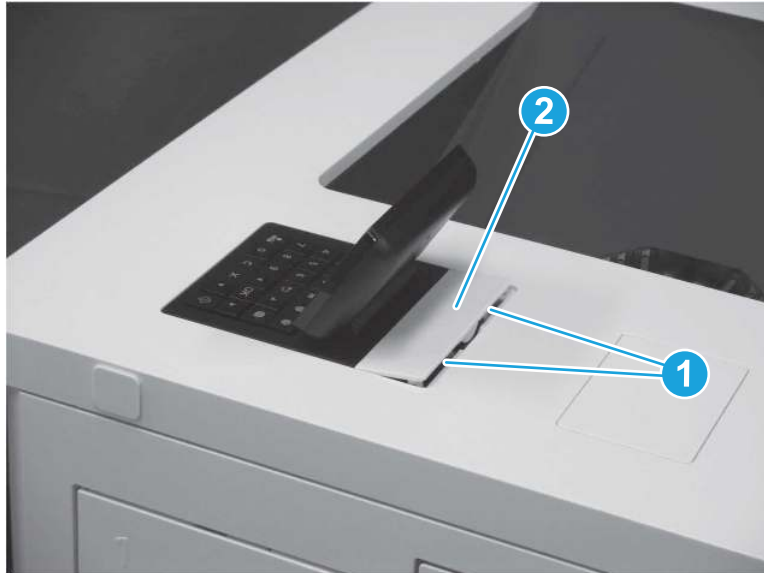
Make sure that the printer initializes to a **Ready** state.

1. Remove the control panel.

 **NOTE:** A screwdriver is included in the control panel kit. The screwdriver has a reversible shaft. Simply pull the shaft out of the handle, and then reinstall it with the desired end facing out.

- a. Use a small, flat-blade screwdriver to release two tabs (callout 1), and then remove the control panel cover (callout 2).

Figure 1-105 Remove the control panel cover



- b. Remove one screw (callout 1).

Figure 1-106 Remove one screw



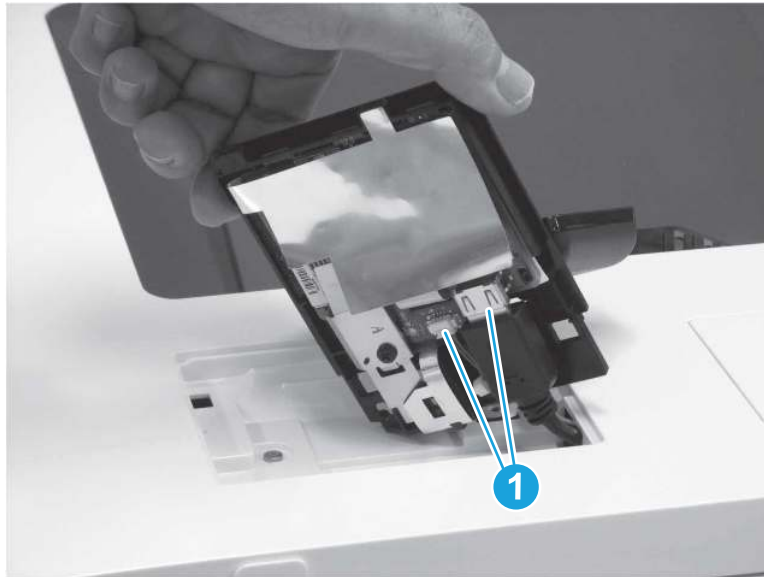
- c. Lift the back edge of the control panel up (callout 1), and then slide the control panel toward the back of the printer (callout 2).

Figure 1-107 Slide the control panel back



- d. Turn the control panel so that the bottom is facing up, and then disconnect two connectors (callout 1) to remove the control panel.

Figure 1-108 Disconnect two connectors



2. Unpack the replacement assembly.
 - a. Dispose of the defective part.




NOTE: HP recommends responsible disposal of the defective part.

<http://www8.hp.com/us/en/hp-information/environment/product-recycling.html>

- b. Unpack the replacement part from the packaging.



CAUTION:  Some parts are sensitive to electrostatic discharge (ESD). Always perform service work at an ESD-protected workstation or mat. If an ESD workstation or mat is not available, touch the sheet-metal chassis to provide a static ground before touching an ESD-sensitive assembly. Protect the ESD-sensitive assemblies by placing them in ESD pouches when they are out of the printer.

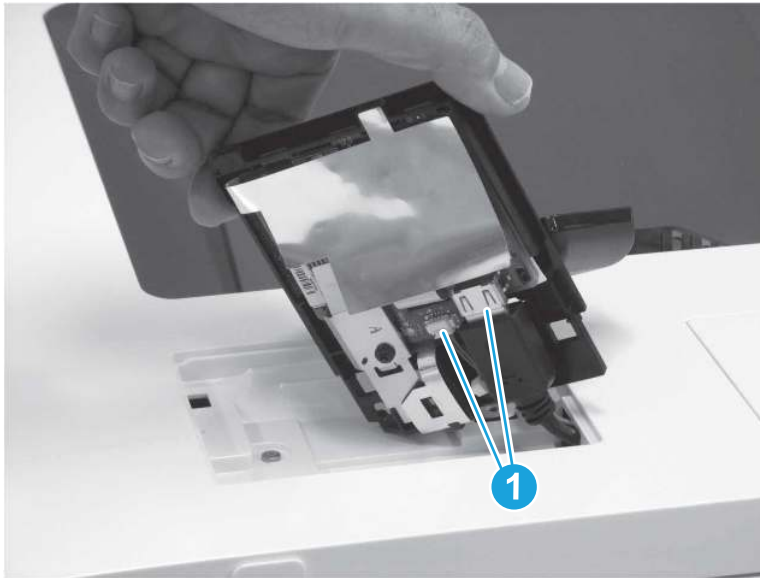


IMPORTANT: Make sure that all of the shipping materials (for example shipping tape) are removed from the replacement part prior to installation.

3. Install the control panel.

- a. Connect two connectors (callout 1).

Figure 1-109 Connect two connectors



- b. Slide the front edge of the control panel into the opening in the top cover (callout 1), and then lower the back edge down (callout 2).

Figure 1-110 Position the control panel



- c. Install one screw (callout 1).

Figure 1-111 Install one screw



- d. Install the control panel cover (callout 1).

Figure 1-112 Install the control panel cover



Removal and replacement: Control panel (M856/E85055)

Learn how to remove and replace the control panel.

[View a video of how to remove and replace the control panel.](#)


Mean time to repair: 3 minutes

Service level: CSR A

Before performing service

Turn the printer power off

- Disconnect the power cable.

 **WARNING!** To avoid damage to the printer, turn the printer off, wait 30 seconds, and then remove the power cord before attempting to service the printer.

Use the table below to identify the correct part number for your printer. To order the part, go to www.hp.com/buy/parts.

Table 1-17 Part information

Part number	Part description
K0Q15-67901	Control panel (M856/E85055)

Required tools

- #2 Phillips screwdriver with a magnetic tip

After performing service

Turn the printer power on


- Connect the power cable.
- Use the power switch to turn the power on.

Post service test

Make sure that the printer initializes to a **Ready** state.

Print a page to make sure that the printer is functioning correctly.

1. Remove the control panel (M856/E85055).

 **NOTE:** A screwdriver is included in the control panel kit. The screwdriver has a reversible shaft. Simply pull the shaft out of the handle, and then reinstall it with the desired end facing out.

- a. Use a small, flat-blade screwdriver to release two tabs (callout 1), and then remove the control panel cover (callout 2).

Figure 1-113 Remove the control panel cover



- b. Remove one screw (callout 1).

Figure 1-114 Remove one screw



- c. Lift the back edge of the control panel up (callout 1), and then slide the control panel toward the back of the printer (callout 2).

Figure 1-115 Slide the control panel back



- d. Turn the control panel so that the bottom is facing up, and then disconnect two connectors to remove the control panel.

Figure 1-116 Disconnect two connectors




2. Unpack the replacement assembly.
 - a. Dispose of the defective part.




NOTE: HP recommends responsible disposal of the defective part.

<http://www8.hp.com/us/en/hp-information/environment/product-recycling.html>

- b. Unpack the replacement part from the packaging.

CAUTION:  Some parts are sensitive to electrostatic discharge (ESD). Always perform service work at an ESD-protected workstation or mat. If an ESD workstation or mat is not available, touch the sheet-metal chassis to provide a static ground before touching an ESD-sensitive assembly. Protect the ESD-sensitive assemblies by placing them in ESD pouches when they are out of the printer.

IMPORTANT:  Make sure that all of the shipping materials (for example shipping tape) are removed from the replacement part prior to installation.

3. Install the control panel (M856/E85055).

- a. Connect two connectors (callout 1).

Figure 1-117 Connect two connectors



- b. Slide the front edge of the control panel into the opening in the top cover (callout 1), and then lower the back edge down (callout 2).

Figure 1-118 Position the control panel



- c. Install one screw (callout 1).

Figure 1-119 Install one screw



- d. Position the front of the control panel cover in the opening (callout 1), and then rotate the cover down to install it (callout 2).

Figure 1-120 Install the control panel cover



Removal and replacement: Control panel (M776)

Learn how to remove and replace the control panel.

[View a video of how to remove and replace the control panel.](#)

Mean time to repair: 7 minutes

Service level: CSR A

Before performing service

Turn the printer power off

- Disconnect the power cable.

⚠ WARNING! To avoid damage to the printer, turn the printer off, wait 30 seconds, and then remove the power cord before attempting to service the printer.

Use the table below to identify the correct part number for your printer. To order the part, go to www.hp.com/buy/parts.

Table 1-18 Part information

Part number	Part description
J7Z09-67928	Control panel (M776dn/M776z/M776zs)

Required tools

- #2 Phillips screwdriver with a magnetic tip

After performing service

Turn the printer power on

- Connect the power cable.
- Use the power switch to turn the power on.

Post service test

Make sure that the printer initializes to a **Ready** state.

Print a page to make sure that the printer is functioning correctly.

1. Remove the control panel (M776).
 - a. Rotate the control panel to the fully raised position (callout 1), and then raise the document feeder (callout 2).

Figure 1-121 Raise the control panel and document feeder



- b. Beginning at the right side of the control-panel cover, carefully release five tabs along the top edge of the cover.



NOTE: The thin black-plastic cover will separate from the white-plastic control-panel base.

Figure 1-122 Release the control panel cover



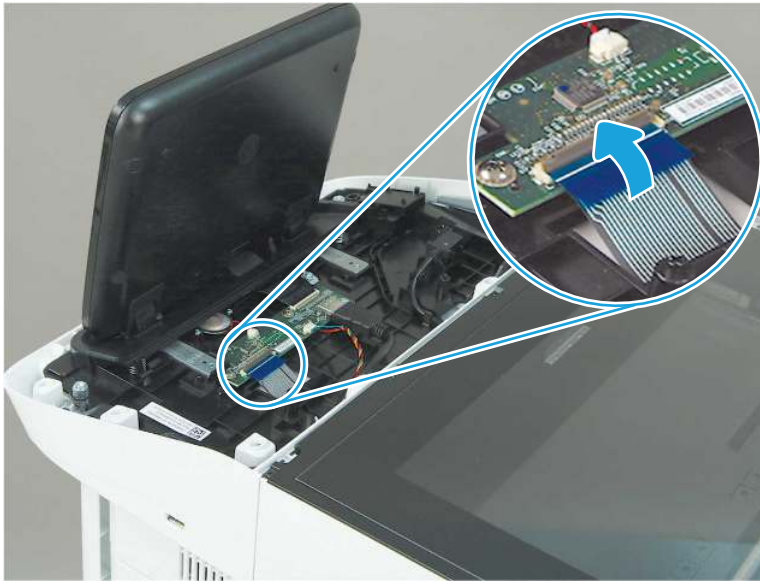
- c. Rotate the control panel cover slightly forward (callout 1), and then lift up to remove the cover (callout 2).

Figure 1-123 Remove the control panel cover



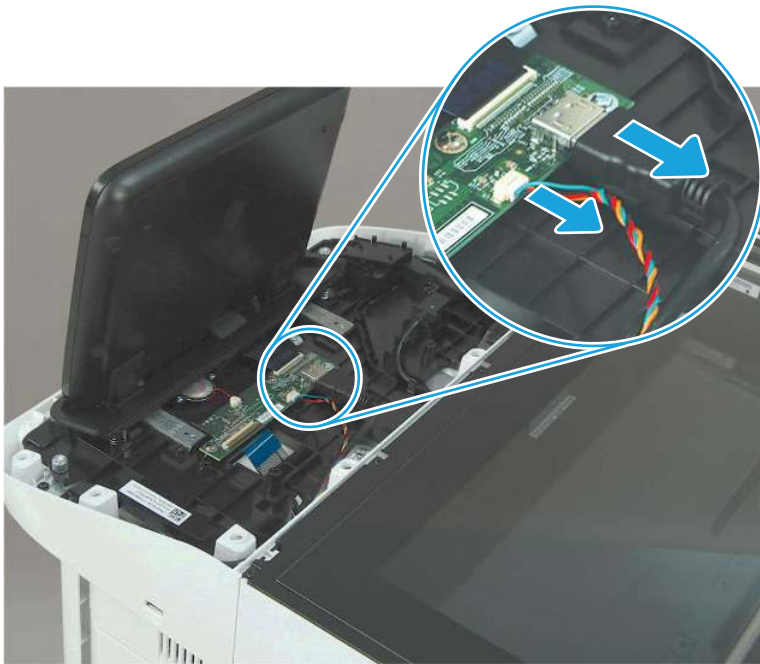
- d. **M776z or M776zs only:** Open the connector latch to release the keyboard flat cable.

Figure 1-124 Release the keyboard flat cable (M776z/M776zs)



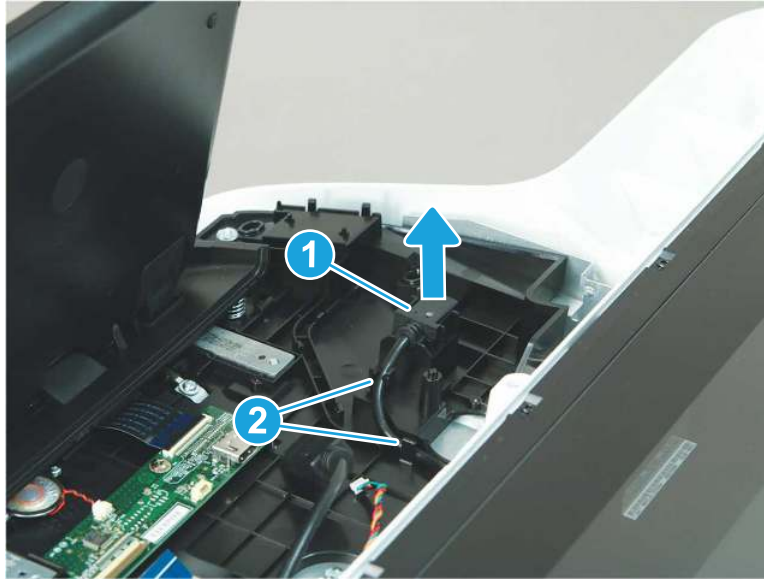
- e. Disconnect two connectors

Figure 1-125 Disconnect two connectors



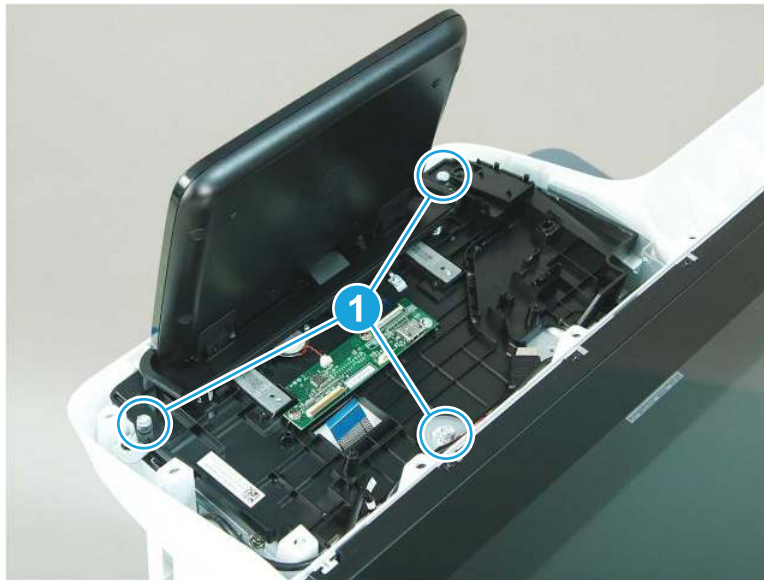
- f. Remove the USB cable (callout 1) from the holder, and then release the cable from two retainers (callout 2).

Figure 1-126 Release the USB cable



- g. Remove three screws (callout 1).

Figure 1-127 Remove three screws



- h. Lift the front of the control panel off of the printer (callout 1), and then slide it towards the front of the printer (callout 2) to remove it.

Figure 1-128 Remove the control panel



2. Unpack the replacement assembly.
 - a. Dispose of the defective part.




NOTE: HP recommends responsible disposal of the defective part.

<http://www8.hp.com/us/en/hp-information/environment/product-recycling.html>

2. Unpack the replacement part from the packaging.



CAUTION:  Some parts are sensitive to electrostatic discharge (ESD). Always perform service work at an ESD-protected workstation or mat. If an ESD workstation or mat is not available, touch the sheet-metal chassis to provide a static ground before touching an ESD-sensitive assembly. Protect the ESD-sensitive assemblies by placing them in ESD pouches when they are out of the printer.

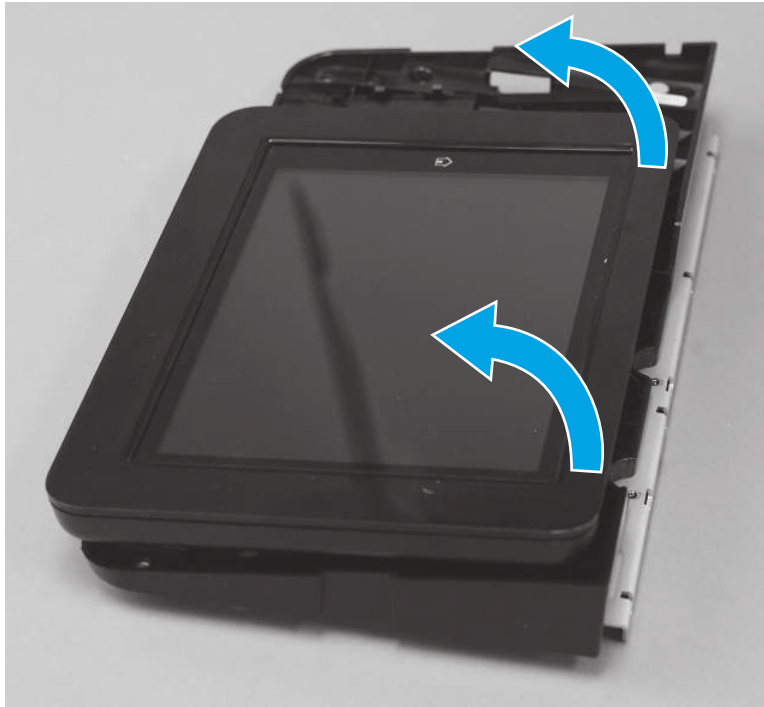


IMPORTANT: Make sure that all of the shipping materials (for example shipping tape) are removed from the replacement part prior to installation.

3. Install the control panel (M776).

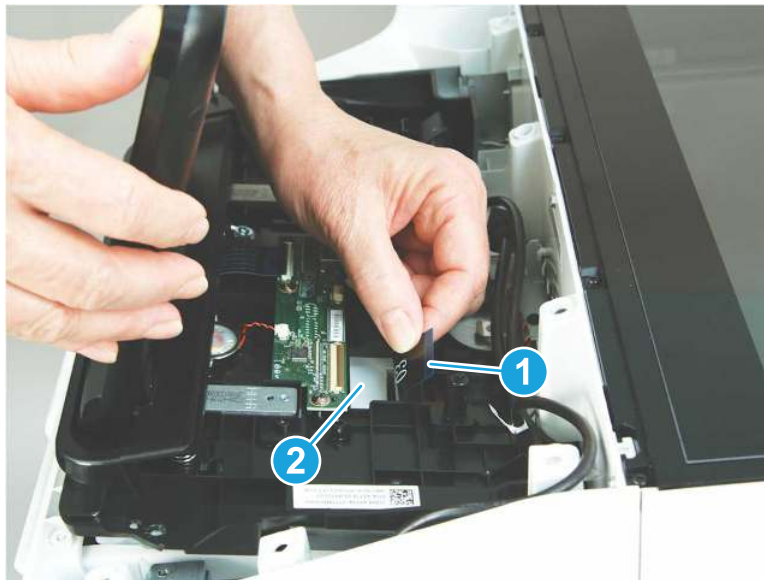
- a. Raise the display on the replacement control panel.

Figure 1-129 Raise the control panel display



- b. **M776z or M776zs only:** When installing the control panel, make sure that the keyboard flat cable (callout 1) passes through the opening (callout 2) in the control panel base.

Figure 1-130 Check the keyboard flat cable (M776z/M776zs)

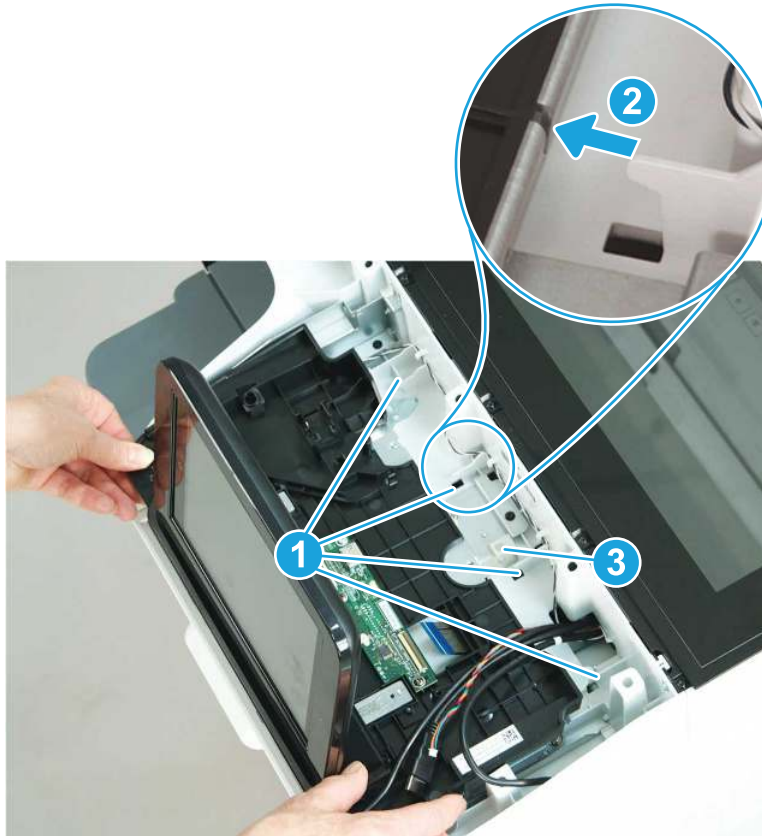


- c. Locate the four hooks on the printer and matching slots in the control-panel base (callout 1). The hooks fit into the slots (callout 2) when the assembly is installed.



NOTE: Make sure that the grounding clip (callout 3) is on top of the assembly base when it is installed.

Figure 1-131 Locate the hooks and slots



- d. Position the rear edge of the control panel in the printer (callout 1), and then lower the front edge down (callout 2) to install it.


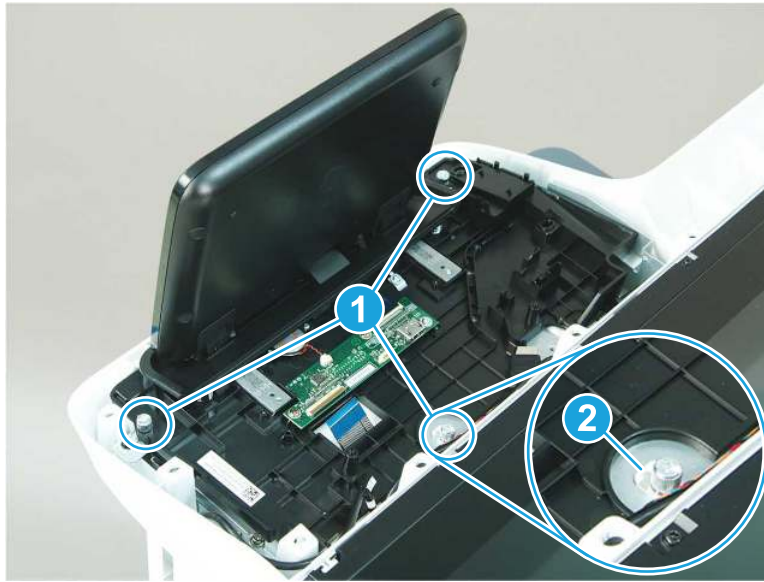
 **NOTE:** If the control panel is difficult to install, make sure that the hooks, slots, and grounding clip are correctly engaged. See the previous step.

Figure 1-132 Install the control panel



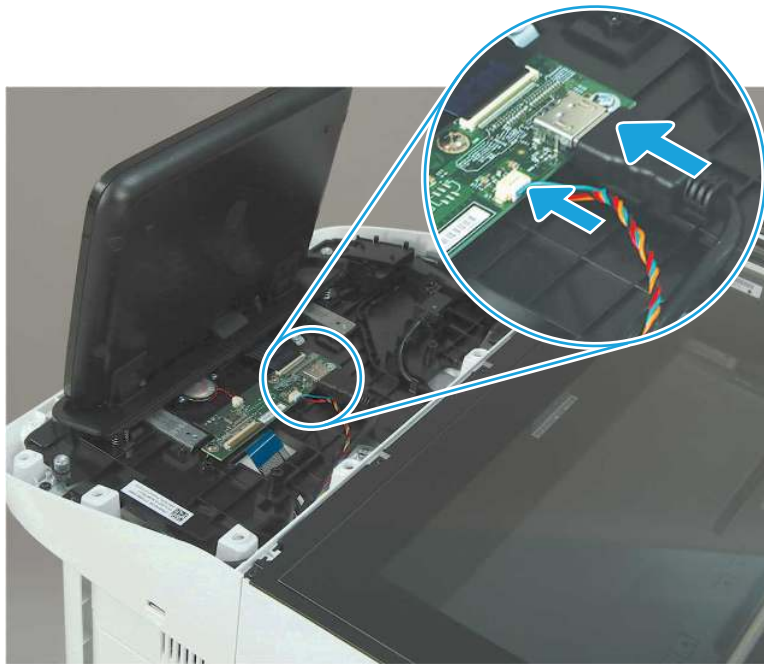
- e. Install three screws (callout 1), making sure that the grounding clip (callout 2) is correctly installed.

Figure 1-133 Install three screws



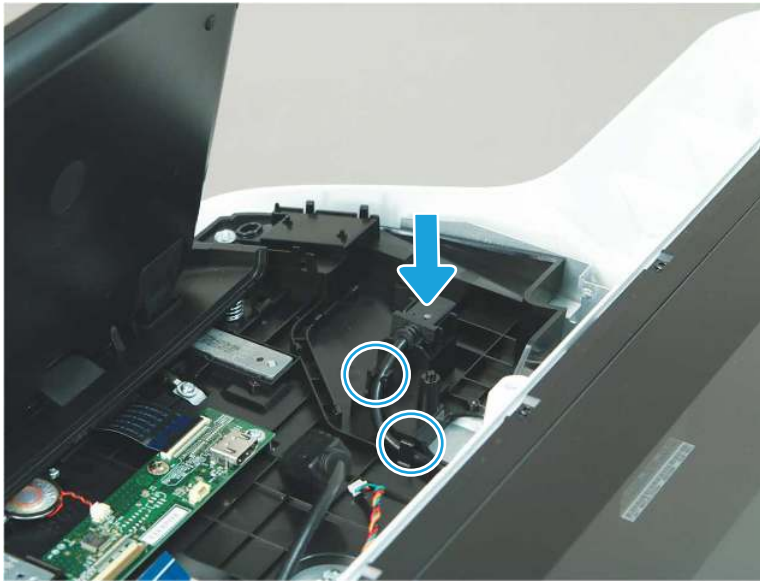
- f. Connect two connectors

Figure 1-134 Connect two connectors



- g. Position the USB cable in the holder, and then install the cable into two retainers.

Figure 1-135 Install the USB cable



- h. **M776z or M776zs only:** Position the keyboard flat cable in the connector, and then close the connector latch..

 **IMPORTANT:** Slightly tug on the cable to make sure that it is fully captured in the connector.


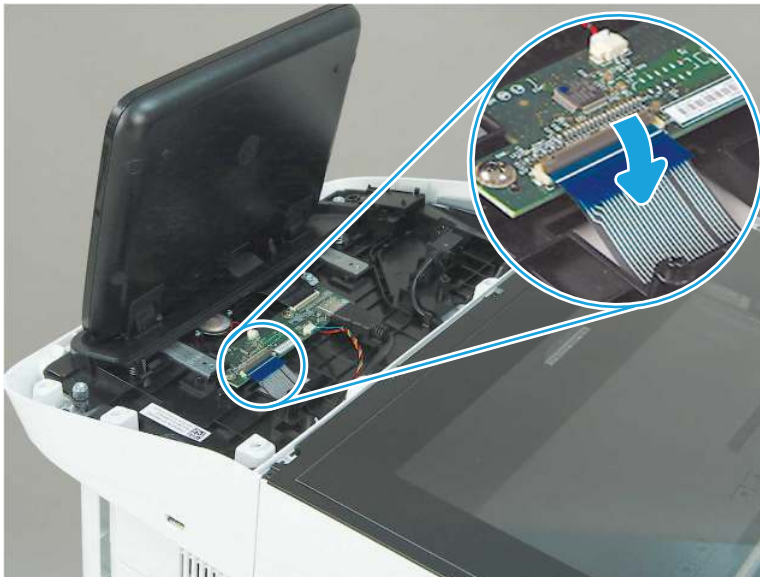
 **NOTE:** When the connector latch is closed and the cable is correctly installed, the white line on the cable is parallel to the connector latch.

Figure 1-136 Install the keyboard flat cable (M776z/M776zs)



- i. Position the control panel cover over the control panel (callout 1), and then tilt the back of the cover down (callout 2).

Figure 1-137 Position the control panel cover



- j. Beginning at the left side of the control-panel cover, carefully push down along the top edge of the cover to engage five tabs.

Figure 1-138 Install the control panel cover



- k. Lower the document feeder (callout 1) and the control panel (callout 2).

Figure 1-139 Close the document feeder



Removal and replacement: Document feeder reflector (M776)

Learn how to remove and replace the document feeder reflector.

Mean time to repair: 2 minutes

Service level: CSR A

Before performing service

Turn the printer power off

- Disconnect the power cable.

⚠ WARNING! To avoid damage to the printer, turn the printer off, wait 30 seconds, and then remove the power cord before attempting to service the printer.

Use the table below to identify the correct part number for your printer. To order the part, go to www.hp.com/buy/parts.

Table 1-19 Part information

Part number	Part description
J7Z09-67926	White backing A3 kit

Required tools

- No special tools are required to remove or install this assembly.

After performing service

Turn the printer power on

- Connect the power cable.

- Use the power switch to turn the power on.

Post service test

No post service test is available for this assembly.

1. Remove the document feeder reflector (M776dn/M776z/M776zs).
 - a. Raise the document feeder.

Figure 1-140 Raise the document feeder



- b. Before proceeding, take note of the location of the tabs that fasten the reflector to the document feeder.

Figure 1-141 Reflector tabs location



- c. Starting along the top edge of the reflector, carefully pull it away from the document feeder to release it.

Figure 1-142 Release the reflector



- d. Remove the reflector.

Figure 1-143 Remove the reflector



- e. Check the document feeder for any reflector tabs (callout 1) that were not removed with the reflector. Remove any tabs still attached to the document feeder.

Figure 1-144 Check for reflector tabs



2. Unpack the replacement assembly.

- a. Dispose of the defective part.



NOTE: HP recommends responsible disposal of the defective part.

<http://www8.hp.com/us/en/hp-information/environment/product-recycling.html>

- b. Unpack the replacement part from the packaging.



IMPORTANT: Make sure that all of the shipping materials (for example shipping tape) are removed from the replacement part prior to installation.

- c. To install an assembly, reverse the removal steps.



NOTE: When applicable, special installation instructions are provided for an assembly at the end of the removal procedure. Always completely read the removal instructions and follow all special installation instructions.

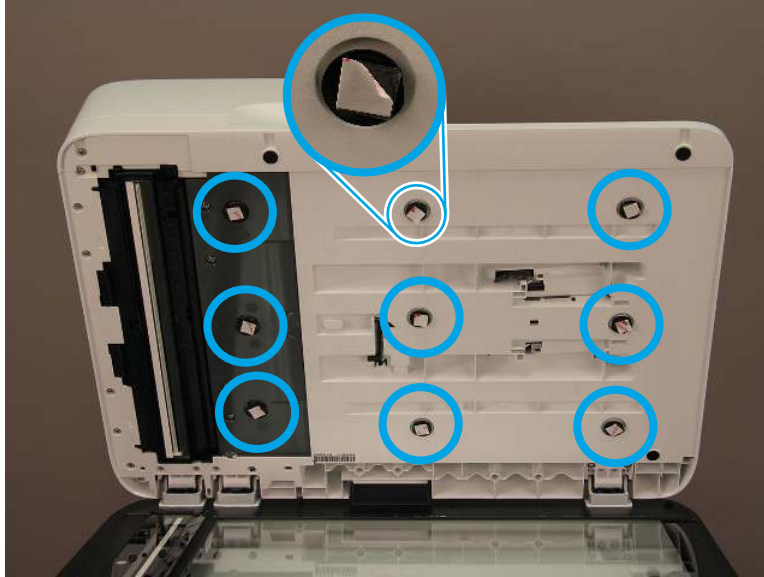
3. Install the document feeder reflector (M776dn/M776z/M776zs).

- a. Install nine clips (provided in the kit) into the mounting holes in document feeder.



TIP: The clips make an audible click when they are snapped into place.

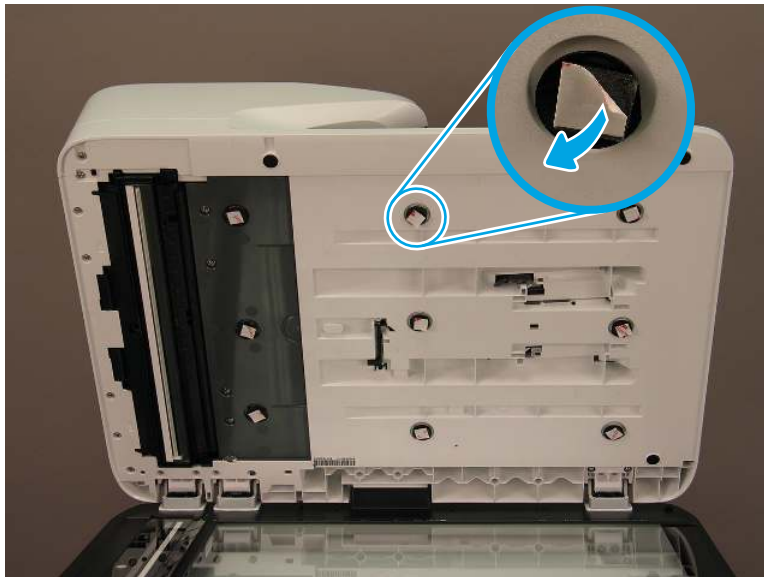
Figure 1-145 Install nine clips



- b. Peel the protective backing off of the adhesive pads on each clip.

 **IMPORTANT:** Do not touch the exposed sticky side of the adhesive pad after removing the protective backing.

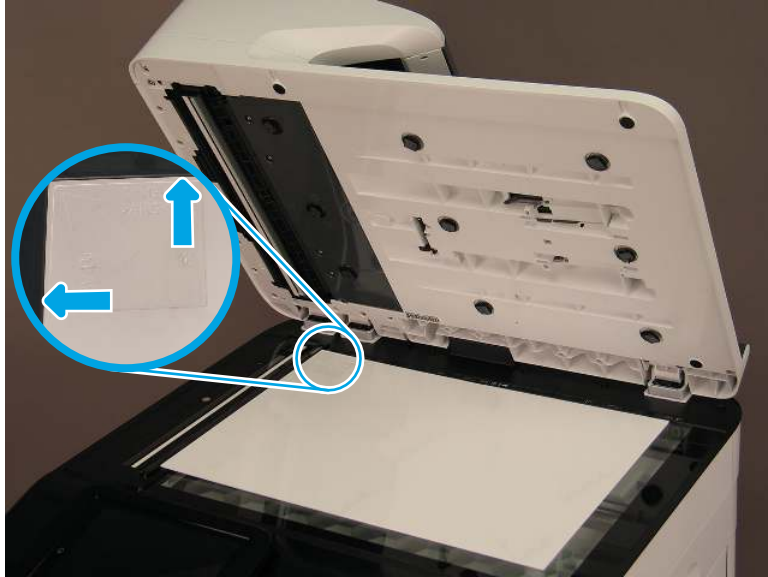
Figure 1-146 Peel the protective backing



- c. Place the reflector on the scanner glass. Make sure that the rear and left edge of the reflector are aligned with the rear and left edge of the scanner glass.

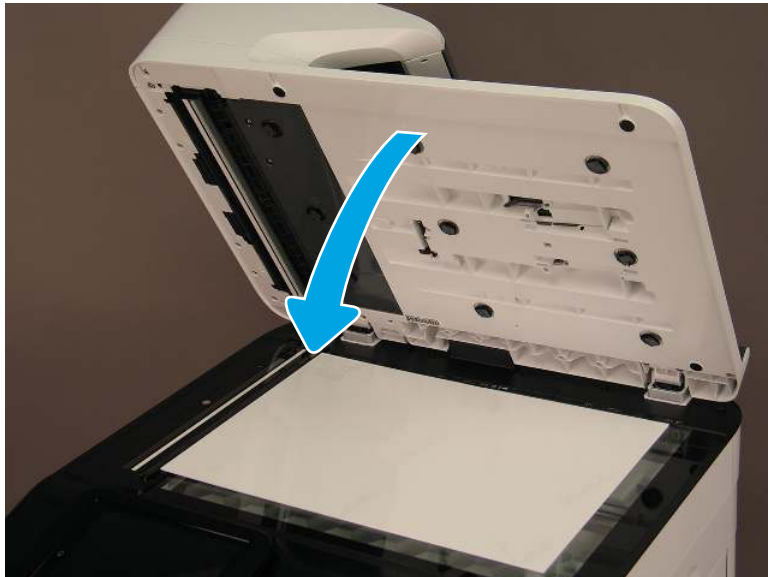
 **IMPORTANT:** The embossed arrow on the reflector must be positioned in the bottom-left corner.

Figure 1-147 Position the reflector



- d. Close the document feeder.

Figure 1-148 Close the document feeder



- e. Push down on the document feeder to adhere the reflector to the mounting clips.

Figure 1-149 Push down on the document feeder



- f. Open the document feeder, and then push in on the nine reflector tabs to make sure they are fully adhered to the reflector.

Figure 1-150 Push the nine tabs



- g. Close the document feeder.

Figure 1-151 Close the document feeder



Field replaceable units (FRUs)

Learn how to remove and replace the printer field replaceable assemblies.

Removal and replacement: External panels, covers, and doors

Learn how to remove and replace the printer external panels, covers, and doors.

Removal and replacement: Front door (M751/E75245/M856/E85055/M776)

Learn how to remove and replace the front door.

[View a video of how to remove and replace the front door.](#)

Mean time to repair: 3 minutes

Service level: Easy

Before performing service

Turn the printer power off

- Disconnect the power cable.

⚠ WARNING! To avoid damage to the printer, turn the printer off, wait 30 seconds, and then remove the power cord before attempting to service the printer.

Use the table below to identify the correct part number for your printer. To order the part, go to www.hp.com/buy/parts.

Table 1-20 Part information

Part number	Part description
RM2-1368-000CN	Front door assembly

Required tools

- Small, flat-blade screwdriver

After performing service

Turn the printer power on

- Connect the power cable.
- Use the power switch to turn the power on.

Post service test

Make sure that the printer initializes to a **Ready** state.

Print a page to make sure that the printer is functioning correctly.

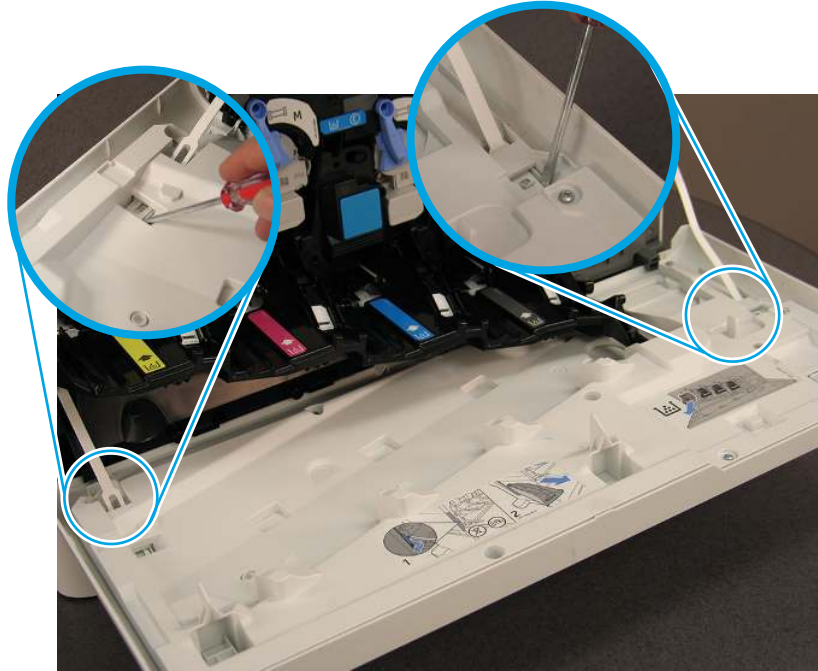
1. Remove the front door.
 - a. Open the front door.

Figure 1-152 Open the front door



- b. Use a small, flat-blade screwdriver to release the tab on the left hinge, and then release the hinge from the retainer. Repeat this process for the right hinge.

Figure 1-153 Release the hinges



- c. Press in to release one tab (callout 1), and then slide the front door to the right.


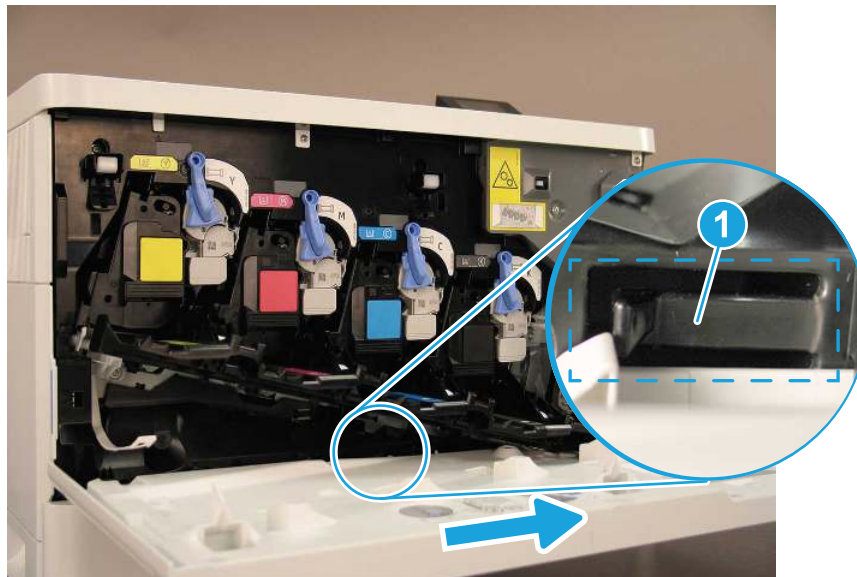
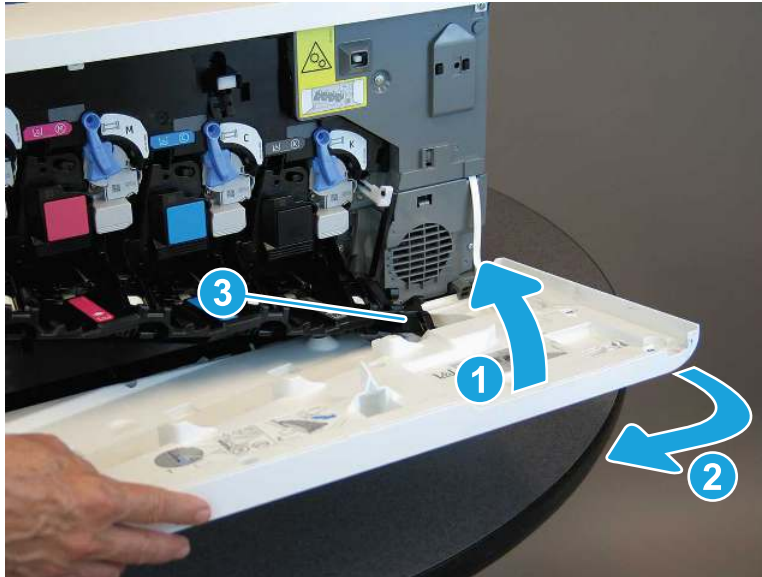
 **NOTE:** The figure below shows the M751. The procedure is correct for all models.


Figure 1-154 Release one tab

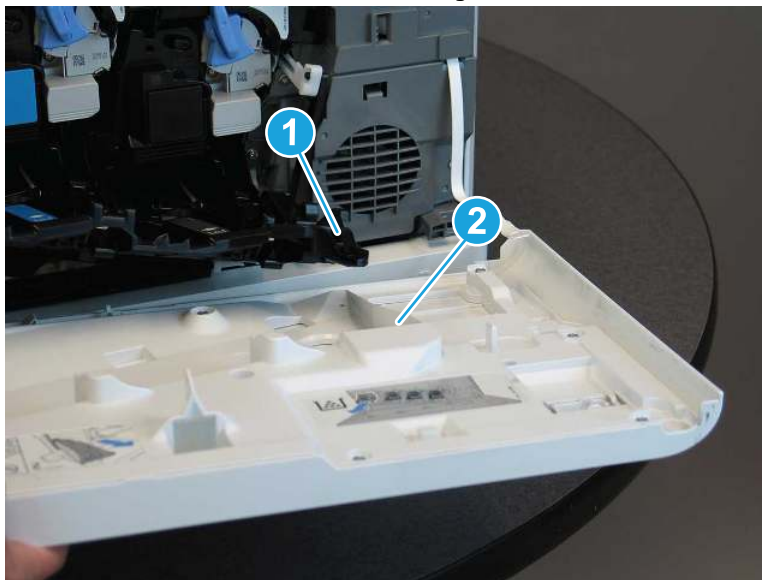


- d. Raise the door slightly (callout 1), and then rotate the right side of the door away from the printer (callout 2) to release the inner cover hook (callout 3).

Figure 1-155 Release the inner cover hook



-  **TIP:** When reinstalling the door, make sure to install the inner cover hook (callout 1) into the opening in the front door (callout 2) before installing the door on the shafts.



- e. Release three shafts (callout 1), and then remove the front door.


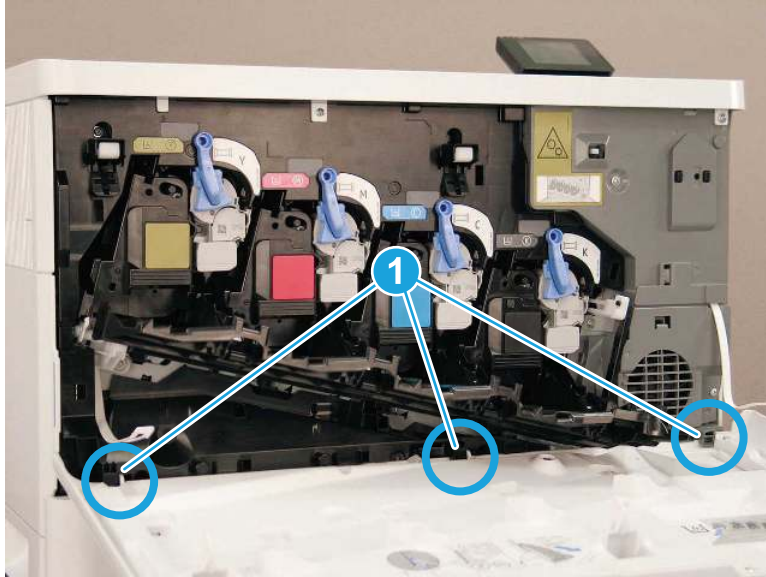
-  **NOTE:** The figure below shows the M751. The procedure is correct for all models.

Figure 1-156 Remove the front door



2. Unpack the replacement assembly.

- a. Dispose of the defective part.



NOTE: HP recommends responsible disposal of the defective part.

<http://www8.hp.com/us/en/hp-information/environment/product-recycling.html>

- b. Unpack the replacement part from the packaging.



IMPORTANT: Make sure that all of the shipping materials (for example shipping tape) are removed from the replacement part prior to installation.

- c. To install an assembly, reverse the removal steps.



NOTE: When applicable, special installation instructions are provided for an assembly at the end of the removal procedure. Always completely read the removal instructions and follow all special installation instructions.

Removal and replacement: Formatter cover (M751/E75245/M856/E85055/M776)

Learn how to remove and replace the formatter cover.

[View a video of how to remove and replace the formatter cover.](#)

Mean time to repair: 1 minute

Service level: CSR A

Before performing service

Turn the printer power off

- Disconnect the power cable.



WARNING! To avoid damage to the printer, turn the printer off, wait 30 seconds, and then remove the power cord before attempting to service the printer.

Use the table below to identify the correct part number for your printer. To order the part, go to www.hp.com/buy/parts.

Table 1-21 Part information

Part number	Part description
RM2-1346-000CN	Formatter cover assembly (M751/E75245)
RM2-2683-000CN	Formatter cover assembly (M856/E85055/M776)

Required tools

- No special tools are required to remove or install this assembly.

After performing service

Turn the printer power on

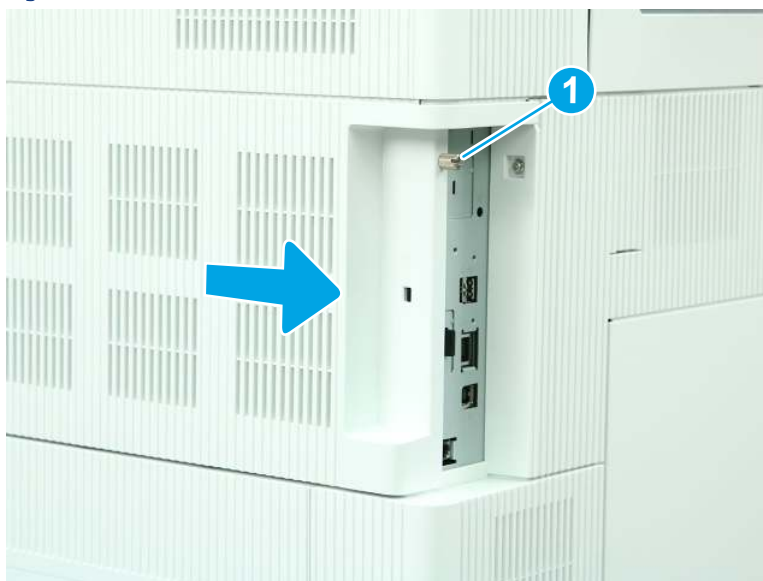
- Connect the power cable.
- Use the power switch to turn the power on.

Post service test

No post service test is available for this assembly.

1. Remove the formatter cover.
 - ▲ Loosen one thumbscrew (callout 1), and then slide the formatter cover (callout 2) away from the printer to remove it.


Figure 1-157 Remove the formatter cover




2. Unpack the replacement assembly.
 - a. Dispose of the defective part.

 **NOTE:** HP recommends responsible disposal of the defective part.

- b. Unpack the replacement part from the packaging.

 **IMPORTANT:** Make sure that all of the shipping materials (for example shipping tape) are removed from the replacement part prior to installation.

- c. To install an assembly, reverse the removal steps.

 **NOTE:** When applicable, special installation instructions are provided for an assembly at the end of the removal procedure. Always completely read the removal instructions and follow all special installation instructions.

Removal and replacement: Left door (M751/E75245/M856/E85055/M776)

Learn how to remove and replace the left door.

[View a video of how to remove and replace the left door.](#)

Mean time to repair: 7 minutes

Service level: Easy

Before performing service

Turn the printer power off

- Disconnect the power cable.

 **WARNING!** To avoid damage to the printer, turn the printer off, wait 30 seconds, and then remove the power cord before attempting to service the printer.

Use the table below to identify the correct part number for your printer. To order the part, go to www.hp.com/buy/parts.

Table 1-22 Part information

Part number	Part description
RM2-1351-000CN	Left door assembly
RM2-1350-000CN	Left cover lock assembly (if needed)

Required tools

- #2 Phillips screwdriver with a magnetic tip
- Small, flat-blade screwdriver

After performing service

Turn the printer power on

- Connect the power cable.
- Use the power switch to turn the power on.

Post service test

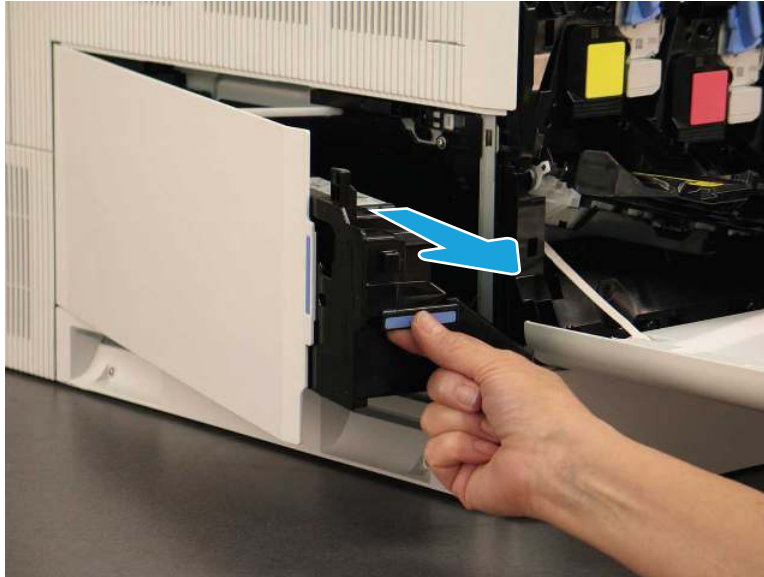
Make sure that the printer initializes to a **Ready** state.

Print a page to make sure that the printer is functioning correctly.

1. Remove the TCU.

- ▲ Open the front door, and then open the left door. Grasp the front of the toner-collection unit, and then remove it from the printer.

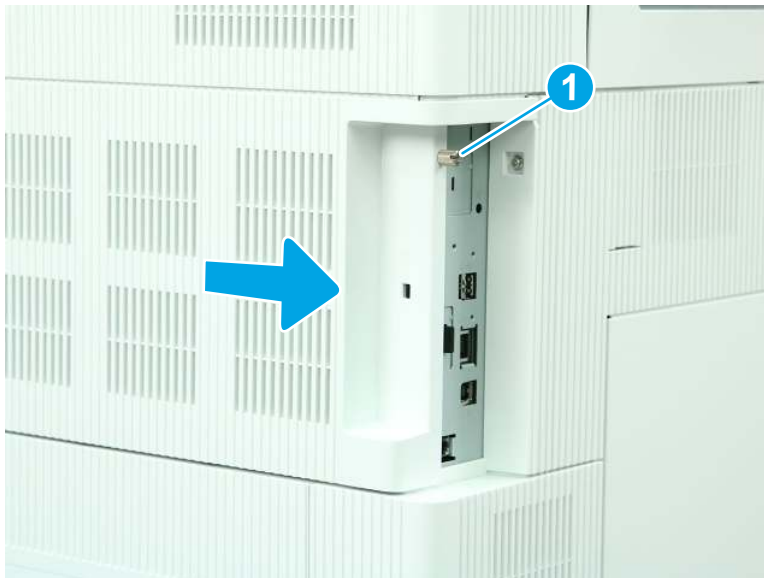
Figure 1-158 Remove the TCU



2. Remove the formatter cover.

- ▲ Loosen one thumbscrew (callout 1), and then slide the formatter cover (callout 2) away from the printer to remove it.

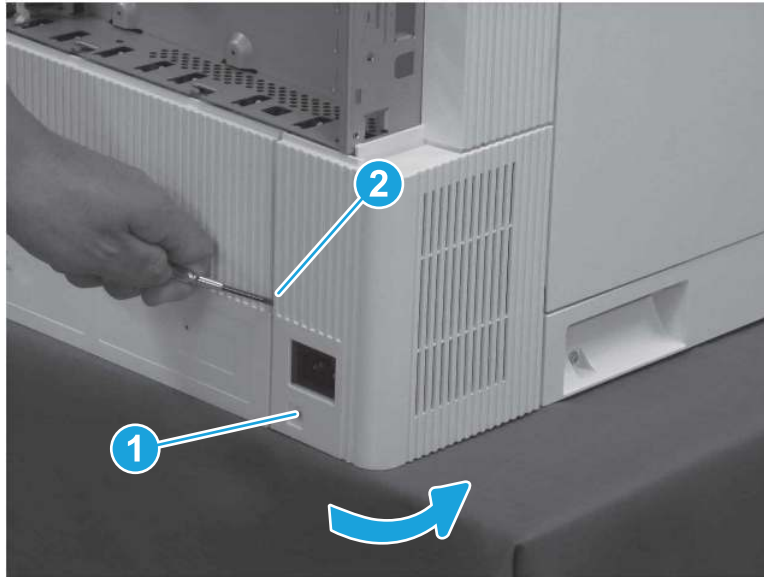
Figure 1-159 Remove the formatter cover



3. Remove the left lower cover (M751/E75245).

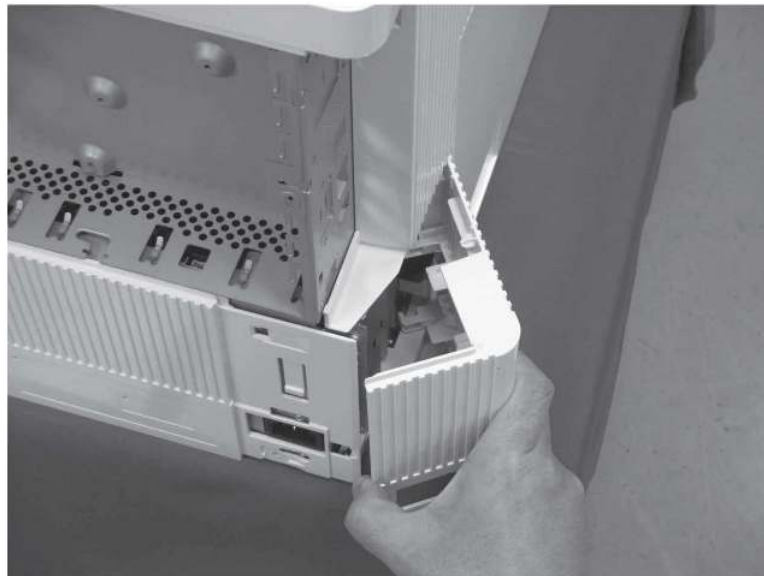
- a. Remove one screw (callout 1), release one tab (callout 2), and then rotate the cover away from the printer.

Figure 1-160 Remove one screw and release one tab



- b. Remove the left lower cover.

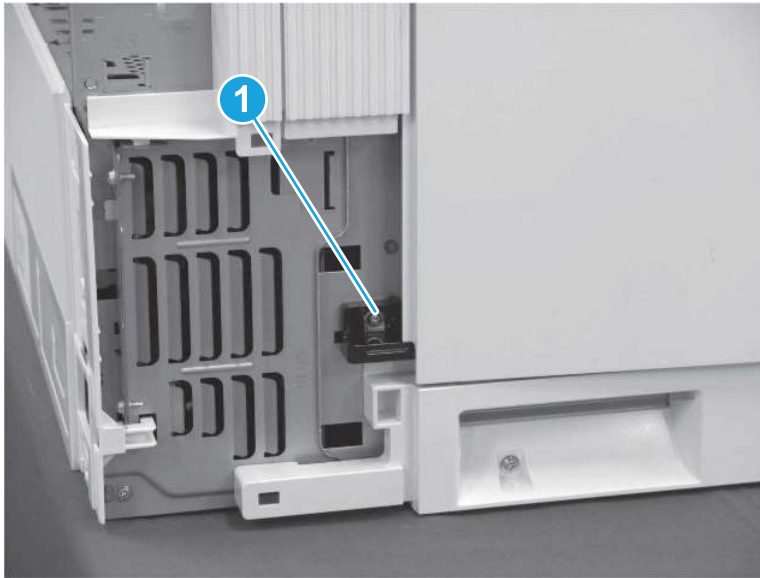
Figure 1-161 Remove the left lower cover



4. Remove the left door.

- a. Remove one screw (callout 1).

Figure 1-162 Remove one screw



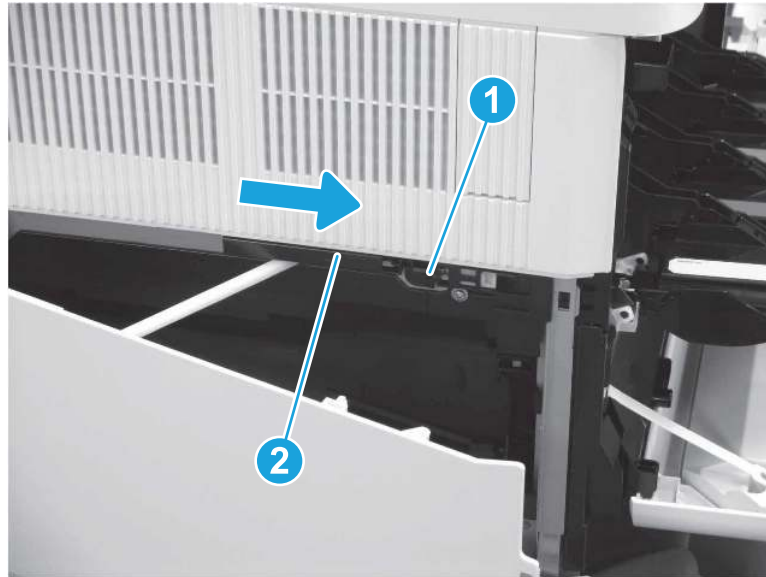
- b. Release the holder, and then remove it from the printer.

Figure 1-163 Remove the holder



- c. Open the left door, and release one tab (callout 1). Slide the holder (callout 2) toward the front of the printer.

Figure 1-164 Slide the holder



- d. Release the holder (callout 1) from the printer, but leave it attached to the hinge.

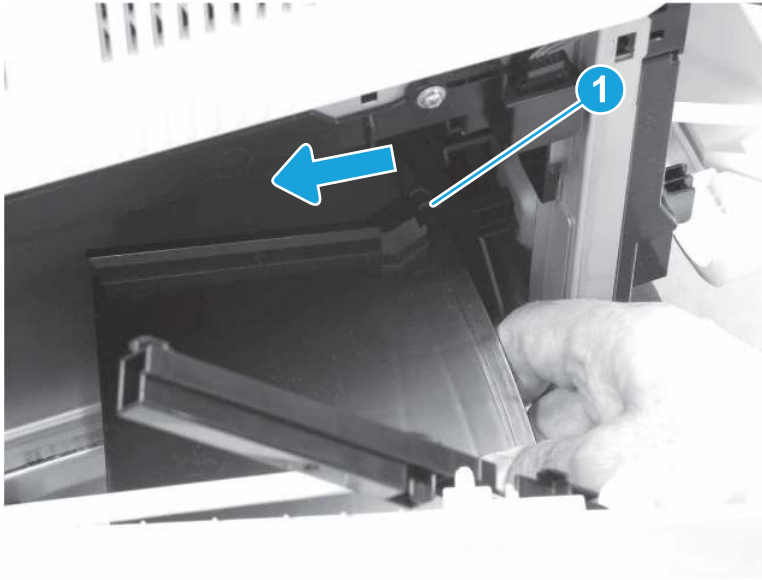
⚠ CAUTION: The holder can become detached or break relatively easily. Lay the holder on top of the door, next to the white hinge, to prevent it from hanging down and potentially breaking.

Figure 1-165 Release the holder



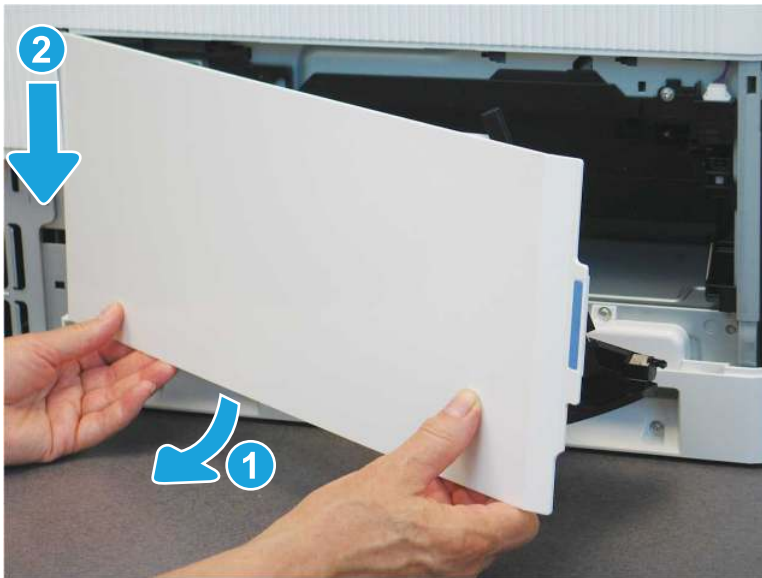
- e. Press the stopper (callout 1) on the bottom of the door to the left to release it from the track.

Figure 1-166 Release the stopper



- f. Rotate the left, lower edge of the door away from the printer (callout 1), and then lower the door to remove it (callout 2).

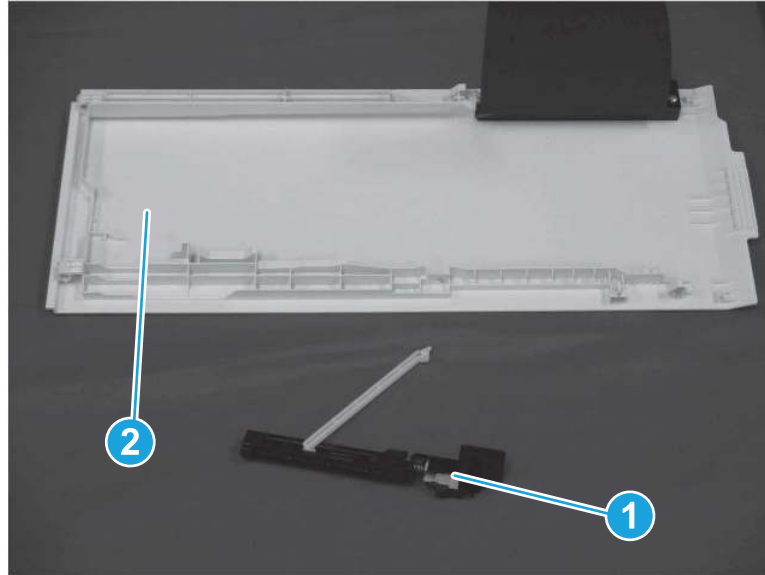
Figure 1-167 Remove the left door



- g. Rotate the left cover lock assembly (callout 1) until the tab lines up with the opening in the door, and then remove the hinge and lock assembly from the door (callout 2).

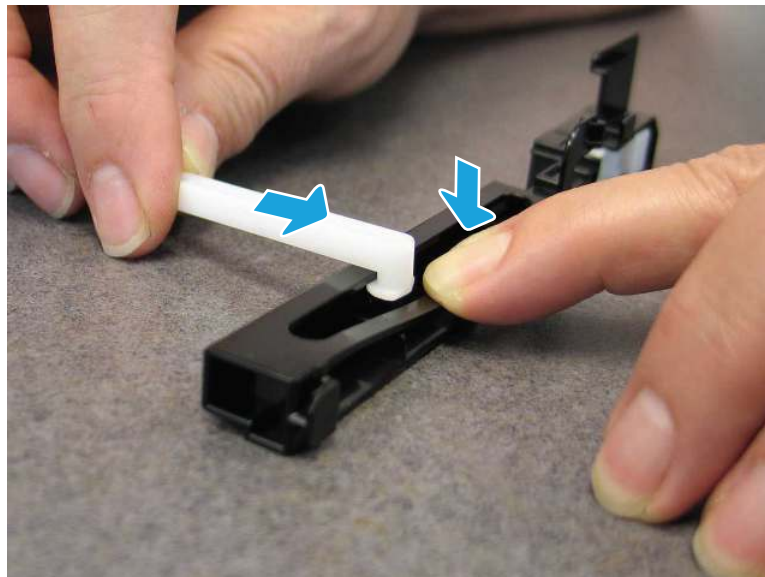
⚠ CAUTION: The white hinge is easily broken. Use care when handling this part.

Figure 1-168 Remove the left cover lock assembly and hinge



- h. If the left cover lock assembly breaks and must be replaced, press down on one side of the lock assembly, and then slide the white hinge away from the assembly. Install the hinge on the replacement lock assembly.

Figure 1-169 Remove the hinge




- 5. Unpack the replacement assembly.
 - a. Dispose of the defective part.




NOTE: HP recommends responsible disposal of the defective part.

<http://www8.hp.com/us/en/hp-information/environment/product-recycling.html>

- b. Unpack the replacement part from the packaging.

 **IMPORTANT:** Make sure that all of the shipping materials (for example shipping tape) are removed from the replacement part prior to installation.

- c. To install an assembly, reverse the removal steps.

 **NOTE:** When applicable, special installation instructions are provided for an assembly at the end of the removal procedure. Always completely read the removal instructions and follow all special installation instructions.

Removal and replacement: Top cover (M751/E75245)

Learn how to remove and replace the top cover.

[View a video of how to remove and replace the top cover.](#)


Mean time to repair: 14 minutes

Service level: Easy

Before performing service

Turn the printer power off

- Disconnect the power cable.

 **WARNING!** To avoid damage to the printer, turn the printer off, wait 30 seconds, and then remove the power cord before attempting to service the printer.

Use the table below to identify the correct part number for your printer. To order the part, go to www.hp.com/buy/parts.

Table 1-23 Part information

Part number	Part description
RC5-0658-000CN	Cover, upper

Required tools

- #2 Phillips screwdriver with a magnetic tip
- Small, flat-blade screwdriver

After performing service

Turn the printer power on

- Connect the power cable.
- Use the power switch to turn the power on.

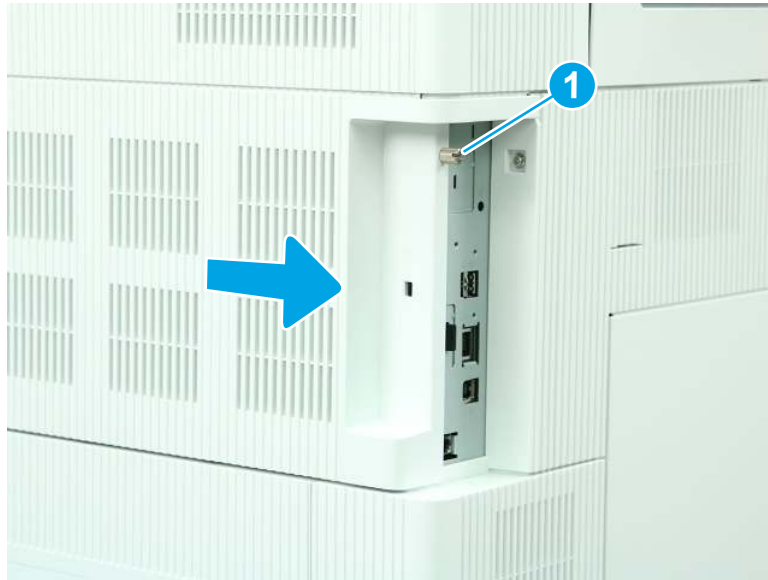
Post service test

Make sure that the printer initializes to a **Ready** state.

Print a page to make sure that the printer is functioning correctly.

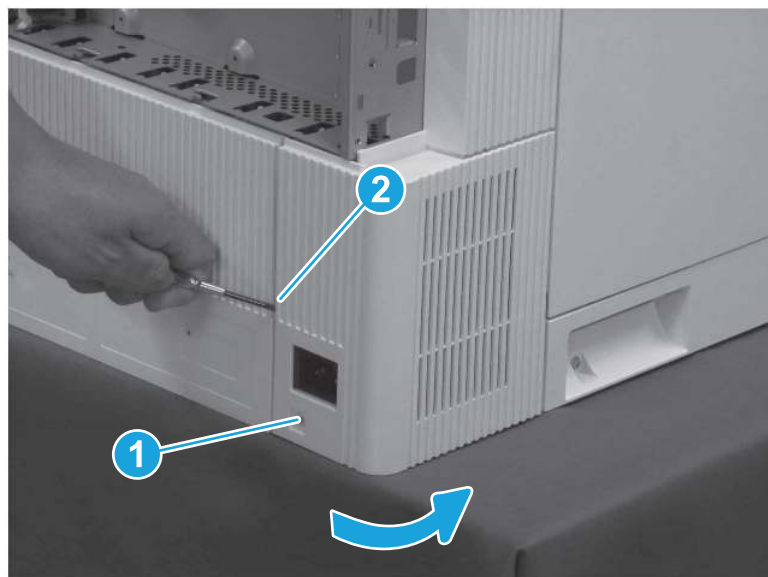
1. Remove the formatter cover.
 - ▲ Loosen one thumbscrew (callout 1), and then slide the formatter cover (callout 2) away from the printer to remove it.

Figure 1-170 Remove the formatter cover



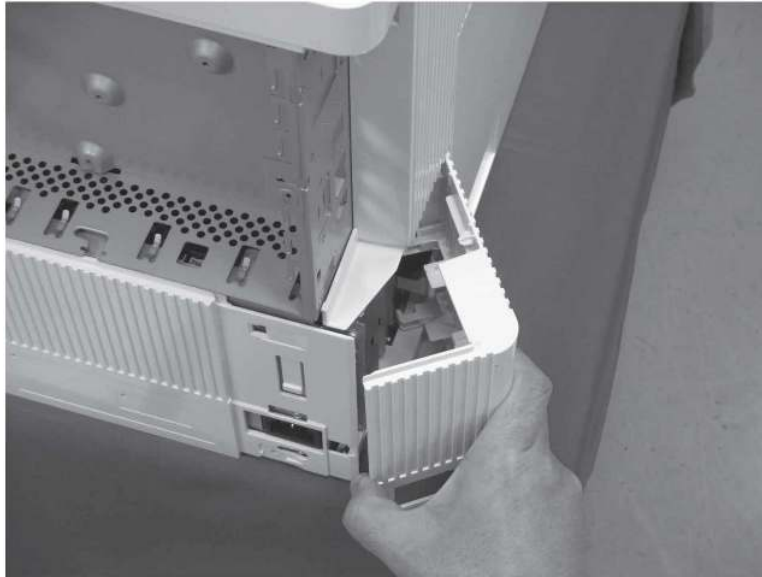
2. Remove the left lower cover (M751/E75245).
 - a. Remove one screw (callout 1), release one tab (callout 2), and then rotate the cover away from the printer.

Figure 1-171 Remove one screw and release one tab



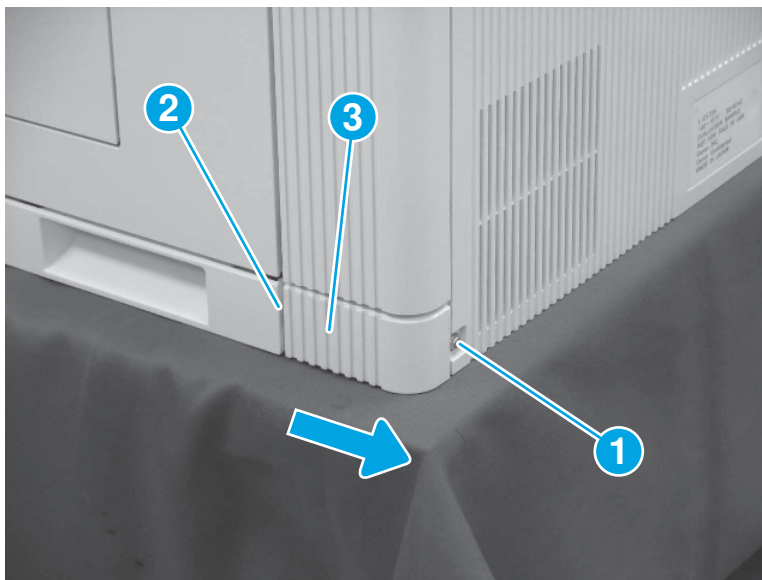
- b. Remove the left lower cover.

Figure 1-172 Remove the left lower cover



3. Remove the right rear lower cover (M751/E75245/M856/E85055/M776).
 - ▲ Remove one screw (callout 1), release one tab (callout 2), and then slide the right rear lower cover (callout 3) toward the back of the printer to remove it.

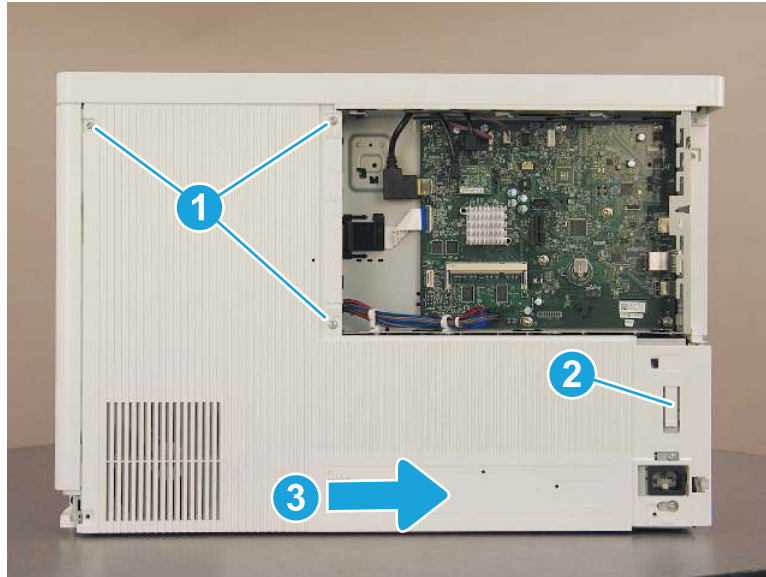
Figure 1-173 Remove the right rear lower cover



4. Remove the rear cover (M751/E75245).

- ▲ Remove three screws (callout 1), release one tab (callout 2), and then slide the rear cover to the right (callout 3) to remove it.

Figure 1-174 Remove the rear cover

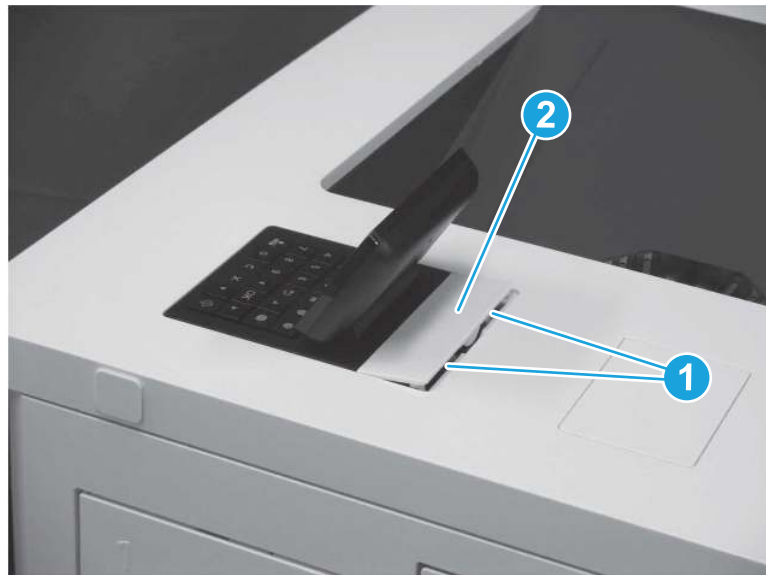


5. Remove the control panel.

 **NOTE:** A screwdriver is included in the control panel kit. The screwdriver has a reversible shaft. Simply pull the shaft out of the handle, and then reinstall it with the desired end facing out.

- a. Use a small, flat-blade screwdriver to release two tabs (callout 1), and then remove the control panel cover (callout 2).

Figure 1-175 Remove the control panel cover



- b. Remove one screw (callout 1).

Figure 1-176 Remove one screw



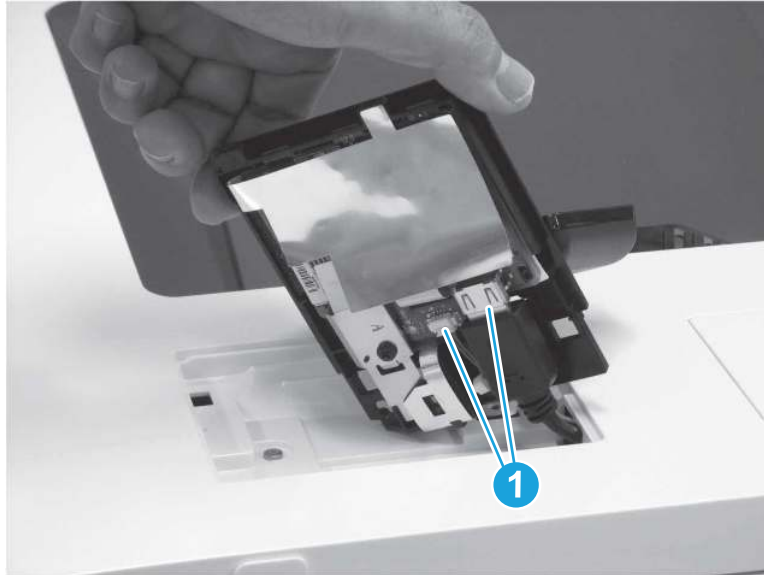
- c. Lift the back edge of the control panel up (callout 1), and then slide the control panel toward the back of the printer (callout 2).

Figure 1-177 Slide the control panel back



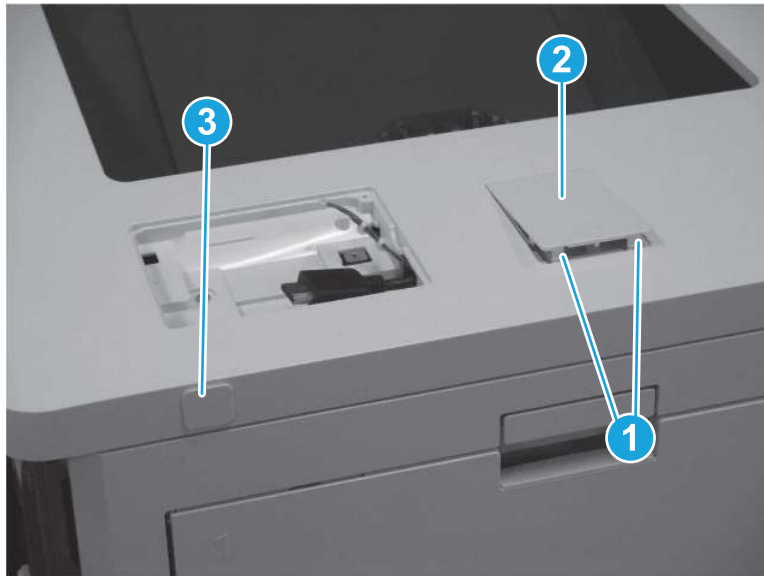
- d. Turn the control panel so that the bottom is facing up, and then disconnect two connectors (callout 1) to remove the control panel.

Figure 1-178 Disconnect two connectors



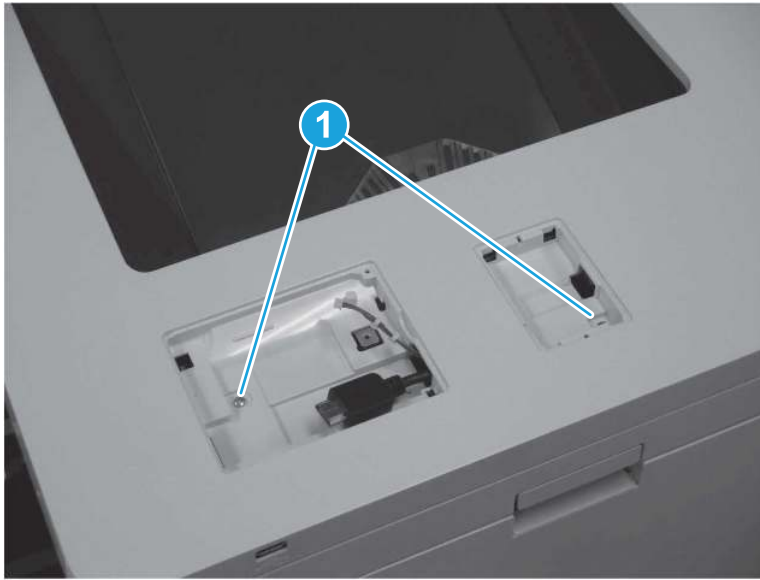
6. Remove the top cover (M751/E75245).
 - a. Release two tabs (callout 1), and then remove the HIP cover (callout 2). Pull the USB cap (callout 3) away from the printer to remove it.

Figure 1-179 Remove the HIP cover and USB cap



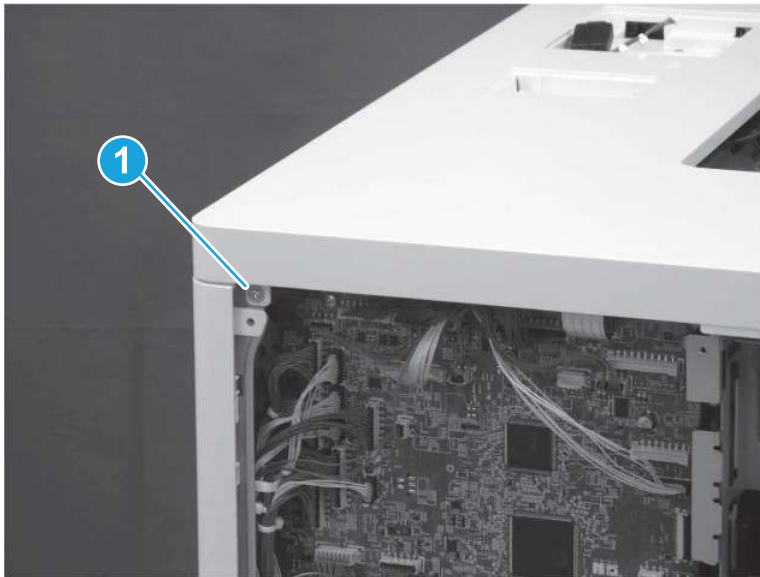
- b. At the top of the printer, remove two screws (callout 1).

Figure 1-180 Remove two screws




- c. At the back of the printer, remove one screw (callout 1).

Figure 1-181 Remove one screw

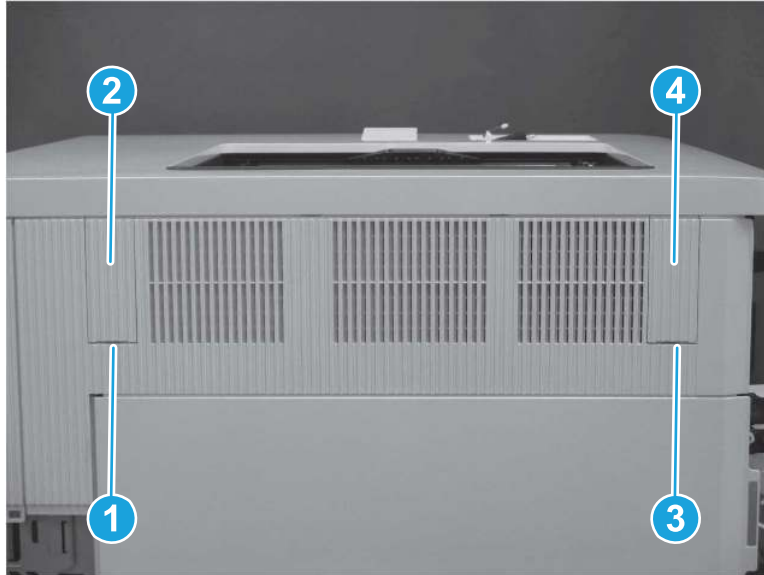


- d. Use a small, flat-blade screwdriver to release one tab (callout 1) and remove the left blanking cover (callout 2). Release one tab (callout 3) and remove the right blanking cover (callout 4).

 **TIP:** These covers are not identical. Make sure to reinstall the correct cover on the correct side.

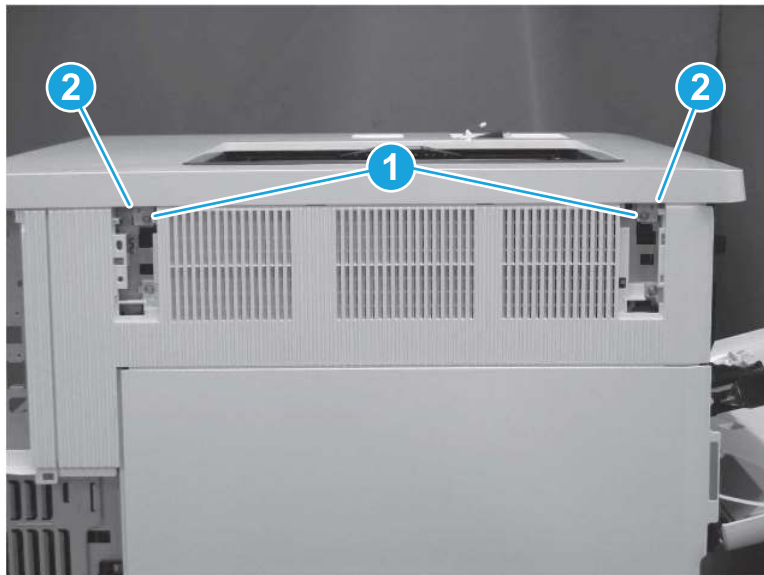
 **NOTE:** The screw under the left blanking cover is a self-tapping screw. Make sure this screw is reinstalled in the correct location.

Figure 1-182 Remove the left and right blanking covers



- e. Remove two screws (callout 1), and then release two tabs (callout 2).

Figure 1-183 Remove two screws and release two tabs



- f. At the front of the printer, remove one washer-head screw (callout 1) and one self-tapping screw (callout 2). Release one tab (callout 3).


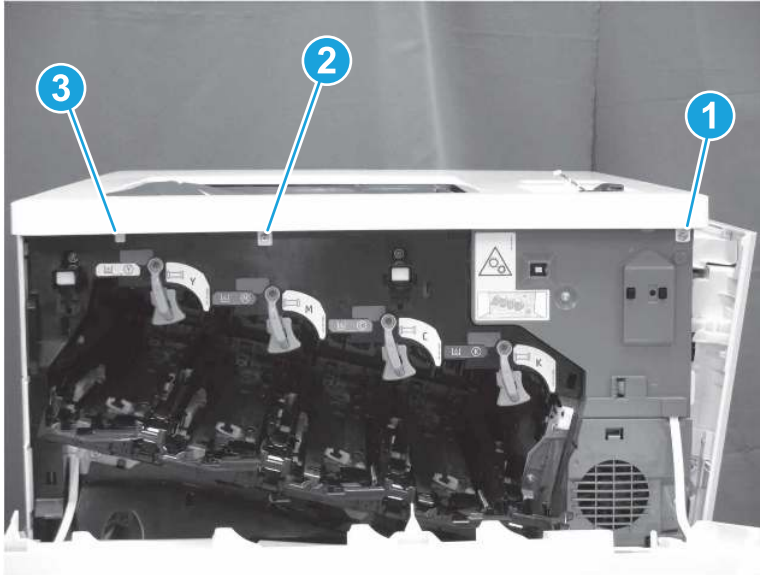
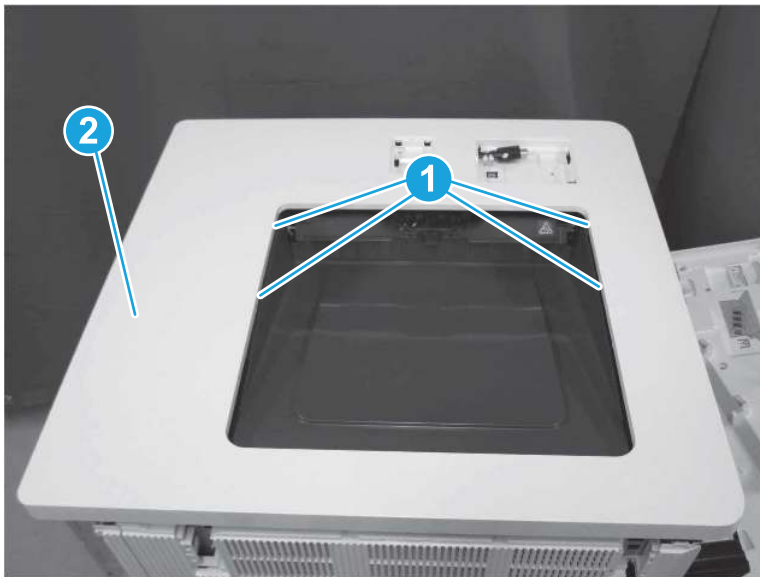
 **TIP:** Make sure to install the correct type of screw in the correct location.

Figure 1-184 Remove two screws and release one tab

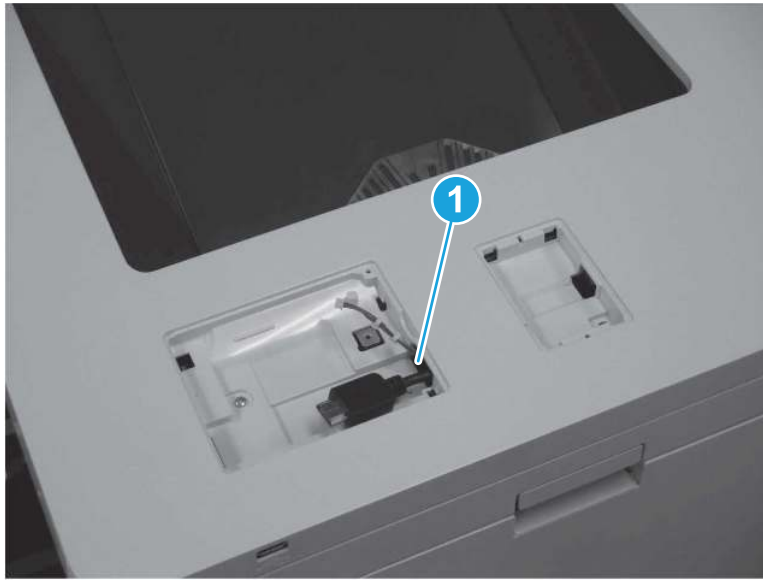


- g. At the top of the printer, release four tabs (callout 1), and then remove the top cover (callout 2).

Figure 1-185 Remove the top cover



 **NOTE:** When removing the top cover, make sure to release the control panel cables (callout 1) through the opening.



7. Unpack the replacement assembly.

a. Dispose of the defective part.



NOTE: HP recommends responsible disposal of the defective part.

<http://www8.hp.com/us/en/hp-information/environment/product-recycling.html>

b. Unpack the replacement part from the packaging.



IMPORTANT: Make sure that all of the shipping materials (for example shipping tape) are removed from the replacement part prior to installation.

c. To install an assembly, reverse the removal steps.



NOTE: When applicable, special installation instructions are provided for an assembly at the end of the removal procedure. Always completely read the removal instructions and follow all special installation instructions.

Removal and replacement: Right door (M751/E75245/M856/E85055/M776)

Learn how to remove and replace the right door.

[View a video of how to remove and replace the right door.](#)

Mean time to repair: 13 minutes

Service level: Easy

Before performing service

Turn the printer power off

○ Disconnect the power cable.



WARNING! To avoid damage to the printer, turn the printer off, wait 30 seconds, and then remove the power cord before attempting to service the printer.

Use the table below to identify the correct part number for your printer. To order the part, go to www.hp.com/buy/parts.

Table 1-24 Part information

Part number	Part description
RM2-1494-000CN	Right door assembly (M751/E75245)
RM2-3434-000CN	Right door assembly (M856/E85055/M776)

Required tools

- #2 Phillips screwdriver with a magnetic tip
- Small, flat-blade screwdriver

After performing service

Turn the printer power on

- Connect the power cable.
- Use the power switch to turn the power on.

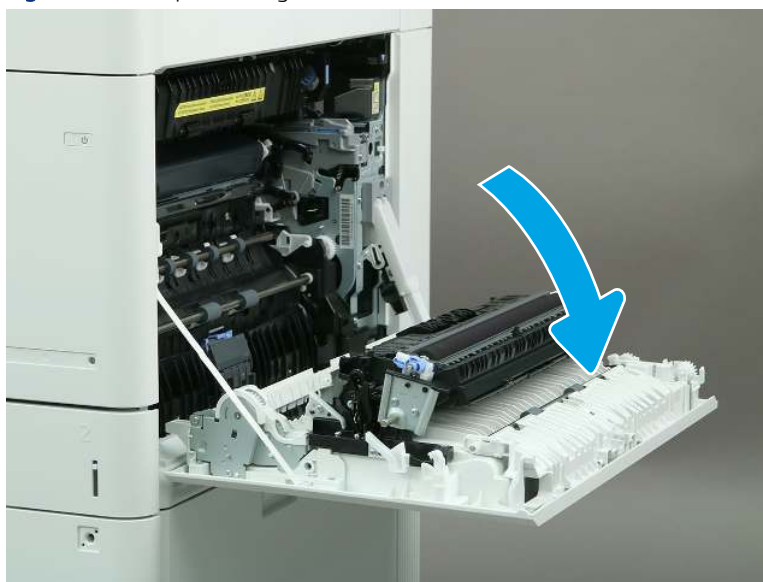
Post service test

Make sure that the printer initializes to a **Ready** state.

Print a page to make sure that the printer is functioning correctly.

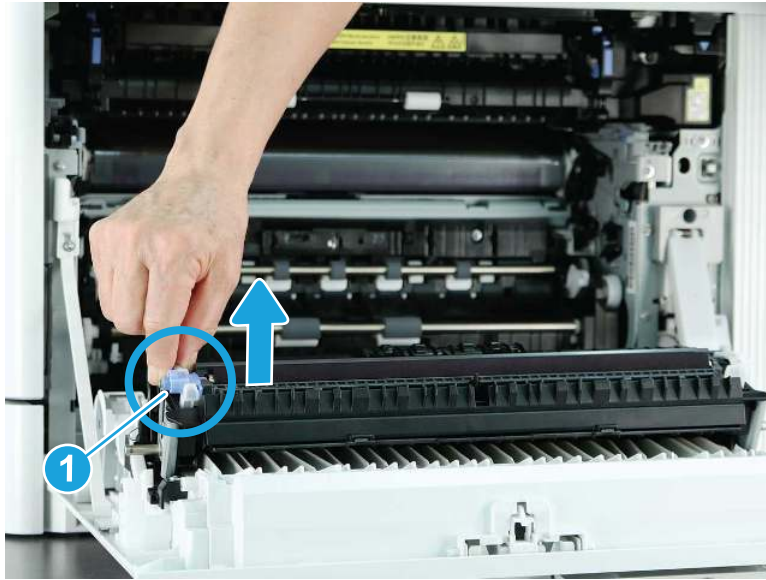
1. Remove the secondary transfer roller.
 - a. Open the right door.

Figure 1-186 Open the right door



- b. Release the latch (callout 1), and then lift the left side of the roller.

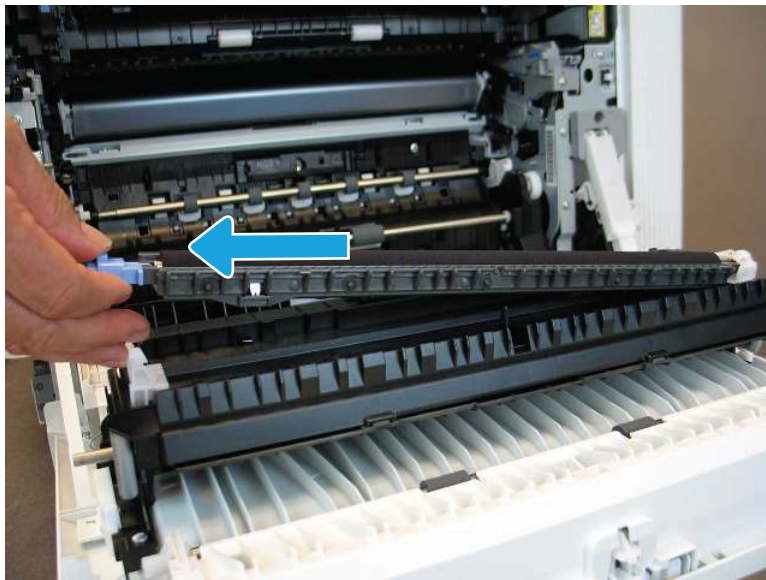
Figure 1-187 Release the transfer roller



- c. Slide the transfer roller to the left to remove it.

⚠ **CAUTION:** Do not touch the surface of the secondary transfer roller.

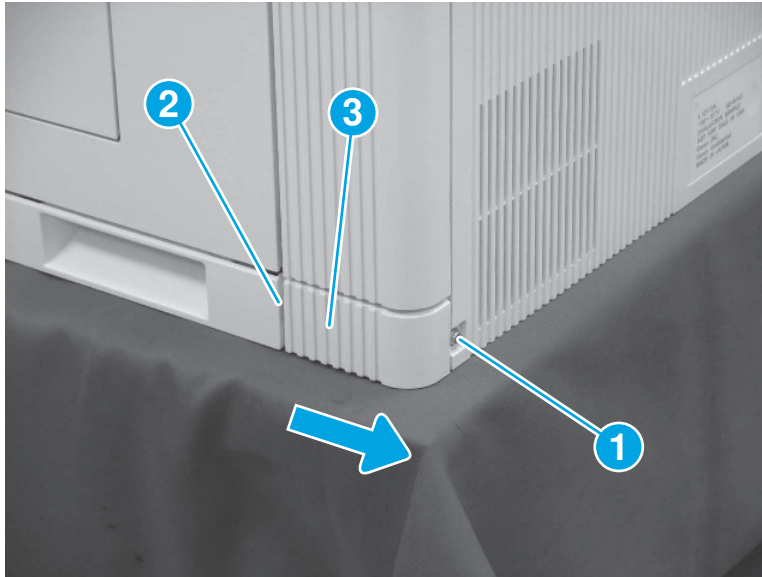
Figure 1-188 Remove the secondary transfer roller



2. Remove the right rear lower cover (M751/E75245/M856/E85055/M776).

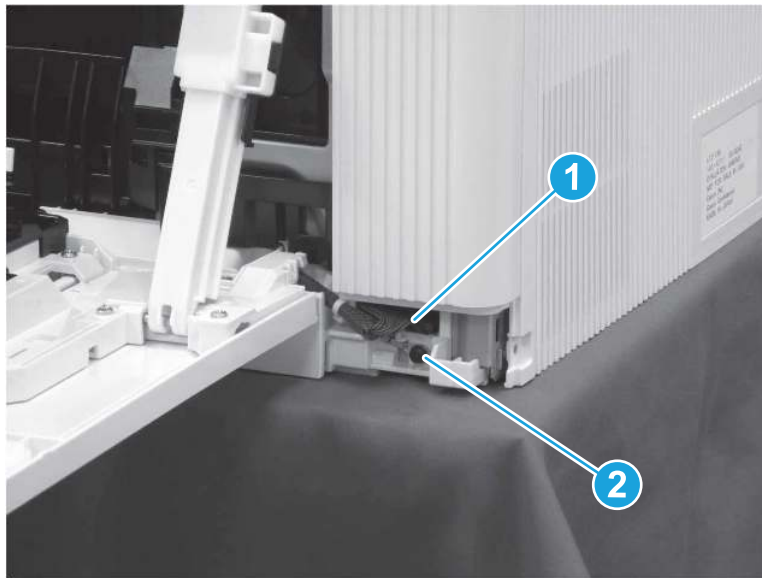
- ▲ Remove one screw (callout 1), release one tab (callout 2), and then slide the right rear lower cover (callout 3) toward the back of the printer to remove it.

Figure 1-189 Remove the right rear lower cover



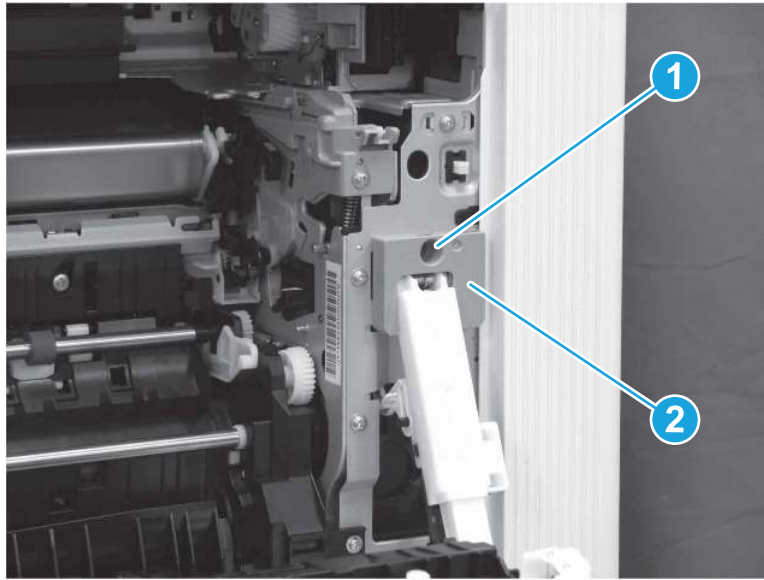
- 3. Remove the right door.
 - a. Disconnect one connector (callout 1), and then remove one black grounding screw (callout 2).

Figure 1-190 Disconnect one connector and remove one screw



- b. Remove one self-tapping screw (callout 1), and then remove the cover (callout 2).

Figure 1-191 Remove the cover



- c. Push the damper slightly to the right, and gently pull the link arm to the left to release the boss (callout 1) from the link arm.


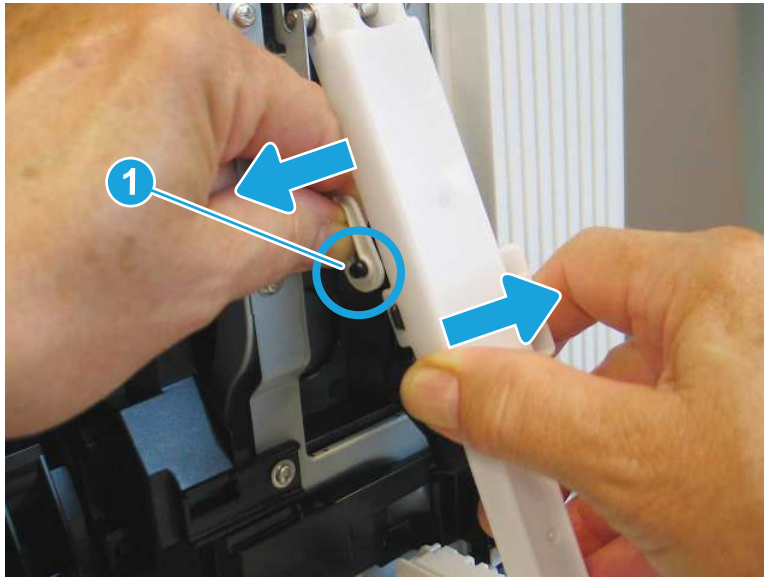
 **IMPORTANT:** Make sure to reattach this link arm when reinstalling the right door. Failure to do so might cause damage to the link arm, requiring a larger repair.

Figure 1-192 Release the link arm



- d. Retract the link arm slightly into the printer to move it out of the way.

Figure 1-193 Retract the link arm



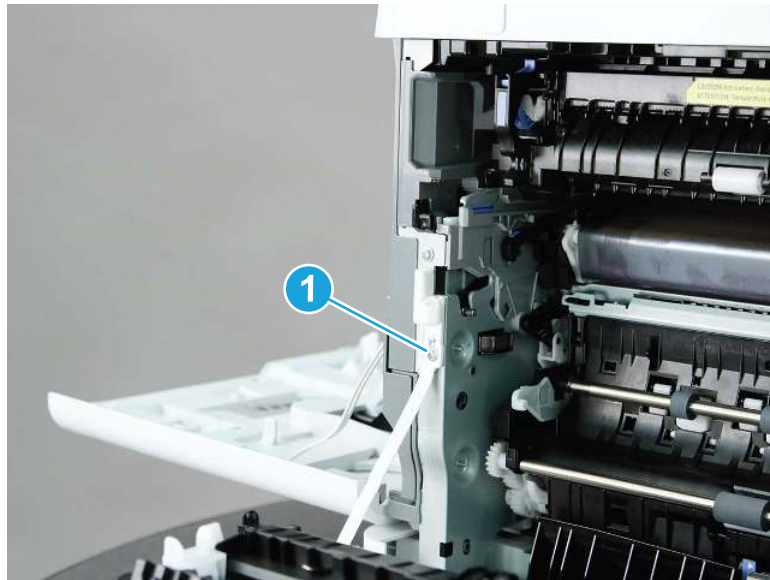
- e. Lift the dampener up, and then pull it away from the printer to release it from the bushing.

Figure 1-194 Release the dampener



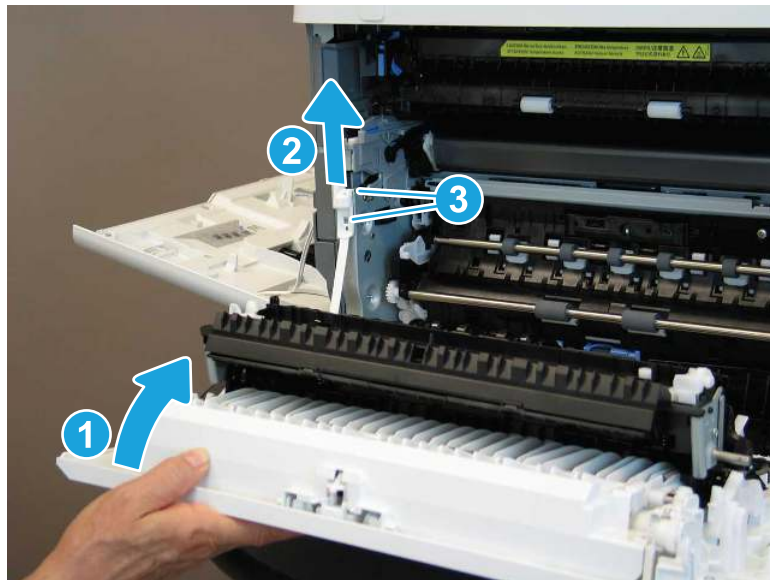
- f. Remove one screw (callout 1).

Figure 1-195 Remove one screw



- g. Raise the door slightly (callout 1) to take tension off of the hinge. Slide the hinge up (callout 2) to release two hooks (callout 3).

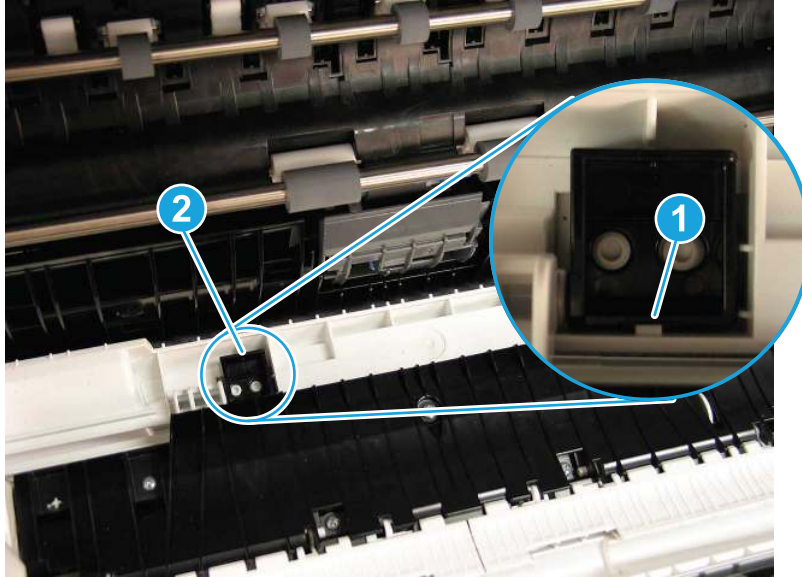
Figure 1-196 Release the hinge



- h. Release one tab (callout 1), and then remove the stopper (callout 2).

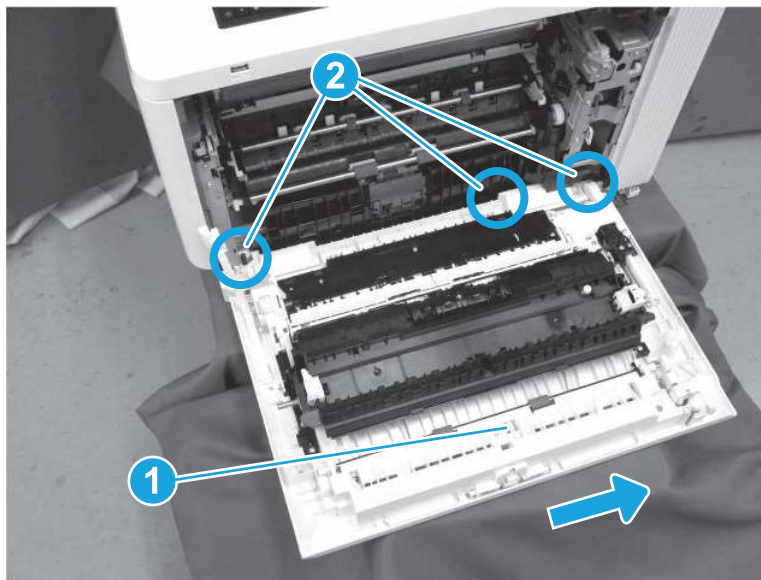
 **TIP:** Use needle-nosed pliers to release the stopper.

Figure 1-197 Remove the stopper



- i. Slide the right door (callout 1) to the right to release it from three tabs (callout 2), and then remove the right door.

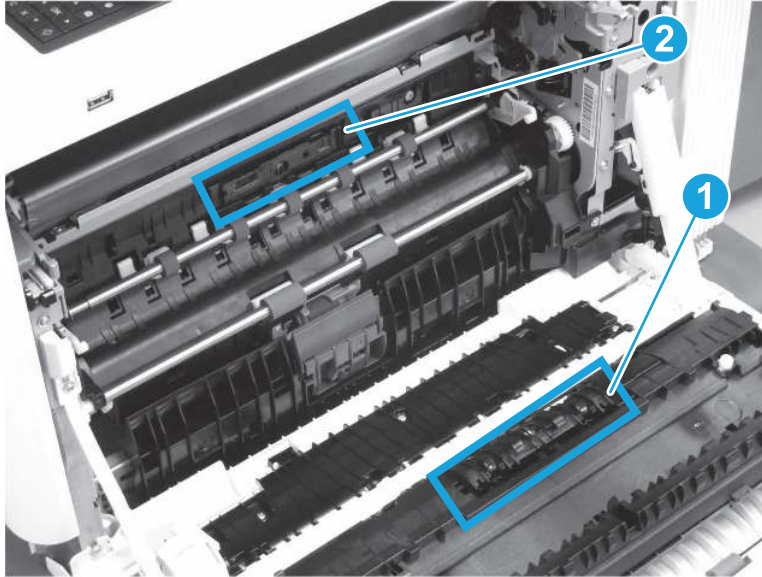
Figure 1-198 Remove the right door



4. The media sensor (callout 1) on the right door and the media sensor (callout 2) inside the printer work together and are adjusted together at the factory. The replacement right door part is similarly adjusted together with a media sensor part that is shipped with the right door. When replacing the right door, follow

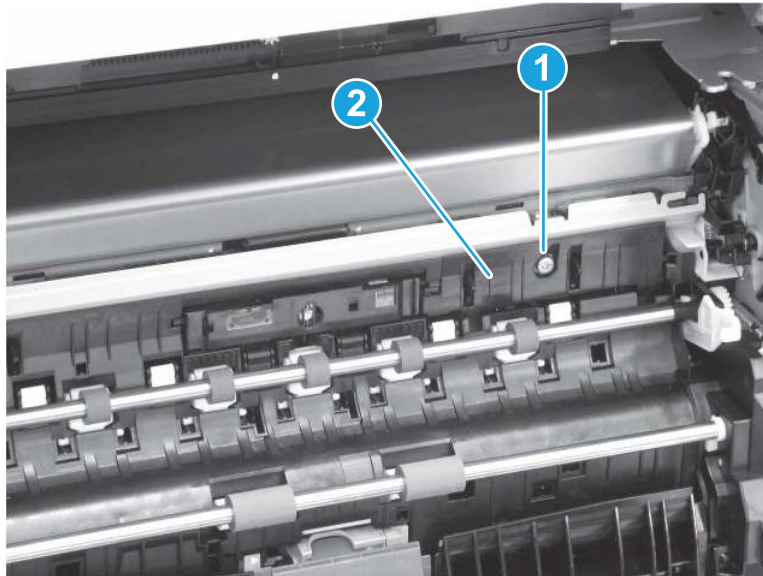
these steps to remove and replace the media sensor on the printer with the new media sensor shipped with the replacement door.

Figure 1-199 Media sensor placement

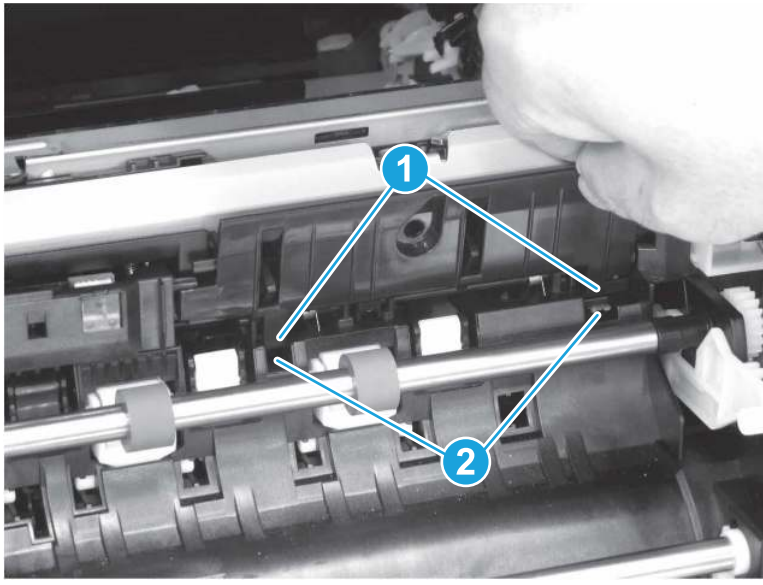


- a. Remove one screw (callout 1), and then remove the cover (callout 2).

Figure 1-200 Remove one screw and the cover

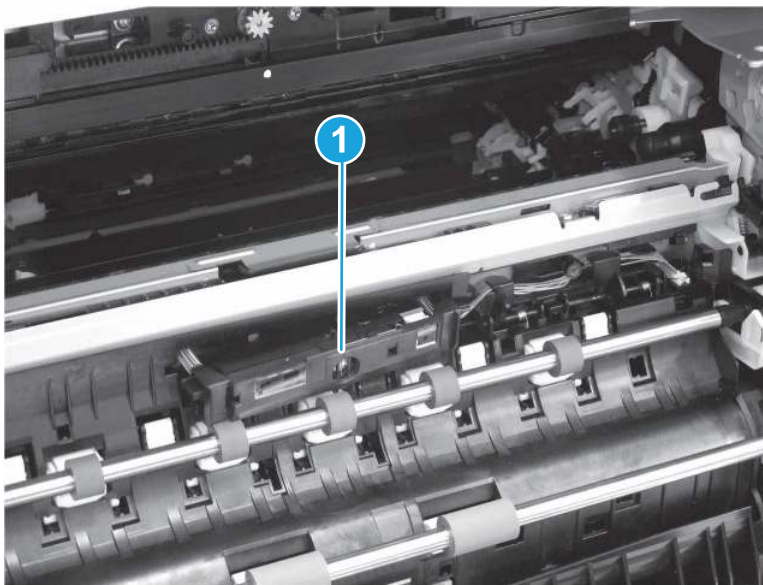


 **TIP:** When reinstalling the cover, make sure that the ribs (callout 1) on the cover are installed into the openings (callout 2) in the printer.



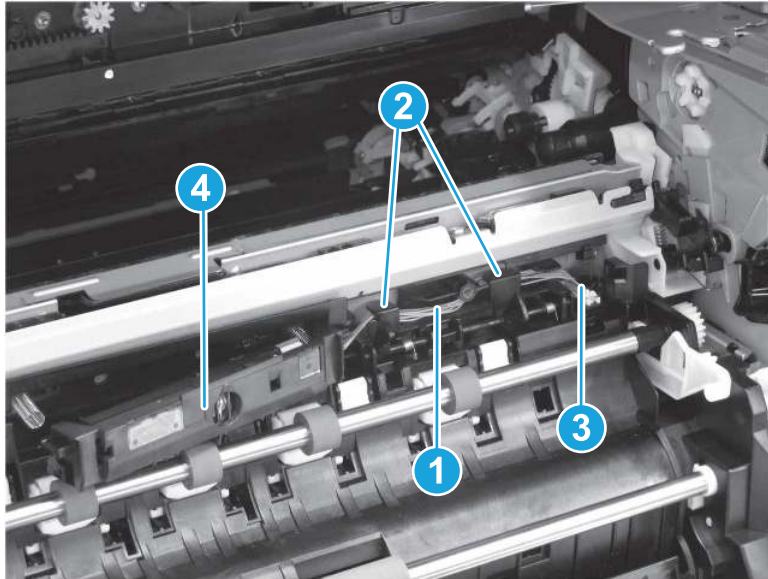
- b. Release the media sensor assembly (callout 1).

Figure 1-201 Release the media sensor



- c. Release the cable (callout 1) from the cable guides (callout 2). Disconnect one connector (callout 3), and then remove the media sensor (callout 4).

Figure 1-202 Remove the media sensor




- d. Reverse the removal steps to install the media sensor shipped with the replacement right door.
5. Unpack the replacement assembly.
 - a. Dispose of the defective part.



NOTE: HP recommends responsible disposal of the defective part.

<http://www8.hp.com/us/en/hp-information/environment/product-recycling.html>

- b. Unpack the replacement part from the packaging.
 -  **IMPORTANT:** Make sure that all of the shipping materials (for example shipping tape) are removed from the replacement part prior to installation.
- c. To install an assembly, reverse the removal steps.



NOTE: When applicable, special installation instructions are provided for an assembly at the end of the removal procedure. Always completely read the removal instructions and follow all special installation instructions.

6. Reverse the removal steps to install the assembly. Also use the following **special installation instructions**.

If the ITB cannot be removed or installed after removing or replacing the right door, remove the main drive assembly and make sure that the tab on the end of the link arm is correctly installed in the track.



NOTE: Failing to properly attach the link arm when installing the right door will result in this failure and the need to perform this procedure. The main drive assembly must be removed in order to reattach the link arm from this side, resulting in a higher service cost.

Figure 1-203 Check the link arm



Removal and replacement: Right handle (M751/E75245/M856/E85055/M776)

Learn how to remove and replace the right handle.

[View a video of how to remove and replace the right handle.](#)

Mean time to repair: 12 minutes

Service level: Medium

Before performing service

Turn the printer power off

- Disconnect the power cable.

⚠ WARNING! To avoid damage to the printer, turn the printer off, wait 30 seconds, and then remove the power cord before attempting to service the printer.

Use the table below to identify the correct part number for your printer. To order the part, go to www.hp.com/buy/parts.

Table 1-25 Part information

Part number	Part description
RM2-1376-000CN	Right handle assembly

Required tools

- #2 Phillips screwdriver with a magnetic tip
- Small, flat-blade screwdriver

After performing service

Turn the printer power on

- Connect the power cable.
- Use the power switch to turn the power on.

Post service test

Make sure that the printer initializes to a **Ready** state.

Print a page to make sure that the printer is functioning correctly.

1. Remove the toner cartridges.
 - ▲ Open the front door, if it is not already open. Grasp the handle of the toner cartridge and pull out to remove it. Repeat the process for the remaining toner cartridges.

Figure 1-204 Remove the toner cartridge



2. Remove the intermediate transfer belt (ITB).

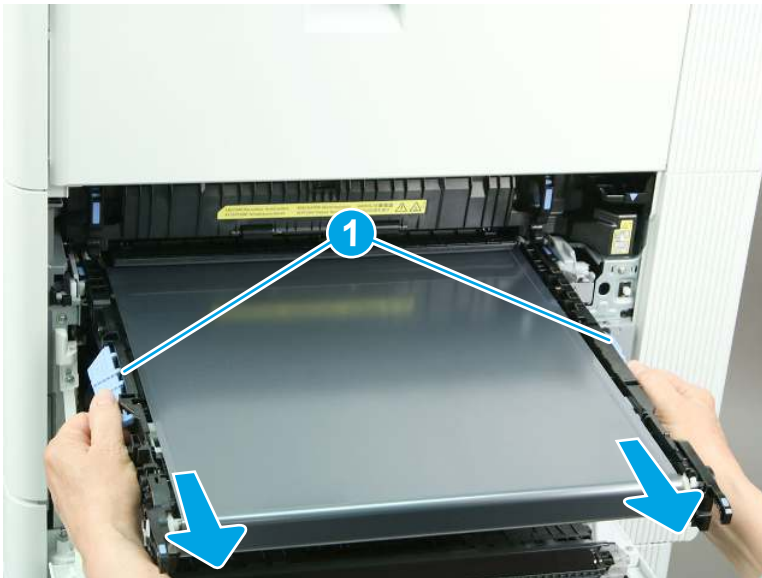
- a. Open the right door. Grasp the two blue handles on the ITB, and then pull the ITB partially out of the printer.

Figure 1-205 Partially remove the ITB



- b. Grasp the blue handles on the side of the ITB (callout 1), and then remove the ITB from the printer.

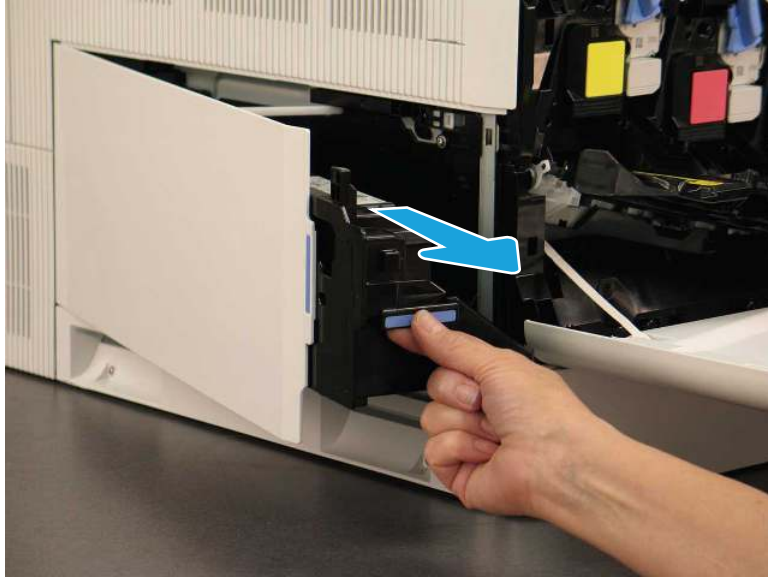
Figure 1-206 Remove the ITB



3. Remove the TCU.

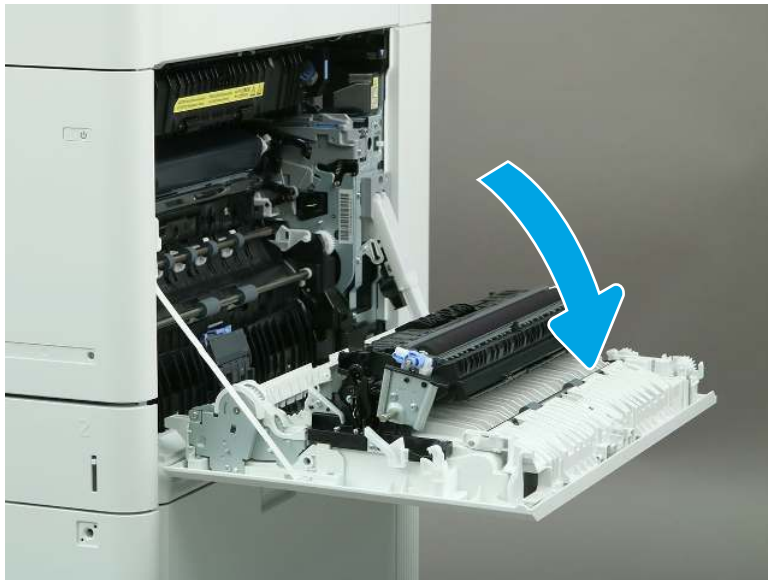
- ▲ Open the front door, and then open the left door. Grasp the front of the toner-collection unit, and then remove it from the printer.

Figure 1-207 Remove the TCU



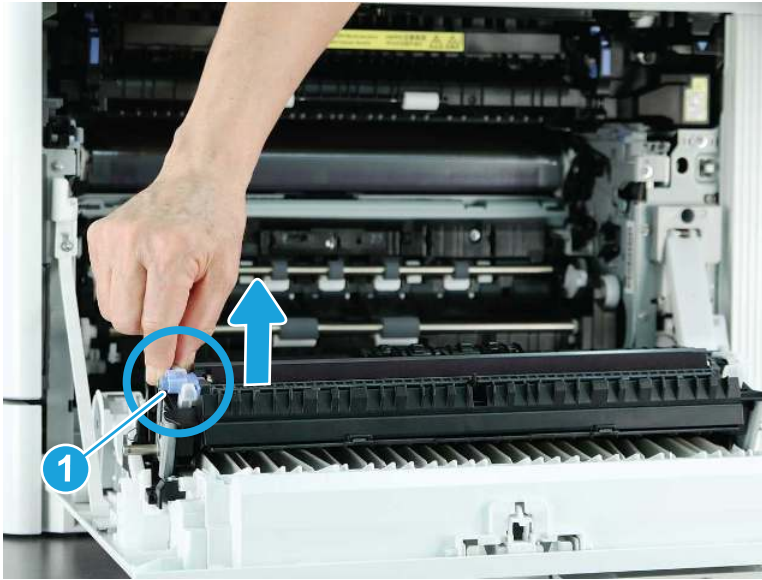
- 4. Remove the secondary transfer roller.
 - a. Open the right door.

Figure 1-208 Open the right door



- b. Release the latch (callout 1), and then lift the left side of the roller.

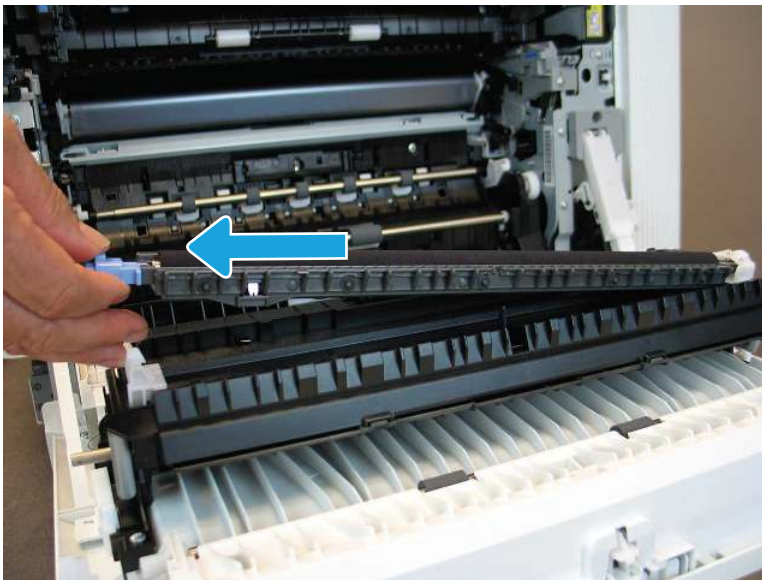
Figure 1-209 Release the transfer roller



- c. Slide the transfer roller to the left to remove it.

⚠ CAUTION: Do not touch the surface of the secondary transfer roller.

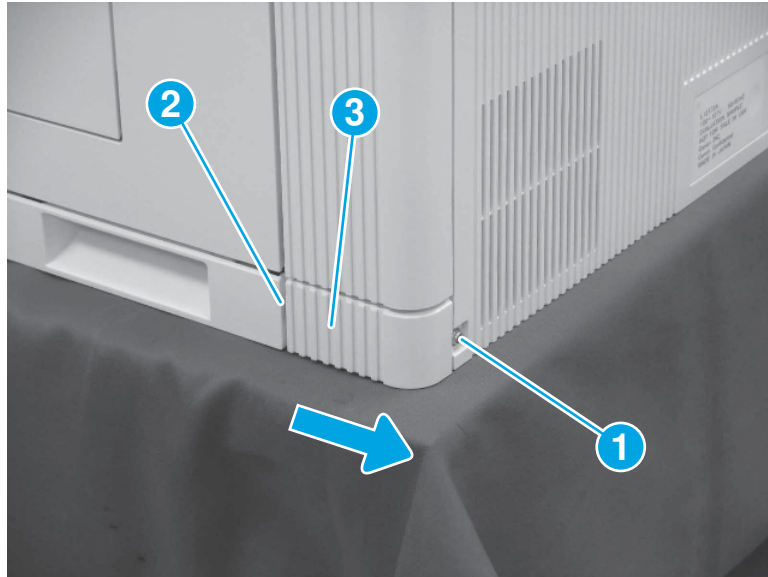
Figure 1-210 Remove the secondary transfer roller



5. Remove the right rear lower cover (M751/E75245/M856/E85055/M776).

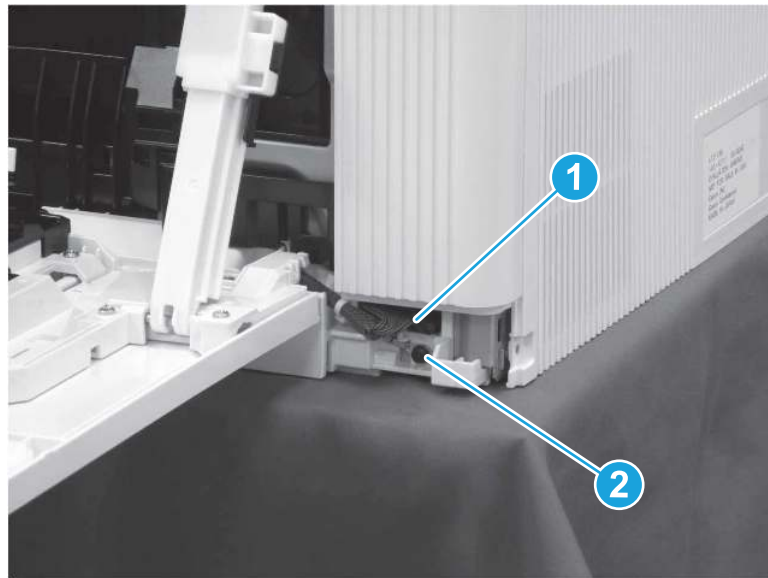
- ▲ Remove one screw (callout 1), release one tab (callout 2), and then slide the right rear lower cover (callout 3) toward the back of the printer to remove it.

Figure 1-211 Remove the right rear lower cover



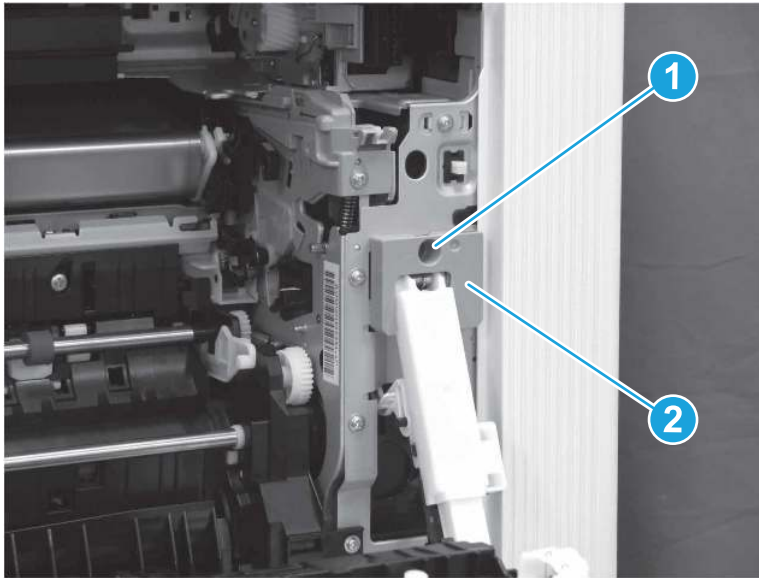
- 6. Remove the right door.
 - a. Disconnect one connector (callout 1), and then remove one black grounding screw (callout 2).

Figure 1-212 Disconnect one connector and remove one screw



- b. Remove one self-tapping screw (callout 1), and then remove the cover (callout 2).

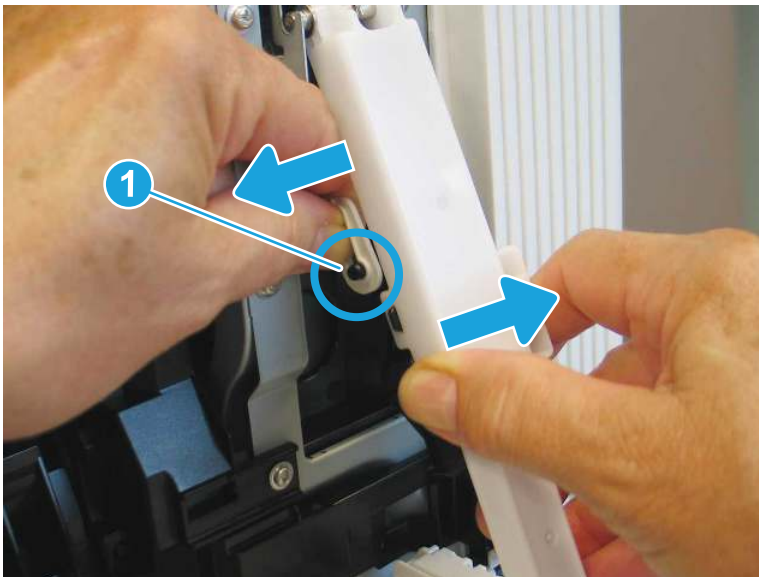
Figure 1-213 Remove the cover



- c. Push the damper slightly to the right, and gently pull the link arm to the left to release the boss (callout 1) from the link arm.

 **IMPORTANT:** Make sure to reattach this link arm when reinstalling the right door. Failure to do so might cause damage to the link arm, requiring a larger repair.

Figure 1-214 Release the link arm



- d. Retract the link arm slightly into the printer to move it out of the way.

Figure 1-215 Retract the link arm



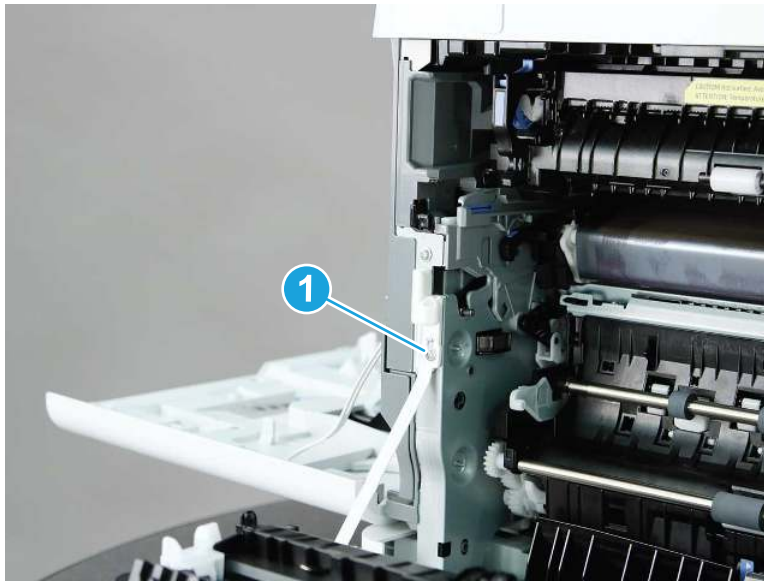
- e. Lift the dampener up, and then pull it away from the printer to release it from the bushing.

Figure 1-216 Release the dampener



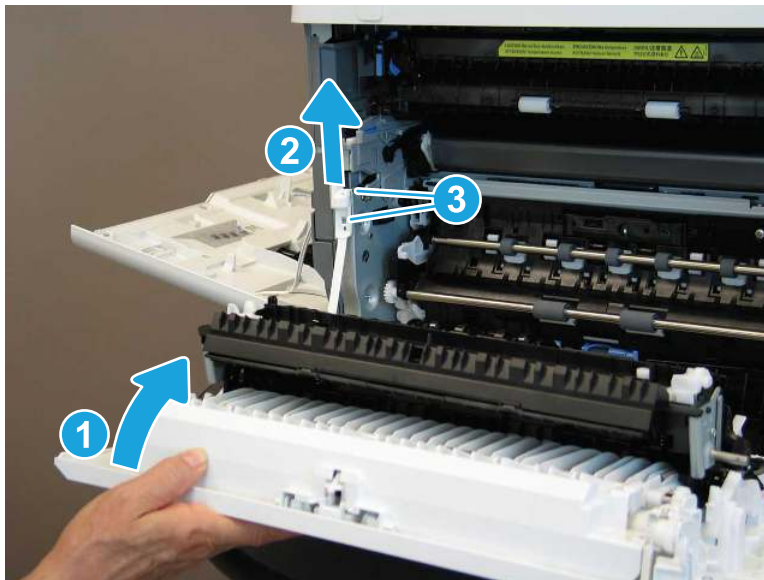
- f. Remove one screw (callout 1).

Figure 1-217 Remove one screw



- g. Raise the door slightly (callout 1) to take tension off of the hinge. Slide the hinge up (callout 2) to release two hooks (callout 3).

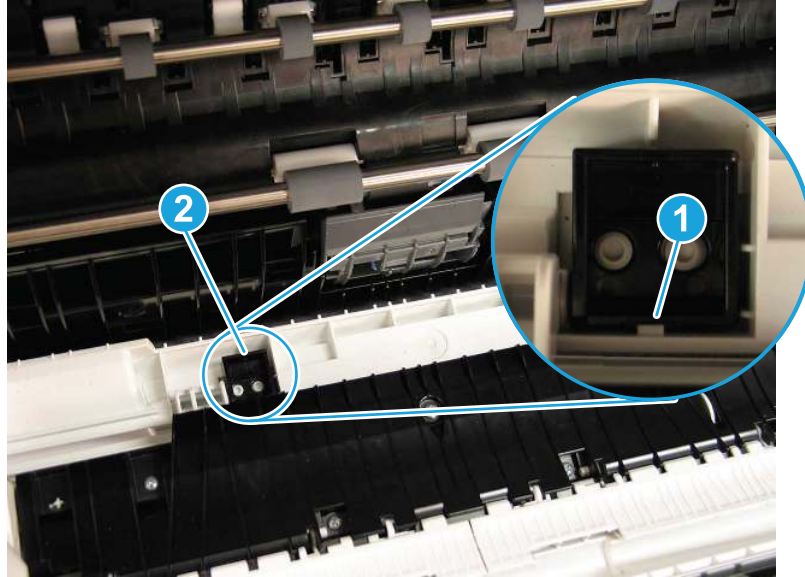
Figure 1-218 Release the hinge



- h. Release one tab (callout 1), and then remove the stopper (callout 2).

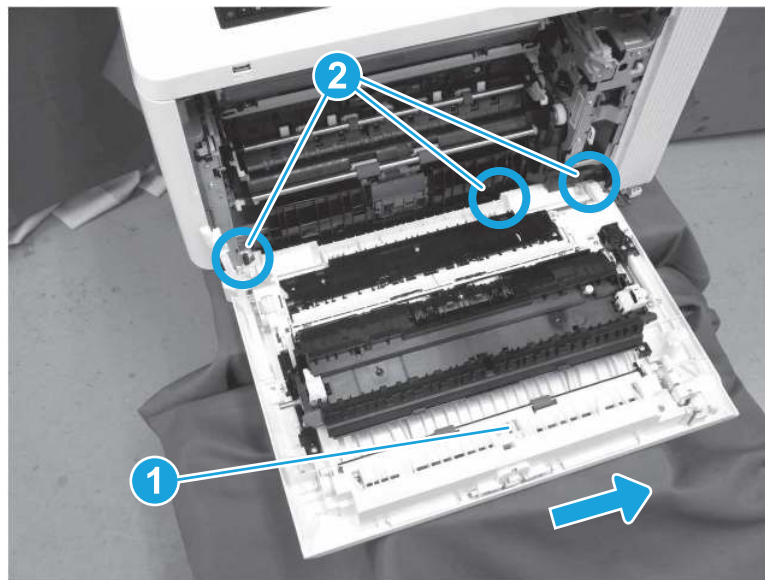
 **TIP:** Use needle-nosed pliers to release the stopper.

Figure 1-219 Remove the stopper



- i. Slide the right door (callout 1) to the right to release it from three tabs (callout 2), and then remove the right door.

Figure 1-220 Remove the right door

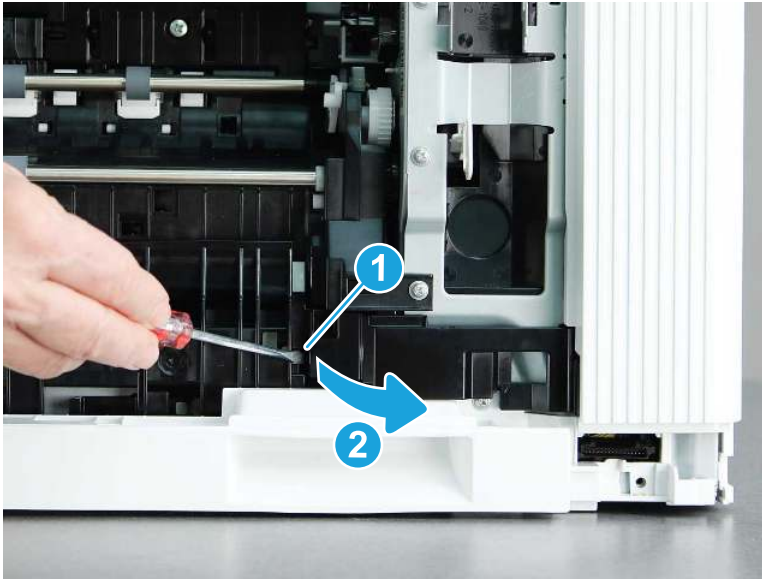


7. Remove the right handle.
 - a. If additional paper trays are installed under the printer, lift the printer off of the trays and onto a flat working surface.

CAUTION: The printer is heavy. HP recommends that three people lift the printer.

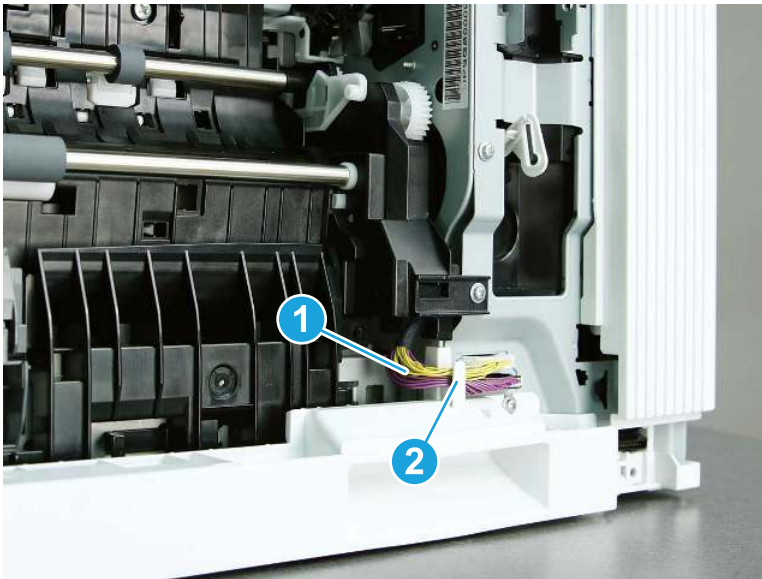
- b. Release one tab (callout 1), and then rotate the cover away (callout 2) to remove it.

Figure 1-221 Release two tabs



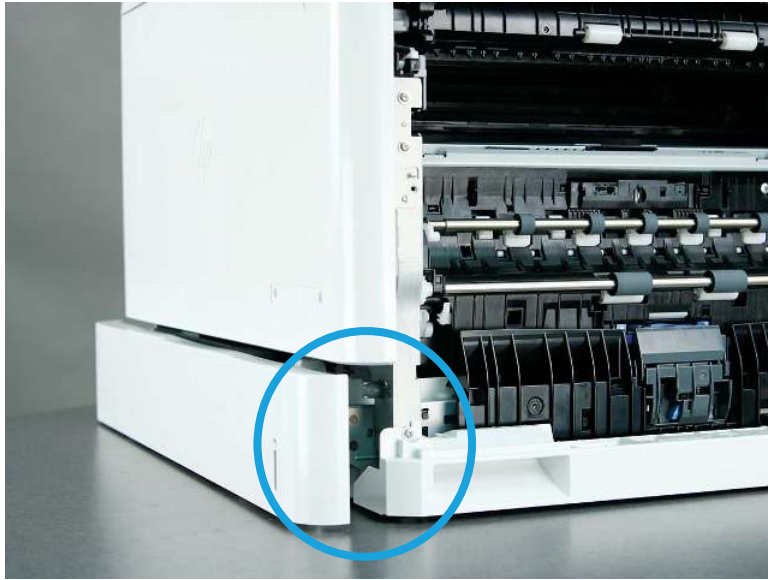
- c. Release the cables (callout 1) from the guide (callout 2).

Figure 1-222 Remove the cables from the guide




- d. Slightly open Tray 2.

Figure 1-223 Slightly open Tray 2



- e. Lift the right side of the printer (callout 1), and then slide a ream of paper (callout 2) under the edge of the printer so that it remains tilted.

 **IMPORTANT:** Make sure that all four imaging drums are installed before tilting the printer to prevent toner leakage inside the printer.


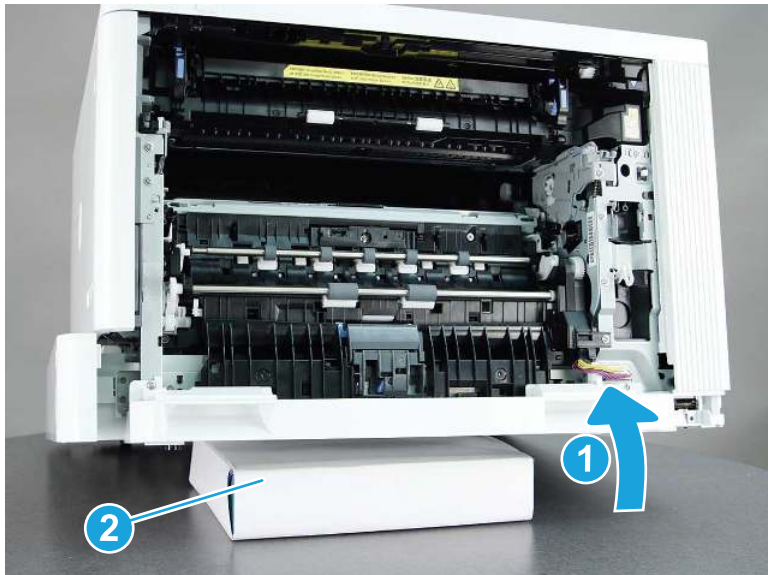
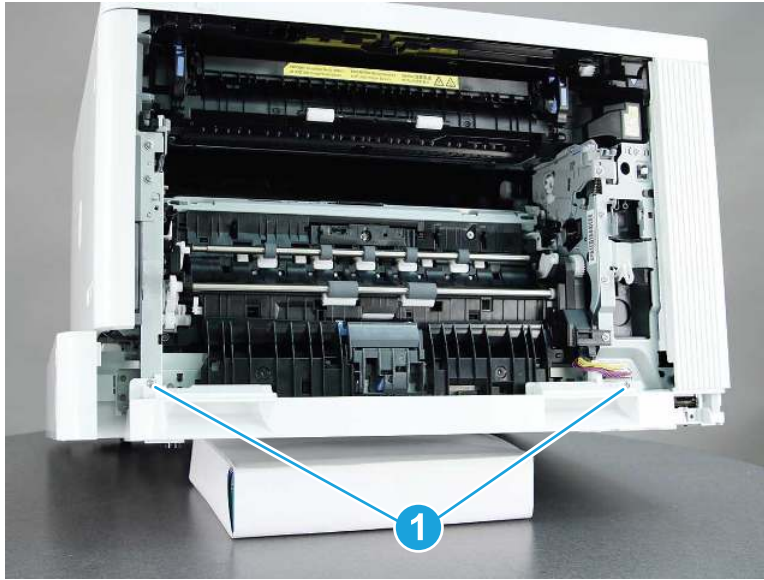
 **CAUTION:** Make sure that the left edge of the printer does not slide off of the work surface.

Figure 1-224 Position the printer



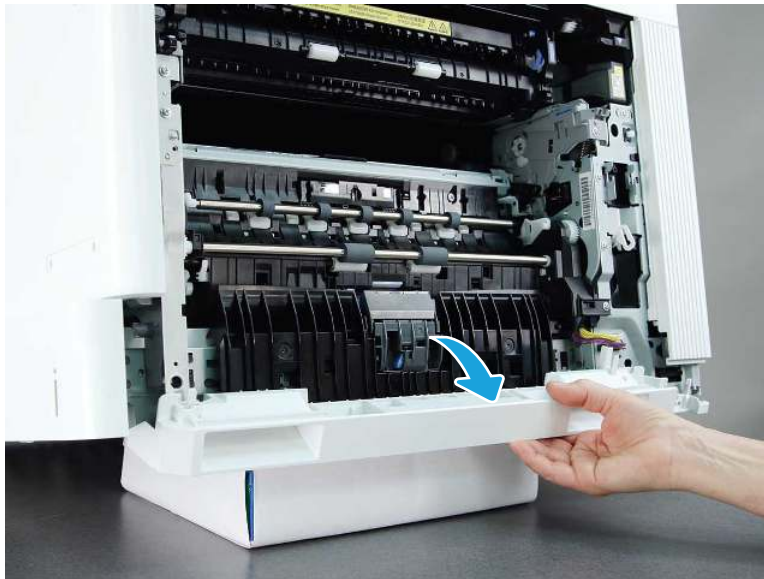
- f. Remove two screws (callout 1).

Figure 1-225 Remove two screws

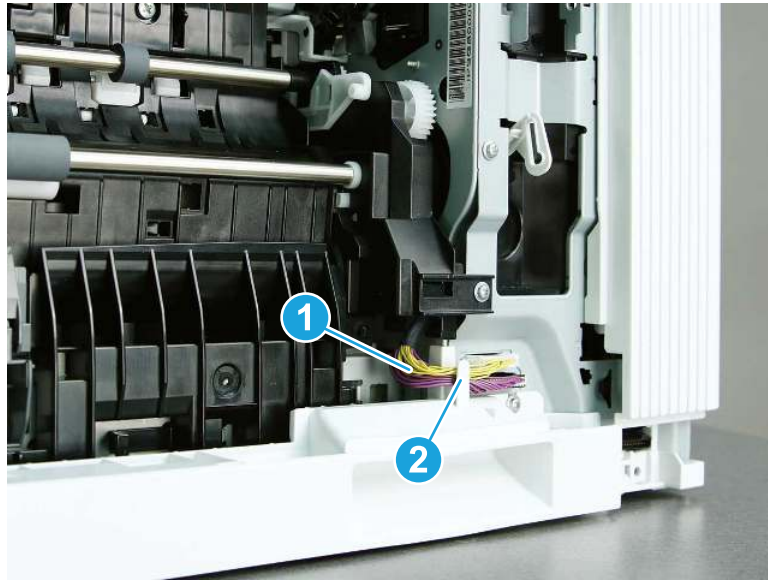


- g. Rotate the right handle (callout 1) away from the printer to remove it.

Figure 1-226 Remove the right handle



 **NOTE:** When installing the right handle, make sure that the cables (callout 1) are installed behind the guide (callout 2) so they are not pinched when the cover is installed.



8. Unpack the replacement assembly.

a. Dispose of the defective part.



NOTE: HP recommends responsible disposal of the defective part.

<http://www8.hp.com/us/en/hp-information/environment/product-recycling.html>

b. Unpack the replacement part from the packaging.



IMPORTANT: Make sure that all of the shipping materials (for example shipping tape) are removed from the replacement part prior to installation.

c. To install an assembly, reverse the removal steps.



NOTE: When applicable, special installation instructions are provided for an assembly at the end of the removal procedure. Always completely read the removal instructions and follow all special installation instructions.

Removal and replacement: Top cover (M856/E85055)

Learn how to remove and replace the top cover.

Mean time to repair: 3 minutes

Service level: Easy

Before performing service

Turn the printer power off

- Disconnect the power cable.



WARNING! To avoid damage to the printer, turn the printer off, wait 30 seconds, and then remove the power cord before attempting to service the printer.

Use the table below to identify the correct part number for your printer. To order the part, go to www.hp.com/buy/parts.

Table 1-26 Part information

Part number	Part description
RCS-2623-000CN	Cover, upper

Required tools

- Small, flat-blade screwdriver
- #2 Phillips screwdriver with a magnetic tip

After performing service

Turn the printer power on

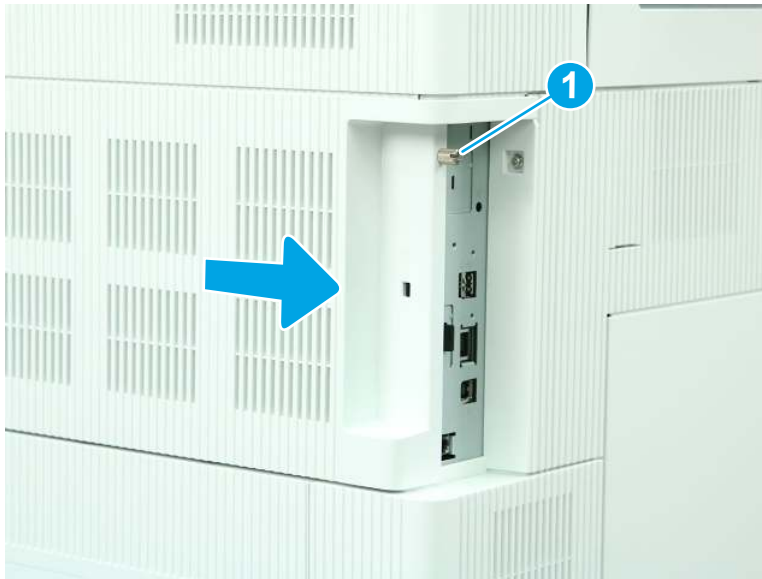
- Connect the power cable.
- Use the power switch to turn the power on.

Post service test

Make sure that the printer initializes to a **Ready** state. Print a page to make sure that the printer is functioning correctly.

1. Remove the formatter cover.
 - ▲ Loosen one thumbscrew (callout 1), and then slide the formatter cover (callout 2) away from the printer to remove it.

Figure 1-227 Remove the formatter cover

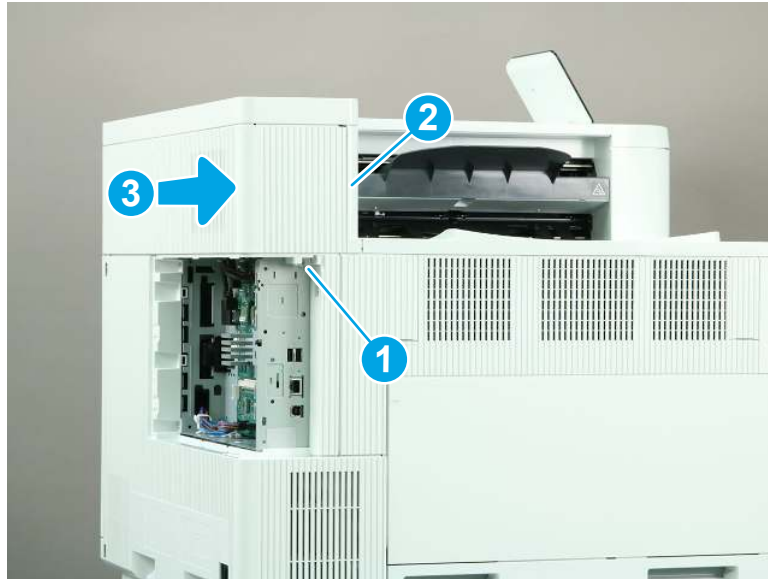


2. Remove the rear upper cover (M856/E85055/M776dn/M776z).

 **NOTE:** The following figure shows the M856 printer. The procedure is correct for all referenced models.

- ▲ Remove one screw (callout 1), release one tab (callout 2), and then slide the rear upper cover away from the printer to remove it (callout 3).

Figure 1-228 Remove the rear upper cover



3. Remove the control panel (M856/E85055).

 **NOTE:** A screwdriver is included in the control panel kit. The screwdriver has a reversible shaft. Simply pull the shaft out of the handle, and then reinstall it with the desired end facing out.

- a. Use a small, flat-blade screwdriver to release two tabs (callout 1), and then remove the control panel cover (callout 2).

Figure 1-229 Remove the control panel cover



- b. Remove one screw (callout 1).

Figure 1-230 Remove one screw



- c. Lift the back edge of the control panel up (callout 1), and then slide the control panel toward the back of the printer (callout 2).

Figure 1-231 Slide the control panel back



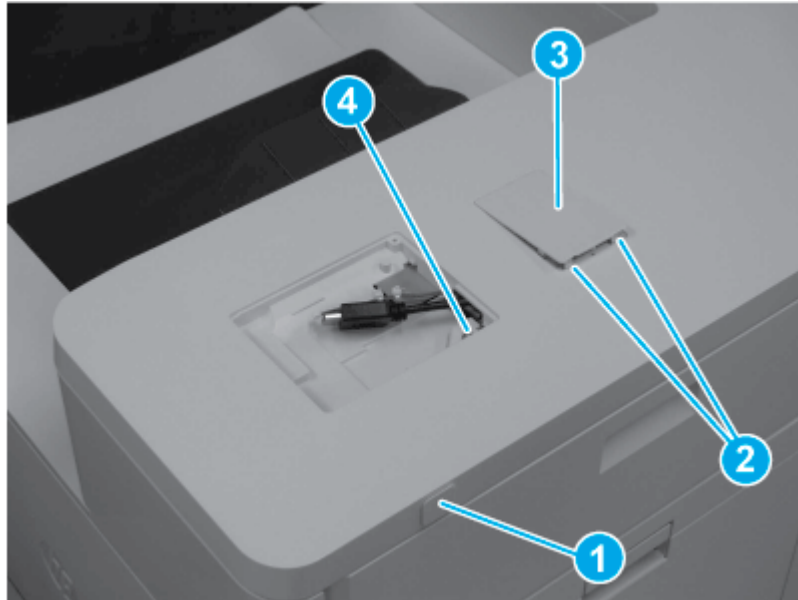
- d. Turn the control panel so that the bottom is facing up, and then disconnect two connectors to remove the control panel.

Figure 1-232 Disconnect two connectors



4. Remove the top cover (M856/E85055).
 - a. Remove the USB cover (callout 1). Release two tabs (callout 2), and then remove the HIP cover (callout 3). Remove one screw (callout 4).

Figure 1-233 Remove covers and one screw



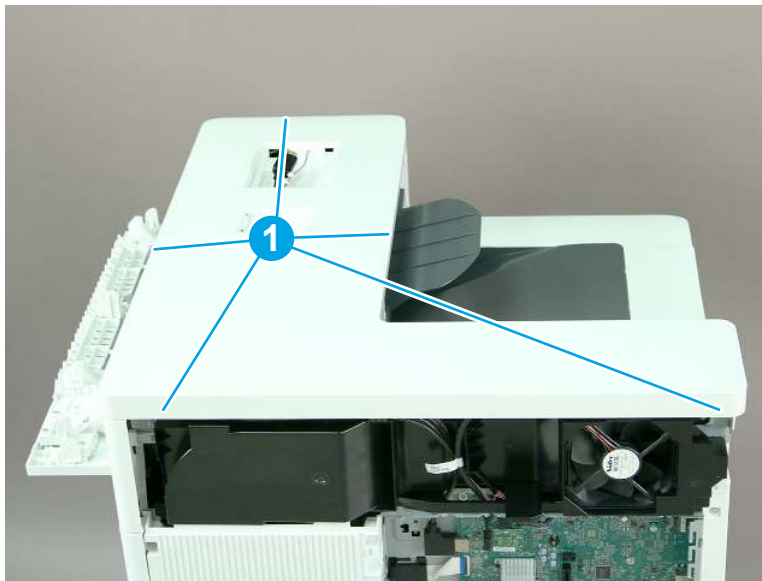
- b. Remove two screws (callout 1).

Figure 1-234 Remove two screws



- c. Release five tabs (callout 1), and then remove the top cover.

Figure 1-235 Release five tabs




5. Unpack the replacement assembly.
 - a. Dispose of the defective part.




NOTE: HP recommends responsible disposal of the defective part.

<http://www8.hp.com/us/en/hp-information/environment/product-recycling.html>

- b. Unpack the replacement part from the packaging.

 **IMPORTANT:** Make sure that all of the shipping materials (for example shipping tape) are removed from the replacement part prior to installation.

- c. To install an assembly, reverse the removal steps.

 **NOTE:** When applicable, special installation instructions are provided for an assembly at the end of the removal procedure. Always completely read the removal instructions and follow all special installation instructions.

Removal and replacement: Accessory upper cover (M856/E85055/M776dn/M776z)

Learn how to remove and replace the accessory upper cover.

[View a video of how to remove and replace the accessory upper cover.](#)


Mean time to repair: 3 minutes

Service level: Easy

Before performing service

Turn the printer power off

- Disconnect the power cable.

 **WARNING!** To avoid damage to the printer, turn the printer off, wait 30 seconds, and then remove the power cord before attempting to service the printer.

Use the table below to identify the correct part number for your printer. To order the part, go to www.hp.com/buy/parts.

Table 1-27 Part information

Part number	Part description
RC5-2621-000CN	Cover, option, upper

Required tools

- Small, flat-blade screwdriver
- #2 Phillips screwdriver with a magnetic tip

After performing service

Turn the printer power on

- Connect the power cable.
- Use the power switch to turn the power on.

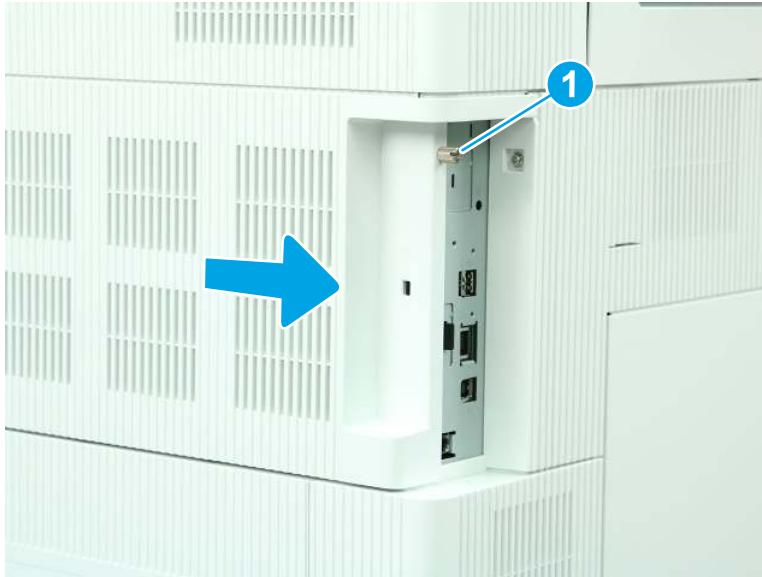
Post service test

Make sure that the printer initializes to a **Ready** state. Print a page to make sure that the printer is functioning correctly.

1. Remove the formatter cover.

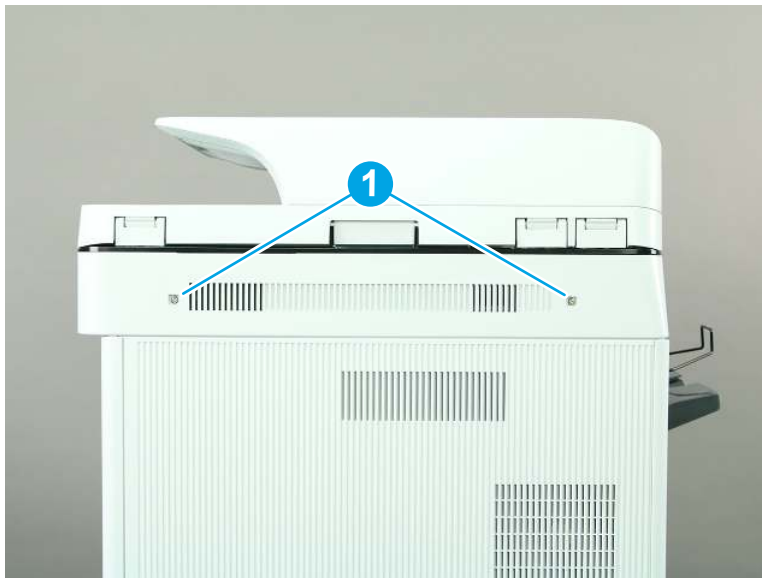
- ▲ Loosen one thumbscrew (callout 1), and then slide the formatter cover (callout 2) away from the printer to remove it.

Figure 1-236 Remove the formatter cover



- 2. Remove the scanner control board (SCB) cover (M776).
 - a. Remove two screws (callout 1).

Figure 1-237 Remove two screws



- b. Remove the SCB cover.

Figure 1-238 Remove the SCB cover

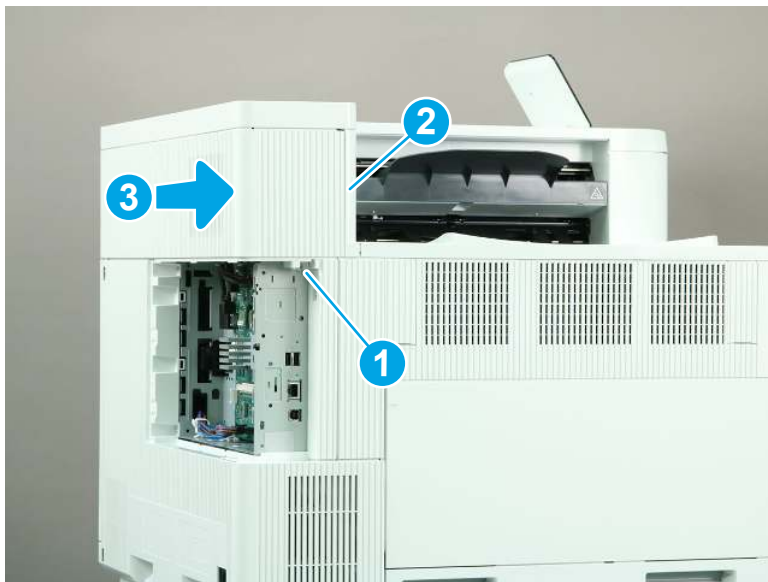


3. Remove the rear upper cover (M856/E85055/M776dn/M776z).

 **NOTE:** The following figure shows the M856 printer. The procedure is correct for all referenced models.

- ▲ Remove one screw (callout 1), release one tab (callout 2), and then slide the rear upper cover away from the printer to remove it (callout 3).

Figure 1-239 Remove the rear upper cover

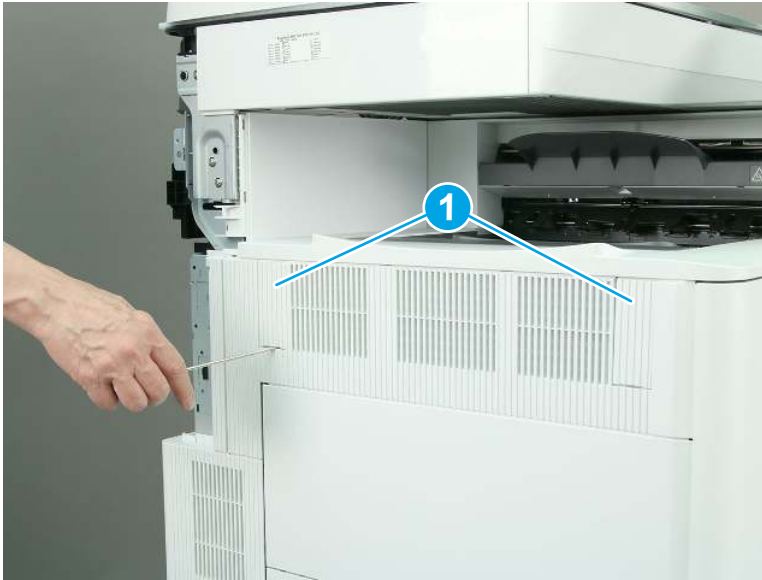


4. Remove the accessory upper cover (M856/E85055/M776dn/M776z).

 **NOTE:** The following figures show the M776z printer. The procedure is correct for all referenced models.

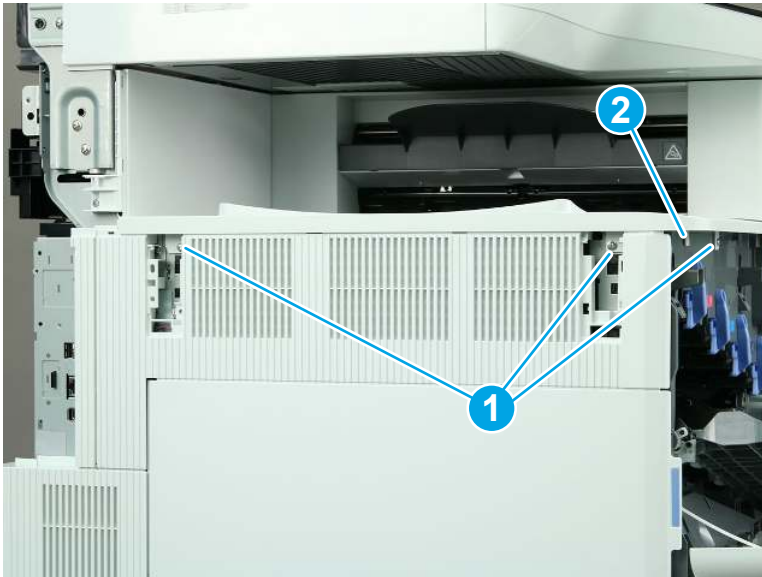
- a. Use a small, flat-blade screwdriver to remove two covers (callout 1).

Figure 1-240 Remove two covers



- b. Remove three screws (callout 1), and then release one tab (callout 2).

Figure 1-241 Remove three screws and release one tab



- c. Slide the accessory upper cover away from the printer to remove it.

Figure 1-242 Remove the accessory upper cover



5. Unpack the replacement assembly.

- a. Dispose of the defective part.



NOTE: HP recommends responsible disposal of the defective part.

<http://www8.hp.com/us/en/hp-information/environment/product-recycling.html>

- b. Unpack the replacement part from the packaging.



IMPORTANT: Make sure that all of the shipping materials (for example shipping tape) are removed from the replacement part prior to installation.

- c. To install an assembly, reverse the removal steps.



NOTE: When applicable, special installation instructions are provided for an assembly at the end of the removal procedure. Always completely read the removal instructions and follow all special installation instructions.

Removal and replacement: Left upper front and rear covers (M751/E75245/M856/E85055/M776)

Learn how to remove and replace the left upper front and rear covers.

Mean time to repair: 1 minute

Service level: Easy

Before performing service

Turn the printer power off

- o Disconnect the power cable.



WARNING! To avoid damage to the printer, turn the printer off, wait 30 seconds, and then remove the power cord before attempting to service the printer.

Use the table below to identify the correct part number for your printer. To order the part, go to www.hp.com/buy/parts.

Table 1-28 Part information

Part number	Part description
RC5-1805-000CN	Cover, left upper, F
RC5-1806-000CN	Cover, left upper, R

Required tools

- Small, flat-blade screwdriver

After performing service

Turn the printer power on

- Connect the power cable.
- Use the power switch to turn the power on.

Post service test

No post service test is available for this assembly.

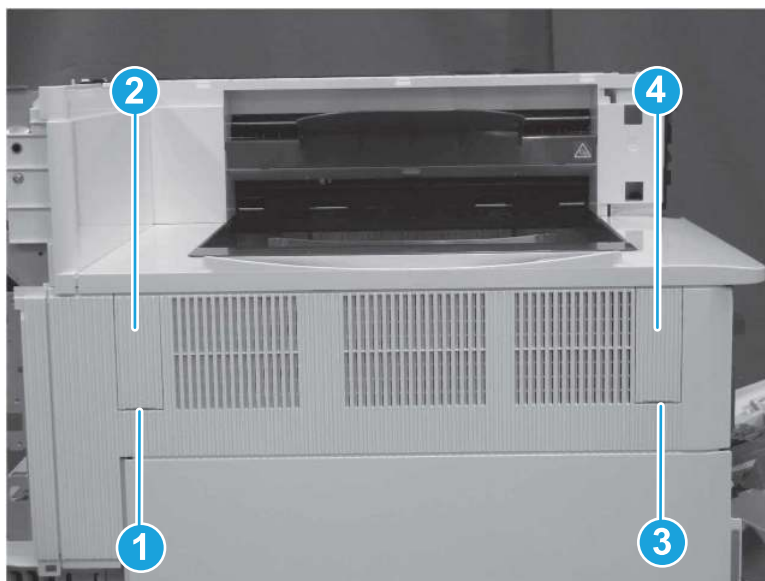
1. Remove the left upper front and rear covers (M751/E75245/M856/E85055/M776).

 **NOTE:** The following figure shows the M856 printer. The procedure is correct for all referenced models.

 **NOTE:** These covers are not identical. Make sure to reinstall the correct cover on the correct side.

- ▲ Use a small, flat-blade screwdriver to release one tab (callout 1), and then remove the left upper rear cover (callout 2). Release one tab (callout 3), and then remove the left upper front cover.

Figure 1-243 Remove the left upper front and rear covers



2. Unpack the replacement assembly.

- a. Dispose of the defective part.



NOTE: HP recommends responsible disposal of the defective part.

<http://www8.hp.com/us/en/hp-information/environment/product-recycling.html>

- b. Unpack the replacement part from the packaging.



IMPORTANT: Make sure that all of the shipping materials (for example shipping tape) are removed from the replacement part prior to installation.

- c. To install an assembly, reverse the removal steps.



NOTE: When applicable, special installation instructions are provided for an assembly at the end of the removal procedure. Always completely read the removal instructions and follow all special installation instructions.

Removal and replacement: Left lower cover (M856/E85055/M776)

Learn how to remove and replace the left lower cover.

Mean time to repair: 1 minute

Service level: Easy

Before performing service

Turn the printer power off

- Disconnect the power cable.



WARNING! To avoid damage to the printer, turn the printer off, wait 30 seconds, and then remove the power cord before attempting to service the printer.

Use the table below to identify the correct part number for your printer. To order the part, go to www.hp.com/buy/parts.

Table 1-29 Part information

Part number	Part description
RC5-2632-000CN	Cover, left rear

Required tools

- Small, flat-blade screwdriver
- #2 Phillips screwdriver with a magnetic tip

After performing service

Turn the printer power on

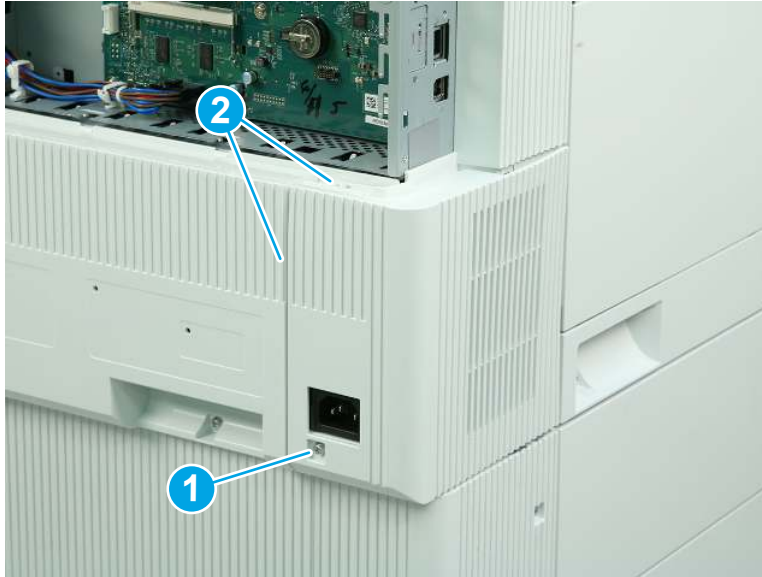
- Connect the power cable.
- Use the power switch to turn the power on.

Post service test

No post service test is available for this assembly.

1. Remove the left lower cover (M856/E85055/M776).
 - a. Remove one screw (callout 1), and then release two tabs (callout 2).

Figure 1-244 Remove one screw and release two tabs



- b. Rotate the cover away from the printer to remove it.

Figure 1-245 Remove the left lower cover




2. Unpack the replacement assembly.
 - a. Dispose of the defective part.




NOTE: HP recommends responsible disposal of the defective part.

<http://www8.hp.com/us/en/hp-information/environment/product-recycling.html>

- b. Unpack the replacement part from the packaging.

 **IMPORTANT:** Make sure that all of the shipping materials (for example shipping tape) are removed from the replacement part prior to installation.

- c. To install an assembly, reverse the removal steps.

 **NOTE:** When applicable, special installation instructions are provided for an assembly at the end of the removal procedure. Always completely read the removal instructions and follow all special installation instructions.

Removal and replacement: Reverse tray (M856/E85055/M776dn/M776z)

Learn how to remove and replace the reverse tray.

[View a video of how to remove and replace the reverse tray.](#)

Mean time to repair: 20 minutes

Service level: Medium

Before performing service

Turn the printer power off

- Disconnect the power cable.

 **WARNING!** To avoid damage to the printer, turn the printer off, wait 30 seconds, and then remove the power cord before attempting to service the printer.

Use the table below to identify the correct part number for your printer. To order the part, go to www.hp.com/buy/parts.

Table 1-30 Part information

Part number	Part description
RL2-2563-000CN	Tray, reverse

Required tools

- #2 Phillips screwdriver with a magnetic tip
- Small, flat-blade screwdriver

After performing service

Turn the printer power on

- Connect the power cable.
- Use the power switch to turn the power on.

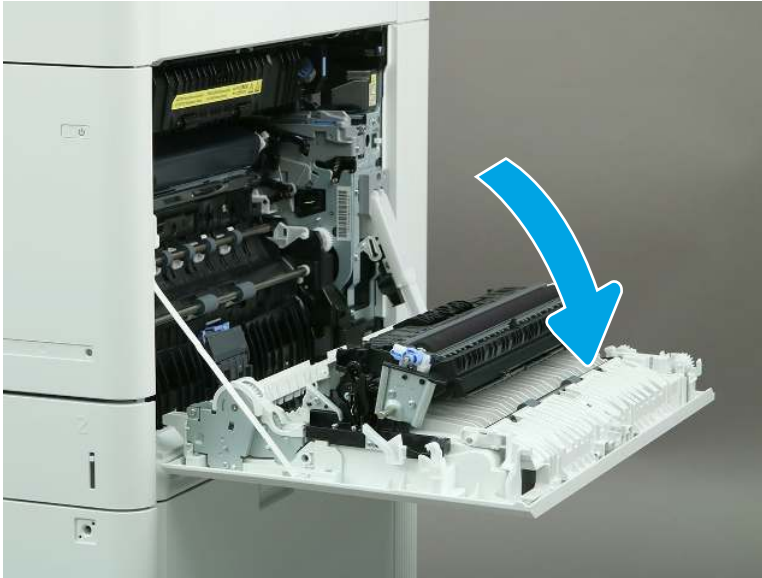
Post service test

Make sure that the printer initializes to a **Ready** state.

Print a page to make sure that the printer is functioning correctly.

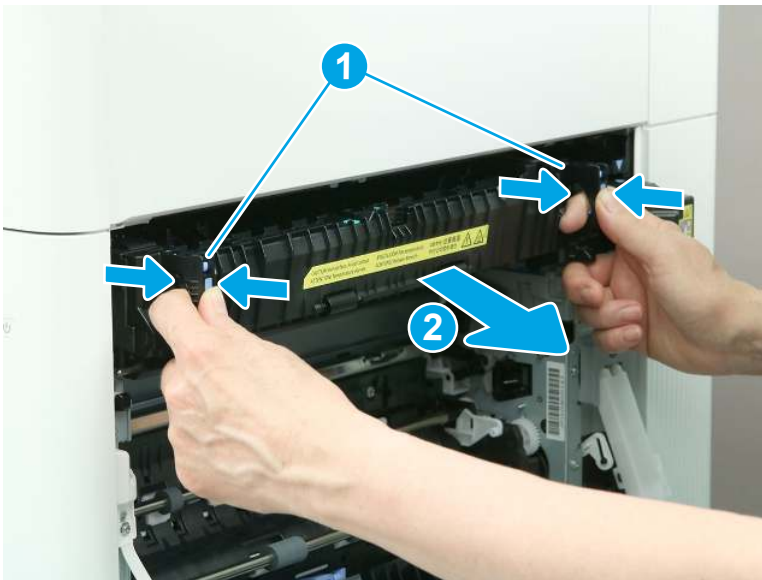
1. Remove the fuser.
 - a. Open the right door.

Figure 1-246 Open the right door



- b. Grasp the fuser handles, and then squeeze the release levers (callout 1). Lift up slightly, and then pull straight out to remove the fuser (callout 2).

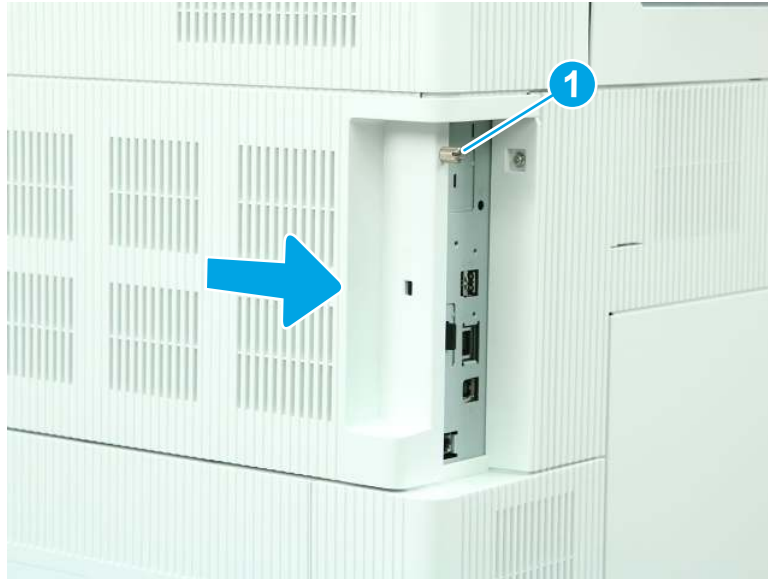
Figure 1-247 Remove the fuser



2. Remove the formatter cover.

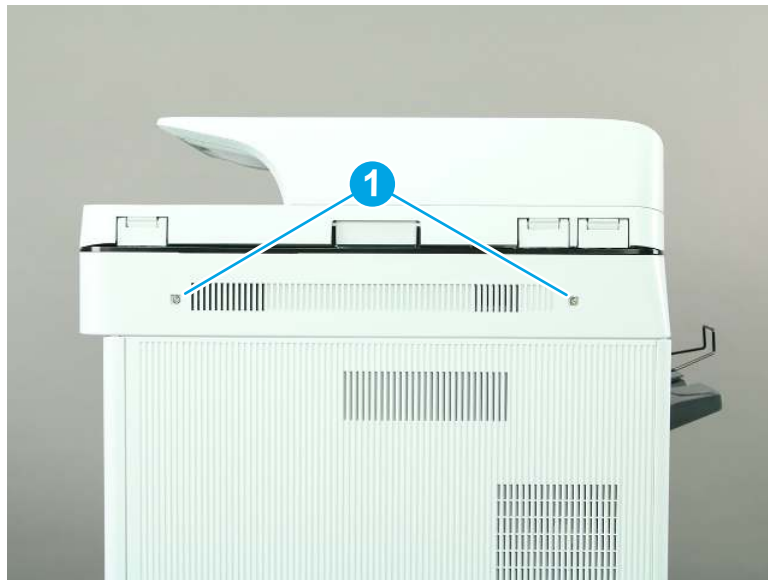
- ▲ Loosen one thumbscrew (callout 1), and then slide the formatter cover (callout 2) away from the printer to remove it.

Figure 1-248 Remove the formatter cover



- 3. Remove the scanner control board (SCB) cover (M776).
 - a. Remove two screws (callout 1).

Figure 1-249 Remove two screws



- b. Remove the SCB cover.

Figure 1-250 Remove the SCB cover

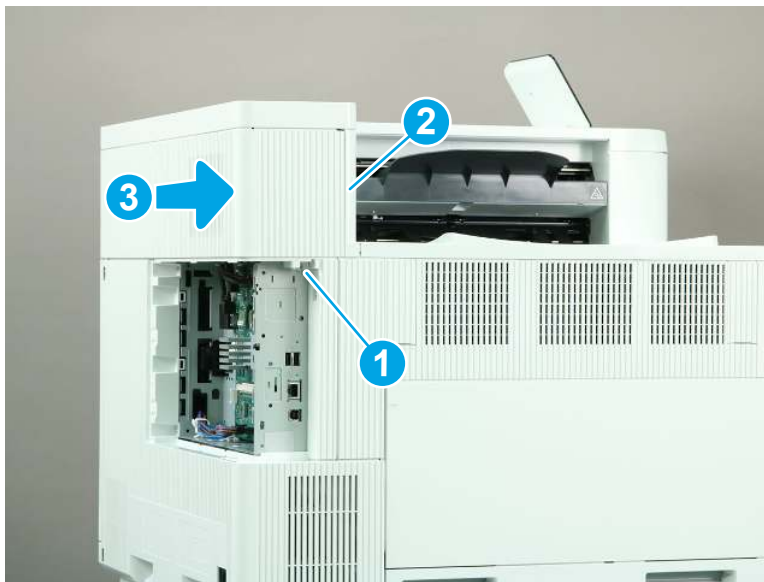


4. Remove the rear upper cover (M856/E85055/M776dn/M776z).


 **NOTE:** The following figure shows the M856 printer. The procedure is correct for all referenced models.

- ▲ Remove one screw (callout 1), release one tab (callout 2), and then slide the rear upper cover away from the printer to remove it (callout 3).

Figure 1-251 Remove the rear upper cover



5. **M856/E85055 only:** Remove the control panel and top cover.

 **NOTE:** This step applies to only the M856/E85055 models. Skip this step for all other models.

- a. Use a small, flat-blade screwdriver to release two tabs (callout 1), and then remove the control panel cover (callout 2).

Figure 1-252 Remove the control panel cover



- b. Remove one screw (callout 1).

Figure 1-253 Remove one screw



- c. Lift the back edge of the control panel up (callout 1), and then slide the control panel toward the back of the printer (callout 2).

Figure 1-254 Slide the control panel back



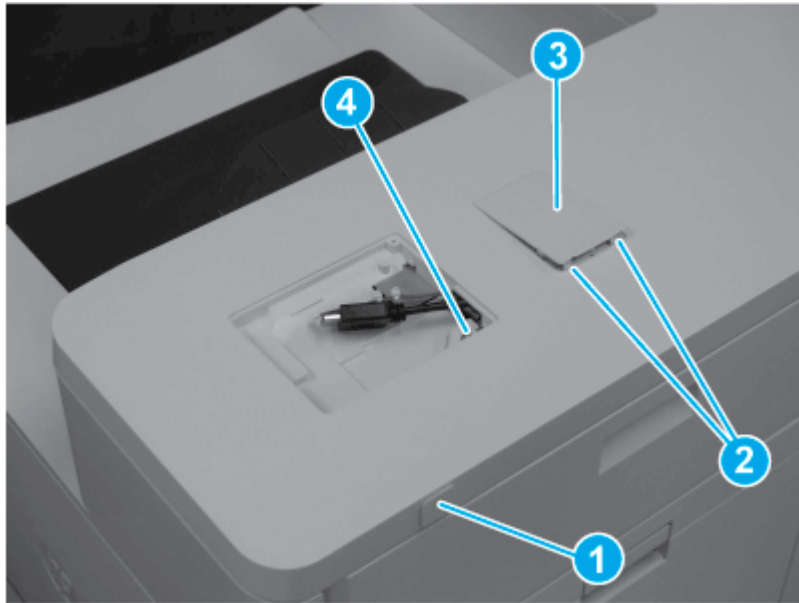
- d. Turn the control panel so that the bottom is facing up, and then disconnect two connectors to remove the control panel.

Figure 1-255 Disconnect two connectors



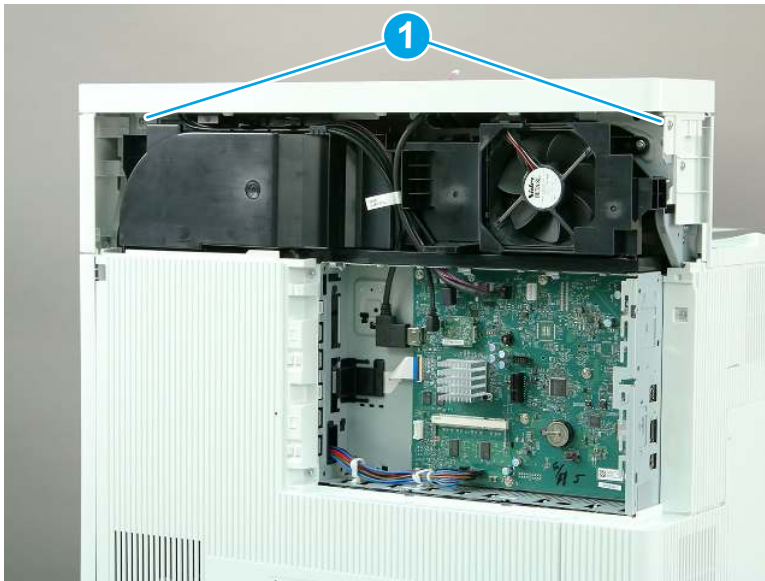
- e. Remove the USB cover (callout 1). Release two tabs (callout 2), and then remove the HIP cover (callout 3). Remove one screw (callout 4).

Figure 1-256 Remove covers and one screw



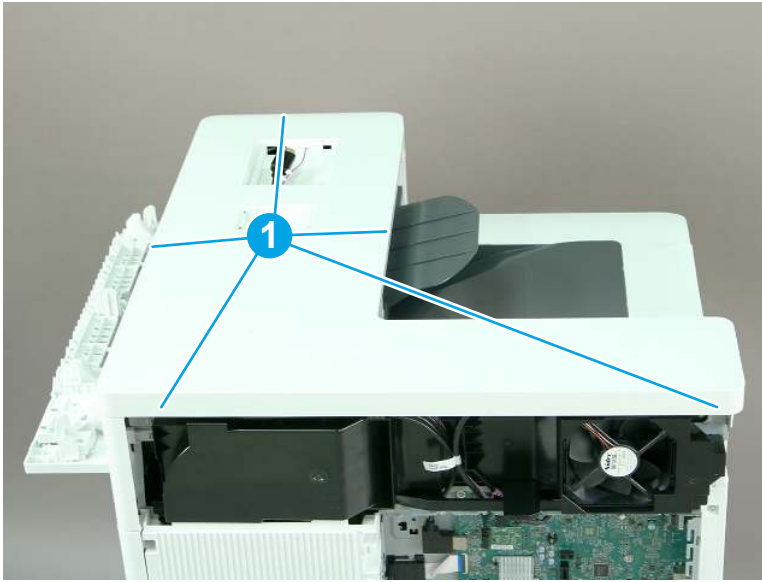
- f. Remove two screws (callout 1).

Figure 1-257 Remove two screws



- g. Release five tabs (callout 1), and then remove the top cover.

Figure 1-258 Release five tabs

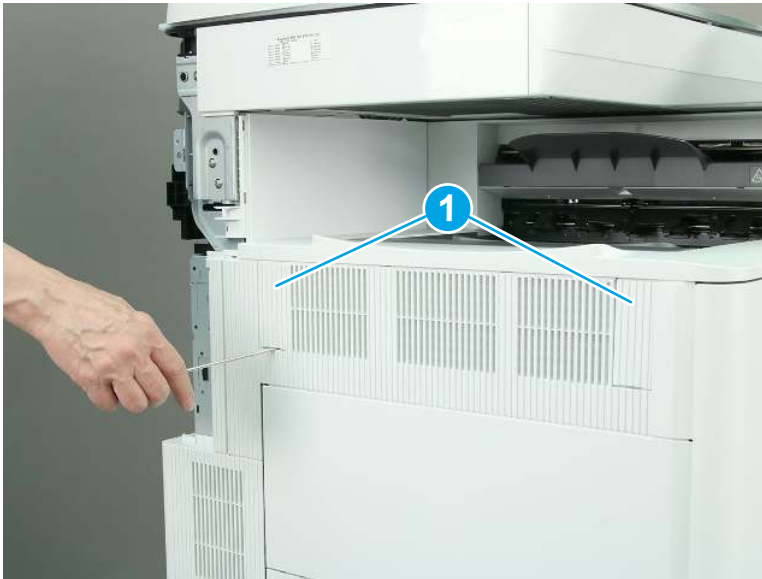


- 6. Remove the accessory upper cover (M856/E85055/M776dn/M776z).

 **NOTE:** The following figures show the M776z printer. The procedure is correct for all referenced models.

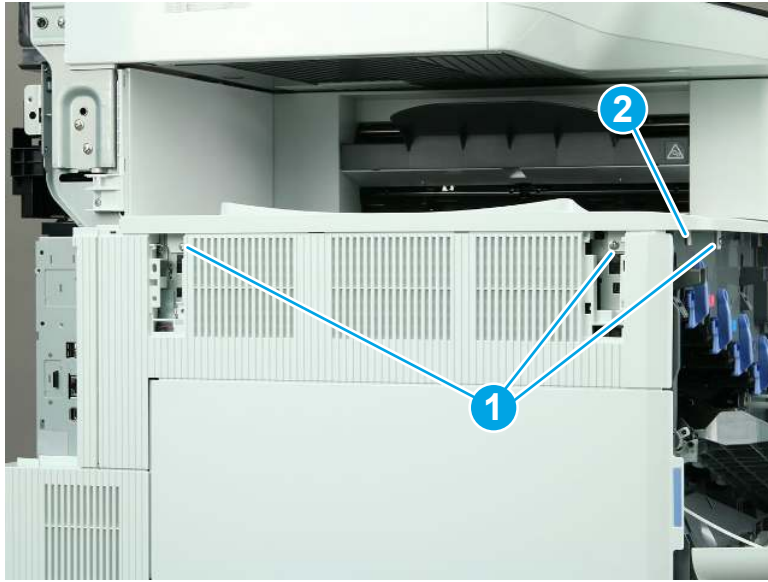
- a. Use a small, flat-blade screwdriver to remove two covers (callout 1).

Figure 1-259 Remove two covers



- b. Remove three screws (callout 1), and then release one tab (callout 2).

Figure 1-260 Remove three screws and release one tab



- c. Slide the accessory upper cover away from the printer to remove it.

Figure 1-261 Remove the accessory upper cover

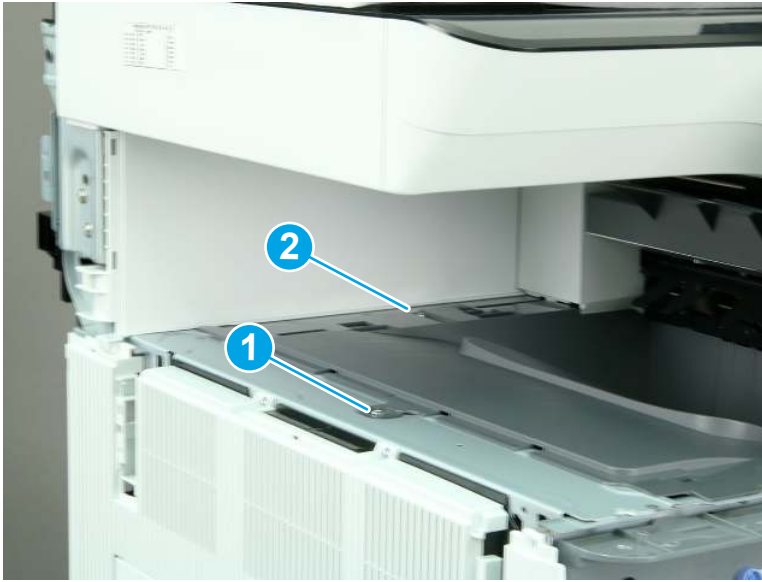


- 7. Remove the output bin (M856/E85055/M776).

 **NOTE:** The following figures show the M776z printer. The procedure is correct for all referenced models.

- a. Remove one washer-head machine screw (callout 1), remove one self-tapping screw (callout 2).

Figure 1-262 Remove two screws



- b. Remove the output bin.

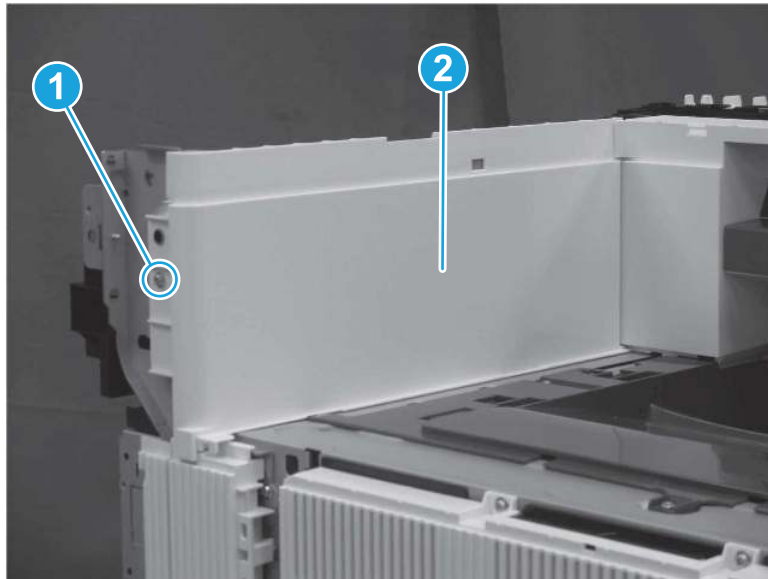
Figure 1-263 Remove the output bin



8. Remove the main cover (M856/E85055)

- ▲ Remove one screw (callout 1), and then slide the main cover (callout 2) away from the printer to remove it.

Figure 1-264 Remove the main cover



9. Remove the main cover (M776dn/M776z)

- ▲ Remove one screw (callout 1), and then slide the main cover (callout 2) away from the printer to remove it.

Figure 1-265 Remove the main cover



10. **M776 only:** Remove the control panel, keyboard, and nose cone.

 **NOTE:** This step applies to only the M776 models. Skip this step for all other models

- a. Rotate the control panel to the fully raised position (callout 1), and then raise the document feeder (callout 2).

Figure 1-266 Raise the control panel and document feeder



- b. Beginning at the right side of the control-panel cover, carefully release five tabs along the top edge of the cover.

 **NOTE:** The thin black-plastic cover will separate from the white-plastic control-panel base.

Figure 1-267 Release the control panel cover



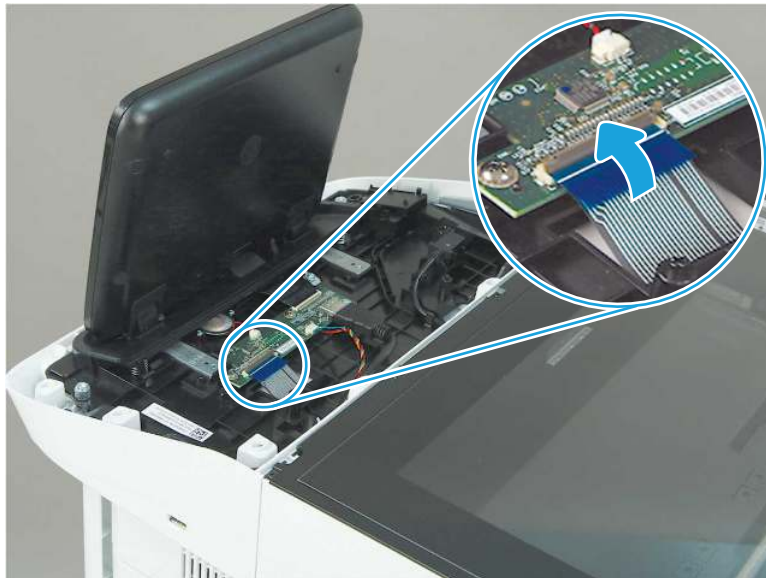
- c. Rotate the control panel cover slightly forward (callout 1), and then lift up to remove the cover (callout 2).

Figure 1-268 Remove the control panel cover



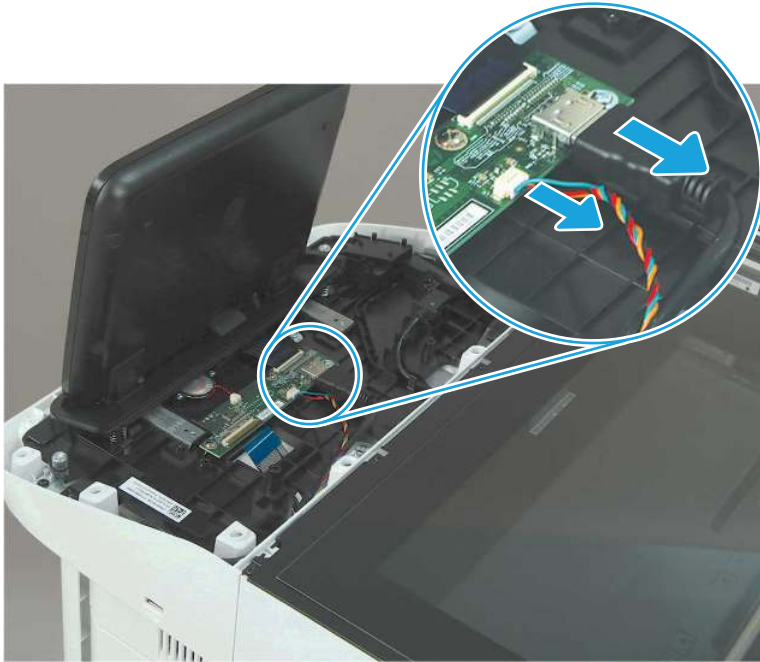
- d. **M776z or M776zs only:** Open the connector latch to release the keyboard flat cable.

Figure 1-269 Release the keyboard flat cable (M776z/M776zs)



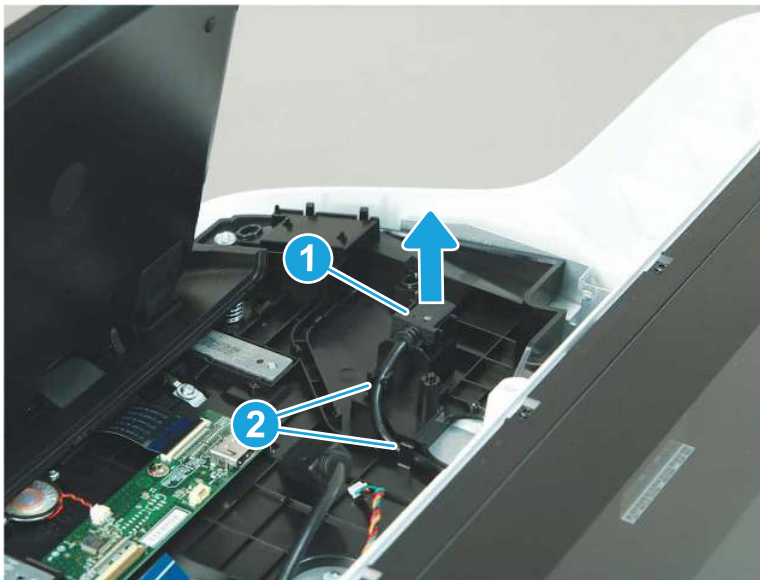
- e. Disconnect two connectors.

Figure 1-270 Disconnect two connectors



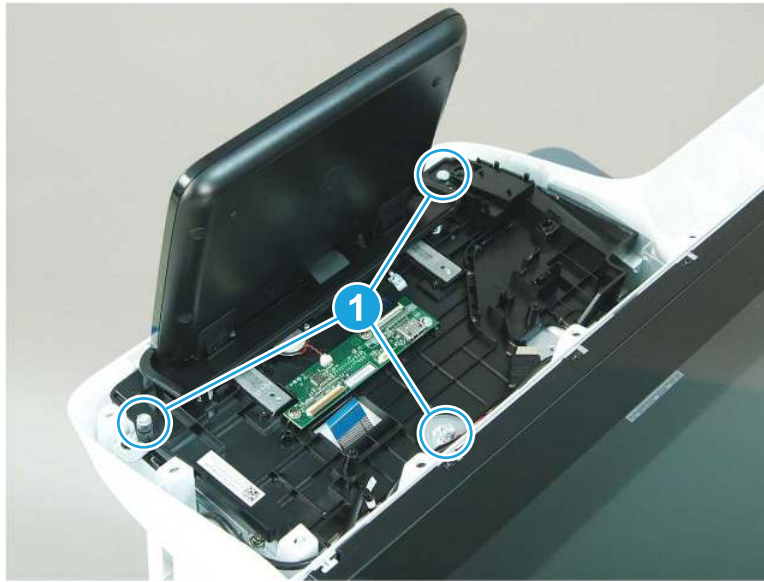
- f. Remove the USB cable (callout 1) from the holder, and then release the cable from two retainers (callout 2).

Figure 1-271 Release the USB cable



- g. Remove three screws (callout 1).

Figure 1-272 Remove three screws



- h. Lift the front of the control panel off of the printer (callout 1), and then slide it towards the front of the printer (callout 2) to remove it.

Figure 1-273 Remove the control panel



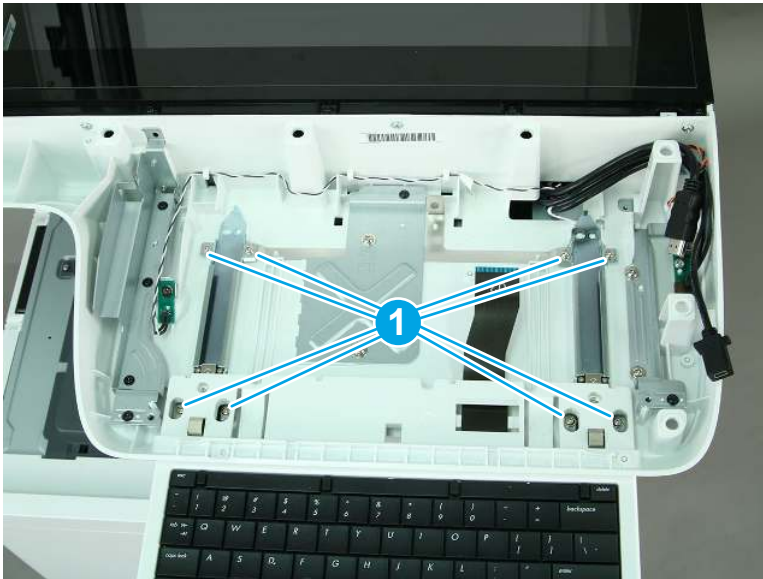
- i. **Keyboard models only:** Pull the keyboard out to its extended position.

Figure 1-274 Pull the keyboard out



- j. **Keyboard models only:** Remove eight screws (callout 1).

Figure 1-275 Remove eight screws



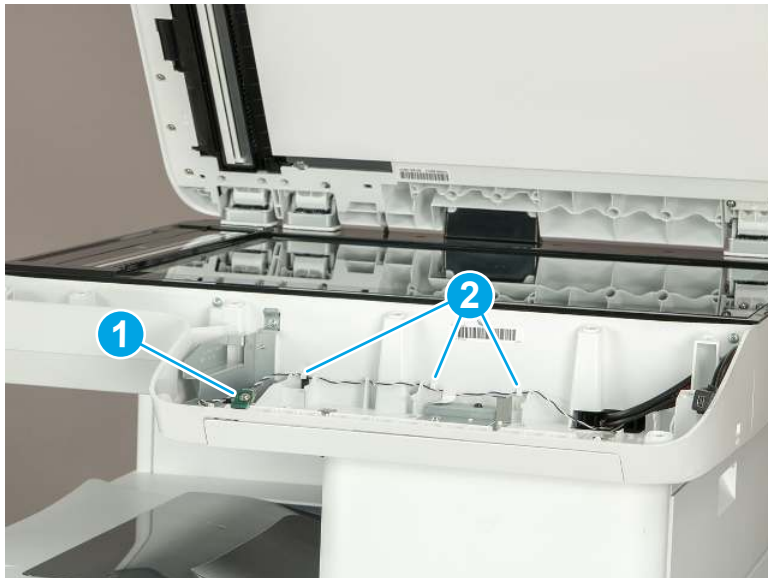
- k. **Keyboard models only:** Remove the keyboard and rails.

Figure 1-276 Remove the keyboard and rails



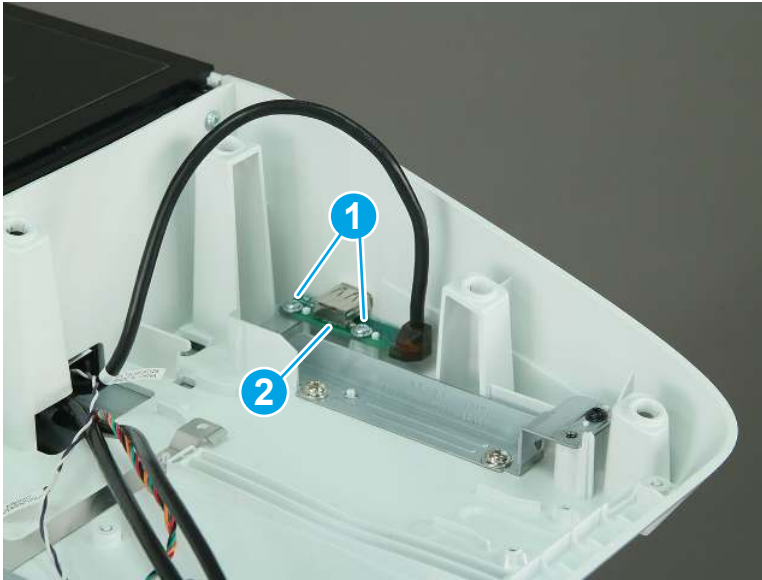
- l. Remove one screw (callout 1) to release the light PCA. Release the cable from three retainers (callout 2), and then move the light PCA out of the way.

Figure 1-277 Release the light PCA



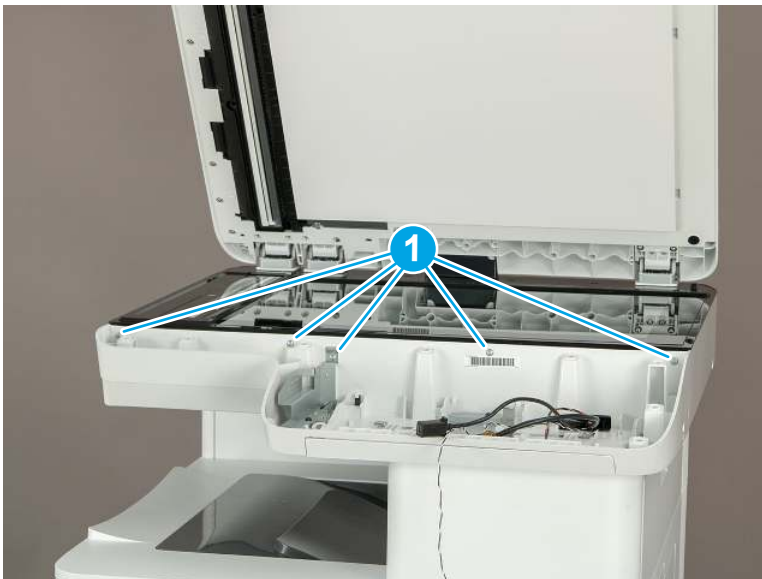
- m. Remove two screws (callout 1), and then move the USB port PCA (callout 2) out of the way.

Figure 1-278 Release the USB port PCA



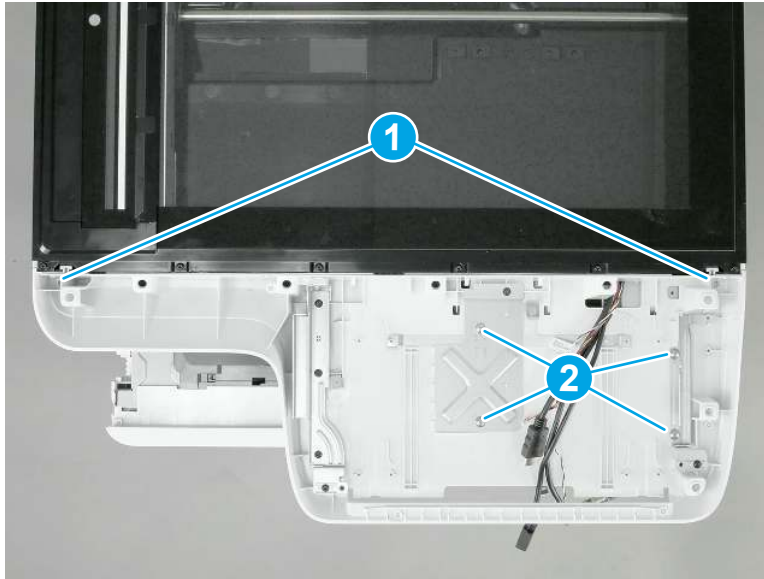
- n. Remove five screws (callout 1).

Figure 1-279 Remove four screws



- o. Remove two small, self-tapping screws (callout 1), and then remove four larger machine screws (callout 2).

Figure 1-280 Remove six screws



- p. Lift the nose cone up and off of the printer to remove it.


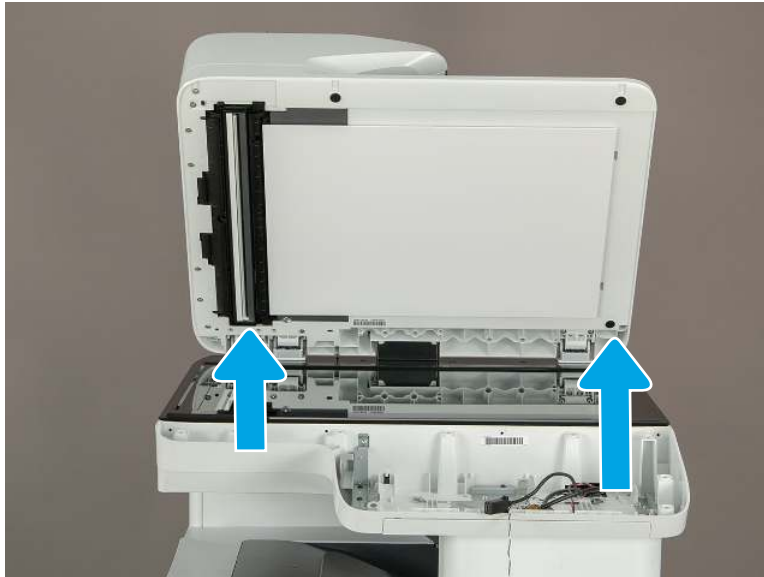
 **NOTE:** Pass the wire harnesses and cables through the opening in the nose cone when removing it.

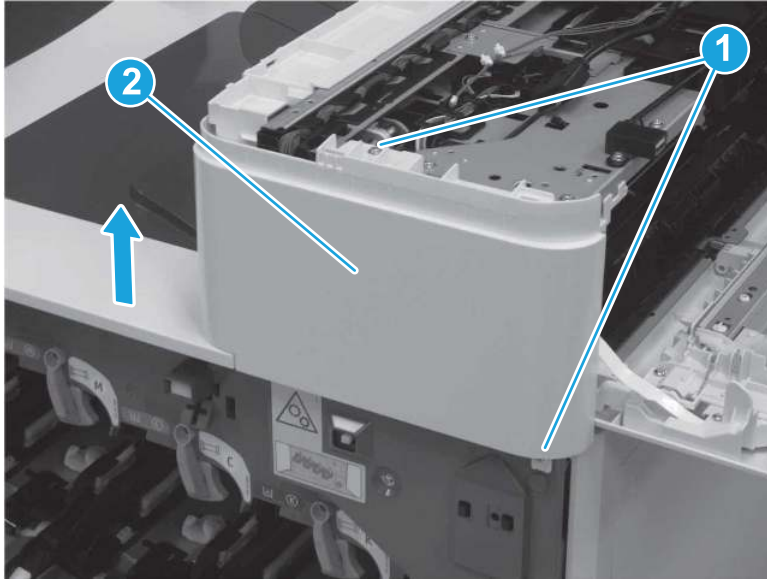
Figure 1-281 Remove the nose cone



11. Remove the right front cover (M856/E85055/M776dn/M776z).

- ▲ Remove two screws (callout 1), and then slide the right front cover (callout 2) up to remove it.

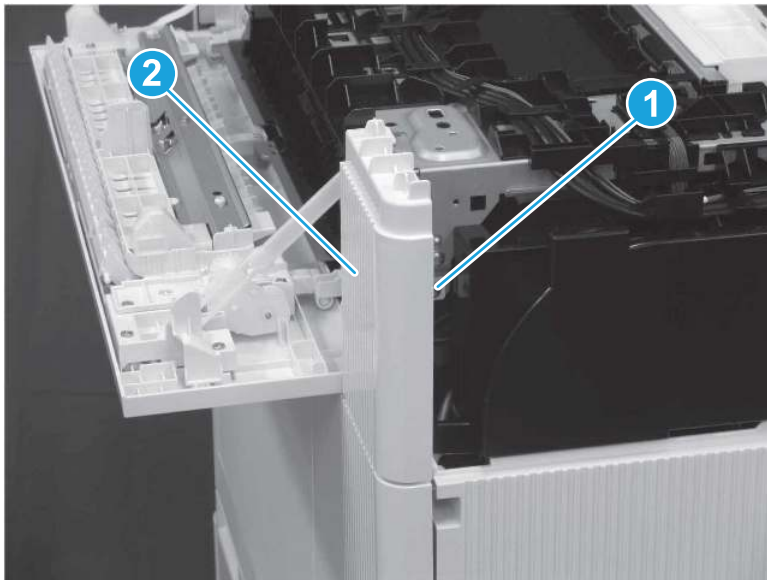
Figure 1-282 Remove the right front cover



12. Remove the right rear upper cover (M856/E85055/M776dn/M776z)

- ▲ Remove one screw (callout 1), and then slide the right rear upper cover (callout 2) away from the printer to remove it.

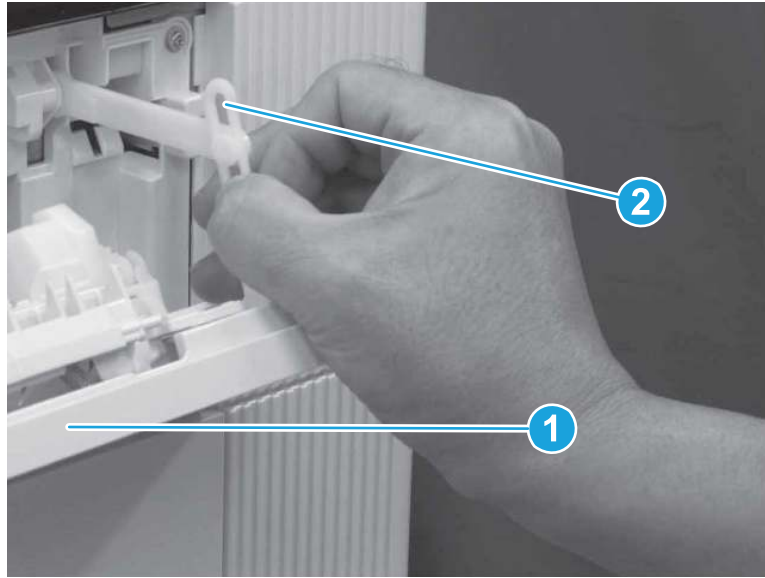
Figure 1-283 Remove the right rear upper cover



13. Remove the right upper door (M856/E85055/M776dn/M776z)

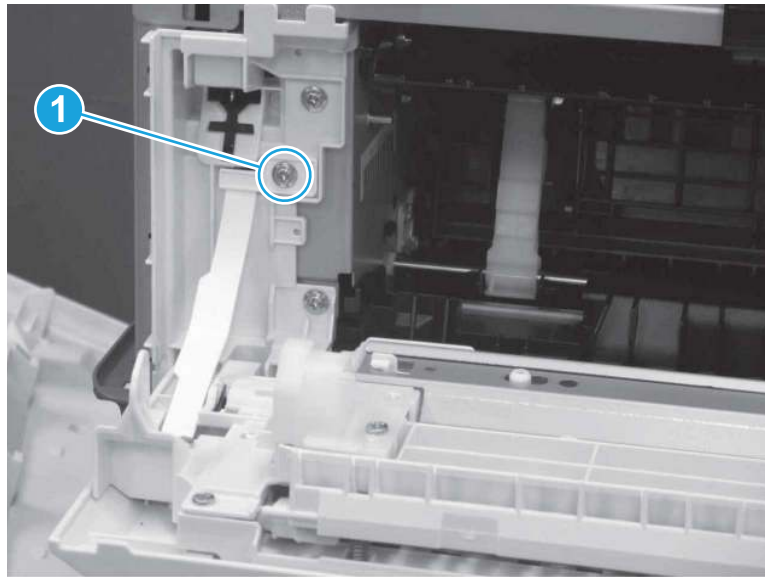
- a. Open the right upper door (callout 1), and then release the link (callout 2).

Figure 1-284 Open the door and release the link



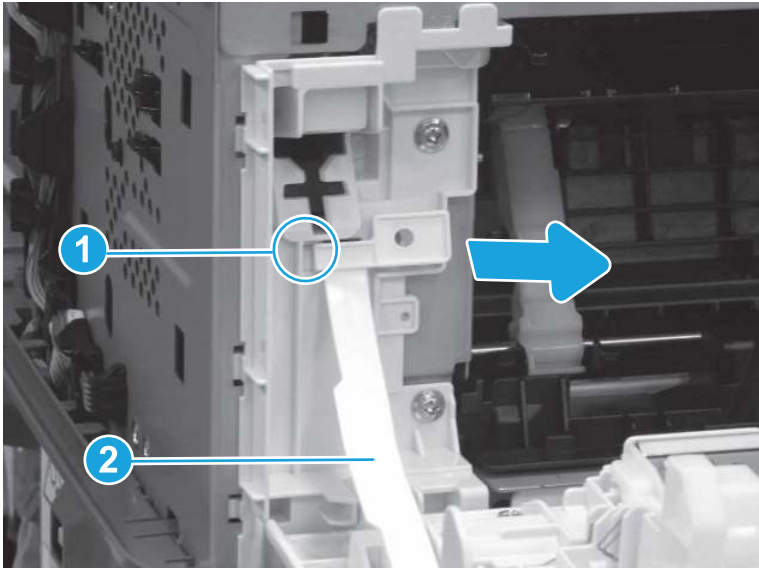
- b. Remove one screw (callout 1).

Figure 1-285 Remove one screw



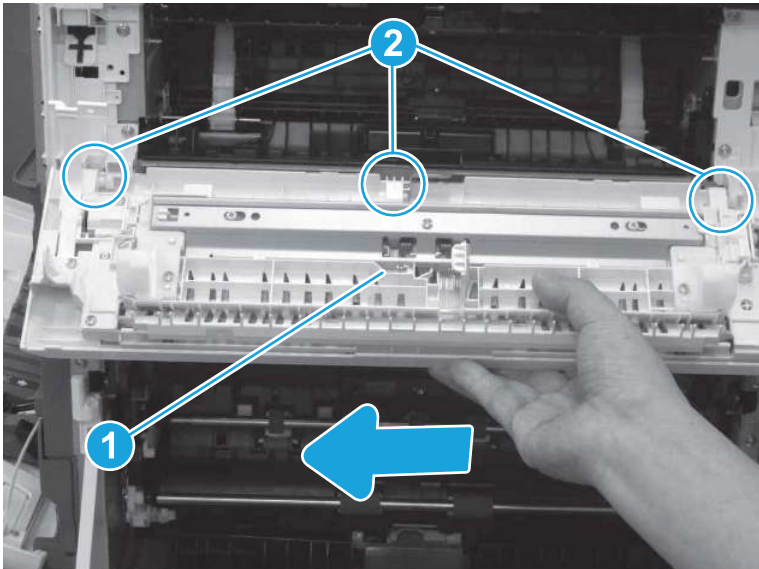
- c. Release one boss (callout 1) and then release the hinge (callout 2) by sliding it to the right.

Figure 1-286 Release one boss and hinge



- d. Slide the right upper door (callout 1) to the right to release it from three bushings (callout 2), and then remove the right upper door.

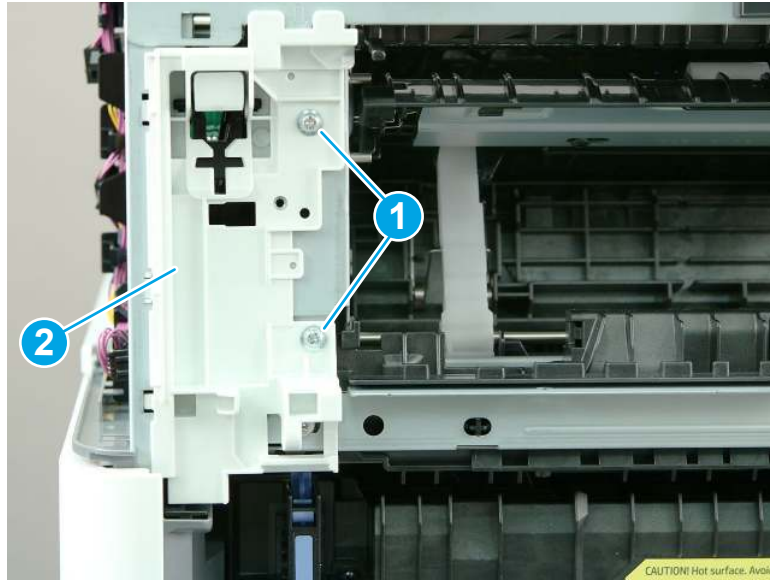
Figure 1-287 Remove the right upper door



- 14. Remove the delivery assembly (M856/E85055/M776dn/M776z).

- a. Remove two screws (callout 1), and then remove the toggle front assembly (callout 2).

Figure 1-288 Remove two screws and toggle front assembly (M856/E85055/M776dn/M776z)



- b. Remove two screws (callout 1). Remove one screw (callout 2), and then remove the toggle rear assembly (callout 3).


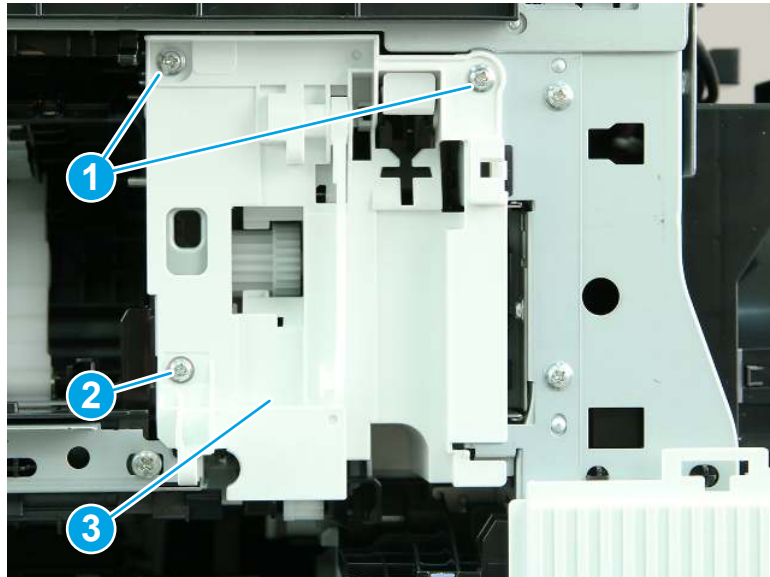
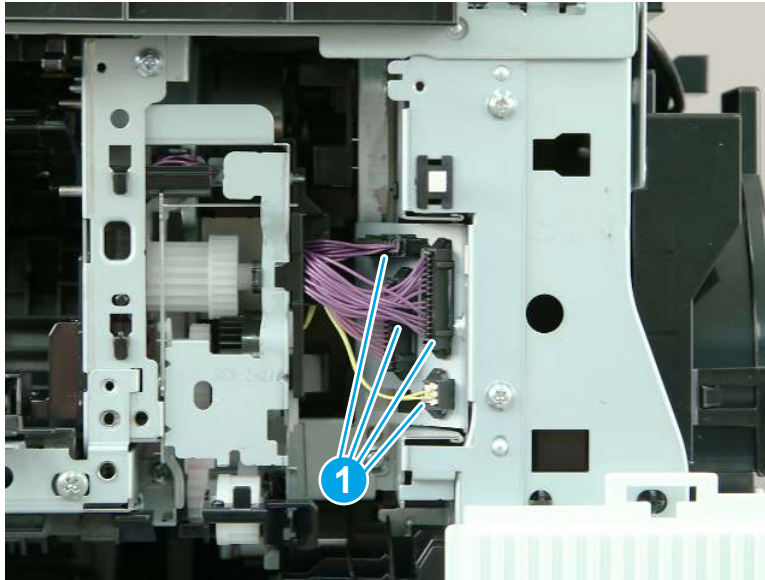
 **NOTE:** The lower screw (callout 2) is shorter than the other two screws. Make sure to reinstall this screw in the correct position.

Figure 1-289 Remove three screws and toggle rear assembly (M856/E85055/M776dn/M776z)



- c. Disconnect four connectors (callout 1).

Figure 1-290 Disconnect four connectors (M856/E85055/M776dn/M776z)

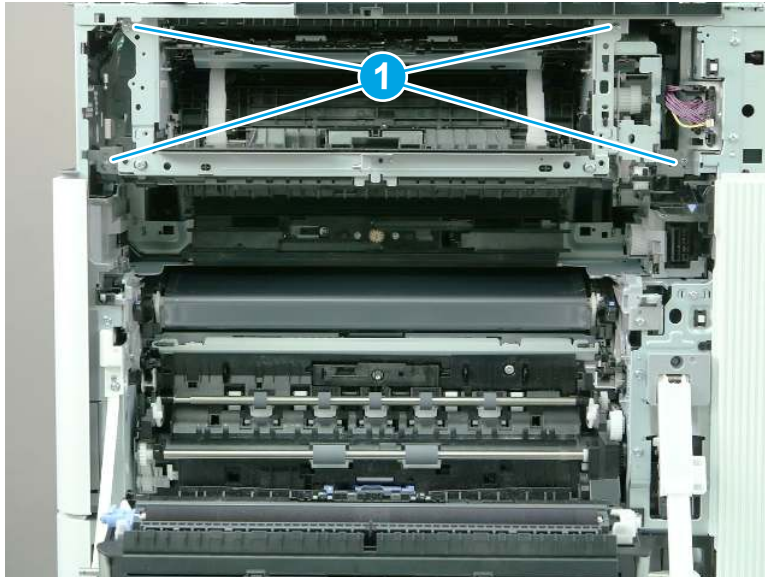


- d. Remove four screws (callout 1).



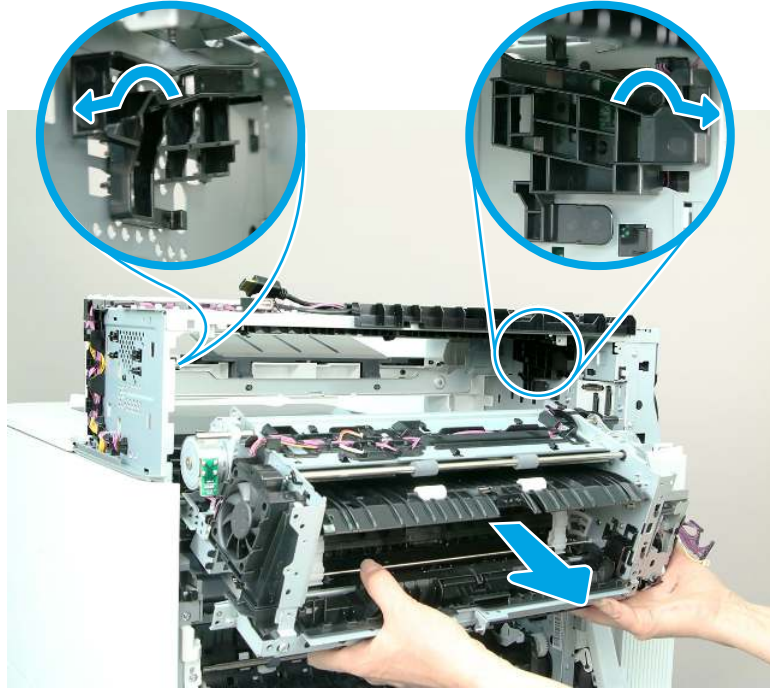
NOTE: The lower screws are shorter than the upper screws. Make sure to reinstall them in the correct position.

Figure 1-291 Remove four screws (M856/E85055/M776dn/M776z)



- e. Slide the delivery assembly away from the printer, and then lift up and out to release the posts from the tracks.

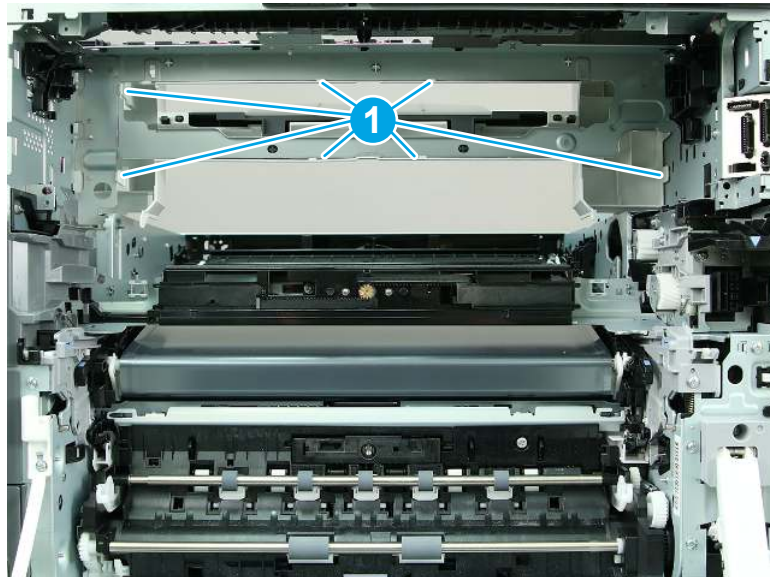
Figure 1-292 Remove the delivery assembly (M856/E85055/M776dn/M776z)



- 15. Remove the reverse tray (M856/E85055/M776dn/M776z).

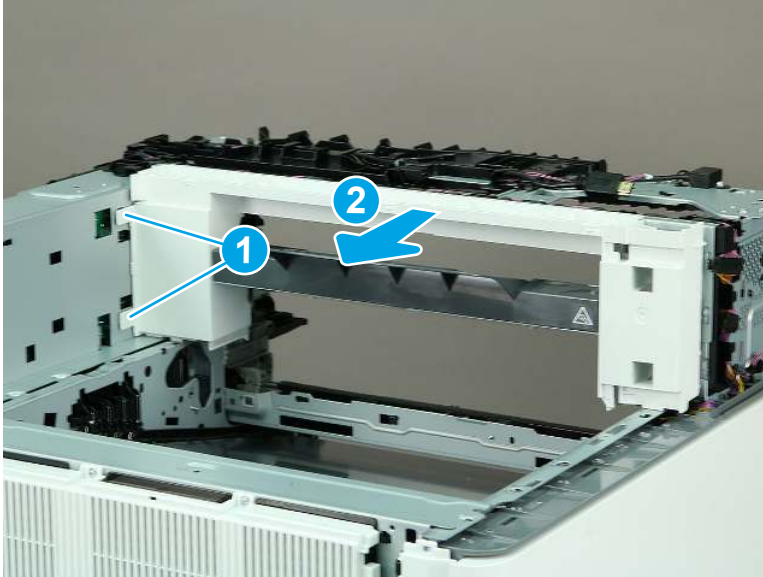
- a. Release seven tabs (callout 1) on the inside of the printer.

Figure 1-293 Release seven tabs



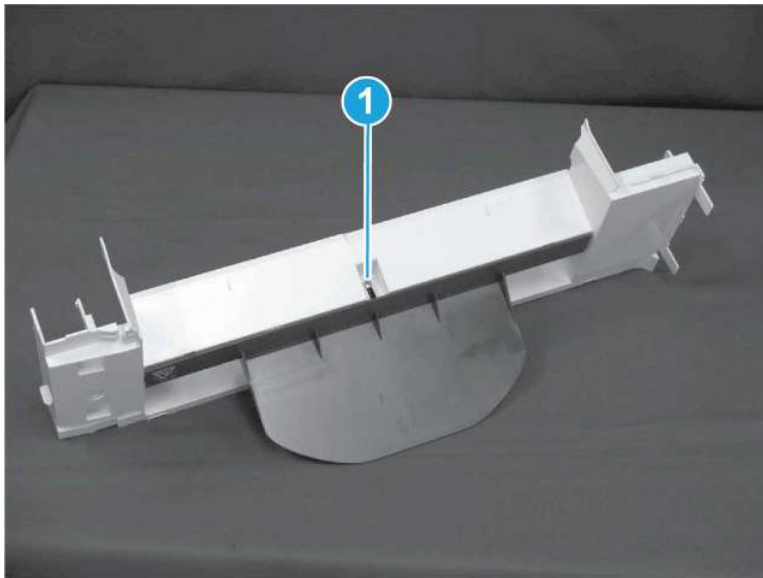
- b. Release two tabs (callout 1), and then slide the delivery cover and the reverse tray (callout 2) away from the printer to remove them.

Figure 1-294 Release two tabs



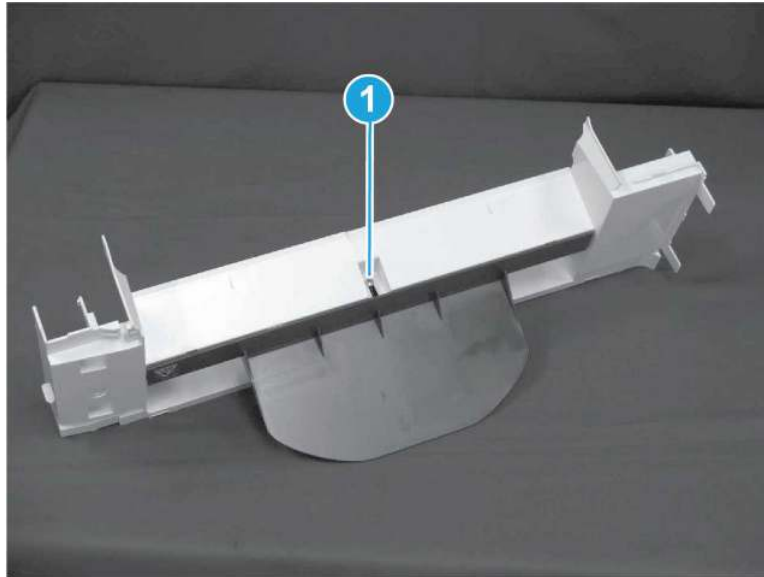
- c. Remove one screw (callout 1).

Figure 1-295 Remove one screw



- d. Release four tabs (callout 1), and then separate the delivery cover (callout 2) from the reverse tray (callout 3).

Figure 1-296 Remove the reverse tray



16. Unpack the replacement assembly.

- a. Dispose of the defective part.



NOTE: HP recommends responsible disposal of the defective part.

<http://www8.hp.com/us/en/hp-information/environment/product-recycling.html>

- b. Unpack the replacement part from the packaging.



IMPORTANT: Make sure that all of the shipping materials (for example shipping tape) are removed from the replacement part prior to installation.

- c. To install an assembly, reverse the removal steps.



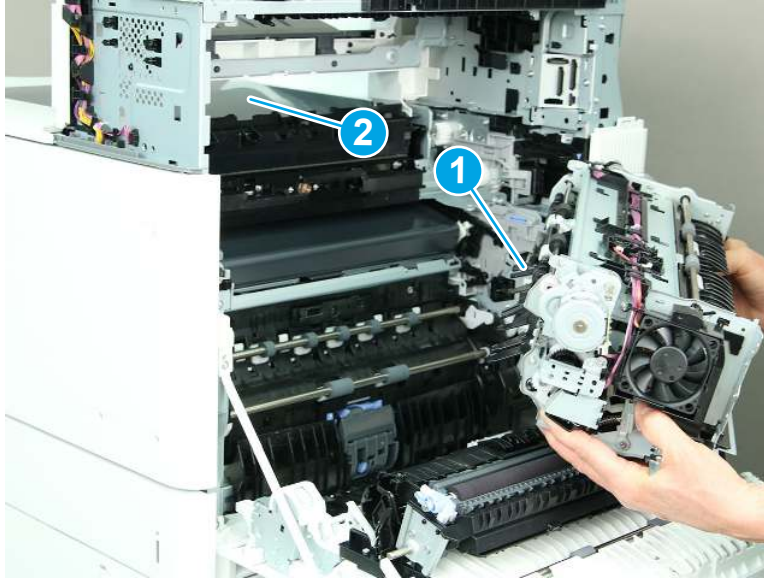
NOTE: When applicable, special installation instructions are provided for an assembly at the end of the removal procedure. Always completely read the removal instructions and follow all special installation instructions.

17. Reverse the removal steps to install the assembly. Also use the following **special installation instructions**.

Install the delivery assembly (M856/E85055/M776dn/M776z).

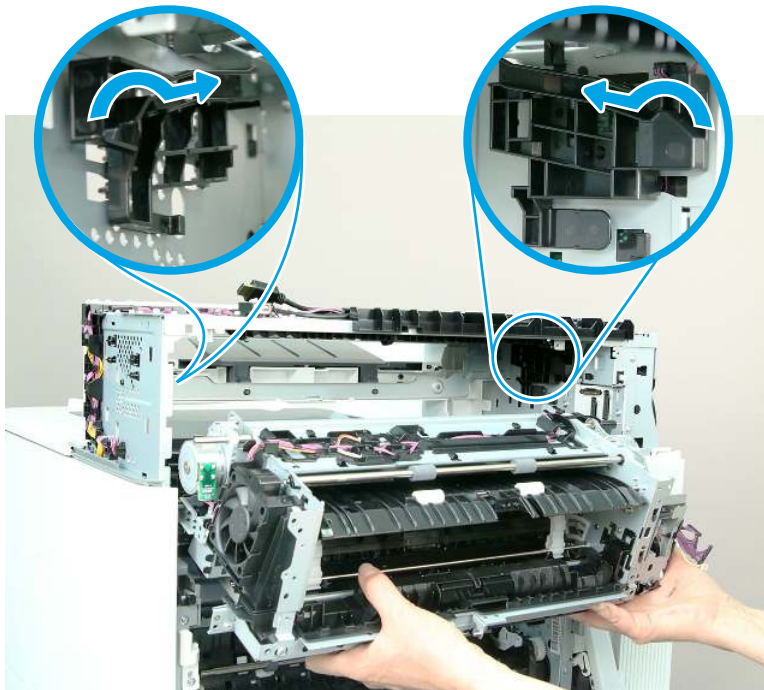
- a. When reinstalling the delivery assembly, make sure that the flap (callout 1) on the delivery assembly goes through the opening (callout 2) in the cover.

Figure 1-297 Install the flap through the opening (M856/E85055/M776dn/M776z)



- b. When reinstalling the delivery assembly, position the posts on the delivery assembly (callout 1) into the tracks (callout 2) in the printer. Lift up and then slide the assembly toward the printer to install the posts in the tracks.

Figure 1-298 Install the delivery assembly (M856/E85055/M776dn/M776z)



Removal and replacement: Document feeder (M776)

Learn how to remove and replace the document feeder.

[View a video of how to remove and replace the document feeder.](#)

Mean time to repair: 3 minutes

Service level: Easy

Before performing service

Turn the printer power off

- Disconnect the power cable.

⚠ WARNING! To avoid damage to the printer, turn the printer off, wait 30 seconds, and then remove the power cord before attempting to service the printer.

Use the table below to identify the correct part number for your printer. To order the part, go to www.hp.com/buy/parts.

Table 1-31 Part information

Part number	Part description
5851-7930	ADF whole unit enterprise
5851-7931	ADF whole unit work flow

Required tools

- #2 Phillips screwdriver with a magnetic tip

After performing service

Turn the printer power on

- Connect the power cable.
- Use the power switch to turn the power on.

Post service test

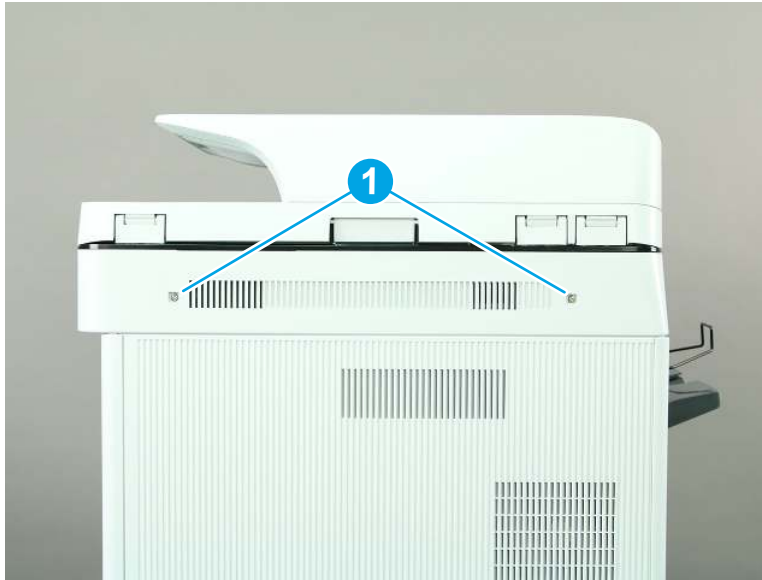
Make sure that the printer initializes to a **Ready** state.

Copy a page from the document feeder and verify it is functioning correctly.

1. Remove the scanner control board (SCB) cover (M776).

- a. Remove two screws (callout 1).

Figure 1-299 Remove two screws



- b. Remove the SCB cover.

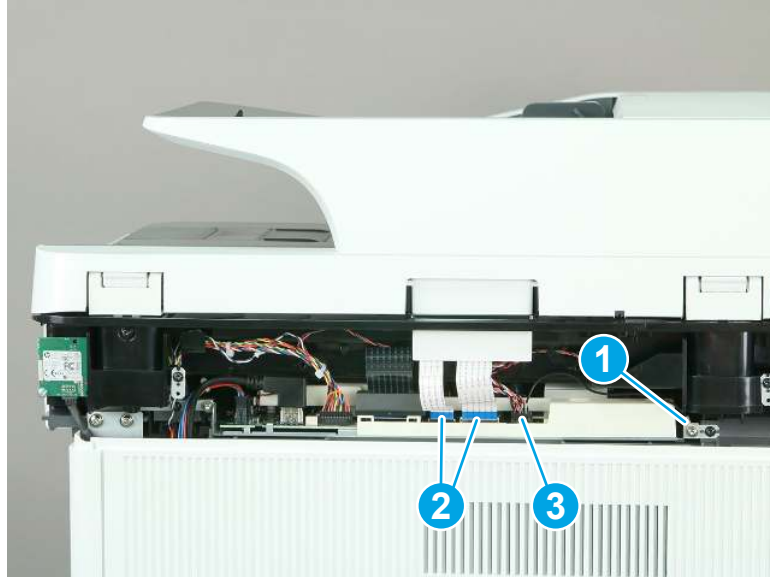
Figure 1-300 Remove the SCB cover



2. Remove the document feeder (M776dn/M776z/M776zs).
 - a. Remove one Torx T10 screw (callout 1) to release the ground wire, disconnect two flat cables (callout 2), and then disconnect one connector (callout 3).

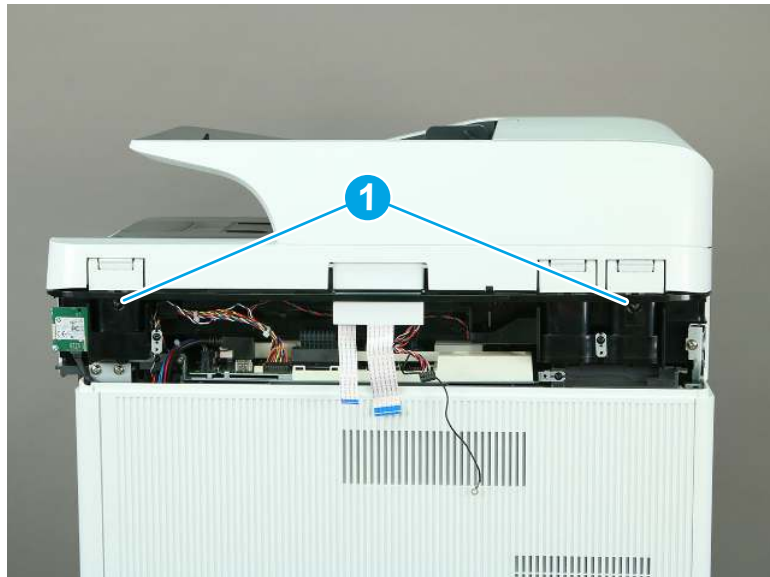
⚠ CAUTION: These connectors (callout 2) are zero insertion force (ZIF) connectors. The clip on these connectors is easily dislodged and lost.

Figure 1-301 Remove one screw and disconnect three connectors



- b. Remove two screws (callout 1).

Figure 1-302 Remove two screws



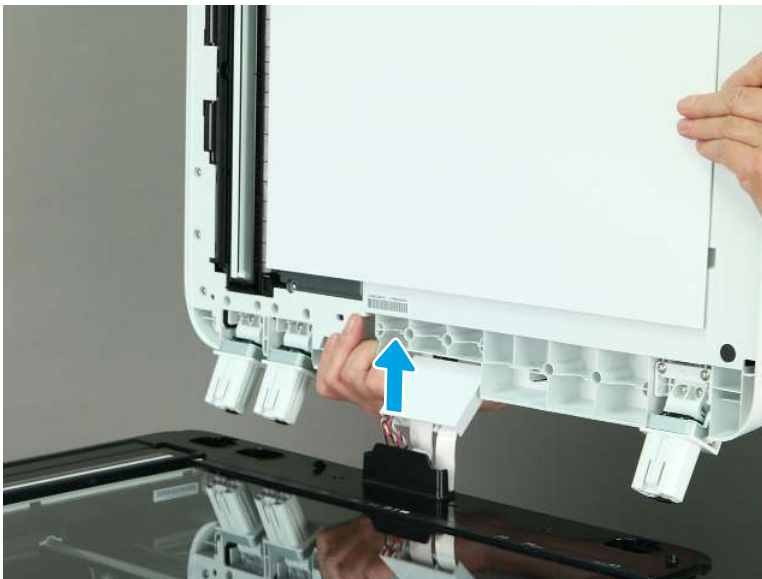
- c. Open the document feeder, and then lift it straight up until it stops at the retention tabs on each hinge (callout 1). Insert a small, flat-blade screwdriver between the hinge body and the slot in the scanner body (on the scanner glass side of the hinge) to release the retention tabs (on each hinge).

Figure 1-303 Release the hinges



- d. Carefully thread the document feeder flat cables, wire harness, and ground wire up and through the opening in the scanner cover to remove the document feeder.

Figure 1-304 Remove the document feeder




3. Unpack the replacement assembly.
 - a. Dispose of the defective part.




NOTE: HP recommends responsible disposal of the defective part.

<http://www8.hp.com/us/en/hp-information/environment/product-recycling.html>

- b. Unpack the replacement part from the packaging.

 **IMPORTANT:** Make sure that all of the shipping materials (for example shipping tape) are removed from the replacement part prior to installation.

- c. To install an assembly, reverse the removal steps.

 **NOTE:** When applicable, special installation instructions are provided for an assembly at the end of the removal procedure. Always completely read the removal instructions and follow all special installation instructions.

Removal and replacement: Image scanner (M776)

Learn how to remove and replace the image scanner.


Mean time to repair: 15 minutes

Service level: Medium

Before performing service

Turn the printer power off

- Disconnect the power cable.

 **WARNING!** To avoid damage to the printer, turn the printer off, wait 30 seconds, and then remove the power cord before attempting to service the printer.

Use the table below to identify the correct part number for your printer. To order the part, go to www.hp.com/buy/parts.

Table 1-32 Part information

Part number	Part description
5851-7915	Kit-image scanner whole unit

Required tools

- #2 Phillips screwdriver with a magnetic tip

After performing service

Turn the printer power on

- Connect the power cable.
- Use the power switch to turn the power on.

Post service test

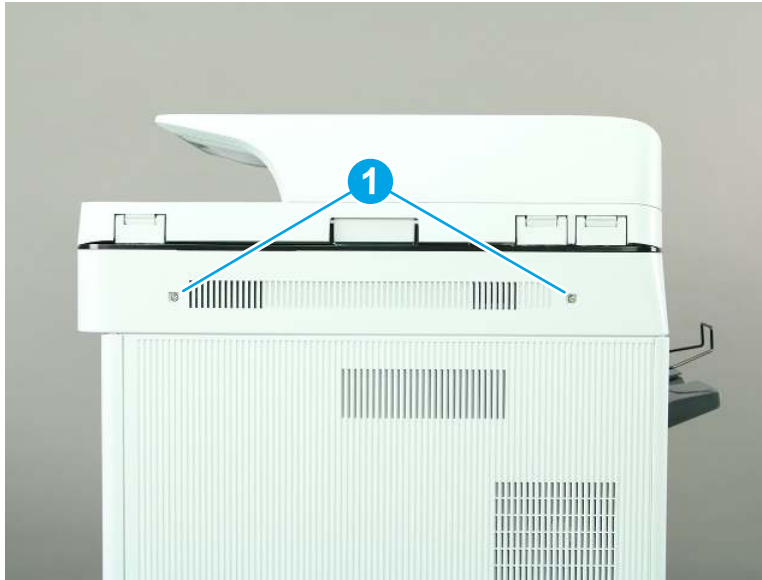
Make sure that the printer initializes to a **Ready** state.

Copy a page from the image scanner and verify it is functioning correctly.

1. Remove the scanner control board (SCB) cover (M776).

- a. Remove two screws (callout 1).

Figure 1-305 Remove two screws



- b. Remove the SCB cover.

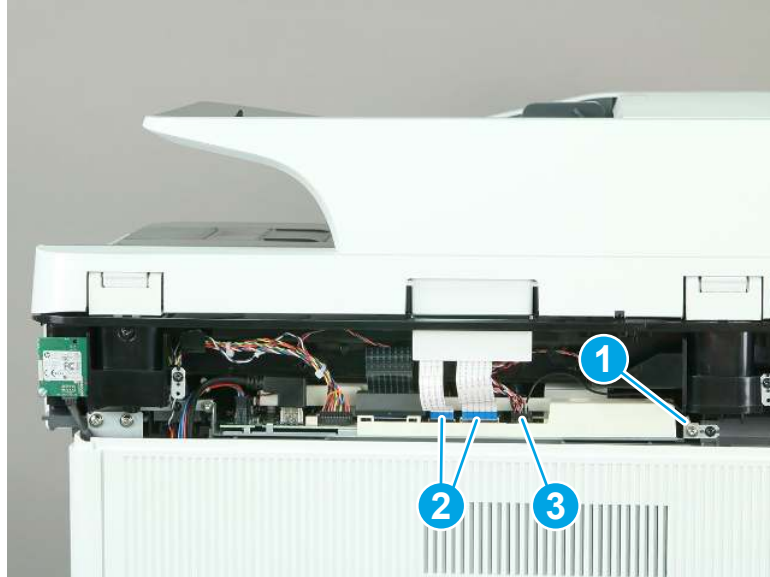
Figure 1-306 Remove the SCB cover



2. Remove the document feeder (M776dn/M776z/M776zs).
 - a. Remove one Torx T10 screw (callout 1) to release the ground wire, disconnect two flat cables (callout 2), and then disconnect one connector (callout 3).

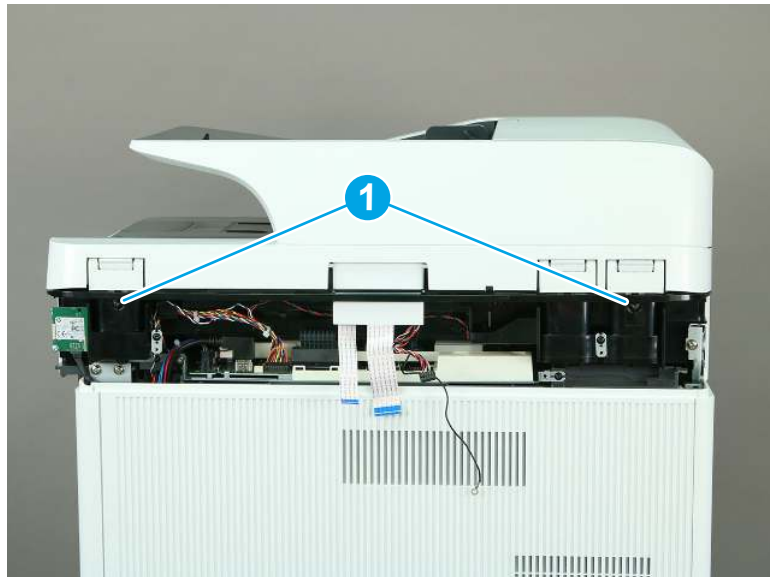
⚠ CAUTION: These connectors (callout 2) are zero insertion force (ZIF) connectors. The clip on these connectors is easily dislodged and lost.

Figure 1-307 Remove one screw and disconnect three connectors



- b. Remove two screws (callout 1).

Figure 1-308 Remove two screws



- c. Open the document feeder, and then lift it straight up until it stops at the retention tabs on each hinge (callout 1). Insert a small, flat-blade screwdriver between the hinge body and the slot in the scanner body (on the scanner glass side of the hinge) to release the retention tabs (on each hinge).

Figure 1-309 Release the hinges



- d. Carefully thread the document feeder flat cables, wire harness, and ground wire up and through the opening in the scanner cover to remove the document feeder.

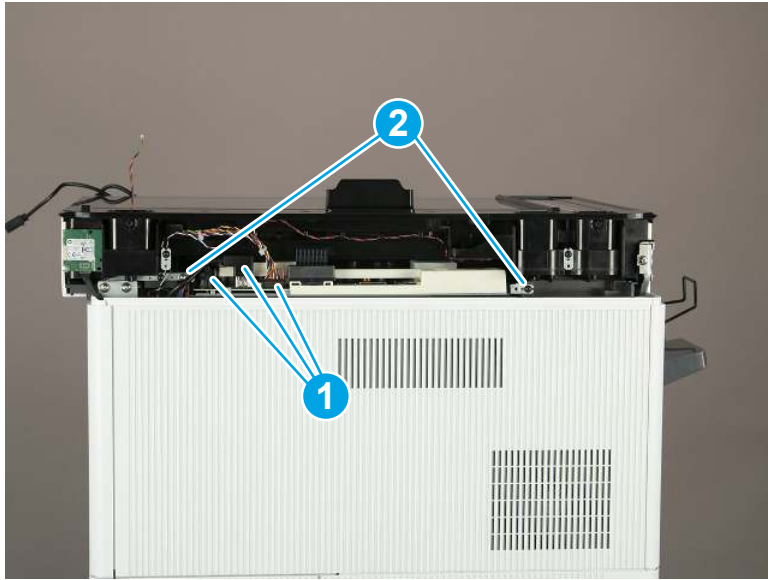
Figure 1-310 Remove the document feeder



3. Remove the image scanner (M776dn/M776z/M776zs).

- a. Disconnect three connectors (callout 1), and then remove two screws (callout 2).

Figure 1-311 Disconnect three connectors and remove two screws



- b. Release the tab on the back of the ferrite holder, and then lift the ferrite up to release it.

Figure 1-312 Release the ferrite holder



- c. Lift the ferrite up, and then disconnect one flat cable (callout 1).

⚠ CAUTION: This connector is a zero insertion force (ZIF) connector. The clip on this connector is easily dislodged and lost.

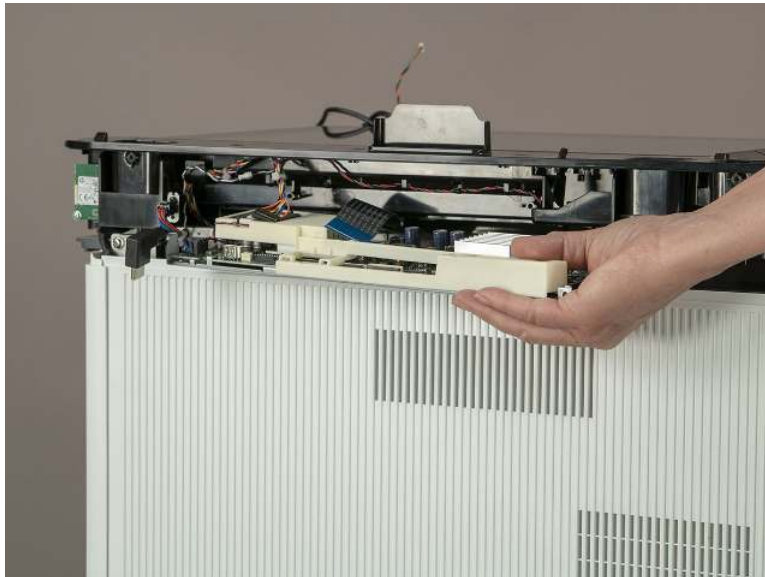
Slide the ferrite off of the flat cable after disconnecting it. The ferrite is not captive and can easily slip off and be damaged.

Figure 1-313 Disconnect one flat cable



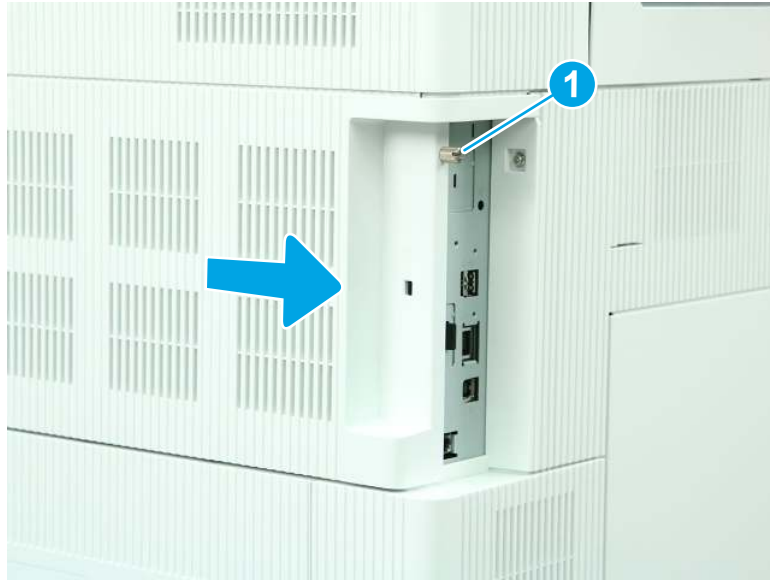
- d. Slide the scanner control board out of the image scanner to remove it.

Figure 1-314 Remove the scanner control board



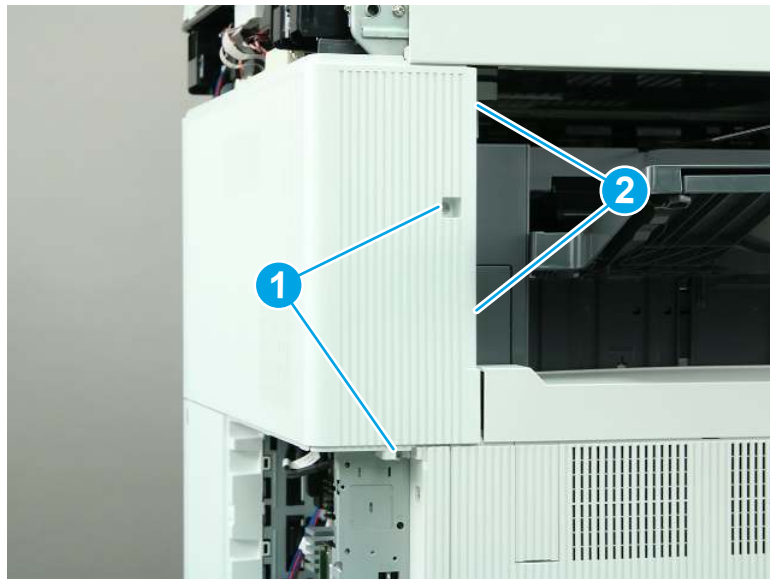
- e. Remove the formatter cover.

Figure 1-315 Remove the formatter cover



- f. Remove two screws (callout 1), and then release two tabs (callout 2).

Figure 1-316 Remove two screws and release two tabs



- g. Slide the cover to the right to remove it.

Figure 1-317 Remove the rear upper and left rear upper cover



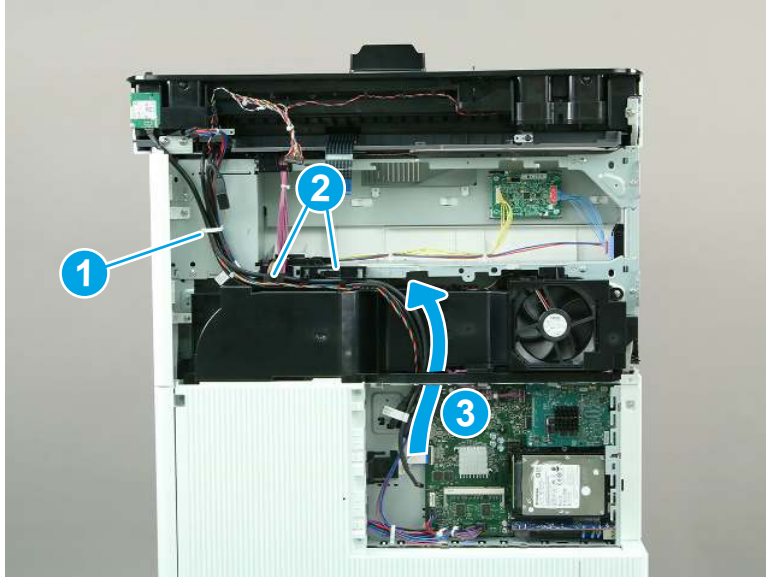
- h. Disconnect five connectors on the formatter (callout 1).

Figure 1-318 Disconnect five connectors



- i. Release one retainer (callout 1), release the cables from the guides (callout 2), and then pass the cables through the upper opening in the formatter cage (callout 3).

Figure 1-319 Release the cables



- j. Remove one screw (callout 1), and then remove the wireless PCA and cable (callout 2).

Figure 1-320 Remove the wireless PCA



- k. Remove four screws (callout 1).

Figure 1-321 Remove four screws



- l. Slightly slide the image scanner toward the front of the printer to release it, and then lift it straight up and off of the printer..


 **NOTE:** Pass the wire harness and cables through the opening in the printer.

Figure 1-322 Remove the image scanner




- 4. Unpack the replacement assembly.
 - a. Dispose of the defective part.


 **NOTE:** HP recommends responsible disposal of the defective part.

<http://www8.hp.com/us/en/hp-information/environment/product-recycling.html>

- b. Unpack the replacement part from the packaging.

 **IMPORTANT:** Make sure that all of the shipping materials (for example shipping tape) are removed from the replacement part prior to installation.

- c. To install an assembly, reverse the removal steps.

 **NOTE:** When applicable, special installation instructions are provided for an assembly at the end of the removal procedure. Always completely read the removal instructions and follow all special installation instructions.

Removal and replacement: Right upper cover (M776zs)

Learn how to remove and replace the right upper cover.


Mean time to repair: 5 minutes

Service level: Easy

Before performing service

Turn the printer power off

- Disconnect the power cable.

 **WARNING!** To avoid damage to the printer, turn the printer off, wait 30 seconds, and then remove the power cord before attempting to service the printer.

Use the table below to identify the correct part number for your printer. To order the part, go to www.hp.com/buy/parts.

Table 1-33 Part information

Part number	Part description
RC5-2733-000CN	Cover, right upper

Required tools

- #2 Phillips screwdriver with a magnetic tip

After performing service

Turn the printer power on

- Connect the power cable.
- Use the power switch to turn the power on.

Post service test

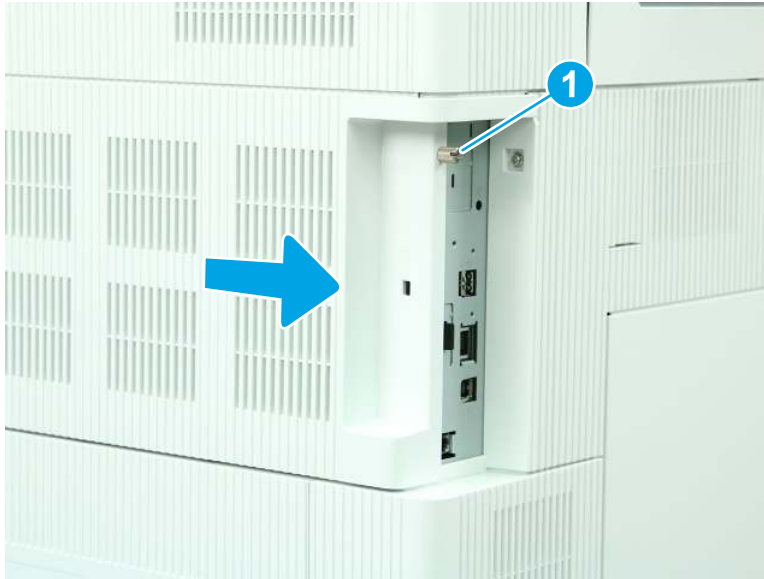
Make sure that the printer initializes to a **Ready** state.

Print a page to make sure that the printer is functioning correctly.

1. Remove the formatter cover.

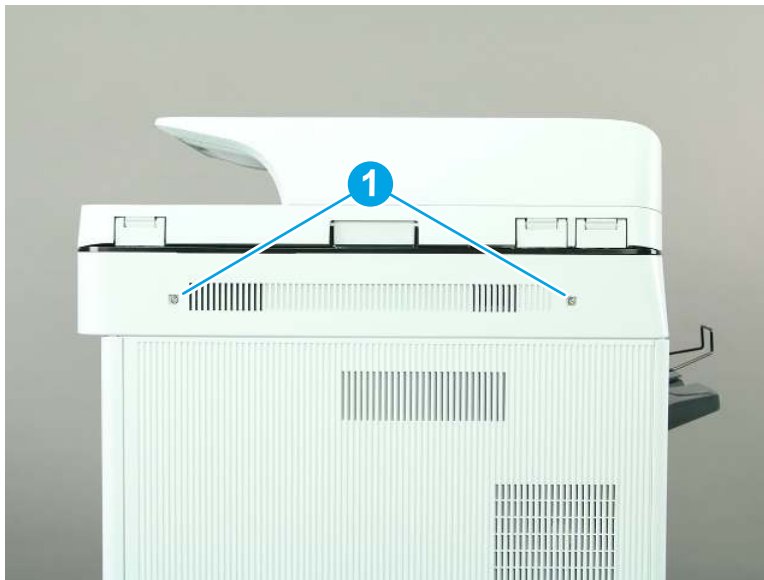
- ▲ Loosen one thumbscrew (callout 1), and then slide the formatter cover (callout 2) away from the printer to remove it.

Figure 1-323 Remove the formatter cover



- 2. Remove the scanner control board (SCB) cover (M776).
 - a. Remove two screws (callout 1).

Figure 1-324 Remove two screws



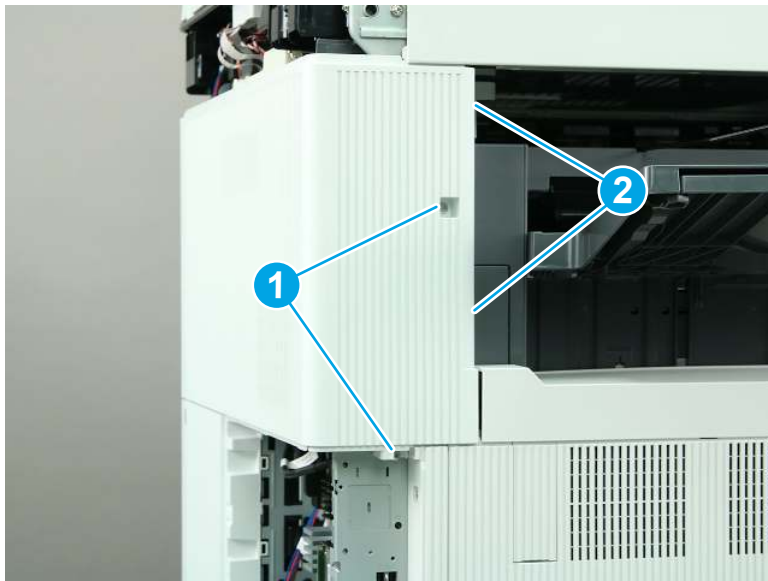
- b. Remove the SCB cover.

Figure 1-325 Remove the SCB cover



3. Remove the rear upper cover and left rear upper cover (M776zs).
 - a. Remove two screws (callout 1), and then release two tabs (callout 2).

Figure 1-326 Remove two screws and release two tabs



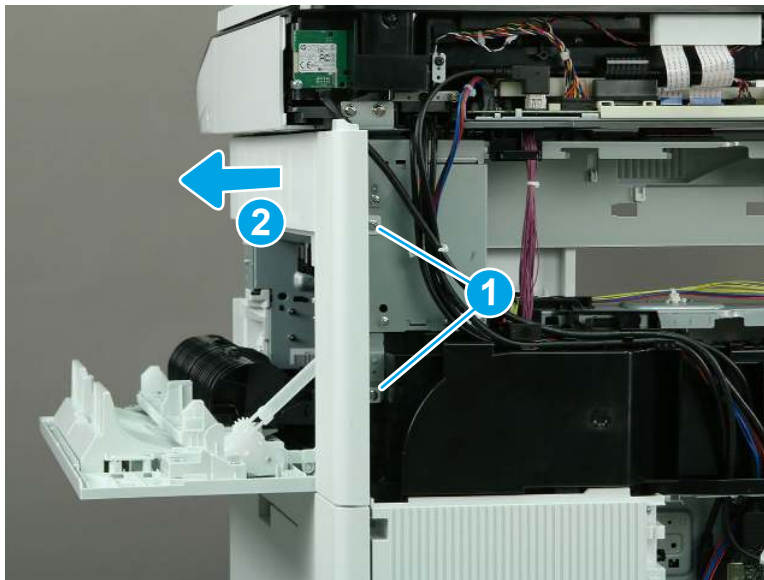
- b. Slide the cover to the right to remove it.

Figure 1-327 Remove the rear upper and left rear upper cover



4. Remove the right rear upper cover (M776zs).
 - ▲ Remove two screws (callout 1), and then slide the right rear upper cover away from the printer to remove it (callout 2).

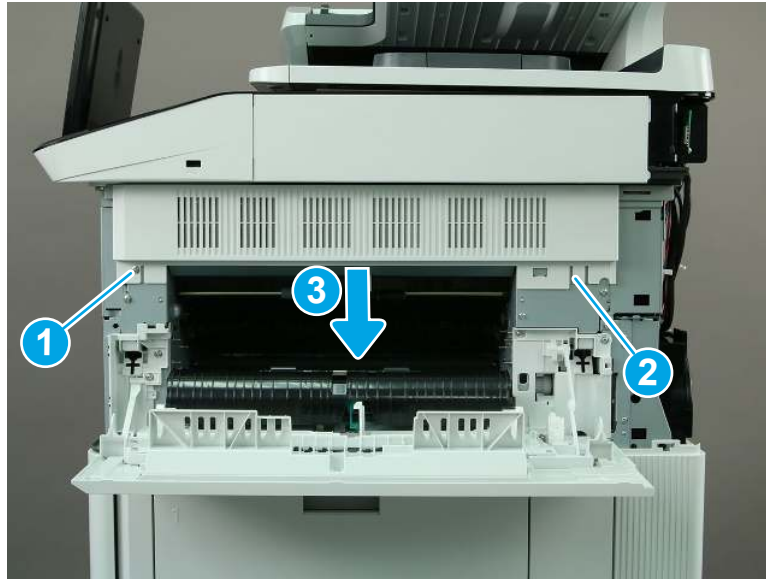
Figure 1-328 Remove the right rear upper cover



5. Remove the right upper cover (M776zs).

- ▲ Remove one screw (callout 1), release one tab (callout 2), and then slide the right upper cover down to remove it (callout 3).

Figure 1-329 Remove the right upper cover



6. Unpack the replacement assembly.

- a. Dispose of the defective part.



NOTE: HP recommends responsible disposal of the defective part.

<http://www8.hp.com/us/en/hp-information/environment/product-recycling.html>

- b. Unpack the replacement part from the packaging.



IMPORTANT: Make sure that all of the shipping materials (for example shipping tape) are removed from the replacement part prior to installation.

- c. To install an assembly, reverse the removal steps.



NOTE: When applicable, special installation instructions are provided for an assembly at the end of the removal procedure. Always completely read the removal instructions and follow all special installation instructions.

Removal and replacement: Right upper door (M776zs)

Learn how to remove and replace the right upper door (M776zs).

Mean time to repair: 8 minutes

Service level: Medium

Before performing service

Turn the printer power off

- Disconnect the power cable.

⚠ WARNING! To avoid damage to the printer, turn the printer off, wait 30 seconds, and then remove the power cord before attempting to service the printer.

Use the table below to identify the correct part number for your printer. To order the part, go to www.hp.com/buy/parts.

Table 1-34 Part information

Part number	Part description
RM2-1785-000CN	Right upper door assembly

Required tools

- Small, flat-blade screwdriver
- #2 Phillips screwdriver with a magnetic tip

After performing service

Turn the printer power on

- Connect the power cable.
- Use the power switch to turn the power on.

Post service test

Make sure that the printer initializes to a **Ready** state.

Print a page to make sure that the printer is functioning correctly.

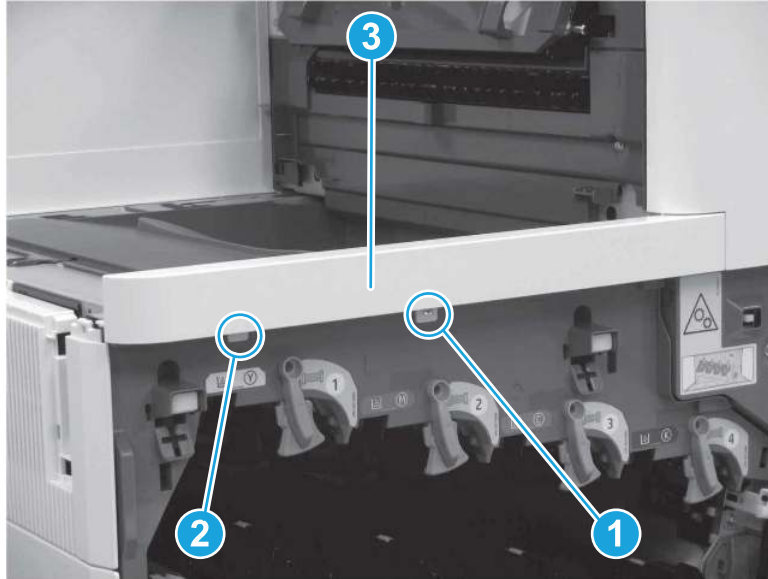
1. Remove the front cover (M776zs).
 - a. Open the front door.

Figure 1-330 Open the front door



- b. Remove one screw (callout 1), release one tab (callout 2), and then remove the front cover (callout 3).

Figure 1-331 Remove the front cover



2. Remove the control panel (M776).

- a. Rotate the control panel to the fully raised position (callout 1), and then raise the document feeder (callout 2).

Figure 1-332 Raise the control panel and document feeder



- b. Beginning at the right side of the control-panel cover, carefully release five tabs along the top edge of the cover.

 **NOTE:** The thin black-plastic cover will separate from the white-plastic control-panel base.

Figure 1-333 Release the control panel cover



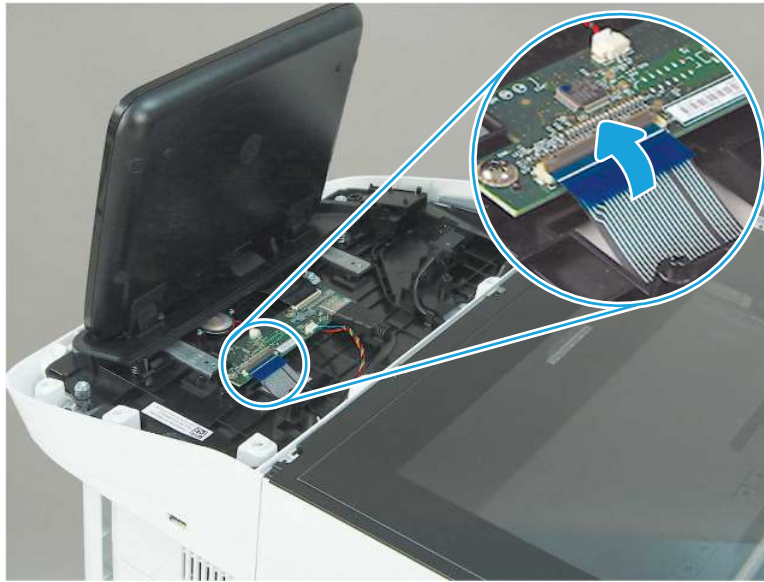
- c. Rotate the control panel cover slightly forward (callout 1), and then lift up to remove the cover (callout 2).

Figure 1-334 Remove the control panel cover



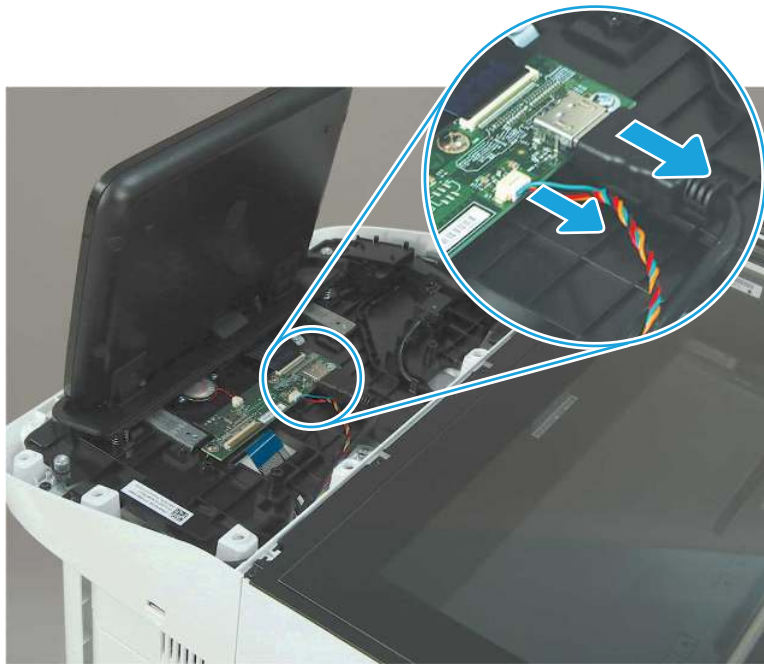
- d. **M776z or M776zs only:** Open the connector latch to release the keyboard flat cable.

Figure 1-335 Release the keyboard flat cable (M776z/M776zs)



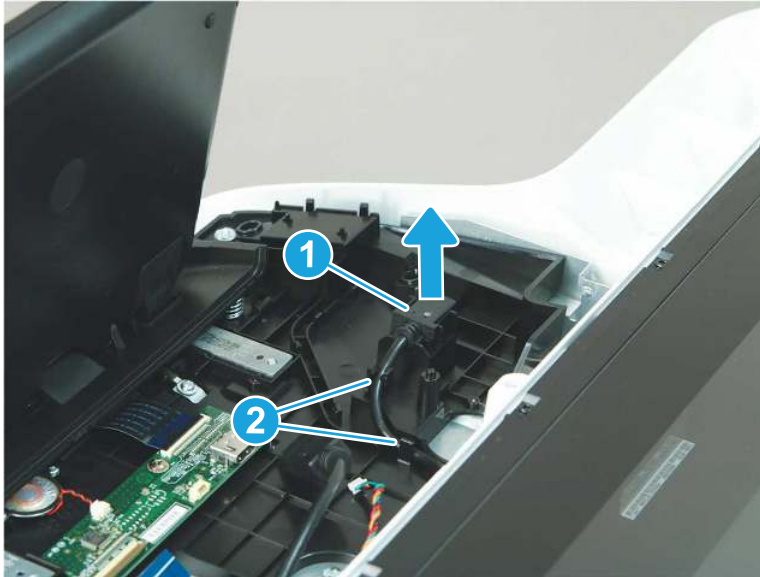
- e. Disconnect two connectors

Figure 1-336 Disconnect two connectors



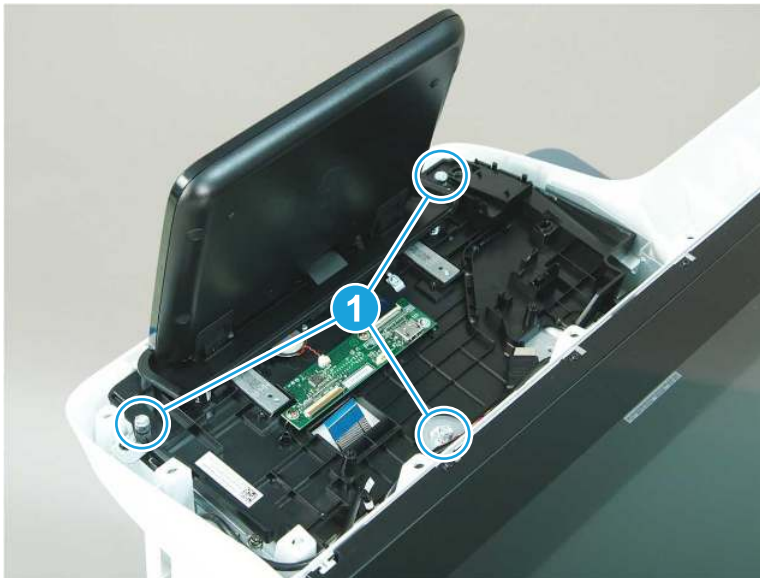
- f. Remove the USB cable (callout 1) from the holder, and then release the cable from two retainers (callout 2).

Figure 1-337 Release the USB cable



- g. Remove three screws (callout 1).

Figure 1-338 Remove three screws



- h. Lift the front of the control panel off of the printer (callout 1), and then slide it towards the front of the printer (callout 2) to remove it.

Figure 1-339 Remove the control panel



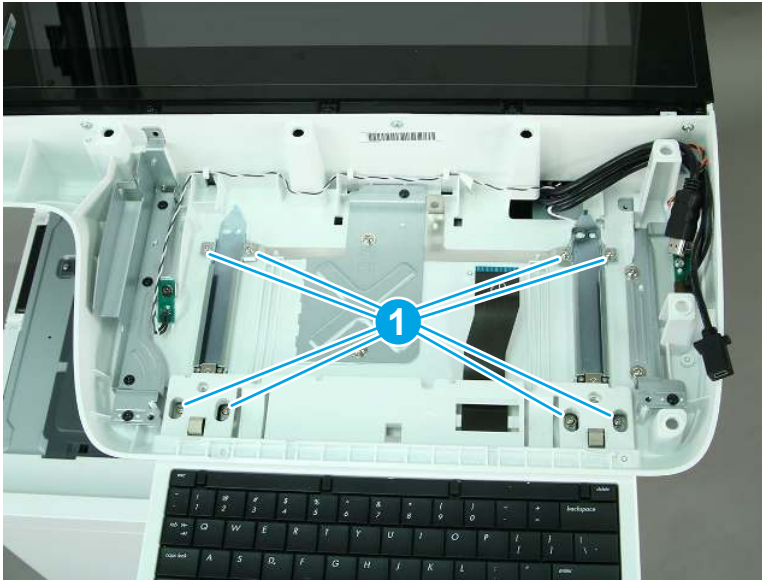
- 3. Remove the keyboard (M776z/M776zs).
 - a. Pull the keyboard out to its extended position.

Figure 1-340 Pull the keyboard out



- b. Remove eight screws (callout 1).

Figure 1-341 Remove eight screws



- c. Remove the keyboard and rails.

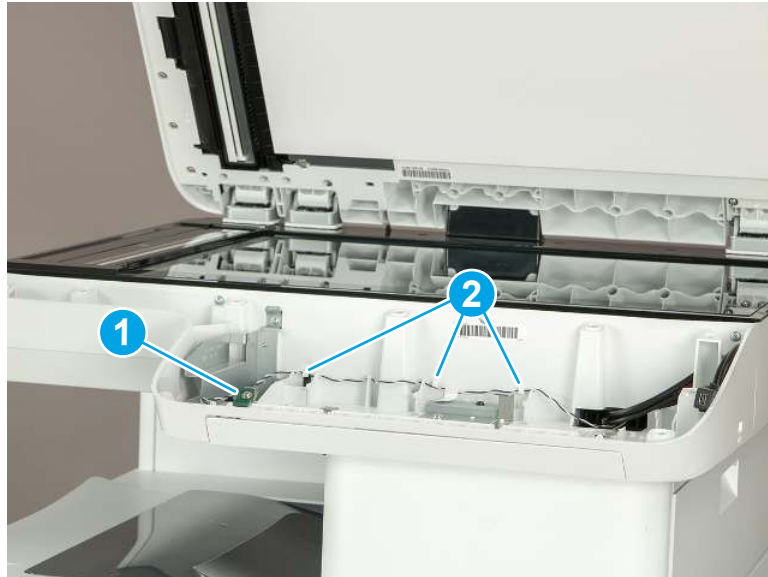
Figure 1-342 Remove the keyboard and rails



- 4. Remove the nose cone (M776).

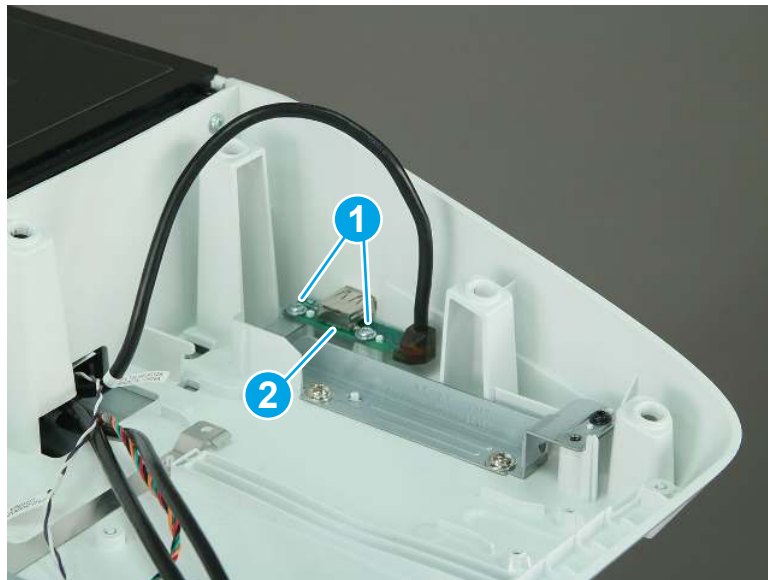
- a. Remove one screw (callout 1) to release the light PCA. Release the cable from three retainers (callout 2), and then move the light PCA out of the way.

Figure 1-343 Release the light PCA



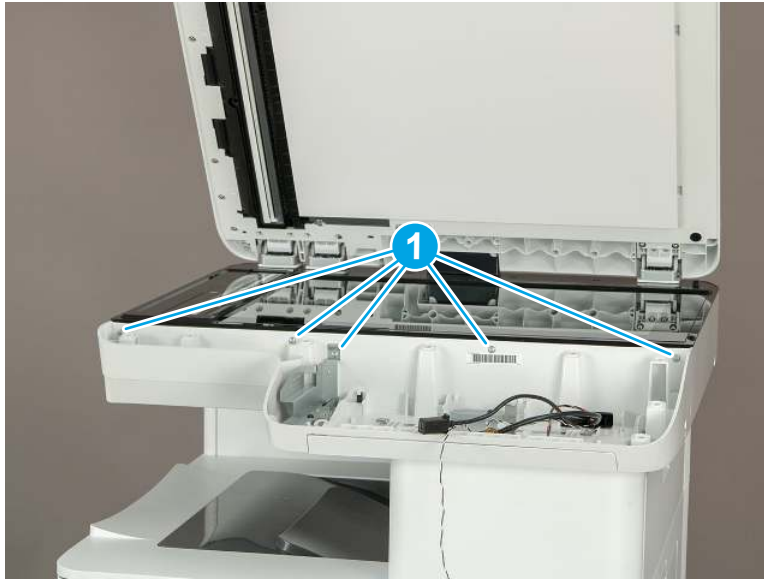
- b. Remove two screws (callout 1), and then move the USB port PCA (callout 2) out of the way.

Figure 1-344 Release the USB port PCA



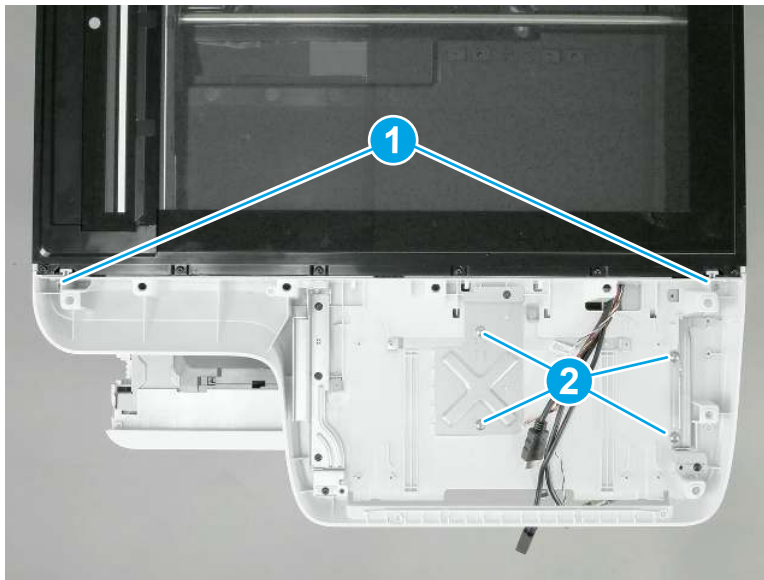
- c. Remove five screws (callout 1).

Figure 1-345 Remove four screws



- d. Remove two small, self-tapping screws (callout 1), and then remove four larger machine screws (callout 2).

Figure 1-346 Remove six screws



- e. Lift the nose cone up and off of the printer to remove it.


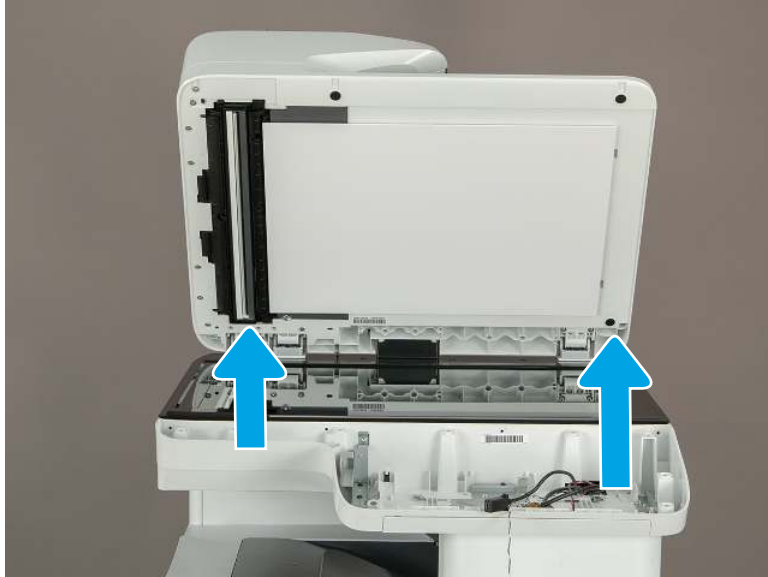
 **NOTE:** Pass the wire harnesses and cables through the opening in the nose cone when removing it.

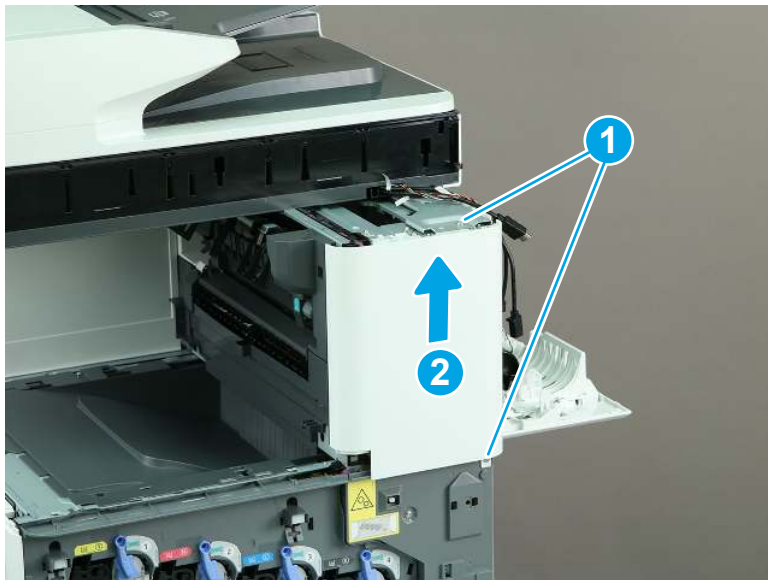
Figure 1-347 Remove the nose cone



5. Remove the right front cover (M776zs).

- ▲ Remove two screws (callout 1), release one tab (callout 2), and then slide the right front cover up (callout 2) to remove it.

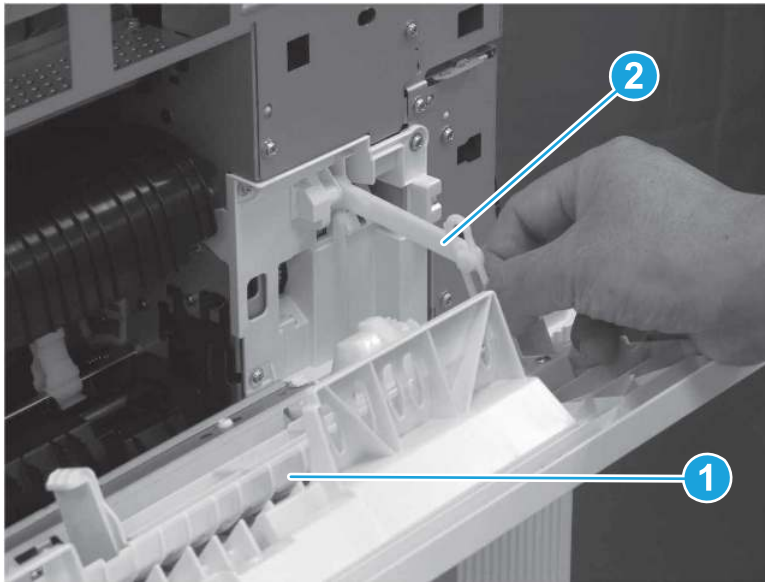
Figure 1-348 Remove the right front cover



6. Remove the right upper door (M776zs).

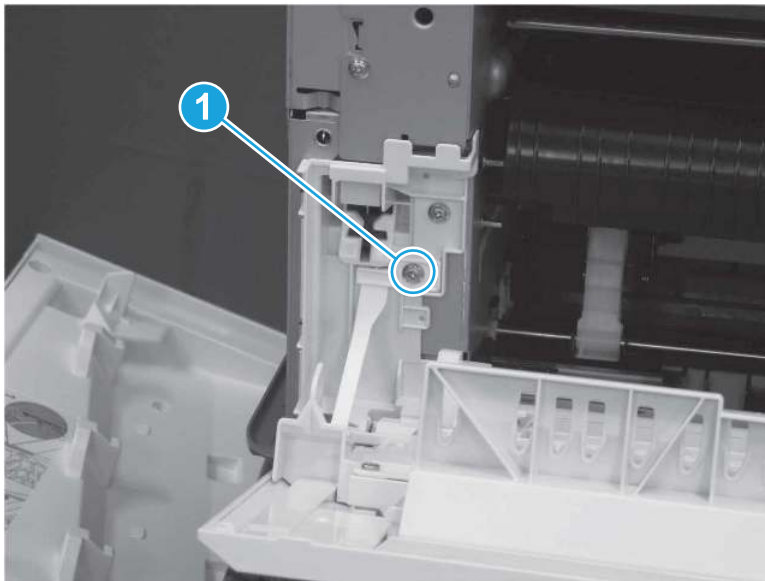
- a. Open the right upper door (callout 1), and then release the link (callout 2).

Figure 1-349 Open the door and release the link



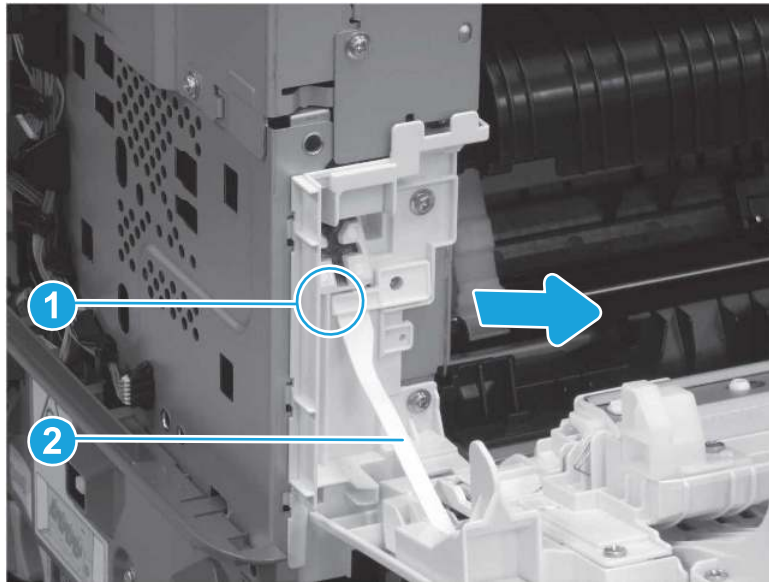
- b. Remove one screw (callout 1).

Figure 1-350 Remove one screw



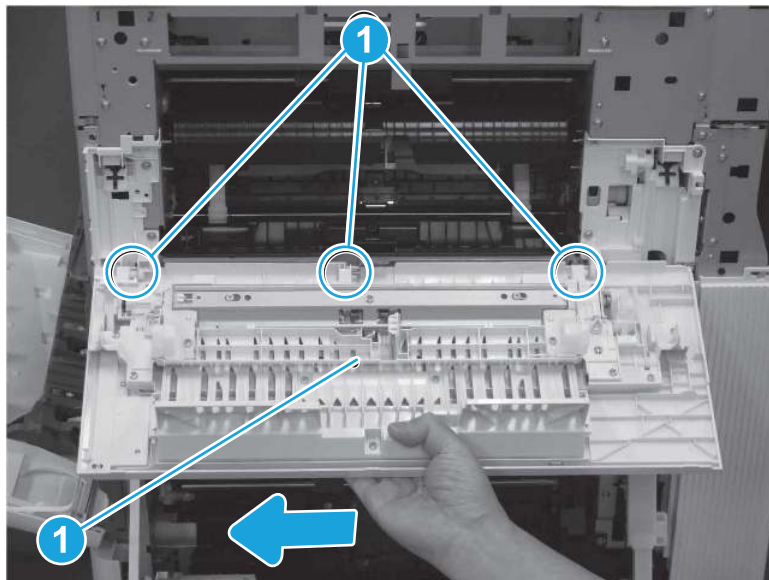
- c. Release one boss (callout 1) and then release the hinge (callout 2) by sliding it to the right.

Figure 1-351 Release one boss and hinge



- d. Slide the right upper door (callout 1) to the right to release it from three bushings (callout 2), and then remove the right upper door.

Figure 1-352 Remove the right upper door




7. Unpack the replacement assembly.
 - a. Dispose of the defective part.




NOTE: HP recommends responsible disposal of the defective part.

<http://www8.hp.com/us/en/hp-information/environment/product-recycling.html>

- b. Unpack the replacement part from the packaging.

 **IMPORTANT:** Make sure that all of the shipping materials (for example shipping tape) are removed from the replacement part prior to installation.

- c. To install an assembly, reverse the removal steps.

 **NOTE:** When applicable, special installation instructions are provided for an assembly at the end of the removal procedure. Always completely read the removal instructions and follow all special installation instructions.

Removal and replacement: Right rear upper cover (M776zs)

Learn how to remove and replace the right rear upper cover.


Mean time to repair: 6 minutes

Service level: Easy

Before performing service

Turn the printer power off

- Disconnect the power cable.

 **WARNING!** To avoid damage to the printer, turn the printer off, wait 30 seconds, and then remove the power cord before attempting to service the printer.

Use the table below to identify the correct part number for your printer. To order the part, go to www.hp.com/buy/parts.

Table 1-35 Part information

Part number	Part description
RC5-2735-000CN	Cover, rear right, upper

Required tools

- #2 Phillips screwdriver with a magnetic tip

After performing service

Turn the printer power on

- Connect the power cable.
- Use the power switch to turn the power on.

Post service test

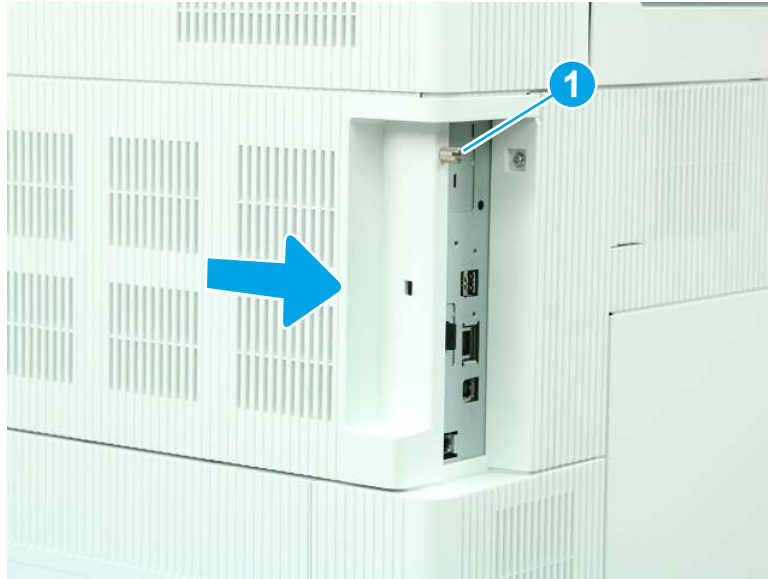
Make sure that the printer initializes to a **Ready** state.

Print a page to make sure that the printer is functioning correctly.

1. Remove the formatter cover.

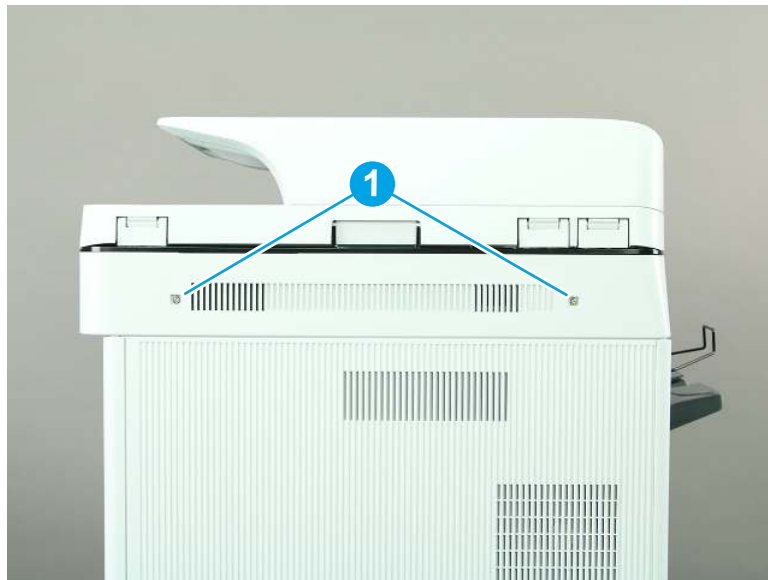
- ▲ Loosen one thumbscrew (callout 1), and then slide the formatter cover (callout 2) away from the printer to remove it.

Figure 1-353 Remove the formatter cover



- 2. Remove the scanner control board (SCB) cover (M776).
 - a. Remove two screws (callout 1).

Figure 1-354 Remove two screws



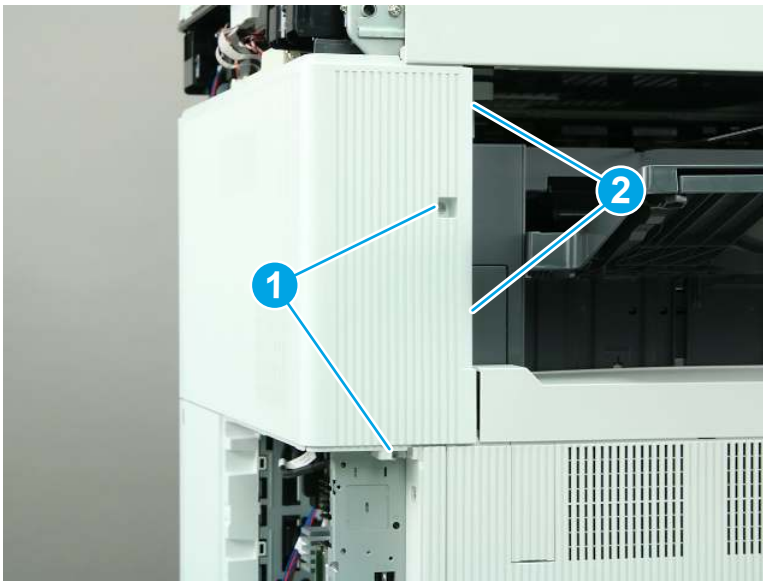
- b. Remove the SCB cover.

Figure 1-355 Remove the SCB cover



3. Remove the rear upper cover and left rear upper cover (M776zs).
 - a. Remove two screws (callout 1), and then release two tabs (callout 2).

Figure 1-356 Remove two screws and release two tabs



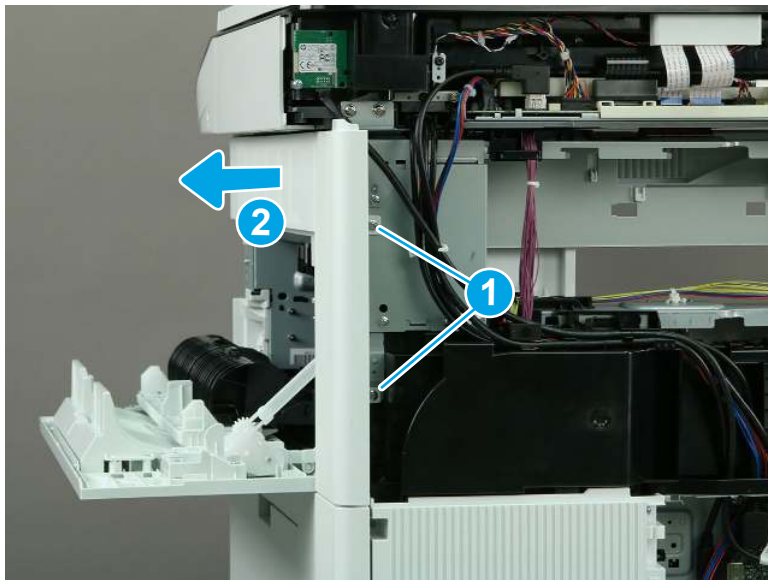
- b. Slide the cover to the right to remove it.

Figure 1-357 Remove the rear upper and left rear upper cover



4. Remove the right rear upper cover (M776zs).
 - ▲ Remove two screws (callout 1), and then slide the right rear upper cover away from the printer to remove it (callout 2).

Figure 1-358 Remove the right rear upper cover




5. Unpack the replacement assembly.
 - a. Dispose of the defective part.




NOTE: HP recommends responsible disposal of the defective part.

<http://www8.hp.com/us/en/hp-information/environment/product-recycling.html>

- b. Unpack the replacement part from the packaging.

 **IMPORTANT:** Make sure that all of the shipping materials (for example shipping tape) are removed from the replacement part prior to installation.

- c. To install an assembly, reverse the removal steps.

 **NOTE:** When applicable, special installation instructions are provided for an assembly at the end of the removal procedure. Always completely read the removal instructions and follow all special installation instructions.

Removal and replacement: Rear upper cover (M776zs)

Learn how to remove and replace the rear upper cover.


Mean time to repair: 3 minutes

Service level: Easy

Before performing service

Turn the printer power off

- Disconnect the power cable.

 **WARNING!** To avoid damage to the printer, turn the printer off, wait 30 seconds, and then remove the power cord before attempting to service the printer.

Use the table below to identify the correct part number for your printer. To order the part, go to www.hp.com/buy/parts.

Table 1-36 Part information

Part number	Part description
RC5-2730-000CN	Cover, rear, upper

Required tools

- #2 Phillips screwdriver with a magnetic tip

After performing service

Turn the printer power on

- Connect the power cable.
- Use the power switch to turn the power on.

Post service test

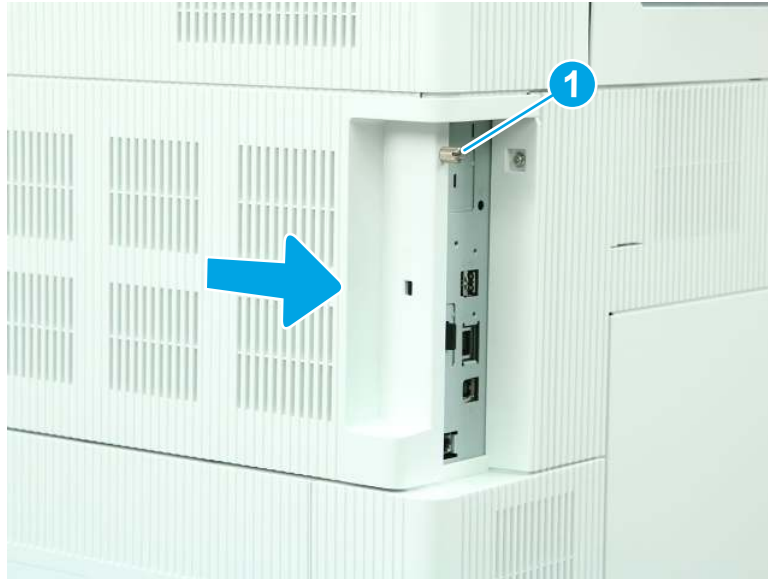
Make sure that the printer initializes to a **Ready** state.

Print a page to make sure that the printer is functioning correctly.

1. Remove the formatter cover.

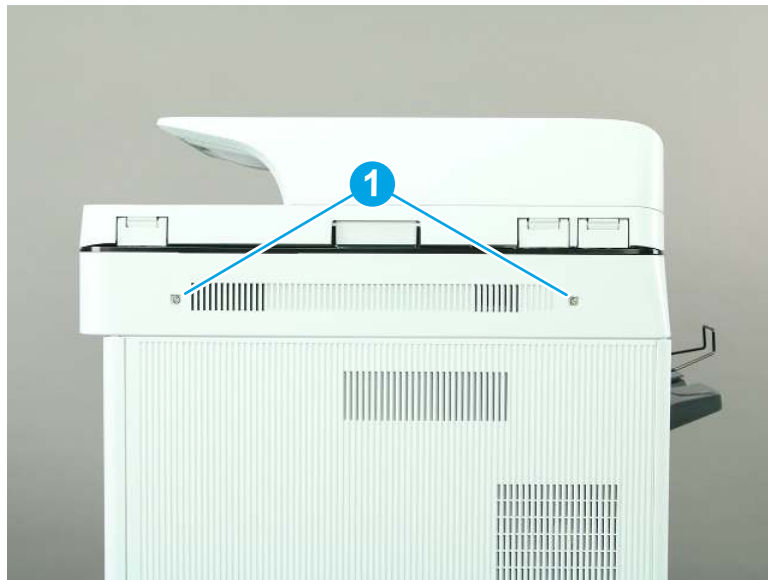
- ▲ Loosen one thumbscrew (callout 1), and then slide the formatter cover (callout 2) away from the printer to remove it.

Figure 1-359 Remove the formatter cover



- 2. Remove the scanner control board (SCB) cover (M776).
 - a. Remove two screws (callout 1).

Figure 1-360 Remove two screws



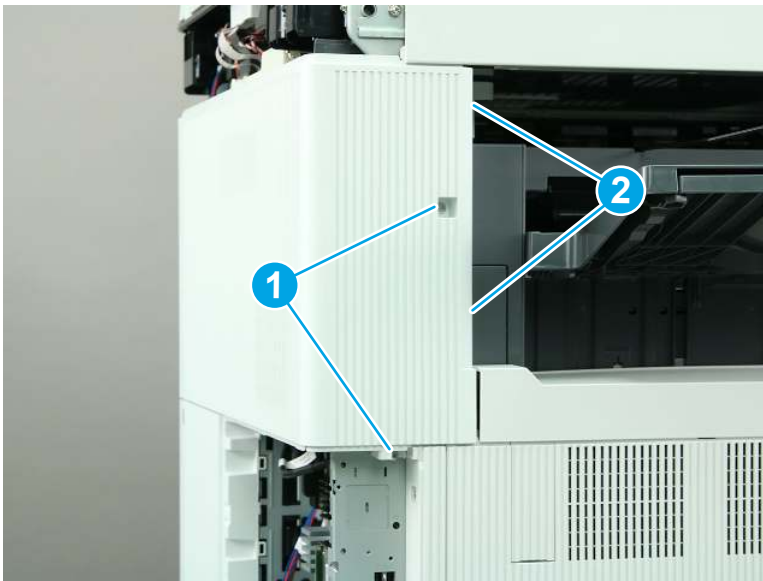
- b. Remove the SCB cover.

Figure 1-361 Remove the SCB cover



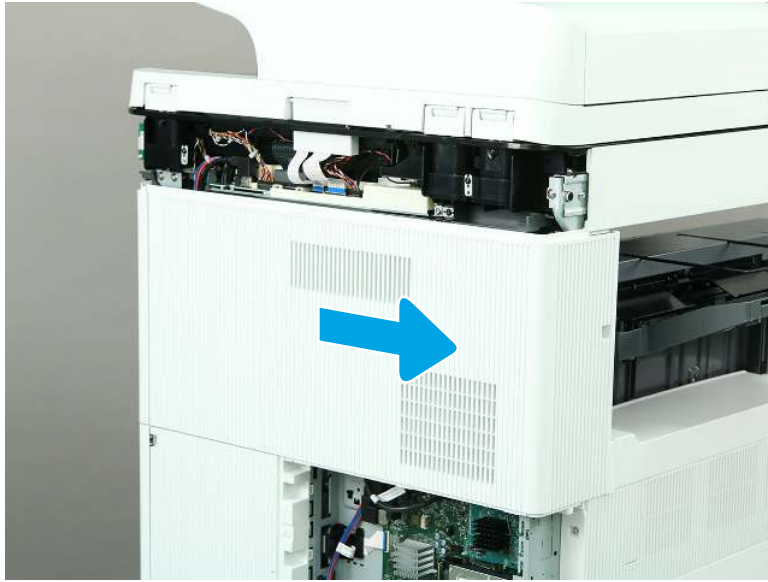
3. Remove the rear upper cover and left rear upper cover (M776zs).
 - a. Remove two screws (callout 1), and then release two tabs (callout 2).

Figure 1-362 Remove two screws and release two tabs



- b. Slide the cover to the right to remove it.

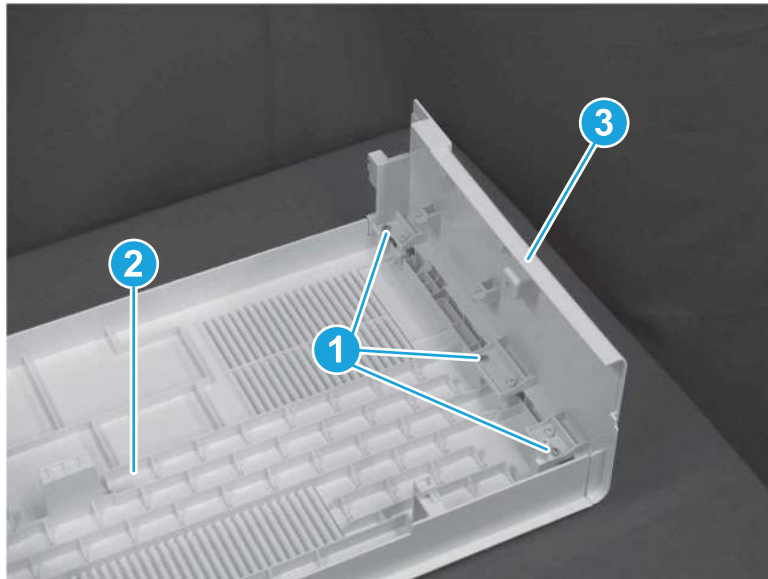
Figure 1-363 Remove the rear upper and left rear upper cover



- c. Remove three screws (callout 1), and then separate the rear upper cover (callout 2) from the left rear upper cover (callout 3).

 **TIP:** Install the left rear upper cover on the replacement rear upper cover.

Figure 1-364 Remove the left rear upper cover




4. Unpack the replacement assembly.
 - a. Dispose of the defective part.


 **NOTE:** HP recommends responsible disposal of the defective part.

<http://www8.hp.com/us/en/hp-information/environment/product-recycling.html>

- b. Unpack the replacement part from the packaging.

 **IMPORTANT:** Make sure that all of the shipping materials (for example shipping tape) are removed from the replacement part prior to installation.

- c. To install an assembly, reverse the removal steps.

 **NOTE:** When applicable, special installation instructions are provided for an assembly at the end of the removal procedure. Always completely read the removal instructions and follow all special installation instructions.

Removal and replacement: Main cover (M776zs)

Learn how to remove and replace the main cover.


Mean time to repair: 3 minutes

Service level: Easy

Before performing service

Turn the printer power off

- Disconnect the power cable.

 **WARNING!** To avoid damage to the printer, turn the printer off, wait 30 seconds, and then remove the power cord before attempting to service the printer.

Use the table below to identify the correct part number for your printer. To order the part, go to www.hp.com/buy/parts.

Table 1-37 Part information

Part number	Part description
RC5-2731-000CN	Cover, main

Required tools

- #2 Phillips screwdriver with a magnetic tip

After performing service

Turn the printer power on

- Connect the power cable.
- Use the power switch to turn the power on.

Post service test

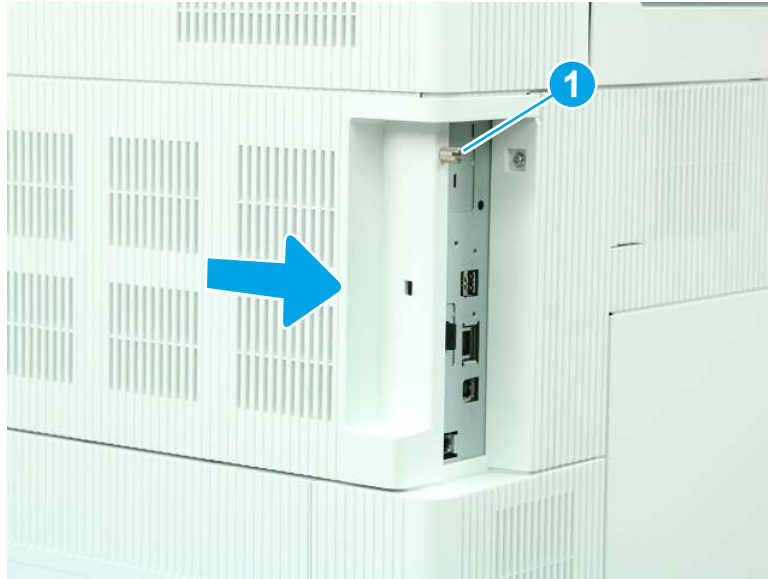
Make sure that the printer initializes to a **Ready** state.

Print a page to make sure that the printer is functioning correctly.

1. Remove the formatter cover.

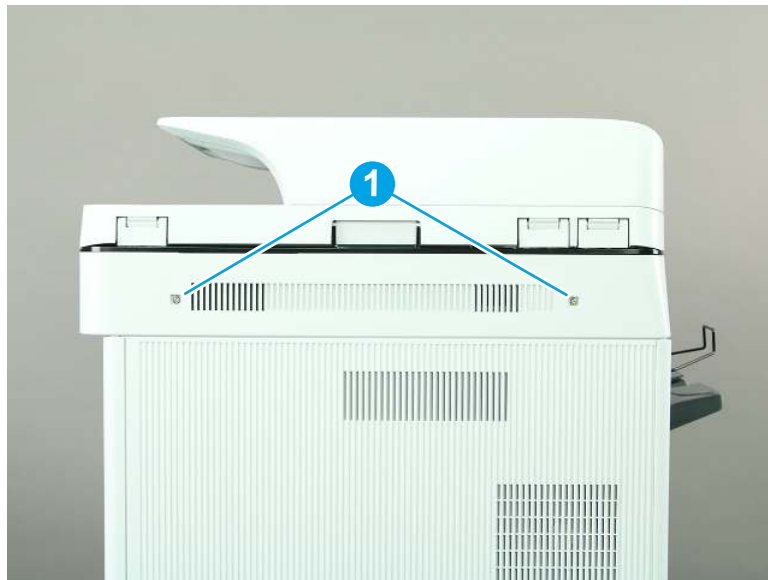
- ▲ Loosen one thumbscrew (callout 1), and then slide the formatter cover (callout 2) away from the printer to remove it.

Figure 1-365 Remove the formatter cover



- 2. Remove the scanner control board (SCB) cover (M776).
 - a. Remove two screws (callout 1).

Figure 1-366 Remove two screws



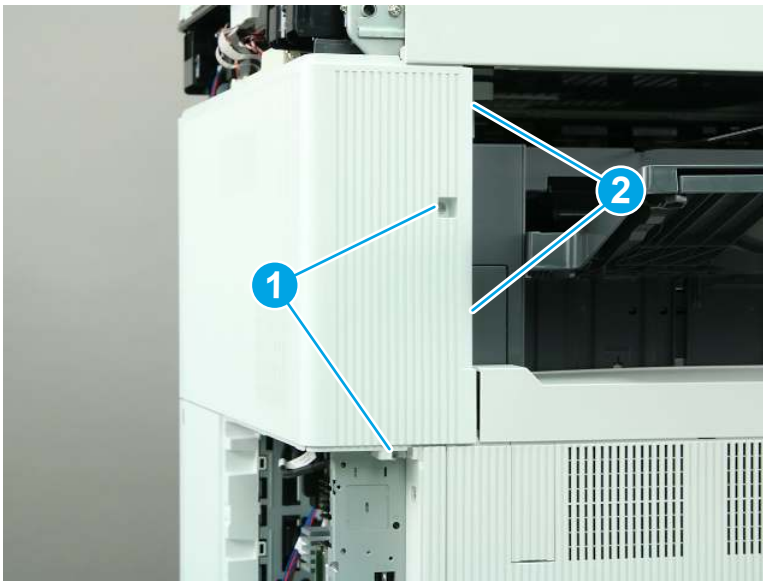
- b. Remove the SCB cover.

Figure 1-367 Remove the SCB cover



3. Remove the rear upper cover and left rear upper cover (M776zs).
 - a. Remove two screws (callout 1), and then release two tabs (callout 2).

Figure 1-368 Remove two screws and release two tabs



- b. Slide the cover to the right to remove it.

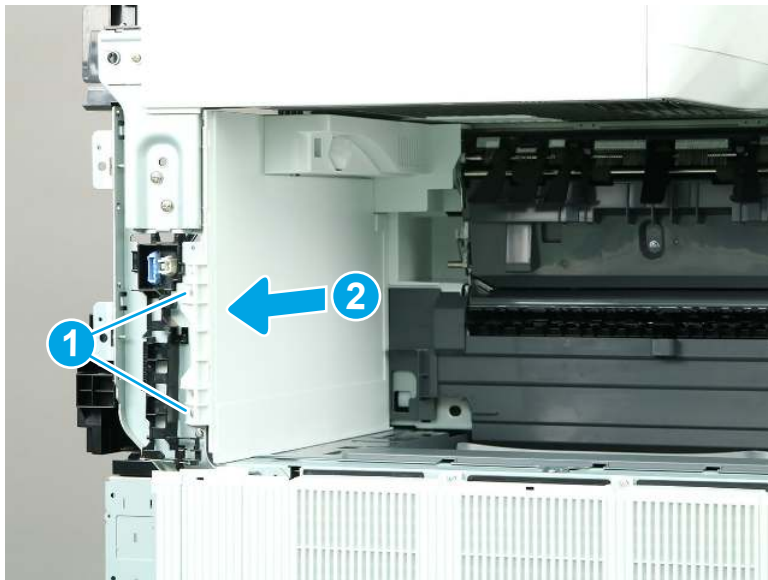
Figure 1-369 Remove the rear upper and left rear upper cover



4. Remove the main cover (M776zs).

- ▲ Remove two screws (callout 1), and then slide the main cover away from the printer to remove it (callout 2).

Figure 1-370 Remove the main cover




5. Unpack the replacement assembly.
 - a. Dispose of the defective part.




NOTE: HP recommends responsible disposal of the defective part.

<http://www8.hp.com/us/en/hp-information/environment/product-recycling.html>

- b. Unpack the replacement part from the packaging.

 **IMPORTANT:** Make sure that all of the shipping materials (for example shipping tape) are removed from the replacement part prior to installation.

- c. To install an assembly, reverse the removal steps.

 **NOTE:** When applicable, special installation instructions are provided for an assembly at the end of the removal procedure. Always completely read the removal instructions and follow all special installation instructions.

Removal and replacement: Front cover (M776zs)

Learn how to remove and replace the front cover.


Mean time to repair: 2 minutes

Service level: Easy

Before performing service

Turn the printer power off

- Disconnect the power cable.

 **WARNING!** To avoid damage to the printer, turn the printer off, wait 30 seconds, and then remove the power cord before attempting to service the printer.

Use the table below to identify the correct part number for your printer. To order the part, go to www.hp.com/buy/parts.

Table 1-38 Part information

Part number	Part description
RC5-2732-000CN	Cover, front

Required tools

- Small, flat-blade screwdriver
- #2 Phillips screwdriver with a magnetic tip

After performing service

Turn the printer power on

- Connect the power cable.
- Use the power switch to turn the power on.

Post service test

Make sure that the printer initializes to a **Ready** state.

Print a page to make sure that the printer is functioning correctly.

1. Remove the front cover (M776zs).

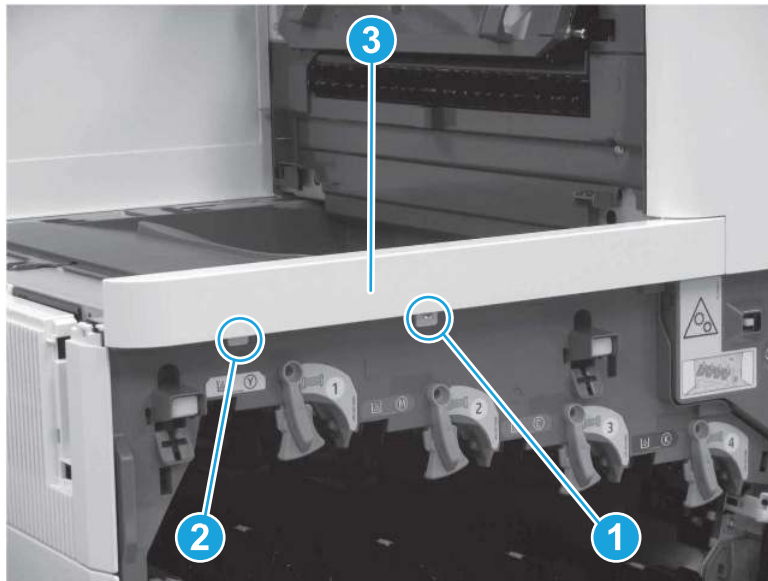
- a. Open the front door.

Figure 1-371 Open the front door



- b. Remove one screw (callout 1), release one tab (callout 2), and then remove the front cover (callout 3).

Figure 1-372 Remove the front cover




2. Unpack the replacement assembly.
 - a. Dispose of the defective part.




NOTE: HP recommends responsible disposal of the defective part.

<http://www8.hp.com/us/en/hp-information/environment/product-recycling.html>

- b. Unpack the replacement part from the packaging.

 **IMPORTANT:** Make sure that all of the shipping materials (for example shipping tape) are removed from the replacement part prior to installation.

- c. To install an assembly, reverse the removal steps.

 **NOTE:** When applicable, special installation instructions are provided for an assembly at the end of the removal procedure. Always completely read the removal instructions and follow all special installation instructions.

Removal and replacement: Right front cover (M776zs)

Learn how to remove and replace the right front cover.


Mean time to repair: 8 minutes

Service level: Easy

Before performing service

Turn the printer power off

- Disconnect the power cable.

 **WARNING!** To avoid damage to the printer, turn the printer off, wait 30 seconds, and then remove the power cord before attempting to service the printer.

Use the table below to identify the correct part number for your printer. To order the part, go to www.hp.com/buy/parts.

Table 1-39 Part information

Part number	Part description
RM2-2661-000CN	Right front cover assembly

Required tools

- Small, flat-blade screwdriver
- #2 Phillips screwdriver with a magnetic tip

After performing service

Turn the printer power on

- Connect the power cable.
- Use the power switch to turn the power on.

Post service test

Make sure that the printer initializes to a **Ready** state.

Print a page to make sure that the printer is functioning correctly.

1. Remove the front cover (M776zs).

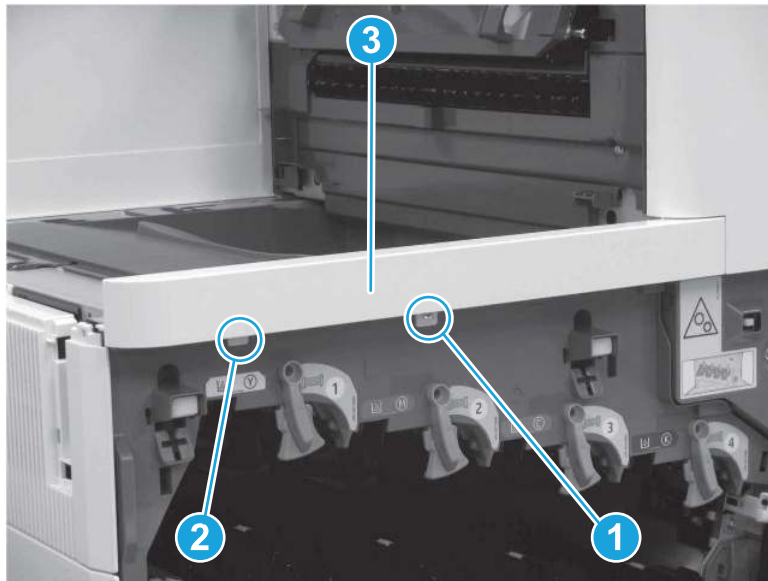
- a. Open the front door.

Figure 1-373 Open the front door



- b. Remove one screw (callout 1), release one tab (callout 2), and then remove the front cover (callout 3).

Figure 1-374 Remove the front cover



2. Remove the control panel (M776).

- a. Rotate the control panel to the fully raised position (callout 1), and then raise the document feeder (callout 2).

Figure 1-375 Raise the control panel and document feeder



- b. Beginning at the right side of the control-panel cover, carefully release five tabs along the top edge of the cover.

 **NOTE:** The thin black-plastic cover will separate from the white-plastic control-panel base.

Figure 1-376 Release the control panel cover



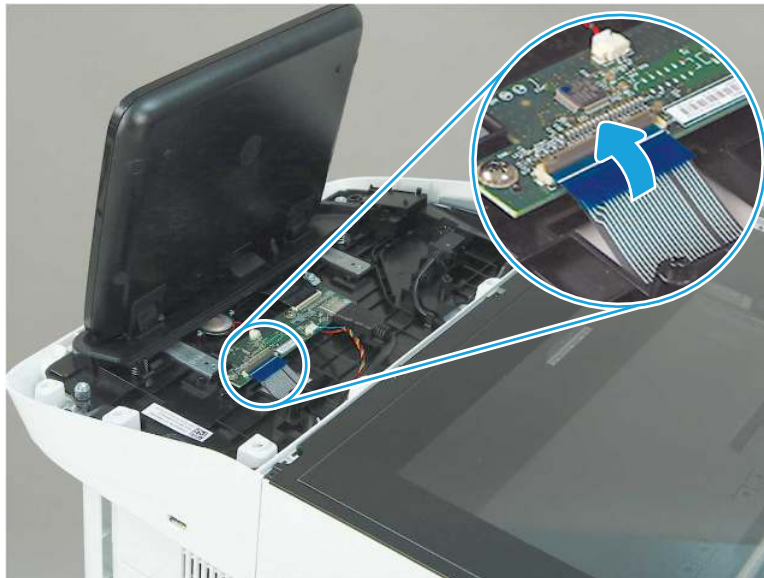
- c. Rotate the control panel cover slightly forward (callout 1), and then lift up to remove the cover (callout 2).

Figure 1-377 Remove the control panel cover



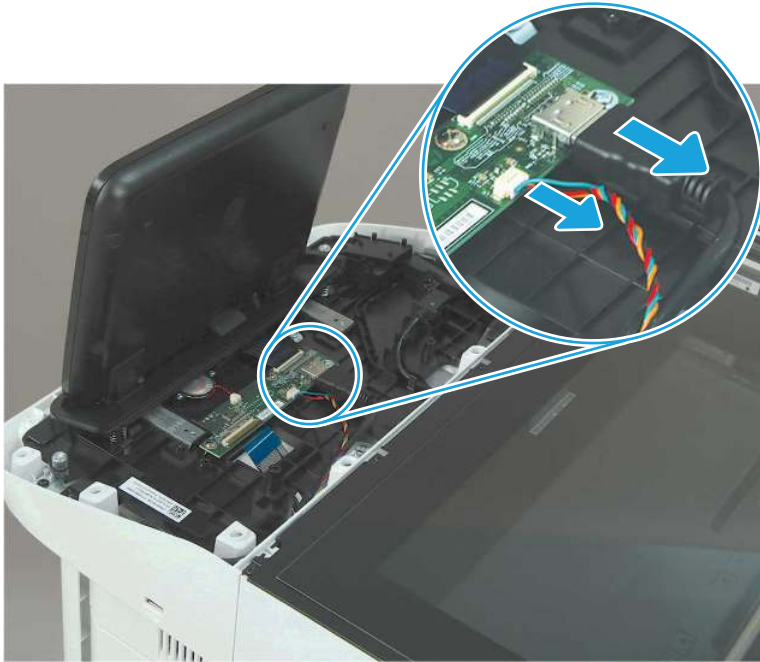
- d. **M776z or M776zs only:** Open the connector latch to release the keyboard flat cable.

Figure 1-378 Release the keyboard flat cable (M776z/M776zs)



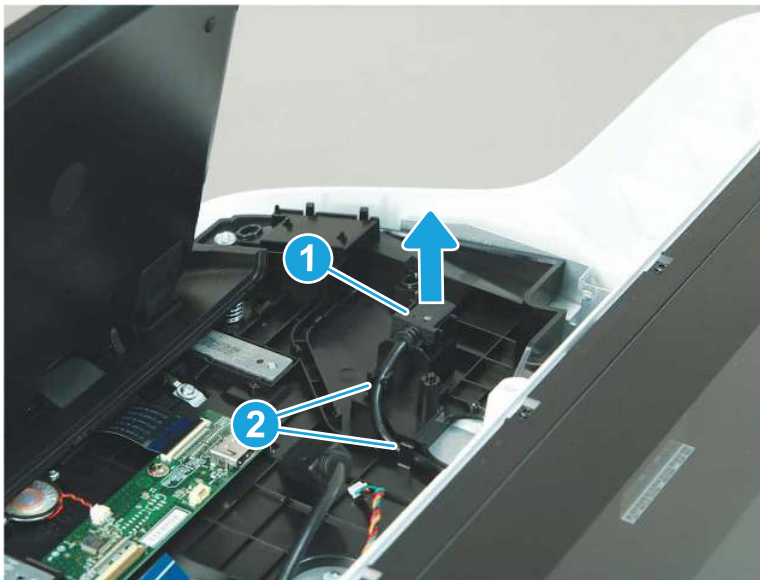
- e. Disconnect two connectors

Figure 1-379 Disconnect two connectors



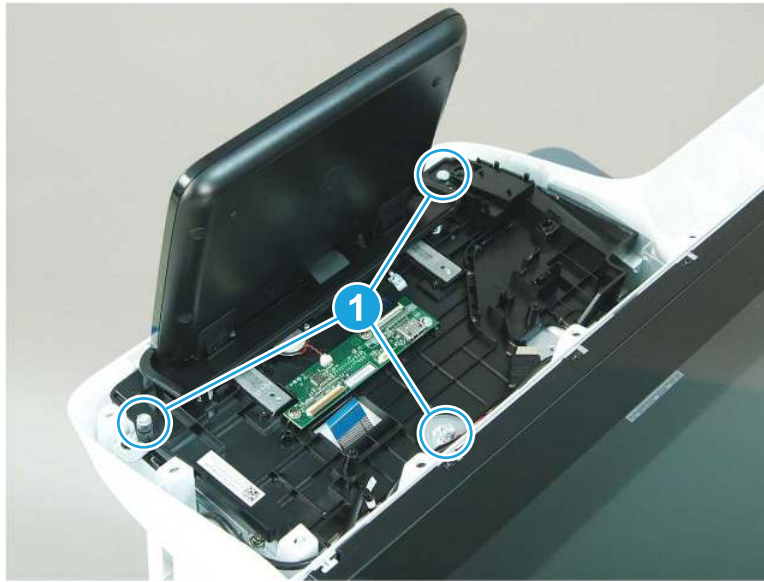
- f. Remove the USB cable (callout 1) from the holder, and then release the cable from two retainers (callout 2).

Figure 1-380 Release the USB cable



- g. Remove three screws (callout 1).

Figure 1-381 Remove three screws



- h. Lift the front of the control panel off of the printer (callout 1), and then slide it towards the front of the printer (callout 2) to remove it.

Figure 1-382 Remove the control panel



- 3. Remove the keyboard (M776z/M776zs).

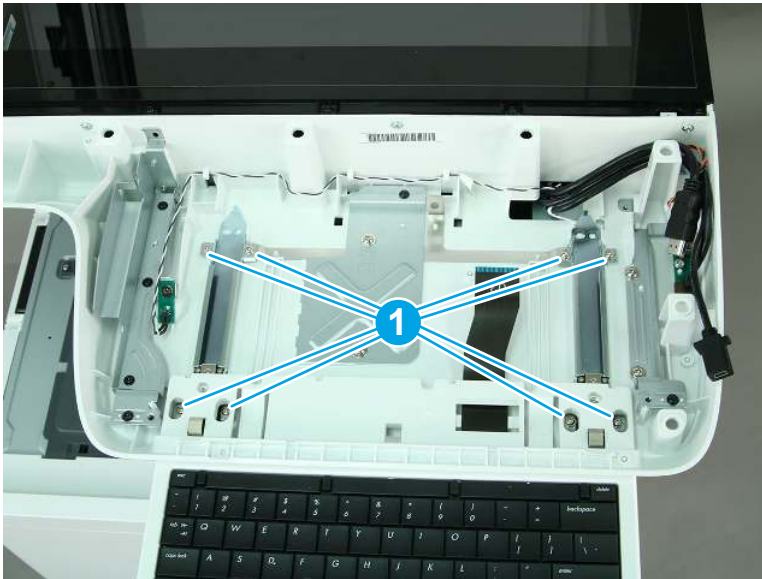
- a. Pull the keyboard out to its extended position.

Figure 1-383 Pull the keyboard out



- b. Remove eight screws (callout 1).

Figure 1-384 Remove eight screws



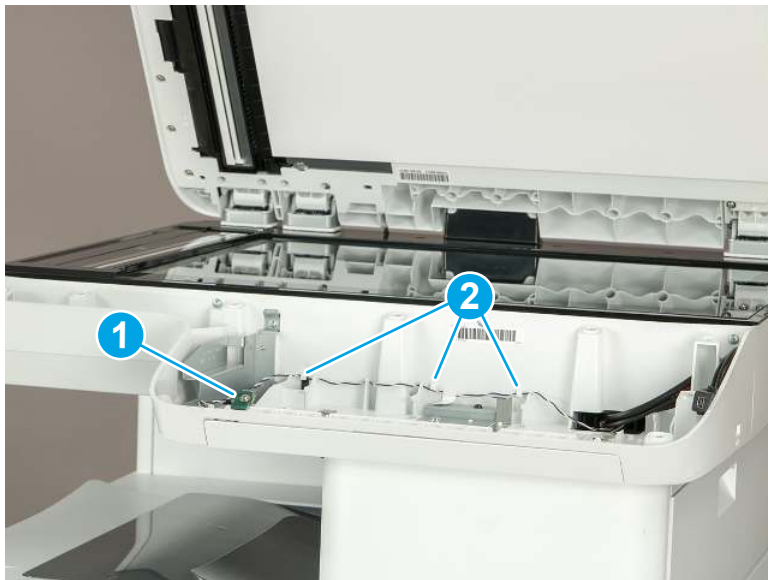
- c. Remove the keyboard and rails.

Figure 1-385 Remove the keyboard and rails



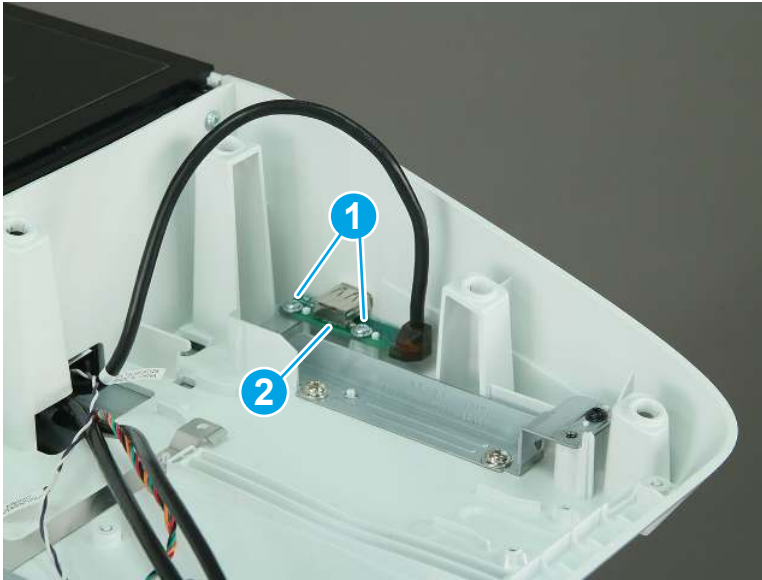
- 4. Remove the nose cone (M776).
 - a. Remove one screw (callout 1) to release the light PCA. Release the cable from three retainers (callout 2), and then move the light PCA out of the way.

Figure 1-386 Release the light PCA



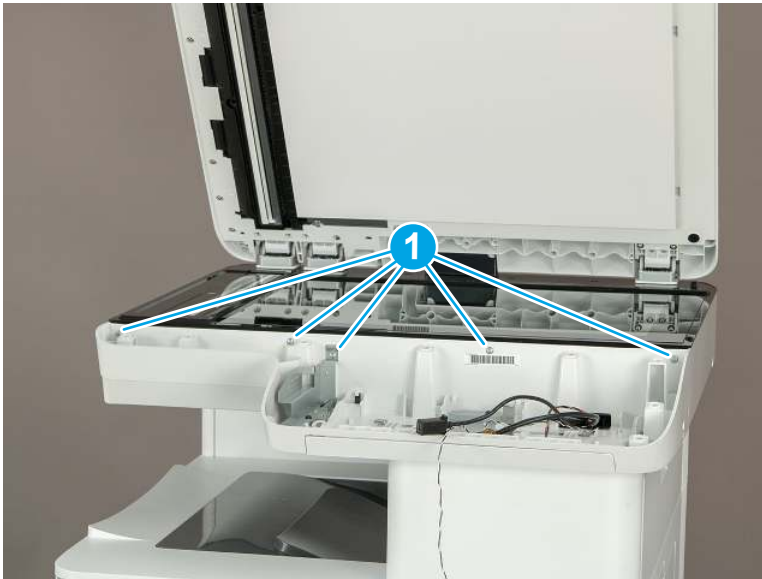
- b. Remove two screws (callout 1), and then move the USB port PCA (callout 2) out of the way.

Figure 1-387 Release the USB port PCA



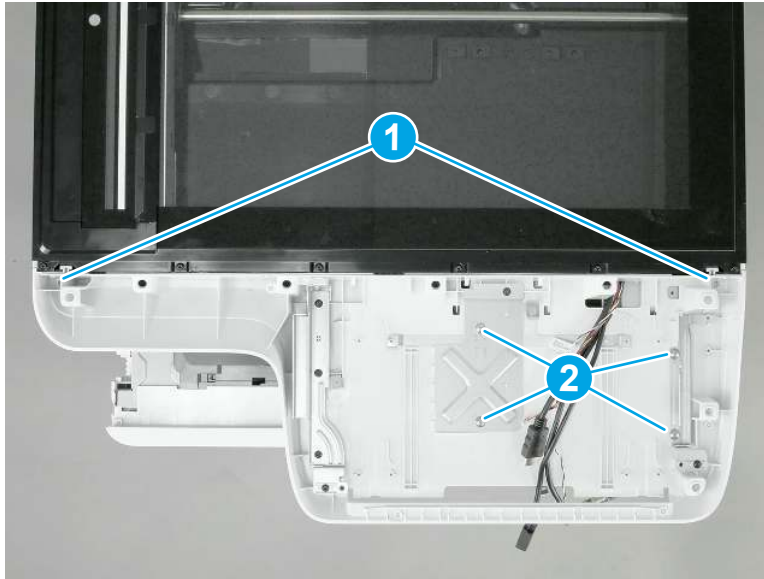
- c. Remove five screws (callout 1).

Figure 1-388 Remove four screws



- d. Remove two small, self-tapping screws (callout 1), and then remove four larger machine screws (callout 2).

Figure 1-389 Remove six screws



- e. Lift the nose cone up and off of the printer to remove it.


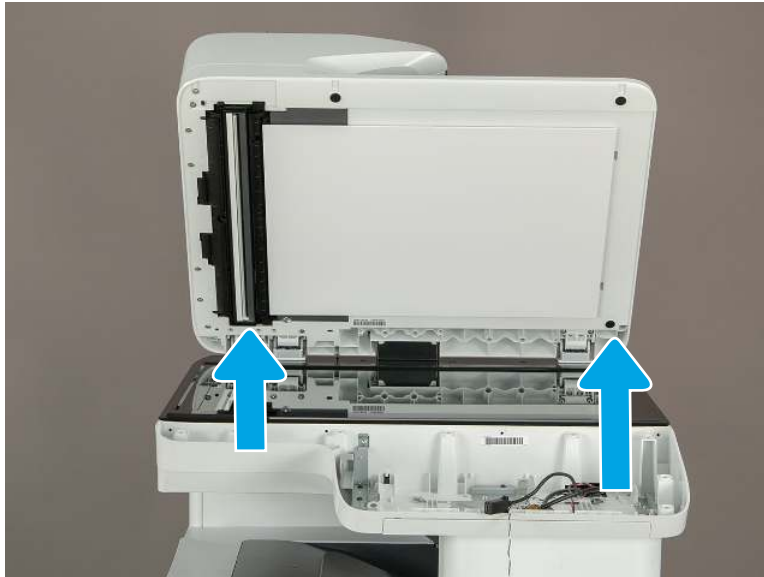
 **NOTE:** Pass the wire harnesses and cables through the opening in the nose cone when removing it.

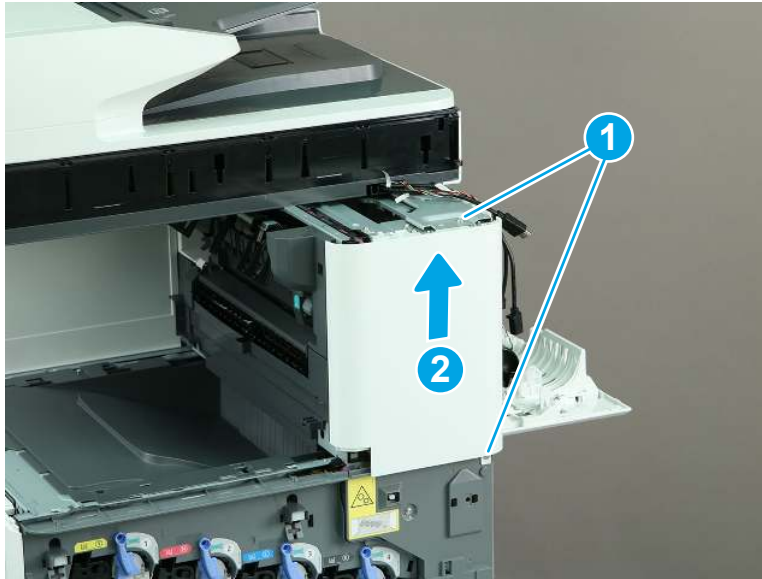
Figure 1-390 Remove the nose cone



- 5. Remove the right front cover (M776zs).

- ▲ Remove two screws (callout 1), release one tab (callout 2), and then slide the right front cover up (callout 2) to remove it.

Figure 1-391 Remove the right front cover



6. Unpack the replacement assembly.
 - a. Dispose of the defective part.



NOTE: HP recommends responsible disposal of the defective part.

<http://www8.hp.com/us/en/hp-information/environment/product-recycling.html>

- b. Unpack the replacement part from the packaging.



IMPORTANT: Make sure that all of the shipping materials (for example shipping tape) are removed from the replacement part prior to installation.

- c. To install an assembly, reverse the removal steps.



NOTE: When applicable, special installation instructions are provided for an assembly at the end of the removal procedure. Always completely read the removal instructions and follow all special installation instructions.

Removal and replacement: Delivery front cover (M776zs)

Learn how to remove and replace the delivery front cover.

Mean time to repair: 9 minutes

Service level: Easy

Before performing service

Turn the printer power off

- Disconnect the power cable.

⚠ WARNING! To avoid damage to the printer, turn the printer off, wait 30 seconds, and then remove the power cord before attempting to service the printer.

Use the table below to identify the correct part number for your printer. To order the part, go to www.hp.com/buy/parts.

Table 1-40 Part information

Part number	Part description
RC5-2728-000CN	Cover, paper delivery, front

Required tools

- Small, flat-blade screwdriver
- #2 Phillips screwdriver with a magnetic tip

After performing service

Turn the printer power on

- Connect the power cable.
- Use the power switch to turn the power on.

Post service test

Make sure that the printer initializes to a **Ready** state.

Print a page to make sure that the printer is functioning correctly.

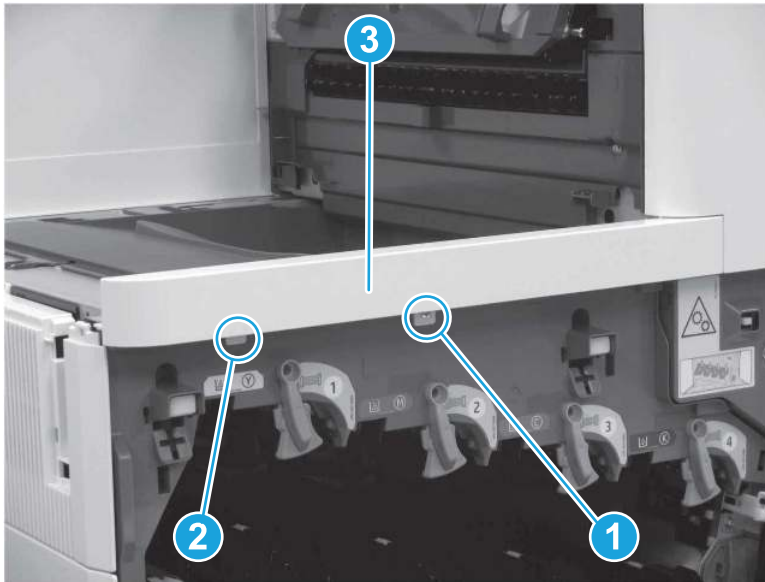
1. Remove the front cover (M776zs).
 - a. Open the front door.

Figure 1-392 Open the front door



- b. Remove one screw (callout 1), release one tab (callout 2), and then remove the front cover (callout 3).

Figure 1-393 Remove the front cover



2. Remove the control panel (M776).
 - a. Rotate the control panel to the fully raised position (callout 1), and then raise the document feeder (callout 2).

Figure 1-394 Raise the control panel and document feeder



- b. Beginning at the right side of the control-panel cover, carefully release five tabs along the top edge of the cover.

 **NOTE:** The thin black-plastic cover will separate from the white-plastic control-panel base.

Figure 1-395 Release the control panel cover



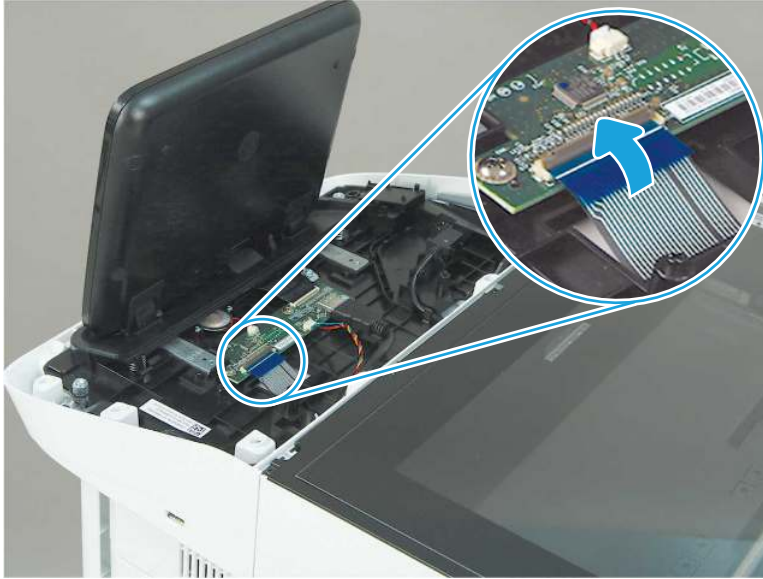
- c. Rotate the control panel cover slightly forward (callout 1), and then lift up to remove the cover (callout 2).

Figure 1-396 Remove the control panel cover



- d. **M776z or M776zs only:** Open the connector latch to release the keyboard flat cable.

Figure 1-397 Release the keyboard flat cable (M776z/M776zs)



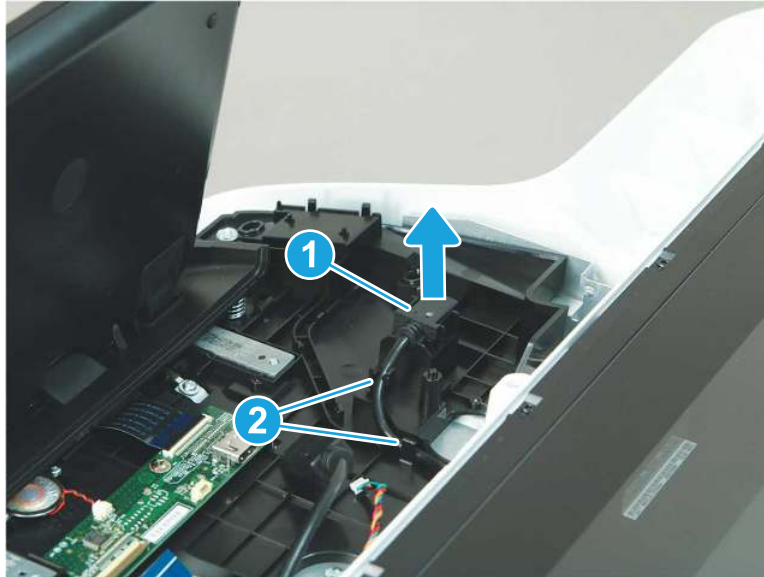
- e. Disconnect two connectors

Figure 1-398 Disconnect two connectors



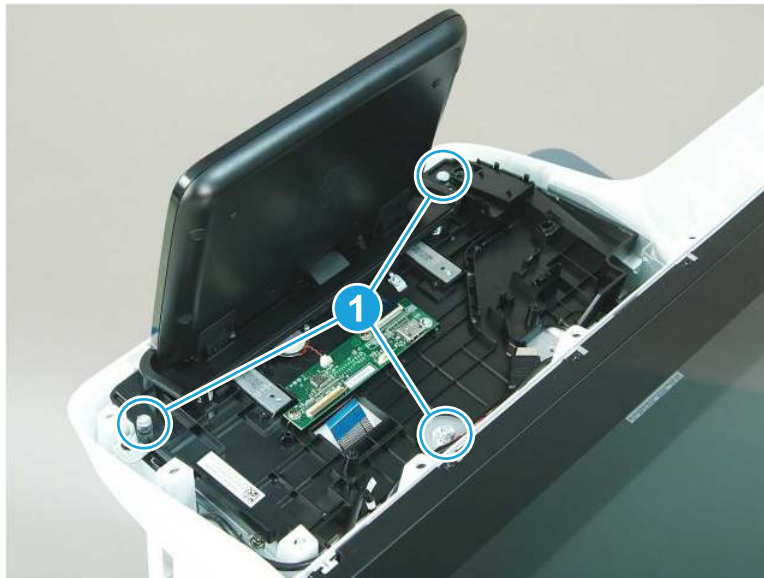
- f. Remove the USB cable (callout 1) from the holder, and then release the cable from two retainers (callout 2).

Figure 1-399 Release the USB cable



- g. Remove three screws (callout 1).

Figure 1-400 Remove three screws



- h. Lift the front of the control panel off of the printer (callout 1), and then slide it towards the front of the printer (callout 2) to remove it.

Figure 1-401 Remove the control panel



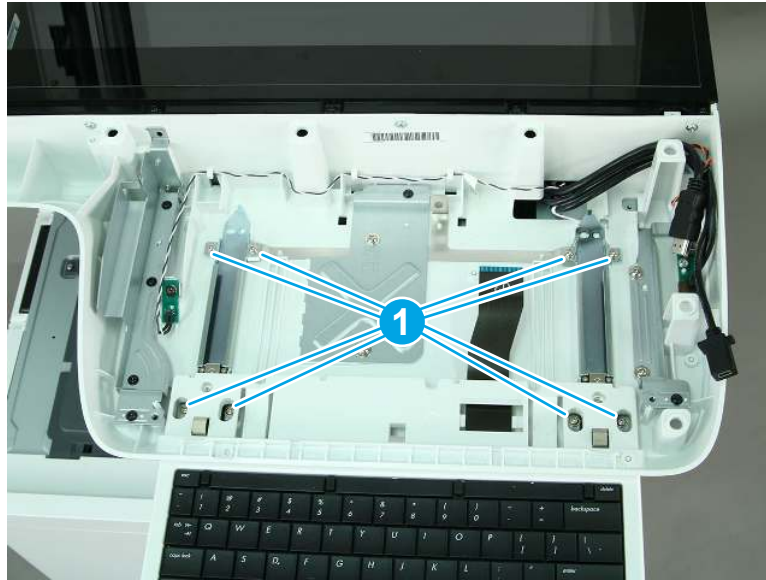
- 3. Remove the keyboard (M776z/M776zs).
 - a. Pull the keyboard out to its extended position.

Figure 1-402 Pull the keyboard out



- b. Remove eight screws (callout 1).

Figure 1-403 Remove eight screws



- c. Remove the keyboard and rails.

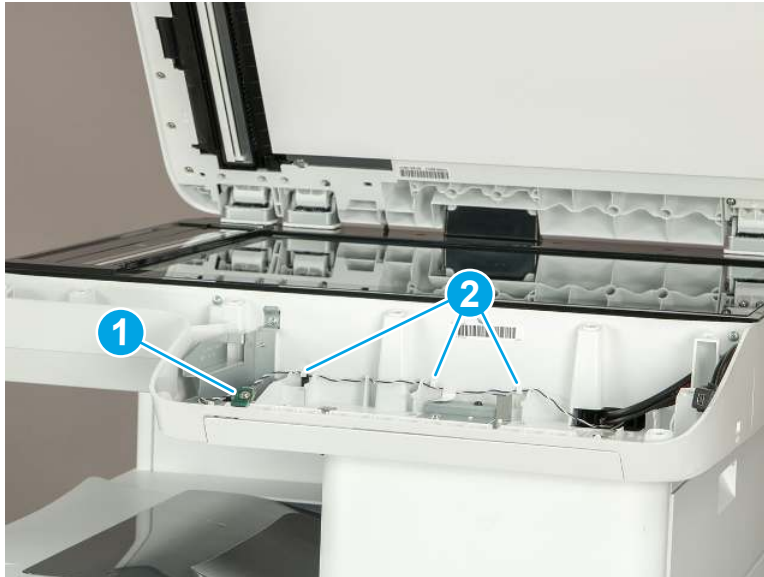
Figure 1-404 Remove the keyboard and rails



- 4. Remove the nose cone (M776).

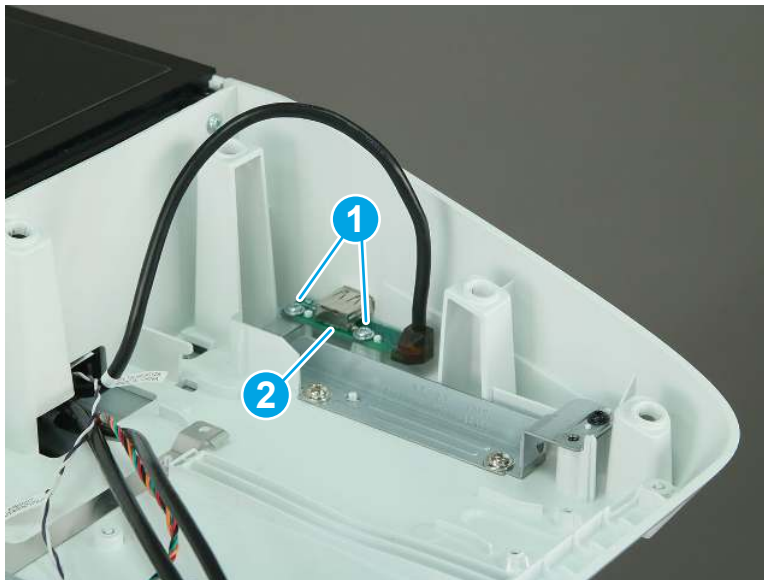
- a. Remove one screw (callout 1) to release the light PCA. Release the cable from three retainers (callout 2), and then move the light PCA out of the way.

Figure 1-405 Release the light PCA



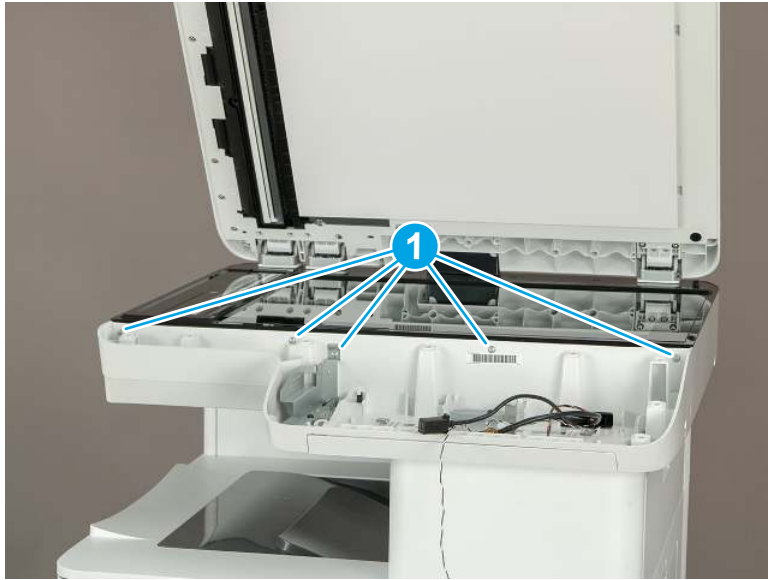
- b. Remove two screws (callout 1), and then move the USB port PCA (callout 2) out of the way.

Figure 1-406 Release the USB port PCA



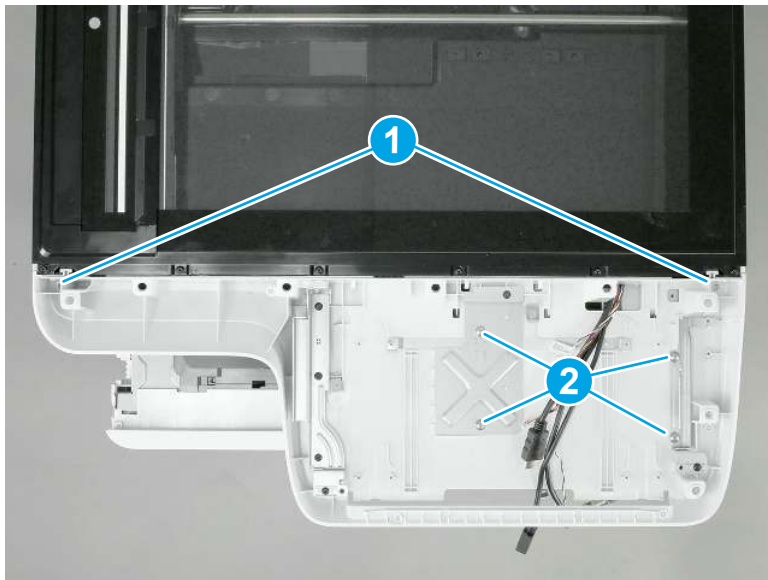
- c. Remove five screws (callout 1).

Figure 1-407 Remove four screws



- d. Remove two small, self-tapping screws (callout 1), and then remove four larger machine screws (callout 2).

Figure 1-408 Remove six screws

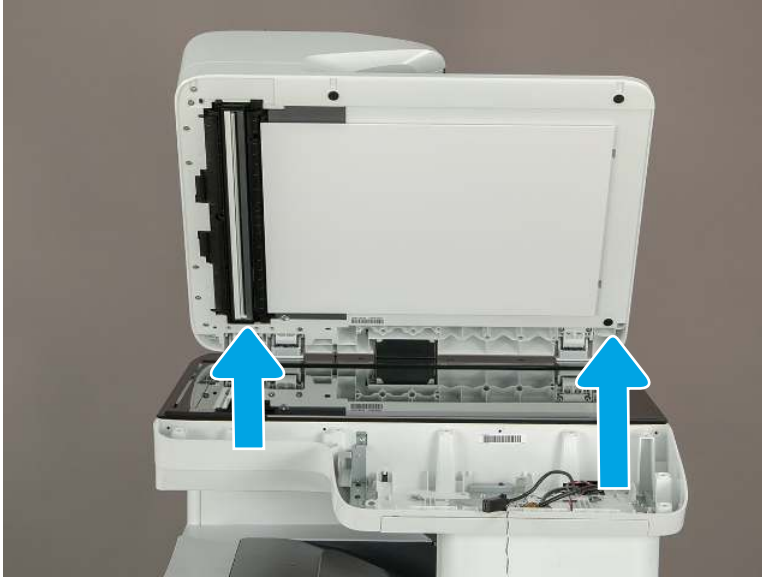


- e. Lift the nose cone up and off of the printer to remove it.



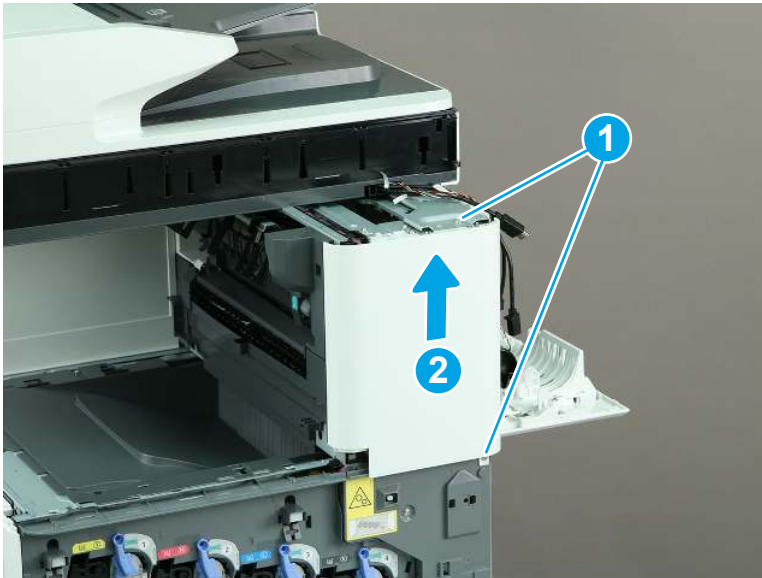
NOTE: Pass the wire harnesses and cables through the opening in the nose cone when removing it.

Figure 1-409 Remove the nose cone



5. Remove the right front cover (M776zs).
 - ▲ Remove two screws (callout 1), release one tab (callout 2), and then slide the right front cover up (callout 2) to remove it.

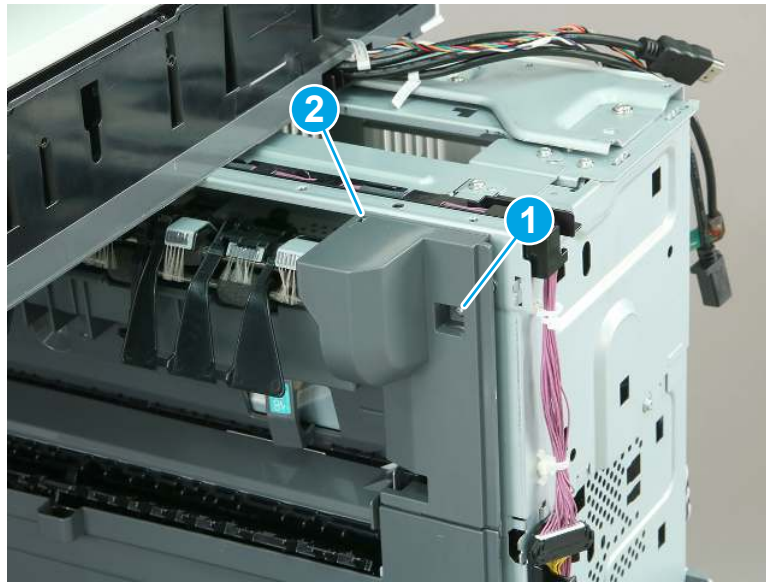
Figure 1-410 Remove the right front cover



6. Remove the delivery front cover (M776zs).

- ▲ Remove one screw (callout 1), and then remove the delivery front cover (callout 2).

Figure 1-411 Remove the delivery front cover



- 7. Unpack the replacement assembly.

- a. Dispose of the defective part.



NOTE: HP recommends responsible disposal of the defective part.

<http://www8.hp.com/us/en/hp-information/environment/product-recycling.html>

- b. Unpack the replacement part from the packaging.



IMPORTANT: Make sure that all of the shipping materials (for example shipping tape) are removed from the replacement part prior to installation.

- c. To install an assembly, reverse the removal steps.



NOTE: When applicable, special installation instructions are provided for an assembly at the end of the removal procedure. Always completely read the removal instructions and follow all special installation instructions.

Removal and replacement: Delivery cover (M776zs)

Learn how to remove and replace the delivery cover.

Mean time to repair: 10 minutes

Service level: Easy

Before performing service

Turn the printer power off

- Disconnect the power cable.

⚠ WARNING! To avoid damage to the printer, turn the printer off, wait 30 seconds, and then remove the power cord before attempting to service the printer.

Use the table below to identify the correct part number for your printer. To order the part, go to www.hp.com/buy/parts.

Table 1-41 Part information

Part number	Part description
RC5-2734-000CN	Cover, paper delivery

Required tools

- Small, flat-blade screwdriver
- #2 Phillips screwdriver with a magnetic tip

After performing service

Turn the printer power on

- Connect the power cable.
- Use the power switch to turn the power on.

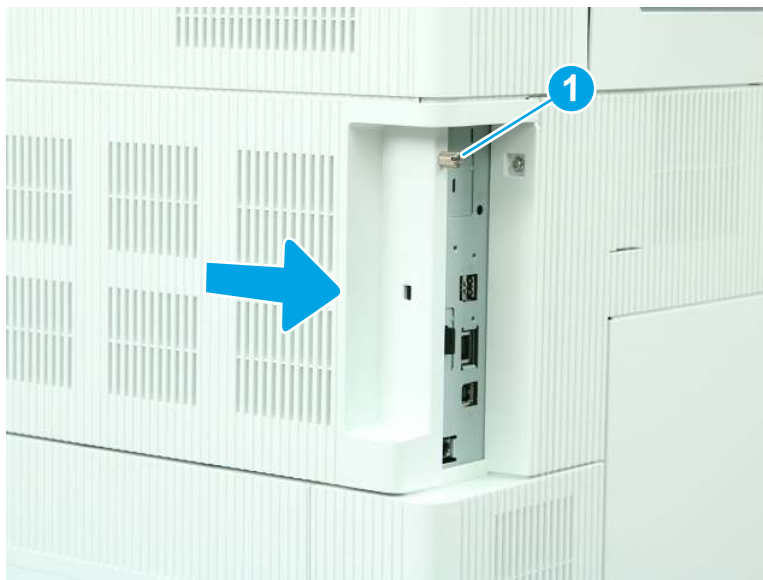
Post service test

Make sure that the printer initializes to a **Ready** state.

Print a page to make sure that the printer is functioning correctly.

1. Remove the formatter cover.
 - ▲ Loosen one thumbscrew (callout 1), and then slide the formatter cover (callout 2) away from the printer to remove it.

Figure 1-412 Remove the formatter cover



2. Remove the front cover (M776zs).

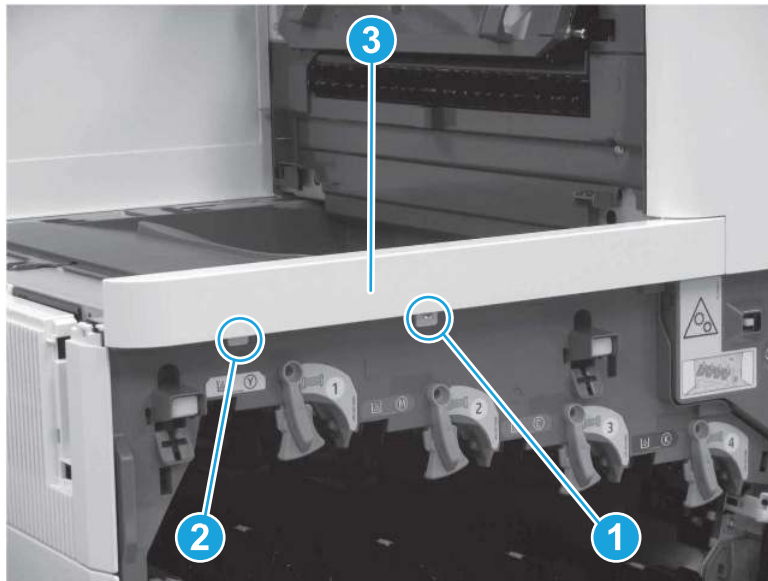
- a. Open the front door.

Figure 1-413 Open the front door



- b. Remove one screw (callout 1), release one tab (callout 2), and then remove the front cover (callout 3).

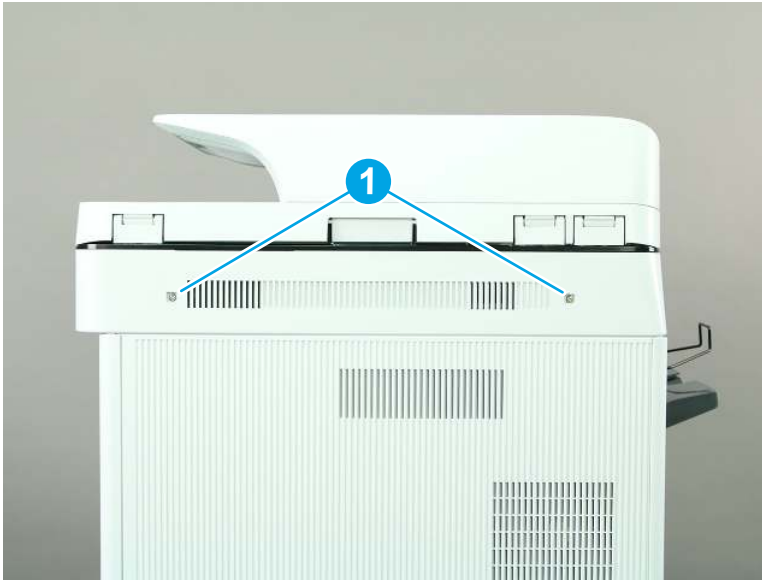
Figure 1-414 Remove the front cover



3. Remove the scanner control board (SCB) cover (M776).

- a. Remove two screws (callout 1).

Figure 1-415 Remove two screws



- b. Remove the SCB cover.

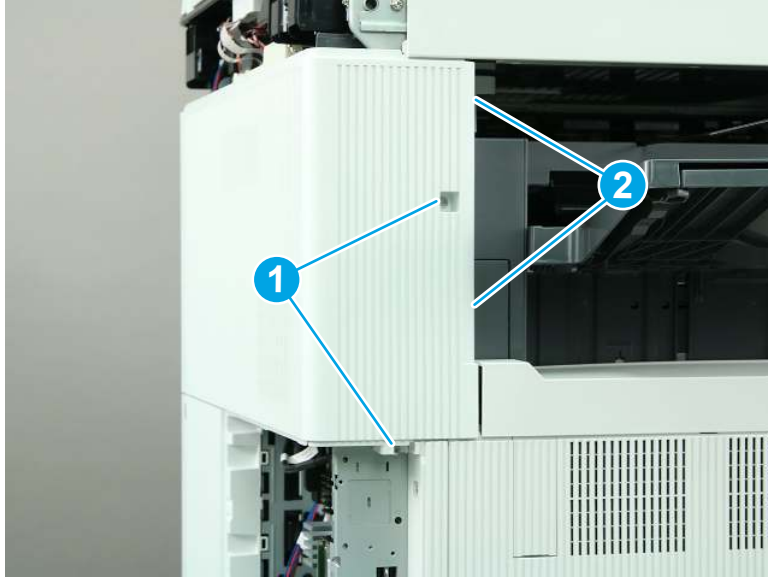
Figure 1-416 Remove the SCB cover



4. Remove the rear upper cover and left rear upper cover (M776zs).

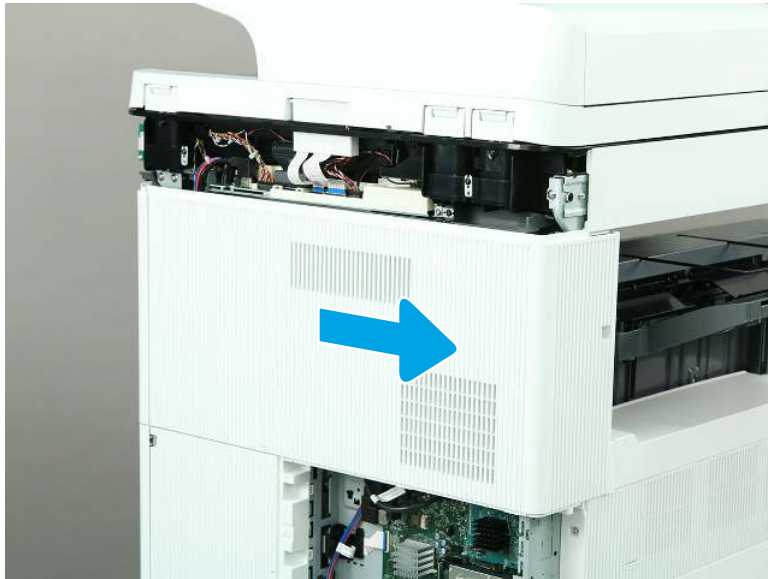
- a. Remove two screws (callout 1), and then release two tabs (callout 2).

Figure 1-417 Remove two screws and release two tabs



- b. Slide the cover to the right to remove it.

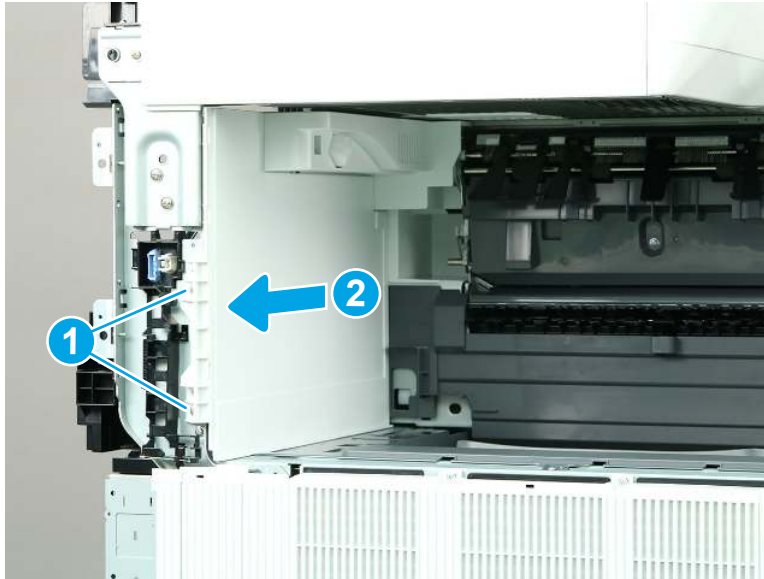
Figure 1-418 Remove the rear upper and left rear upper cover



5. Remove the main cover (M776zs).

- ▲ Remove two screws (callout 1), and then slide the main cover away from the printer to remove it (callout 2).

Figure 1-419 Remove the main cover



- 6. Remove the control panel (M776).
 - a. Rotate the control panel to the fully raised position (callout 1), and then raise the document feeder (callout 2).

Figure 1-420 Raise the control panel and document feeder



- b. Beginning at the right side of the control-panel cover, carefully release five tabs along the top edge of the cover.

 **NOTE:** The thin black-plastic cover will separate from the white-plastic control-panel base.

Figure 1-421 Release the control panel cover



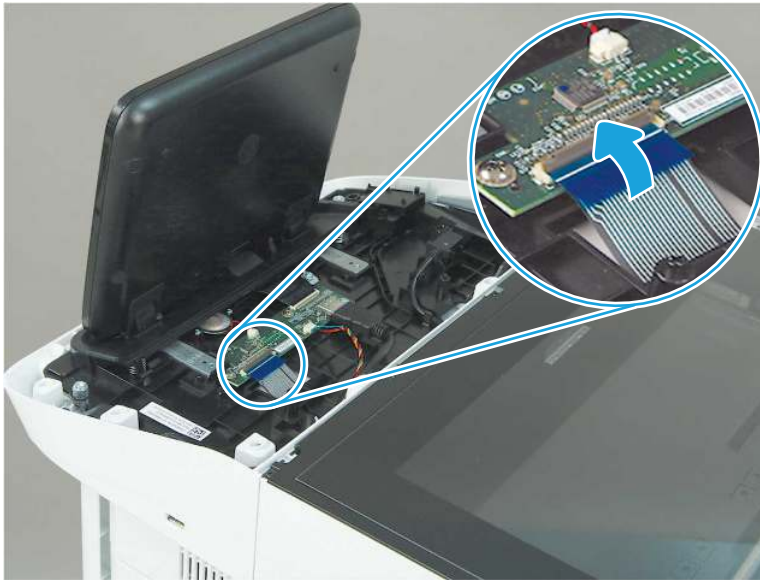
- c. Rotate the control panel cover slightly forward (callout 1), and then lift up to remove the cover (callout 2).

Figure 1-422 Remove the control panel cover



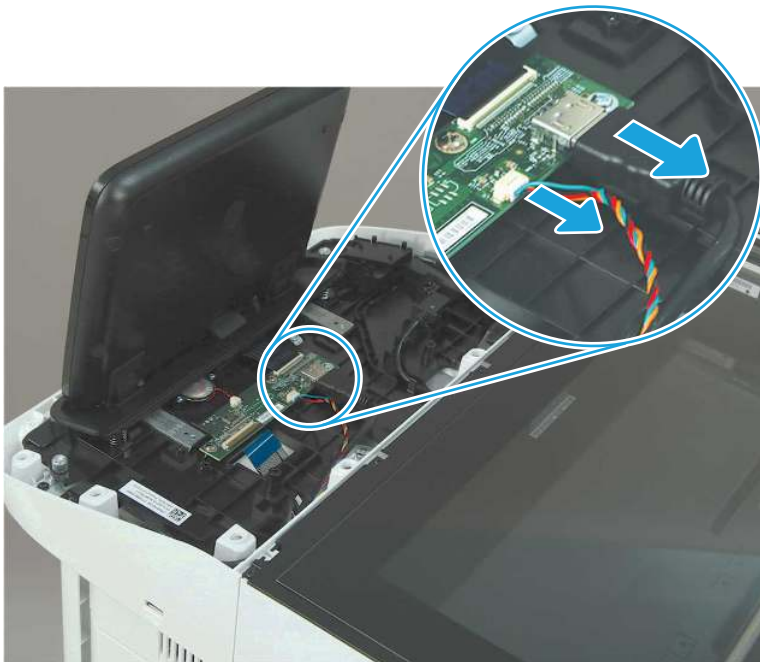
- d. **M776z or M776zs only:** Open the connector latch to release the keyboard flat cable.

Figure 1-423 Release the keyboard flat cable (M776z/M776zs)



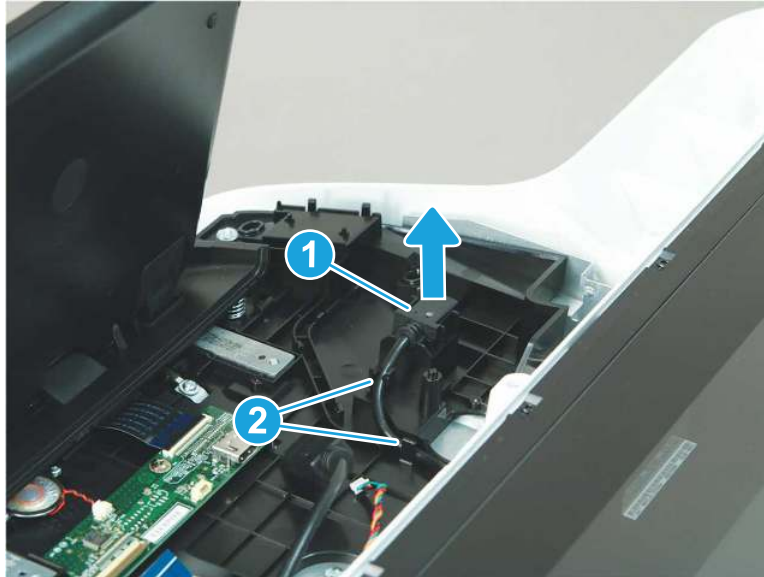
- e. Disconnect two connectors

Figure 1-424 Disconnect two connectors



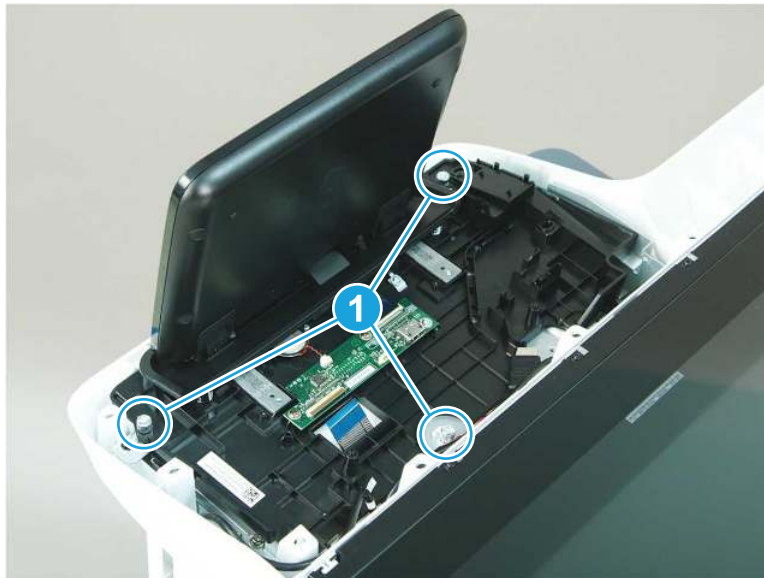
- f. Remove the USB cable (callout 1) from the holder, and then release the cable from two retainers (callout 2).

Figure 1-425 Release the USB cable



- g. Remove three screws (callout 1).

Figure 1-426 Remove three screws



- h. Lift the front of the control panel off of the printer (callout 1), and then slide it towards the front of the printer (callout 2) to remove it.

Figure 1-427 Remove the control panel



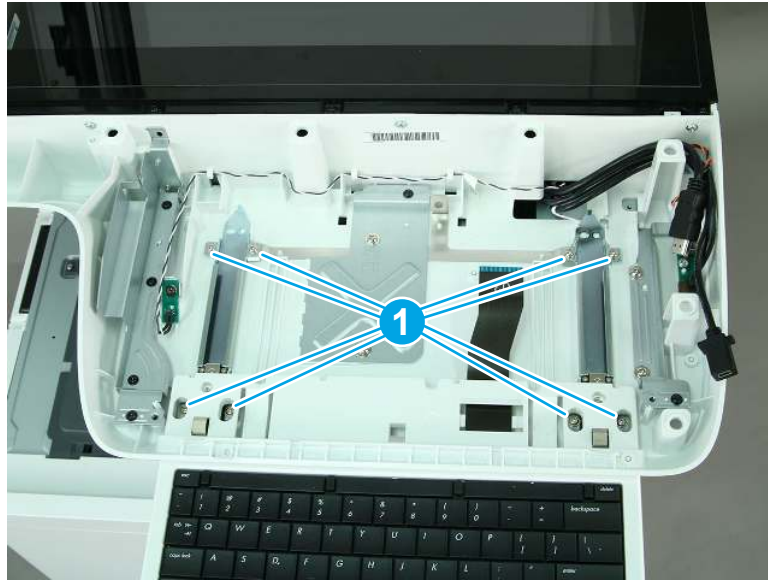
- 7. Remove the keyboard (M776z/M776zs).
 - a. Pull the keyboard out to its extended position.

Figure 1-428 Pull the keyboard out



- b. Remove eight screws (callout 1).

Figure 1-429 Remove eight screws



- c. Remove the keyboard and rails.

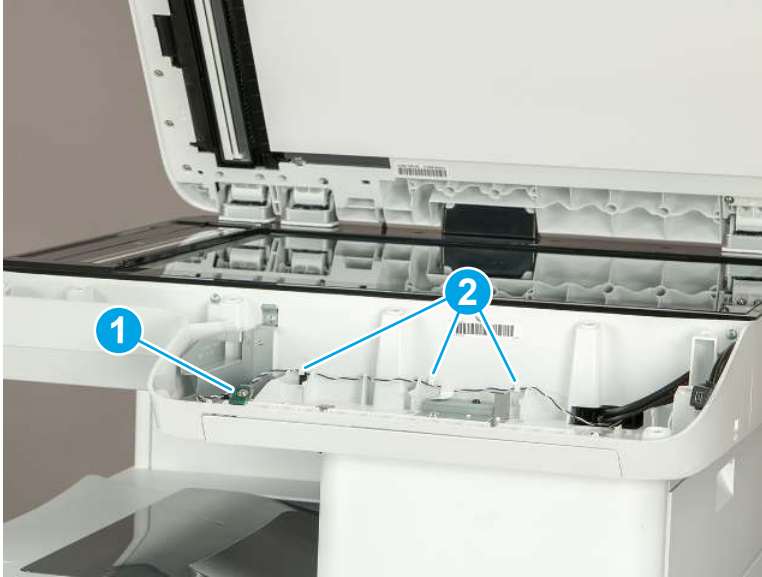
Figure 1-430 Remove the keyboard and rails



- 8. Remove the nose cone (M776).

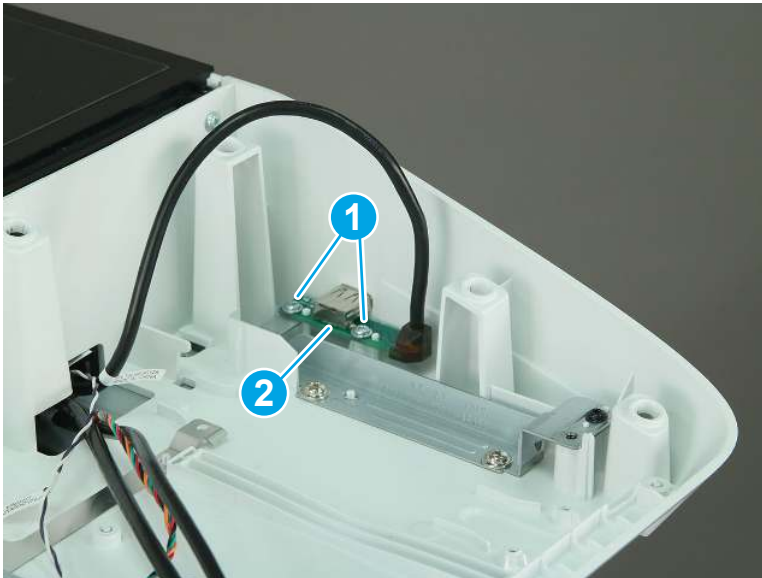
- a. Remove one screw (callout 1) to release the light PCA. Release the cable from three retainers (callout 2), and then move the light PCA out of the way.

Figure 1-431 Release the light PCA



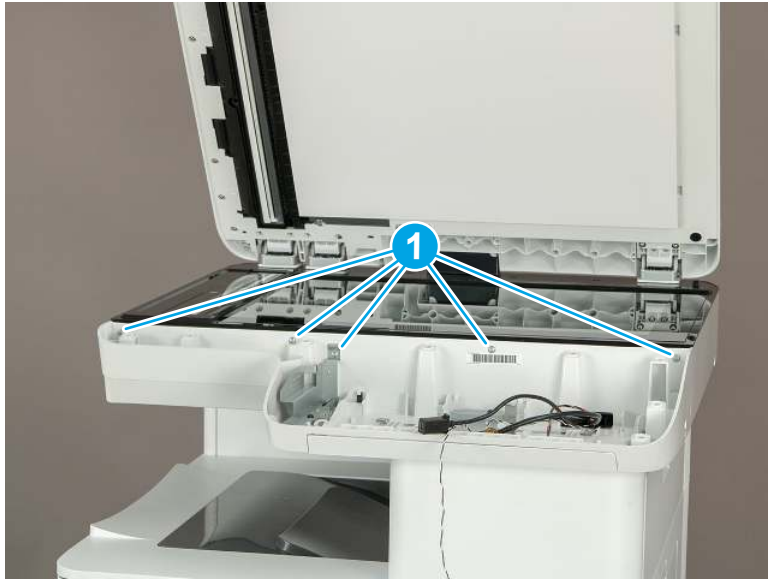
- b. Remove two screws (callout 1), and then move the USB port PCA (callout 2) out of the way.

Figure 1-432 Release the USB port PCA



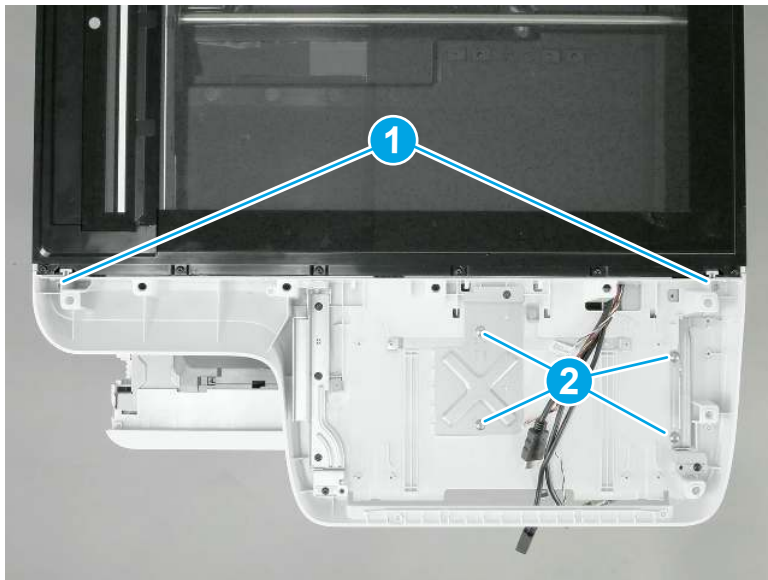
- c. Remove five screws (callout 1).

Figure 1-433 Remove four screws



- d. Remove two small, self-tapping screws (callout 1), and then remove four larger machine screws (callout 2).

Figure 1-434 Remove six screws

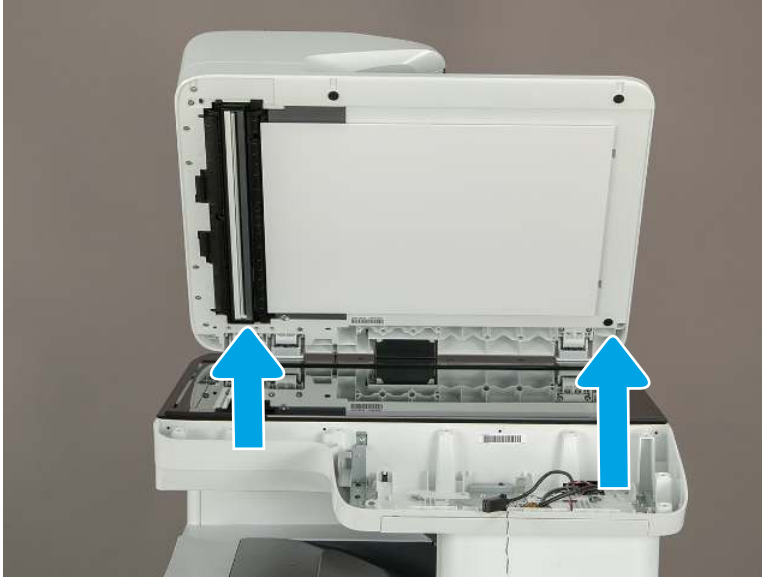


- e. Lift the nose cone up and off of the printer to remove it.



NOTE: Pass the wire harnesses and cables through the opening in the nose cone when removing it.

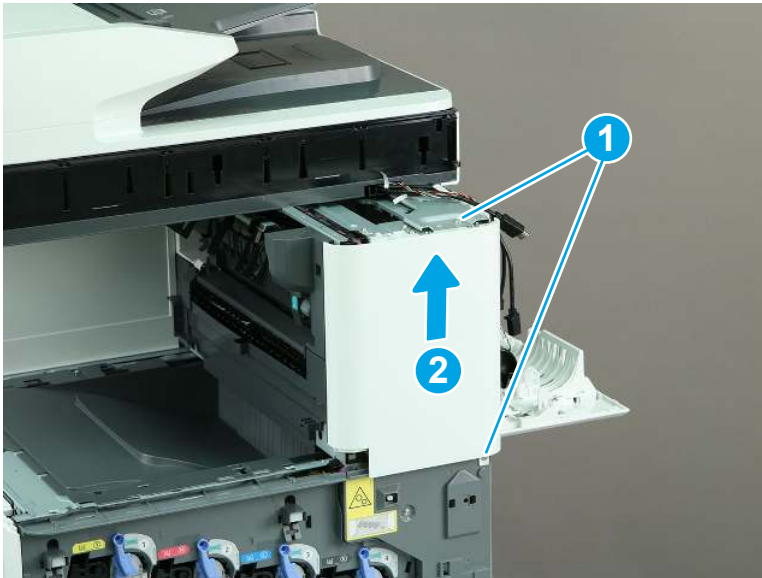
Figure 1-435 Remove the nose cone



9. Remove the right front cover (M776zs).

- ▲ Remove two screws (callout 1), release one tab (callout 2), and then slide the right front cover up (callout 2) to remove it.

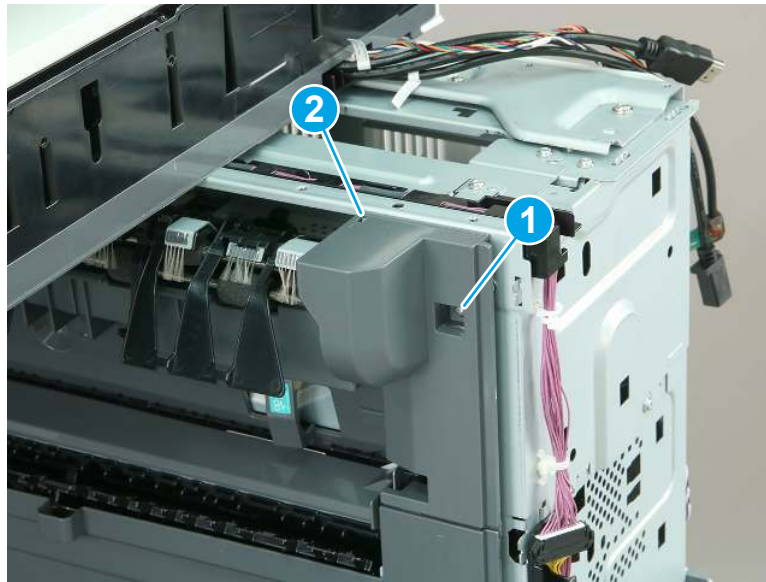
Figure 1-436 Remove the right front cover



10. Remove the delivery front cover (M776zs).

- ▲ Remove one screw (callout 1), and then remove the delivery front cover (callout 2).

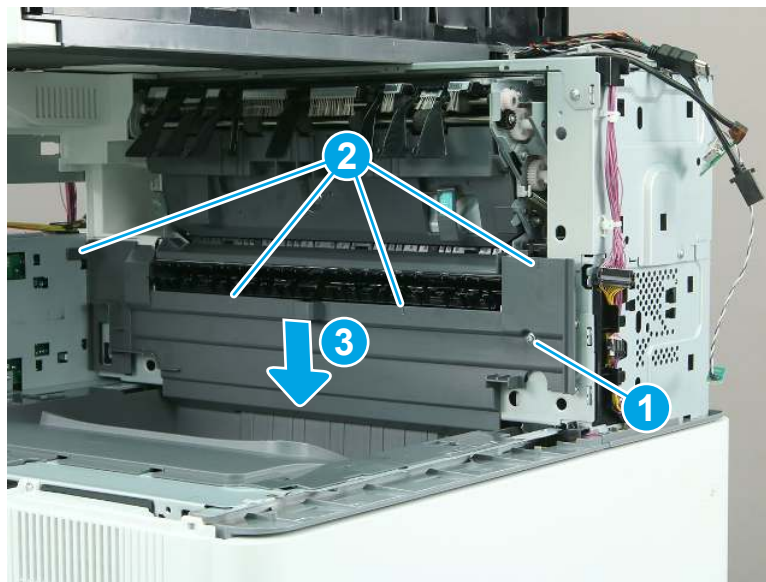
Figure 1-437 Remove the delivery front cover



11. Remove the delivery cover (M776zs).

- ▲ Remove one screw (callout 1), release four tabs (callout 2), and then slide the delivery cover down (callout 3) to remove it.

Figure 1-438 Remove the delivery cover



12. Unpack the replacement assembly.


- a. Dispose of the defective part.




NOTE: HP recommends responsible disposal of the defective part.

<http://www8.hp.com/us/en/hp-information/environment/product-recycling.html>

- b. Unpack the replacement part from the packaging.

 **IMPORTANT:** Make sure that all of the shipping materials (for example shipping tape) are removed from the replacement part prior to installation.

- c. To install an assembly, reverse the removal steps.

 **NOTE:** When applicable, special installation instructions are provided for an assembly at the end of the removal procedure. Always completely read the removal instructions and follow all special installation instructions.

Removal and replacement: Delivery rear cover (M776zs)

Learn how to remove and replace the delivery rear cover.


Mean time to repair: 15 minutes

Service level: Medium

Before performing service

Turn the printer power off

- Disconnect the power cable.

 **WARNING!** To avoid damage to the printer, turn the printer off, wait 30 seconds, and then remove the power cord before attempting to service the printer.

Use the table below to identify the correct part number for your printer. To order the part, go to www.hp.com/buy/parts.

Table 1-42 Part information

Part number	Part description
RM2-1782-000CN	Rear delivery cover assembly

Required tools

- Small, flat-blade screwdriver
- #2 Phillips screwdriver with a magnetic tip

After performing service

Turn the printer power on

- Connect the power cable.
- Use the power switch to turn the power on.

Post service test

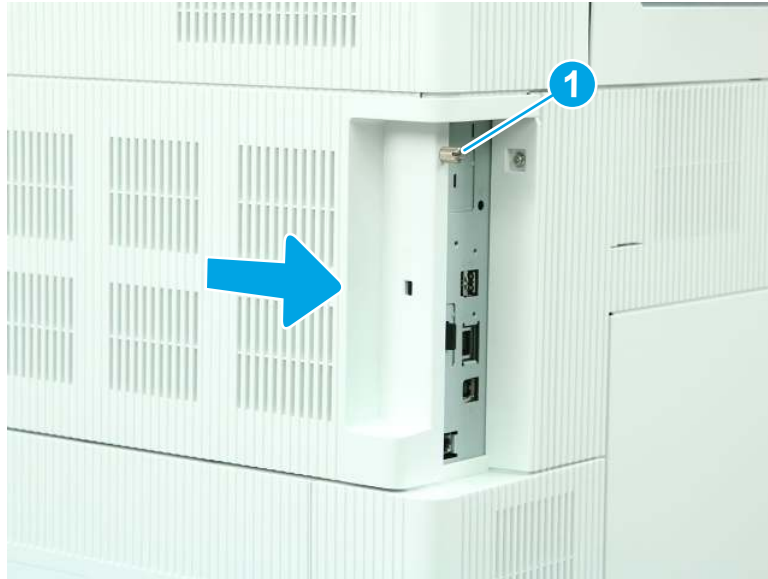
Make sure that the printer initializes to a **Ready** state.

Print a page to make sure that the printer is functioning correctly.

1. Remove the formatter cover.

- ▲ Loosen one thumbscrew (callout 1), and then slide the formatter cover (callout 2) away from the printer to remove it.

Figure 1-439 Remove the formatter cover



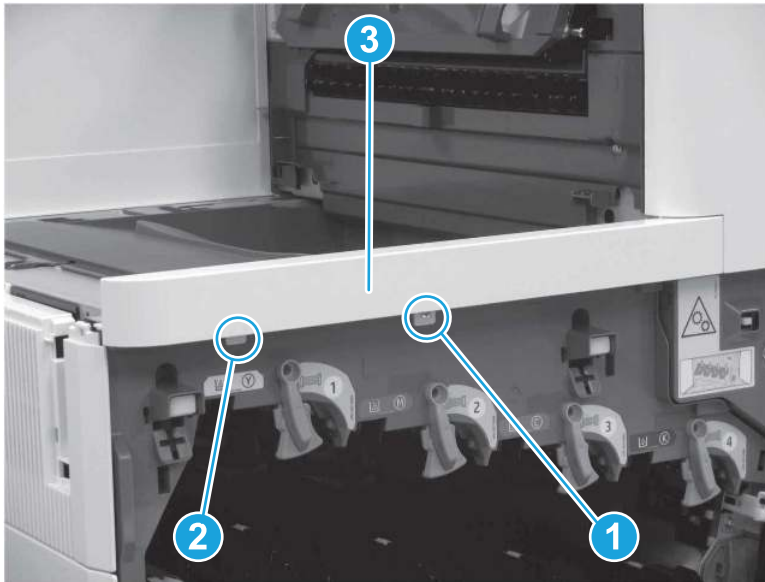
- 2. Remove the front cover (M776zs).
 - a. Open the front door.

Figure 1-440 Open the front door



- b. Remove one screw (callout 1), release one tab (callout 2), and then remove the front cover (callout 3).

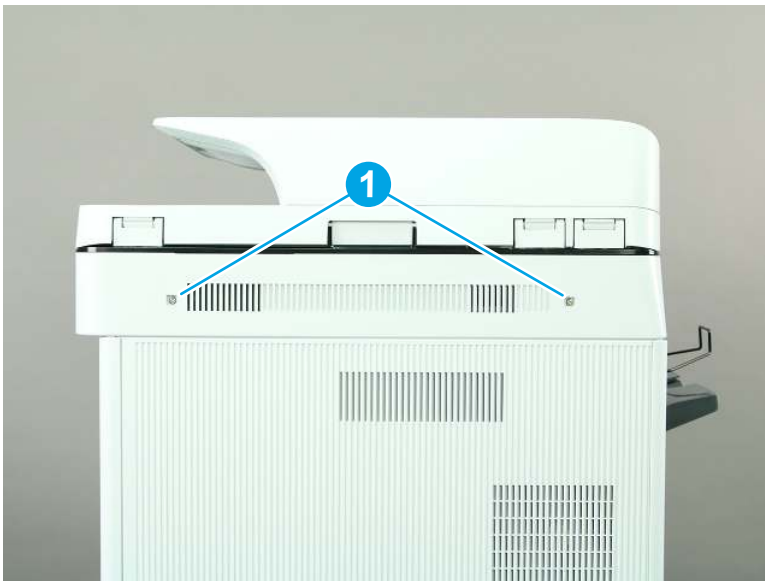
Figure 1-441 Remove the front cover



3. Remove the scanner control board (SCB) cover (M776).

- a. Remove two screws (callout 1).

Figure 1-442 Remove two screws



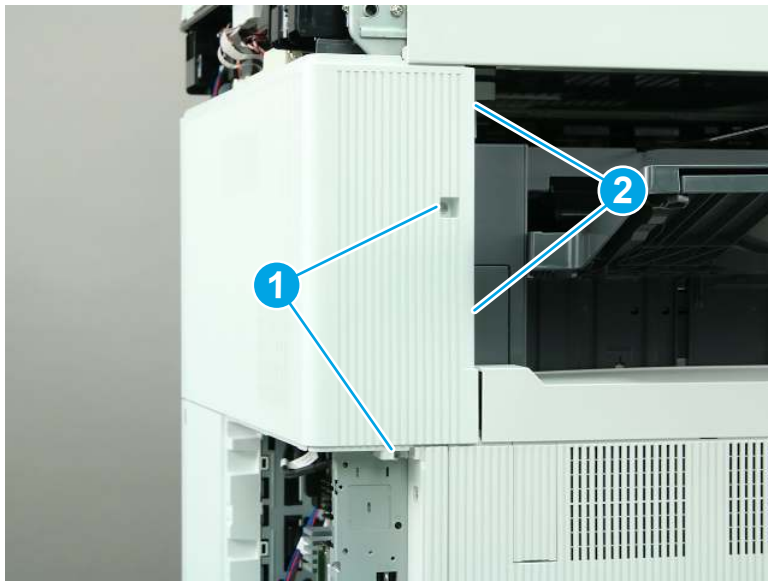
- b. Remove the SCB cover.

Figure 1-443 Remove the SCB cover



4. Remove the rear upper cover and left rear upper cover (M776zs).
 - a. Remove two screws (callout 1), and then release two tabs (callout 2).

Figure 1-444 Remove two screws and release two tabs



- b. Slide the cover to the right to remove it.

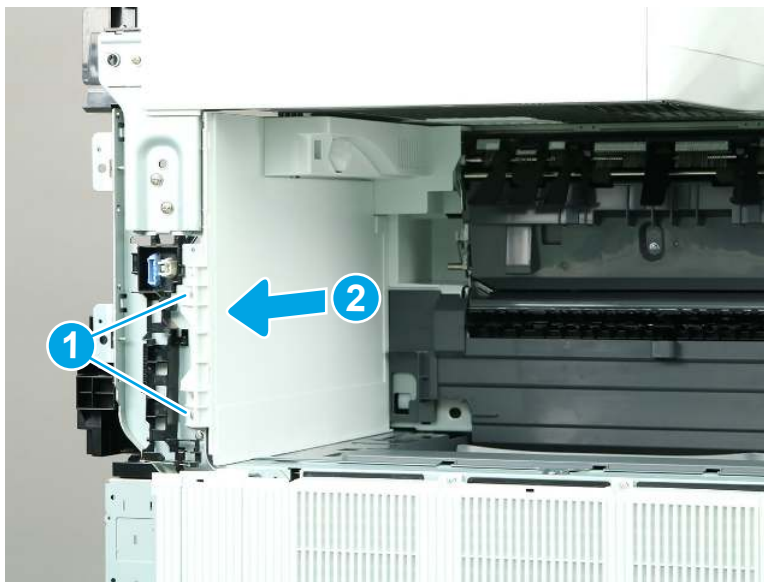
Figure 1-445 Remove the rear upper and left rear upper cover



5. Remove the main cover (M776zs).

- ▲ Remove two screws (callout 1), and then slide the main cover away from the printer to remove it (callout 2).

Figure 1-446 Remove the main cover



6. Remove the control panel (M776).

- a. Rotate the control panel to the fully raised position (callout 1), and then raise the document feeder (callout 2).

Figure 1-447 Raise the control panel and document feeder



- b. Beginning at the right side of the control-panel cover, carefully release five tabs along the top edge of the cover.



NOTE: The thin black-plastic cover will separate from the white-plastic control-panel base.

Figure 1-448 Release the control panel cover



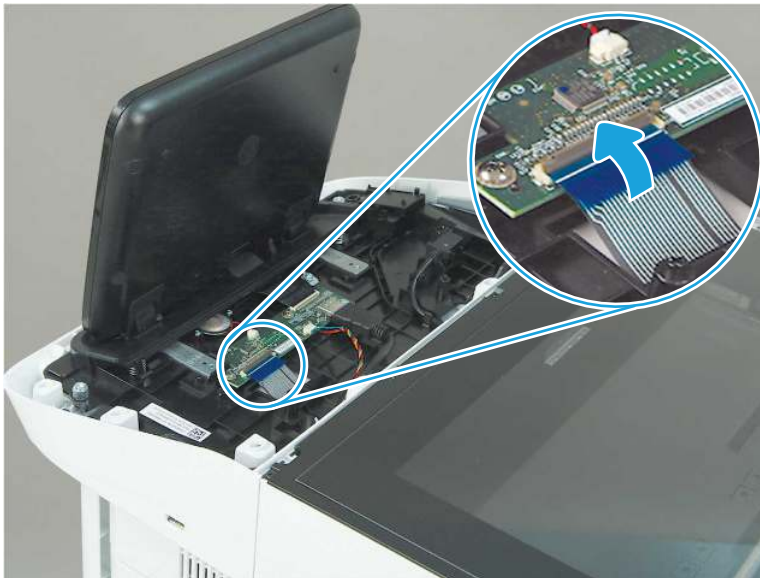
- c. Rotate the control panel cover slightly forward (callout 1), and then lift up to remove the cover (callout 2).

Figure 1-449 Remove the control panel cover



- d. **M776z or M776zs only:** Open the connector latch to release the keyboard flat cable.

Figure 1-450 Release the keyboard flat cable (M776z/M776zs)



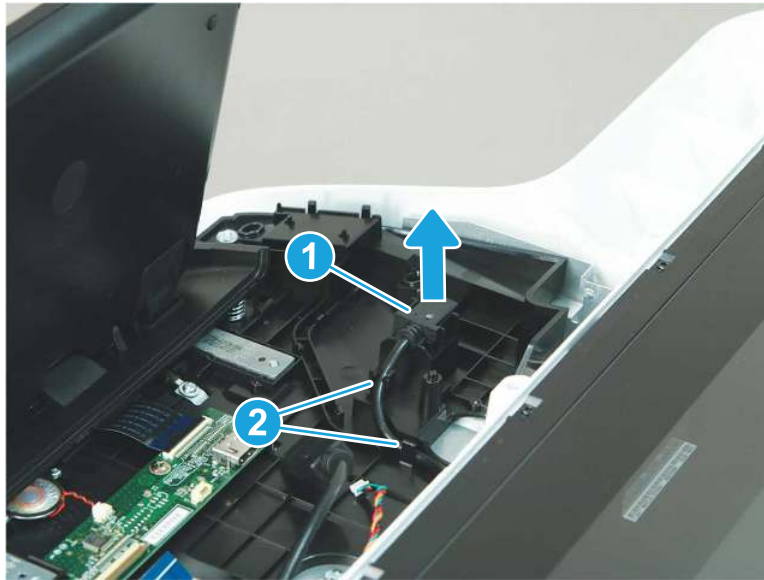
- e. Disconnect two connectors

Figure 1-451 Disconnect two connectors



- f. Remove the USB cable (callout 1) from the holder, and then release the cable from two retainers (callout 2).

Figure 1-452 Release the USB cable



- g. Remove three screws (callout 1).

Figure 1-453 Remove three screws



- h. Lift the front of the control panel off of the printer (callout 1), and then slide it towards the front of the printer (callout 2) to remove it.

Figure 1-454 Remove the control panel



- 7. Remove the keyboard (M776z/M776zs).

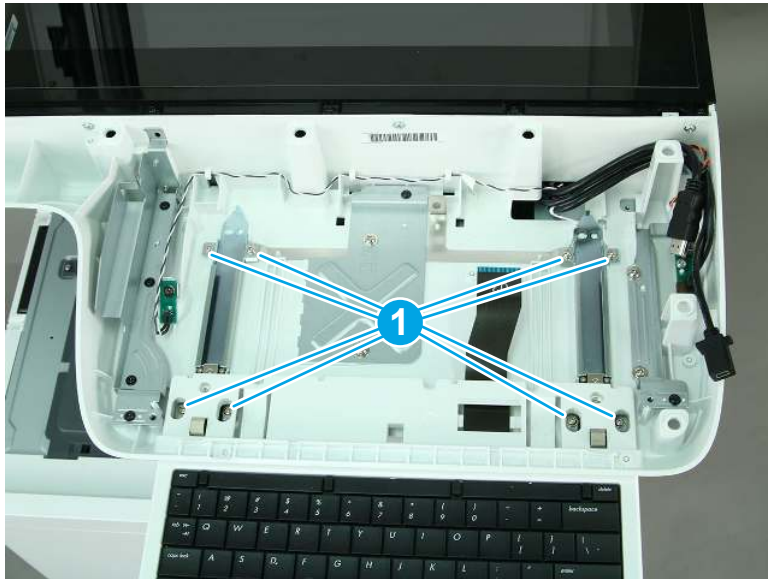
- a. Pull the keyboard out to its extended position.

Figure 1-455 Pull the keyboard out



- b. Remove eight screws (callout 1).

Figure 1-456 Remove eight screws



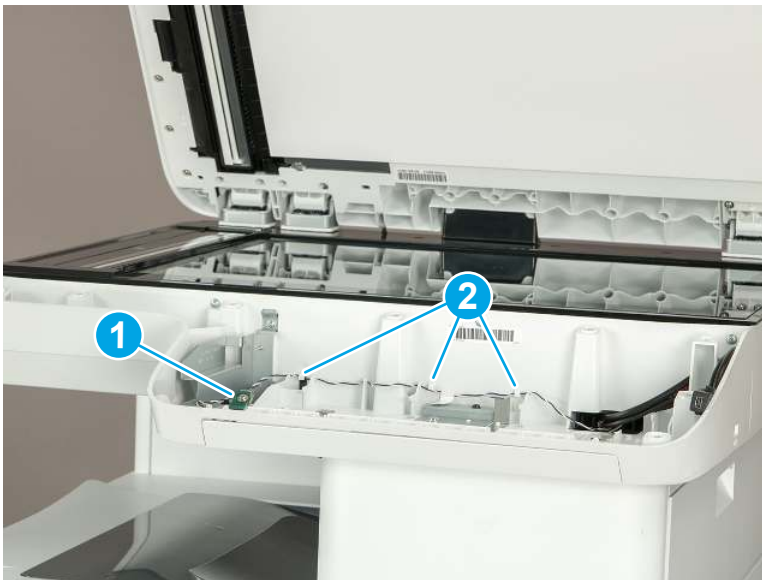
- c. Remove the keyboard and rails.

Figure 1-457 Remove the keyboard and rails



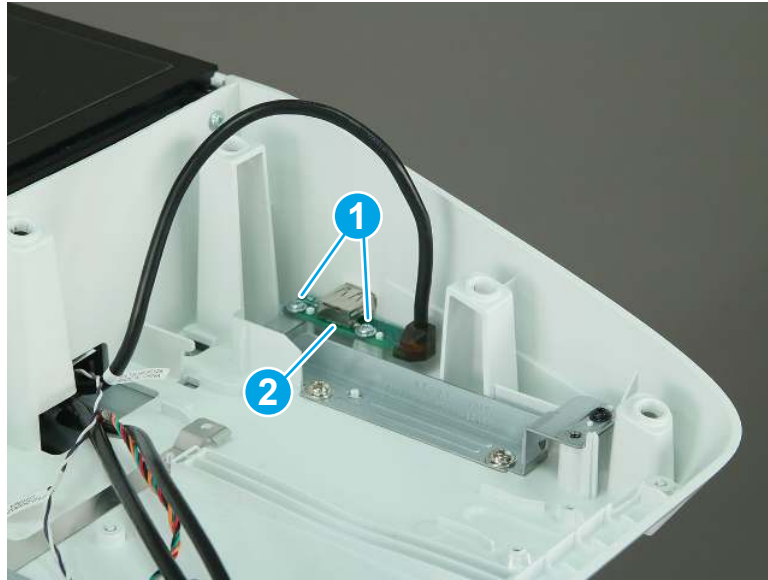
- 8. Remove the nose cone (M776).
 - a. Remove one screw (callout 1) to release the light PCA. Release the cable from three retainers (callout 2), and then move the light PCA out of the way.

Figure 1-458 Release the light PCA



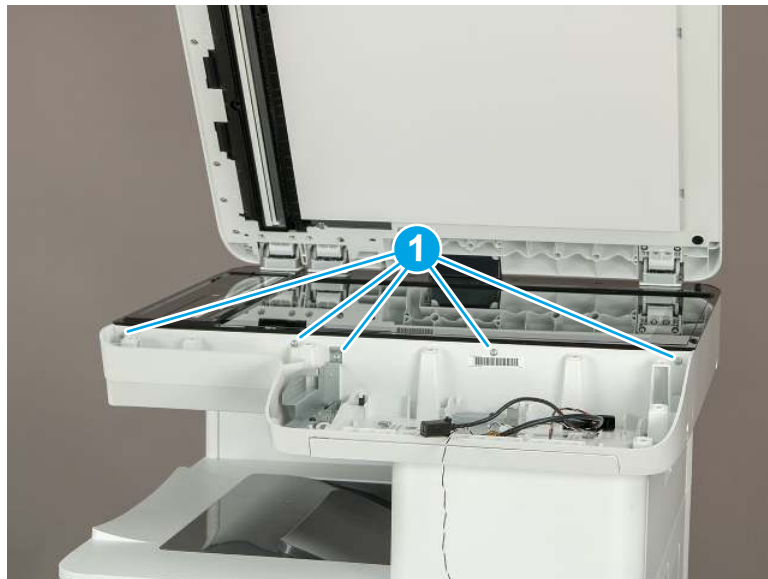
- b. Remove two screws (callout 1), and then move the USB port PCA (callout 2) out of the way.

Figure 1-459 Release the USB port PCA



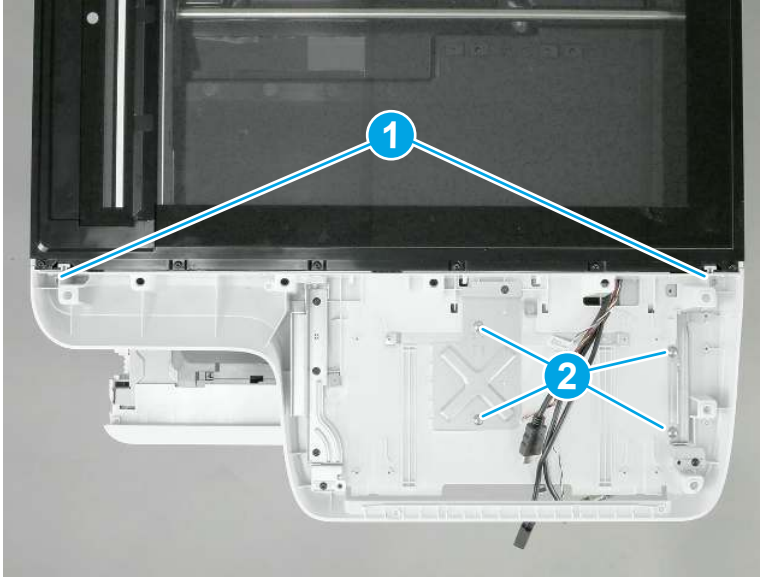
- c. Remove five screws (callout 1).

Figure 1-460 Remove four screws



- d. Remove two small, self-tapping screws (callout 1), and then remove four larger machine screws (callout 2).

Figure 1-461 Remove six screws



- e. Lift the nose cone up and off of the printer to remove it.


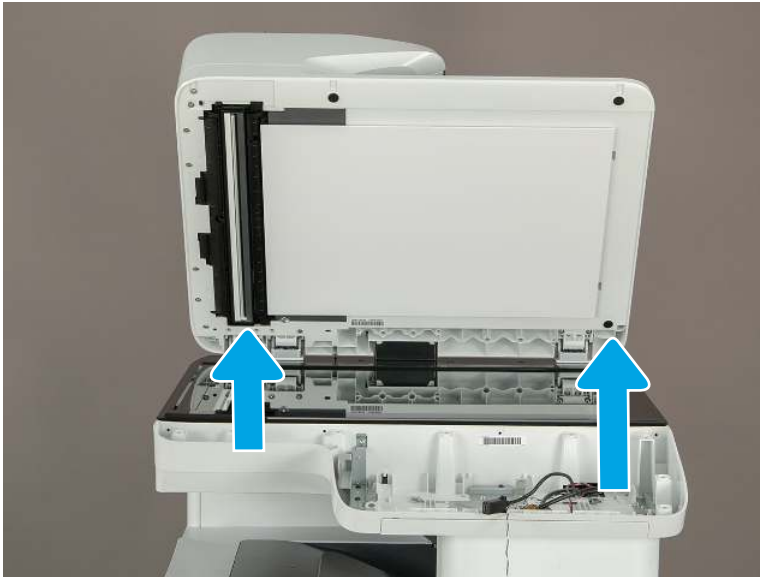
 **NOTE:** Pass the wire harnesses and cables through the opening in the nose cone when removing it.

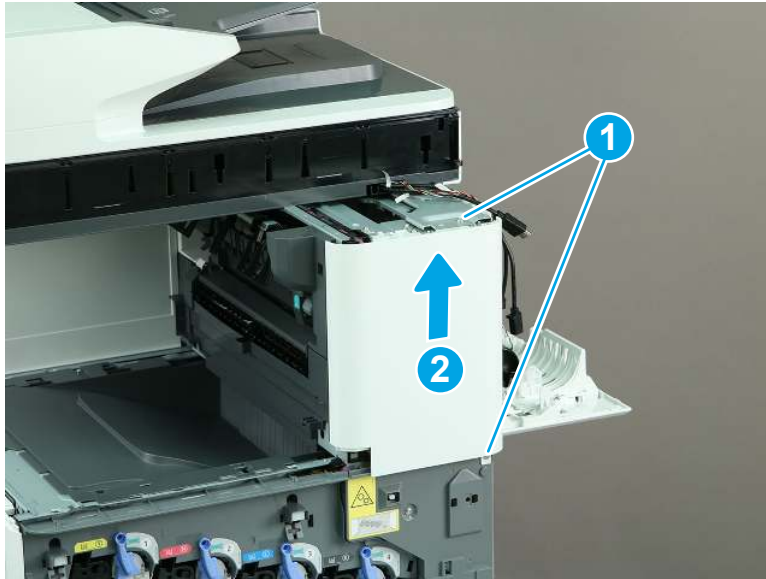
Figure 1-462 Remove the nose cone



- 9. Remove the right front cover (M776zs).

- ▲ Remove two screws (callout 1), release one tab (callout 2), and then slide the right front cover up (callout 2) to remove it.

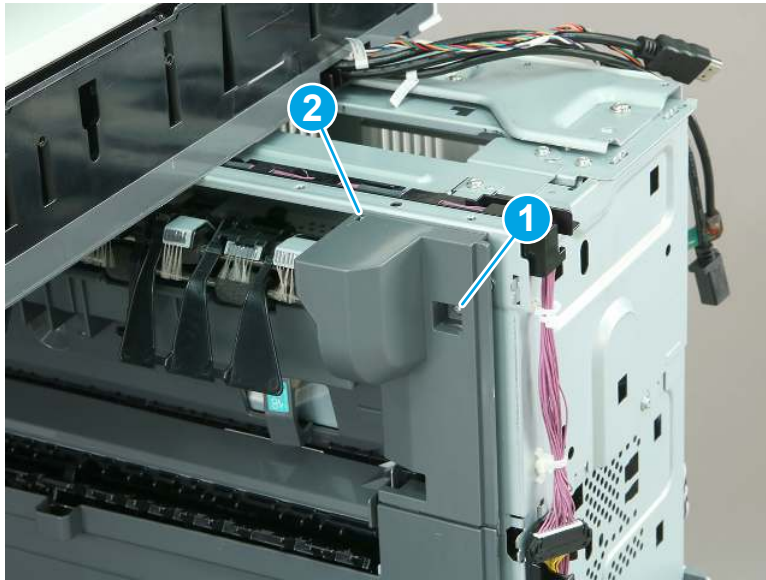
Figure 1-463 Remove the right front cover



10. Remove the delivery front cover (M776zs).

- ▲ Remove one screw (callout 1), and then remove the delivery front cover (callout 2).

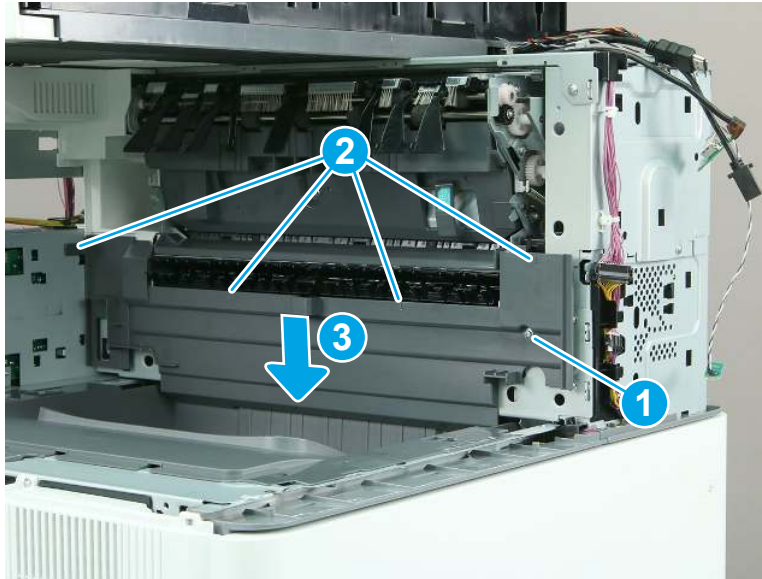
Figure 1-464 Remove the delivery front cover



11. Remove the delivery cover (M776zs).

- ▲ Remove one screw (callout 1), release four tabs (callout 2), and then slide the delivery cover down (callout 3) to remove it.

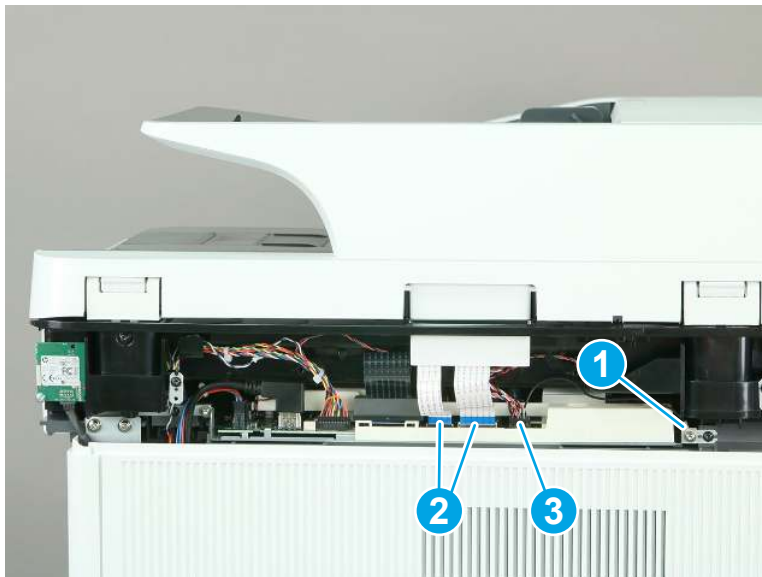
Figure 1-465 Remove the delivery cover



12. Remove the document feeder (M776dn/M776z/M776zs).
 - a. Remove one Torx T10 screw (callout 1) to release the ground wire, disconnect two flat cables (callout 2), and then disconnect one connector (callout 3).

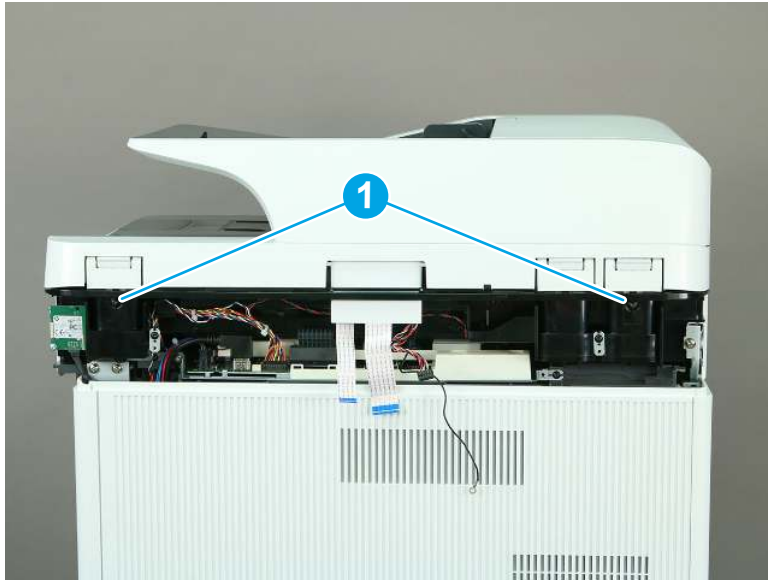
⚠ **CAUTION:** These connectors (callout 2) are zero insertion force (ZIF) connectors. The clip on these connectors is easily dislodged and lost.

Figure 1-466 Remove one screw and disconnect three connectors



- b. Remove two screws (callout 1).

Figure 1-467 Remove two screws



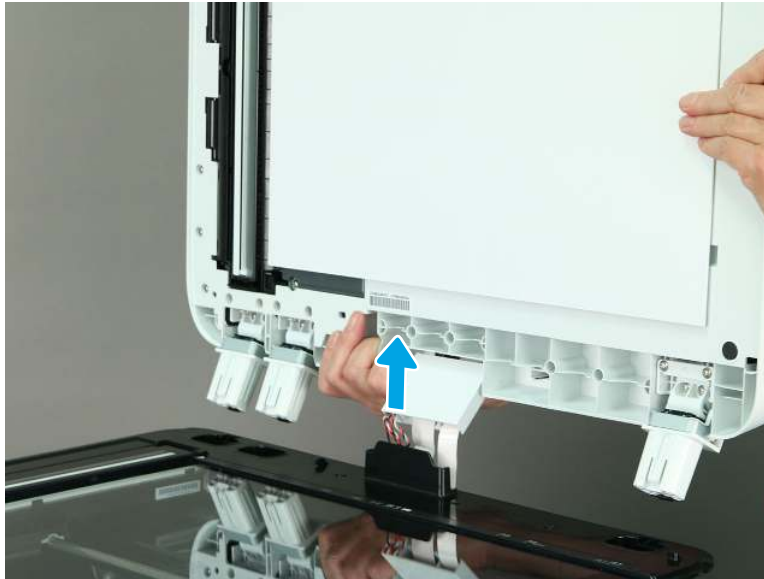
- c. Open the document feeder, and then lift it straight up until it stops at the retention tabs on each hinge (callout 1). Insert a small, flat-blade screwdriver between the hinge body and the slot in the scanner body (on the scanner glass side of the hinge) to release the retention tabs (on each hinge).

Figure 1-468 Release the hinges



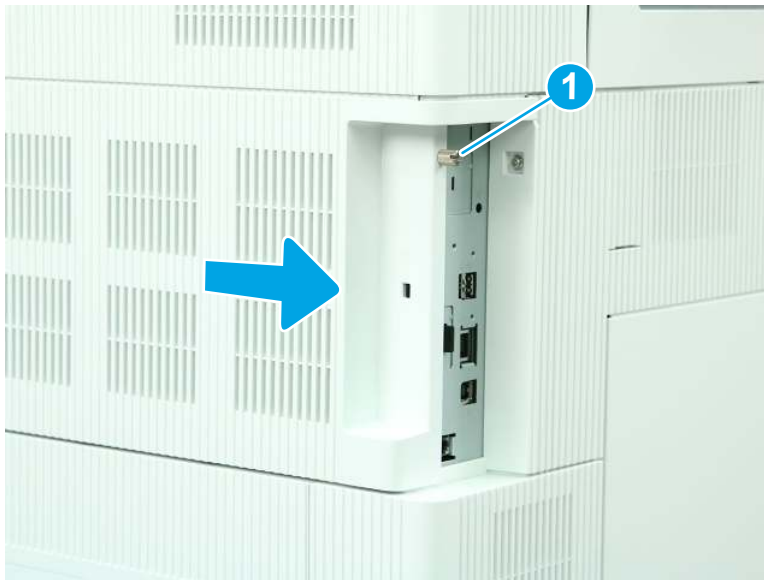
- d. Carefully thread the document feeder flat cables, wire harness, and ground wire up and through the opening in the scanner cover to remove the document feeder.

Figure 1-469 Remove the document feeder



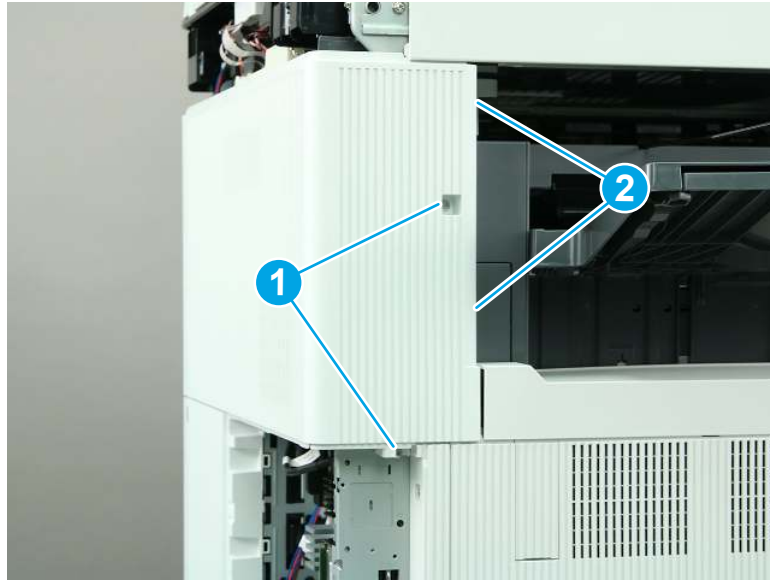
13. Remove the image scanner (M776dn/M776z/M776zs).
 - a. Remove the formatter cover.

Figure 1-470 Remove the formatter cover



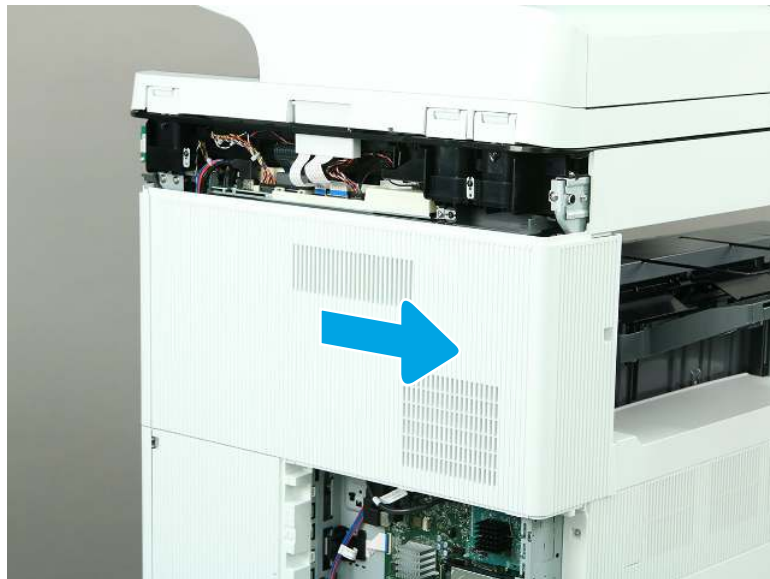
- b. Remove two screws (callout 1), and then release two tabs (callout 2).

Figure 1-471 Remove two screws and release two tabs



- c. Slide the cover to the right to remove it.

Figure 1-472 Remove the rear upper and left rear upper cover



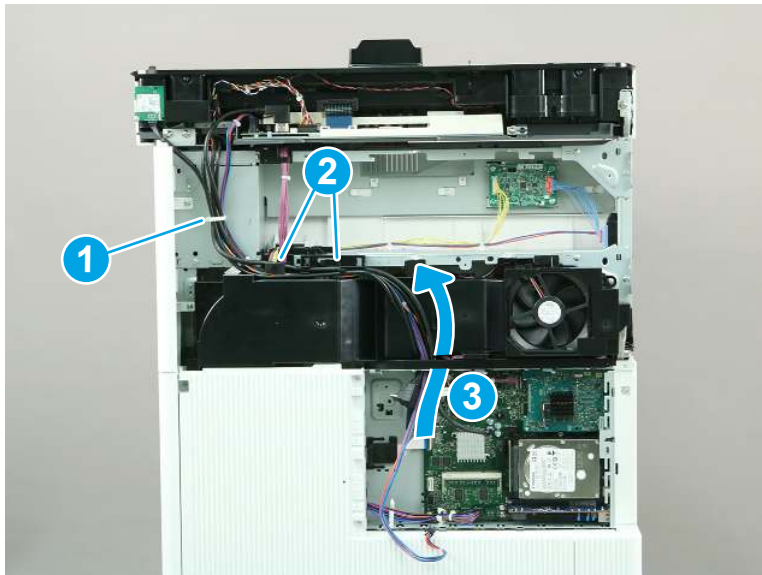
- d. Disconnect five connectors on the formatter (callout 1).

Figure 1-473 Disconnect five connectors



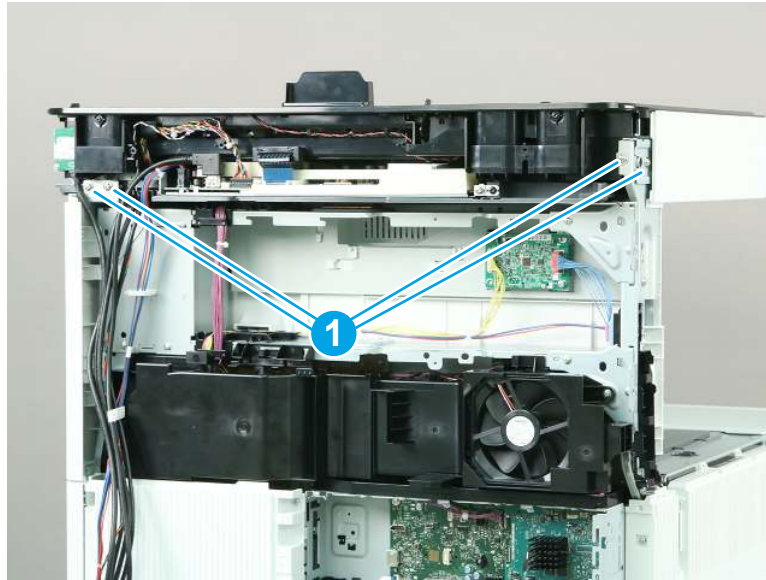
- e. Release one retainer (callout 1), release the cables from the guides (callout 2), and then pass the cables through the upper opening in the formatter cage (callout 3).

Figure 1-474 Release the cables



- f. Remove four screws (callout 1).

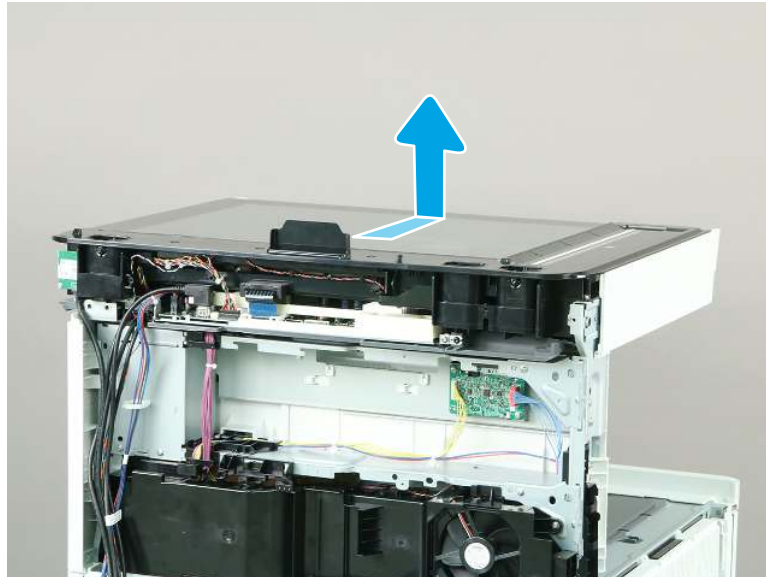
Figure 1-475 Remove four screws



- g. Slightly slide the image scanner toward the front of the printer to release it, and then lift it straight up and off of the printer..

 **NOTE:** Pass the wire harness and cables through the opening in the printer.

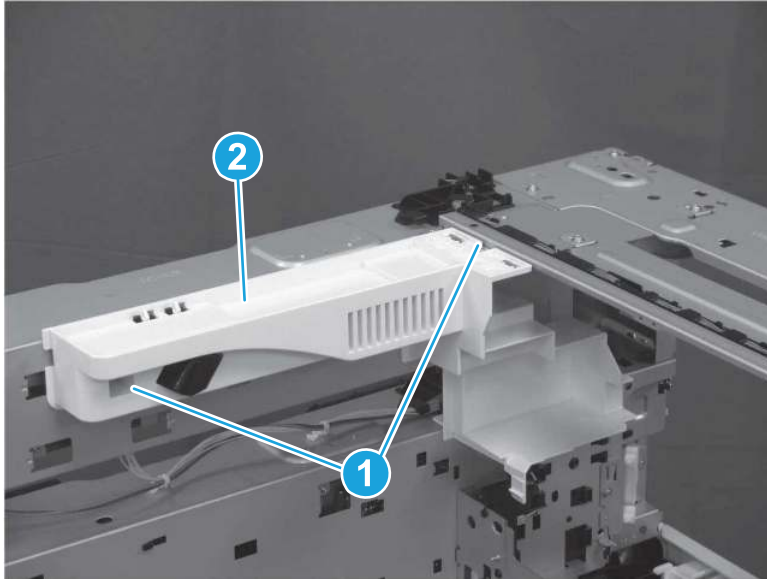
Figure 1-476 Remove the image scanner



- 14. Remove the rear delivery cover (M776zs).

- ▲ Remove two screws (callout 1), and then remove the rear delivery cover (callout 2).

Figure 1-477 Remove the rear delivery cover



15. Unpack the replacement assembly.

- a. Dispose of the defective part.



NOTE: HP recommends responsible disposal of the defective part.

<http://www8.hp.com/us/en/hp-information/environment/product-recycling.html>

- b. Unpack the replacement part from the packaging.



IMPORTANT: Make sure that all of the shipping materials (for example shipping tape) are removed from the replacement part prior to installation.

- c. To install an assembly, reverse the removal steps.



NOTE: When applicable, special installation instructions are provided for an assembly at the end of the removal procedure. Always completely read the removal instructions and follow all special installation instructions.

Removal and replacement: Internal parts and assemblies

Learn how to remove and replace the printer internal parts and assemblies.

Removal and replacement: Keyboard (M776z/M776zs)

Learn how to remove and replace the keyboard.

[View a video of how to remove and replace the keyboard.](#)

Mean time to repair: 5 minutes

Service level: Easy

Before performing service

Turn the printer power off

- Disconnect the power cable.

⚠ WARNING! To avoid damage to the printer, turn the printer off, wait 30 seconds, and then remove the power cord before attempting to service the printer.

Use the table below to identify the correct part number for your printer. To order the part, go to www.hp.com/buy/parts.

Table 1-43 Part information

Part number	Part description
Y6V12-67002	Keyboard (US; M776z/M776zs)
Y6V12-67001	Keyboard (UK; M776z/M776zs)

Required tools

- #2 Phillips screwdriver with a magnetic tip

After performing service

Turn the printer power on

- Connect the power cable.
- Use the power switch to turn the power on.

Post service test

Make sure that the printer initializes to a **Ready** state.

Print a page to make sure that the printer is functioning correctly.

1. Remove the control panel (M776).

- a. Rotate the control panel to the fully raised position (callout 1), and then raise the document feeder (callout 2).

Figure 1-478 Raise the control panel and document feeder



- b. Beginning at the right side of the control-panel cover, carefully release five tabs along the top edge of the cover.

 **NOTE:** The thin black-plastic cover will separate from the white-plastic control-panel base.

Figure 1-479 Release the control panel cover



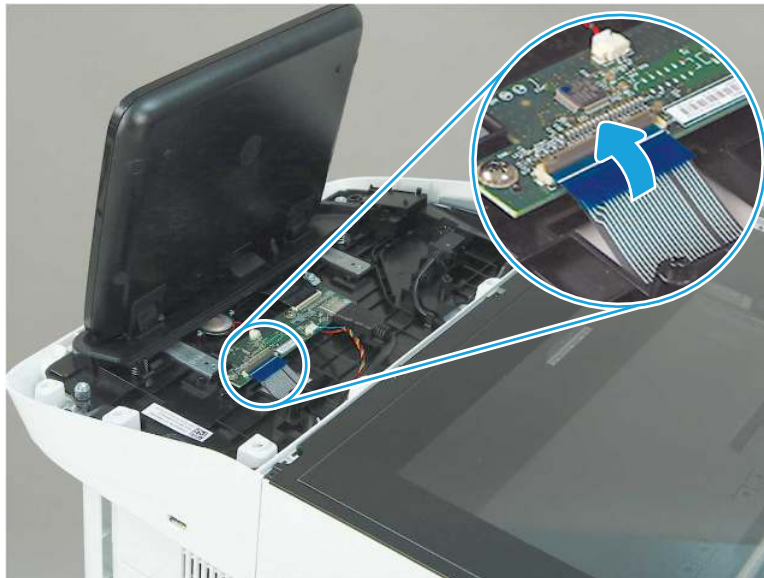
- c. Rotate the control panel cover slightly forward (callout 1), and then lift up to remove the cover (callout 2).

Figure 1-480 Remove the control panel cover



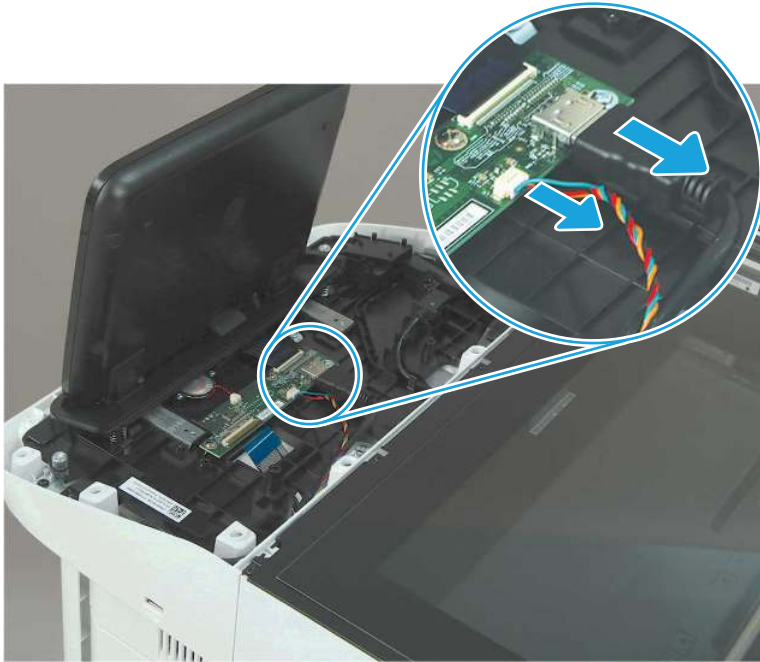
- d. **M776z or M776zs only:** Open the connector latch to release the keyboard flat cable.

Figure 1-481 Release the keyboard flat cable (M776z/M776zs)



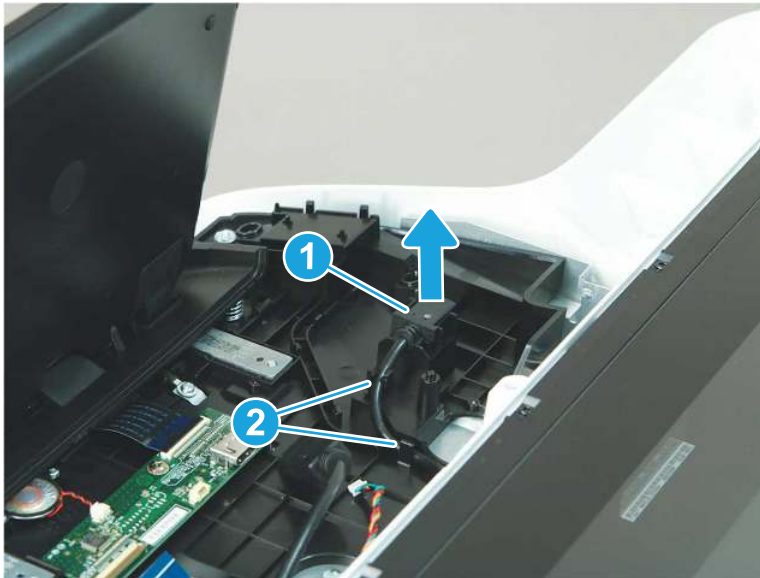
- e. Disconnect two connectors

Figure 1-482 Disconnect two connectors



- f. Remove the USB cable (callout 1) from the holder, and then release the cable from two retainers (callout 2).

Figure 1-483 Release the USB cable



- g. Remove three screws (callout 1).

Figure 1-484 Remove three screws



- h. Lift the front of the control panel off of the printer (callout 1), and then slide it towards the front of the printer (callout 2) to remove it.

Figure 1-485 Remove the control panel



- 2. Remove the keyboard (M776z/M776zs).

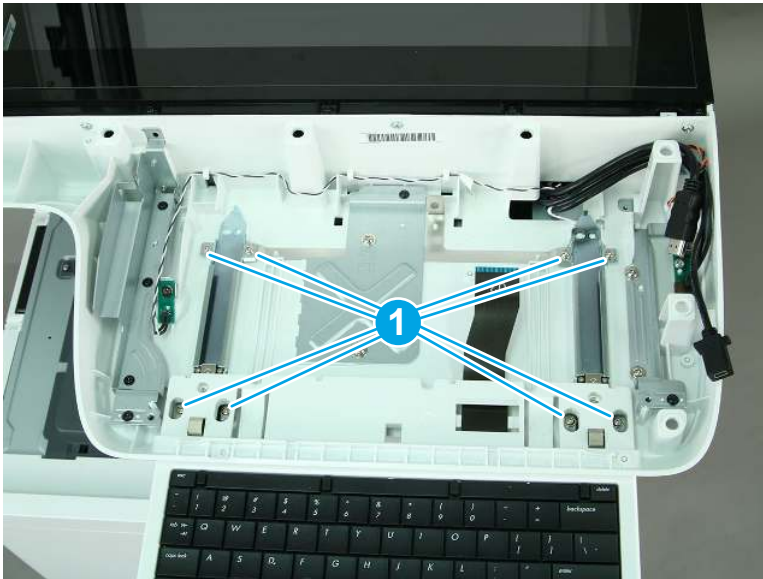
- a. Pull the keyboard out to its extended position.

Figure 1-486 Pull the keyboard out



- b. Remove eight screws (callout 1).

Figure 1-487 Remove eight screws



- c. Remove the keyboard and rails.

Figure 1-488 Remove the keyboard and rails



3. Unpack the replacement assembly.

- a. Dispose of the defective part.



NOTE: HP recommends responsible disposal of the defective part.

<http://www8.hp.com/us/en/hp-information/environment/product-recycling.html>

- b. Unpack the replacement part from the packaging.



IMPORTANT: Make sure that all of the shipping materials (for example shipping tape) are removed from the replacement part prior to installation.

- c. To install an assembly, reverse the removal steps.



NOTE: When applicable, special installation instructions are provided for an assembly at the end of the removal procedure. Always completely read the removal instructions and follow all special installation instructions.

Removal and replacement: Scanner control board (M776)

Learn how to remove and replace the scanner control board.

[View a video of how to remove and replace the scanner control board.](#)

Mean time to repair: 4 minutes

Service level: Easy

Before performing service

Turn the printer power off

- Disconnect the power cable.

⚠ WARNING! To avoid damage to the printer, turn the printer off, wait 30 seconds, and then remove the power cord before attempting to service the printer.

Use the table below to identify the correct part number for your printer. To order the part, go to www.hp.com/buy/parts.

Table 1-44 Part information

Part number	Part description
5851-7916	Kit-SCB enterprise
5851-7917	Kit-SCB work flow

Required tools

- #2 Phillips screwdriver with a magnetic tip

After performing service

Turn the printer power on

- Connect the power cable.
- Use the power switch to turn the power on.

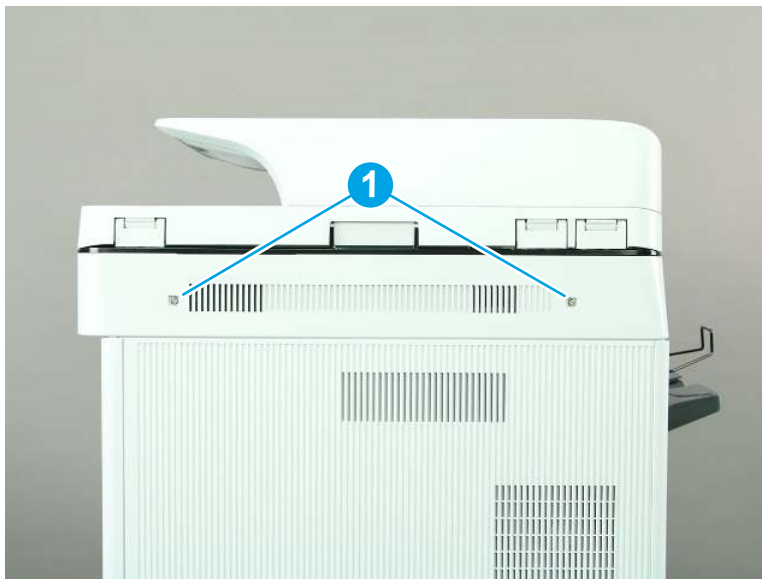
Post service test

Make sure that the printer initializes to a **Ready** state.

Copy a page from the image scanner and verify it is functioning correctly.

1. Remove the scanner control board (SCB) cover (M776).
 - a. Remove two screws (callout 1).

Figure 1-489 Remove two screws



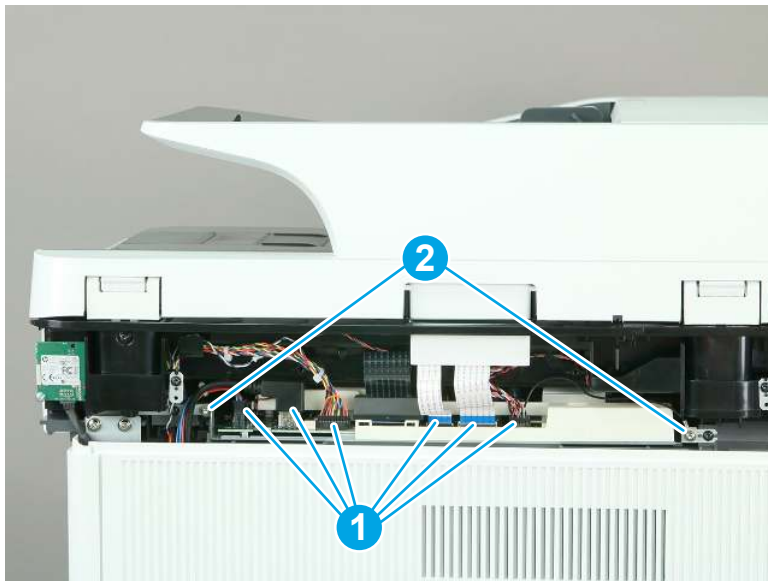
- b. Remove the SCB cover.

Figure 1-490 Remove the SCB cover



- 2. Remove the scanner control board (SCB) (M776dn/M776z/M776zs).
 - a. Disconnect six connectors (callout 1), and then remove two screws (callout 2).

Figure 1-491 Disconnect six connectors and remove two screws



- b. Release the tab on the back of the ferrite holder, and then lift the ferrite up to release it.

Figure 1-492 Release the ferrite



- c. Lift the ferrite up, and then disconnect one flat cable (callout 1).

⚠ CAUTION: This connector is a zero insertion force (ZIF) connector. The clip on this connector is easily dislodged and lost.

Slide the ferrite off of the flat cable after disconnecting it. The ferrite is not captive and can easily slip off and be damaged.

Figure 1-493 Disconnect one flat cable



- d. Slide the scanner control board (SCB) out of the printer to remove it.

Figure 1-494 Remove the SCB



3. Unpack the replacement assembly.
 - a. Dispose of the defective part.




NOTE: HP recommends responsible disposal of the defective part.

<http://www8.hp.com/us/en/hp-information/environment/product-recycling.html>

- b. Unpack the replacement part from the packaging.



CAUTION:  Some parts are sensitive to electrostatic discharge (ESD). Always perform service work at an ESD-protected workstation or mat. If an ESD workstation or mat is not available, touch the sheet-metal chassis to provide a static ground before touching an ESD-sensitive assembly. Protect the ESD-sensitive assemblies by placing them in ESD pouches when they are out of the printer.



IMPORTANT: Make sure that all of the shipping materials (for example shipping tape) are removed from the replacement part prior to installation.

- c. To install an assembly, reverse the removal steps.



NOTE: When applicable, special installation instructions are provided for an assembly at the end of the removal procedure. Always completely read the removal instructions and follow all special installation instructions.

Removal and replacement: Wireless PCA (M856/E85055)

Learn how to remove and replace the wireless PCA.

Mean time to repair: 4 minutes

Service level: Easy

Before performing service

Turn the printer power off

- Disconnect the power cable.

⚠ WARNING! To avoid damage to the printer, turn the printer off, wait 30 seconds, and then remove the power cord before attempting to service the printer.

Use the table below to identify the correct part number for your printer. To order the part, go to www.hp.com/buy/parts.

Table 1-45 Part information

Part number	Part description
0960-3659	Wireless PCA board

Required tools

- Small, flat-blade screwdriver
- #2 Phillips screwdriver with a magnetic tip

After performing service

Turn the printer power on

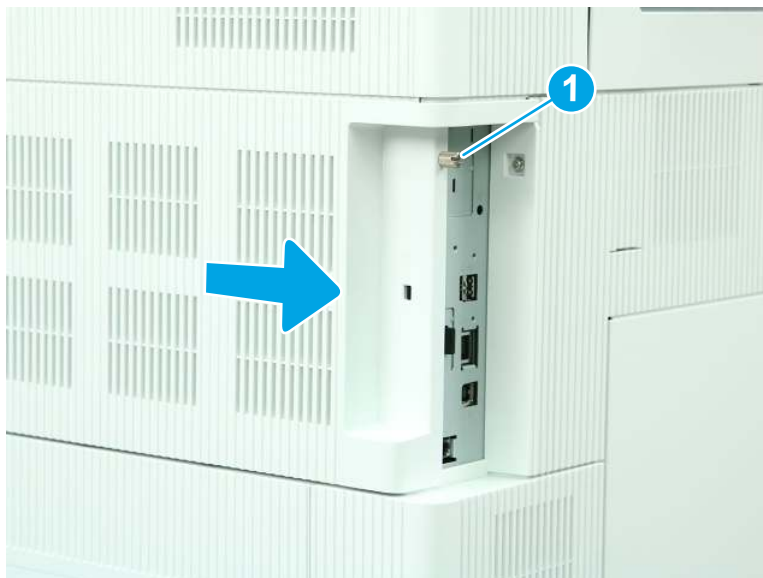
- Connect the power cable.
- Use the power switch to turn the power on.

Post service test

Make sure that the printer initializes to a **Ready** state. Print a page to make sure that the printer is functioning correctly.

1. Remove the formatter cover.
 - ▲ Loosen one thumbscrew (callout 1), and then slide the formatter cover (callout 2) away from the printer to remove it.

Figure 1-495 Remove the formatter cover

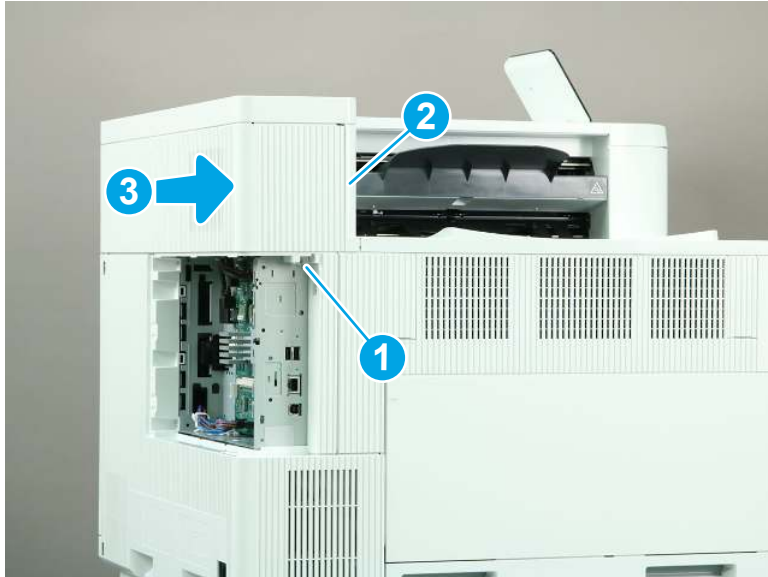


2. Remove the rear upper cover (M856/E85055/M776dn/M776z).

 **NOTE:** The following figure shows the M856 printer. The procedure is correct for all referenced models.

- ▲ Remove one screw (callout 1), release one tab (callout 2), and then slide the rear upper cover away from the printer to remove it (callout 3).

Figure 1-496 Remove the rear upper cover



3. Remove the control panel (M856/E85055).

 **NOTE:** A screwdriver is included in the control panel kit. The screwdriver has a reversible shaft. Simply pull the shaft out of the handle, and then reinstall it with the desired end facing out.

- a. Use a small, flat-blade screwdriver to release two tabs (callout 1), and then remove the control panel cover (callout 2).

Figure 1-497 Remove the control panel cover



- b. Remove one screw (callout 1).

Figure 1-498 Remove one screw



- c. Lift the back edge of the control panel up (callout 1), and then slide the control panel toward the back of the printer (callout 2).

Figure 1-499 Slide the control panel back



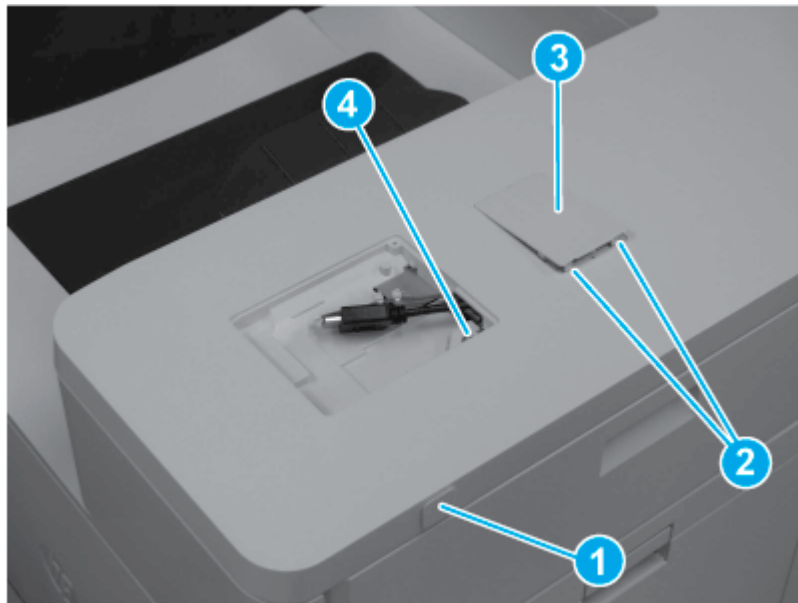
- d. Turn the control panel so that the bottom is facing up, and then disconnect two connectors to remove the control panel.

Figure 1-500 Disconnect two connectors



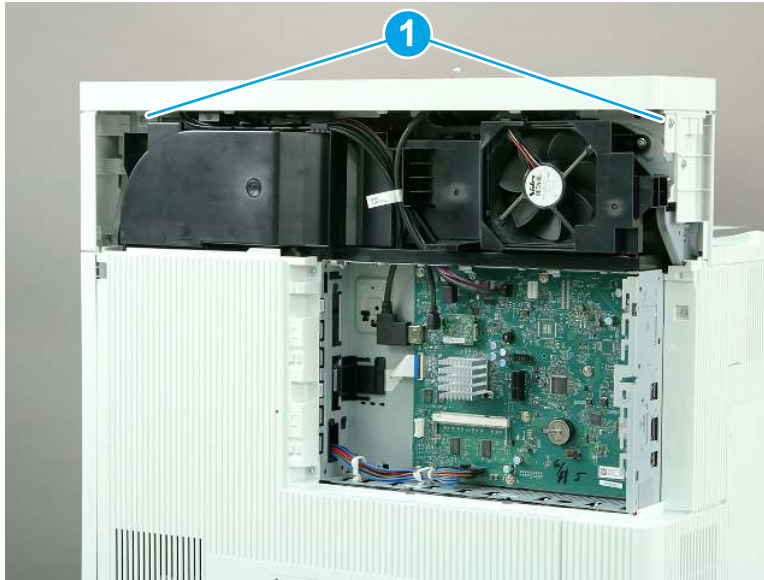
- 4. Remove the top cover (M856/E85055).
 - a. Remove the USB cover (callout 1). Release two tabs (callout 2), and then remove the HIP cover (callout 3). Remove one screw (callout 4).

Figure 1-501 Remove covers and one screw



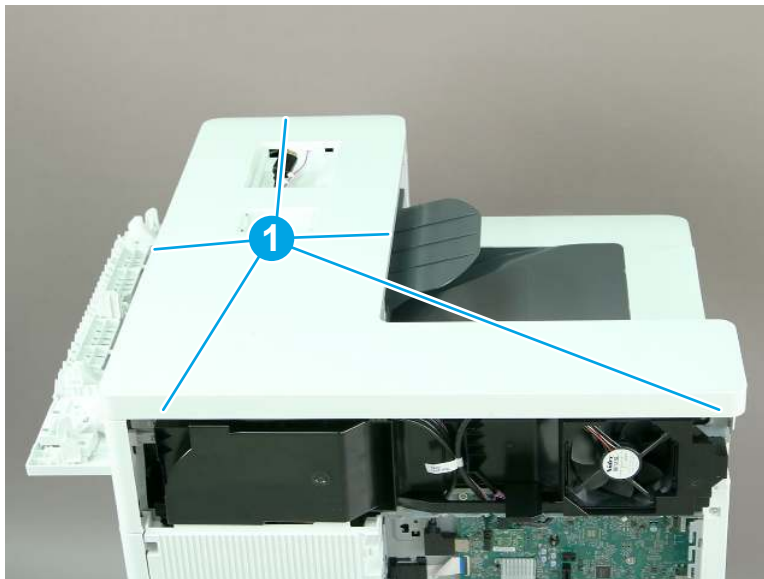
- b. Remove two screws (callout 1).

Figure 1-502 Remove two screws



- c. Release five tabs (callout 1), and then remove the top cover.

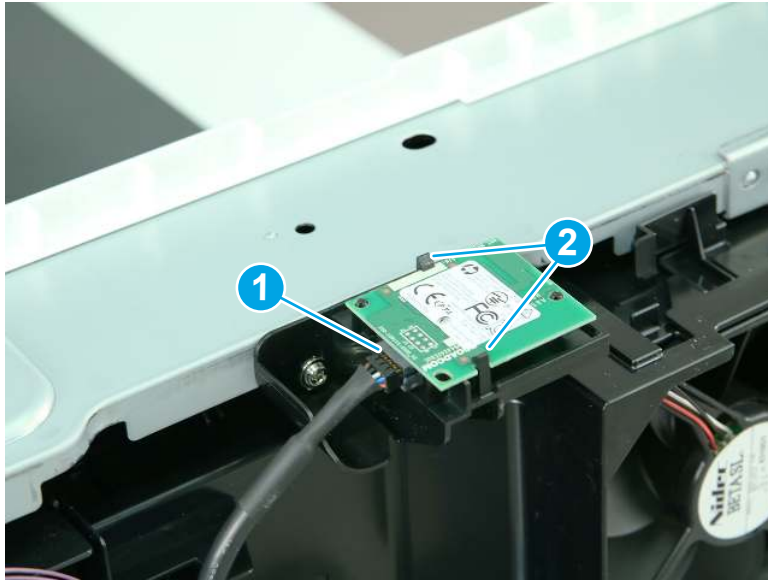
Figure 1-503 Release five tabs



- 5. Remove the wireless PCA (M856/E85055)

- ▲ Disconnect one connector (callout 1), release two tabs (callout 2), and then remove the wireless pca

Figure 1-504 Remove the wireless PCA



- 6. Unpack the replacement assembly.

- a. Dispose of the defective part.




NOTE: HP recommends responsible disposal of the defective part.

<http://www8.hp.com/us/en/hp-information/environment/product-recycling.html>

- b. Unpack the replacement part from the packaging.



CAUTION:  Some parts are sensitive to electrostatic discharge (ESD). Always perform service work at an ESD-protected workstation or mat. If an ESD workstation or mat is not available, touch the sheet-metal chassis to provide a static ground before touching an ESD-sensitive assembly. Protect the ESD-sensitive assemblies by placing them in ESD pouches when they are out of the printer.



IMPORTANT: Make sure that all of the shipping materials (for example shipping tape) are removed from the replacement part prior to installation.

- c. To install an assembly, reverse the removal steps.



NOTE: When applicable, special installation instructions are provided for an assembly at the end of the removal procedure. Always completely read the removal instructions and follow all special installation instructions.

Removal and replacement: Wireless PCA (M776)

Learn how to remove and replace the wireless PCA.

[View a video of how to remove and replace the wireless PCA.](#)

Mean time to repair: 3 minutes

Service level: Easy

Before performing service

Turn the printer power off

- Disconnect the power cable.

⚠ WARNING! To avoid damage to the printer, turn the printer off, wait 30 seconds, and then remove the power cord before attempting to service the printer.

Use the table below to identify the correct part number for your printer. To order the part, go to www.hp.com/buy/parts.

Table 1-46 Part information

Part number	Part description
0960-3659	Wireless PCA board

Required tools

- Small, flat-blade screwdriver
- #2 Phillips screwdriver with a magnetic tip

After performing service

Turn the printer power on

- Connect the power cable.
- Use the power switch to turn the power on.

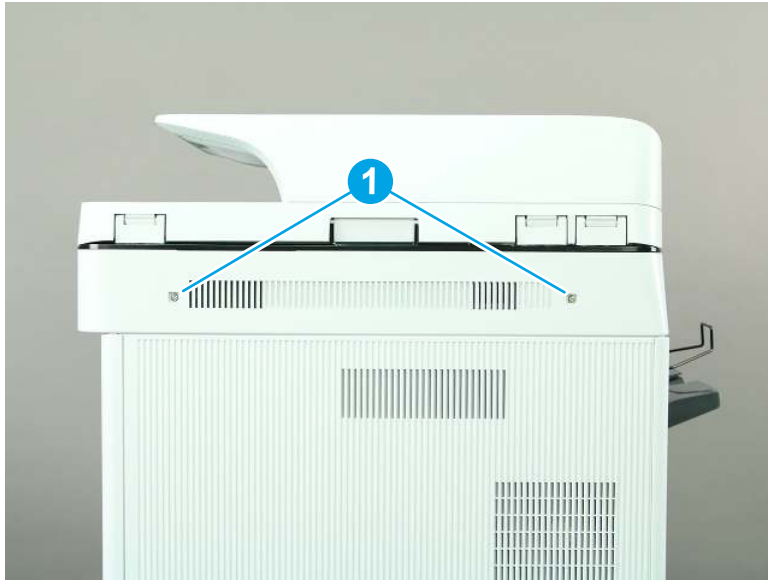
Post service test

Make sure that the printer initializes to a **Ready** state. Print a page to make sure that the printer is functioning correctly.

1. Remove the scanner control board (SCB) cover (M776).

- a. Remove two screws (callout 1).

Figure 1-505 Remove two screws



- b. Remove the SCB cover.

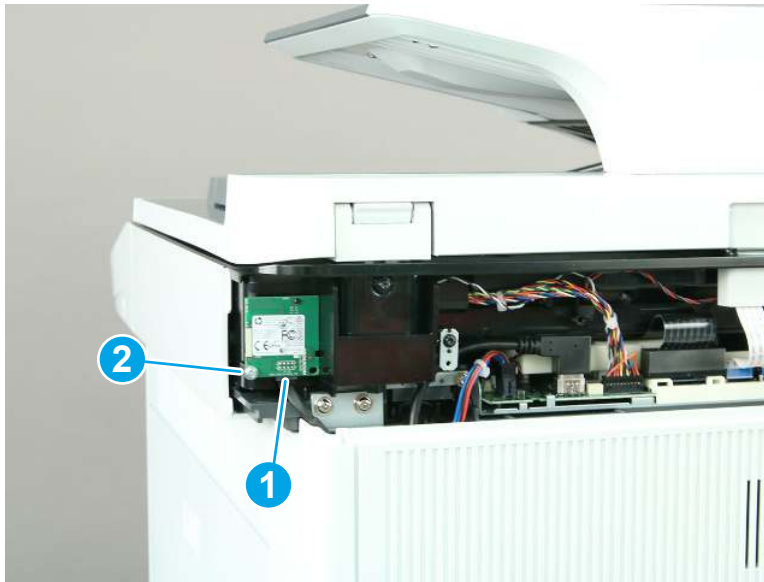
Figure 1-506 Remove the SCB cover



2. Remove the wireless PCA (M776)

- ▲ Disconnect one connector (callout 1), remove one screw (callout 2), and then remove the wireless pca

Figure 1-507 Remove the wireless PCA



- 3. Unpack the replacement assembly.
 - a. Dispose of the defective part.




NOTE: HP recommends responsible disposal of the defective part.

<http://www8.hp.com/us/en/hp-information/environment/product-recycling.html>

- b. Unpack the replacement part from the packaging.



CAUTION:  Some parts are sensitive to electrostatic discharge (ESD). Always perform service work at an ESD-protected workstation or mat. If an ESD workstation or mat is not available, touch the sheet-metal chassis to provide a static ground before touching an ESD-sensitive assembly. Protect the ESD-sensitive assemblies by placing them in ESD pouches when they are out of the printer.



IMPORTANT: Make sure that all of the shipping materials (for example shipping tape) are removed from the replacement part prior to installation.

- c. To install an assembly, reverse the removal steps.



NOTE: When applicable, special installation instructions are provided for an assembly at the end of the removal procedure. Always completely read the removal instructions and follow all special installation instructions.

Removal and replacement: Communication PCA (M776)

Learn how to remove and replace the communication PCA.

Mean time to repair: 4 minutes

Service level: Easy

Before performing service

Turn the printer power off

- Disconnect the power cable.

⚠ WARNING! To avoid damage to the printer, turn the printer off, wait 30 seconds, and then remove the power cord before attempting to service the printer.

Use the table below to identify the correct part number for your printer. To order the part, go to www.hp.com/buy/parts.

Table 1-47 Part information

Part number	Part description
RM3-7341-000CN	Communication PCB assembly

Required tools

- #2 Phillips screwdriver with a magnetic tip

After performing service

Turn the printer power on

- Connect the power cable.
- Use the power switch to turn the power on.

Post service test

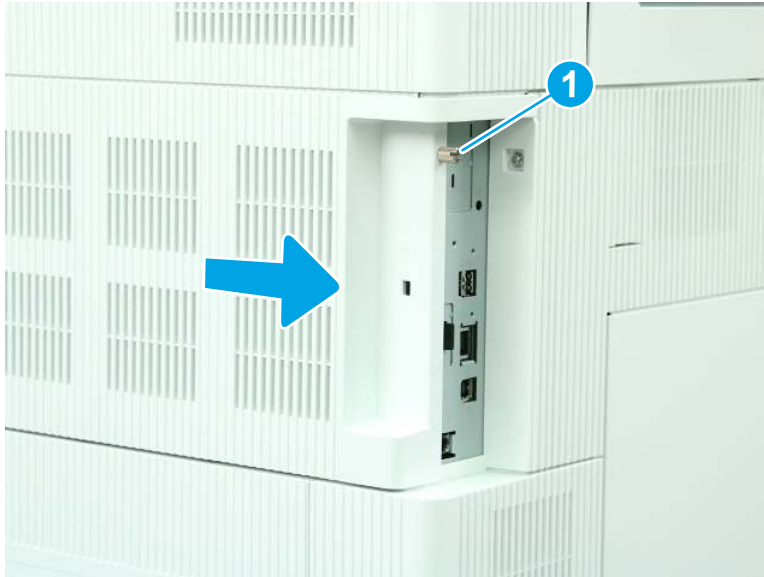
Make sure that the printer initializes to a **Ready** state.

Print a page to make sure that the printer is functioning correctly.

1. Remove the formatter cover.

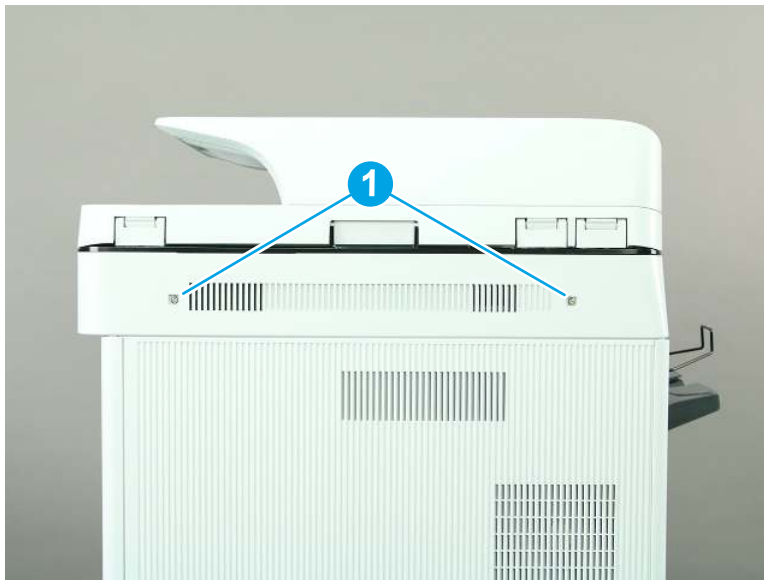
- ▲ Loosen one thumbscrew (callout 1), and then slide the formatter cover (callout 2) away from the printer to remove it.

Figure 1-508 Remove the formatter cover



- 2. Remove the scanner control board (SCB) cover (M776).
 - a. Remove two screws (callout 1).

Figure 1-509 Remove two screws



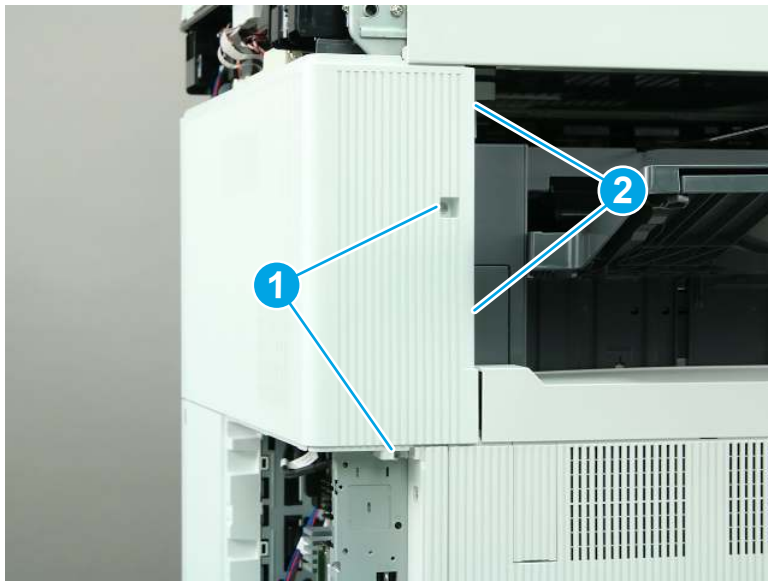
- b. Remove the SCB cover.

Figure 1-510 Remove the SCB cover



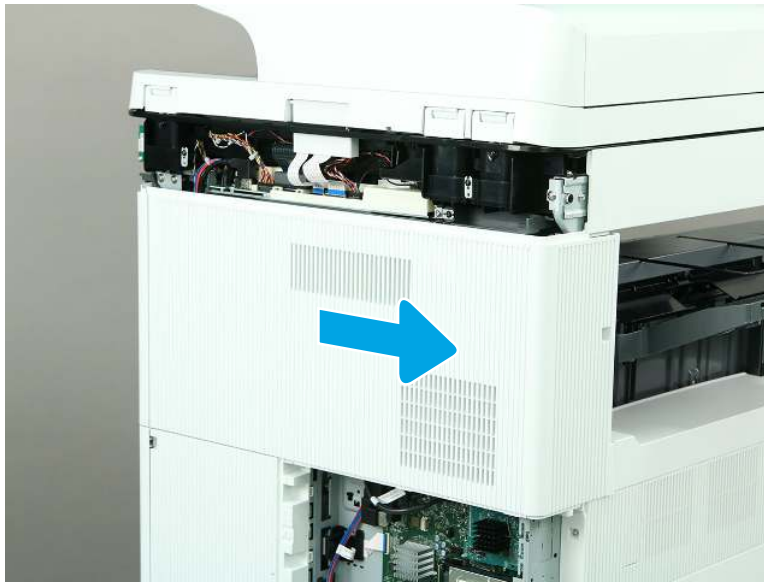
3. Remove the rear upper cover and left rear upper cover (M776zs).
 - a. Remove two screws (callout 1), and then release two tabs (callout 2).

Figure 1-511 Remove two screws and release two tabs



- b. Slide the cover to the right to remove it.

Figure 1-512 Remove the rear upper and left rear upper cover

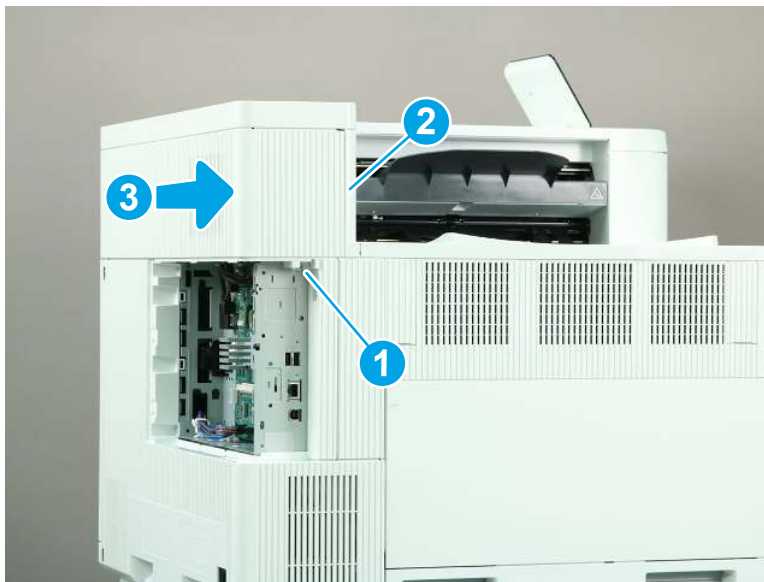


4. Remove the rear upper cover (M856/E85055/M776dn/M776z).

 **NOTE:** The following figure shows the M856 printer. The procedure is correct for all referenced models.

- ▲ Remove one screw (callout 1), release one tab (callout 2), and then slide the rear upper cover away from the printer to remove it (callout 3).

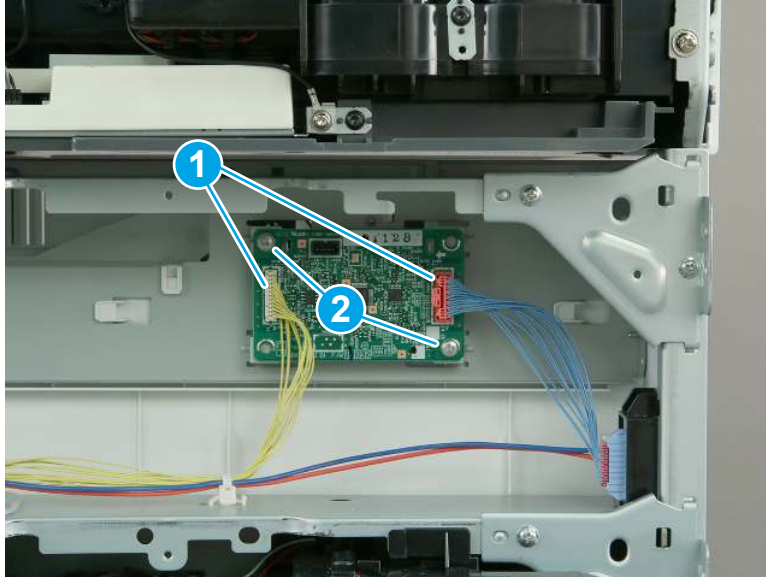
Figure 1-513 Remove the rear upper cover



5. Remove the communication PCA (M776).

- ▲ Disconnect two connectors (callout 1), and the remove two screws (callout 2). Remove the communication PCA.

Figure 1-514 Remove the communication PCA



6. Unpack the replacement assembly.

- a. Dispose of the defective part.




NOTE: HP recommends responsible disposal of the defective part.

<http://www8.hp.com/us/en/hp-information/environment/product-recycling.html>

- b. Unpack the replacement part from the packaging.



CAUTION:  Some parts are sensitive to electrostatic discharge (ESD). Always perform service work at an ESD-protected workstation or mat. If an ESD workstation or mat is not available, touch the sheet-metal chassis to provide a static ground before touching an ESD-sensitive assembly. Protect the ESD-sensitive assemblies by placing them in ESD pouches when they are out of the printer.



IMPORTANT: Make sure that all of the shipping materials (for example shipping tape) are removed from the replacement part prior to installation.

- c. To install an assembly, reverse the removal steps.



NOTE: When applicable, special installation instructions are provided for an assembly at the end of the removal procedure. Always completely read the removal instructions and follow all special installation instructions.

Removal and replacement: Duplexing controller PCA (M856/E85055/M776)

Learn how to remove and replace the duplexing controller PCA.

[View a video of how to remove and replace the duplexing controller PCA.](#)

Mean time to repair: 5 minutes

Service level: Easy

Before performing service

Turn the printer power off

- Disconnect the power cable.

⚠ WARNING! To avoid damage to the printer, turn the printer off, wait 30 seconds, and then remove the power cord before attempting to service the printer.

Use the table below to identify the correct part number for your printer. To order the part, go to www.hp.com/buy/parts.

Table 1-48 Part information

Part number	Part description
RM3-7380-000CN	Duplexing controller PCB assembly

Required tools

- #2 Phillips screwdriver with a magnetic tip

After performing service

Turn the printer power on

- Connect the power cable.
- Use the power switch to turn the power on.

Post service test

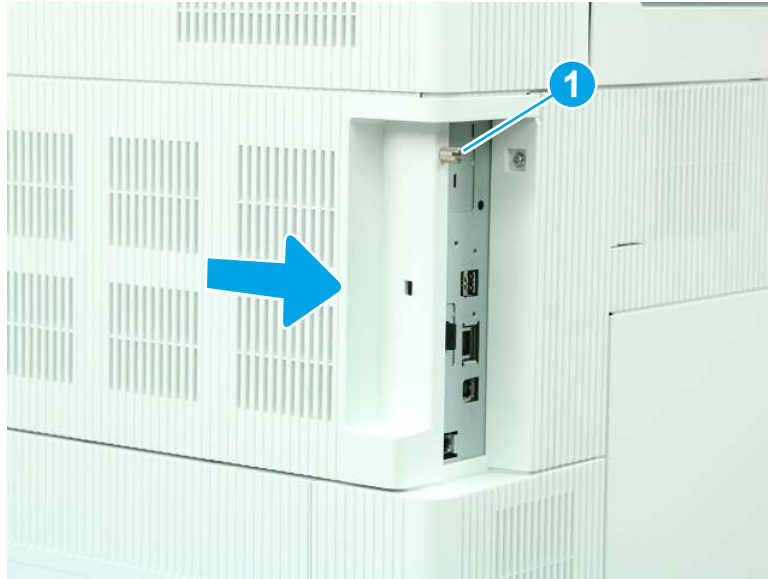
Make sure that the printer initializes to a **Ready** state.

Print a page to make sure that the printer is functioning correctly.

1. Remove the formatter cover.

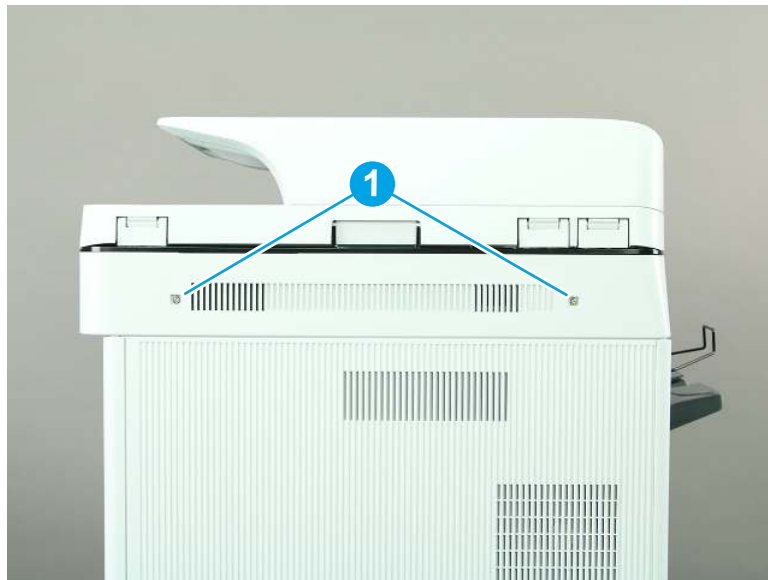
- ▲ Loosen one thumbscrew (callout 1), and then slide the formatter cover (callout 2) away from the printer to remove it.

Figure 1-515 Remove the formatter cover



- 2. Remove the scanner control board (SCB) cover (M776).
 - a. Remove two screws (callout 1).

Figure 1-516 Remove two screws



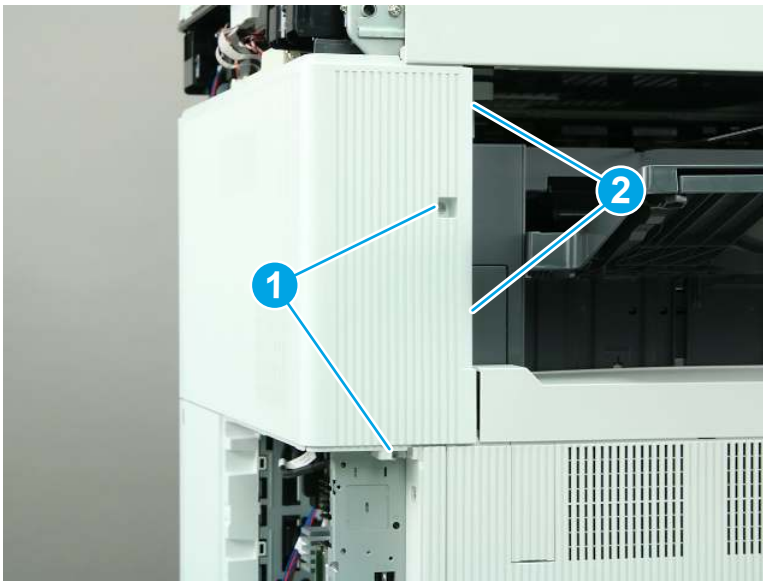
- b. Remove the SCB cover.

Figure 1-517 Remove the SCB cover



3. Remove the rear upper cover and left rear upper cover (M776zs).
 - a. Remove two screws (callout 1), and then release two tabs (callout 2).

Figure 1-518 Remove two screws and release two tabs



- b. Slide the cover to the right to remove it.

Figure 1-519 Remove the rear upper and left rear upper cover

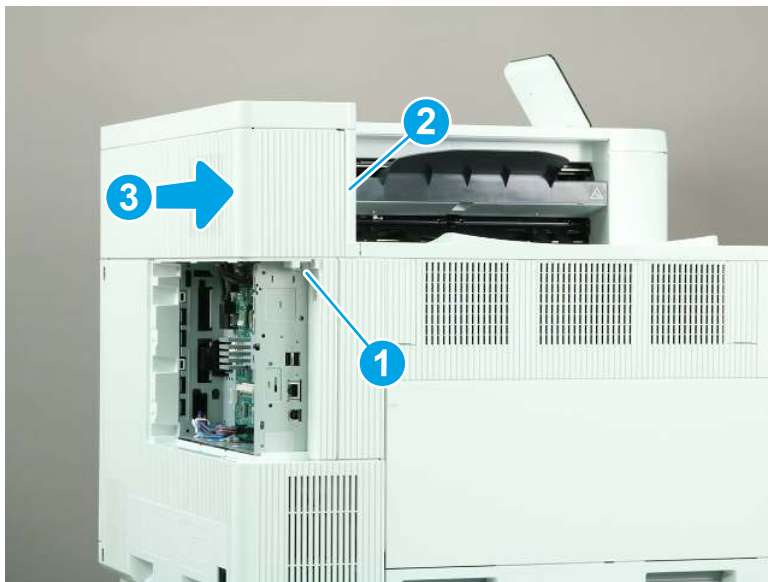


4. Remove the rear upper cover (M856/E85055/M776dn/M776z).

 **NOTE:** The following figure shows the M856 printer. The procedure is correct for all referenced models.

- ▲ Remove one screw (callout 1), release one tab (callout 2), and then slide the rear upper cover away from the printer to remove it (callout 3).

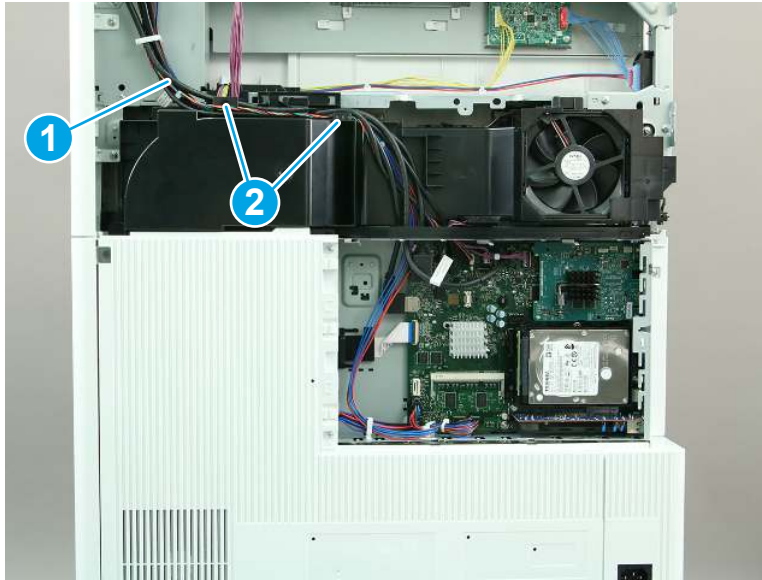
Figure 1-520 Remove the rear upper cover



5. Remove the duplexing controller PCA (M856/E85055/M776).

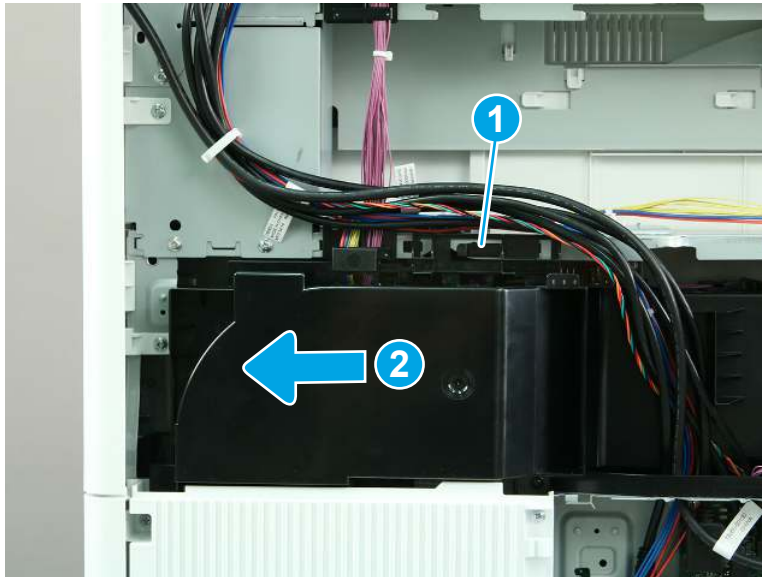
- a. Release the cables (callout 1) from the guides (callout 2).

Figure 1-521 Release the cables from the guides



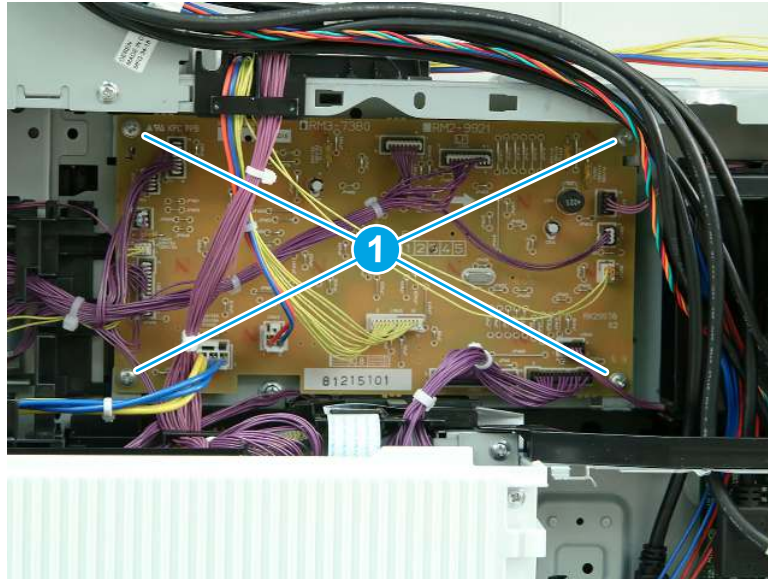
- b. Release one tab (callout 1), and then slide the fan duct to the left (callout 2) to remove it.

Figure 1-522 Remove the fan duct



- c. Disconnect all of the connectors on the duplexing controller PCA. Remove four screws (callout 1), and then remove the duplexing controller PCA.

Figure 1-523 Remove the duplexing controller PCA



6. Unpack the replacement assembly.

- a. Dispose of the defective part.




NOTE: HP recommends responsible disposal of the defective part.

<http://www8.hp.com/us/en/hp-information/environment/product-recycling.html>

- b. Unpack the replacement part from the packaging.



CAUTION:  Some parts are sensitive to electrostatic discharge (ESD). Always perform service work at an ESD-protected workstation or mat. If an ESD workstation or mat is not available, touch the sheet-metal chassis to provide a static ground before touching an ESD-sensitive assembly. Protect the ESD-sensitive assemblies by placing them in ESD pouches when they are out of the printer.



IMPORTANT: Make sure that all of the shipping materials (for example shipping tape) are removed from the replacement part prior to installation.

- c. To install an assembly, reverse the removal steps.



NOTE: When applicable, special installation instructions are provided for an assembly at the end of the removal procedure. Always completely read the removal instructions and follow all special installation instructions.

Removal and replacement: Delivery assembly (M751/E75245)

Learn how to remove and replace the delivery assembly.

[View a video of how to remove and replace the delivery assembly.](#)

Mean time to repair: 19 minutes

Service level: Easy

Before performing service

Turn the printer power off

- Disconnect the power cable.

⚠ WARNING! To avoid damage to the printer, turn the printer off, wait 30 seconds, and then remove the power cord before attempting to service the printer.

Use the table below to identify the correct part number for your printer. To order the part, go to www.hp.com/buy/parts.

Table 1-49 Part information

Part number	Part description
RM2-1498-000CN	Paper delivery assembly

Required tools

- #2 Phillips screwdriver with a magnetic tip
- Small, flat-blade screwdriver

After performing service

Turn the printer power on

- Connect the power cable.
- Use the power switch to turn the power on.

Post service test

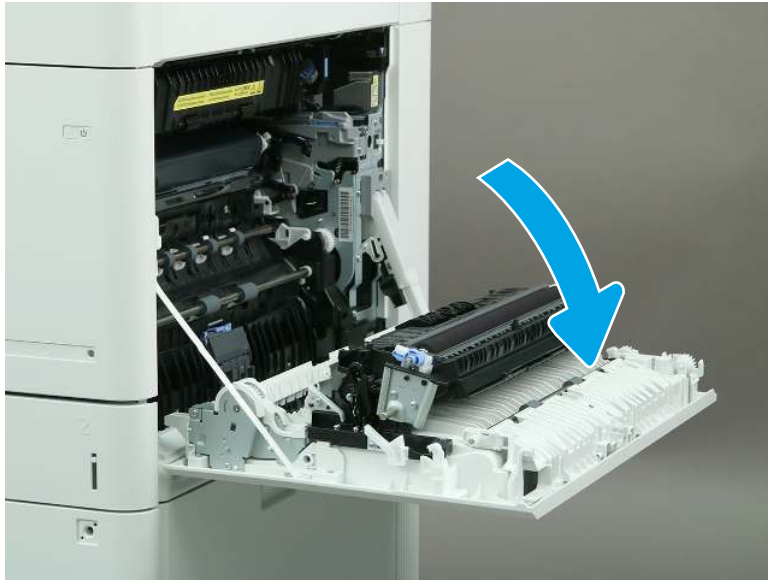
Make sure that the printer initializes to a **Ready** state.

Print a page to make sure that the printer is functioning correctly.

1. Remove the fuser.

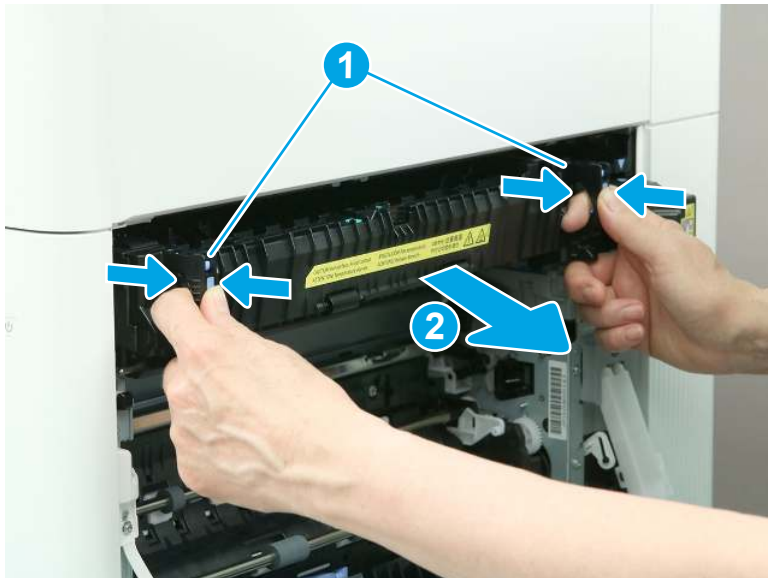
- a. Open the right door.

Figure 1-524 Open the right door



- b. Grasp the fuser handles, and then squeeze the release levers (callout 1). Lift up slightly, and then pull straight out to remove the fuser (callout 2).

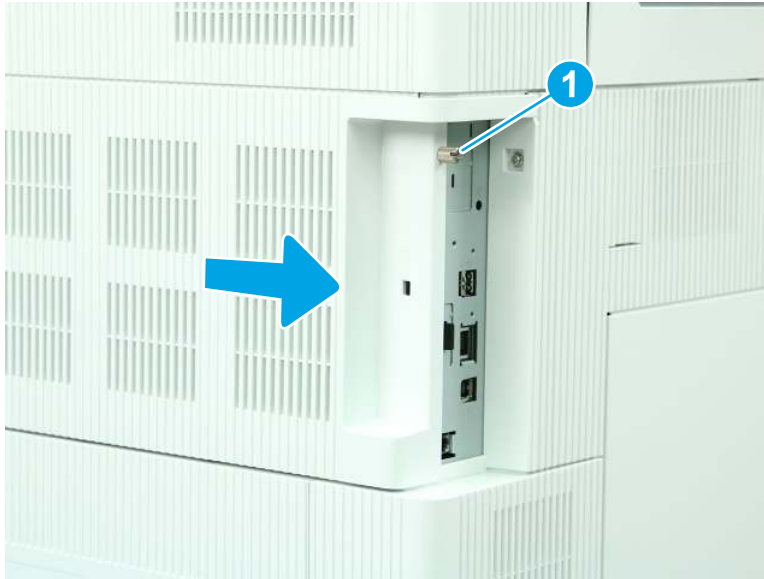
Figure 1-525 Remove the fuser



2. Remove the formatter cover.

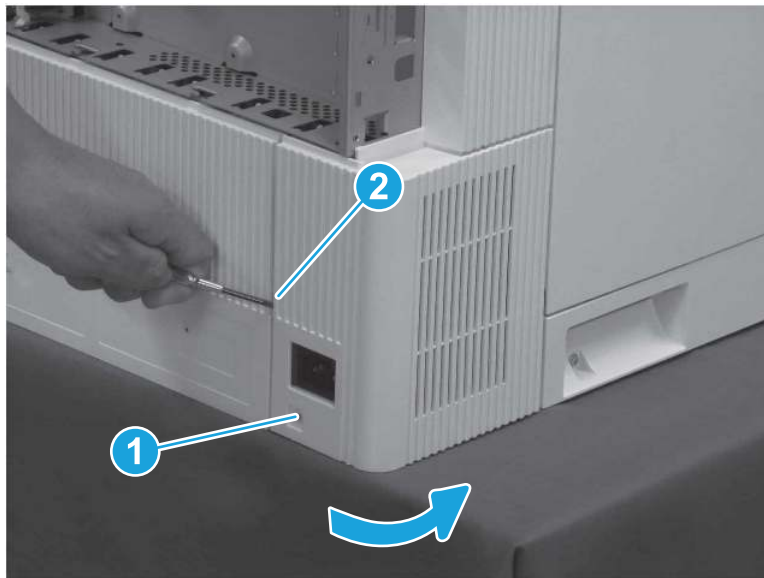
- ▲ Loosen one thumbscrew (callout 1), and then slide the formatter cover (callout 2) away from the printer to remove it.

Figure 1-526 Remove the formatter cover



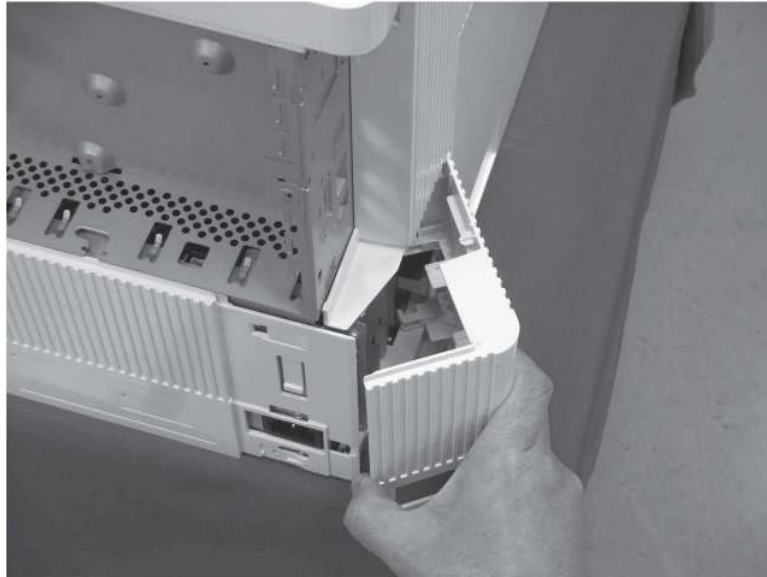
- 3. Remove the left lower cover (M751/E75245).
 - a. Remove one screw (callout 1), release one tab (callout 2), and then rotate the cover away from the printer.

Figure 1-527 Remove one screw and release one tab



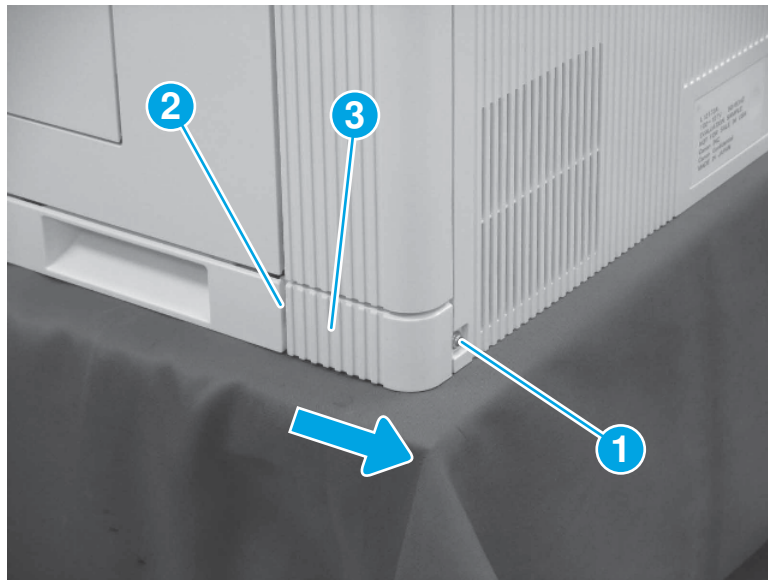
- b. Remove the left lower cover.

Figure 1-528 Remove the left lower cover



4. Remove the right rear lower cover (M751/E75245/M856/E85055/M776).
 - ▲ Remove one screw (callout 1), release one tab (callout 2), and then slide the right rear lower cover (callout 3) toward the back of the printer to remove it.

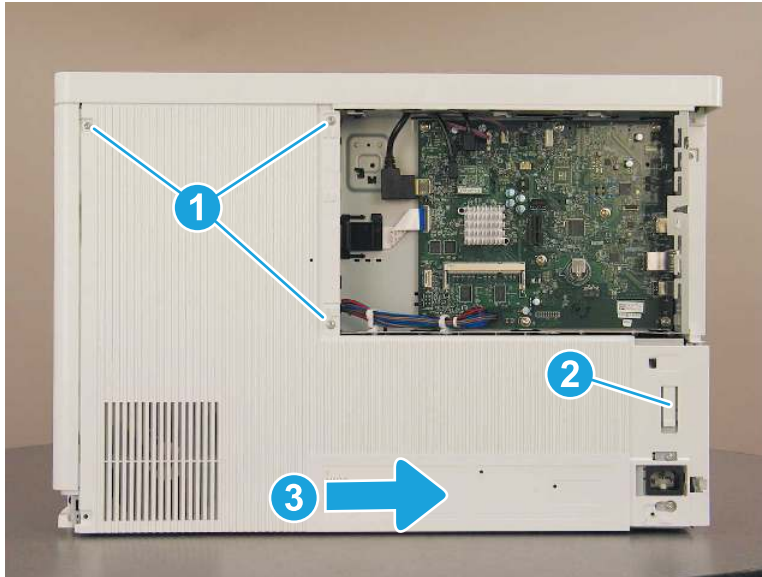
Figure 1-529 Remove the right rear lower cover



5. Remove the rear cover (M751/E75245).

- ▲ Remove three screws (callout 1), release one tab (callout 2), and then slide the rear cover to the right (callout 3) to remove it.

Figure 1-530 Remove the rear cover

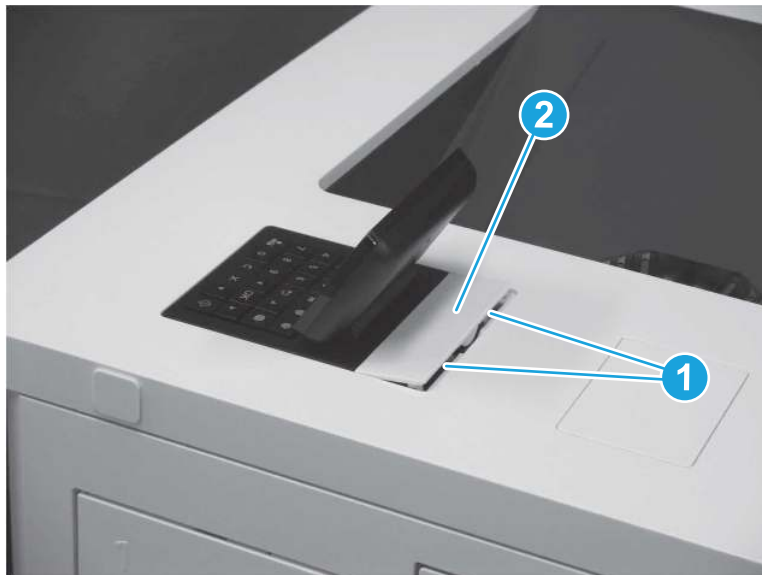


6. Remove the control panel.

 **NOTE:** A screwdriver is included in the control panel kit. The screwdriver has a reversible shaft. Simply pull the shaft out of the handle, and then reinstall it with the desired end facing out.

- a. Use a small, flat-blade screwdriver to release two tabs (callout 1), and then remove the control panel cover (callout 2).

Figure 1-531 Remove the control panel cover



- b. Remove one screw (callout 1).

Figure 1-532 Remove one screw



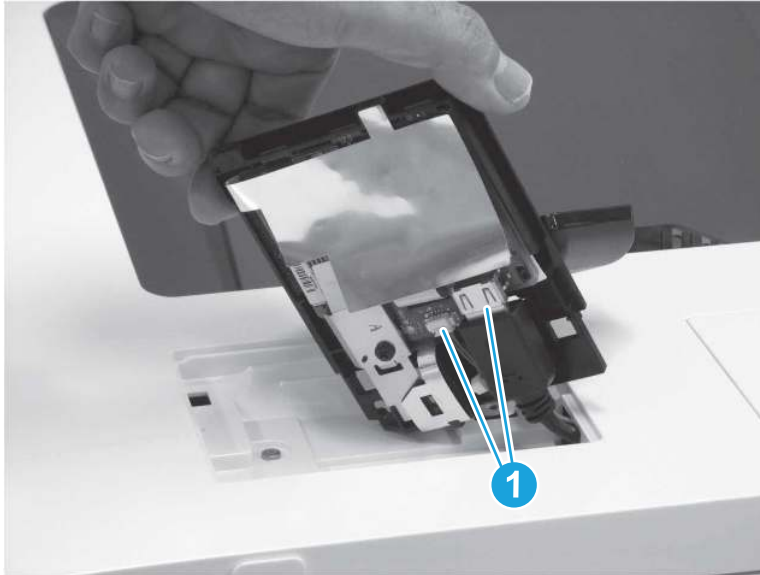
- c. Lift the back edge of the control panel up (callout 1), and then slide the control panel toward the back of the printer (callout 2).

Figure 1-533 Slide the control panel back



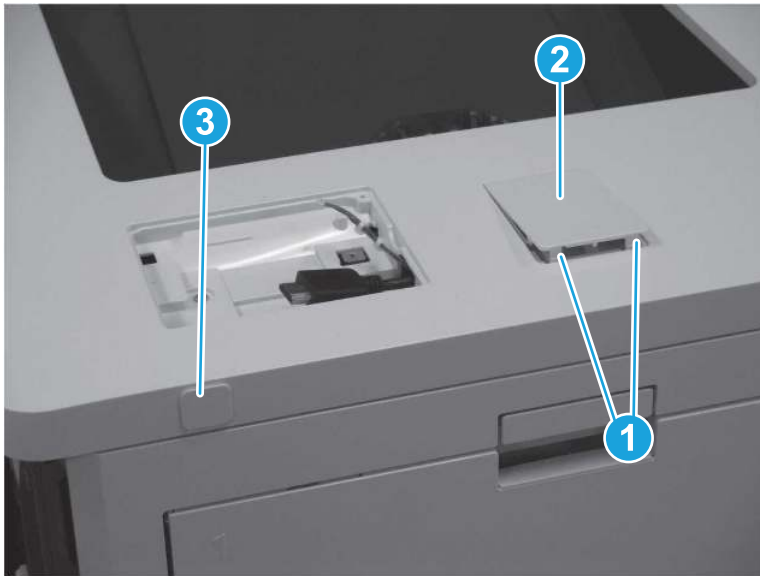
- d. Turn the control panel so that the bottom is facing up, and then disconnect two connectors (callout 1) to remove the control panel.

Figure 1-534 Disconnect two connectors



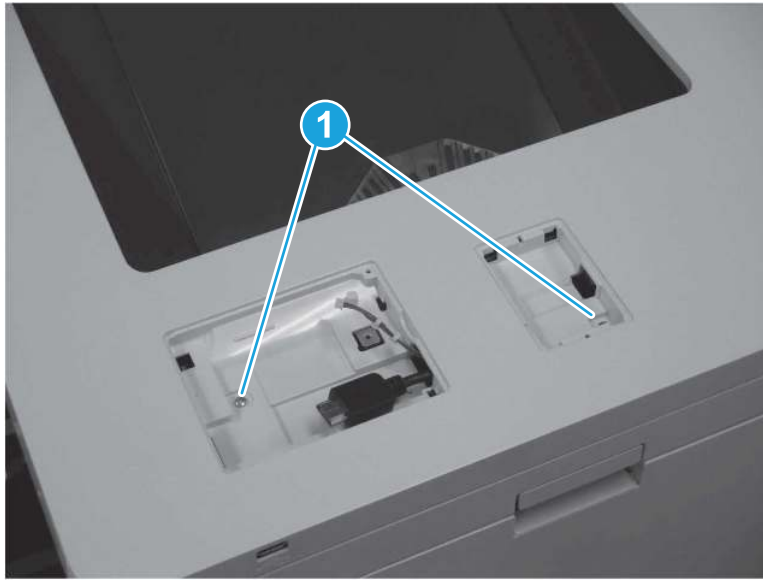
7. Remove the top cover (M751/E75245).
 - a. Release two tabs (callout 1), and then remove the HIP cover (callout 2). Pull the USB cap (callout 3) away from the printer to remove it.

Figure 1-535 Remove the HIP cover and USB cap



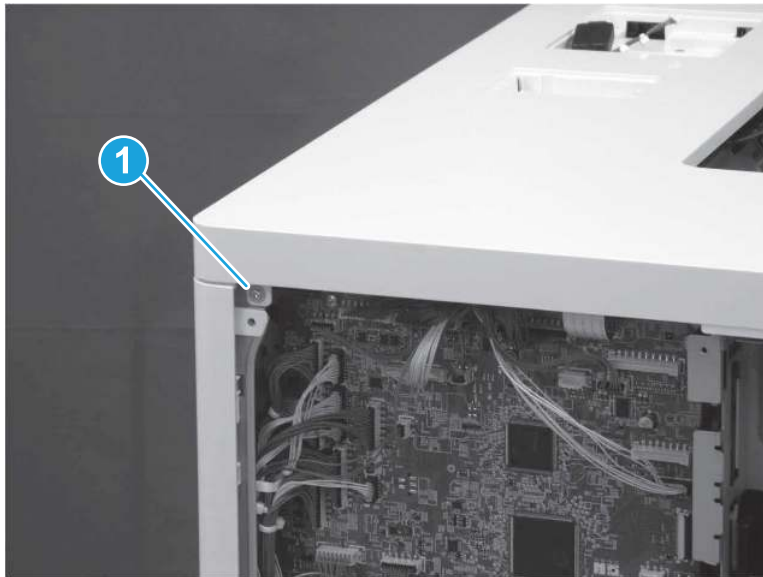
- b. At the top of the printer, remove two screws (callout 1).

Figure 1-536 Remove two screws



- c. At the back of the printer, remove one screw (callout 1).

Figure 1-537 Remove one screw

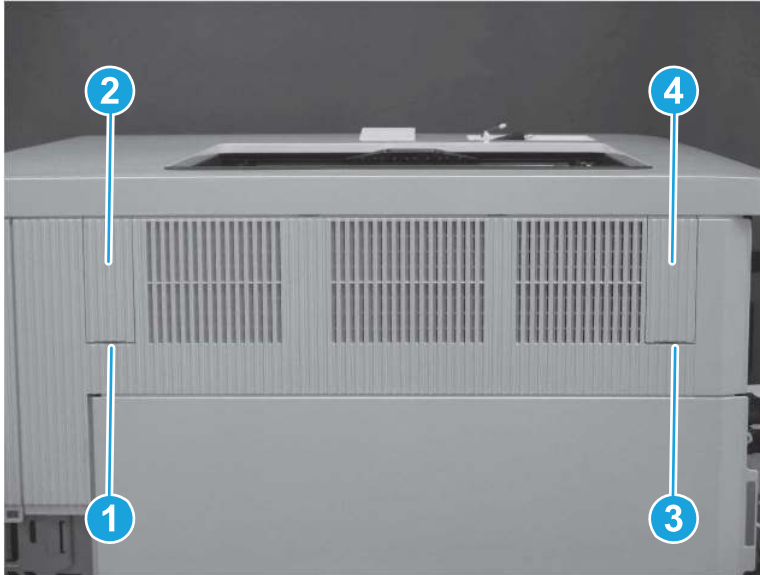


- d. Use a small, flat-blade screwdriver to release one tab (callout 1) and remove the left blanking cover (callout 2). Release one tab (callout 3) and remove the right blanking cover (callout 4).

 **TIP:** These covers are not identical. Make sure to reinstall the correct cover on the correct side.

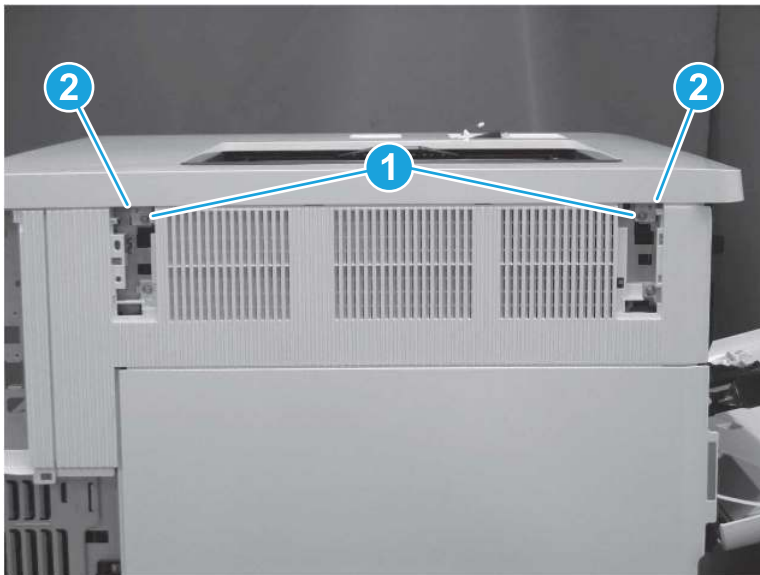
 **NOTE:** The screw under the left blanking cover is a self-tapping screw. Make sure this screw is reinstalled in the correct location.

Figure 1-538 Remove the left and right blanking covers



- e. Remove two screws (callout 1), and then release two tabs (callout 2).

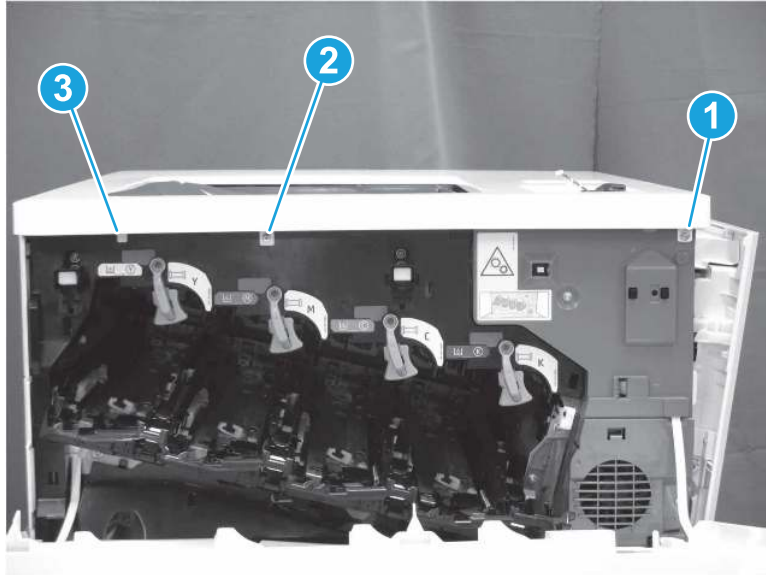
Figure 1-539 Remove two screws and release two tabs



- f. At the front of the printer, remove one washer-head screw (callout 1) and one self-tapping screw (callout 2). Release one tab (callout 3).

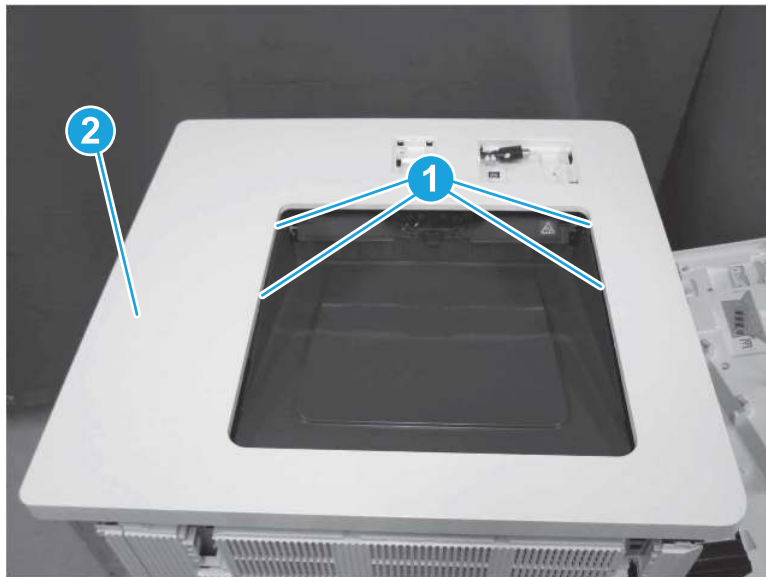
 **TIP:** Make sure to install the correct type of screw in the correct location.


Figure 1-540 Remove two screws and release one tab



- g. At the top of the printer, release four tabs (callout 1), and then remove the top cover (callout 2).

Figure 1-541 Remove the top cover

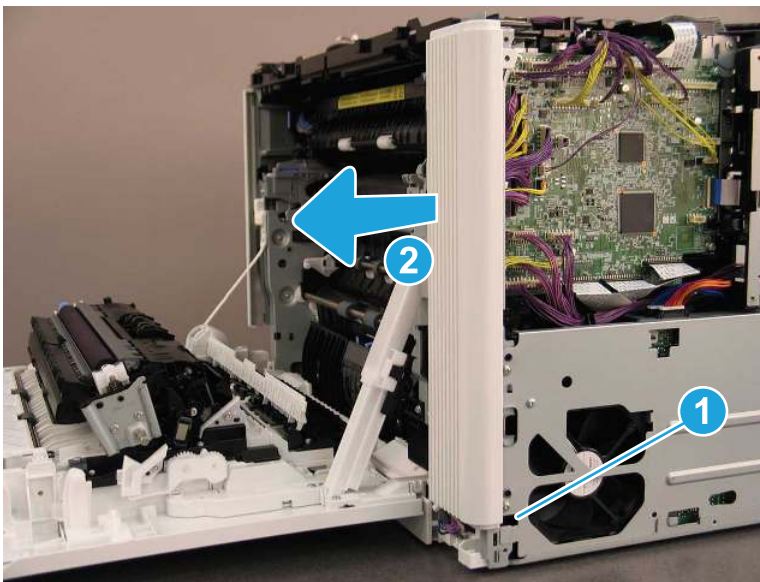


 **NOTE:** When removing the top cover, make sure to release the control panel cables (callout 1) through the opening.



8. Remove the right rear cover (M751/E75245).
 - ▲ Release one tab (callout 1), and then slide the right rear cover (callout 2) away from the printer to remove it.

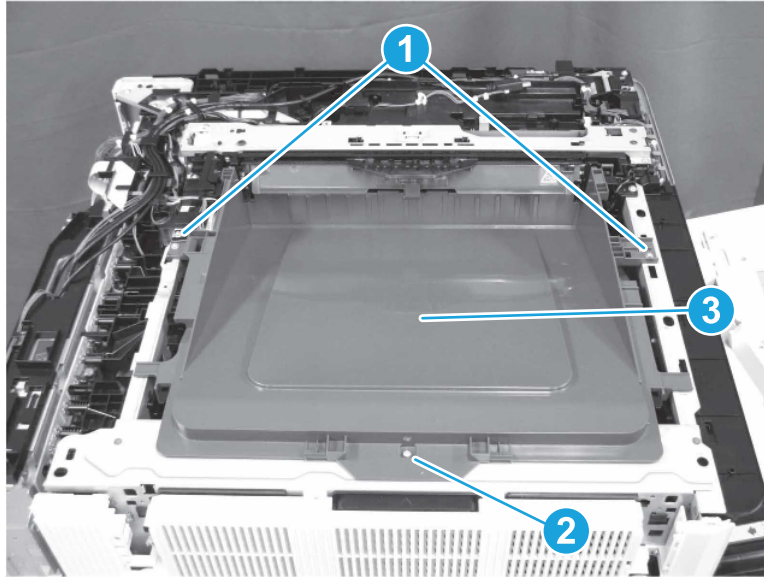
Figure 1-542 Remove the right rear cover



9. Remove the output bin (M751/E75245).
 - ▲ Remove two washer-head machine screws (callout 1), remove one self-tapping screw (callout 2), and then remove the output bin (callout 3).

 **NOTE:** When reinstalling the output bin, make sure to install the correct type of screw in the correct location.

Figure 1-543 Remove the output bin



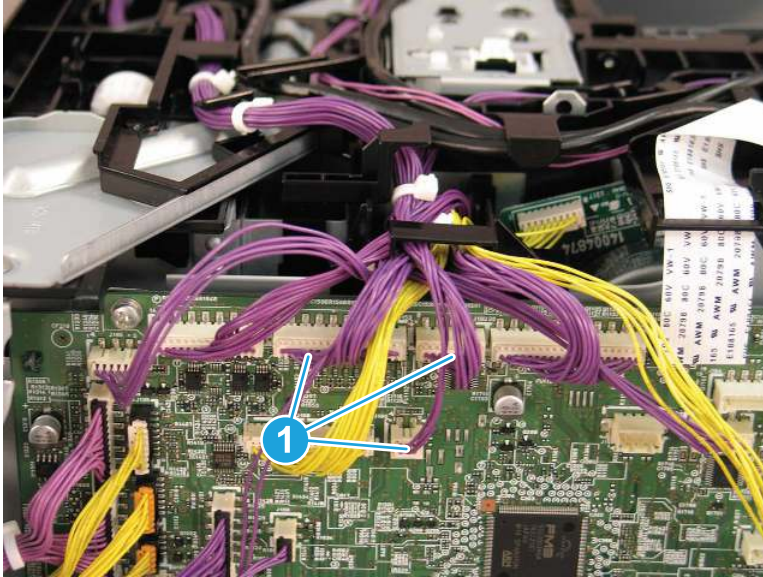
10. Remove the delivery assembly.
 - a. Disconnect four connectors (callout 1) on the formatter board.

Figure 1-544 Disconnect four connectors



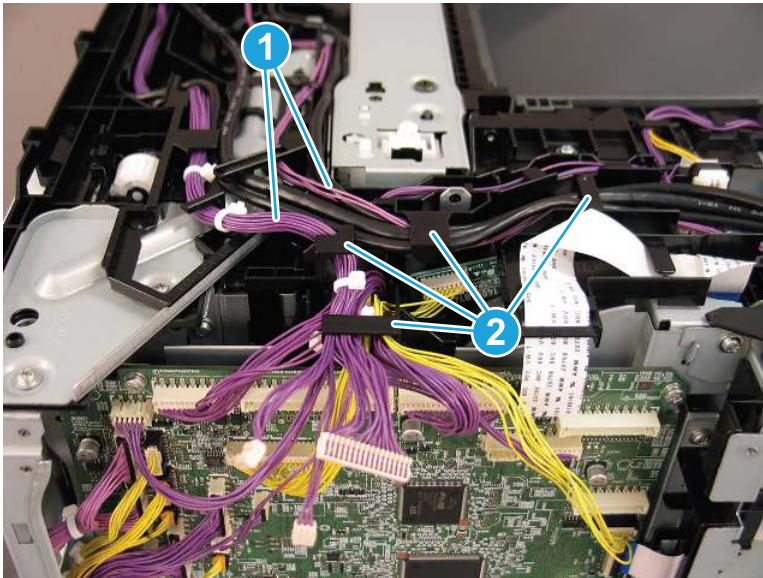
- b. Disconnect three connectors on the DC controller (callout 1), and then remove the cables (callout 2) from the guides (callout 3).

Figure 1-545 Disconnect three connectors



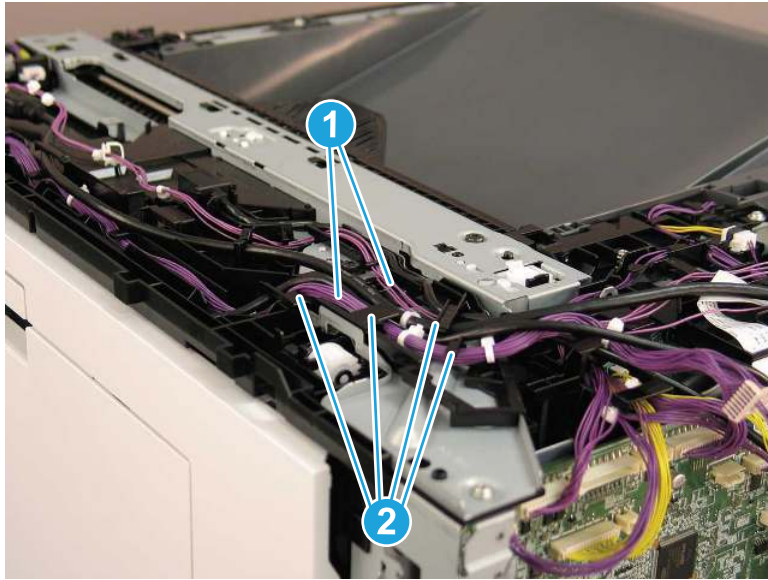
- c. Release the cables (callout 1) from the guides (callout 2).

Figure 1-546 Release the cables from the guides



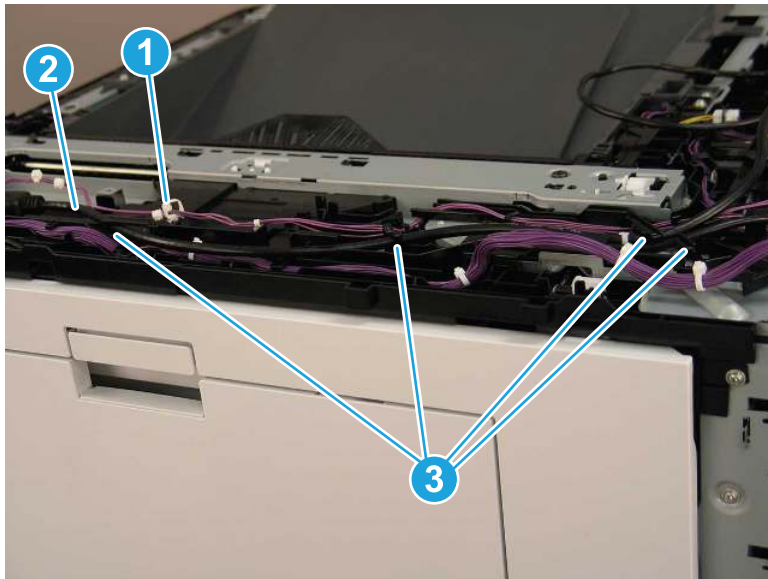
- d. Release the cables (callout 1) from the guides (callout 2).

Figure 1-547 Release the cables from the guides



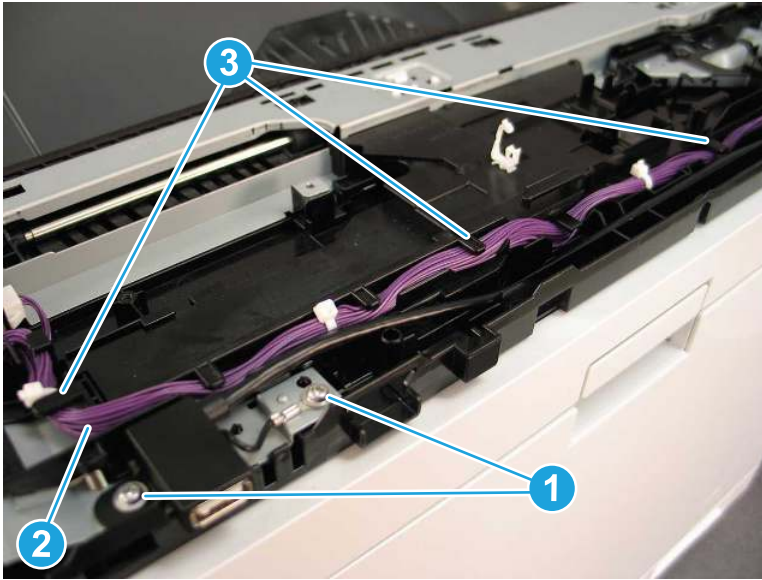
- e. Open one retainer (callout 1), and then release the cables (callout 2) from the guides (callout 3).

Figure 1-548 Release the cables from the guides



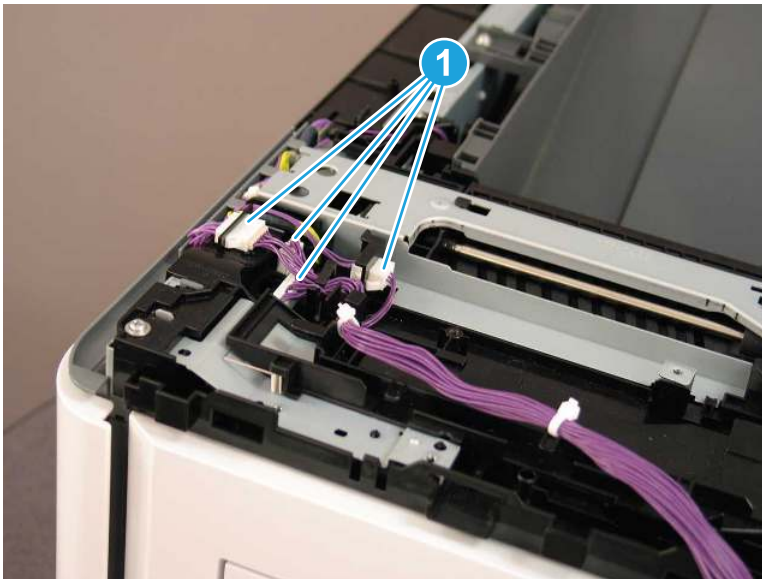
- f. Remove two screws (callout 1), and then release the cables (callout 2) from the guides (callout 3).

Figure 1-549 Remove two screws and release the cables



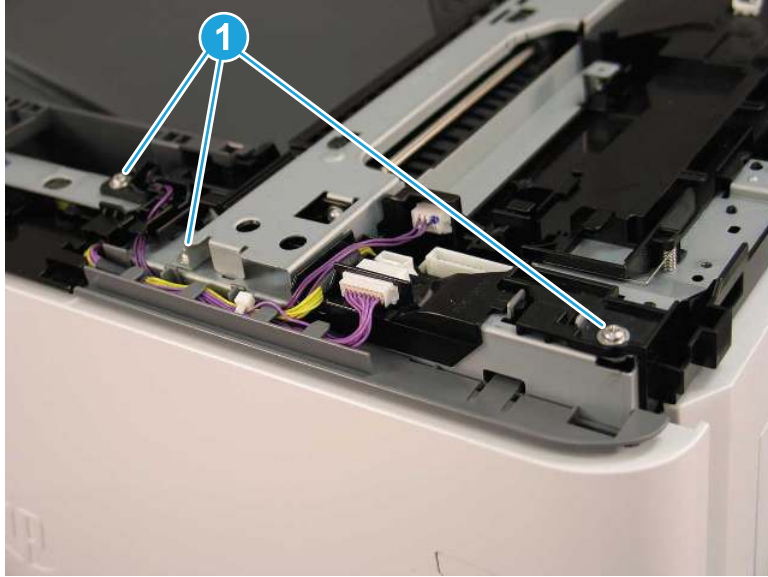
- g. Disconnect four connectors (callout 1).

Figure 1-550 Disconnect four connectors



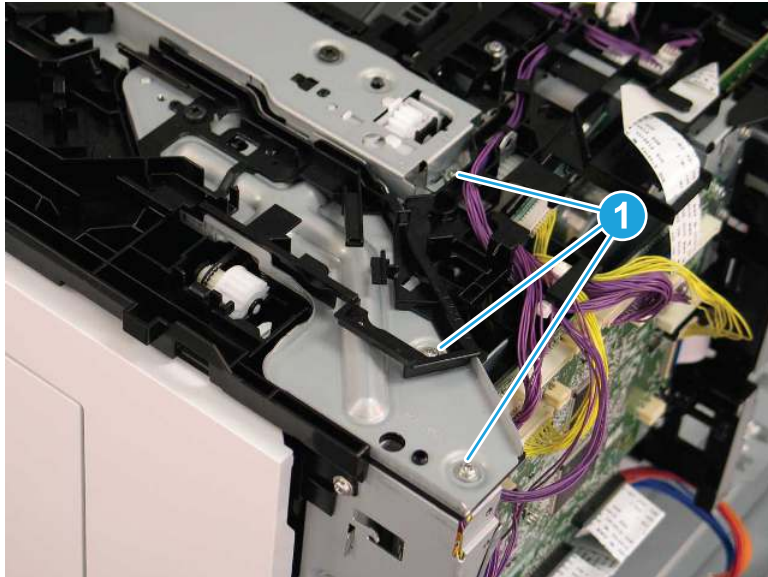
- h. Remove three screws (callout 1).

Figure 1-551 Remove three screws



- i. Remove three screws (callout 1).

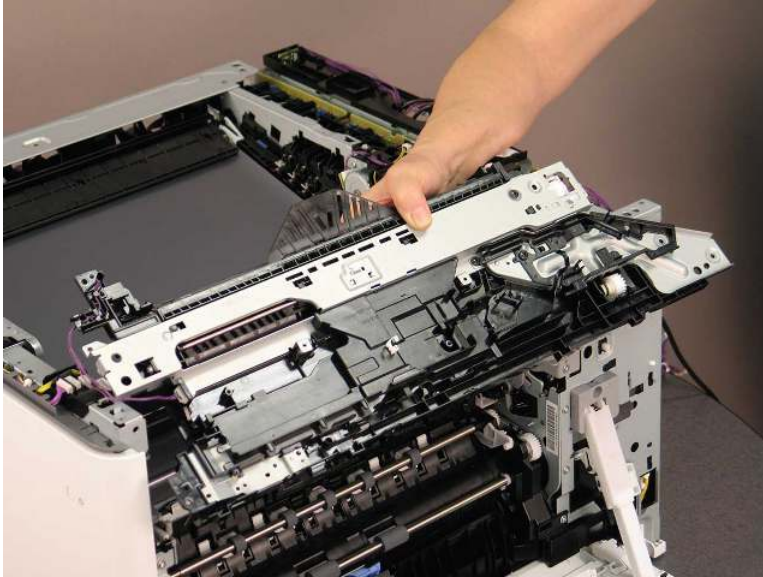
Figure 1-552 Remove three screws



- j. Remove the duplex switchback assembly and the delivery assembly together.

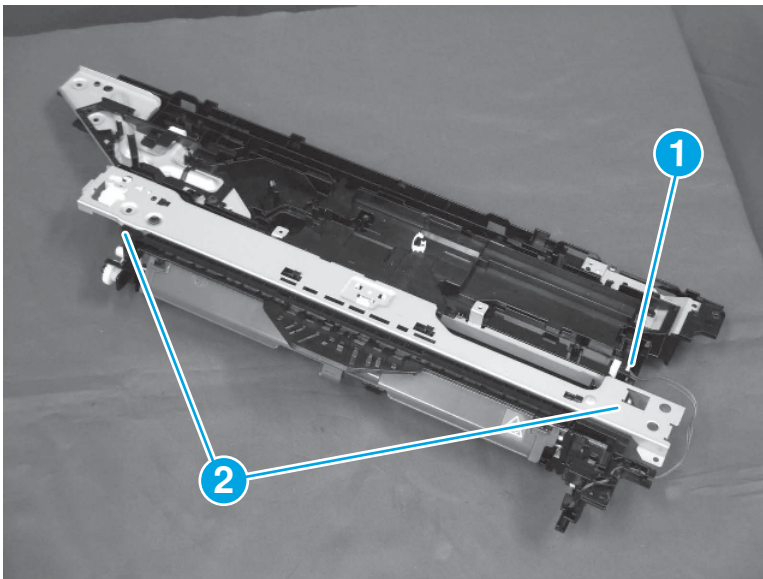
⚠ CAUTION: The gears on the delivery assembly are not captive. Do not lose the gears when handling the assembly.

Figure 1-553 Remove the duplex switchback assembly and delivery assembly



- k. Disconnect one connector (callout 1), and then remove two screws (callout 2).

Figure 1-554 Disconnect one connector and remove two screws

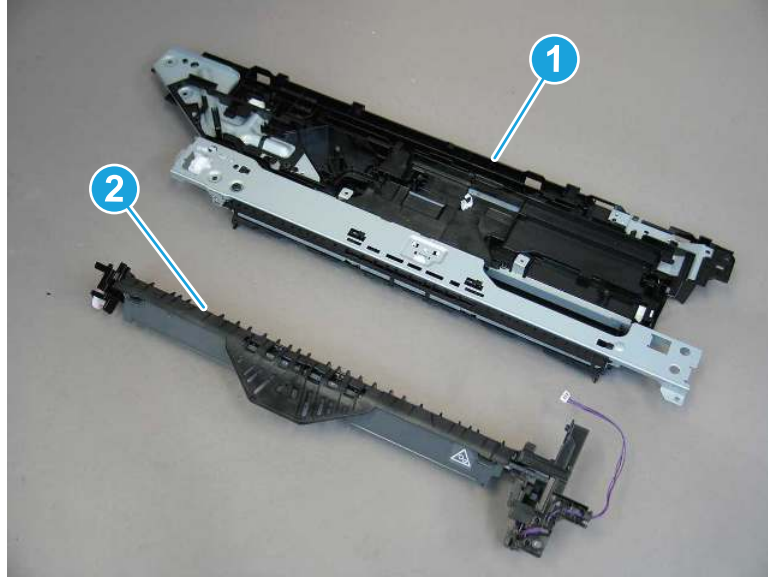


- l. Separate the duplex switchback assembly (callout 1) from the delivery assembly (callout 2).



NOTE: Save the duplex switchback assembly and install it on the replacement delivery assembly.

Figure 1-555 Separate the duplex switchback assembly from the delivery assembly



11. Unpack the replacement assembly.

- a. Dispose of the defective part.



NOTE: HP recommends responsible disposal of the defective part.

<http://www8.hp.com/us/en/hp-information/environment/product-recycling.html>

- b. Unpack the replacement part from the packaging.



IMPORTANT: Make sure that all of the shipping materials (for example shipping tape) are removed from the replacement part prior to installation.

- c. To install an assembly, reverse the removal steps.



NOTE: When applicable, special installation instructions are provided for an assembly at the end of the removal procedure. Always completely read the removal instructions and follow all special installation instructions.

Removal and replacement: Delivery assembly (M856/E85055)

Learn how to remove and replace the delivery assembly.

Mean time to repair: 17 minutes

Service level: Easy

Before performing service

Turn the printer power off

- Disconnect the power cable.



WARNING! To avoid damage to the printer, turn the printer off, wait 30 seconds, and then remove the power cord before attempting to service the printer.

Use the table below to identify the correct part number for your printer. To order the part, go to www.hp.com/buy/parts.

Table 1-50 Part information

Part number	Part description
RM2-1777-000CN	Paper delivery assembly

Required tools

- #2 Phillips screwdriver with a magnetic tip
- Small, flat-blade screwdriver

After performing service

Turn the printer power on

- Connect the power cable.
- Use the power switch to turn the power on.

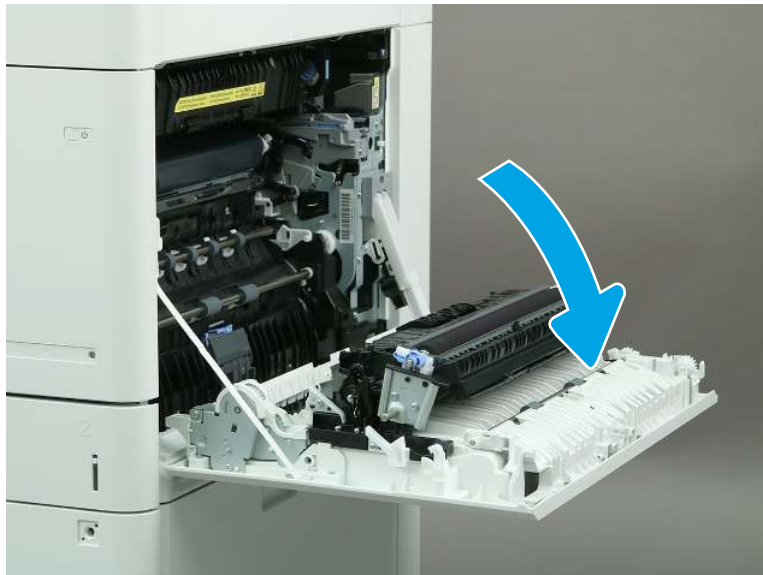
Post service test

Make sure that the printer initializes to a **Ready** state.

Print a page to make sure that the printer is functioning correctly.

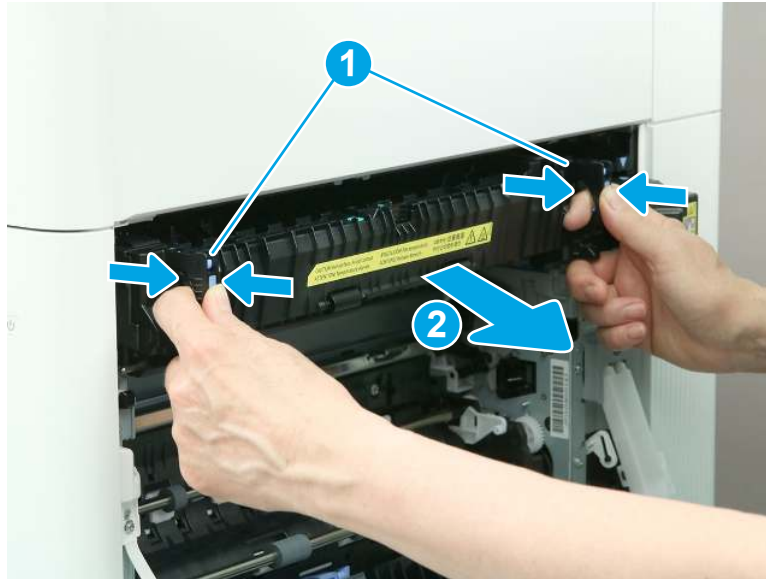
1. Remove the fuser.
 - a. Open the right door.

Figure 1-556 Open the right door



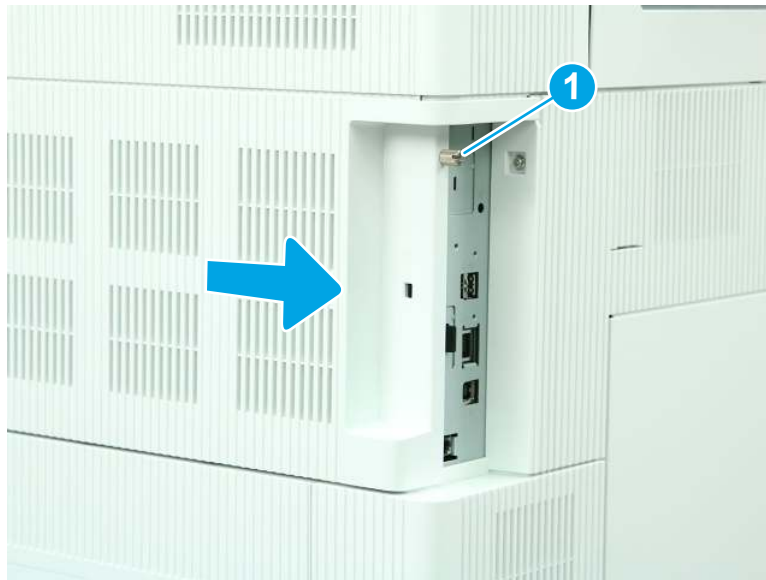
- b. Grasp the fuser handles, and then squeeze the release levers (callout 1). Lift up slightly, and then pull straight out to remove the fuser (callout 2).

Figure 1-557 Remove the fuser



2. Remove the formatter cover.
 - ▲ Loosen one thumbscrew (callout 1), and then slide the formatter cover (callout 2) away from the printer to remove it.

Figure 1-558 Remove the formatter cover

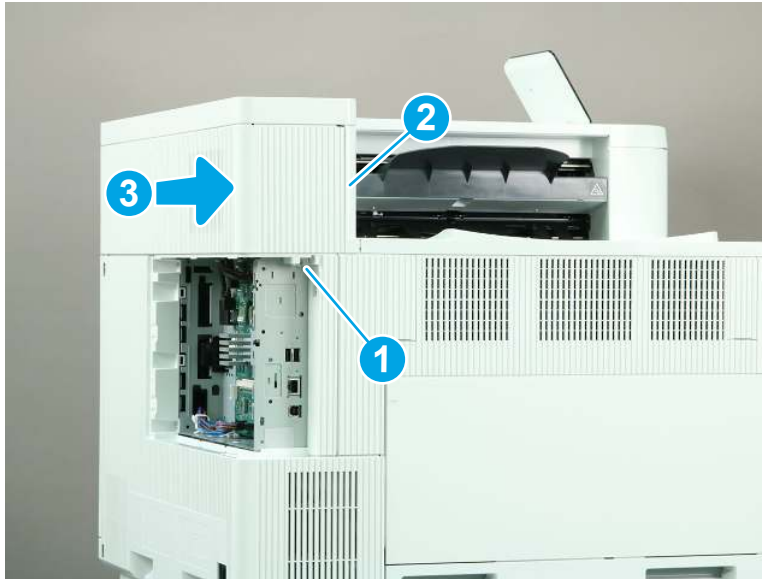


3. Remove the rear upper cover (M856/E85055/M776dn/M776z).

 **NOTE:** The following figure shows the M856 printer. The procedure is correct for all referenced models.

- ▲ Remove one screw (callout 1), release one tab (callout 2), and then slide the rear upper cover away from the printer to remove it (callout 3).

Figure 1-559 Remove the rear upper cover



4. **M856/E85055 only:** Remove the control panel and top cover.

 **NOTE:** This step applies to only the M856/E85055 models. Skip this step for all other models.

- a. Use a small, flat-blade screwdriver to release two tabs (callout 1), and then remove the control panel cover (callout 2).

Figure 1-560 Remove the control panel cover



- b. Remove one screw (callout 1).

Figure 1-561 Remove one screw



- c. Lift the back edge of the control panel up (callout 1), and then slide the control panel toward the back of the printer (callout 2).

Figure 1-562 Slide the control panel back



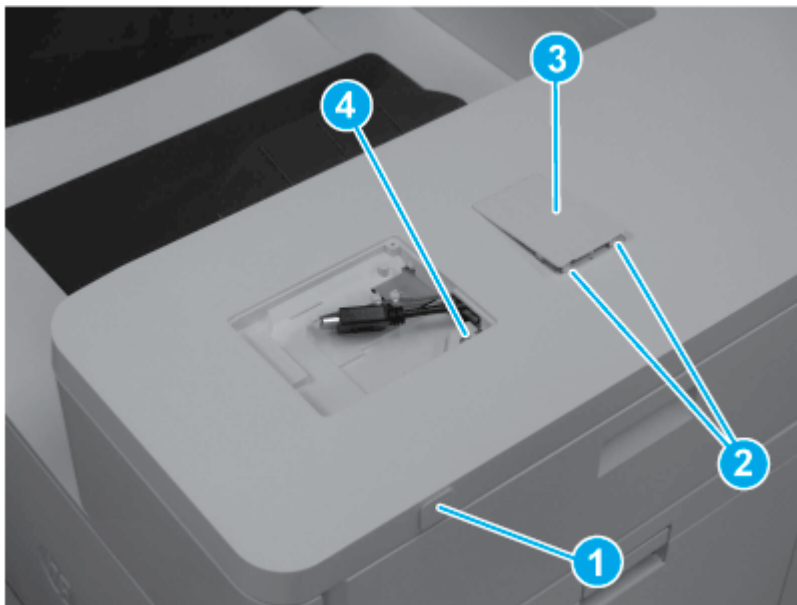
- d. Turn the control panel so that the bottom is facing up, and then disconnect two connectors to remove the control panel.

Figure 1-563 Disconnect two connectors



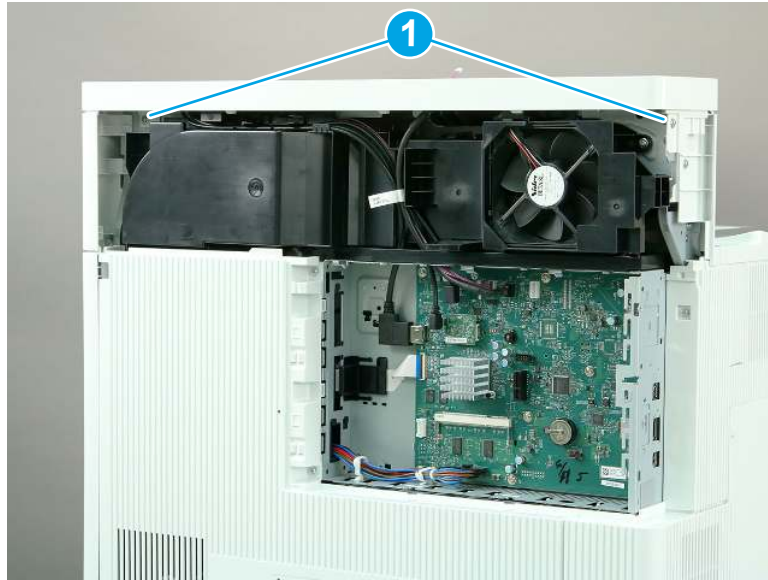
- e. Remove the USB cover (callout 1). Release two tabs (callout 2), and then remove the HIP cover (callout 3). Remove one screw (callout 4).

Figure 1-564 Remove covers and one screw



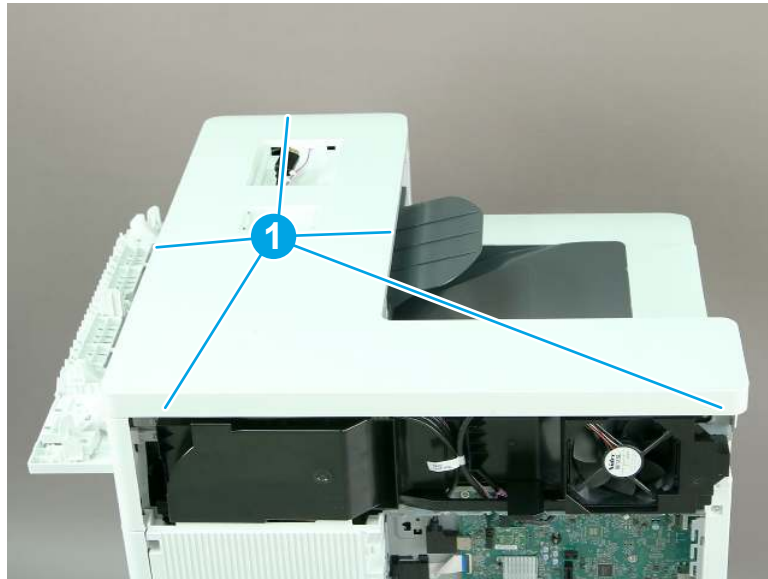
- f. Remove two screws (callout 1).

Figure 1-565 Remove two screws



- g. Release five tabs (callout 1), and then remove the top cover.

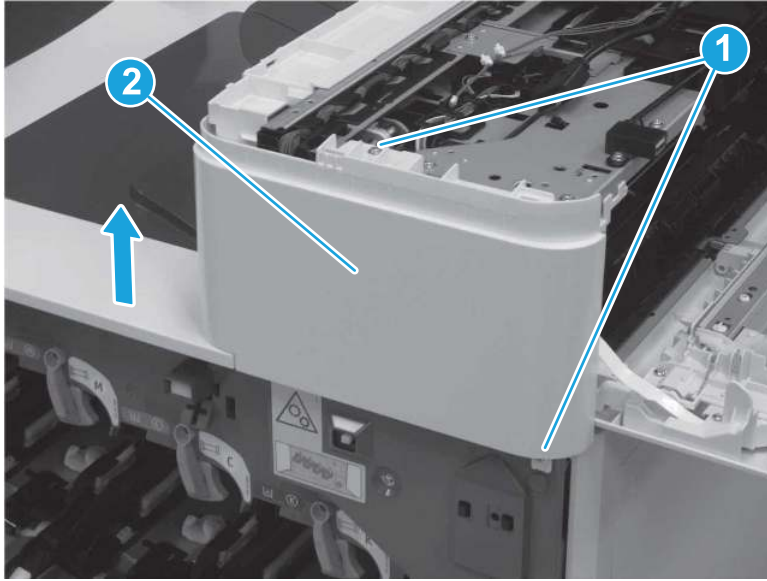
Figure 1-566 Release five tabs



- 5. Remove the right front cover (M856/E85055/M776dn/M776z).

- ▲ Remove two screws (callout 1), and then slide the right front cover (callout 2) up to remove it.

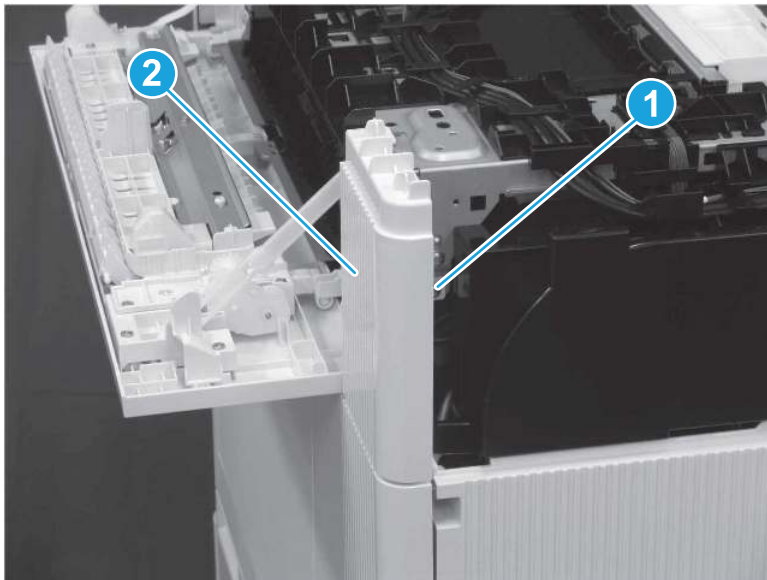
Figure 1-567 Remove the right front cover



6. Remove the right rear upper cover (M856/E85055/M776dn/M776z)

- ▲ Remove one screw (callout 1), and then slide the right rear upper cover (callout 2) away from the printer to remove it.

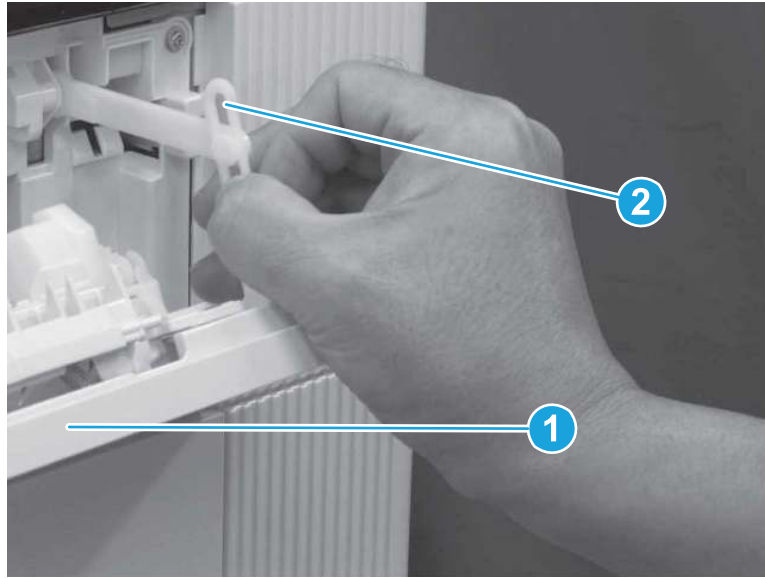
Figure 1-568 Remove the right rear upper cover



7. Remove the right upper door (M856/E85055/M776dn/M776z)

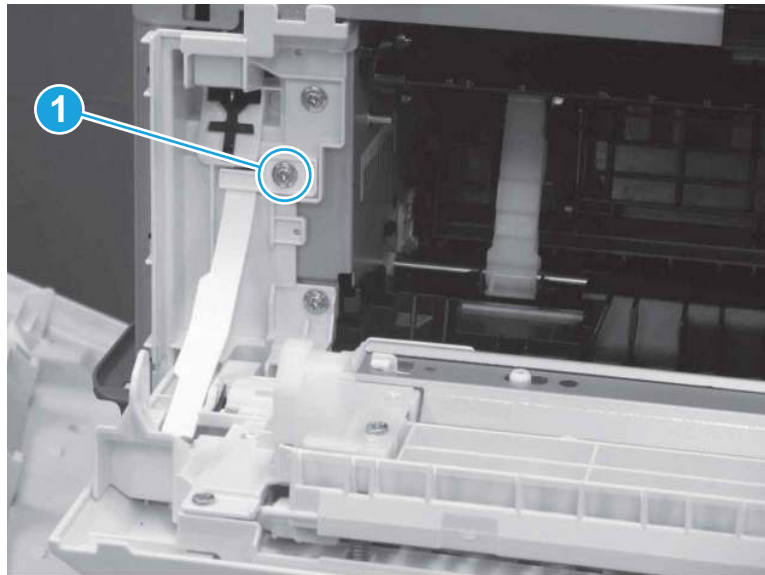
- a. Open the right upper door (callout 1), and then release the link (callout 2).

Figure 1-569 Open the door and release the link



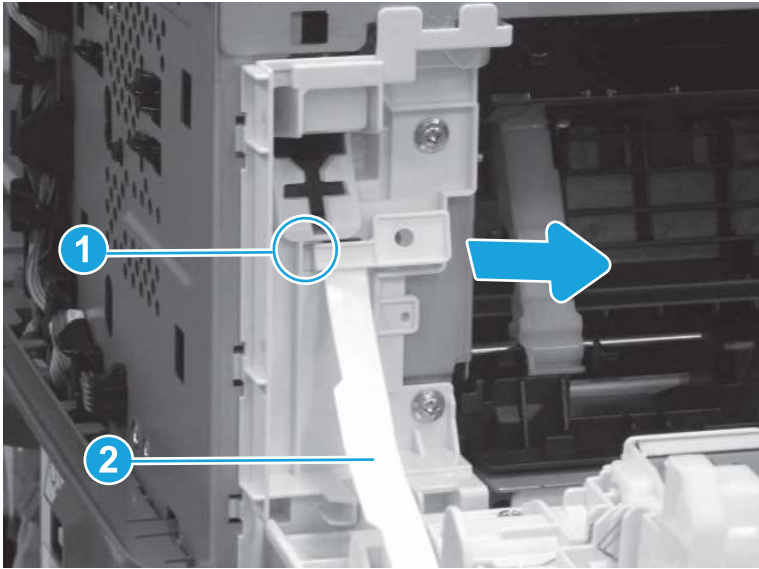
- b. Remove one screw (callout 1).

Figure 1-570 Remove one screw



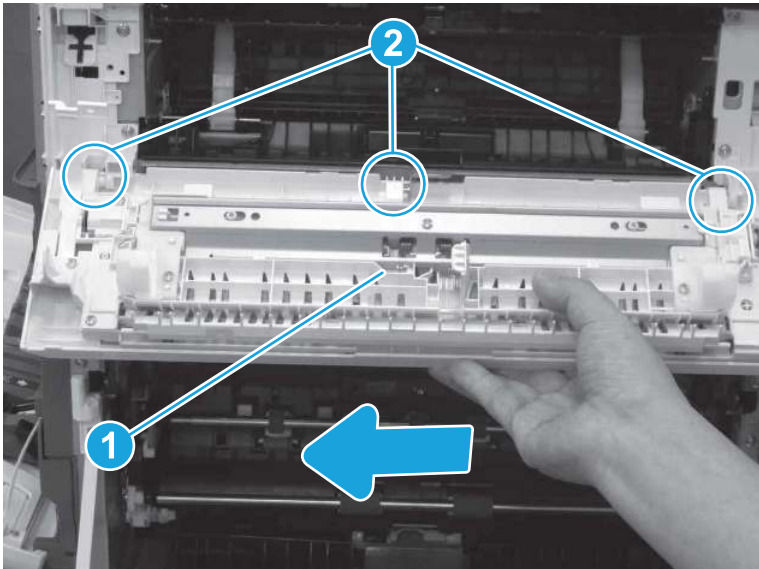
- c. Release one boss (callout 1) and then release the hinge (callout 2) by sliding it to the right.

Figure 1-571 Release one boss and hinge



- d. Slide the right upper door (callout 1) to the right to release it from three bushings (callout 2), and then remove the right upper door.

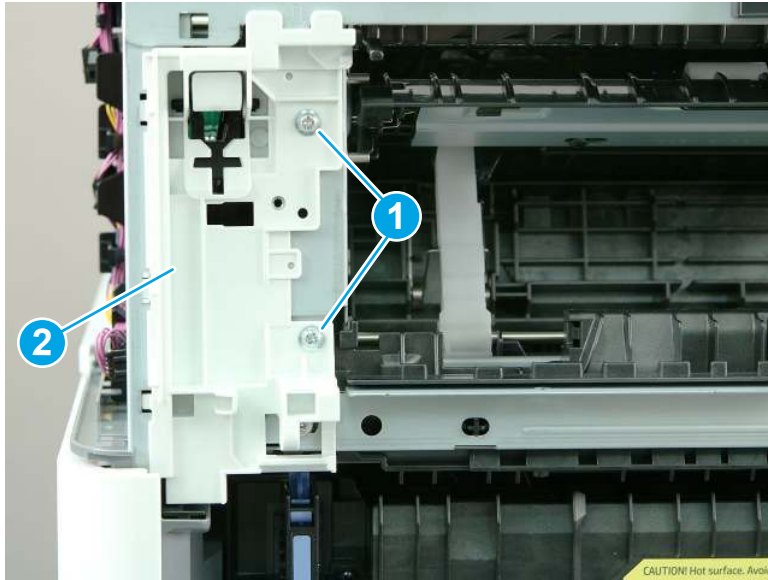
Figure 1-572 Remove the right upper door



8. Remove the delivery assembly (M856/E85055/M776dn/M776z).

- a. Remove two screws (callout 1), and then remove the toggle front assembly (callout 2).

Figure 1-573 Remove two screws and toggle front assembly (M856/E85055/M776dn/M776z)



- b. Remove two screws (callout 1). Remove one screw (callout 2), and then remove the toggle rear assembly (callout 3).


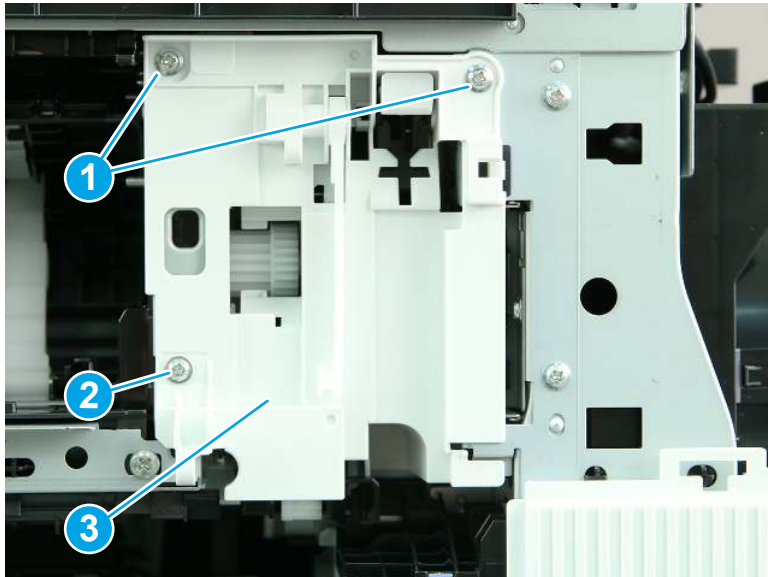
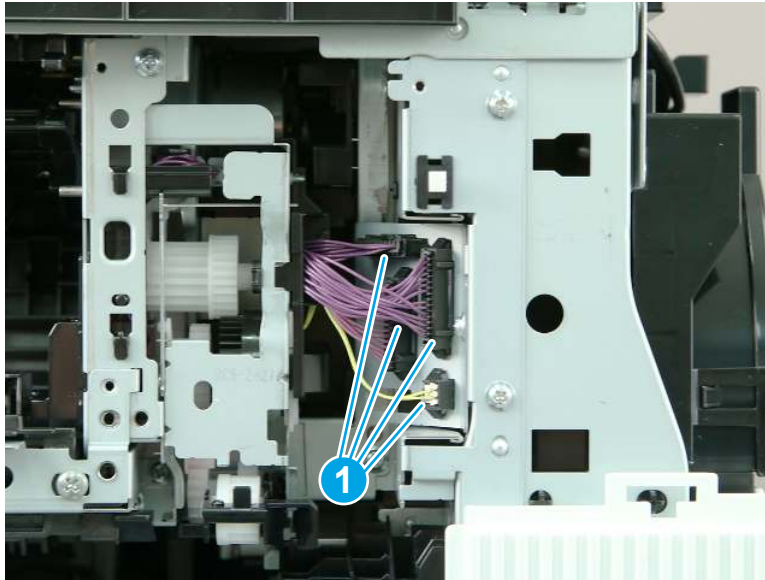
 **NOTE:** The lower screw (callout 2) is shorter than the other two screws. Make sure to reinstall this screw in the correct position.

Figure 1-574 Remove three screws and toggle rear assembly (M856/E85055/M776dn/M776z)



- c. Disconnect four connectors (callout 1).

Figure 1-575 Disconnect four connectors (M856/E85055/M776dn/M776z)

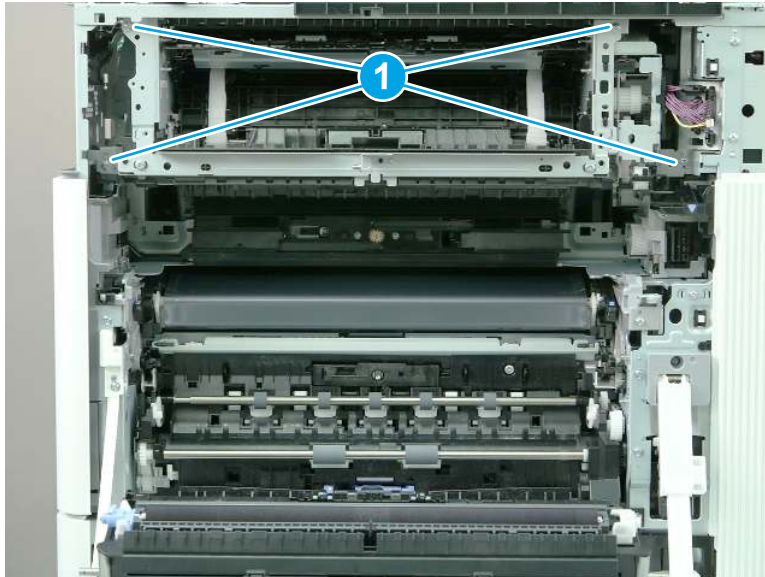


- d. Remove four screws (callout 1).



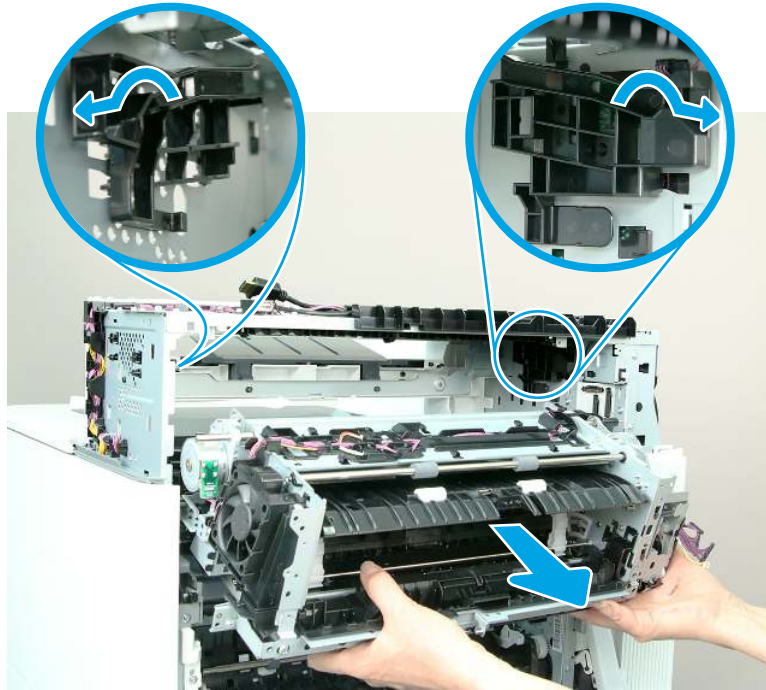
NOTE: The lower screws are shorter than the upper screws. Make sure to reinstall them in the correct position.

Figure 1-576 Remove four screws (M856/E85055/M776dn/M776z)



- e. Slide the delivery assembly away from the printer, and then lift up and out to release the posts from the tracks.

Figure 1-577 Remove the delivery assembly (M856/E85055/M776dn/M776z)



- 9. Unpack the replacement assembly.

- a. Dispose of the defective part.



NOTE: HP recommends responsible disposal of the defective part.

<http://www8.hp.com/us/en/hp-information/environment/product-recycling.html>

- b. Unpack the replacement part from the packaging.



IMPORTANT: Make sure that all of the shipping materials (for example shipping tape) are removed from the replacement part prior to installation.

- c. To install an assembly, reverse the removal steps.



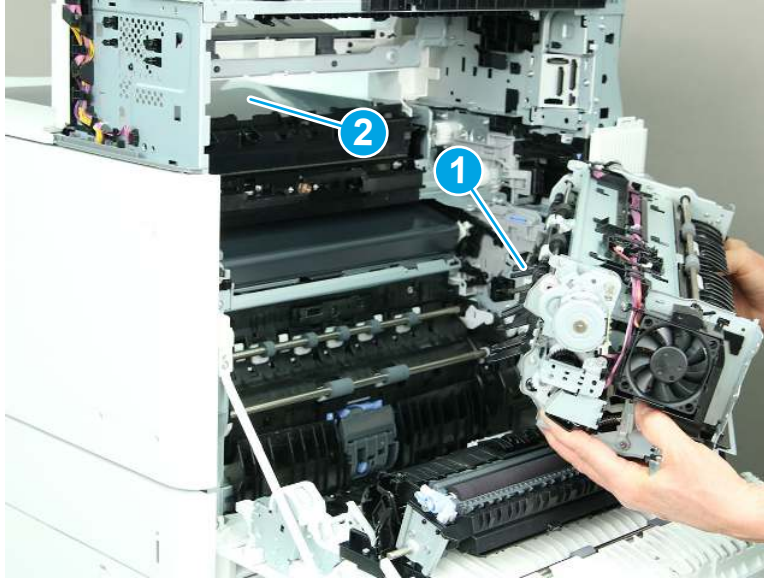
NOTE: When applicable, special installation instructions are provided for an assembly at the end of the removal procedure. Always completely read the removal instructions and follow all special installation instructions.

- 10. Reverse the removal steps to install the assembly. Also use the following **special installation instructions**.

Install the delivery assembly (M856/E85055/M776dn/M776z).

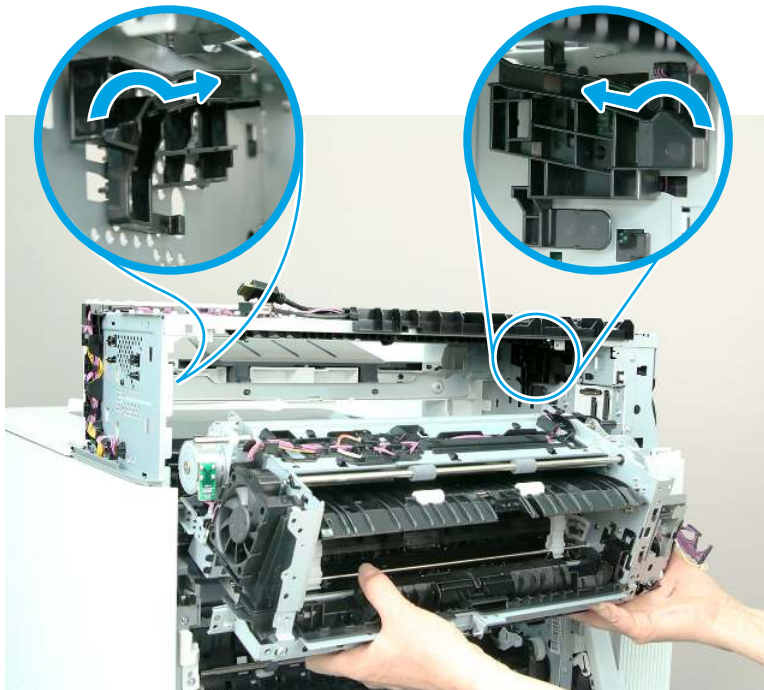
- a. When reinstalling the delivery assembly, make sure that the flap (callout 1) on the delivery assembly goes through the opening (callout 2) in the cover.

Figure 1-578 Install the flap through the opening (M856/E85055/M776dn/M776z)



- b. When reinstalling the delivery assembly, position the posts on the delivery assembly (callout 1) into the tracks (callout 2) in the printer. Lift up and then slide the assembly toward the printer to install the posts in the tracks.

Figure 1-579 Install the delivery assembly (M856/E85055/M776dn/M776z)



Removal and replacement: Delivery assembly (M776dn/M776z)

Learn how to remove and replace the delivery assembly.

[View a video of how to remove and replace the delivery assembly.](#)

Mean time to repair: 17 minutes

Service level: Easy

Before performing service

Turn the printer power off

- Disconnect the power cable.

⚠ WARNING! To avoid damage to the printer, turn the printer off, wait 30 seconds, and then remove the power cord before attempting to service the printer.

Use the table below to identify the correct part number for your printer. To order the part, go to www.hp.com/buy/parts.

Table 1-51 Part information

Part number	Part description
RM2-1777-000CN	Paper delivery assembly

Required tools

- #2 Phillips screwdriver with a magnetic tip
- Small, flat-blade screwdriver

After performing service

Turn the printer power on

- Connect the power cable.
- Use the power switch to turn the power on.

Post service test

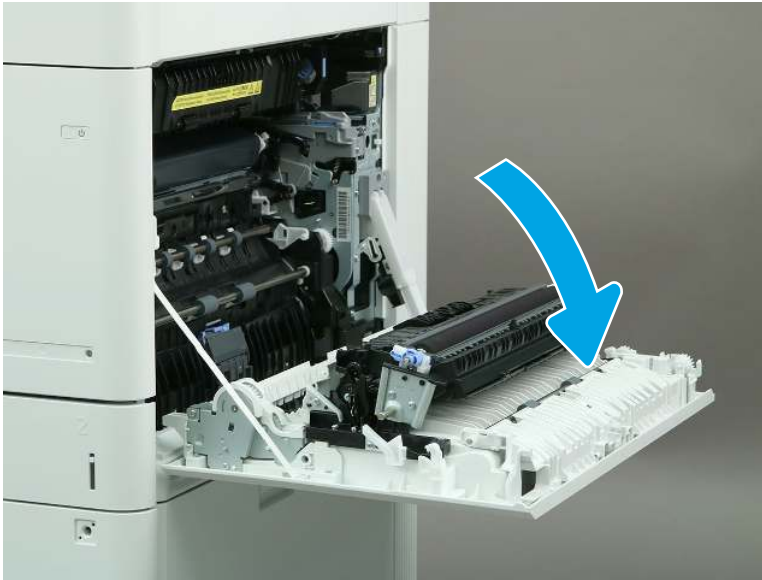
Make sure that the printer initializes to a **Ready** state.

Print a page to make sure that the printer is functioning correctly.

1. Remove the fuser.

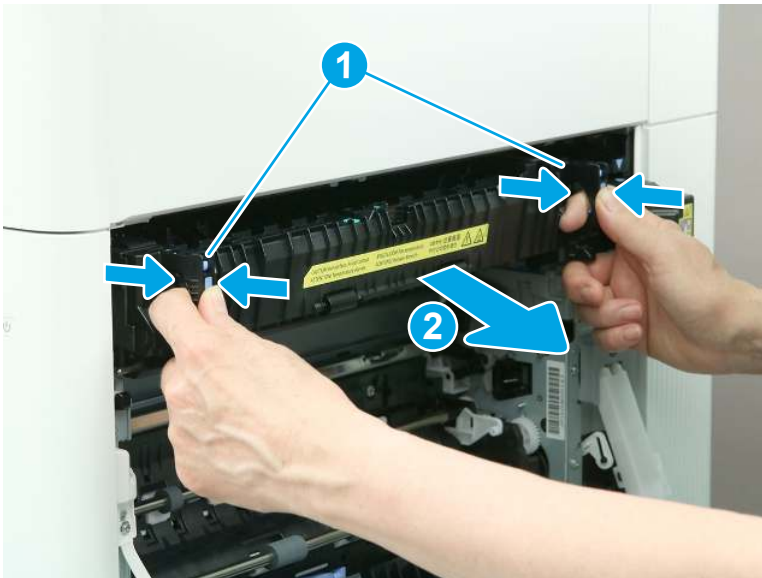
- a. Open the right door.

Figure 1-580 Open the right door



- b. Grasp the fuser handles, and then squeeze the release levers (callout 1). Lift up slightly, and then pull straight out to remove the fuser (callout 2).

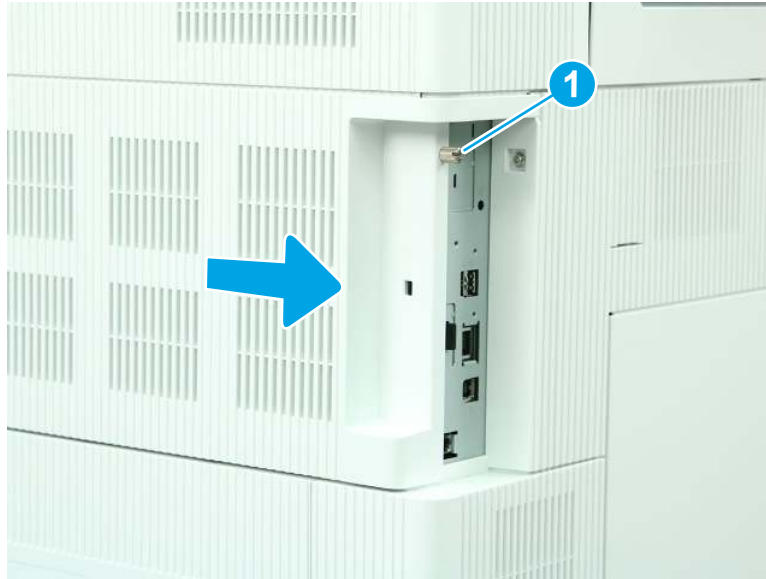
Figure 1-581 Remove the fuser



2. Remove the formatter cover.

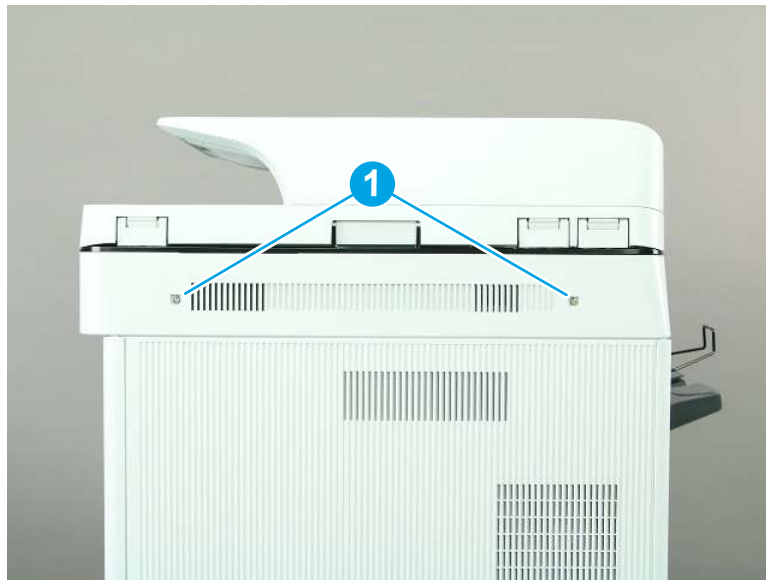
- ▲ Loosen one thumbscrew (callout 1), and then slide the formatter cover (callout 2) away from the printer to remove it.

Figure 1-582 Remove the formatter cover



- 3. Remove the scanner control board (SCB) cover (M776).
 - a. Remove two screws (callout 1).

Figure 1-583 Remove two screws



- b. Remove the SCB cover.

Figure 1-584 Remove the SCB cover

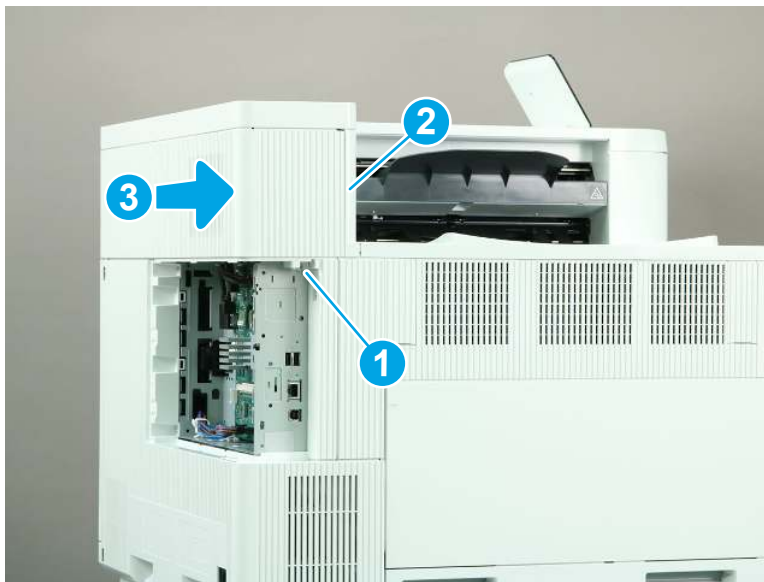


4. Remove the rear upper cover (M856/E85055/M776dn/M776z).

 **NOTE:** The following figure shows the M856 printer. The procedure is correct for all referenced models.

- ▲ Remove one screw (callout 1), release one tab (callout 2), and then slide the rear upper cover away from the printer to remove it (callout 3).

Figure 1-585 Remove the rear upper cover



5. **M776 only:** Remove the control panel, keyboard, and nose cone.

 **NOTE:** This step applies to only the M776 models. Skip this step for all other models

- a. Rotate the control panel to the fully raised position (callout 1), and then raise the document feeder (callout 2).

Figure 1-586 Raise the control panel and document feeder



- b. Beginning at the right side of the control-panel cover, carefully release five tabs along the top edge of the cover.



NOTE: The thin black-plastic cover will separate from the white-plastic control-panel base.

Figure 1-587 Release the control panel cover



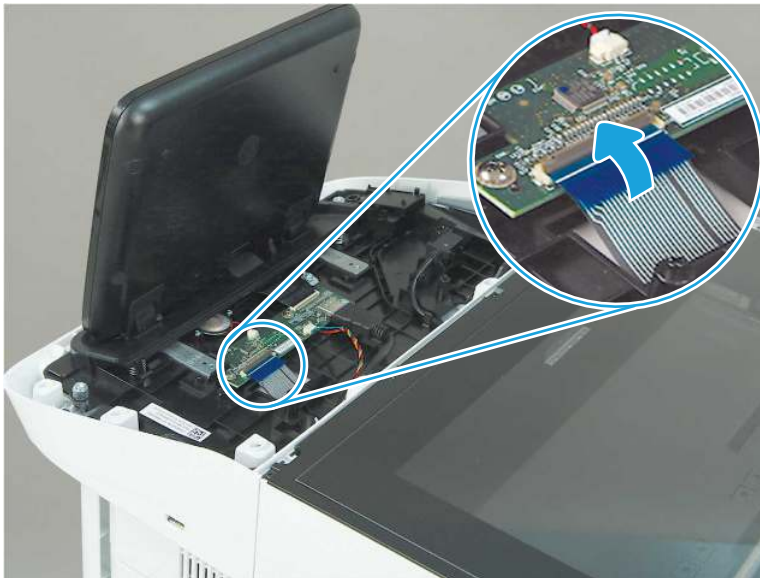
- c. Rotate the control panel cover slightly forward (callout 1), and then lift up to remove the cover (callout 2).

Figure 1-588 Remove the control panel cover



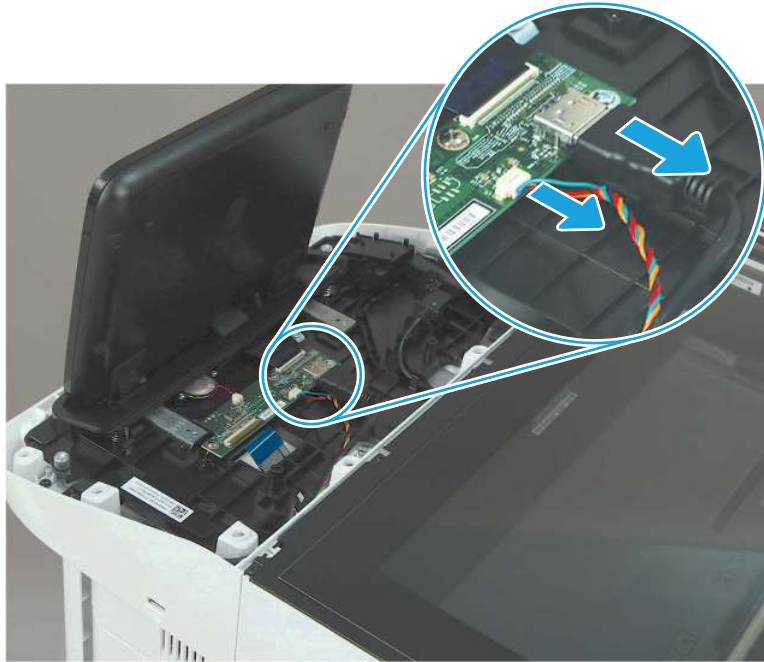
- d. **M776z or M776zs only:** Open the connector latch to release the keyboard flat cable.

Figure 1-589 Release the keyboard flat cable (M776z/M776zs)



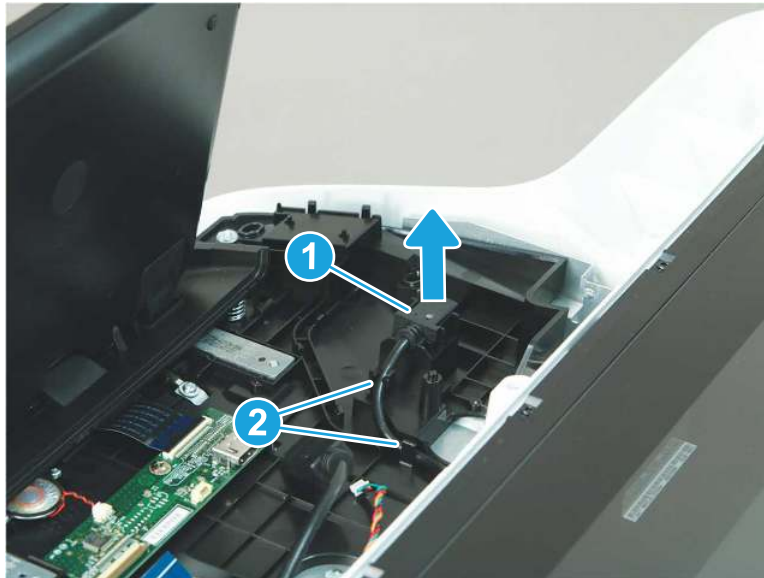
- e. Disconnect two connectors.

Figure 1-590 Disconnect two connectors



- f. Remove the USB cable (callout 1) from the holder, and then release the cable from two retainers (callout 2).

Figure 1-591 Release the USB cable



- g. Remove three screws (callout 1).

Figure 1-592 Remove three screws



- h. Lift the front of the control panel off of the printer (callout 1), and then slide it towards the front of the printer (callout 2) to remove it.

Figure 1-593 Remove the control panel



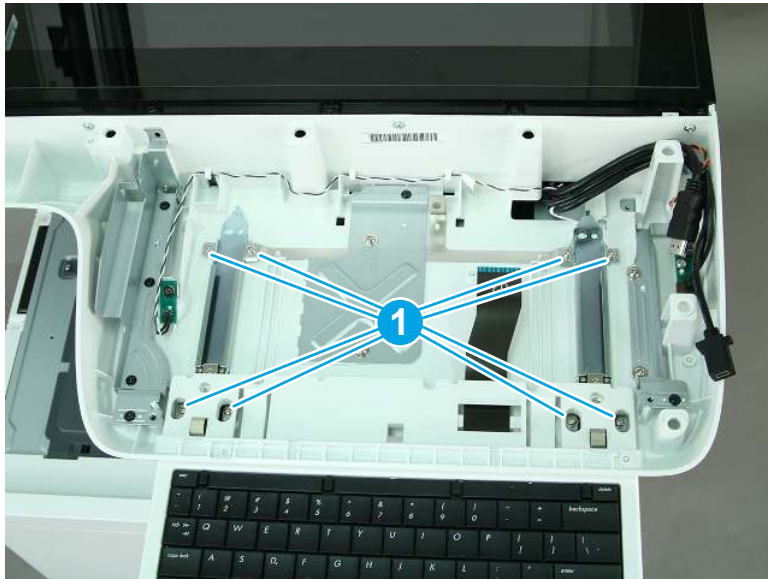
- i. **Keyboard models only:** Pull the keyboard out to its extended position.

Figure 1-594 Pull the keyboard out



- j. **Keyboard models only:** Remove eight screws (callout 1).

Figure 1-595 Remove eight screws



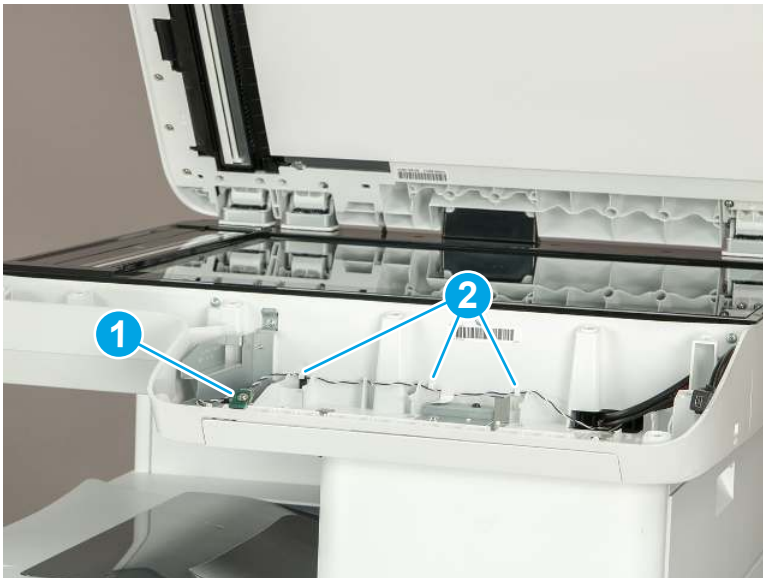
- k. **Keyboard models only:** Remove the keyboard and rails.

Figure 1-596 Remove the keyboard and rails



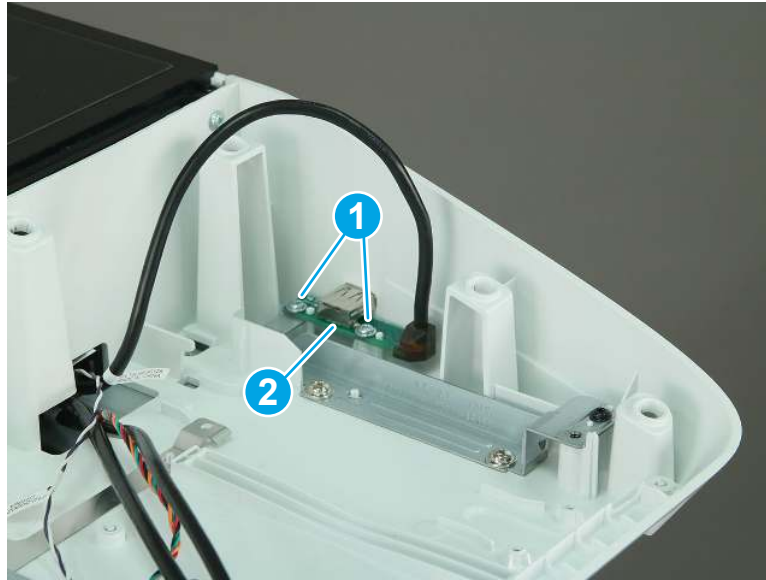
- l. Remove one screw (callout 1) to release the light PCA. Release the cable from three retainers (callout 2), and then move the light PCA out of the way.

Figure 1-597 Release the light PCA



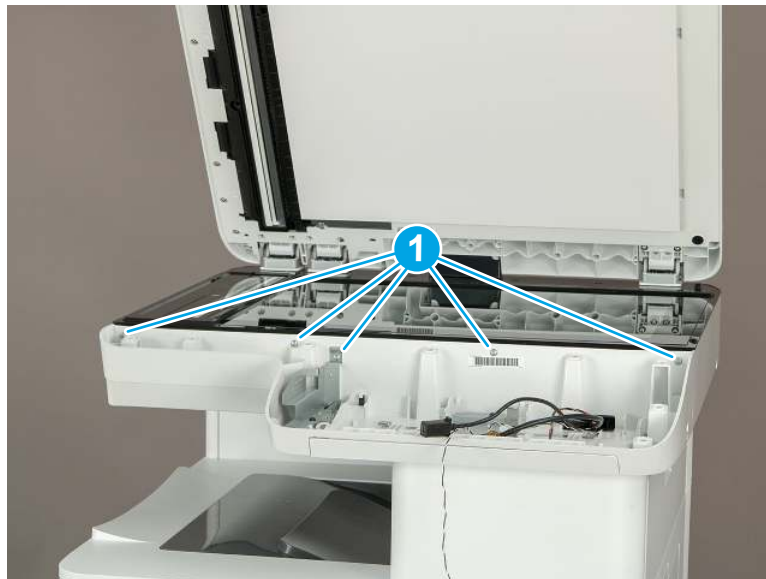
- m. Remove two screws (callout 1), and then move the USB port PCA (callout 2) out of the way.

Figure 1-598 Release the USB port PCA



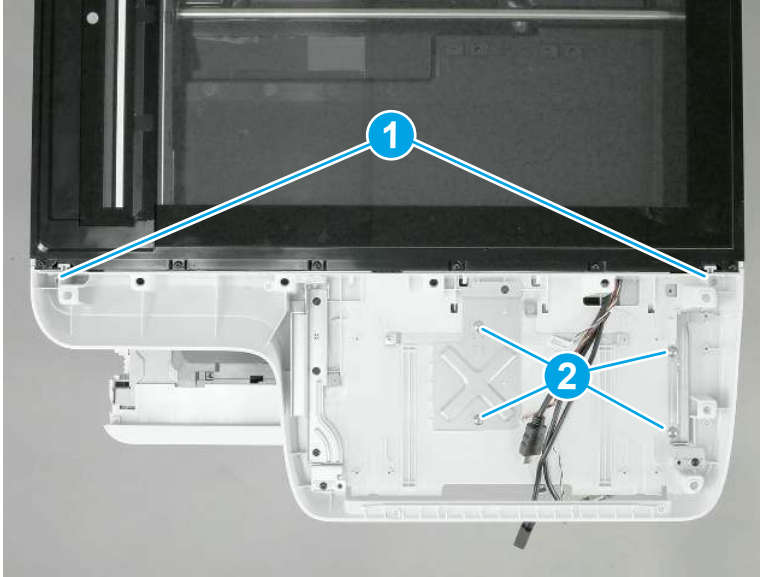
- n. Remove five screws (callout 1).

Figure 1-599 Remove four screws



- o. Remove two small, self-tapping screws (callout 1), and then remove four larger machine screws (callout 2).

Figure 1-600 Remove six screws

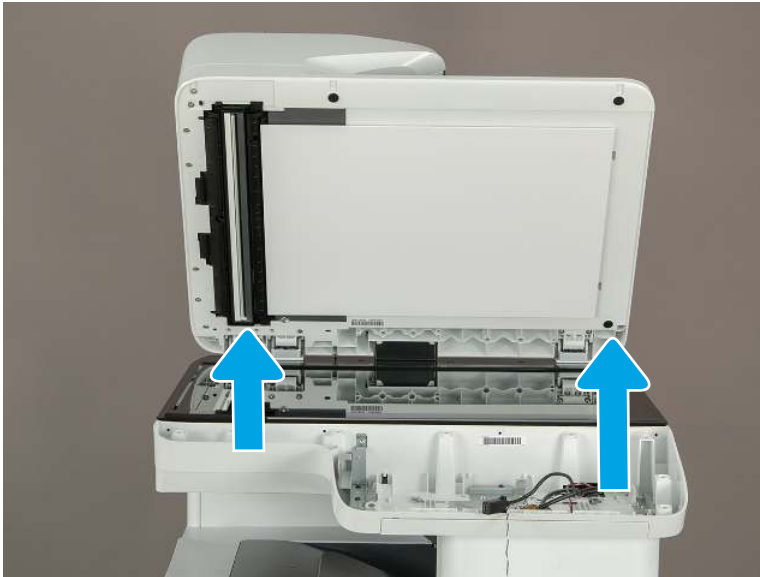


- p. Lift the nose cone up and off of the printer to remove it.



NOTE: Pass the wire harnesses and cables through the opening in the nose cone when removing it.

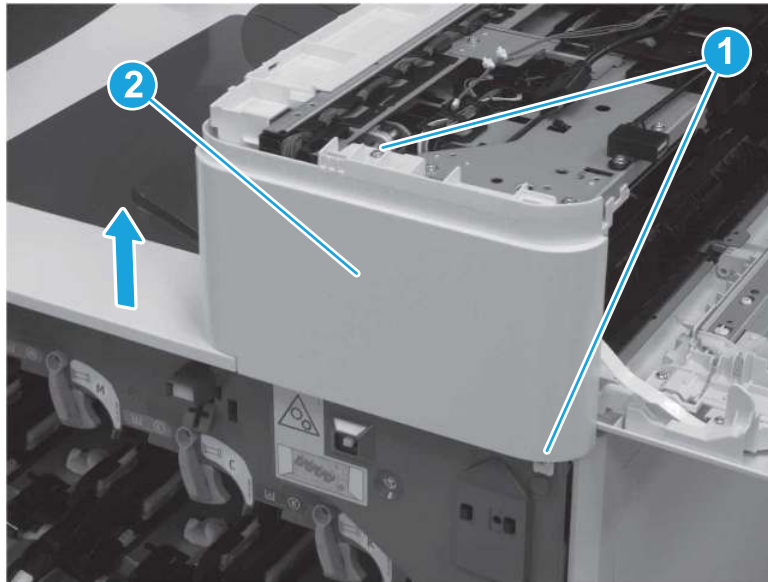
Figure 1-601 Remove the nose cone



- 6. Remove the right front cover (M856/E85055/M776dn/M776z).

- ▲ Remove two screws (callout 1), and then slide the right front cover (callout 2) up to remove it.

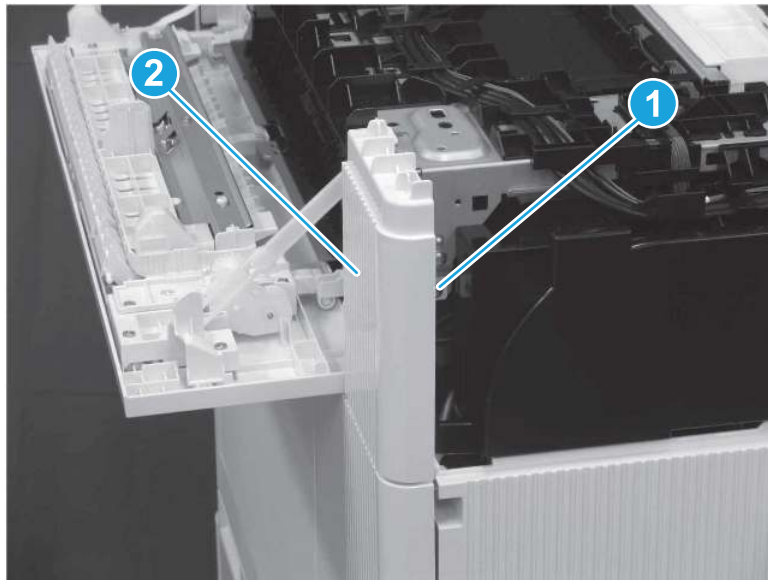
Figure 1-602 Remove the right front cover



7. Remove the right rear upper cover (M856/E85055/M776dn/M776z)

- ▲ Remove one screw (callout 1), and then slide the right rear upper cover (callout 2) away from the printer to remove it.

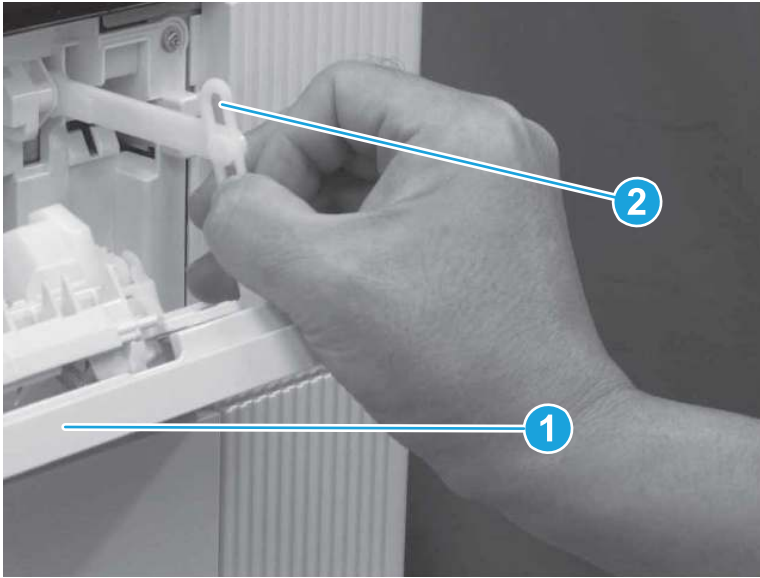
Figure 1-603 Remove the right rear upper cover



8. Remove the right upper door (M856/E85055/M776dn/M776z)

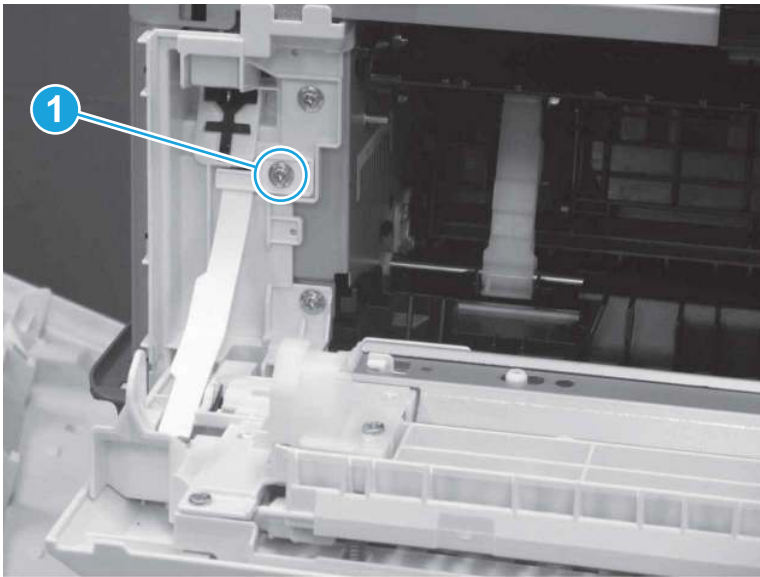
- a. Open the right upper door (callout 1), and then release the link (callout 2).

Figure 1-604 Open the door and release the link



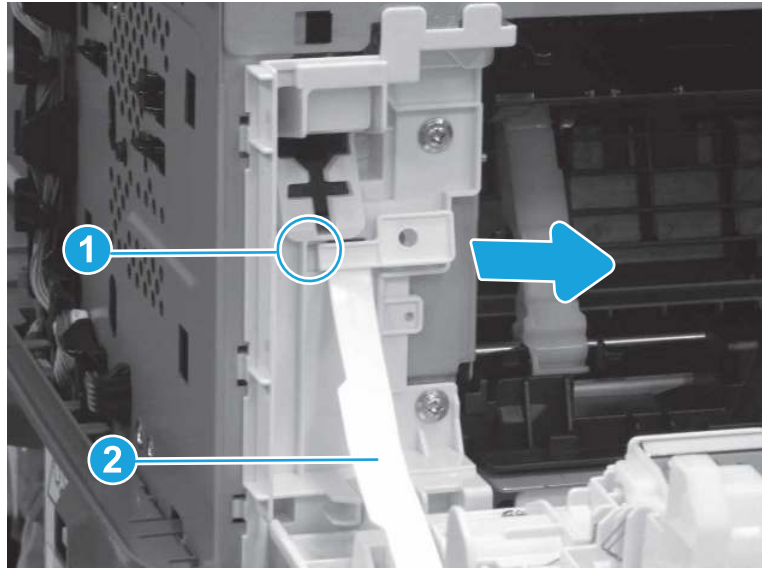
- b. Remove one screw (callout 1).

Figure 1-605 Remove one screw



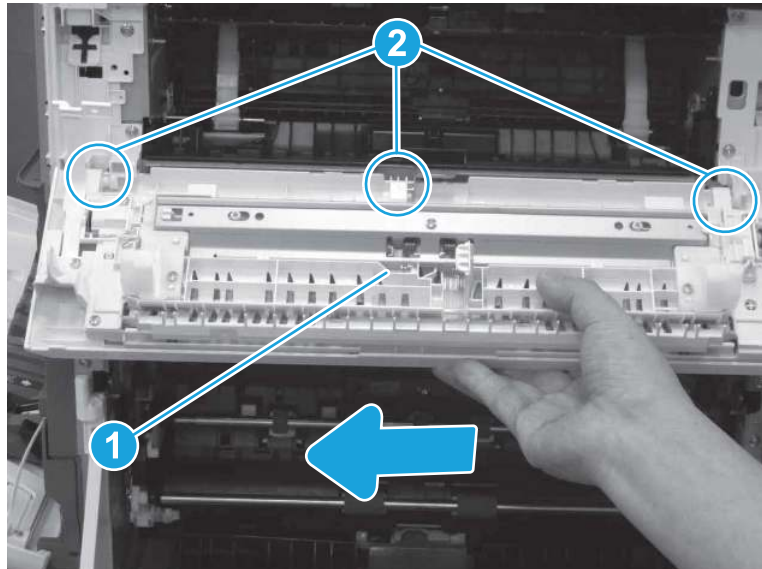
- c. Release one boss (callout 1) and then release the hinge (callout 2) by sliding it to the right.

Figure 1-606 Release one boss and hinge



- d. Slide the right upper door (callout 1) to the right to release it from three bushings (callout 2), and then remove the right upper door.

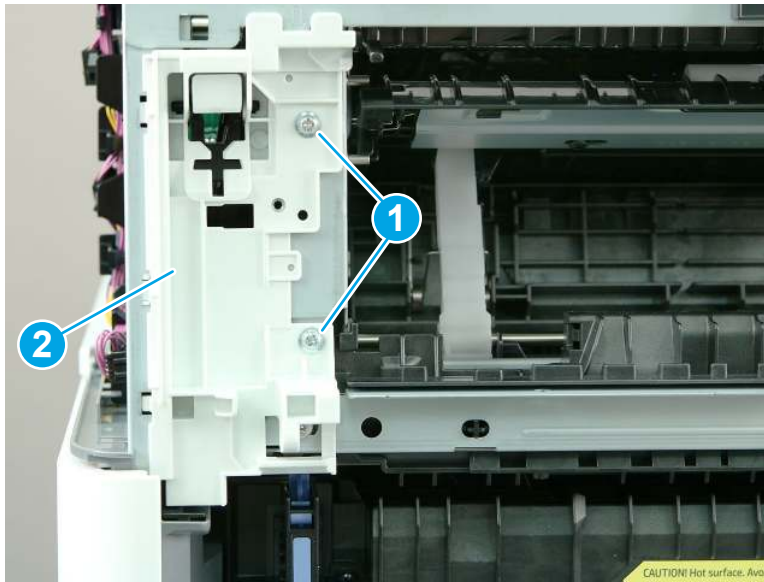
Figure 1-607 Remove the right upper door



- 9. Remove the delivery assembly (M856/E85055/M776dn/M776z).

- a. Remove two screws (callout 1), and then remove the toggle front assembly (callout 2).

Figure 1-608 Remove two screws and toggle front assembly (M856/E85055/M776dn/M776z)



- b. Remove two screws (callout 1). Remove one screw (callout 2), and then remove the toggle rear assembly (callout 3).


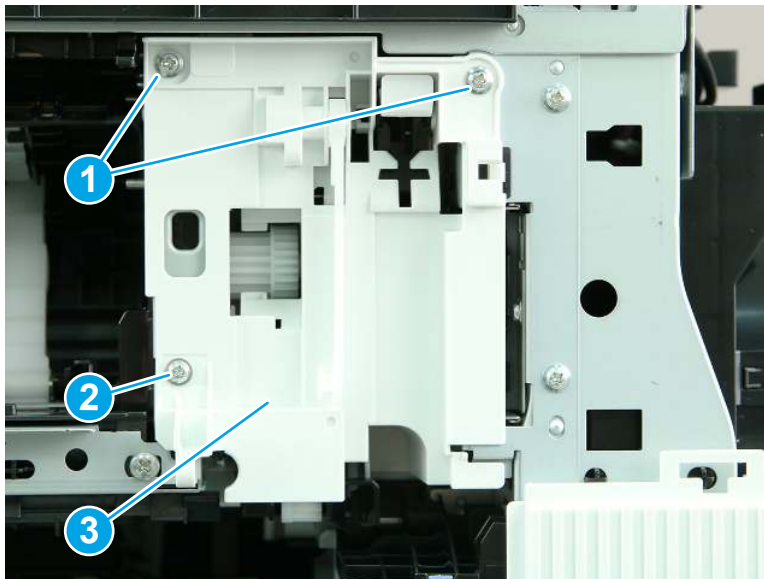
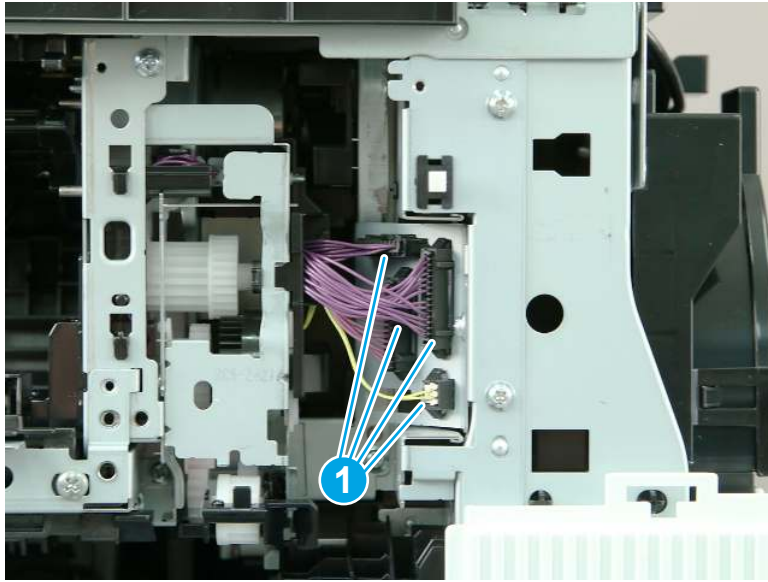
 **NOTE:** The lower screw (callout 2) is shorter than the other two screws. Make sure to reinstall this screw in the correct position.

Figure 1-609 Remove three screws and toggle rear assembly (M856/E85055/M776dn/M776z)



- c. Disconnect four connectors (callout 1).

Figure 1-610 Disconnect four connectors (M856/E85055/M776dn/M776z)



- d. Remove four screws (callout 1).


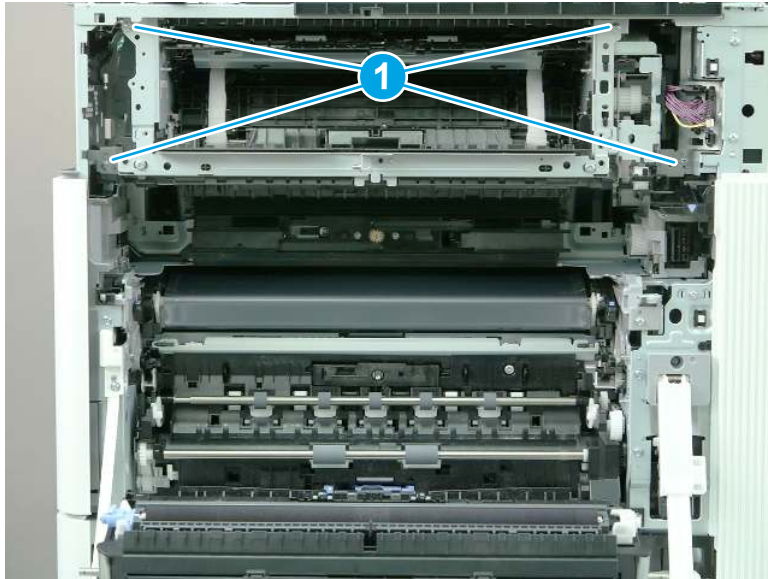
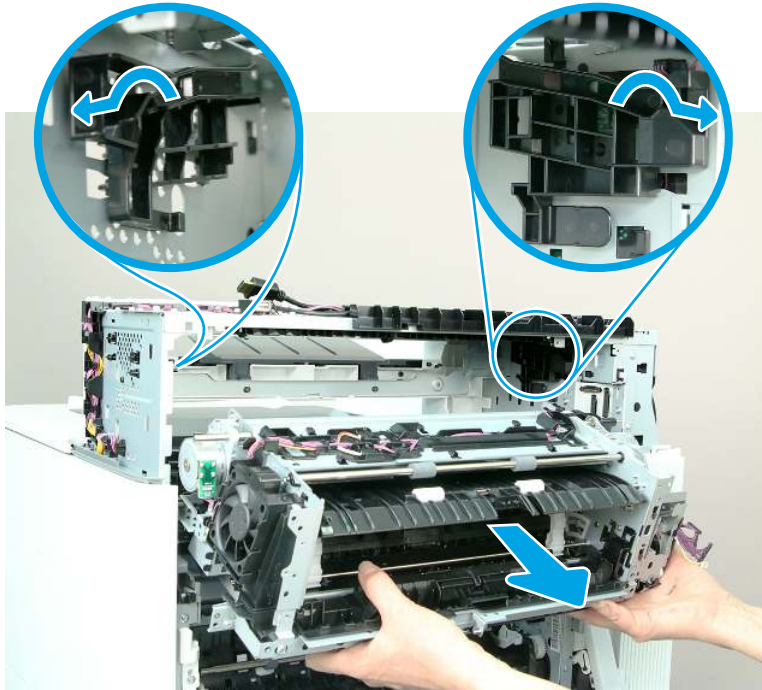
 **NOTE:** The lower screws are shorter than the upper screws. Make sure to reinstall them in the correct position.

Figure 1-611 Remove four screws (M856/E85055/M776dn/M776z)



- e. Slide the delivery assembly away from the printer, and then lift up and out to release the posts from the tracks.

Figure 1-612 Remove the delivery assembly (M856/E85055/M776dn/M776z)



10. Unpack the replacement assembly.

- a. Dispose of the defective part.



NOTE: HP recommends responsible disposal of the defective part.

<http://www8.hp.com/us/en/hp-information/environment/product-recycling.html>

- b. Unpack the replacement part from the packaging.



IMPORTANT: Make sure that all of the shipping materials (for example shipping tape) are removed from the replacement part prior to installation.

- c. To install an assembly, reverse the removal steps.



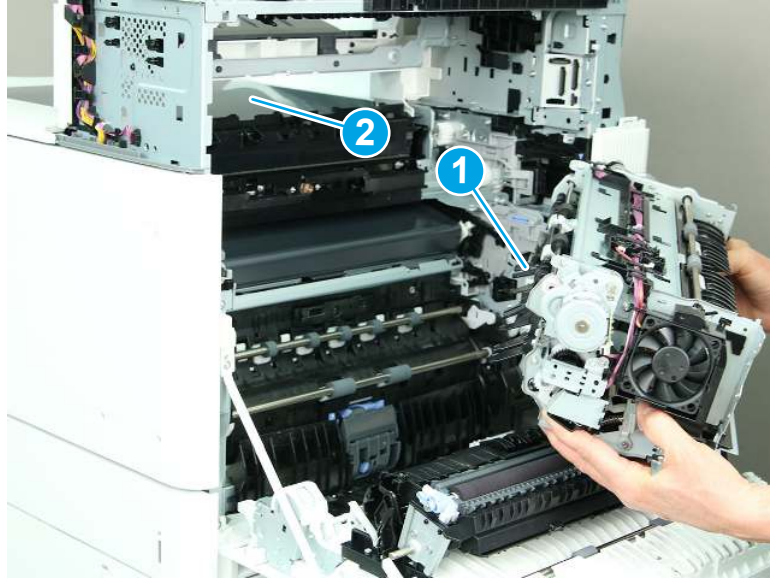
NOTE: When applicable, special installation instructions are provided for an assembly at the end of the removal procedure. Always completely read the removal instructions and follow all special installation instructions.

11. Reverse the removal steps to install the assembly. Also use the following **special installation instructions**.

Install the delivery assembly (M856/E85055/M776dn/M776z).

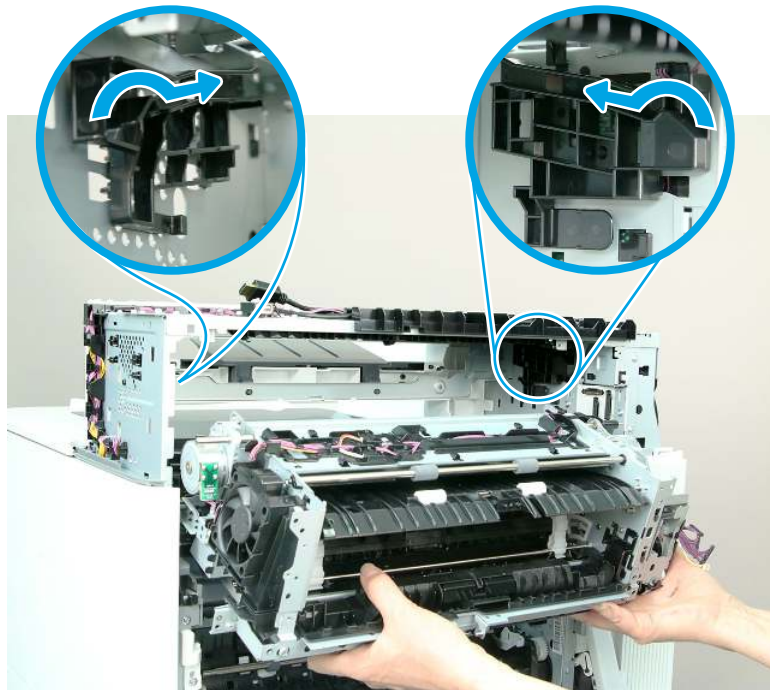
- a. When reinstalling the delivery assembly, make sure that the flap (callout 1) on the delivery assembly goes through the opening (callout 2) in the cover.

Figure 1-613 Install the flap through the opening (M856/E85055/M776dn/M776z)



- b. When reinstalling the delivery assembly, position the posts on the delivery assembly (callout 1) into the tracks (callout 2) in the printer. Lift up and then slide the assembly toward the printer to install the posts in the tracks.

Figure 1-614 Install the delivery assembly (M856/E85055/M776dn/M776z)



Removal and replacement: Delivery assembly (M776zs)

Learn how to remove and replace the delivery assembly.

Mean time to repair: 17 minutes

Service level: Easy

Before performing service

Turn the printer power off

- Disconnect the power cable.

⚠ WARNING! To avoid damage to the printer, turn the printer off, wait 30 seconds, and then remove the power cord before attempting to service the printer.

Use the table below to identify the correct part number for your printer. To order the part, go to www.hp.com/buy/parts.

Table 1-52 Part information

Part number	Part description
RM2-1786-000CN	Paper delivery assembly

Required tools

- #2 Phillips screwdriver with a magnetic tip
- Small, flat-blade screwdriver

After performing service

Turn the printer power on

- Connect the power cable.
- Use the power switch to turn the power on.

Post service test

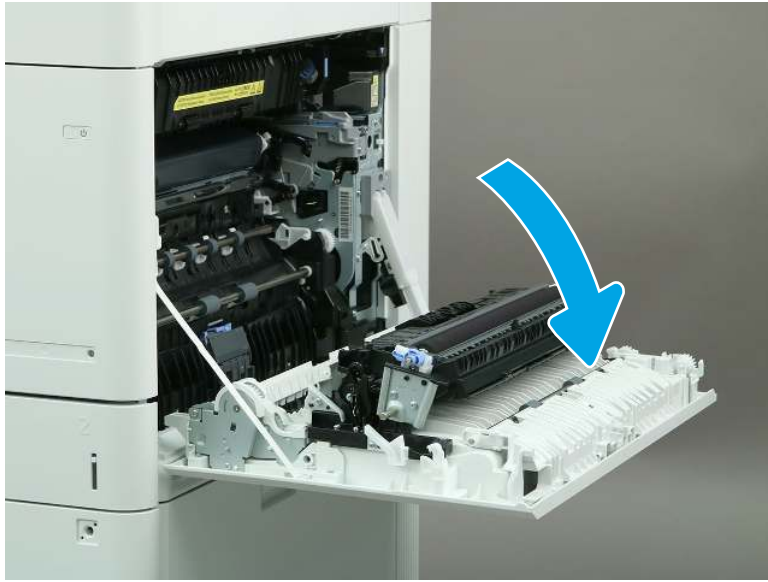
Make sure that the printer initializes to a **Ready** state.

Print a page to make sure that the printer is functioning correctly.

1. Remove the fuser.

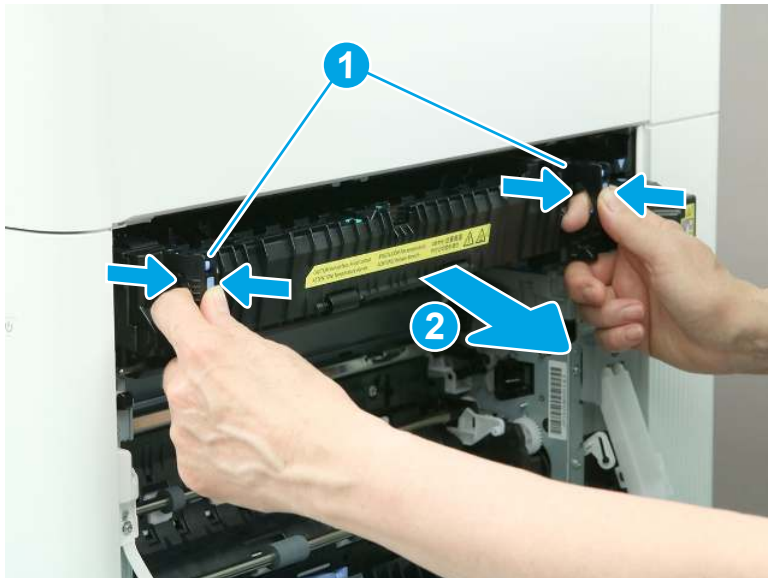
- a. Open the right door.

Figure 1-615 Open the right door



- b. Grasp the fuser handles, and then squeeze the release levers (callout 1). Lift up slightly, and then pull straight out to remove the fuser (callout 2).

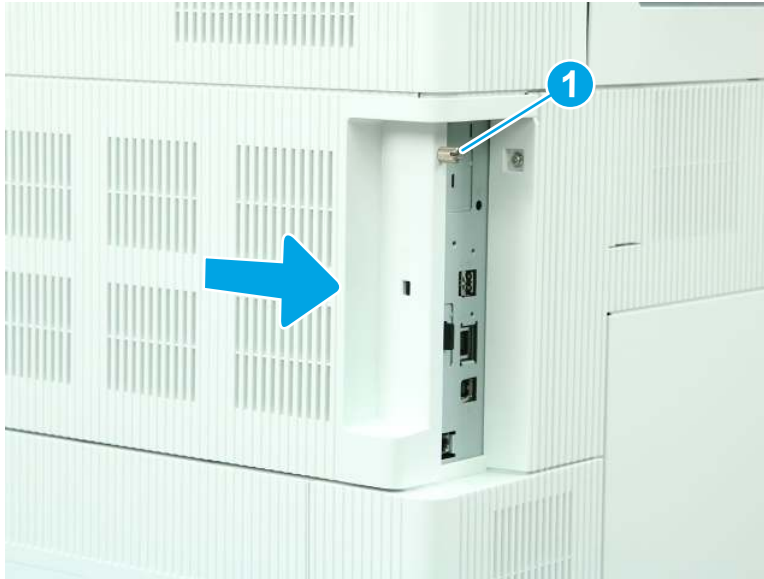
Figure 1-616 Remove the fuser



2. Remove the formatter cover.

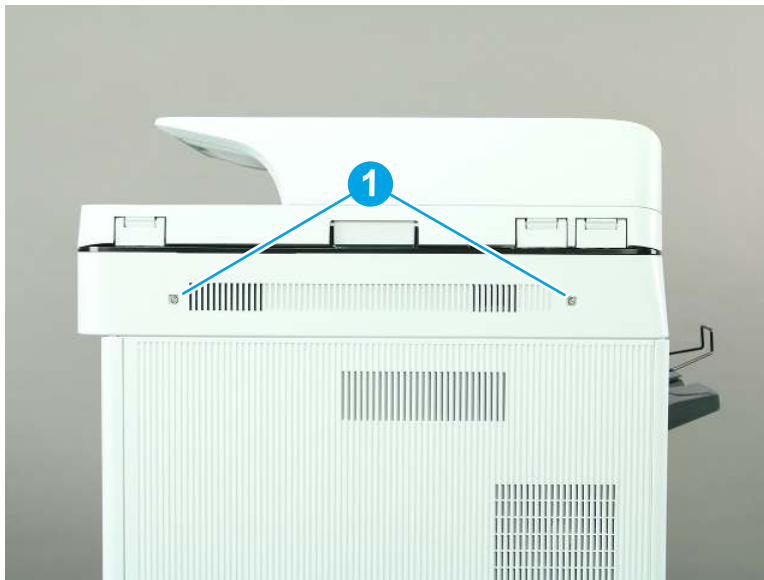
- ▲ Loosen one thumbscrew (callout 1), and then slide the formatter cover (callout 2) away from the printer to remove it.

Figure 1-617 Remove the formatter cover



- 3. Remove the scanner control board (SCB) cover (M776).
 - a. Remove two screws (callout 1).

Figure 1-618 Remove two screws



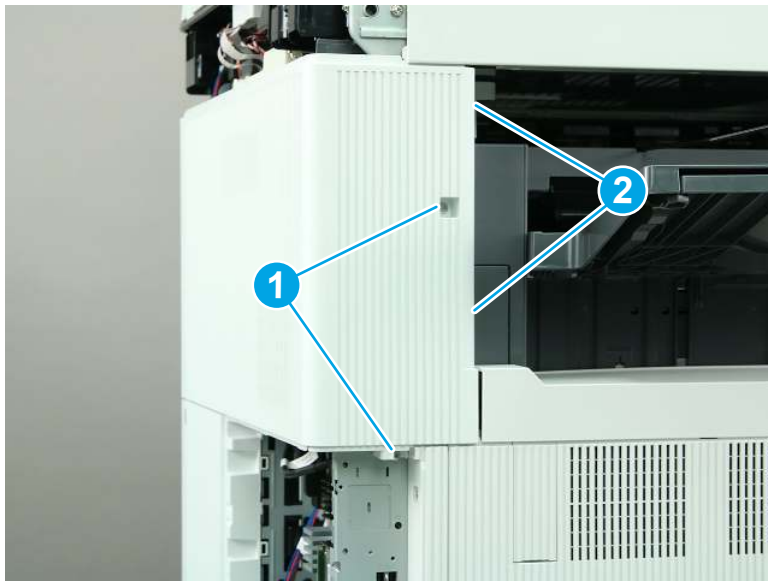
- b. Remove the SCB cover.

Figure 1-619 Remove the SCB cover



4. Remove the rear upper cover and left rear upper cover (M776zs).
 - a. Remove two screws (callout 1), and then release two tabs (callout 2).

Figure 1-620 Remove two screws and release two tabs



- b. Slide the cover to the right to remove it.

Figure 1-621 Remove the rear upper and left rear upper cover



- 5. Remove the front cover (M776zs).

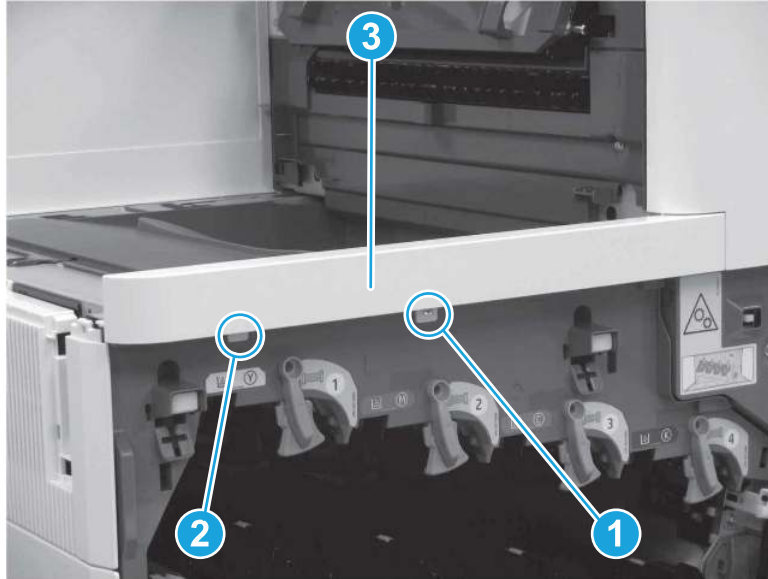
- a. Open the front door.

Figure 1-622 Open the front door



- b. Remove one screw (callout 1), release one tab (callout 2), and then remove the front cover (callout 3).

Figure 1-623 Remove the front cover



- 6. Remove the control panel (M776).
 - a. Rotate the control panel to the fully raised position (callout 1), and then raise the document feeder (callout 2).

Figure 1-624 Raise the control panel and document feeder



- b. Beginning at the right side of the control-panel cover, carefully release five tabs along the top edge of the cover.

 **NOTE:** The thin black-plastic cover will separate from the white-plastic control-panel base.

Figure 1-625 Release the control panel cover



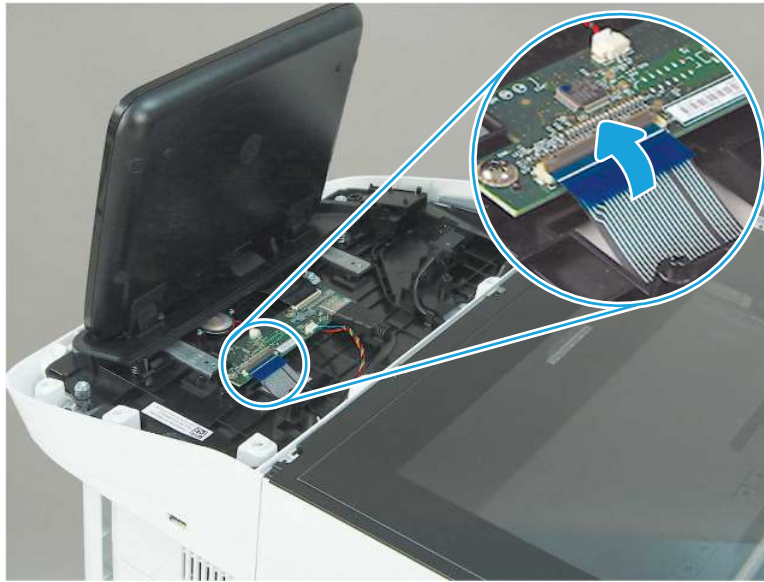
- c. Rotate the control panel cover slightly forward (callout 1), and then lift up to remove the cover (callout 2).

Figure 1-626 Remove the control panel cover



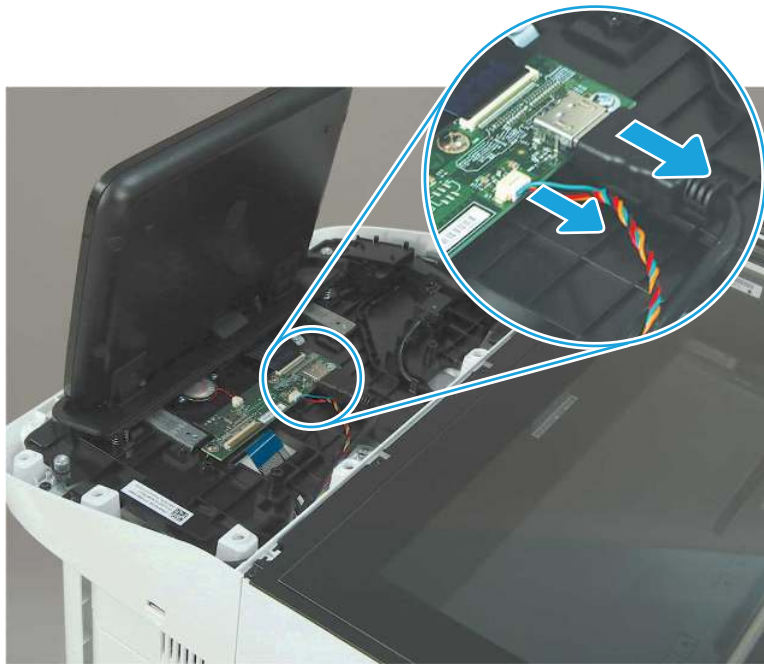
- d. **M776z or M776zs only:** Open the connector latch to release the keyboard flat cable.

Figure 1-627 Release the keyboard flat cable (M776z/M776zs)



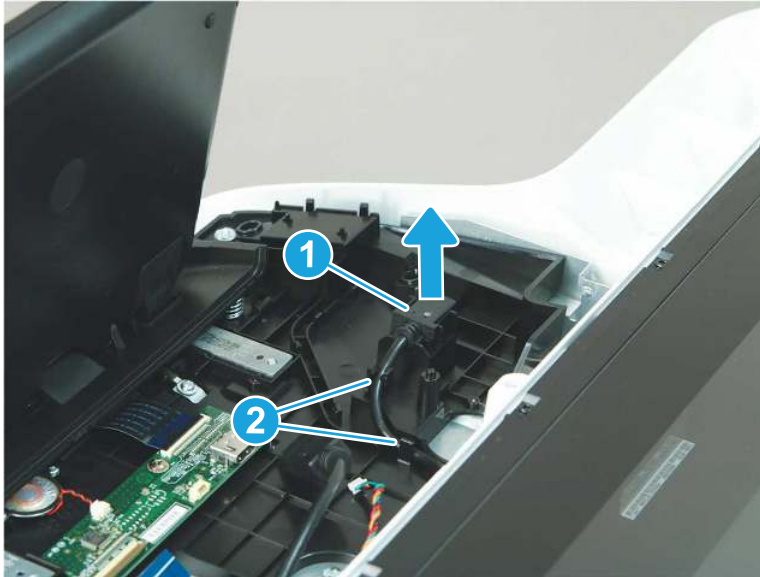
- e. Disconnect two connectors

Figure 1-628 Disconnect two connectors



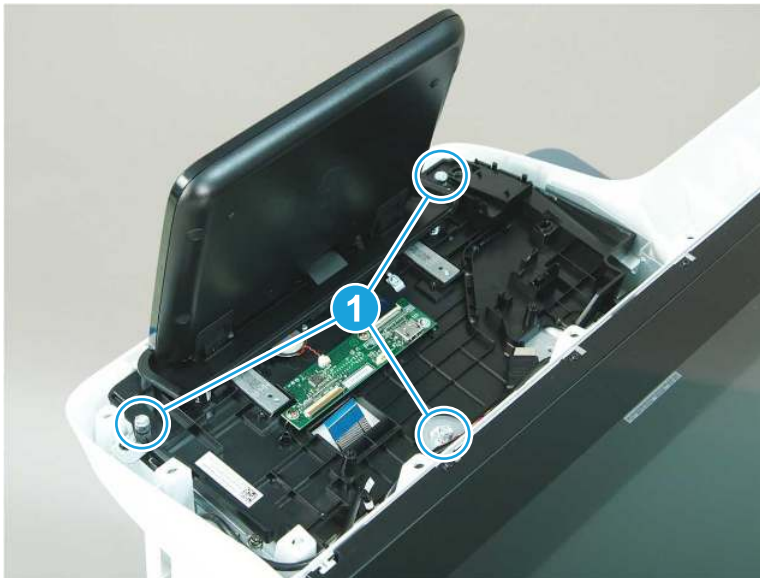
- f. Remove the USB cable (callout 1) from the holder, and then release the cable from two retainers (callout 2).

Figure 1-629 Release the USB cable



- g. Remove three screws (callout 1).

Figure 1-630 Remove three screws



- h. Lift the front of the control panel off of the printer (callout 1), and then slide it towards the front of the printer (callout 2) to remove it.

Figure 1-631 Remove the control panel



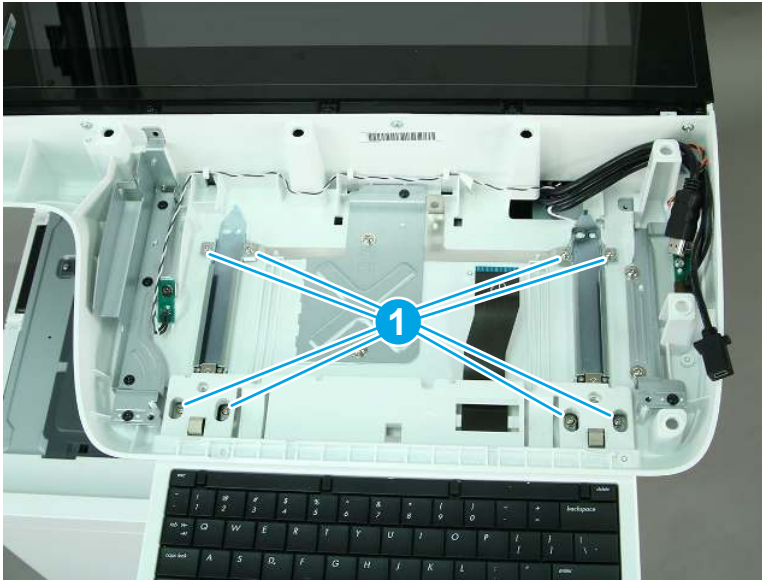
- 7. Remove the keyboard (M776z/M776zs).
 - a. Pull the keyboard out to its extended position.

Figure 1-632 Pull the keyboard out



- b. Remove eight screws (callout 1).

Figure 1-633 Remove eight screws



- c. Remove the keyboard and rails.

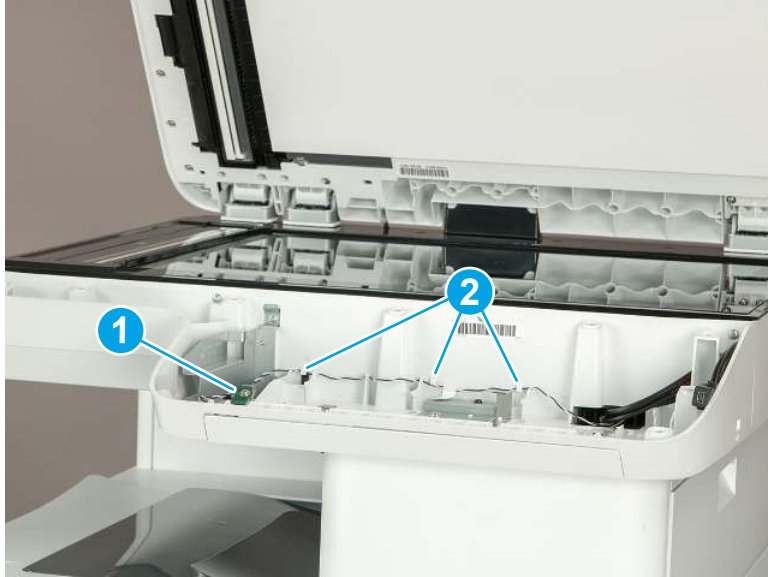
Figure 1-634 Remove the keyboard and rails



- 8. Remove the nose cone (M776).

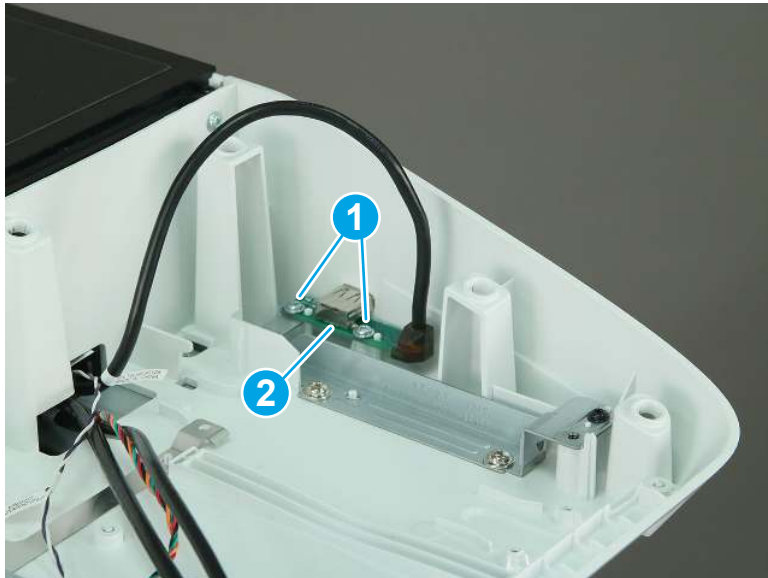
- a. Remove one screw (callout 1) to release the light PCA. Release the cable from three retainers (callout 2), and then move the light PCA out of the way.

Figure 1-635 Release the light PCA



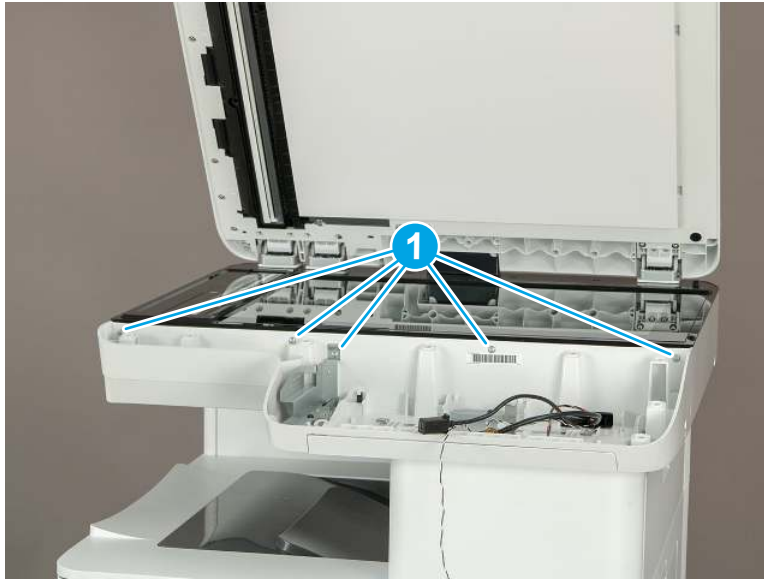
- b. Remove two screws (callout 1), and then move the USB port PCA (callout 2) out of the way.

Figure 1-636 Release the USB port PCA



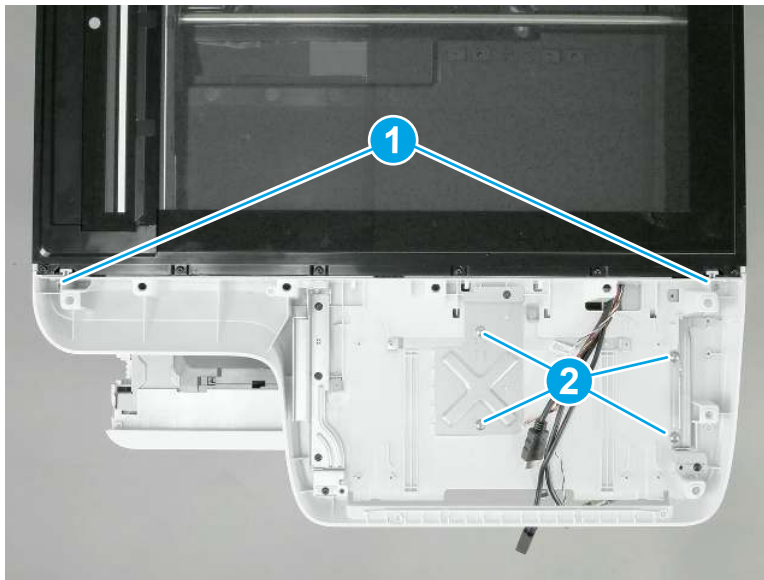
- c. Remove five screws (callout 1).

Figure 1-637 Remove four screws



- d. Remove two small, self-tapping screws (callout 1), and then remove four larger machine screws (callout 2).

Figure 1-638 Remove six screws

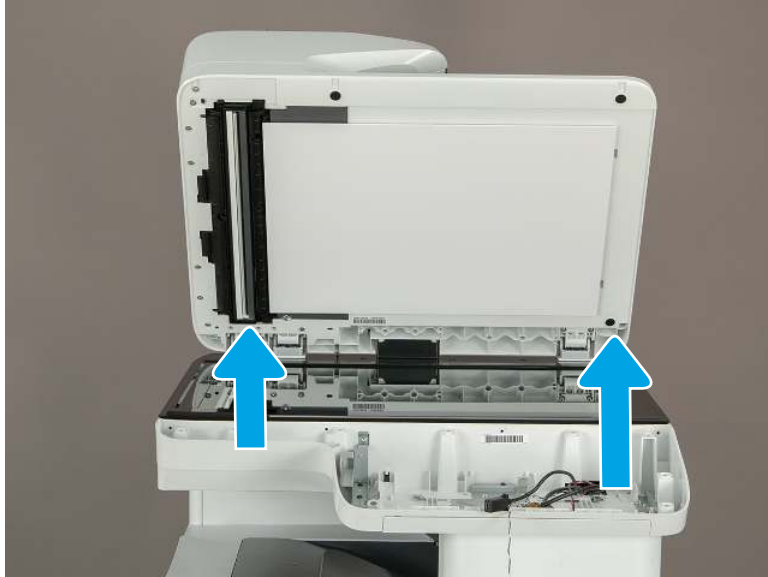


- e. Lift the nose cone up and off of the printer to remove it.



NOTE: Pass the wire harnesses and cables through the opening in the nose cone when removing it.

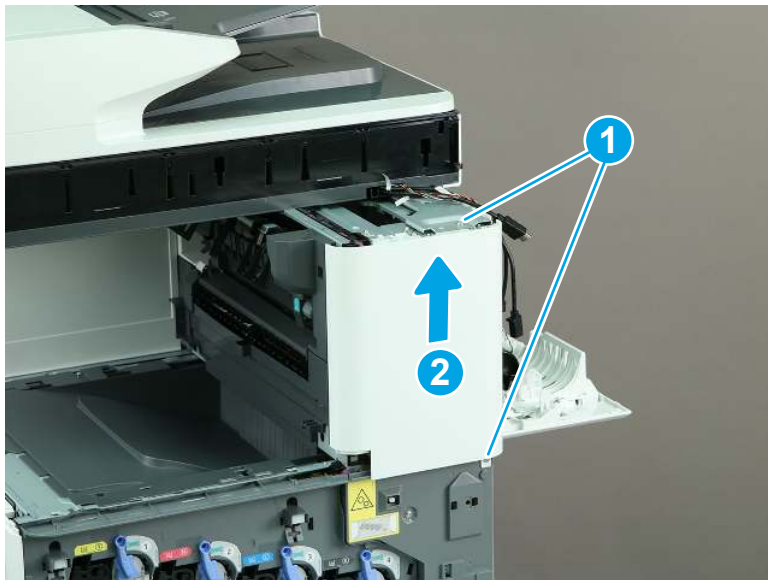
Figure 1-639 Remove the nose cone



9. Remove the right front cover (M776zs).

- ▲ Remove two screws (callout 1), release one tab (callout 2), and then slide the right front cover up (callout 2) to remove it.

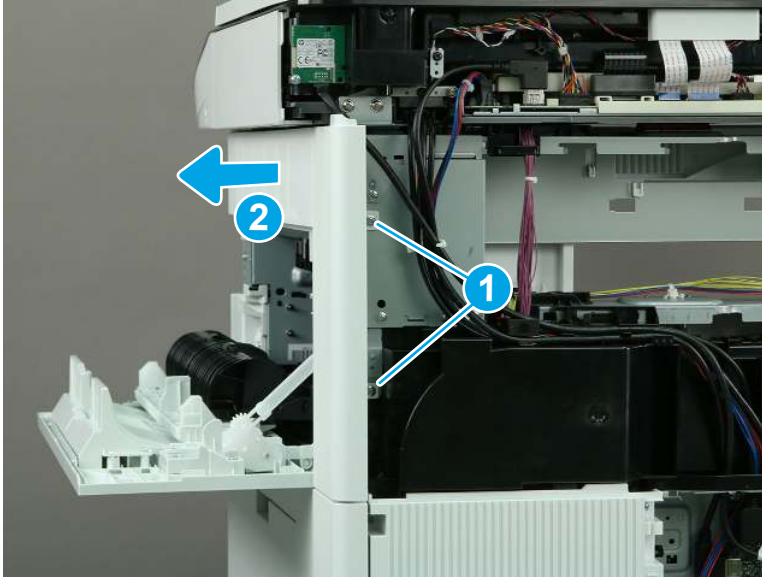
Figure 1-640 Remove the right front cover



10. Remove the right rear upper cover (M776zs).

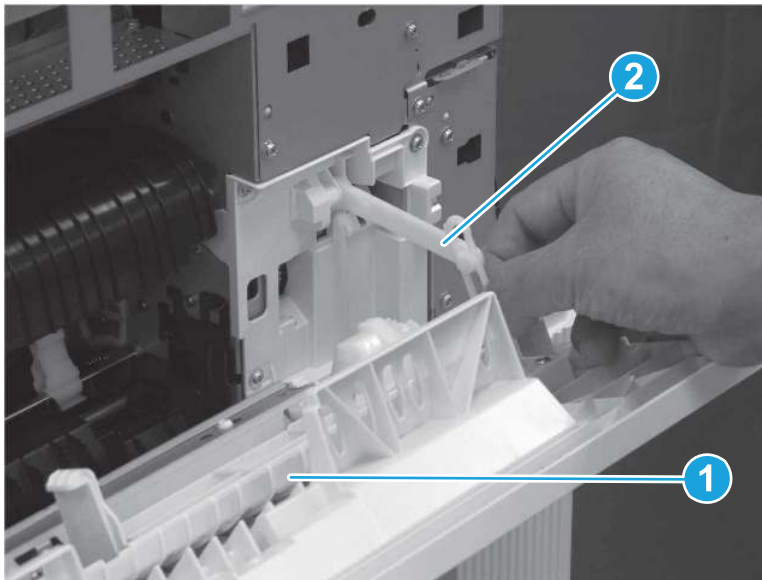
- ▲ Remove two screws (callout 1), and then slide the right rear upper cover away from the printer to remove it (callout 2).

Figure 1-641 Remove the right rear upper cover



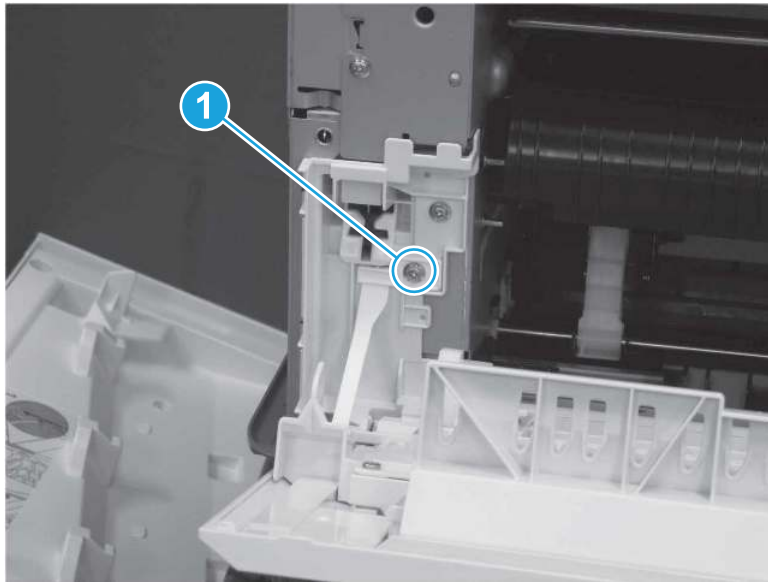
11. Remove the right upper door (M776zs).
 - a. Open the right upper door (callout 1), and then release the link (callout 2).

Figure 1-642 Open the door and release the link



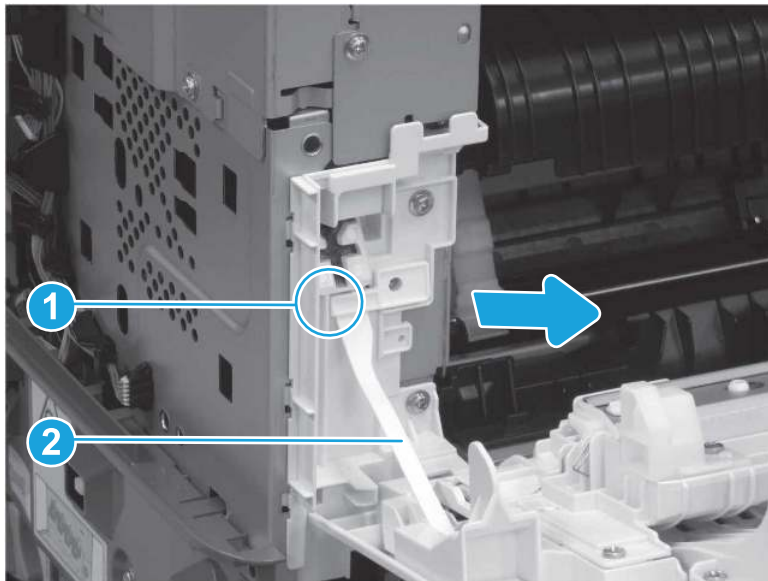
- b. Remove one screw (callout 1).

Figure 1-643 Remove one screw



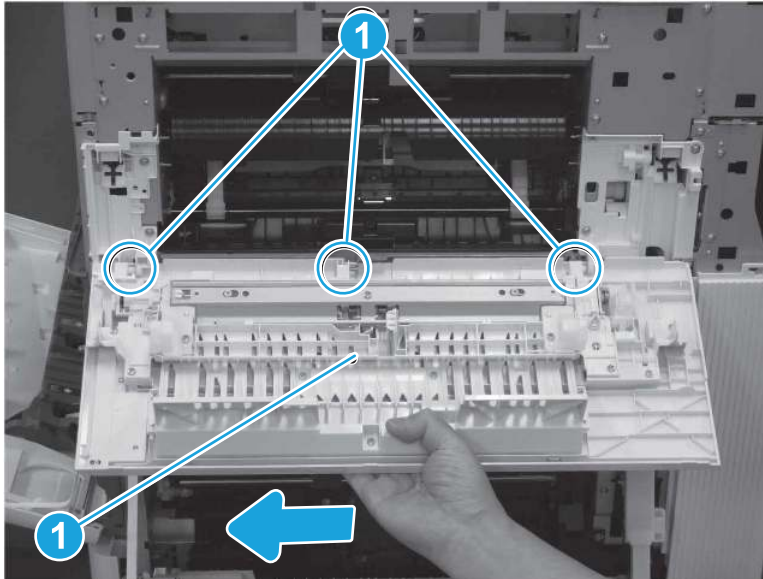
- c. Release one boss (callout 1) and then release the hinge (callout 2) by sliding it to the right.

Figure 1-644 Release one boss and hinge



- d. Slide the right upper door (callout 1) to the right to release it from three bushings (callout 2), and then remove the right upper door.

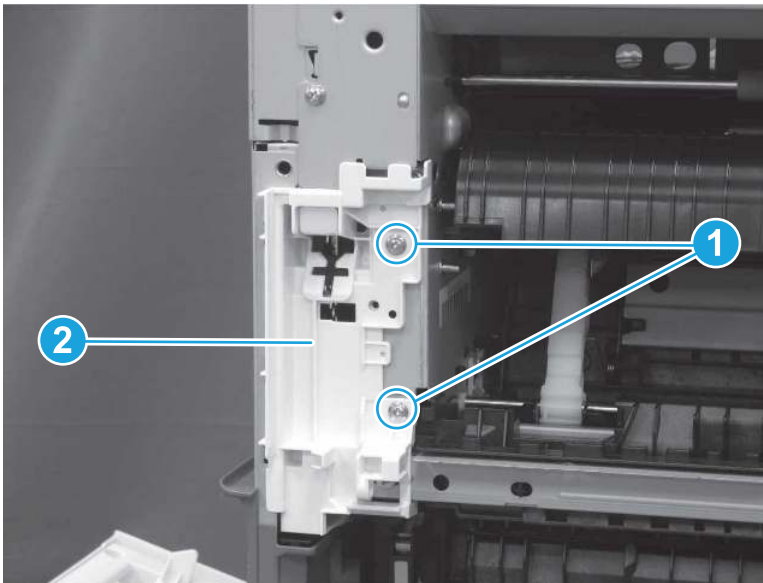
Figure 1-645 Remove the right upper door



- 12. Remove the delivery assembly (M776zs).

- a. Remove two screws (callout 1), and then remove the toggle front assembly (callout 2).

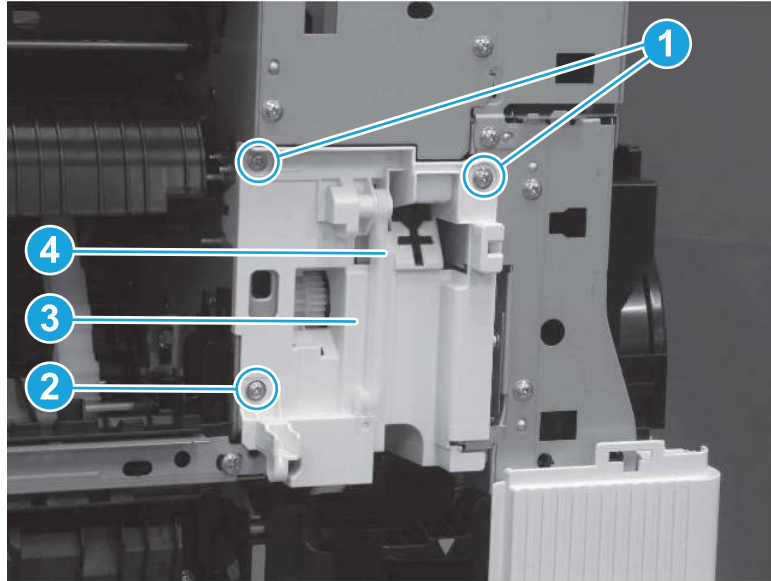
Figure 1-646 Remove two screws and toggle front assembly (M776zs)



- b. Remove two screws (callout 1). Remove one screw (callout 2), and then remove the toggle rear assembly (callout 3) and the link (callout 4) together.

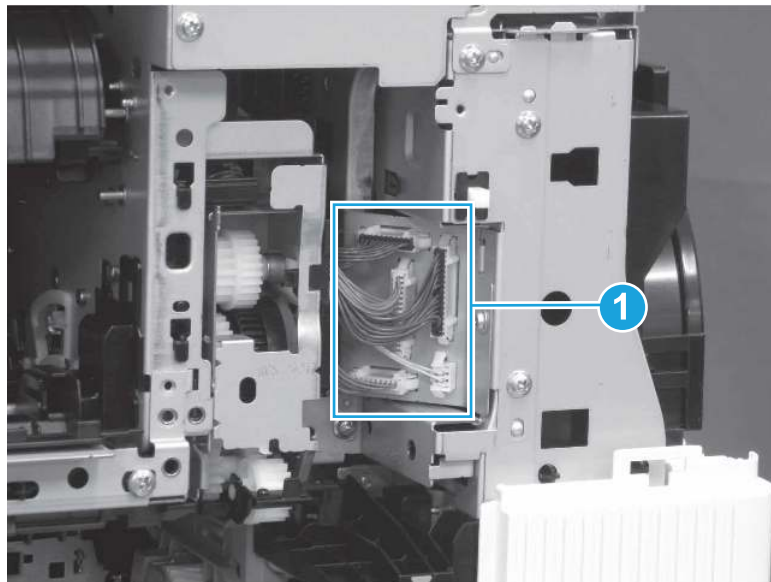
 **NOTE:** The lower screw (callout 2) is shorter than the other two screws. Make sure to reinstall this screw in the correct position.

Figure 1-647 Remove three screws and toggle rear assembly (M776zs)



- c. Disconnect five connectors (callout 1).

Figure 1-648 Disconnect five connectors (M776zs)

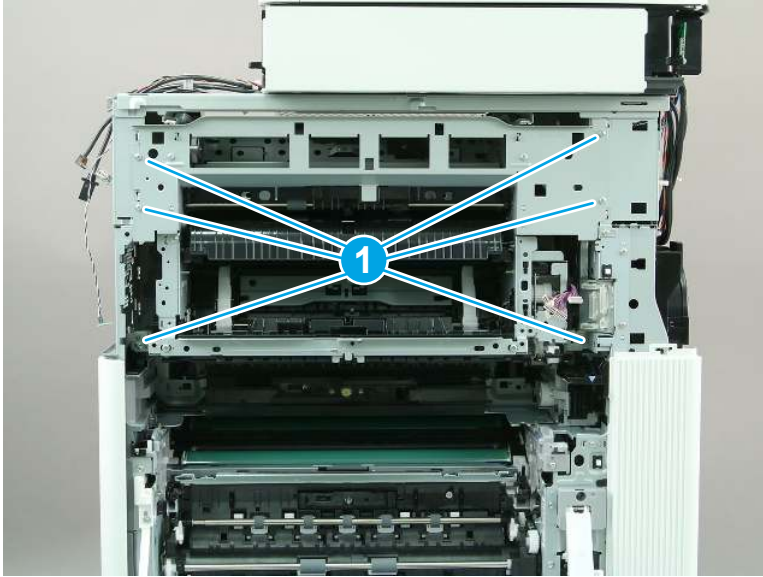


- d. Remove six screws (callout 1).



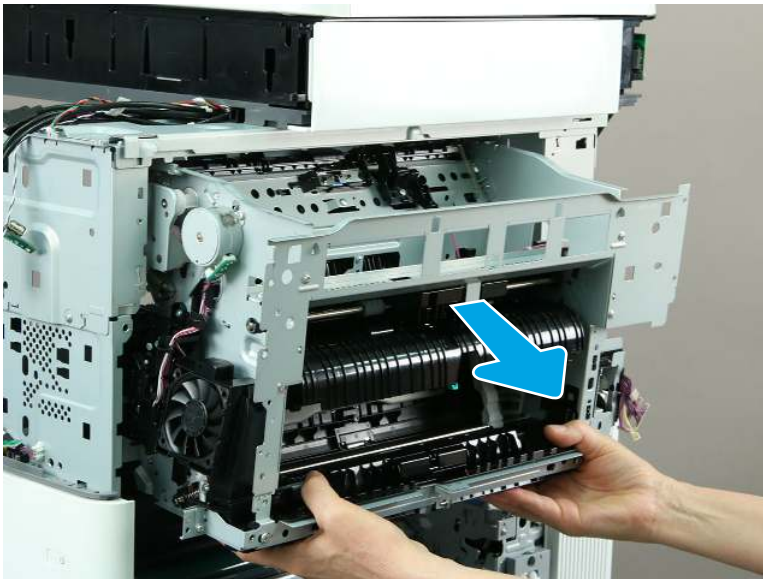
NOTE: The lower two screws are shorter than the upper screws. Make sure to reinstall them in the correct position.

Figure 1-649 Remove six screws (M776zs)



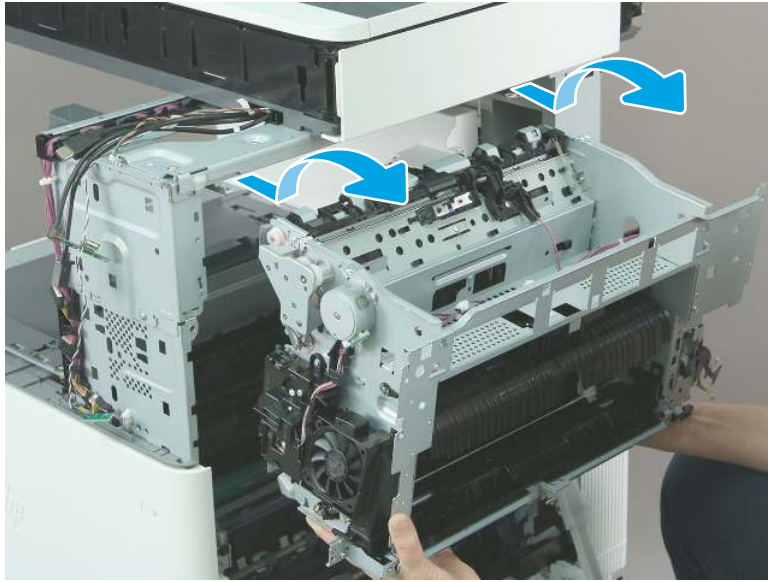
- e. Slide the delivery assembly away from the printer.

Figure 1-650 Slide the delivery assembly (M776zs)



- f. Lift up and out to release the stoppers from the tracks, and then remove the delivery assembly.

Figure 1-651 Remove the delivery assembly (M776zs)



- 13. Unpack the replacement assembly.

- a. Dispose of the defective part.



NOTE: HP recommends responsible disposal of the defective part.

<http://www8.hp.com/us/en/hp-information/environment/product-recycling.html>

- b. Unpack the replacement part from the packaging.



IMPORTANT: Make sure that all of the shipping materials (for example shipping tape) are removed from the replacement part prior to installation.

- c. To install an assembly, reverse the removal steps.



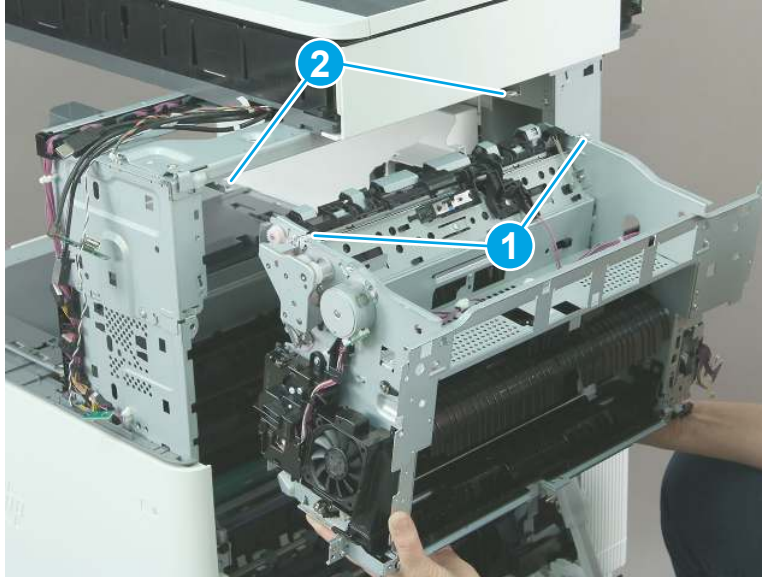
NOTE: When applicable, special installation instructions are provided for an assembly at the end of the removal procedure. Always completely read the removal instructions and follow all special installation instructions.

- 14. Reverse the removal steps to install the assembly. Also use the following **special installation instructions**.

Install the delivery assembly (M776zs).

- ▲ When reinstalling the delivery assembly, position the stoppers on the delivery assembly (callout 1) into the tracks (callout 2) in the printer. Lift up and then slide the assembly toward the printer to install the stoppers in the tracks.

Figure 1-652 Install the delivery assembly (M776zs)



Removal and replacement: Toggle front assembly (M856/E85055/M776dn/M776z)

Learn how to remove and replace the toggle front assembly (M856/E85055/M776dn/M776z).

[View a video of how to remove and replace the toggle front assembly \(M856/E85055/M776dn/M776z\).](#)

Mean time to repair: 12 minutes

Service level: Easy

Before performing service

Turn the printer power off

- Disconnect the power cable.

⚠ WARNING! To avoid damage to the printer, turn the printer off, wait 30 seconds, and then remove the power cord before attempting to service the printer.

Use the table below to identify the correct part number for your printer. To order the part, go to www.hp.com/buy/parts.

Table 1-53 Part information

Part number	Part description
RM2-1764-000CN	Toggle front assembly

Required tools

- #2 Phillips screwdriver with a magnetic tip
- Small, flat-blade screwdriver

After performing service

Turn the printer power on

- Connect the power cable.
- Use the power switch to turn the power on.

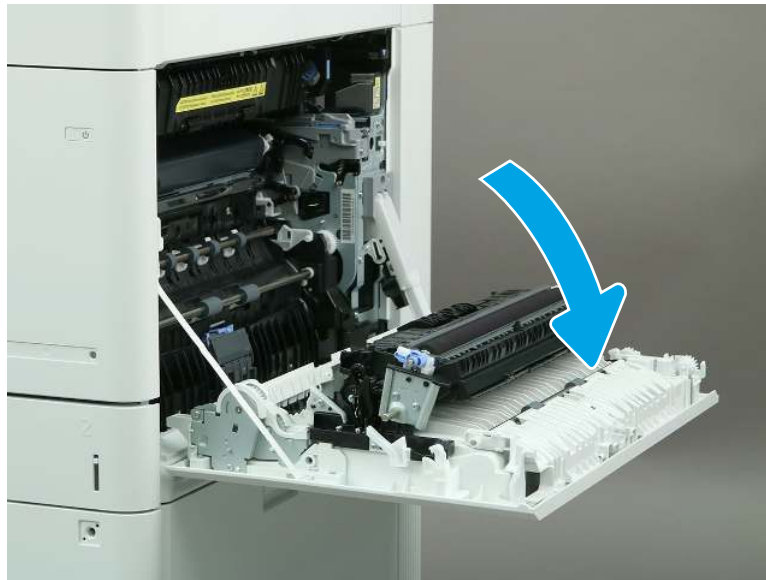
Post service test

Make sure that the printer initializes to a **Ready** state.

Print a page to make sure that the printer is functioning correctly.

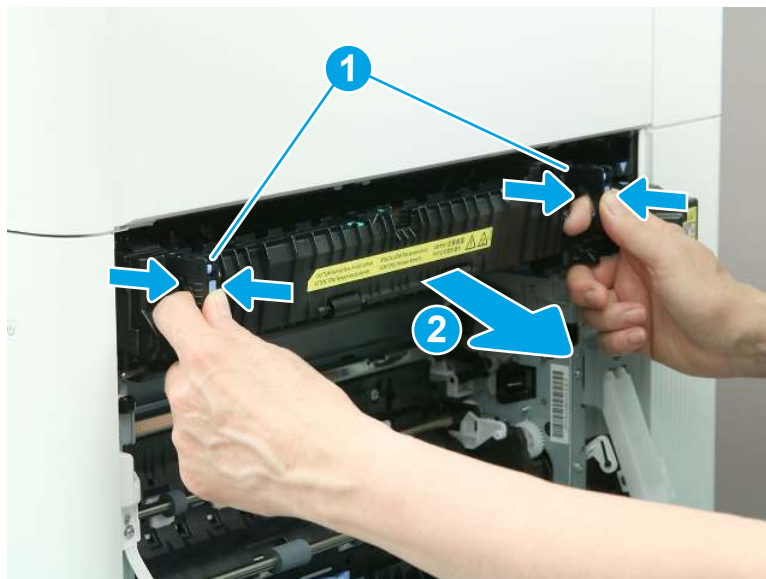
1. Remove the fuser.
 - a. Open the right door.

Figure 1-653 Open the right door



- b. Grasp the fuser handles, and then squeeze the release levers (callout 1). Lift up slightly, and then pull straight out to remove the fuser (callout 2).

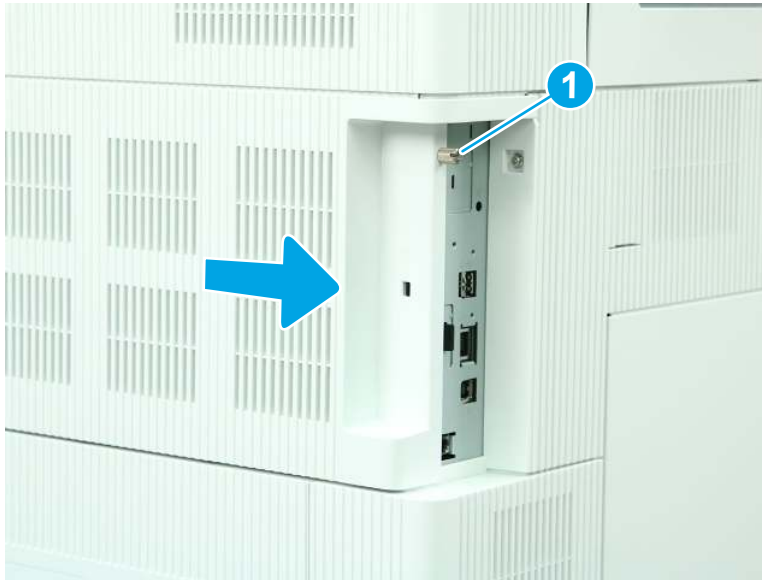
Figure 1-654 Remove the fuser



2. Remove the formatter cover.

- ▲ Loosen one thumbscrew (callout 1), and then slide the formatter cover (callout 2) away from the printer to remove it.

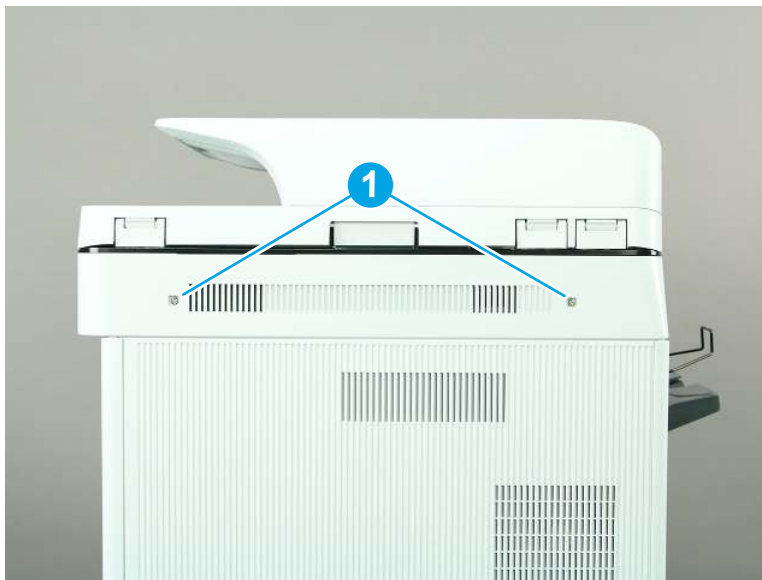
Figure 1-655 Remove the formatter cover



3. Remove the scanner control board (SCB) cover (M776).

- a. Remove two screws (callout 1).

Figure 1-656 Remove two screws



- b. Remove the SCB cover.

Figure 1-657 Remove the SCB cover

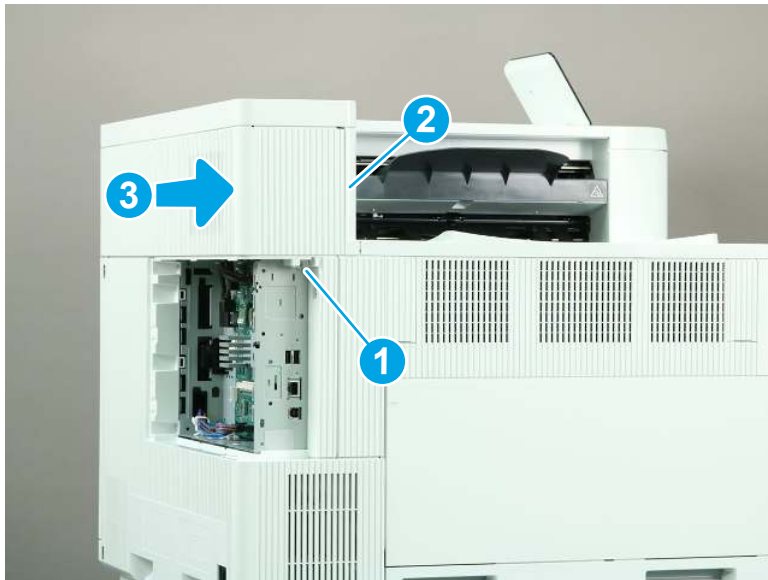


4. Remove the rear upper cover (M856/E85055/M776dn/M776z).


 **NOTE:** The following figure shows the M856 printer. The procedure is correct for all referenced models.

- ▲ Remove one screw (callout 1), release one tab (callout 2), and then slide the rear upper cover away from the printer to remove it (callout 3).

Figure 1-658 Remove the rear upper cover



5. **M856/E85055 only:** Remove the control panel and top cover.

 **NOTE:** This step applies to only the M856/E85055 models. Skip this step for all other models.

- a. Use a small, flat-blade screwdriver to release two tabs (callout 1), and then remove the control panel cover (callout 2).

Figure 1-659 Remove the control panel cover



- b. Remove one screw (callout 1).

Figure 1-660 Remove one screw



- c. Lift the back edge of the control panel up (callout 1), and then slide the control panel toward the back of the printer (callout 2).

Figure 1-661 Slide the control panel back



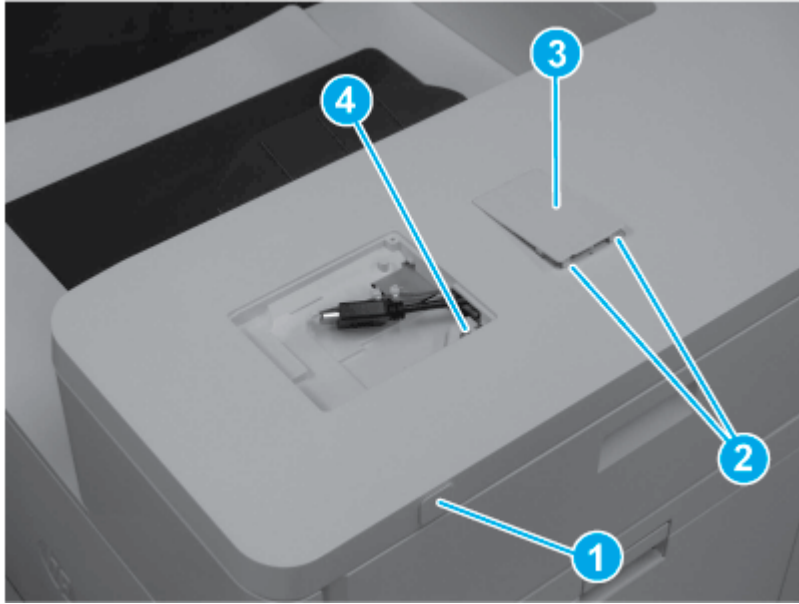
- d. Turn the control panel so that the bottom is facing up, and then disconnect two connectors to remove the control panel.

Figure 1-662 Disconnect two connectors



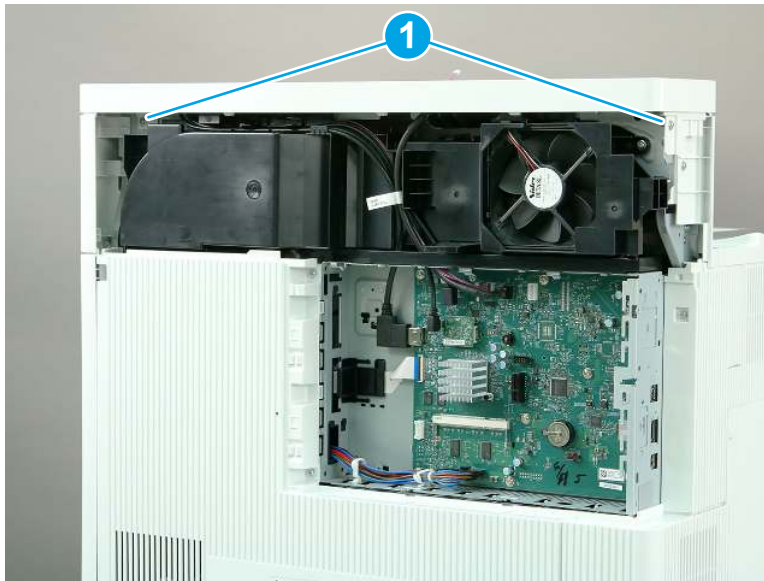
- e. Remove the USB cover (callout 1). Release two tabs (callout 2), and then remove the HIP cover (callout 3). Remove one screw (callout 4).

Figure 1-663 Remove covers and one screw



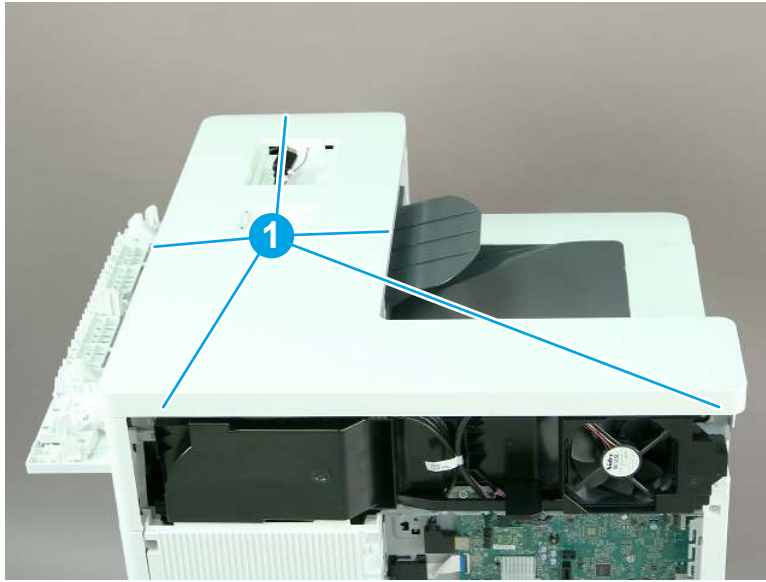
- f. Remove two screws (callout 1).

Figure 1-664 Remove two screws



- g. Release five tabs (callout 1), and then remove the top cover.

Figure 1-665 Release five tabs



6. **M776 only:** Remove the control panel, keyboard, and nose cone.

 **NOTE:** This step applies to only the M776 models. Skip this step for all other models

- a. Rotate the control panel to the fully raised position (callout 1), and then raise the document feeder (callout 2).

Figure 1-666 Raise the control panel and document feeder



- b. Beginning at the right side of the control-panel cover, carefully release five tabs along the top edge of the cover.

 **NOTE:** The thin black-plastic cover will separate from the white-plastic control-panel base.

Figure 1-667 Release the control panel cover



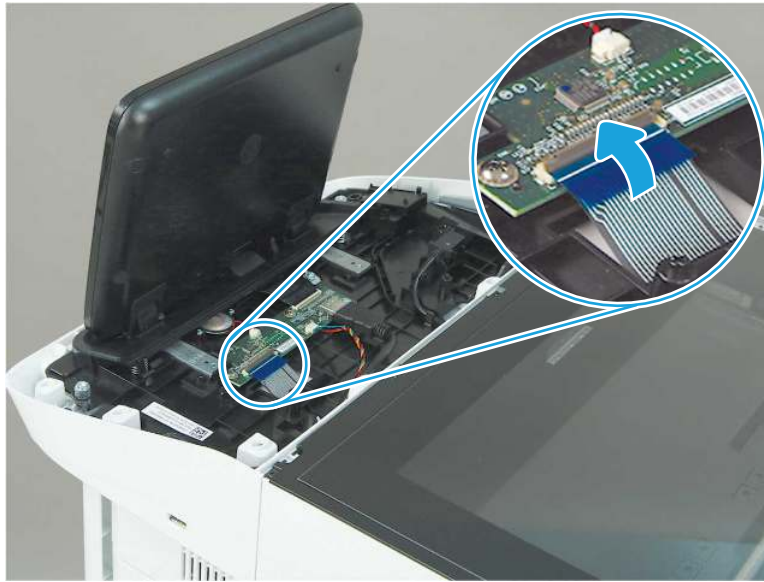
- c. Rotate the control panel cover slightly forward (callout 1), and then lift up to remove the cover (callout 2).

Figure 1-668 Remove the control panel cover



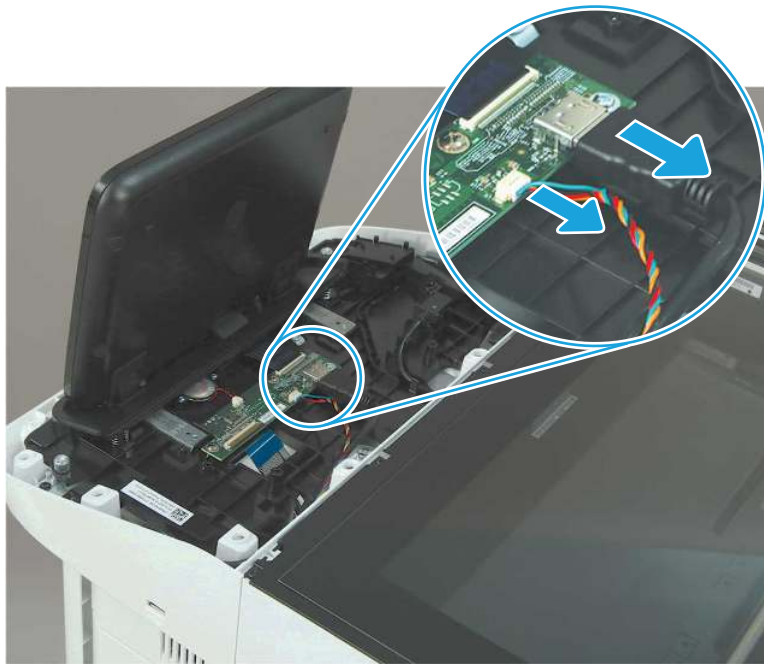
- d. **M776z or M776zs only:** Open the connector latch to release the keyboard flat cable.

Figure 1-669 Release the keyboard flat cable (M776z/M776zs)



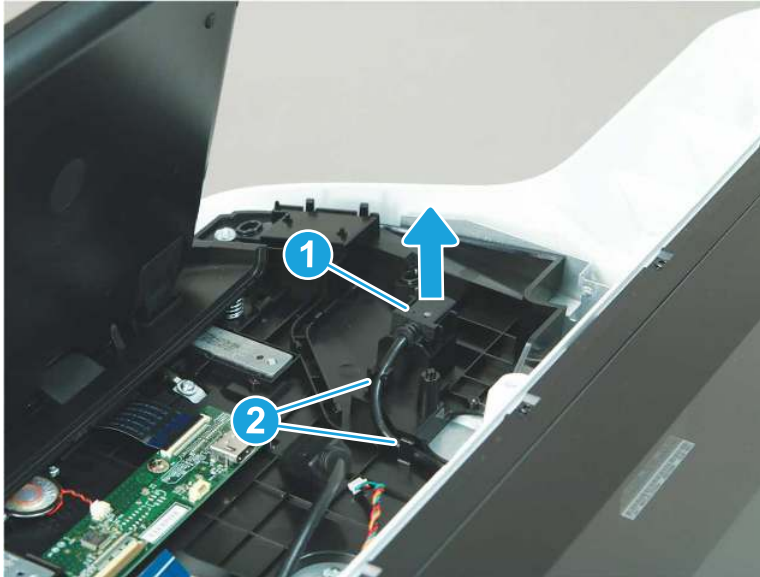
- e. Disconnect two connectors.

Figure 1-670 Disconnect two connectors



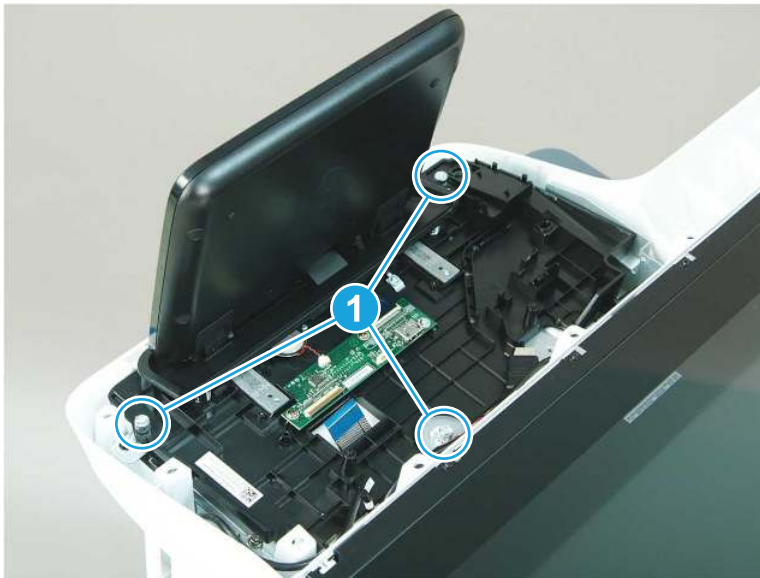
- f. Remove the USB cable (callout 1) from the holder, and then release the cable from two retainers (callout 2).

Figure 1-671 Release the USB cable



- g. Remove three screws (callout 1).

Figure 1-672 Remove three screws



- h. Lift the front of the control panel off of the printer (callout 1), and then slide it towards the front of the printer (callout 2) to remove it.

Figure 1-673 Remove the control panel



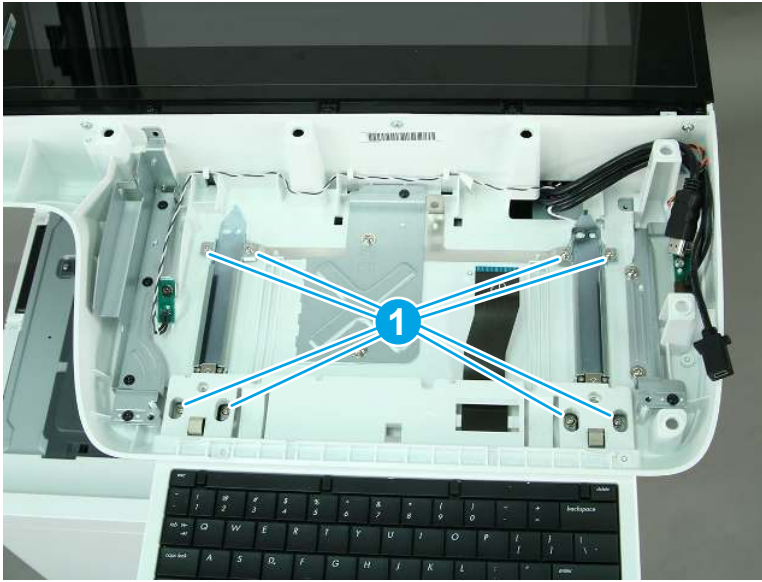
- i. **Keyboard models only:** Pull the keyboard out to its extended position.

Figure 1-674 Pull the keyboard out



- j. **Keyboard models only:** Remove eight screws (callout 1).

Figure 1-675 Remove eight screws



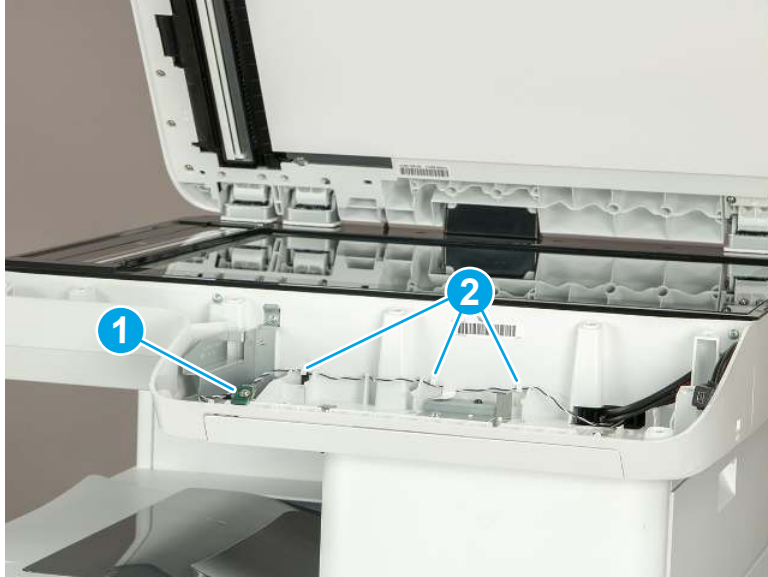
- k. **Keyboard models only:** Remove the keyboard and rails.

Figure 1-676 Remove the keyboard and rails



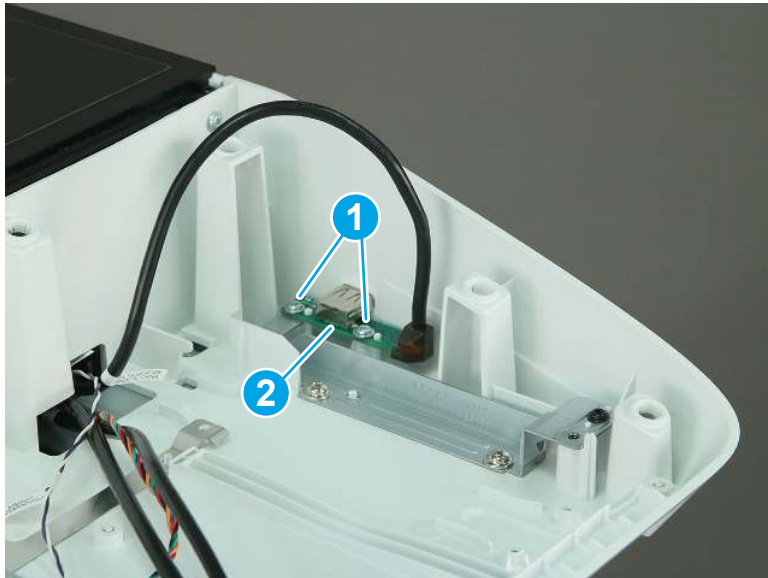
- l. Remove one screw (callout 1) to release the light PCA. Release the cable from three retainers (callout 2), and then move the light PCA out of the way.

Figure 1-677 Release the light PCA



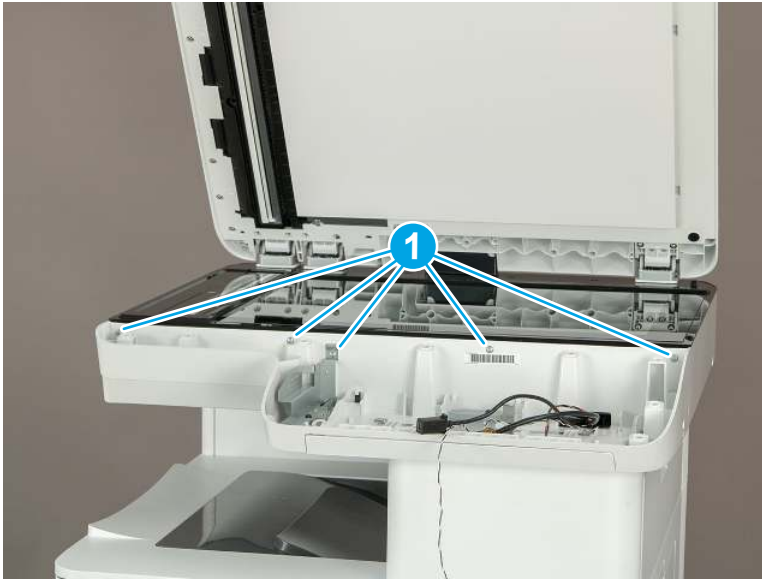
- m. Remove two screws (callout 1), and then move the USB port PCA (callout 2) out of the way.

Figure 1-678 Release the USB port PCA



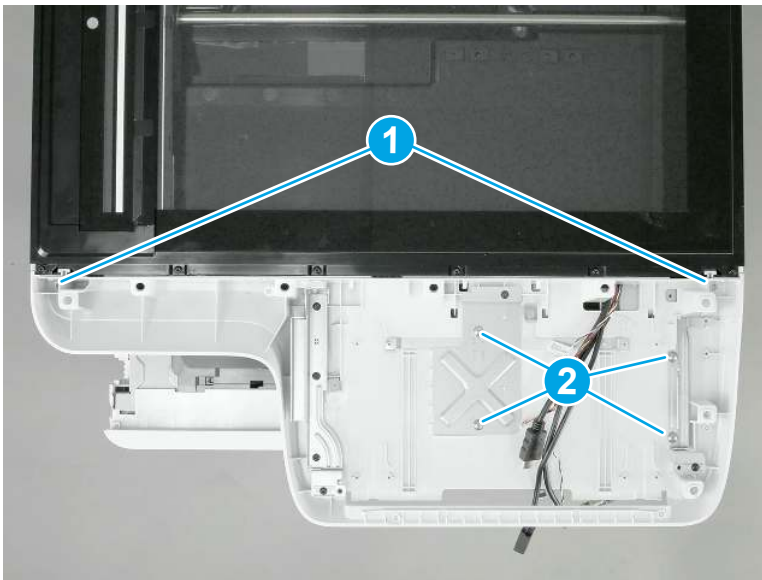
- n. Remove five screws (callout 1).

Figure 1-679 Remove four screws



- o. Remove two small, self-tapping screws (callout 1), and then remove four larger machine screws (callout 2).

Figure 1-680 Remove six screws



- p. Lift the nose cone up and off of the printer to remove it.


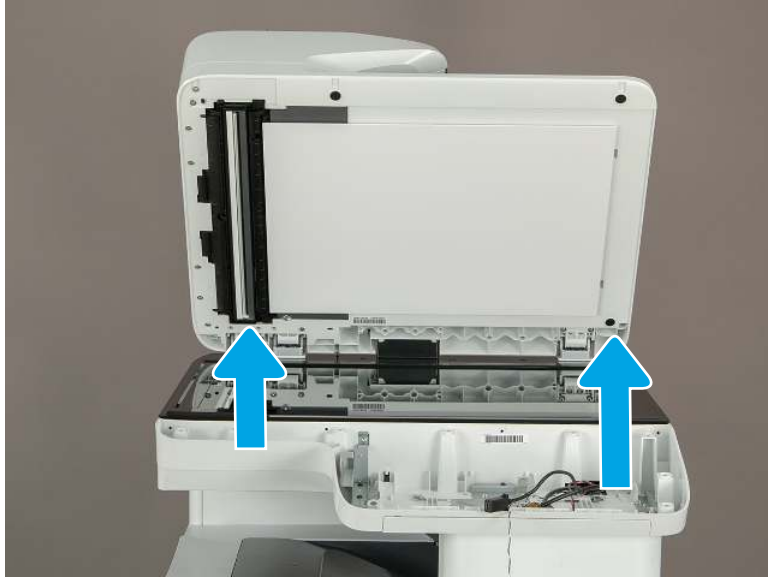
 **NOTE:** Pass the wire harnesses and cables through the opening in the nose cone when removing it.

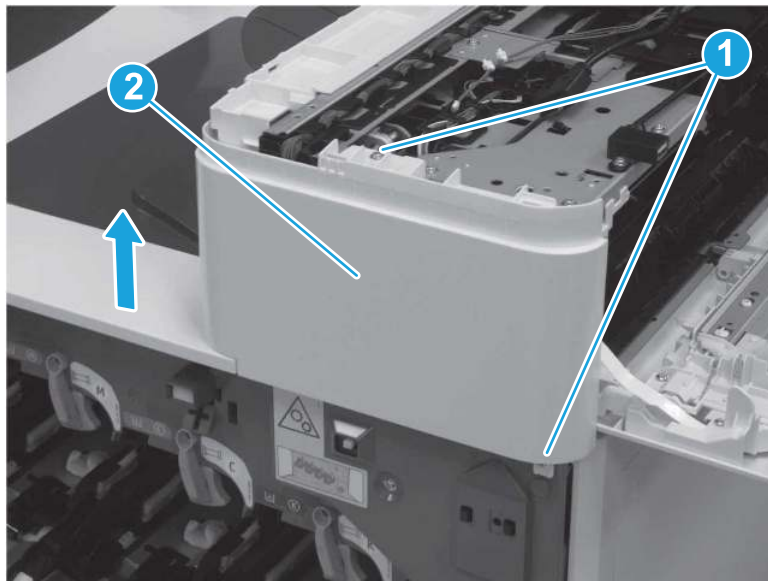
Figure 1-681 Remove the nose cone



7. Remove the right front cover (M856/E85055/M776dn/M776z).

- ▲ Remove two screws (callout 1), and then slide the right front cover (callout 2) up to remove it.

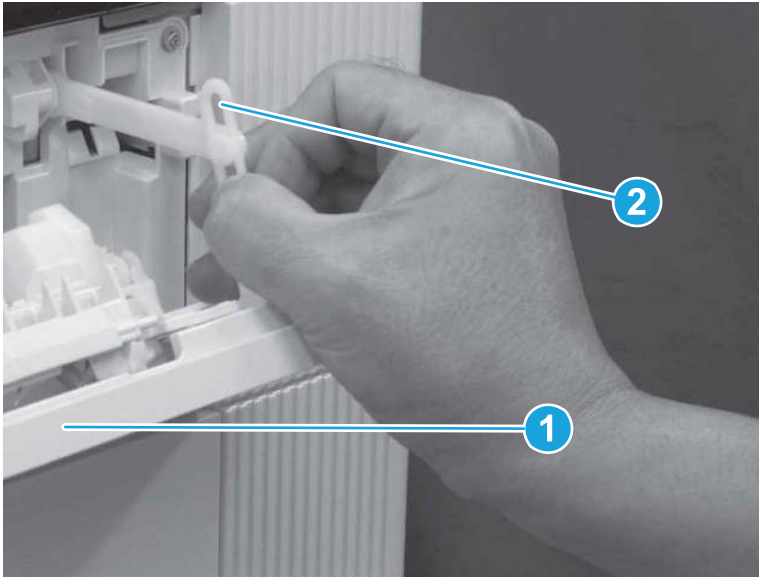
Figure 1-682 Remove the right front cover



8. Remove the right upper door (M856/E85055/M776dn/M776z)

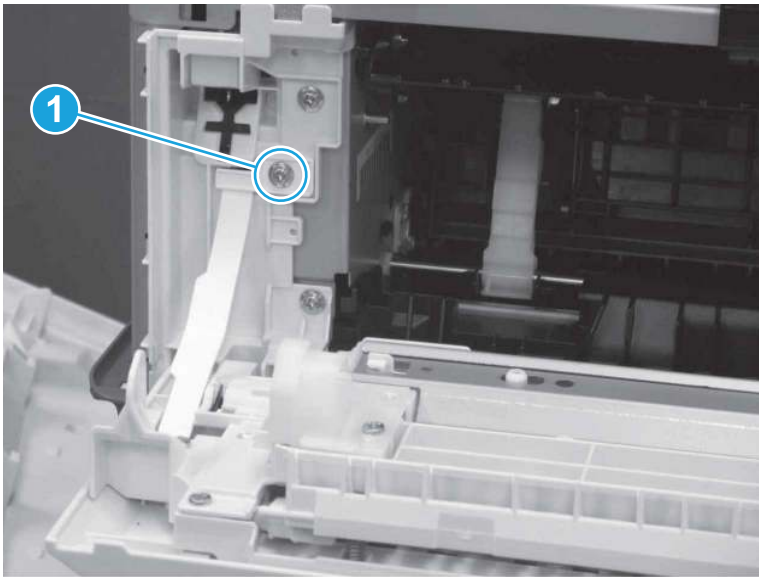
- a. Open the right upper door (callout 1), and then release the link (callout 2).

Figure 1-683 Open the door and release the link



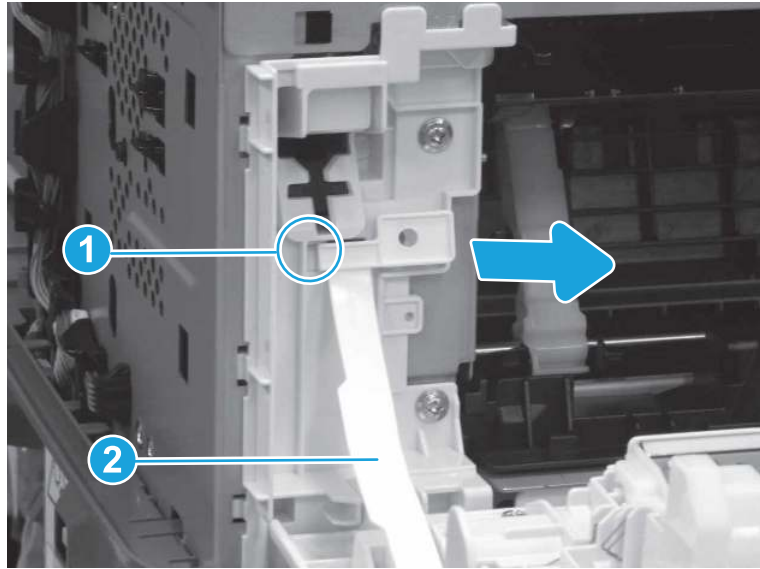
- b. Remove one screw (callout 1).

Figure 1-684 Remove one screw



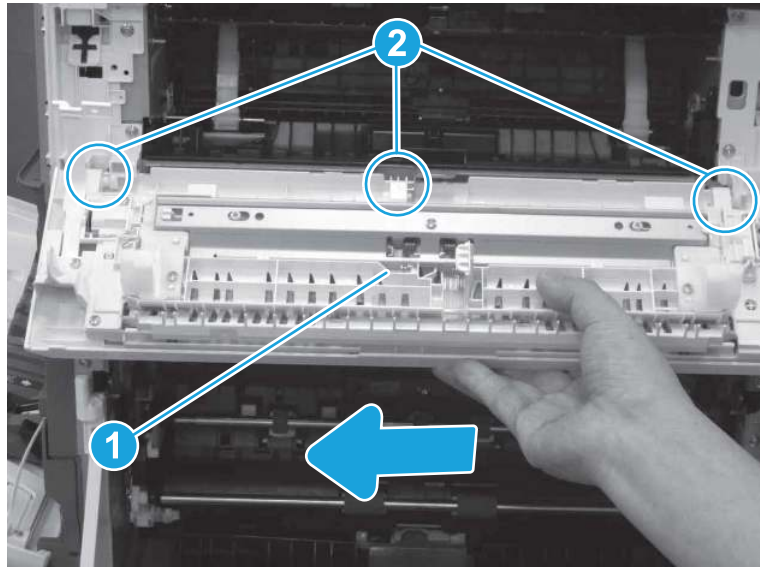
- c. Release one boss (callout 1) and then release the hinge (callout 2) by sliding it to the right.

Figure 1-685 Release one boss and hinge



- d. Slide the right upper door (callout 1) to the right to release it from three bushings (callout 2), and then remove the right upper door.

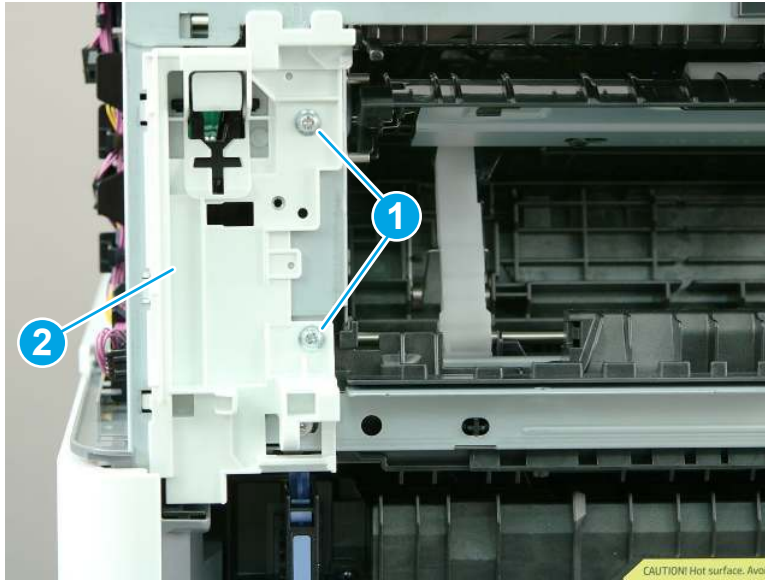
Figure 1-686 Remove the right upper door



- 9. Remove the toggle front assembly (M856/E85055/M776dn/M776z).

- ▲ Remove two screws (callout 1), and then remove the toggle front assembly (callout 2).

Figure 1-687 Remove two screws and toggle front assembly (M856/E85055/M776dn/M776z)



10. Unpack the replacement assembly.

- a. Dispose of the defective part.



NOTE: HP recommends responsible disposal of the defective part.

<http://www8.hp.com/us/en/hp-information/environment/product-recycling.html>

- b. Unpack the replacement part from the packaging.



IMPORTANT: Make sure that all of the shipping materials (for example shipping tape) are removed from the replacement part prior to installation.

- c. To install an assembly, reverse the removal steps.



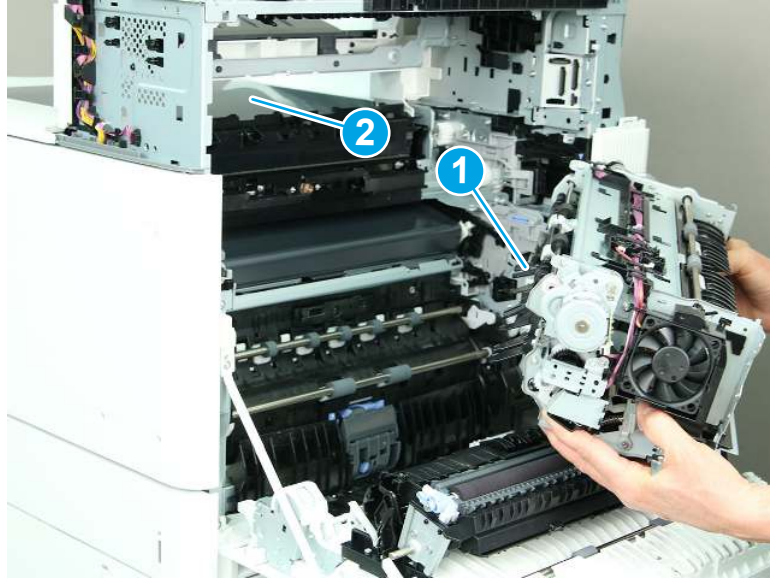
NOTE: When applicable, special installation instructions are provided for an assembly at the end of the removal procedure. Always completely read the removal instructions and follow all special installation instructions.

11. Reverse the removal steps to install the assembly. Also use the following **special installation instructions**.

Install the delivery assembly (M856/E85055/M776dn/M776z).

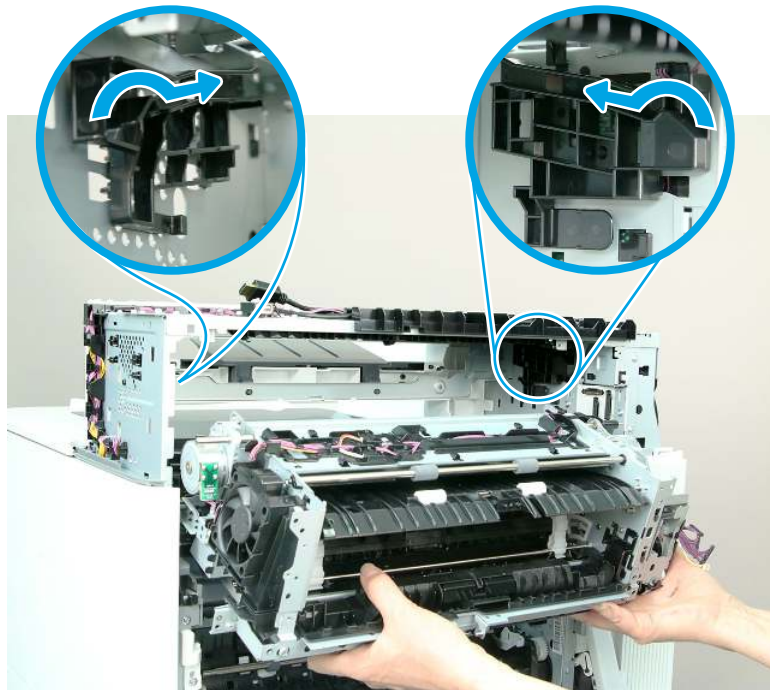
- a. When reinstalling the delivery assembly, make sure that the flap (callout 1) on the delivery assembly goes through the opening (callout 2) in the cover.

Figure 1-688 Install the flap through the opening (M856/E85055/M776dn/M776z)



- b. When reinstalling the delivery assembly, position the posts on the delivery assembly (callout 1) into the tracks (callout 2) in the printer. Lift up and then slide the assembly toward the printer to install the posts in the tracks.

Figure 1-689 Install the delivery assembly (M856/E85055/M776dn/M776z)



Removal and replacement: Toggle rear assembly (M856/E85055/M776dn/M776z)

Learn how to remove and replace the toggle rear assembly (M856/E85055/M776dn/M776z).

[View a video of how to remove and replace the toggle rear assembly \(M856/E85055/M776dn/M776z\).](#)

Mean time to repair: 12 minutes

Service level: Easy

Before performing service

Turn the printer power off

- Disconnect the power cable.

⚠ WARNING! To avoid damage to the printer, turn the printer off, wait 30 seconds, and then remove the power cord before attempting to service the printer.

Use the table below to identify the correct part number for your printer. To order the part, go to www.hp.com/buy/parts.

Table 1-54 Part information

Part number	Part description
RM2-1763-000CN	Toggle rear assembly

Required tools

- #2 Phillips screwdriver with a magnetic tip
- Small, flat-blade screwdriver

After performing service

Turn the printer power on

- Connect the power cable.
- Use the power switch to turn the power on.

Post service test

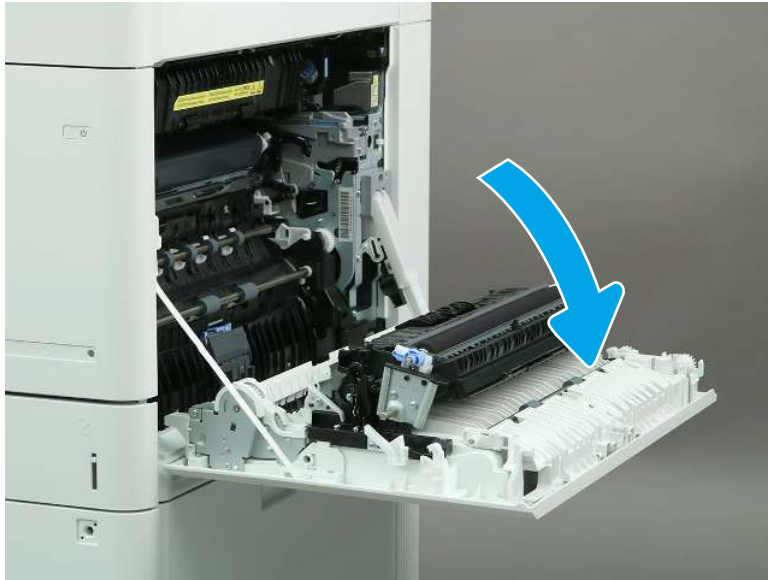
Make sure that the printer initializes to a **Ready** state.

Print a page to make sure that the printer is functioning correctly.

1. Remove the fuser.

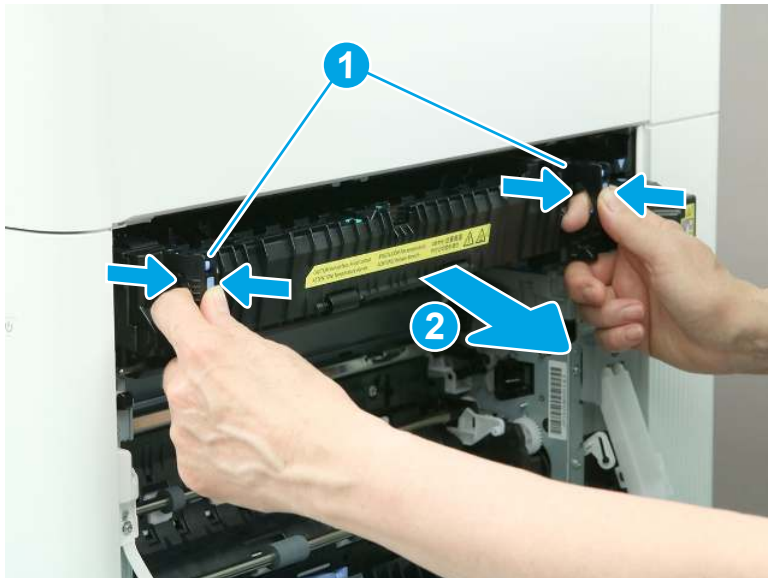
- a. Open the right door.

Figure 1-690 Open the right door



- b. Grasp the fuser handles, and then squeeze the release levers (callout 1). Lift up slightly, and then pull straight out to remove the fuser (callout 2).

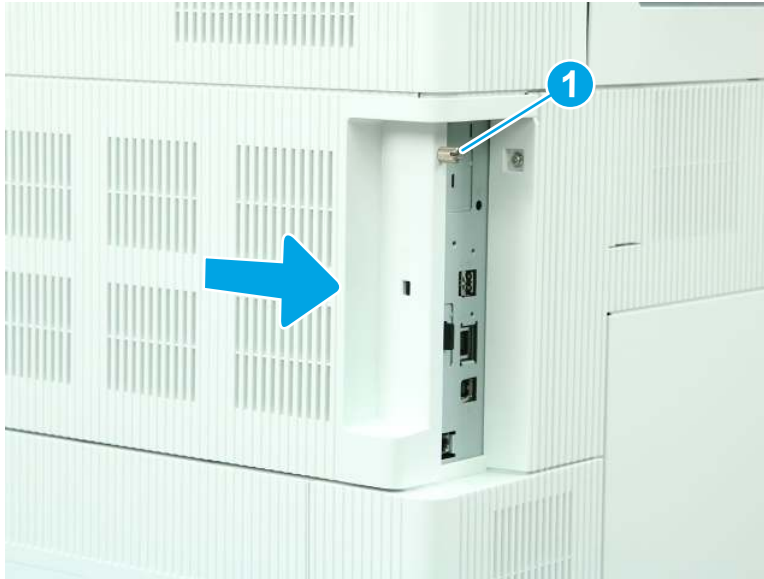
Figure 1-691 Remove the fuser



2. Remove the formatter cover.

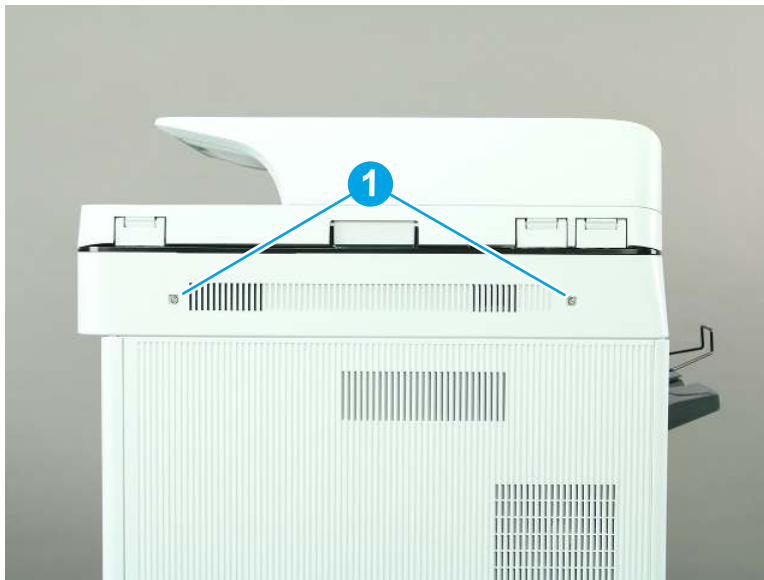
- ▲ Loosen one thumbscrew (callout 1), and then slide the formatter cover (callout 2) away from the printer to remove it.

Figure 1-692 Remove the formatter cover



- 3. Remove the scanner control board (SCB) cover (M776).
 - a. Remove two screws (callout 1).

Figure 1-693 Remove two screws



- b. Remove the SCB cover.

Figure 1-694 Remove the SCB cover

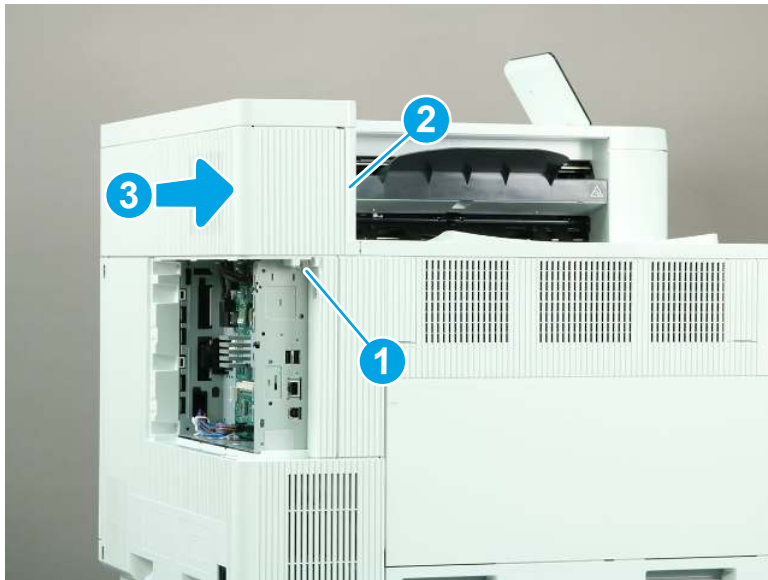


4. Remove the rear upper cover (M856/E85055/M776dn/M776z).

 **NOTE:** The following figure shows the M856 printer. The procedure is correct for all referenced models.

- ▲ Remove one screw (callout 1), release one tab (callout 2), and then slide the rear upper cover away from the printer to remove it (callout 3).

Figure 1-695 Remove the rear upper cover



5. **M856/E85055 only:** Remove the control panel and top cover.

 **NOTE:** This step applies to only the M856/E85055 models. Skip this step for all other models.

- a. Use a small, flat-blade screwdriver to release two tabs (callout 1), and then remove the control panel cover (callout 2).

Figure 1-696 Remove the control panel cover



- b. Remove one screw (callout 1).

Figure 1-697 Remove one screw



- c. Lift the back edge of the control panel up (callout 1), and then slide the control panel toward the back of the printer (callout 2).

Figure 1-698 Slide the control panel back



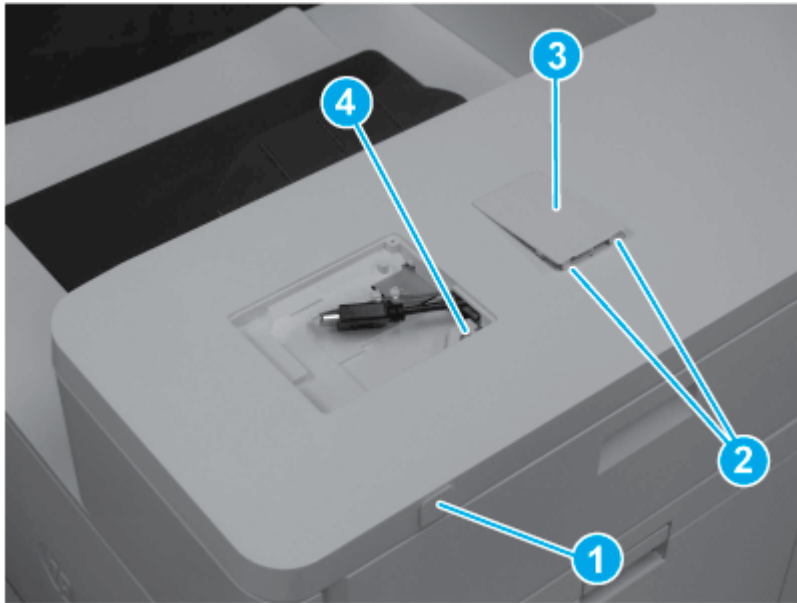
- d. Turn the control panel so that the bottom is facing up, and then disconnect two connectors to remove the control panel.

Figure 1-699 Disconnect two connectors



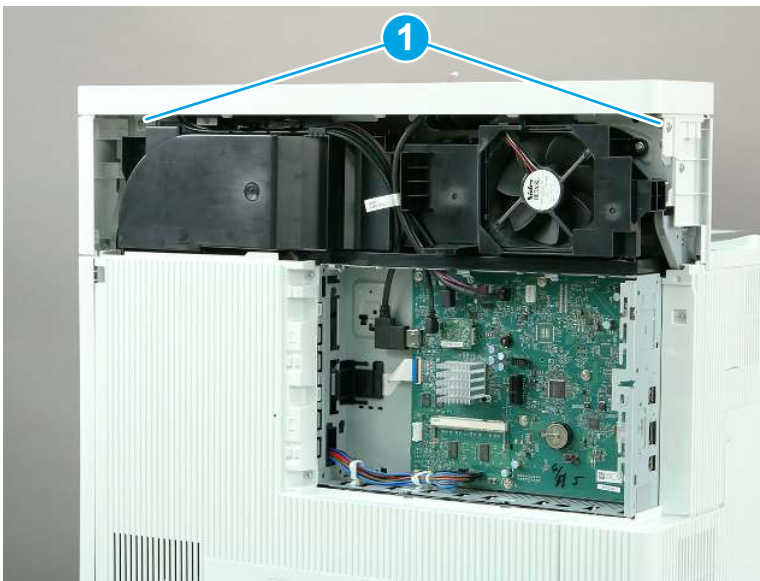
- e. Remove the USB cover (callout 1). Release two tabs (callout 2), and then remove the HIP cover (callout 3). Remove one screw (callout 4).

Figure 1-700 Remove covers and one screw



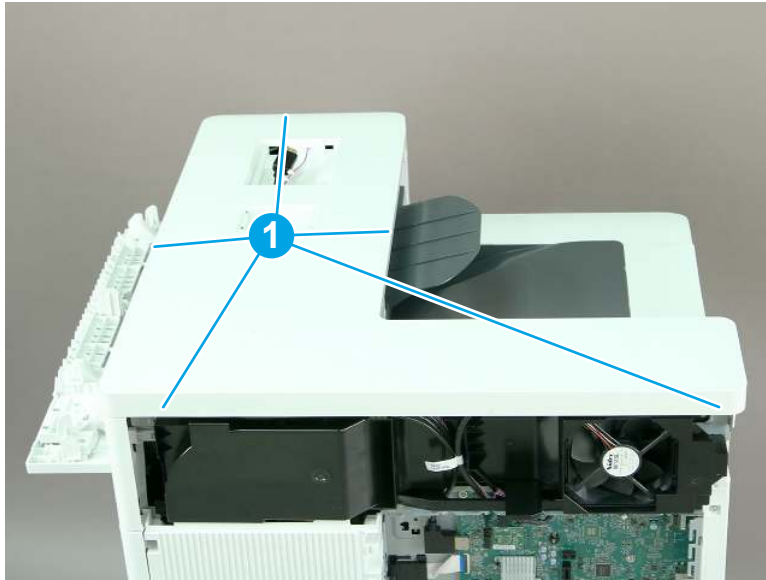
- f. Remove two screws (callout 1).

Figure 1-701 Remove two screws




- g. Release five tabs (callout 1), and then remove the top cover.

Figure 1-702 Release five tabs



6. **M776 only:** Remove the control panel, keyboard, and nose cone.

 **NOTE:** This step applies to only the M776 models. Skip this step for all other models

- a. Rotate the control panel to the fully raised position (callout 1), and then raise the document feeder (callout 2).

Figure 1-703 Raise the control panel and document feeder



- b. Beginning at the right side of the control-panel cover, carefully release five tabs along the top edge of the cover.

 **NOTE:** The thin black-plastic cover will separate from the white-plastic control-panel base.

Figure 1-704 Release the control panel cover



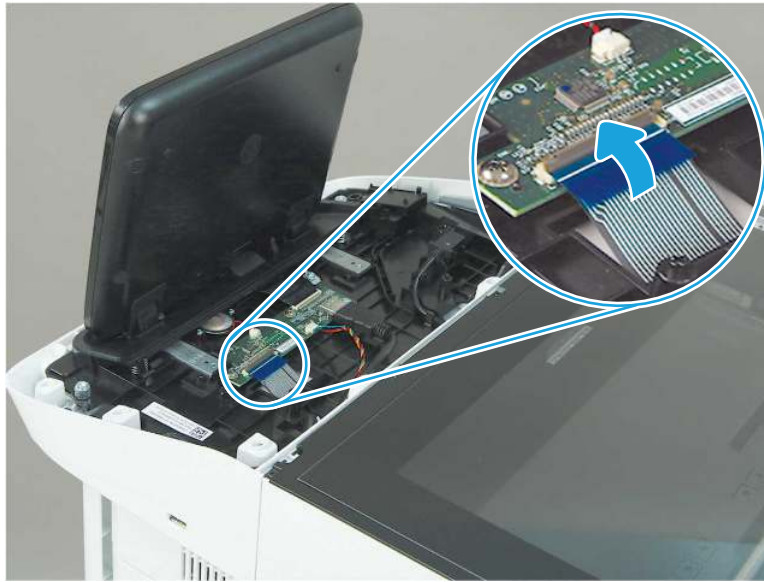
- c. Rotate the control panel cover slightly forward (callout 1), and then lift up to remove the cover (callout 2).

Figure 1-705 Remove the control panel cover



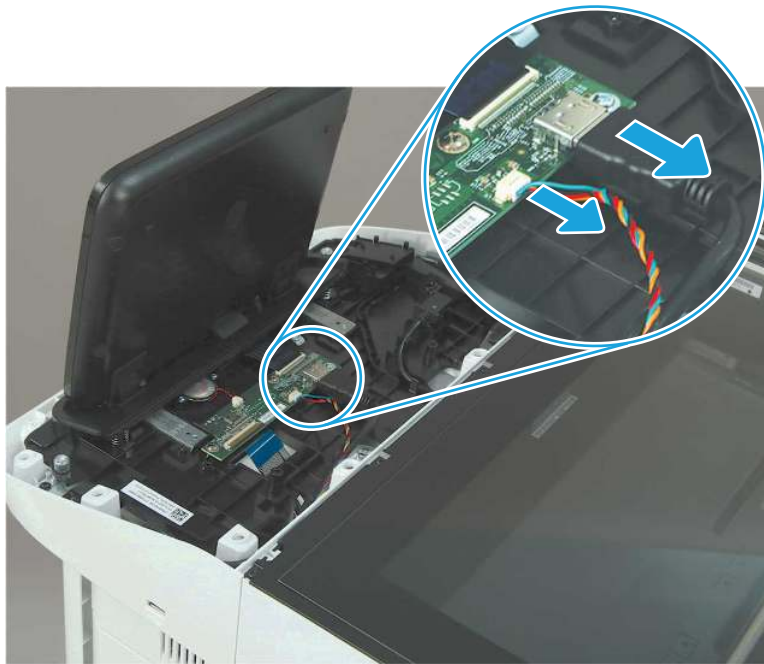
- d. **M776z or M776zs only:** Open the connector latch to release the keyboard flat cable.

Figure 1-706 Release the keyboard flat cable (M776z/M776zs)



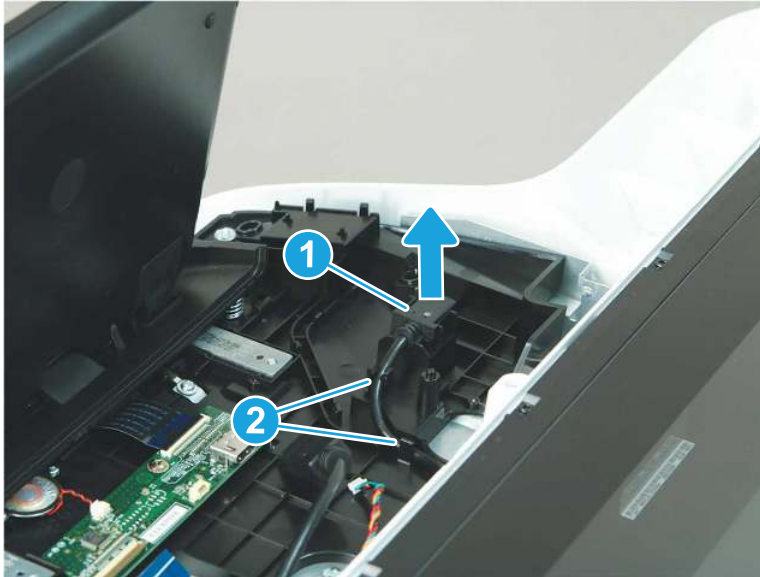
- e. Disconnect two connectors.

Figure 1-707 Disconnect two connectors



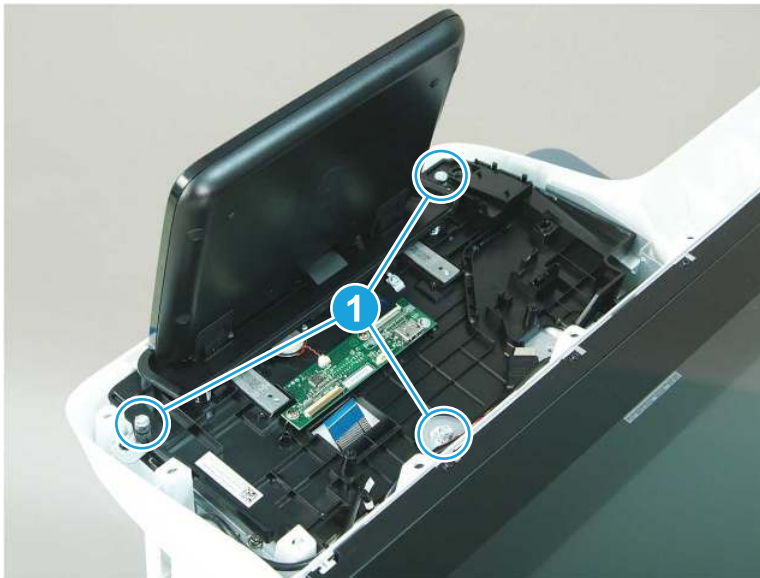
- f. Remove the USB cable (callout 1) from the holder, and then release the cable from two retainers (callout 2).

Figure 1-708 Release the USB cable



- g. Remove three screws (callout 1).

Figure 1-709 Remove three screws



- h. Lift the front of the control panel off of the printer (callout 1), and then slide it towards the front of the printer (callout 2) to remove it.

Figure 1-710 Remove the control panel



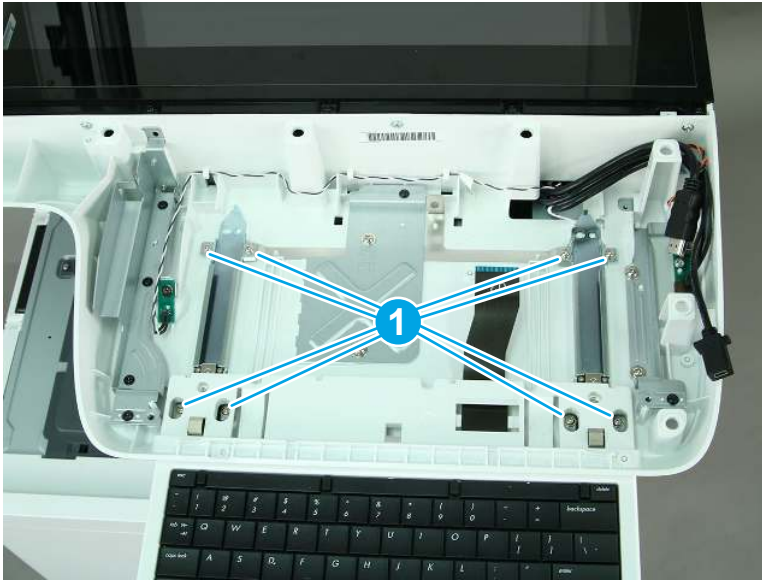
- i. **Keyboard models only:** Pull the keyboard out to its extended position.

Figure 1-711 Pull the keyboard out



- j. **Keyboard models only:** Remove eight screws (callout 1).

Figure 1-712 Remove eight screws



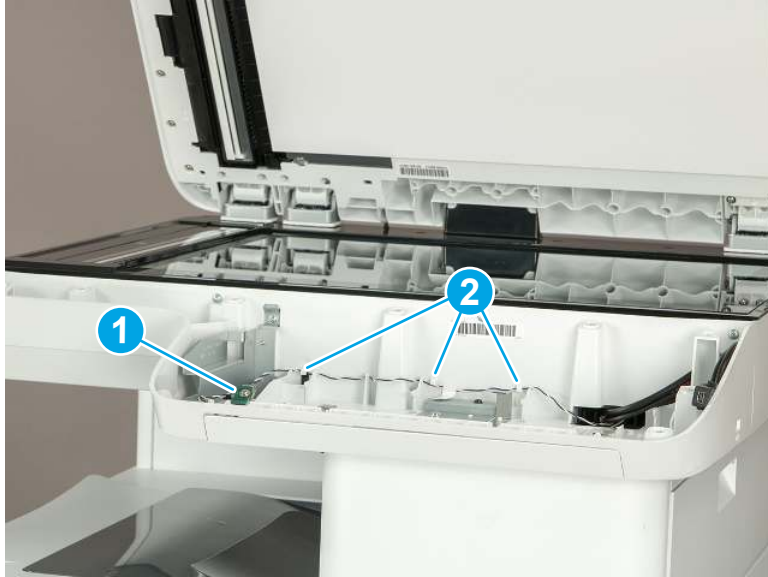
- k. **Keyboard models only:** Remove the keyboard and rails.

Figure 1-713 Remove the keyboard and rails



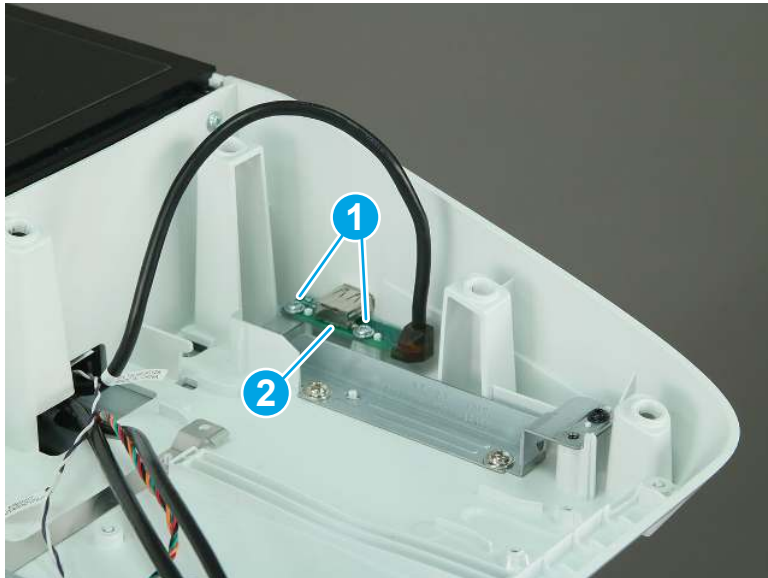
- l. Remove one screw (callout 1) to release the light PCA. Release the cable from three retainers (callout 2), and then move the light PCA out of the way.

Figure 1-714 Release the light PCA



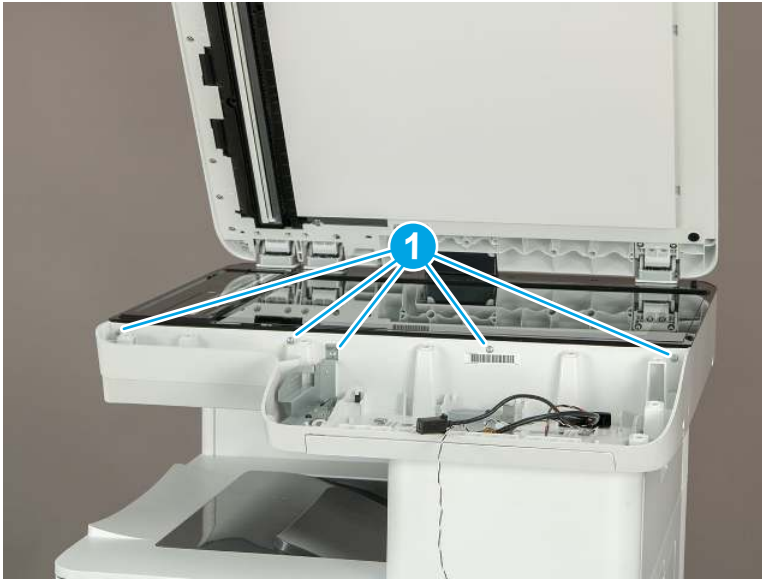
- m. Remove two screws (callout 1), and then move the USB port PCA (callout 2) out of the way.

Figure 1-715 Release the USB port PCA



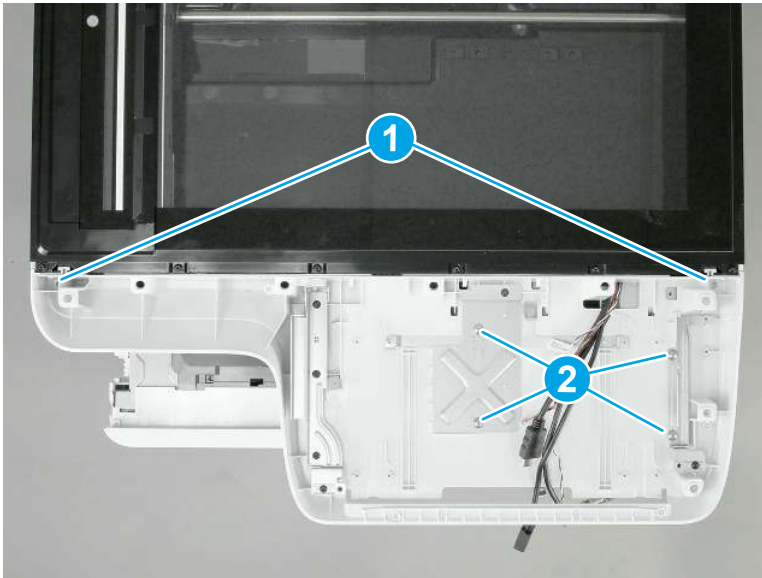
- n. Remove five screws (callout 1).

Figure 1-716 Remove four screws



- o. Remove two small, self-tapping screws (callout 1), and then remove four larger machine screws (callout 2).

Figure 1-717 Remove six screws



- p. Lift the nose cone up and off of the printer to remove it.



NOTE: Pass the wire harnesses and cables through the opening in the nose cone when removing it.

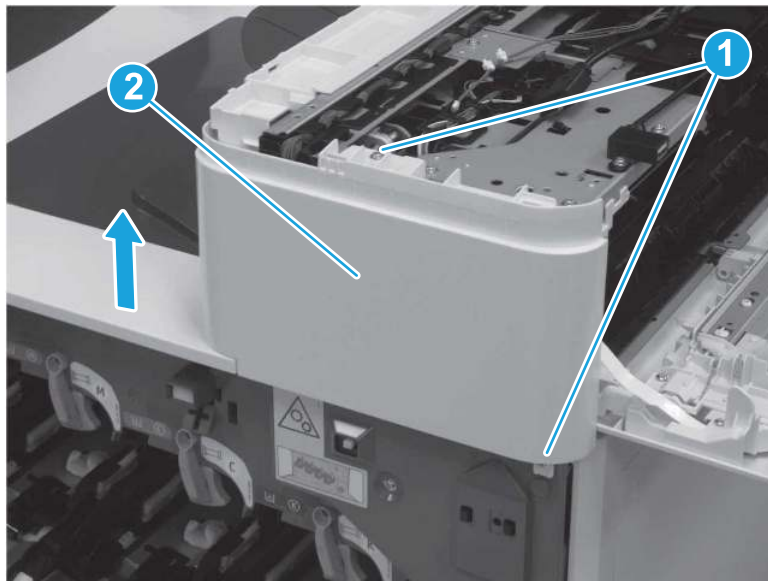
Figure 1-718 Remove the nose cone



7. Remove the right front cover (M856/E85055/M776dn/M776z).

- ▲ Remove two screws (callout 1), and then slide the right front cover (callout 2) up to remove it.

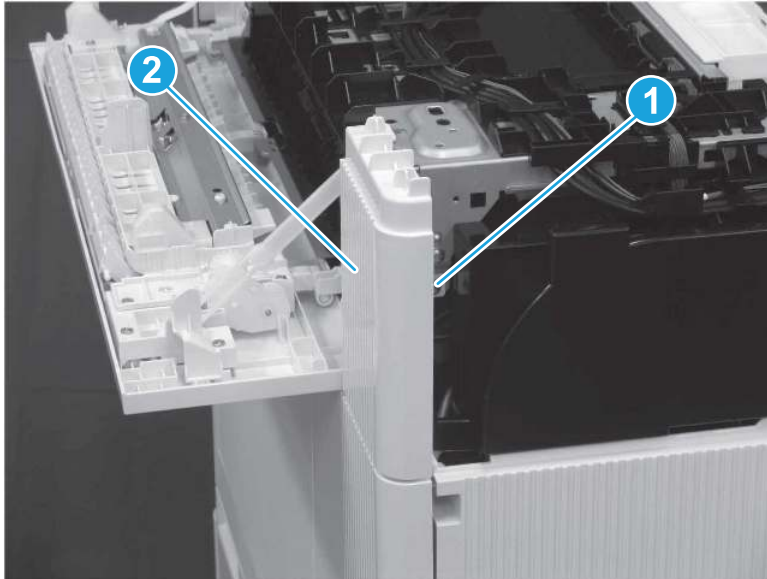
Figure 1-719 Remove the right front cover



8. Remove the right rear upper cover (M856/E85055/M776dn/M776z)

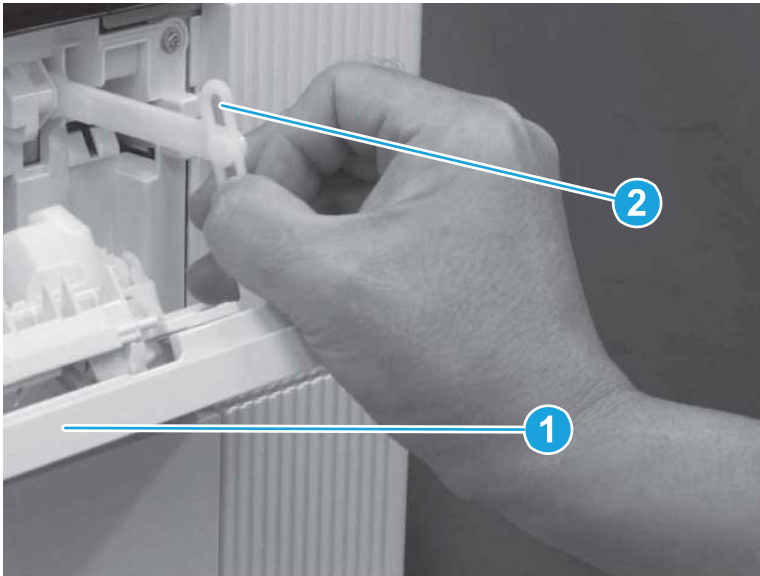
- ▲ Remove one screw (callout 1), and then slide the right rear upper cover (callout 2) away from the printer to remove it.

Figure 1-720 Remove the right rear upper cover



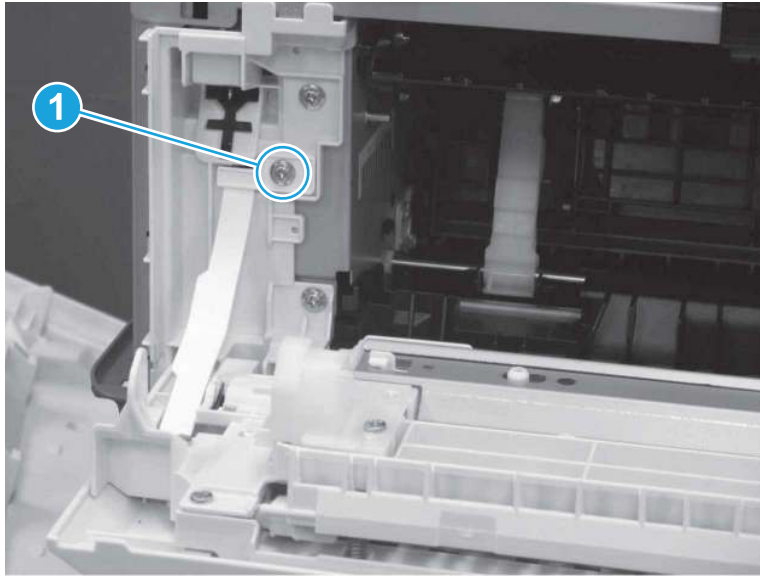
- 9. Remove the right upper door (M856/E85055/M776dn/M776z)
 - a. Open the right upper door (callout 1), and then release the link (callout 2).

Figure 1-721 Open the door and release the link



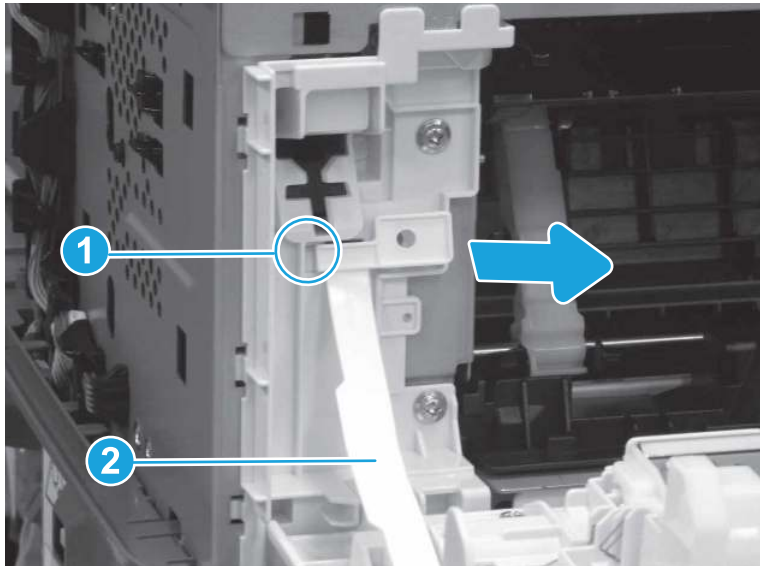
- b. Remove one screw (callout 1).

Figure 1-722 Remove one screw



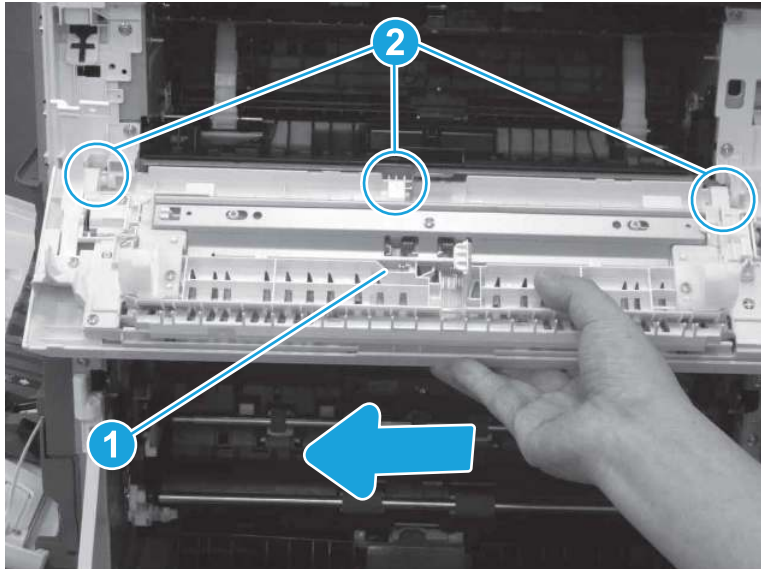
- c. Release one boss (callout 1) and then release the hinge (callout 2) by sliding it to the right.

Figure 1-723 Release one boss and hinge



- d. Slide the right upper door (callout 1) to the right to release it from three bushings (callout 2), and then remove the right upper door.

Figure 1-724 Remove the right upper door



10. Remove the toggle rear assembly (M856/E85055/M776dn/M776z).

- ▲ Remove two screws (callout 1). Remove one screw (callout 2), and then remove the toggle rear assembly (callout 3).


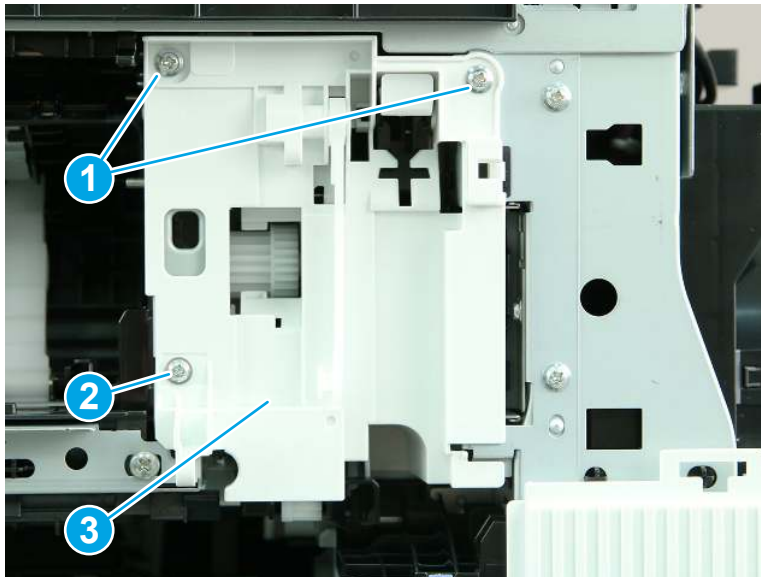
 **NOTE:** The lower screw (callout 2) is shorter than the other two screws. Make sure to reinstall this screw in the correct position.

Figure 1-725 Remove two screws and toggle rear assembly (M856/E85055/M776dn/M776z)



11. Unpack the replacement assembly.

- a. Dispose of the defective part.



NOTE: HP recommends responsible disposal of the defective part.

<http://www8.hp.com/us/en/hp-information/environment/product-recycling.html>

- b. Unpack the replacement part from the packaging.



IMPORTANT: Make sure that all of the shipping materials (for example shipping tape) are removed from the replacement part prior to installation.

- c. To install an assembly, reverse the removal steps.



NOTE: When applicable, special installation instructions are provided for an assembly at the end of the removal procedure. Always completely read the removal instructions and follow all special installation instructions.

Removal and replacement: Duplex reverse guide assembly (M856/E85055)

Learn how to remove and replace the duplex reverse guide assembly (M856/E85055/M776dn/M776z).

Mean time to repair: 18 minutes

Service level: Easy

Before performing service

Turn the printer power off

- Disconnect the power cable.



WARNING! To avoid damage to the printer, turn the printer off, wait 30 seconds, and then remove the power cord before attempting to service the printer.

Use the table below to identify the correct part number for your printer. To order the part, go to www.hp.com/buy/parts.

Table 1-55 Part information

Part number	Part description
RM2-2690-000CN	Duplex reverse guide assembly

Required tools

- #2 Phillips screwdriver with a magnetic tip
- Small, flat-blade screwdriver

After performing service

Turn the printer power on

- Connect the power cable.
- Use the power switch to turn the power on.

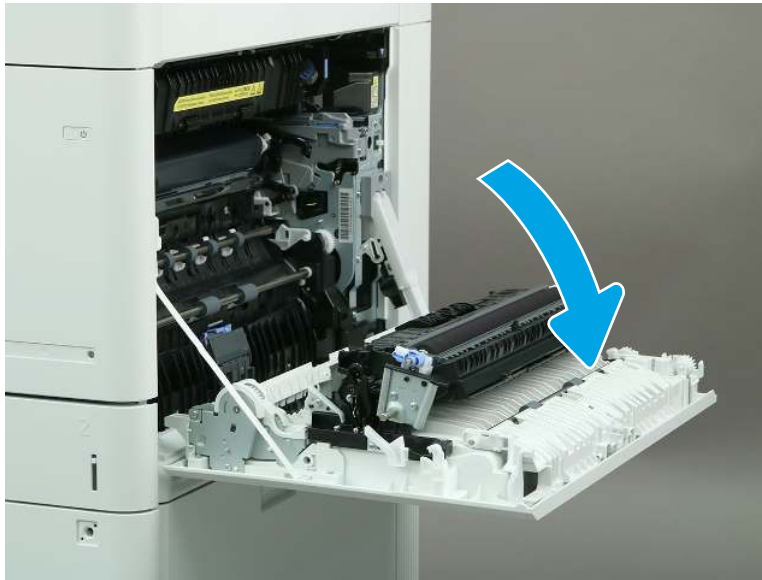
Post service test

Make sure that the printer initializes to a **Ready** state.

Print a page to make sure that the printer is functioning correctly.

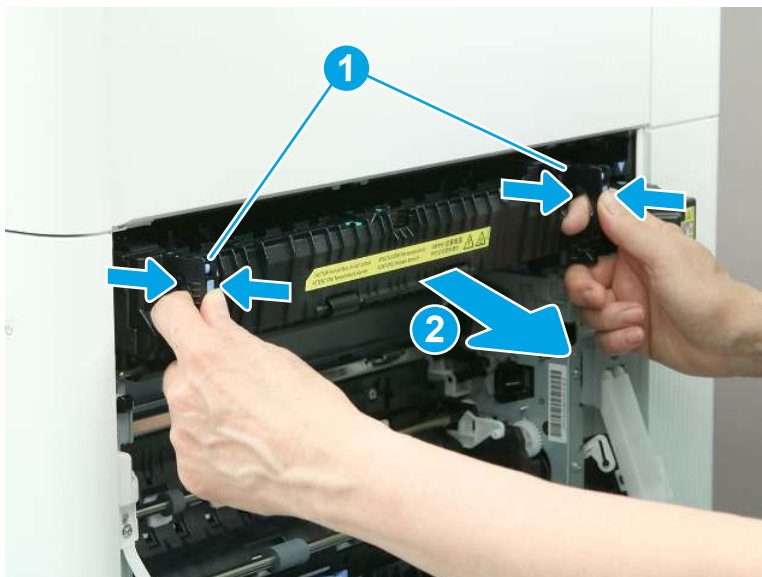
1. Remove the fuser.
 - a. Open the right door.

Figure 1-726 Open the right door



- b. Grasp the fuser handles, and then squeeze the release levers (callout 1). Lift up slightly, and then pull straight out to remove the fuser (callout 2).

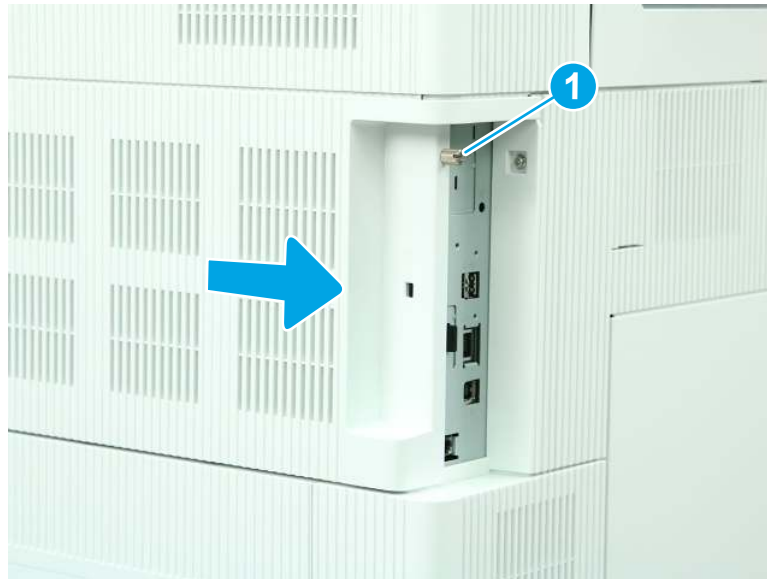
Figure 1-727 Remove the fuser



2. Remove the formatter cover.

- ▲ Loosen one thumbscrew (callout 1), and then slide the formatter cover (callout 2) away from the printer to remove it.

Figure 1-728 Remove the formatter cover

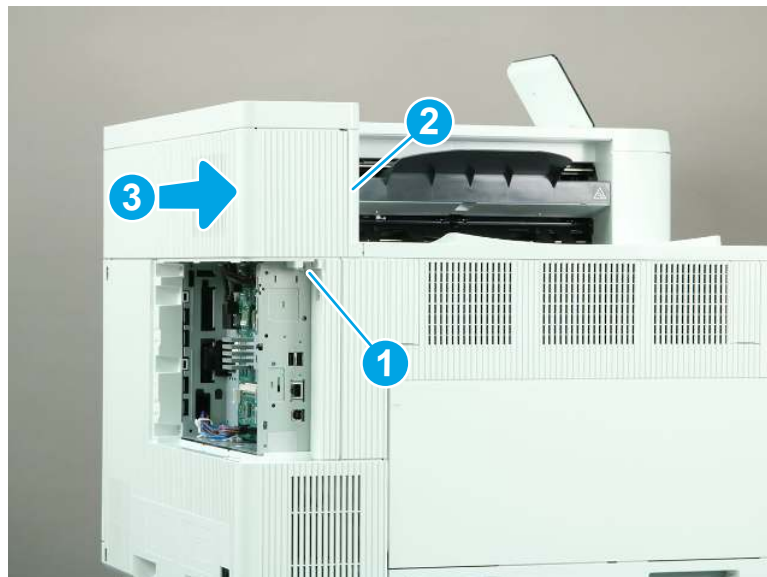


3. Remove the rear upper cover (M856/E85055/M776dn/M776z).

 **NOTE:** The following figure shows the M856 printer. The procedure is correct for all referenced models.

- ▲ Remove one screw (callout 1), release one tab (callout 2), and then slide the rear upper cover away from the printer to remove it (callout 3).

Figure 1-729 Remove the rear upper cover



4. **M856/E85055 only:** Remove the control panel and top cover.

 **NOTE:** This step applies to only the M856/E85055 models. Skip this step for all other models.

- a. Use a small, flat-blade screwdriver to release two tabs (callout 1), and then remove the control panel cover (callout 2).

Figure 1-730 Remove the control panel cover



- b. Remove one screw (callout 1).

Figure 1-731 Remove one screw



- c. Lift the back edge of the control panel up (callout 1), and then slide the control panel toward the back of the printer (callout 2).

Figure 1-732 Slide the control panel back



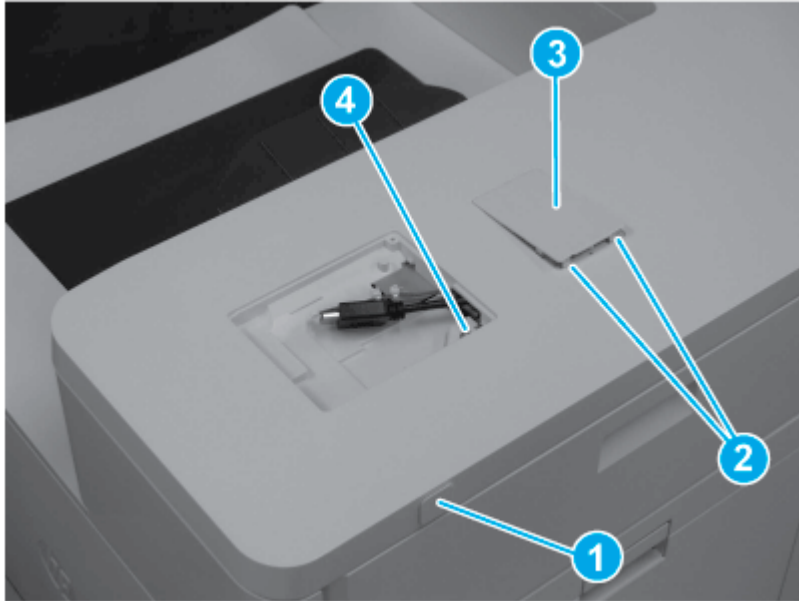
- d. Turn the control panel so that the bottom is facing up, and then disconnect two connectors to remove the control panel.

Figure 1-733 Disconnect two connectors



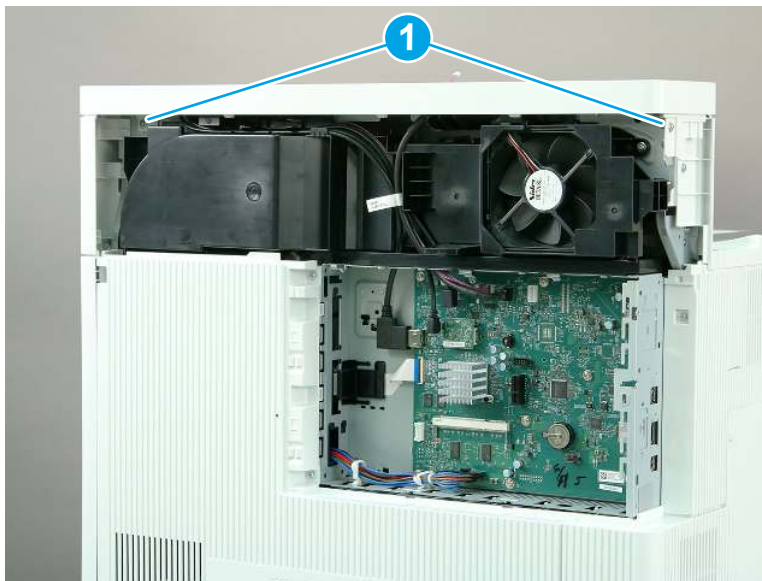
- e. Remove the USB cover (callout 1). Release two tabs (callout 2), and then remove the HIP cover (callout 3). Remove one screw (callout 4).

Figure 1-734 Remove covers and one screw



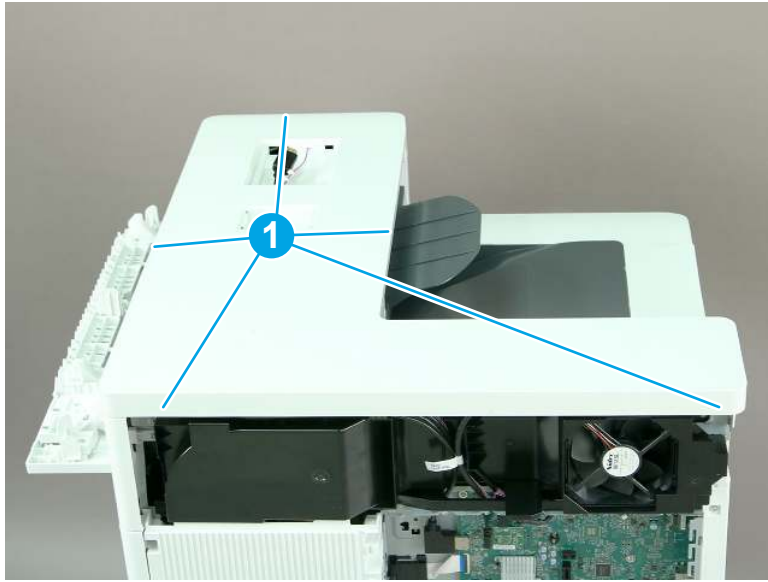
- f. Remove two screws (callout 1).

Figure 1-735 Remove two screws



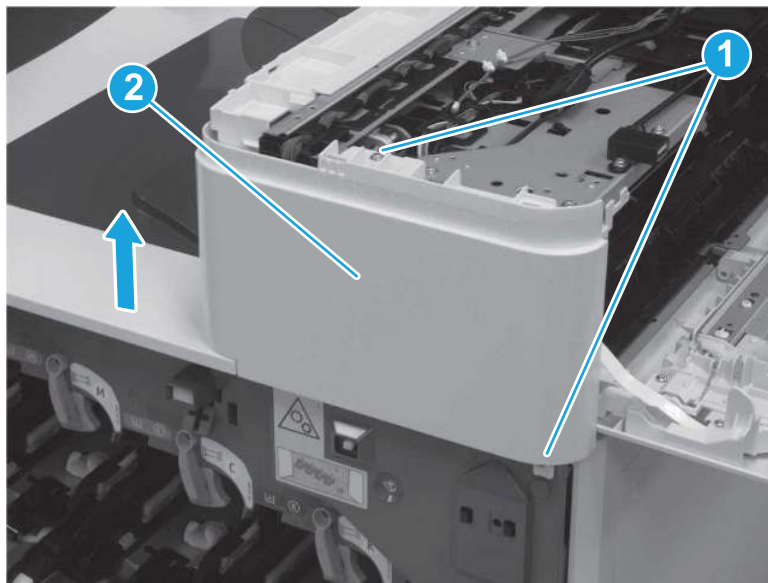
- g. Release five tabs (callout 1), and then remove the top cover.

Figure 1-736 Release five tabs



5. Remove the right front cover (M856/E85055/M776dn/M776z).
- ▲ Remove two screws (callout 1), and then slide the right front cover (callout 2) up to remove it.

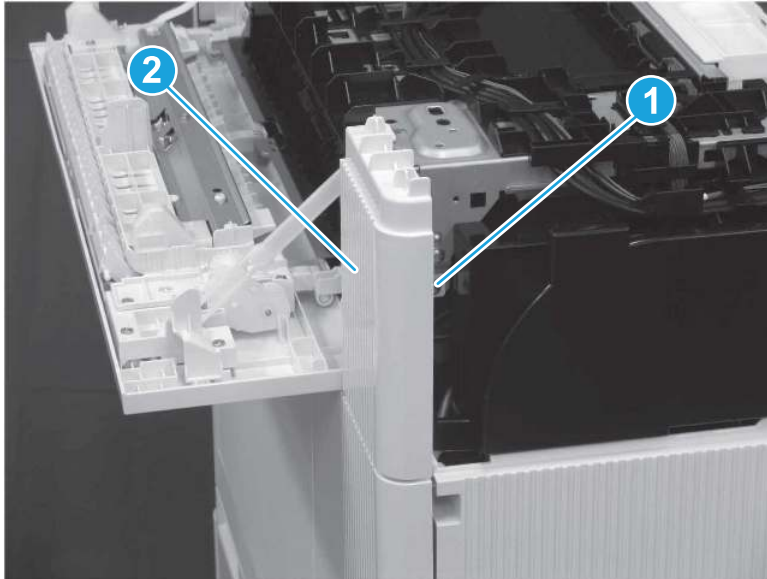
Figure 1-737 Remove the right front cover



6. Remove the right rear upper cover (M856/E85055/M776dn/M776z)

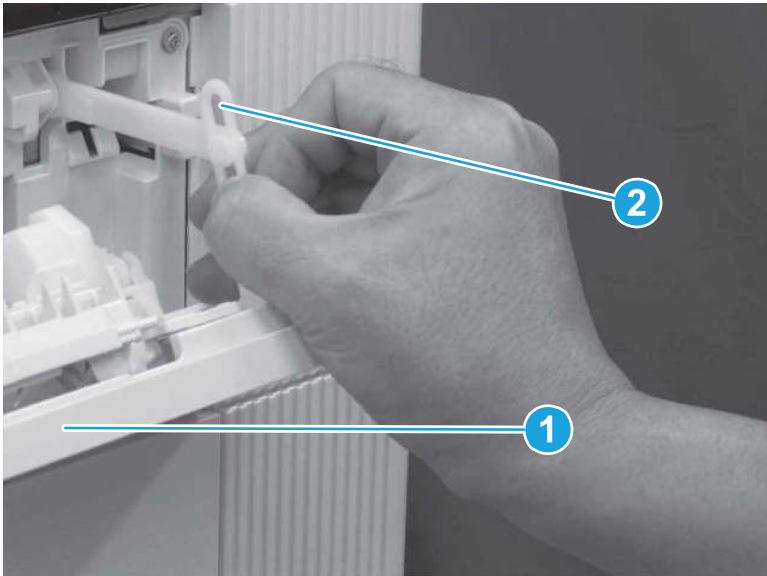
- ▲ Remove one screw (callout 1), and then slide the right rear upper cover (callout 2) away from the printer to remove it.

Figure 1-738 Remove the right rear upper cover



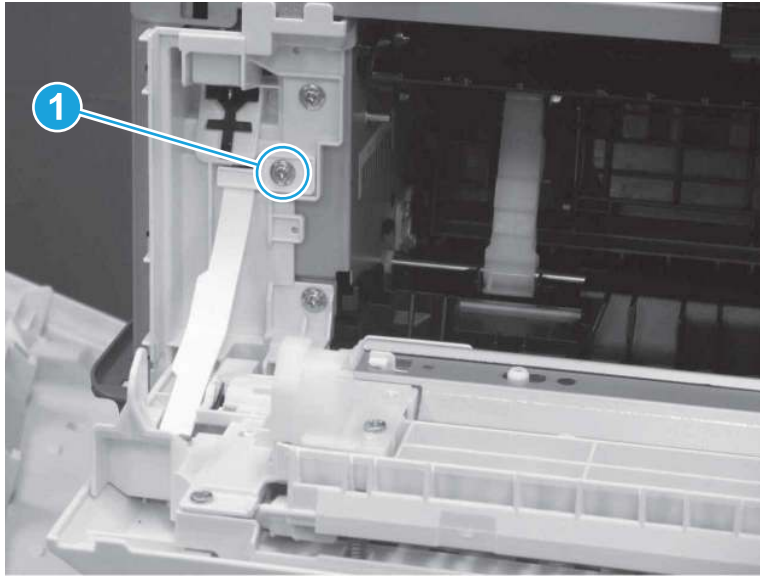
7. Remove the right upper door (M856/E85055/M776dn/M776z)
 - a. Open the right upper door (callout 1), and then release the link (callout 2).

Figure 1-739 Open the door and release the link



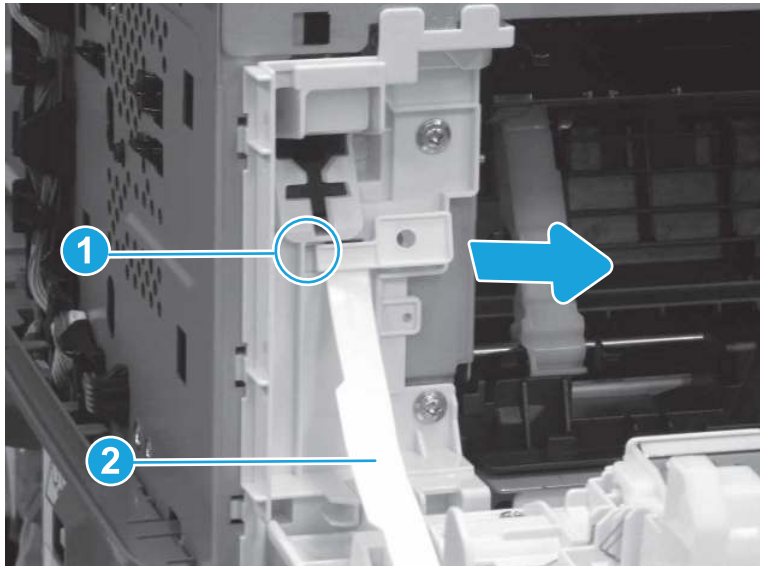
- b. Remove one screw (callout 1).

Figure 1-740 Remove one screw



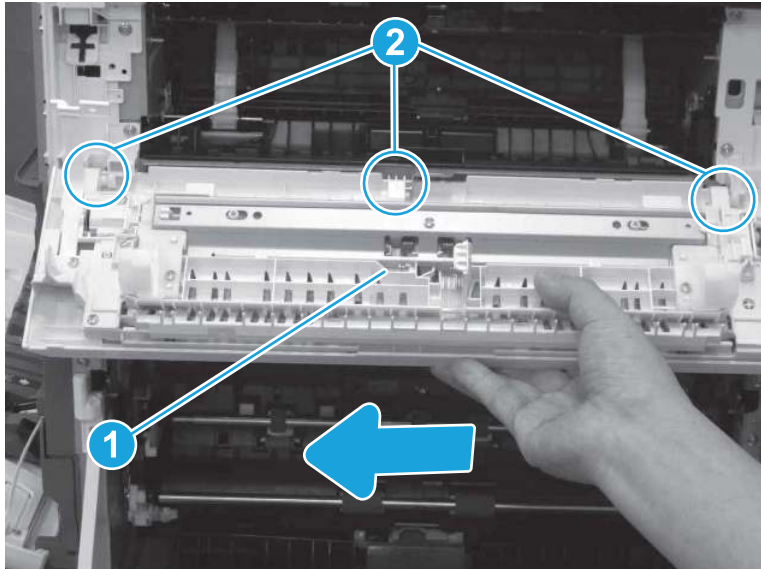
- c. Release one boss (callout 1) and then release the hinge (callout 2) by sliding it to the right.

Figure 1-741 Release one boss and hinge



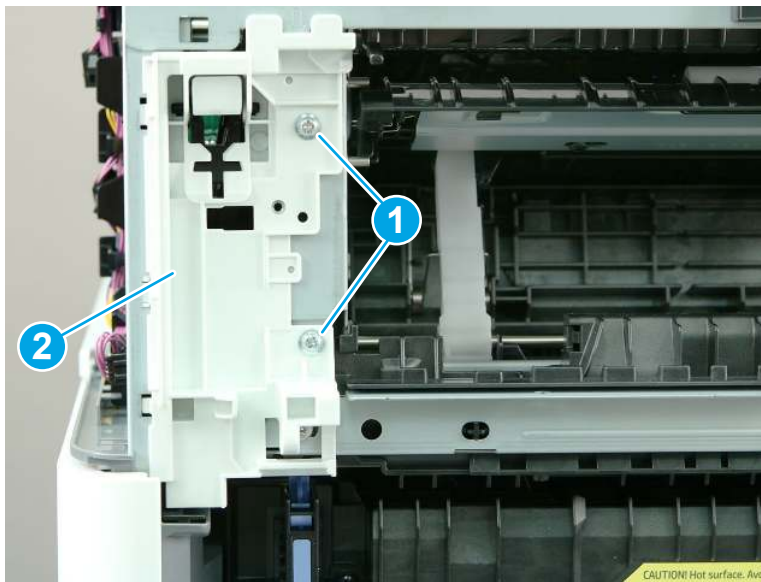
- d. Slide the right upper door (callout 1) to the right to release it from three bushings (callout 2), and then remove the right upper door.

Figure 1-742 Remove the right upper door



8. Remove the delivery assembly (M856/E85055/M776dn/M776z).
 - a. Remove two screws (callout 1), and then remove the toggle front assembly (callout 2).

Figure 1-743 Remove two screws and toggle front assembly (M856/E85055/M776dn/M776z)



- b. Remove two screws (callout 1). Remove one screw (callout 2), and then remove the toggle rear assembly (callout 3).


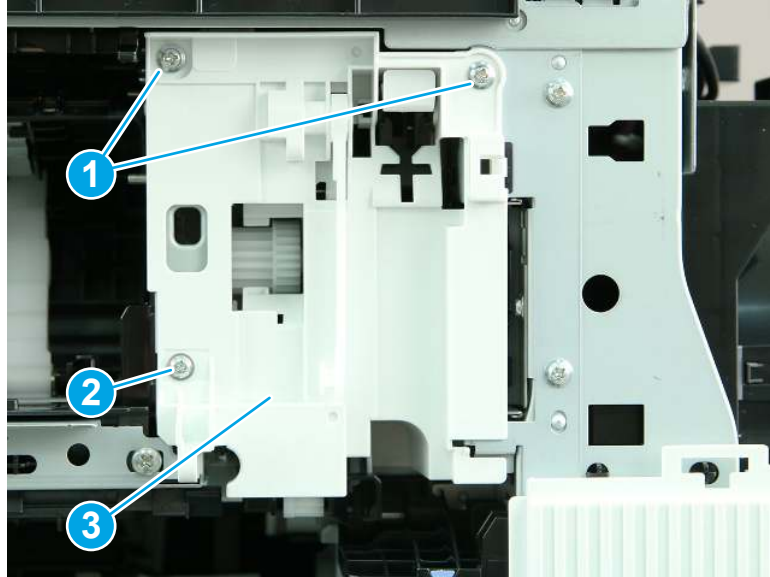
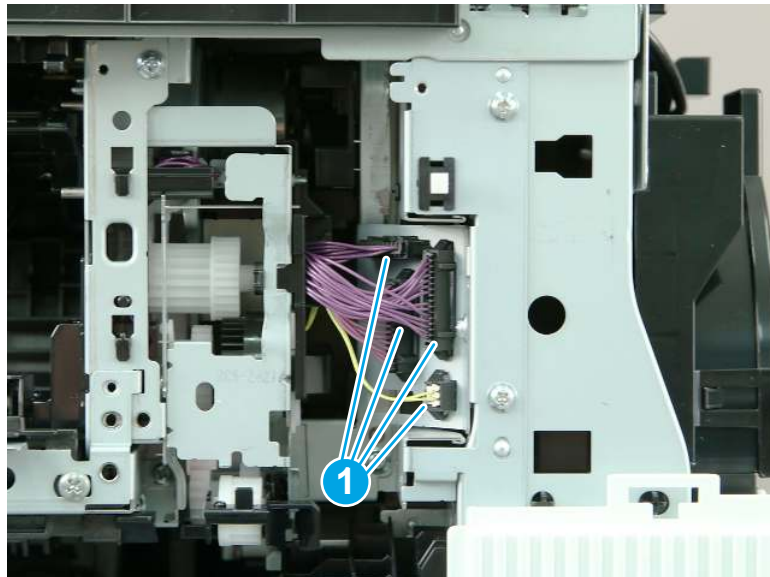
 **NOTE:** The lower screw (callout 2) is shorter than the other two screws. Make sure to reinstall this screw in the correct position.

Figure 1-744 Remove three screws and toggle rear assembly (M856/E85055/M776dn/M776z)



- c. Disconnect four connectors (callout 1).

Figure 1-745 Disconnect four connectors (M856/E85055/M776dn/M776z)

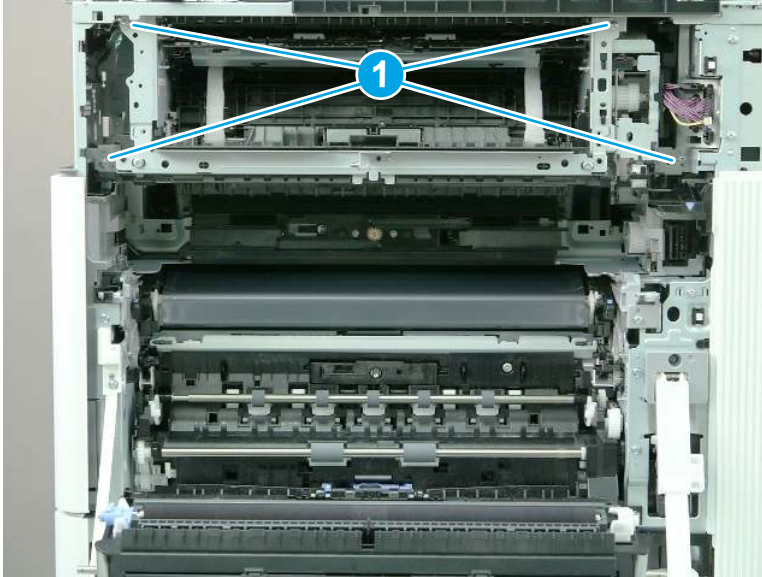


- d. Remove four screws (callout 1).



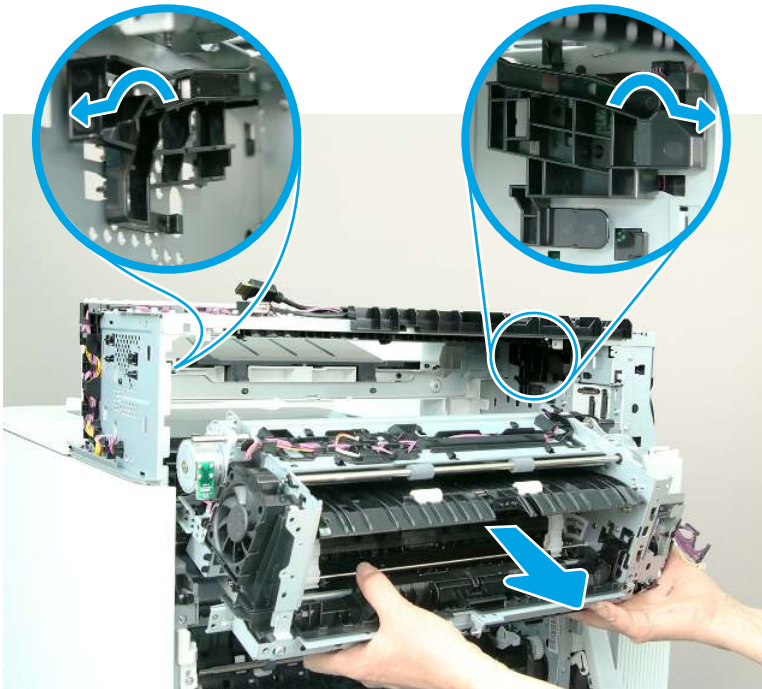
NOTE: The lower screws are shorter than the upper screws. Make sure to reinstall them in the correct position.

Figure 1-746 Remove four screws (M856/E85055/M776dn/M776z)



- e. Slide the delivery assembly away from the printer, and then lift up and out to release the posts from the tracks.

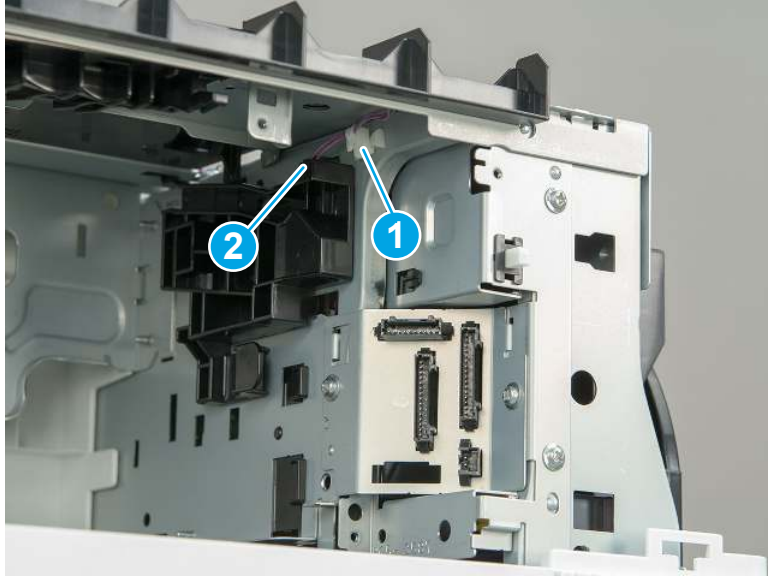
Figure 1-747 Remove the delivery assembly (M856/E85055/M776dn/M776z)



- 9. Remove the duplex reverse guide (M856/E85055/M776dn/M776z).

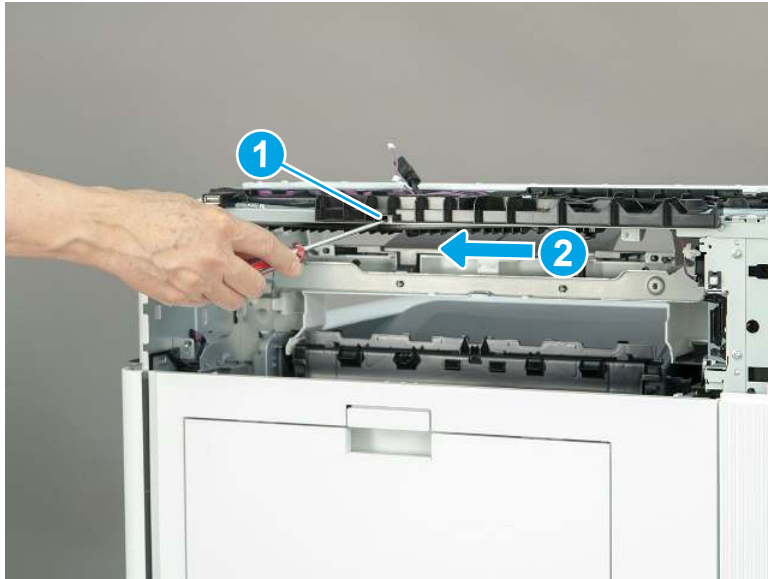
- a. Release one retainer (callout 1), and then disconnect one connector (callout 2).

Figure 1-748 Release one retainer and disconnect one connector



- b. Release one tab (callout 1), and then slide the duplex reverse guide to the left to release it (callout 2).

Figure 1-749 Release the duplex reverse guide



- c. Remove the duplex reverse guide.

Figure 1-750 Remove the duplex reverse guide



10. Unpack the replacement assembly.

- a. Dispose of the defective part.



NOTE: HP recommends responsible disposal of the defective part.

<http://www8.hp.com/us/en/hp-information/environment/product-recycling.html>

- b. Unpack the replacement part from the packaging.



IMPORTANT: Make sure that all of the shipping materials (for example shipping tape) are removed from the replacement part prior to installation.

- c. To install an assembly, reverse the removal steps.



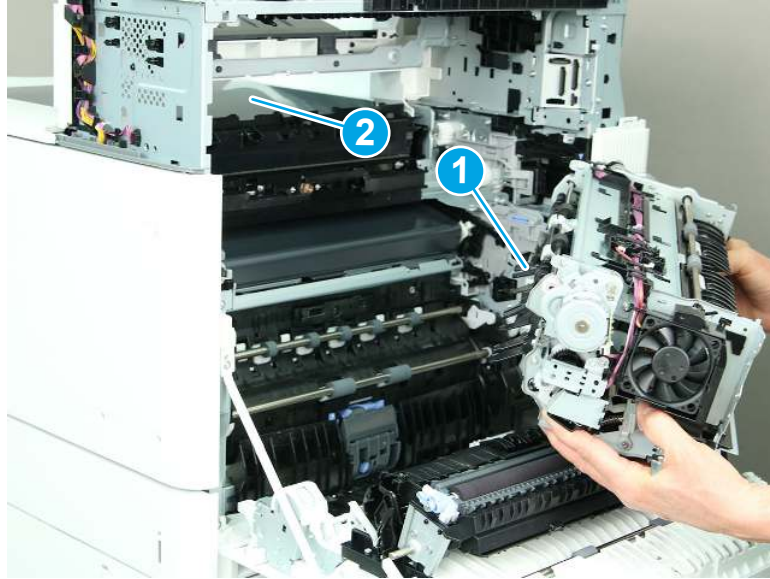
NOTE: When applicable, special installation instructions are provided for an assembly at the end of the removal procedure. Always completely read the removal instructions and follow all special installation instructions.

11. Reverse the removal steps to install the assembly. Also use the following **special installation instructions**.

Install the delivery assembly (M856/E85055/M776dn/M776z).

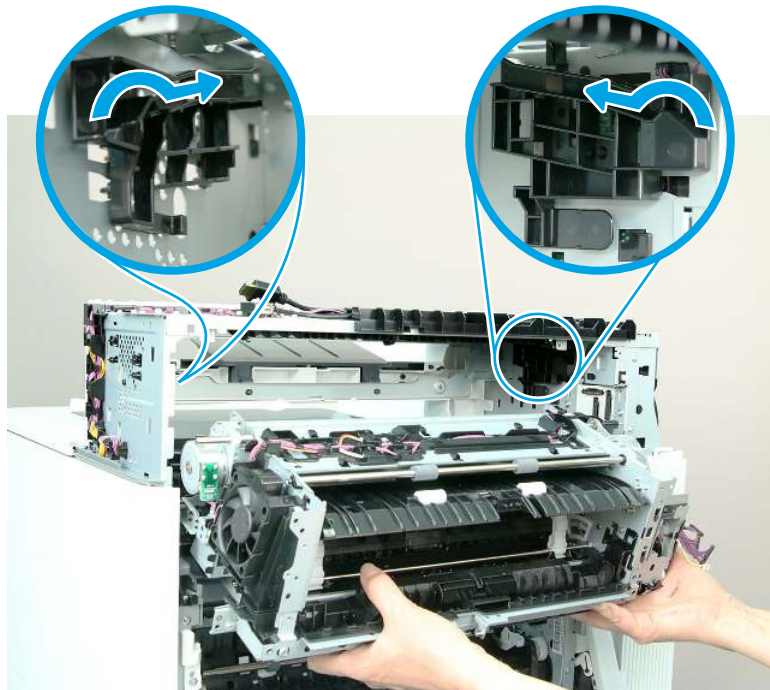
- a. When reinstalling the delivery assembly, make sure that the flap (callout 1) on the delivery assembly goes through the opening (callout 2) in the cover.

Figure 1-751 Install the flap through the opening (M856/E85055/M776dn/M776z)



- b. When reinstalling the delivery assembly, position the posts on the delivery assembly (callout 1) into the tracks (callout 2) in the printer. Lift up and then slide the assembly toward the printer to install the posts in the tracks.

Figure 1-752 Install the delivery assembly (M856/E85055/M776dn/M776z)



Removal and replacement: Duplex reverse guide assembly (M776dn/M776z)

Learn how to remove and replace the duplex reverse guide assembly (M856/E85055/M776dn/M776z).

Mean time to repair: 18 minutes

Service level: Easy

Before performing service

Turn the printer power off

- Disconnect the power cable.

⚠ WARNING! To avoid damage to the printer, turn the printer off, wait 30 seconds, and then remove the power cord before attempting to service the printer.

Use the table below to identify the correct part number for your printer. To order the part, go to www.hp.com/buy/parts.

Table 1-56 Part information

Part number	Part description
RM2-2690-000CN	Duplex reverse guide assembly

Required tools

- #2 Phillips screwdriver with a magnetic tip
- Small, flat-blade screwdriver

After performing service

Turn the printer power on

- Connect the power cable.
- Use the power switch to turn the power on.

Post service test

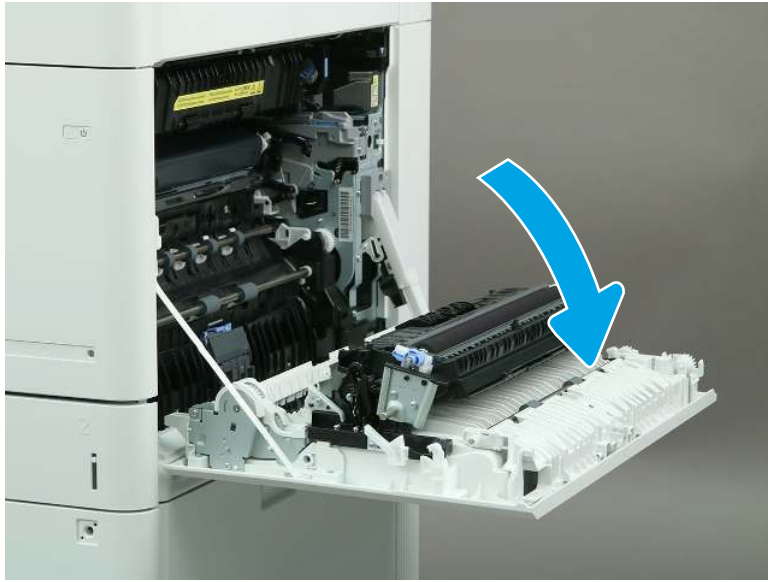
Make sure that the printer initializes to a **Ready** state.

Print a page to make sure that the printer is functioning correctly.

1. Remove the fuser.

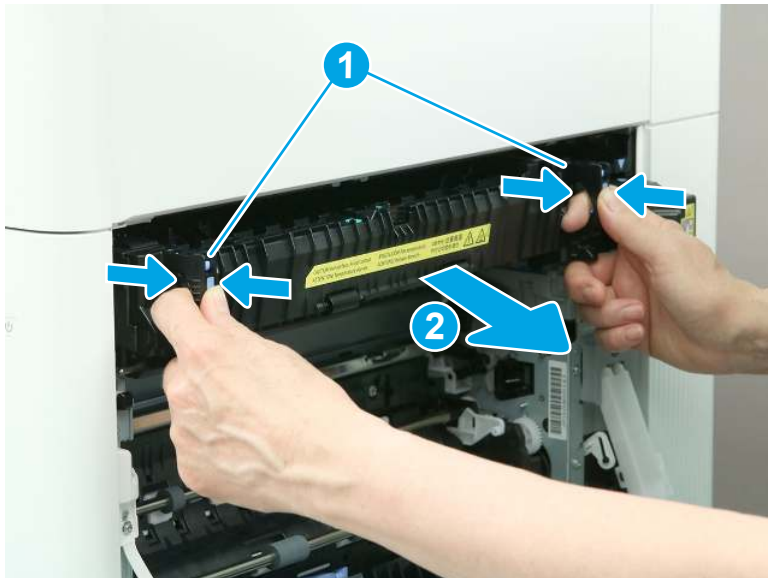
- a. Open the right door.

Figure 1-753 Open the right door



- b. Grasp the fuser handles, and then squeeze the release levers (callout 1). Lift up slightly, and then pull straight out to remove the fuser (callout 2).

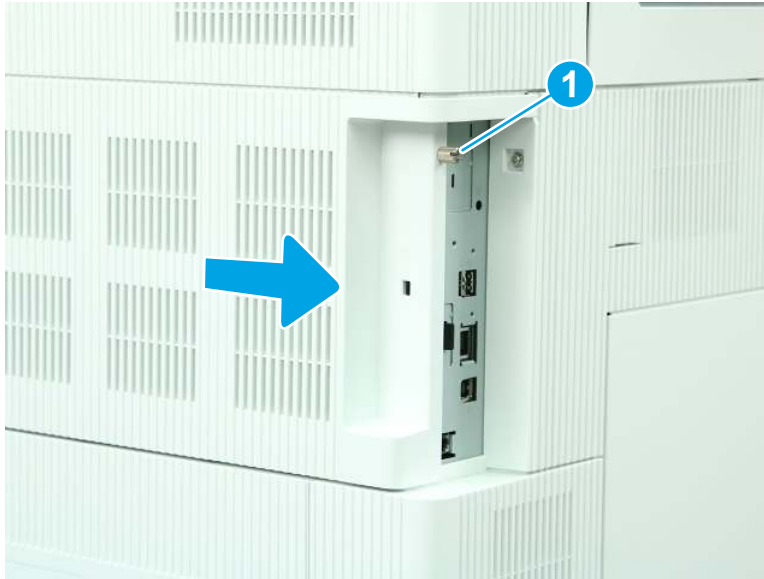
Figure 1-754 Remove the fuser



2. Remove the formatter cover.

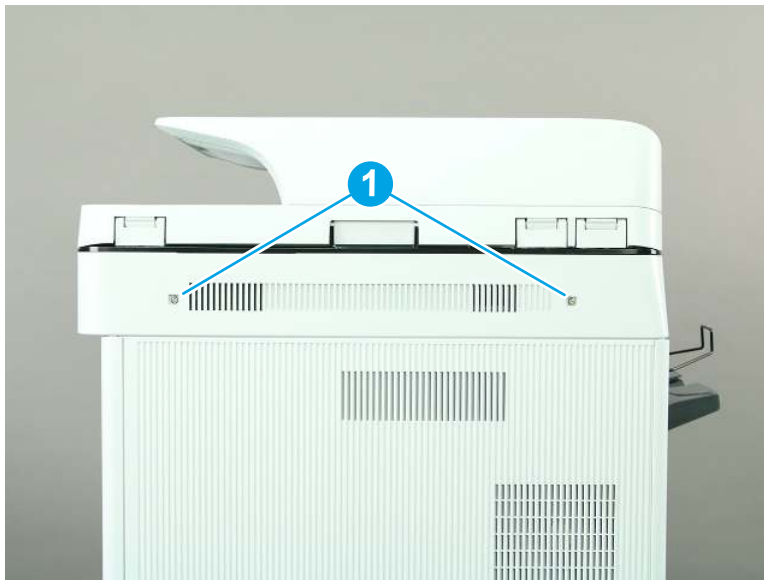
- ▲ Loosen one thumbscrew (callout 1), and then slide the formatter cover (callout 2) away from the printer to remove it.

Figure 1-755 Remove the formatter cover



- 3. Remove the scanner control board (SCB) cover (M776).
 - a. Remove two screws (callout 1).

Figure 1-756 Remove two screws



- b. Remove the SCB cover.

Figure 1-757 Remove the SCB cover

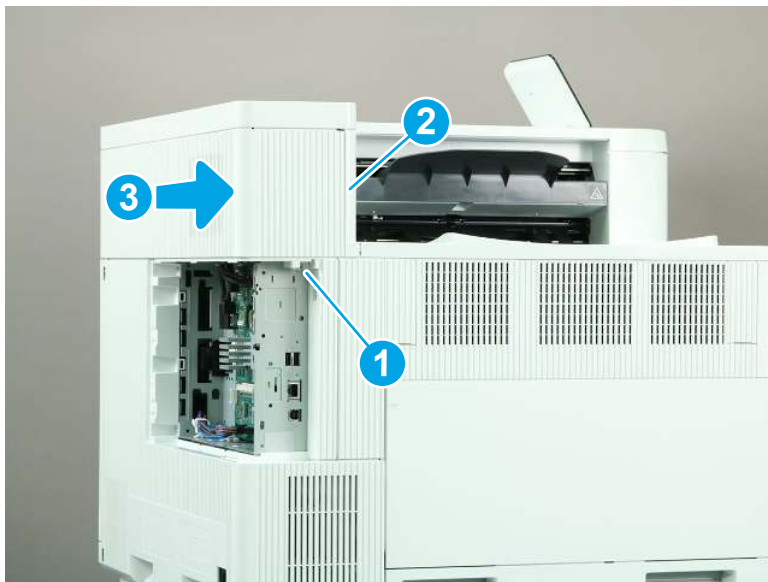


4. Remove the rear upper cover (M856/E85055/M776dn/M776z).

 **NOTE:** The following figure shows the M856 printer. The procedure is correct for all referenced models.

- ▲ Remove one screw (callout 1), release one tab (callout 2), and then slide the rear upper cover away from the printer to remove it (callout 3).

Figure 1-758 Remove the rear upper cover



5. **M776 only:** Remove the control panel, keyboard, and nose cone.

 **NOTE:** This step applies to only the M776 models. Skip this step for all other models

- a. Rotate the control panel to the fully raised position (callout 1), and then raise the document feeder (callout 2).

Figure 1-759 Raise the control panel and document feeder



- b. Beginning at the right side of the control-panel cover, carefully release five tabs along the top edge of the cover.

 **NOTE:** The thin black-plastic cover will separate from the white-plastic control-panel base.

Figure 1-760 Release the control panel cover



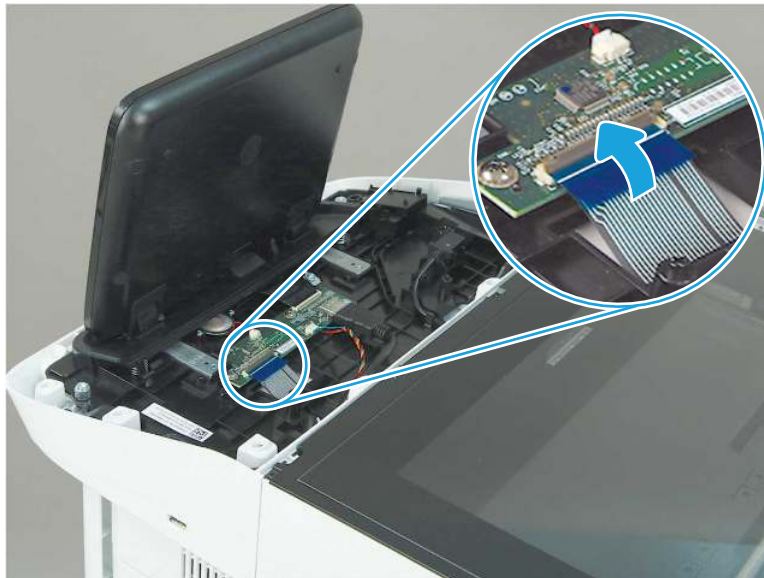
- c. Rotate the control panel cover slightly forward (callout 1), and then lift up to remove the cover (callout 2).

Figure 1-761 Remove the control panel cover



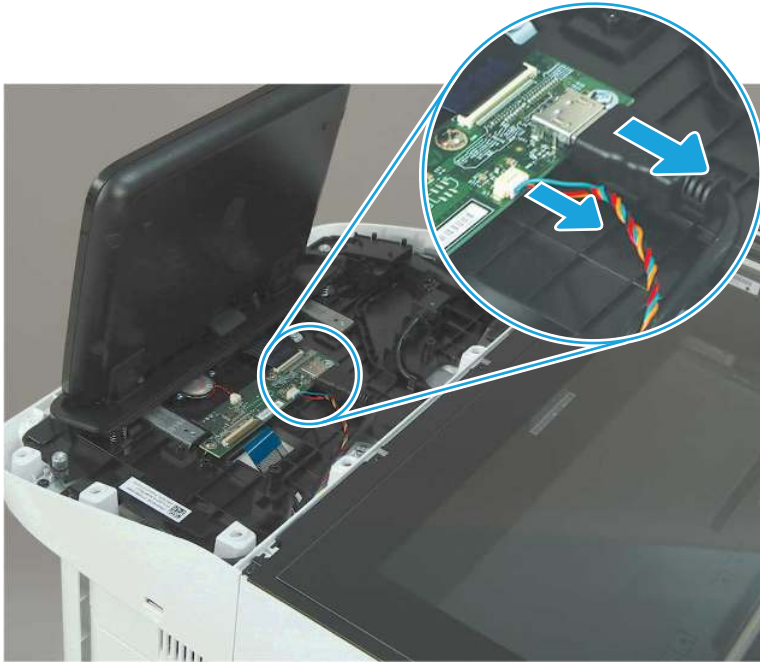
- d. **M776z or M776zs only:** Open the connector latch to release the keyboard flat cable.

Figure 1-762 Release the keyboard flat cable (M776z/M776zs)



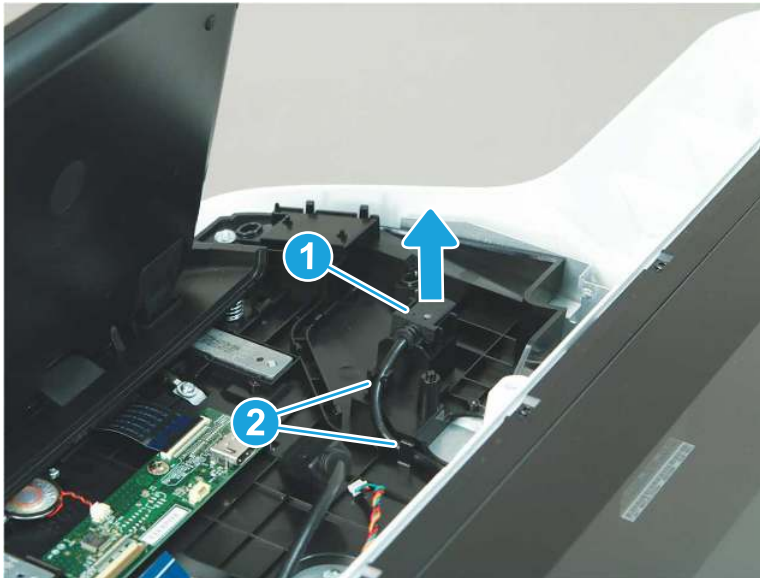
- e. Disconnect two connectors.

Figure 1-763 Disconnect two connectors



- f. Remove the USB cable (callout 1) from the holder, and then release the cable from two retainers (callout 2).

Figure 1-764 Release the USB cable



- g. Remove three screws (callout 1).

Figure 1-765 Remove three screws



- h. Lift the front of the control panel off of the printer (callout 1), and then slide it towards the front of the printer (callout 2) to remove it.

Figure 1-766 Remove the control panel



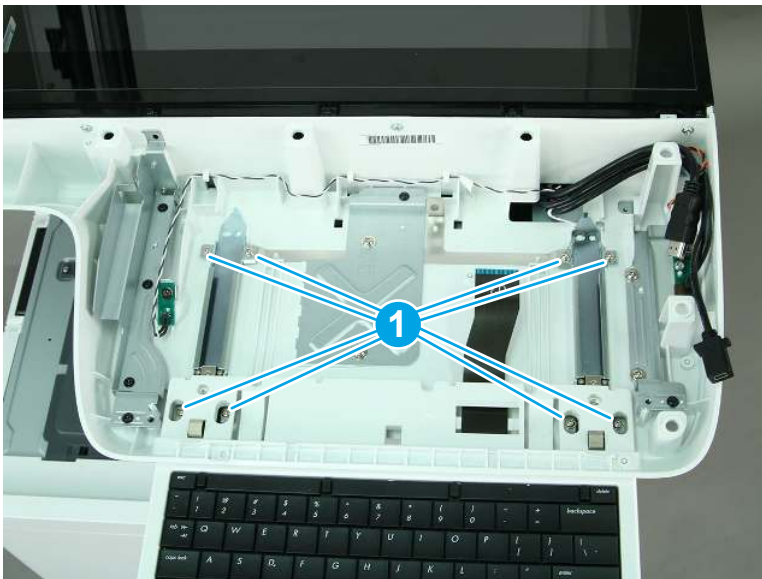
- i. **Keyboard models only:** Pull the keyboard out to its extended position.

Figure 1-767 Pull the keyboard out



- j. **Keyboard models only:** Remove eight screws (callout 1).

Figure 1-768 Remove eight screws



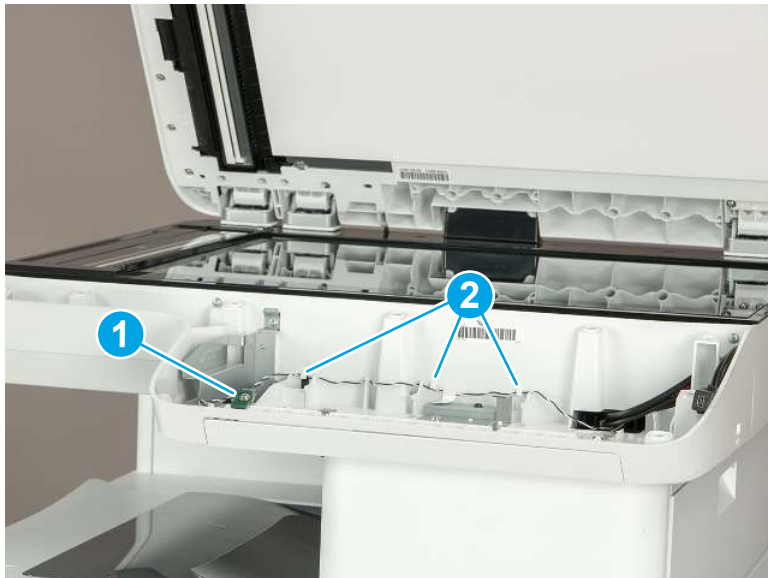
- k. **Keyboard models only:** Remove the keyboard and rails.

Figure 1-769 Remove the keyboard and rails



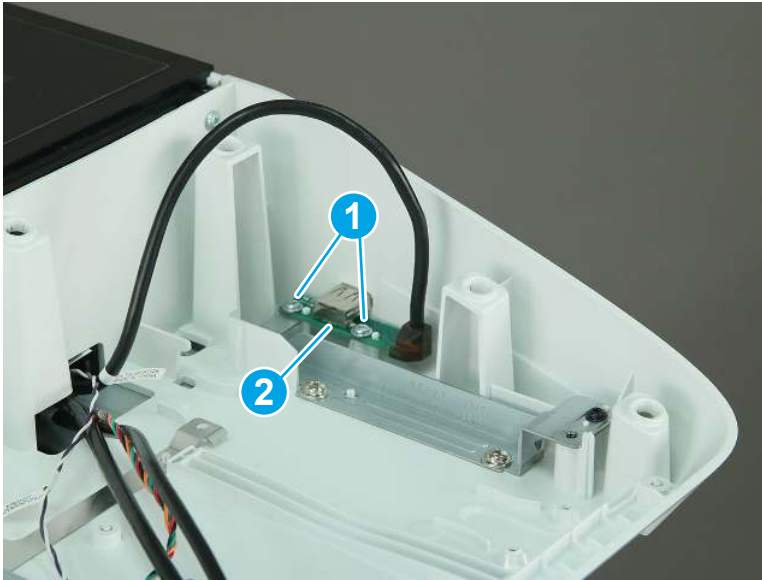
- l. Remove one screw (callout 1) to release the light PCA. Release the cable from three retainers (callout 2), and then move the light PCA out of the way.

Figure 1-770 Release the light PCA



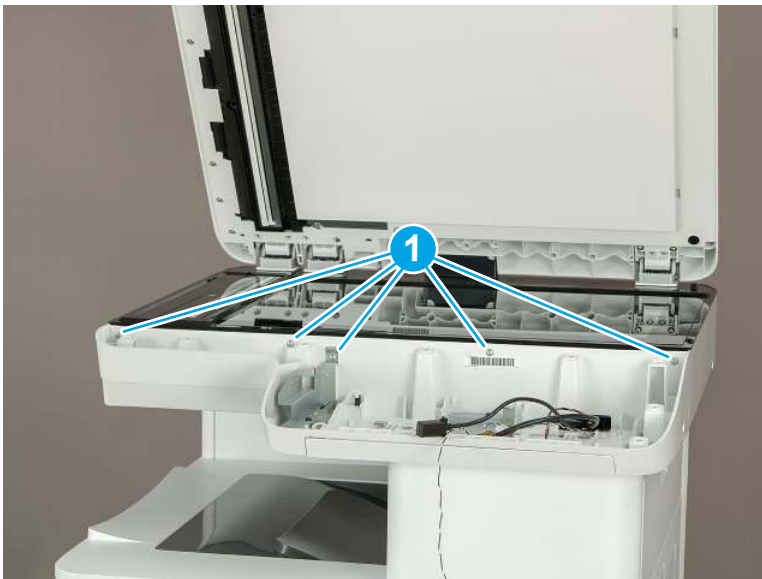
- m. Remove two screws (callout 1), and then move the USB port PCA (callout 2) out of the way.

Figure 1-771 Release the USB port PCA



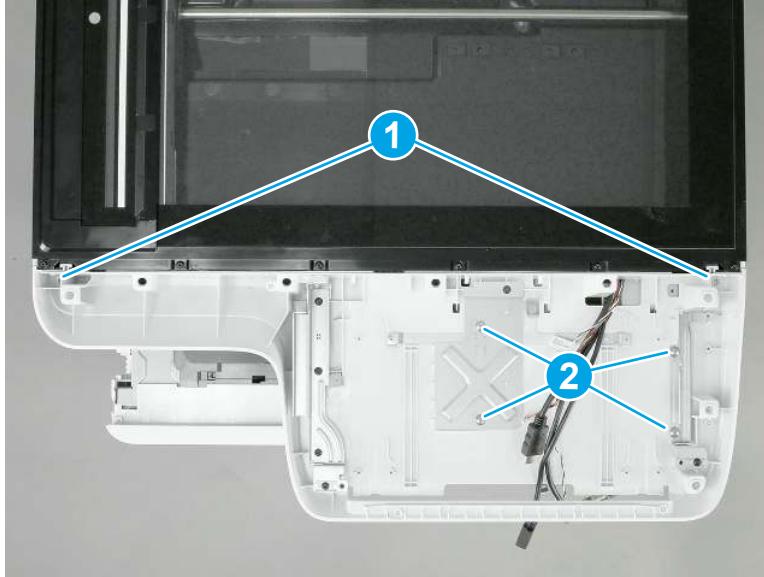
- n. Remove five screws (callout 1).

Figure 1-772 Remove four screws



- o. Remove two small, self-tapping screws (callout 1), and then remove four larger machine screws (callout 2).

Figure 1-773 Remove six screws



- p. Lift the nose cone up and off of the printer to remove it.


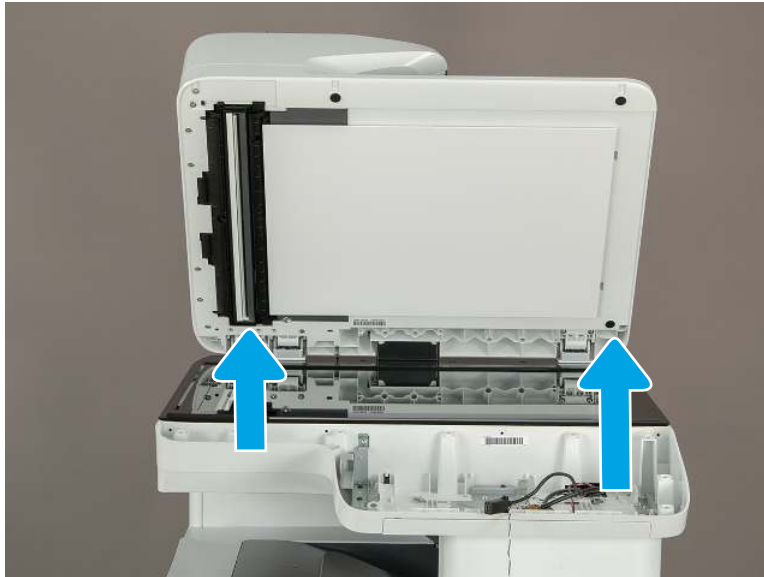
 **NOTE:** Pass the wire harnesses and cables through the opening in the nose cone when removing it.

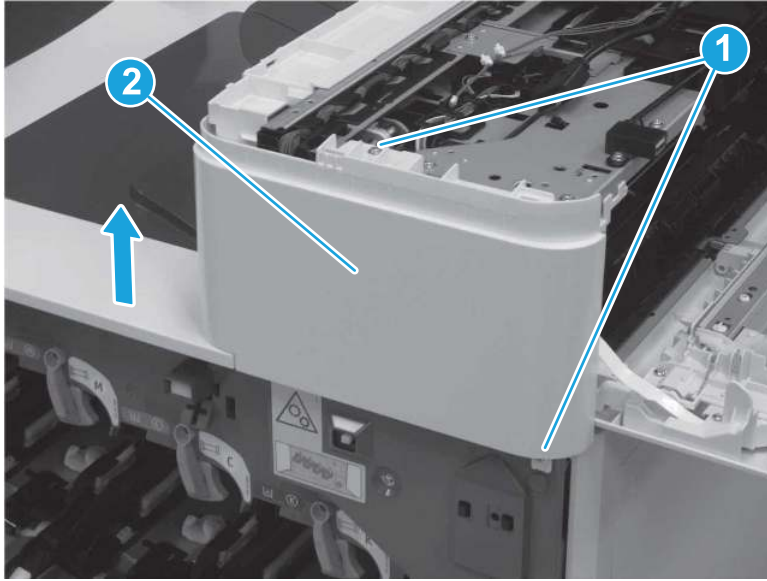
Figure 1-774 Remove the nose cone



- 6. Remove the right front cover (M856/E85055/M776dn/M776z).

- ▲ Remove two screws (callout 1), and then slide the right front cover (callout 2) up to remove it.

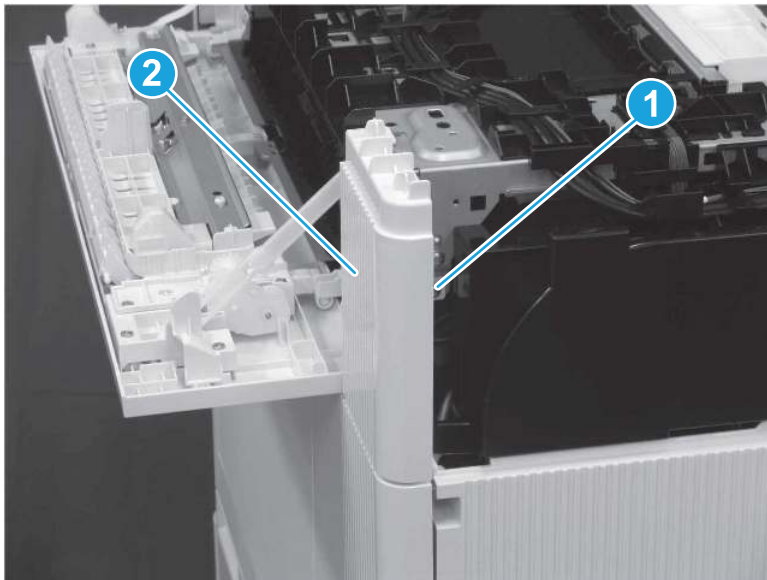
Figure 1-775 Remove the right front cover



7. Remove the right rear upper cover (M856/E85055/M776dn/M776z)

- ▲ Remove one screw (callout 1), and then slide the right rear upper cover (callout 2) away from the printer to remove it.

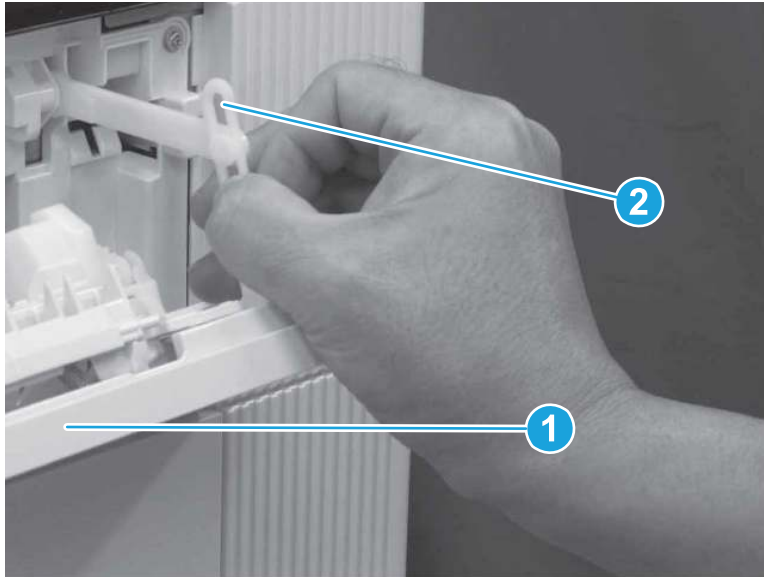
Figure 1-776 Remove the right rear upper cover



8. Remove the right upper door (M856/E85055/M776dn/M776z)

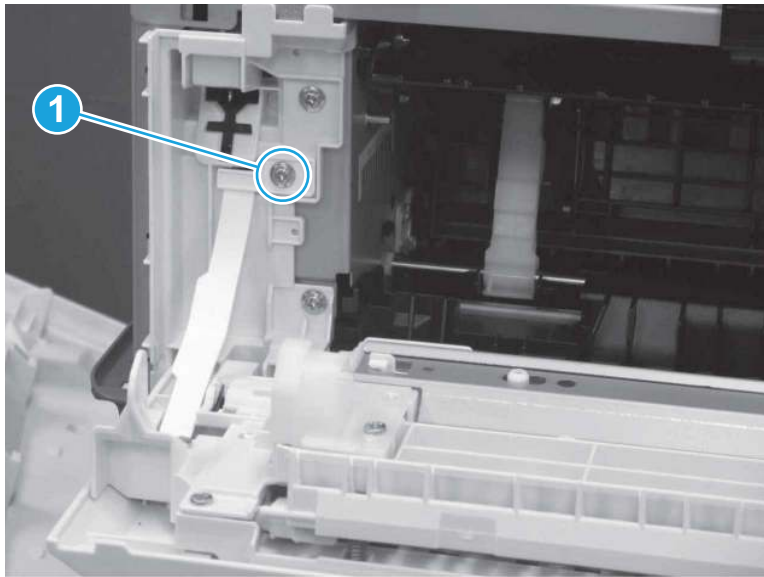
- a. Open the right upper door (callout 1), and then release the link (callout 2).

Figure 1-777 Open the door and release the link



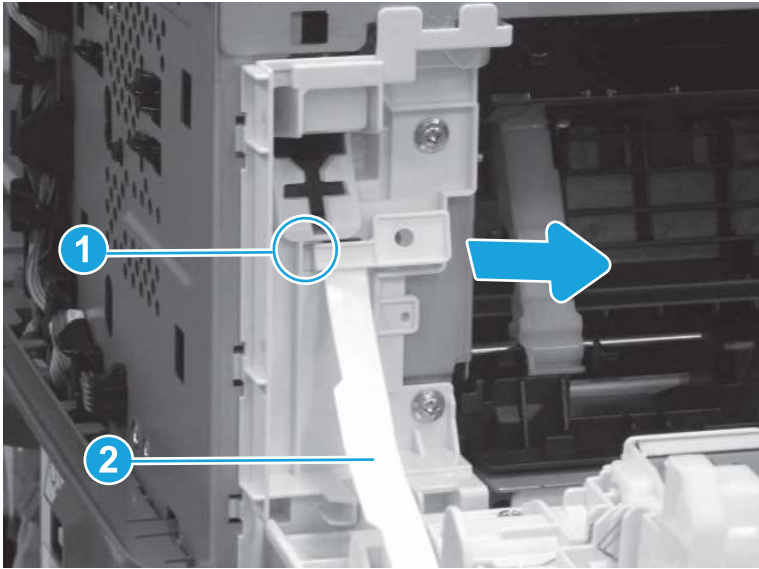
- b. Remove one screw (callout 1).

Figure 1-778 Remove one screw



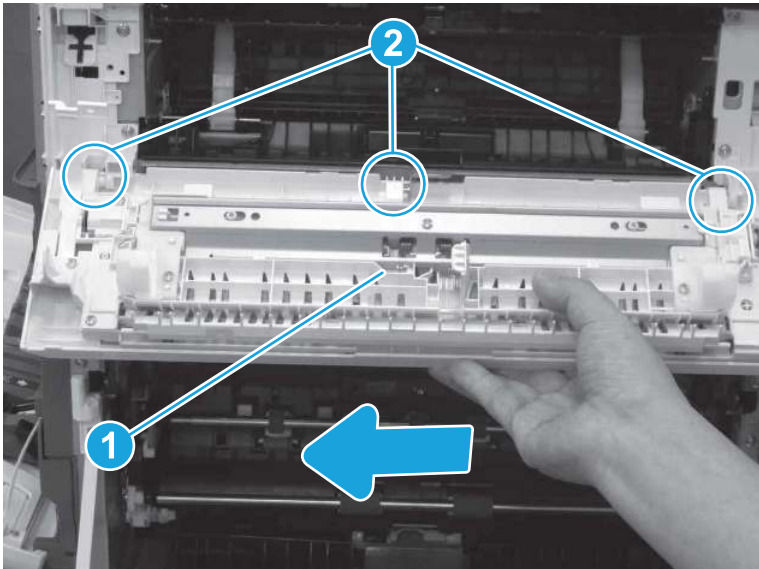
- c. Release one boss (callout 1) and then release the hinge (callout 2) by sliding it to the right.

Figure 1-779 Release one boss and hinge



- d. Slide the right upper door (callout 1) to the right to release it from three bushings (callout 2), and then remove the right upper door.

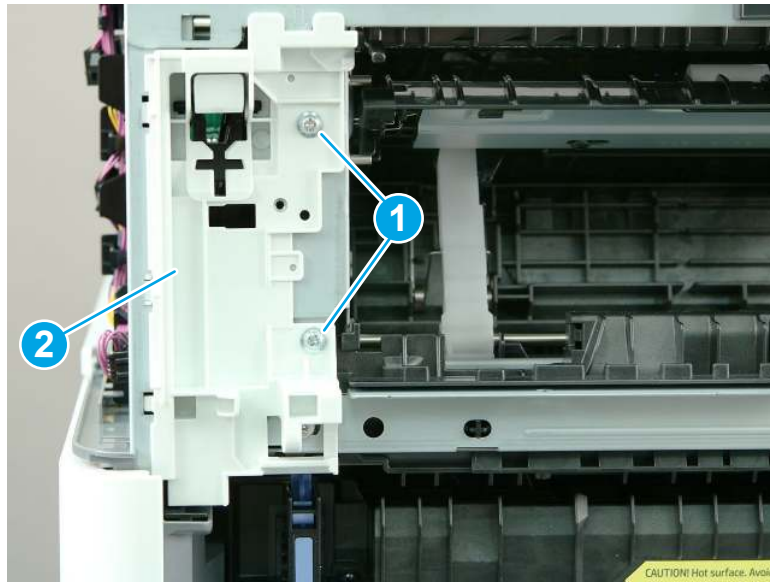
Figure 1-780 Remove the right upper door



9. Remove the delivery assembly (M856/E85055/M776dn/M776z).

- a. Remove two screws (callout 1), and then remove the toggle front assembly (callout 2).

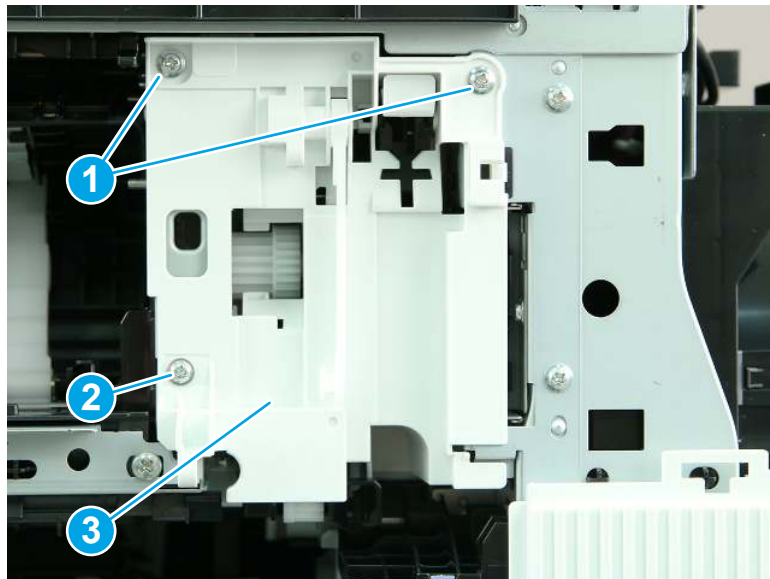
Figure 1-781 Remove two screws and toggle front assembly (M856/E85055/M776dn/M776z)



- b. Remove two screws (callout 1). Remove one screw (callout 2), and then remove the toggle rear assembly (callout 3).

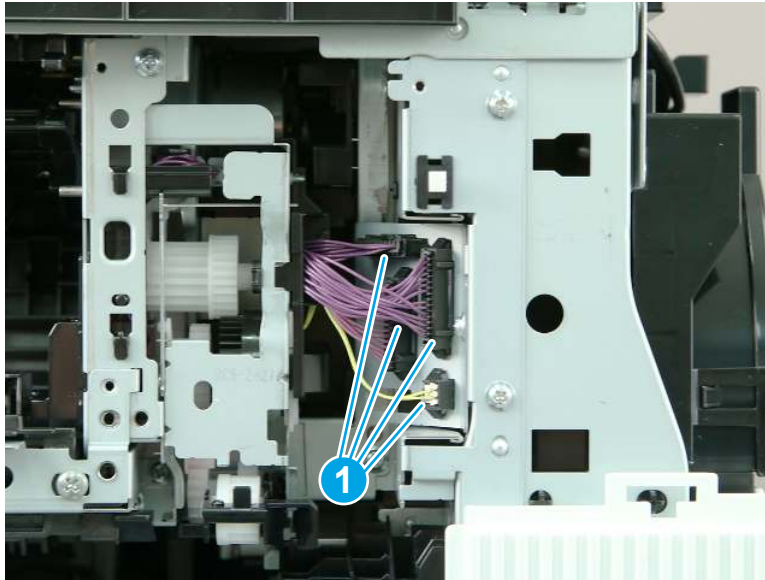
 **NOTE:** The lower screw (callout 2) is shorter than the other two screws. Make sure to reinstall this screw in the correct position.

Figure 1-782 Remove three screws and toggle rear assembly (M856/E85055/M776dn/M776z)



- c. Disconnect four connectors (callout 1).

Figure 1-783 Disconnect four connectors (M856/E85055/M776dn/M776z)

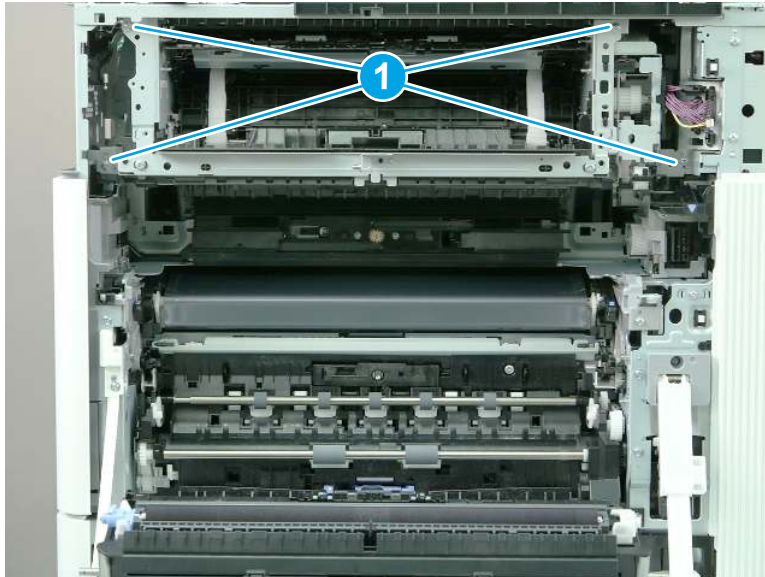


- d. Remove four screws (callout 1).



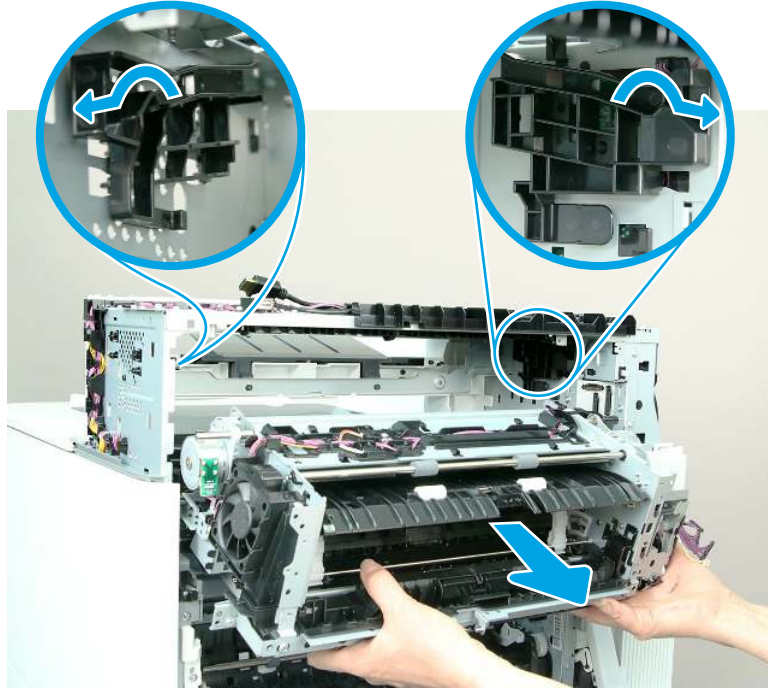
NOTE: The lower screws are shorter than the upper screws. Make sure to reinstall them in the correct position.

Figure 1-784 Remove four screws (M856/E85055/M776dn/M776z)



- e. Slide the delivery assembly away from the printer, and then lift up and out to release the posts from the tracks.

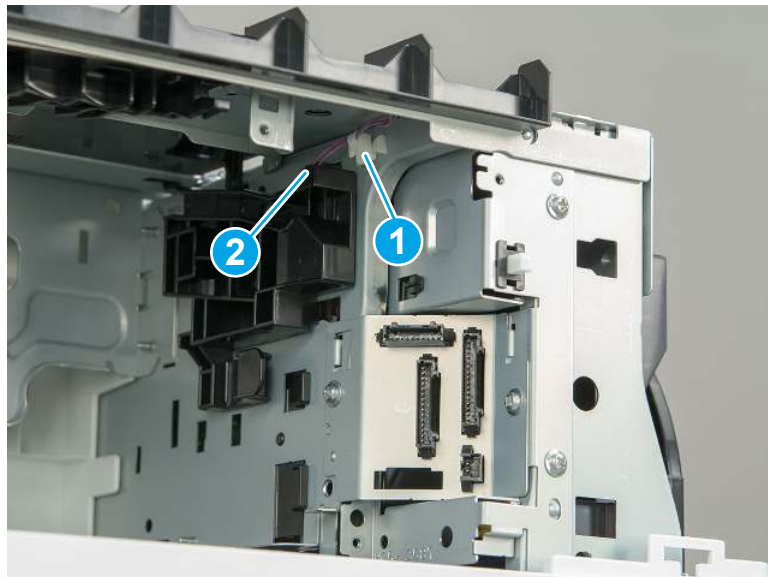
Figure 1-785 Remove the delivery assembly (M856/E85055/M776dn/M776z)



- 10. Remove the duplex reverse guide (M856/E85055/M776dn/M776z).

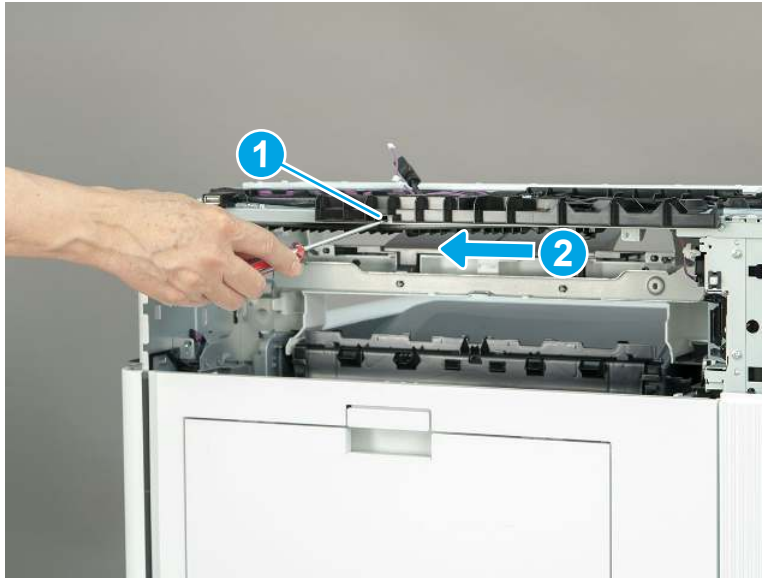
- a. Release one retainer (callout 1), and then disconnect one connector (callout 2).

Figure 1-786 Release one retainer and disconnect one connector



- b. Release one tab (callout 1), and then slide the duplex reverse guide to the left to release it (callout 2).

Figure 1-787 Release the duplex reverse guide



- c. Remove the duplex reverse guide.

Figure 1-788 Remove the duplex reverse guide



11. Unpack the replacement assembly.


- a. Dispose of the defective part.




NOTE: HP recommends responsible disposal of the defective part.

<http://www8.hp.com/us/en/hp-information/environment/product-recycling.html>

- b. Unpack the replacement part from the packaging.

 **IMPORTANT:** Make sure that all of the shipping materials (for example shipping tape) are removed from the replacement part prior to installation.

- c. To install an assembly, reverse the removal steps.

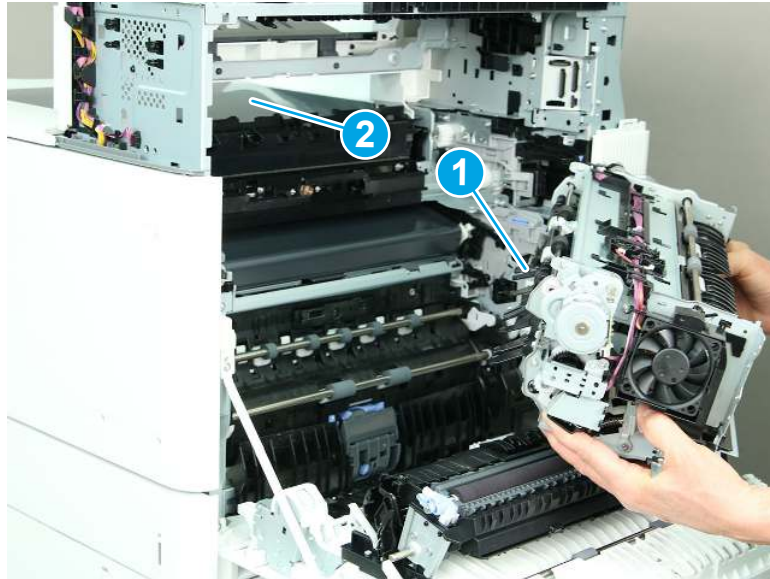
 **NOTE:** When applicable, special installation instructions are provided for an assembly at the end of the removal procedure. Always completely read the removal instructions and follow all special installation instructions.

- 12. Reverse the removal steps to install the assembly. Also use the following **special installation instructions**.

Install the delivery assembly (M856/E85055/M776dn/M776z).

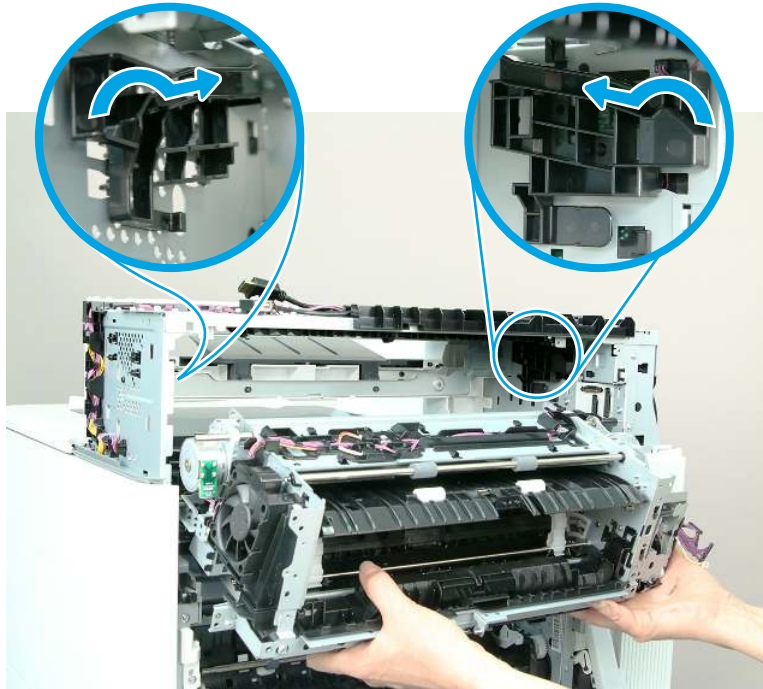
- a. When reinstalling the delivery assembly, make sure that the flap (callout 1) on the delivery assembly goes through the opening (callout 2) in the cover.

Figure 1-789 Install the flap through the opening (M856/E85055/M776dn/M776z)



- b. When reinstalling the delivery assembly, position the posts on the delivery assembly (callout 1) into the tracks (callout 2) in the printer. Lift up and then slide the assembly toward the printer to install the posts in the tracks.

Figure 1-790 Install the delivery assembly (M856/E85055/M776dn/M776z)



Removal and replacement: Toggle front assembly (M776zs)

Learn how to remove and replace the toggle front assembly (M776zs).

Mean time to repair: 15 minutes

Service level: Easy

Before performing service

Turn the printer power off

- Disconnect the power cable.

⚠ WARNING! To avoid damage to the printer, turn the printer off, wait 30 seconds, and then remove the power cord before attempting to service the printer.

Use the table below to identify the correct part number for your printer. To order the part, go to www.hp.com/buy/parts.

Table 1-57 Part information

Part number	Part description
RM2-1764-000CN	Toggle front assembly

Required tools

- #2 Phillips screwdriver with a magnetic tip
- Small, flat-blade screwdriver

After performing service

Turn the printer power on

- Connect the power cable.
- Use the power switch to turn the power on.

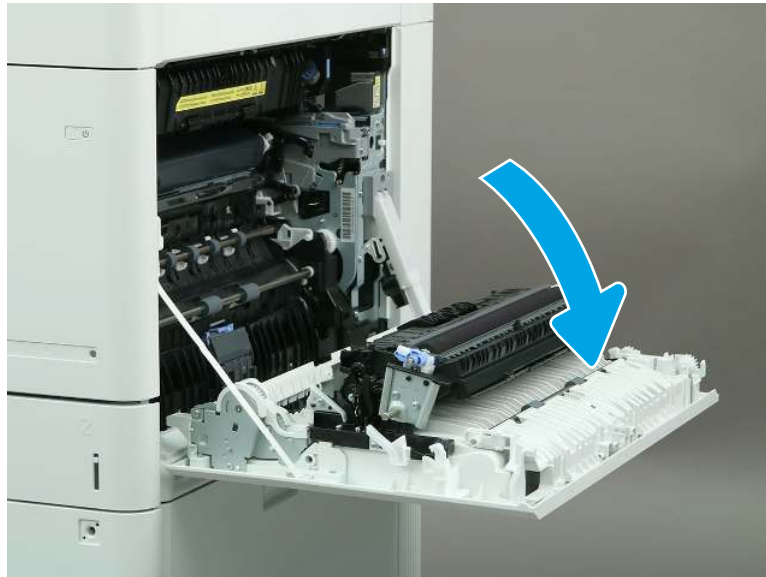
Post service test

Make sure that the printer initializes to a **Ready** state.

Print a page to make sure that the printer is functioning correctly.

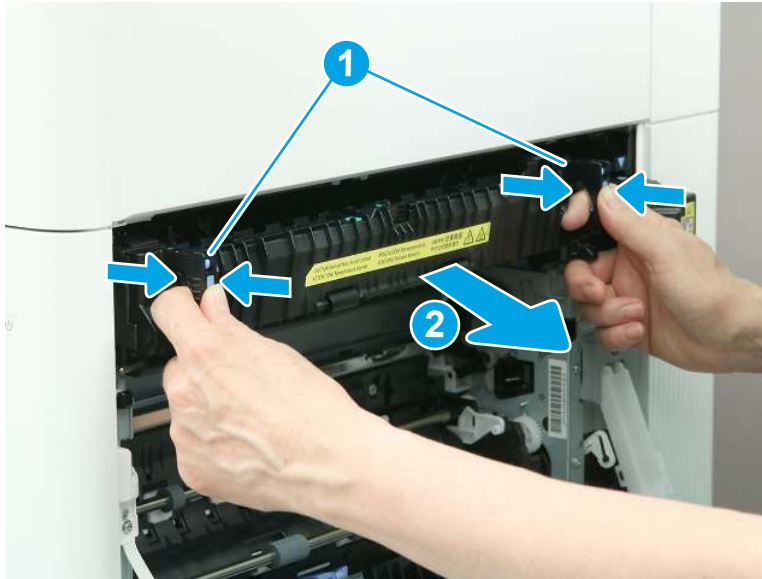
1. Remove the fuser.
 - a. Open the right door.

Figure 1-791 Open the right door



- b. Grasp the fuser handles, and then squeeze the release levers (callout 1). Lift up slightly, and then pull straight out to remove the fuser (callout 2).

Figure 1-792 Remove the fuser



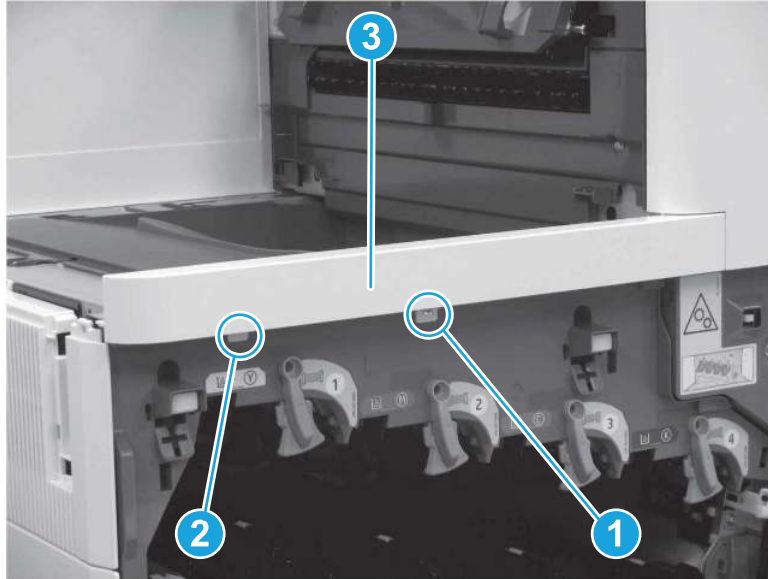
- 2. Remove the front cover (M776zs).
 - a. Open the front door.

Figure 1-793 Open the front door



- b. Remove one screw (callout 1), release one tab (callout 2), and then remove the front cover (callout 3).

Figure 1-794 Remove the front cover



- 3. Remove the control panel (M776).

- a. Rotate the control panel to the fully raised position (callout 1), and then raise the document feeder (callout 2).

Figure 1-795 Raise the control panel and document feeder



- b. Beginning at the right side of the control-panel cover, carefully release five tabs along the top edge of the cover.

 **NOTE:** The thin black-plastic cover will separate from the white-plastic control-panel base.

Figure 1-796 Release the control panel cover



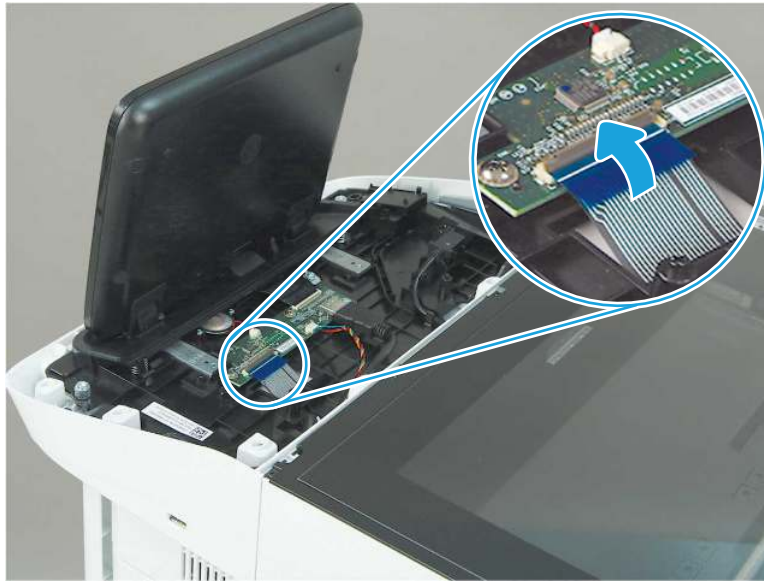
- c. Rotate the control panel cover slightly forward (callout 1), and then lift up to remove the cover (callout 2).

Figure 1-797 Remove the control panel cover



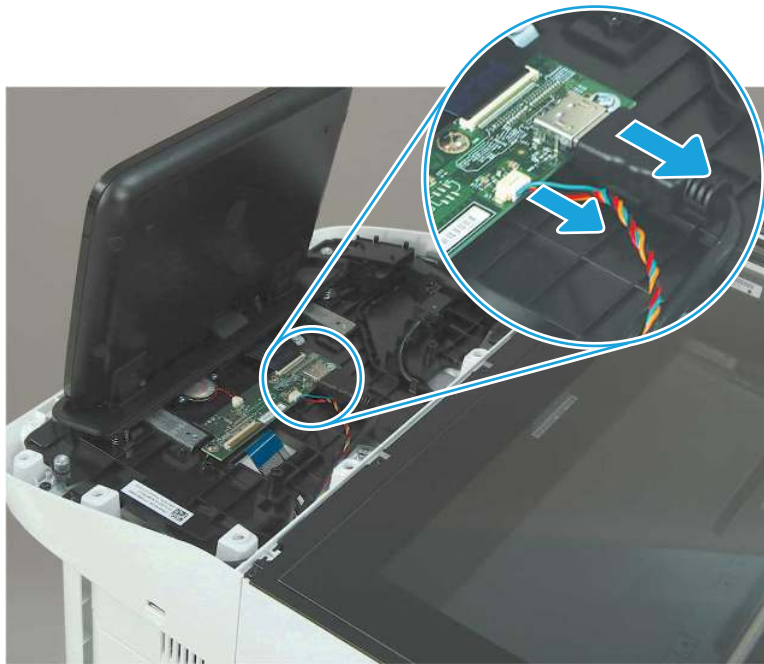
- d. **M776z or M776zs only:** Open the connector latch to release the keyboard flat cable.

Figure 1-798 Release the keyboard flat cable (M776z/M776zs)



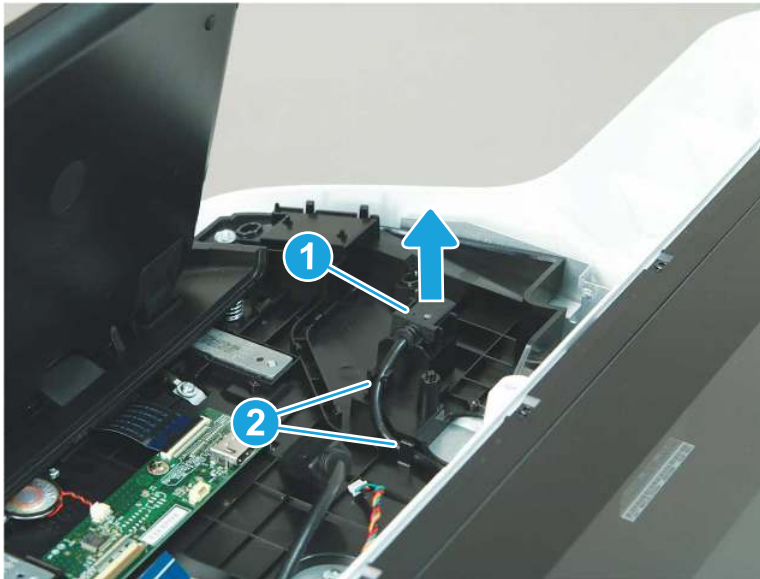
- e. Disconnect two connectors

Figure 1-799 Disconnect two connectors



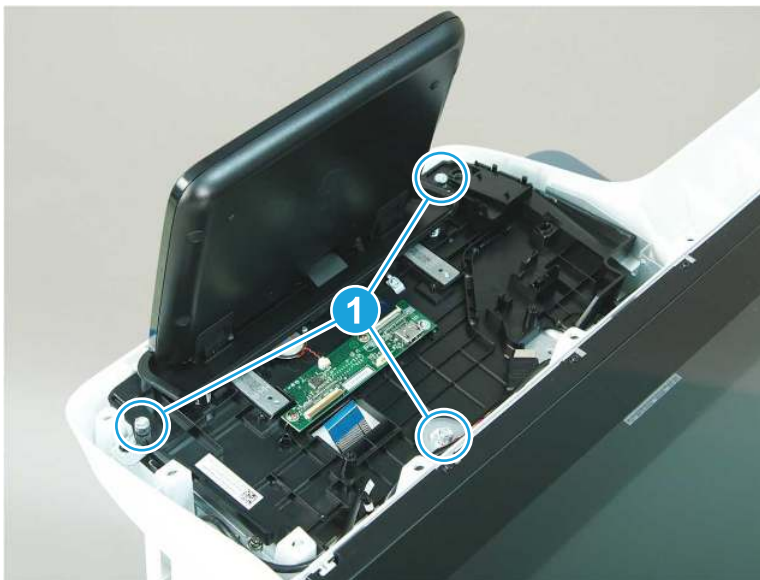
- f. Remove the USB cable (callout 1) from the holder, and then release the cable from two retainers (callout 2).

Figure 1-800 Release the USB cable



- g. Remove three screws (callout 1).

Figure 1-801 Remove three screws



- h. Lift the front of the control panel off of the printer (callout 1), and then slide it towards the front of the printer (callout 2) to remove it.

Figure 1-802 Remove the control panel



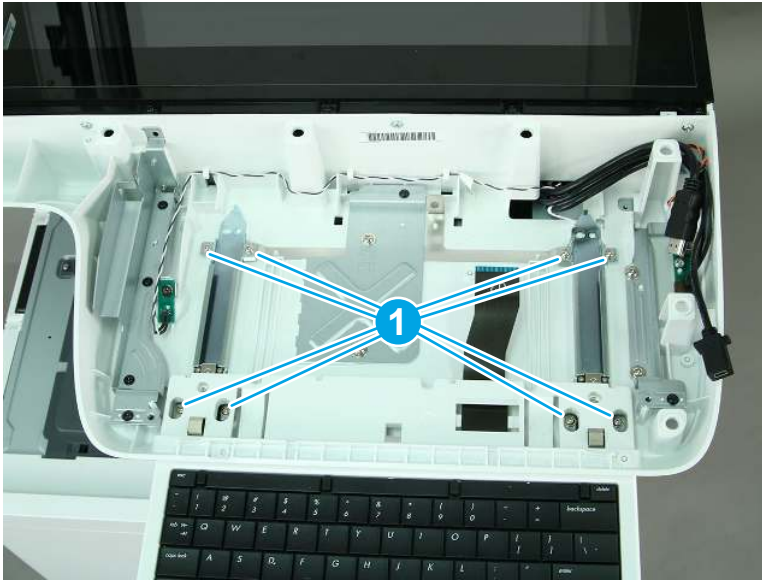
- 4. Remove the keyboard (M776z/M776zs).
 - a. Pull the keyboard out to its extended position.

Figure 1-803 Pull the keyboard out



- b. Remove eight screws (callout 1).

Figure 1-804 Remove eight screws



- c. Remove the keyboard and rails.

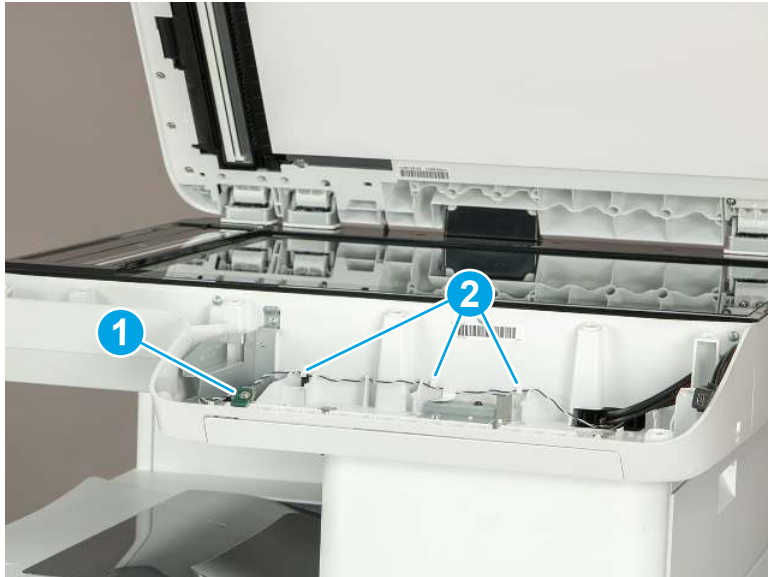
Figure 1-805 Remove the keyboard and rails



- 5. Remove the nose cone (M776).

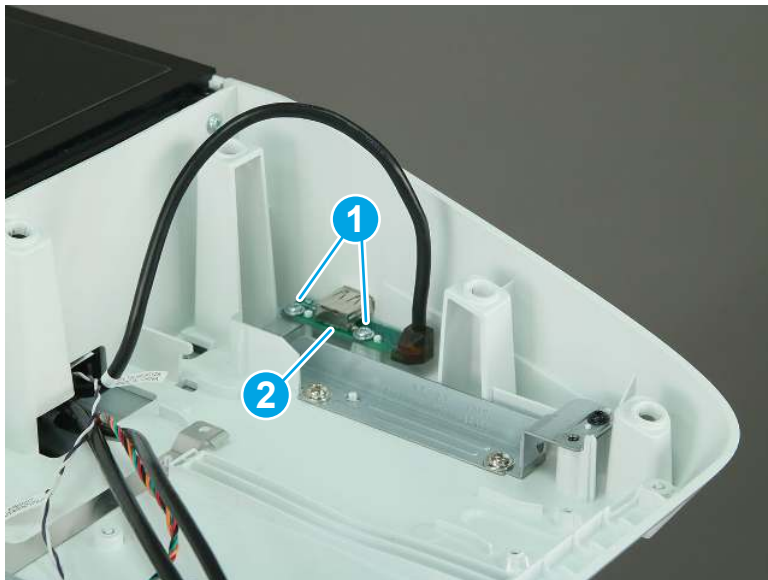
- a. Remove one screw (callout 1) to release the light PCA. Release the cable from three retainers (callout 2), and then move the light PCA out of the way.

Figure 1-806 Release the light PCA



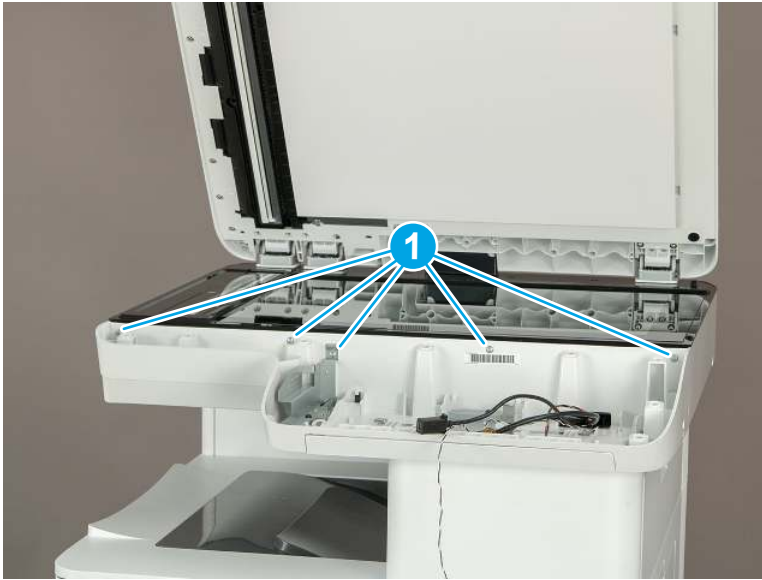
- b. Remove two screws (callout 1), and then move the USB port PCA (callout 2) out of the way.

Figure 1-807 Release the USB port PCA



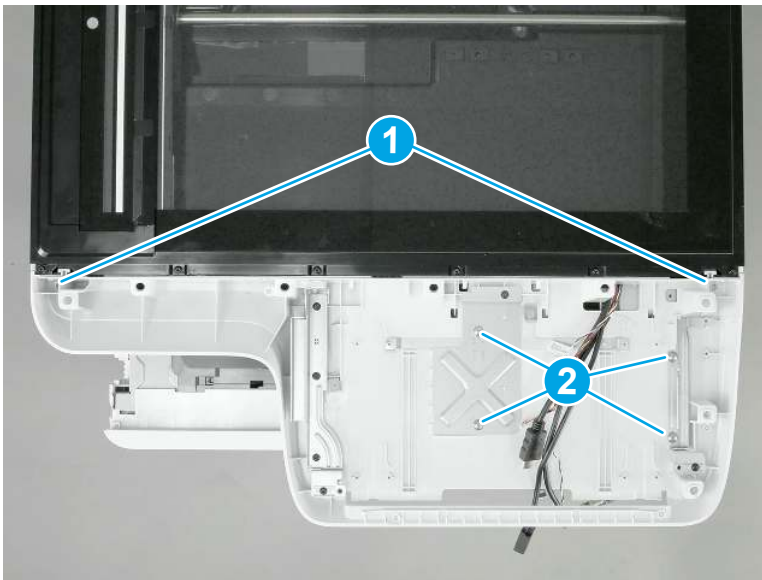
- c. Remove five screws (callout 1).

Figure 1-808 Remove four screws



- d. Remove two small, self-tapping screws (callout 1), and then remove four larger machine screws (callout 2).

Figure 1-809 Remove six screws



- e. Lift the nose cone up and off of the printer to remove it.



NOTE: Pass the wire harnesses and cables through the opening in the nose cone when removing it.

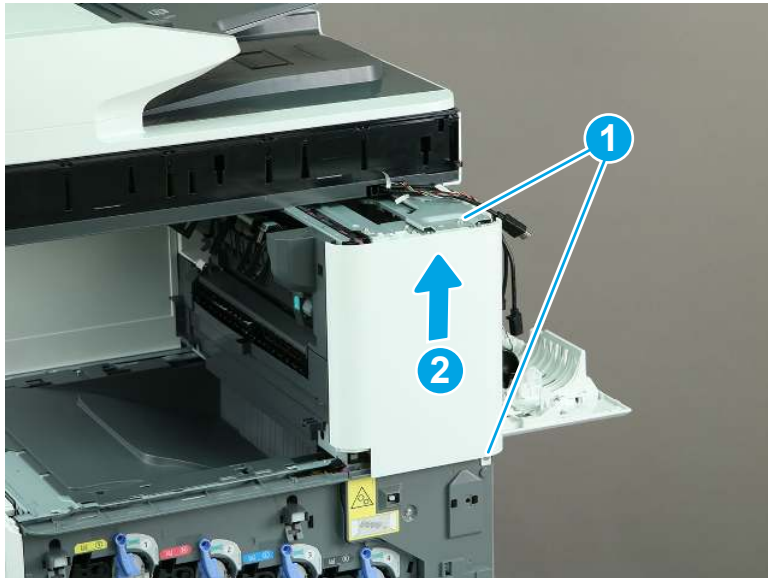
Figure 1-810 Remove the nose cone



6. Remove the right front cover (M776zs).

- ▲ Remove two screws (callout 1), release one tab (callout 2), and then slide the right front cover up (callout 2) to remove it.

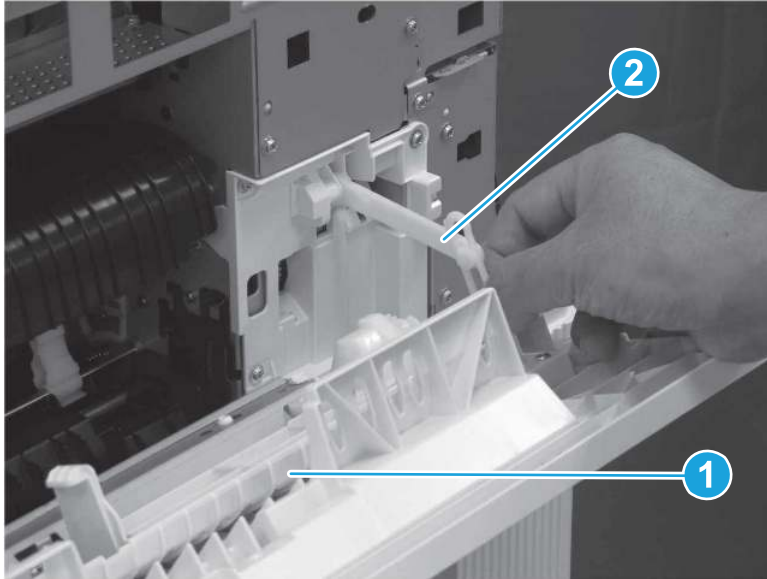
Figure 1-811 Remove the right front cover



7. Remove the right upper door (M776zs).

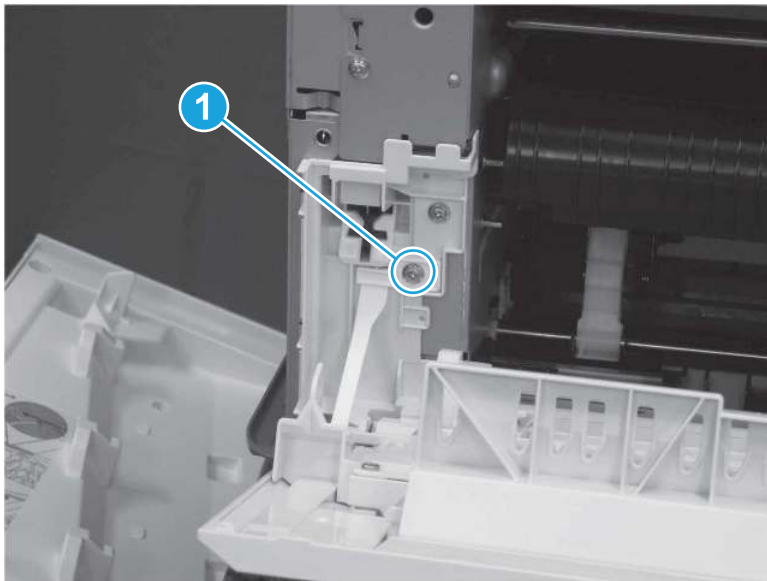
- a. Open the right upper door (callout 1), and then release the link (callout 2).

Figure 1-812 Open the door and release the link



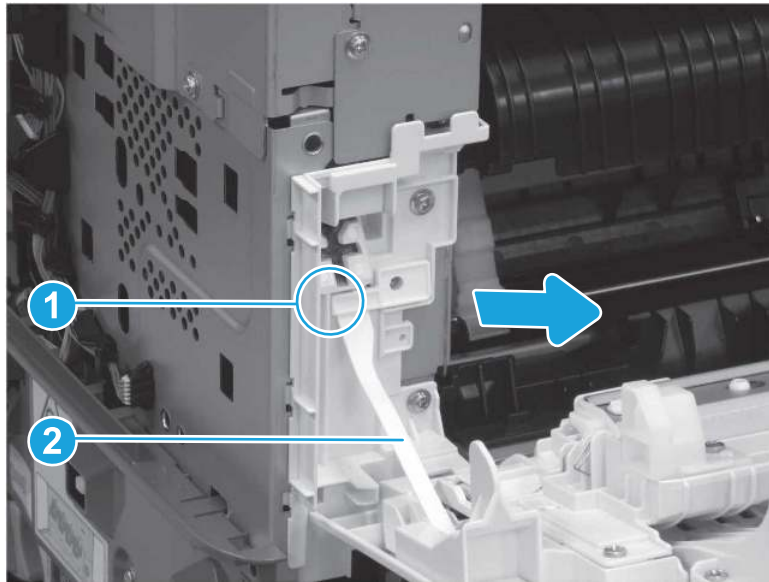
- b. Remove one screw (callout 1).

Figure 1-813 Remove one screw



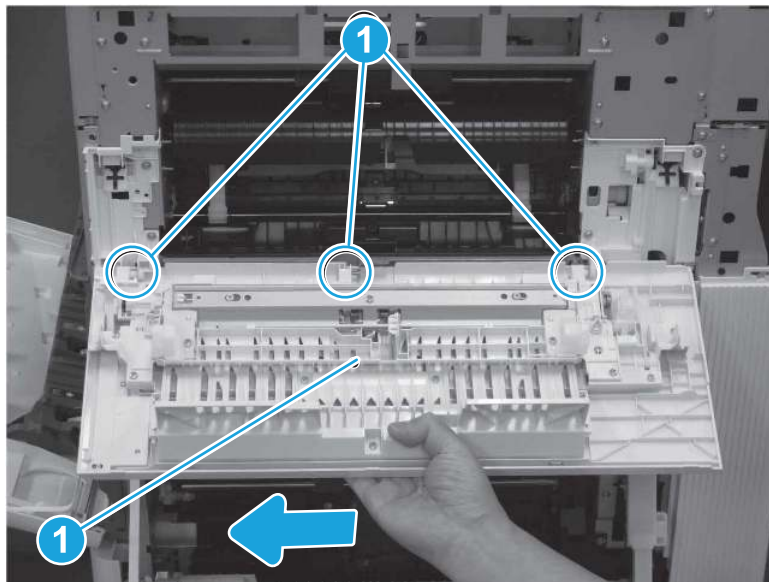
- c. Release one boss (callout 1) and then release the hinge (callout 2) by sliding it to the right.

Figure 1-814 Release one boss and hinge



- d. Slide the right upper door (callout 1) to the right to release it from three bushings (callout 2), and then remove the right upper door.

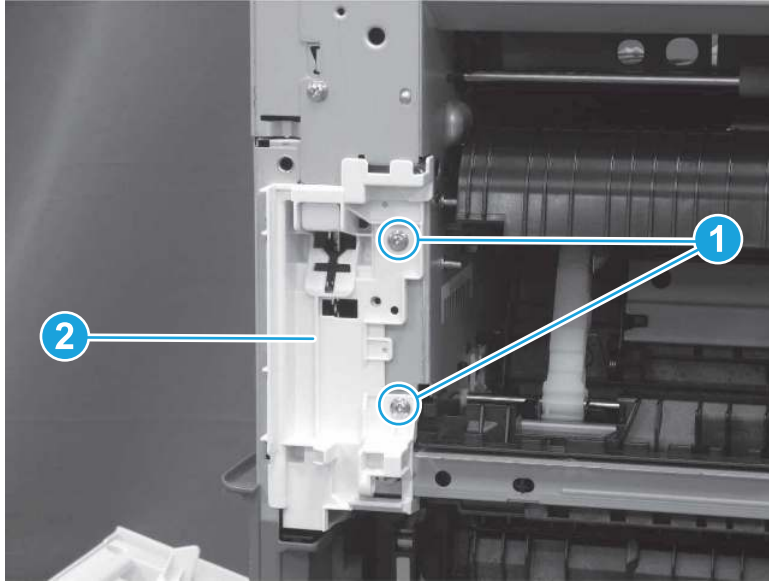
Figure 1-815 Remove the right upper door



- 8. Remove the toggle front assembly (M776zs).

- ▲ Remove two screws (callout 1), and then remove the toggle front assembly (callout 2).

Figure 1-816 Remove two screws and toggle front assembly (M776zs)



9. Unpack the replacement assembly.

- a. Dispose of the defective part.



NOTE: HP recommends responsible disposal of the defective part.

<http://www8.hp.com/us/en/hp-information/environment/product-recycling.html>

- b. Unpack the replacement part from the packaging.



IMPORTANT: Make sure that all of the shipping materials (for example shipping tape) are removed from the replacement part prior to installation.

- c. To install an assembly, reverse the removal steps.



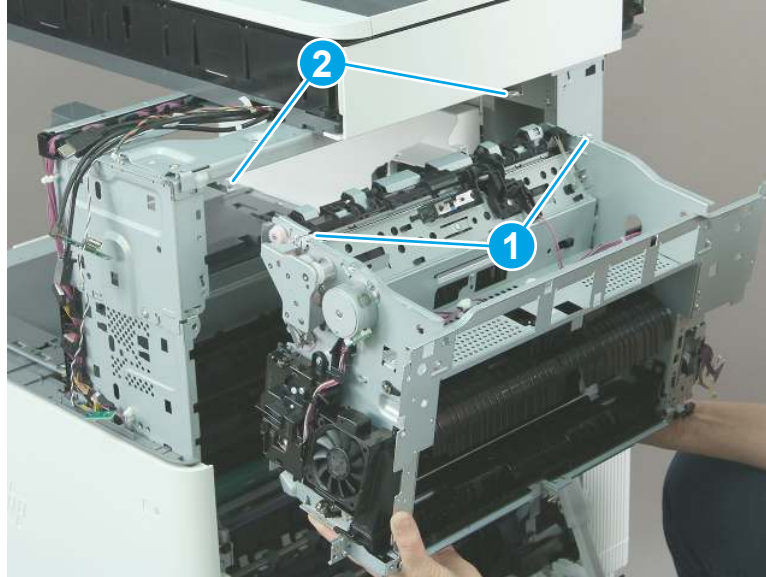
NOTE: When applicable, special installation instructions are provided for an assembly at the end of the removal procedure. Always completely read the removal instructions and follow all special installation instructions.

10. Reverse the removal steps to install the assembly. Also use the following **special installation instructions**.

Install the delivery assembly (M776zs).

- ▲ When reinstalling the delivery assembly, position the stoppers on the delivery assembly (callout 1) into the tracks (callout 2) in the printer. Lift up and then slide the assembly toward the printer to install the stoppers in the tracks.

Figure 1-817 Install the delivery assembly (M776zs)



Removal and replacement: Toggle rear assembly (M776zs)

Learn how to remove and replace the toggle rear assembly (M776zs).

Mean time to repair: 15 minutes

Service level: Easy

Before performing service

Turn the printer power off

- Disconnect the power cable.

⚠ WARNING! To avoid damage to the printer, turn the printer off, wait 30 seconds, and then remove the power cord before attempting to service the printer.

Use the table below to identify the correct part number for your printer. To order the part, go to www.hp.com/buy/parts.

Table 1-58 Part information

Part number	Part description
RM2-1763-000CN	Toggle rear assembly

Required tools

- #2 Phillips screwdriver with a magnetic tip
- Small, flat-blade screwdriver

After performing service

Turn the printer power on

- Connect the power cable.

- Use the power switch to turn the power on.

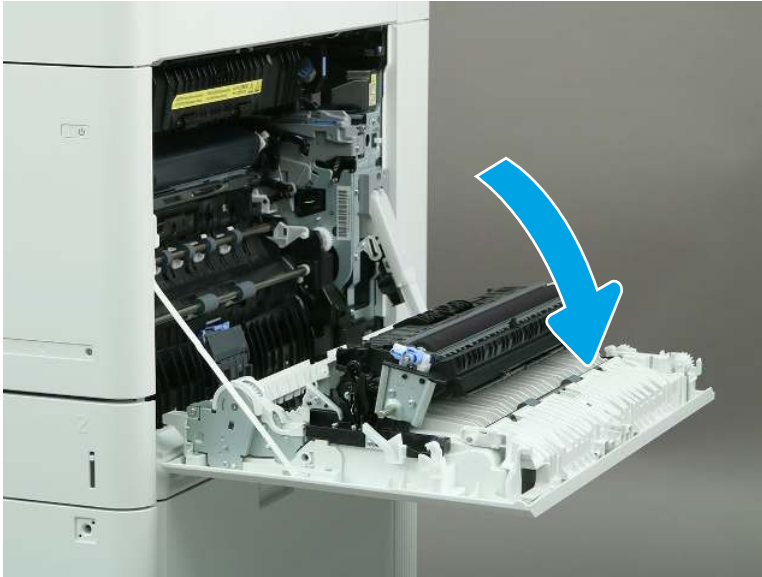
Post service test

Make sure that the printer initializes to a **Ready** state.

Print a page to make sure that the printer is functioning correctly.

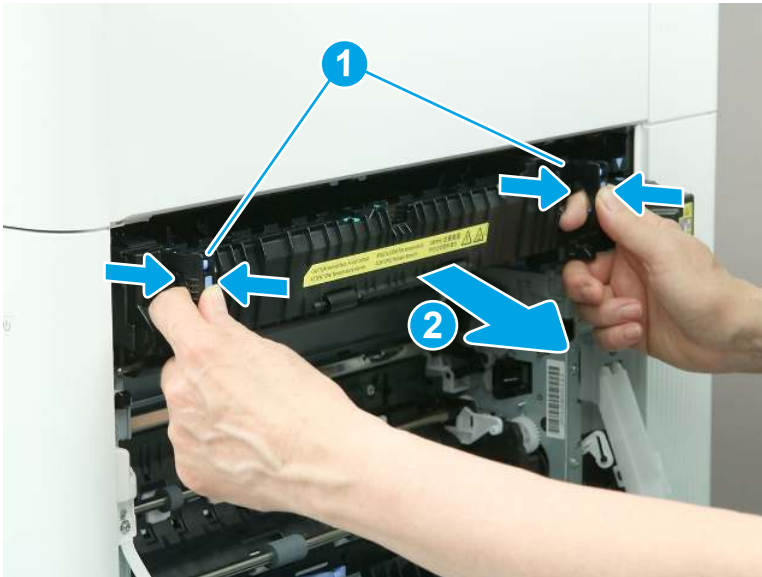
1. Remove the fuser.
 - a. Open the right door.

Figure 1-818 Open the right door



- b. Grasp the fuser handles, and then squeeze the release levers (callout 1). Lift up slightly, and then pull straight out to remove the fuser (callout 2).

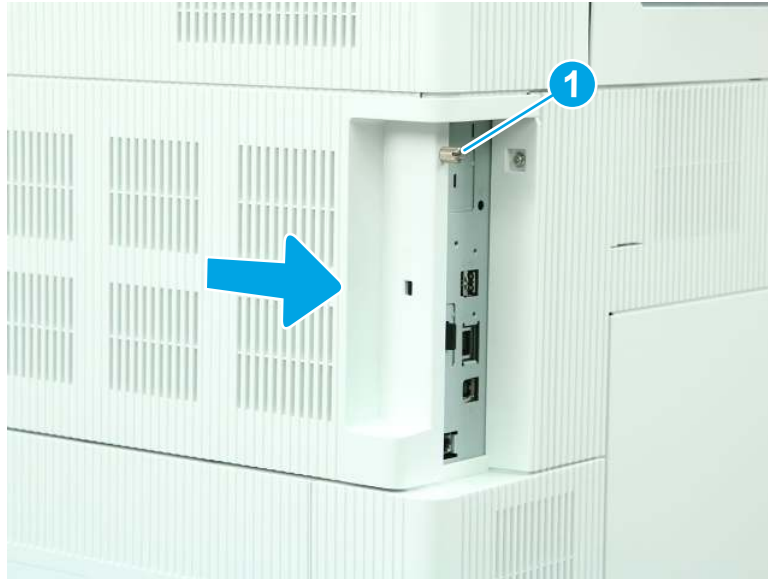
Figure 1-819 Remove the fuser



2. Remove the formatter cover.

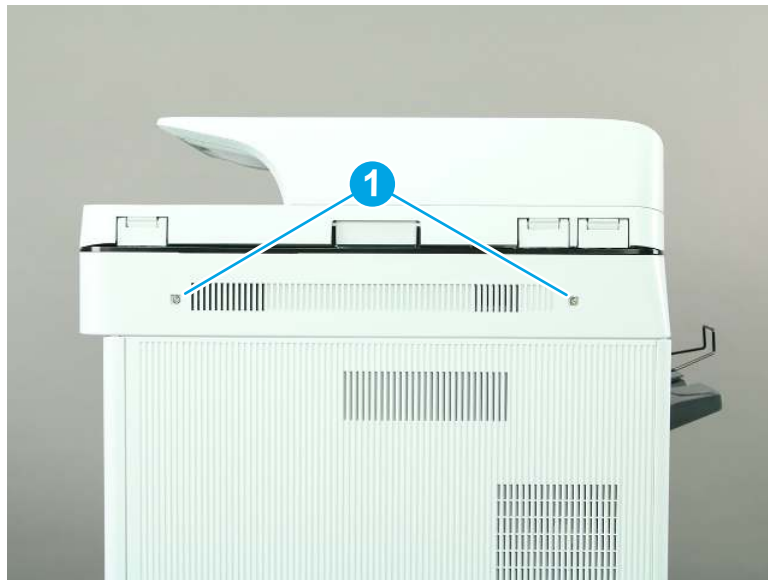
- ▲ Loosen one thumbscrew (callout 1), and then slide the formatter cover (callout 2) away from the printer to remove it.

Figure 1-820 Remove the formatter cover



- 3. Remove the scanner control board (SCB) cover (M776).
 - a. Remove two screws (callout 1).

Figure 1-821 Remove two screws



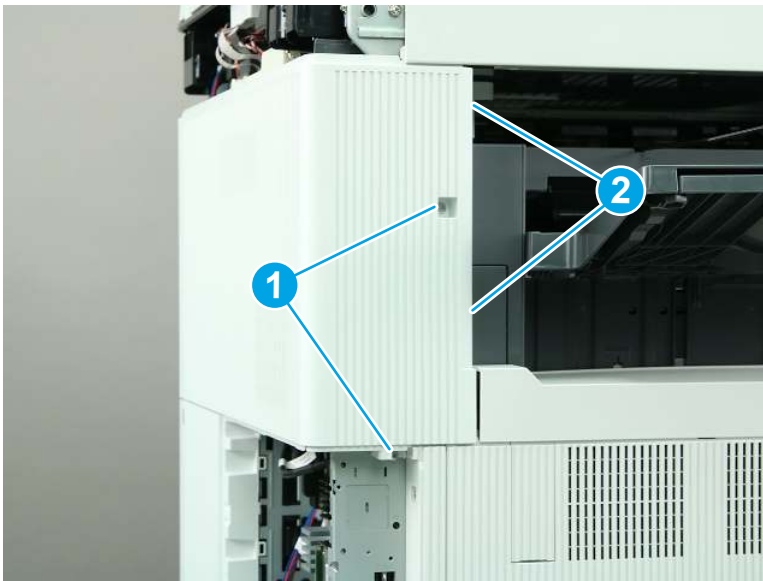
- b. Remove the SCB cover.

Figure 1-822 Remove the SCB cover



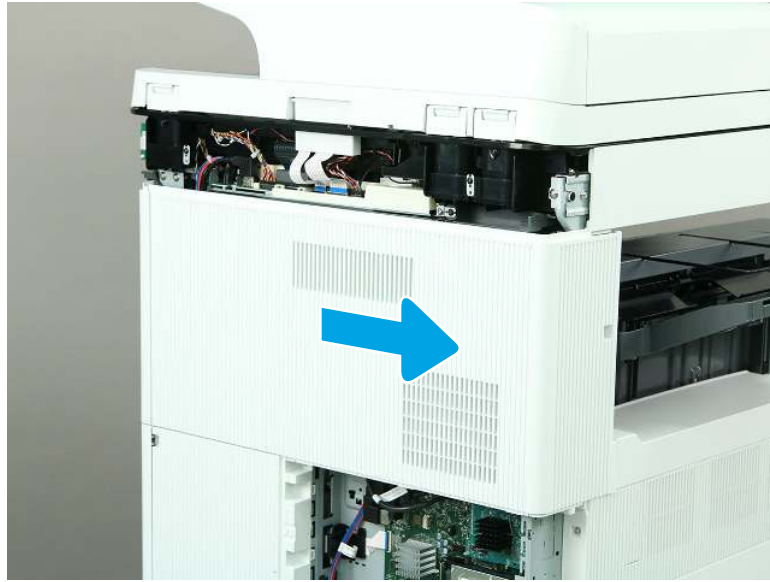
4. Remove the rear upper cover and left rear upper cover (M776zs).
 - a. Remove two screws (callout 1), and then release two tabs (callout 2).

Figure 1-823 Remove two screws and release two tabs



- b. Slide the cover to the right to remove it.

Figure 1-824 Remove the rear upper and left rear upper cover



5. Remove the front cover (M776zs).

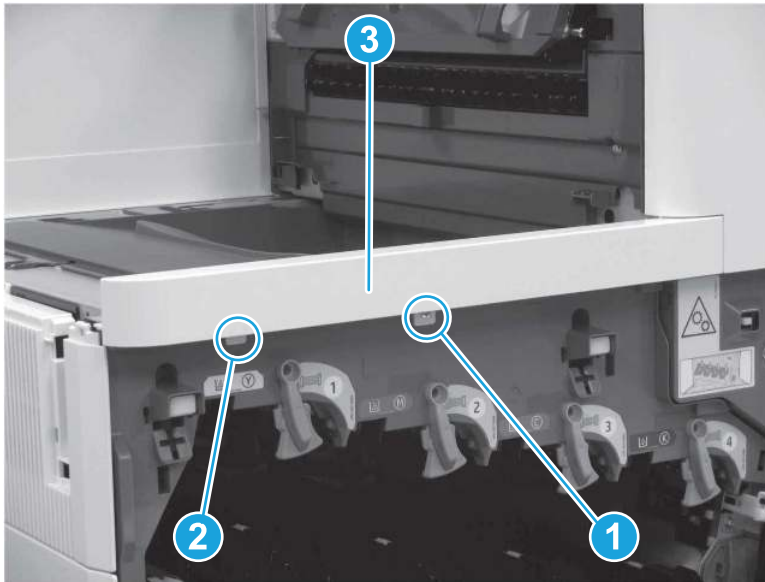
- a. Open the front door.

Figure 1-825 Open the front door



- b. Remove one screw (callout 1), release one tab (callout 2), and then remove the front cover (callout 3).

Figure 1-826 Remove the front cover



6. Remove the control panel (M776).
 - a. Rotate the control panel to the fully raised position (callout 1), and then raise the document feeder (callout 2).

Figure 1-827 Raise the control panel and document feeder



- b. Beginning at the right side of the control-panel cover, carefully release five tabs along the top edge of the cover.

 **NOTE:** The thin black-plastic cover will separate from the white-plastic control-panel base.

Figure 1-828 Release the control panel cover



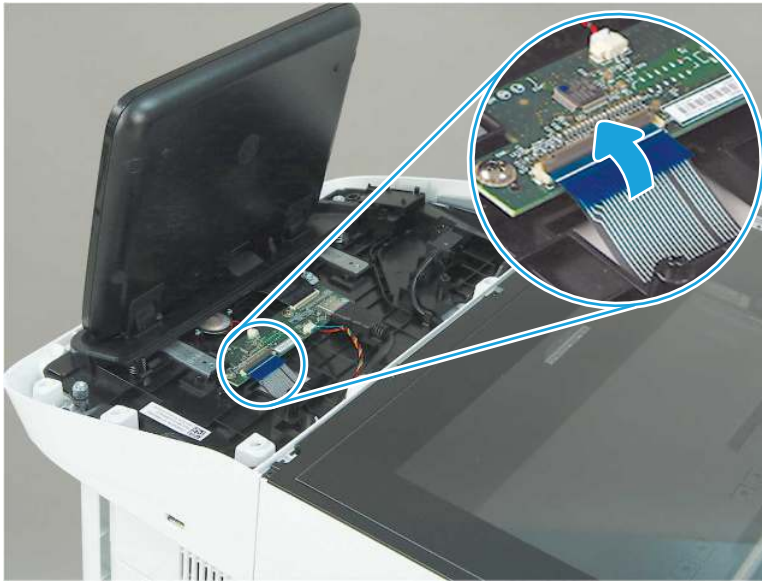
- c. Rotate the control panel cover slightly forward (callout 1), and then lift up to remove the cover (callout 2).

Figure 1-829 Remove the control panel cover



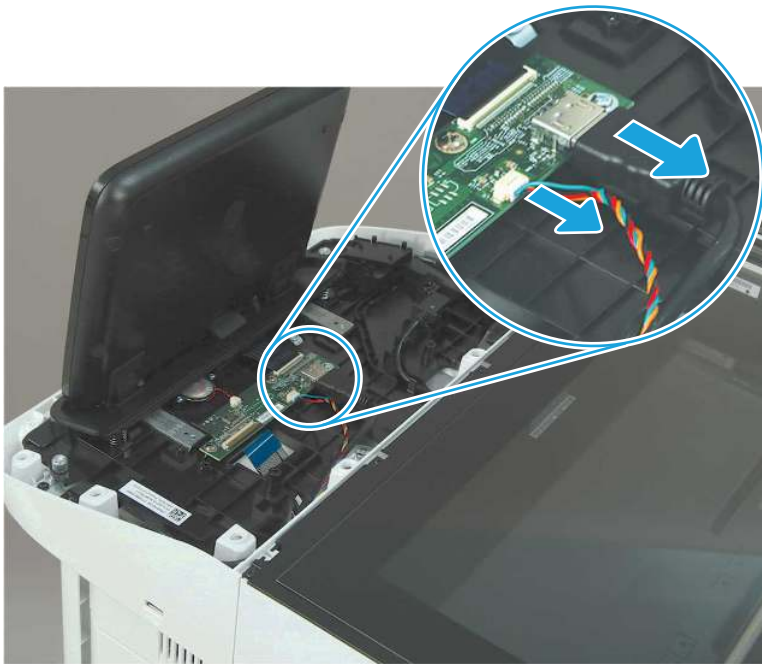
- d. **M776z or M776zs only:** Open the connector latch to release the keyboard flat cable.

Figure 1-830 Release the keyboard flat cable (M776z/M776zs)



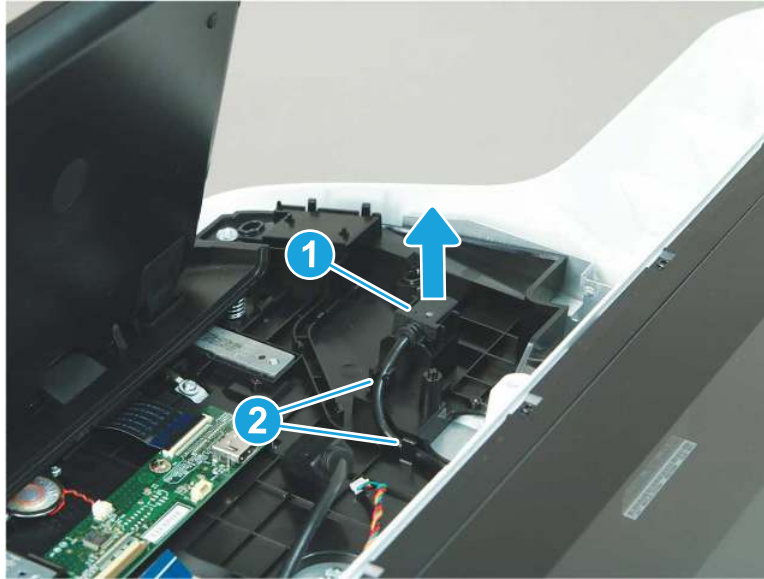
- e. Disconnect two connectors

Figure 1-831 Disconnect two connectors



- f. Remove the USB cable (callout 1) from the holder, and then release the cable from two retainers (callout 2).

Figure 1-832 Release the USB cable



- g. Remove three screws (callout 1).

Figure 1-833 Remove three screws



- h. Lift the front of the control panel off of the printer (callout 1), and then slide it towards the front of the printer (callout 2) to remove it.

Figure 1-834 Remove the control panel



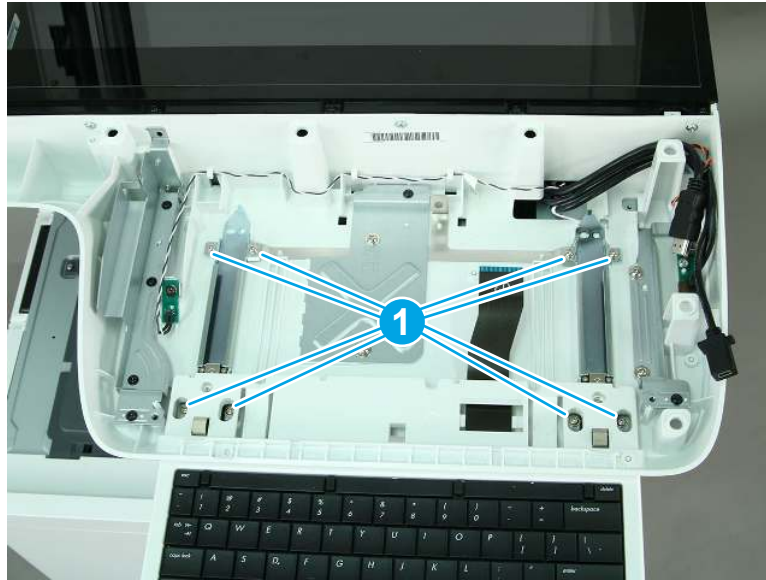
- 7. Remove the keyboard (M776z/M776zs).
 - a. Pull the keyboard out to its extended position.

Figure 1-835 Pull the keyboard out



- b. Remove eight screws (callout 1).

Figure 1-836 Remove eight screws



- c. Remove the keyboard and rails.

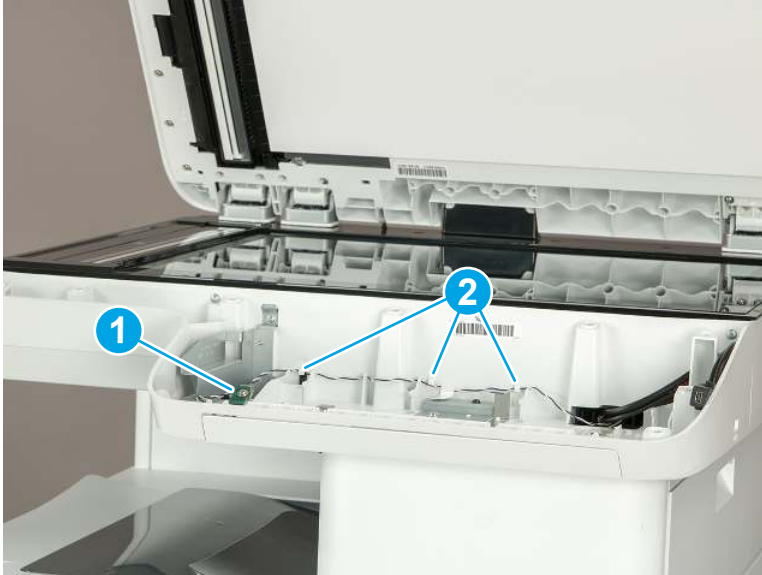
Figure 1-837 Remove the keyboard and rails



- 8. Remove the nose cone (M776).

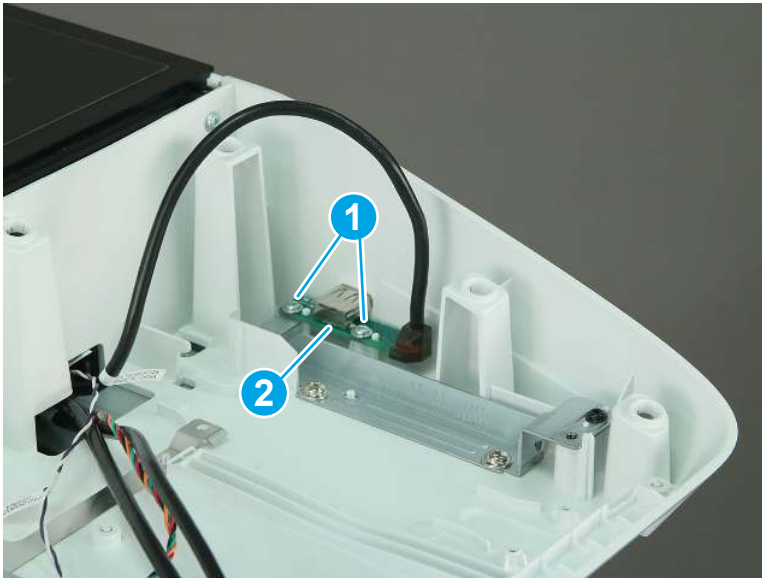
- a. Remove one screw (callout 1) to release the light PCA. Release the cable from three retainers (callout 2), and then move the light PCA out of the way.

Figure 1-838 Release the light PCA



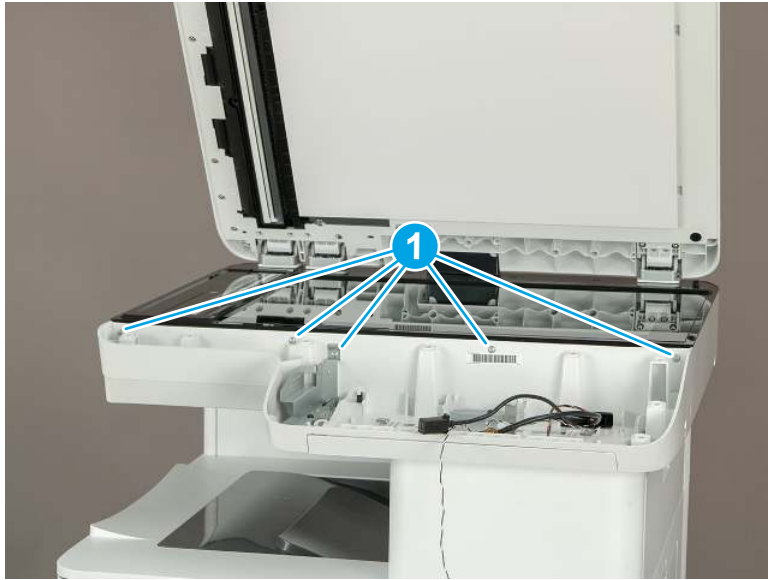
- b. Remove two screws (callout 1), and then move the USB port PCA (callout 2) out of the way.

Figure 1-839 Release the USB port PCA



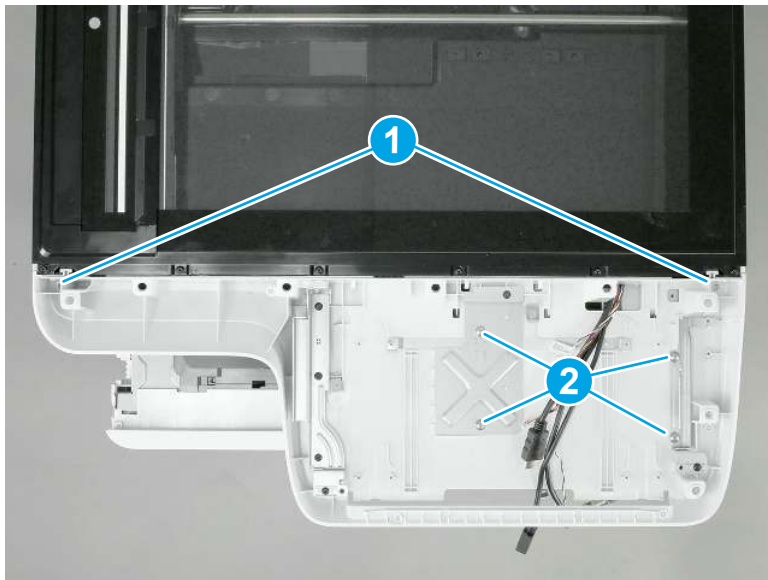
- c. Remove five screws (callout 1).

Figure 1-840 Remove four screws



- d. Remove two small, self-tapping screws (callout 1), and then remove four larger machine screws (callout 2).

Figure 1-841 Remove six screws

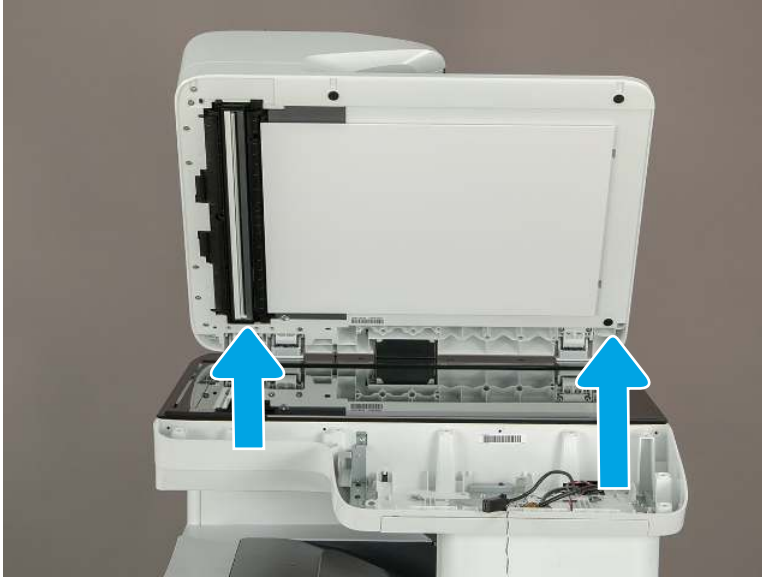


- e. Lift the nose cone up and off of the printer to remove it.



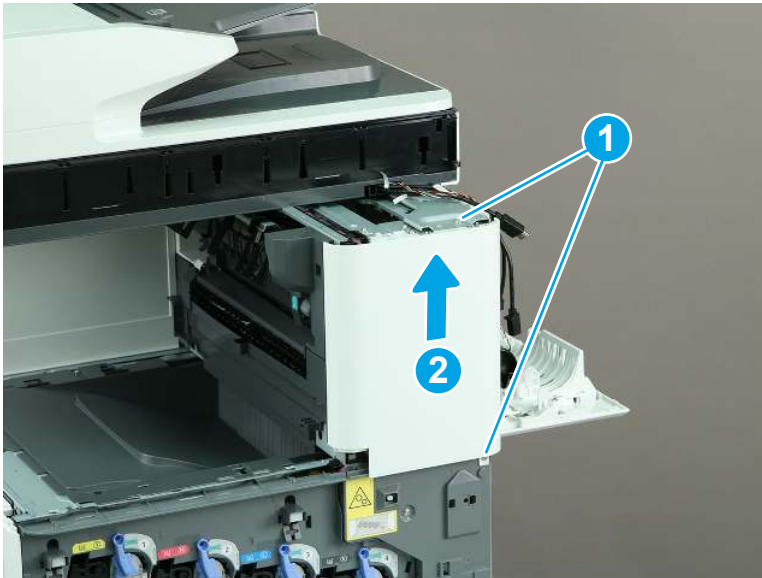
NOTE: Pass the wire harnesses and cables through the opening in the nose cone when removing it.

Figure 1-842 Remove the nose cone



9. Remove the right front cover (M776zs).
 - ▲ Remove two screws (callout 1), release one tab (callout 2), and then slide the right front cover up (callout 2) to remove it.

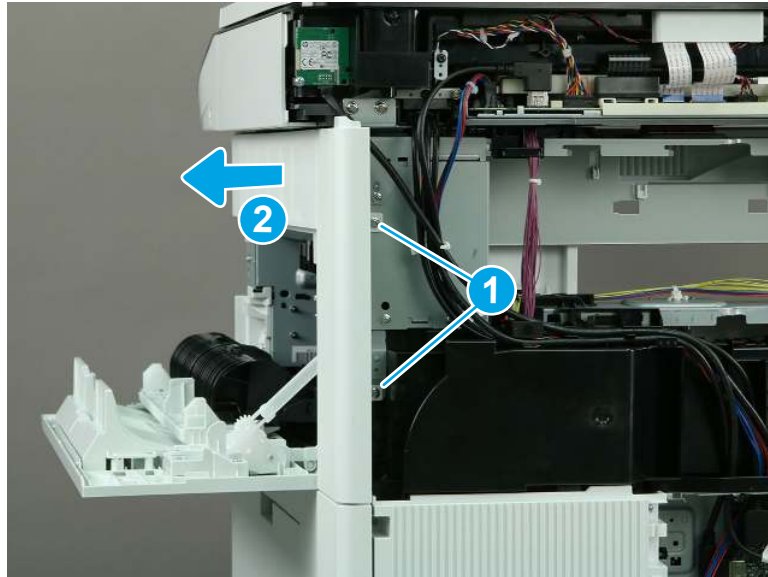
Figure 1-843 Remove the right front cover



10. Remove the right rear upper cover (M776zs).

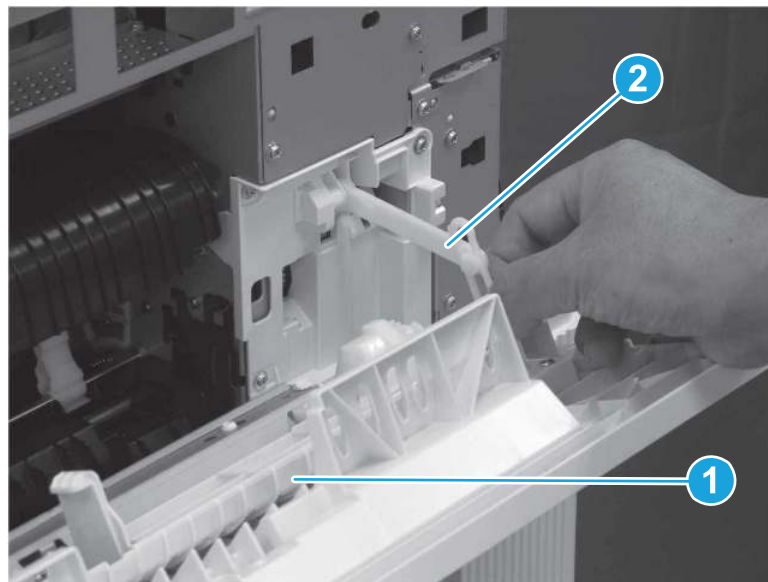
- ▲ Remove two screws (callout 1), and then slide the right rear upper cover away from the printer to remove it (callout 2).

Figure 1-844 Remove the right rear upper cover



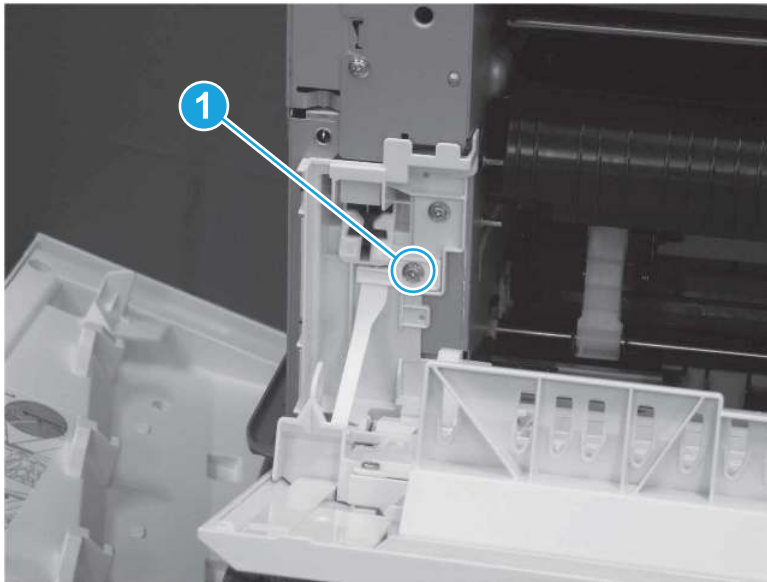
11. Remove the right upper door (M776zs).
 - a. Open the right upper door (callout 1), and then release the link (callout 2).

Figure 1-845 Open the door and release the link



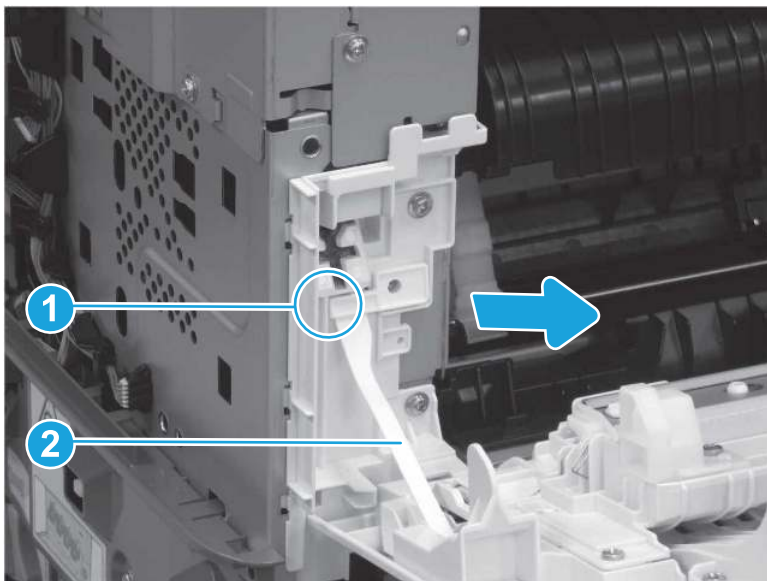
- b. Remove one screw (callout 1).

Figure 1-846 Remove one screw



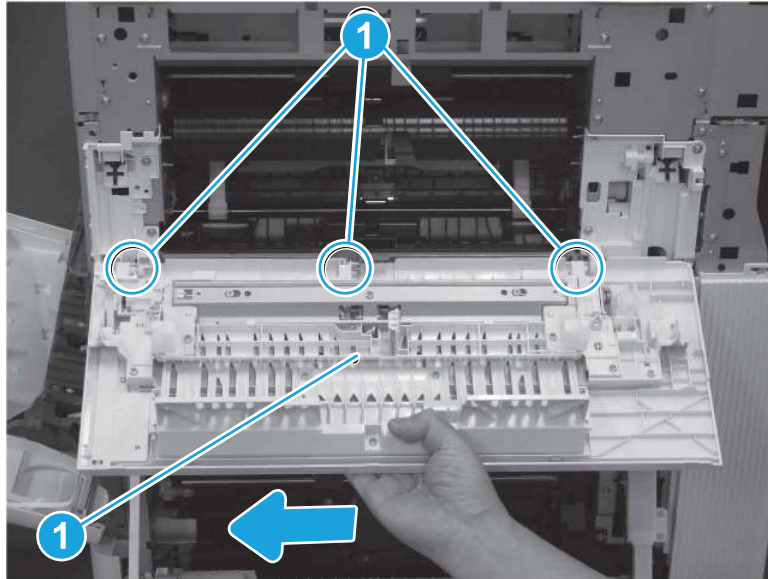
- c. Release one boss (callout 1) and then release the hinge (callout 2) by sliding it to the right.

Figure 1-847 Release one boss and hinge



- d. Slide the right upper door (callout 1) to the right to release it from three bushings (callout 2), and then remove the right upper door.

Figure 1-848 Remove the right upper door



12. Remove the toggle rear assembly (M776zs).

- ▲ Remove two screws (callout 1). Remove one screw (callout 2), and then remove the toggle rear assembly (callout 3) and the link (callout 4) together.


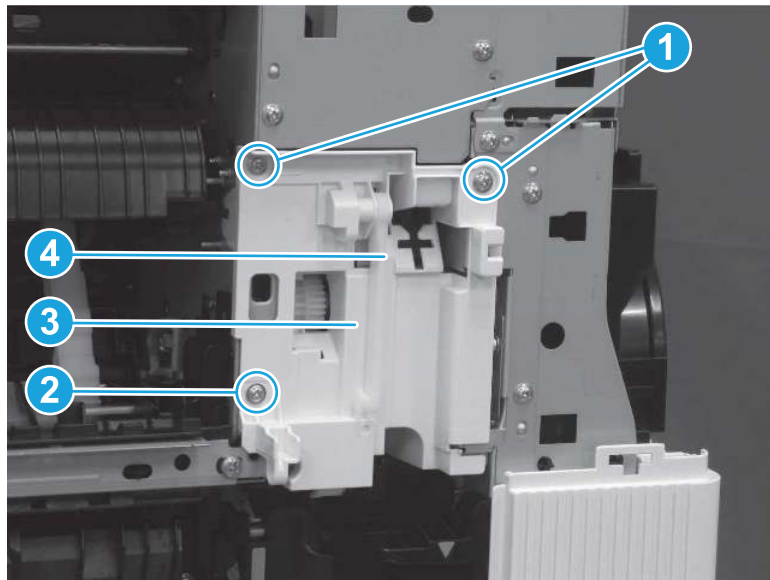
 **NOTE:** The lower screw (callout 2) is shorter than the other two screws. Make sure to reinstall this screw in the correct position.

Figure 1-849 Remove three screws and toggle rear assembly (M776zs)




13. Unpack the replacement assembly.

- a. Dispose of the defective part.


 **NOTE:** HP recommends responsible disposal of the defective part.

<http://www8.hp.com/us/en/hp-information/environment/product-recycling.html>

- b. Unpack the replacement part from the packaging.

 **IMPORTANT:** Make sure that all of the shipping materials (for example shipping tape) are removed from the replacement part prior to installation.

- c. To install an assembly, reverse the removal steps.

 **NOTE:** When applicable, special installation instructions are provided for an assembly at the end of the removal procedure. Always completely read the removal instructions and follow all special installation instructions.

Removal and replacement: Fuser motor (M856/E85055/M776)

Learn how to remove and replace the fuser motor (M856/E85055/M776dn/M776z/M776zs).

Mean time to repair: 30 minutes

Service level: Medium

Before performing service

Turn the printer power off

- Disconnect the power cable.

 **WARNING!** To avoid damage to the printer, turn the printer off, wait 30 seconds, and then remove the power cord before attempting to service the printer.

Use the table below to identify the correct part number for your printer. To order the part, go to www.hp.com/buy/parts.

Table 1-59 Part information

Part number	Part description
RM2-1456-000CN	Fuser motor assembly

Required tools

- #2 Phillips screwdriver with a magnetic tip
- Small, flat-blade screwdriver

After performing service

Turn the printer power on

- Connect the power cable.
- Use the power switch to turn the power on.

Post service test

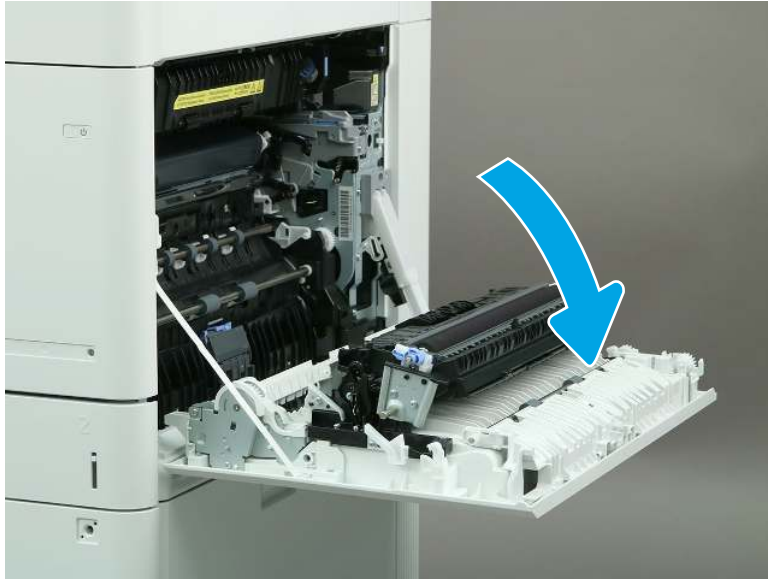
Make sure that the printer initializes to a **Ready** state.

Print a page to make sure that the printer is functioning correctly.

1. Remove the fuser.

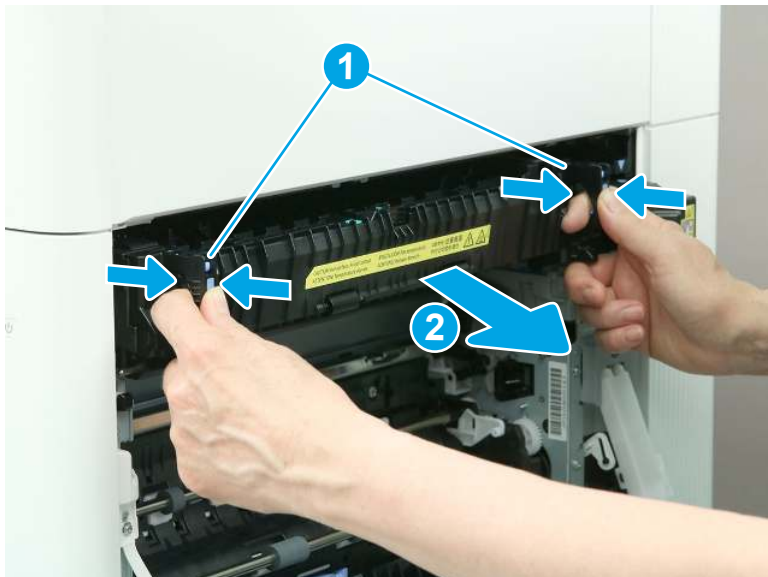
- a. Open the right door.

Figure 1-850 Open the right door



- b. Grasp the fuser handles, and then squeeze the release levers (callout 1). Lift up slightly, and then pull straight out to remove the fuser (callout 2).

Figure 1-851 Remove the fuser



2. Remove the intermediate transfer belt (ITB).

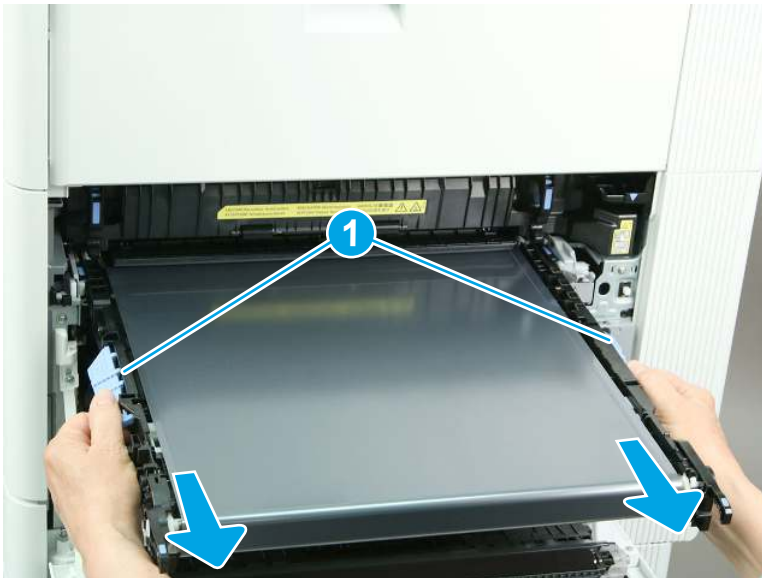
- a. Open the right door. Grasp the two blue handles on the ITB, and then pull the ITB partially out of the printer.

Figure 1-852 Partially remove the ITB



- b. Grasp the blue handles on the side of the ITB (callout 1), and then remove the ITB from the printer.

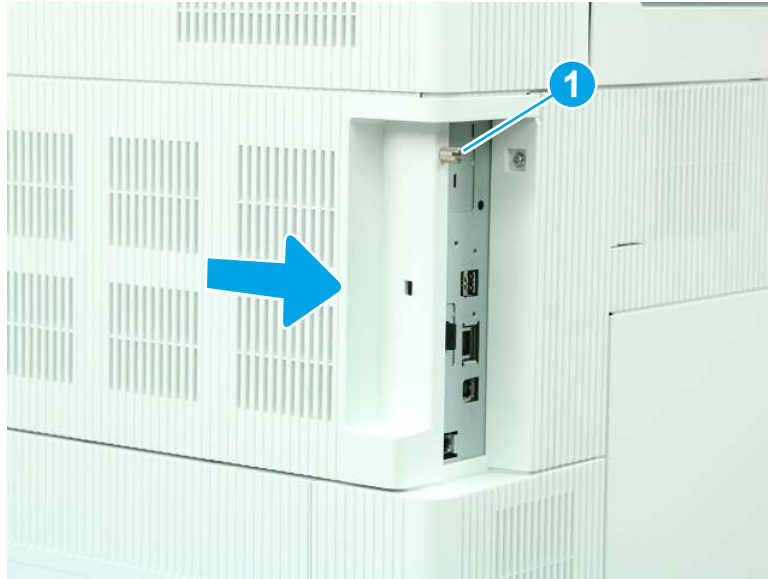
Figure 1-853 Remove the ITB



3. Remove the formatter cover.

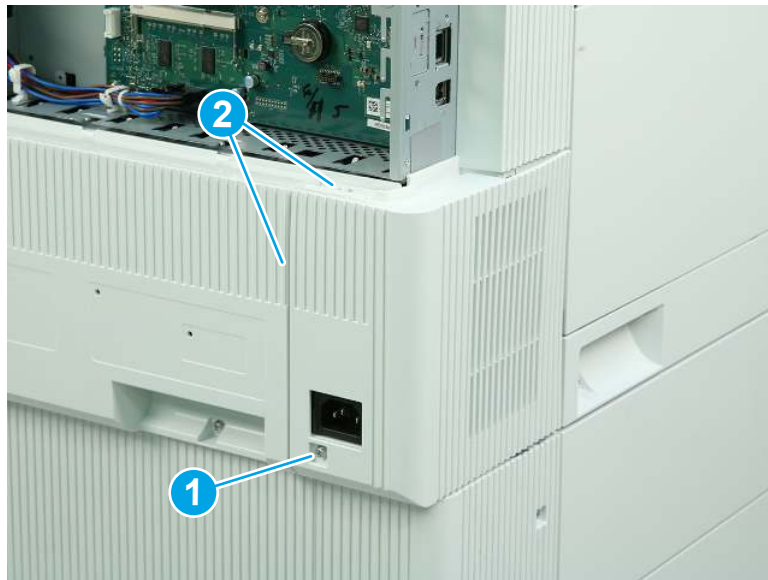
- ▲ Loosen one thumbscrew (callout 1), and then slide the formatter cover (callout 2) away from the printer to remove it.

Figure 1-854 Remove the formatter cover



- 4. Remove the left lower cover (M856/E85055/M776).
 - a. Remove one screw (callout 1), and then release two tabs (callout 2).

Figure 1-855 Remove one screw and release two tabs



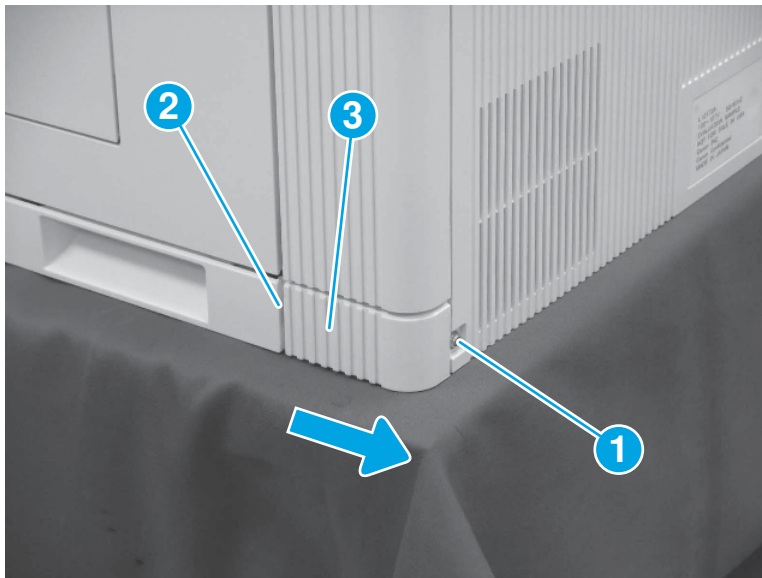
- b. Rotate the cover away from the printer to remove it.

Figure 1-856 Remove the left lower cover



5. Remove the right rear lower cover (M751/E75245/M856/E85055/M776).
 - ▲ Remove one screw (callout 1), release one tab (callout 2), and then slide the right rear lower cover (callout 3) toward the back of the printer to remove it.

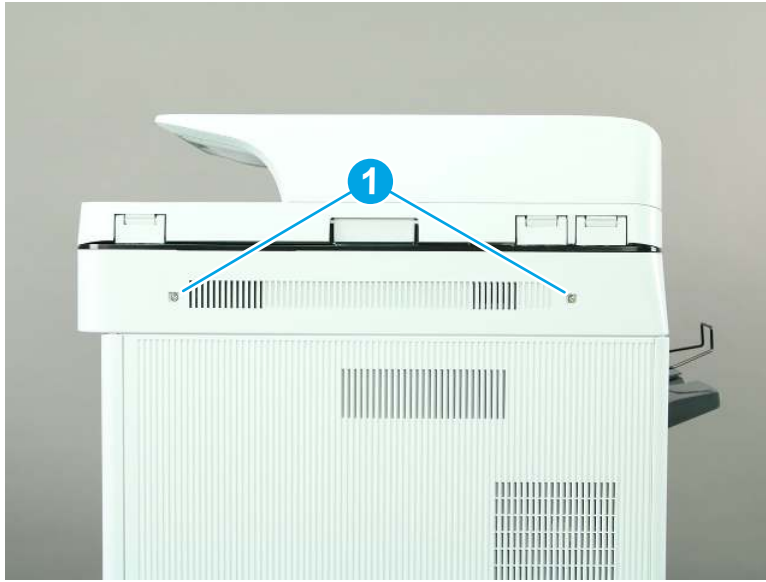
Figure 1-857 Remove the right rear lower cover



6. Remove the scanner control board (SCB) cover (M776).

- a. Remove two screws (callout 1).

Figure 1-858 Remove two screws



- b. Remove the SCB cover.

Figure 1-859 Remove the SCB cover

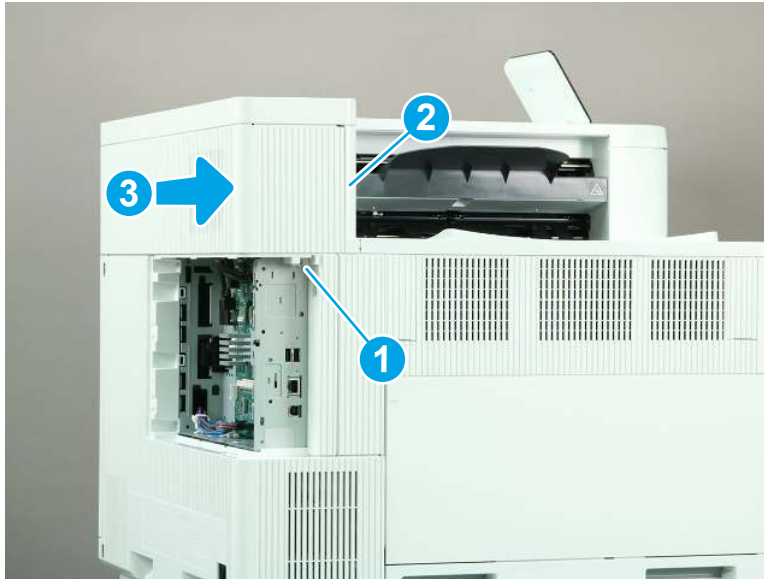


7. Remove the rear upper cover (M856/E85055/M776dn/M776z).

 **NOTE:** The following figure shows the M856 printer. The procedure is correct for all referenced models.

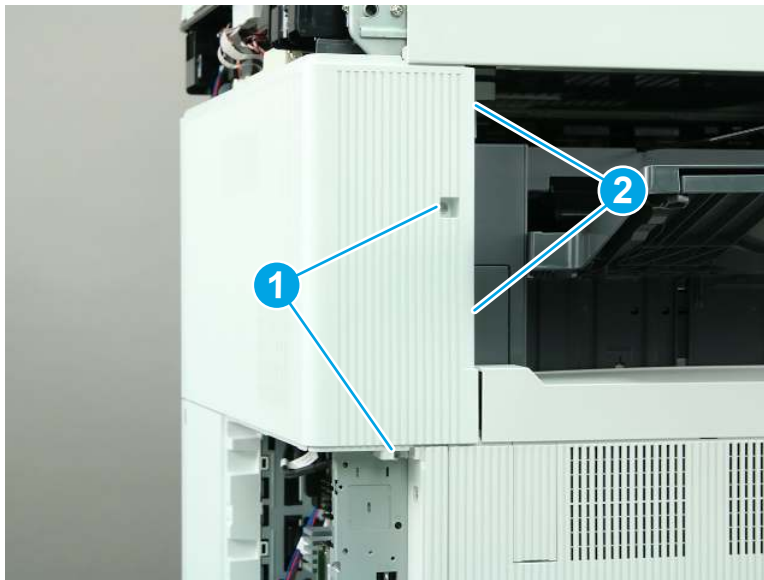
- ▲ Remove one screw (callout 1), release one tab (callout 2), and then slide the rear upper cover away from the printer to remove it (callout 3).

Figure 1-860 Remove the rear upper cover



- 8. Remove the rear upper cover and left rear upper cover (M776zs).
 - a. Remove two screws (callout 1), and then release two tabs (callout 2).

Figure 1-861 Remove two screws and release two tabs



- b. Slide the cover to the right to remove it.

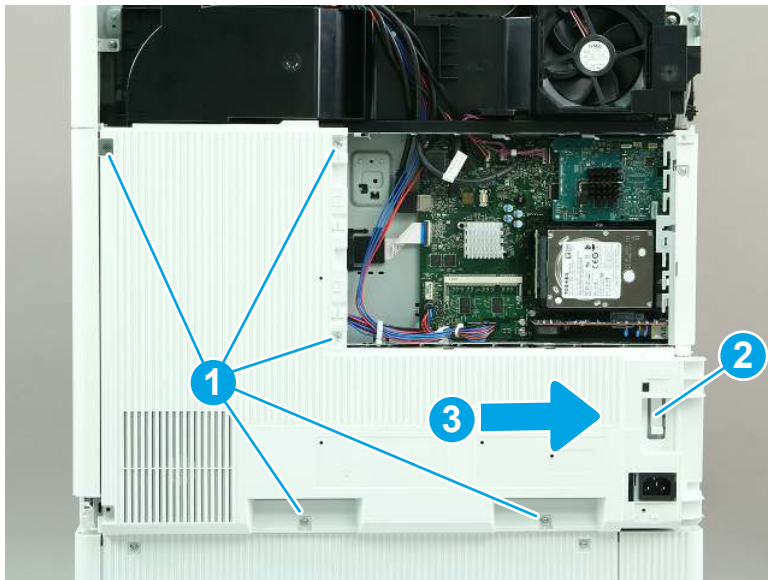
Figure 1-862 Remove the rear upper and left rear upper cover



- 9. Remove the rear cover (M856/E85055/M776).

- ▲ Remove five screws (callout 1), release one tab (callout 2), and then slide the rear cover to the right to remove it.

Figure 1-863 Remove the rear cover (M856/E85055/M776)



- 10. **M856/E85055 only:** Remove the control panel and top cover.

 **NOTE:** This step applies to only the M856/E85055 models. Skip this step for all other models.

- a. Use a small, flat-blade screwdriver to release two tabs (callout 1), and then remove the control panel cover (callout 2).

Figure 1-864 Remove the control panel cover



- b. Remove one screw (callout 1).

Figure 1-865 Remove one screw



- c. Lift the back edge of the control panel up (callout 1), and then slide the control panel toward the back of the printer (callout 2).

Figure 1-866 Slide the control panel back



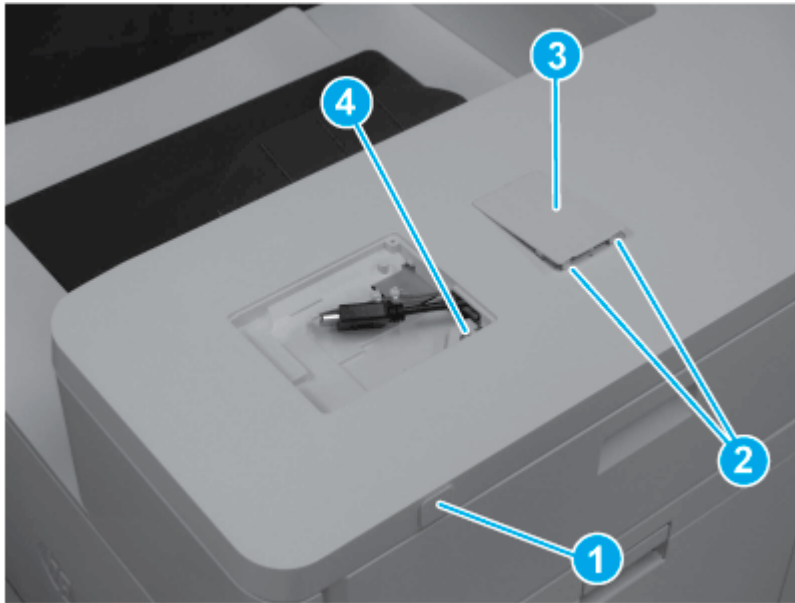
- d. Turn the control panel so that the bottom is facing up, and then disconnect two connectors to remove the control panel.

Figure 1-867 Disconnect two connectors



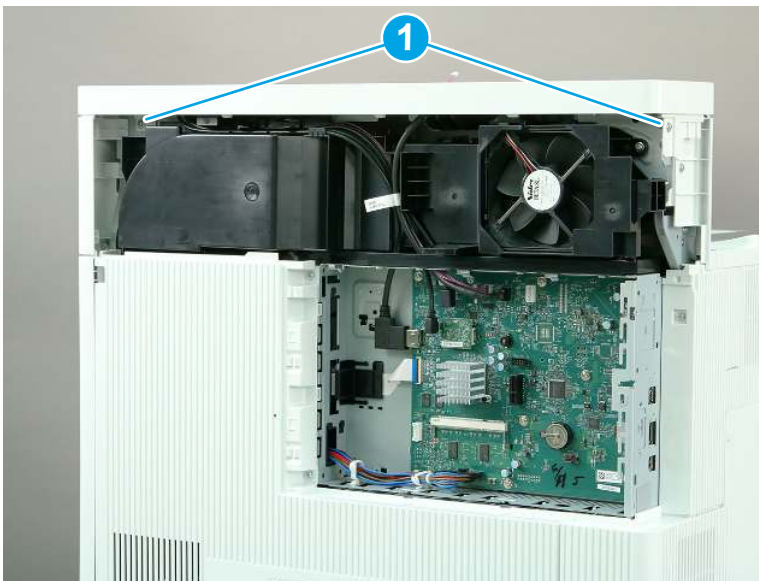
- e. Remove the USB cover (callout 1). Release two tabs (callout 2), and then remove the HIP cover (callout 3). Remove one screw (callout 4).

Figure 1-868 Remove covers and one screw



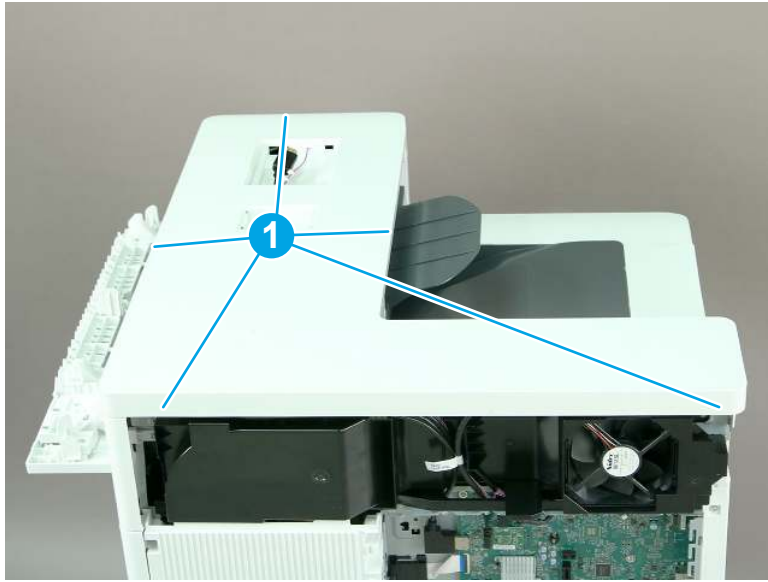
- f. Remove two screws (callout 1).

Figure 1-869 Remove two screws



- g. Release five tabs (callout 1), and then remove the top cover.

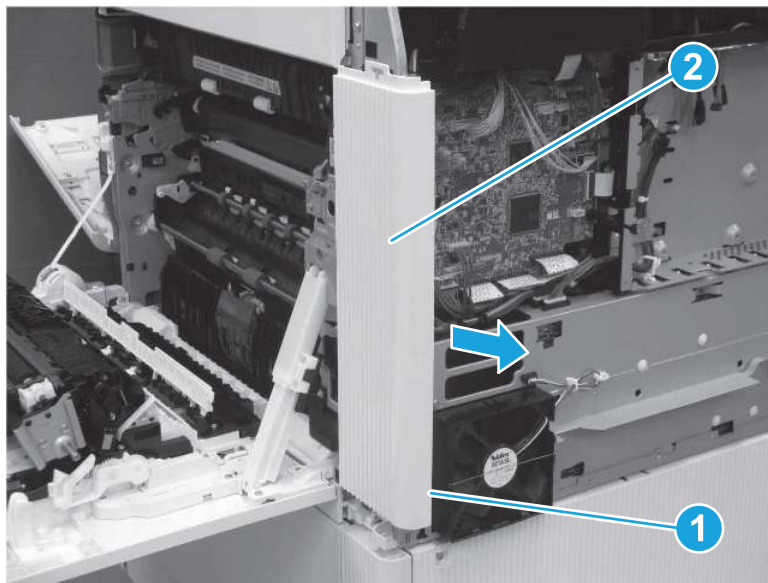
Figure 1-870 Release five tabs



11. Remove the right rear cover (M856/E85055/M776).

- ▲ Release one tab (callout 1), and then slide the rear cover away from the printer to remove it.

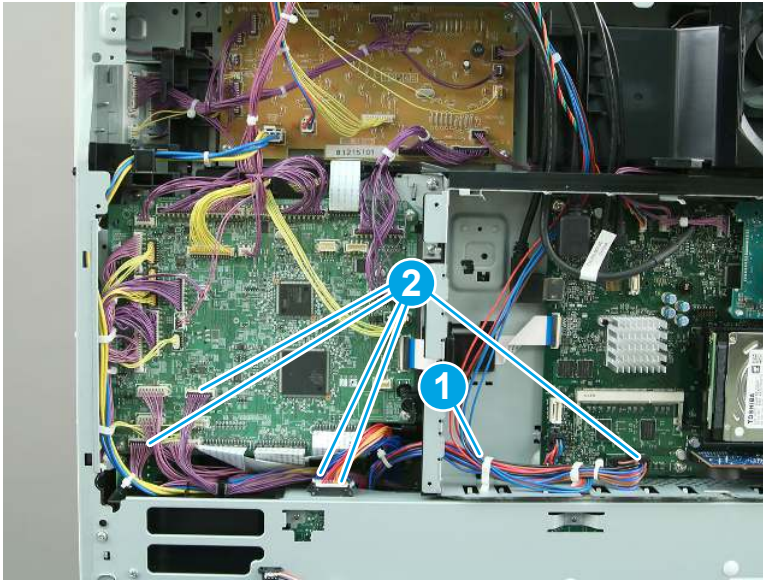
Figure 1-871 Remove right rear cover



12. Remove the low-voltage power supply (LVPS) (M856/E85055/M776).

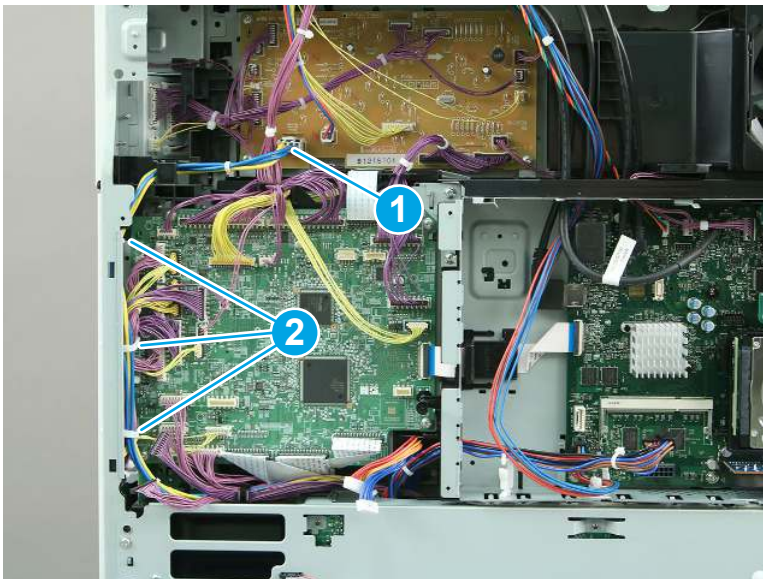
- a. Release one retainer (callout 1), and then disconnect five connectors (callout 2).

Figure 1-872 Release the retainer and disconnect five connectors



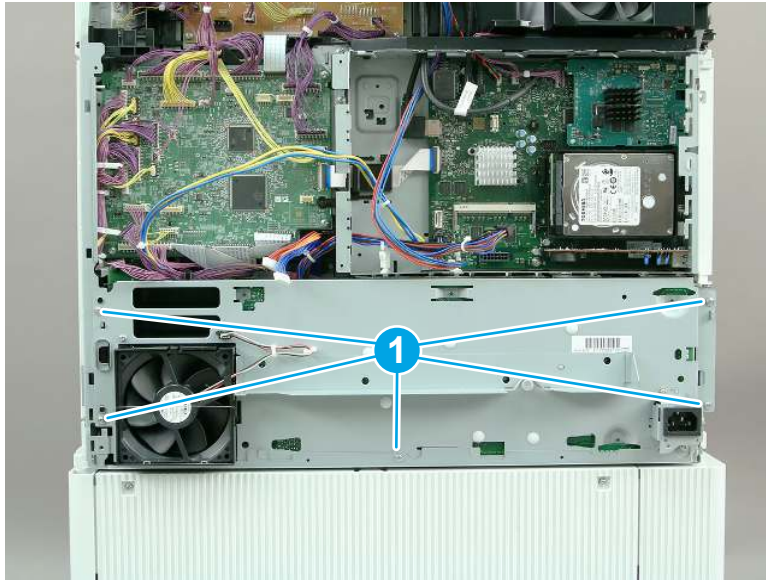
- b. Disconnect one connector (callout 1), and then release three retainers (callout 2).

Figure 1-873 Disconnect one connector and release five retainers




- c. Remove five screws (callout 1).

Figure 1-874 Remove five screws



- d. Tilt the LVPS away from the printer (callout 1). Thread the cable (callout 2) through the opening in the formatter case.

 **NOTE:** Due to mechanical tolerances on the formatter cage, rotating the LVPS out might be difficult.


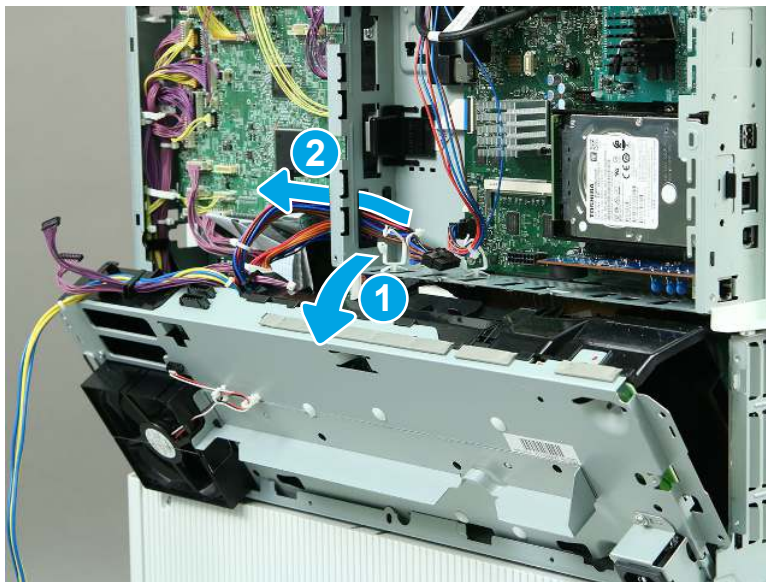
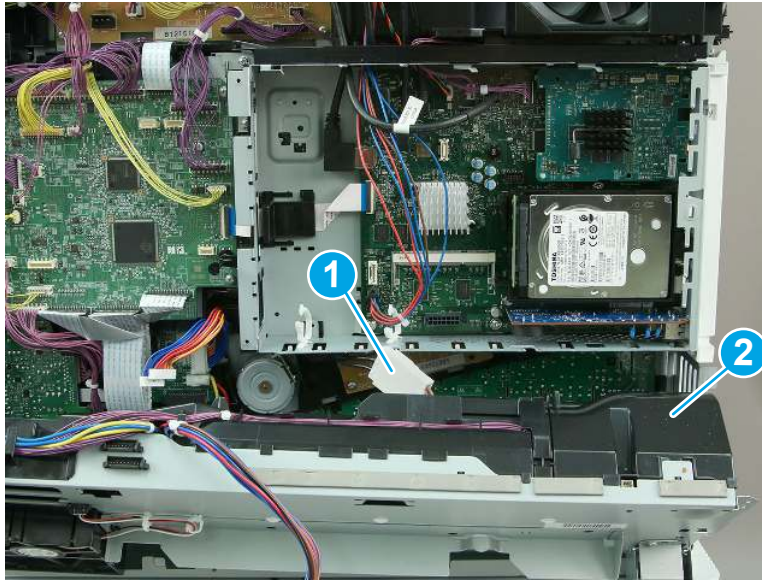
 **CAUTION:** One connector is still connected, so tilt the LVPS carefully.

Figure 1-875 Thread the cable



- e. Disconnect one connector (callout 1), and then lift up to remove the LVPS (callout 2).

Figure 1-876 Remove the LVPS



- 13. Remove the formatter and case (M856/E85055/M776).

 **NOTE:** The figures below show the M776zs formatter. The procedure is correct for all referenced models.

- a. Release two retainers (callout 1), and then open the retainer (callout 2) to release the flat cable. Disconnect all of the remaining connectors on the formatter board.


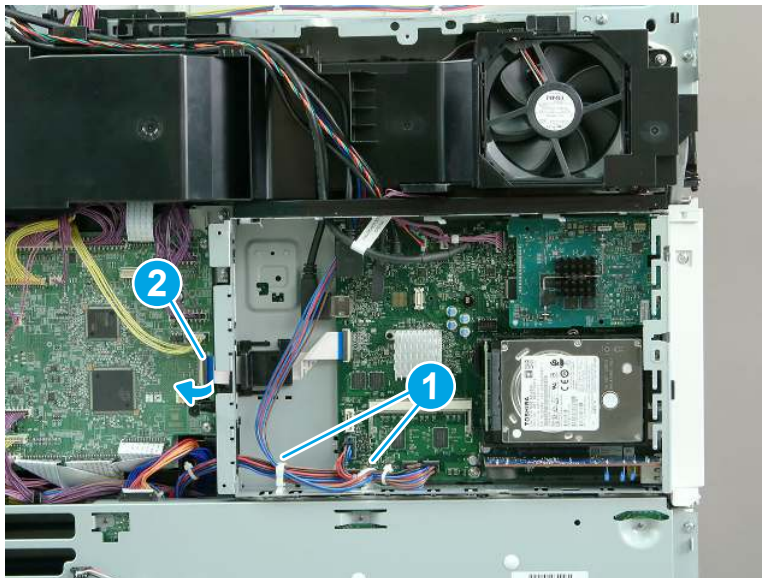
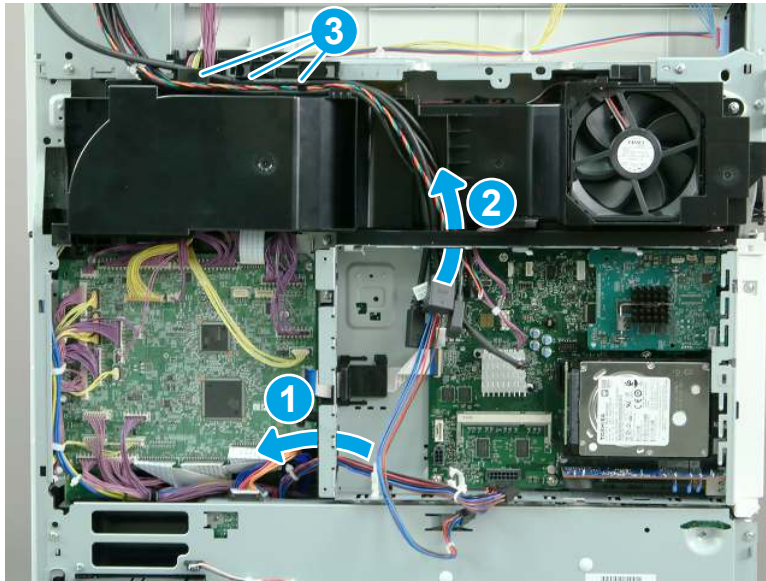
 **NOTE:** The figures below show the M776zs model. The procedures are correct for all of the referenced models.

Figure 1-877 Disconnect the connectors



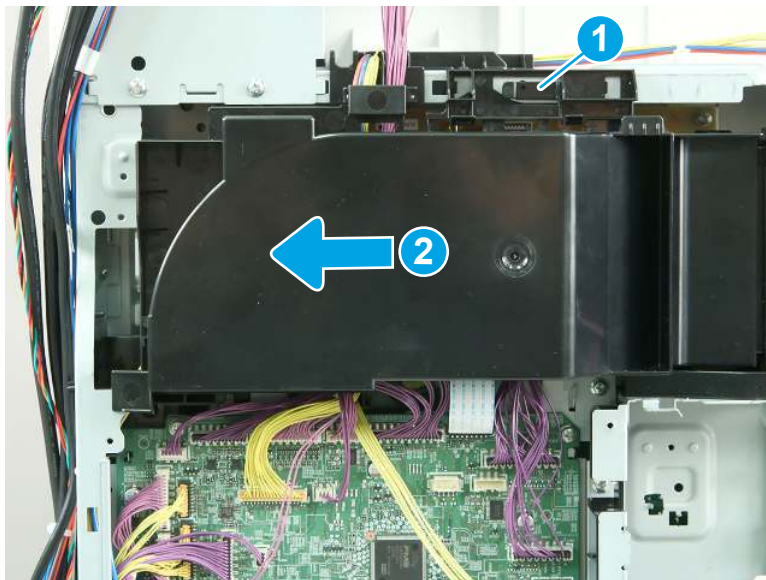
- b. Release one cable through the opening in the left side of the formatter case (callout 1). Release the remaining cables through the opening in the top of the formatter case (callout 2). Release the cables from the upper cable guide (callout 3).

Figure 1-878 Release the cables



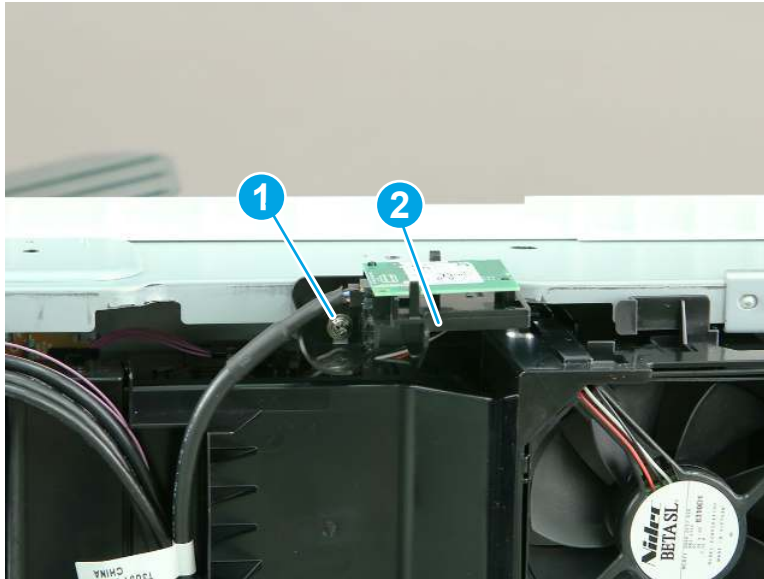
- c. Release one tab (callout 1), and then slide the fan duct to the left (callout 2) to remove it.

Figure 1-879 Remove the fan duct



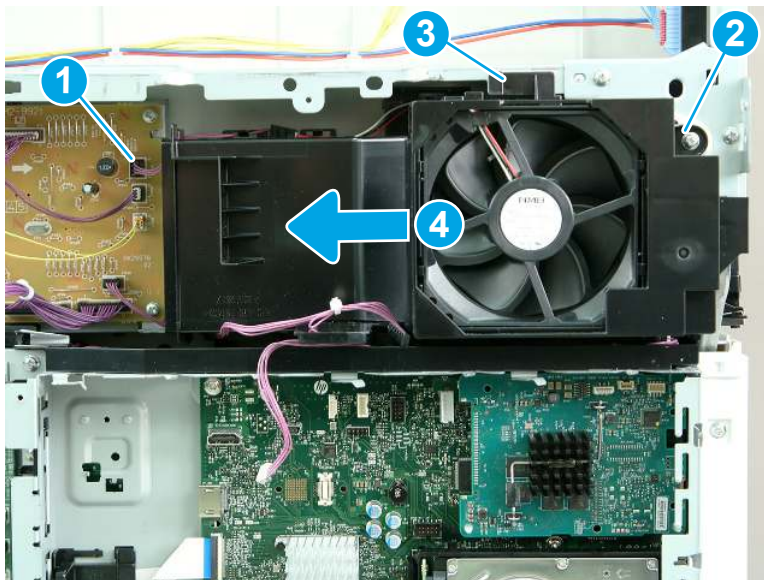
- d. **M856 and E85055 only:** Remove one screw (callout 1), and then remove the wireless card and bracket (callout 2).

Figure 1-880 Remove the wireless card and bracket



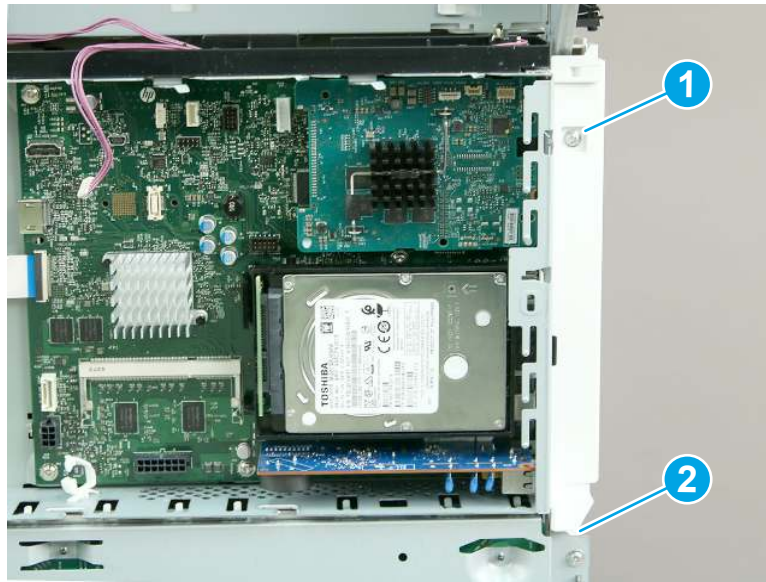
- e. Disconnect one connector (callout 1), and remove one screw (callout 2). Release one tab (callout 3), and then slide the fan assembly to the left (callout 4) to remove it.

Figure 1-881 Remove the fan assembly



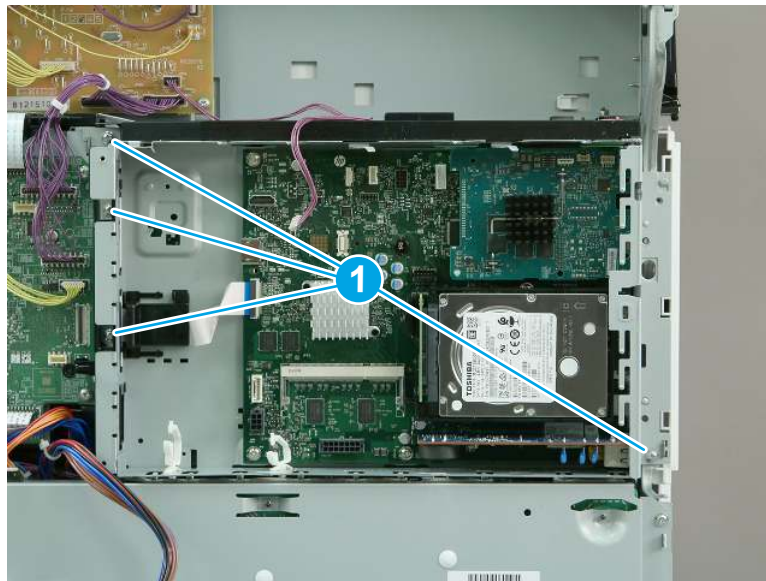
- f. Remove one screw (callout 1), release one tab (callout 2), and then remove the left rear cover.

Figure 1-882 Remove the left rear cover



- g. Remove four screws (callout 1).

Figure 1-883 Remove four screws



- h. Remove the formatter and case.

Figure 1-884 Remove the formatter and case



- 14. Remove the upper high-voltage power supply (HVPS) (M856/E85055/M776).
 - a. Disconnect one connector (callout 1), and then remove one screw (callout 2).

Figure 1-885 Disconnect one connector and remove one screw



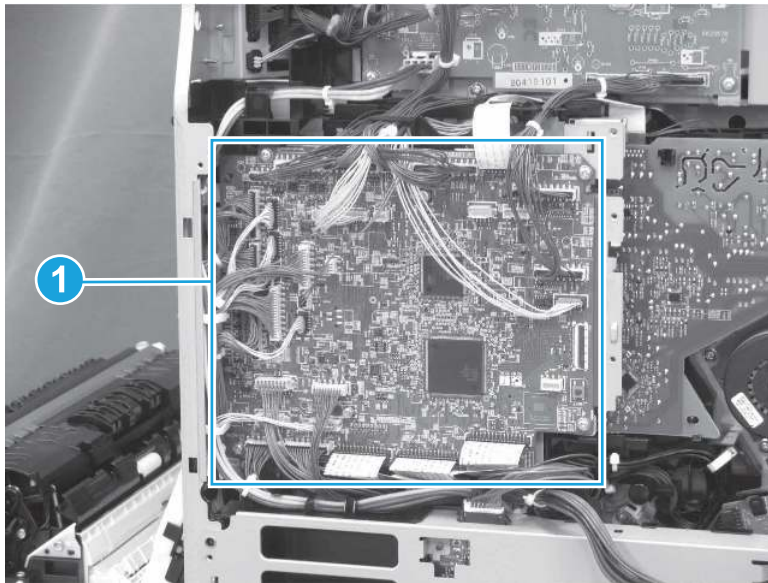
- b. Release six tabs (callout 1), and then remove the upper HVPS.

Figure 1-886 Release six tabs



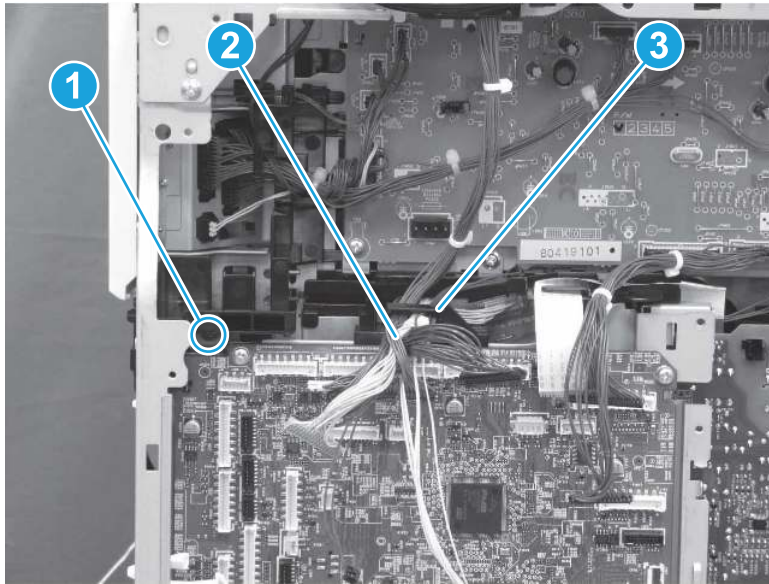
15. Remove the DC controller and case (M856/E85055/M776).
 - a. Disconnect all of the connectors on the DC controller.

Figure 1-887 Disconnect the connectors



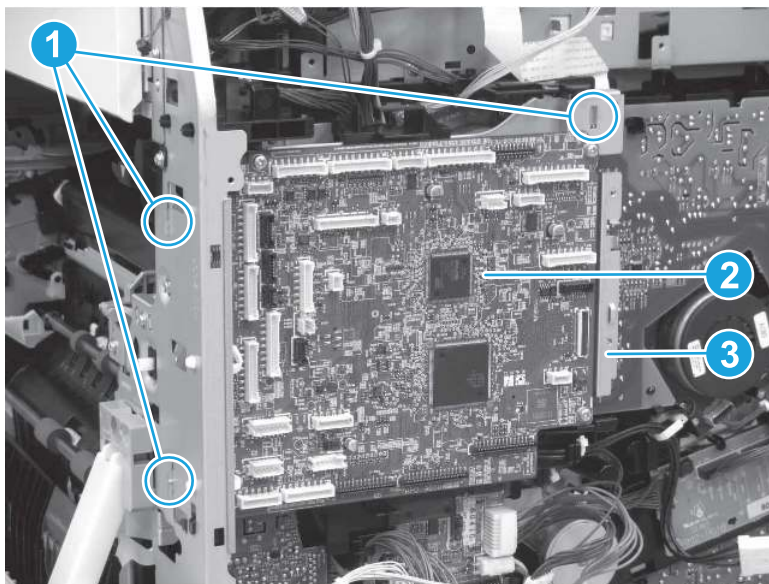
- b. Remove one screw (callout 1), and then release the cables (callout 2) from the cable guide (callout 3).

Figure 1-888 Remove one screw and release the cables



- c. Remove one screw (callout 1), and then remove the DC controller (callout 2) together with the metal case (callout 3).

Figure 1-889 Remove the DC controller and case

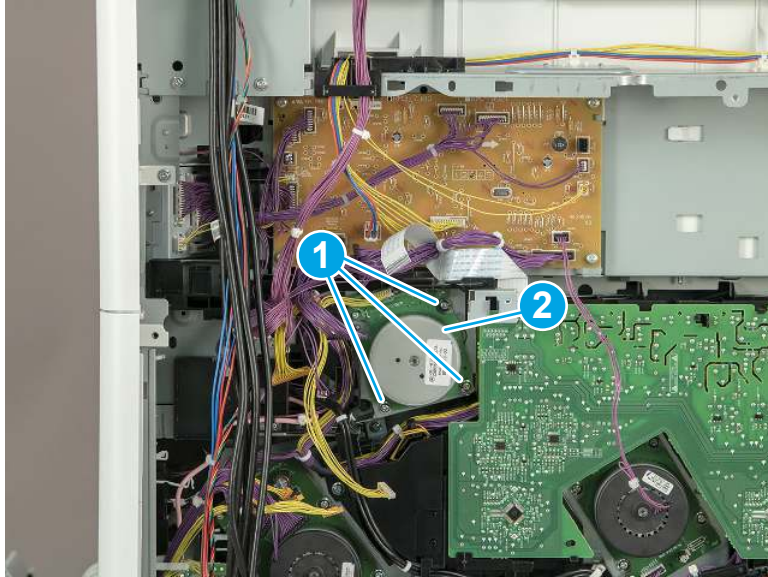


16. Remove the fuser motor (M856/E85055/M776).

- ▲ Remove three screws (callout 1), and then remove the fuser motor (callout 2).

 **NOTE:** Disconnect the connector on the motor and reconnect it to the replacement part.

Figure 1-890 Remove the fuser motor



17. Unpack the replacement assembly.

- a. Dispose of the defective part.



NOTE: HP recommends responsible disposal of the defective part.

<http://www8.hp.com/us/en/hp-information/environment/product-recycling.html>

- b. Unpack the replacement part from the packaging.



IMPORTANT: Make sure that all of the shipping materials (for example shipping tape) are removed from the replacement part prior to installation.

- c. To install an assembly, reverse the removal steps.



NOTE: When applicable, special installation instructions are provided for an assembly at the end of the removal procedure. Always completely read the removal instructions and follow all special installation instructions.

Removal and replacement: Fuser drive assembly (M751/E75245)

Learn how to remove and replace the fuser drive assembly.

[View a video of how to remove and replace the fuser drive assembly.](#)

Mean time to repair: 42 minutes

Service level: Medium

Before performing service

Turn the printer power off

- Disconnect the power cable.



WARNING! To avoid damage to the printer, turn the printer off, wait 30 seconds, and then remove the power cord before attempting to service the printer.

Use the table below to identify the correct part number for your printer. To order the part, go to www.hp.com/buy/parts.

Table 1-60 Part information

Part number	Part description
RM2-1391-000CN	Fuser drive assembly

Required tools

- #2 Phillips screwdriver with a magnetic tip
- Small, flat-blade screwdriver

After performing service

Turn the printer power on

- Connect the power cable.
- Use the power switch to turn the power on.

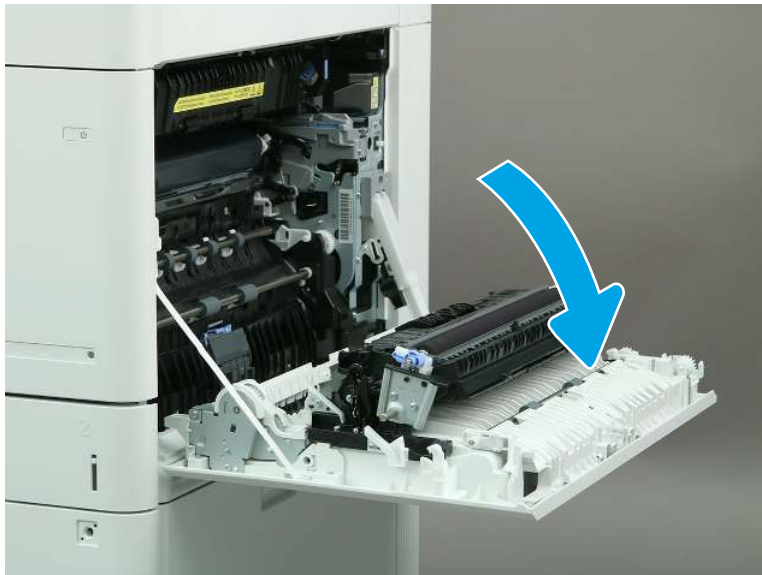
Post service test

Make sure that the printer initializes to a **Ready** state.

Print a page to make sure that the printer is functioning correctly.

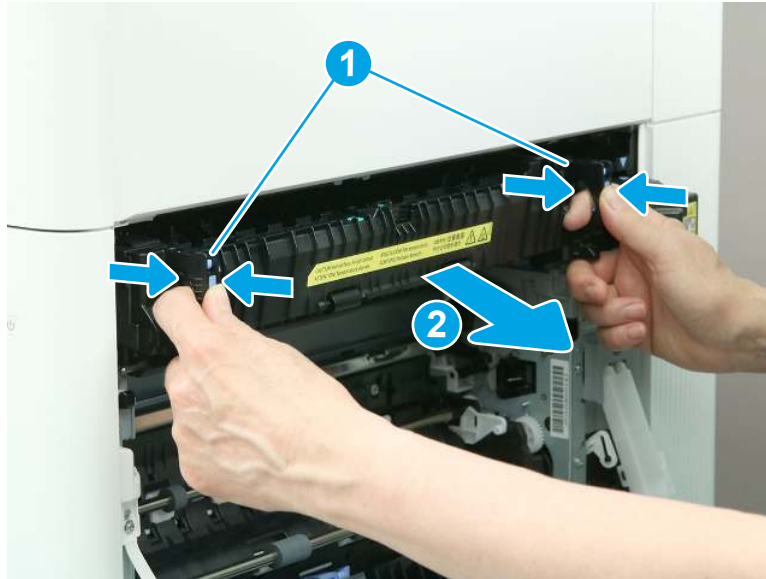
1. Remove the fuser.
 - a. Open the right door.

Figure 1-891 Open the right door



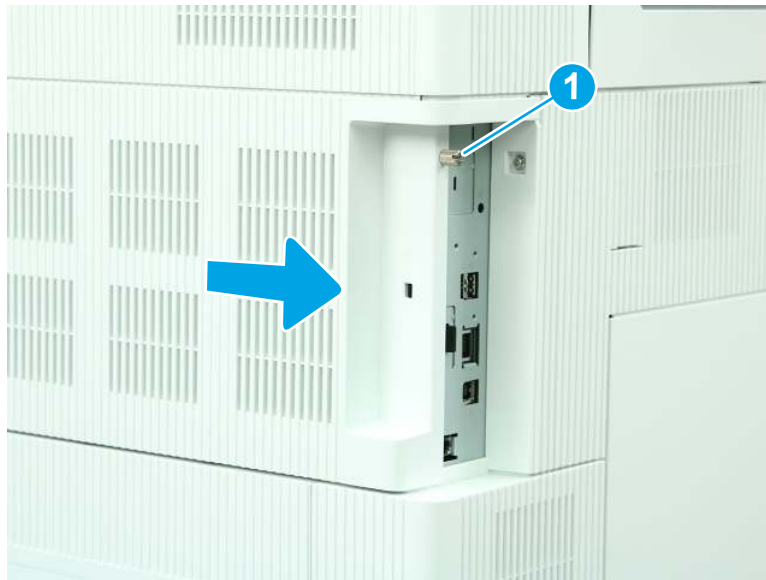
- b. Grasp the fuser handles, and then squeeze the release levers (callout 1). Lift up slightly, and then pull straight out to remove the fuser (callout 2).

Figure 1-892 Remove the fuser



2. Remove the formatter cover.
 - ▲ Loosen one thumbscrew (callout 1), and then slide the formatter cover (callout 2) away from the printer to remove it.

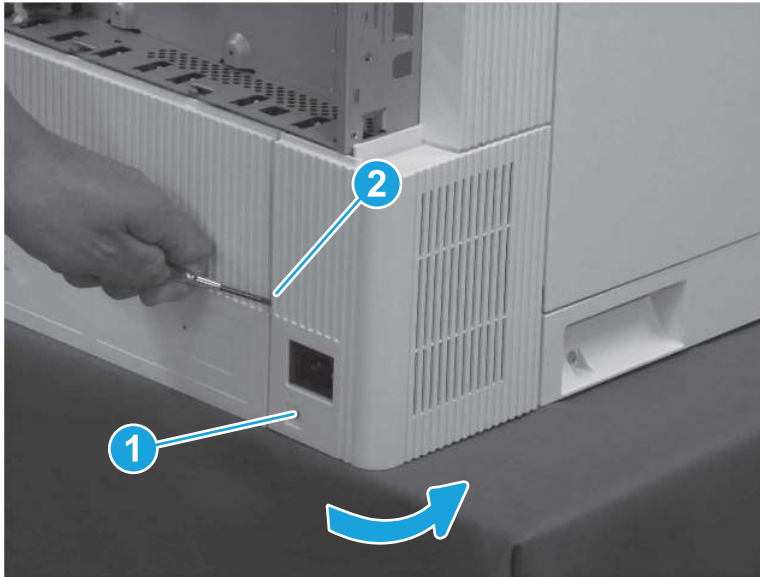
Figure 1-893 Remove the formatter cover



3. Remove the left lower cover (M751/E75245).

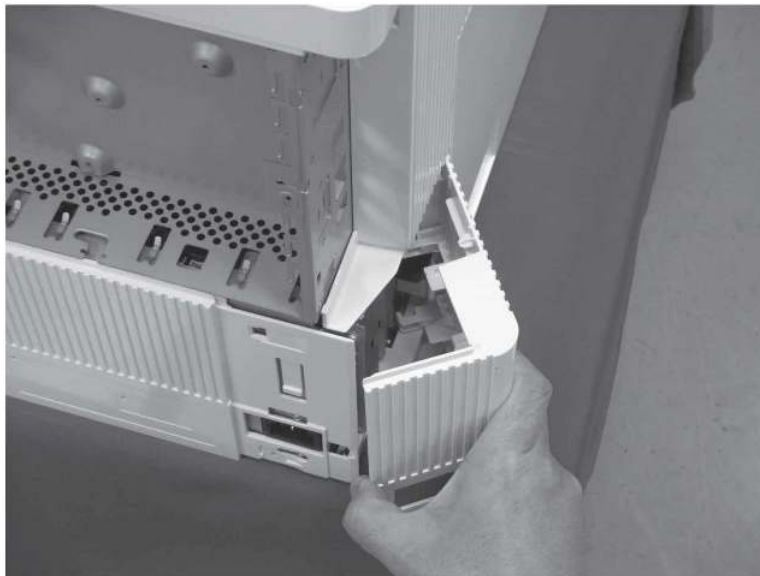
- a. Remove one screw (callout 1), release one tab (callout 2), and then rotate the cover away from the printer.

Figure 1-894 Remove one screw and release one tab



- b. Remove the left lower cover.

Figure 1-895 Remove the left lower cover



4. Remove the left rear cover (M751/E75245/M856/E85055/M776).

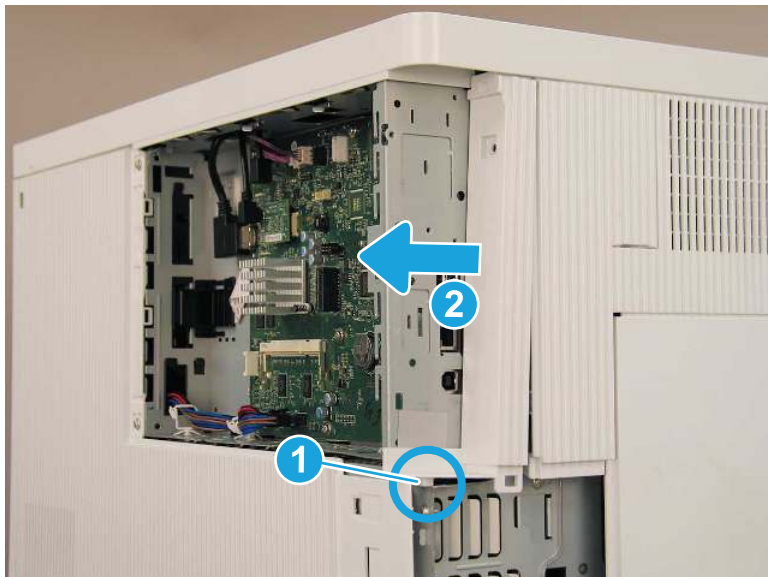
- a. Remove one screw (callout 1).

Figure 1-896 Remove one screw



- b. Release one boss (callout 1), and then slide the cover toward the back of the printer (callout 2) to remove it.

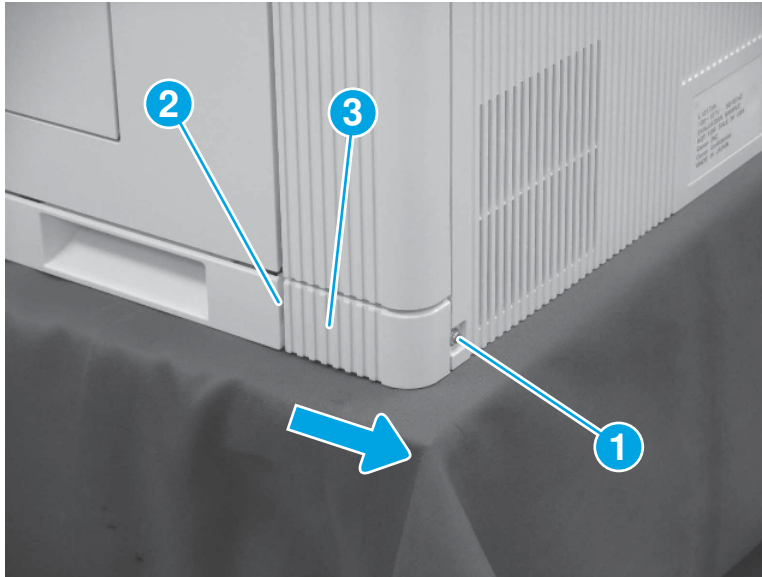
Figure 1-897 Remove the left rear cover



5. Remove the right rear lower cover (M751/E75245/M856/E85055/M776).

- ▲ Remove one screw (callout 1), release one tab (callout 2), and then slide the right rear lower cover (callout 3) toward the back of the printer to remove it.

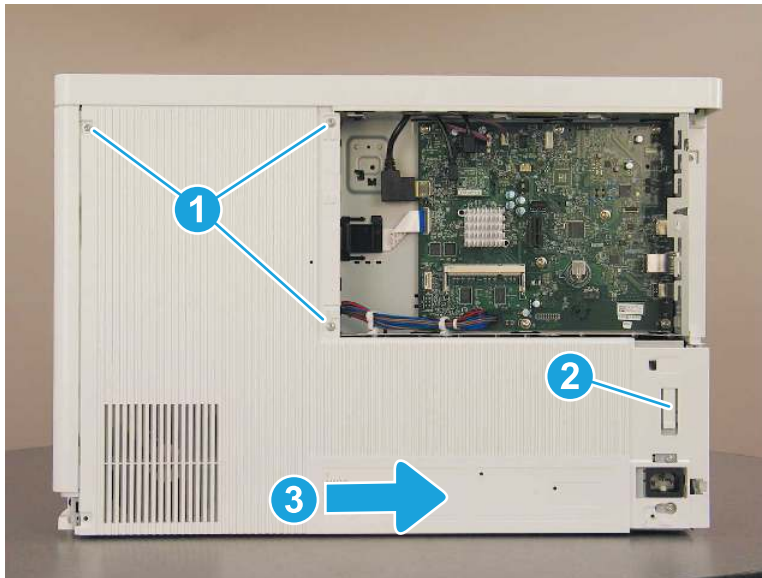
Figure 1-898 Remove the right rear lower cover



6. Remove the rear cover (M751/E75245).

- ▲ Remove three screws (callout 1), release one tab (callout 2), and then slide the rear cover to the right (callout 3) to remove it.

Figure 1-899 Remove the rear cover

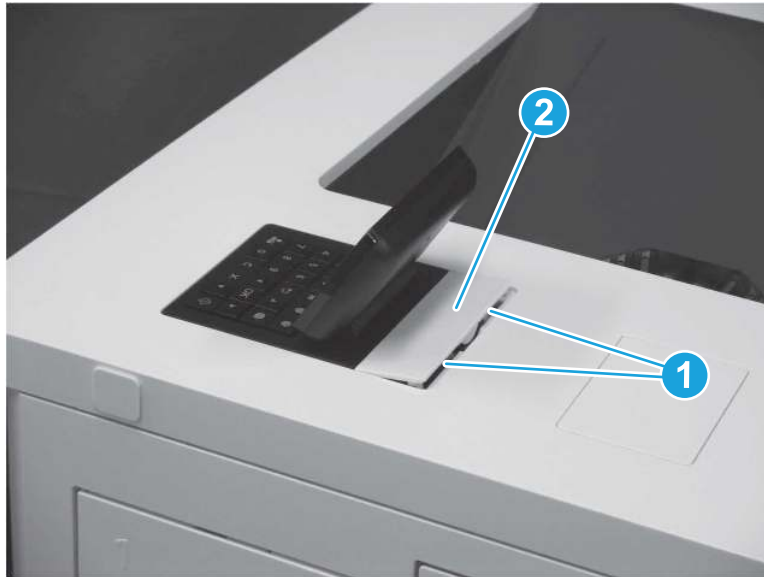


7. Remove the control panel.

 **NOTE:** A screwdriver is included in the control panel kit. The screwdriver has a reversible shaft. Simply pull the shaft out of the handle, and then reinstall it with the desired end facing out.

- a. Use a small, flat-blade screwdriver to release two tabs (callout 1), and then remove the control panel cover (callout 2).

Figure 1-900 Remove the control panel cover



- b. Remove one screw (callout 1).

Figure 1-901 Remove one screw



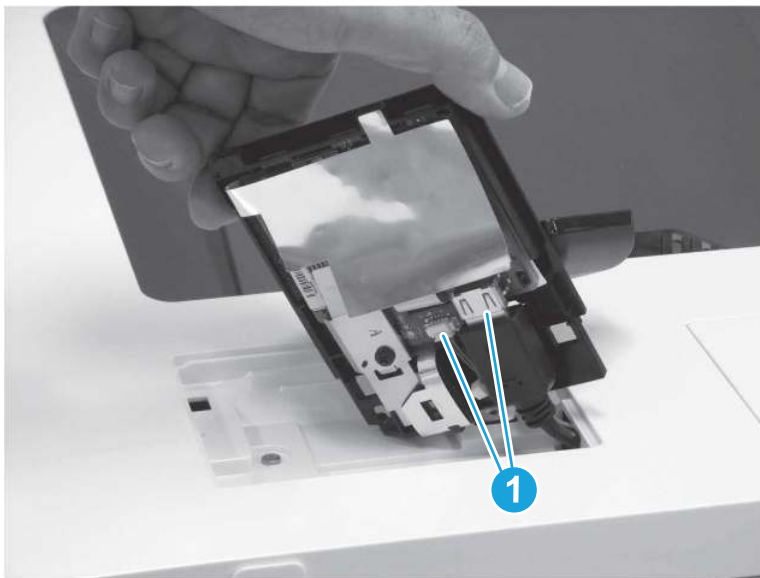
- c. Lift the back edge of the control panel up (callout 1), and then slide the control panel toward the back of the printer (callout 2).

Figure 1-902 Slide the control panel back



- d. Turn the control panel so that the bottom is facing up, and then disconnect two connectors (callout 1) to remove the control panel.

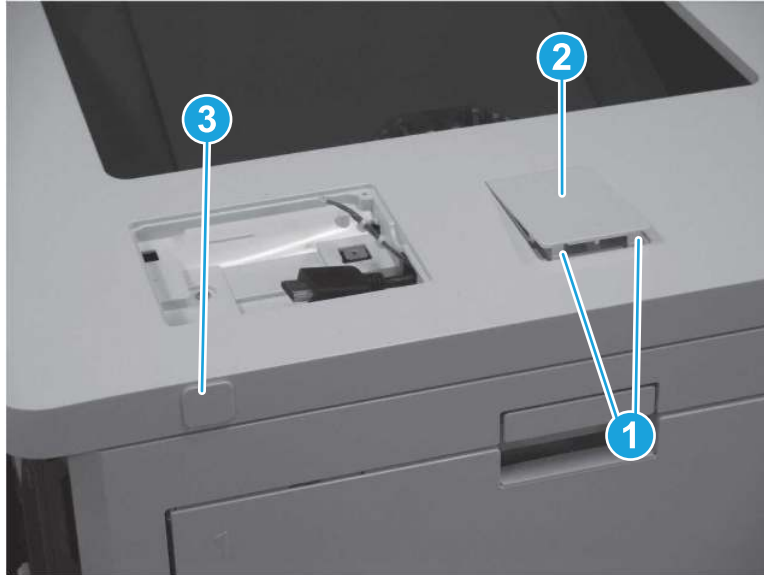
Figure 1-903 Disconnect two connectors



8. Remove the top cover (M751/E75245).

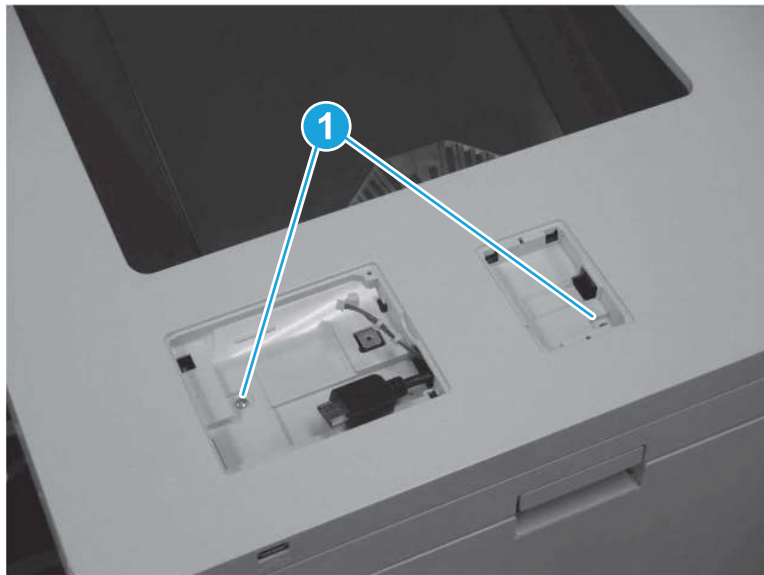
- a. Release two tabs (callout 1), and then remove the HIP cover (callout 2). Pull the USB cap (callout 3) away from the printer to remove it.

Figure 1-904 Remove the HIP cover and USB cap



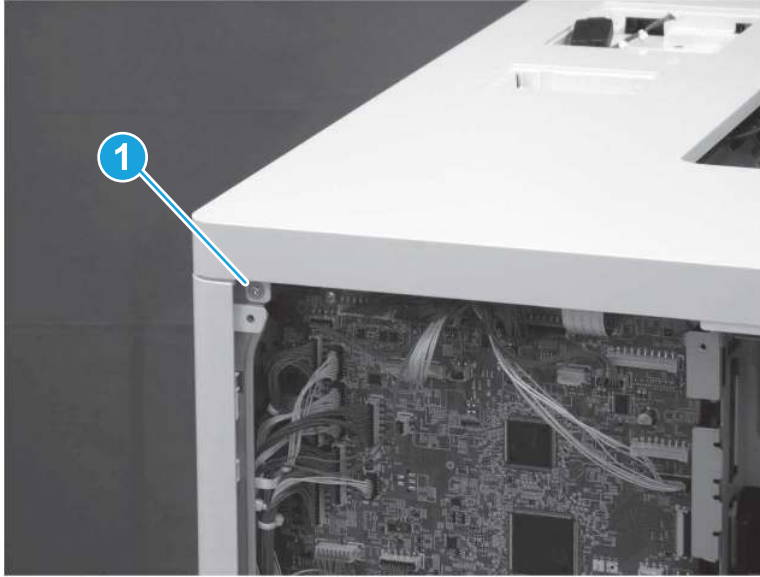
- b. At the top of the printer, remove two screws (callout 1).

Figure 1-905 Remove two screws




- c. At the back of the printer, remove one screw (callout 1).

Figure 1-906 Remove one screw

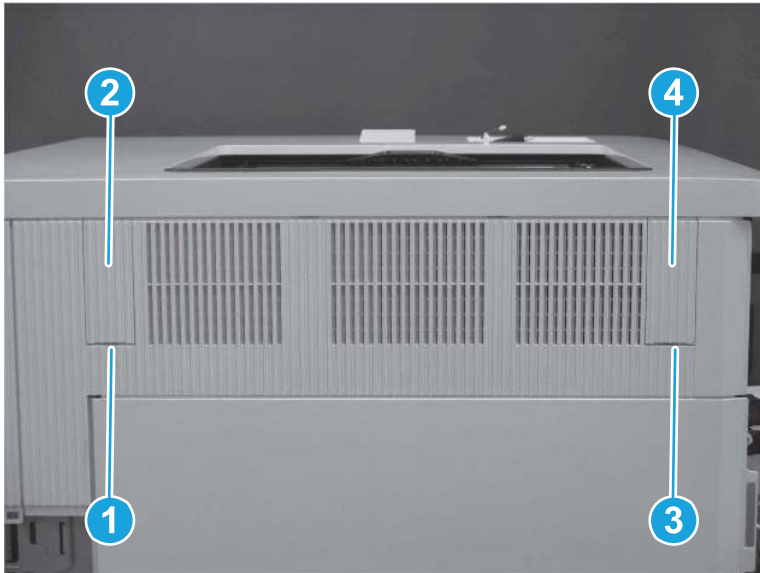


- d. Use a small, flat-blade screwdriver to release one tab (callout 1) and remove the left blanking cover (callout 2). Release one tab (callout 3) and remove the right blanking cover (callout 4).

 **TIP:** These covers are not identical. Make sure to reinstall the correct cover on the correct side.

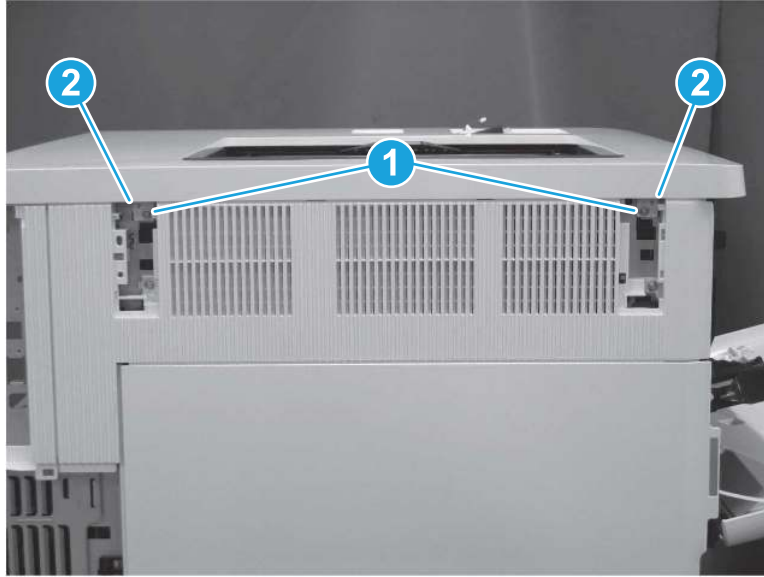
 **NOTE:** The screw under the left blanking cover is a self-tapping screw. Make sure this screw is reinstalled in the correct location.

Figure 1-907 Remove the left and right blanking covers



- e. Remove two screws (callout 1), and then release two tabs (callout 2).

Figure 1-908 Remove two screws and release two tabs



- f. At the front of the printer, remove one washer-head screw (callout 1) and one self-tapping screw (callout 2). Release one tab (callout 3).


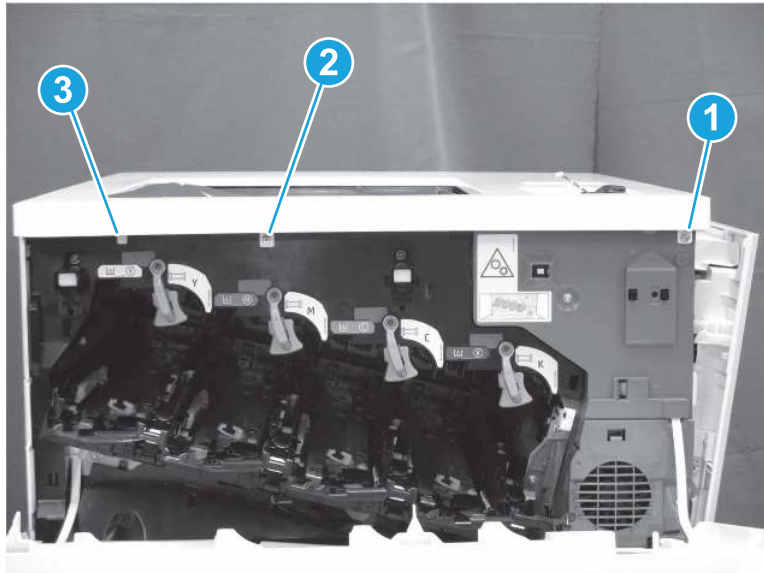
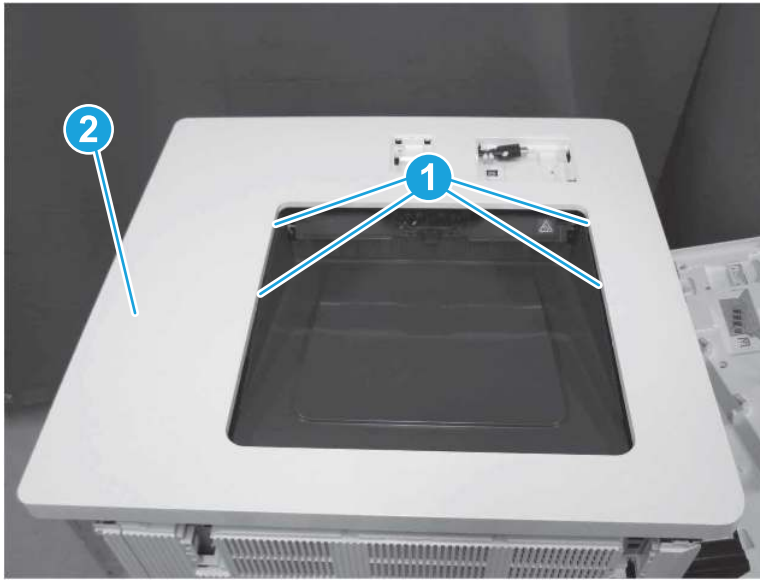
 **TIP:** Make sure to install the correct type of screw in the correct location.

Figure 1-909 Remove two screws and release one tab

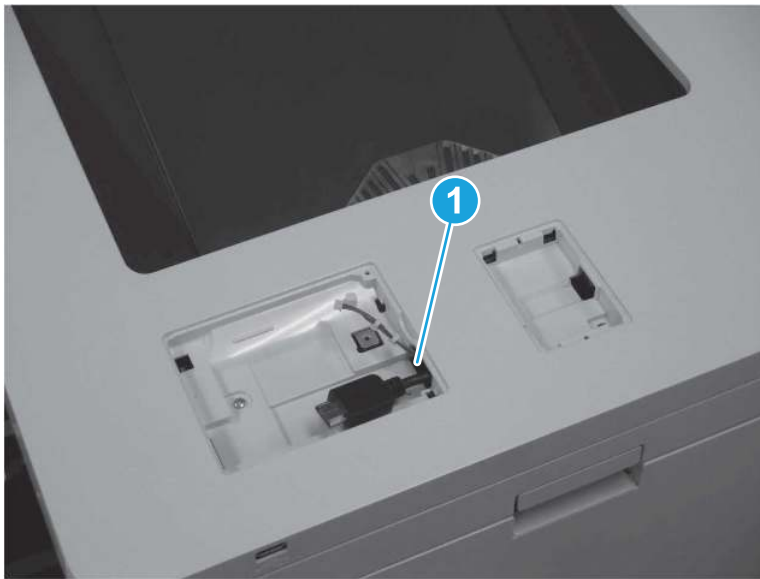


- g. At the top of the printer, release four tabs (callout 1), and then remove the top cover (callout 2).

Figure 1-910 Remove the top cover



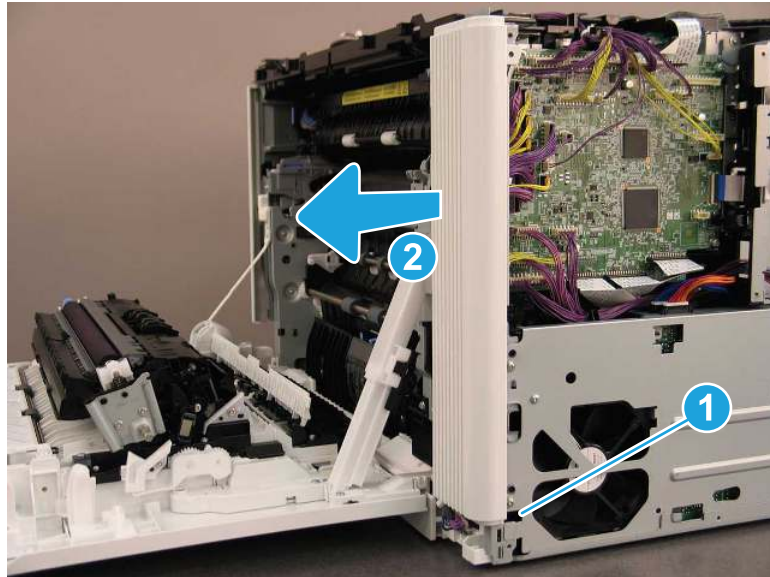
 **NOTE:** When removing the top cover, make sure to release the control panel cables (callout 1) through the opening.



9. Remove the right rear cover (M751/E75245).

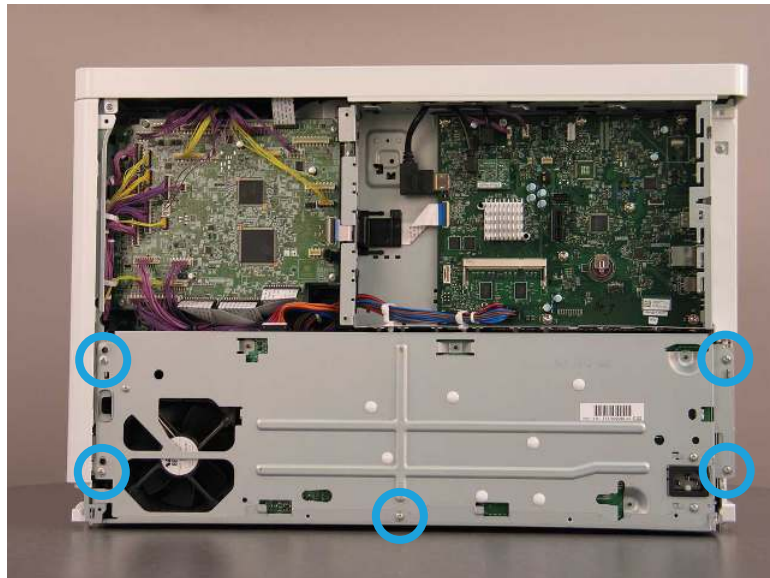
- ▲ Release one tab (callout 1), and then slide the right rear cover (callout 2) away from the printer to remove it.

Figure 1-911 Remove the right rear cover



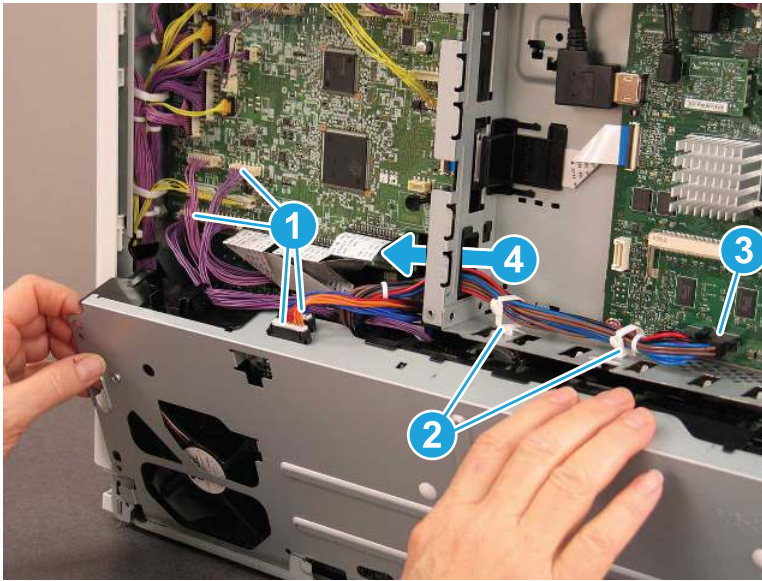
10. Remove the low-voltage power supply (LVPS).
 - a. Remove five screws.

Figure 1-912 Remove five screws



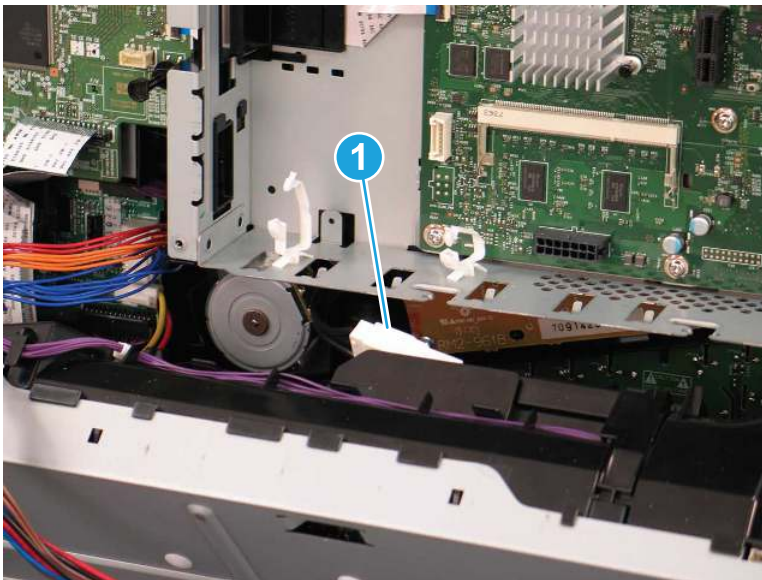
- b. Lift up on the LVPS, and then slightly rotate the top away from the printer. Disconnect four connectors (callout 1), and then release two retainers (callout 2). Press down on the latch to disconnect one connector (callout 3), and then release the wires through the hole (callout 4) in the formatter case.

Figure 1-913 Disconnect five connectors



- c. Press down on the latch to disconnect one connector (callout 1), and then lift up to remove the LVPS.

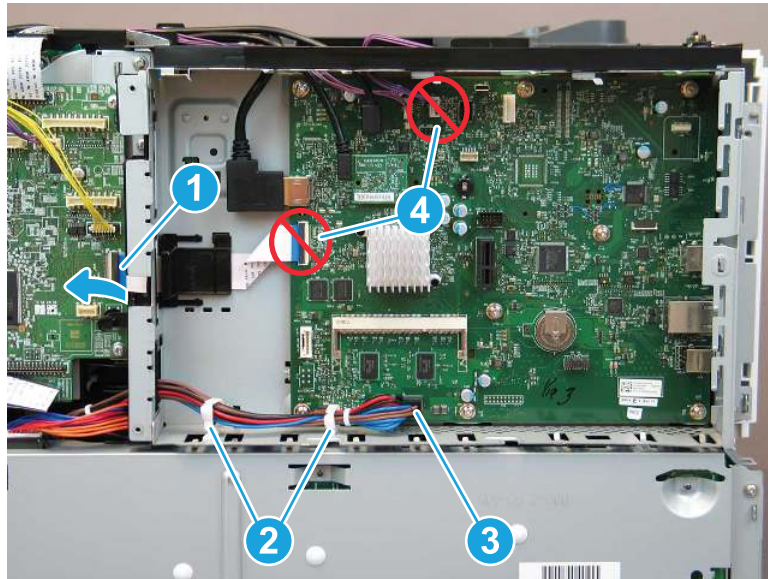
Figure 1-914 Remove the LVPS



11. Remove the formatter and case.

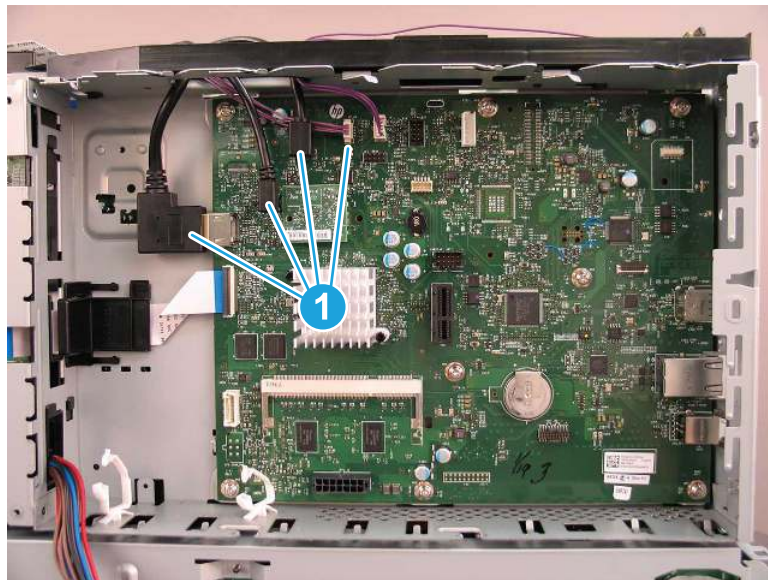
- a. Open the retainer (callout 1) to release the flat cable. Release the cables from two retainers (callout 2). Squeeze the latch to disconnect the connector (callout 3) at the lower edge of the formatter. It is not necessary to disconnect two connectors (callout 4).

Figure 1-915 Disconnect the connectors



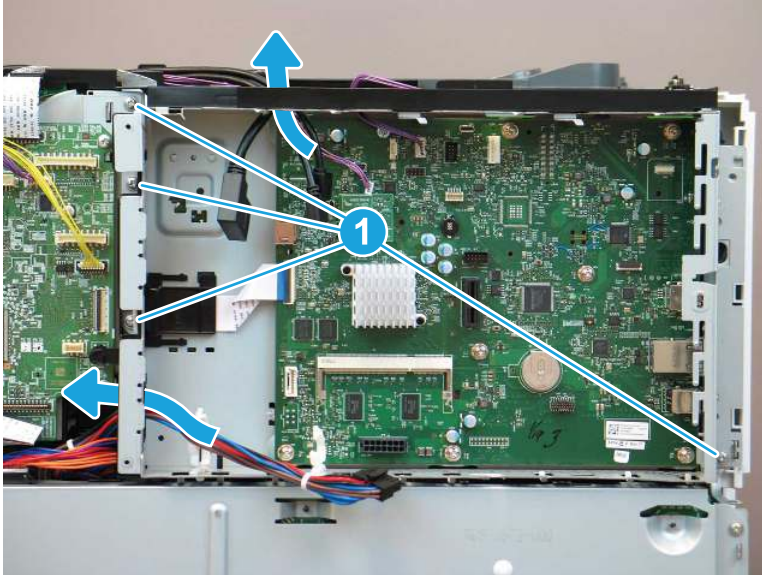
- b. Disconnect all of the remaining connectors on the formatter (callout 1).

Figure 1-916 Disconnect the connectors



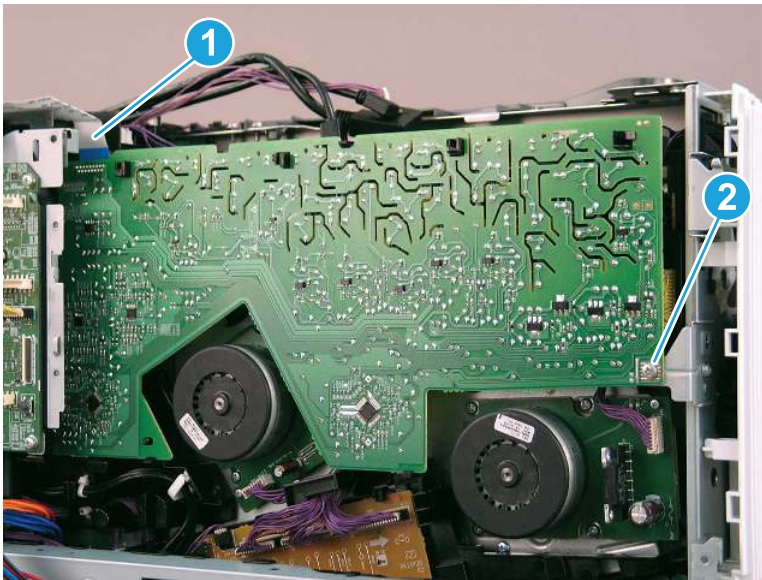
- c. Release the cables through the opening on top and on the left side of the formatter case. Remove four screws (callout 1), and then remove the formatter and case.

Figure 1-917 Remove the formatter and case



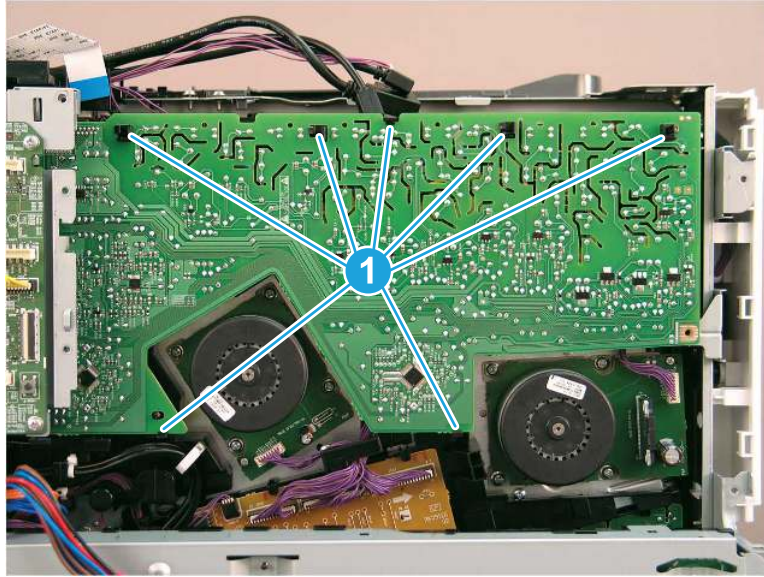
- 12. Remove the upper high-voltage power supply A (upper HVPS).
 - a. Disconnect one flat cable (callout 1), and then remove one screw (callout 2).

Figure 1-918 Disconnect one flat cable and remove one screw



- b. Release seven tabs (callout 1), and then remove the upper HVPS.

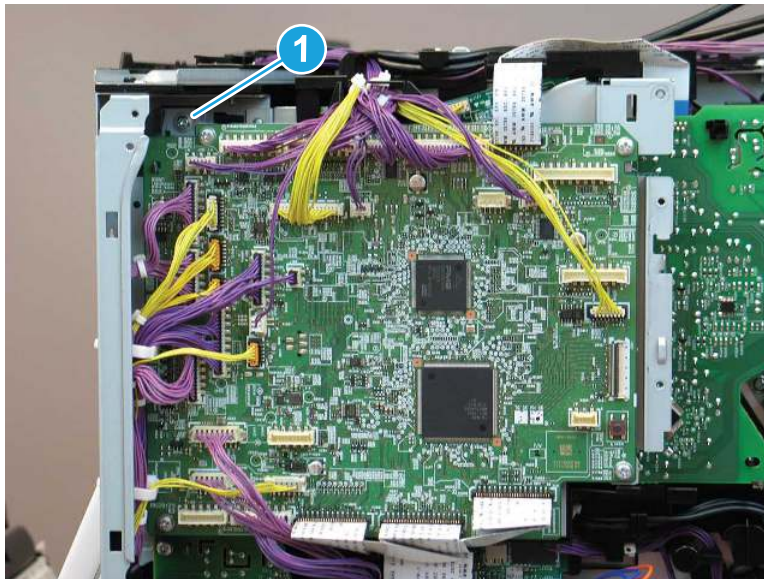
Figure 1-919 Release seven tabs and remove the upper HVPS



- 13. Remove the DC controller and case.

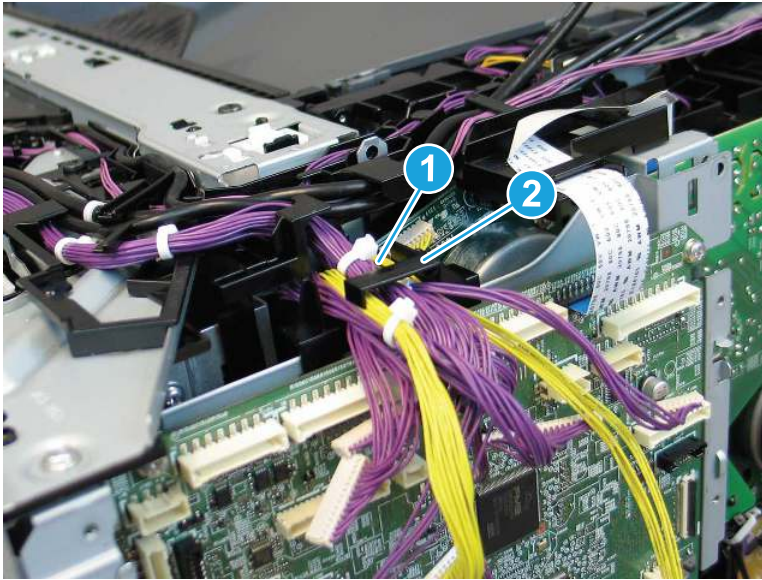
- a. Disconnect all of the connectors on the DC controller, and then remove one screw (callout 1).

Figure 1-920 Disconnect connectors and remove one screw



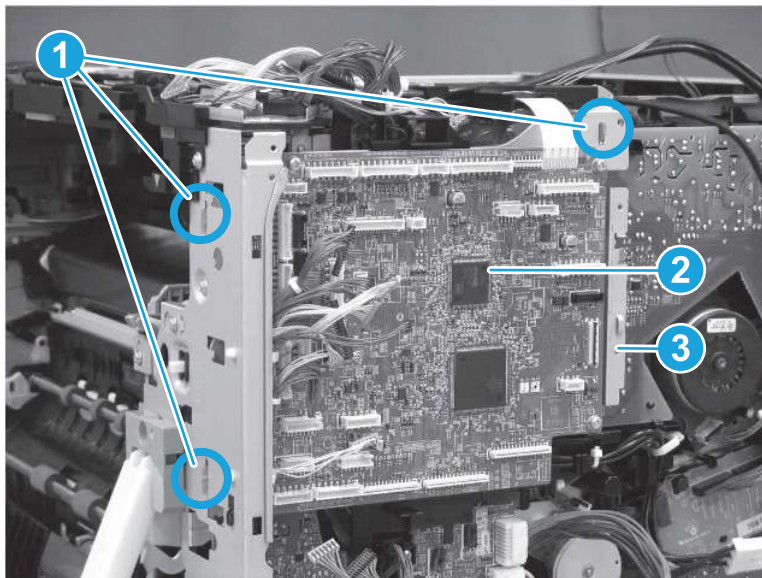
- b. Release the wire harnesses (callout 1) from the retainer (callout 2).

Figure 1-921 Remove the wire harnesses from the retainer



- c. Lift up to release three tabs (callout 1), and then remove the DC controller (callout 2) together with the case (callout 3).

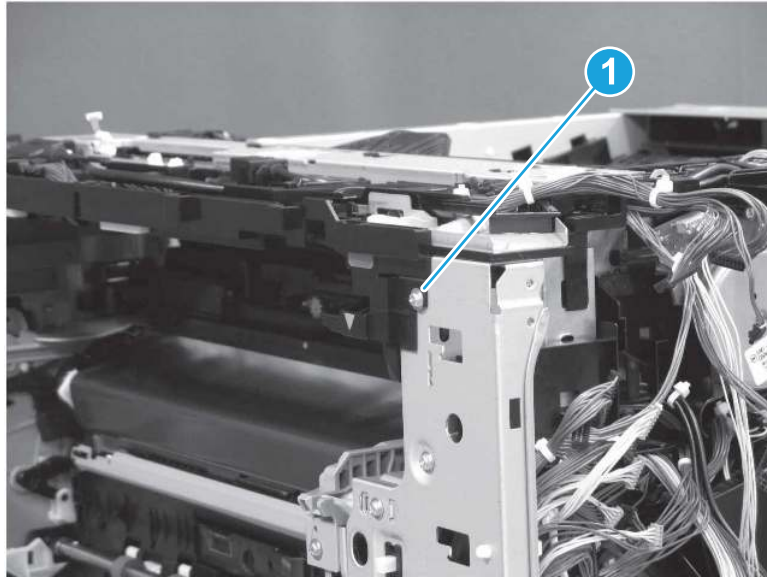
Figure 1-922 Remove the DC controller and case



- 14. Remove the fuser drive assembly.

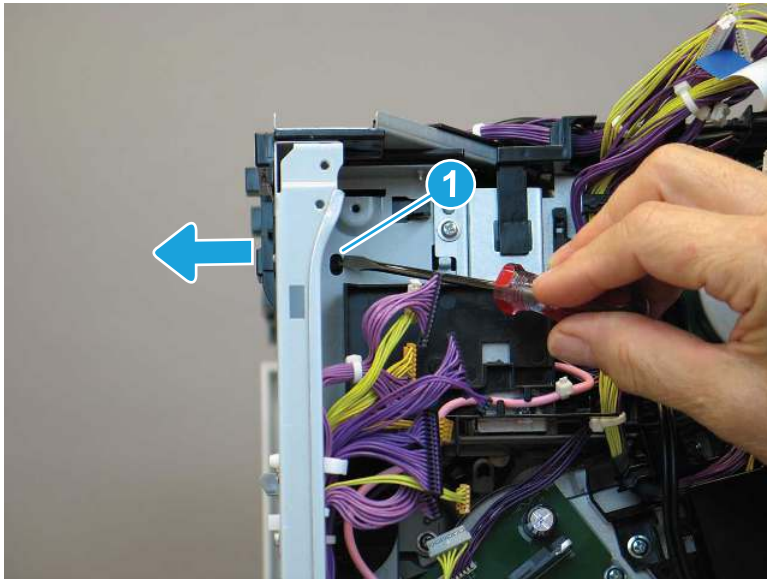
- a. Remove one screw (callout 1).

Figure 1-923 Remove one screw



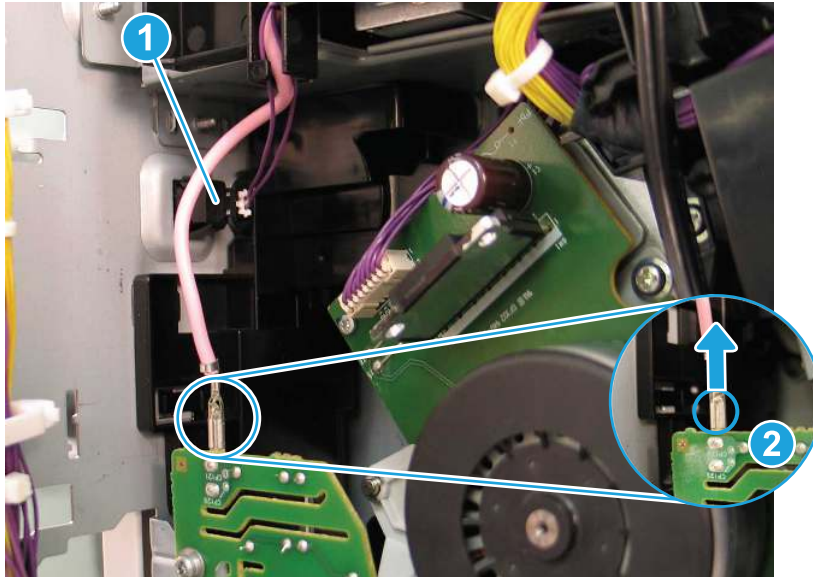
- b. Release one tab (callout 1), and then slide the guide away from the printer to remove it.

Figure 1-924 Remove the guide



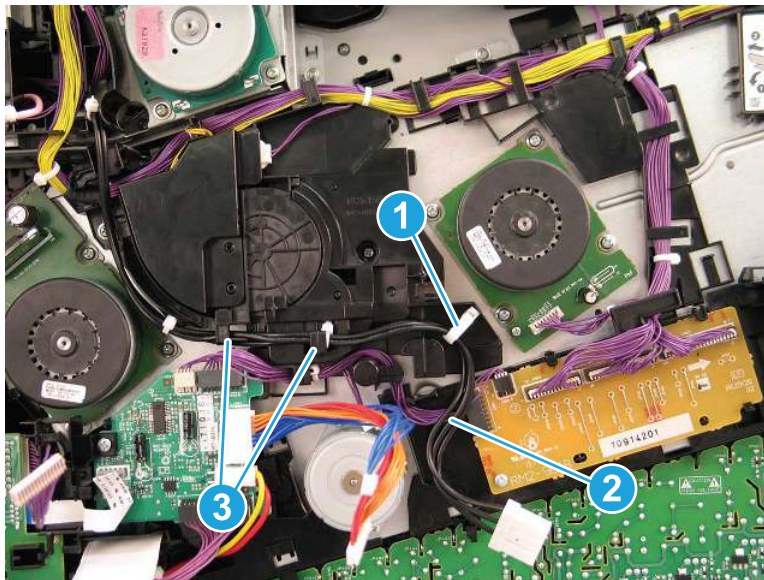
- c. Disconnect one connector (callout 1). Press and hold the small tab (callout 2), and then lift up to disconnect the connector.

Figure 1-925 Disconnect two connectors



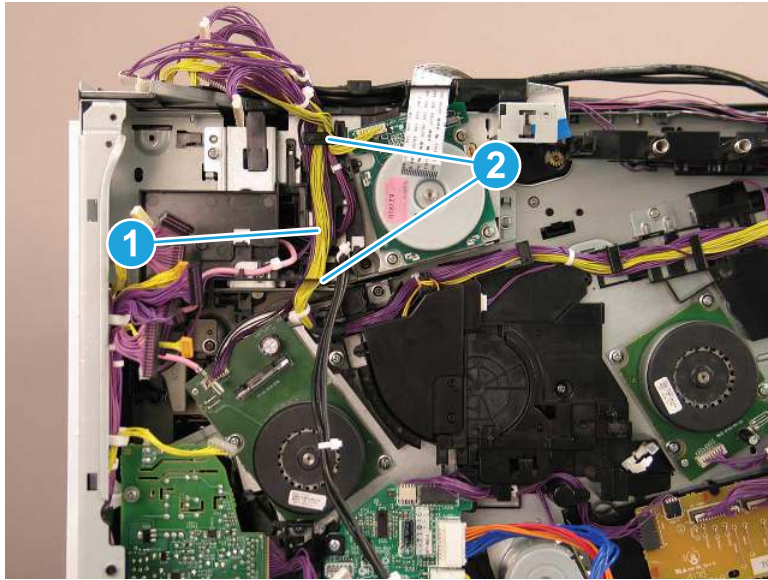
- d. Release one retainer (callout 1), and then release the cables (callout 2) from the guides (callout 3).

Figure 1-926 Release the cables from the guides



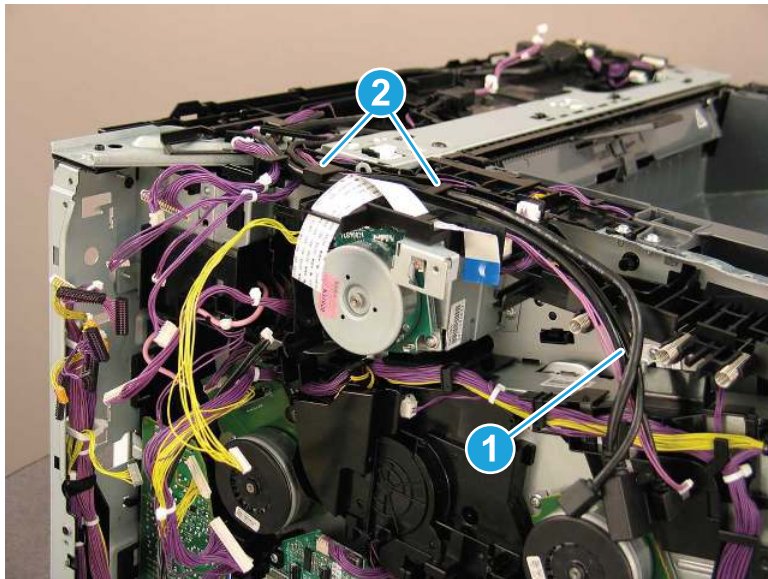
- e. Release the cables (callout 1) from the guides (callout 2).

Figure 1-927 Release the cables from the guides



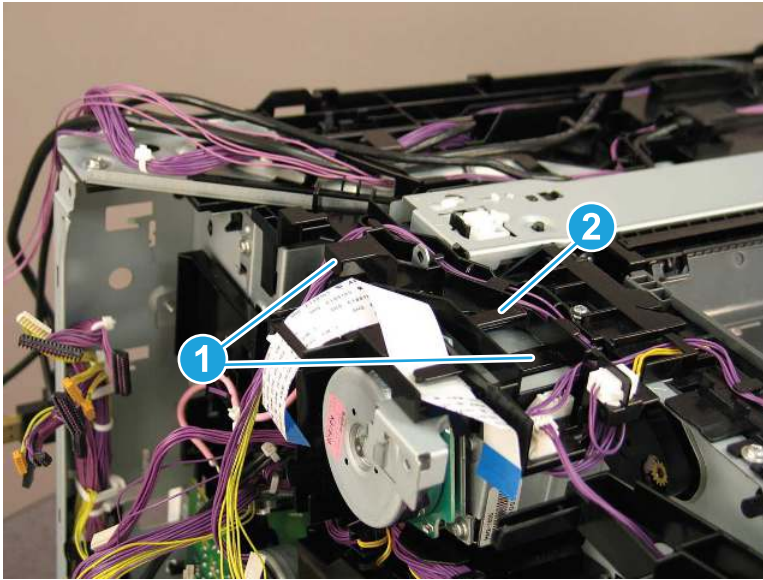
- f. Release the cables (callout 1) from the guides (callout 2).

Figure 1-928 Release the cables from the guides



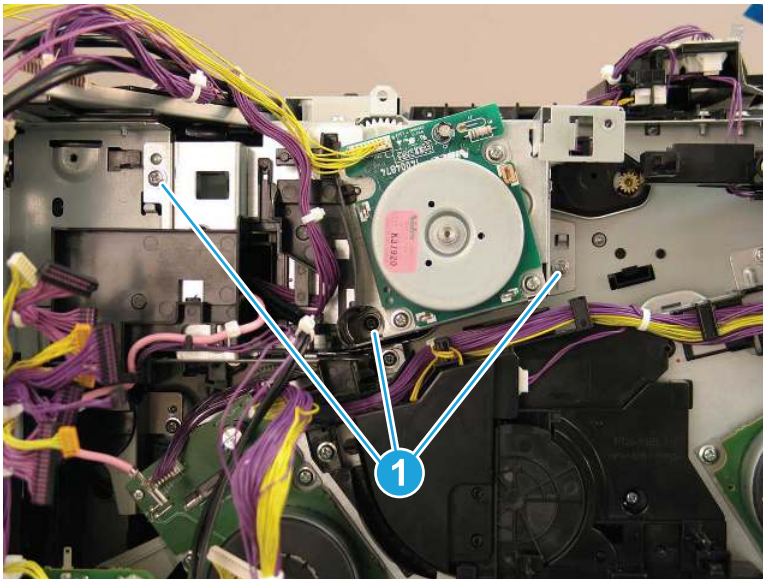
- g. Release two tabs (callout 1), and then release the cable guide (callout 2).

Figure 1-929 Release the cable guide



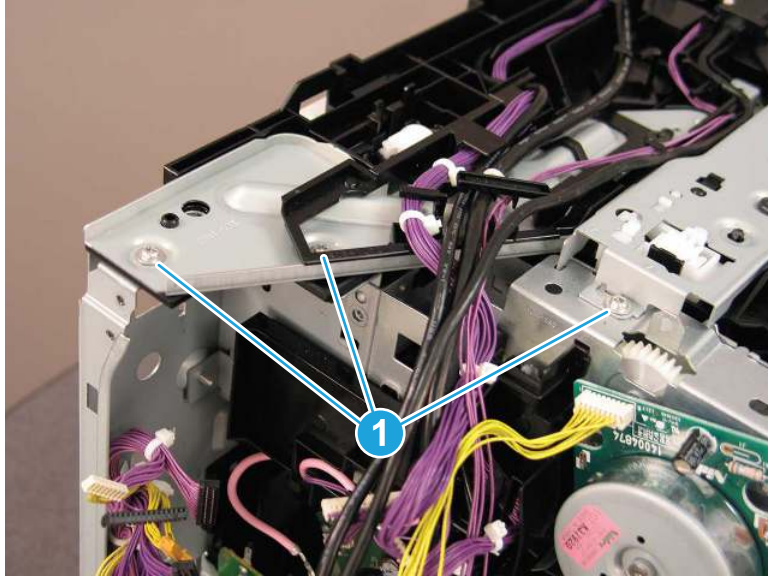
- h. At the back of the printer, remove three screws (callout 1).

Figure 1-930 Remove three screws



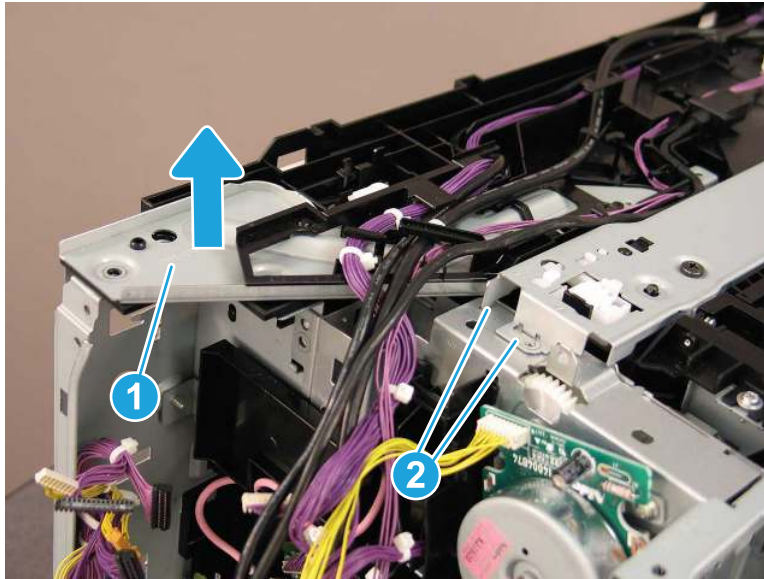
- i. At the top of the printer, remove three screws (callout 1).

Figure 1-931 Remove three screws



- j. Raise the plate (callout 1), and then release two bosses (callout 2).

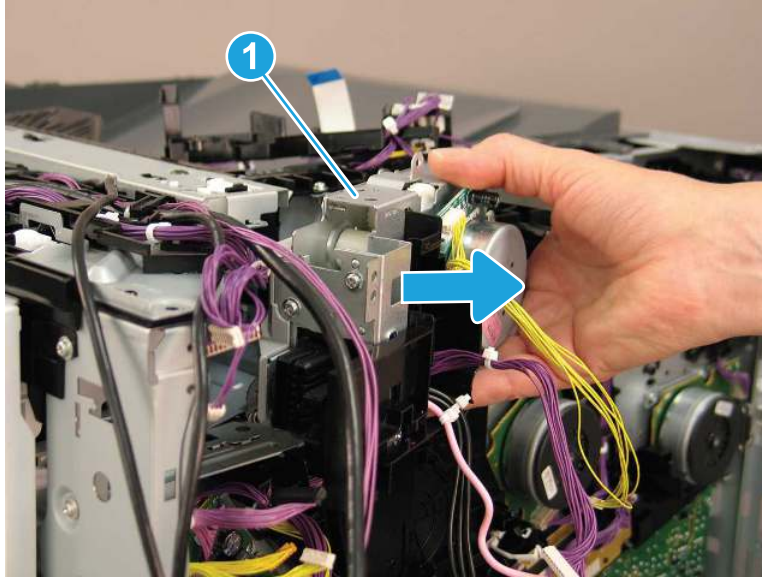
Figure 1-932 Release two bosses



- k. Carefully lift the fuser drive assembly (callout 1) slightly away from the printer.

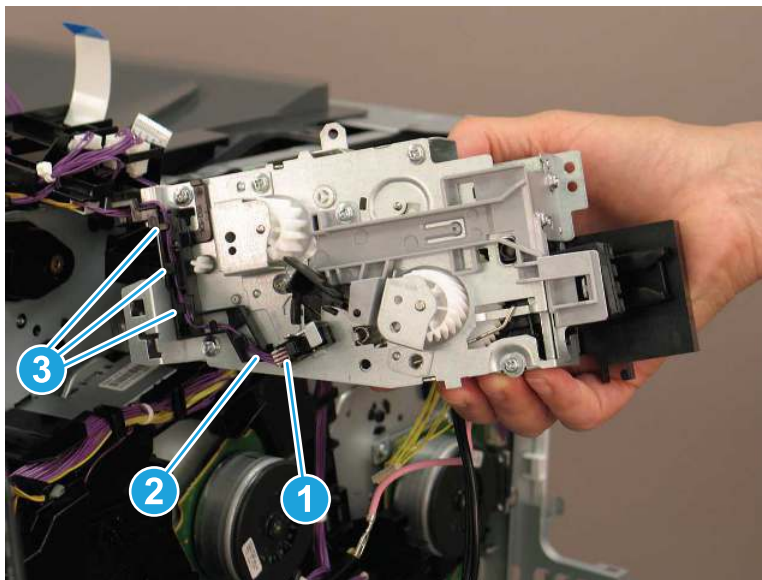
⚠ CAUTION: The fuser drive assembly is still attached to the printer. Do not try to remove it completely

Figure 1-933 Lift the fuser drive assembly



- L. Disconnect one connector (callout 1), and then release the wire harness (callout 2) from the guides (callout 3).

Figure 1-934 Remove the fuser drive assembly



- 15. Unpack the replacement assembly.

- a. Dispose of the defective part.



NOTE: HP recommends responsible disposal of the defective part.

<http://www8.hp.com/us/en/hp-information/environment/product-recycling.html>

- b. Unpack the replacement part from the packaging.



IMPORTANT: Make sure that all of the shipping materials (for example shipping tape) are removed from the replacement part prior to installation.

- c. To install an assembly, reverse the removal steps.



NOTE: When applicable, special installation instructions are provided for an assembly at the end of the removal procedure. Always completely read the removal instructions and follow all special installation instructions.

Removal and replacement: Fuser drive assembly (M856/E85055/M776)

Learn how to remove and replace the fuser drive assembly (M856/E85055/M776dn/M776z/M776zs).

Mean time to repair: 35 minutes

Service level: Medium

Before performing service

Turn the printer power off

- Disconnect the power cable.

WARNING! To avoid damage to the printer, turn the printer off, wait 30 seconds, and then remove the power cord before attempting to service the printer.

Use the table below to identify the correct part number for your printer. To order the part, go to www.hp.com/buy/parts.

Table 1-61 Part information

Part number	Part description
RM2-1391-000CN	Fuser drive assembly

Required tools

- #2 Phillips screwdriver with a magnetic tip
- Small, flat-blade screwdriver

After performing service

Turn the printer power on

- Connect the power cable.
- Use the power switch to turn the power on.

Post service test

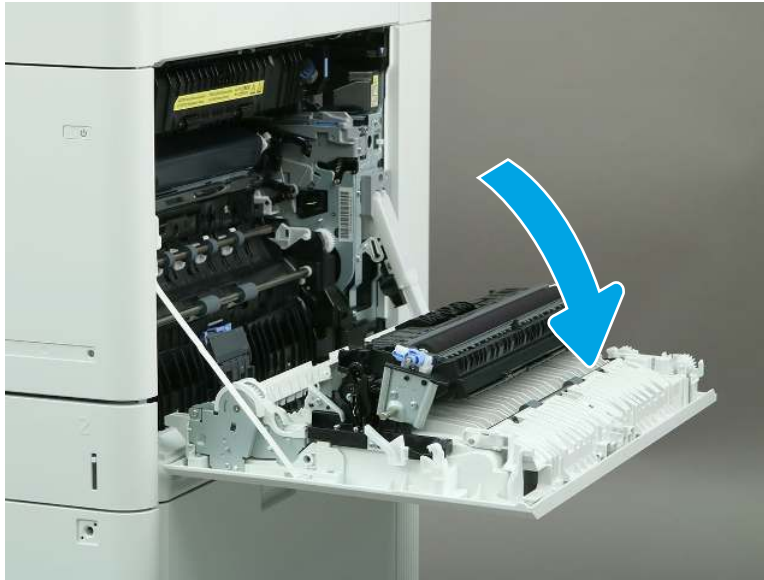
Make sure that the printer initializes to a **Ready** state.

Print a page to make sure that the printer is functioning correctly.

1. Remove the fuser.

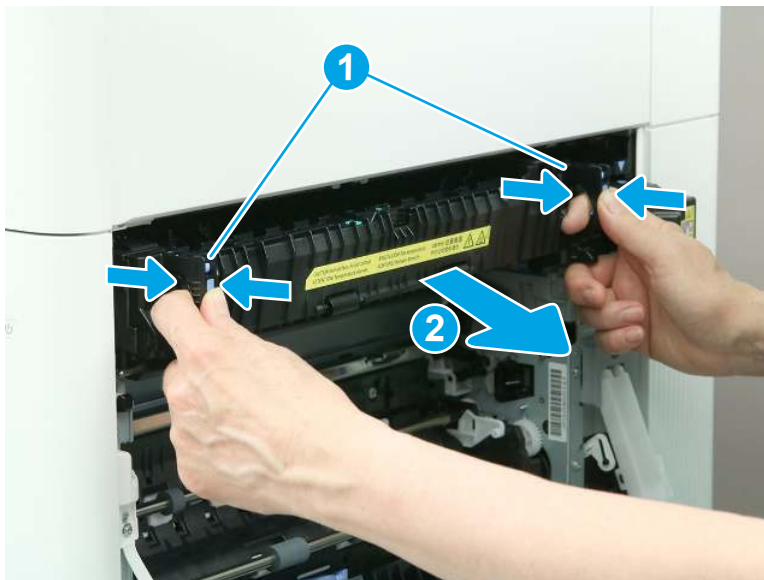
- a. Open the right door.

Figure 1-935 Open the right door



- b. Grasp the fuser handles, and then squeeze the release levers (callout 1). Lift up slightly, and then pull straight out to remove the fuser (callout 2).

Figure 1-936 Remove the fuser



2. Remove the intermediate transfer belt (ITB).

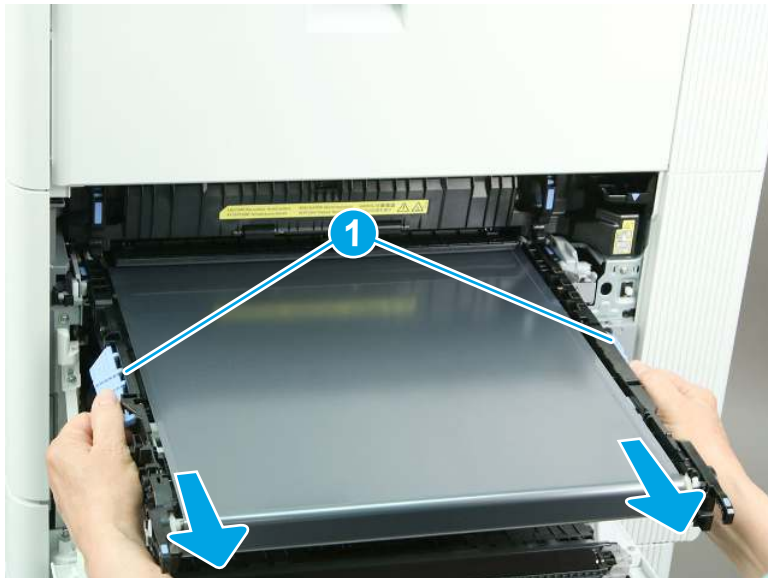
- a. Open the right door. Grasp the two blue handles on the ITB, and then pull the ITB partially out of the printer.

Figure 1-937 Partially remove the ITB



- b. Grasp the blue handles on the side of the ITB (callout 1), and then remove the ITB from the printer.

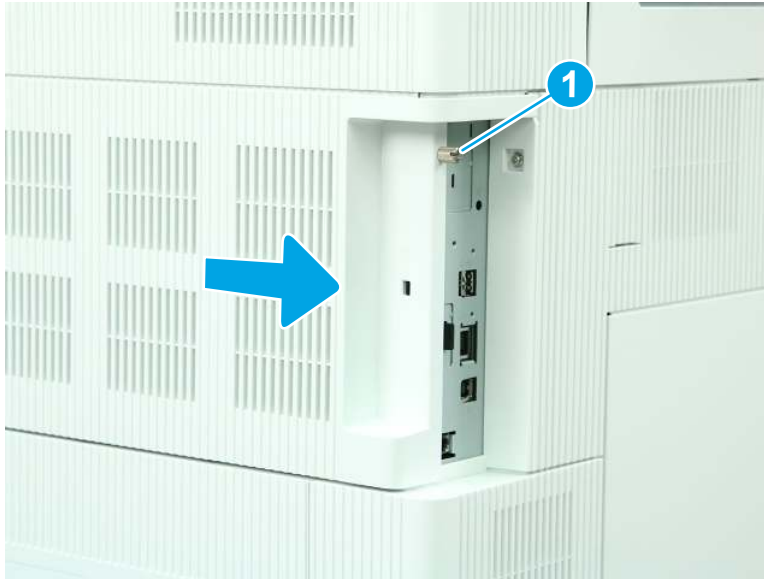
Figure 1-938 Remove the ITB



3. Remove the formatter cover.

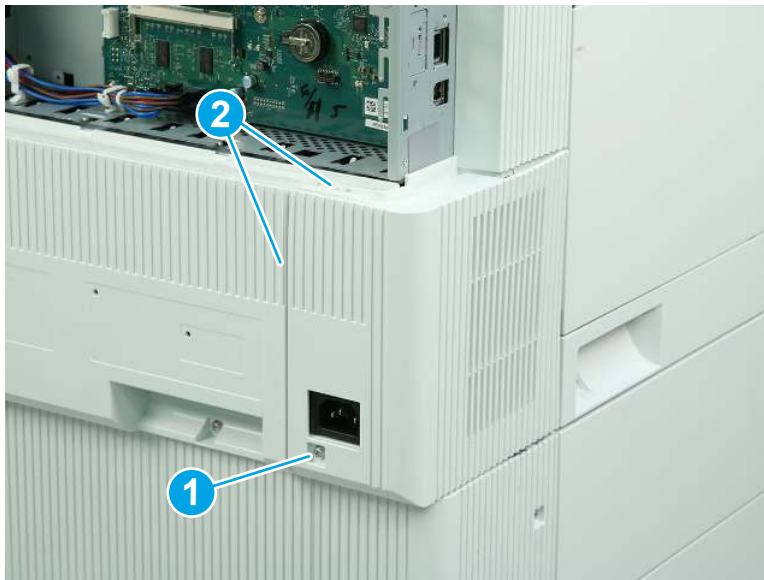
- ▲ Loosen one thumbscrew (callout 1), and then slide the formatter cover (callout 2) away from the printer to remove it.

Figure 1-939 Remove the formatter cover



- 4. Remove the left lower cover (M856/E85055/M776).
 - a. Remove one screw (callout 1), and then release two tabs (callout 2).

Figure 1-940 Remove one screw and release two tabs



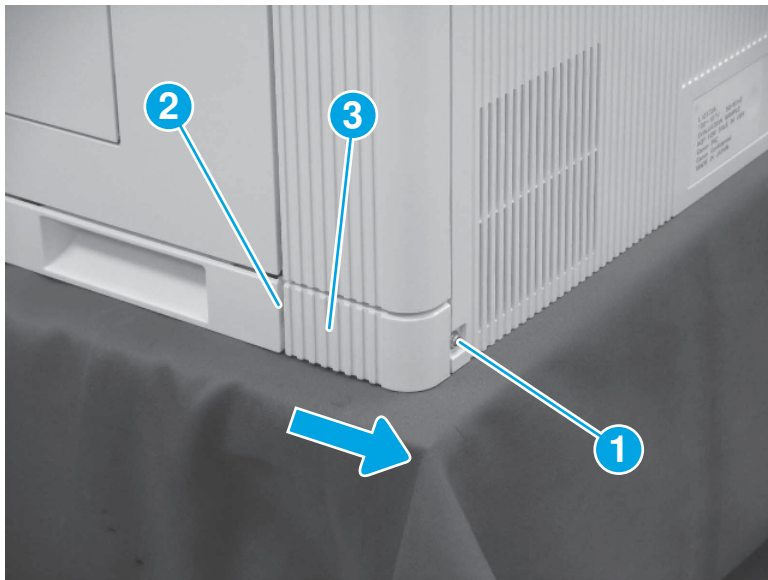
- b. Rotate the cover away from the printer to remove it.

Figure 1-941 Remove the left lower cover



5. Remove the right rear lower cover (M751/E75245/M856/E85055/M776).
 - ▲ Remove one screw (callout 1), release one tab (callout 2), and then slide the right rear lower cover (callout 3) toward the back of the printer to remove it.

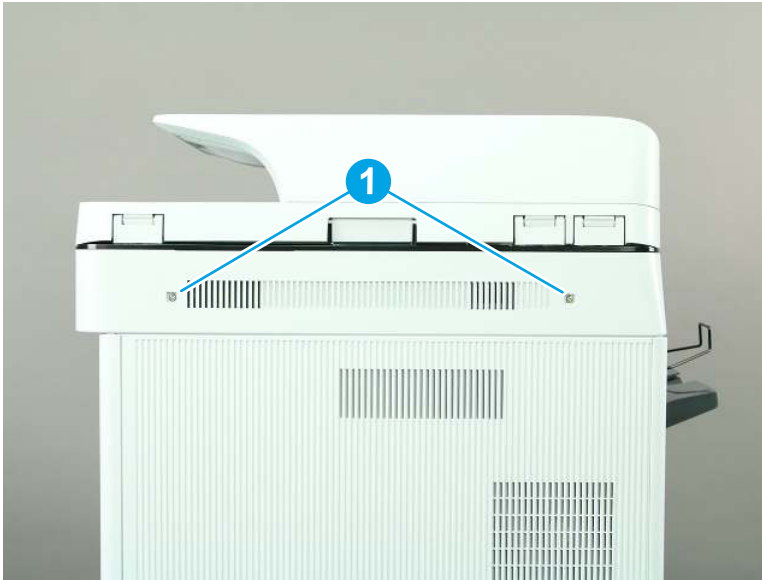
Figure 1-942 Remove the right rear lower cover



6. Remove the scanner control board (SCB) cover (M776).

- a. Remove two screws (callout 1).

Figure 1-943 Remove two screws



- b. Remove the SCB cover.

Figure 1-944 Remove the SCB cover



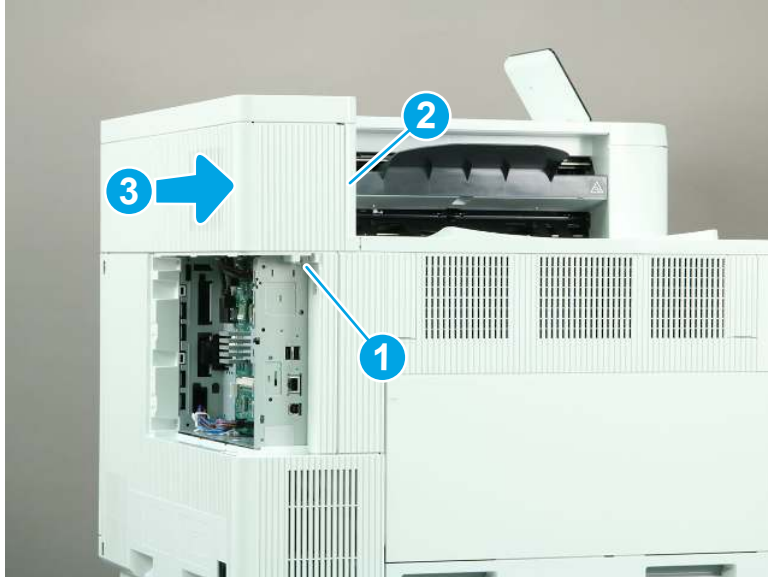
7. Remove the rear upper cover (M856/E85055/M776dn/M776z).



NOTE: The following figure shows the M856 printer. The procedure is correct for all referenced models.

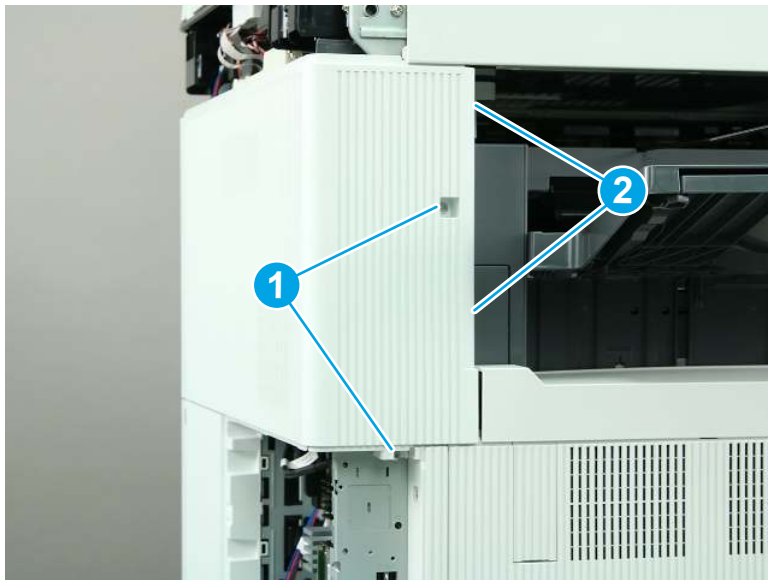
- ▲ Remove one screw (callout 1), release one tab (callout 2), and then slide the rear upper cover away from the printer to remove it (callout 3).

Figure 1-945 Remove the rear upper cover



- 8. Remove the rear upper cover and left rear upper cover (M776zs).
 - a. Remove two screws (callout 1), and then release two tabs (callout 2).

Figure 1-946 Remove two screws and release two tabs



- b. Slide the cover to the right to remove it.

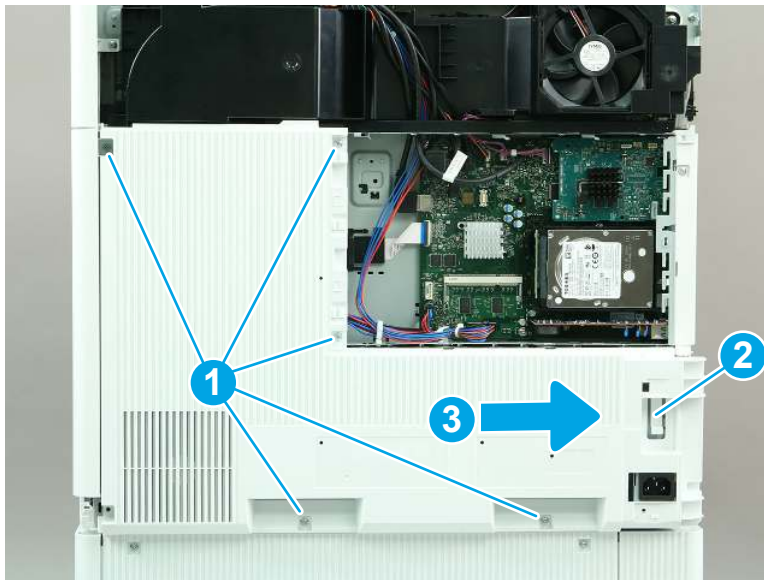
Figure 1-947 Remove the rear upper and left rear upper cover




9. Remove the rear cover (M856/E85055/M776).

- ▲ Remove five screws (callout 1), release one tab (callout 2), and then slide the rear cover to the right to remove it.

Figure 1-948 Remove the rear cover (M856/E85055/M776)



10. **M856/E85055 only:** Remove the control panel and top cover.

 **NOTE:** This step applies to only the M856/E85055 models. Skip this step for all other models.

- a. Use a small, flat-blade screwdriver to release two tabs (callout 1), and then remove the control panel cover (callout 2).

Figure 1-949 Remove the control panel cover



- b. Remove one screw (callout 1).

Figure 1-950 Remove one screw



- c. Lift the back edge of the control panel up (callout 1), and then slide the control panel toward the back of the printer (callout 2).

Figure 1-951 Slide the control panel back



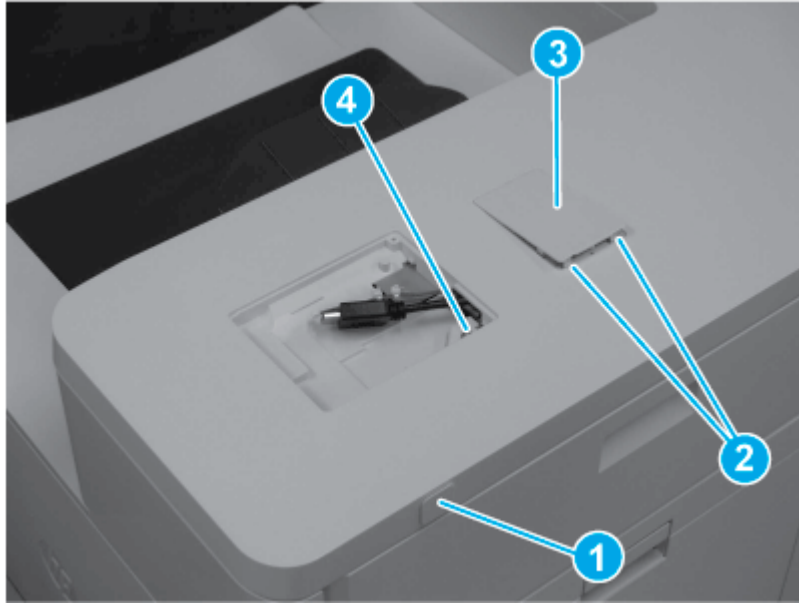
- d. Turn the control panel so that the bottom is facing up, and then disconnect two connectors to remove the control panel.

Figure 1-952 Disconnect two connectors



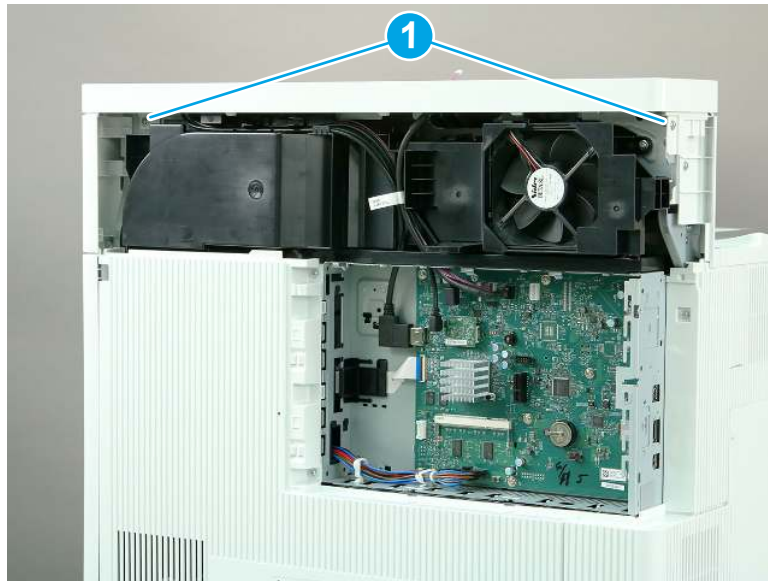
- e. Remove the USB cover (callout 1). Release two tabs (callout 2), and then remove the HIP cover (callout 3). Remove one screw (callout 4).

Figure 1-953 Remove covers and one screw



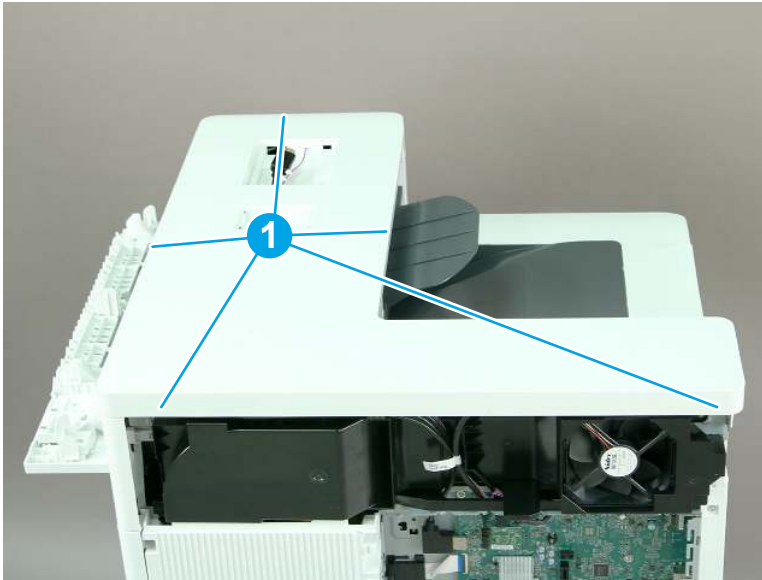
- f. Remove two screws (callout 1).

Figure 1-954 Remove two screws



- g. Release five tabs (callout 1), and then remove the top cover.

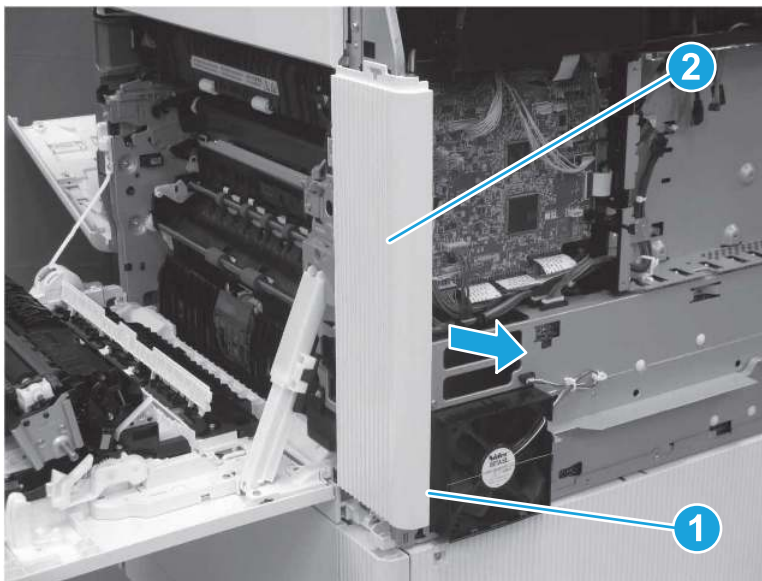
Figure 1-955 Release five tabs



11. Remove the right rear cover (M856/E85055/M776).

- ▲ Release one tab (callout 1), and then slide the rear cover away from the printer to remove it.

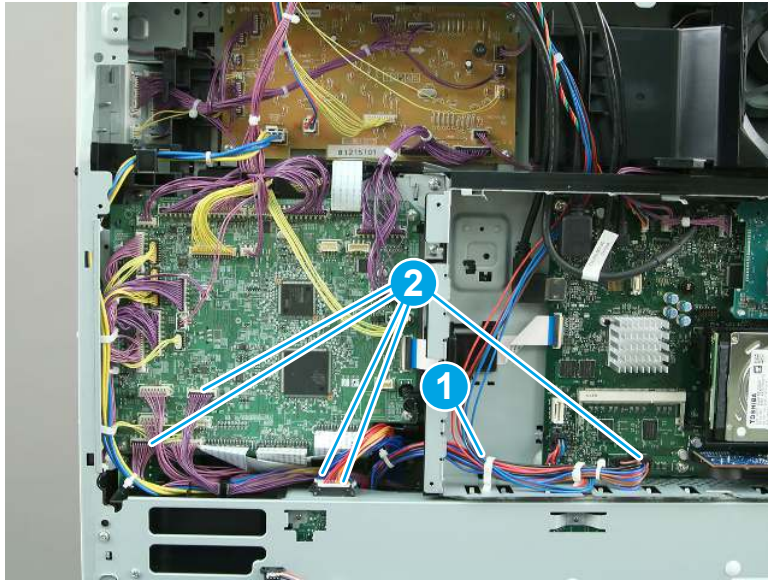
Figure 1-956 Remove right rear cover



12. Remove the low-voltage power supply (LVPS) (M856/E85055/M776).

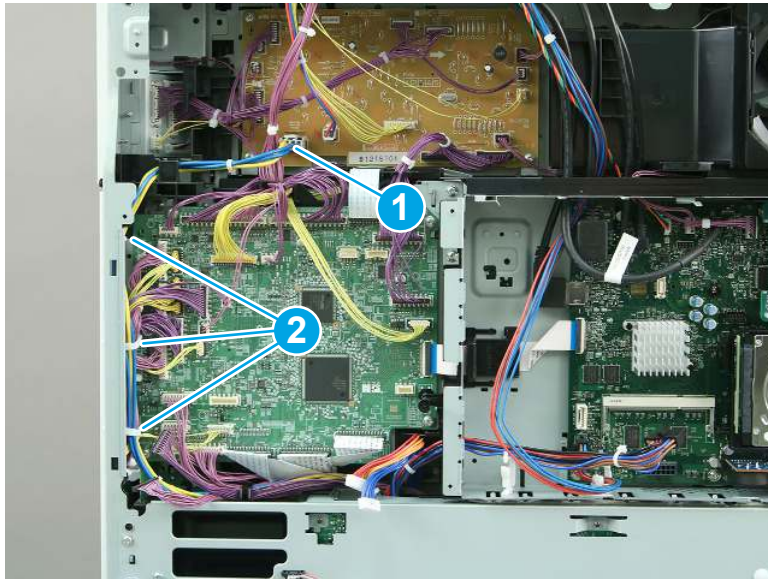
- a. Release one retainer (callout 1), and then disconnect five connectors (callout 2).

Figure 1-957 Release the retainer and disconnect five connectors



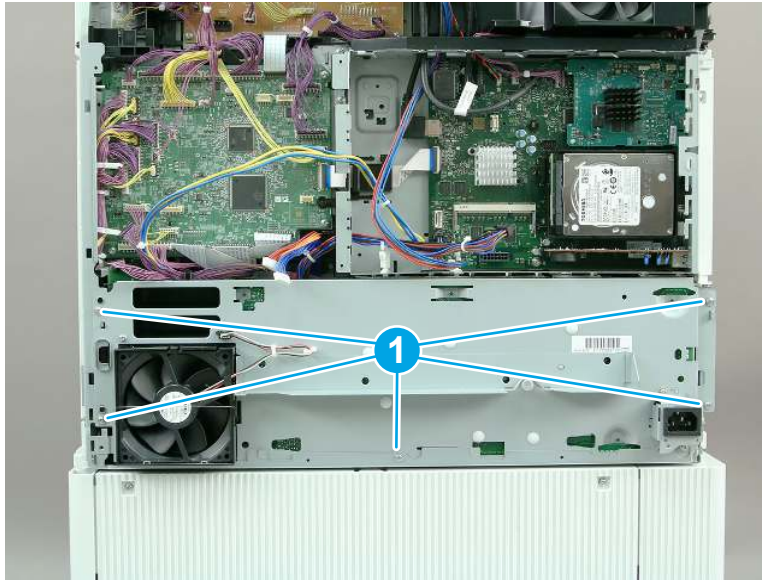
- b. Disconnect one connector (callout 1), and then release three retainers (callout 2).

Figure 1-958 Disconnect one connector and release five retainers



- c. Remove five screws (callout 1).

Figure 1-959 Remove five screws



- d. Tilt the LVPS away from the printer (callout 1). Thread the cable (callout 2) through the opening in the formatter case.

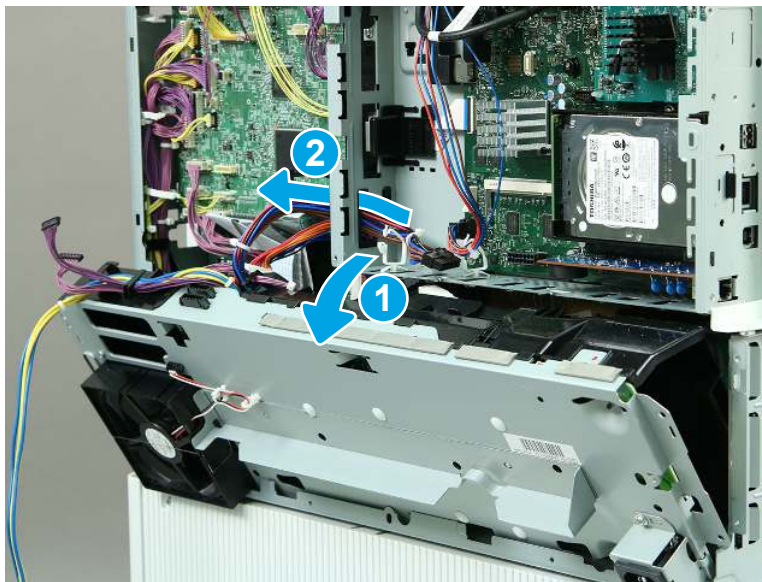


NOTE: Due to mechanical tolerances on the formatter cage, rotating the LVPS out might be difficult.



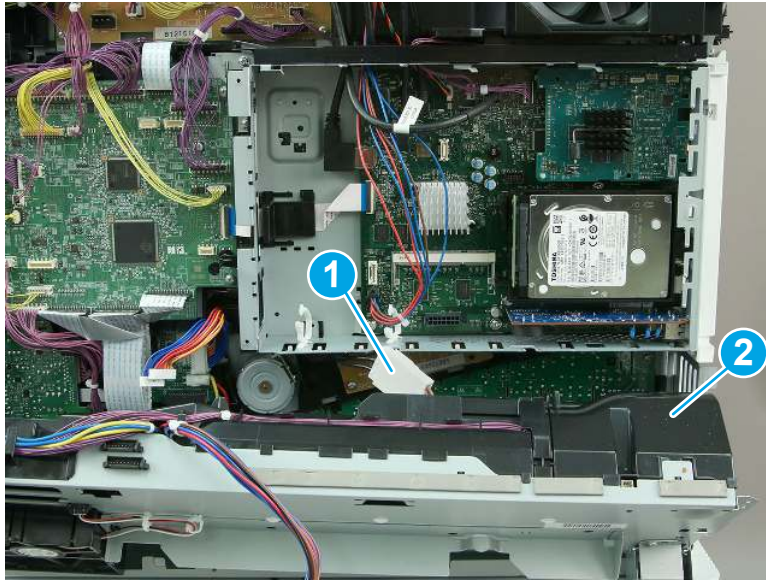
CAUTION: One connector is still connected, so tilt the LVPS carefully.

Figure 1-960 Thread the cable



- e. Disconnect one connector (callout 1), and then lift up to remove the LVPS (callout 2).

Figure 1-961 Remove the LVPS



- 13. Remove the formatter and case (M856/E85055/M776).

 **NOTE:** The figures below show the M776zs formatter. The procedure is correct for all referenced models.

- a. Release two retainers (callout 1), and then open the retainer (callout 2) to release the flat cable. Disconnect all of the remaining connectors on the formatter board.


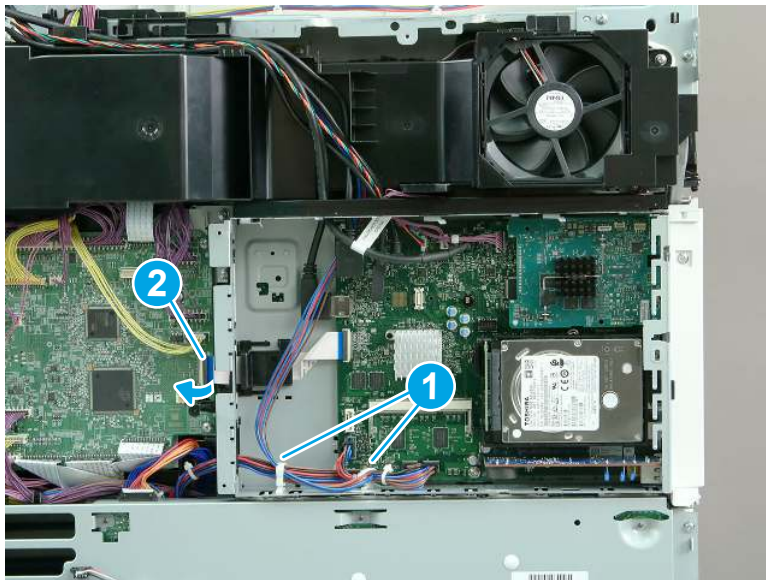
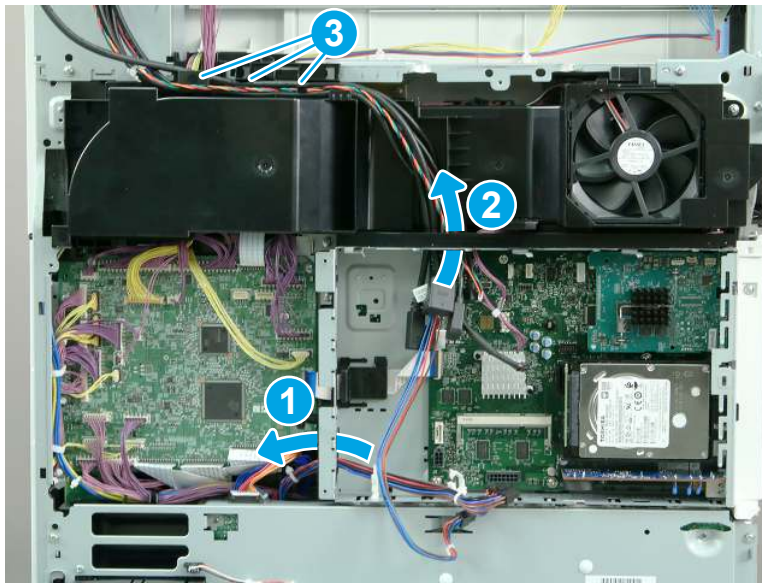
 **NOTE:** The figures below show the M776zs model. The procedures are correct for all of the referenced models.

Figure 1-962 Disconnect the connectors



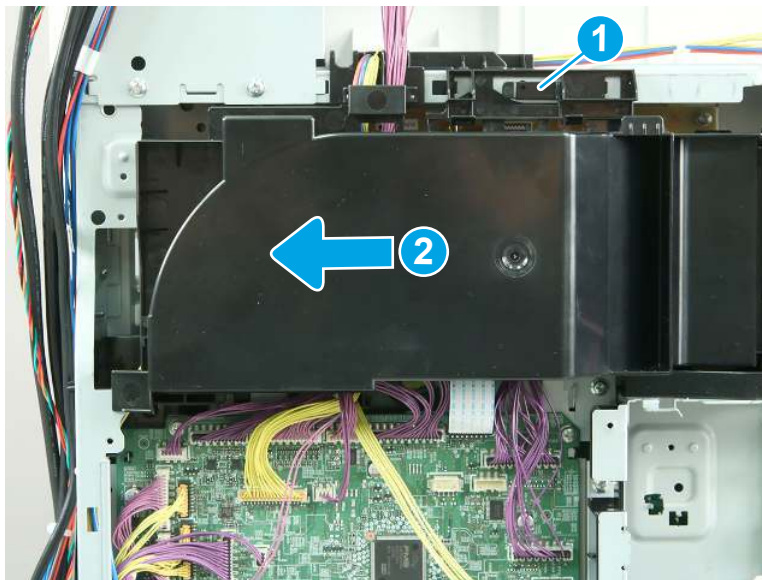
- b. Release one cable through the opening in the left side of the formatter case (callout 1). Release the remaining cables through the opening in the top of the formatter case (callout 2). Release the cables from the upper cable guide (callout 3).

Figure 1-963 Release the cables



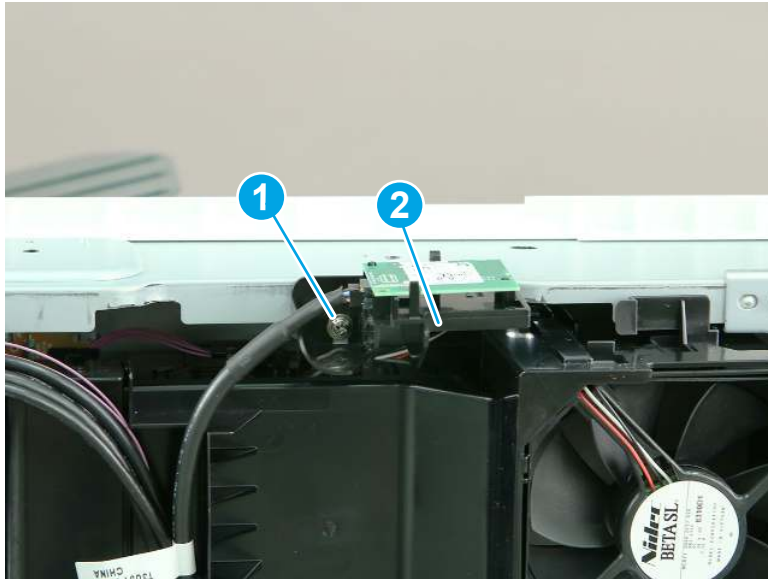
- c. Release one tab (callout 1), and then slide the fan duct to the left (callout 2) to remove it.

Figure 1-964 Remove the fan duct



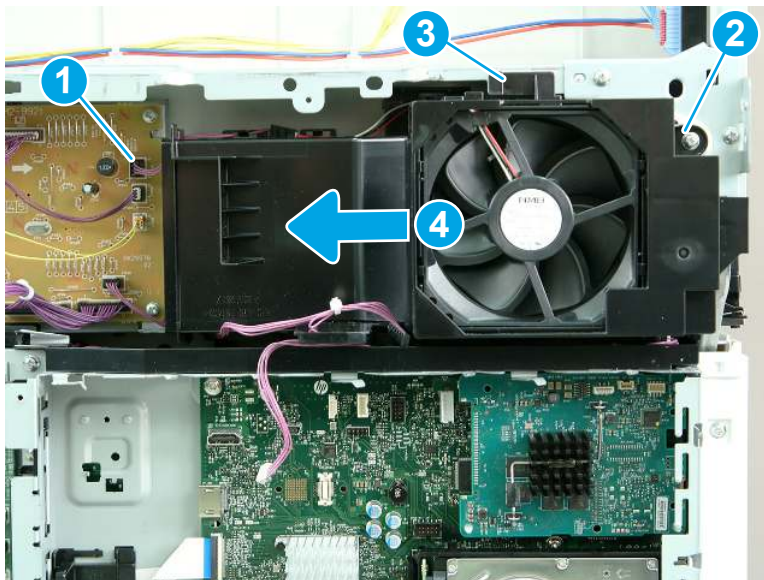
- d. **M856 and E85055 only:** Remove one screw (callout 1), and then remove the wireless card and bracket (callout 2).

Figure 1-965 Remove the wireless card and bracket



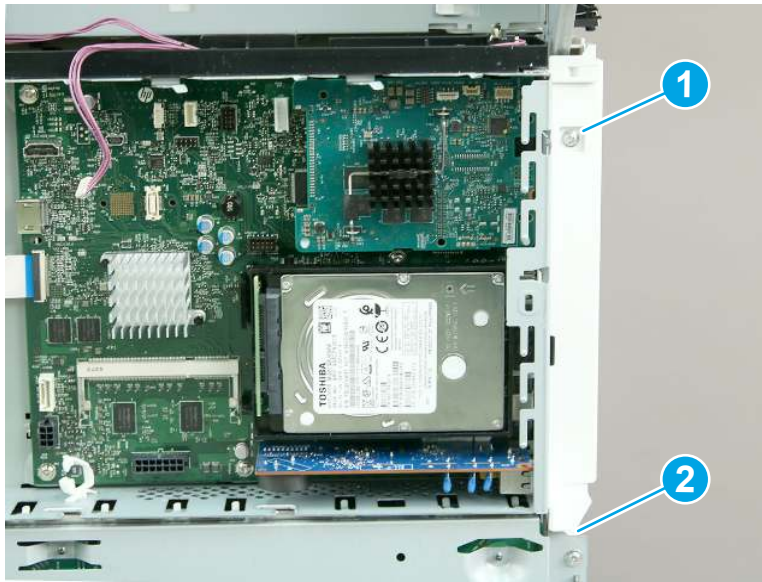
- e. Disconnect one connector (callout 1), and remove one screw (callout 2). Release one tab (callout 3), and then slide the fan assembly to the left (callout 4) to remove it.

Figure 1-966 Remove the fan assembly



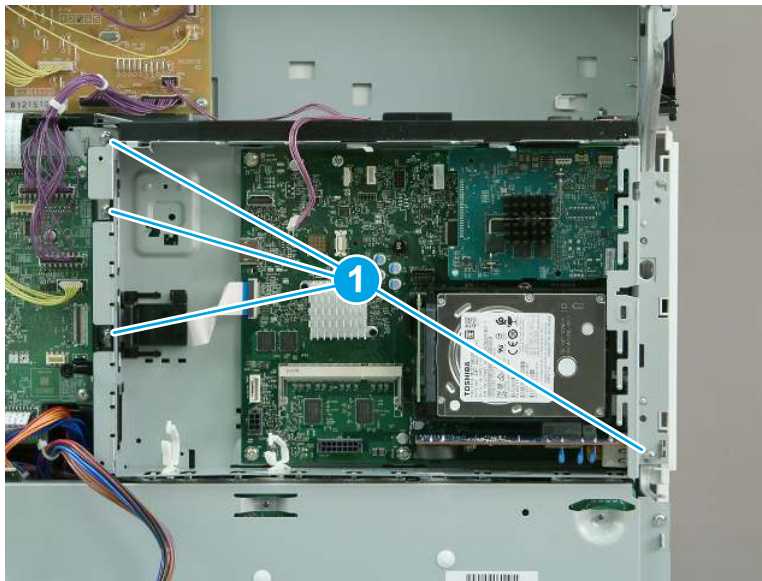
- f. Remove one screw (callout 1), release one tab (callout 2), and then remove the left rear cover.

Figure 1-967 Remove the left rear cover



- g. Remove four screws (callout 1).

Figure 1-968 Remove four screws



- h. Remove the formatter and case.

Figure 1-969 Remove the formatter and case



- 14. Remove the upper high-voltage power supply (HVPS) (M856/E85055/M776).
 - a. Disconnect one connector (callout 1), and then remove one screw (callout 2).

Figure 1-970 Disconnect one connector and remove one screw



- b. Release six tabs (callout 1), and then remove the upper HVPS.

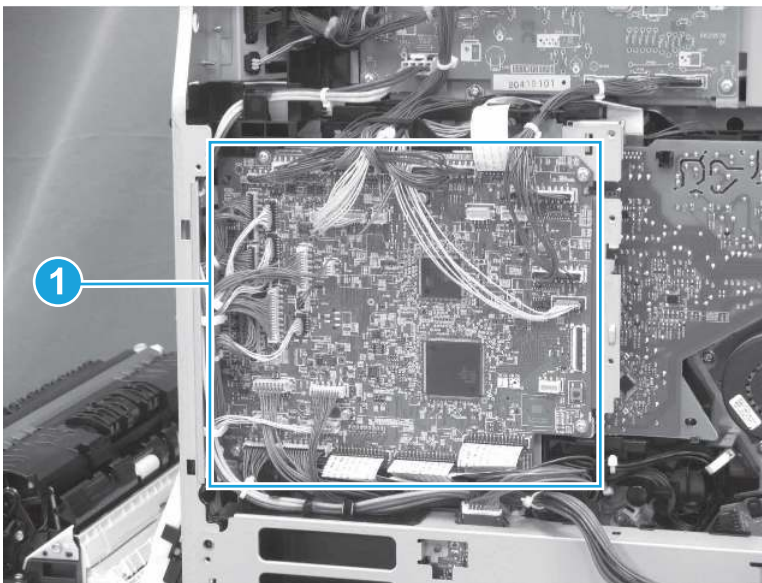
Figure 1-971 Release six tabs



15. Remove the DC controller and case (M856/E85055/M776).

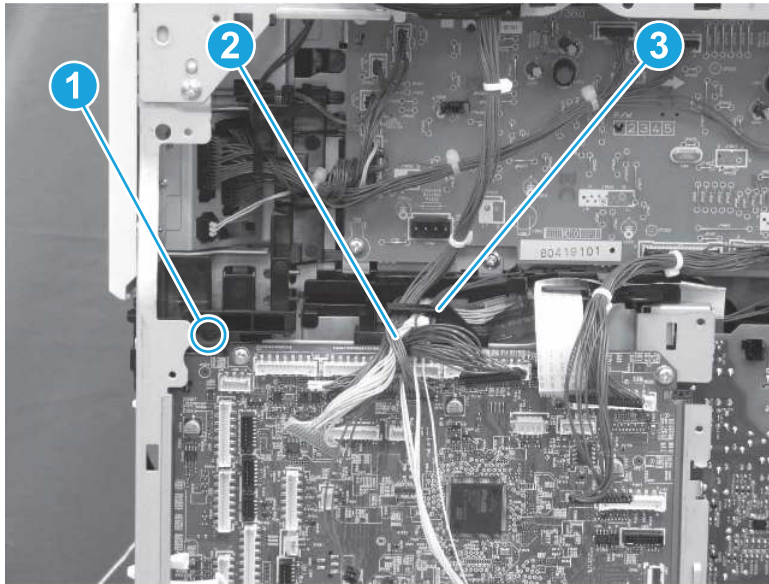
- a. Disconnect all of the connectors on the DC controller.

Figure 1-972 Disconnect the connectors



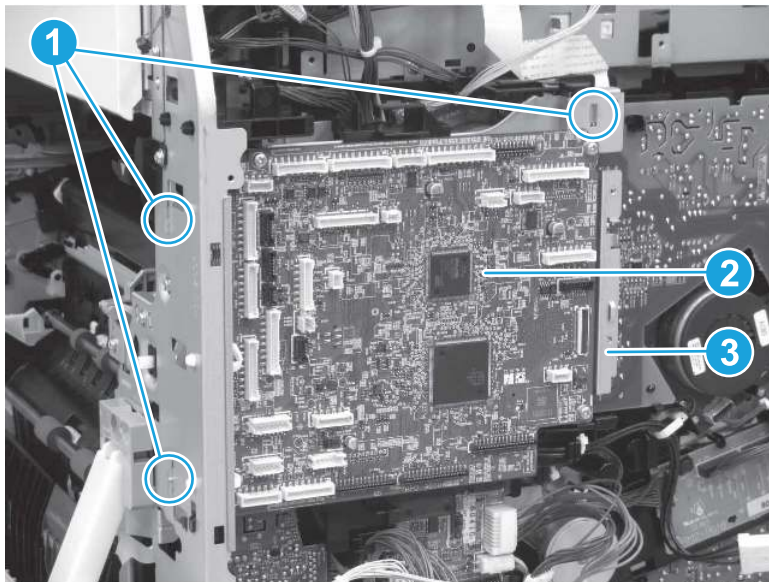
- b. Remove one screw (callout 1), and then release the cables (callout 2) from the cable guide (callout 3).

Figure 1-973 Remove one screw and release the cables



- c. Remove one screw (callout 1), and then remove the DC controller (callout 2) together with the metal case (callout 3).

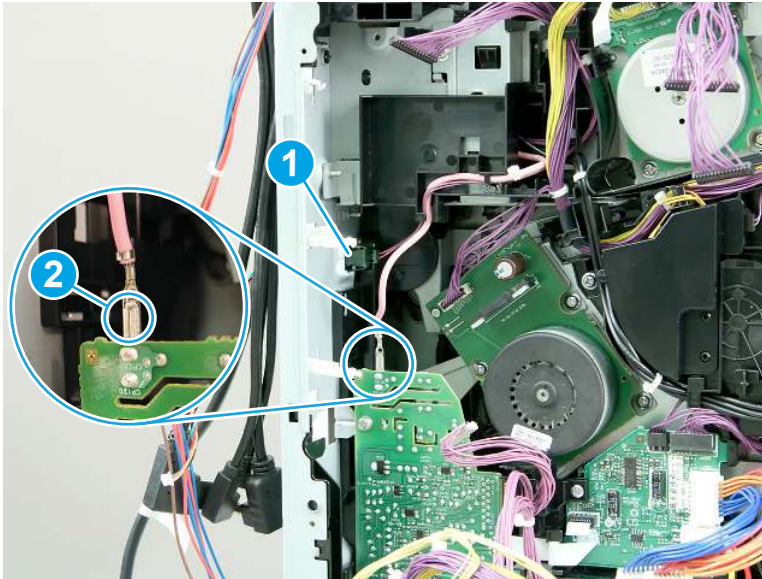
Figure 1-974 Remove the DC controller and case



- 16. Remove the fuser drive assembly (M856/E85055/M776).

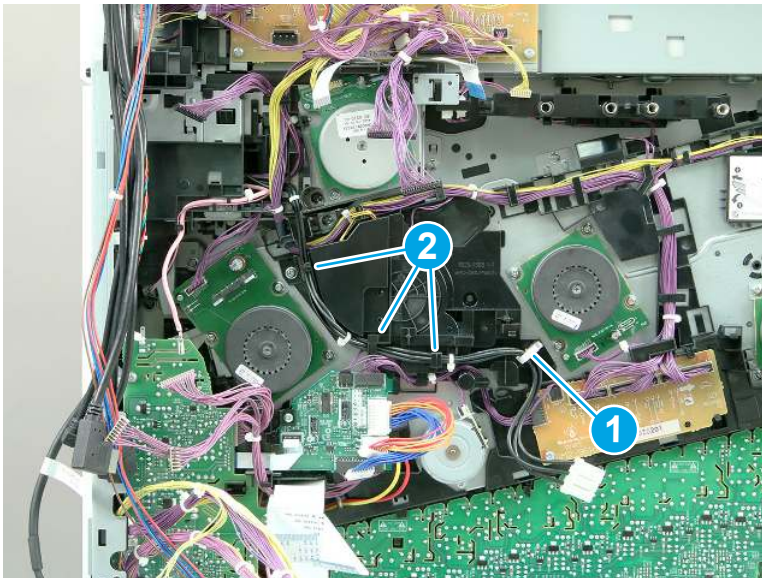
- a. Disconnect one connector (callout 1). Press and hold the small release tab on one connector (callout 2), and then slide the connector away from the board to disconnect it.

Figure 1-975 Disconnect two connectors



- b. Release one retainer (callout 1), and then release the cable from the guides (callout 2).

Figure 1-976 Release the cable



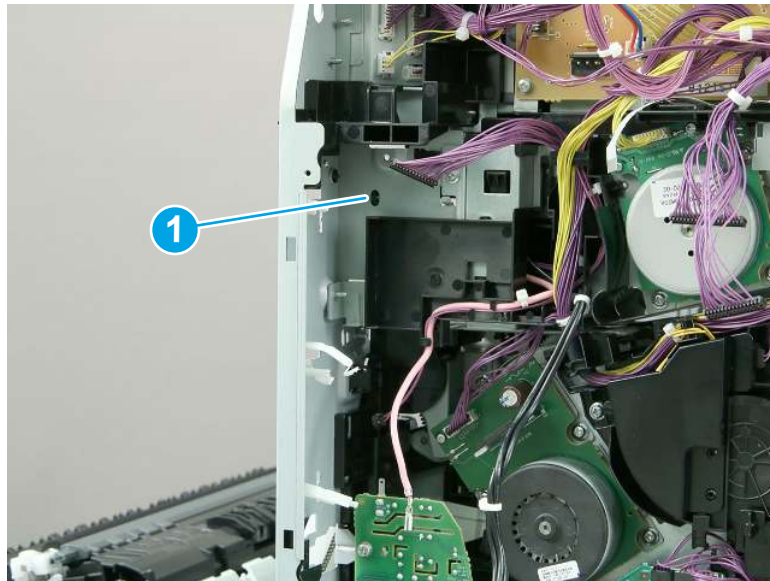
- c. Open the right door, and then remove one screw (callout 1).

Figure 1-977 Remove one screw



- d. Release one tab (callout 1).

Figure 1-978 Release one tab



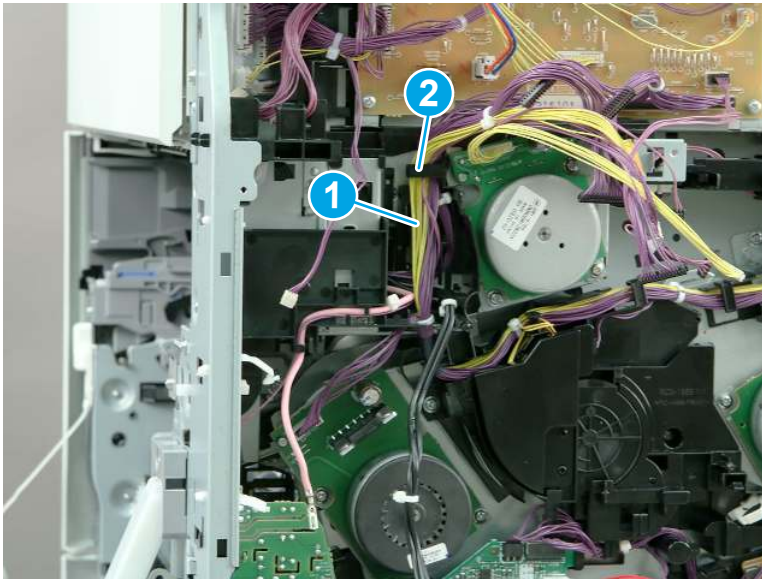
- e. Remove the guide (callout 1).

Figure 1-979 Remove the guide



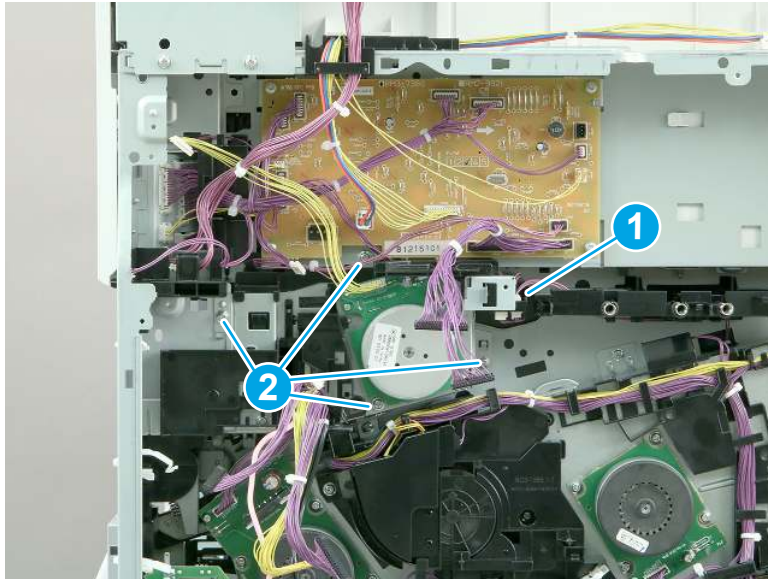
- f. Release the cables (callout 1) from the guide.

Figure 1-980 Release the cables



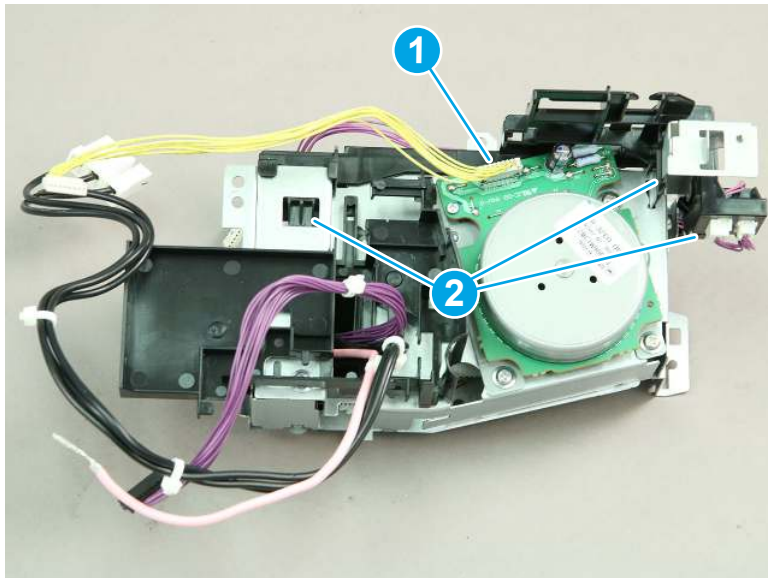
- g. Disconnect one connector (callout 1), and then remove four screws (callout 2). Remove the fuser drive assembly and the guide.

Figure 1-981 Remove the fuser drive assembly



- h. Disconnect one connector (callout 1), and then release four tabs (callout 2) to remove the guide from the fuser drive assembly.

Figure 1-982 Remove the guide




- 17. Unpack the replacement assembly.
 - a. Dispose of the defective part.




NOTE: HP recommends responsible disposal of the defective part.

<http://www8.hp.com/us/en/hp-information/environment/product-recycling.html>

- b. Unpack the replacement part from the packaging.

 **IMPORTANT:** Make sure that all of the shipping materials (for example shipping tape) are removed from the replacement part prior to installation.

- c. To install an assembly, reverse the removal steps.

 **NOTE:** When applicable, special installation instructions are provided for an assembly at the end of the removal procedure. Always completely read the removal instructions and follow all special installation instructions.

Removal and replacement: Cartridge guide (M751/E75245/M856/E85055/M776)

Learn how to remove and replace the cartridge guide.


Mean time to repair: 2 minutes

Service level: Easy

Before performing service

Turn the printer power off

- Disconnect the power cable.

 **WARNING!** To avoid damage to the printer, turn the printer off, wait 30 seconds, and then remove the power cord before attempting to service the printer.

Use the table below to identify the correct part number for your printer. To order the part, go to www.hp.com/buy/parts.

Table 1-62 Part information

Part number	Part description
RL2-2091-000CN	Guide, cartridge

Required tools

- Small, flat-blade screwdriver

After performing service

Turn the printer power on

- Connect the power cable.
- Use the power switch to turn the power on.

Post service test

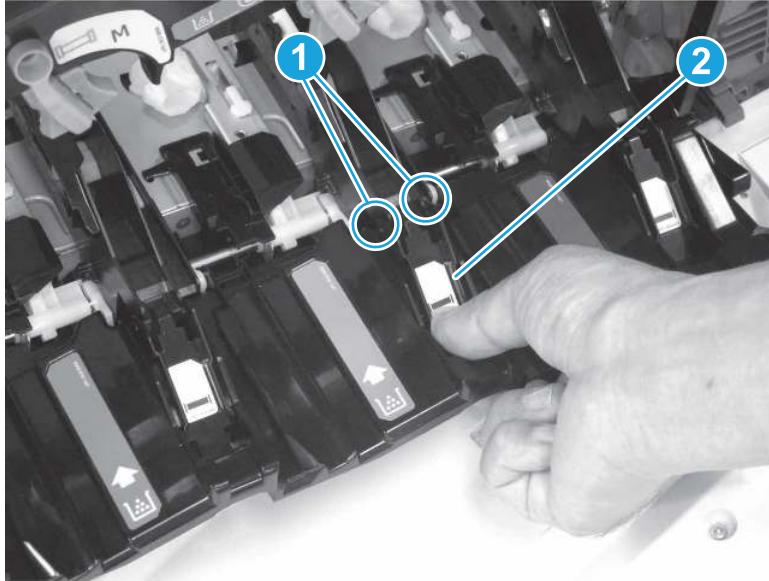
Make sure that the printer initializes to a **Ready** state.

Print a page to make sure that the printer is functioning correctly.

1. Remove the cartridge guide (M751/E75245/M856/E85055/M776).

- ▲ Open the front door. Release two bosses (callout 1), and then remove the cartridge guide (callout 2).

Figure 1-983 Remove the cartridge guide



- 2. Unpack the replacement assembly.
 - a. Dispose of the defective part.



NOTE: HP recommends responsible disposal of the defective part.

<http://www8.hp.com/us/en/hp-information/environment/product-recycling.html>

- b. Unpack the replacement part from the packaging.



IMPORTANT: Make sure that all of the shipping materials (for example shipping tape) are removed from the replacement part prior to installation.

- c. To install an assembly, reverse the removal steps.



NOTE: When applicable, special installation instructions are provided for an assembly at the end of the removal procedure. Always completely read the removal instructions and follow all special installation instructions.

Removal and replacement: Cartridge rail assembly (M751/E75245)

Learn how to remove and replace the cartridge rail assembly.

Mean time to repair: 30 minutes

Service level: Hard

Before performing service

Turn the printer power off

- Disconnect the power cable.

⚠ WARNING! To avoid damage to the printer, turn the printer off, wait 30 seconds, and then remove the power cord before attempting to service the printer.

Use the table below to identify the correct part number for your printer. To order the part, go to www.hp.com/buy/parts.

Table 1-63 Part information

Part number	Part description
RM2-1354-000CN	First cartridge rail assembly (Yellow; M751/E75245)
RM2-1353-000CN	Second cartridge rail assembly (Magenta; M751/E75245)
RM2-1355-000CN	Third cartridge rail assembly (Cyan; M751/E75245)
RM2-1356-000CN	Black cartridge rail assembly (M751/E75245/M856/E85055/M776dn/M776z/M776zs)

Required tools

- #2 Phillips screwdriver with a magnetic tip
- Small, flat-blade screwdriver

After performing service

Turn the printer power on

- Connect the power cable.
- Use the power switch to turn the power on.

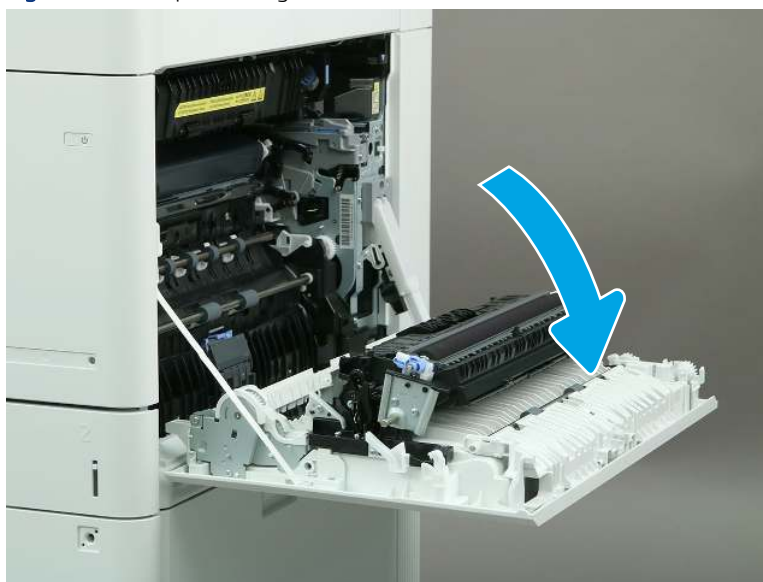
Post service test

Make sure that the printer initializes to a **Ready** state.

Print a page to make sure that the printer is functioning correctly.

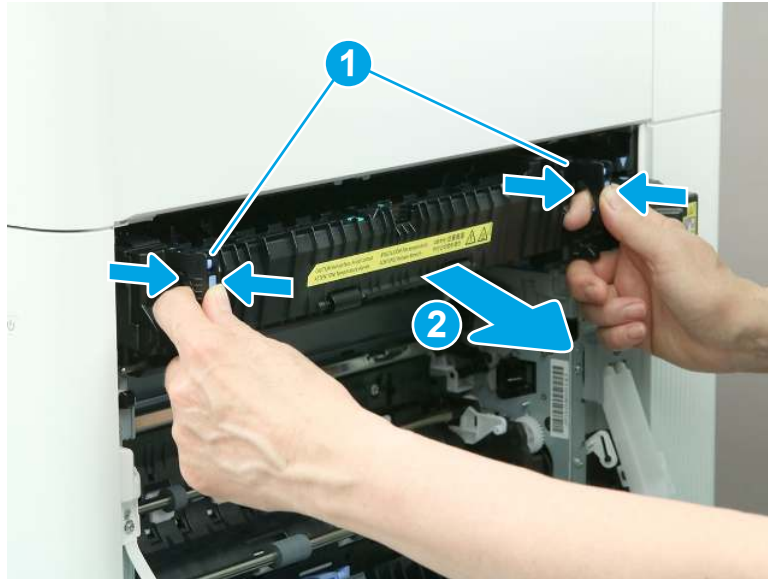
1. Remove the fuser.
 - a. Open the right door.

Figure 1-984 Open the right door



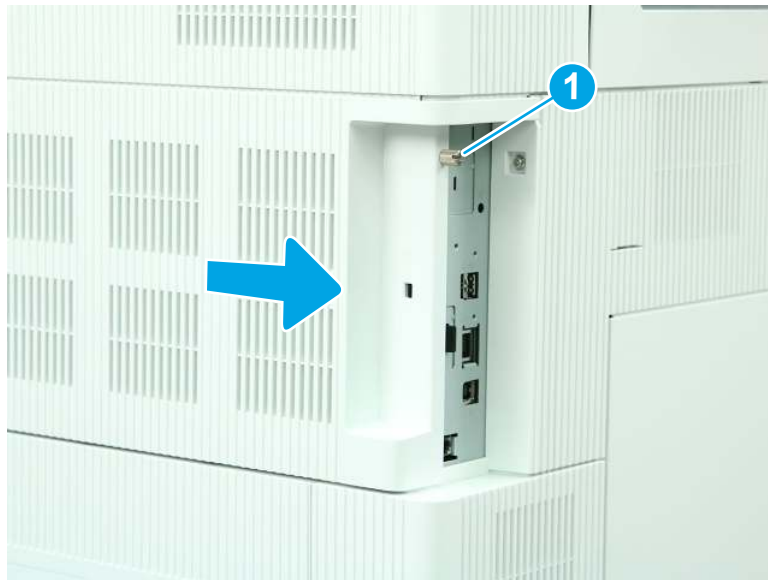
- b. Grasp the fuser handles, and then squeeze the release levers (callout 1). Lift up slightly, and then pull straight out to remove the fuser (callout 2).

Figure 1-985 Remove the fuser



2. Remove the formatter cover.
 - ▲ Loosen one thumbscrew (callout 1), and then slide the formatter cover (callout 2) away from the printer to remove it.

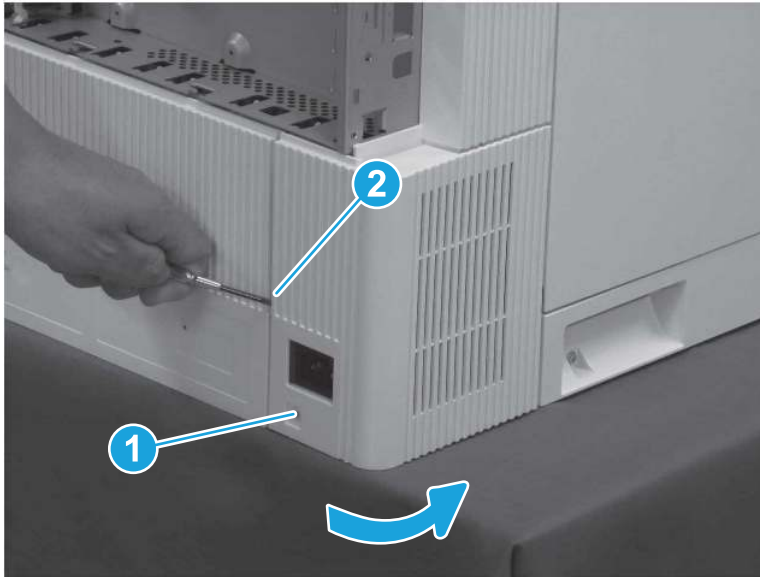
Figure 1-986 Remove the formatter cover



3. Remove the left lower cover (M751/E75245).

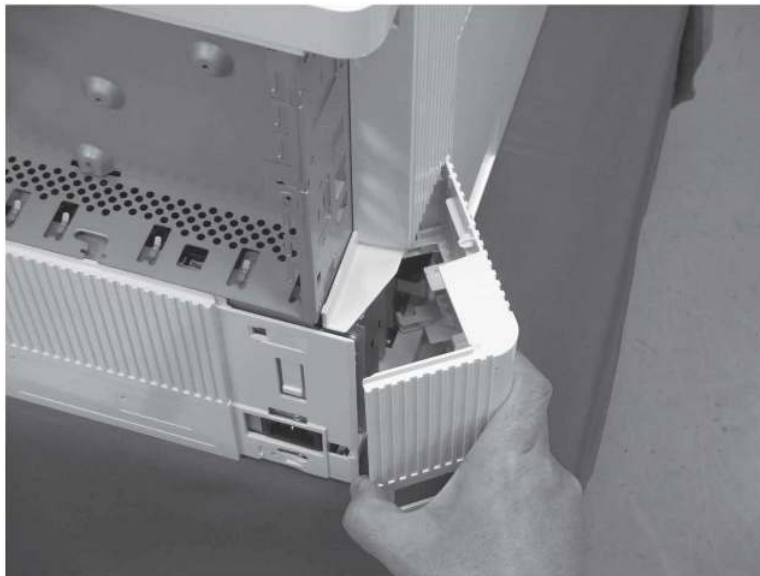
- a. Remove one screw (callout 1), release one tab (callout 2), and then rotate the cover away from the printer.

Figure 1-987 Remove one screw and release one tab



- b. Remove the left lower cover.

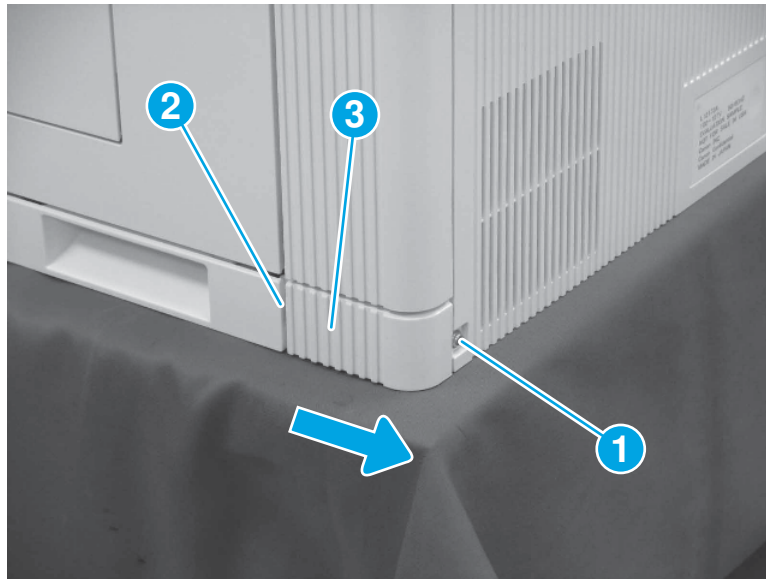
Figure 1-988 Remove the left lower cover



4. Remove the right rear lower cover (M751/E75245/M856/E85055/M776).

- ▲ Remove one screw (callout 1), release one tab (callout 2), and then slide the right rear lower cover (callout 3) toward the back of the printer to remove it.

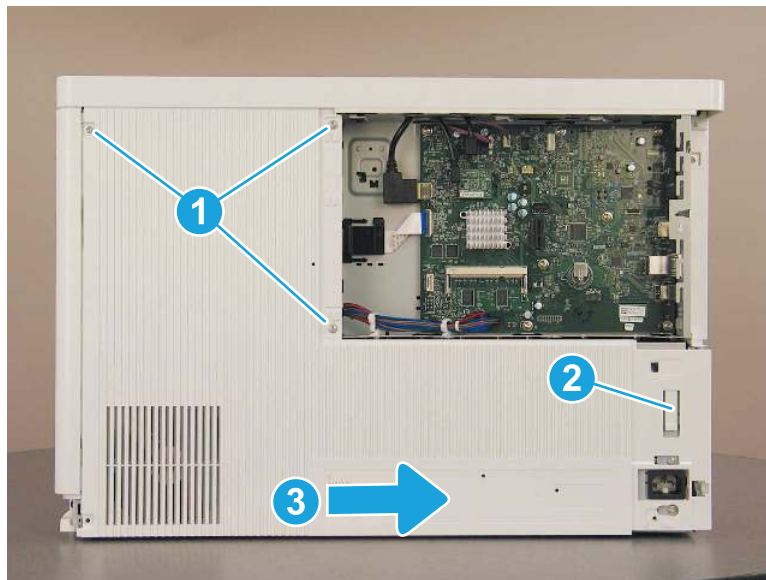
Figure 1-989 Remove the right rear lower cover



5. Remove the rear cover (M751/E75245).

- ▲ Remove three screws (callout 1), release one tab (callout 2), and then slide the rear cover to the right (callout 3) to remove it.

Figure 1-990 Remove the rear cover

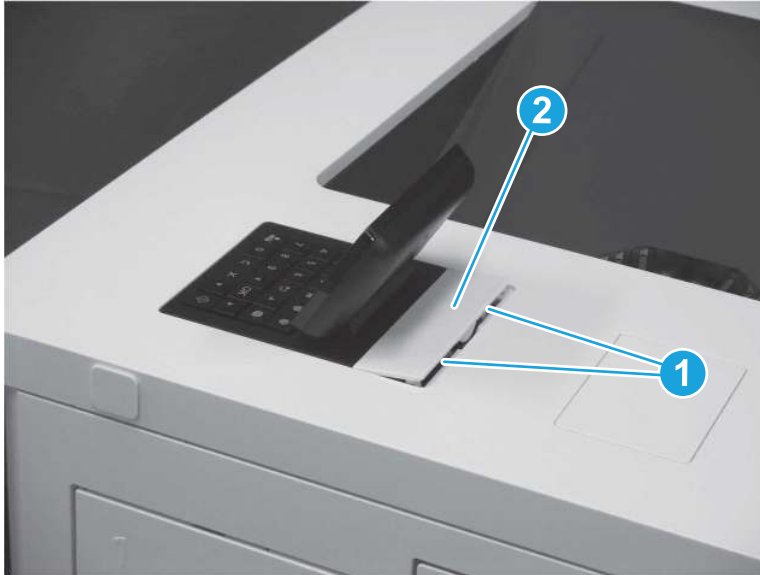


6. Remove the control panel.

 **NOTE:** A screwdriver is included in the control panel kit. The screwdriver has a reversible shaft. Simply pull the shaft out of the handle, and then reinstall it with the desired end facing out.

- a. Use a small, flat-blade screwdriver to release two tabs (callout 1), and then remove the control panel cover (callout 2).

Figure 1-991 Remove the control panel cover



- b. Remove one screw (callout 1).

Figure 1-992 Remove one screw



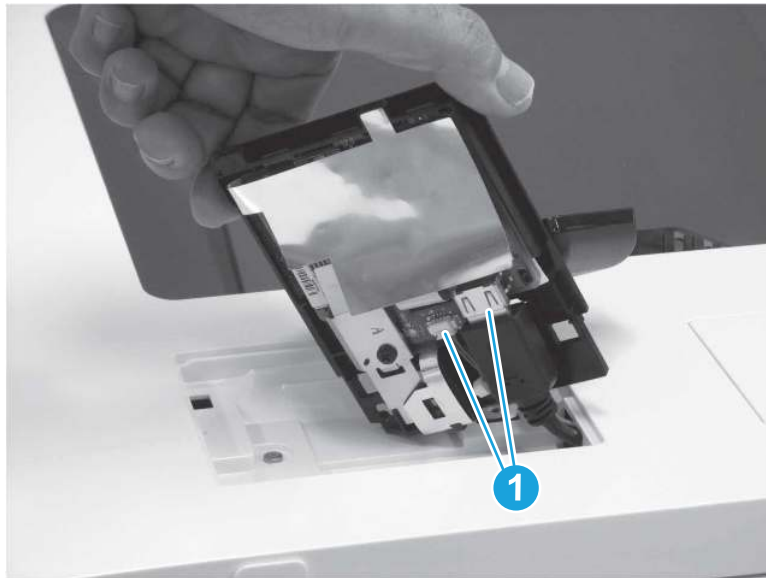
- c. Lift the back edge of the control panel up (callout 1), and then slide the control panel toward the back of the printer (callout 2).

Figure 1-993 Slide the control panel back



- d. Turn the control panel so that the bottom is facing up, and then disconnect two connectors (callout 1) to remove the control panel.

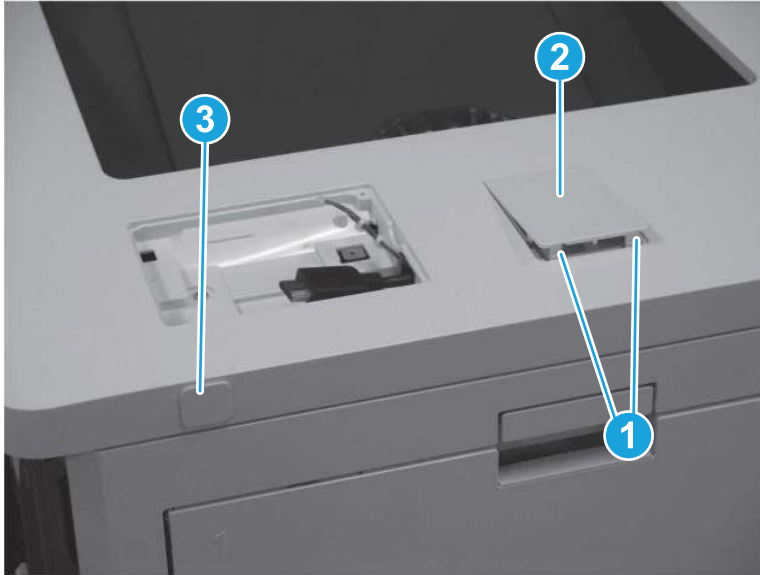
Figure 1-994 Disconnect two connectors



7. Remove the top cover (M751/E75245).

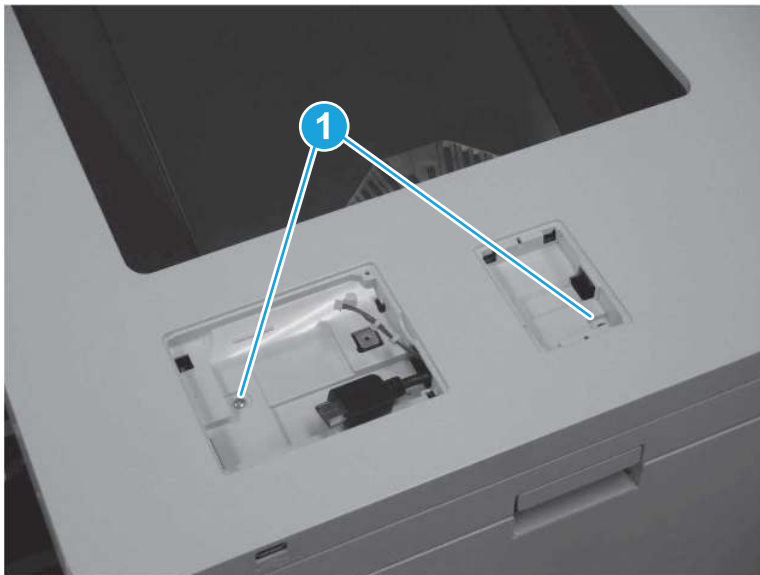
- a. Release two tabs (callout 1), and then remove the HIP cover (callout 2). Pull the USB cap (callout 3) away from the printer to remove it.

Figure 1-995 Remove the HIP cover and USB cap



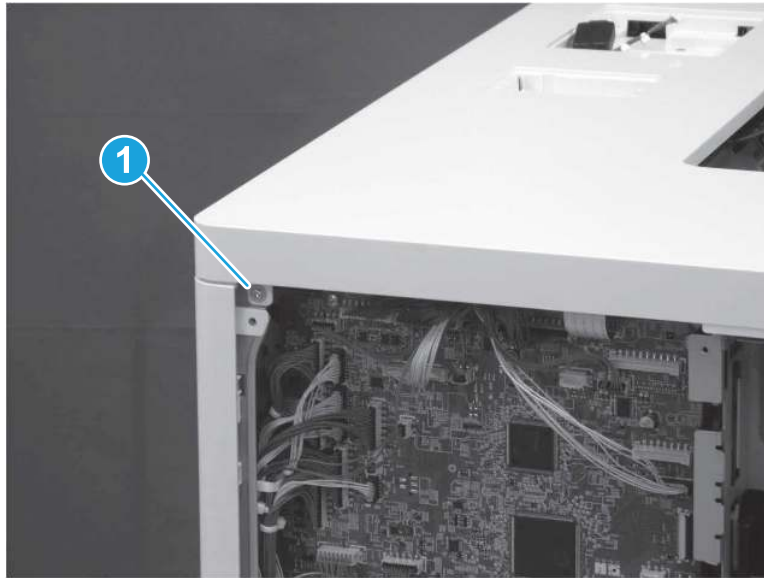
- b. At the top of the printer, remove two screws (callout 1).

Figure 1-996 Remove two screws




- c. At the back of the printer, remove one screw (callout 1).

Figure 1-997 Remove one screw

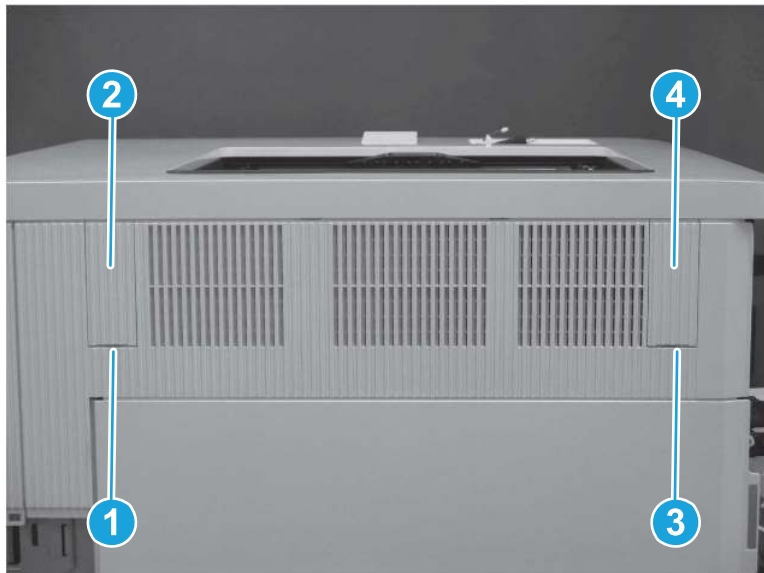


- d. Use a small, flat-blade screwdriver to release one tab (callout 1) and remove the left blanking cover (callout 2). Release one tab (callout 3) and remove the right blanking cover (callout 4).

 **TIP:** These covers are not identical. Make sure to reinstall the correct cover on the correct side.

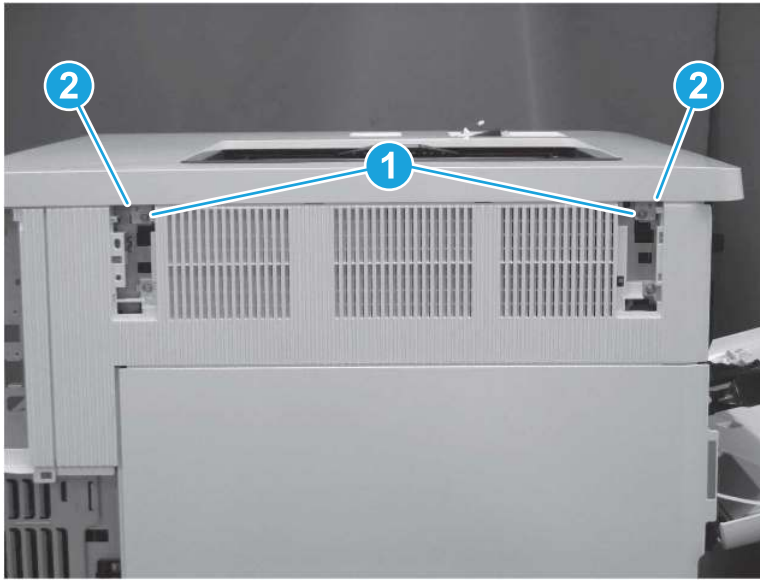
 **NOTE:** The screw under the left blanking cover is a self-tapping screw. Make sure this screw is reinstalled in the correct location.

Figure 1-998 Remove the left and right blanking covers



- e. Remove two screws (callout 1), and then release two tabs (callout 2).

Figure 1-999 Remove two screws and release two tabs



- f. At the front of the printer, remove one washer-head screw (callout 1) and one self-tapping screw (callout 2). Release one tab (callout 3).


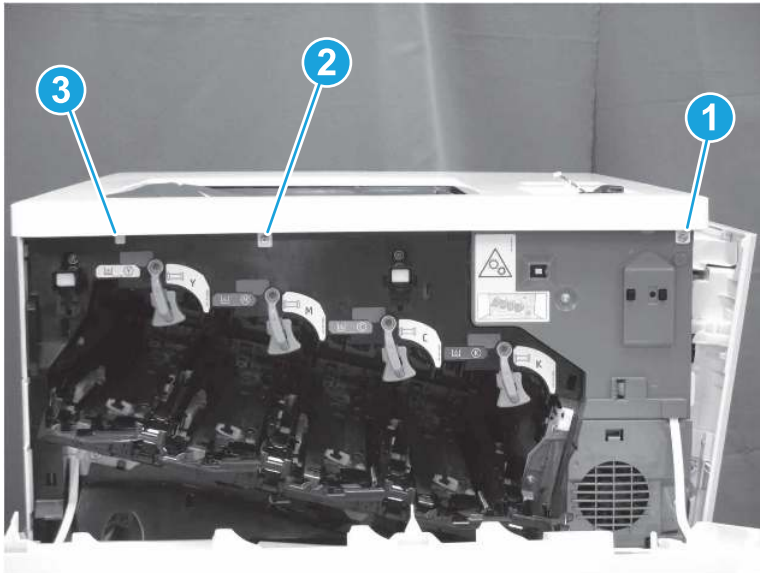
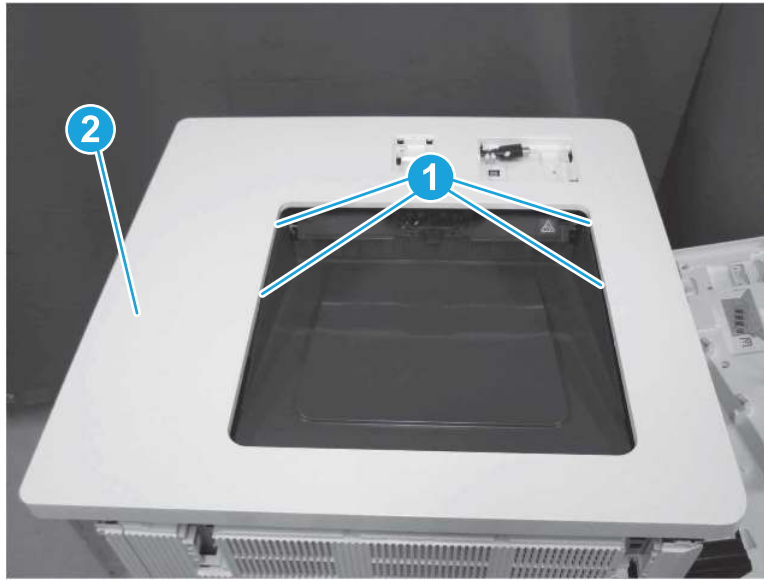
 **TIP:** Make sure to install the correct type of screw in the correct location.


Figure 1-1000 Remove two screws and release one tab



- g. At the top of the printer, release four tabs (callout 1), and then remove the top cover (callout 2).

Figure 1-1001 Remove the top cover



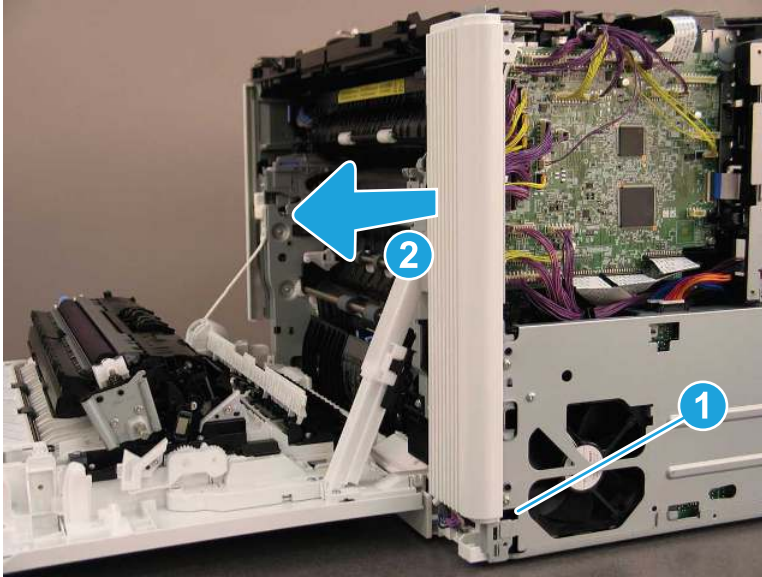
 **NOTE:** When removing the top cover, make sure to release the control panel cables (callout 1) through the opening.



8. Remove the right rear cover (M751/E75245).

- ▲ Release one tab (callout 1), and then slide the right rear cover (callout 2) away from the printer to remove it.

Figure 1-1002 Remove the right rear cover



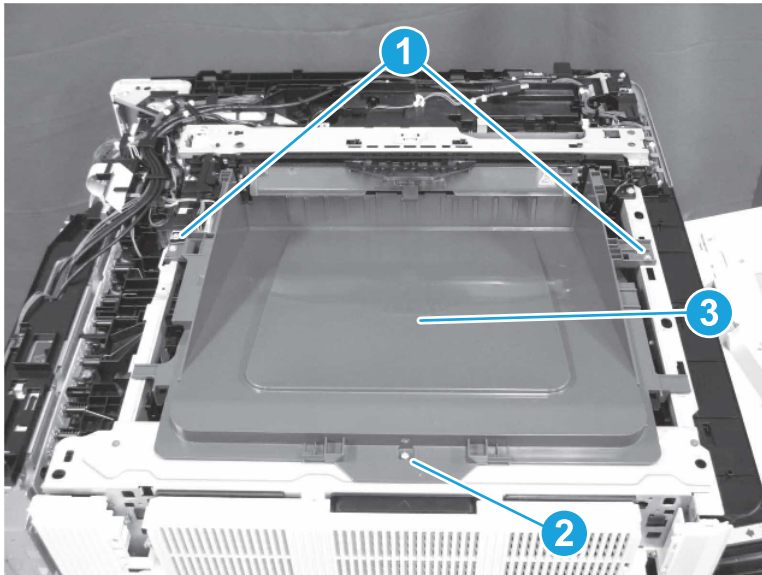
9. Remove the output bin (M751/E75245).

- ▲ Remove two washer-head machine screws (callout 1), remove one self-tapping screw (callout 2), and then remove the output bin (callout 3).



NOTE: When reinstalling the output bin, make sure to install the correct type of screw in the correct location.

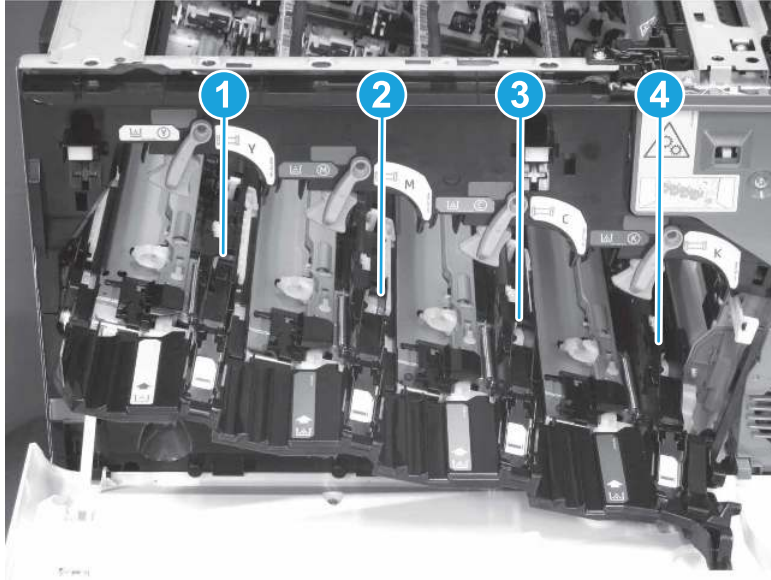
Figure 1-1003 Remove the output bin



10. Remove the cartridge rail assembly (M751/E75245/M856/E85055/M776).

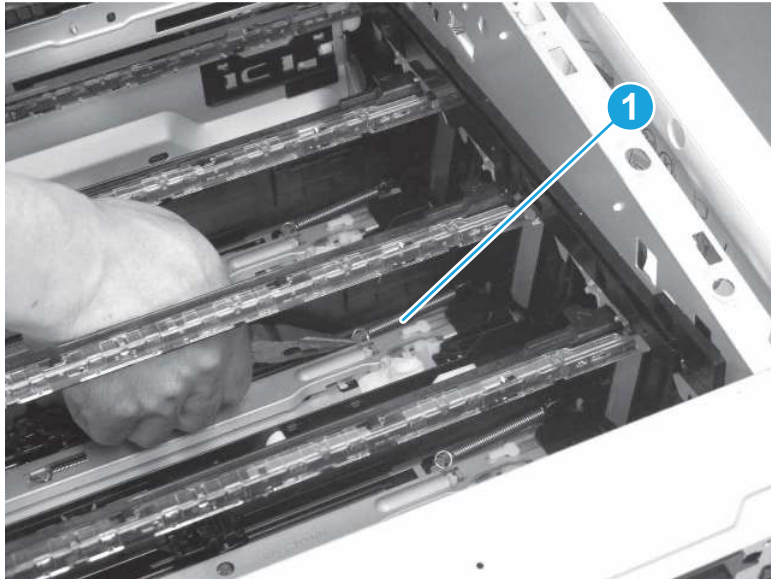
- a. This procedure provides instructions for removing the cyan cartridge rail assembly (callout 3). However, the procedure is also correct for removing any of the four cartridge rail assemblies in the printer.
- Yellow cartridge rail assembly (callout 1)
 - Magenta cartridge rail assembly (callout 2)
 - Cyan cartridge rail assembly (callout 3)
 - Black cartridge rail assembly (callout 4)

Figure 1-1004 Cartridge rail assembly locations



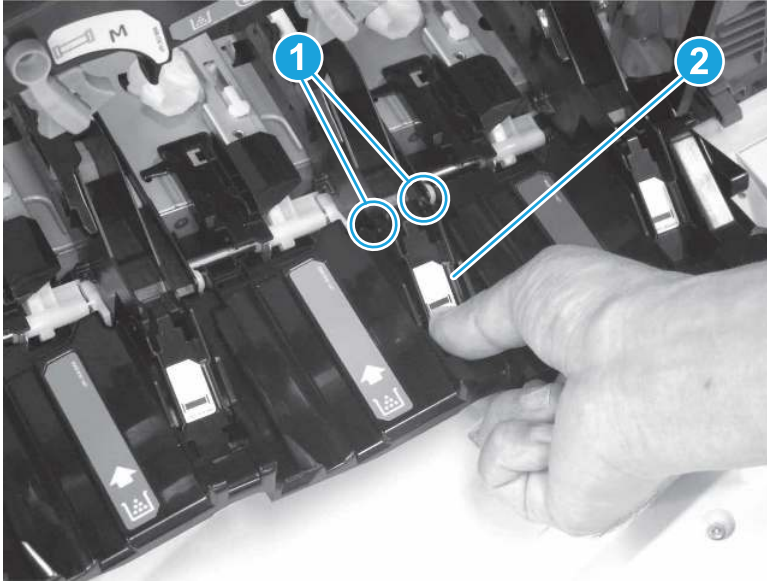
- b. Close the front door. Use needle-nosed pliers to unhook one spring (callout 1).

Figure 1-1005 Unhook one spring



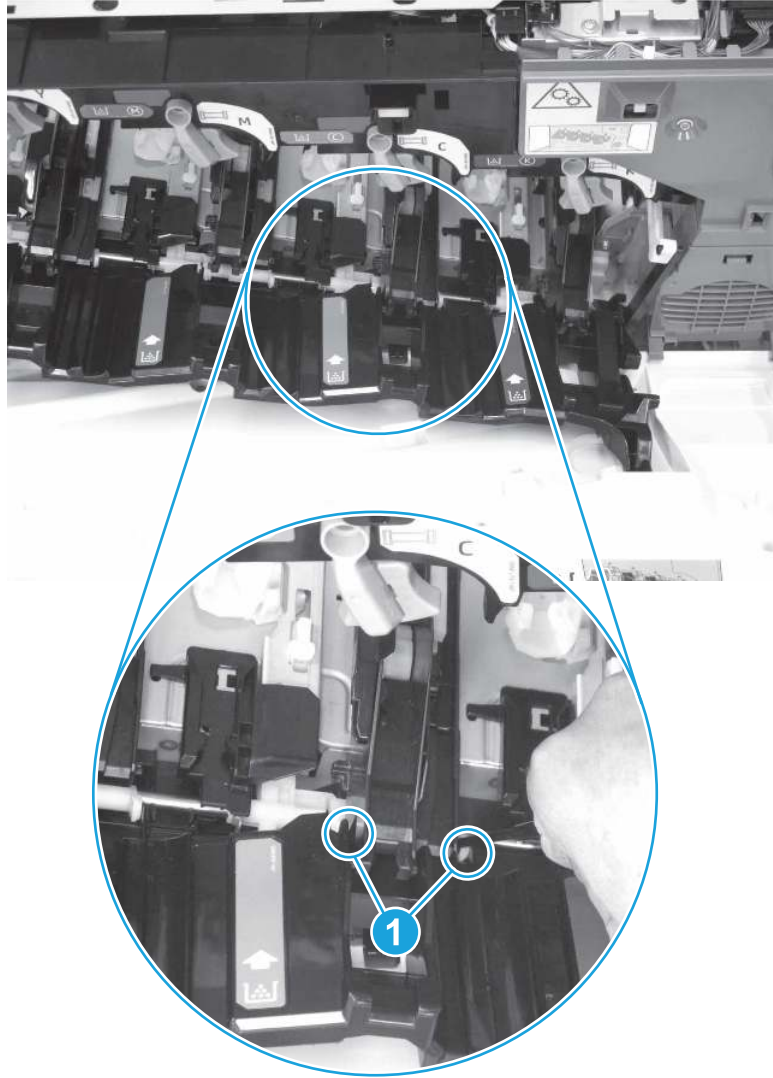
- c. Open the front door. Release two bosses (callout 1), and then remove the link (callout 2).

Figure 1-1006 Remove the link



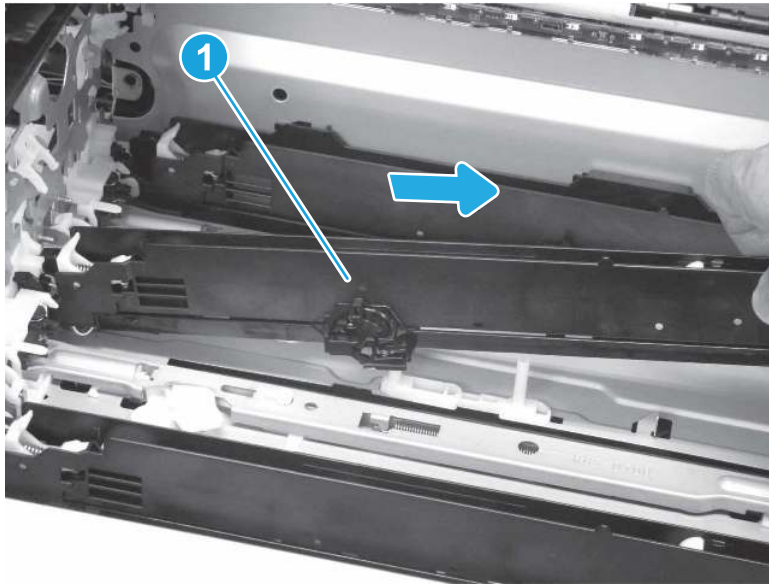
- d. Release two bosses (callout 1).

Figure 1-1007 Release two bosses



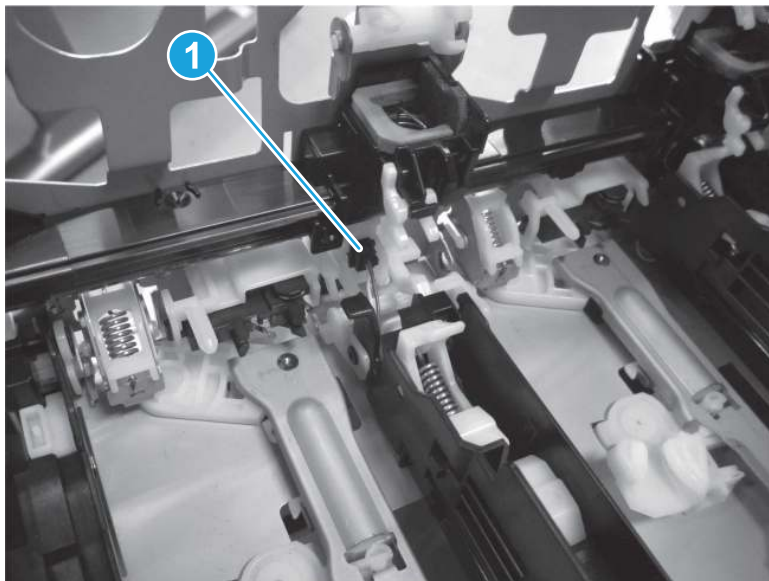
- e. Pull the cartridge rail assembly (callout 1) toward the front of the printer about 2 cm (0.79 in).

Figure 1-1008 Pull the cartridge rail assembly



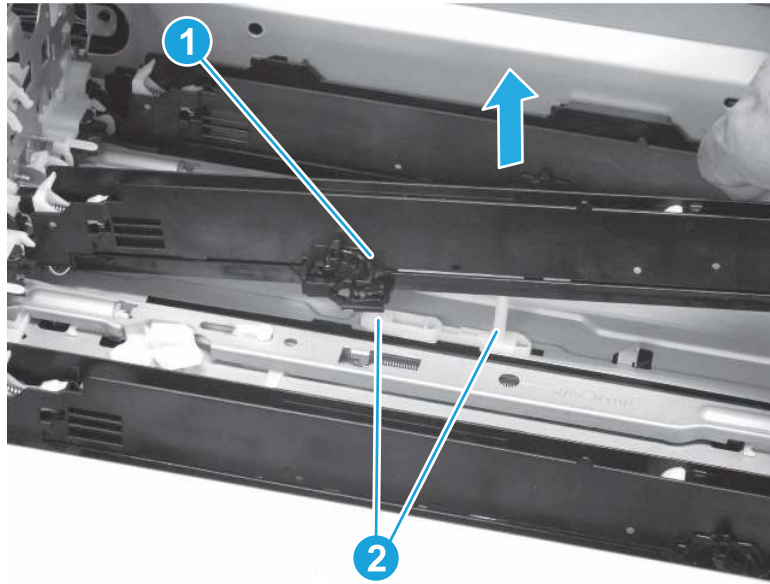
- f. Disconnect one connector (callout 1).

Figure 1-1009 Disconnect one connector



- g. Lift up to remove the cartridge rail assembly (callout 1) from the tag guide (callout 2).

Figure 1-1010 Remove the cartridge rail assembly



- 11. Unpack the replacement assembly.

- a. Dispose of the defective part.



NOTE: HP recommends responsible disposal of the defective part.

<http://www8.hp.com/us/en/hp-information/environment/product-recycling.html>

- b. Unpack the replacement part from the packaging.



IMPORTANT: Make sure that all of the shipping materials (for example shipping tape) are removed from the replacement part prior to installation.

- c. To install an assembly, reverse the removal steps.



NOTE: When applicable, special installation instructions are provided for an assembly at the end of the removal procedure. Always completely read the removal instructions and follow all special installation instructions.

- 12. Reverse the removal steps to install the assembly. Also use the following **special installation instructions**.

Install the cartridge rail assembly.

- a. When installing the cartridge rail assembly, make sure that the lever of the PCG assembly is positioned correctly. If the lever is positioned incorrectly, the cartridge cannot be installed.

Figure 1-1011 Check the PGC lever (M751/E75245/M856/E85055/M776dn/M776z/M776zs)

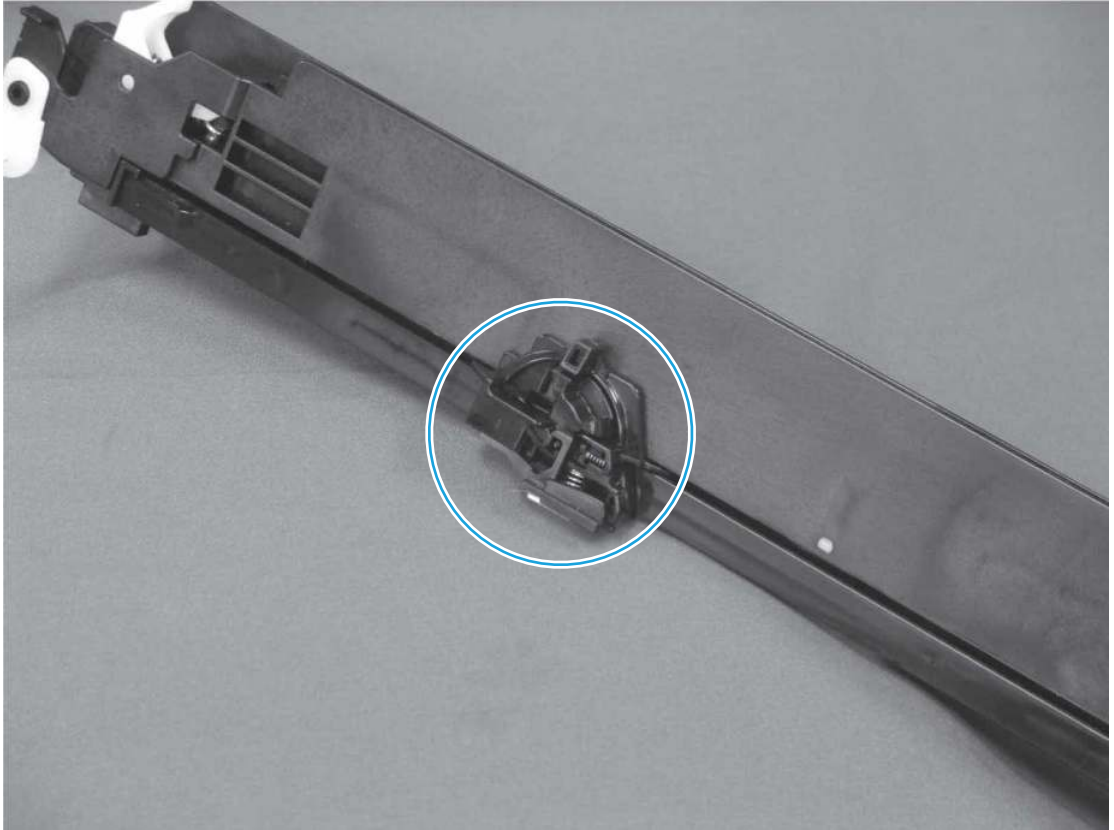
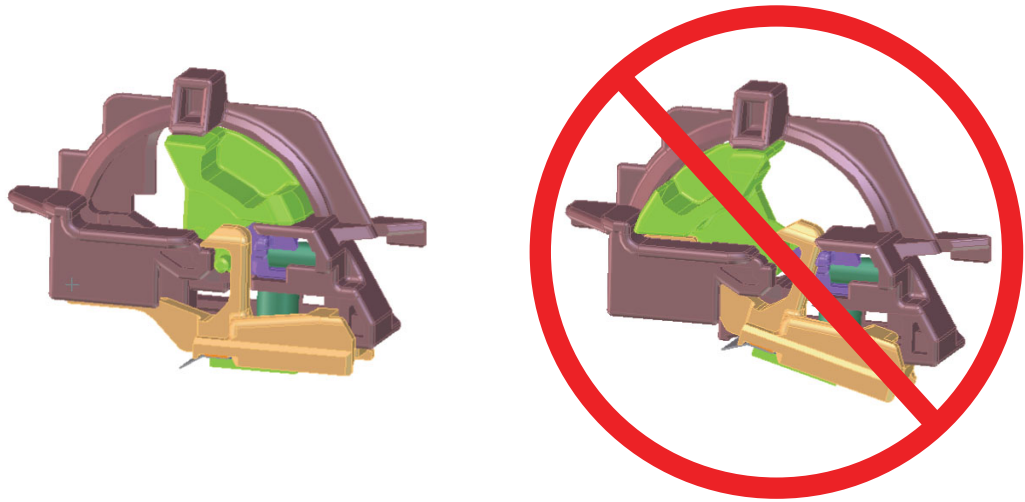
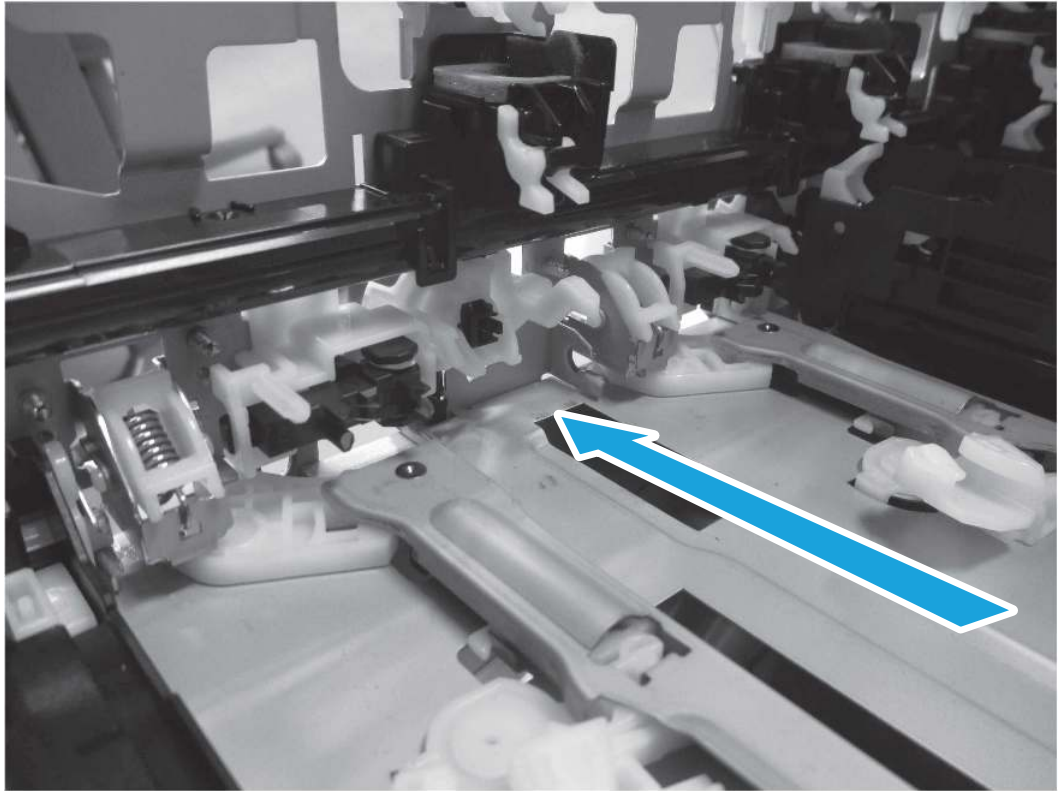


Figure 1-1012 PGC lever correct and incorrect positions (M751/E75245/M856/E85055/M776dn/M776z/M776zs)



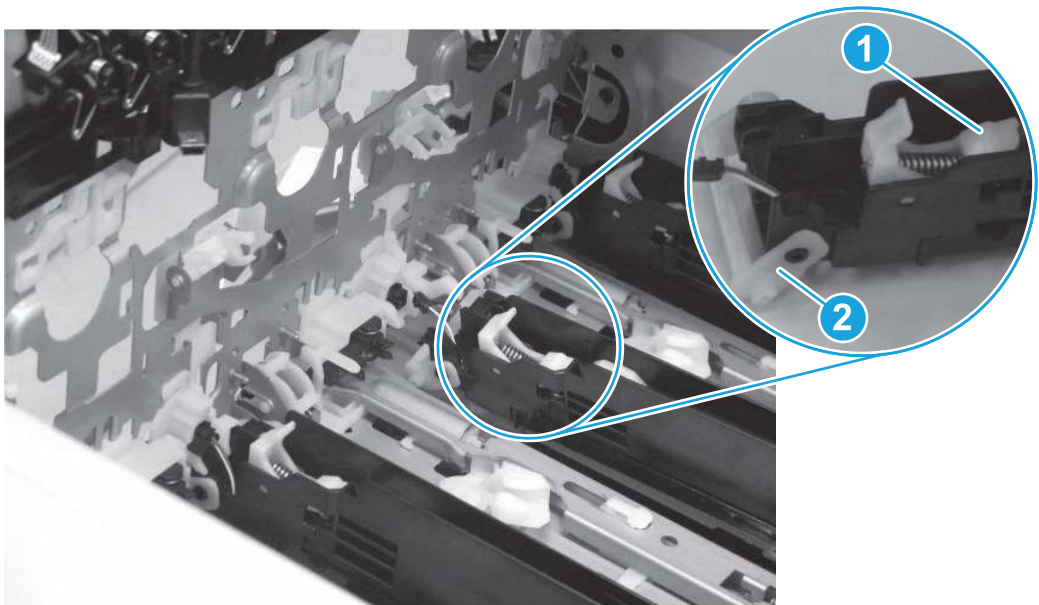
- b. Slide the cartridge rail assembly into position.

Figure 1-1013 Position the cartridge rail assembly
(M751/E75245/M856/E85055/M776dn/M776z/M776zs)



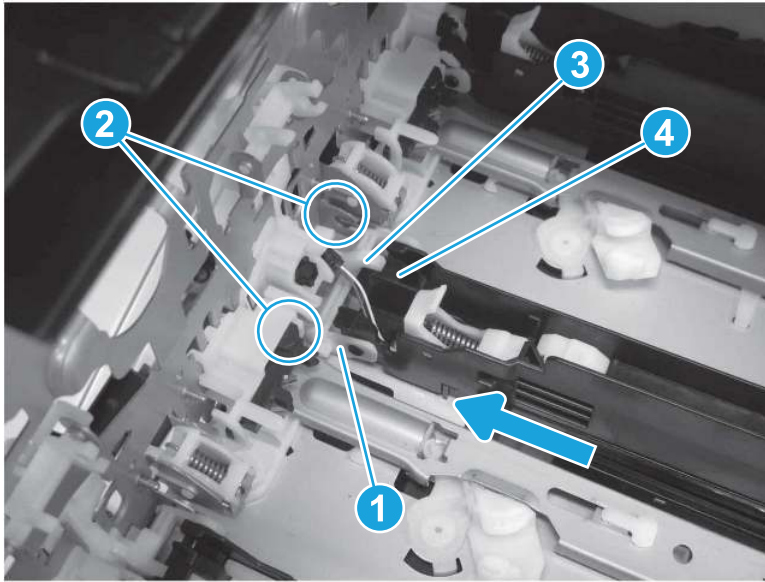
- c. Make sure that the lock lever (callout 1) is in the down position and the link arm (callout 2) is positioned under the casing. If these parts are positioned incorrectly, the cartridge cannot be installed.

Figure 1-1014 Check the lock lever and link arm positions
(M751/E75245/M856/E85055/M776dn/M776z/M776zs)



- d. When installing the link arm (callout 1) on the cartridge rail assembly to the bushing (callout 2) on the printer frame, insert the protrusion on the arm (callout 3) on the printer into the guide (callout 4) on the cartridge rail.

Figure 1-1015 Install the link arm (M751/E75245/M856/E85055/M776dn/M776z/M776zs)



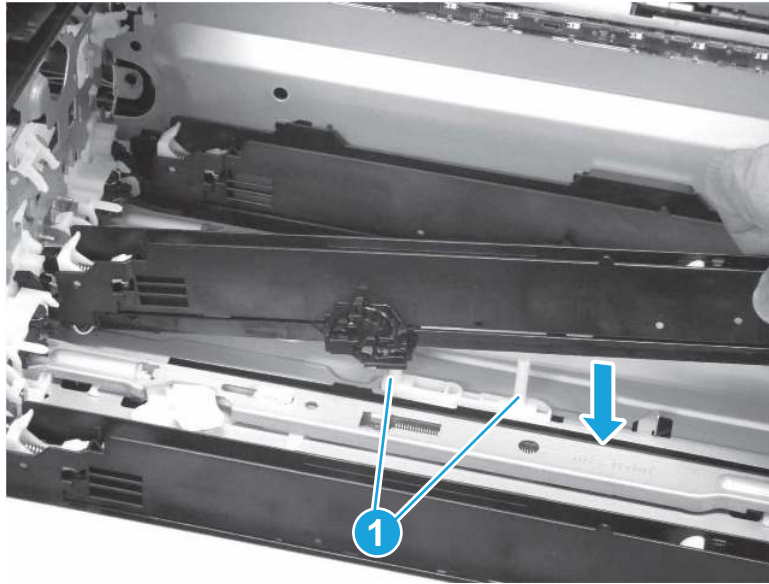
- e. This figure shows the correct installation of the link arm.

Figure 1-1016 Link arm correct installation (M751/E75245/M856/E85055/M776dn/M776z/M776zs)



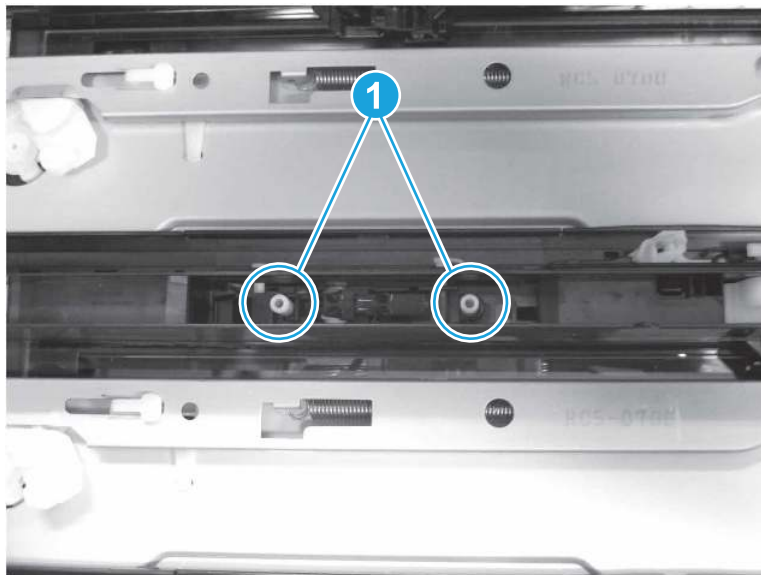
- f. Install the cartridge rail assembly into the cartridge tag guide (callout 1).

Figure 1-1017 Install the cartridge rail assembly into the cartridge tag guide (M751/E75245/M856/E85055/M776dn/M776z/M776zs)



- g. Make sure that the white cartridge tag guide is correctly positioned. Look at the cartridge rail assembly from above and verify that the white cartridge tag guide (callout 1) is visible.

Figure 1-1018 Check the cartridge tag guide (M751/E75245/M856/E85055/M776dn/M776z/M776zs)



Removal and replacement: Cartridge rail assembly (M856/E85055/M776dn/M776z)

Learn how to remove and replace the cartridge rail assembly.

Mean time to repair: 35 minutes

Service level: Hard

Before performing service

Turn the printer power off

- Disconnect the power cable.

⚠ WARNING! To avoid damage to the printer, turn the printer off, wait 30 seconds, and then remove the power cord before attempting to service the printer.

Use the table below to identify the correct part number for your printer. To order the part, go to www.hp.com/buy/parts.

Table 1-64 Part information

Part number	Part description
RM2-2481-000CN	First cartridge rail assembly (Yellow; M856/E85055/M776dn/M776z)
RM2-2480-000CN	Second cartridge rail assembly (Magenta; M856/E85055/M776dn/M776z/M776zs)
RM2-2482-000CN	Third cartridge rail assembly (Cyan; M856/E85055/M776dn/M776z)
RM2-1356-000CN	Black cartridge rail assembly (M751/E75245/M856/E85055/M776dn/M776z/M776zs)

Required tools

- #2 Phillips screwdriver with a magnetic tip
- Small, flat-blade screwdriver

After performing service

Turn the printer power on

- Connect the power cable.
- Use the power switch to turn the power on.

Post service test

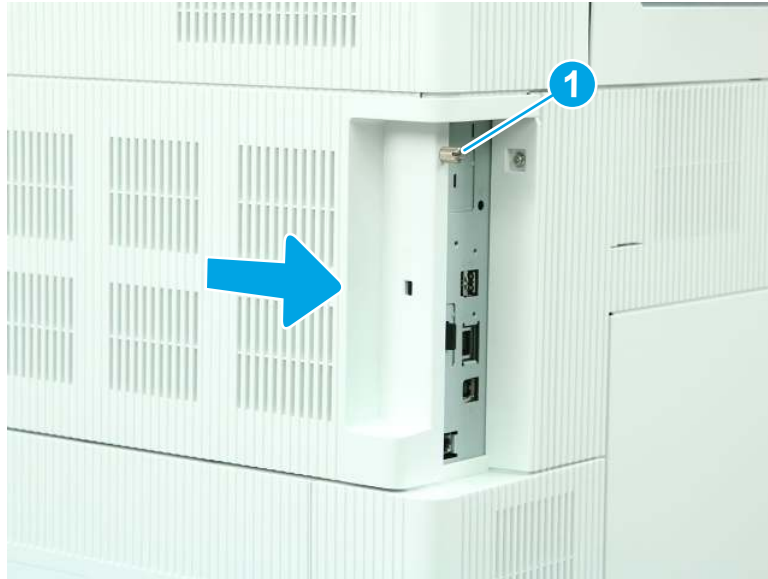
Make sure that the printer initializes to a **Ready** state.

Print a page to make sure that the printer is functioning correctly.

1. Remove the formatter cover.

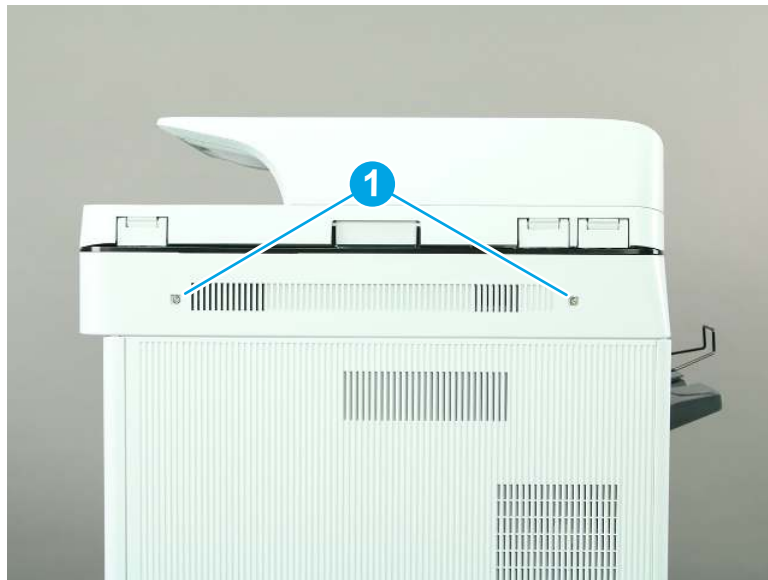
- ▲ Loosen one thumbscrew (callout 1), and then slide the formatter cover (callout 2) away from the printer to remove it.

Figure 1-1019 Remove the formatter cover



- 2. Remove the scanner control board (SCB) cover (M776).
 - a. Remove two screws (callout 1).

Figure 1-1020 Remove two screws



- b. Remove the SCB cover.

Figure 1-1021 Remove the SCB cover

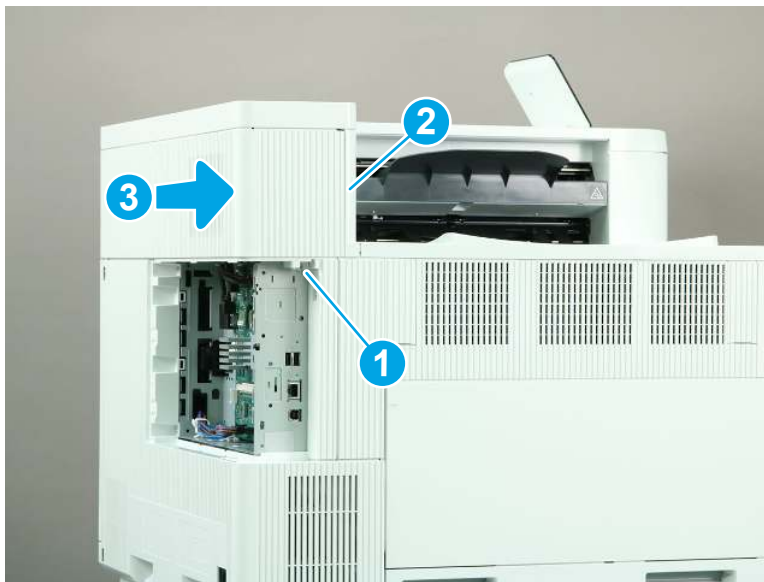


3. Remove the rear upper cover (M856/E85055/M776dn/M776z).

 **NOTE:** The following figure shows the M856 printer. The procedure is correct for all referenced models.

- ▲ Remove one screw (callout 1), release one tab (callout 2), and then slide the rear upper cover away from the printer to remove it (callout 3).

Figure 1-1022 Remove the rear upper cover

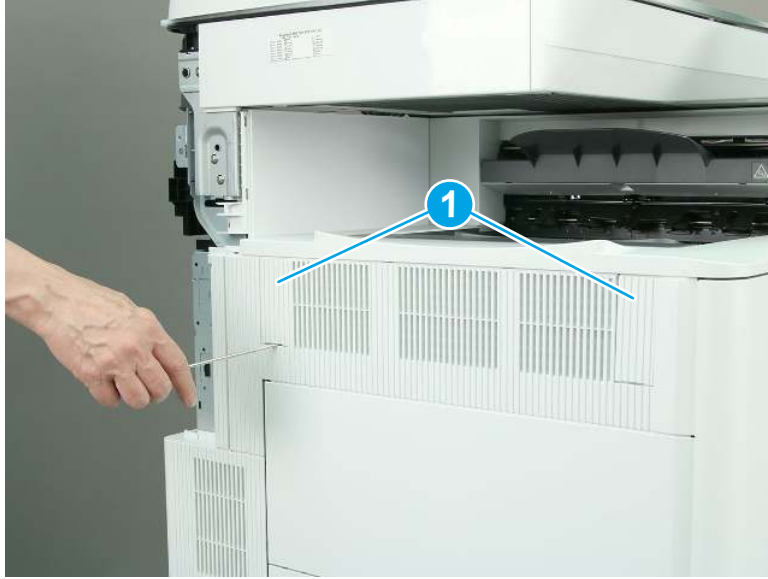


4. Remove the accessory upper cover (M856/E85055/M776dn/M776z).

 **NOTE:** The following figures show the M776z printer. The procedure is correct for all referenced models.

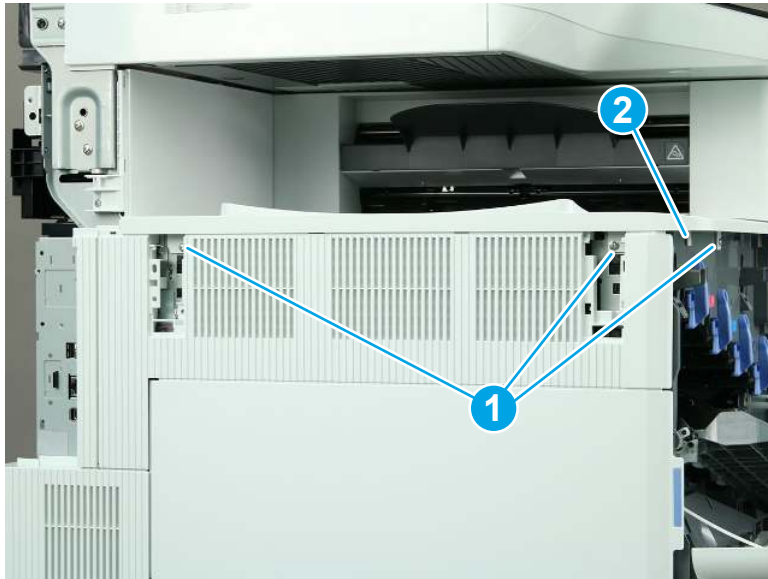
- a. Use a small, flat-blade screwdriver to remove two covers (callout 1).

Figure 1-1023 Remove two covers



- b. Remove three screws (callout 1), and then release one tab (callout 2).

Figure 1-1024 Remove three screws and release one tab



- c. Slide the accessory upper cover away from the printer to remove it.

Figure 1-1025 Remove the accessory upper cover

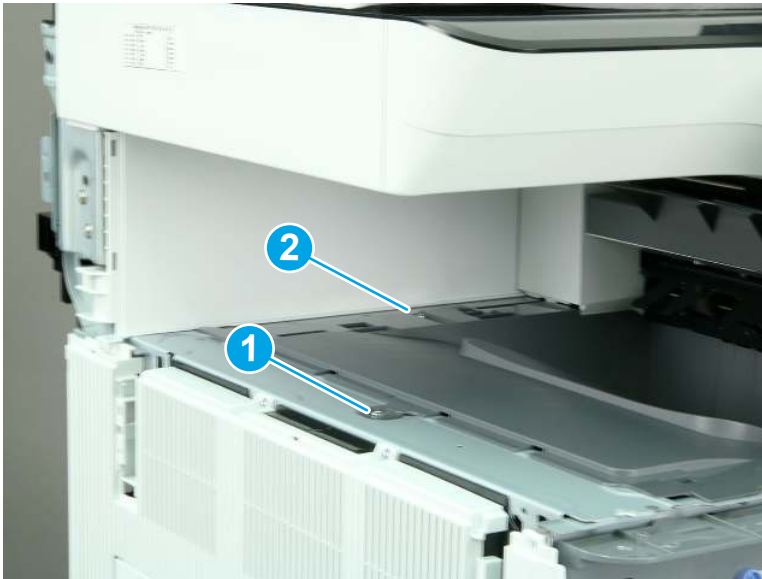


5. Remove the output bin (M856/E85055/M776).

 **NOTE:** The following figures show the M776z printer. The procedure is correct for all referenced models.

- a. Remove one washer-head machine screw (callout 1), remove one self-tapping screw (callout 2).

Figure 1-1026 Remove two screws



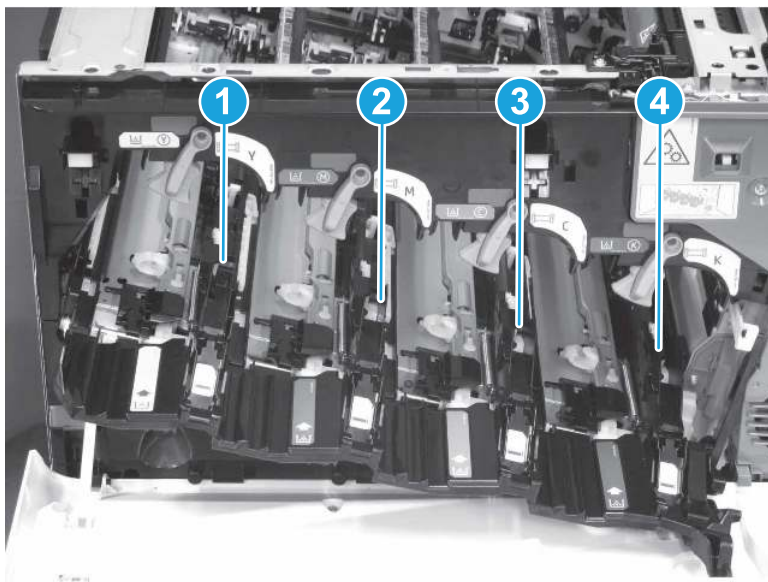
- b. Remove the output bin.

Figure 1-1027 Remove the output bin



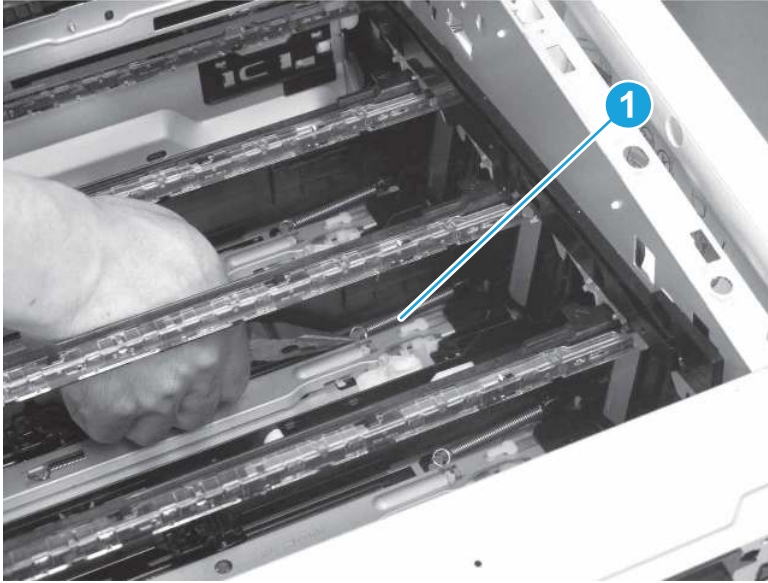
6. Remove the cartridge rail assembly (M751/E75245/M856/E85055/M776).
- a. This procedure provides instructions for removing the cyan cartridge rail assembly (callout 3). However, the procedure is also correct for removing any of the four cartridge rail assemblies in the printer.
- Yellow cartridge rail assembly (callout 1)
 - Magenta cartridge rail assembly (callout 2)
 - Cyan cartridge rail assembly (callout 3)
 - Black cartridge rail assembly (callout 4)

Figure 1-1028 Cartridge rail assembly locations



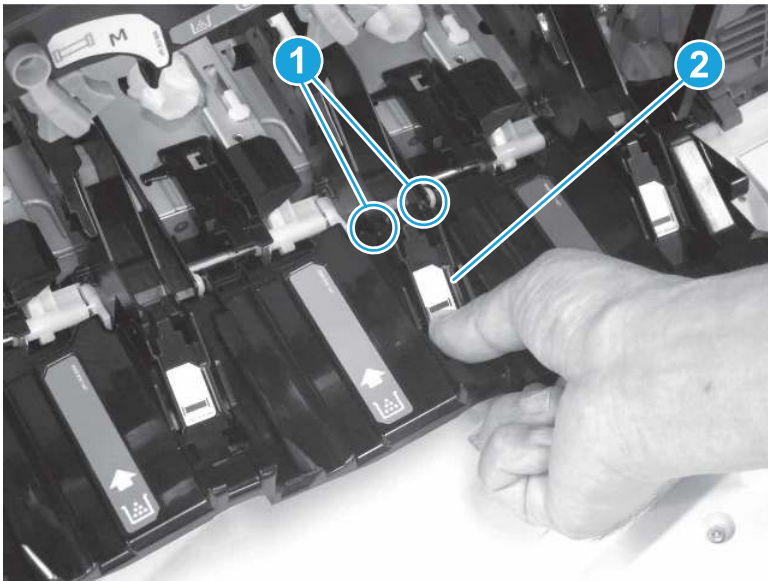
- b. Close the front door. Use needle-nosed pliers to unhook one spring (callout 1).

Figure 1-1029 Unhook one spring



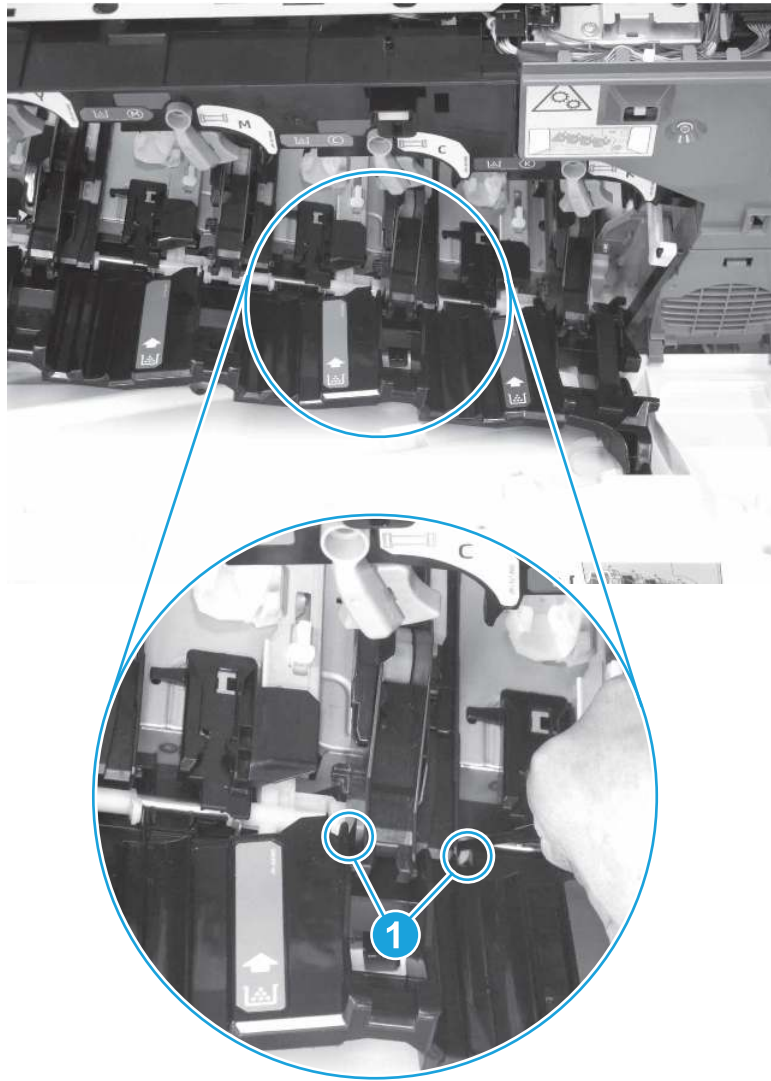
- c. Open the front door. Release two bosses (callout 1), and then remove the link (callout 2).

Figure 1-1030 Remove the link



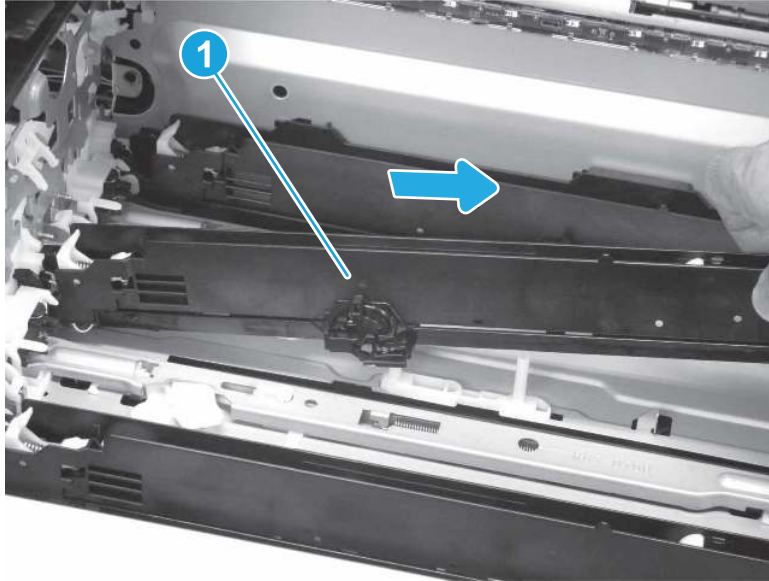
- d. Release two bosses (callout 1).

Figure 1-1031 Release two bosses



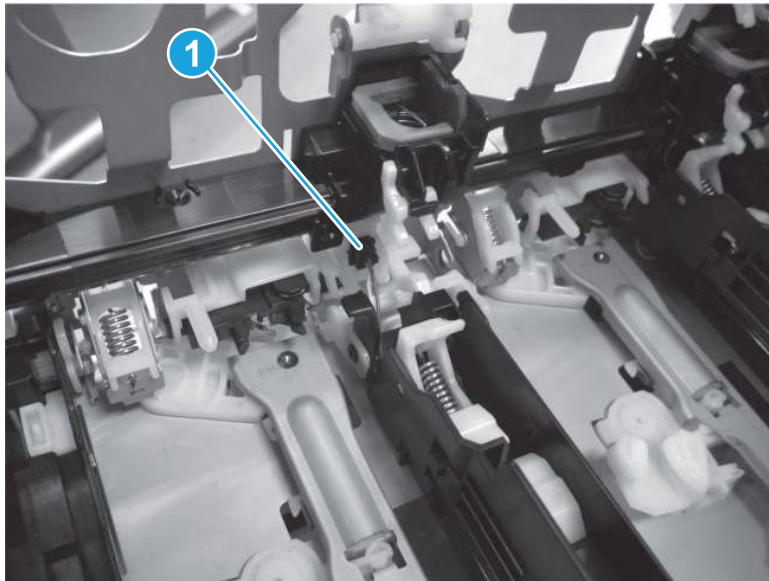
- e. Pull the cartridge rail assembly (callout 1) toward the front of the printer about 2 cm (0.79 in).

Figure 1-1032 Pull the cartridge rail assembly



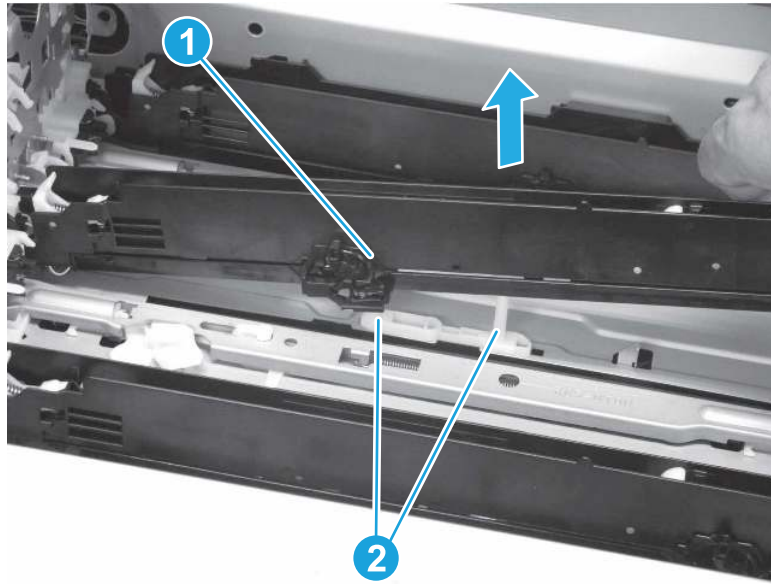
- f. Disconnect one connector (callout 1).

Figure 1-1033 Disconnect one connector



- g. Lift up to remove the cartridge rail assembly (callout 1) from the tag guide (callout 2).

Figure 1-1034 Remove the cartridge rail assembly



7. Unpack the replacement assembly.

- a. Dispose of the defective part.



NOTE: HP recommends responsible disposal of the defective part.

<http://www8.hp.com/us/en/hp-information/environment/product-recycling.html>

- b. Unpack the replacement part from the packaging.



IMPORTANT: Make sure that all of the shipping materials (for example shipping tape) are removed from the replacement part prior to installation.

- c. To install an assembly, reverse the removal steps.



NOTE: When applicable, special installation instructions are provided for an assembly at the end of the removal procedure. Always completely read the removal instructions and follow all special installation instructions.

8. Reverse the removal steps to install the assembly. Also use the following **special installation instructions**.

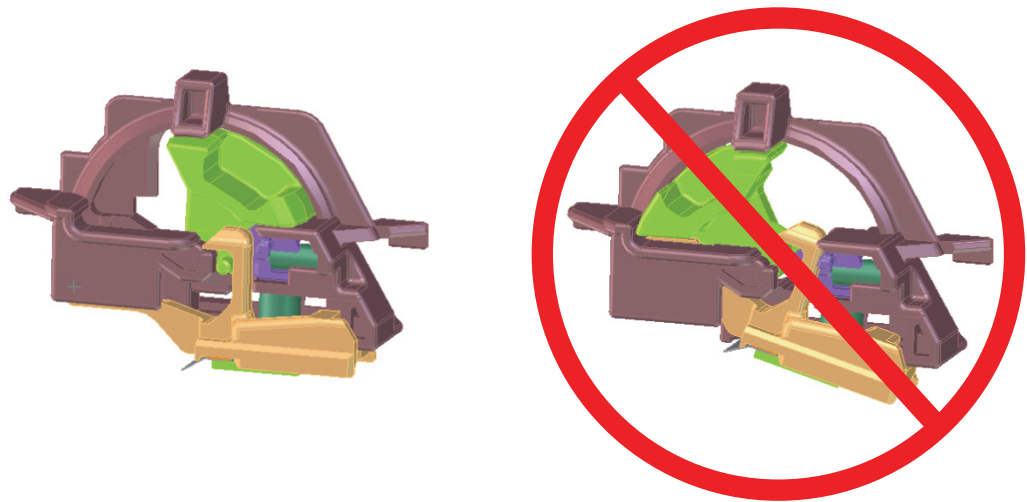
Install the cartridge rail assembly.

- a. When installing the cartridge rail assembly, make sure that the lever of the PCG assembly is positioned correctly. If the lever is positioned incorrectly, the cartridge cannot be installed.

Figure 1-1035 Check the PGC lever (M751/E75245/M856/E85055/M776dn/M776z/M776zs)

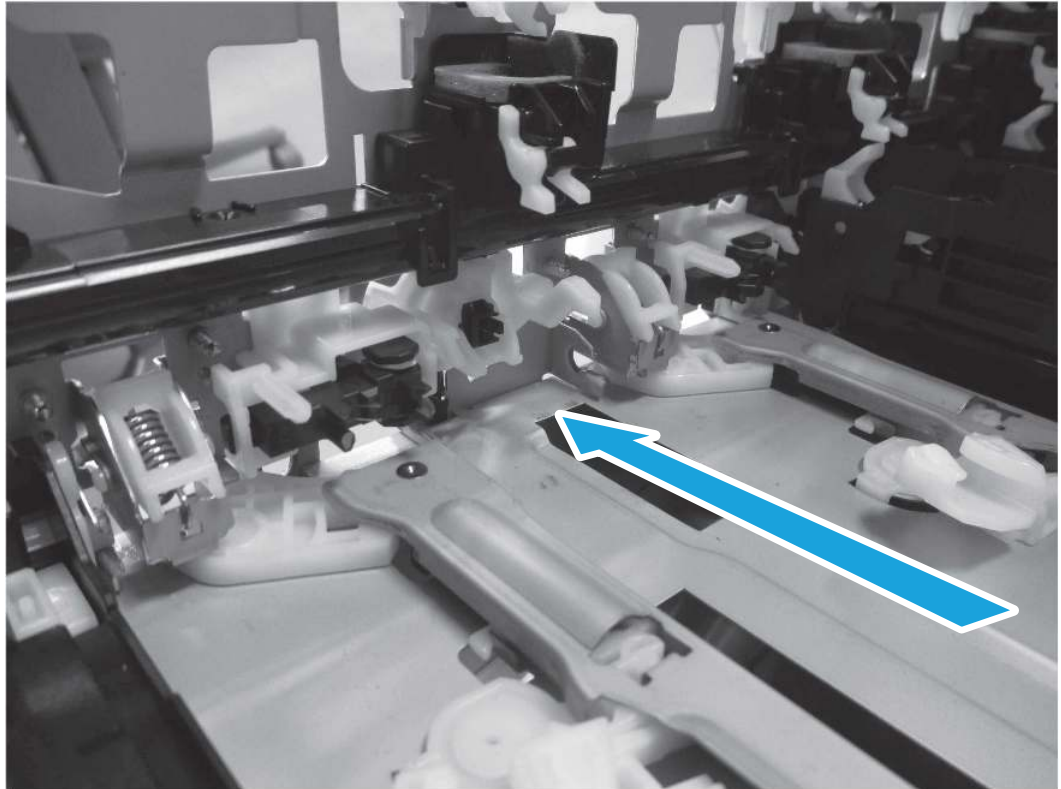


Figure 1-1036 PGC lever correct and incorrect positions (M751/E75245/M856/E85055/M776dn/M776z/M776zs)



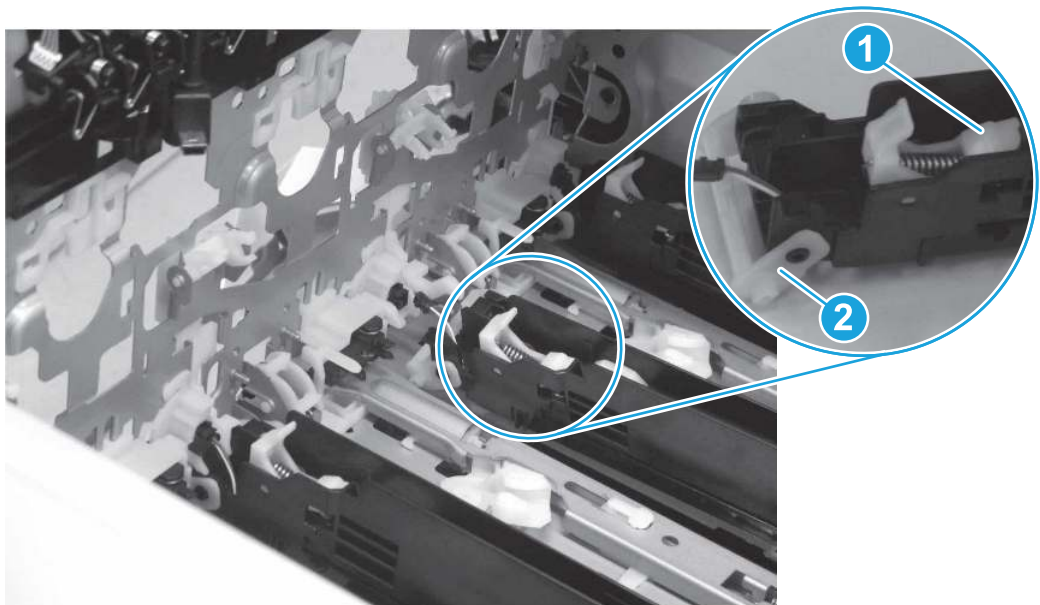
- b. Slide the cartridge rail assembly into position.

Figure 1-1037 Position the cartridge rail assembly
(M751/E75245/M856/E85055/M776dn/M776z/M776zs)



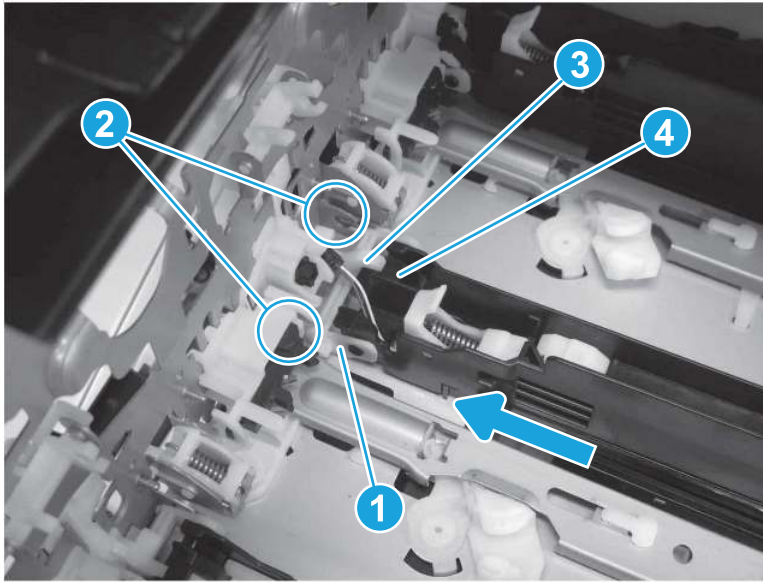
- c. Make sure that the lock lever (callout 1) is in the down position and the link arm (callout 2) is positioned under the casing. If these parts are positioned incorrectly, the cartridge cannot be installed.

Figure 1-1038 Check the lock lever and link arm positions
(M751/E75245/M856/E85055/M776dn/M776z/M776zs)



- d. When installing the link arm (callout 1) on the cartridge rail assembly to the bushing (callout 2) on the printer frame, insert the protrusion on the arm (callout 3) on the printer into the guide (callout 4) on the cartridge rail.

Figure 1-1039 Install the link arm (M751/E75245/M856/E85055/M776dn/M776z/M776zs)



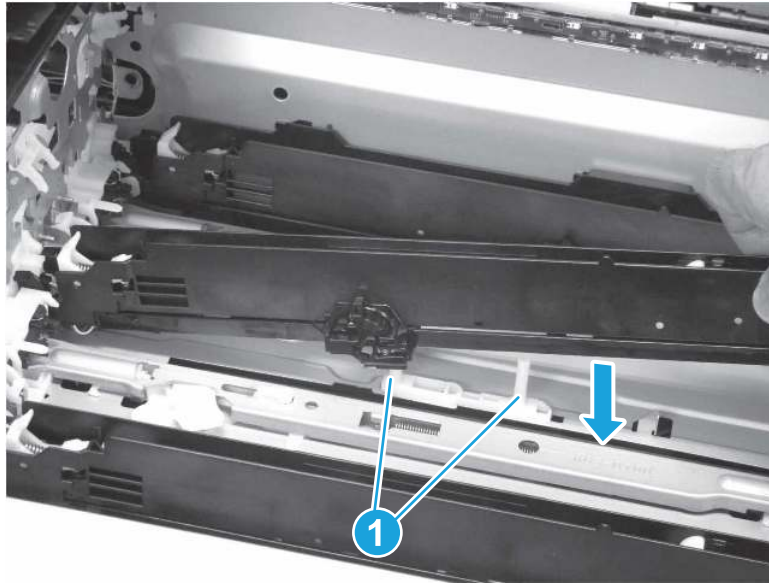
- e. This figure shows the correct installation of the link arm.

Figure 1-1040 Link arm correct installation (M751/E75245/M856/E85055/M776dn/M776z/M776zs)



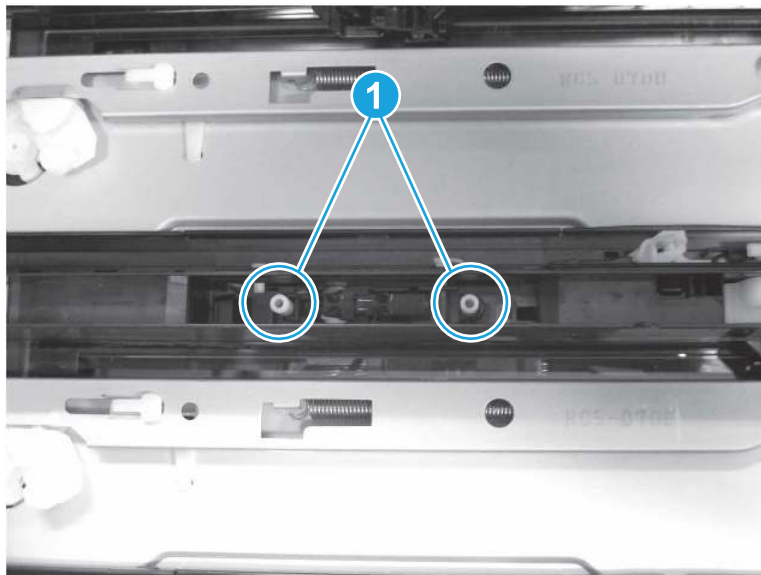
- f. Install the cartridge rail assembly into the cartridge tag guide (callout 1).

Figure 1-1041 Install the cartridge rail assembly into the cartridge tag guide (M751/E75245/M856/E85055/M776dn/M776z/M776zs)



- g. Make sure that the white cartridge tag guide is correctly positioned. Look at the cartridge rail assembly from above and verify that the white cartridge tag guide (callout 1) is visible.

Figure 1-1042 Check the cartridge tag guide (M751/E75245/M856/E85055/M776dn/M776z/M776zs)



Removal and replacement: Cartridge rail assembly (M776zs)

Learn how to remove and replace the cartridge rail assembly.

Mean time to repair: 35 minutes

Service level: Hard

Before performing service

Turn the printer power off

- Disconnect the power cable.

⚠ WARNING! To avoid damage to the printer, turn the printer off, wait 30 seconds, and then remove the power cord before attempting to service the printer.

Use the table below to identify the correct part number for your printer. To order the part, go to www.hp.com/buy/parts.

Table 1-65 Part information

Part number	Part description
RM2-2681-000CN	First cartridge rail assembly (Yellow; M776zs)
RM2-2480-000CN	Second cartridge rail assembly (Magenta; M856/E85055/M776dn/M776z/M776zs)
RM2-2682-000CN	Third cartridge rail assembly (Cyan; M776zs)
RM2-1356-000CN	Black cartridge rail assembly (M751/E75245/M856/E85055/M776dn/M776z/M776zs)

Required tools

- #2 Phillips screwdriver with a magnetic tip
- Small, flat-blade screwdriver

After performing service

Turn the printer power on

- Connect the power cable.
- Use the power switch to turn the power on.

Post service test

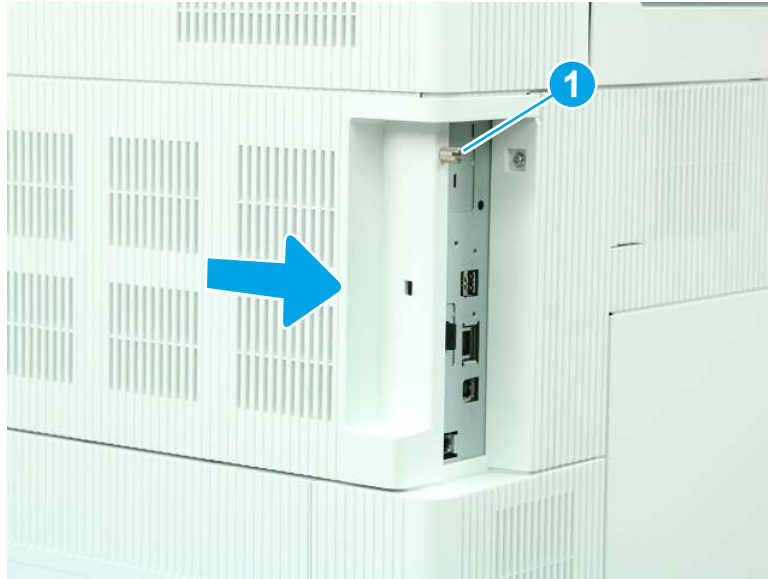
Make sure that the printer initializes to a **Ready** state.

Print a page to make sure that the printer is functioning correctly.

1. Remove the formatter cover.

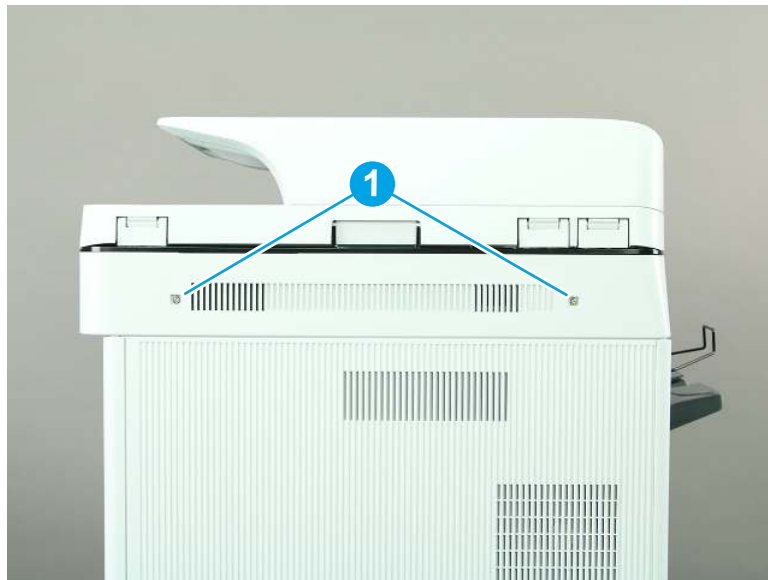
- ▲ Loosen one thumbscrew (callout 1), and then slide the formatter cover (callout 2) away from the printer to remove it.

Figure 1-1043 Remove the formatter cover



- 2. Remove the scanner control board (SCB) cover (M776).
 - a. Remove two screws (callout 1).

Figure 1-1044 Remove two screws



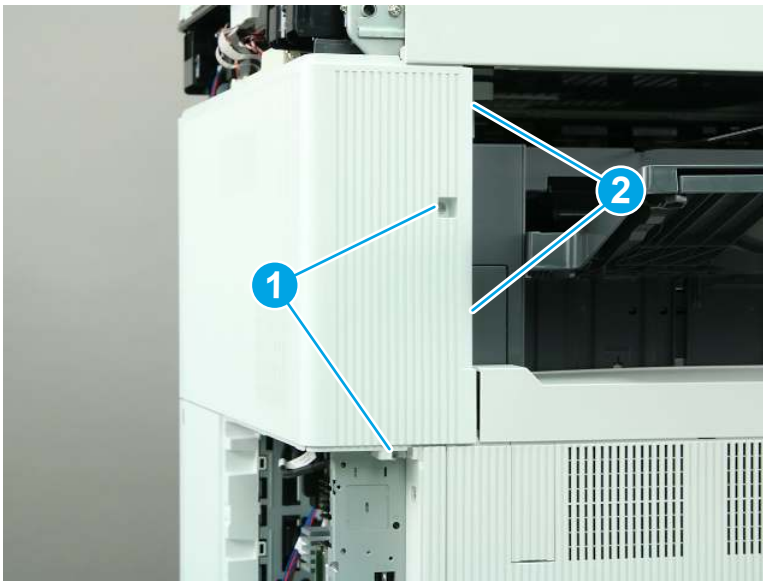
- b. Remove the SCB cover.

Figure 1-1045 Remove the SCB cover



3. Remove the rear upper cover and left rear upper cover (M776zs).
 - a. Remove two screws (callout 1), and then release two tabs (callout 2).

Figure 1-1046 Remove two screws and release two tabs



- b. Slide the cover to the right to remove it.

Figure 1-1047 Remove the rear upper and left rear upper cover



4. Remove the front cover (M776zs).

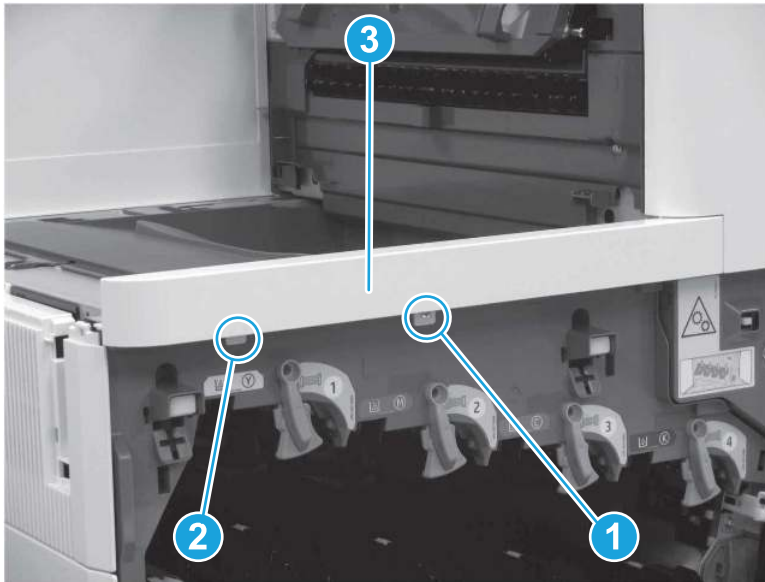
- a. Open the front door.

Figure 1-1048 Open the front door



- b. Remove one screw (callout 1), release one tab (callout 2), and then remove the front cover (callout 3).

Figure 1-1049 Remove the front cover



5. Remove the control panel (M776).
 - a. Rotate the control panel to the fully raised position (callout 1), and then raise the document feeder (callout 2).

Figure 1-1050 Raise the control panel and document feeder



- b. Beginning at the right side of the control-panel cover, carefully release five tabs along the top edge of the cover.

 **NOTE:** The thin black-plastic cover will separate from the white-plastic control-panel base.

Figure 1-1051 Release the control panel cover



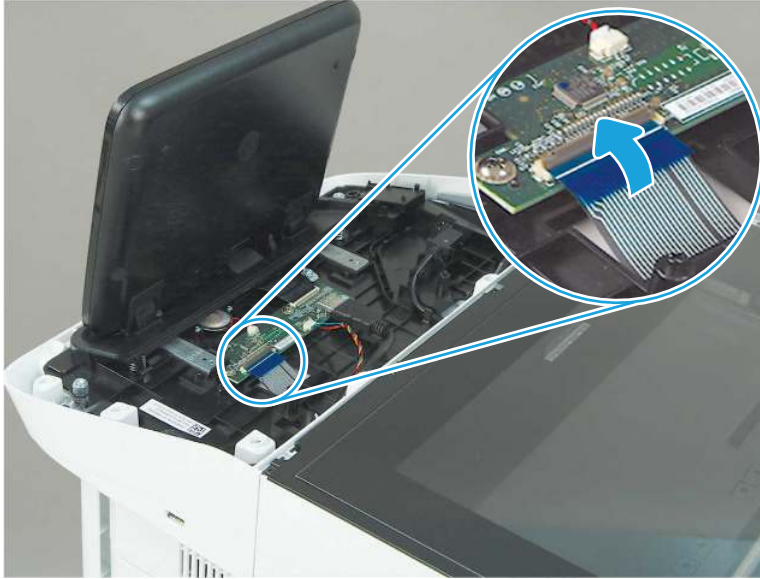
- c. Rotate the control panel cover slightly forward (callout 1), and then lift up to remove the cover (callout 2).

Figure 1-1052 Remove the control panel cover



- d. **M776z or M776zs only:** Open the connector latch to release the keyboard flat cable.

Figure 1-1053 Release the keyboard flat cable (M776z/M776zs)



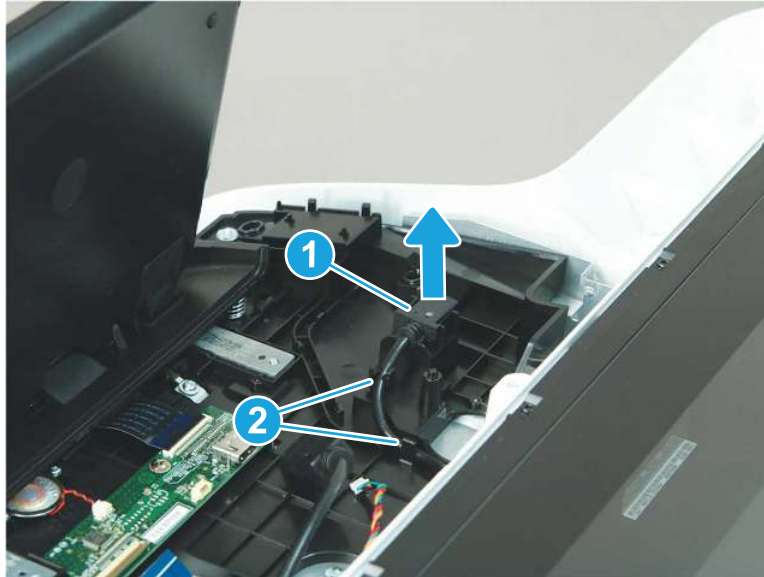
- e. Disconnect two connectors

Figure 1-1054 Disconnect two connectors



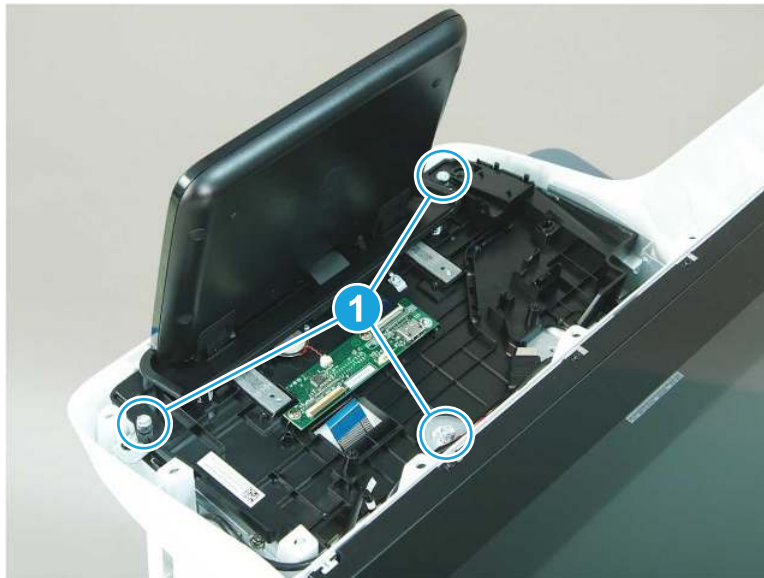
- f. Remove the USB cable (callout 1) from the holder, and then release the cable from two retainers (callout 2).

Figure 1-1055 Release the USB cable



- g. Remove three screws (callout 1).

Figure 1-1056 Remove three screws



- h. Lift the front of the control panel off of the printer (callout 1), and then slide it towards the front of the printer (callout 2) to remove it.

Figure 1-1057 Remove the control panel



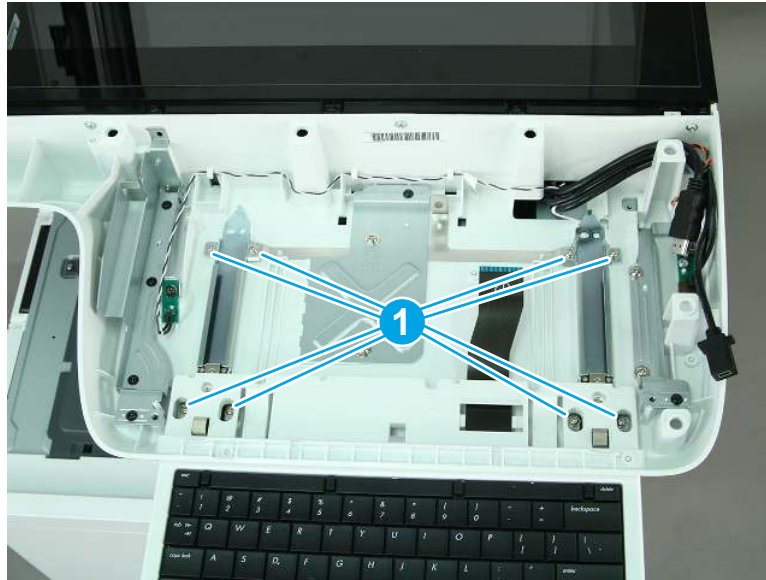
- 6. Remove the keyboard (M776z/M776zs).
 - a. Pull the keyboard out to its extended position.

Figure 1-1058 Pull the keyboard out



- b. Remove eight screws (callout 1).

Figure 1-1059 Remove eight screws



- c. Remove the keyboard and rails.

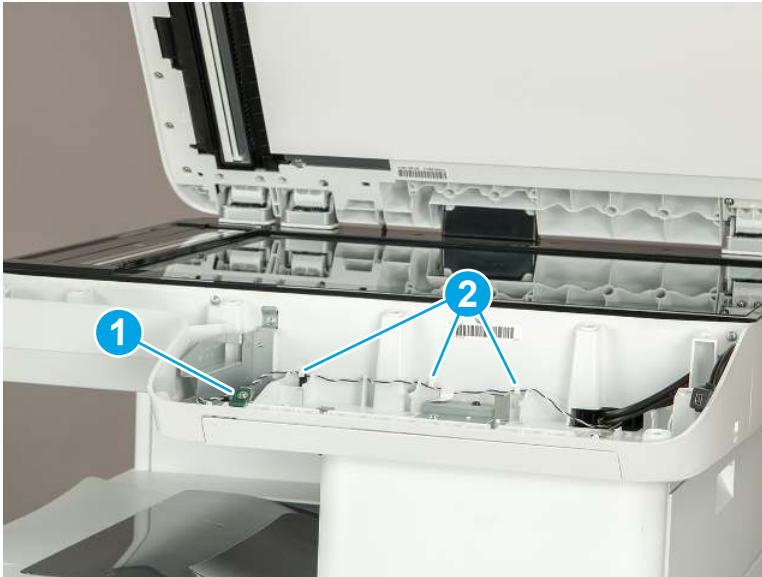
Figure 1-1060 Remove the keyboard and rails



- 7. Remove the nose cone (M776).

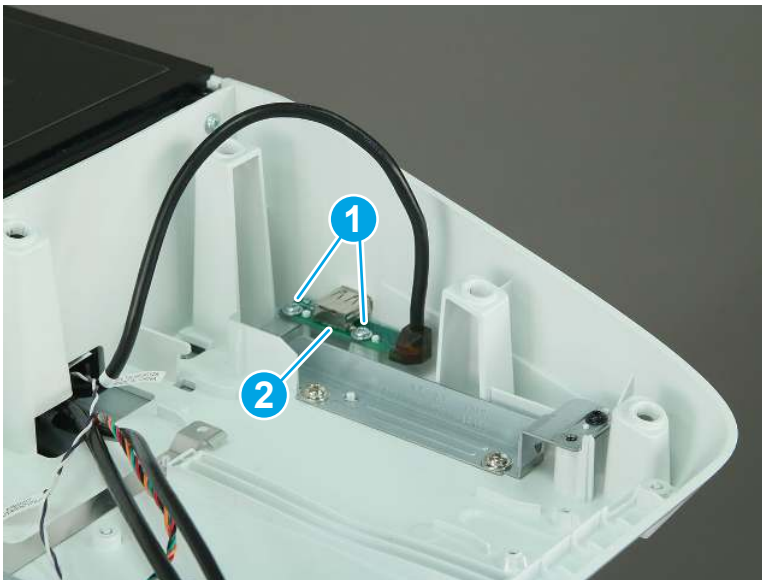
- a. Remove one screw (callout 1) to release the light PCA. Release the cable from three retainers (callout 2), and then move the light PCA out of the way.

Figure 1-1061 Release the light PCA



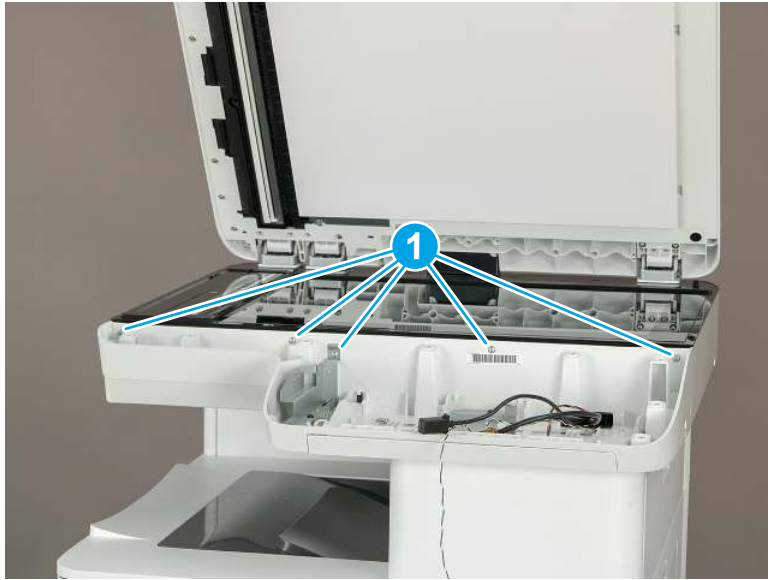
- b. Remove two screws (callout 1), and then move the USB port PCA (callout 2) out of the way.

Figure 1-1062 Release the USB port PCA



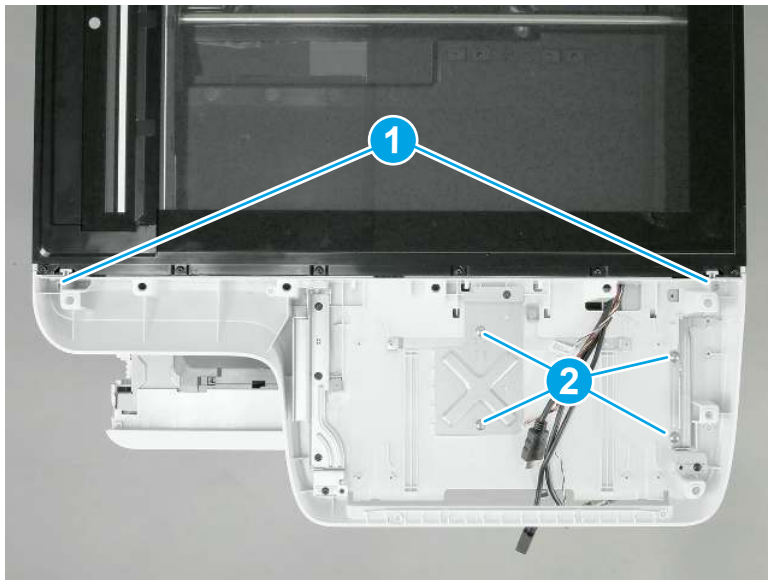
- c. Remove five screws (callout 1).

Figure 1-1063 Remove four screws



- d. Remove two small, self-tapping screws (callout 1), and then remove four larger machine screws (callout 2).

Figure 1-1064 Remove six screws

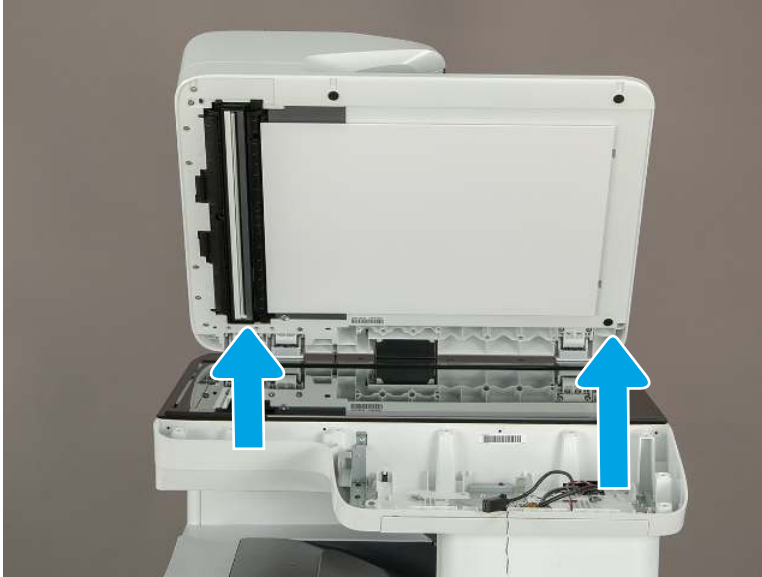


- e. Lift the nose cone up and off of the printer to remove it.



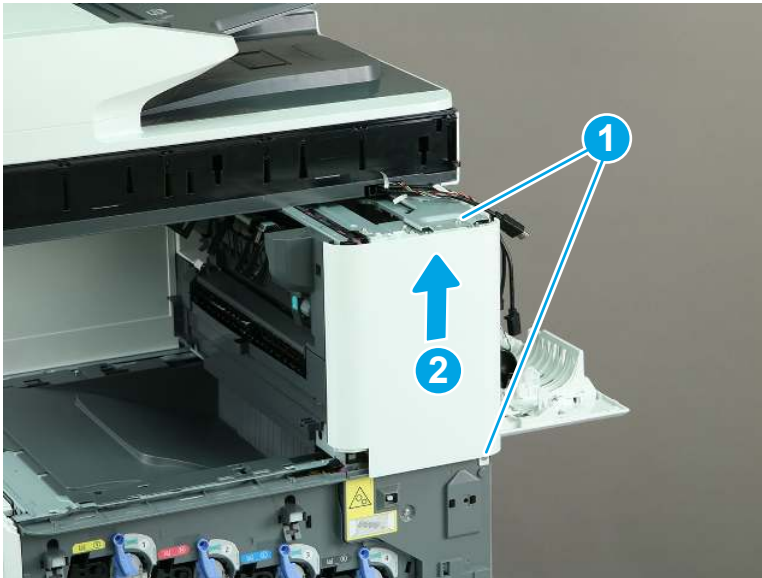
NOTE: Pass the wire harnesses and cables through the opening in the nose cone when removing it.

Figure 1-1065 Remove the nose cone



8. Remove the right front cover (M776zs).
 - ▲ Remove two screws (callout 1), release one tab (callout 2), and then slide the right front cover up (callout 2) to remove it.

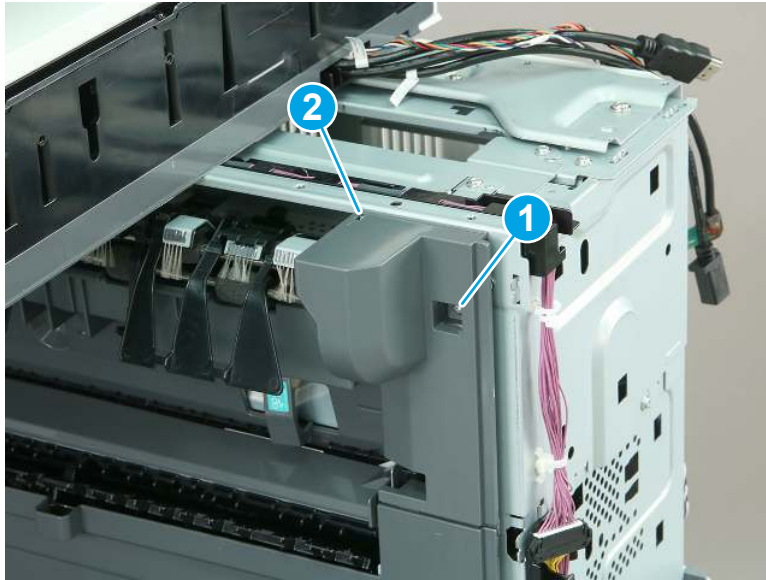
Figure 1-1066 Remove the right front cover



9. Remove the delivery front cover (M776zs).

- ▲ Remove one screw (callout 1), and then remove the delivery front cover (callout 2).

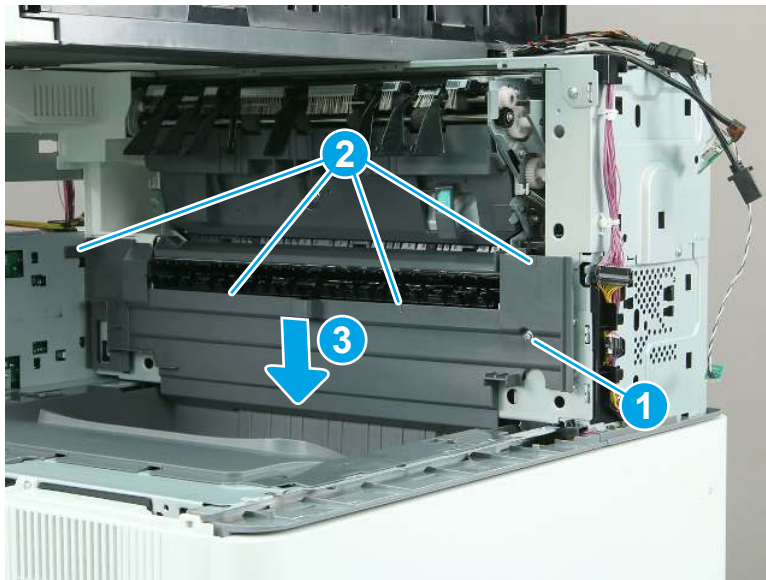
Figure 1-1067 Remove the delivery front cover



10. Remove the delivery cover (M776zs).

- ▲ Remove one screw (callout 1), release four tabs (callout 2), and then slide the delivery cover down (callout 3) to remove it.

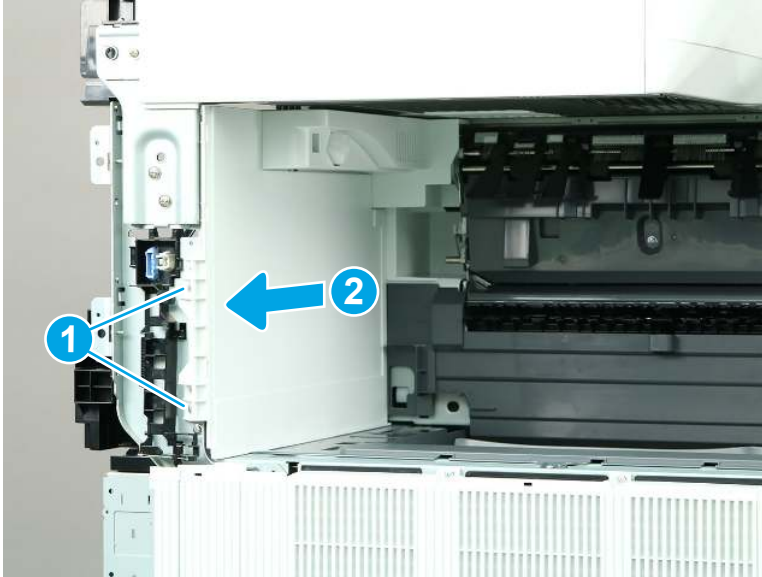
Figure 1-1068 Remove the delivery cover



11. Remove the main cover (M776zs).

- ▲ Remove two screws (callout 1), and then slide the main cover away from the printer to remove it (callout 2).

Figure 1-1069 Remove the main cover

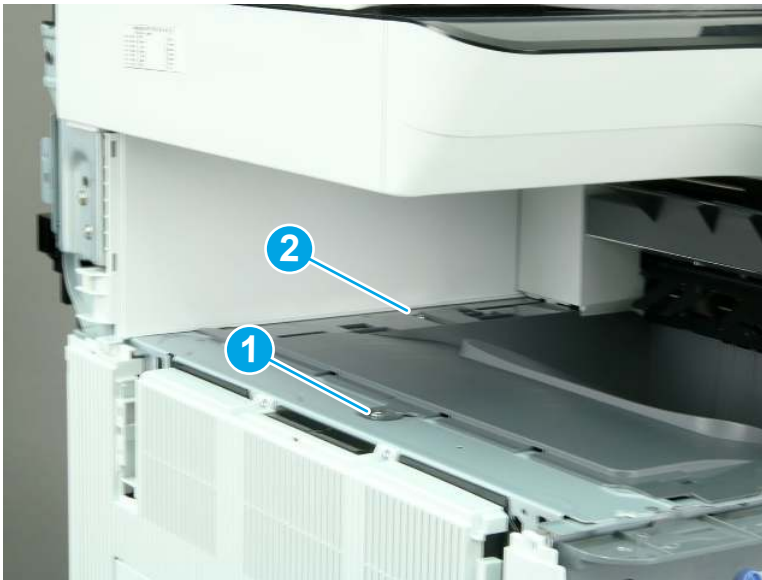


12. Remove the output bin (M856/E85055/M776).

 **NOTE:** The following figures show the M776z printer. The procedure is correct for all referenced models.

- a. Remove one washer-head machine screw (callout 1), remove one self-tapping screw (callout 2).

Figure 1-1070 Remove two screws



- b. Remove the output bin.

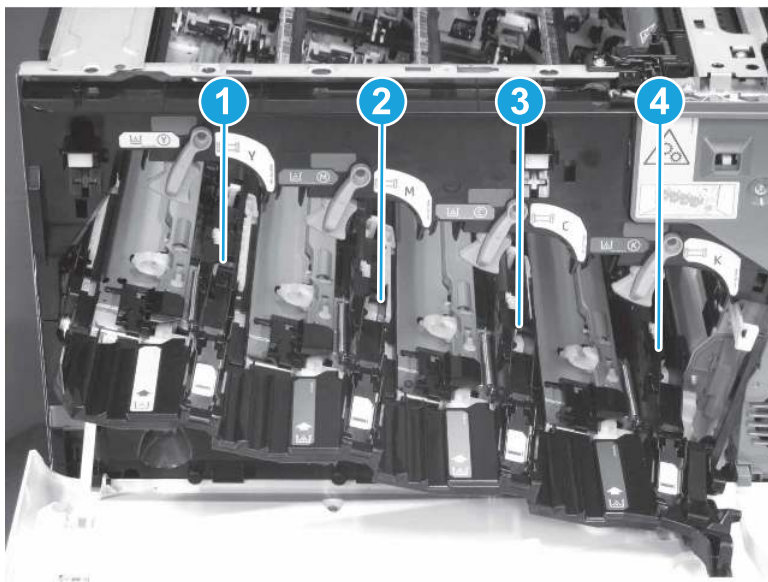
Figure 1-1071 Remove the output bin



13. Remove the cartridge rail assembly (M751/E75245/M856/E85055/M776).

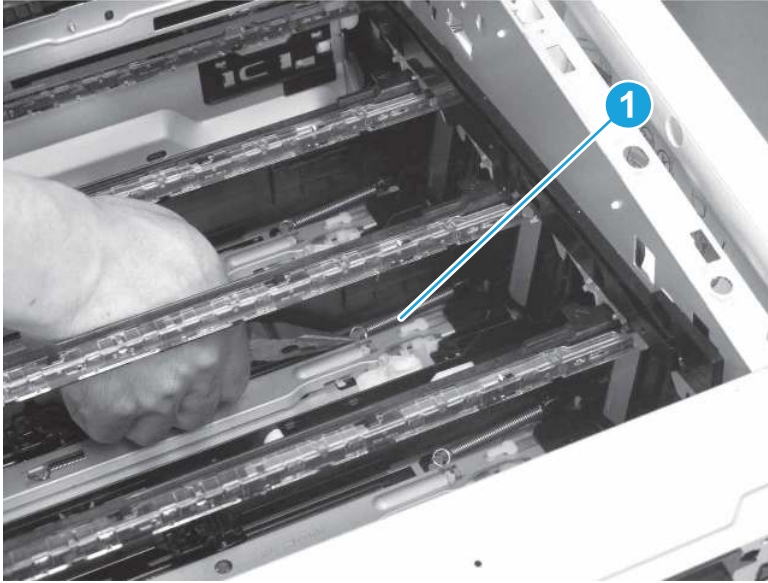
- a. This procedure provides instructions for removing the cyan cartridge rail assembly (callout 3). However, the procedure is also correct for removing any of the four cartridge rail assemblies in the printer.
- Yellow cartridge rail assembly (callout 1)
 - Magenta cartridge rail assembly (callout 2)
 - Cyan cartridge rail assembly (callout 3)
 - Black cartridge rail assembly (callout 4)

Figure 1-1072 Cartridge rail assembly locations



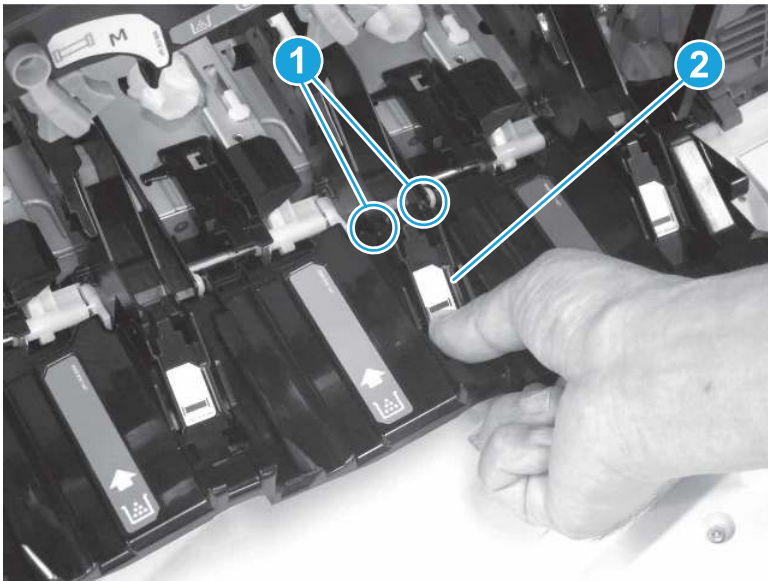
- b. Close the front door. Use needle-nosed pliers to unhook one spring (callout 1).

Figure 1-1073 Unhook one spring



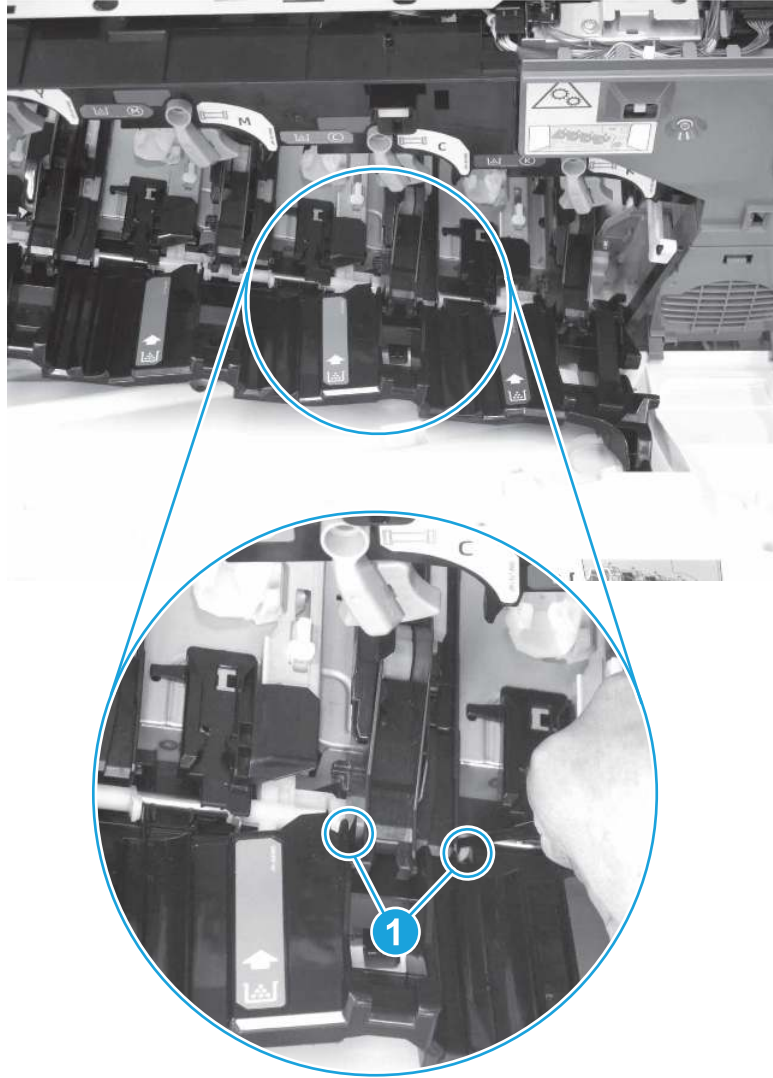
- c. Open the front door. Release two bosses (callout 1), and then remove the link (callout 2).

Figure 1-1074 Remove the link



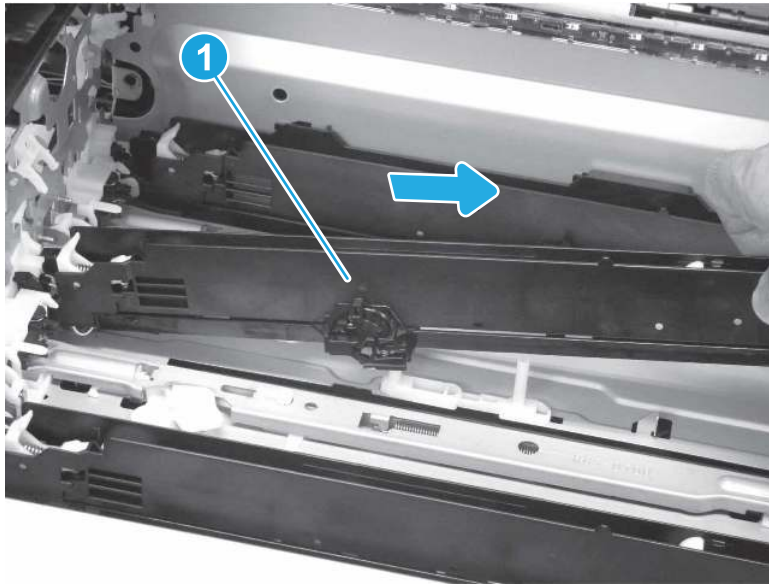
- d. Release two bosses (callout 1).

Figure 1-1075 Release two bosses



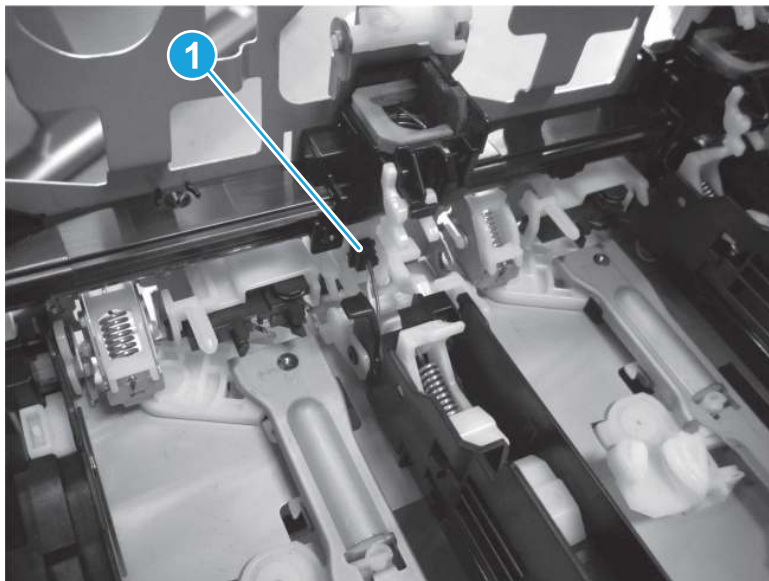
- e. Pull the cartridge rail assembly (callout 1) toward the front of the printer about 2 cm (0.79 in).

Figure 1-1076 Pull the cartridge rail assembly



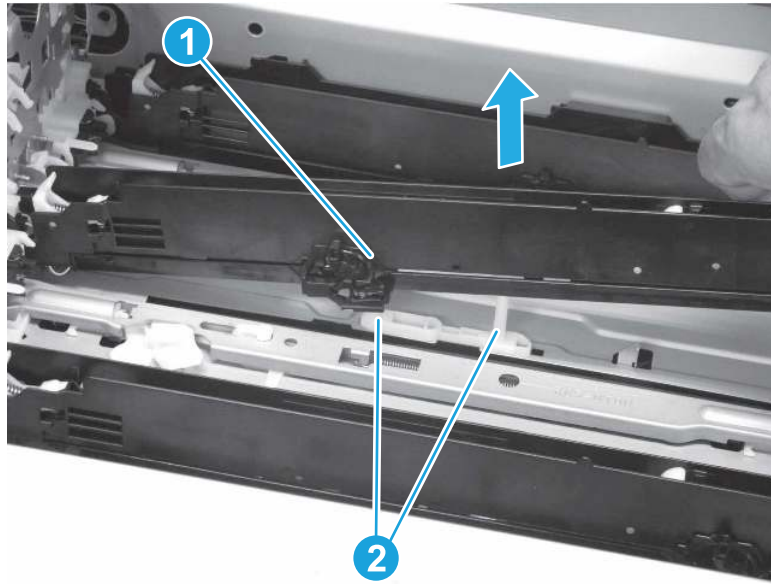
- f. Disconnect one connector (callout 1).

Figure 1-1077 Disconnect one connector



- g. Lift up to remove the cartridge rail assembly (callout 1) from the tag guide (callout 2).

Figure 1-1078 Remove the cartridge rail assembly



14. Unpack the replacement assembly.

- a. Dispose of the defective part.



NOTE: HP recommends responsible disposal of the defective part.

<http://www8.hp.com/us/en/hp-information/environment/product-recycling.html>

- b. Unpack the replacement part from the packaging.



IMPORTANT: Make sure that all of the shipping materials (for example shipping tape) are removed from the replacement part prior to installation.

- c. To install an assembly, reverse the removal steps.



NOTE: When applicable, special installation instructions are provided for an assembly at the end of the removal procedure. Always completely read the removal instructions and follow all special installation instructions.

15. Reverse the removal steps to install the assembly. Also use the following **special installation instructions**.

Install the cartridge rail assembly.

- a. When installing the cartridge rail assembly, make sure that the lever of the PCG assembly is positioned correctly. If the lever is positioned incorrectly, the cartridge cannot be installed.

Figure 1-1079 Check the PGC lever (M751/E75245/M856/E85055/M776dn/M776z/M776zs)

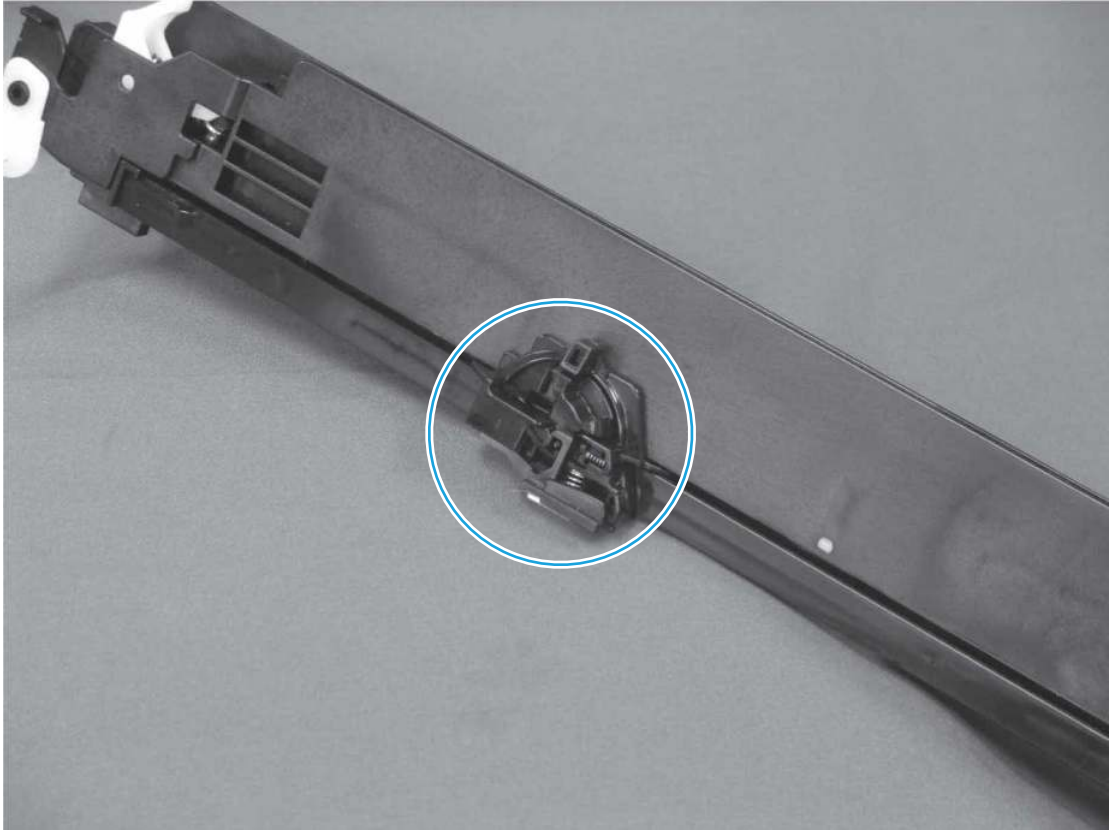
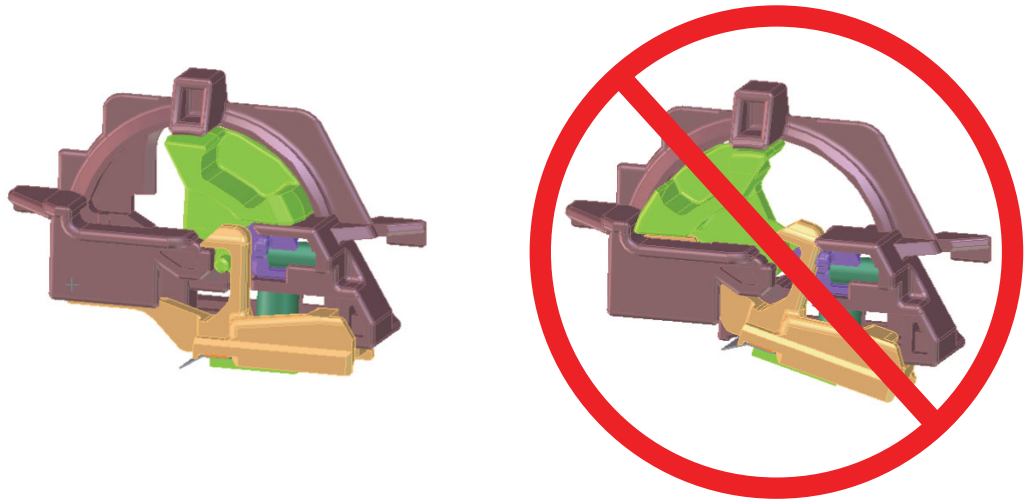
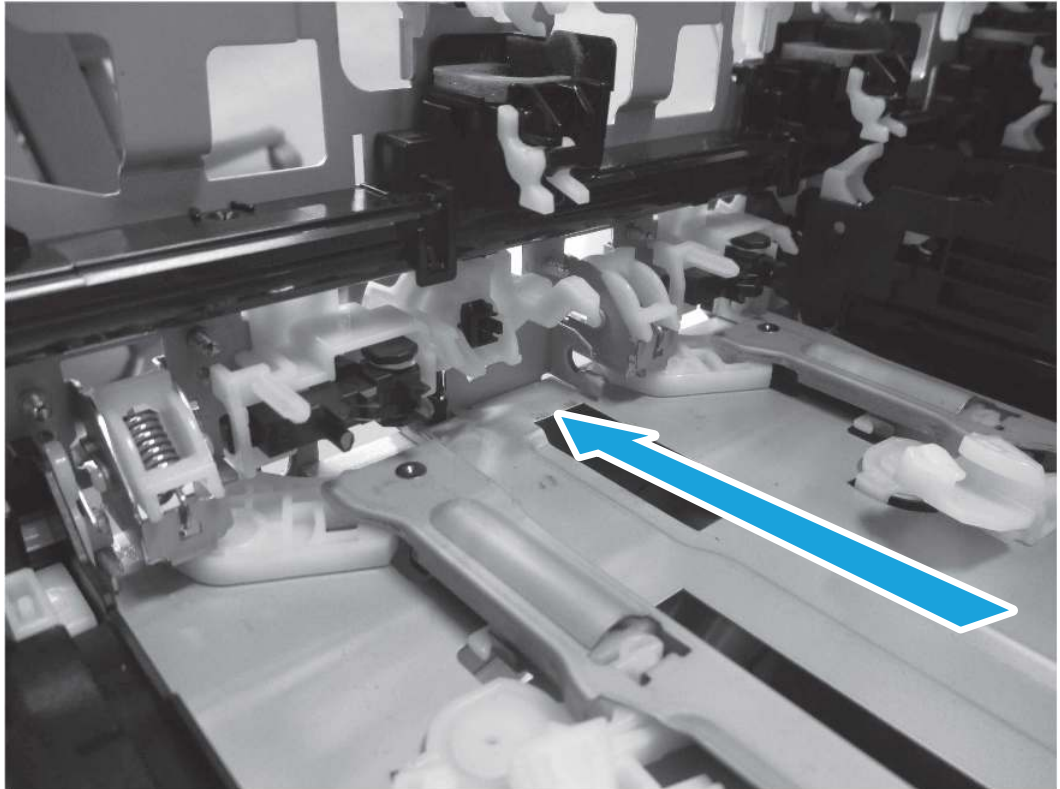


Figure 1-1080 PGC lever correct and incorrect positions (M751/E75245/M856/E85055/M776dn/M776z/M776zs)



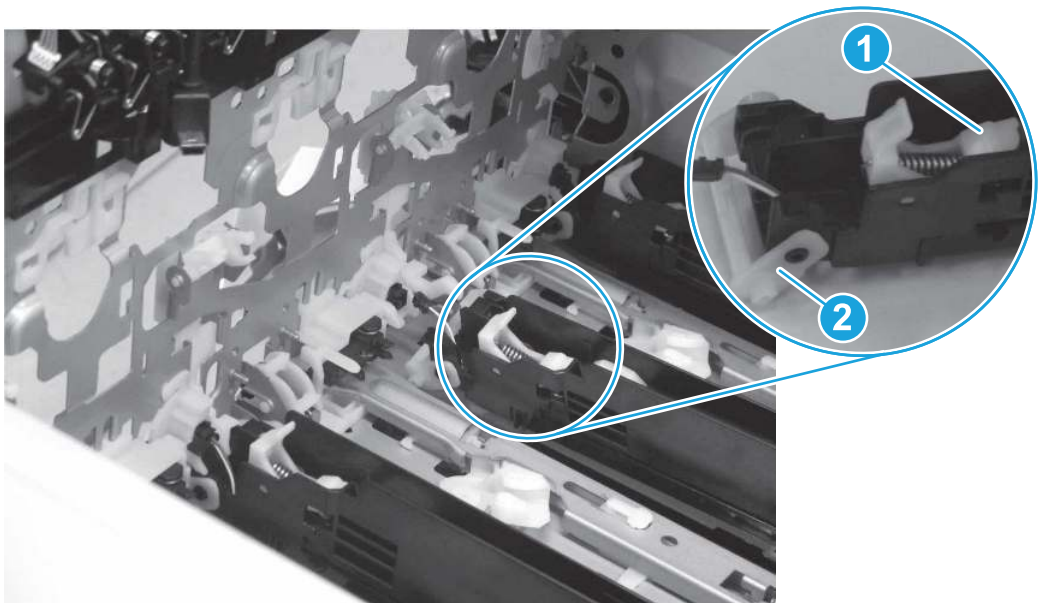
- b. Slide the cartridge rail assembly into position.

Figure 1-1081 Position the cartridge rail assembly
(M751/E75245/M856/E85055/M776dn/M776z/M776zs)



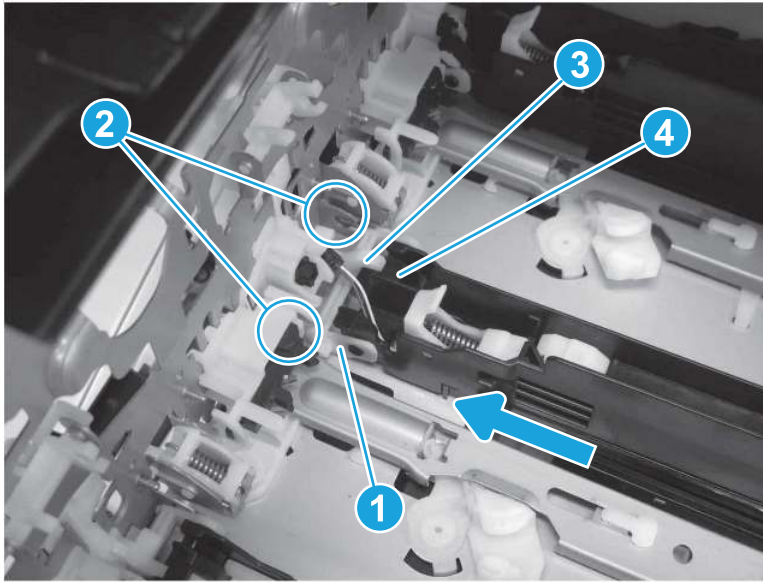
- c. Make sure that the lock lever (callout 1) is in the down position and the link arm (callout 2) is positioned under the casing. If these parts are positioned incorrectly, the cartridge cannot be installed.

Figure 1-1082 Check the lock lever and link arm positions
(M751/E75245/M856/E85055/M776dn/M776z/M776zs)



- d. When installing the link arm (callout 1) on the cartridge rail assembly to the bushing (callout 2) on the printer frame, insert the protrusion on the arm (callout 3) on the printer into the guide (callout 4) on the cartridge rail.

Figure 1-1083 Install the link arm (M751/E75245/M856/E85055/M776dn/M776z/M776zs)



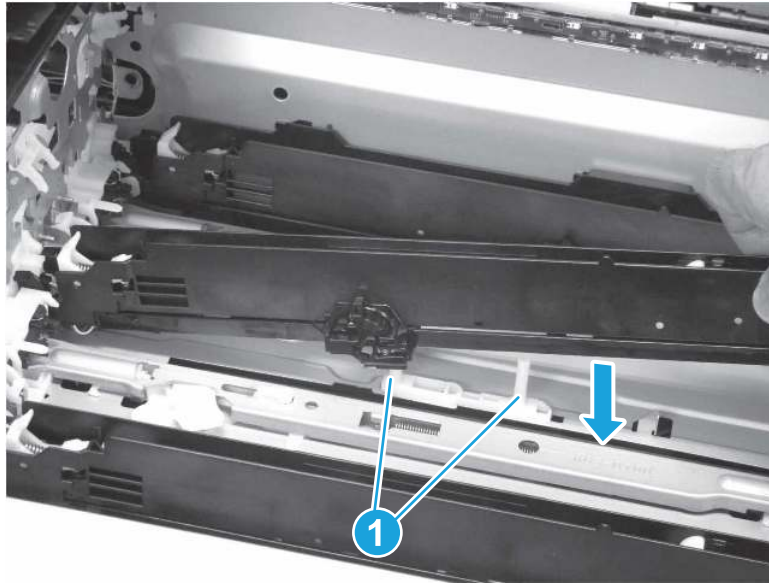
- e. This figure shows the correct installation of the link arm.

Figure 1-1084 Link arm correct installation (M751/E75245/M856/E85055/M776dn/M776z/M776zs)



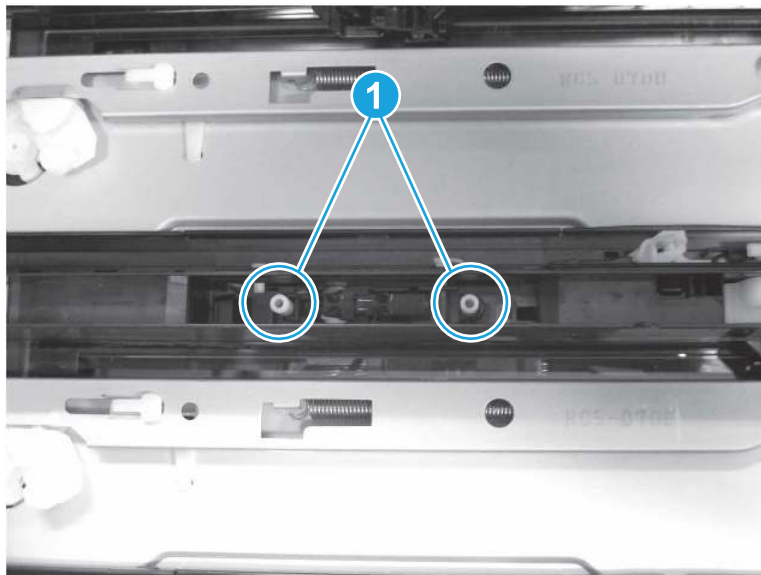
- f. Install the cartridge rail assembly into the cartridge tag guide (callout 1).

Figure 1-1085 Install the cartridge rail assembly into the cartridge tag guide (M751/E75245/M856/E85055/M776dn/M776z/M776zs)



- g. Make sure that the white cartridge tag guide is correctly positioned. Look at the cartridge rail assembly from above and verify that the white cartridge tag guide (callout 1) is visible.

Figure 1-1086 Check the cartridge tag guide (M751/E75245/M856/E85055/M776dn/M776z/M776zs)



Removal and replacement: DT-cartridge rail assembly (M751/E75245)

Learn how to remove and replace the DT cartridge rail assembly.

Mean time to repair: 25 minutes

Service level: Hard

Before performing service

Turn the printer power off

- Disconnect the power cable.

⚠ WARNING! To avoid damage to the printer, turn the printer off, wait 30 seconds, and then remove the power cord before attempting to service the printer.

Use the table below to identify the correct part number for your printer. To order the part, go to www.hp.com/buy/parts.

Table 1-66 Part information

Part number	Part description
RM2-1357-000CN	DT cartridge rail assembly

Required tools

- #2 Phillips screwdriver with a magnetic tip
- Small, flat-blade screwdriver

After performing service

Turn the printer power on

- Connect the power cable.
- Use the power switch to turn the power on.

Post service test

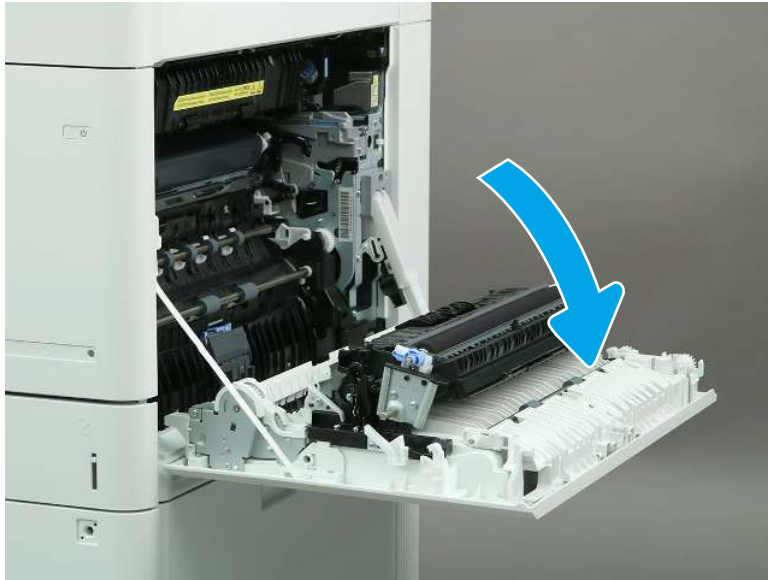
Make sure that the printer initializes to a **Ready** state.

Print a page to make sure that the printer is functioning correctly.

1. Remove the fuser.

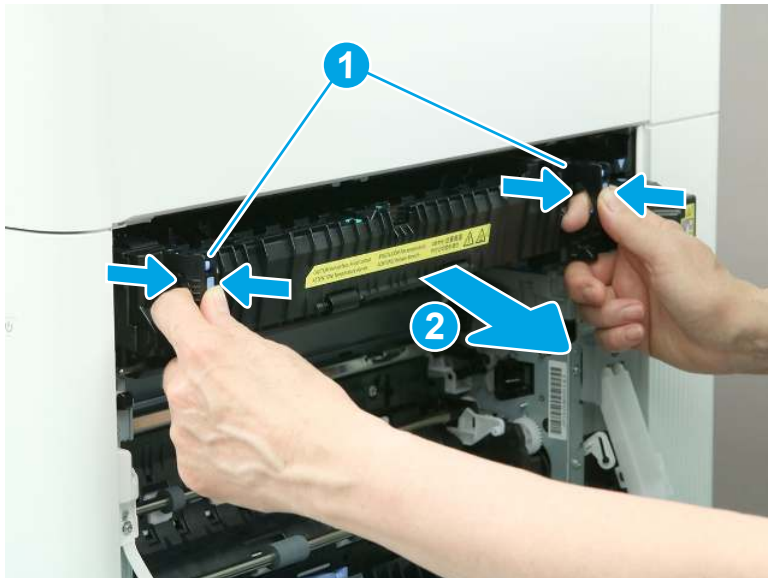
- a. Open the right door.

Figure 1-1087 Open the right door



- b. Grasp the fuser handles, and then squeeze the release levers (callout 1). Lift up slightly, and then pull straight out to remove the fuser (callout 2).

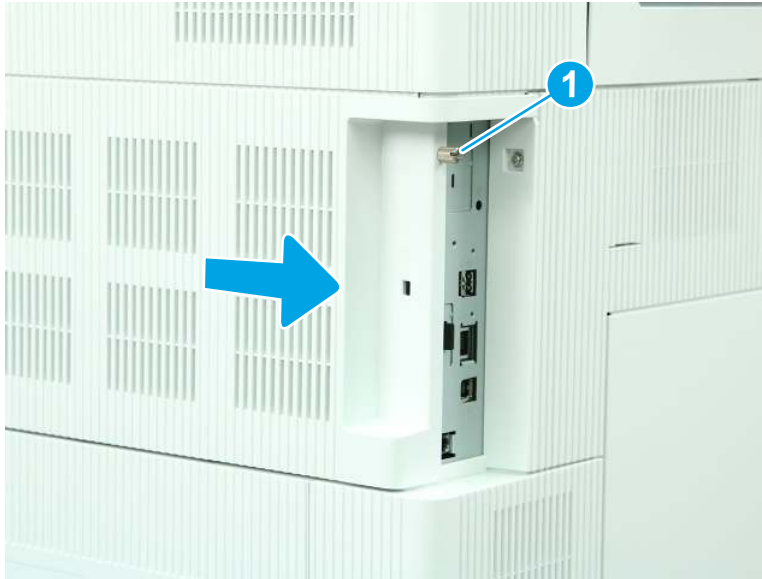
Figure 1-1088 Remove the fuser



2. Remove the formatter cover.

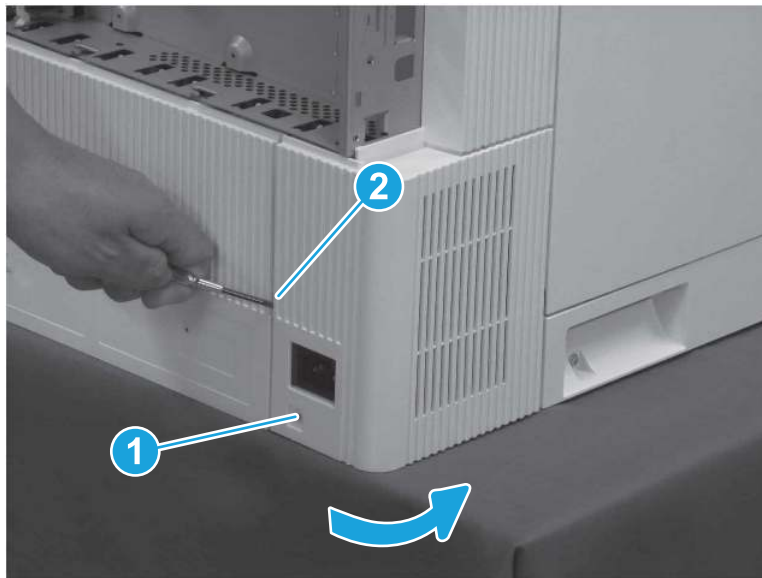
- ▲ Loosen one thumbscrew (callout 1), and then slide the formatter cover (callout 2) away from the printer to remove it.

Figure 1-1089 Remove the formatter cover



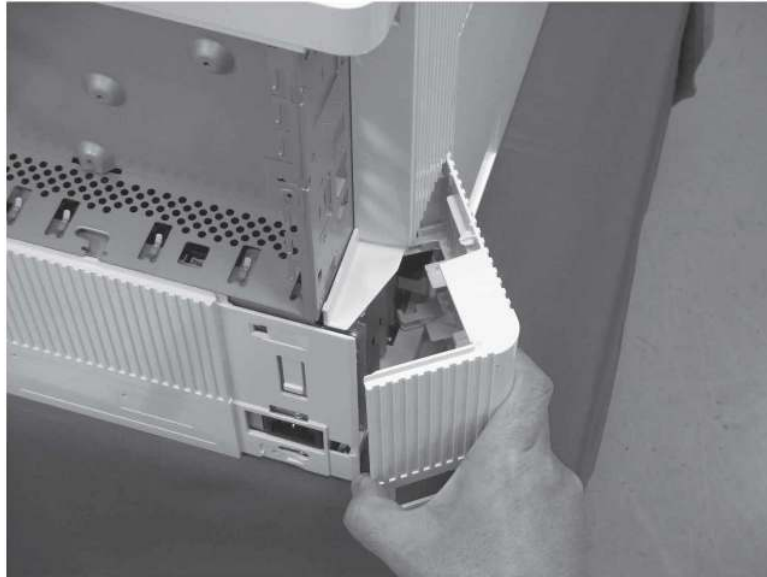
- 3. Remove the left lower cover (M751/E75245).
 - a. Remove one screw (callout 1), release one tab (callout 2), and then rotate the cover away from the printer.

Figure 1-1090 Remove one screw and release one tab



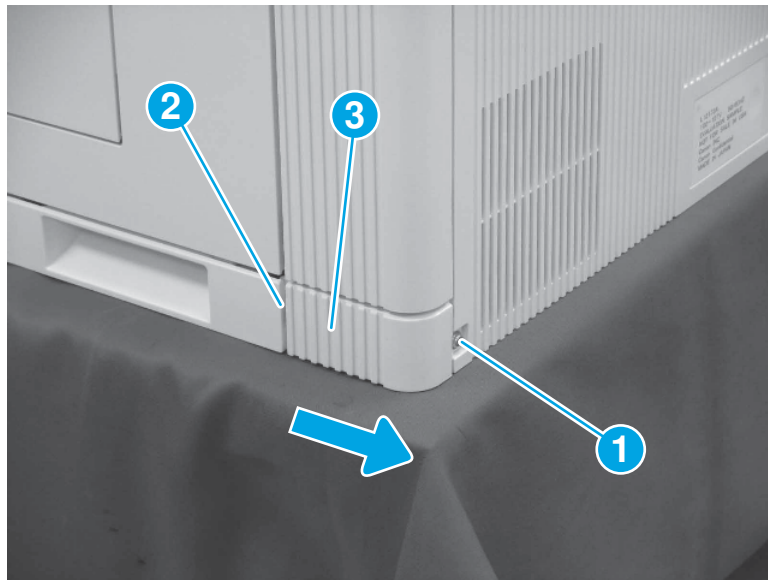
- b. Remove the left lower cover.

Figure 1-1091 Remove the left lower cover



4. Remove the right rear lower cover (M751/E75245/M856/E85055/M776).
 - ▲ Remove one screw (callout 1), release one tab (callout 2), and then slide the right rear lower cover (callout 3) toward the back of the printer to remove it.

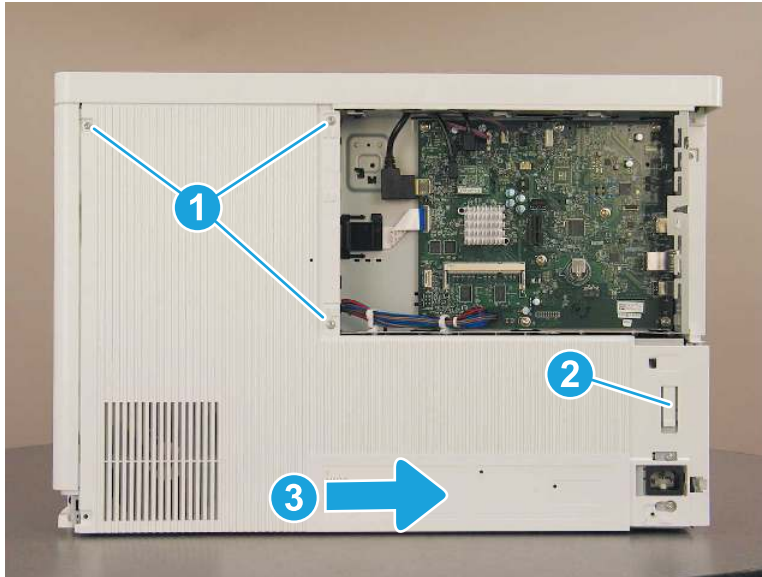
Figure 1-1092 Remove the right rear lower cover



5. Remove the rear cover (M751/E75245).

- ▲ Remove three screws (callout 1), release one tab (callout 2), and then slide the rear cover to the right (callout 3) to remove it.

Figure 1-1093 Remove the rear cover



- 6. Remove the control panel.

 **NOTE:** A screwdriver is included in the control panel kit. The screwdriver has a reversible shaft. Simply pull the shaft out of the handle, and then reinstall it with the desired end facing out.

- a. Use a small, flat-blade screwdriver to release two tabs (callout 1), and then remove the control panel cover (callout 2).

Figure 1-1094 Remove the control panel cover



- b. Remove one screw (callout 1).

Figure 1-1095 Remove one screw



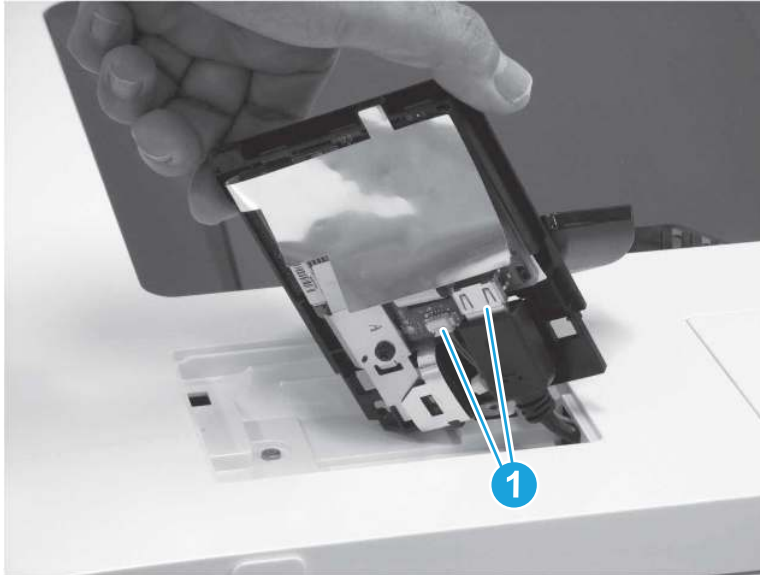
- c. Lift the back edge of the control panel up (callout 1), and then slide the control panel toward the back of the printer (callout 2).

Figure 1-1096 Slide the control panel back



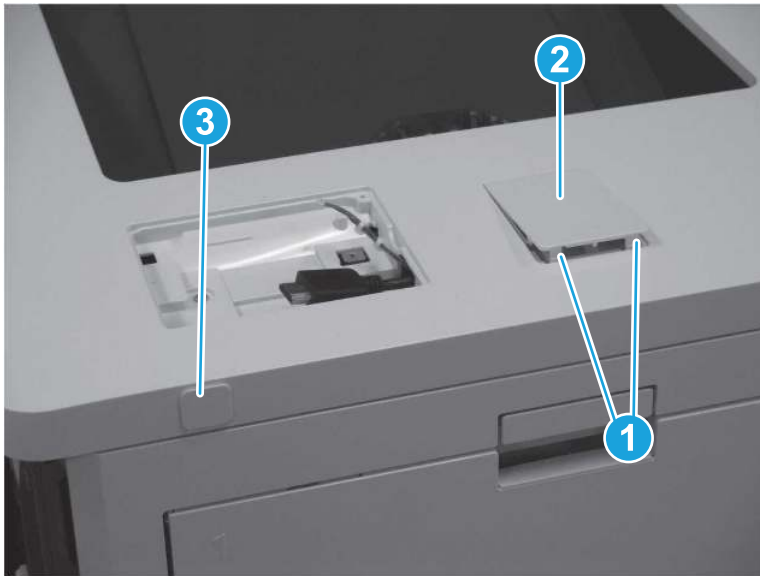
- d. Turn the control panel so that the bottom is facing up, and then disconnect two connectors (callout 1) to remove the control panel.

Figure 1-1097 Disconnect two connectors



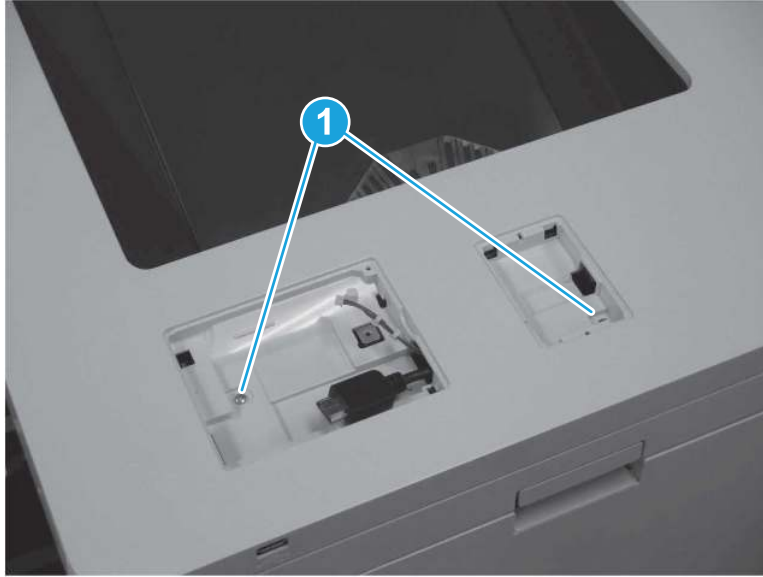
- 7. Remove the top cover (M751/E75245).
 - a. Release two tabs (callout 1), and then remove the HIP cover (callout 2). Pull the USB cap (callout 3) away from the printer to remove it.

Figure 1-1098 Remove the HIP cover and USB cap



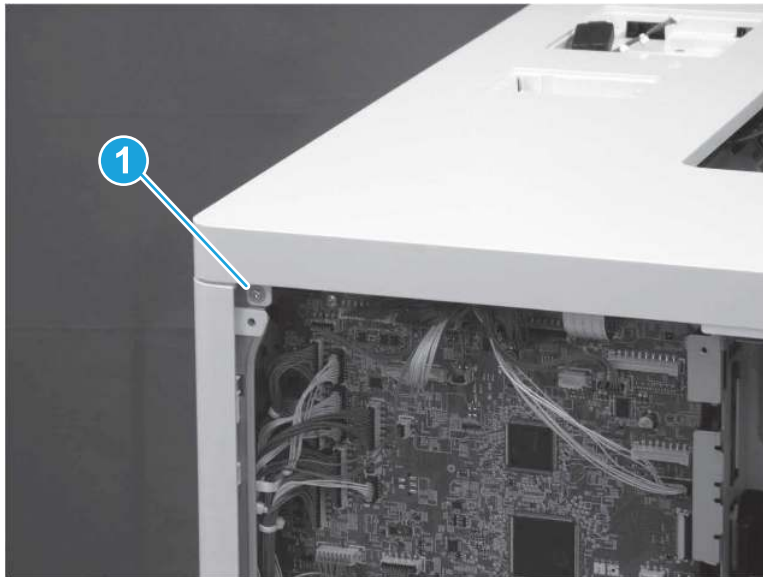
- b. At the top of the printer, remove two screws (callout 1).

Figure 1-1099 Remove two screws



- c. At the back of the printer, remove one screw (callout 1).

Figure 1-1100 Remove one screw

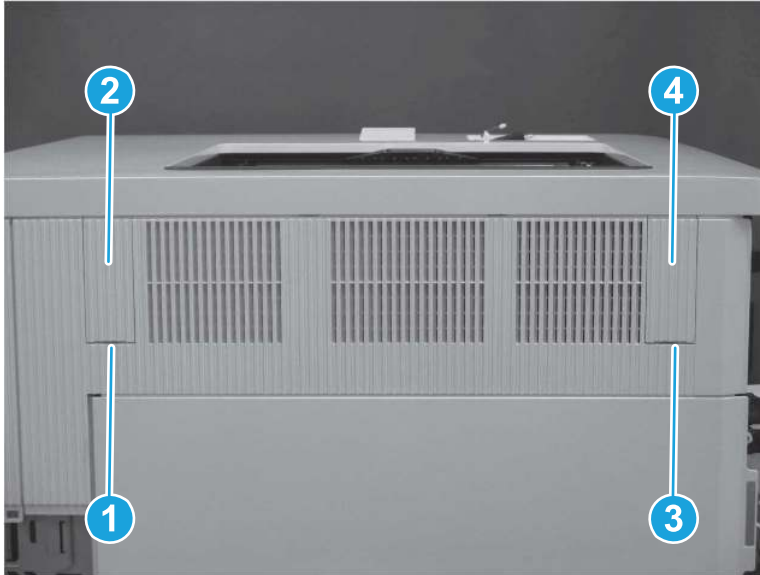


- d. Use a small, flat-blade screwdriver to release one tab (callout 1) and remove the left blanking cover (callout 2). Release one tab (callout 3) and remove the right blanking cover (callout 4).

 **TIP:** These covers are not identical. Make sure to reinstall the correct cover on the correct side.

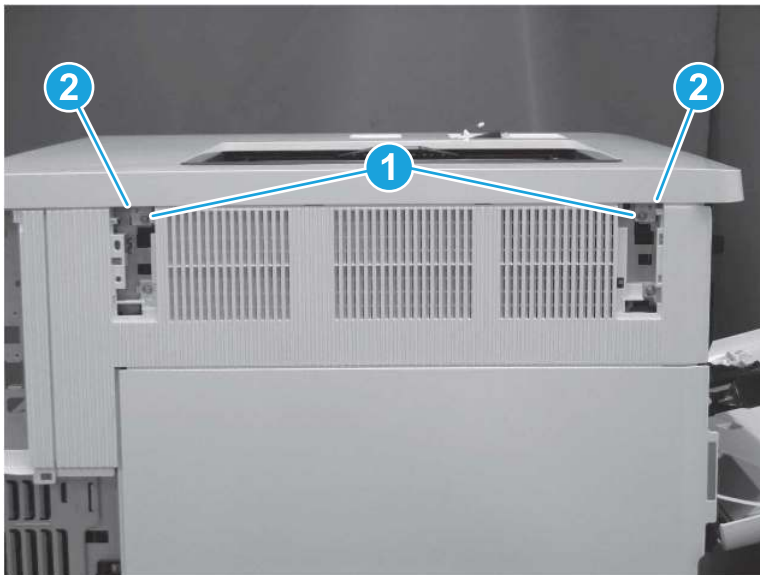
 **NOTE:** The screw under the left blanking cover is a self-tapping screw. Make sure this screw is reinstalled in the correct location.

Figure 1-1101 Remove the left and right blanking covers



- e. Remove two screws (callout 1), and then release two tabs (callout 2).

Figure 1-1102 Remove two screws and release two tabs



- f. At the front of the printer, remove one washer-head screw (callout 1) and one self-tapping screw (callout 2). Release one tab (callout 3).


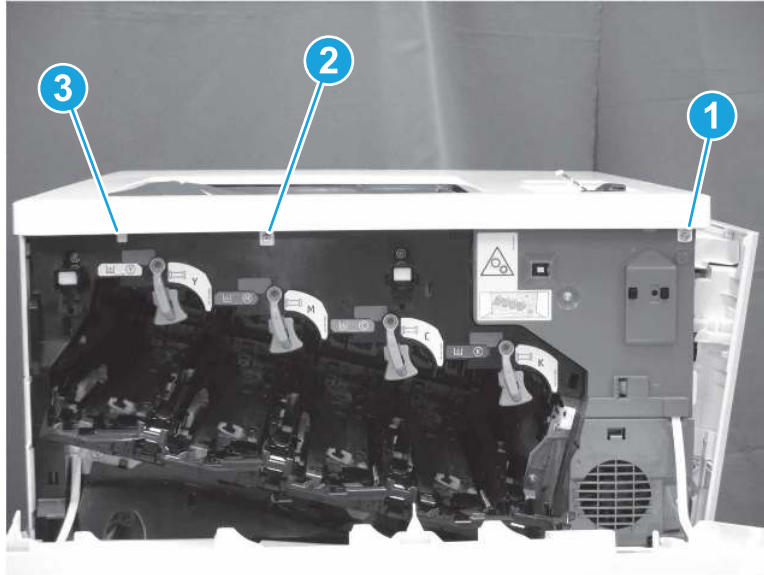
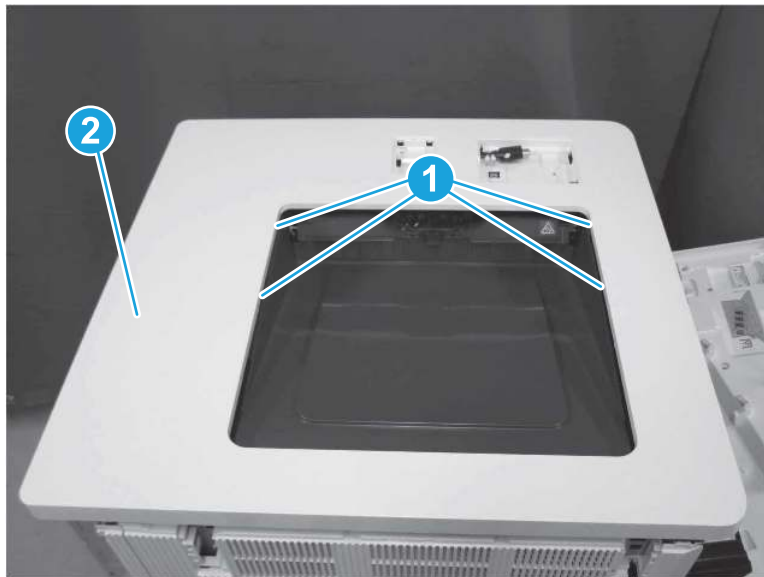
 **TIP:** Make sure to install the correct type of screw in the correct location.


Figure 1-1103 Remove two screws and release one tab



- g. At the top of the printer, release four tabs (callout 1), and then remove the top cover (callout 2).

Figure 1-1104 Remove the top cover

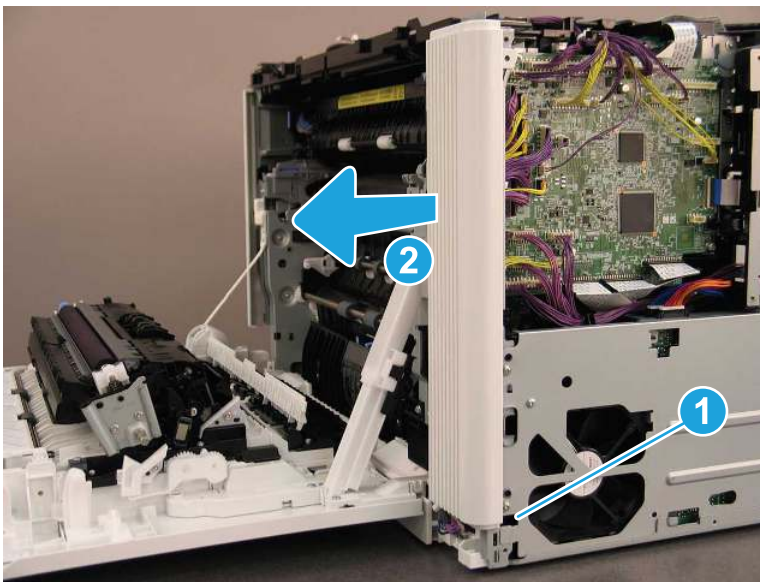


 **NOTE:** When removing the top cover, make sure to release the control panel cables (callout 1) through the opening.



8. Remove the right rear cover (M751/E75245).
 - ▲ Release one tab (callout 1), and then slide the right rear cover (callout 2) away from the printer to remove it.

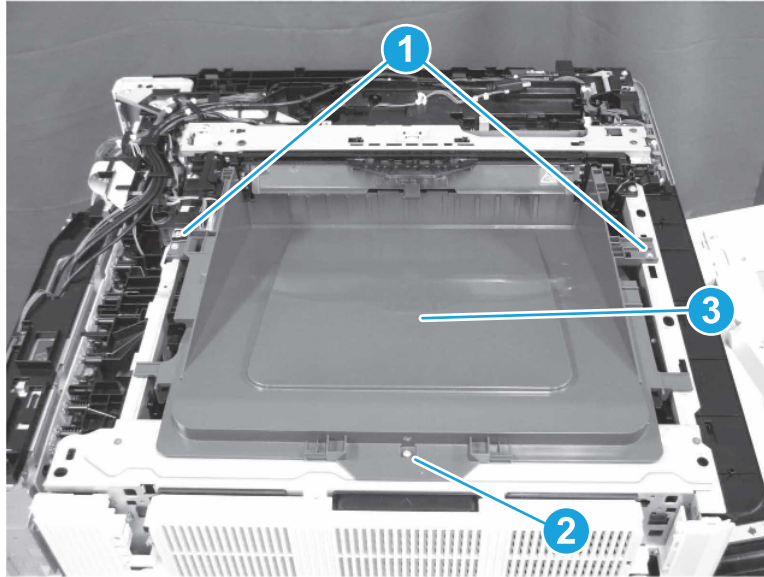
Figure 1-1105 Remove the right rear cover



9. Remove the output bin (M751/E75245).
 - ▲ Remove two washer-head machine screws (callout 1), remove one self-tapping screw (callout 2), and then remove the output bin (callout 3).

 **NOTE:** When reinstalling the output bin, make sure to install the correct type of screw in the correct location.

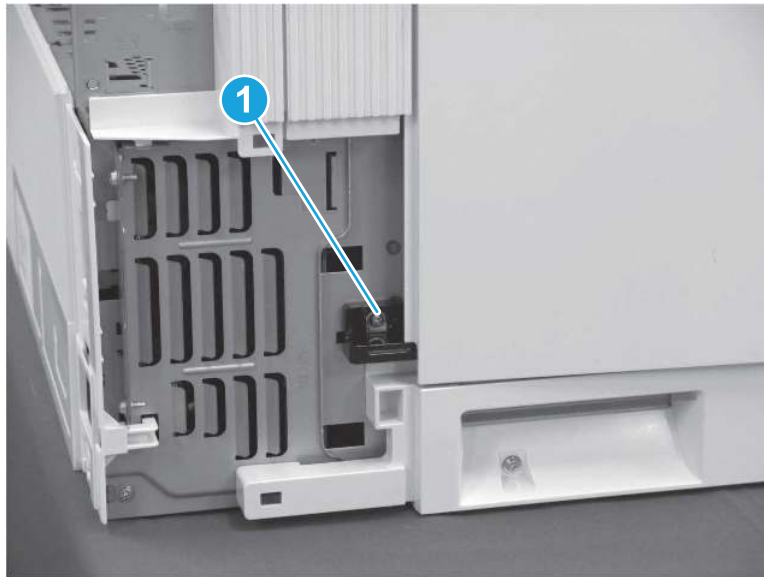
Figure 1-1106 Remove the output bin



10. Remove the left door.

- a. Remove one screw (callout 1).

Figure 1-1107 Remove one screw



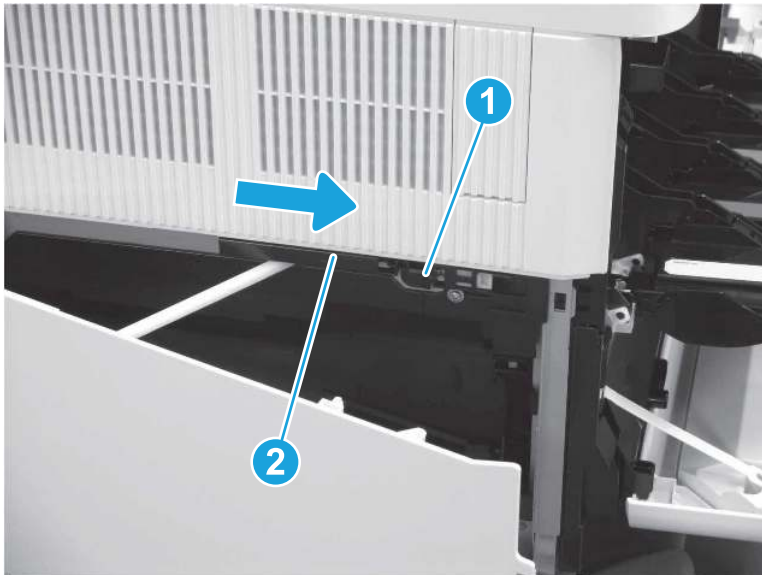
- b. Release the holder, and then remove it from the printer.

Figure 1-1108 Remove the holder



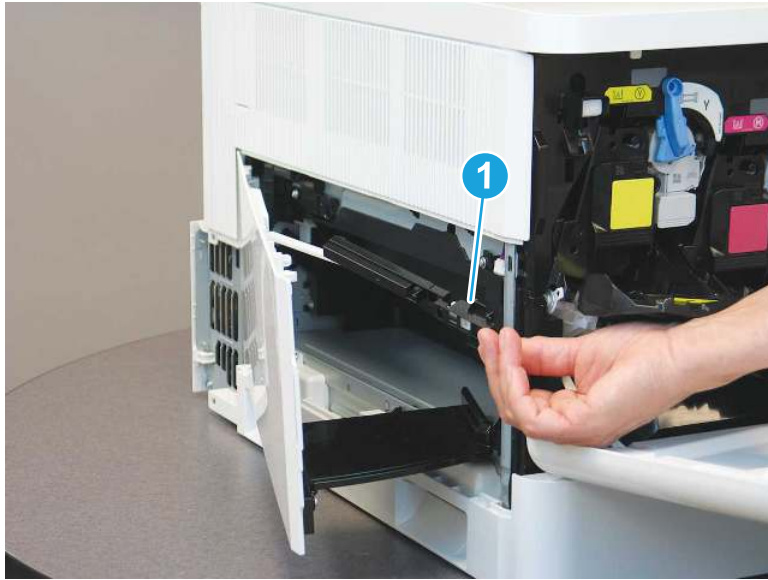
- c. Open the left door, and release one tab (callout 1). Slide the holder (callout 2) toward the front of the printer.

Figure 1-1109 Slide the holder



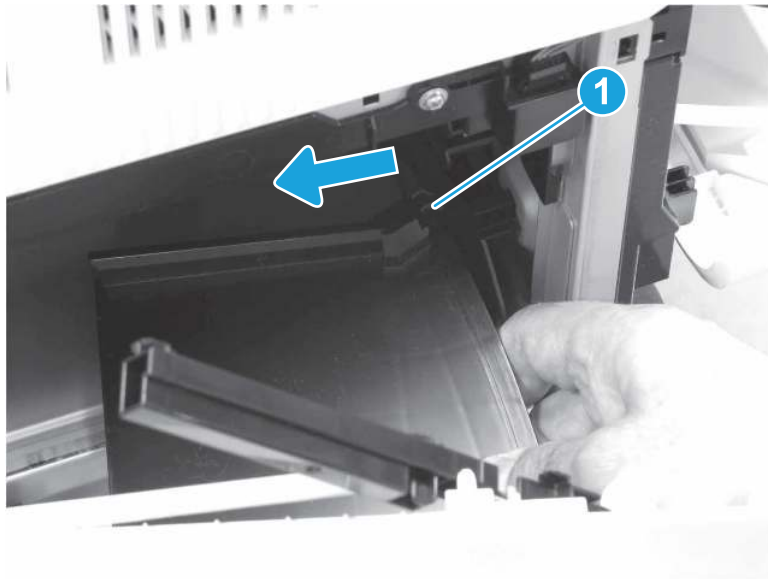
- d. Release the holder (callout 1) from the printer, but leave it attached to the hinge.

Figure 1-1110 Release the holder



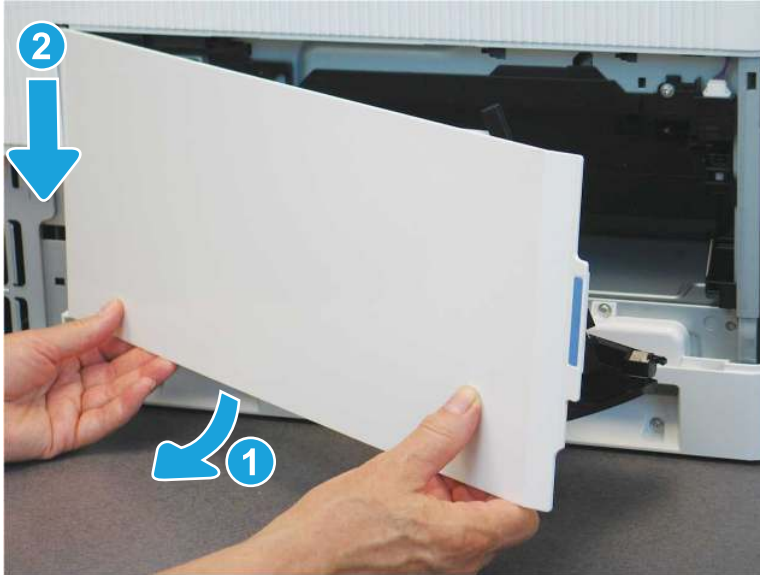
- e. Press the stopper (callout 1) on the bottom of the door to the left to release it from the track.

Figure 1-1111 Release the stopper



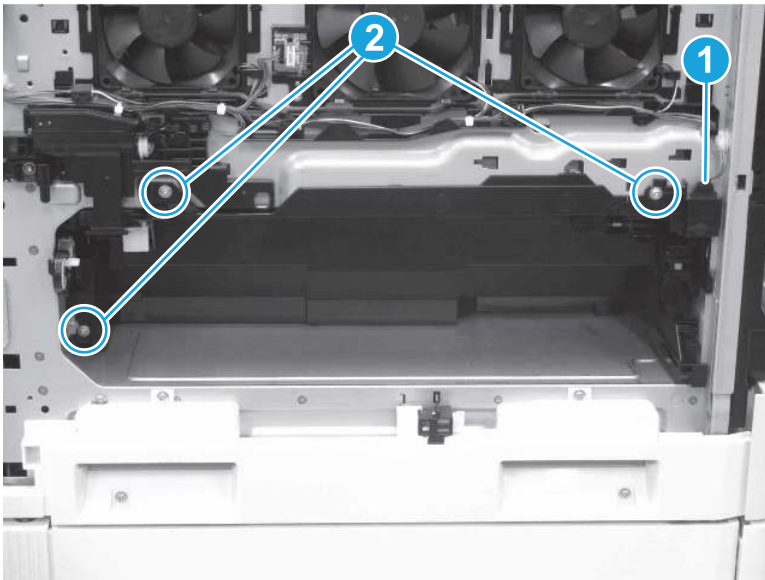
- f. Rotate the left, lower edge of the door away from the printer (callout 1), and then lower the door to remove it (callout 2).

Figure 1-1112 Remove the left door



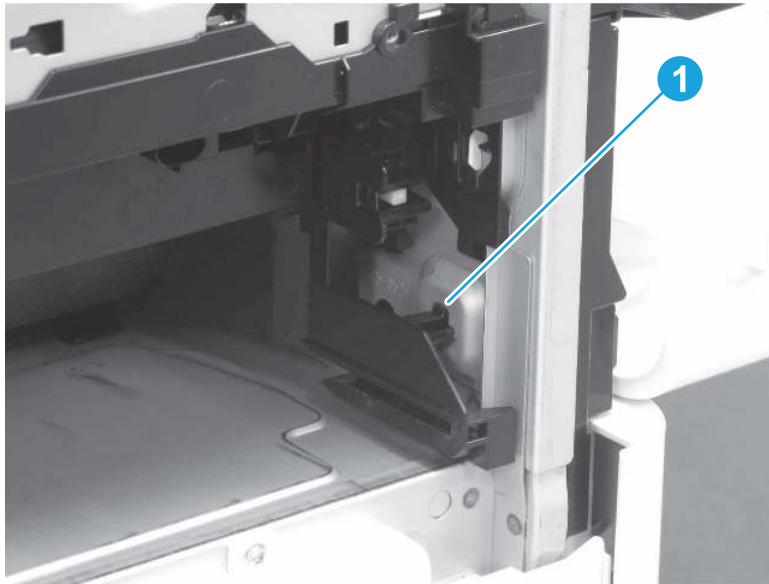
11. Remove the DT cartridge rail assembly (M751/E75245/M856/E85055/M776).
 - a. Disconnect one connector (callout 1), and then remove three screws (callout 2).

Figure 1-1113 Disconnect one connector and remove two screws



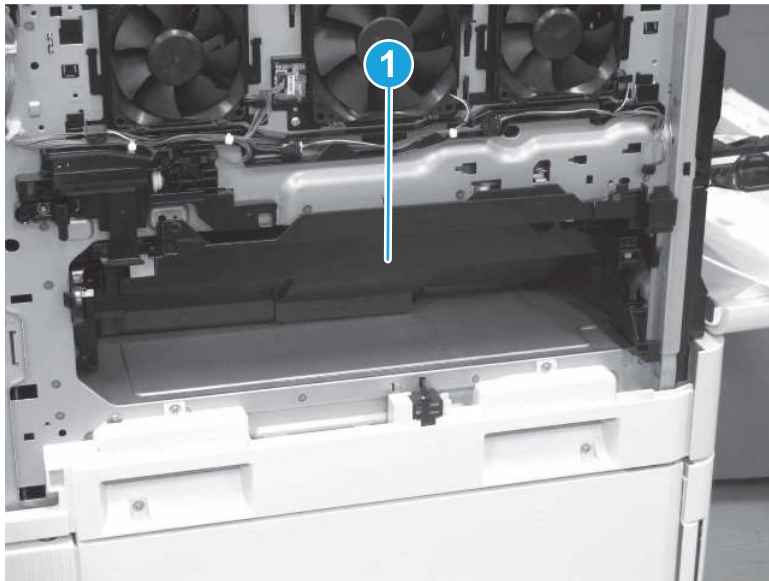
- b. Release one tab (callout 1).

Figure 1-1114 Release one tab



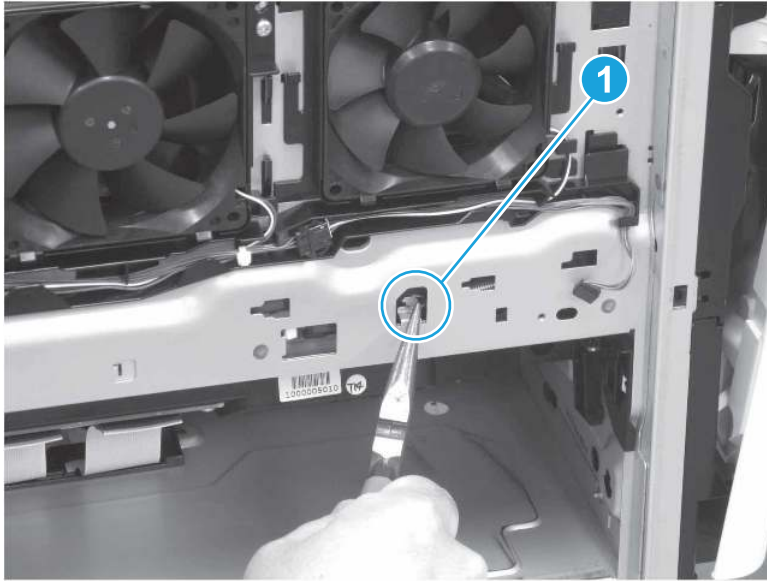
- c. Remove the scanner cover (callout 1).

Figure 1-1115 Remove the scanner cover



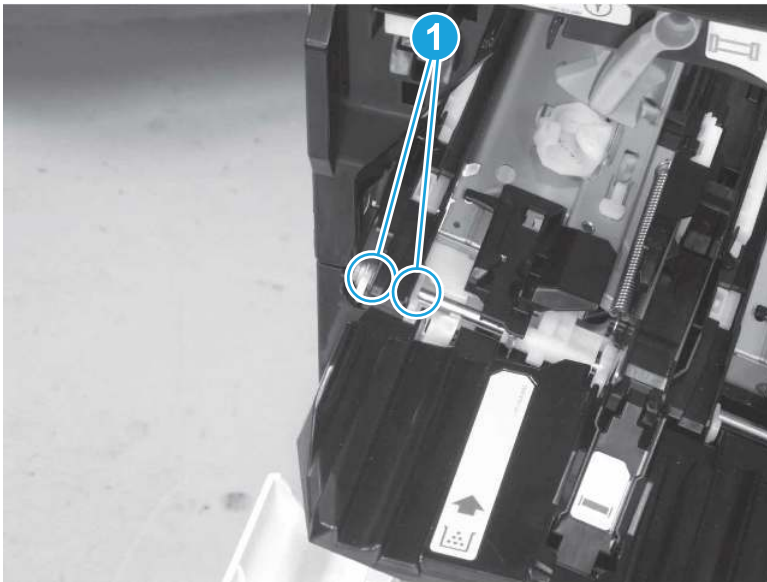
- d. Close the front door, and then unhook one spring (callout 1).

Figure 1-1116 Unhook one spring



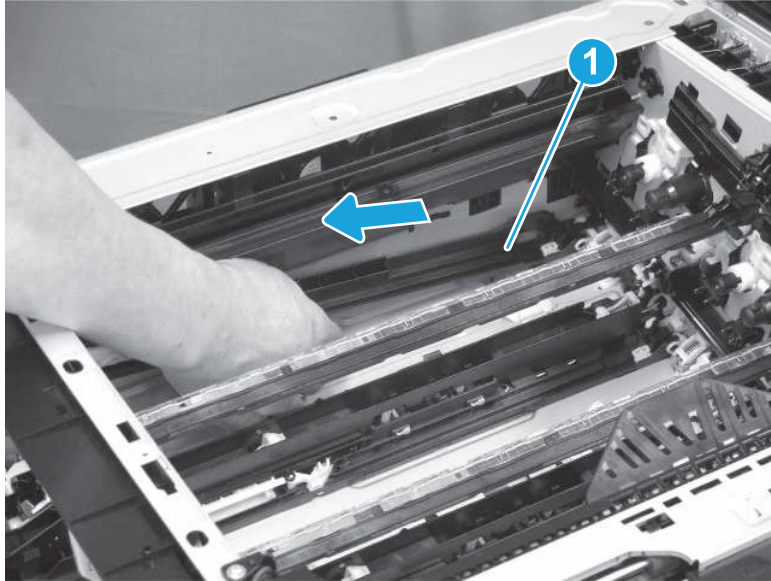
- e. Release two bosses (callout 1).

Figure 1-1117 Release two bosses



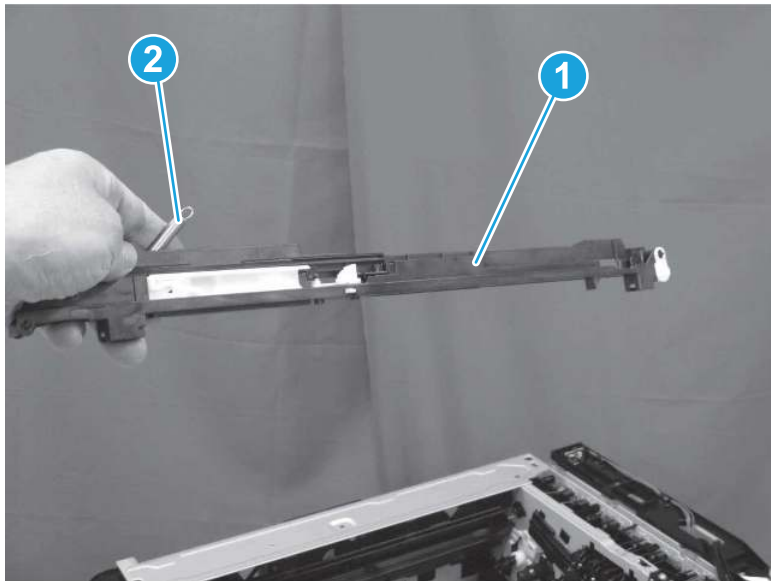
- f. Pull the DT cartridge rail assembly (callout 1) toward the front of the printer about 2 cm (0.79 in).

Figure 1-1118 Pull the DT cartridge rail assembly



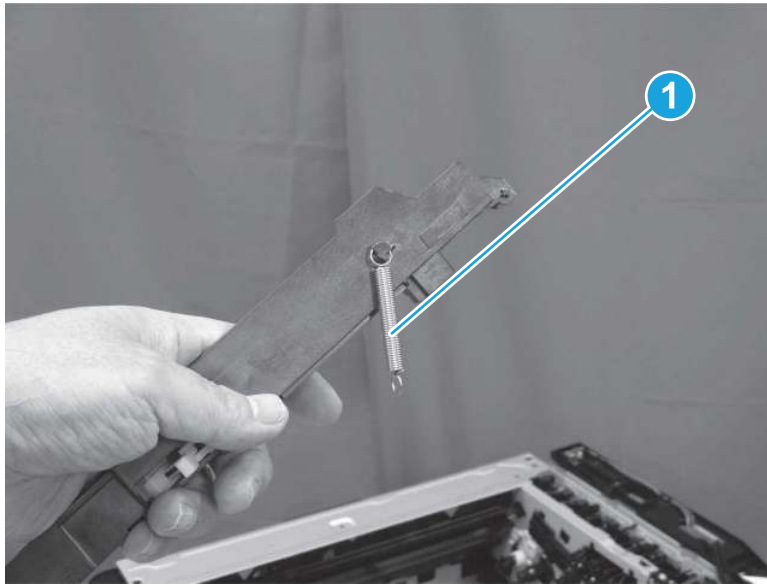
- g. Remove the DT cartridge assembly (callout 1) and the spring (callout 2) together.

Figure 1-1119 Remove the DT cartridge assembly and spring



- h. Remove the spring (callout 1).

Figure 1-1120 Remove the spring



- 12. Unpack the replacement assembly.

- a. Dispose of the defective part.



NOTE: HP recommends responsible disposal of the defective part.

<http://www8.hp.com/us/en/hp-information/environment/product-recycling.html>

- b. Unpack the replacement part from the packaging.



IMPORTANT: Make sure that all of the shipping materials (for example shipping tape) are removed from the replacement part prior to installation.

- c. To install an assembly, reverse the removal steps.



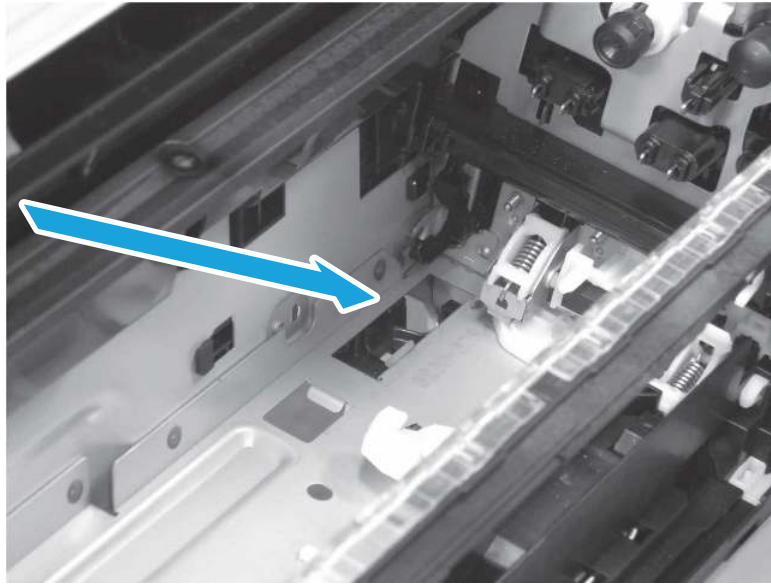
NOTE: When applicable, special installation instructions are provided for an assembly at the end of the removal procedure. Always completely read the removal instructions and follow all special installation instructions.

- 13. Reverse the removal steps to install the assembly. Also use the following **special installation instructions**.

Install the DT cartridge rail assembly.

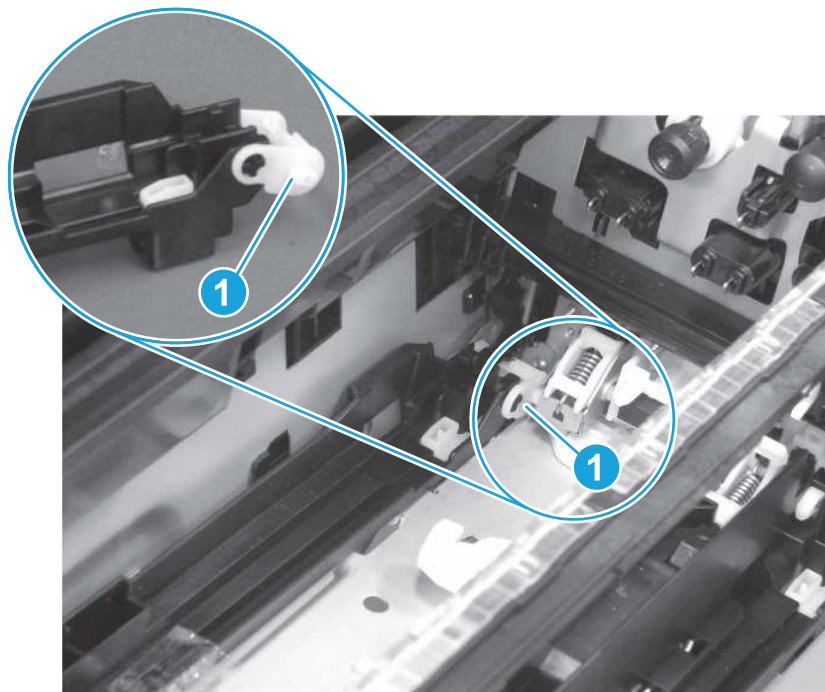
- a. Slide the DT-cartridge rail assembly into position.

Figure 1-1121 Position the DT-cartridge rail assembly (M751/E75245/M856/E85055/M776dn/M776z/M776zs)



- b. Make sure that the link arm (callout 1) is correctly positioned. If this part is positioned incorrectly, the cartridge cannot be installed.

Figure 1-1122 Check the link arm position (M751/E75245/M856/E85055/M776dn/M776z/M776zs)



Removal and replacement: DT-cartridge rail assembly (M856/E85055/M776dn/M776z)

Learn how to remove and replace the DT cartridge rail assembly.

Mean time to repair: 25 minutes

Service level: Hard

Before performing service

Turn the printer power off

- Disconnect the power cable.

⚠ WARNING! To avoid damage to the printer, turn the printer off, wait 30 seconds, and then remove the power cord before attempting to service the printer.

Use the table below to identify the correct part number for your printer. To order the part, go to www.hp.com/buy/parts.

Table 1-67 Part information

Part number	Part description
RM2-2479-000CN	DT cartridge rail assembly

Required tools

- #2 Phillips screwdriver with a magnetic tip
- Small, flat-blade screwdriver

After performing service

Turn the printer power on

- Connect the power cable.
- Use the power switch to turn the power on.

Post service test

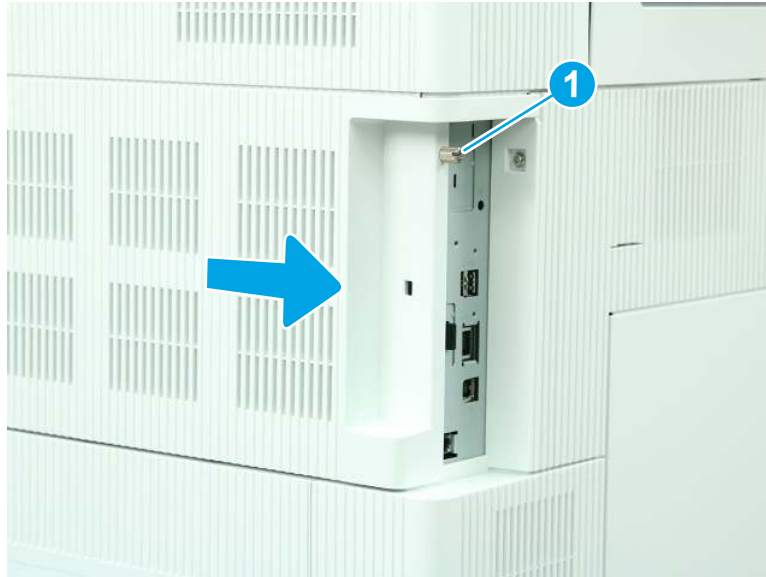
Make sure that the printer initializes to a **Ready** state.

Print a page to make sure that the printer is functioning correctly.

1. Remove the formatter cover.

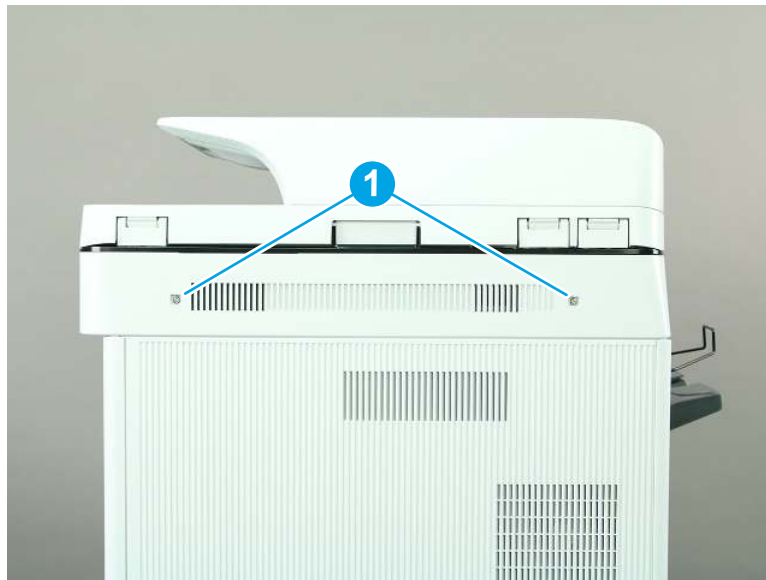
- ▲ Loosen one thumbscrew (callout 1), and then slide the formatter cover (callout 2) away from the printer to remove it.

Figure 1-1123 Remove the formatter cover



- 2. Remove the scanner control board (SCB) cover (M776).
 - a. Remove two screws (callout 1).

Figure 1-1124 Remove two screws



- b. Remove the SCB cover.

Figure 1-1125 Remove the SCB cover

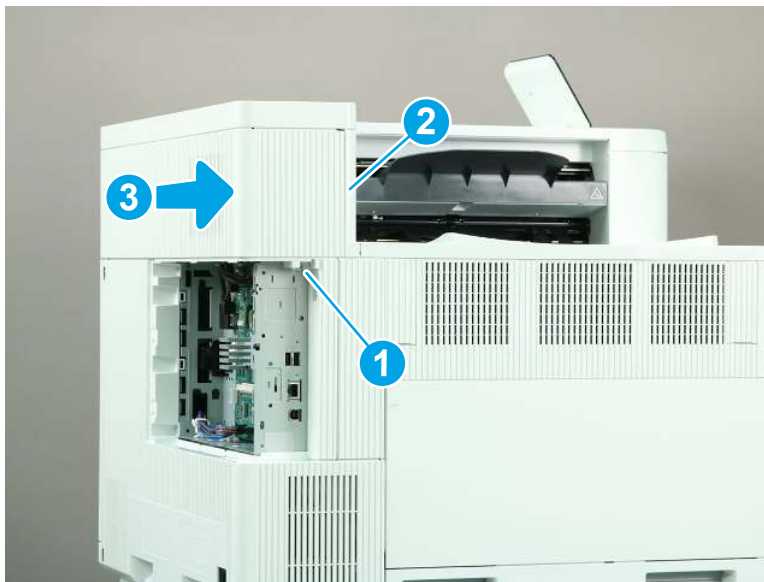


3. Remove the rear upper cover (M856/E85055/M776dn/M776z).

 **NOTE:** The following figure shows the M856 printer. The procedure is correct for all referenced models.

- ▲ Remove one screw (callout 1), release one tab (callout 2), and then slide the rear upper cover away from the printer to remove it (callout 3).

Figure 1-1126 Remove the rear upper cover

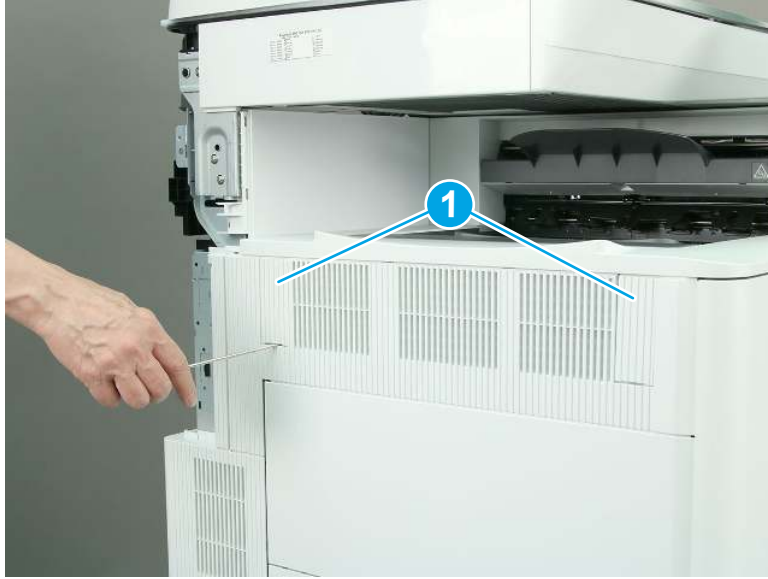


4. Remove the accessory upper cover (M856/E85055/M776dn/M776z).

 **NOTE:** The following figures show the M776z printer. The procedure is correct for all referenced models.

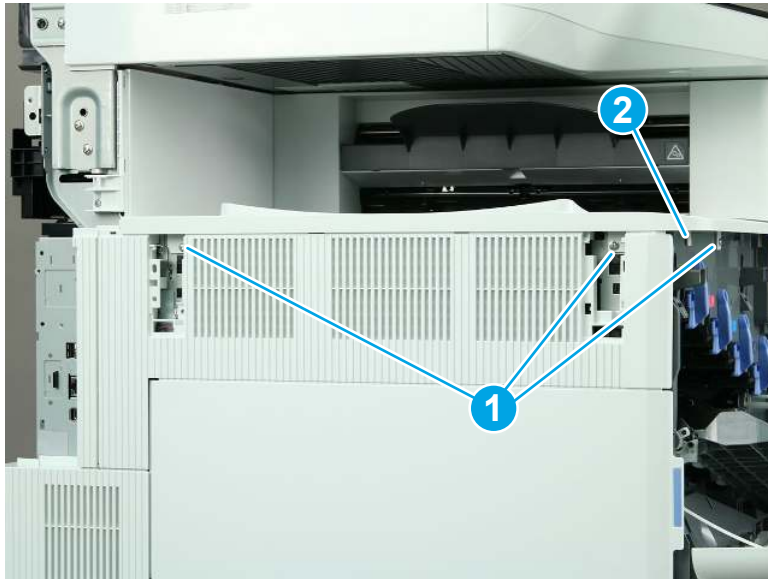
- a. Use a small, flat-blade screwdriver to remove two covers (callout 1).

Figure 1-1127 Remove two covers



- b. Remove three screws (callout 1), and then release one tab (callout 2).

Figure 1-1128 Remove three screws and release one tab



- c. Slide the accessory upper cover away from the printer to remove it.

Figure 1-1129 Remove the accessory upper cover

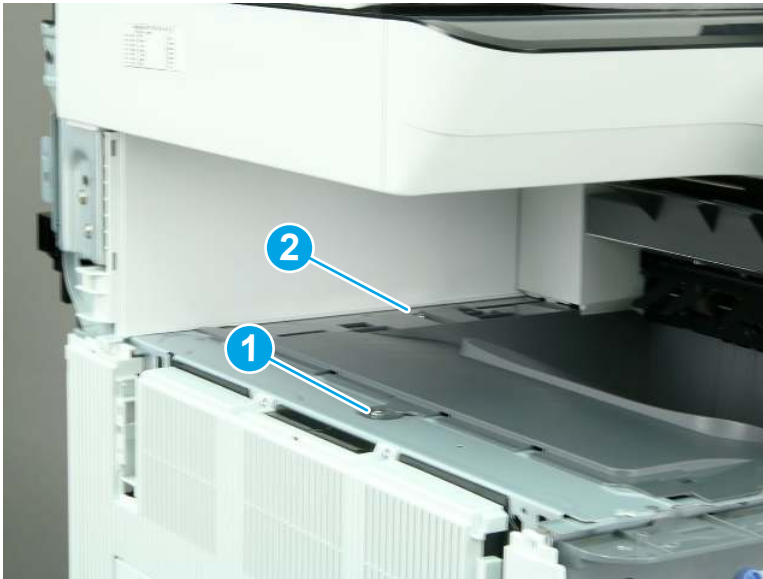


- 5. Remove the output bin (M856/E85055/M776).

 **NOTE:** The following figures show the M776z printer. The procedure is correct for all referenced models.

- a. Remove one washer-head machine screw (callout 1), remove one self-tapping screw (callout 2).

Figure 1-1130 Remove two screws



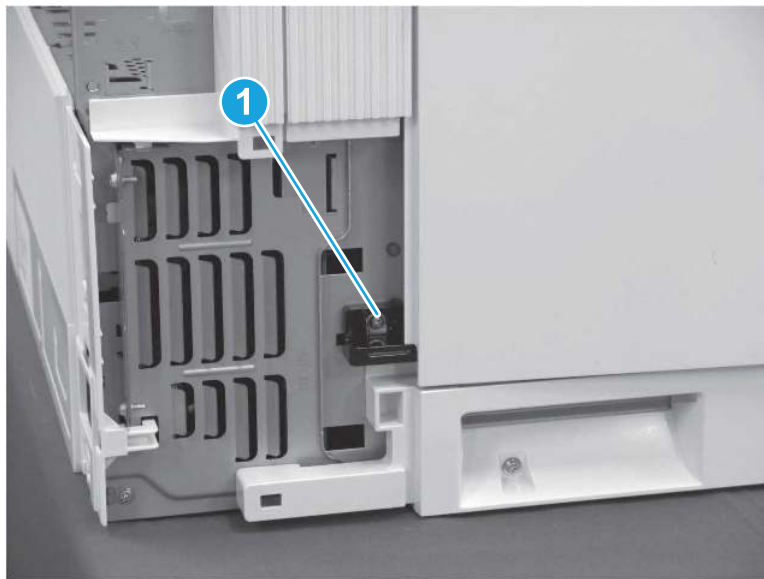
- b. Remove the output bin.

Figure 1-1131 Remove the output bin



6. Remove the left door.
 - a. Remove one screw (callout 1).

Figure 1-1132 Remove one screw



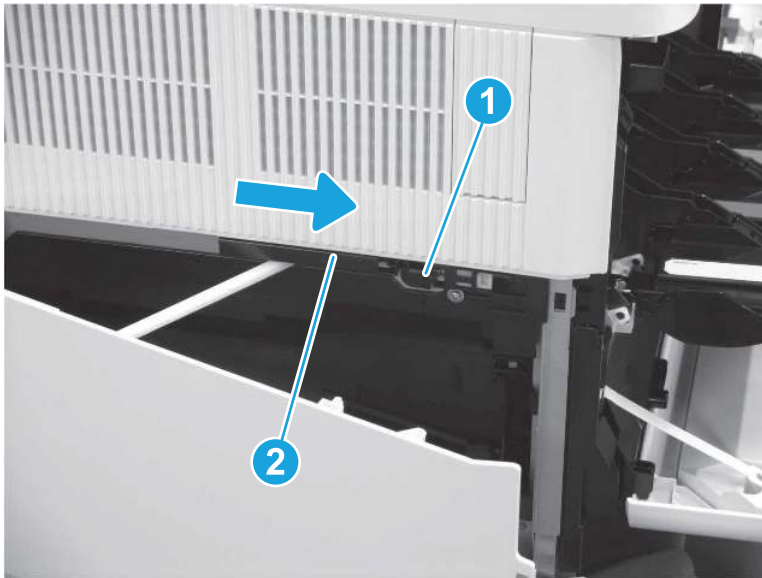
- b. Release the holder, and then remove it from the printer.

Figure 1-1133 Remove the holder



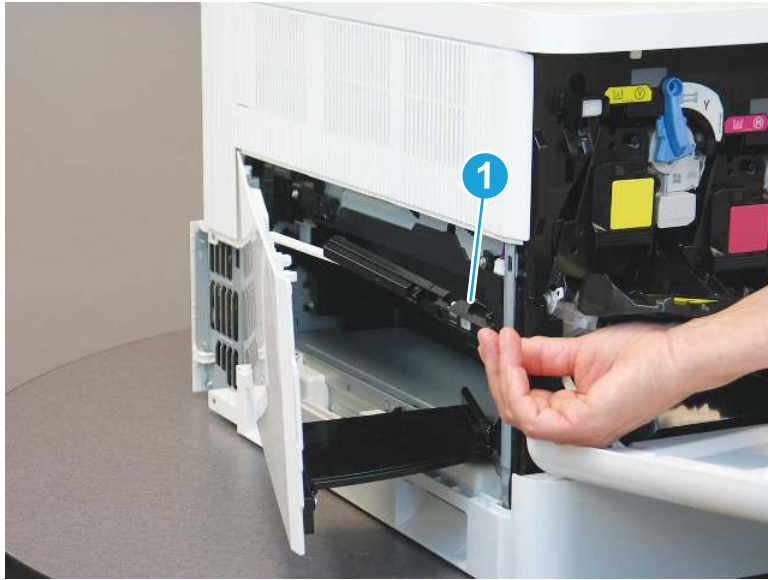
- c. Open the left door, and release one tab (callout 1). Slide the holder (callout 2) toward the front of the printer.

Figure 1-1134 Slide the holder



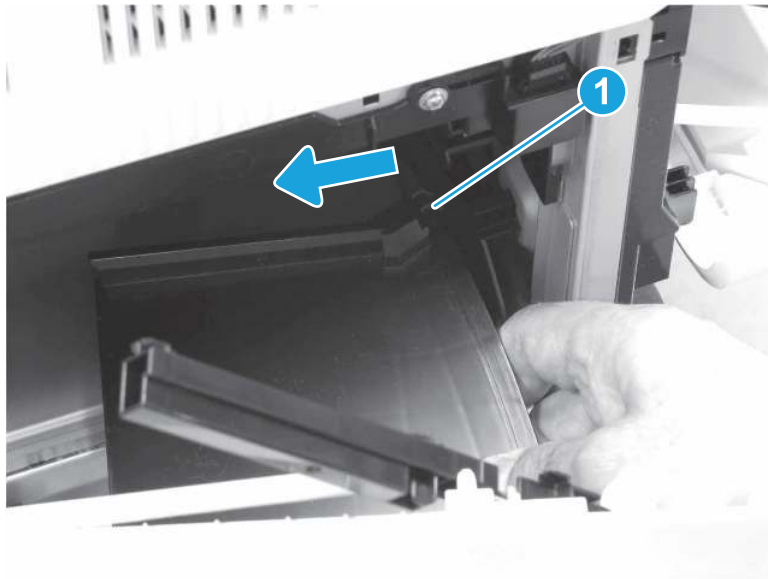
- d. Release the holder (callout 1) from the printer, but leave it attached to the hinge.

Figure 1-1135 Release the holder



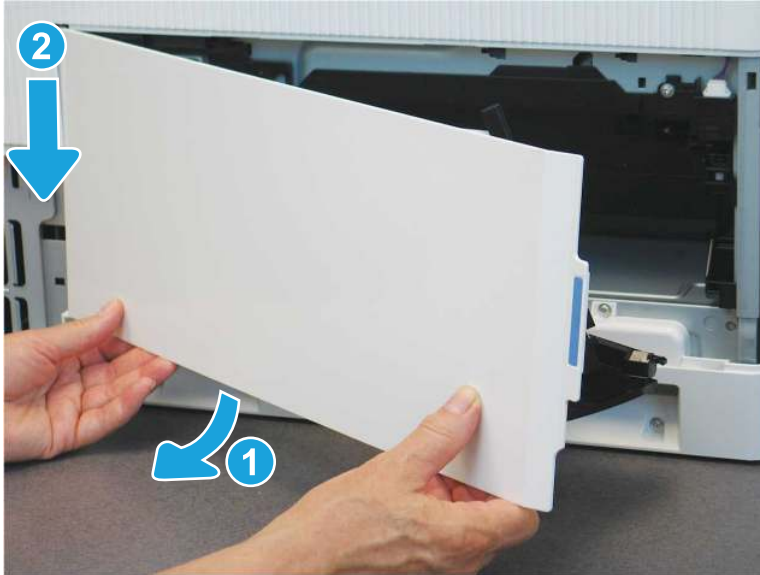
- e. Press the stopper (callout 1) on the bottom of the door to the left to release it from the track.

Figure 1-1136 Release the stopper



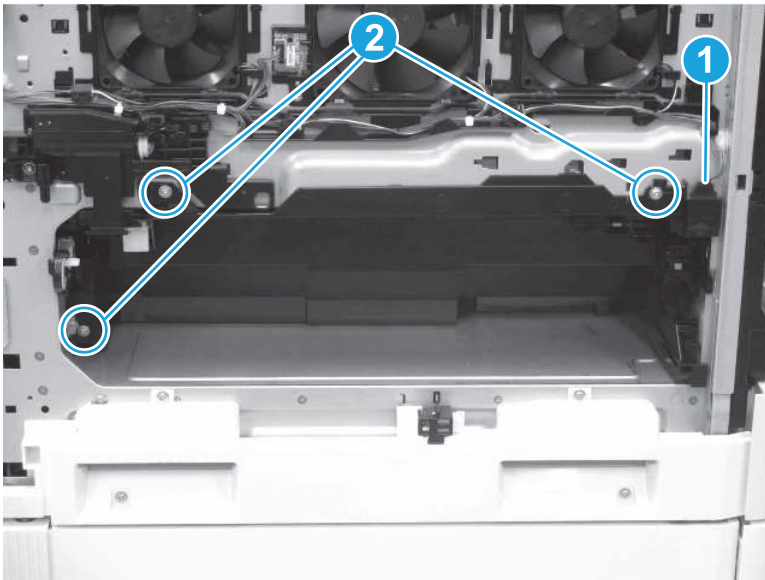
- f. Rotate the left, lower edge of the door away from the printer (callout 1), and then lower the door to remove it (callout 2).

Figure 1-1137 Remove the left door



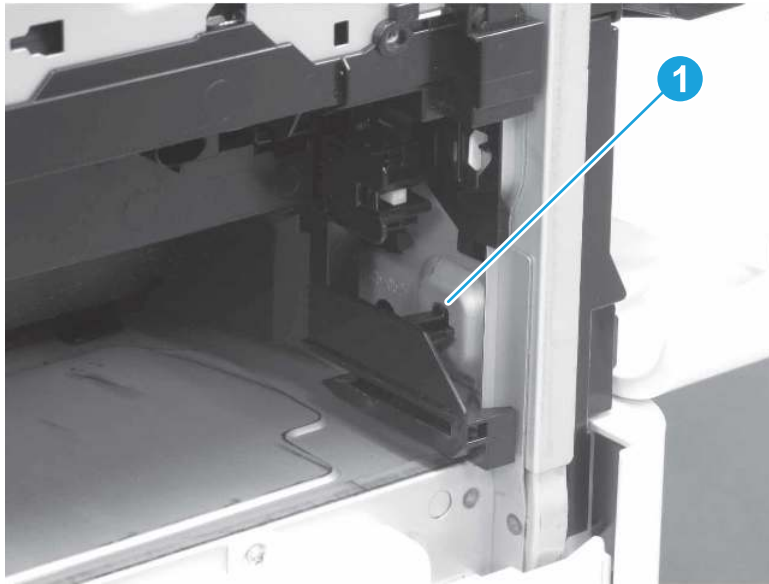
7. Remove the DT cartridge rail assembly (M751/E75245/M856/E85055/M776).
 - a. Disconnect one connector (callout 1), and then remove three screws (callout 2).

Figure 1-1138 Disconnect one connector and remove two screws



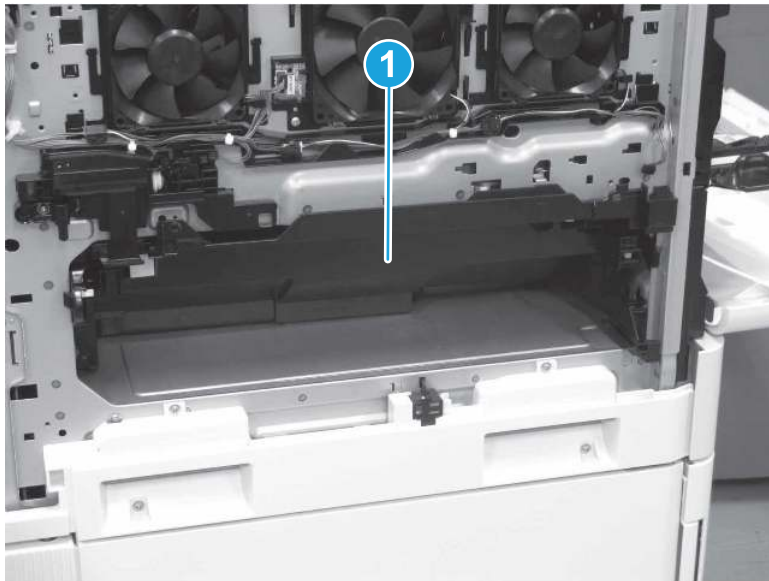
- b. Release one tab (callout 1).

Figure 1-1139 Release one tab



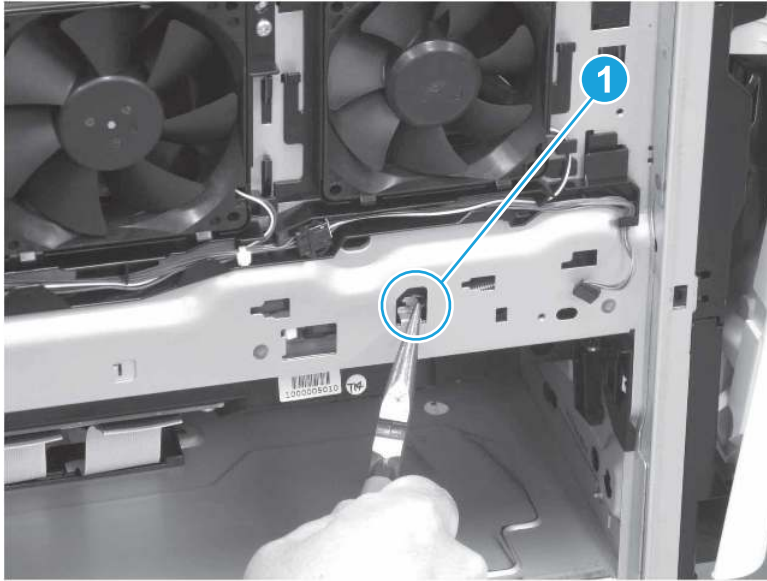
- c. Remove the scanner cover (callout 1).

Figure 1-1140 Remove the scanner cover



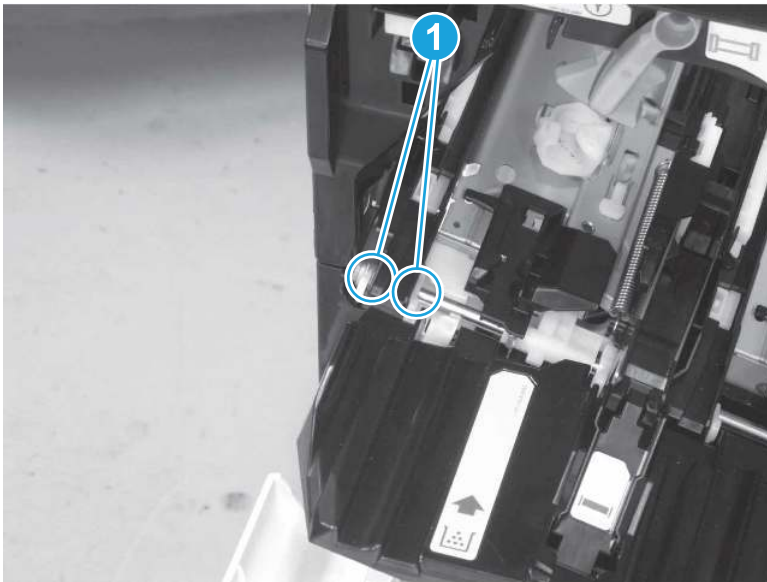
- d. Close the front door, and then unhook one spring (callout 1).

Figure 1-1141 Unhook one spring



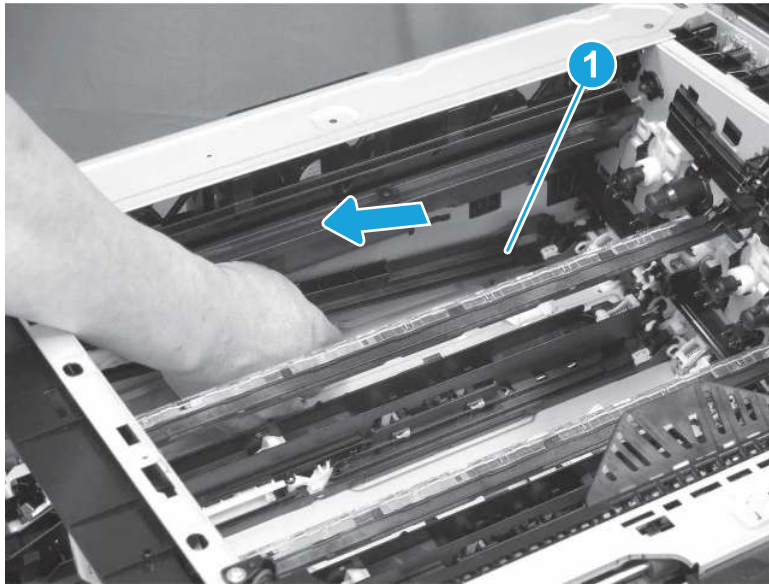
- e. Release two bosses (callout 1).

Figure 1-1142 Release two bosses



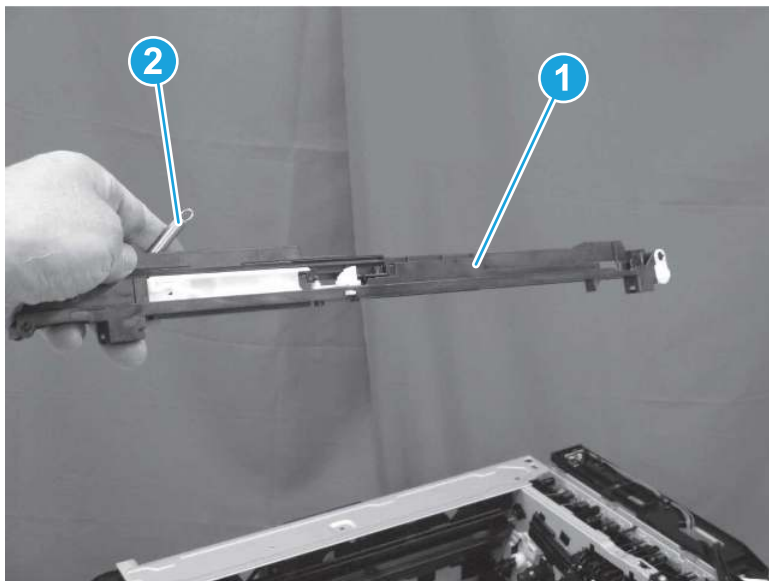
- f. Pull the DT cartridge rail assembly (callout 1) toward the front of the printer about 2 cm (0.79 in).

Figure 1-1143 Pull the DT cartridge rail assembly



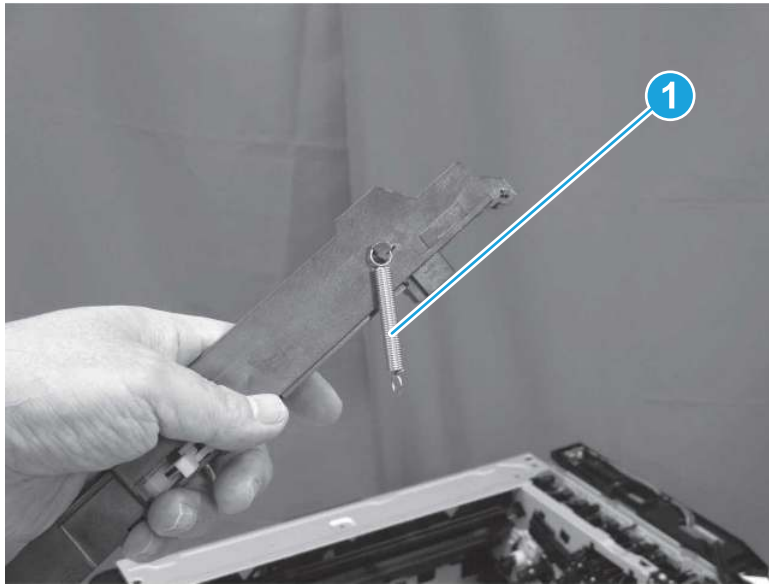
- g. Remove the DT cartridge assembly (callout 1) and the spring (callout 2) together.

Figure 1-1144 Remove the DT cartridge assembly and spring



- h. Remove the spring (callout 1).

Figure 1-1145 Remove the spring



- 8. Unpack the replacement assembly.

- a. Dispose of the defective part.



NOTE: HP recommends responsible disposal of the defective part.

<http://www8.hp.com/us/en/hp-information/environment/product-recycling.html>

- b. Unpack the replacement part from the packaging.



IMPORTANT: Make sure that all of the shipping materials (for example shipping tape) are removed from the replacement part prior to installation.

- c. To install an assembly, reverse the removal steps.



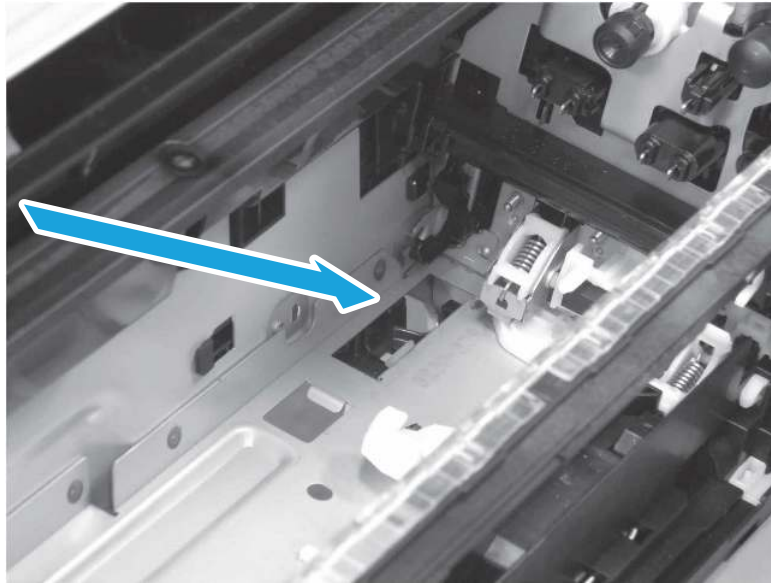
NOTE: When applicable, special installation instructions are provided for an assembly at the end of the removal procedure. Always completely read the removal instructions and follow all special installation instructions.

- 9. Reverse the removal steps to install the assembly. Also use the following **special installation instructions**.

Install the DT cartridge rail assembly.

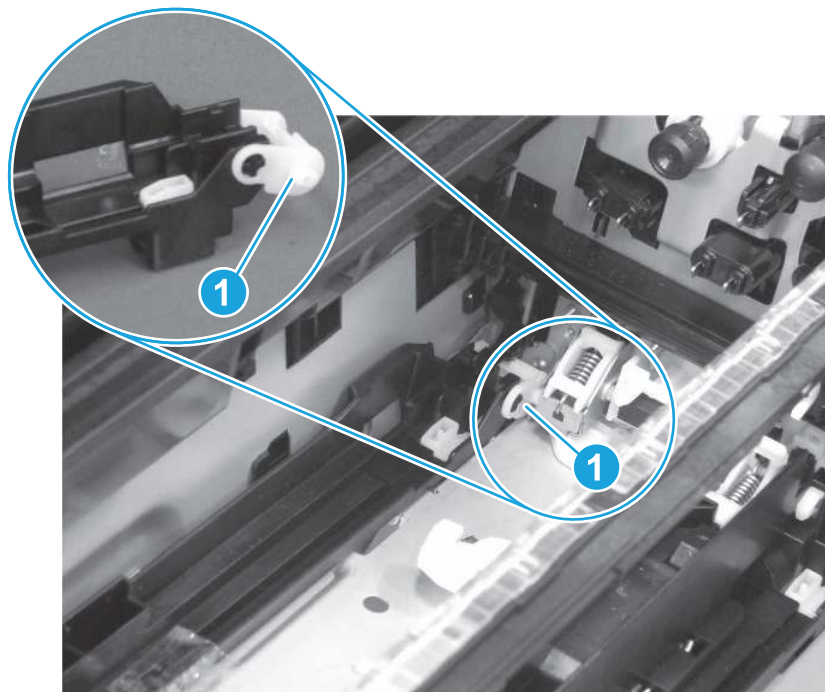
- a. Slide the DT-cartridge rail assembly into position.

Figure 1-1146 Position the DT-cartridge rail assembly (M751/E75245/M856/E85055/M776dn/M776z/M776zs)



- b. Make sure that the link arm (callout 1) is correctly positioned. If this part is positioned incorrectly, the cartridge cannot be installed.

Figure 1-1147 Check the link arm position (M751/E75245/M856/E85055/M776dn/M776z/M776zs)



Removal and replacement: DT-cartridge rail assembly (M776zs)

Learn how to remove and replace the DT cartridge rail assembly.

Mean time to repair: 25 minutes

Service level: Hard

Before performing service

Turn the printer power off

- Disconnect the power cable.

⚠ WARNING! To avoid damage to the printer, turn the printer off, wait 30 seconds, and then remove the power cord before attempting to service the printer.

Use the table below to identify the correct part number for your printer. To order the part, go to www.hp.com/buy/parts.

Table 1-68 Part information

Part number	Part description
RM2-2479-000CN	DT cartridge rail assembly

Required tools

- #2 Phillips screwdriver with a magnetic tip
- Small, flat-blade screwdriver

After performing service

Turn the printer power on

- Connect the power cable.
- Use the power switch to turn the power on.

Post service test

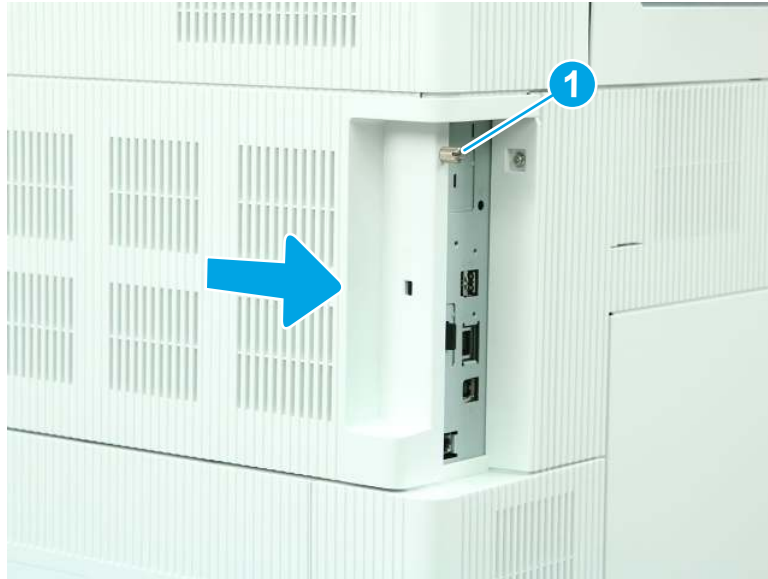
Make sure that the printer initializes to a **Ready** state.

Print a page to make sure that the printer is functioning correctly.

1. Remove the formatter cover.

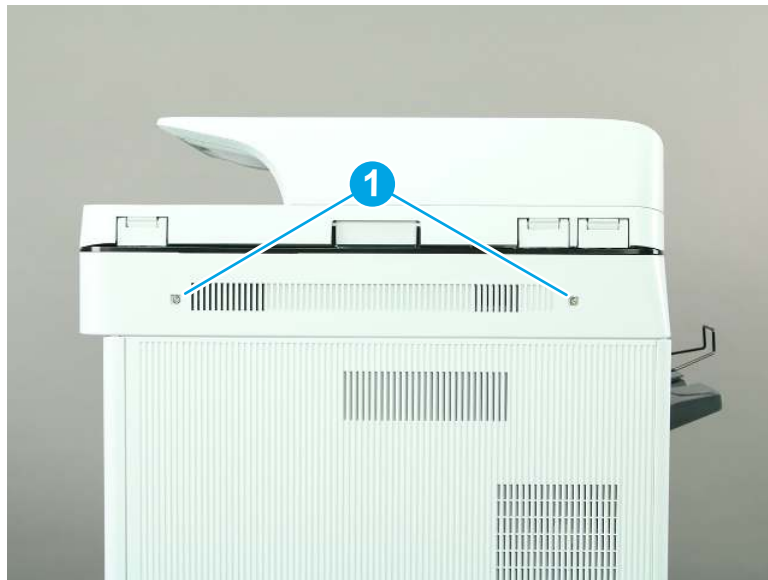
- ▲ Loosen one thumbscrew (callout 1), and then slide the formatter cover (callout 2) away from the printer to remove it.

Figure 1-1148 Remove the formatter cover



- 2. Remove the scanner control board (SCB) cover (M776).
 - a. Remove two screws (callout 1).

Figure 1-1149 Remove two screws



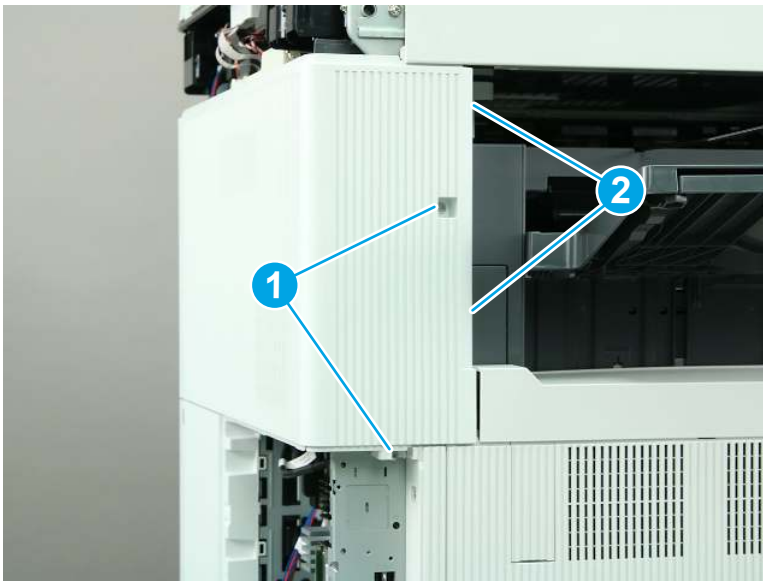
- b. Remove the SCB cover.

Figure 1-1150 Remove the SCB cover



3. Remove the rear upper cover and left rear upper cover (M776zs).
 - a. Remove two screws (callout 1), and then release two tabs (callout 2).

Figure 1-1151 Remove two screws and release two tabs



- b. Slide the cover to the right to remove it.

Figure 1-1152 Remove the rear upper and left rear upper cover



4. Remove the front cover (M776zs).

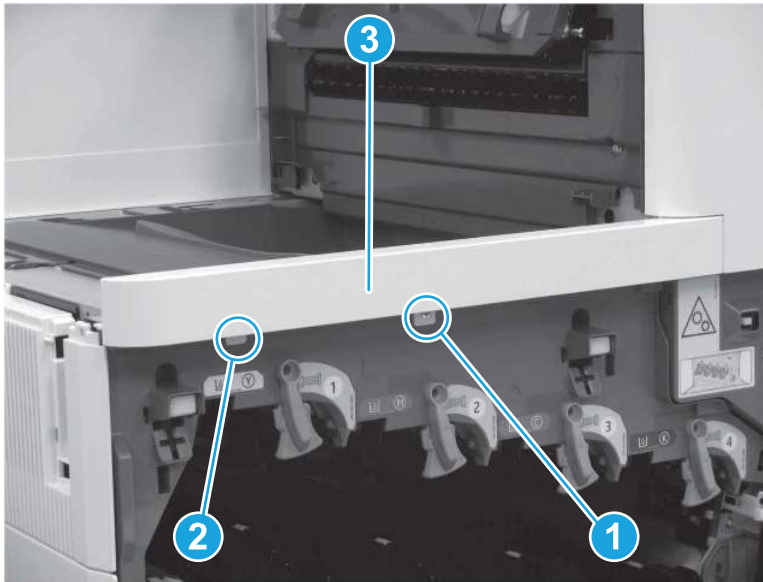
- a. Open the front door.

Figure 1-1153 Open the front door



- b. Remove one screw (callout 1), release one tab (callout 2), and then remove the front cover (callout 3).

Figure 1-1154 Remove the front cover



- 5. Remove the control panel (M776).
 - a. Rotate the control panel to the fully raised position (callout 1), and then raise the document feeder (callout 2).

Figure 1-1155 Raise the control panel and document feeder



- b. Beginning at the right side of the control-panel cover, carefully release five tabs along the top edge of the cover.

 **NOTE:** The thin black-plastic cover will separate from the white-plastic control-panel base.

Figure 1-1156 Release the control panel cover



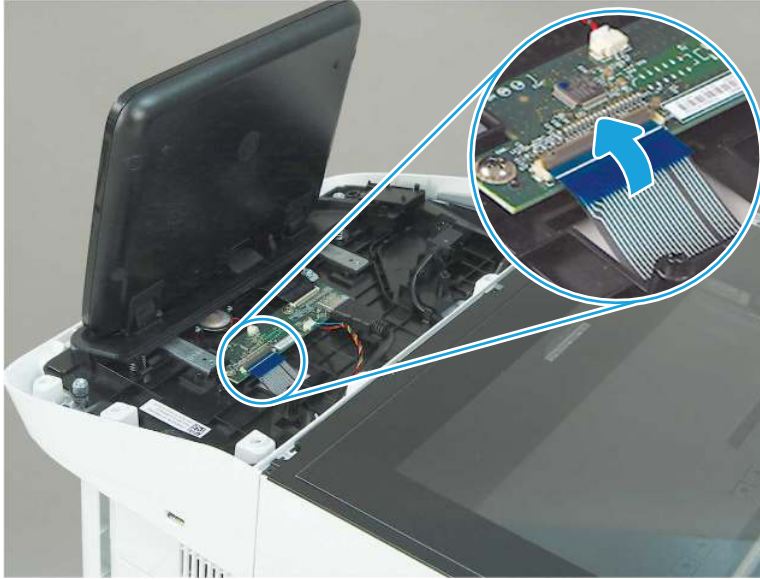
- c. Rotate the control panel cover slightly forward (callout 1), and then lift up to remove the cover (callout 2).

Figure 1-1157 Remove the control panel cover



- d. **M776z or M776zs only:** Open the connector latch to release the keyboard flat cable.

Figure 1-1158 Release the keyboard flat cable (M776z/M776zs)



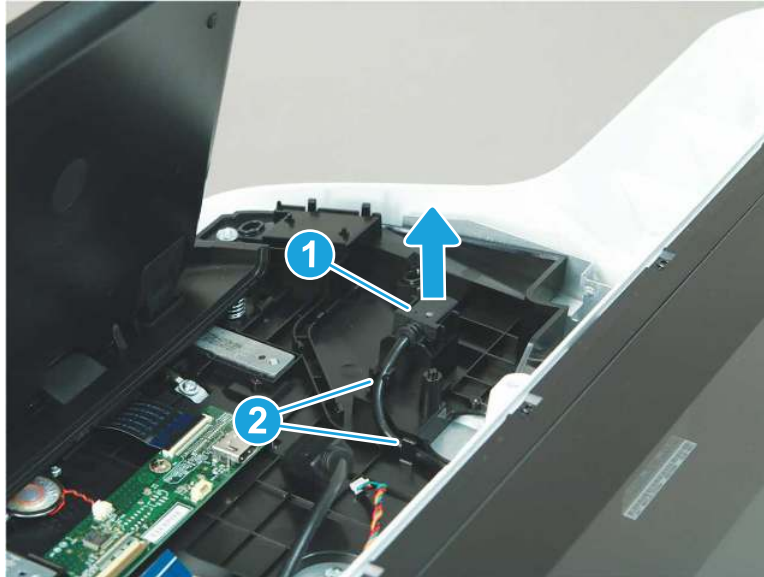
- e. Disconnect two connectors

Figure 1-1159 Disconnect two connectors



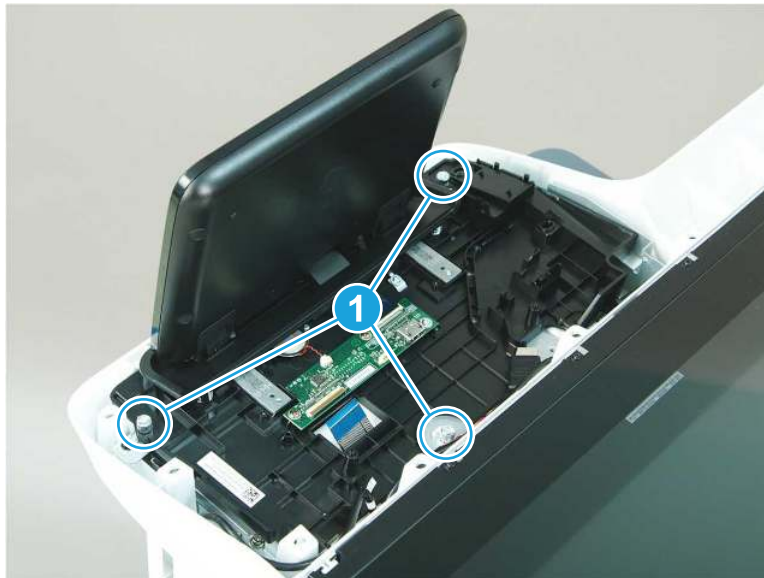
- f. Remove the USB cable (callout 1) from the holder, and then release the cable from two retainers (callout 2).

Figure 1-1160 Release the USB cable



- g. Remove three screws (callout 1).

Figure 1-1161 Remove three screws



- h. Lift the front of the control panel off of the printer (callout 1), and then slide it towards the front of the printer (callout 2) to remove it.

Figure 1-1162 Remove the control panel



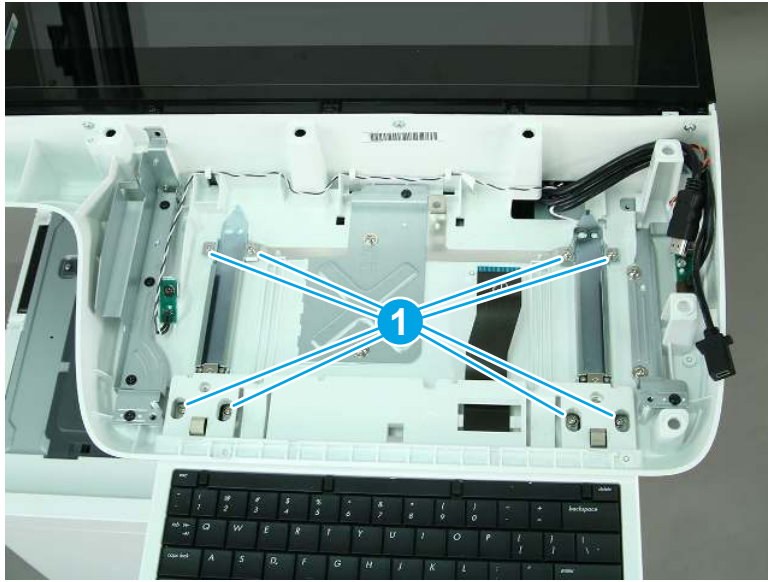
- 6. Remove the keyboard (M776z/M776zs).
 - a. Pull the keyboard out to its extended position.

Figure 1-1163 Pull the keyboard out



- b. Remove eight screws (callout 1).

Figure 1-1164 Remove eight screws



- c. Remove the keyboard and rails.

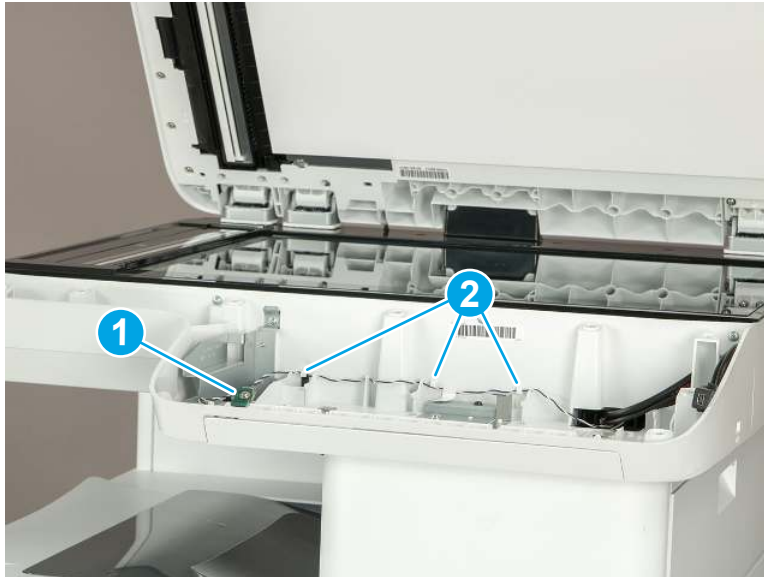
Figure 1-1165 Remove the keyboard and rails



- 7. Remove the nose cone (M776).

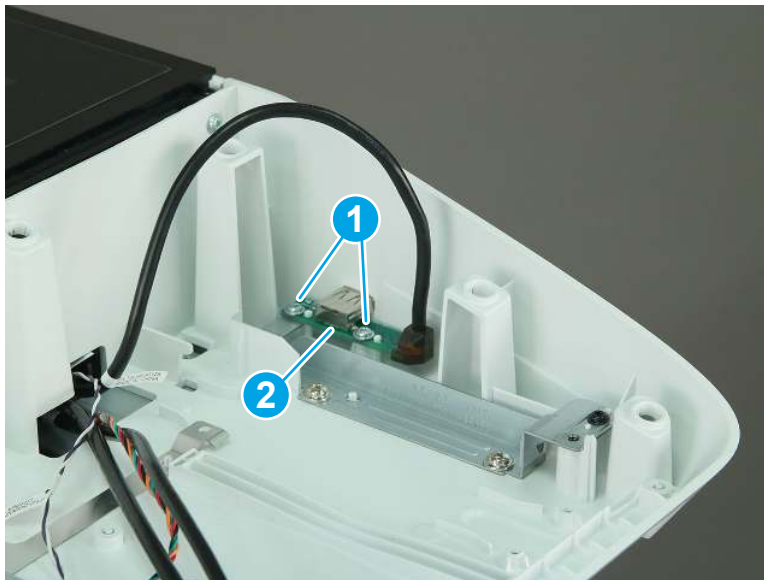
- a. Remove one screw (callout 1) to release the light PCA. Release the cable from three retainers (callout 2), and then move the light PCA out of the way.

Figure 1-1166 Release the light PCA



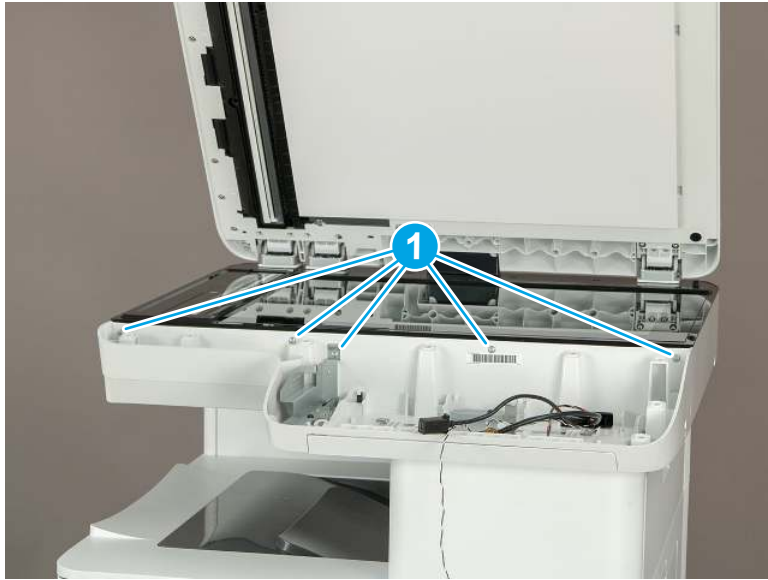
- b. Remove two screws (callout 1), and then move the USB port PCA (callout 2) out of the way.

Figure 1-1167 Release the USB port PCA



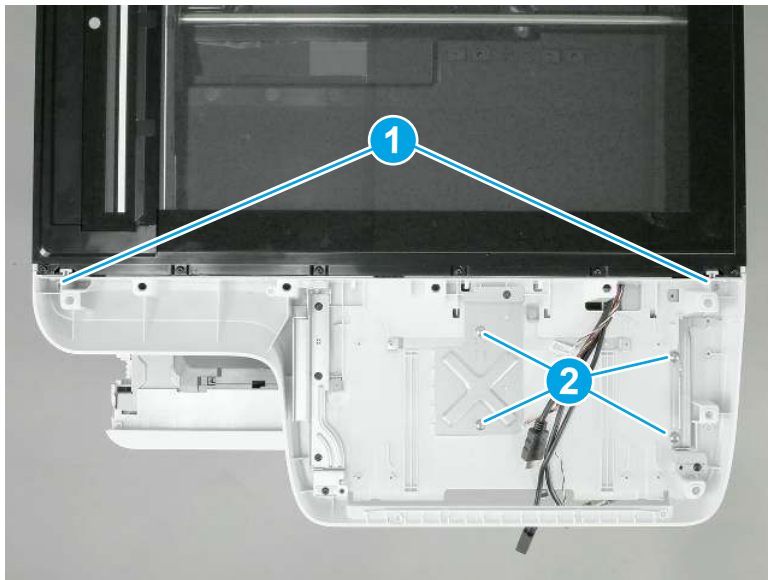
- c. Remove five screws (callout 1).

Figure 1-1168 Remove four screws



- d. Remove two small, self-tapping screws (callout 1), and then remove four larger machine screws (callout 2).

Figure 1-1169 Remove six screws



- e. Lift the nose cone up and off of the printer to remove it.



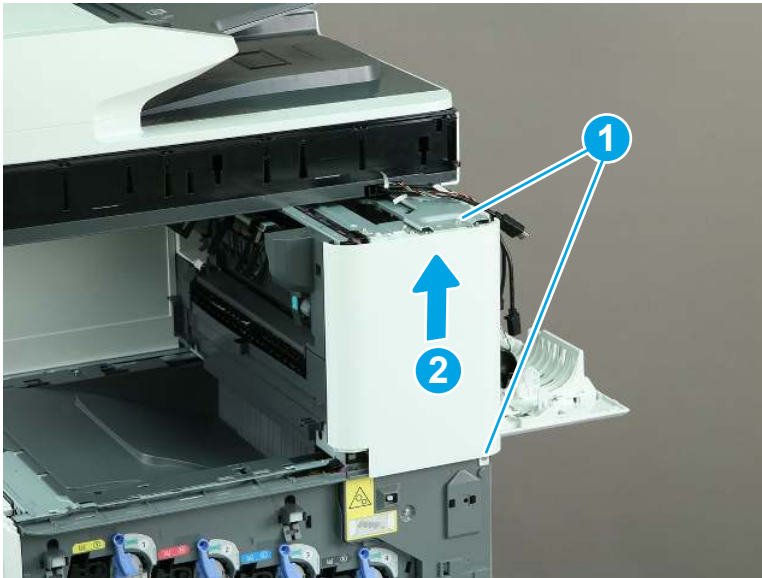
NOTE: Pass the wire harnesses and cables through the opening in the nose cone when removing it.

Figure 1-1170 Remove the nose cone



8. Remove the right front cover (M776zs).
 - ▲ Remove two screws (callout 1), release one tab (callout 2), and then slide the right front cover up (callout 2) to remove it.

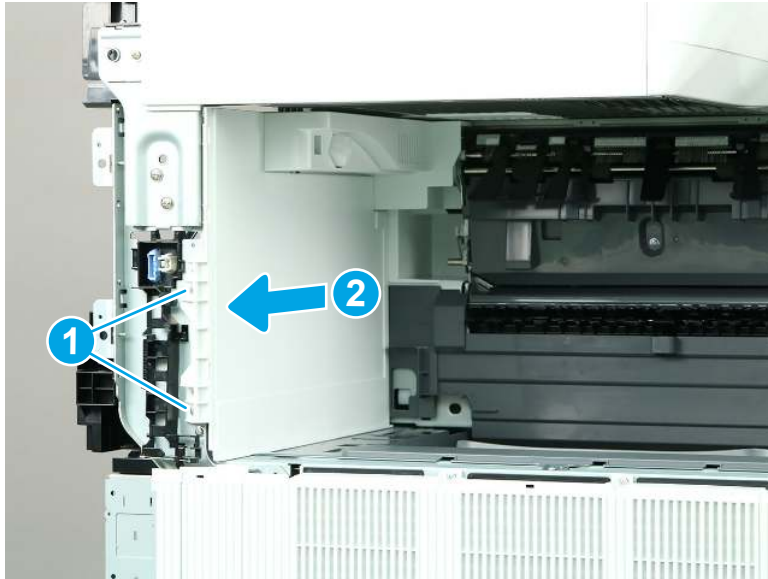
Figure 1-1171 Remove the right front cover



9. Remove the main cover (M776zs).

- ▲ Remove two screws (callout 1), and then slide the main cover away from the printer to remove it (callout 2).

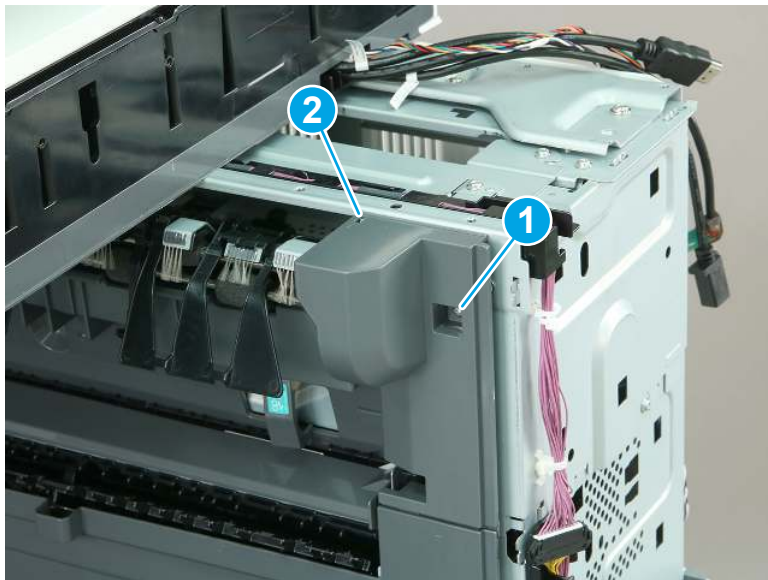
Figure 1-1172 Remove the main cover



10. Remove the delivery front cover (M776zs).

- ▲ Remove one screw (callout 1), and then remove the delivery front cover (callout 2).

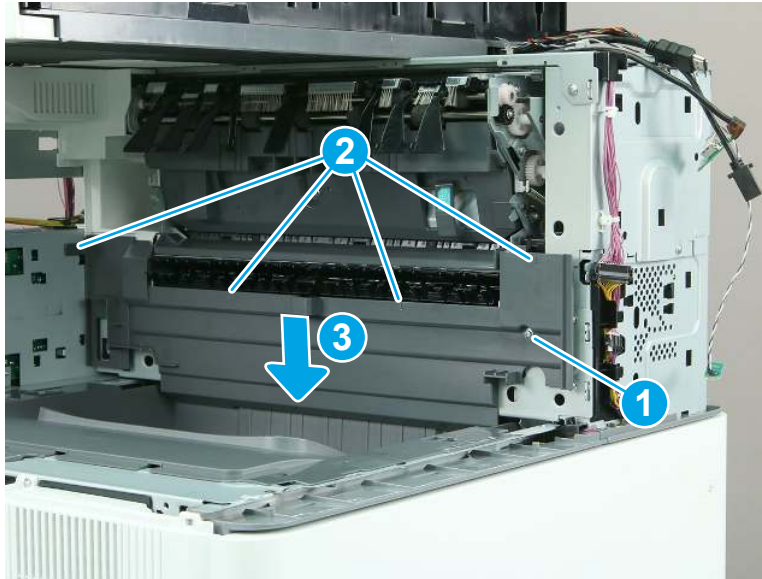
Figure 1-1173 Remove the delivery front cover



11. Remove the delivery cover (M776zs).

- ▲ Remove one screw (callout 1), release four tabs (callout 2), and then slide the delivery cover down (callout 3) to remove it.

Figure 1-1174 Remove the delivery cover

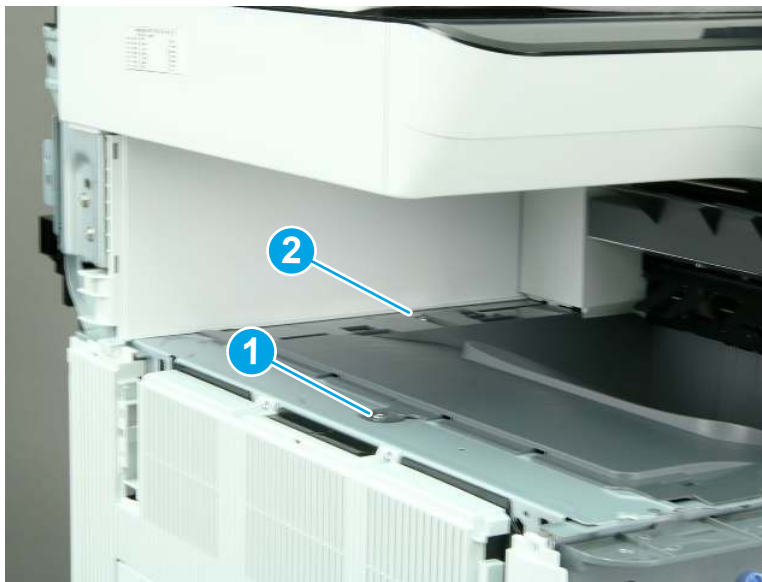


12. Remove the output bin (M856/E85055/M776).

 **NOTE:** The following figures show the M776z printer. The procedure is correct for all referenced models.

- a. Remove one washer-head machine screw (callout 1), remove one self-tapping screw (callout 2).

Figure 1-1175 Remove two screws



- b. Remove the output bin.

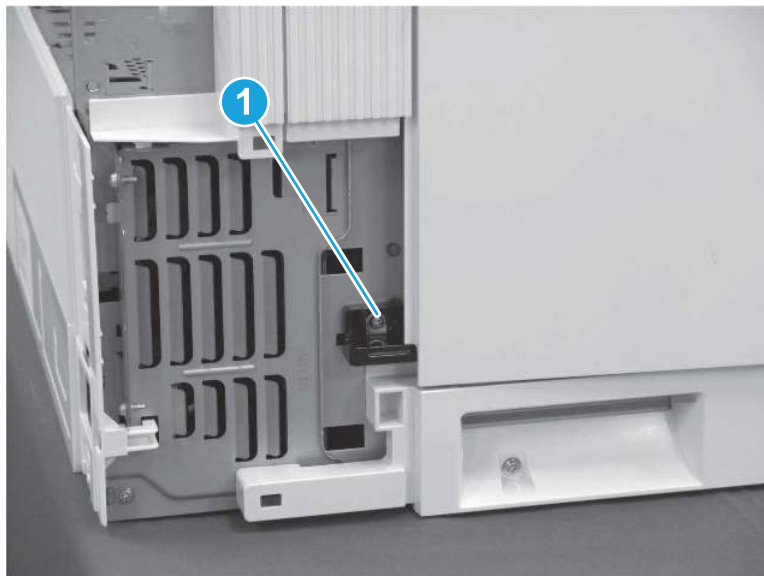
Figure 1-1176 Remove the output bin



- 13. Remove the left door.

- a. Remove one screw (callout 1).

Figure 1-1177 Remove one screw



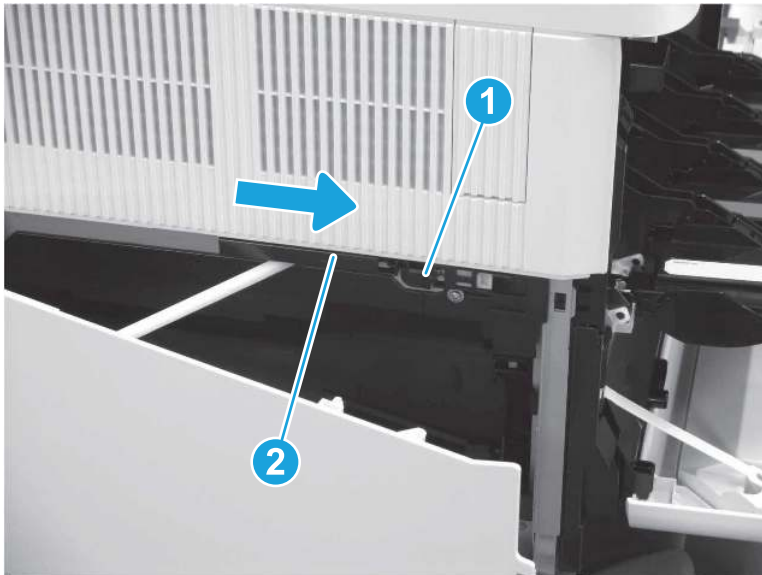
- b. Release the holder, and then remove it from the printer.

Figure 1-1178 Remove the holder



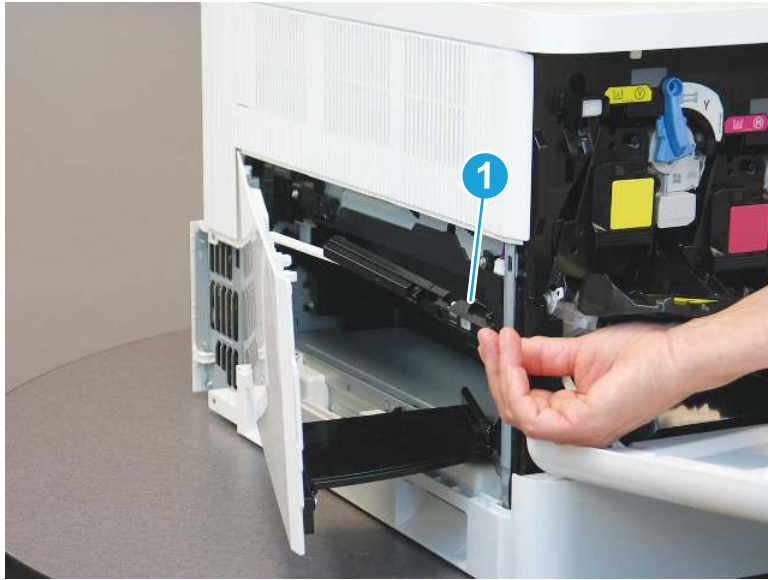
- c. Open the left door, and release one tab (callout 1). Slide the holder (callout 2) toward the front of the printer.

Figure 1-1179 Slide the holder



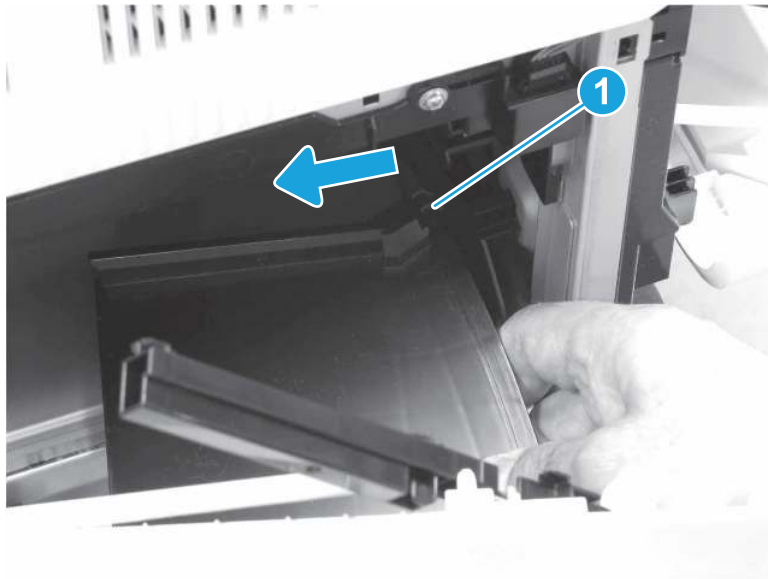
- d. Release the holder (callout 1) from the printer, but leave it attached to the hinge.

Figure 1-1180 Release the holder



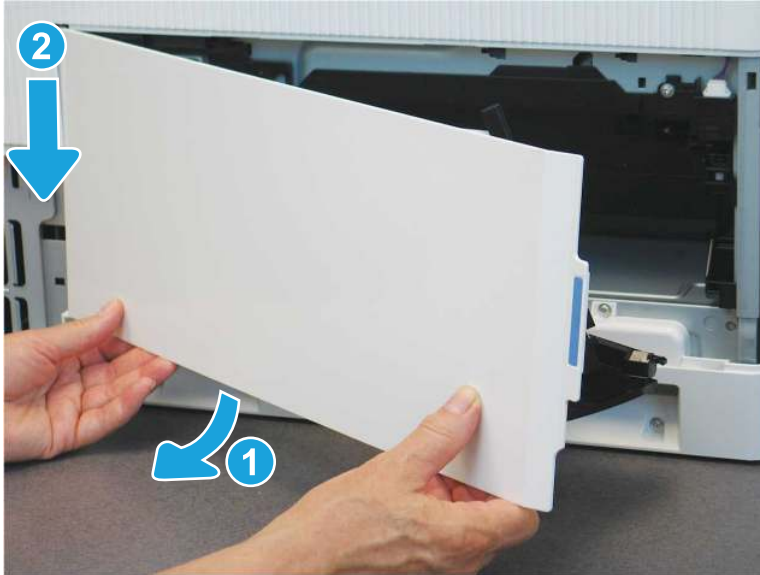
- e. Press the stopper (callout 1) on the bottom of the door to the left to release it from the track.

Figure 1-1181 Release the stopper



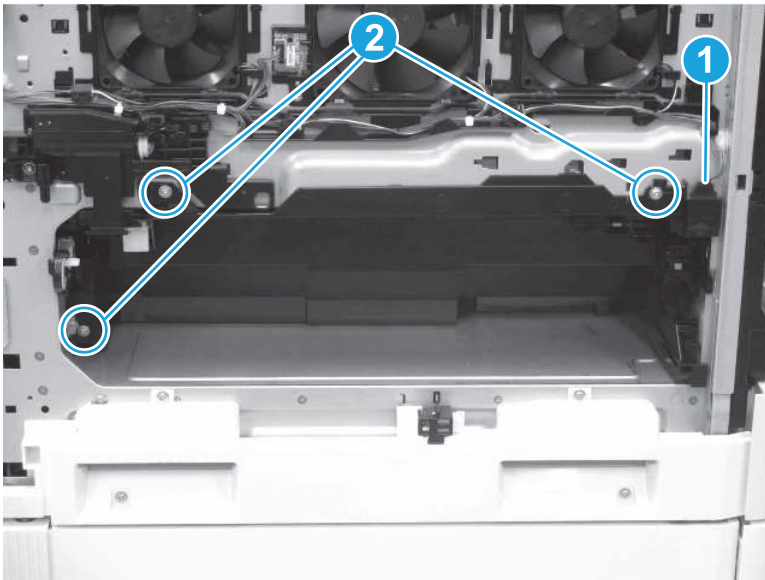
- f. Rotate the left, lower edge of the door away from the printer (callout 1), and then lower the door to remove it (callout 2).

Figure 1-1182 Remove the left door



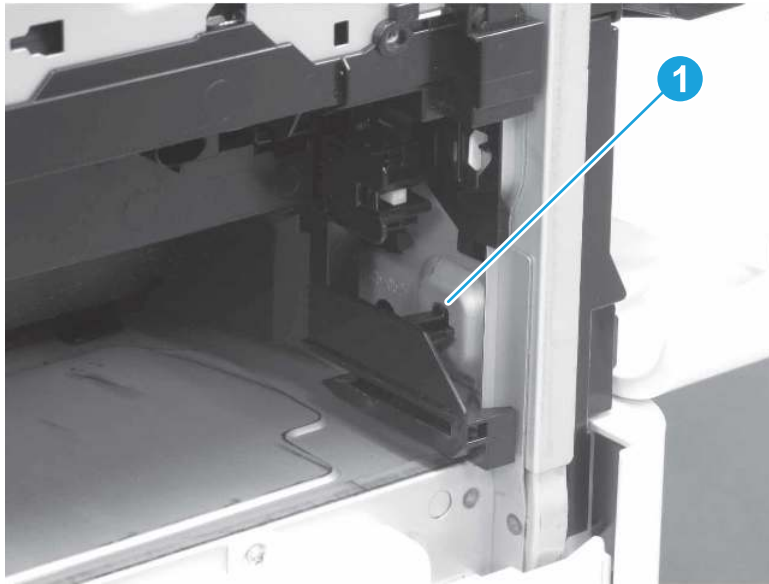
- 14. Remove the DT cartridge rail assembly (M751/E75245/M856/E85055/M776).
 - a. Disconnect one connector (callout 1), and then remove three screws (callout 2).

Figure 1-1183 Disconnect one connector and remove two screws



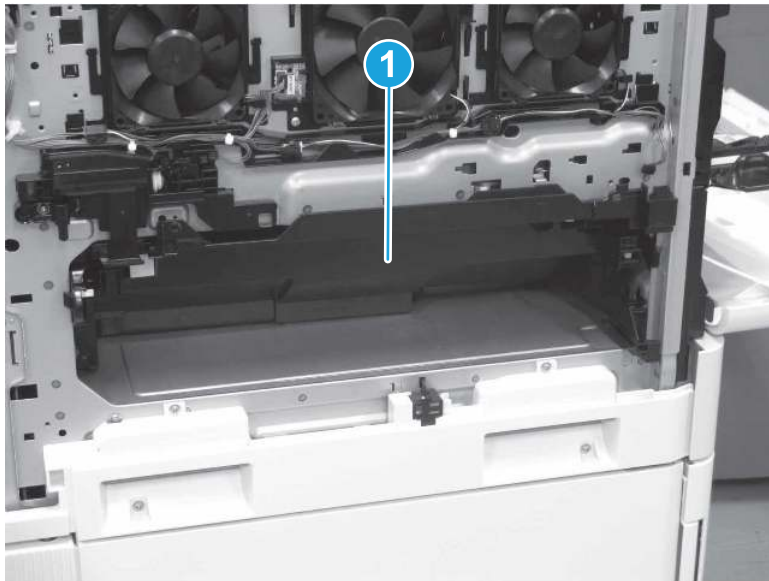
- b. Release one tab (callout 1).

Figure 1-1184 Release one tab



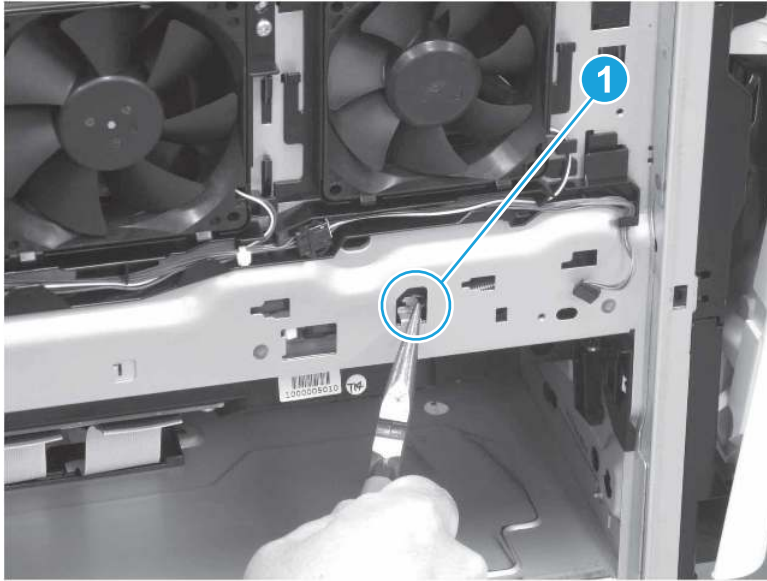
- c. Remove the scanner cover (callout 1).

Figure 1-1185 Remove the scanner cover



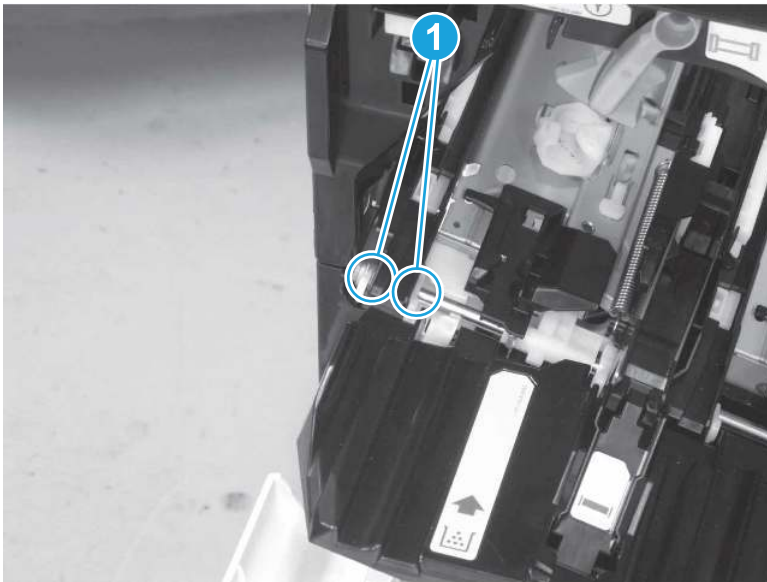
- d. Close the front door, and then unhook one spring (callout 1).

Figure 1-1186 Unhook one spring



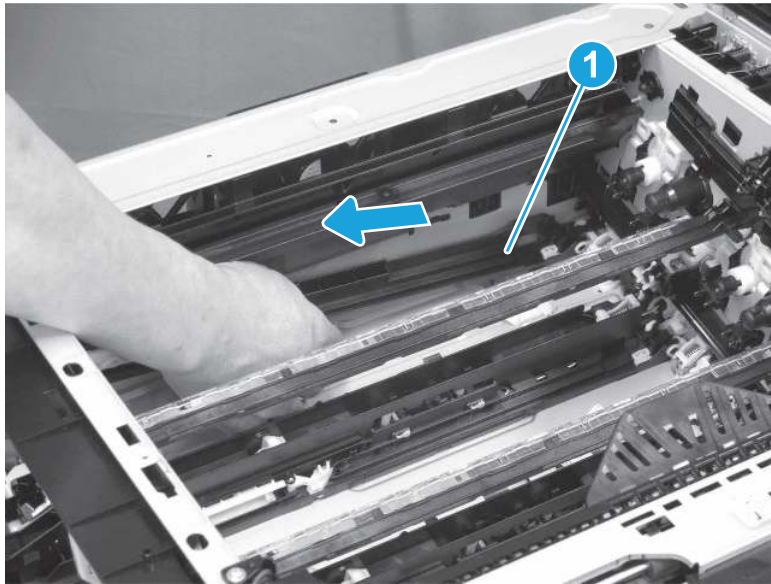
- e. Release two bosses (callout 1).

Figure 1-1187 Release two bosses



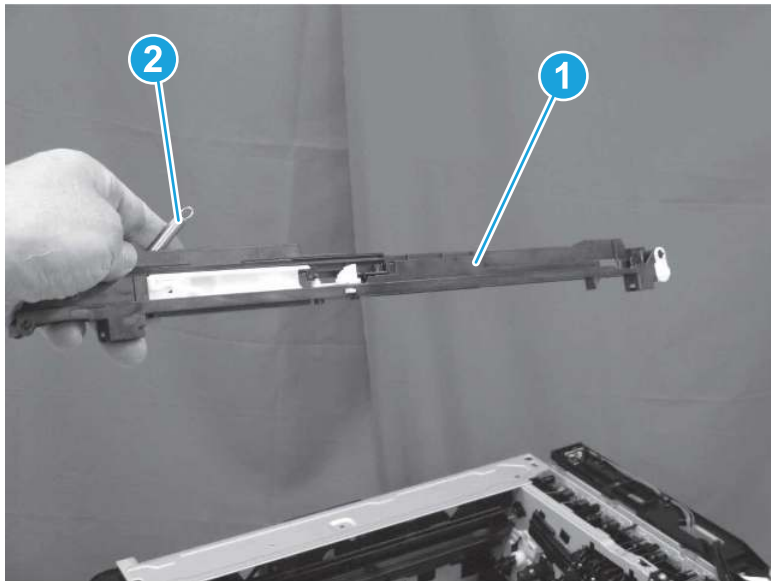
- f. Pull the DT cartridge rail assembly (callout 1) toward the front of the printer about 2 cm (0.79 in).

Figure 1-1188 Pull the DT cartridge rail assembly



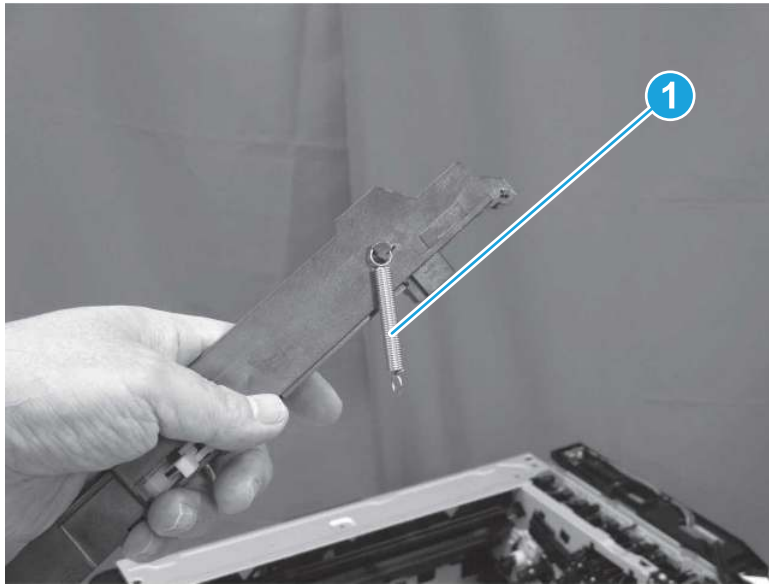
- g. Remove the DT cartridge assembly (callout 1) and the spring (callout 2) together.

Figure 1-1189 Remove the DT cartridge assembly and spring



- h. Remove the spring (callout 1).

Figure 1-1190 Remove the spring



- 15. Unpack the replacement assembly.

- a. Dispose of the defective part.



NOTE: HP recommends responsible disposal of the defective part.

<http://www8.hp.com/us/en/hp-information/environment/product-recycling.html>

- b. Unpack the replacement part from the packaging.



IMPORTANT: Make sure that all of the shipping materials (for example shipping tape) are removed from the replacement part prior to installation.

- c. To install an assembly, reverse the removal steps.



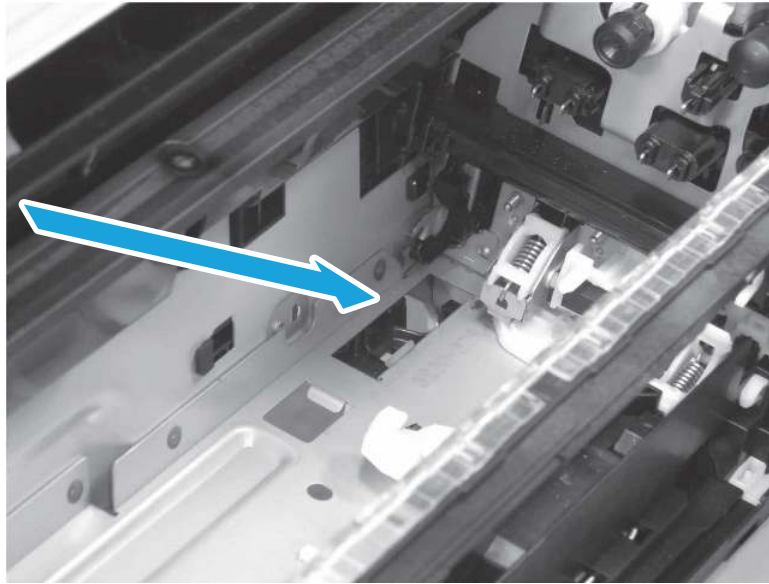
NOTE: When applicable, special installation instructions are provided for an assembly at the end of the removal procedure. Always completely read the removal instructions and follow all special installation instructions.

- 16. Reverse the removal steps to install the assembly. Also use the following **special installation instructions**.

Install the DT cartridge rail assembly.

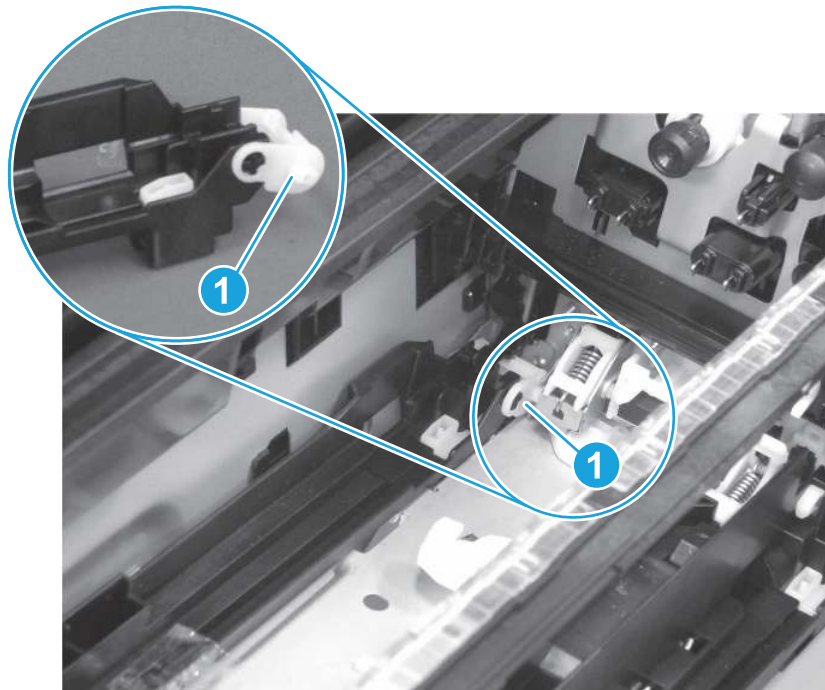
- a. Slide the DT-cartridge rail assembly into position.

Figure 1-1191 Position the DT-cartridge rail assembly (M751/E75245/M856/E85055/M776dn/M776z/M776zs)



- b. Make sure that the link arm (callout 1) is correctly positioned. If this part is positioned incorrectly, the cartridge cannot be installed.

Figure 1-1192 Check the link arm position (M751/E75245/M856/E85055/M776dn/M776z/M776zs)



Removal and replacement: Transfer cleaner assembly (E75245/E85055)

Learn how to remove and replace the transfer cleaner assembly.

[View a video of how to remove and replace the transfer cleaner assembly.](#)

Mean time to repair: 8 minutes

Service level: Medium

Before performing service

Turn the printer power off

- Disconnect the power cable.

⚠ WARNING! To avoid damage to the printer, turn the printer off, wait 30 seconds, and then remove the power cord before attempting to service the printer.

Use the table below to identify the correct part number for your printer. To order the part, go to www.hp.com/buy/parts.

Table 1-69 Part information

Part number	Part description
RM2-1490-000CN	Transfer cleaner assembly

Required tools

- #2 Phillips screwdriver with a magnetic tip

After performing service

Turn the printer power on

- Connect the power cable.
- Use the power switch to turn the power on.

Post service test

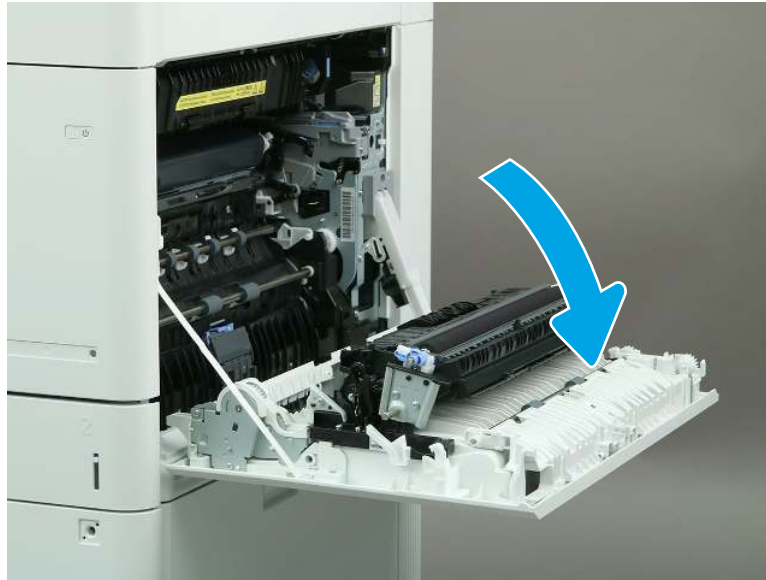
Make sure that the printer initializes to a **Ready** state.

Print a page to make sure that the printer is functioning correctly.

1. Remove the intermediate transfer belt (ITB).

- a. Open the right door.

Figure 1-1193 Open the right door



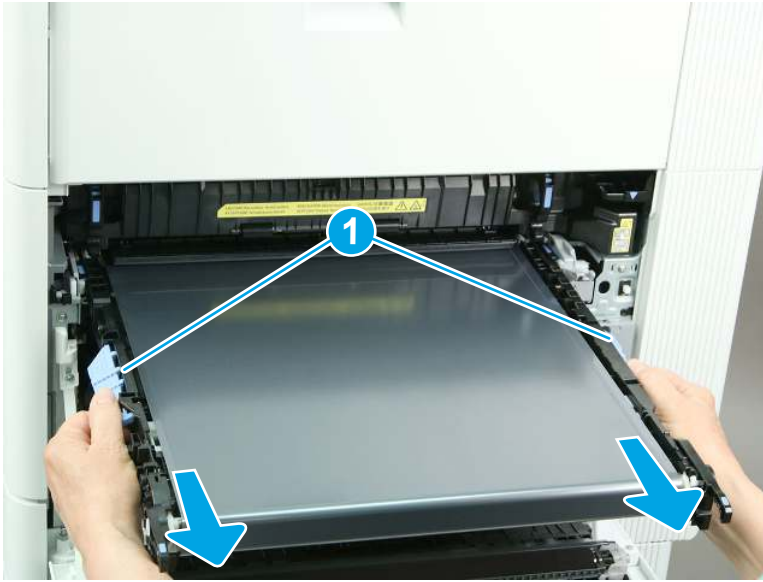
- b. Grasp the two blue handles on the ITB, and then pull the ITB partially out of the printer.

Figure 1-1194 Partially remove the ITB



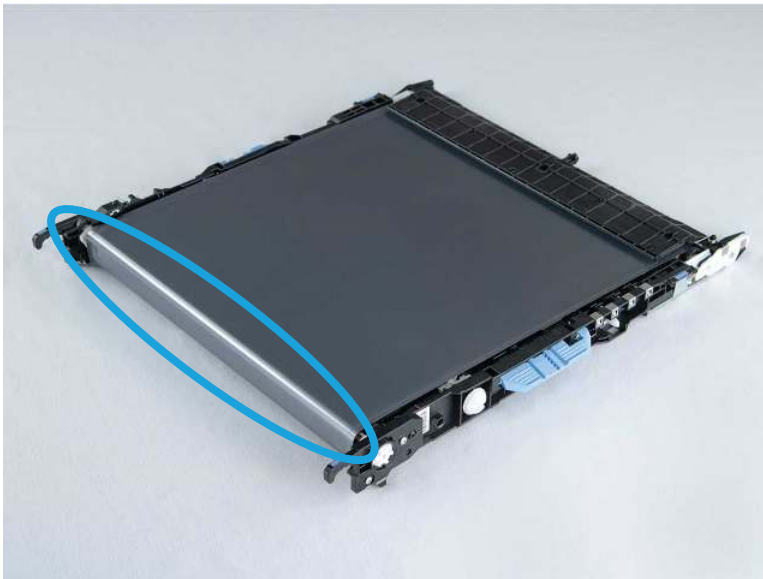
- c. Grasp the blue handles on the side of the ITB (callout 1), and then remove the ITB from the printer.

Figure 1-1195 Remove the ITB



2. Examine the ITB.
 - a. Examine the front edge of the ITB.

Figure 1-1196 Examine the front edge of the ITB



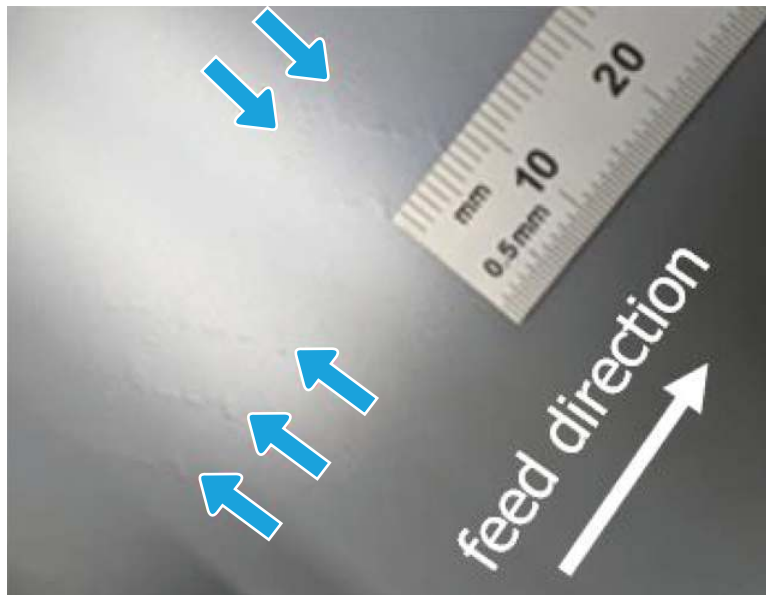
- b. If a convex streak is visible on the ITB in the paper feed direction, **do not replace the transfer cleaner.** Replace the ITB.

Figure 1-1197 Check for convex streak



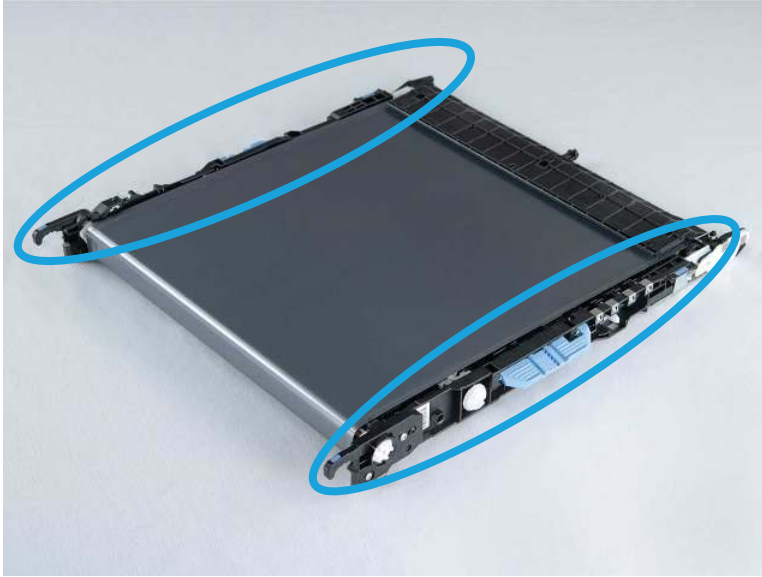
- c. If repeating ripples or ridges are visible on the ITB in the paper feed direction, **do not replace the transfer cleaner.** Replace the ITB.

Figure 1-1198 Check for repeating lines



- d. Examine the right and left sides of the ITB.

Figure 1-1199 Examine the right and left sides of the ITB



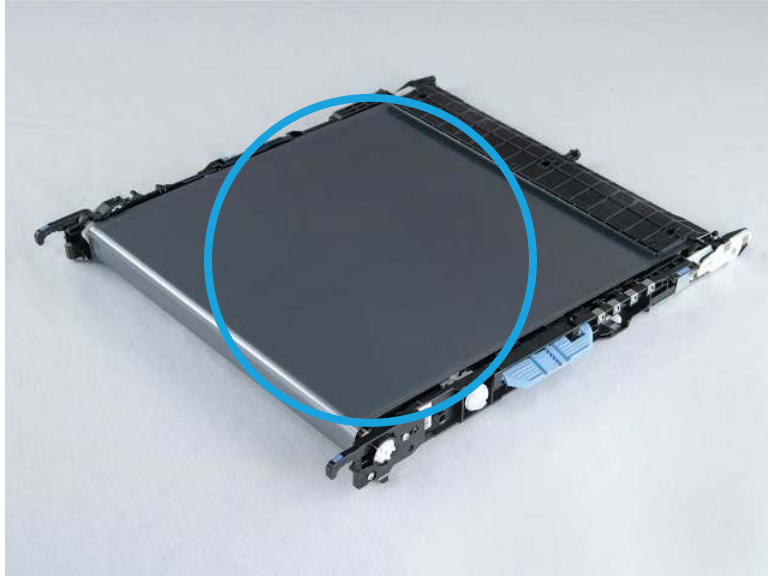
- e. If the edges of the belt are bent or creased, **do not** replace the transfer cleaner. Replace the ITB.

Figure 1-1200 Check for bent or creased edges



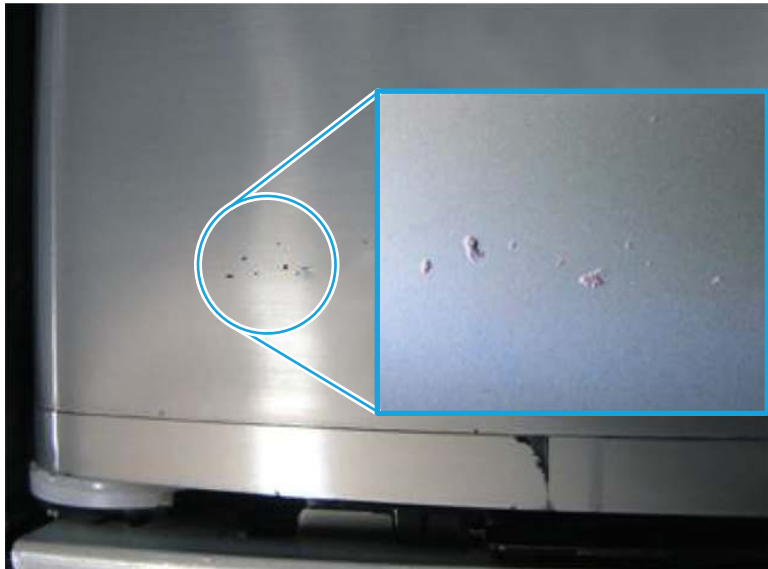
- f. Examine the surface of the ITB.

Figure 1-1201 Examine the surface of the ITB



- g. Look for any debris, dimpling, or toner streaks on the surface of the ITB.

Figure 1-1202 Look for debris, dimpling, or toner streaks on the ITB



- h. If debris or toner streaks are present, clean the surface of the ITB with a clean, soft cloth.

Figure 1-1203 Clean the ITB



- i. If any debris or toner streaks remain on the ITB after cleaning, **do not replace the transfer cleaner. Replace the ITB.**

Figure 1-1204 Look for debris or toner streaks on the ITB



- j. If no debris or toner streaks remain on the ITB, replace the transfer cleaner.
3. Remove the transfer cleaner assembly.

- a. Locate the transfer cleaner assembly on the intermediate transfer belt (ITB).

Figure 1-1205 Locate the transfer cleaner assembly



- b. Remove one screw (callout 1).

Figure 1-1206 Remove one screw



- c. Remove the capture plate (callout 1).



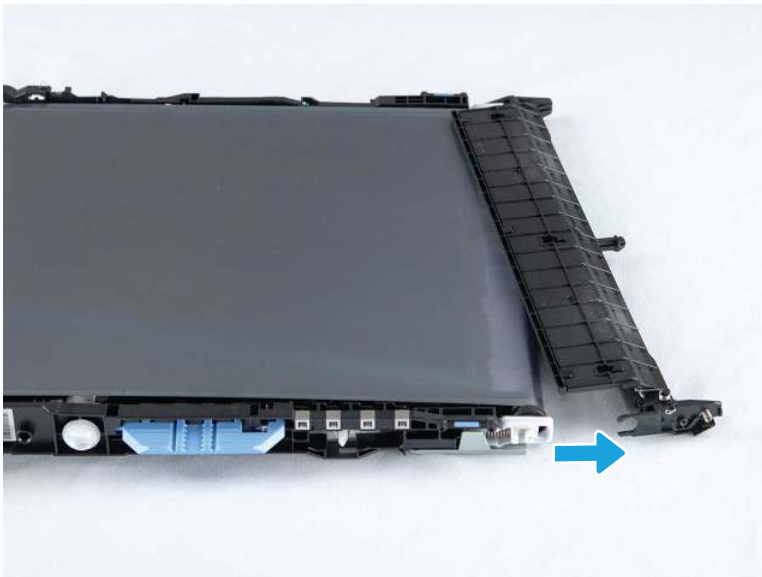
NOTE: All springs remain attached to the ITB.

Figure 1-1207 Remove the capture plate



- d. Pivot the end of the transfer cleaner away from the ITB.

Figure 1-1208 Pivot the cleaner away from the ITB



- e. Remove the transfer cleaner (callout 1).

Figure 1-1209 Remove the transfer cleaner



4. Unpack the replacement assembly.

- a. Dispose of the defective part.



NOTE: HP recommends responsible disposal of the defective part.

<http://www8.hp.com/us/en/hp-information/environment/product-recycling.html>

- b. Unpack the replacement part from the packaging.



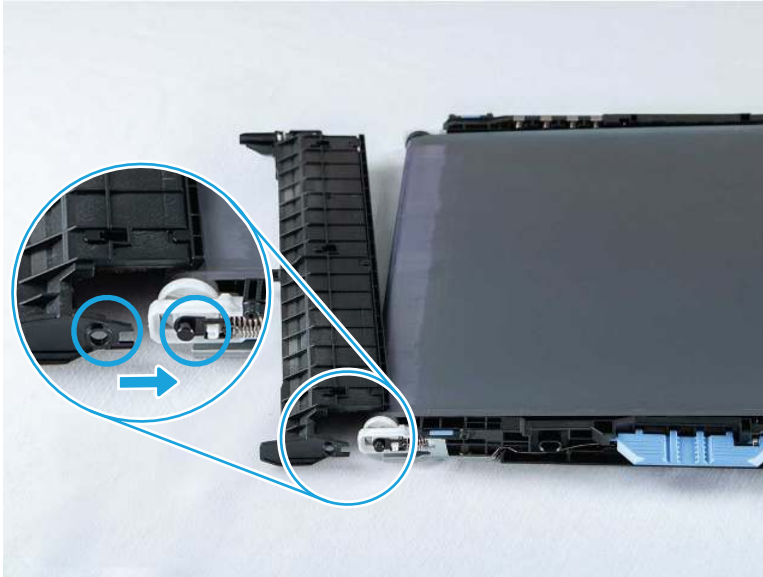
IMPORTANT: Make sure that all of the shipping materials (for example shipping tape) are removed from the replacement part prior to installation.

5. Reverse the removal steps to install the assembly. Also use the following **special installation instructions**.

Install the transfer cleaner assembly.

- a. When installing the transfer cleaner, position the end of the assembly over the square coupler and the locator pin on the ITB.

Figure 1-1210 Position the transfer cleaner assembly



- b. Pivot the transfer cleaner assembly toward the ITB to install it.

Figure 1-1211 Install the transfer cleaner assembly



- c. Squeeze the edge of the transfer cleaner and the ITB together to compress the spring, and then install the capture plate.

Figure 1-1212 Install the capture plate



- d. Install one screw (callout 1).

Figure 1-1213 Install one screw



Removal and replacement: PEFS board (E75245/E85055)

Learn how to remove and replace the PEFS board (E75245/E85055 only).

[View a video of how to remove and replace the PEFS board.](#)

Mean time to repair: 1 minute

Service level: Easy

Before performing service

Turn the printer power off

- Disconnect the power cable.

⚠ WARNING! To avoid damage to the printer, turn the printer off, wait 30 seconds, and then remove the power cord before attempting to service the printer.

Use the table below to identify the correct part number for your printer. To order the part, go to www.hp.com/buy/parts.

Table 1-70 Part information

Part number	Part description
T3U43-67902	Kit - PEFS (includes PEFS board and flat cable)

Required tools

- #2 Phillips screwdriver with a magnetic tip

After performing service

Turn the printer power on

- Connect the power cable.
- Use the power switch to turn the power on.

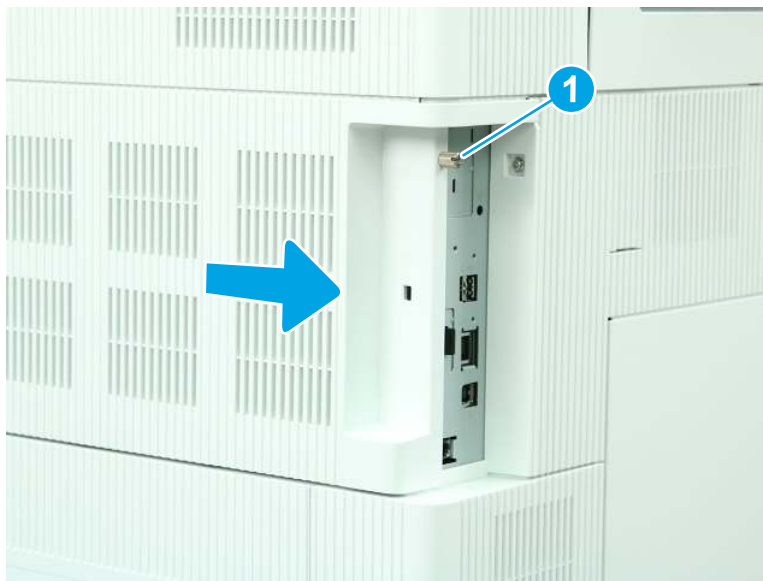
Post service test

Make sure that the printer initializes to a **Ready** state.

Print a page to make sure that the printer is functioning correctly.

1. Remove the formatter cover.
 - ▲ Loosen one thumbscrew (callout 1), and then slide the formatter cover (callout 2) away from the printer to remove it.

Figure 1-1214 Remove the formatter cover



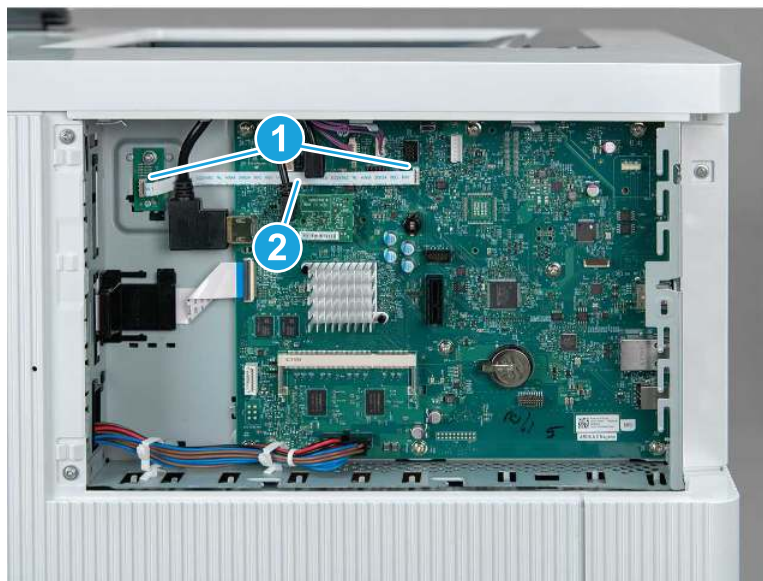
2. Remove the print engine failure sensor (PEFS) board.
 - a. Locate the PEFS board on the formatter board.

Figure 1-1215 Locate the PEFS board



- b. Disconnect two connectors (callout 1), and then remove the cable (callout 2).

Figure 1-1216 Disconnect two connectors and remove the cable



- c. Remove one screw (callout 1), and then remove the PEFS board).

Figure 1-1217 Remove the PEFS board



3. Unpack the replacement assembly.
 - a. Dispose of the defective part.




NOTE: HP recommends responsible disposal of the defective part.

<http://www8.hp.com/us/en/hp-information/environment/product-recycling.html>

- b. Unpack the replacement part from the packaging.



CAUTION:  Some parts are sensitive to electrostatic discharge (ESD). Always perform service work at an ESD-protected workstation or mat. If an ESD workstation or mat is not available, touch the sheet-metal chassis to provide a static ground before touching an ESD-sensitive assembly. Protect the ESD-sensitive assemblies by placing them in ESD pouches when they are out of the printer.



IMPORTANT: Make sure that all of the shipping materials (for example shipping tape) are removed from the replacement part prior to installation.

- c. To install an assembly, reverse the removal steps.



NOTE: When applicable, special installation instructions are provided for an assembly at the end of the removal procedure. Always completely read the removal instructions and follow all special installation instructions.

Removal and replacement: Formatter (M751/E75245)

Learn how to remove and replace the formatter.



IMPORTANT: Only install new service formatters into the printer under service. Used formatters will result in 33.xx errors because the data on the formatter will not match the data on the printer. Continuing past these errors might lead to loss of critical customer data, such as product speeds and page counts.

[View a video of how to remove and replace the formatter.](#)

Mean time to repair: 22 minutes

Service level: Medium

Before performing service

Turn the printer power off

- Disconnect the power cable.

⚠ WARNING! To avoid damage to the printer, turn the printer off, wait 30 seconds, and then remove the power cord before attempting to service the printer.

Use the table below to identify the correct part number for your printer. To order the part, go to www.hp.com/buy/parts.

Table 1-71 Part information

Part number	Part description
5851-7702	Formatter PCA (M751/E75245/M856/E85055) (sPAB - SFP)
5851-7703	Formatter PCA (M751/E75245/M856/E85055) (sPAB - SFP; India/China)
5851-7704	Formatter PCA + SDS (M751/E75245/M856/E85055) (sPAB - SFP)
5851-7705	Formatter PCA + SDS (M751/E75245/M856/E85055) (sPAB - SFP; India/China)

Required tools

- #2 Phillips screwdriver with a magnetic tip

After performing service

Turn the printer power on

- Connect the power cable.
- Use the power switch to turn the power on.

Post service test

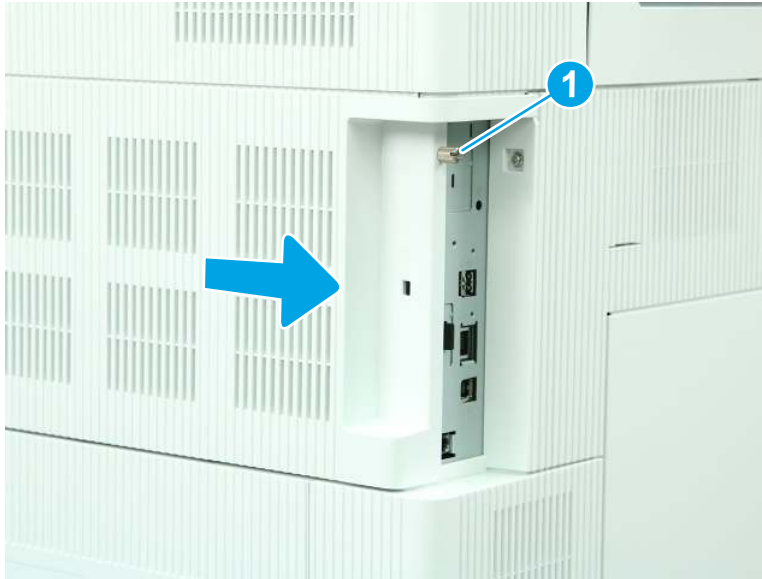
Make sure that the printer initializes to a **Ready** state.

Print a page to make sure that the printer is functioning correctly.


1. Remove the formatter cover.


- ▲ Loosen one thumbscrew (callout 1), and then slide the formatter cover (callout 2) away from the printer to remove it.

Figure 1-1218 Remove the formatter cover



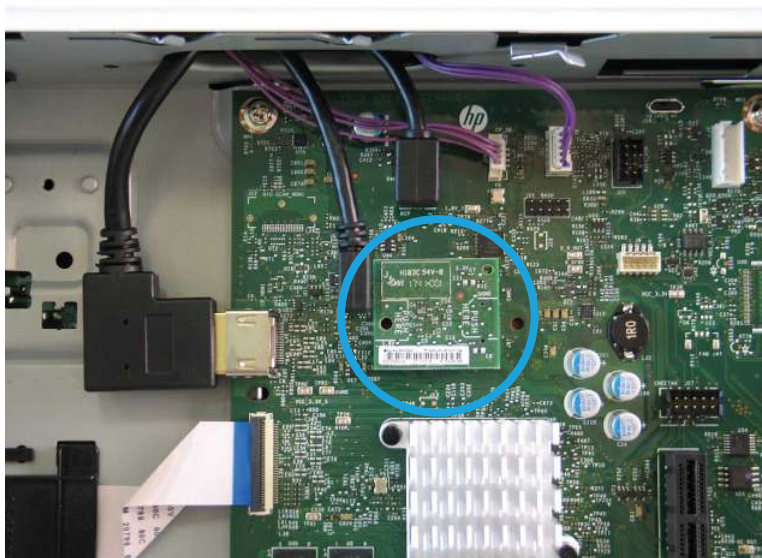
2. Remove the formatter (M751/E75245).

 **NOTE:** Before removing the formatter, remove any accessories installed, such as the hard disk drive, internal USB ports, memory DIMM, or any other third-party solutions. **Make sure to install these components on the replacement formatter at the end of the repair.**

 **IMPORTANT:** Do not replace the formatter and DC controller at the same time. Replace one part and allow the printer to boot to a READY state. Then, turn the power off, unplug the printer, and replace the other part. Failure to do this may render the printer non-operational.

- a. Locate the embedded Multi-Media Controller (eMMC) on the formatter board.

Figure 1-1219 Locate the eMMC



- b. Lift the eMMC off of the formatter board to remove it.


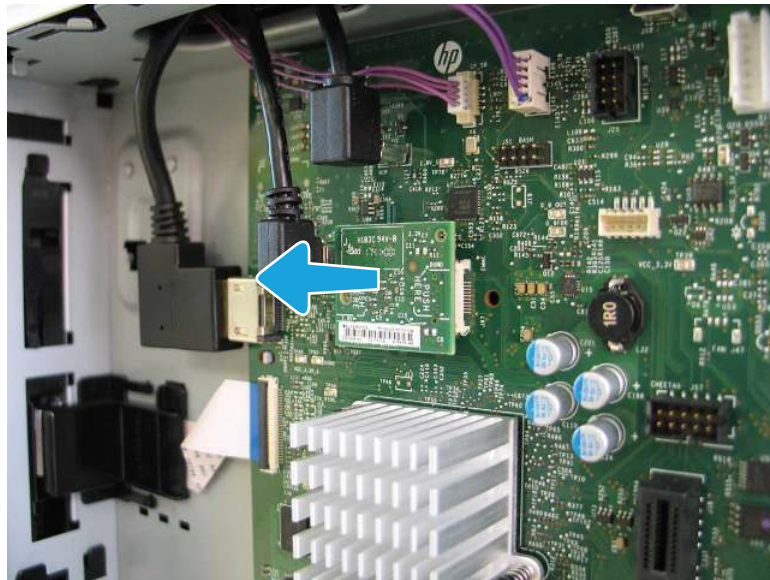
 **IMPORTANT:** Do not discard the eMMC. Save it and install it on the replacement formatter board.

Figure 1-1220 Remove the eMMC



- c. Lift the Trusted Platform Module (TPM) off of the formatter board to remove it.


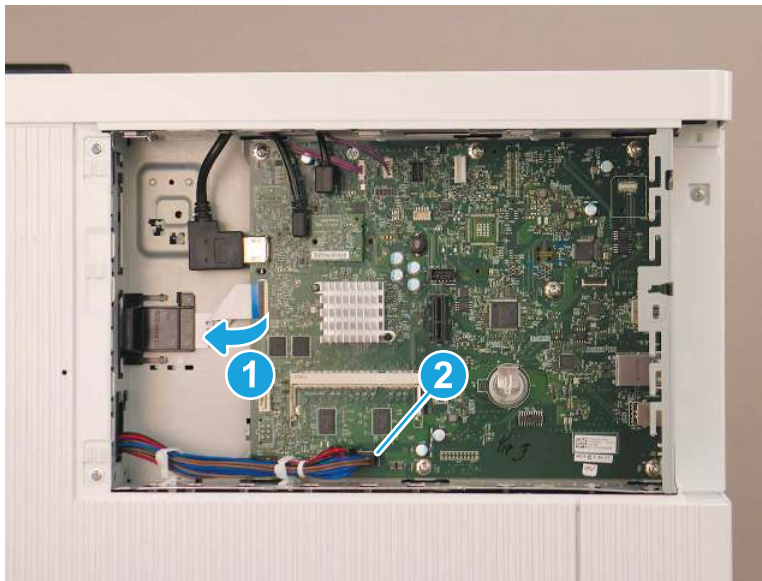
 **IMPORTANT:** Do not discard the TPM. Save it and install it on the replacement formatter board.

Figure 1-1221 Remove the TPM



- d. Open the retainer (callout 1) to release the flat cable. Squeeze the latch (callout 2) to disconnect the connector (callout 2) at the lower edge of the formatter. Disconnect all of the remaining connectors on the formatter.

Figure 1-1222 Disconnect all of the connectors



- e. Remove eight screws (callout 1), and then remove the formatter.


 **NOTE:** The lower right screw might be missing in some later versions of the printer.

Figure 1-1223 Remove eight screws






3. Unpack the replacement assembly.
 - a. Dispose of the defective part.

 **NOTE:** HP recommends responsible disposal of the defective part.


<http://www8.hp.com/us/en/hp-information/environment/product-recycling.html>

- b. Unpack the replacement part from the packaging.

 **CAUTION:**  Some parts are sensitive to electrostatic discharge (ESD). Always perform service work at an ESD-protected workstation or mat. If an ESD workstation or mat is not available, touch the sheet-metal chassis to provide a static ground before touching an ESD-sensitive assembly. Protect the ESD-sensitive assemblies by placing them in ESD pouches when they are out of the printer.


 **IMPORTANT:** Make sure that all of the shipping materials (for example shipping tape) are removed from the replacement part prior to installation.

- c. To install an assembly, reverse the removal steps.

 **NOTE:** When applicable, special installation instructions are provided for an assembly at the end of the removal procedure. Always completely read the removal instructions and follow all special installation instructions.

Removal and replacement: Formatter (M856/E85055/M776)

Learn how to remove and replace the formatter.

 **IMPORTANT:** Only install new service formatters into the printer under service. Used formatters will result in 33.xx errors because the data on the formatter will not match the data on the printer. Continuing past these errors might lead to loss of critical customer data, such as product speeds and page counts.

[View a video of how to remove and replace the formatter.](#)


Mean time to repair: 22 minutes

Service level: Medium

Before performing service

Turn the printer power off

- Disconnect the power cable.

 **WARNING!** To avoid damage to the printer, turn the printer off, wait 30 seconds, and then remove the power cord before attempting to service the printer.

Use the table below to identify the correct part number for your printer. To order the part, go to www.hp.com/buy/parts.

Table 1-72 Part information

Part number	Part description
5851-7702	Formatter PCA (M751/E75245/M856/E85055) (sPAB - SFP)
5851-7703	Formatter PCA (M751/E75245/M856/E85055) (sPAB - SFP; India/China)
5851-7704	Formatter PCA + SDS (M751/E75245/M856/E85055) (sPAB - SFP)
5851-7705	Formatter PCA + SDS (M751/E75245/M856/E85055) (sPAB - SFP; India/China)
5851-7913	Formatter PCA (M776) (sPAB - SFP)
5851-7914	Formatter PCA (M776) (sPAB - SFP; India/China)

Required tools

- #2 Phillips screwdriver with a magnetic tip

After performing service

Turn the printer power on

- Connect the power cable.
- Use the power switch to turn the power on.

Post service test

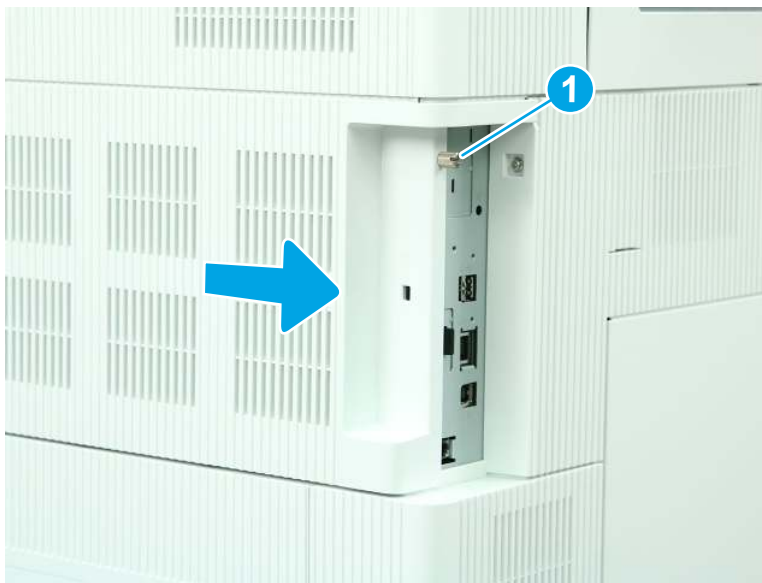
Make sure that the printer initializes to a **Ready** state.

Print a page to make sure that the printer is functioning correctly.

1. Remove the formatter cover.


- ▲ Loosen one thumbscrew (callout 1), and then slide the formatter cover (callout 2) away from the printer to remove it.


Figure 1-1224 Remove the formatter cover



2. Remove the formatter (M856/E85055/M776).

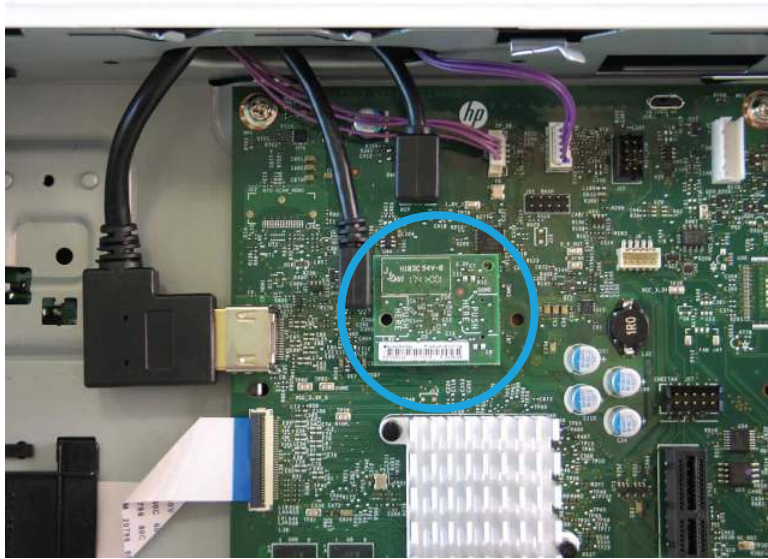
 **NOTE:** The figures below show the M776zs formatter. The procedure is correct for all referenced models

 **NOTE:** Before removing the formatter, remove any accessories installed, such as the hard disk drive, internal USB ports, memory DIMM, fax card, or any other third-party solutions. **Make sure to install these components on the replacement formatter at the end of the repair.**

 **NOTE:** Do not replace the formatter and DC controller at the same time. Replace one part and allow the printer to boot to a READY state. Then, turn the power off, unplug the printer, and replace the other part. Failure to do this may render the printer non-operational.

- a. **M856/E85055 only:** Locate the embedded Multi-Media Card (eMMC) on the formatter board.

Figure 1-1225 Locate the eMMC



- b. **M856/E85055 only:** Lift the eMMC off of the formatter board to remove it.


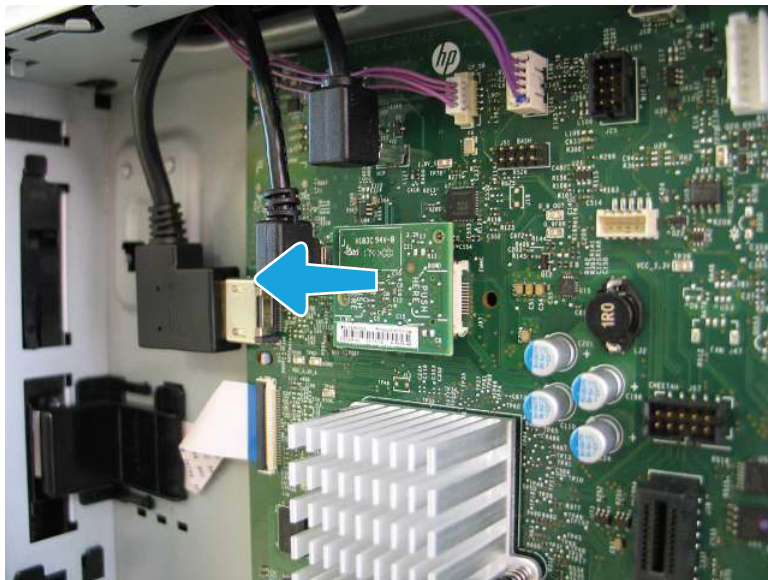
 **IMPORTANT:** Do not discard the eMMC. Save it and install it on the replacement formatter board.

Figure 1-1226 Remove the eMMC



- c. **M776 only:** Release the locking connector (callout 1) on the hard disk drive (HDD), and then pinch the retainer (callout 2) to release it.

Figure 1-1227 Release the hard disk drive



- d. **M776 only:** Raise the connector end of the HDD out and away from the formatter (callout 1), and then slide it to the left (callout 2) to remove it.

Figure 1-1228 Remove the hard disk drive



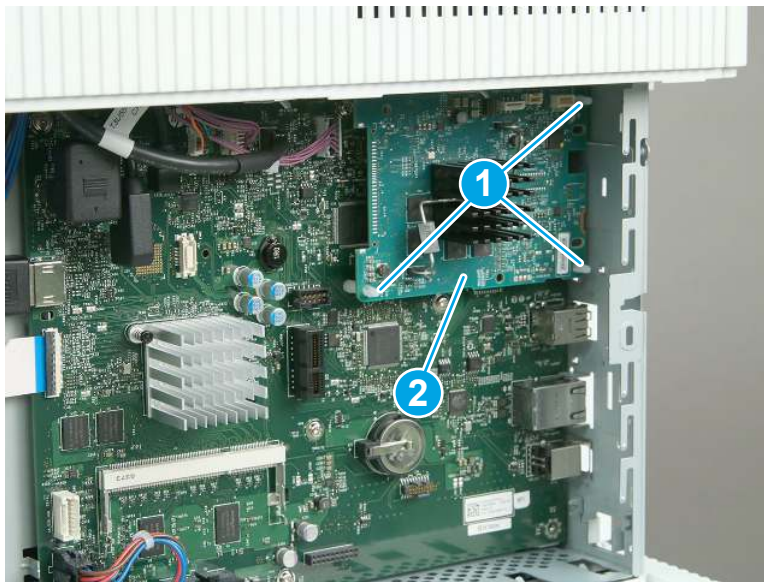
- e. Open the retainer (callout 1) to release the flat cable. Squeeze the latch (callout 2) at the lower edge of the formatter. Disconnect all of the remaining connectors on the formatter.

Figure 1-1229 Disconnect all of the connectors



- f. **M776 only:** Release three standoff tabs (callout 1).

Figure 1-1230 Release three tabs



- g. **M776 only:** Remove the accelerator board.

Figure 1-1231 Remove the accelerator board



- h. Lift the Trusted Platform Module (TPM) off of the formatter board to remove it.


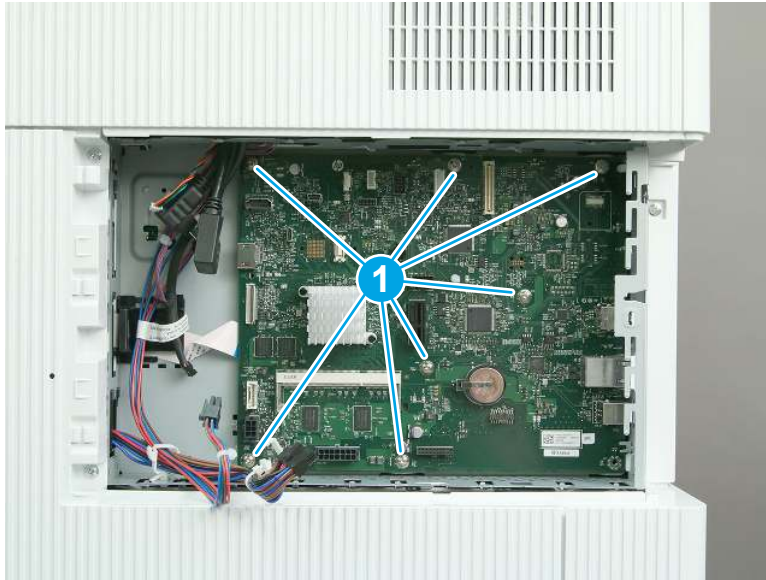
 **IMPORTANT:** Do not discard the TPM. Save it and install it on the replacement formatter board.

Figure 1-1232 Remove the TPM



- i. Remove seven screws (callout 1), and then remove the formatter.

Figure 1-1233 Remove seven screws



3. Unpack the replacement assembly.

- a. Dispose of the defective part.




NOTE: HP recommends responsible disposal of the defective part.

<http://www8.hp.com/us/en/hp-information/environment/product-recycling.html>

- b. Unpack the replacement part from the packaging.



CAUTION:  Some parts are sensitive to electrostatic discharge (ESD). Always perform service work at an ESD-protected workstation or mat. If an ESD workstation or mat is not available, touch the sheet-metal chassis to provide a static ground before touching an ESD-sensitive assembly. Protect the ESD-sensitive assemblies by placing them in ESD pouches when they are out of the printer.



IMPORTANT: Make sure that all of the shipping materials (for example shipping tape) are removed from the replacement part prior to installation.

- c. To install an assembly, reverse the removal steps.



NOTE: When applicable, special installation instructions are provided for an assembly at the end of the removal procedure. Always completely read the removal instructions and follow all special installation instructions.

Removal and replacement: Formatter case (M856/E85055/M776)

Learn how to remove and replace the formatter case.

Mean time to repair: 15 minutes

Service level: Easy

Before performing service

Turn the printer power off

- Disconnect the power cable.

⚠ WARNING! To avoid damage to the printer, turn the printer off, wait 30 seconds, and then remove the power cord before attempting to service the printer.

Use the table below to identify the correct part number for your printer. To order the part, go to www.hp.com/buy/parts.

Table 1-73 Part information

Part number	Part description
RM2-2476-000CN	Formatter case assembly

Required tools

- #2 Phillips screwdriver with a magnetic tip
- Small, flat-blade screwdriver

After performing service

Turn the printer power on

- Connect the power cable.
- Use the power switch to turn the power on.

Post service test

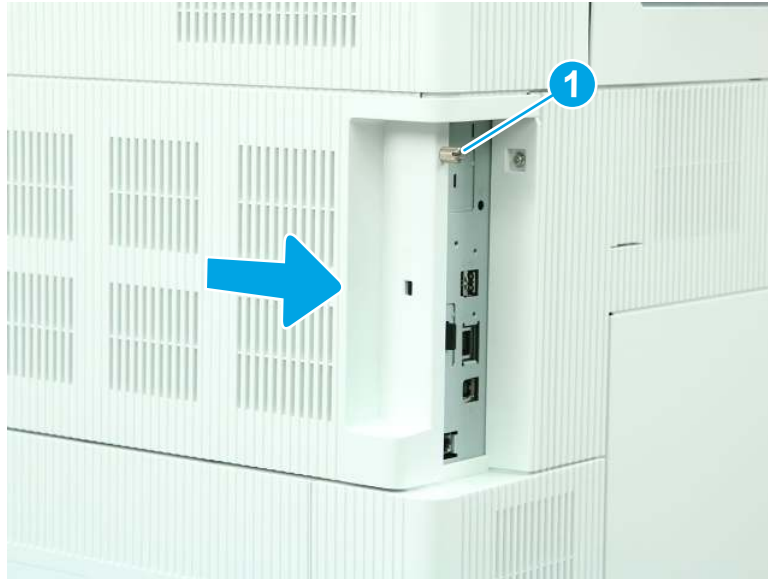
Make sure that the printer initializes to a **Ready** state.

Print a page to make sure that the printer is functioning correctly.

1. Remove the formatter cover.

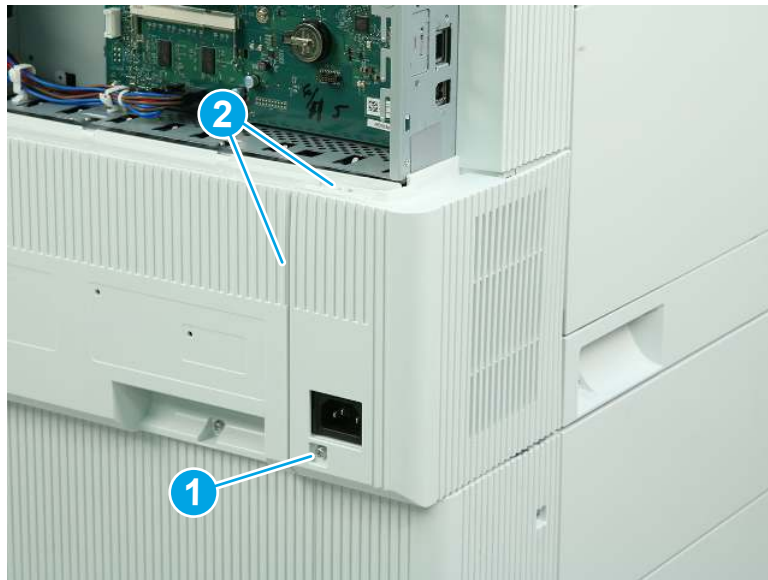
- ▲ Loosen one thumbscrew (callout 1), and then slide the formatter cover (callout 2) away from the printer to remove it.

Figure 1-1234 Remove the formatter cover



- 2. Remove the left lower cover (M856/E85055/M776).
 - a. Remove one screw (callout 1), and then release two tabs (callout 2).

Figure 1-1235 Remove one screw and release two tabs



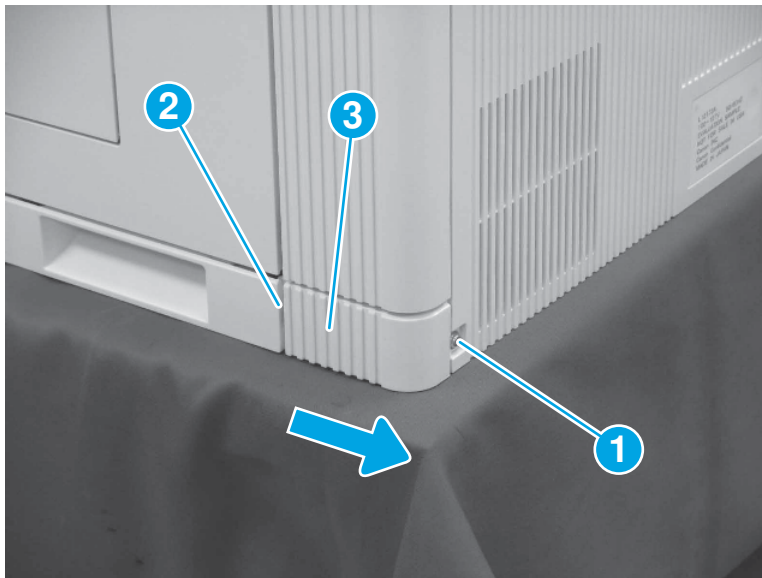
- b. Rotate the cover away from the printer to remove it.

Figure 1-1236 Remove the left lower cover



3. Remove the right rear lower cover (M751/E75245/M856/E85055/M776).
 - ▲ Remove one screw (callout 1), release one tab (callout 2), and then slide the right rear lower cover (callout 3) toward the back of the printer to remove it.

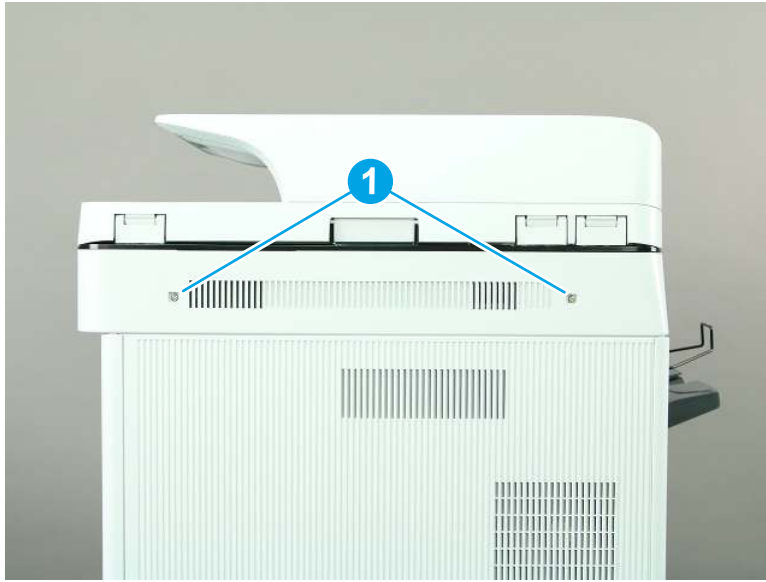
Figure 1-1237 Remove the right rear lower cover



4. Remove the scanner control board (SCB) cover (M776).

- a. Remove two screws (callout 1).

Figure 1-1238 Remove two screws



- b. Remove the SCB cover.

Figure 1-1239 Remove the SCB cover

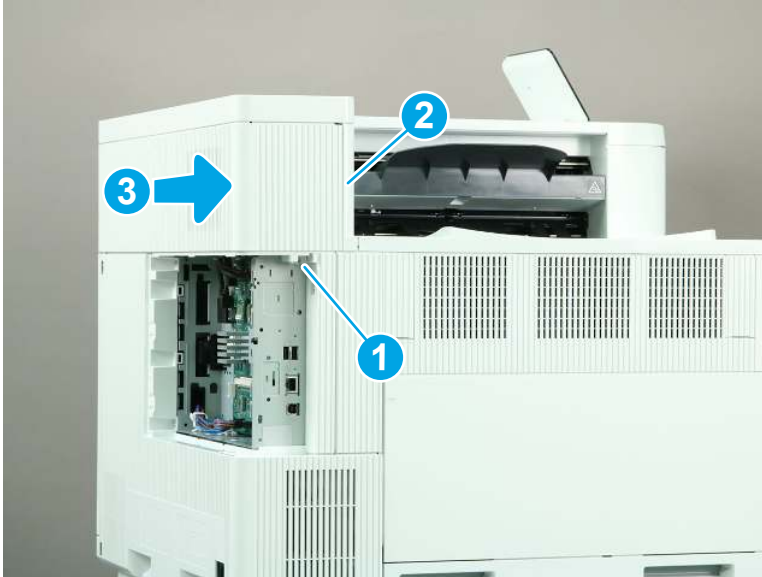


5. Remove the rear upper cover (M856/E85055/M776dn/M776z).

 **NOTE:** The following figure shows the M856 printer. The procedure is correct for all referenced models.

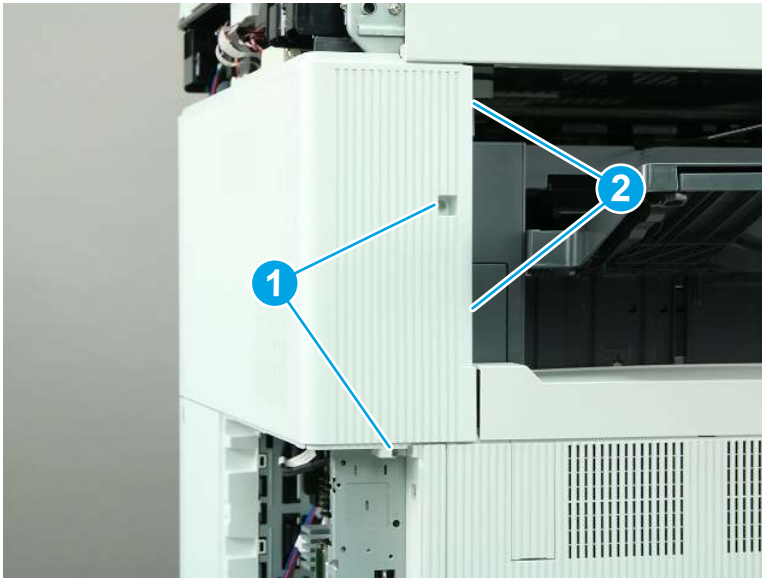
- ▲ Remove one screw (callout 1), release one tab (callout 2), and then slide the rear upper cover away from the printer to remove it (callout 3).

Figure 1-1240 Remove the rear upper cover



- 6. Remove the rear upper cover and left rear upper cover (M776zs).
 - a. Remove two screws (callout 1), and then release two tabs (callout 2).

Figure 1-1241 Remove two screws and release two tabs



- b. Slide the cover to the right to remove it.

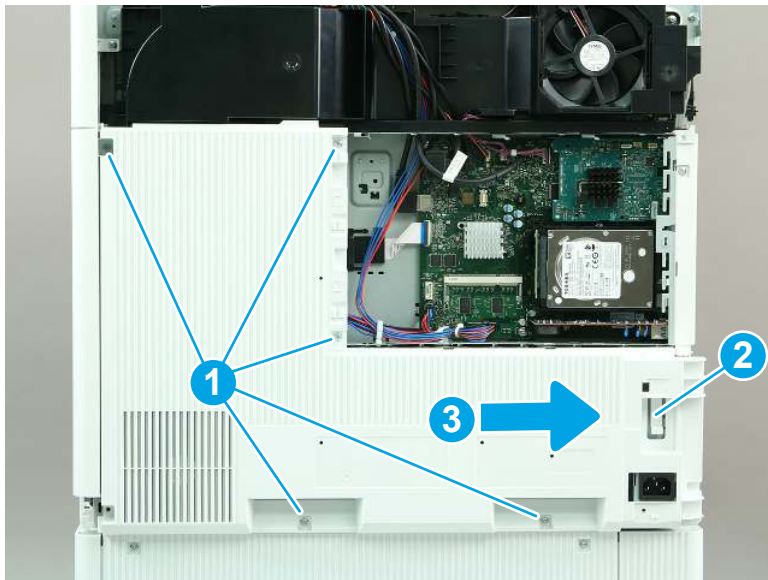
Figure 1-1242 Remove the rear upper and left rear upper cover



- 7. Remove the rear cover (M856/E85055/M776).

- ▲ Remove five screws (callout 1), release one tab (callout 2), and then slide the rear cover to the right to remove it.

Figure 1-1243 Remove the rear cover (M856/E85055/M776)



- 8. Remove the formatter and case (M856/E85055/M776).

 **NOTE:** The figures below show the M776zs formatter. The procedure is correct for all referenced models.

- a. Release two retainers (callout 1), and then open the retainer (callout 2) to release the flat cable. Disconnect all of the remaining connectors on the formatter board.


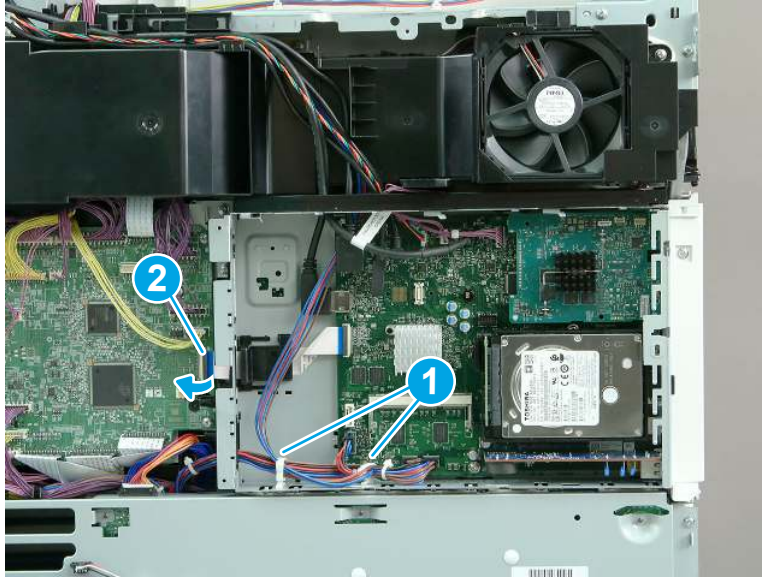
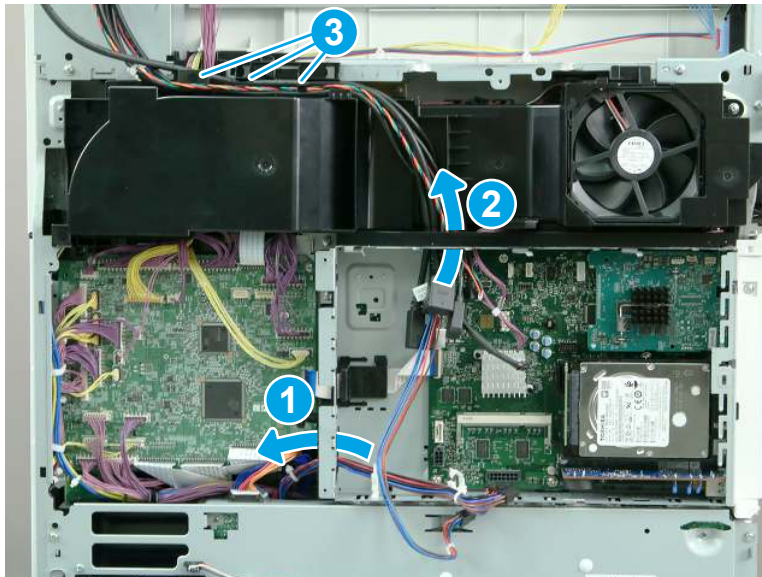
 **NOTE:** The figures below show the M776zs model. The procedures are correct for all of the referenced models.

Figure 1-1244 Disconnect the connectors



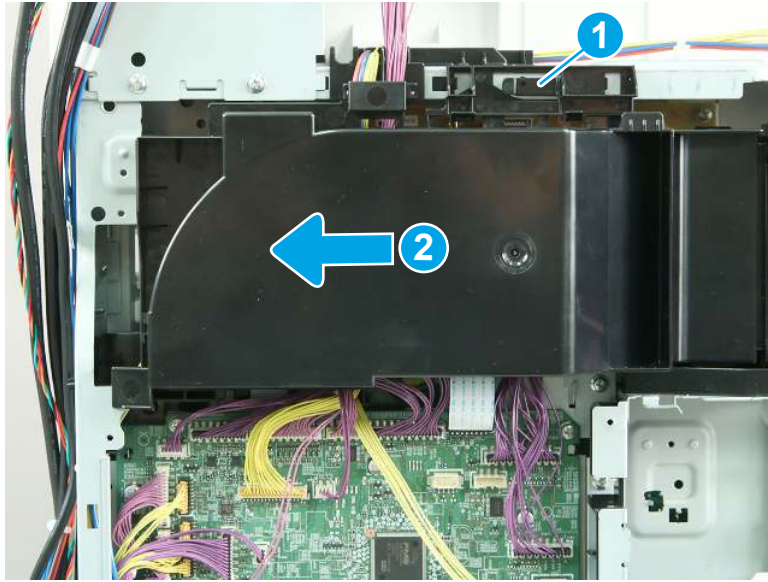
- b. Release one cable through the opening in the left side of the formatter case (callout 1). Release the remaining cables through the opening in the top of the formatter case (callout 2). Release the cables from the upper cable guide (callout 3).

Figure 1-1245 Release the cables



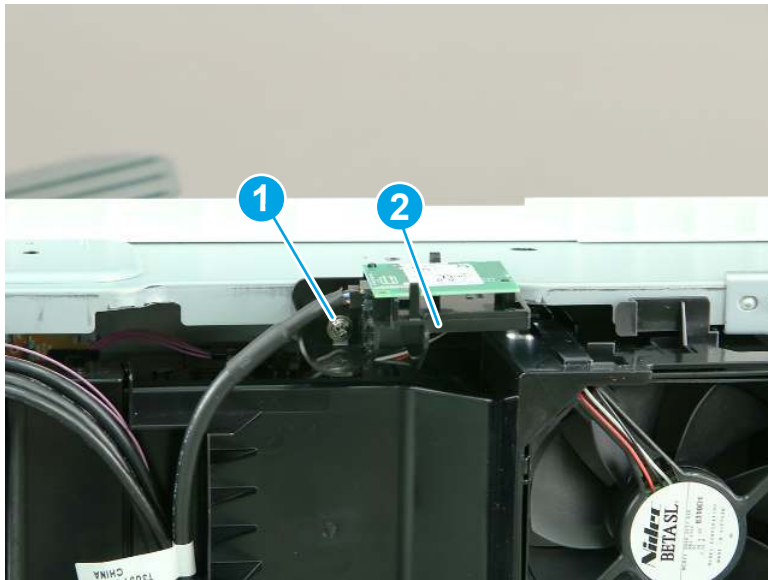
- c. Release one tab (callout 1), and then slide the fan duct to the left (callout 2) to remove it.

Figure 1-1246 Remove the fan duct



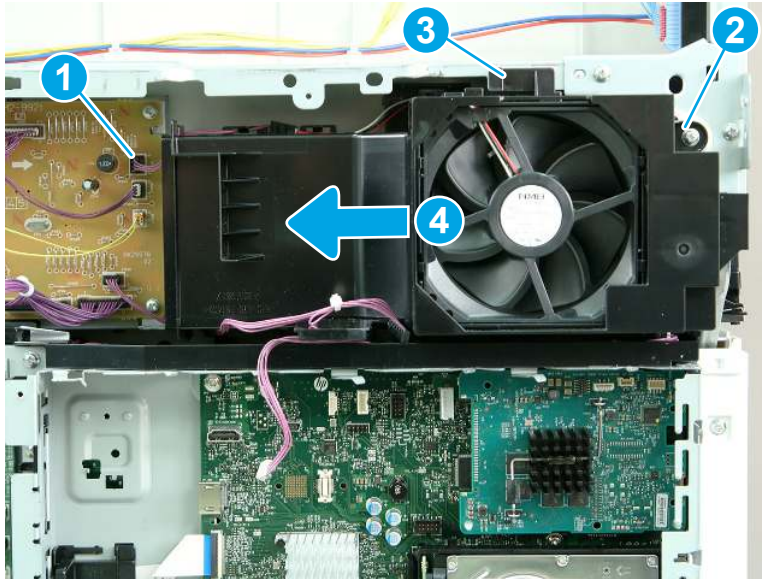
- d. **M856 and E85055 only:** Remove one screw (callout 1), and then remove the wireless card and bracket (callout 2).

Figure 1-1247 Remove the wireless card and bracket



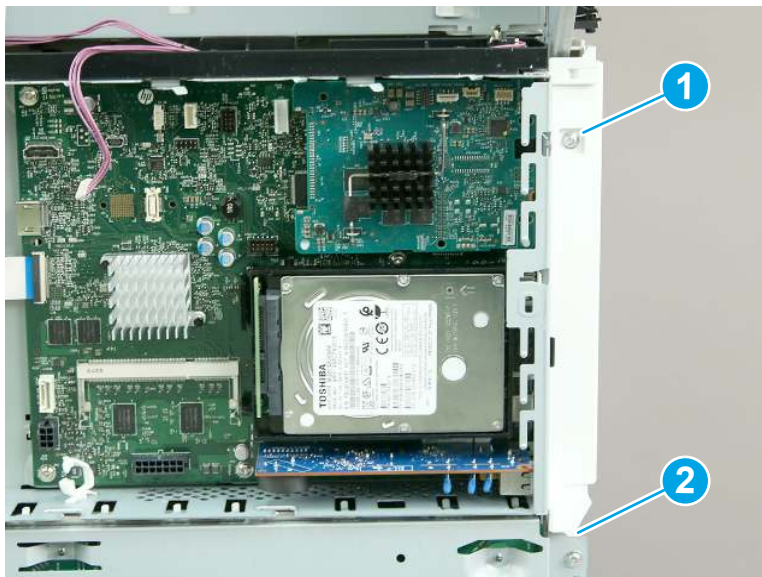
- e. Disconnect one connector (callout 1), and remove one screw (callout 2). Release one tab (callout 3), and then slide the fan assembly to the left (callout 4) to remove it.

Figure 1-1248 Remove the fan assembly



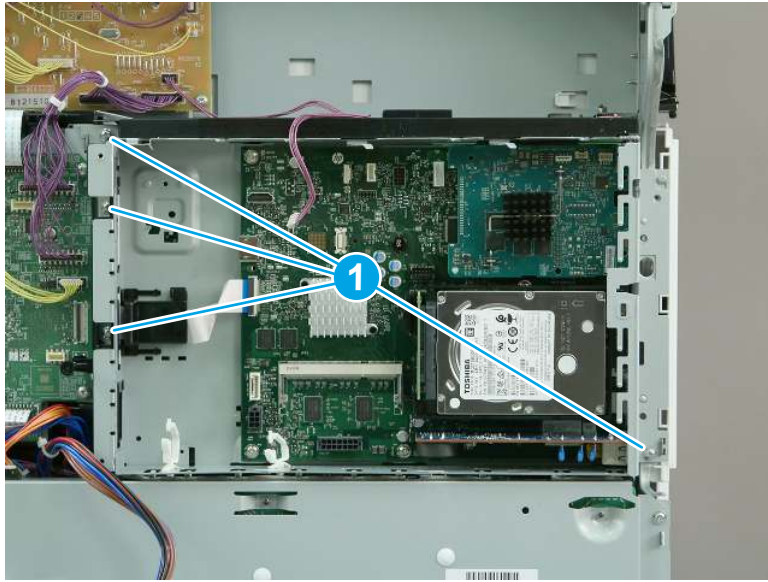
- f. Remove one screw (callout 1), release one tab (callout 2), and then remove the left rear cover.

Figure 1-1249 Remove the left rear cover



- g. Remove four screws (callout 1).

Figure 1-1250 Remove four screws



- h. Remove the formatter and case.

Figure 1-1251 Remove the formatter and case



9. Remove the formatter case (M856/E85055/M776).

- a. **M776 only:** Release the locking connector (callout 1) on the hard disk drive (HDD), and then pinch the retainer (callout 2) to release it.

Figure 1-1252 Release the hard disk drive



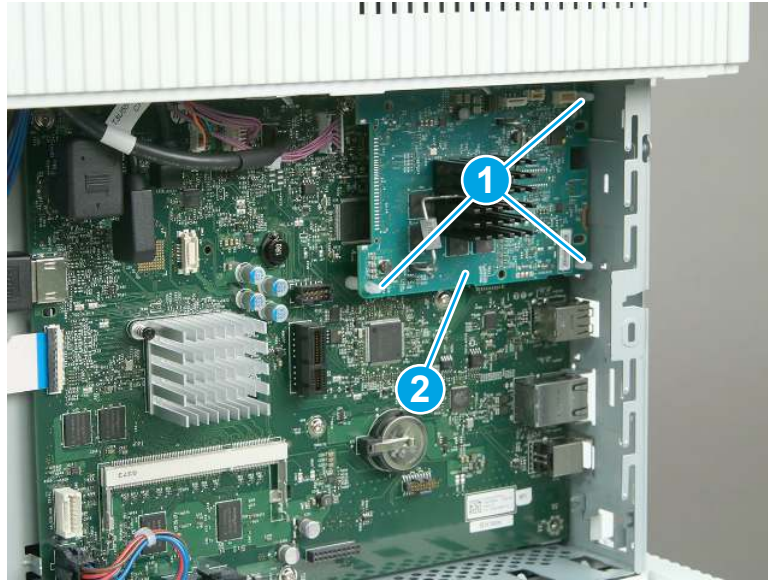
- b. **M776 only:** Raise the connector end of the HDD out and away from the formatter (callout 1), and then slide it to the left (callout 2) to remove it.

Figure 1-1253 Remove the hard disk drive



- c. **M776 only:** Release three standoff tabs (callout 1).

Figure 1-1254 Release three tabs



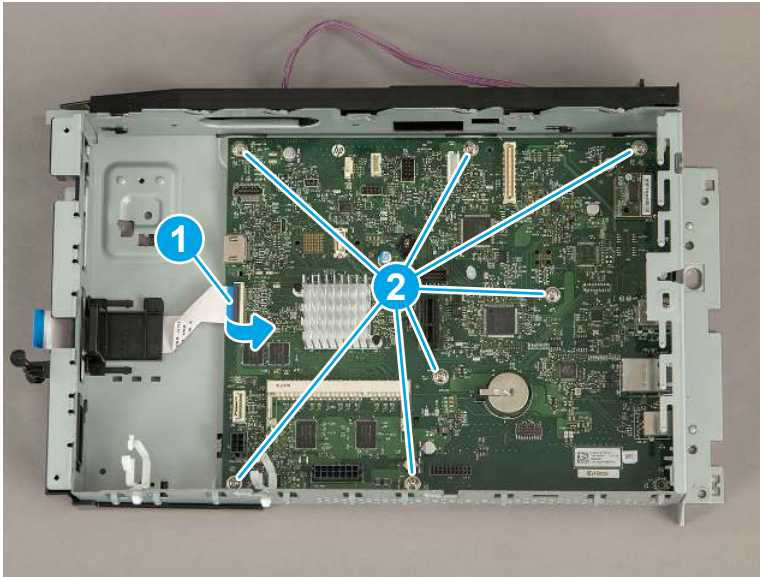
- d. **M776 only:** Remove the accelerator board.

Figure 1-1255 Remove the accelerator board



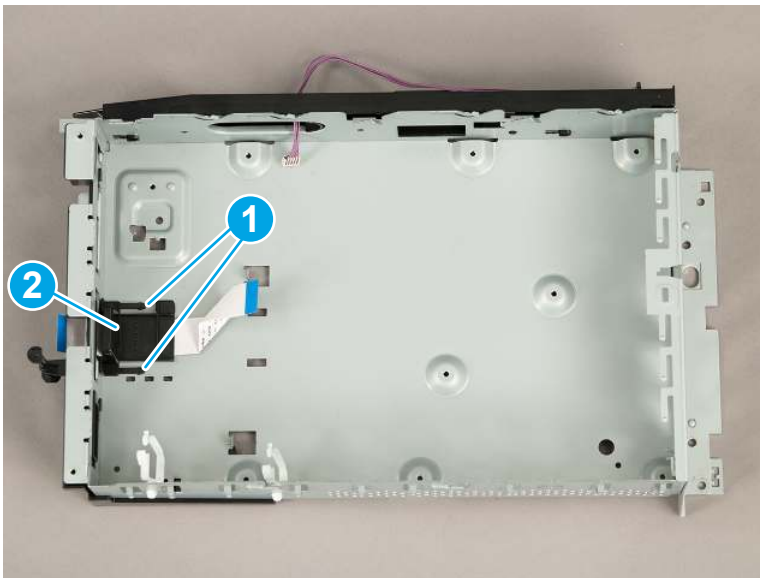
- e. Open the retainer (callout 1) to release the flat cable. Remove seven screws (callout 2), and then remove the formatter from the case.

Figure 1-1256 Remove the formatter



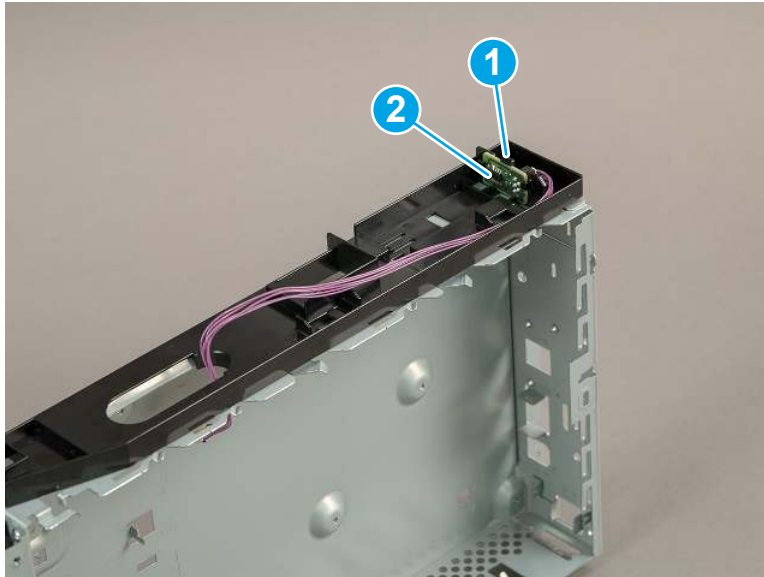
- f. Release two tabs (callout 1), and then remove the flat cable and retainer. Install these on the replacement formatter case.

Figure 1-1257 Release the retainer



- g. Release one tab (callout 1), and then remove the memory PCA and cable (callout 2). Install these on the replacement formatter case.

Figure 1-1258 Remove the memory PCA



10. Unpack the replacement assembly.
 - a. Dispose of the defective part.
- b. Unpack the replacement part from the packaging.
- c. To install an assembly, reverse the removal steps.



NOTE: HP recommends responsible disposal of the defective part.

<http://www8.hp.com/us/en/hp-information/environment/product-recycling.html>



IMPORTANT: Make sure that all of the shipping materials (for example shipping tape) are removed from the replacement part prior to installation.



NOTE: When applicable, special installation instructions are provided for an assembly at the end of the removal procedure. Always completely read the removal instructions and follow all special installation instructions.

Removal and replacement: Memory PCA (M856/E85055/M776)

Learn how to remove and replace the memory PCA.

[View a video of how to remove and replace the memory PCA.](#)

Mean time to repair: 8 minutes

Service level: Easy

Before performing service

Turn the printer power off

- Disconnect the power cable.

⚠ WARNING! To avoid damage to the printer, turn the printer off, wait 30 seconds, and then remove the power cord before attempting to service the printer.

Use the table below to identify the correct part number for your printer. To order the part, go to www.hp.com/buy/parts.

Table 1-74 Part information

Part number	Part description
RM3-7351-000CN	Memory PCB assembly

Required tools

- #2 Phillips screwdriver with a magnetic tip

After performing service

Turn the printer power on

- Connect the power cable.
- Use the power switch to turn the power on.

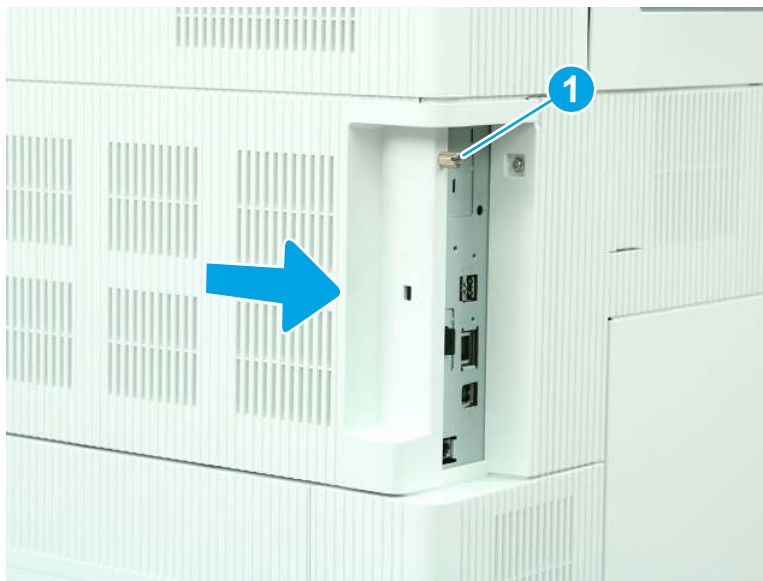
Post service test

Make sure that the printer initializes to a **Ready** state.

Print a page to make sure that the printer is functioning correctly.

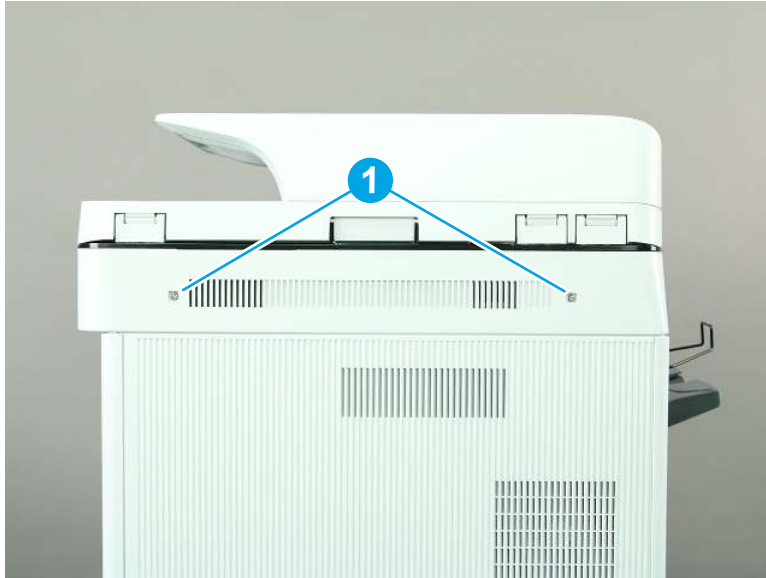
1. Remove the formatter cover.
 - ▲ Loosen one thumbscrew (callout 1), and then slide the formatter cover (callout 2) away from the printer to remove it.

Figure 1-1259 Remove the formatter cover



2. Remove the scanner control board (SCB) cover (M776).
 - a. Remove two screws (callout 1).

Figure 1-1260 Remove two screws



- b. Remove the SCB cover.

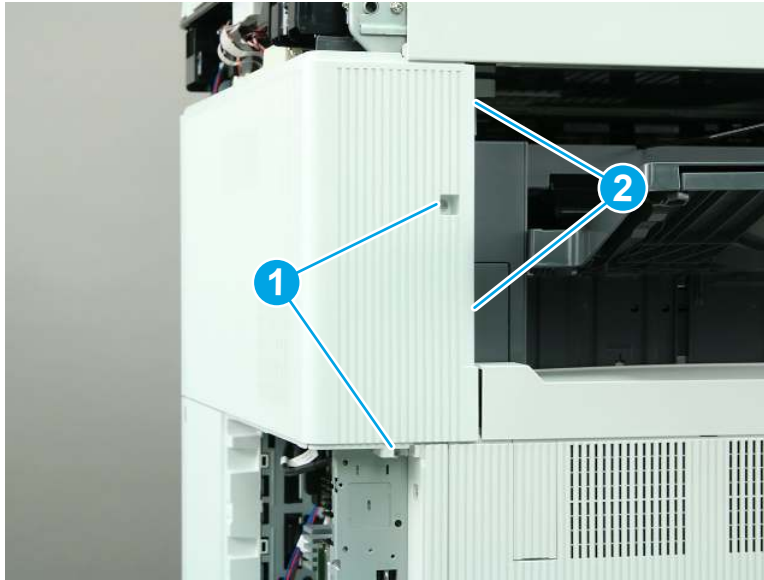
Figure 1-1261 Remove the SCB cover



3. Remove the rear upper cover and left rear upper cover (M776zs).

- a. Remove two screws (callout 1), and then release two tabs (callout 2).

Figure 1-1262 Remove two screws and release two tabs



- b. Slide the cover to the right to remove it.

Figure 1-1263 Remove the rear upper and left rear upper cover

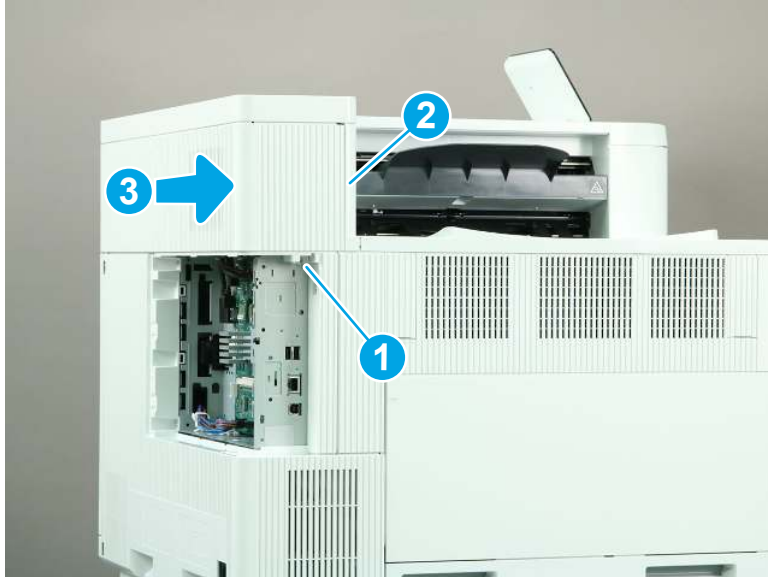


4. Remove the rear upper cover (M856/E85055/M776dn/M776z).

 **NOTE:** The following figure shows the M856 printer. The procedure is correct for all referenced models.

- ▲ Remove one screw (callout 1), release one tab (callout 2), and then slide the rear upper cover away from the printer to remove it (callout 3).

Figure 1-1264 Remove the rear upper cover



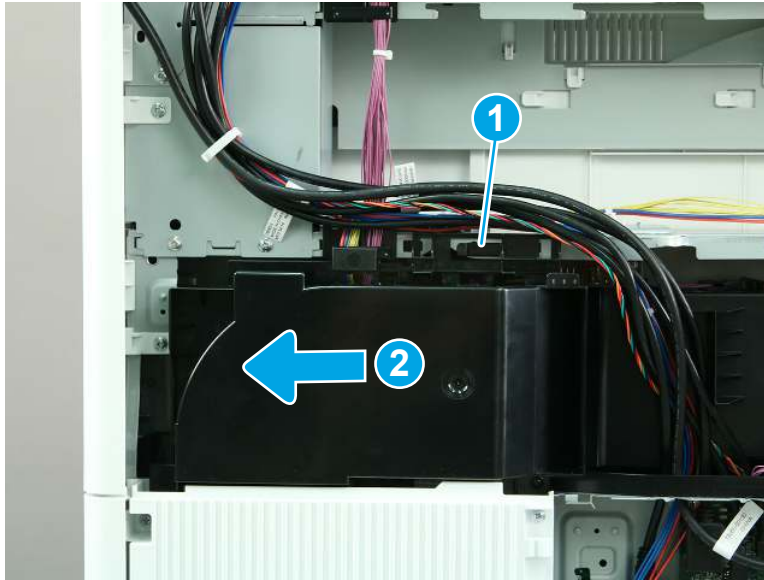
- 5. Remove the memory PCA (M856/E85055/M776).
 - a. Release the cables (callout 1) from the guides (callout 2).

Figure 1-1265 Release the cables from the guides



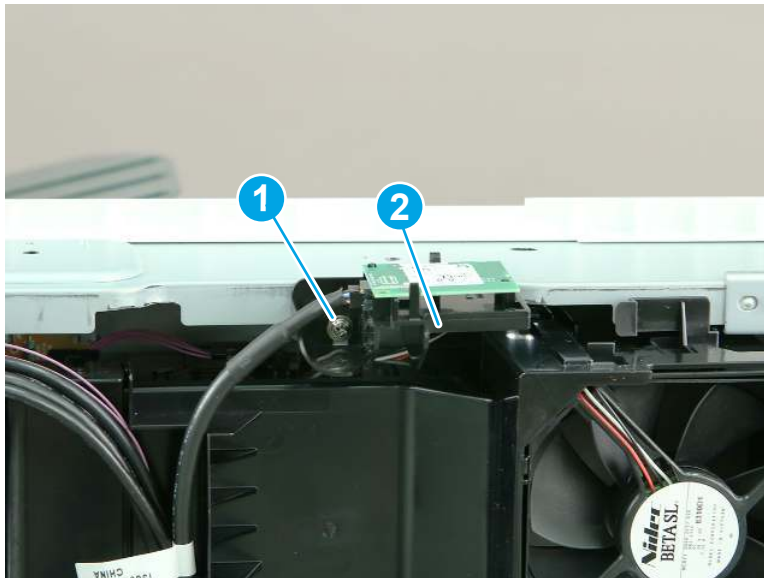
- b. Release one tab (callout 1), and then slide the fan duct to the left (callout 2) to remove it.

Figure 1-1266 Remove the fan duct



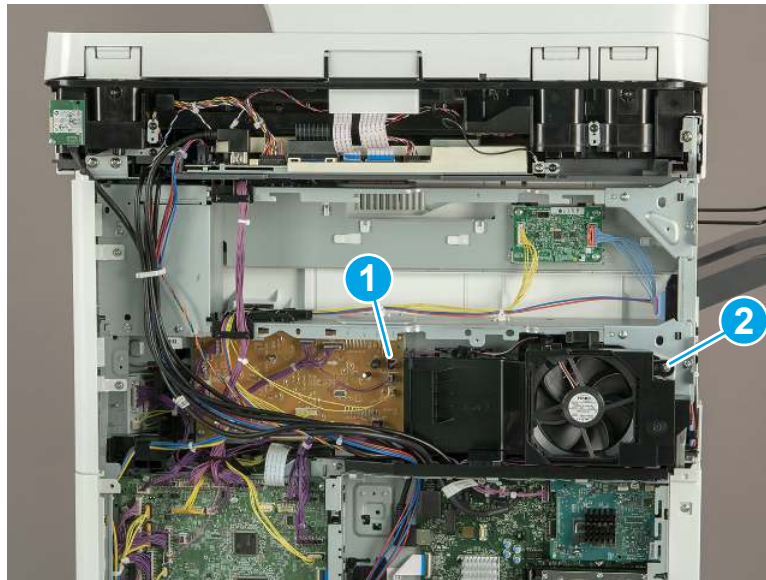
- c. **M856 and E85055 only:** Remove one screw (callout 1), and then remove the wireless card and bracket (callout 2).

Figure 1-1267 Remove the wireless card and bracket (M856/E85055)



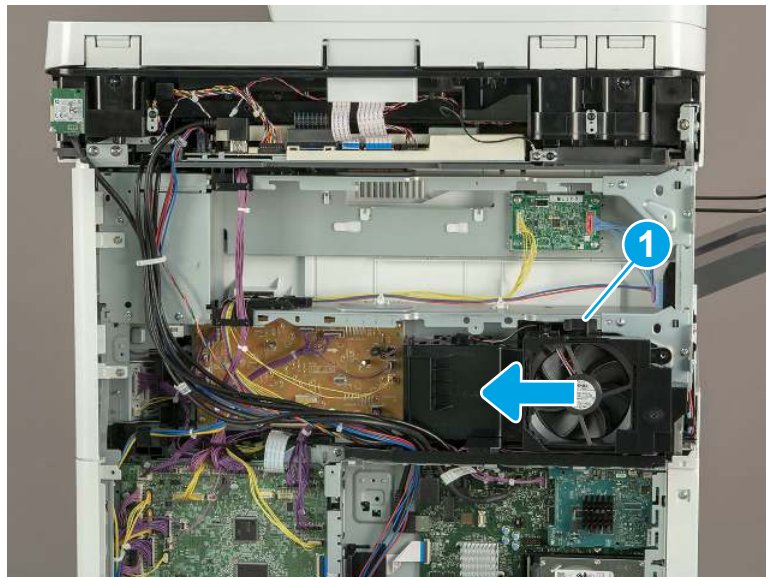
- d. Disconnect one connector (callout 1), and then remove one screw (callout 2).

Figure 1-1268 Disconnect one connector and remove one screw



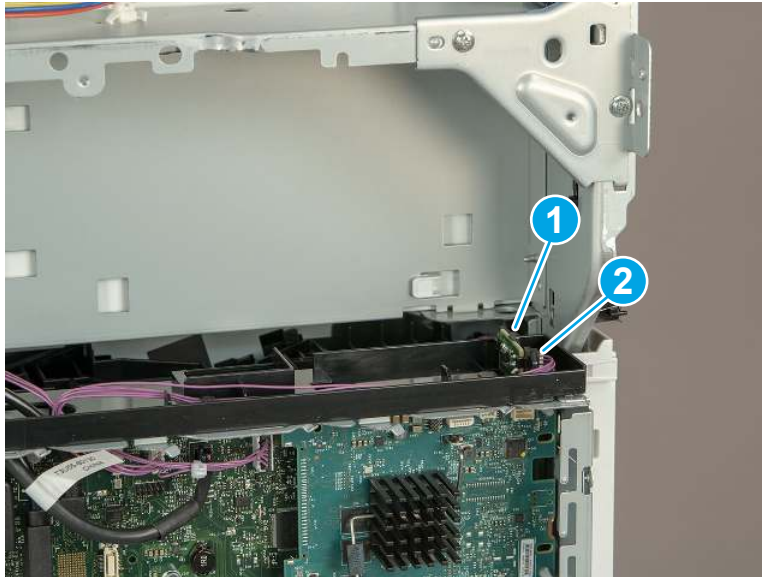
- e. Release one tab (callout 1), and then slide the fan assembly to the left to release it. Pull the assembly away from the printer to remove it.

Figure 1-1269 Remove the fan assembly



- f. Release one tab (callout 1) to release the PCA from the formatter cage, and then disconnect one connector (callout 2).

Figure 1-1270 Remove the memory PCA



6. Unpack the replacement assembly.
 - a. Dispose of the defective part.




NOTE: HP recommends responsible disposal of the defective part.

<http://www8.hp.com/us/en/hp-information/environment/product-recycling.html>

- b. Unpack the replacement part from the packaging.



CAUTION:  Some parts are sensitive to electrostatic discharge (ESD). Always perform service work at an ESD-protected workstation or mat. If an ESD workstation or mat is not available, touch the sheet-metal chassis to provide a static ground before touching an ESD-sensitive assembly. Protect the ESD-sensitive assemblies by placing them in ESD pouches when they are out of the printer.



IMPORTANT: Make sure that all of the shipping materials (for example shipping tape) are removed from the replacement part prior to installation.

- c. To install an assembly, reverse the removal steps.



NOTE: When applicable, special installation instructions are provided for an assembly at the end of the removal procedure. Always completely read the removal instructions and follow all special installation instructions.

Removal and replacement: Main connecting PCA (M751/E75245)

Learn how to remove and replace the main connecting PCA.

[View a video of how to remove and replace the upper HVPS.](#)

Mean time to repair: 45 minutes

Service level: Medium

Before performing service

Turn the printer power off

- Disconnect the power cable.

⚠ WARNING! To avoid damage to the printer, turn the printer off, wait 30 seconds, and then remove the power cord before attempting to service the printer.

Use the table below to identify the correct part number for your printer. To order the part, go to www.hp.com/buy/parts.

Table 1-75 Part information

Part number	Part description
RM2-9618-000CN	Main connecting PCB assembly

Required tools

- #2 Phillips screwdriver with a magnetic tip
- Small, flat-blade screwdriver

After performing service

Turn the printer power on

- Connect the power cable.
- Use the power switch to turn the power on.

Post service test

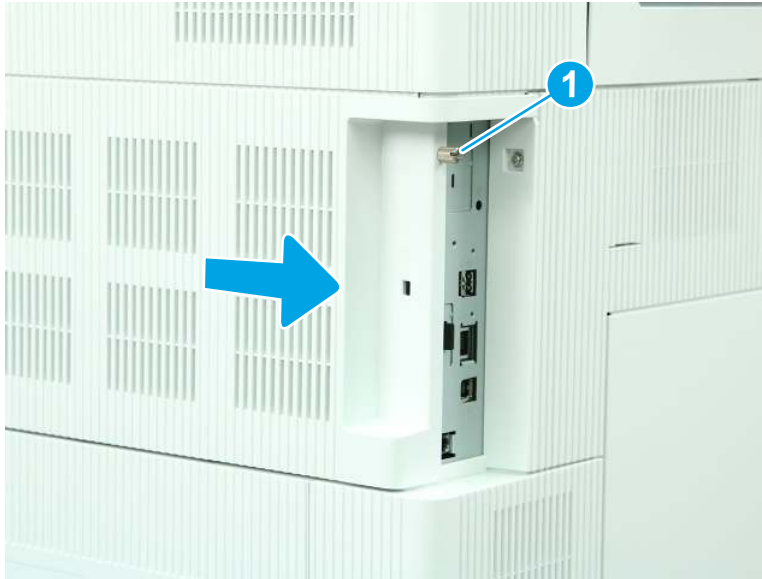
Make sure that the printer initializes to a **Ready** state.

Print a page to make sure that the printer is functioning correctly.

1. Remove the formatter cover.

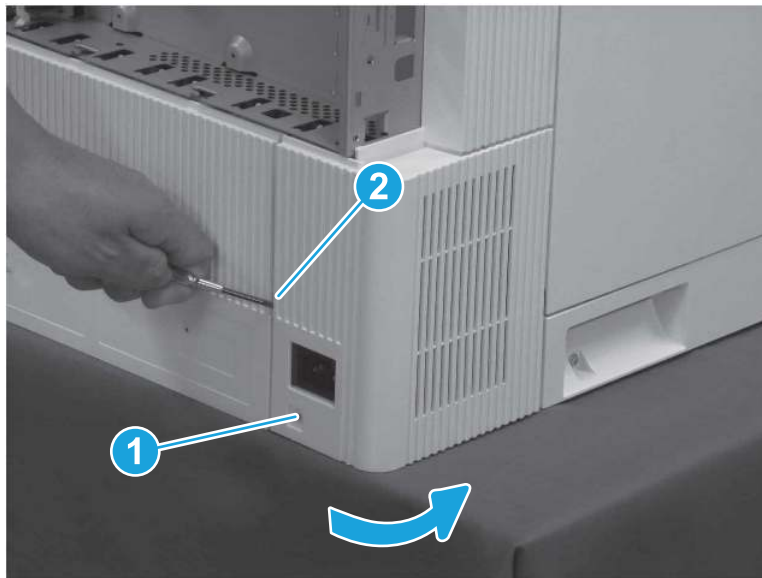
- ▲ Loosen one thumbscrew (callout 1), and then slide the formatter cover (callout 2) away from the printer to remove it.

Figure 1-1271 Remove the formatter cover



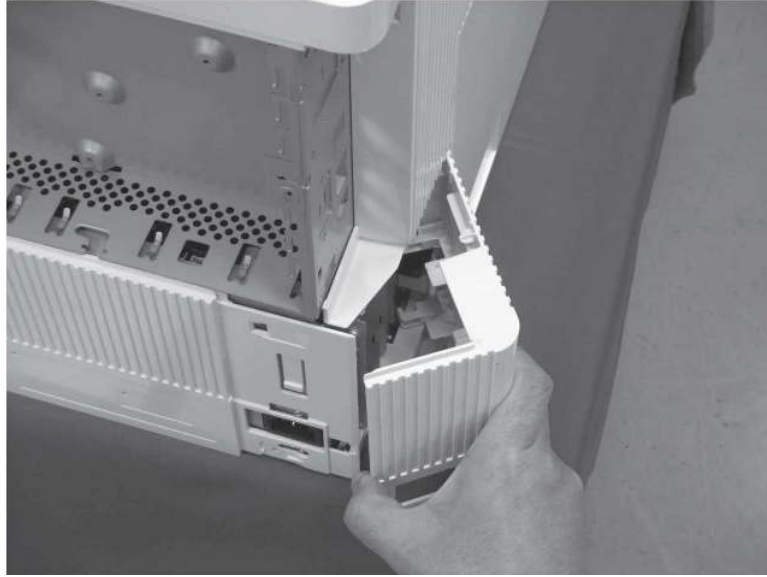
- 2. Remove the left lower cover (M751/E75245).
 - a. Remove one screw (callout 1), release one tab (callout 2), and then rotate the cover away from the printer.

Figure 1-1272 Remove one screw and release one tab



- b. Remove the left lower cover.

Figure 1-1273 Remove the left lower cover



3. Remove the left rear cover (M751/E75245/M856/E85055/M776).

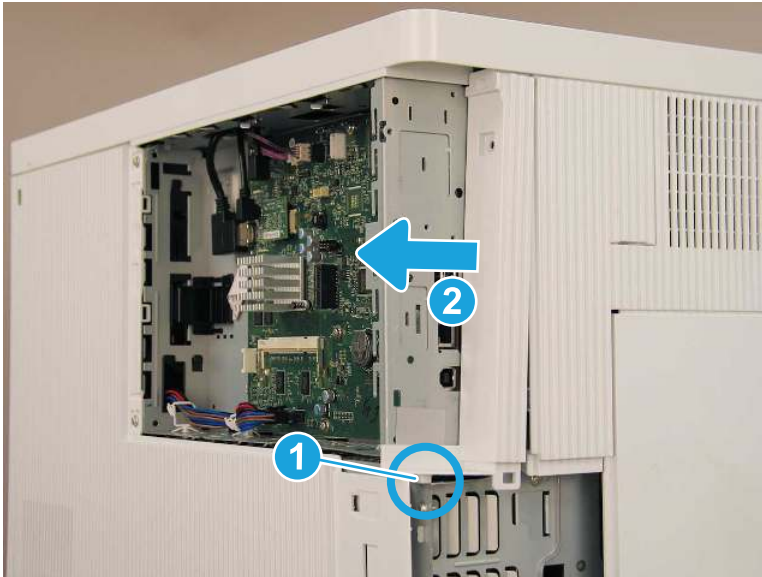
- a. Remove one screw (callout 1).

Figure 1-1274 Remove one screw



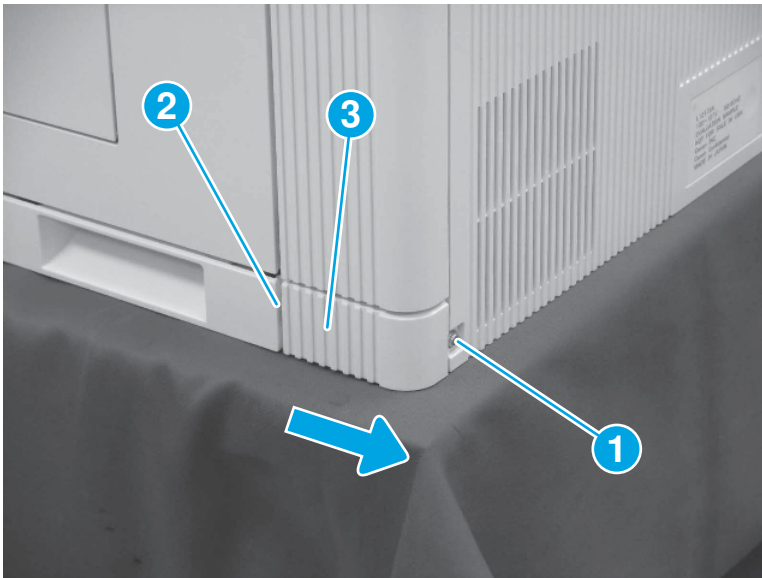
- b. Release one boss (callout 1), and then slide the cover toward the back of the printer (callout 2) to remove it.

Figure 1-1275 Remove the left rear cover



4. Remove the right rear lower cover (M751/E75245/M856/E85055/M776).
 - ▲ Remove one screw (callout 1), release one tab (callout 2), and then slide the right rear lower cover (callout 3) toward the back of the printer to remove it.

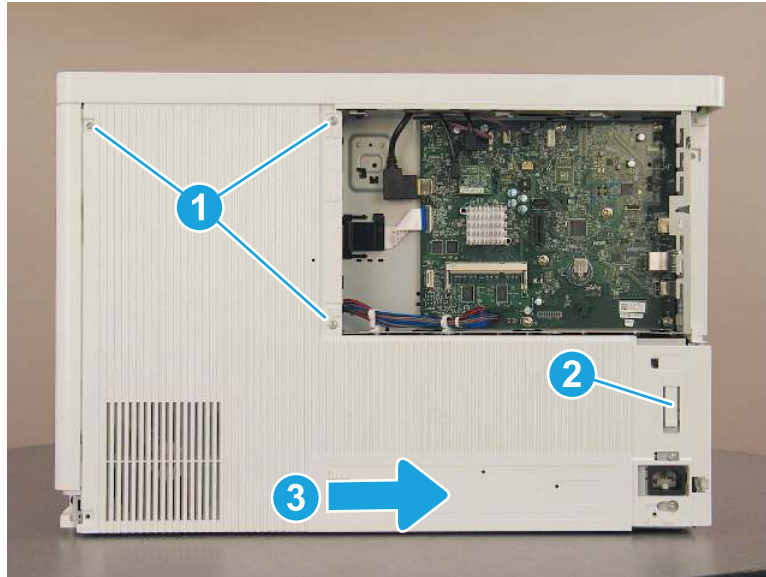
Figure 1-1276 Remove the right rear lower cover



5. Remove the rear cover (M751/E75245).

- ▲ Remove three screws (callout 1), release one tab (callout 2), and then slide the rear cover to the right (callout 3) to remove it.

Figure 1-1277 Remove the rear cover

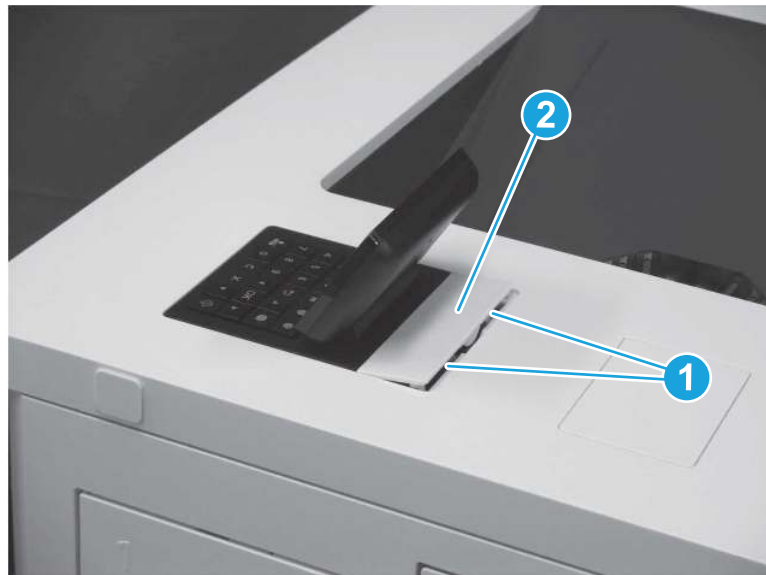


6. Remove the control panel.

 **NOTE:** A screwdriver is included in the control panel kit. The screwdriver has a reversible shaft. Simply pull the shaft out of the handle, and then reinstall it with the desired end facing out.

- a. Use a small, flat-blade screwdriver to release two tabs (callout 1), and then remove the control panel cover (callout 2).

Figure 1-1278 Remove the control panel cover



- b. Remove one screw (callout 1).

Figure 1-1279 Remove one screw



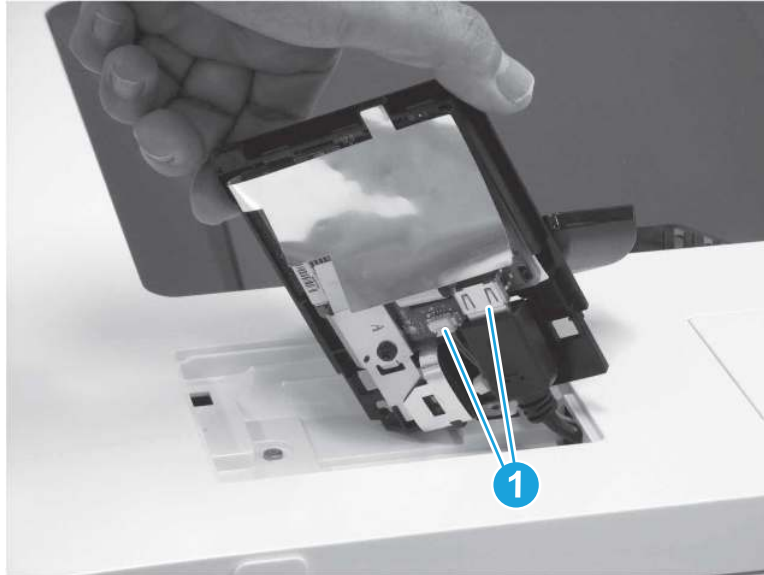
- c. Lift the back edge of the control panel up (callout 1), and then slide the control panel toward the back of the printer (callout 2).

Figure 1-1280 Slide the control panel back



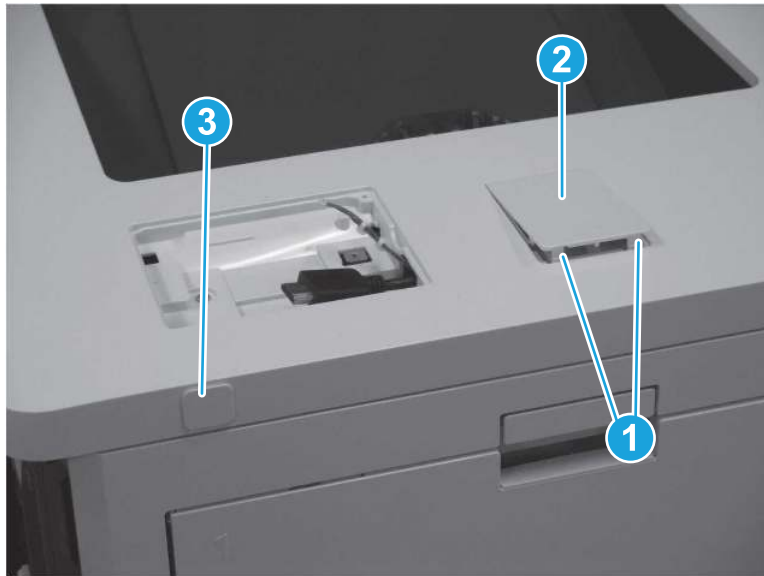
- d. Turn the control panel so that the bottom is facing up, and then disconnect two connectors (callout 1) to remove the control panel.

Figure 1-1281 Disconnect two connectors



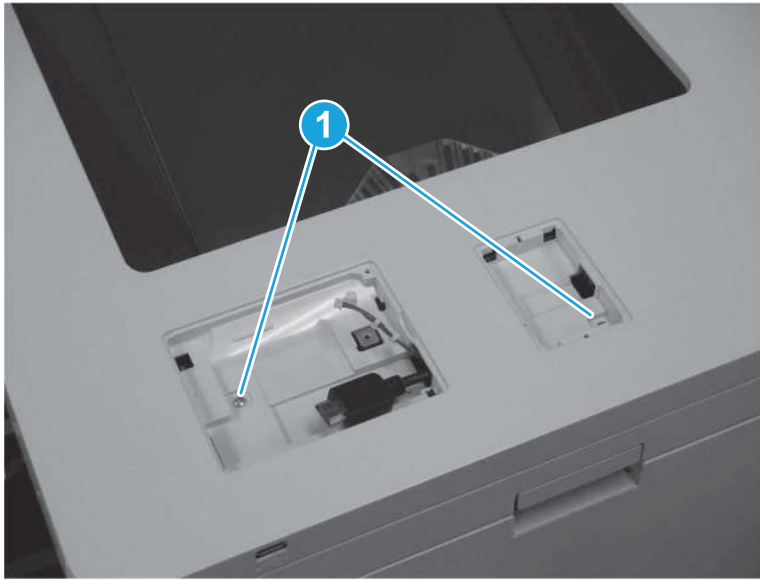
7. Remove the top cover (M751/E75245).
 - a. Release two tabs (callout 1), and then remove the HIP cover (callout 2). Pull the USB cap (callout 3) away from the printer to remove it.

Figure 1-1282 Remove the HIP cover and USB cap



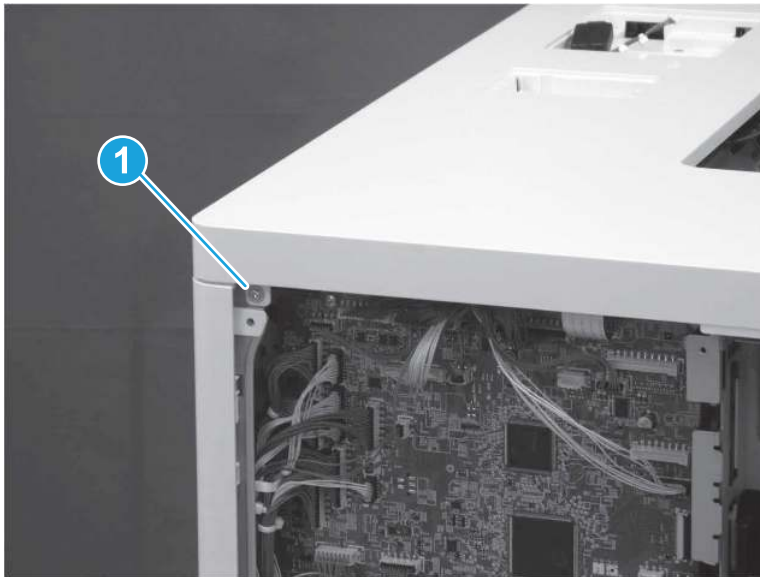
- b. At the top of the printer, remove two screws (callout 1).

Figure 1-1283 Remove two screws



- c. At the back of the printer, remove one screw (callout 1).

Figure 1-1284 Remove one screw

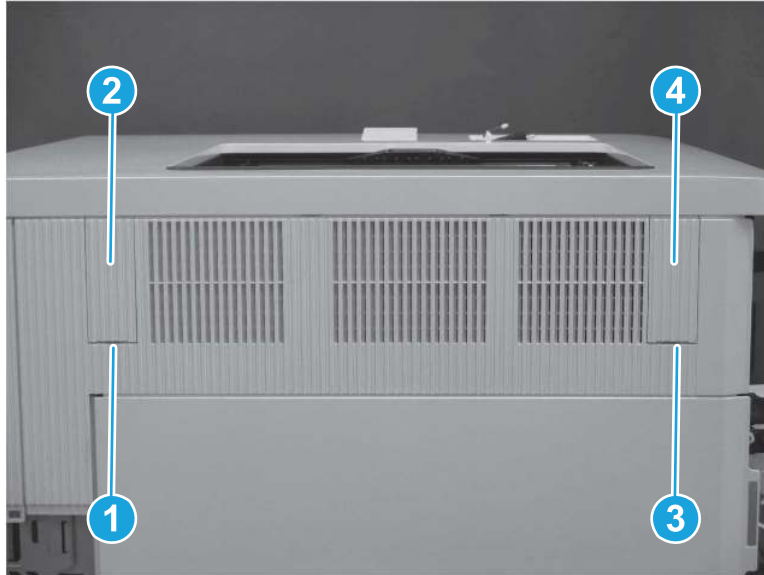


- d. Use a small, flat-blade screwdriver to release one tab (callout 1) and remove the left blanking cover (callout 2). Release one tab (callout 3) and remove the right blanking cover (callout 4).

 **TIP:** These covers are not identical. Make sure to reinstall the correct cover on the correct side.

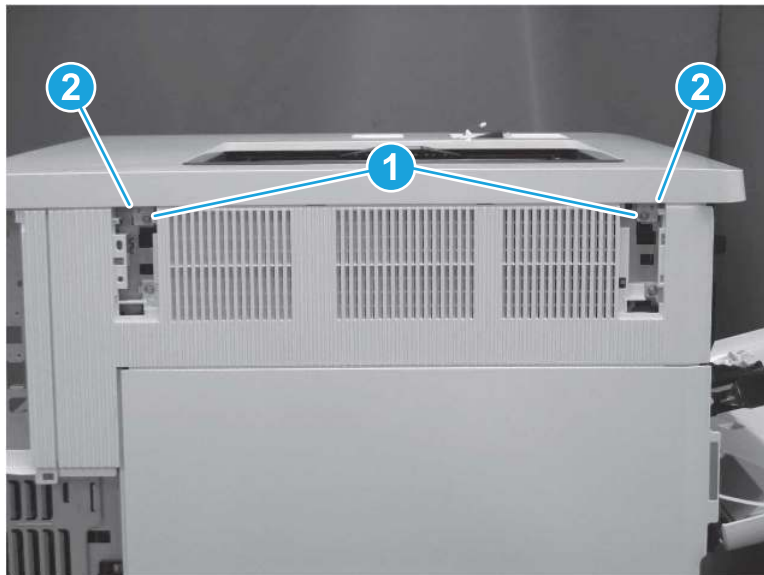
 **NOTE:** The screw under the left blanking cover is a self-tapping screw. Make sure this screw is reinstalled in the correct location.

Figure 1-1285 Remove the left and right blanking covers



- e. Remove two screws (callout 1), and then release two tabs (callout 2).

Figure 1-1286 Remove two screws and release two tabs



- f. At the front of the printer, remove one washer-head screw (callout 1) and one self-tapping screw (callout 2). Release one tab (callout 3).


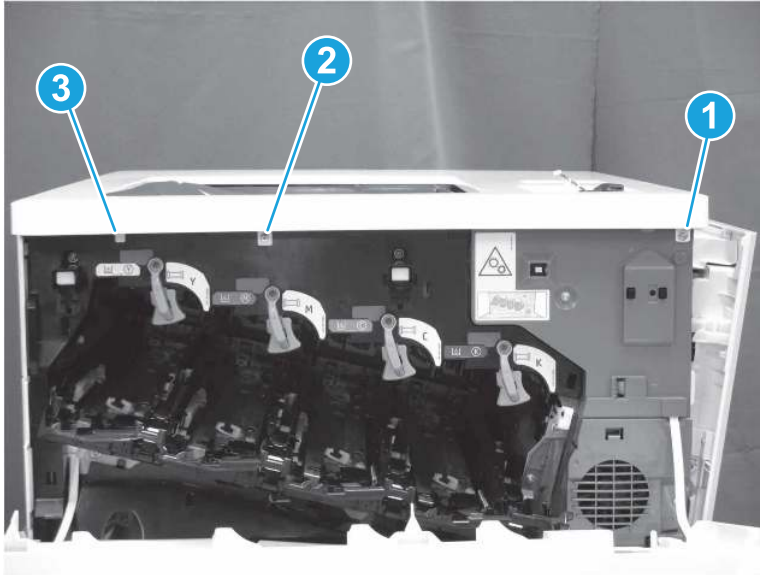
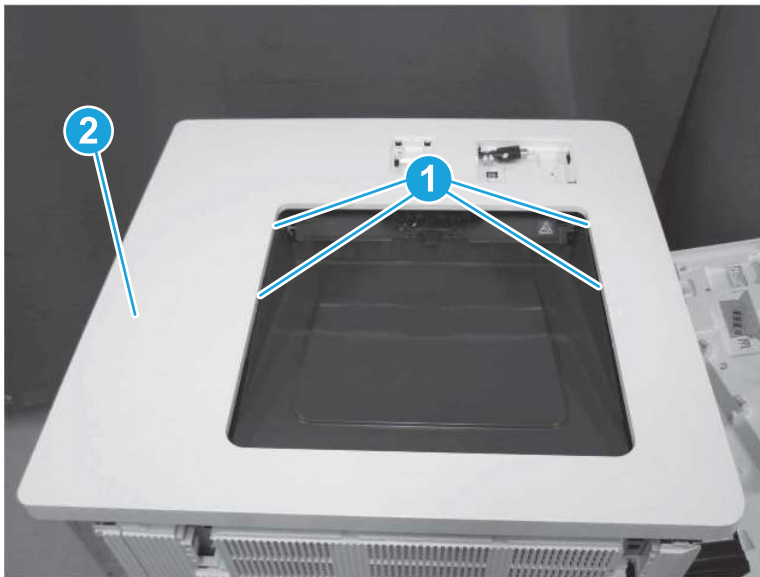
 **TIP:** Make sure to install the correct type of screw in the correct location.

Figure 1-1287 Remove two screws and release one tab

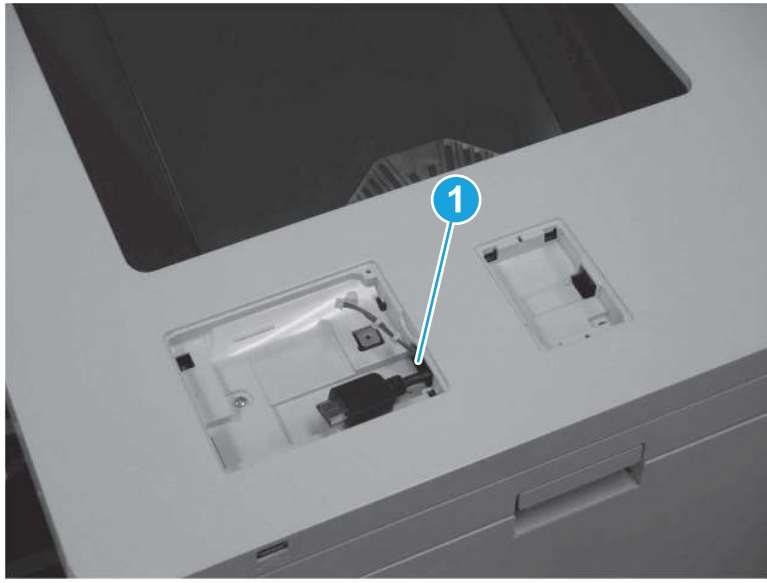


- g. At the top of the printer, release four tabs (callout 1), and then remove the top cover (callout 2).

Figure 1-1288 Remove the top cover

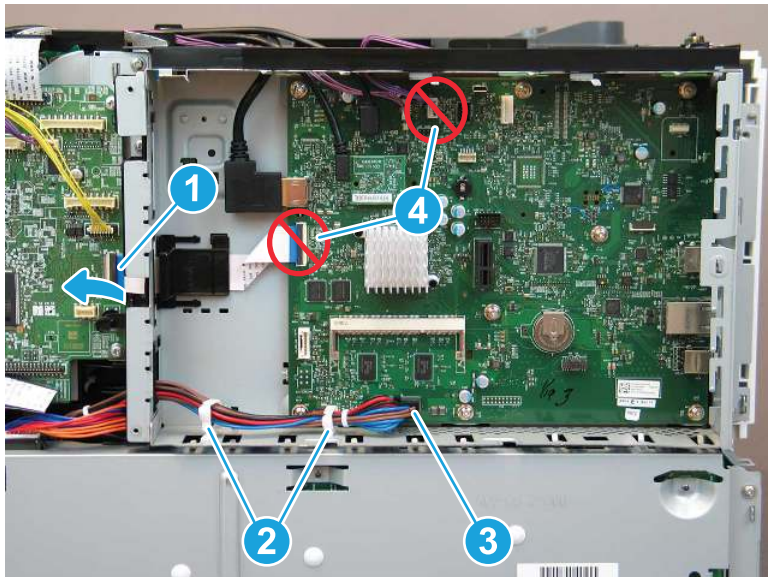


 **NOTE:** When removing the top cover, make sure to release the control panel cables (callout 1) through the opening.



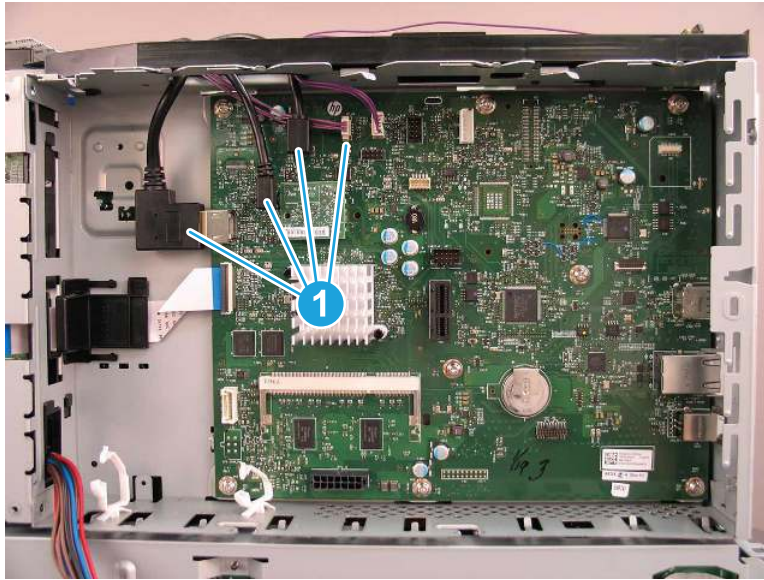
8. Remove the formatter and case.
 - a. Open the retainer (callout 1) to release the flat cable. Release the cables from two retainers (callout 2). Squeeze the latch to disconnect the connector (callout 3) at the lower edge of the formatter. It is not necessary to disconnect two connectors (callout 4).

Figure 1-1289 Disconnect the connectors



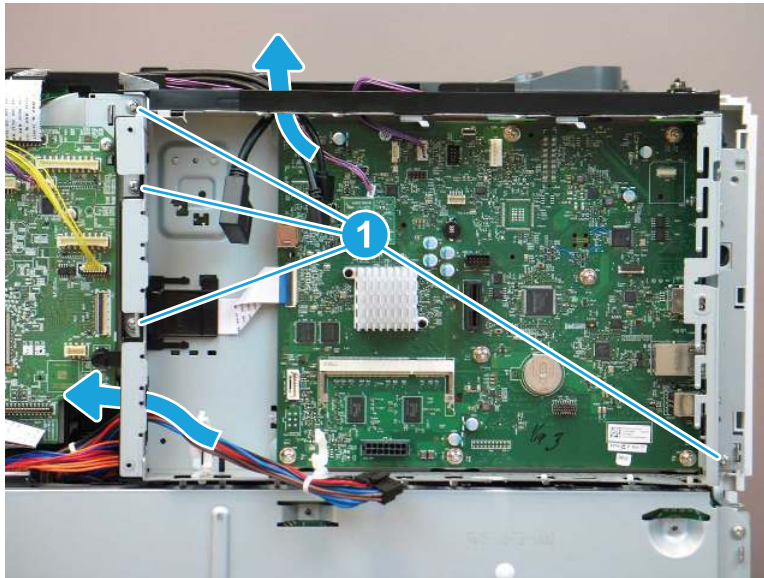
- b. Disconnect all of the remaining connectors on the formatter (callout 1).

Figure 1-1290 Disconnect the connectors



- c. Release the cables through the opening on top and on the left side of the formatter case. Remove four screws (callout 1), and then remove the formatter and case.

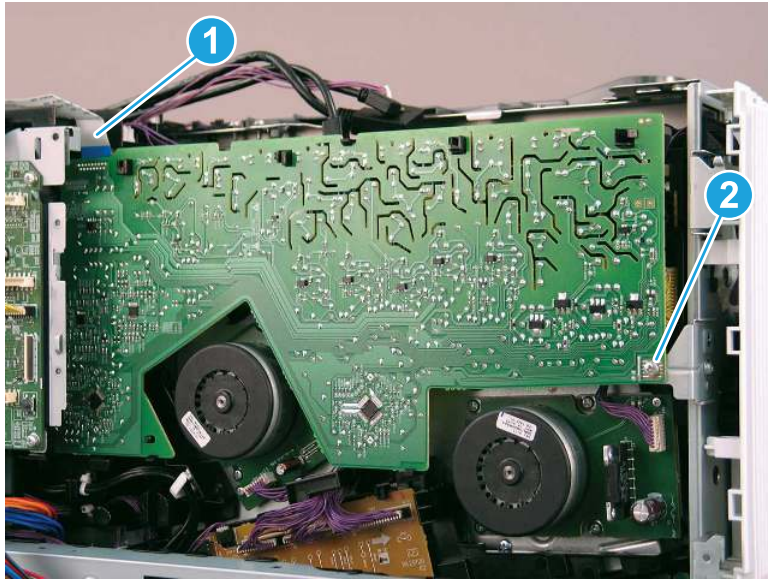
Figure 1-1291 Remove the formatter and case



9. Remove the upper high-voltage power supply A (upper HVPS).

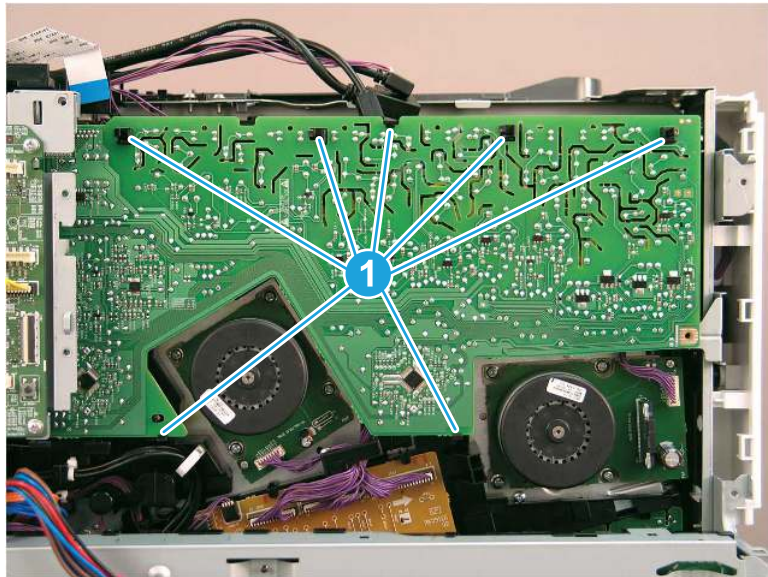
- a. Disconnect one flat cable (callout 1), and then remove one screw (callout 2).

Figure 1-1292 Disconnect one flat cable and remove one screw



- b. Release seven tabs (callout 1), and then remove the upper HVPS.

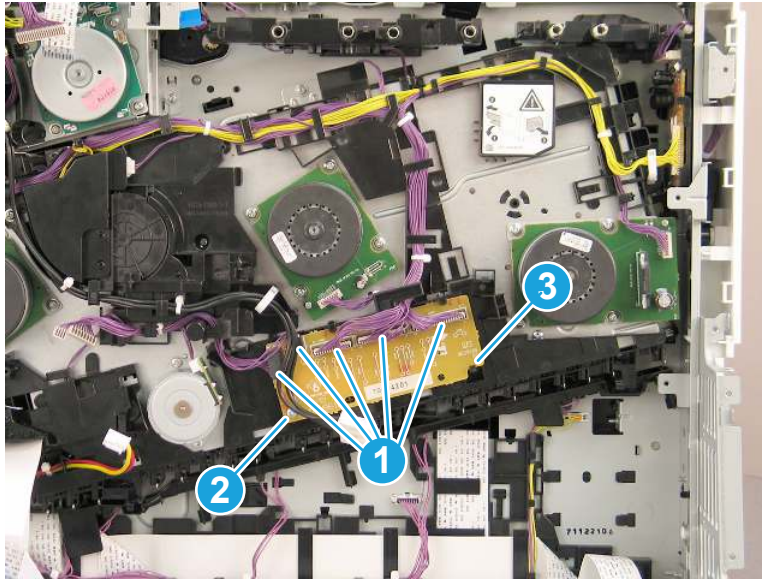
Figure 1-1293 Release seven tabs and remove the upper HVPS



10. Remove the main connecting PCA.

- ▲ Disconnect five connectors (callout 1), and then remove one screw (callout 2). Release one tab (callout 3), and then remove the main connecting PCA.

Figure 1-1294 Remove the main connecting PCA



11. Unpack the replacement assembly.

- a. Dispose of the defective part.




NOTE: HP recommends responsible disposal of the defective part.

<http://www8.hp.com/us/en/hp-information/environment/product-recycling.html>

- b. Unpack the replacement part from the packaging.



CAUTION:  Some parts are sensitive to electrostatic discharge (ESD). Always perform service work at an ESD-protected workstation or mat. If an ESD workstation or mat is not available, touch the sheet-metal chassis to provide a static ground before touching an ESD-sensitive assembly. Protect the ESD-sensitive assemblies by placing them in ESD pouches when they are out of the printer.



IMPORTANT: Make sure that all of the shipping materials (for example shipping tape) are removed from the replacement part prior to installation.

- c. To install an assembly, reverse the removal steps.



NOTE: When applicable, special installation instructions are provided for an assembly at the end of the removal procedure. Always completely read the removal instructions and follow all special installation instructions.

Removal and replacement: Main connecting PCA (M856/E85055/M776)

Learn how to remove and replace the main connecting PCA.

[View a video of how to remove and replace the main connecting PCA.](#)

Mean time to repair: 45 minutes

Service level: Medium

Before performing service

Turn the printer power off

- Disconnect the power cable.

⚠ WARNING! To avoid damage to the printer, turn the printer off, wait 30 seconds, and then remove the power cord before attempting to service the printer.

Use the table below to identify the correct part number for your printer. To order the part, go to www.hp.com/buy/parts.

Table 1-76 Part information

Part number	Part description
RM2-9618-000CN	Main connecting PCB assembly

Required tools

- #2 Phillips screwdriver with a magnetic tip
- Small, flat-blade screwdriver

After performing service

Turn the printer power on

- Connect the power cable.
- Use the power switch to turn the power on.

Post service test

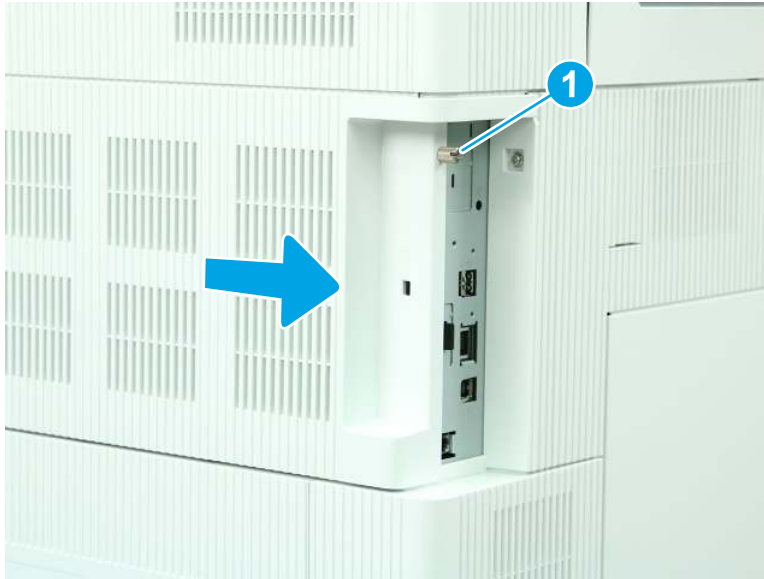
Make sure that the printer initializes to a **Ready** state.

Print a page to make sure that the printer is functioning correctly.

1. Remove the formatter cover.

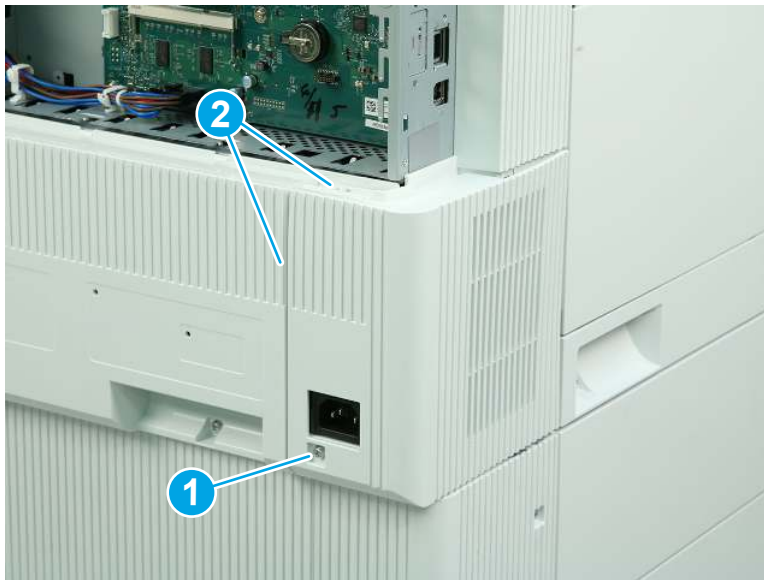
- ▲ Loosen one thumbscrew (callout 1), and then slide the formatter cover (callout 2) away from the printer to remove it.

Figure 1-1295 Remove the formatter cover



- 2. Remove the left lower cover (M856/E85055/M776).
 - a. Remove one screw (callout 1), and then release two tabs (callout 2).

Figure 1-1296 Remove one screw and release two tabs



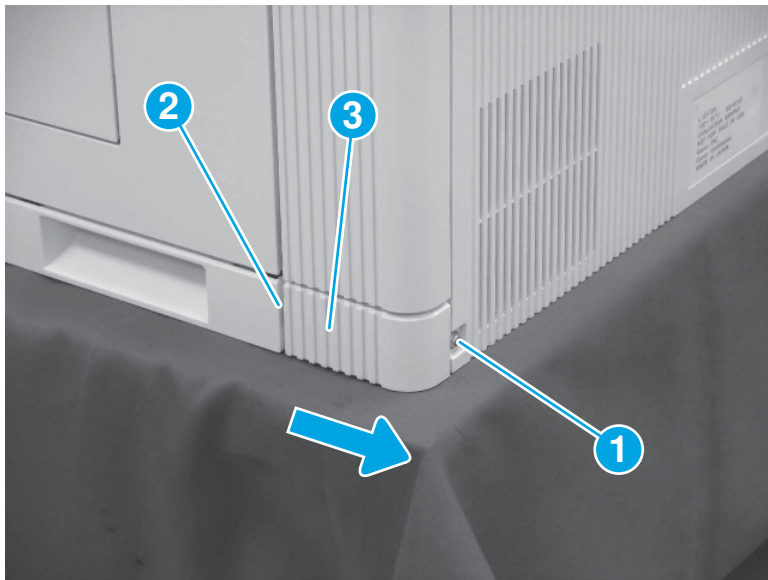
- b. Rotate the cover away from the printer to remove it.

Figure 1-1297 Remove the left lower cover



- 3. Remove the right rear lower cover (M751/E75245/M856/E85055/M776).
 - ▲ Remove one screw (callout 1), release one tab (callout 2), and then slide the right rear lower cover (callout 3) toward the back of the printer to remove it.

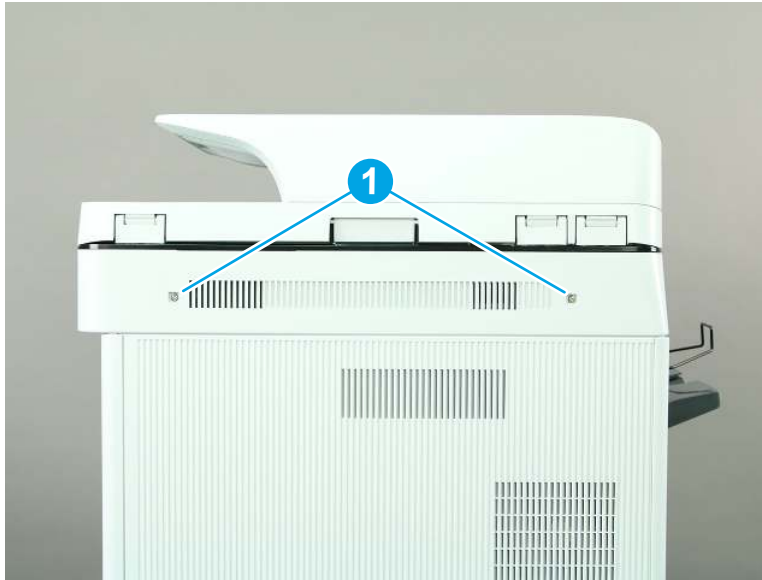
Figure 1-1298 Remove the right rear lower cover



- 4. Remove the scanner control board (SCB) cover (M776).

- a. Remove two screws (callout 1).

Figure 1-1299 Remove two screws



- b. Remove the SCB cover.

Figure 1-1300 Remove the SCB cover



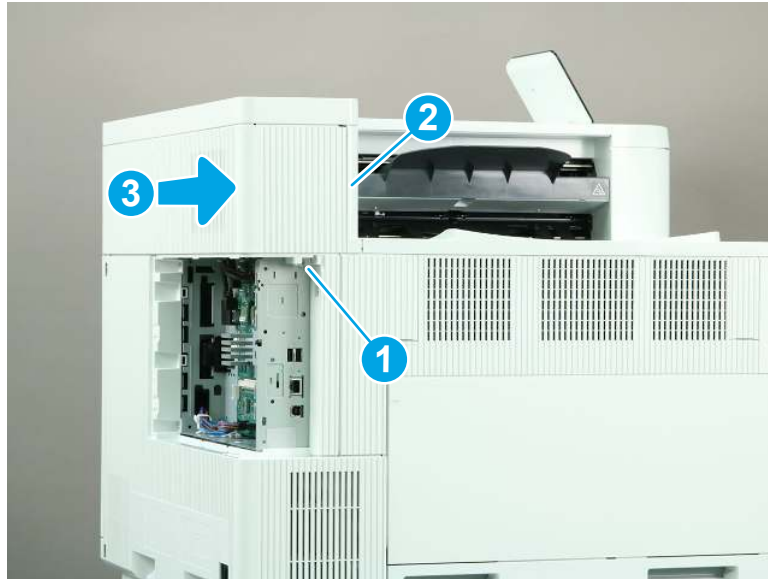
5. Remove the rear upper cover (M856/E85055/M776dn/M776z).



NOTE: The following figure shows the M856 printer. The procedure is correct for all referenced models.

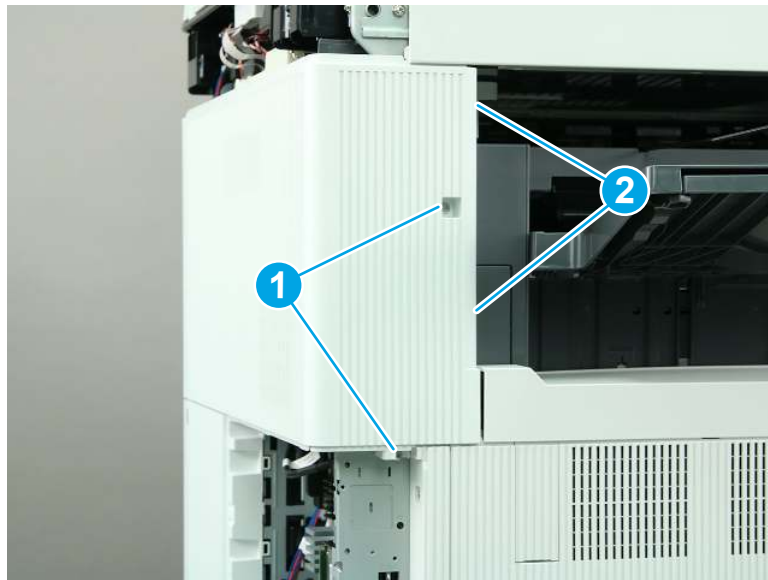
- ▲ Remove one screw (callout 1), release one tab (callout 2), and then slide the rear upper cover away from the printer to remove it (callout 3).

Figure 1-1301 Remove the rear upper cover



- 6. Remove the rear upper cover and left rear upper cover (M776zs).
 - a. Remove two screws (callout 1), and then release two tabs (callout 2).

Figure 1-1302 Remove two screws and release two tabs



- b. Slide the cover to the right to remove it.

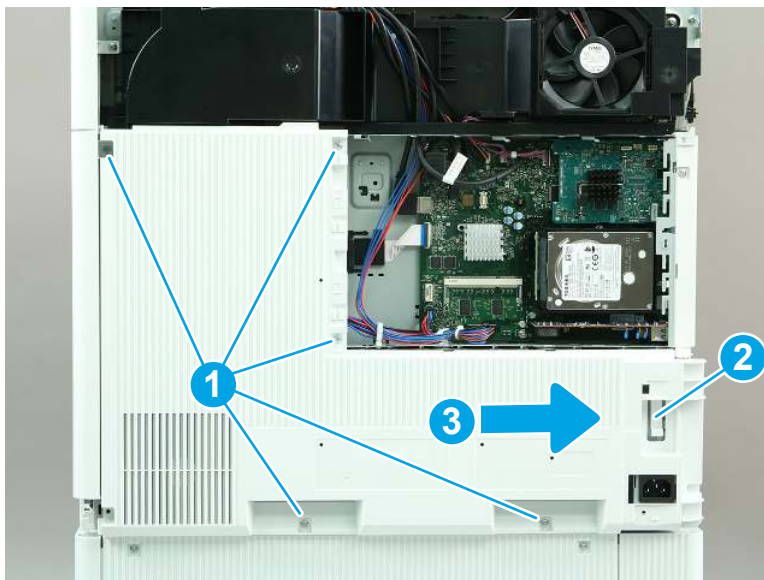
Figure 1-1303 Remove the rear upper and left rear upper cover



7. Remove the rear cover (M856/E85055/M776).

- ▲ Remove five screws (callout 1), release one tab (callout 2), and then slide the rear cover to the right to remove it.

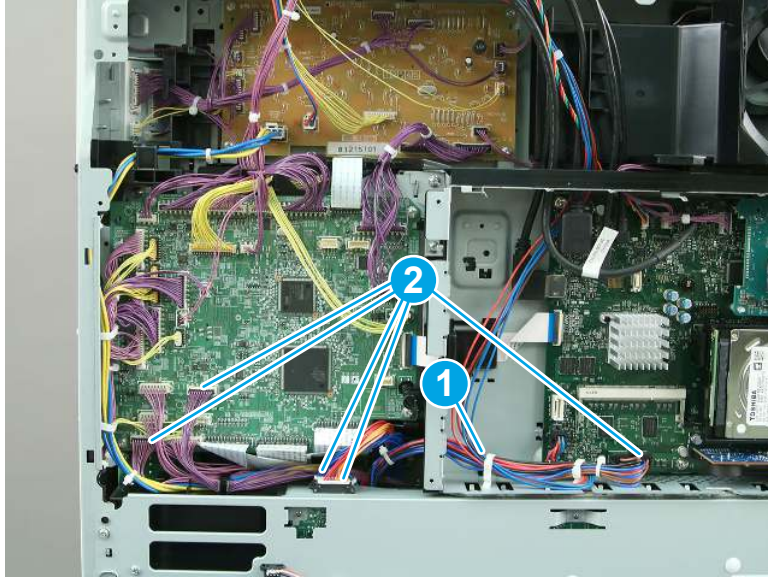
Figure 1-1304 Remove the rear cover (M856/E85055/M776)



8. Remove the low-voltage power supply (LVPS) (M856/E85055/M776).

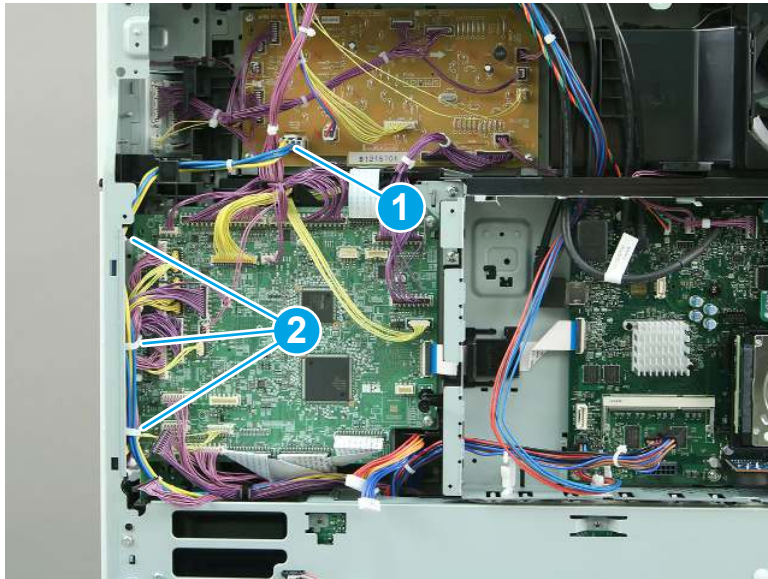
- a. Release one retainer (callout 1), and then disconnect five connectors (callout 2).

Figure 1-1305 Release the retainer and disconnect five connectors



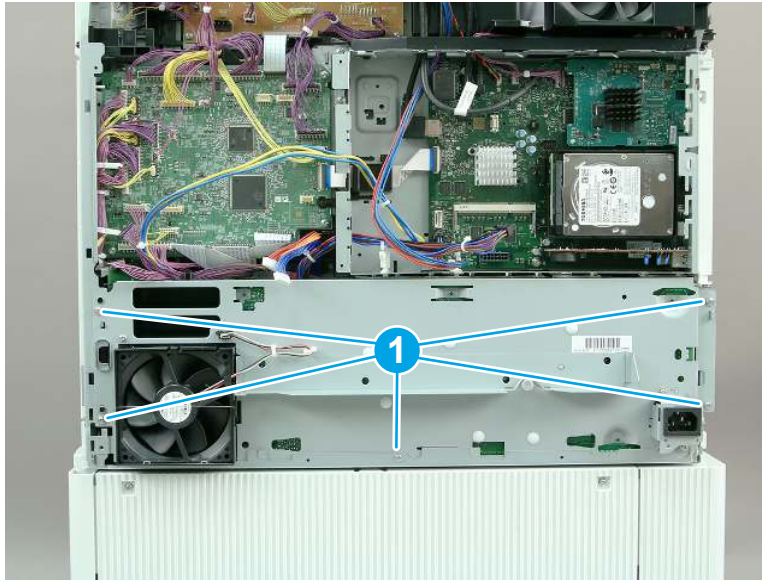
- b. Disconnect one connector (callout 1), and then release three retainers (callout 2).

Figure 1-1306 Disconnect one connector and release five retainers



- c. Remove five screws (callout 1).

Figure 1-1307 Remove five screws



- d. Tilt the LVPS away from the printer (callout 1). Thread the cable (callout 2) through the opening in the formatter case.

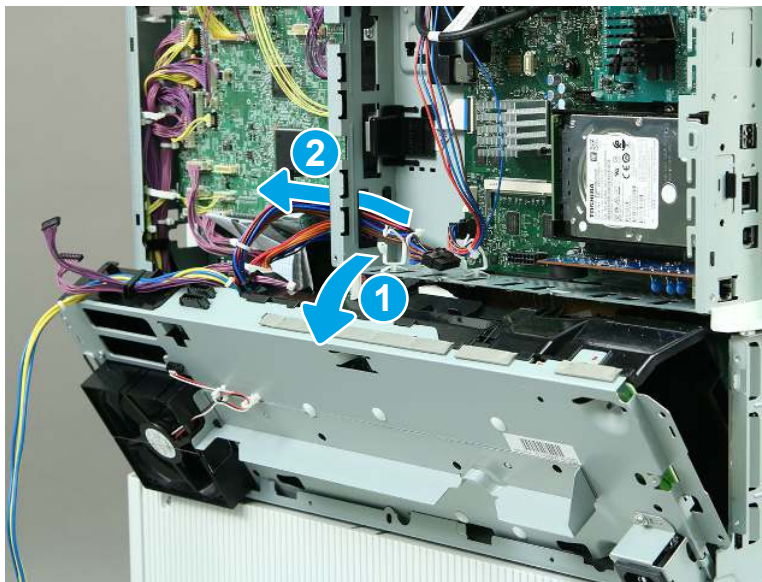


NOTE: Due to mechanical tolerances on the formatter cage, rotating the LVPS out might be difficult.



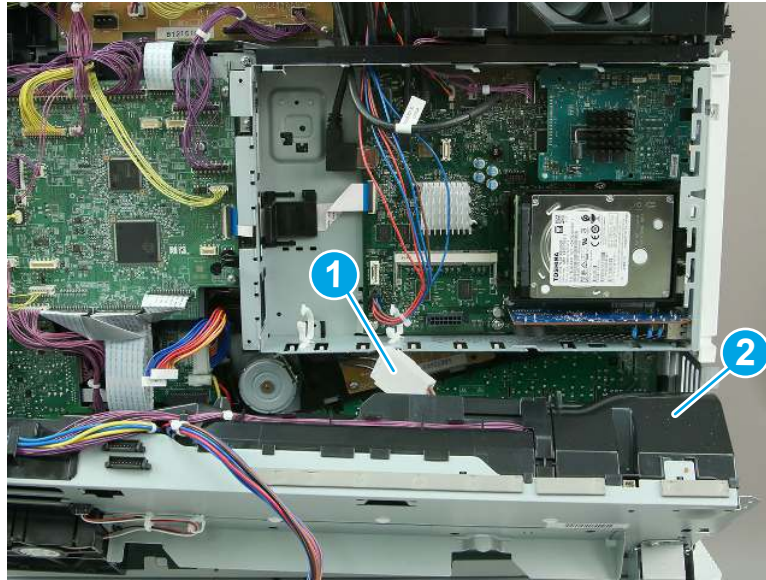
CAUTION: One connector is still connected, so tilt the LVPS carefully.

Figure 1-1308 Thread the cable



- e. Disconnect one connector (callout 1), and then lift up to remove the LVPS (callout 2).

Figure 1-1309 Remove the LVPS



- 9. Remove the formatter and case (M856/E85055/M776).

 **NOTE:** The figures below show the M776zs formatter. The procedure is correct for all referenced models.

- a. Release two retainers (callout 1), and then open the retainer (callout 2) to release the flat cable. Disconnect all of the remaining connectors on the formatter board.


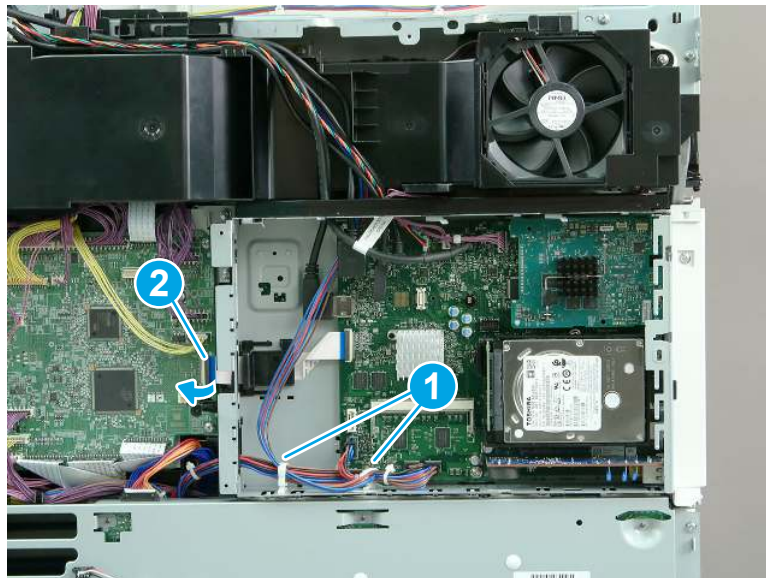
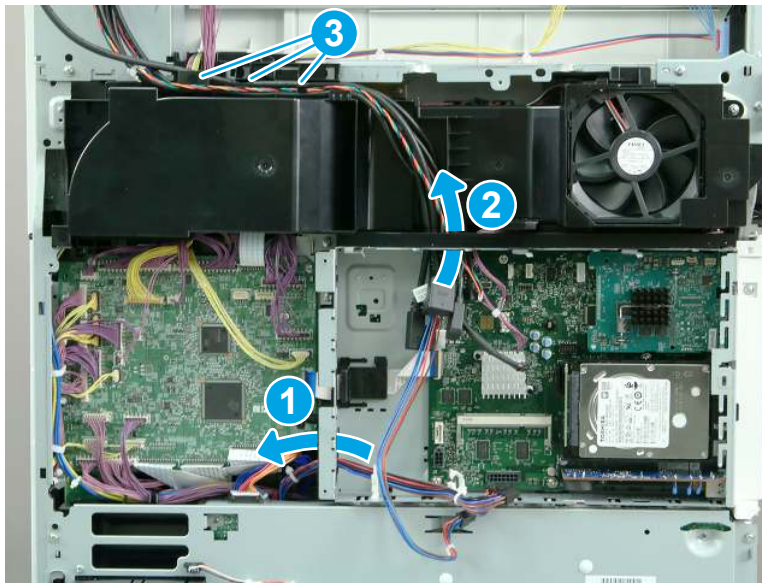
 **NOTE:** The figures below show the M776zs model. The procedures are correct for all of the referenced models.

Figure 1-1310 Disconnect the connectors



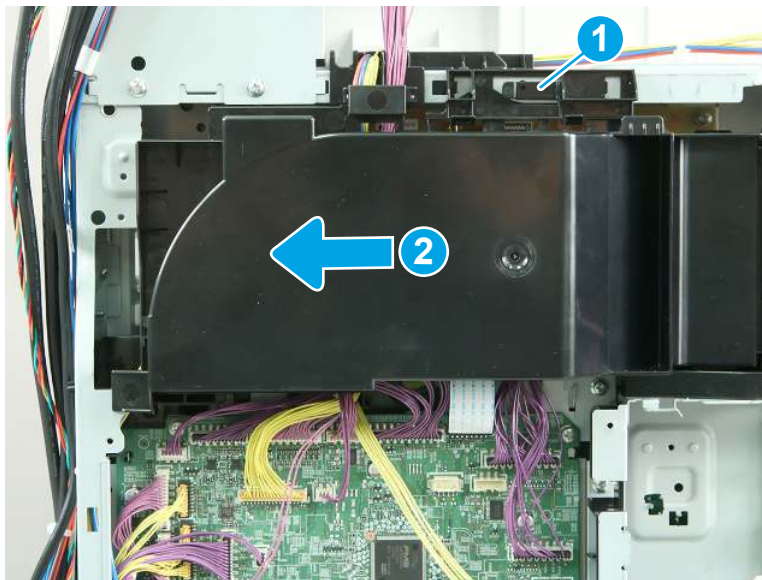
- b. Release one cable through the opening in the left side of the formatter case (callout 1). Release the remaining cables through the opening in the top of the formatter case (callout 2). Release the cables from the upper cable guide (callout 3).

Figure 1-1311 Release the cables



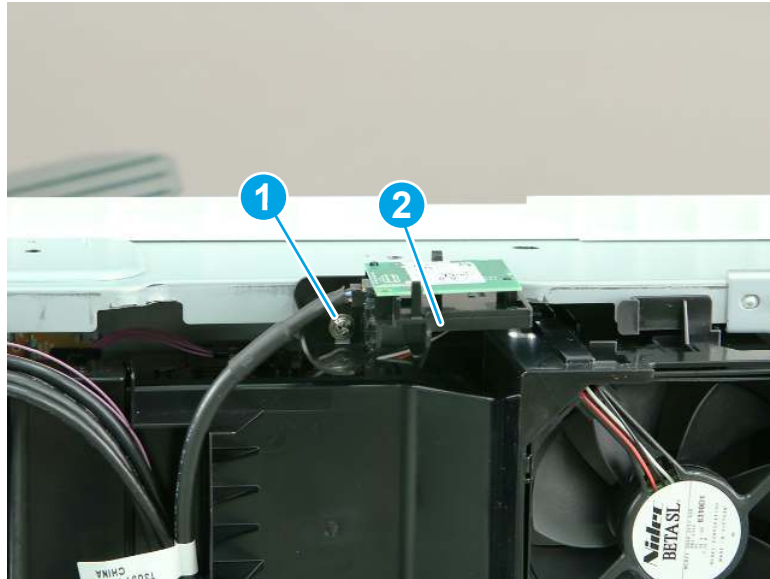
- c. Release one tab (callout 1), and then slide the fan duct to the left (callout 2) to remove it.

Figure 1-1312 Remove the fan duct



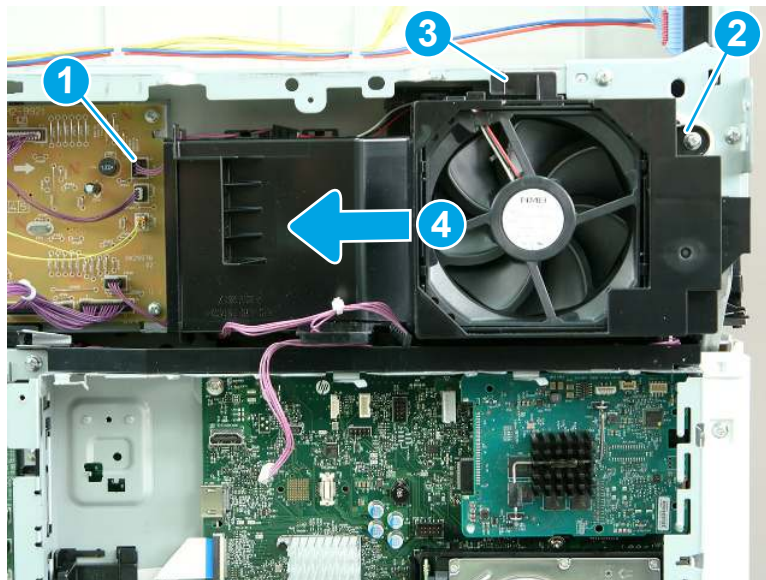
- d. **M856 and E85055 only:** Remove one screw (callout 1), and then remove the wireless card and bracket (callout 2).

Figure 1-1313 Remove the wireless card and bracket



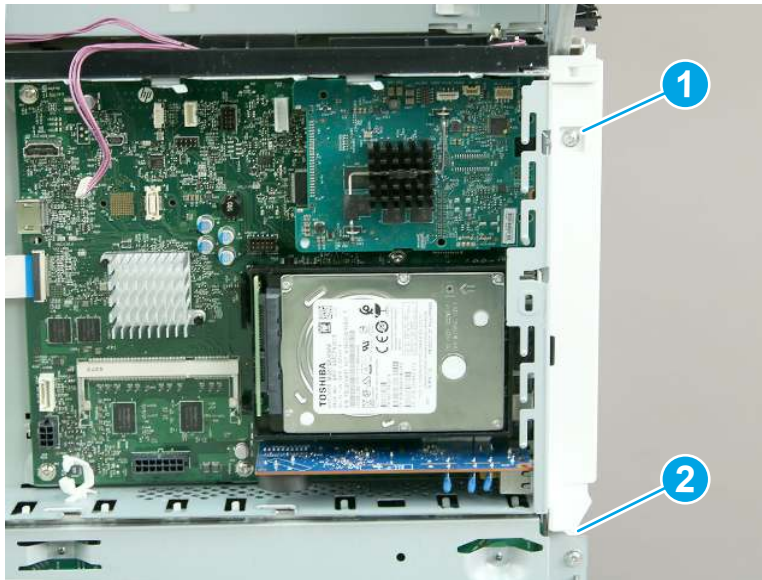
- e. Disconnect one connector (callout 1), and remove one screw (callout 2). Release one tab (callout 3), and then slide the fan assembly to the left (callout 4) to remove it.

Figure 1-1314 Remove the fan assembly



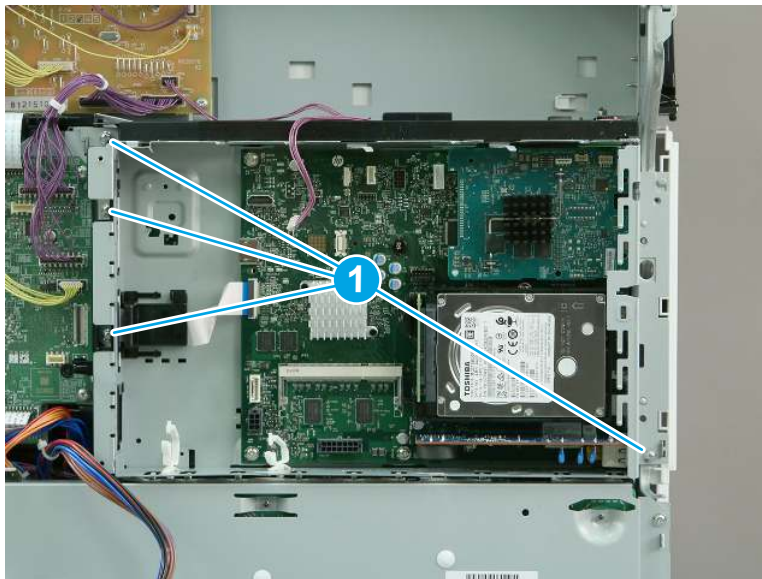
- f. Remove one screw (callout 1), release one tab (callout 2), and then remove the left rear cover.

Figure 1-1315 Remove the left rear cover



- g. Remove four screws (callout 1).

Figure 1-1316 Remove four screws



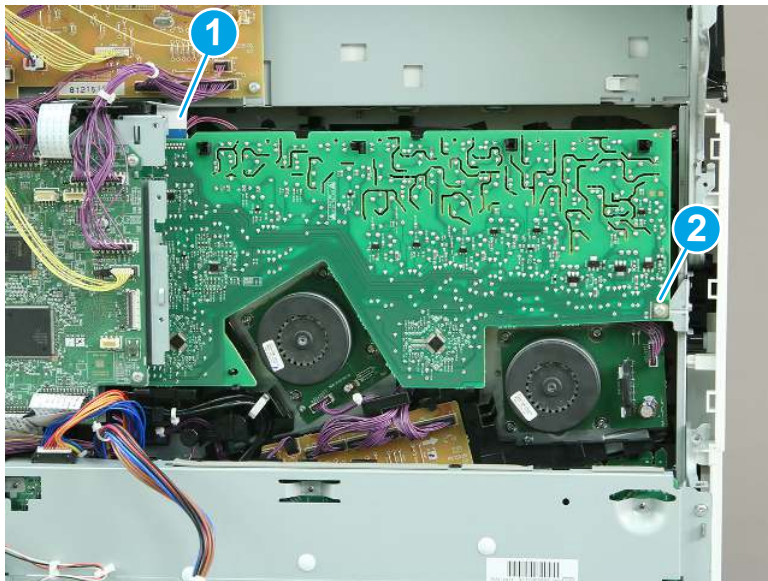
- h. Remove the formatter and case.

Figure 1-1317 Remove the formatter and case



- 10. Remove the upper high-voltage power supply (HVPS) (M856/E85055/M776).
 - a. Disconnect one connector (callout 1), and then remove one screw (callout 2).

Figure 1-1318 Disconnect one connector and remove one screw



- b. Release six tabs (callout 1), and then remove the upper HVPS.

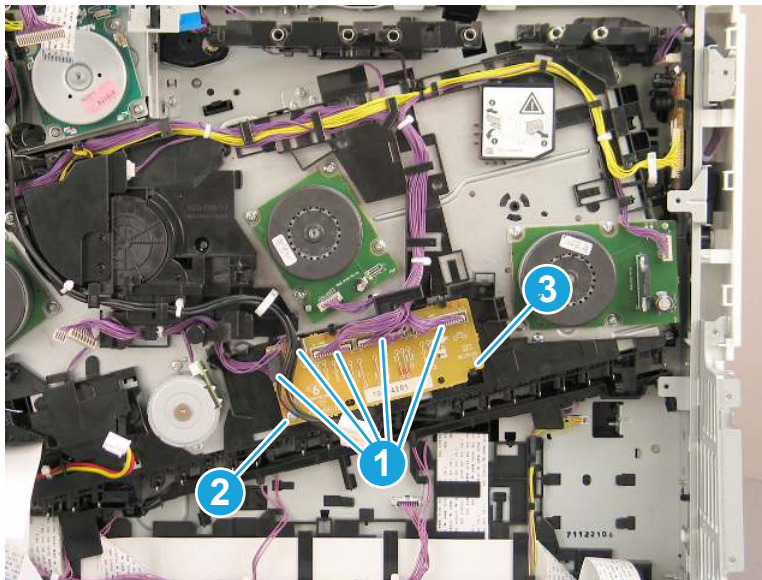
Figure 1-1319 Release six tabs



11. Remove the main connecting PCA.

- ▲ Disconnect five connectors (callout 1), and then remove one screw (callout 2). Release one tab (callout 3), and then remove the main connecting PCA.

Figure 1-1320 Remove the main connecting PCA



12. Unpack the replacement assembly.


- a. Dispose of the defective part.




NOTE: HP recommends responsible disposal of the defective part.

<http://www8.hp.com/us/en/hp-information/environment/product-recycling.html>

- b. Unpack the replacement part from the packaging.

 **IMPORTANT:** Make sure that all of the shipping materials (for example shipping tape) are removed from the replacement part prior to installation.

- c. To install an assembly, reverse the removal steps.

 **NOTE:** When applicable, special installation instructions are provided for an assembly at the end of the removal procedure. Always completely read the removal instructions and follow all special installation instructions.

Removal and replacement: Controller fan (M856/E85055/M776)

Learn how to remove and replace the controller fan.


Mean time to repair: 10 minutes

Service level: Easy

Before performing service

Turn the printer power off

- Disconnect the power cable.

 **WARNING!** To avoid damage to the printer, turn the printer off, wait 30 seconds, and then remove the power cord before attempting to service the printer.

Use the table below to identify the correct part number for your printer. To order the part, go to www.hp.com/buy/parts.

Table 1-77 Part information

Part number	Part description
RK2-9148-000CN	Fan

Required tools

- #2 Phillips screwdriver with a magnetic tip

After performing service

Turn the printer power on

- Connect the power cable.
- Use the power switch to turn the power on.

Post service test

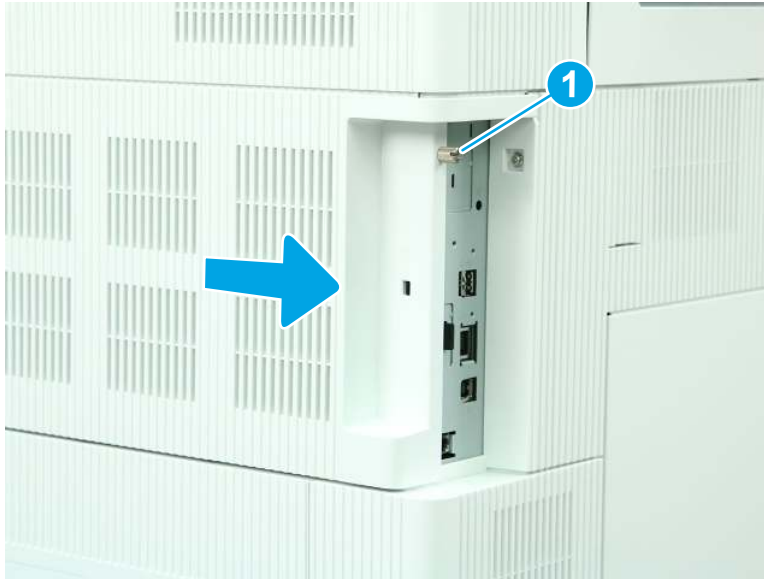
Make sure that the printer initializes to a **Ready** state.

Print a page to make sure that the printer is functioning correctly.

1. Remove the formatter cover.

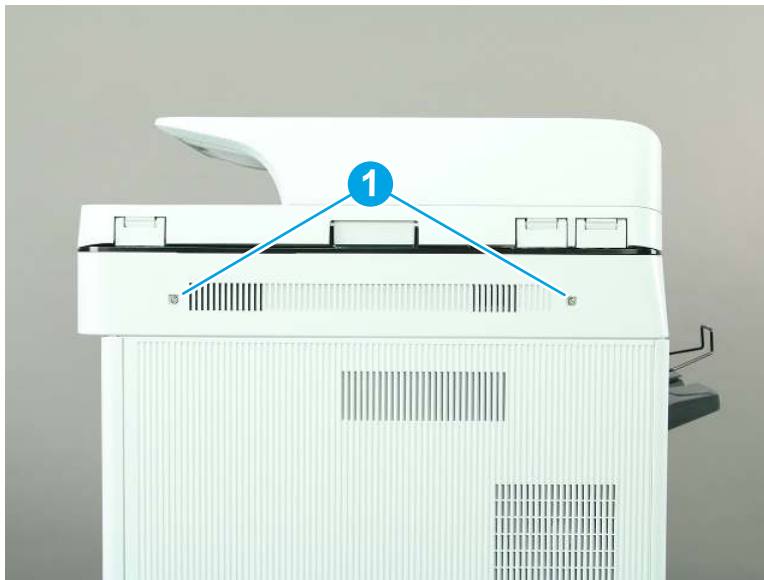
- ▲ Loosen one thumbscrew (callout 1), and then slide the formatter cover (callout 2) away from the printer to remove it.

Figure 1-1321 Remove the formatter cover



- 2. Remove the scanner control board (SCB) cover (M776).
 - a. Remove two screws (callout 1).

Figure 1-1322 Remove two screws



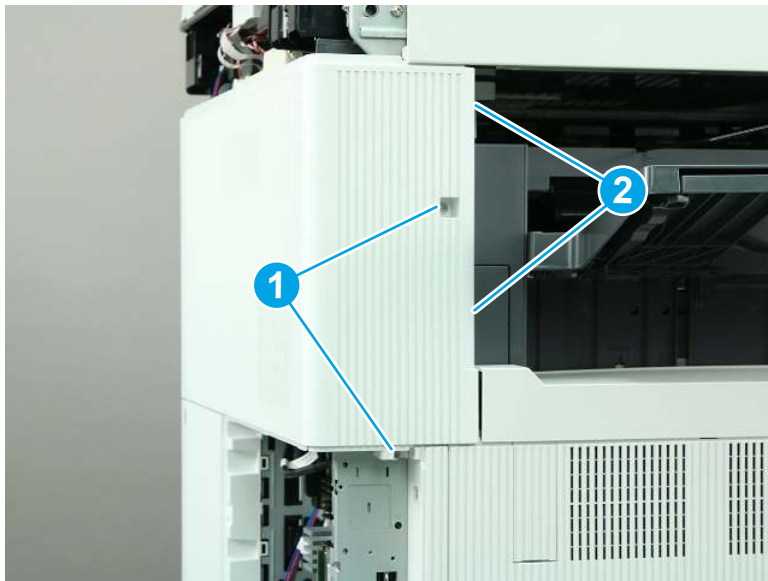
- b. Remove the SCB cover.

Figure 1-1323 Remove the SCB cover



3. Remove the rear upper cover and left rear upper cover (M776zs).
 - a. Remove two screws (callout 1), and then release two tabs (callout 2).

Figure 1-1324 Remove two screws and release two tabs



- b. Slide the cover to the right to remove it.

Figure 1-1325 Remove the rear upper and left rear upper cover

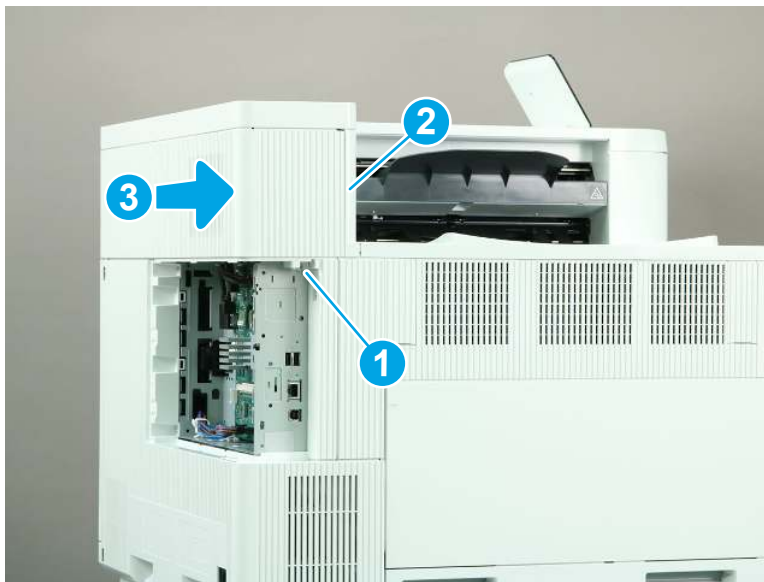


4. Remove the rear upper cover (M856/E85055/M776dn/M776z).

 **NOTE:** The following figure shows the M856 printer. The procedure is correct for all referenced models.

- ▲ Remove one screw (callout 1), release one tab (callout 2), and then slide the rear upper cover away from the printer to remove it (callout 3).

Figure 1-1326 Remove the rear upper cover



5. Remove the controller fan (M856/E85055/M776).

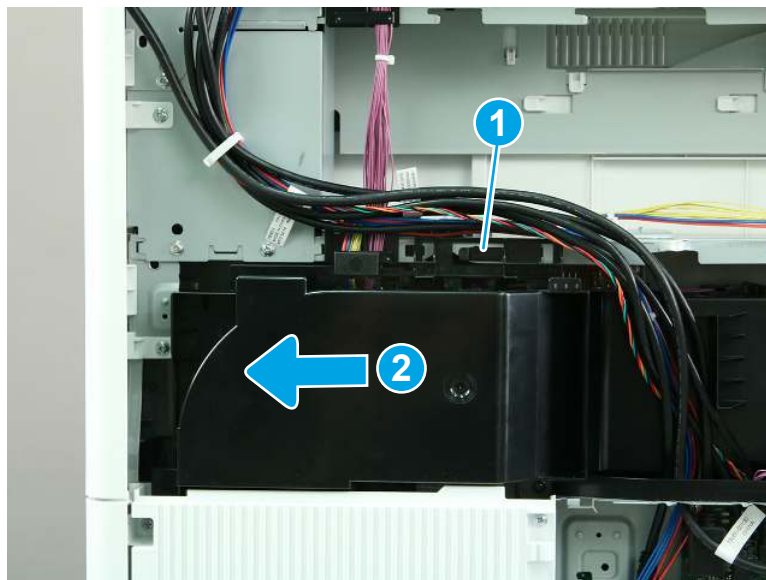
- a. Release the cables (callout 1) from the guides (callout 2).

Figure 1-1327 Release the cables from the guides



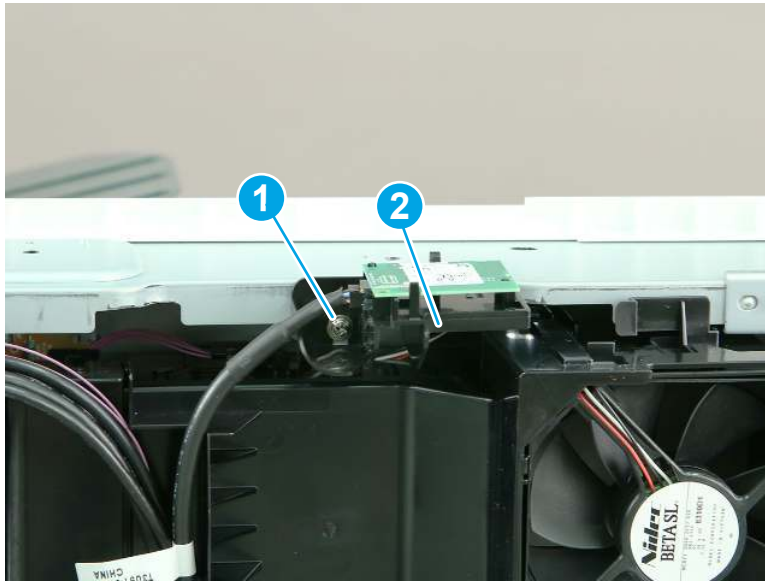
- b. Release one tab (callout 1), and then slide the fan duct to the left (callout 2) to remove it.

Remove the fan duct



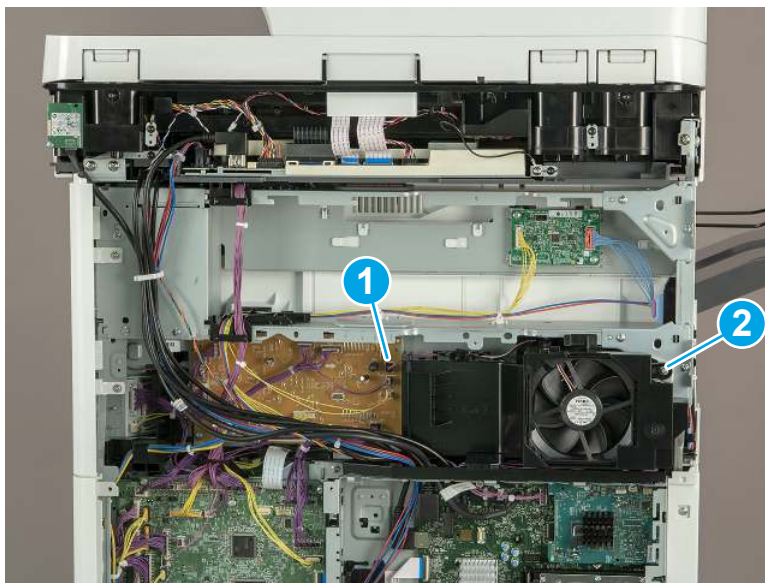
- c. **M856 and E85055 only:** Remove one screw (callout 1), and then remove the wireless card and bracket (callout 2).

Figure 1-1328 Remove the wireless card and bracket (M856/E85055)



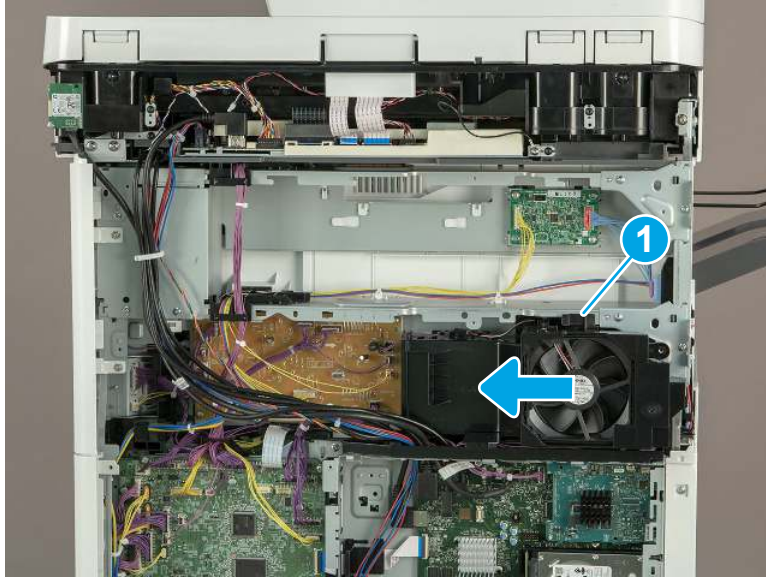
- d. Disconnect one connector (callout 1), and then remove one screw (callout 2).

Figure 1-1329 Disconnect one connector and remove one screw



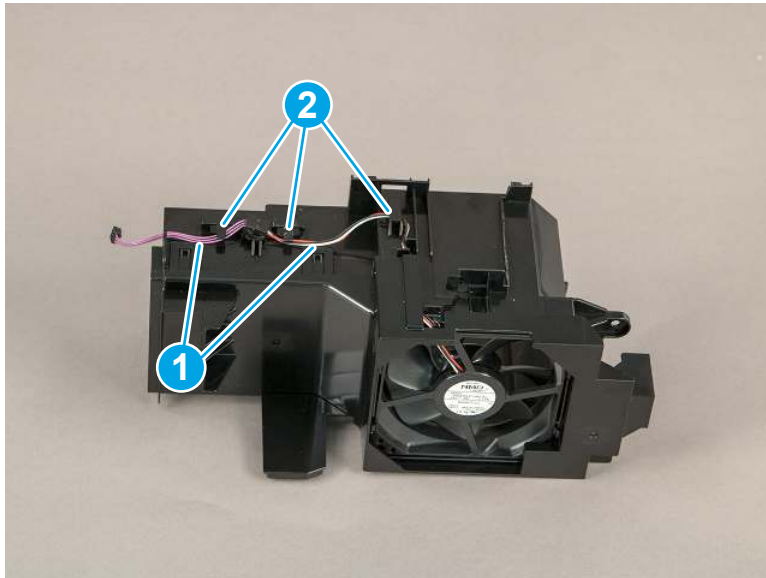
- e. Release one tab (callout 1), and then slide the fan assembly to the left to release it. Pull the assembly away from the printer to remove it.

Figure 1-1330 Remove the fan assembly



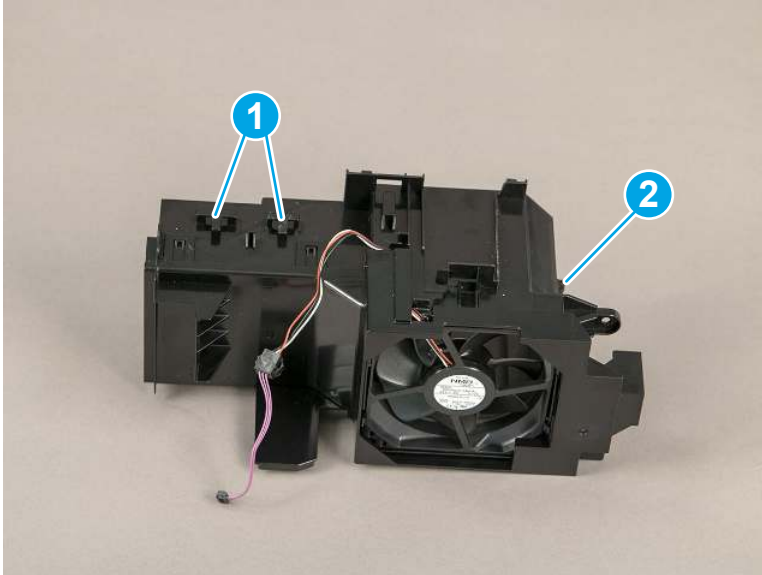
- f. Release the cables (callout 1) from the retainers (callout 2) on the fan housing.

Figure 1-1331 Release the cables



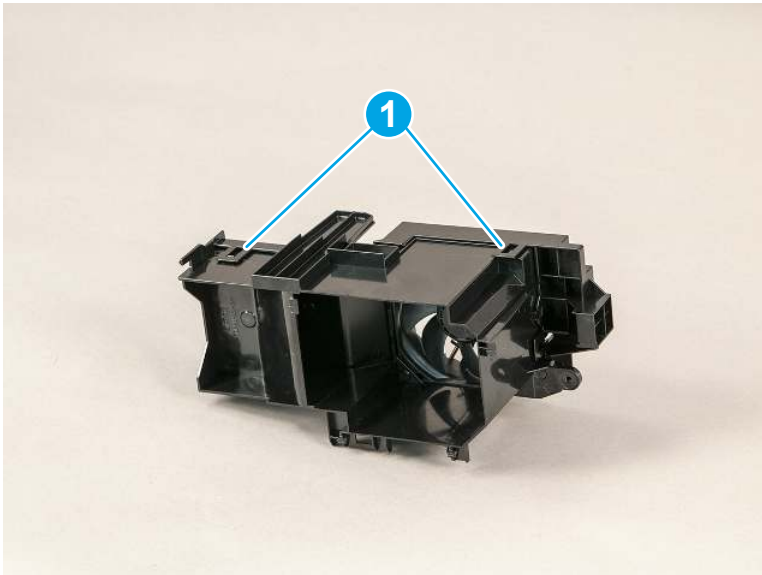
- g. Release two tabs (callout 1) on the top of the fan housing, and then release one tab (callout 2) on the end.

Figure 1-1332 Release three tabs



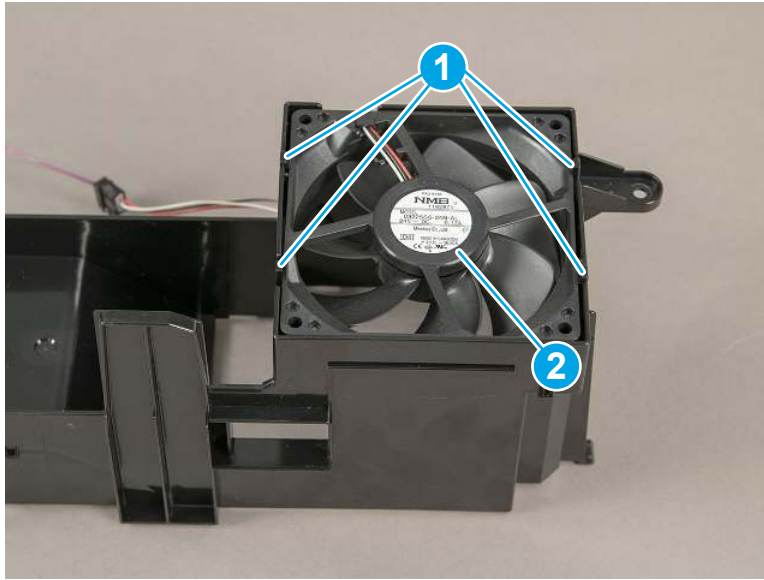
- h. Release two tabs (callout 1) on the bottom of the fan housing.

Figure 1-1333 Release two tabs



- i. Separate the fan housing. Release four tabs (callout 1), and then remove the controller tan (callout 2).

Figure 1-1334 Remove the controller fan



- 6. Unpack the replacement assembly.

- a. Dispose of the defective part.




NOTE: HP recommends responsible disposal of the defective part.

<http://www8.hp.com/us/en/hp-information/environment/product-recycling.html>

- b. Unpack the replacement part from the packaging.



CAUTION:  Some parts are sensitive to electrostatic discharge (ESD). Always perform service work at an ESD-protected workstation or mat. If an ESD workstation or mat is not available, touch the sheet-metal chassis to provide a static ground before touching an ESD-sensitive assembly. Protect the ESD-sensitive assemblies by placing them in ESD pouches when they are out of the printer.



IMPORTANT: Make sure that all of the shipping materials (for example shipping tape) are removed from the replacement part prior to installation.

- c. To install an assembly, reverse the removal steps.



NOTE: When applicable, special installation instructions are provided for an assembly at the end of the removal procedure. Always completely read the removal instructions and follow all special installation instructions.

Removal and replacement: Laser scanner (M751/E75245/M856/E85055/M776)

Learn how to remove and replace the laser scanner.

[View a video of how to remove and replace the laser scanner.](#)

Mean time to repair: 7 minutes

Service level: Easy

Before performing service

Turn the printer power off

- Disconnect the power cable.

⚠ WARNING! To avoid damage to the printer, turn the printer off, wait 30 seconds, and then remove the power cord before attempting to service the printer.

Use the table below to identify the correct part number for your printer. To order the part, go to www.hp.com/buy/parts.

Table 1-78 Part information

Part number	Part description
RM2-1328-020CN	Laser scanner assembly

Required tools

- #2 Phillips screwdriver with a magnetic tip
- Small, flat-blade screwdriver

After performing service

Turn the printer power on

- Connect the power cable.
- Use the power switch to turn the power on.

Post service test

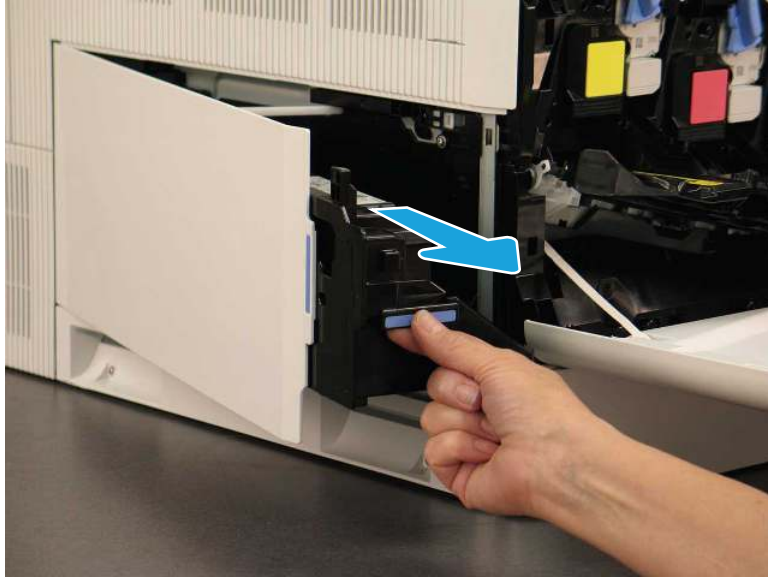
Make sure that the printer initializes to a **Ready** state.

Print a page to make sure that the printer is functioning correctly.

1. Remove the TCU.

- ▲ Open the front door, and then open the left door. Grasp the front of the toner-collection unit, and then remove it from the printer.

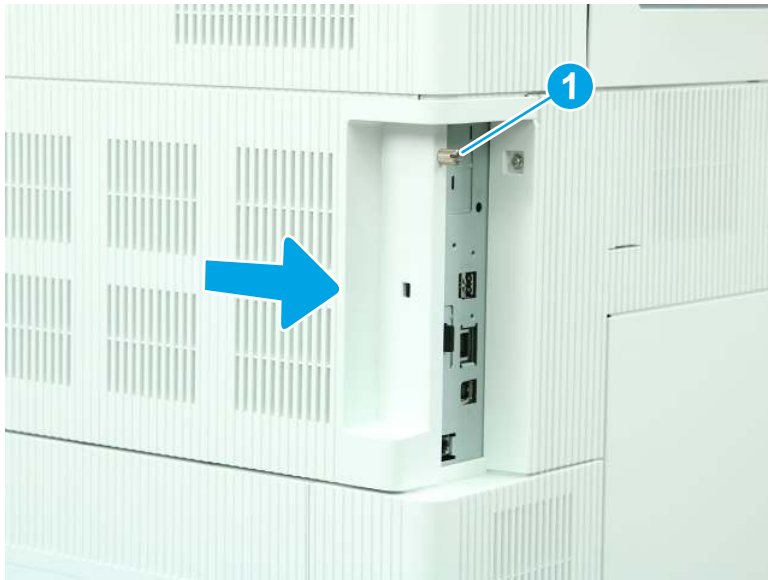
Figure 1-1335 Remove the TCU



2. Remove the formatter cover.

- ▲ Loosen one thumbscrew (callout 1), and then slide the formatter cover (callout 2) away from the printer to remove it.

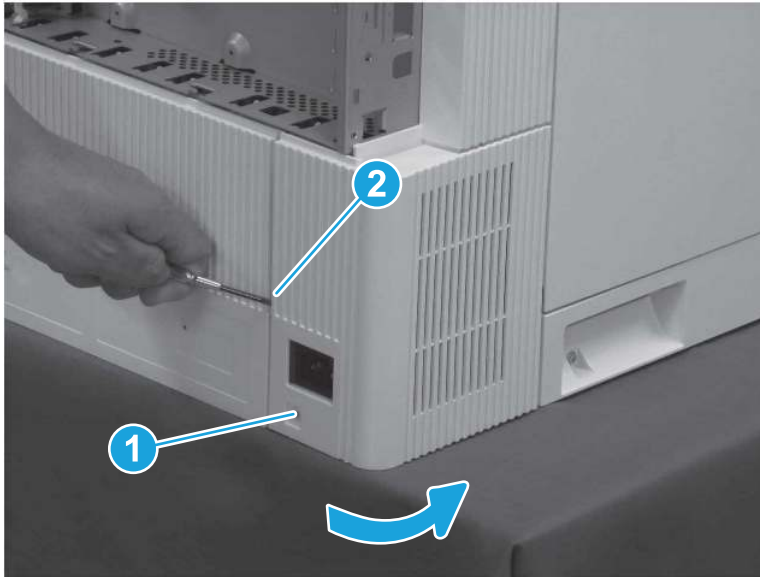
Figure 1-1336 Remove the formatter cover



3. Remove the left lower cover (M751/E75245).

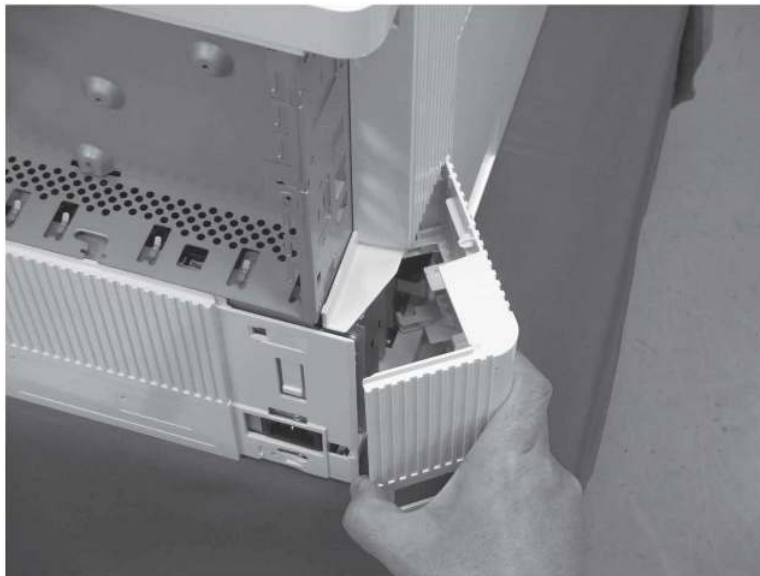
- a. Remove one screw (callout 1), release one tab (callout 2), and then rotate the cover away from the printer.

Figure 1-1337 Remove one screw and release one tab



- b. Remove the left lower cover.

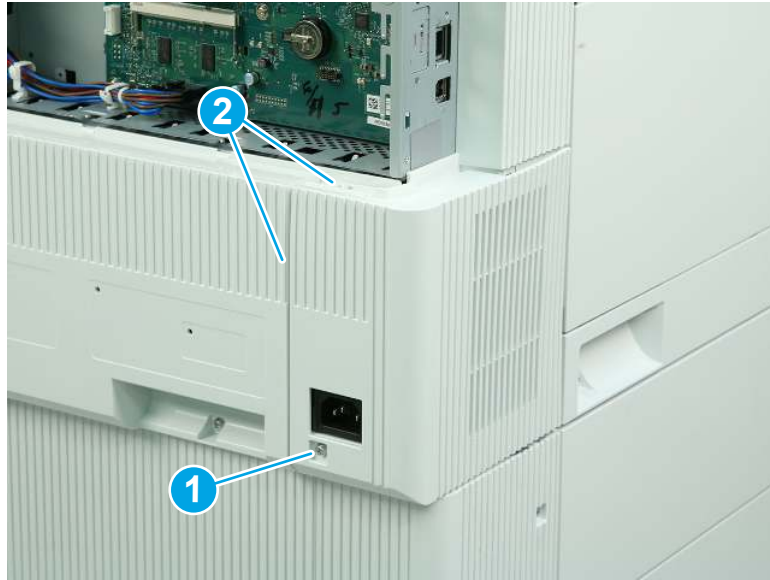
Figure 1-1338 Remove the left lower cover



4. Remove the left lower cover (M856/E85055/M776).

- a. Remove one screw (callout 1), and then release two tabs (callout 2).

Figure 1-1339 Remove one screw and release two tabs



- b. Rotate the cover away from the printer to remove it.

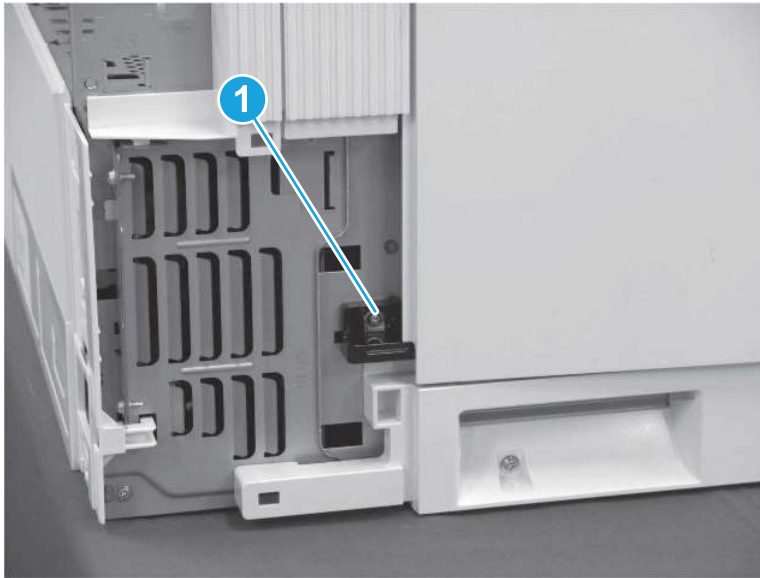
Figure 1-1340 Remove the left lower cover



5. Remove the left door.

- a. Remove one screw (callout 1).

Figure 1-1341 Remove one screw



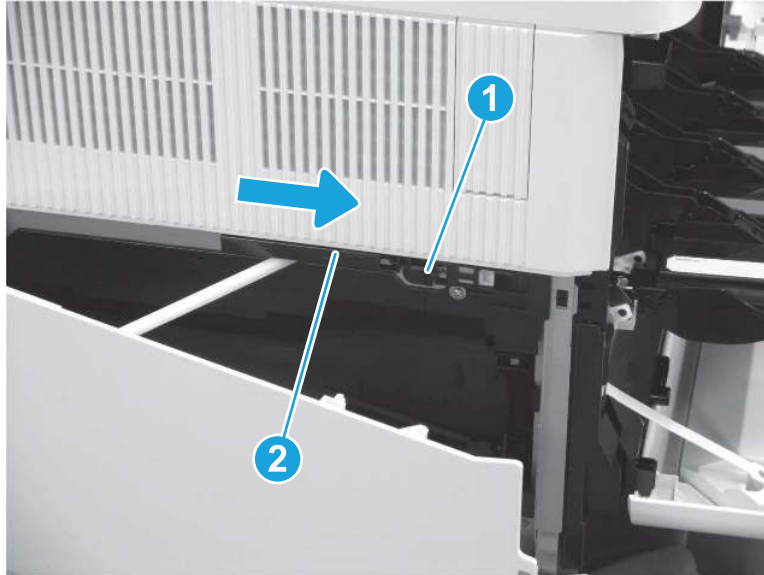
- b. Release the holder, and then remove it from the printer.

Figure 1-1342 Remove the holder



- c. Open the left door, and release one tab (callout 1). Slide the holder (callout 2) toward the front of the printer.

Figure 1-1343 Slide the holder



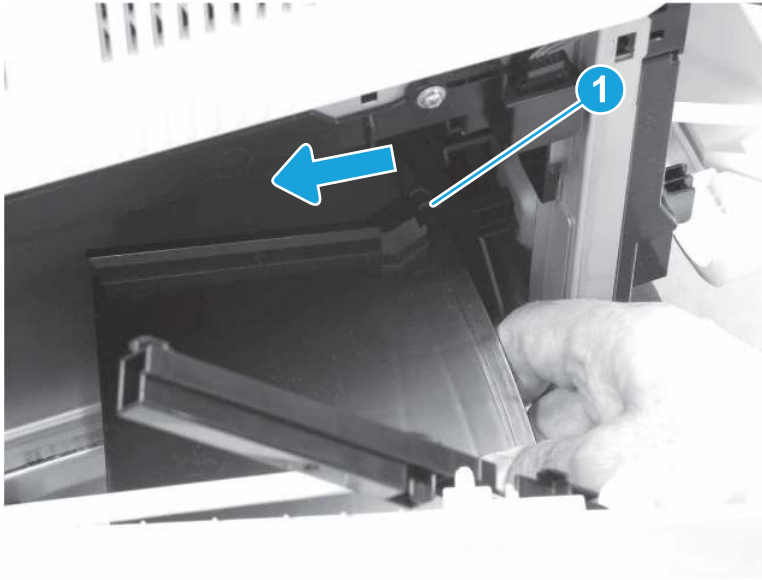
- d. Release the holder (callout 1) from the printer, but leave it attached to the hinge.

Figure 1-1344 Release the holder



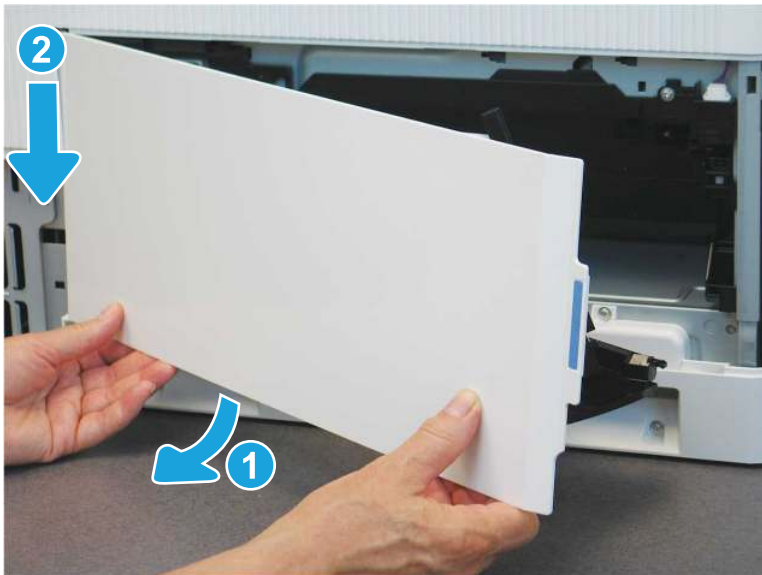
- e. Press the stopper (callout 1) on the bottom of the door to the left to release it from the track.

Figure 1-1345 Release the stopper



- f. Rotate the left, lower edge of the door away from the printer (callout 1), and then lower the door to remove it (callout 2).

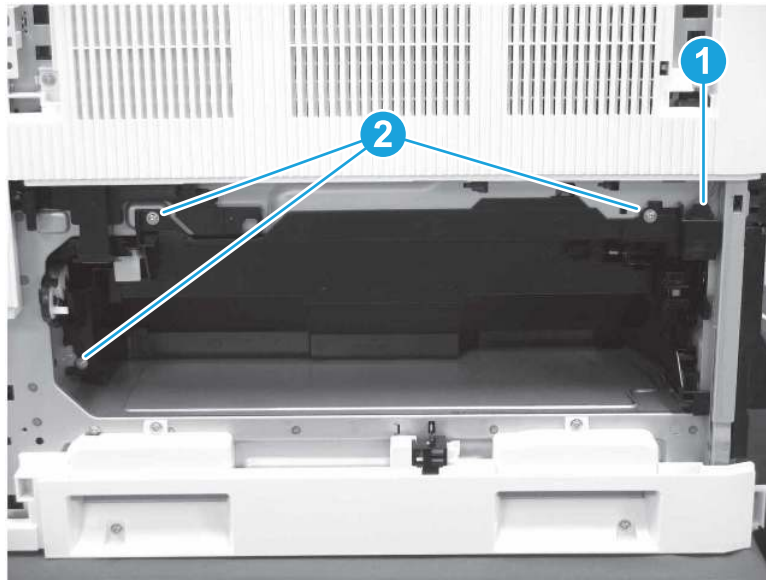
Figure 1-1346 Remove the left door



- 6. Remove the scanner cover.

- a. Disconnect one connector (callout 1), and then remove three screws (callout 2).

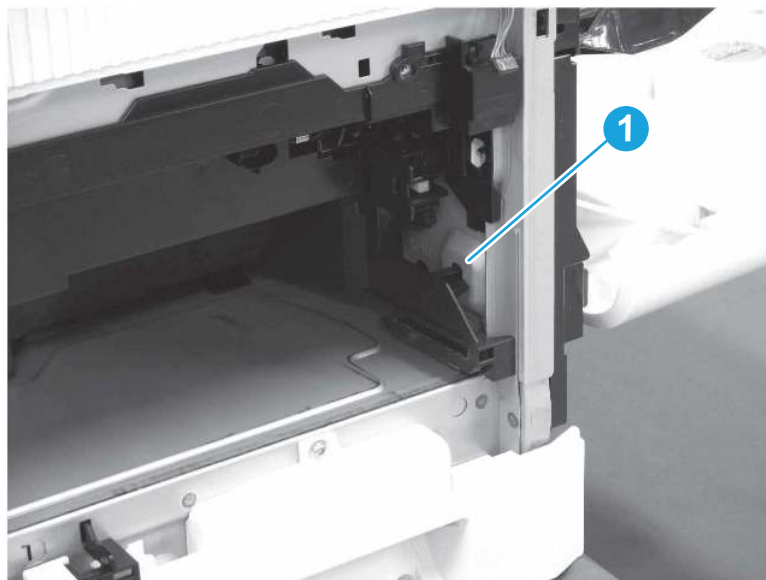
Figure 1-1347 Disconnect one connector and remove three screws




 **TIP:** Connect the connector before reinstalling the screws.

- b. Release one tab (callout 1), and then flex the scanner cover to remove it.

Figure 1-1348 Remove the scanner cover

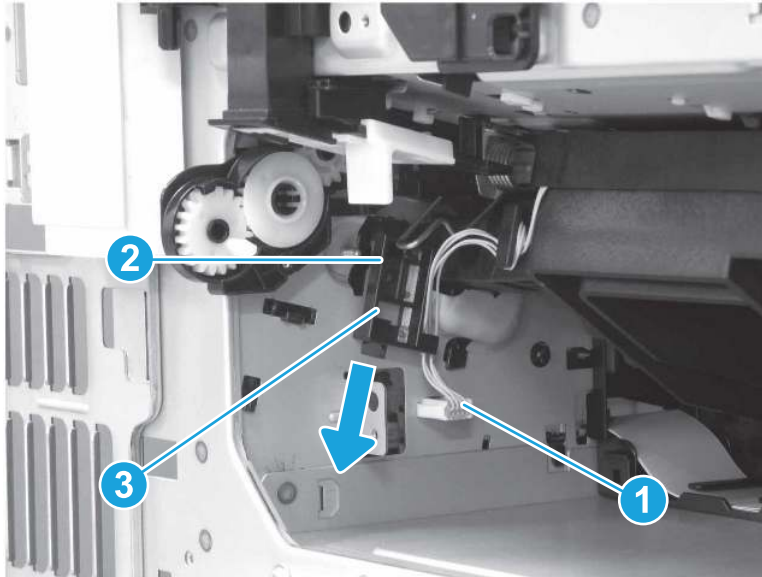


7. Remove the laser scanner.

 **IMPORTANT:** The front door must be open while removing and installing the laser scanner to avoid damaging the laser scanner cleaning pads.

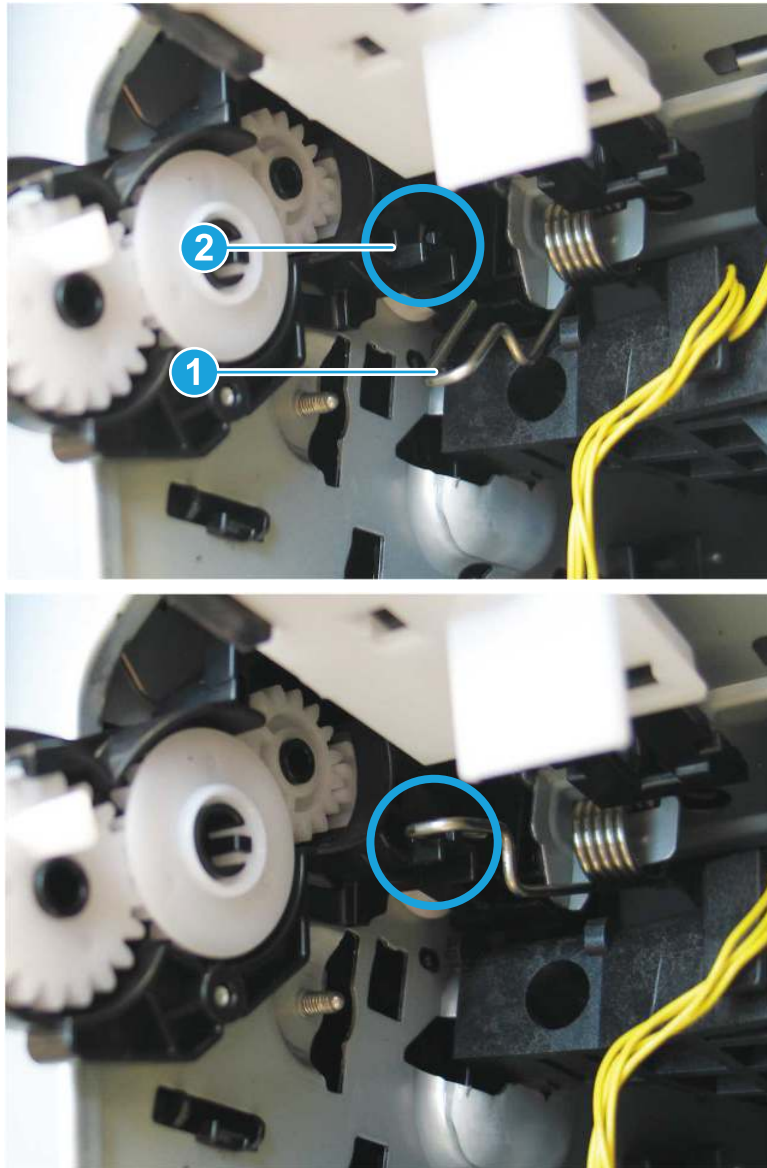
- a. Disconnect one connector (callout 1), release one tab (callout 2), and then slide the stopper (callout 3) down to remove it.

Figure 1-1349 Remove the stopper

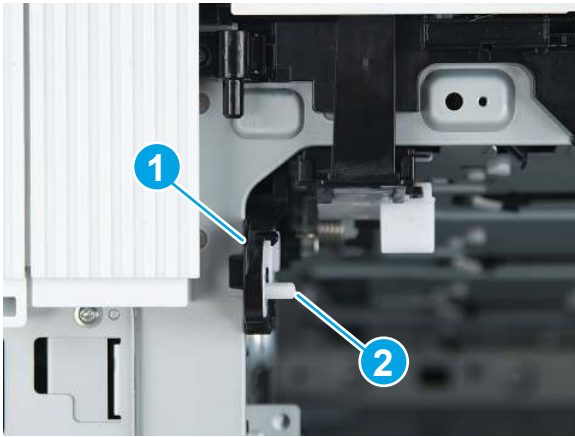


- b. Hook the spring (callout 1) on the hook (callout 2).

Figure 1-1350 Hook the spring

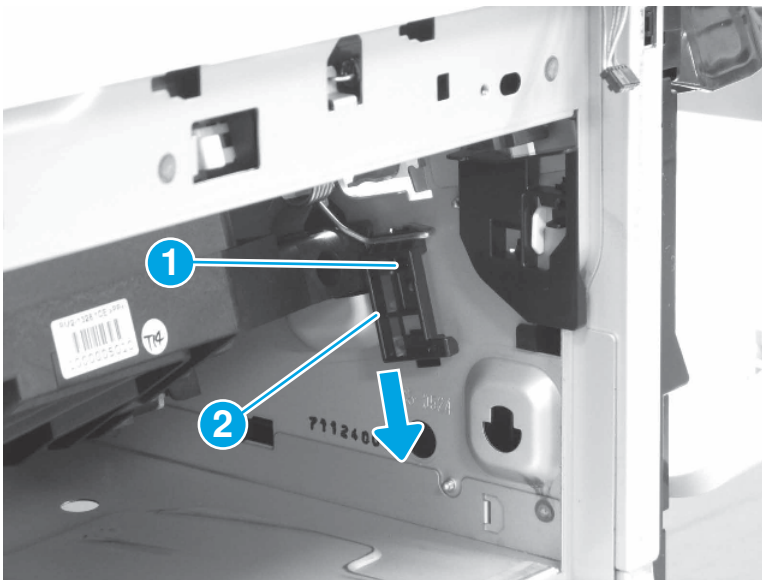


TIP: When the laser scanner is installed, make sure that the gear case is flat against the printer chassis (callout 1). The pin on the gear (callout 2) might need to be rotated out of the way when the assembly is installed.



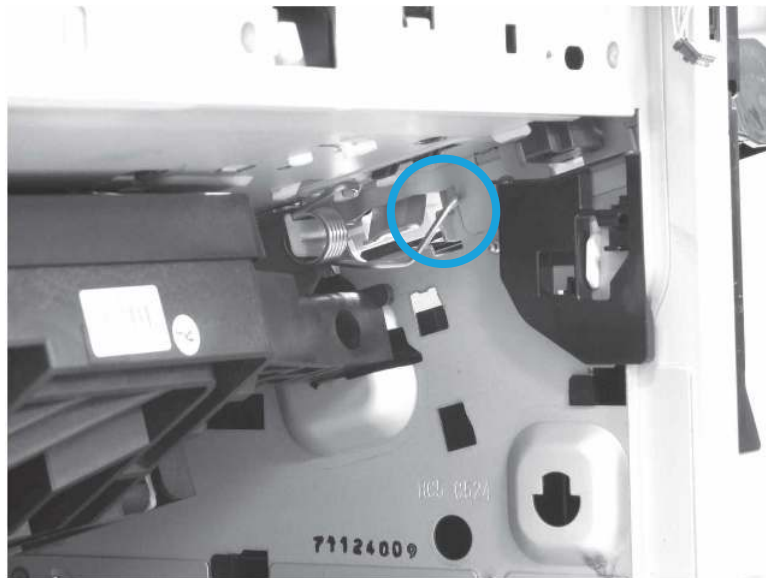
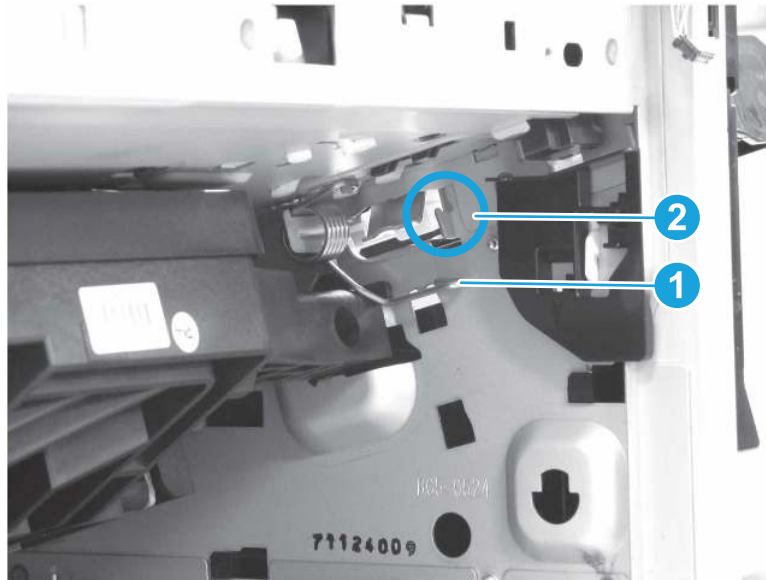
- c. On the right side of the laser scanner, release one tab (callout 1), and then slide the stopper (callout 2) down to remove it.

Figure 1-1351 Remove the stopper



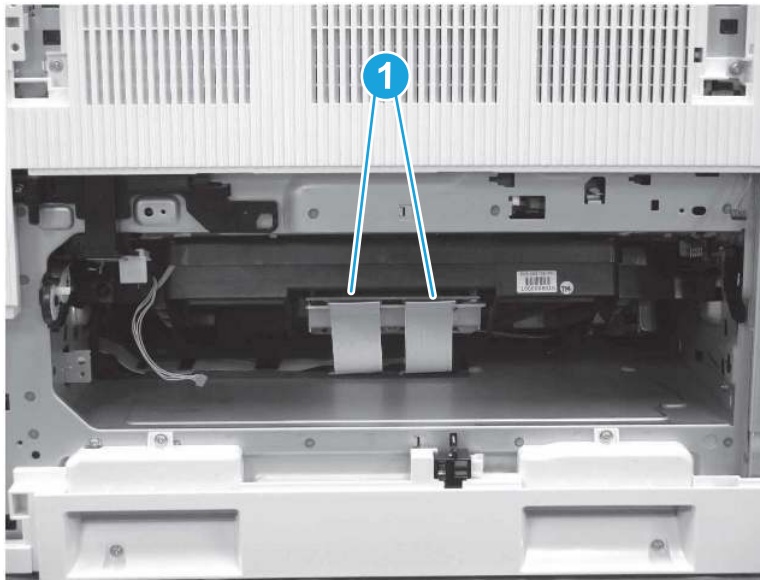
- d. Hook the spring (callout 1) on the hook (callout 2).

Figure 1-1352 Hook the spring



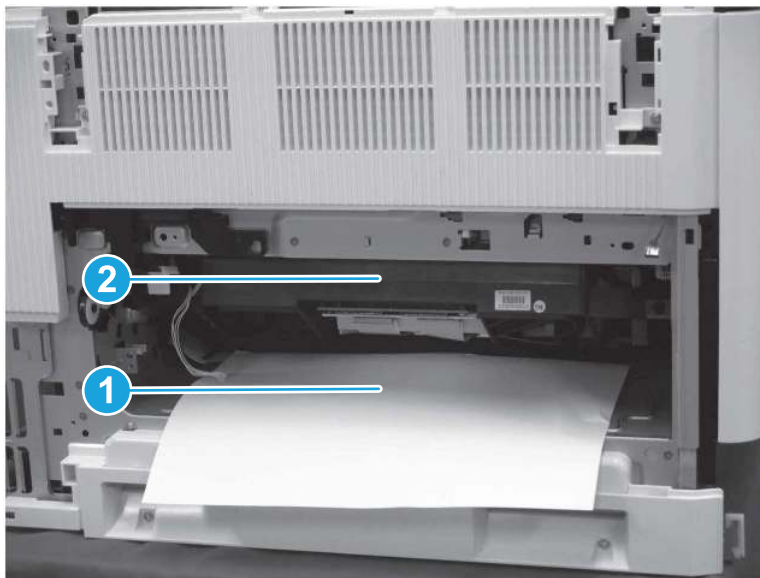
- e. Disconnect two flat cables (callout 1).


Figure 1-1353 Disconnect two flat cables




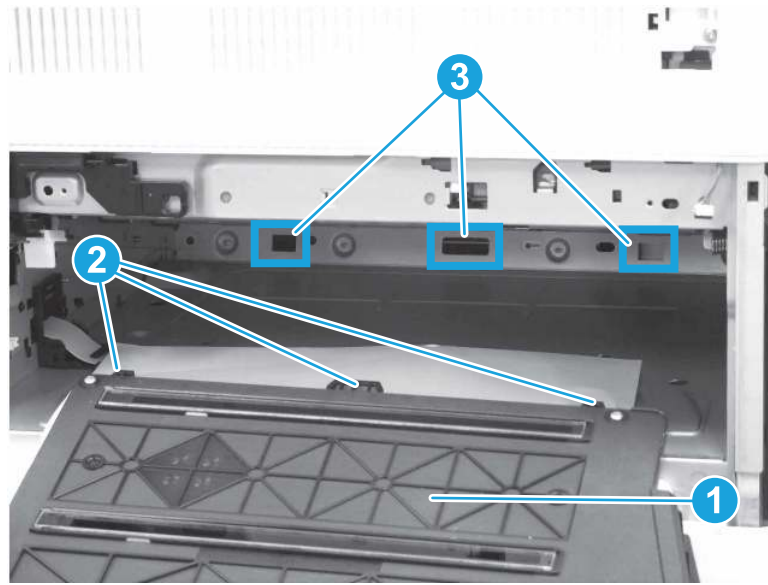
- f. Lay a sheet of paper on top of the flat cables (callout 1) to protect them. Pull the laser scanner (callout 2) out of the printer to remove it.

Figure 1-1354 Remove the laser scanner



 **IMPORTANT:** The front door must be open while removing and installing the laser scanner to avoid damaging the laser scanner cleaning pads.

 **TIP:** When installing the laser scanner (callout 1), position the pins (callout 2) on the laser scanner into the openings (callout 3) inside the printer.



8. Unpack the replacement assembly.

a. Dispose of the defective part.



NOTE: HP recommends responsible disposal of the defective part.

<http://www8.hp.com/us/en/hp-information/environment/product-recycling.html>

b. Unpack the replacement part from the packaging.



CAUTION: 

Some parts are sensitive to electrostatic discharge (ESD). Always perform service work at an ESD-protected workstation or mat. If an ESD workstation or mat is not available, touch the sheet-metal chassis to provide a static ground before touching an ESD-sensitive assembly. Protect the ESD-sensitive assemblies by placing them in ESD pouches when they are out of the printer.



IMPORTANT: Make sure that all of the shipping materials (for example shipping tape) are removed from the replacement part prior to installation.

c. To install an assembly, reverse the removal steps.



NOTE: When applicable, special installation instructions are provided for an assembly at the end of the removal procedure. Always completely read the removal instructions and follow all special installation instructions.

Removal and replacement: Pickup assembly (M751/E75245/M856/E85055/M776)

Learn how to remove and replace the pickup assembly.

[View a video of how to remove and replace the pickup assembly.](#)

Mean time to repair: 28 minutes

Service level: Medium

Before performing service

Turn the printer power off

- Disconnect the power cable.

⚠ WARNING! To avoid damage to the printer, turn the printer off, wait 30 seconds, and then remove the power cord before attempting to service the printer.

Use the table below to identify the correct part number for your printer. To order the part, go to www.hp.com/buy/parts.

Table 1-79 Part information

Part number	Part description
RM2-1393-010CN	Pickup assembly (M751/E75245)
RM2-3908-000CN	Pickup assembly (M856/E85055/M776)

Required tools

- #2 Phillips screwdriver with a magnetic tip
- Small, flat-blade screwdriver

After performing service

Turn the printer power on

- Connect the power cable.
- Use the power switch to turn the power on.

Post service test

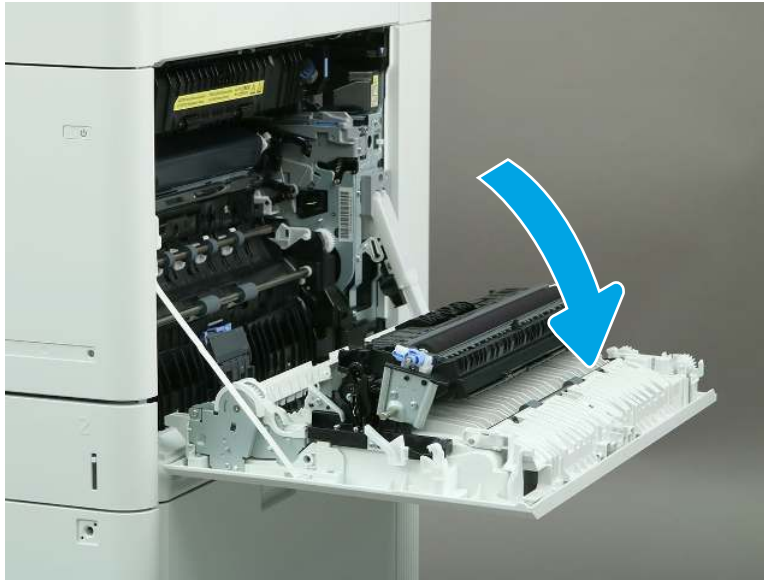
Make sure that the printer initializes to a **Ready** state.

Print a page to make sure that the printer is functioning correctly.

1. Remove the secondary transfer roller.

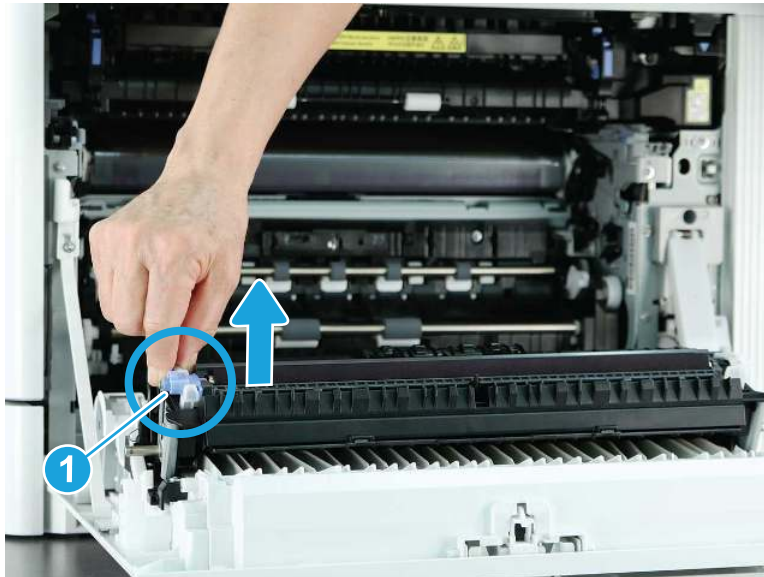
- a. Open the right door.

Figure 1-1355 Open the right door



- b. Release the latch (callout 1), and then lift the left side of the roller.

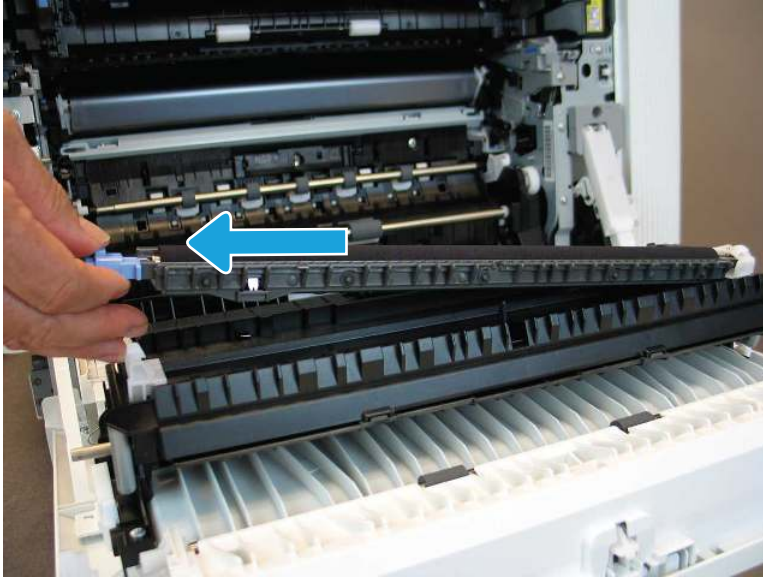
Figure 1-1356 Release the transfer roller



- c. Slide the transfer roller to the left to remove it.

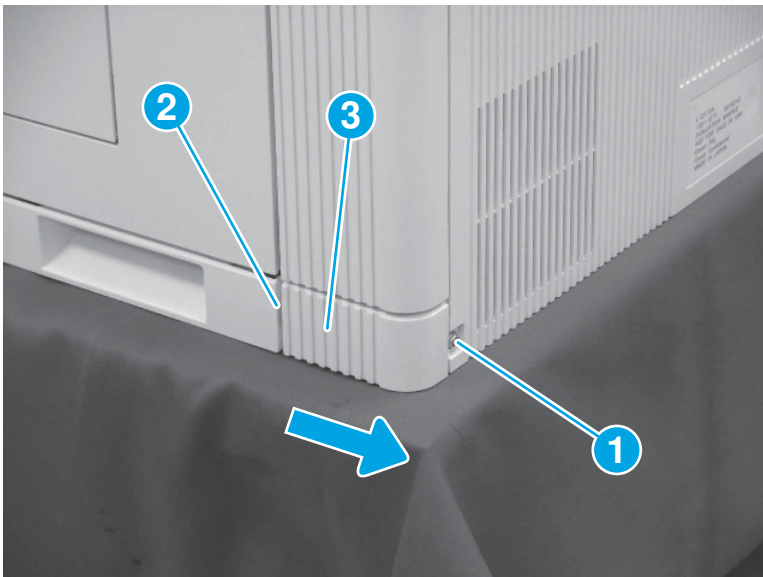
⚠ CAUTION: Do not touch the surface of the secondary transfer roller.

Figure 1-1357 Remove the secondary transfer roller



2. Remove the right rear lower cover (M751/E75245/M856/E85055/M776).
 - ▲ Remove one screw (callout 1), release one tab (callout 2), and then slide the right rear lower cover (callout 3) toward the back of the printer to remove it.

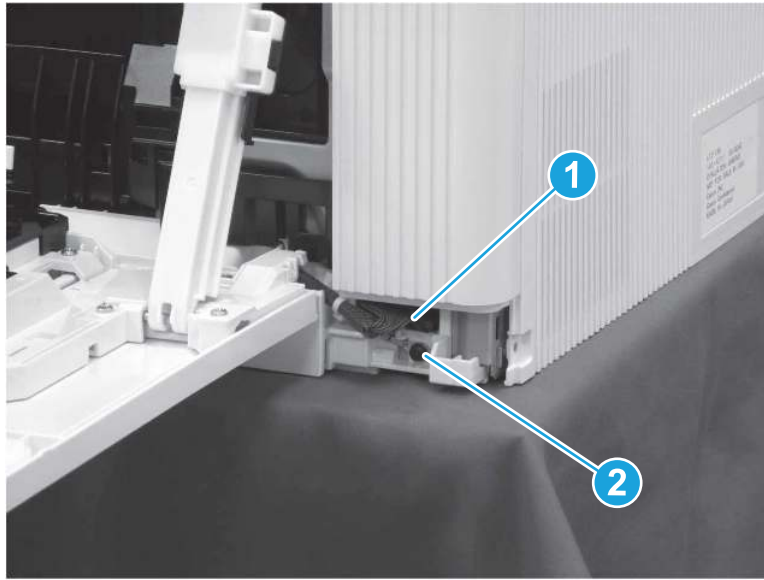
Figure 1-1358 Remove the right rear lower cover



3. Remove the right door.

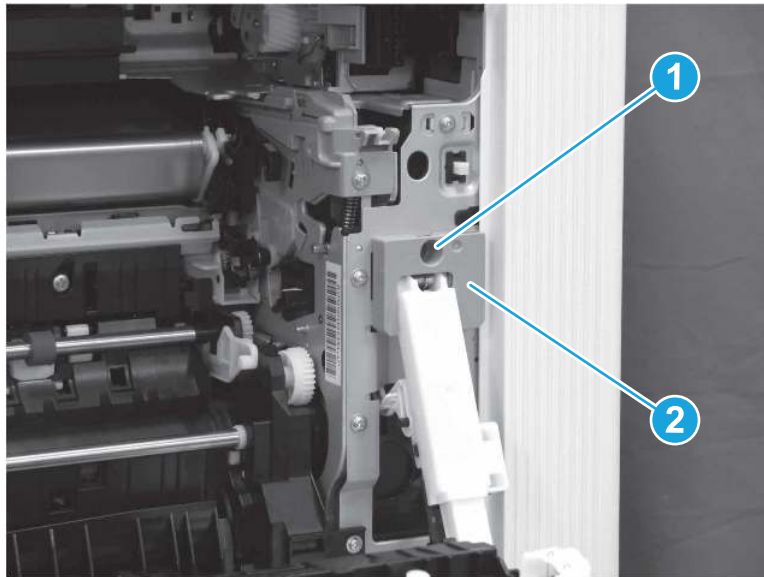
- a. Disconnect one connector (callout 1), and then remove one black grounding screw (callout 2).

Figure 1-1359 Disconnect one connector and remove one screw



- b. Remove one self-tapping screw (callout 1), and then remove the cover (callout 2).

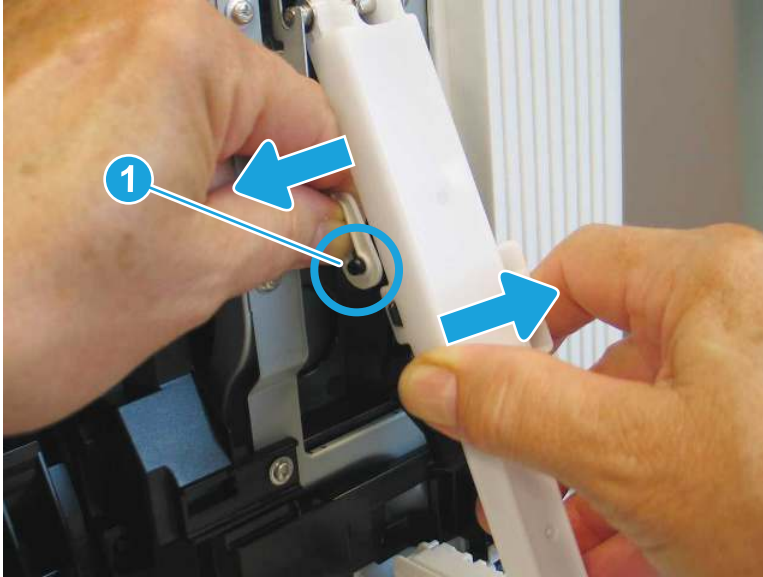
Figure 1-1360 Remove the cover



- c. Push the damper slightly to the right, and gently pull the link arm to the left to release the boss (callout 1) from the link arm.

 **IMPORTANT:** Make sure to reattach this link arm when reinstalling the right door. Failure to do so might cause damage to the link arm, requiring a larger repair.

Figure 1-1361 Release the link arm



- d. Retract the link arm slightly into the printer to move it out of the way.

Figure 1-1362 Retract the link arm



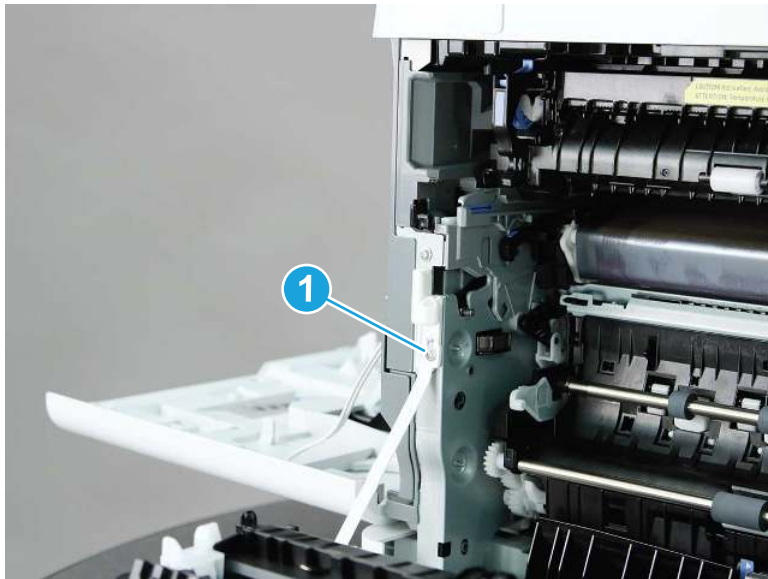
- e. Lift the dampener up, and then pull it away from the printer to release it from the bushing.

Figure 1-1363 Release the dampener



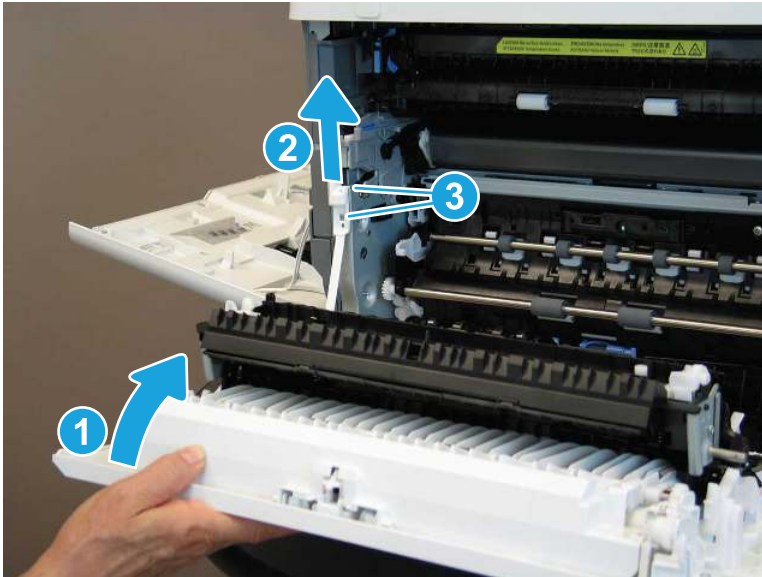
- f. Remove one screw (callout 1).

Figure 1-1364 Remove one screw



- g. Raise the door slightly (callout 1) to take tension off of the hinge. Slide the hinge up (callout 2) to release two hooks (callout 3).

Figure 1-1365 Release the hinge



- h. Release one tab (callout 1), and then remove the stopper (callout 2).


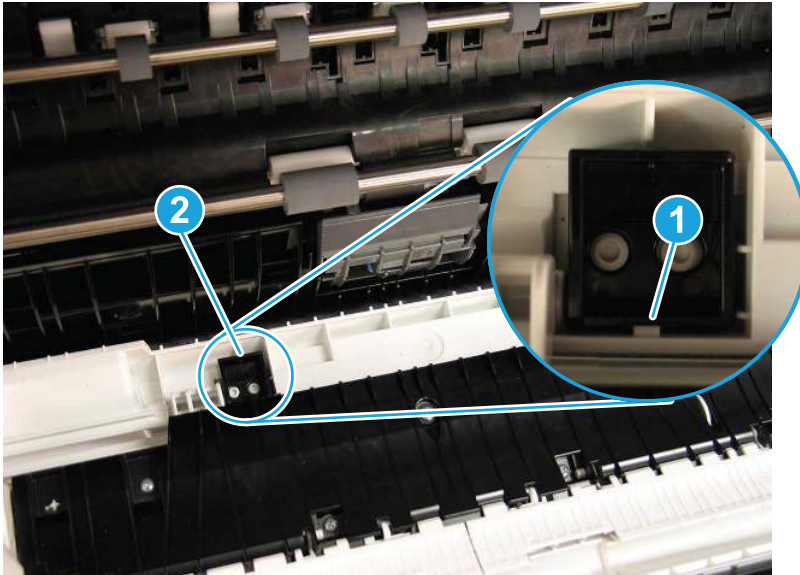
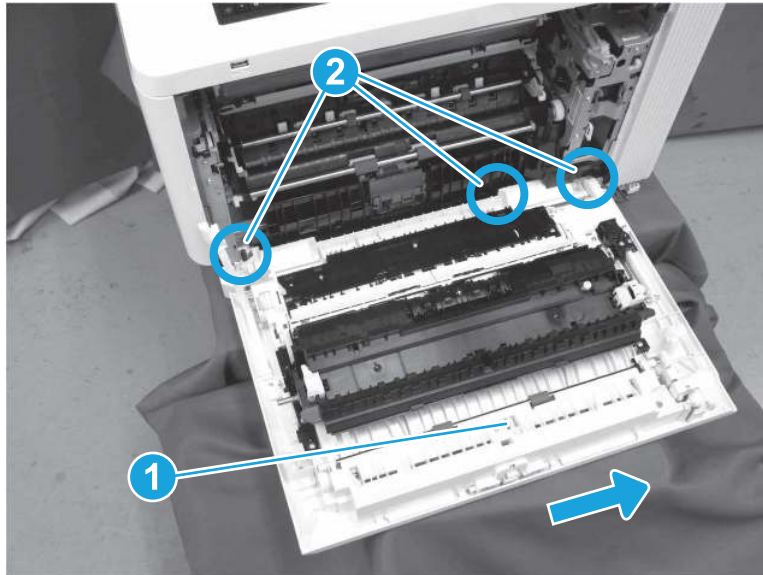
 **TIP:** Use needle-nosed pliers to release the stopper.

Figure 1-1366 Remove the stopper



- i. Slide the right door (callout 1) to the right to release it from three tabs (callout 2), and then remove the right door.

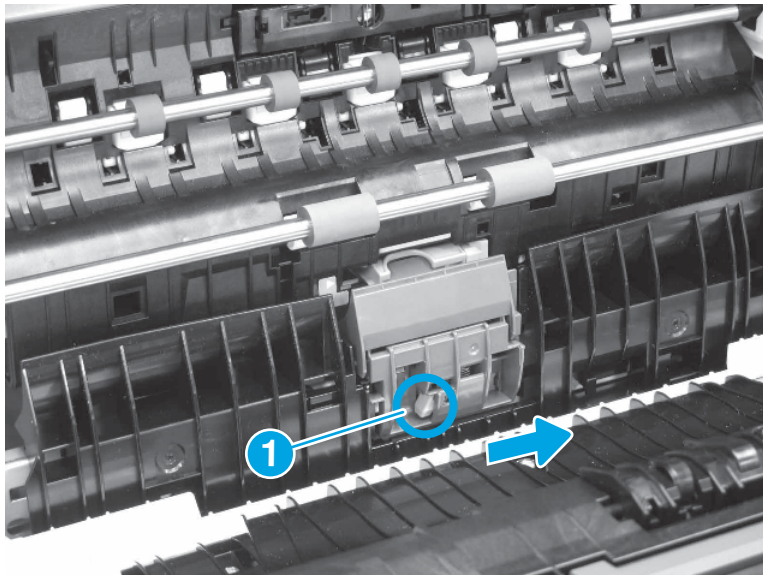
Figure 1-1367 Remove the right door



4. Remove the pickup assembly.
 - a. Press the release button (callout 1) on the Tray 2 separation roller. Slide the assembly to the right, and then pull it away from the printer to remove it.

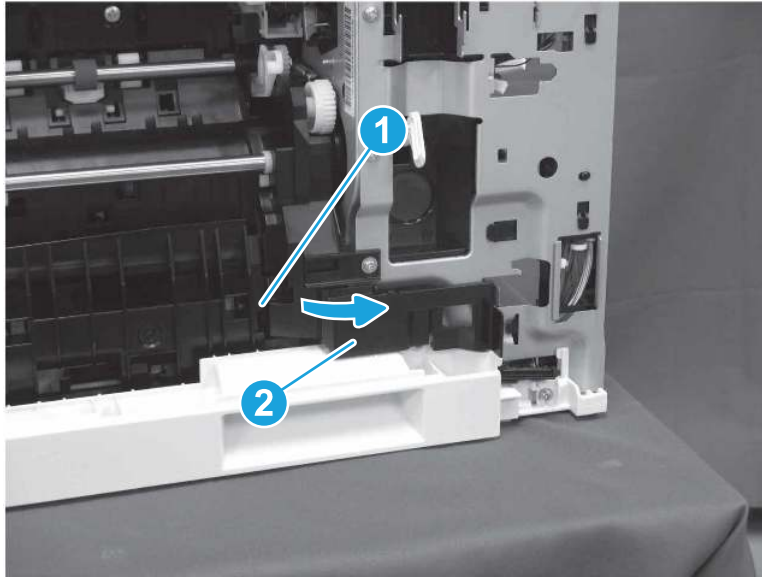
 **NOTE:** Make sure that Tray 2 is open when removing and installing the separation roller assembly.

Figure 1-1368 Remove the Tray 2 separation roller assembly



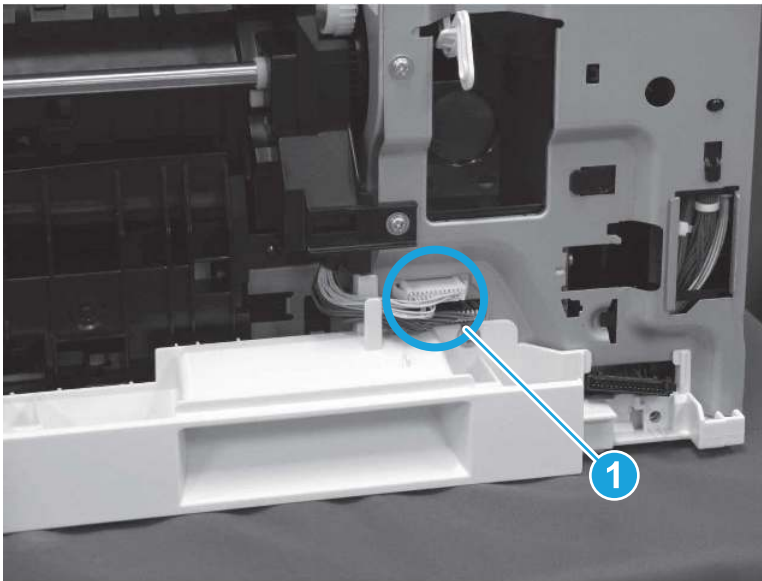
- b. Release one tab (callout 1), and then rotate the cover (callout 2) away from the printer to remove it.

Figure 1-1369 Remove the cover



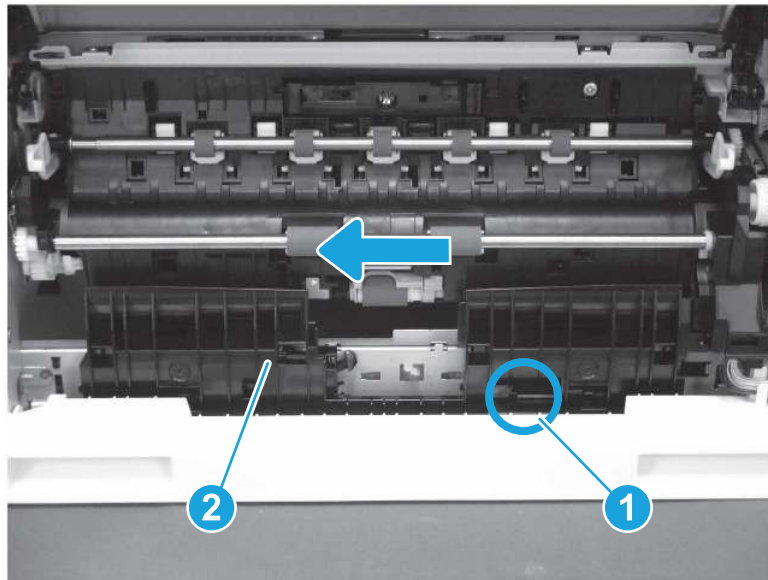
- c. Disconnect two connectors (callout 1).

Figure 1-1370 Disconnect two connectors



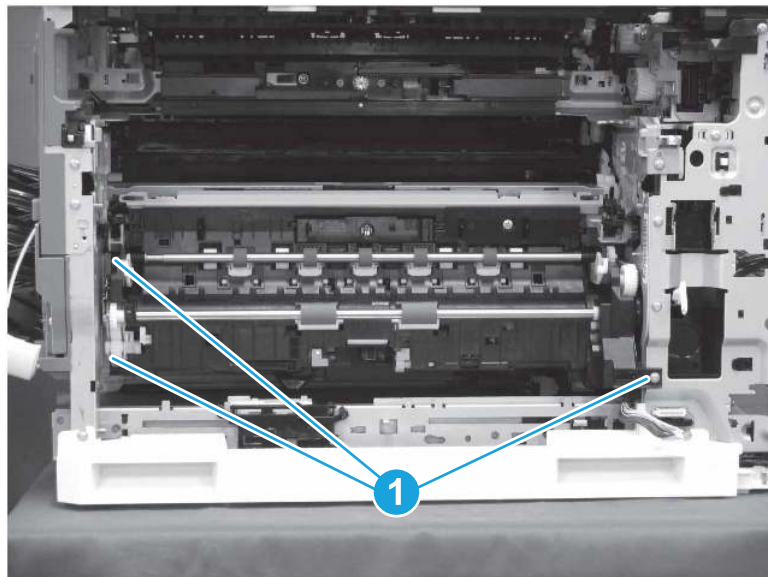
- d. Release one tab (callout 1), and then slide the guide (callout 2) to the left to remove it.

Figure 1-1371 Remove the guide



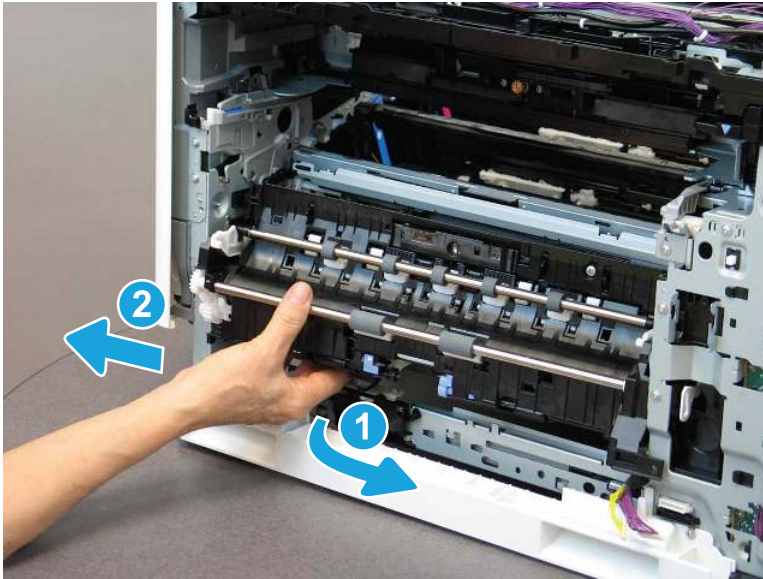
- e. Remove three screws (callout 1).

Figure 1-1372 Remove three screws



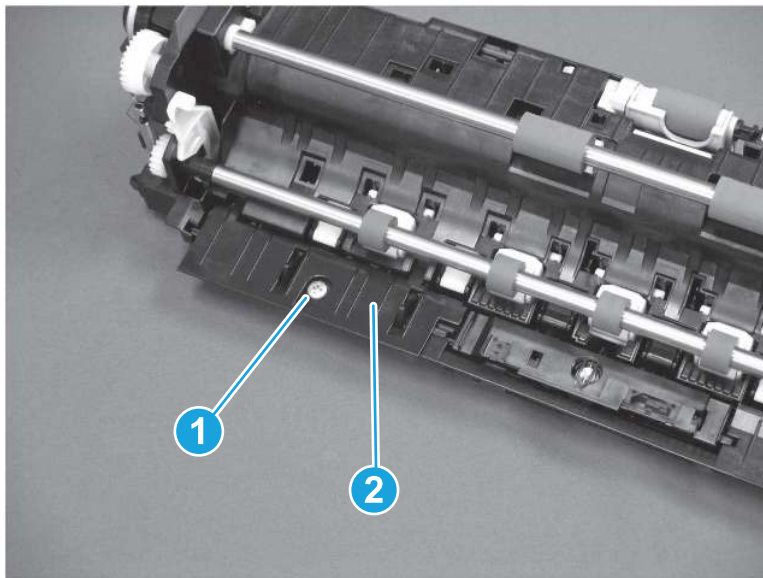
- f. Rotate the left side of the pickup assembly away from the printer (callout 1), and then slide the assembly to the left (callout 2) to remove it.

Figure 1-1373 Remove the pickup assembly



- g. Remove one screw (callout 1), and then remove the cover (callout 2).

Figure 1-1374 Remove the cover

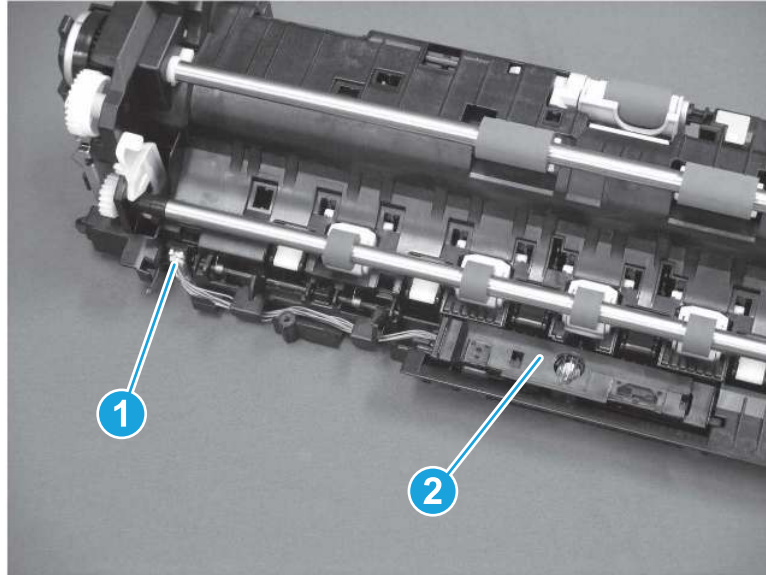


- h. Disconnect one connector (callout 1), and then remove the media sensor assembly (callout 2).



NOTE: Save the media sensor assembly and install it on the replacement pickup assembly.

Figure 1-1375 Remove the media sensor



5. Unpack the replacement assembly.

a. Dispose of the defective part.



NOTE: HP recommends responsible disposal of the defective part.

<http://www8.hp.com/us/en/hp-information/environment/product-recycling.html>

b. Unpack the replacement part from the packaging.



IMPORTANT: Make sure that all of the shipping materials (for example shipping tape) are removed from the replacement part prior to installation.

c. To install an assembly, reverse the removal steps.



NOTE: When applicable, special installation instructions are provided for an assembly at the end of the removal procedure. Always completely read the removal instructions and follow all special installation instructions.

Removal and replacement: Registration density sensor (M751/E75245/M856/E85055/M776)

Learn how to remove and replace the registration density sensor.

[View a video of how to remove and replace the registration density sensor.](#)

Mean time to repair: 25 minutes

Service level: Medium

Before performing service

Turn the printer power off

- Disconnect the power cable.

⚠ WARNING! To avoid damage to the printer, turn the printer off, wait 30 seconds, and then remove the power cord before attempting to service the printer.

Use the table below to identify the correct part number for your printer. To order the part, go to www.hp.com/buy/parts.

Table 1-80 Part information

Part number	Part description
RM2-1501-000CN	Registration density sensor
RM2-1390-000CN	RD pressure link accessory - rear (if needed)
RM2-1389-000CN	RD pressure link accessory - front (if needed)

Required tools

- #2 Phillips screwdriver with a magnetic tip
- Small, flat-blade screwdriver

After performing service

Turn the printer power on

- Connect the power cable.
- Use the power switch to turn the power on.

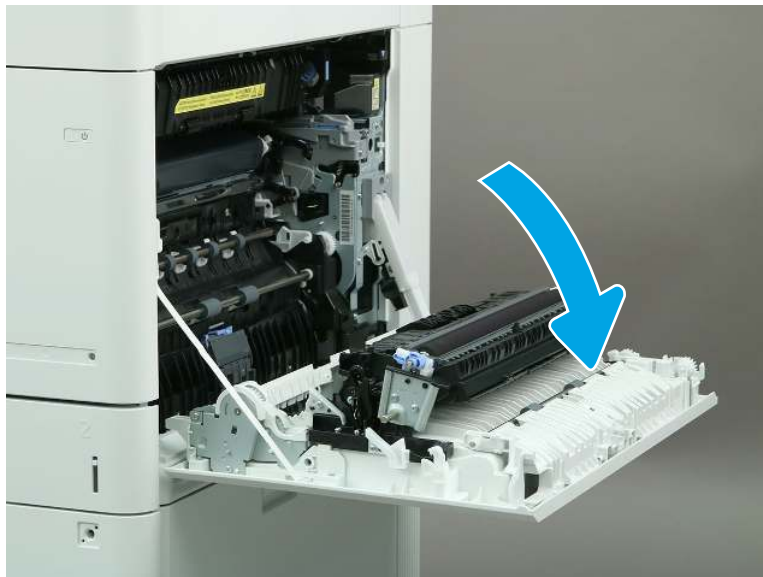
Post service test

Make sure that the printer initializes to a **Ready** state.

Print a page to make sure that the printer is functioning correctly.

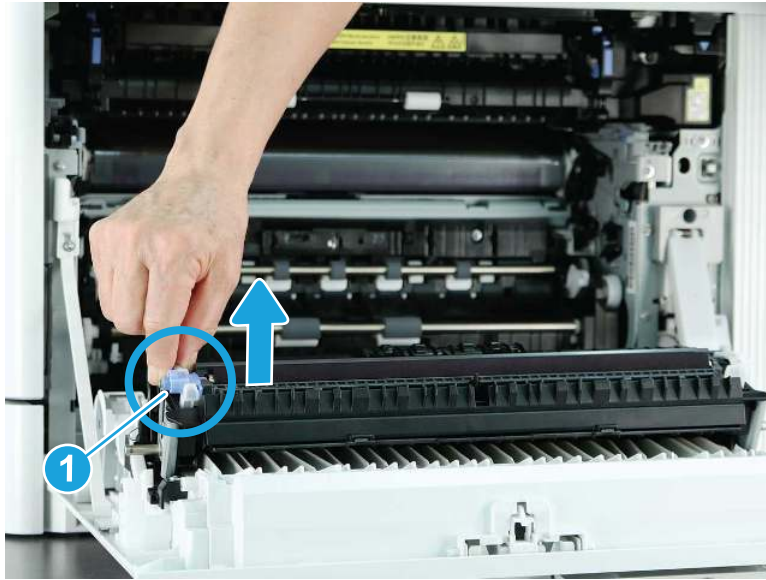
1. Remove the secondary transfer roller.
 - a. Open the right door.

Figure 1-1376 Open the right door



- b. Release the latch (callout 1), and then lift the left side of the roller.

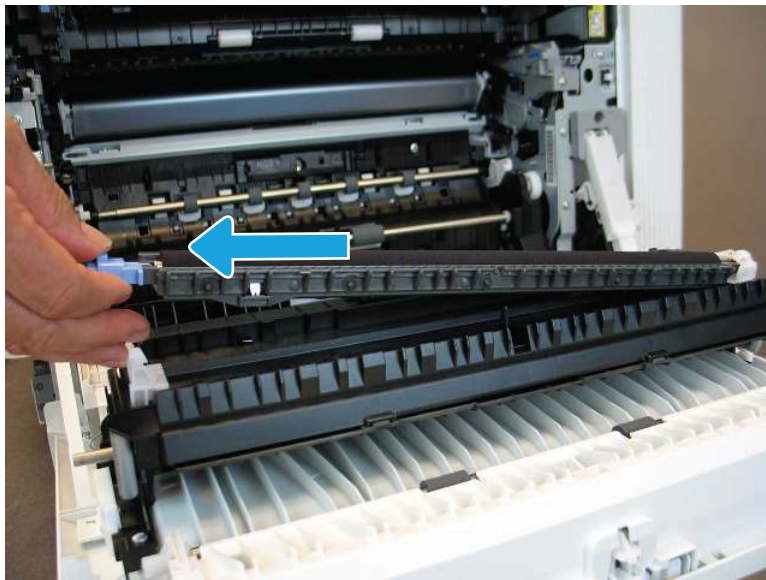
Figure 1-1377 Release the transfer roller



- c. Slide the transfer roller to the left to remove it.

⚠ CAUTION: Do not touch the surface of the secondary transfer roller.

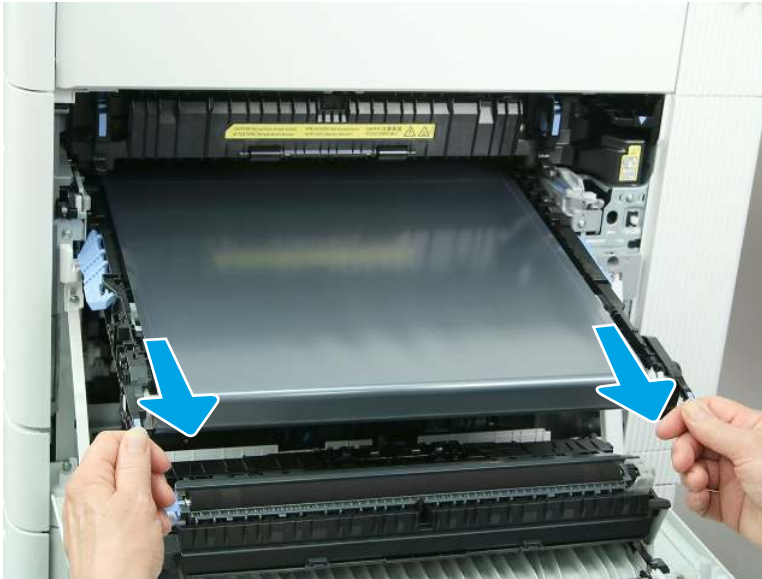
Figure 1-1378 Remove the secondary transfer roller



2. Remove the intermediate transfer belt (ITB).

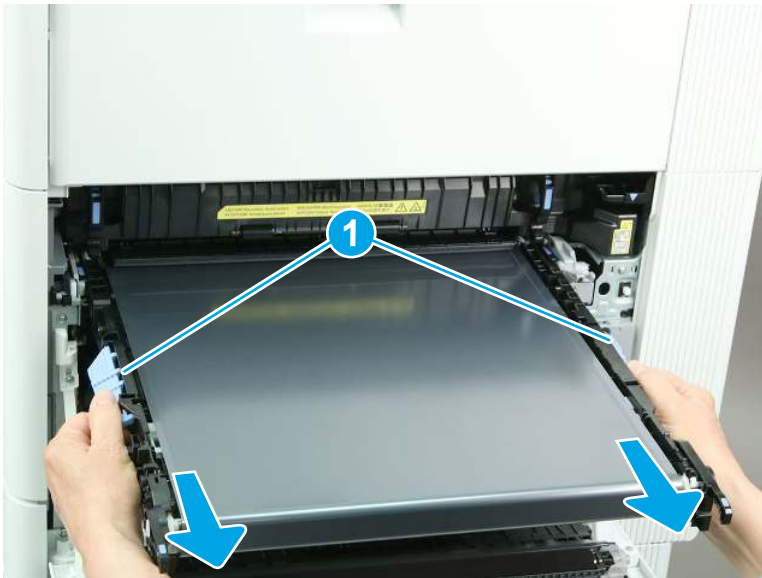
- a. Open the right door. Grasp the two blue handles on the ITB, and then pull the ITB partially out of the printer.

Figure 1-1379 Partially remove the ITB



- b. Grasp the blue handles on the side of the ITB (callout 1), and then remove the ITB from the printer.

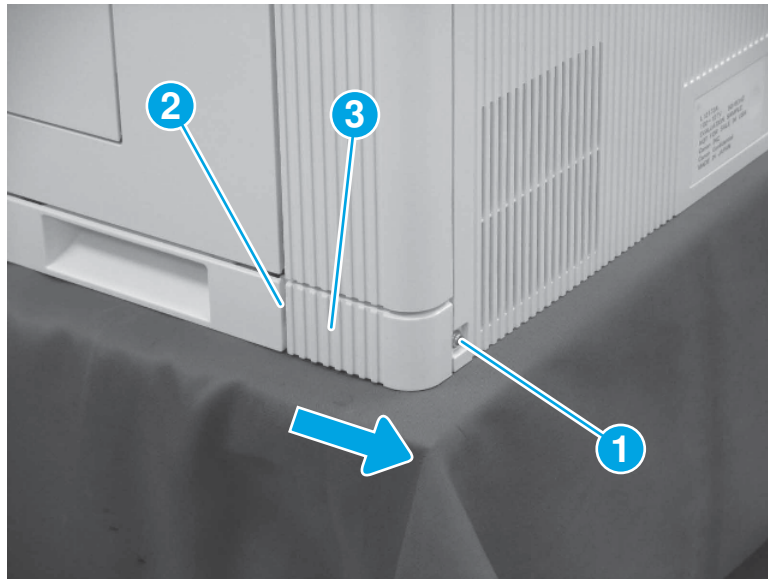
Figure 1-1380 Remove the ITB



3. Remove the right rear lower cover (M751/E75245/M856/E85055/M776).

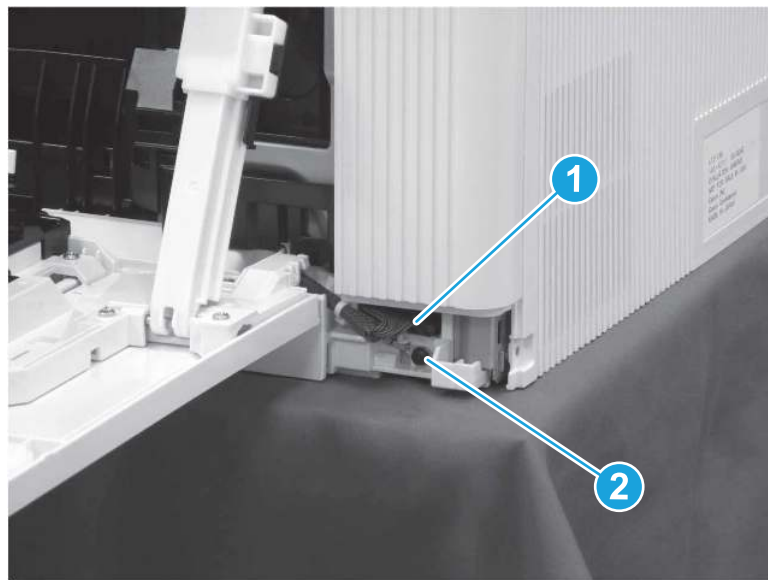
- ▲ Remove one screw (callout 1), release one tab (callout 2), and then slide the right rear lower cover (callout 3) toward the back of the printer to remove it.

Figure 1-1381 Remove the right rear lower cover



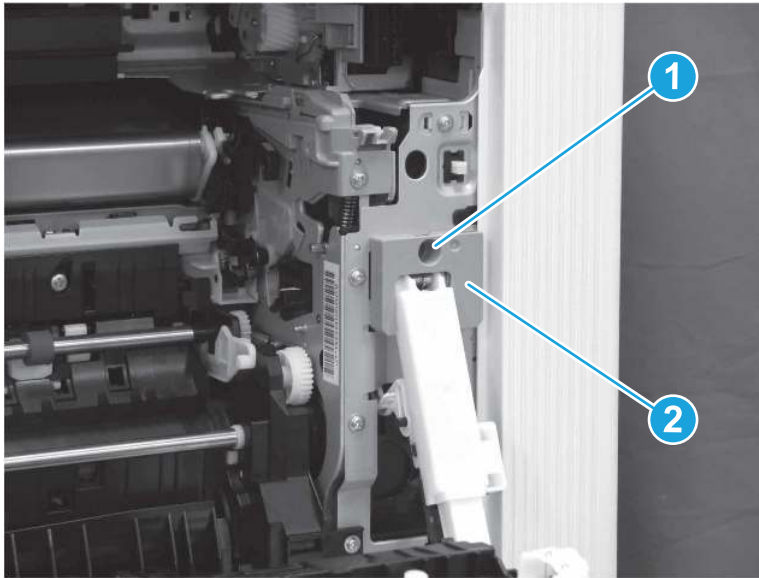
- 4. Remove the right door.
 - a. Disconnect one connector (callout 1), and then remove one black grounding screw (callout 2).

Figure 1-1382 Disconnect one connector and remove one screw



- b. Remove one self-tapping screw (callout 1), and then remove the cover (callout 2).

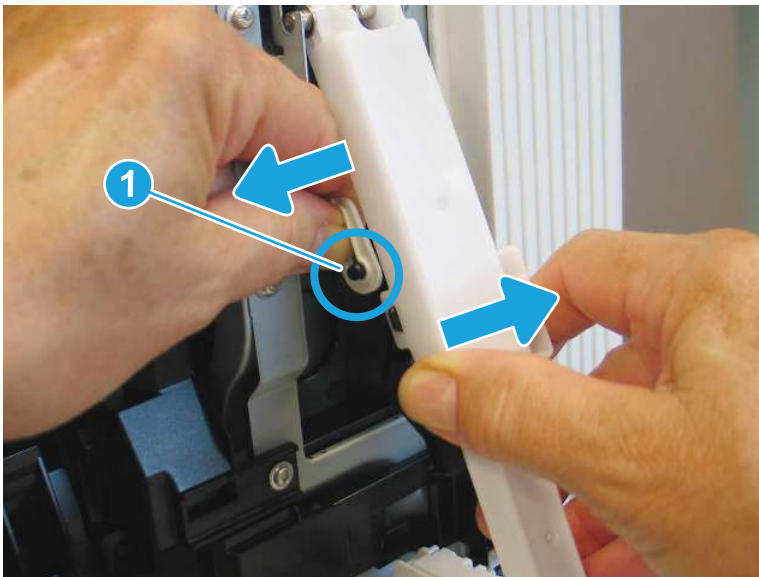
Figure 1-1383 Remove the cover



- c. Push the damper slightly to the right, and gently pull the link arm to the left to release the boss (callout 1) from the link arm.

 **IMPORTANT:** Make sure to reattach this link arm when reinstalling the right door. Failure to do so might cause damage to the link arm, requiring a larger repair.

Figure 1-1384 Release the link arm



- d. Retract the link arm slightly into the printer to move it out of the way.

Figure 1-1385 Retract the link arm



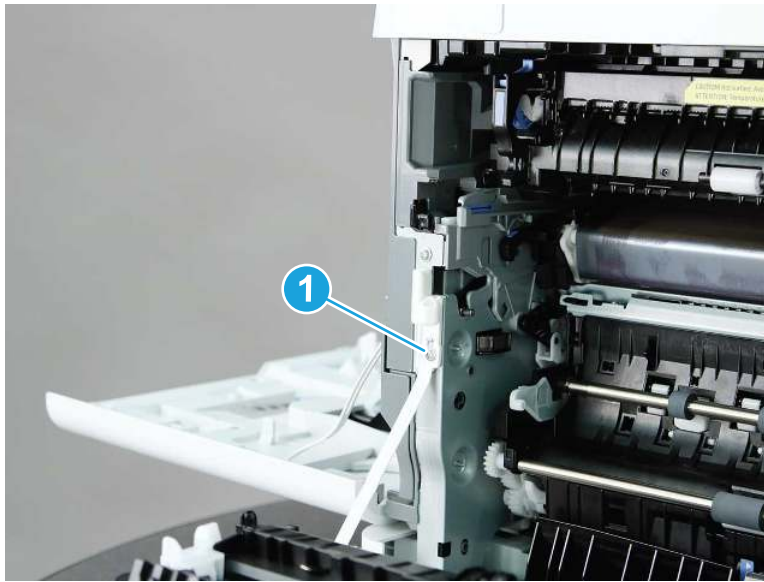
- e. Lift the dampener up, and then pull it away from the printer to release it from the bushing.

Figure 1-1386 Release the dampener



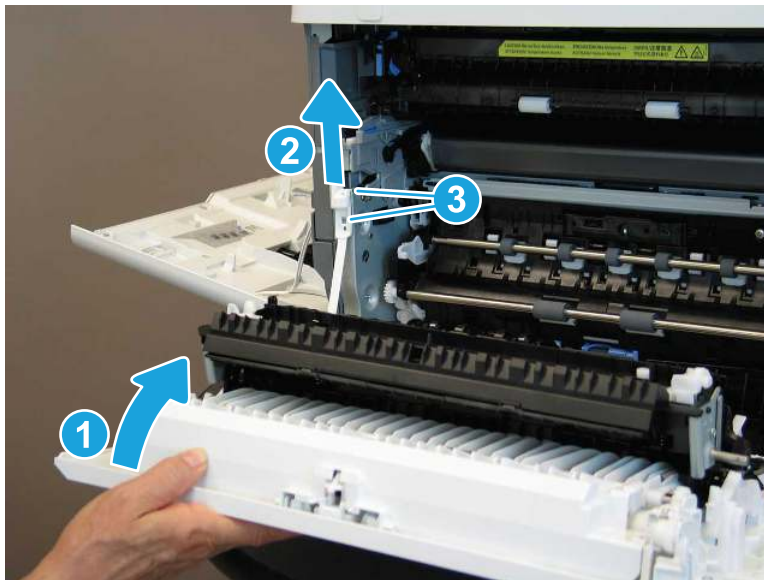
- f. Remove one screw (callout 1).

Figure 1-1387 Remove one screw



- g. Raise the door slightly (callout 1) to take tension off of the hinge. Slide the hinge up (callout 2) to release two hooks (callout 3).

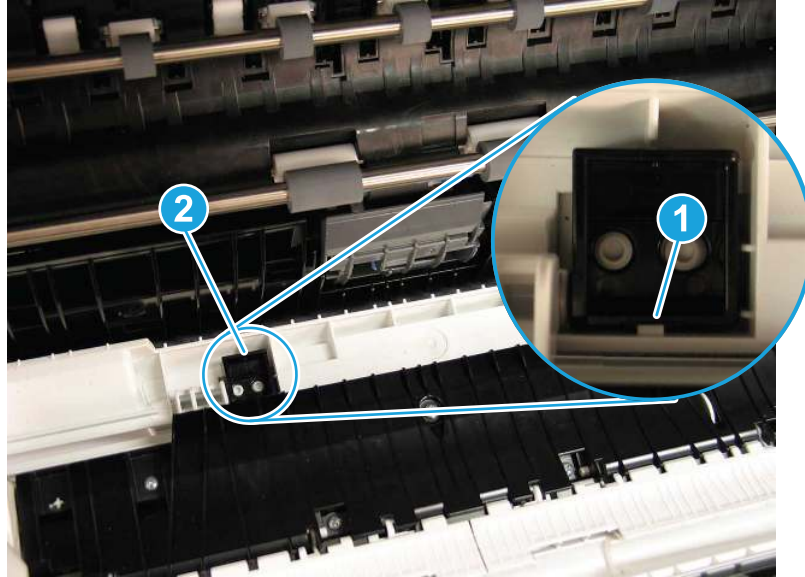
Figure 1-1388 Release the hinge



- h. Release one tab (callout 1), and then remove the stopper (callout 2).

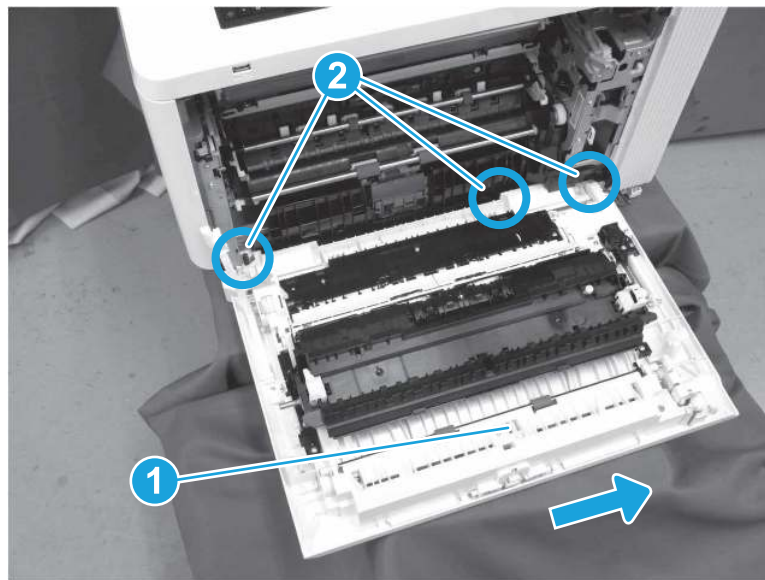
 **TIP:** Use needle-nosed pliers to release the stopper.

Figure 1-1389 Remove the stopper



- i. Slide the right door (callout 1) to the right to release it from three tabs (callout 2), and then remove the right door.

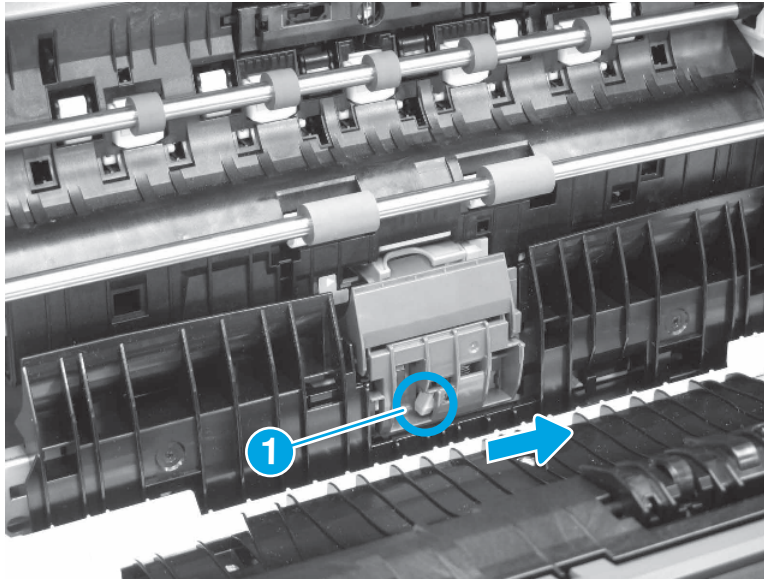
Figure 1-1390 Remove the right door



5. Remove the pickup assembly.

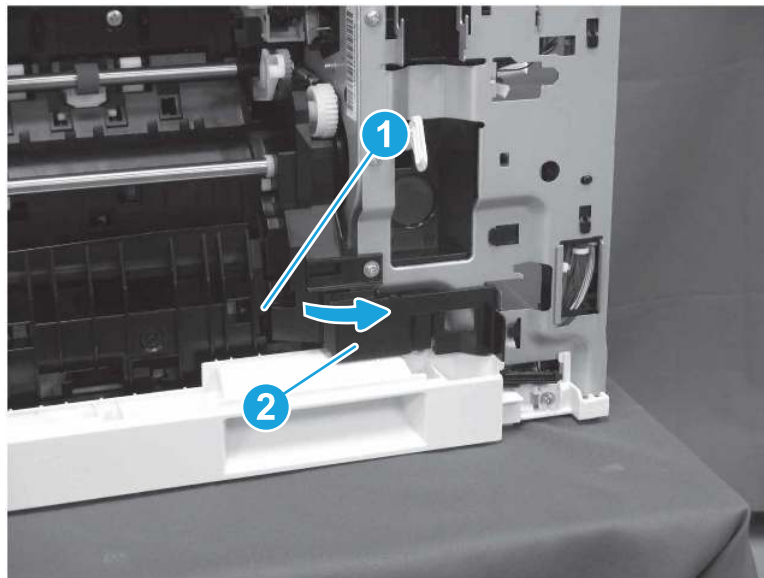
- a. Press the release button (callout 1) on the Tray 2 separation roller. Slide the assembly to the right, and then pull it away from the printer to remove it.

Figure 1-1391 Remove the Tray 2 separation roller assembly



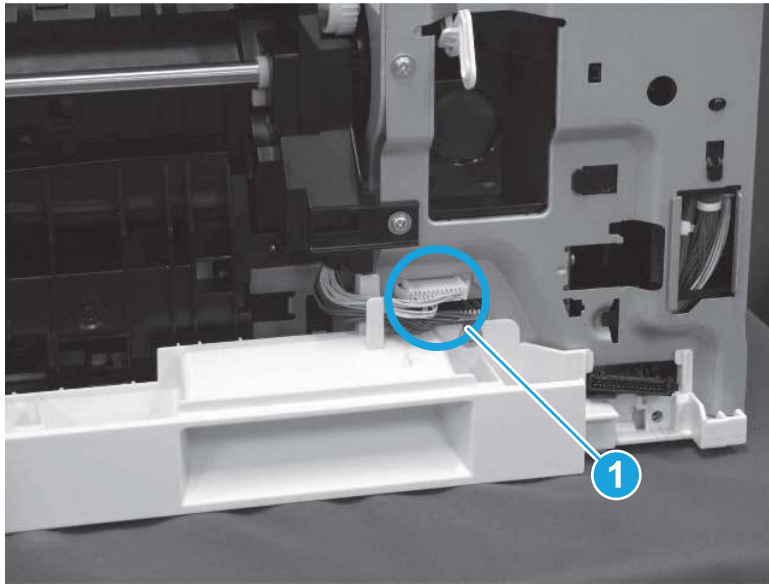
- b. Release one tab (callout 1), and then rotate the cover (callout 2) away from the printer to remove it.

Figure 1-1392 Remove the cover



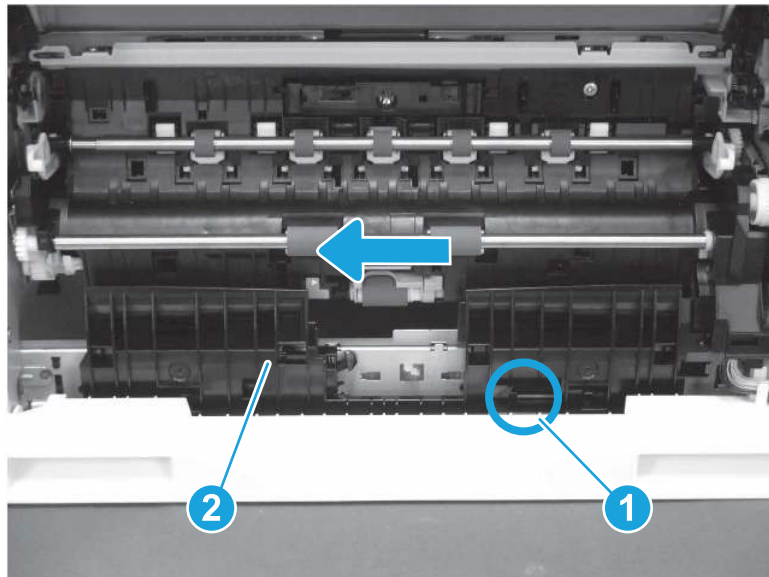
- c. Disconnect two connectors (callout 1).

Figure 1-1393 Disconnect two connectors



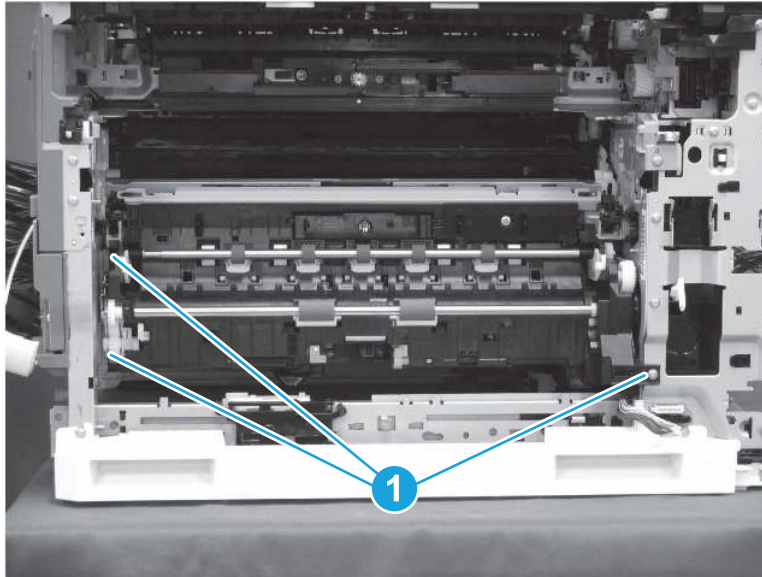
- d. Release one tab (callout 1), and then slide the guide (callout 2) to the left to remove it.

Figure 1-1394 Remove the guide



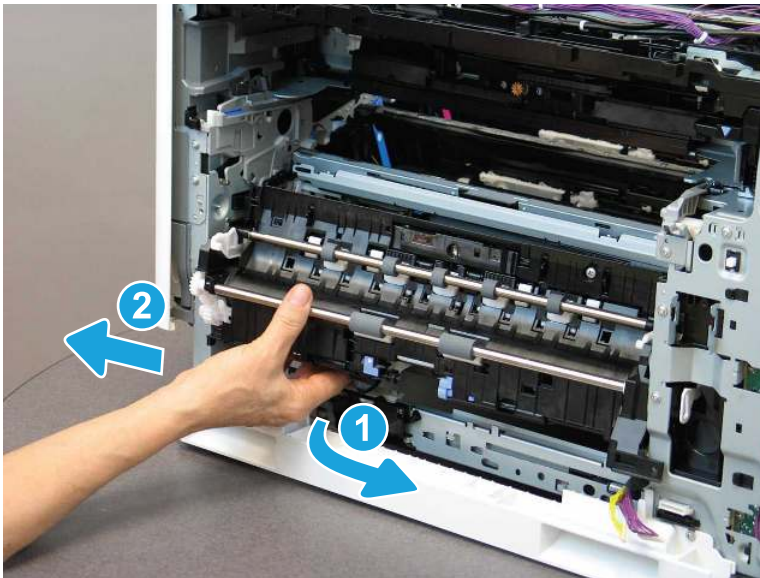
- e. Remove three screws (callout 1).

Figure 1-1395 Remove three screws



- f. Rotate the left side of the pickup assembly away from the printer (callout 1), and then slide the assembly to the left (callout 2) to remove it.

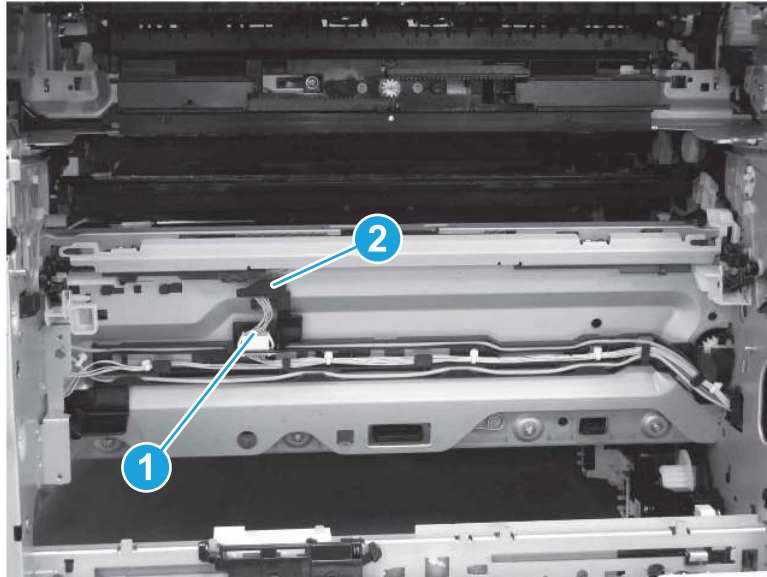
Figure 1-1396 Remove the pickup assembly



- 6. Remove the registration density sensor.

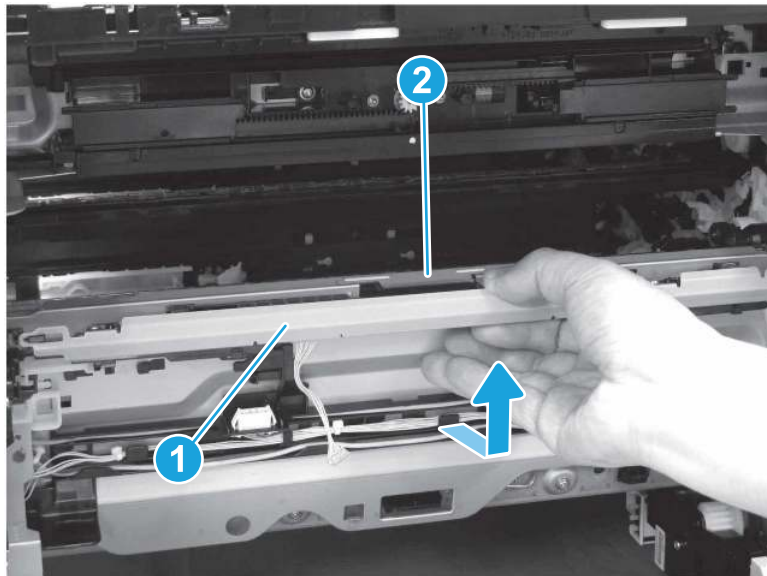
- a. Disconnect one connector (callout 1), and then release the wire harness from the guide (callout 2).

Figure 1-1397 Disconnect one connector



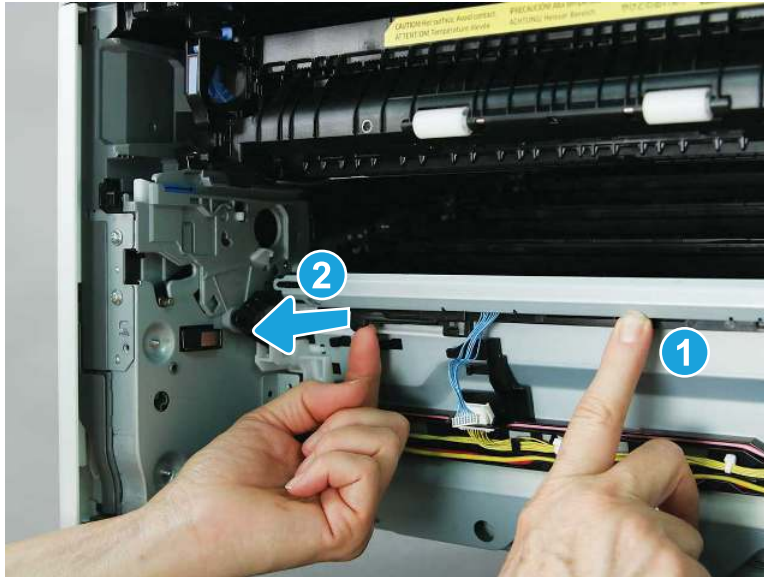
- b. Pull the center of the registration density sensor (callout 1) away from the printer and lift up to release it from the stopper (callout 2).

Figure 1-1398 Release the registration density sensor



- c. Raise the metal shutter and hold it in the raised position (callout 1). Pull the end of the black shutter (callout 2) away from the printer to release one tab.

Figure 1-1399 Release one tab



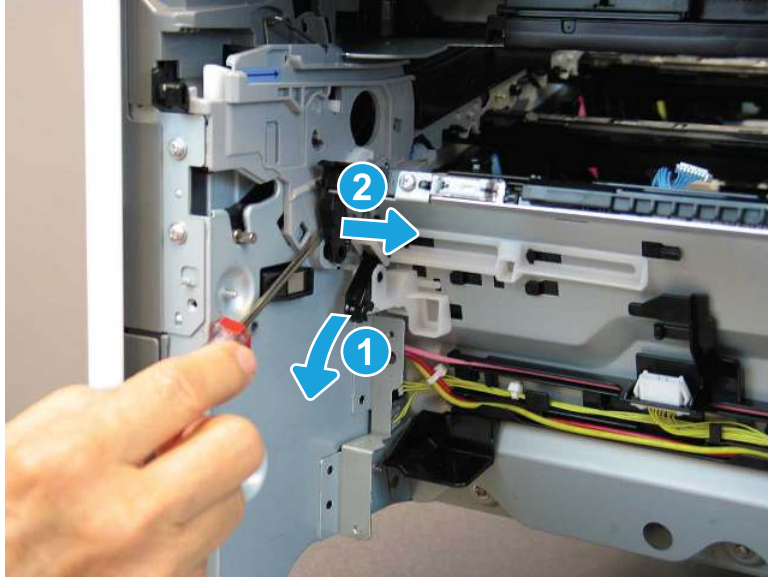
- d. Rotate the registration density sensor (callout 1) up and away from the printer.

Figure 1-1400 Rotate the registration density sensor



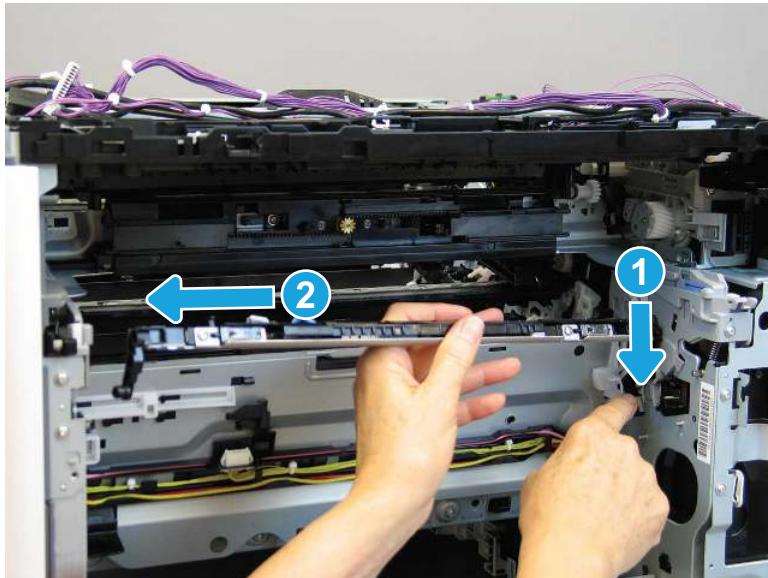
- e. Lower the lever (callout 1), and then use a small, flat-blade screwdriver to release the shaft (callout 2) from the printer.

Figure 1-1401 Release the shaft

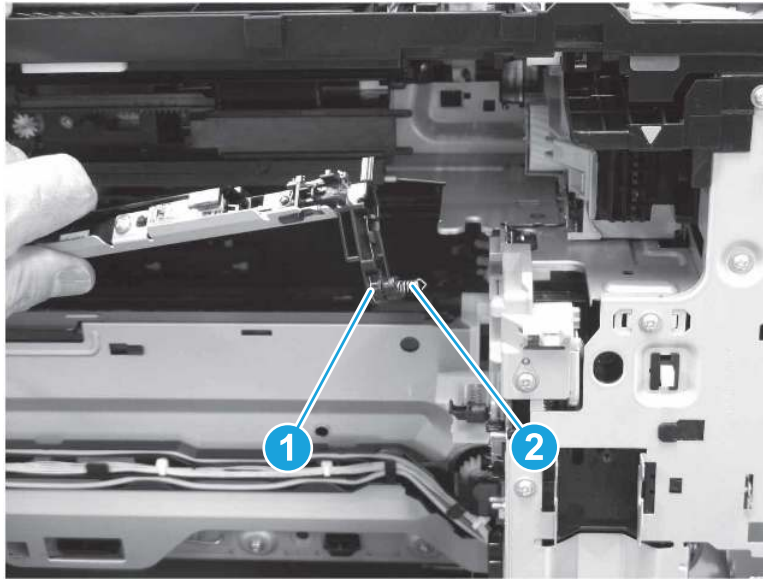


- f. Hold down the spring-loaded lever on the right side of the shaft (callout 1), and then slide the sensor away (callout 2) from the printer to remove it.

Figure 1-1402 Remove the registration density sensor

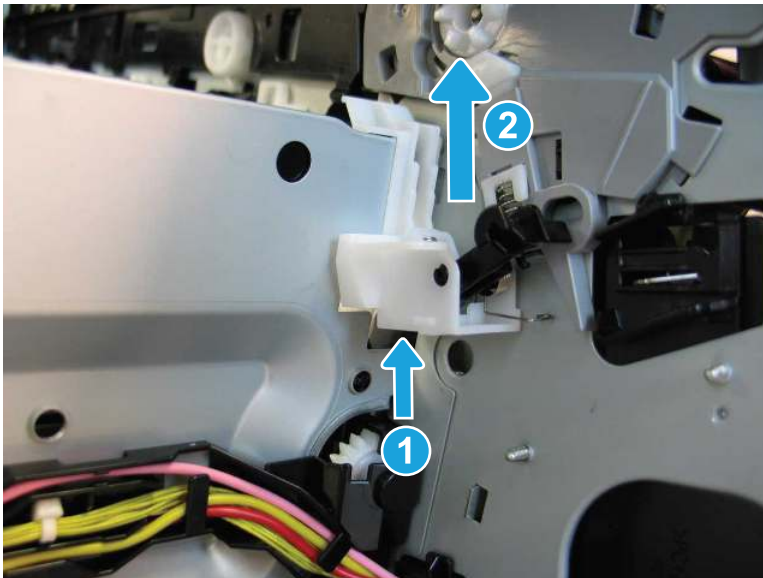


⚠ CAUTION: When removing the shaft (callout 1), be careful not to damage the spring (callout 2).



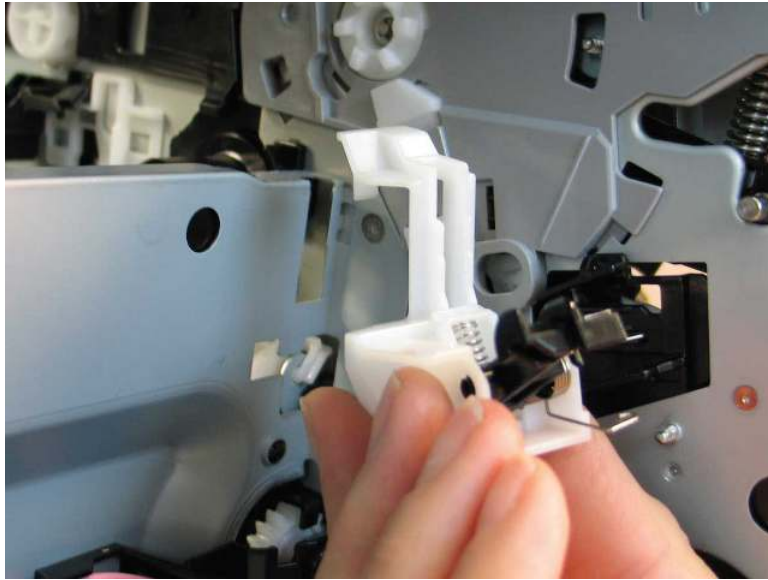
- g. If the rear RD pressure link accessory breaks, release one tab (callout 1) at the bottom of the accessory, and then lift up (callout 2) to release it.

Figure 1-1403 Release one tab and lift the accessory



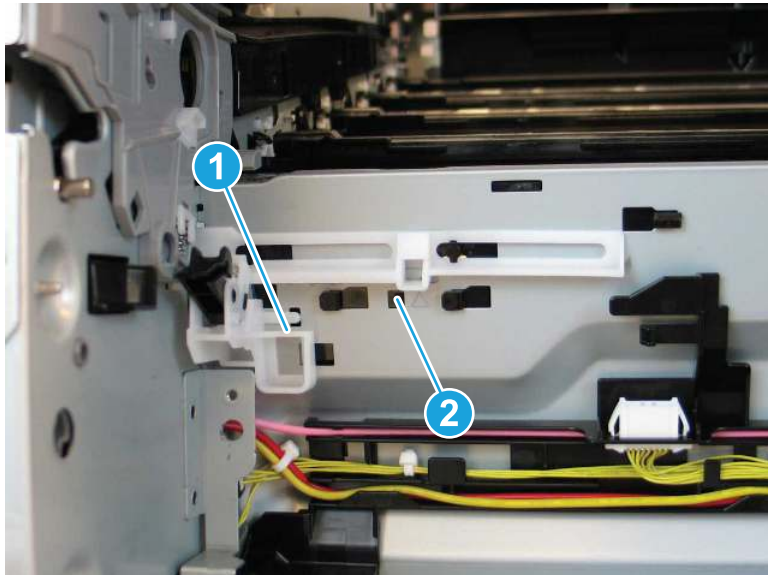
- h. Remove the rear RD pressure link accessory.

Figure 1-1404 Remove the rear pressure link accessory



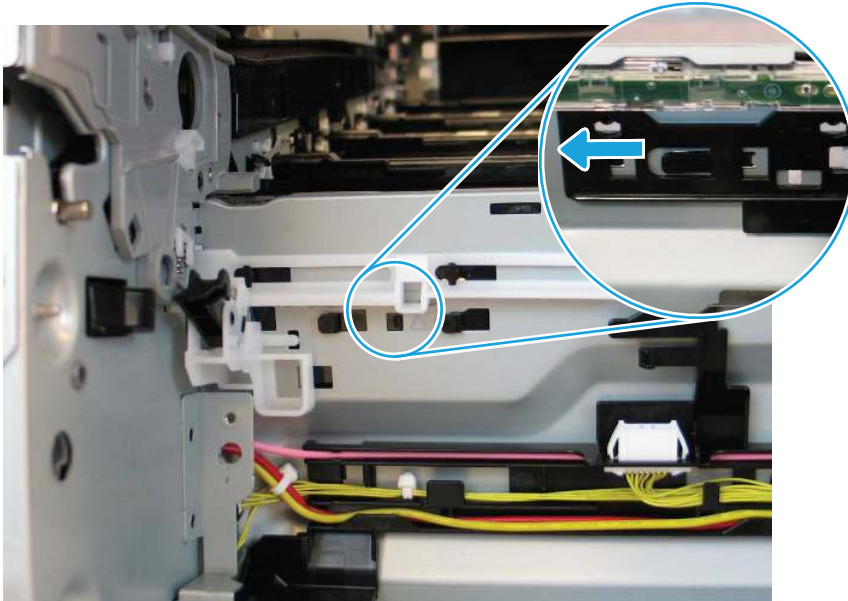
- i. If the front RD pressure release accessory breaks, release one tab (callout 1), and then press next to the embossed arrow to release one tab (callout 2) on the retainer on the back of the accessory.

Figure 1-1405 Release two tabs



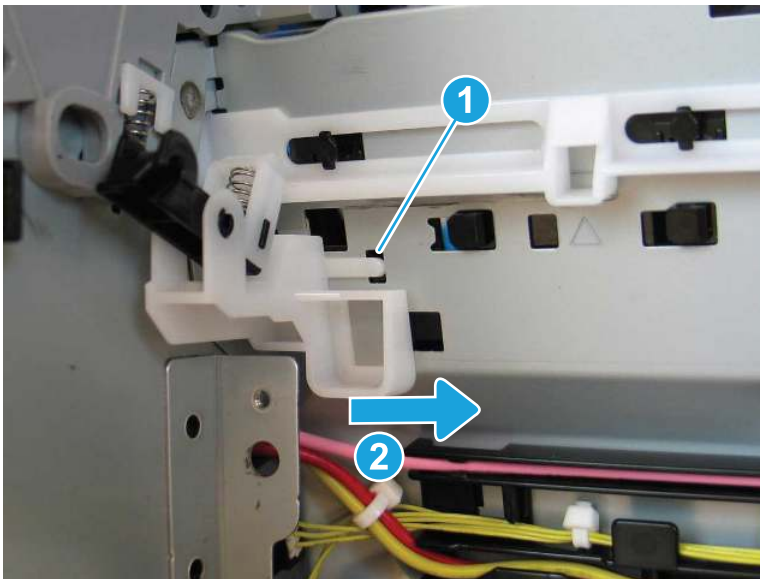
- j. On the back of the sheet metal plate, slide the retainer to the right to release the pressure link accessory.

Figure 1-1406 Slide the retainer



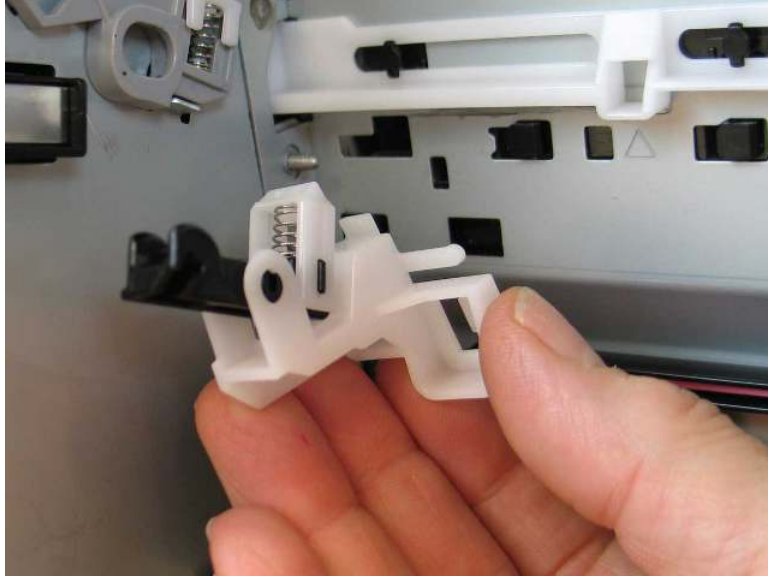
- k. Release one tab (callout 1), and then slide the pressure link accessory to the right (callout 2).

Figure 1-1407 Release one tab and slide the accessory



- l. Remove the front RD pressure release accessory.

Figure 1-1408 Remove the front RD pressure release accessory



7. Unpack the replacement assembly.

- a. Dispose of the defective part.




NOTE: HP recommends responsible disposal of the defective part.

<http://www8.hp.com/us/en/hp-information/environment/product-recycling.html>

- b. Unpack the replacement part from the packaging.



CAUTION:  Some parts are sensitive to electrostatic discharge (ESD). Always perform service work at an ESD-protected workstation or mat. If an ESD workstation or mat is not available, touch the sheet-metal chassis to provide a static ground before touching an ESD-sensitive assembly. Protect the ESD-sensitive assemblies by placing them in ESD pouches when they are out of the printer.



IMPORTANT: Make sure that all of the shipping materials (for example shipping tape) are removed from the replacement part prior to installation.

- c. To install an assembly, reverse the removal steps.



NOTE: When applicable, special installation instructions are provided for an assembly at the end of the removal procedure. Always completely read the removal instructions and follow all special installation instructions.

Removal and replacement: Duplex drive assembly (M751/E75245)

Learn how to remove and replace the duplex drive assembly.

[View a video of how to remove and replace the duplex drive assembly.](#)

Mean time to repair: 22 minutes

Service level: Medium

Before performing service

Turn the printer power off

- Disconnect the power cable.

⚠ WARNING! To avoid damage to the printer, turn the printer off, wait 30 seconds, and then remove the power cord before attempting to service the printer.

Use the table below to identify the correct part number for your printer. To order the part, go to www.hp.com/buy/parts.

Table 1-81 Part information

Part number	Part description
RM2-1392-000CN	Duplexing drive assembly

Required tools

- #2 Phillips screwdriver with a magnetic tip
- Small, flat-blade screwdriver

After performing service

Turn the printer power on

- Connect the power cable.
- Use the power switch to turn the power on.

Post service test

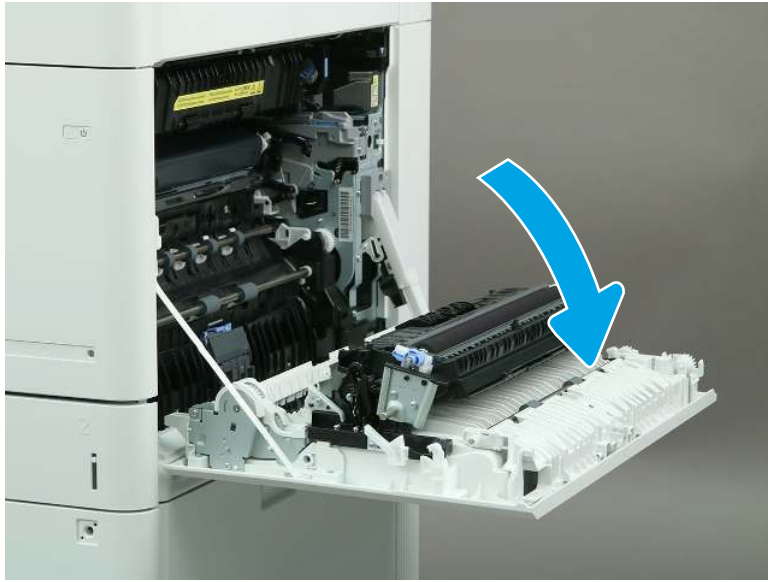
Make sure that the printer initializes to a **Ready** state.

Print a page to make sure that the printer is functioning correctly.

1. Remove the fuser.

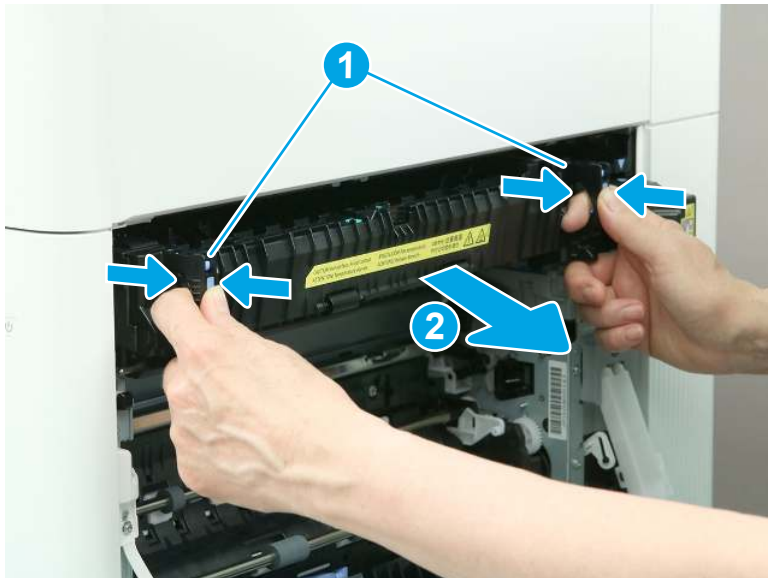
- a. Open the right door.

Figure 1-1409 Open the right door



- b. Grasp the fuser handles, and then squeeze the release levers (callout 1). Lift up slightly, and then pull straight out to remove the fuser (callout 2).

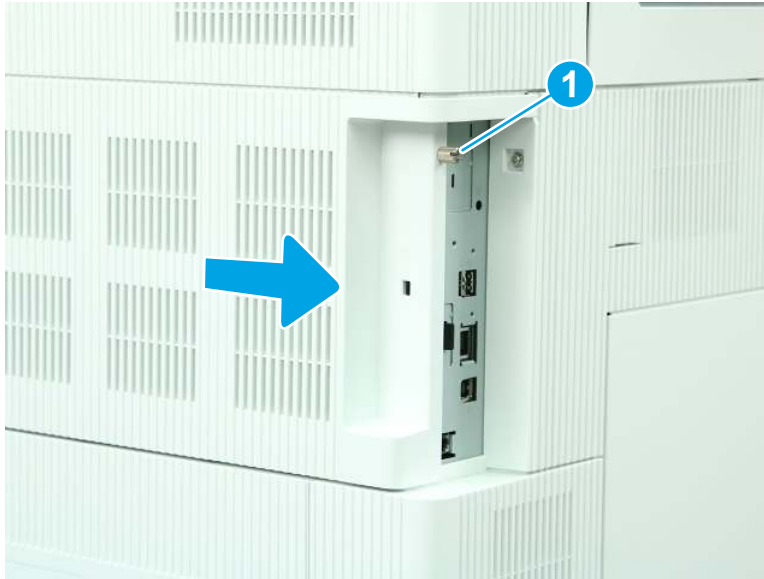
Figure 1-1410 Remove the fuser



2. Remove the formatter cover.

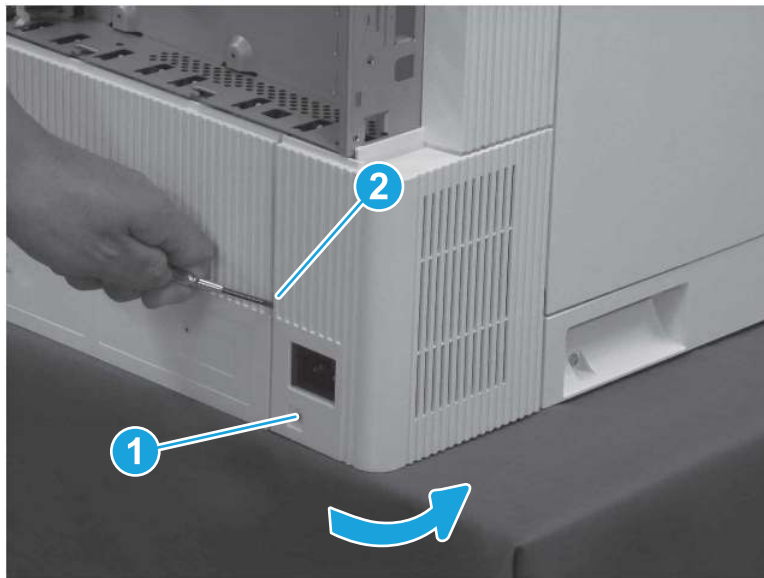
- ▲ Loosen one thumbscrew (callout 1), and then slide the formatter cover (callout 2) away from the printer to remove it.

Figure 1-1411 Remove the formatter cover



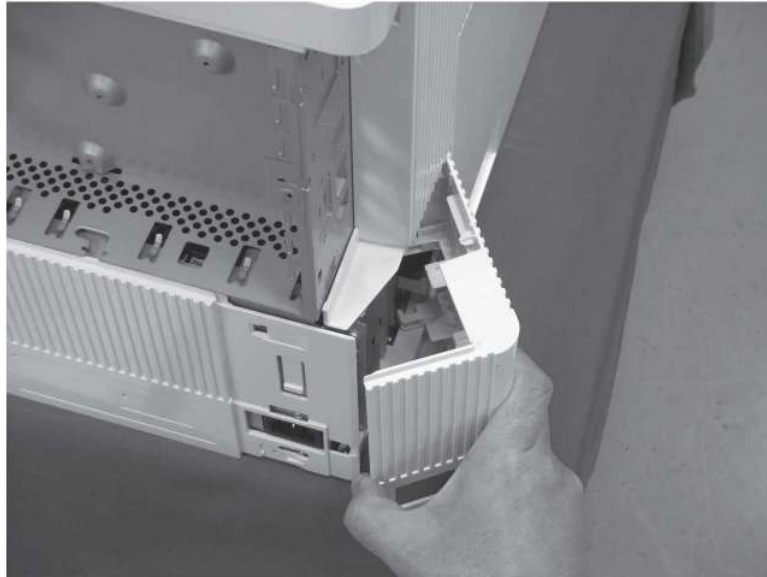
- 3. Remove the left lower cover (M751/E75245).
 - a. Remove one screw (callout 1), release one tab (callout 2), and then rotate the cover away from the printer.

Figure 1-1412 Remove one screw and release one tab



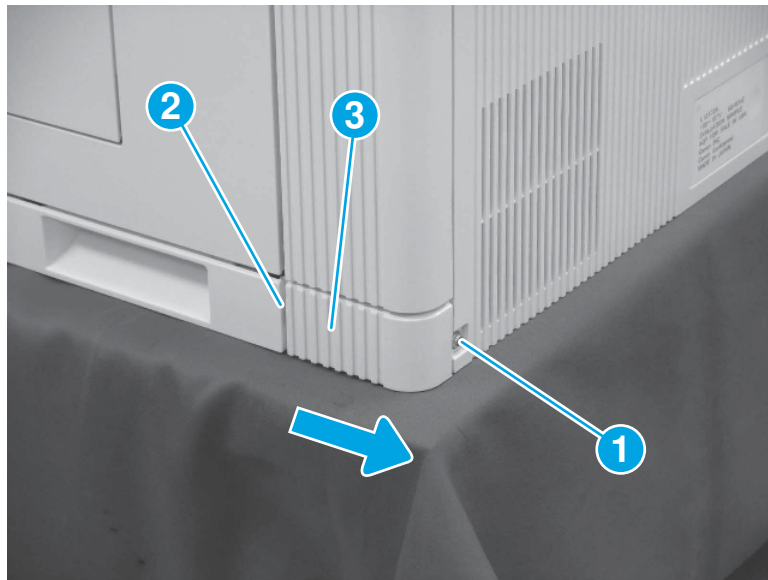
- b. Remove the left lower cover.

Figure 1-1413 Remove the left lower cover



4. Remove the right rear lower cover (M751/E75245/M856/E85055/M776).
 - ▲ Remove one screw (callout 1), release one tab (callout 2), and then slide the right rear lower cover (callout 3) toward the back of the printer to remove it.

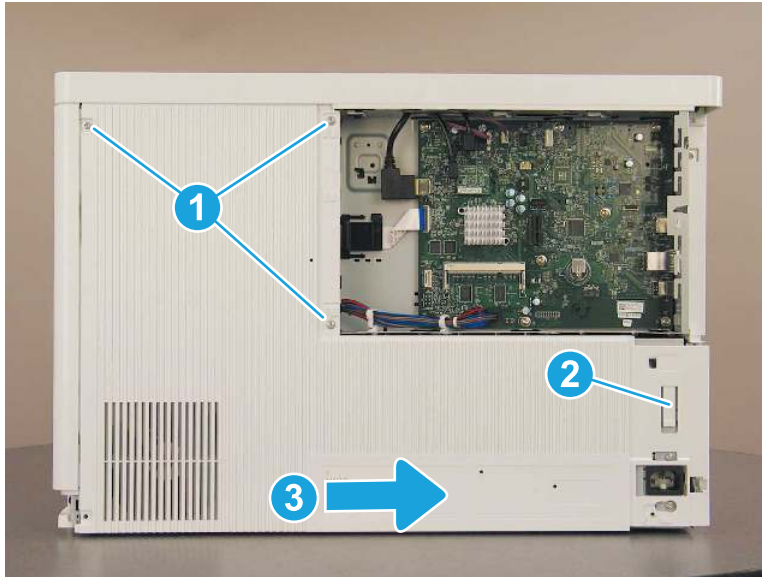
Figure 1-1414 Remove the right rear lower cover



5. Remove the rear cover (M751/E75245).

- ▲ Remove three screws (callout 1), release one tab (callout 2), and then slide the rear cover to the right (callout 3) to remove it.

Figure 1-1415 Remove the rear cover

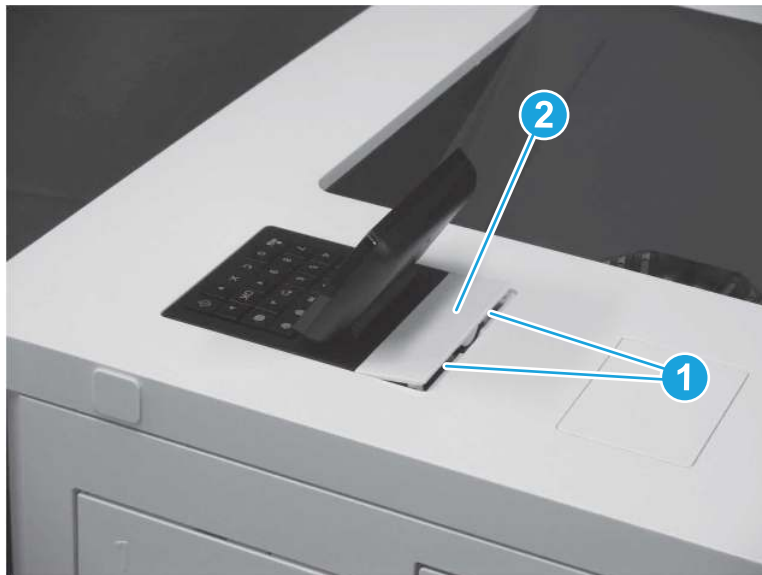


6. Remove the control panel.

 **NOTE:** A screwdriver is included in the control panel kit. The screwdriver has a reversible shaft. Simply pull the shaft out of the handle, and then reinstall it with the desired end facing out.

- a. Use a small, flat-blade screwdriver to release two tabs (callout 1), and then remove the control panel cover (callout 2).

Figure 1-1416 Remove the control panel cover



- b. Remove one screw (callout 1).

Figure 1-1417 Remove one screw



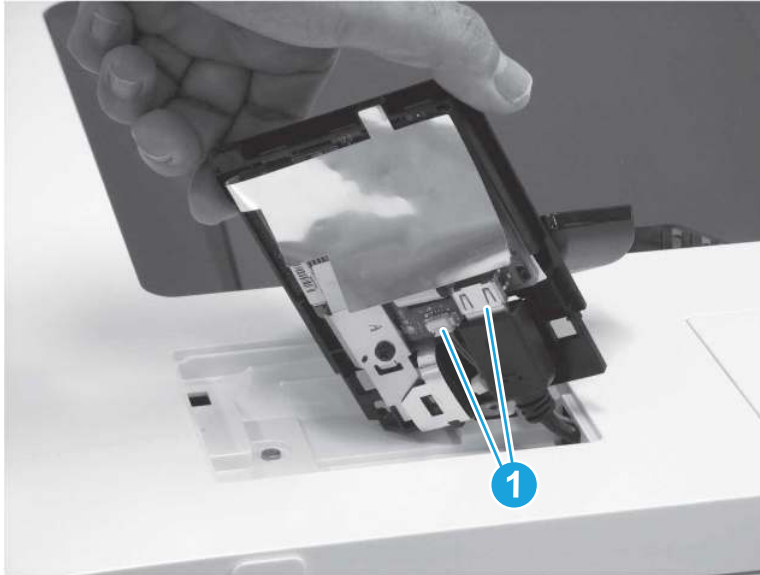
- c. Lift the back edge of the control panel up (callout 1), and then slide the control panel toward the back of the printer (callout 2).

Figure 1-1418 Slide the control panel back



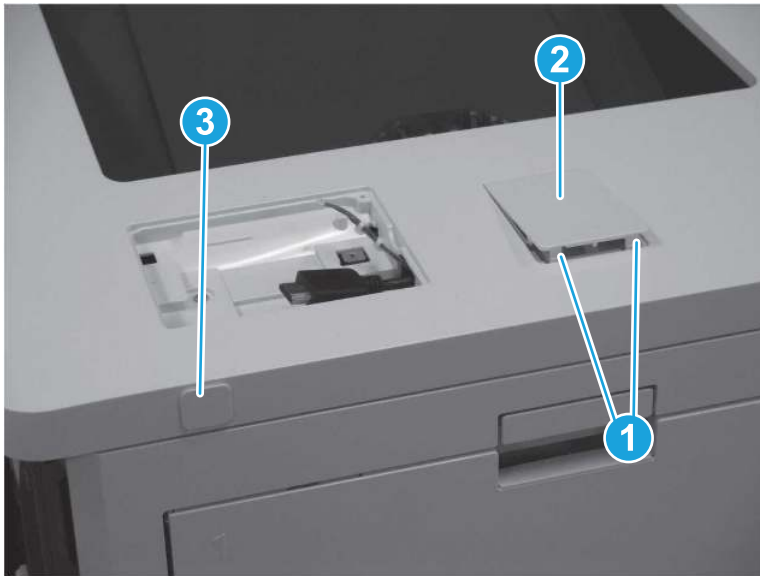
- d. Turn the control panel so that the bottom is facing up, and then disconnect two connectors (callout 1) to remove the control panel.

Figure 1-1419 Disconnect two connectors



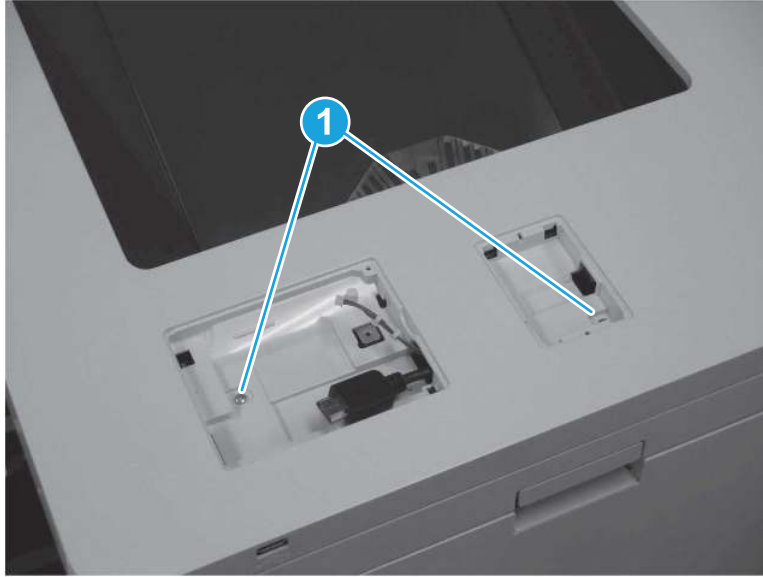
7. Remove the top cover (M751/E75245).
 - a. Release two tabs (callout 1), and then remove the HIP cover (callout 2). Pull the USB cap (callout 3) away from the printer to remove it.

Figure 1-1420 Remove the HIP cover and USB cap



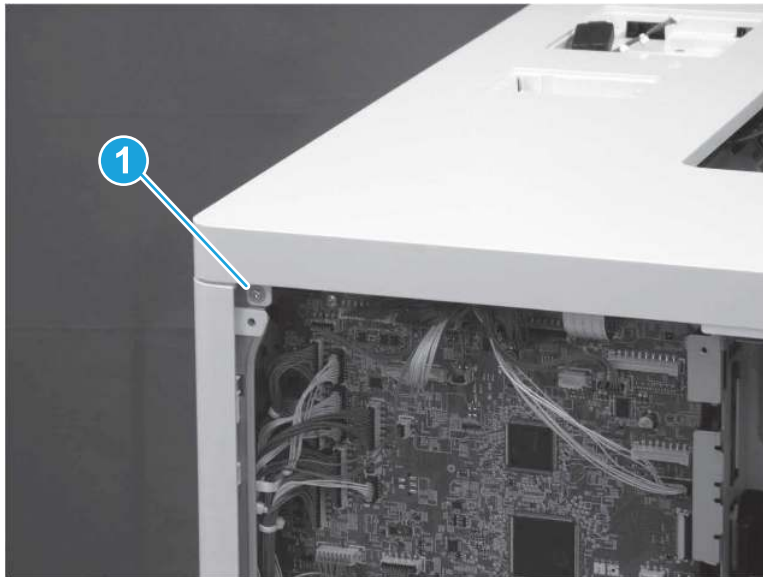
- b. At the top of the printer, remove two screws (callout 1).

Figure 1-1421 Remove two screws



- c. At the back of the printer, remove one screw (callout 1).

Figure 1-1422 Remove one screw

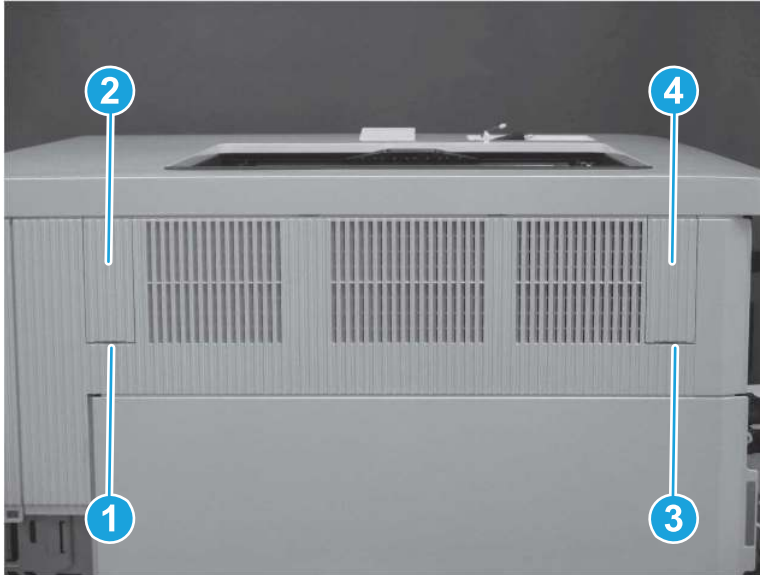


- d. Use a small, flat-blade screwdriver to release one tab (callout 1) and remove the left blanking cover (callout 2). Release one tab (callout 3) and remove the right blanking cover (callout 4).

 **TIP:** These covers are not identical. Make sure to reinstall the correct cover on the correct side.

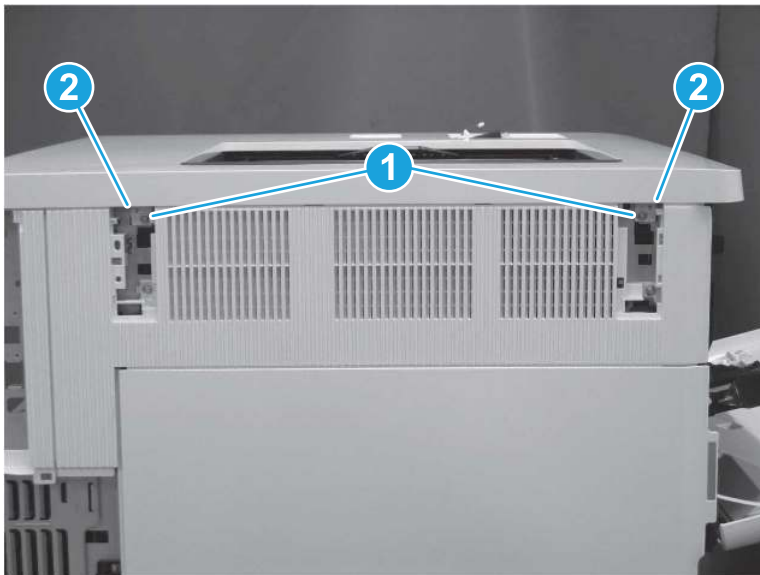
 **NOTE:** The screw under the left blanking cover is a self-tapping screw. Make sure this screw is reinstalled in the correct location.

Figure 1-1423 Remove the left and right blanking covers



- e. Remove two screws (callout 1), and then release two tabs (callout 2).

Figure 1-1424 Remove two screws and release two tabs



- f. At the front of the printer, remove one washer-head screw (callout 1) and one self-tapping screw (callout 2). Release one tab (callout 3).


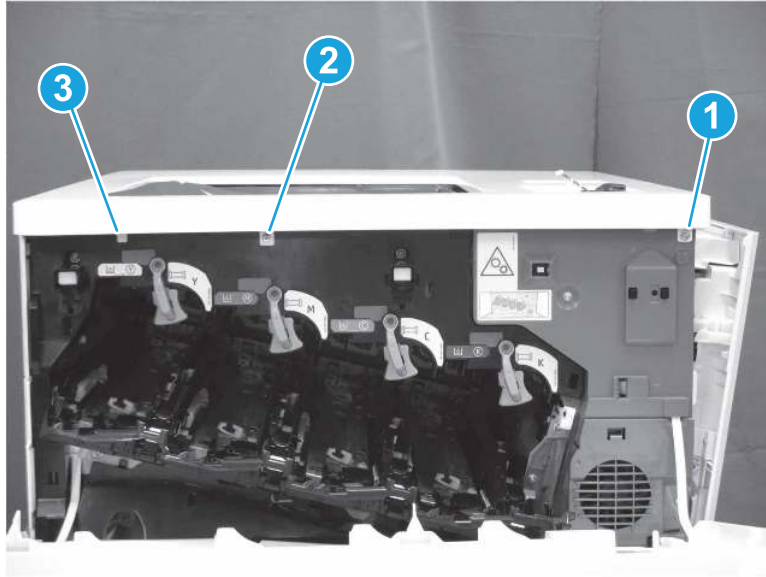
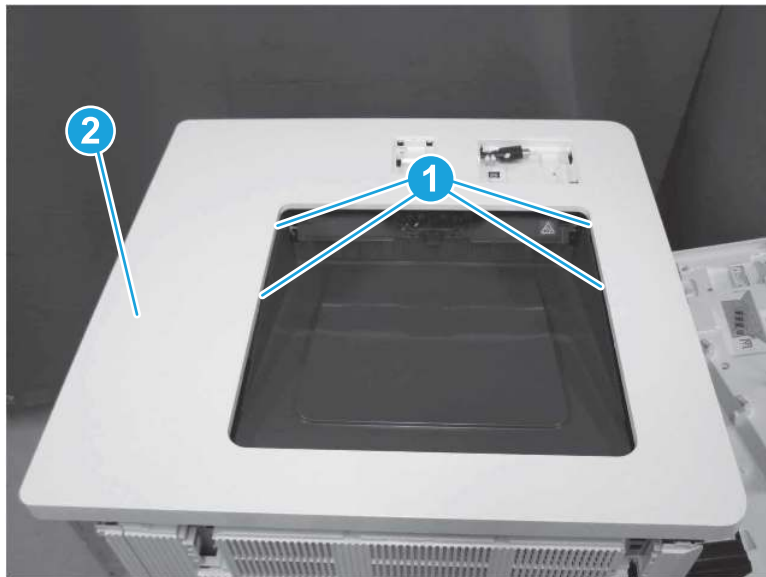
 **TIP:** Make sure to install the correct type of screw in the correct location.


Figure 1-1425 Remove two screws and release one tab

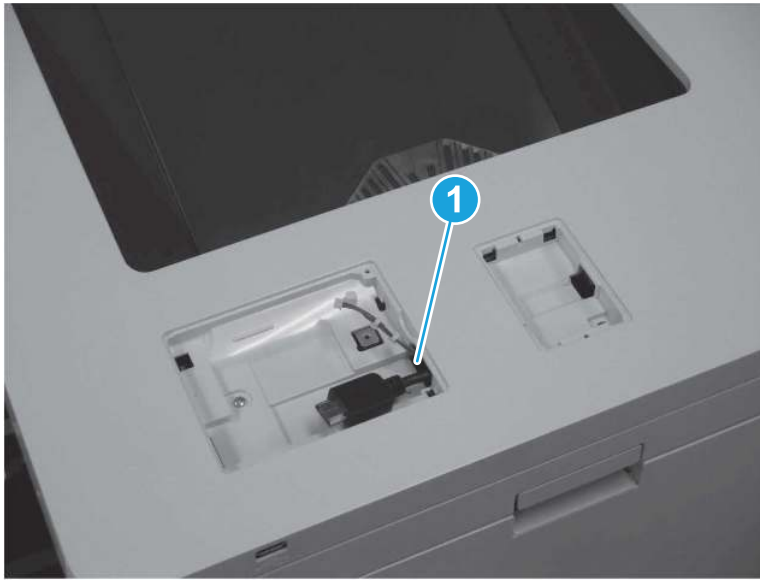


- g. At the top of the printer, release four tabs (callout 1), and then remove the top cover (callout 2).

Figure 1-1426 Remove the top cover

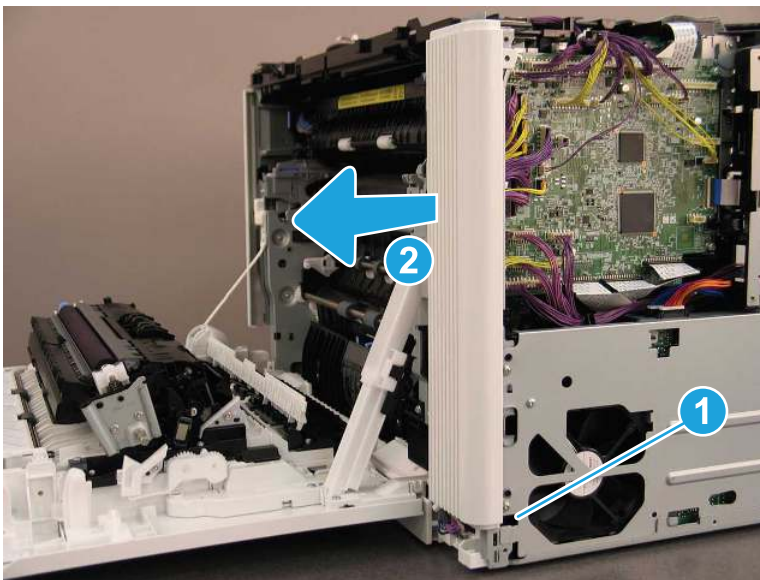


 **NOTE:** When removing the top cover, make sure to release the control panel cables (callout 1) through the opening.



8. Remove the right rear cover (M751/E75245).
 - ▲ Release one tab (callout 1), and then slide the right rear cover (callout 2) away from the printer to remove it.

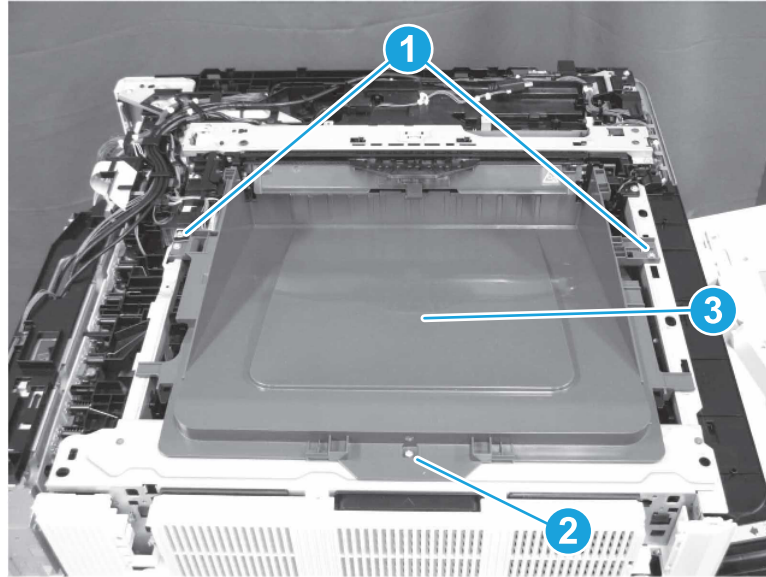
Figure 1-1427 Remove the right rear cover



9. Remove the output bin (M751/E75245).
 - ▲ Remove two washer-head machine screws (callout 1), remove one self-tapping screw (callout 2), and then remove the output bin (callout 3).

 **NOTE:** When reinstalling the output bin, make sure to install the correct type of screw in the correct location.

Figure 1-1428 Remove the output bin



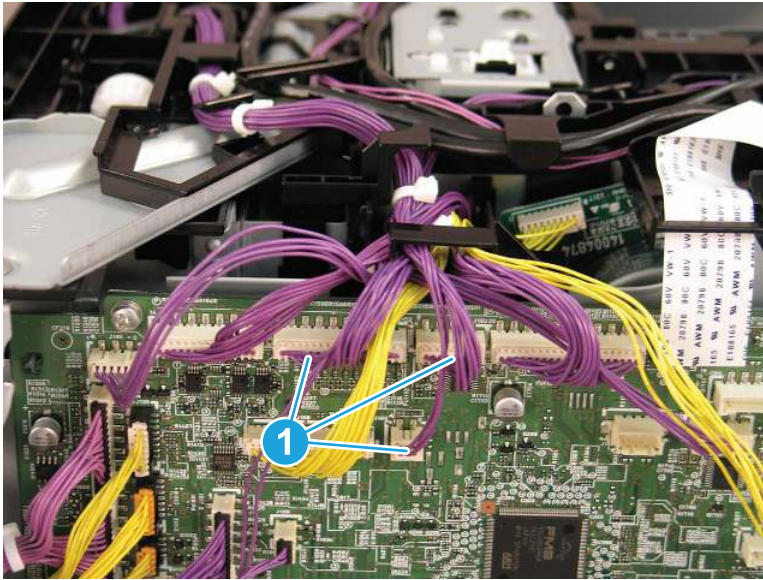
10. Remove the delivery assembly.
 - a. Disconnect four connectors (callout 1) on the formatter board.

Figure 1-1429 Disconnect four connectors



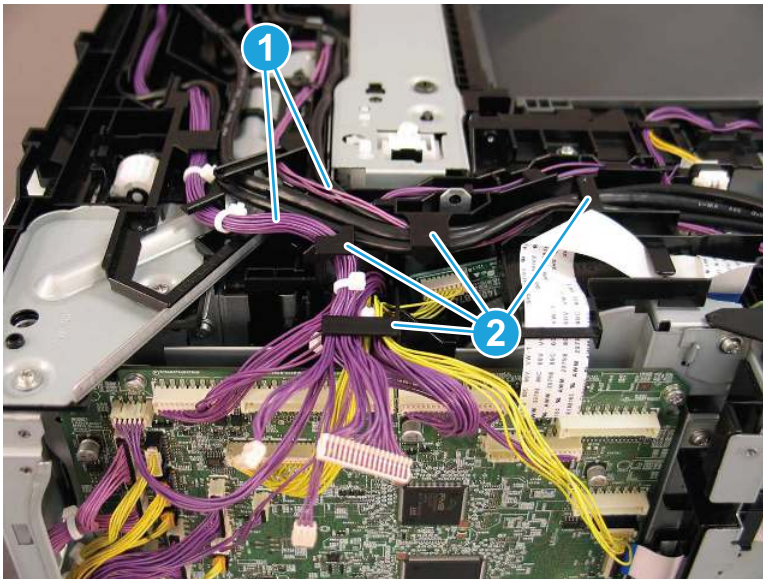
- b. Disconnect three connectors on the DC controller (callout 1).

Figure 1-1430 Disconnect three connectors



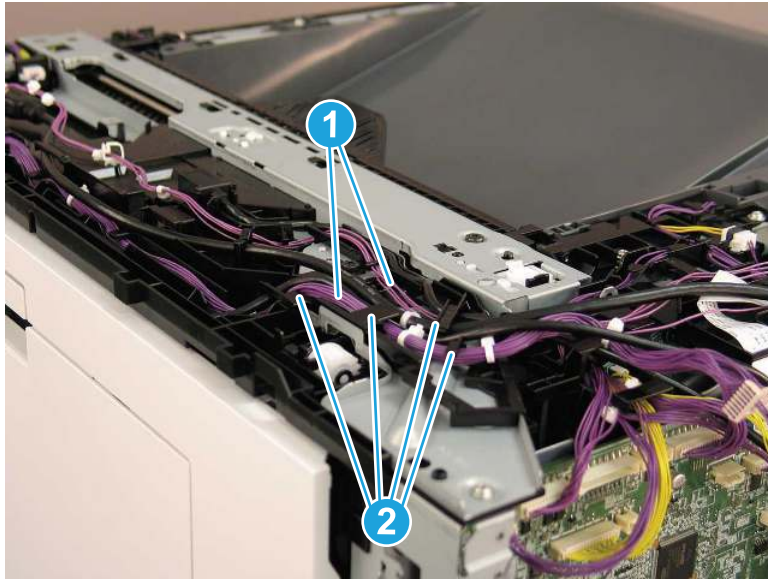
- c. Release the cables (callout 1) from the guides (callout 2).

Figure 1-1431 Release the cables from the guides



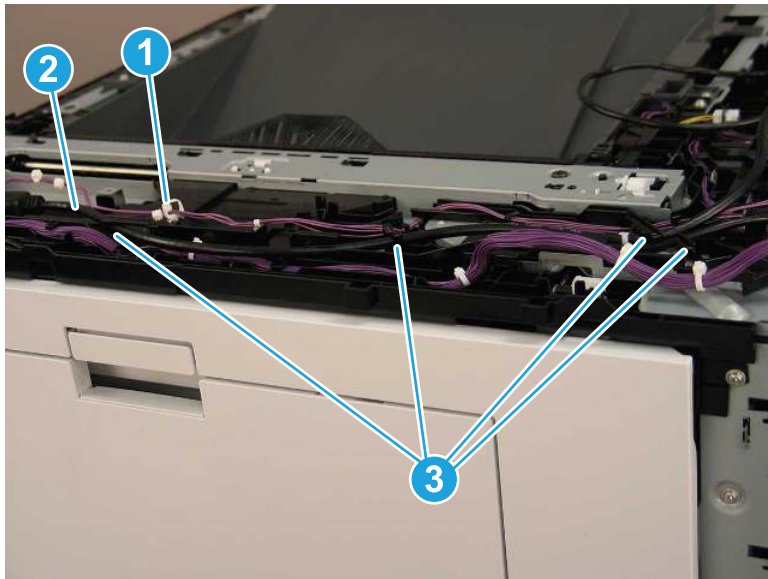
- d. Release the cables (callout 1) from the guides (callout 2).

Figure 1-1432 Release the cables from the guides



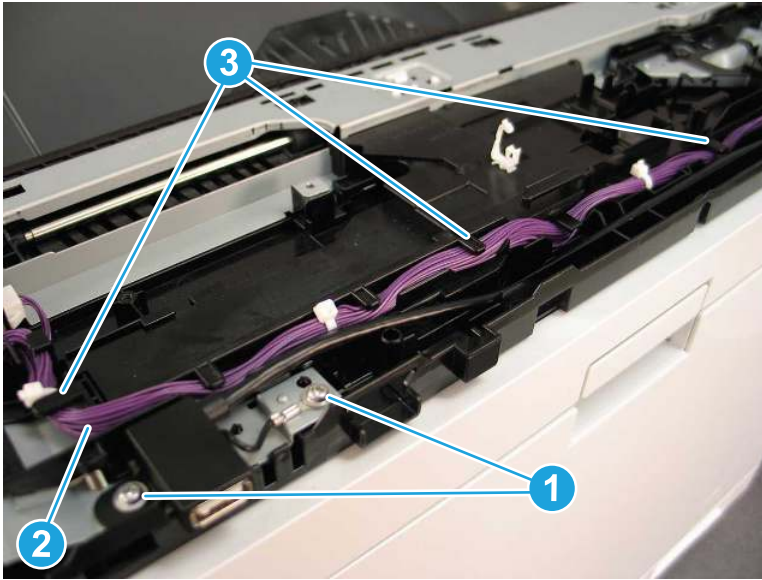
- e. Open one retainer (callout 1), and then release the cables (callout 2) from the guides (callout 3).

Figure 1-1433 Release the cables from the guides



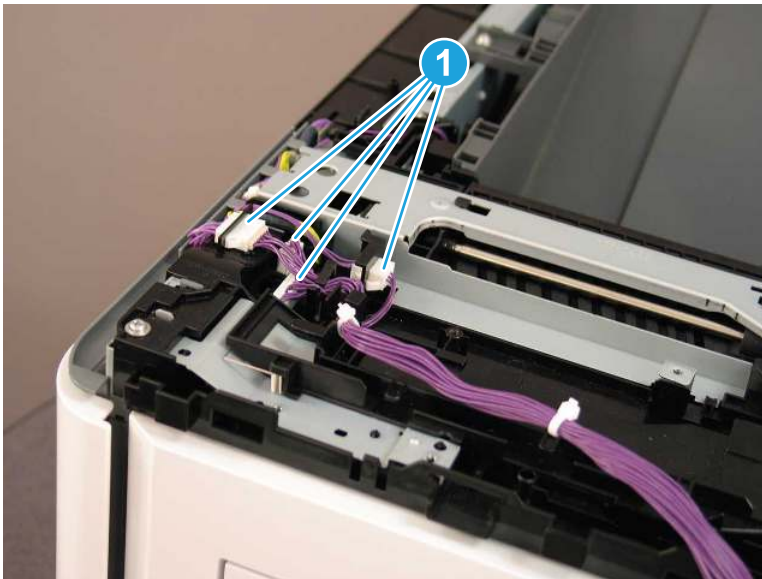
- f. Remove two screws (callout 1), and then release the cables (callout 2) from the guides (callout 3).

Figure 1-1434 Remove two screws and release the cables



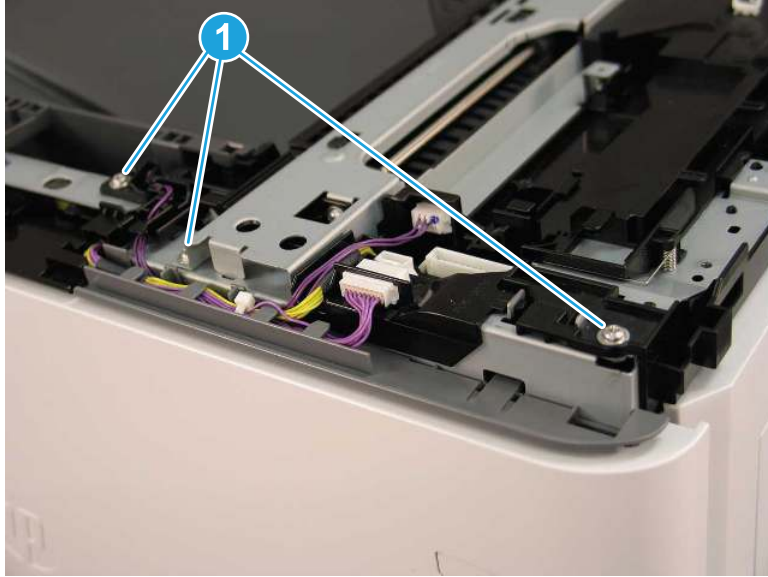
- g. Disconnect four connectors (callout 1).

Figure 1-1435 Disconnect four connectors



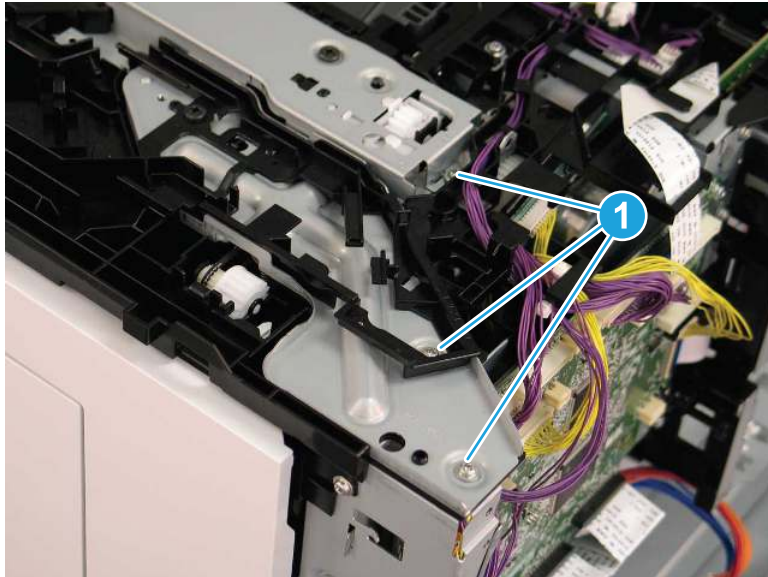
- h. Remove three screws (callout 1).

Figure 1-1436 Remove three screws



- i. Remove three screws (callout 1).

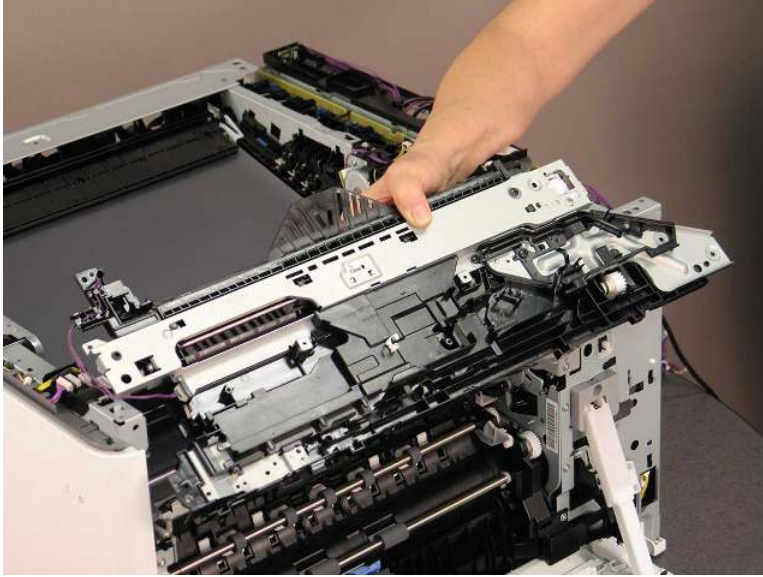
Figure 1-1437 Remove three screws



- j. Remove the duplex switchback assembly and the delivery assembly together.

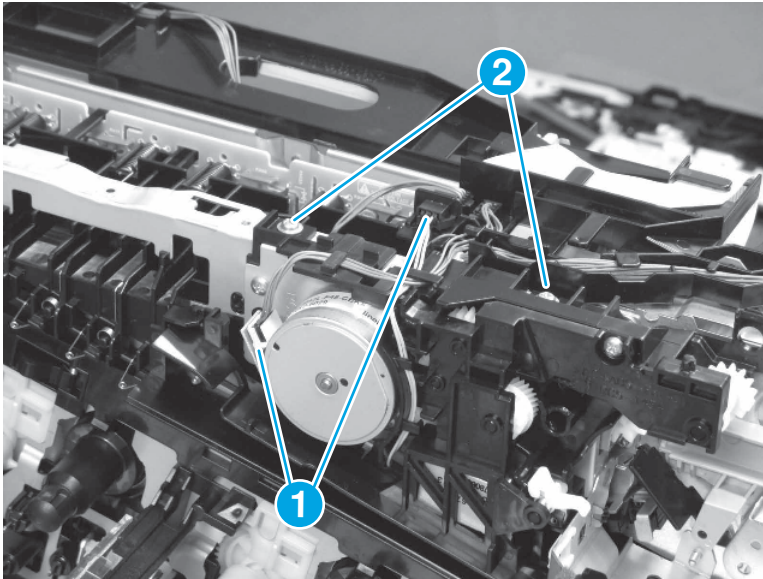
⚠ CAUTION: The gears on the delivery assembly are not captive. Do not lose the gears when handling the assembly.

Figure 1-1438 Remove the duplex switchback assembly and delivery assembly



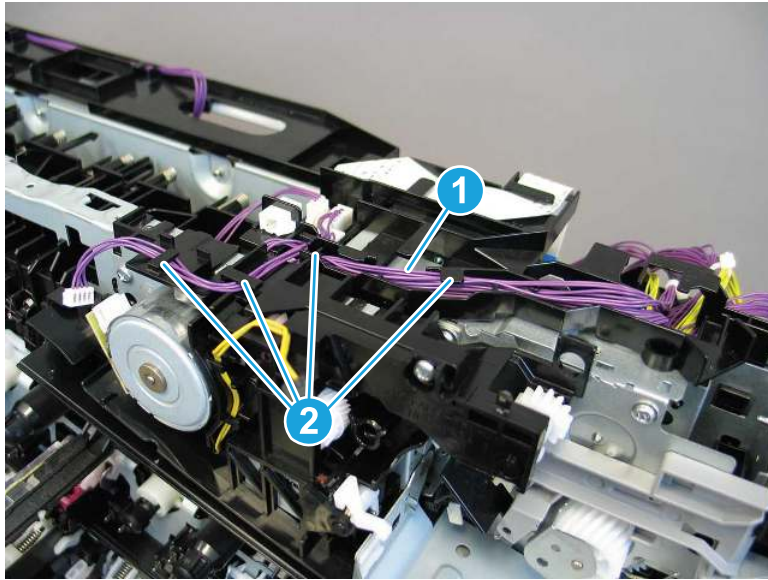
11. Remove the duplex drive assembly.
 - a. Disconnect two connectors (callout 1) and then remove two screws (callout 2).

Figure 1-1439 Disconnect two connectors and remove two screws



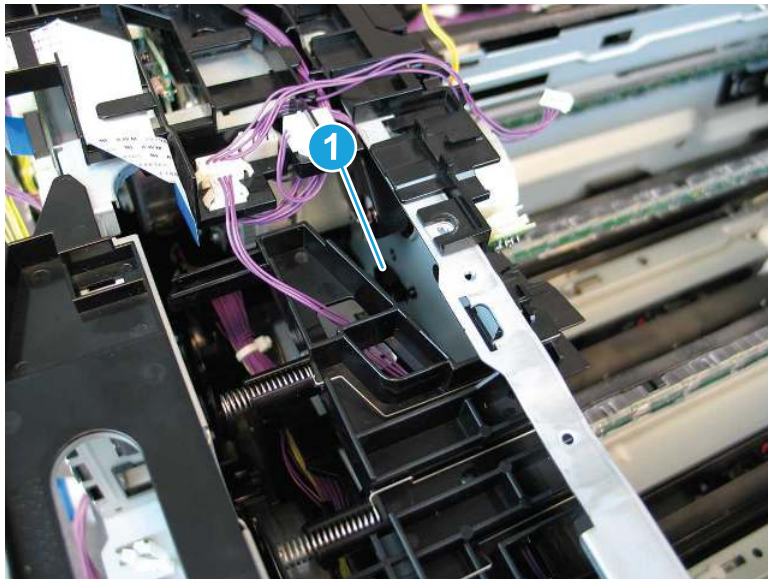
- b. Remove the wire harness (callout 1) from the guides (callout 2).

Figure 1-1440 Remove the wire harness from the guides



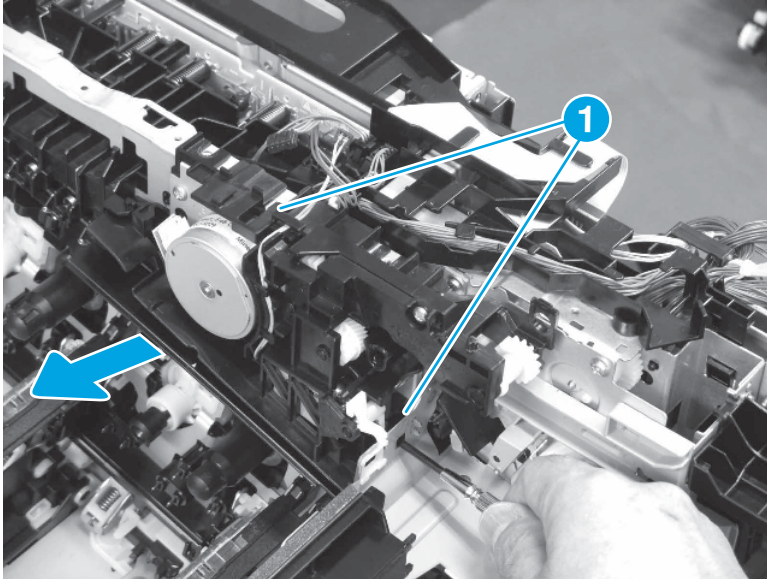
- c. Release one tab (callout 1).

Figure 1-1441 Release one tab



- d. Release two tabs (callout 1). Use a small, flat-blade screwdriver to release the right tab. Pull the duplex drive assembly away from the printer.

Figure 1-1442 Release two tabs



- e. Remove the duplex drive assembly.

Figure 1-1443 Remove the duplex drive assembly



12. Unpack the replacement assembly.


- a. Dispose of the defective part.




NOTE: HP recommends responsible disposal of the defective part.

<http://www8.hp.com/us/en/hp-information/environment/product-recycling.html>

- b. Unpack the replacement part from the packaging.

 **IMPORTANT:** Make sure that all of the shipping materials (for example shipping tape) are removed from the replacement part prior to installation.

- c. To install an assembly, reverse the removal steps.

 **NOTE:** When applicable, special installation instructions are provided for an assembly at the end of the removal procedure. Always completely read the removal instructions and follow all special installation instructions.

Removal and replacement: Main drive assembly (M751/E75245)

Learn how to remove and replace the main drive assembly.

[View a video of how to remove and replace the main drive assembly.](#)


Mean time to repair: 42 minutes

Service level: Medium

Before performing service

Turn the printer power off

- Disconnect the power cable.

 **WARNING!** To avoid damage to the printer, turn the printer off, wait 30 seconds, and then remove the power cord before attempting to service the printer.

Use the table below to identify the correct part number for your printer. To order the part, go to www.hp.com/buy/parts.

Table 1-82 Part information

Part number	Part description
RM2-1614-000CN	Main drive assembly
RC5-1055-000CN	Cam, coupling estrangement (if needed)

Required tools

- #2 Phillips screwdriver with a magnetic tip
- Small, flat-blade screwdriver

After performing service

Turn the printer power on

- Connect the power cable.
- Use the power switch to turn the power on.

Post service test

Make sure that the printer initializes to a **Ready** state.

Print a page to make sure that the printer is functioning correctly.

1. Remove the toner cartridges.

- ▲ Open the front door, if it is not already open. Grasp the handle of the toner cartridge and pull out to remove it. Repeat the process for the remaining toner cartridges.

Figure 1-1444 Remove the toner cartridge



2. Remove the imaging drums.

- a. Open the front door, if it is not already open. Rotate the blue lever in front of the imaging drum to the left.

Figure 1-1445 Rotate the blue lever



- b. Grasp the handle of the imaging drum and pull out to remove it. Repeat the process for the remaining imaging drums.

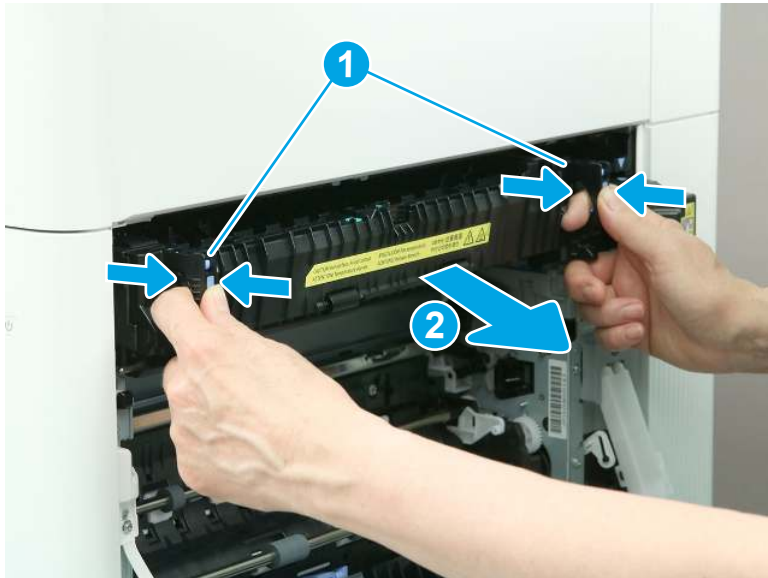
Figure 1-1446 Remove the imaging drum



3. Remove the fuser.

- ▲ Grasp the fuser handles, and then squeeze the release levers (callout 1). Lift up slightly, and then pull straight out to remove the fuser (callout 2).

Figure 1-1447



4. Remove the intermediate transfer belt (ITB).

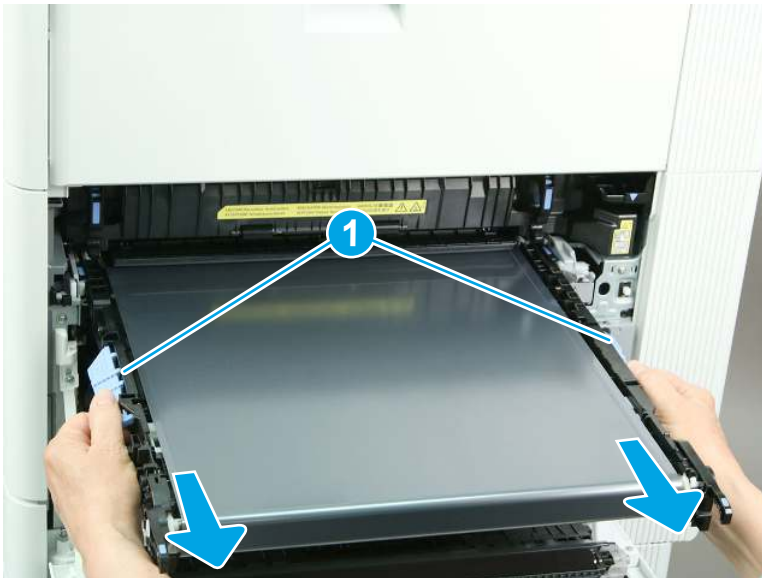
- a. Open the right door. Grasp the two blue handles on the ITB, and then pull the ITB partially out of the printer.

Figure 1-1448 Partially remove the ITB



- b. Grasp the blue handles on the side of the ITB (callout 1), and then remove the ITB from the printer.

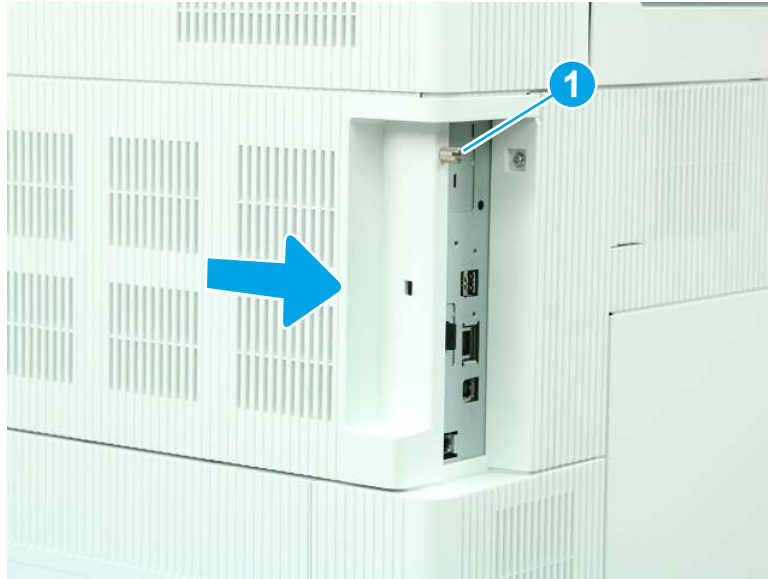
Figure 1-1449 Remove the ITB



5. Remove the formatter cover.

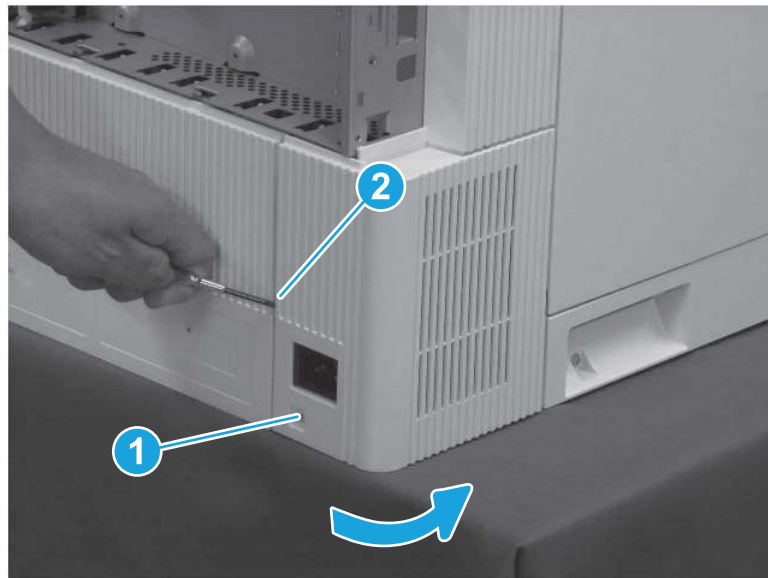
- ▲ Loosen one thumbscrew (callout 1), and then slide the formatter cover (callout 2) away from the printer to remove it.

Figure 1-1450 Remove the formatter cover



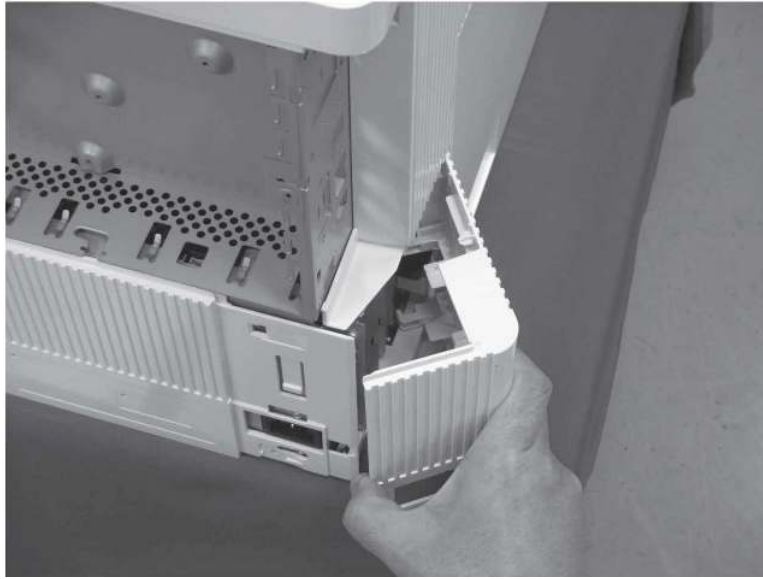
6. Remove the left lower cover (M751/E75245).
 - a. Remove one screw (callout 1), release one tab (callout 2), and then rotate the cover away from the printer.

Figure 1-1451 Remove one screw and release one tab



- b. Remove the left lower cover.

Figure 1-1452 Remove the left lower cover



- 7. Remove the left rear cover (M751/E75245/M856/E85055/M776).

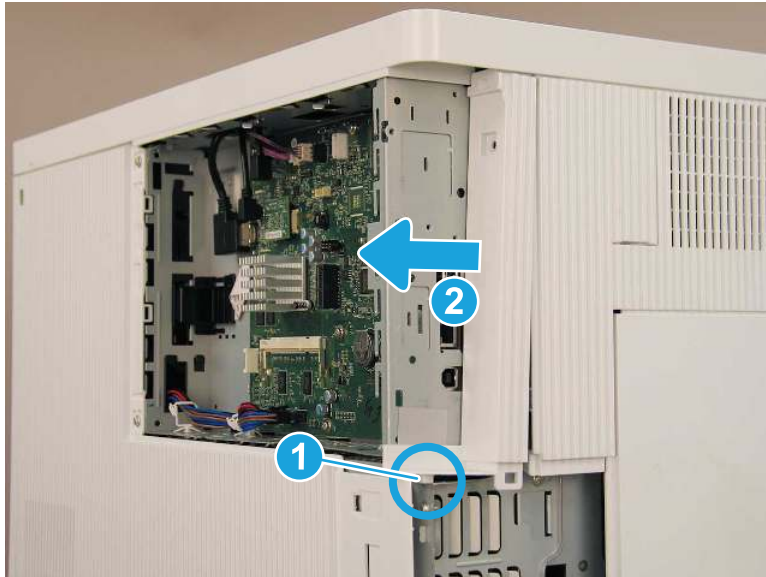
- a. Remove one screw (callout 1).

Figure 1-1453 Remove one screw



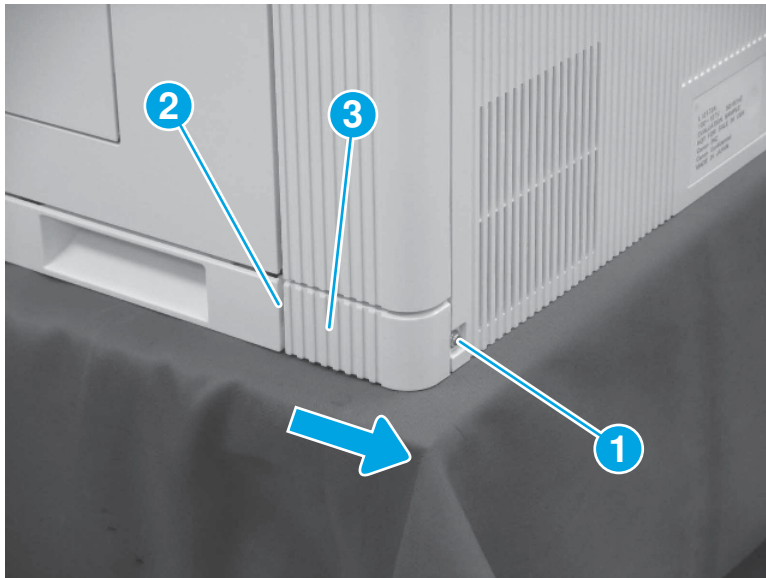
- b. Release one boss (callout 1), and then slide the cover toward the back of the printer (callout 2) to remove it.

Figure 1-1454 Remove the left rear cover



8. Remove the right rear lower cover (M751/E75245/M856/E85055/M776).
 - ▲ Remove one screw (callout 1), release one tab (callout 2), and then slide the right rear lower cover (callout 3) toward the back of the printer to remove it.

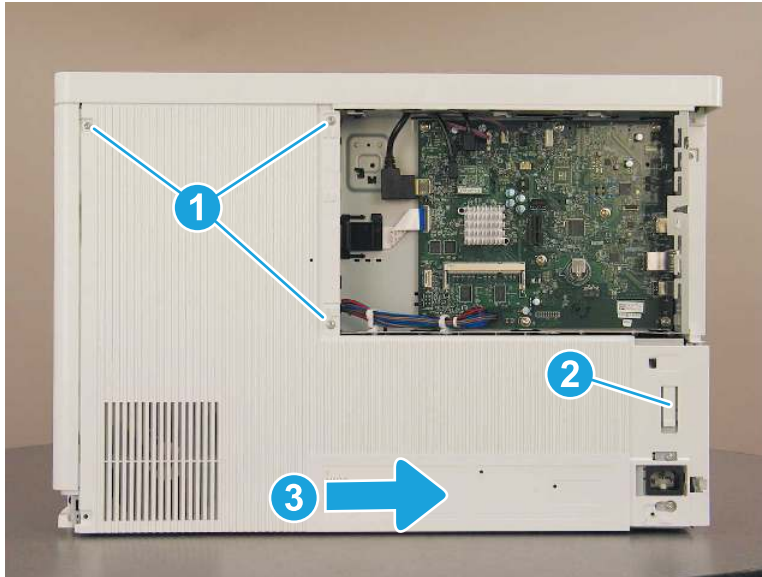
Figure 1-1455 Remove the right rear lower cover



9. Remove the rear cover (M751/E75245).

- ▲ Remove three screws (callout 1), release one tab (callout 2), and then slide the rear cover to the right (callout 3) to remove it.

Figure 1-1456 Remove the rear cover

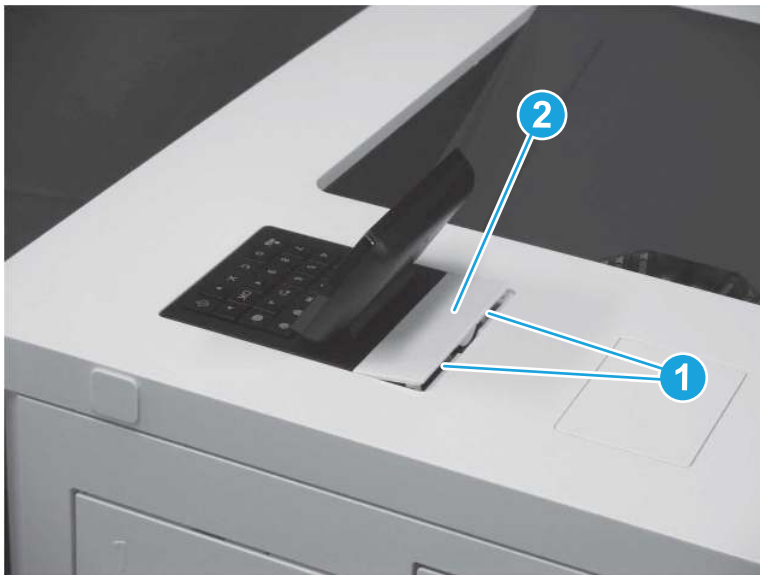


10. Remove the control panel.

 **NOTE:** A screwdriver is included in the control panel kit. The screwdriver has a reversible shaft. Simply pull the shaft out of the handle, and then reinstall it with the desired end facing out.

- a. Use a small, flat-blade screwdriver to release two tabs (callout 1), and then remove the control panel cover (callout 2).

Figure 1-1457 Remove the control panel cover



- b. Remove one screw (callout 1).

Figure 1-1458 Remove one screw



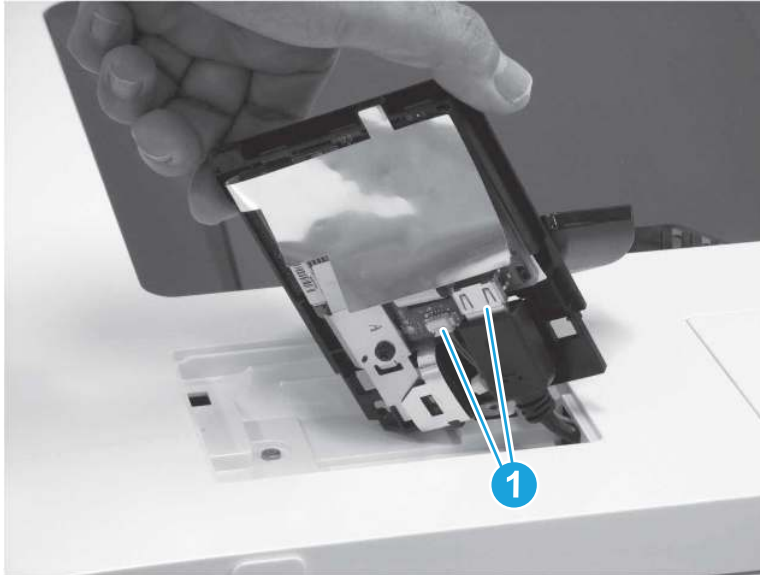
- c. Lift the back edge of the control panel up (callout 1), and then slide the control panel toward the back of the printer (callout 2).

Figure 1-1459 Slide the control panel back



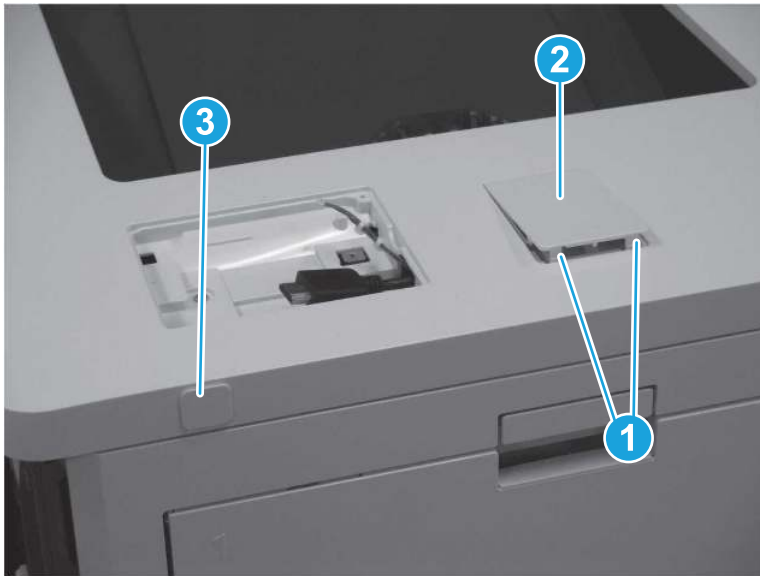
- d. Turn the control panel so that the bottom is facing up, and then disconnect two connectors (callout 1) to remove the control panel.

Figure 1-1460 Disconnect two connectors



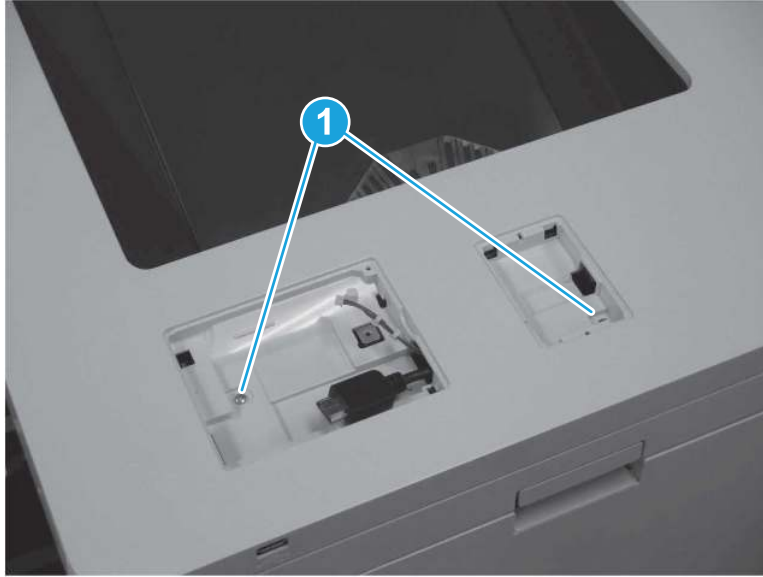
11. Remove the top cover (M751/E75245).
 - a. Release two tabs (callout 1), and then remove the HIP cover (callout 2). Pull the USB cap (callout 3) away from the printer to remove it.

Figure 1-1461 Remove the HIP cover and USB cap



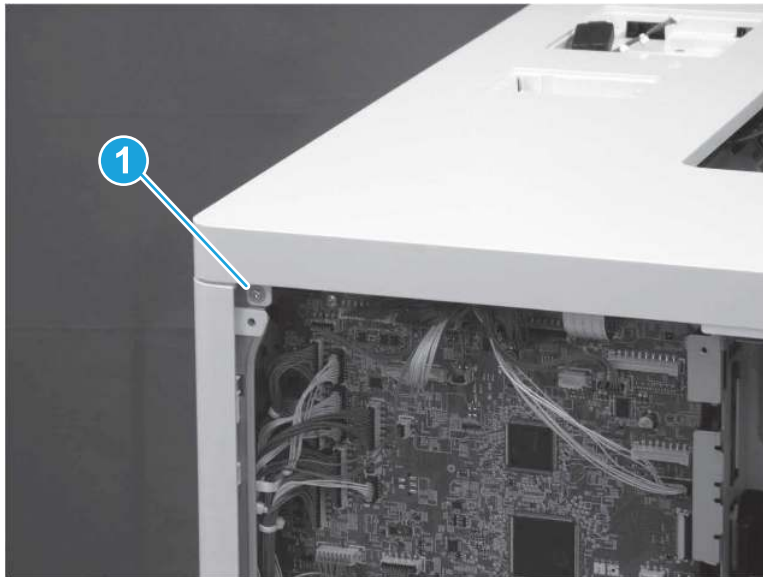
- b. At the top of the printer, remove two screws (callout 1).

Figure 1-1462 Remove two screws



- c. At the back of the printer, remove one screw (callout 1).

Figure 1-1463 Remove one screw

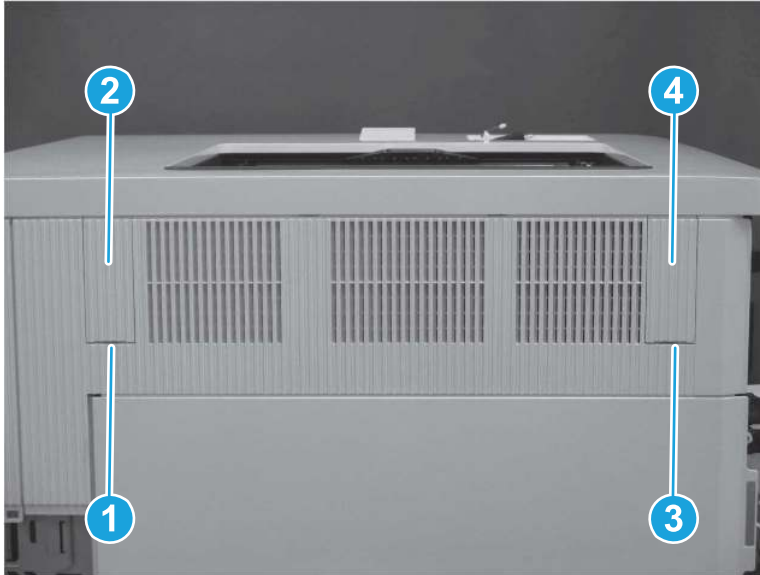


- d. Use a small, flat-blade screwdriver to release one tab (callout 1) and remove the left blanking cover (callout 2). Release one tab (callout 3) and remove the right blanking cover (callout 4).

 **TIP:** These covers are not identical. Make sure to reinstall the correct cover on the correct side.

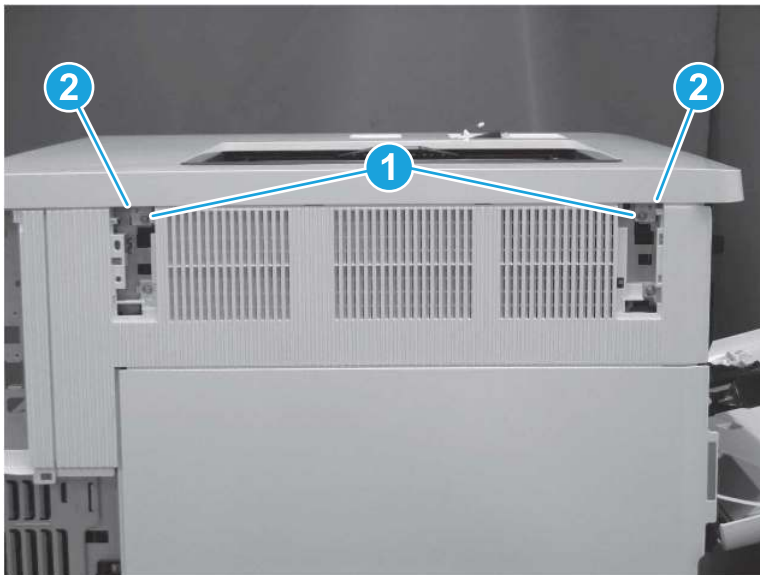
 **NOTE:** The screw under the left blanking cover is a self-tapping screw. Make sure this screw is reinstalled in the correct location.

Figure 1-1464 Remove the left and right blanking covers



- e. Remove two screws (callout 1), and then release two tabs (callout 2).

Figure 1-1465 Remove two screws and release two tabs



- f. At the front of the printer, remove one washer-head screw (callout 1) and one self-tapping screw (callout 2). Release one tab (callout 3).


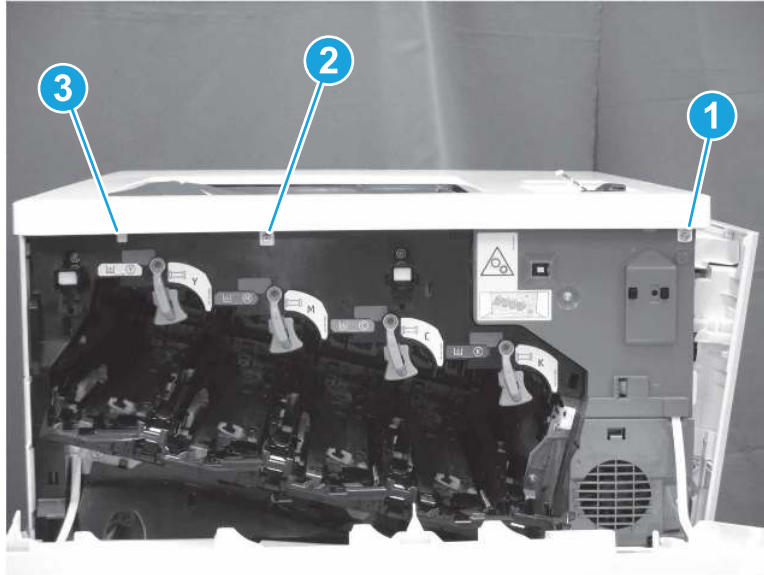
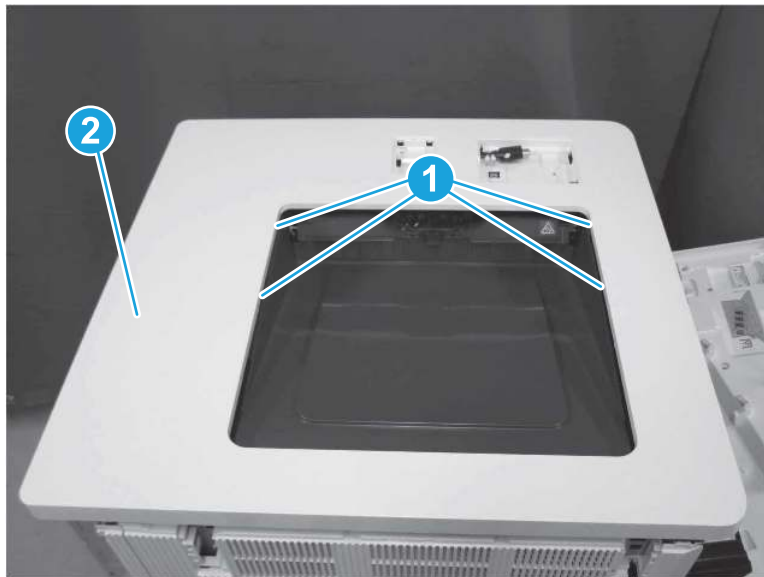
 **TIP:** Make sure to install the correct type of screw in the correct location.


Figure 1-1466 Remove two screws and release one tab



- g. At the top of the printer, release four tabs (callout 1), and then remove the top cover (callout 2).

Figure 1-1467 Remove the top cover



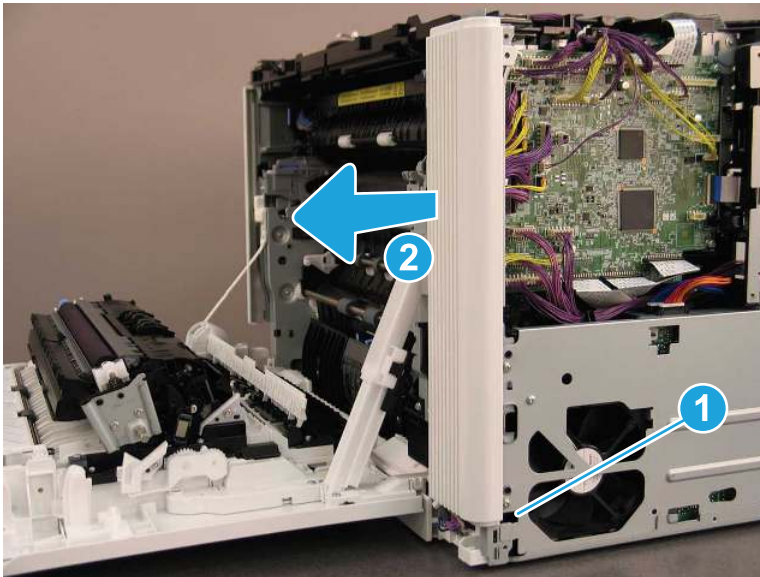
 **NOTE:** When removing the top cover, make sure to release the control panel cables (callout 1) through the opening.



12. Remove the right rear cover (M751/E75245).

- ▲ Release one tab (callout 1), and then slide the right rear cover (callout 2) away from the printer to remove it.

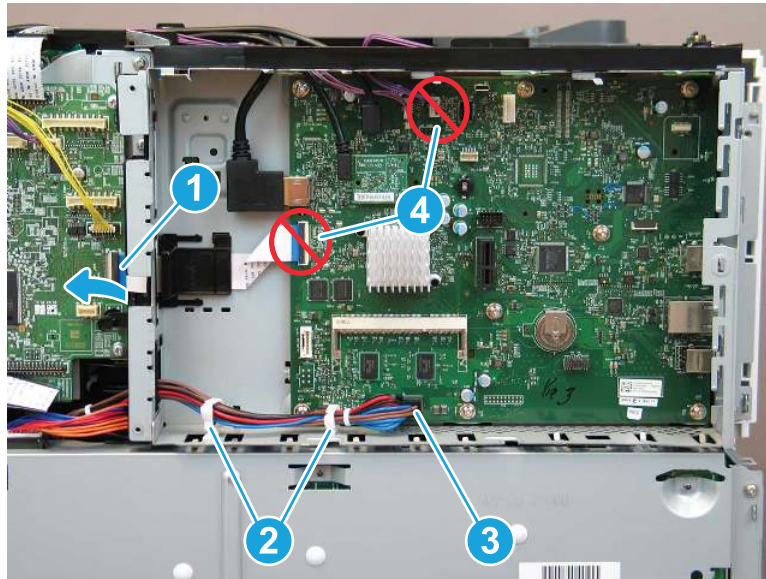
Figure 1-1468 Remove the right rear cover



13. Remove the formatter and case.

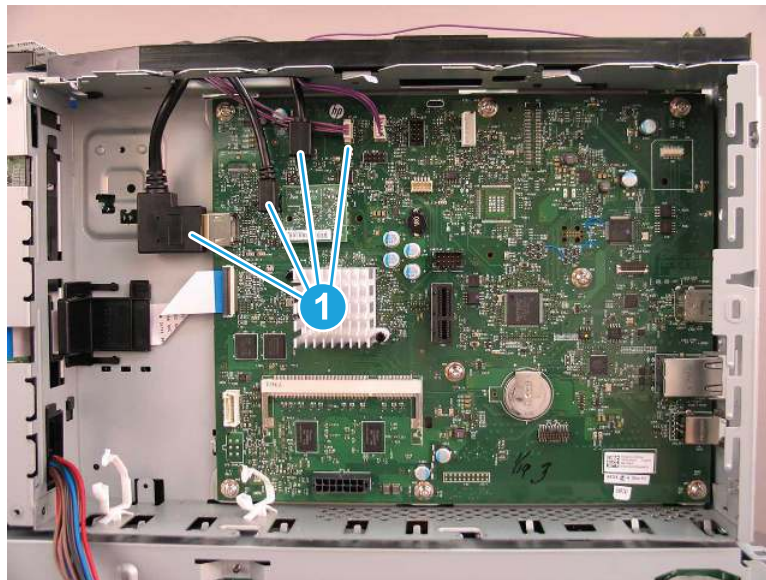
- a. Open the retainer (callout 1) to release the flat cable. Release the cables from two retainers (callout 2). Squeeze the latch to disconnect the connector (callout 3) at the lower edge of the formatter. It is not necessary to disconnect two connectors (callout 4).

Figure 1-1469 Disconnect the connectors



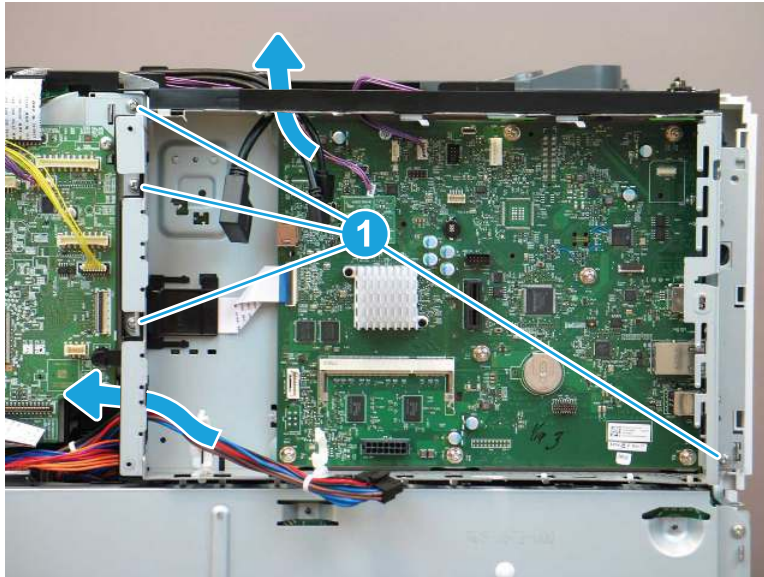
- b. Disconnect all of the remaining connectors on the formatter (callout 1).

Figure 1-1470 Disconnect the connectors



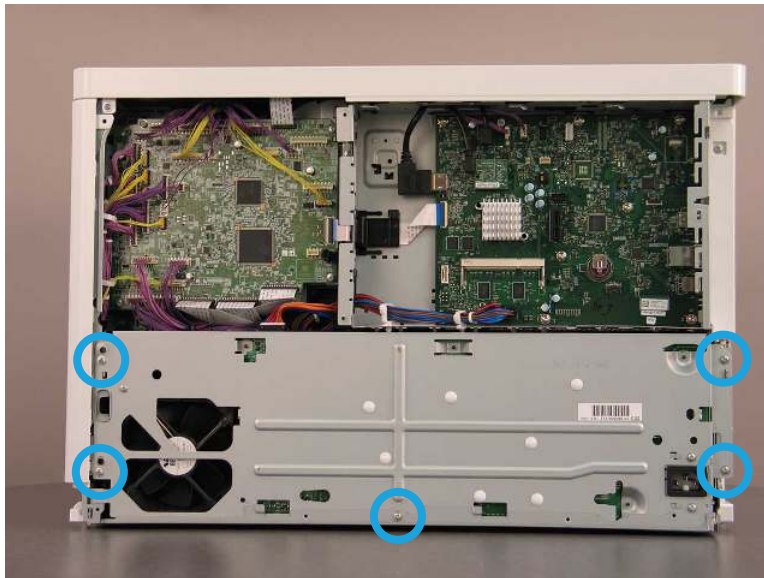
- c. Release the cables through the opening on top and on the left side of the formatter case. Remove four screws (callout 1), and then remove the formatter and case.

Figure 1-1471 Remove the formatter and case



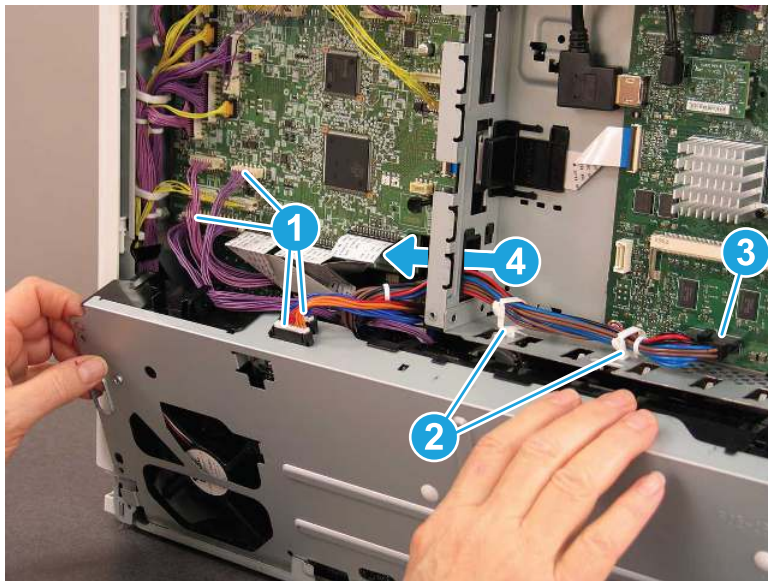
- 14. Remove the low-voltage power supply (LVPS).
 - a. Remove five screws.

Figure 1-1472 Remove five screws



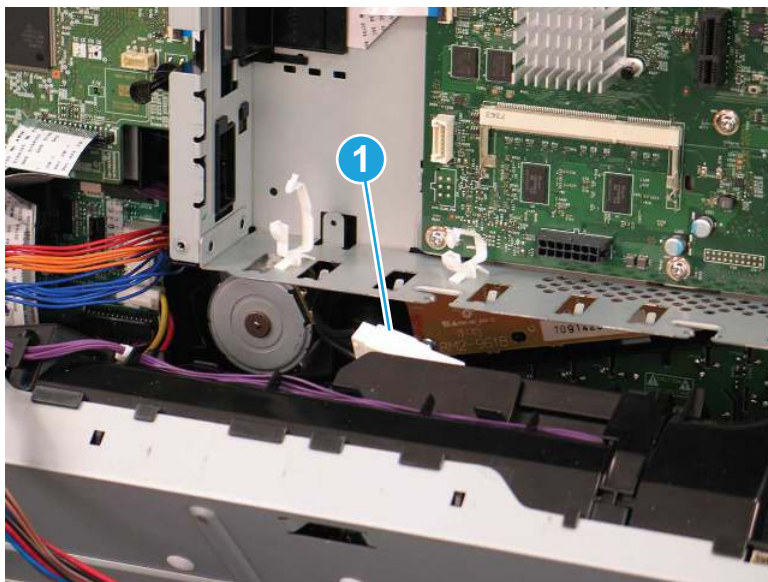
- b. Lift up on the LVPS, and then slightly rotate the top away from the printer. Disconnect four connectors (callout 1), and then release two retainers (callout 2). Press down on the latch to disconnect one connector (callout 3), and then release the wires through the hole (callout 4) in the formatter case.

Figure 1-1473 Disconnect five connectors



- c. Press down on the latch to disconnect one connector (callout 1), and then lift up to remove the LVPS.

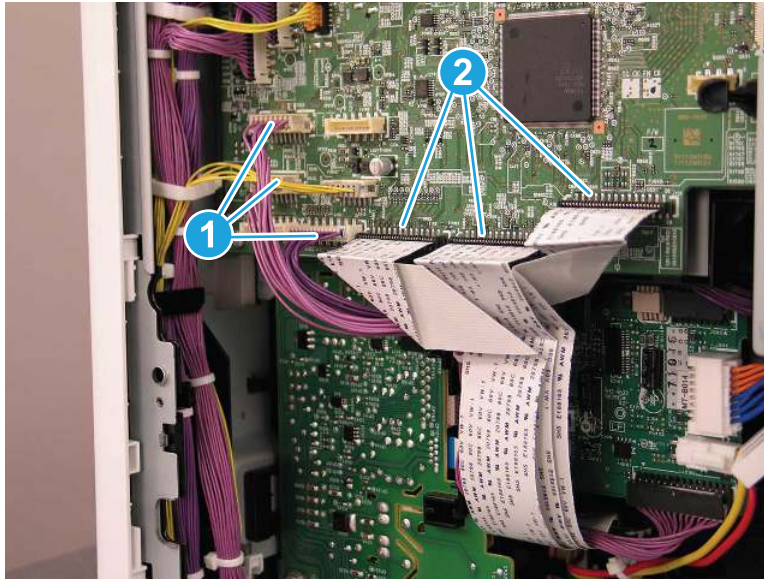
Figure 1-1474 Remove the LVPS



15. Remove the T2 connecting PCA.

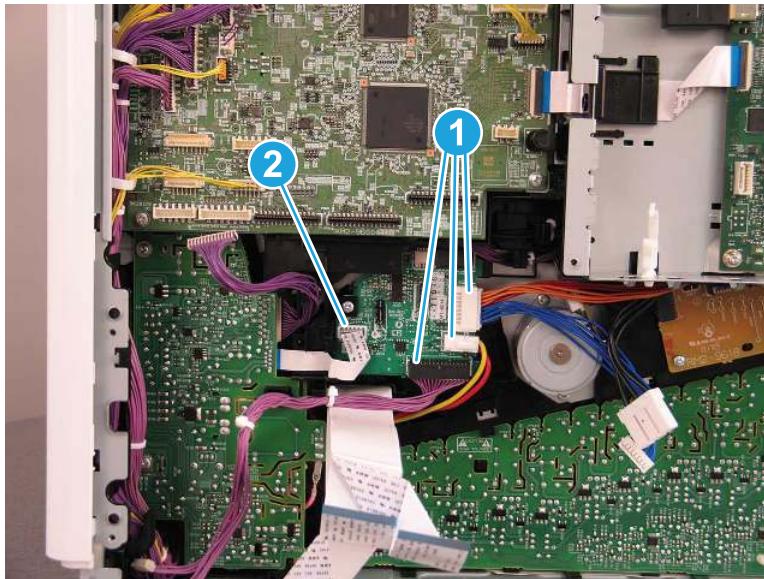
- a. Disconnect three connectors (callout 1), and then disconnect three flat cables (callout 2).

Figure 1-1475 Disconnect six connectors



- b. Disconnect three connectors (callout 1), and then disconnect one flat cable (callout 2).

Figure 1-1476 Disconnect three connectors and one flat cable



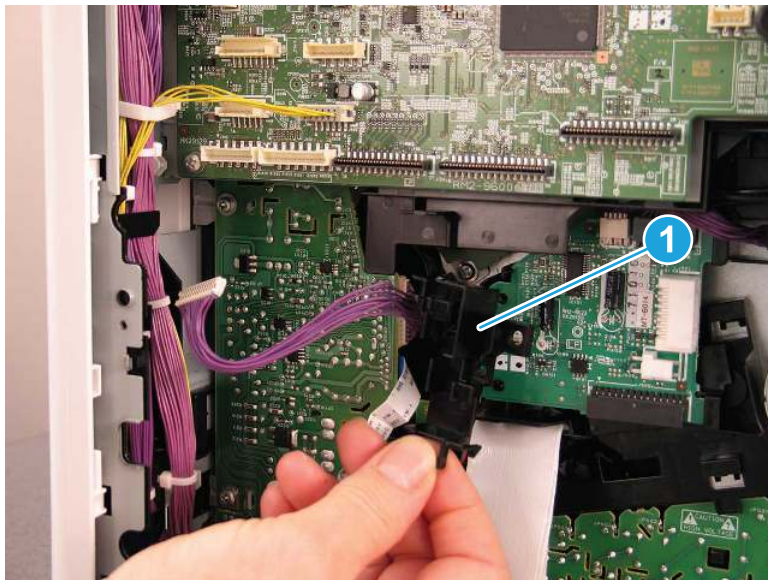
- c. Remove one screw (callout 1).

Figure 1-1477 Remove one screw



- d. Remove the cable guide (callout 1). If the cable guide is lost or damaged during the repair procedure, order a replacement part and install it along with the replacement T2 connecting PCA.

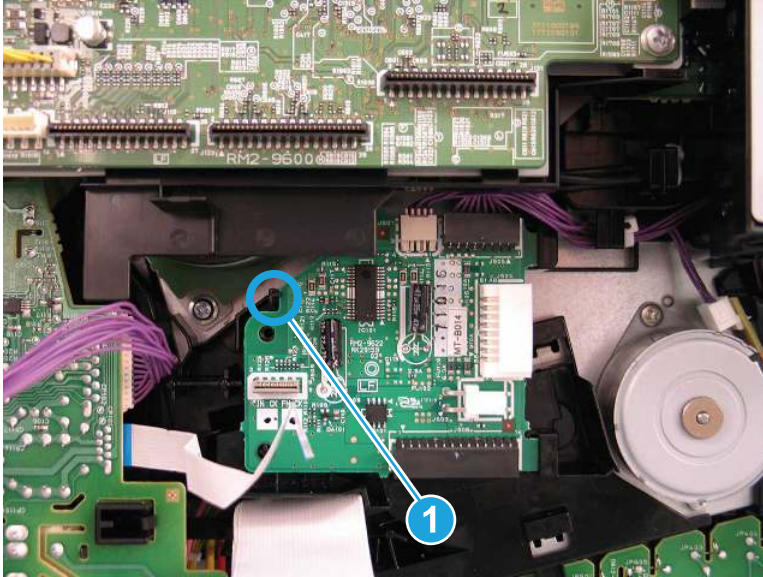
Figure 1-1478 Remove the cable guide



- e. Release one tab (callout 1), and then pull the T2 connecting PCA slightly away from the printer.

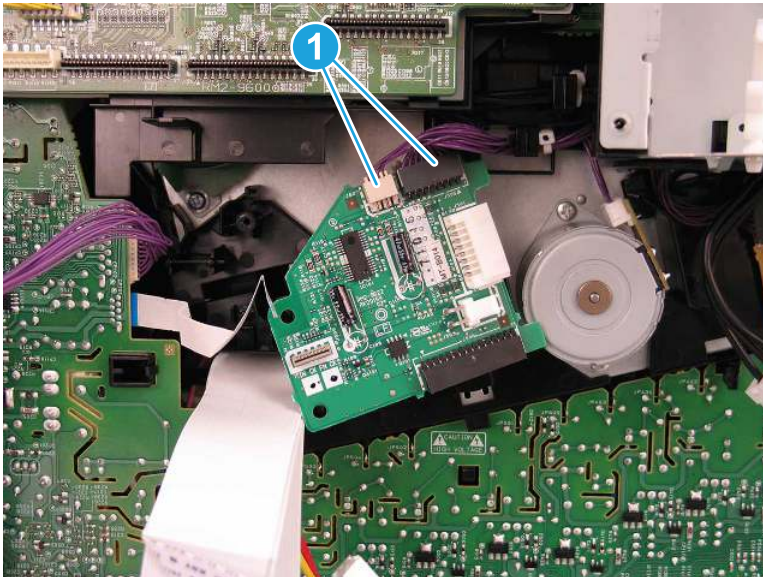
⚠ CAUTION: The T2 connecting PCA is still attached to the printer. Do not attempt to remove it completely.

Figure 1-1479 Release one tab



- f. Disconnect two connectors (callout 1), and then remove the T2 connecting PCA (callout 2).

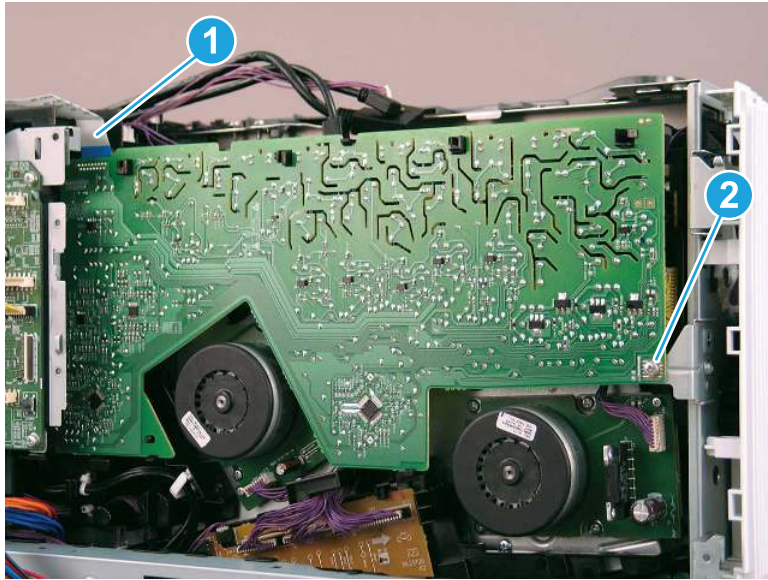
Figure 1-1480 Disconnect two connectors and remove the PCA



- 16. Remove the upper high-voltage power supply A (upper HVPS).

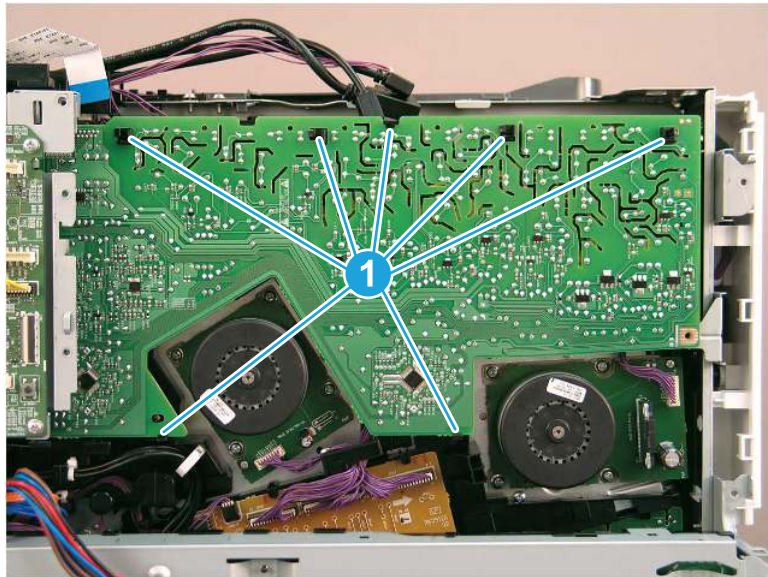
- a. Disconnect one flat cable (callout 1), and then remove one screw (callout 2).

Figure 1-1481 Disconnect one flat cable and remove one screw



- b. Release seven tabs (callout 1), and then remove the upper HVPS.

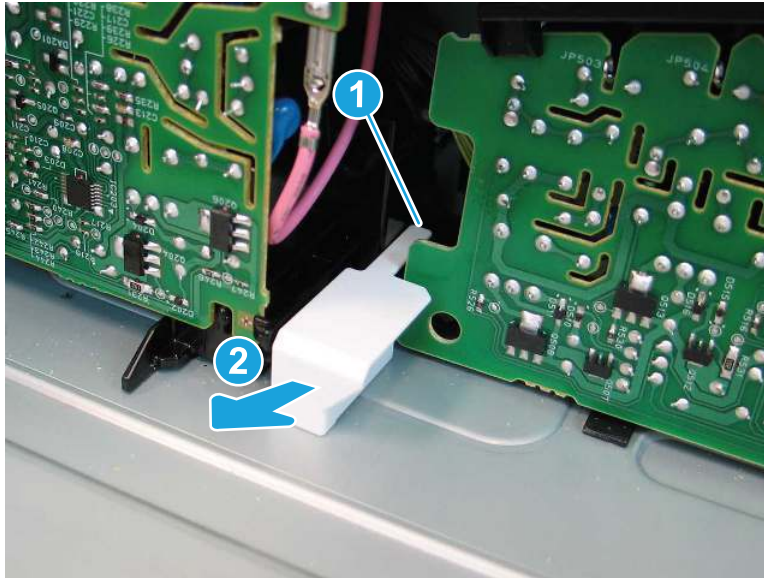
Figure 1-1482 Release seven tabs and remove the upper HVPS



17. Remove the lower high-voltage power supply (lower HVPS).

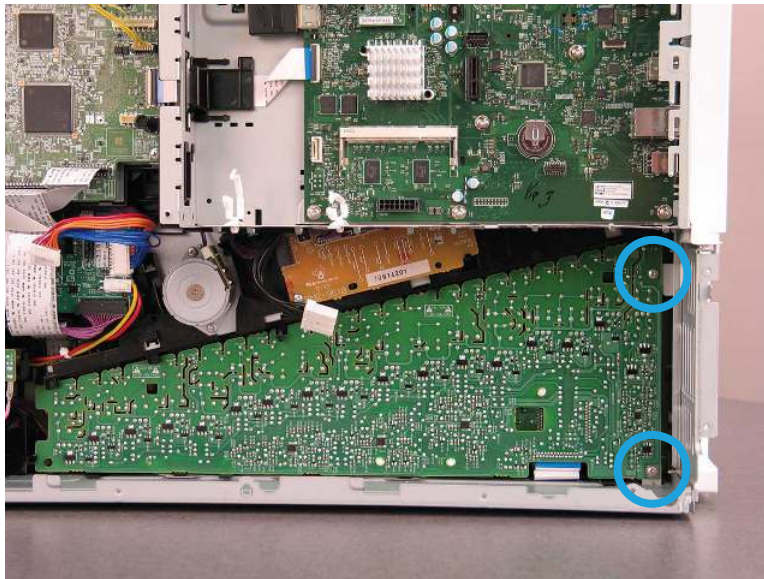
- a. Release one tab (callout 1) and then slide the stopper (callout 2) away from the printer to remove it.

Figure 1-1483 Remove the stopper



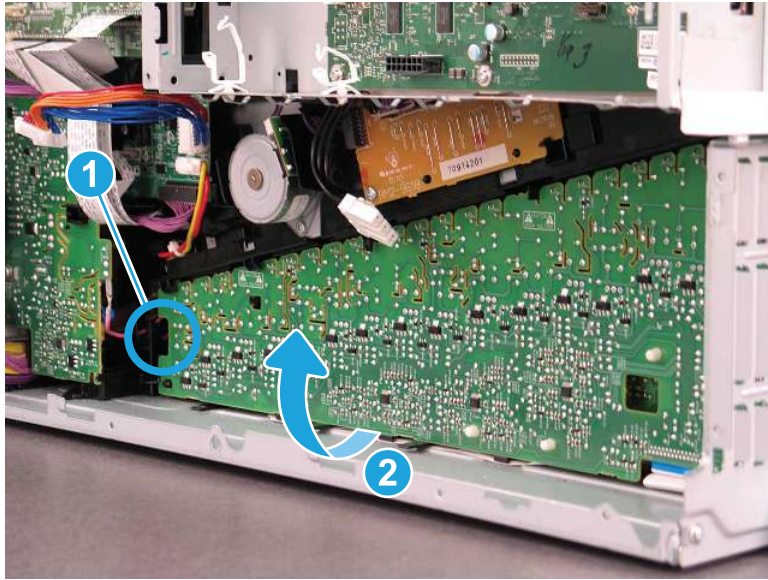
- b. Remove two screws (callout 1).

Figure 1-1484 Remove two screws



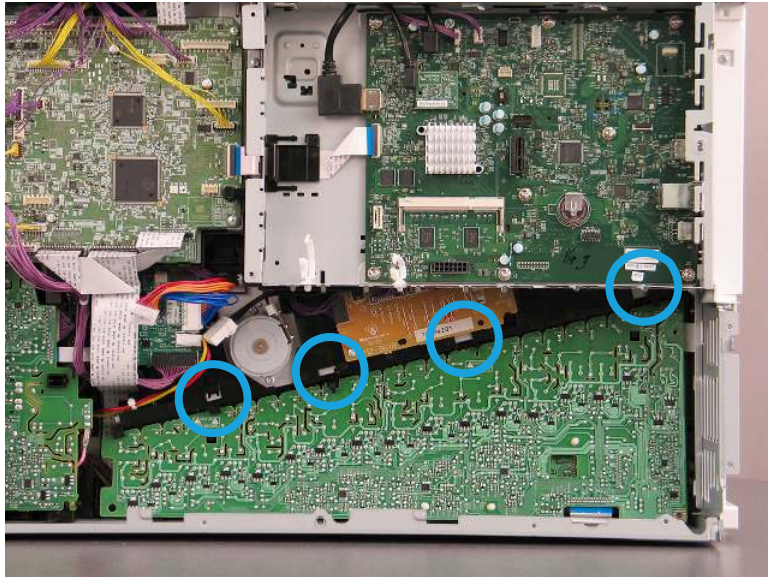
- c. Release one tab (callout 1), and then gently release the lower edge of the lower HVPS.

Figure 1-1485 Release the lower edge of the lower HVPS



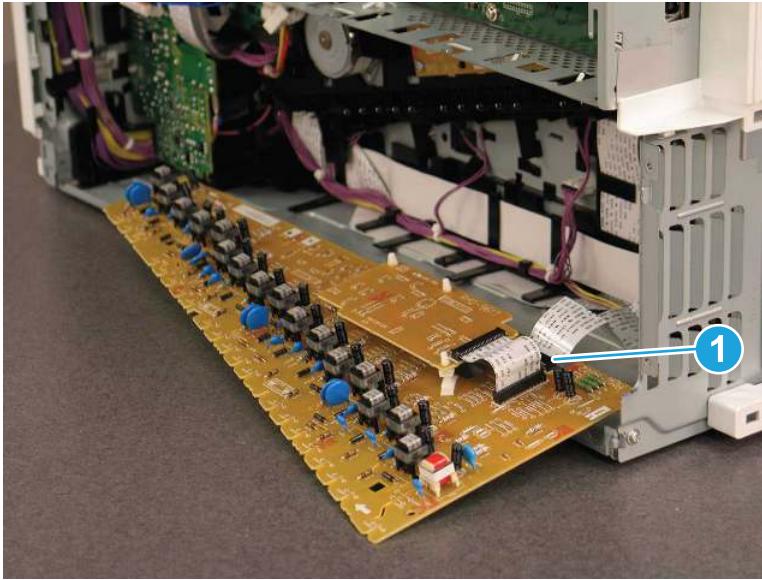
- d. Release the lower HVPS from four tabs.

Figure 1-1486 Release four tabs



- e. Disconnect one flat cable (callout 1) from the back of the lower HVPS.

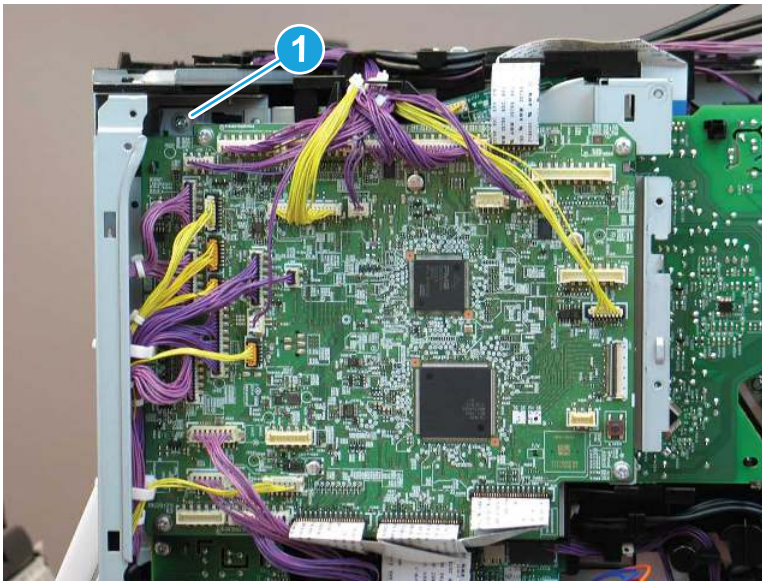
Figure 1-1487 Disconnect one flat cable



- 18. Remove the DC controller and case.

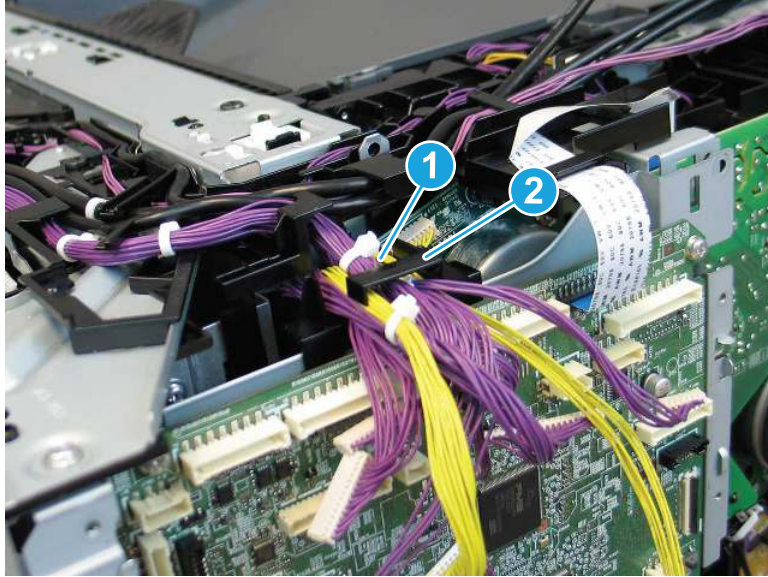
- a. Disconnect all of the connectors on the DC controller, and then remove one screw (callout 1).

Figure 1-1488 Disconnect connectors and remove one screw



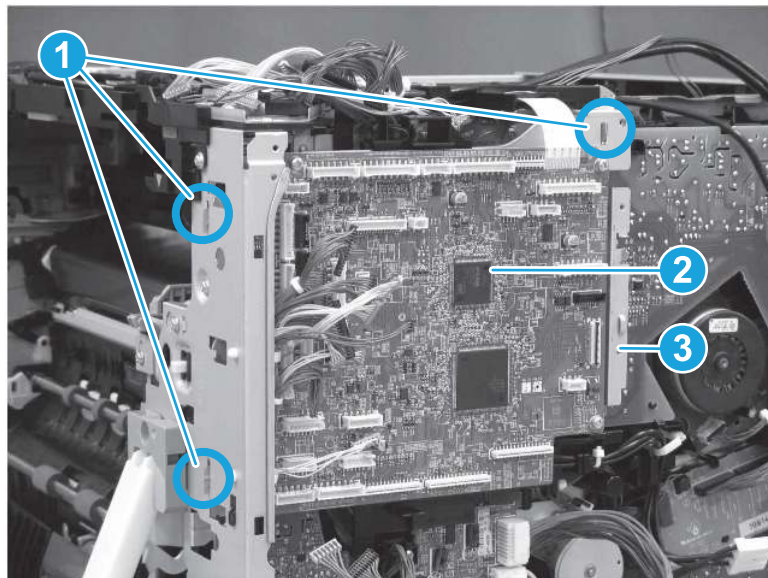
- b. Release the wire harnesses (callout 1) from the retainer (callout 2).

Figure 1-1489 Remove the wire harnesses from the retainer



- c. Lift up to release three tabs (callout 1), and then remove the DC controller (callout 2) together with the case (callout 3).

Figure 1-1490 Remove the DC controller and case



- 19. Remove the main drive assembly.

- a. Open the front door.



IMPORTANT: The front door must remain open during removal and installation of the main drive assembly to prevent issues.

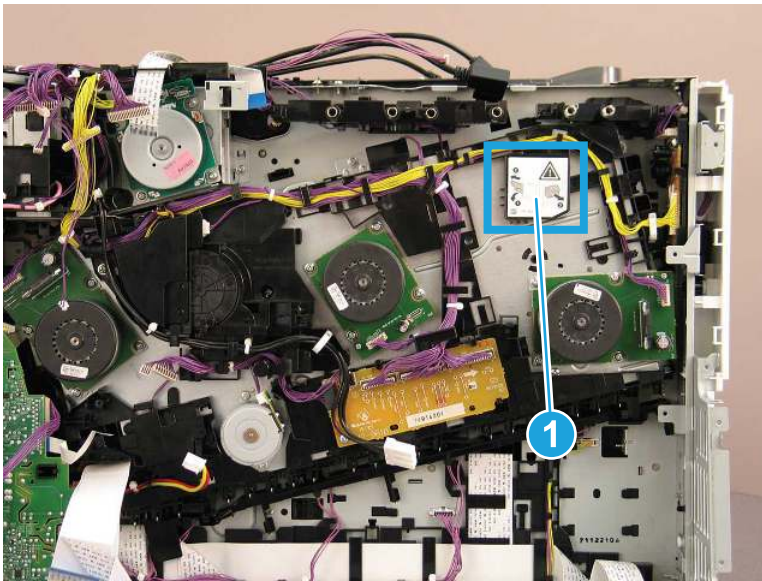
To prevent the front door from closing on its own, install one of the toner cartridges halfway.

Figure 1-1491 Open the front door



- b. Note the label (callout 1) on the main drive assembly indicating that the front door must be open and all toner cartridges and imaging drums removed before removing the main drive assembly.

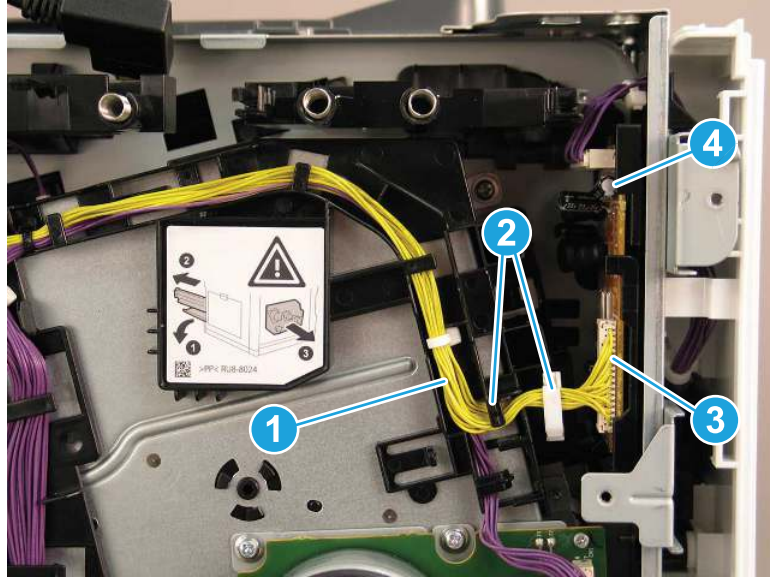
Figure 1-1492 Main drive assembly label



- c. Release the cable (callout 1) from the cable guide (callout 2), and then disconnect one connector (callout 3).

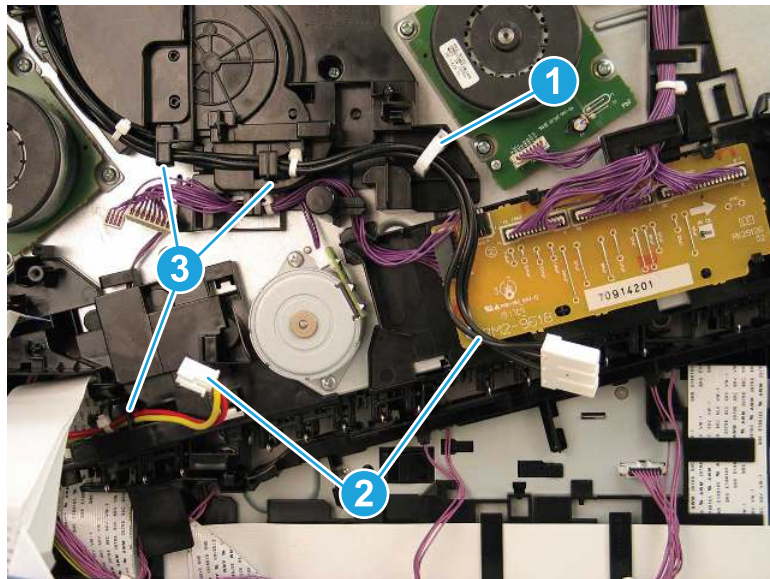
⚠ CAUTION: The capacitor on the PCA (callout 4) can rotate out and prevent the main drive assembly from reseating.

Figure 1-1493 Disconnect one connector



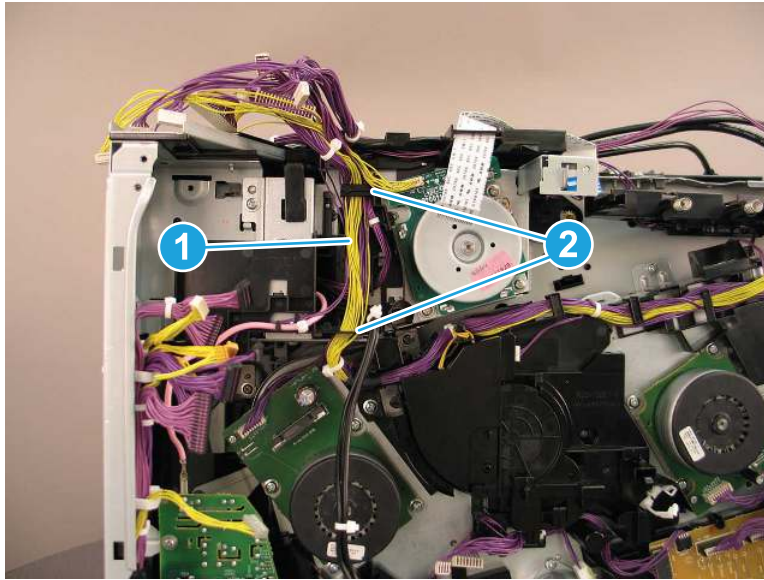
- d. Release the cables (callout 1) from the cable guides (callout 2).

Figure 1-1494 Release the cables from the guides




- e. Release the cables (callout 1) from the cable guides (callout 2).

Figure 1-1495 Release the cables from the guides

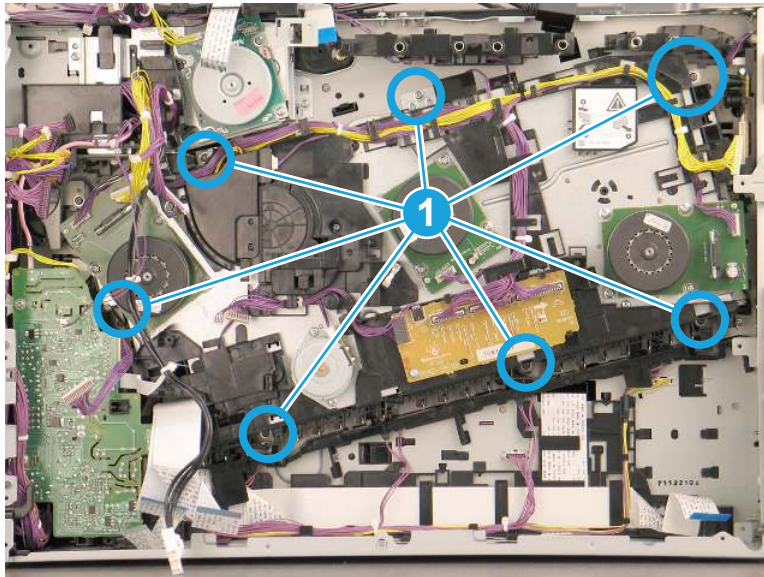


- f. Remove seven screws (callout 1), and then remove the main drive assembly.

 **IMPORTANT:** When reinstalling the main drive assembly, make sure that the front door is open.

Partially reinstall one toner cartridge to prevent the front door from closing.

Figure 1-1496 Remove seven screws and the main drive assembly




- 20. Unpack the replacement assembly.

- a. Dispose of the defective part.


 **NOTE:** HP recommends responsible disposal of the defective part.

<http://www8.hp.com/us/en/hp-information/environment/product-recycling.html>

- b. Unpack the replacement part from the packaging.

 **IMPORTANT:** Make sure that all of the shipping materials (for example shipping tape) are removed from the replacement part prior to installation.

- c. To install an assembly, reverse the removal steps.

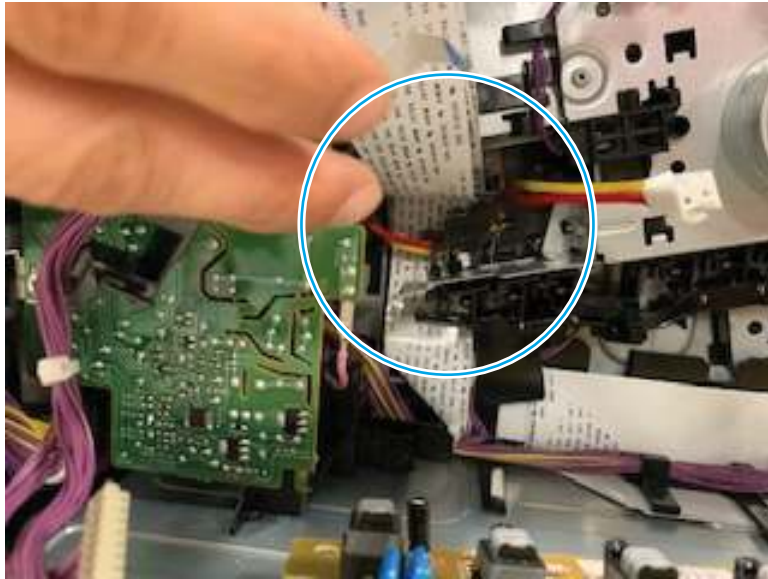
 **NOTE:** When applicable, special installation instructions are provided for an assembly at the end of the removal procedure. Always completely read the removal instructions and follow all special installation instructions.

- 21. Reverse the removal steps to install the assembly. Also use the following **special installation instructions**.

Install the main drive assembly.

- a. Route the red and yellow cables back into the main drive assembly guides prior to re-installation. This will prevent the cables from being pinched behind the main drive assembly.

Figure 1-1497 Main drive wire harness



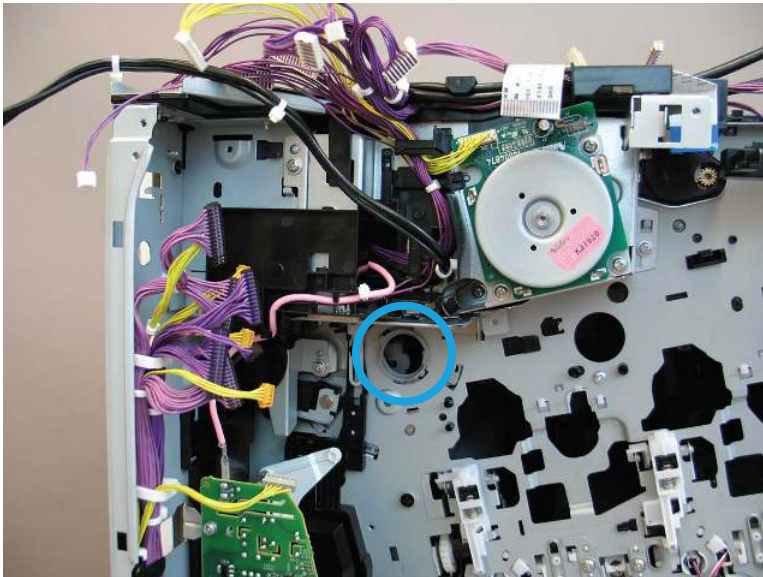
- b. If the coupling estrangement cam falls off of the printer or is broken or lost in the process of removing the main drive assembly, follow these steps to reinstall it.

Figure 1-1498 Coupling estrangement cam



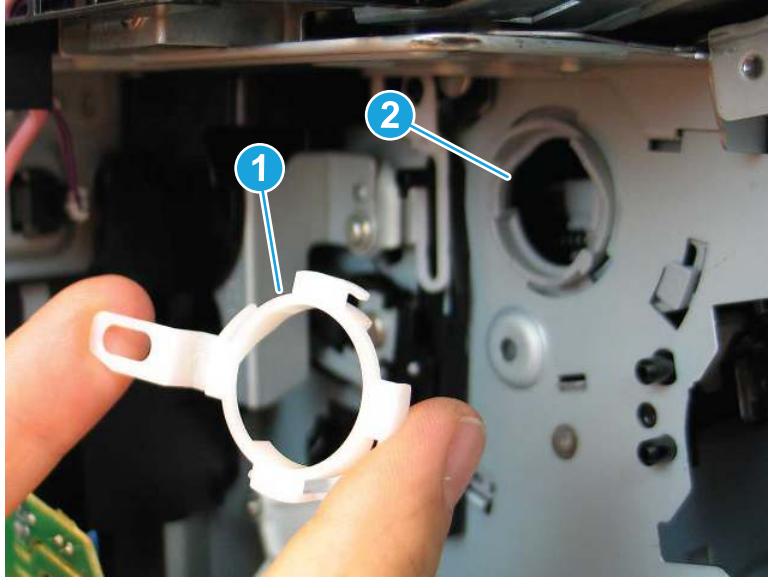
- c. Note the location where the cam will be installed.

Figure 1-1499 Cam location



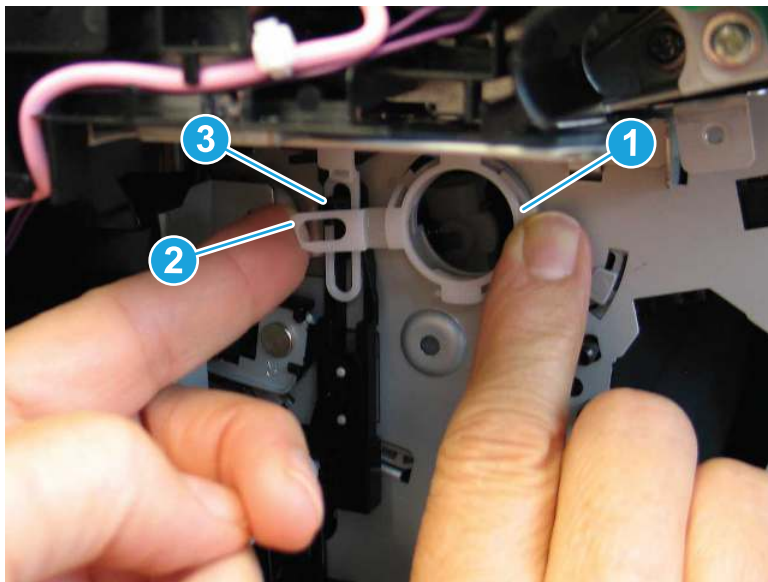
- d. Position the cam (callout 1) over the gray ring (callout 2) on the printer. The tabs on the cam fit into openings on the gray ring.

Figure 1-1500 Position the cam



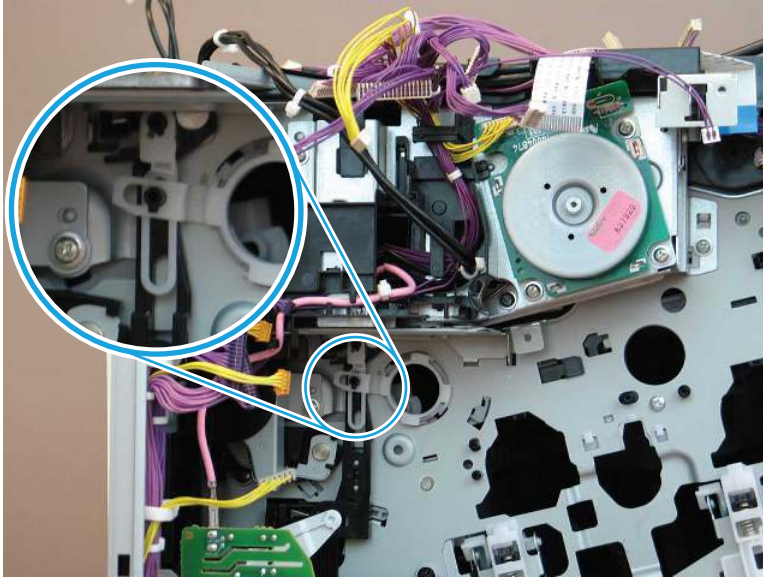
- e. Hold the cam in position (callout 1), and then position the opening in the left side of the cam (callout 2) over the boss (callout 3) on the black link arm on the printer.

Figure 1-1501 Install the cam



- f. When installed correctly, the cam engages with the black link arm on the printer.

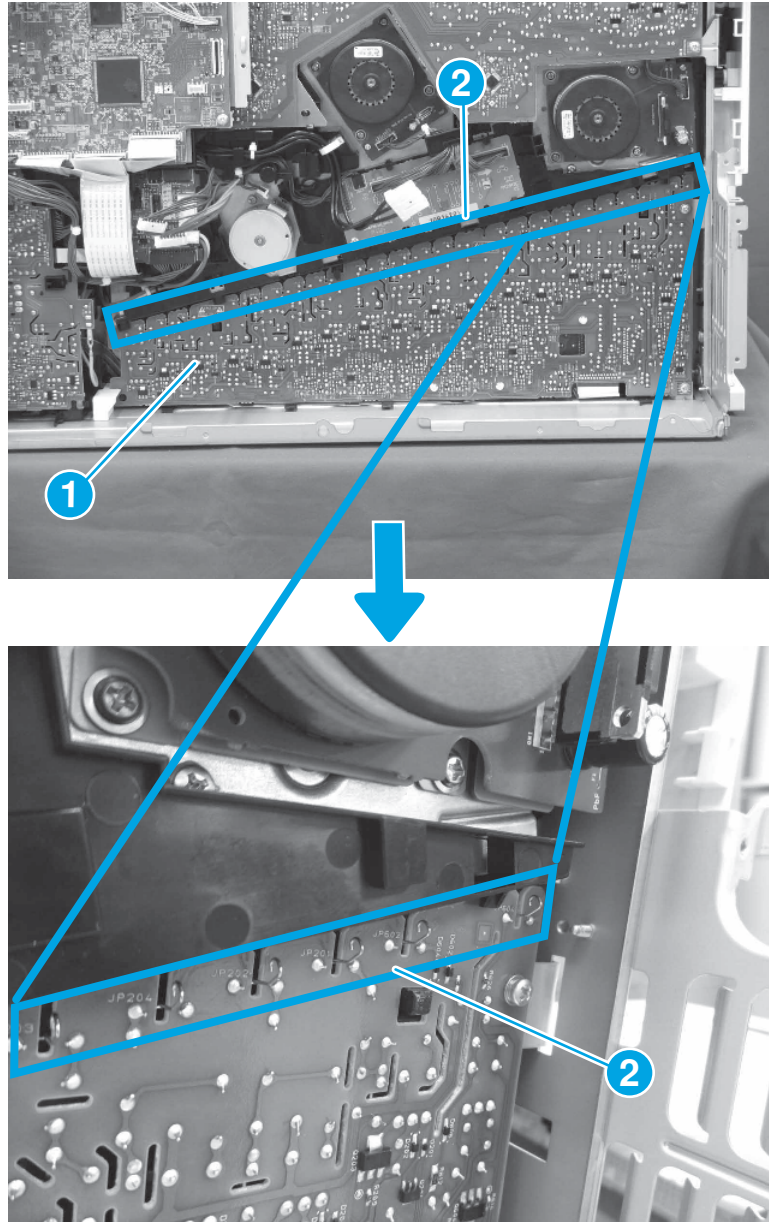
Figure 1-1502 Cam correctly installed



Install the lower HVPS

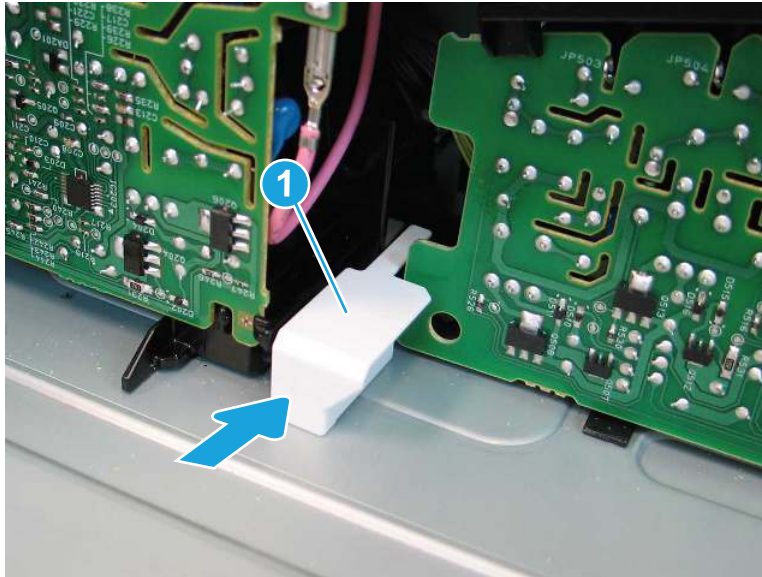
- a. When reinstalling the lower HVPS (callout 1), make sure that the top of the lower HVPS engages with the contact springs (callout 2) and that the springs are in the correct position.

Figure 1-1503 Check the springs



- b. Make sure that the stopper (callout 1) is reinstalled at the bottom of the lower HVPS.

Figure 1-1504 Install the stopper



Removal and replacement: Main drive assembly (M856/E85055/M776)

Learn how to remove and replace the main drive assembly.

[View a video of how to remove and replace the main drive assembly.](#)

Mean time to repair: 42 minutes

Service level: Medium

Before performing service

Turn the printer power off

- Disconnect the power cable.

⚠ WARNING! To avoid damage to the printer, turn the printer off, wait 30 seconds, and then remove the power cord before attempting to service the printer.

Use the table below to identify the correct part number for your printer. To order the part, go to www.hp.com/buy/parts.

Table 1-83 Part information

Part number	Part description
RM2-1614-000CN	Main drive assembly
RCS-1055-000CN	Cam, coupling estrangement (if needed)

Required tools

- #2 Phillips screwdriver with a magnetic tip
- Small, flat-blade screwdriver

After performing service

Turn the printer power on

- Connect the power cable.
- Use the power switch to turn the power on.

Post service test

Make sure that the printer initializes to a **Ready** state.

Print a page to make sure that the printer is functioning correctly.

1. Remove the toner cartridges.

- ▲ Open the front door, if it is not already open. Grasp the handle of the toner cartridge and pull out to remove it. Repeat the process for the remaining toner cartridges.

Figure 1-1505 Remove the toner cartridge



2. Remove the imaging drums.

- a. Open the front door, if it is not already open. Rotate the blue lever in front of the imaging drum to the left.

Figure 1-1506 Rotate the blue lever



- b. Grasp the handle of the imaging drum and pull out to remove it. Repeat the process for the remaining imaging drums.

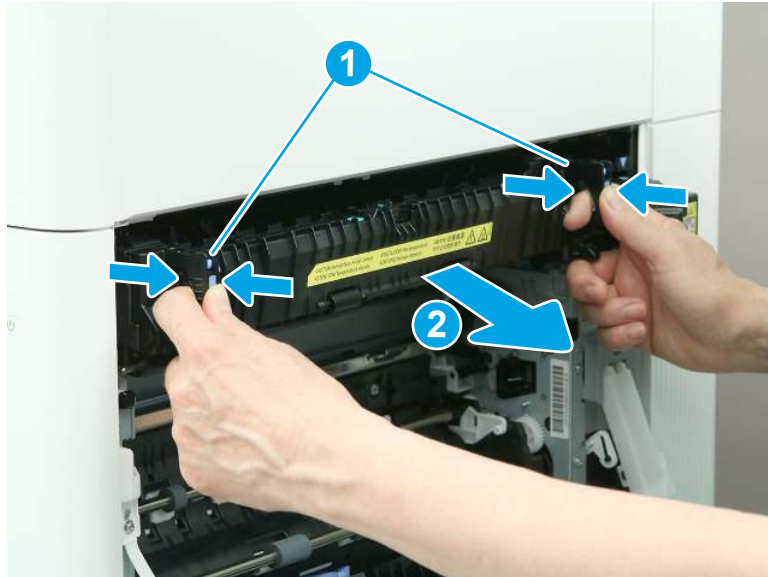
Figure 1-1507 Remove the imaging drum



3. Remove the fuser.

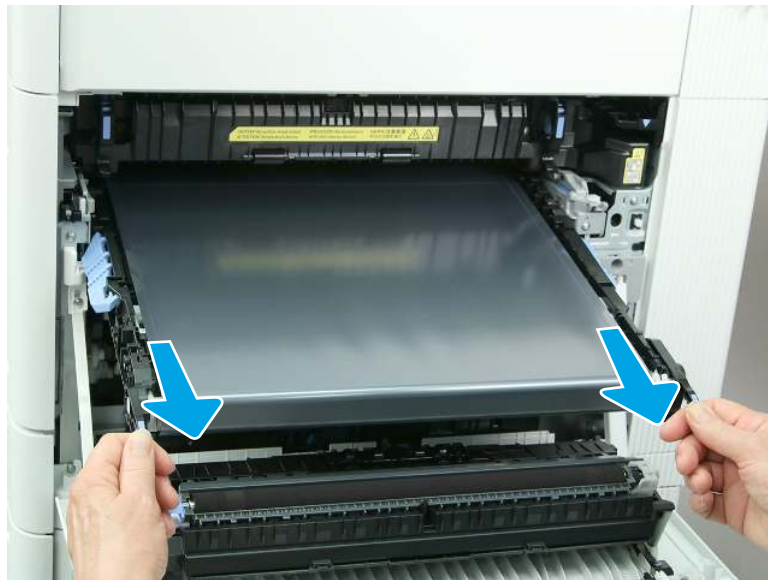
- ▲ Grasp the fuser handles, and then squeeze the release levers (callout 1). Lift up slightly, and then pull straight out to remove the fuser (callout 2).

Figure 1-1508



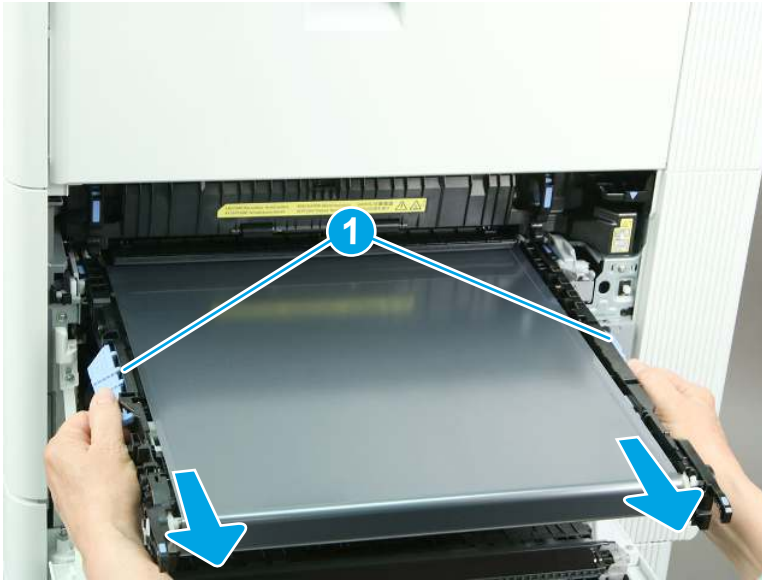
4. Remove the intermediate transfer belt (ITB).
 - a. Open the right door. Grasp the two blue handles on the ITB, and then pull the ITB partially out of the printer.

Figure 1-1509 Partially remove the ITB



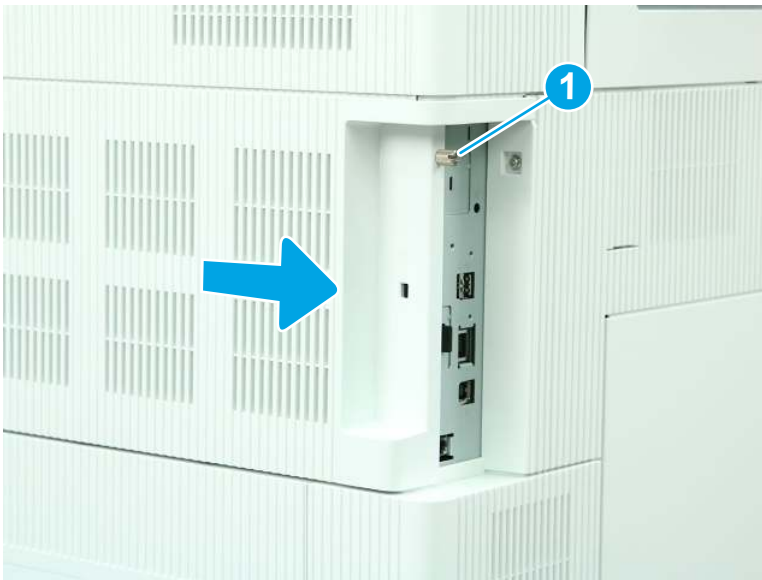
- b. Grasp the blue handles on the side of the ITB (callout 1), and then remove the ITB from the printer.

Figure 1-1510 Remove the ITB



5. Remove the formatter cover.
 - ▲ Loosen one thumbscrew (callout 1), and then slide the formatter cover (callout 2) away from the printer to remove it.

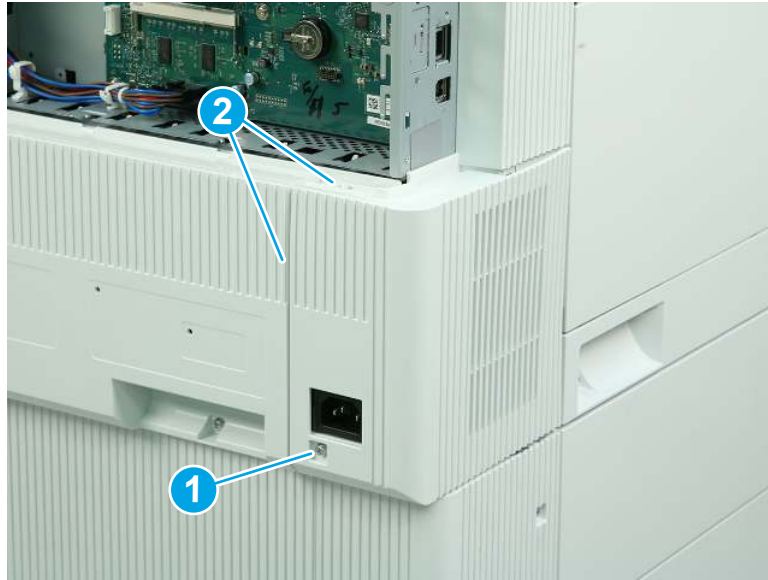
Figure 1-1511 Remove the formatter cover



6. Remove the left lower cover (M856/E85055/M776).

- a. Remove one screw (callout 1), and then release two tabs (callout 2).

Figure 1-1512 Remove one screw and release two tabs



- b. Rotate the cover away from the printer to remove it.

Figure 1-1513 Remove the left lower cover



7. Remove the left rear cover (M751/E75245/M856/E85055/M776).

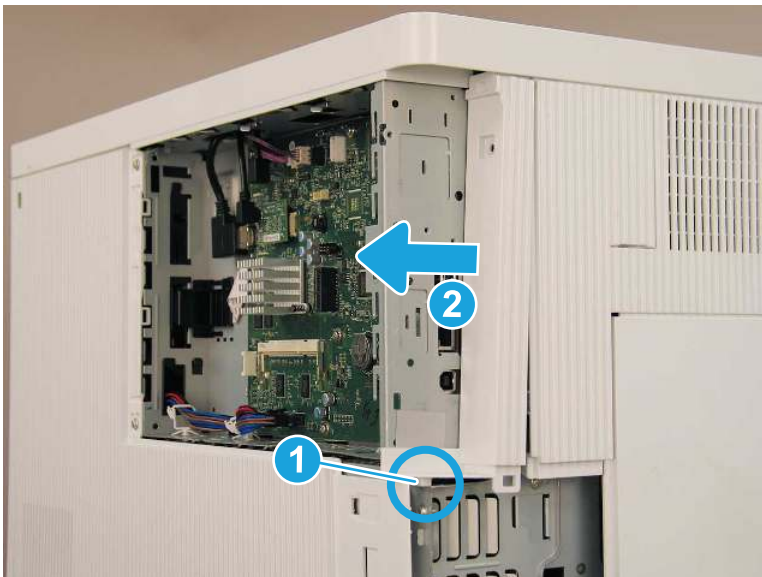
- a. Remove one screw (callout 1).

Figure 1-1514 Remove one screw



- b. Release one boss (callout 1), and then slide the cover toward the back of the printer (callout 2) to remove it.

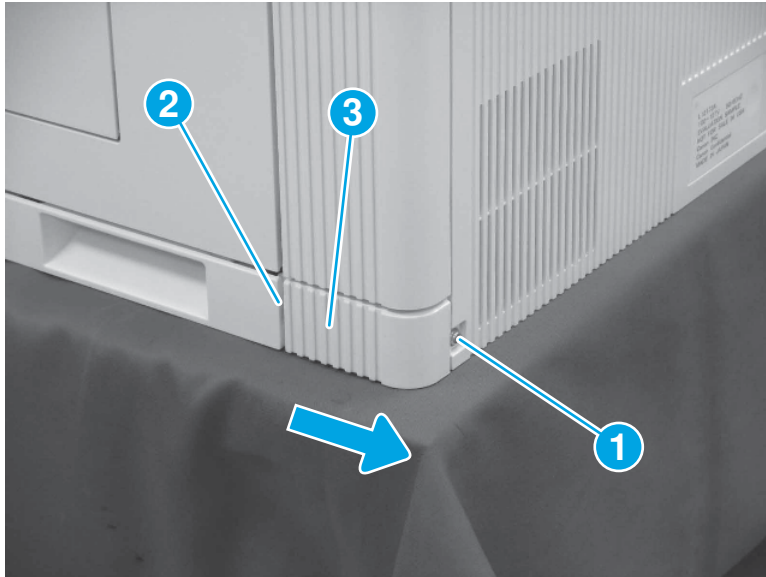
Figure 1-1515 Remove the left rear cover



8. Remove the right rear lower cover (M751/E75245/M856/E85055/M776).

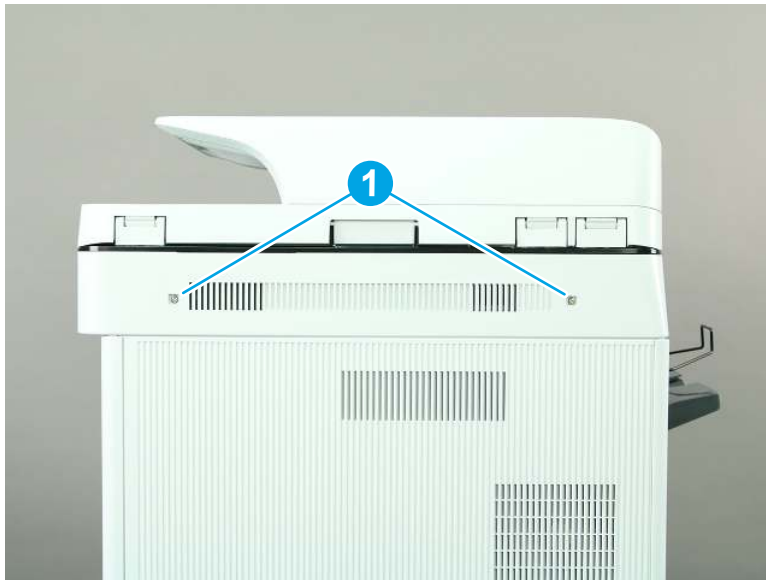
- ▲ Remove one screw (callout 1), release one tab (callout 2), and then slide the right rear lower cover (callout 3) toward the back of the printer to remove it.

Figure 1-1516 Remove the right rear lower cover



- 9. Remove the scanner control board (SCB) cover (M776).
 - a. Remove two screws (callout 1).

Figure 1-1517 Remove two screws



- b. Remove the SCB cover.

Figure 1-1518 Remove the SCB cover

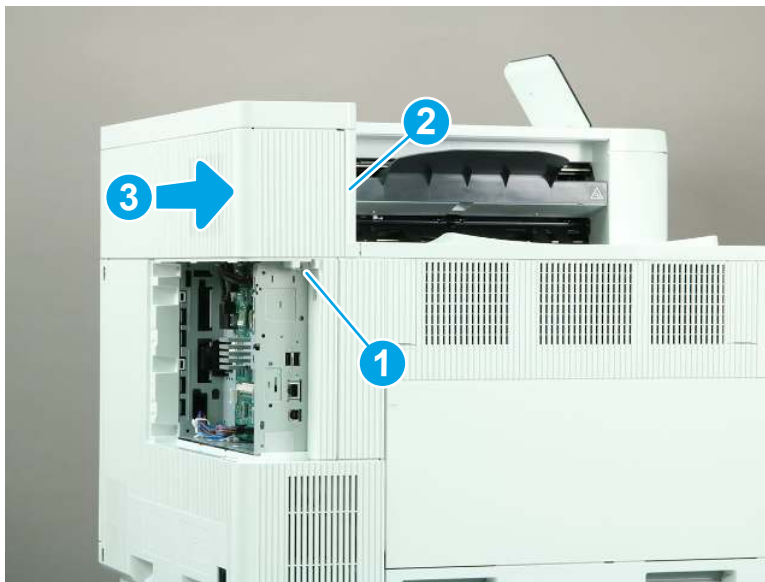


10. Remove the rear upper cover (M856/E85055/M776dn/M776z).

 **NOTE:** The following figure shows the M856 printer. The procedure is correct for all referenced models.

- ▲ Remove one screw (callout 1), release one tab (callout 2), and then slide the rear upper cover away from the printer to remove it (callout 3).

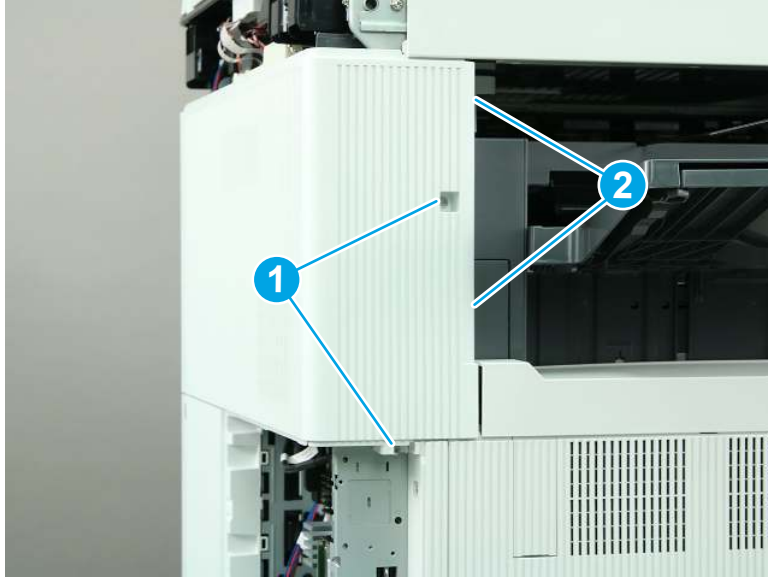
Figure 1-1519 Remove the rear upper cover



11. Remove the rear upper cover and left rear upper cover (M776zs).

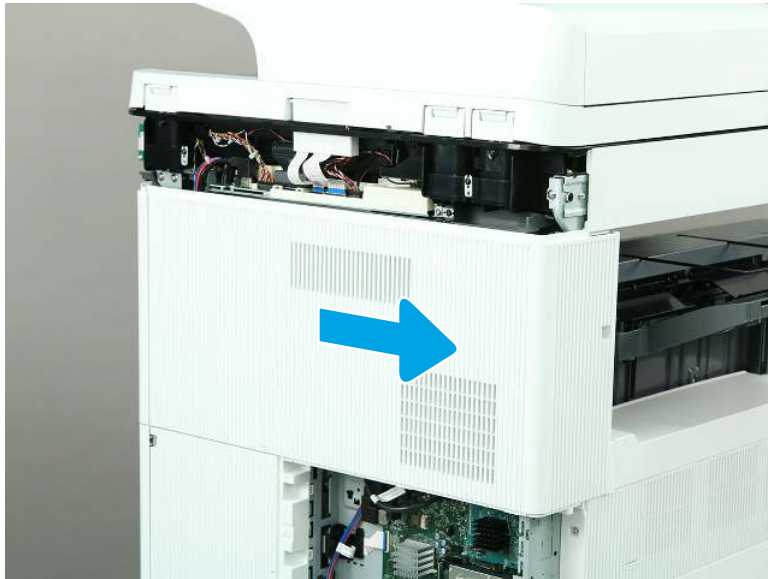
- a. Remove two screws (callout 1), and then release two tabs (callout 2).

Figure 1-1520 Remove two screws and release two tabs



- b. Slide the cover to the right to remove it.

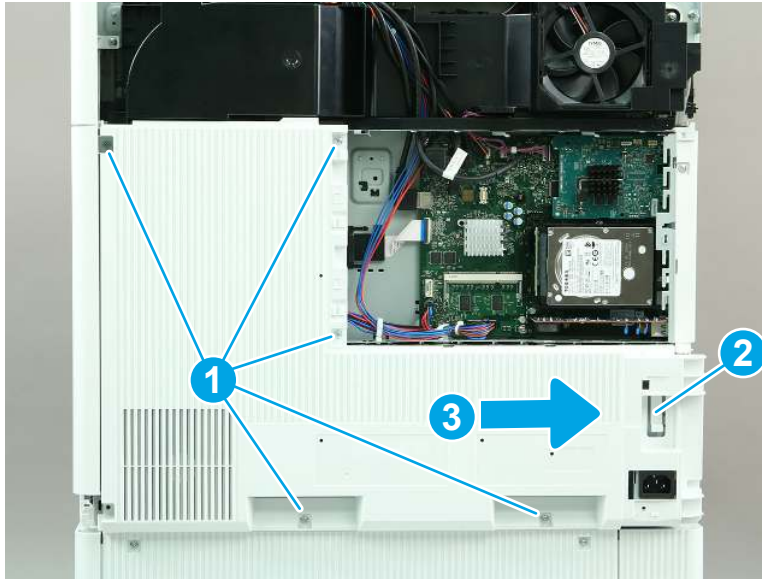
Figure 1-1521 Remove the rear upper and left rear upper cover




12. Remove the rear cover (M856/E85055/M776).

- ▲ Remove five screws (callout 1), release one tab (callout 2), and then slide the rear cover to the right to remove it.

Figure 1-1522 Remove the rear cover (M856/E85055/M776)



13. **M856/E85055 only:** Remove the control panel and top cover.

 **NOTE:** This step applies to only the M856/E85055 models. Skip this step for all other models.

- a. Use a small, flat-blade screwdriver to release two tabs (callout 1), and then remove the control panel cover (callout 2).

Figure 1-1523 Remove the control panel cover



- b. Remove one screw (callout 1).

Figure 1-1524 Remove one screw



- c. Lift the back edge of the control panel up (callout 1), and then slide the control panel toward the back of the printer (callout 2).

Figure 1-1525 Slide the control panel back



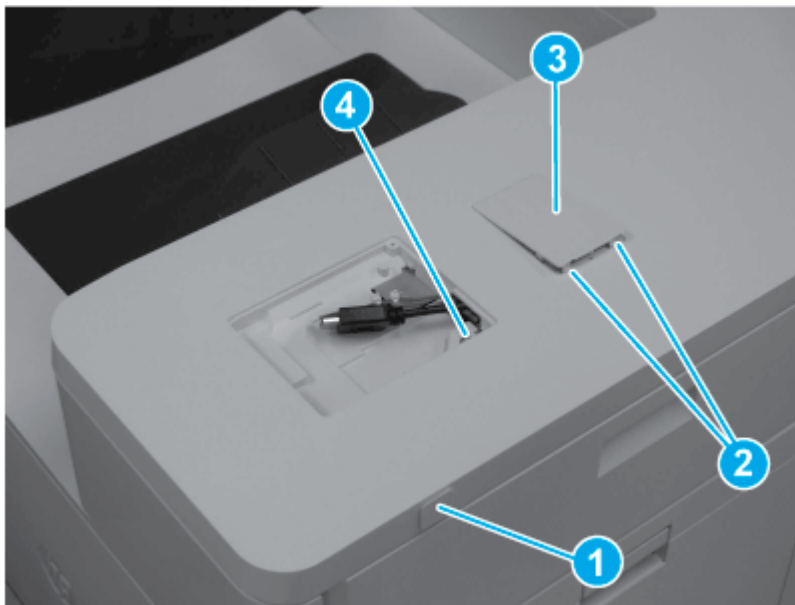
- d. Turn the control panel so that the bottom is facing up, and then disconnect two connectors to remove the control panel.

Figure 1-1526 Disconnect two connectors



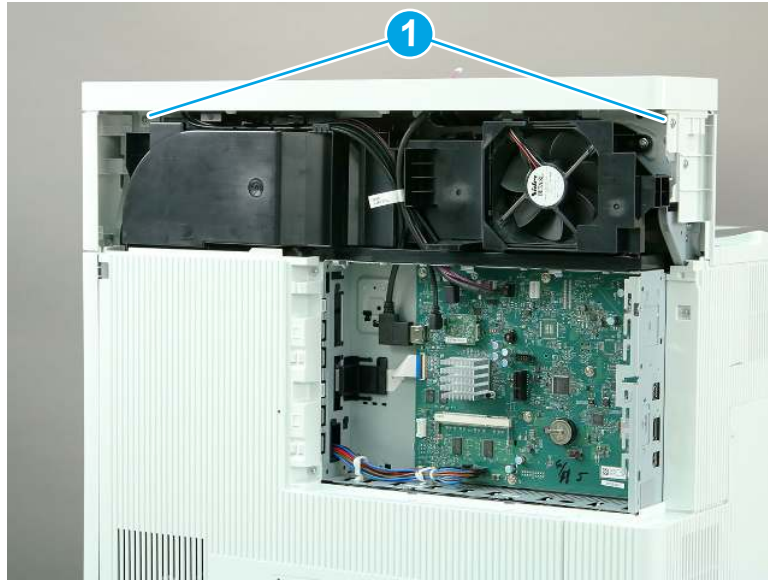
- e. Remove the USB cover (callout 1). Release two tabs (callout 2), and then remove the HIP cover (callout 3). Remove one screw (callout 4).

Figure 1-1527 Remove covers and one screw



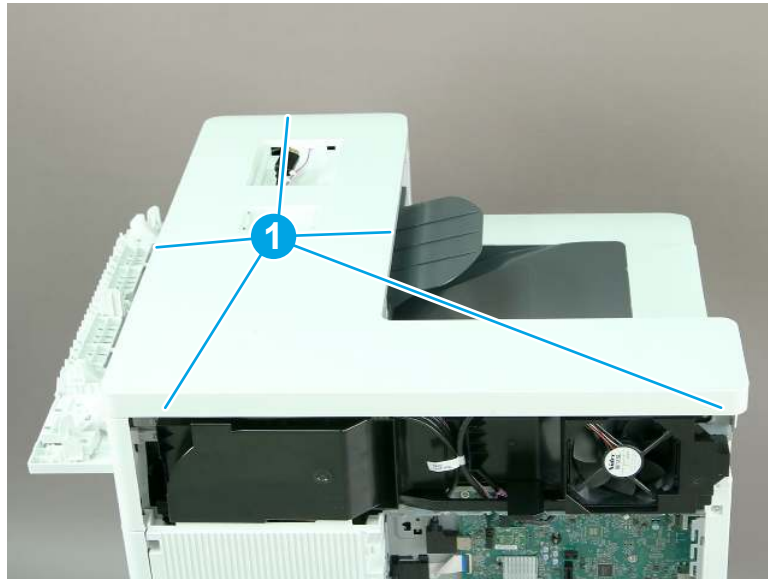
- f. Remove two screws (callout 1).

Figure 1-1528 Remove two screws



- g. Release five tabs (callout 1), and then remove the top cover.

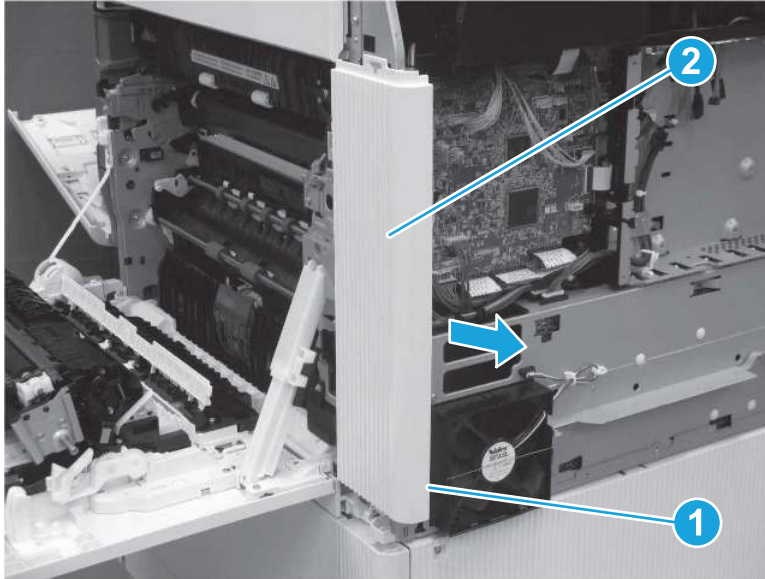
Figure 1-1529 Release five tabs



- 14. Remove the right rear cover (M856/E85055/M776).

- ▲ Release one tab (callout 1), and then slide the rear cover away from the printer to remove it.

Figure 1-1530 Remove right rear cover



15. Remove the formatter and case (M856/E85055/M776).

 **NOTE:** The figures below show the M776zs formatter. The procedure is correct for all referenced models.

- a. Release two retainers (callout 1), and then open the retainer (callout 2) to release the flat cable. Disconnect all of the remaining connectors on the formatter board.


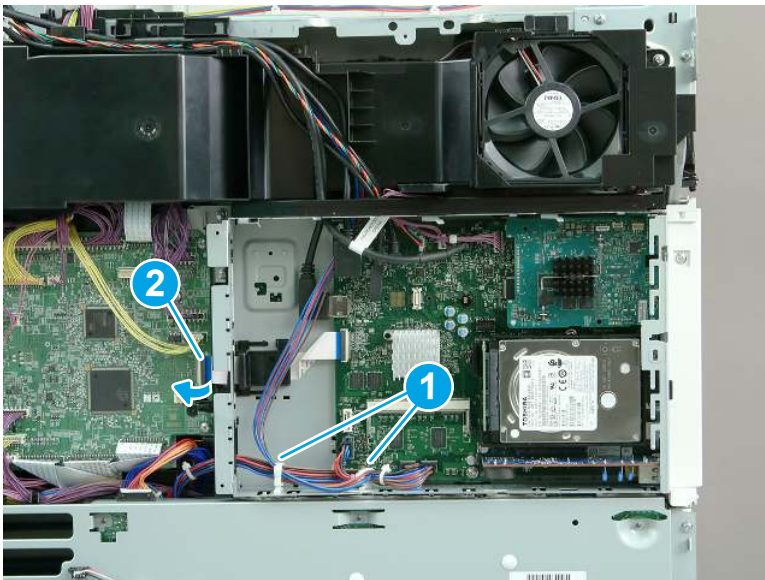
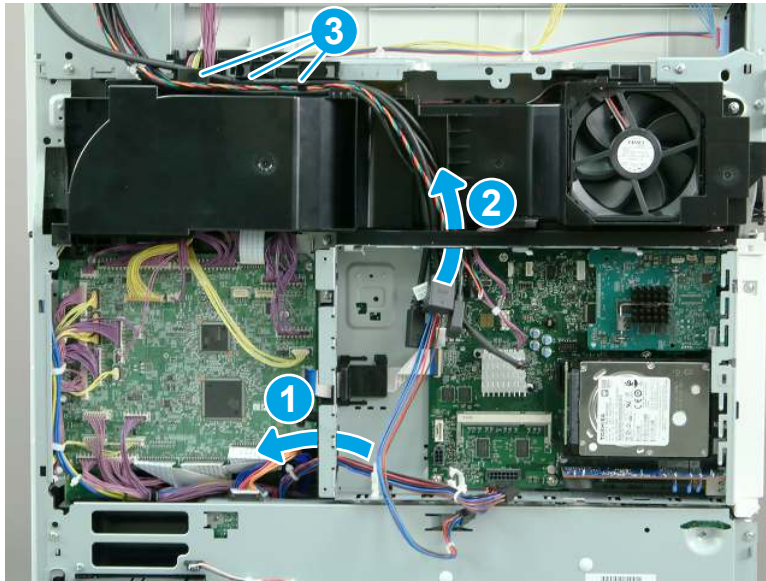
 **NOTE:** The figures below show the M776zs model. The procedures are correct for all of the referenced models.

Figure 1-1531 Disconnect the connectors



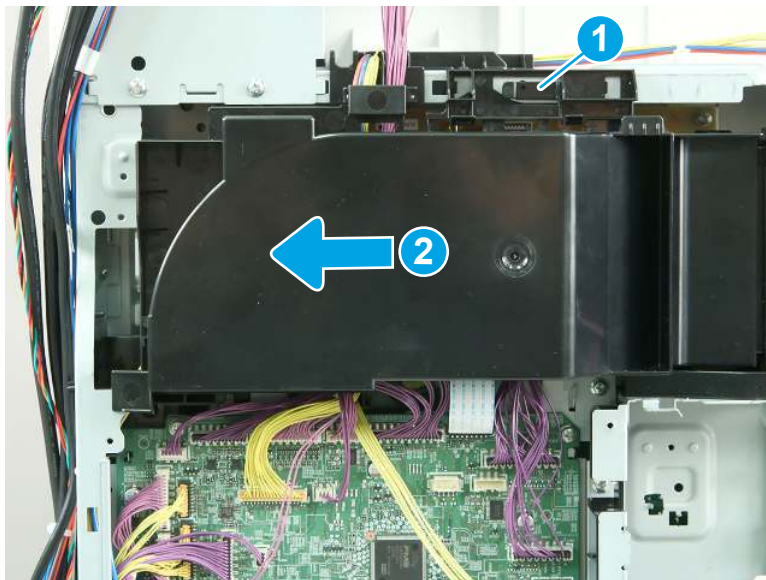
- b. Release one cable through the opening in the left side of the formatter case (callout 1). Release the remaining cables through the opening in the top of the formatter case (callout 2). Release the cables from the upper cable guide (callout 3).

Figure 1-1532 Release the cables



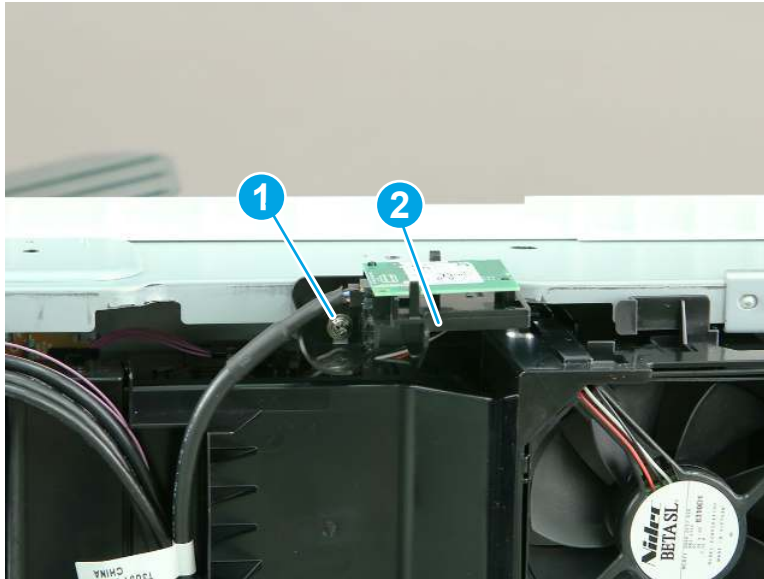
- c. Release one tab (callout 1), and then slide the fan duct to the left (callout 2) to remove it.

Figure 1-1533 Remove the fan duct



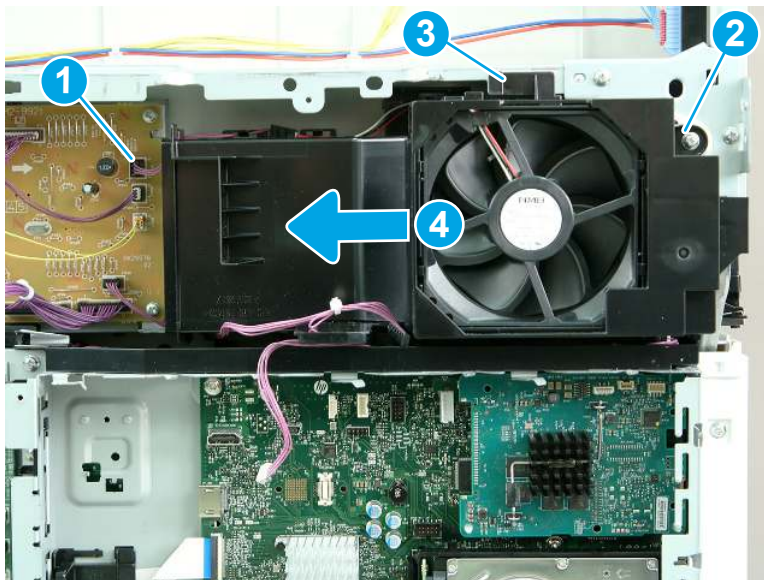
- d. **M856 and E85055 only:** Remove one screw (callout 1), and then remove the wireless card and bracket (callout 2).

Figure 1-1534 Remove the wireless card and bracket



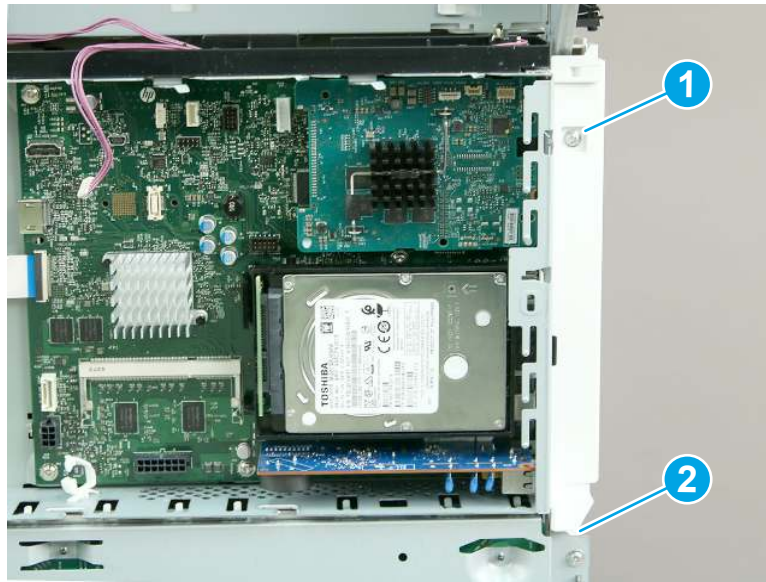
- e. Disconnect one connector (callout 1), and remove one screw (callout 2). Release one tab (callout 3), and then slide the fan assembly to the left (callout 4) to remove it.

Figure 1-1535 Remove the fan assembly



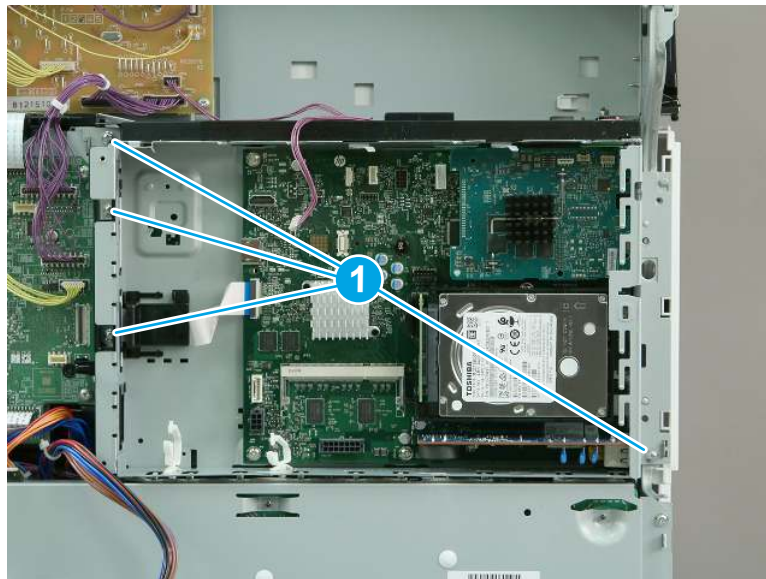
- f. Remove one screw (callout 1), release one tab (callout 2), and then remove the left rear cover.

Figure 1-1536 Remove the left rear cover



- g. Remove four screws (callout 1).

Figure 1-1537 Remove four screws



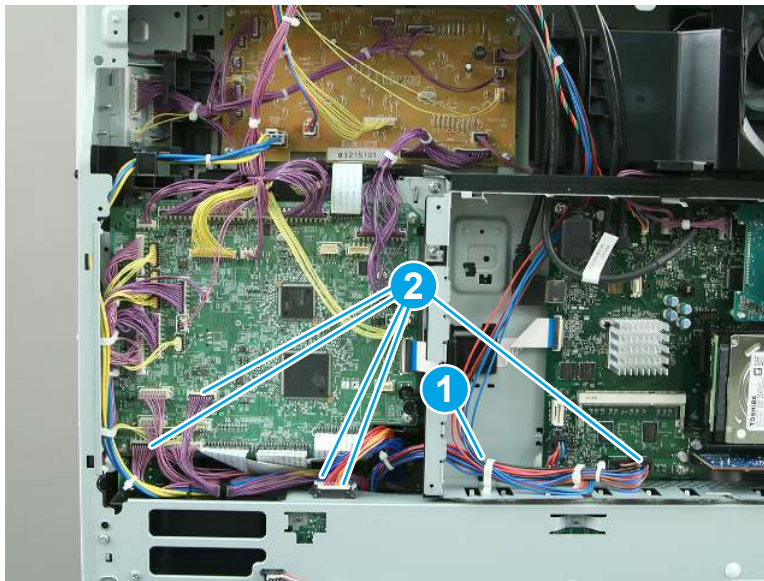
- h. Remove the formatter and case.

Figure 1-1538 Remove the formatter and case



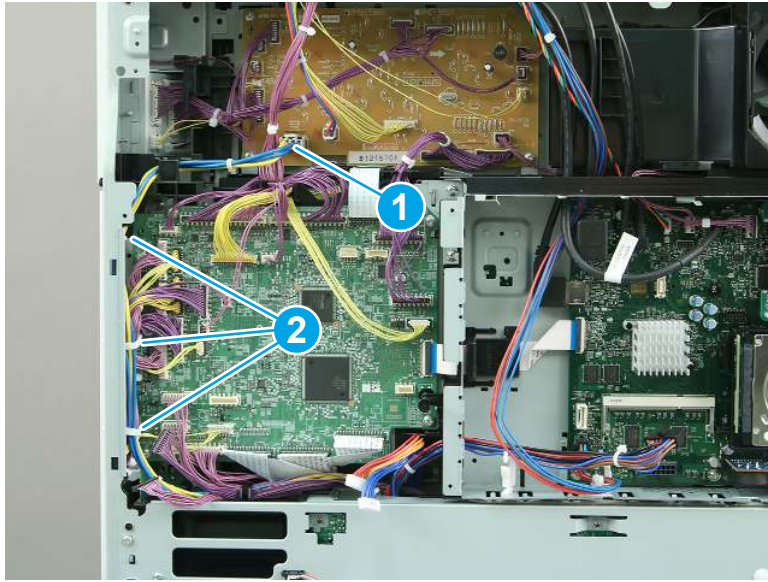
- 16. Remove the low-voltage power supply (LVPS) (M856/E85055/M776).
 - a. Release one retainer (callout 1), and then disconnect five connectors (callout 2).

Figure 1-1539 Release the retainer and disconnect five connectors



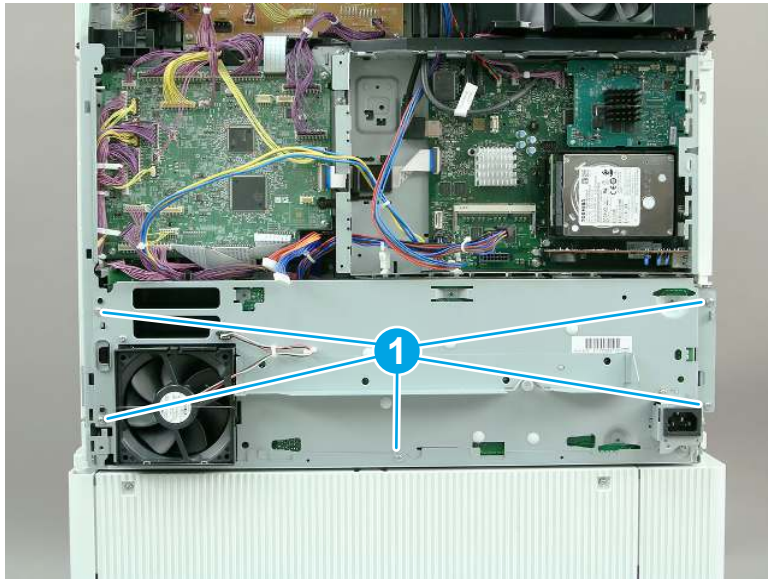
- b. Disconnect one connector (callout 1), and then release three retainers (callout 2).

Figure 1-1540 Disconnect one connector and release five retainers




- c. Remove five screws (callout 1).

Figure 1-1541 Remove five screws



- d. Tilt the LVPS away from the printer (callout 1). Thread the cable (callout 2) through the opening in the formatter case.

 **NOTE:** Due to mechanical tolerances on the formatter cage, rotating the LVPS out might be difficult.


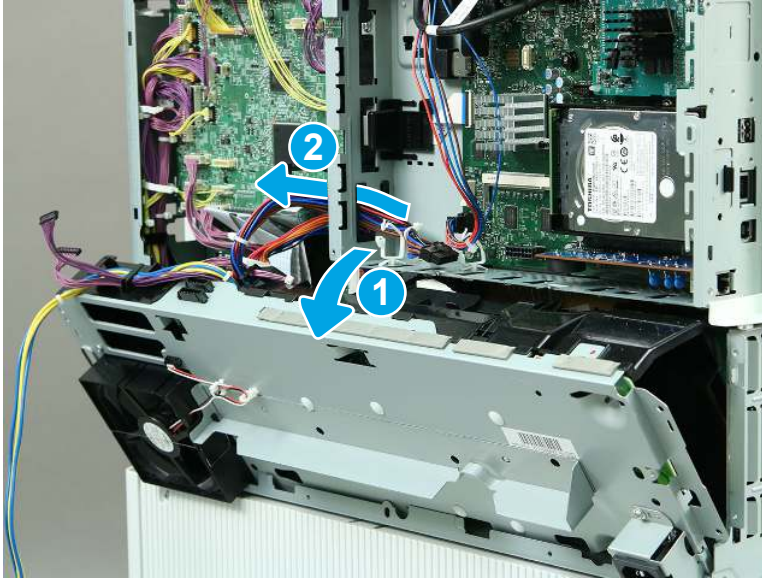
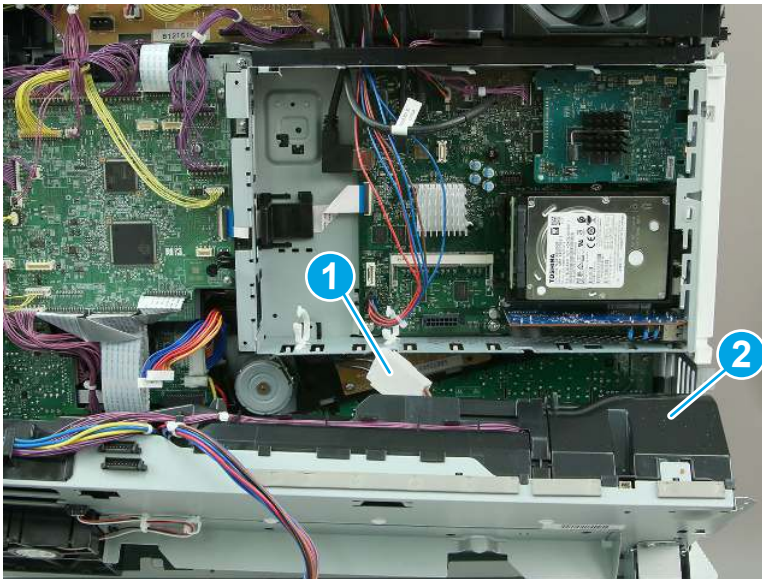
 **CAUTION:** One connector is still connected, so tilt the LVPS carefully.

Figure 1-1542 Thread the cable



- e. Disconnect one connector (callout 1), and then lift up to remove the LVPS (callout 2).

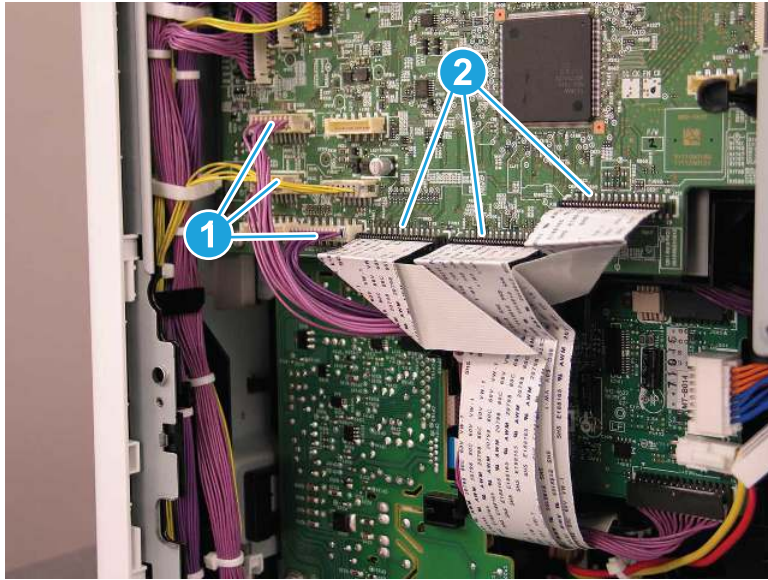
Figure 1-1543 Remove the LVPS



- 17. Remove the T2 connecting PCA.

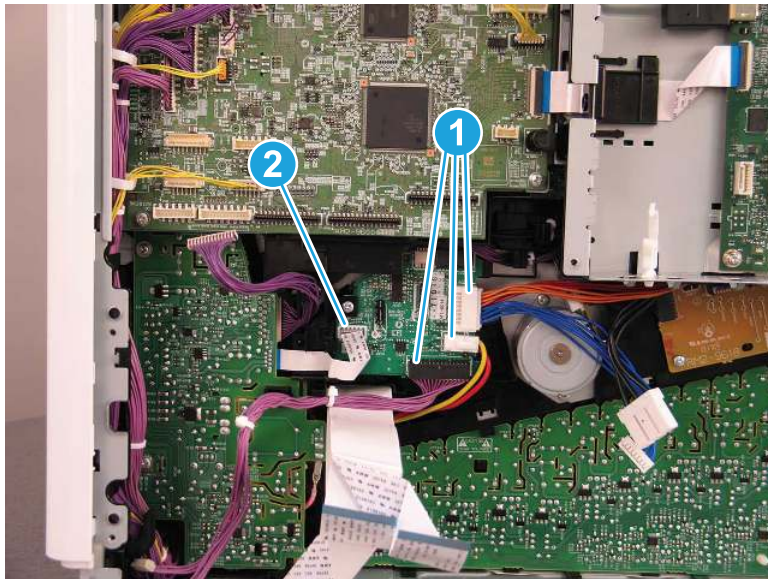
- a. Disconnect three connectors (callout 1), and then disconnect three flat cables (callout 2).

Figure 1-1544 Disconnect six connectors



- b. Disconnect three connectors (callout 1), and then disconnect one flat cable (callout 2).

Figure 1-1545 Disconnect three connectors and one flat cable



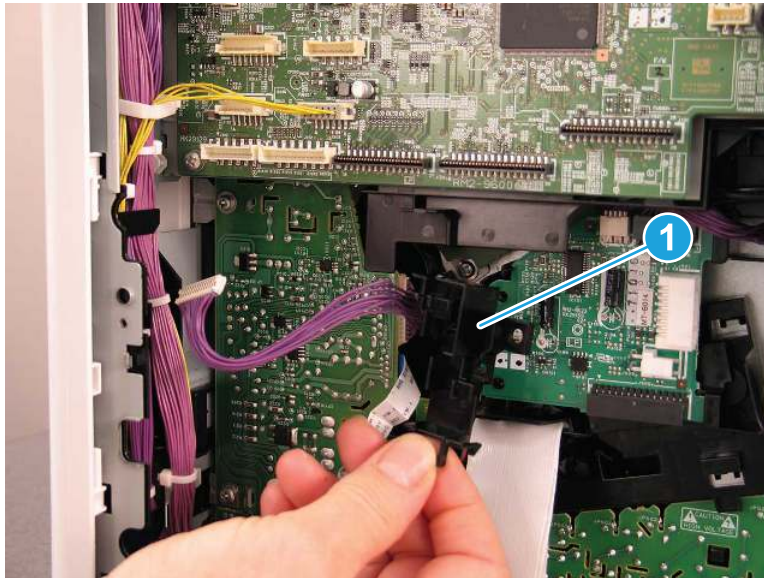
- c. Remove one screw (callout 1).

Figure 1-1546 Remove one screw



- d. Remove the cable guide (callout 1). If the cable guide is lost or damaged during the repair procedure, order a replacement part and install it along with the replacement T2 connecting PCA.

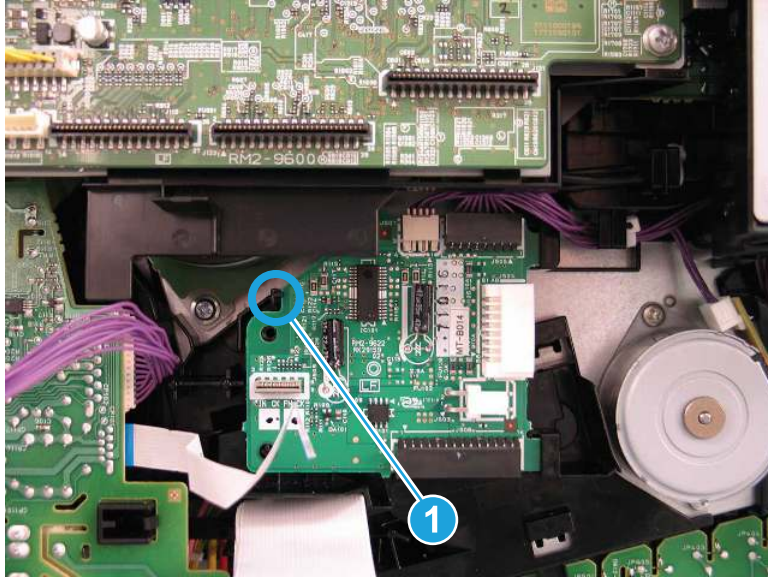
Figure 1-1547 Remove the cable guide



- e. Release one tab (callout 1), and then pull the T2 connecting PCA slightly away from the printer.

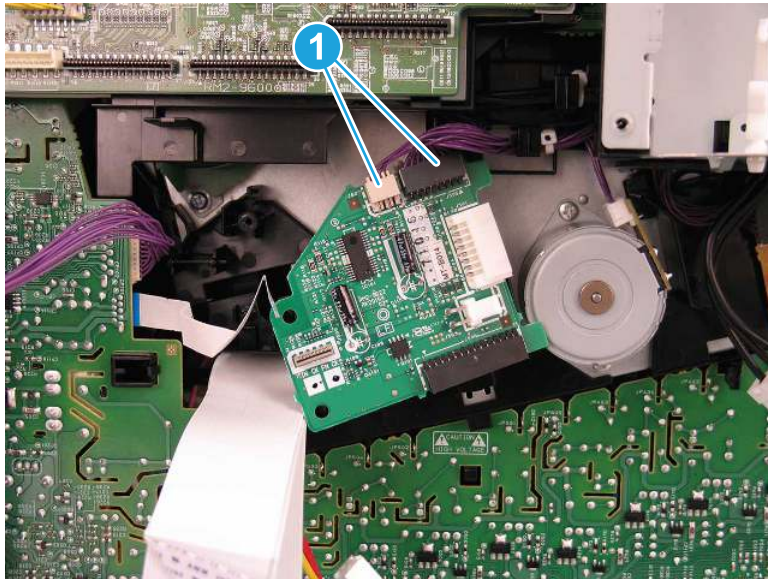
⚠ CAUTION: The T2 connecting PCA is still attached to the printer. Do not attempt to remove it completely.

Figure 1-1548 Release one tab



- f. Disconnect two connectors (callout 1), and then remove the T2 connecting PCA (callout 2).

Figure 1-1549 Disconnect two connectors and remove the PCA



18. Remove the upper high-voltage power supply (HVPS) (M856/E85055/M776).

- a. Disconnect one connector (callout 1), and then remove one screw (callout 2).

Figure 1-1550 Disconnect one connector and remove one screw



- b. Release six tabs (callout 1), and then remove the upper HVPS.

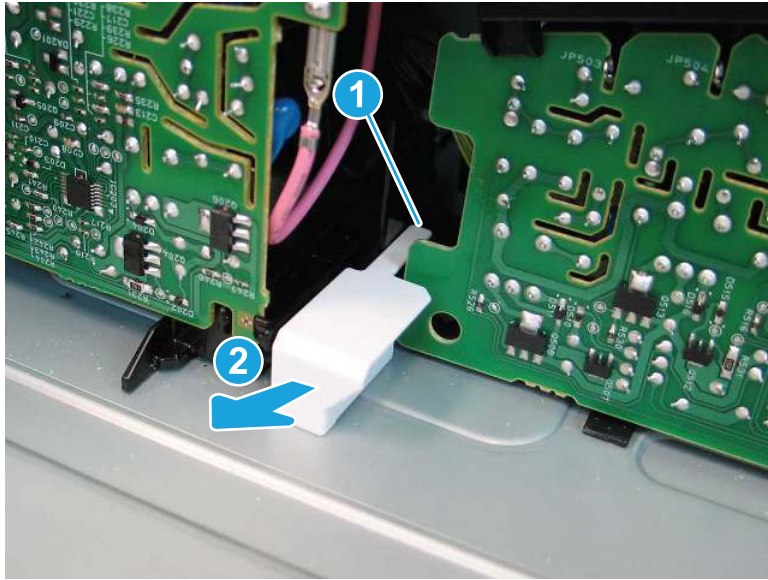
Figure 1-1551 Release six tabs



19. Remove the lower high-voltage power supply (lower HVPS).

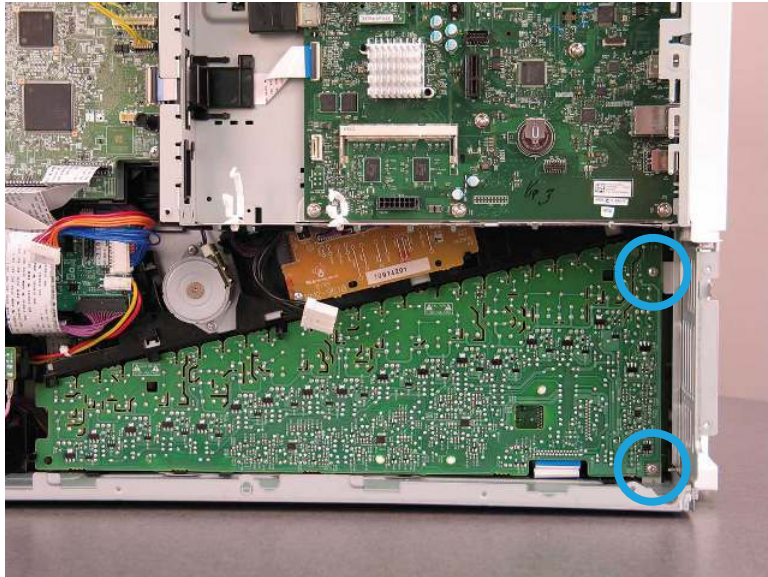
- a. Release one tab (callout 1) and then slide the stopper (callout 2) away from the printer to remove it.

Figure 1-1552 Remove the stopper



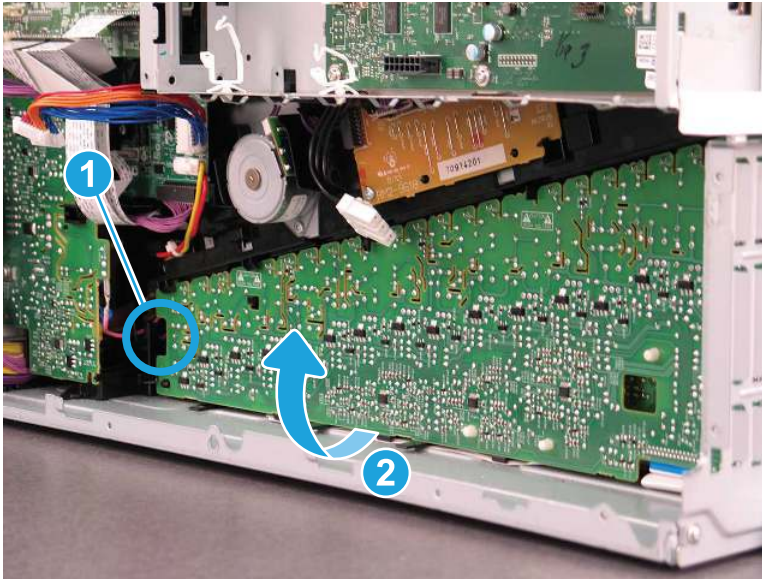
- b. Remove two screws (callout 1).

Figure 1-1553 Remove two screws



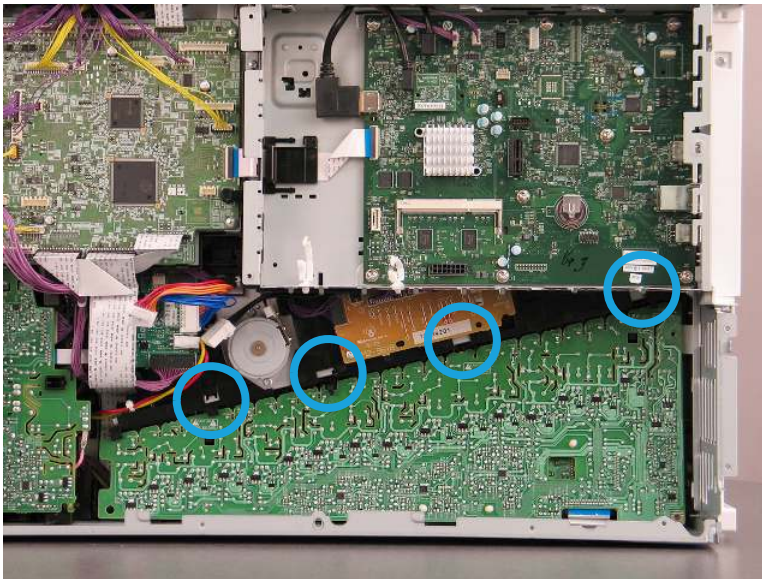
- c. Release one tab (callout 1), and then gently release the lower edge of the lower HVPS.

Figure 1-1554 Release the lower edge of the lower HVPS



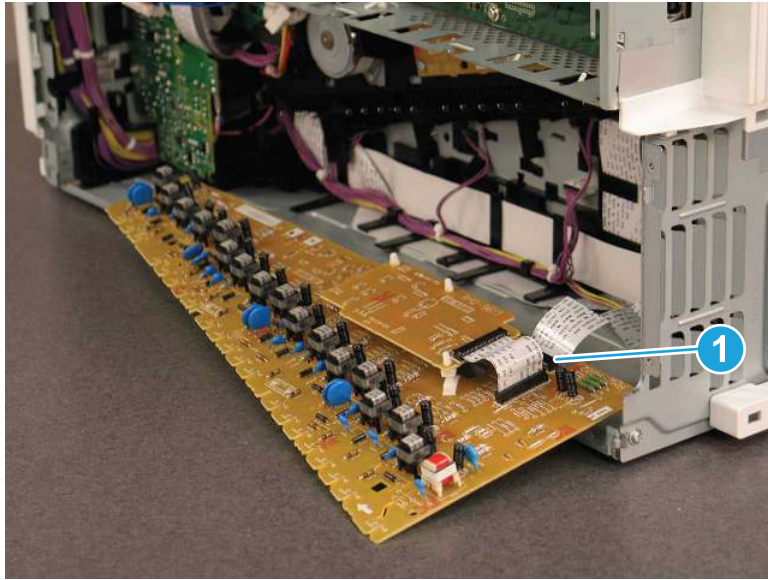
- d. Release the lower HVPS from four tabs.

Figure 1-1555 Release four tabs



- e. Disconnect one flat cable (callout 1) from the back of the lower HVPS.

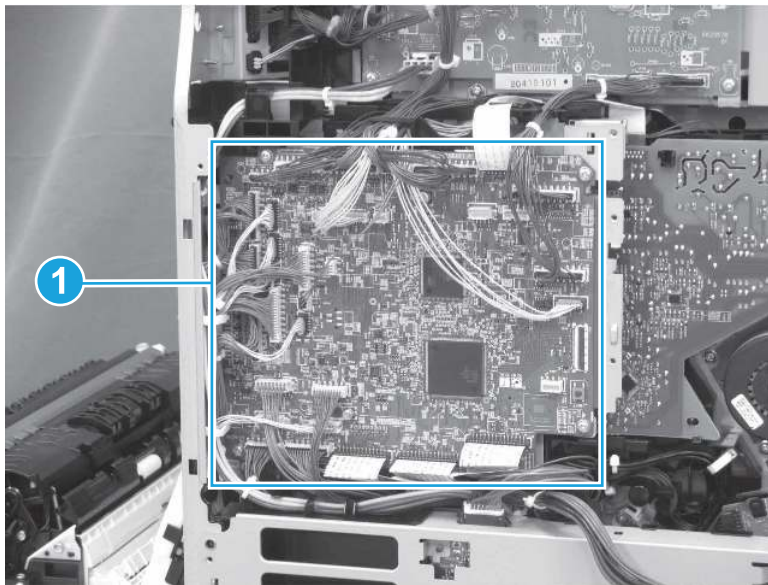
Figure 1-1556 Disconnect one flat cable



- 20. Remove the DC controller and case (M856/E85055/M776).

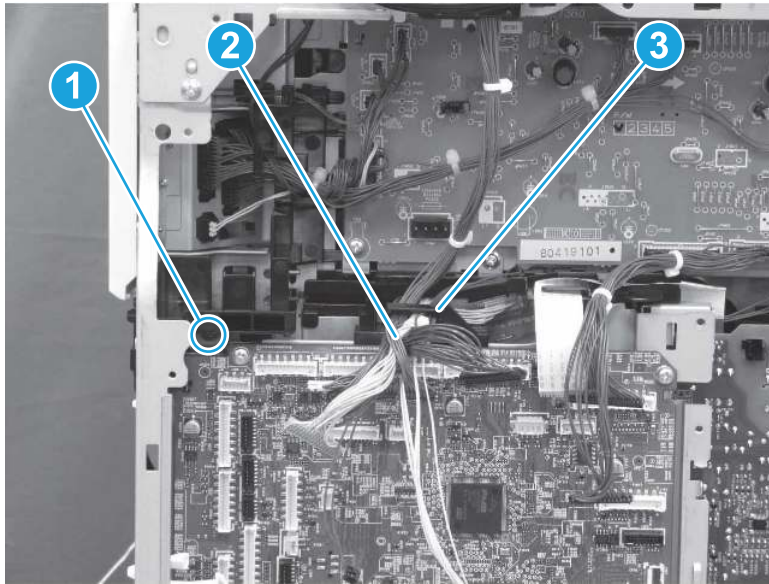
- a. Disconnect all of the connectors on the DC controller.

Figure 1-1557 Disconnect the connectors



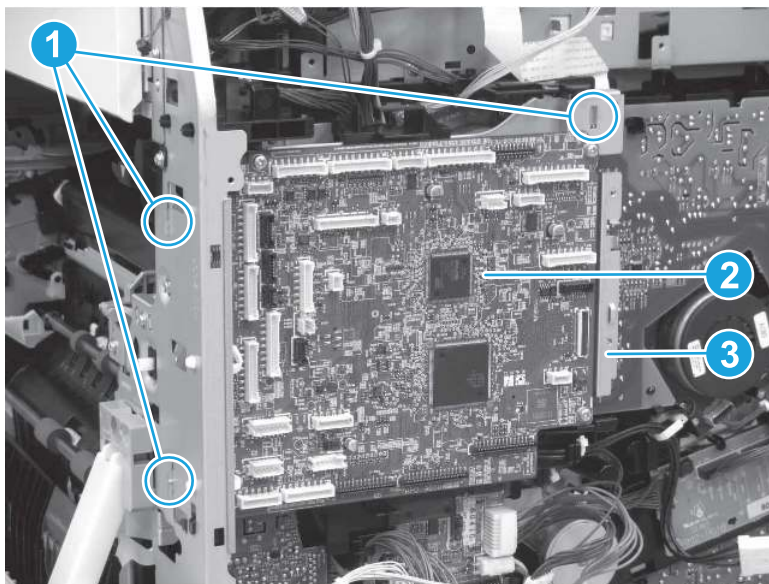
- b. Remove one screw (callout 1), and then release the cables (callout 2) from the cable guide (callout 3).

Figure 1-1558 Remove one screw and release the cables




- c. Remove one screw (callout 1), and then remove the DC controller (callout 2) together with the metal case (callout 3).

Figure 1-1559 Remove the DC controller and case



21. Remove the main drive assembly.

- a. Open the front door.

 **IMPORTANT:** The front door must remain open during removal and installation of the main drive assembly to prevent issues.

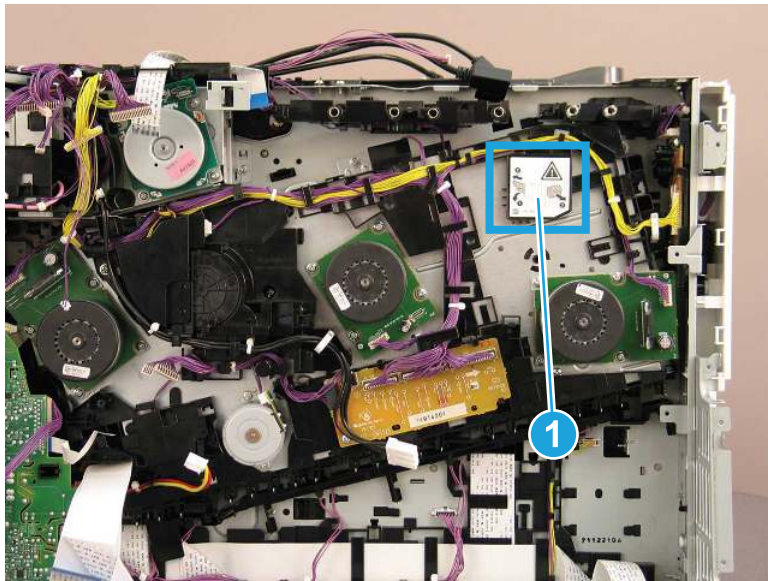
To prevent the front door from closing on its own, install one of the toner cartridges halfway.

Figure 1-1560 Open the front door



- b. Note the label (callout 1) on the main drive assembly indicating that the front door must be open and all toner cartridges and imaging drums removed before removing the main drive assembly.

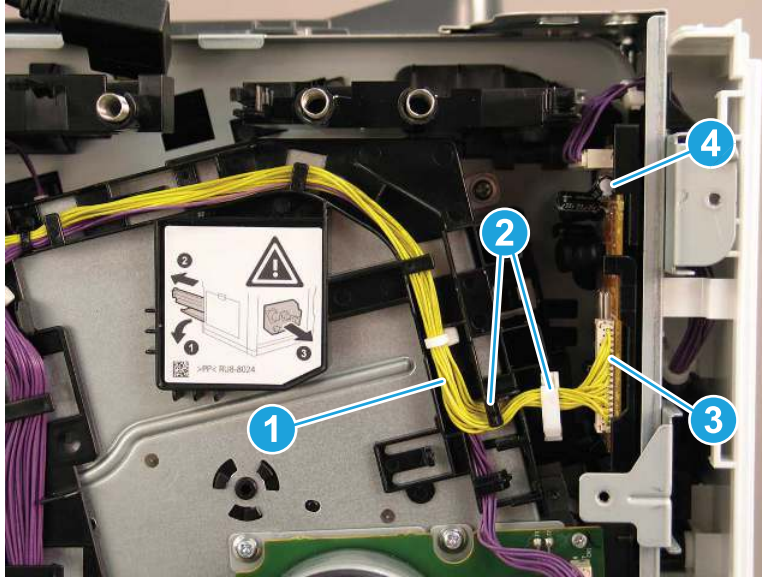
Figure 1-1561 Main drive assembly label



- c. Release the cable (callout 1) from the cable guide (callout 2), and then disconnect one connector (callout 3).

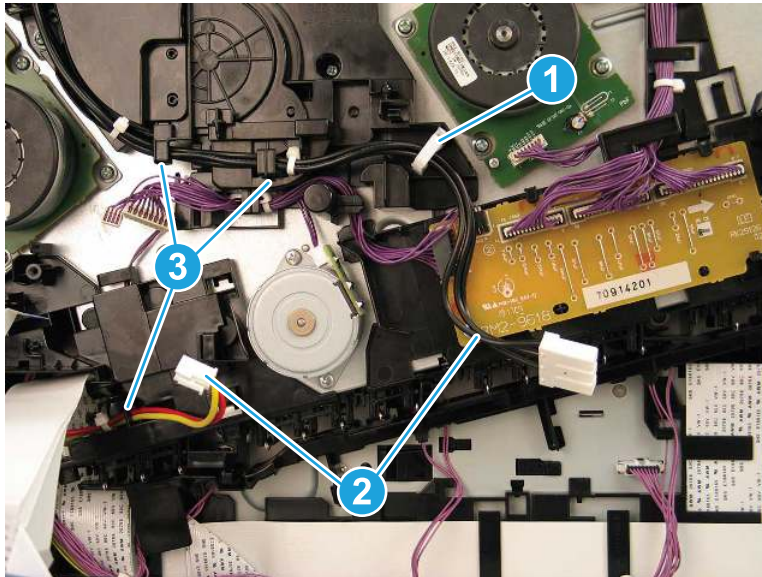
⚠ CAUTION: The capacitor on the PCA (callout 4) can rotate out and prevent the main drive assembly from reseating.

Figure 1-1562 Disconnect one connector



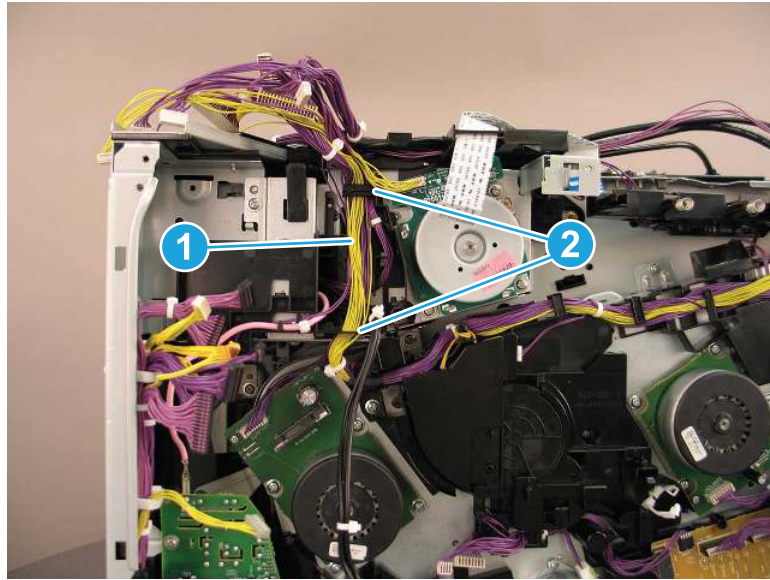
- d. Release the cables (callout 1) from the cable guides (callout 2).

Figure 1-1563 Release the cables from the guides



- e. Release the cables (callout 1) from the cable guides (callout 2).

Figure 1-1564 Release the cables from the guides

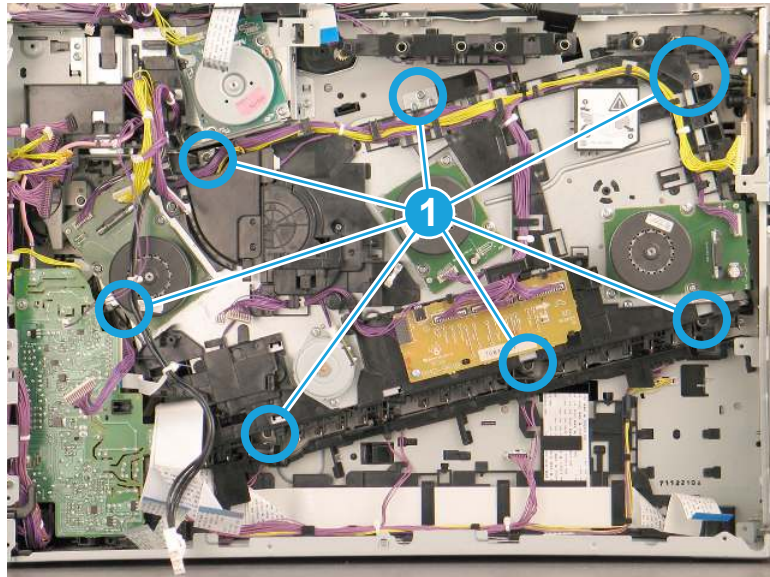


- f. Remove seven screws (callout 1), and then remove the main drive assembly.

 **IMPORTANT:** When reinstalling the main drive assembly, make sure that the front door is open.

Partially reinstall one toner cartridge to prevent the front door from closing.

Figure 1-1565 Remove seven screws and the main drive assembly




- 22. Unpack the replacement assembly.

- a. Dispose of the defective part.


 **NOTE:** HP recommends responsible disposal of the defective part.

<http://www8.hp.com/us/en/hp-information/environment/product-recycling.html>

- b. Unpack the replacement part from the packaging.

 **IMPORTANT:** Make sure that all of the shipping materials (for example shipping tape) are removed from the replacement part prior to installation.

- c. To install an assembly, reverse the removal steps.

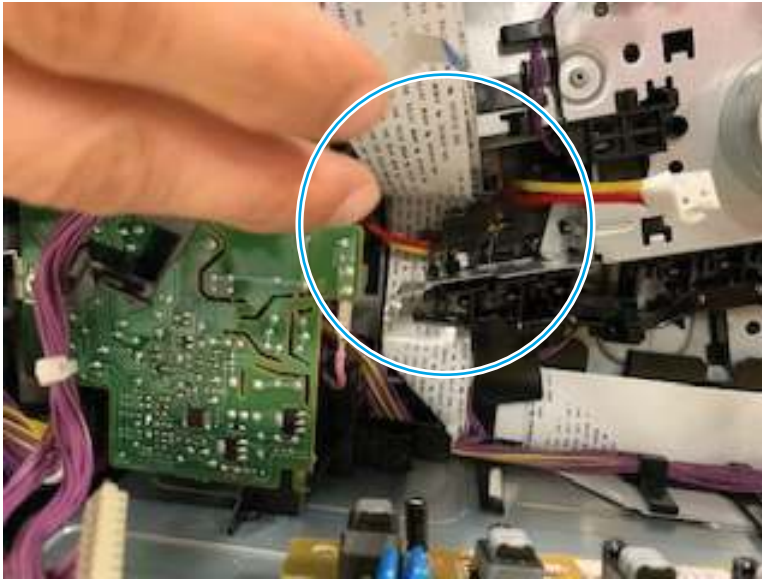
 **NOTE:** When applicable, special installation instructions are provided for an assembly at the end of the removal procedure. Always completely read the removal instructions and follow all special installation instructions.

- 23. Reverse the removal steps to install the assembly. Also use the following **special installation instructions**.

Install the main drive assembly.

- a. Route the red and yellow cables back into the main drive assembly guides prior to re-installation. This will prevent the cables from being pinched behind the main drive assembly.

Figure 1-1566 Main drive wire harness



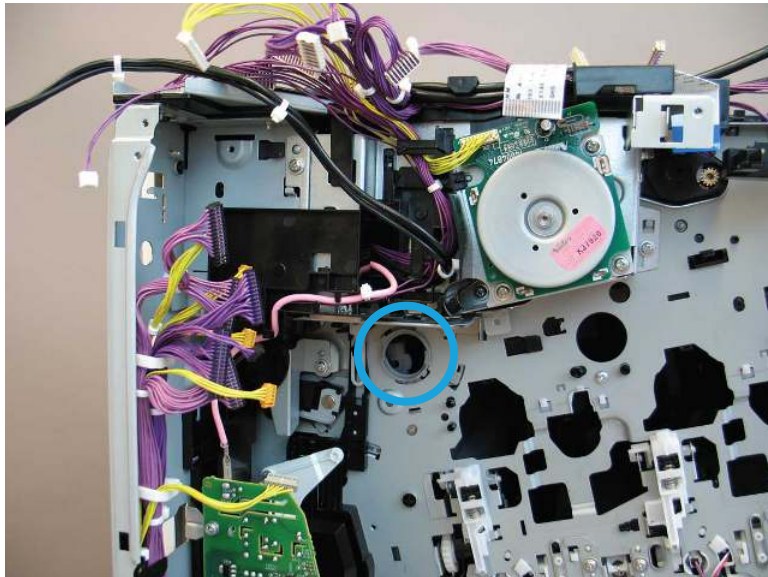
- b. If the coupling estrangement cam falls off of the printer or is broken or lost in the process of removing the main drive assembly, follow these steps to reinstall it.

Figure 1-1567 Coupling estrangement cam



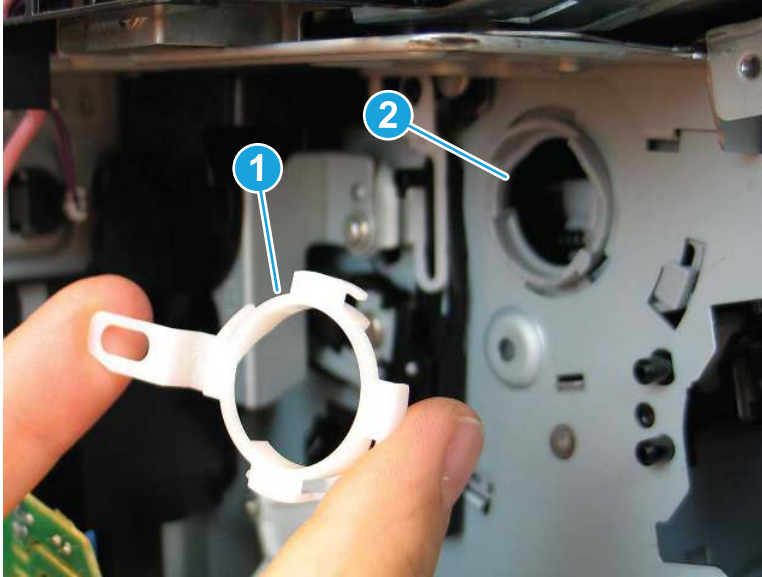
- c. Note the location where the cam will be installed.

Figure 1-1568 Cam location



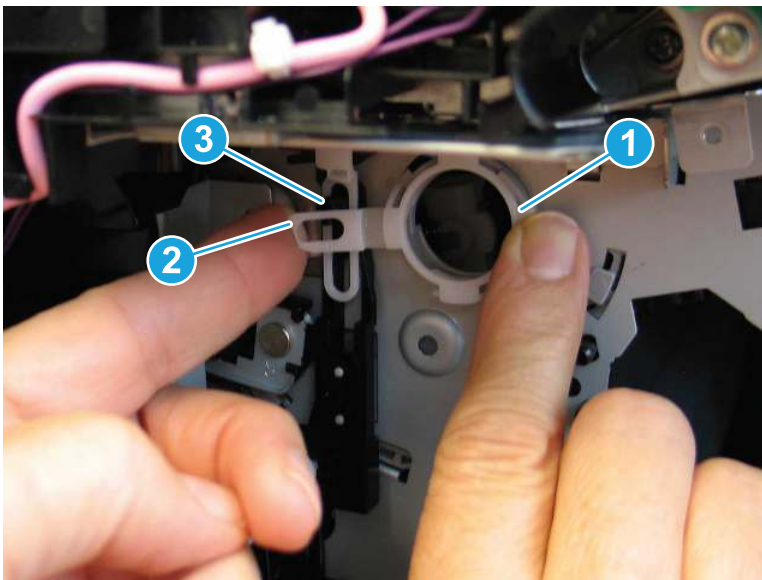
- d. Position the cam (callout 1) over the gray ring (callout 2) on the printer. The tabs on the cam fit into openings on the gray ring.

Figure 1-1569 Position the cam



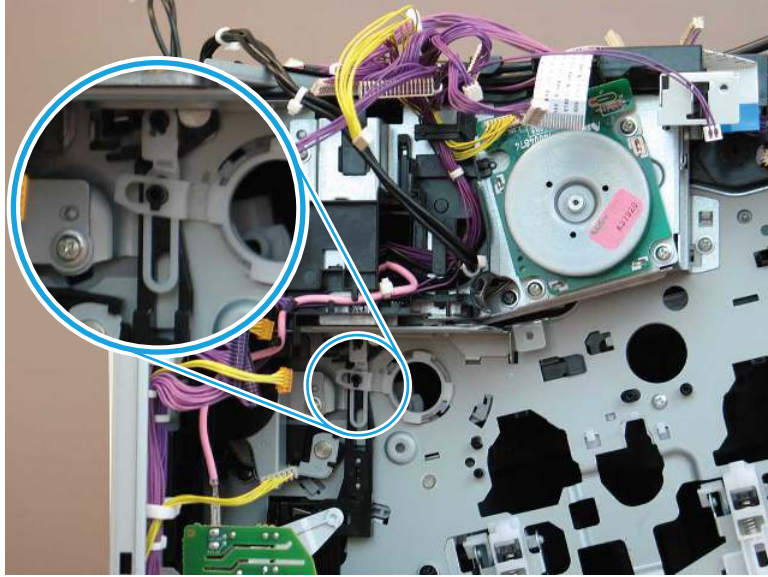
- e. Hold the cam in position (callout 1), and then position the opening in the left side of the cam (callout 2) over the boss (callout 3) on the black link arm on the printer.

Figure 1-1570 Install the cam



- f. When installed correctly, the cam engages with the black link arm on the printer.

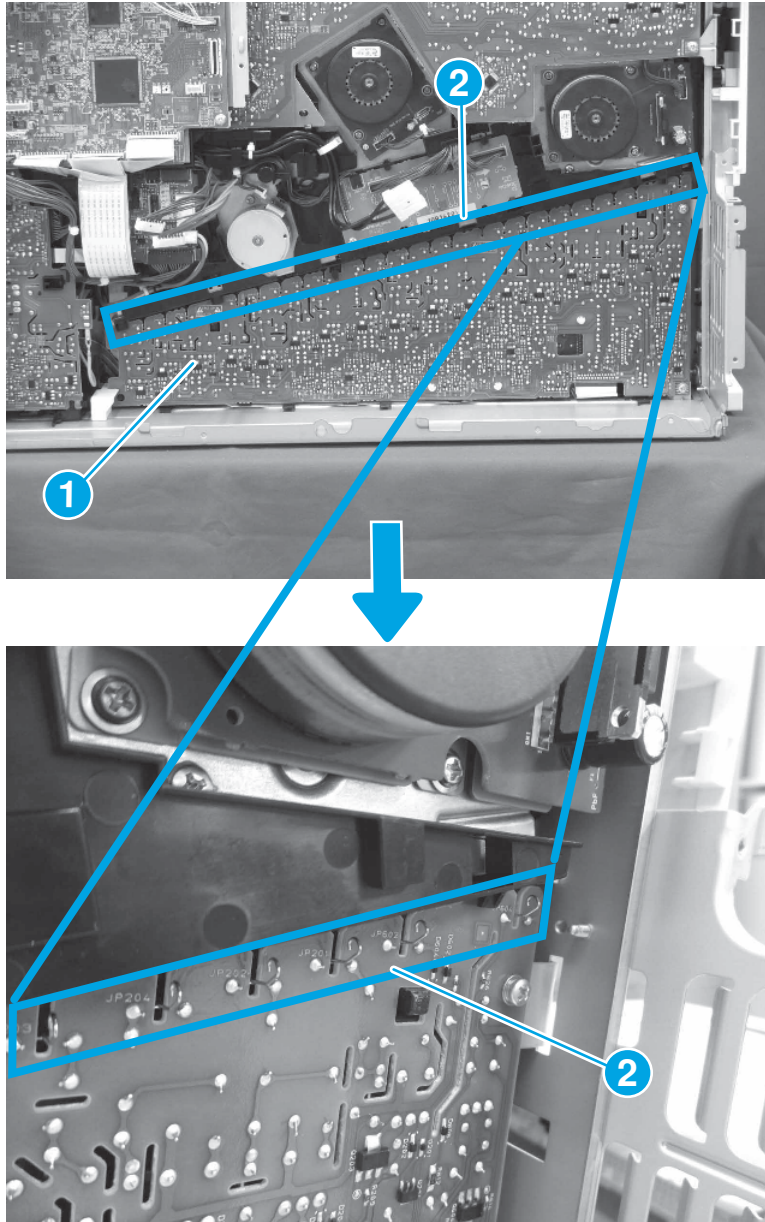
Figure 1-1571 Cam correctly installed



Install the lower HVPS

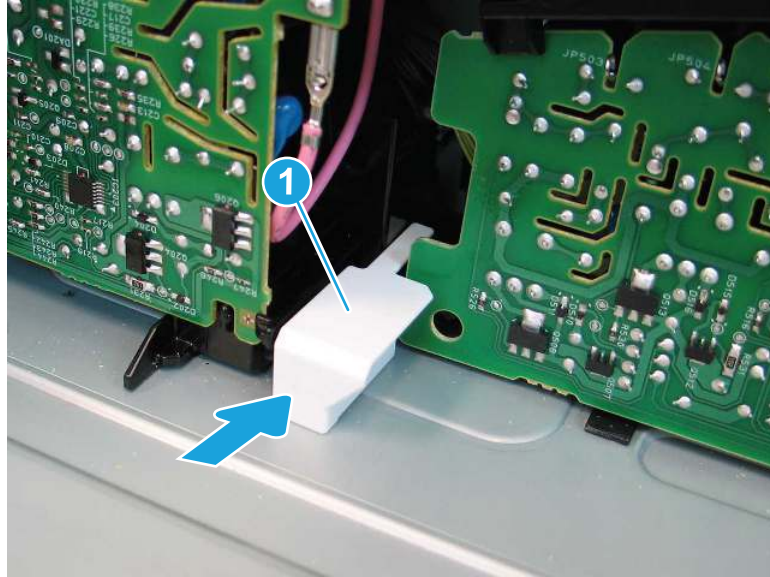
- a. When reinstalling the lower HVPS (callout 1), make sure that the top of the lower HVPS engages with the contact springs (callout 2) and that the springs are in the correct position.

Figure 1-1572 Check the springs



- b. Make sure that the stopper (callout 1) is reinstalled at the bottom of the lower HVPS.

Figure 1-1573 Install the stopper



Removal and replacement: Lifter drive assembly (M751/E75245/M856/E85055/M776)

Learn how to remove and replace the lifter drive assembly.

[View a video of how to remove and replace the lifter drive assembly.](#)

Mean time to repair: 32 minutes

Service level: Medium

Before performing service

Turn the printer power off

- Disconnect the power cable.

⚠ WARNING! To avoid damage to the printer, turn the printer off, wait 30 seconds, and then remove the power cord before attempting to service the printer.

Use the table below to identify the correct part number for your printer. To order the part, go to www.hp.com/buy/parts.

Table 1-84 Part information

Part number	Part description
RM2-1604-000CN	Lifter drive assembly

Required tools

- #2 Phillips screwdriver with a magnetic tip
- Small, flat-blade screwdriver

After performing service

Turn the printer power on

- Connect the power cable.
- Use the power switch to turn the power on.

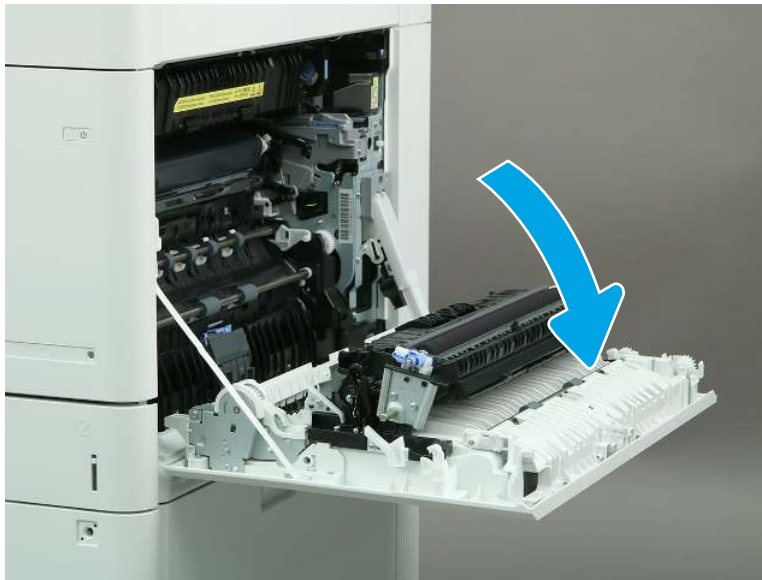
Post service test

Make sure that the printer initializes to a **Ready** state.

Print a page to make sure that the printer is functioning correctly.

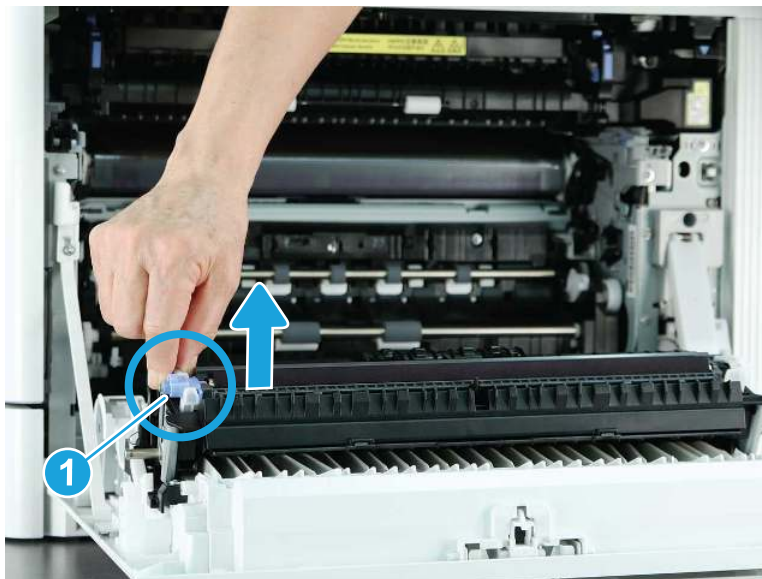
1. Remove the secondary transfer roller.
 - a. Open the right door.

Figure 1-1574 Open the right door



- b. Release the latch (callout 1), and then lift the left side of the roller.

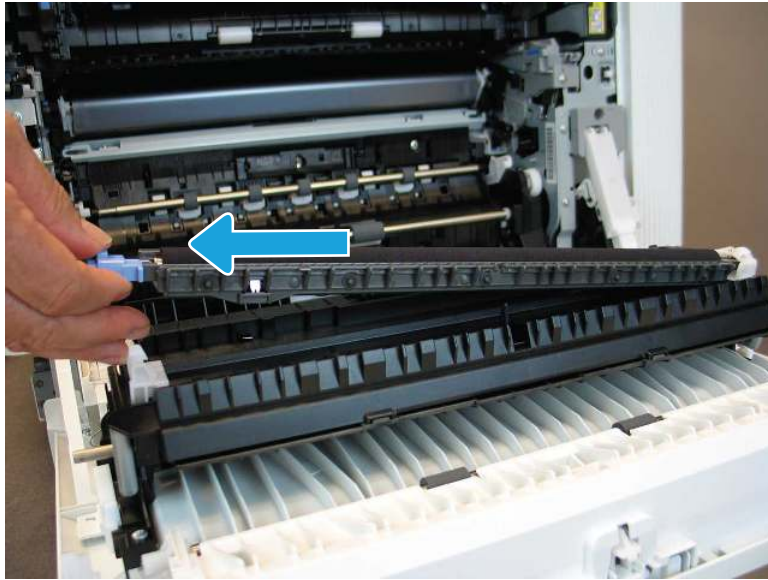
Figure 1-1575 Release the transfer roller



- c. Slide the transfer roller to the left to remove it.

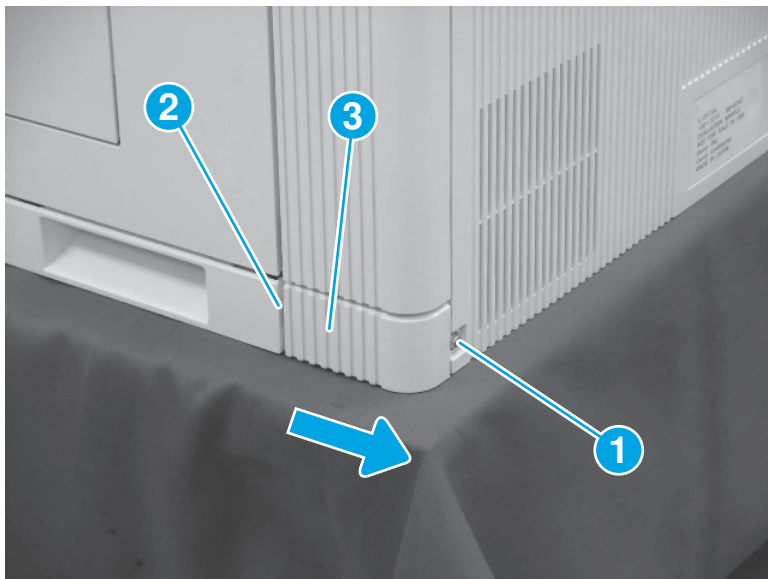
⚠ CAUTION: Do not touch the surface of the secondary transfer roller.

Figure 1-1576 Remove the secondary transfer roller



- 2. Remove the right rear lower cover (M751/E75245/M856/E85055/M776).
 - ▲ Remove one screw (callout 1), release one tab (callout 2), and then slide the right rear lower cover (callout 3) toward the back of the printer to remove it.

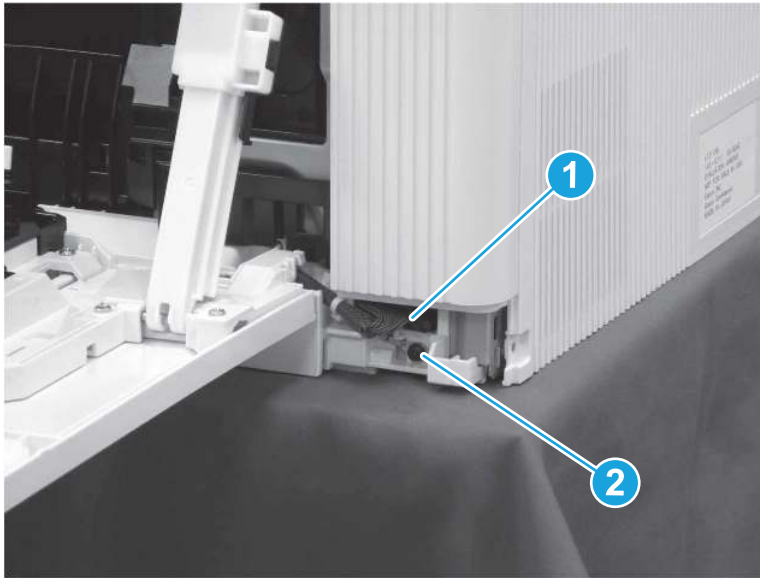
Figure 1-1577 Remove the right rear lower cover



- 3. Remove the right door.

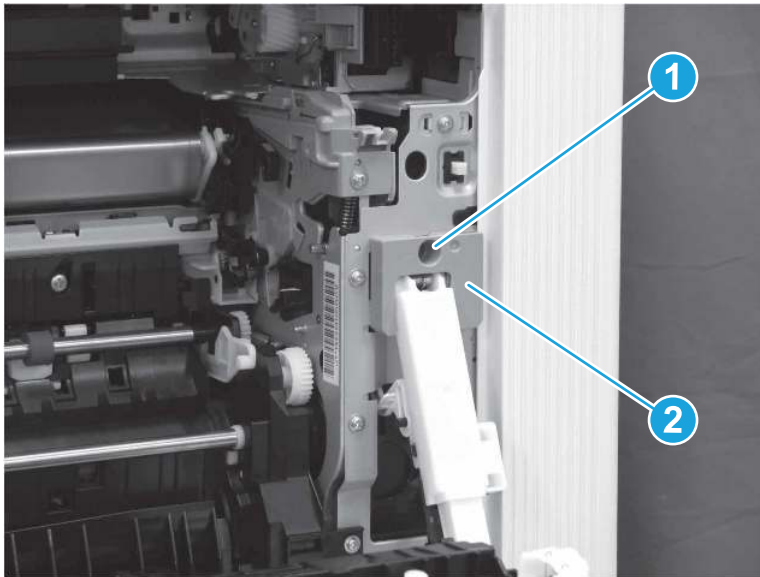
- a. Disconnect one connector (callout 1), and then remove one black grounding screw (callout 2).

Figure 1-1578 Disconnect one connector and remove one screw



- b. Remove one self-tapping screw (callout 1), and then remove the cover (callout 2).

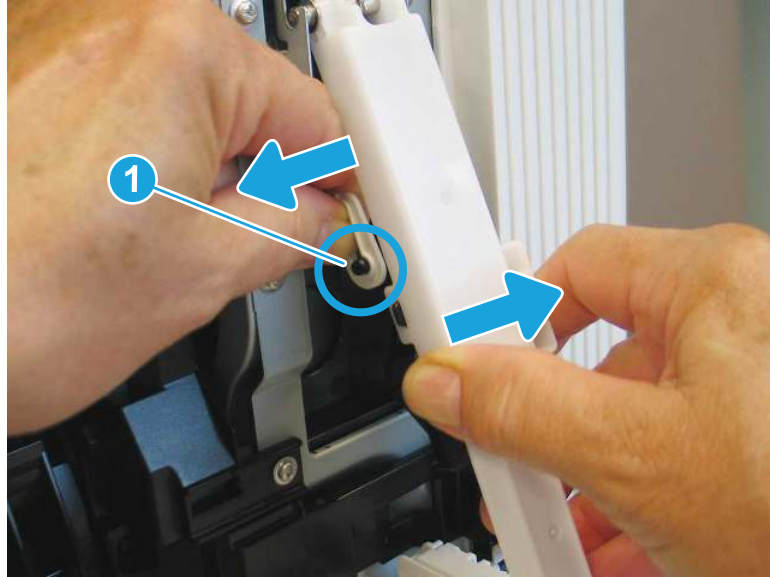
Figure 1-1579 Remove the cover



- c. Push the damper slightly to the right, and gently pull the link arm to the left to release the boss (callout 1) from the link arm.

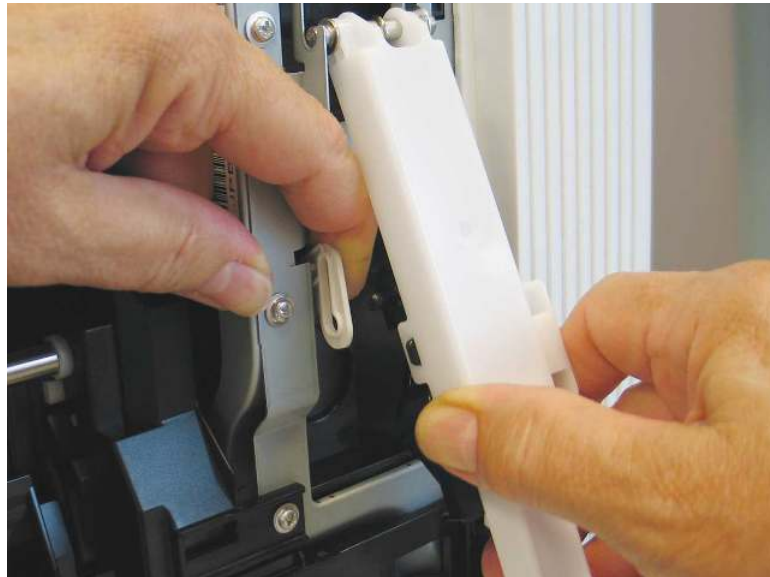
 **IMPORTANT:** Make sure to reattach this link arm when reinstalling the right door. Failure to do so might cause damage to the link arm, requiring a larger repair.

Figure 1-1580 Release the link arm



- d. Retract the link arm slightly into the printer to move it out of the way.

Figure 1-1581 Retract the link arm



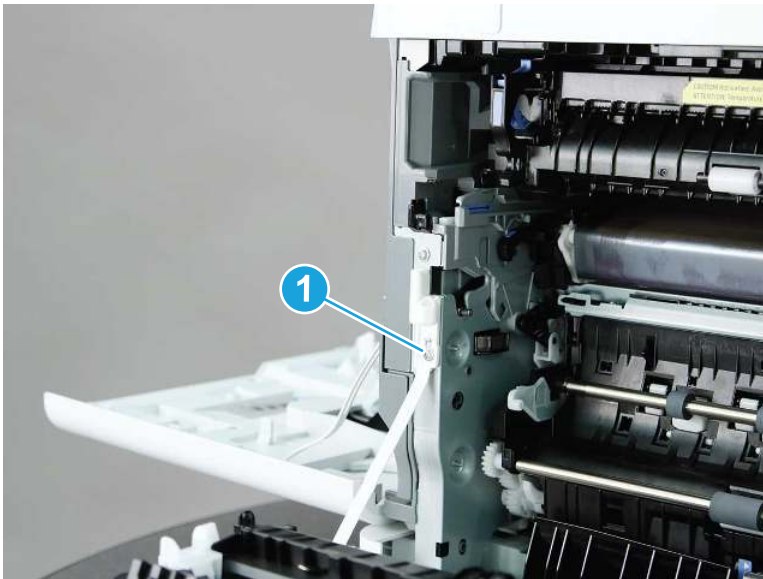
- e. Lift the dampener up, and then pull it away from the printer to release it from the bushing.

Figure 1-1582 Release the dampener



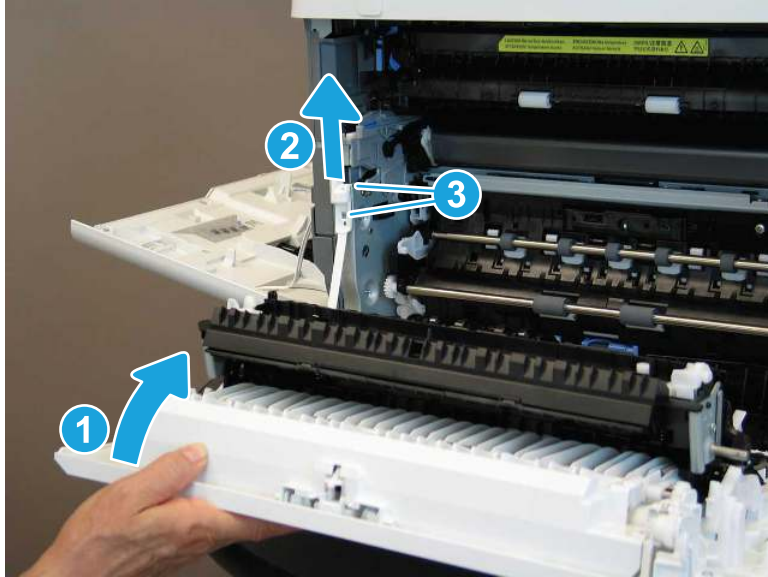
- f. Remove one screw (callout 1).

Figure 1-1583 Remove one screw



- g. Raise the door slightly (callout 1) to take tension off of the hinge. Slide the hinge up (callout 2) to release two hooks (callout 3).

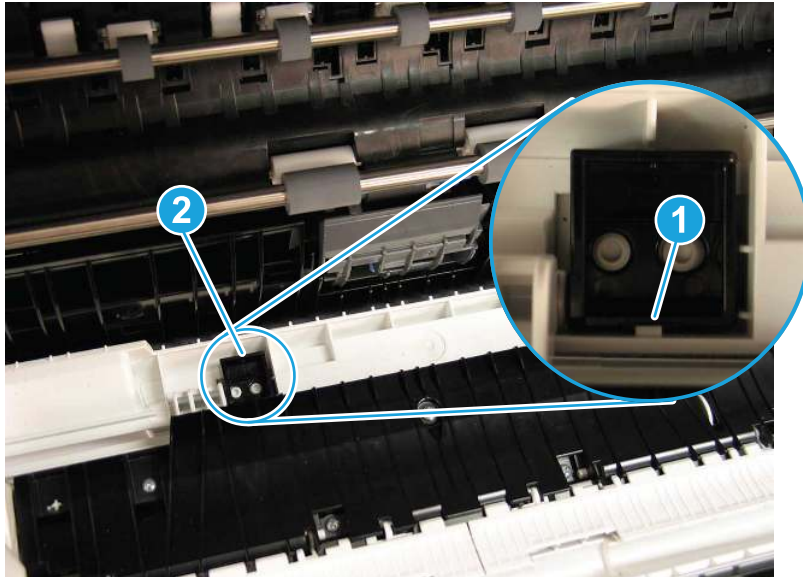
Figure 1-1584 Release the hinge



- h. Release one tab (callout 1), and then remove the stopper (callout 2).

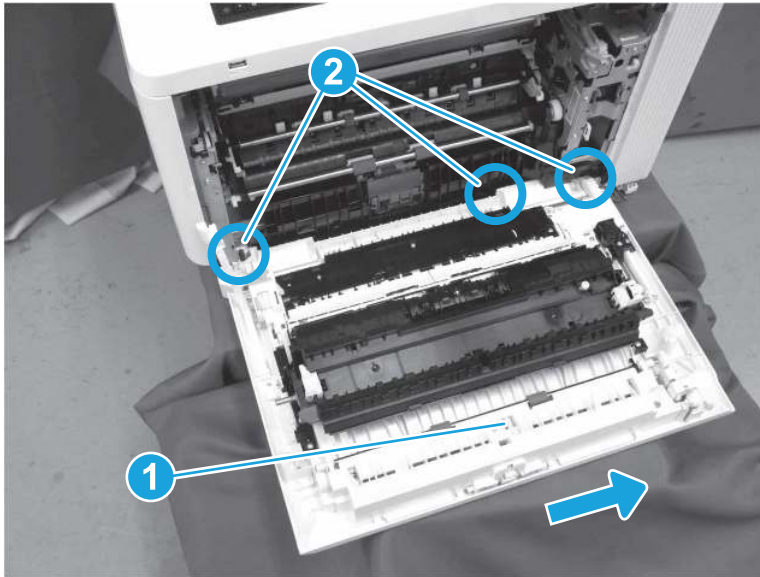
 **TIP:** Use needle-nosed pliers to release the stopper.

Figure 1-1585 Remove the stopper



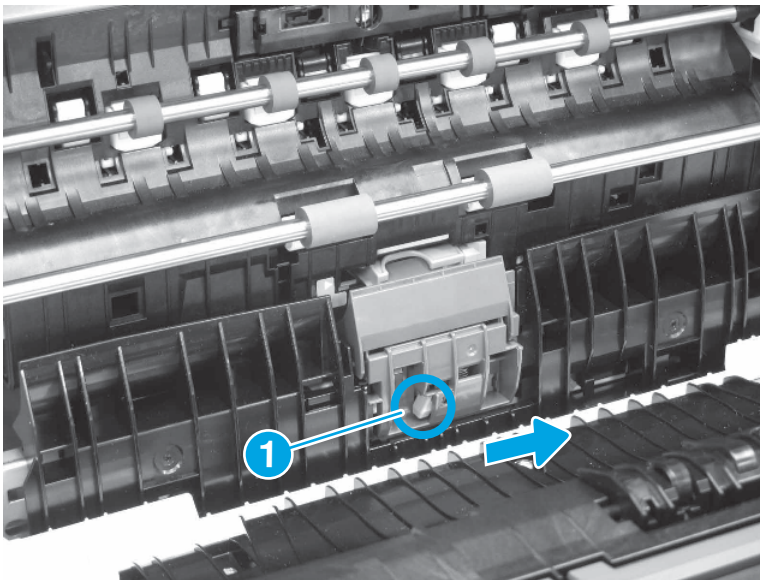
- i. Slide the right door (callout 1) to the right to release it from three tabs (callout 2), and then remove the right door.

Figure 1-1586 Remove the right door



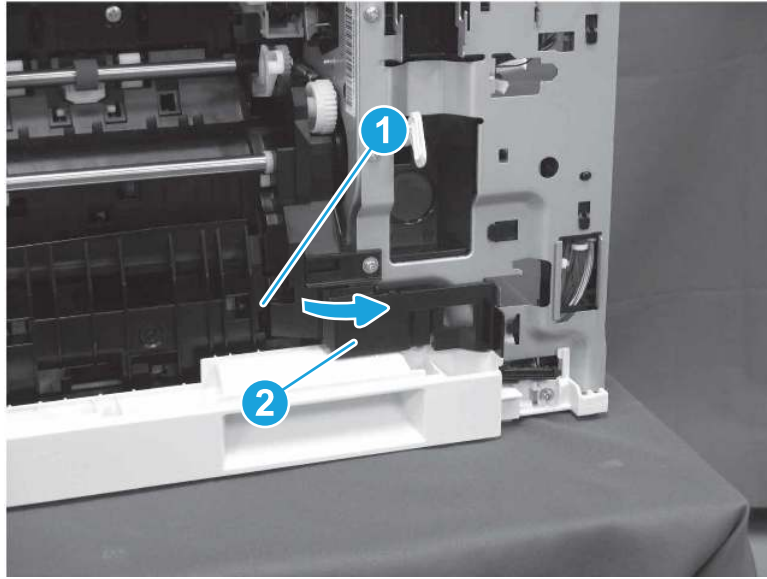
4. Remove the pickup assembly.
 - a. Press the release button (callout 1) on the Tray 2 separation roller. Slide the assembly to the right, and then pull it away from the printer to remove it.

Figure 1-1587 Remove the Tray 2 separation roller assembly



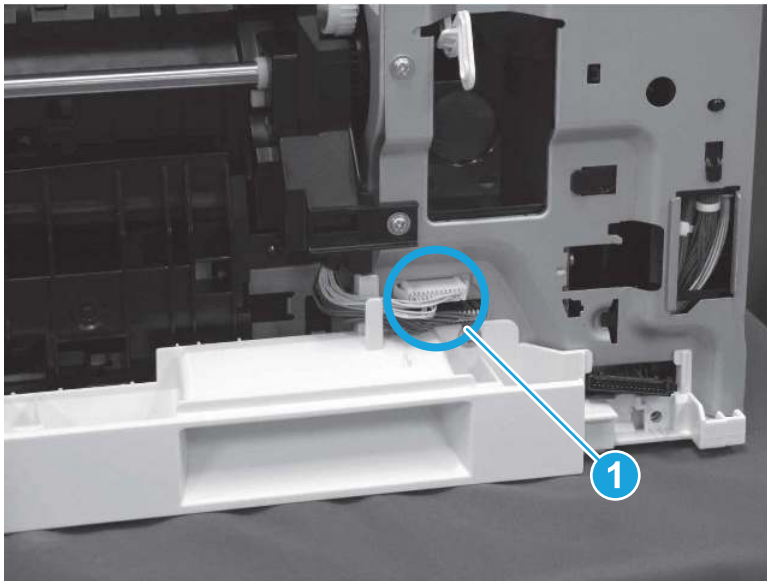
- b. Release one tab (callout 1), and then rotate the cover (callout 2) away from the printer to remove it.

Figure 1-1588 Remove the cover



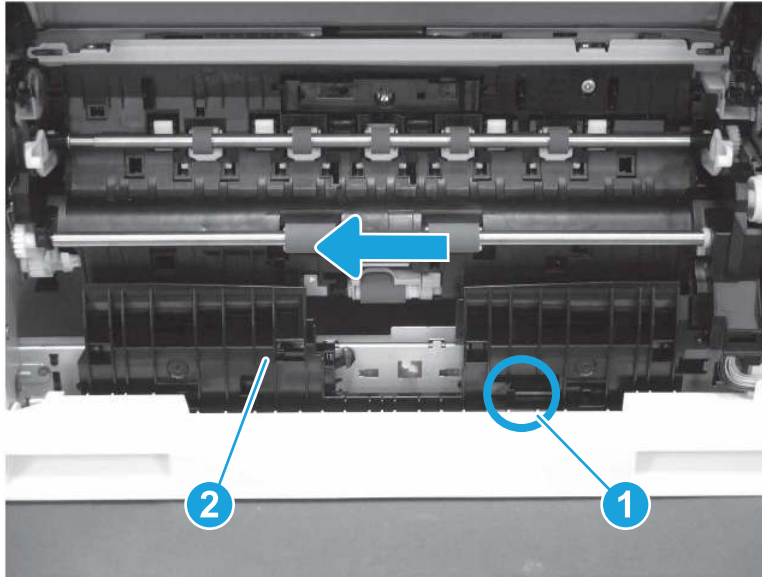
- c. Disconnect two connectors (callout 1).

Figure 1-1589 Disconnect two connectors



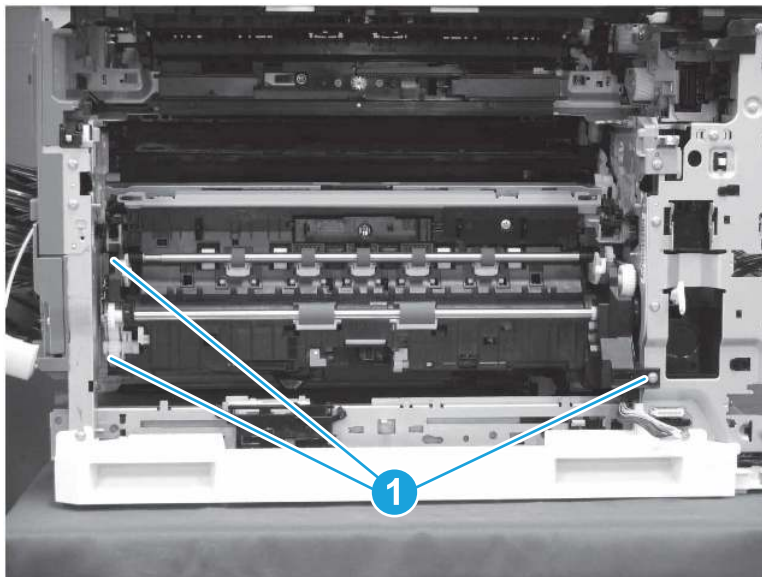
- d. Release one tab (callout 1), and then slide the guide (callout 2) to the left to remove it.

Figure 1-1590 Remove the guide



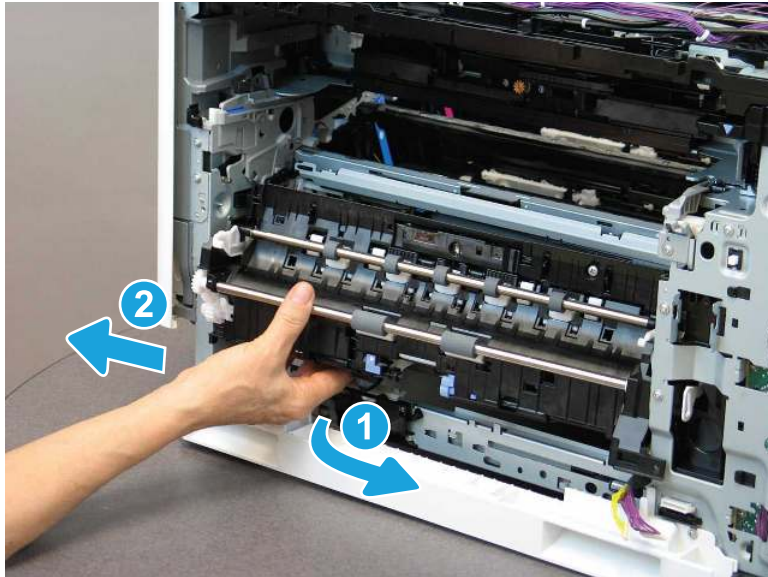
- e. Remove three screws (callout 1).

Figure 1-1591 Remove three screws



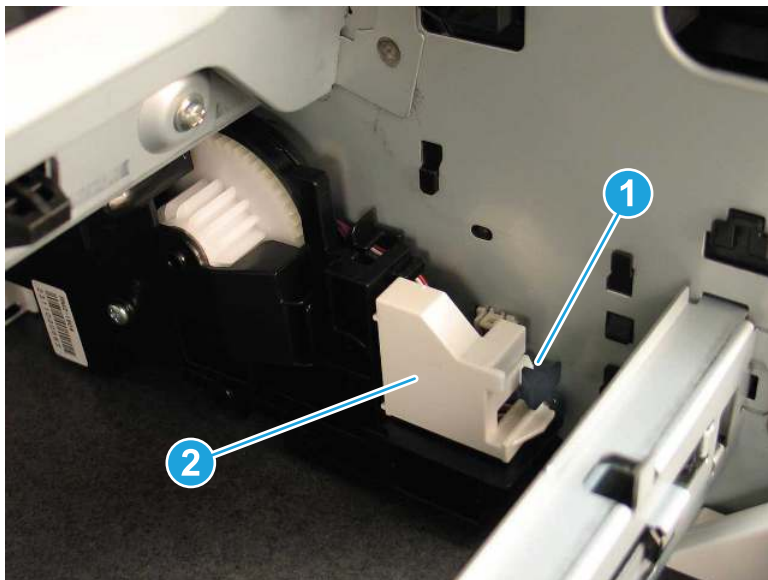
- f. Rotate the left side of the pickup assembly away from the printer (callout 1), and then slide the assembly to the left (callout 2) to remove it.

Figure 1-1592 Remove the pickup assembly



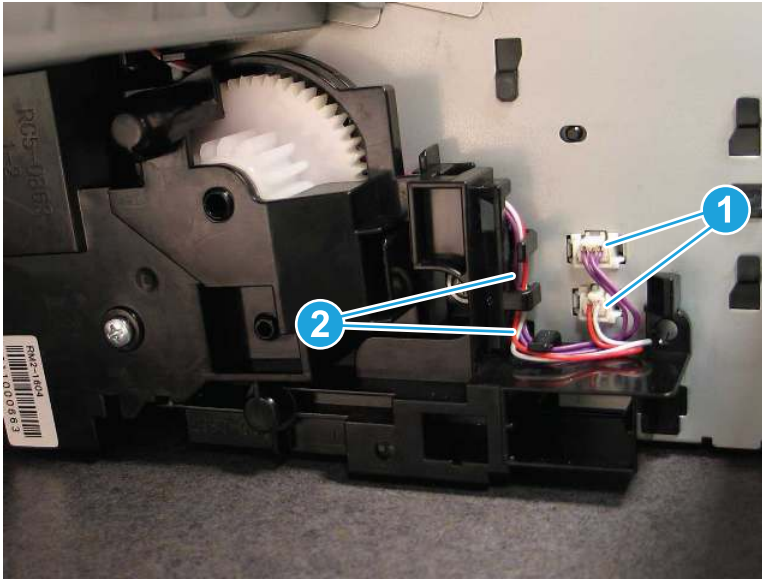
5. Remove the lifter drive assembly.
 - a. Release one tab (callout 1), and then remove the connector cover (callout 2).

Figure 1-1593 Remove the connector cover



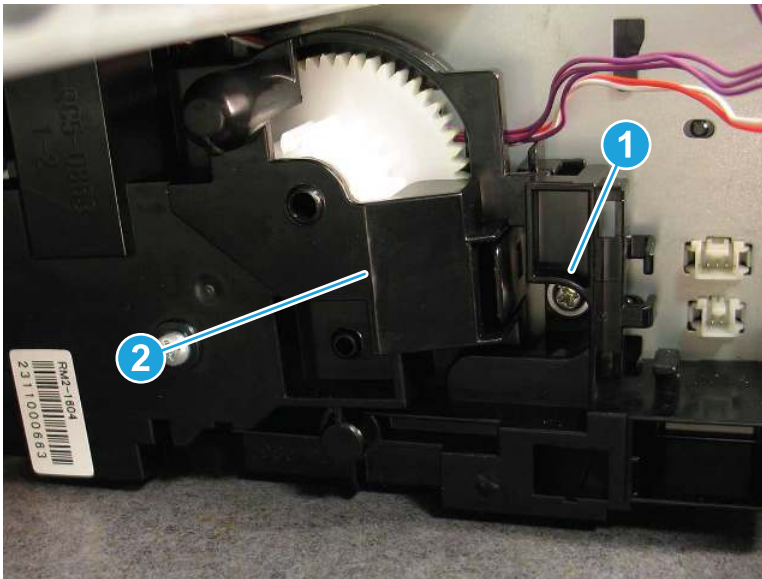
- b. Disconnect two connectors (callout 1), and then release the cables from the guides (callout 2).

Figure 1-1594 Disconnect two connectors



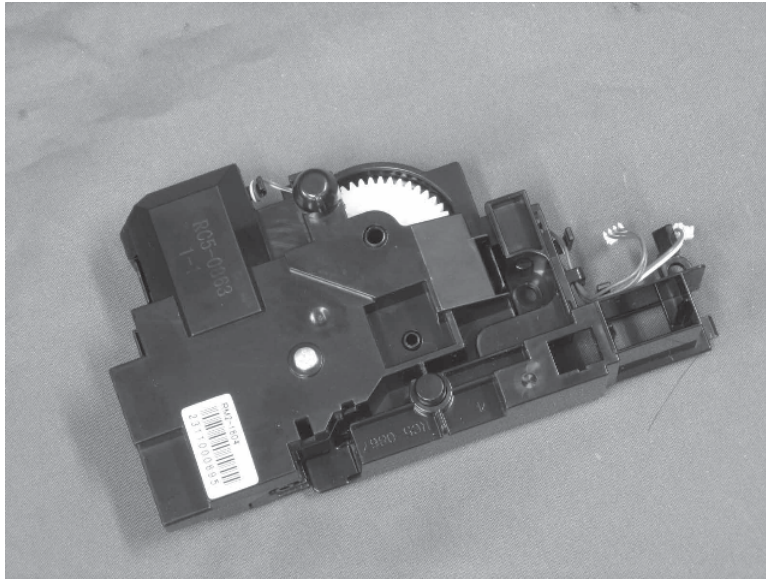
- c. Remove one screw (callout 1) and then remove the lifter drive assembly and holder (callout 2).

Figure 1-1595 Remove the lifter drive assembly



- d. Remove the lifter drive assembly (callout 1) from the holder (callout 2).

Figure 1-1596 Remove the holder



6. Unpack the replacement assembly.

- a. Dispose of the defective part.



NOTE: HP recommends responsible disposal of the defective part.

<http://www8.hp.com/us/en/hp-information/environment/product-recycling.html>

- b. Unpack the replacement part from the packaging.



IMPORTANT: Make sure that all of the shipping materials (for example shipping tape) are removed from the replacement part prior to installation.

- c. To install an assembly, reverse the removal steps.



NOTE: When applicable, special installation instructions are provided for an assembly at the end of the removal procedure. Always completely read the removal instructions and follow all special installation instructions.

Removal and replacement: Auto close assembly (Tray 2; M751/E75245/M856/E85055/M776)

Learn how to remove and replace the auto close assembly for Tray 2.

[View a video of how to remove and replace the auto close assembly \(Tray 2\).](#)

Mean time to repair: 27 minutes

Service level: Medium

Before performing service

Turn the printer power off

- Disconnect the power cable.

⚠ WARNING! To avoid damage to the printer, turn the printer off, wait 30 seconds, and then remove the power cord before attempting to service the printer.

Use the table below to identify the correct part number for your printer. To order the part, go to www.hp.com/buy/parts.

Table 1-85 Part information

Part number	Part description
RM2-1605-000CN	Auto close assembly

Required tools

- #2 Phillips screwdriver with a magnetic tip
- Small, flat-blade screwdriver

After performing service

Turn the printer power on

- Connect the power cable.
- Use the power switch to turn the power on.

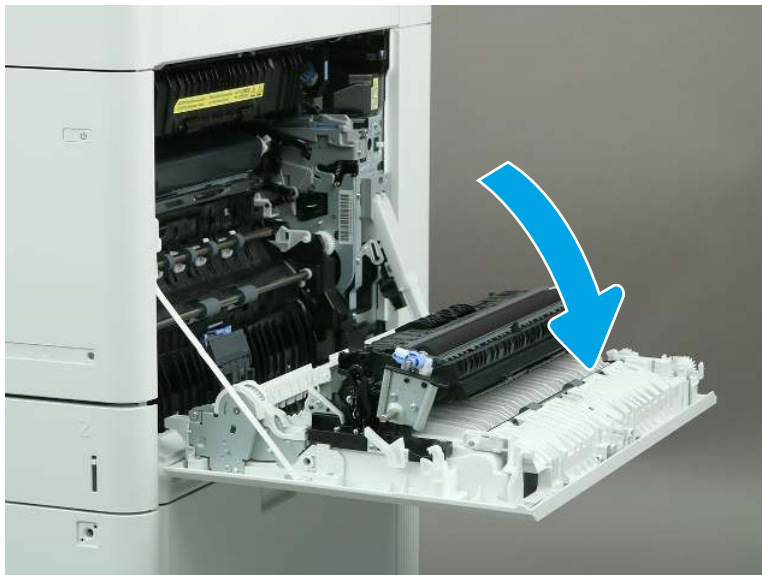
Post service test

Make sure that the printer initializes to a **Ready** state.

Print a page to make sure that the printer is functioning correctly.

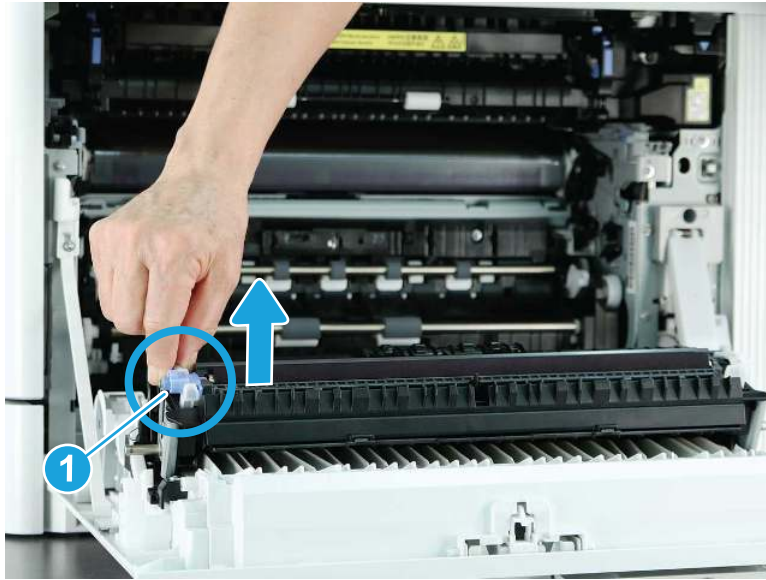
1. Remove the secondary transfer roller.
 - a. Open the right door.

Figure 1-1597 Open the right door



- b. Release the latch (callout 1), and then lift the left side of the roller.

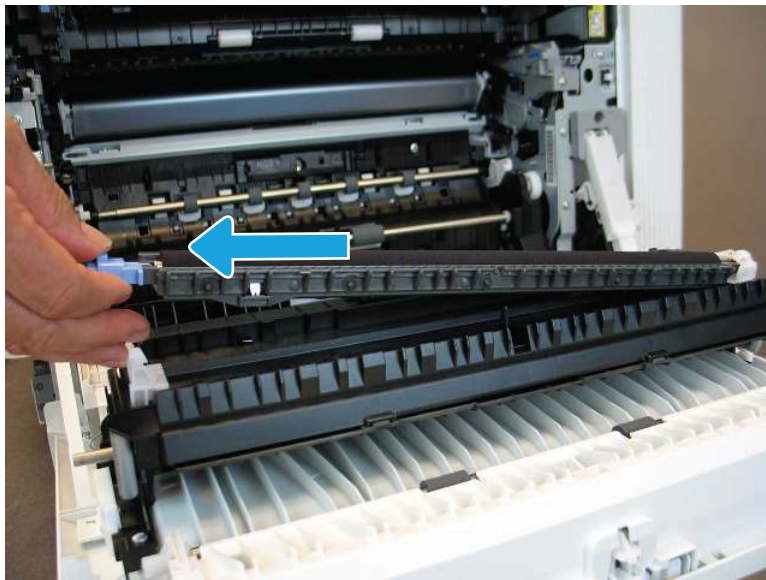
Figure 1-1598 Release the transfer roller



- c. Slide the transfer roller to the left to remove it.

⚠ **CAUTION:** Do not touch the surface of the secondary transfer roller.

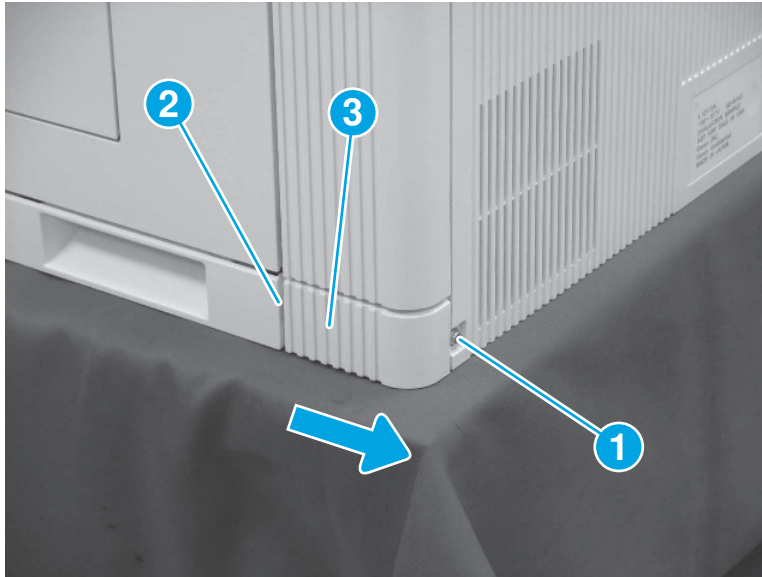
Figure 1-1599 Remove the secondary transfer roller



2. Remove the right rear lower cover (M751/E75245/M856/E85055/M776).

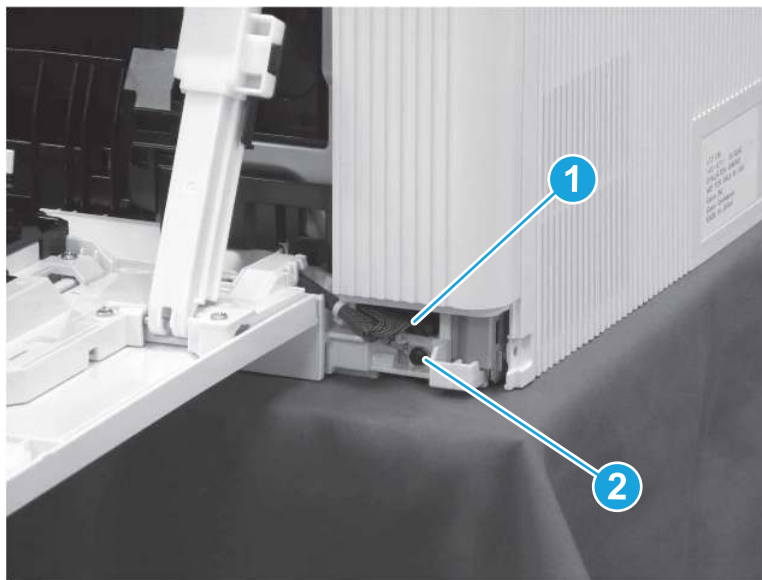
- ▲ Remove one screw (callout 1), release one tab (callout 2), and then slide the right rear lower cover (callout 3) toward the back of the printer to remove it.

Figure 1-1600 Remove the right rear lower cover



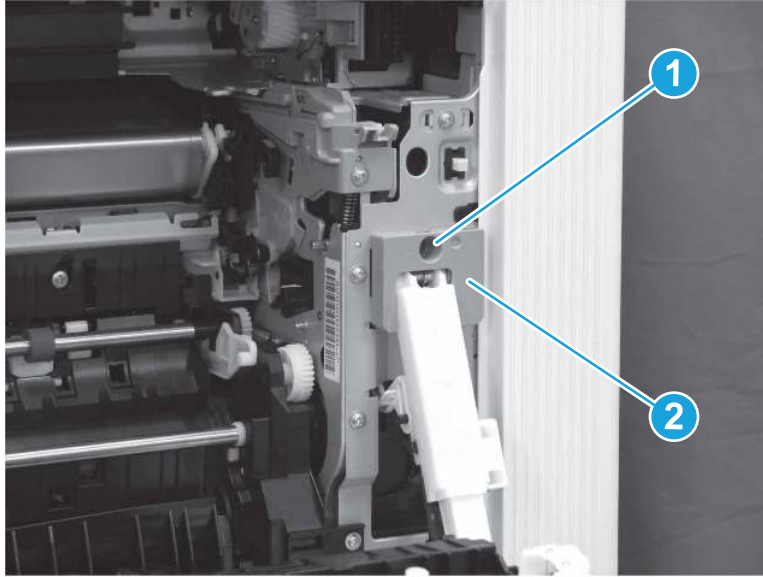
- 3. Remove the right door.
 - a. Disconnect one connector (callout 1), and then remove one black grounding screw (callout 2).

Figure 1-1601 Disconnect one connector and remove one screw



- b. Remove one self-tapping screw (callout 1), and then remove the cover (callout 2).

Figure 1-1602 Remove the cover



- c. Push the damper slightly to the right, and gently pull the link arm to the left to release the boss (callout 1) from the link arm.


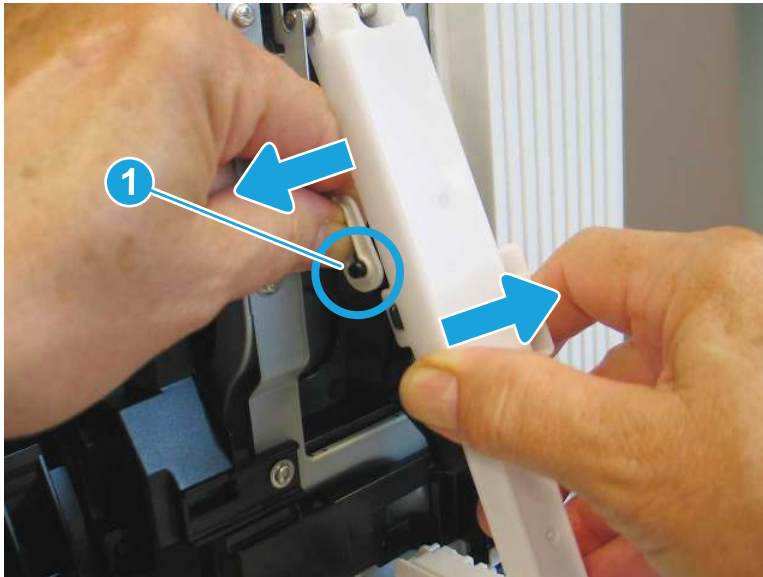
 **IMPORTANT:** Make sure to reattach this link arm when reinstalling the right door. Failure to do so might cause damage to the link arm, requiring a larger repair.

Figure 1-1603 Release the link arm



- d. Retract the link arm slightly into the printer to move it out of the way.

Figure 1-1604 Retract the link arm



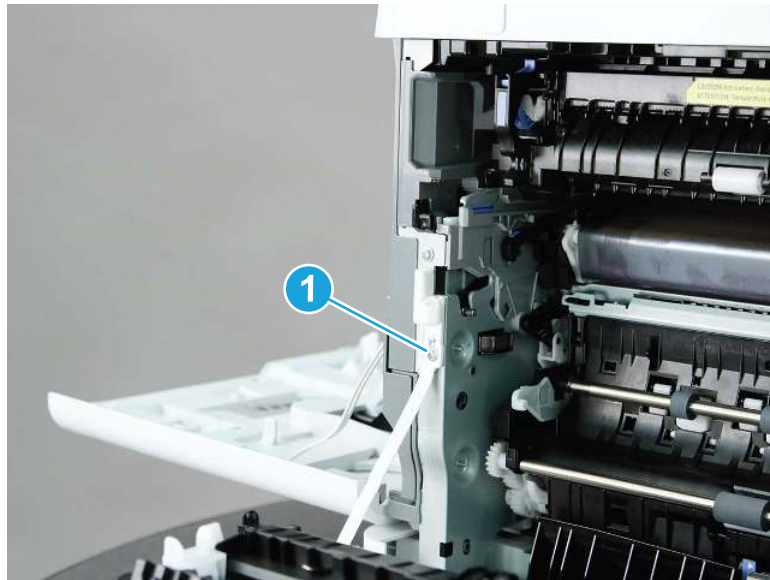
- e. Lift the dampener up, and then pull it away from the printer to release it from the bushing.

Figure 1-1605 Release the dampener



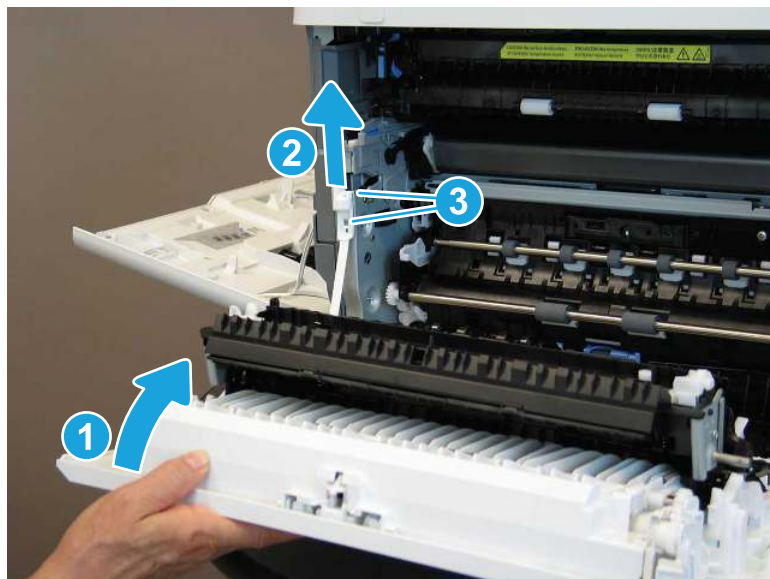
- f. Remove one screw (callout 1).

Figure 1-1606 Remove one screw



- g. Raise the door slightly (callout 1) to take tension off of the hinge. Slide the hinge up (callout 2) to release two hooks (callout 3).

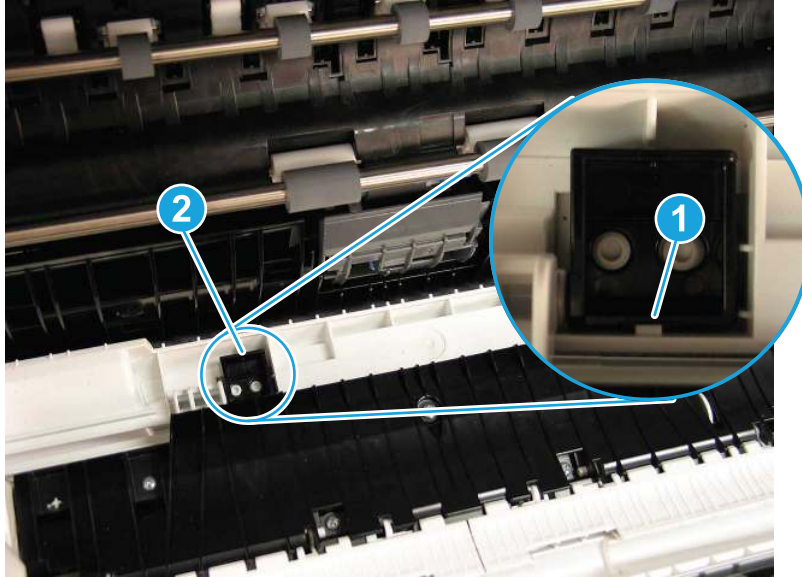
Figure 1-1607 Release the hinge



- h. Release one tab (callout 1), and then remove the stopper (callout 2).

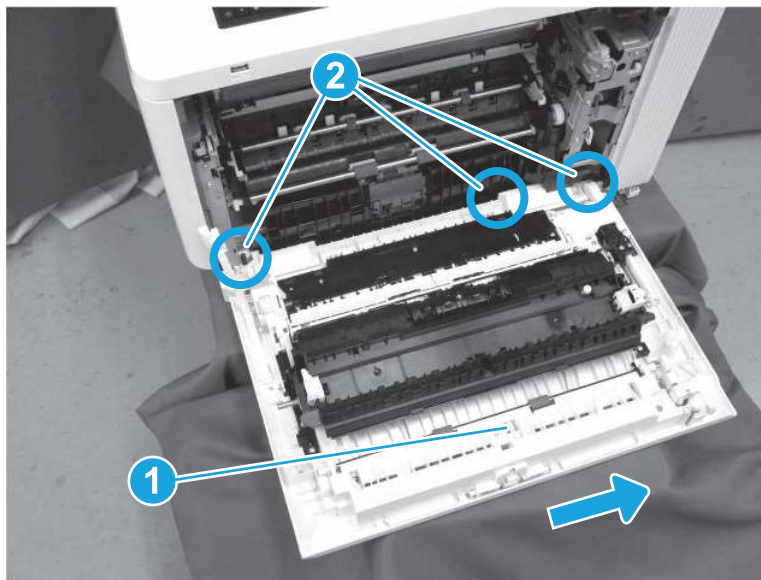
 **TIP:** Use needle-nosed pliers to release the stopper.

Figure 1-1608 Remove the stopper



- i. Slide the right door (callout 1) to the right to release it from three tabs (callout 2), and then remove the right door.

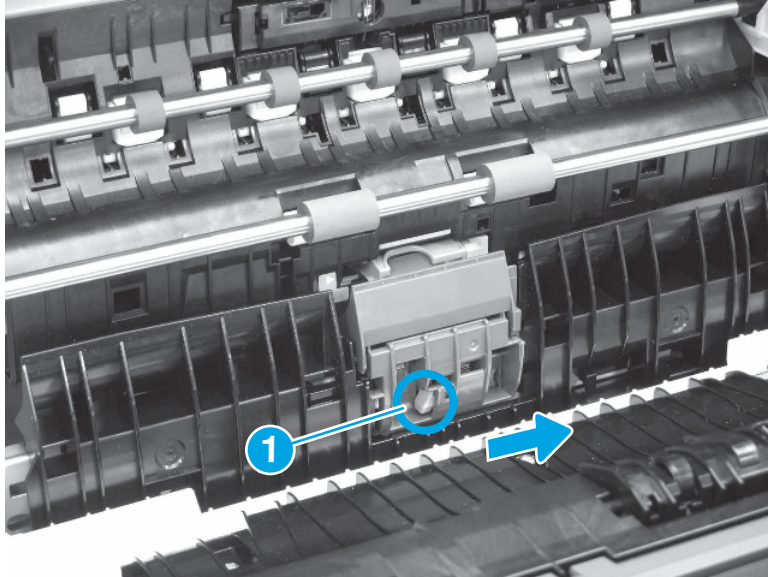
Figure 1-1609 Remove the right door



- 4. Remove the pickup assembly.

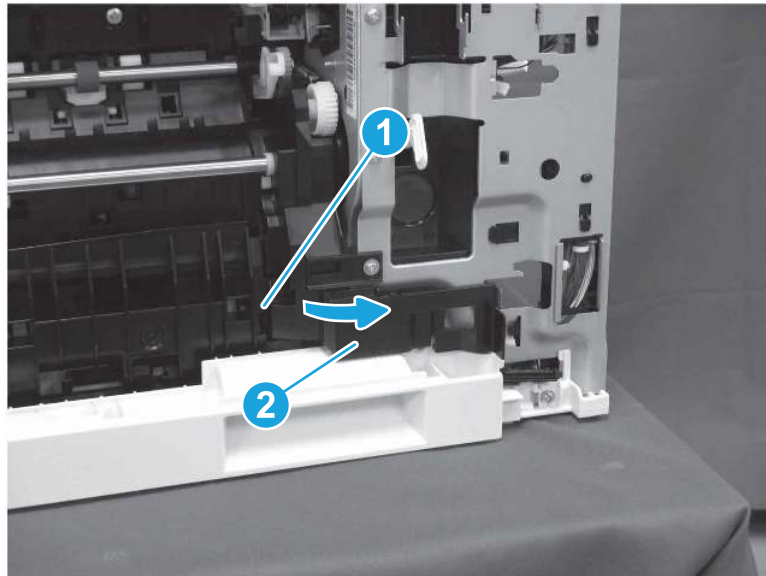
- a. Press the release button (callout 1) on the Tray 2 separation roller. Slide the assembly to the right, and then pull it away from the printer to remove it.

Figure 1-1610 Remove the Tray 2 separation roller assembly



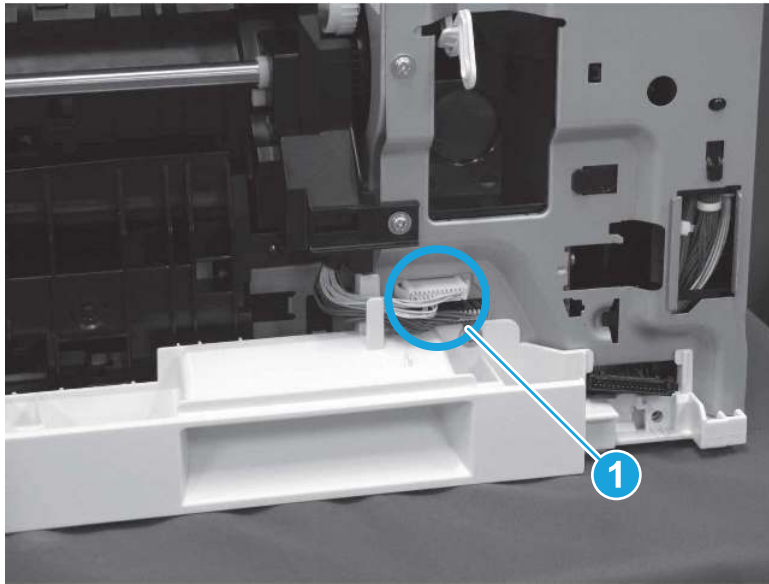
- b. Release one tab (callout 1), and then rotate the cover (callout 2) away from the printer to remove it.

Figure 1-1611 Remove the cover



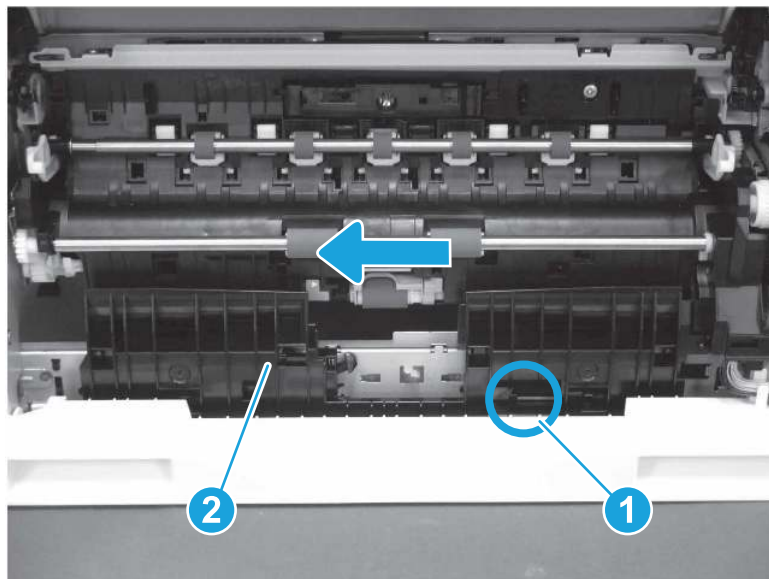
- c. Disconnect two connectors (callout 1).

Figure 1-1612 Disconnect two connectors



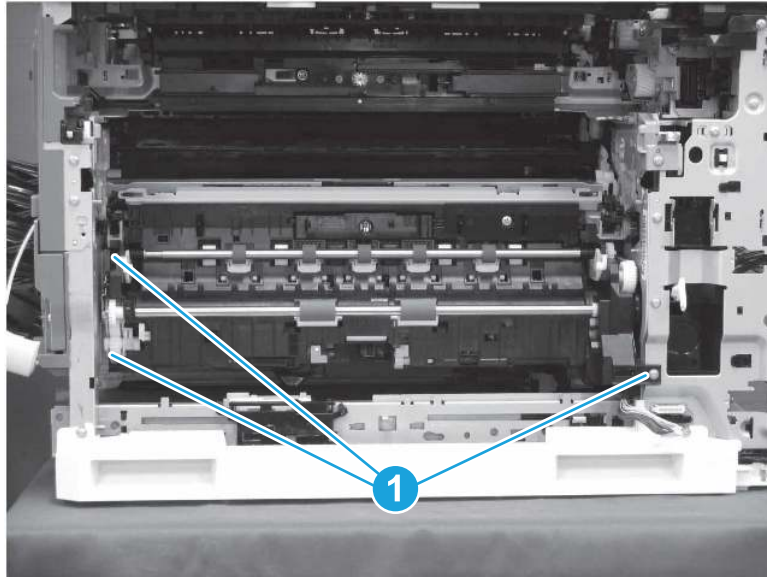
- d. Release one tab (callout 1), and then slide the guide (callout 2) to the left to remove it.

Figure 1-1613 Remove the guide



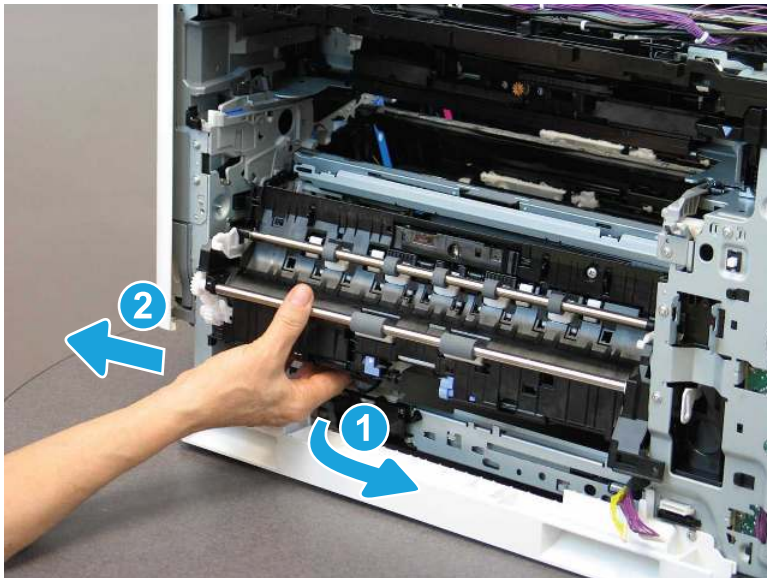
- e. Remove three screws (callout 1).

Figure 1-1614 Remove three screws



- f. Rotate the left side of the pickup assembly away from the printer (callout 1), and then slide the assembly to the left (callout 2) to remove it.

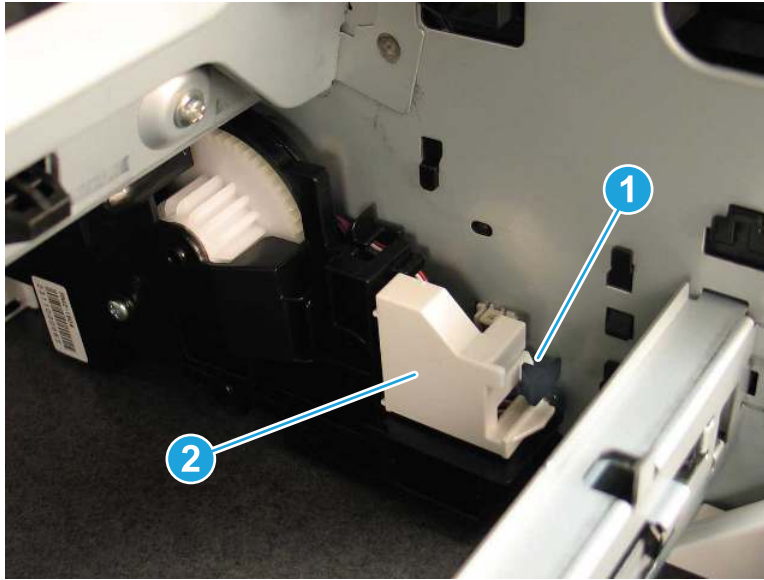
Figure 1-1615 Remove the pickup assembly



- 5. Remove the lifter drive assembly.

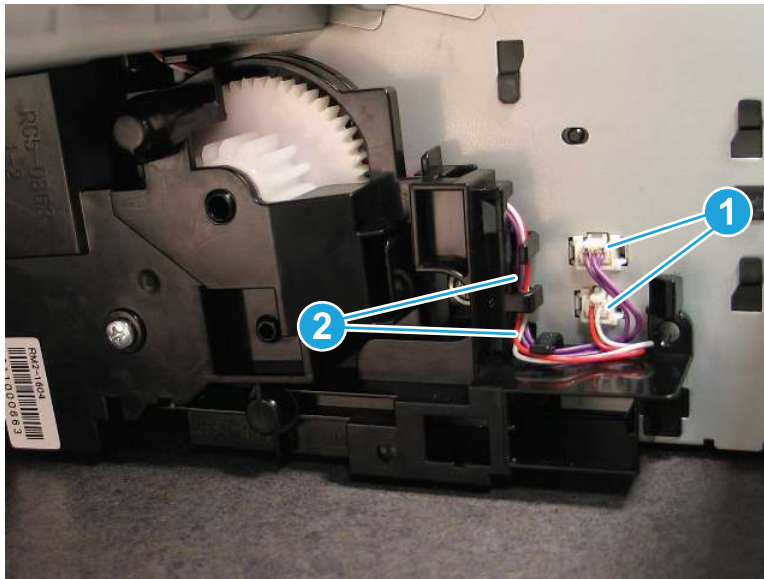
- a. Release one tab (callout 1), and then remove the connector cover (callout 2).

Figure 1-1616 Remove the connector cover



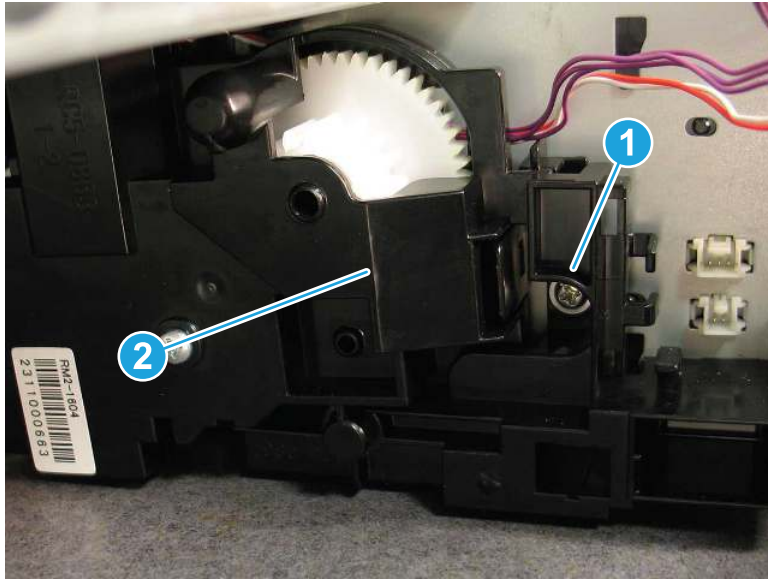
- b. Disconnect two connectors (callout 1), and then release the cables from the guides (callout 2).

Figure 1-1617 Disconnect two connectors



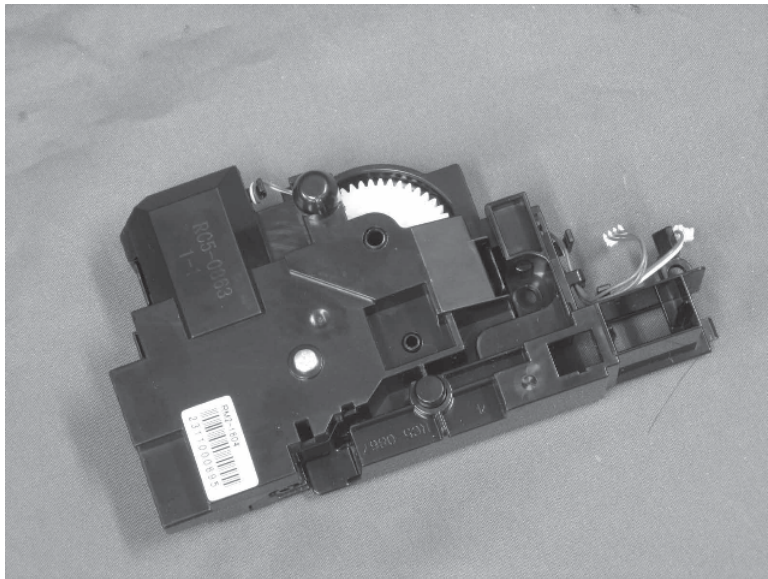
- c. Remove one screw (callout 1).and then remove the lifter drive assembly and holder (callout 2).

Figure 1-1618 Remove the lifter drive assembly



- d. Remove the lifter drive assembly (callout 1) from the holder (callout 2).

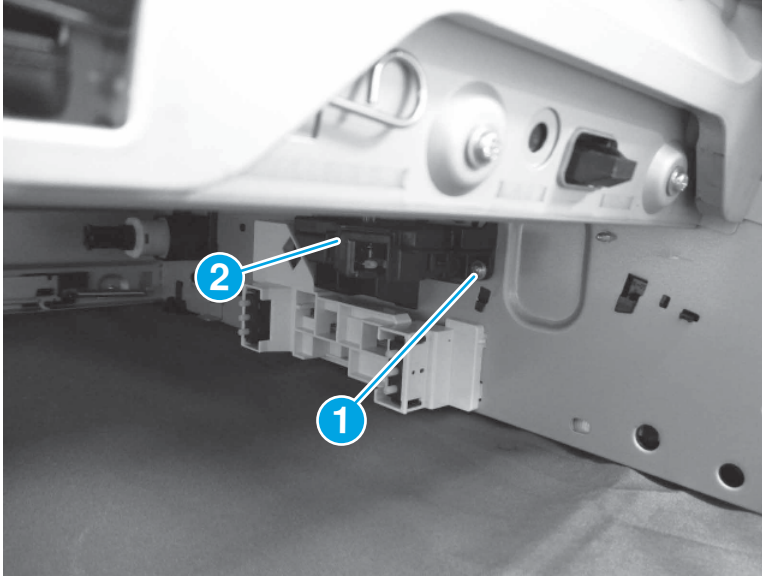
Figure 1-1619 Remove the holder



6. Remove the auto close assembly.

- ▲ Remove one screw (callout 1), and then remove the auto close assembly (callout 2).

Figure 1-1620 Remove one screw and the auto close assembly



7. Unpack the replacement assembly.

- a. Dispose of the defective part.



NOTE: HP recommends responsible disposal of the defective part.

<http://www8.hp.com/us/en/hp-information/environment/product-recycling.html>

- b. Unpack the replacement part from the packaging.



IMPORTANT: Make sure that all of the shipping materials (for example shipping tape) are removed from the replacement part prior to installation.

- c. To install an assembly, reverse the removal steps.



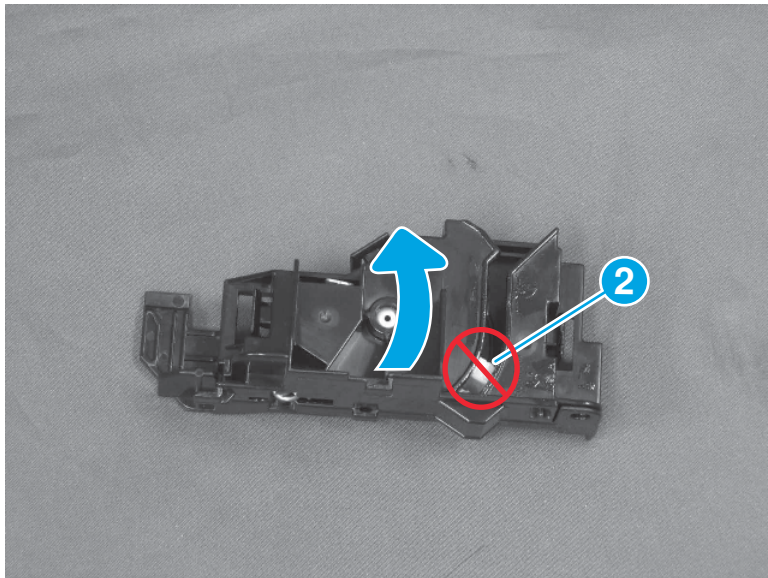
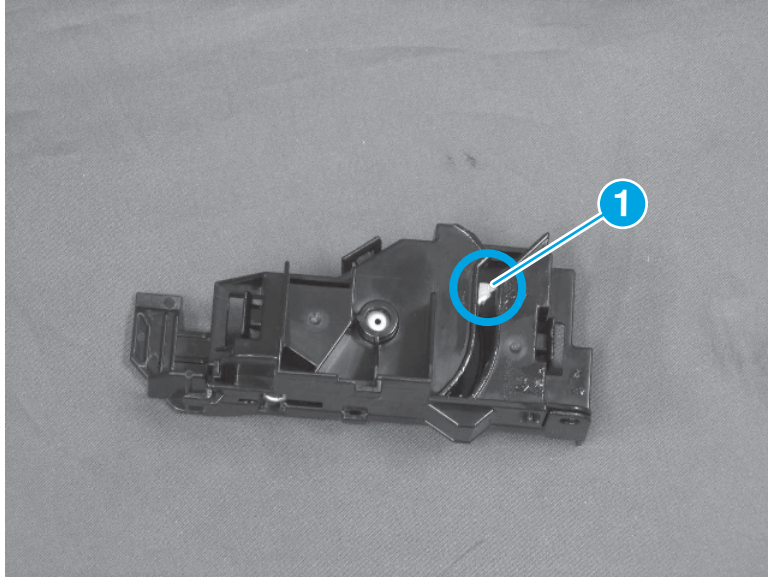
NOTE: When applicable, special installation instructions are provided for an assembly at the end of the removal procedure. Always completely read the removal instructions and follow all special installation instructions.

8. Reverse the removal steps to install the assembly. Also use the following **special installation instructions**.

Check the auto close toggle position.

- ▲ Confirm the position of the toggle when installing the auto close assembly. The correct position of the toggle is toward the top of the auto close assembly (callout 1). If the toggle is in the wrong position (callout 2), use a small, flat-blade screwdriver to rotate it up to the correct position.

Figure 1-1621 Check the toggle position



Removal and replacement: DC controller (M751/E75245)

Learn how to remove and replace the DC controller.

[View a video of how to remove and replace the DC controller.](#)

Mean time to repair: 24 minutes

Service level: Medium

Before performing service

Turn the printer power off

- Disconnect the power cable.

⚠ WARNING! To avoid damage to the printer, turn the printer off, wait 30 seconds, and then remove the power cord before attempting to service the printer.

Use the table below to identify the correct part number for your printer. To order the part, go to www.hp.com/buy/parts.

Table 1-86 Part information

Part number	Part description
RM2-9630-000CN	DC controller PCB assembly (M751/E75245)

Required tools

- #2 Phillips screwdriver with a magnetic tip
- Small, flat-blade screwdriver

After performing service

Turn the printer power on

- Connect the power cable.
- Use the power switch to turn the power on.

Post service test

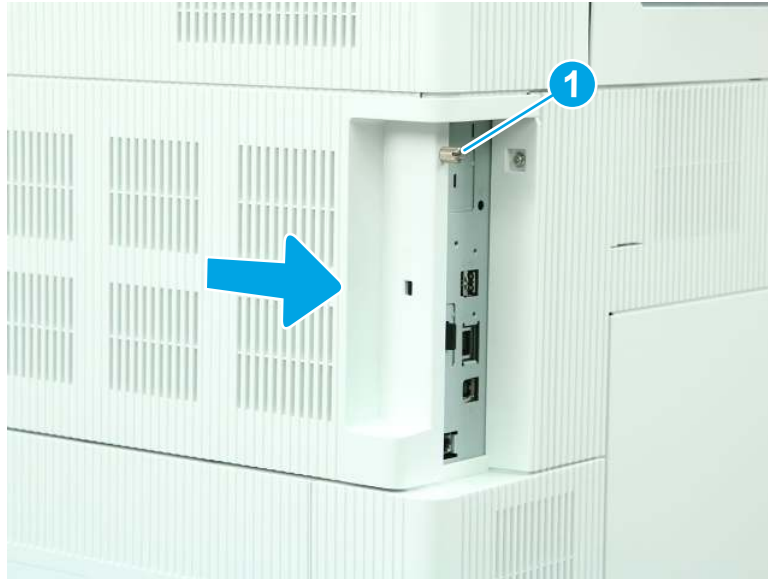
Make sure that the printer initializes to a **Ready** state.

Print a page to make sure that the printer is functioning correctly.

1. Remove the formatter cover.

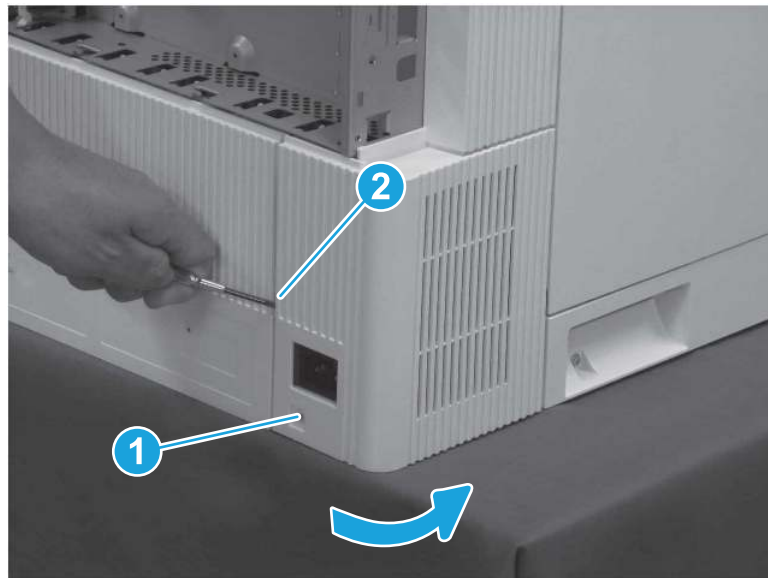
- ▲ Loosen one thumbscrew (callout 1), and then slide the formatter cover (callout 2) away from the printer to remove it.

Figure 1-1622 Remove the formatter cover



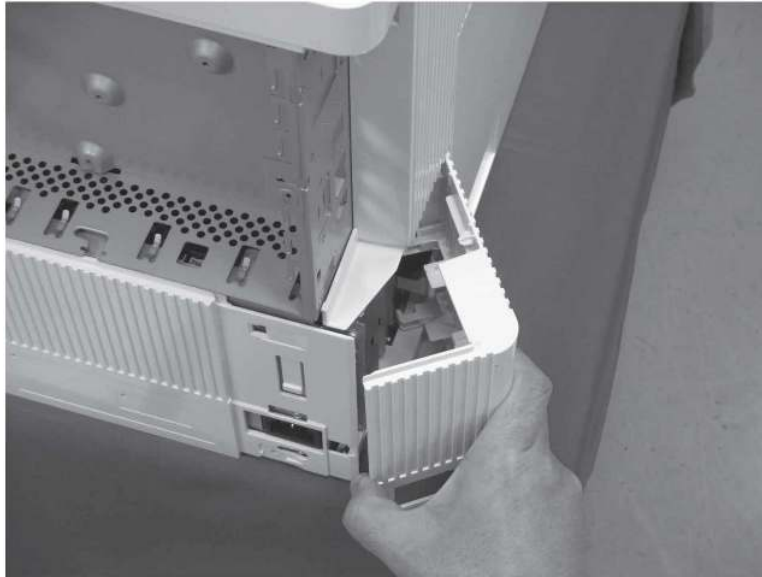
- 2. Remove the left lower cover (M751/E75245).
 - a. Remove one screw (callout 1), release one tab (callout 2), and then rotate the cover away from the printer.

Figure 1-1623 Remove one screw and release one tab



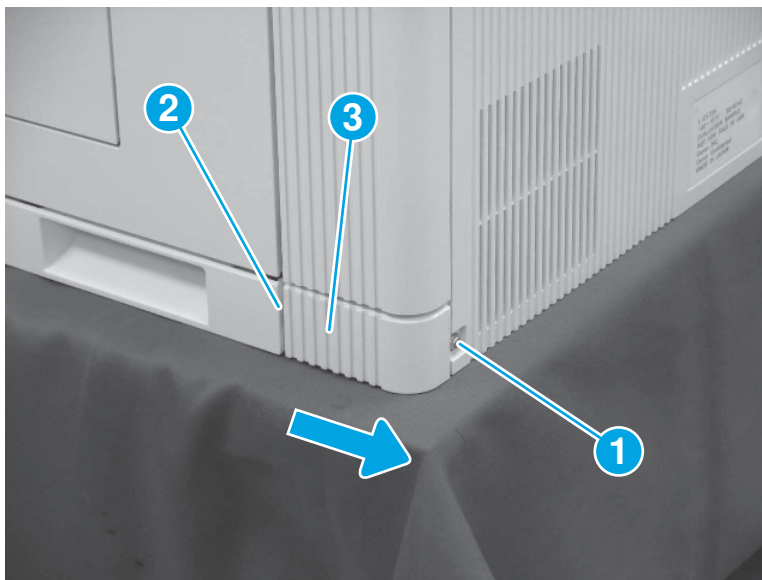
- b. Remove the left lower cover.

Figure 1-1624 Remove the left lower cover



3. Remove the right rear lower cover (M751/E75245/M856/E85055/M776).
 - ▲ Remove one screw (callout 1), release one tab (callout 2), and then slide the right rear lower cover (callout 3) toward the back of the printer to remove it.

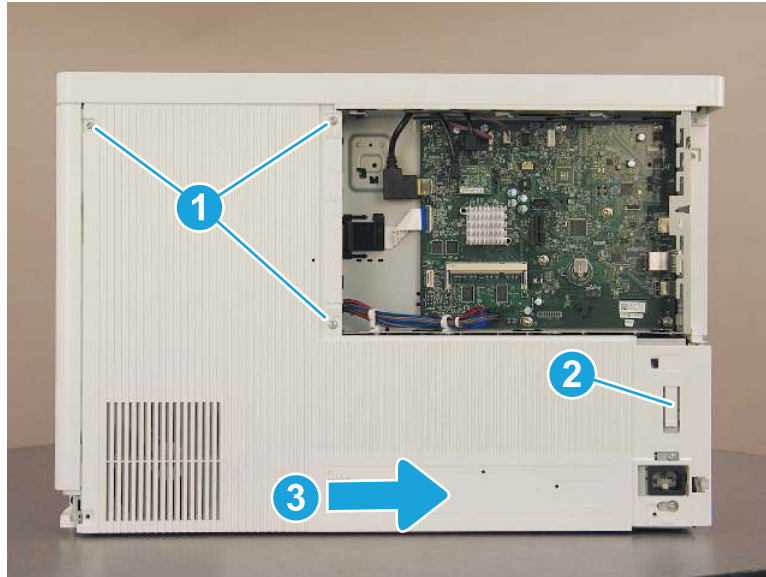
Figure 1-1625 Remove the right rear lower cover



4. Remove the rear cover (M751/E75245).

- ▲ Remove three screws (callout 1), release one tab (callout 2), and then slide the rear cover to the right (callout 3) to remove it.

Figure 1-1626 Remove the rear cover

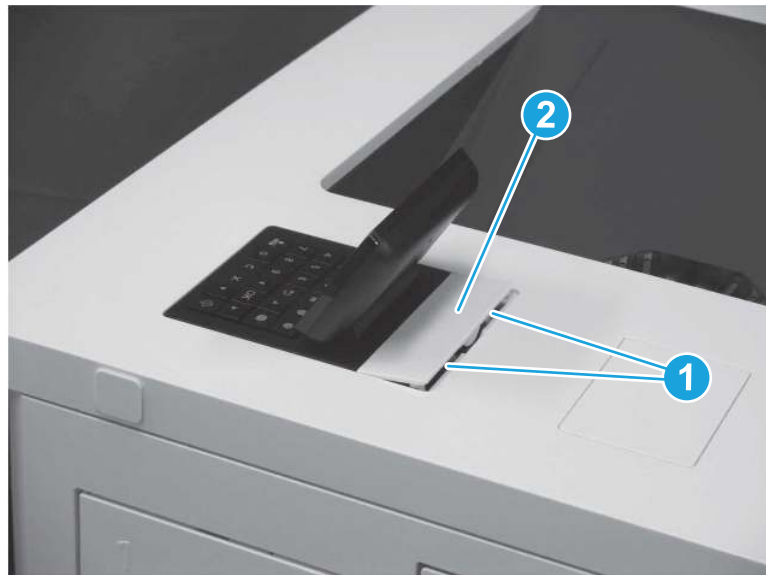


5. Remove the control panel.

 **NOTE:** A screwdriver is included in the control panel kit. The screwdriver has a reversible shaft. Simply pull the shaft out of the handle, and then reinstall it with the desired end facing out.

- a. Use a small, flat-blade screwdriver to release two tabs (callout 1), and then remove the control panel cover (callout 2).

Figure 1-1627 Remove the control panel cover



- b. Remove one screw (callout 1).

Figure 1-1628 Remove one screw



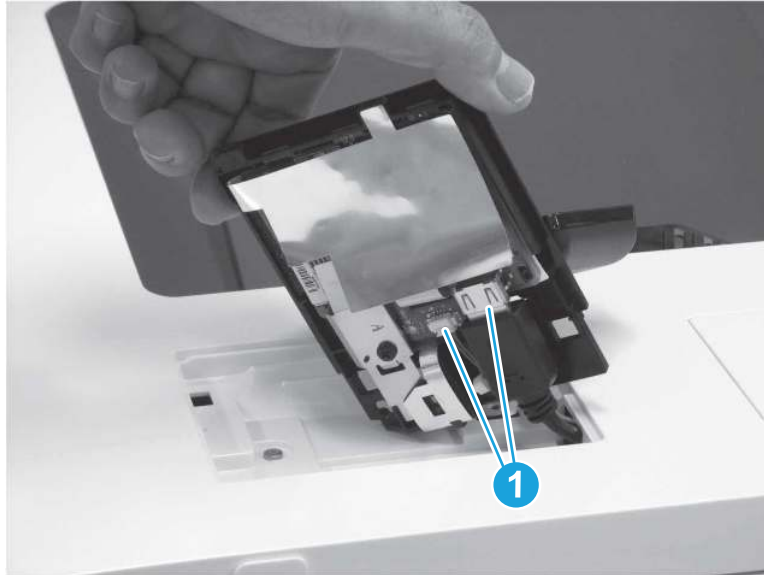
- c. Lift the back edge of the control panel up (callout 1), and then slide the control panel toward the back of the printer (callout 2).

Figure 1-1629 Slide the control panel back



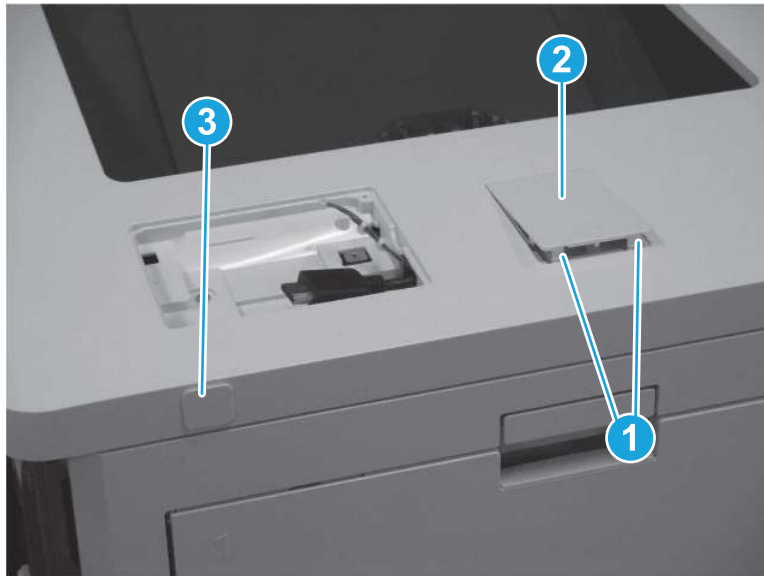
- d. Turn the control panel so that the bottom is facing up, and then disconnect two connectors (callout 1) to remove the control panel.

Figure 1-1630 Disconnect two connectors



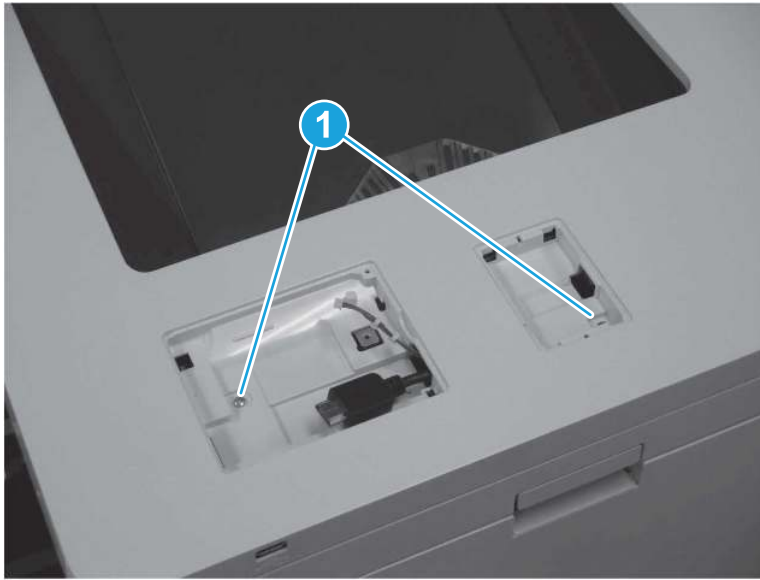
6. Remove the top cover (M751/E75245).
 - a. Release two tabs (callout 1), and then remove the HIP cover (callout 2). Pull the USB cap (callout 3) away from the printer to remove it.

Figure 1-1631 Remove the HIP cover and USB cap



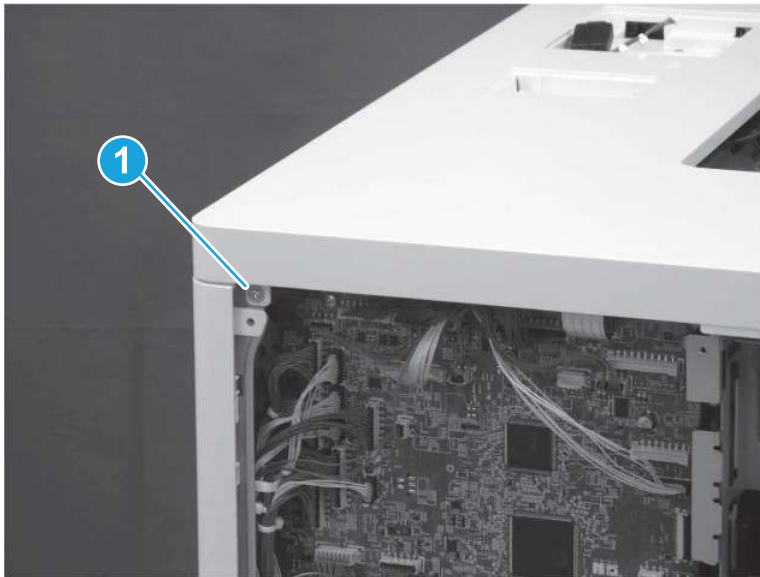
- b. At the top of the printer, remove two screws (callout 1).

Figure 1-1632 Remove two screws




- c. At the back of the printer, remove one screw (callout 1).

Figure 1-1633 Remove one screw

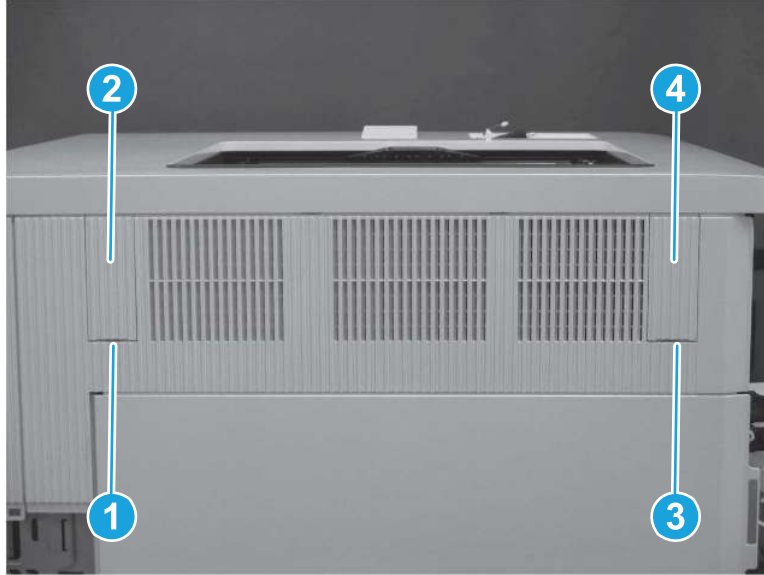


- d. Use a small, flat-blade screwdriver to release one tab (callout 1) and remove the left blanking cover (callout 2). Release one tab (callout 3) and remove the right blanking cover (callout 4).

 **TIP:** These covers are not identical. Make sure to reinstall the correct cover on the correct side.

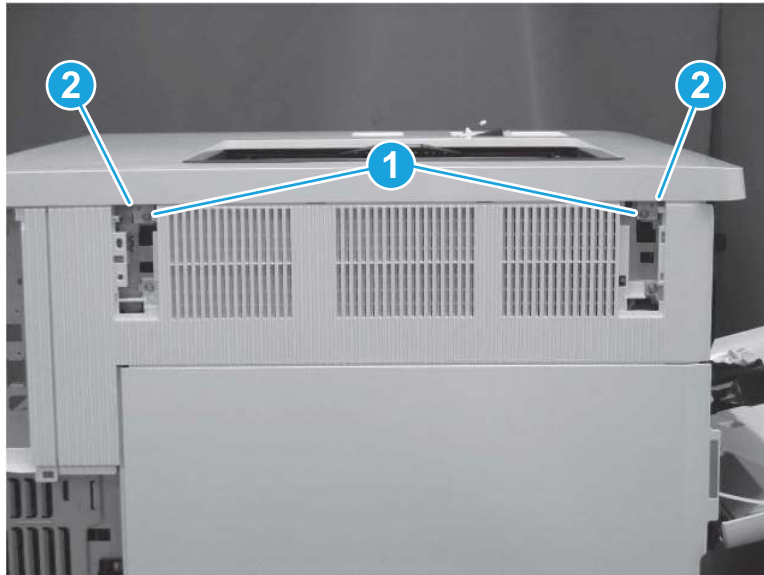
 **NOTE:** The screw under the left blanking cover is a self-tapping screw. Make sure this screw is reinstalled in the correct location.

Figure 1-1634 Remove the left and right blanking covers



- e. Remove two screws (callout 1), and then release two tabs (callout 2).

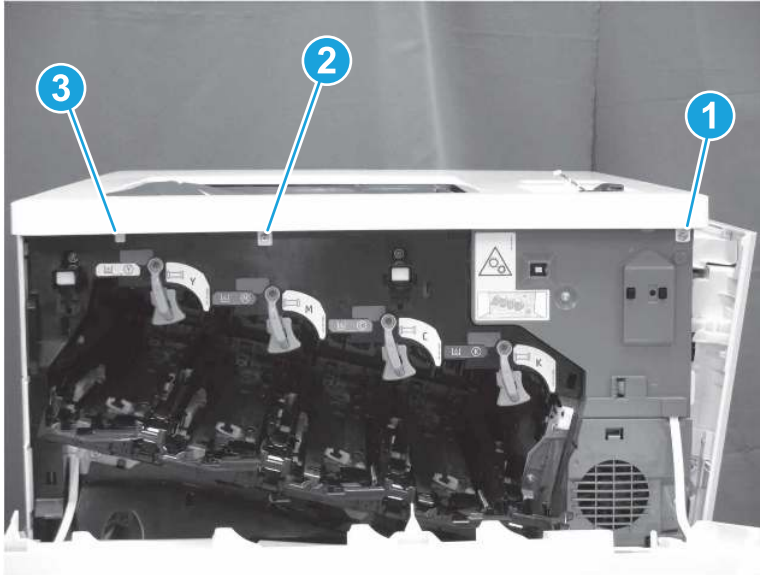
Figure 1-1635 Remove two screws and release two tabs



- f. At the front of the printer, remove one washer-head screw (callout 1) and one self-tapping screw (callout 2). Release one tab (callout 3).

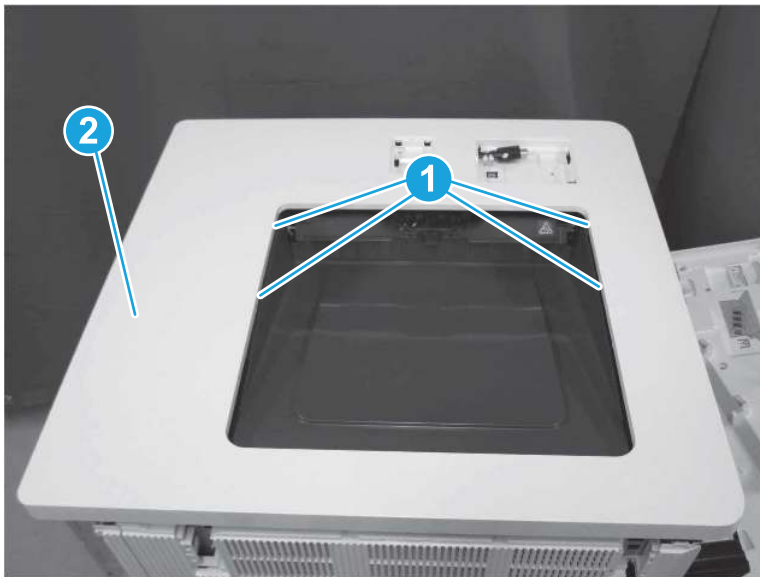
 **TIP:** Make sure to install the correct type of screw in the correct location.

Figure 1-1636 Remove two screws and release one tab



- g. At the top of the printer, release four tabs (callout 1), and then remove the top cover (callout 2).

Figure 1-1637 Remove the top cover

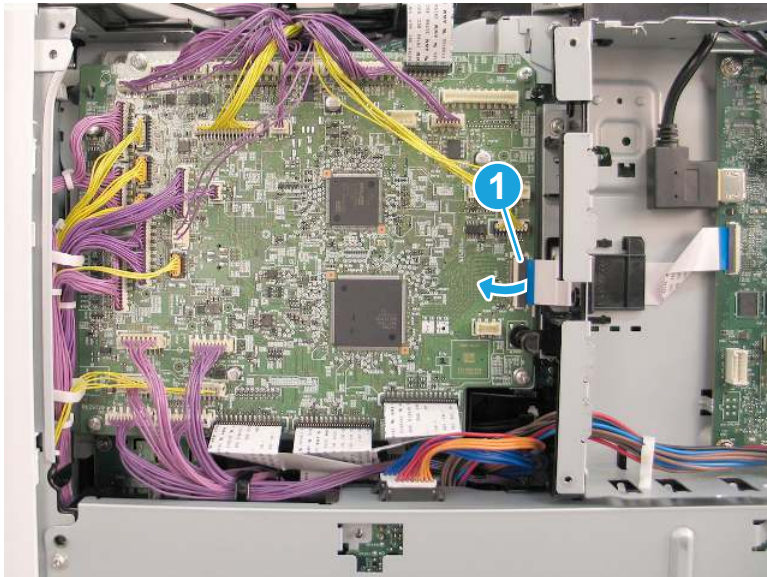


 **NOTE:** When removing the top cover, make sure to release the control panel cables (callout 1) through the opening.



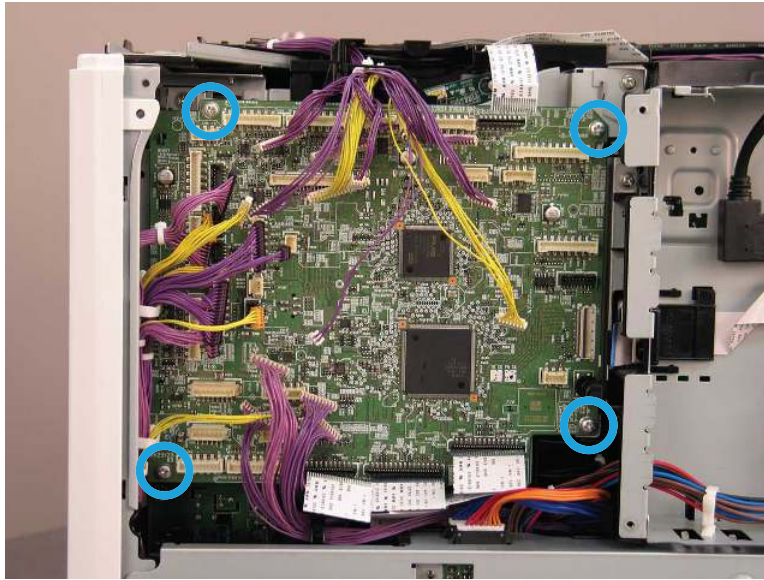
7. Remove the DC controller.
 - a. Lift the latch to release the flat cable (callout 1), and then disconnect all of the remaining connectors on the DC controller.

Figure 1-1638 Disconnect all of the connectors



- b. Remove four screws, and then remove the DC controller.

Figure 1-1639 Remove four screws



8. Unpack the replacement assembly.

- a. Dispose of the defective part.




NOTE: HP recommends responsible disposal of the defective part.

<http://www8.hp.com/us/en/hp-information/environment/product-recycling.html>

- b. Unpack the replacement part from the packaging.



CAUTION:  Some parts are sensitive to electrostatic discharge (ESD). Always perform service work at an ESD-protected workstation or mat. If an ESD workstation or mat is not available, touch the sheet-metal chassis to provide a static ground before touching an ESD-sensitive assembly. Protect the ESD-sensitive assemblies by placing them in ESD pouches when they are out of the printer.



IMPORTANT: Make sure that all of the shipping materials (for example shipping tape) are removed from the replacement part prior to installation.

- c. To install an assembly, reverse the removal steps.



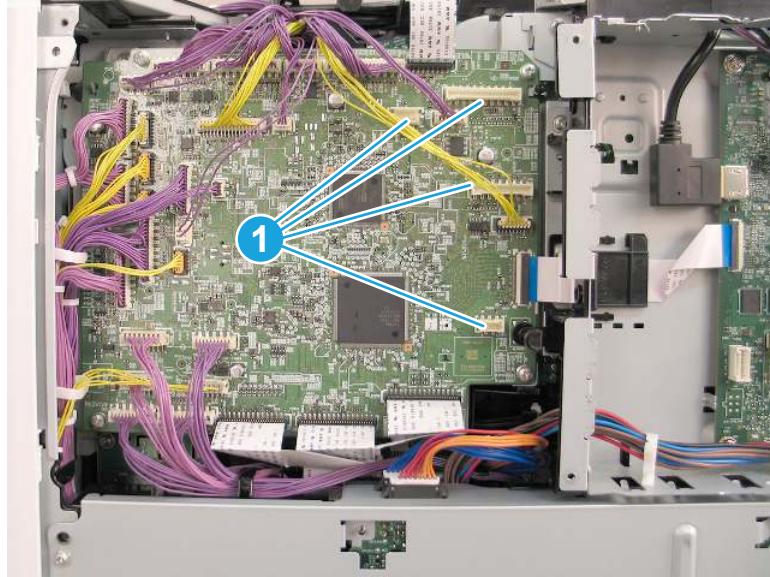
NOTE: When applicable, special installation instructions are provided for an assembly at the end of the removal procedure. Always completely read the removal instructions and follow all special installation instructions.

9. Reverse the removal steps to install the assembly. Also use the following **special installation instructions**.

Install the DC controller.

- ▲ When installing the DC controller, note four connectors (callout 1) that remain empty.

Figure 1-1640 DC controller empty connectors



Removal and replacement: DC controller (M856/E85055/M776)

Learn how to remove and replace the DC controller.

[View a video of how to remove and replace the DC controller.](#)

Mean time to repair: 24 minutes

Service level: Medium

Before performing service

Turn the printer power off

- Disconnect the power cable.

⚠ WARNING! To avoid damage to the printer, turn the printer off, wait 30 seconds, and then remove the power cord before attempting to service the printer.

Use the table below to identify the correct part number for your printer. To order the part, go to www.hp.com/buy/parts.

Table 1-87 Part information

Part number	Part description
RM2-9930-000CN	DC controller PCB assembly (M856/E85055/M776dn/M776z)
RM2-9931-000CN	DC controller PCB assembly (M776zs)

Required tools

- #2 Phillips screwdriver with a magnetic tip
- Small, flat-blade screwdriver

After performing service

Turn the printer power on

- Connect the power cable.
- Use the power switch to turn the power on.

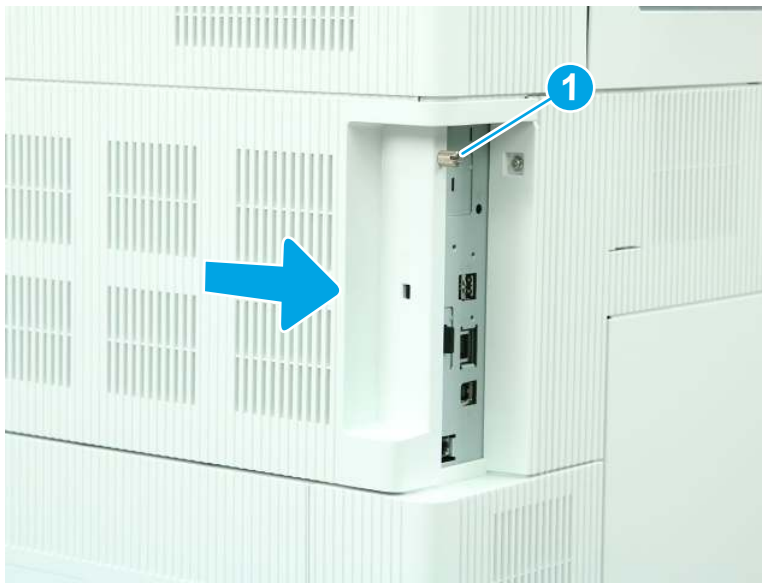
Post service test

Make sure that the printer initializes to a **Ready** state.

Print a page to make sure that the printer is functioning correctly.

1. Remove the formatter cover.
 - ▲ Loosen one thumbscrew (callout 1), and then slide the formatter cover (callout 2) away from the printer to remove it.

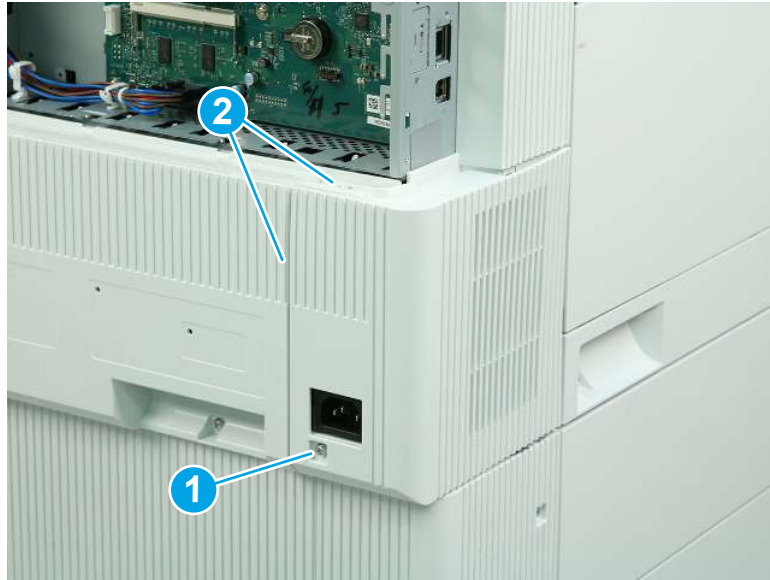
Figure 1-1641 Remove the formatter cover



2. Remove the left lower cover (M856/E85055/M776).

- a. Remove one screw (callout 1), and then release two tabs (callout 2).

Figure 1-1642 Remove one screw and release two tabs



- b. Rotate the cover away from the printer to remove it.

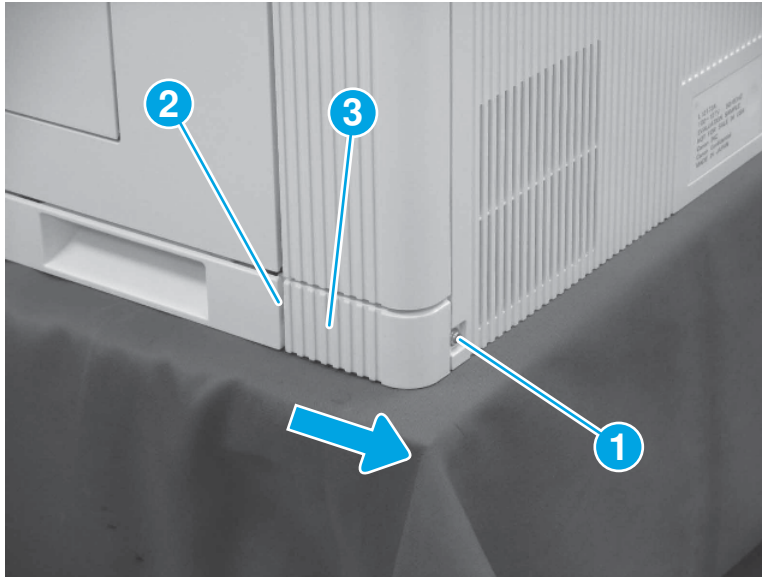
Figure 1-1643 Remove the left lower cover



3. Remove the right rear lower cover (M751/E75245/M856/E85055/M776).

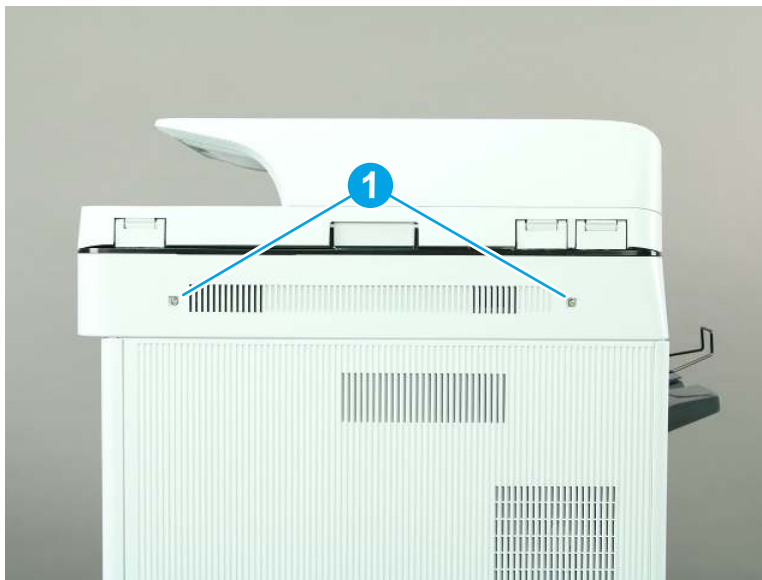
- ▲ Remove one screw (callout 1), release one tab (callout 2), and then slide the right rear lower cover (callout 3) toward the back of the printer to remove it.

Figure 1-1644 Remove the right rear lower cover



- 4. Remove the scanner control board (SCB) cover (M776).
 - a. Remove two screws (callout 1).

Figure 1-1645 Remove two screws



- b. Remove the SCB cover.

Figure 1-1646 Remove the SCB cover

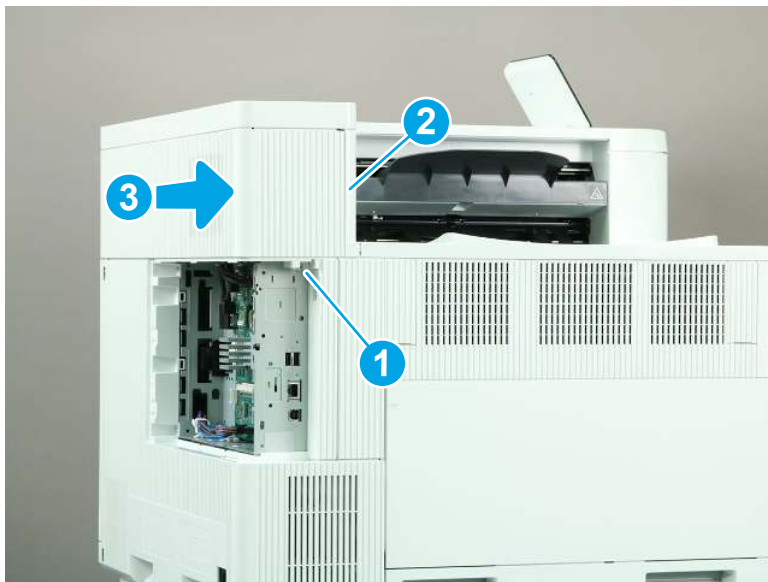


5. Remove the rear upper cover (M856/E85055/M776dn/M776z).

 **NOTE:** The following figure shows the M856 printer. The procedure is correct for all referenced models.

- ▲ Remove one screw (callout 1), release one tab (callout 2), and then slide the rear upper cover away from the printer to remove it (callout 3).

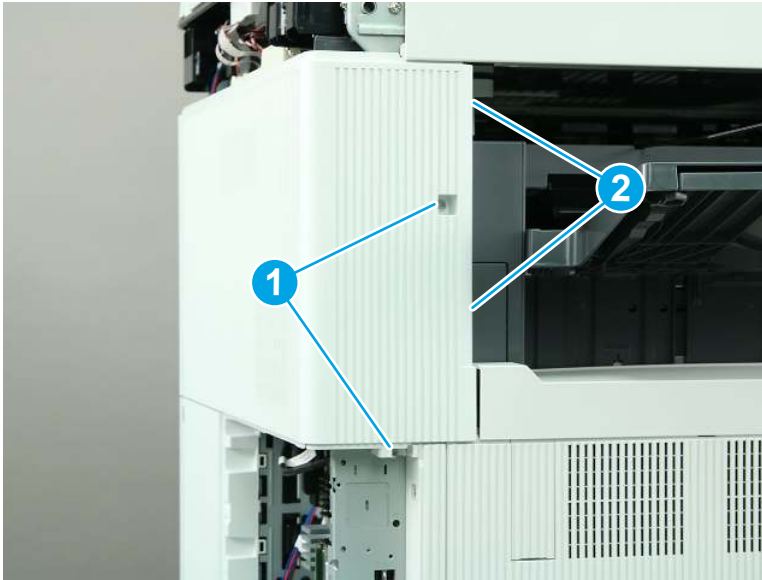
Figure 1-1647 Remove the rear upper cover



6. Remove the rear upper cover and left rear upper cover (M776zs).

- a. Remove two screws (callout 1), and then release two tabs (callout 2).

Figure 1-1648 Remove two screws and release two tabs



- b. Slide the cover to the right to remove it.

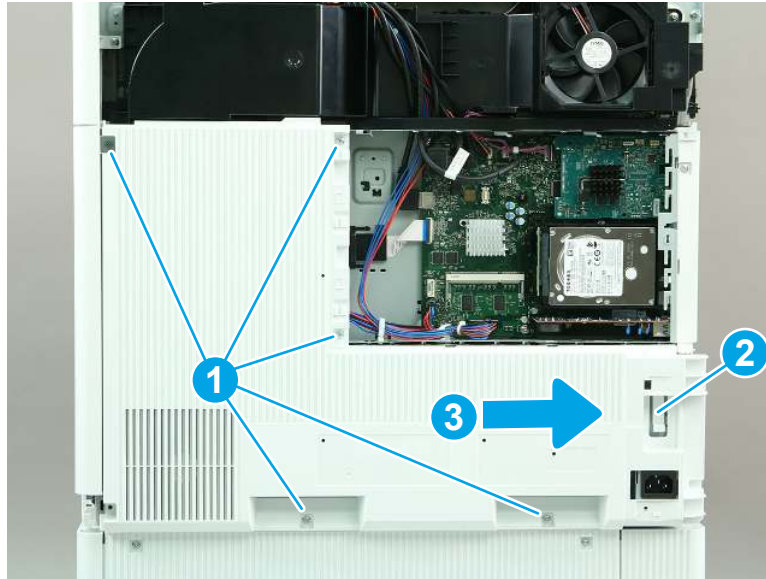
Figure 1-1649 Remove the rear upper and left rear upper cover




7. Remove the rear cover (M856/E85055/M776).

- ▲ Remove five screws (callout 1), release one tab (callout 2), and then slide the rear cover to the right to remove it.

Figure 1-1650 Remove the rear cover (M856/E85055/M776)



- 8. **M856/E85055 only:** Remove the control panel and top cover.

 **NOTE:** This step applies to only the M856/E85055 models. Skip this step for all other models.

- a. Use a small, flat-blade screwdriver to release two tabs (callout 1), and then remove the control panel cover (callout 2).

Figure 1-1651 Remove the control panel cover



- b. Remove one screw (callout 1).

Figure 1-1652 Remove one screw



- c. Lift the back edge of the control panel up (callout 1), and then slide the control panel toward the back of the printer (callout 2).

Figure 1-1653 Slide the control panel back



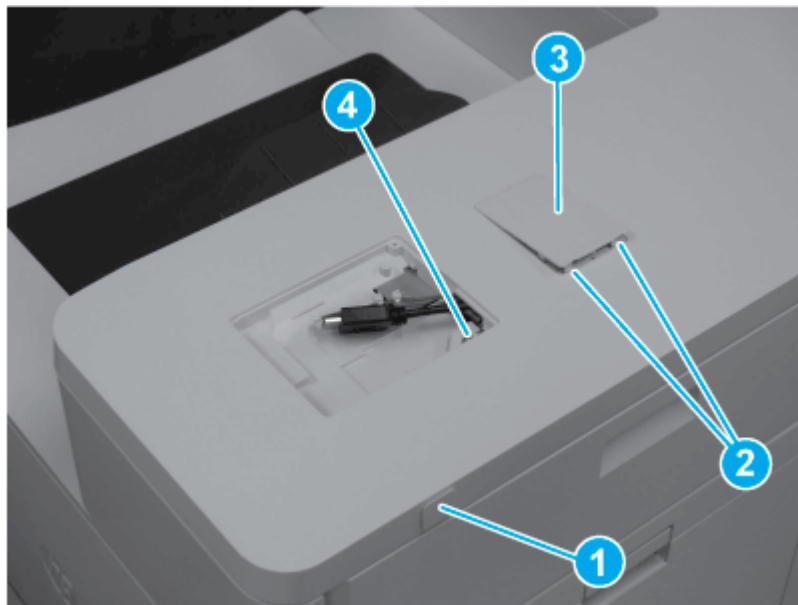
- d. Turn the control panel so that the bottom is facing up, and then disconnect two connectors to remove the control panel.

Figure 1-1654 Disconnect two connectors



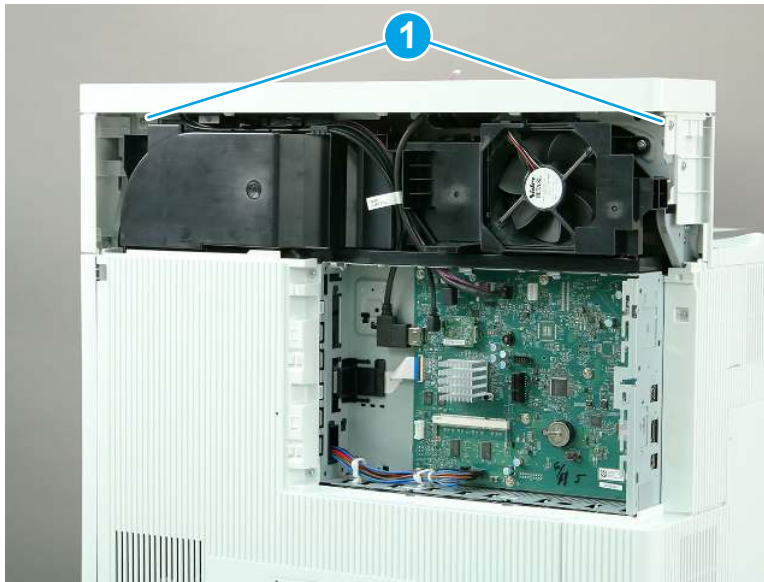
- e. Remove the USB cover (callout 1). Release two tabs (callout 2), and then remove the HIP cover (callout 3). Remove one screw (callout 4).

Figure 1-1655 Remove covers and one screw



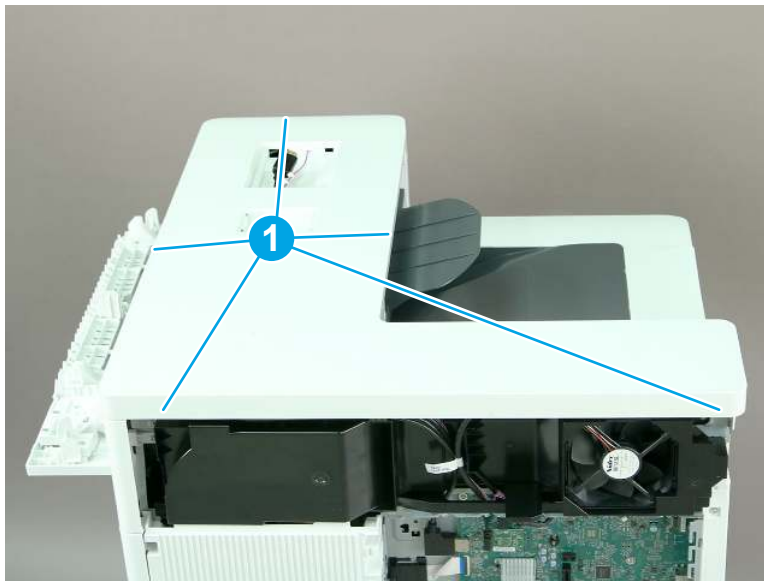
- f. Remove two screws (callout 1).

Figure 1-1656 Remove two screws



- g. Release five tabs (callout 1), and then remove the top cover.

Figure 1-1657 Release five tabs



- 9. Remove the DC controller.
 - a. Lift the latch to release the flat cable (callout 1), and then disconnect all of the remaining connectors on the DC controller.


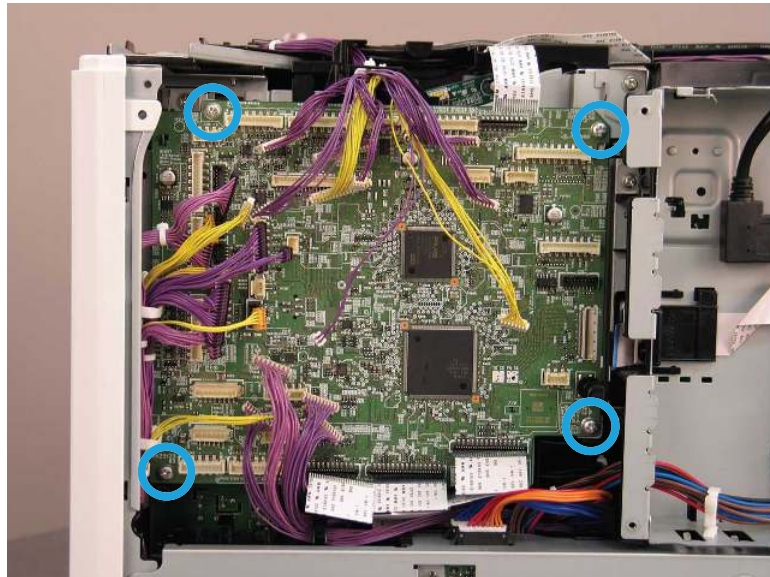
 **NOTE:** The figures below show the M856/E85055 DC controller. The procedure is correct for all referenced models.

Figure 1-1658 Disconnect all of the connectors



- b. Remove four screws, and then remove the DC controller.

Figure 1-1659 Remove four screws



- 10. Unpack the replacement assembly.

- a. Dispose of the defective part.




NOTE: HP recommends responsible disposal of the defective part.


<http://www8.hp.com/us/en/hp-information/environment/product-recycling.html>

- b. Unpack the replacement part from the packaging.




CAUTION:  Some parts are sensitive to electrostatic discharge (ESD). Always perform service work at an ESD-protected workstation or mat. If an ESD workstation or mat is not available, touch the

sheet-metal chassis to provide a static ground before touching an ESD-sensitive assembly. Protect the ESD-sensitive assemblies by placing them in ESD pouches when they are out of the printer.

 **IMPORTANT:** Make sure that all of the shipping materials (for example shipping tape) are removed from the replacement part prior to installation.

c. To install an assembly, reverse the removal steps.

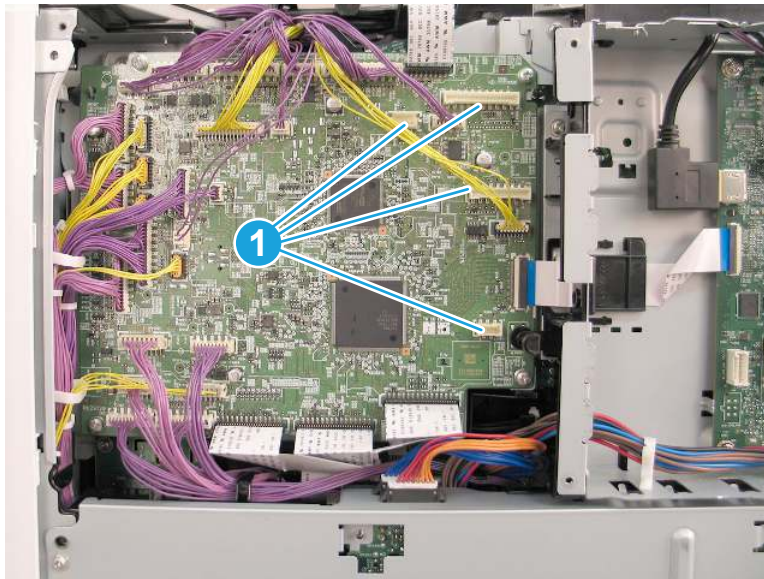
 **NOTE:** When applicable, special installation instructions are provided for an assembly at the end of the removal procedure. Always completely read the removal instructions and follow all special installation instructions.

11. Reverse the removal steps to install the assembly. Also use the following **special installation instructions**.

Install the DC controller (M856/E85055).

▲ **M856/E85055 only:** When installing the DC controller, note four connectors (callout 1) that remain empty.

Figure 1-1660 DC controller empty connectors

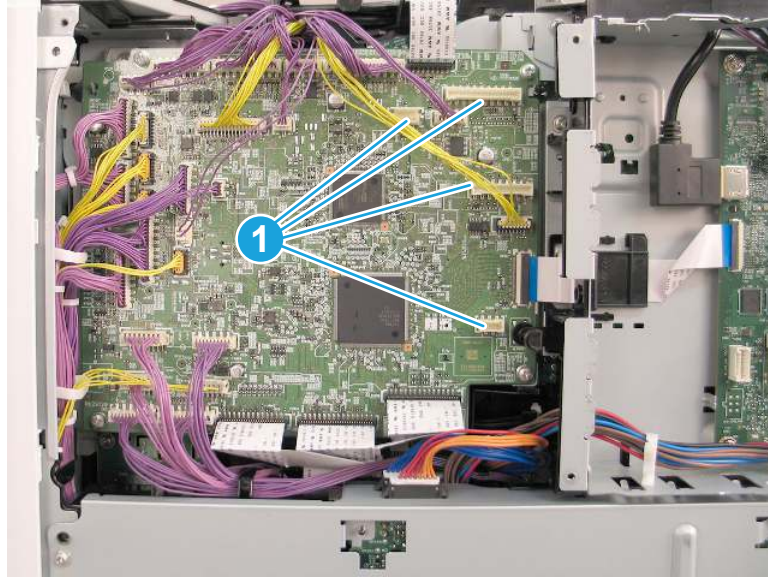


12. Reverse the removal steps to install the assembly. Also use the following **special installation instructions**.

Install the DC controller.

▲ When installing the DC controller, note four connectors (callout 1) that remain empty.

Figure 1-1661 DC controller empty connectors



Removal and replacement: Low-voltage power supply (M751/E75245)

Learn how to remove and replace the low-voltage power supply (LVPS).

[View a video of how to remove and replace the low-voltage power supply.](#)

Mean time to repair: 13 minutes

Service level: Easy

Before performing service

Turn the printer power off

- Disconnect the power cable.

⚠ WARNING! To avoid damage to the printer, turn the printer off, wait 30 seconds, and then remove the power cord before attempting to service the printer.

Use the table below to identify the correct part number for your printer. To order the part, go to www.hp.com/buy/parts.

Table 1-88 Part information

Part number	Part description
RM2-1445-000CN	Low-voltage power supply assembly (110-127V)
RM2-1453-000CN	Low-voltage power supply assembly (220-240V)

Required tools

- #2 Phillips screwdriver with a magnetic tip
- Small, flat-blade screwdriver

After performing service

Turn the printer power on

- Connect the power cable.
- Use the power switch to turn the power on.

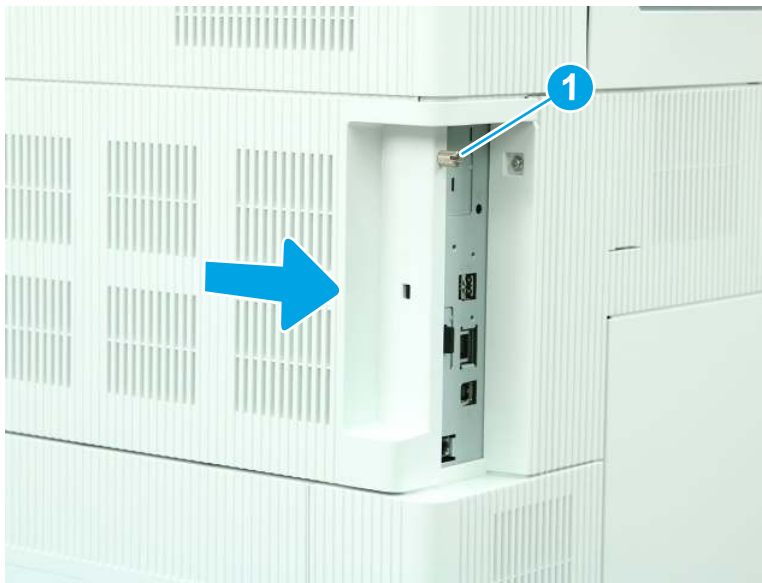
Post service test

Make sure that the printer initializes to a **Ready** state.

Print a page to make sure that the printer is functioning correctly.

1. Remove the formatter cover.
 - ▲ Loosen one thumbscrew (callout 1), and then slide the formatter cover (callout 2) away from the printer to remove it.

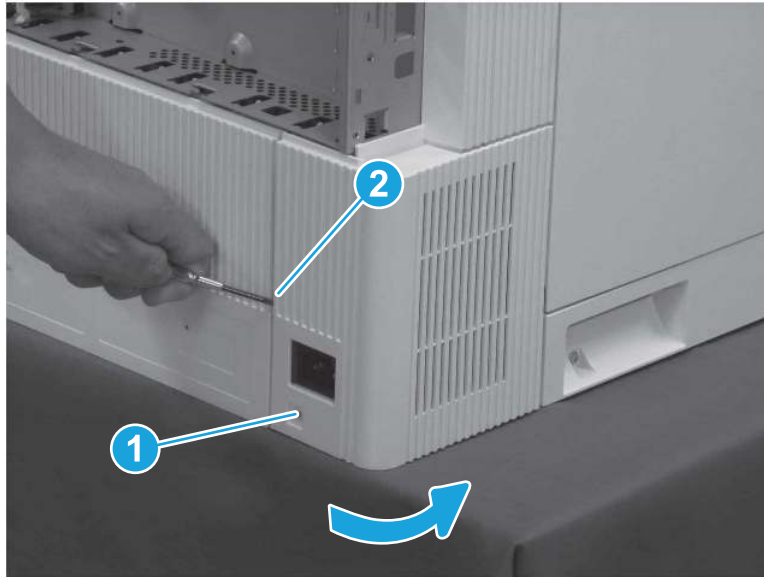
Figure 1-1662 Remove the formatter cover



2. Remove the left lower cover (M751/E75245).

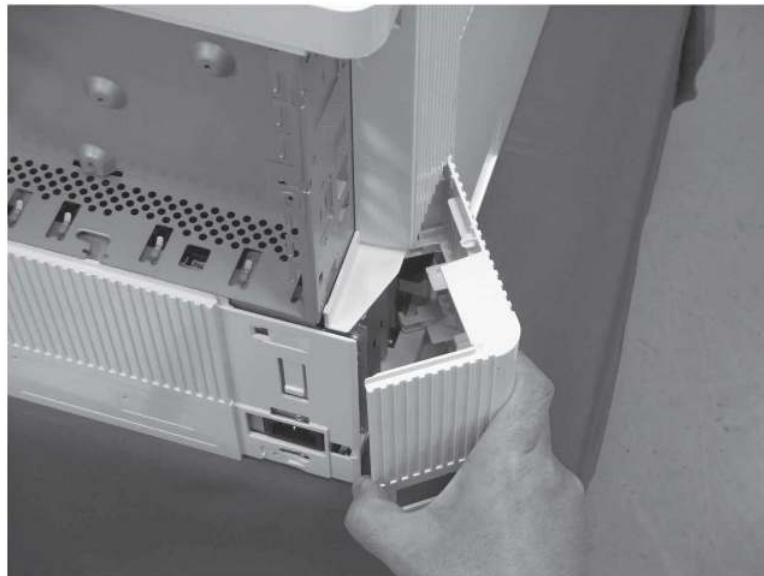
- a. Remove one screw (callout 1), release one tab (callout 2), and then rotate the cover away from the printer.

Figure 1-1663 Remove one screw and release one tab



- b. Remove the left lower cover.

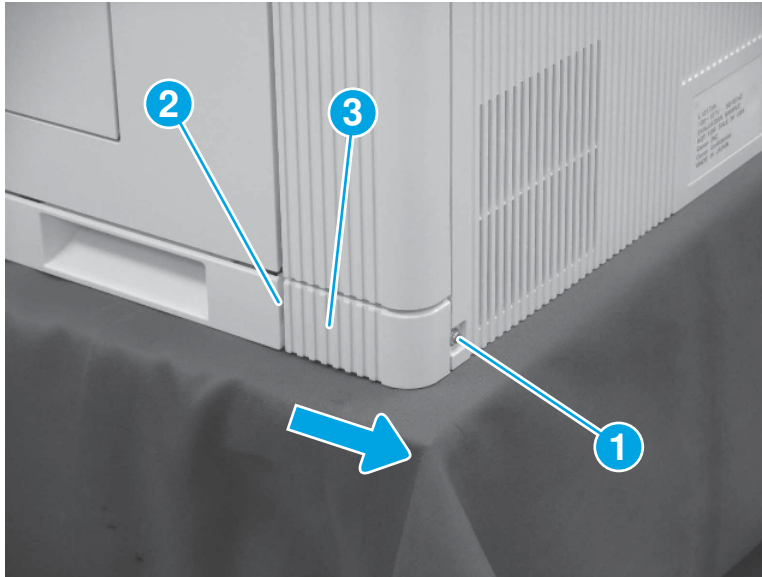
Figure 1-1664 Remove the left lower cover



3. Remove the right rear lower cover (M751/E75245/M856/E85055/M776).

- ▲ Remove one screw (callout 1), release one tab (callout 2), and then slide the right rear lower cover (callout 3) toward the back of the printer to remove it.

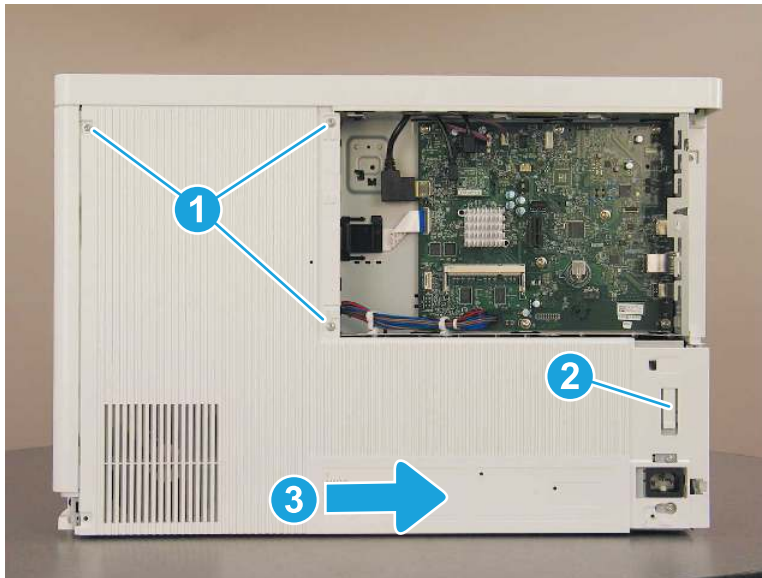
Figure 1-1665 Remove the right rear lower cover



4. Remove the rear cover (M751/E75245).

- ▲ Remove three screws (callout 1), release one tab (callout 2), and then slide the rear cover to the right (callout 3) to remove it.

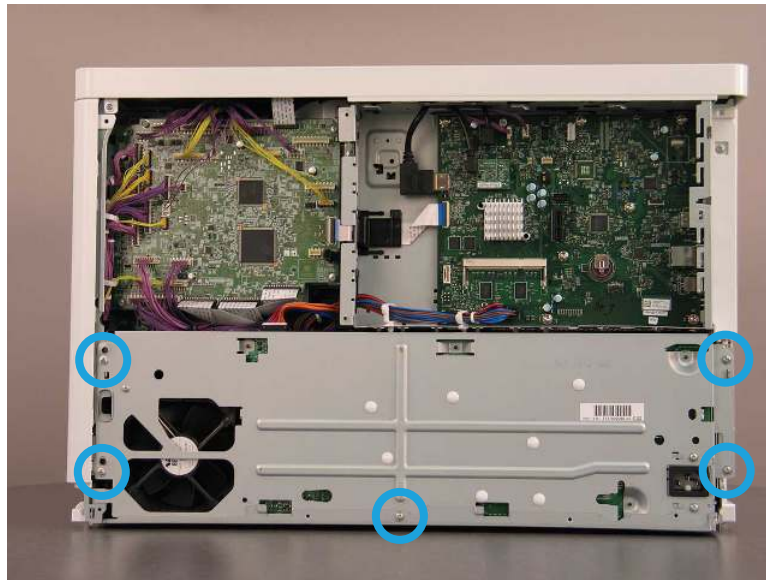
Figure 1-1666 Remove the rear cover



5. Remove the low-voltage power supply (LVPS).

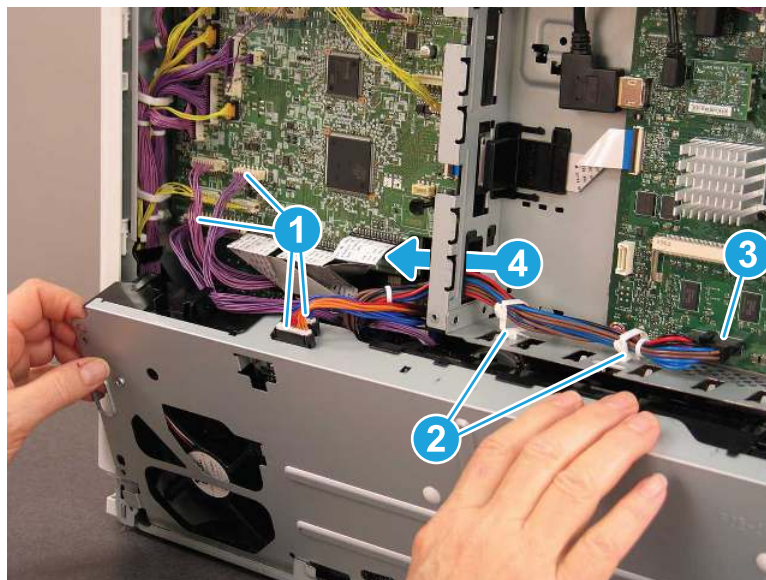
- a. Remove five screws.

Figure 1-1667 Remove five screws



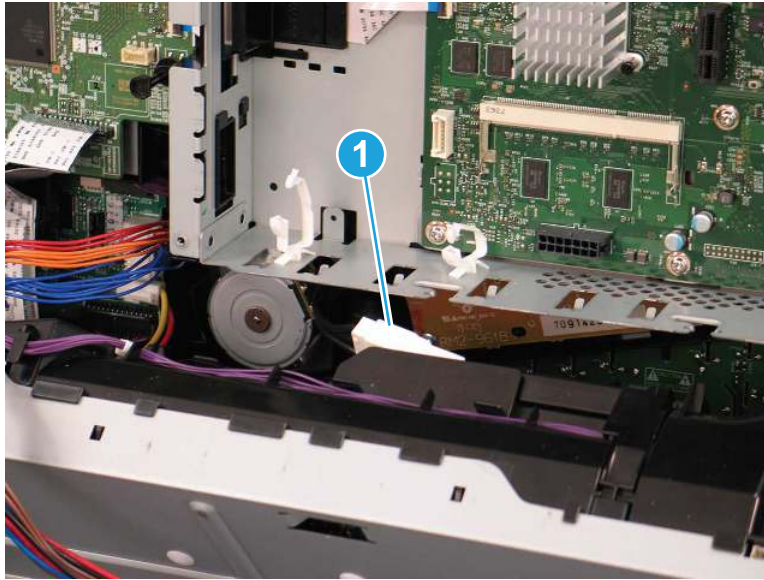
- b. Lift up on the LVPS, and then slightly rotate the top away from the printer. Disconnect four connectors (callout 1), and then release two retainers (callout 2). Press down on the latch to disconnect one connector (callout 3), and then release the wires through the hole (callout 4) in the formatter case.

Figure 1-1668 Disconnect five connectors



- c. Press down on the latch to disconnect one connector (callout 1), and then lift up to remove the LVPS.

Figure 1-1669 Remove the LVPS



6. Unpack the replacement assembly.

- a. Dispose of the defective part.




NOTE: HP recommends responsible disposal of the defective part.

<http://www8.hp.com/us/en/hp-information/environment/product-recycling.html>

- b. Unpack the replacement part from the packaging.



CAUTION:  Some parts are sensitive to electrostatic discharge (ESD). Always perform service work at an ESD-protected workstation or mat. If an ESD workstation or mat is not available, touch the sheet-metal chassis to provide a static ground before touching an ESD-sensitive assembly. Protect the ESD-sensitive assemblies by placing them in ESD pouches when they are out of the printer.



IMPORTANT: Make sure that all of the shipping materials (for example shipping tape) are removed from the replacement part prior to installation.

- c. To install an assembly, reverse the removal steps.



NOTE: When applicable, special installation instructions are provided for an assembly at the end of the removal procedure. Always completely read the removal instructions and follow all special installation instructions.

Removal and replacement: Low-voltage power supply (LVPS) (M856/E85055/M776)

Learn how to remove and replace the low-voltage power supply (LVPS).

[View a video of how to remove and replace the low-voltage power supply.](#)

Mean time to repair: 15 minutes

Service level: Medium

Before performing service

Turn the printer power off

- Disconnect the power cable.

⚠ WARNING! To avoid damage to the printer, turn the printer off, wait 30 seconds, and then remove the power cord before attempting to service the printer.

Use the table below to identify the correct part number for your printer. To order the part, go to www.hp.com/buy/parts.

Table 1-89 Part information

Part number	Part description
RM2-2473-000CN	Low voltage power supply assembly (110V)
RM2-2474-000CN	Low voltage power supply assembly (220V)

Required tools

- #2 Phillips screwdriver with a magnetic tip
- Small, flat-blade screwdriver

After performing service

Turn the printer power on

- Connect the power cable.
- Use the power switch to turn the power on.

Post service test

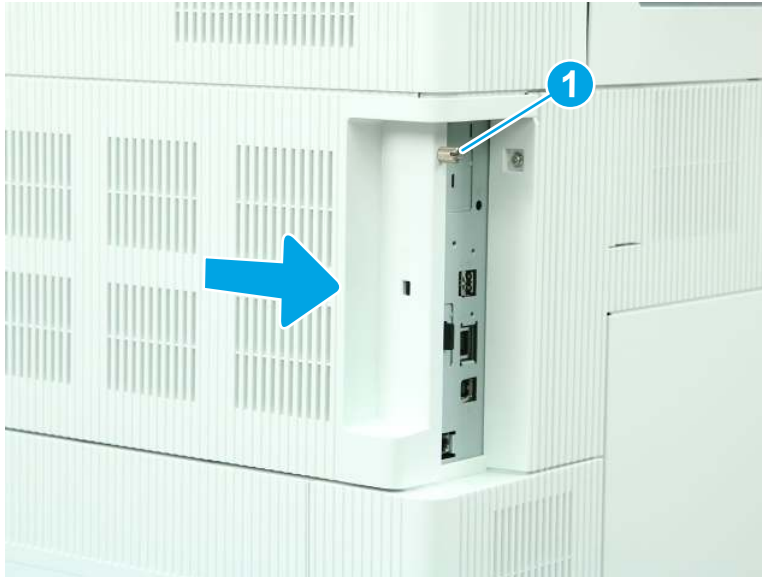
Make sure that the printer initializes to a **Ready** state.

Print a page to make sure that the printer is functioning correctly.

1. Remove the formatter cover.

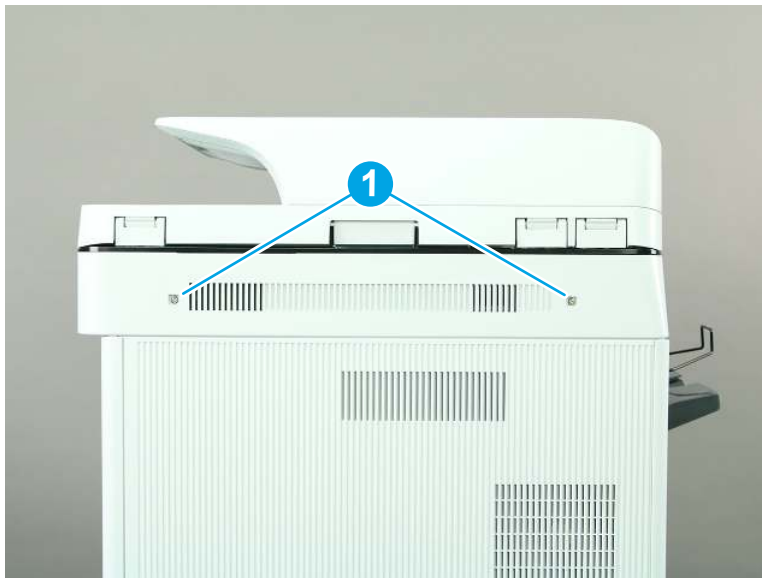
- ▲ Loosen one thumbscrew (callout 1), and then slide the formatter cover (callout 2) away from the printer to remove it.

Figure 1-1670 Remove the formatter cover



- 2. Remove the scanner control board (SCB) cover (M776).
 - a. Remove two screws (callout 1).

Figure 1-1671 Remove two screws



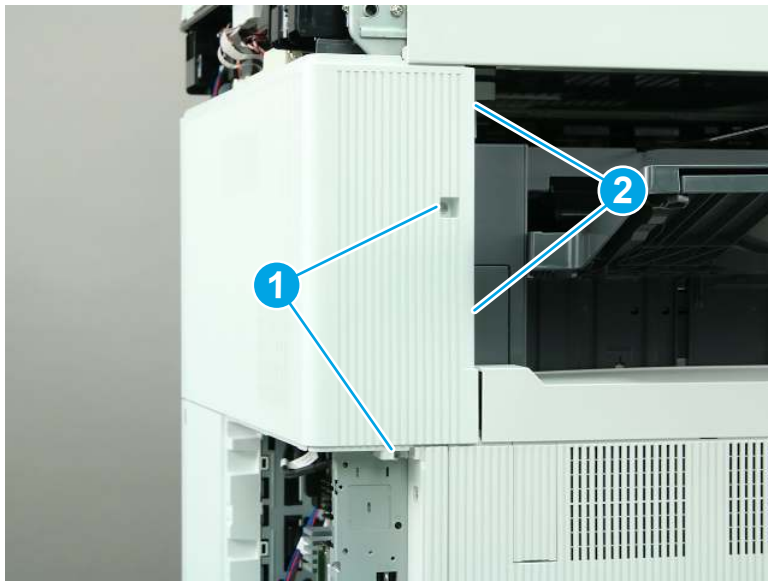
- b. Remove the SCB cover.

Figure 1-1672 Remove the SCB cover



3. Remove the rear upper cover and left rear upper cover (M776zs).
 - a. Remove two screws (callout 1), and then release two tabs (callout 2).

Figure 1-1673 Remove two screws and release two tabs



- b. Slide the cover to the right to remove it.

Figure 1-1674 Remove the rear upper and left rear upper cover

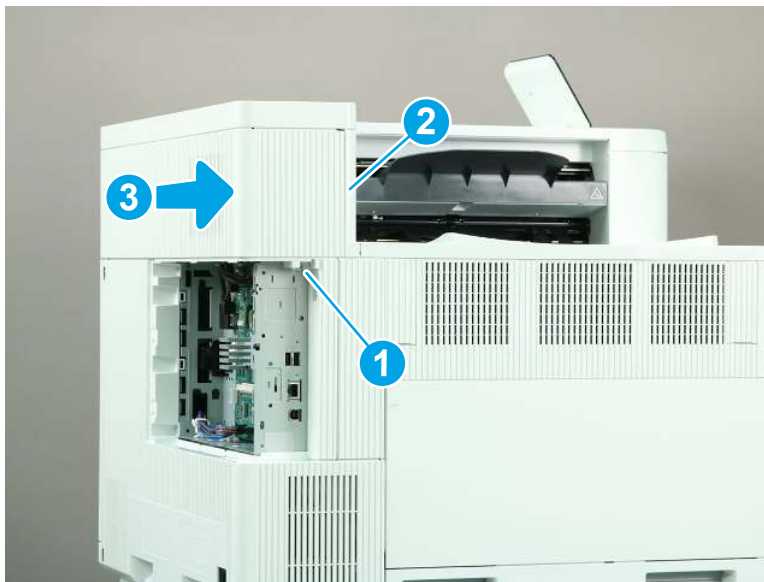


4. Remove the rear upper cover (M856/E85055/M776dn/M776z).

 **NOTE:** The following figure shows the M856 printer. The procedure is correct for all referenced models.

- ▲ Remove one screw (callout 1), release one tab (callout 2), and then slide the rear upper cover away from the printer to remove it (callout 3).

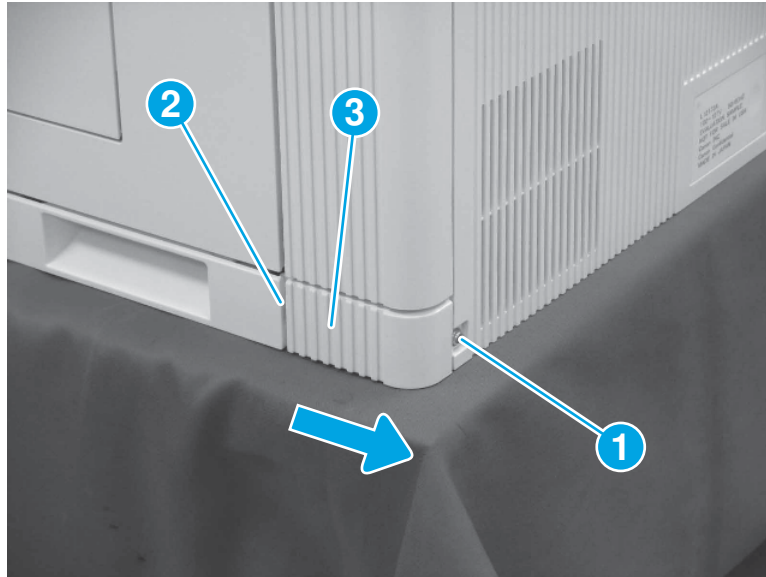
Figure 1-1675 Remove the rear upper cover



5. Remove the right rear lower cover (M751/E75245/M856/E85055/M776).

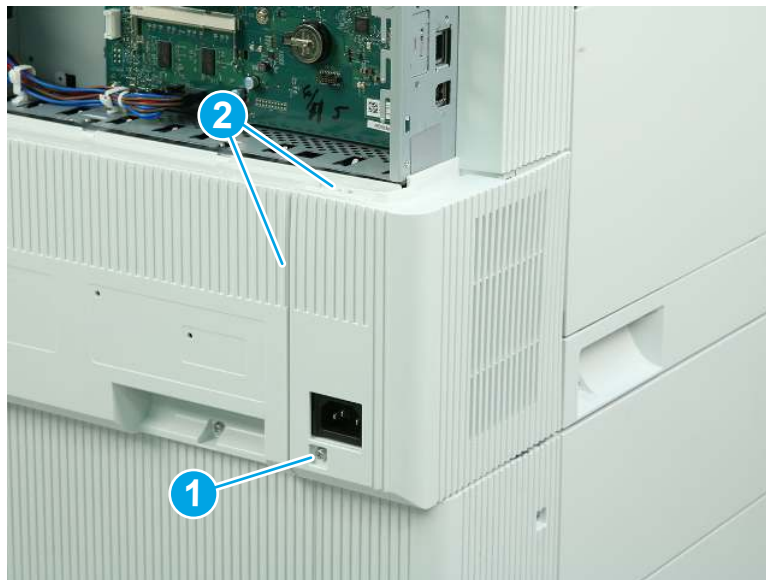
- ▲ Remove one screw (callout 1), release one tab (callout 2), and then slide the right rear lower cover (callout 3) toward the back of the printer to remove it.

Figure 1-1676 Remove the right rear lower cover



6. Remove the left lower cover (M856/E85055/M776).
 - a. Remove one screw (callout 1), and then release two tabs (callout 2).

Figure 1-1677 Remove one screw and release two tabs



- b. Rotate the cover away from the printer to remove it.

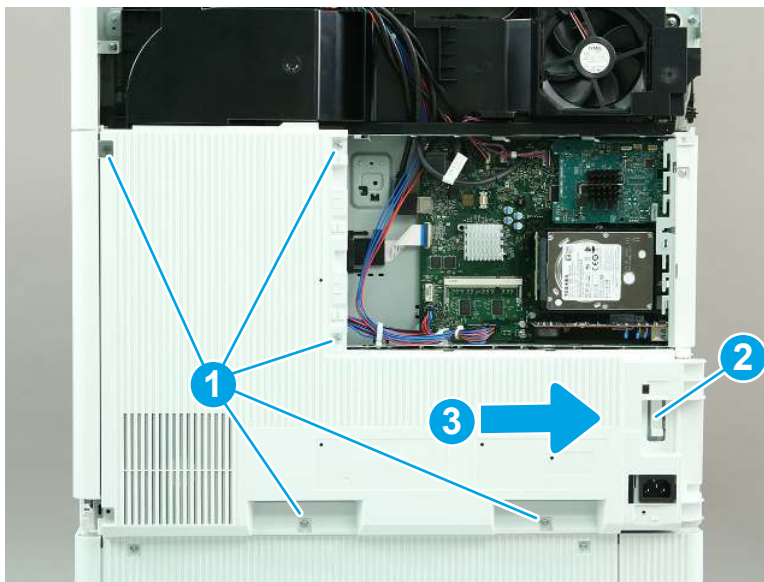
Figure 1-1678 Remove the left lower cover



7. Remove the rear cover (M856/E85055/M776).

- ▲ Remove five screws (callout 1), release one tab (callout 2), and then slide the rear cover to the right to remove it.

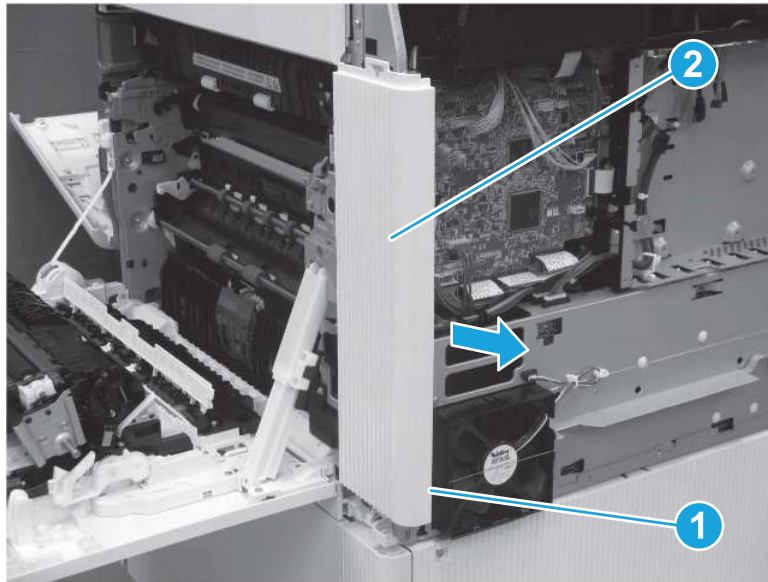
Figure 1-1679 Remove the rear cover (M856/E85055/M776)



8. Remove the right rear cover (M856/E85055/M776).

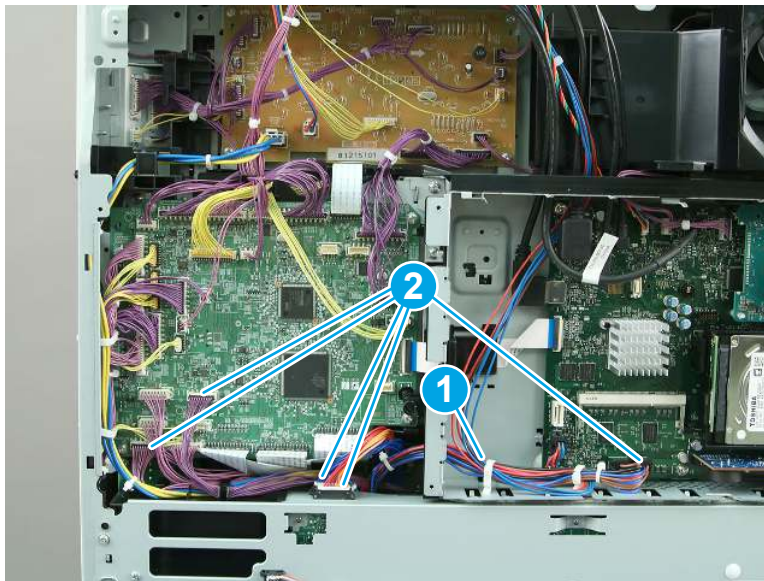
- ▲ Release one tab (callout 1), and then slide the rear cover away from the printer to remove it.

Figure 1-1680 Remove right rear cover



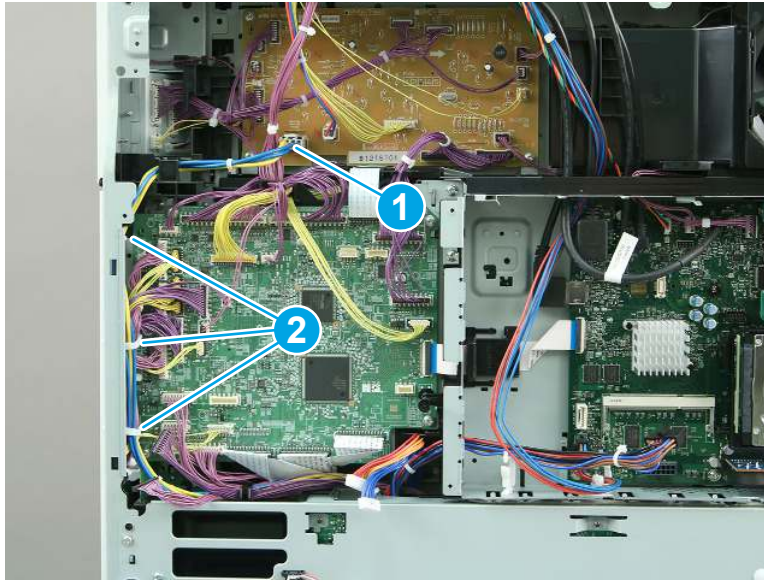
9. Remove the low-voltage power supply (LVPS) (M856/E85055/M776).
 - a. Release one retainer (callout 1), and then disconnect five connectors (callout 2).

Figure 1-1681 Release the retainer and disconnect five connectors



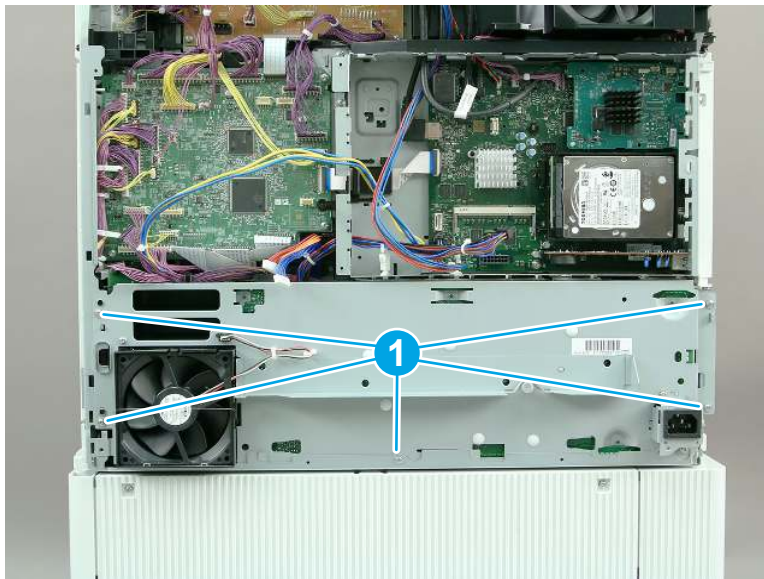
- b. Disconnect one connector (callout 1), and then release three retainers (callout 2).

Figure 1-1682 Disconnect one connector and release five retainers



- c. Remove five screws (callout 1).

Figure 1-1683 Remove five screws



- d. Tilt the LVPS away from the printer (callout 1). Thread the cable (callout 2) through the opening in the formatter case.

 **NOTE:** Due to mechanical tolerances on the formatter cage, rotating the LVPS out might be difficult.


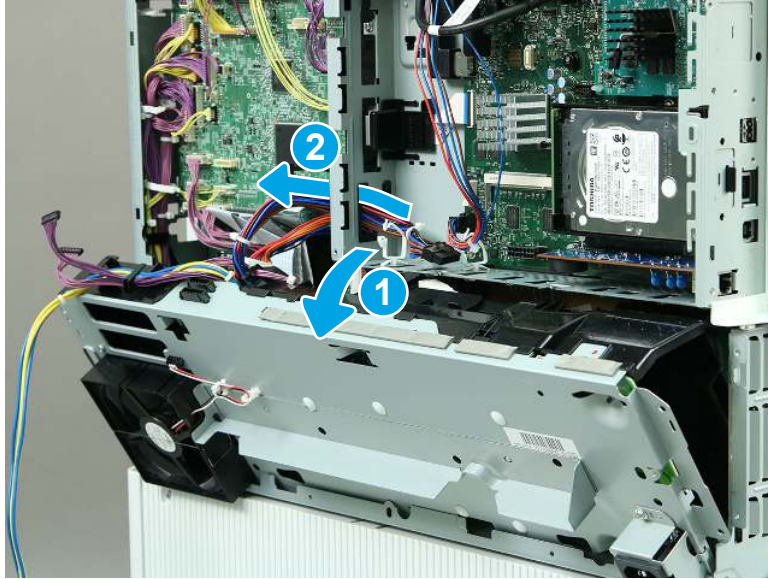
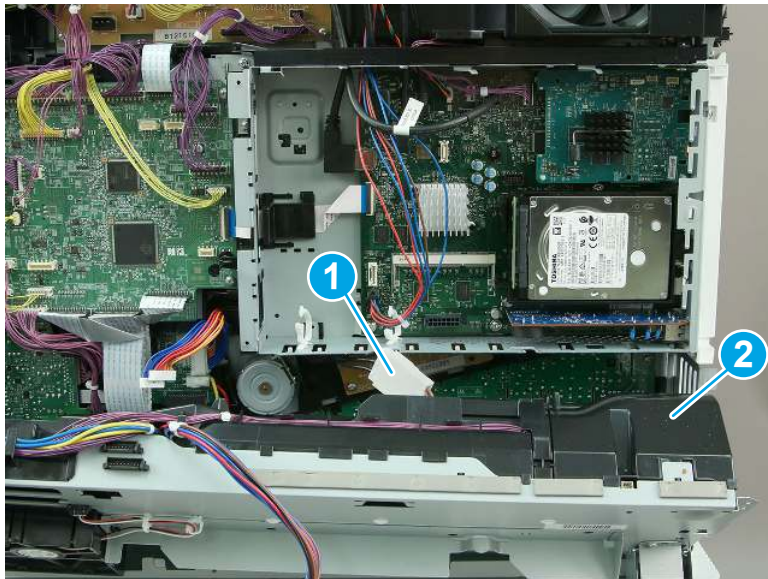
 **CAUTION:** One connector is still connected, so tilt the LVPS carefully.

Figure 1-1684 Thread the cable



- e. Disconnect one connector (callout 1), and then lift up to remove the LVPS (callout 2).

Figure 1-1685 Remove the LVPS



10. Unpack the replacement assembly.

- a. Dispose of the defective part.




NOTE: HP recommends responsible disposal of the defective part.


<http://www8.hp.com/us/en/hp-information/environment/product-recycling.html>

- b. Unpack the replacement part from the packaging.




CAUTION:  Some parts are sensitive to electrostatic discharge (ESD). Always perform service work at an ESD-protected workstation or mat. If an ESD workstation or mat is not available, touch the

sheet-metal chassis to provide a static ground before touching an ESD-sensitive assembly. Protect the ESD-sensitive assemblies by placing them in ESD pouches when they are out of the printer.

 **IMPORTANT:** Make sure that all of the shipping materials (for example shipping tape) are removed from the replacement part prior to installation.

c. To install an assembly, reverse the removal steps.

 **NOTE:** When applicable, special installation instructions are provided for an assembly at the end of the removal procedure. Always completely read the removal instructions and follow all special installation instructions.

Removal and replacement: Lower high-voltage power supply (M751/E75245)

Learn how to remove and replace the lower high-voltage power supply (lower HVPS).

[View a video of how to remove and replace the lower HVPS.](#)


Mean time to repair: 16 minutes

Service level: Easy

Before performing service

Turn the printer power off

- Disconnect the power cable.

 **WARNING!** To avoid damage to the printer, turn the printer off, wait 30 seconds, and then remove the power cord before attempting to service the printer.

Use the table below to identify the correct part number for your printer. To order the part, go to www.hp.com/buy/parts.

Table 1-90 Part information

Part number	Part description
RM2-9624-000CN	Lower high-voltage power supply PCB assembly

Required tools

- #2 Phillips screwdriver with a magnetic tip
- Small, flat-blade screwdriver

After performing service

Turn the printer power on

- Connect the power cable.
- Use the power switch to turn the power on.

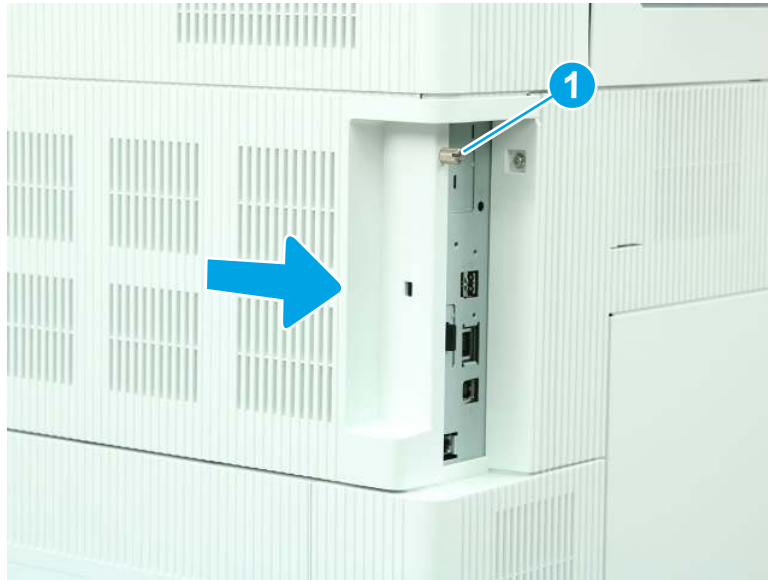
Post service test

Make sure that the printer initializes to a **Ready** state.

Print a page to make sure that the printer is functioning correctly.

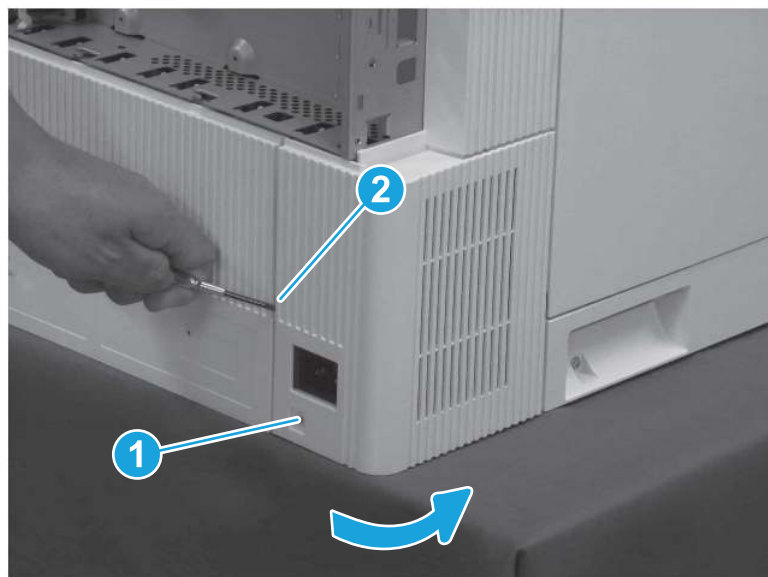
1. Remove the formatter cover.
 - ▲ Loosen one thumbscrew (callout 1), and then slide the formatter cover (callout 2) away from the printer to remove it.

Figure 1-1686 Remove the formatter cover



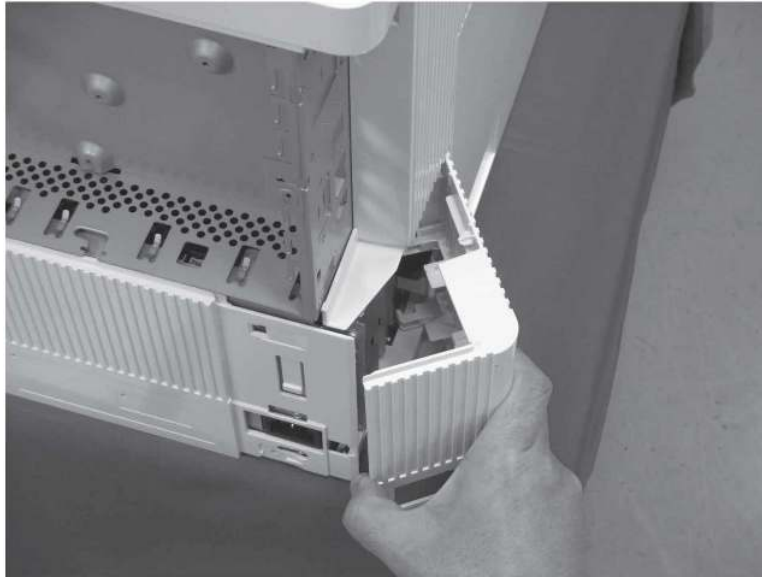
2. Remove the left lower cover (M751/E75245).
 - a. Remove one screw (callout 1), release one tab (callout 2), and then rotate the cover away from the printer.

Figure 1-1687 Remove one screw and release one tab



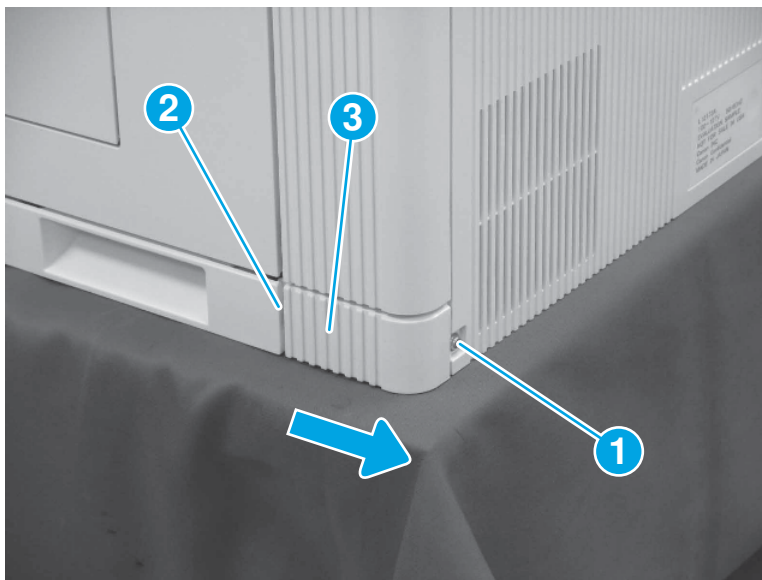
- b. Remove the left lower cover.

Figure 1-1688 Remove the left lower cover



3. Remove the right rear lower cover (M751/E75245/M856/E85055/M776).
 - ▲ Remove one screw (callout 1), release one tab (callout 2), and then slide the right rear lower cover (callout 3) toward the back of the printer to remove it.

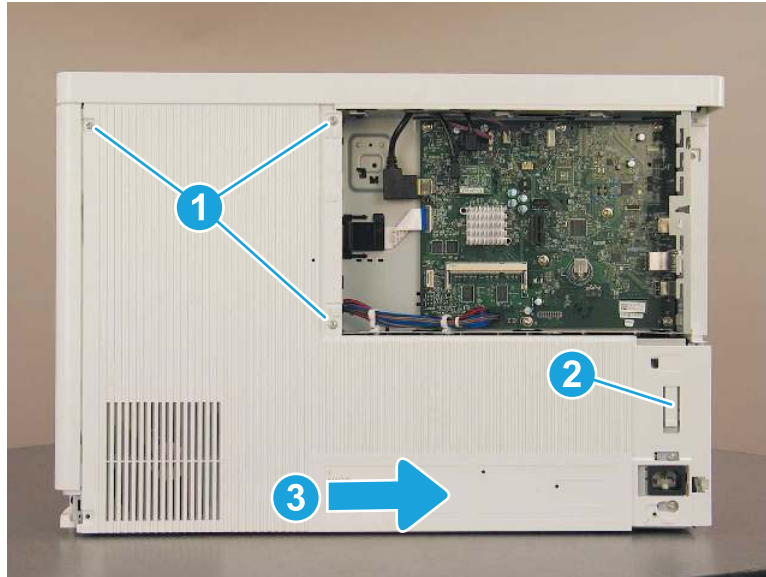
Figure 1-1689 Remove the right rear lower cover



4. Remove the rear cover (M751/E75245).

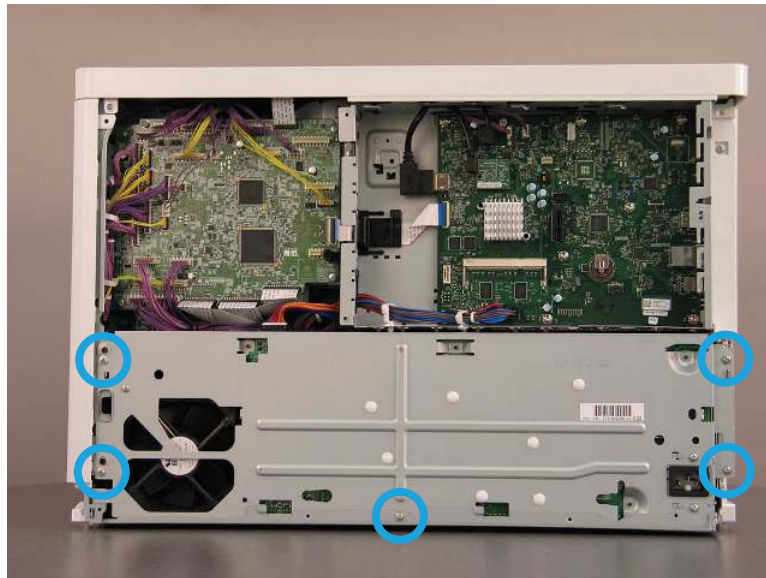
- ▲ Remove three screws (callout 1), release one tab (callout 2), and then slide the rear cover to the right (callout 3) to remove it.

Figure 1-1690 Remove the rear cover



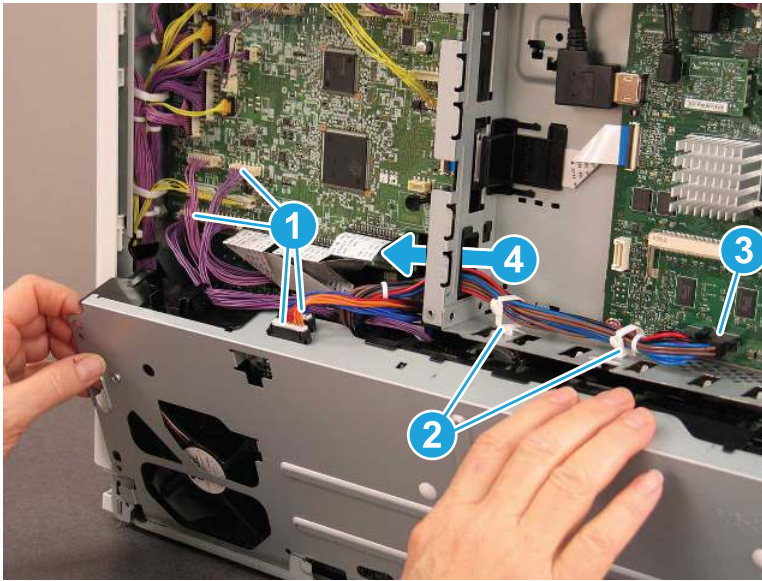
- 5. Remove the low-voltage power supply (LVPS).
 - a. Remove five screws.

Figure 1-1691 Remove five screws



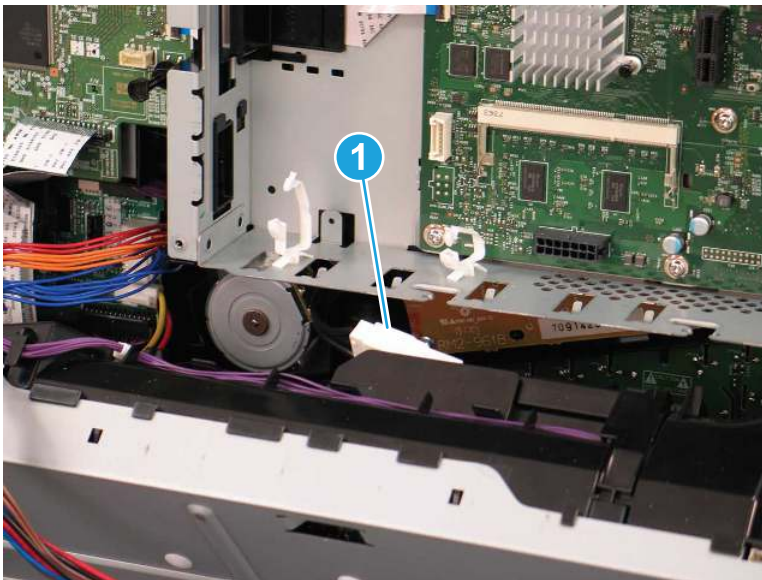
- b. Lift up on the LVPS, and then slightly rotate the top away from the printer. Disconnect four connectors (callout 1), and then release two retainers (callout 2). Press down on the latch to disconnect one connector (callout 3), and then release the wires through the hole (callout 4) in the formatter case.

Figure 1-1692 Disconnect five connectors



- c. Press down on the latch to disconnect one connector (callout 1), and then lift up to remove the LVPS.

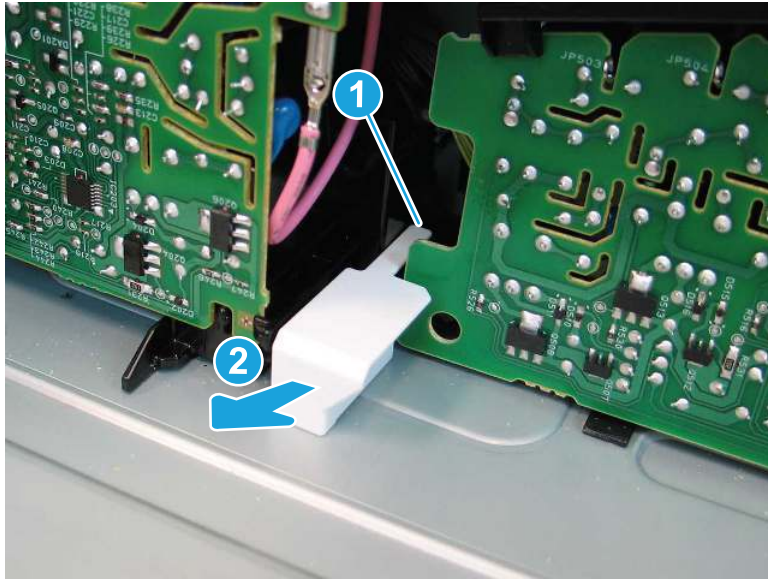
Figure 1-1693 Remove the LVPS



6. Remove the lower high-voltage power supply (lower HVPS).

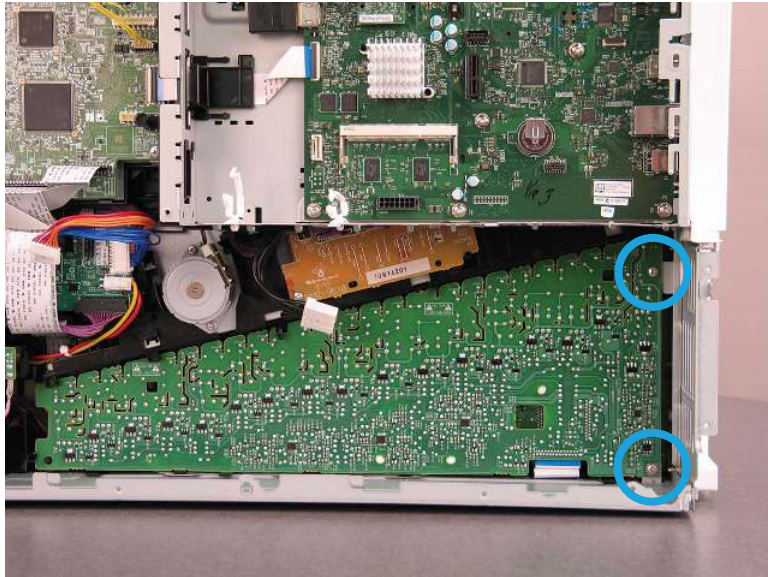
- a. Release one tab (callout 1) and then slide the stopper (callout 2) away from the printer to remove it.

Figure 1-1694 Remove the stopper



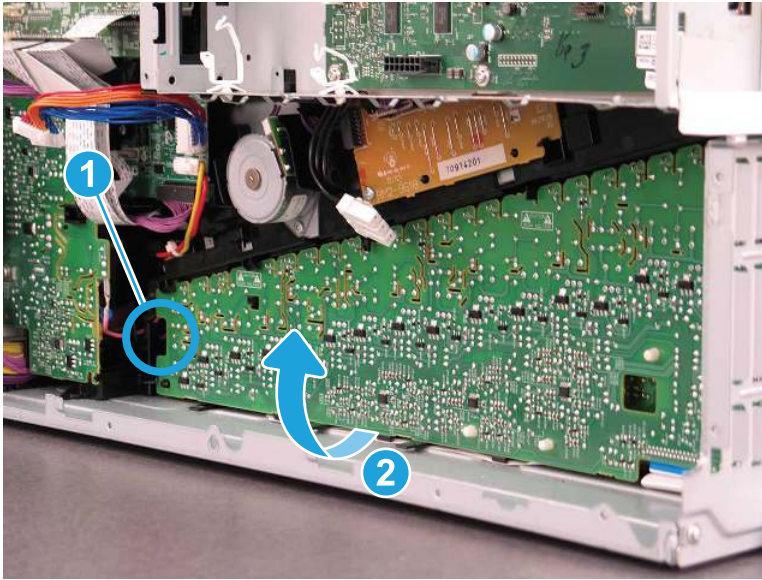
- b. Remove two screws (callout 1).

Figure 1-1695 Remove two screws



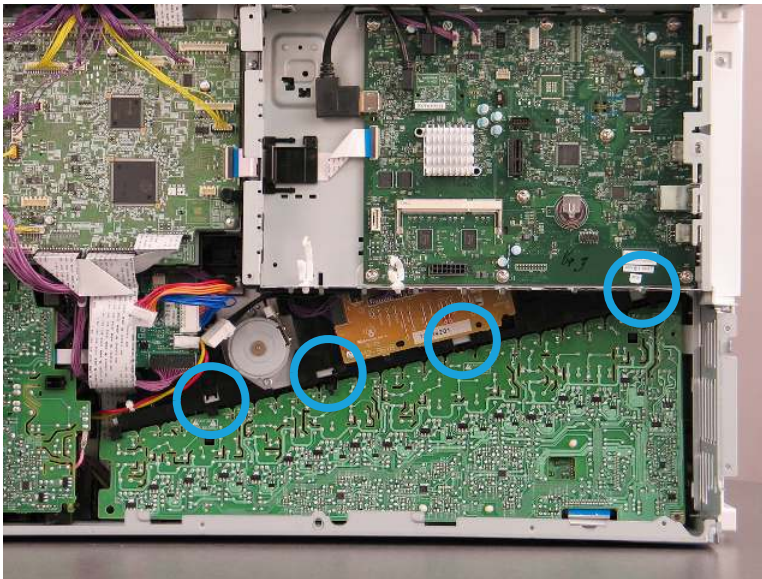
- c. Release one tab (callout 1), and then gently release the lower edge of the lower HVPS.

Figure 1-1696 Release the lower edge of the lower HVPS



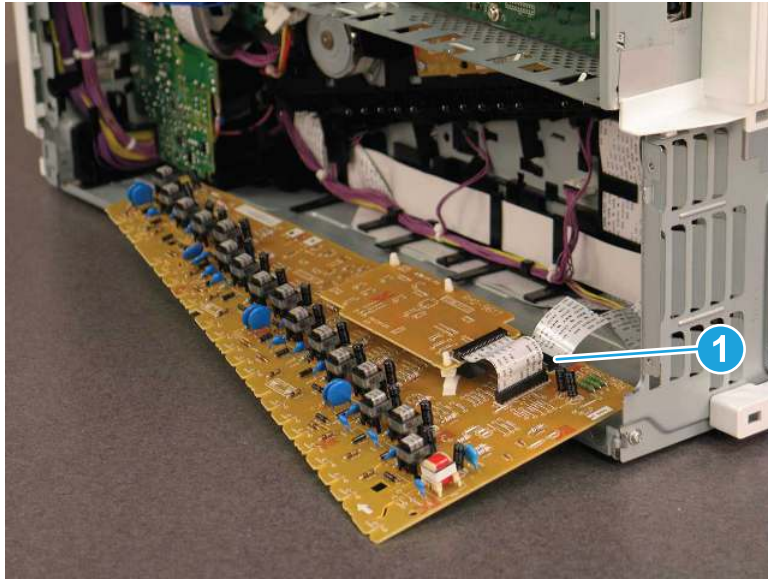
- d. Release the lower HVPS from four tabs.

Figure 1-1697 Release four tabs



- e. Disconnect one flat cable (callout 1) from the back of the lower HVPS.

Figure 1-1698 Disconnect one flat cable



7. Unpack the replacement assembly.

- a. Dispose of the defective part.




NOTE: HP recommends responsible disposal of the defective part.

<http://www8.hp.com/us/en/hp-information/environment/product-recycling.html>

- b. Unpack the replacement part from the packaging.



CAUTION:  Some parts are sensitive to electrostatic discharge (ESD). Always perform service work at an ESD-protected workstation or mat. If an ESD workstation or mat is not available, touch the sheet-metal chassis to provide a static ground before touching an ESD-sensitive assembly. Protect the ESD-sensitive assemblies by placing them in ESD pouches when they are out of the printer.



IMPORTANT: Make sure that all of the shipping materials (for example shipping tape) are removed from the replacement part prior to installation.

- c. To install an assembly, reverse the removal steps.



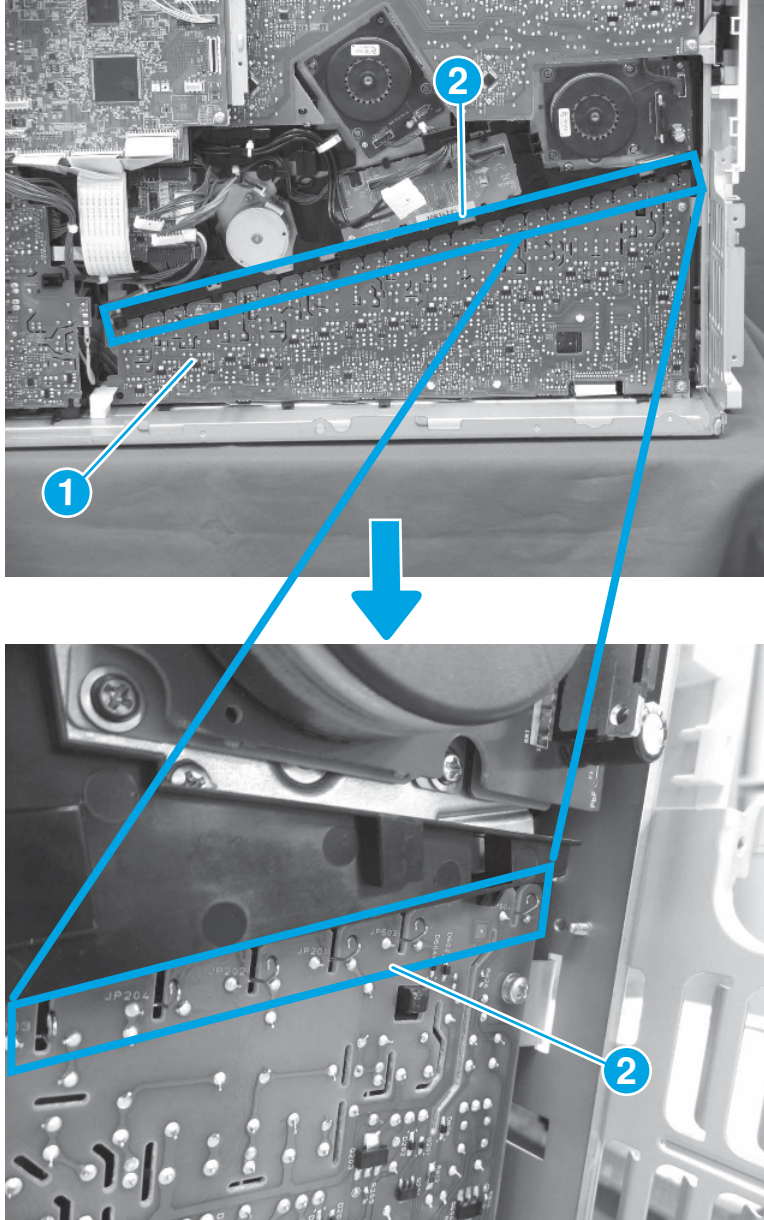
NOTE: When applicable, special installation instructions are provided for an assembly at the end of the removal procedure. Always completely read the removal instructions and follow all special installation instructions.

8. Reverse the removal steps to install the assembly. Also use the following **special installation instructions**.

Install the lower HVPS

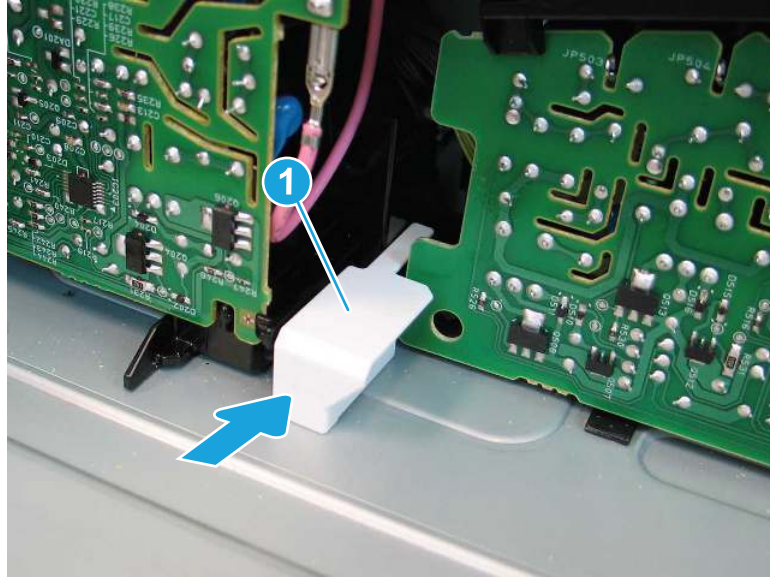
- a. When reinstalling the lower HVPS (callout 1), make sure that the top of the lower HVPS engages with the contact springs (callout 2) and that the springs are in the correct position.

Figure 1-1699 Check the springs



- b. Make sure that the stopper (callout 1) is reinstalled at the bottom of the lower HVPS.

Figure 1-1700 Install the stopper



Removal and replacement: Lower high-voltage power supply (M856/E85055/M776)

Learn how to remove and replace the lower high-voltage power supply (lower HVPS).

[View a video of how to remove and replace the lower HVPS.](#)

Mean time to repair: 16 minutes

Service level: Easy

Before performing service

Turn the printer power off

- Disconnect the power cable.

⚠ WARNING! To avoid damage to the printer, turn the printer off, wait 30 seconds, and then remove the power cord before attempting to service the printer.

Use the table below to identify the correct part number for your printer. To order the part, go to www.hp.com/buy/parts.

Table 1-91 Part information

Part number	Part description
RM2-9624-000CN	Lower high-voltage power supply PCB assembly

Required tools

- #2 Phillips screwdriver with a magnetic tip
- Small, flat-blade screwdriver

After performing service

Turn the printer power on

- Connect the power cable.
- Use the power switch to turn the power on.

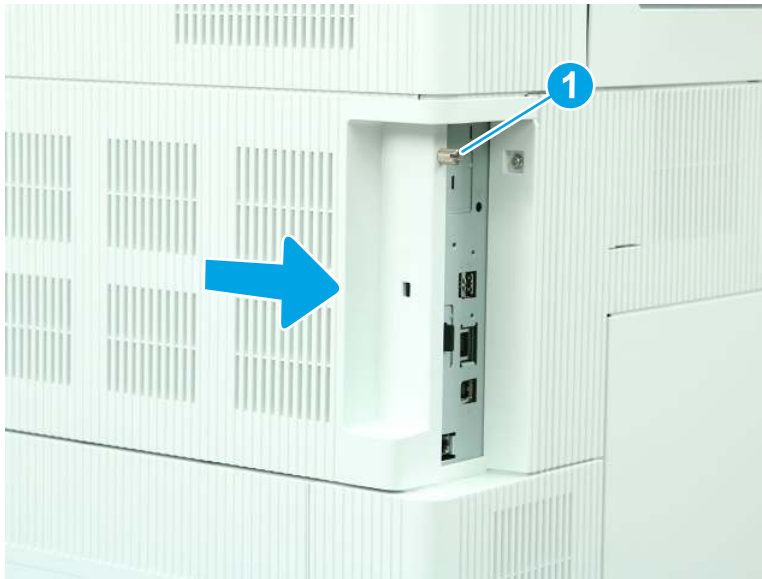
Post service test

Make sure that the printer initializes to a **Ready** state.

Print a page to make sure that the printer is functioning correctly.

1. Remove the formatter cover.
 - ▲ Loosen one thumbscrew (callout 1), and then slide the formatter cover (callout 2) away from the printer to remove it.

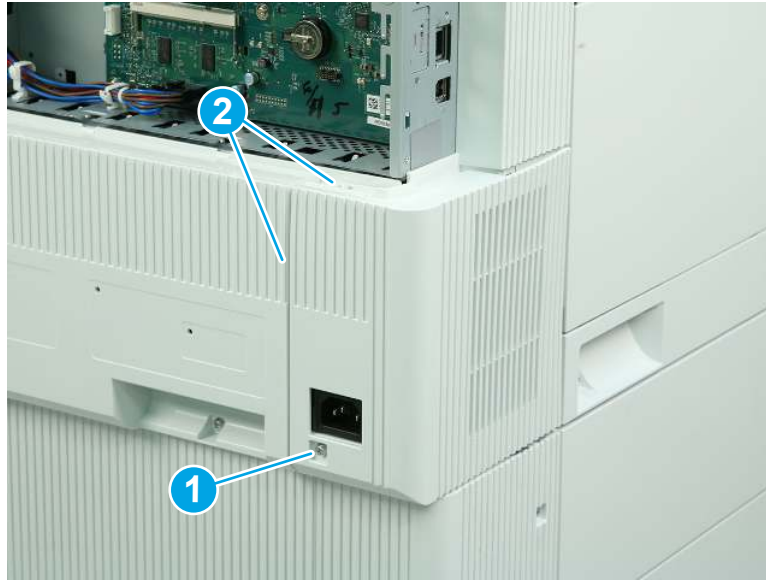
Figure 1-1701 Remove the formatter cover



2. Remove the left lower cover (M856/E85055/M776).

- a. Remove one screw (callout 1), and then release two tabs (callout 2).

Figure 1-1702 Remove one screw and release two tabs



- b. Rotate the cover away from the printer to remove it.

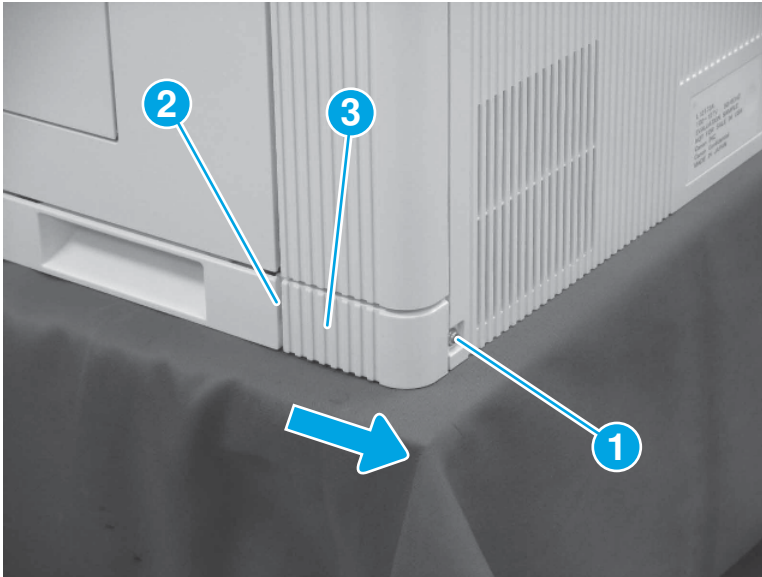
Figure 1-1703 Remove the left lower cover



3. Remove the right rear lower cover (M751/E75245/M856/E85055/M776).

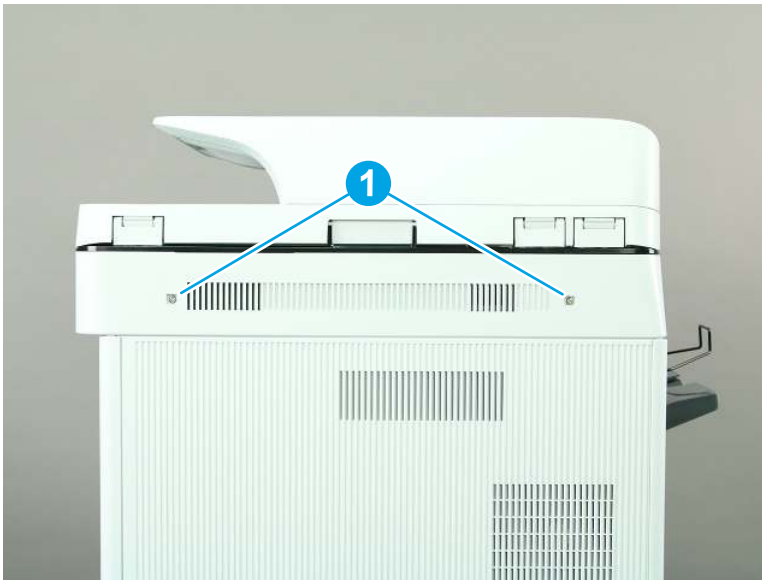
- ▲ Remove one screw (callout 1), release one tab (callout 2), and then slide the right rear lower cover (callout 3) toward the back of the printer to remove it.

Figure 1-1704 Remove the right rear lower cover



- 4. Remove the scanner control board (SCB) cover (M776).
 - a. Remove two screws (callout 1).

Figure 1-1705 Remove two screws



- b. Remove the SCB cover.

Figure 1-1706 Remove the SCB cover

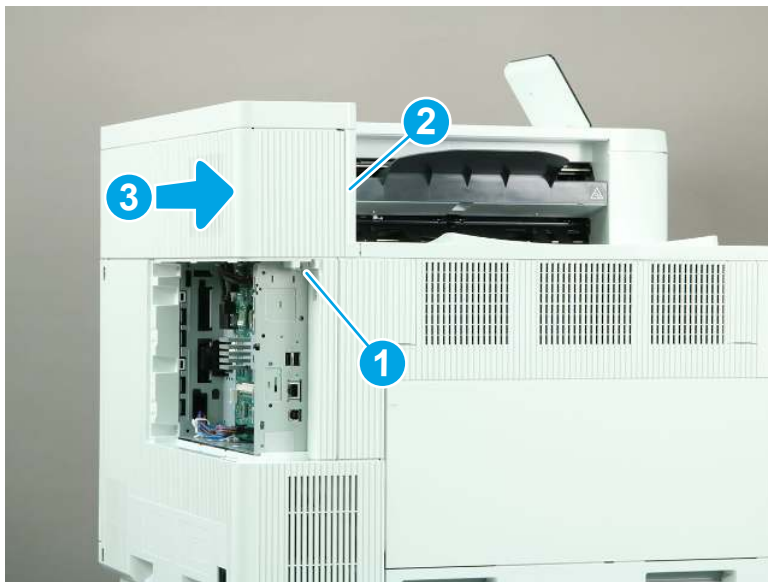


5. Remove the rear upper cover (M856/E85055/M776dn/M776z).

 **NOTE:** The following figure shows the M856 printer. The procedure is correct for all referenced models.

- ▲ Remove one screw (callout 1), release one tab (callout 2), and then slide the rear upper cover away from the printer to remove it (callout 3).

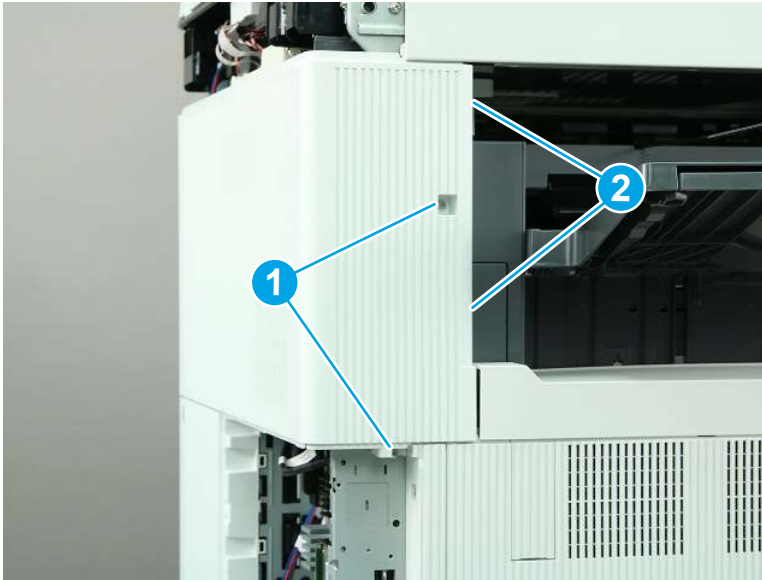
Figure 1-1707 Remove the rear upper cover



6. Remove the rear upper cover and left rear upper cover (M776zs).

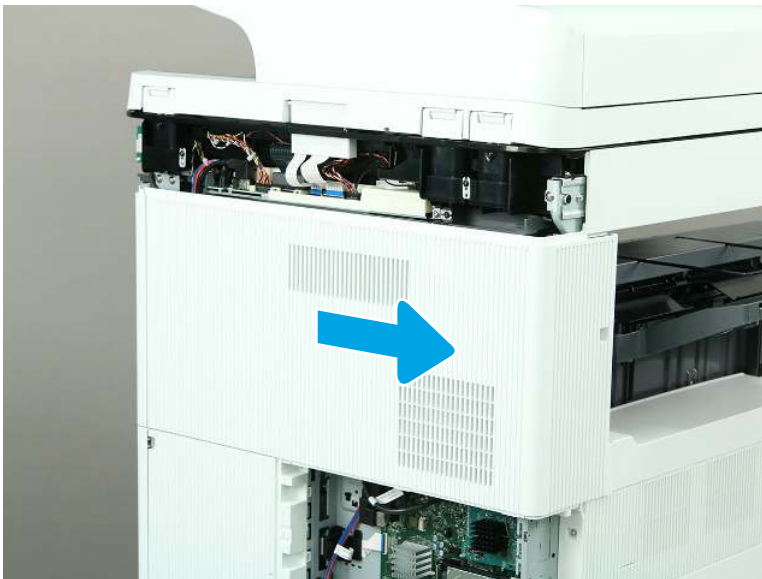
- a. Remove two screws (callout 1), and then release two tabs (callout 2).

Figure 1-1708 Remove two screws and release two tabs



- b. Slide the cover to the right to remove it.

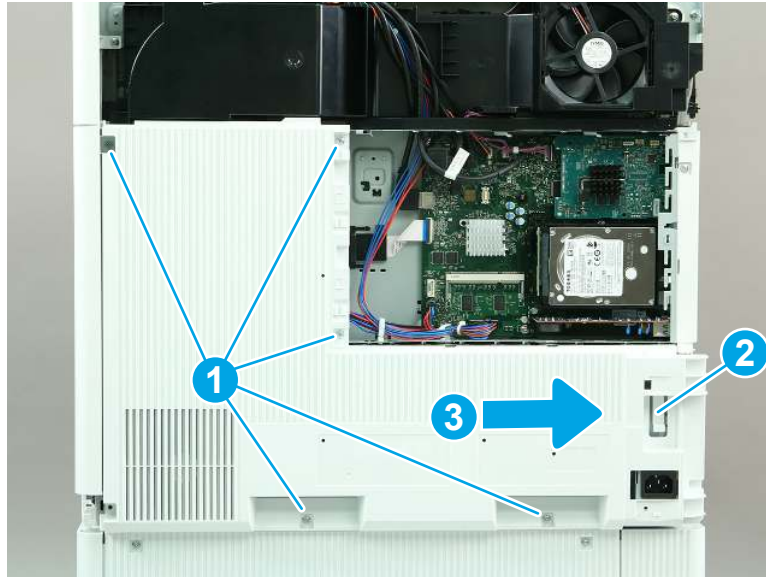
Figure 1-1709 Remove the rear upper and left rear upper cover



7. Remove the rear cover (M856/E85055/M776).

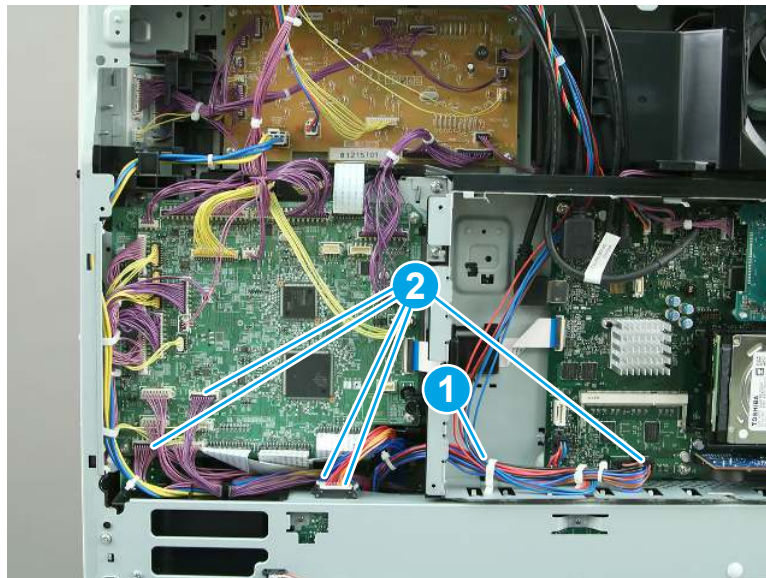
- ▲ Remove five screws (callout 1), release one tab (callout 2), and then slide the rear cover to the right to remove it.

Figure 1-1710 Remove the rear cover (M856/E85055/M776)



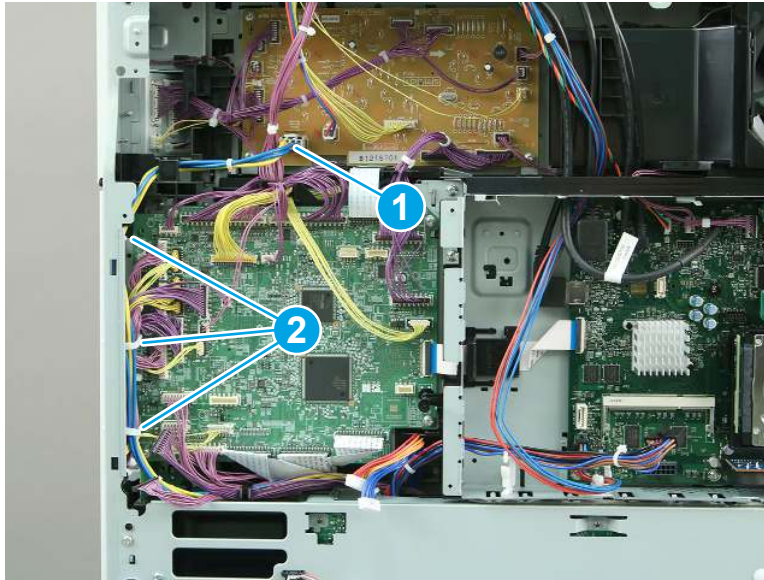
- 8. Remove the low-voltage power supply (LVPS) (M856/E85055/M776).
 - a. Release one retainer (callout 1), and then disconnect five connectors (callout 2).

Figure 1-1711 Release the retainer and disconnect five connectors



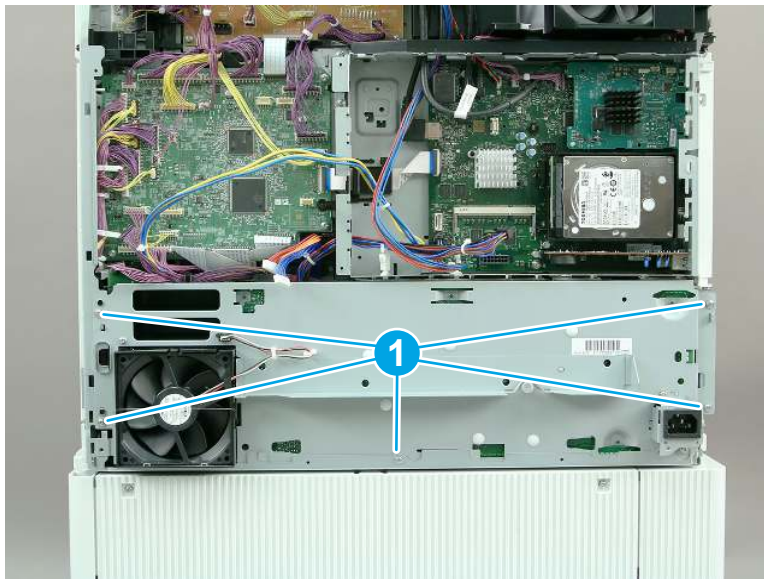
- b. Disconnect one connector (callout 1), and then release three retainers (callout 2).

Figure 1-1712 Disconnect one connector and release five retainers



- c. Remove five screws (callout 1).

Figure 1-1713 Remove five screws



- d. Tilt the LVPS away from the printer (callout 1). Thread the cable (callout 2) through the opening in the formatter case.

 **NOTE:** Due to mechanical tolerances on the formatter cage, rotating the LVPS out might be difficult.


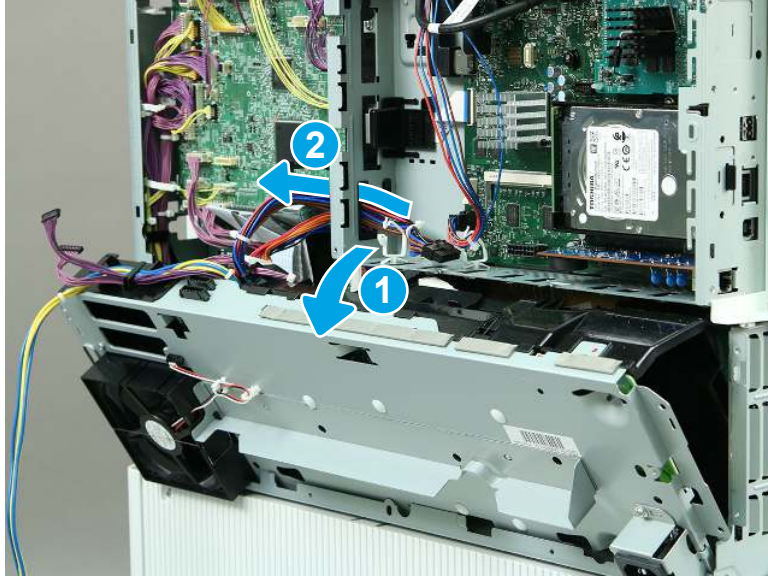
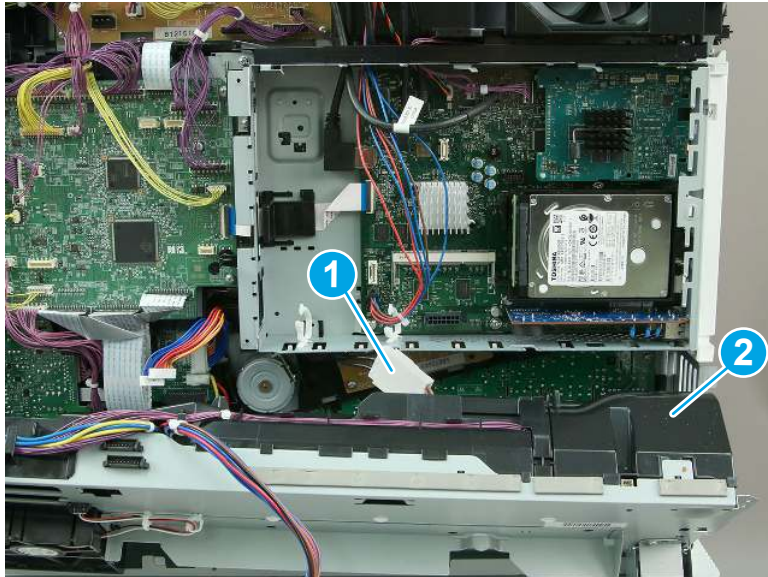
 **CAUTION:** One connector is still connected, so tilt the LVPS carefully.

Figure 1-1714 Thread the cable



- e. Disconnect one connector (callout 1), and then lift up to remove the LVPS (callout 2).

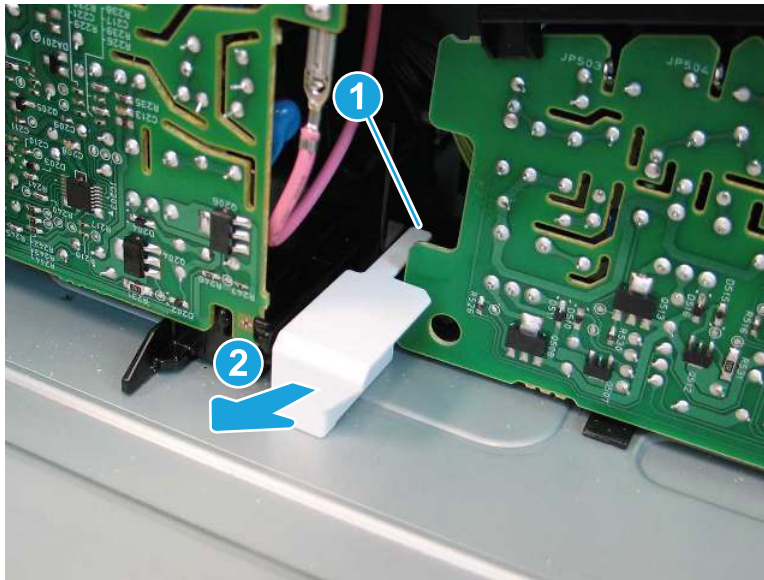
Figure 1-1715 Remove the LVPS



- 9. Remove the lower high-voltage power supply (lower HVPS).

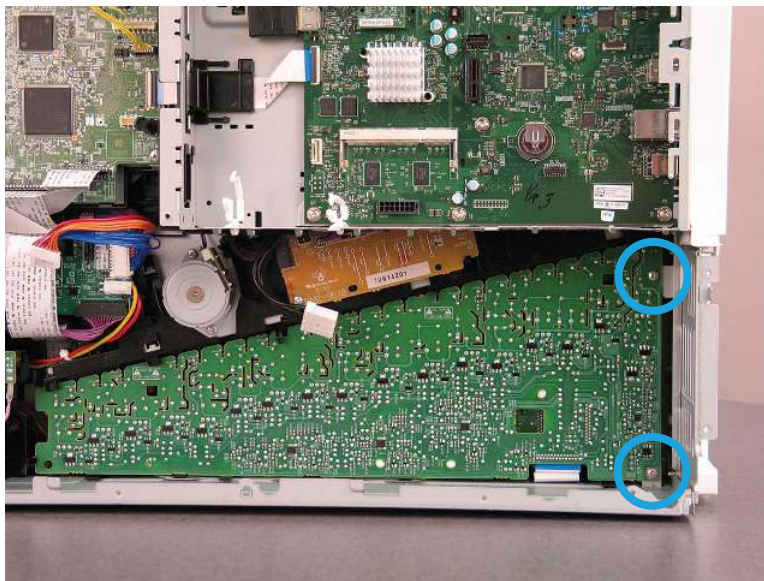
- a. Release one tab (callout 1) and then slide the stopper (callout 2) away from the printer to remove it.

Figure 1-1716 Remove the stopper



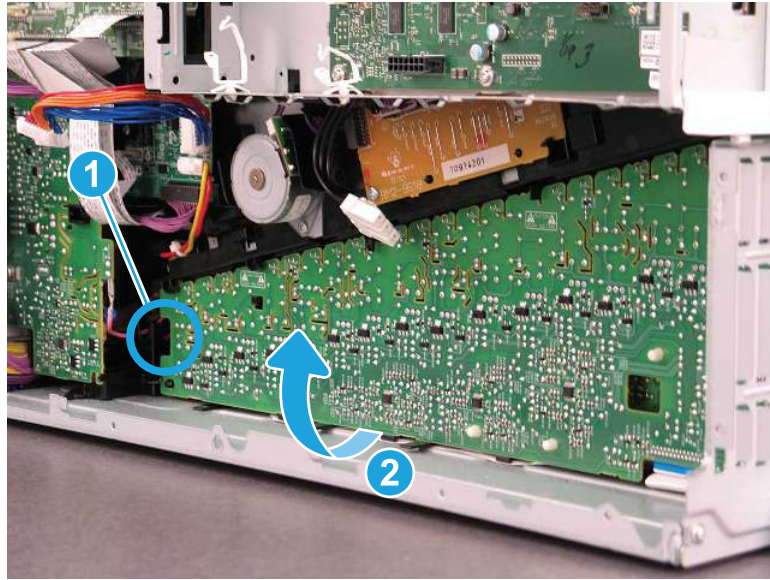
- b. Remove two screws (callout 1).

Figure 1-1717 Remove two screws



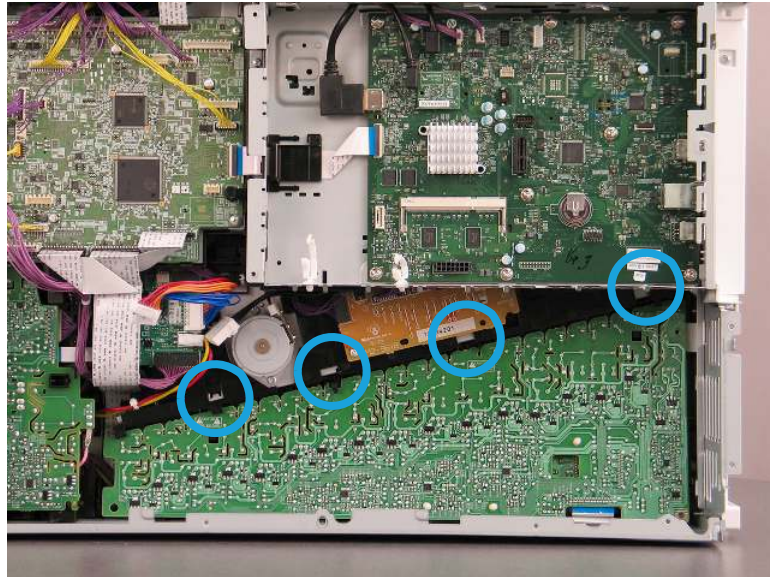
- c. Release one tab (callout 1), and then gently release the lower edge of the lower HVPS.

Figure 1-1718 Release the lower edge of the lower HVPS



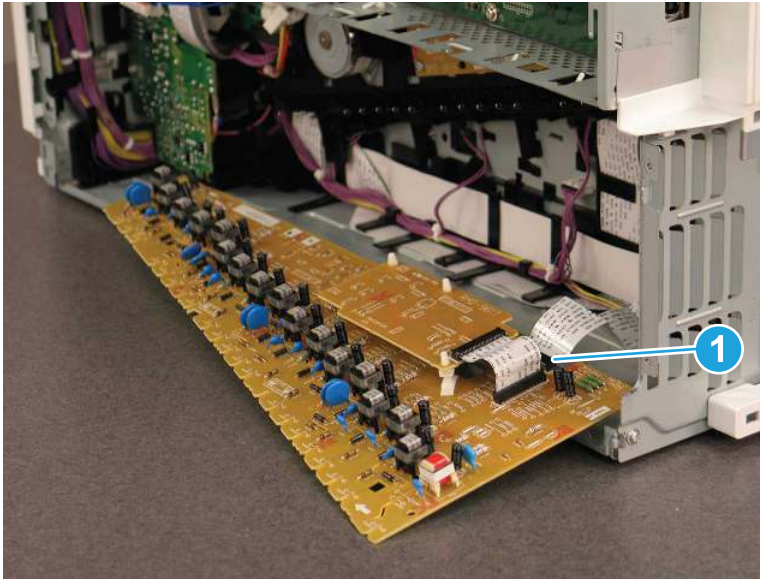
- d. Release the lower HVPS from four tabs.

Figure 1-1719 Release four tabs



- e. Disconnect one flat cable (callout 1) from the back of the lower HVPS.

Figure 1-1720 Disconnect one flat cable



10. Unpack the replacement assembly.

- a. Dispose of the defective part.




NOTE: HP recommends responsible disposal of the defective part.

<http://www8.hp.com/us/en/hp-information/environment/product-recycling.html>

- b. Unpack the replacement part from the packaging.



CAUTION:  Some parts are sensitive to electrostatic discharge (ESD). Always perform service work at an ESD-protected workstation or mat. If an ESD workstation or mat is not available, touch the sheet-metal chassis to provide a static ground before touching an ESD-sensitive assembly. Protect the ESD-sensitive assemblies by placing them in ESD pouches when they are out of the printer.



IMPORTANT: Make sure that all of the shipping materials (for example shipping tape) are removed from the replacement part prior to installation.

- c. To install an assembly, reverse the removal steps.



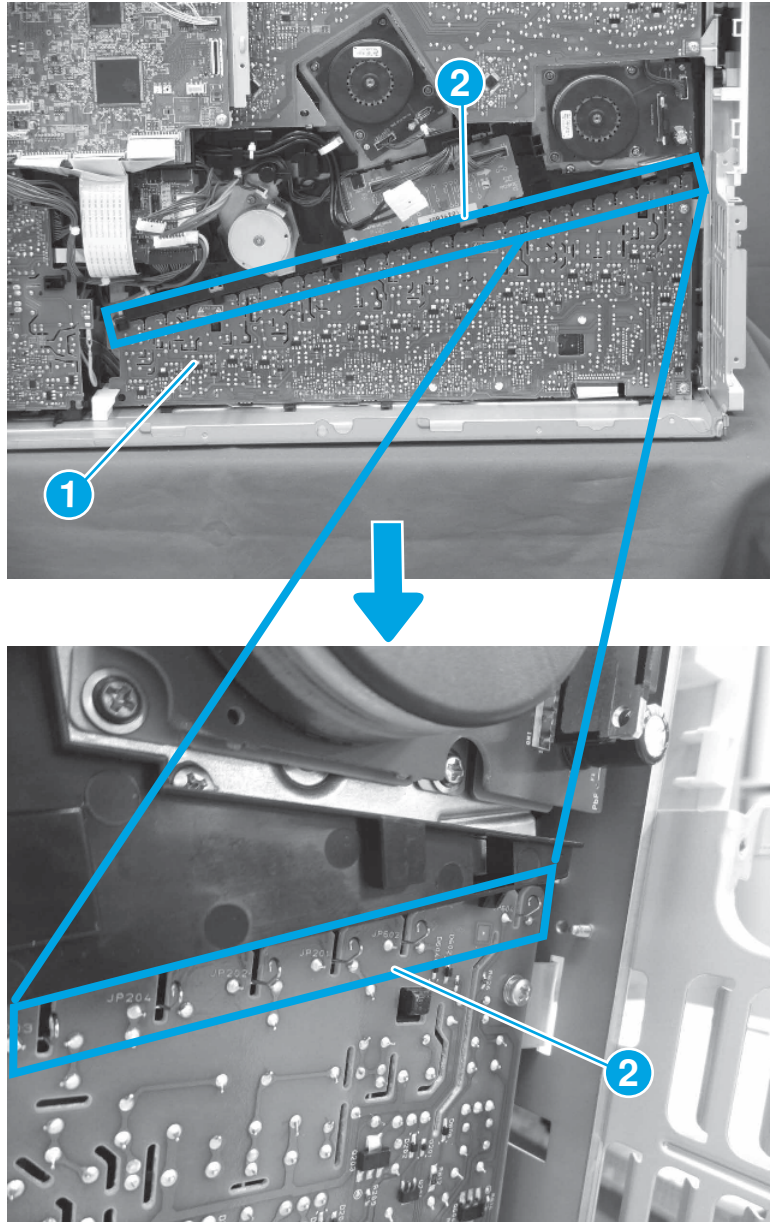
NOTE: When applicable, special installation instructions are provided for an assembly at the end of the removal procedure. Always completely read the removal instructions and follow all special installation instructions.

11. Reverse the removal steps to install the assembly. Also use the following **special installation instructions**.

Install the lower HVPS

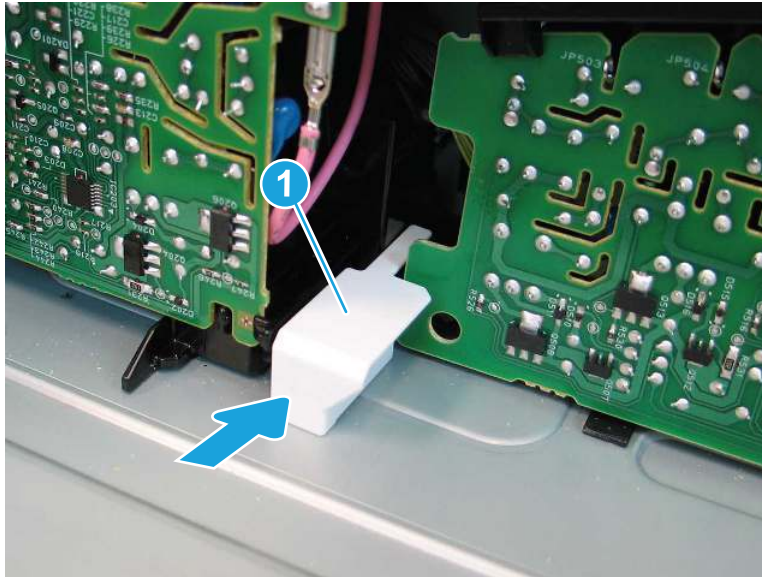
- a. When reinstalling the lower HVPS (callout 1), make sure that the top of the lower HVPS engages with the contact springs (callout 2) and that the springs are in the correct position.

Figure 1-1721 Check the springs



- b. Make sure that the stopper (callout 1) is reinstalled at the bottom of the lower HVPS.

Figure 1-1722 Install the stopper



Removal and replacement: Upper high-voltage power supply (M751/E75245)

Learn how to remove and replace the upper high-voltage power supply (upper HVPS).

[View a video of how to remove and replace the upper HVPS.](#)

Mean time to repair: 35 minutes

Service level: Medium

Before performing service

Turn the printer power off

- Disconnect the power cable.

⚠ WARNING! To avoid damage to the printer, turn the printer off, wait 30 seconds, and then remove the power cord before attempting to service the printer.

Use the table below to identify the correct part number for your printer. To order the part, go to www.hp.com/buy/parts.

Table 1-92 Part information

Part number	Part description
RM2-9601-000CN	Upper high-voltage power supply PCB assembly

Required tools

- #2 Phillips screwdriver with a magnetic tip
- Small, flat-blade screwdriver

After performing service

Turn the printer power on

- Connect the power cable.
- Use the power switch to turn the power on.

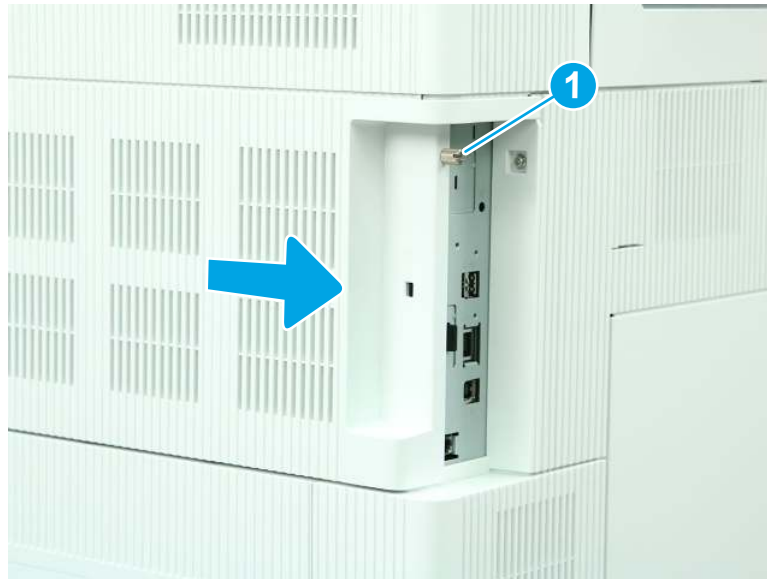
Post service test

Make sure that the printer initializes to a **Ready** state.

Print a page to make sure that the printer is functioning correctly.

1. Remove the formatter cover.
 - ▲ Loosen one thumbscrew (callout 1), and then slide the formatter cover (callout 2) away from the printer to remove it.

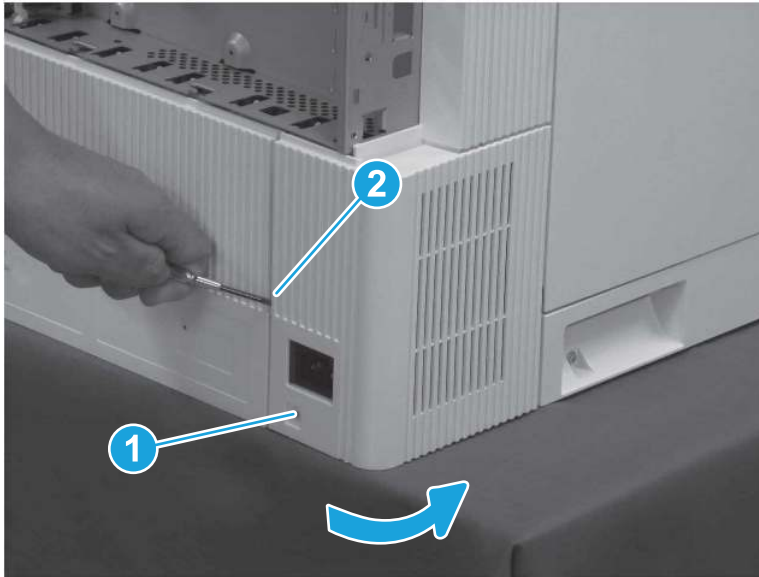
Figure 1-1723 Remove the formatter cover



2. Remove the left lower cover (M751/E75245).

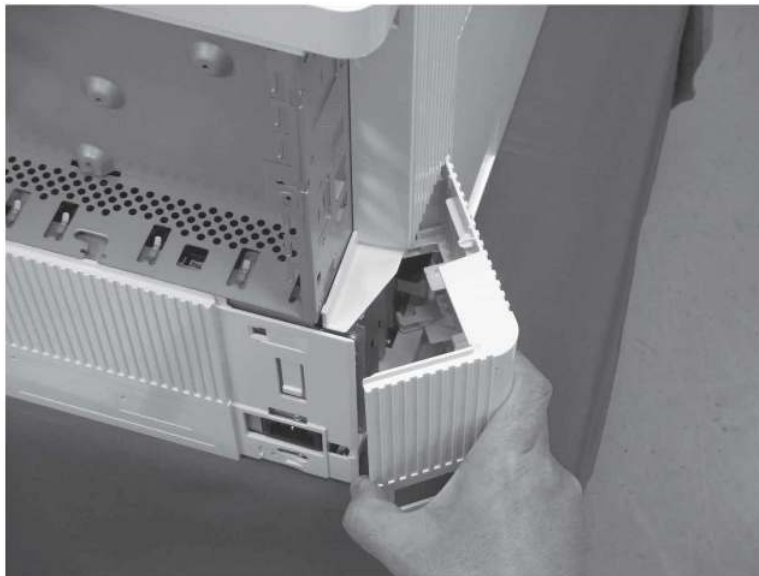
- a. Remove one screw (callout 1), release one tab (callout 2), and then rotate the cover away from the printer.

Figure 1-1724 Remove one screw and release one tab



- b. Remove the left lower cover.

Figure 1-1725 Remove the left lower cover



3. Remove the left rear cover (M751/E75245/M856/E85055/M776).

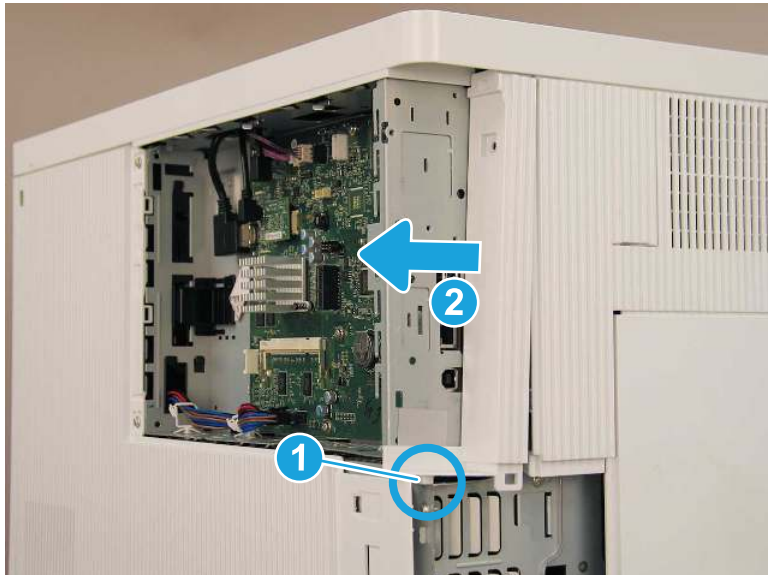
- a. Remove one screw (callout 1).

Figure 1-1726 Remove one screw



- b. Release one boss (callout 1), and then slide the cover toward the back of the printer (callout 2) to remove it.

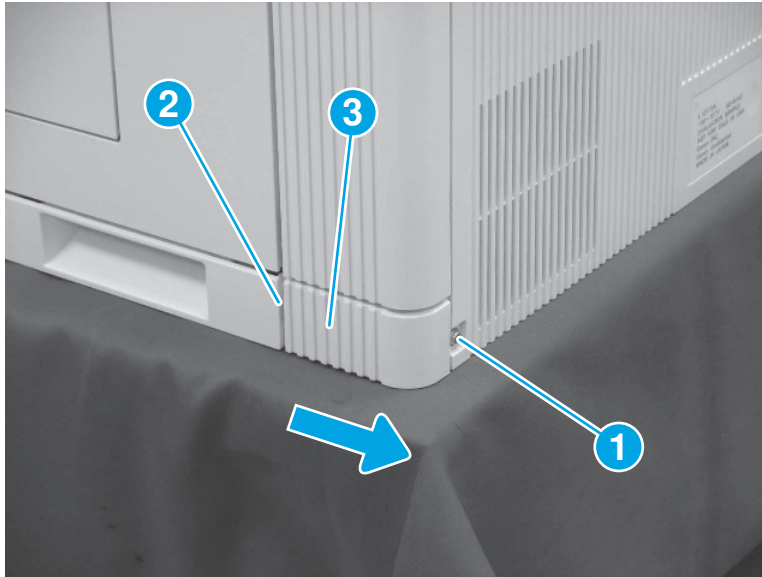
Figure 1-1727 Remove the left rear cover



4. Remove the right rear lower cover (M751/E75245/M856/E85055/M776).

- ▲ Remove one screw (callout 1), release one tab (callout 2), and then slide the right rear lower cover (callout 3) toward the back of the printer to remove it.

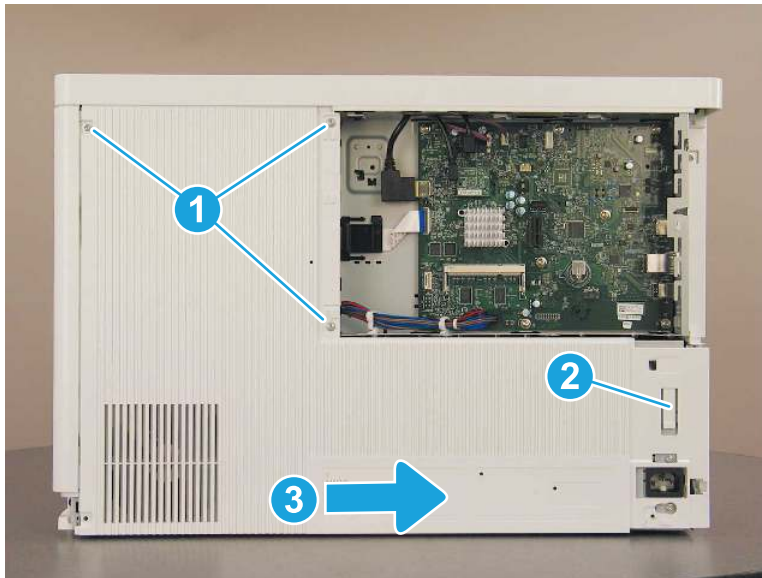
Figure 1-1728 Remove the right rear lower cover



5. Remove the rear cover (M751/E75245).

- ▲ Remove three screws (callout 1), release one tab (callout 2), and then slide the rear cover to the right (callout 3) to remove it.

Figure 1-1729 Remove the rear cover

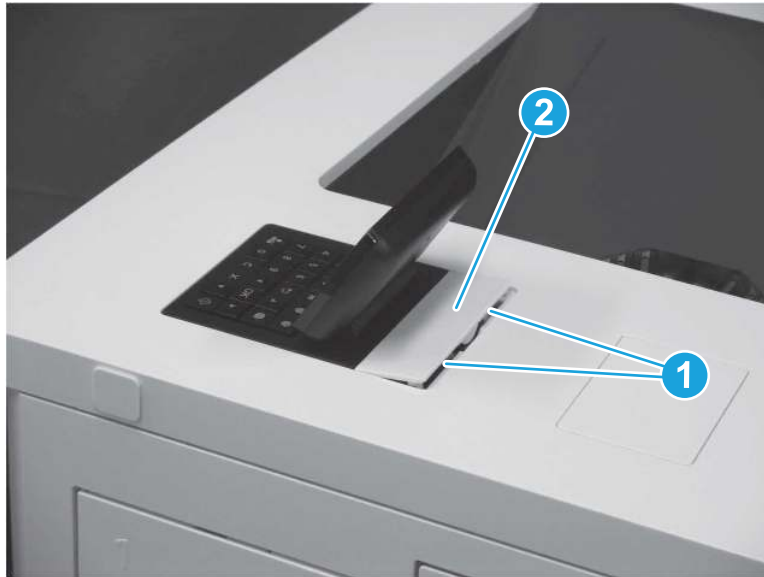


6. Remove the control panel.

 **NOTE:** A screwdriver is included in the control panel kit. The screwdriver has a reversible shaft. Simply pull the shaft out of the handle, and then reinstall it with the desired end facing out.

- a. Use a small, flat-blade screwdriver to release two tabs (callout 1), and then remove the control panel cover (callout 2).

Figure 1-1730 Remove the control panel cover



- b. Remove one screw (callout 1).

Figure 1-1731 Remove one screw



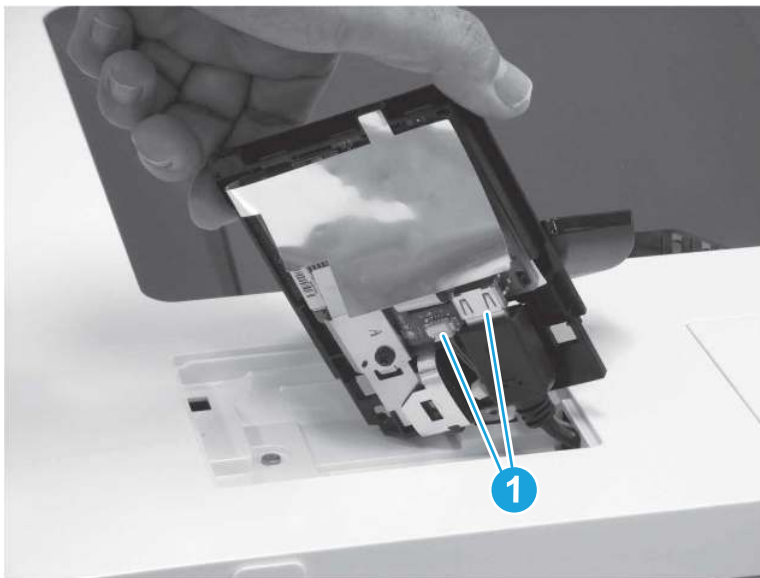
- c. Lift the back edge of the control panel up (callout 1), and then slide the control panel toward the back of the printer (callout 2).

Figure 1-1732 Slide the control panel back



- d. Turn the control panel so that the bottom is facing up, and then disconnect two connectors (callout 1) to remove the control panel.

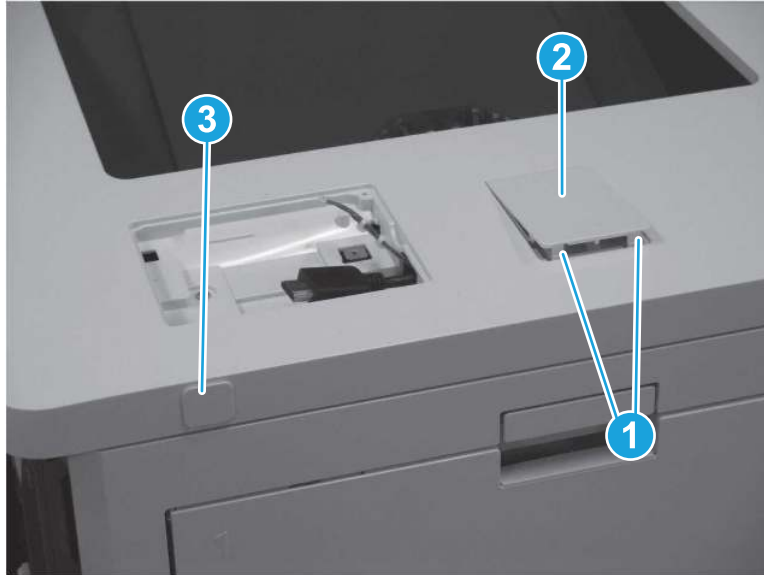
Figure 1-1733 Disconnect two connectors



7. Remove the top cover (M751/E75245).

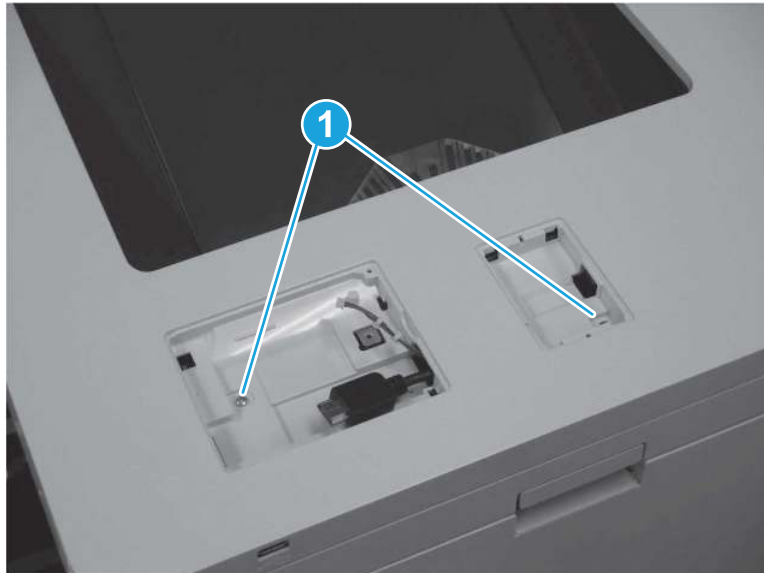
- a. Release two tabs (callout 1), and then remove the HIP cover (callout 2). Pull the USB cap (callout 3) away from the printer to remove it.

Figure 1-1734 Remove the HIP cover and USB cap



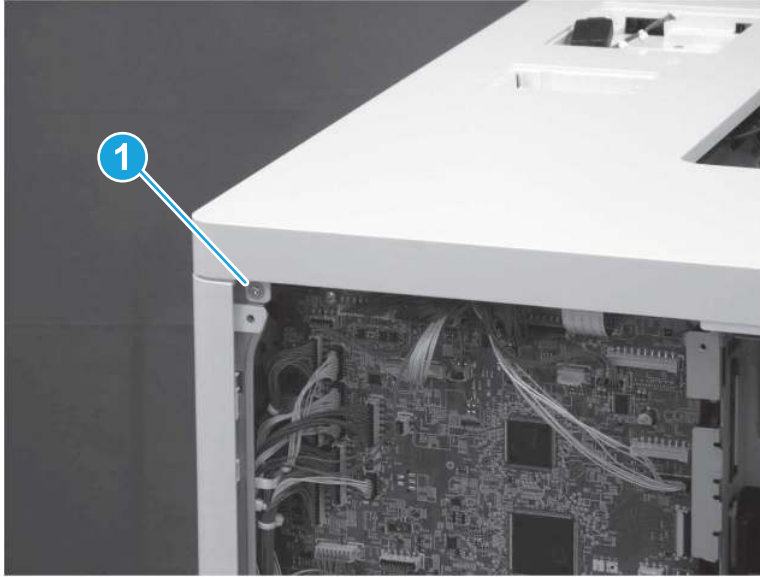
- b. At the top of the printer, remove two screws (callout 1).

Figure 1-1735 Remove two screws




- c. At the back of the printer, remove one screw (callout 1).

Figure 1-1736 Remove one screw

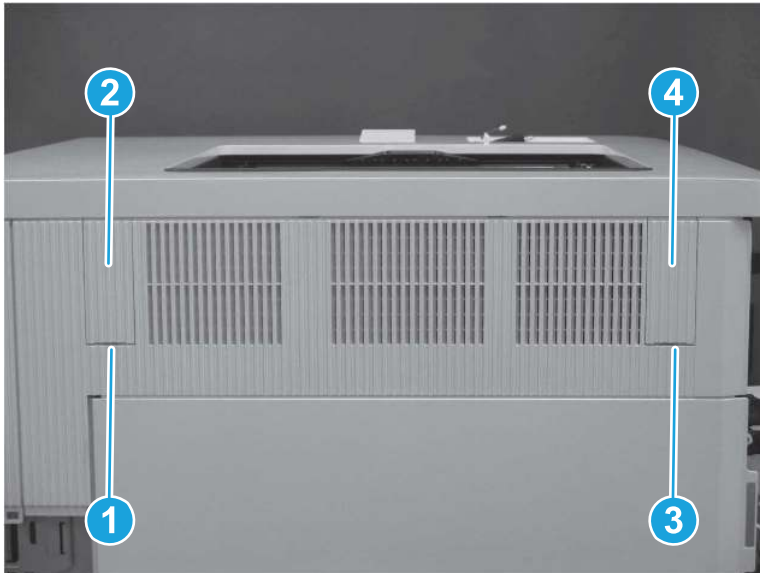


- d. Use a small, flat-blade screwdriver to release one tab (callout 1) and remove the left blanking cover (callout 2). Release one tab (callout 3) and remove the right blanking cover (callout 4).

 **TIP:** These covers are not identical. Make sure to reinstall the correct cover on the correct side.

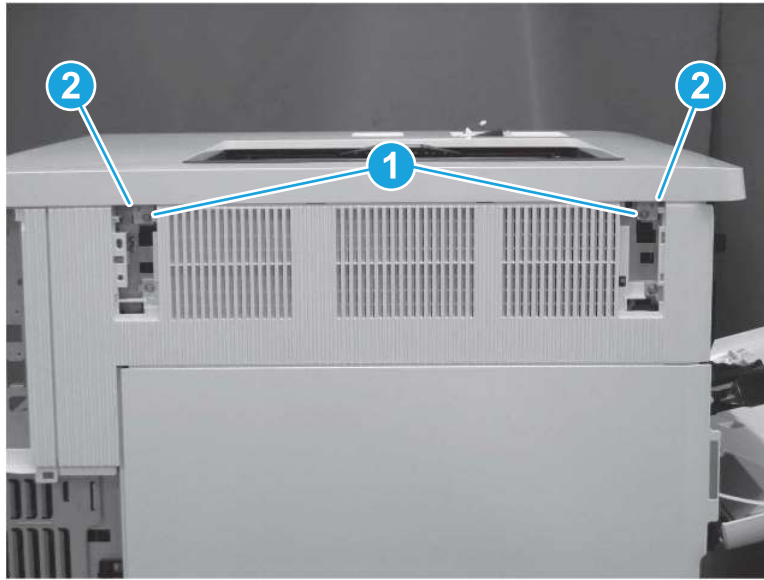
 **NOTE:** The screw under the left blanking cover is a self-tapping screw. Make sure this screw is reinstalled in the correct location.

Figure 1-1737 Remove the left and right blanking covers



- e. Remove two screws (callout 1), and then release two tabs (callout 2).

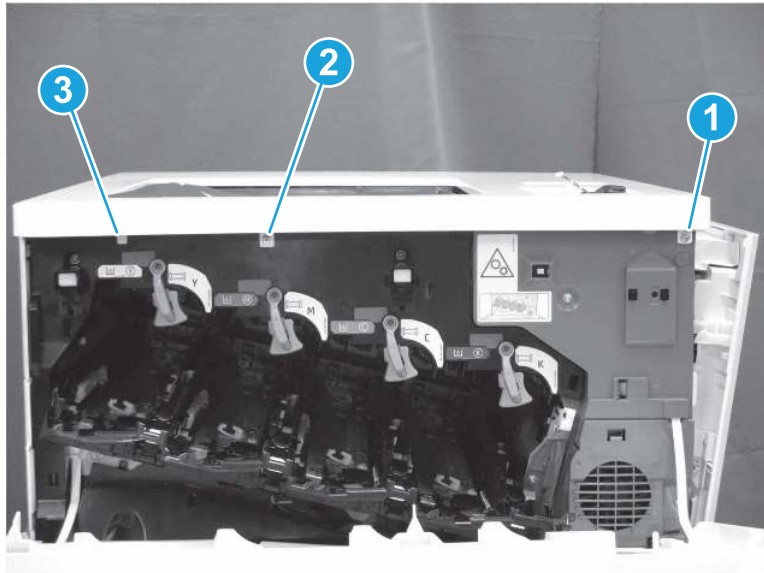
Figure 1-1738 Remove two screws and release two tabs



- f. At the front of the printer, remove one washer-head screw (callout 1) and one self-tapping screw (callout 2). Release one tab (callout 3).

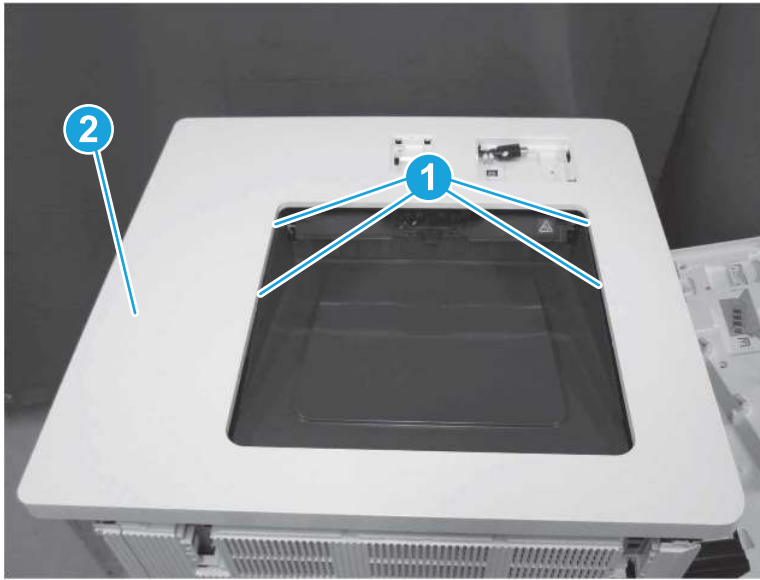
 **TIP:** Make sure to install the correct type of screw in the correct location.

Figure 1-1739 Remove two screws and release one tab

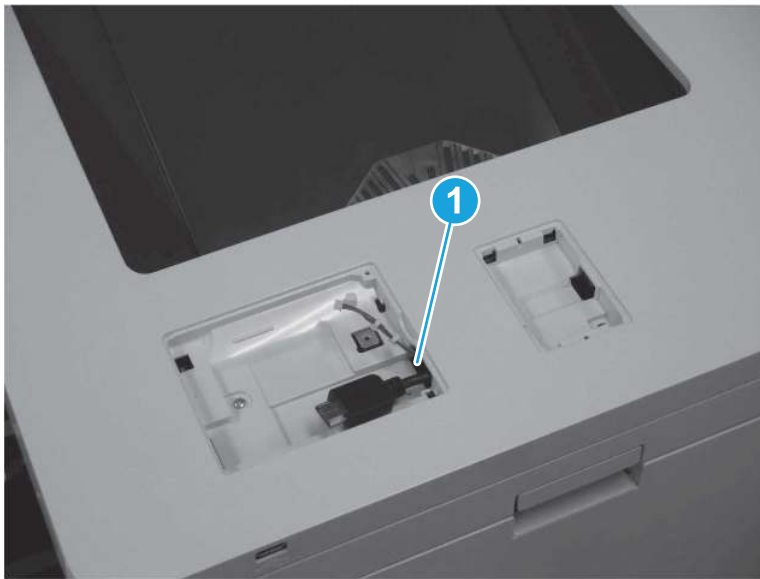


- g. At the top of the printer, release four tabs (callout 1), and then remove the top cover (callout 2).

Figure 1-1740 Remove the top cover



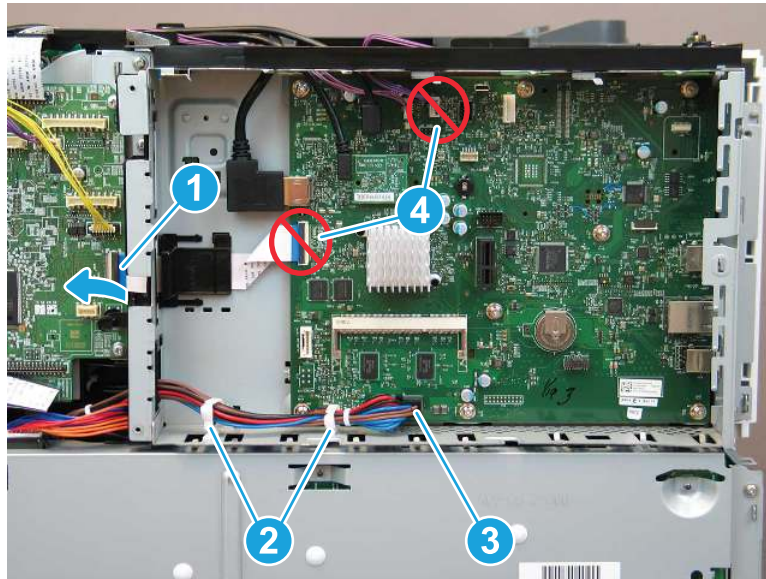
 **NOTE:** When removing the top cover, make sure to release the control panel cables (callout 1) through the opening.



8. Remove the formatter and case.

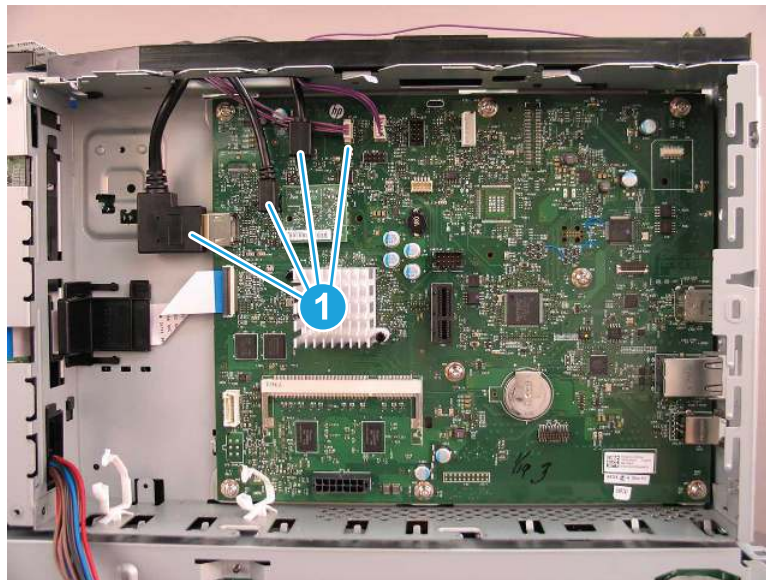
- a. Open the retainer (callout 1) to release the flat cable. Release the cables from two retainers (callout 2). Squeeze the latch to disconnect the connector (callout 3) at the lower edge of the formatter. It is not necessary to disconnect two connectors (callout 4).

Figure 1-1741 Disconnect the connectors



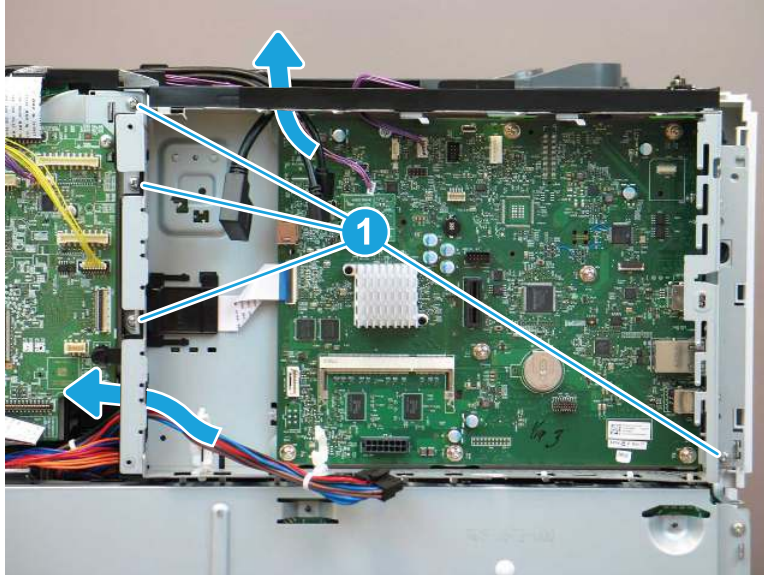
- b. Disconnect all of the remaining connectors on the formatter (callout 1).

Figure 1-1742 Disconnect the connectors



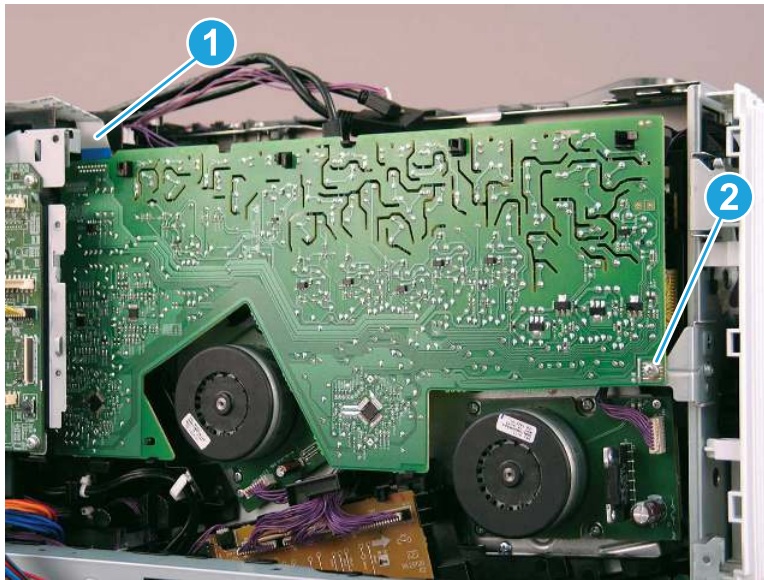
- c. Release the cables through the opening on top and on the left side of the formatter case. Remove four screws (callout 1), and then remove the formatter and case.

Figure 1-1743 Remove the formatter and case



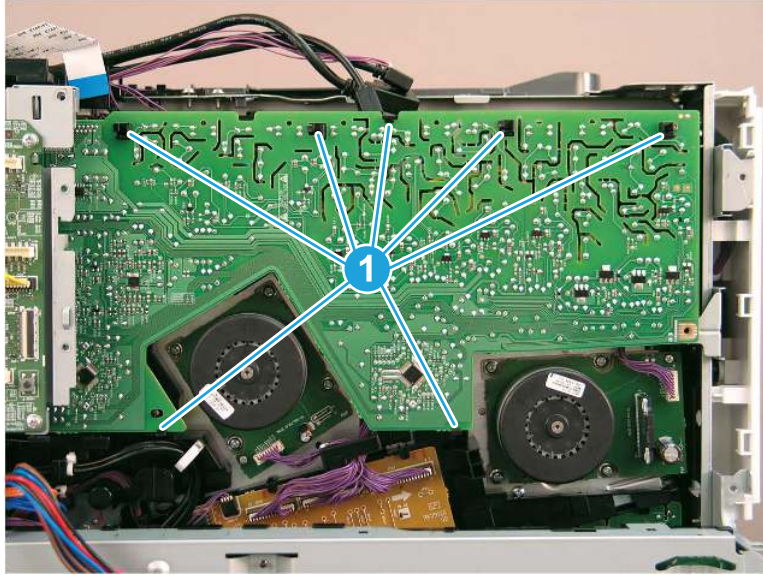
- 9. Remove the upper high-voltage power supply A (upper HVPS).
 - a. Disconnect one flat cable (callout 1), and then remove one screw (callout 2).

Figure 1-1744 Disconnect one flat cable and remove one screw



- b. Release seven tabs (callout 1), and then remove the upper HVPS.

Figure 1-1745 Release seven tabs and remove the upper HVPS



- 10. Unpack the replacement assembly.

- a. Dispose of the defective part.




NOTE: HP recommends responsible disposal of the defective part.

<http://www8.hp.com/us/en/hp-information/environment/product-recycling.html>

- b. Unpack the replacement part from the packaging.



CAUTION:  Some parts are sensitive to electrostatic discharge (ESD). Always perform service work at an ESD-protected workstation or mat. If an ESD workstation or mat is not available, touch the sheet-metal chassis to provide a static ground before touching an ESD-sensitive assembly. Protect the ESD-sensitive assemblies by placing them in ESD pouches when they are out of the printer.



IMPORTANT: Make sure that all of the shipping materials (for example shipping tape) are removed from the replacement part prior to installation.

- c. To install an assembly, reverse the removal steps.



NOTE: When applicable, special installation instructions are provided for an assembly at the end of the removal procedure. Always completely read the removal instructions and follow all special installation instructions.

Removal and replacement: Upper high-voltage power supply (M856/E85055/M776)

Learn how to remove and replace the upper high-voltage power supply (HVPS).

[View a video of how to remove and replace the upper high-voltage power supply.](#)

Mean time to repair: 35 minutes

Service level: Medium

Before performing service

Turn the printer power off

- Disconnect the power cable.

⚠ WARNING! To avoid damage to the printer, turn the printer off, wait 30 seconds, and then remove the power cord before attempting to service the printer.

Use the table below to identify the correct part number for your printer. To order the part, go to www.hp.com/buy/parts.

Table 1-93 Part information

Part number	Part description
RM2-9601-000CN	Upper high-voltage power supply PCB assembly

Required tools

- #2 Phillips screwdriver with a magnetic tip
- Small, flat-blade screwdriver

After performing service

Turn the printer power on

- Connect the power cable.
- Use the power switch to turn the power on.

Post service test

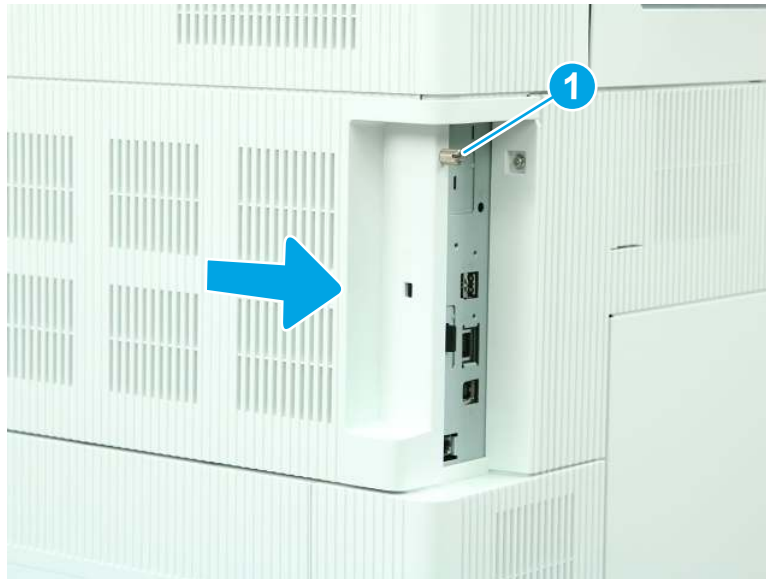
Make sure that the printer initializes to a **Ready** state.

Print a page to make sure that the printer is functioning correctly.

1. Remove the formatter cover.

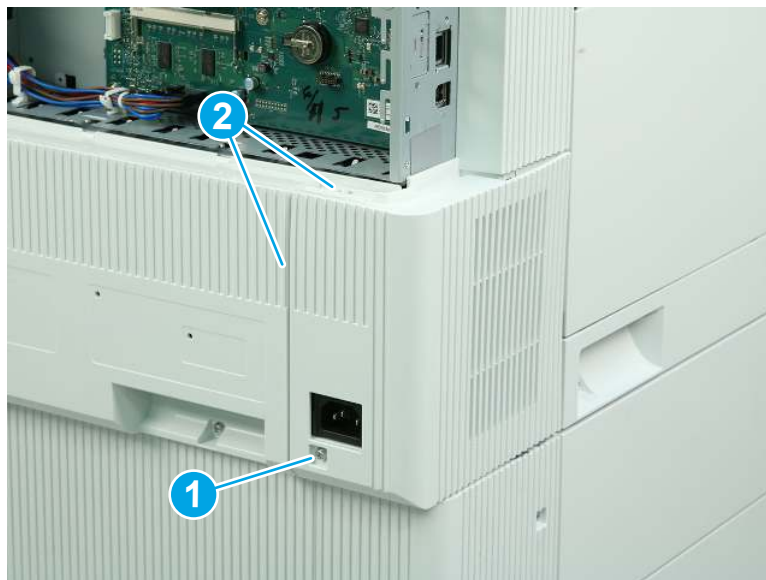
- ▲ Loosen one thumbscrew (callout 1), and then slide the formatter cover (callout 2) away from the printer to remove it.

Figure 1-1746 Remove the formatter cover



- 2. Remove the left lower cover (M856/E85055/M776).
 - a. Remove one screw (callout 1), and then release two tabs (callout 2).

Figure 1-1747 Remove one screw and release two tabs



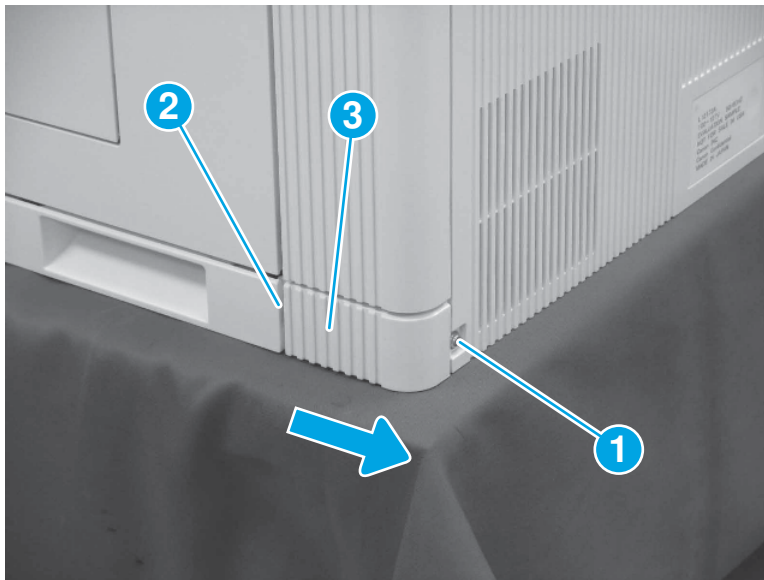
- b. Rotate the cover away from the printer to remove it.

Figure 1-1748 Remove the left lower cover



3. Remove the right rear lower cover (M751/E75245/M856/E85055/M776).
 - ▲ Remove one screw (callout 1), release one tab (callout 2), and then slide the right rear lower cover (callout 3) toward the back of the printer to remove it.

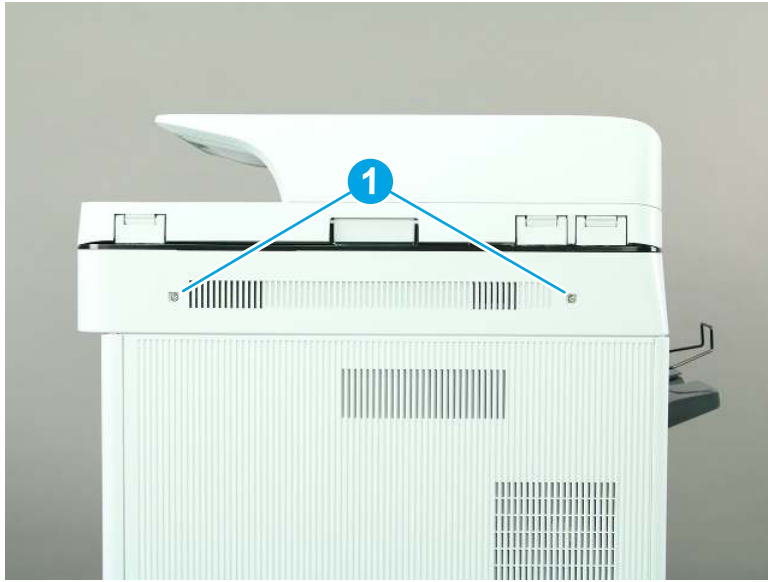
Figure 1-1749 Remove the right rear lower cover



4. Remove the scanner control board (SCB) cover (M776).

- a. Remove two screws (callout 1).

Figure 1-1750 Remove two screws



- b. Remove the SCB cover.

Figure 1-1751 Remove the SCB cover

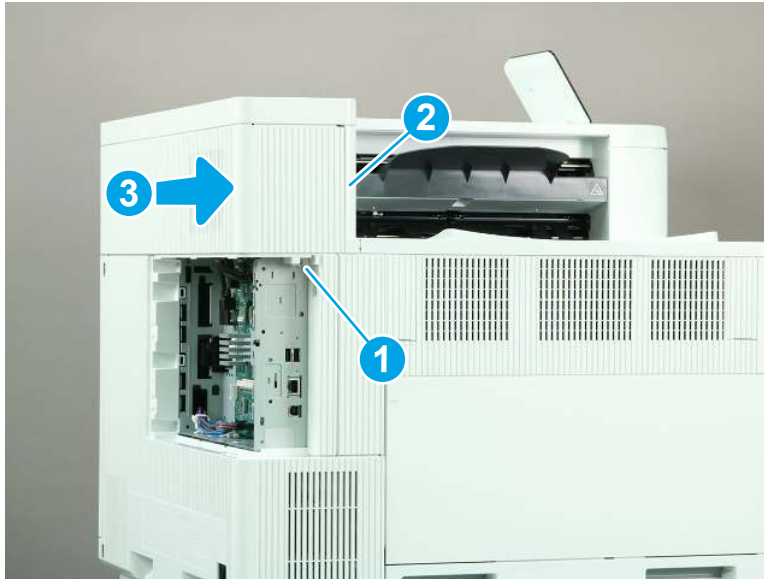


5. Remove the rear upper cover (M856/E85055/M776dn/M776z).

 **NOTE:** The following figure shows the M856 printer. The procedure is correct for all referenced models.

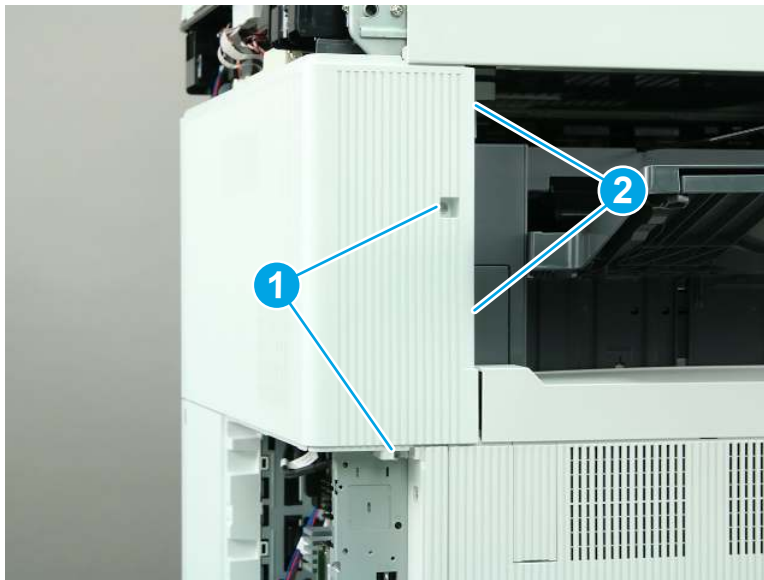
- ▲ Remove one screw (callout 1), release one tab (callout 2), and then slide the rear upper cover away from the printer to remove it (callout 3).

Figure 1-1752 Remove the rear upper cover



- 6. Remove the rear upper cover and left rear upper cover (M776zs).
 - a. Remove two screws (callout 1), and then release two tabs (callout 2).

Figure 1-1753 Remove two screws and release two tabs



- b. Slide the cover to the right to remove it.

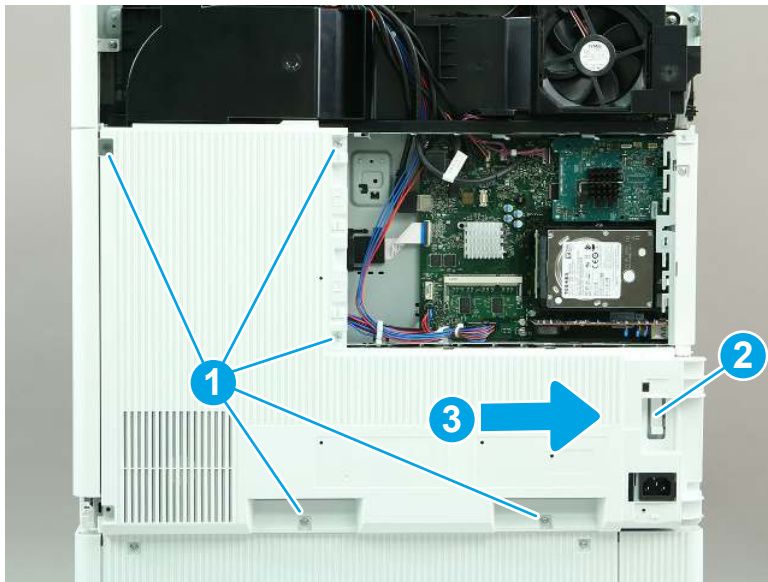
Figure 1-1754 Remove the rear upper and left rear upper cover



- 7. Remove the rear cover (M856/E85055/M776).

- ▲ Remove five screws (callout 1), release one tab (callout 2), and then slide the rear cover to the right to remove it.

Figure 1-1755 Remove the rear cover (M856/E85055/M776)



- 8. Remove the formatter and case (M856/E85055/M776).

 **NOTE:** The figures below show the M776zs formatter. The procedure is correct for all referenced models.

- a. Release two retainers (callout 1), and then open the retainer (callout 2) to release the flat cable. Disconnect all of the remaining connectors on the formatter board.


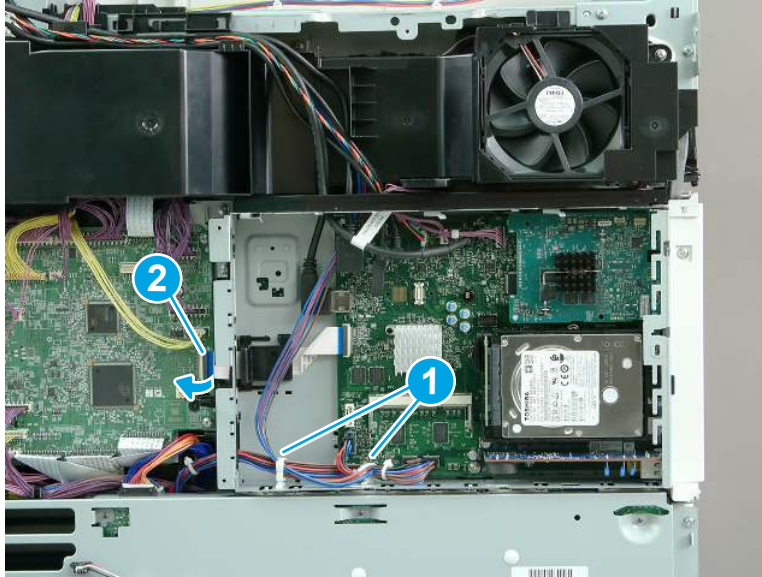
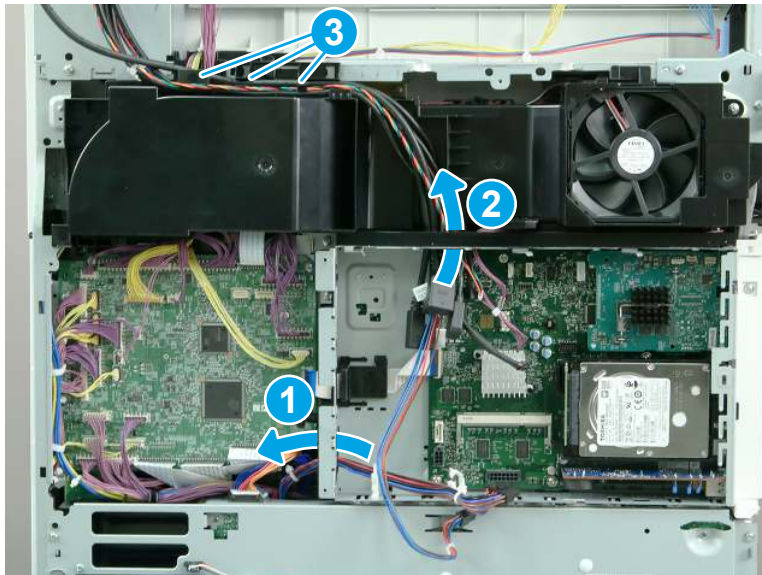
 **NOTE:** The figures below show the M776zs model. The procedures are correct for all of the referenced models.

Figure 1-1756 Disconnect the connectors



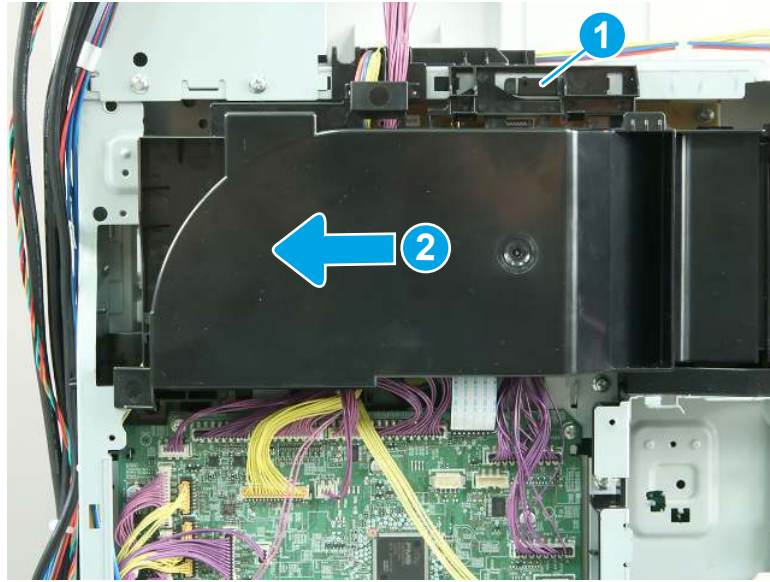
- b. Release one cable through the opening in the left side of the formatter case (callout 1). Release the remaining cables through the opening in the top of the formatter case (callout 2). Release the cables from the upper cable guide (callout 3).

Figure 1-1757 Release the cables



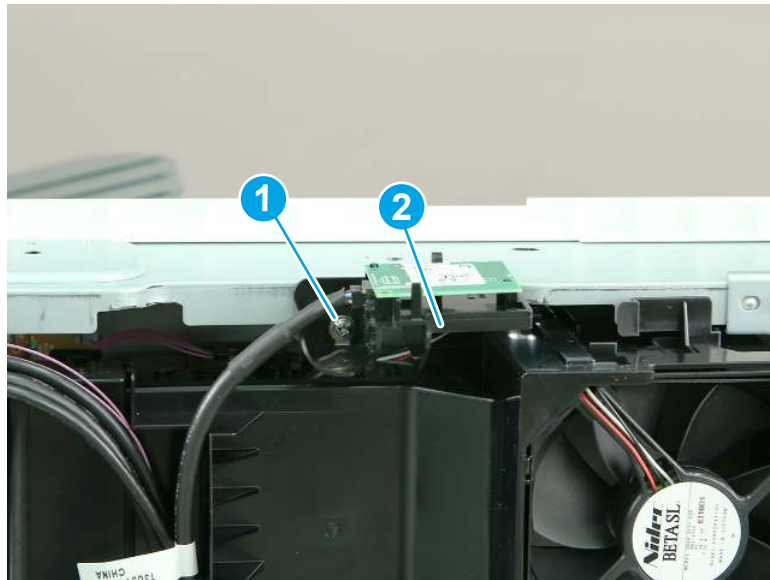
- c. Release one tab (callout 1), and then slide the fan duct to the left (callout 2) to remove it.

Figure 1-1758 Remove the fan duct



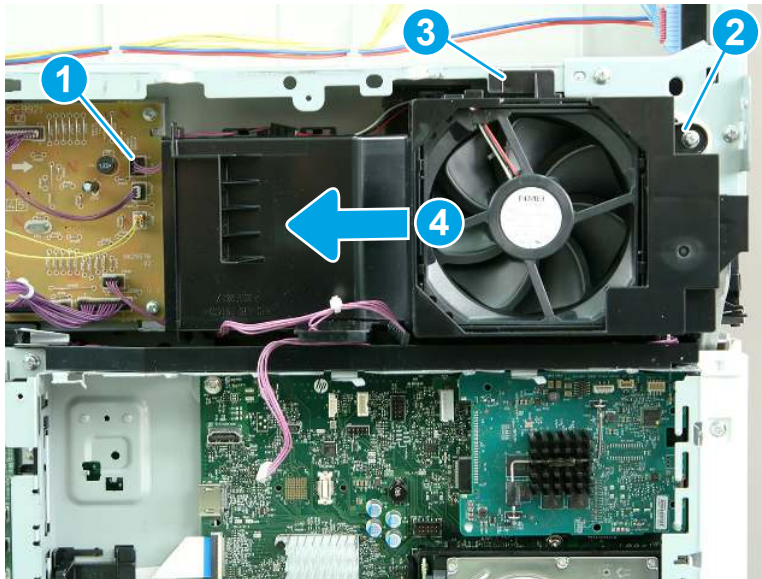
- d. **M856 and E85055 only:** Remove one screw (callout 1), and then remove the wireless card and bracket (callout 2).

Figure 1-1759 Remove the wireless card and bracket



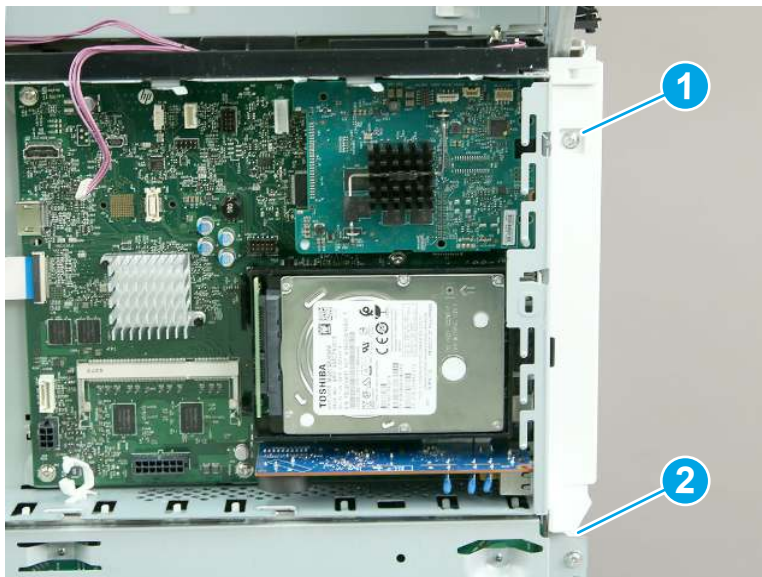
- e. Disconnect one connector (callout 1), and remove one screw (callout 2). Release one tab (callout 3), and then slide the fan assembly to the left (callout 4) to remove it.

Figure 1-1760 Remove the fan assembly



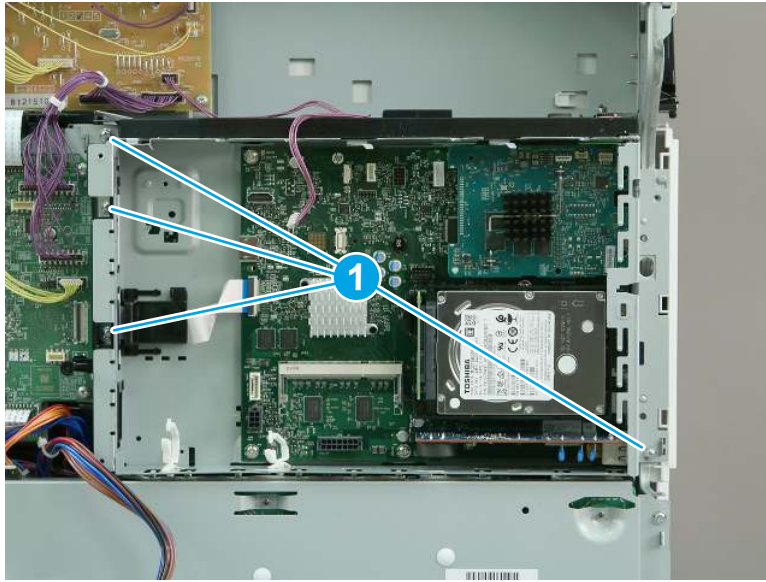
- f. Remove one screw (callout 1), release one tab (callout 2), and then remove the left rear cover.

Figure 1-1761 Remove the left rear cover



- g. Remove four screws (callout 1).

Figure 1-1762 Remove four screws



- h. Remove the formatter and case.

Figure 1-1763 Remove the formatter and case



9. Remove the upper high-voltage power supply (HVPS) (M856/E85055/M776).

- a. Disconnect one connector (callout 1), and then remove one screw (callout 2).

Figure 1-1764 Disconnect one connector and remove one screw



- b. Release six tabs (callout 1), and then remove the upper HVPS.

Figure 1-1765 Release six tabs



10. Unpack the replacement assembly.


- a. Dispose of the defective part.




NOTE: HP recommends responsible disposal of the defective part.

<http://www8.hp.com/us/en/hp-information/environment/product-recycling.html>

- b. Unpack the replacement part from the packaging.

 **IMPORTANT:** Make sure that all of the shipping materials (for example shipping tape) are removed from the replacement part prior to installation.

- c. To install an assembly, reverse the removal steps.

 **NOTE:** When applicable, special installation instructions are provided for an assembly at the end of the removal procedure. Always completely read the removal instructions and follow all special installation instructions.

Removal and replacement: High-voltage power supply T2 (M751/E75245)

Learn how to remove and replace the high-voltage power supply T2 (HVPS-T2).

[View a video of how to remove and replace the high-voltage power supply T2.](#)


Mean time to repair: 36 minutes

Service level: Medium

Before performing service

Turn the printer power off

- Disconnect the power cable.

 **WARNING!** To avoid damage to the printer, turn the printer off, wait 30 seconds, and then remove the power cord before attempting to service the printer.

Use the table below to identify the correct part number for your printer. To order the part, go to www.hp.com/buy/parts.

Table 1-94 Part information

Part number	Part description
RM2-9623-000CN	Second transfer high voltage PCB assembly

Required tools

- #2 Phillips screwdriver with a magnetic tip
- Small, flat-blade screwdriver

After performing service

Turn the printer power on

- Connect the power cable.
- Use the power switch to turn the power on.

Post service test

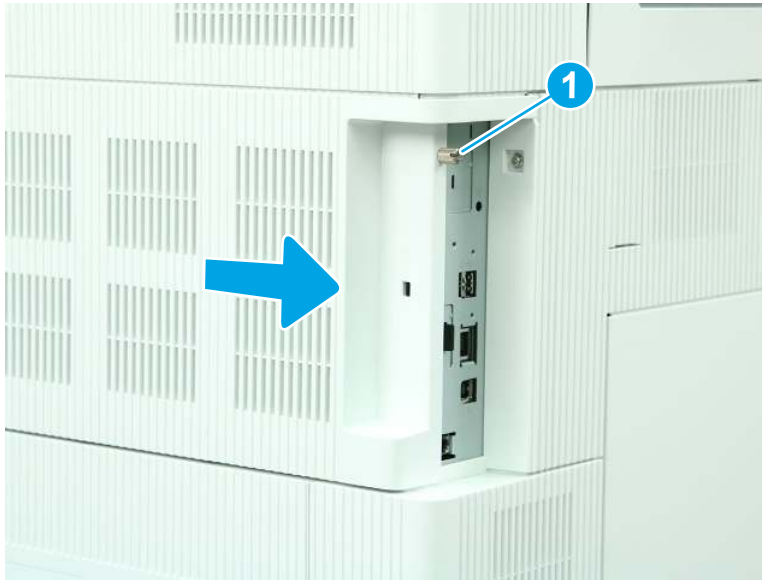
Make sure that the printer initializes to a **Ready** state.

Print a page to make sure that the printer is functioning correctly.

1. Remove the formatter cover.

- ▲ Loosen one thumbscrew (callout 1), and then slide the formatter cover (callout 2) away from the printer to remove it.

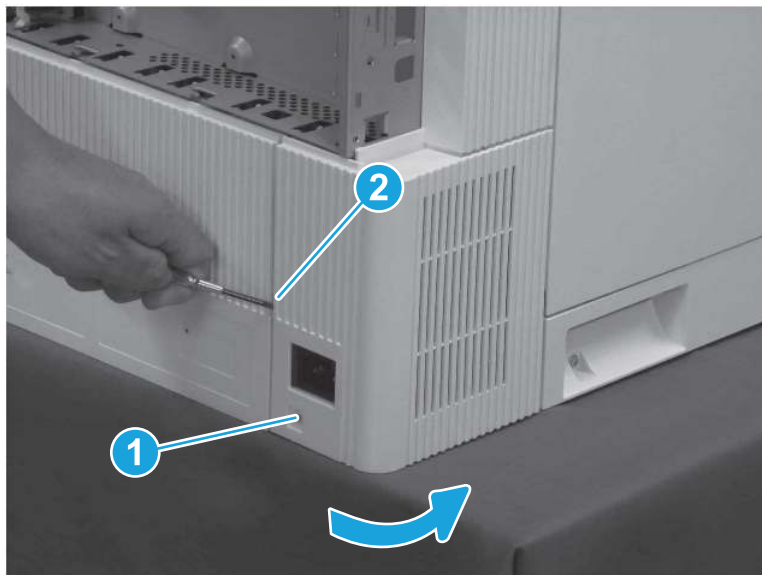
Figure 1-1766 Remove the formatter cover



2. Remove the left lower cover (M751/E75245).

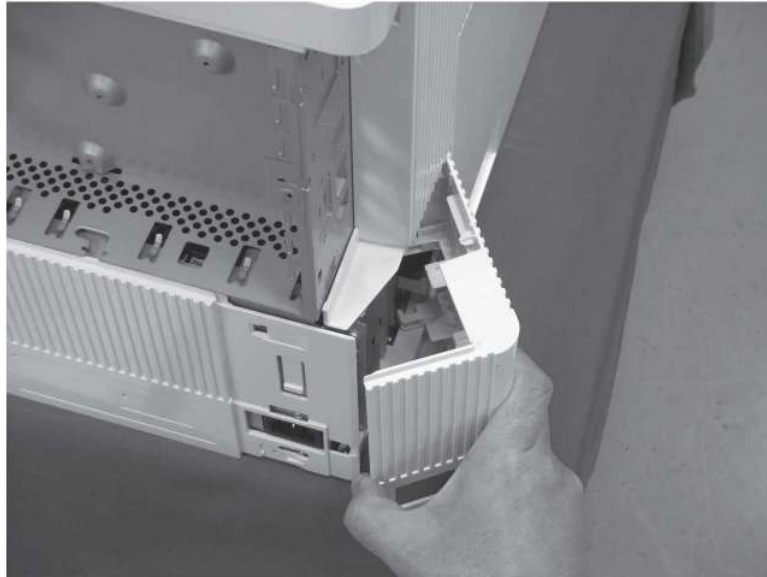
- a. Remove one screw (callout 1), release one tab (callout 2), and then rotate the cover away from the printer.

Figure 1-1767 Remove one screw and release one tab



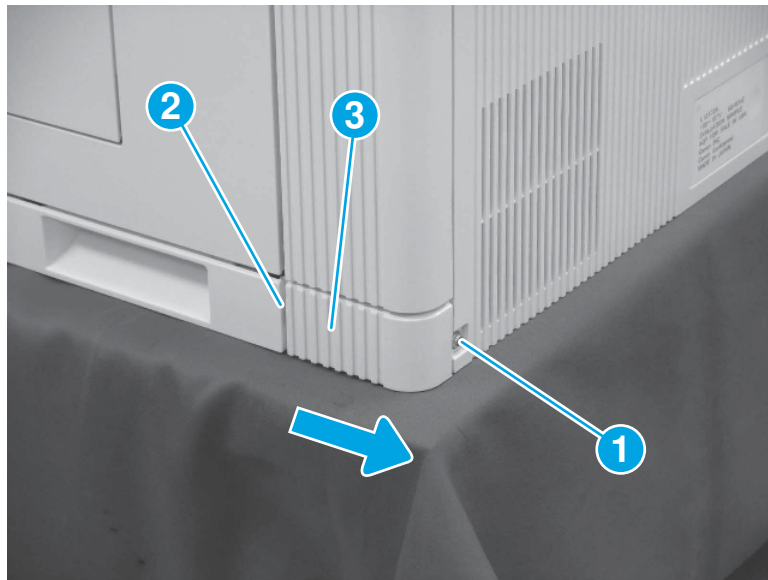
- b. Remove the left lower cover.

Figure 1-1768 Remove the left lower cover



3. Remove the right rear lower cover (M751/E75245/M856/E85055/M776).
 - ▲ Remove one screw (callout 1), release one tab (callout 2), and then slide the right rear lower cover (callout 3) toward the back of the printer to remove it.

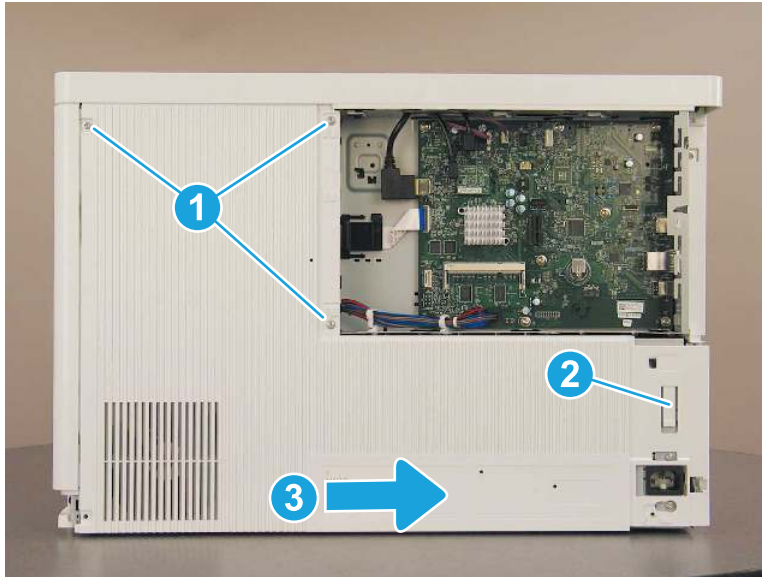
Figure 1-1769 Remove the right rear lower cover



4. Remove the rear cover (M751/E75245).

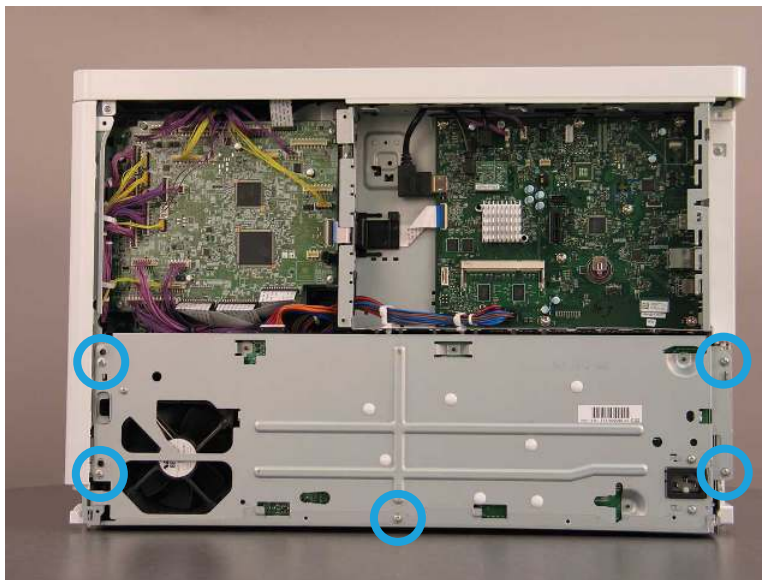
- ▲ Remove three screws (callout 1), release one tab (callout 2), and then slide the rear cover to the right (callout 3) to remove it.

Figure 1-1770 Remove the rear cover



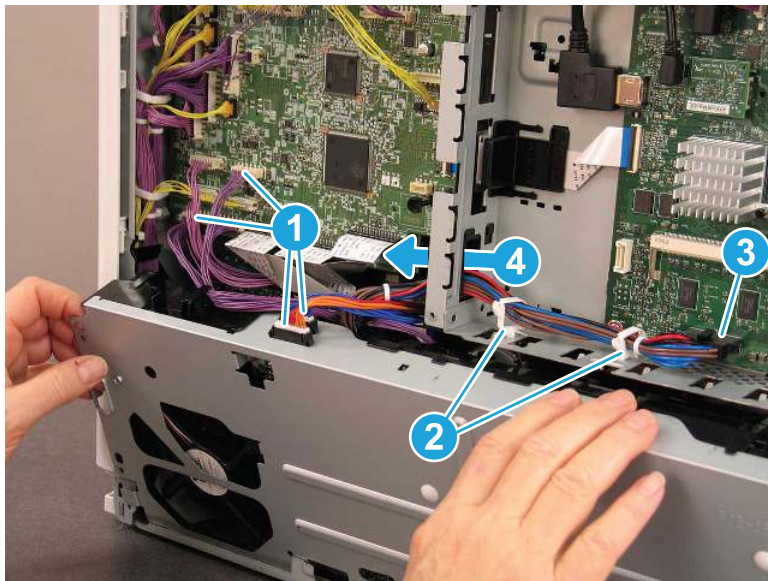
- 5. Remove the low-voltage power supply (LVPS).
 - a. Remove five screws.

Figure 1-1771 Remove five screws



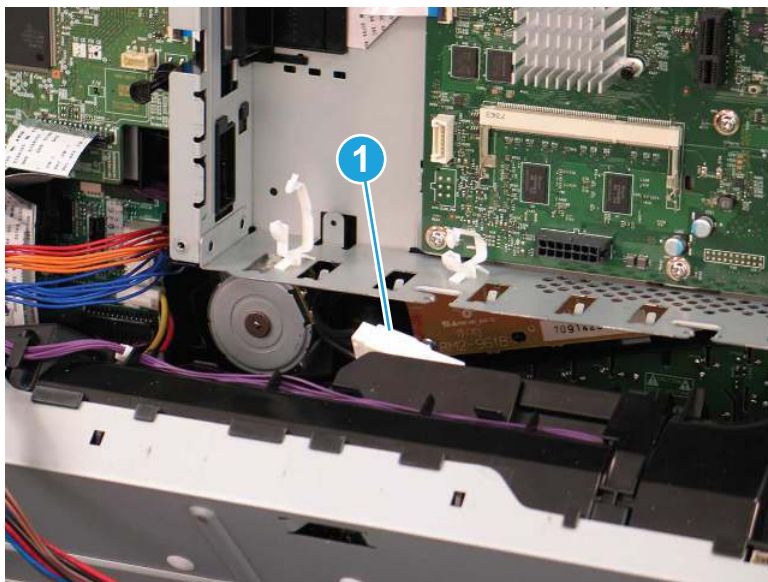
- b. Lift up on the LVPS, and then slightly rotate the top away from the printer. Disconnect four connectors (callout 1), and then release two retainers (callout 2). Press down on the latch to disconnect one connector (callout 3), and then release the wires through the hole (callout 4) in the formatter case.

Figure 1-1772 Disconnect five connectors



- c. Press down on the latch to disconnect one connector (callout 1), and then lift up to remove the LVPS.

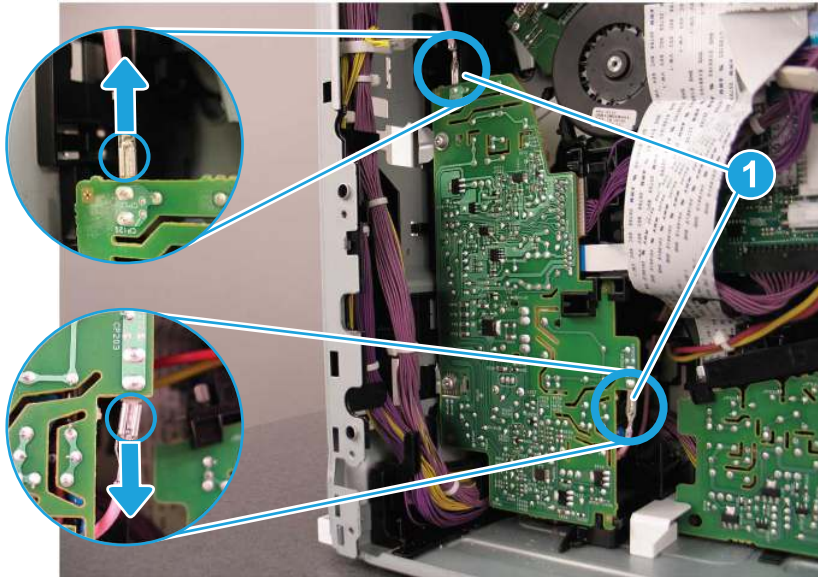
Figure 1-1773 Remove the LVPS



6. Remove the high-voltage power supply T2 (HVPS-T2).

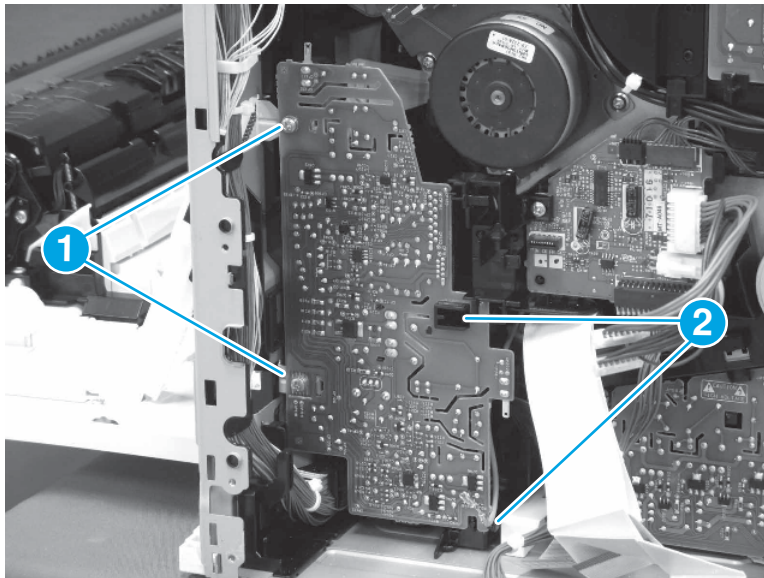
- a. Disconnect two connectors (callout 1). For each connector, press and hold the small release tab, and then slide the connector away from the board to disconnect it.

Figure 1-1774 Disconnect two connectors



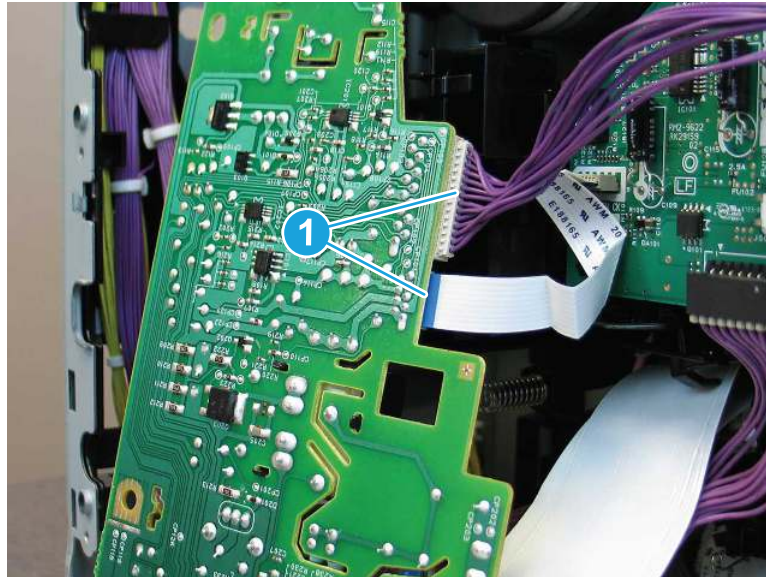
- b. Remove two screws (callout 1), and then release two tabs (callout 2).

Figure 1-1775 Remove two screws and release two tabs



- c. Rotate the HVPS-T2 slightly away from the printer, and then disconnect two connectors (callout 1) to remove it.

Figure 1-1776 Disconnect two connectors and remove the HVPS-T2



7. Unpack the replacement assembly.

- a. Dispose of the defective part.




NOTE: HP recommends responsible disposal of the defective part.

<http://www8.hp.com/us/en/hp-information/environment/product-recycling.html>

- b. Unpack the replacement part from the packaging.



CAUTION:  Some parts are sensitive to electrostatic discharge (ESD). Always perform service work at an ESD-protected workstation or mat. If an ESD workstation or mat is not available, touch the sheet-metal chassis to provide a static ground before touching an ESD-sensitive assembly. Protect the ESD-sensitive assemblies by placing them in ESD pouches when they are out of the printer.



IMPORTANT: Make sure that all of the shipping materials (for example shipping tape) are removed from the replacement part prior to installation.

- c. To install an assembly, reverse the removal steps.



NOTE: When applicable, special installation instructions are provided for an assembly at the end of the removal procedure. Always completely read the removal instructions and follow all special installation instructions.

Removal and replacement: High-voltage power supply T2 (M856/E85055/M776)

Learn how to remove and replace the high-voltage power supply T2 (HVPS-T2).

[View a video of how to remove and replace the high-voltage power supply T2.](#)

Mean time to repair: 36 minutes

Service level: Medium

Before performing service

Turn the printer power off

- Disconnect the power cable.

⚠ WARNING! To avoid damage to the printer, turn the printer off, wait 30 seconds, and then remove the power cord before attempting to service the printer.

Use the table below to identify the correct part number for your printer. To order the part, go to www.hp.com/buy/parts.

Table 1-95 Part information

Part number	Part description
RM2-9623-000CN	Second transfer high voltage PCB assembly

Required tools

- #2 Phillips screwdriver with a magnetic tip
- Small, flat-blade screwdriver

After performing service

Turn the printer power on

- Connect the power cable.
- Use the power switch to turn the power on.

Post service test

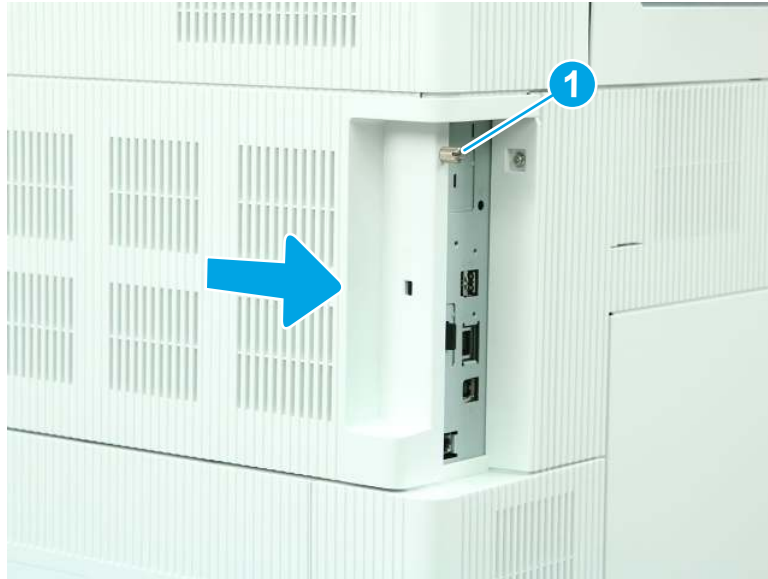
Make sure that the printer initializes to a **Ready** state.

Print a page to make sure that the printer is functioning correctly.

1. Remove the formatter cover.

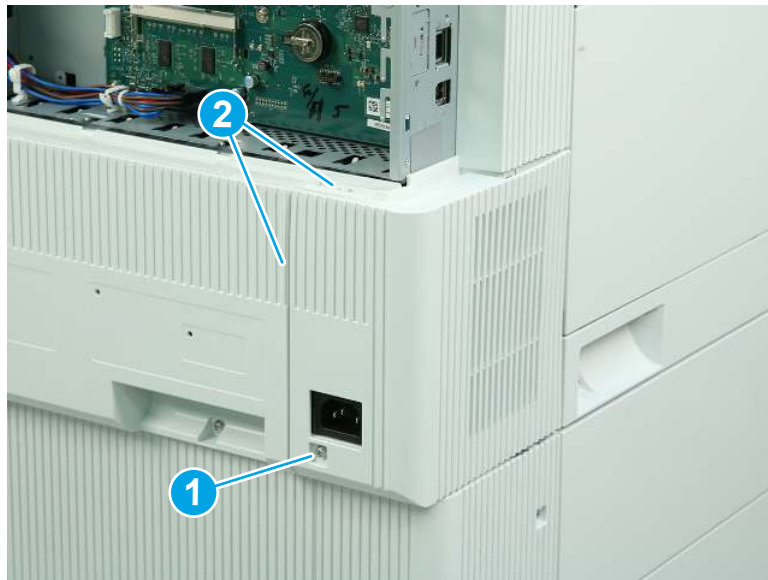
- ▲ Loosen one thumbscrew (callout 1), and then slide the formatter cover (callout 2) away from the printer to remove it.

Figure 1-1777 Remove the formatter cover



- 2. Remove the left lower cover (M856/E85055/M776).
 - a. Remove one screw (callout 1), and then release two tabs (callout 2).

Figure 1-1778 Remove one screw and release two tabs



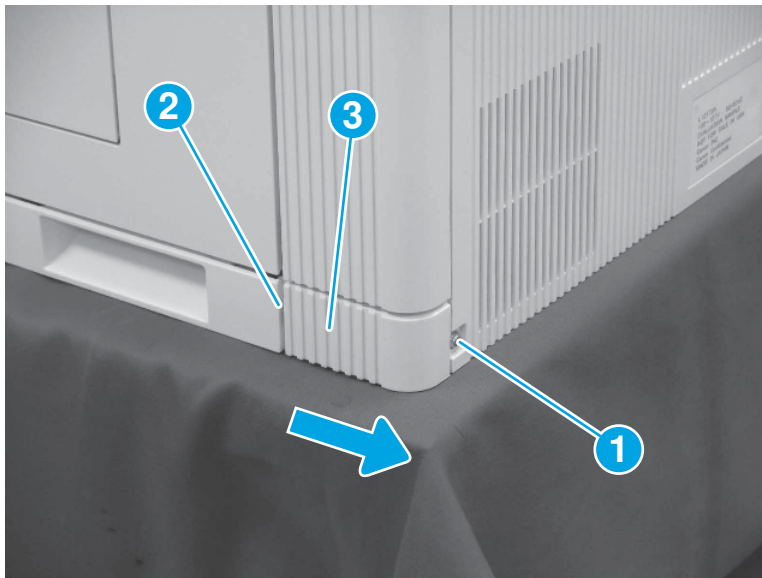
- b. Rotate the cover away from the printer to remove it.

Figure 1-1779 Remove the left lower cover



3. Remove the right rear lower cover (M751/E75245/M856/E85055/M776).
 - ▲ Remove one screw (callout 1), release one tab (callout 2), and then slide the right rear lower cover (callout 3) toward the back of the printer to remove it.

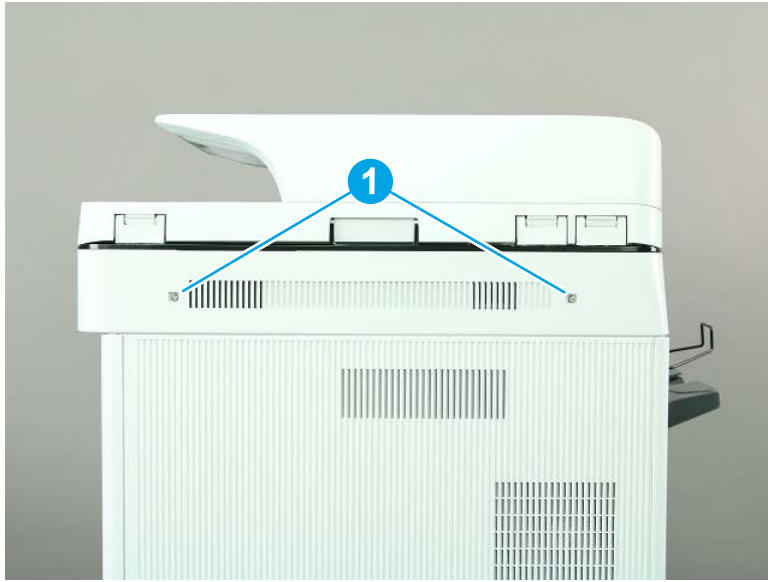
Figure 1-1780 Remove the right rear lower cover



4. Remove the scanner control board (SCB) cover (M776).

- a. Remove two screws (callout 1).

Figure 1-1781 Remove two screws



- b. Remove the SCB cover.

Figure 1-1782 Remove the SCB cover

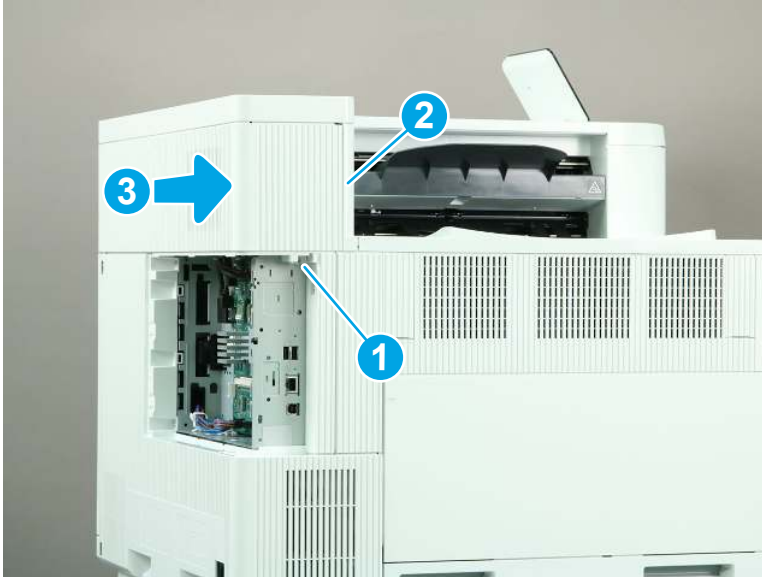


5. Remove the rear upper cover (M856/E85055/M776dn/M776z).

 **NOTE:** The following figure shows the M856 printer. The procedure is correct for all referenced models.

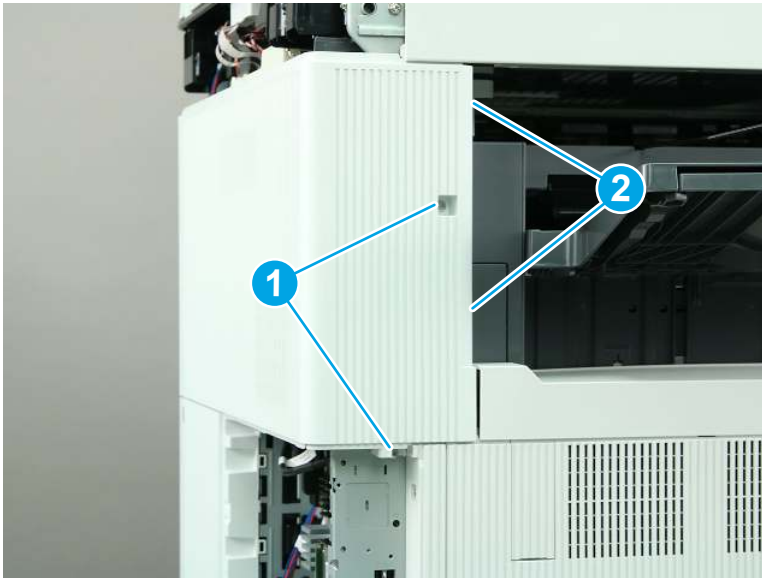
- ▲ Remove one screw (callout 1), release one tab (callout 2), and then slide the rear upper cover away from the printer to remove it (callout 3).

Figure 1-1783 Remove the rear upper cover



- 6. Remove the rear upper cover and left rear upper cover (M776zs).
 - a. Remove two screws (callout 1), and then release two tabs (callout 2).

Figure 1-1784 Remove two screws and release two tabs



- b. Slide the cover to the right to remove it.

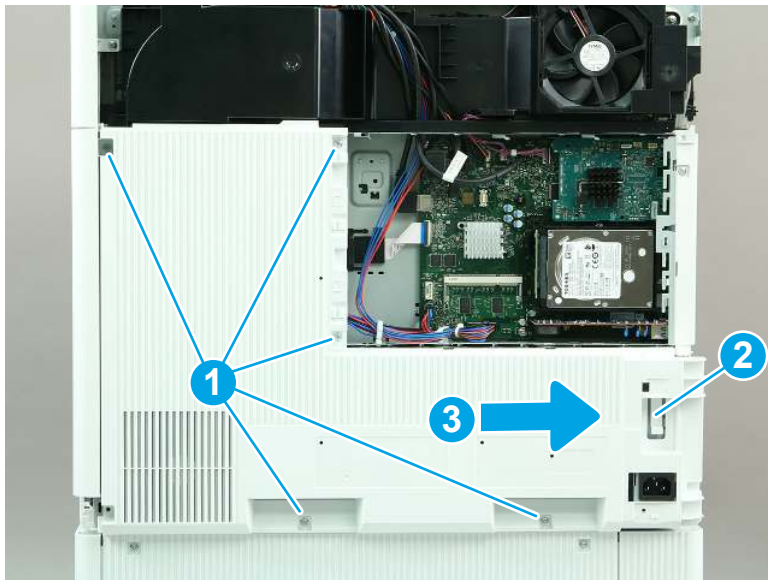
Figure 1-1785 Remove the rear upper and left rear upper cover



- 7. Remove the rear cover (M856/E85055/M776).

- ▲ Remove five screws (callout 1), release one tab (callout 2), and then slide the rear cover to the right to remove it.

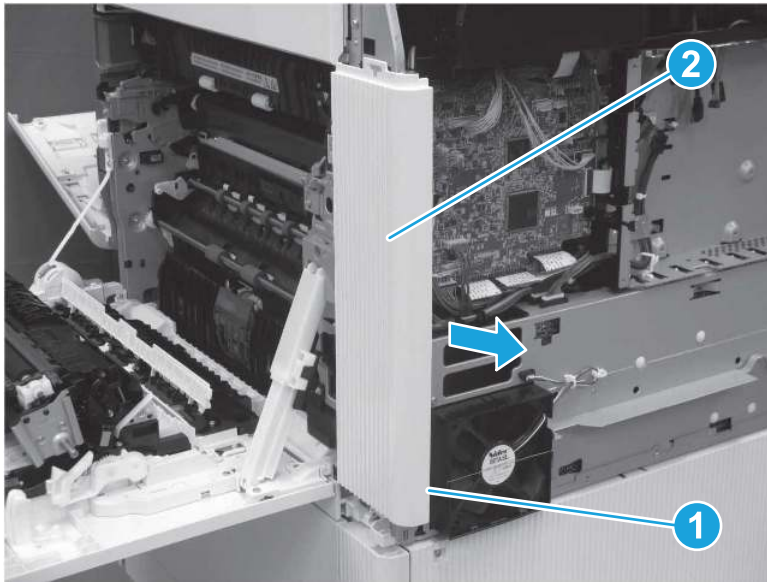
Figure 1-1786 Remove the rear cover (M856/E85055/M776)



- 8. Remove the right rear cover (M856/E85055/M776).

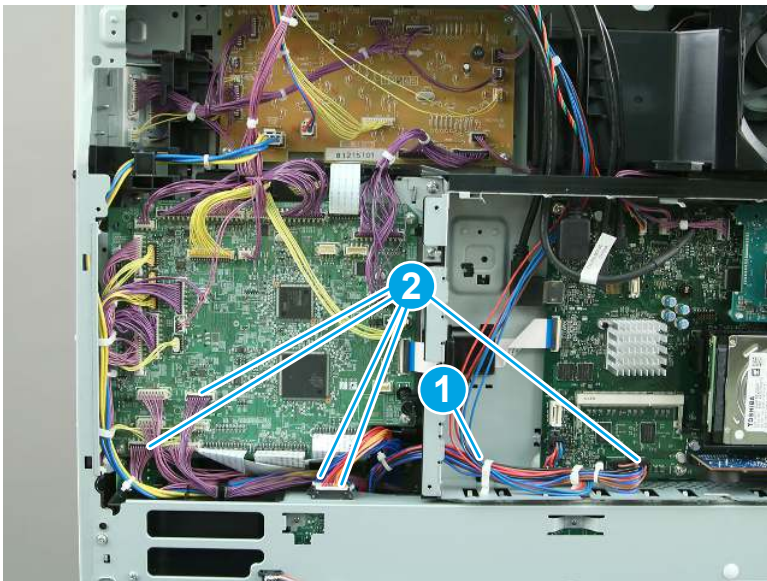
- ▲ Release one tab (callout 1), and then slide the rear cover away from the printer to remove it.

Figure 1-1787 Remove right rear cover



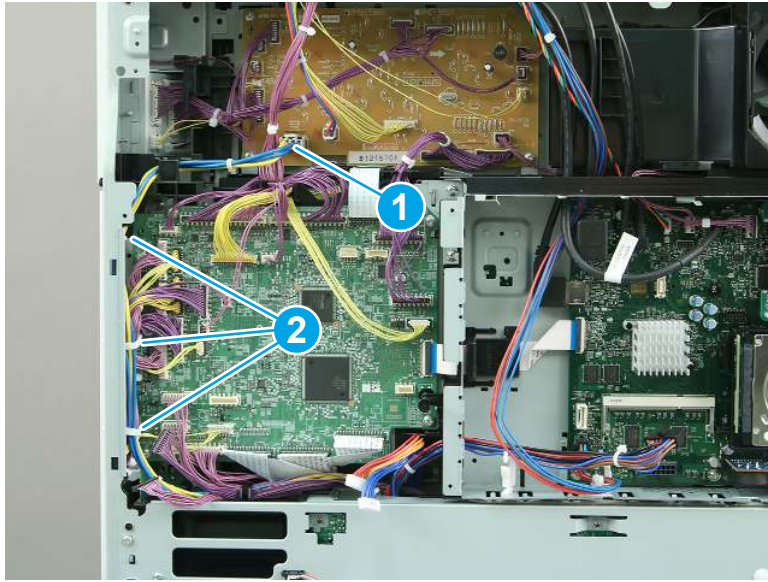
- 9. Remove the low-voltage power supply (LVPS) (M856/E85055/M776).
 - a. Release one retainer (callout 1), and then disconnect five connectors (callout 2).

Figure 1-1788 Release the retainer and disconnect five connectors



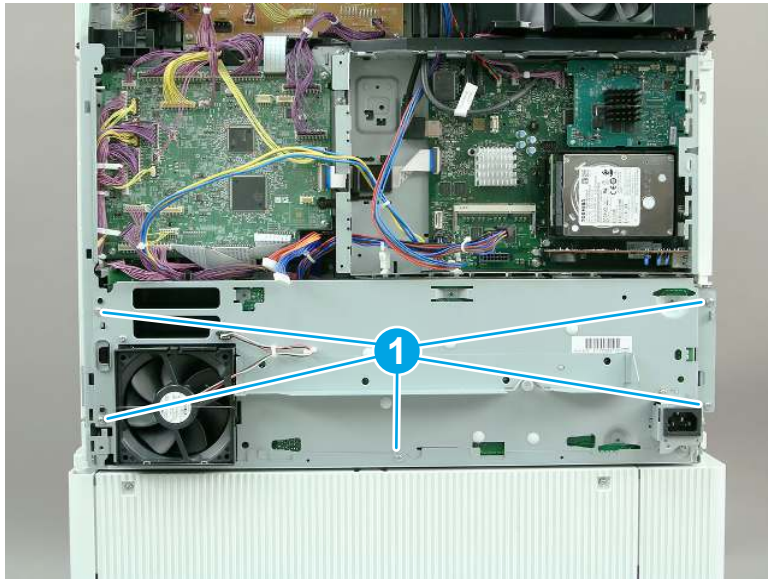
- b. Disconnect one connector (callout 1), and then release three retainers (callout 2).

Figure 1-1789 Disconnect one connector and release five retainers



- c. Remove five screws (callout 1).

Figure 1-1790 Remove five screws



- d. Tilt the LVPS away from the printer (callout 1). Thread the cable (callout 2) through the opening in the formatter case.

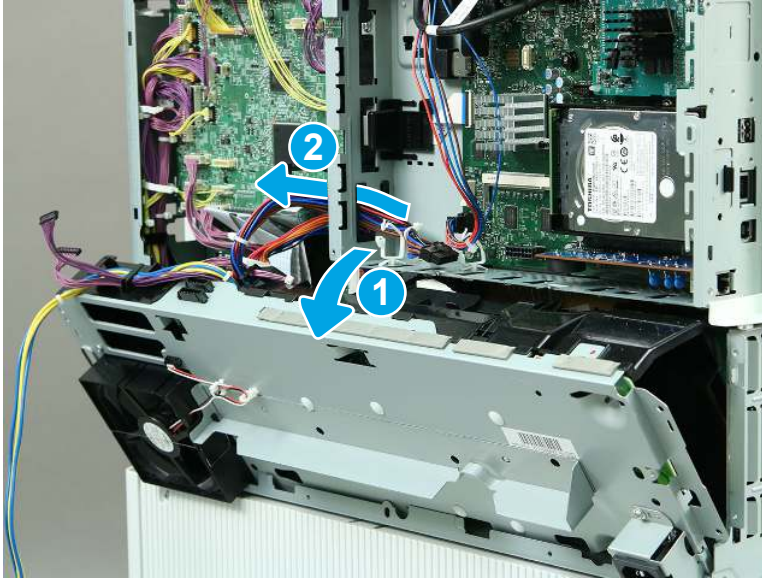


NOTE: Due to mechanical tolerances on the formatter cage, rotating the LVPS out might be difficult.



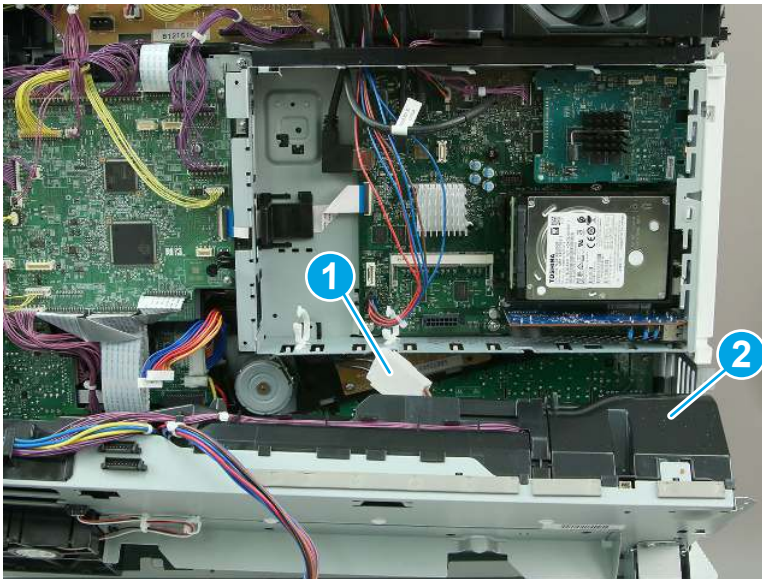
CAUTION: One connector is still connected, so tilt the LVPS carefully.

Figure 1-1791 Thread the cable



- e. Disconnect one connector (callout 1), and then lift up to remove the LVPS (callout 2).

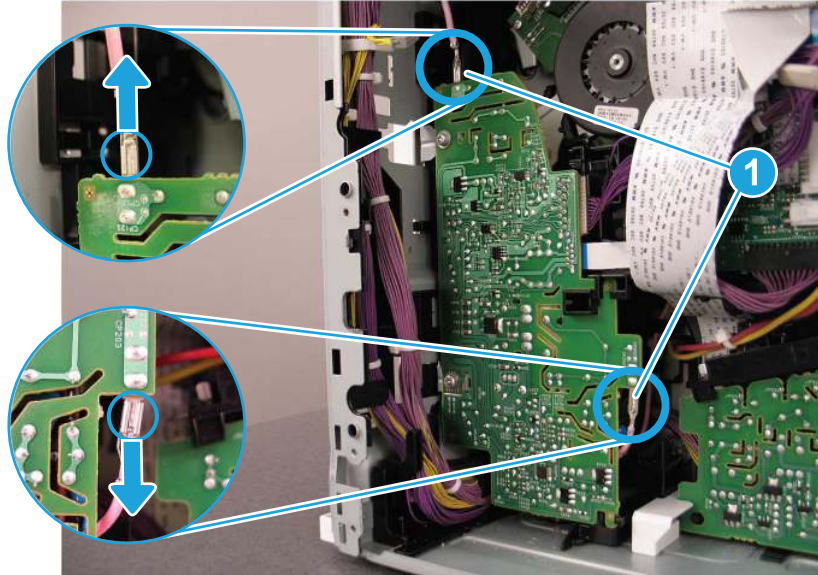
Figure 1-1792 Remove the LVPS



- 10. Remove the high-voltage power supply T2 (HVPS-T2).

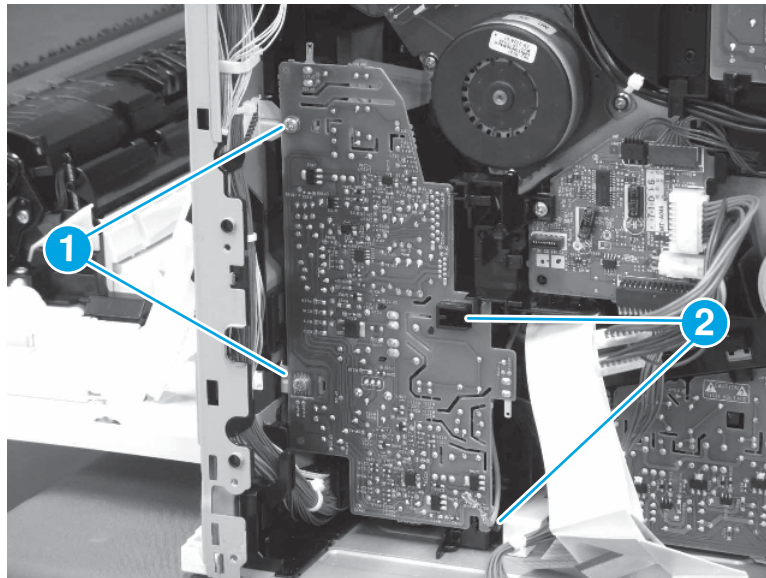
- a. Disconnect two connectors (callout 1). For each connector, press and hold the small release tab, and then slide the connector away from the board to disconnect it.

Figure 1-1793 Disconnect two connectors



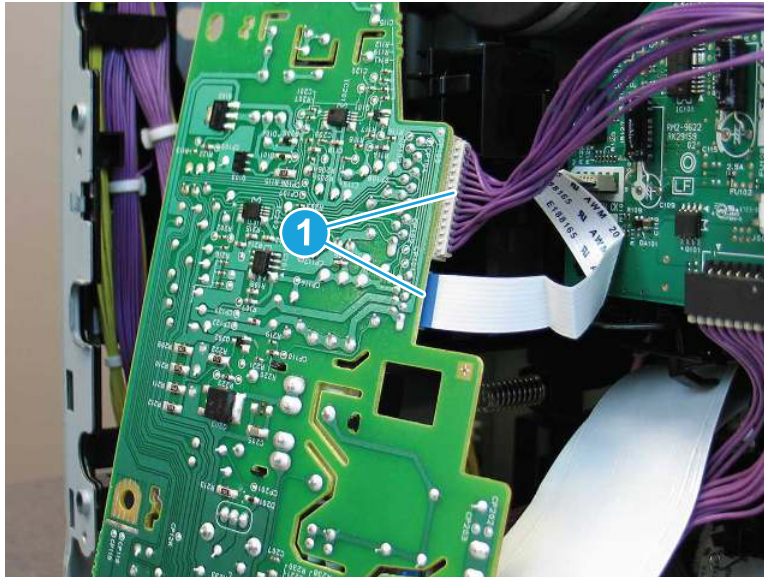
- b. Remove two screws (callout 1), and then release two tabs (callout 2).

Figure 1-1794 Remove two screws and release two tabs



- c. Rotate the HVPS-T2 slightly away from the printer, and then disconnect two connectors (callout 1) to remove it.

Figure 1-1795 Disconnect two connectors and remove the HVPS-T2



11. Unpack the replacement assembly.

- a. Dispose of the defective part.




NOTE: HP recommends responsible disposal of the defective part.

<http://www8.hp.com/us/en/hp-information/environment/product-recycling.html>

- b. Unpack the replacement part from the packaging.



CAUTION:  Some parts are sensitive to electrostatic discharge (ESD). Always perform service work at an ESD-protected workstation or mat. If an ESD workstation or mat is not available, touch the sheet-metal chassis to provide a static ground before touching an ESD-sensitive assembly. Protect the ESD-sensitive assemblies by placing them in ESD pouches when they are out of the printer.



IMPORTANT: Make sure that all of the shipping materials (for example shipping tape) are removed from the replacement part prior to installation.

- c. To install an assembly, reverse the removal steps.



NOTE: When applicable, special installation instructions are provided for an assembly at the end of the removal procedure. Always completely read the removal instructions and follow all special installation instructions.

Removal and replacement: T2 connecting PCA (M751/E75245)

Learn how to remove and replace the T2 connecting PCA.

[View a video of how to remove and replace the T2 connecting PCA.](#)

Mean time to repair: 36 minutes

Service level: Medium

Before performing service

Turn the printer power off

- Disconnect the power cable.

⚠ WARNING! To avoid damage to the printer, turn the printer off, wait 30 seconds, and then remove the power cord before attempting to service the printer.

Use the table below to identify the correct part number for your printer. To order the part, go to www.hp.com/buy/parts.

Table 1-96 Part information

Part number	Part description
RM2-9622-000CN	Connecting PCB assembly

Required tools

- #2 Phillips screwdriver with a magnetic tip
- Small, flat-blade screwdriver

After performing service

Turn the printer power on

- Connect the power cable.
- Use the power switch to turn the power on.

Post service test

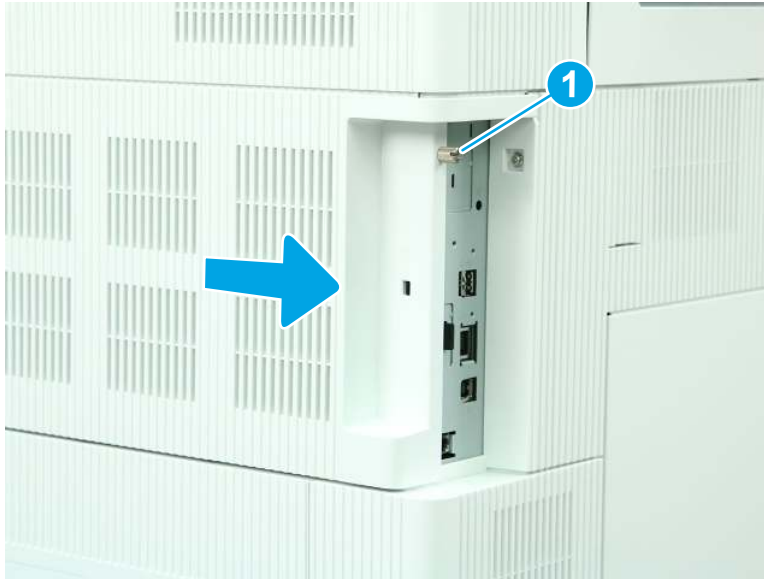
Make sure that the printer initializes to a **Ready** state.

Print a page to make sure that the printer is functioning correctly.

1. Remove the formatter cover.

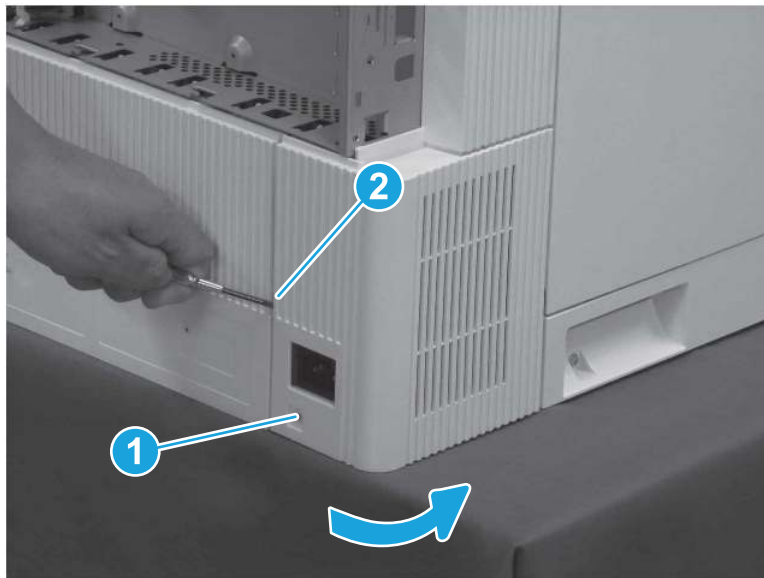
- ▲ Loosen one thumbscrew (callout 1), and then slide the formatter cover (callout 2) away from the printer to remove it.

Figure 1-1796 Remove the formatter cover



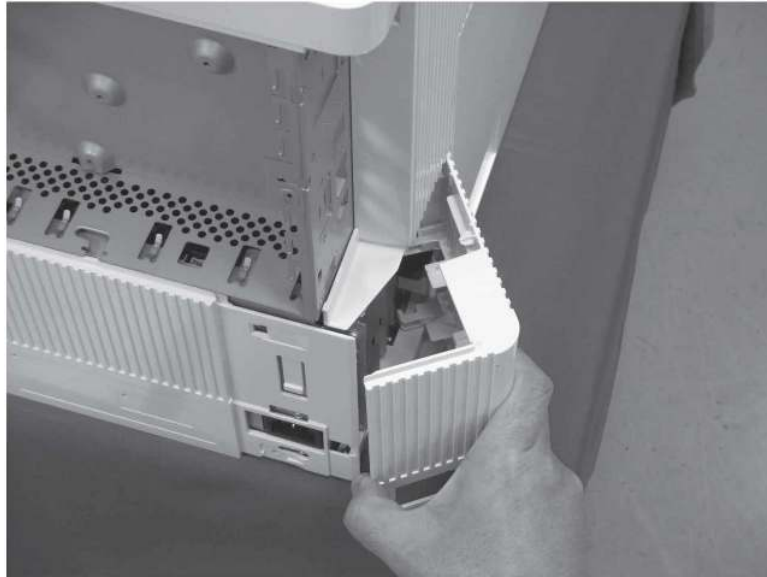
- 2. Remove the left lower cover (M751/E75245).
 - a. Remove one screw (callout 1), release one tab (callout 2), and then rotate the cover away from the printer.

Figure 1-1797 Remove one screw and release one tab



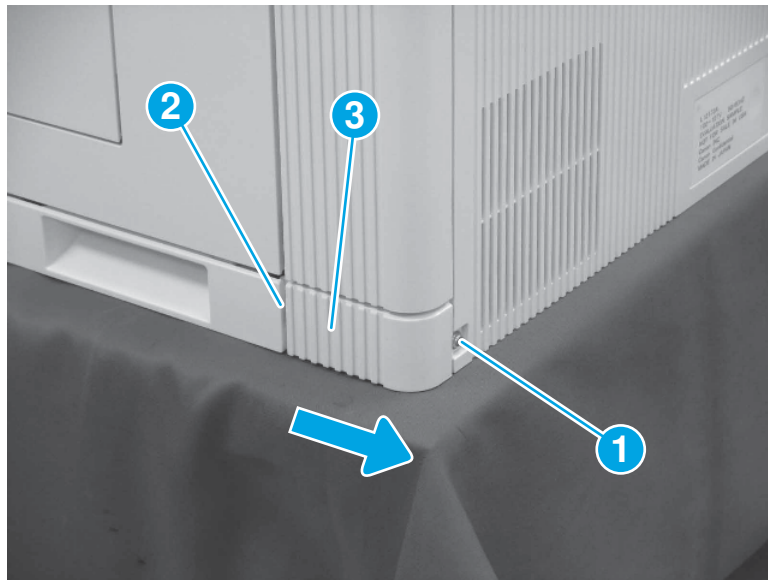
- b. Remove the left lower cover.

Figure 1-1798 Remove the left lower cover



3. Remove the right rear lower cover (M751/E75245/M856/E85055/M776).
 - ▲ Remove one screw (callout 1), release one tab (callout 2), and then slide the right rear lower cover (callout 3) toward the back of the printer to remove it.

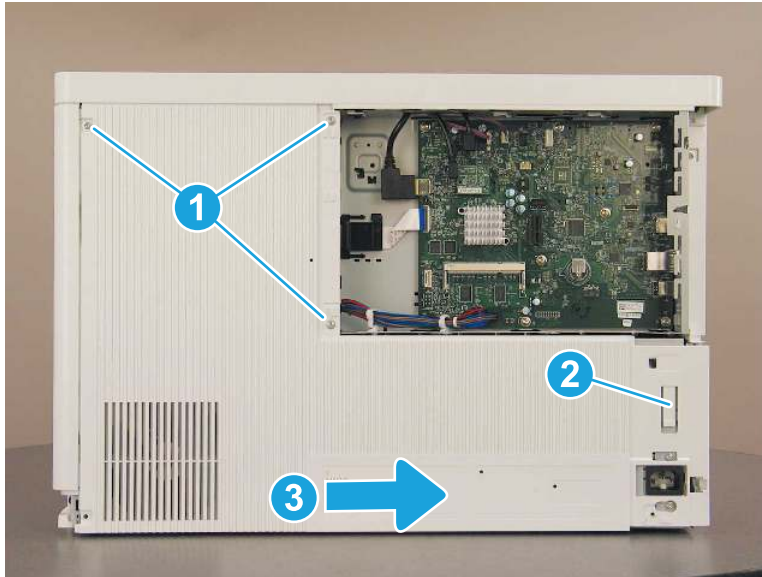
Figure 1-1799 Remove the right rear lower cover



4. Remove the rear cover (M751/E75245).

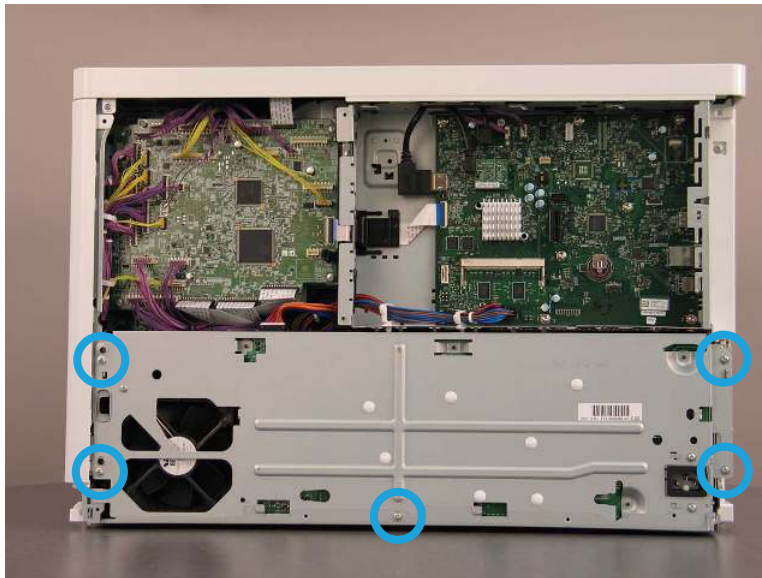
- ▲ Remove three screws (callout 1), release one tab (callout 2), and then slide the rear cover to the right (callout 3) to remove it.

Figure 1-1800 Remove the rear cover



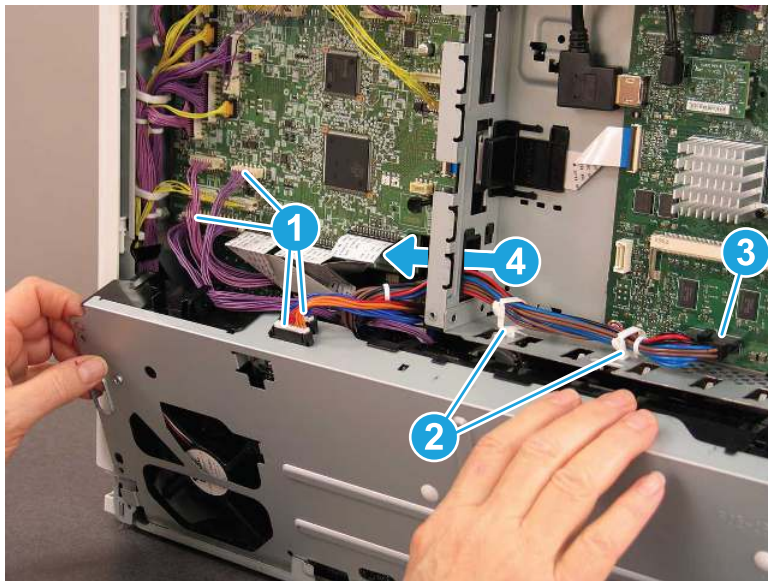
- 5. Remove the low-voltage power supply (LVPS).
 - a. Remove five screws.

Figure 1-1801 Remove five screws



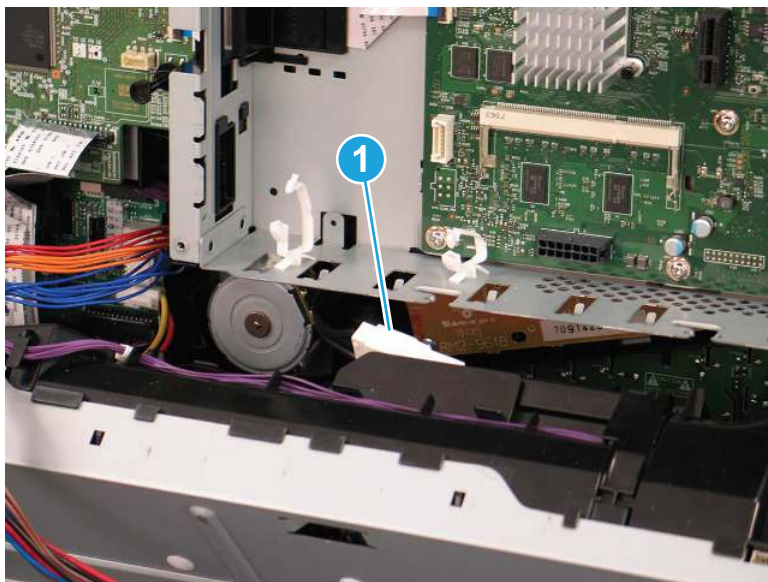
- b. Lift up on the LVPS, and then slightly rotate the top away from the printer. Disconnect four connectors (callout 1), and then release two retainers (callout 2). Press down on the latch to disconnect one connector (callout 3), and then release the wires through the hole (callout 4) in the formatter case.

Figure 1-1802 Disconnect five connectors



- c. Press down on the latch to disconnect one connector (callout 1), and then lift up to remove the LVPS.

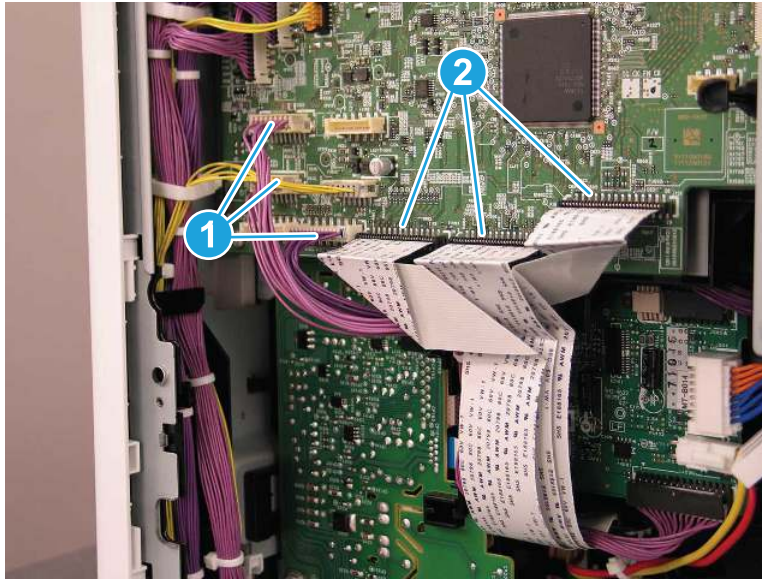
Figure 1-1803 Remove the LVPS



6. Remove the T2 connecting PCA.

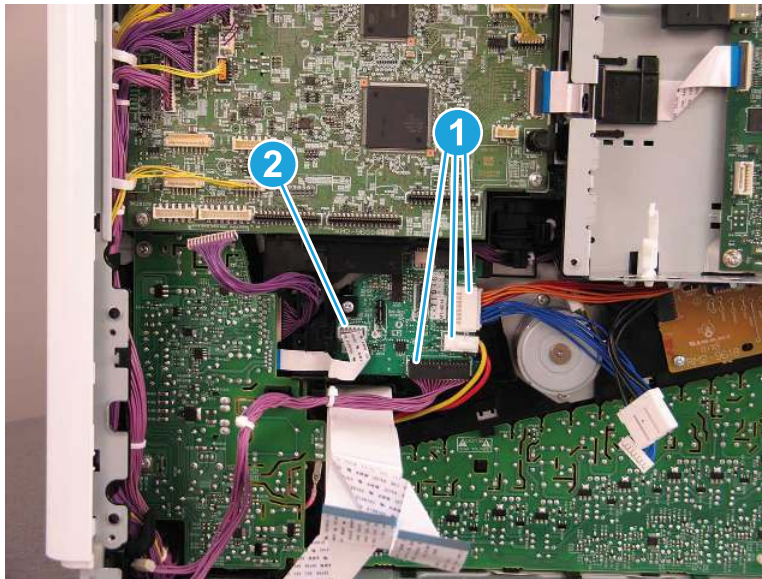
- a. Disconnect three connectors (callout 1), and then disconnect three flat cables (callout 2).

Figure 1-1804 Disconnect six connectors



- b. Disconnect three connectors (callout 1), and then disconnect one flat cable (callout 2).

Figure 1-1805 Disconnect three connectors and one flat cable



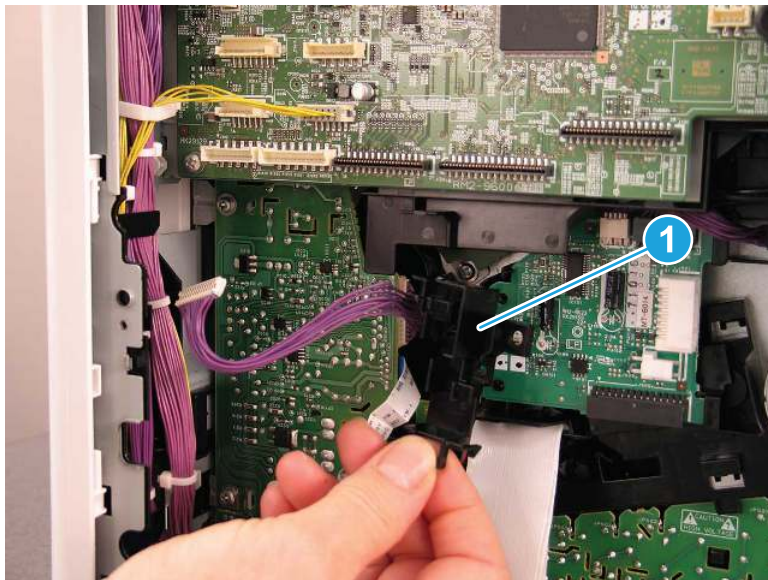
- c. Remove one screw (callout 1).

Figure 1-1806 Remove one screw



- d. Remove the cable guide (callout 1). If the cable guide is lost or damaged during the repair procedure, order a replacement part and install it along with the replacement T2 connecting PCA.

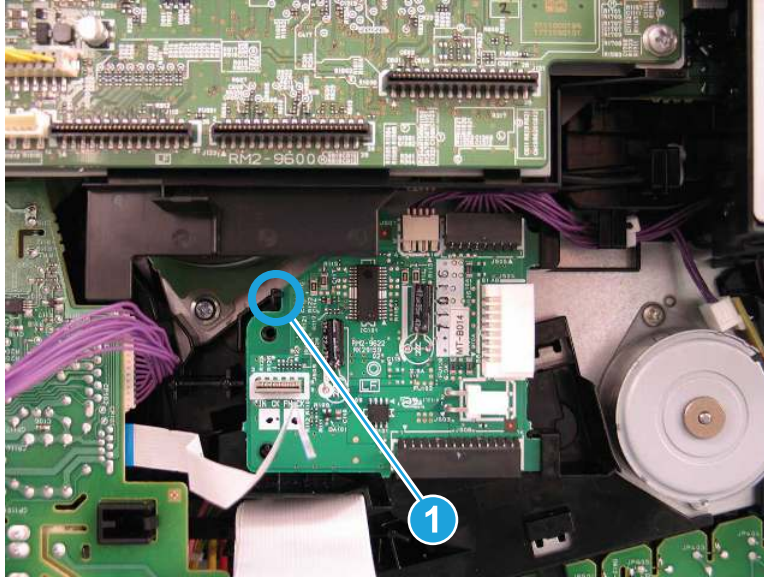
Figure 1-1807 Remove the cable guide



- e. Release one tab (callout 1), and then pull the T2 connecting PCA slightly away from the printer.

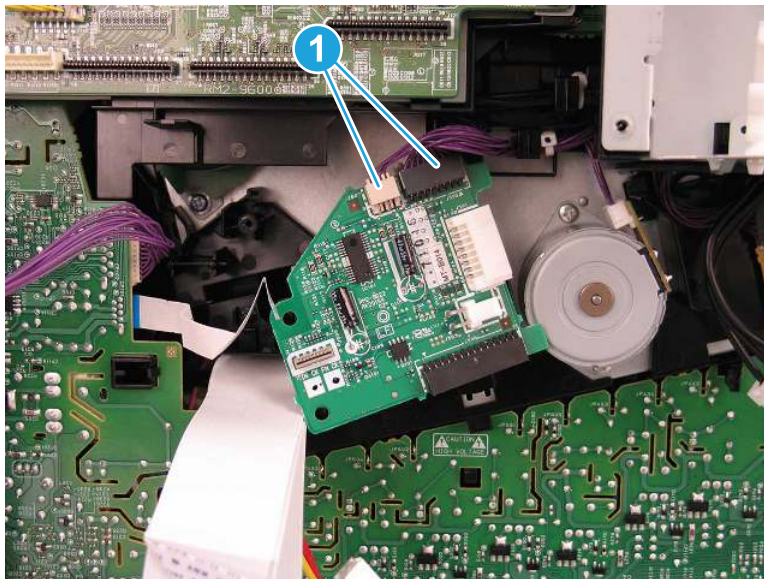
⚠ CAUTION: The T2 connecting PCA is still attached to the printer. Do not attempt to remove it completely.

Figure 1-1808 Release one tab



- f. Disconnect two connectors (callout 1), and then remove the T2 connecting PCA (callout 2).

Figure 1-1809 Disconnect two connectors and remove the PCA



- 7. Unpack the replacement assembly.
 - a. Dispose of the defective part.




NOTE: HP recommends responsible disposal of the defective part.


<http://www8.hp.com/us/en/hp-information/environment/product-recycling.html>

- b. Unpack the replacement part from the packaging.




CAUTION:  Some parts are sensitive to electrostatic discharge (ESD). Always perform service work at an ESD-protected workstation or mat. If an ESD workstation or mat is not available, touch the

sheet-metal chassis to provide a static ground before touching an ESD-sensitive assembly. Protect the ESD-sensitive assemblies by placing them in ESD pouches when they are out of the printer.

 **IMPORTANT:** Make sure that all of the shipping materials (for example shipping tape) are removed from the replacement part prior to installation.

c. To install an assembly, reverse the removal steps.

 **NOTE:** When applicable, special installation instructions are provided for an assembly at the end of the removal procedure. Always completely read the removal instructions and follow all special installation instructions.

Removal and replacement: T2 connecting PCA (M856/E85055/M776)

Learn how to remove and replace the T2 connecting PCA.

[View a video of how to remove and replace the T2 connecting PCA.](#)


Mean time to repair: 36 minutes

Service level: Medium

Before performing service

Turn the printer power off

- Disconnect the power cable.

 **WARNING!** To avoid damage to the printer, turn the printer off, wait 30 seconds, and then remove the power cord before attempting to service the printer.

Use the table below to identify the correct part number for your printer. To order the part, go to www.hp.com/buy/parts.

Table 1-97 Part information

Part number	Part description
RM2-9622-000CN	Connecting PCB assembly

Required tools

- #2 Phillips screwdriver with a magnetic tip
- Small, flat-blade screwdriver

After performing service

Turn the printer power on

- Connect the power cable.
- Use the power switch to turn the power on.

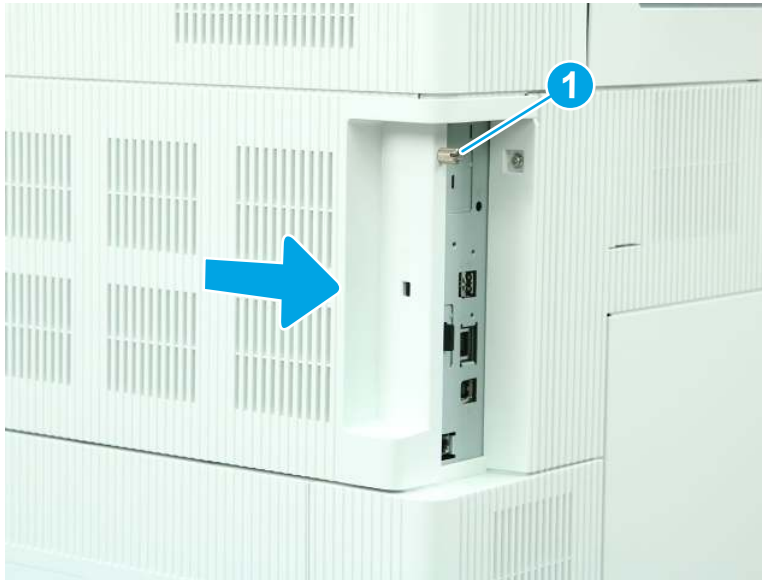
Post service test

Make sure that the printer initializes to a **Ready** state.

Print a page to make sure that the printer is functioning correctly.

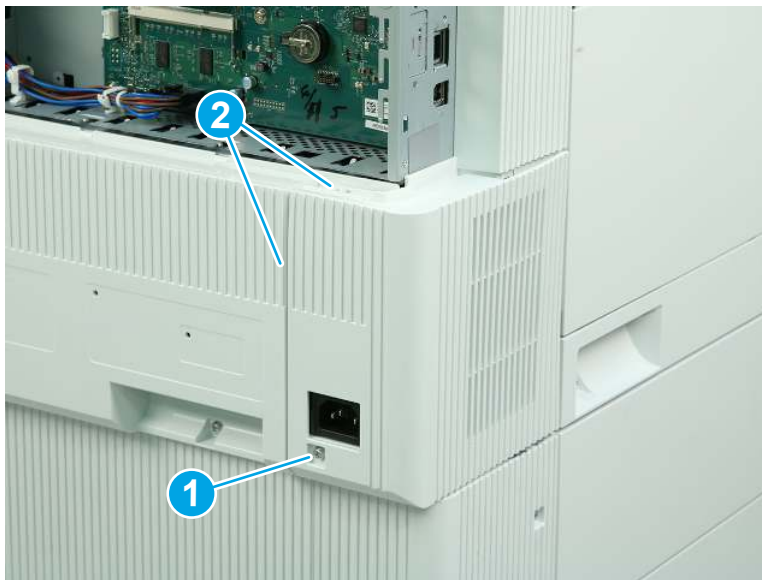
1. Remove the formatter cover.
 - ▲ Loosen one thumbscrew (callout 1), and then slide the formatter cover (callout 2) away from the printer to remove it.

Figure 1-1810 Remove the formatter cover



2. Remove the left lower cover (M856/E85055/M776).
 - a. Remove one screw (callout 1), and then release two tabs (callout 2).

Figure 1-1811 Remove one screw and release two tabs



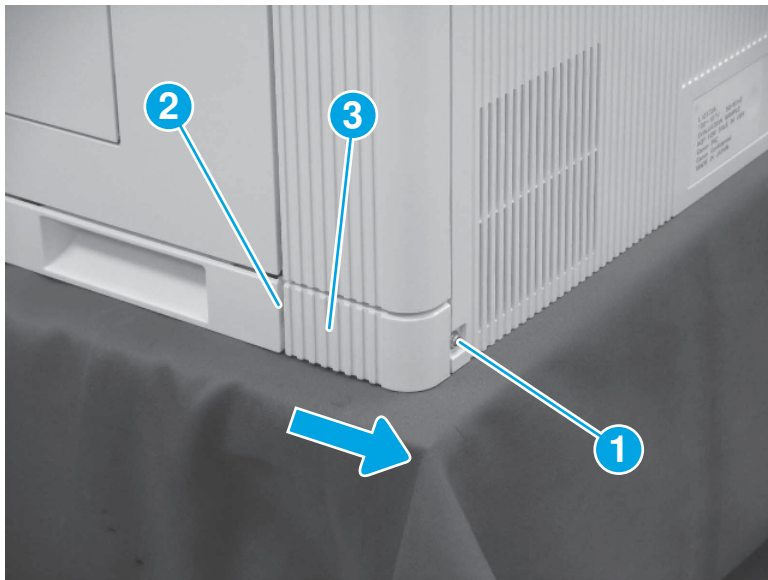
- b. Rotate the cover away from the printer to remove it.

Figure 1-1812 Remove the left lower cover



- 3. Remove the right rear lower cover (M751/E75245/M856/E85055/M776).
 - ▲ Remove one screw (callout 1), release one tab (callout 2), and then slide the right rear lower cover (callout 3) toward the back of the printer to remove it.

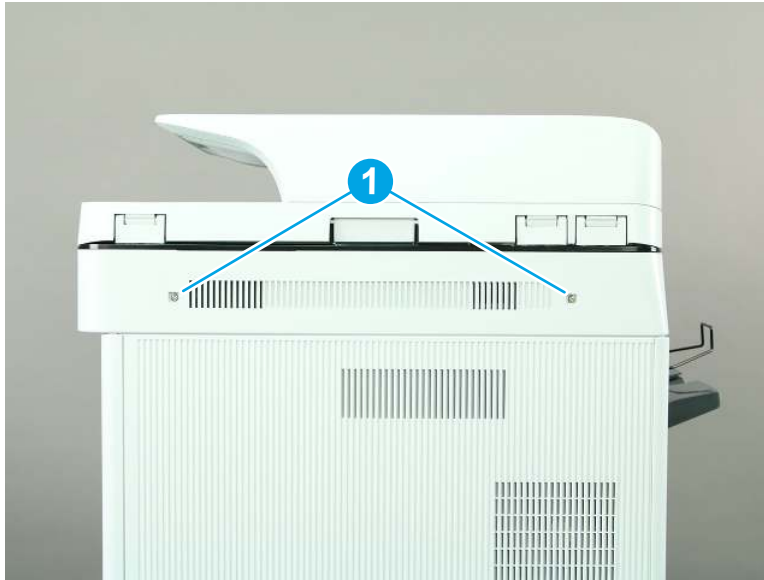
Figure 1-1813 Remove the right rear lower cover



- 4. Remove the scanner control board (SCB) cover (M776).

- a. Remove two screws (callout 1).

Figure 1-1814 Remove two screws



- b. Remove the SCB cover.

Figure 1-1815 Remove the SCB cover



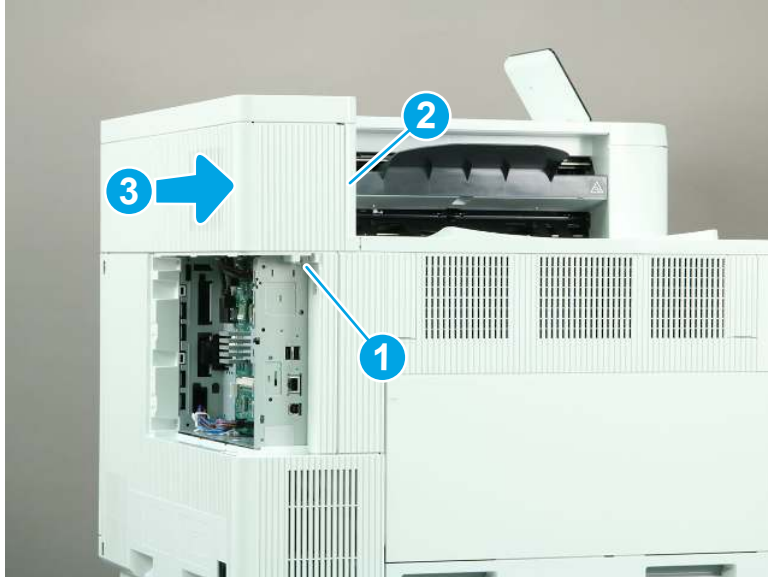
5. Remove the rear upper cover (M856/E85055/M776dn/M776z).



NOTE: The following figure shows the M856 printer. The procedure is correct for all referenced models.

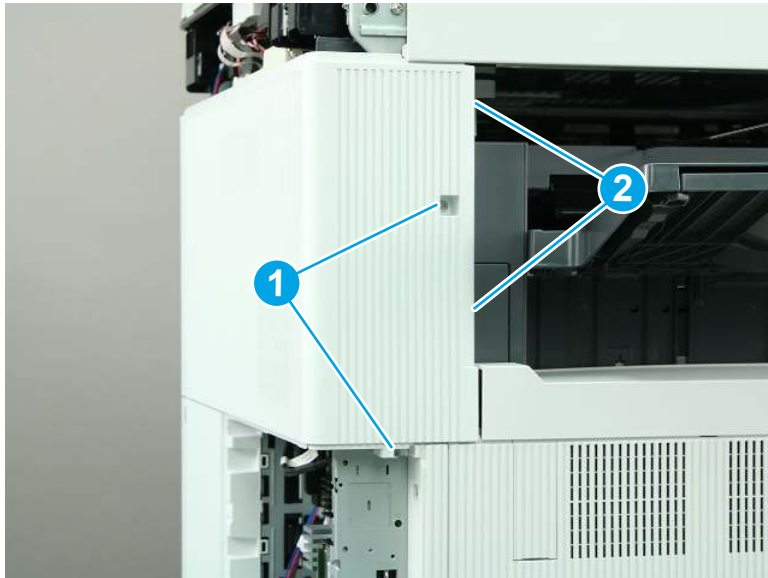
- ▲ Remove one screw (callout 1), release one tab (callout 2), and then slide the rear upper cover away from the printer to remove it (callout 3).

Figure 1-1816 Remove the rear upper cover



- 6. Remove the rear upper cover and left rear upper cover (M776zs).
 - a. Remove two screws (callout 1), and then release two tabs (callout 2).

Figure 1-1817 Remove two screws and release two tabs



- b. Slide the cover to the right to remove it.

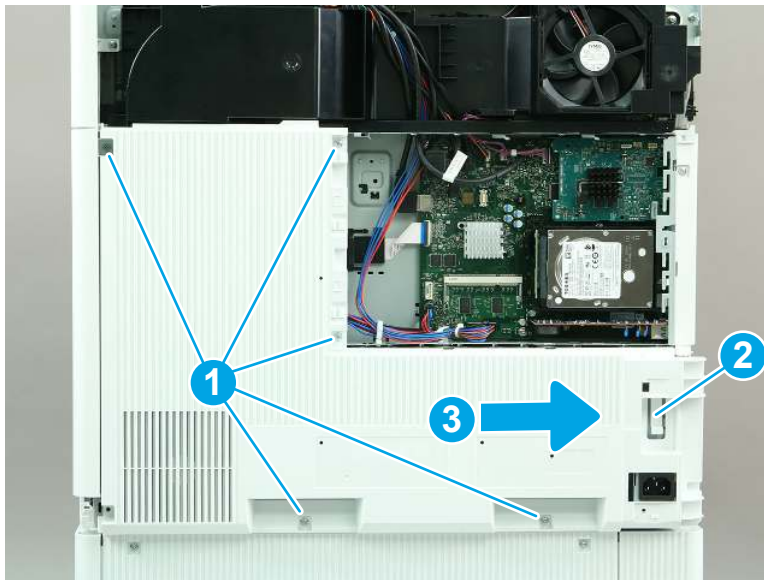
Figure 1-1818 Remove the rear upper and left rear upper cover



- 7. Remove the rear cover (M856/E85055/M776).

- ▲ Remove five screws (callout 1), release one tab (callout 2), and then slide the rear cover to the right to remove it.

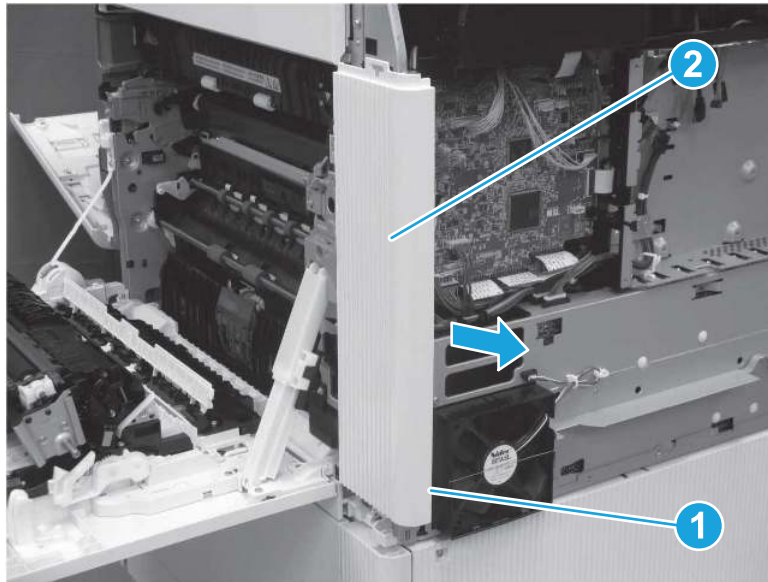
Figure 1-1819 Remove the rear cover (M856/E85055/M776)



- 8. Remove the right rear cover (M856/E85055/M776).

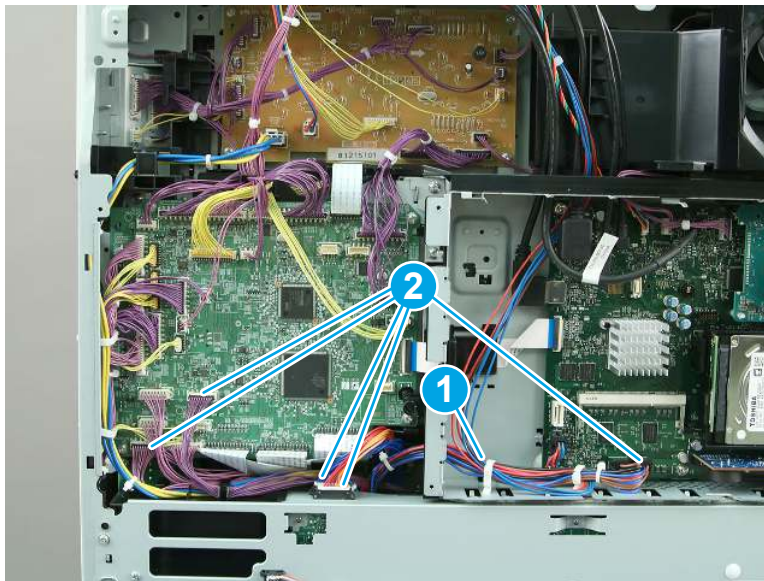
- ▲ Release one tab (callout 1), and then slide the rear cover away from the printer to remove it.

Figure 1-1820 Remove right rear cover



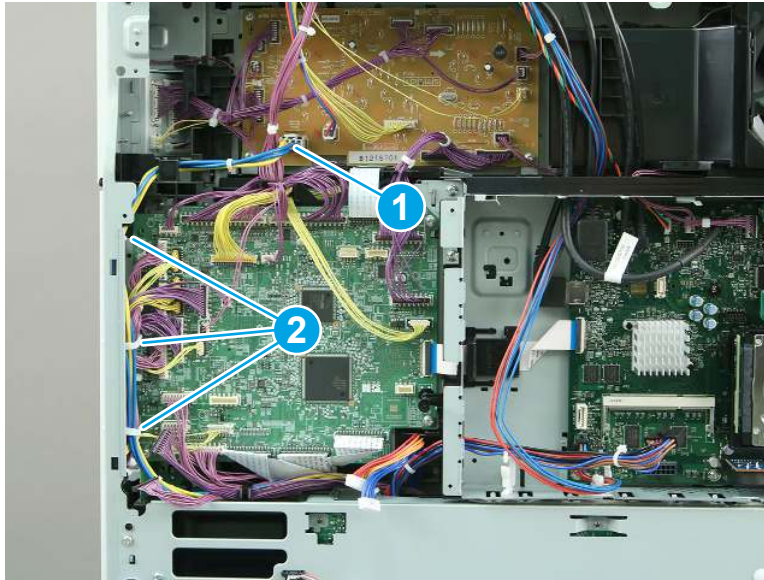
- 9. Remove the low-voltage power supply (LVPS) (M856/E85055/M776).
 - a. Release one retainer (callout 1), and then disconnect five connectors (callout 2).

Figure 1-1821 Release the retainer and disconnect five connectors



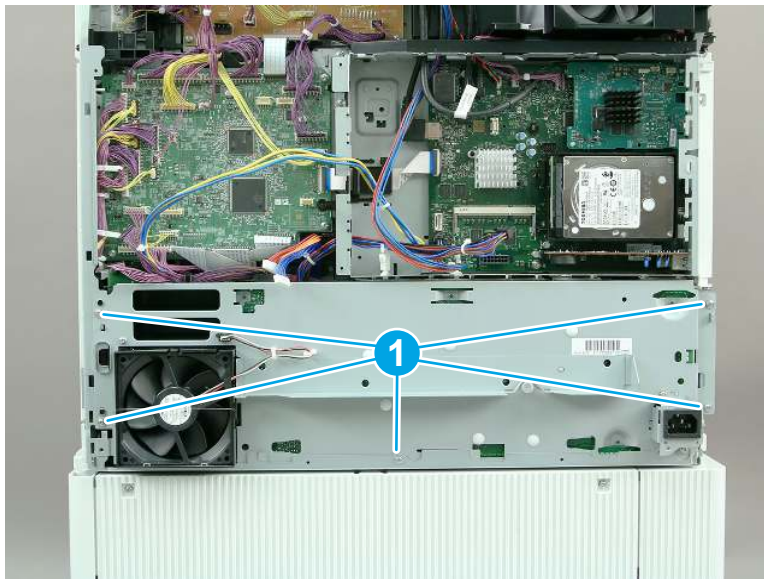
- b. Disconnect one connector (callout 1), and then release three retainers (callout 2).

Figure 1-1822 Disconnect one connector and release five retainers




- c. Remove five screws (callout 1).

Figure 1-1823 Remove five screws



- d. Tilt the LVPS away from the printer (callout 1). Thread the cable (callout 2) through the opening in the formatter case.

 **NOTE:** Due to mechanical tolerances on the formatter cage, rotating the LVPS out might be difficult.


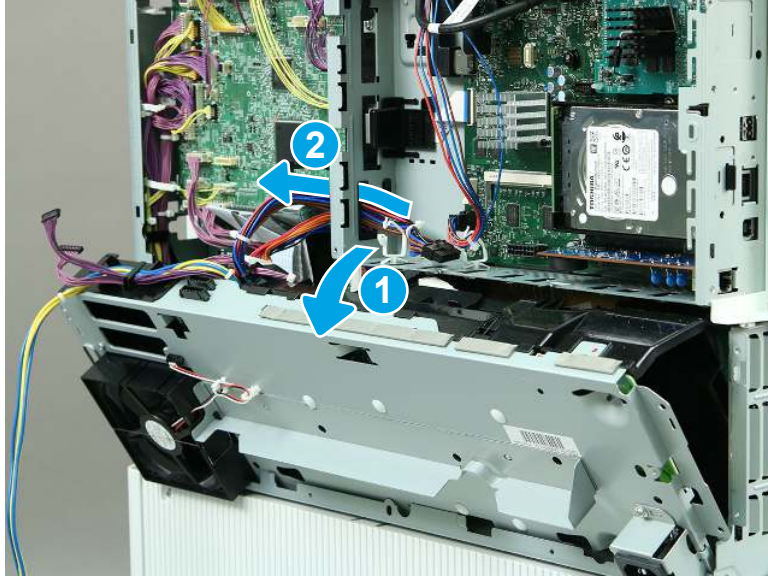
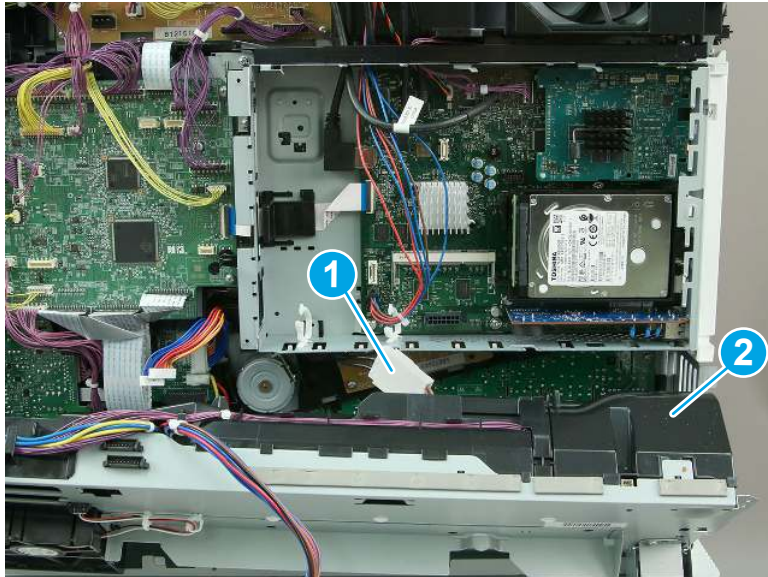
 **CAUTION:** One connector is still connected, so tilt the LVPS carefully.

Figure 1-1824 Thread the cable



- e. Disconnect one connector (callout 1), and then lift up to remove the LVPS (callout 2).

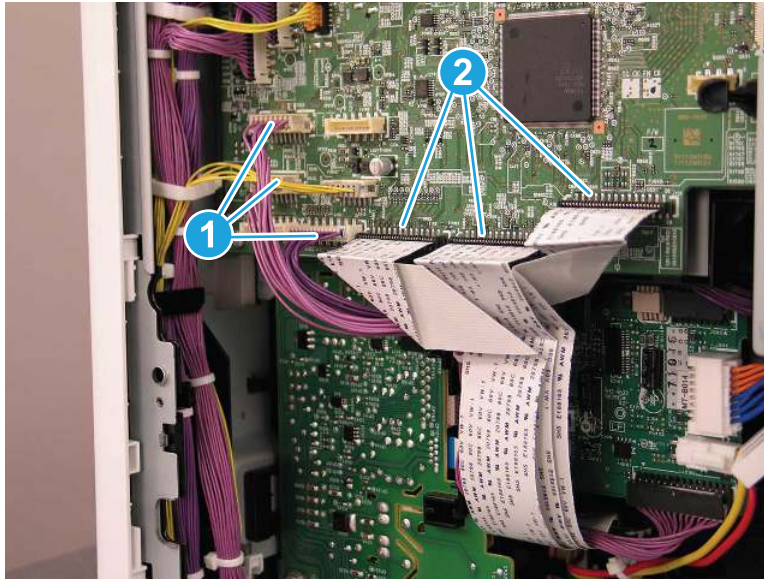
Figure 1-1825 Remove the LVPS



- 10. Remove the T2 connecting PCA.

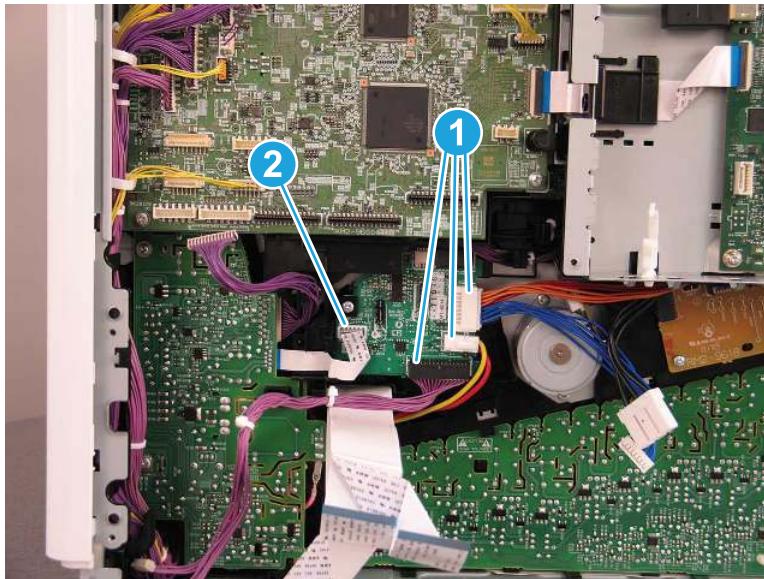
- a. Disconnect three connectors (callout 1), and then disconnect three flat cables (callout 2).

Figure 1-1826 Disconnect six connectors



- b. Disconnect three connectors (callout 1), and then disconnect one flat cable (callout 2).

Figure 1-1827 Disconnect three connectors and one flat cable



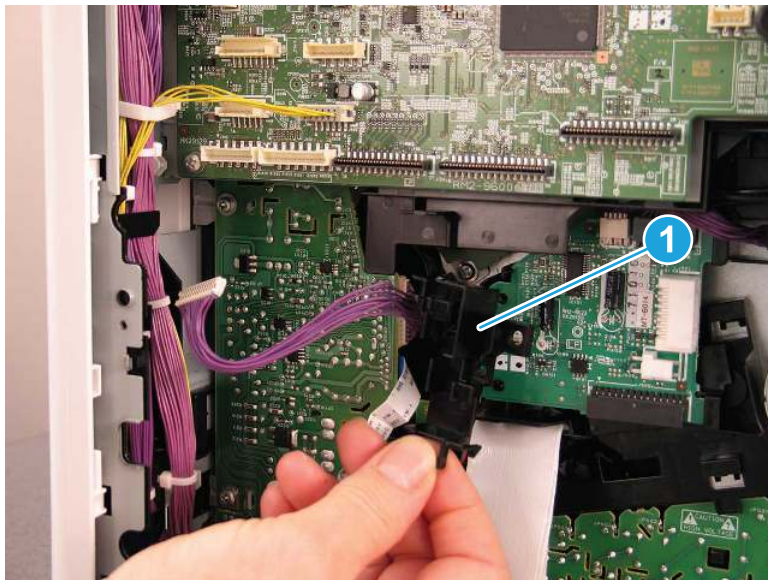
- c. Remove one screw (callout 1).

Figure 1-1828 Remove one screw



- d. Remove the cable guide (callout 1). If the cable guide is lost or damaged during the repair procedure, order a replacement part and install it along with the replacement T2 connecting PCA.

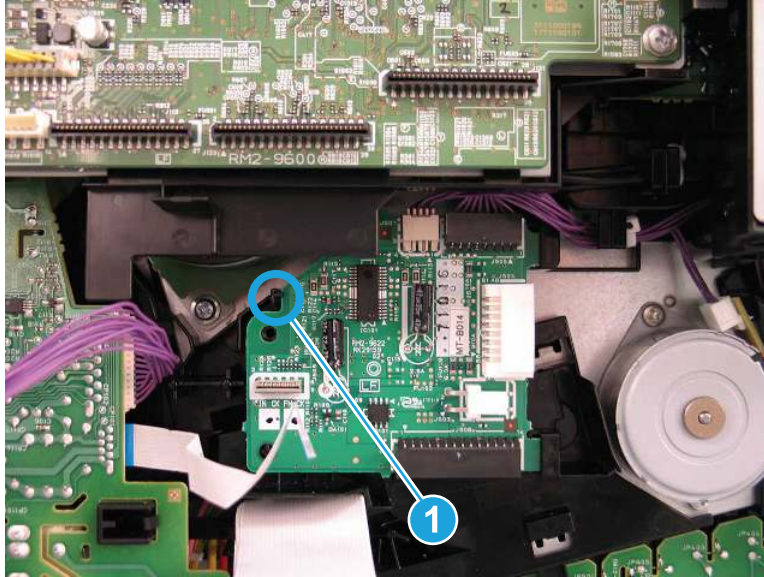
Figure 1-1829 Remove the cable guide



- e. Release one tab (callout 1), and then pull the T2 connecting PCA slightly away from the printer.

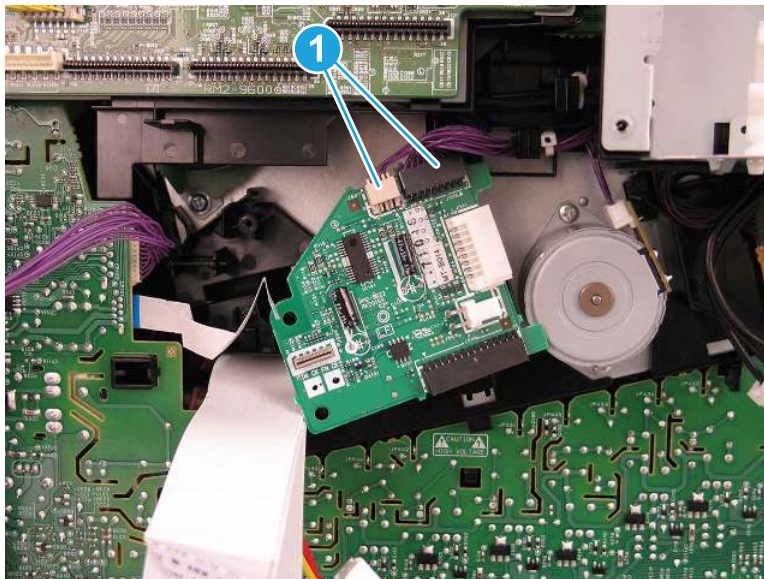
⚠ CAUTION: The T2 connecting PCA is still attached to the printer. Do not attempt to remove it completely.

Figure 1-1830 Release one tab



- f. Disconnect two connectors (callout 1), and then remove the T2 connecting PCA (callout 2).

Figure 1-1831 Disconnect two connectors and remove the PCA



- 11. Unpack the replacement assembly.
 - a. Dispose of the defective part.



NOTE: HP recommends responsible disposal of the defective part.


<http://www8.hp.com/us/en/hp-information/environment/product-recycling.html>

- b. Unpack the replacement part from the packaging.




CAUTION:  Some parts are sensitive to electrostatic discharge (ESD). Always perform service work at an ESD-protected workstation or mat. If an ESD workstation or mat is not available, touch the

sheet-metal chassis to provide a static ground before touching an ESD-sensitive assembly. Protect the ESD-sensitive assemblies by placing them in ESD pouches when they are out of the printer.

 **IMPORTANT:** Make sure that all of the shipping materials (for example shipping tape) are removed from the replacement part prior to installation.

c. To install an assembly, reverse the removal steps.

 **NOTE:** When applicable, special installation instructions are provided for an assembly at the end of the removal procedure. Always completely read the removal instructions and follow all special installation instructions.

Removal and replacement: Environmental sensor PCA (M751/E75245)

Learn how to remove and replace the environmental sensor PCA.

[View a video of how to remove and replace the environmental sensor PCA.](#)


Mean time to repair: 14 minutes

Service level: Easy

Before performing service

Turn the printer power off

- Disconnect the power cable.

 **WARNING!** To avoid damage to the printer, turn the printer off, wait 30 seconds, and then remove the power cord before attempting to service the printer.

Use the table below to identify the correct part number for your printer. To order the part, go to www.hp.com/buy/parts.

Table 1-98 Part information

Part number	Part description
RM2-9620-000CN	Environmental sensor PCB assembly

Required tools

- #2 Phillips screwdriver with a magnetic tip
- Small, flat-blade screwdriver

After performing service

Turn the printer power on

- Connect the power cable.
- Use the power switch to turn the power on.

Post service test

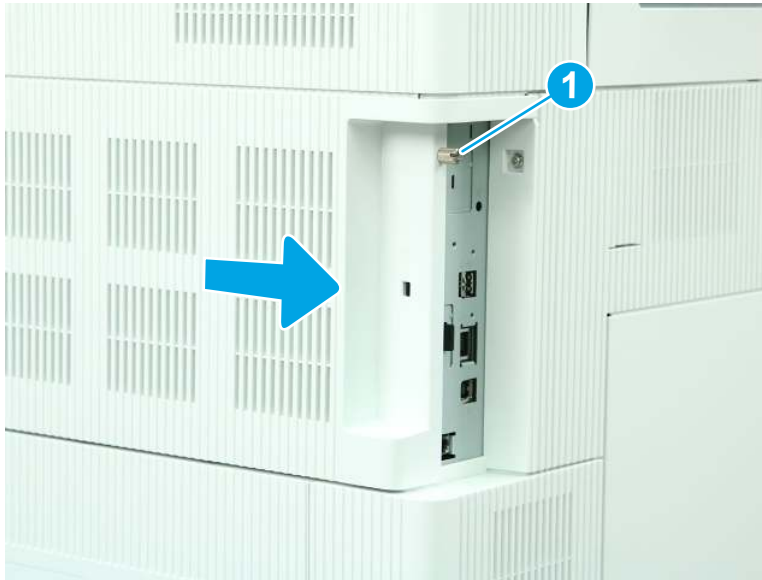
Make sure that the printer initializes to a **Ready** state.

Print a page to make sure that the printer is functioning correctly.

1. Remove the formatter cover.

- ▲ Loosen one thumbscrew (callout 1), and then slide the formatter cover (callout 2) away from the printer to remove it.

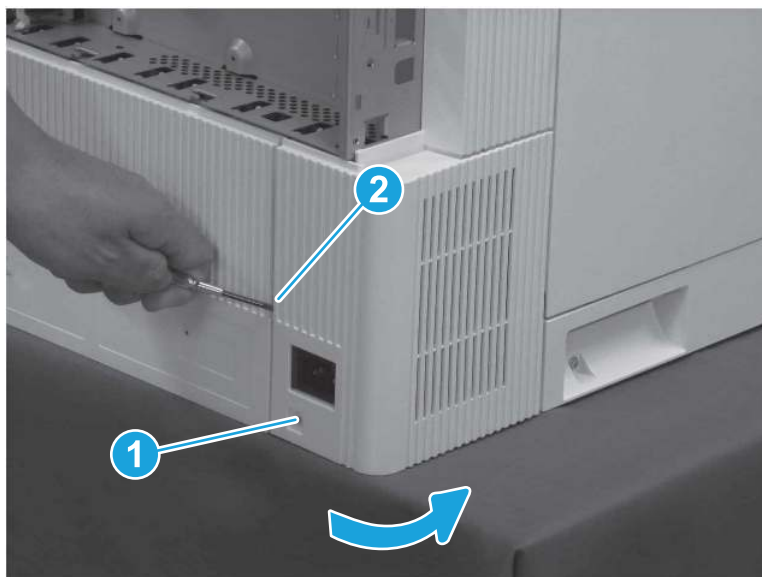
Figure 1-1832 Remove the formatter cover



2. Remove the left lower cover (M751/E75245).

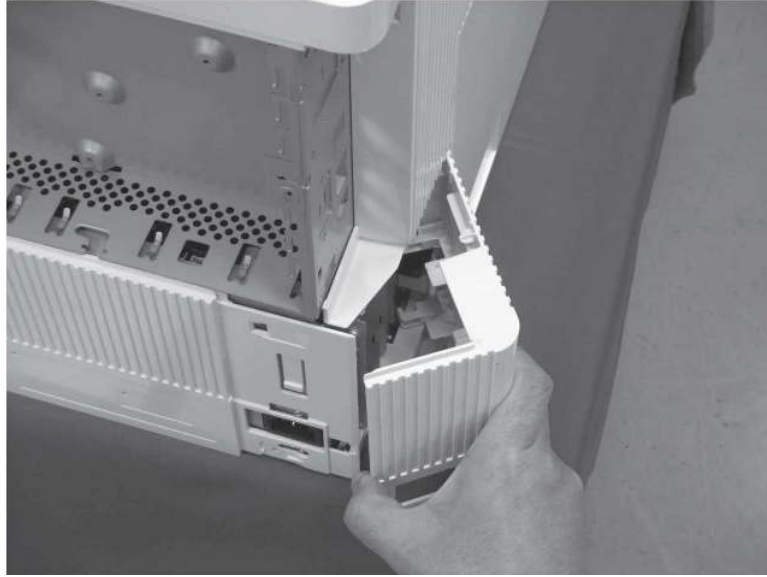
- a. Remove one screw (callout 1), release one tab (callout 2), and then rotate the cover away from the printer.

Figure 1-1833 Remove one screw and release one tab



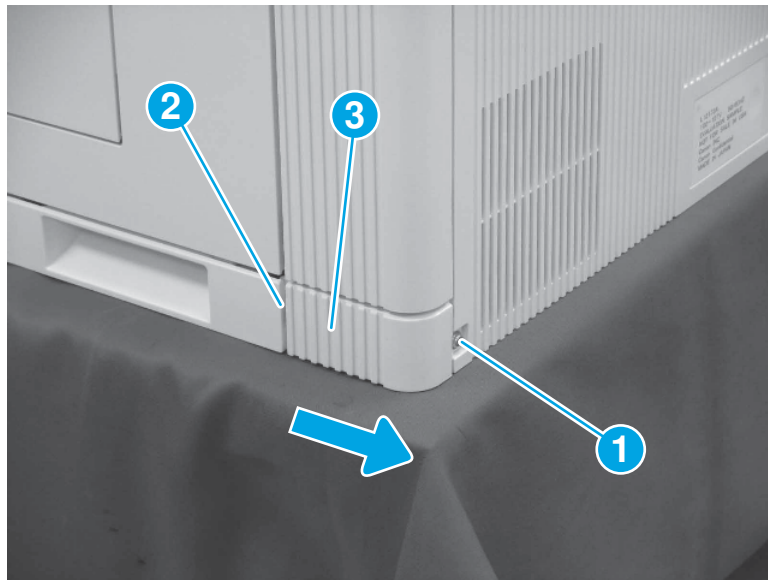
- b. Remove the left lower cover.

Figure 1-1834 Remove the left lower cover



3. Remove the right rear lower cover (M751/E75245/M856/E85055/M776).
 - ▲ Remove one screw (callout 1), release one tab (callout 2), and then slide the right rear lower cover (callout 3) toward the back of the printer to remove it.

Figure 1-1835 Remove the right rear lower cover



4. Remove the left rear cover (M751/E75245/M856/E85055/M776).

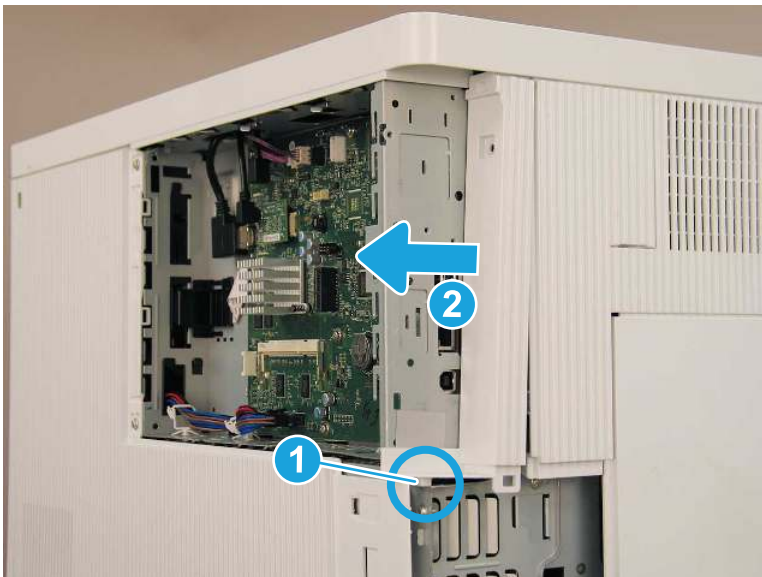
- a. Remove one screw (callout 1).

Figure 1-1836 Remove one screw



- b. Release one boss (callout 1), and then slide the cover toward the back of the printer (callout 2) to remove it.

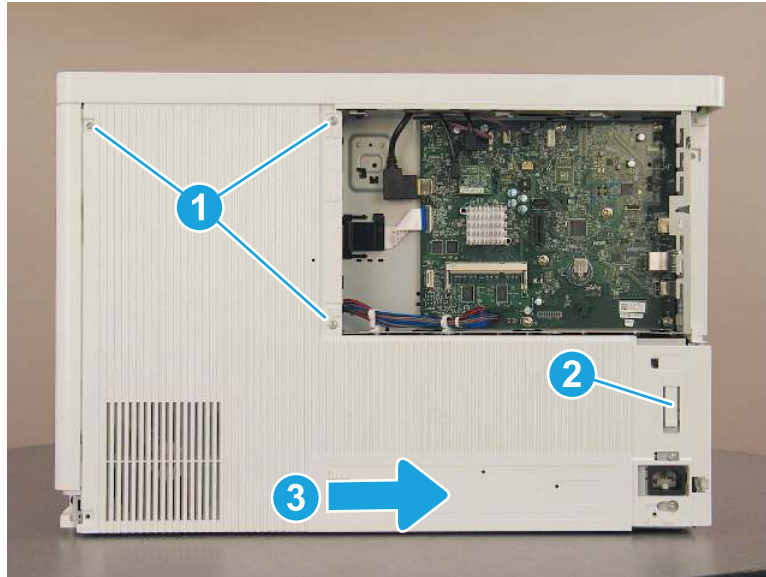
Figure 1-1837 Remove the left rear cover



5. Remove the rear cover (M751/E75245).

- ▲ Remove three screws (callout 1), release one tab (callout 2), and then slide the rear cover to the right (callout 3) to remove it.

Figure 1-1838 Remove the rear cover

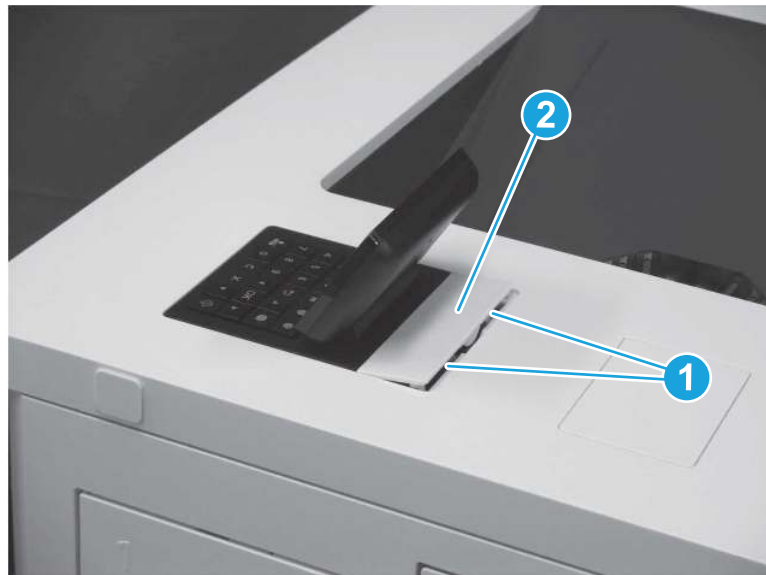


6. Remove the control panel.

 **NOTE:** A screwdriver is included in the control panel kit. The screwdriver has a reversible shaft. Simply pull the shaft out of the handle, and then reinstall it with the desired end facing out.

- a. Use a small, flat-blade screwdriver to release two tabs (callout 1), and then remove the control panel cover (callout 2).

Figure 1-1839 Remove the control panel cover



- b. Remove one screw (callout 1).

Figure 1-1840 Remove one screw



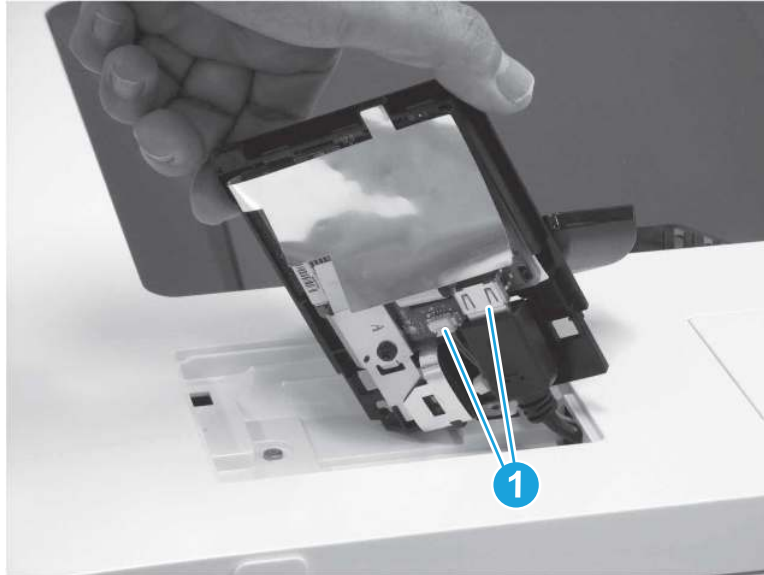
- c. Lift the back edge of the control panel up (callout 1), and then slide the control panel toward the back of the printer (callout 2).

Figure 1-1841 Slide the control panel back



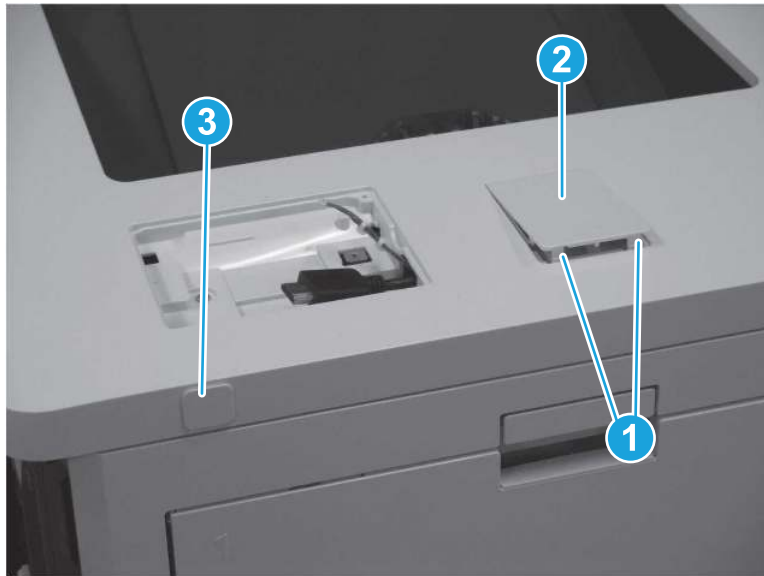
- d. Turn the control panel so that the bottom is facing up, and then disconnect two connectors (callout 1) to remove the control panel.

Figure 1-1842 Disconnect two connectors



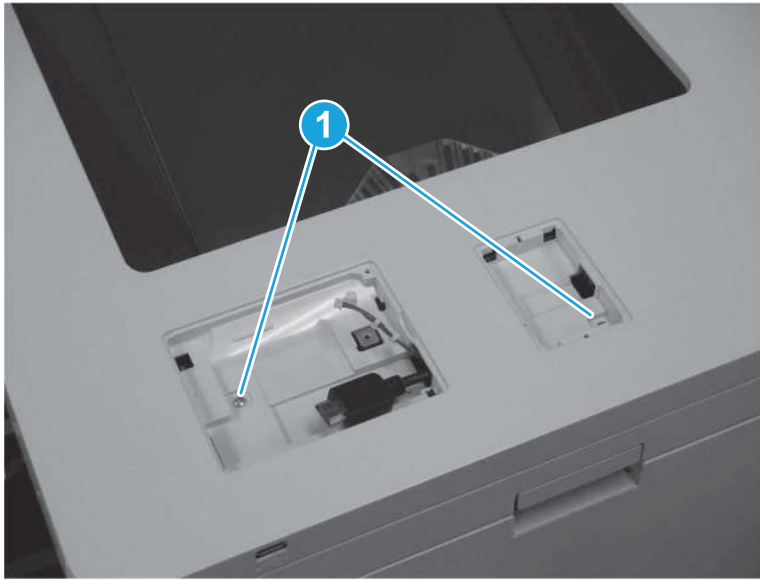
7. Remove the top cover (M751/E75245).
 - a. Release two tabs (callout 1), and then remove the HIP cover (callout 2). Pull the USB cap (callout 3) away from the printer to remove it.

Figure 1-1843 Remove the HIP cover and USB cap



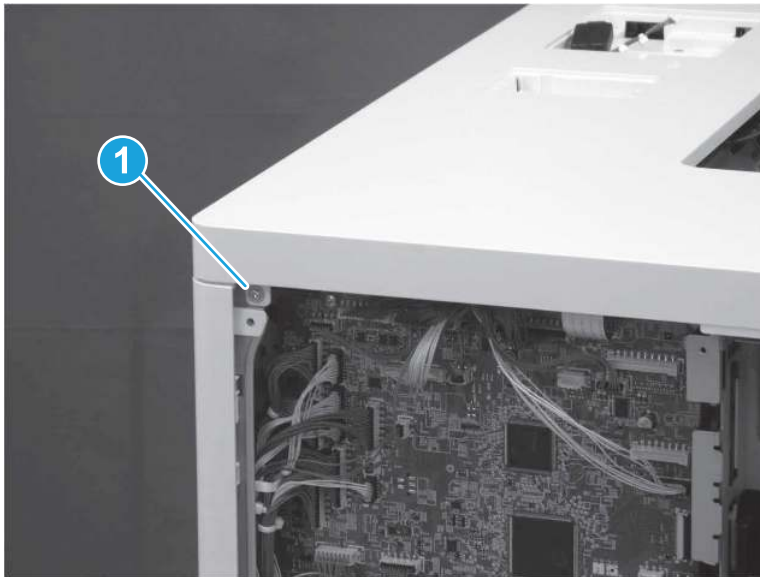
- b. At the top of the printer, remove two screws (callout 1).

Figure 1-1844 Remove two screws




- c. At the back of the printer, remove one screw (callout 1).

Figure 1-1845 Remove one screw

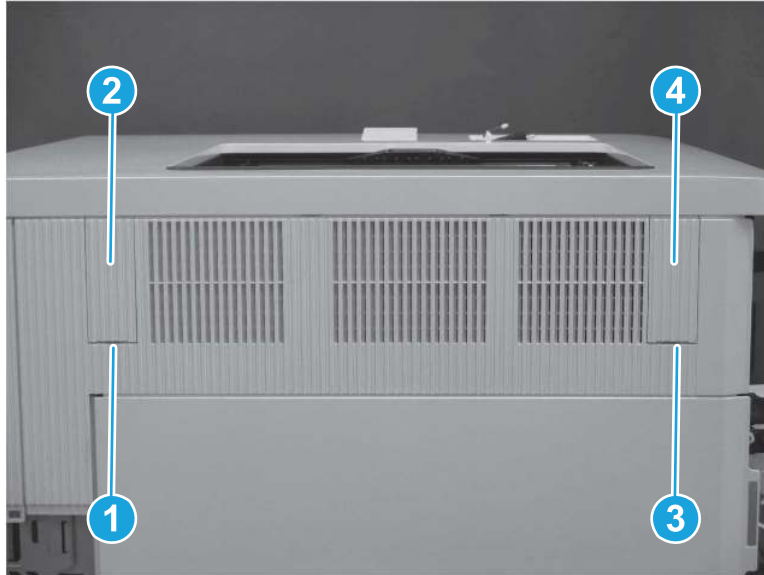


- d. Use a small, flat-blade screwdriver to release one tab (callout 1) and remove the left blanking cover (callout 2). Release one tab (callout 3) and remove the right blanking cover (callout 4).

 **TIP:** These covers are not identical. Make sure to reinstall the correct cover on the correct side.

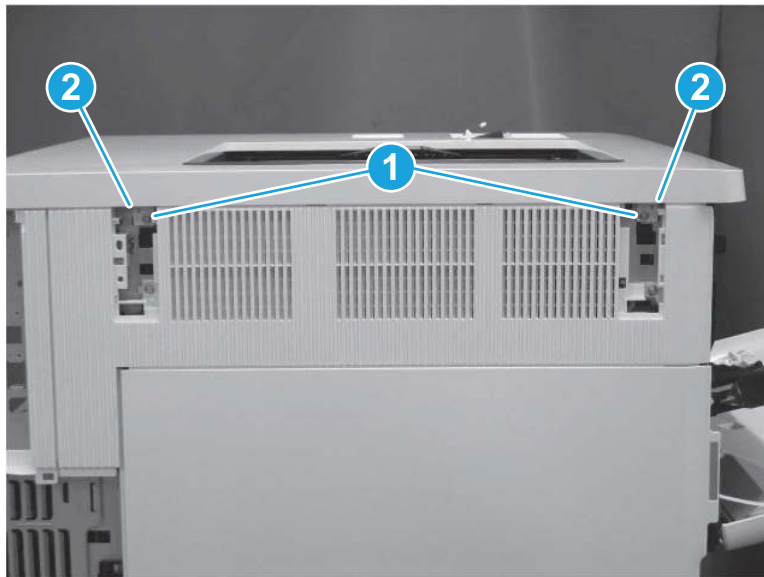
 **NOTE:** The screw under the left blanking cover is a self-tapping screw. Make sure this screw is reinstalled in the correct location.

Figure 1-1846 Remove the left and right blanking covers



- e. Remove two screws (callout 1), and then release two tabs (callout 2).

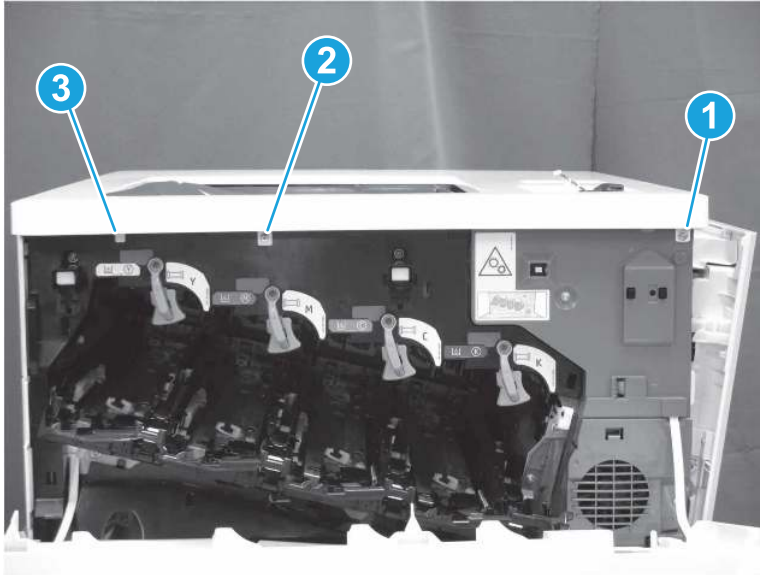
Figure 1-1847 Remove two screws and release two tabs



- f. At the front of the printer, remove one washer-head screw (callout 1) and one self-tapping screw (callout 2). Release one tab (callout 3).

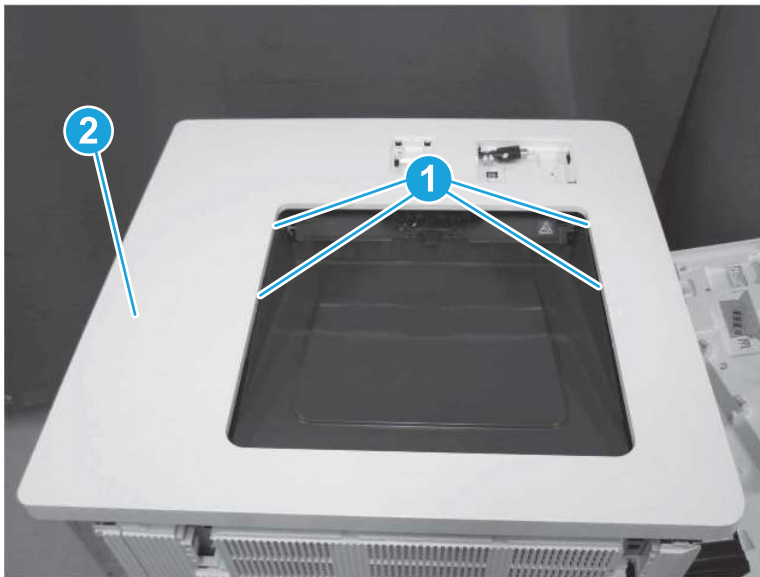
 **TIP:** Make sure to install the correct type of screw in the correct location.

Figure 1-1848 Remove two screws and release one tab

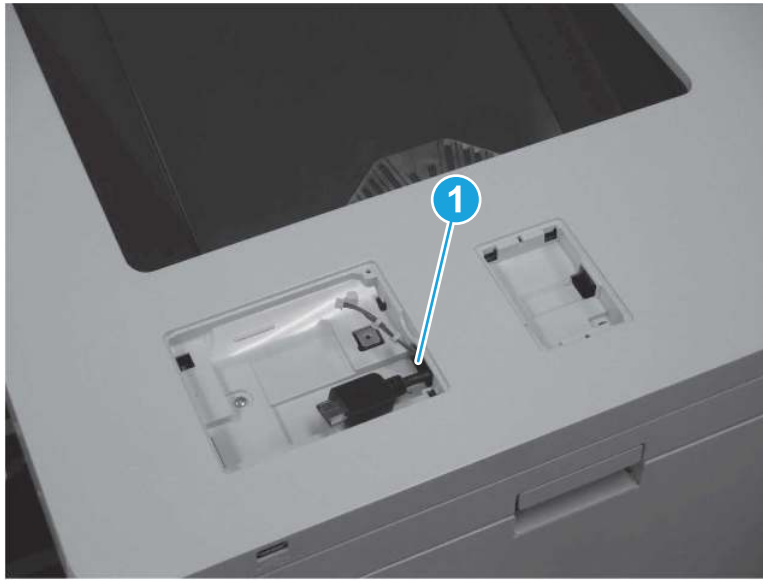


- g. At the top of the printer, release four tabs (callout 1), and then remove the top cover (callout 2).

Figure 1-1849 Remove the top cover

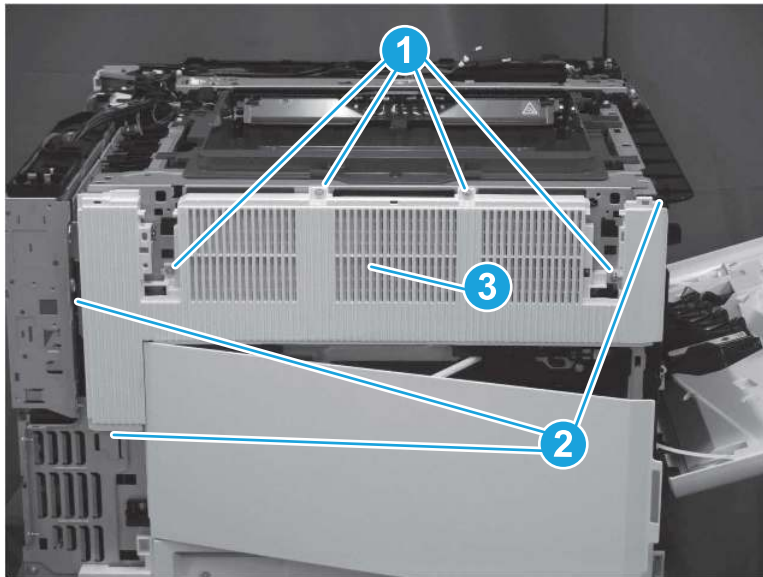


 **NOTE:** When removing the top cover, make sure to release the control panel cables (callout 1) through the opening.



8. Remove the left upper cover (M751/E75245).
 - ▲ Remove four screws (callout 1), release three tabs (callout 2), and then remove the left upper cover (callout 3).

Figure 1-1850 Remove the left upper cover



9. Remove the environmental sensor PCA.
 - ▲ Disconnect one connector (callout 1), release one tab (callout 2), and then slide the environmental sensor PCA away from the printer to remove it.


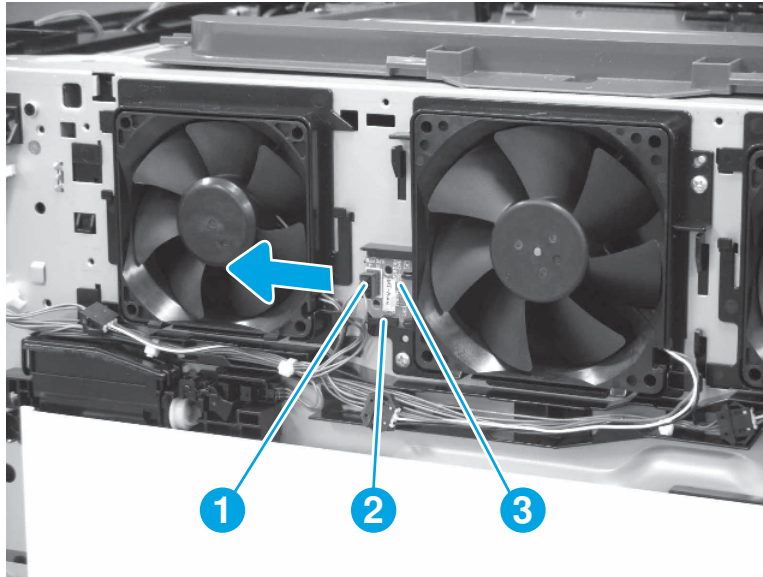
 **IMPORTANT:** When reinstalling the fuser fan, make sure that the cables are installed in the guides so that the fan cover fits correctly and does not pinch any wires.

Figure 1-1851 Remove the environmental sensor PCA



10. Unpack the replacement assembly.

a. Dispose of the defective part.




NOTE: HP recommends responsible disposal of the defective part.

<http://www8.hp.com/us/en/hp-information/environment/product-recycling.html>

b. Unpack the replacement part from the packaging.



CAUTION:  Some parts are sensitive to electrostatic discharge (ESD). Always perform service work at an ESD-protected workstation or mat. If an ESD workstation or mat is not available, touch the sheet-metal chassis to provide a static ground before touching an ESD-sensitive assembly. Protect the ESD-sensitive assemblies by placing them in ESD pouches when they are out of the printer.



IMPORTANT: Make sure that all of the shipping materials (for example shipping tape) are removed from the replacement part prior to installation.

c. To install an assembly, reverse the removal steps.



NOTE: When applicable, special installation instructions are provided for an assembly at the end of the removal procedure. Always completely read the removal instructions and follow all special installation instructions.

Removal and replacement: Environmental sensor PCA (M856/E85055/M776)

Learn how to remove and replace the environmental sensor PCA.

[View a video of how to remove and replace the environmental sensor PCA.](#)

Mean time to repair: 14 minutes

Service level: Easy

Before performing service

Turn the printer power off

- Disconnect the power cable.

⚠ WARNING! To avoid damage to the printer, turn the printer off, wait 30 seconds, and then remove the power cord before attempting to service the printer.

Use the table below to identify the correct part number for your printer. To order the part, go to www.hp.com/buy/parts.

Table 1-99 Part information

Part number	Part description
RM2-9620-000CN	Environmental sensor PCB assembly

Required tools

- #2 Phillips screwdriver with a magnetic tip
- Small, flat-blade screwdriver

After performing service

Turn the printer power on

- Connect the power cable.
- Use the power switch to turn the power on.

Post service test

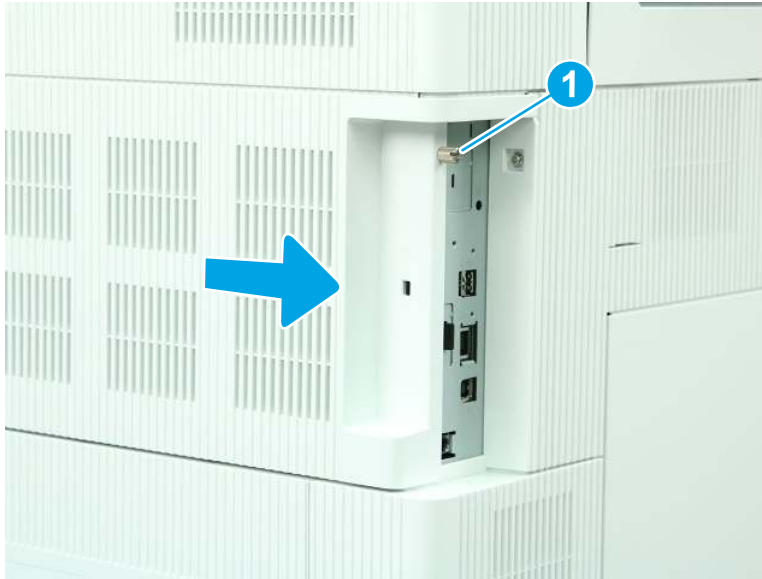
Make sure that the printer initializes to a **Ready** state.

Print a page to make sure that the printer is functioning correctly.

1. Remove the formatter cover.

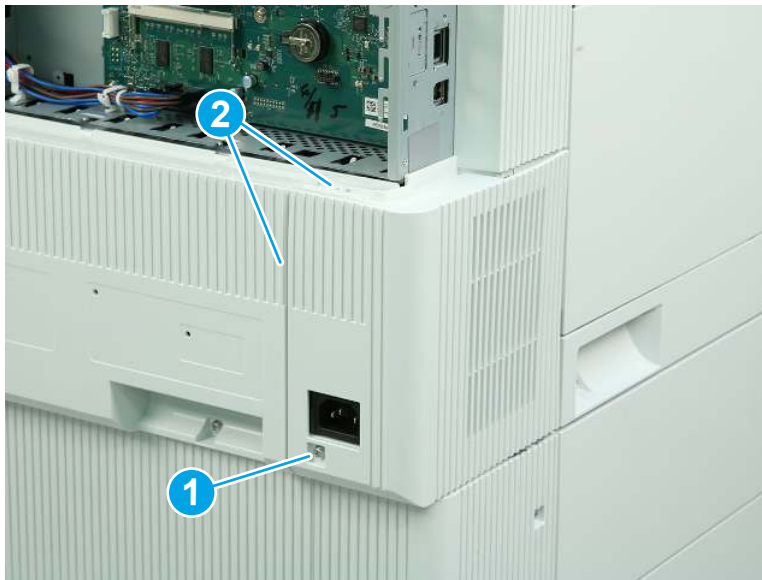
- ▲ Loosen one thumbscrew (callout 1), and then slide the formatter cover (callout 2) away from the printer to remove it.

Figure 1-1852 Remove the formatter cover



- 2. Remove the left lower cover (M856/E85055/M776).
 - a. Remove one screw (callout 1), and then release two tabs (callout 2).

Figure 1-1853 Remove one screw and release two tabs



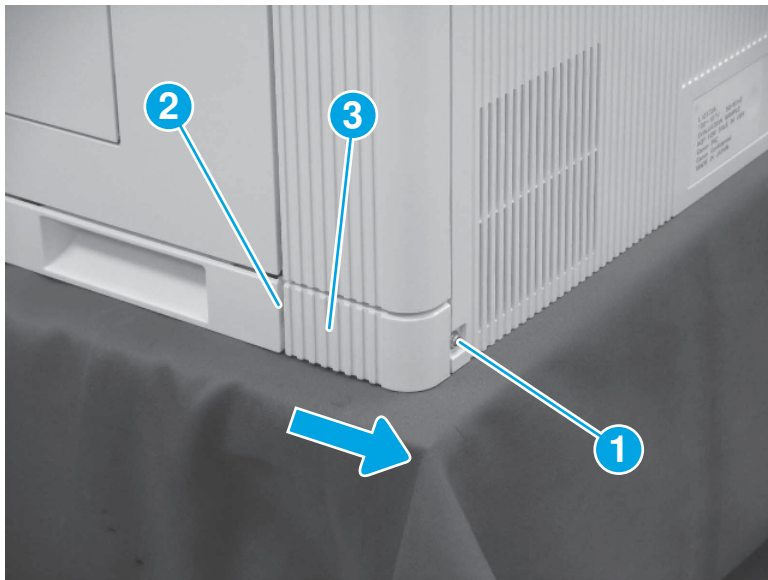
- b. Rotate the cover away from the printer to remove it.

Figure 1-1854 Remove the left lower cover



3. Remove the right rear lower cover (M751/E75245/M856/E85055/M776).
 - ▲ Remove one screw (callout 1), release one tab (callout 2), and then slide the right rear lower cover (callout 3) toward the back of the printer to remove it.

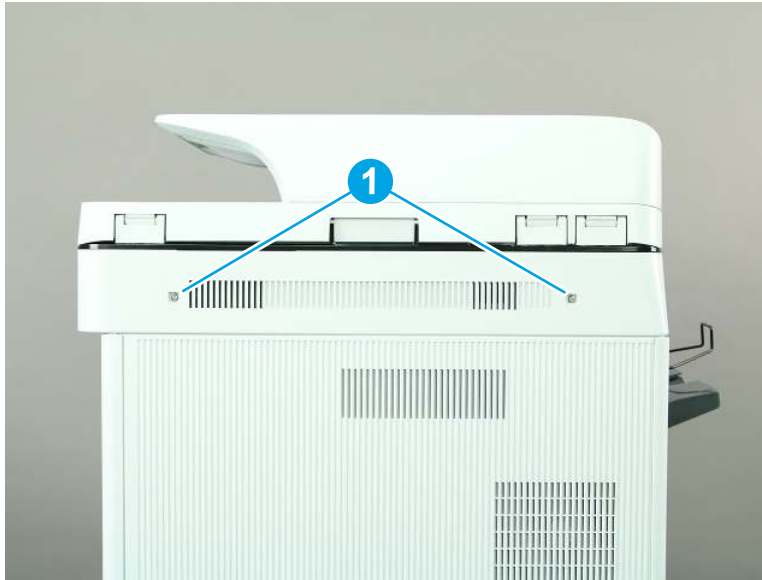
Figure 1-1855 Remove the right rear lower cover



4. Remove the scanner control board (SCB) cover (M776).

- a. Remove two screws (callout 1).

Figure 1-1856 Remove two screws



- b. Remove the SCB cover.

Figure 1-1857 Remove the SCB cover



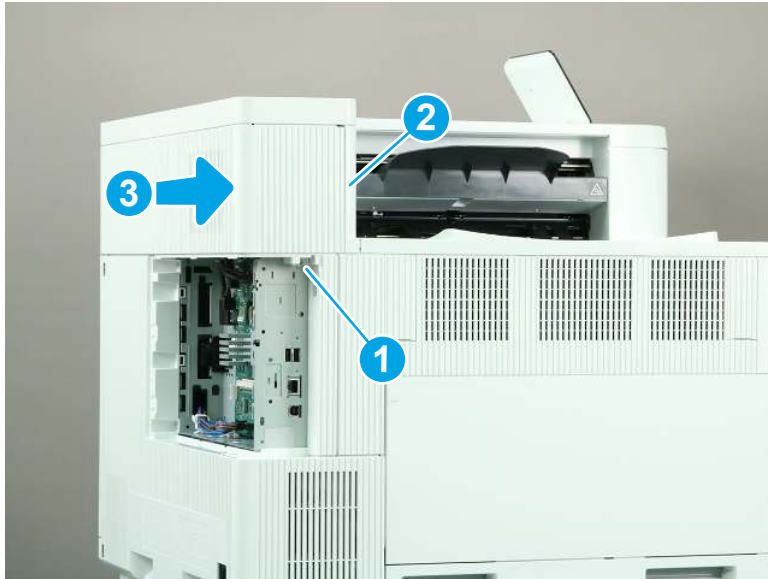
5. Remove the rear upper cover (M856/E85055/M776dn/M776z).



NOTE: The following figure shows the M856 printer. The procedure is correct for all referenced models.

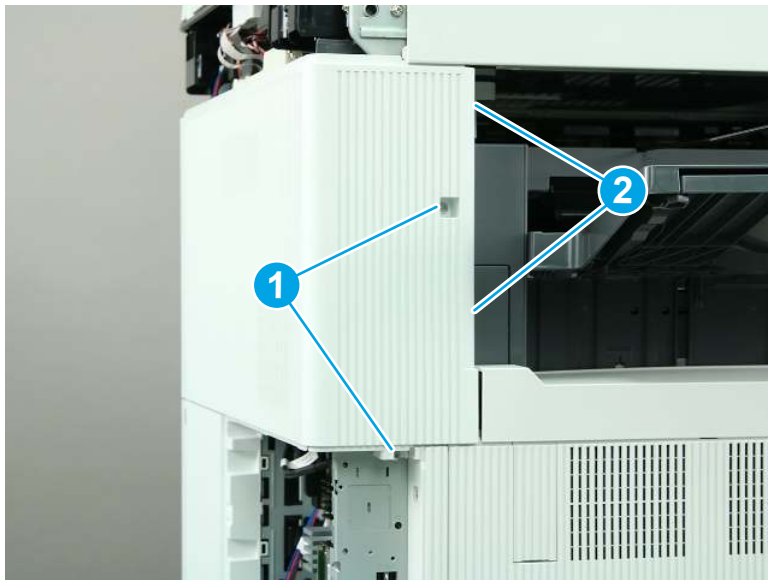
- ▲ Remove one screw (callout 1), release one tab (callout 2), and then slide the rear upper cover away from the printer to remove it (callout 3).

Figure 1-1858 Remove the rear upper cover



- 6. Remove the rear upper cover and left rear upper cover (M776zs).
 - a. Remove two screws (callout 1), and then release two tabs (callout 2).

Figure 1-1859 Remove two screws and release two tabs



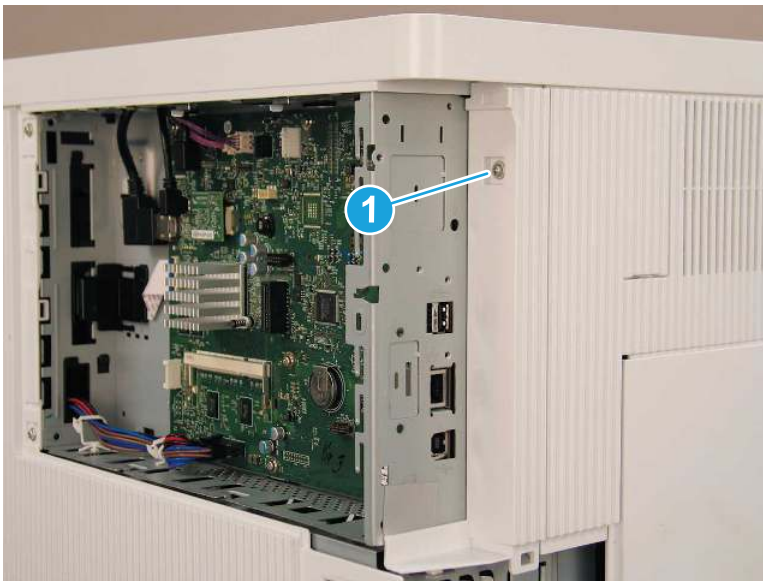
- b. Slide the cover to the right to remove it.

Figure 1-1860 Remove the rear upper and left rear upper cover



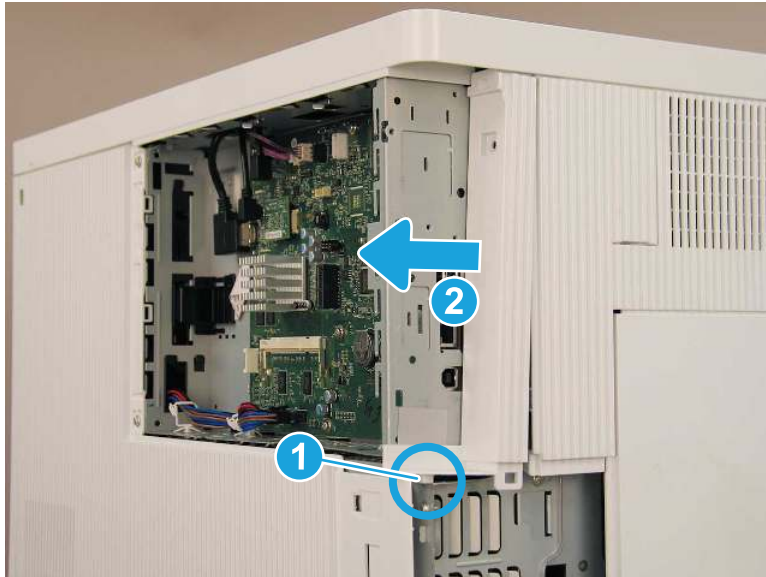
7. Remove the left rear cover (M751/E75245/M856/E85055/M776).
 - a. Remove one screw (callout 1).

Figure 1-1861 Remove one screw



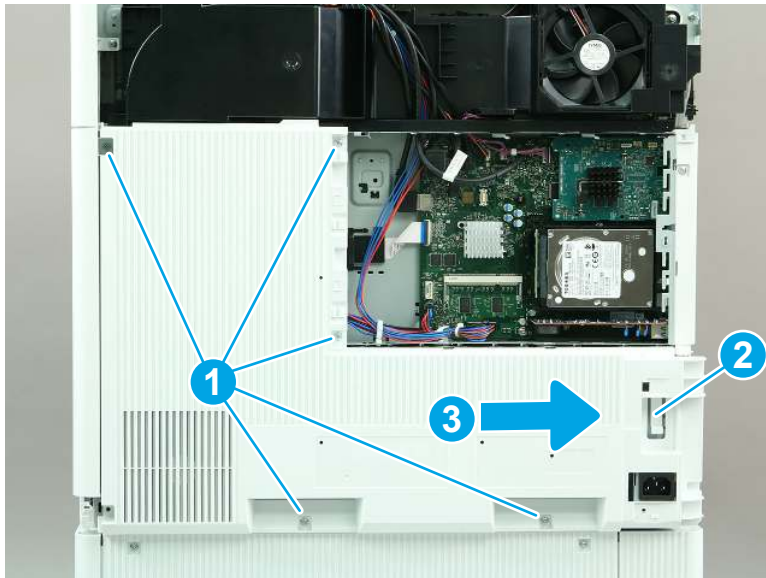
- b. Release one boss (callout 1), and then slide the cover toward the back of the printer (callout 2) to remove it.

Figure 1-1862 Remove the left rear cover



8. Remove the rear cover (M856/E85055/M776).
 - ▲ Remove five screws (callout 1), release one tab (callout 2), and then slide the rear cover to the right to remove it.

Figure 1-1863 Remove the rear cover (M856/E85055/M776)



9. **M856/E85055 only:** Remove the control panel and top cover.

 **NOTE:** This step applies to only the M856/E85055 models. Skip this step for all other models.

- a. Use a small, flat-blade screwdriver to release two tabs (callout 1), and then remove the control panel cover (callout 2).

Figure 1-1864 Remove the control panel cover



- b. Remove one screw (callout 1).

Figure 1-1865 Remove one screw



- c. Lift the back edge of the control panel up (callout 1), and then slide the control panel toward the back of the printer (callout 2).

Figure 1-1866 Slide the control panel back



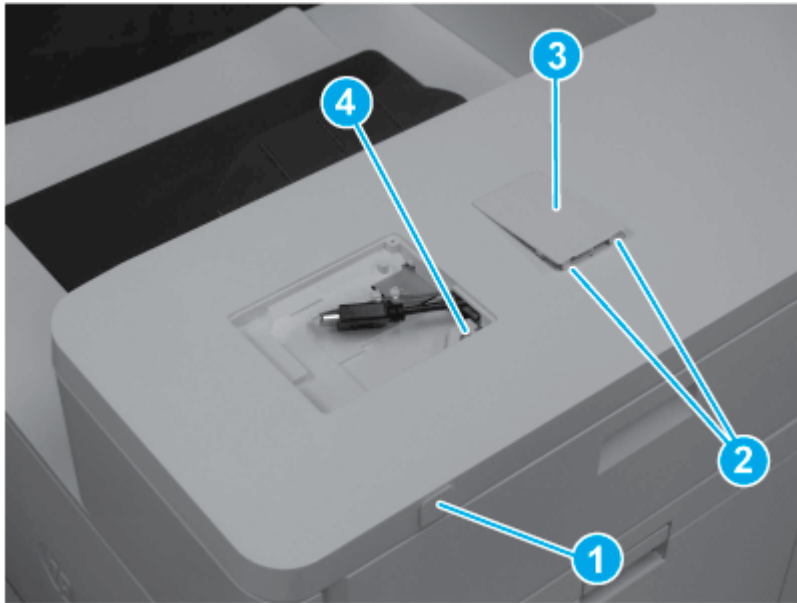
- d. Turn the control panel so that the bottom is facing up, and then disconnect two connectors to remove the control panel.

Figure 1-1867 Disconnect two connectors



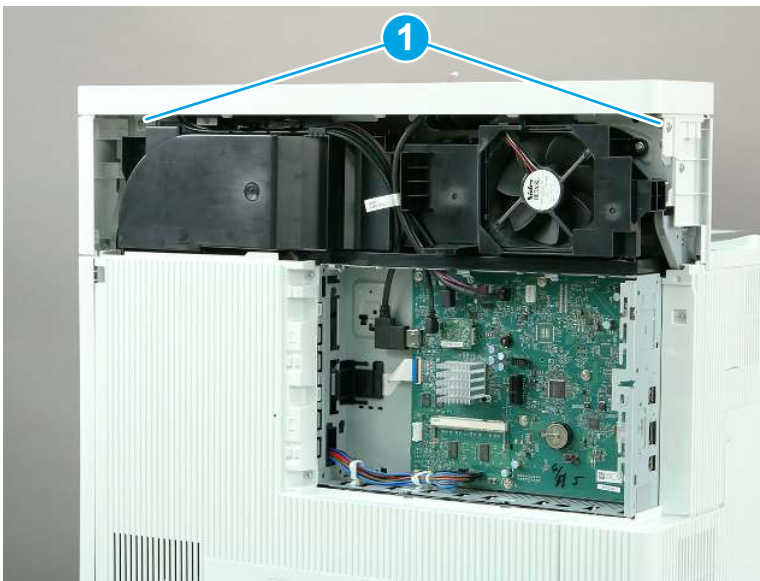
- e. Remove the USB cover (callout 1). Release two tabs (callout 2), and then remove the HIP cover (callout 3). Remove one screw (callout 4).

Figure 1-1868 Remove covers and one screw



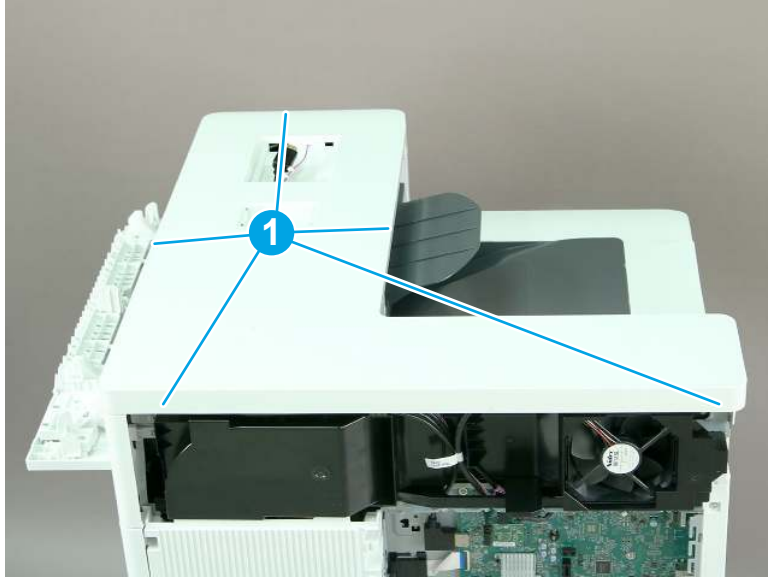
- f. Remove two screws (callout 1).

Figure 1-1869 Remove two screws



- g. Release five tabs (callout 1), and then remove the top cover.

Figure 1-1870 Release five tabs

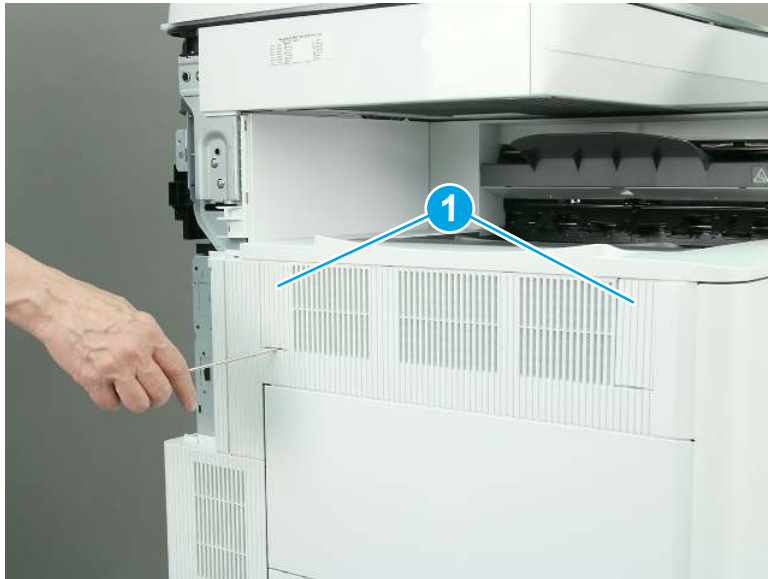


- 10. Remove the accessory upper cover (M856/E85055/M776dn/M776z).

 **NOTE:** The following figures show the M776z printer. The procedure is correct for all referenced models.

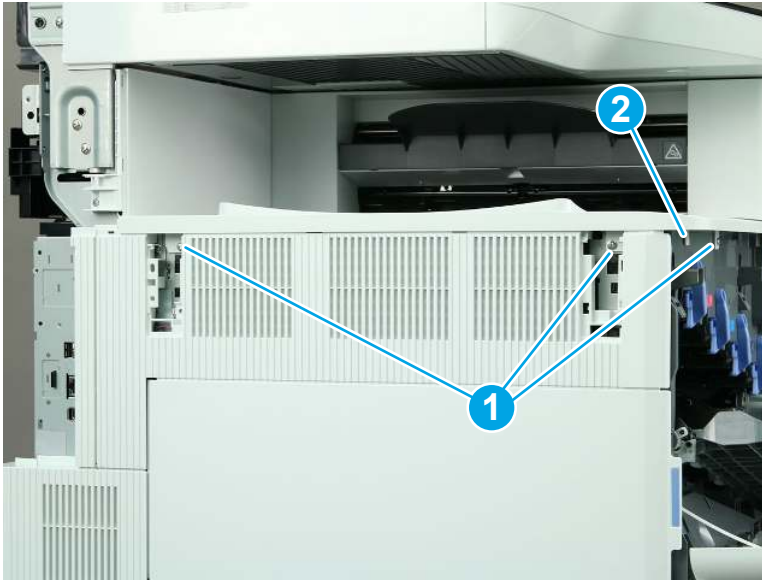
- a. Use a small, flat-blade screwdriver to remove two covers (callout 1).

Figure 1-1871 Remove two covers



- b. Remove three screws (callout 1), and then release one tab (callout 2).

Figure 1-1872 Remove three screws and release one tab



- c. Slide the accessory upper cover away from the printer to remove it.

Figure 1-1873 Remove the accessory upper cover

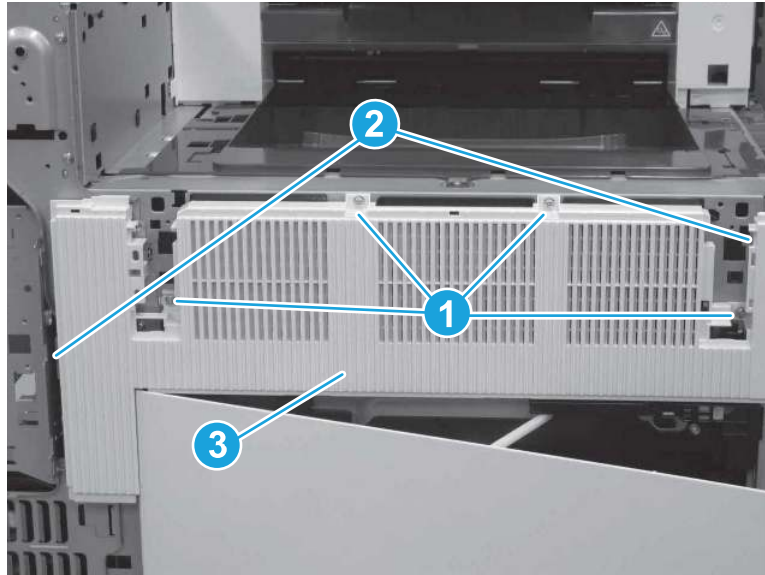


- 11. Remove the left upper cover (M856/E85055/M776).

 **NOTE:** The following figures show the M776z printer. The procedure is correct for all referenced models.

- ▲ Remove four screws (callout 1), release two tabs (callout 2), and then remove the left upper cover (callout 3).

Figure 1-1874 Remove the left upper cover



12. Remove the environmental sensor PCA.

- ▲ Disconnect one connector (callout 1), release one tab (callout 2), and then slide the environmental sensor PCA away from the printer to remove it.


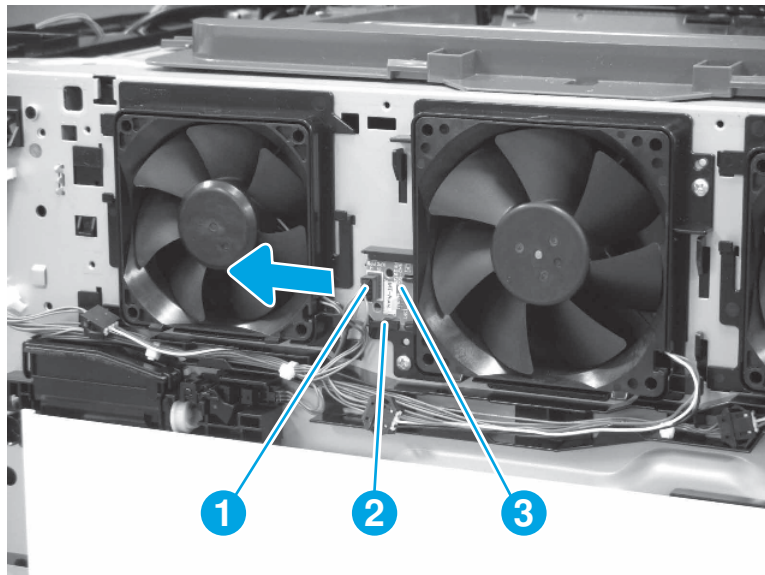
 **IMPORTANT:** When reinstalling the fuser fan, make sure that the cables are installed in the guides so that the fan cover fits correctly and does not pinch any wires.

Figure 1-1875 Remove the environmental sensor PCA





13. Unpack the replacement assembly.


- a. Dispose of the defective part.

 **NOTE:** HP recommends responsible disposal of the defective part.


<http://www8.hp.com/us/en/hp-information/environment/product-recycling.html>

- b. Unpack the replacement part from the packaging.

 **CAUTION:**  Some parts are sensitive to electrostatic discharge (ESD). Always perform service work at an ESD-protected workstation or mat. If an ESD workstation or mat is not available, touch the sheet-metal chassis to provide a static ground before touching an ESD-sensitive assembly. Protect the ESD-sensitive assemblies by placing them in ESD pouches when they are out of the printer.

 **IMPORTANT:** Make sure that all of the shipping materials (for example shipping tape) are removed from the replacement part prior to installation.

- c. To install an assembly, reverse the removal steps.

 **NOTE:** When applicable, special installation instructions are provided for an assembly at the end of the removal procedure. Always completely read the removal instructions and follow all special installation instructions.

Removal and replacement: Memory PCA (M751/E75245)

Learn how to remove and replace the memory PCA.

[View a video of how to remove and replace the memory PCA.](#)


Mean time to repair: 7 minutes

Service level: Easy

Before performing service

Turn the printer power off

- Disconnect the power cable.

 **WARNING!** To avoid damage to the printer, turn the printer off, wait 30 seconds, and then remove the power cord before attempting to service the printer.

Use the table below to identify the correct part number for your printer. To order the part, go to www.hp.com/buy/parts.

Table 1-100 Part information

Part number	Part description
RM2-7138-000CN	Memory PCB assembly

Required tools

- #2 Phillips screwdriver with a magnetic tip
- Small, flat-blade screwdriver

After performing service

Turn the printer power on

- Connect the power cable.
- Use the power switch to turn the power on.

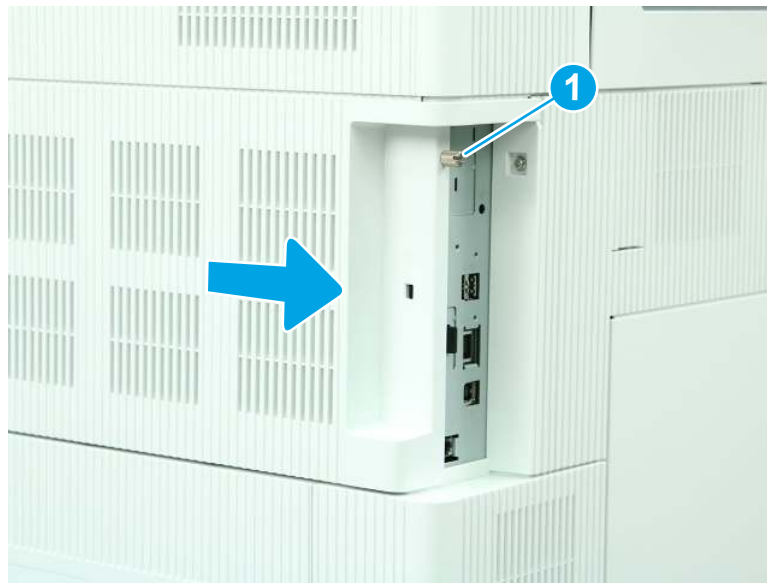
Post service test

Make sure that the printer initializes to a **Ready** state.

Print a page to make sure that the printer is functioning correctly.

1. Remove the formatter cover.
 - ▲ Loosen one thumbscrew (callout 1), and then slide the formatter cover (callout 2) away from the printer to remove it.

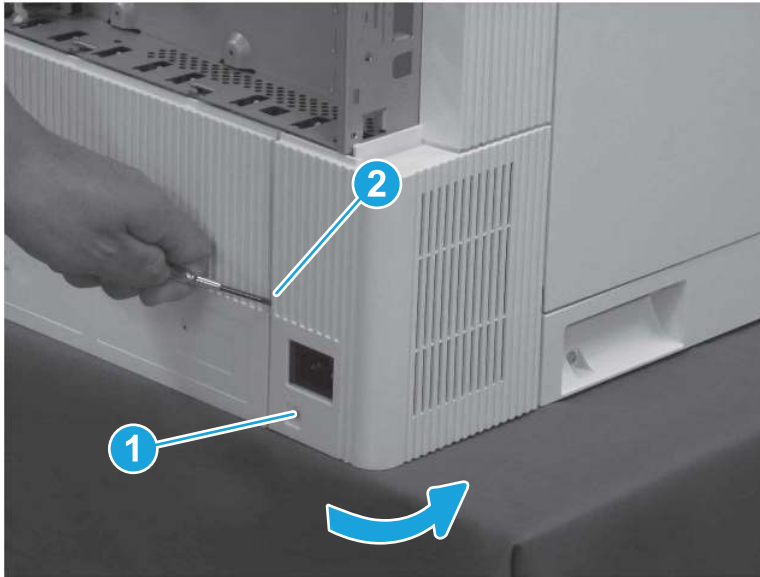
Figure 1-1876 Remove the formatter cover



2. Remove the left lower cover (M751/E75245).

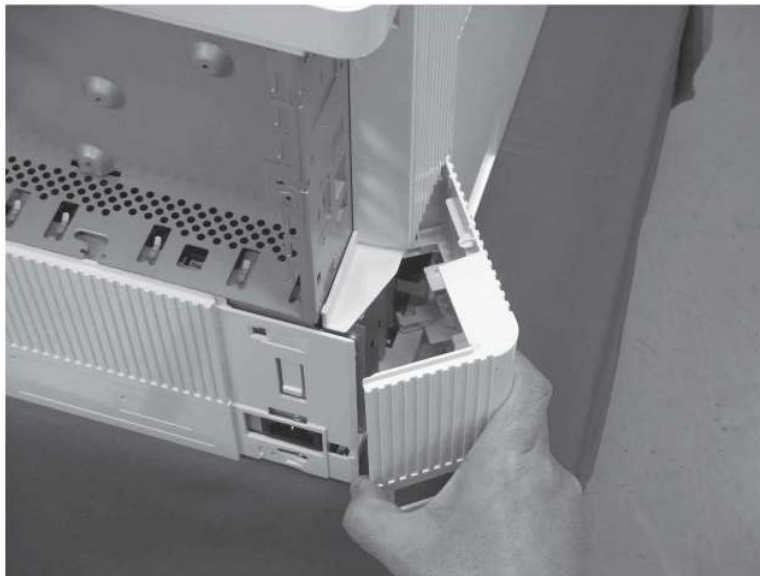
- a. Remove one screw (callout 1), release one tab (callout 2), and then rotate the cover away from the printer.

Figure 1-1877 Remove one screw and release one tab



- b. Remove the left lower cover.

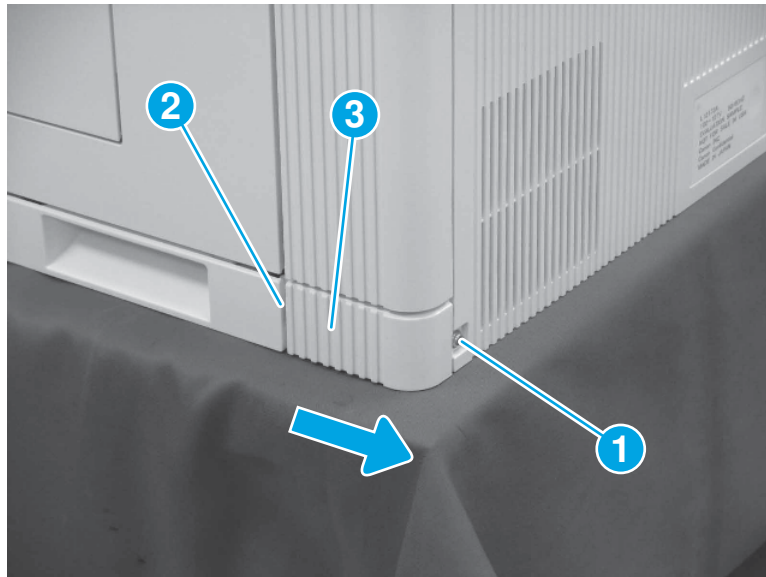
Figure 1-1878 Remove the left lower cover



3. Remove the right rear lower cover (M751/E75245/M856/E85055/M776).

- ▲ Remove one screw (callout 1), release one tab (callout 2), and then slide the right rear lower cover (callout 3) toward the back of the printer to remove it.

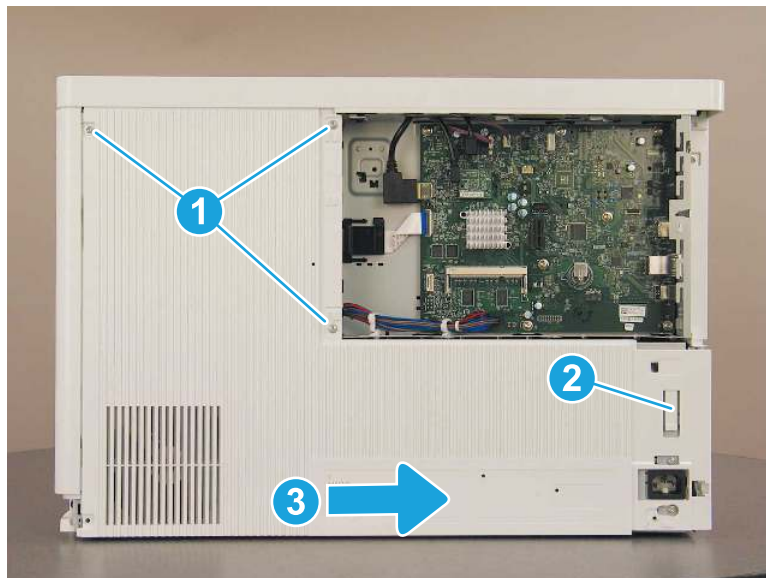
Figure 1-1879 Remove the right rear lower cover



4. Remove the rear cover (M751/E75245).

- ▲ Remove three screws (callout 1), release one tab (callout 2), and then slide the rear cover to the right (callout 3) to remove it.

Figure 1-1880 Remove the rear cover

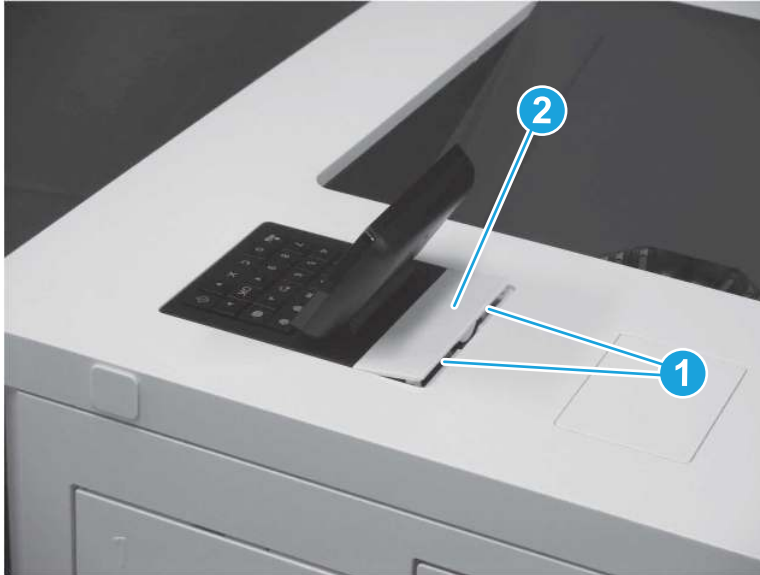


5. Remove the control panel.

 **NOTE:** A screwdriver is included in the control panel kit. The screwdriver has a reversible shaft. Simply pull the shaft out of the handle, and then reinstall it with the desired end facing out.

- a. Use a small, flat-blade screwdriver to release two tabs (callout 1), and then remove the control panel cover (callout 2).

Figure 1-1881 Remove the control panel cover



- b. Remove one screw (callout 1).

Figure 1-1882 Remove one screw



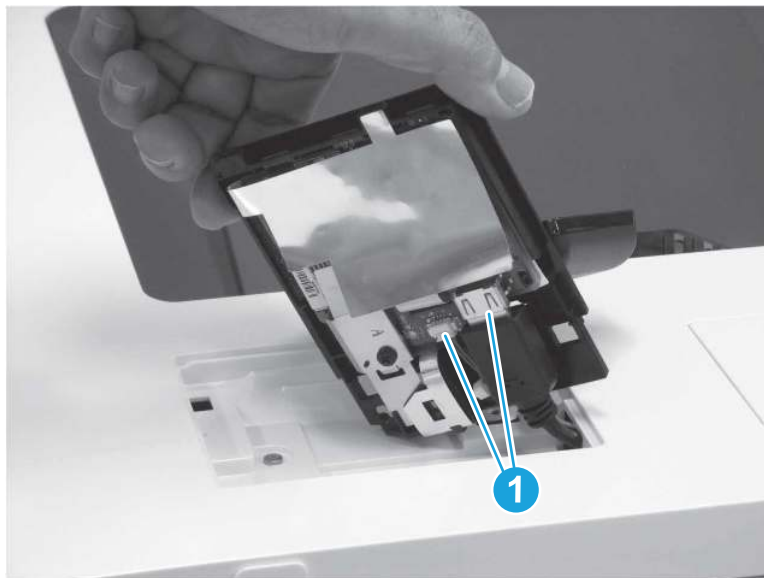
- c. Lift the back edge of the control panel up (callout 1), and then slide the control panel toward the back of the printer (callout 2).

Figure 1-1883 Slide the control panel back



- d. Turn the control panel so that the bottom is facing up, and then disconnect two connectors (callout 1) to remove the control panel.

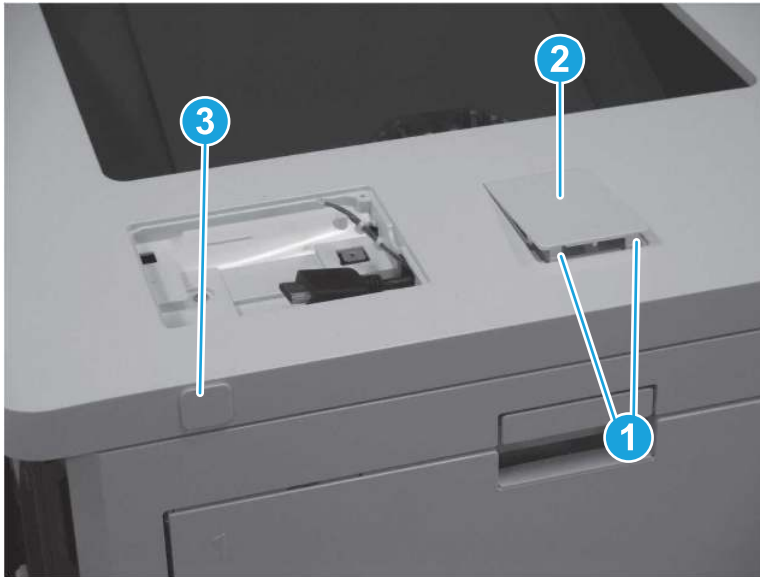
Figure 1-1884 Disconnect two connectors



6. Remove the top cover (M751/E75245).

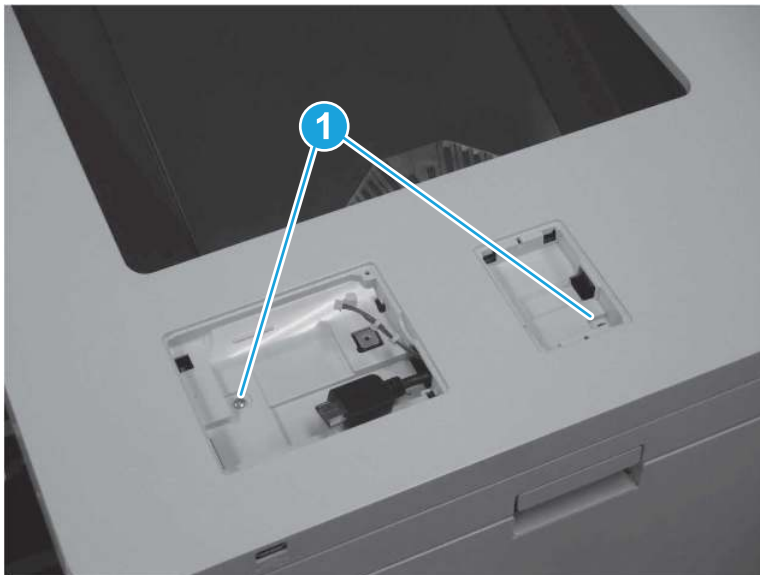
- a. Release two tabs (callout 1), and then remove the HIP cover (callout 2). Pull the USB cap (callout 3) away from the printer to remove it.

Figure 1-1885 Remove the HIP cover and USB cap



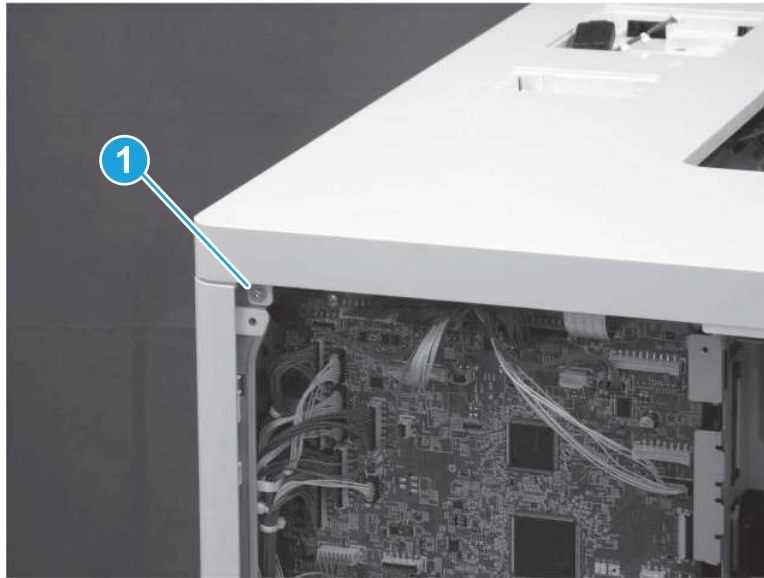
- b. At the top of the printer, remove two screws (callout 1).

Figure 1-1886 Remove two screws




- c. At the back of the printer, remove one screw (callout 1).

Figure 1-1887 Remove one screw

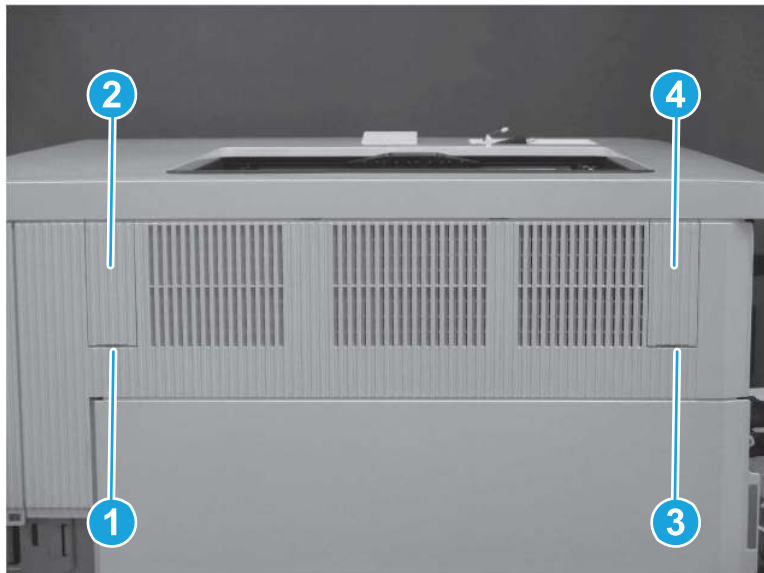


- d. Use a small, flat-blade screwdriver to release one tab (callout 1) and remove the left blanking cover (callout 2). Release one tab (callout 3) and remove the right blanking cover (callout 4).

 **TIP:** These covers are not identical. Make sure to reinstall the correct cover on the correct side.

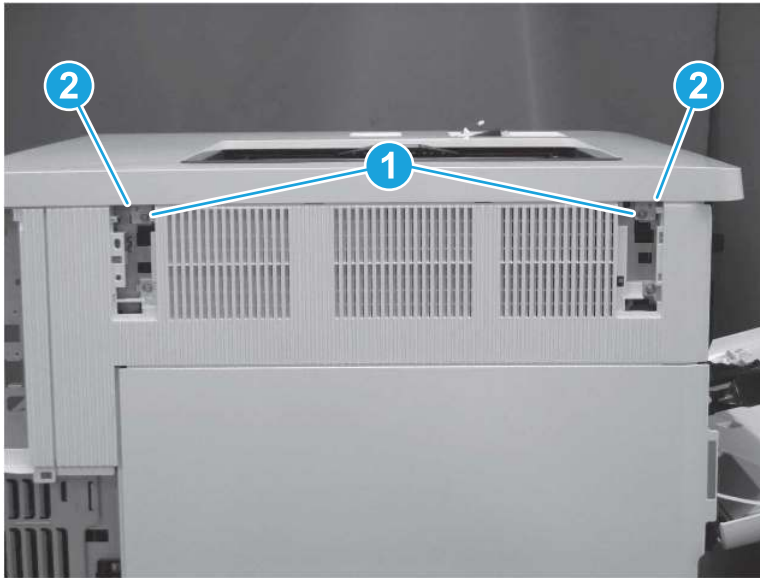
 **NOTE:** The screw under the left blanking cover is a self-tapping screw. Make sure this screw is reinstalled in the correct location.

Figure 1-1888 Remove the left and right blanking covers



- e. Remove two screws (callout 1), and then release two tabs (callout 2).

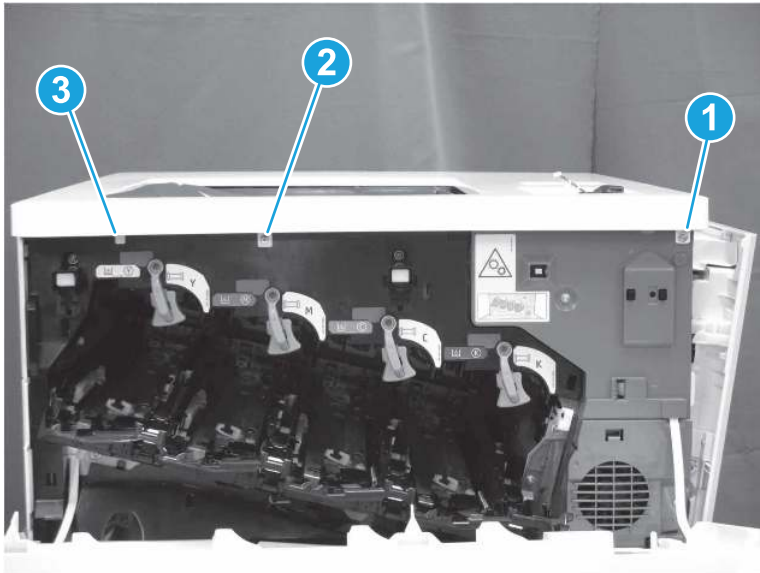
Figure 1-1889 Remove two screws and release two tabs



- f. At the front of the printer, remove one washer-head screw (callout 1) and one self-tapping screw (callout 2). Release one tab (callout 3).

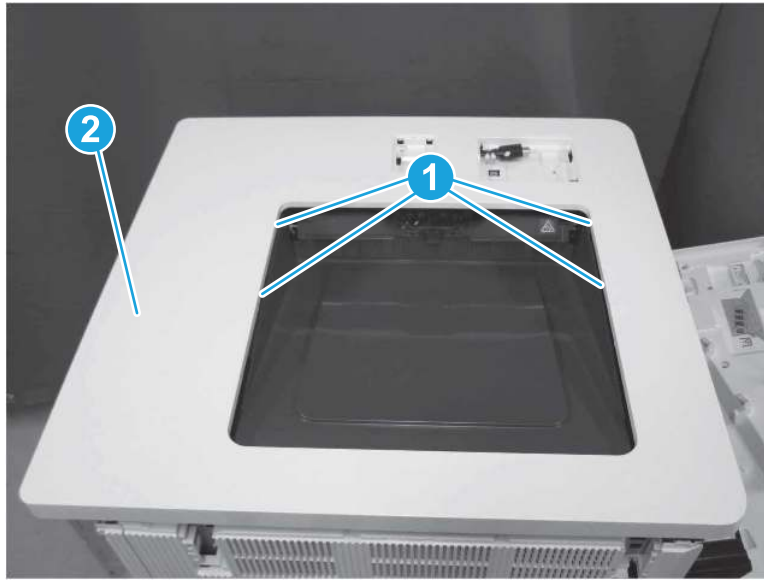
 **TIP:** Make sure to install the correct type of screw in the correct location.

Figure 1-1890 Remove two screws and release one tab

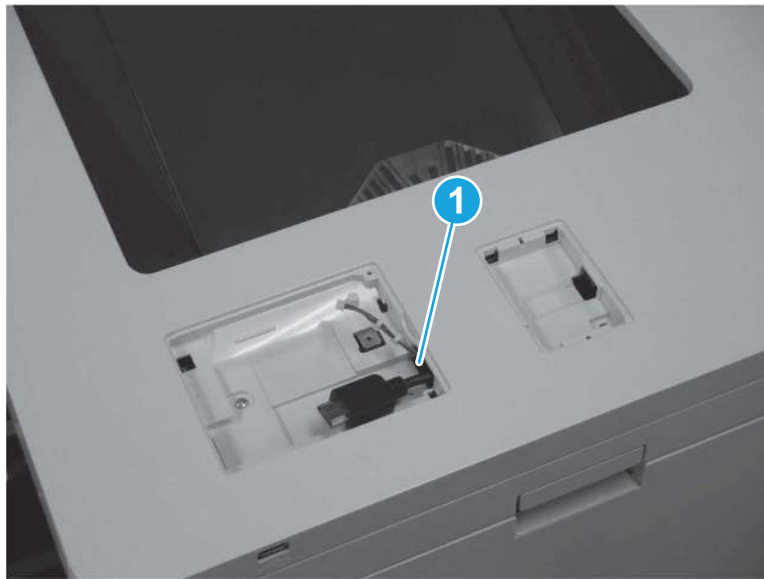


- g. At the top of the printer, release four tabs (callout 1), and then remove the top cover (callout 2).

Figure 1-1891 Remove the top cover



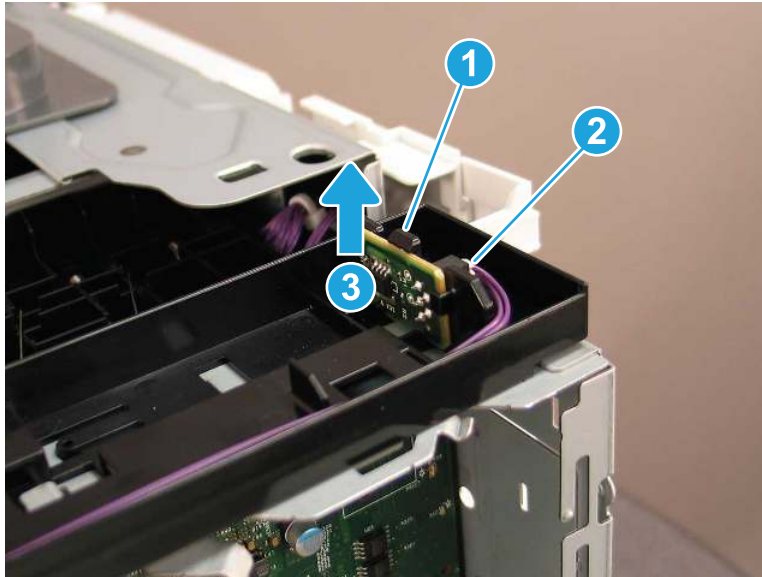
 **NOTE:** When removing the top cover, make sure to release the control panel cables (callout 1) through the opening.



7. Remove the memory PCA.

- ▲ Release one tab (callout 1), disconnect one connector (callout 2), and then lift the memory PCA (callout 3) up to remove it.

Figure 1-1892 Remove the memory PCA



8. Unpack the replacement assembly.
 - a. Dispose of the defective part.




NOTE: HP recommends responsible disposal of the defective part.

<http://www8.hp.com/us/en/hp-information/environment/product-recycling.html>

- b. Unpack the replacement part from the packaging.



CAUTION:  Some parts are sensitive to electrostatic discharge (ESD). Always perform service work at an ESD-protected workstation or mat. If an ESD workstation or mat is not available, touch the sheet-metal chassis to provide a static ground before touching an ESD-sensitive assembly. Protect the ESD-sensitive assemblies by placing them in ESD pouches when they are out of the printer.



IMPORTANT: Make sure that all of the shipping materials (for example shipping tape) are removed from the replacement part prior to installation.

- c. To install an assembly, reverse the removal steps.



NOTE: When applicable, special installation instructions are provided for an assembly at the end of the removal procedure. Always completely read the removal instructions and follow all special installation instructions.

Removal and replacement: Drum motor 1 (M751/E75245)

Learn how to remove and replace drum motor 1.

[View a video of how to remove and replace the drum motor 1.](#)

Mean time to repair: 30 minutes

Service level: Medium

Before performing service

Turn the printer power off

- Disconnect the power cable.

⚠ WARNING! To avoid damage to the printer, turn the printer off, wait 30 seconds, and then remove the power cord before attempting to service the printer.

Use the table below to identify the correct part number for your printer. To order the part, go to www.hp.com/buy/parts.

Table 1-101 Part information

Part number	Part description
RM2-1612-000CN	Main motor assembly

Required tools

- #2 Phillips screwdriver with a magnetic tip
- Small, flat-blade screwdriver

After performing service

Turn the printer power on

- Connect the power cable.
- Use the power switch to turn the power on.

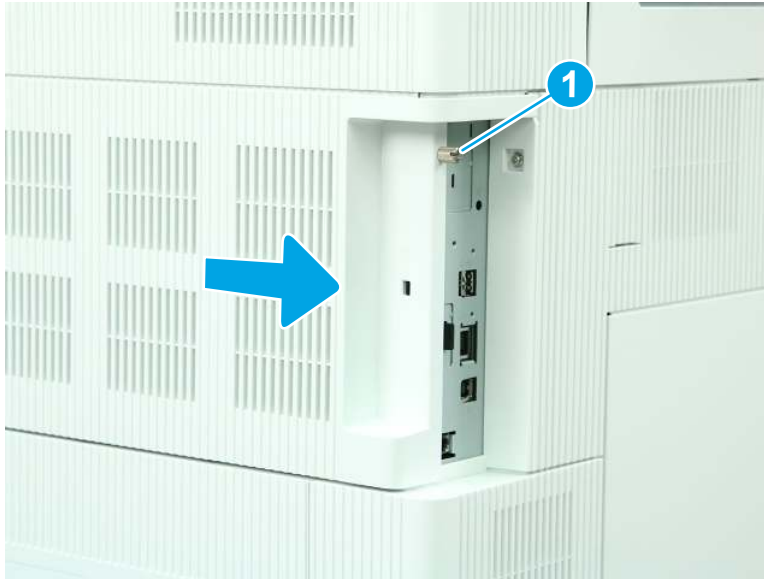
Post service test

No post service test is available for this assembly.

1. Remove the formatter cover.

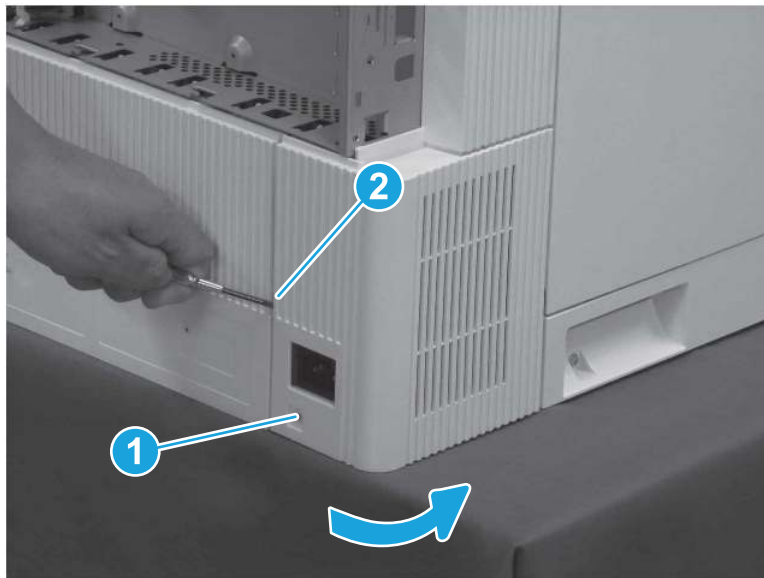
- ▲ Loosen one thumbscrew (callout 1), and then slide the formatter cover (callout 2) away from the printer to remove it.

Figure 1-1893 Remove the formatter cover



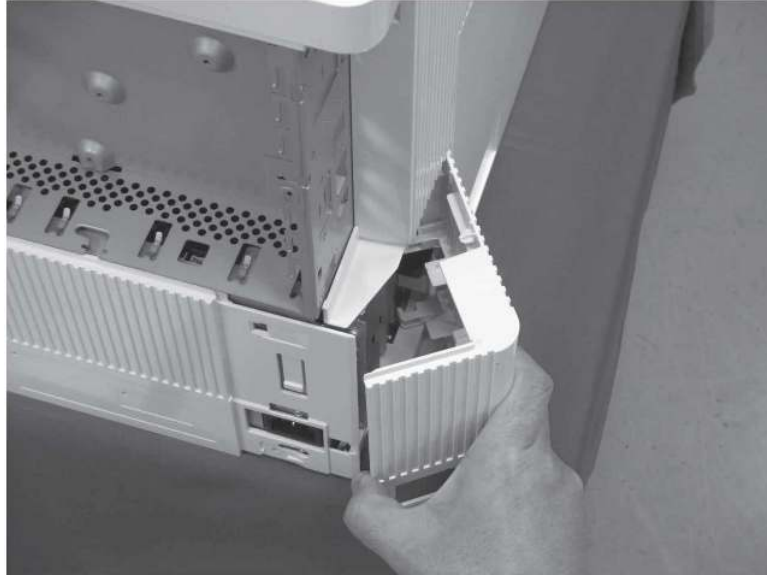
- 2. Remove the left lower cover (M751/E75245).
 - a. Remove one screw (callout 1), release one tab (callout 2), and then rotate the cover away from the printer.

Figure 1-1894 Remove one screw and release one tab



- b. Remove the left lower cover.

Figure 1-1895 Remove the left lower cover



3. Remove the left rear cover (M751/E75245/M856/E85055/M776).

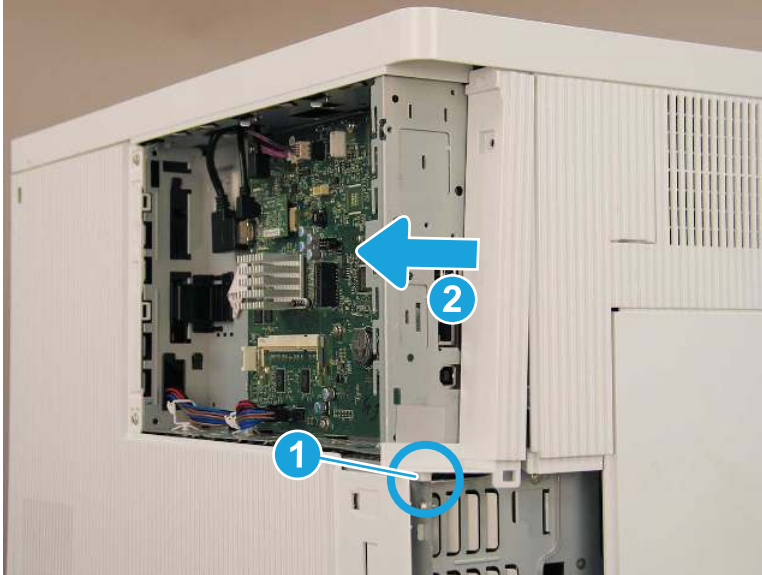
- a. Remove one screw (callout 1).

Figure 1-1896 Remove one screw



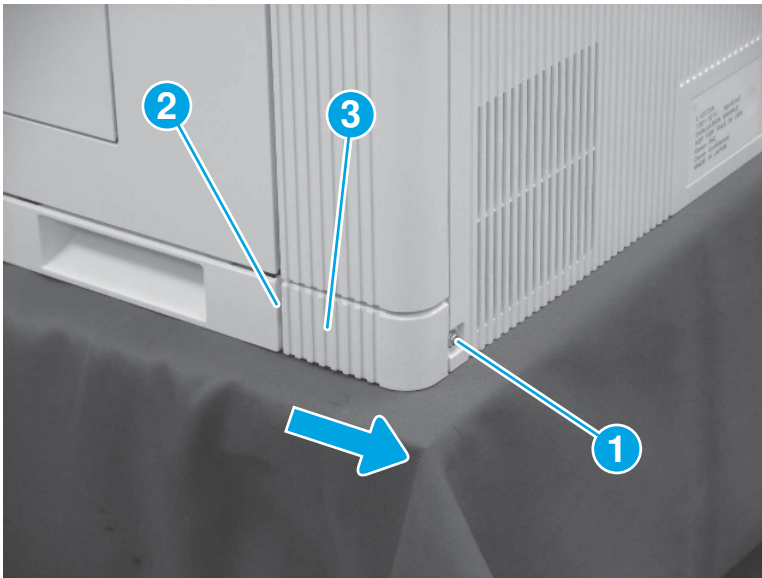
- b. Release one boss (callout 1), and then slide the cover toward the back of the printer (callout 2) to remove it.

Figure 1-1897 Remove the left rear cover



4. Remove the right rear lower cover (M751/E75245/M856/E85055/M776).
 - ▲ Remove one screw (callout 1), release one tab (callout 2), and then slide the right rear lower cover (callout 3) toward the back of the printer to remove it.

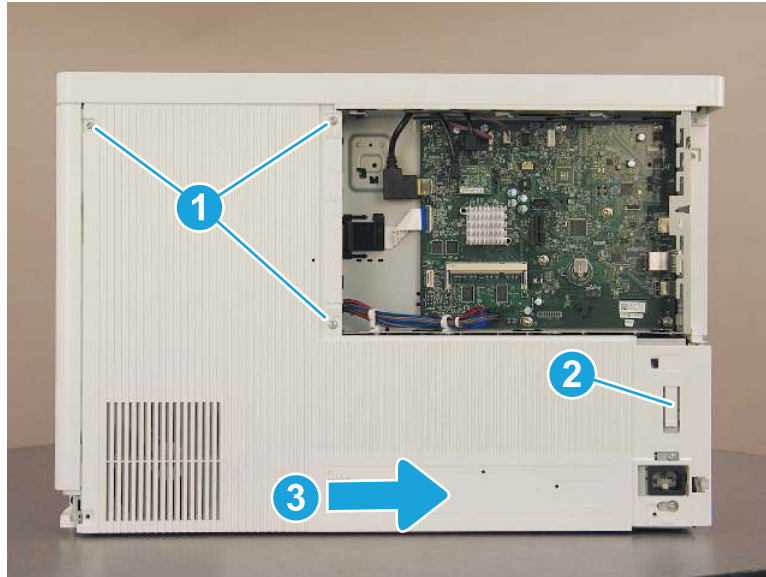
Figure 1-1898 Remove the right rear lower cover



5. Remove the rear cover (M751/E75245).

- ▲ Remove three screws (callout 1), release one tab (callout 2), and then slide the rear cover to the right (callout 3) to remove it.

Figure 1-1899 Remove the rear cover

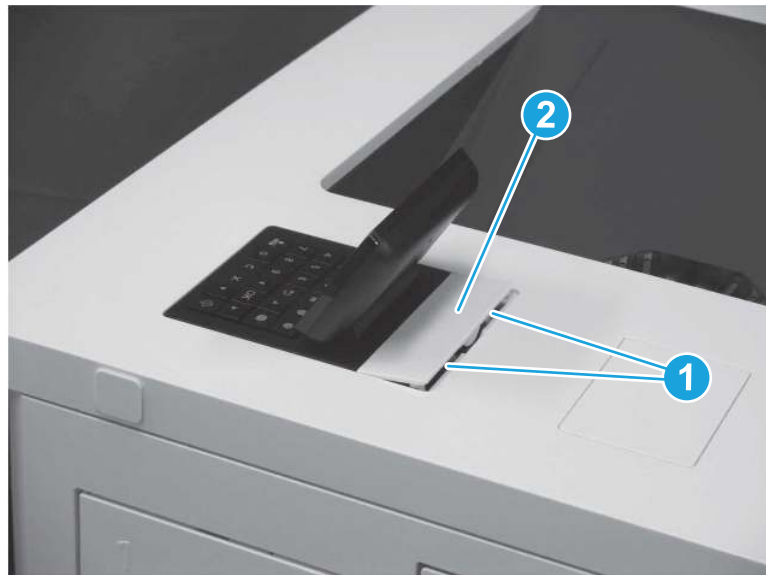


6. Remove the control panel.

 **NOTE:** A screwdriver is included in the control panel kit. The screwdriver has a reversible shaft. Simply pull the shaft out of the handle, and then reinstall it with the desired end facing out.

- a. Use a small, flat-blade screwdriver to release two tabs (callout 1), and then remove the control panel cover (callout 2).

Figure 1-1900 Remove the control panel cover



- b. Remove one screw (callout 1).

Figure 1-1901 Remove one screw



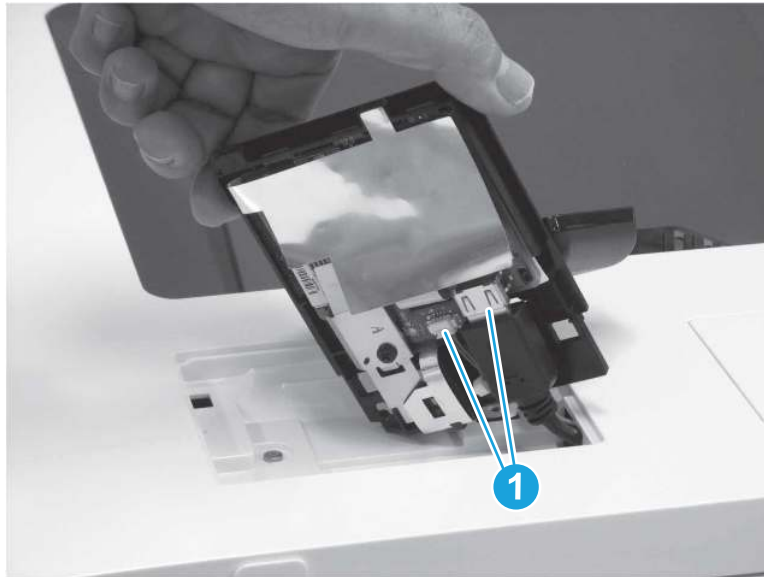
- c. Lift the back edge of the control panel up (callout 1), and then slide the control panel toward the back of the printer (callout 2).

Figure 1-1902 Slide the control panel back



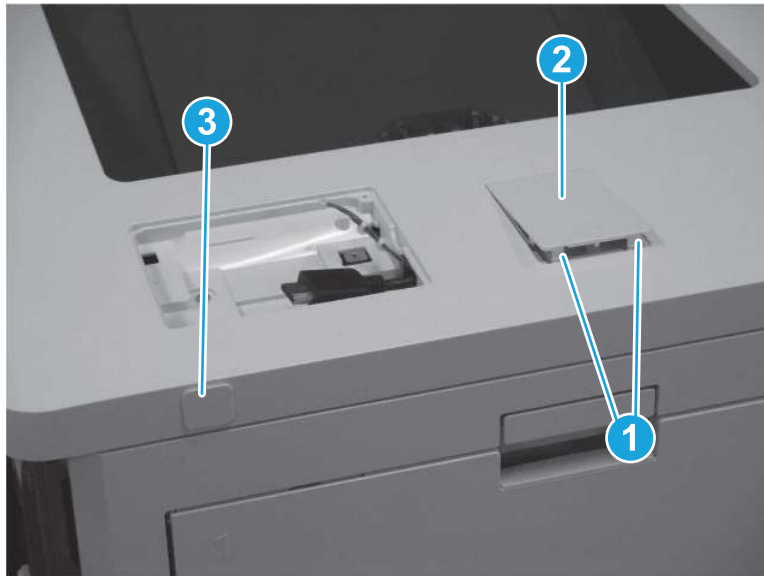
- d. Turn the control panel so that the bottom is facing up, and then disconnect two connectors (callout 1) to remove the control panel.

Figure 1-1903 Disconnect two connectors



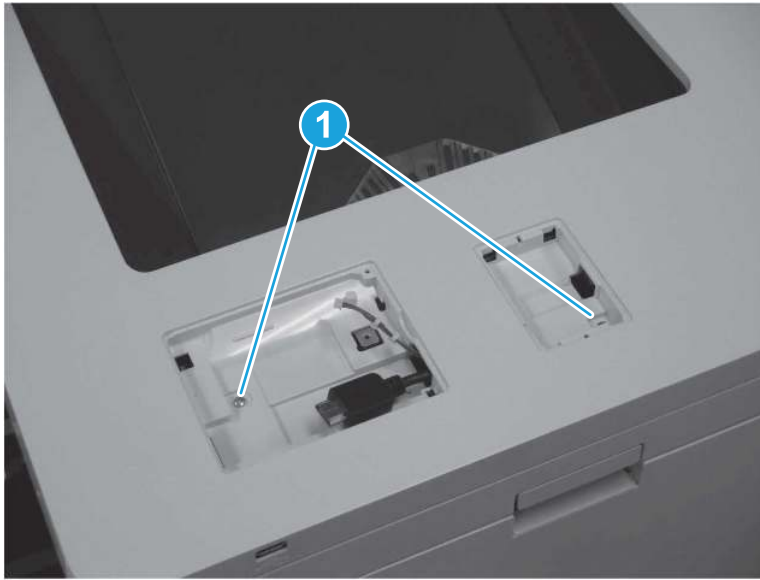
7. Remove the top cover (M751/E75245).
 - a. Release two tabs (callout 1), and then remove the HIP cover (callout 2). Pull the USB cap (callout 3) away from the printer to remove it.

Figure 1-1904 Remove the HIP cover and USB cap



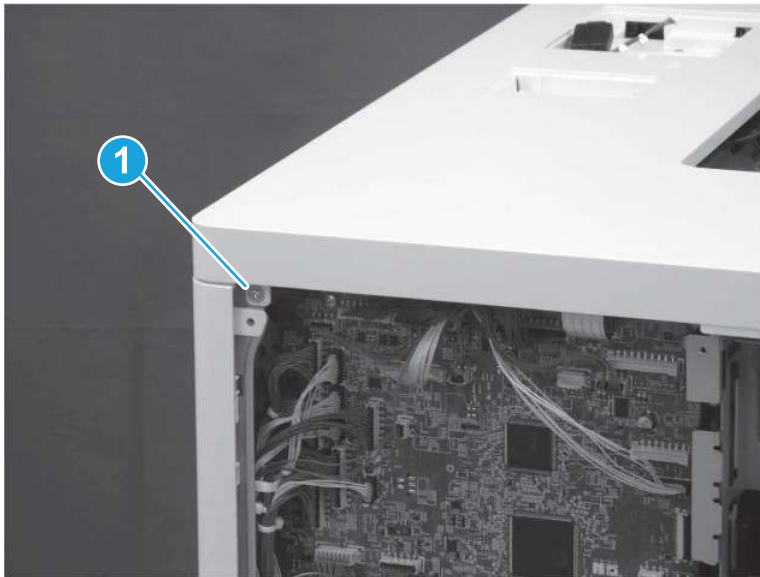
- b. At the top of the printer, remove two screws (callout 1).

Figure 1-1905 Remove two screws




- c. At the back of the printer, remove one screw (callout 1).

Figure 1-1906 Remove one screw

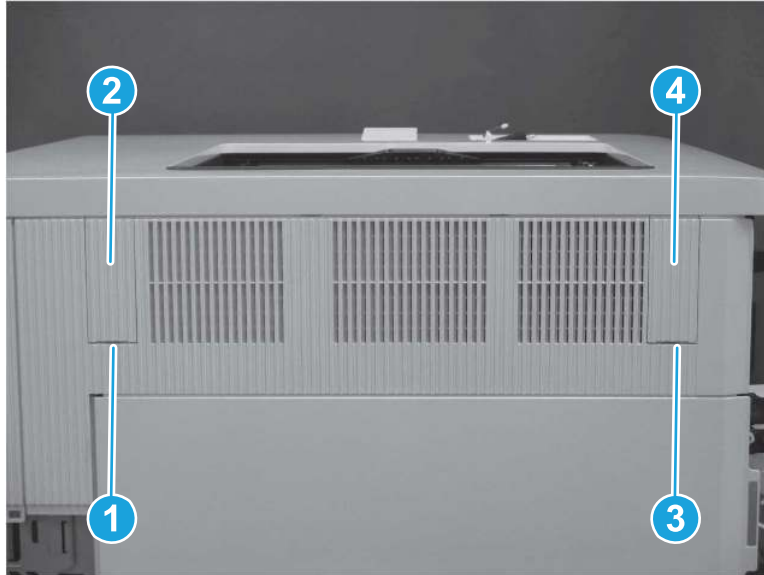


- d. Use a small, flat-blade screwdriver to release one tab (callout 1) and remove the left blanking cover (callout 2). Release one tab (callout 3) and remove the right blanking cover (callout 4).

 **TIP:** These covers are not identical. Make sure to reinstall the correct cover on the correct side.

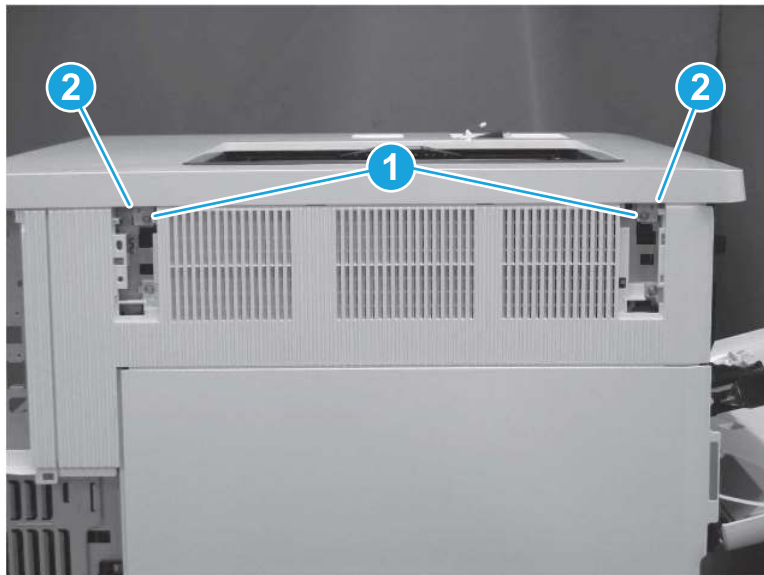
 **NOTE:** The screw under the left blanking cover is a self-tapping screw. Make sure this screw is reinstalled in the correct location.

Figure 1-1907 Remove the left and right blanking covers



- e. Remove two screws (callout 1), and then release two tabs (callout 2).

Figure 1-1908 Remove two screws and release two tabs



- f. At the front of the printer, remove one washer-head screw (callout 1) and one self-tapping screw (callout 2). Release one tab (callout 3).


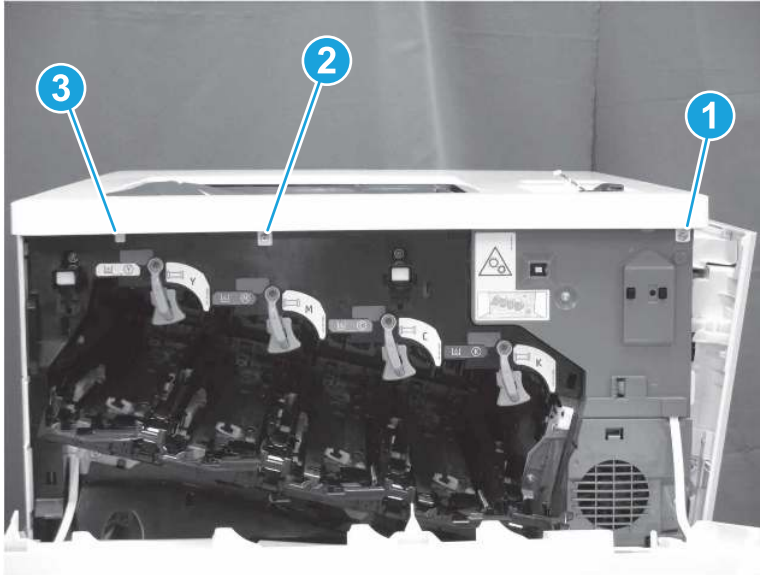
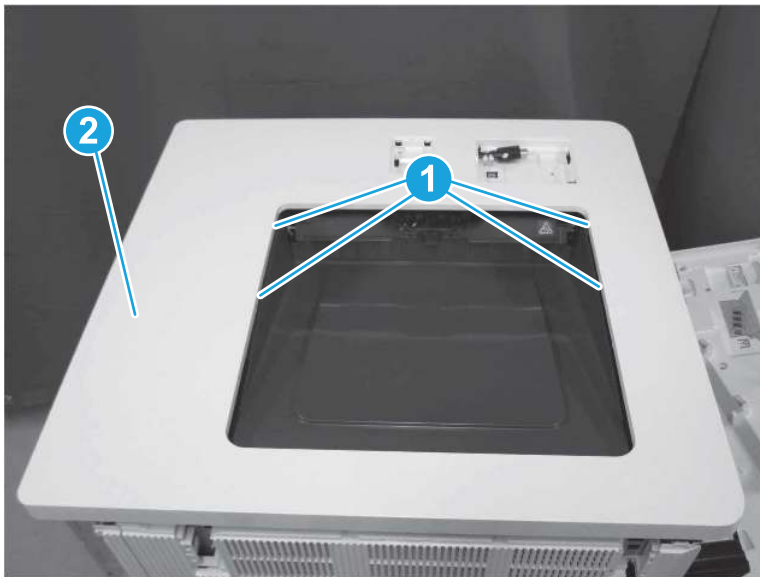
 **TIP:** Make sure to install the correct type of screw in the correct location.

Figure 1-1909 Remove two screws and release one tab



- g. At the top of the printer, release four tabs (callout 1), and then remove the top cover (callout 2).

Figure 1-1910 Remove the top cover

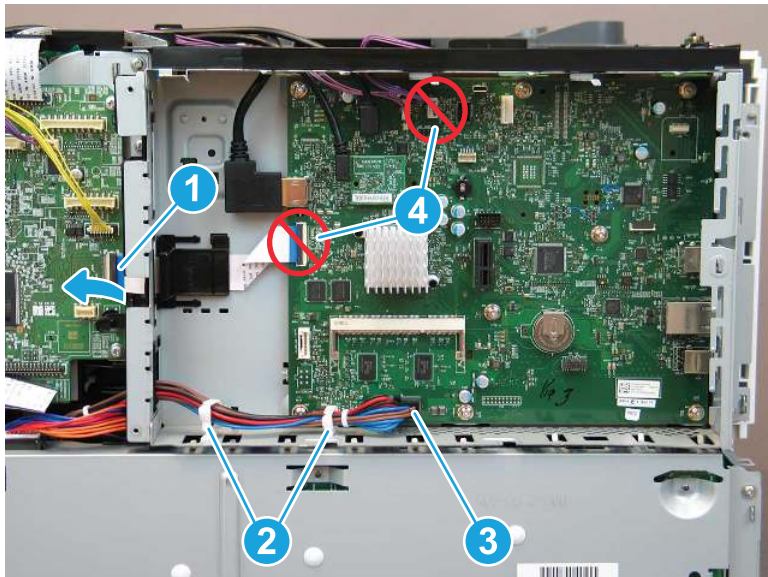


 **NOTE:** When removing the top cover, make sure to release the control panel cables (callout 1) through the opening.



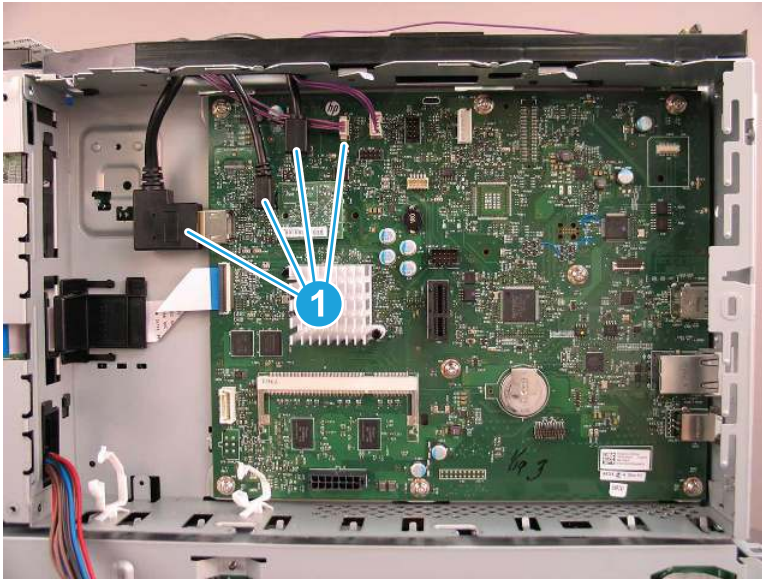
8. Remove the formatter and case.
 - a. Open the retainer (callout 1) to release the flat cable. Release the cables from two retainers (callout 2). Squeeze the latch to disconnect the connector (callout 3) at the lower edge of the formatter. It is not necessary to disconnect two connectors (callout 4).

Figure 1-1911 Disconnect the connectors



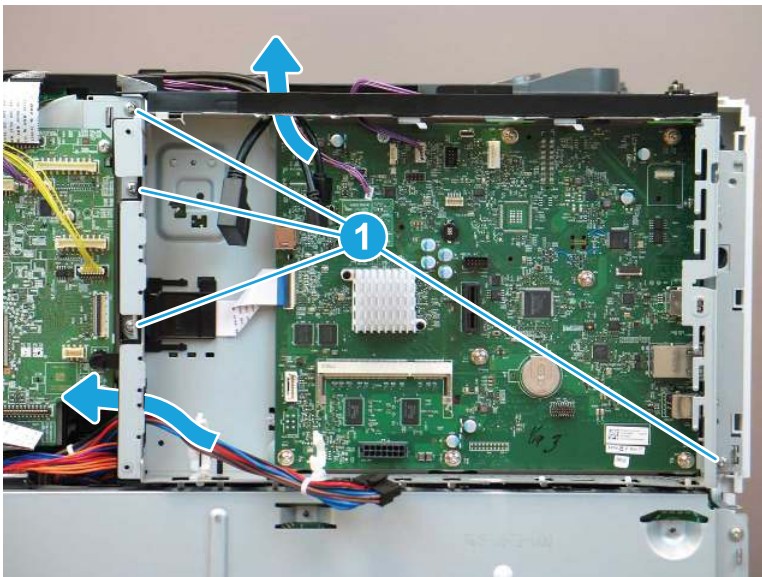
- b. Disconnect all of the remaining connectors on the formatter (callout 1).

Figure 1-1912 Disconnect the connectors



- c. Release the cables through the opening on top and on the left side of the formatter case. Remove four screws (callout 1), and then remove the formatter and case.

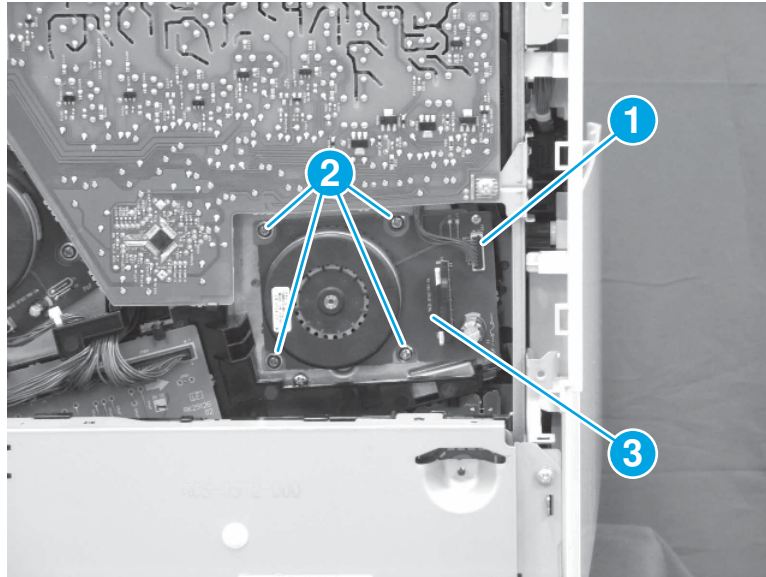
Figure 1-1913 Remove the formatter and case



- 9. Remove drum motor 1.

- ▲ Disconnect one connector (callout 1), remove four screws (callout 2), and then remove drum motor 1 (callout 3).

Figure 1-1914 Remove drum motor 1



10. Unpack the replacement assembly.

- a. Dispose of the defective part.




NOTE: HP recommends responsible disposal of the defective part.

<http://www8.hp.com/us/en/hp-information/environment/product-recycling.html>

- b. Unpack the replacement part from the packaging.



CAUTION:  Some parts are sensitive to electrostatic discharge (ESD). Always perform service work at an ESD-protected workstation or mat. If an ESD workstation or mat is not available, touch the sheet-metal chassis to provide a static ground before touching an ESD-sensitive assembly. Protect the ESD-sensitive assemblies by placing them in ESD pouches when they are out of the printer.



IMPORTANT: Make sure that all of the shipping materials (for example shipping tape) are removed from the replacement part prior to installation.

- c. To install an assembly, reverse the removal steps.



NOTE: When applicable, special installation instructions are provided for an assembly at the end of the removal procedure. Always completely read the removal instructions and follow all special installation instructions.

Removal and replacement: Drum motor 1 (M856/E85055/M776)

Learn how to remove and replace drum motor 1.

[View a video of how to remove and replace the drum motor 1.](#)

Mean time to repair: 30 minutes

Service level: Medium

Before performing service

Turn the printer power off

- Disconnect the power cable.

⚠ WARNING! To avoid damage to the printer, turn the printer off, wait 30 seconds, and then remove the power cord before attempting to service the printer.

Use the table below to identify the correct part number for your printer. To order the part, go to www.hp.com/buy/parts.

Table 1-102 Part information

Part number	Part description
RM2-1612-000CN	Main motor assembly

Required tools

- #2 Phillips screwdriver with a magnetic tip
- Small, flat-blade screwdriver

After performing service

Turn the printer power on

- Connect the power cable.
- Use the power switch to turn the power on.

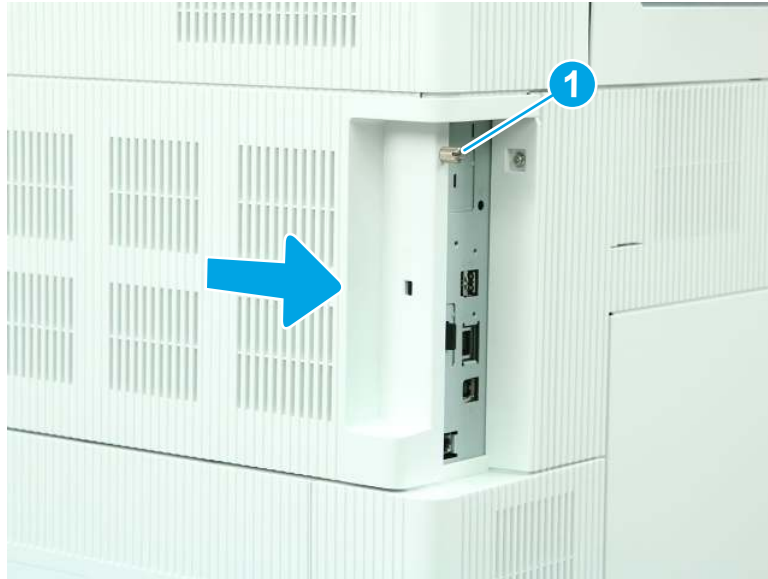
Post service test

No post service test is available for this assembly.

1. Remove the formatter cover.

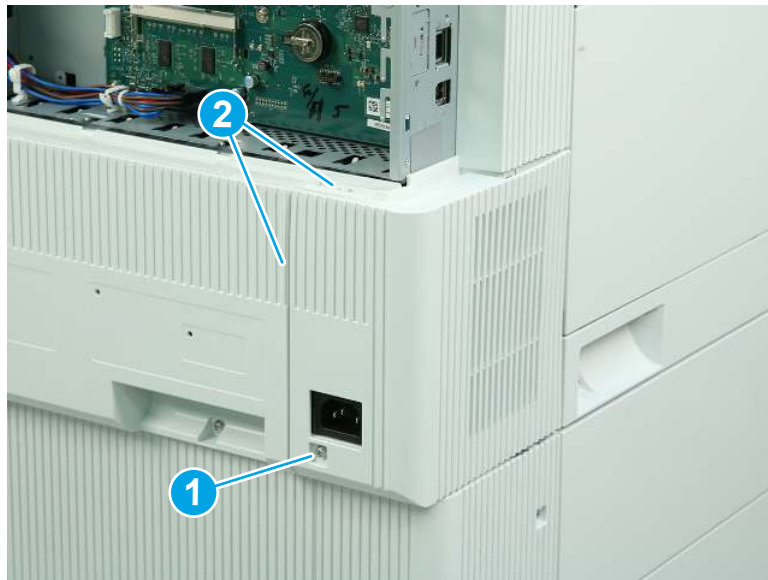
- ▲ Loosen one thumbscrew (callout 1), and then slide the formatter cover (callout 2) away from the printer to remove it.

Figure 1-1915 Remove the formatter cover



- 2. Remove the left lower cover (M856/E85055/M776).
 - a. Remove one screw (callout 1), and then release two tabs (callout 2).

Figure 1-1916 Remove one screw and release two tabs



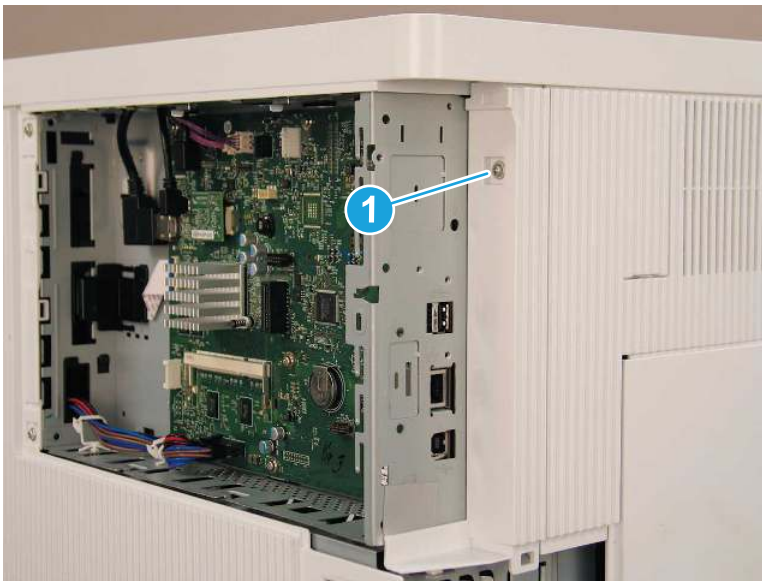
- b. Rotate the cover away from the printer to remove it.

Figure 1-1917 Remove the left lower cover



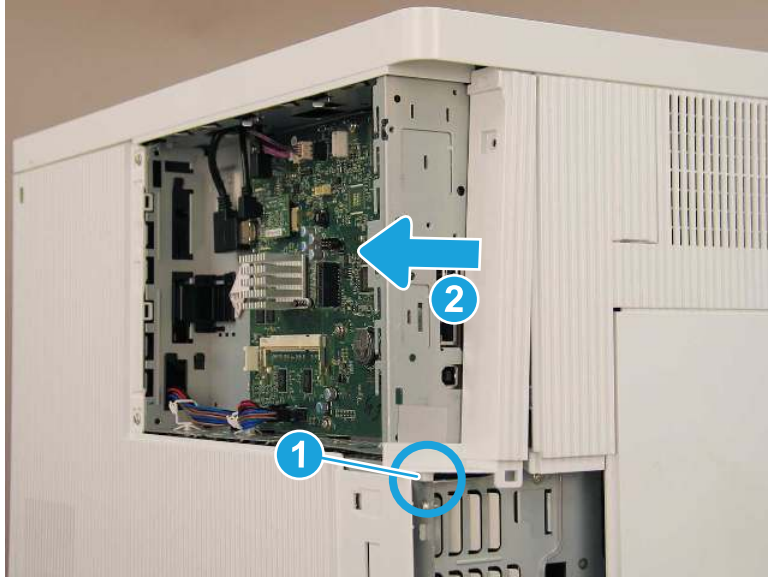
3. Remove the left rear cover (M751/E75245/M856/E85055/M776).
 - a. Remove one screw (callout 1).

Figure 1-1918 Remove one screw



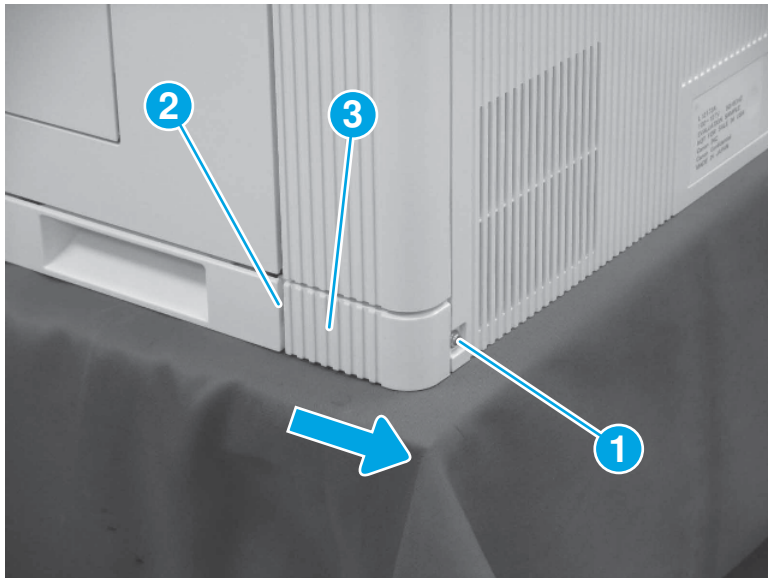
- b. Release one boss (callout 1), and then slide the cover toward the back of the printer (callout 2) to remove it.

Figure 1-1919 Remove the left rear cover



4. Remove the right rear lower cover (M751/E75245/M856/E85055/M776).
 - ▲ Remove one screw (callout 1), release one tab (callout 2), and then slide the right rear lower cover (callout 3) toward the back of the printer to remove it.

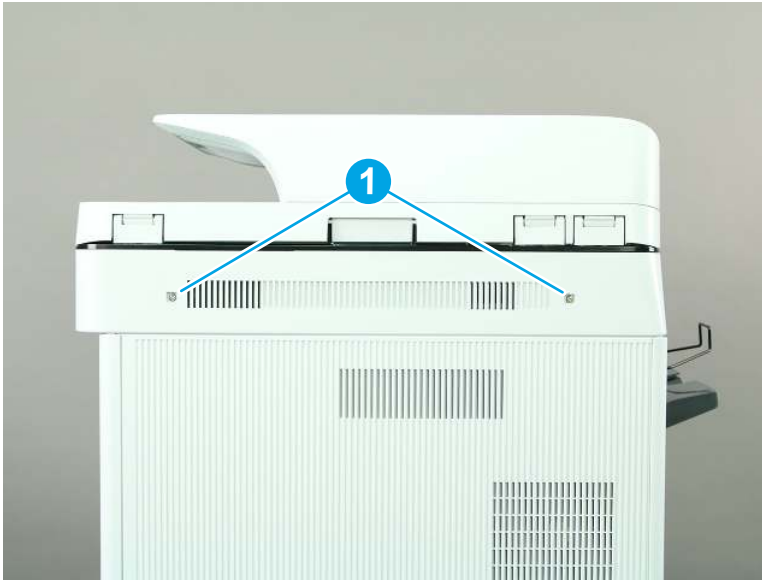
Figure 1-1920 Remove the right rear lower cover



5. Remove the scanner control board (SCB) cover (M776).

- a. Remove two screws (callout 1).

Figure 1-1921 Remove two screws



- b. Remove the SCB cover.

Figure 1-1922 Remove the SCB cover

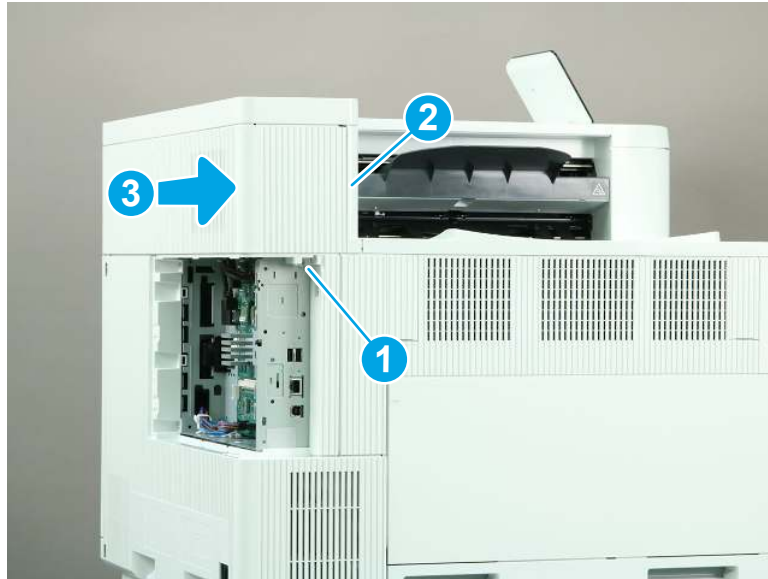


6. Remove the rear upper cover (M856/E85055/M776dn/M776z).

 **NOTE:** The following figure shows the M856 printer. The procedure is correct for all referenced models.

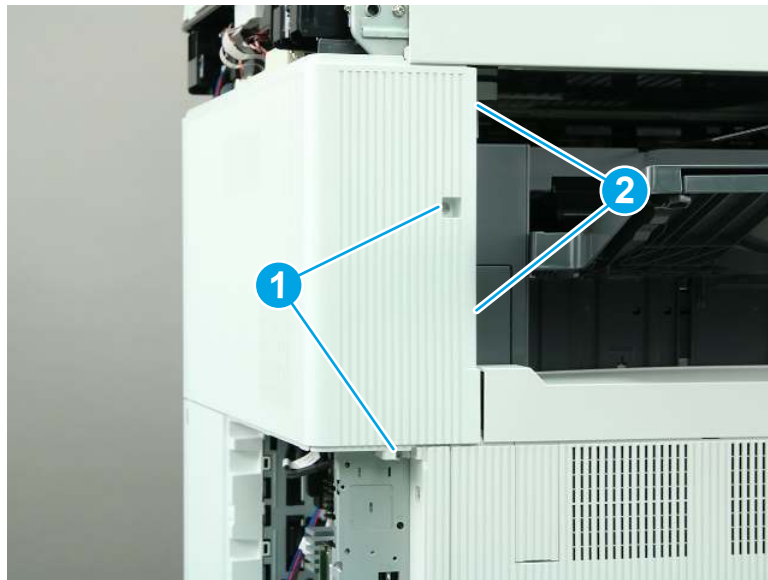
- ▲ Remove one screw (callout 1), release one tab (callout 2), and then slide the rear upper cover away from the printer to remove it (callout 3).

Figure 1-1923 Remove the rear upper cover



- 7. Remove the rear upper cover and left rear upper cover (M776zs).
 - a. Remove two screws (callout 1), and then release two tabs (callout 2).

Figure 1-1924 Remove two screws and release two tabs



- b. Slide the cover to the right to remove it.

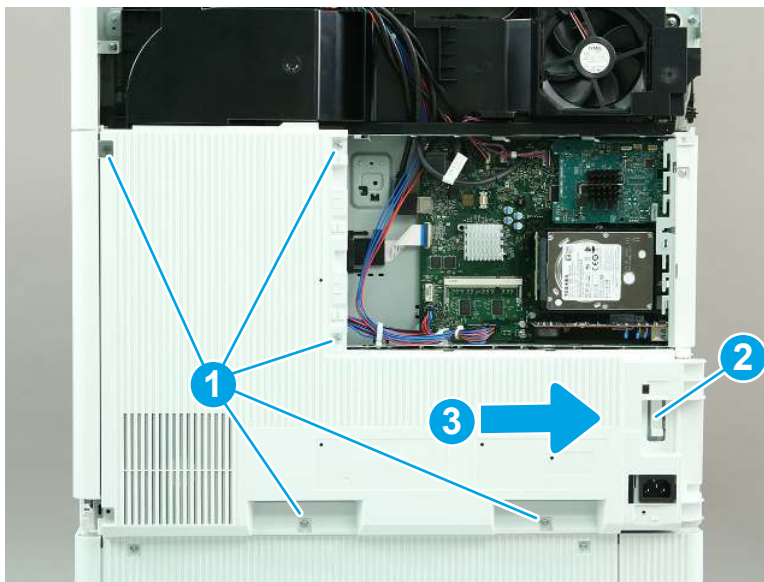
Figure 1-1925 Remove the rear upper and left rear upper cover




8. Remove the rear cover (M856/E85055/M776).

- ▲ Remove five screws (callout 1), release one tab (callout 2), and then slide the rear cover to the right to remove it.

Figure 1-1926 Remove the rear cover (M856/E85055/M776)



9. **M856/E85055 only:** Remove the control panel and top cover.

 **NOTE:** This step applies to only the M856/E85055 models. Skip this step for all other models.

- a. Use a small, flat-blade screwdriver to release two tabs (callout 1), and then remove the control panel cover (callout 2).

Figure 1-1927 Remove the control panel cover



- b. Remove one screw (callout 1).

Figure 1-1928 Remove one screw



- c. Lift the back edge of the control panel up (callout 1), and then slide the control panel toward the back of the printer (callout 2).

Figure 1-1929 Slide the control panel back



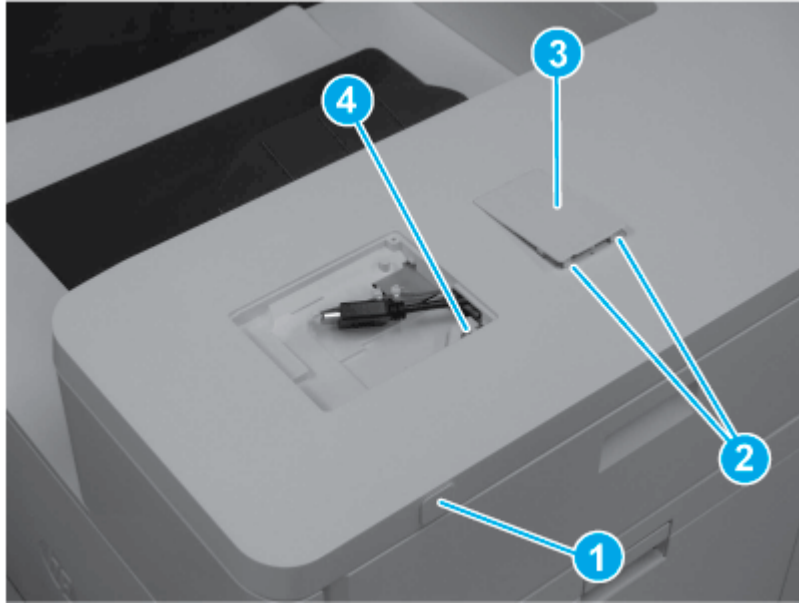
- d. Turn the control panel so that the bottom is facing up, and then disconnect two connectors to remove the control panel.

Figure 1-1930 Disconnect two connectors



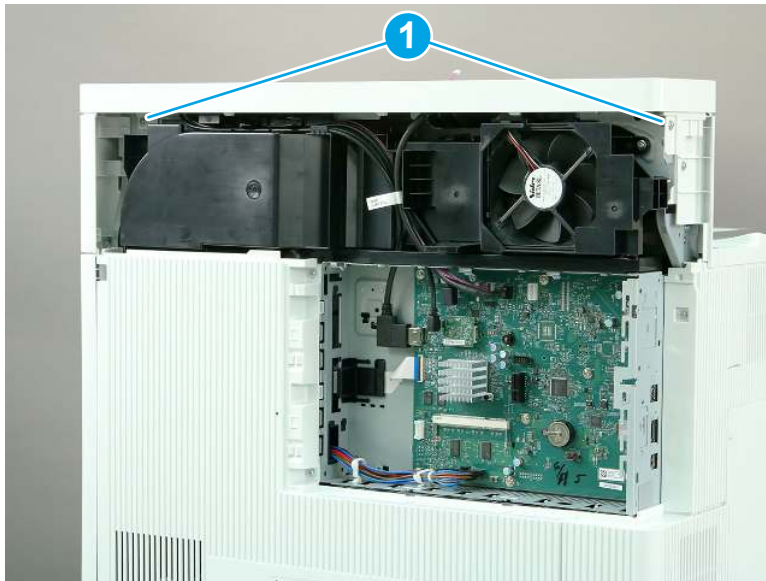
- e. Remove the USB cover (callout 1). Release two tabs (callout 2), and then remove the HIP cover (callout 3). Remove one screw (callout 4).

Figure 1-1931 Remove covers and one screw



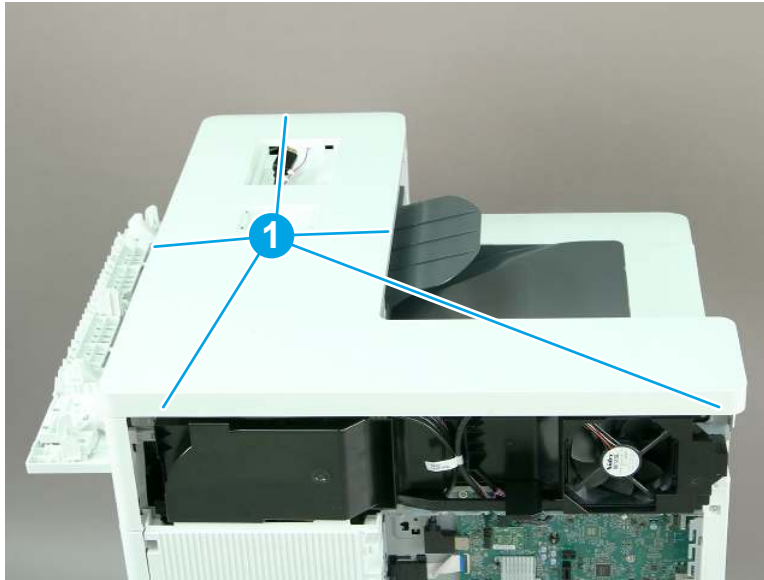
- f. Remove two screws (callout 1).

Figure 1-1932 Remove two screws



- g. Release five tabs (callout 1), and then remove the top cover.

Figure 1-1933 Release five tabs



- 10. Remove the formatter and case (M856/E85055/M776).

 **NOTE:** The figures below show the M776zs formatter. The procedure is correct for all referenced models.

- a. Release two retainers (callout 1), and then open the retainer (callout 2) to release the flat cable. Disconnect all of the remaining connectors on the formatter board.


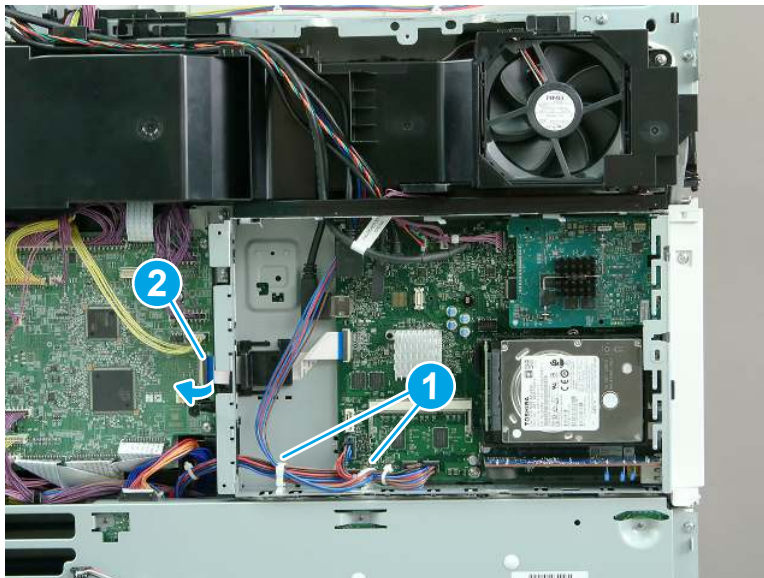
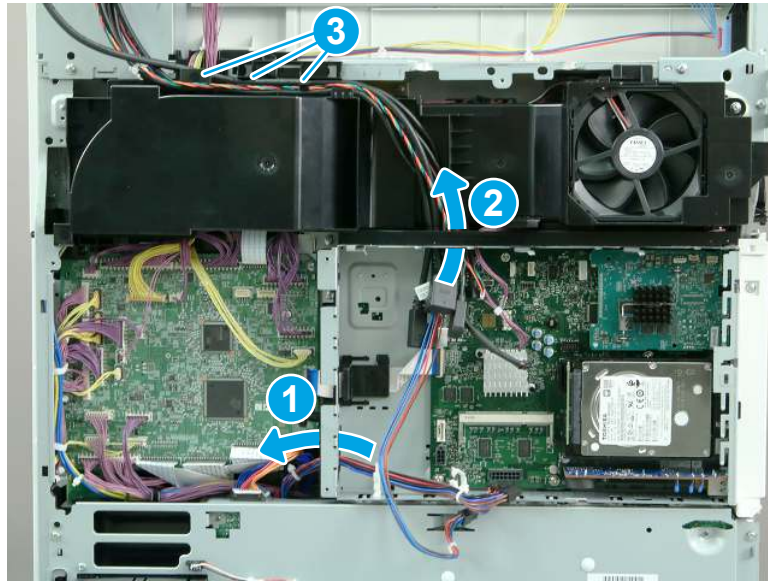
 **NOTE:** The figures below show the M776zs model. The procedures are correct for all of the referenced models.

Figure 1-1934 Disconnect the connectors



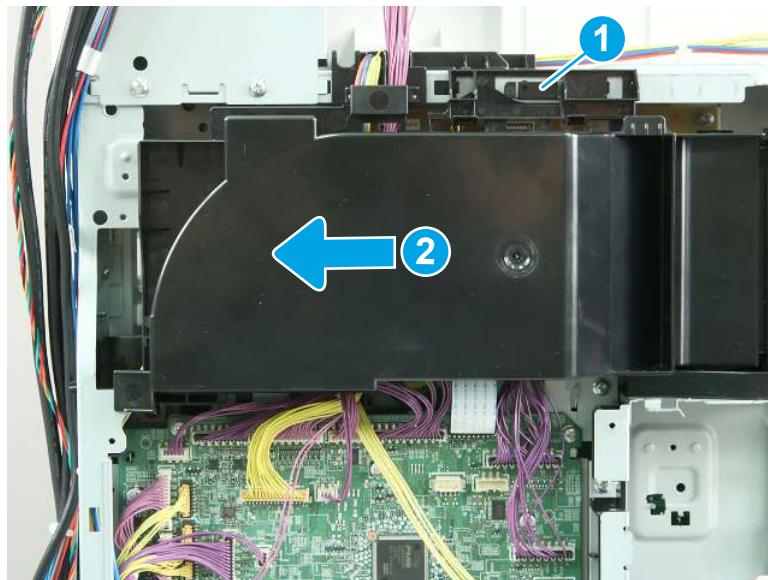
- b. Release one cable through the opening in the left side of the formatter case (callout 1). Release the remaining cables through the opening in the top of the formatter case (callout 2). Release the cables from the upper cable guide (callout 3).

Figure 1-1935 Release the cables



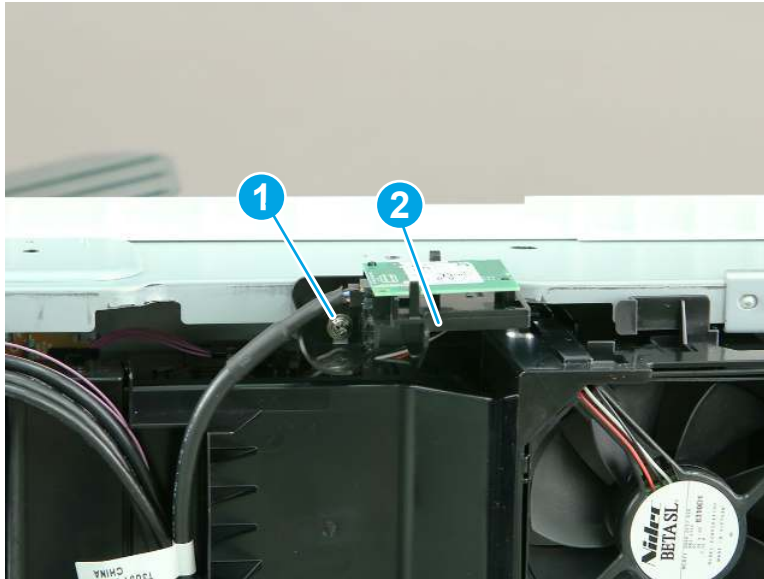
- c. Release one tab (callout 1), and then slide the fan duct to the left (callout 2) to remove it.

Figure 1-1936 Remove the fan duct



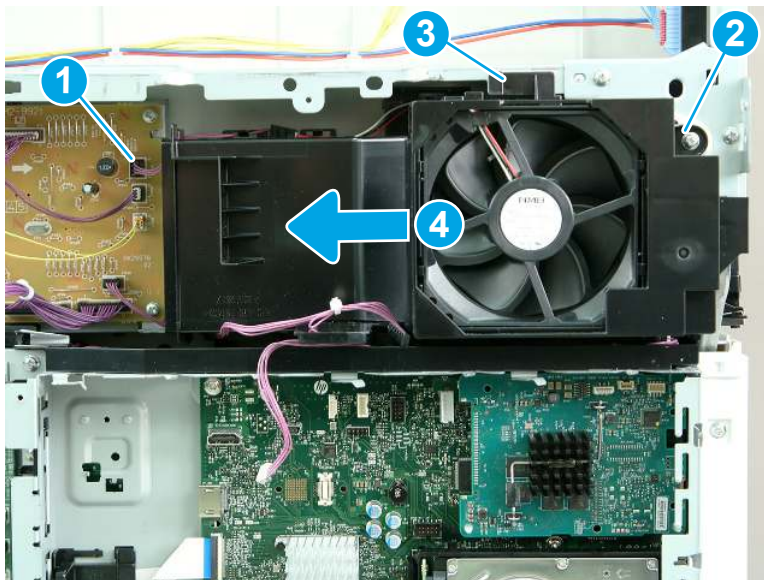
- d. **M856 and E85055 only:** Remove one screw (callout 1), and then remove the wireless card and bracket (callout 2).

Figure 1-1937 Remove the wireless card and bracket



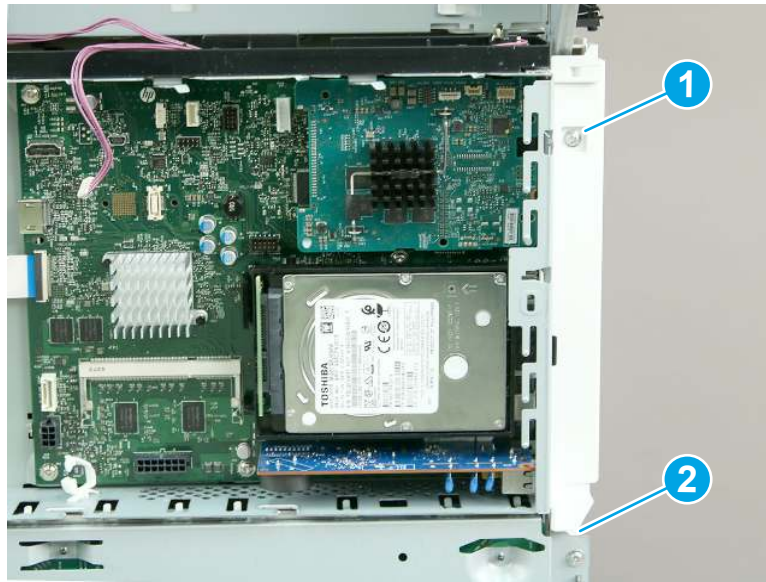
- e. Disconnect one connector (callout 1), and remove one screw (callout 2). Release one tab (callout 3), and then slide the fan assembly to the left (callout 4) to remove it.

Figure 1-1938 Remove the fan assembly



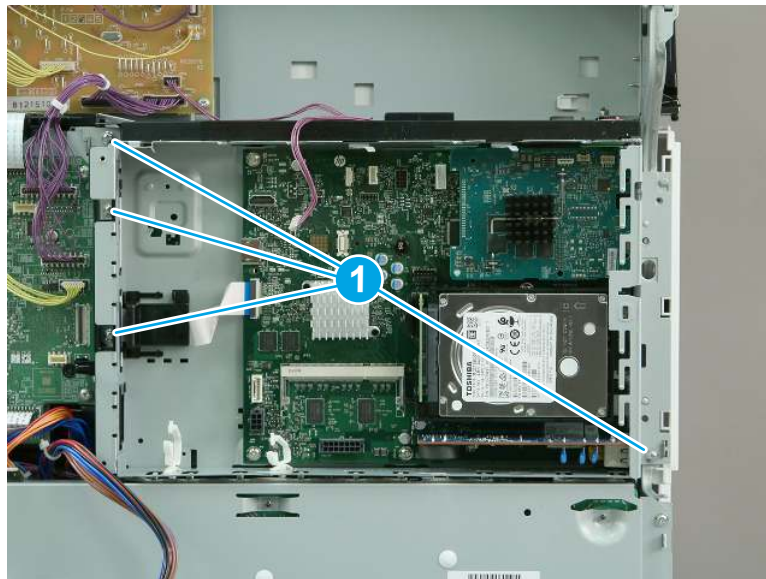
- f. Remove one screw (callout 1), release one tab (callout 2), and then remove the left rear cover.

Figure 1-1939 Remove the left rear cover



- g. Remove four screws (callout 1).

Figure 1-1940 Remove four screws



- h. Remove the formatter and case.

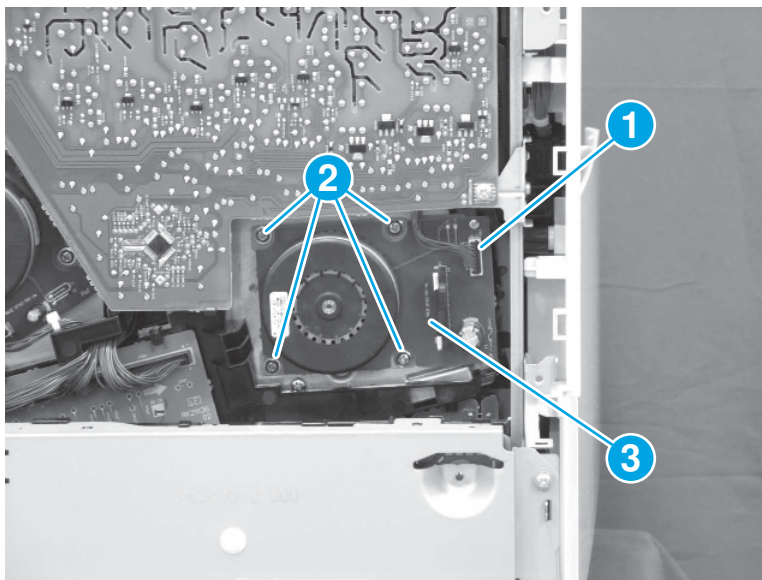
Figure 1-1941 Remove the formatter and case



- 11. Remove drum motor 1.

- ▲ Disconnect one connector (callout 1), remove four screws (callout 2), and then remove drum motor 1 (callout 3).

Figure 1-1942 Remove drum motor 1



- 12. Unpack the replacement assembly.



- a. Dispose of the defective part.




NOTE: HP recommends responsible disposal of the defective part.


<http://www8.hp.com/us/en/hp-information/environment/product-recycling.html>

- b. Unpack the replacement part from the packaging.

 **CAUTION:**  Some parts are sensitive to electrostatic discharge (ESD). Always perform service work at an ESD-protected workstation or mat. If an ESD workstation or mat is not available, touch the sheet-metal chassis to provide a static ground before touching an ESD-sensitive assembly. Protect the ESD-sensitive assemblies by placing them in ESD pouches when they are out of the printer.

 **IMPORTANT:** Make sure that all of the shipping materials (for example shipping tape) are removed from the replacement part prior to installation.

- c. To install an assembly, reverse the removal steps.

 **NOTE:** When applicable, special installation instructions are provided for an assembly at the end of the removal procedure. Always completely read the removal instructions and follow all special installation instructions.

Removal and replacement: Drum motor 2 (M751/E75245)

Learn how to remove and replace drum motor 2.

[View a video of how to remove and replace the drum motor 2.](#)

Mean time to repair: 30 minutes

Service level: Medium

Before performing service

Turn the printer power off

- Disconnect the power cable.

 **WARNING!** To avoid damage to the printer, turn the printer off, wait 30 seconds, and then remove the power cord before attempting to service the printer.

Use the table below to identify the correct part number for your printer. To order the part, go to www.hp.com/buy/parts.

Table 1-103 Part information

Part number	Part description
RM2-1613-000CN	Main motor assembly

Required tools

- #2 Phillips screwdriver with a magnetic tip
- Small, flat-blade screwdriver

After performing service

Turn the printer power on

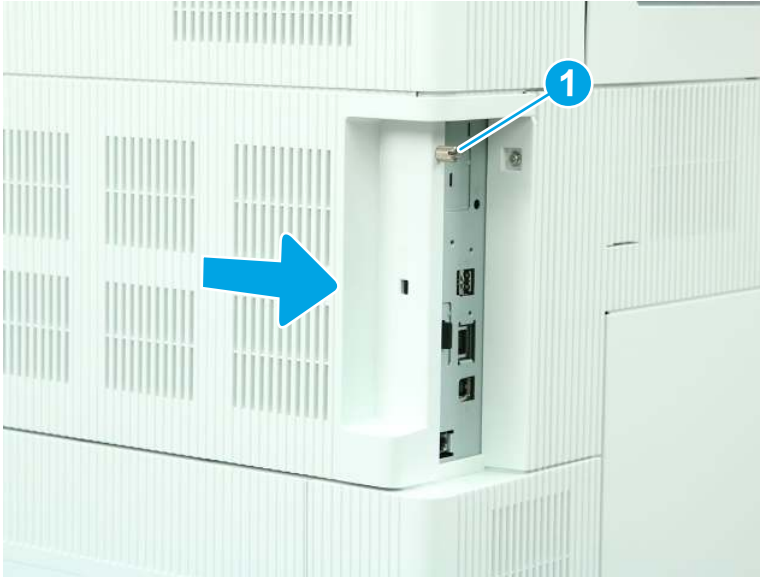
- Connect the power cable.
- Use the power switch to turn the power on.

Post service test

No post service test is available for this assembly.

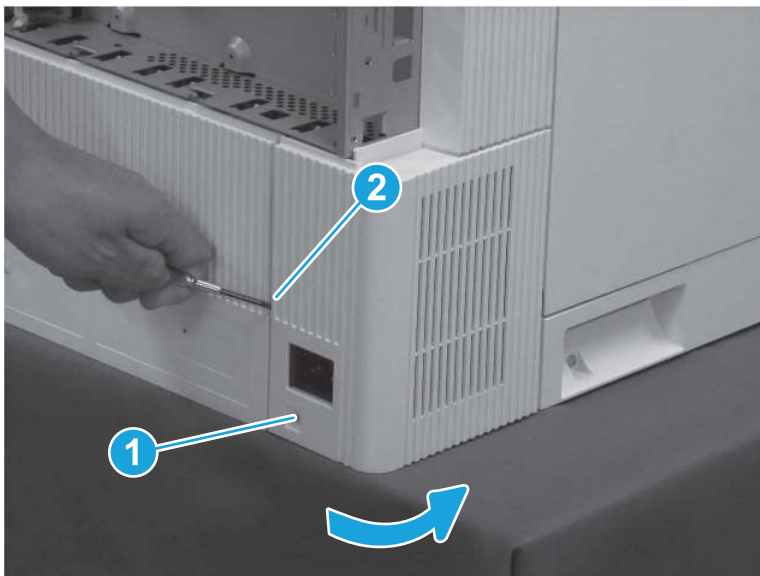
1. Remove the formatter cover.
 - ▲ Loosen one thumbscrew (callout 1), and then slide the formatter cover (callout 2) away from the printer to remove it.

Figure 1-1943 Remove the formatter cover



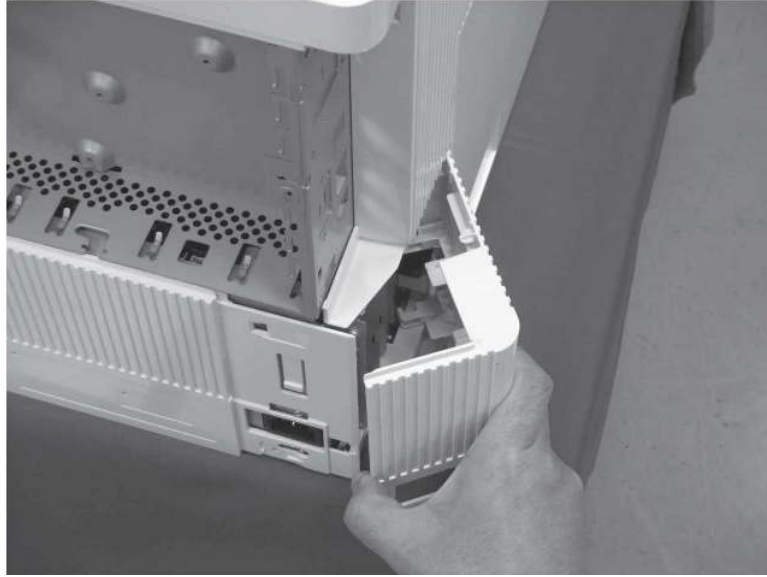
2. Remove the left lower cover (M751/E75245).
 - a. Remove one screw (callout 1), release one tab (callout 2), and then rotate the cover away from the printer.

Figure 1-1944 Remove one screw and release one tab



- b. Remove the left lower cover.

Figure 1-1945 Remove the left lower cover



3. Remove the left rear cover (M751/E75245/M856/E85055/M776).

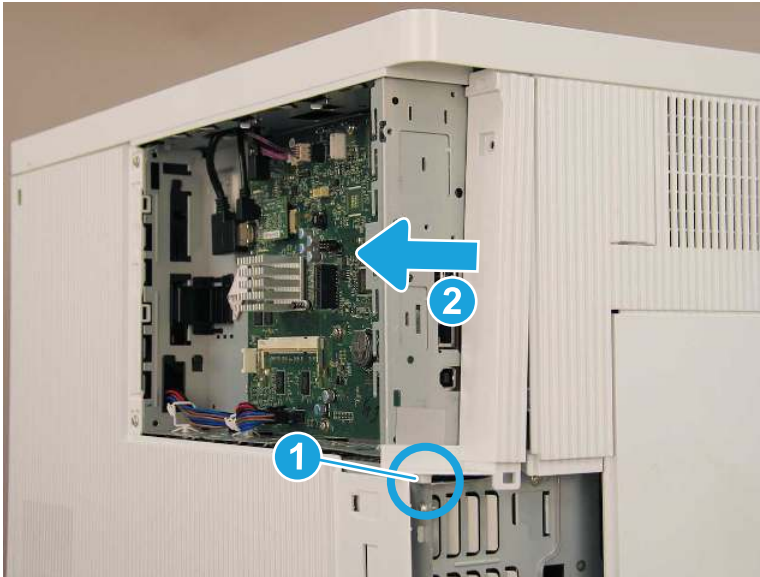
- a. Remove one screw (callout 1).

Figure 1-1946 Remove one screw



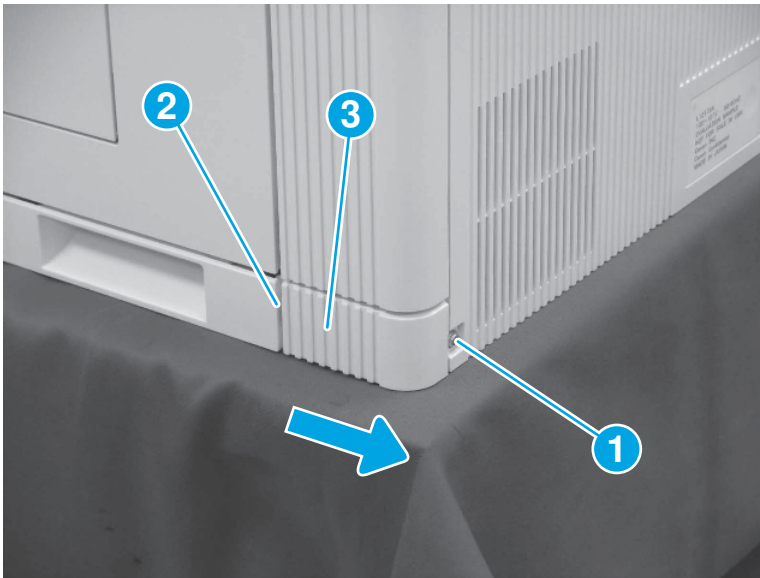
- b. Release one boss (callout 1), and then slide the cover toward the back of the printer (callout 2) to remove it.

Figure 1-1947 Remove the left rear cover



4. Remove the right rear lower cover (M751/E75245/M856/E85055/M776).
 - ▲ Remove one screw (callout 1), release one tab (callout 2), and then slide the right rear lower cover (callout 3) toward the back of the printer to remove it.

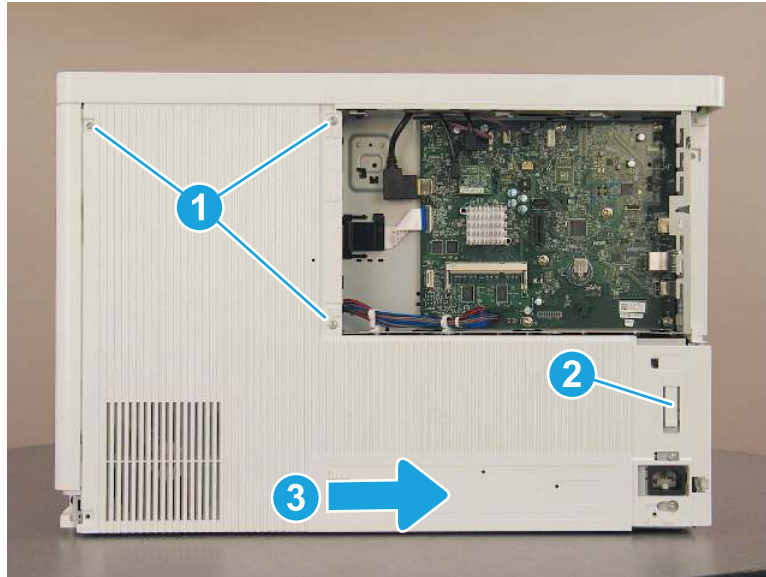
Figure 1-1948 Remove the right rear lower cover



5. Remove the rear cover (M751/E75245).

- ▲ Remove three screws (callout 1), release one tab (callout 2), and then slide the rear cover to the right (callout 3) to remove it.

Figure 1-1949 Remove the rear cover

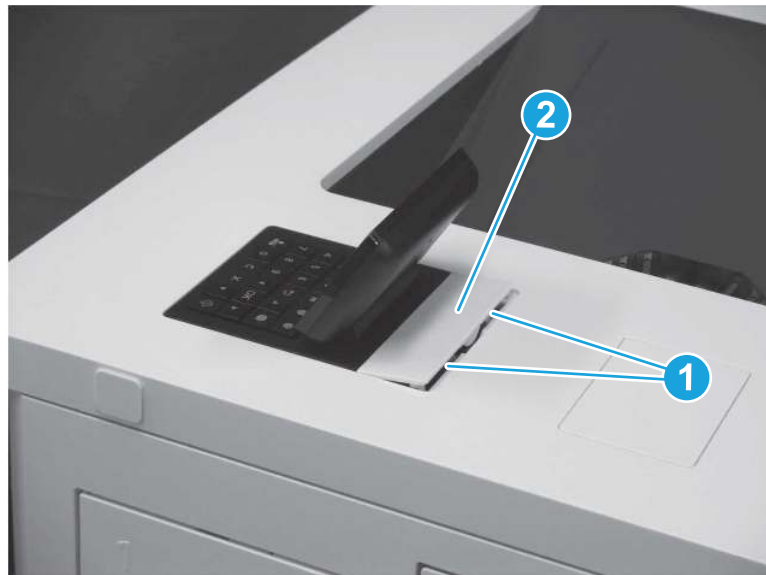


6. Remove the control panel.

 **NOTE:** A screwdriver is included in the control panel kit. The screwdriver has a reversible shaft. Simply pull the shaft out of the handle, and then reinstall it with the desired end facing out.

- a. Use a small, flat-blade screwdriver to release two tabs (callout 1), and then remove the control panel cover (callout 2).

Figure 1-1950 Remove the control panel cover



- b. Remove one screw (callout 1).

Figure 1-1951 Remove one screw



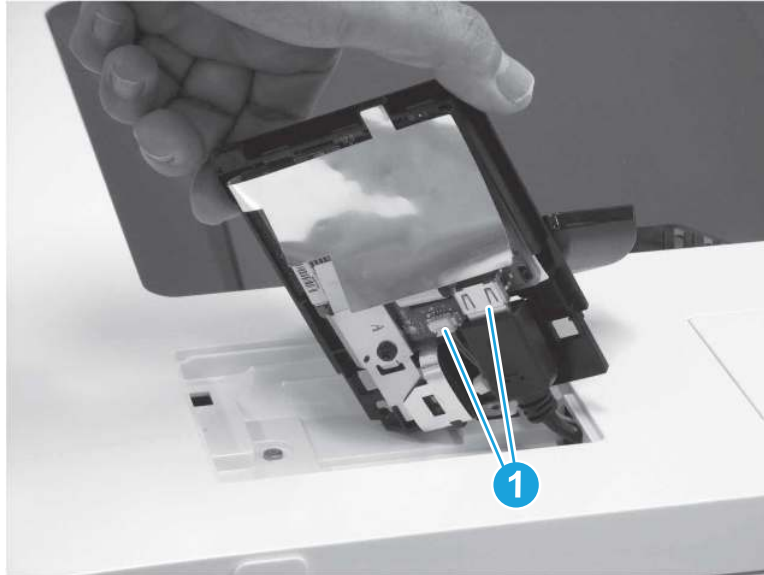
- c. Lift the back edge of the control panel up (callout 1), and then slide the control panel toward the back of the printer (callout 2).

Figure 1-1952 Slide the control panel back



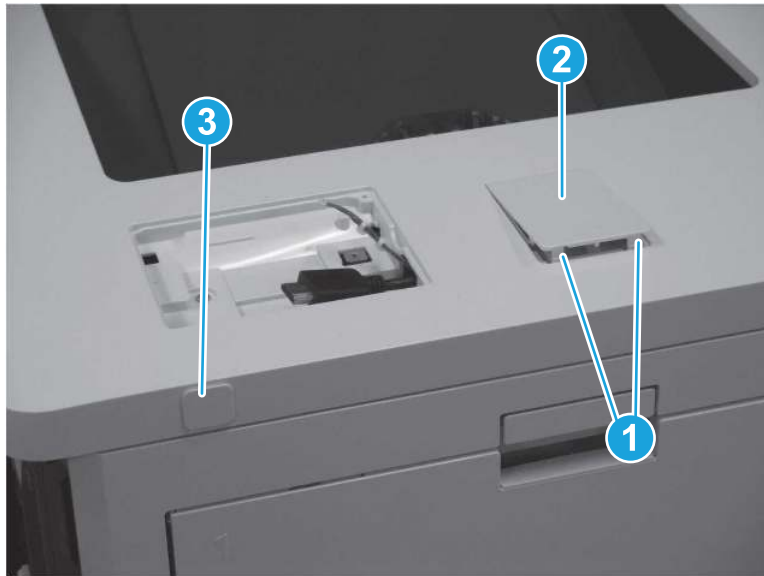
- d. Turn the control panel so that the bottom is facing up, and then disconnect two connectors (callout 1) to remove the control panel.

Figure 1-1953 Disconnect two connectors



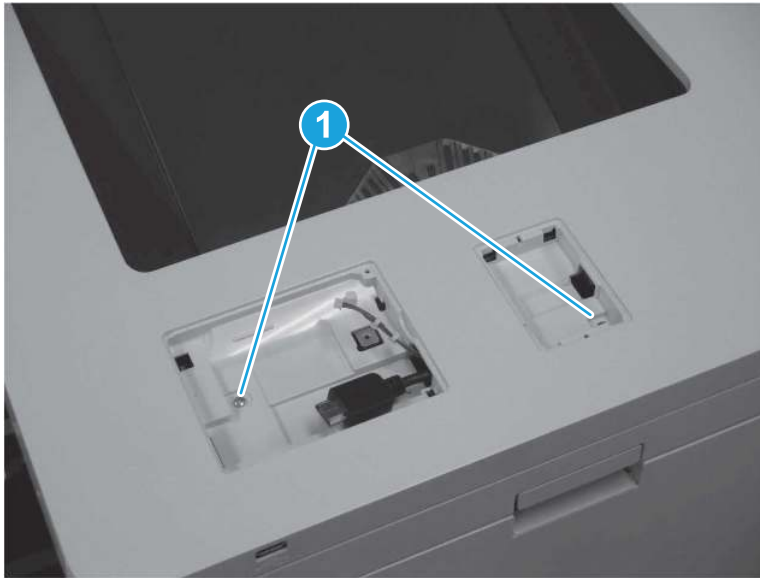
7. Remove the top cover (M751/E75245).
 - a. Release two tabs (callout 1), and then remove the HIP cover (callout 2). Pull the USB cap (callout 3) away from the printer to remove it.

Figure 1-1954 Remove the HIP cover and USB cap



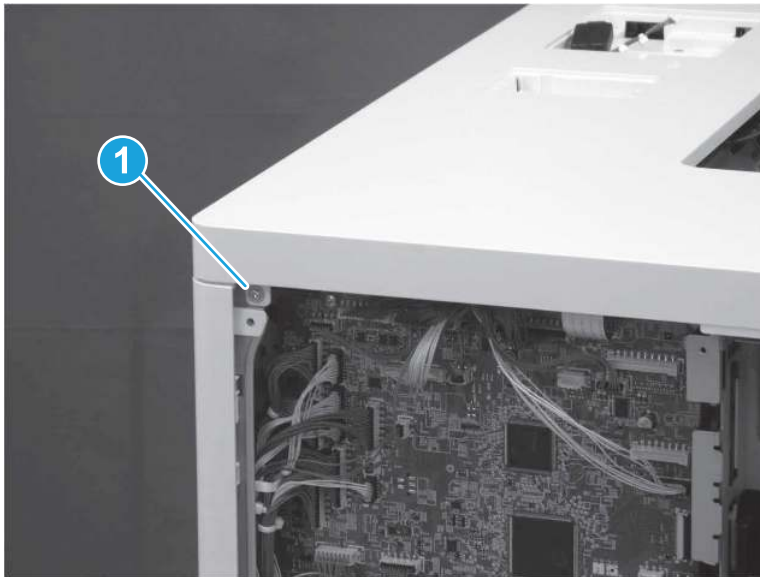
- b. At the top of the printer, remove two screws (callout 1).

Figure 1-1955 Remove two screws



- c. At the back of the printer, remove one screw (callout 1).

Figure 1-1956 Remove one screw

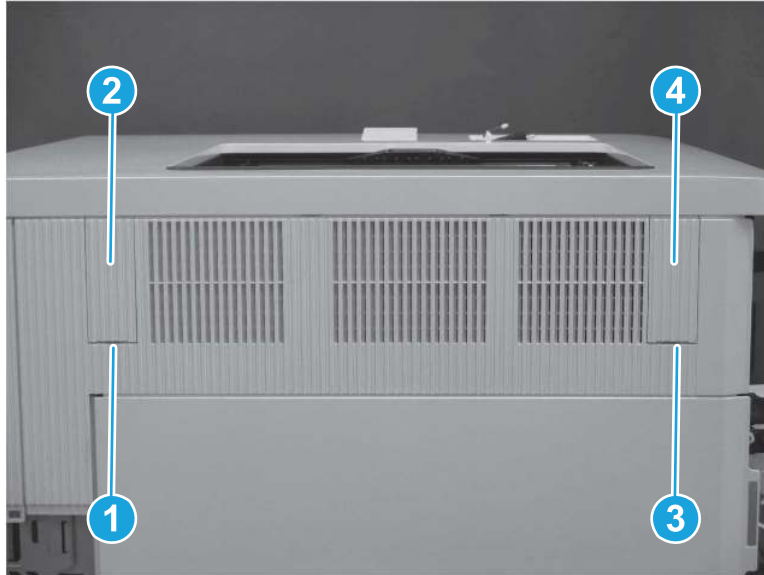


- d. Use a small, flat-blade screwdriver to release one tab (callout 1) and remove the left blanking cover (callout 2). Release one tab (callout 3) and remove the right blanking cover (callout 4).

 **TIP:** These covers are not identical. Make sure to reinstall the correct cover on the correct side.

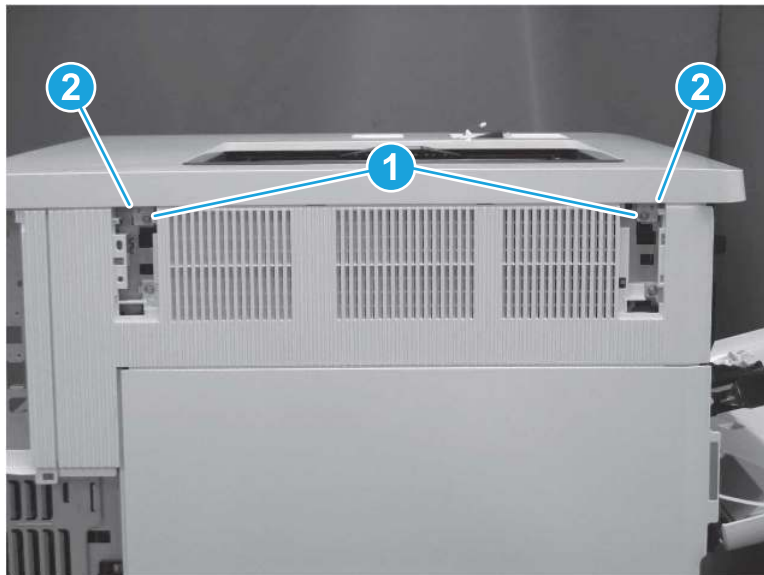
 **NOTE:** The screw under the left blanking cover is a self-tapping screw. Make sure this screw is reinstalled in the correct location.

Figure 1-1957 Remove the left and right blanking covers



- e. Remove two screws (callout 1), and then release two tabs (callout 2).

Figure 1-1958 Remove two screws and release two tabs



- f. At the front of the printer, remove one washer-head screw (callout 1) and one self-tapping screw (callout 2). Release one tab (callout 3).


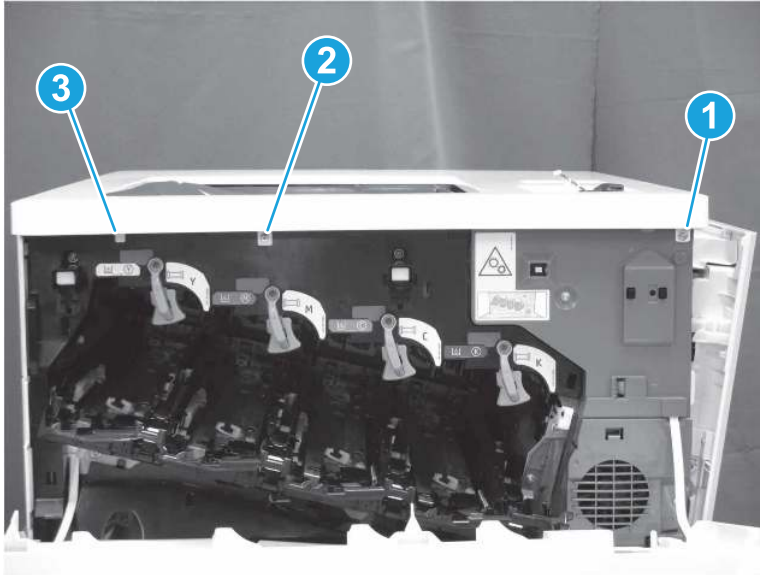
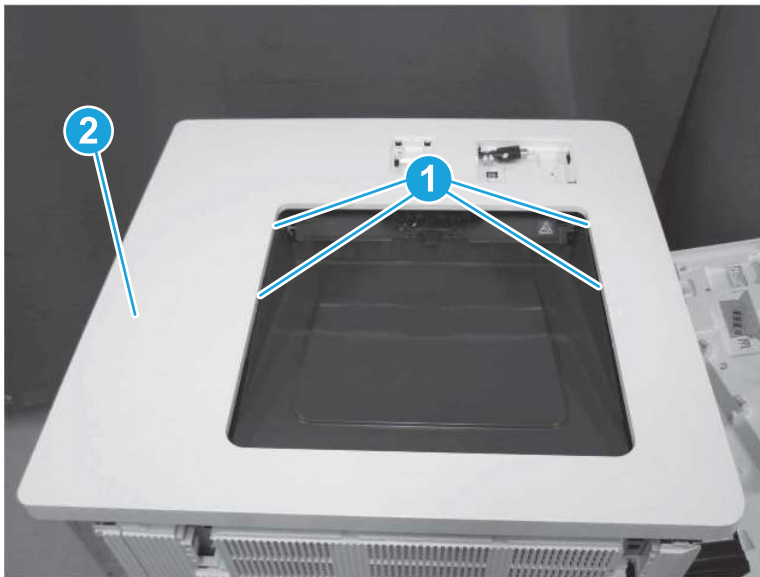
 **TIP:** Make sure to install the correct type of screw in the correct location.

Figure 1-1959 Remove two screws and release one tab

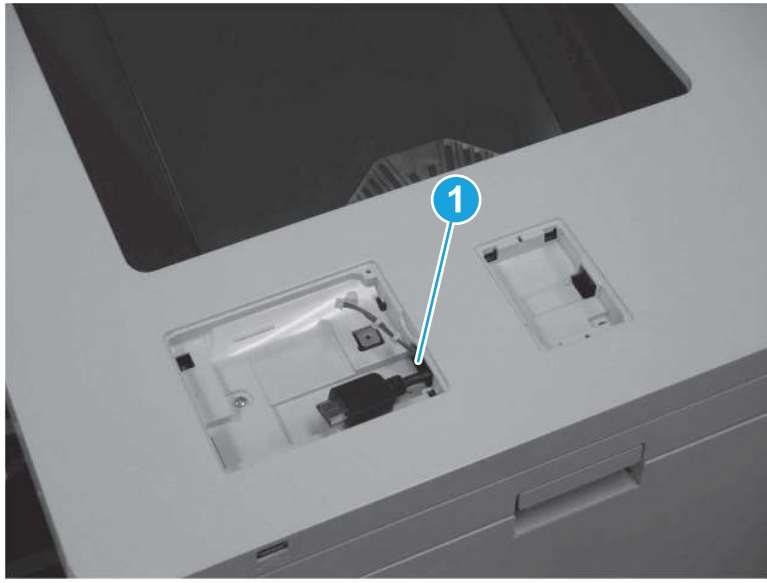


- g. At the top of the printer, release four tabs (callout 1), and then remove the top cover (callout 2).

Figure 1-1960 Remove the top cover

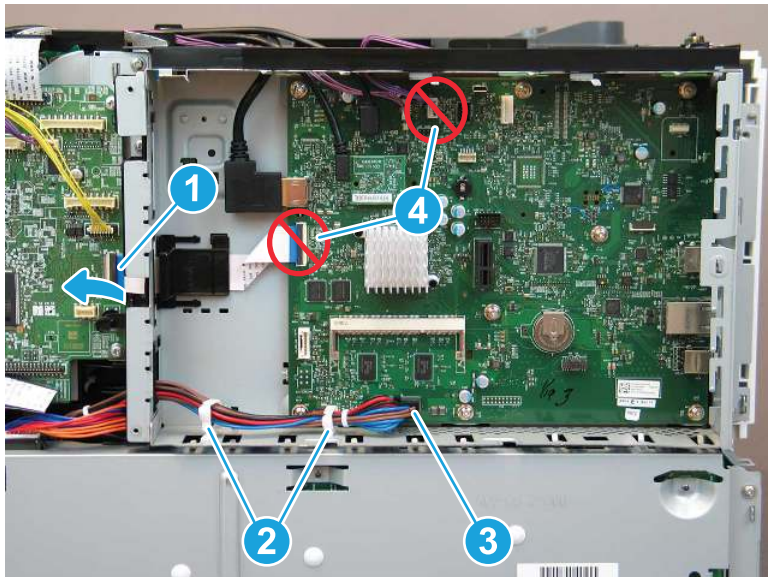


 **NOTE:** When removing the top cover, make sure to release the control panel cables (callout 1) through the opening.



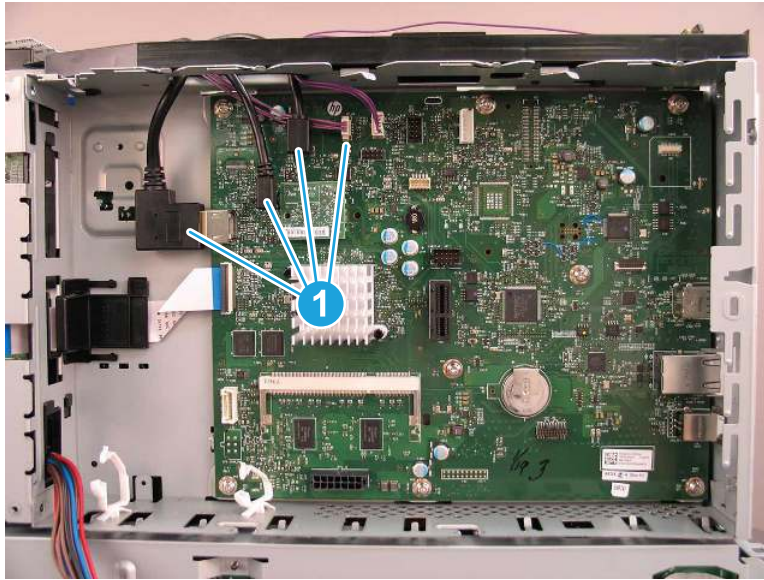
8. Remove the formatter and case.
 - a. Open the retainer (callout 1) to release the flat cable. Release the cables from two retainers (callout 2). Squeeze the latch to disconnect the connector (callout 3) at the lower edge of the formatter. It is not necessary to disconnect two connectors (callout 4).

Figure 1-1961 Disconnect the connectors



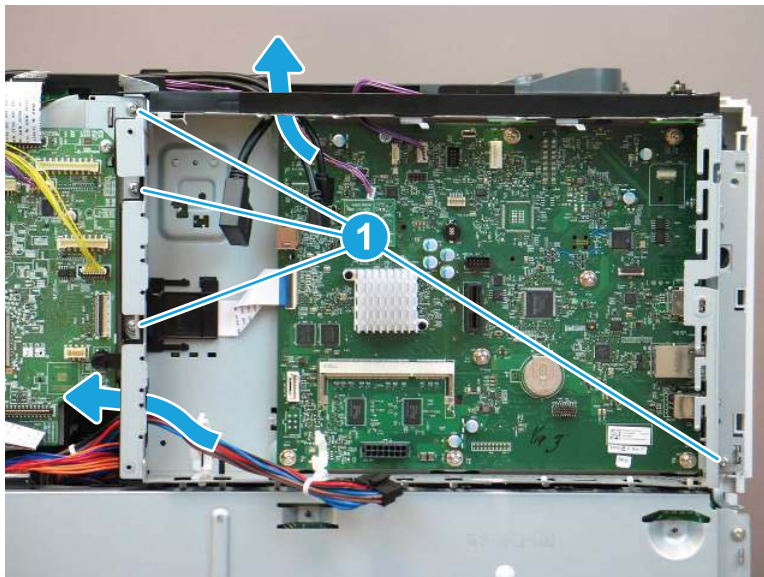
- b. Disconnect all of the remaining connectors on the formatter (callout 1).

Figure 1-1962 Disconnect the connectors



- c. Release the cables through the opening on top and on the left side of the formatter case. Remove four screws (callout 1), and then remove the formatter and case.

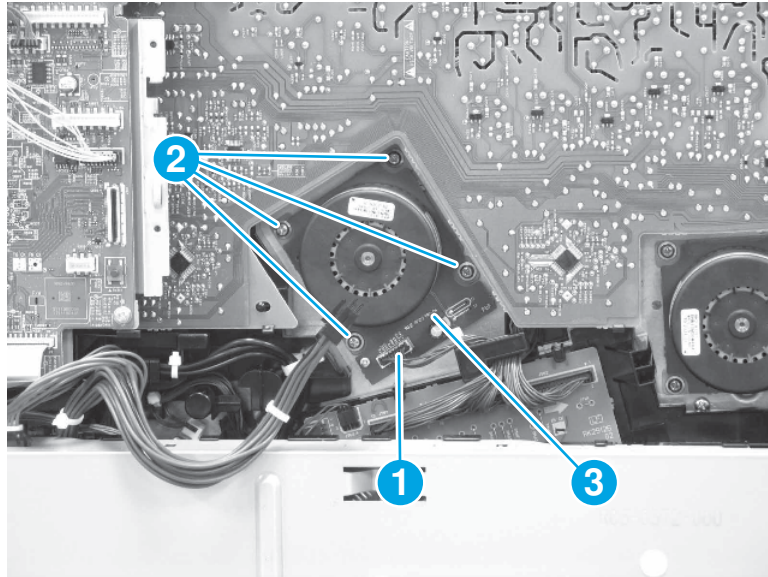
Figure 1-1963 Remove the formatter and case



- 9. Remove drum motor 2.

- ▲ Disconnect one connector (callout 1), remove four screws (callout 2), and then remove drum motor 2 (callout 3).

Figure 1-1964 Remove drum motor 2



10. Unpack the replacement assembly.

- a. Dispose of the defective part.




NOTE: HP recommends responsible disposal of the defective part.

<http://www8.hp.com/us/en/hp-information/environment/product-recycling.html>

- b. Unpack the replacement part from the packaging.



CAUTION:  Some parts are sensitive to electrostatic discharge (ESD). Always perform service work at an ESD-protected workstation or mat. If an ESD workstation or mat is not available, touch the sheet-metal chassis to provide a static ground before touching an ESD-sensitive assembly. Protect the ESD-sensitive assemblies by placing them in ESD pouches when they are out of the printer.



IMPORTANT: Make sure that all of the shipping materials (for example shipping tape) are removed from the replacement part prior to installation.

- c. To install an assembly, reverse the removal steps.



NOTE: When applicable, special installation instructions are provided for an assembly at the end of the removal procedure. Always completely read the removal instructions and follow all special installation instructions.

Removal and replacement: Drum motor 2 (M856/E85055/M776)

Learn how to remove and replace drum motor 2.

[View a video of how to remove and replace the drum motor 2.](#)

Mean time to repair: 30 minutes

Service level: Medium

Before performing service

Turn the printer power off

- Disconnect the power cable.

⚠ WARNING! To avoid damage to the printer, turn the printer off, wait 30 seconds, and then remove the power cord before attempting to service the printer.

Use the table below to identify the correct part number for your printer. To order the part, go to www.hp.com/buy/parts.

Table 1-104 Part information

Part number	Part description
RM2-1613-000CN	Main motor assembly

Required tools

- #2 Phillips screwdriver with a magnetic tip
- Small, flat-blade screwdriver

After performing service

Turn the printer power on

- Connect the power cable.
- Use the power switch to turn the power on.

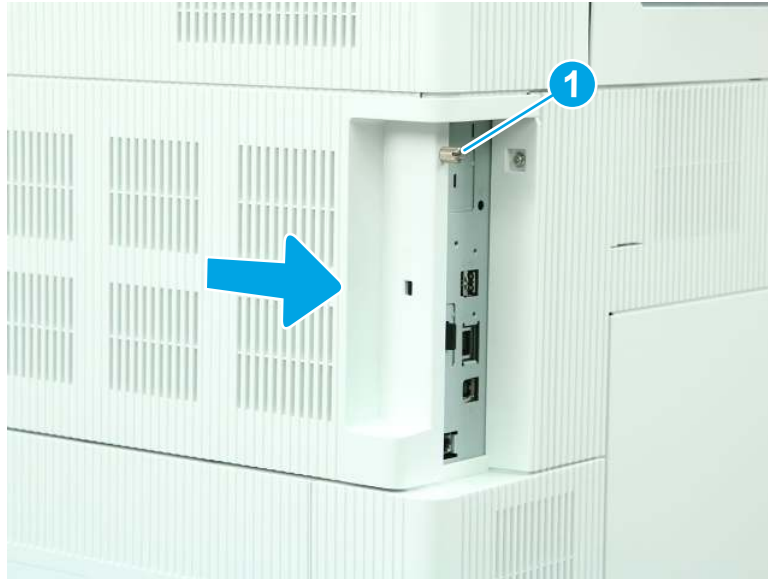
Post service test

No post service test is available for this assembly.

1. Remove the formatter cover.

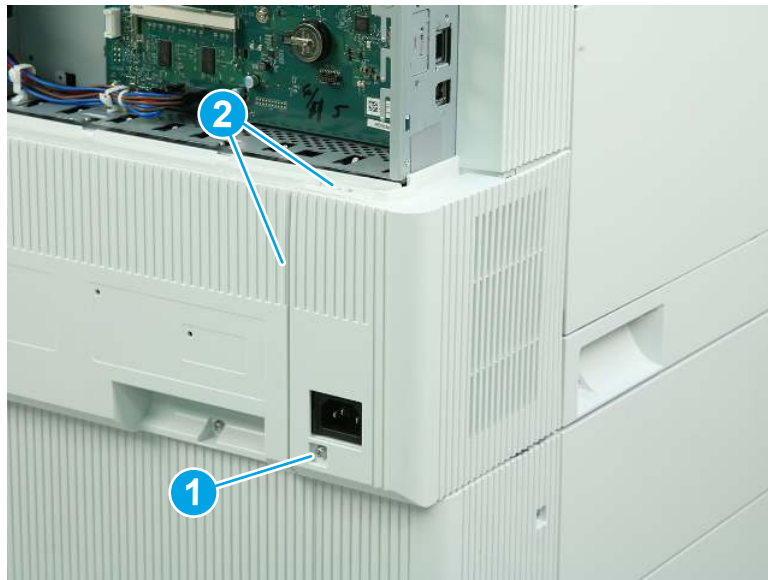
- ▲ Loosen one thumbscrew (callout 1), and then slide the formatter cover (callout 2) away from the printer to remove it.

Figure 1-1965 Remove the formatter cover



- 2. Remove the left lower cover (M856/E85055/M776).
 - a. Remove one screw (callout 1), and then release two tabs (callout 2).

Figure 1-1966 Remove one screw and release two tabs



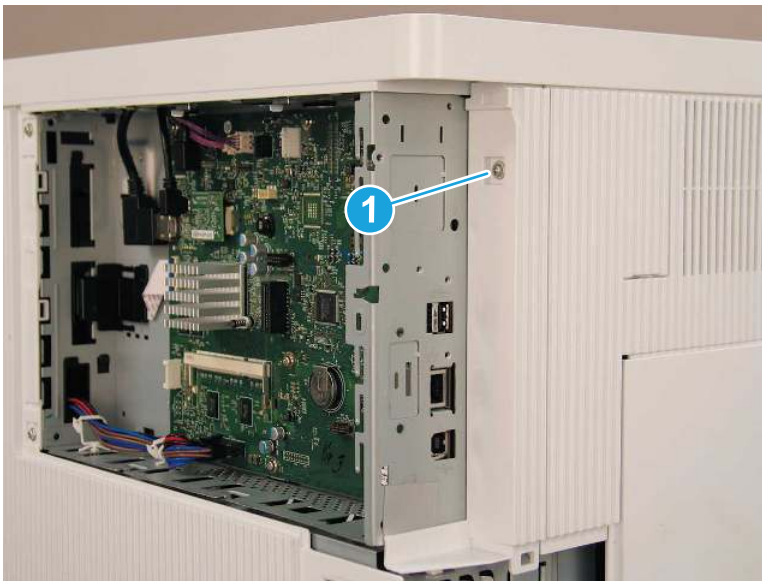
- b. Rotate the cover away from the printer to remove it.

Figure 1-1967 Remove the left lower cover



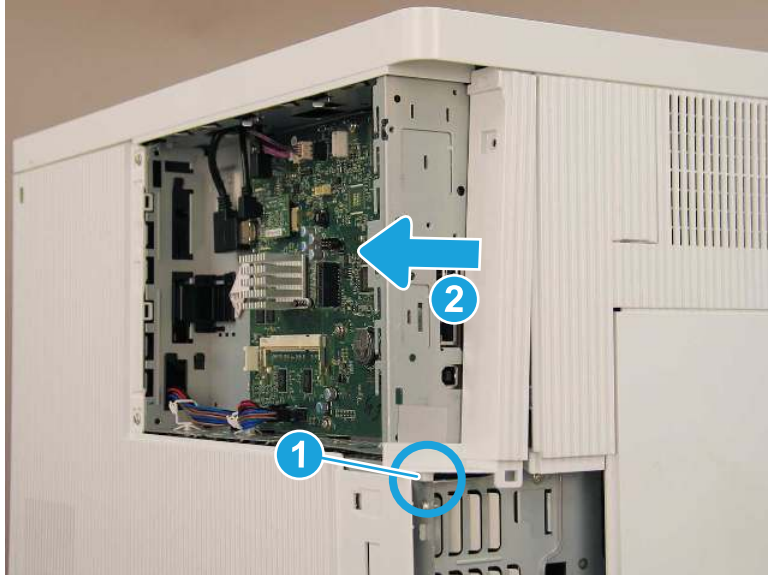
3. Remove the left rear cover (M751/E75245/M856/E85055/M776).
 - a. Remove one screw (callout 1).

Figure 1-1968 Remove one screw



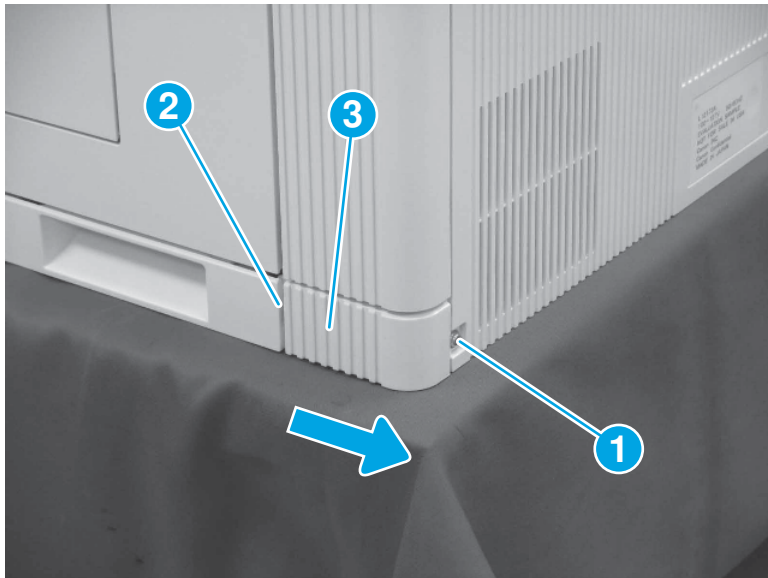
- b. Release one boss (callout 1), and then slide the cover toward the back of the printer (callout 2) to remove it.

Figure 1-1969 Remove the left rear cover



4. Remove the right rear lower cover (M751/E75245/M856/E85055/M776).
 - ▲ Remove one screw (callout 1), release one tab (callout 2), and then slide the right rear lower cover (callout 3) toward the back of the printer to remove it.

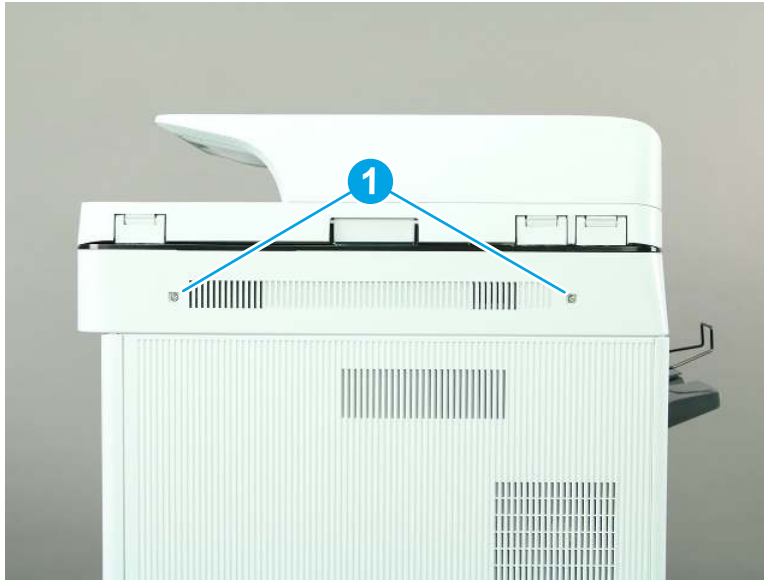
Figure 1-1970 Remove the right rear lower cover



5. Remove the scanner control board (SCB) cover (M776).

- a. Remove two screws (callout 1).

Figure 1-1971 Remove two screws



- b. Remove the SCB cover.

Figure 1-1972 Remove the SCB cover



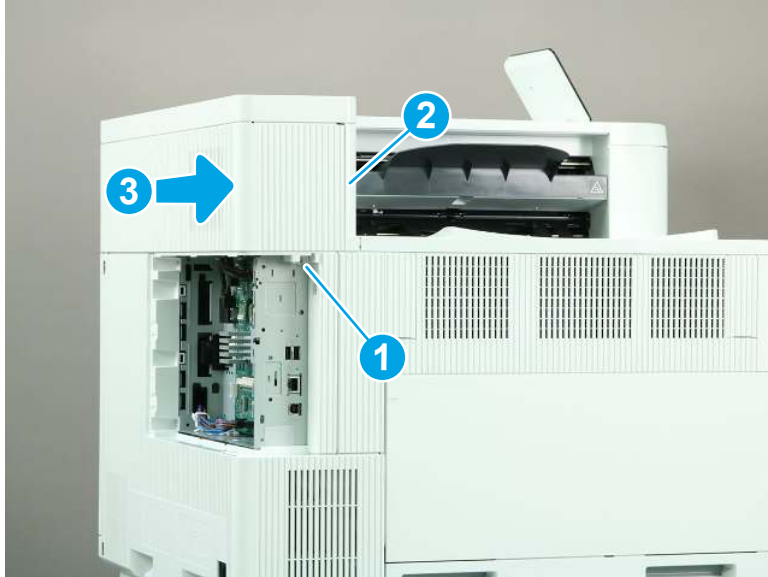
6. Remove the rear upper cover (M856/E85055/M776dn/M776z).



NOTE: The following figure shows the M856 printer. The procedure is correct for all referenced models.

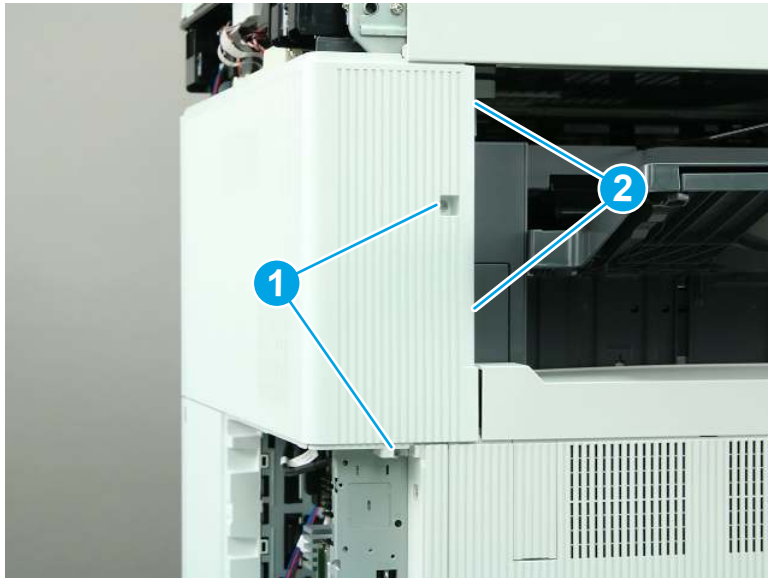
- ▲ Remove one screw (callout 1), release one tab (callout 2), and then slide the rear upper cover away from the printer to remove it (callout 3).

Figure 1-1973 Remove the rear upper cover



- 7. Remove the rear upper cover and left rear upper cover (M776zs).
 - a. Remove two screws (callout 1), and then release two tabs (callout 2).

Figure 1-1974 Remove two screws and release two tabs



- b. Slide the cover to the right to remove it.

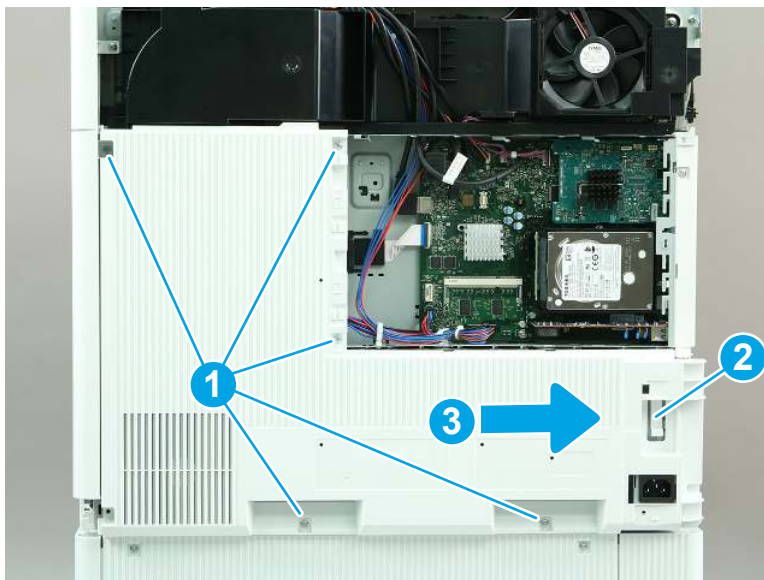
Figure 1-1975 Remove the rear upper and left rear upper cover




8. Remove the rear cover (M856/E85055/M776).

- ▲ Remove five screws (callout 1), release one tab (callout 2), and then slide the rear cover to the right to remove it.

Figure 1-1976 Remove the rear cover (M856/E85055/M776)



9. **M856/E85055 only:** Remove the control panel and top cover.

 **NOTE:** This step applies to only the M856/E85055 models. Skip this step for all other models.

- a. Use a small, flat-blade screwdriver to release two tabs (callout 1), and then remove the control panel cover (callout 2).

Figure 1-1977 Remove the control panel cover



- b. Remove one screw (callout 1).

Figure 1-1978 Remove one screw



- c. Lift the back edge of the control panel up (callout 1), and then slide the control panel toward the back of the printer (callout 2).

Figure 1-1979 Slide the control panel back



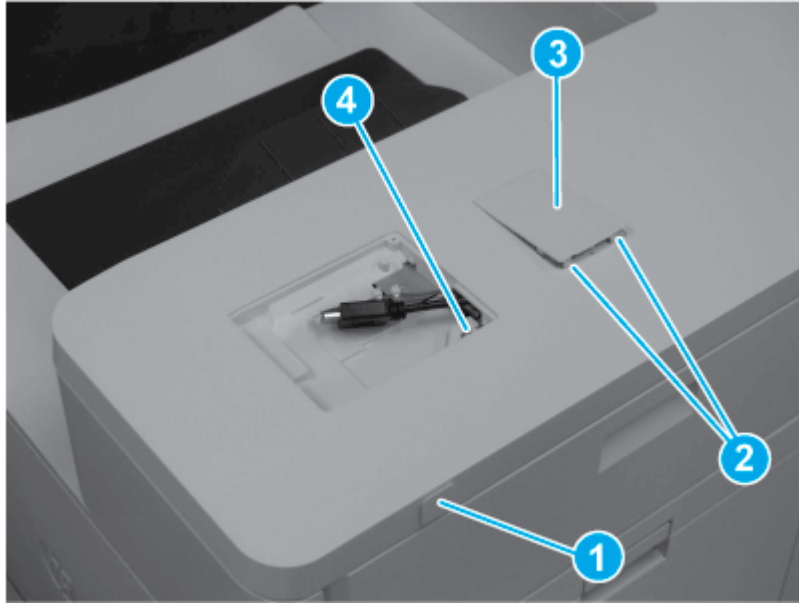
- d. Turn the control panel so that the bottom is facing up, and then disconnect two connectors to remove the control panel.

Figure 1-1980 Disconnect two connectors



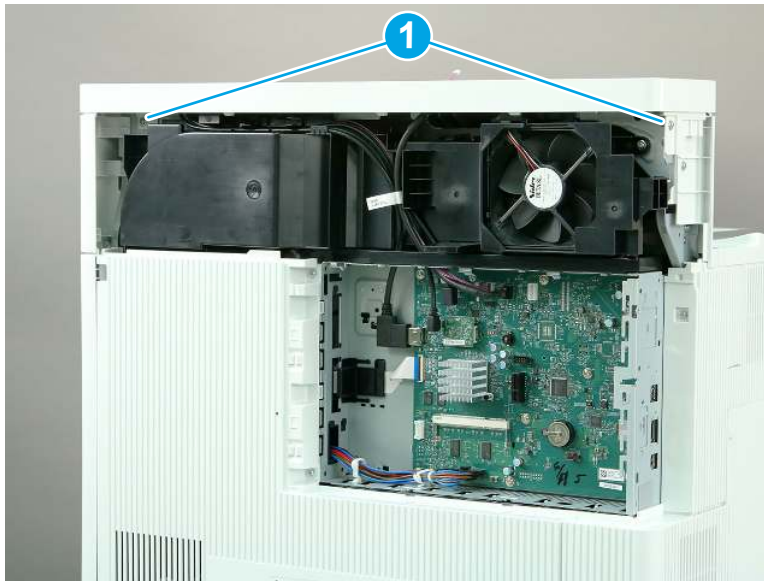
- e. Remove the USB cover (callout 1). Release two tabs (callout 2), and then remove the HIP cover (callout 3). Remove one screw (callout 4).

Figure 1-1981 Remove covers and one screw



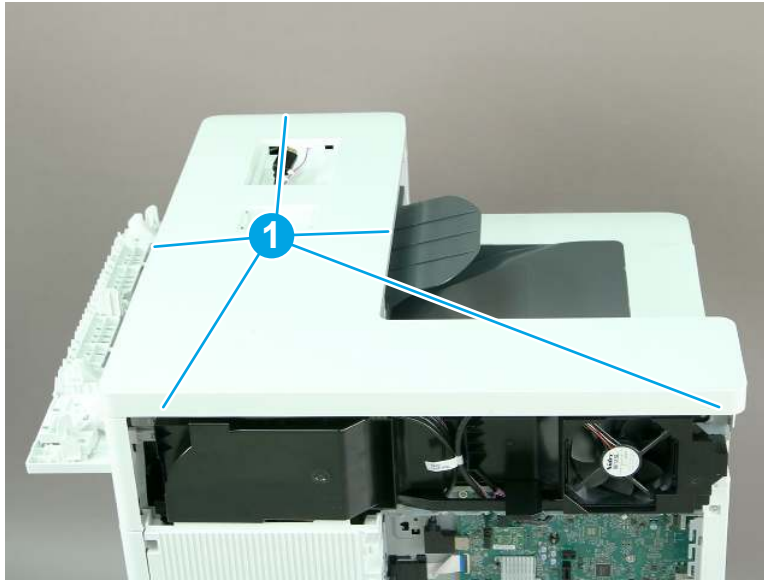
- f. Remove two screws (callout 1).

Figure 1-1982 Remove two screws



- g. Release five tabs (callout 1), and then remove the top cover.

Figure 1-1983 Release five tabs



- 10. Remove the formatter and case (M856/E85055/M776).

 **NOTE:** The figures below show the M776zs formatter. The procedure is correct for all referenced models.

- a. Release two retainers (callout 1), and then open the retainer (callout 2) to release the flat cable. Disconnect all of the remaining connectors on the formatter board.


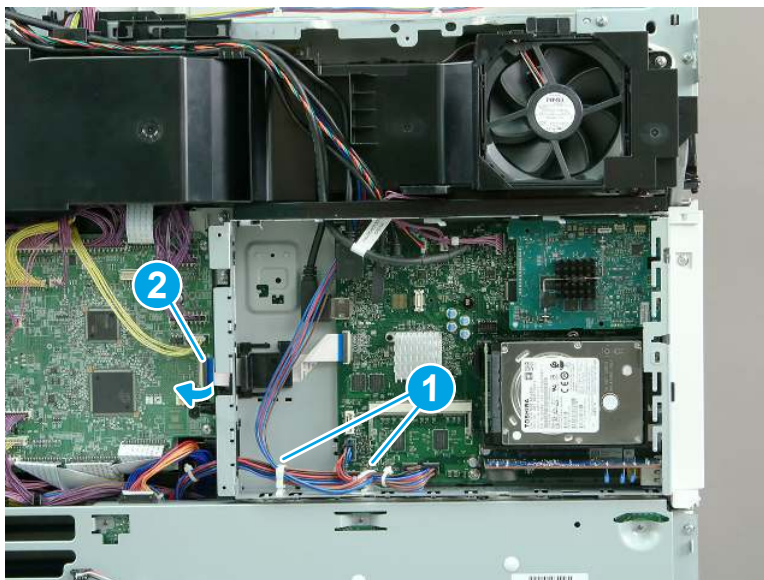
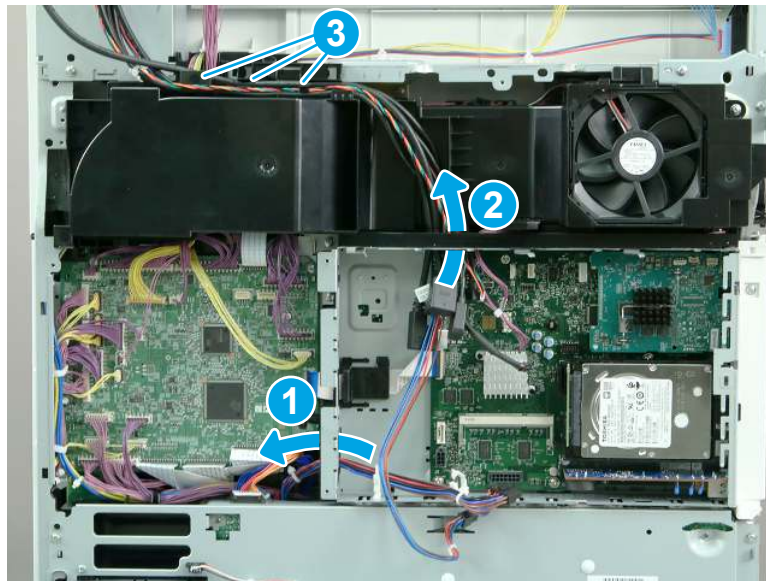
 **NOTE:** The figures below show the M776zs model. The procedures are correct for all of the referenced models.

Figure 1-1984 Disconnect the connectors



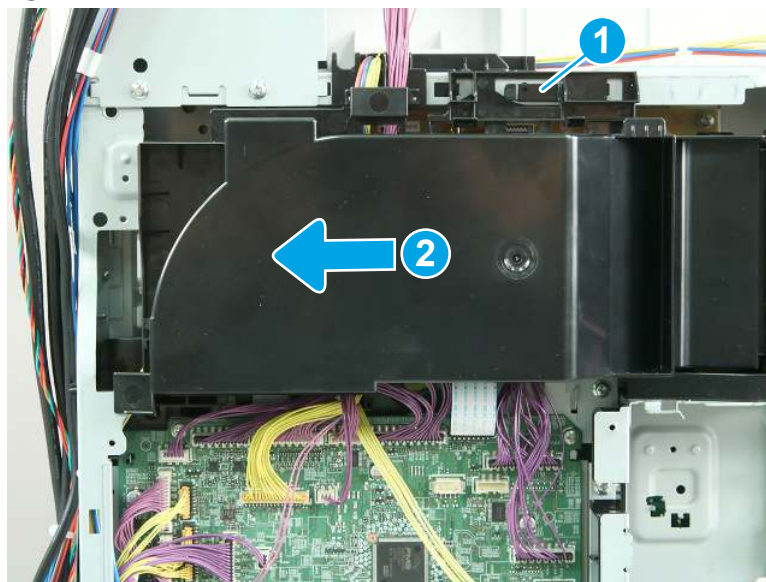
- b. Release one cable through the opening in the left side of the formatter case (callout 1). Release the remaining cables through the opening in the top of the formatter case (callout 2). Release the cables from the upper cable guide (callout 3).

Figure 1-1985 Release the cables



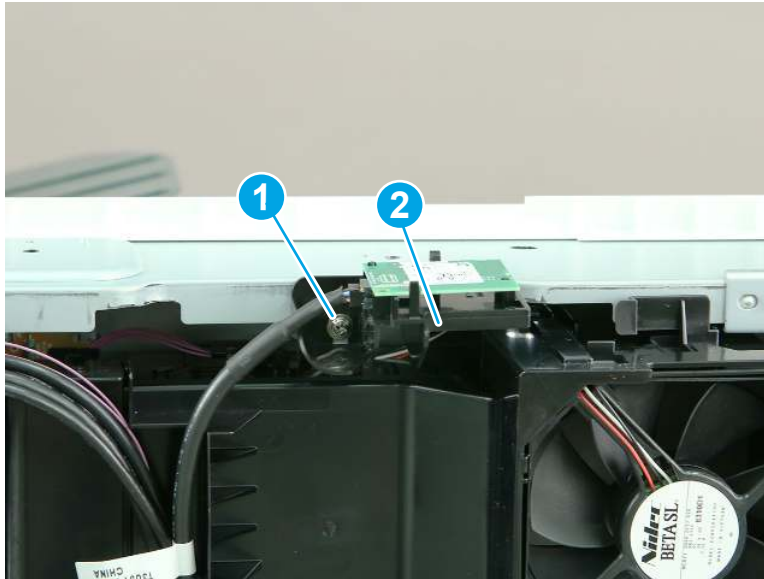
- c. Release one tab (callout 1), and then slide the fan duct to the left (callout 2) to remove it.

Figure 1-1986 Remove the fan duct



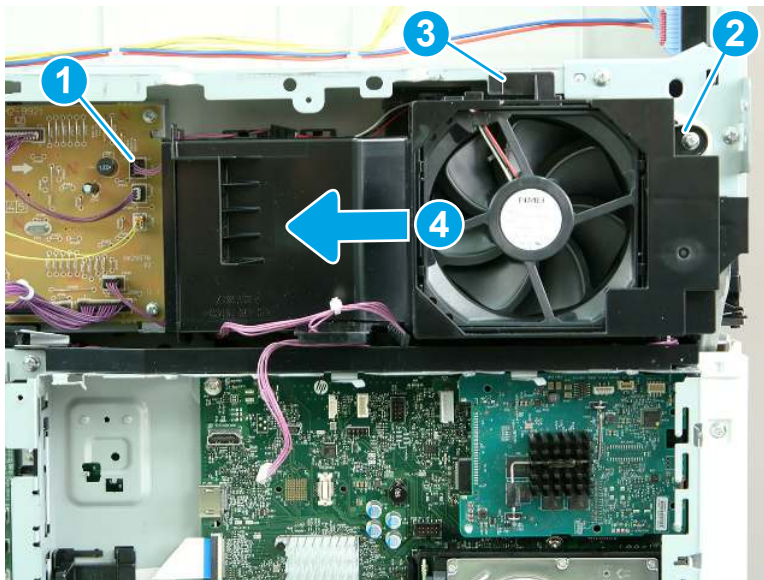
- d. **M856 and E85055 only:** Remove one screw (callout 1), and then remove the wireless card and bracket (callout 2).

Figure 1-1987 Remove the wireless card and bracket



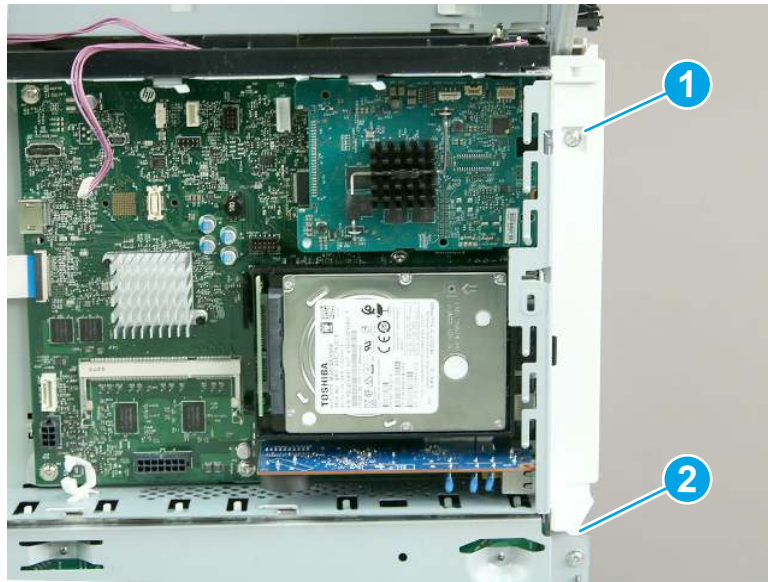
- e. Disconnect one connector (callout 1), and remove one screw (callout 2). Release one tab (callout 3), and then slide the fan assembly to the left (callout 4) to remove it.

Figure 1-1988 Remove the fan assembly



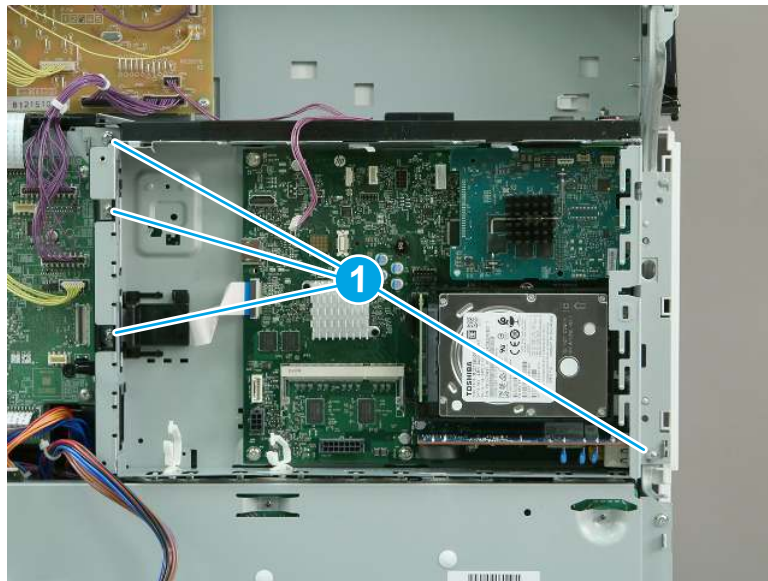
- f. Remove one screw (callout 1), release one tab (callout 2), and then remove the left rear cover.

Figure 1-1989 Remove the left rear cover



- g. Remove four screws (callout 1).

Figure 1-1990 Remove four screws



- h. Remove the formatter and case.

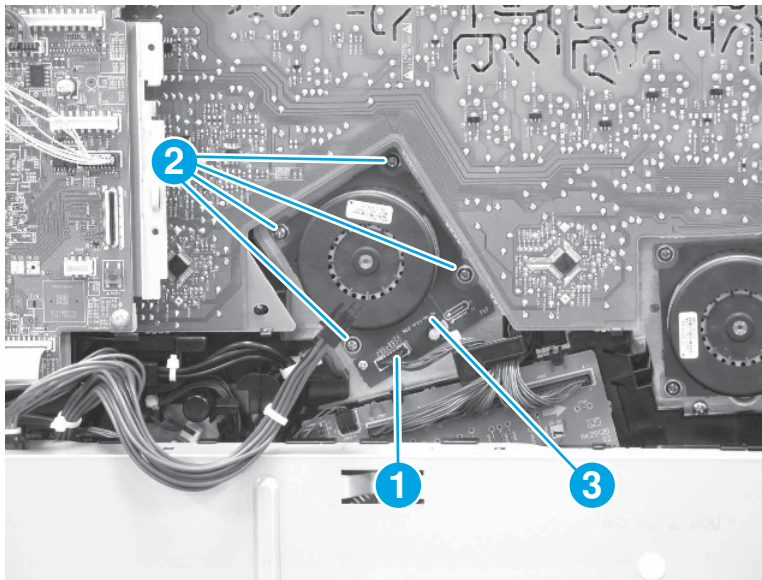
Figure 1-1991 Remove the formatter and case



- 11. Remove drum motor 2.

- ▲ Disconnect one connector (callout 1), remove four screws (callout 2), and then remove drum motor 2 (callout 3).

Figure 1-1992 Remove drum motor 2



- 12. Unpack the replacement assembly.



- a. Dispose of the defective part.




NOTE: HP recommends responsible disposal of the defective part.


<http://www8.hp.com/us/en/hp-information/environment/product-recycling.html>

- b. Unpack the replacement part from the packaging.

 **CAUTION:**  Some parts are sensitive to electrostatic discharge (ESD). Always perform service work at an ESD-protected workstation or mat. If an ESD workstation or mat is not available, touch the sheet-metal chassis to provide a static ground before touching an ESD-sensitive assembly. Protect the ESD-sensitive assemblies by placing them in ESD pouches when they are out of the printer.

 **IMPORTANT:** Make sure that all of the shipping materials (for example shipping tape) are removed from the replacement part prior to installation.

- c. To install an assembly, reverse the removal steps.

 **NOTE:** When applicable, special installation instructions are provided for an assembly at the end of the removal procedure. Always completely read the removal instructions and follow all special installation instructions.

Removal and replacement: Drum motor 3 (M751/E75245)

Learn how to remove and replace drum motor 3.

[View a video of how to remove and replace the drum motor 3.](#)

Mean time to repair: 40 minutes

Service level: Medium

Before performing service

Turn the printer power off

- Disconnect the power cable.

 **WARNING!** To avoid damage to the printer, turn the printer off, wait 30 seconds, and then remove the power cord before attempting to service the printer.

Use the table below to identify the correct part number for your printer. To order the part, go to www.hp.com/buy/parts.

Table 1-105 Part information

Part number	Part description
RM2-1612-000CN	Main motor assembly

Required tools

- #2 Phillips screwdriver with a magnetic tip
- Small, flat-blade screwdriver

After performing service

Turn the printer power on

- Connect the power cable.
- Use the power switch to turn the power on.

Post service test

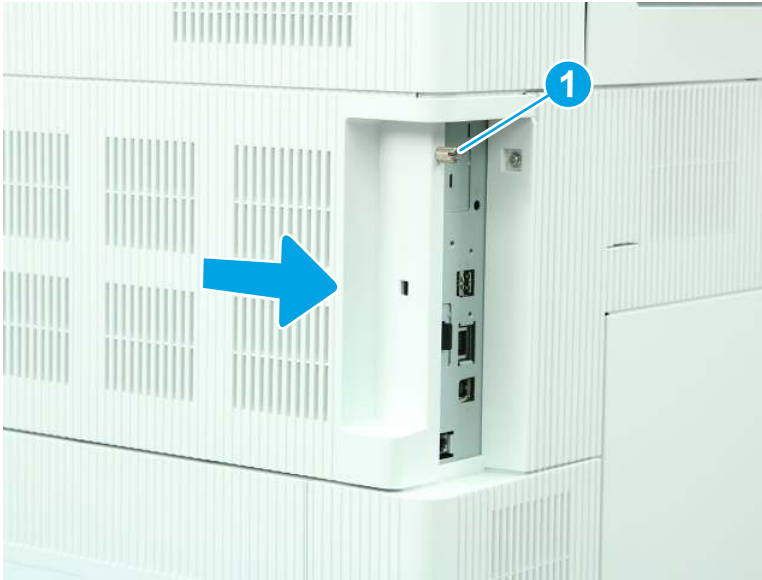
Make sure that the printer initializes to a **Ready** state.

Print a page to make sure that the printer is functioning correctly.

1. Remove the formatter cover.

- ▲ Loosen one thumbscrew (callout 1), and then slide the formatter cover (callout 2) away from the printer to remove it.

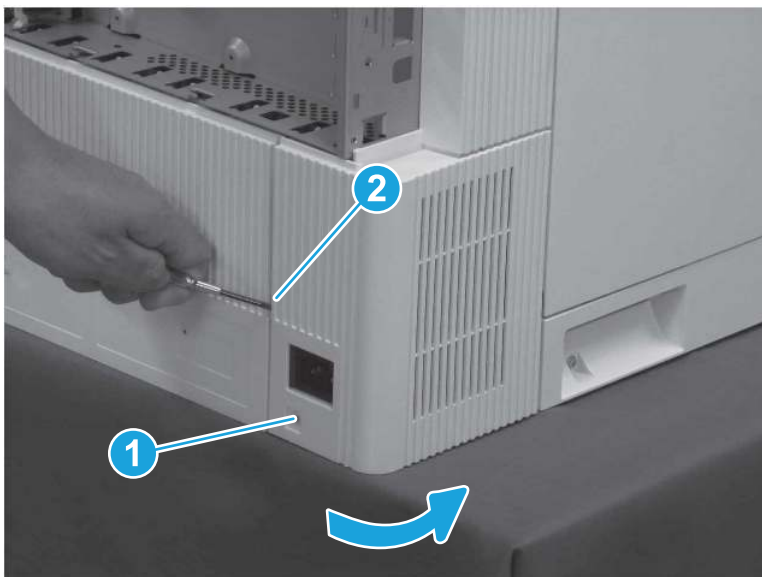
Figure 1-1993 Remove the formatter cover



2. Remove the left lower cover (M751/E75245).

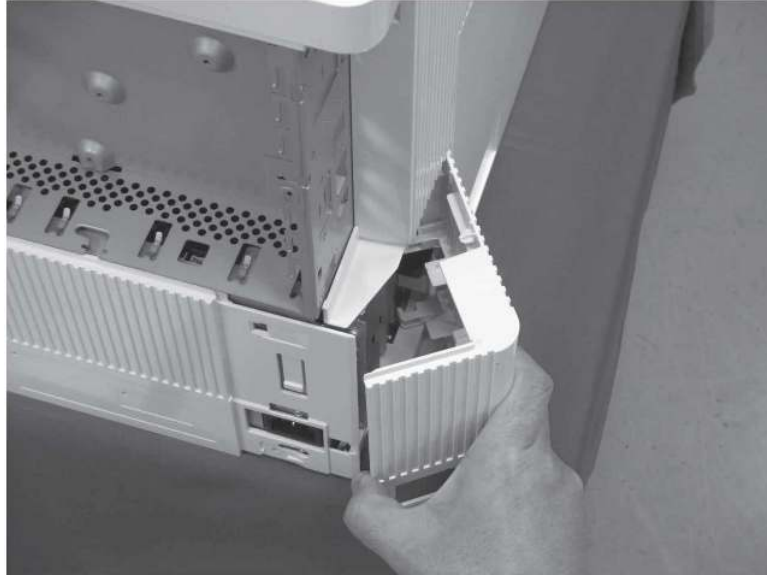
- a. Remove one screw (callout 1), release one tab (callout 2), and then rotate the cover away from the printer.

Figure 1-1994 Remove one screw and release one tab



- b. Remove the left lower cover.

Figure 1-1995 Remove the left lower cover



3. Remove the left rear cover (M751/E75245/M856/E85055/M776).

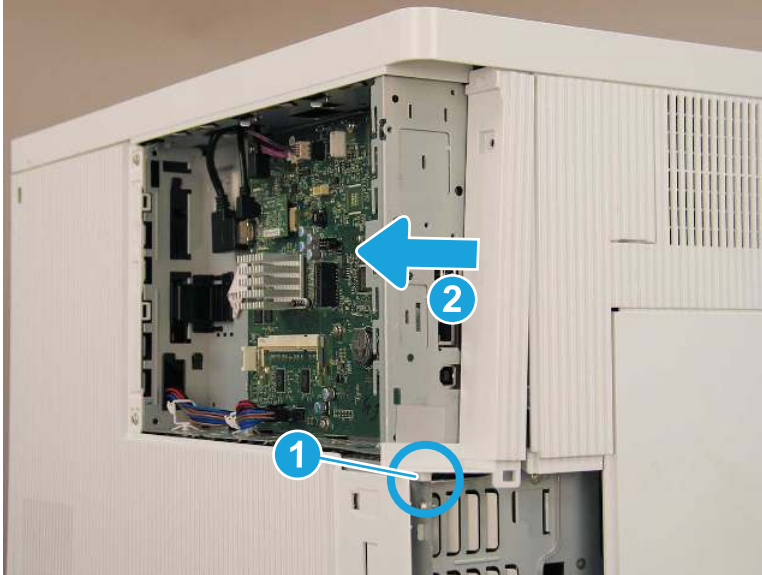
- a. Remove one screw (callout 1).

Figure 1-1996 Remove one screw



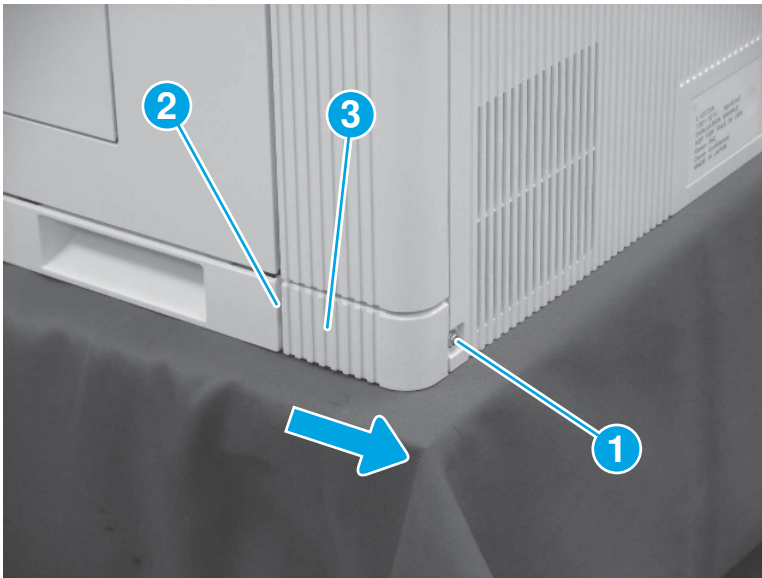
- b. Release one boss (callout 1), and then slide the cover toward the back of the printer (callout 2) to remove it.

Figure 1-1997 Remove the left rear cover



4. Remove the right rear lower cover (M751/E75245/M856/E85055/M776).
 - ▲ Remove one screw (callout 1), release one tab (callout 2), and then slide the right rear lower cover (callout 3) toward the back of the printer to remove it.

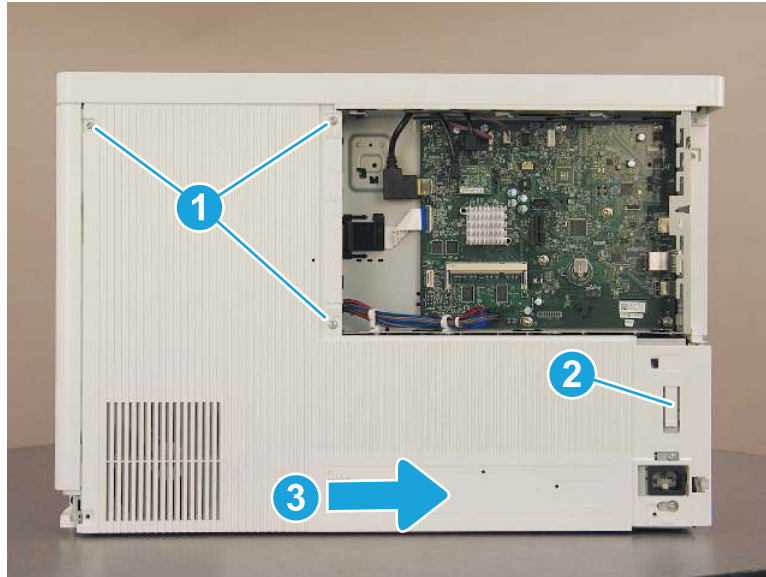
Figure 1-1998 Remove the right rear lower cover



5. Remove the rear cover (M751/E75245).

- ▲ Remove three screws (callout 1), release one tab (callout 2), and then slide the rear cover to the right (callout 3) to remove it.

Figure 1-1999 Remove the rear cover

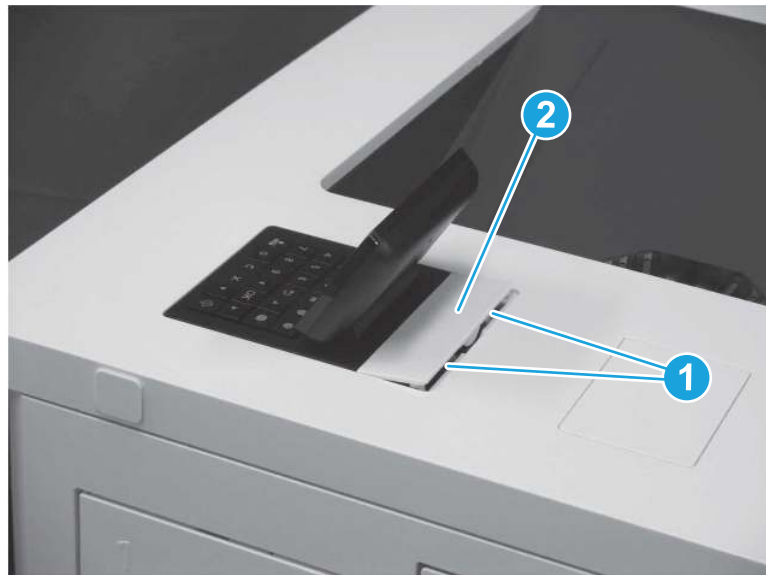


6. Remove the control panel.

 **NOTE:** A screwdriver is included in the control panel kit. The screwdriver has a reversible shaft. Simply pull the shaft out of the handle, and then reinstall it with the desired end facing out.

- a. Use a small, flat-blade screwdriver to release two tabs (callout 1), and then remove the control panel cover (callout 2).

Figure 1-2000 Remove the control panel cover



- b. Remove one screw (callout 1).

Figure 1-2001 Remove one screw



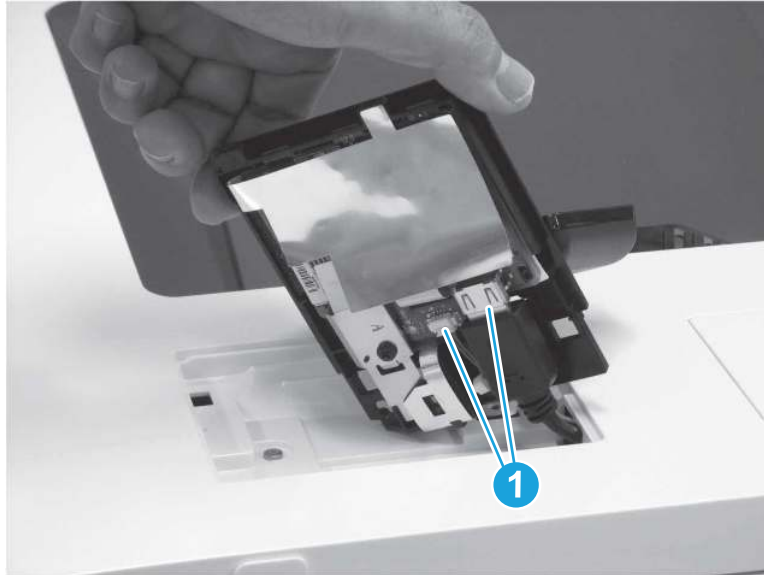
- c. Lift the back edge of the control panel up (callout 1), and then slide the control panel toward the back of the printer (callout 2).

Figure 1-2002 Slide the control panel back



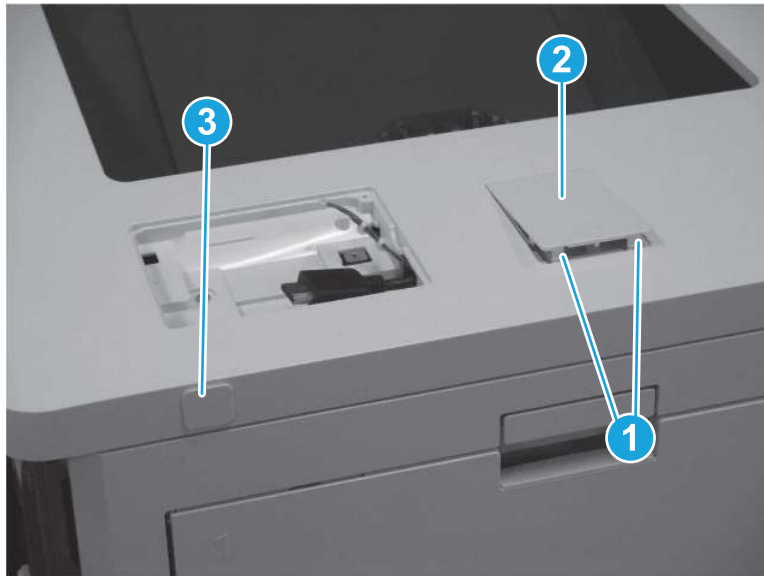
- d. Turn the control panel so that the bottom is facing up, and then disconnect two connectors (callout 1) to remove the control panel.

Figure 1-2003 Disconnect two connectors



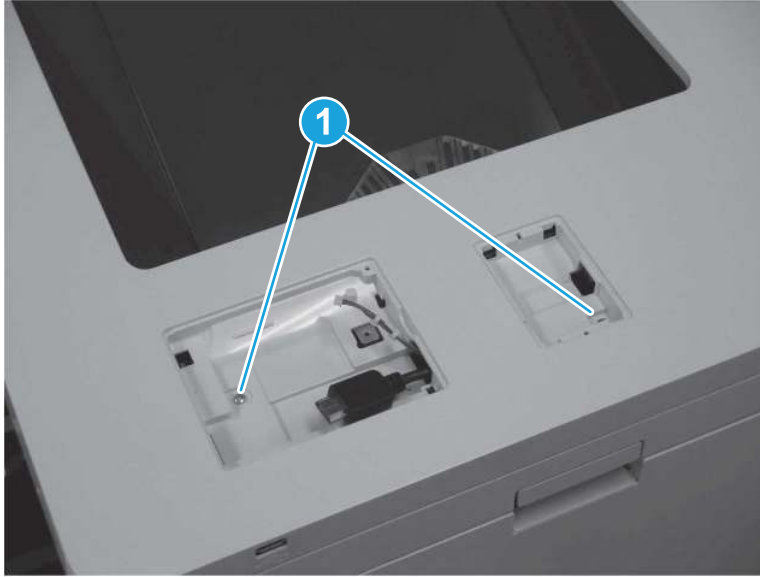
7. Remove the top cover (M751/E75245).
 - a. Release two tabs (callout 1), and then remove the HIP cover (callout 2). Pull the USB cap (callout 3) away from the printer to remove it.

Figure 1-2004 Remove the HIP cover and USB cap



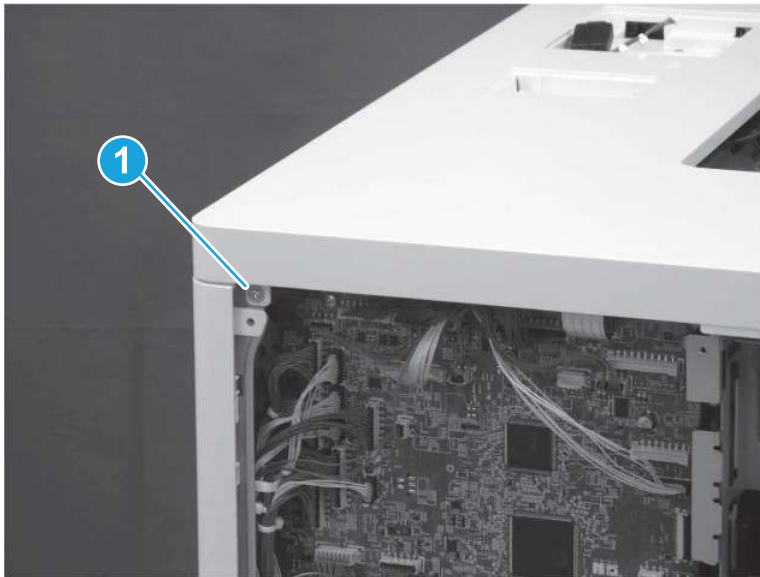
- b. At the top of the printer, remove two screws (callout 1).

Figure 1-2005 Remove two screws




- c. At the back of the printer, remove one screw (callout 1).

Figure 1-2006 Remove one screw

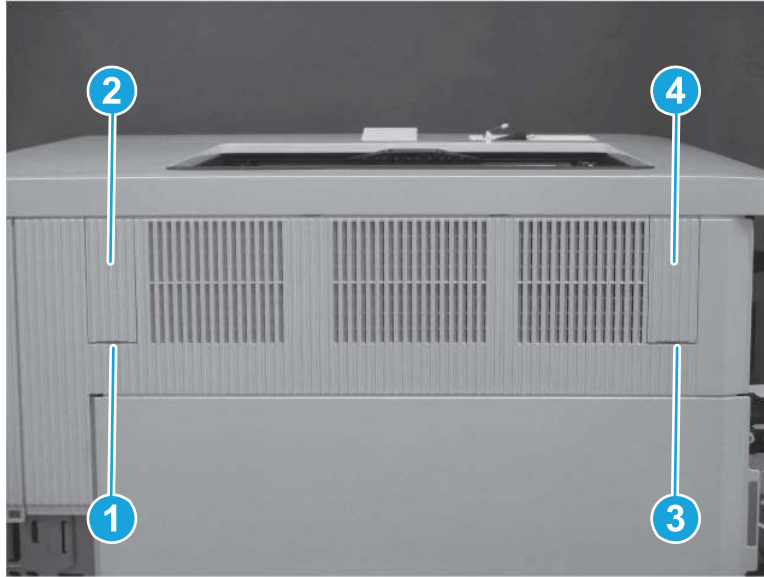


- d. Use a small, flat-blade screwdriver to release one tab (callout 1) and remove the left blanking cover (callout 2). Release one tab (callout 3) and remove the right blanking cover (callout 4).

 **TIP:** These covers are not identical. Make sure to reinstall the correct cover on the correct side.

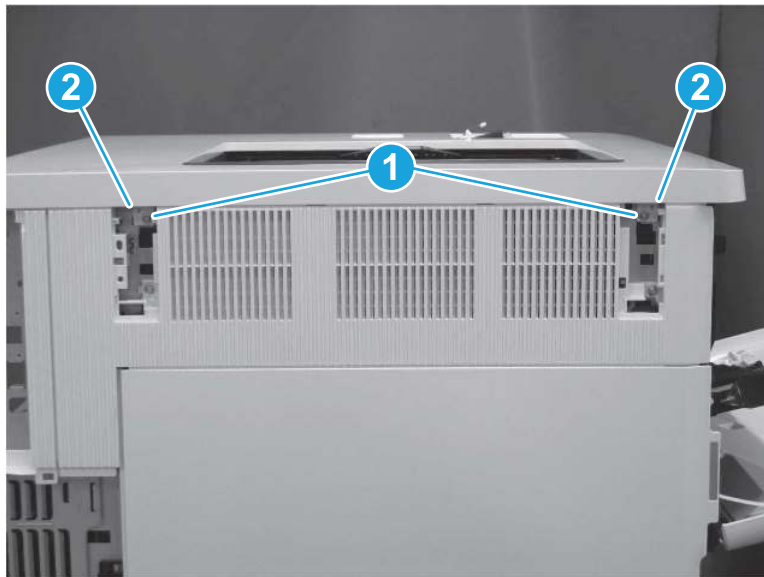
 **NOTE:** The screw under the left blanking cover is a self-tapping screw. Make sure this screw is reinstalled in the correct location.

Figure 1-2007 Remove the left and right blanking covers



- e. Remove two screws (callout 1), and then release two tabs (callout 2).

Figure 1-2008 Remove two screws and release two tabs



- f. At the front of the printer, remove one washer-head screw (callout 1) and one self-tapping screw (callout 2). Release one tab (callout 3).


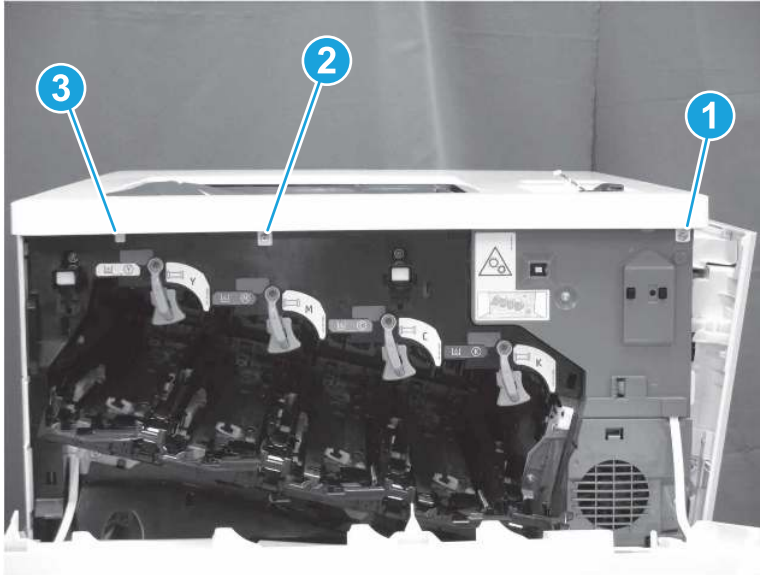
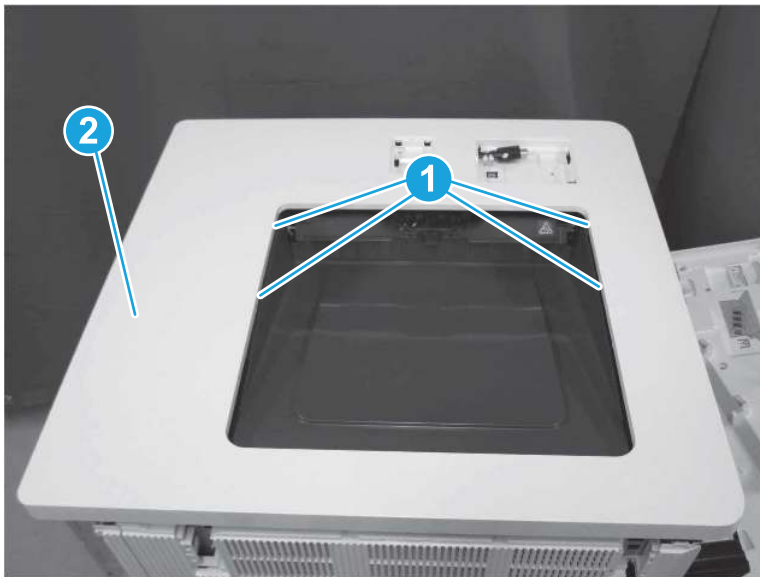
 **TIP:** Make sure to install the correct type of screw in the correct location.

Figure 1-2009 Remove two screws and release one tab



- g. At the top of the printer, release four tabs (callout 1), and then remove the top cover (callout 2).

Figure 1-2010 Remove the top cover

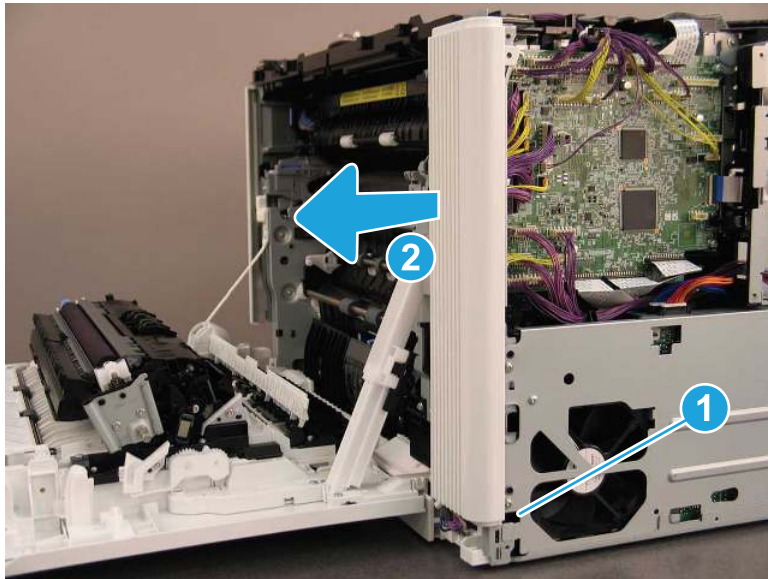


 **NOTE:** When removing the top cover, make sure to release the control panel cables (callout 1) through the opening.



8. Remove the right rear cover (M751/E75245).
 - ▲ Release one tab (callout 1), and then slide the right rear cover (callout 2) away from the printer to remove it.

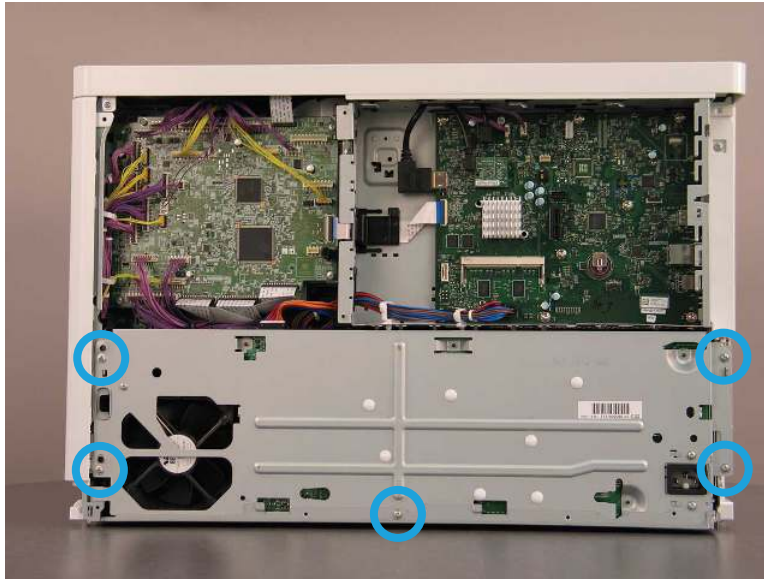
Figure 1-2011 Remove the right rear cover



9. Remove the low-voltage power supply (LVPS).

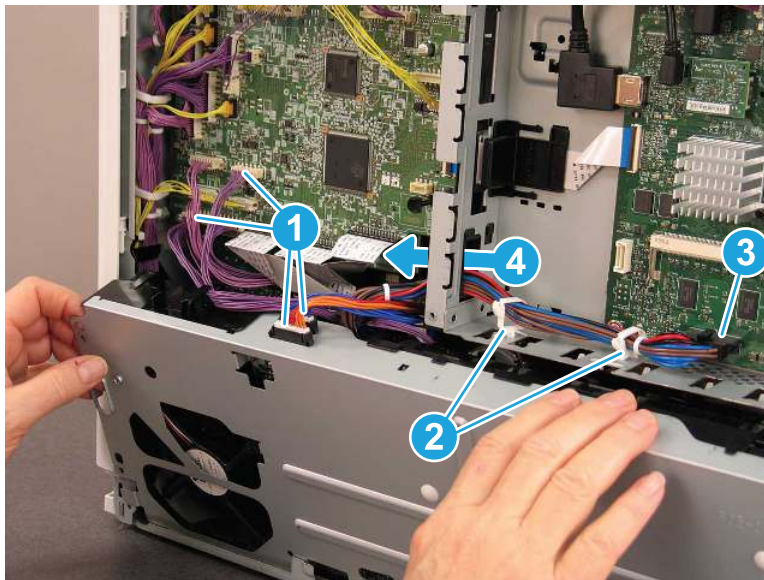
- a. Remove five screws.

Figure 1-2012 Remove five screws



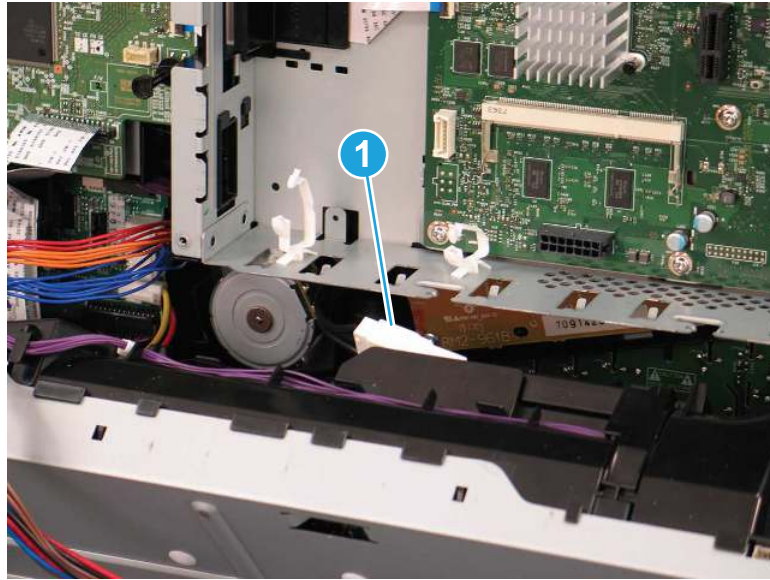
- b. Lift up on the LVPS, and then slightly rotate the top away from the printer. Disconnect four connectors (callout 1), and then release two retainers (callout 2). Press down on the latch to disconnect one connector (callout 3), and then release the wires through the hole (callout 4) in the formatter case.

Figure 1-2013 Disconnect five connectors



- c. Press down on the latch to disconnect one connector (callout 1), and then lift up to remove the LVPS.

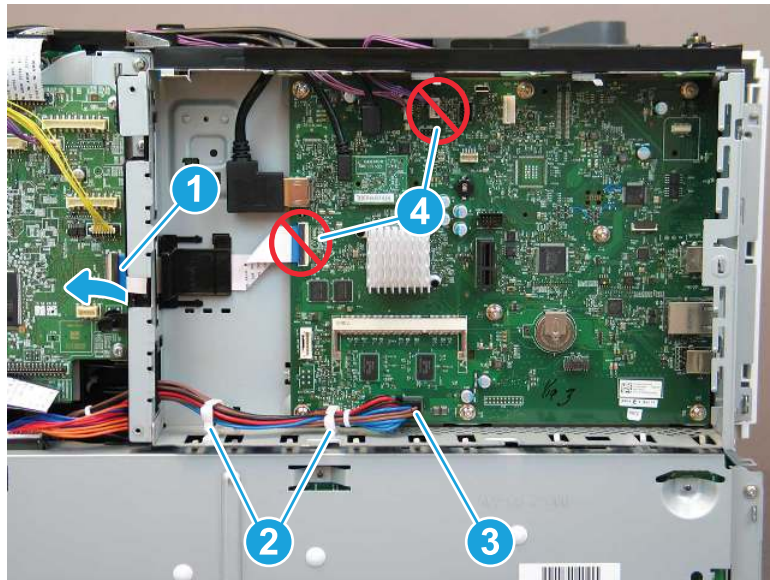
Figure 1-2014 Remove the LVPS



- 10. Remove the formatter and case.

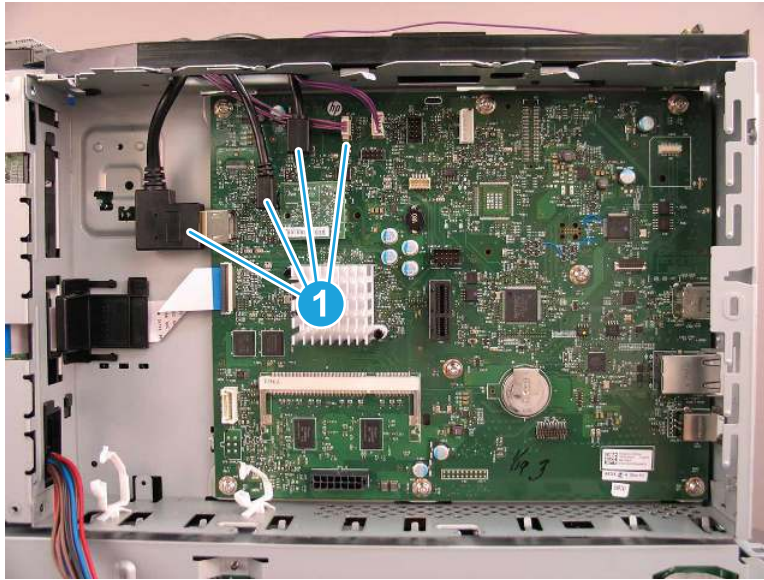
- a. Open the retainer (callout 1) to release the flat cable. Release the cables from two retainers (callout 2). Squeeze the latch to disconnect the connector (callout 3) at the lower edge of the formatter. It is not necessary to disconnect two connectors (callout 4).

Figure 1-2015 Disconnect the connectors



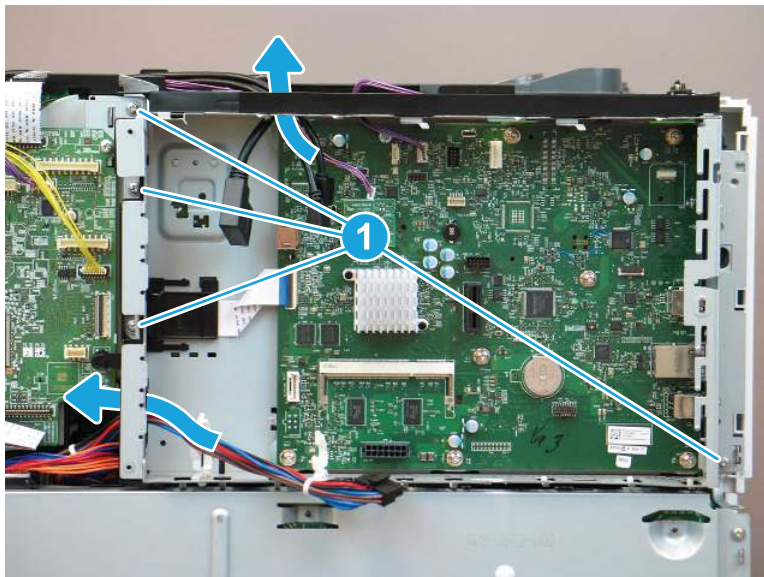
- b. Disconnect all of the remaining connectors on the formatter (callout 1).

Figure 1-2016 Disconnect the connectors



- c. Release the cables through the opening on top and on the left side of the formatter case. Remove four screws (callout 1), and then remove the formatter and case.

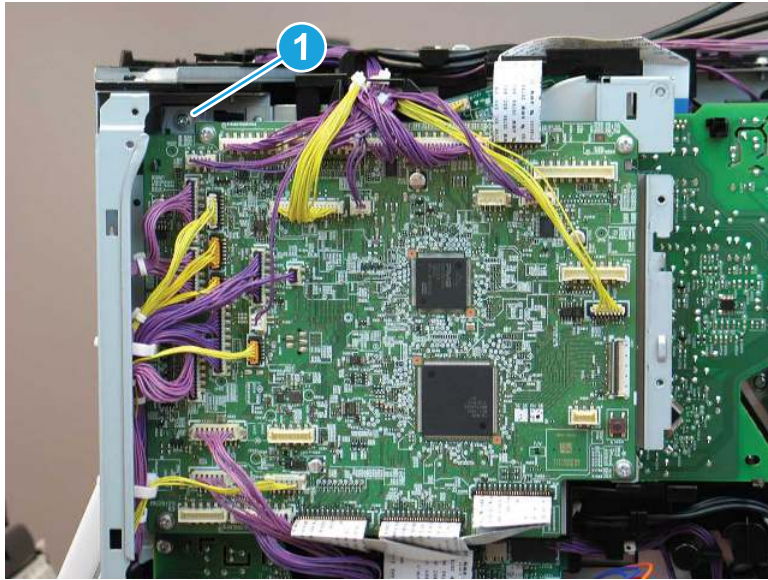
Figure 1-2017 Remove the formatter and case



- 11. Remove the DC controller and case.

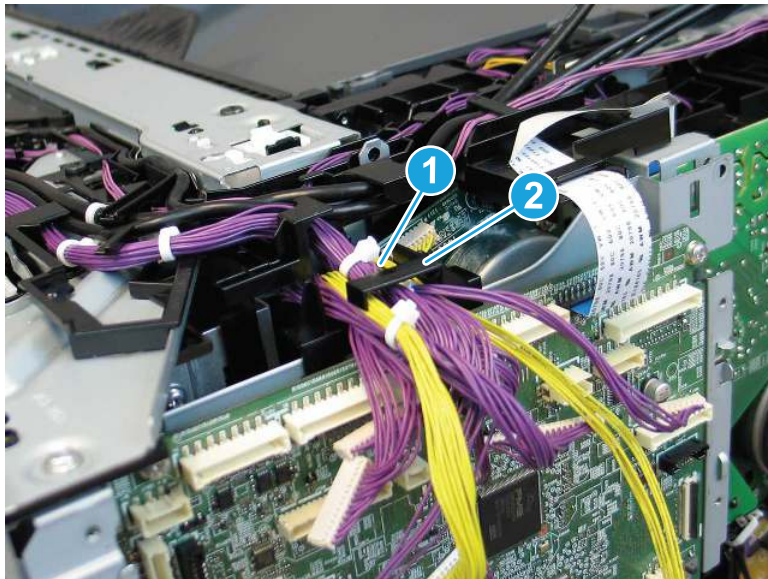
- a. Disconnect all of the connectors on the DC controller, and then remove one screw (callout 1).

Figure 1-2018 Disconnect connectors and remove one screw



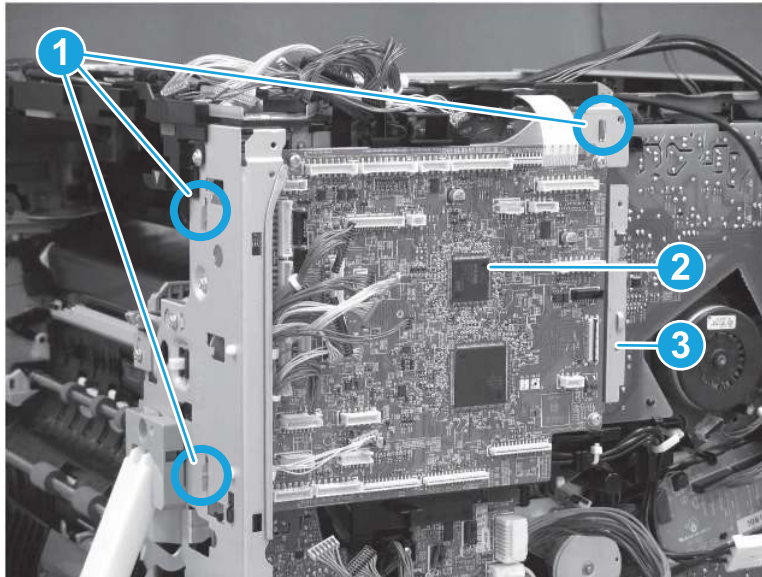
- b. Release the wire harnesses (callout 1) from the retainer (callout 2).

Figure 1-2019 Remove the wire harnesses from the retainer



- c. Lift up to release three tabs (callout 1), and then remove the DC controller (callout 2) together with the case (callout 3).

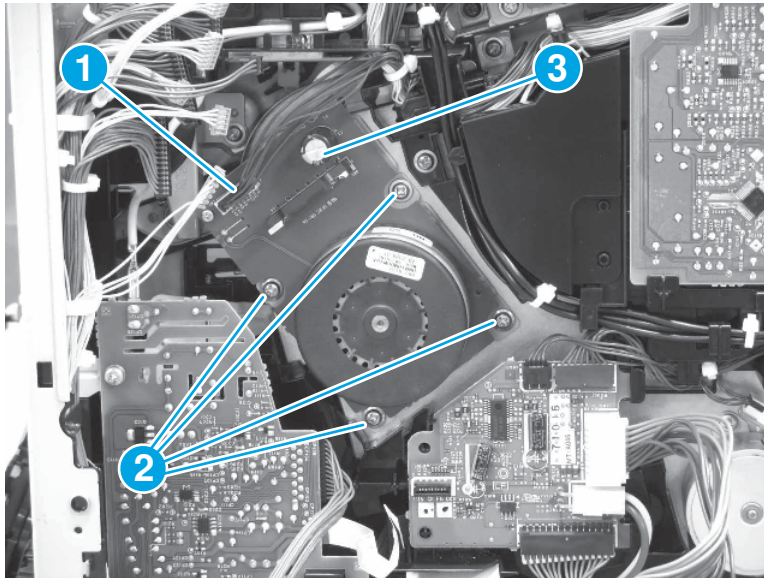
Figure 1-2020 Remove the DC controller and case



12. Remove drum motor 3.

- ▲ Disconnect one connector (callout 1), remove four screws (callout 2), and then remove drum motor 3 (callout 3).

Figure 1-2021 Remove drum motor 3



13. Unpack the replacement assembly.



- a. Dispose of the defective part.




NOTE: HP recommends responsible disposal of the defective part.


<http://www8.hp.com/us/en/hp-information/environment/product-recycling.html>

- b. Unpack the replacement part from the packaging.

 **CAUTION:**  Some parts are sensitive to electrostatic discharge (ESD). Always perform service work at an ESD-protected workstation or mat. If an ESD workstation or mat is not available, touch the sheet-metal chassis to provide a static ground before touching an ESD-sensitive assembly. Protect the ESD-sensitive assemblies by placing them in ESD pouches when they are out of the printer.

 **IMPORTANT:** Make sure that all of the shipping materials (for example shipping tape) are removed from the replacement part prior to installation.

- c. To install an assembly, reverse the removal steps.

 **NOTE:** When applicable, special installation instructions are provided for an assembly at the end of the removal procedure. Always completely read the removal instructions and follow all special installation instructions.

Removal and replacement: Drum motor 3 (M856/E85055/M776)

Learn how to remove and replace drum motor 3.

[View a video of how to remove and replace the drum motor 3.](#)

Mean time to repair: 40 minutes

Service level: Medium

Before performing service

Turn the printer power off

- Disconnect the power cable.

 **WARNING!** To avoid damage to the printer, turn the printer off, wait 30 seconds, and then remove the power cord before attempting to service the printer.

Use the table below to identify the correct part number for your printer. To order the part, go to www.hp.com/buy/parts.

Table 1-106 Part information

Part number	Part description
RM2-1612-000CN	Main motor assembly

Required tools

- #2 Phillips screwdriver with a magnetic tip
- Small, flat-blade screwdriver

After performing service

Turn the printer power on

- Connect the power cable.
- Use the power switch to turn the power on.

Post service test

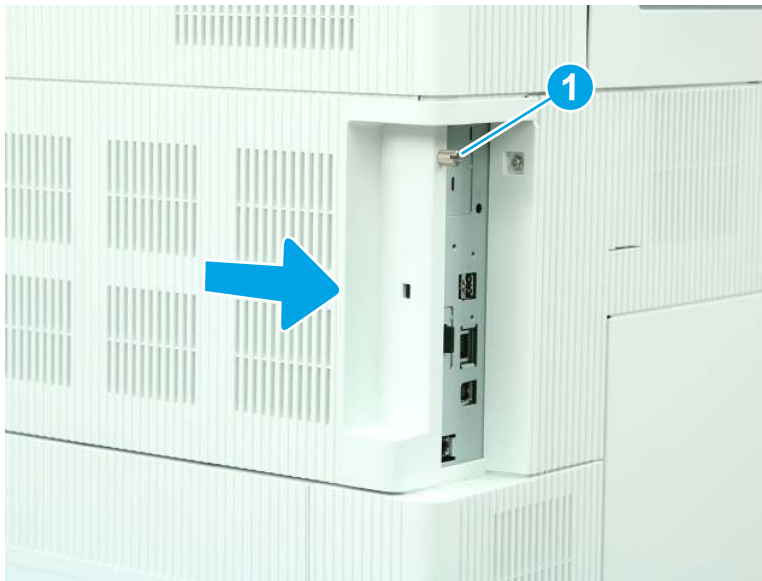
Make sure that the printer initializes to a **Ready** state.

Print a page to make sure that the printer is functioning correctly.

1. Remove the formatter cover.

- ▲ Loosen one thumbscrew (callout 1), and then slide the formatter cover (callout 2) away from the printer to remove it.

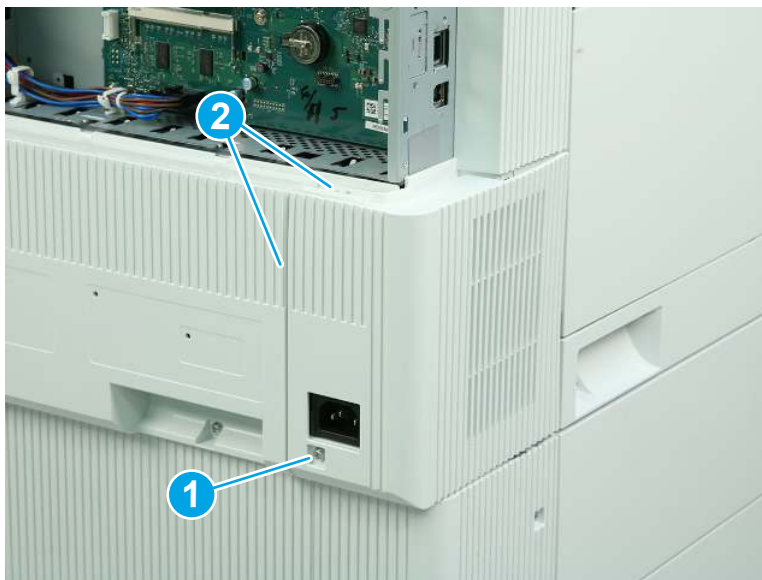
Figure 1-2022 Remove the formatter cover



2. Remove the left lower cover (M856/E85055/M776).

- a. Remove one screw (callout 1), and then release two tabs (callout 2).

Figure 1-2023 Remove one screw and release two tabs



- b. Rotate the cover away from the printer to remove it.

Figure 1-2024 Remove the left lower cover



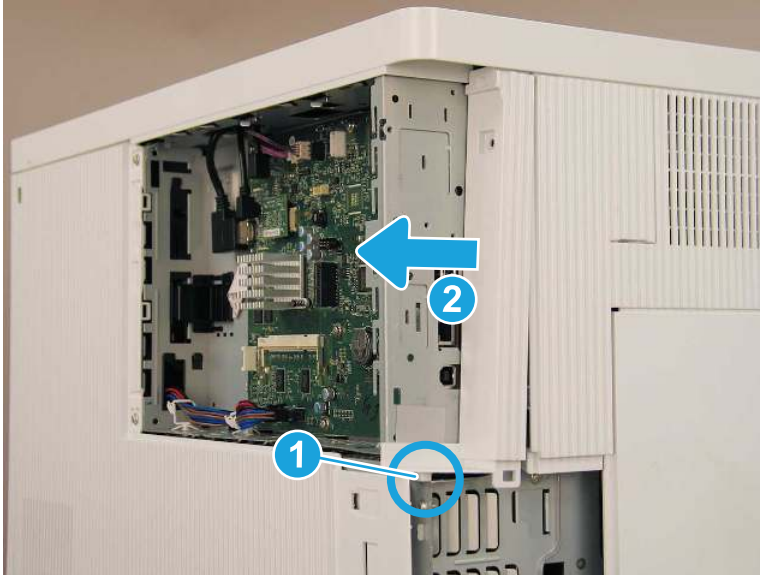
3. Remove the left rear cover (M751/E75245/M856/E85055/M776).
 - a. Remove one screw (callout 1).

Figure 1-2025 Remove one screw



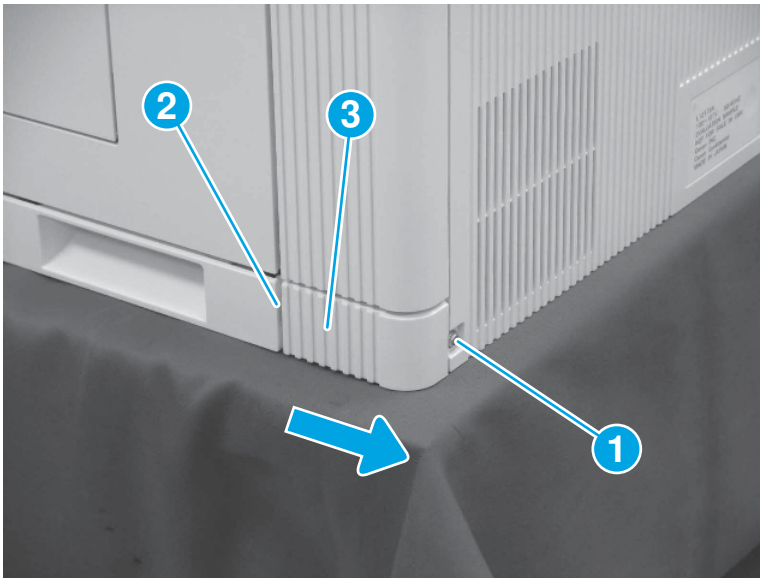
- b. Release one boss (callout 1), and then slide the cover toward the back of the printer (callout 2) to remove it.

Figure 1-2026 Remove the left rear cover



4. Remove the right rear lower cover (M751/E75245/M856/E85055/M776).
 - ▲ Remove one screw (callout 1), release one tab (callout 2), and then slide the right rear lower cover (callout 3) toward the back of the printer to remove it.

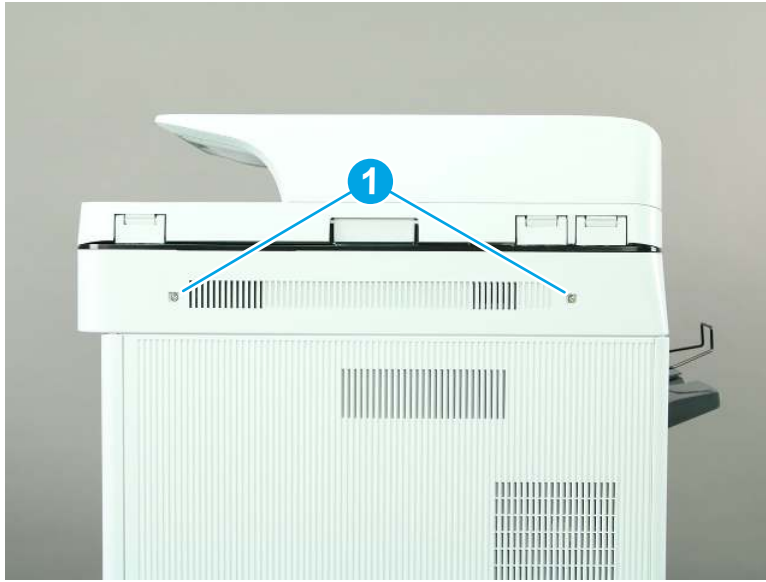
Figure 1-2027 Remove the right rear lower cover



5. Remove the scanner control board (SCB) cover (M776).

- a. Remove two screws (callout 1).

Figure 1-2028 Remove two screws



- b. Remove the SCB cover.

Figure 1-2029 Remove the SCB cover

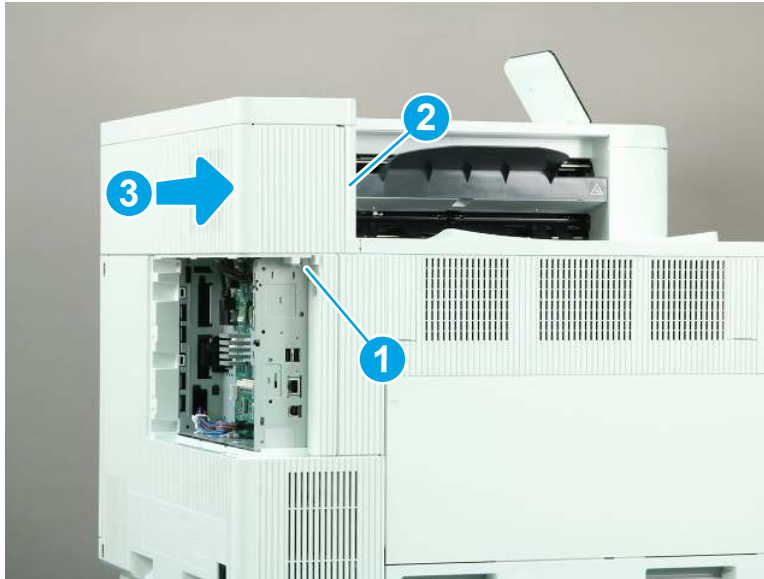


6. Remove the rear upper cover (M856/E85055/M776dn/M776z).

 **NOTE:** The following figure shows the M856 printer. The procedure is correct for all referenced models.

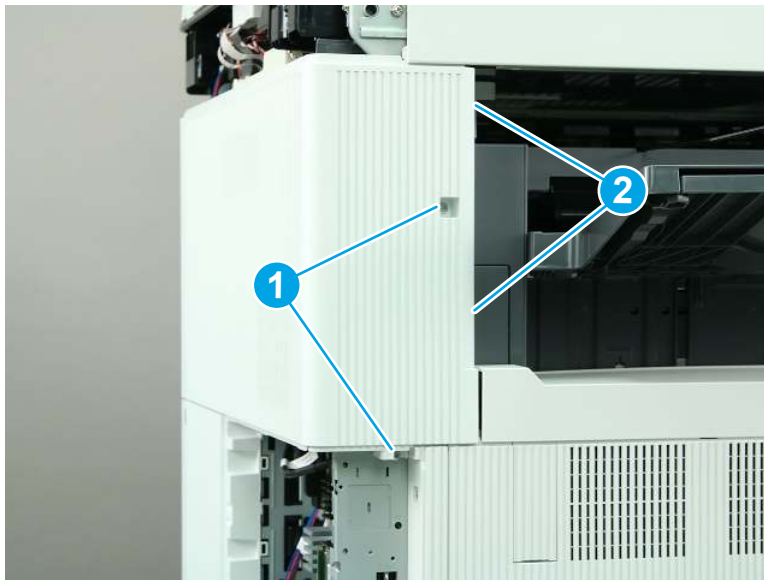
- ▲ Remove one screw (callout 1), release one tab (callout 2), and then slide the rear upper cover away from the printer to remove it (callout 3).

Figure 1-2030 Remove the rear upper cover



- 7. Remove the rear upper cover and left rear upper cover (M776zs).
 - a. Remove two screws (callout 1), and then release two tabs (callout 2).

Figure 1-2031 Remove two screws and release two tabs



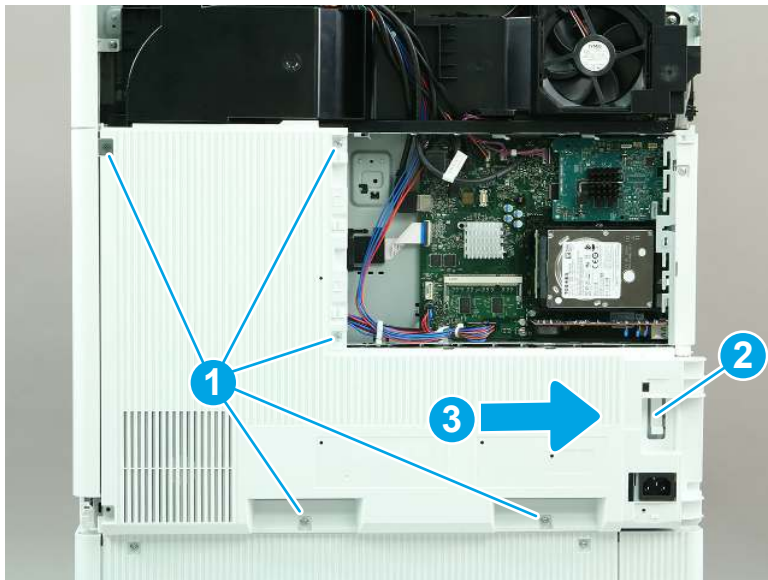
- b. Slide the cover to the right to remove it.

Figure 1-2032 Remove the rear upper and left rear upper cover




- 8. Remove the rear cover (M856/E85055/M776).
 - ▲ Remove five screws (callout 1), release one tab (callout 2), and then slide the rear cover to the right to remove it.

Figure 1-2033 Remove the rear cover (M856/E85055/M776)



- 9. **M856/E85055 only:** Remove the control panel and top cover.

 **NOTE:** This step applies to only the M856/E85055 models. Skip this step for all other models.

- a. Use a small, flat-blade screwdriver to release two tabs (callout 1), and then remove the control panel cover (callout 2).

Figure 1-2034 Remove the control panel cover



- b. Remove one screw (callout 1).

Figure 1-2035 Remove one screw



- c. Lift the back edge of the control panel up (callout 1), and then slide the control panel toward the back of the printer (callout 2).

Figure 1-2036 Slide the control panel back



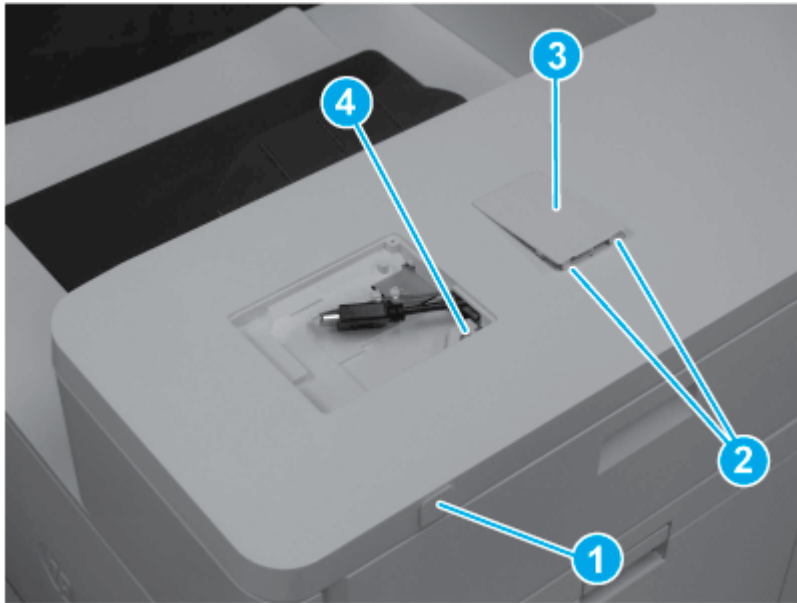
- d. Turn the control panel so that the bottom is facing up, and then disconnect two connectors to remove the control panel.

Figure 1-2037 Disconnect two connectors



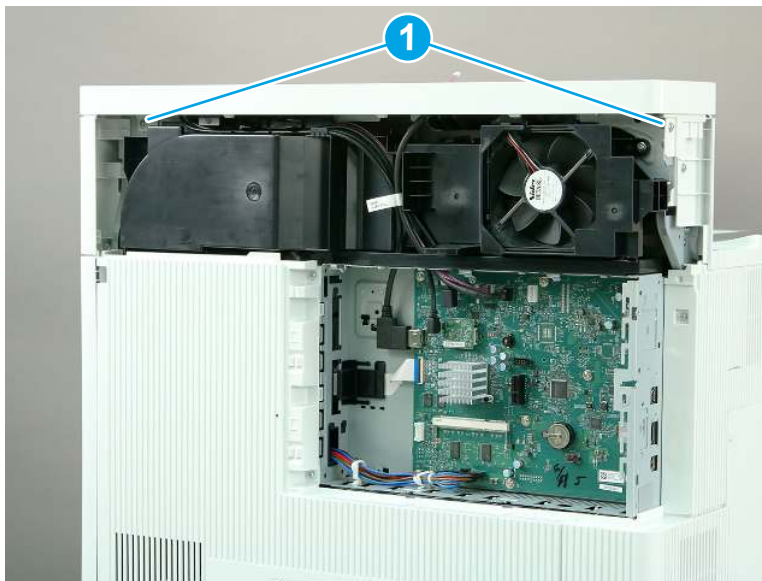
- e. Remove the USB cover (callout 1). Release two tabs (callout 2), and then remove the HIP cover (callout 3). Remove one screw (callout 4).

Figure 1-2038 Remove covers and one screw



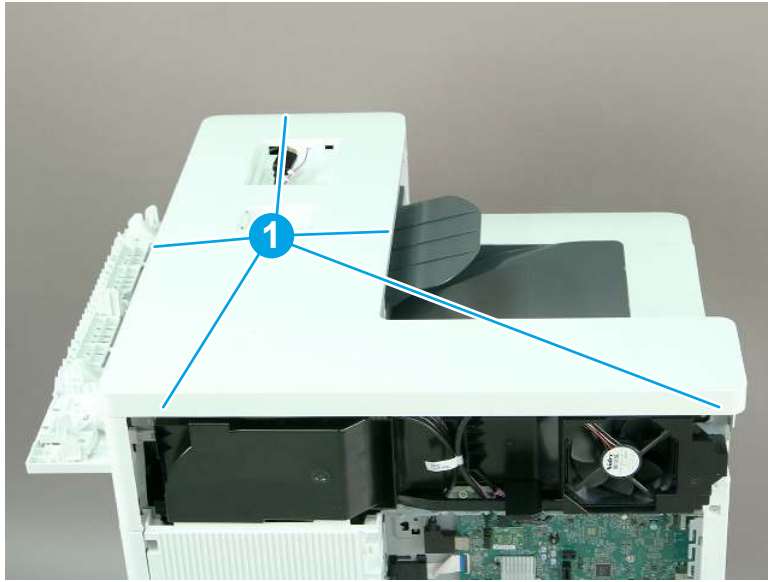
- f. Remove two screws (callout 1).

Figure 1-2039 Remove two screws



- g. Release five tabs (callout 1), and then remove the top cover.

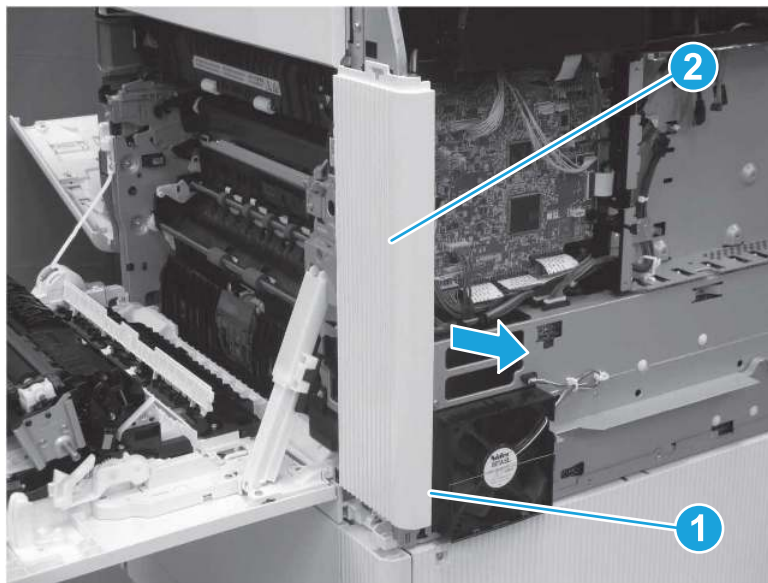
Figure 1-2040 Release five tabs



10. Remove the right rear cover (M856/E85055/M776).

- ▲ Release one tab (callout 1), and then slide the rear cover away from the printer to remove it.

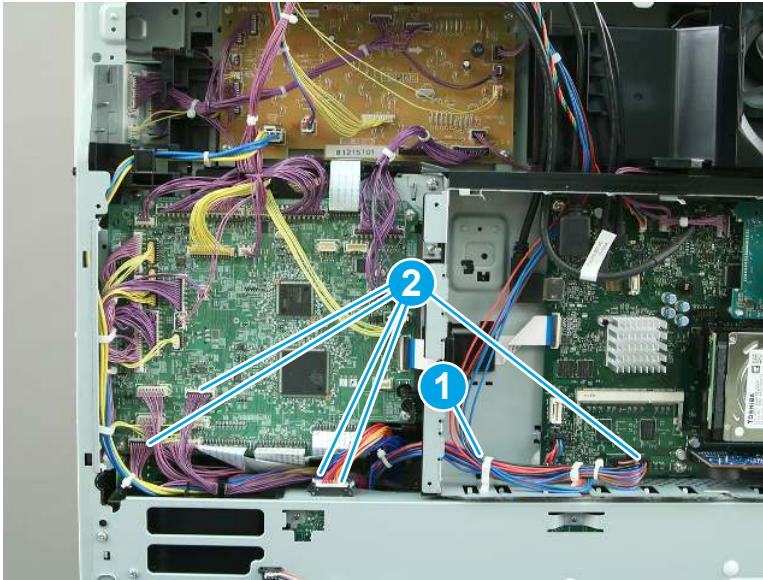
Figure 1-2041 Remove right rear cover



11. Remove the low-voltage power supply (LVPS) (M856/E85055/M776).

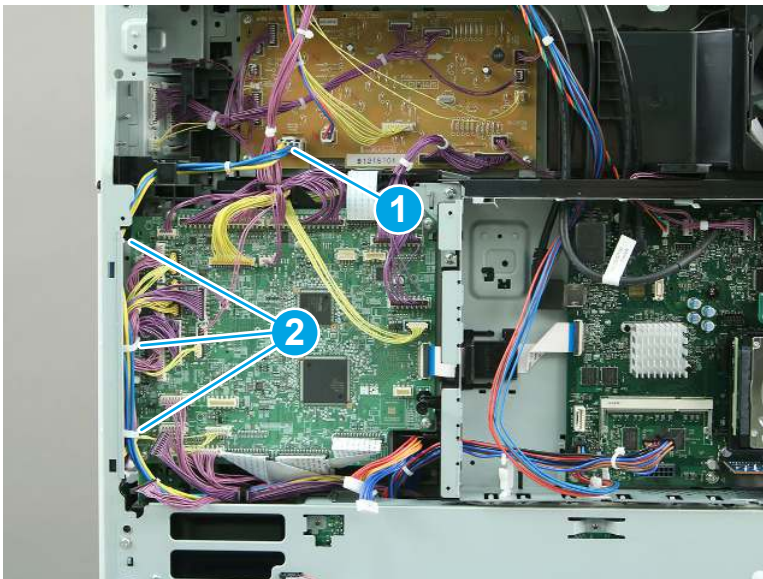
- a. Release one retainer (callout 1), and then disconnect five connectors (callout 2).

Figure 1-2042 Release the retainer and disconnect five connectors



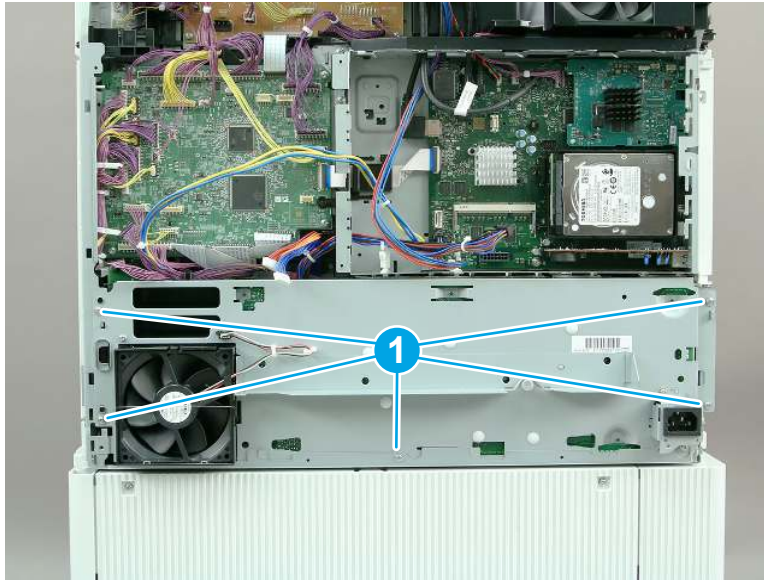
- b. Disconnect one connector (callout 1), and then release three retainers (callout 2).

Figure 1-2043 Disconnect one connector and release five retainers



- c. Remove five screws (callout 1).

Figure 1-2044 Remove five screws



- d. Tilt the LVPS away from the printer (callout 1). Thread the cable (callout 2) through the opening in the formatter case.

 **NOTE:** Due to mechanical tolerances on the formatter cage, rotating the LVPS out might be difficult.


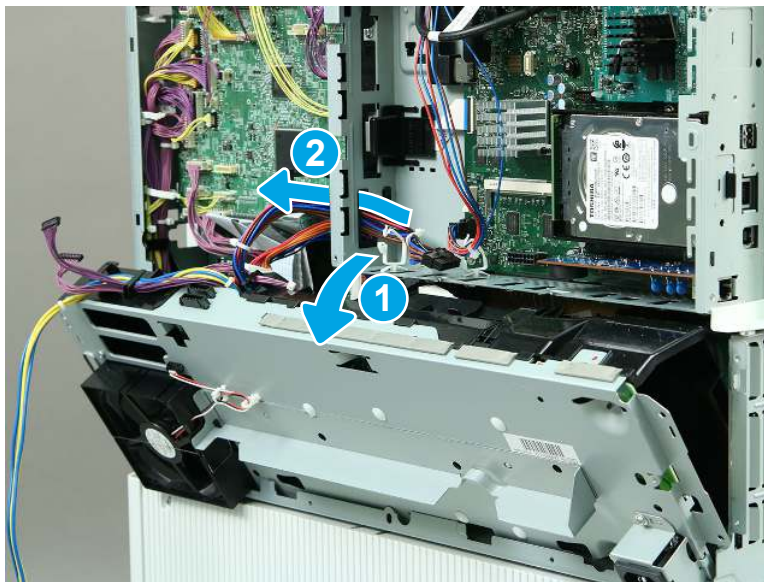
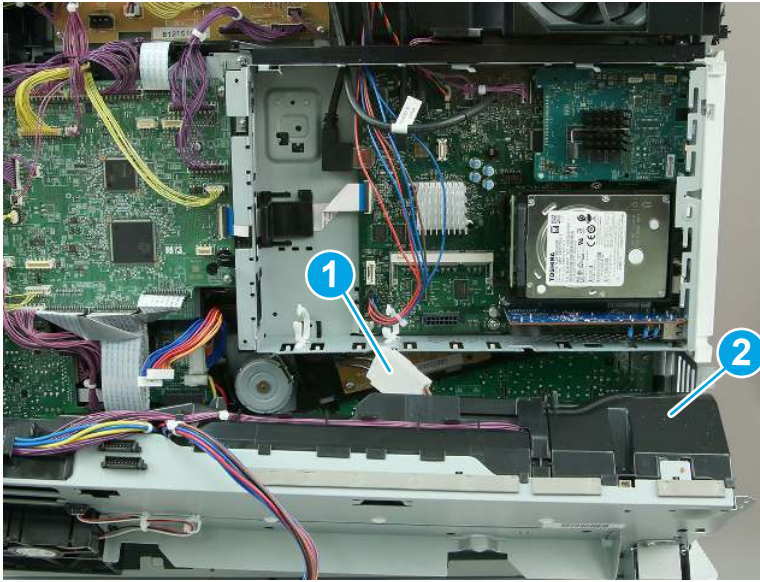
 **CAUTION:** One connector is still connected, so tilt the LVPS carefully.

Figure 1-2045 Thread the cable



- e. Disconnect one connector (callout 1), and then lift up to remove the LVPS (callout 2).

Figure 1-2046 Remove the LVPS



- 12. Remove the formatter and case (M856/E85055/M776).

 **NOTE:** The figures below show the M776zs formatter. The procedure is correct for all referenced models.

- a. Release two retainers (callout 1), and then open the retainer (callout 2) to release the flat cable. Disconnect all of the remaining connectors on the formatter board.


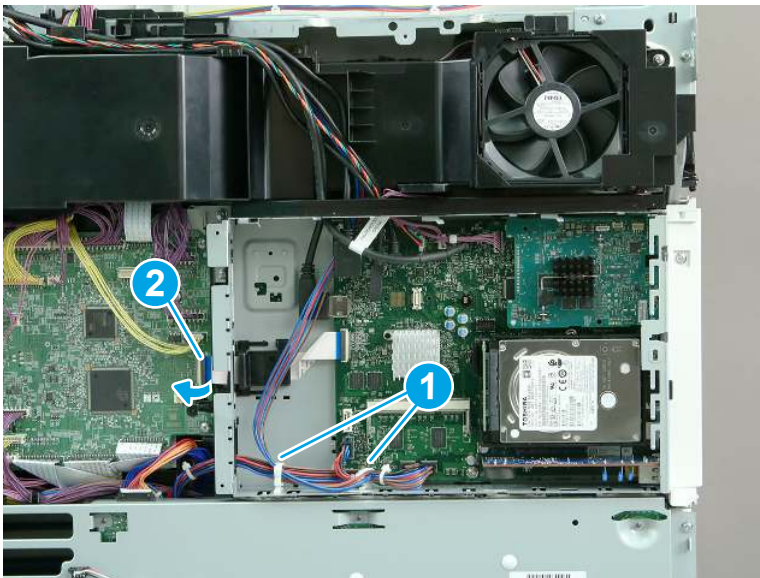
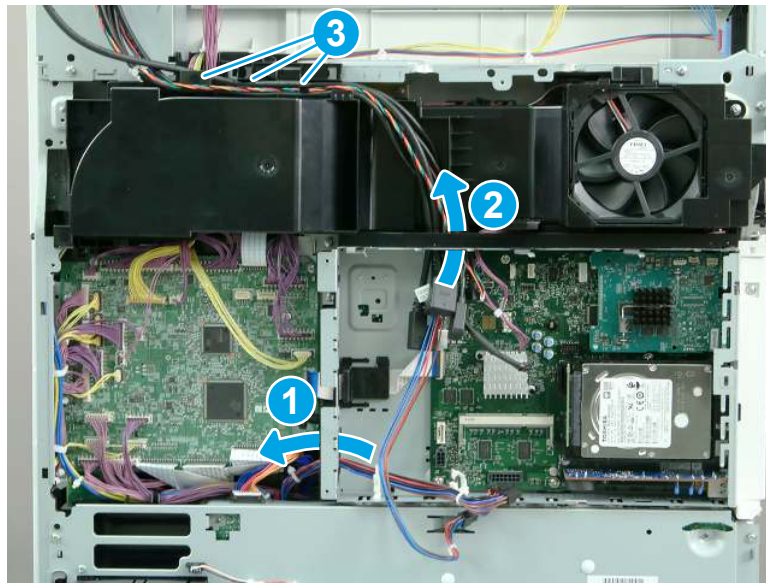
 **NOTE:** The figures below show the M776zs model. The procedures are correct for all of the referenced models.

Figure 1-2047 Disconnect the connectors



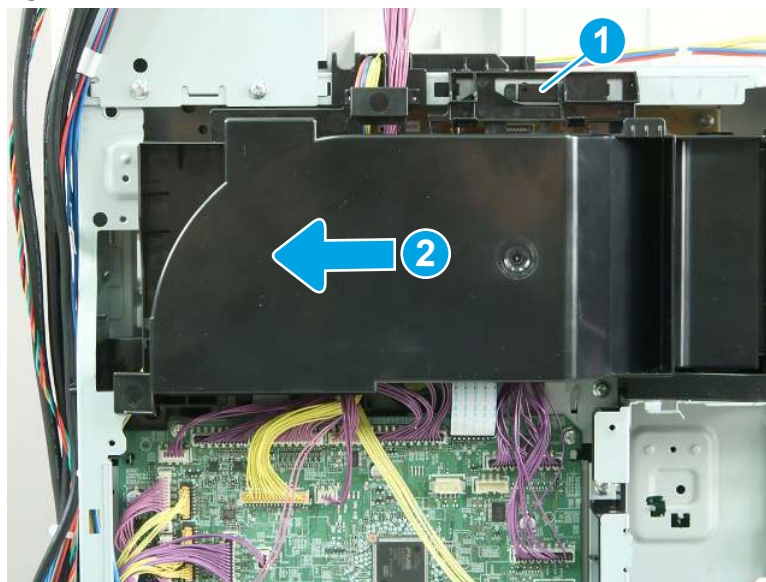
- b. Release one cable through the opening in the left side of the formatter case (callout 1). Release the remaining cables through the opening in the top of the formatter case (callout 2). Release the cables from the upper cable guide (callout 3).

Figure 1-2048 Release the cables



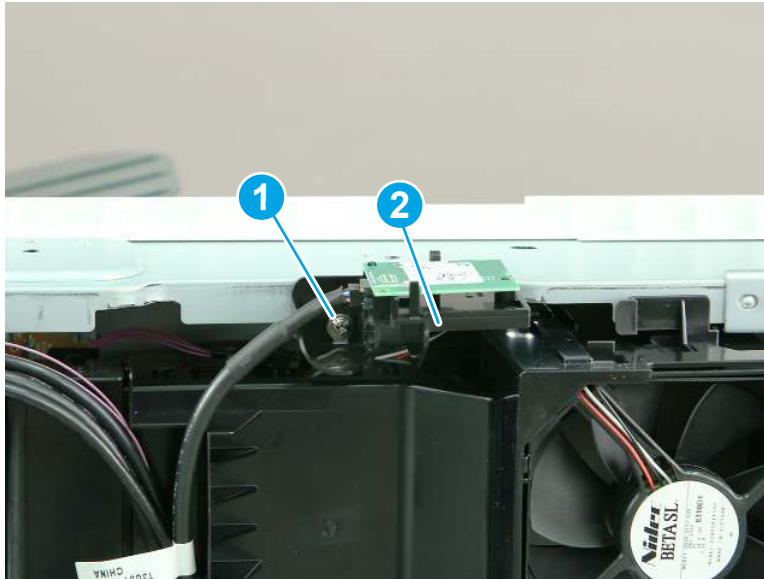
- c. Release one tab (callout 1), and then slide the fan duct to the left (callout 2) to remove it.

Figure 1-2049 Remove the fan duct



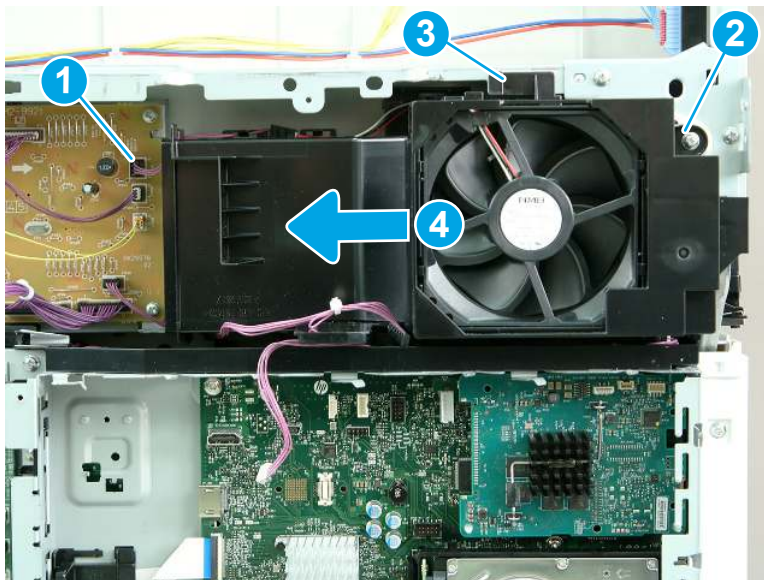
- d. **M856 and E85055 only:** Remove one screw (callout 1), and then remove the wireless card and bracket (callout 2).

Figure 1-2050 Remove the wireless card and bracket



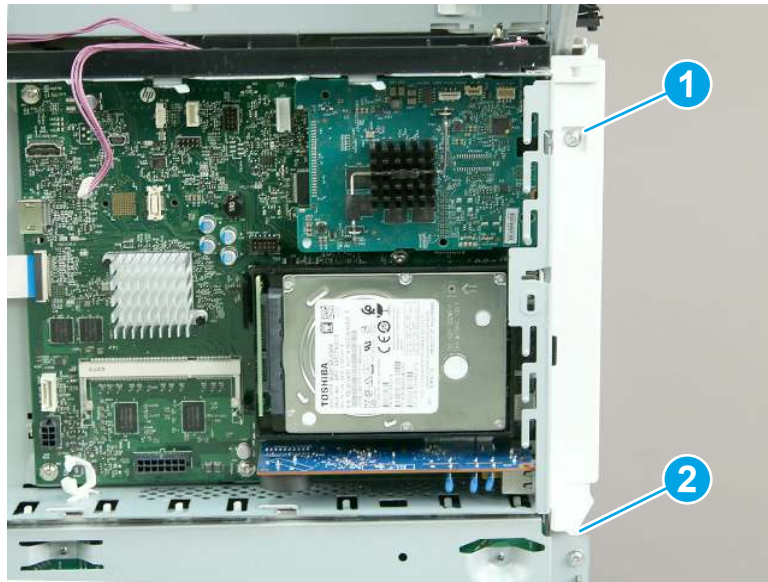
- e. Disconnect one connector (callout 1), and remove one screw (callout 2). Release one tab (callout 3), and then slide the fan assembly to the left (callout 4) to remove it.

Figure 1-2051 Remove the fan assembly



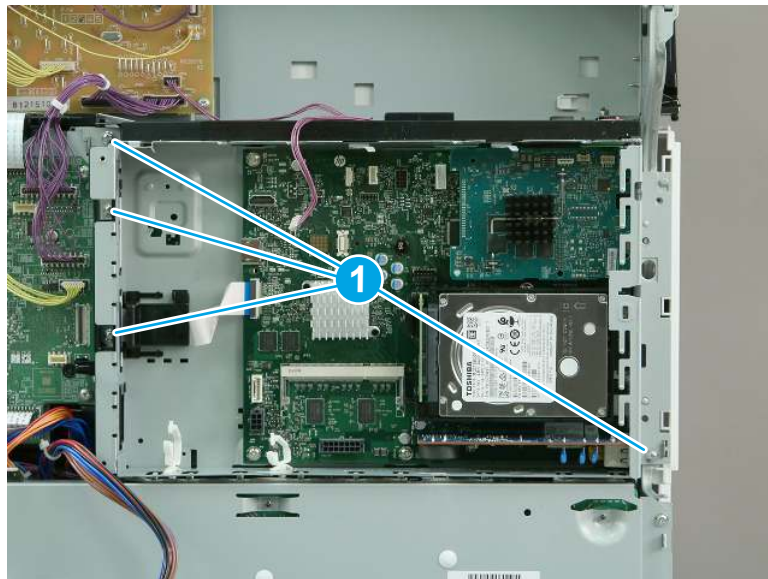
- f. Remove one screw (callout 1), release one tab (callout 2), and then remove the left rear cover.

Figure 1-2052 Remove the left rear cover



- g. Remove four screws (callout 1).

Figure 1-2053 Remove four screws



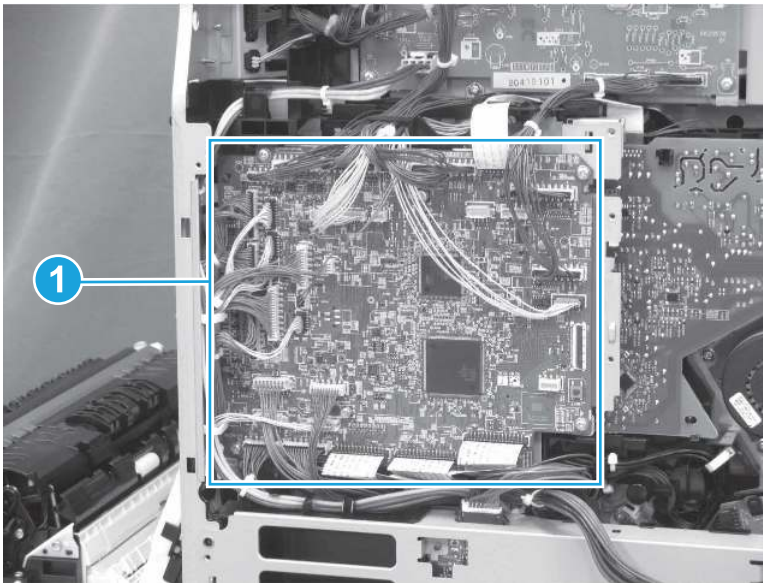
- h. Remove the formatter and case.

Figure 1-2054 Remove the formatter and case



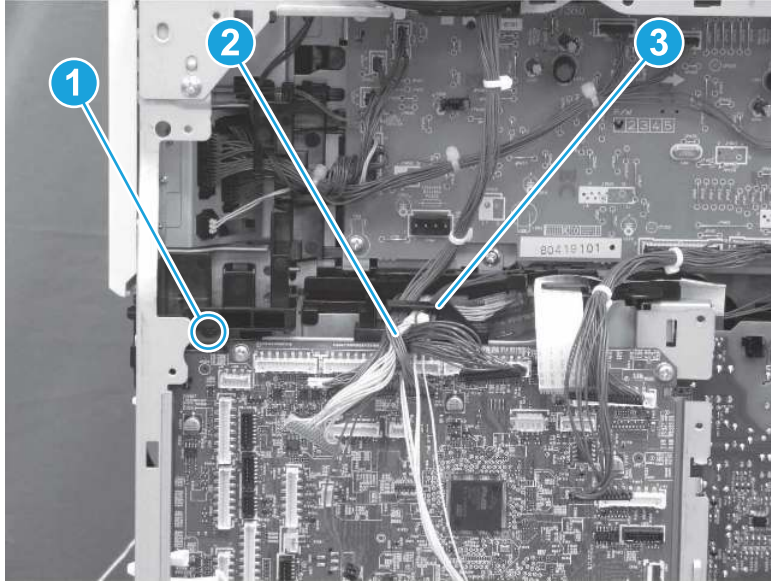
- 13. Remove the DC controller and case (M856/E85055/M776).
 - a. Disconnect all of the connectors on the DC controller.

Figure 1-2055 Disconnect the connectors



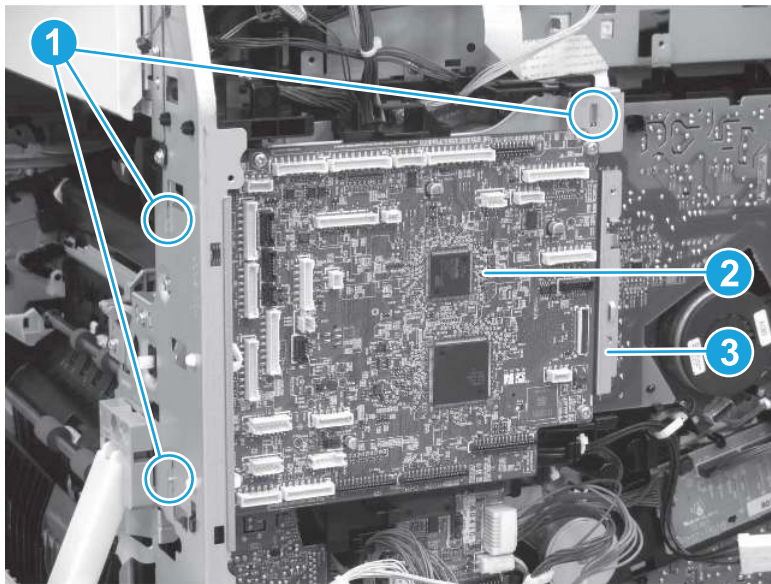
- b. Remove one screw (callout 1), and then release the cables (callout 2) from the cable guide (callout 3).

Figure 1-2056 Remove one screw and release the cables



- c. Remove one screw (callout 1), and then remove the DC controller (callout 2) together with the metal case (callout 3).

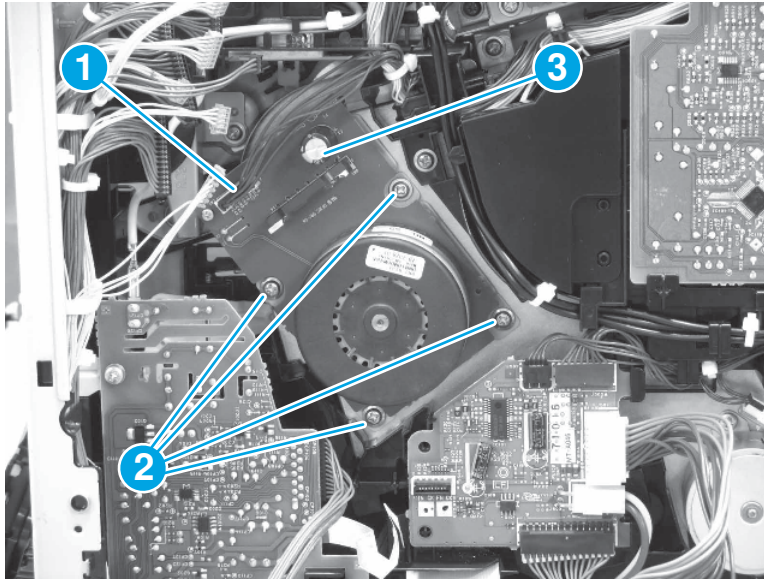
Figure 1-2057 Remove the DC controller and case



- 14. Remove drum motor 3.

- ▲ Disconnect one connector (callout 1), remove four screws (callout 2), and then remove drum motor 3 (callout 3).

Figure 1-2058 Remove drum motor 3



15. Unpack the replacement assembly.

- a. Dispose of the defective part.




NOTE: HP recommends responsible disposal of the defective part.

<http://www8.hp.com/us/en/hp-information/environment/product-recycling.html>

- b. Unpack the replacement part from the packaging.



CAUTION:  Some parts are sensitive to electrostatic discharge (ESD). Always perform service work at an ESD-protected workstation or mat. If an ESD workstation or mat is not available, touch the sheet-metal chassis to provide a static ground before touching an ESD-sensitive assembly. Protect the ESD-sensitive assemblies by placing them in ESD pouches when they are out of the printer.



IMPORTANT: Make sure that all of the shipping materials (for example shipping tape) are removed from the replacement part prior to installation.

- c. To install an assembly, reverse the removal steps.



NOTE: When applicable, special installation instructions are provided for an assembly at the end of the removal procedure. Always completely read the removal instructions and follow all special installation instructions.

Removal and replacement: Developer alienation motor (M751/E75245)

Learn how to remove and replace developer alienation motor.

[View a video of how to remove and replace the developer alienation motor.](#)

Mean time to repair: 15 minutes

Service level: Medium

Before performing service

Turn the printer power off

- Disconnect the power cable.

⚠ WARNING! To avoid damage to the printer, turn the printer off, wait 30 seconds, and then remove the power cord before attempting to service the printer.

Use the table below to identify the correct part number for your printer. To order the part, go to www.hp.com/buy/parts.

Table 1-107 Part information

Part number	Part description
RK2-6027-000CN	Motor, stepping

Required tools

- #2 Phillips screwdriver with a magnetic tip
- Small, flat-blade screwdriver

After performing service

Turn the printer power on

- Connect the power cable.
- Use the power switch to turn the power on.

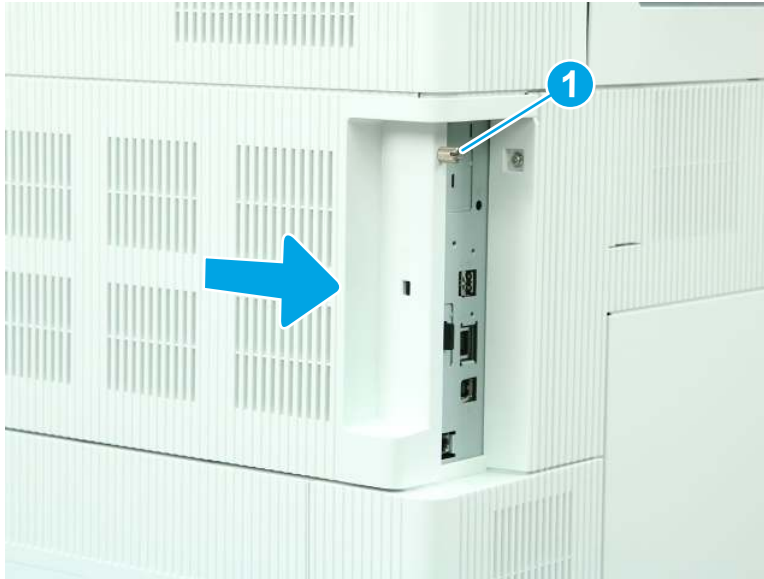
Post service test

No post service test is available for this assembly.

1. Remove the formatter cover.

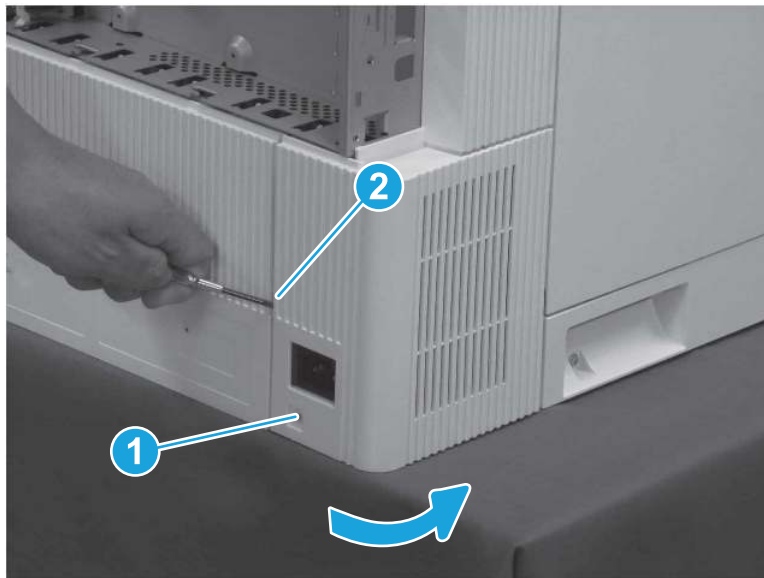
- ▲ Loosen one thumbscrew (callout 1), and then slide the formatter cover (callout 2) away from the printer to remove it.

Figure 1-2059 Remove the formatter cover



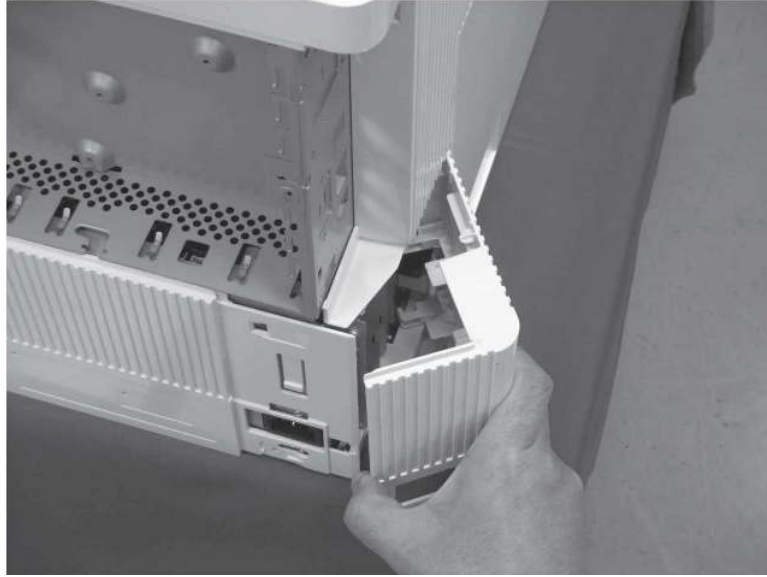
- 2. Remove the left lower cover (M751/E75245).
 - a. Remove one screw (callout 1), release one tab (callout 2), and then rotate the cover away from the printer.

Figure 1-2060 Remove one screw and release one tab



- b. Remove the left lower cover.

Figure 1-2061 Remove the left lower cover



3. Remove the left rear cover (M751/E75245/M856/E85055/M776).

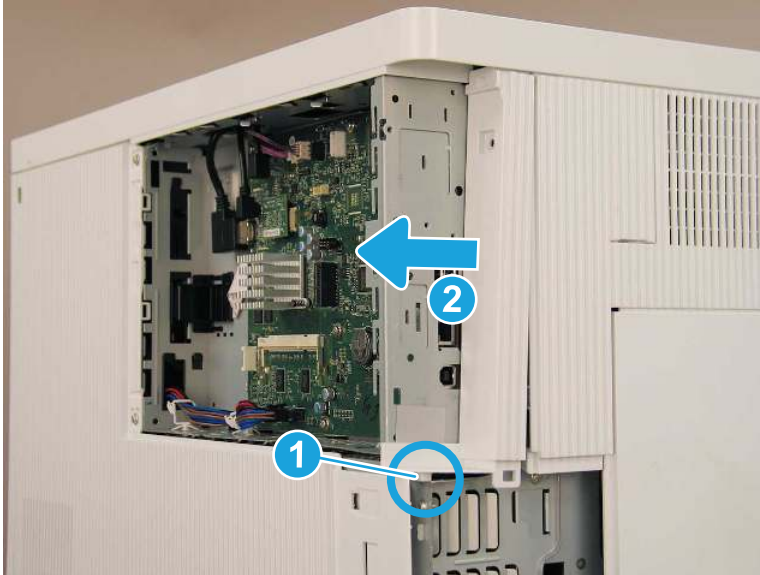
- a. Remove one screw (callout 1).

Figure 1-2062 Remove one screw



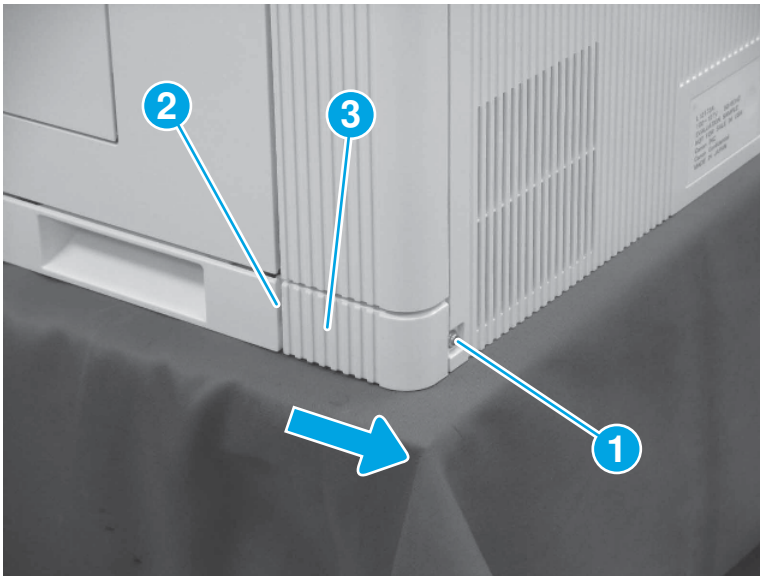
- b. Release one boss (callout 1), and then slide the cover toward the back of the printer (callout 2) to remove it.

Figure 1-2063 Remove the left rear cover



4. Remove the right rear lower cover (M751/E75245/M856/E85055/M776).
 - ▲ Remove one screw (callout 1), release one tab (callout 2), and then slide the right rear lower cover (callout 3) toward the back of the printer to remove it.

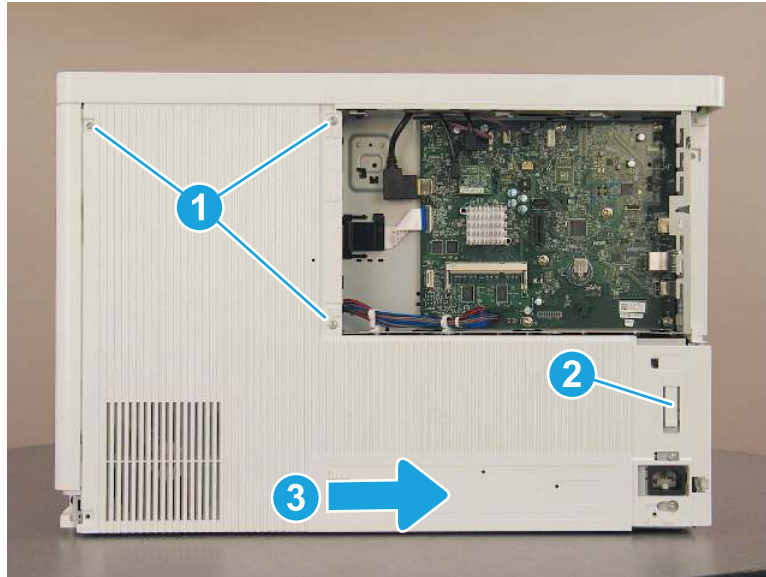
Figure 1-2064 Remove the right rear lower cover



5. Remove the rear cover (M751/E75245).

- ▲ Remove three screws (callout 1), release one tab (callout 2), and then slide the rear cover to the right (callout 3) to remove it.

Figure 1-2065 Remove the rear cover

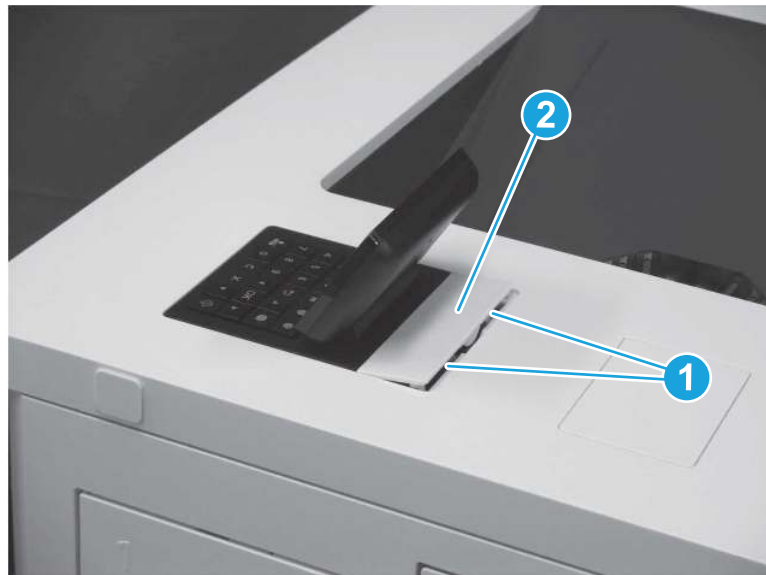


6. Remove the control panel.

 **NOTE:** A screwdriver is included in the control panel kit. The screwdriver has a reversible shaft. Simply pull the shaft out of the handle, and then reinstall it with the desired end facing out.

- a. Use a small, flat-blade screwdriver to release two tabs (callout 1), and then remove the control panel cover (callout 2).

Figure 1-2066 Remove the control panel cover



- b. Remove one screw (callout 1).

Figure 1-2067 Remove one screw



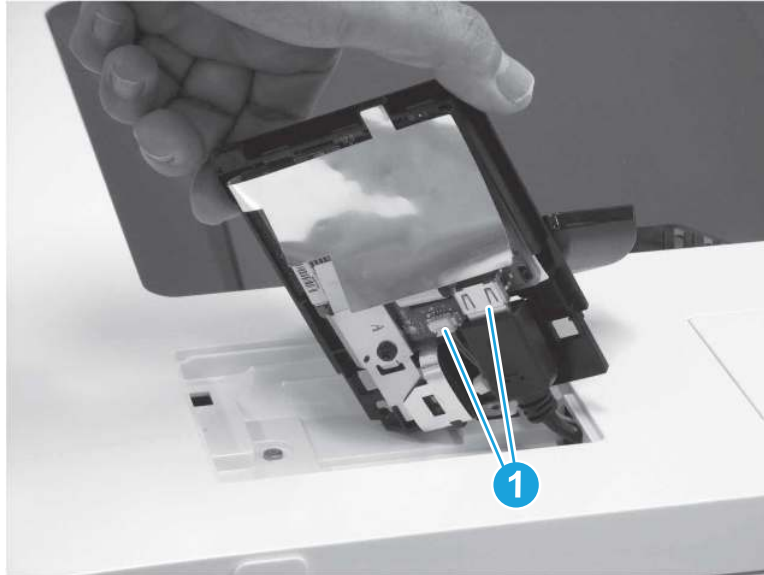
- c. Lift the back edge of the control panel up (callout 1), and then slide the control panel toward the back of the printer (callout 2).

Figure 1-2068 Slide the control panel back



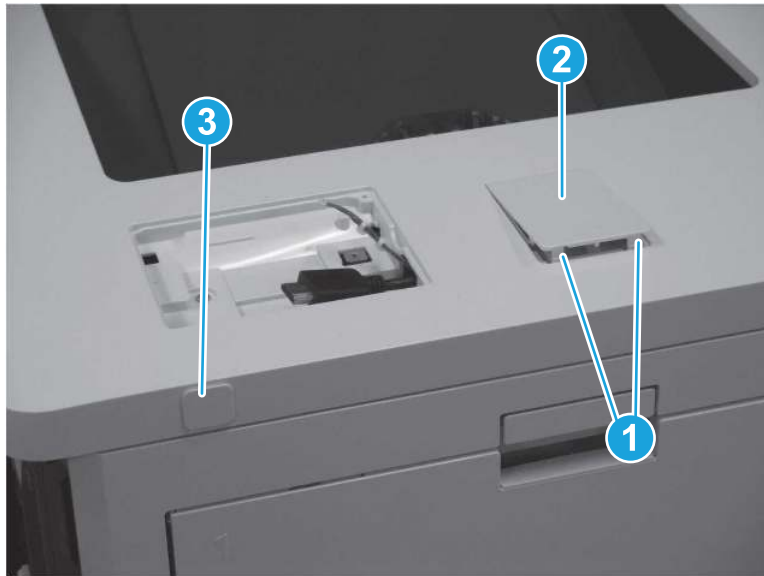
- d. Turn the control panel so that the bottom is facing up, and then disconnect two connectors (callout 1) to remove the control panel.

Figure 1-2069 Disconnect two connectors



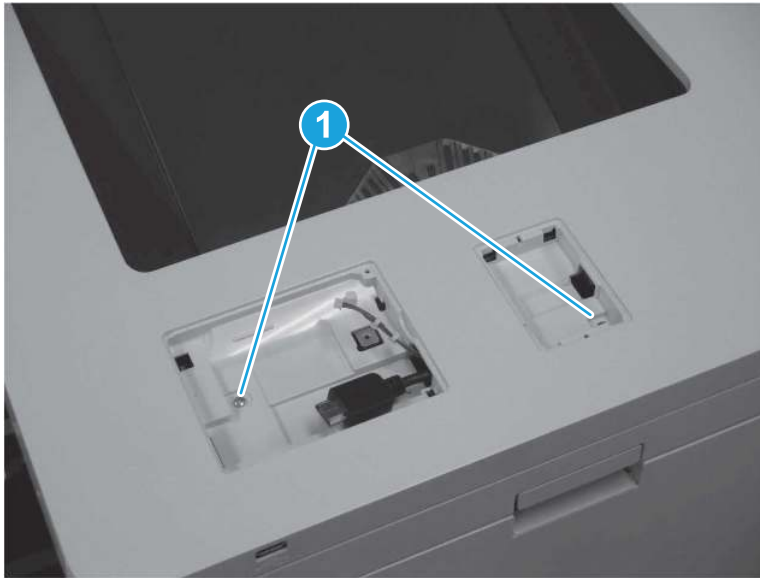
7. Remove the top cover (M751/E75245).
 - a. Release two tabs (callout 1), and then remove the HIP cover (callout 2). Pull the USB cap (callout 3) away from the printer to remove it.

Figure 1-2070 Remove the HIP cover and USB cap



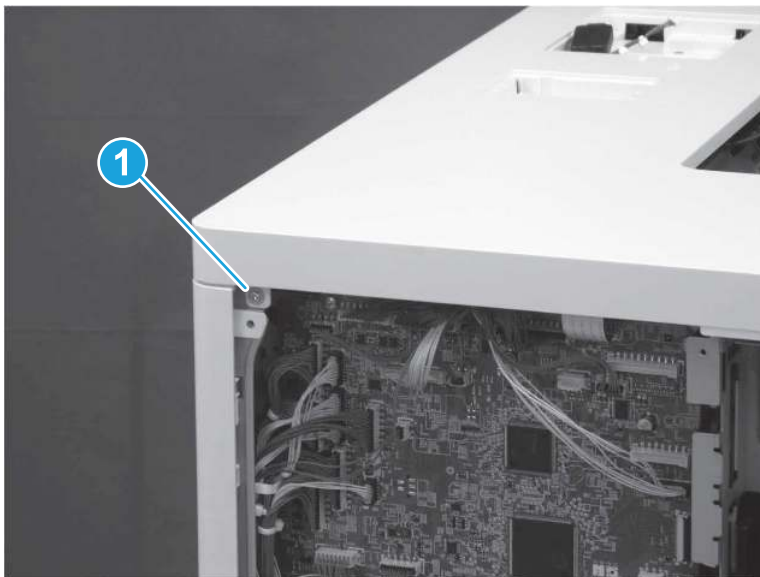
- b. At the top of the printer, remove two screws (callout 1).

Figure 1-2071 Remove two screws




- c. At the back of the printer, remove one screw (callout 1).

Figure 1-2072 Remove one screw

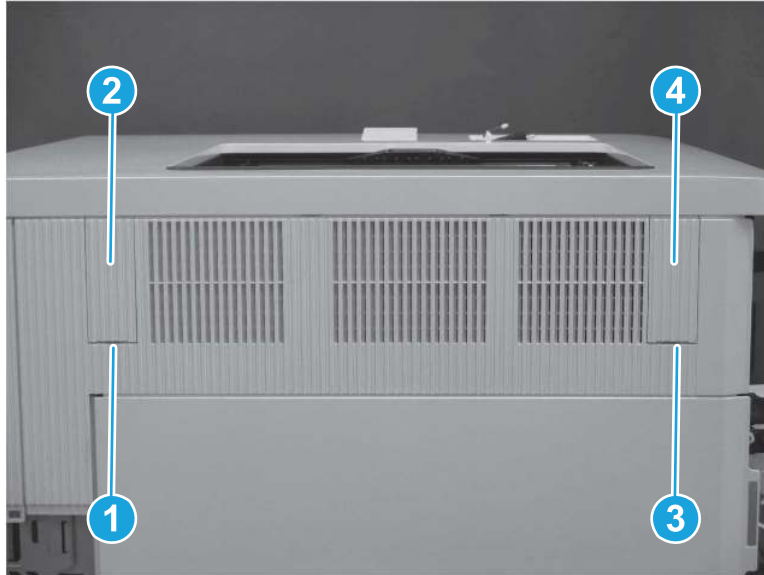


- d. Use a small, flat-blade screwdriver to release one tab (callout 1) and remove the left blanking cover (callout 2). Release one tab (callout 3) and remove the right blanking cover (callout 4).

 **TIP:** These covers are not identical. Make sure to reinstall the correct cover on the correct side.

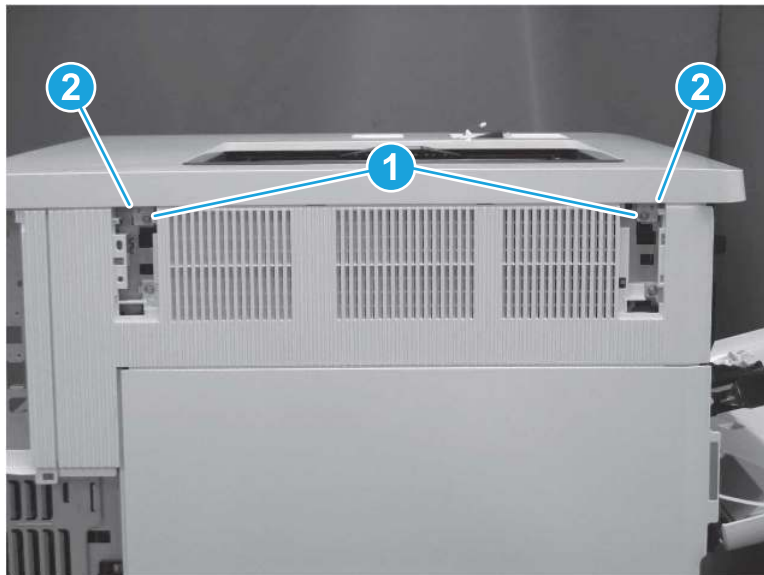
 **NOTE:** The screw under the left blanking cover is a self-tapping screw. Make sure this screw is reinstalled in the correct location.

Figure 1-2073 Remove the left and right blanking covers



- e. Remove two screws (callout 1), and then release two tabs (callout 2).

Figure 1-2074 Remove two screws and release two tabs



- f. At the front of the printer, remove one washer-head screw (callout 1) and one self-tapping screw (callout 2). Release one tab (callout 3).


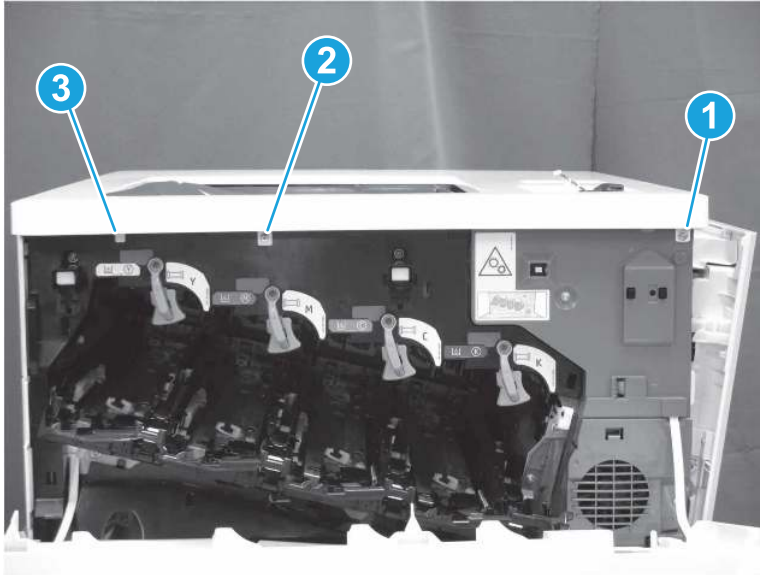
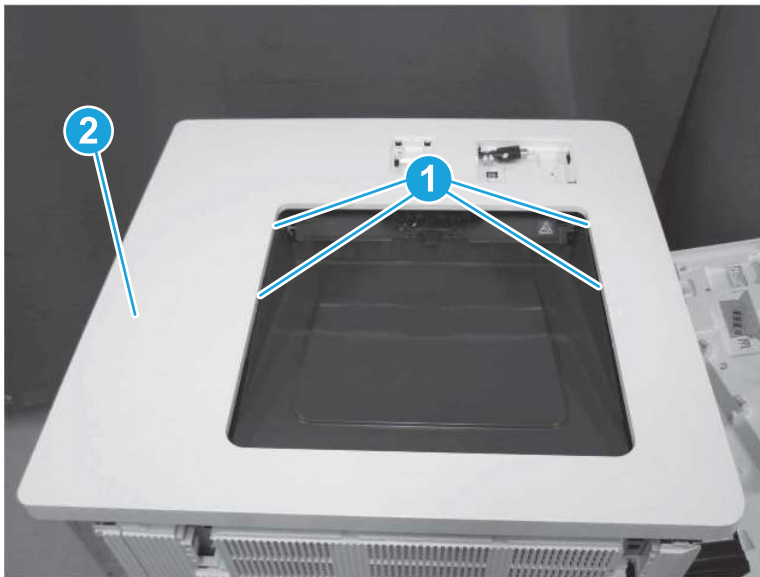
 **TIP:** Make sure to install the correct type of screw in the correct location.

Figure 1-2075 Remove two screws and release one tab

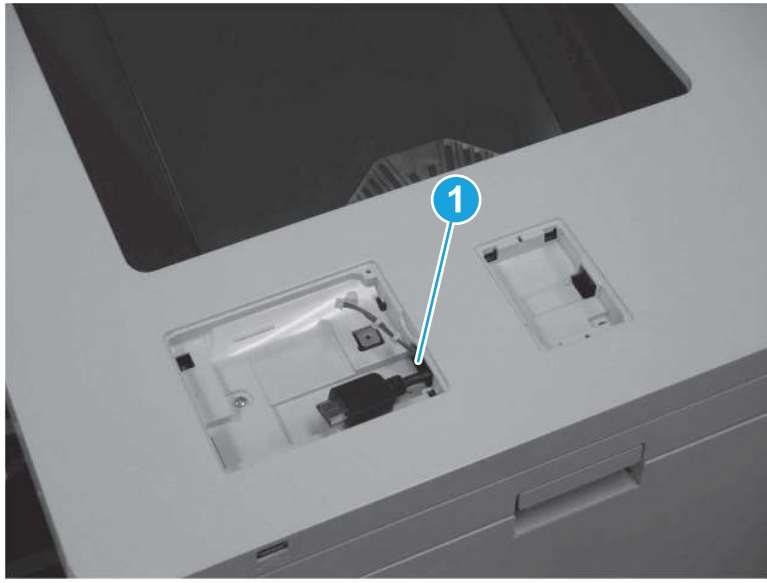


- g. At the top of the printer, release four tabs (callout 1), and then remove the top cover (callout 2).

Figure 1-2076 Remove the top cover

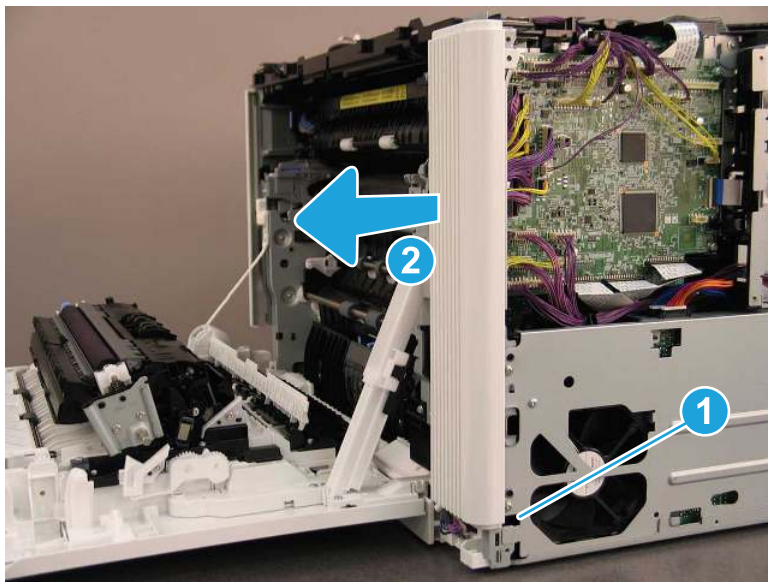


 **NOTE:** When removing the top cover, make sure to release the control panel cables (callout 1) through the opening.



8. Remove the right rear cover (M751/E75245).
 - ▲ Release one tab (callout 1), and then slide the right rear cover (callout 2) away from the printer to remove it.

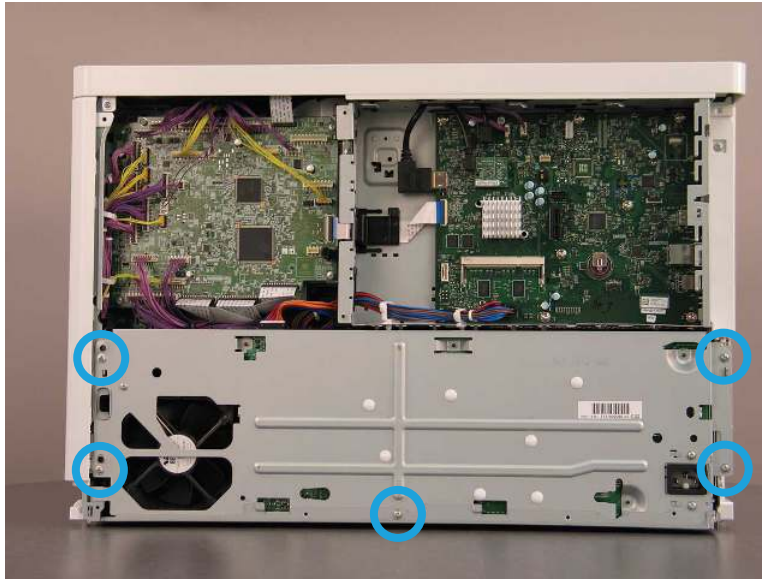
Figure 1-2077 Remove the right rear cover



9. Remove the low-voltage power supply (LVPS).

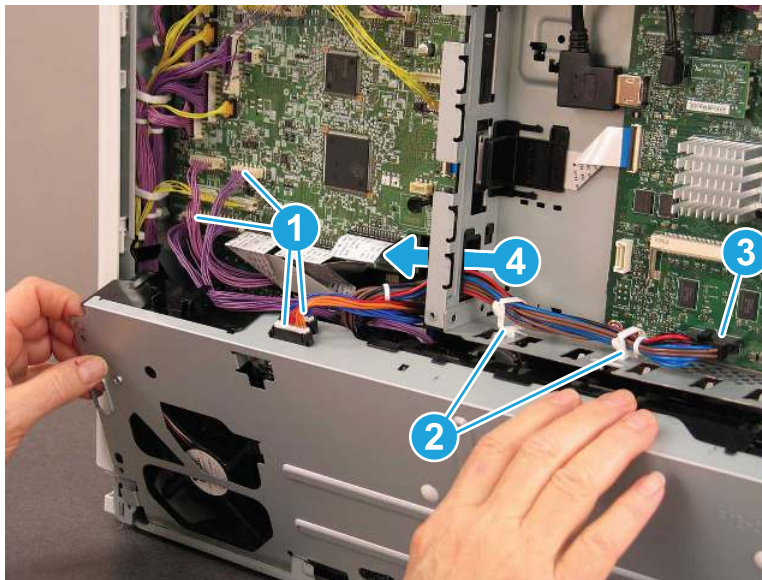
- a. Remove five screws.

Figure 1-2078 Remove five screws



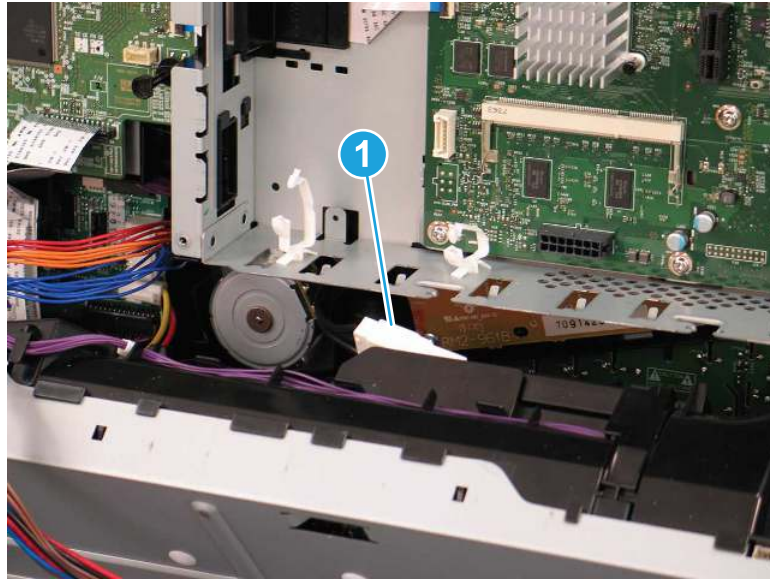
- b. Lift up on the LVPS, and then slightly rotate the top away from the printer. Disconnect four connectors (callout 1), and then release two retainers (callout 2). Press down on the latch to disconnect one connector (callout 3), and then release the wires through the hole (callout 4) in the formatter case.

Figure 1-2079 Disconnect five connectors



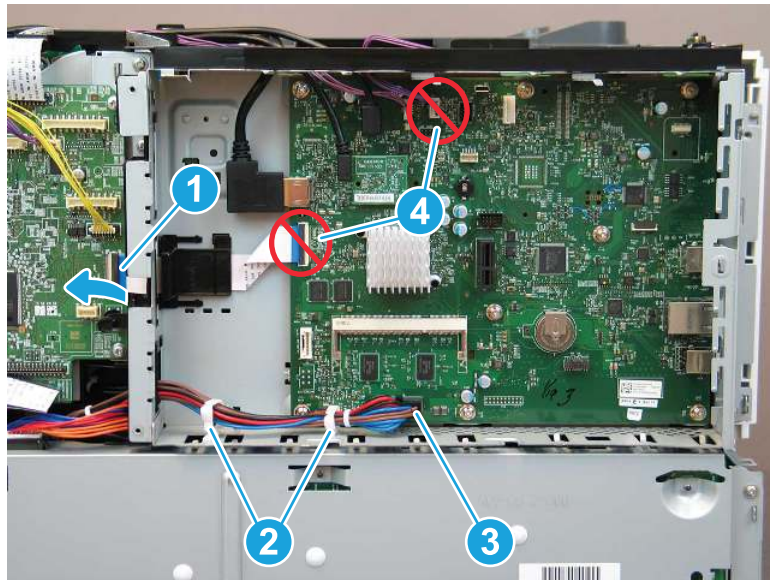
- c. Press down on the latch to disconnect one connector (callout 1), and then lift up to remove the LVPS.

Figure 1-2080 Remove the LVPS



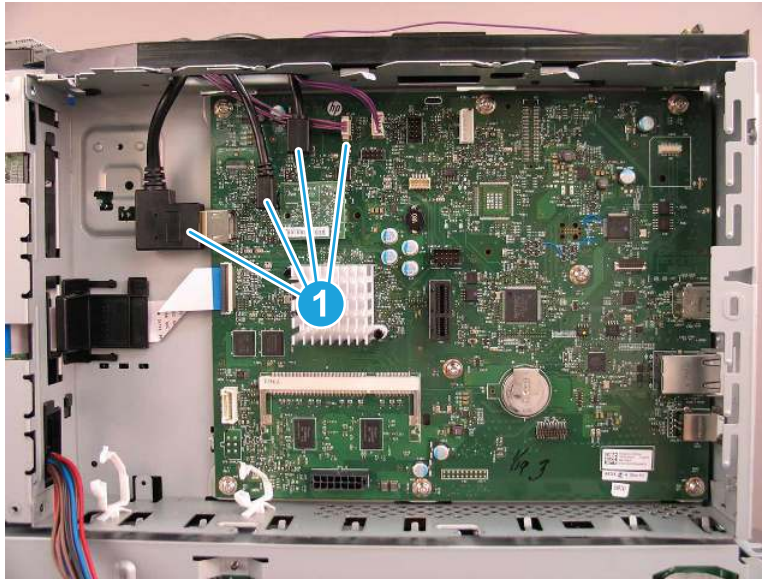
- 10. Remove the formatter and case.
 - a. Open the retainer (callout 1) to release the flat cable. Release the cables from two retainers (callout 2). Squeeze the latch to disconnect the connector (callout 3) at the lower edge of the formatter. It is not necessary to disconnect two connectors (callout 4).

Figure 1-2081 Disconnect the connectors



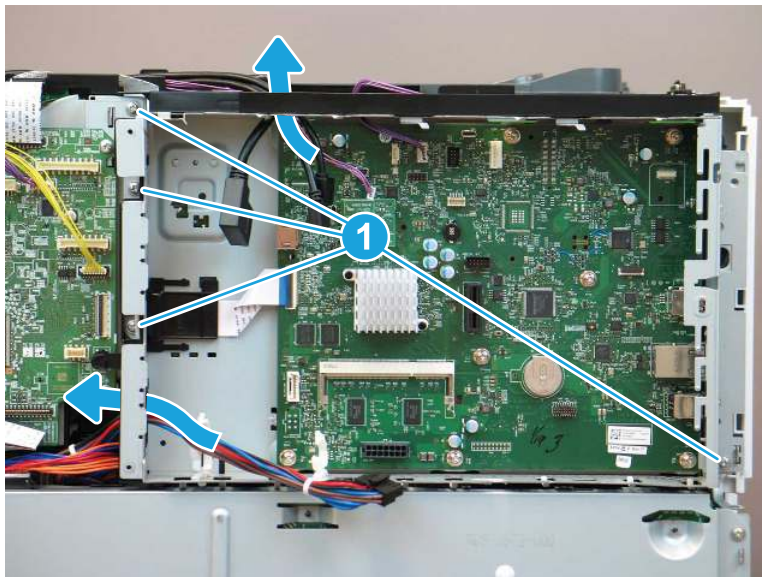
- b. Disconnect all of the remaining connectors on the formatter (callout 1).

Figure 1-2082 Disconnect the connectors



- c. Release the cables through the opening on top and on the left side of the formatter case. Remove four screws (callout 1), and then remove the formatter and case.

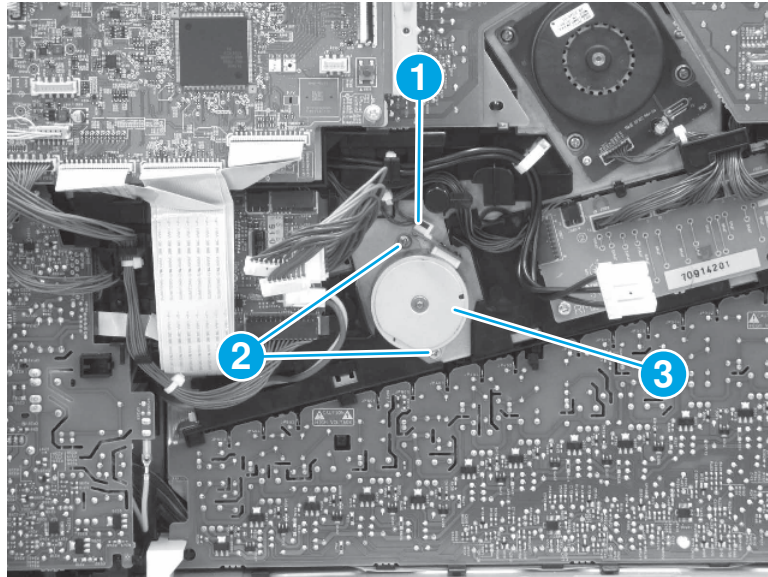
Figure 1-2083 Remove the formatter and case



- 11. Remove the developer alienation motor.

- ▲ Disconnect one connector (callout 1), remove two screws (callout 2), and then remove the developer alienation motor (callout 3).

Figure 1-2084 Remove the developer alienation motor



12. Unpack the replacement assembly.

- a. Dispose of the defective part.




NOTE: HP recommends responsible disposal of the defective part.

<http://www8.hp.com/us/en/hp-information/environment/product-recycling.html>

- b. Unpack the replacement part from the packaging.



CAUTION:  Some parts are sensitive to electrostatic discharge (ESD). Always perform service work at an ESD-protected workstation or mat. If an ESD workstation or mat is not available, touch the sheet-metal chassis to provide a static ground before touching an ESD-sensitive assembly. Protect the ESD-sensitive assemblies by placing them in ESD pouches when they are out of the printer.



IMPORTANT: Make sure that all of the shipping materials (for example shipping tape) are removed from the replacement part prior to installation.

- c. To install an assembly, reverse the removal steps.



NOTE: When applicable, special installation instructions are provided for an assembly at the end of the removal procedure. Always completely read the removal instructions and follow all special installation instructions.

Removal and replacement: Developer alienation motor (M856/E85055/M776)

Learn how to remove and replace developer alienation motor.

[View a video of how to remove and replace the developer alienation motor.](#)

Mean time to repair: 15 minutes

Service level: Medium

Before performing service

Turn the printer power off

- Disconnect the power cable.

⚠ WARNING! To avoid damage to the printer, turn the printer off, wait 30 seconds, and then remove the power cord before attempting to service the printer.

Use the table below to identify the correct part number for your printer. To order the part, go to www.hp.com/buy/parts.

Table 1-108 Part information

Part number	Part description
RK2-6027-000CN	Motor, stepping

Required tools

- #2 Phillips screwdriver with a magnetic tip
- Small, flat-blade screwdriver

After performing service

Turn the printer power on

- Connect the power cable.
- Use the power switch to turn the power on.

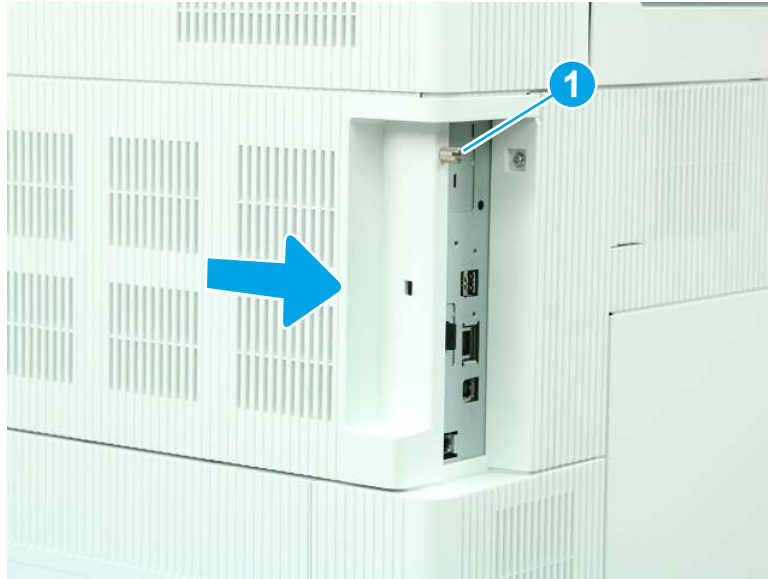
Post service test

No post service test is available for this assembly.

1. Remove the formatter cover.

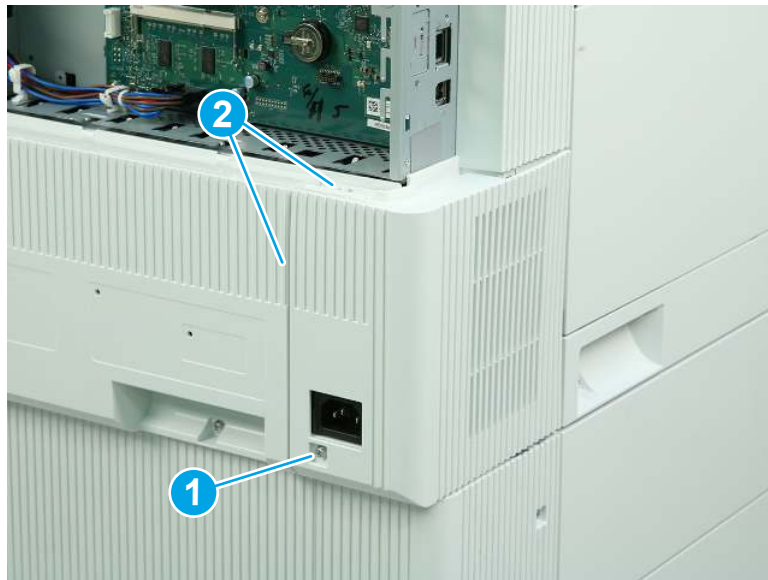
- ▲ Loosen one thumbscrew (callout 1), and then slide the formatter cover (callout 2) away from the printer to remove it.

Figure 1-2085 Remove the formatter cover



- 2. Remove the left lower cover (M856/E85055/M776).
 - a. Remove one screw (callout 1), and then release two tabs (callout 2).

Figure 1-2086 Remove one screw and release two tabs



- b. Rotate the cover away from the printer to remove it.

Figure 1-2087 Remove the left lower cover



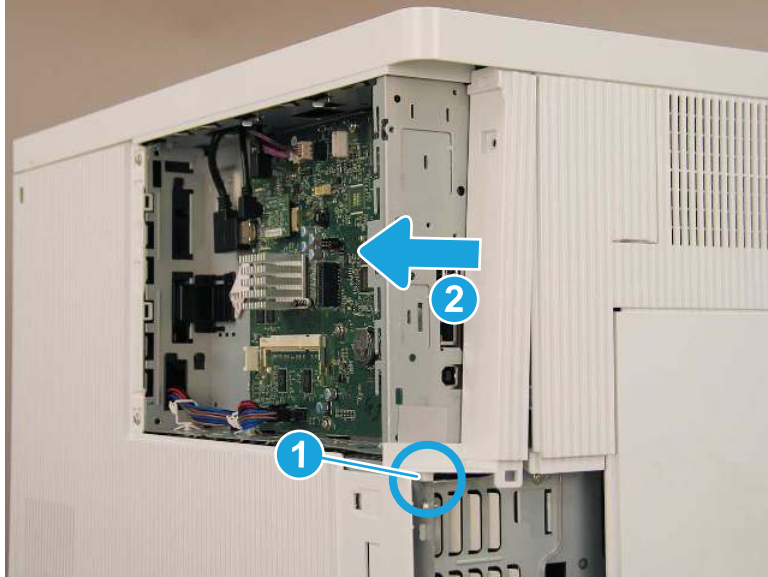
3. Remove the left rear cover (M751/E75245/M856/E85055/M776).
 - a. Remove one screw (callout 1).

Figure 1-2088 Remove one screw



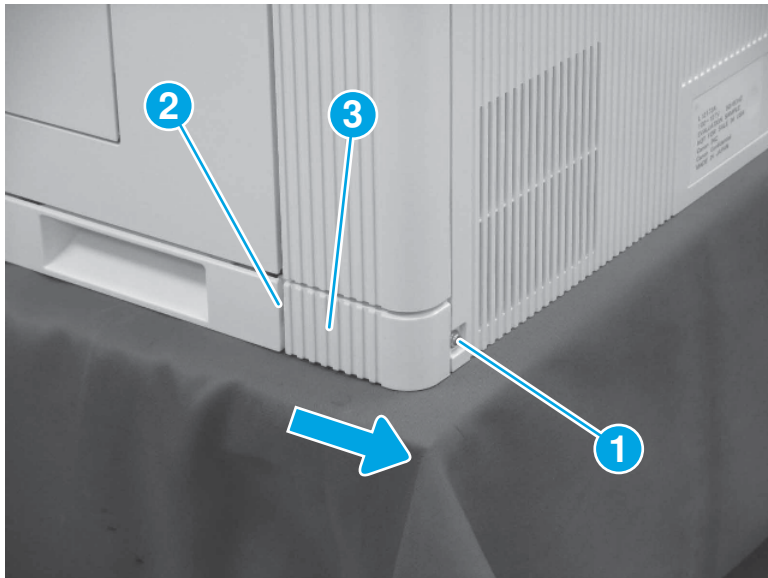
- b. Release one boss (callout 1), and then slide the cover toward the back of the printer (callout 2) to remove it.

Figure 1-2089 Remove the left rear cover



4. Remove the right rear lower cover (M751/E75245/M856/E85055/M776).
 - ▲ Remove one screw (callout 1), release one tab (callout 2), and then slide the right rear lower cover (callout 3) toward the back of the printer to remove it.

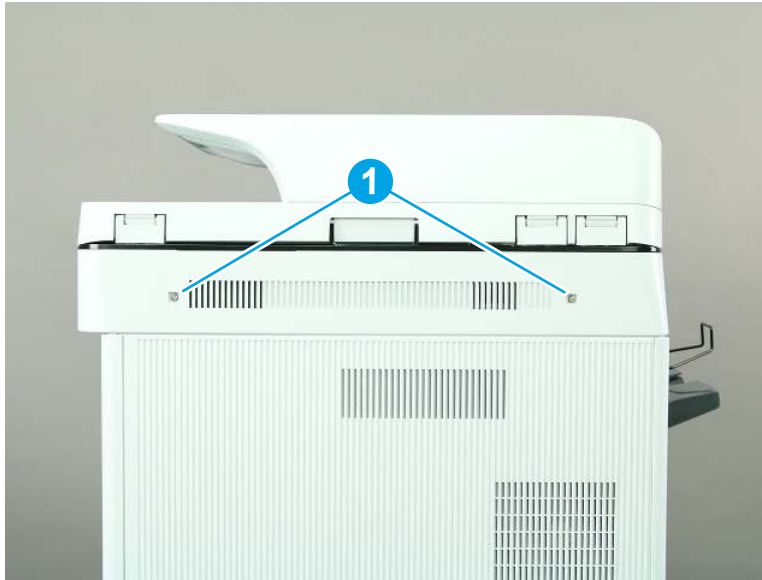
Figure 1-2090 Remove the right rear lower cover



5. Remove the scanner control board (SCB) cover (M776).

- a. Remove two screws (callout 1).

Figure 1-2091 Remove two screws



- b. Remove the SCB cover.

Figure 1-2092 Remove the SCB cover

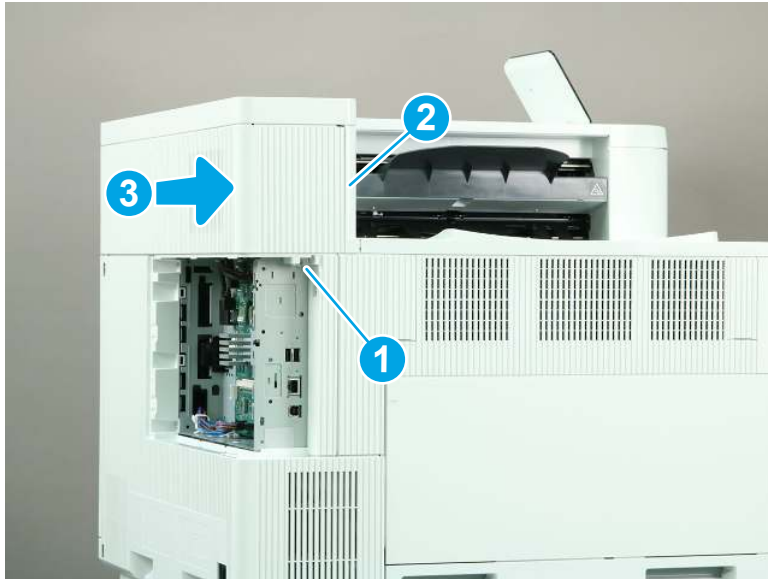


6. Remove the rear upper cover (M856/E85055/M776dn/M776z).

 **NOTE:** The following figure shows the M856 printer. The procedure is correct for all referenced models.

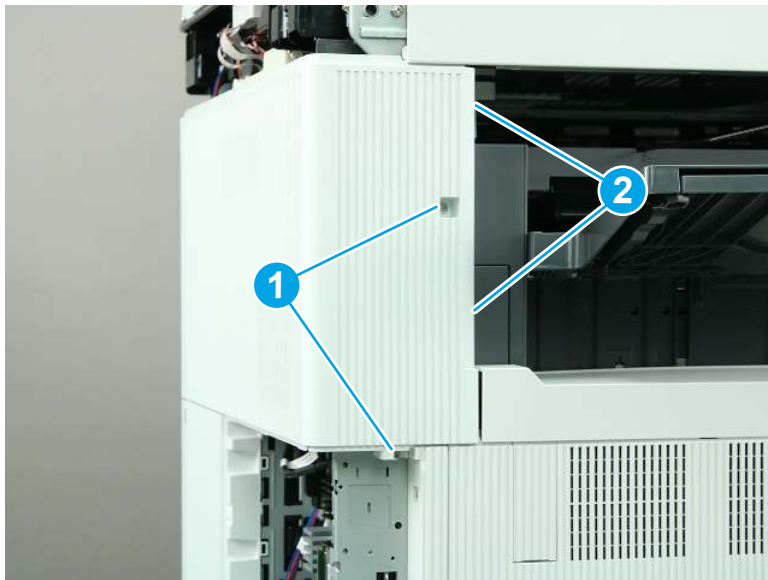
- ▲ Remove one screw (callout 1), release one tab (callout 2), and then slide the rear upper cover away from the printer to remove it (callout 3).

Figure 1-2093 Remove the rear upper cover



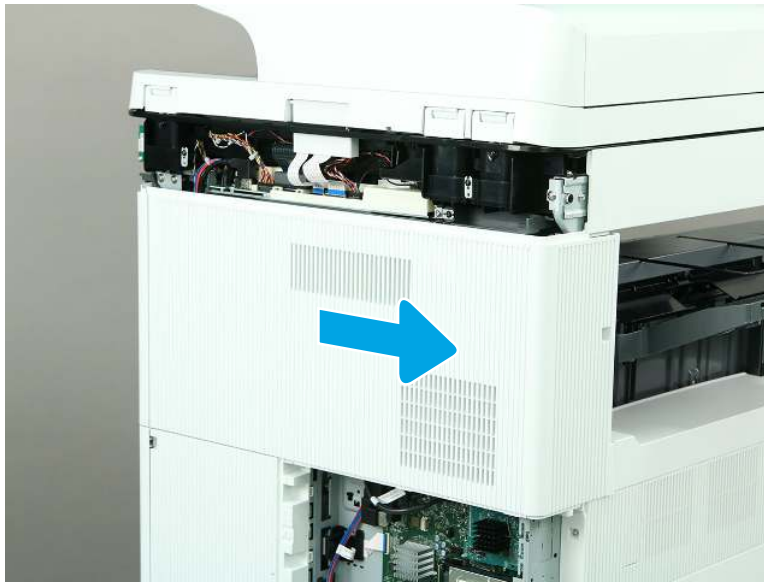
- 7. Remove the rear upper cover and left rear upper cover (M776zs).
 - a. Remove two screws (callout 1), and then release two tabs (callout 2).

Figure 1-2094 Remove two screws and release two tabs



- b. Slide the cover to the right to remove it.

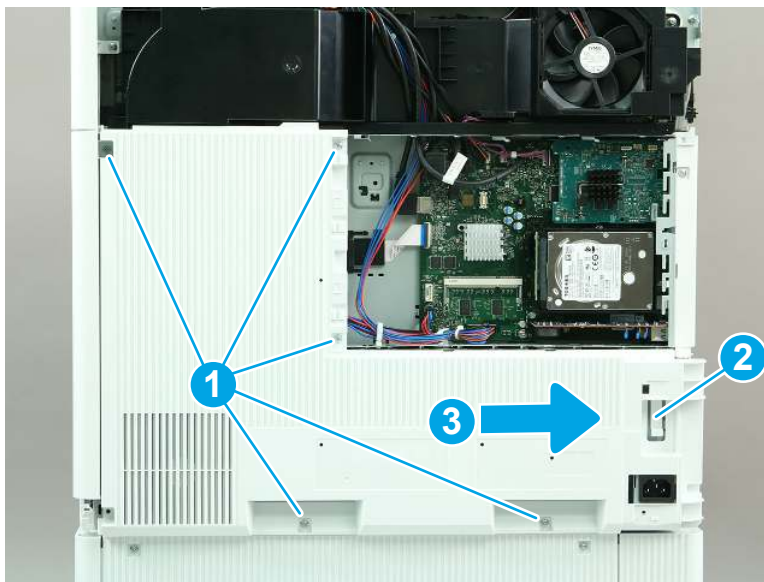
Figure 1-2095 Remove the rear upper and left rear upper cover




8. Remove the rear cover (M856/E85055/M776).

- ▲ Remove five screws (callout 1), release one tab (callout 2), and then slide the rear cover to the right to remove it.

Figure 1-2096 Remove the rear cover (M856/E85055/M776)



9. **M856/E85055 only:** Remove the control panel and top cover.

 **NOTE:** This step applies to only the M856/E85055 models. Skip this step for all other models.

- a. Use a small, flat-blade screwdriver to release two tabs (callout 1), and then remove the control panel cover (callout 2).

Figure 1-2097 Remove the control panel cover



- b. Remove one screw (callout 1).

Figure 1-2098 Remove one screw



- c. Lift the back edge of the control panel up (callout 1), and then slide the control panel toward the back of the printer (callout 2).

Figure 1-2099 Slide the control panel back



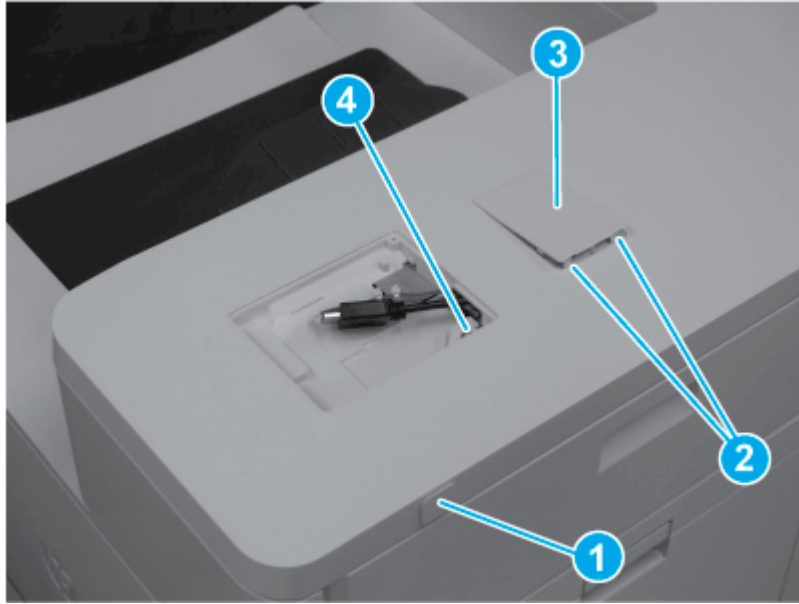
- d. Turn the control panel so that the bottom is facing up, and then disconnect two connectors to remove the control panel.

Figure 1-2100 Disconnect two connectors



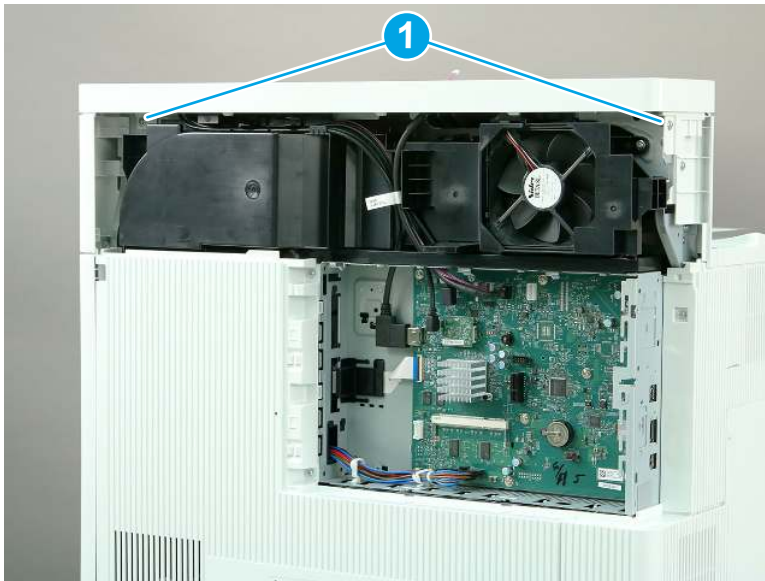
- e. Remove the USB cover (callout 1). Release two tabs (callout 2), and then remove the HIP cover (callout 3). Remove one screw (callout 4).

Figure 1-2101 Remove covers and one screw



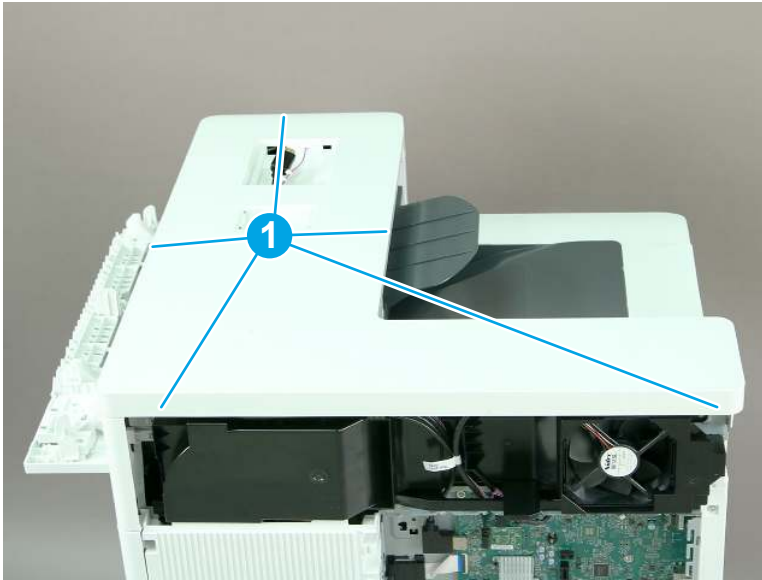
- f. Remove two screws (callout 1).

Figure 1-2102 Remove two screws



- g. Release five tabs (callout 1), and then remove the top cover.

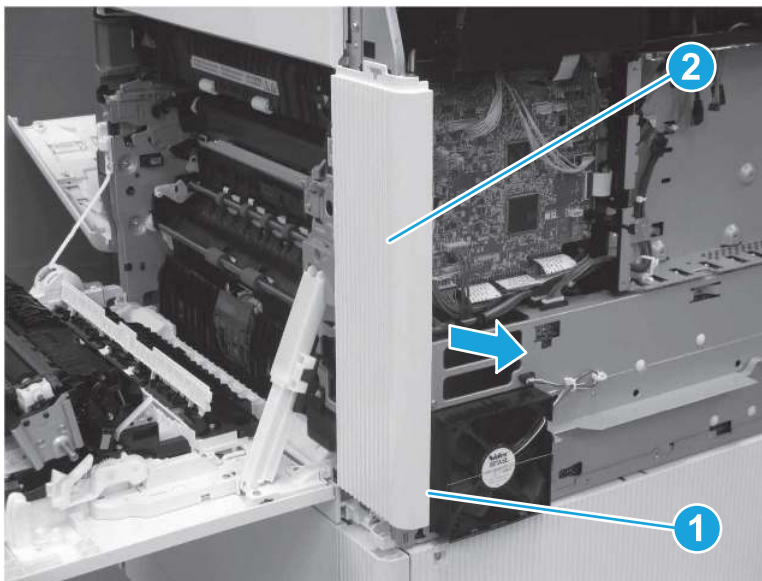
Figure 1-2103 Release five tabs



10. Remove the right rear cover (M856/E85055/M776).

- ▲ Release one tab (callout 1), and then slide the rear cover away from the printer to remove it.

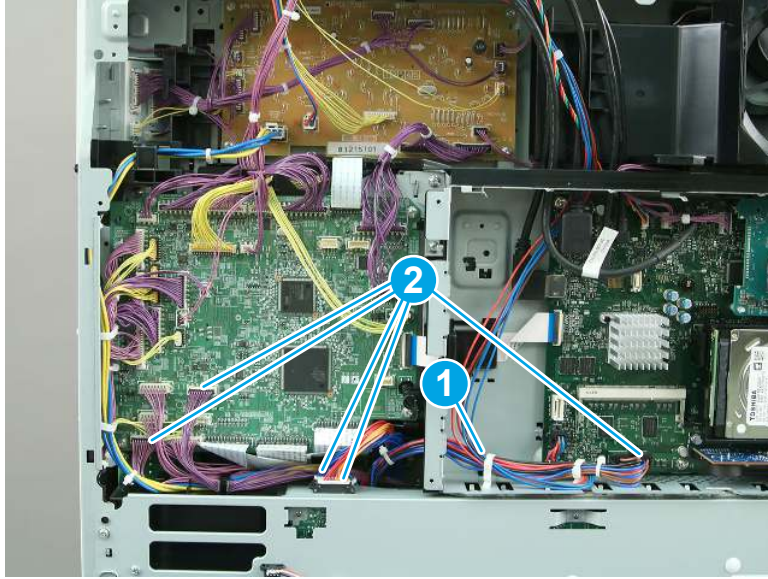
Figure 1-2104 Remove right rear cover



11. Remove the low-voltage power supply (LVPS) (M856/E85055/M776).

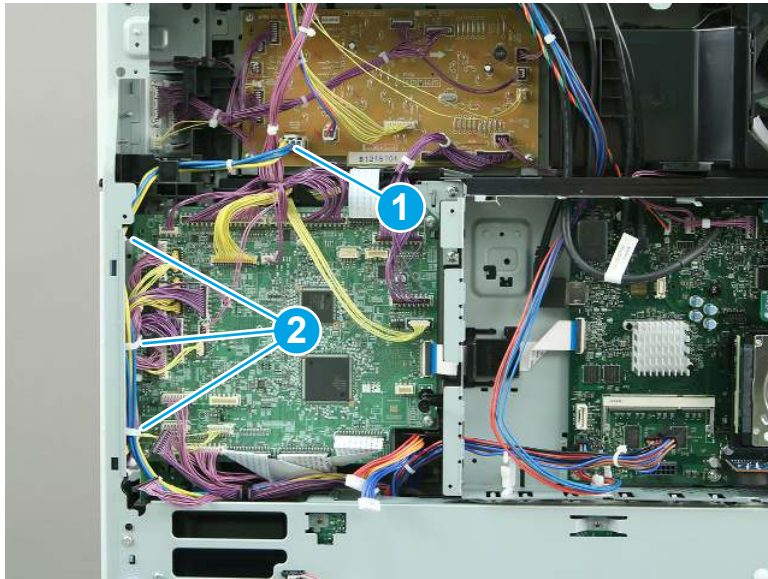
- a. Release one retainer (callout 1), and then disconnect five connectors (callout 2).

Figure 1-2105 Release the retainer and disconnect five connectors



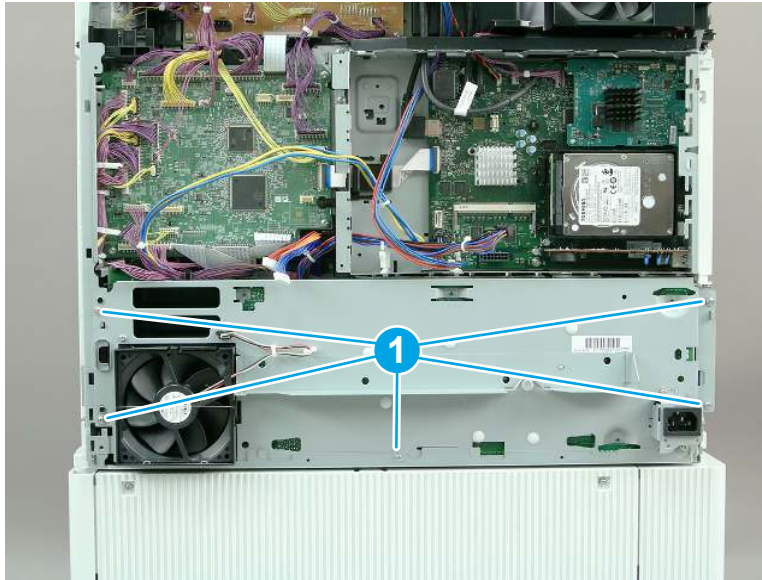
- b. Disconnect one connector (callout 1), and then release three retainers (callout 2).

Figure 1-2106 Disconnect one connector and release five retainers



- c. Remove five screws (callout 1).

Figure 1-2107 Remove five screws



- d. Tilt the LVPS away from the printer (callout 1). Thread the cable (callout 2) through the opening in the formatter case.

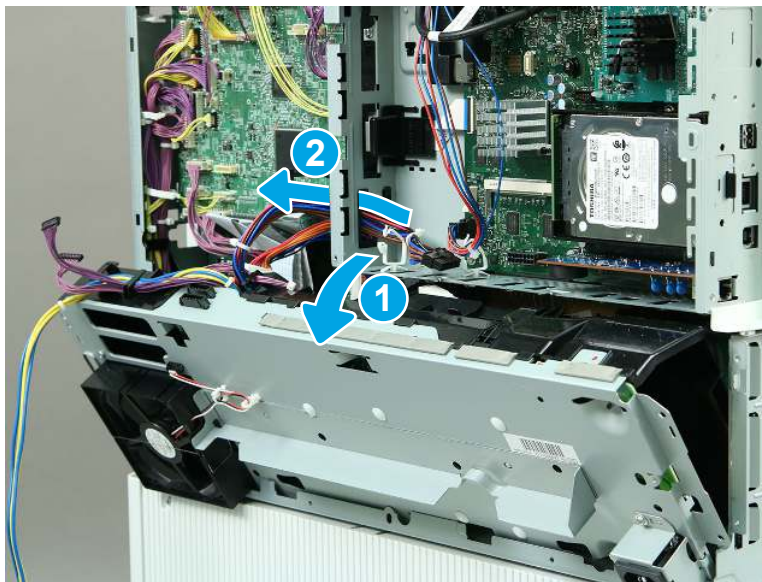


NOTE: Due to mechanical tolerances on the formatter cage, rotating the LVPS out might be difficult.



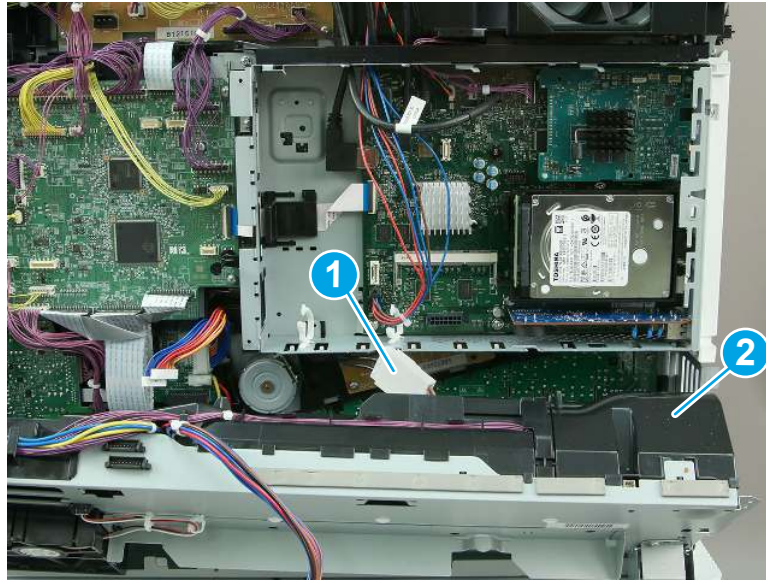
CAUTION: One connector is still connected, so tilt the LVPS carefully.

Figure 1-2108 Thread the cable



- e. Disconnect one connector (callout 1), and then lift up to remove the LVPS (callout 2).

Figure 1-2109 Remove the LVPS



- 12. Remove the formatter and case (M856/E85055/M776).

 **NOTE:** The figures below show the M776zs formatter. The procedure is correct for all referenced models.

- a. Release two retainers (callout 1), and then open the retainer (callout 2) to release the flat cable. Disconnect all of the remaining connectors on the formatter board.


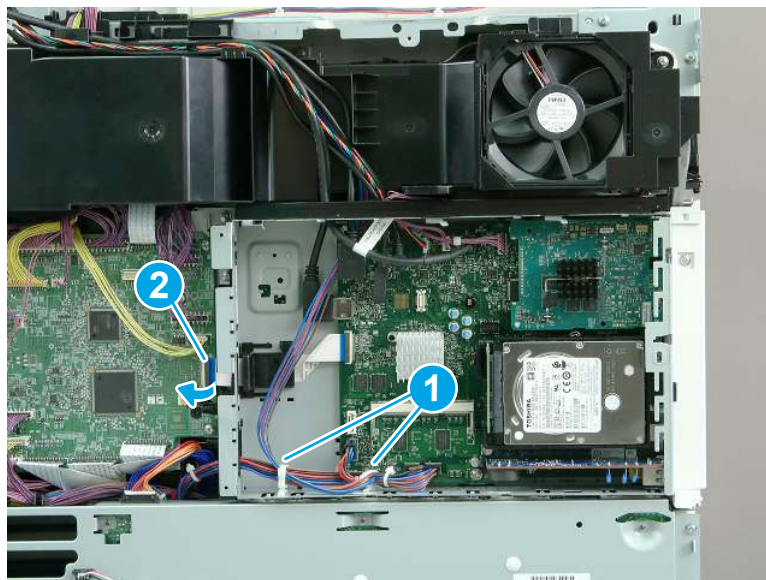
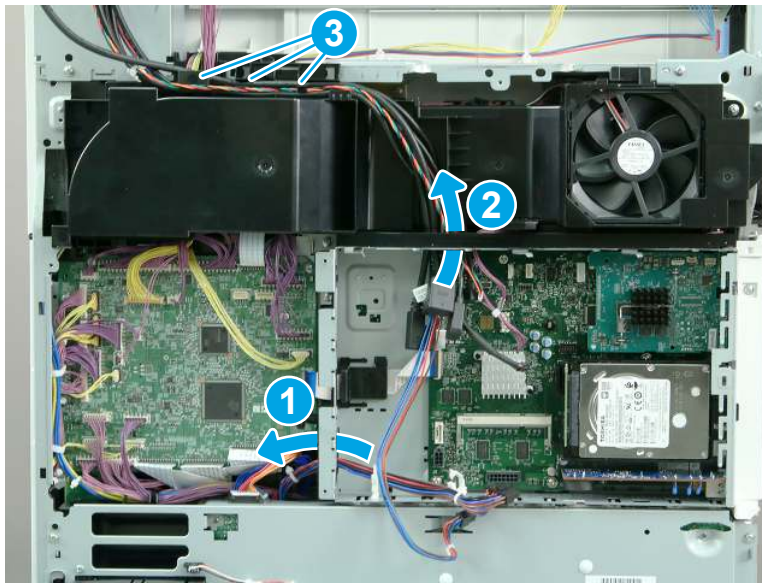
 **NOTE:** The figures below show the M776zs model. The procedures are correct for all of the referenced models.

Figure 1-2110 Disconnect the connectors



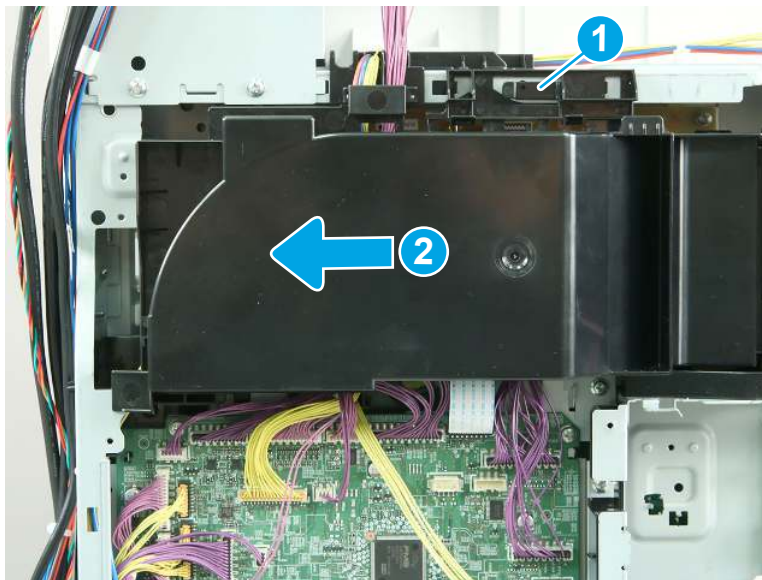
- b. Release one cable through the opening in the left side of the formatter case (callout 1). Release the remaining cables through the opening in the top of the formatter case (callout 2). Release the cables from the upper cable guide (callout 3).

Figure 1-2111 Release the cables



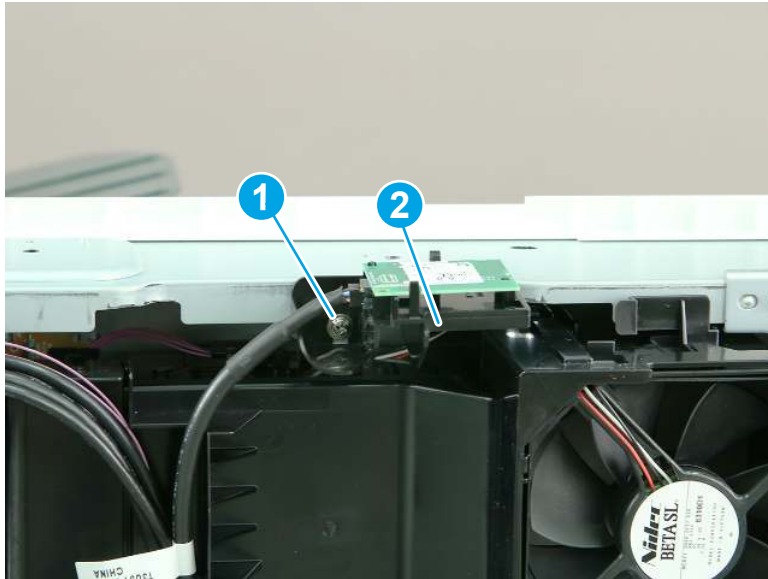
- c. Release one tab (callout 1), and then slide the fan duct to the left (callout 2) to remove it.

Figure 1-2112 Remove the fan duct



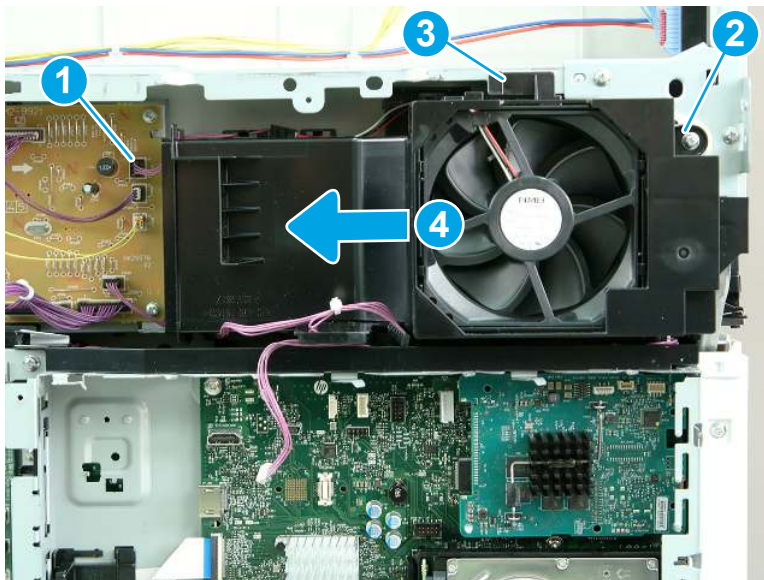
- d. **M856 and E85055 only:** Remove one screw (callout 1), and then remove the wireless card and bracket (callout 2).

Figure 1-2113 Remove the wireless card and bracket



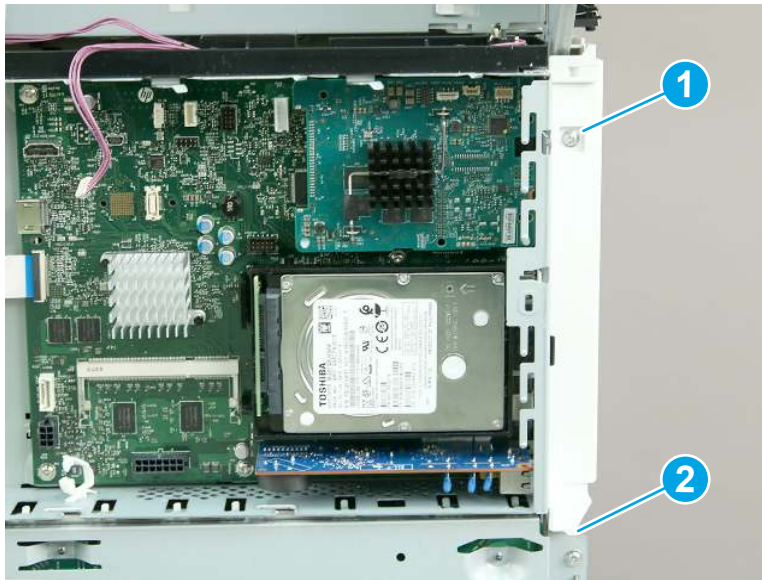
- e. Disconnect one connector (callout 1), and remove one screw (callout 2). Release one tab (callout 3), and then slide the fan assembly to the left (callout 4) to remove it.

Figure 1-2114 Remove the fan assembly



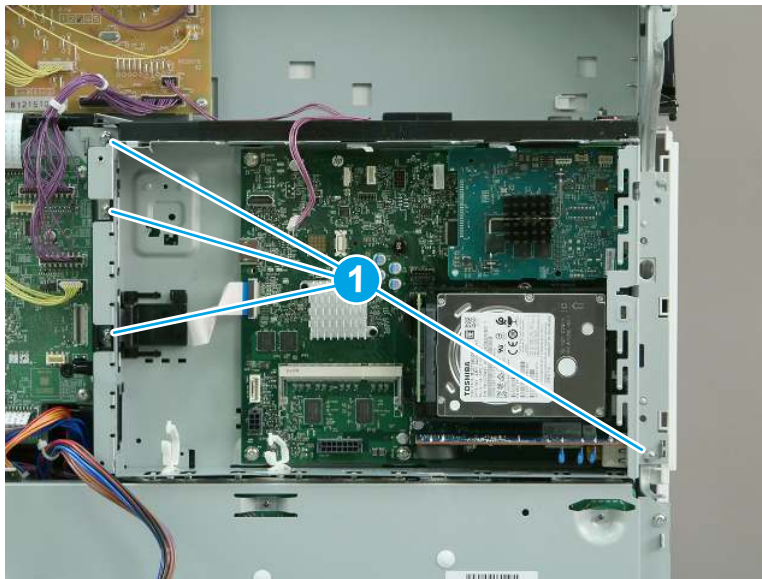
- f. Remove one screw (callout 1), release one tab (callout 2), and then remove the left rear cover.

Figure 1-2115 Remove the left rear cover



- g. Remove four screws (callout 1).

Figure 1-2116 Remove four screws



- h. Remove the formatter and case.

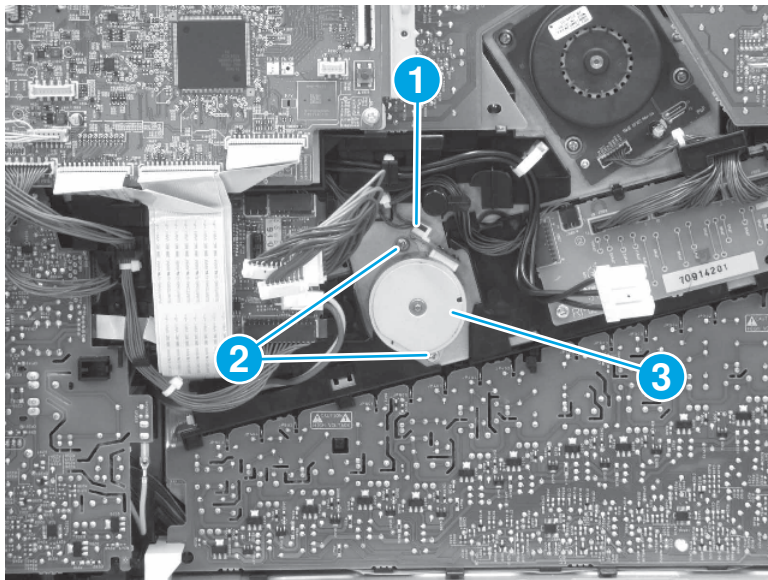
Figure 1-2117 Remove the formatter and case



- 13. Remove the developer alienation motor.

- ▲ Disconnect one connector (callout 1), remove two screws (callout 2), and then remove the developer alienation motor (callout 3).

Figure 1-2118 Remove the developer alienation motor



- 14. Unpack the replacement assembly.



- a. Dispose of the defective part.




NOTE: HP recommends responsible disposal of the defective part.


<http://www8.hp.com/us/en/hp-information/environment/product-recycling.html>

- b. Unpack the replacement part from the packaging.

 **CAUTION:**  Some parts are sensitive to electrostatic discharge (ESD). Always perform service work at an ESD-protected workstation or mat. If an ESD workstation or mat is not available, touch the sheet-metal chassis to provide a static ground before touching an ESD-sensitive assembly. Protect the ESD-sensitive assemblies by placing them in ESD pouches when they are out of the printer.

 **IMPORTANT:** Make sure that all of the shipping materials (for example shipping tape) are removed from the replacement part prior to installation.

- c. To install an assembly, reverse the removal steps.

 **NOTE:** When applicable, special installation instructions are provided for an assembly at the end of the removal procedure. Always completely read the removal instructions and follow all special installation instructions.

Removal and replacement: Low-voltage power supply fan (M751/E75245)

Learn how to remove and replace the low-voltage power supply (LVPS) fan.

[View a video of how to remove and replace the LVPS fan.](#)


Mean time to repair: 17 minutes

Service level: Medium

Before performing service

Turn the printer power off

- Disconnect the power cable.

 **WARNING!** To avoid damage to the printer, turn the printer off, wait 30 seconds, and then remove the power cord before attempting to service the printer.

Use the table below to identify the correct part number for your printer. To order the part, go to www.hp.com/buy/parts.

Table 1-109 Part information

Part number	Part description
RK2-9148-000CN	Fan

Required tools

- #2 Phillips screwdriver with a magnetic tip
- Small, flat-blade screwdriver

After performing service

Turn the printer power on

- Connect the power cable.
- Use the power switch to turn the power on.

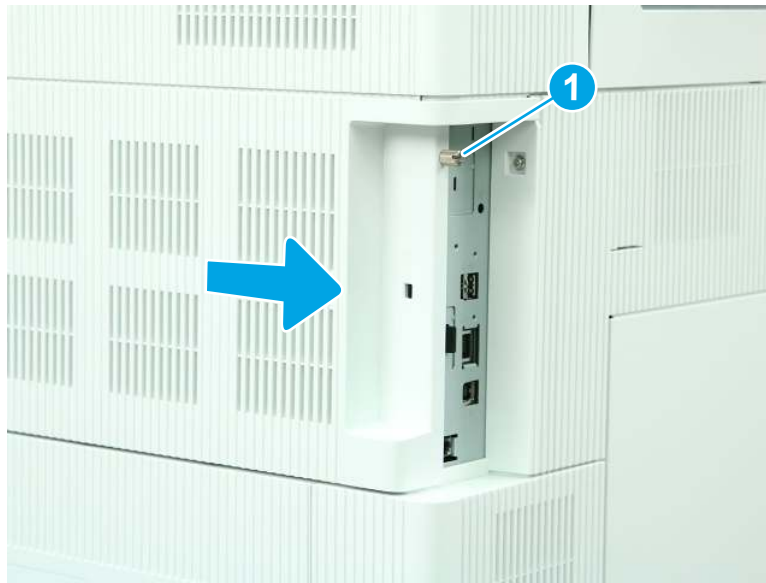
Post service test

Make sure that the printer initializes to a **Ready** state.

Print a page to make sure that the printer is functioning correctly.

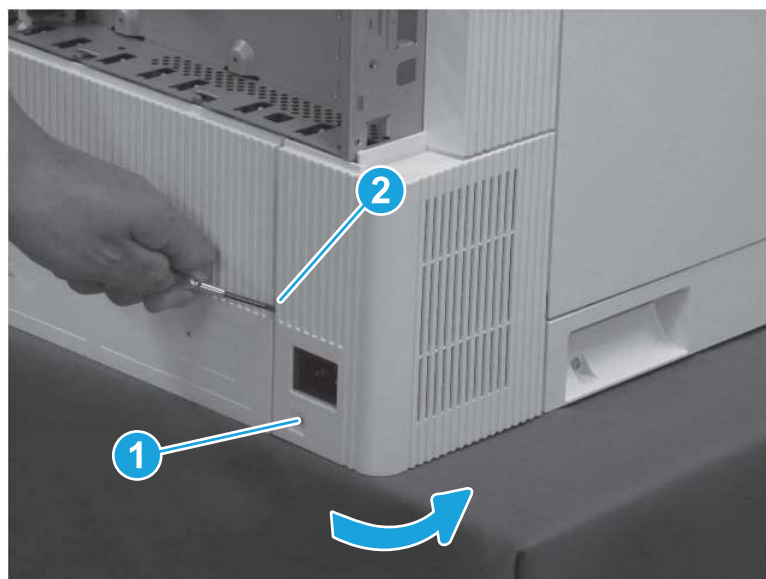
1. Remove the formatter cover.
 - ▲ Loosen one thumbscrew (callout 1), and then slide the formatter cover (callout 2) away from the printer to remove it.

Figure 1-2119 Remove the formatter cover



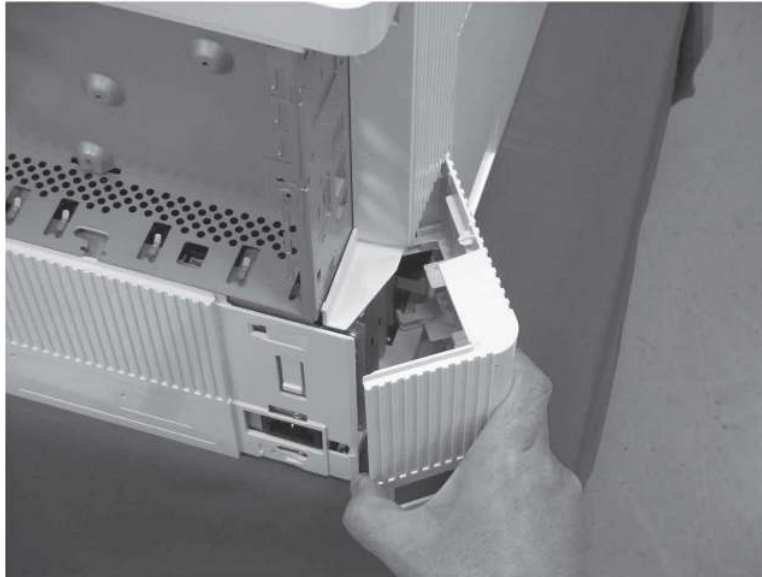
2. Remove the left lower cover (M751/E75245).
 - a. Remove one screw (callout 1), release one tab (callout 2), and then rotate the cover away from the printer.

Figure 1-2120 Remove one screw and release one tab



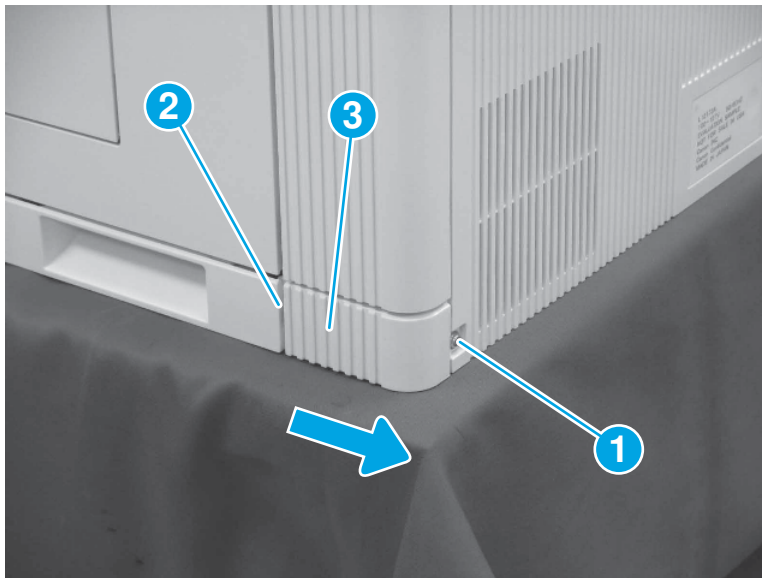
- b. Remove the left lower cover.

Figure 1-2121 Remove the left lower cover



3. Remove the right rear lower cover (M751/E75245/M856/E85055/M776).
 - ▲ Remove one screw (callout 1), release one tab (callout 2), and then slide the right rear lower cover (callout 3) toward the back of the printer to remove it.

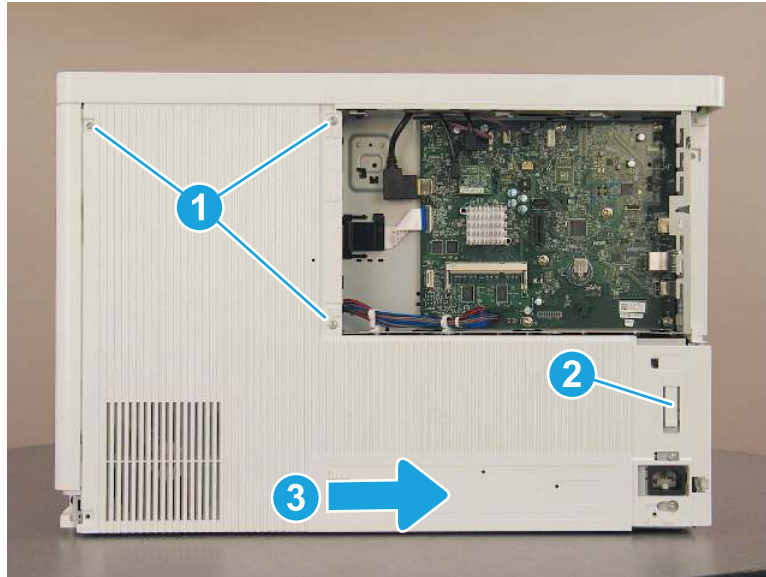
Figure 1-2122 Remove the right rear lower cover



4. Remove the rear cover (M751/E75245).

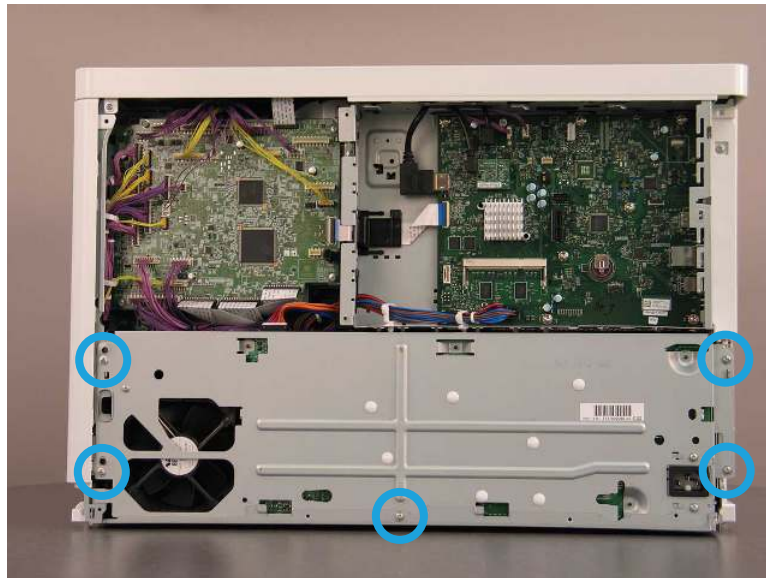
- ▲ Remove three screws (callout 1), release one tab (callout 2), and then slide the rear cover to the right (callout 3) to remove it.

Figure 1-2123 Remove the rear cover



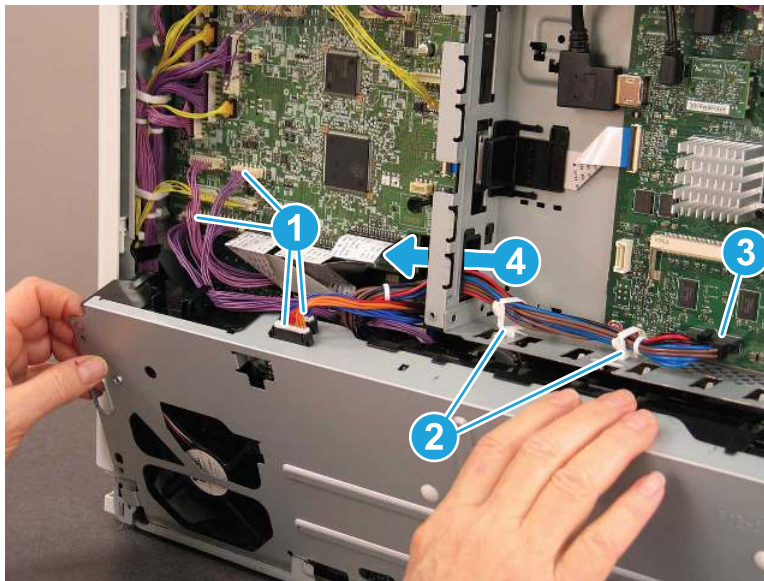
- 5. Remove the low-voltage power supply (LVPS).
 - a. Remove five screws.

Figure 1-2124 Remove five screws



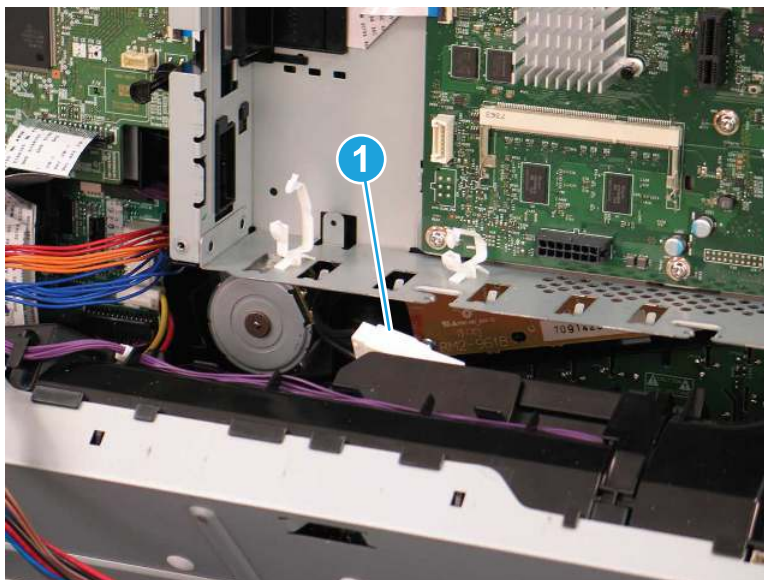
- b. Lift up on the LVPS, and then slightly rotate the top away from the printer. Disconnect four connectors (callout 1), and then release two retainers (callout 2). Press down on the latch to disconnect one connector (callout 3), and then release the wires through the hole (callout 4) in the formatter case.

Figure 1-2125 Disconnect five connectors



- c. Press down on the latch to disconnect one connector (callout 1), and then lift up to remove the LVPS.

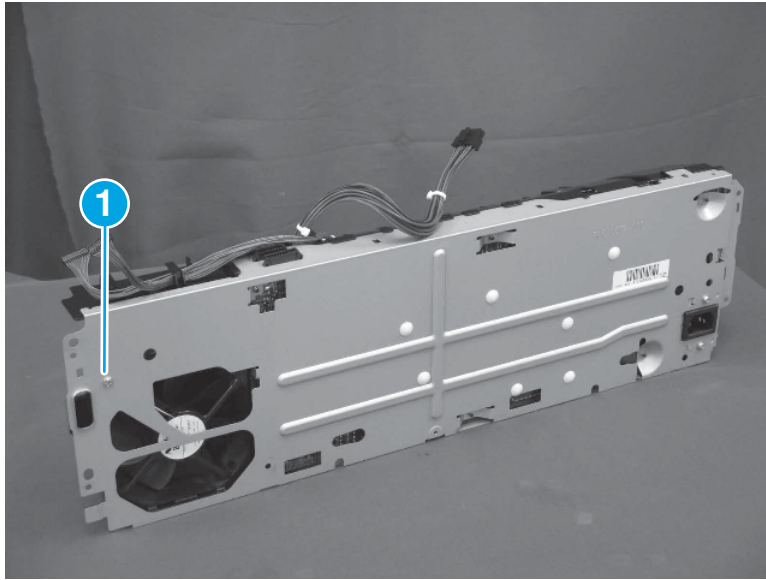
Figure 1-2126 Remove the LVPS



6. Remove the low-voltage power supply (LVPS) fan.

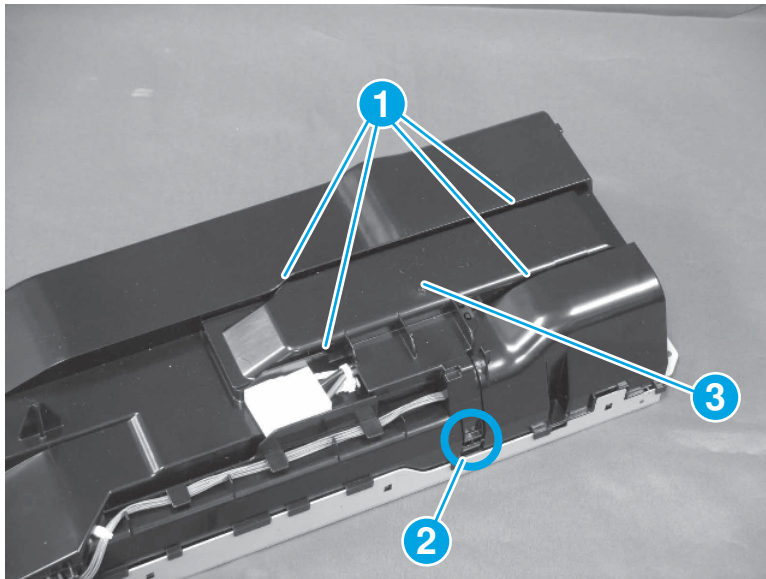
- a. Remove one screw (callout 1).

Figure 1-2127 Remove one screw



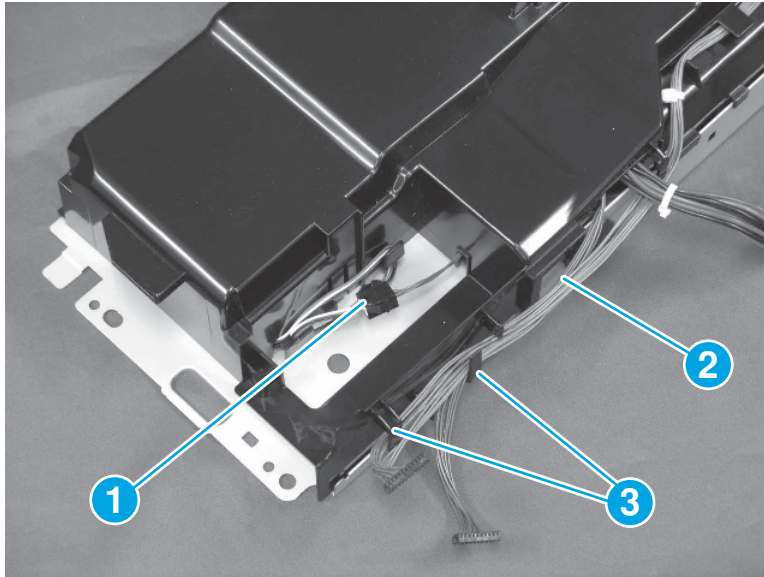
- b. Release four tabs (callout 1), release one boss (callout 2), and then remove the cable cover (callout 3).

Figure 1-2128 Remove the cable cover



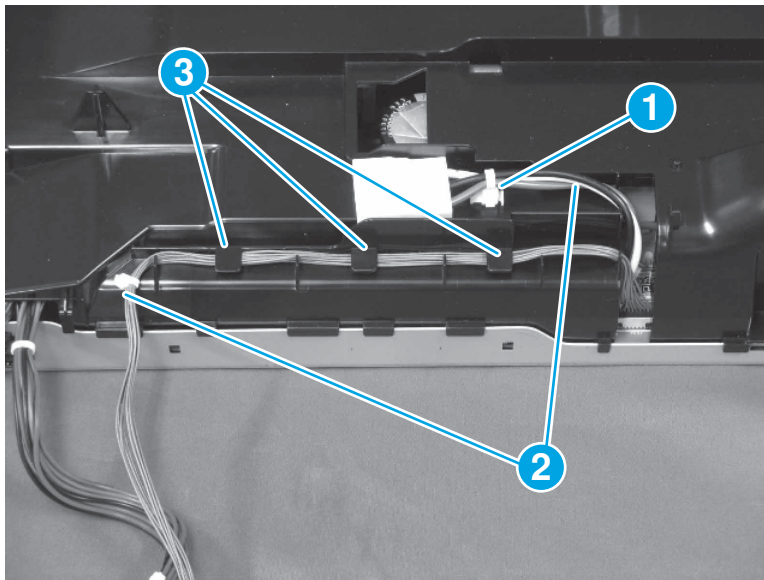
- c. Disconnect one connector (callout 1), and then release the cables (callout 2) from the guides (callout 3).

Figure 1-2129 Disconnect one connector and release the cables



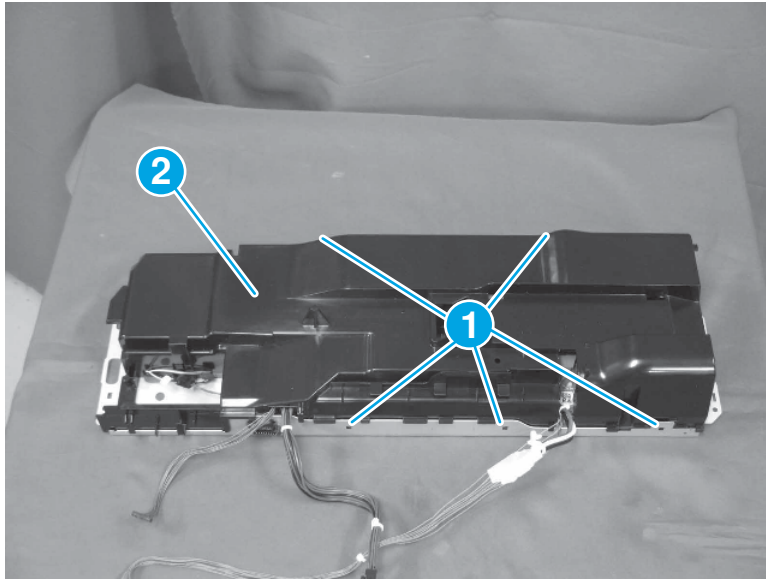
- d. Pinch the clasp to release one retainer (callout 1), and then remove the cables (callout 2) from the guides (callout 3).

Figure 1-2130 Release the cables from the guides



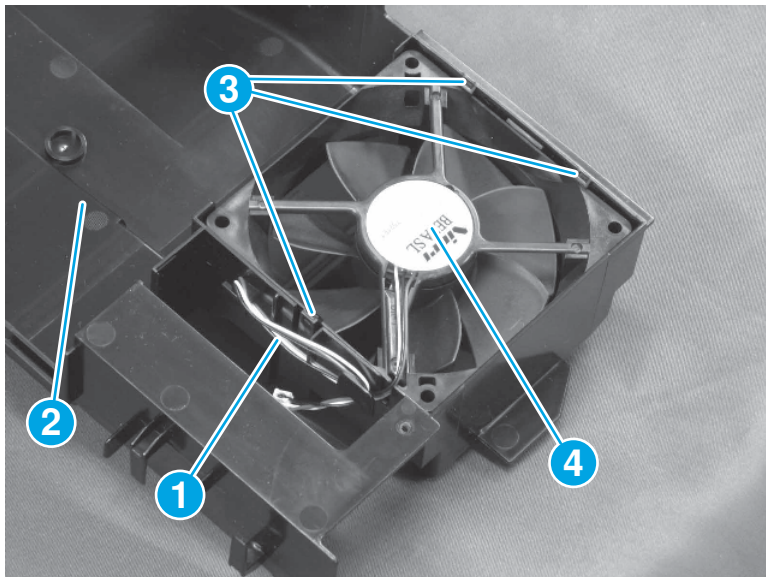
- e. Release five tabs (callout 1), and then remove the power supply cover (callout 2).

Figure 1-2131 Remove the power supply cover



- f. Release the cable (callout 1) from the power supply cover (callout 2). Release three tabs (callout 3), and then remove the LVPS fan (callout 4).

Figure 1-2132 Remove the LVPS fan



7. Unpack the replacement assembly.


- a. Dispose of the defective part.




NOTE: HP recommends responsible disposal of the defective part.

<http://www8.hp.com/us/en/hp-information/environment/product-recycling.html>

- b. Unpack the replacement part from the packaging.

 **IMPORTANT:** Make sure that all of the shipping materials (for example shipping tape) are removed from the replacement part prior to installation.

- c. To install an assembly, reverse the removal steps.

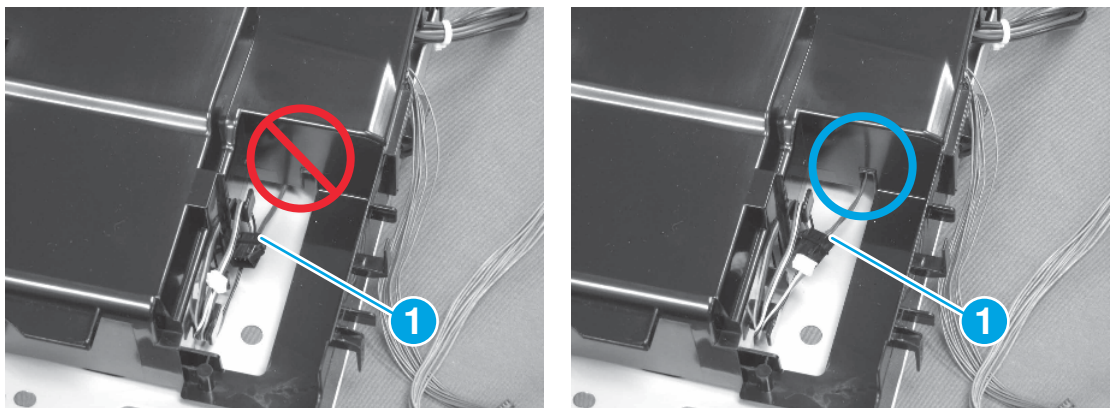
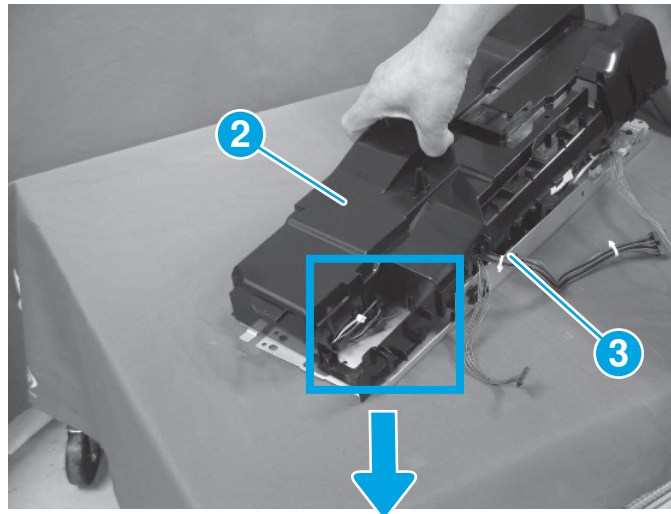
 **NOTE:** When applicable, special installation instructions are provided for an assembly at the end of the removal procedure. Always completely read the removal instructions and follow all special installation instructions.

- 8. Reverse the removal steps to install the assembly. Also use the following **special installation instructions**.

Install the low-voltage power supply fan.

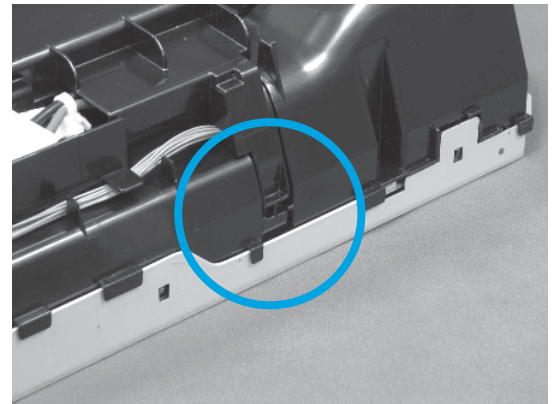
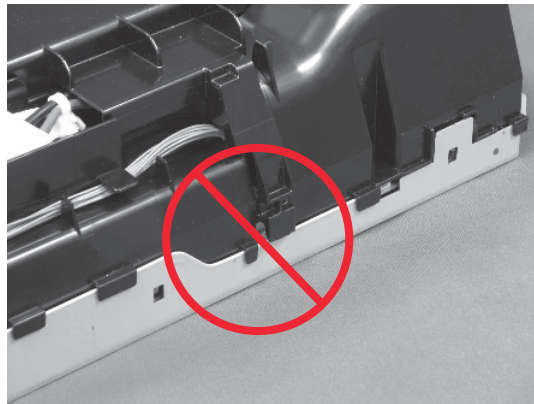
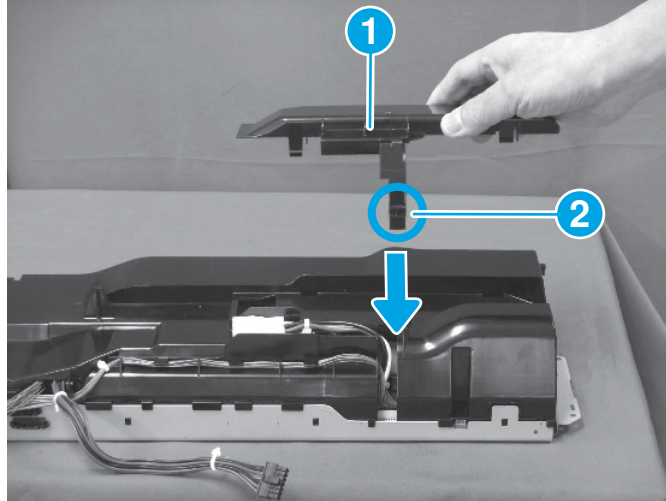
- a. Make sure that the cables (callout 1) are not pinched when installing the power supply cover (callout 2) on the low-voltage power supply (callout 3).

Figure 1-2133 Install the power supply cover



- b. When installing the cable cover (callout 1), make sure that the tab (callout 2) is installed correctly.

Figure 1-2134 Install the cable cover



Removal and replacement: Low-voltage power supply fan (M856/E85055/M776)

Learn how to remove and replace the low-voltage power supply fan.

[View a video of how to remove and replace the low-voltage power supply fan.](#)

Mean time to repair: 6 minutes

Service level: Easy

Before performing service

Turn the printer power off

- Disconnect the power cable.

⚠ WARNING! To avoid damage to the printer, turn the printer off, wait 30 seconds, and then remove the power cord before attempting to service the printer.

Use the table below to identify the correct part number for your printer. To order the part, go to www.hp.com/buy/parts.

Table 1-110 Part information

Part number	Part description
RK2-9148-000CN	Fan

Required tools

- #2 Phillips screwdriver with a magnetic tip
- Small, flat-blade screwdriver

After performing service

Turn the printer power on

- Connect the power cable.
- Use the power switch to turn the power on.

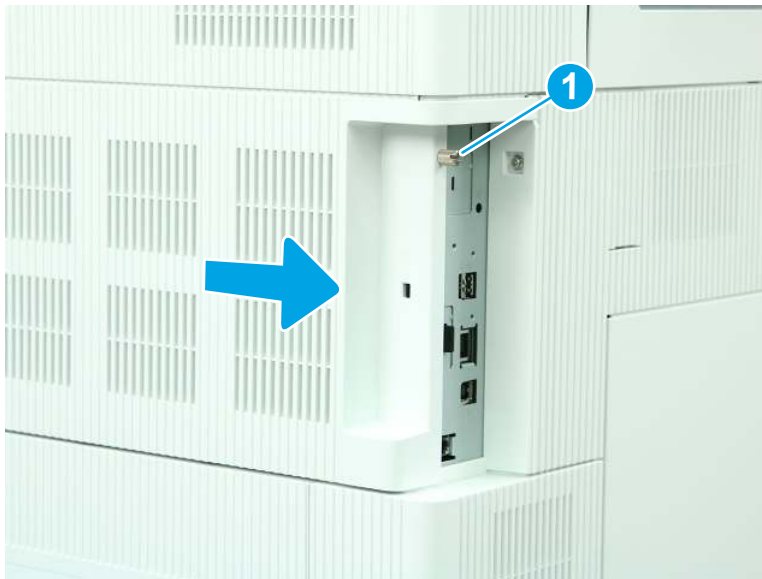
Post service test

Make sure that the printer initializes to a **Ready** state.

Print a page to make sure that the printer is functioning correctly.

1. Remove the formatter cover.
 - ▲ Loosen one thumbscrew (callout 1), and then slide the formatter cover (callout 2) away from the printer to remove it.

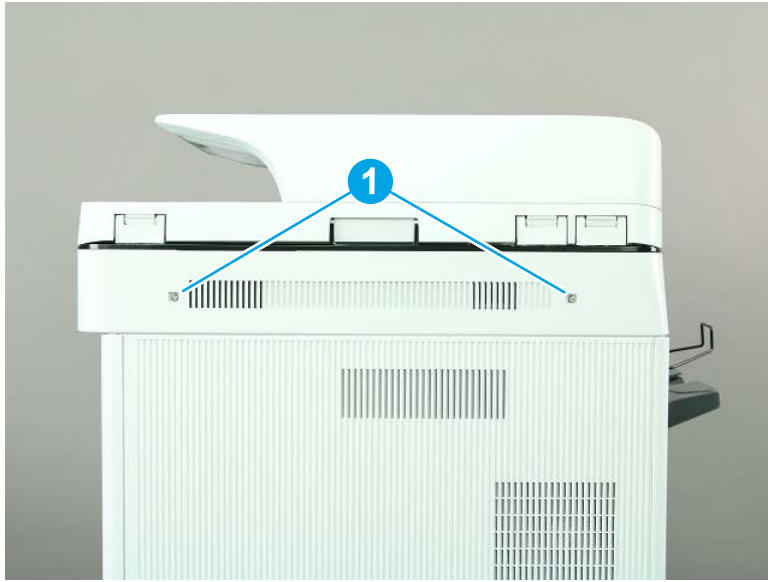
Figure 1-2135 Remove the formatter cover



2. Remove the scanner control board (SCB) cover (M776).

- a. Remove two screws (callout 1).

Figure 1-2136 Remove two screws



- b. Remove the SCB cover.

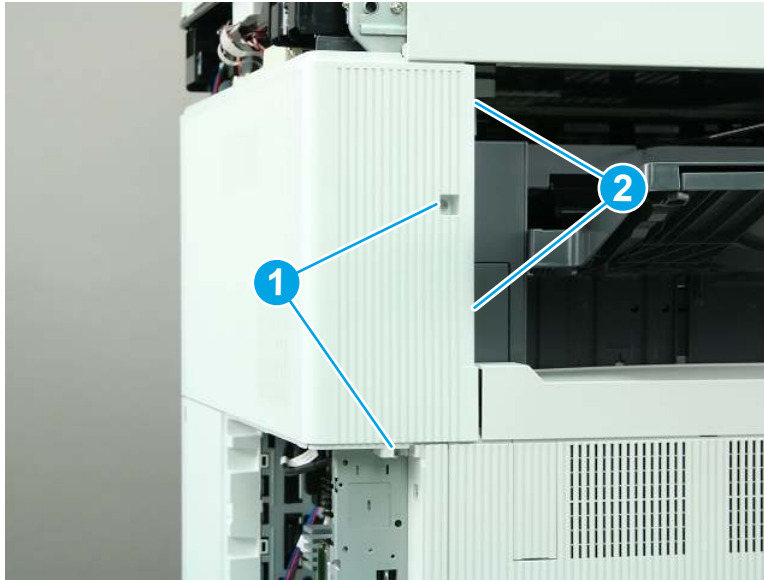
Figure 1-2137 Remove the SCB cover



3. Remove the rear upper cover and left rear upper cover (M776zs).

- a. Remove two screws (callout 1), and then release two tabs (callout 2).

Figure 1-2138 Remove two screws and release two tabs



- b. Slide the cover to the right to remove it.

Figure 1-2139 Remove the rear upper and left rear upper cover



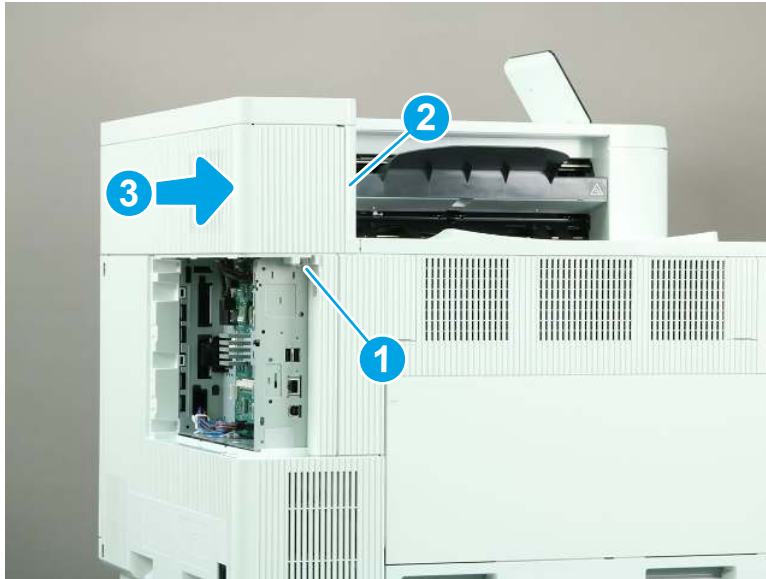
4. Remove the rear upper cover (M856/E85055/M776dn/M776z).



NOTE: The following figure shows the M856 printer. The procedure is correct for all referenced models.

- ▲ Remove one screw (callout 1), release one tab (callout 2), and then slide the rear upper cover away from the printer to remove it (callout 3).

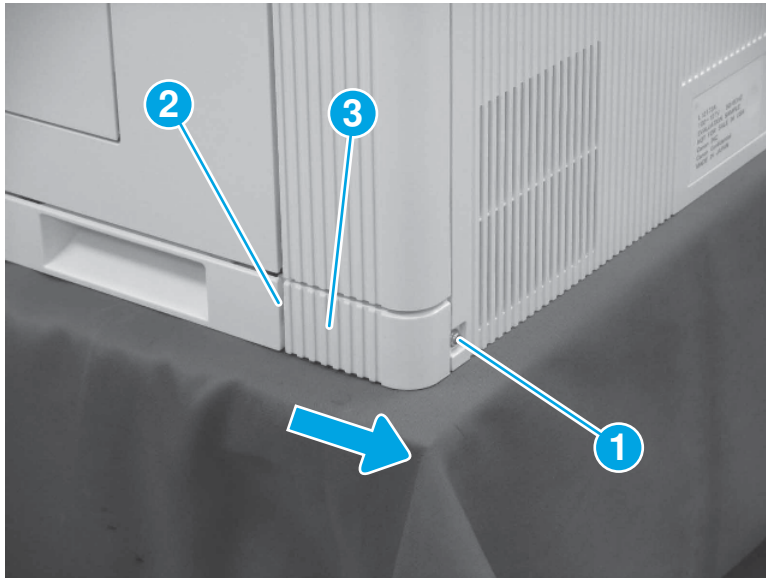
Figure 1-2140 Remove the rear upper cover



5. Remove the right rear lower cover (M751/E75245/M856/E85055/M776).

- ▲ Remove one screw (callout 1), release one tab (callout 2), and then slide the right rear lower cover (callout 3) toward the back of the printer to remove it.

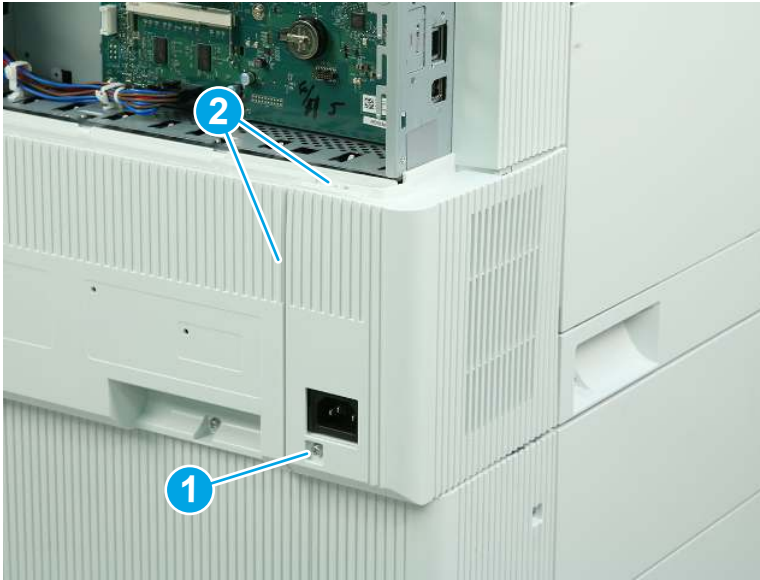
Figure 1-2141 Remove the right rear lower cover



6. Remove the left lower cover (M856/E85055/M776).

- a. Remove one screw (callout 1), and then release two tabs (callout 2).

Figure 1-2142 Remove one screw and release two tabs



- b. Rotate the cover away from the printer to remove it.

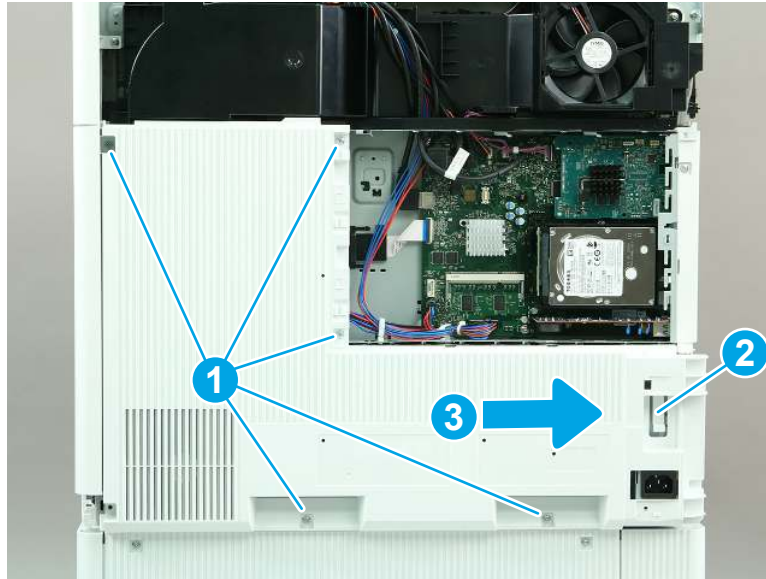
Figure 1-2143 Remove the left lower cover



7. Remove the rear cover (M856/E85055/M776).

- ▲ Remove five screws (callout 1), release one tab (callout 2), and then slide the rear cover to the right to remove it.

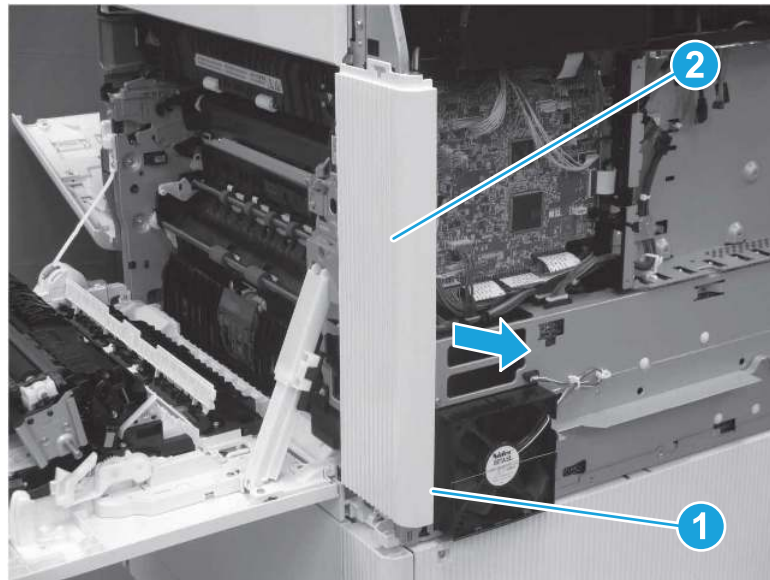
Figure 1-2144 Remove the rear cover (M856/E85055/M776)



8. Remove the right rear cover (M856/E85055/M776).

- ▲ Release one tab (callout 1), and then slide the rear cover away from the printer to remove it.

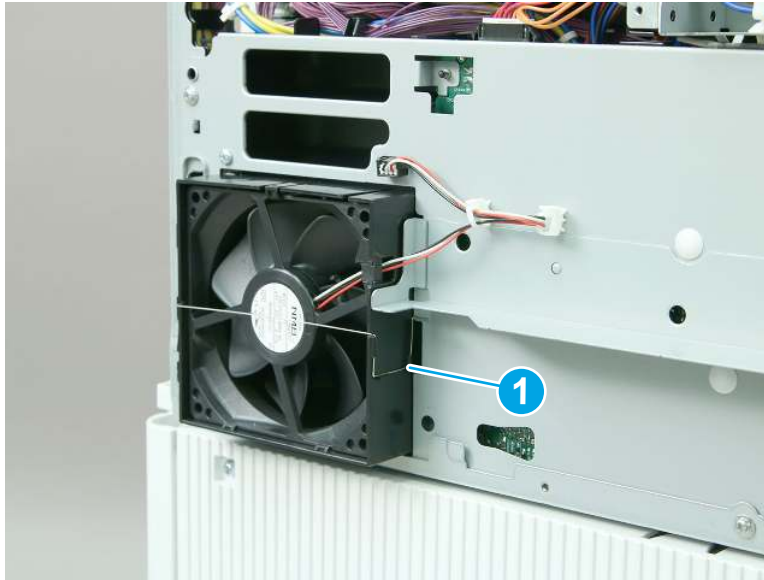
Figure 1-2145 Remove right rear cover



9. Remove the low-voltage power supply (LVPS) fan (M856/E85055/M776).

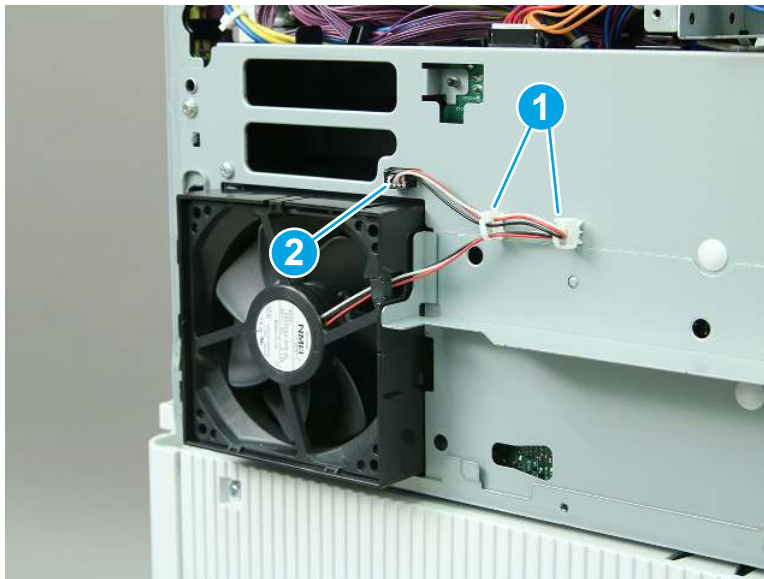
- a. Release the spring (callout 1).

Figure 1-2146 Release the spring



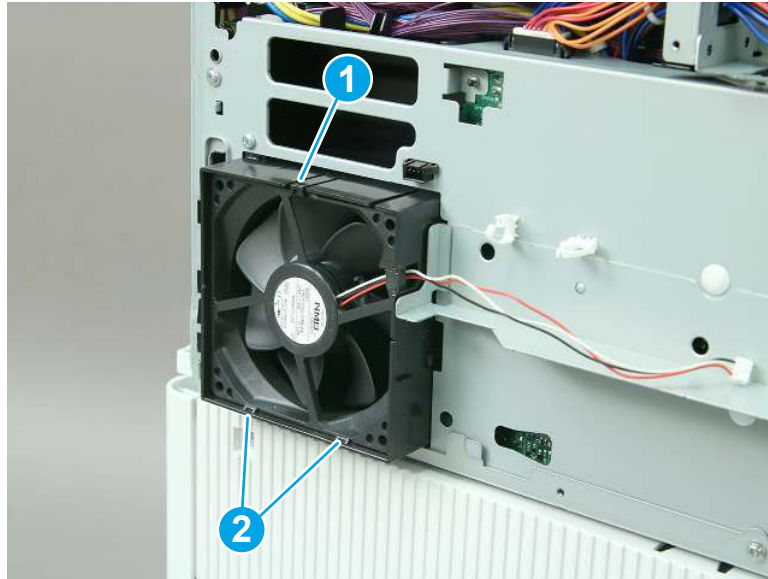
- b. Release two retainers (callout 1), and then disconnect one connector (callout 2).

Figure 1-2147 Release retainers and disconnect one connector



- c. Release one tab (callout 1) on the top of the fan, and then release two tabs (callout 2) at the bottom of the fan to remove it.

Figure 1-2148 Release three tabs



10. Unpack the replacement assembly.

- a. Dispose of the defective part.



NOTE: HP recommends responsible disposal of the defective part.

<http://www8.hp.com/us/en/hp-information/environment/product-recycling.html>

- b. Unpack the replacement part from the packaging.



IMPORTANT: Make sure that all of the shipping materials (for example shipping tape) are removed from the replacement part prior to installation.

- c. To install an assembly, reverse the removal steps.



NOTE: When applicable, special installation instructions are provided for an assembly at the end of the removal procedure. Always completely read the removal instructions and follow all special installation instructions.

Removal and replacement: Fuser fan (M751/E75245)

Learn how to remove and replace the fuser fan.

[View a video of how to remove and replace the fuser fan.](#)

Mean time to repair: 16 minutes

Service level: Easy

Before performing service

Turn the printer power off

- Disconnect the power cable.

⚠ WARNING! To avoid damage to the printer, turn the printer off, wait 30 seconds, and then remove the power cord before attempting to service the printer.

Use the table below to identify the correct part number for your printer. To order the part, go to www.hp.com/buy/parts.

Table 1-111 Part information

Part number	Part description
RK2-9148-000CN	Fan

Required tools

- #2 Phillips screwdriver with a magnetic tip
- Small, flat-blade screwdriver

After performing service

Turn the printer power on

- Connect the power cable.
- Use the power switch to turn the power on.

Post service test

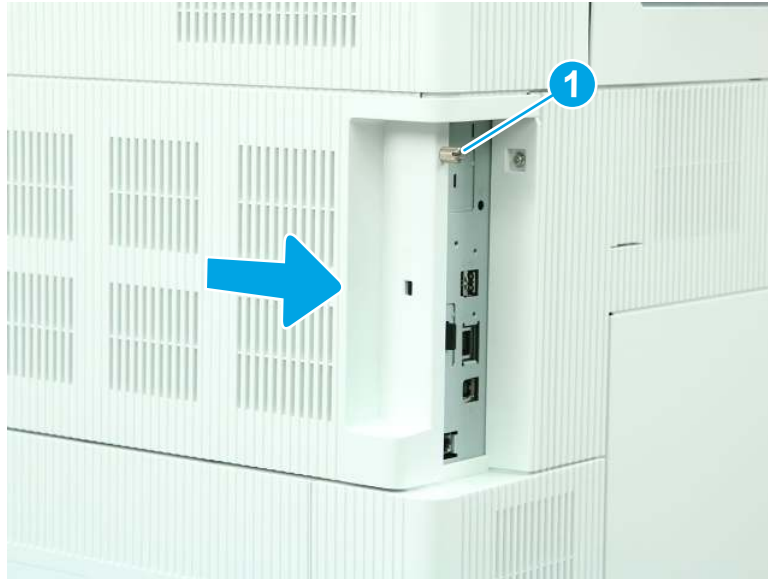
Make sure that the printer initializes to a **Ready** state.

Print a page to make sure that the printer is functioning correctly.

1. Remove the formatter cover.

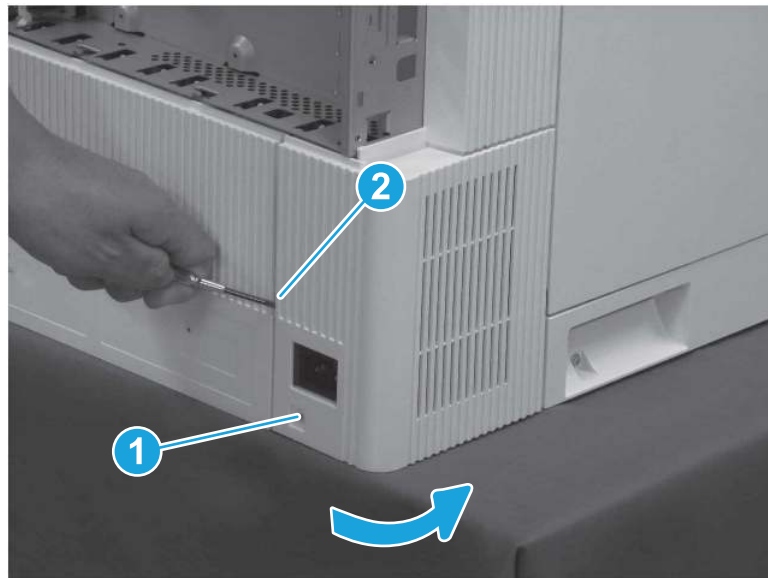
- ▲ Loosen one thumbscrew (callout 1), and then slide the formatter cover (callout 2) away from the printer to remove it.

Figure 1-2149 Remove the formatter cover



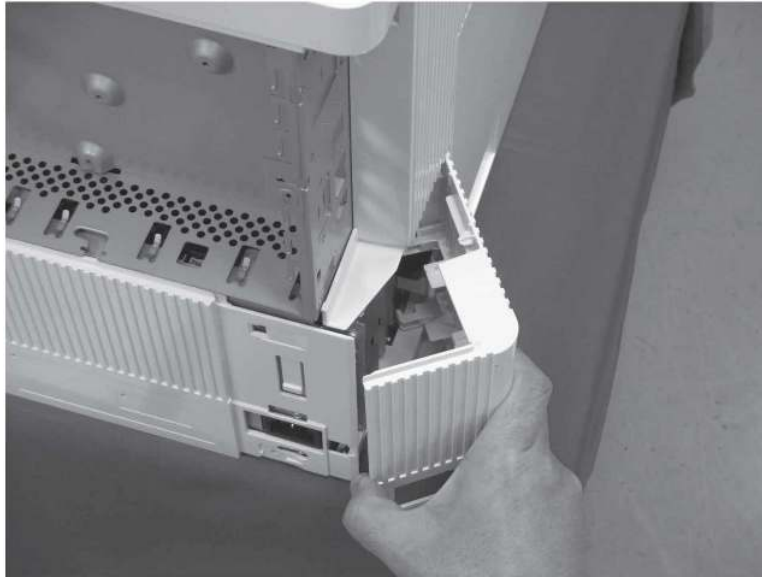
- 2. Remove the left lower cover (M751/E75245).
 - a. Remove one screw (callout 1), release one tab (callout 2), and then rotate the cover away from the printer.

Figure 1-2150 Remove one screw and release one tab



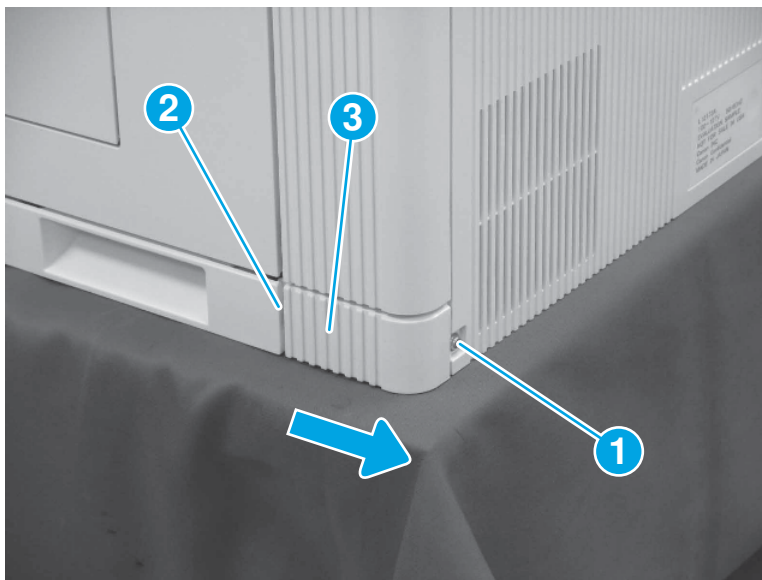
- b. Remove the left lower cover.

Figure 1-2151 Remove the left lower cover



3. Remove the right rear lower cover (M751/E75245/M856/E85055/M776).
 - ▲ Remove one screw (callout 1), release one tab (callout 2), and then slide the right rear lower cover (callout 3) toward the back of the printer to remove it.

Figure 1-2152 Remove the right rear lower cover



4. Remove the left rear cover (M751/E75245/M856/E85055/M776).

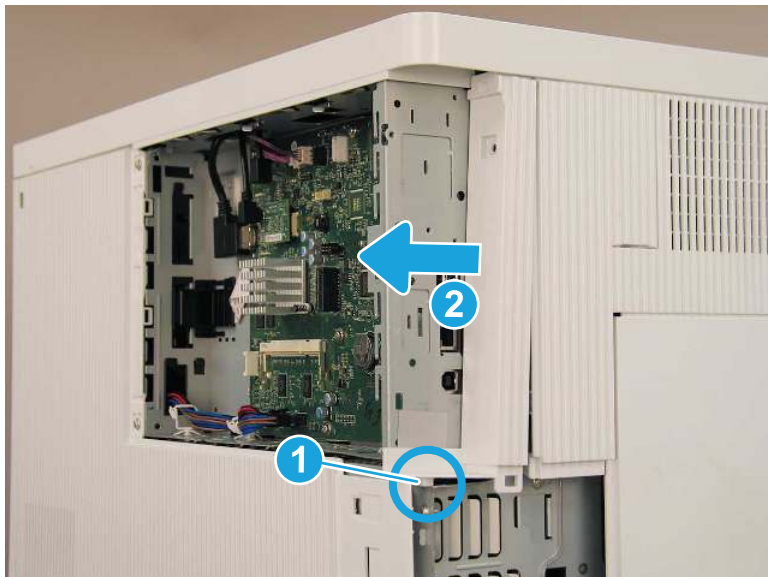
- a. Remove one screw (callout 1).

Figure 1-2153 Remove one screw



- b. Release one boss (callout 1), and then slide the cover toward the back of the printer (callout 2) to remove it.

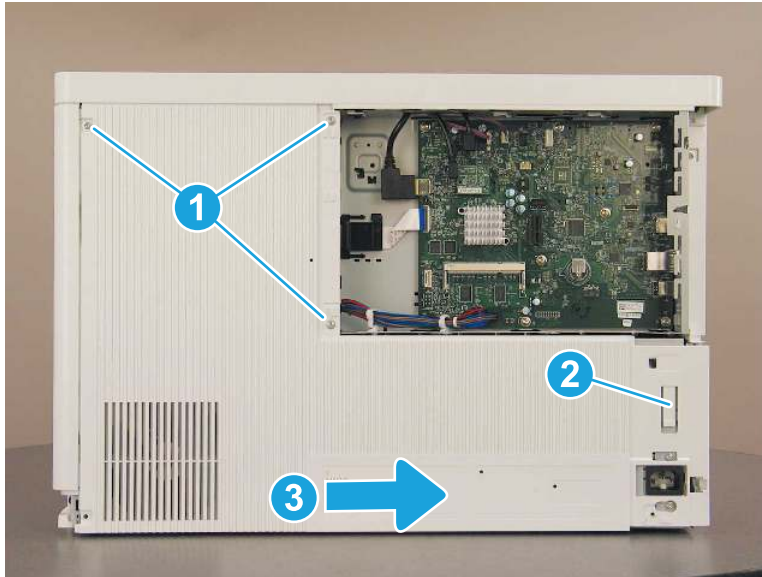
Figure 1-2154 Remove the left rear cover



5. Remove the rear cover (M751/E75245).

- ▲ Remove three screws (callout 1), release one tab (callout 2), and then slide the rear cover to the right (callout 3) to remove it.

Figure 1-2155 Remove the rear cover

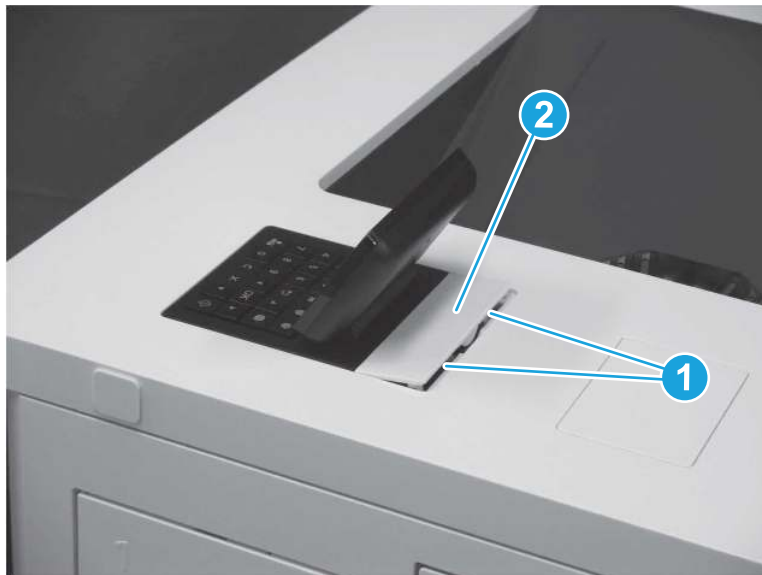


6. Remove the control panel.

 **NOTE:** A screwdriver is included in the control panel kit. The screwdriver has a reversible shaft. Simply pull the shaft out of the handle, and then reinstall it with the desired end facing out.

- a. Use a small, flat-blade screwdriver to release two tabs (callout 1), and then remove the control panel cover (callout 2).

Figure 1-2156 Remove the control panel cover



- b. Remove one screw (callout 1).

Figure 1-2157 Remove one screw



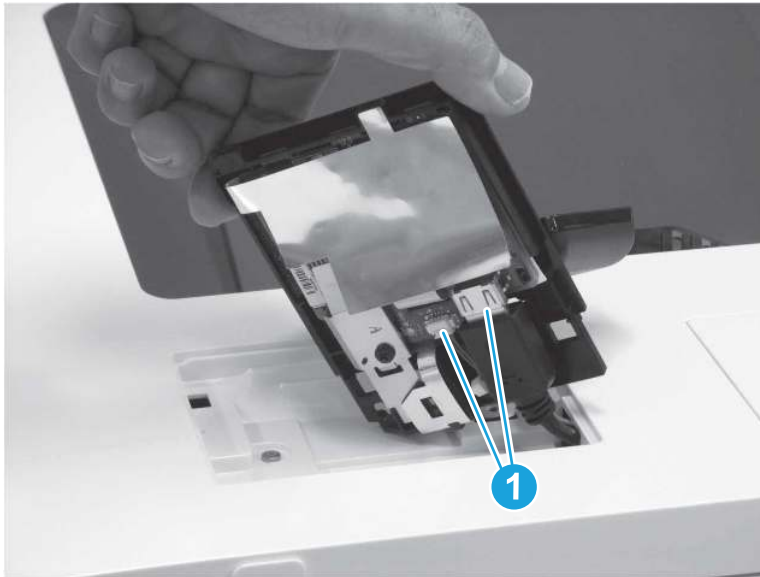
- c. Lift the back edge of the control panel up (callout 1), and then slide the control panel toward the back of the printer (callout 2).

Figure 1-2158 Slide the control panel back



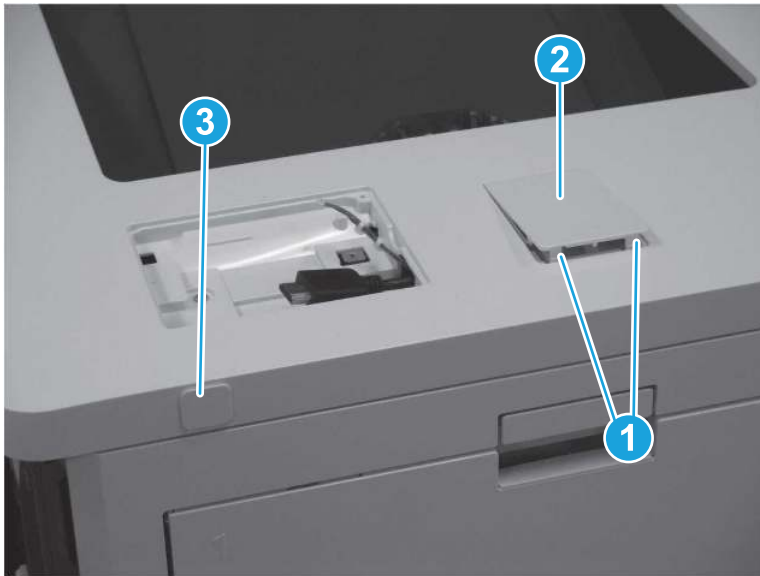
- d. Turn the control panel so that the bottom is facing up, and then disconnect two connectors (callout 1) to remove the control panel.

Figure 1-2159 Disconnect two connectors



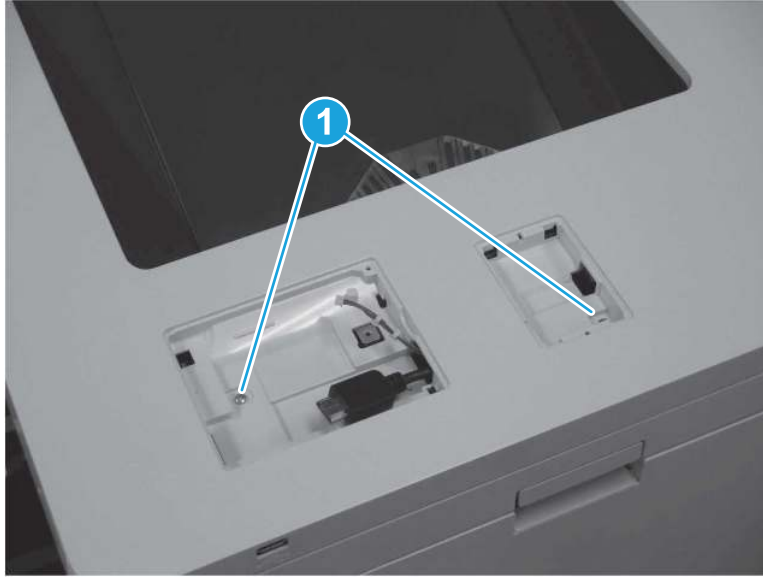
7. Remove the top cover (M751/E75245).
 - a. Release two tabs (callout 1), and then remove the HIP cover (callout 2). Pull the USB cap (callout 3) away from the printer to remove it.

Figure 1-2160 Remove the HIP cover and USB cap



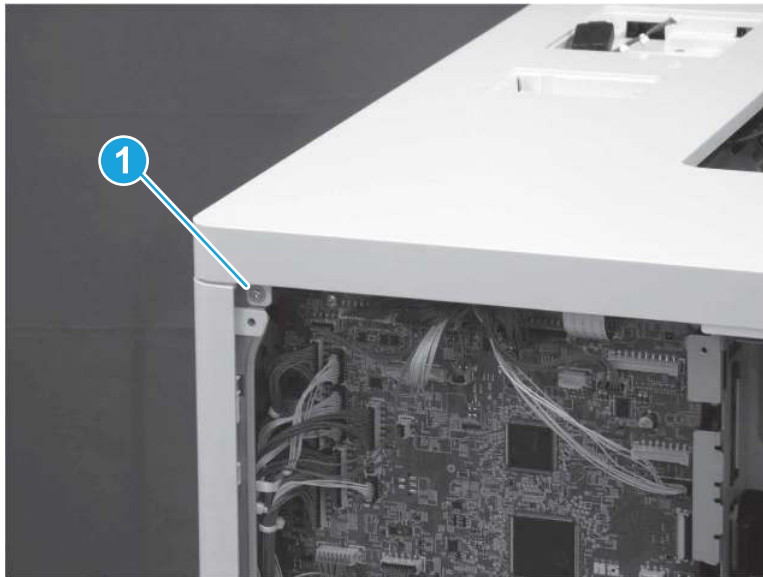
- b. At the top of the printer, remove two screws (callout 1).

Figure 1-2161 Remove two screws



- c. At the back of the printer, remove one screw (callout 1).

Figure 1-2162 Remove one screw

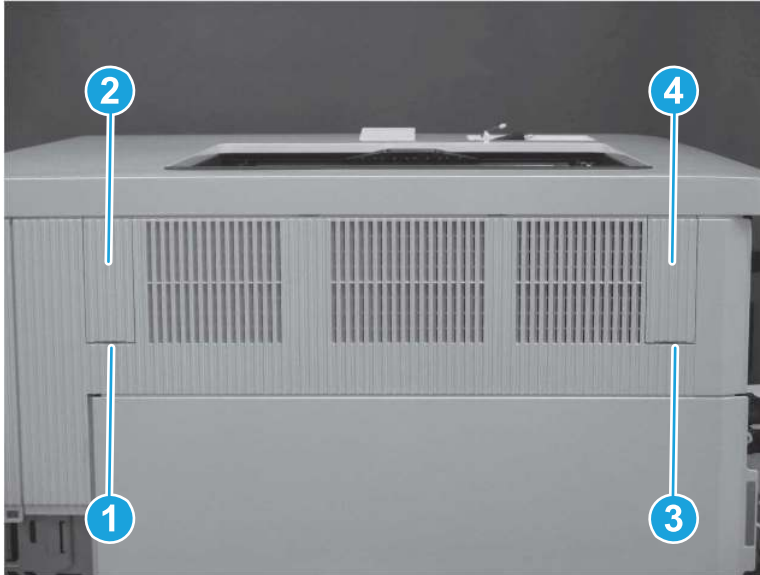


- d. Use a small, flat-blade screwdriver to release one tab (callout 1) and remove the left blanking cover (callout 2). Release one tab (callout 3) and remove the right blanking cover (callout 4).

 **TIP:** These covers are not identical. Make sure to reinstall the correct cover on the correct side.

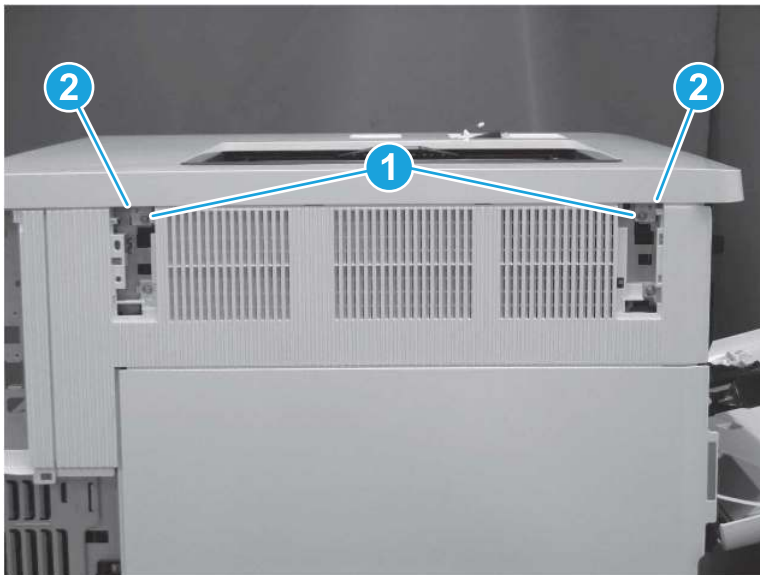
 **NOTE:** The screw under the left blanking cover is a self-tapping screw. Make sure this screw is reinstalled in the correct location.

Figure 1-2163 Remove the left and right blanking covers



- e. Remove two screws (callout 1), and then release two tabs (callout 2).

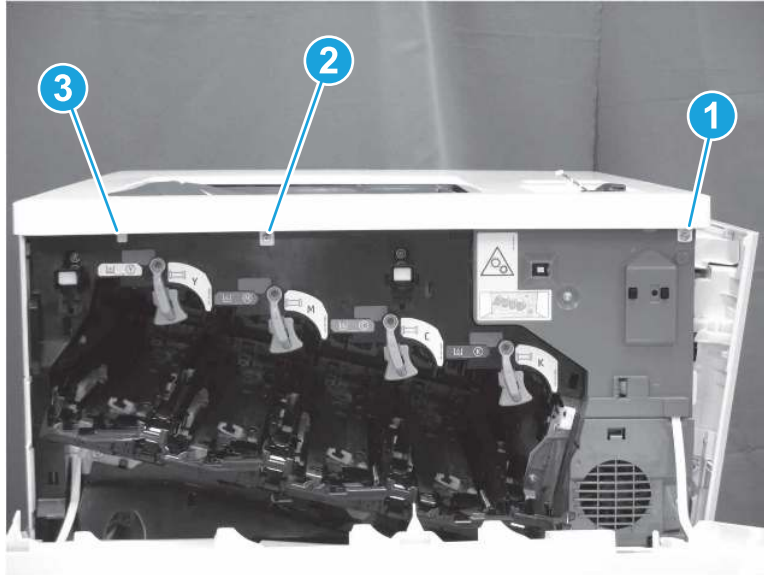
Figure 1-2164 Remove two screws and release two tabs



- f. At the front of the printer, remove one washer-head screw (callout 1) and one self-tapping screw (callout 2). Release one tab (callout 3).

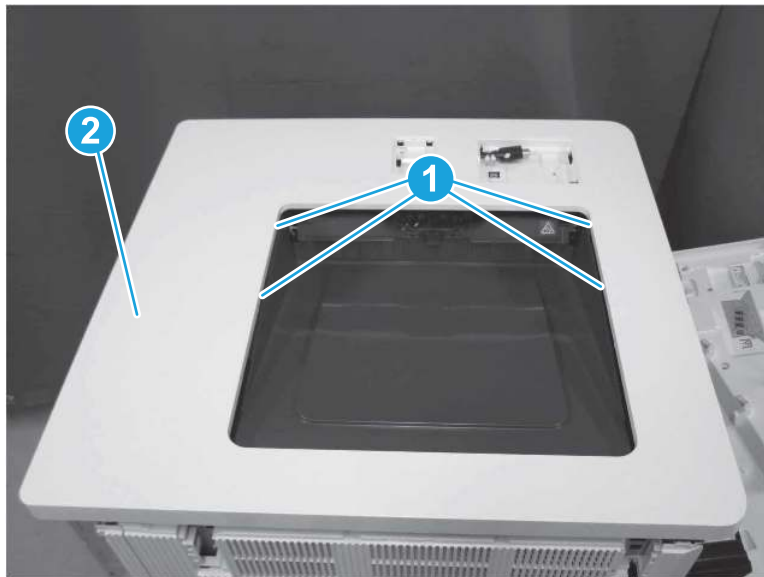
 **TIP:** Make sure to install the correct type of screw in the correct location.

Figure 1-2165 Remove two screws and release one tab



- g. At the top of the printer, release four tabs (callout 1), and then remove the top cover (callout 2).

Figure 1-2166 Remove the top cover

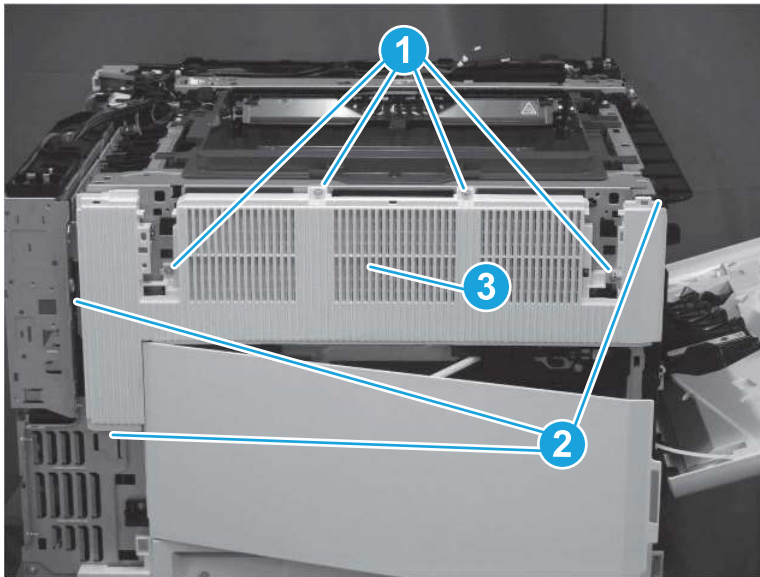


 **NOTE:** When removing the top cover, make sure to release the control panel cables (callout 1) through the opening.



8. Remove the left upper cover (M751/E75245).
 - ▲ Remove four screws (callout 1), release three tabs (callout 2), and then remove the left upper cover (callout 3).

Figure 1-2167 Remove the left upper cover



9. Remove the fuser fan.
 - ▲ Disconnect one connector (callout 1), release two tabs (callout 2), and then remove the fuser fan (callout 3).


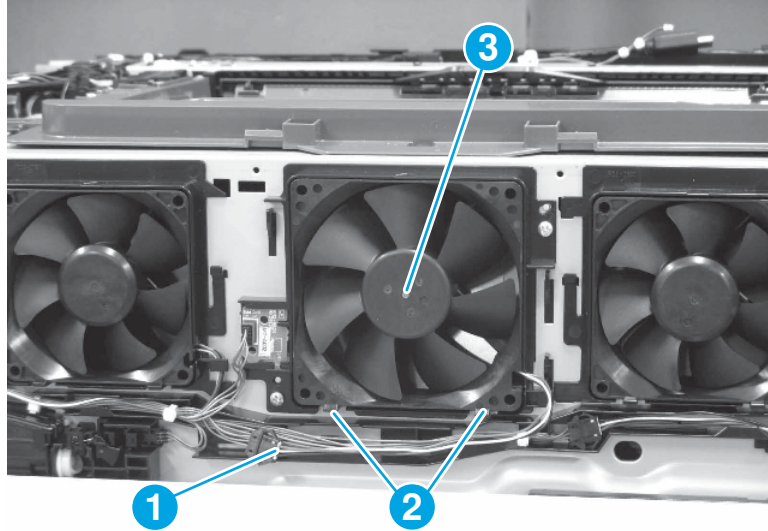
 **IMPORTANT:** When reinstalling the fuser fan, make sure that the cables are installed in the guides so that the fan cover fits correctly and does not pinch any wires.

Figure 1-2168 Remove the fuser fan



10. Unpack the replacement assembly.

- a. Dispose of the defective part.



NOTE: HP recommends responsible disposal of the defective part.

<http://www8.hp.com/us/en/hp-information/environment/product-recycling.html>

- b. Unpack the replacement part from the packaging.



IMPORTANT: Make sure that all of the shipping materials (for example shipping tape) are removed from the replacement part prior to installation.

- c. To install an assembly, reverse the removal steps.



NOTE: When applicable, special installation instructions are provided for an assembly at the end of the removal procedure. Always completely read the removal instructions and follow all special installation instructions.

Removal and replacement: Fuser fan (M856/E85055/M776)

Learn how to remove and replace the fuser fan.

[View a video of how to remove and replace the fuser fan.](#)

Mean time to repair: 16 minutes

Service level: Easy

Before performing service

Turn the printer power off

- Disconnect the power cable.



WARNING! To avoid damage to the printer, turn the printer off, wait 30 seconds, and then remove the power cord before attempting to service the printer.

Use the table below to identify the correct part number for your printer. To order the part, go to www.hp.com/buy/parts.

Table 1-112 Part information

Part number	Part description
RK2-9148-000CN	Fan

Required tools

- #2 Phillips screwdriver with a magnetic tip
- Small, flat-blade screwdriver

After performing service

Turn the printer power on

- Connect the power cable.
- Use the power switch to turn the power on.

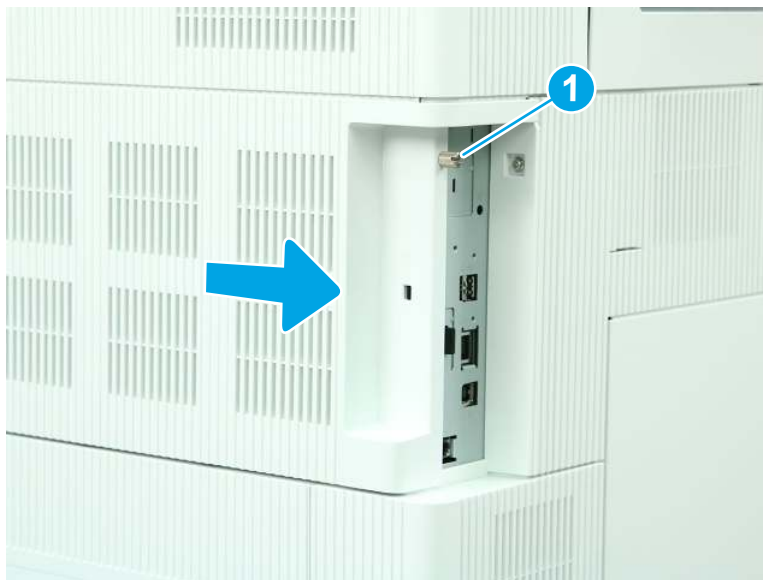
Post service test

Make sure that the printer initializes to a **Ready** state.

Print a page to make sure that the printer is functioning correctly.

1. Remove the formatter cover.
 - ▲ Loosen one thumbscrew (callout 1), and then slide the formatter cover (callout 2) away from the printer to remove it.

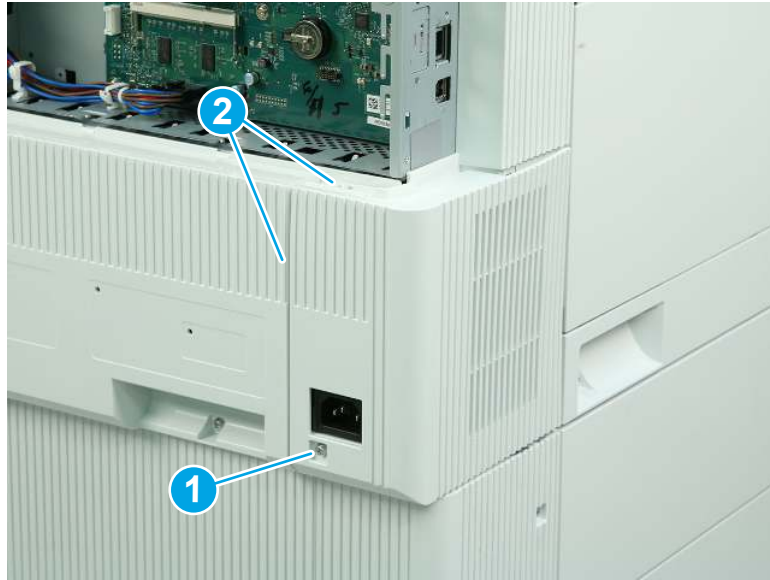
Figure 1-2169 Remove the formatter cover



2. Remove the left lower cover (M856/E85055/M776).

- a. Remove one screw (callout 1), and then release two tabs (callout 2).

Figure 1-2170 Remove one screw and release two tabs



- b. Rotate the cover away from the printer to remove it.

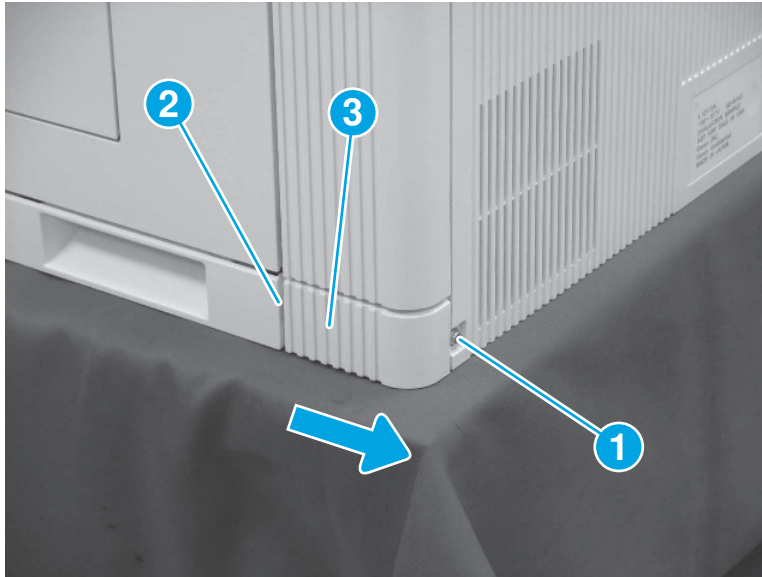
Figure 1-2171 Remove the left lower cover



3. Remove the right rear lower cover (M751/E75245/M856/E85055/M776).

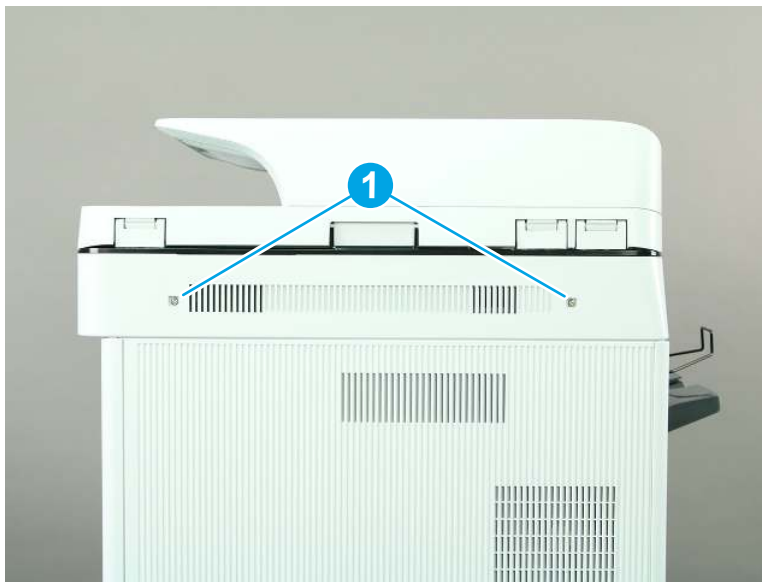
- ▲ Remove one screw (callout 1), release one tab (callout 2), and then slide the right rear lower cover (callout 3) toward the back of the printer to remove it.

Figure 1-2172 Remove the right rear lower cover



- 4. Remove the scanner control board (SCB) cover (M776).
 - a. Remove two screws (callout 1).

Figure 1-2173 Remove two screws



- b. Remove the SCB cover.

Figure 1-2174 Remove the SCB cover

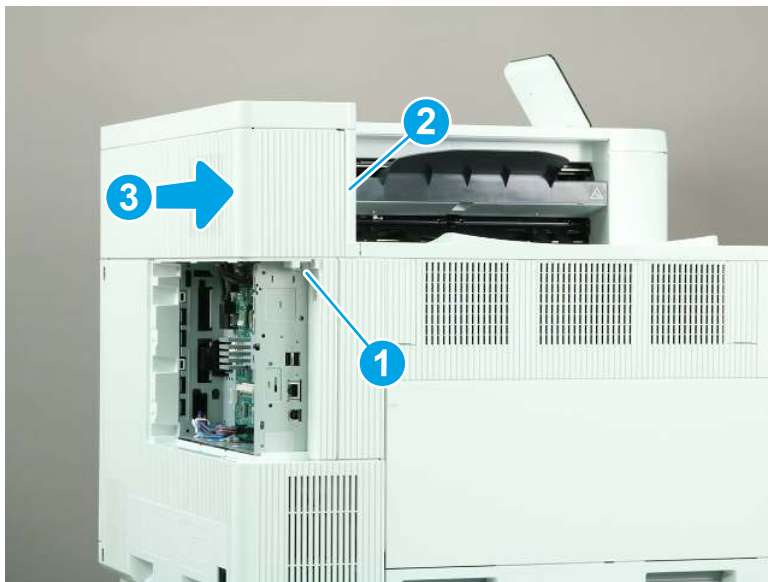


5. Remove the rear upper cover (M856/E85055/M776dn/M776z).

 **NOTE:** The following figure shows the M856 printer. The procedure is correct for all referenced models.

- ▲ Remove one screw (callout 1), release one tab (callout 2), and then slide the rear upper cover away from the printer to remove it (callout 3).

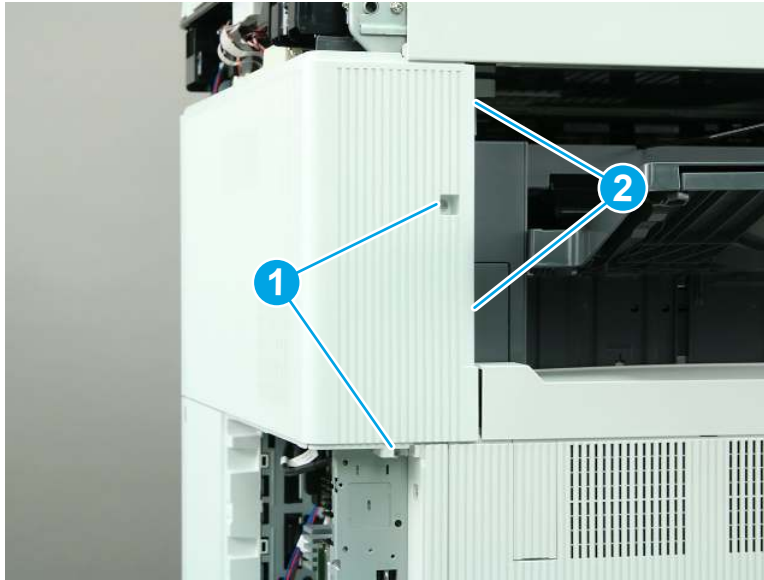
Figure 1-2175 Remove the rear upper cover



6. Remove the rear upper cover and left rear upper cover (M776zs).

- a. Remove two screws (callout 1), and then release two tabs (callout 2).

Figure 1-2176 Remove two screws and release two tabs



- b. Slide the cover to the right to remove it.

Figure 1-2177 Remove the rear upper and left rear upper cover



7. Remove the left rear cover (M751/E75245/M856/E85055/M776).

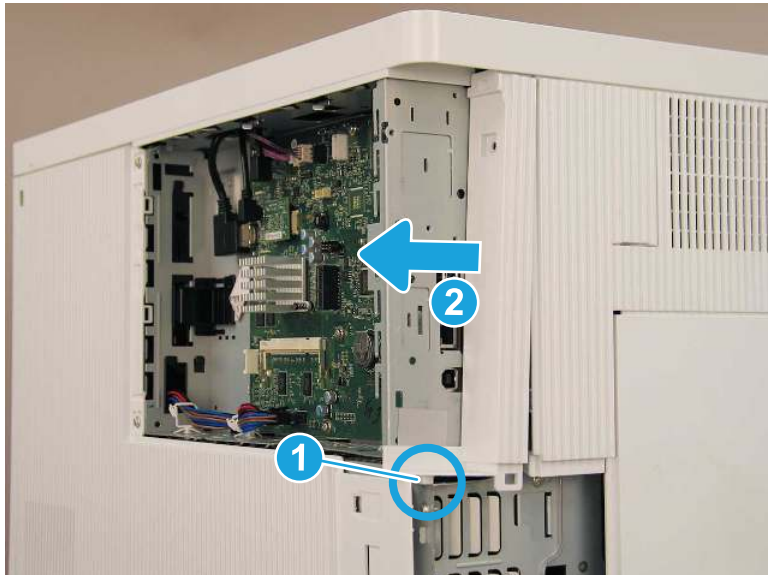
- a. Remove one screw (callout 1).

Figure 1-2178 Remove one screw



- b. Release one boss (callout 1), and then slide the cover toward the back of the printer (callout 2) to remove it.

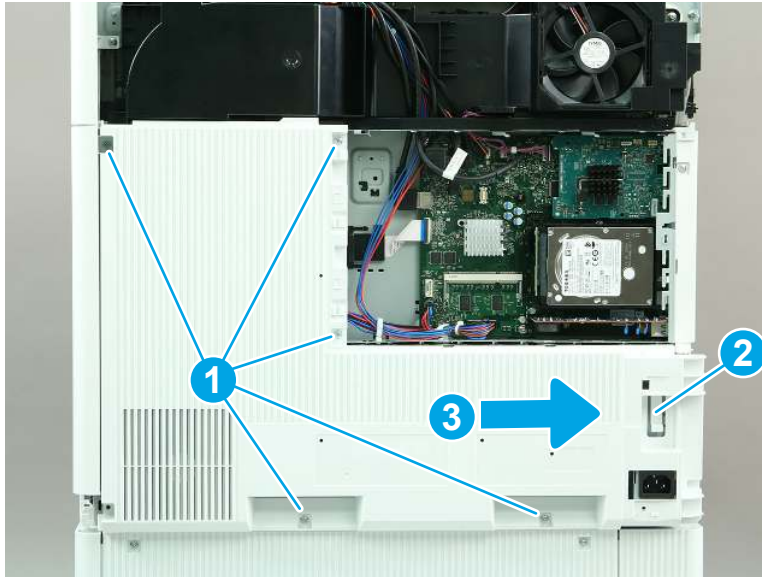
Figure 1-2179 Remove the left rear cover



8. Remove the rear cover (M856/E85055/M776).

- ▲ Remove five screws (callout 1), release one tab (callout 2), and then slide the rear cover to the right to remove it.

Figure 1-2180 Remove the rear cover (M856/E85055/M776)



- 9. **M856/E85055 only:** Remove the control panel and top cover.

 **NOTE:** This step applies to only the M856/E85055 models. Skip this step for all other models.

- a. Use a small, flat-blade screwdriver to release two tabs (callout 1), and then remove the control panel cover (callout 2).

Figure 1-2181 Remove the control panel cover



- b. Remove one screw (callout 1).

Figure 1-2182 Remove one screw



- c. Lift the back edge of the control panel up (callout 1), and then slide the control panel toward the back of the printer (callout 2).

Figure 1-2183 Slide the control panel back



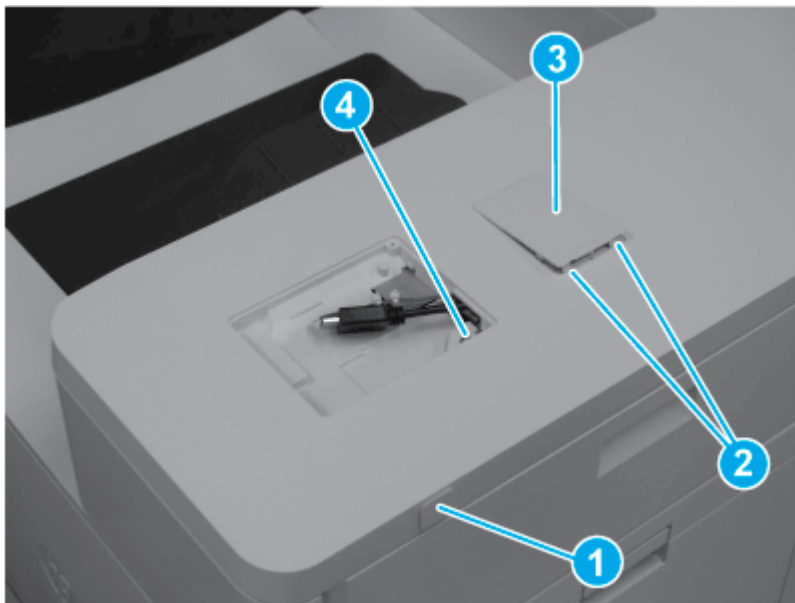
- d. Turn the control panel so that the bottom is facing up, and then disconnect two connectors to remove the control panel.

Figure 1-2184 Disconnect two connectors



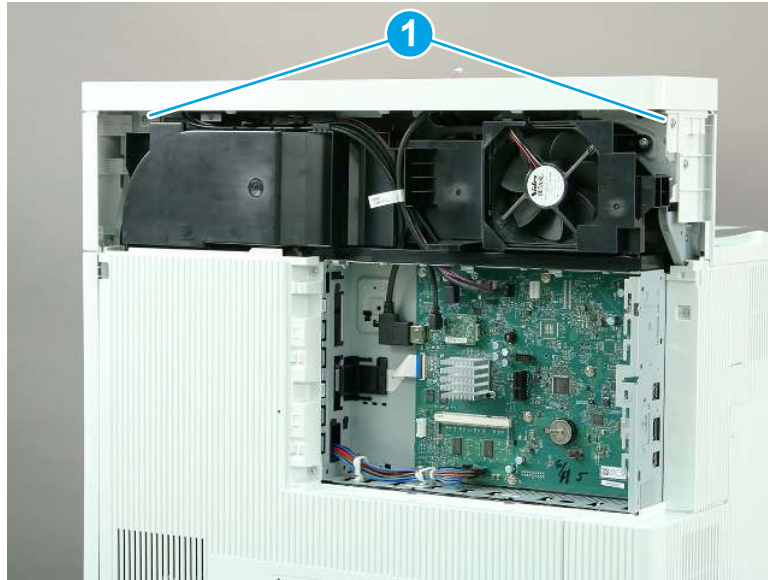
- e. Remove the USB cover (callout 1). Release two tabs (callout 2), and then remove the HIP cover (callout 3). Remove one screw (callout 4).

Figure 1-2185 Remove covers and one screw



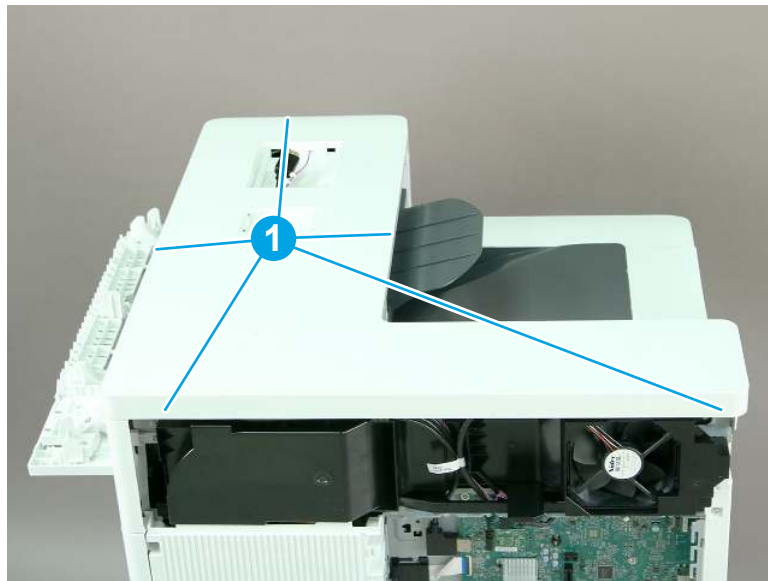
- f. Remove two screws (callout 1).

Figure 1-2186 Remove two screws



- g. Release five tabs (callout 1), and then remove the top cover.

Figure 1-2187 Release five tabs

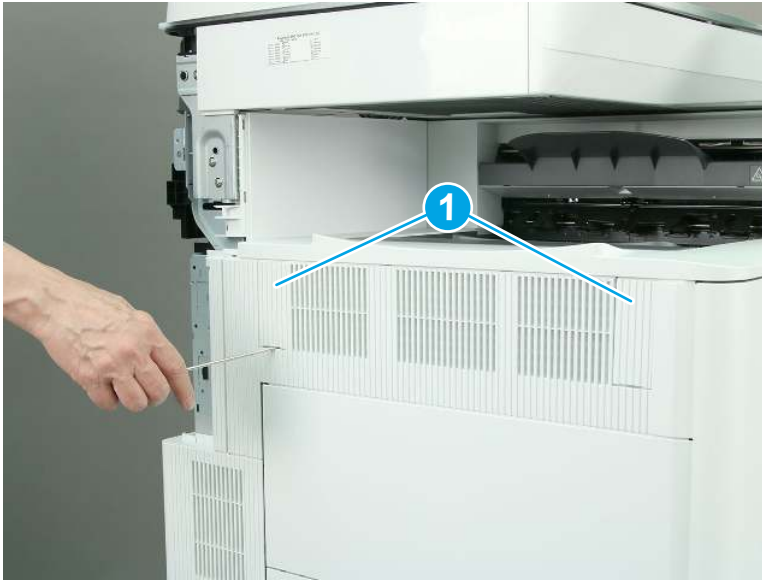


- 10. Remove the accessory upper cover (M856/E85055/M776dn/M776z).

 **NOTE:** The following figures show the M776z printer. The procedure is correct for all referenced models.

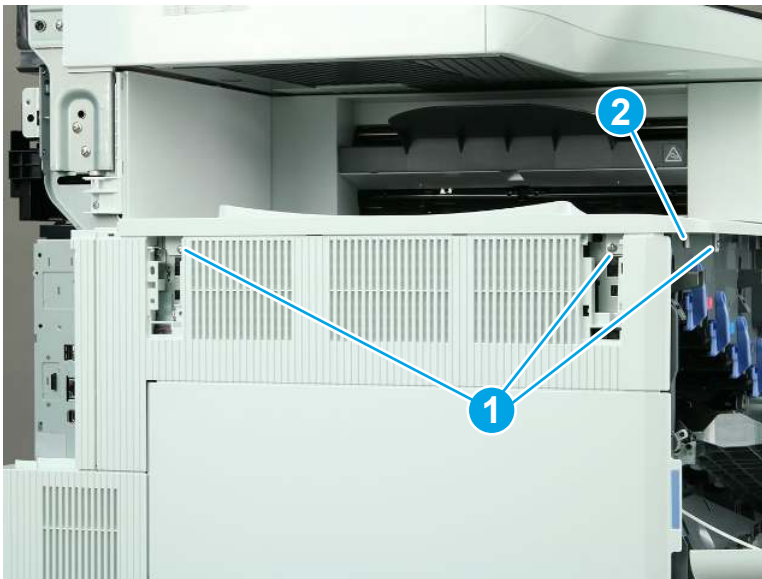
- a. Use a small, flat-blade screwdriver to remove two covers (callout 1).

Figure 1-2188 Remove two covers



- b. Remove three screws (callout 1), and then release one tab (callout 2).

Figure 1-2189 Remove three screws and release one tab



- c. Slide the accessory upper cover away from the printer to remove it.

Figure 1-2190 Remove the accessory upper cover

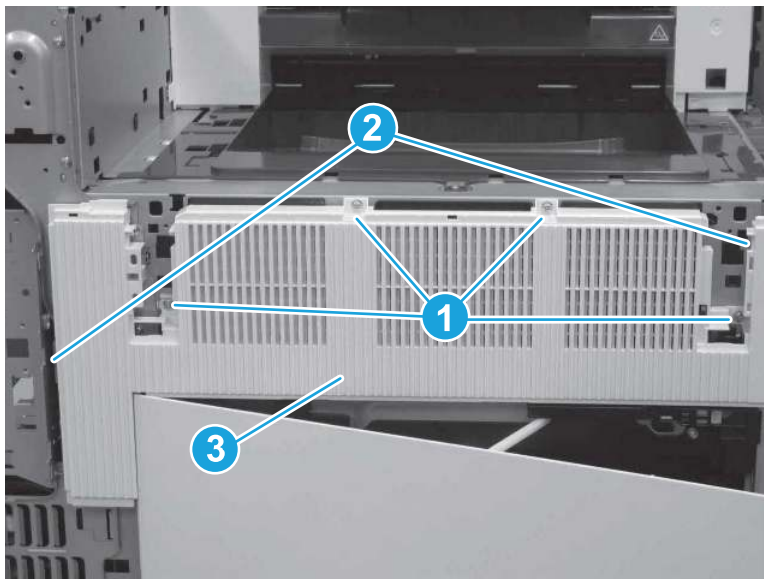


- 11. Remove the left upper cover (M856/E85055/M776).

 **NOTE:** The following figures show the M776z printer. The procedure is correct for all referenced models.

- ▲ Remove four screws (callout 1), release two tabs (callout 2), and then remove the left upper cover (callout 3).

Figure 1-2191 Remove the left upper cover



- 12. Remove the fuser fan.

- ▲ Disconnect one connector (callout 1), release two tabs (callout 2), and then remove the fuser fan (callout 3).


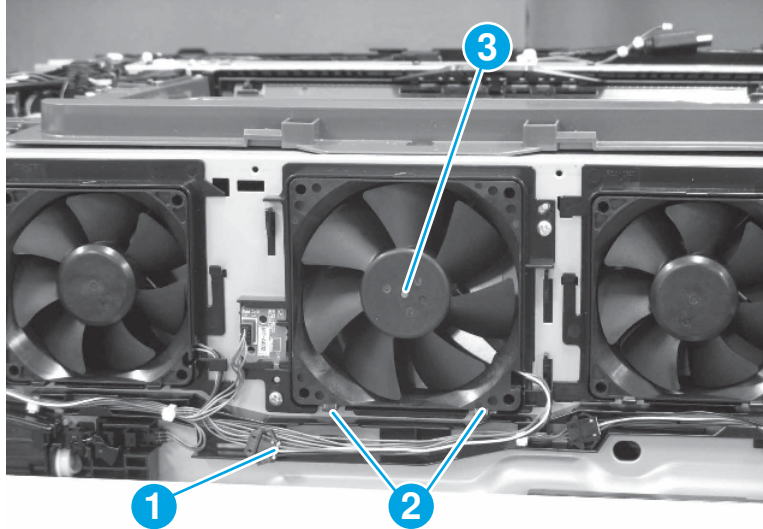
 **IMPORTANT:** When reinstalling the fuser fan, make sure that the cables are installed in the guides so that the fan cover fits correctly and does not pinch any wires.

Figure 1-2192 Remove the fuser fan




13. Unpack the replacement assembly.

- a. Dispose of the defective part.


 **NOTE:** HP recommends responsible disposal of the defective part.

<http://www8.hp.com/us/en/hp-information/environment/product-recycling.html>

- b. Unpack the replacement part from the packaging.

 **IMPORTANT:** Make sure that all of the shipping materials (for example shipping tape) are removed from the replacement part prior to installation.

- c. To install an assembly, reverse the removal steps.

 **NOTE:** When applicable, special installation instructions are provided for an assembly at the end of the removal procedure. Always completely read the removal instructions and follow all special installation instructions.

Removal and replacement: Cartridge front fan (M751/E75245)

Learn how to remove and replace the cartridge front fan.

[View a video of how to remove and replace the cartridge front fan.](#)

Mean time to repair: 16 minutes

Service level: Easy

Before performing service

Turn the printer power off

- Disconnect the power cable.

⚠ WARNING! To avoid damage to the printer, turn the printer off, wait 30 seconds, and then remove the power cord before attempting to service the printer.

Use the table below to identify the correct part number for your printer. To order the part, go to www.hp.com/buy/parts.

Table 1-113 Part information

Part number	Part description
RK2-2276-000CN	Fan

Required tools

- #2 Phillips screwdriver with a magnetic tip
- Small, flat-blade screwdriver

After performing service

Turn the printer power on

- Connect the power cable.
- Use the power switch to turn the power on.

Post service test

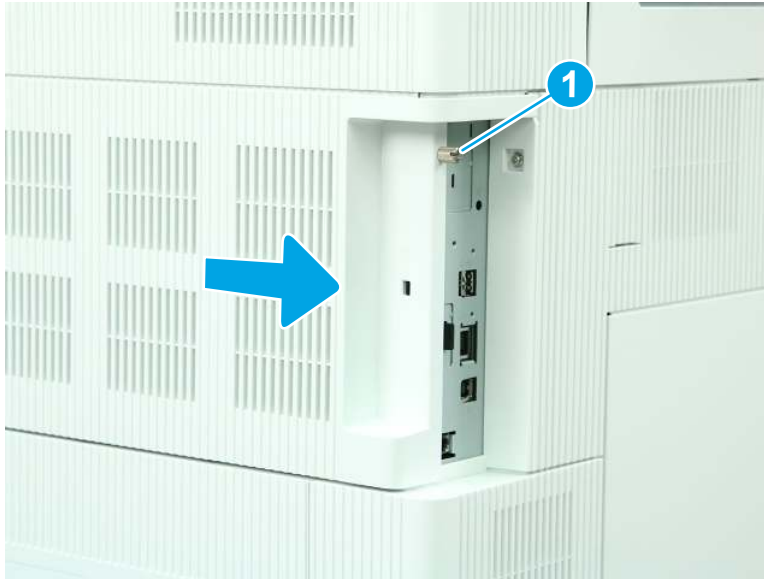
Make sure that the printer initializes to a **Ready** state.

Print a page to make sure that the printer is functioning correctly.

1. Remove the formatter cover.

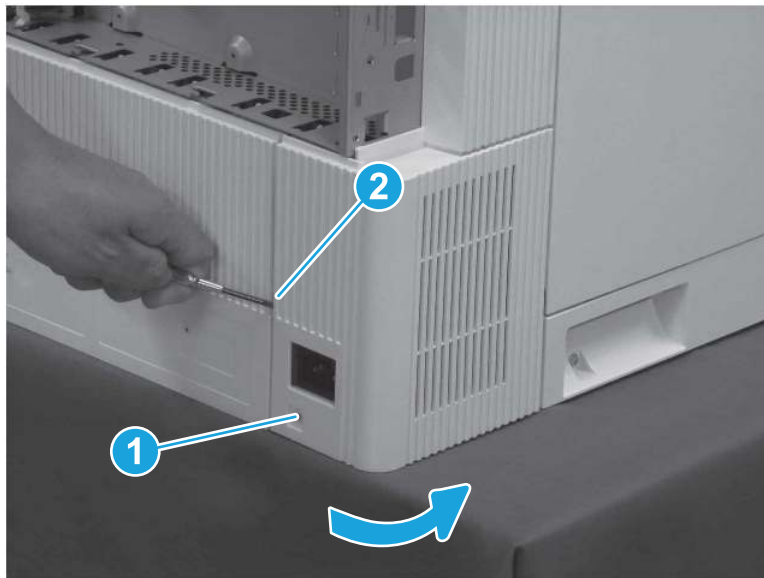
- ▲ Loosen one thumbscrew (callout 1), and then slide the formatter cover (callout 2) away from the printer to remove it.

Figure 1-2193 Remove the formatter cover



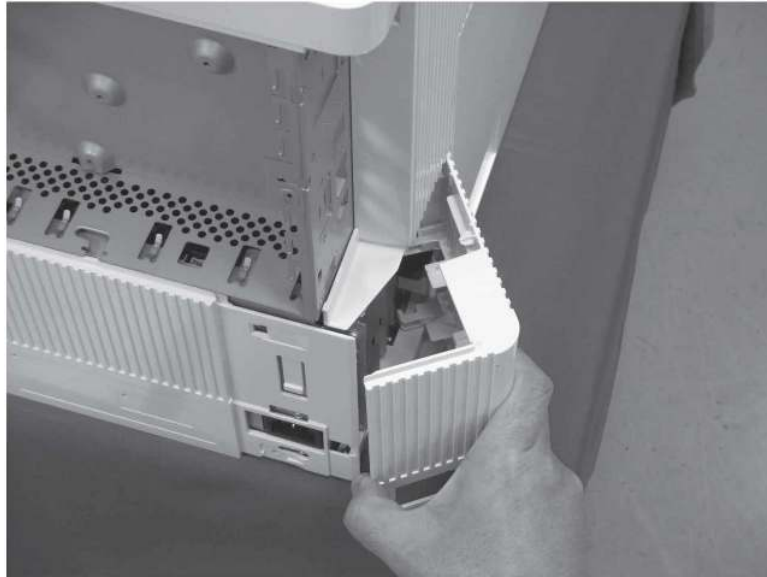
- 2. Remove the left lower cover (M751/E75245).
 - a. Remove one screw (callout 1), release one tab (callout 2), and then rotate the cover away from the printer.

Figure 1-2194 Remove one screw and release one tab



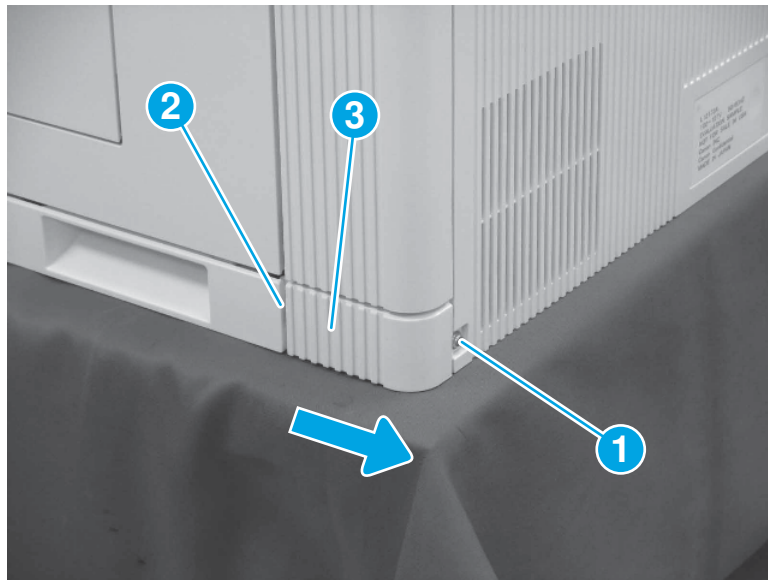
- b. Remove the left lower cover.

Figure 1-2195 Remove the left lower cover



3. Remove the right rear lower cover (M751/E75245/M856/E85055/M776).
 - ▲ Remove one screw (callout 1), release one tab (callout 2), and then slide the right rear lower cover (callout 3) toward the back of the printer to remove it.

Figure 1-2196 Remove the right rear lower cover



4. Remove the left rear cover (M751/E75245/M856/E85055/M776).

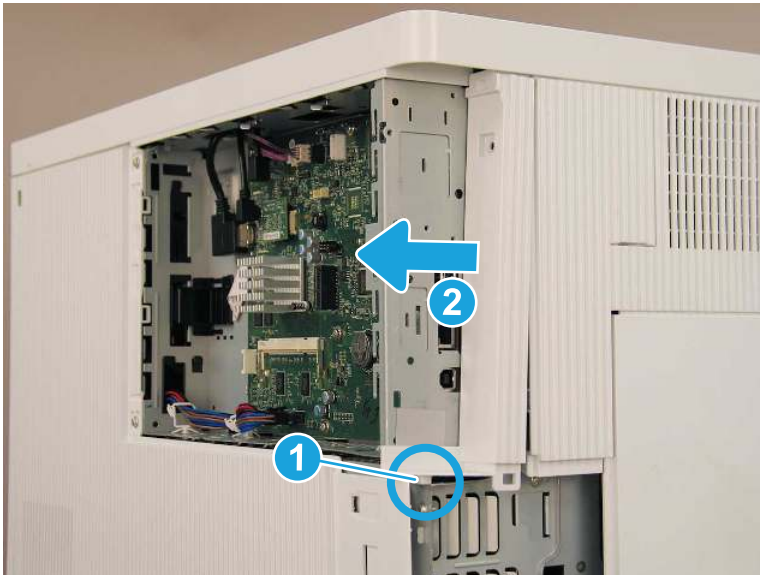
- a. Remove one screw (callout 1).

Figure 1-2197 Remove one screw



- b. Release one boss (callout 1), and then slide the cover toward the back of the printer (callout 2) to remove it.

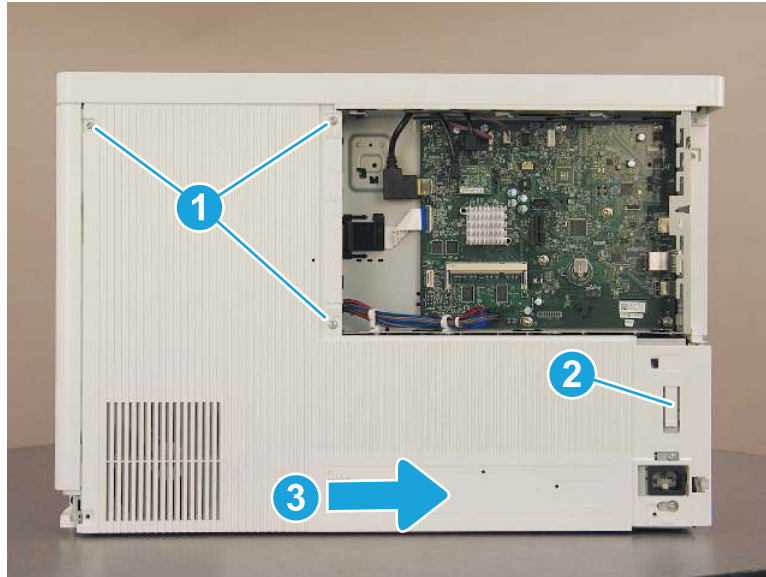
Figure 1-2198 Remove the left rear cover



5. Remove the rear cover (M751/E75245).

- ▲ Remove three screws (callout 1), release one tab (callout 2), and then slide the rear cover to the right (callout 3) to remove it.

Figure 1-2199 Remove the rear cover

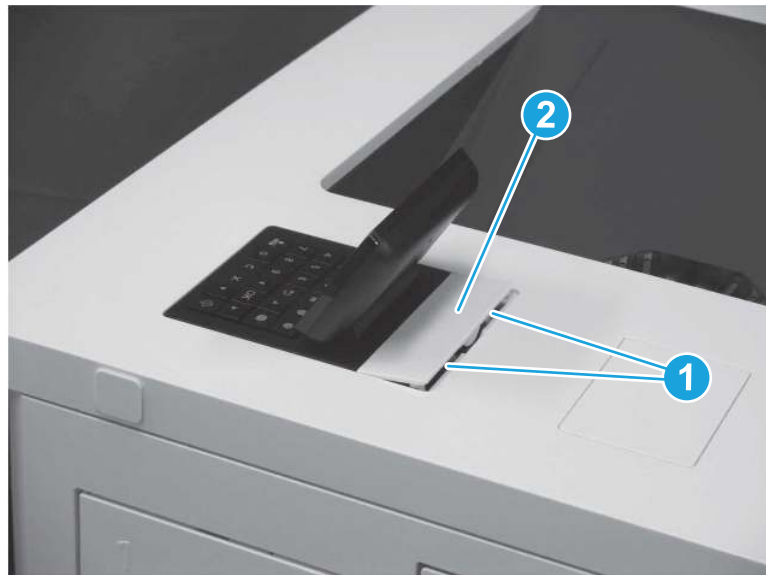


6. Remove the control panel.

 **NOTE:** A screwdriver is included in the control panel kit. The screwdriver has a reversible shaft. Simply pull the shaft out of the handle, and then reinstall it with the desired end facing out.

- a. Use a small, flat-blade screwdriver to release two tabs (callout 1), and then remove the control panel cover (callout 2).

Figure 1-2200 Remove the control panel cover



- b. Remove one screw (callout 1).

Figure 1-2201 Remove one screw



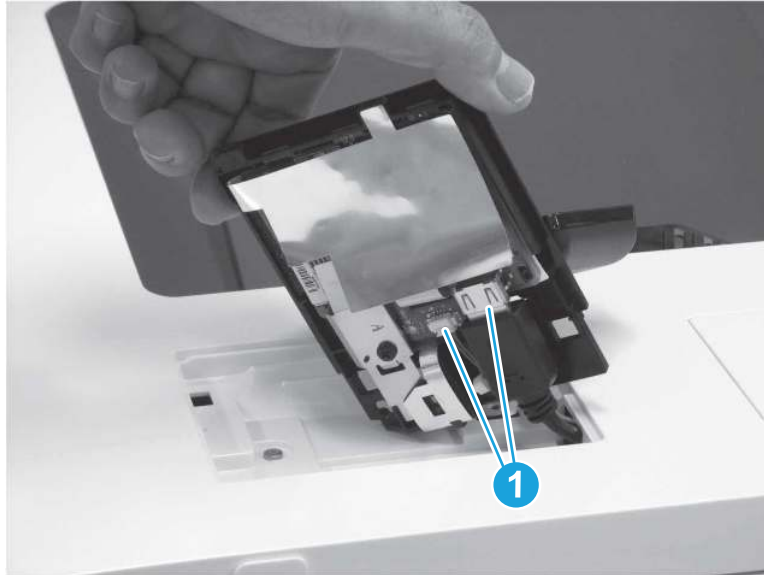
- c. Lift the back edge of the control panel up (callout 1), and then slide the control panel toward the back of the printer (callout 2).

Figure 1-2202 Slide the control panel back



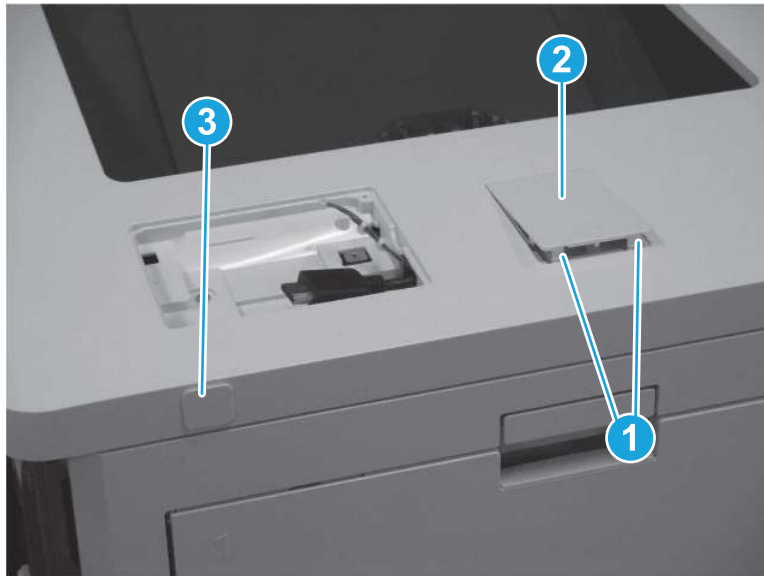
- d. Turn the control panel so that the bottom is facing up, and then disconnect two connectors (callout 1) to remove the control panel.

Figure 1-2203 Disconnect two connectors



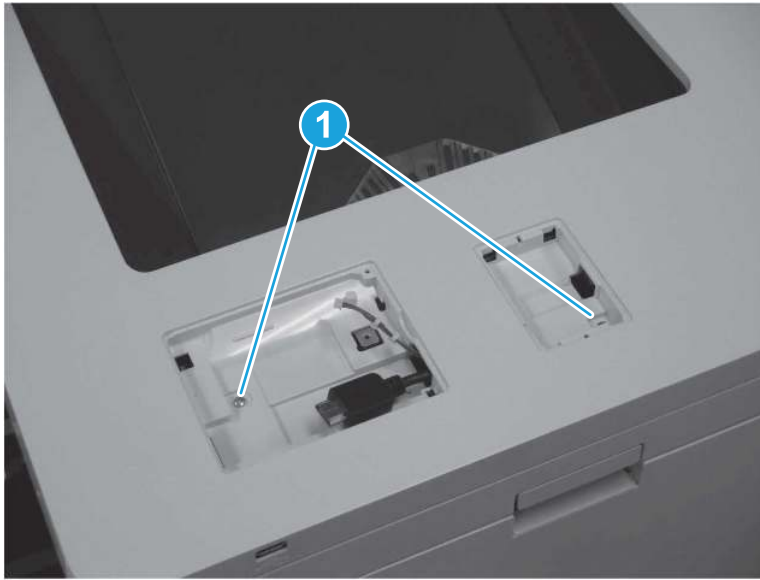
7. Remove the top cover (M751/E75245).
 - a. Release two tabs (callout 1), and then remove the HIP cover (callout 2). Pull the USB cap (callout 3) away from the printer to remove it.

Figure 1-2204 Remove the HIP cover and USB cap



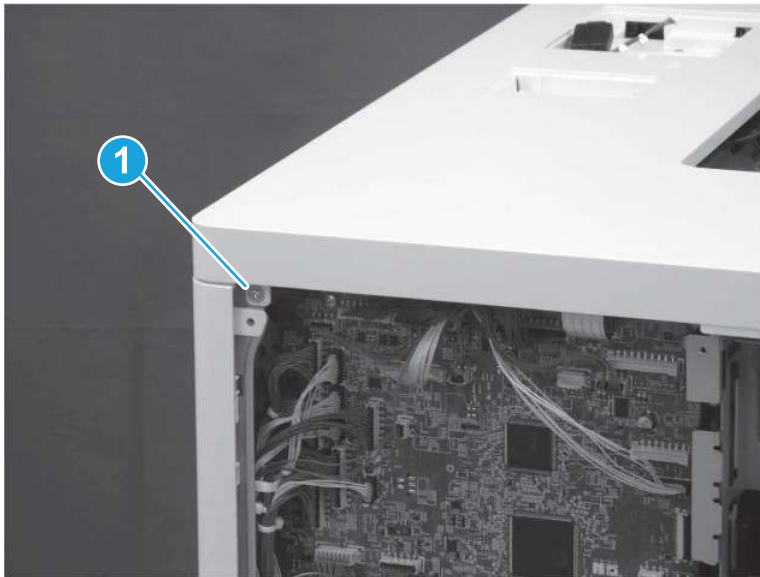
- b. At the top of the printer, remove two screws (callout 1).

Figure 1-2205 Remove two screws




- c. At the back of the printer, remove one screw (callout 1).

Figure 1-2206 Remove one screw

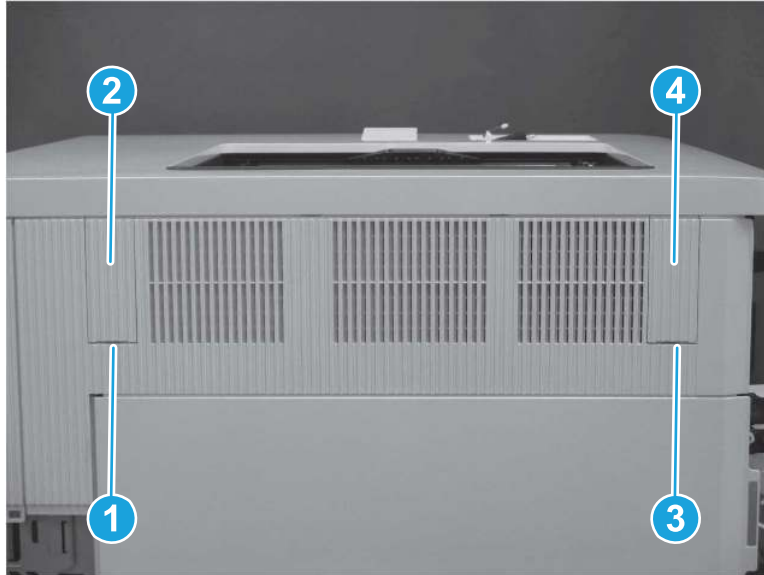


- d. Use a small, flat-blade screwdriver to release one tab (callout 1) and remove the left blanking cover (callout 2). Release one tab (callout 3) and remove the right blanking cover (callout 4).

 **TIP:** These covers are not identical. Make sure to reinstall the correct cover on the correct side.

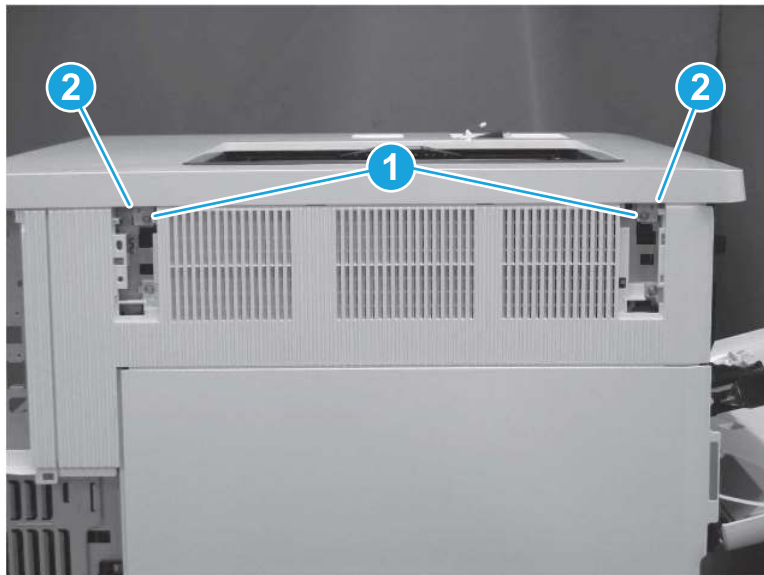
 **NOTE:** The screw under the left blanking cover is a self-tapping screw. Make sure this screw is reinstalled in the correct location.

Figure 1-2207 Remove the left and right blanking covers



- e. Remove two screws (callout 1), and then release two tabs (callout 2).

Figure 1-2208 Remove two screws and release two tabs



- f. At the front of the printer, remove one washer-head screw (callout 1) and one self-tapping screw (callout 2). Release one tab (callout 3).


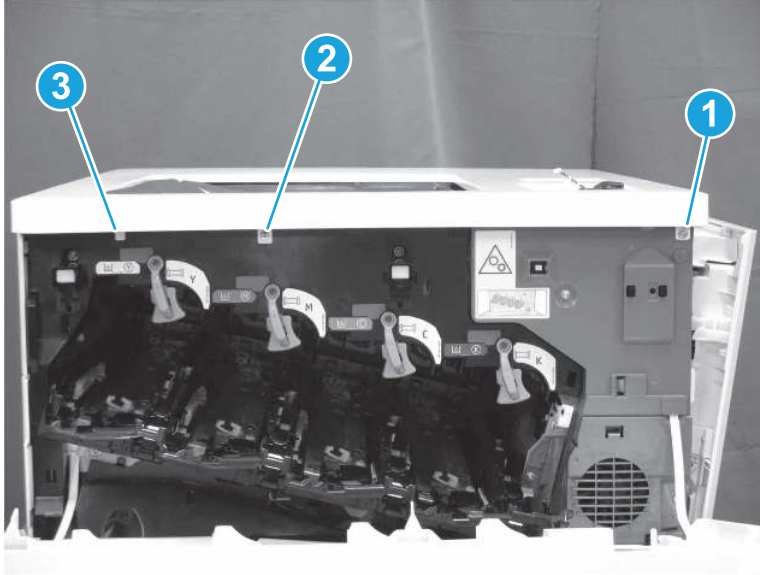
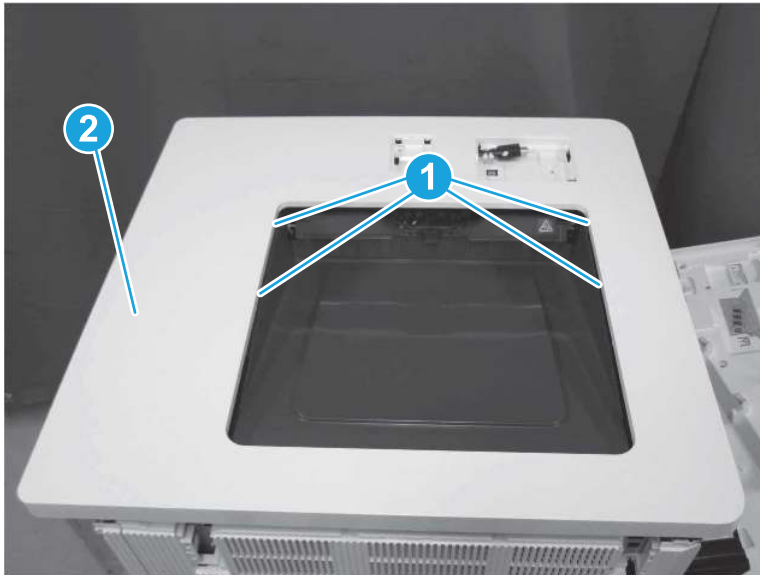
 **TIP:** Make sure to install the correct type of screw in the correct location.

Figure 1-2209 Remove two screws and release one tab

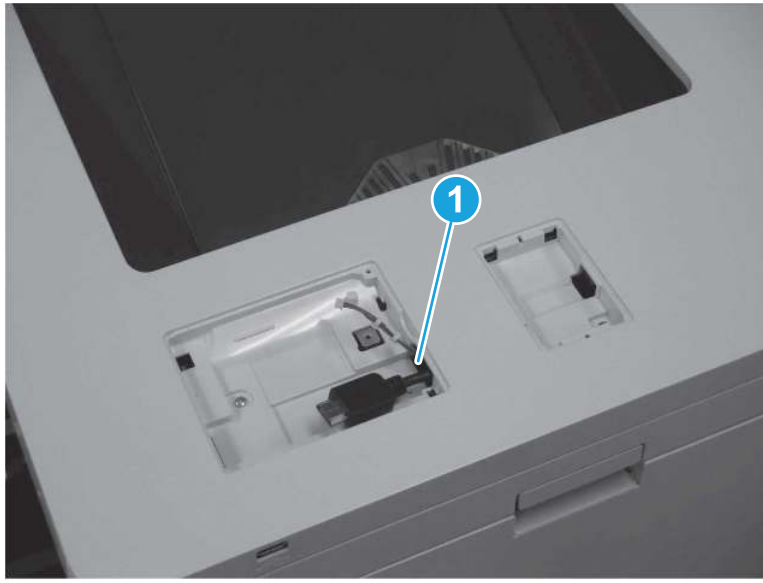


- g. At the top of the printer, release four tabs (callout 1), and then remove the top cover (callout 2).

Figure 1-2210 Remove the top cover

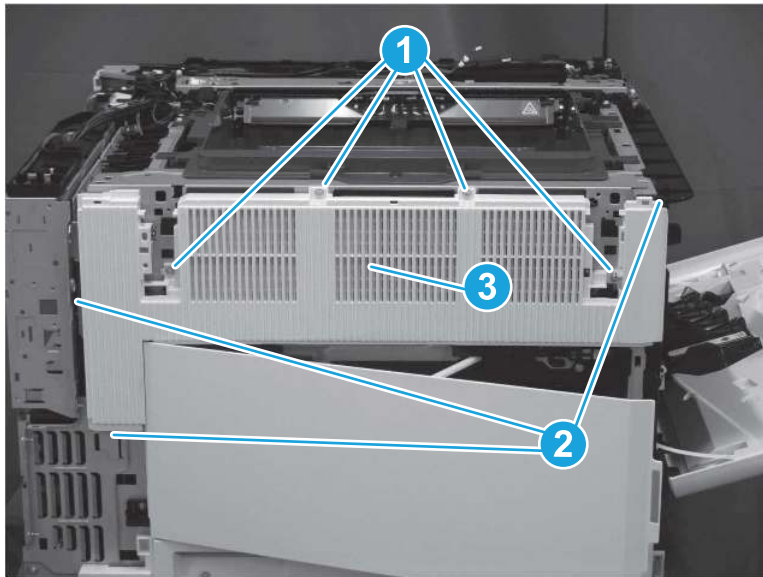


 **NOTE:** When removing the top cover, make sure to release the control panel cables (callout 1) through the opening.



8. Remove the left upper cover (M751/E75245).
 - ▲ Remove four screws (callout 1), release three tabs (callout 2), and then remove the left upper cover (callout 3).

Figure 1-2211 Remove the left upper cover



9. Remove the cartridge front fan.
 - ▲ Disconnect one connector (callout 1), release two tabs (callout 2), and then remove the cartridge front fan (callout 3).


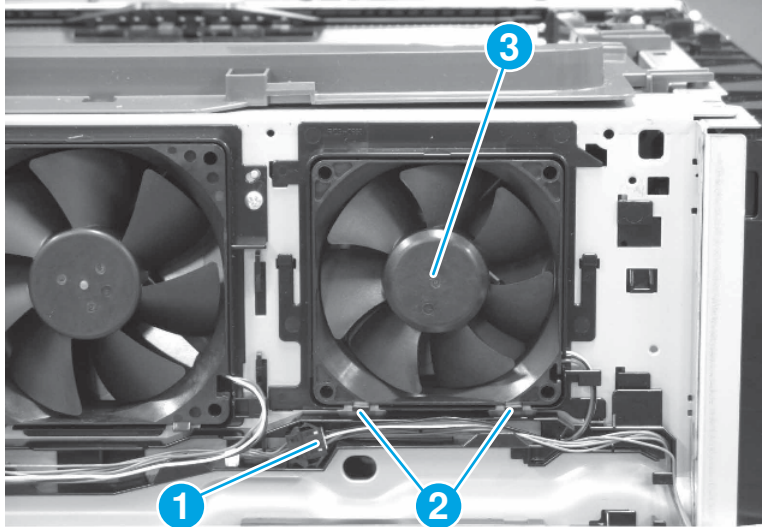
 **IMPORTANT:** When reinstalling the cartridge front fan, make sure that the cables are installed in the guides so that the fan cover fits correctly and does not pinch any wires.

Figure 1-2212 Remove the cartridge front fan



10. Unpack the replacement assembly.

a. Dispose of the defective part.



NOTE: HP recommends responsible disposal of the defective part.

<http://www8.hp.com/us/en/hp-information/environment/product-recycling.html>

b. Unpack the replacement part from the packaging.



IMPORTANT: Make sure that all of the shipping materials (for example shipping tape) are removed from the replacement part prior to installation.

c. To install an assembly, reverse the removal steps.



NOTE: When applicable, special installation instructions are provided for an assembly at the end of the removal procedure. Always completely read the removal instructions and follow all special installation instructions.

Removal and replacement: Cartridge front fan (M856/E85055/M776)

Learn how to remove and replace the cartridge front fan.

[View a video of how to remove and replace the cartridge front fan.](#)

Mean time to repair: 16 minutes

Service level: Easy

Before performing service

Turn the printer power off

- Disconnect the power cable.



WARNING! To avoid damage to the printer, turn the printer off, wait 30 seconds, and then remove the power cord before attempting to service the printer.

Use the table below to identify the correct part number for your printer. To order the part, go to www.hp.com/buy/parts.

Table 1-114 Part information

Part number	Part description
RK2-2276-000CN	Fan

Required tools

- #2 Phillips screwdriver with a magnetic tip
- Small, flat-blade screwdriver

After performing service

Turn the printer power on

- Connect the power cable.
- Use the power switch to turn the power on.

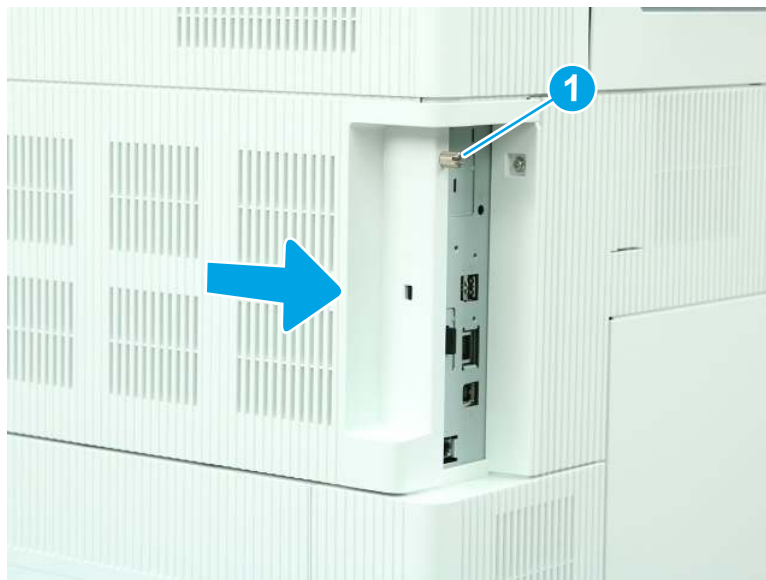
Post service test

Make sure that the printer initializes to a **Ready** state.

Print a page to make sure that the printer is functioning correctly.

1. Remove the formatter cover.
 - ▲ Loosen one thumbscrew (callout 1), and then slide the formatter cover (callout 2) away from the printer to remove it.

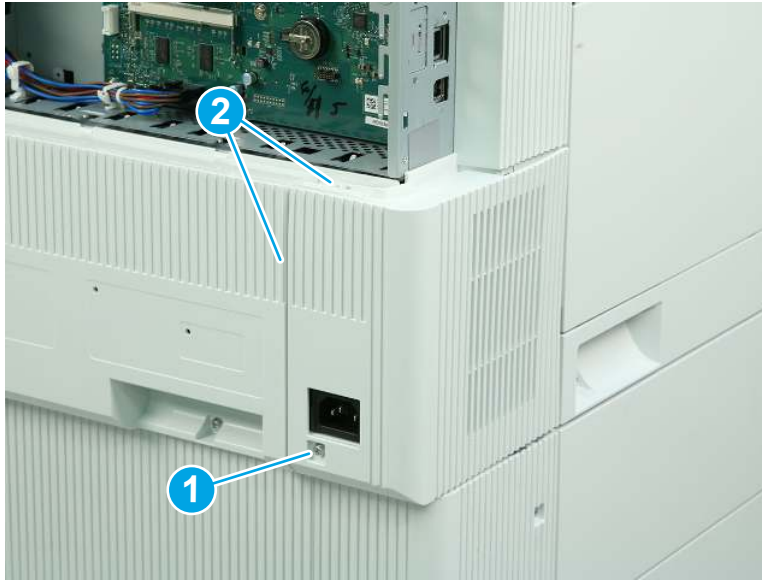
Figure 1-2213 Remove the formatter cover



2. Remove the left lower cover (M856/E85055/M776).

- a. Remove one screw (callout 1), and then release two tabs (callout 2).

Figure 1-2214 Remove one screw and release two tabs



- b. Rotate the cover away from the printer to remove it.

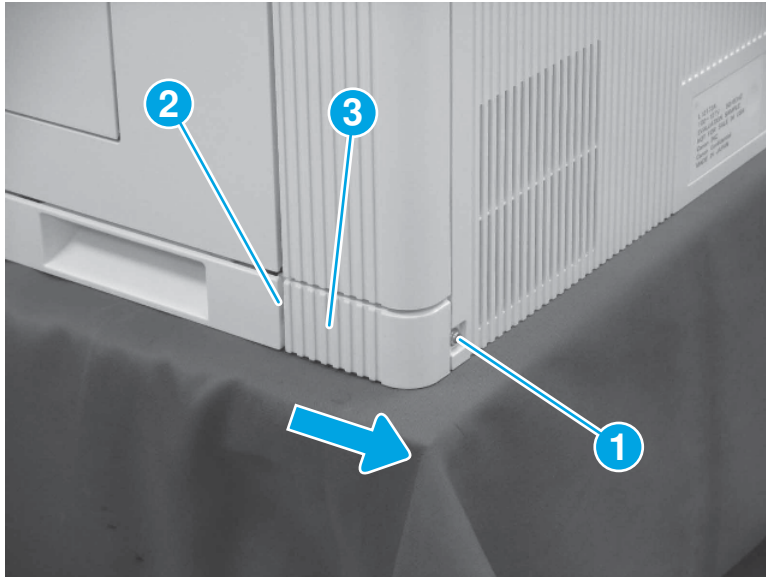
Figure 1-2215 Remove the left lower cover



3. Remove the right rear lower cover (M751/E75245/M856/E85055/M776).

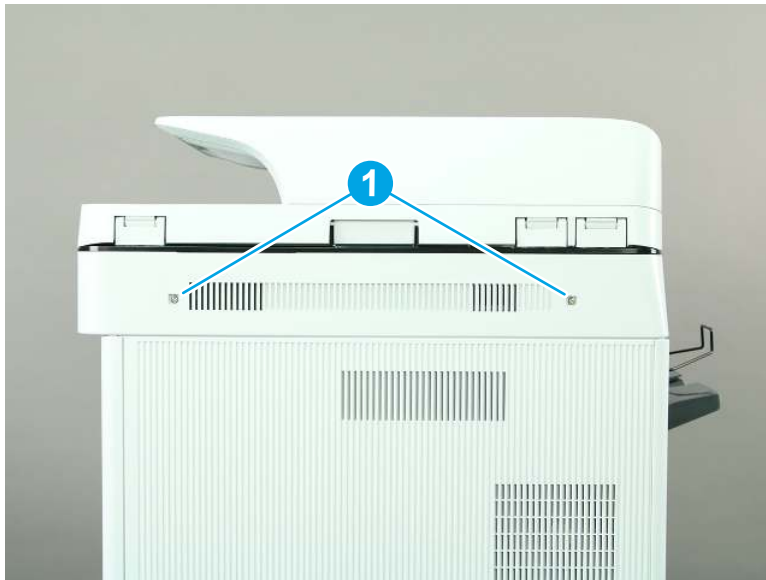
- ▲ Remove one screw (callout 1), release one tab (callout 2), and then slide the right rear lower cover (callout 3) toward the back of the printer to remove it.

Figure 1-2216 Remove the right rear lower cover



- 4. Remove the scanner control board (SCB) cover (M776).
 - a. Remove two screws (callout 1).

Figure 1-2217 Remove two screws



- b. Remove the SCB cover.

Figure 1-2218 Remove the SCB cover

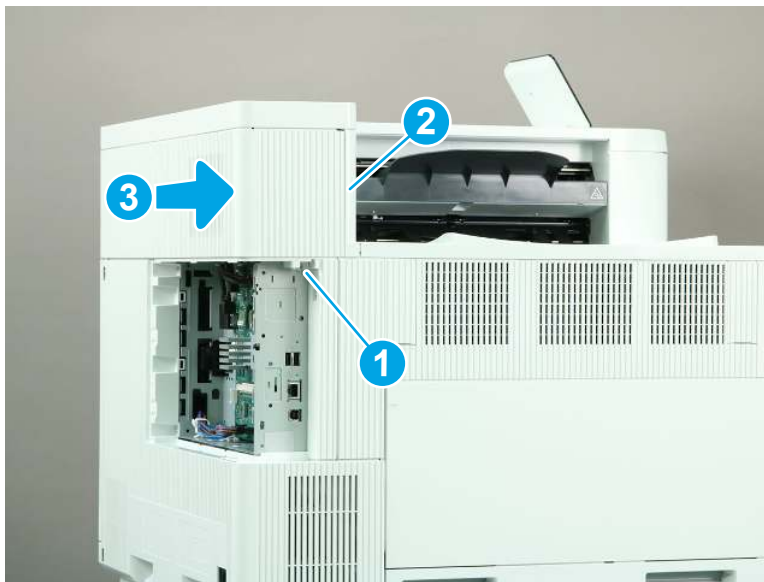


5. Remove the rear upper cover (M856/E85055/M776dn/M776z).

 **NOTE:** The following figure shows the M856 printer. The procedure is correct for all referenced models.

- ▲ Remove one screw (callout 1), release one tab (callout 2), and then slide the rear upper cover away from the printer to remove it (callout 3).

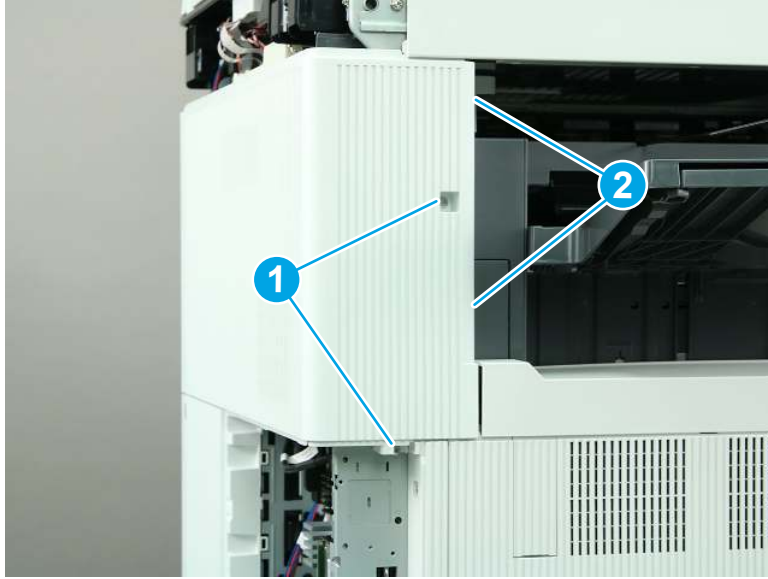
Figure 1-2219 Remove the rear upper cover



6. Remove the rear upper cover and left rear upper cover (M776zs).

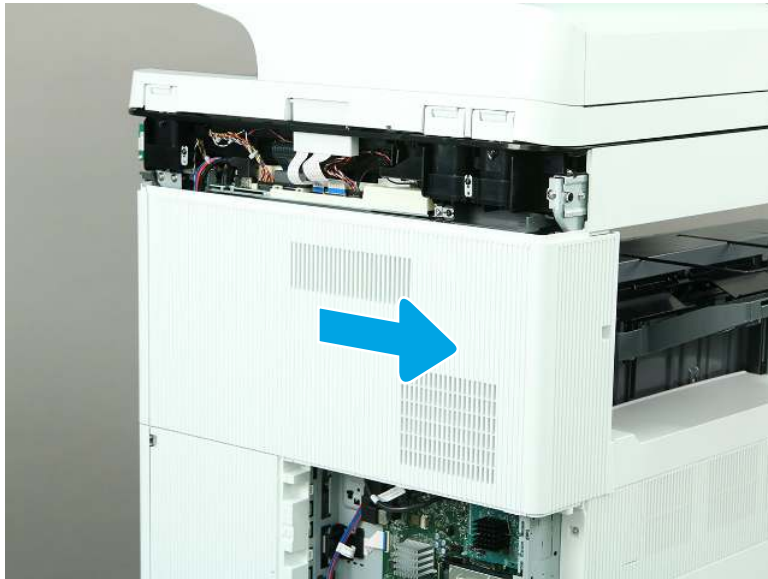
- a. Remove two screws (callout 1), and then release two tabs (callout 2).

Figure 1-2220 Remove two screws and release two tabs



- b. Slide the cover to the right to remove it.

Figure 1-2221 Remove the rear upper and left rear upper cover



7. Remove the left rear cover (M751/E75245/M856/E85055/M776).

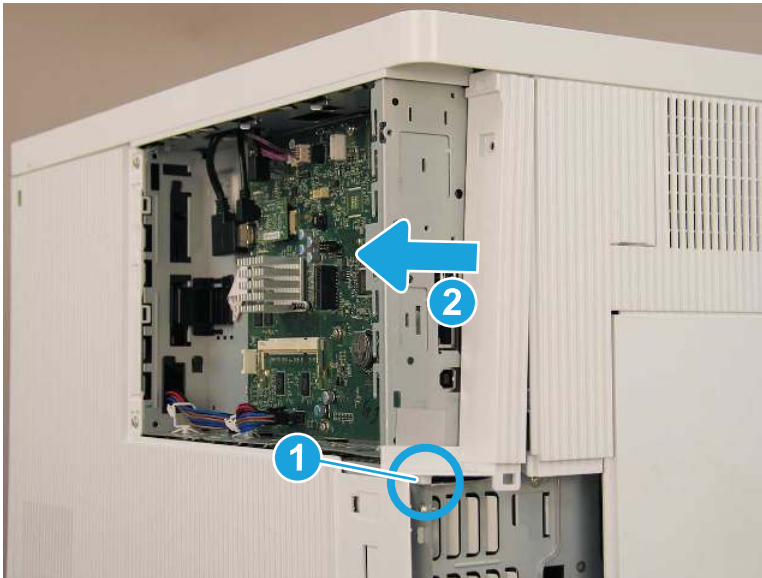
- a. Remove one screw (callout 1).

Figure 1-2222 Remove one screw



- b. Release one boss (callout 1), and then slide the cover toward the back of the printer (callout 2) to remove it.

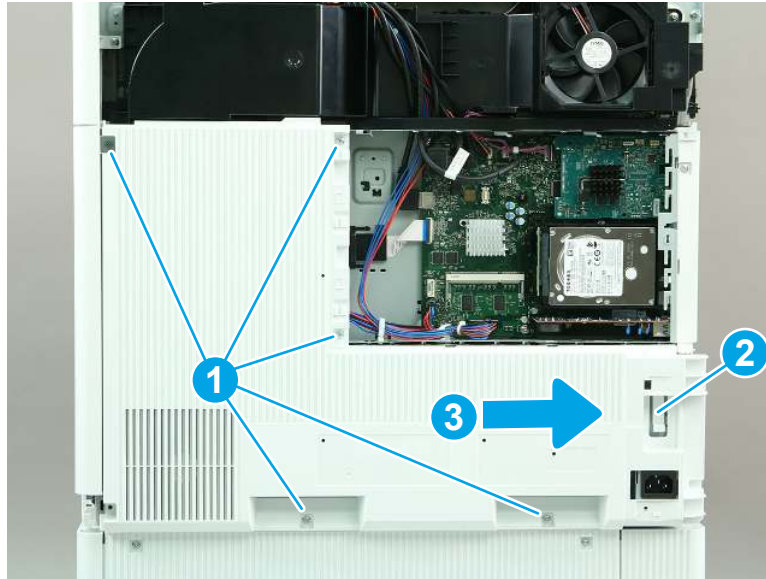
Figure 1-2223 Remove the left rear cover




8. Remove the rear cover (M856/E85055/M776).

- ▲ Remove five screws (callout 1), release one tab (callout 2), and then slide the rear cover to the right to remove it.

Figure 1-2224 Remove the rear cover (M856/E85055/M776)



- 9. **M856/E85055 only:** Remove the control panel and top cover.

 **NOTE:** This step applies to only the M856/E85055 models. Skip this step for all other models.

- a. Use a small, flat-blade screwdriver to release two tabs (callout 1), and then remove the control panel cover (callout 2).

Figure 1-2225 Remove the control panel cover



- b. Remove one screw (callout 1).

Figure 1-2226 Remove one screw



- c. Lift the back edge of the control panel up (callout 1), and then slide the control panel toward the back of the printer (callout 2).

Figure 1-2227 Slide the control panel back



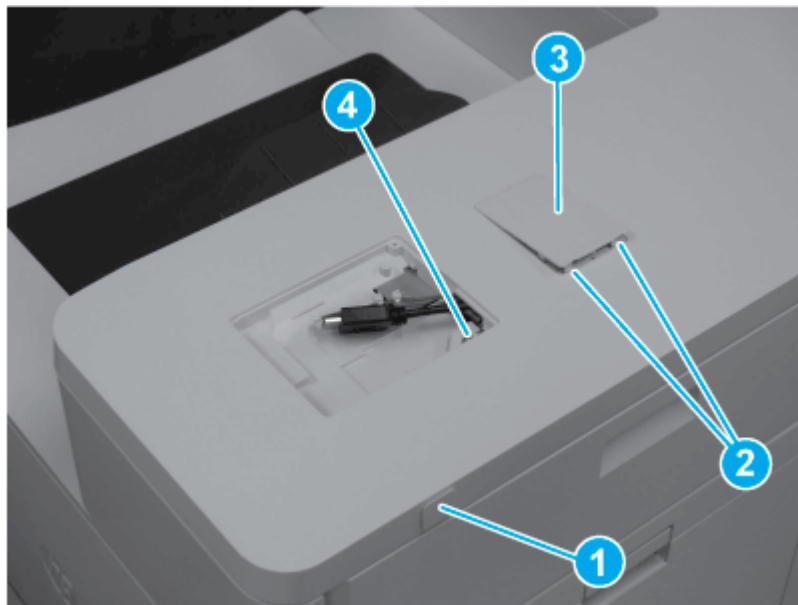
- d. Turn the control panel so that the bottom is facing up, and then disconnect two connectors to remove the control panel.

Figure 1-2228 Disconnect two connectors



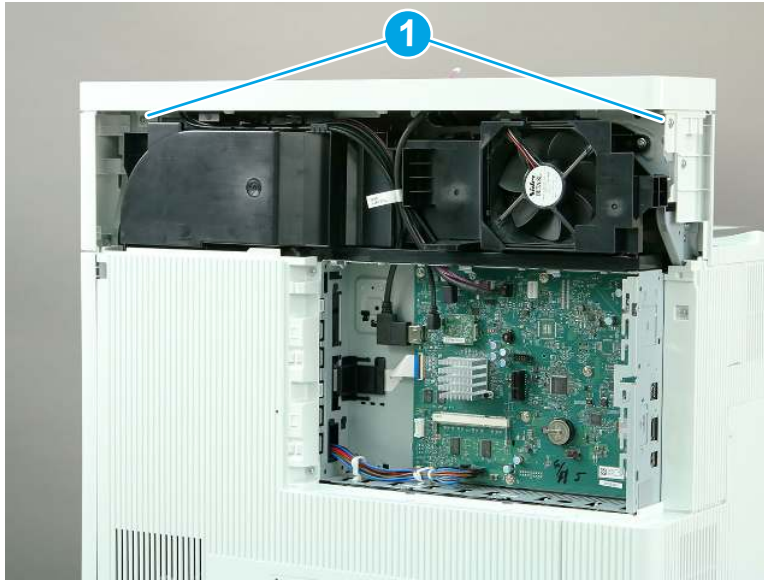
- e. Remove the USB cover (callout 1). Release two tabs (callout 2), and then remove the HIP cover (callout 3). Remove one screw (callout 4).

Figure 1-2229 Remove covers and one screw



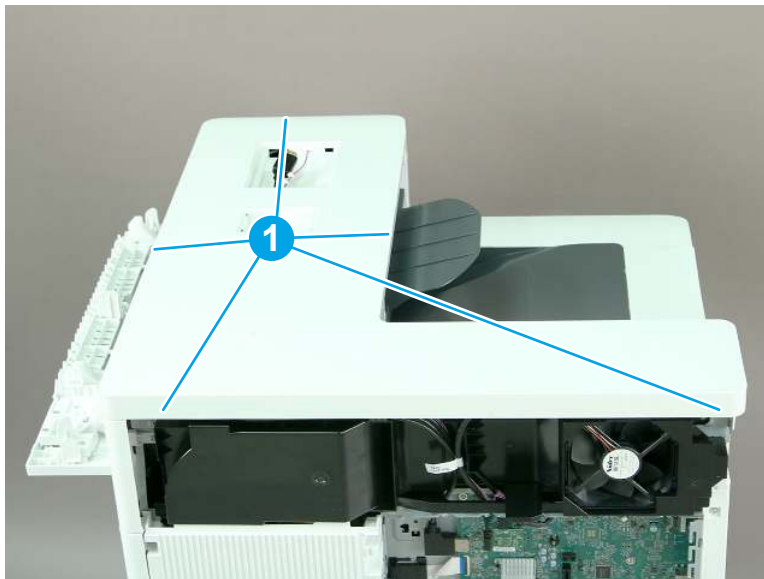
- f. Remove two screws (callout 1).

Figure 1-2230 Remove two screws



- g. Release five tabs (callout 1), and then remove the top cover.

Figure 1-2231 Release five tabs

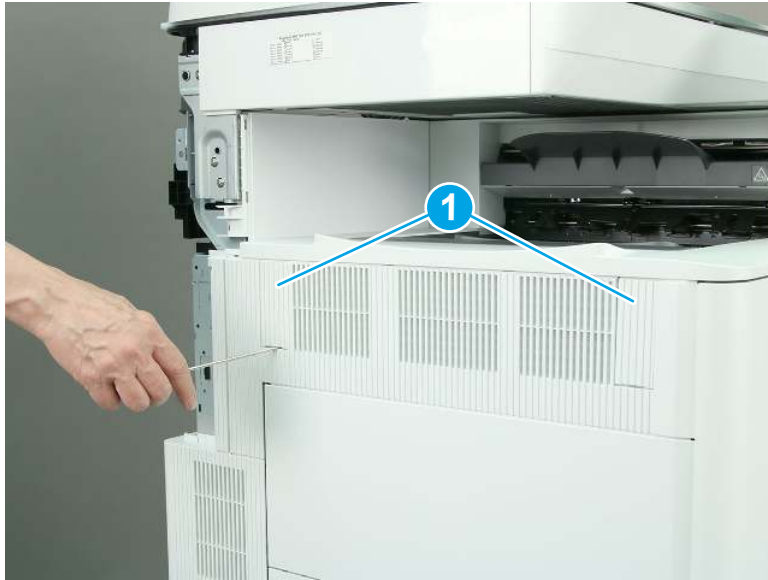


- 10. Remove the accessory upper cover (M856/E85055/M776dn/M776z).

 **NOTE:** The following figures show the M776z printer. The procedure is correct for all referenced models.

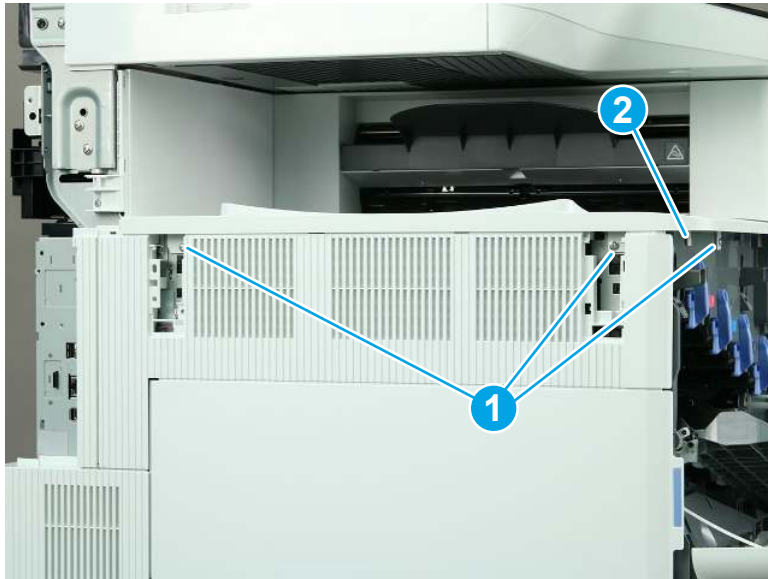
- a. Use a small, flat-blade screwdriver to remove two covers (callout 1).

Figure 1-2232 Remove two covers



- b. Remove three screws (callout 1), and then release one tab (callout 2).

Figure 1-2233 Remove three screws and release one tab



- c. Slide the accessory upper cover away from the printer to remove it.

Figure 1-2234 Remove the accessory upper cover

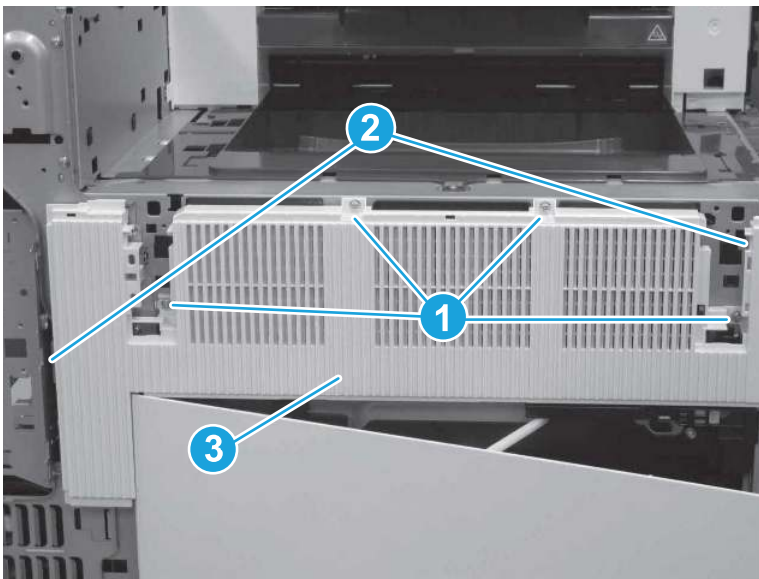


- 11. Remove the left upper cover (M856/E85055/M776).

 **NOTE:** The following figures show the M776z printer. The procedure is correct for all referenced models.

- ▲ Remove four screws (callout 1), release two tabs (callout 2), and then remove the left upper cover (callout 3).

Figure 1-2235 Remove the left upper cover

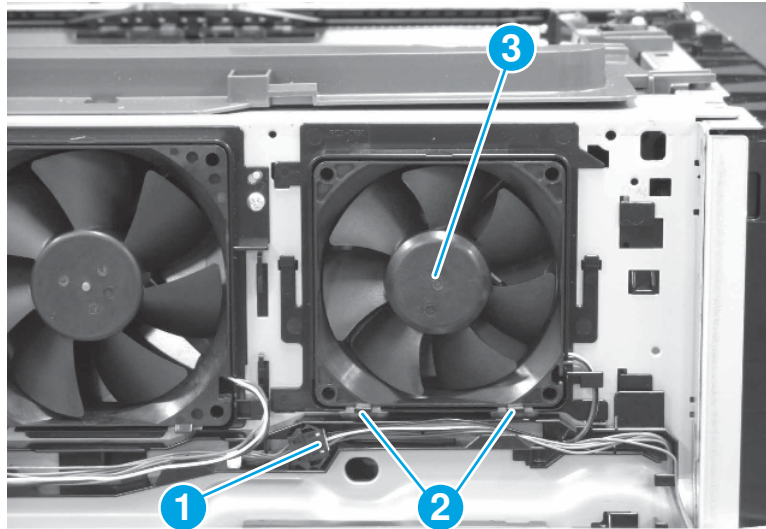


- 12. Remove the cartridge front fan.

- ▲ Disconnect one connector (callout 1), release two tabs (callout 2), and then remove the cartridge front fan (callout 3).

 **IMPORTANT:** When reinstalling the cartridge front fan, make sure that the cables are installed in the guides so that the fan cover fits correctly and does not pinch any wires.

Figure 1-2236 Remove the cartridge front fan




13. Unpack the replacement assembly.

- a. Dispose of the defective part.


 **NOTE:** HP recommends responsible disposal of the defective part.

<http://www8.hp.com/us/en/hp-information/environment/product-recycling.html>

- b. Unpack the replacement part from the packaging.

 **IMPORTANT:** Make sure that all of the shipping materials (for example shipping tape) are removed from the replacement part prior to installation.

- c. To install an assembly, reverse the removal steps.

 **NOTE:** When applicable, special installation instructions are provided for an assembly at the end of the removal procedure. Always completely read the removal instructions and follow all special installation instructions.

Removal and replacement: Cartridge rear fan (M751/E75245)

Learn how to remove and replace the cartridge rear fan.

[View a video of how to remove and replace the cartridge rear fan.](#)

Mean time to repair: 16 minutes

Service level: Easy

Before performing service

Turn the printer power off

- Disconnect the power cable.

⚠ WARNING! To avoid damage to the printer, turn the printer off, wait 30 seconds, and then remove the power cord before attempting to service the printer.

Use the table below to identify the correct part number for your printer. To order the part, go to www.hp.com/buy/parts.

Table 1-115 Part information

Part number	Part description
RK2-2276-000CN	Fan

Required tools

- #2 Phillips screwdriver with a magnetic tip
- Small, flat-blade screwdriver

After performing service

Turn the printer power on

- Connect the power cable.
- Use the power switch to turn the power on.

Post service test

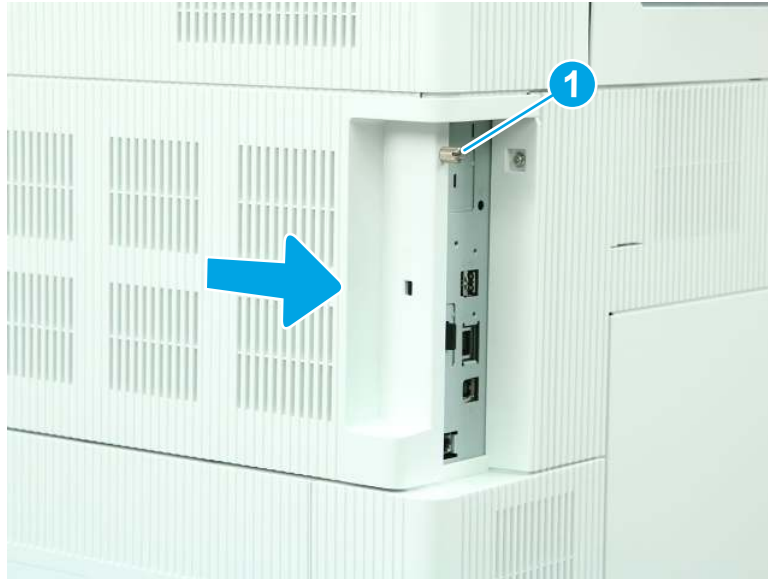
Make sure that the printer initializes to a **Ready** state.

Print a page to make sure that the printer is functioning correctly.

1. Remove the formatter cover.

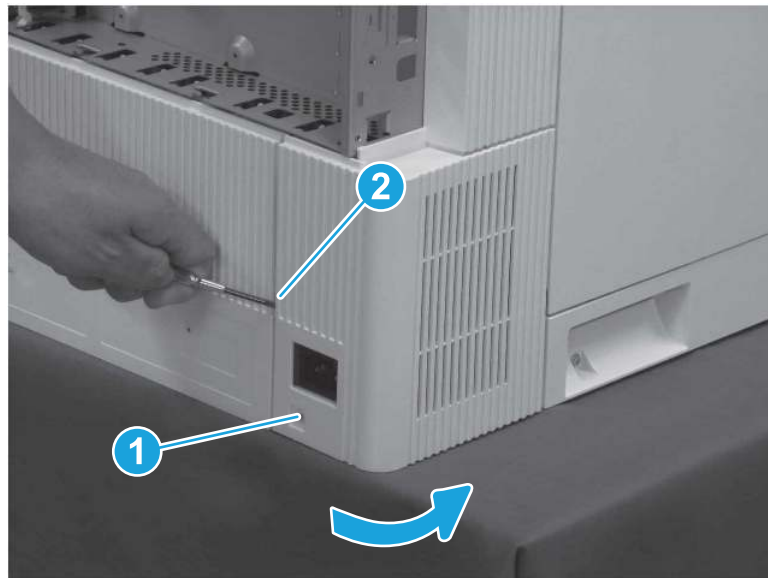
- ▲ Loosen one thumbscrew (callout 1), and then slide the formatter cover (callout 2) away from the printer to remove it.

Figure 1-2237 Remove the formatter cover



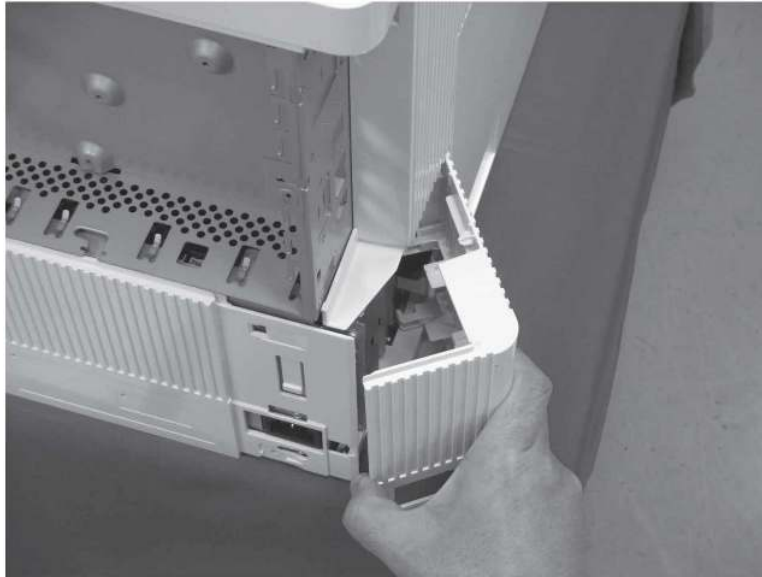
- 2. Remove the left lower cover (M751/E75245).
 - a. Remove one screw (callout 1), release one tab (callout 2), and then rotate the cover away from the printer.

Figure 1-2238 Remove one screw and release one tab



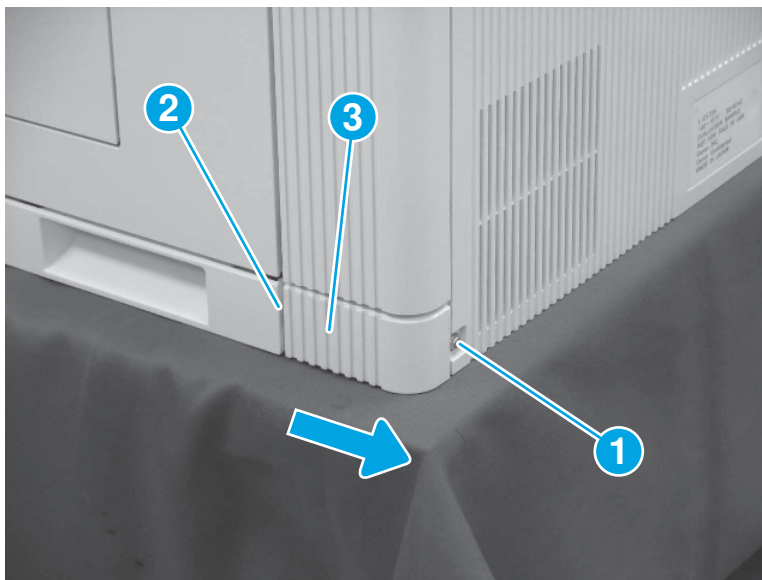
- b. Remove the left lower cover.

Figure 1-2239 Remove the left lower cover



3. Remove the right rear lower cover (M751/E75245/M856/E85055/M776).
 - ▲ Remove one screw (callout 1), release one tab (callout 2), and then slide the right rear lower cover (callout 3) toward the back of the printer to remove it.

Figure 1-2240 Remove the right rear lower cover



4. Remove the left rear cover (M751/E75245/M856/E85055/M776).

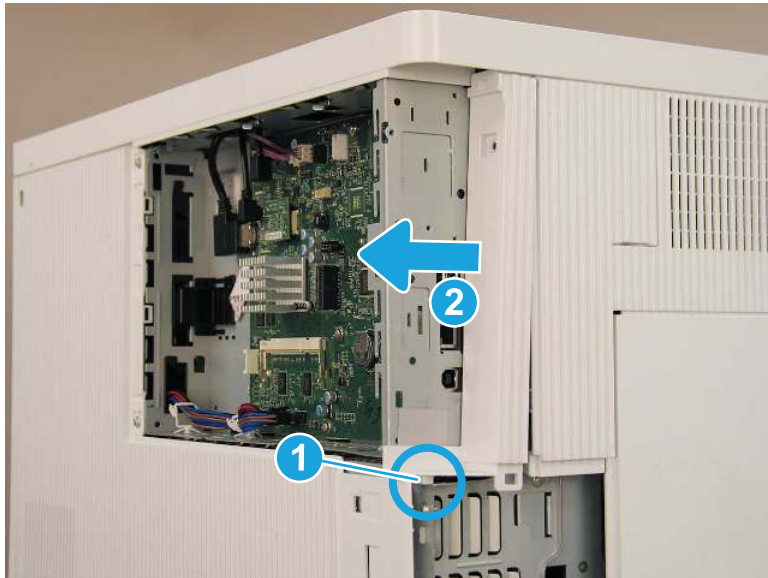
- a. Remove one screw (callout 1).

Figure 1-2241 Remove one screw



- b. Release one boss (callout 1), and then slide the cover toward the back of the printer (callout 2) to remove it.

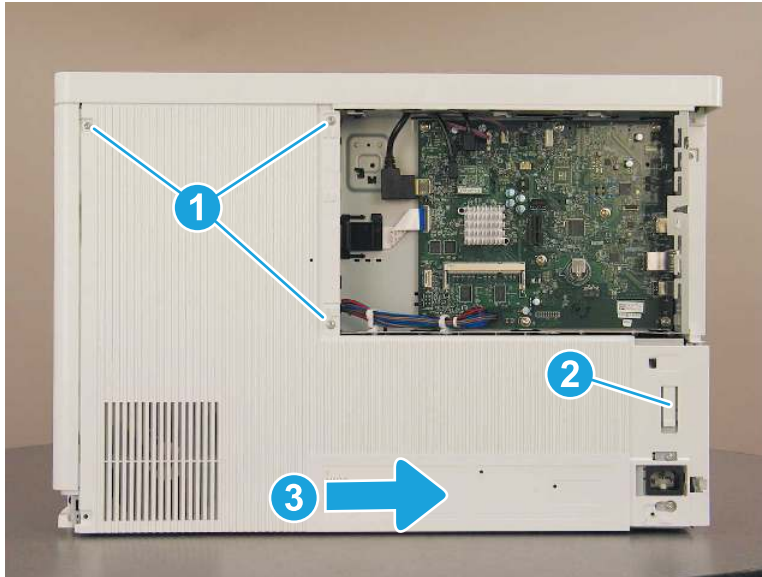
Figure 1-2242 Remove the left rear cover



5. Remove the rear cover (M751/E75245).

- ▲ Remove three screws (callout 1), release one tab (callout 2), and then slide the rear cover to the right (callout 3) to remove it.

Figure 1-2243 Remove the rear cover

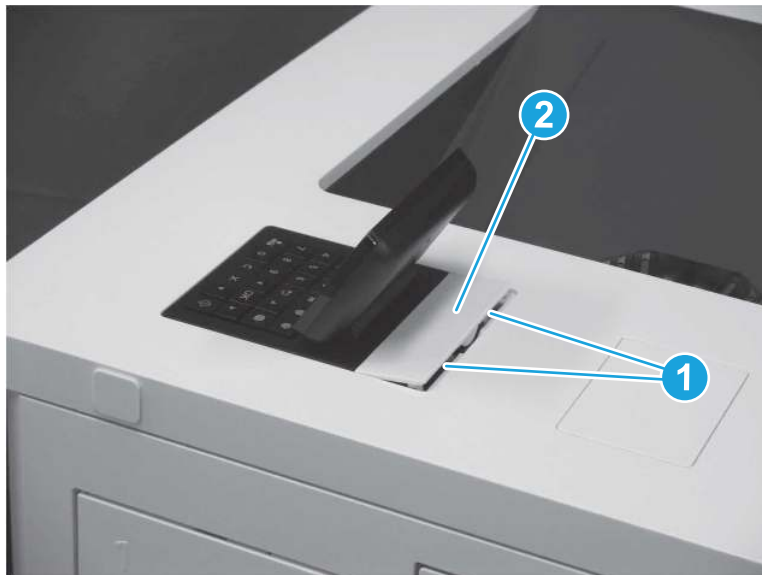


6. Remove the control panel.

 **NOTE:** A screwdriver is included in the control panel kit. The screwdriver has a reversible shaft. Simply pull the shaft out of the handle, and then reinstall it with the desired end facing out.

- a. Use a small, flat-blade screwdriver to release two tabs (callout 1), and then remove the control panel cover (callout 2).

Figure 1-2244 Remove the control panel cover



- b. Remove one screw (callout 1).

Figure 1-2245 Remove one screw



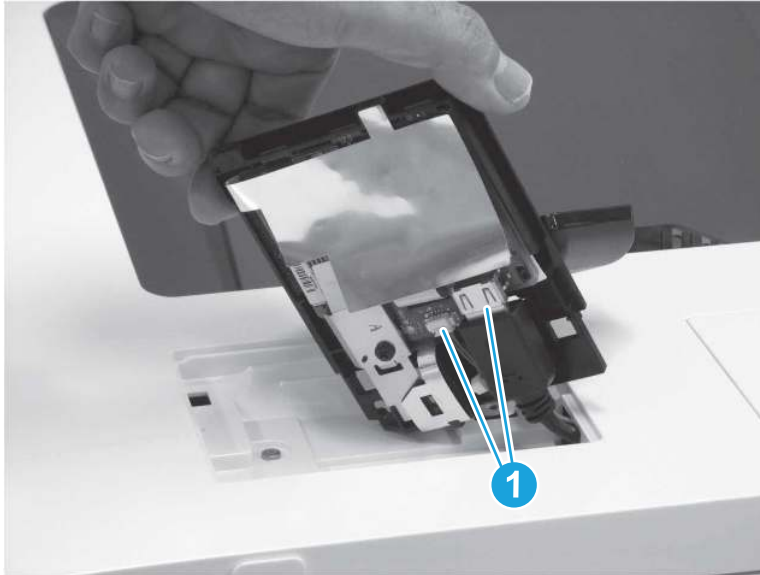
- c. Lift the back edge of the control panel up (callout 1), and then slide the control panel toward the back of the printer (callout 2).

Figure 1-2246 Slide the control panel back



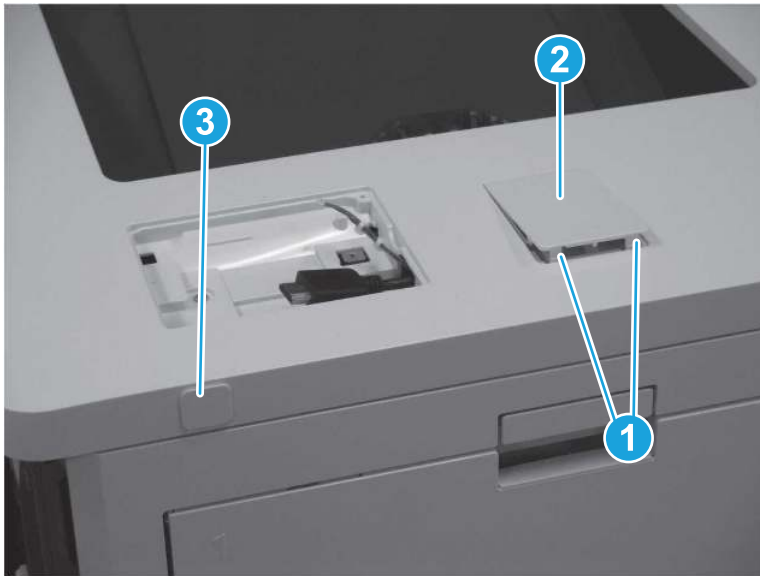
- d. Turn the control panel so that the bottom is facing up, and then disconnect two connectors (callout 1) to remove the control panel.

Figure 1-2247 Disconnect two connectors



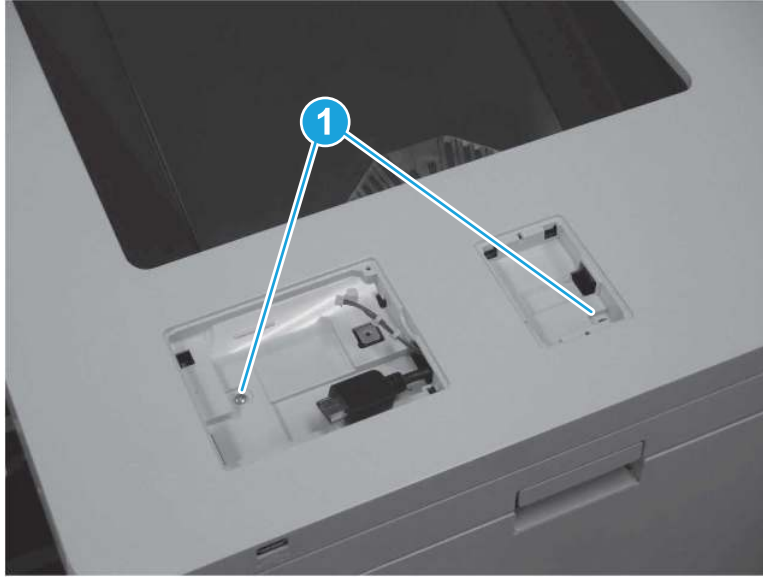
7. Remove the top cover (M751/E75245).
 - a. Release two tabs (callout 1), and then remove the HIP cover (callout 2). Pull the USB cap (callout 3) away from the printer to remove it.

Figure 1-2248 Remove the HIP cover and USB cap



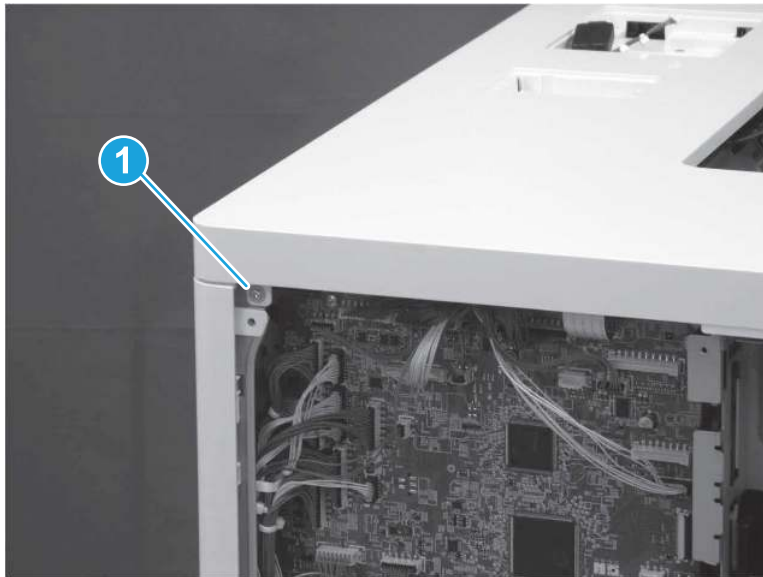
- b. At the top of the printer, remove two screws (callout 1).

Figure 1-2249 Remove two screws




- c. At the back of the printer, remove one screw (callout 1).

Figure 1-2250 Remove one screw

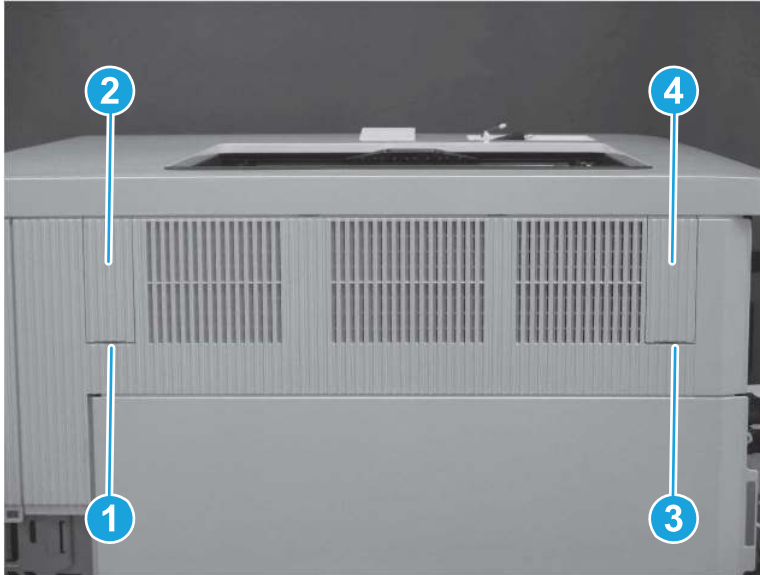


- d. Use a small, flat-blade screwdriver to release one tab (callout 1) and remove the left blanking cover (callout 2). Release one tab (callout 3) and remove the right blanking cover (callout 4).

 **TIP:** These covers are not identical. Make sure to reinstall the correct cover on the correct side.

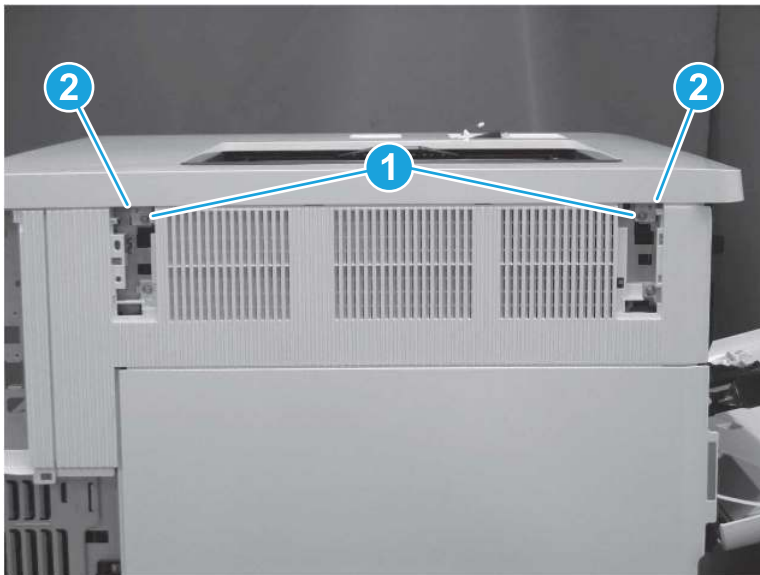
 **NOTE:** The screw under the left blanking cover is a self-tapping screw. Make sure this screw is reinstalled in the correct location.

Figure 1-2251 Remove the left and right blanking covers



- e. Remove two screws (callout 1), and then release two tabs (callout 2).

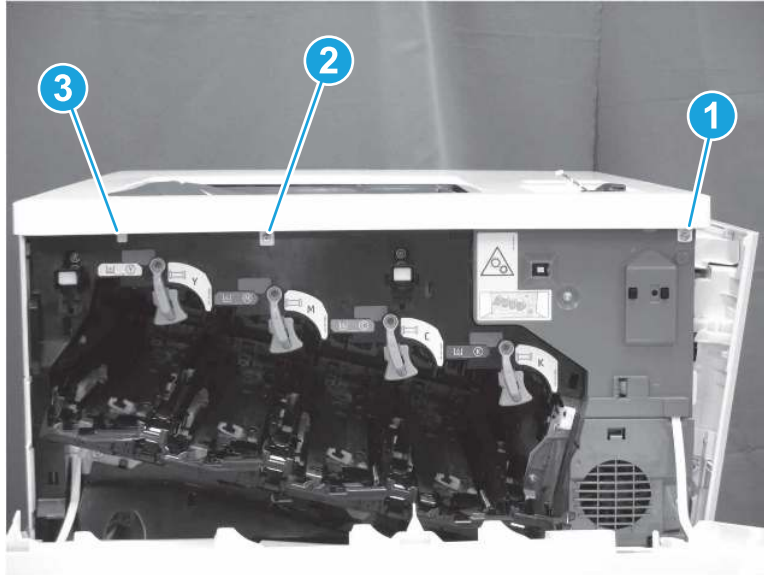
Figure 1-2252 Remove two screws and release two tabs



- f. At the front of the printer, remove one washer-head screw (callout 1) and one self-tapping screw (callout 2). Release one tab (callout 3).

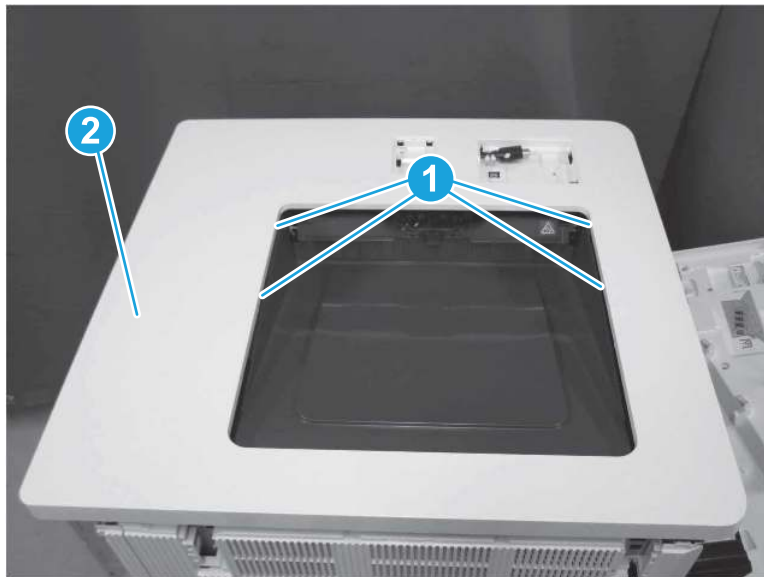
 **TIP:** Make sure to install the correct type of screw in the correct location.


Figure 1-2253 Remove two screws and release one tab



- g. At the top of the printer, release four tabs (callout 1), and then remove the top cover (callout 2).

Figure 1-2254 Remove the top cover

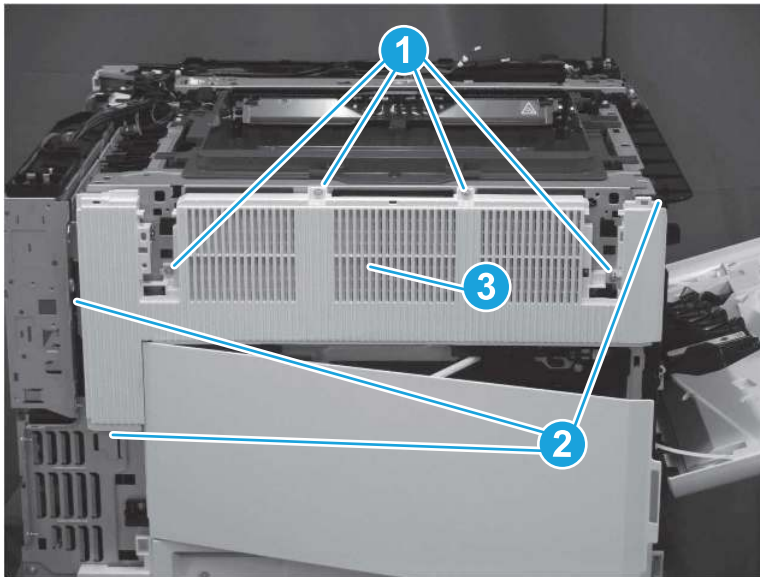


 **NOTE:** When removing the top cover, make sure to release the control panel cables (callout 1) through the opening.



8. Remove the left upper cover (M751/E75245).
 - ▲ Remove four screws (callout 1), release three tabs (callout 2), and then remove the left upper cover (callout 3).

Figure 1-2255 Remove the left upper cover



9. Remove the cartridge rear fan.
 - ▲ Disconnect one connector (callout 1), release two tabs (callout 2), and then remove the cartridge rear fan (callout 3).


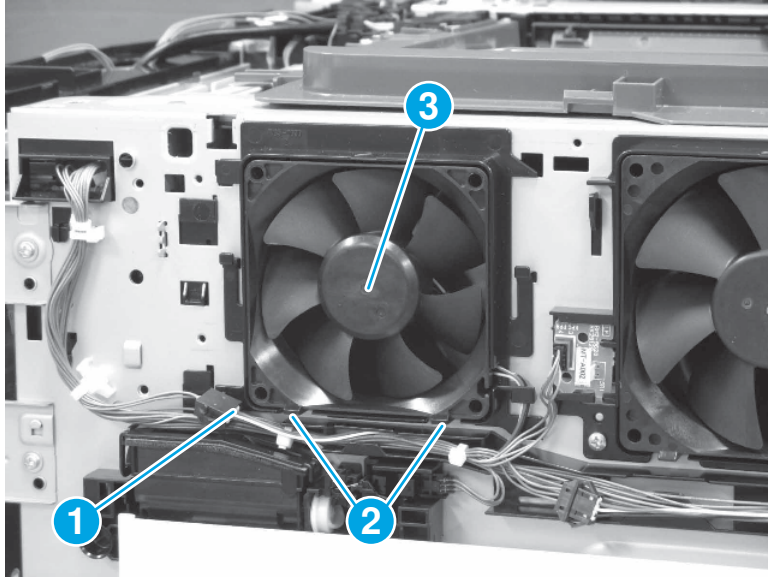
 **IMPORTANT:** When reinstalling the cartridge rear fan, make sure that the cables are installed in the guides so that the fan cover fits correctly and does not pinch any wires.

Figure 1-2256 Remove the cartridge rear fan



10. Unpack the replacement assembly.

- a. Dispose of the defective part.



NOTE: HP recommends responsible disposal of the defective part.

<http://www8.hp.com/us/en/hp-information/environment/product-recycling.html>

- b. Unpack the replacement part from the packaging.



IMPORTANT: Make sure that all of the shipping materials (for example shipping tape) are removed from the replacement part prior to installation.

- c. To install an assembly, reverse the removal steps.



NOTE: When applicable, special installation instructions are provided for an assembly at the end of the removal procedure. Always completely read the removal instructions and follow all special installation instructions.

Removal and replacement: Cartridge rear fan (M856/E85055/M776)

Learn how to remove and replace the cartridge rear fan.

[View a video of how to remove and replace the cartridge rear fan.](#)

Mean time to repair: 16 minutes

Service level: Easy

Before performing service

Turn the printer power off

- Disconnect the power cable.



WARNING! To avoid damage to the printer, turn the printer off, wait 30 seconds, and then remove the power cord before attempting to service the printer.

Use the table below to identify the correct part number for your printer. To order the part, go to www.hp.com/buy/parts.

Table 1-116 Part information

Part number	Part description
RK2-2276-000CN	Fan

Required tools

- #2 Phillips screwdriver with a magnetic tip
- Small, flat-blade screwdriver

After performing service

Turn the printer power on

- Connect the power cable.
- Use the power switch to turn the power on.

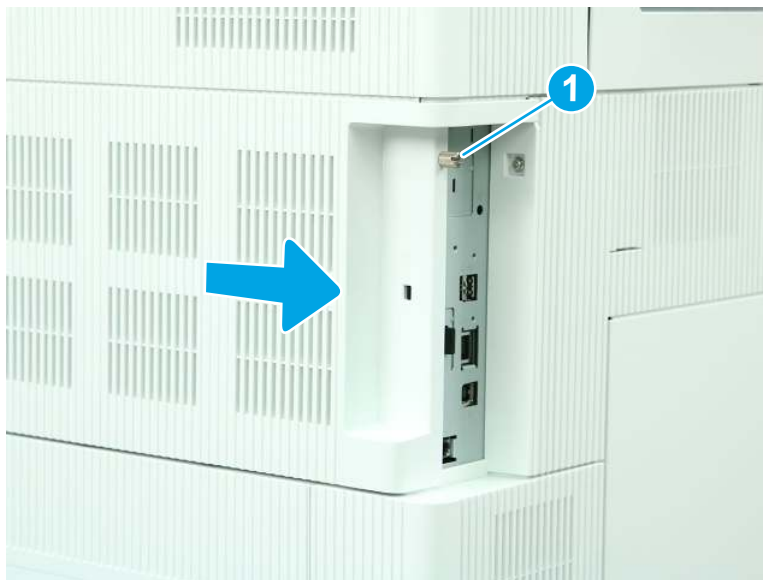
Post service test

Make sure that the printer initializes to a **Ready** state.

Print a page to make sure that the printer is functioning correctly.

1. Remove the formatter cover.
 - ▲ Loosen one thumbscrew (callout 1), and then slide the formatter cover (callout 2) away from the printer to remove it.

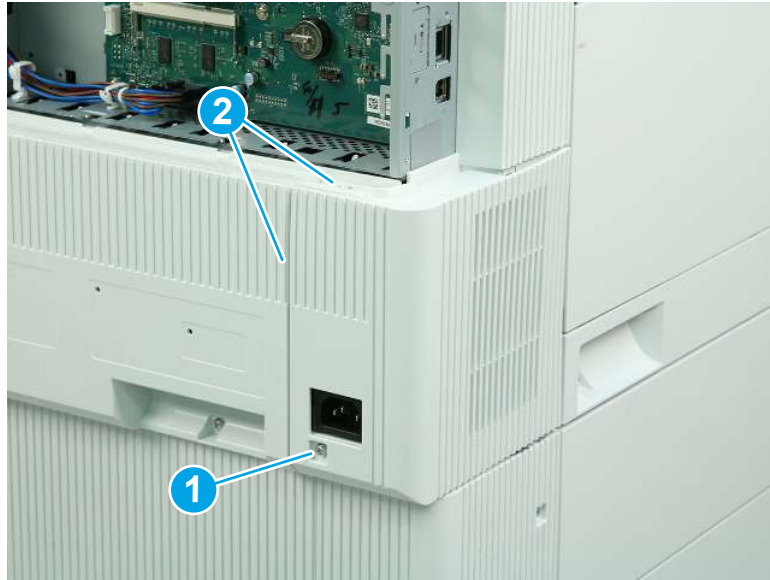
Figure 1-2257 Remove the formatter cover



2. Remove the left lower cover (M856/E85055/M776).

- a. Remove one screw (callout 1), and then release two tabs (callout 2).

Figure 1-2258 Remove one screw and release two tabs



- b. Rotate the cover away from the printer to remove it.

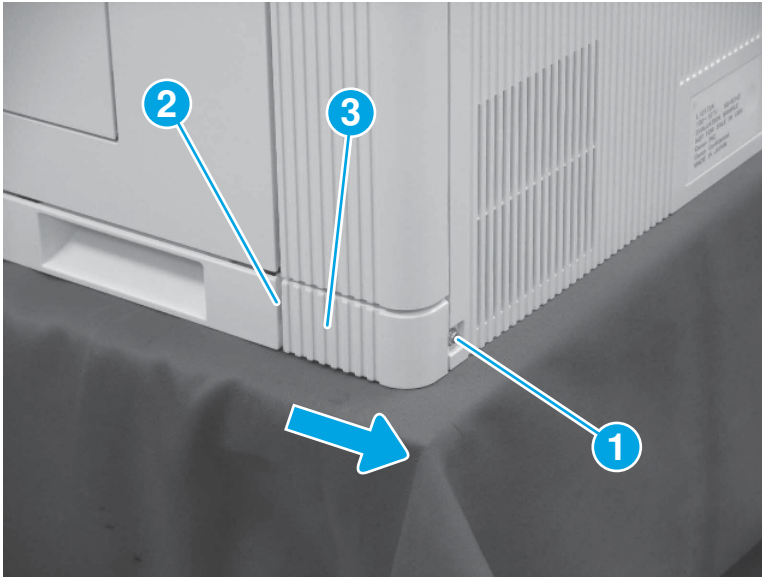
Figure 1-2259 Remove the left lower cover



3. Remove the right rear lower cover (M751/E75245/M856/E85055/M776).

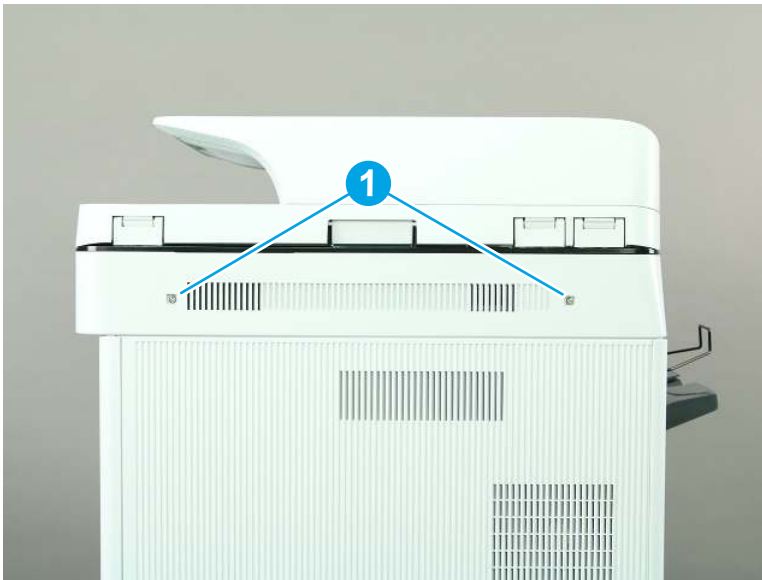
- ▲ Remove one screw (callout 1), release one tab (callout 2), and then slide the right rear lower cover (callout 3) toward the back of the printer to remove it.

Figure 1-2260 Remove the right rear lower cover



- 4. Remove the scanner control board (SCB) cover (M776).
 - a. Remove two screws (callout 1).

Figure 1-2261 Remove two screws



- b. Remove the SCB cover.

Figure 1-2262 Remove the SCB cover

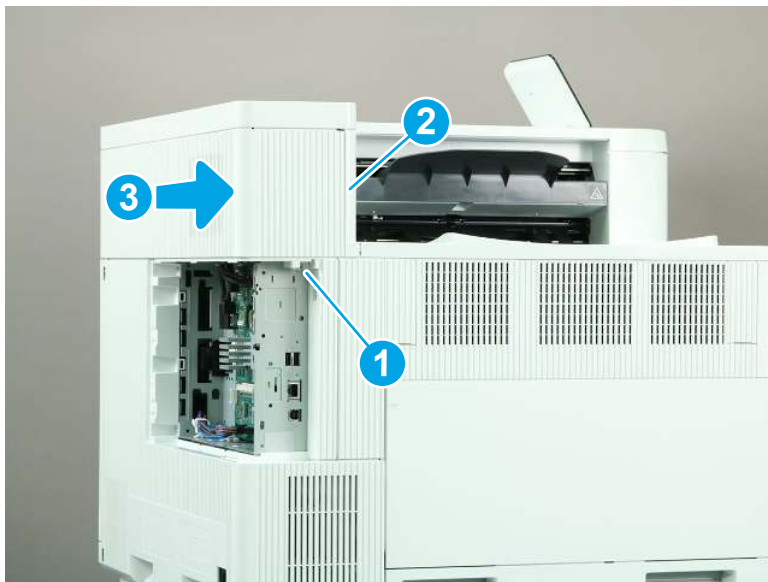


5. Remove the rear upper cover (M856/E85055/M776dn/M776z).

 **NOTE:** The following figure shows the M856 printer. The procedure is correct for all referenced models.

- ▲ Remove one screw (callout 1), release one tab (callout 2), and then slide the rear upper cover away from the printer to remove it (callout 3).

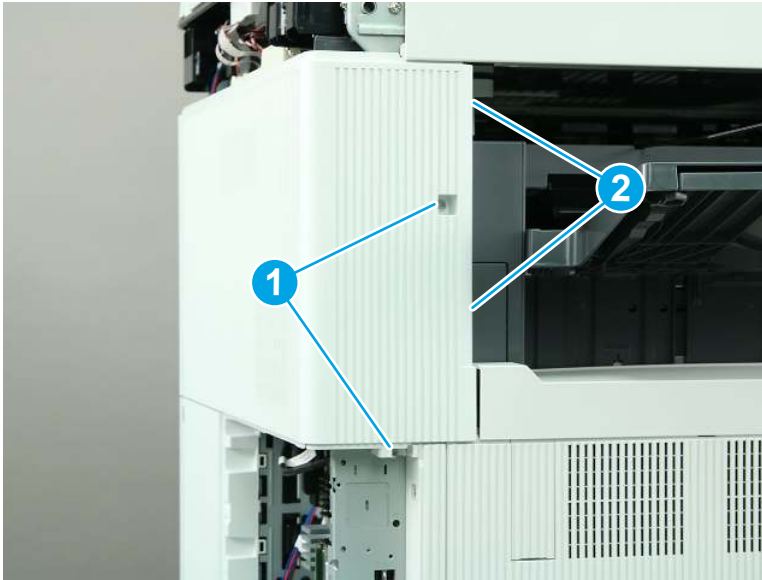
Figure 1-2263 Remove the rear upper cover



6. Remove the rear upper cover and left rear upper cover (M776zs).

- a. Remove two screws (callout 1), and then release two tabs (callout 2).

Figure 1-2264 Remove two screws and release two tabs



- b. Slide the cover to the right to remove it.

Figure 1-2265 Remove the rear upper and left rear upper cover



7. Remove the left rear cover (M751/E75245/M856/E85055/M776).

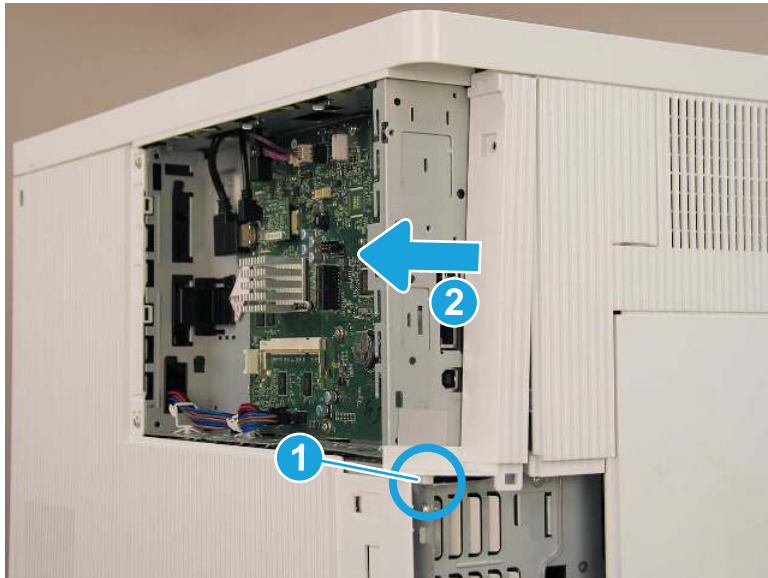
- a. Remove one screw (callout 1).

Figure 1-2266 Remove one screw



- b. Release one boss (callout 1), and then slide the cover toward the back of the printer (callout 2) to remove it.

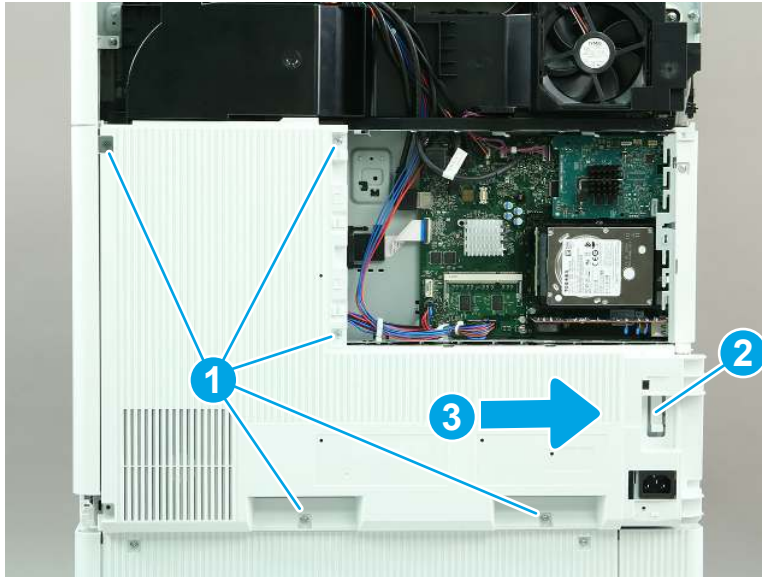
Figure 1-2267 Remove the left rear cover



8. Remove the rear cover (M856/E85055/M776).

- ▲ Remove five screws (callout 1), release one tab (callout 2), and then slide the rear cover to the right to remove it.

Figure 1-2268 Remove the rear cover (M856/E85055/M776)



9. **M856/E85055 only:** Remove the control panel and top cover.

 **NOTE:** This step applies to only the M856/E85055 models. Skip this step for all other models.

- a. Use a small, flat-blade screwdriver to release two tabs (callout 1), and then remove the control panel cover (callout 2).

Figure 1-2269 Remove the control panel cover



- b. Remove one screw (callout 1).

Figure 1-2270 Remove one screw



- c. Lift the back edge of the control panel up (callout 1), and then slide the control panel toward the back of the printer (callout 2).

Figure 1-2271 Slide the control panel back



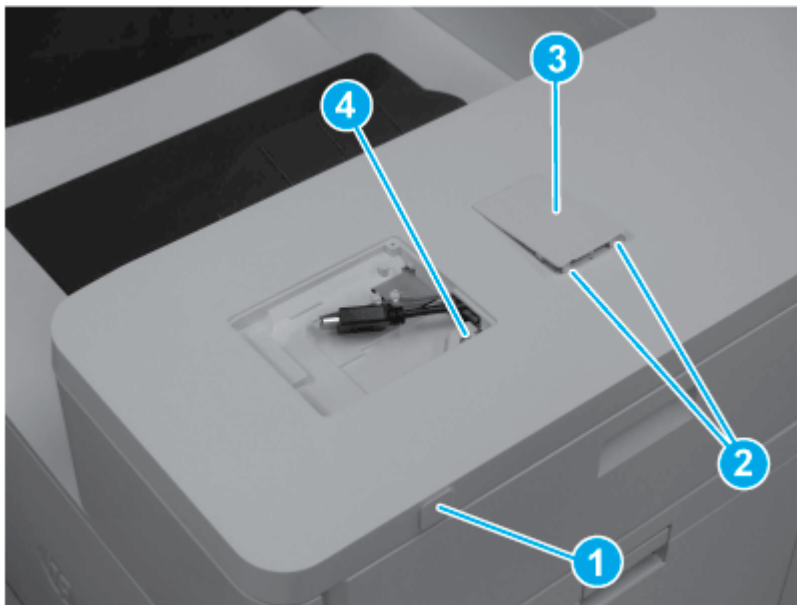
- d. Turn the control panel so that the bottom is facing up, and then disconnect two connectors to remove the control panel.

Figure 1-2272 Disconnect two connectors



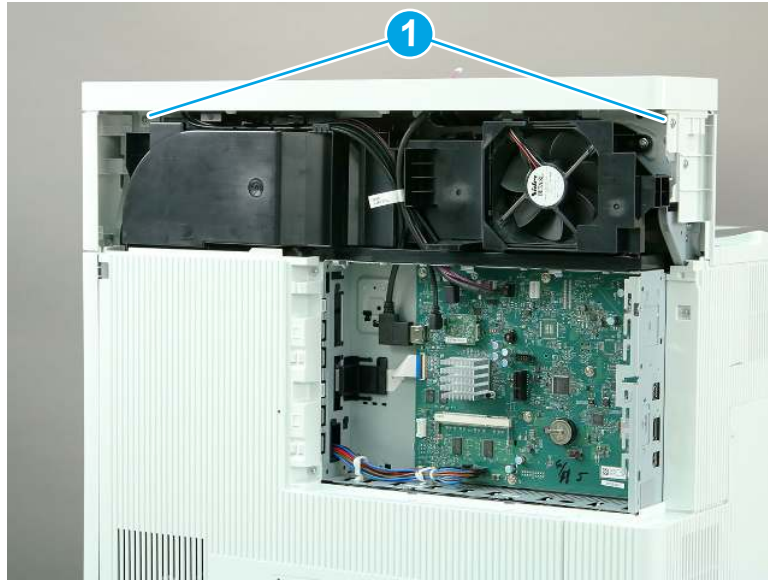
- e. Remove the USB cover (callout 1). Release two tabs (callout 2), and then remove the HIP cover (callout 3). Remove one screw (callout 4).

Figure 1-2273 Remove covers and one screw



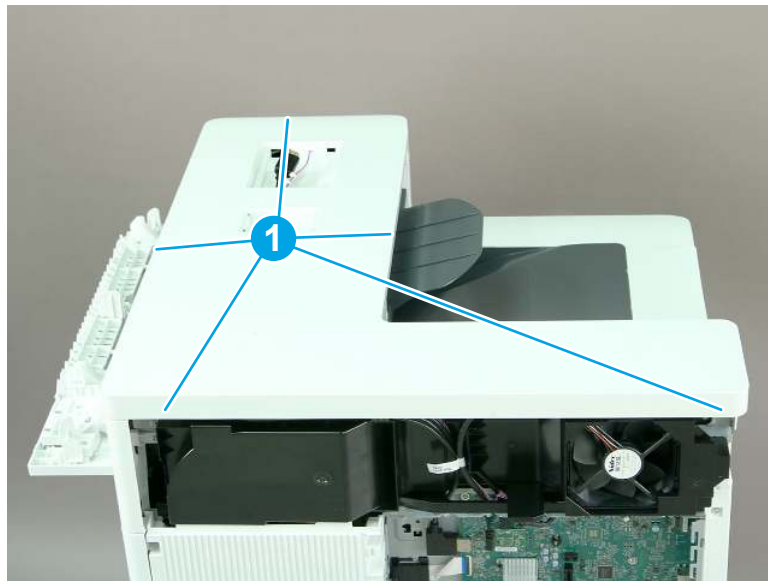
- f. Remove two screws (callout 1).

Figure 1-2274 Remove two screws



- g. Release five tabs (callout 1), and then remove the top cover.

Figure 1-2275 Release five tabs

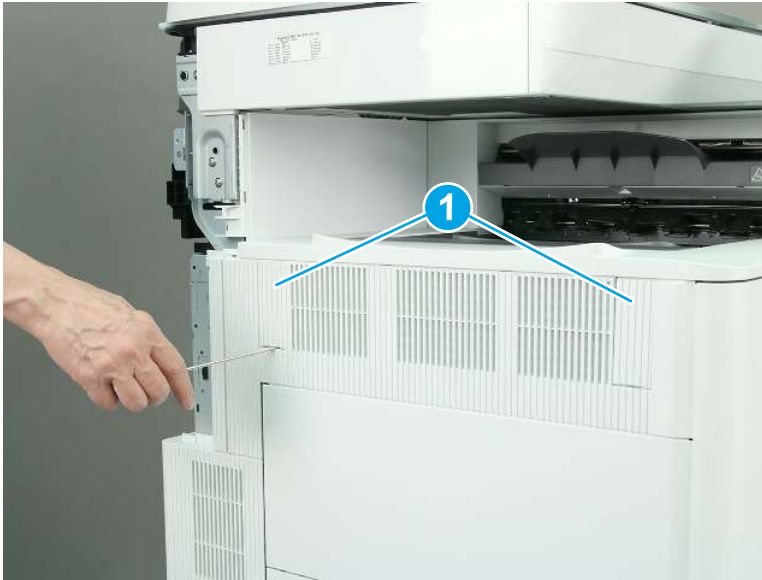


- 10. Remove the accessory upper cover (M856/E85055/M776dn/M776z).

 **NOTE:** The following figures show the M776z printer. The procedure is correct for all referenced models.

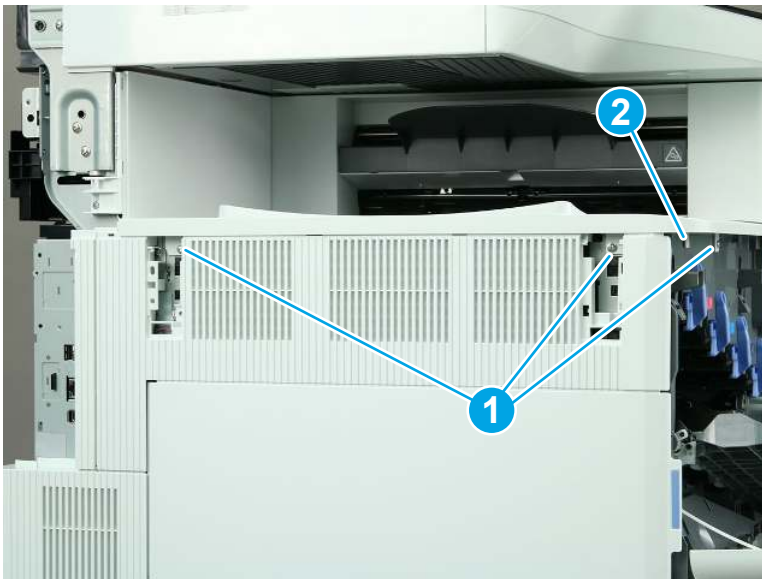
- a. Use a small, flat-blade screwdriver to remove two covers (callout 1).

Figure 1-2276 Remove two covers



- b. Remove three screws (callout 1), and then release one tab (callout 2).

Figure 1-2277 Remove three screws and release one tab



- c. Slide the accessory upper cover away from the printer to remove it.

Figure 1-2278 Remove the accessory upper cover

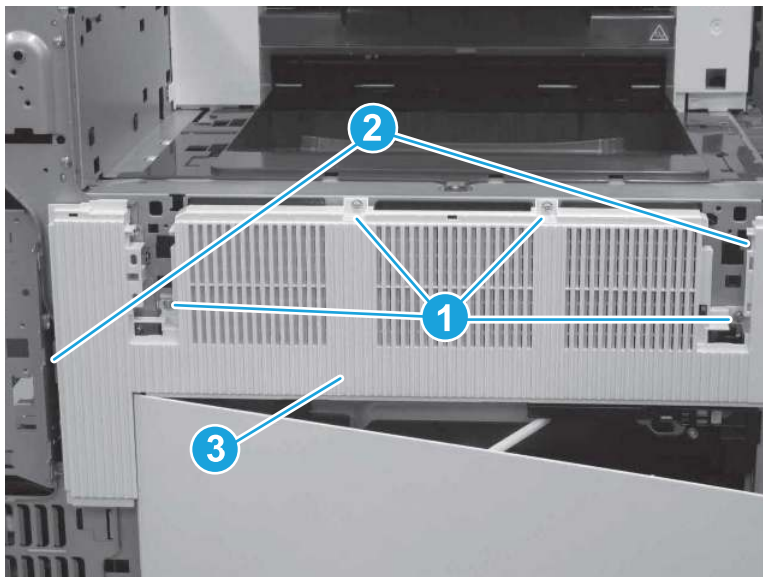


- 11. Remove the left upper cover (M856/E85055/M776).

 **NOTE:** The following figures show the M776z printer. The procedure is correct for all referenced models.

- ▲ Remove four screws (callout 1), release two tabs (callout 2), and then remove the left upper cover (callout 3).

Figure 1-2279 Remove the left upper cover



- 12. Remove the cartridge rear fan.

- ▲ Disconnect one connector (callout 1), release two tabs (callout 2), and then remove the cartridge rear fan (callout 3).


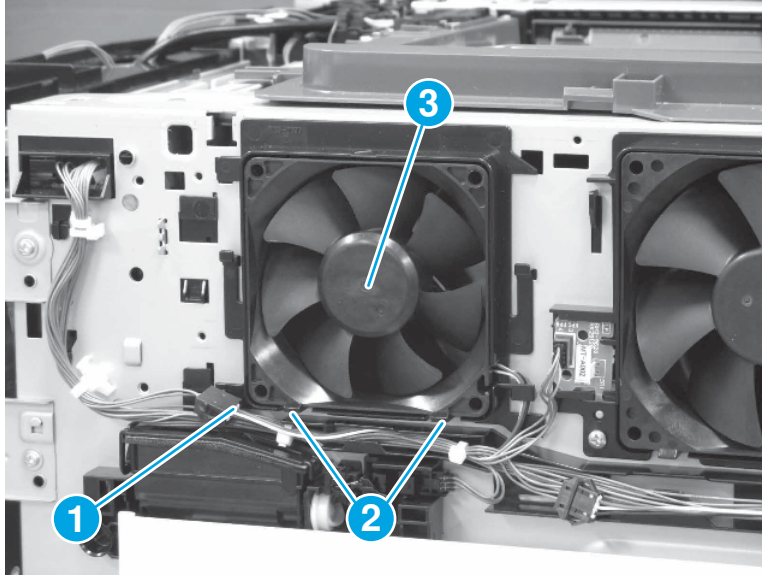
 **IMPORTANT:** When reinstalling the cartridge rear fan, make sure that the cables are installed in the guides so that the fan cover fits correctly and does not pinch any wires.

Figure 1-2280 Remove the cartridge rear fan




13. Unpack the replacement assembly.
 - a. Dispose of the defective part.


 **NOTE:** HP recommends responsible disposal of the defective part.

<http://www8.hp.com/us/en/hp-information/environment/product-recycling.html>

- b. Unpack the replacement part from the packaging.

 **IMPORTANT:** Make sure that all of the shipping materials (for example shipping tape) are removed from the replacement part prior to installation.

- c. To install an assembly, reverse the removal steps.

 **NOTE:** When applicable, special installation instructions are provided for an assembly at the end of the removal procedure. Always completely read the removal instructions and follow all special installation instructions.

Removal and replacement: Cartridge upper guide (M751/E75245)

Learn how to remove and replace the cartridge upper guide.

[View a video of how to remove and replace the cartridge upper guide.](#)

Mean time to repair: 10 minutes

Service level: Medium

Before performing service

Turn the printer power off

- Disconnect the power cable.

⚠ WARNING! To avoid damage to the printer, turn the printer off, wait 30 seconds, and then remove the power cord before attempting to service the printer.

Use the table below to identify the correct part number for your printer. To order the part, go to www.hp.com/buy/parts.

Table 1-117 Part information

Part number	Part description
RM2-1343-000CN	Cartridge upper guide assembly

Required tools

- #2 Phillips screwdriver with a magnetic tip
- Small, flat-blade screwdriver

After performing service

Turn the printer power on

- Connect the power cable.
- Use the power switch to turn the power on.

Post service test

Make sure that the printer initializes to a **Ready** state.

Print a page to make sure that the printer is functioning correctly.

1. Remove the toner cartridges.

- ▲ Open the front door, if it is not already open. Grasp the handle of the toner cartridge and pull out to remove it. Repeat the process for the remaining toner cartridges.

Figure 1-2281 Remove the toner cartridge



- 2. Remove the imaging drums.

- a. Open the front door, if it is not already open. Rotate the blue lever in front of the imaging drum to the left.

Figure 1-2282 Rotate the blue lever



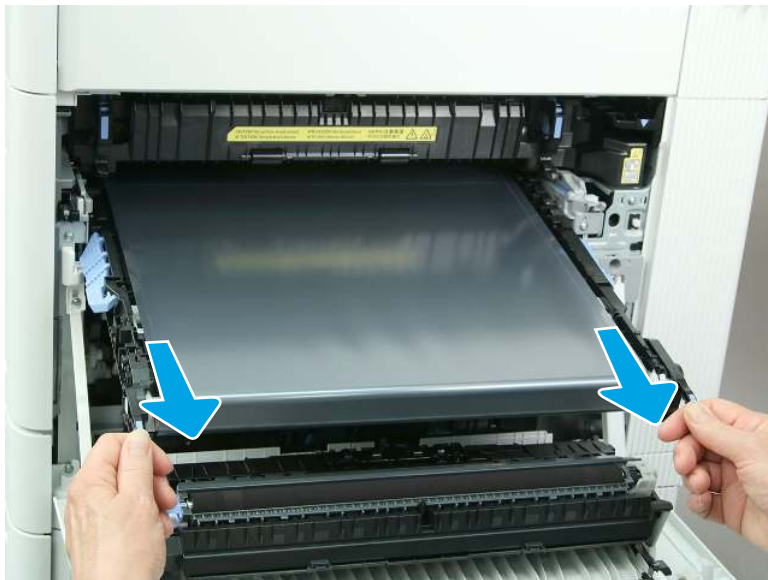
- b. Grasp the handle of the imaging drum and pull out to remove it. Repeat the process for the remaining imaging drums.

Figure 1-2283 Remove the imaging drum



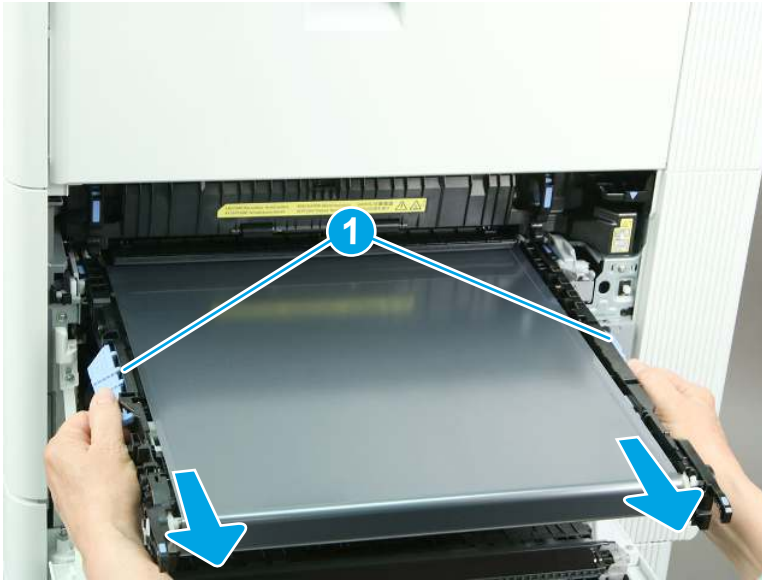
3. Remove the intermediate transfer belt (ITB).
 - a. Open the right door. Grasp the two blue handles on the ITB, and then pull the ITB partially out of the printer.

Figure 1-2284 Partially remove the ITB



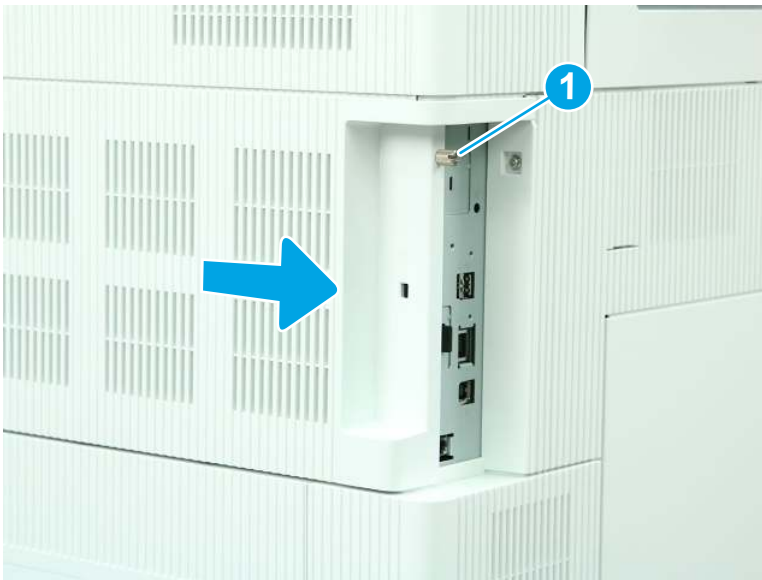
- b. Grasp the blue handles on the side of the ITB (callout 1), and then remove the ITB from the printer.

Figure 1-2285 Remove the ITB



4. Remove the formatter cover.
 - ▲ Loosen one thumbscrew (callout 1), and then slide the formatter cover (callout 2) away from the printer to remove it.

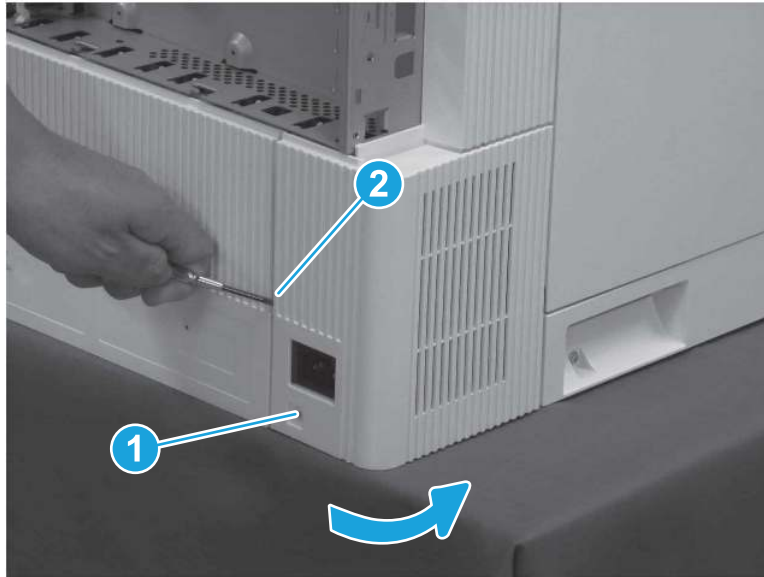
Figure 1-2286 Remove the formatter cover



5. Remove the left lower cover (M751/E75245).

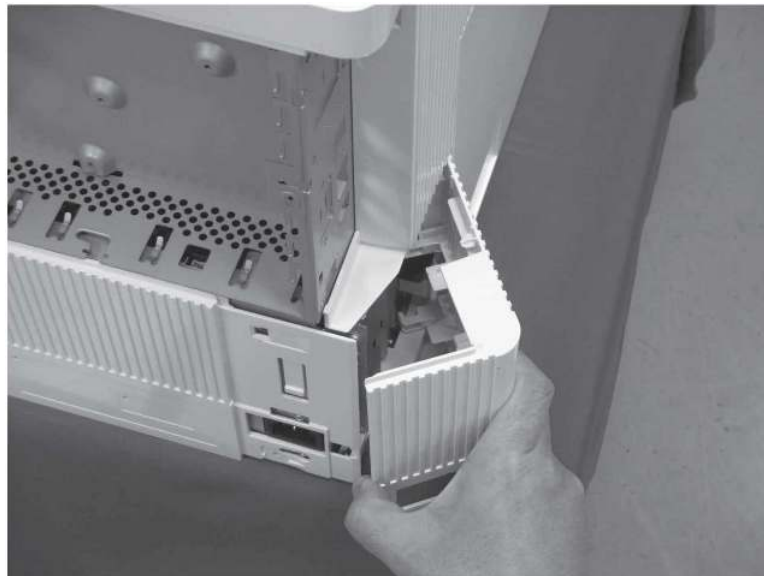
- a. Remove one screw (callout 1), release one tab (callout 2), and then rotate the cover away from the printer.

Figure 1-2287 Remove one screw and release one tab



- b. Remove the left lower cover.

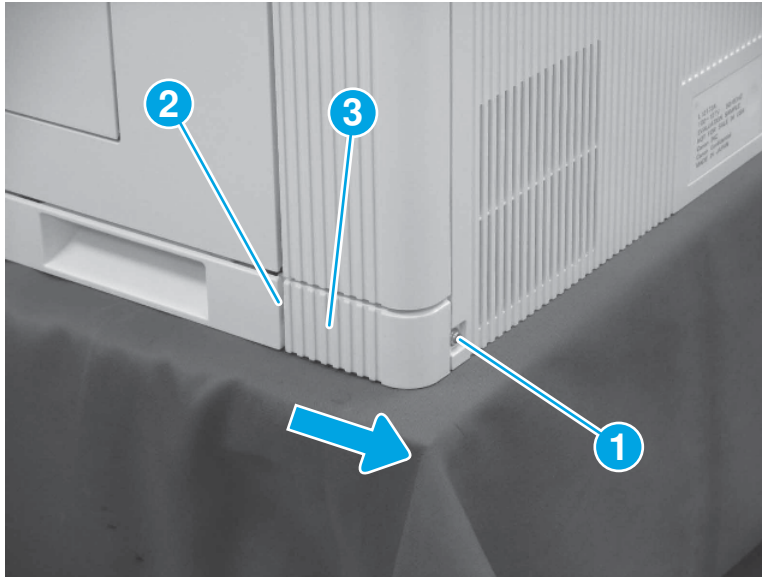
Figure 1-2288 Remove the left lower cover



6. Remove the right rear lower cover (M751/E75245/M856/E85055/M776).

- ▲ Remove one screw (callout 1), release one tab (callout 2), and then slide the right rear lower cover (callout 3) toward the back of the printer to remove it.

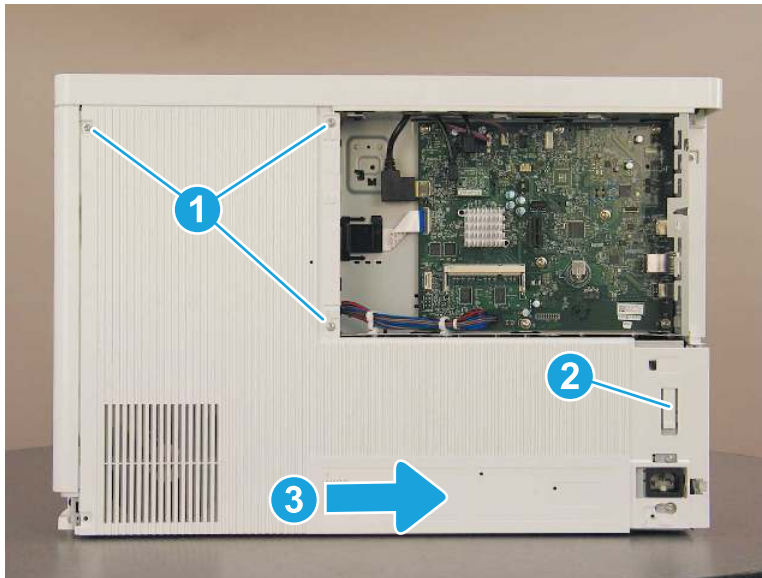
Figure 1-2289 Remove the right rear lower cover



7. Remove the rear cover (M751/E75245).

- ▲ Remove three screws (callout 1), release one tab (callout 2), and then slide the rear cover to the right (callout 3) to remove it.

Figure 1-2290 Remove the rear cover

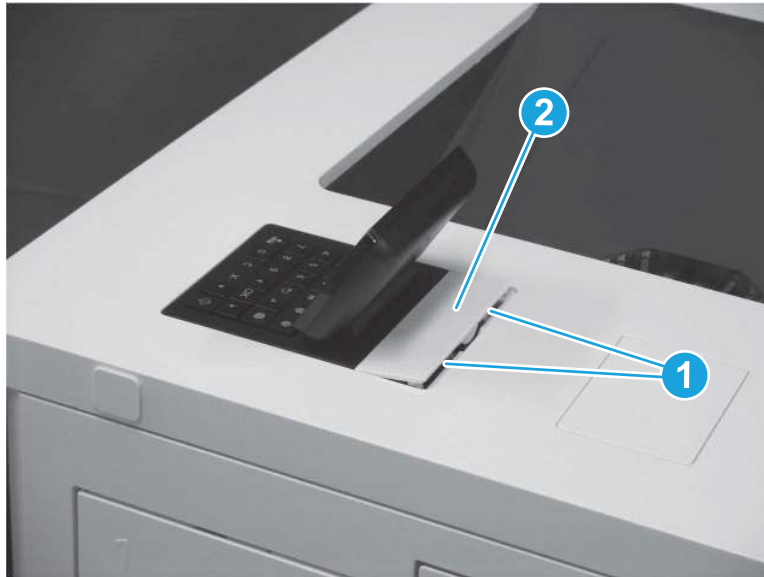


8. Remove the control panel.

 **NOTE:** A screwdriver is included in the control panel kit. The screwdriver has a reversible shaft. Simply pull the shaft out of the handle, and then reinstall it with the desired end facing out.

- a. Use a small, flat-blade screwdriver to release two tabs (callout 1), and then remove the control panel cover (callout 2).

Figure 1-2291 Remove the control panel cover



- b. Remove one screw (callout 1).

Figure 1-2292 Remove one screw



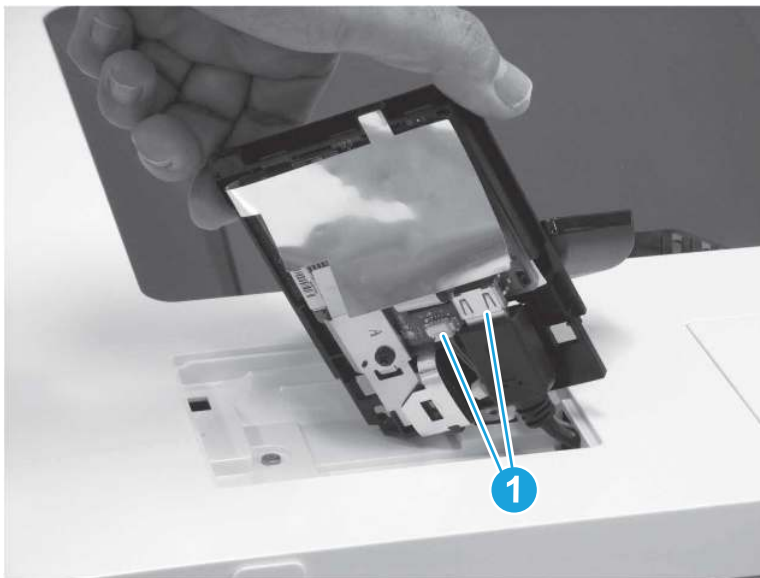
- c. Lift the back edge of the control panel up (callout 1), and then slide the control panel toward the back of the printer (callout 2).

Figure 1-2293 Slide the control panel back



- d. Turn the control panel so that the bottom is facing up, and then disconnect two connectors (callout 1) to remove the control panel.

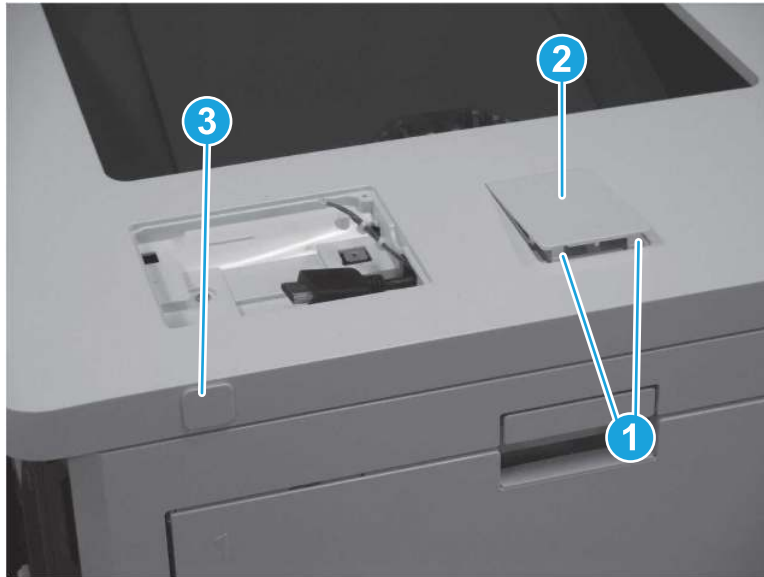
Figure 1-2294 Disconnect two connectors



9. Remove the top cover (M751/E75245).

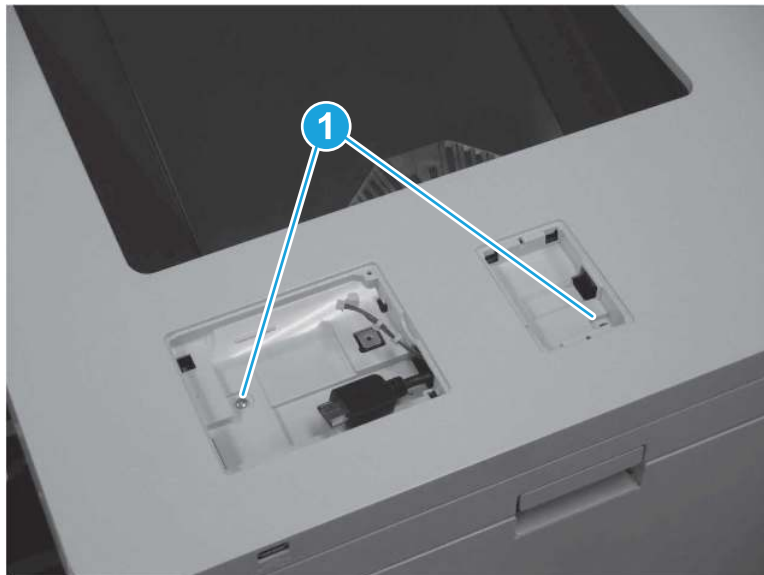
- a. Release two tabs (callout 1), and then remove the HIP cover (callout 2). Pull the USB cap (callout 3) away from the printer to remove it.

Figure 1-2295 Remove the HIP cover and USB cap



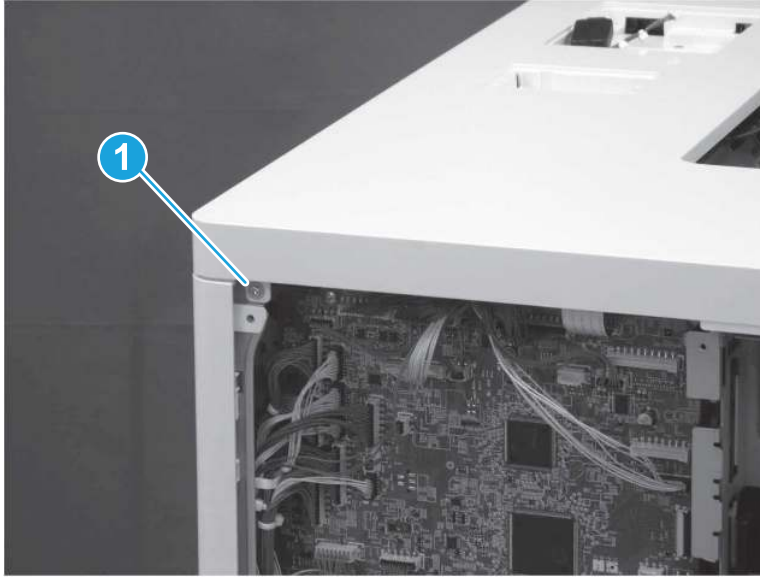
- b. At the top of the printer, remove two screws (callout 1).

Figure 1-2296 Remove two screws




- c. At the back of the printer, remove one screw (callout 1).

Figure 1-2297 Remove one screw

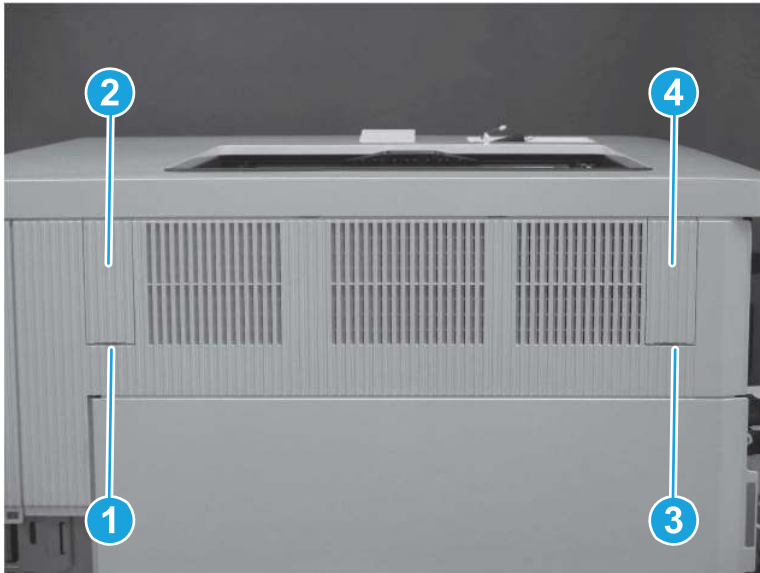


- d. Use a small, flat-blade screwdriver to release one tab (callout 1) and remove the left blanking cover (callout 2). Release one tab (callout 3) and remove the right blanking cover (callout 4).

 **TIP:** These covers are not identical. Make sure to reinstall the correct cover on the correct side.

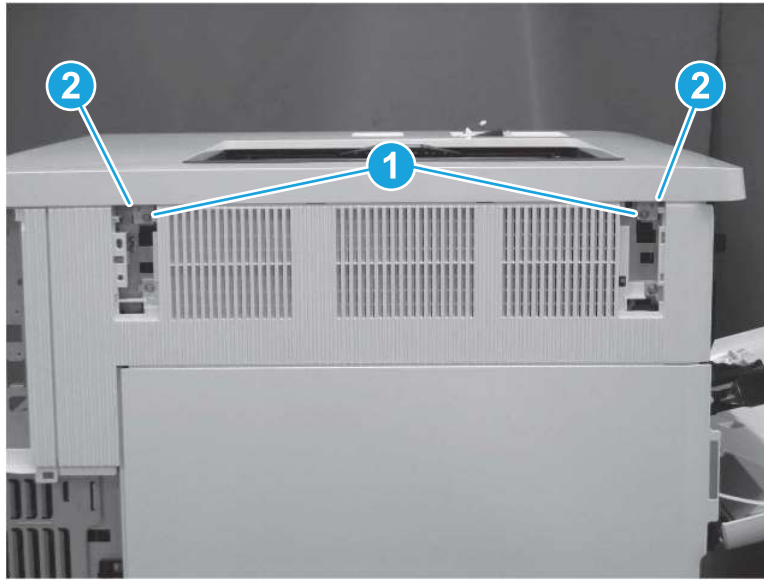
 **NOTE:** The screw under the left blanking cover is a self-tapping screw. Make sure this screw is reinstalled in the correct location.

Figure 1-2298 Remove the left and right blanking covers



- e. Remove two screws (callout 1), and then release two tabs (callout 2).

Figure 1-2299 Remove two screws and release two tabs



- f. At the front of the printer, remove one washer-head screw (callout 1) and one self-tapping screw (callout 2). Release one tab (callout 3).


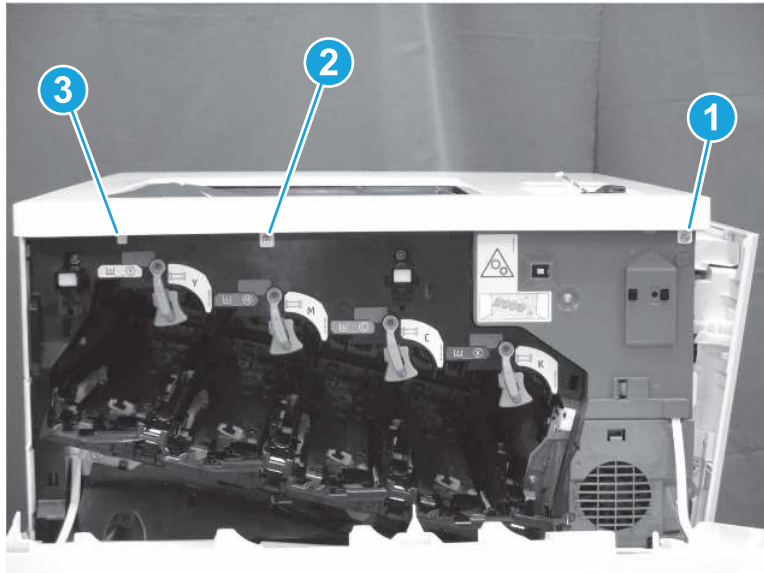
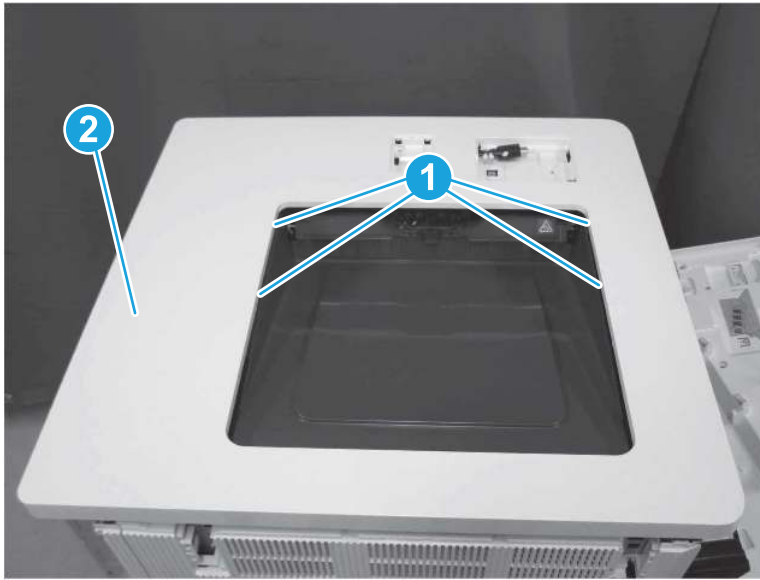
 **TIP:** Make sure to install the correct type of screw in the correct location.

Figure 1-2300 Remove two screws and release one tab

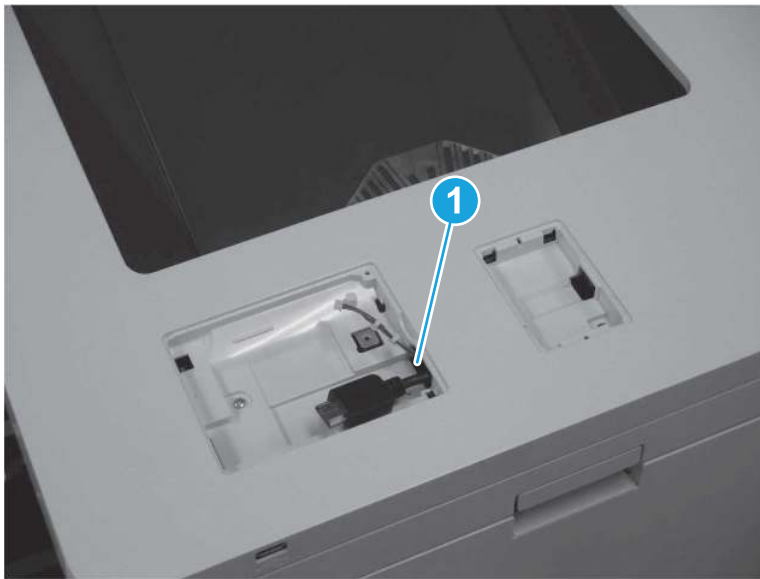


- g. At the top of the printer, release four tabs (callout 1), and then remove the top cover (callout 2).

Figure 1-2301 Remove the top cover



-  **NOTE:** When removing the top cover, make sure to release the control panel cables (callout 1) through the opening.

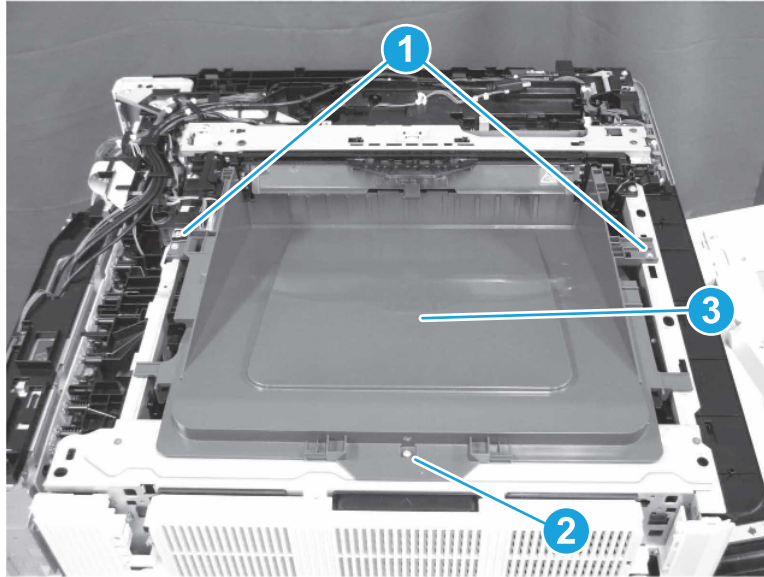


10. Remove the output bin (M751/E75245).

- ▲ Remove two washer-head machine screws (callout 1), remove one self-tapping screw (callout 2), and then remove the output bin (callout 3).

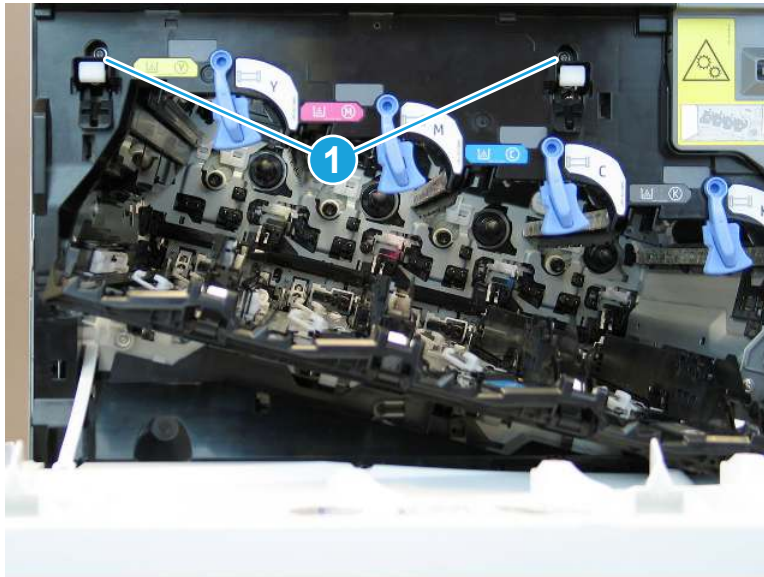
-  **NOTE:** When reinstalling the output bin, make sure to install the correct type of screw in the correct location.

Figure 1-2302 Remove the output bin



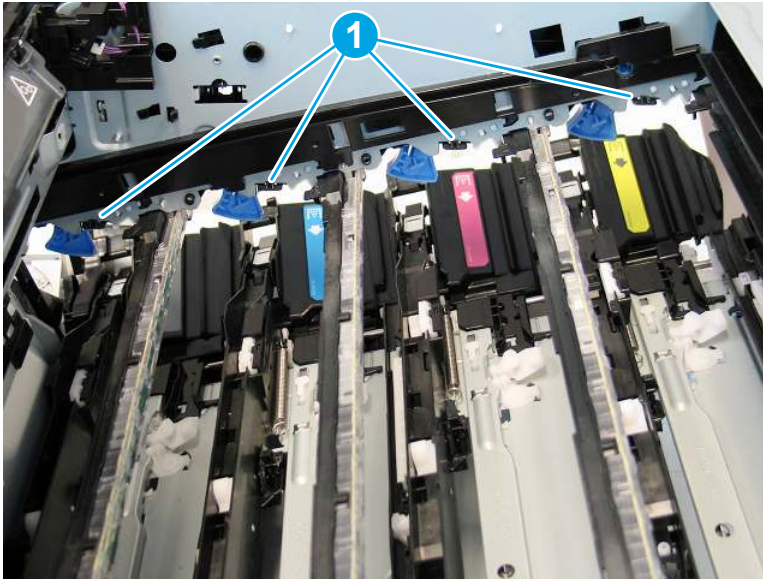
11. Remove the cartridge upper guide.
 - a. Remove two screws (callout 1).

Figure 1-2303 Remove two screws



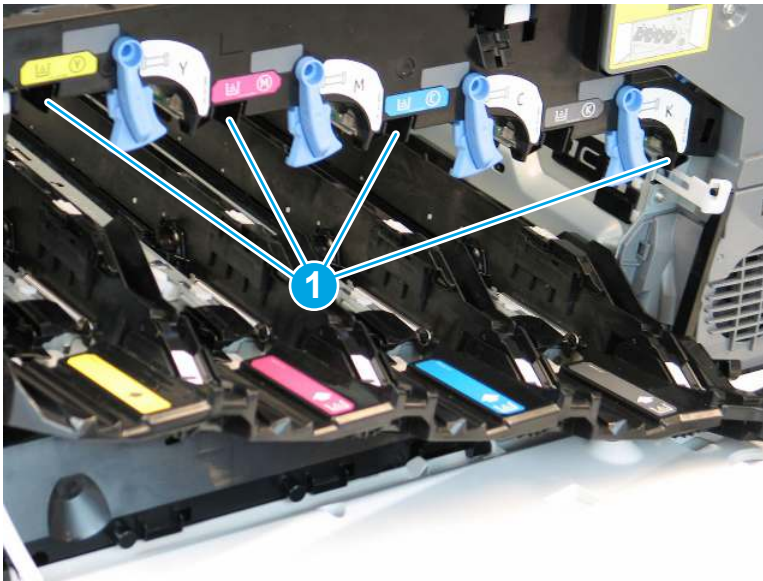
- b. Inside the printer, release four tabs (callout 1) on the back side of the cartridge guide.

Figure 1-2304 Release four tabs



- c. Release four tabs (callout 1), and then remove the cartridge upper guide.

Figure 1-2305 Release four tabs



- 12. Unpack the replacement assembly.


- a. Dispose of the defective part.




NOTE: HP recommends responsible disposal of the defective part.

<http://www8.hp.com/us/en/hp-information/environment/product-recycling.html>

- b. Unpack the replacement part from the packaging.

 **IMPORTANT:** Make sure that all of the shipping materials (for example shipping tape) are removed from the replacement part prior to installation.

- c. To install an assembly, reverse the removal steps.

 **NOTE:** When applicable, special installation instructions are provided for an assembly at the end of the removal procedure. Always completely read the removal instructions and follow all special installation instructions.

Removal and replacement: Cartridge upper guide (M856/E85055/M776dn/M776z)

Learn how to remove and replace the cartridge upper guide.

[View a video of how to remove and replace the cartridge upper guide.](#)


Mean time to repair: 10 minutes

Service level: Medium

Before performing service

Turn the printer power off

- Disconnect the power cable.

 **WARNING!** To avoid damage to the printer, turn the printer off, wait 30 seconds, and then remove the power cord before attempting to service the printer.

Use the table below to identify the correct part number for your printer. To order the part, go to www.hp.com/buy/parts.

Table 1-118 Part information

Part number	Part description
RM2-1343-000CN	Cartridge upper guide assembly

Required tools

- #2 Phillips screwdriver with a magnetic tip
- Small, flat-blade screwdriver

After performing service

Turn the printer power on

- Connect the power cable.
- Use the power switch to turn the power on.

Post service test

Make sure that the printer initializes to a **Ready** state.

Print a page to make sure that the printer is functioning correctly.

1. Remove the toner cartridges.

- ▲ Open the front door, if it is not already open. Grasp the handle of the toner cartridge and pull out to remove it. Repeat the process for the remaining toner cartridges.

Figure 1-2306 Remove the toner cartridge



2. Remove the imaging drums.

- a. Open the front door, if it is not already open. Rotate the blue lever in front of the imaging drum to the left.

Figure 1-2307 Rotate the blue lever



- b. Grasp the handle of the imaging drum and pull out to remove it. Repeat the process for the remaining imaging drums.

Figure 1-2308 Remove the imaging drum



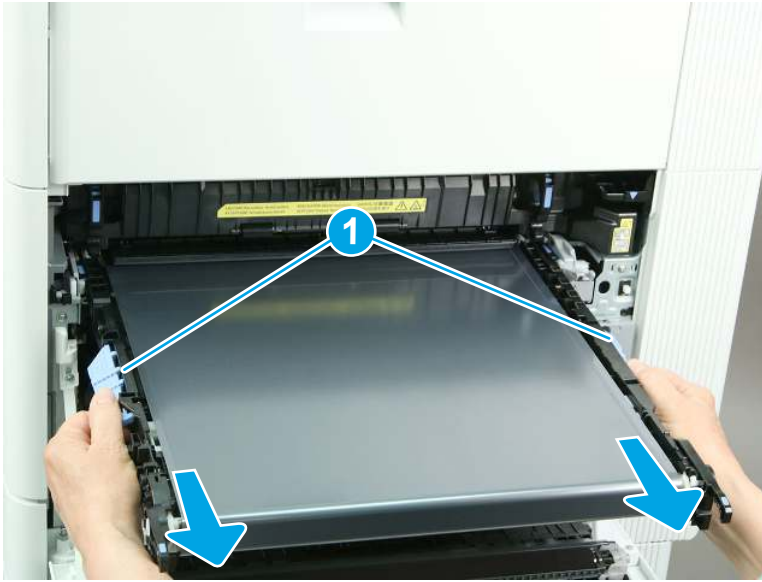
3. Remove the intermediate transfer belt (ITB).
 - a. Open the right door. Grasp the two blue handles on the ITB, and then pull the ITB partially out of the printer.

Figure 1-2309 Partially remove the ITB



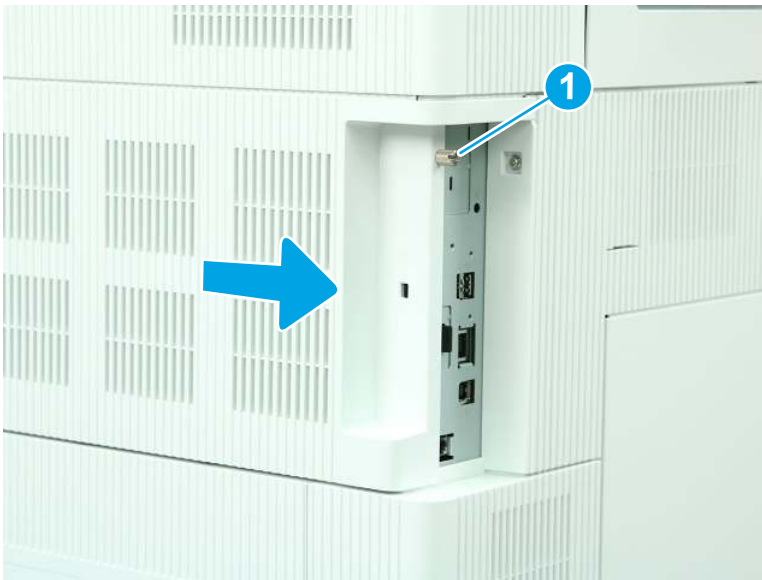
- b. Grasp the blue handles on the side of the ITB (callout 1), and then remove the ITB from the printer.

Figure 1-2310 Remove the ITB



4. Remove the formatter cover.
 - ▲ Loosen one thumbscrew (callout 1), and then slide the formatter cover (callout 2) away from the printer to remove it.

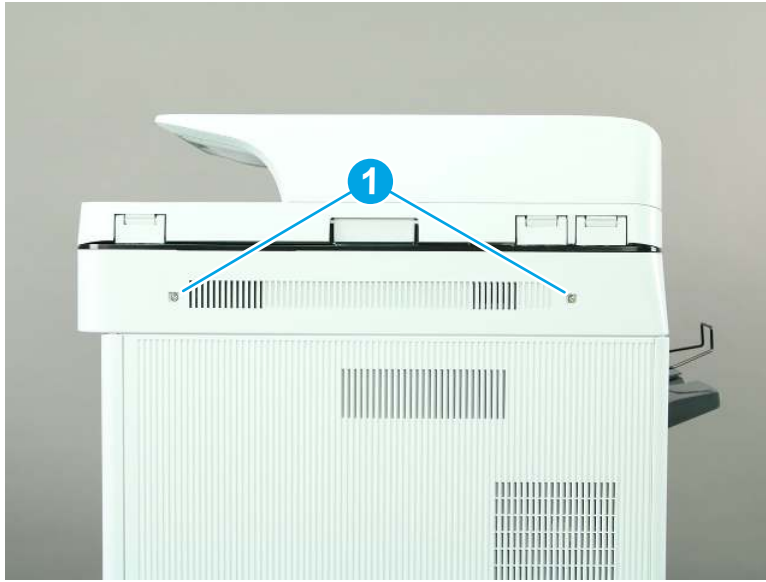
Figure 1-2311 Remove the formatter cover



5. Remove the scanner control board (SCB) cover (M776).

- a. Remove two screws (callout 1).

Figure 1-2312 Remove two screws



- b. Remove the SCB cover.

Figure 1-2313 Remove the SCB cover

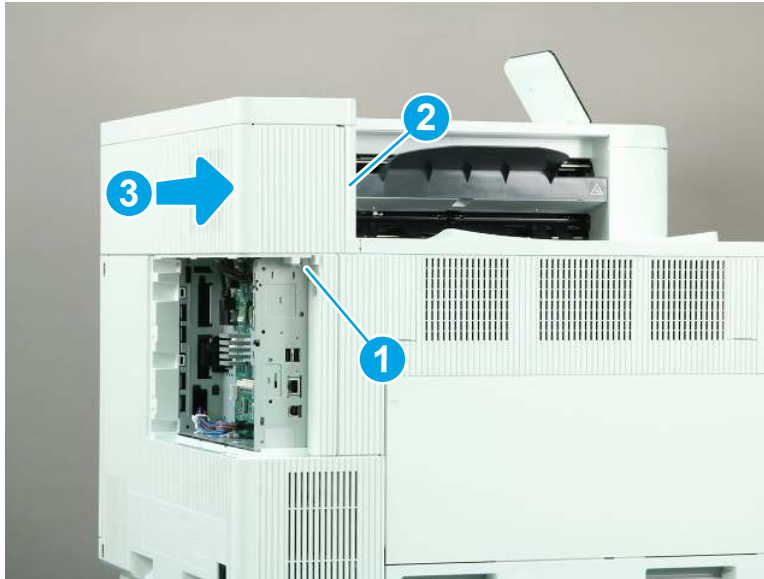


6. Remove the rear upper cover (M856/E85055/M776dn/M776z).

 **NOTE:** The following figure shows the M856 printer. The procedure is correct for all referenced models.

- ▲ Remove one screw (callout 1), release one tab (callout 2), and then slide the rear upper cover away from the printer to remove it (callout 3).

Figure 1-2314 Remove the rear upper cover

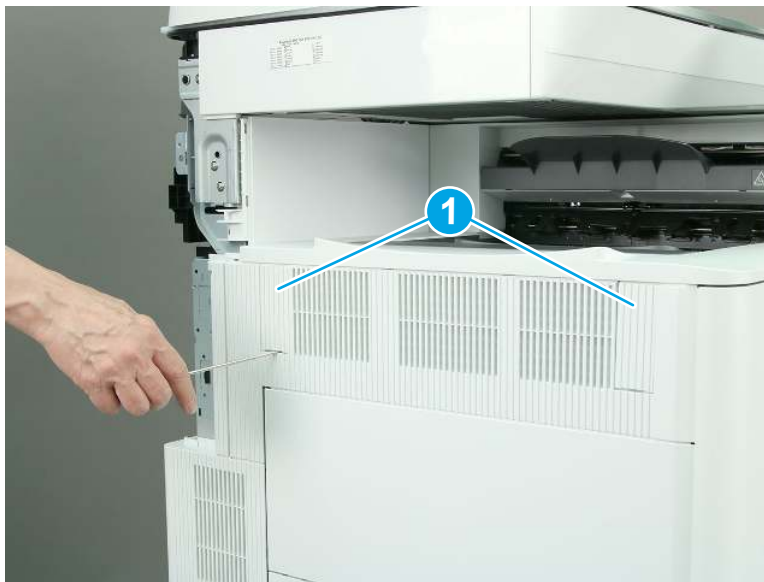


7. Remove the accessory upper cover (M856/E85055/M776dn/M776z).

 **NOTE:** The following figures show the M776z printer. The procedure is correct for all referenced models.

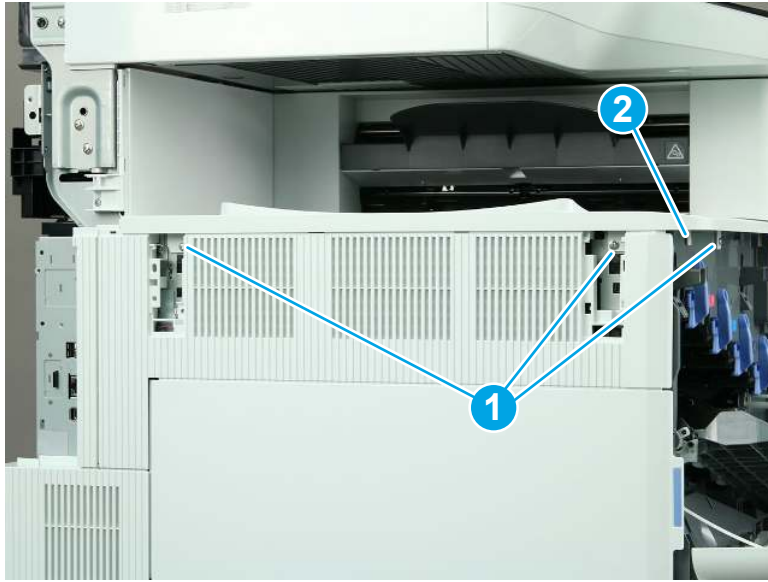
- a. Use a small, flat-blade screwdriver to remove two covers (callout 1).

Figure 1-2315 Remove two covers



- b. Remove three screws (callout 1), and then release one tab (callout 2).

Figure 1-2316 Remove three screws and release one tab



- c. Slide the accessory upper cover away from the printer to remove it.

Figure 1-2317 Remove the accessory upper cover

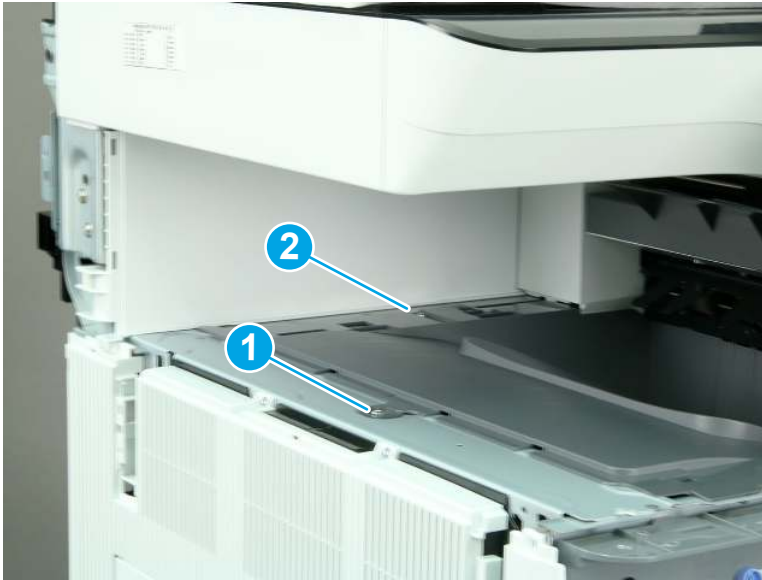


- 8. Remove the output bin (M856/E85055/M776).

 **NOTE:** The following figures show the M776z printer. The procedure is correct for all referenced models.

- a. Remove one washer-head machine screw (callout 1), remove one self-tapping screw (callout 2).

Figure 1-2318 Remove two screws



- b. Remove the output bin.

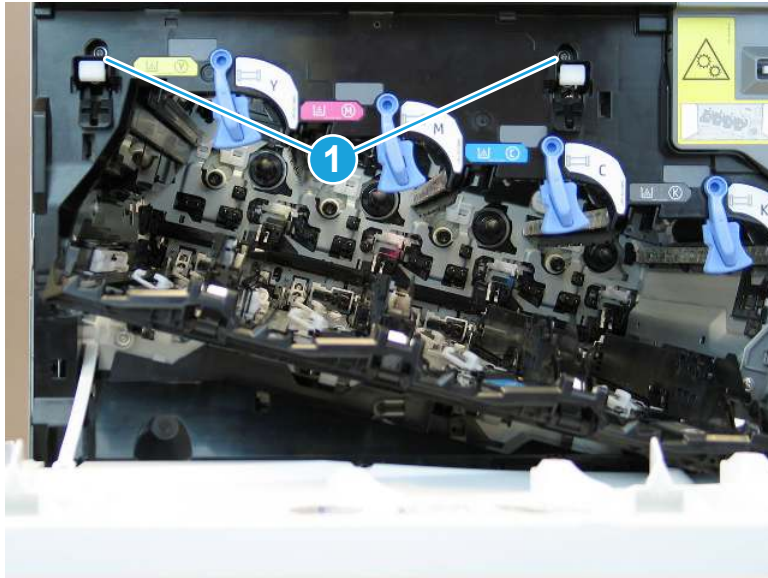
Figure 1-2319 Remove the output bin



9. Remove the cartridge upper guide.

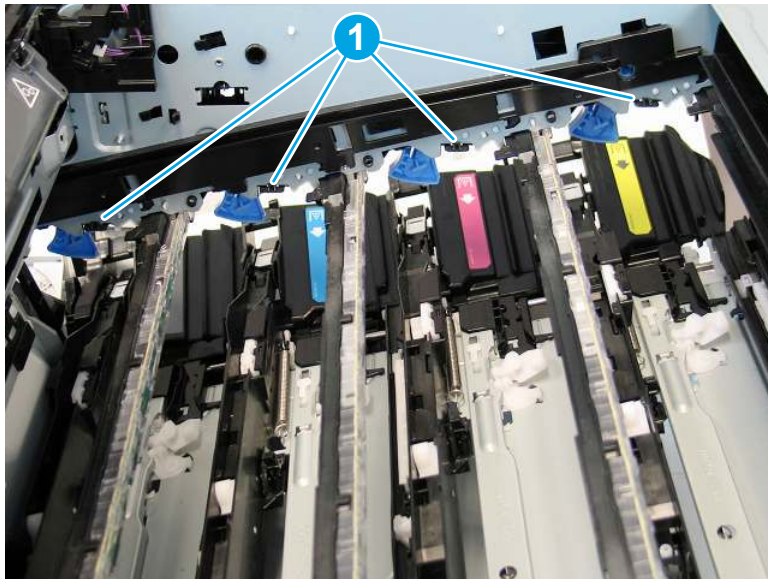
- a. Remove two screws (callout 1).

Figure 1-2320 Remove two screws



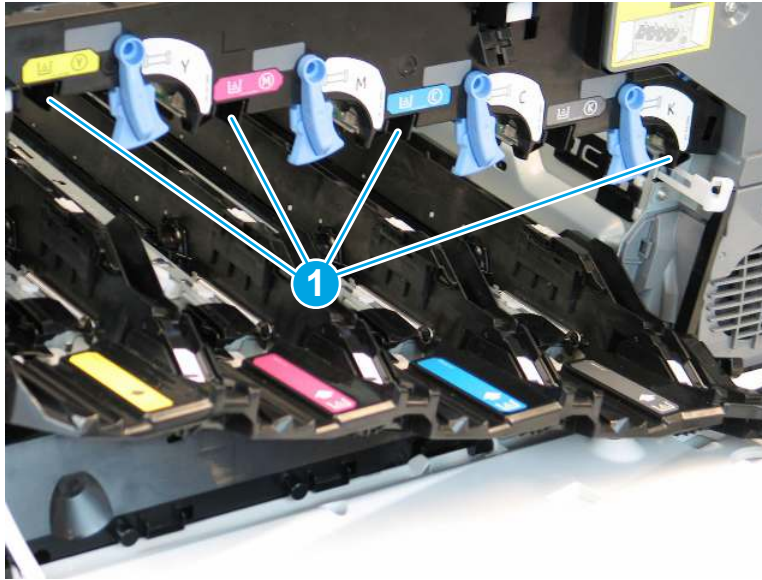
- b. Inside the printer, release four tabs (callout 1) on the back side of the cartridge guide.

Figure 1-2321 Release four tabs



- c. Release four tabs (callout 1), and then remove the cartridge upper guide.

Figure 1-2322 Release four tabs



10. Unpack the replacement assembly.
 - a. Dispose of the defective part.
-
- b. Unpack the replacement part from the packaging.
-
- c. To install an assembly, reverse the removal steps.



NOTE: HP recommends responsible disposal of the defective part.

<http://www8.hp.com/us/en/hp-information/environment/product-recycling.html>



IMPORTANT: Make sure that all of the shipping materials (for example shipping tape) are removed from the replacement part prior to installation.



NOTE: When applicable, special installation instructions are provided for an assembly at the end of the removal procedure. Always completely read the removal instructions and follow all special installation instructions.

Removal and replacement: Cartridge upper guide (M776zs)

Learn how to remove and replace the cartridge upper guide.

Mean time to repair: 10 minutes

Service level: Medium

Before performing service

Turn the printer power off

- Disconnect the power cable.



WARNING! To avoid damage to the printer, turn the printer off, wait 30 seconds, and then remove the power cord before attempting to service the printer.

Use the table below to identify the correct part number for your printer. To order the part, go to www.hp.com/buy/parts.

Table 1-119 Part information

Part number	Part description
RM2-1343-000CN	Cartridge upper guide assembly

Required tools

- #2 Phillips screwdriver with a magnetic tip
- Small, flat-blade screwdriver

After performing service

Turn the printer power on

- Connect the power cable.
- Use the power switch to turn the power on.

Post service test

Make sure that the printer initializes to a **Ready** state.

Print a page to make sure that the printer is functioning correctly.

1. Remove the toner cartridges.
 - ▲ Open the front door, if it is not already open. Grasp the handle of the toner cartridge and pull out to remove it. Repeat the process for the remaining toner cartridges.

Figure 1-2323 Remove the toner cartridge



2. Remove the imaging drums.

- a. Open the front door, if it is not already open. Rotate the blue lever in front of the imaging drum to the left.

Figure 1-2324 Rotate the blue lever



- b. Grasp the handle of the imaging drum and pull out to remove it. Repeat the process for the remaining imaging drums.

Figure 1-2325 Remove the imaging drum



3. Remove the intermediate transfer belt (ITB).

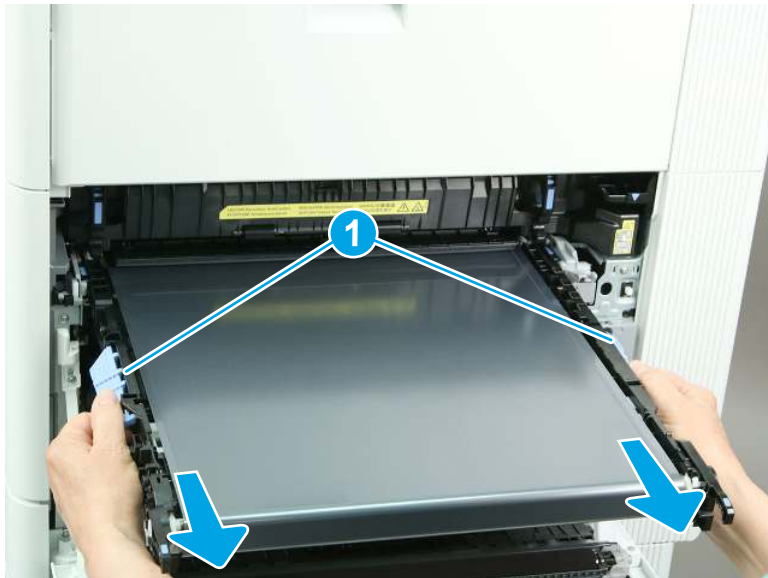
- a. Open the right door. Grasp the two blue handles on the ITB, and then pull the ITB partially out of the printer.

Figure 1-2326 Partially remove the ITB



- b. Grasp the blue handles on the side of the ITB (callout 1), and then remove the ITB from the printer.

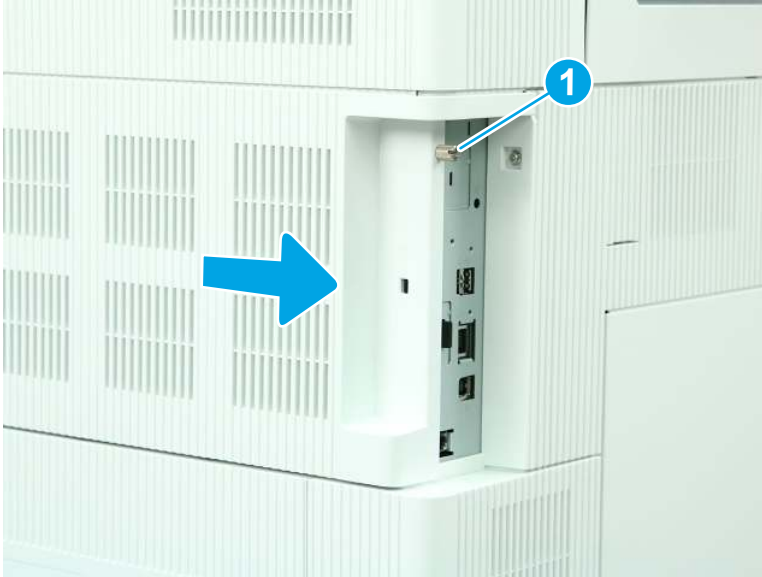
Figure 1-2327 Remove the ITB



4. Remove the formatter cover.

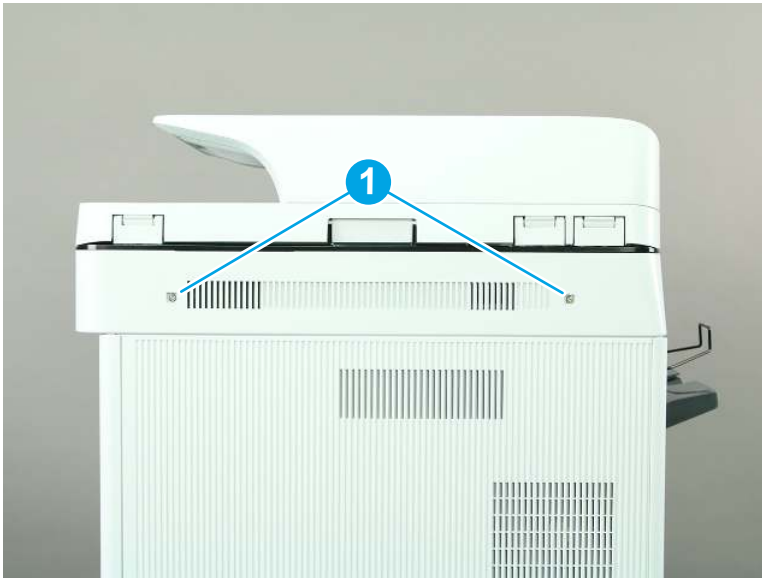
- ▲ Loosen one thumbscrew (callout 1), and then slide the formatter cover (callout 2) away from the printer to remove it.

Figure 1-2328 Remove the formatter cover



- 5. Remove the scanner control board (SCB) cover (M776).
 - a. Remove two screws (callout 1).

Figure 1-2329 Remove two screws



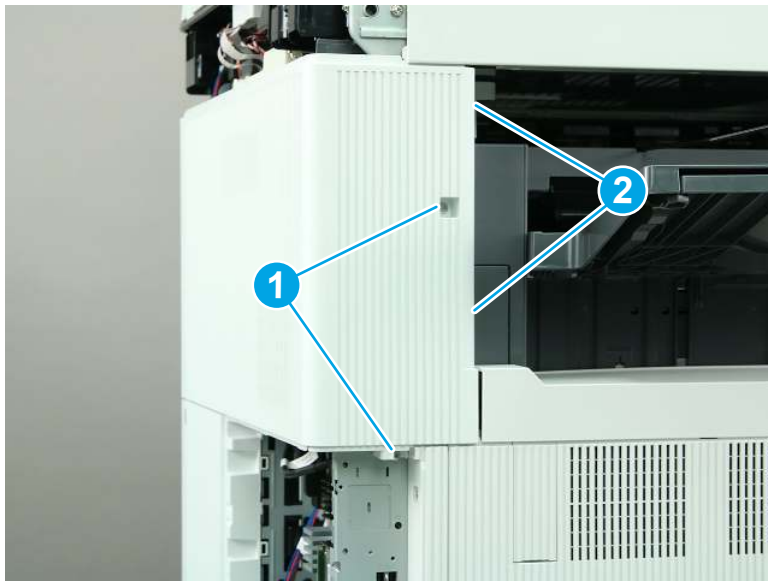
- b. Remove the SCB cover.

Figure 1-2330 Remove the SCB cover



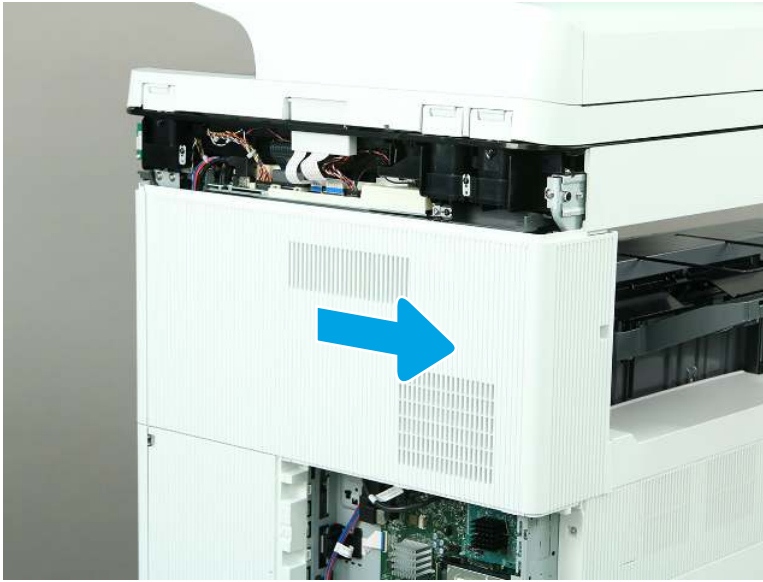
- 6. Remove the rear upper cover and left rear upper cover (M776zs).
 - a. Remove two screws (callout 1), and then release two tabs (callout 2).

Figure 1-2331 Remove two screws and release two tabs



- b. Slide the cover to the right to remove it.

Figure 1-2332 Remove the rear upper and left rear upper cover



- 7. Remove the front cover (M776zs).

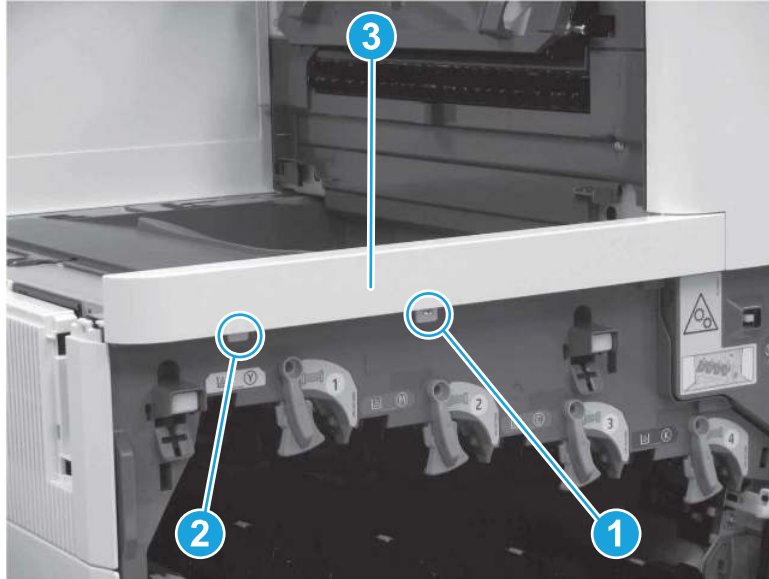
- a. Open the front door.

Figure 1-2333 Open the front door



- b. Remove one screw (callout 1), release one tab (callout 2), and then remove the front cover (callout 3).

Figure 1-2334 Remove the front cover



- 8. Remove the control panel (M776).
 - a. Rotate the control panel to the fully raised position (callout 1), and then raise the document feeder (callout 2).

Figure 1-2335 Raise the control panel and document feeder



- b. Beginning at the right side of the control-panel cover, carefully release five tabs along the top edge of the cover.

 **NOTE:** The thin black-plastic cover will separate from the white-plastic control-panel base.

Figure 1-2336 Release the control panel cover



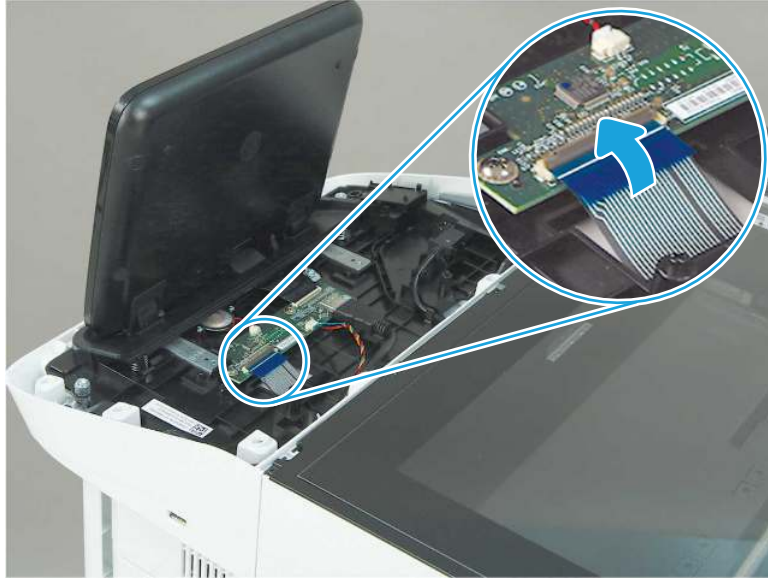
- c. Rotate the control panel cover slightly forward (callout 1), and then lift up to remove the cover (callout 2).

Figure 1-2337 Remove the control panel cover



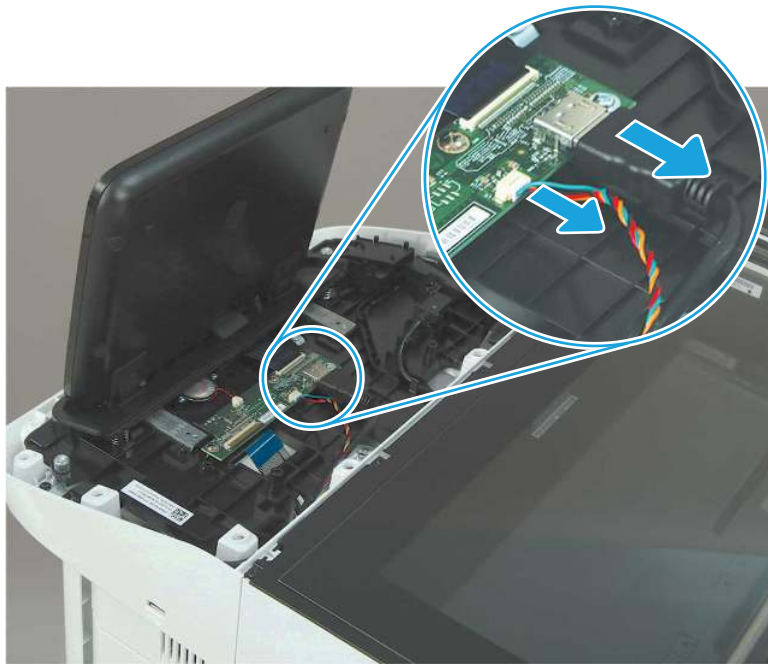
- d. **M776z or M776zs only:** Open the connector latch to release the keyboard flat cable.

Figure 1-2338 Release the keyboard flat cable (M776z/M776zs)



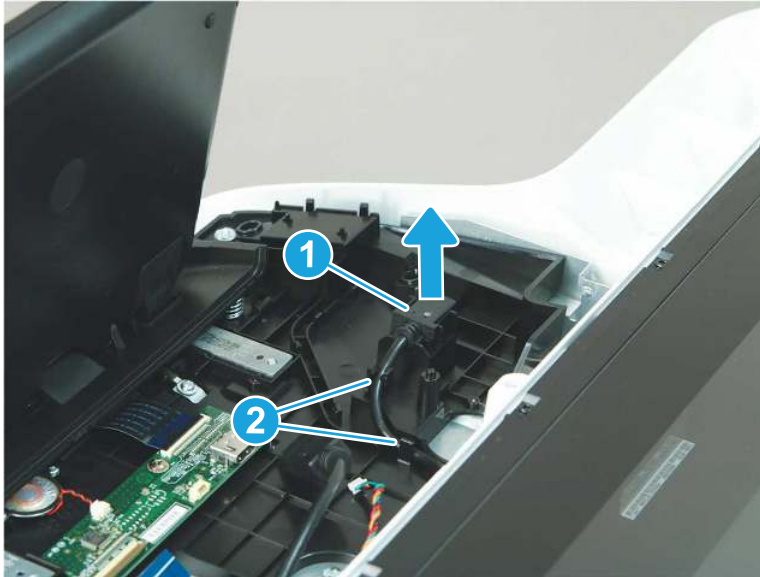
- e. Disconnect two connectors

Figure 1-2339 Disconnect two connectors



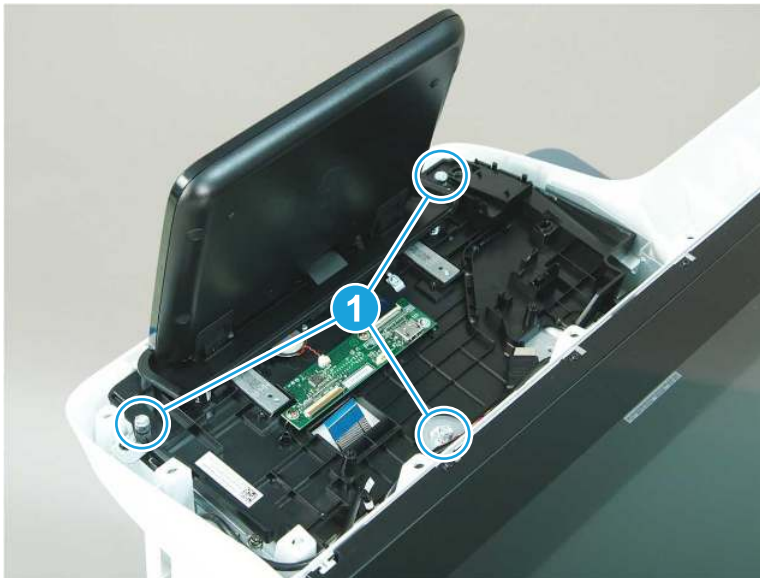
- f. Remove the USB cable (callout 1) from the holder, and then release the cable from two retainers (callout 2).

Figure 1-2340 Release the USB cable



- g. Remove three screws (callout 1).

Figure 1-2341 Remove three screws



- h. Lift the front of the control panel off of the printer (callout 1), and then slide it towards the front of the printer (callout 2) to remove it.

Figure 1-2342 Remove the control panel



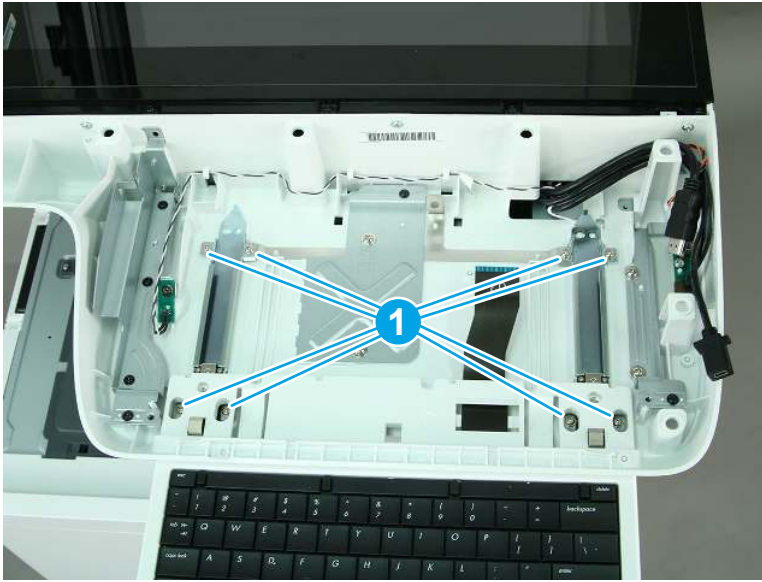
- 9. Remove the keyboard (M776z/M776zs).
 - a. Pull the keyboard out to its extended position.

Figure 1-2343 Pull the keyboard out



- b. Remove eight screws (callout 1).

Figure 1-2344 Remove eight screws



- c. Remove the keyboard and rails.

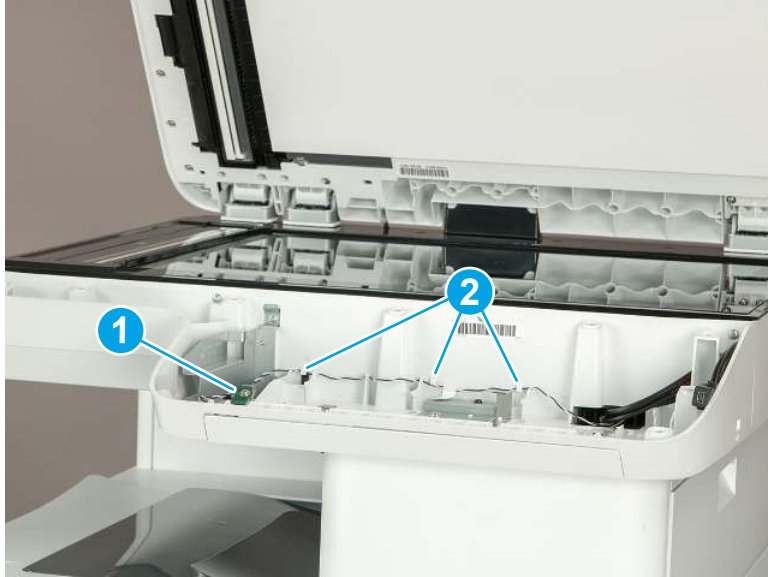
Figure 1-2345 Remove the keyboard and rails



- 10. Remove the nose cone (M776).

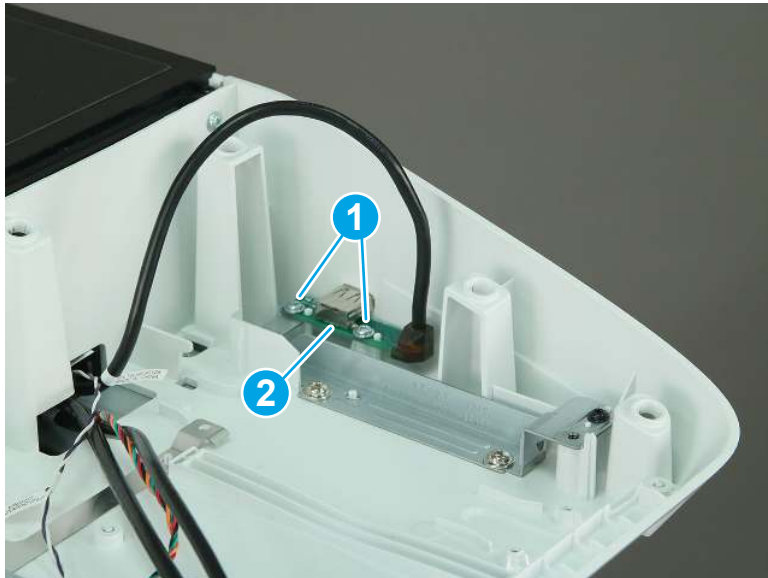
- a. Remove one screw (callout 1) to release the light PCA. Release the cable from three retainers (callout 2), and then move the light PCA out of the way.

Figure 1-2346 Release the light PCA



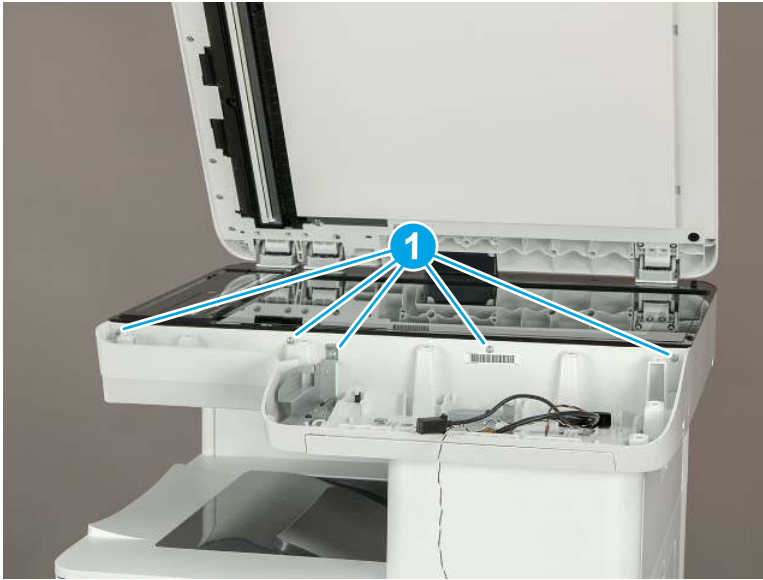
- b. Remove two screws (callout 1), and then move the USB port PCA (callout 2) out of the way.

Figure 1-2347 Release the USB port PCA



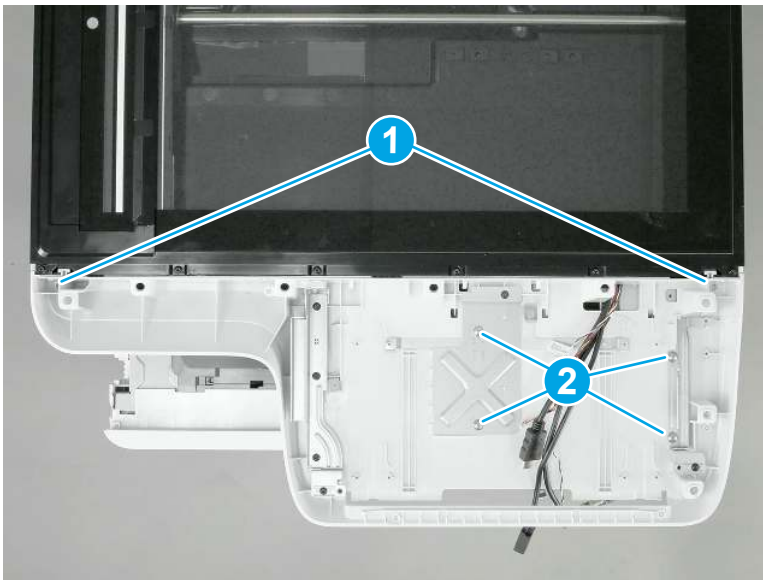
- c. Remove five screws (callout 1).

Figure 1-2348 Remove four screws



- d. Remove two small, self-tapping screws (callout 1), and then remove four larger machine screws (callout 2).

Figure 1-2349 Remove six screws

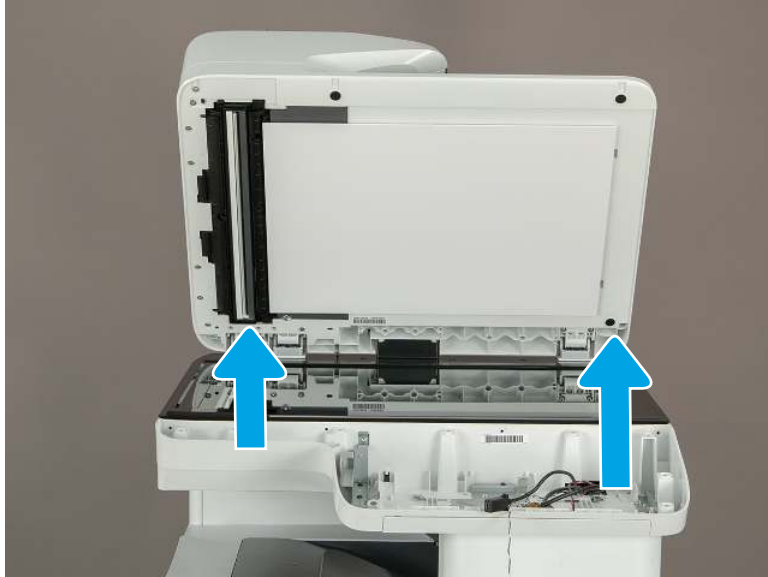


- e. Lift the nose cone up and off of the printer to remove it.



NOTE: Pass the wire harnesses and cables through the opening in the nose cone when removing it.

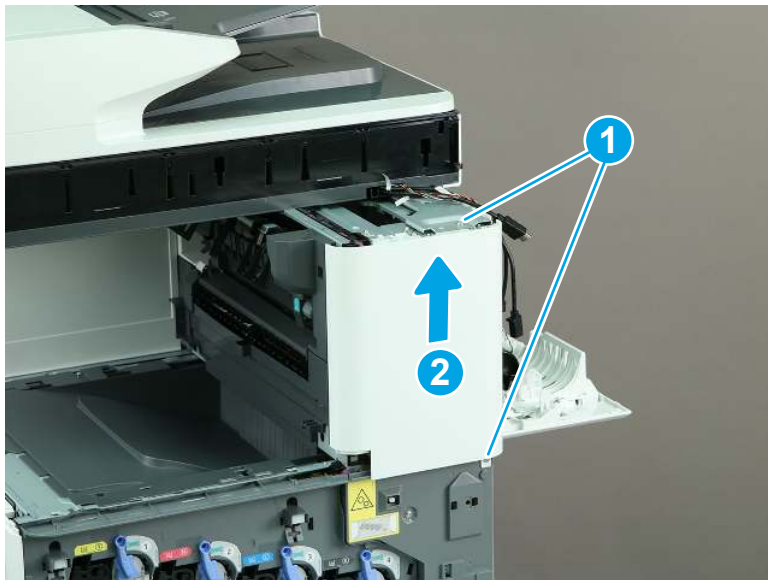
Figure 1-2350 Remove the nose cone



11. Remove the right front cover (M776zs).

- ▲ Remove two screws (callout 1), release one tab (callout 2), and then slide the right front cover up (callout 2) to remove it.

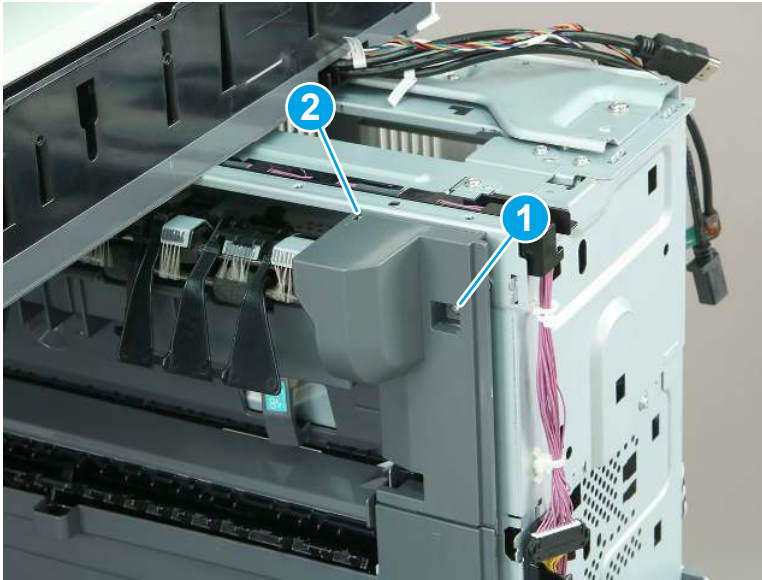
Figure 1-2351 Remove the right front cover



12. Remove the delivery front cover (M776zs).

- ▲ Remove one screw (callout 1), and then remove the delivery front cover (callout 2).

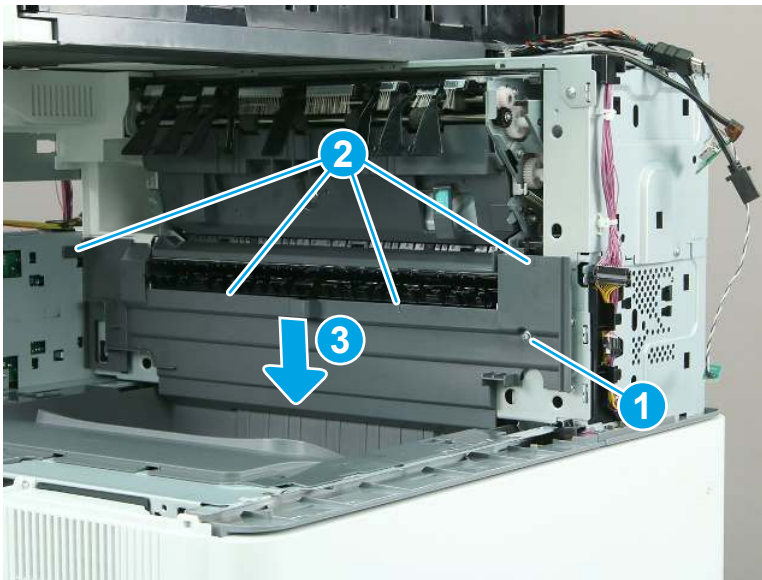
Figure 1-2352 Remove the delivery front cover



13. Remove the delivery cover (M776zs).

- ▲ Remove one screw (callout 1), release four tabs (callout 2), and then slide the delivery cover down (callout 3) to remove it.

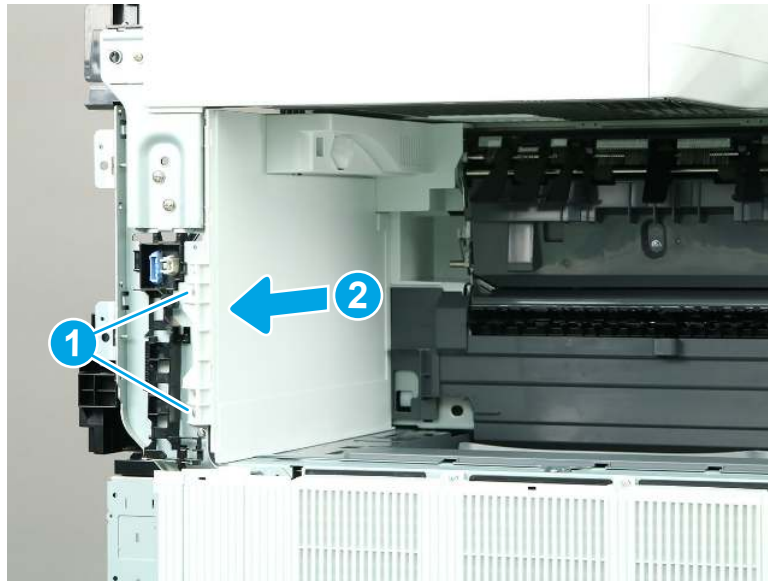
Figure 1-2353 Remove the delivery cover



14. Remove the main cover (M776zs).

- ▲ Remove two screws (callout 1), and then slide the main cover away from the printer to remove it (callout 2).

Figure 1-2354 Remove the main cover

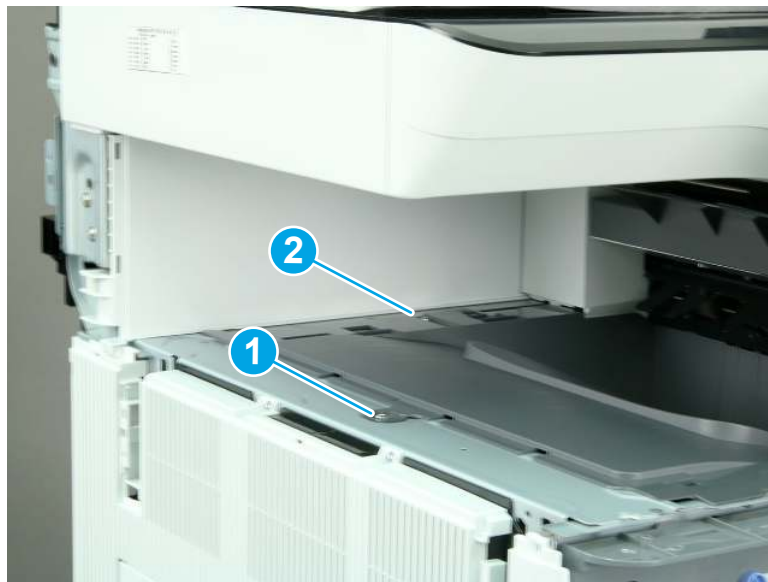


15. Remove the output bin (M856/E85055/M776).

 **NOTE:** The following figures show the M776z printer. The procedure is correct for all referenced models.

- a. Remove one washer-head machine screw (callout 1), remove one self-tapping screw (callout 2).

Figure 1-2355 Remove two screws



- b. Remove the output bin.

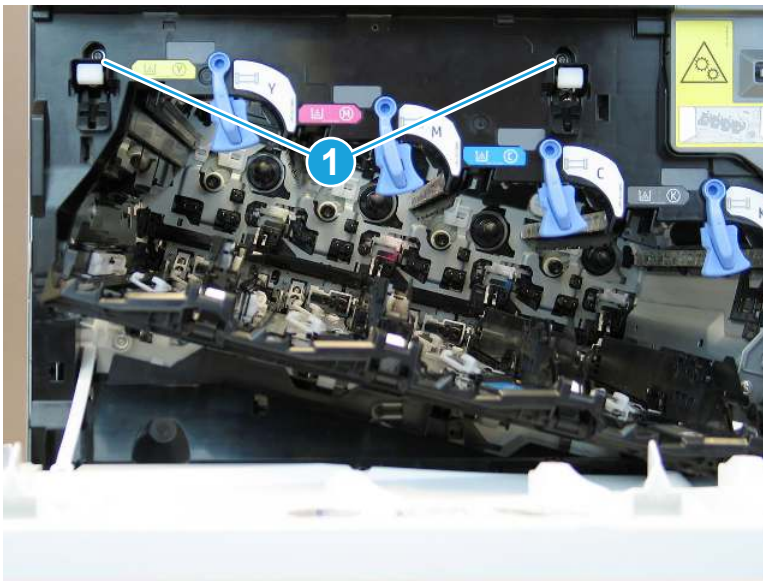
Figure 1-2356 Remove the output bin



- 16. Remove the cartridge upper guide.

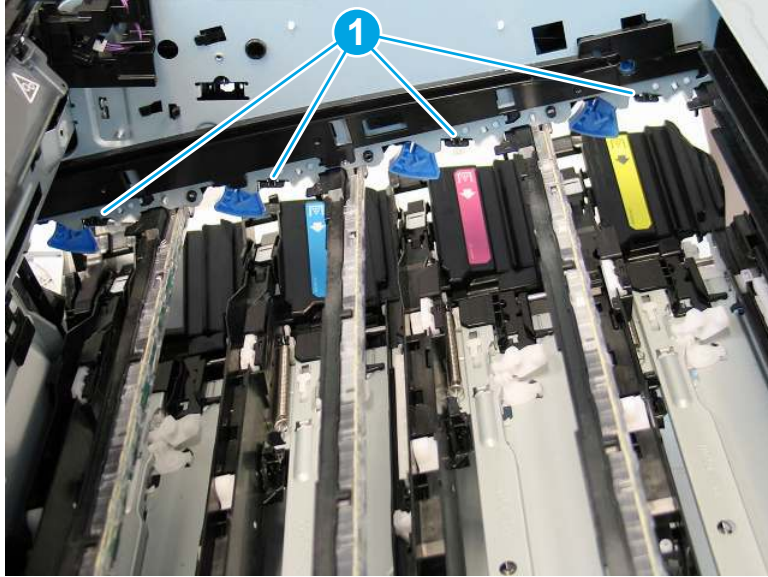
- a. Remove two screws (callout 1).

Figure 1-2357 Remove two screws



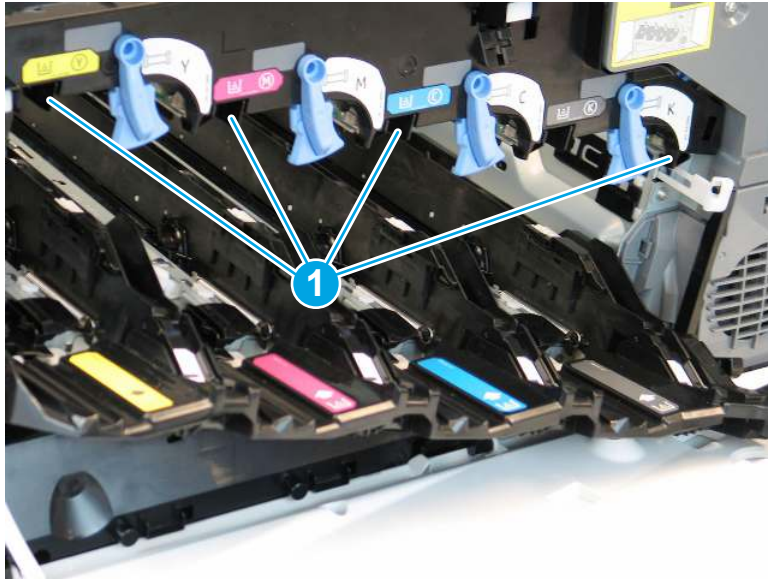
- b. Inside the printer, release four tabs (callout 1) on the back side of the cartridge guide.

Figure 1-2358 Release four tabs



- c. Release four tabs (callout 1), and then remove the cartridge upper guide.

Figure 1-2359 Release four tabs



- 17. Unpack the replacement assembly.


- a. Dispose of the defective part.




NOTE: HP recommends responsible disposal of the defective part.

<http://www8.hp.com/us/en/hp-information/environment/product-recycling.html>

- b. Unpack the replacement part from the packaging.

 **IMPORTANT:** Make sure that all of the shipping materials (for example shipping tape) are removed from the replacement part prior to installation.

- c. To install an assembly, reverse the removal steps.

 **NOTE:** When applicable, special installation instructions are provided for an assembly at the end of the removal procedure. Always completely read the removal instructions and follow all special installation instructions.

Removal and replacement: Black pre-exposure assembly (M751/E75245)

Learn how to remove and replace the black pre-exposure assembly.

[View a video of how to remove and replace the black pre-exposure assembly.](#)


Mean time to repair: 12 minutes

Service level: Medium

Before performing service

Turn the printer power off

- Disconnect the power cable.

 **WARNING!** To avoid damage to the printer, turn the printer off, wait 30 seconds, and then remove the power cord before attempting to service the printer.

Use the table below to identify the correct part number for your printer. To order the part, go to www.hp.com/buy/parts.

Table 1-120 Part information

Part number	Part description
RM2-1340-000CN	Black pre-exposure assembly

Required tools

- #2 Phillips screwdriver with a magnetic tip
- Small, flat-blade screwdriver

After performing service

Turn the printer power on

- Connect the power cable.
- Use the power switch to turn the power on.

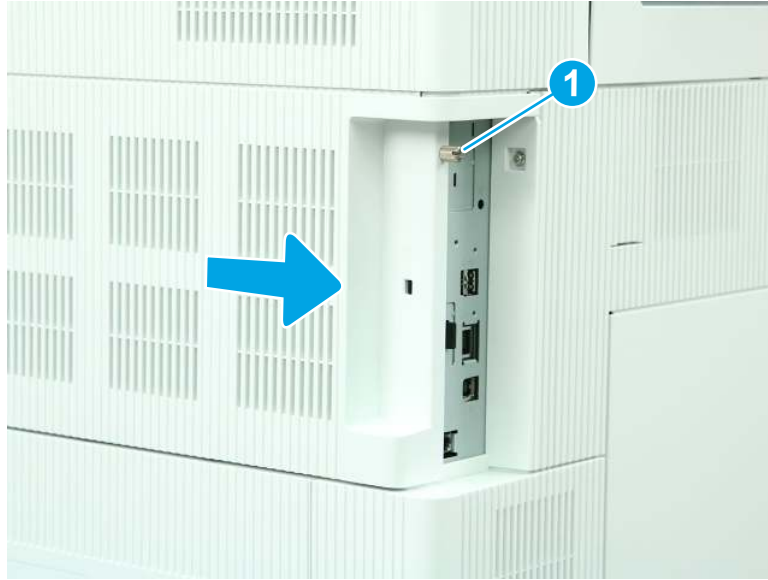
Post service test

Make sure that the printer initializes to a **Ready** state.

Print a page to make sure that the printer is functioning correctly.

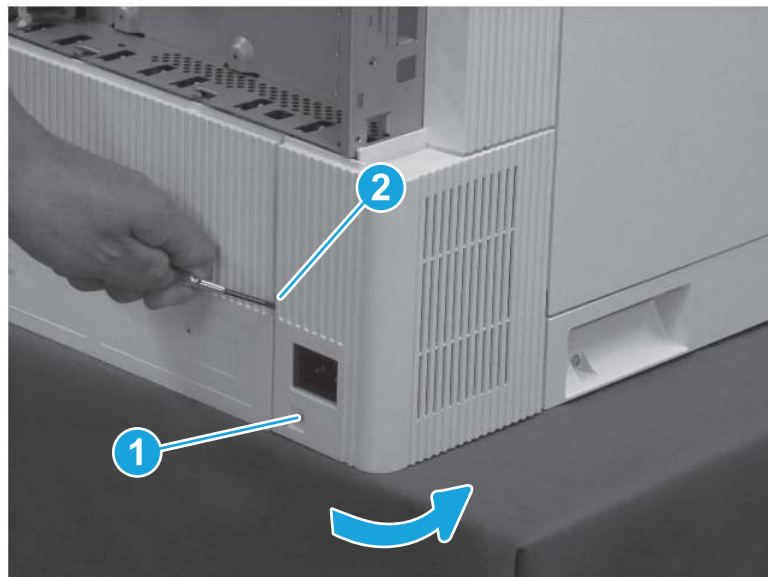
1. Remove the formatter cover.
 - ▲ Loosen one thumbscrew (callout 1), and then slide the formatter cover (callout 2) away from the printer to remove it.

Figure 1-2360 Remove the formatter cover



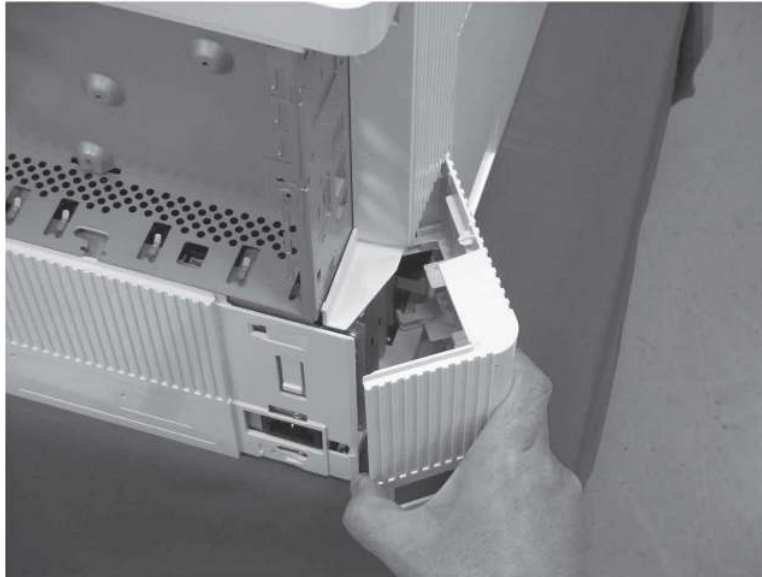
2. Remove the left lower cover (M751/E75245).
 - a. Remove one screw (callout 1), release one tab (callout 2), and then rotate the cover away from the printer.

Figure 1-2361 Remove one screw and release one tab



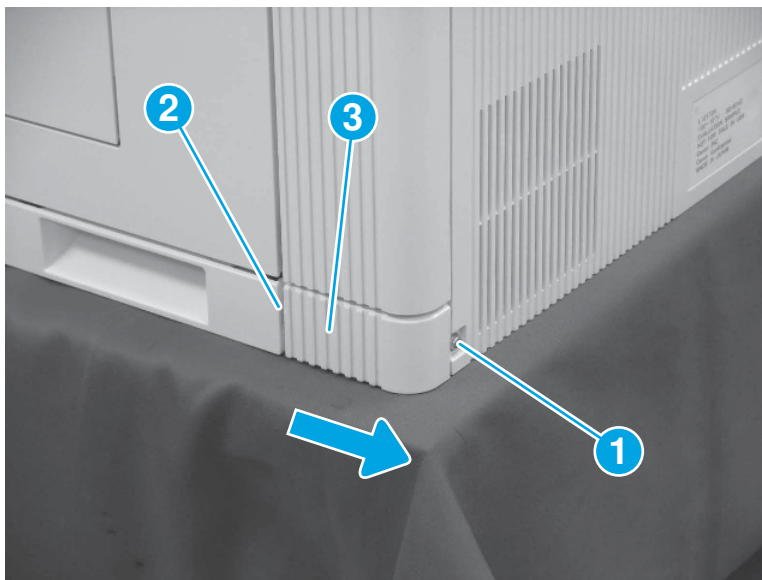
- b. Remove the left lower cover.

Figure 1-2362 Remove the left lower cover



3. Remove the right rear lower cover (M751/E75245/M856/E85055/M776).
 - ▲ Remove one screw (callout 1), release one tab (callout 2), and then slide the right rear lower cover (callout 3) toward the back of the printer to remove it.

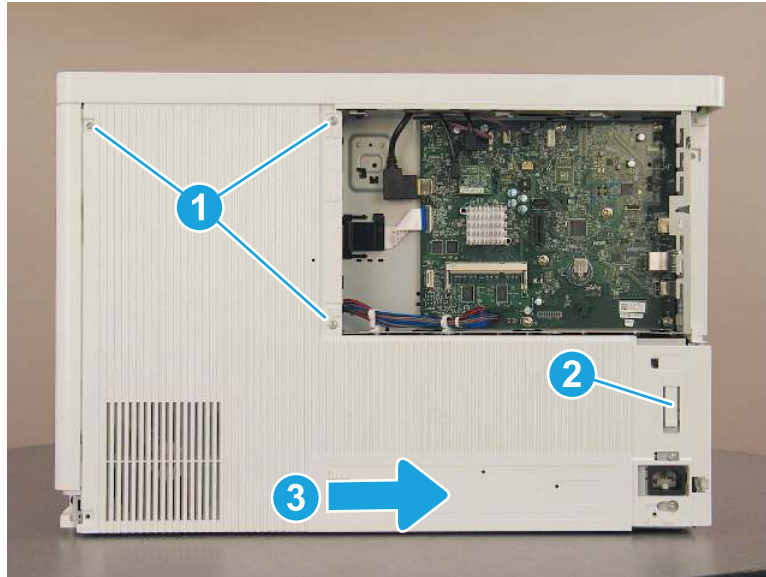
Figure 1-2363 Remove the right rear lower cover



4. Remove the rear cover (M751/E75245).

- ▲ Remove three screws (callout 1), release one tab (callout 2), and then slide the rear cover to the right (callout 3) to remove it.

Figure 1-2364 Remove the rear cover

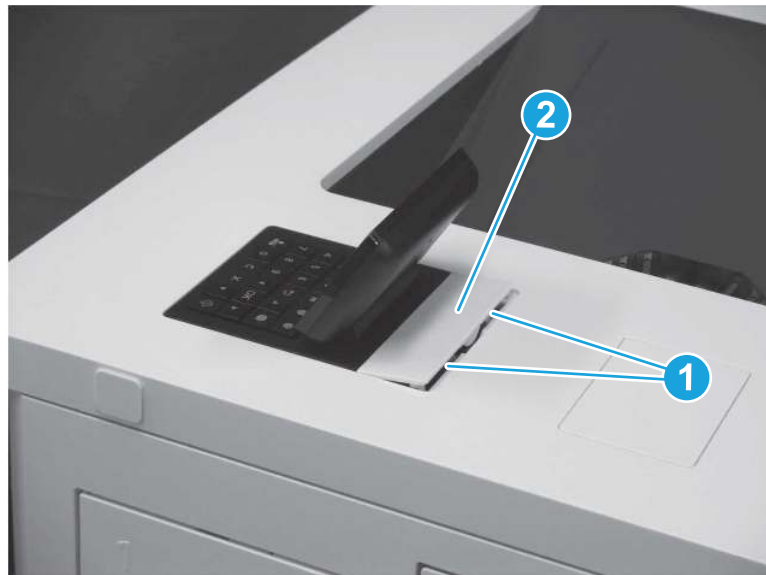


5. Remove the control panel.

 **NOTE:** A screwdriver is included in the control panel kit. The screwdriver has a reversible shaft. Simply pull the shaft out of the handle, and then reinstall it with the desired end facing out.

- a. Use a small, flat-blade screwdriver to release two tabs (callout 1), and then remove the control panel cover (callout 2).

Figure 1-2365 Remove the control panel cover



- b. Remove one screw (callout 1).

Figure 1-2366 Remove one screw



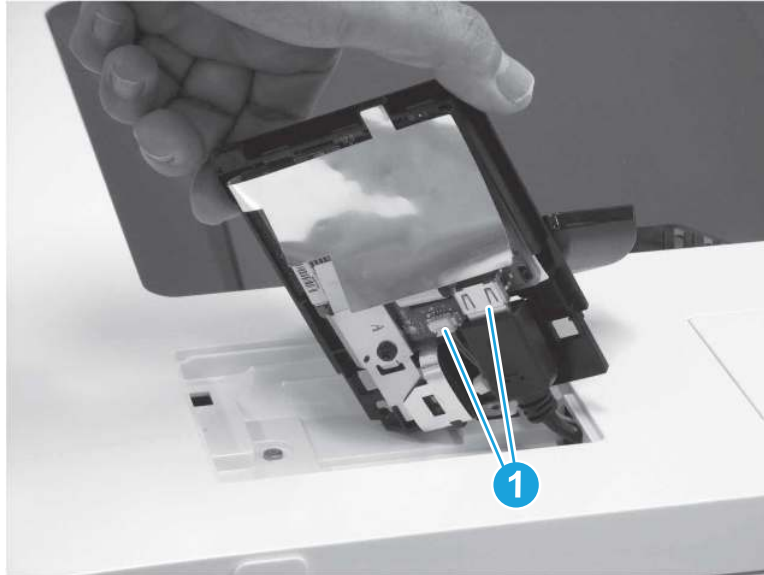
- c. Lift the back edge of the control panel up (callout 1), and then slide the control panel toward the back of the printer (callout 2).

Figure 1-2367 Slide the control panel back



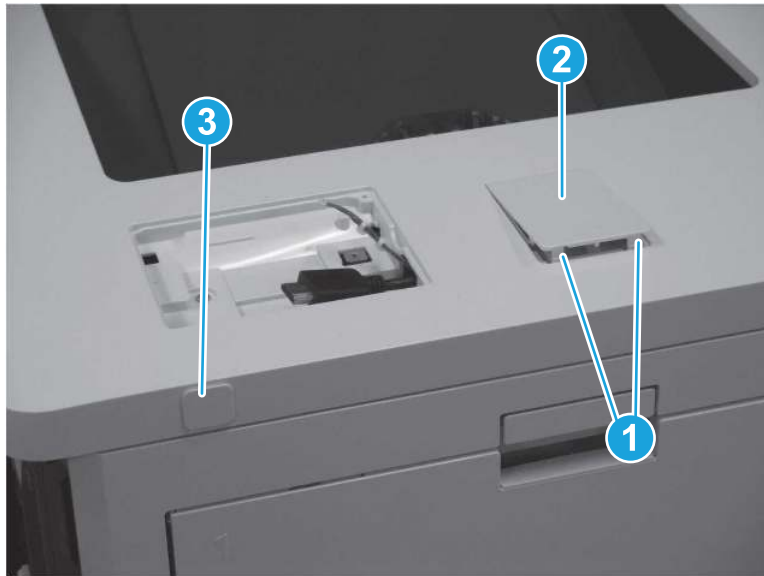
- d. Turn the control panel so that the bottom is facing up, and then disconnect two connectors (callout 1) to remove the control panel.

Figure 1-2368 Disconnect two connectors



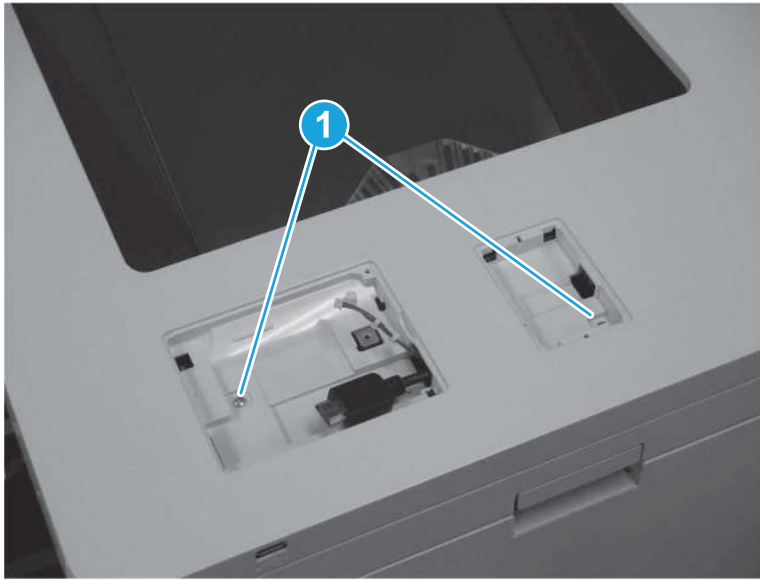
6. Remove the top cover (M751/E75245).
 - a. Release two tabs (callout 1), and then remove the HIP cover (callout 2). Pull the USB cap (callout 3) away from the printer to remove it.

Figure 1-2369 Remove the HIP cover and USB cap



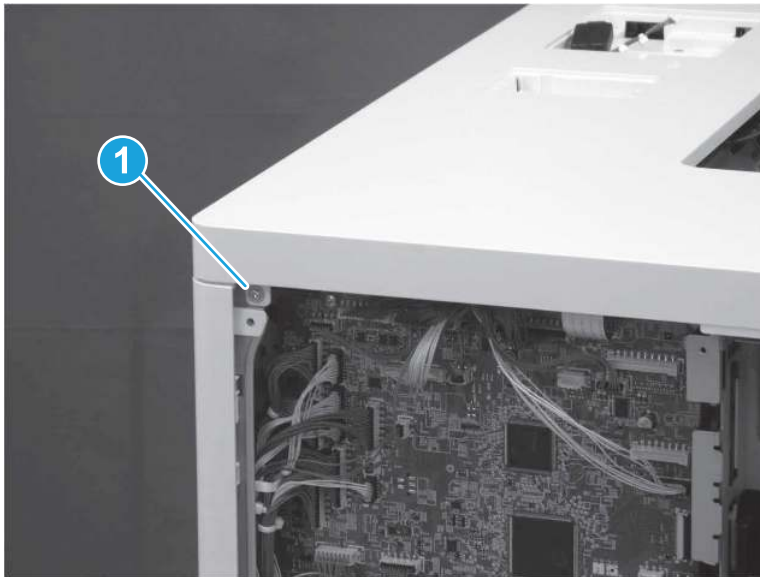
- b. At the top of the printer, remove two screws (callout 1).

Figure 1-2370 Remove two screws




- c. At the back of the printer, remove one screw (callout 1).

Figure 1-2371 Remove one screw

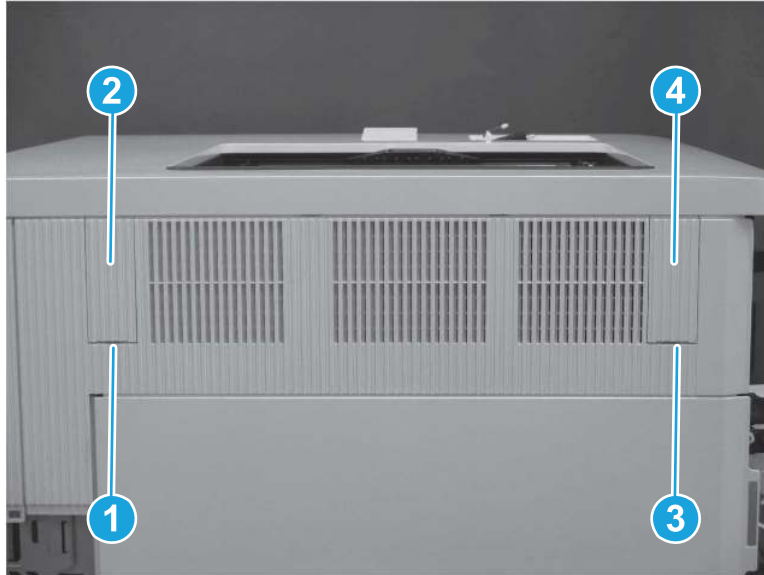


- d. Use a small, flat-blade screwdriver to release one tab (callout 1) and remove the left blanking cover (callout 2). Release one tab (callout 3) and remove the right blanking cover (callout 4).

 **TIP:** These covers are not identical. Make sure to reinstall the correct cover on the correct side.

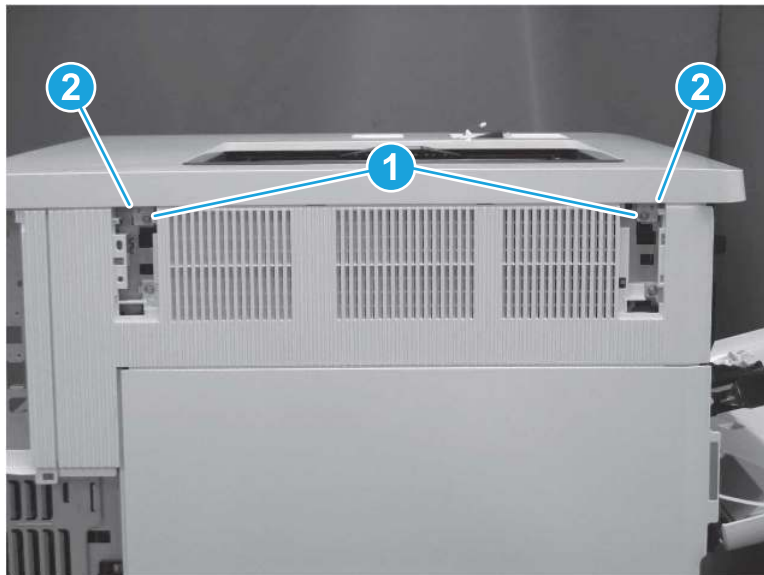
 **NOTE:** The screw under the left blanking cover is a self-tapping screw. Make sure this screw is reinstalled in the correct location.

Figure 1-2372 Remove the left and right blanking covers



- e. Remove two screws (callout 1), and then release two tabs (callout 2).

Figure 1-2373 Remove two screws and release two tabs



- f. At the front of the printer, remove one washer-head screw (callout 1) and one self-tapping screw (callout 2). Release one tab (callout 3).


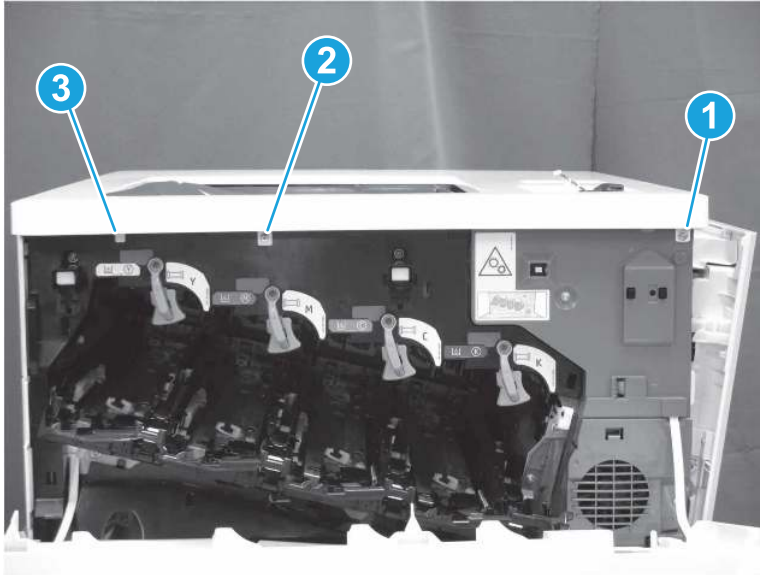
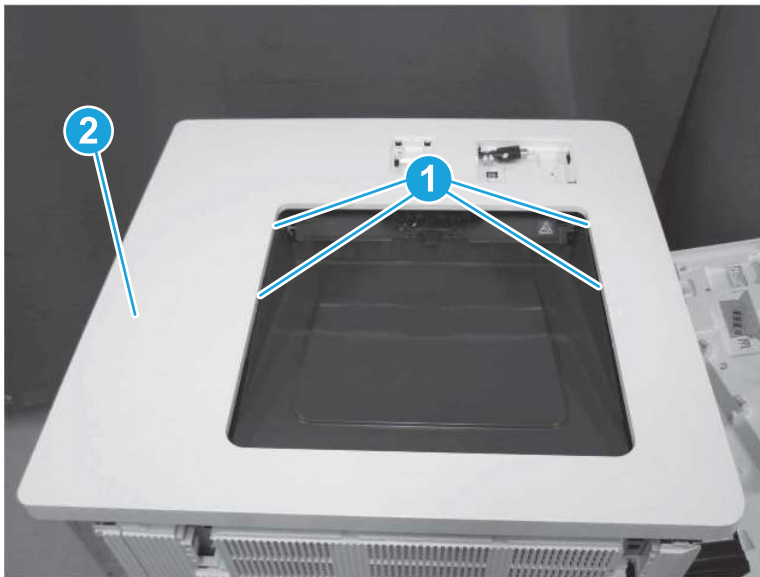
 **TIP:** Make sure to install the correct type of screw in the correct location.

Figure 1-2374 Remove two screws and release one tab

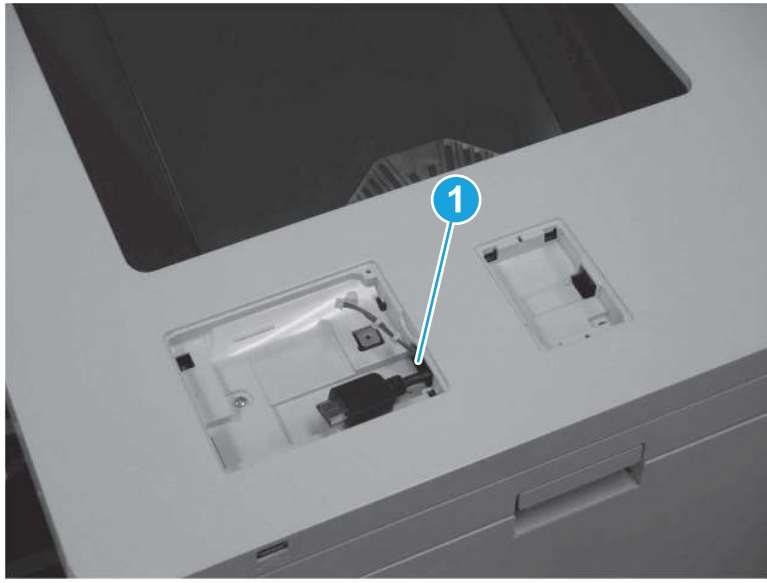


- g. At the top of the printer, release four tabs (callout 1), and then remove the top cover (callout 2).

Figure 1-2375 Remove the top cover



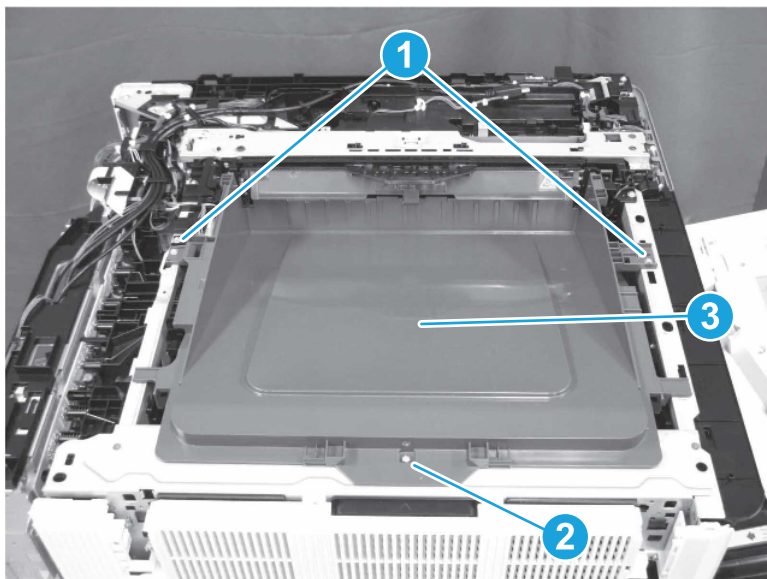
 **NOTE:** When removing the top cover, make sure to release the control panel cables (callout 1) through the opening.



7. Remove the output bin (M751/E75245).
 - ▲ Remove two washer-head machine screws (callout 1), remove one self-tapping screw (callout 2), and then remove the output bin (callout 3).

 **NOTE:** When reinstalling the output bin, make sure to install the correct type of screw in the correct location.

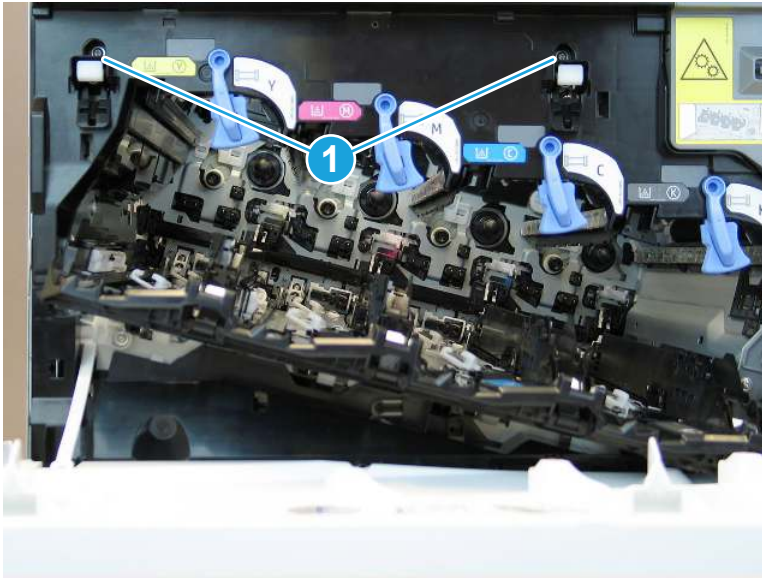
Figure 1-2376 Remove the output bin



8. Remove the cartridge upper guide.

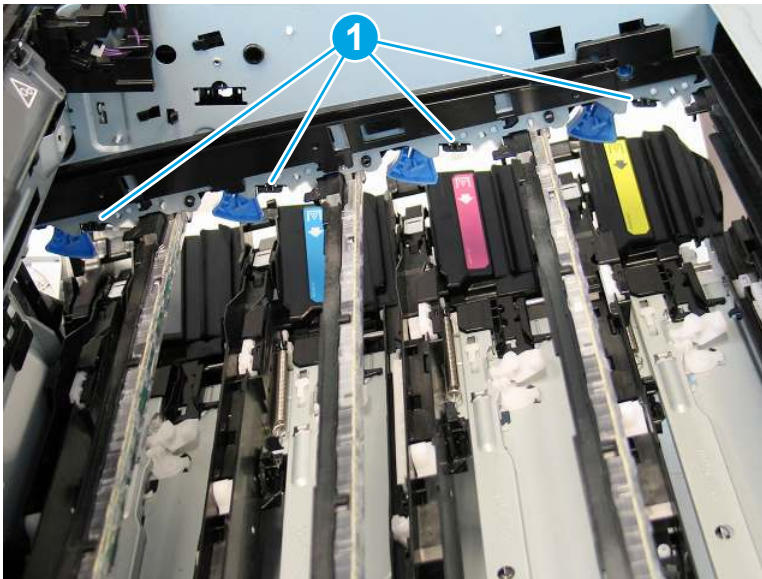
- a. Remove two screws (callout 1).

Figure 1-2377 Remove two screws



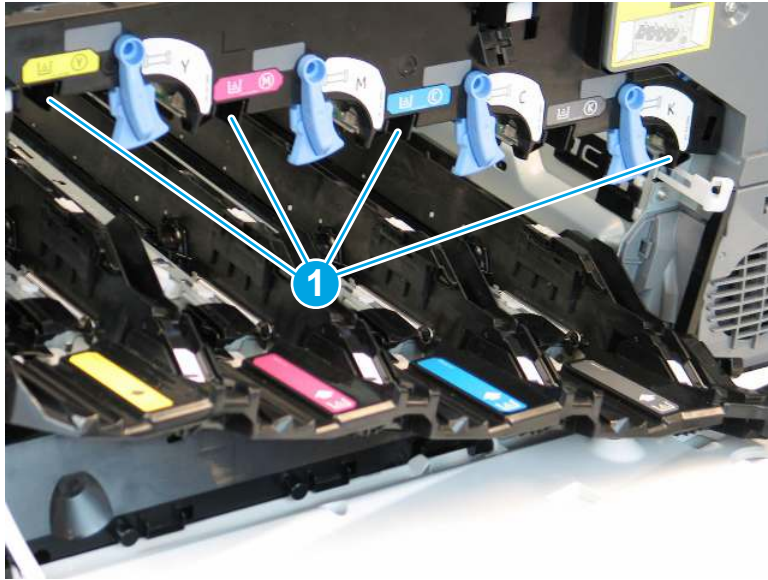
- b. Inside the printer, release four tabs (callout 1) on the back side of the cartridge guide.

Figure 1-2378 Release four tabs



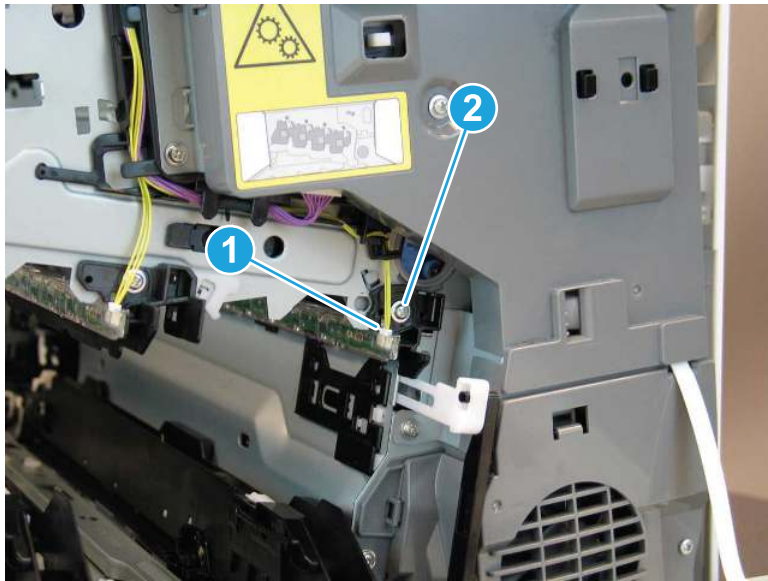
- c. Release four tabs (callout 1), and then remove the cartridge upper guide.

Figure 1-2379 Release four tabs



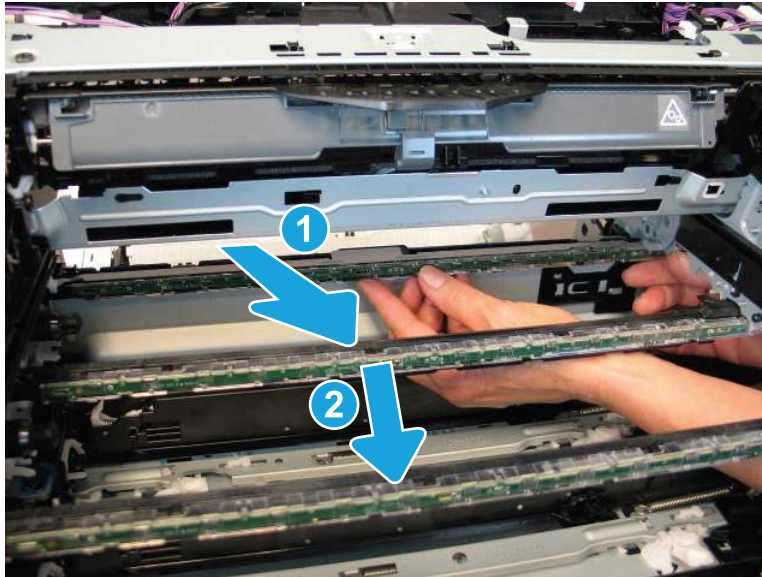
9. Remove the black pre-exposure assembly.
 - a. Disconnect one connector (callout 1), and then remove one screw (callout 2).

Figure 1-2380 Disconnect one connector and remove one screw



- b. Lift the pre-exposure assembly away from the printer (callout 1), and then lower it (callout 2) to remove it.

Figure 1-2381 Remove the black pre-exposure assembly



10. Unpack the replacement assembly.

- a. Dispose of the defective part.




NOTE: HP recommends responsible disposal of the defective part.

<http://www8.hp.com/us/en/hp-information/environment/product-recycling.html>

- b. Unpack the replacement part from the packaging.



CAUTION:  Some parts are sensitive to electrostatic discharge (ESD). Always perform service work at an ESD-protected workstation or mat. If an ESD workstation or mat is not available, touch the sheet-metal chassis to provide a static ground before touching an ESD-sensitive assembly. Protect the ESD-sensitive assemblies by placing them in ESD pouches when they are out of the printer.



IMPORTANT: Make sure that all of the shipping materials (for example shipping tape) are removed from the replacement part prior to installation.

- c. To install an assembly, reverse the removal steps.



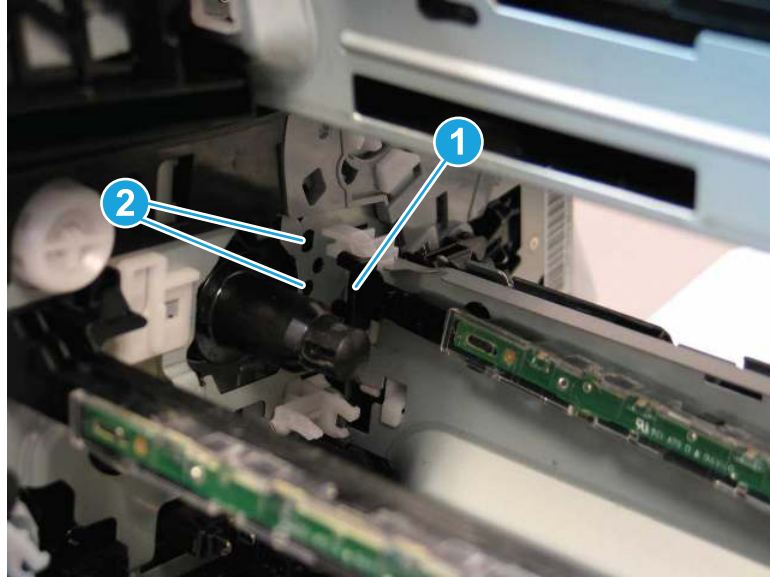
NOTE: When applicable, special installation instructions are provided for an assembly at the end of the removal procedure. Always completely read the removal instructions and follow all special installation instructions.

11. Reverse the removal steps to install the assembly. Also use the following **special installation instructions**.

Install the black pre-exposure assembly.

- ▲ When installing the black pre-exposure assembly, position the tabs (callout 1) on the end of the assembly into the holes (callout 2) in the printer.

Figure 1-2382 Install the black pre-exposure assembly



Removal and replacement: Black pre-exposure assembly (M856/E85055/M776dn/M776z)

Learn how to remove and replace the black pre-exposure assembly.

[View a video of how to remove and replace the black pre-exposure assembly.](#)

Mean time to repair: 12 minutes

Service level: Medium

Before performing service

Turn the printer power off

- Disconnect the power cable.

⚠ WARNING! To avoid damage to the printer, turn the printer off, wait 30 seconds, and then remove the power cord before attempting to service the printer.

Use the table below to identify the correct part number for your printer. To order the part, go to www.hp.com/buy/parts.

Table 1-121 Part information

Part number	Part description
RM2-1340-000CN	Black pre-exposure assembly

Required tools

- #2 Phillips screwdriver with a magnetic tip
- Small, flat-blade screwdriver

After performing service

Turn the printer power on

- Connect the power cable.
- Use the power switch to turn the power on.

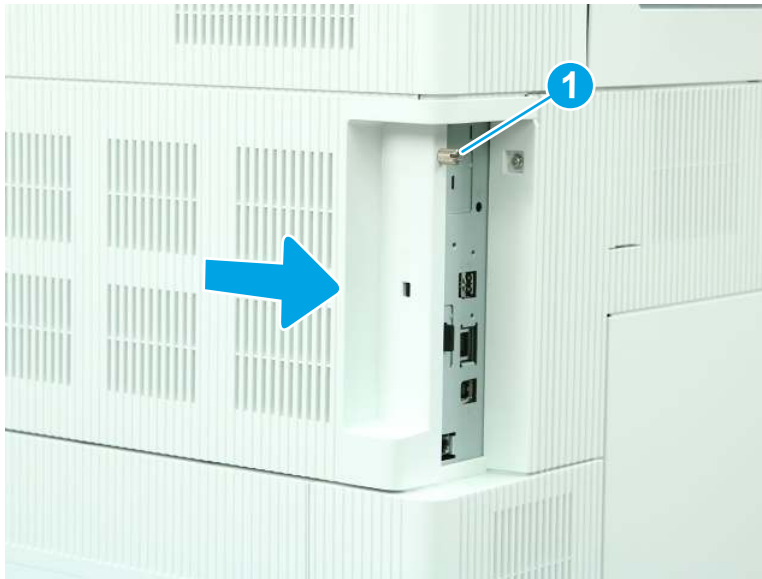
Post service test

Make sure that the printer initializes to a **Ready** state.

Print a page to make sure that the printer is functioning correctly.

1. Remove the formatter cover.
 - ▲ Loosen one thumbscrew (callout 1), and then slide the formatter cover (callout 2) away from the printer to remove it.

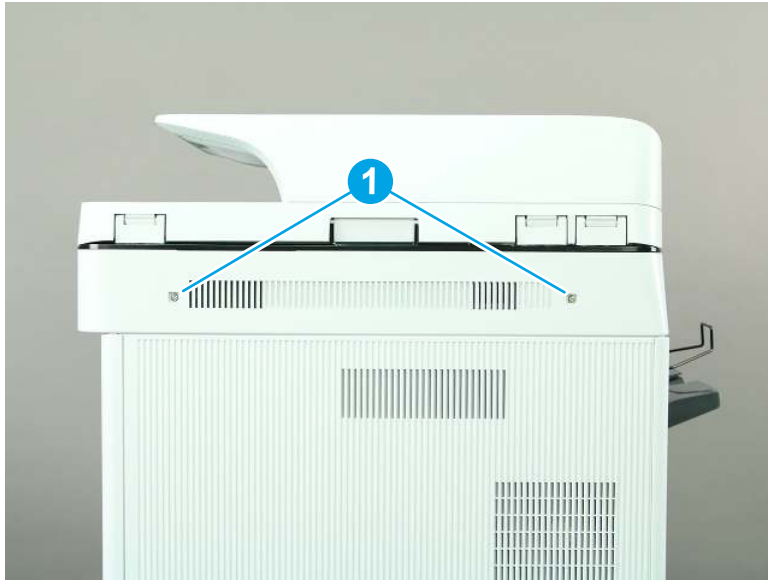
Figure 1-2383 Remove the formatter cover



2. Remove the scanner control board (SCB) cover (M776).

- a. Remove two screws (callout 1).

Figure 1-2384 Remove two screws



- b. Remove the SCB cover.

Figure 1-2385 Remove the SCB cover

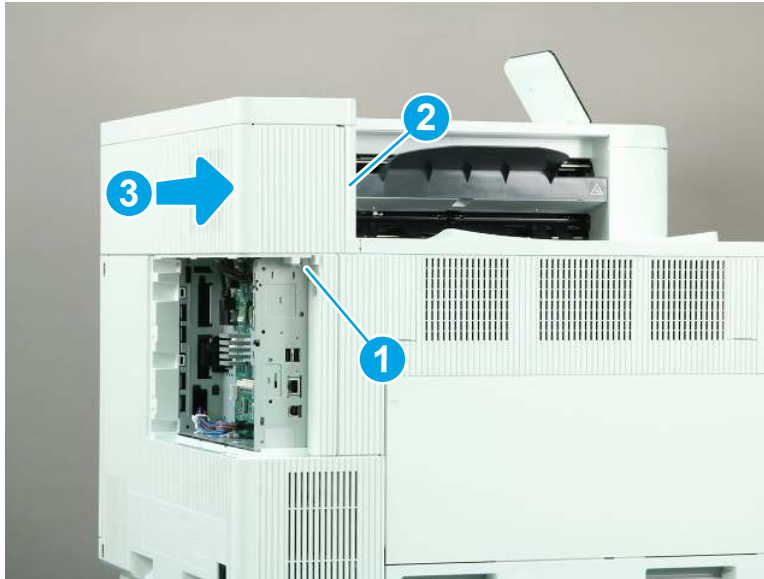


3. Remove the rear upper cover (M856/E85055/M776dn/M776z).

 **NOTE:** The following figure shows the M856 printer. The procedure is correct for all referenced models.

- ▲ Remove one screw (callout 1), release one tab (callout 2), and then slide the rear upper cover away from the printer to remove it (callout 3).

Figure 1-2386 Remove the rear upper cover

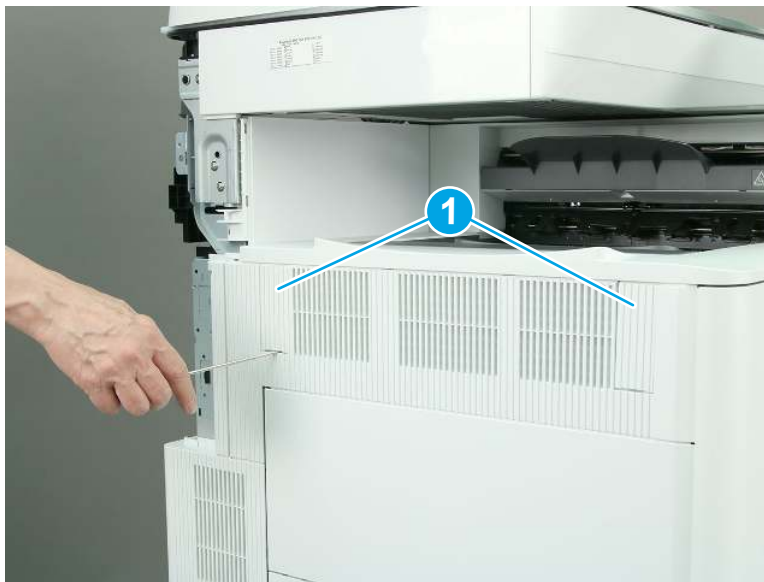


- 4. Remove the accessory upper cover (M856/E85055/M776dn/M776z).

 **NOTE:** The following figures show the M776z printer. The procedure is correct for all referenced models.

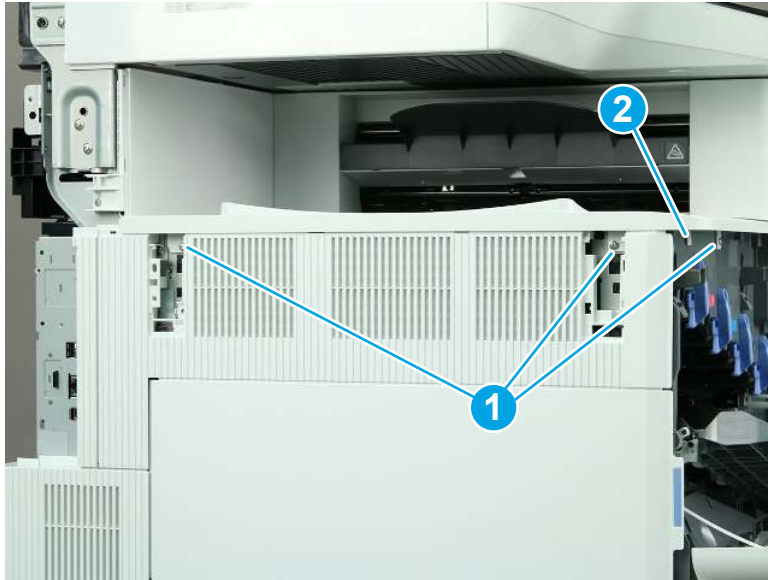
- a. Use a small, flat-blade screwdriver to remove two covers (callout 1).

Figure 1-2387 Remove two covers



- b. Remove three screws (callout 1), and then release one tab (callout 2).

Figure 1-2388 Remove three screws and release one tab



- c. Slide the accessory upper cover away from the printer to remove it.

Figure 1-2389 Remove the accessory upper cover

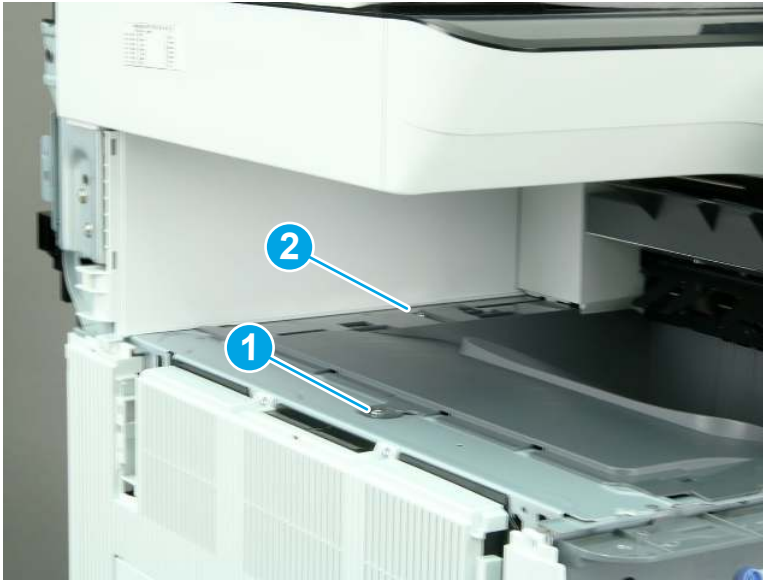


- 5. Remove the output bin (M856/E85055/M776).

 **NOTE:** The following figures show the M776z printer. The procedure is correct for all referenced models.

- a. Remove one washer-head machine screw (callout 1), remove one self-tapping screw (callout 2).

Figure 1-2390 Remove two screws



- b. Remove the output bin.

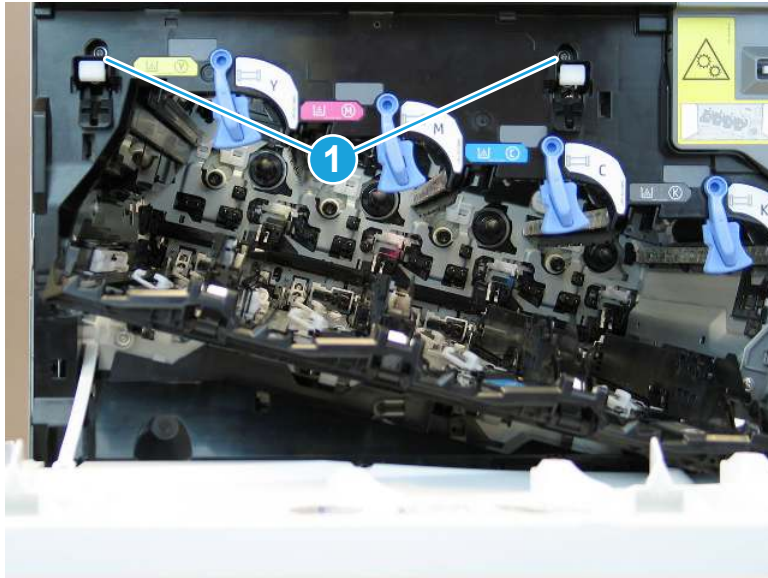
Figure 1-2391 Remove the output bin



6. Remove the cartridge upper guide.

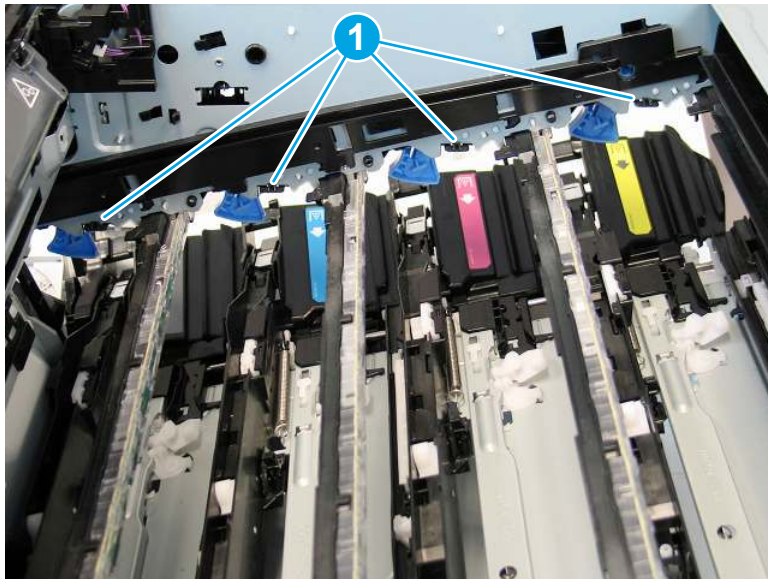
- a. Remove two screws (callout 1).

Figure 1-2392 Remove two screws



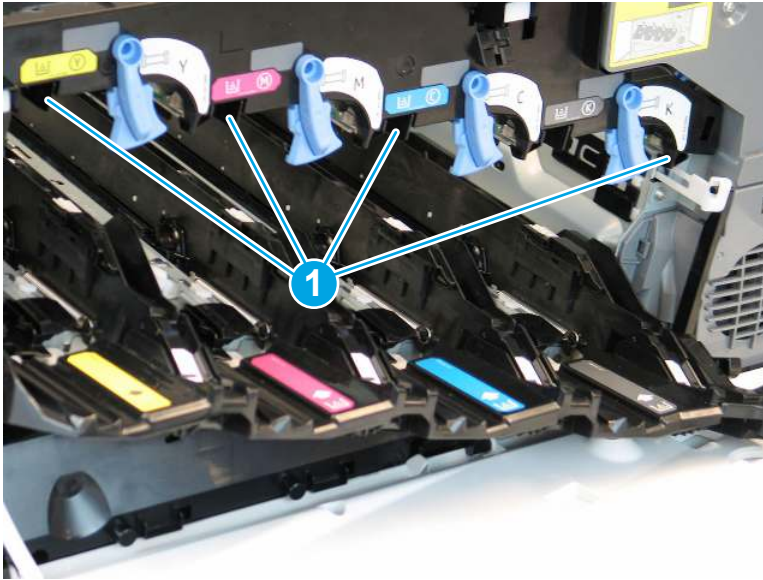
- b. Inside the printer, release four tabs (callout 1) on the back side of the cartridge guide.

Figure 1-2393 Release four tabs



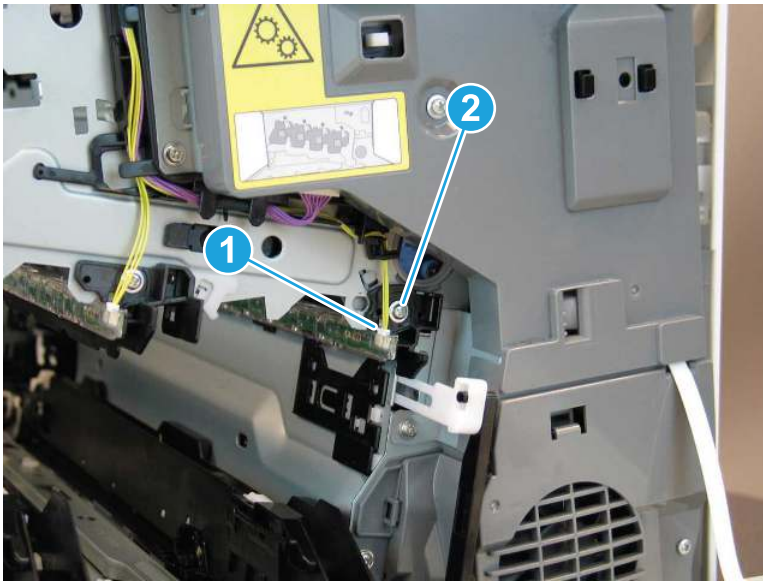
- c. Release four tabs (callout 1), and then remove the cartridge upper guide.

Figure 1-2394 Release four tabs



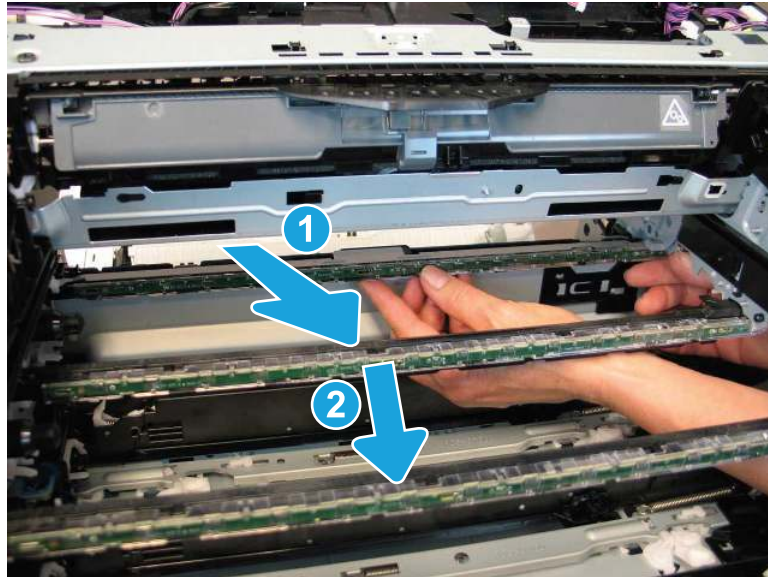
- 7. Remove the black pre-exposure assembly.
 - a. Disconnect one connector (callout 1), and then remove one screw (callout 2).

Figure 1-2395 Disconnect one connector and remove one screw



- b. Lift the pre-exposure assembly away from the printer (callout 1), and then lower it (callout 2) to remove it.

Figure 1-2396 Remove the black pre-exposure assembly



8. Unpack the replacement assembly.

- a. Dispose of the defective part.




NOTE: HP recommends responsible disposal of the defective part.

<http://www8.hp.com/us/en/hp-information/environment/product-recycling.html>

- b. Unpack the replacement part from the packaging.



CAUTION:  Some parts are sensitive to electrostatic discharge (ESD). Always perform service work at an ESD-protected workstation or mat. If an ESD workstation or mat is not available, touch the sheet-metal chassis to provide a static ground before touching an ESD-sensitive assembly. Protect the ESD-sensitive assemblies by placing them in ESD pouches when they are out of the printer.



IMPORTANT: Make sure that all of the shipping materials (for example shipping tape) are removed from the replacement part prior to installation.

- c. To install an assembly, reverse the removal steps.



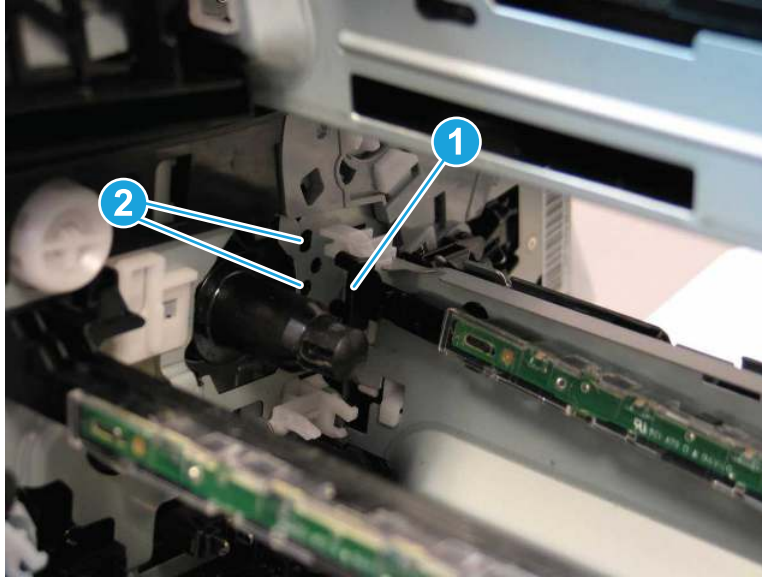
NOTE: When applicable, special installation instructions are provided for an assembly at the end of the removal procedure. Always completely read the removal instructions and follow all special installation instructions.

9. Reverse the removal steps to install the assembly. Also use the following **special installation instructions**.

Install the black pre-exposure assembly.

- ▲ When installing the black pre-exposure assembly, position the tabs (callout 1) on the end of the assembly into the holes (callout 2) in the printer.

Figure 1-2397 Install the black pre-exposure assembly



Removal and replacement: Black pre-exposure assembly (M776zs)

Learn how to remove and replace the black pre-exposure assembly.

Mean time to repair: 12 minutes

Service level: Medium

Before performing service

Turn the printer power off

- Disconnect the power cable.

⚠ WARNING! To avoid damage to the printer, turn the printer off, wait 30 seconds, and then remove the power cord before attempting to service the printer.

Use the table below to identify the correct part number for your printer. To order the part, go to www.hp.com/buy/parts.

Table 1-122 Part information

Part number	Part description
RM2-1340-000CN	Black pre-exposure assembly

Required tools

- #2 Phillips screwdriver with a magnetic tip
- Small, flat-blade screwdriver

After performing service

Turn the printer power on

- Connect the power cable.

- Use the power switch to turn the power on.

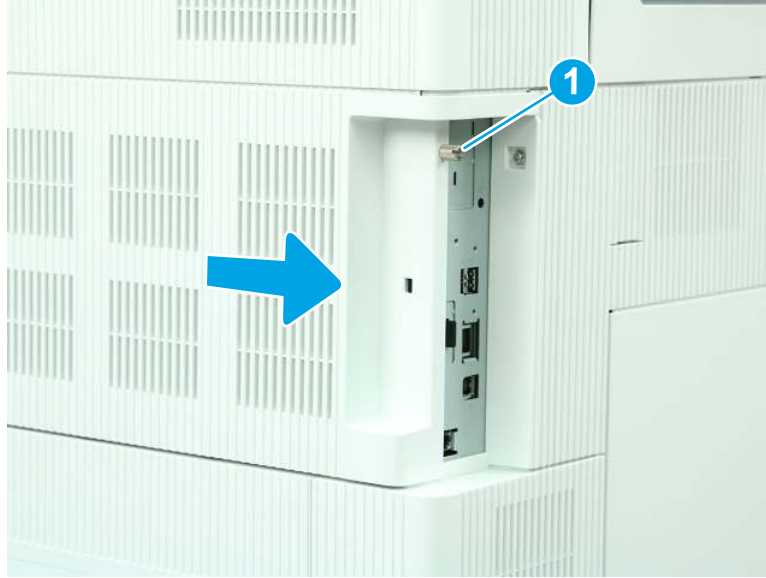
Post service test

Make sure that the printer initializes to a **Ready** state.

Print a page to make sure that the printer is functioning correctly.

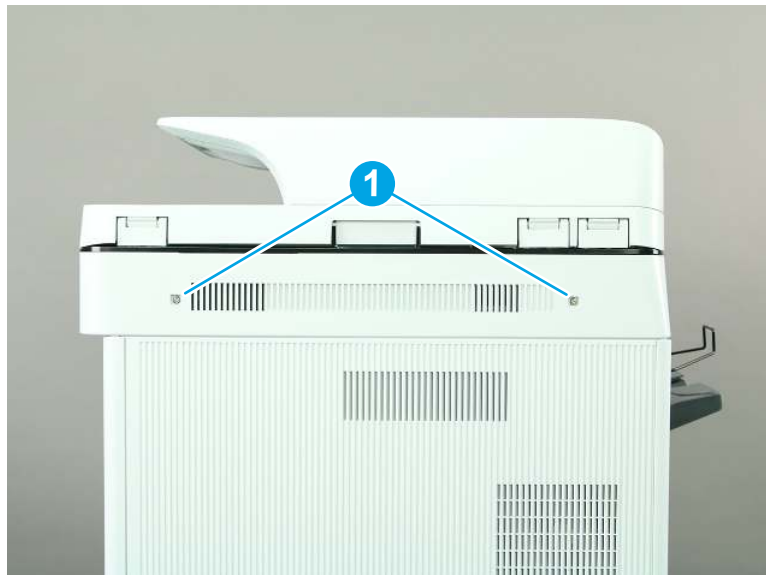
1. Remove the formatter cover.
 - ▲ Loosen one thumbscrew (callout 1), and then slide the formatter cover (callout 2) away from the printer to remove it.

Figure 1-2398 Remove the formatter cover



2. Remove the scanner control board (SCB) cover (M776).
 - a. Remove two screws (callout 1).

Figure 1-2399 Remove two screws



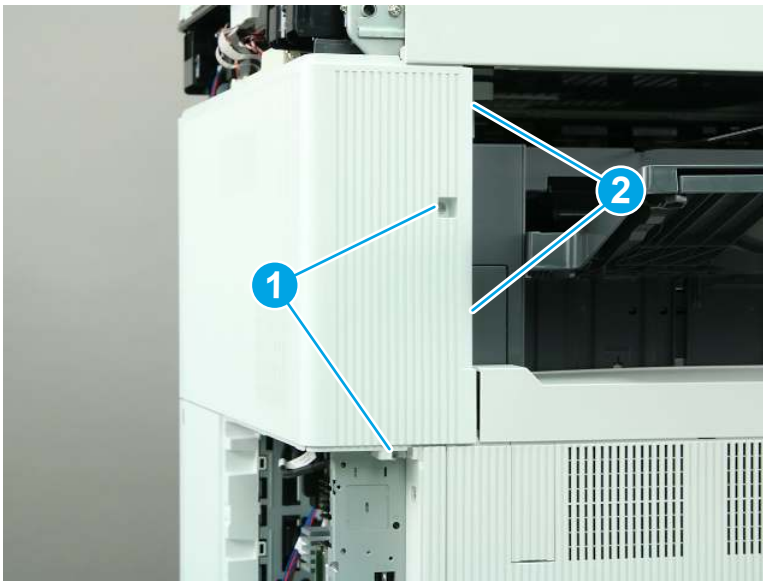
- b. Remove the SCB cover.

Figure 1-2400 Remove the SCB cover



3. Remove the rear upper cover and left rear upper cover (M776zs).
 - a. Remove two screws (callout 1), and then release two tabs (callout 2).

Figure 1-2401 Remove two screws and release two tabs



- b. Slide the cover to the right to remove it.

Figure 1-2402 Remove the rear upper and left rear upper cover



4. Remove the front cover (M776zs).

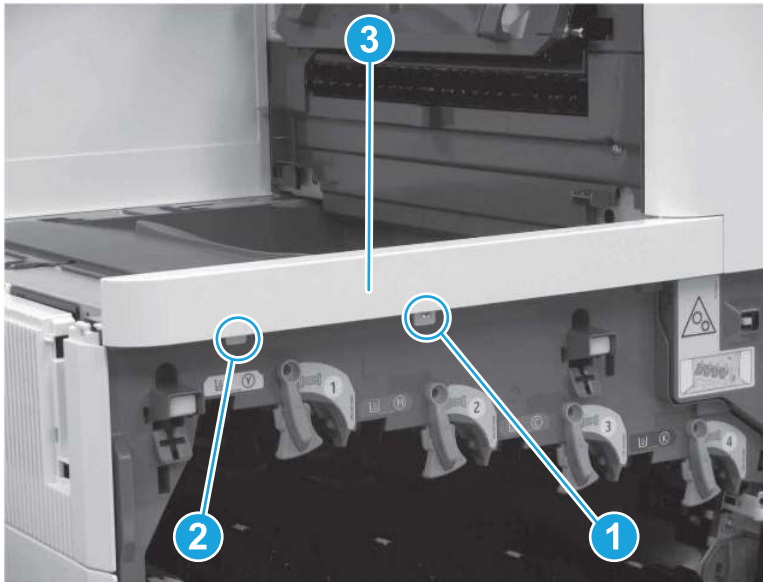
- a. Open the front door.

Figure 1-2403 Open the front door



- b. Remove one screw (callout 1), release one tab (callout 2), and then remove the front cover (callout 3).

Figure 1-2404 Remove the front cover



5. Remove the control panel (M776).
 - a. Rotate the control panel to the fully raised position (callout 1), and then raise the document feeder (callout 2).

Figure 1-2405 Raise the control panel and document feeder



- b. Beginning at the right side of the control-panel cover, carefully release five tabs along the top edge of the cover.

 **NOTE:** The thin black-plastic cover will separate from the white-plastic control-panel base.

Figure 1-2406 Release the control panel cover



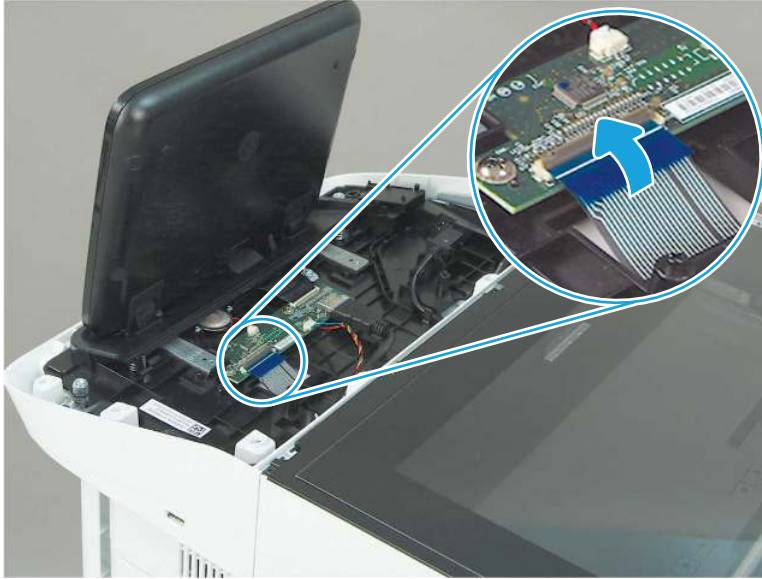
- c. Rotate the control panel cover slightly forward (callout 1), and then lift up to remove the cover (callout 2).

Figure 1-2407 Remove the control panel cover



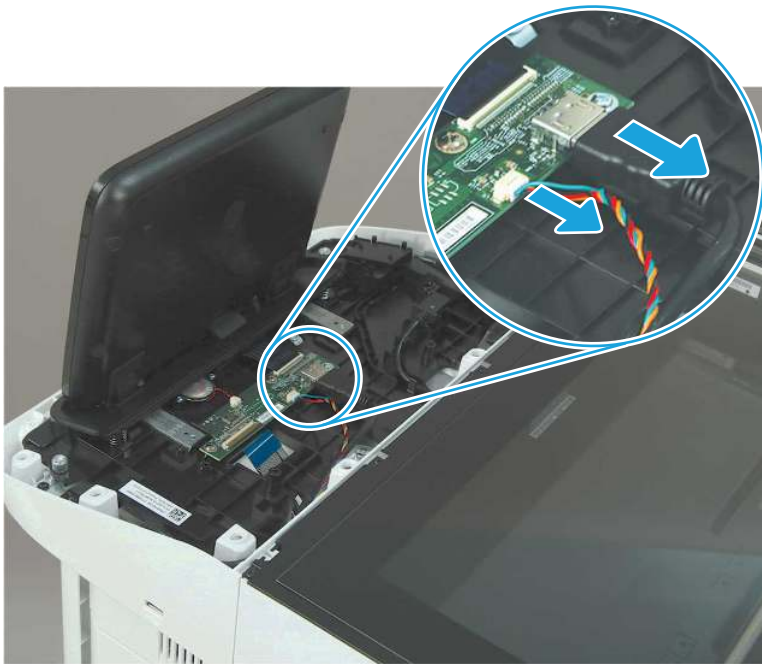
- d. **M776z or M776zs only:** Open the connector latch to release the keyboard flat cable.

Figure 1-2408 Release the keyboard flat cable (M776z/M776zs)



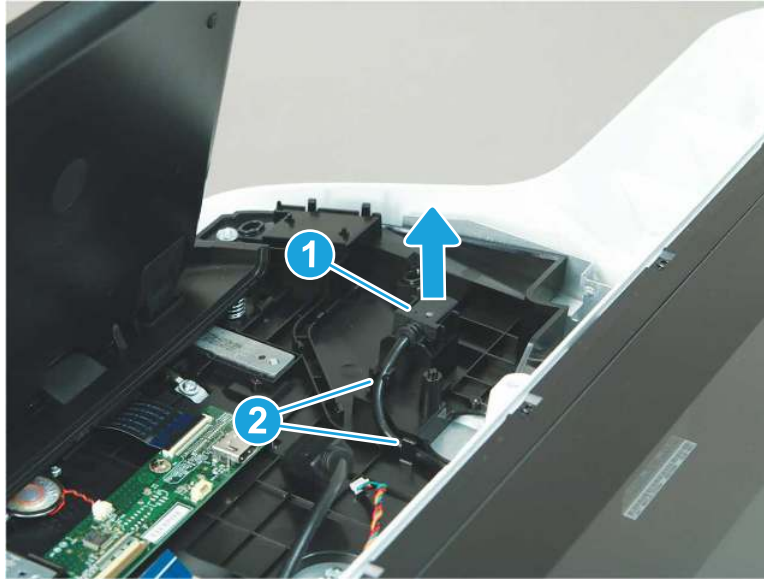
- e. Disconnect two connectors

Figure 1-2409 Disconnect two connectors



- f. Remove the USB cable (callout 1) from the holder, and then release the cable from two retainers (callout 2).

Figure 1-2410 Release the USB cable



- g. Remove three screws (callout 1).

Figure 1-2411 Remove three screws



- h. Lift the front of the control panel off of the printer (callout 1), and then slide it towards the front of the printer (callout 2) to remove it.

Figure 1-2412 Remove the control panel



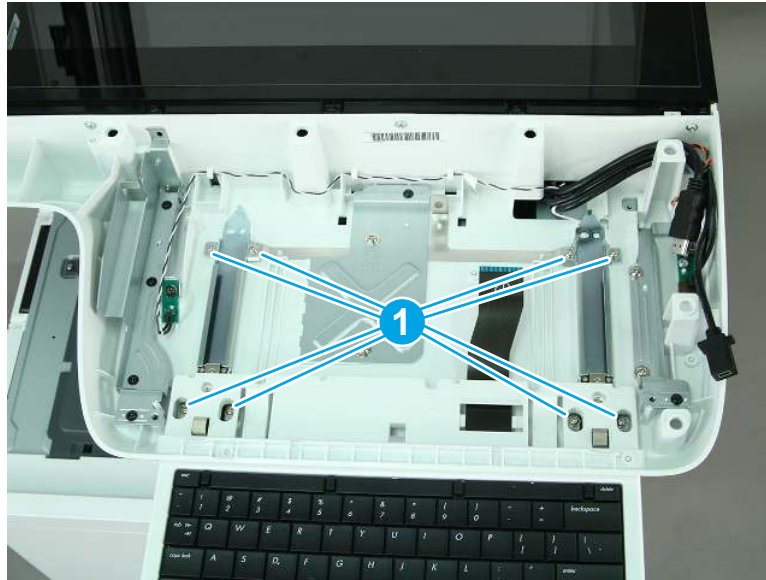
- 6. Remove the keyboard (M776z/M776zs).
 - a. Pull the keyboard out to its extended position.

Figure 1-2413 Pull the keyboard out



- b. Remove eight screws (callout 1).

Figure 1-2414 Remove eight screws



- c. Remove the keyboard and rails.

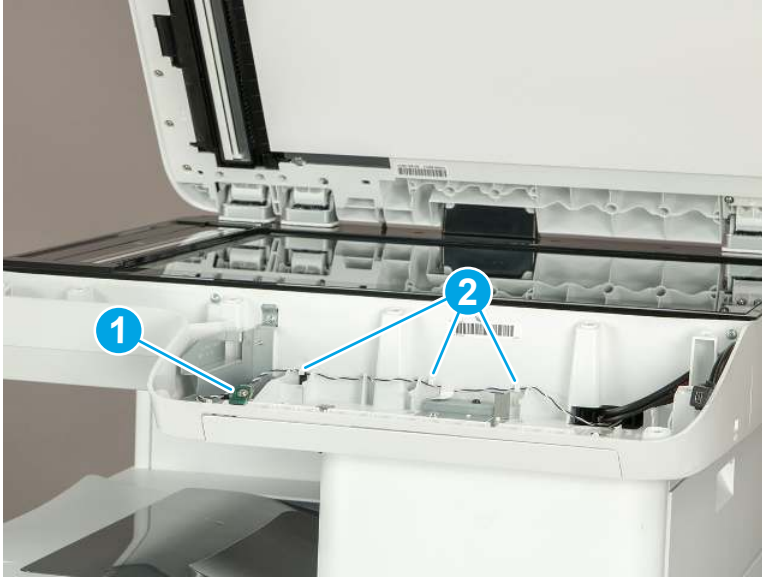
Figure 1-2415 Remove the keyboard and rails



- 7. Remove the nose cone (M776).

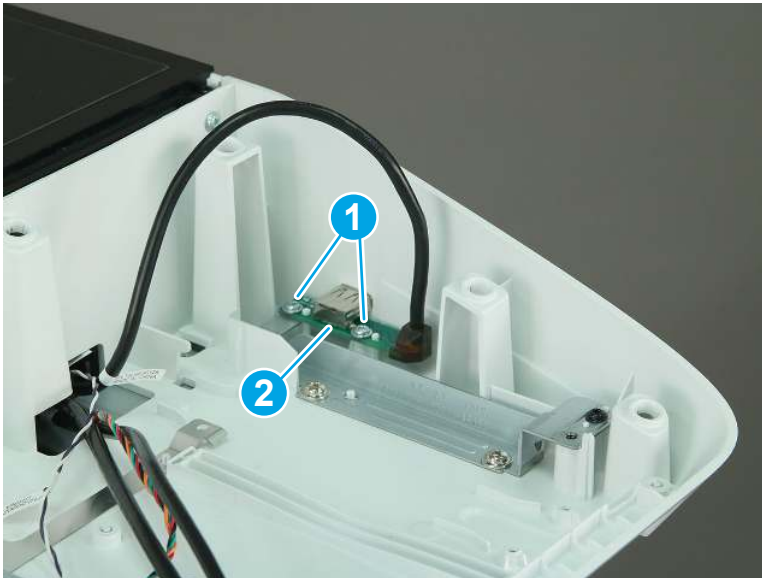
- a. Remove one screw (callout 1) to release the light PCA. Release the cable from three retainers (callout 2), and then move the light PCA out of the way.

Figure 1-2416 Release the light PCA



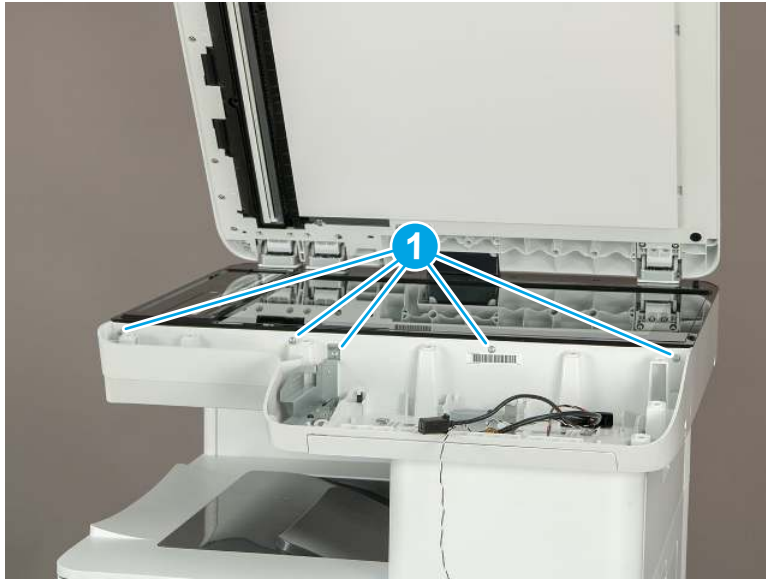
- b. Remove two screws (callout 1), and then move the USB port PCA (callout 2) out of the way.

Figure 1-2417 Release the USB port PCA



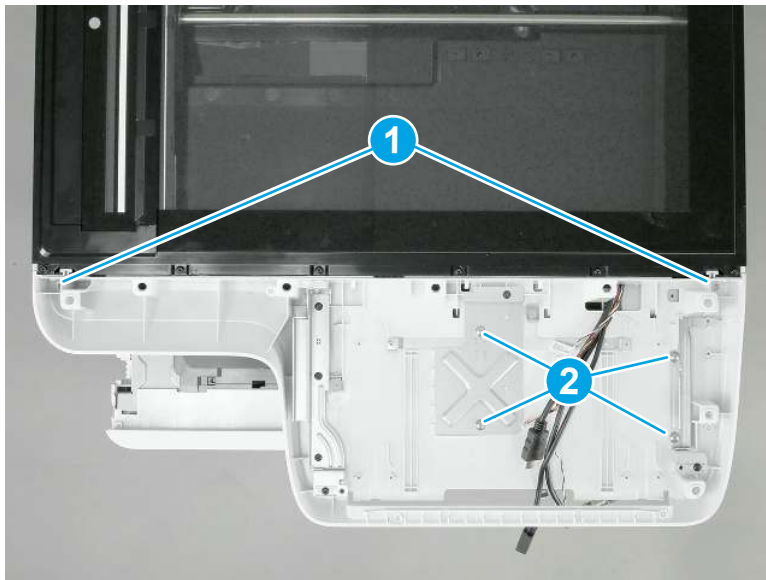
- c. Remove five screws (callout 1).

Figure 1-2418 Remove four screws



- d. Remove two small, self-tapping screws (callout 1), and then remove four larger machine screws (callout 2).

Figure 1-2419 Remove six screws

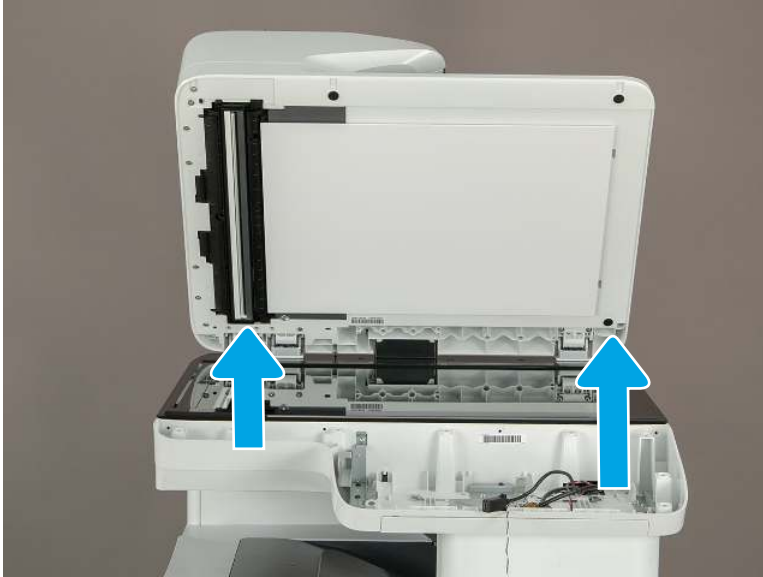


- e. Lift the nose cone up and off of the printer to remove it.



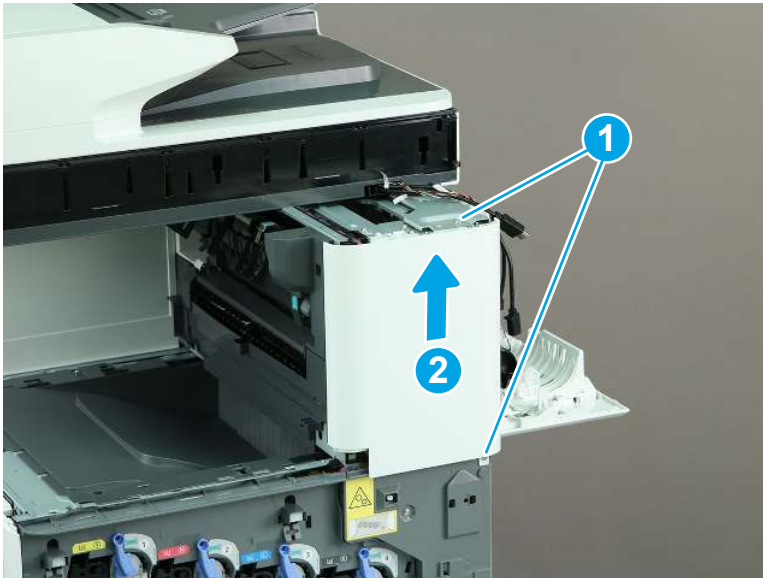
NOTE: Pass the wire harnesses and cables through the opening in the nose cone when removing it.

Figure 1-2420 Remove the nose cone



8. Remove the right front cover (M776zs).
 - ▲ Remove two screws (callout 1), release one tab (callout 2), and then slide the right front cover up (callout 2) to remove it.

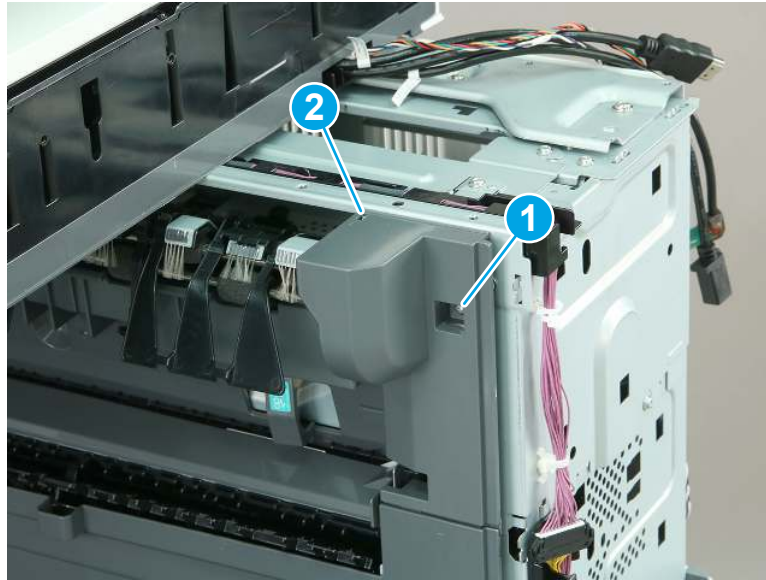
Figure 1-2421 Remove the right front cover



9. Remove the delivery front cover (M776zs).

- ▲ Remove one screw (callout 1), and then remove the delivery front cover (callout 2).

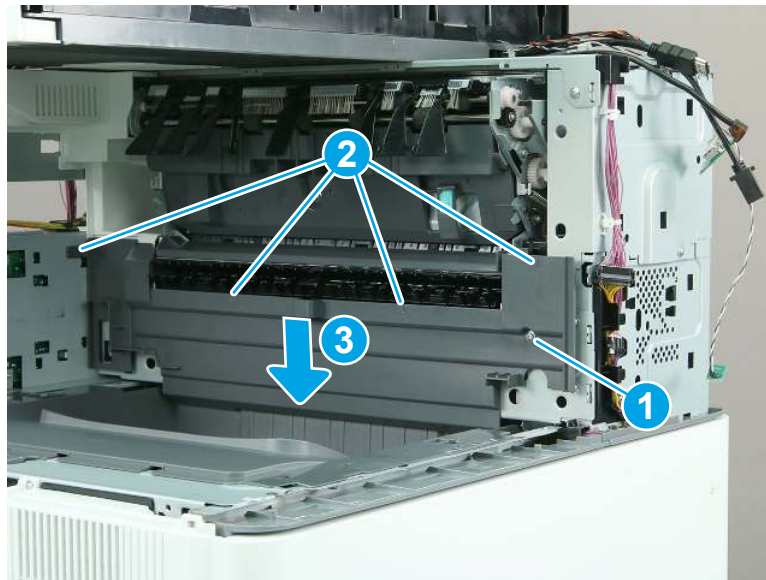
Figure 1-2422 Remove the delivery front cover



10. Remove the delivery cover (M776zs).

- ▲ Remove one screw (callout 1), release four tabs (callout 2), and then slide the delivery cover down (callout 3) to remove it.

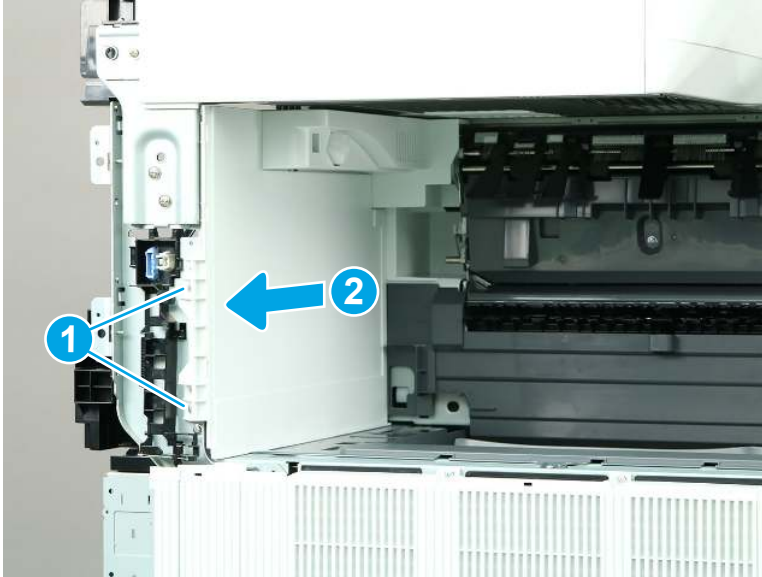
Figure 1-2423 Remove the delivery cover



11. Remove the main cover (M776zs).

- ▲ Remove two screws (callout 1), and then slide the main cover away from the printer to remove it (callout 2).

Figure 1-2424 Remove the main cover

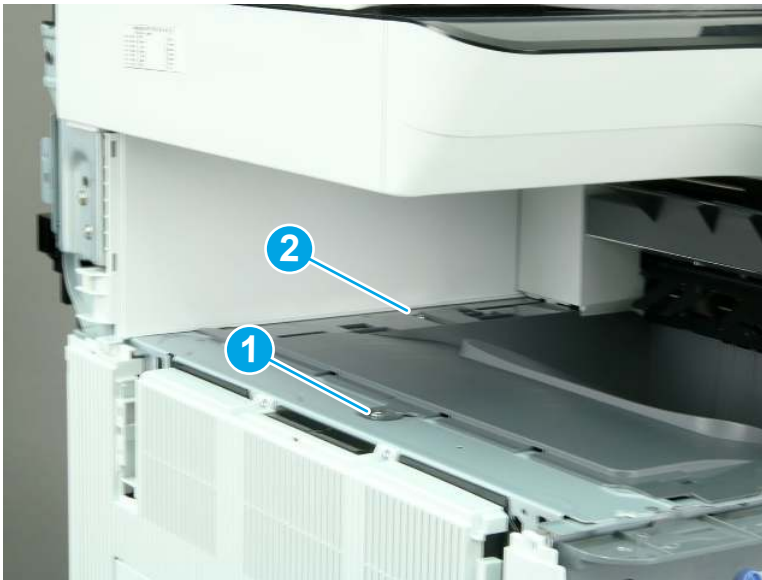


12. Remove the output bin (M856/E85055/M776).

 **NOTE:** The following figures show the M776z printer. The procedure is correct for all referenced models.

- a. Remove one washer-head machine screw (callout 1), remove one self-tapping screw (callout 2).

Figure 1-2425 Remove two screws



- b. Remove the output bin.

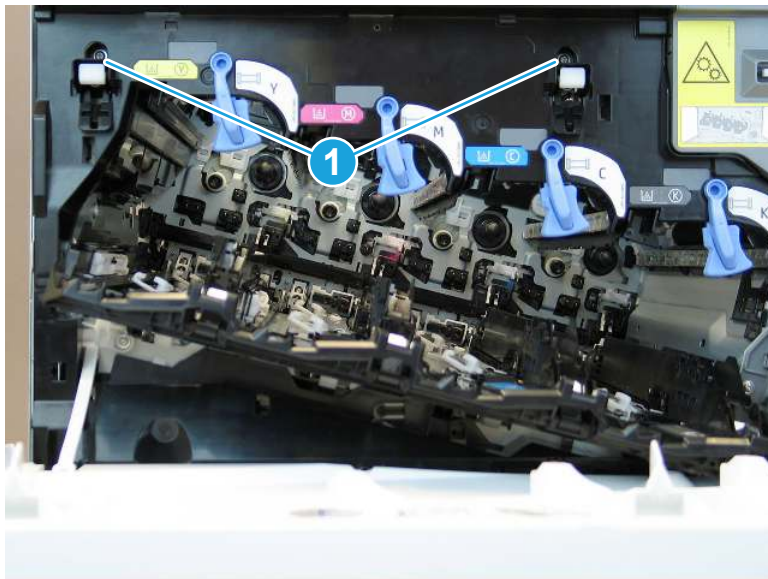
Figure 1-2426 Remove the output bin



- 13. Remove the cartridge upper guide.

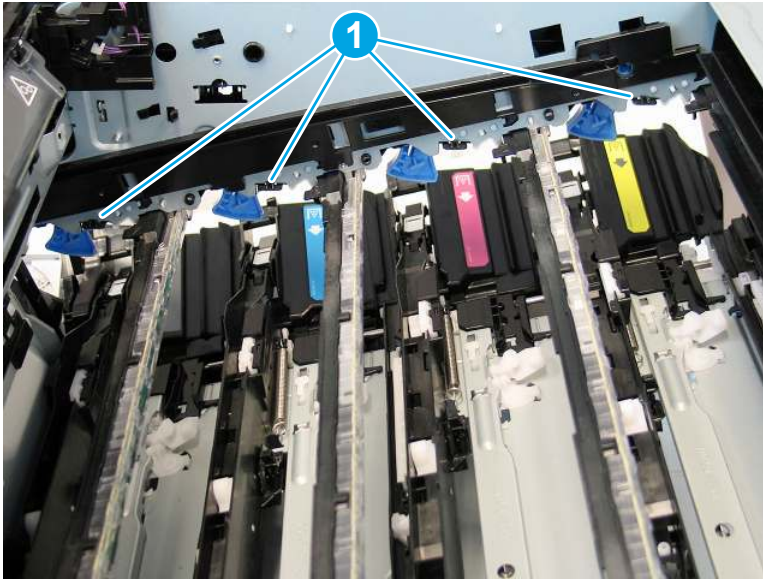
- a. Remove two screws (callout 1).

Figure 1-2427 Remove two screws



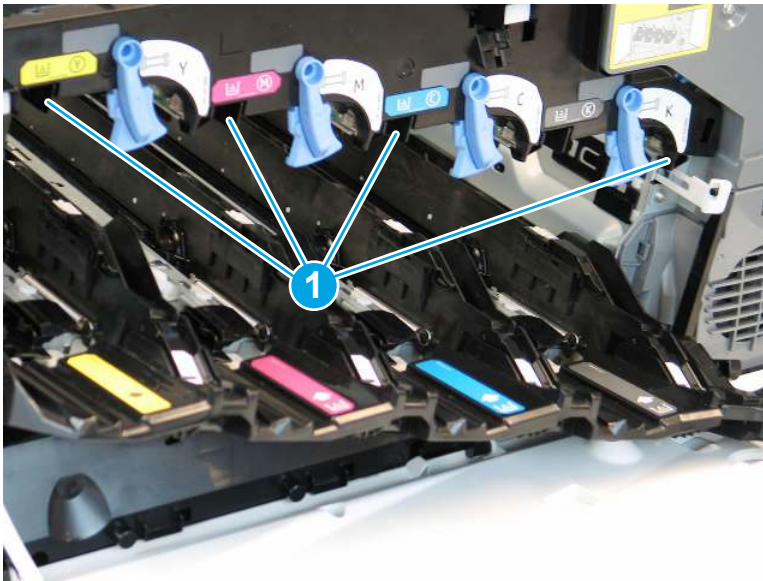
- b. Inside the printer, release four tabs (callout 1) on the back side of the cartridge guide.

Figure 1-2428 Release four tabs



- c. Release four tabs (callout 1), and then remove the cartridge upper guide.

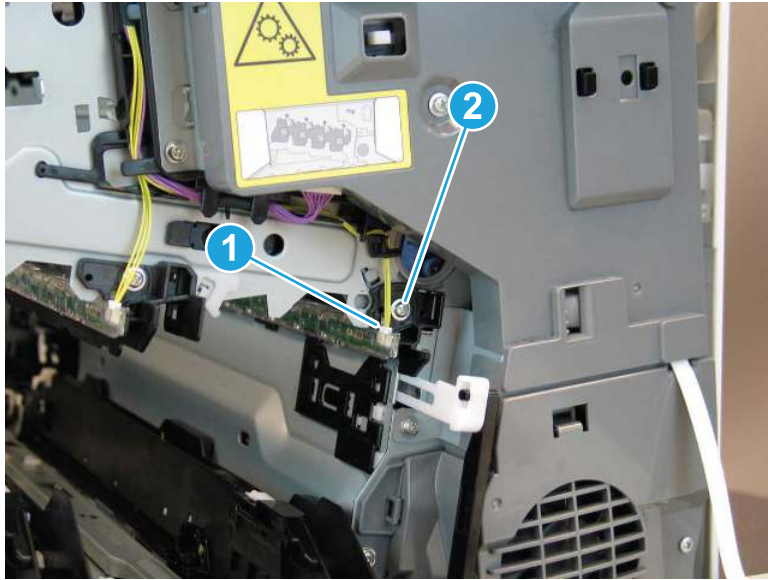
Figure 1-2429 Release four tabs



- 14. Remove the black pre-exposure assembly.

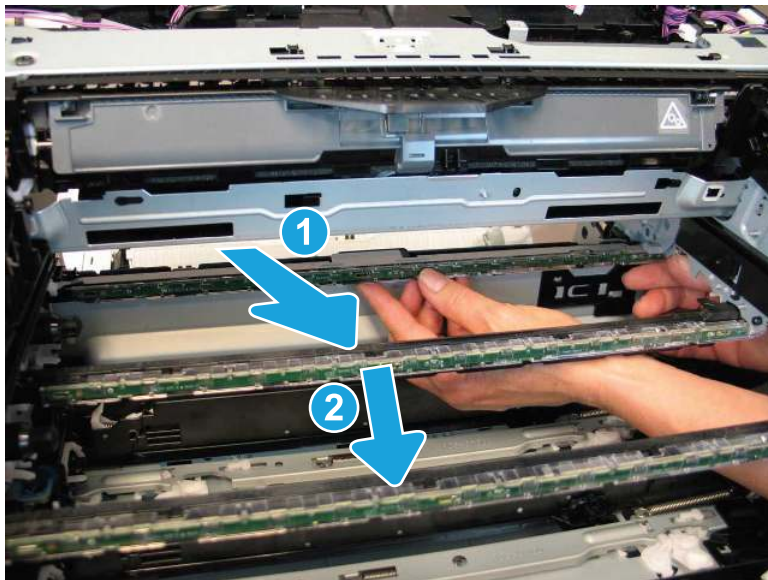
- a. Disconnect one connector (callout 1), and then remove one screw (callout 2).

Figure 1-2430 Disconnect one connector and remove one screw



- b. Lift the pre-exposure assembly away from the printer (callout 1), and then lower it (callout 2) to remove it.

Figure 1-2431 Remove the black pre-exposure assembly



15. Unpack the replacement assembly.


- a. Dispose of the defective part.




NOTE: HP recommends responsible disposal of the defective part.


<http://www8.hp.com/us/en/hp-information/environment/product-recycling.html>

- b. Unpack the replacement part from the packaging.

CAUTION:  Some parts are sensitive to electrostatic discharge (ESD). Always perform service work at an ESD-protected workstation or mat. If an ESD workstation or mat is not available, touch the sheet-metal chassis to provide a static ground before touching an ESD-sensitive assembly. Protect the ESD-sensitive assemblies by placing them in ESD pouches when they are out of the printer.

IMPORTANT:  Make sure that all of the shipping materials (for example shipping tape) are removed from the replacement part prior to installation.

- c. To install an assembly, reverse the removal steps.

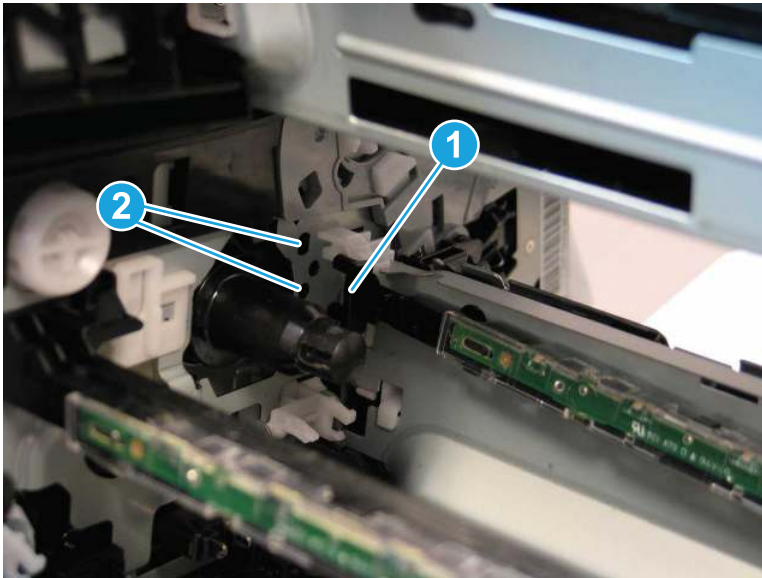
NOTE:  When applicable, special installation instructions are provided for an assembly at the end of the removal procedure. Always completely read the removal instructions and follow all special installation instructions.

16. Reverse the removal steps to install the assembly. Also use the following **special installation instructions**.

Install the black pre-exposure assembly.

- ▲ When installing the black pre-exposure assembly, position the tabs (callout 1) on the end of the assembly into the holes (callout 2) in the printer.

Figure 1-2432 Install the black pre-exposure assembly



Removal and replacement: Power switch PCA (M751/E75245)

Learn how to remove and replace the power switch PCA.

[View a video of how to remove and replace the power switch PCA.](#)

Mean time to repair: 12 minutes

Service level: Medium

Before performing service

Turn the printer power off

- Disconnect the power cable.

⚠ WARNING! To avoid damage to the printer, turn the printer off, wait 30 seconds, and then remove the power cord before attempting to service the printer.

Use the table below to identify the correct part number for your printer. To order the part, go to www.hp.com/buy/parts.

Table 1-123 Part information

Part number	Part description
RM2-9610-000CN	Power switch PCB assembly

Required tools

- #2 Phillips screwdriver with a magnetic tip
- Small, flat-blade screwdriver

After performing service

Turn the printer power on

- Connect the power cable.
- Use the power switch to turn the power on.

Post service test

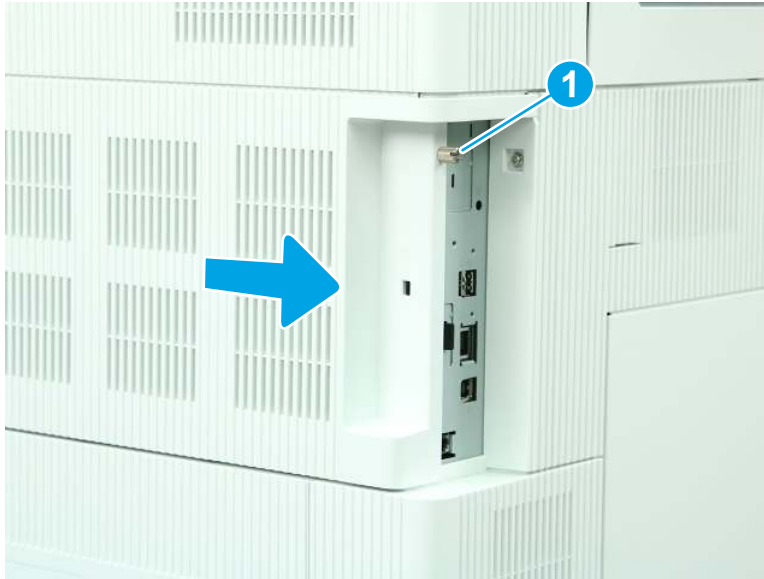
Make sure that the printer initializes to a **Ready** state.

Print a page to make sure that the printer is functioning correctly.

1. Remove the formatter cover.

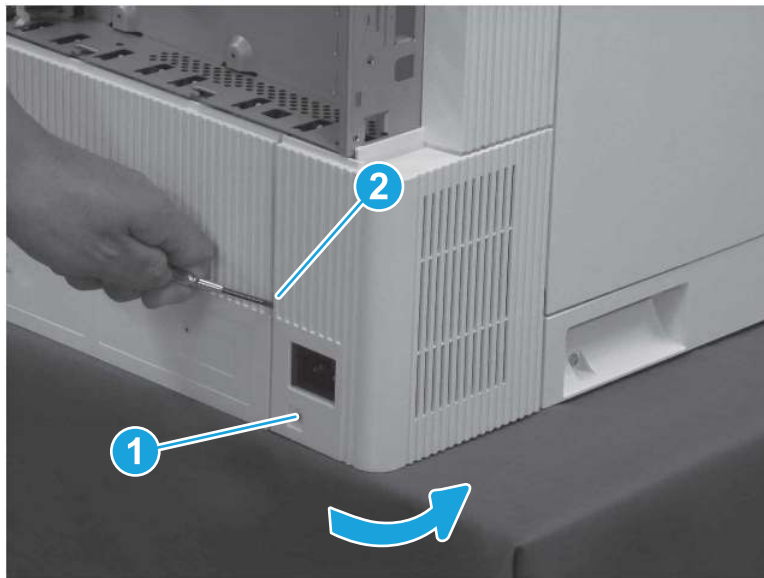
- ▲ Loosen one thumbscrew (callout 1), and then slide the formatter cover (callout 2) away from the printer to remove it.

Figure 1-2433 Remove the formatter cover



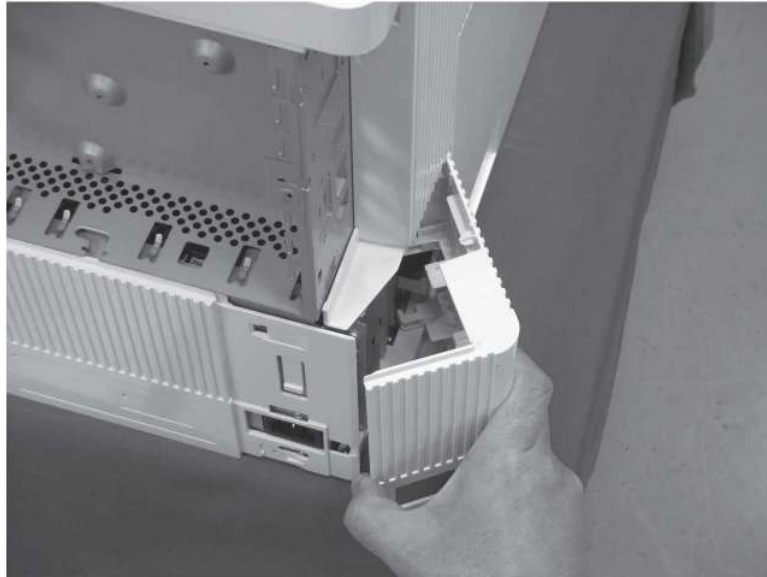
- 2. Remove the left lower cover (M751/E75245).
 - a. Remove one screw (callout 1), release one tab (callout 2), and then rotate the cover away from the printer.

Figure 1-2434 Remove one screw and release one tab



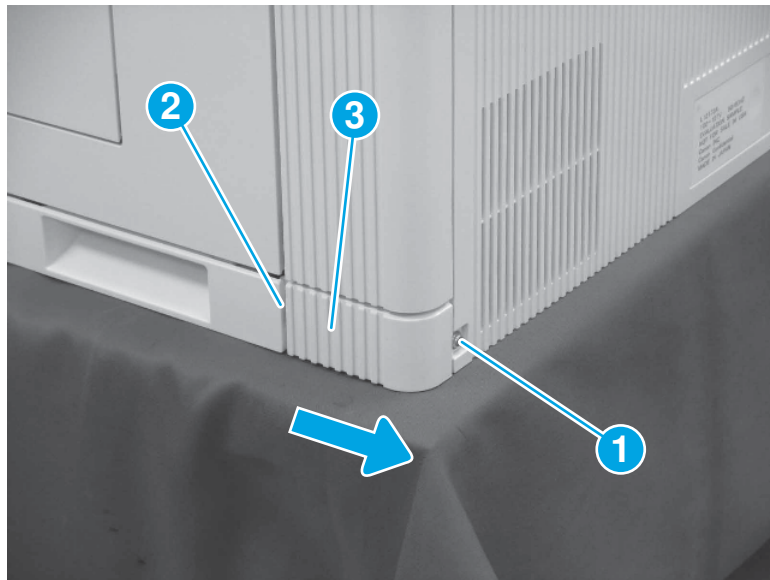
- b. Remove the left lower cover.

Figure 1-2435 Remove the left lower cover



3. Remove the right rear lower cover (M751/E75245/M856/E85055/M776).
 - ▲ Remove one screw (callout 1), release one tab (callout 2), and then slide the right rear lower cover (callout 3) toward the back of the printer to remove it.

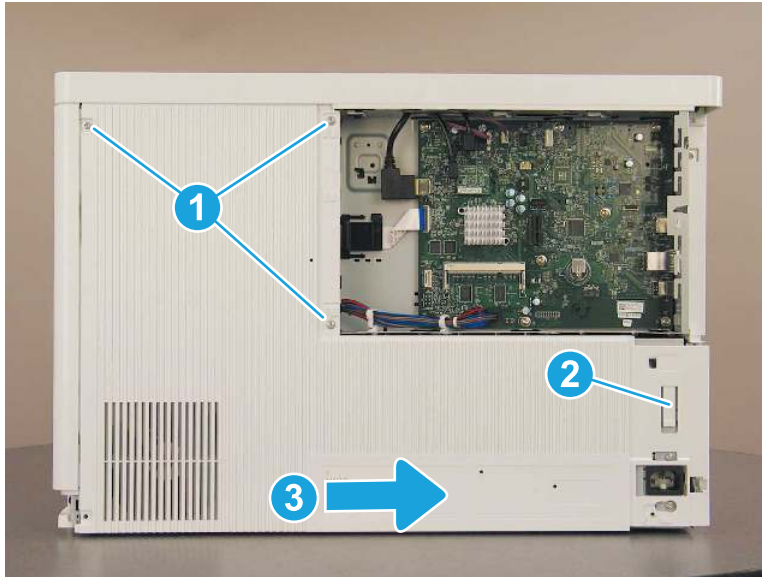
Figure 1-2436 Remove the right rear lower cover



4. Remove the rear cover (M751/E75245).

- ▲ Remove three screws (callout 1), release one tab (callout 2), and then slide the rear cover to the right (callout 3) to remove it.

Figure 1-2437 Remove the rear cover



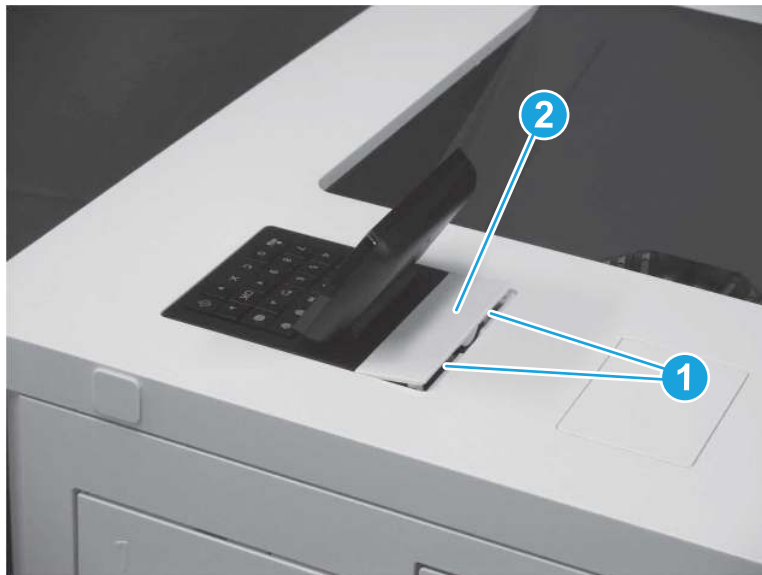
- 5. Remove the control panel.



NOTE: A screwdriver is included in the control panel kit. The screwdriver has a reversible shaft. Simply pull the shaft out of the handle, and then reinstall it with the desired end facing out.

- a. Use a small, flat-blade screwdriver to release two tabs (callout 1), and then remove the control panel cover (callout 2).

Figure 1-2438 Remove the control panel cover



- b. Remove one screw (callout 1).

Figure 1-2439 Remove one screw



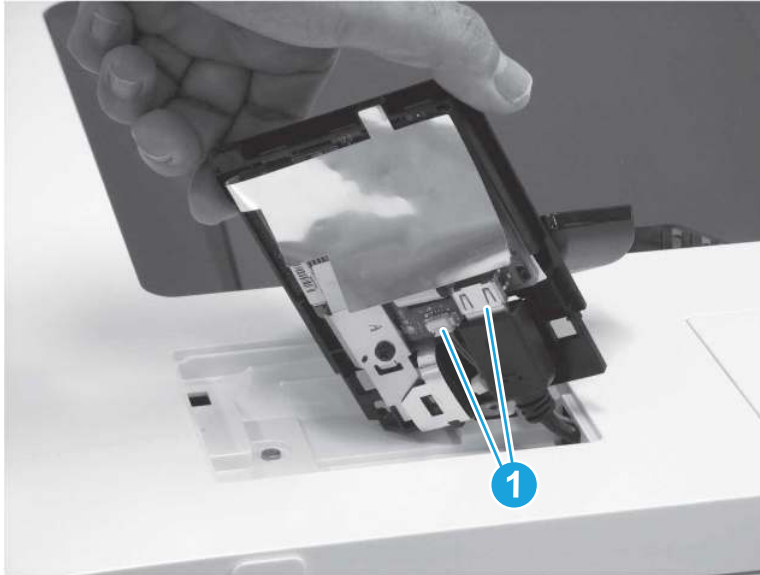
- c. Lift the back edge of the control panel up (callout 1), and then slide the control panel toward the back of the printer (callout 2).

Figure 1-2440 Slide the control panel back



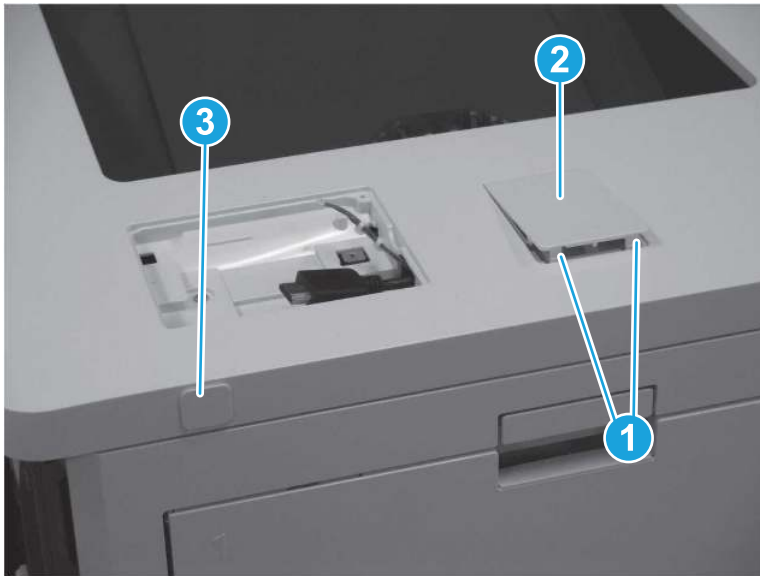
- d. Turn the control panel so that the bottom is facing up, and then disconnect two connectors (callout 1) to remove the control panel.

Figure 1-2441 Disconnect two connectors



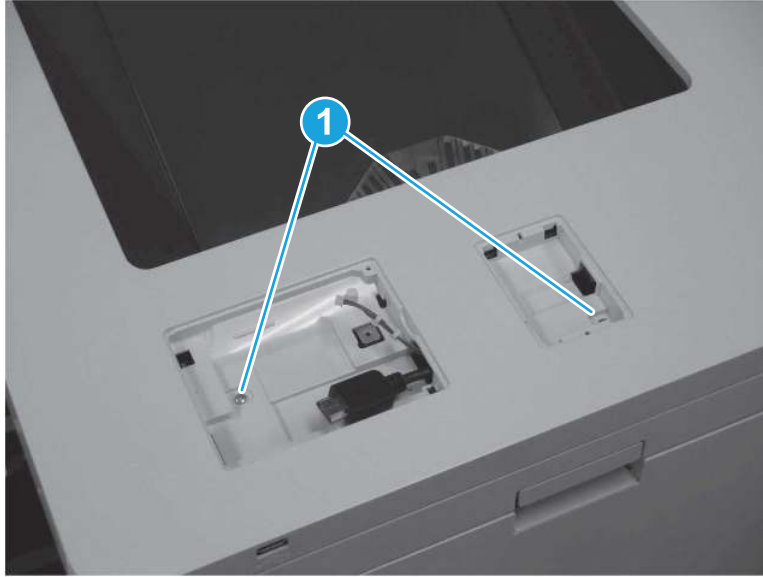
6. Remove the top cover (M751/E75245).
 - a. Release two tabs (callout 1), and then remove the HIP cover (callout 2). Pull the USB cap (callout 3) away from the printer to remove it.

Figure 1-2442 Remove the HIP cover and USB cap



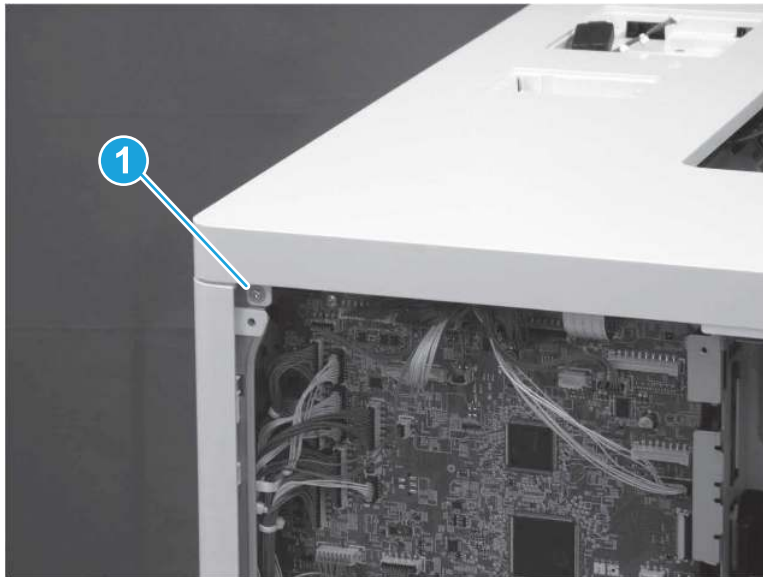
- b. At the top of the printer, remove two screws (callout 1).

Figure 1-2443 Remove two screws



- c. At the back of the printer, remove one screw (callout 1).

Figure 1-2444 Remove one screw

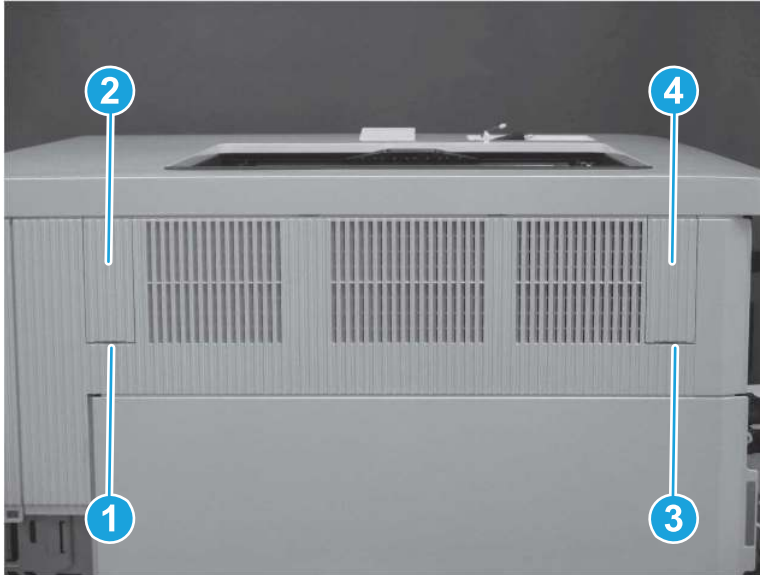


- d. Use a small, flat-blade screwdriver to release one tab (callout 1) and remove the left blanking cover (callout 2). Release one tab (callout 3) and remove the right blanking cover (callout 4).

 **TIP:** These covers are not identical. Make sure to reinstall the correct cover on the correct side.

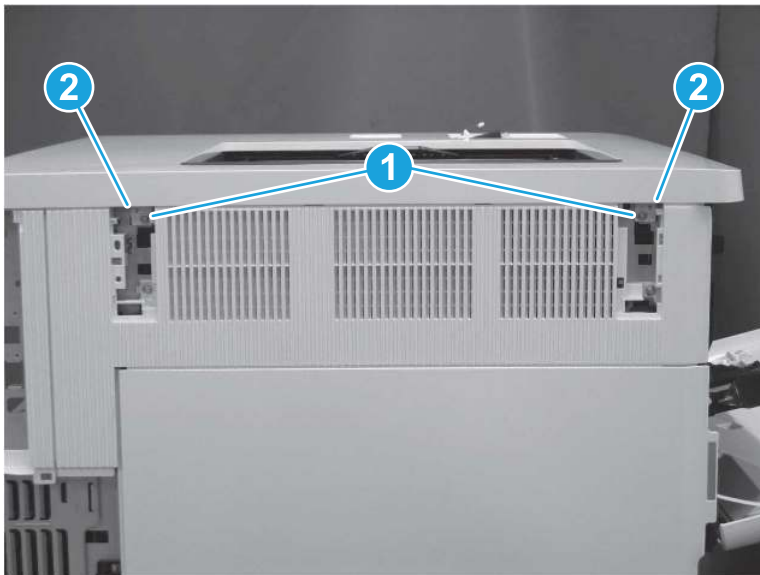
 **NOTE:** The screw under the left blanking cover is a self-tapping screw. Make sure this screw is reinstalled in the correct location.

Figure 1-2445 Remove the left and right blanking covers



- e. Remove two screws (callout 1), and then release two tabs (callout 2).

Figure 1-2446 Remove two screws and release two tabs



- f. At the front of the printer, remove one washer-head screw (callout 1) and one self-tapping screw (callout 2). Release one tab (callout 3).


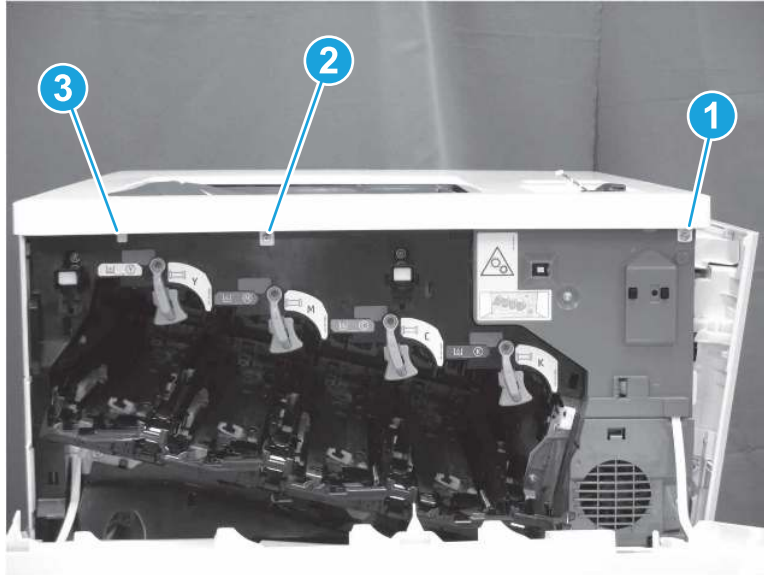
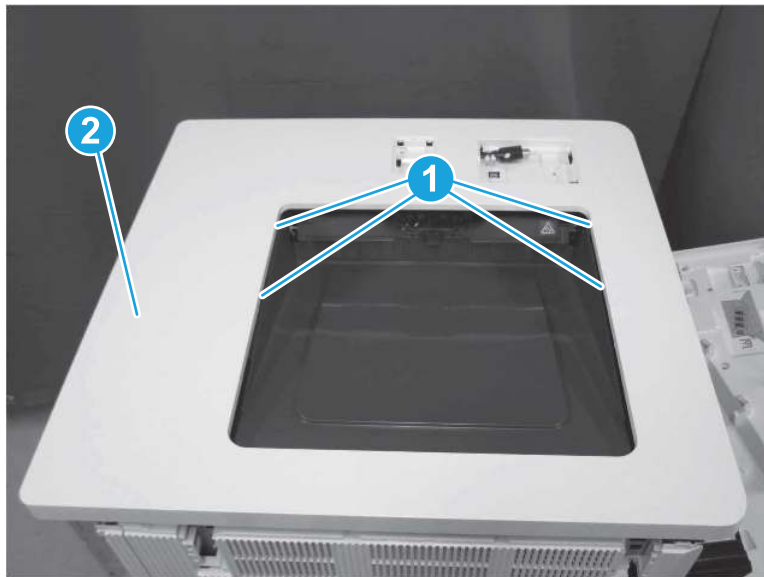
 **TIP:** Make sure to install the correct type of screw in the correct location.

Figure 1-2447 Remove two screws and release one tab

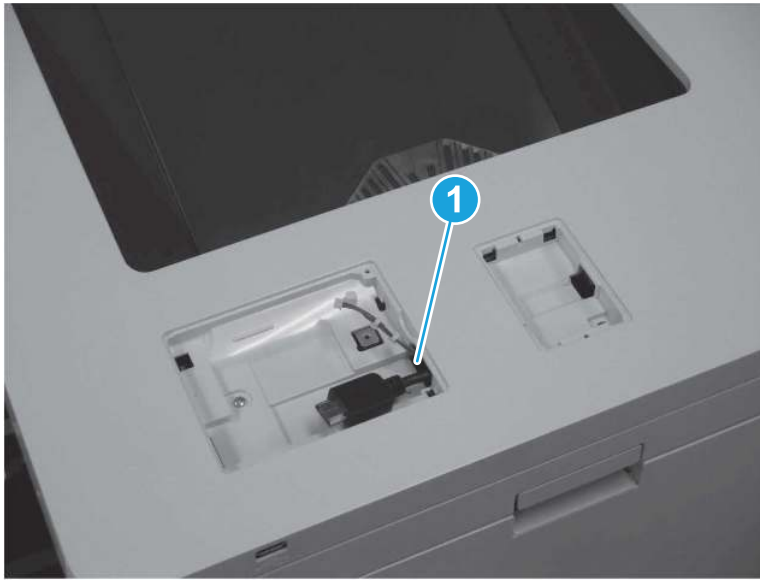


- g. At the top of the printer, release four tabs (callout 1), and then remove the top cover (callout 2).

Figure 1-2448 Remove the top cover

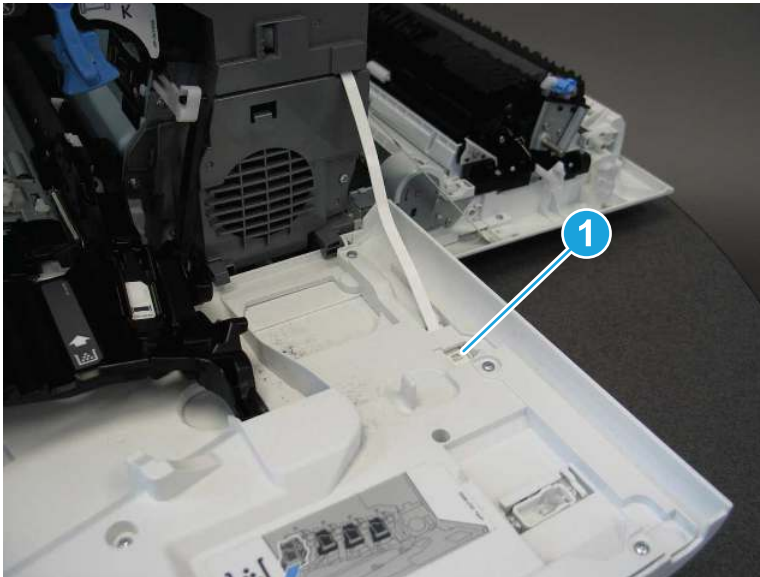


 **NOTE:** When removing the top cover, make sure to release the control panel cables (callout 1) through the opening.



7. Remove the duplex fan cover.
 - a. Use a small, flat-blade screwdriver to release the tab (callout 1) on the right front door hinge.

Figure 1-2449 Release the hinge tab



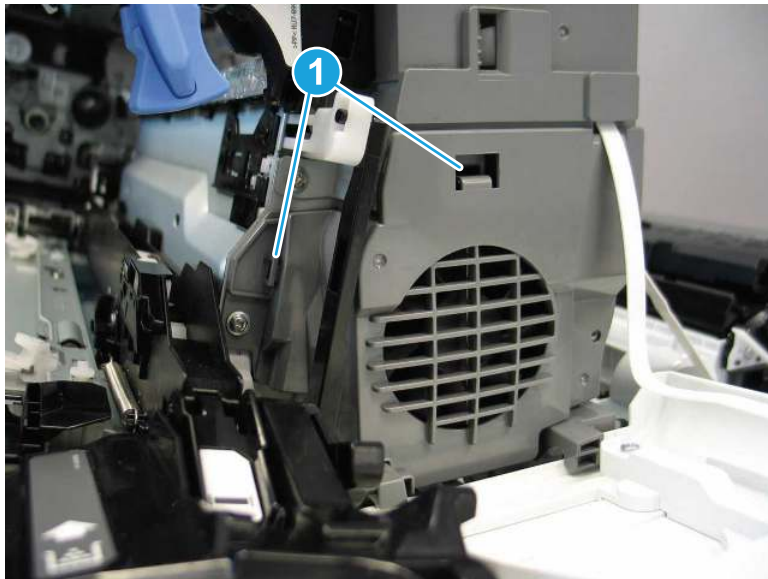
- b. Remove one screw (callout 1).

Figure 1-2450 Remove one screw



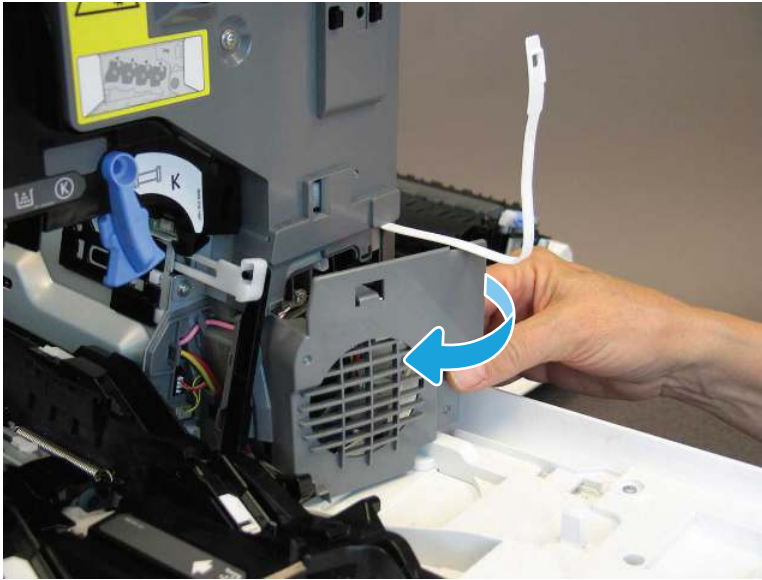
- c. Release two tabs (callout 1).

Figure 1-2451 Release two tabs



- d. Rotate the cover away from the printer to remove it.

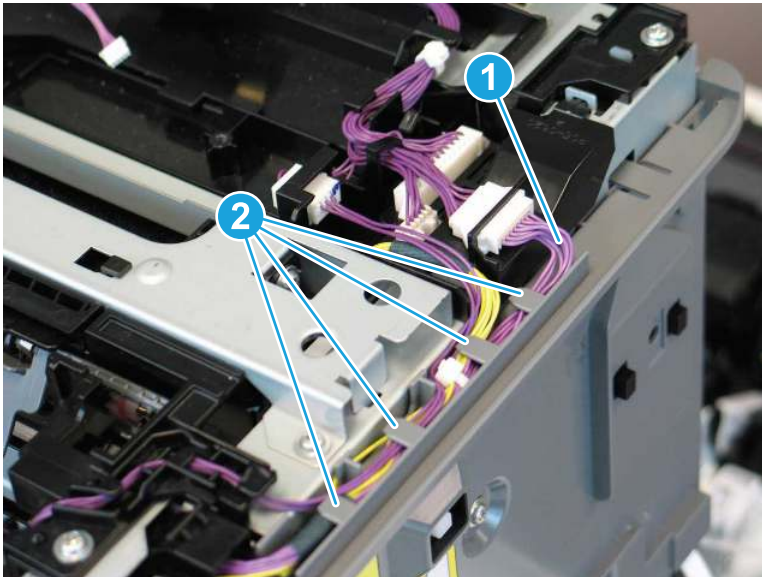
Figure 1-2452 Remove the fan cover



8. Remove the front inner right upper cover.
 - a. At the top of the printer, release the wire harness (callout 1) from the guides (callout 2).

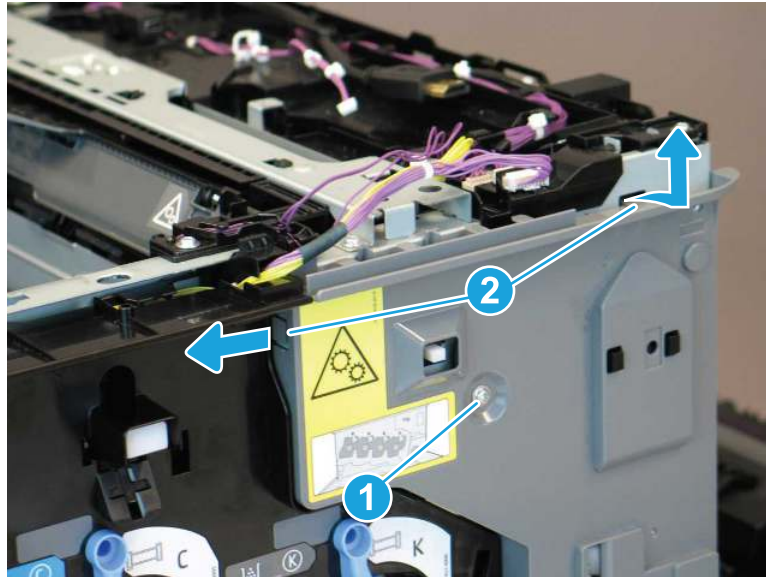
 **NOTE:** The M751 is pictured in the figures below. The procedure is correct for all referenced models.

Figure 1-2453 Release the wires from the guides



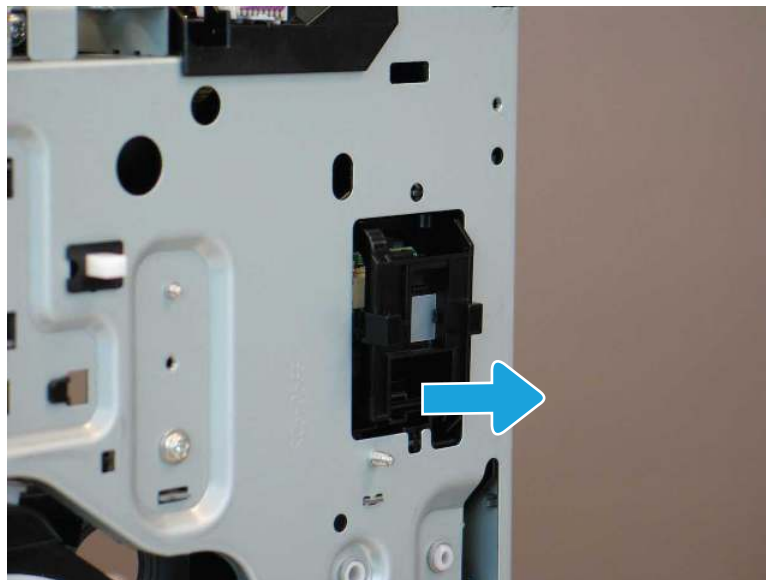
- b. Remove one screw (callout 1), release two tabs (callout 2), and then remove the front inner right upper cover.

Figure 1-2454 Remove the front inner right upper cover



9. Remove the power switch PCA.
 - a. Pull the power switch cover away from the printer to release it.

Figure 1-2455 Release the power switch cover



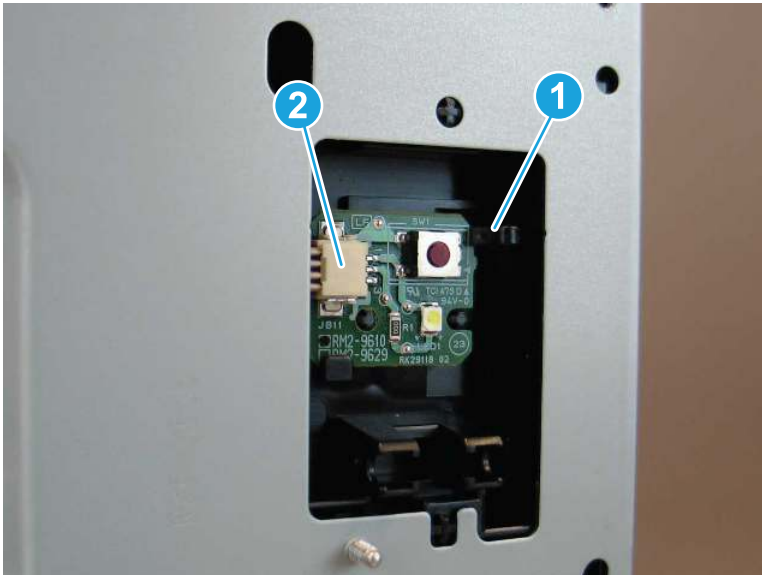
- b. Remove the power switch cover.

Figure 1-2456 Remove the power switch cover



- c. Release one tab (callout 1), disconnect one connector (callout 2), and then remove the power switch PCA.

Figure 1-2457 Remove the power switch PCA



10. Unpack the replacement assembly.



- a. Dispose of the defective part.




NOTE: HP recommends responsible disposal of the defective part.


<http://www8.hp.com/us/en/hp-information/environment/product-recycling.html>

- b. Unpack the replacement part from the packaging.

 **CAUTION:**  Some parts are sensitive to electrostatic discharge (ESD). Always perform service work at an ESD-protected workstation or mat. If an ESD workstation or mat is not available, touch the sheet-metal chassis to provide a static ground before touching an ESD-sensitive assembly. Protect the ESD-sensitive assemblies by placing them in ESD pouches when they are out of the printer.

 **IMPORTANT:** Make sure that all of the shipping materials (for example shipping tape) are removed from the replacement part prior to installation.

- c. To install an assembly, reverse the removal steps.

 **NOTE:** When applicable, special installation instructions are provided for an assembly at the end of the removal procedure. Always completely read the removal instructions and follow all special installation instructions.

Removal and replacement: Power switch PCA (M856/E85055)

Learn how to remove and replace the power switch PCA.


Mean time to repair: 12 minutes

Service level: Medium

Before performing service

Turn the printer power off

- Disconnect the power cable.

 **WARNING!** To avoid damage to the printer, turn the printer off, wait 30 seconds, and then remove the power cord before attempting to service the printer.

Use the table below to identify the correct part number for your printer. To order the part, go to www.hp.com/buy/parts.

Table 1-124 Part information

Part number	Part description
RM2-9610-000CN	Power switch PCB assembly

Required tools

- #2 Phillips screwdriver with a magnetic tip
- Small, flat-blade screwdriver

After performing service

Turn the printer power on

- Connect the power cable.
- Use the power switch to turn the power on.

Post service test

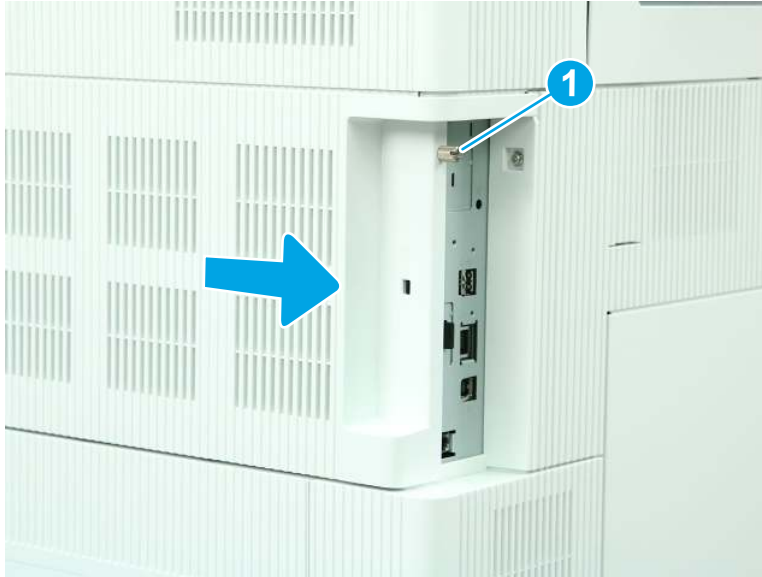
Make sure that the printer initializes to a **Ready** state.

Print a page to make sure that the printer is functioning correctly.

1. Remove the formatter cover.

- ▲ Loosen one thumbscrew (callout 1), and then slide the formatter cover (callout 2) away from the printer to remove it.

Figure 1-2458 Remove the formatter cover

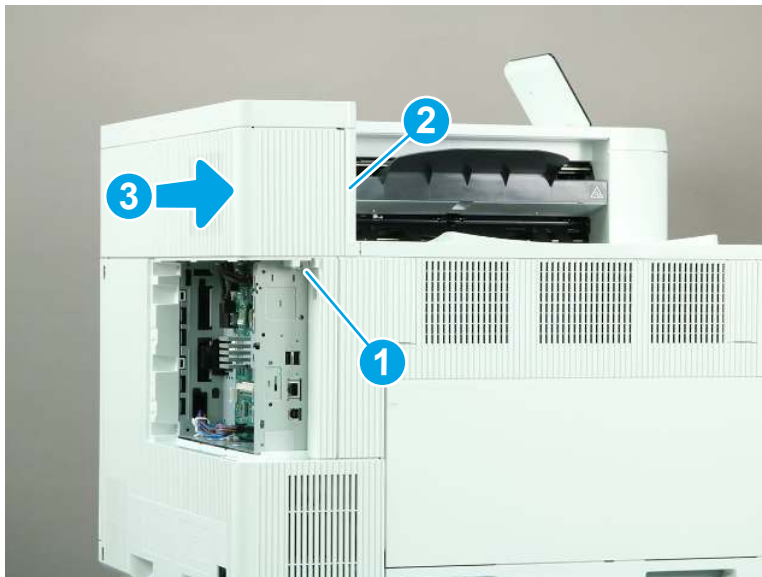


2. Remove the rear upper cover (M856/E85055/M776dn/M776z).

 **NOTE:** The following figure shows the M856 printer. The procedure is correct for all referenced models.

- ▲ Remove one screw (callout 1), release one tab (callout 2), and then slide the rear upper cover away from the printer to remove it (callout 3).

Figure 1-2459 Remove the rear upper cover



3. **M856/E85055 only:** Remove the control panel and top cover.

 **NOTE:** This step applies to only the M856/E85055 models. Skip this step for all other models.

- a. Use a small, flat-blade screwdriver to release two tabs (callout 1), and then remove the control panel cover (callout 2).

Figure 1-2460 Remove the control panel cover



- b. Remove one screw (callout 1).

Figure 1-2461 Remove one screw



- c. Lift the back edge of the control panel up (callout 1), and then slide the control panel toward the back of the printer (callout 2).

Figure 1-2462 Slide the control panel back



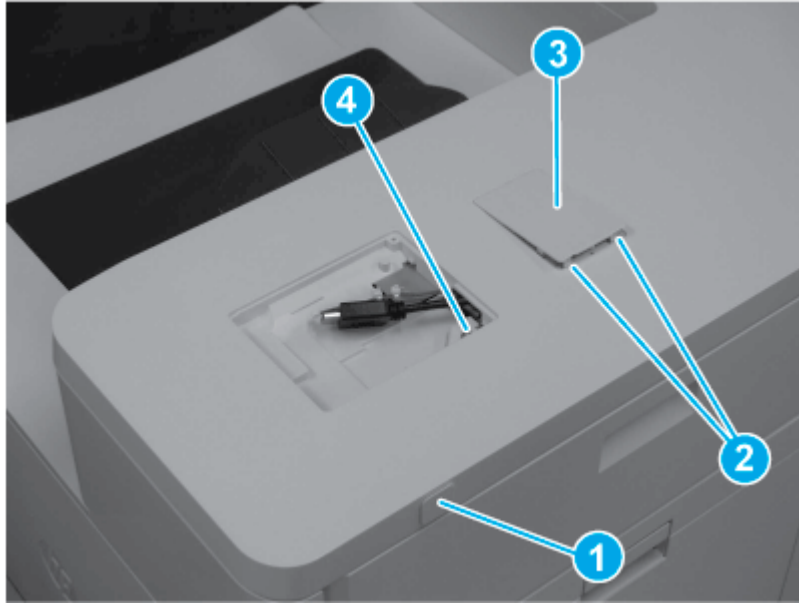
- d. Turn the control panel so that the bottom is facing up, and then disconnect two connectors to remove the control panel.

Figure 1-2463 Disconnect two connectors



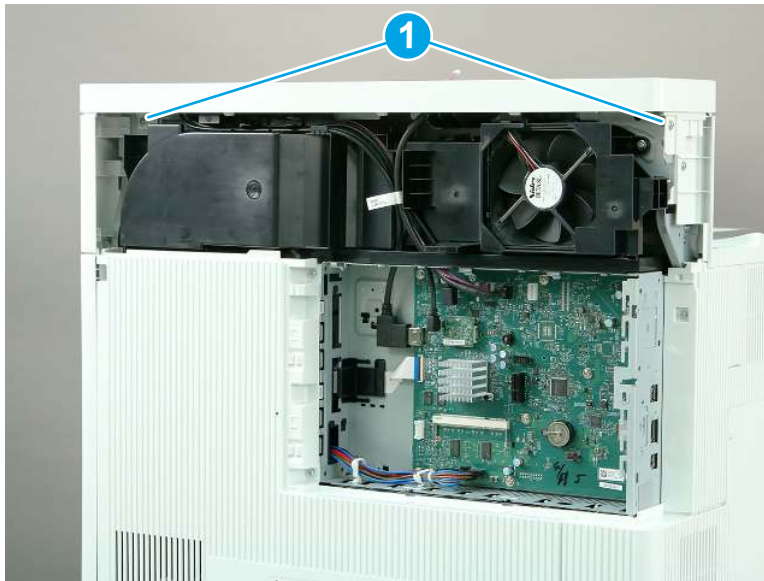
- e. Remove the USB cover (callout 1). Release two tabs (callout 2), and then remove the HIP cover (callout 3). Remove one screw (callout 4).

Figure 1-2464 Remove covers and one screw



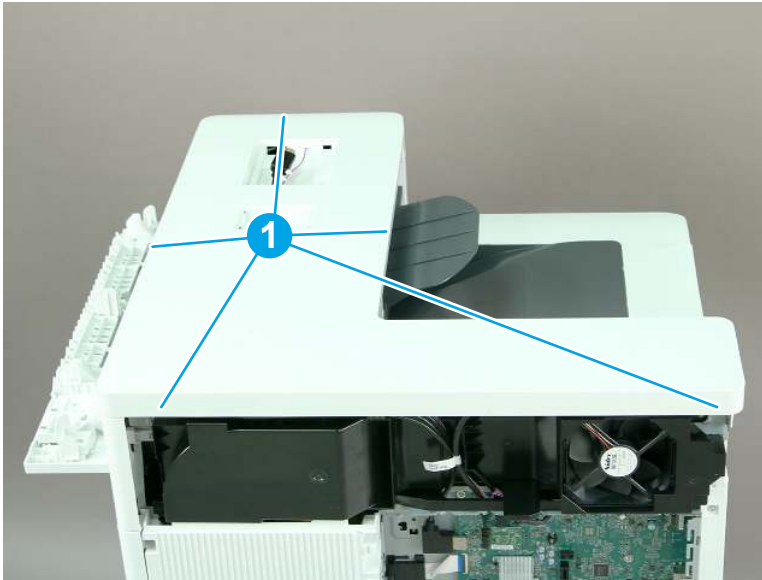
- f. Remove two screws (callout 1).

Figure 1-2465 Remove two screws



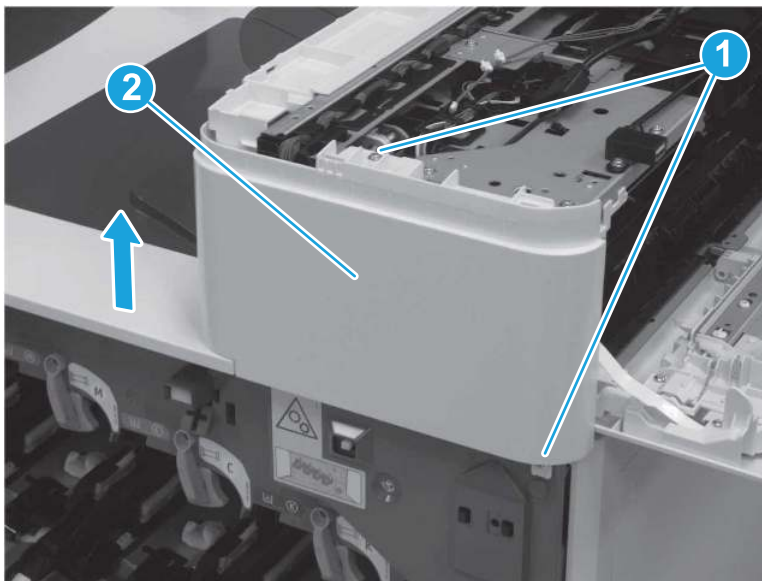
- g. Release five tabs (callout 1), and then remove the top cover.

Figure 1-2466 Release five tabs



4. Remove the right front cover (M856/E85055/M776dn/M776z).
- ▲ Remove two screws (callout 1), and then slide the right front cover (callout 2) up to remove it.

Figure 1-2467 Remove the right front cover

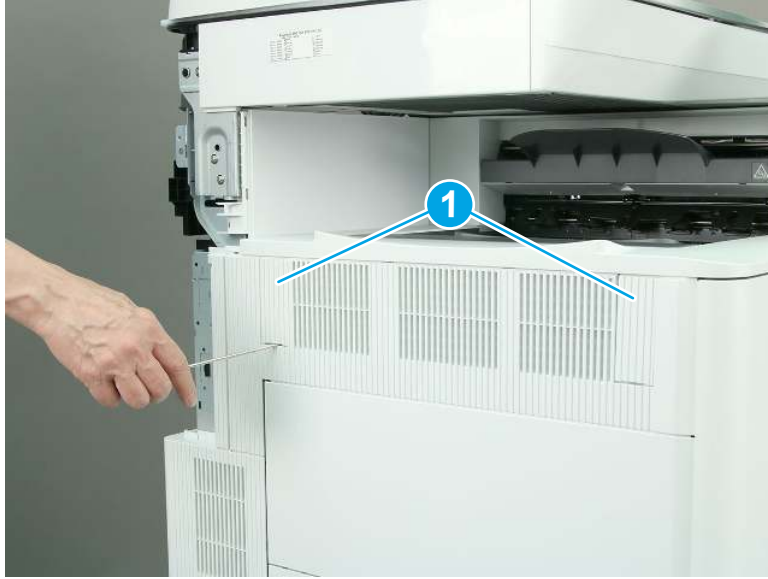


5. Remove the accessory upper cover (M856/E85055/M776dn/M776z).

 **NOTE:** The following figures show the M776z printer. The procedure is correct for all referenced models.

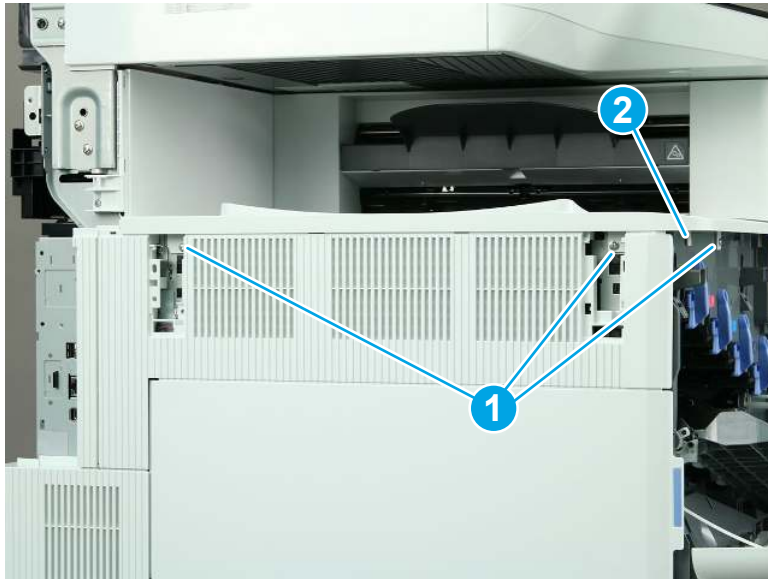
- a. Use a small, flat-blade screwdriver to remove two covers (callout 1).

Figure 1-2468 Remove two covers



- b. Remove three screws (callout 1), and then release one tab (callout 2).

Figure 1-2469 Remove three screws and release one tab



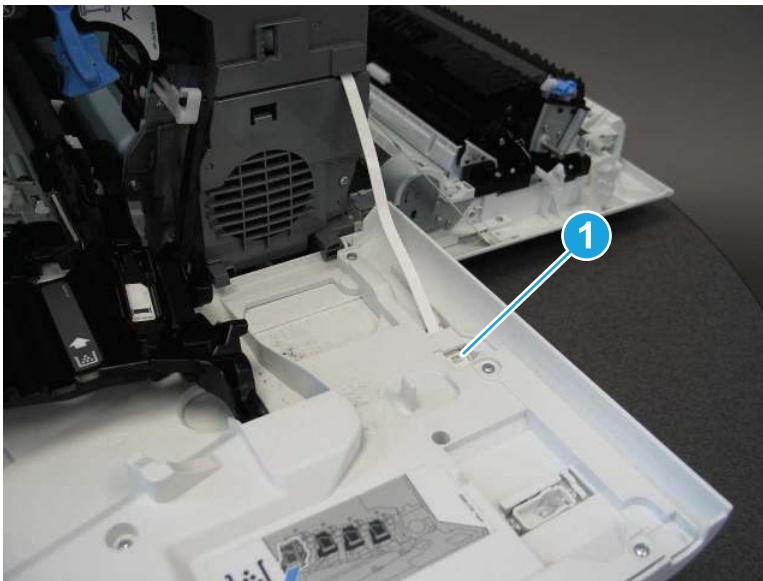
- c. Slide the accessory upper cover away from the printer to remove it.

Figure 1-2470 Remove the accessory upper cover



- 6. Remove the duplex fan cover.
 - a. Use a small, flat-blade screwdriver to release the tab (callout 1) on the right front door hinge.

Figure 1-2471 Release the hinge tab



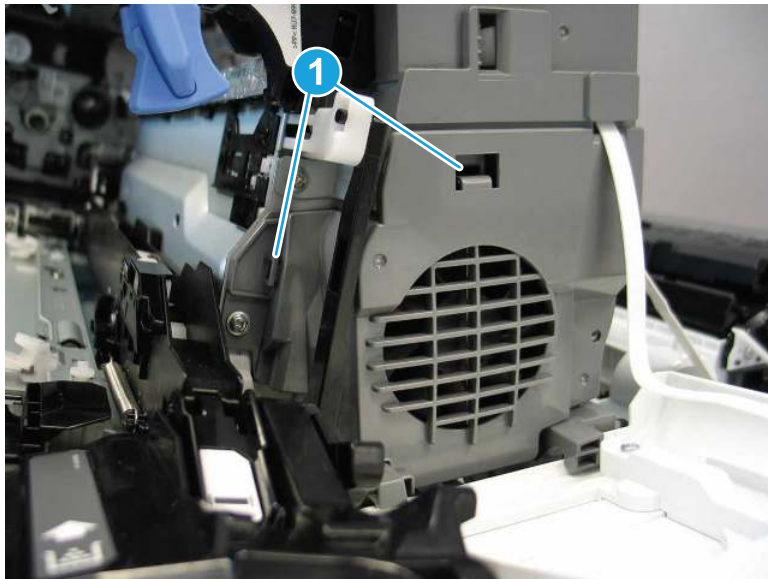
- b. Remove one screw (callout 1).

Figure 1-2472 Remove one screw



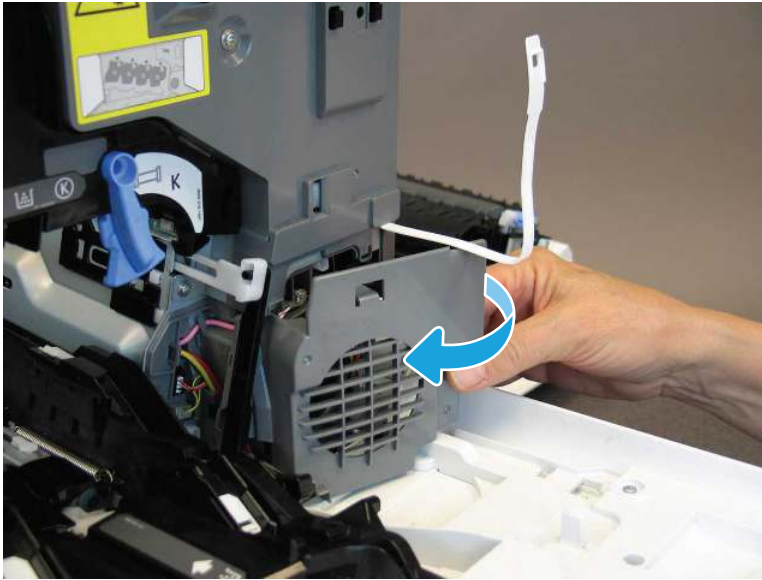
- c. Release two tabs (callout 1).

Figure 1-2473 Release two tabs



- d. Rotate the cover away from the printer to remove it.

Figure 1-2474 Remove the fan cover



7. Remove the front inner right upper cover.
 - a. At the top of the printer, release the wire harness (callout 1) from the guides (callout 2).


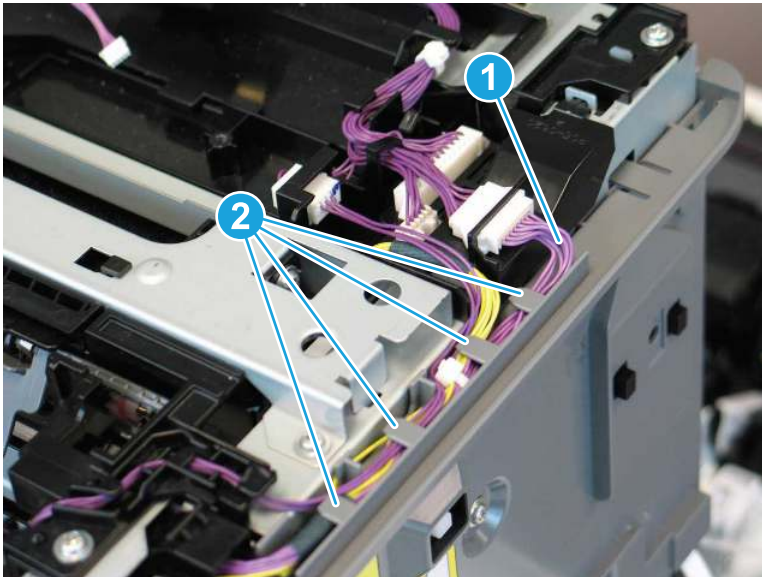
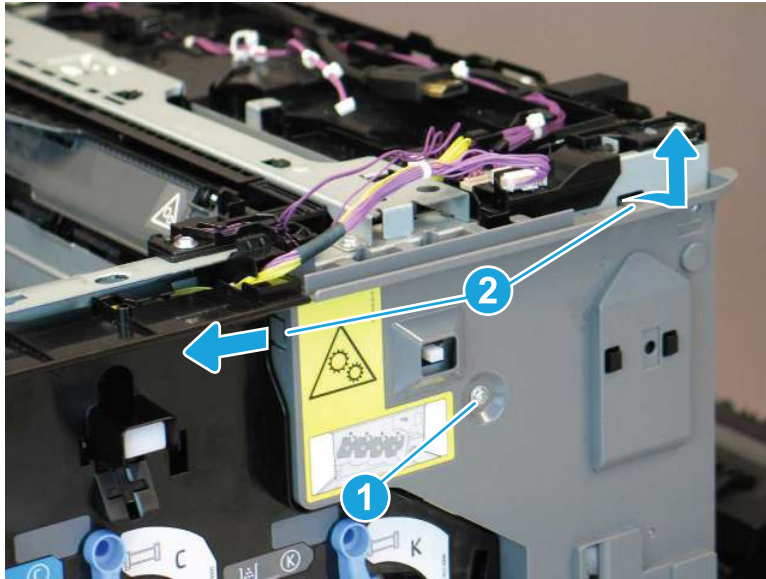
 **NOTE:** The M751 is pictured in the figures below. The procedure is correct for all referenced models.

Figure 1-2475 Release the wires from the guides



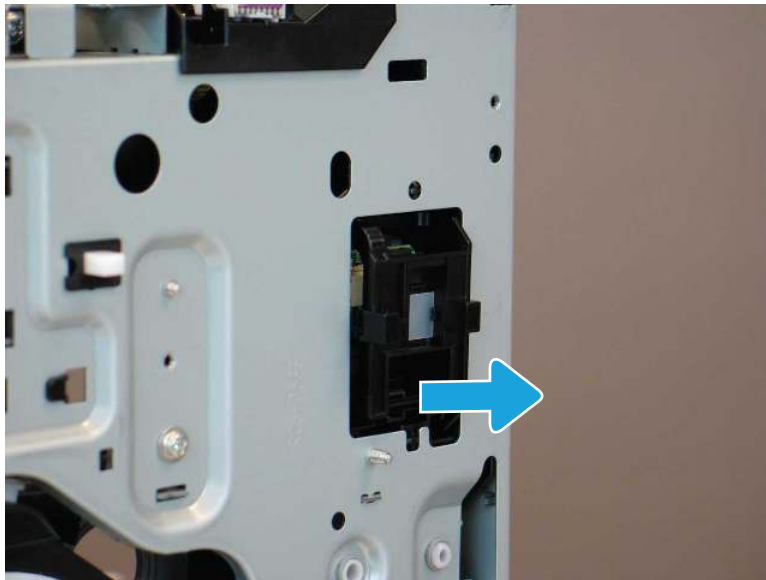
- b. Remove one screw (callout 1), release two tabs (callout 2), and then remove the front inner right upper cover.

Figure 1-2476 Remove the front inner right upper cover



8. Remove the power switch PCA.
 - a. Pull the power switch cover away from the printer to release it.

Figure 1-2477 Release the power switch cover



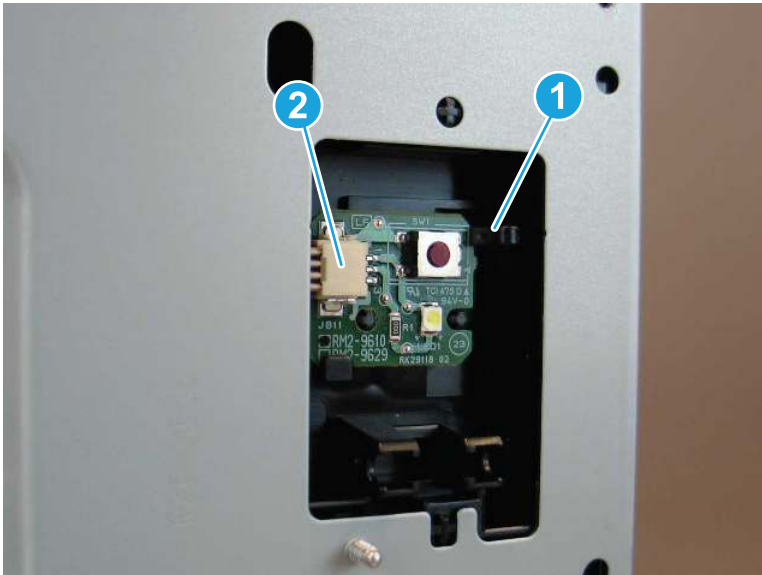
- b. Remove the power switch cover.

Figure 1-2478 Remove the power switch cover



- c. Release one tab (callout 1), disconnect one connector (callout 2), and then remove the power switch PCA.

Figure 1-2479 Remove the power switch PCA





9. Unpack the replacement assembly.
 - a. Dispose of the defective part.




NOTE: HP recommends responsible disposal of the defective part.


<http://www8.hp.com/us/en/hp-information/environment/product-recycling.html>

- b. Unpack the replacement part from the packaging.

 **CAUTION:**  Some parts are sensitive to electrostatic discharge (ESD). Always perform service work at an ESD-protected workstation or mat. If an ESD workstation or mat is not available, touch the sheet-metal chassis to provide a static ground before touching an ESD-sensitive assembly. Protect the ESD-sensitive assemblies by placing them in ESD pouches when they are out of the printer.

 **IMPORTANT:** Make sure that all of the shipping materials (for example shipping tape) are removed from the replacement part prior to installation.

- c. To install an assembly, reverse the removal steps.

 **NOTE:** When applicable, special installation instructions are provided for an assembly at the end of the removal procedure. Always completely read the removal instructions and follow all special installation instructions.

Removal and replacement: Power switch PCA (M776dn/M776z)

Learn how to remove and replace the power switch PCA.

[View a video of how to remove and replace the power switch PCA.](#)

Mean time to repair: 12 minutes

Service level: Medium

Before performing service

Turn the printer power off

- Disconnect the power cable.

 **WARNING!** To avoid damage to the printer, turn the printer off, wait 30 seconds, and then remove the power cord before attempting to service the printer.

Use the table below to identify the correct part number for your printer. To order the part, go to www.hp.com/buy/parts.

Table 1-125 Part information

Part number	Part description
RM2-9610-000CN	Power switch PCB assembly

Required tools

- #2 Phillips screwdriver with a magnetic tip
- Small, flat-blade screwdriver

After performing service

Turn the printer power on

- Connect the power cable.
- Use the power switch to turn the power on.

Post service test

Make sure that the printer initializes to a **Ready** state.

Print a page to make sure that the printer is functioning correctly.

1. Remove the control panel (M776).
 - a. Rotate the control panel to the fully raised position (callout 1), and then raise the document feeder (callout 2).

Figure 1-2480 Raise the control panel and document feeder



- b. Beginning at the right side of the control-panel cover, carefully release five tabs along the top edge of the cover.



NOTE: The thin black-plastic cover will separate from the white-plastic control-panel base.

Figure 1-2481 Release the control panel cover



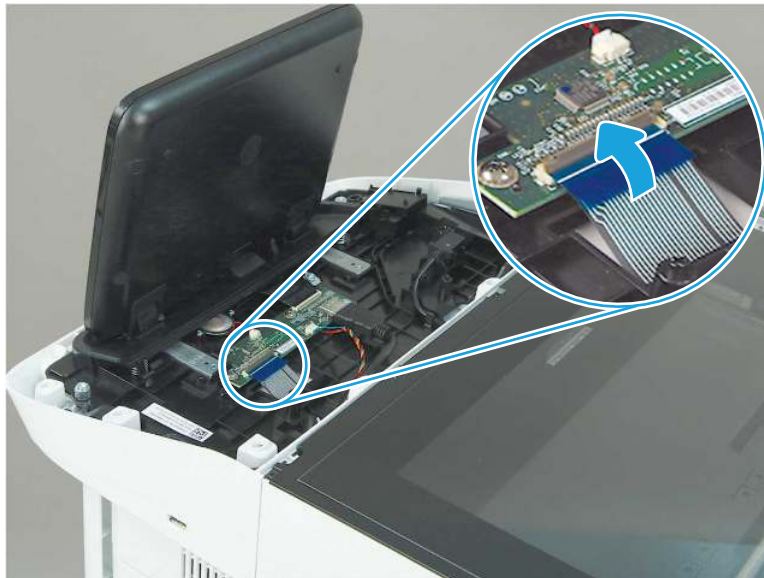
- c. Rotate the control panel cover slightly forward (callout 1), and then lift up to remove the cover (callout 2).

Figure 1-2482 Remove the control panel cover



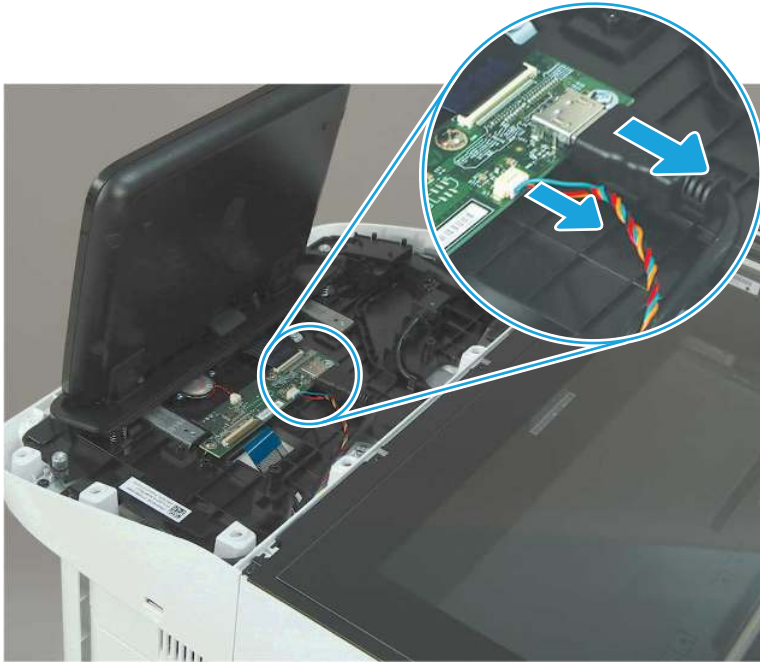
- d. **M776z or M776zs only:** Open the connector latch to release the keyboard flat cable.

Figure 1-2483 Release the keyboard flat cable (M776z/M776zs)



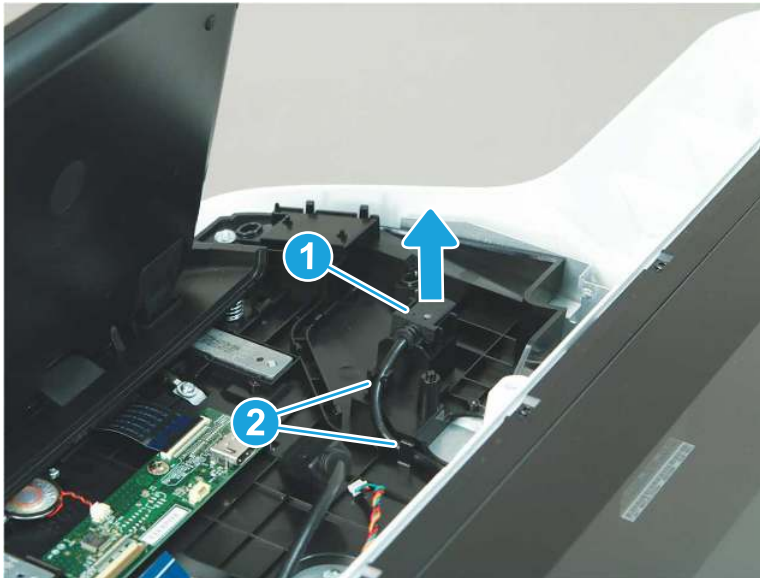
- e. Disconnect two connectors

Figure 1-2484 Disconnect two connectors



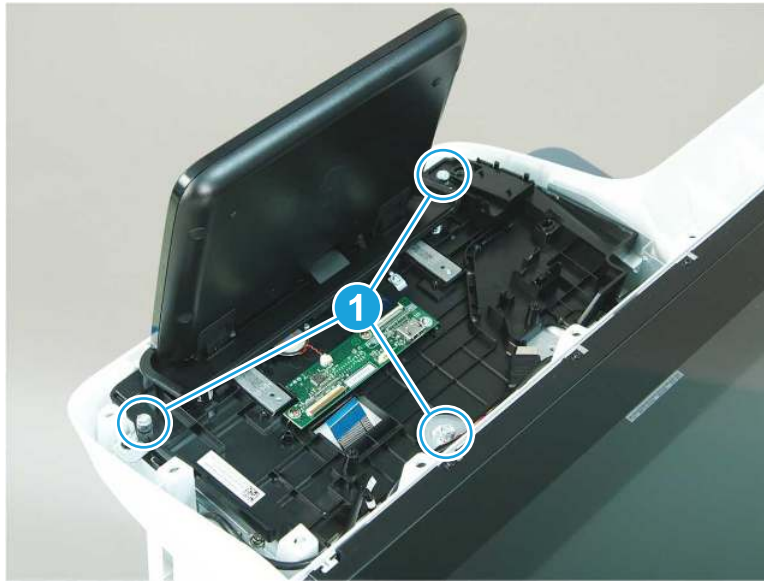
- f. Remove the USB cable (callout 1) from the holder, and then release the cable from two retainers (callout 2).

Figure 1-2485 Release the USB cable



- g. Remove three screws (callout 1).

Figure 1-2486 Remove three screws



- h. Lift the front of the control panel off of the printer (callout 1), and then slide it towards the front of the printer (callout 2) to remove it.

Figure 1-2487 Remove the control panel



- 2. Remove the keyboard (M776z/M776zs).

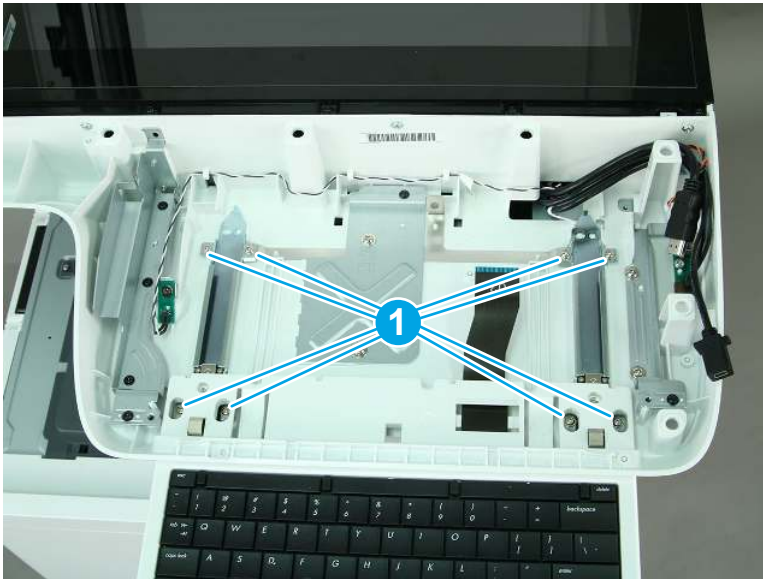
- a. Pull the keyboard out to its extended position.

Figure 1-2488 Pull the keyboard out



- b. Remove eight screws (callout 1).

Figure 1-2489 Remove eight screws



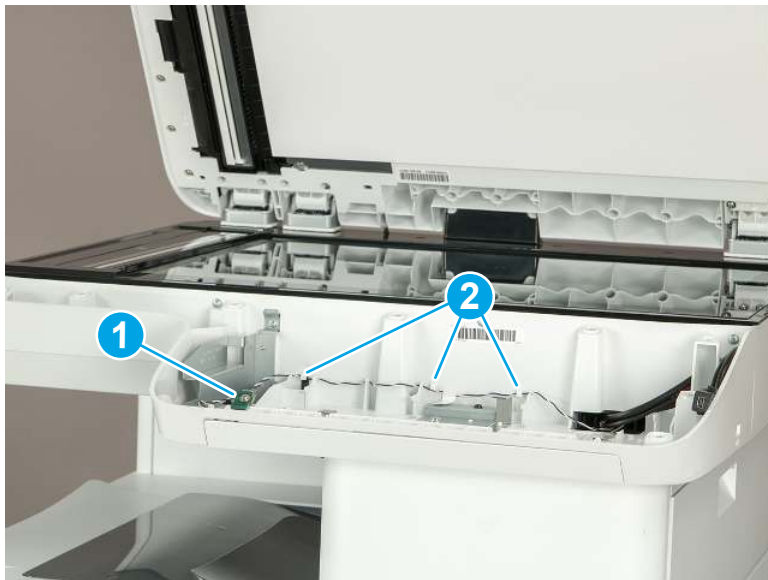
- c. Remove the keyboard and rails.

Figure 1-2490 Remove the keyboard and rails



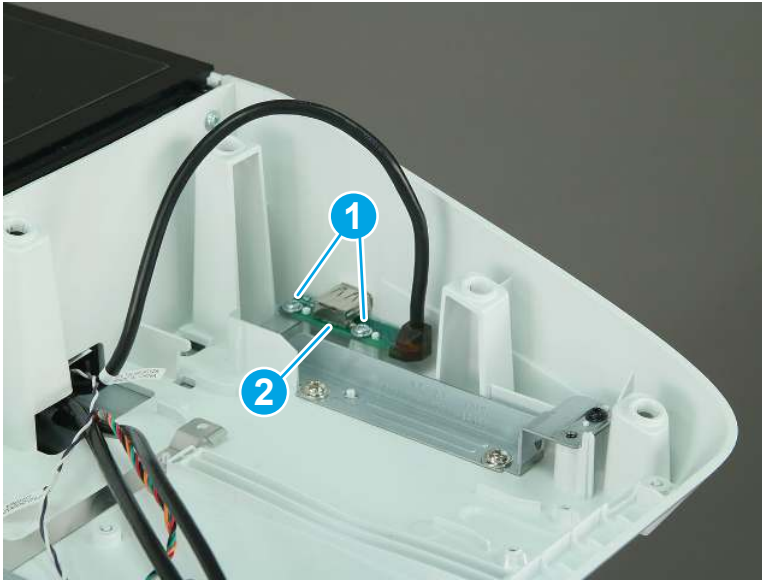
- 3. Remove the nose cone (M776).
 - a. Remove one screw (callout 1) to release the light PCA. Release the cable from three retainers (callout 2), and then move the light PCA out of the way.

Figure 1-2491 Release the light PCA



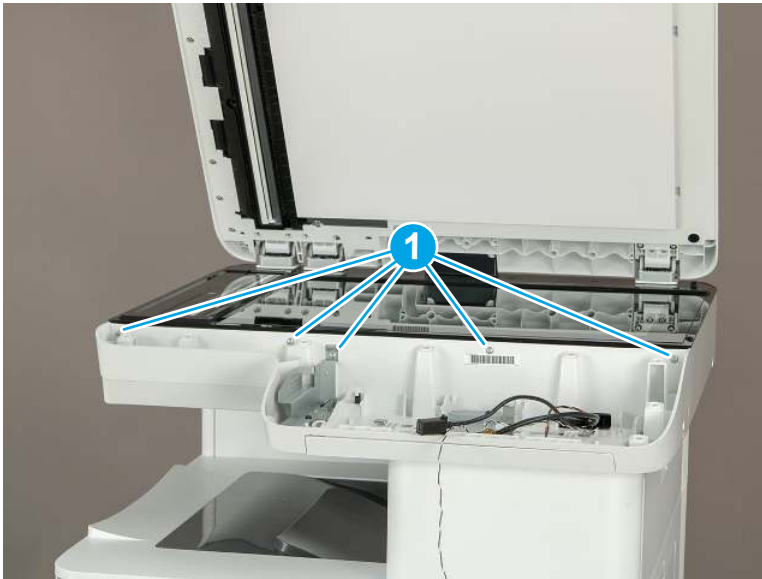
- b. Remove two screws (callout 1), and then move the USB port PCA (callout 2) out of the way.

Figure 1-2492 Release the USB port PCA



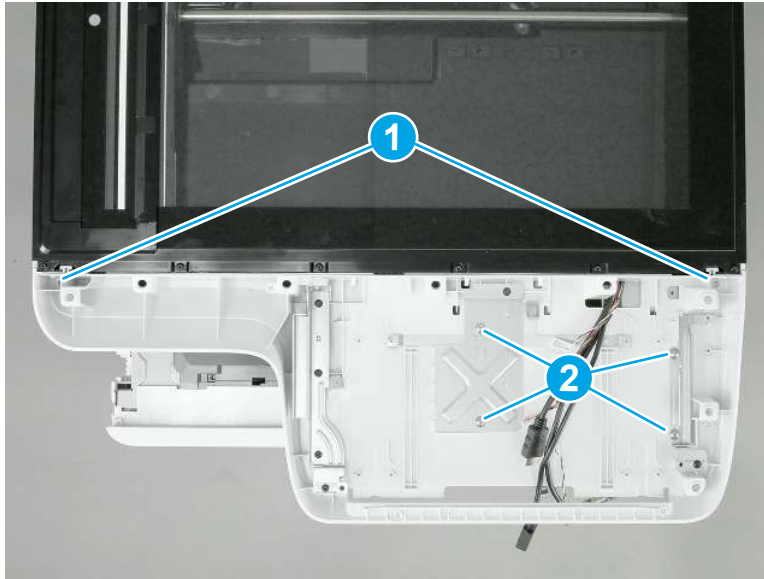
- c. Remove five screws (callout 1).

Figure 1-2493 Remove four screws



- d. Remove two small, self-tapping screws (callout 1), and then remove four larger machine screws (callout 2).

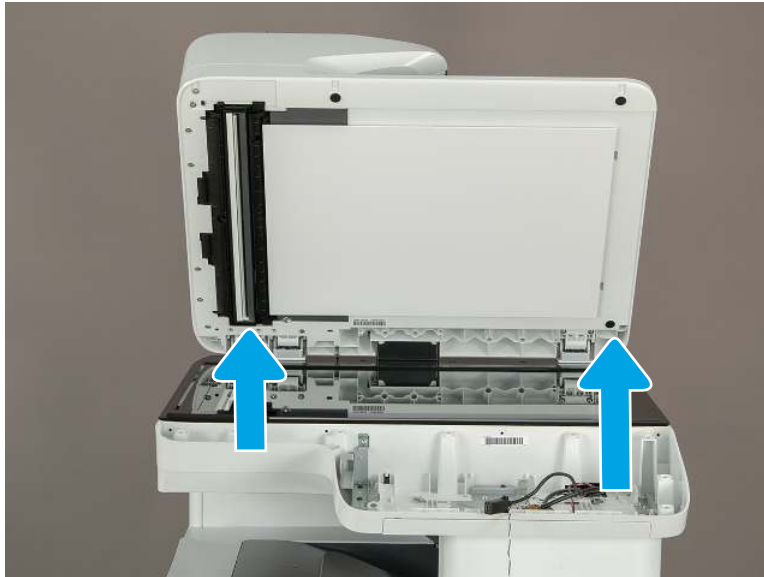
Figure 1-2494 Remove six screws



- e. Lift the nose cone up and off of the printer to remove it.

 **NOTE:** Pass the wire harnesses and cables through the opening in the nose cone when removing it.

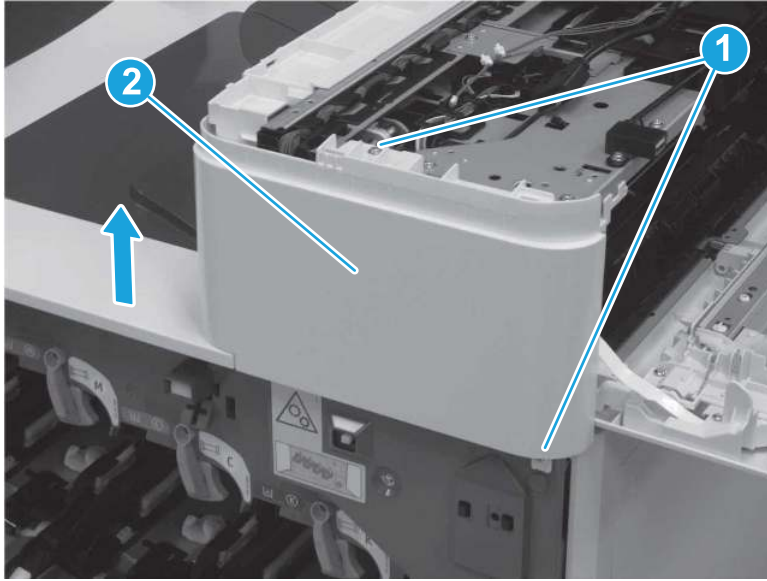
Figure 1-2495 Remove the nose cone



- 4. Remove the right front cover (M856/E85055/M776dn/M776z).

- ▲ Remove two screws (callout 1), and then slide the right front cover (callout 2) up to remove it.

Figure 1-2496 Remove the right front cover

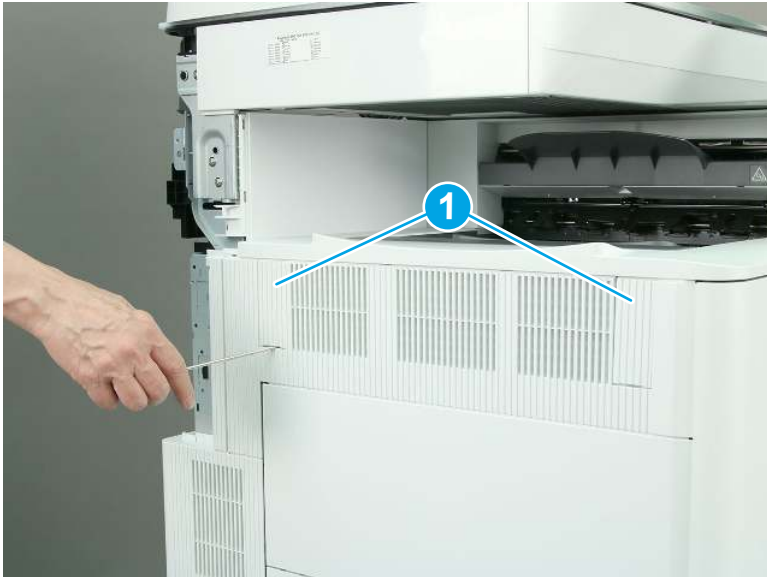


- 5. Remove the accessory upper cover (M856/E85055/M776dn/M776z).

 **NOTE:** The following figures show the M776z printer. The procedure is correct for all referenced models.

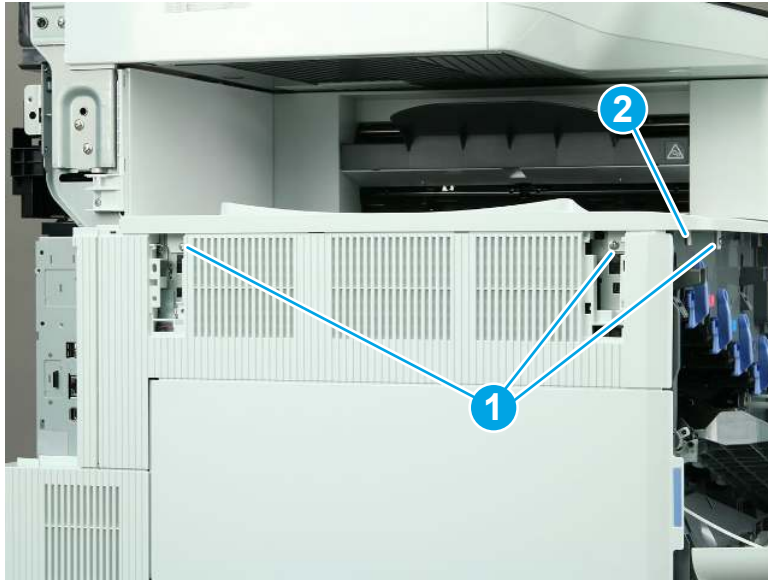
- a. Use a small, flat-blade screwdriver to remove two covers (callout 1).

Figure 1-2497 Remove two covers



- b. Remove three screws (callout 1), and then release one tab (callout 2).

Figure 1-2498 Remove three screws and release one tab



- c. Slide the accessory upper cover away from the printer to remove it.

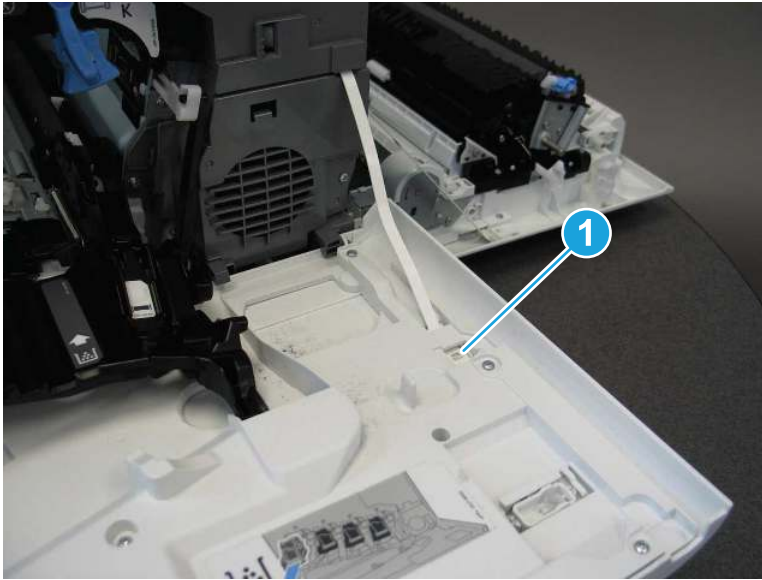
Figure 1-2499 Remove the accessory upper cover



- 6. Remove the duplex fan cover.

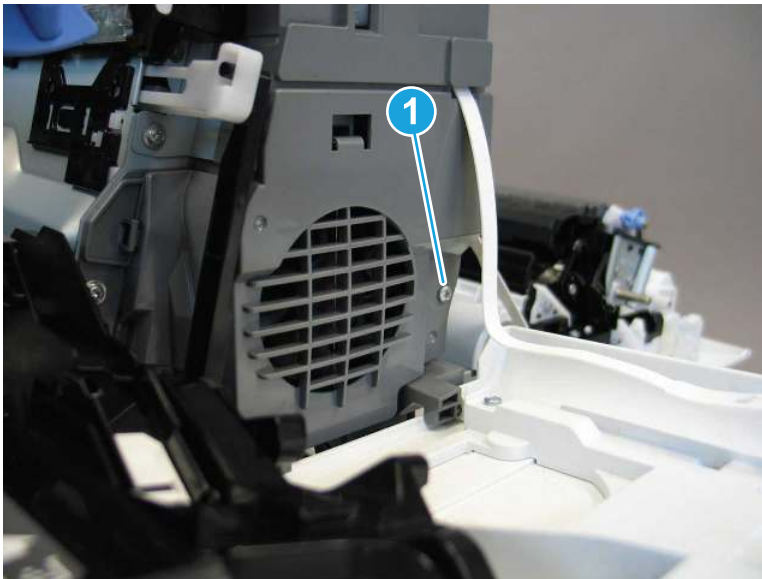
- a. Use a small, flat-blade screwdriver to release the tab (callout 1) on the right front door hinge.

Figure 1-2500 Release the hinge tab



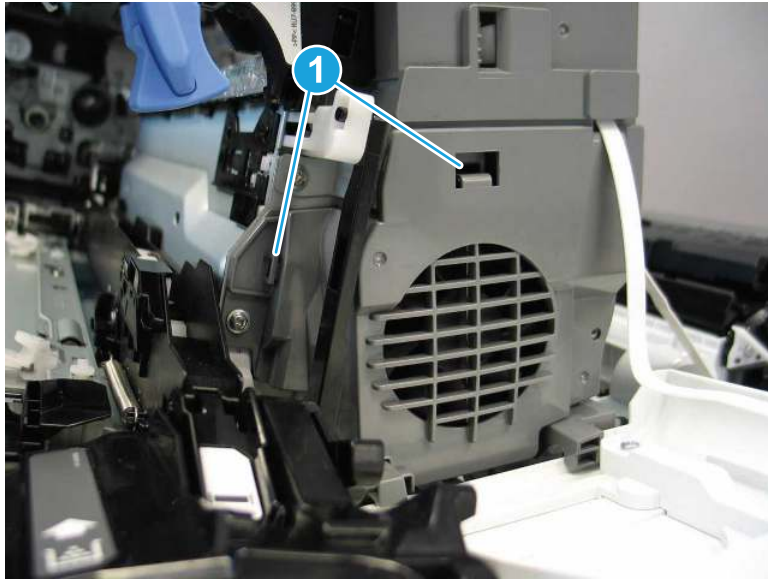
- b. Remove one screw (callout 1).

Figure 1-2501 Remove one screw



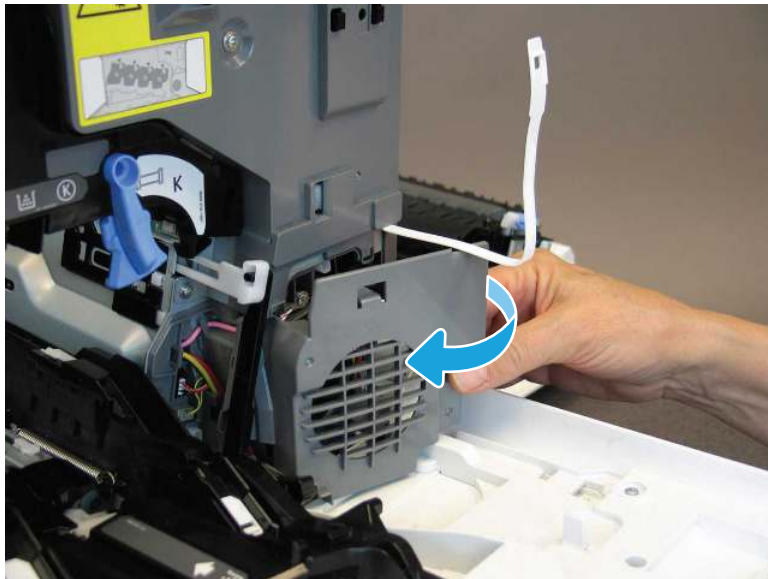
- c. Release two tabs (callout 1).

Figure 1-2502 Release two tabs



- d. Rotate the cover away from the printer to remove it.

Figure 1-2503 Remove the fan cover



- 7. Remove the front inner right upper cover.
 - a. At the top of the printer, release the wire harness (callout 1) from the guides (callout 2).


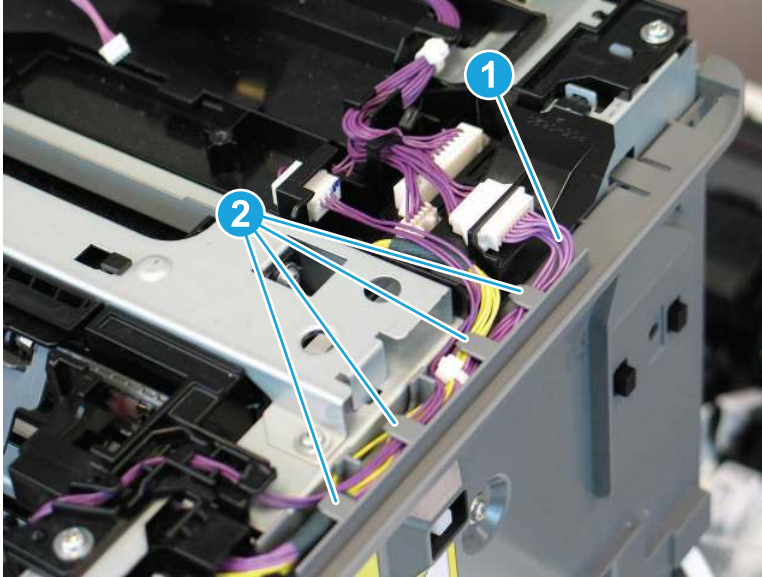
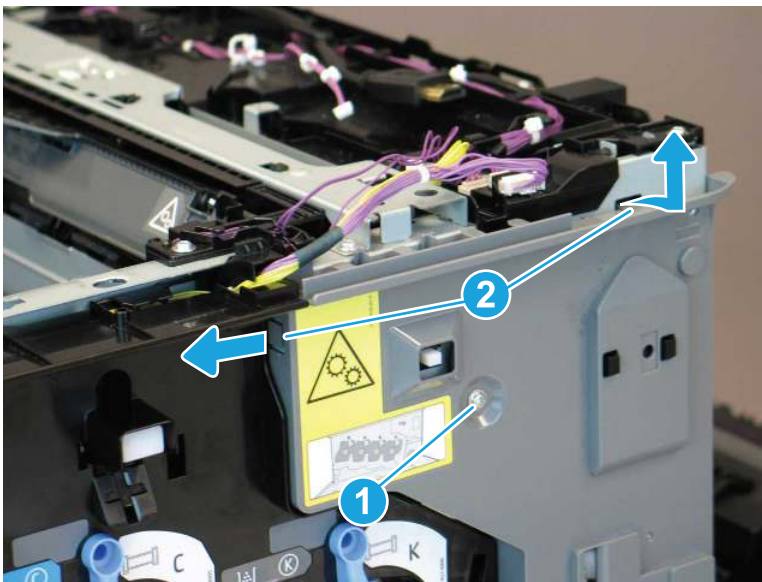
 **NOTE:** The M751 is pictured in the figures below. The procedure is correct for all referenced models.

Figure 1-2504 Release the wires from the guides



- b. Remove one screw (callout 1), release two tabs (callout 2), and then remove the front inner right upper cover.

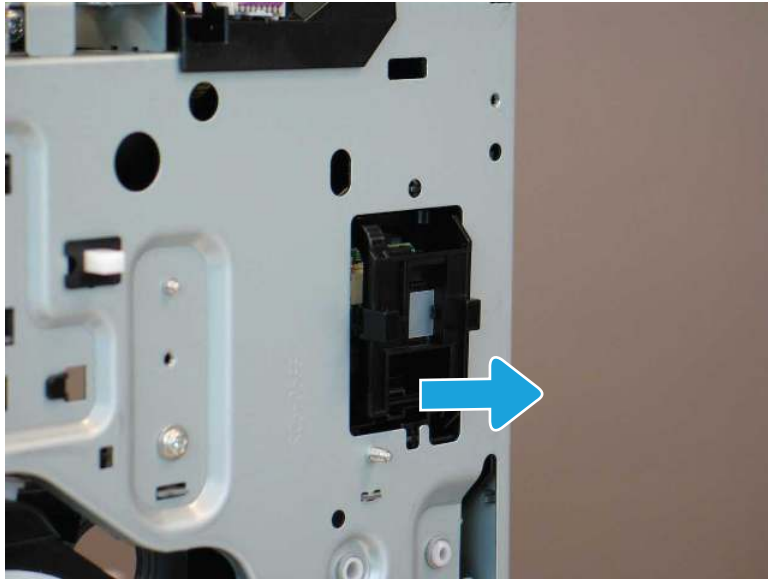
Figure 1-2505 Remove the front inner right upper cover



- 8. Remove the power switch PCA.

- a. Pull the power switch cover away from the printer to release it.

Figure 1-2506 Release the power switch cover



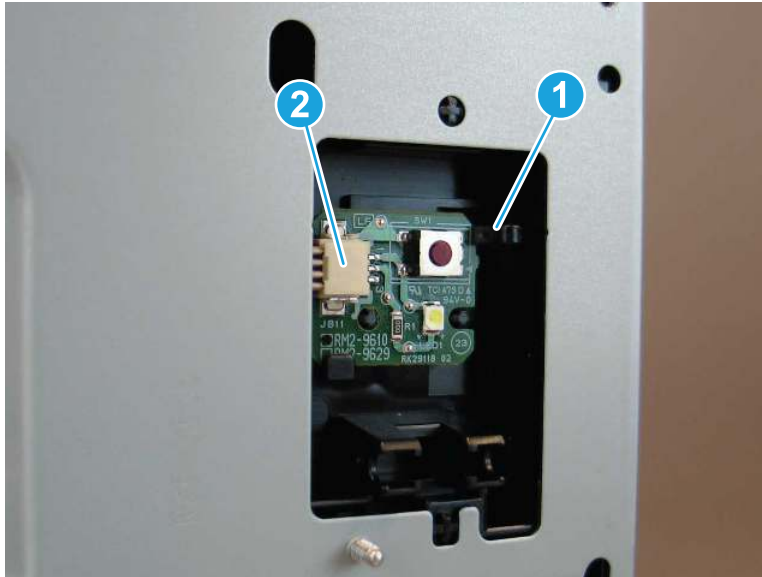
- b. Remove the power switch cover.

Figure 1-2507 Remove the power switch cover



- c. Release one tab (callout 1), disconnect one connector (callout 2), and then remove the power switch PCA.

Figure 1-2508 Remove the power switch PCA



9. Unpack the replacement assembly.
 - a. Dispose of the defective part.




NOTE: HP recommends responsible disposal of the defective part.

<http://www8.hp.com/us/en/hp-information/environment/product-recycling.html>

- b. Unpack the replacement part from the packaging.



CAUTION:  Some parts are sensitive to electrostatic discharge (ESD). Always perform service work at an ESD-protected workstation or mat. If an ESD workstation or mat is not available, touch the sheet-metal chassis to provide a static ground before touching an ESD-sensitive assembly. Protect the ESD-sensitive assemblies by placing them in ESD pouches when they are out of the printer.



IMPORTANT: Make sure that all of the shipping materials (for example shipping tape) are removed from the replacement part prior to installation.

- c. To install an assembly, reverse the removal steps.



NOTE: When applicable, special installation instructions are provided for an assembly at the end of the removal procedure. Always completely read the removal instructions and follow all special installation instructions.

Removal and replacement: Power switch PCA (M776zs)

Learn how to remove and replace the power switch PCA.

Mean time to repair: 12 minutes

Service level: Medium

Before performing service

Turn the printer power off

- Disconnect the power cable.

⚠ WARNING! To avoid damage to the printer, turn the printer off, wait 30 seconds, and then remove the power cord before attempting to service the printer.

Use the table below to identify the correct part number for your printer. To order the part, go to www.hp.com/buy/parts.

Table 1-126 Part information

Part number	Part description
RM2-9610-000CN	Power switch PCB assembly

Required tools

- #2 Phillips screwdriver with a magnetic tip
- Small, flat-blade screwdriver

After performing service

Turn the printer power on

- Connect the power cable.
- Use the power switch to turn the power on.

Post service test

Make sure that the printer initializes to a **Ready** state.

Print a page to make sure that the printer is functioning correctly.

1. Remove the control panel (M776).

- a. Rotate the control panel to the fully raised position (callout 1), and then raise the document feeder (callout 2).

Figure 1-2509 Raise the control panel and document feeder



- b. Beginning at the right side of the control-panel cover, carefully release five tabs along the top edge of the cover.

 **NOTE:** The thin black-plastic cover will separate from the white-plastic control-panel base.

Figure 1-2510 Release the control panel cover



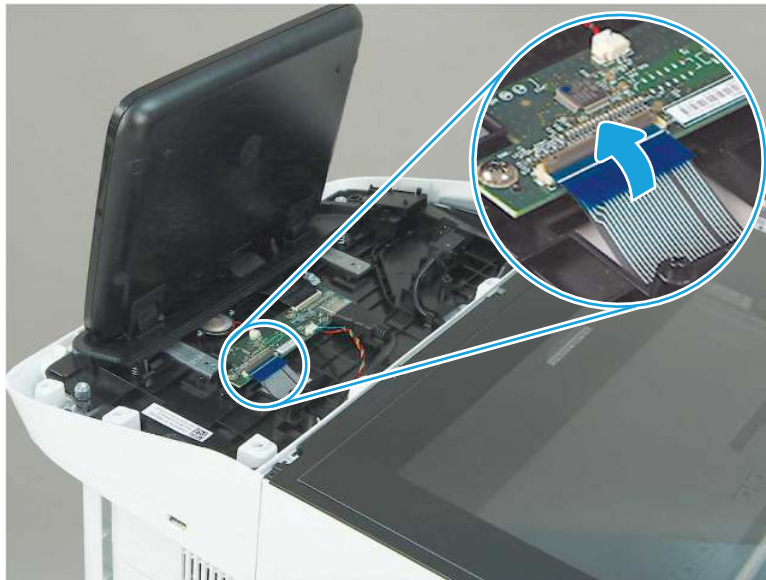
- c. Rotate the control panel cover slightly forward (callout 1), and then lift up to remove the cover (callout 2).

Figure 1-2511 Remove the control panel cover



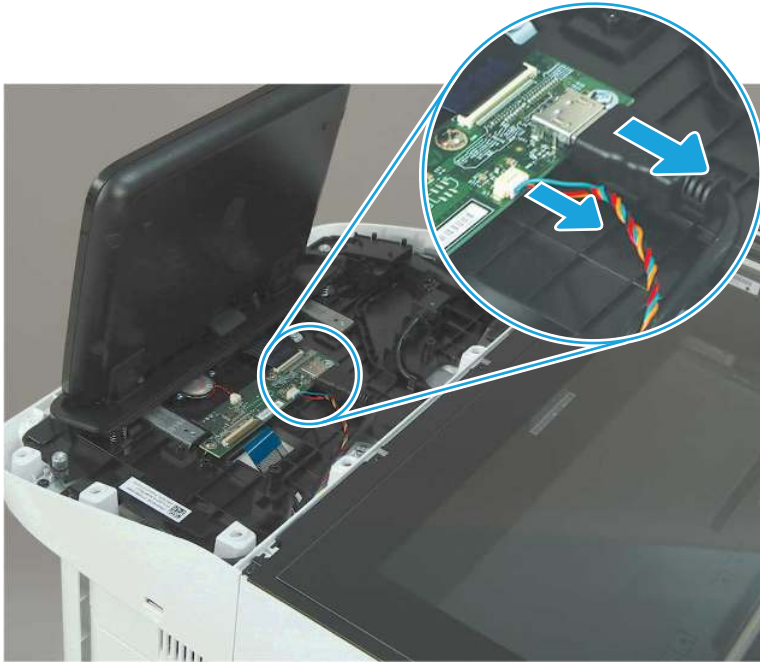
- d. **M776z or M776zs only:** Open the connector latch to release the keyboard flat cable.

Figure 1-2512 Release the keyboard flat cable (M776z/M776zs)



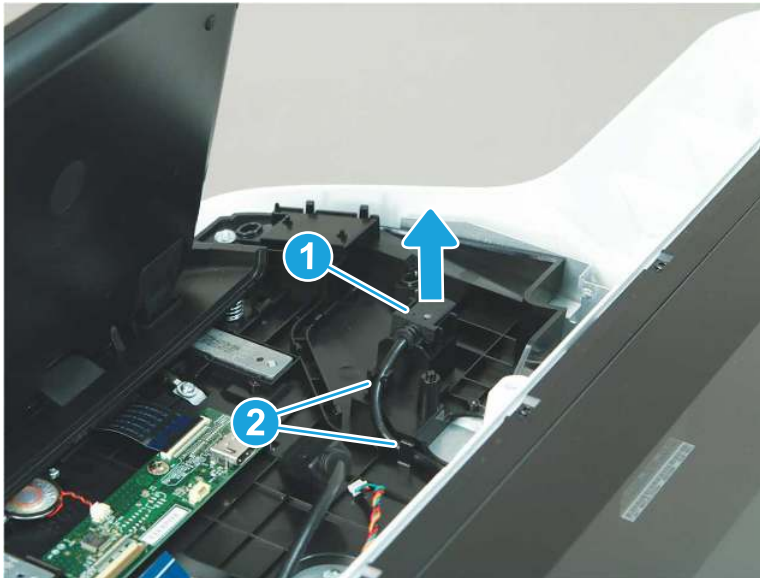
- e. Disconnect two connectors

Figure 1-2513 Disconnect two connectors



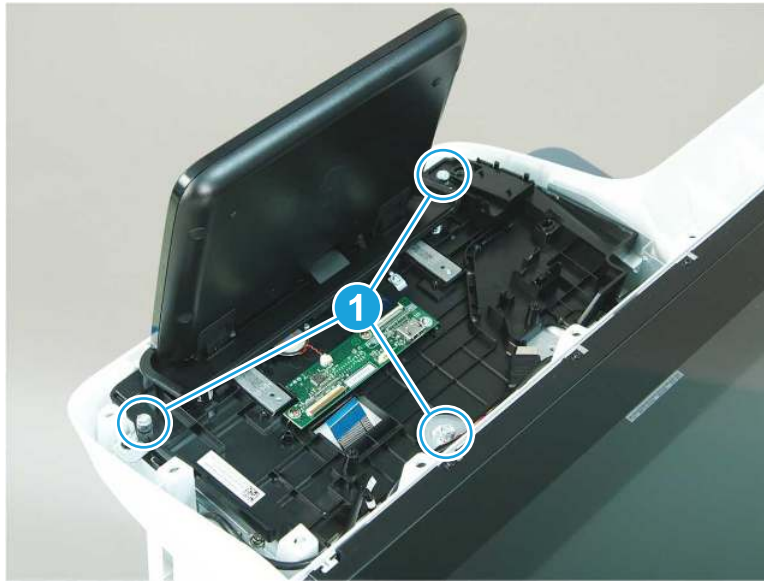
- f. Remove the USB cable (callout 1) from the holder, and then release the cable from two retainers (callout 2).

Figure 1-2514 Release the USB cable



- g. Remove three screws (callout 1).

Figure 1-2515 Remove three screws



- h. Lift the front of the control panel off of the printer (callout 1), and then slide it towards the front of the printer (callout 2) to remove it.

Figure 1-2516 Remove the control panel



- 2. Remove the keyboard (M776z/M776zs).

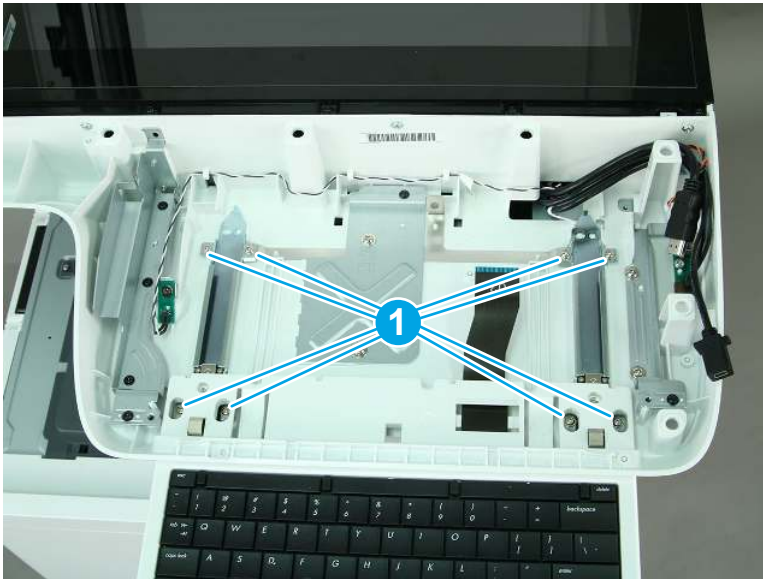
- a. Pull the keyboard out to its extended position.

Figure 1-2517 Pull the keyboard out



- b. Remove eight screws (callout 1).

Figure 1-2518 Remove eight screws



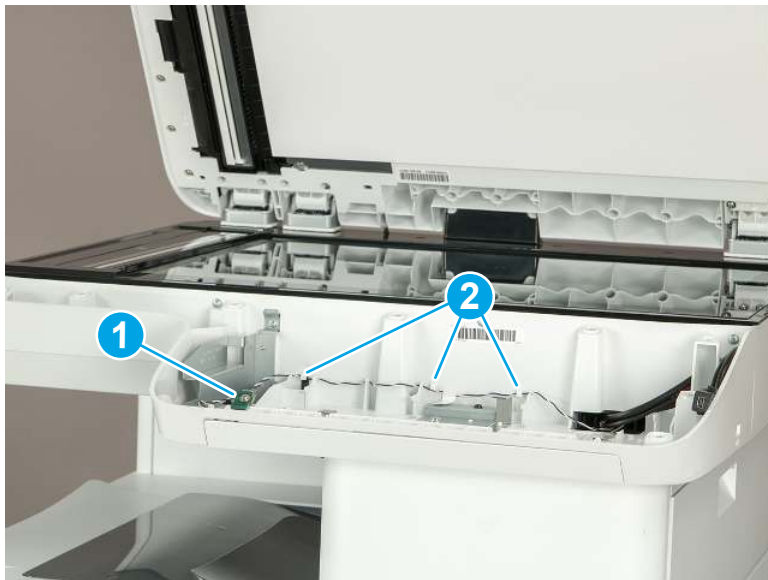
- c. Remove the keyboard and rails.

Figure 1-2519 Remove the keyboard and rails



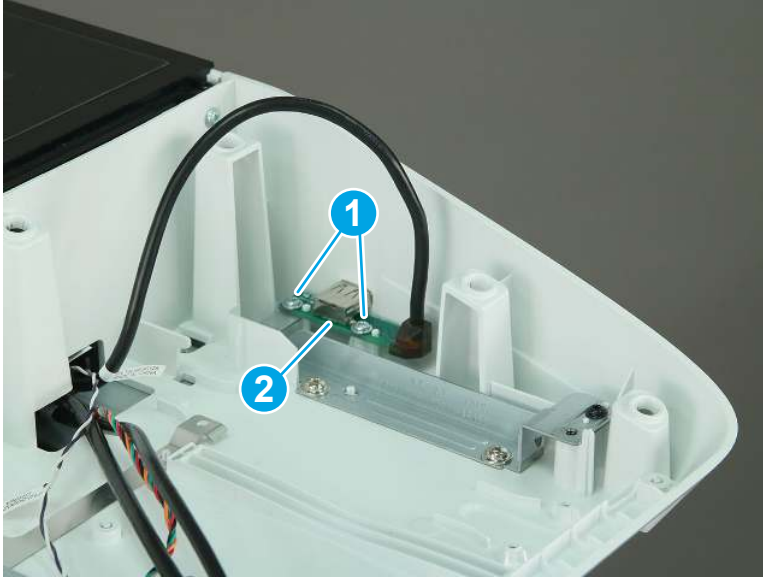
- 3. Remove the nose cone (M776).
 - a. Remove one screw (callout 1) to release the light PCA. Release the cable from three retainers (callout 2), and then move the light PCA out of the way.

Figure 1-2520 Release the light PCA



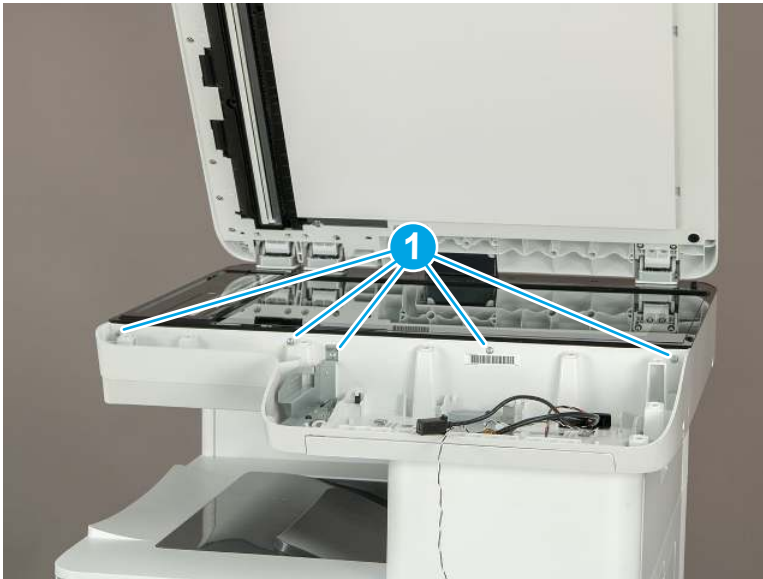
- b. Remove two screws (callout 1), and then move the USB port PCA (callout 2) out of the way.

Figure 1-2521 Release the USB port PCA



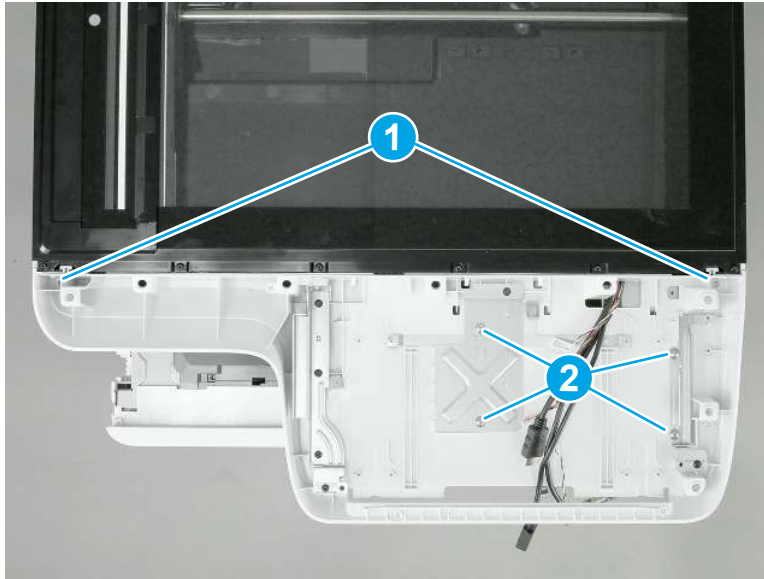
- c. Remove five screws (callout 1).

Figure 1-2522 Remove four screws



- d. Remove two small, self-tapping screws (callout 1), and then remove four larger machine screws (callout 2).

Figure 1-2523 Remove six screws



- e. Lift the nose cone up and off of the printer to remove it.


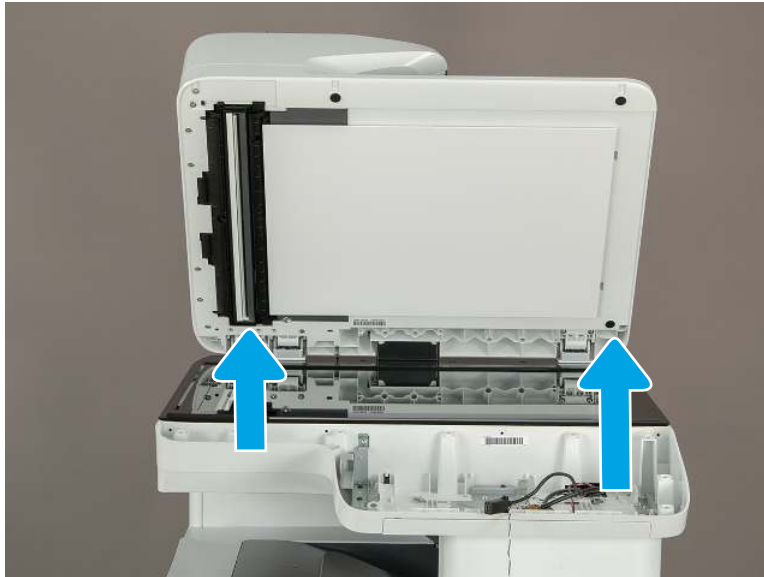
 **NOTE:** Pass the wire harnesses and cables through the opening in the nose cone when removing it.

Figure 1-2524 Remove the nose cone



- 4. Remove the front cover (M776zs).

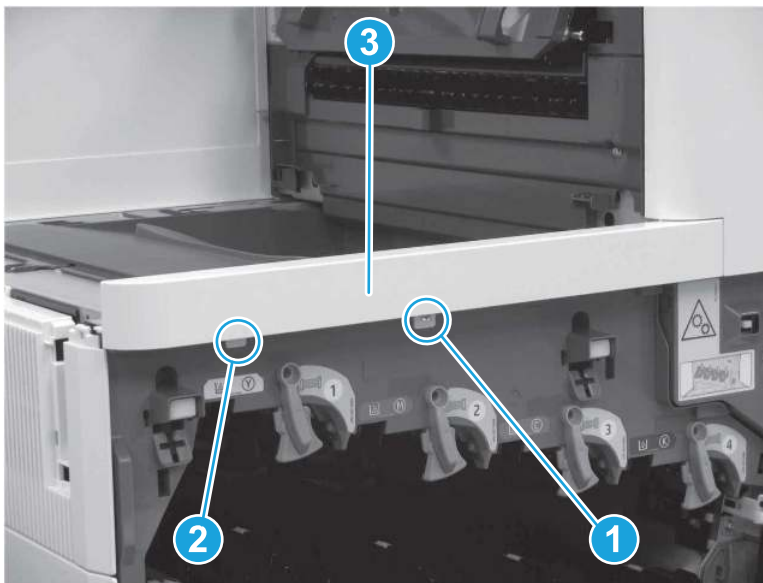
- a. Open the front door.

Figure 1-2525 Open the front door



- b. Remove one screw (callout 1), release one tab (callout 2), and then remove the front cover (callout 3).

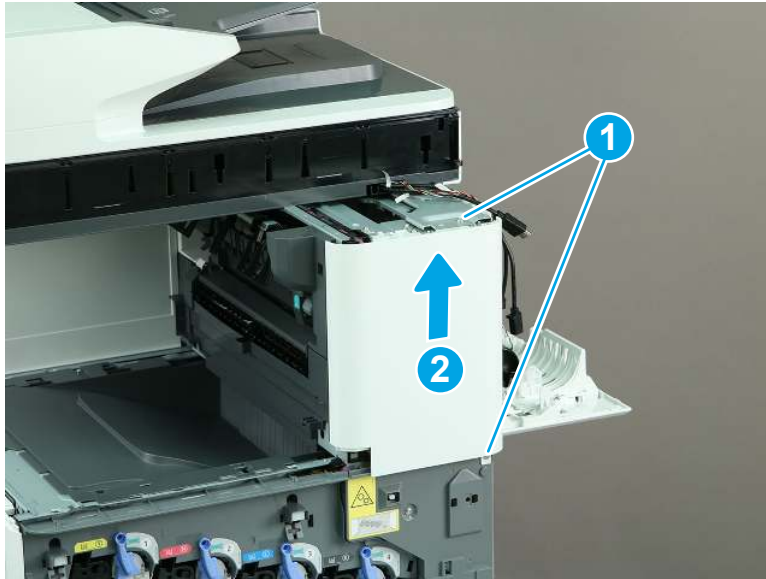
Figure 1-2526 Remove the front cover



5. Remove the right front cover (M776zs).

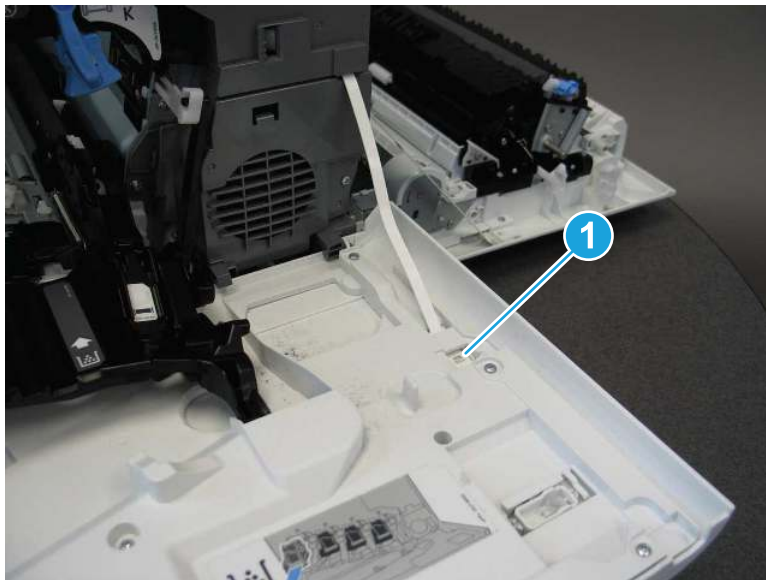
- ▲ Remove two screws (callout 1), release one tab (callout 2), and then slide the right front cover up (callout 2) to remove it.

Figure 1-2527 Remove the right front cover



- 6. Remove the duplex fan cover.
 - a. Use a small, flat-blade screwdriver to release the tab (callout 1) on the right front door hinge.

Figure 1-2528 Release the hinge tab



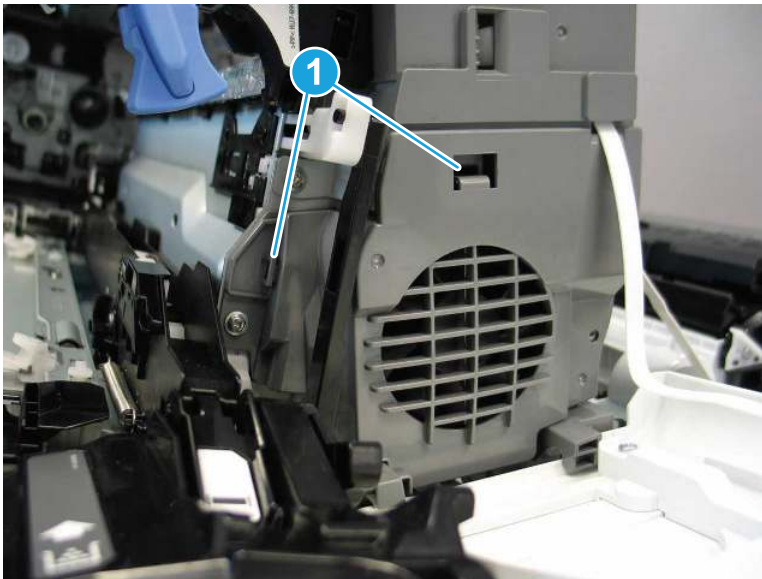
- b. Remove one screw (callout 1).

Figure 1-2529 Remove one screw



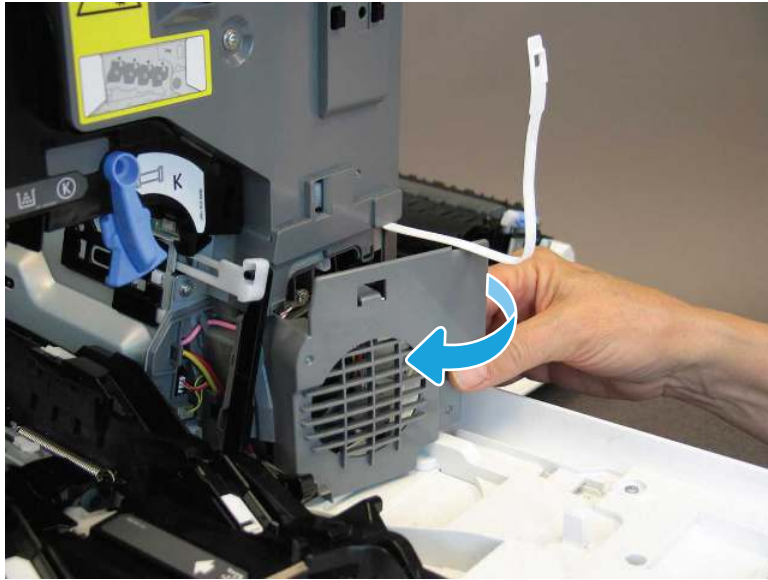
- c. Release two tabs (callout 1).

Figure 1-2530 Release two tabs



- d. Rotate the cover away from the printer to remove it.

Figure 1-2531 Remove the fan cover



- 7. Remove the front inner right upper cover.
 - a. At the top of the printer, release the wire harness (callout 1) from the guides (callout 2).


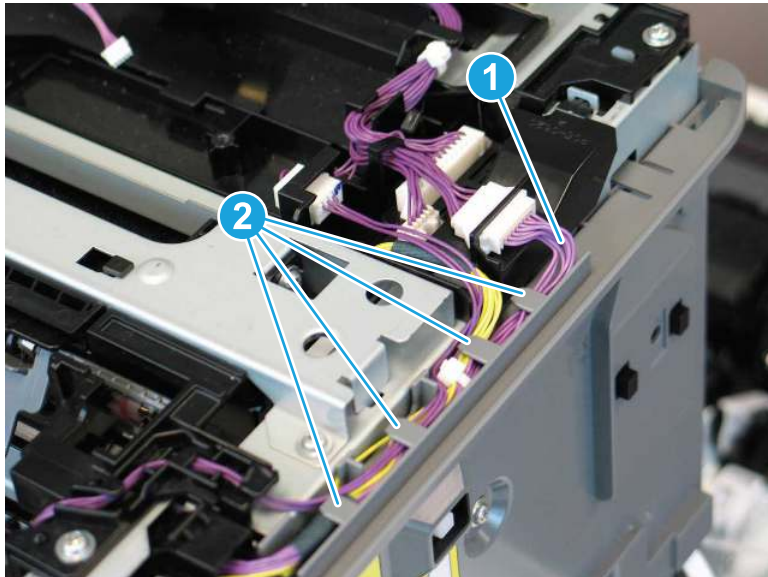
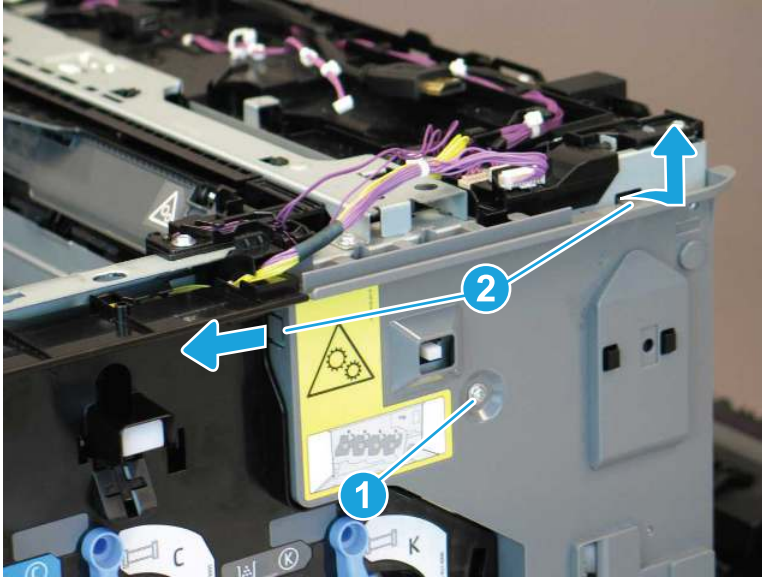
 **NOTE:** The M751 is pictured in the figures below. The procedure is correct for all referenced models.

Figure 1-2532 Release the wires from the guides



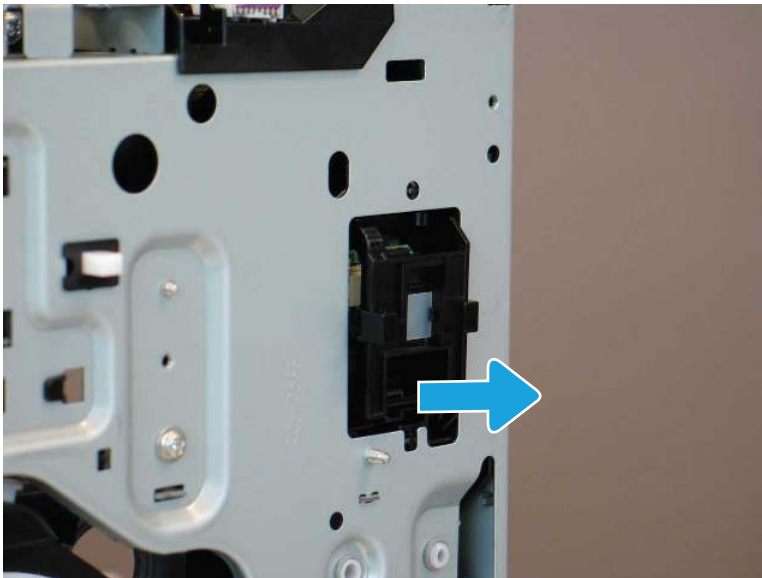
- b. Remove one screw (callout 1), release two tabs (callout 2), and then remove the front inner right upper cover.

Figure 1-2533 Remove the front inner right upper cover



8. Remove the power switch PCA.
 - a. Pull the power switch cover away from the printer to release it.

Figure 1-2534 Release the power switch cover



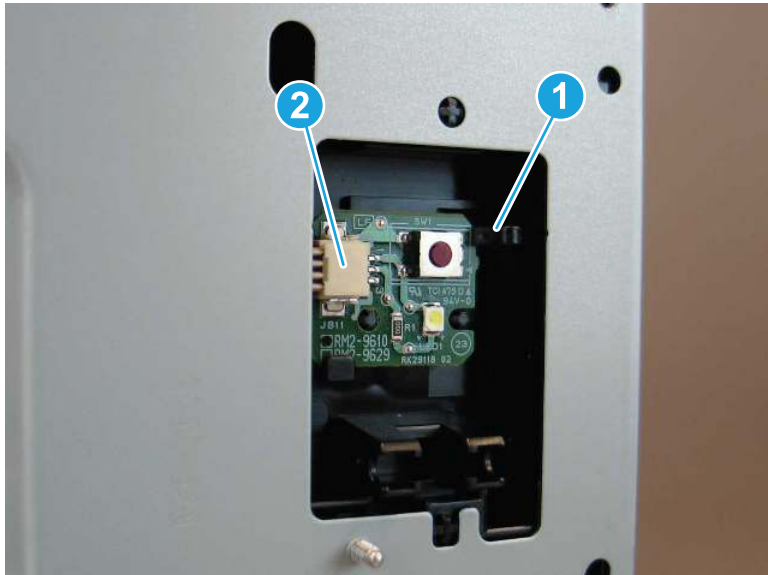
- b. Remove the power switch cover.

Figure 1-2535 Remove the power switch cover



- c. Release one tab (callout 1), disconnect one connector (callout 2), and then remove the power switch PCA.

Figure 1-2536 Remove the power switch PCA



9. Unpack the replacement assembly.

- a. Dispose of the defective part.




NOTE: HP recommends responsible disposal of the defective part.

<http://www8.hp.com/us/en/hp-information/environment/product-recycling.html>

- b. Unpack the replacement part from the packaging.



CAUTION:  Some parts are sensitive to electrostatic discharge (ESD). Always perform service work at an ESD-protected workstation or mat. If an ESD workstation or mat is not available, touch the sheet-metal chassis to provide a static ground before touching an ESD-sensitive assembly. Protect the ESD-sensitive assemblies by placing them in ESD pouches when they are out of the printer.



IMPORTANT: Make sure that all of the shipping materials (for example shipping tape) are removed from the replacement part prior to installation.

- c. To install an assembly, reverse the removal steps.



NOTE: When applicable, special installation instructions are provided for an assembly at the end of the removal procedure. Always completely read the removal instructions and follow all special installation instructions.

Removal and replacement: Tray 2 size detect switch (M751/E75245/M856/E85055/M776)

Learn how to remove and replace the Tray 2 size detect switch.

[View a video of how to remove and replace the Tray 2 size detect switch.](#)

Mean time to repair: 2 minutes

Service level: Easy

Before performing service

Turn the printer power off

- Disconnect the power cable.



WARNING! To avoid damage to the printer, turn the printer off, wait 30 seconds, and then remove the power cord before attempting to service the printer.

Use the table below to identify the correct part number for your printer. To order the part, go to www.hp.com/buy/parts.

Table 1-127 Part information

Part number	Part description
RM2-1436-000CN	Size detect switch assembly

Required tools

- No special tools are required to remove or install this assembly.

After performing service

Turn the printer power on

- Connect the power cable.
- Use the power switch to turn the power on.

Post service test

Make sure that the printer initializes to a **Ready** state.

Print a page to make sure that the printer is functioning correctly.

1. Remove Tray 2.

- ▲ Pull Tray 2 away from the printer until it stops, and then lift up slightly to remove it.

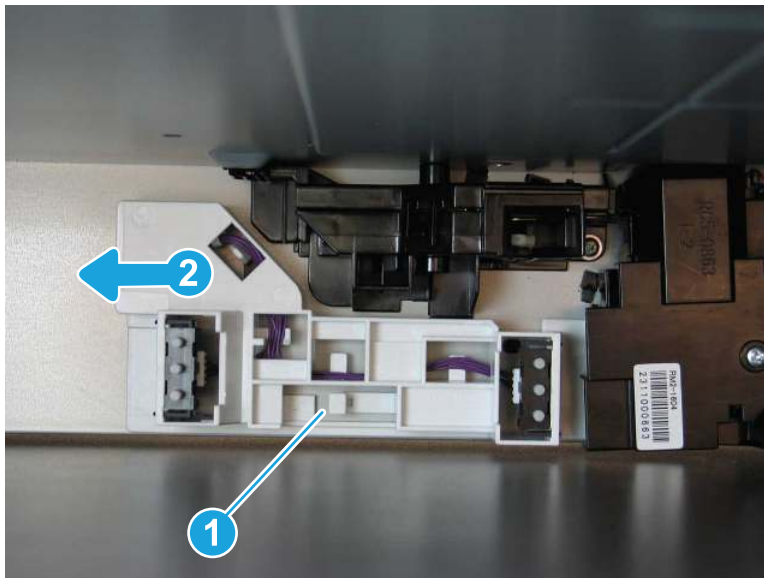
Figure 1-2537 Remove Tray 2



2. Remove the size detect switch.

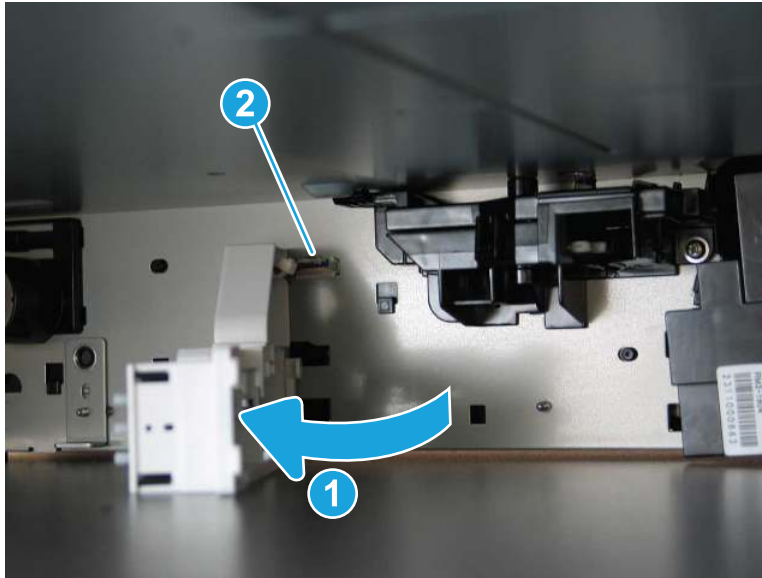
- a. Inside the Tray 2 opening, release one tab (callout 1) and then slide the size detect sensor to the left (callout 2) to release it.

Figure 1-2538 Release the tab and slide left



- b. Rotate the size detect switch to the left (callout 1), and then disconnect one connector (callout 2).

Figure 1-2539 Disconnect one connector



3. Unpack the replacement assembly.

- a. Dispose of the defective part.



NOTE: HP recommends responsible disposal of the defective part.

<http://www8.hp.com/us/en/hp-information/environment/product-recycling.html>

- b. Unpack the replacement part from the packaging.



IMPORTANT: Make sure that all of the shipping materials (for example shipping tape) are removed from the replacement part prior to installation.

- c. To install an assembly, reverse the removal steps.



NOTE: When applicable, special installation instructions are provided for an assembly at the end of the removal procedure. Always completely read the removal instructions and follow all special installation instructions.

Removal and replacement: Waste toner feed assembly (M751/E75245)

Learn how to remove and replace the waste toner feed assembly.

[View a video of how to remove and replace the waste toner feed assembly.](#)

Mean time to repair: 18 minutes

Service level: Easy

Before performing service

Turn the printer power off

- Disconnect the power cable.

⚠ WARNING! To avoid damage to the printer, turn the printer off, wait 30 seconds, and then remove the power cord before attempting to service the printer.

Use the table below to identify the correct part number for your printer. To order the part, go to www.hp.com/buy/parts.

Table 1-128 Part information

Part number	Part description
RM2-1520-000CN	Waste toner feed assembly
RC5-0770-000CN	Hinge, left door, upper (if needed)

Required tools

- #2 Phillips screwdriver with a magnetic tip
- Small, flat-blade screwdriver

After performing service

Turn the printer power on

- Connect the power cable.
- Use the power switch to turn the power on.

Post service test

Make sure that the printer initializes to a **Ready** state.

Print a page to make sure that the printer is functioning correctly.

1. Remove the TCU.

- a. Open the front door.

Figure 1-2540 Open the front door



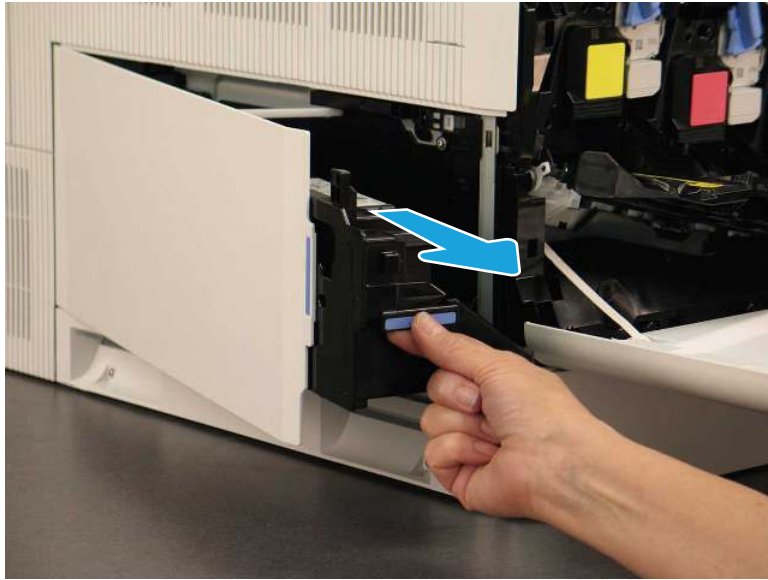
- b. Open the left door.

Figure 1-2541 Open the left door



- c. Grasp the front of the TCU, and then remove it from the printer.

Figure 1-2542 Remove the TCU



2. Remove the imaging drums.
 - a. Open the front door, if it is not already open. Rotate the blue lever in front of the imaging drum to the left.

Figure 1-2543 Rotate the blue lever



- b. Grasp the handle of the imaging drum and pull out to remove it. Repeat the process for the remaining imaging drums.

Figure 1-2544 Remove the imaging drum



3. Remove the toner cartridges.

- ▲ Open the front door, if it is not already open. Grasp the handle of the toner cartridge and pull out to remove it. Repeat the process for the remaining toner cartridges.

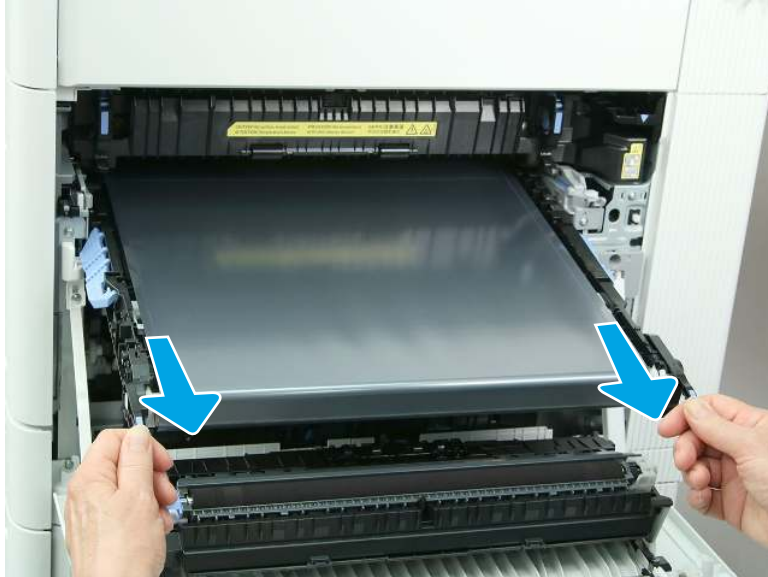
Figure 1-2545 Remove the toner cartridge



4. Remove the intermediate transfer belt (ITB).

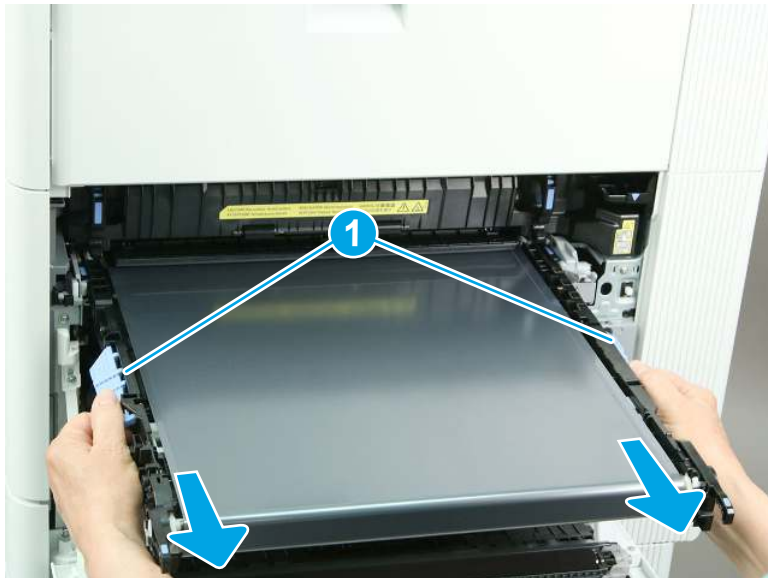
- a. Open the right door. Grasp the two blue handles on the ITB, and then pull the ITB partially out of the printer.

Figure 1-2546 Partially remove the ITB



- b. Grasp the blue handles on the side of the ITB (callout 1), and then remove the ITB from the printer.

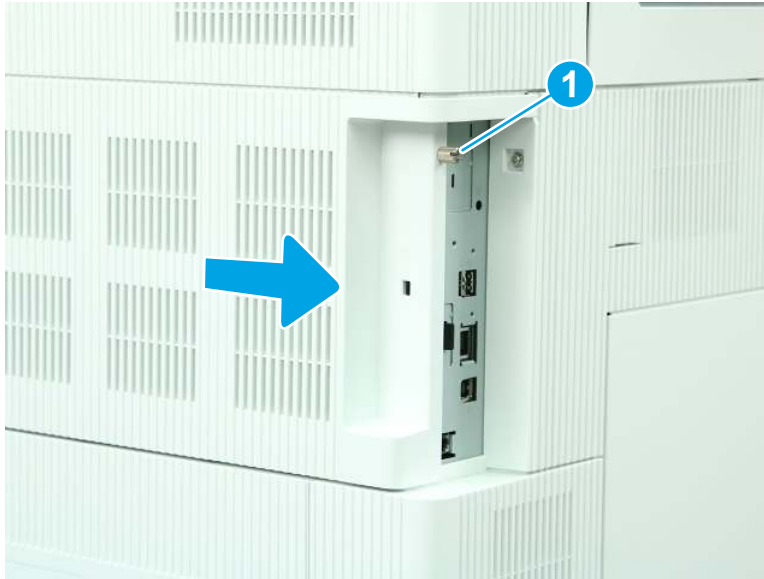
Figure 1-2547 Remove the ITB



5. Remove the formatter cover.

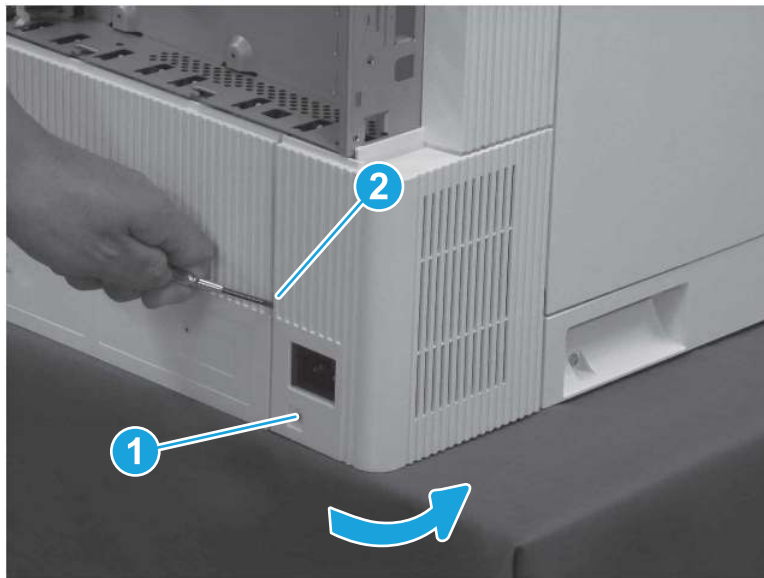
- ▲ Loosen one thumbscrew (callout 1), and then slide the formatter cover (callout 2) away from the printer to remove it.

Figure 1-2548 Remove the formatter cover



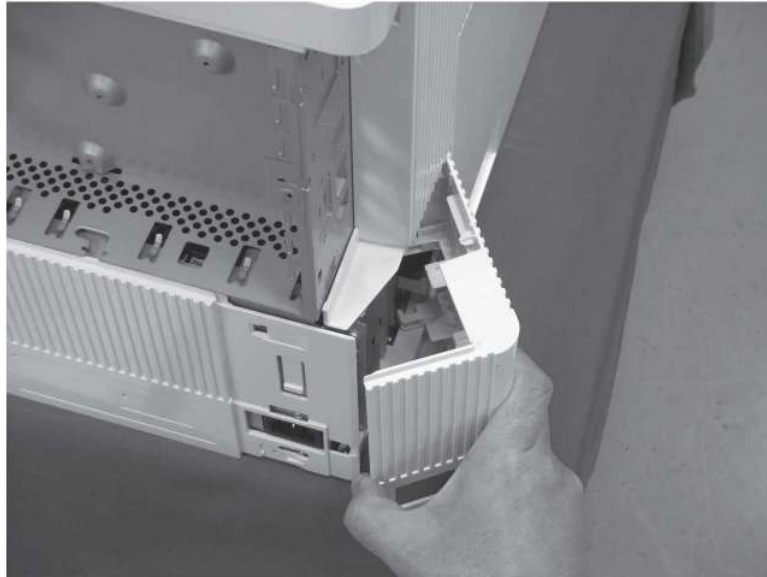
- 6. Remove the left lower cover (M751/E75245).
 - a. Remove one screw (callout 1), release one tab (callout 2), and then rotate the cover away from the printer.

Figure 1-2549 Remove one screw and release one tab



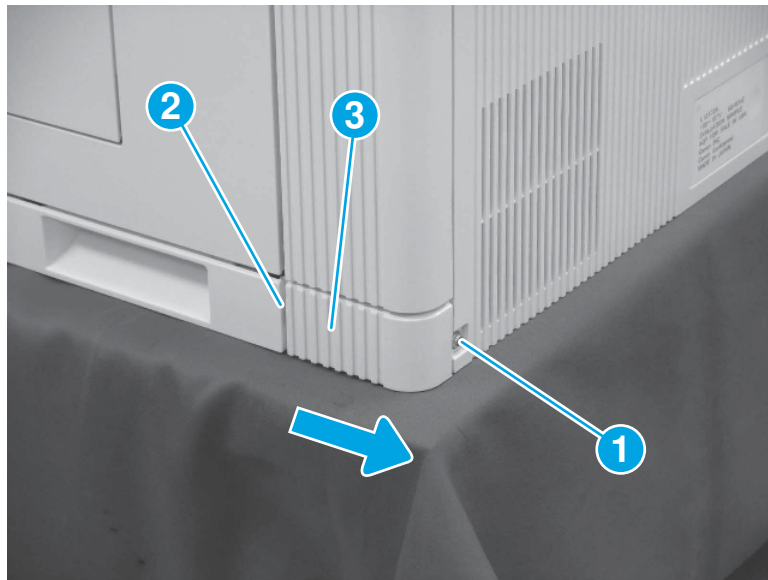
- b. Remove the left lower cover.

Figure 1-2550 Remove the left lower cover



7. Remove the right rear lower cover (M751/E75245/M856/E85055/M776).
 - ▲ Remove one screw (callout 1), release one tab (callout 2), and then slide the right rear lower cover (callout 3) toward the back of the printer to remove it.

Figure 1-2551 Remove the right rear lower cover



8. Remove the left rear cover (M751/E75245/M856/E85055/M776).

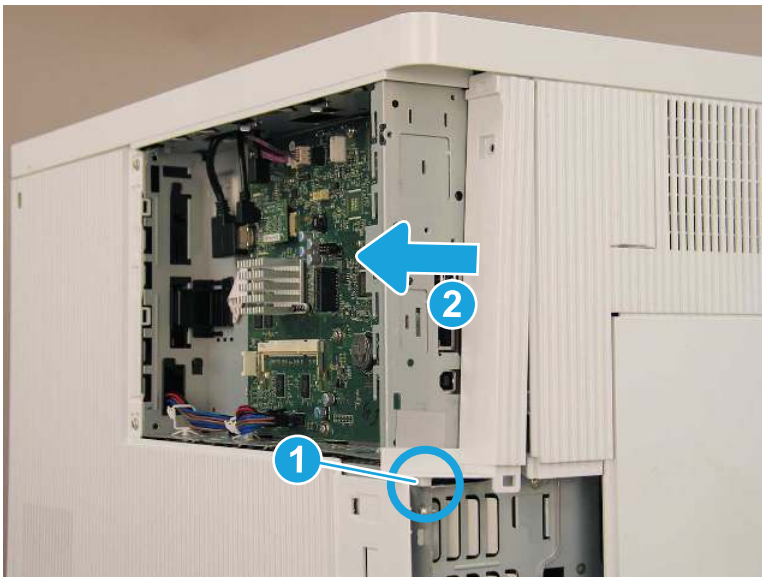
- a. Remove one screw (callout 1).

Figure 1-2552 Remove one screw



- b. Release one boss (callout 1), and then slide the cover toward the back of the printer (callout 2) to remove it.

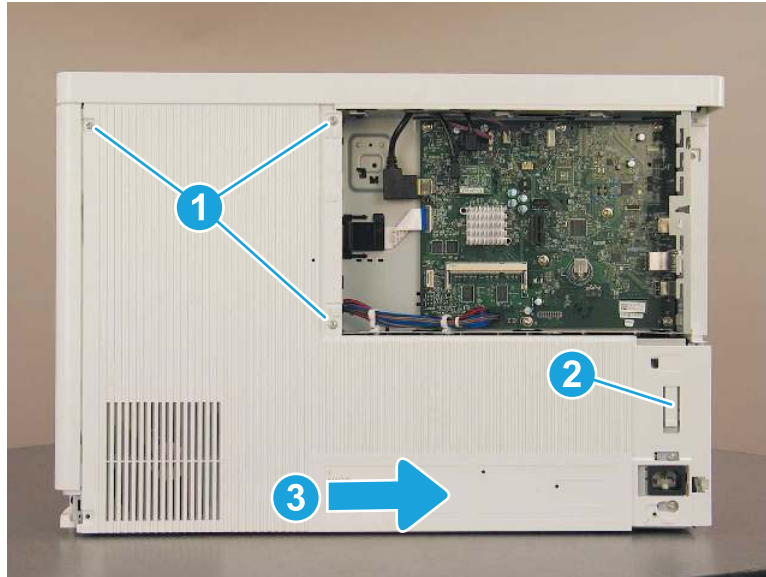
Figure 1-2553 Remove the left rear cover



9. Remove the rear cover (M751/E75245).

- ▲ Remove three screws (callout 1), release one tab (callout 2), and then slide the rear cover to the right (callout 3) to remove it.

Figure 1-2554 Remove the rear cover

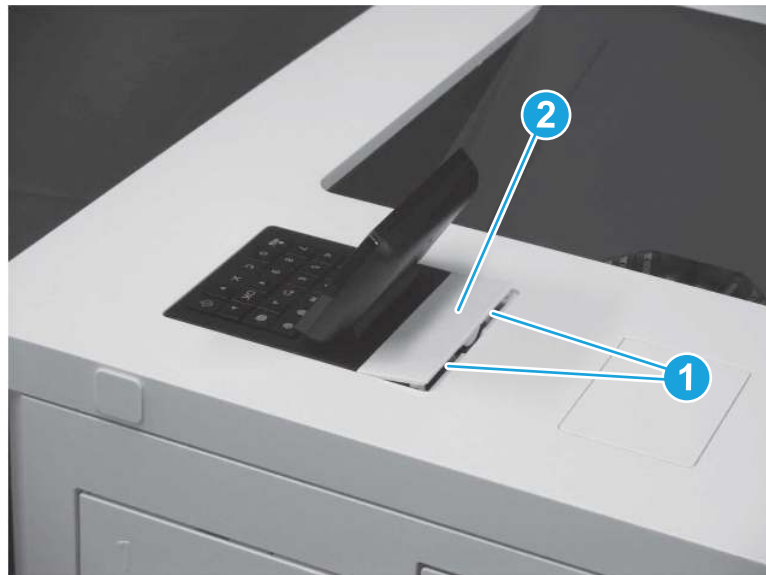


10. Remove the control panel.

 **NOTE:** A screwdriver is included in the control panel kit. The screwdriver has a reversible shaft. Simply pull the shaft out of the handle, and then reinstall it with the desired end facing out.

- a. Use a small, flat-blade screwdriver to release two tabs (callout 1), and then remove the control panel cover (callout 2).

Figure 1-2555 Remove the control panel cover



- b. Remove one screw (callout 1).

Figure 1-2556 Remove one screw



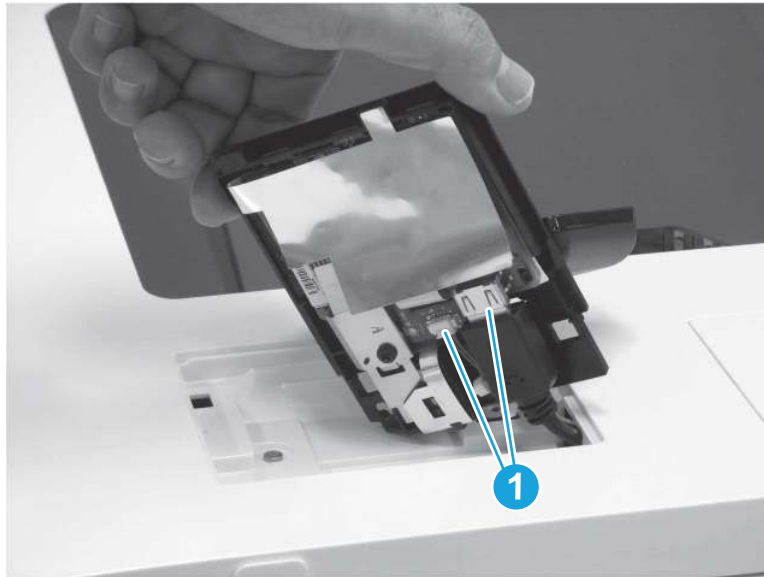
- c. Lift the back edge of the control panel up (callout 1), and then slide the control panel toward the back of the printer (callout 2).

Figure 1-2557 Slide the control panel back



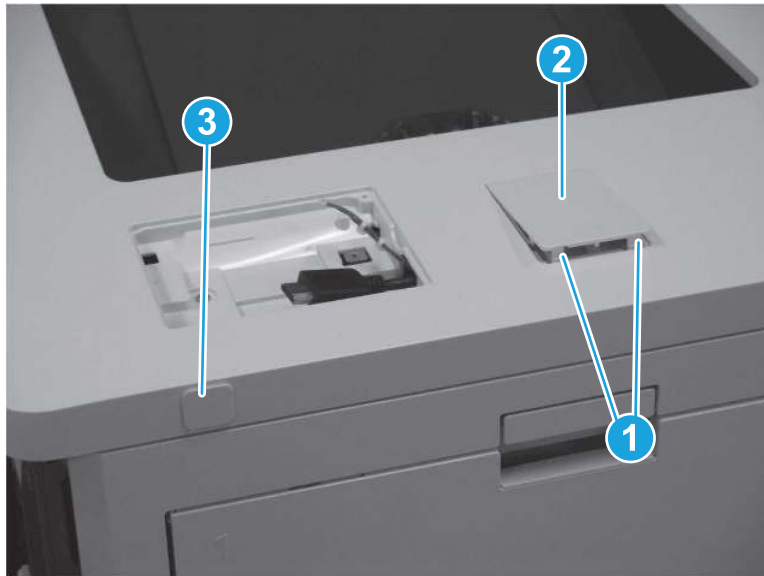
- d. Turn the control panel so that the bottom is facing up, and then disconnect two connectors (callout 1) to remove the control panel.

Figure 1-2558 Disconnect two connectors



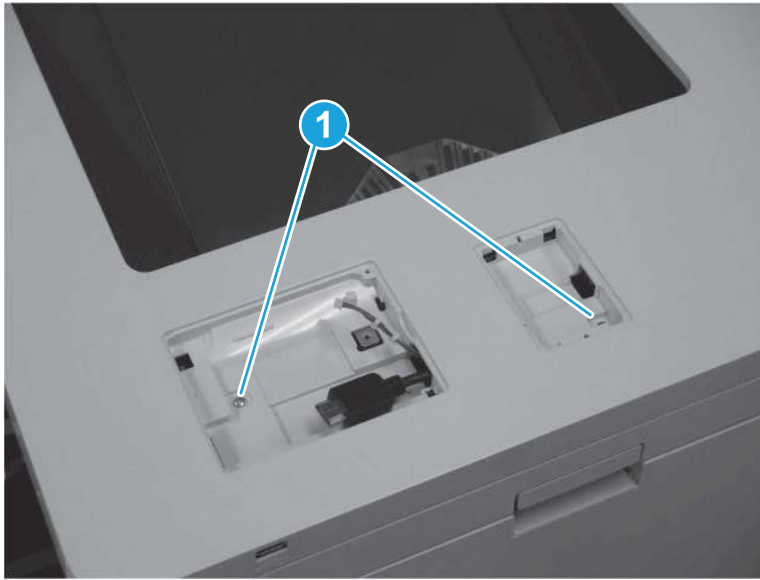
11. Remove the top cover (M751/E75245).
 - a. Release two tabs (callout 1), and then remove the HIP cover (callout 2). Pull the USB cap (callout 3) away from the printer to remove it.

Figure 1-2559 Remove the HIP cover and USB cap



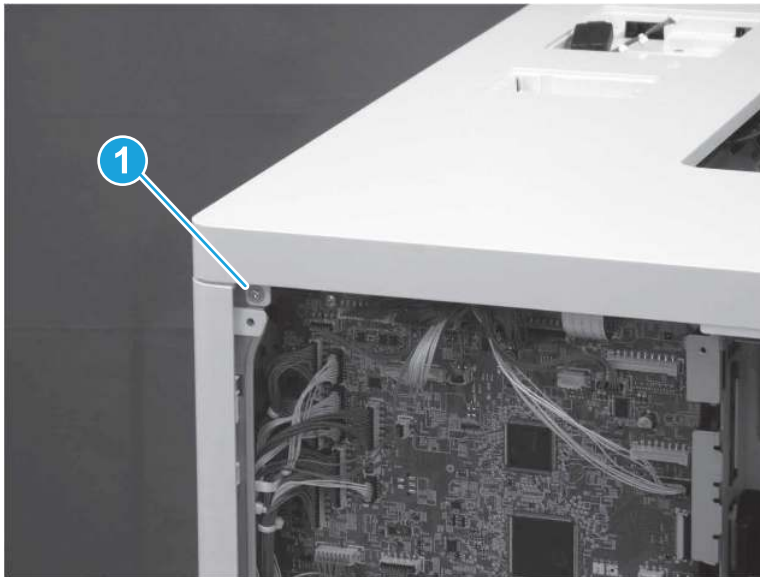
- b. At the top of the printer, remove two screws (callout 1).

Figure 1-2560 Remove two screws



- c. At the back of the printer, remove one screw (callout 1).

Figure 1-2561 Remove one screw



- d. Use a small, flat-blade screwdriver to release one tab (callout 1) and remove the left blanking cover (callout 2). Release one tab (callout 3) and remove the right blanking cover (callout 4).

 **TIP:** These covers are not identical. Make sure to reinstall the correct cover on the correct side.


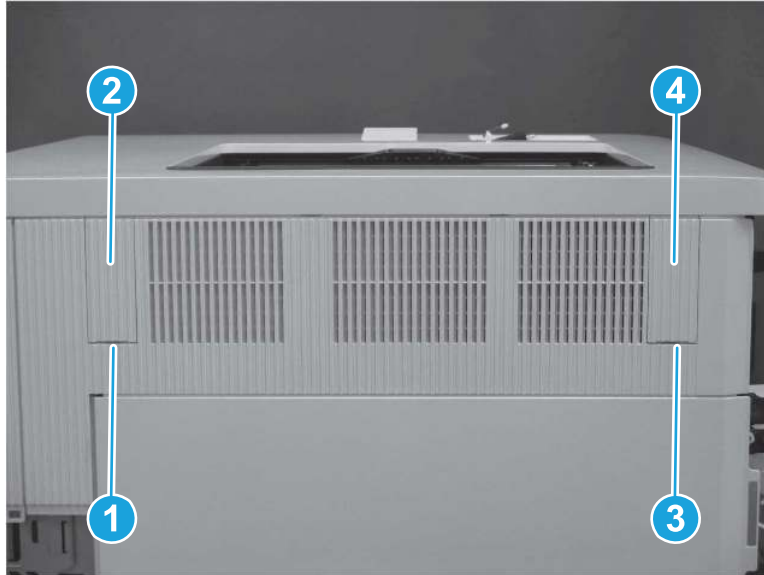
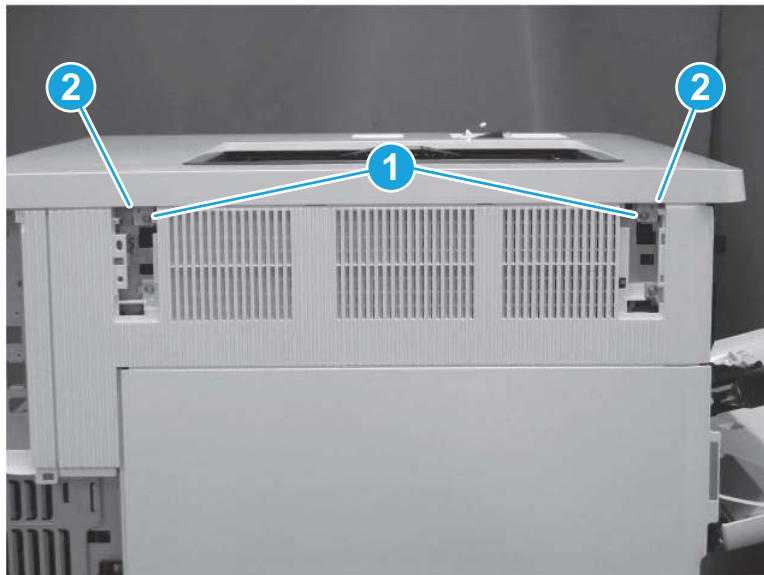
 **NOTE:** The screw under the left blanking cover is a self-tapping screw. Make sure this screw is reinstalled in the correct location.

Figure 1-2562 Remove the left and right blanking covers



- e. Remove two screws (callout 1), and then release two tabs (callout 2).

Figure 1-2563 Remove two screws and release two tabs



- f. At the front of the printer, remove one washer-head screw (callout 1) and one self-tapping screw (callout 2). Release one tab (callout 3).


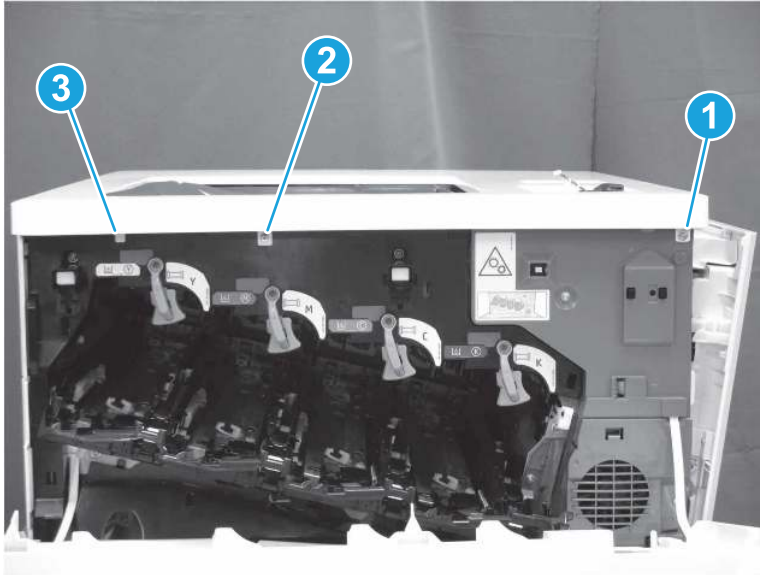
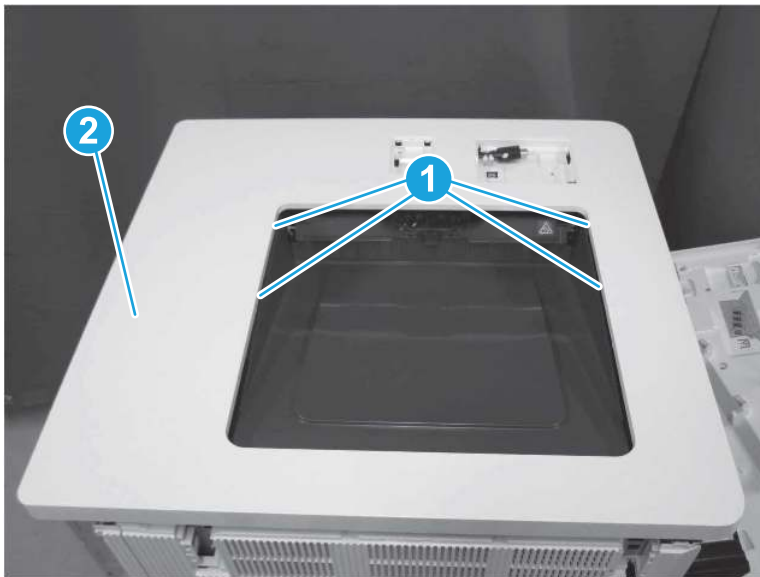
 **TIP:** Make sure to install the correct type of screw in the correct location.

Figure 1-2564 Remove two screws and release one tab



- g. At the top of the printer, release four tabs (callout 1), and then remove the top cover (callout 2).

Figure 1-2565 Remove the top cover



 **NOTE:** When removing the top cover, make sure to release the control panel cables (callout 1) through the opening.

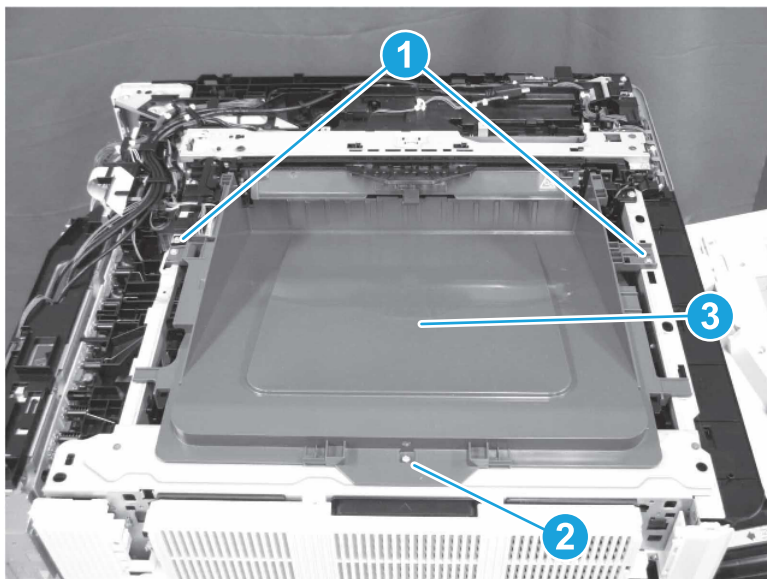


12. Remove the output bin (M751/E75245).

- ▲ Remove two washer-head machine screws (callout 1), remove one self-tapping screw (callout 2), and then remove the output bin (callout 3).

 **NOTE:** When reinstalling the output bin, make sure to install the correct type of screw in the correct location.

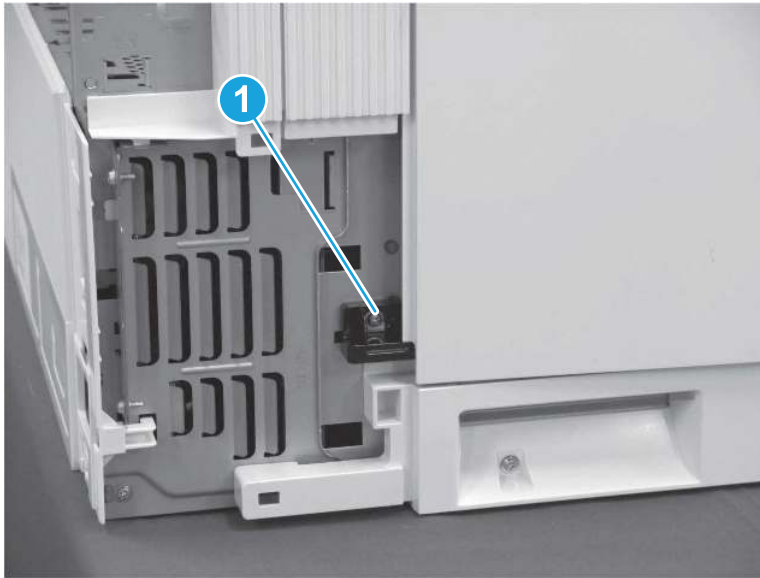
Figure 1-2566 Remove the output bin



13. Remove the left door.

- a. Remove one screw (callout 1).

Figure 1-2567 Remove one screw



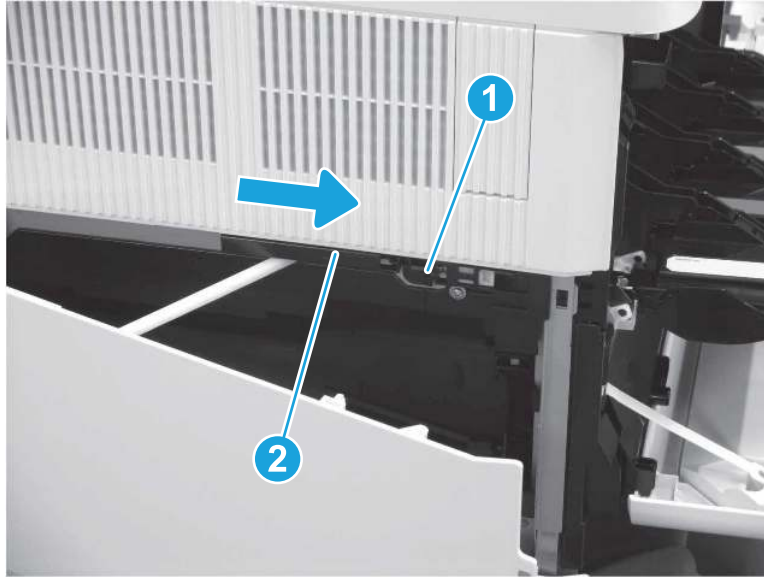
- b. Release the holder, and then remove it from the printer.

Figure 1-2568 Remove the holder



- c. Open the left door, and release one tab (callout 1). Slide the holder (callout 2) toward the front of the printer.

Figure 1-2569 Slide the holder



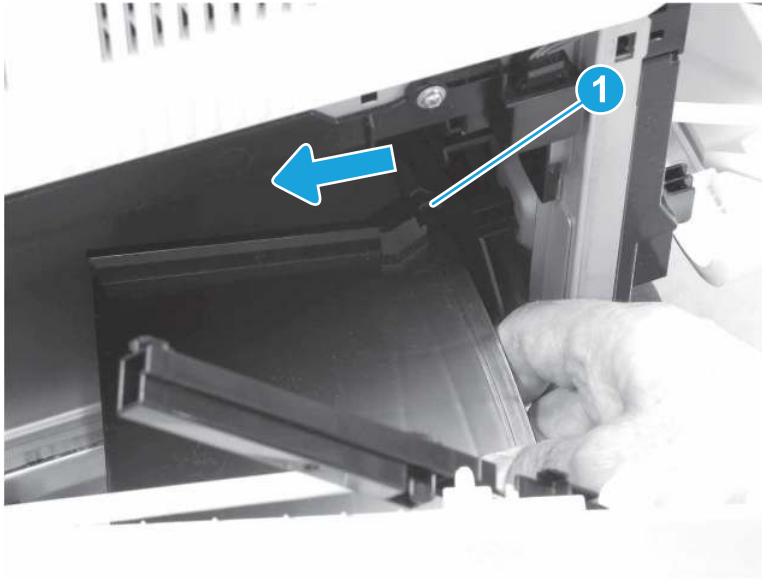
- d. Release the holder (callout 1) from the printer, but leave it attached to the hinge.

Figure 1-2570 Release the holder



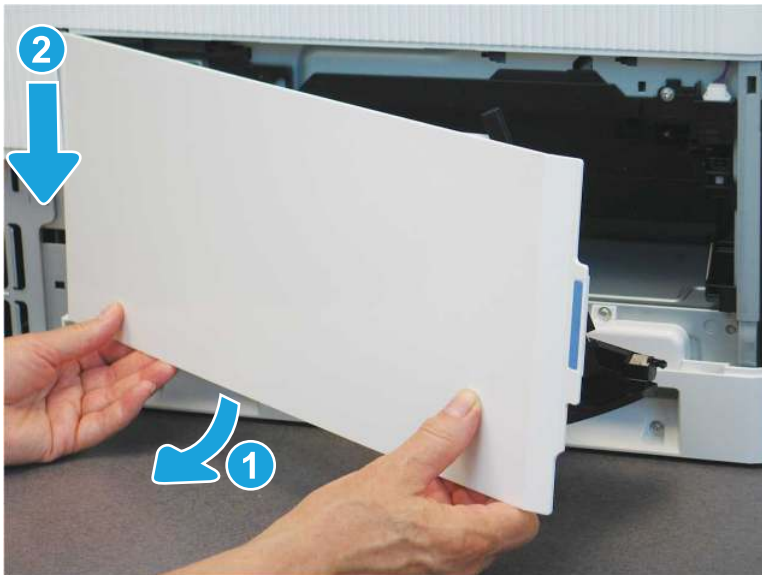
- e. Press the stopper (callout 1) on the bottom of the door to the left to release it from the track.

Figure 1-2571 Release the stopper



- f. Rotate the left, lower edge of the door away from the printer (callout 1), and then lower the door to remove it (callout 2).

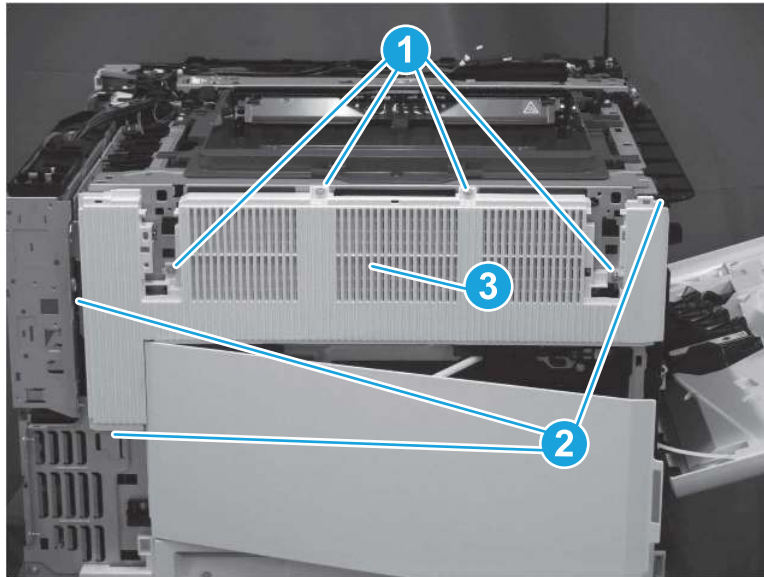
Figure 1-2572 Remove the left door



- 14. Remove the left upper cover (M751/E75245).

- ▲ Remove four screws (callout 1), release three tabs (callout 2), and then remove the left upper cover (callout 3).

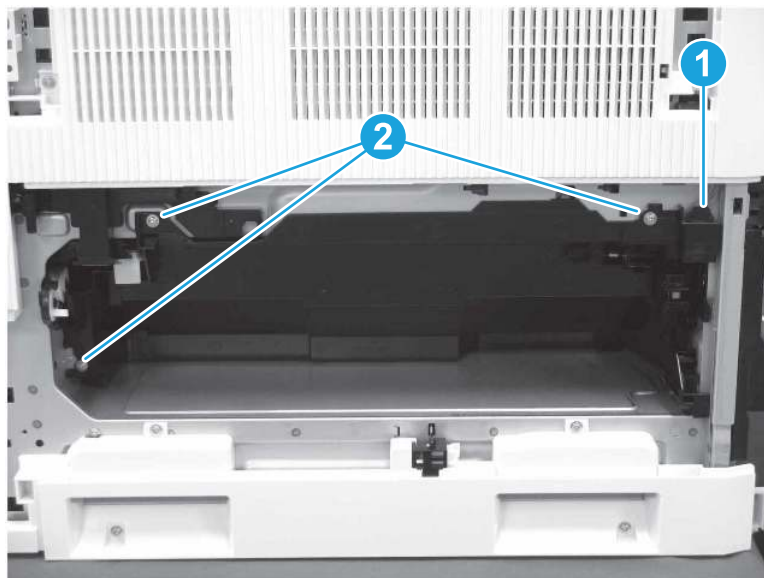
Figure 1-2573 Remove the left upper cover



- 15. Remove the scanner cover.

- a. Disconnect one connector (callout 1), and then remove three screws (callout 2).

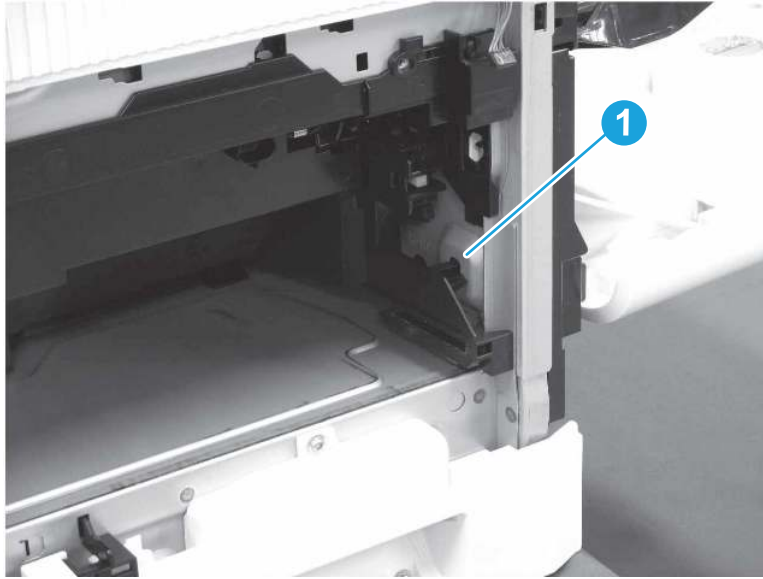
Figure 1-2574 Disconnect one connector and remove three screws



 **TIP:** Connect the connector before reinstalling the screws.

- b. Release one tab (callout 1), and then flex the scanner cover to remove it.

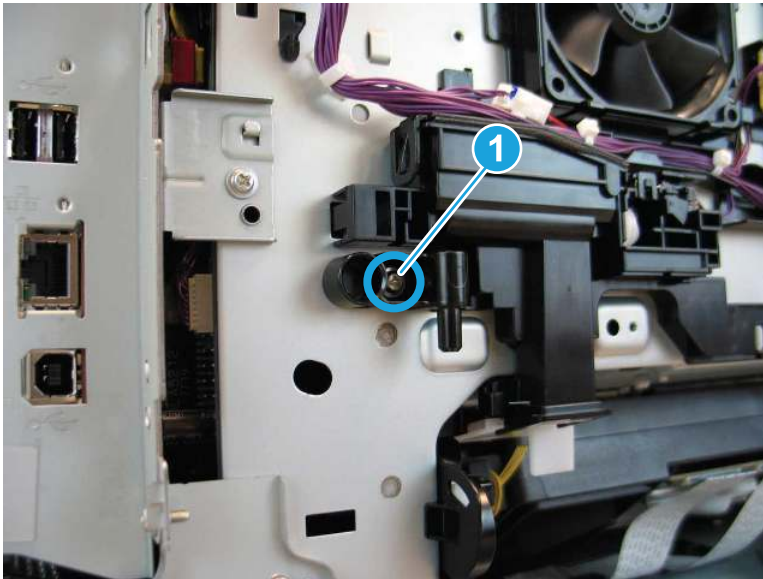
Figure 1-2575 Remove the scanner cover



- 16. Remove the secondary auger.

- a. Remove one screw (callout 1).

Figure 1-2576 Remove one screws



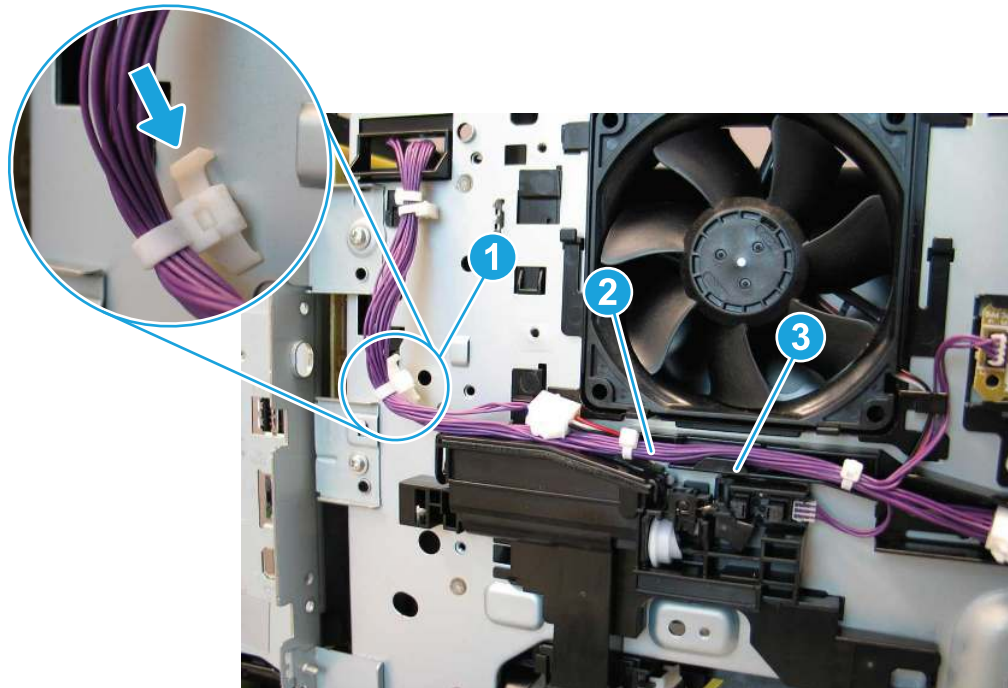
- b. Remove the left door upper hinge.

Figure 1-2577 Remove the left door upper hinge



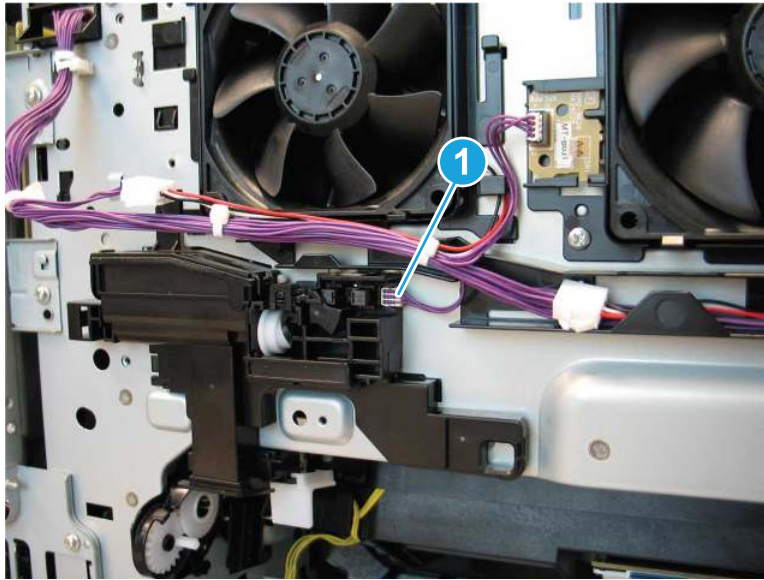
- c. Press the latch to release one retainer (callout 1) from the sheet metal. Remove the wire harness (callout 2) from the guides (callout 3).

Figure 1-2578 Release the wire harness from the guides



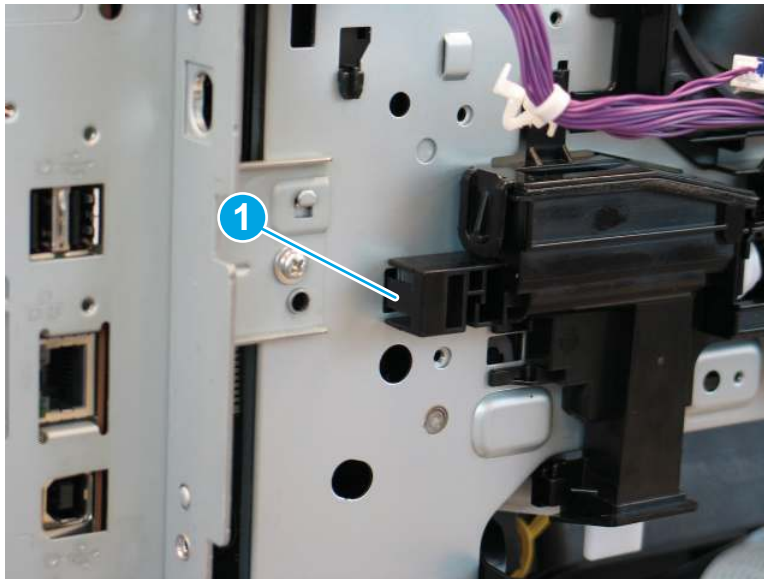
- d. Disconnect one connector (callout 1).

Figure 1-2579 Disconnect one connector



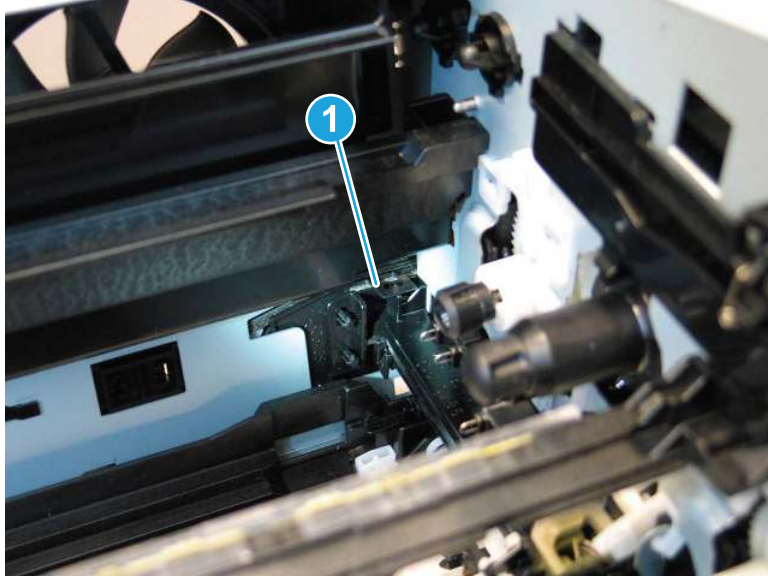
- e. Release one tab (callout 1).

Figure 1-2580 Release one tab



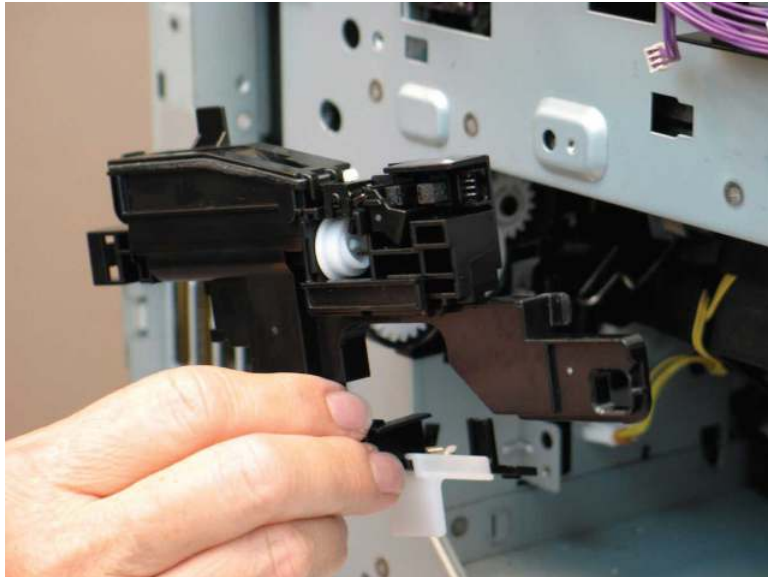
- f. Inside the printer, release one tab that connects to the primary auger (callout 1).

Figure 1-2581 Release one tab



- g. Remove the secondary auger assembly.

Figure 1-2582 Remove the secondary auger assembly

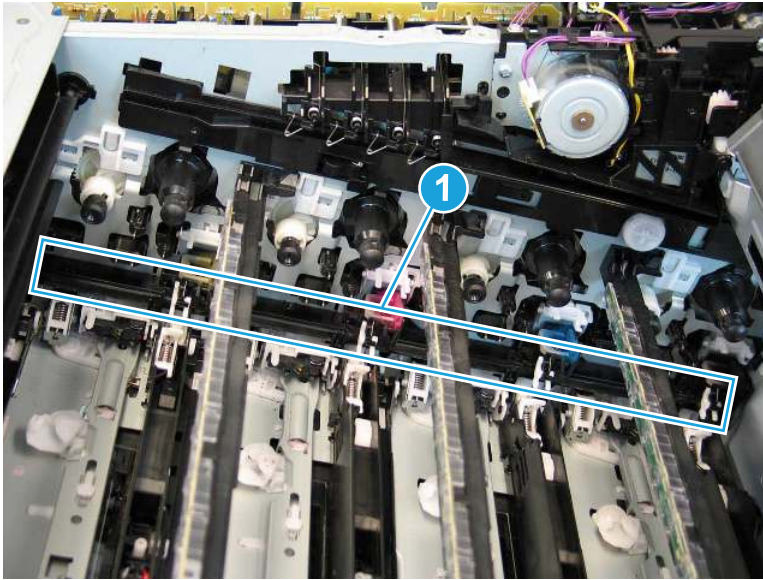


17. Remove the primary auger.

 **IMPORTANT:** Make sure that the front door is open before removing the primary auger.

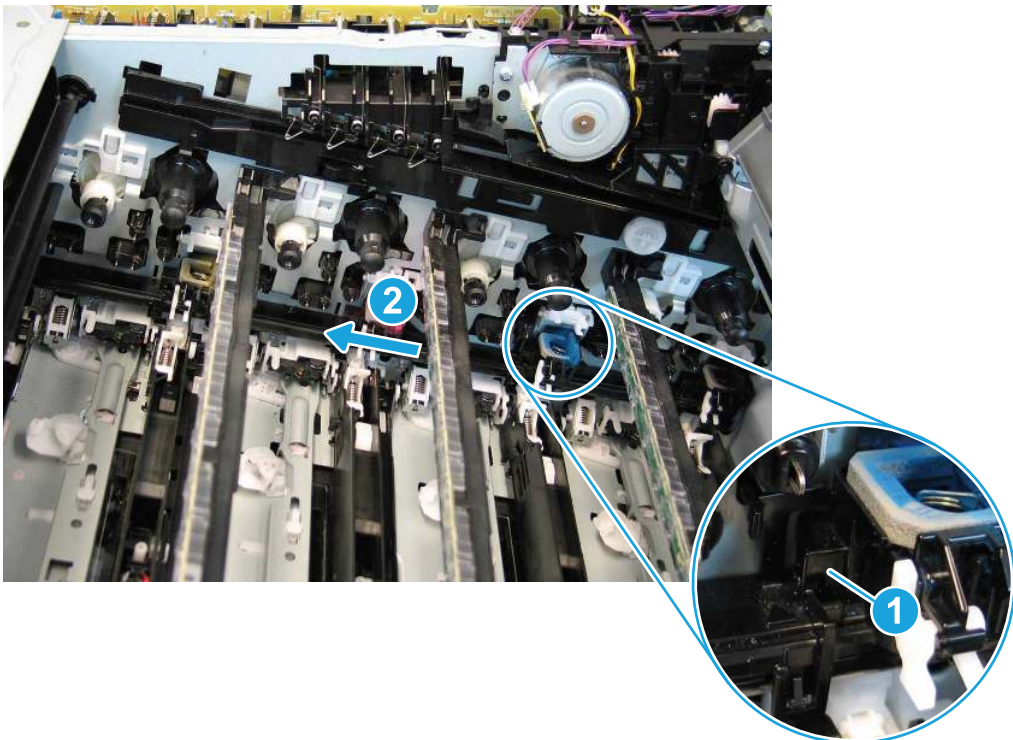
- a. Inside the printer, locate the primary auger (callout 1).

Figure 1-2583 Locate the primary auger



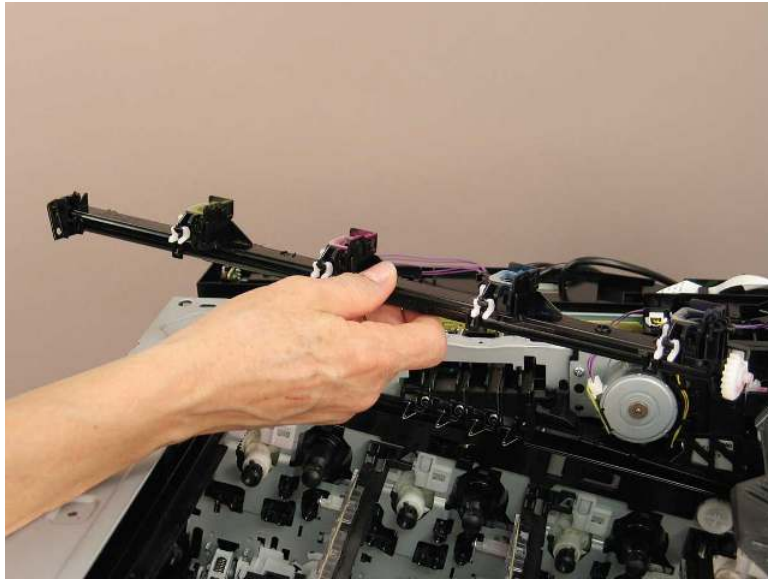
- b. Release one tab (callout 1) next to the cyan opening, and then slide the primary auger toward the left side of the printer (callout 2) to release it.

Figure 1-2584 Release the primary auger



- c. Turn the primary auger as needed to maneuver it out through the top of the printer.

Figure 1-2585 Remove the primary auger



18. Unpack the replacement assembly.

- a. Dispose of the defective part.



NOTE: HP recommends responsible disposal of the defective part.

<http://www8.hp.com/us/en/hp-information/environment/product-recycling.html>

- b. Unpack the replacement part from the packaging.



IMPORTANT: Make sure that all of the shipping materials (for example shipping tape) are removed from the replacement part prior to installation.

- c. To install an assembly, reverse the removal steps.



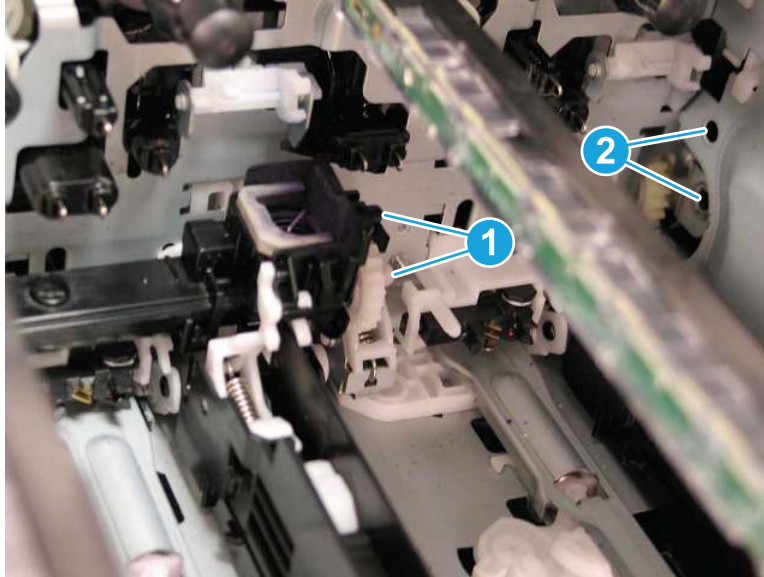
NOTE: When applicable, special installation instructions are provided for an assembly at the end of the removal procedure. Always completely read the removal instructions and follow all special installation instructions.

19. Reverse the removal steps to install the assembly. Also use the following **special installation instructions**.

Install the primary auger.

- ▲ When installing the primary auger, position the black boss and the center of the gear (callout 1) into the openings (callout 2) in the printer.

Figure 1-2586 Install the primary auger



Removal and replacement: Waste toner feed assembly (M856/E85055/M776dn/M776z)

Learn how to remove and replace the waste toner feed assembly.

[View a video of how to remove and replace the waste toner feed assembly.](#)

Mean time to repair: 18 minutes

Service level: Easy

Before performing service

Turn the printer power off

- Disconnect the power cable.

⚠ WARNING! To avoid damage to the printer, turn the printer off, wait 30 seconds, and then remove the power cord before attempting to service the printer.

Use the table below to identify the correct part number for your printer. To order the part, go to www.hp.com/buy/parts.

Table 1-129 Part information

Part number	Part description
RM2-1520-000CN	Waste toner feed assembly
RC5-0770-000CN	Hinge, left door, upper (if needed)

Required tools

- #2 Phillips screwdriver with a magnetic tip
- Small, flat-blade screwdriver

After performing service

Turn the printer power on

- Connect the power cable.
- Use the power switch to turn the power on.

Post service test

Make sure that the printer initializes to a **Ready** state.

Print a page to make sure that the printer is functioning correctly.

1. Remove the TCU.
 - a. Open the front door.

Figure 1-2587 Open the front door



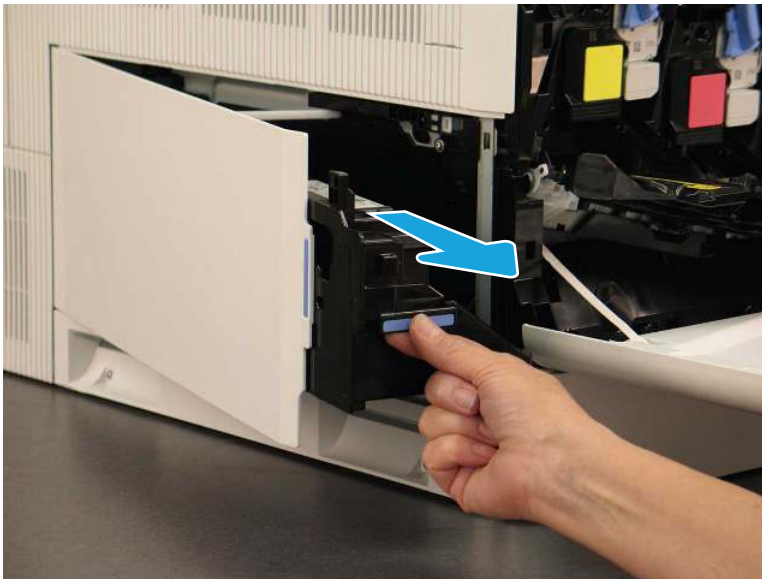
- b. Open the left door.

Figure 1-2588 Open the left door



- c. Grasp the front of the TCU, and then remove it from the printer.

Figure 1-2589 Remove the TCU



2. Remove the imaging drums.

- a. Open the front door, if it is not already open. Rotate the blue lever in front of the imaging drum to the left.

Figure 1-2590 Rotate the blue lever



- b. Grasp the handle of the imaging drum and pull out to remove it. Repeat the process for the remaining imaging drums.

Figure 1-2591 Remove the imaging drum



3. Remove the toner cartridges.

- ▲ Open the front door, if it is not already open. Grasp the handle of the toner cartridge and pull out to remove it. Repeat the process for the remaining toner cartridges.

Figure 1-2592 Remove the toner cartridge



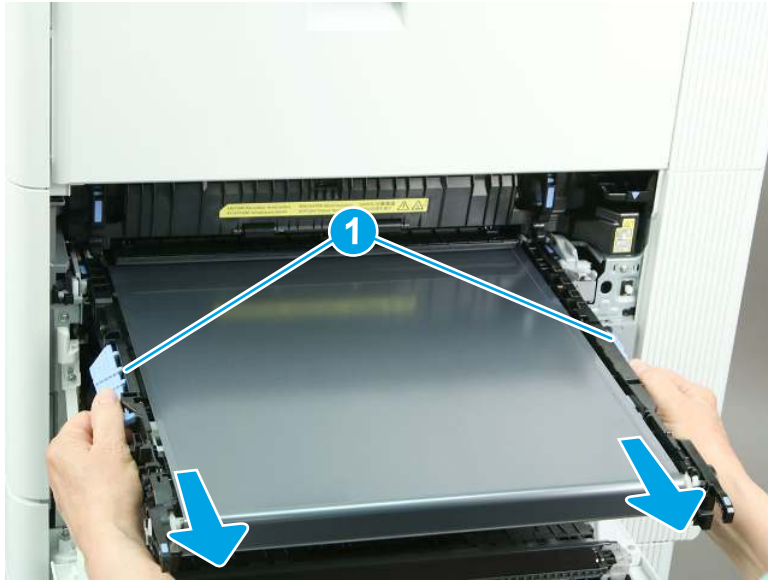
- 4. Remove the intermediate transfer belt (ITB).
 - a. Open the right door. Grasp the two blue handles on the ITB, and then pull the ITB partially out of the printer.

Figure 1-2593 Partially remove the ITB



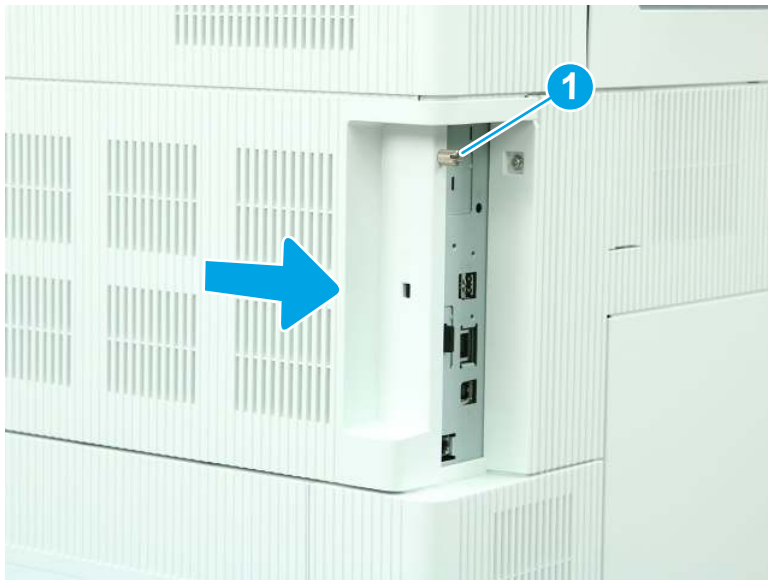
- b. Grasp the blue handles on the side of the ITB (callout 1), and then remove the ITB from the printer.

Figure 1-2594 Remove the ITB



- 5. Remove the formatter cover.
 - ▲ Loosen one thumbscrew (callout 1), and then slide the formatter cover (callout 2) away from the printer to remove it.

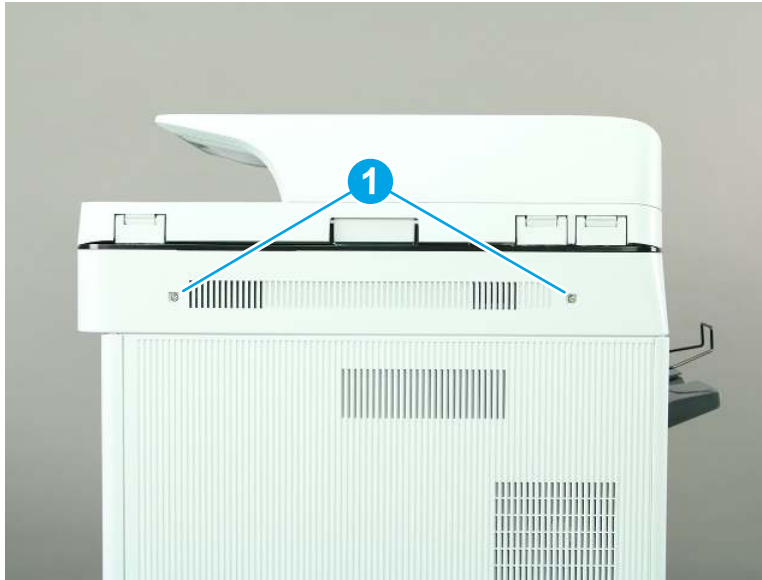
Figure 1-2595 Remove the formatter cover



- 6. Remove the scanner control board (SCB) cover (M776).

- a. Remove two screws (callout 1).

Figure 1-2596 Remove two screws



- b. Remove the SCB cover.

Figure 1-2597 Remove the SCB cover



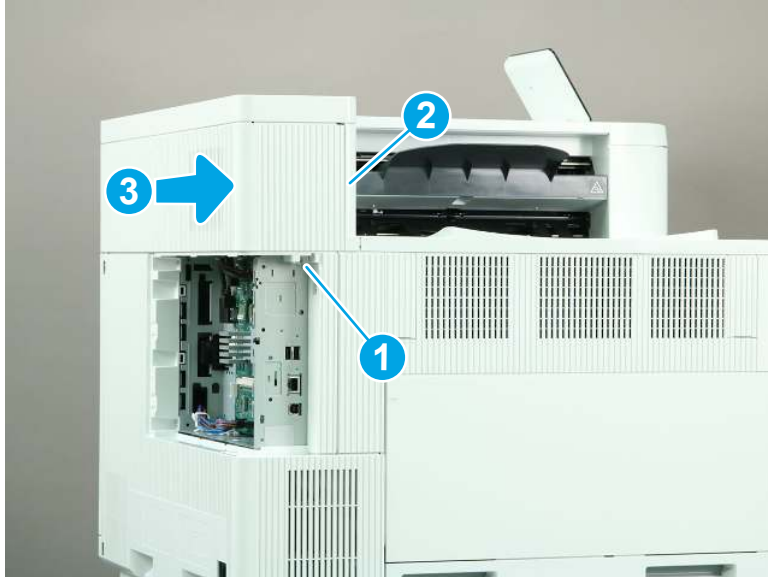
7. Remove the rear upper cover (M856/E85055/M776dn/M776z).



NOTE: The following figure shows the M856 printer. The procedure is correct for all referenced models.

- ▲ Remove one screw (callout 1), release one tab (callout 2), and then slide the rear upper cover away from the printer to remove it (callout 3).

Figure 1-2598 Remove the rear upper cover

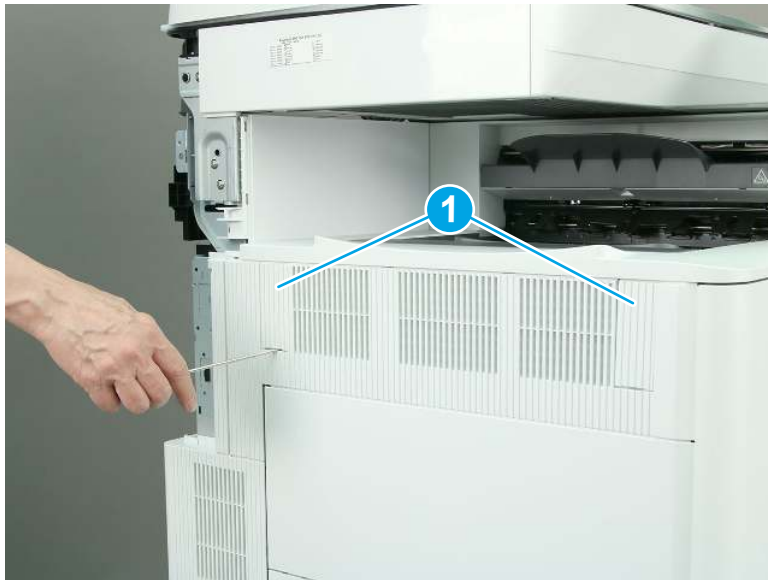


8. Remove the accessory upper cover (M856/E85055/M776dn/M776z).

 **NOTE:** The following figures show the M776z printer. The procedure is correct for all referenced models.

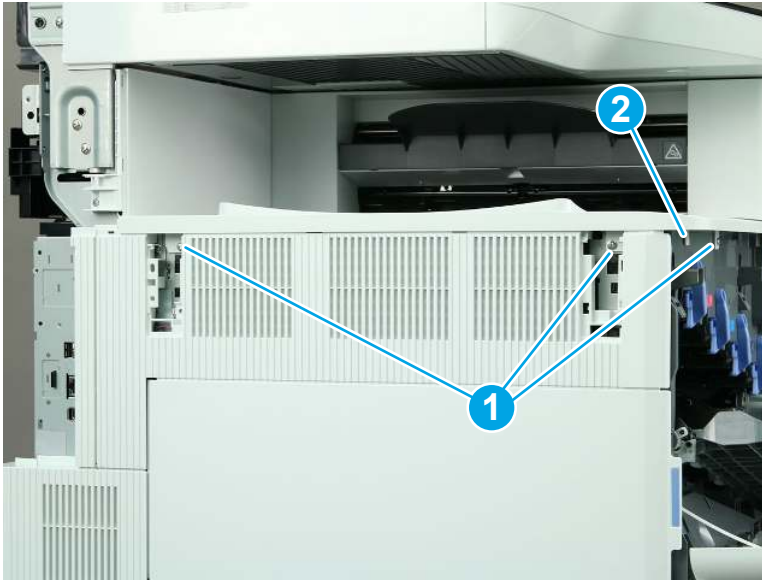
- a. Use a small, flat-blade screwdriver to remove two covers (callout 1).

Figure 1-2599 Remove two covers



- b. Remove three screws (callout 1), and then release one tab (callout 2).

Figure 1-2600 Remove three screws and release one tab



- c. Slide the accessory upper cover away from the printer to remove it.

Figure 1-2601 Remove the accessory upper cover

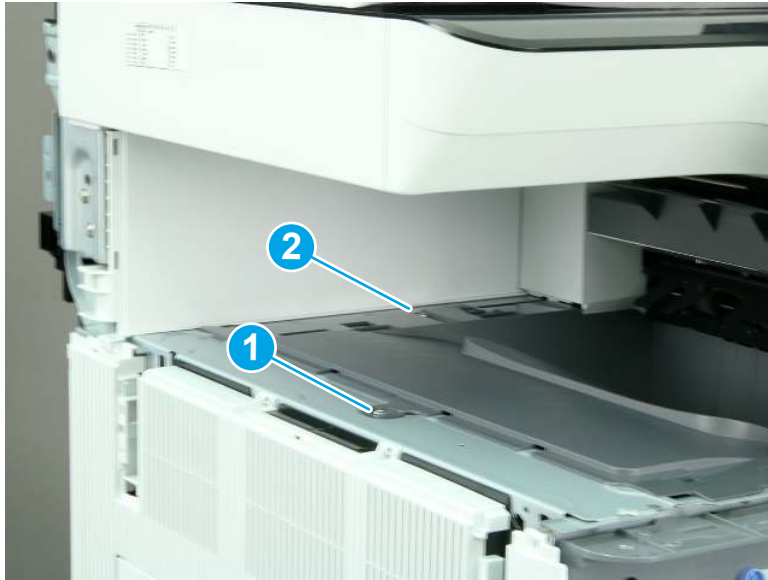


9. Remove the output bin (M856/E85055/M776).

 **NOTE:** The following figures show the M776z printer. The procedure is correct for all referenced models.

- a. Remove one washer-head machine screw (callout 1), remove one self-tapping screw (callout 2).

Figure 1-2602 Remove two screws



- b. Remove the output bin.

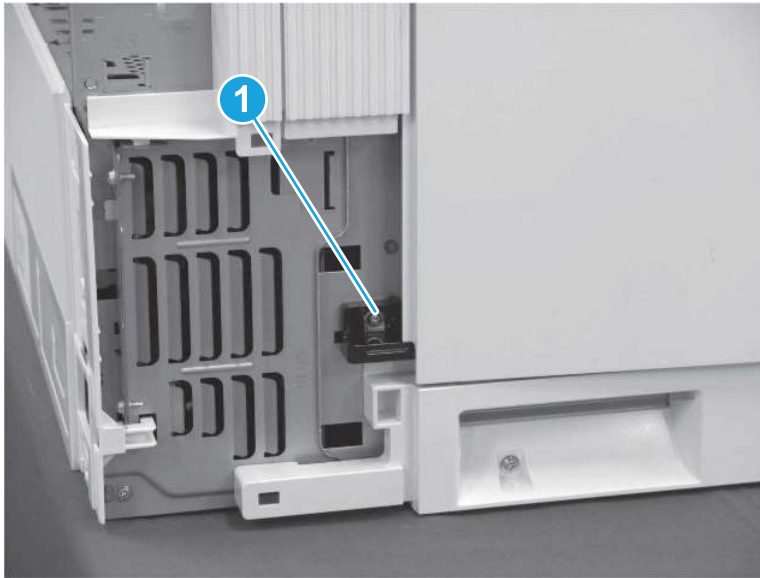
Figure 1-2603 Remove the output bin



10. Remove the left door.

- a. Remove one screw (callout 1).

Figure 1-2604 Remove one screw



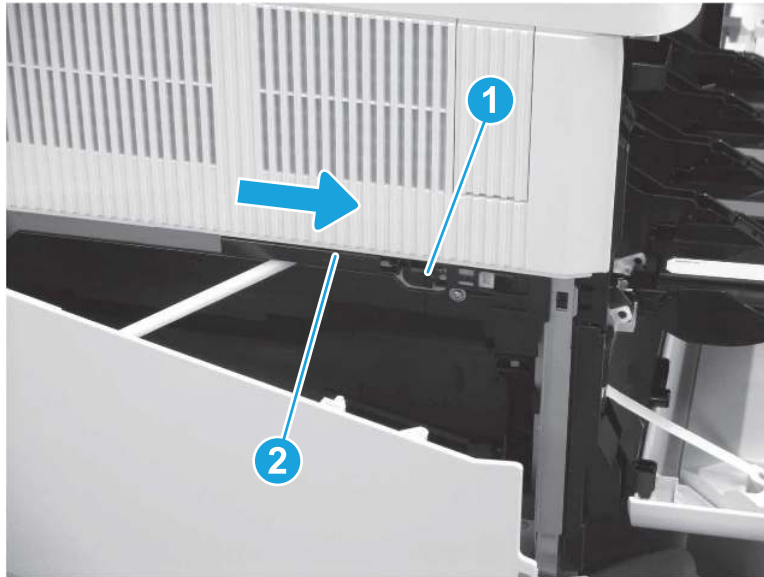
- b. Release the holder, and then remove it from the printer.

Figure 1-2605 Remove the holder



- c. Open the left door, and release one tab (callout 1). Slide the holder (callout 2) toward the front of the printer.

Figure 1-2606 Slide the holder



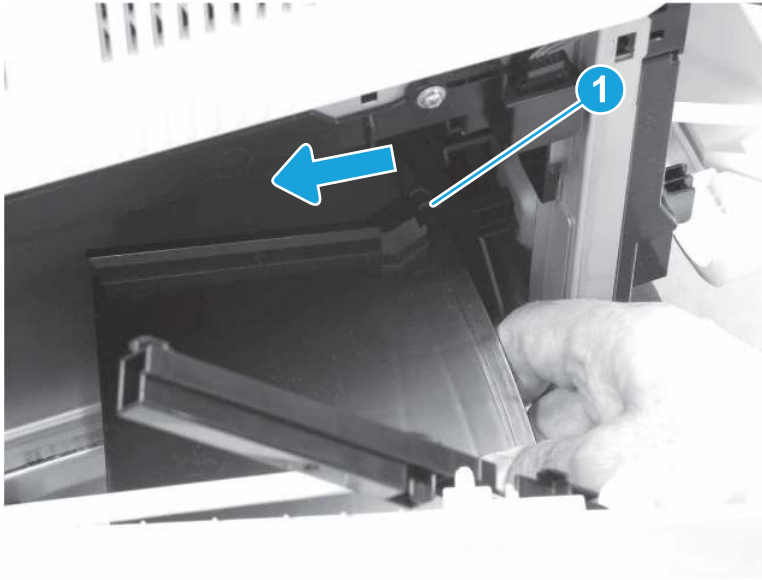
- d. Release the holder (callout 1) from the printer, but leave it attached to the hinge.

Figure 1-2607 Release the holder



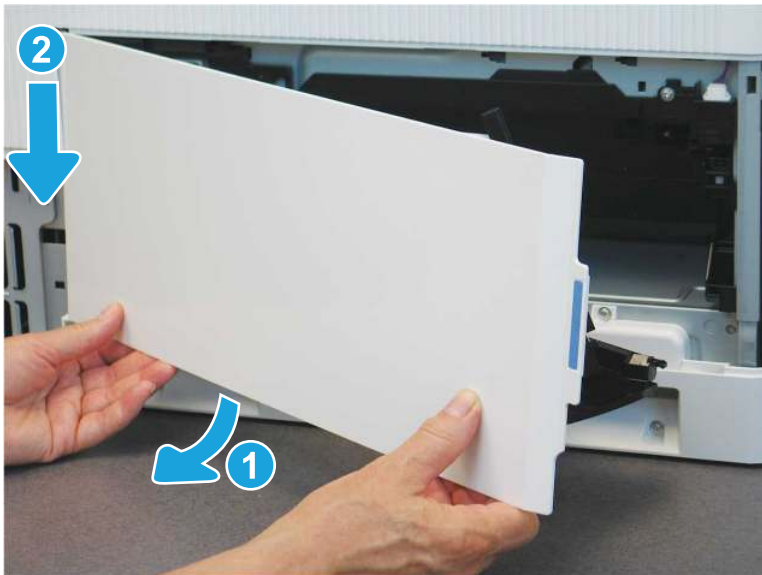
- e. Press the stopper (callout 1) on the bottom of the door to the left to release it from the track.

Figure 1-2608 Release the stopper



- f. Rotate the left, lower edge of the door away from the printer (callout 1), and then lower the door to remove it (callout 2).

Figure 1-2609 Remove the left door



- 11. Remove the left rear cover (M751/E75245/M856/E85055/M776).

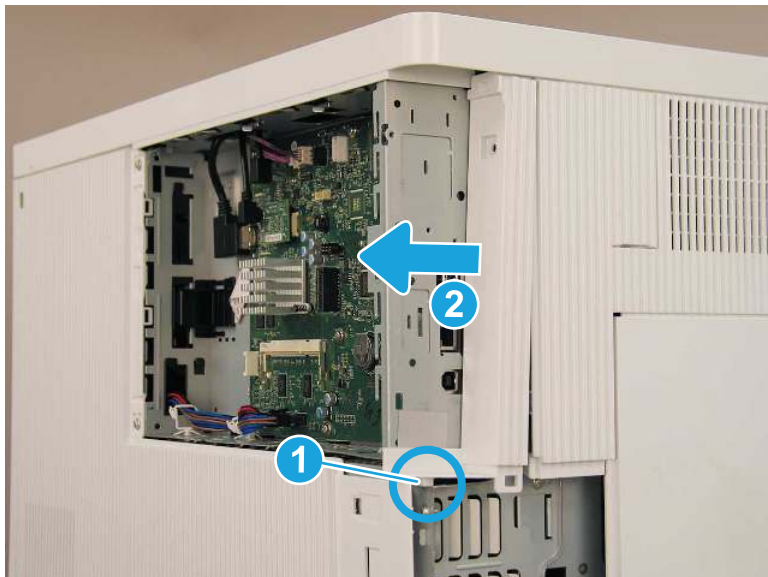
- a. Remove one screw (callout 1).

Figure 1-2610 Remove one screw



- b. Release one boss (callout 1), and then slide the cover toward the back of the printer (callout 2) to remove it.

Figure 1-2611 Remove the left rear cover

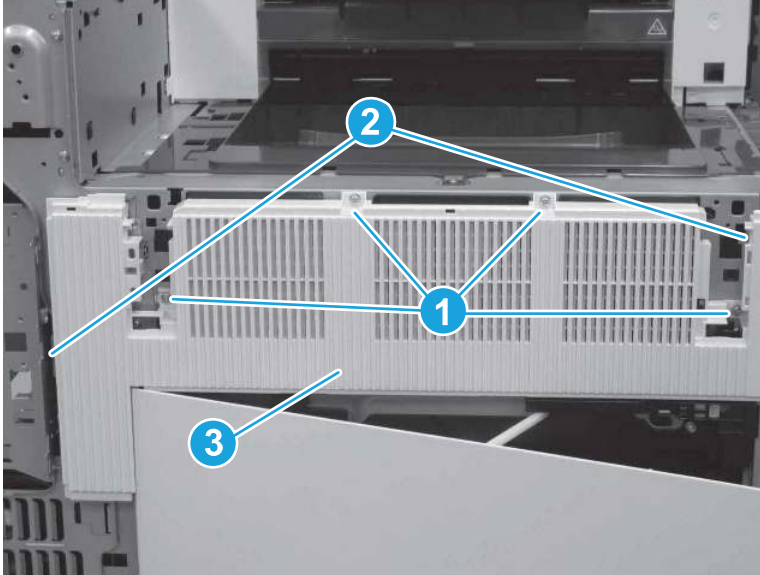


12. Remove the left upper cover (M856/E85055/M776).

 **NOTE:** The following figures show the M776z printer. The procedure is correct for all referenced models.

- ▲ Remove four screws (callout 1), release two tabs (callout 2), and then remove the left upper cover (callout 3).

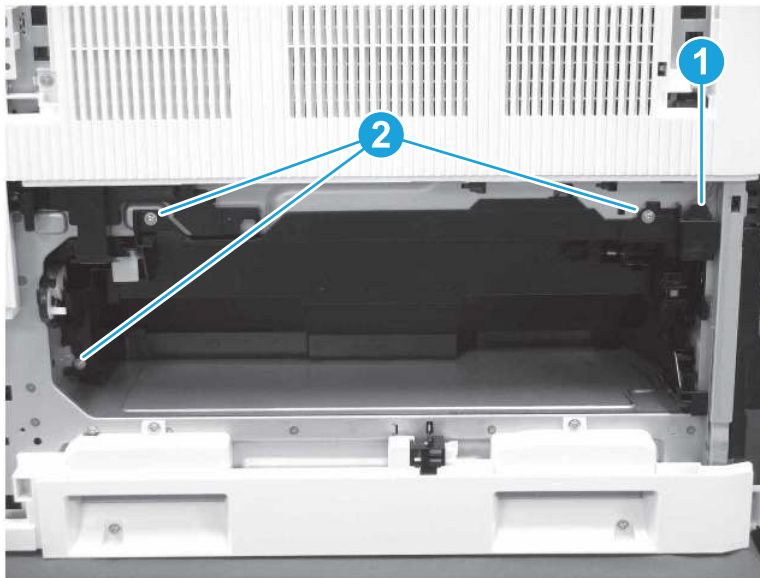
Figure 1-2612 Remove the left upper cover



- 13. Remove the scanner cover.

- a. Disconnect one connector (callout 1), and then remove three screws (callout 2).

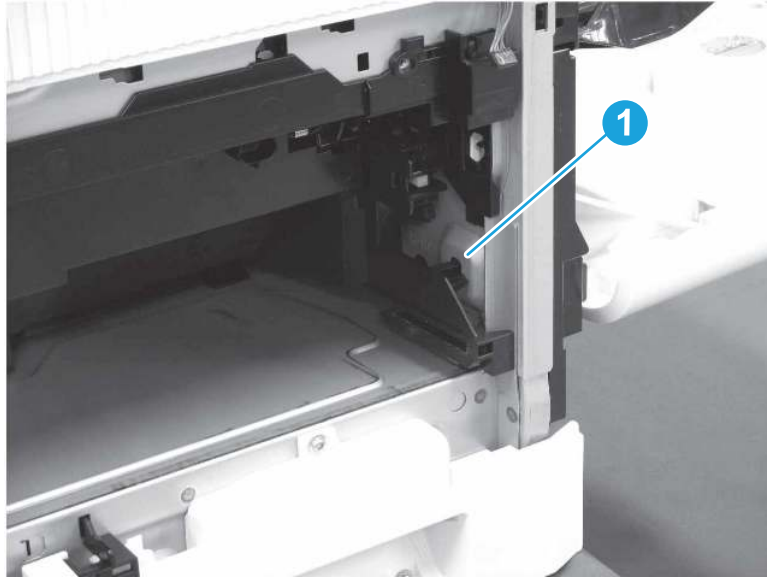
Figure 1-2613 Disconnect one connector and remove three screws



 **TIP:** Connect the connector before reinstalling the screws.

- b. Release one tab (callout 1), and then flex the scanner cover to remove it.

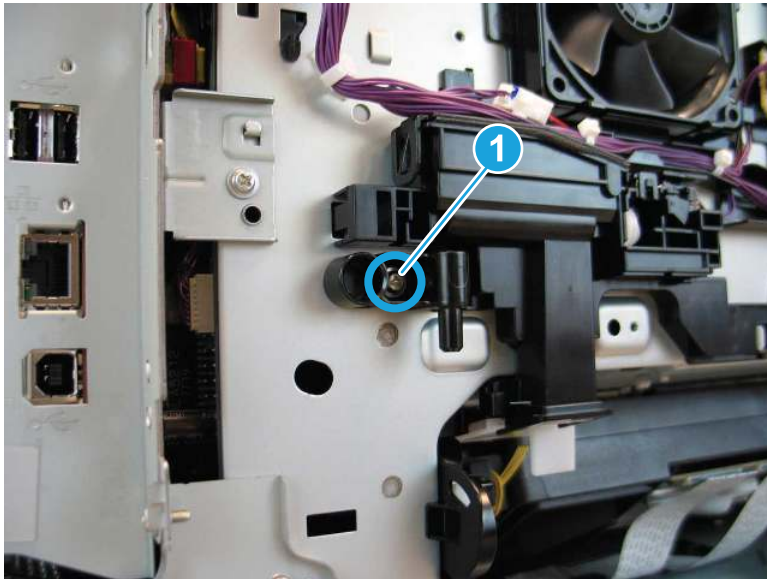
Figure 1-2614 Remove the scanner cover



14. Remove the secondary auger.

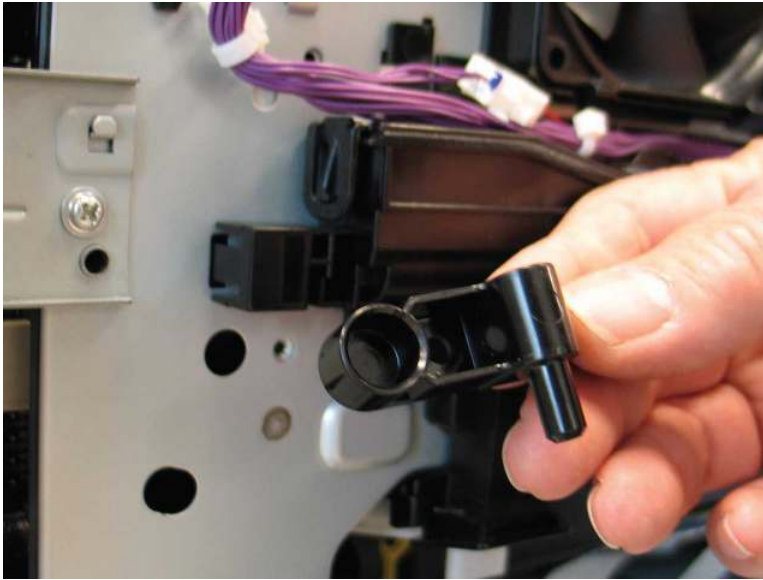
- a. Remove one screw (callout 1).

Figure 1-2615 Remove one screws



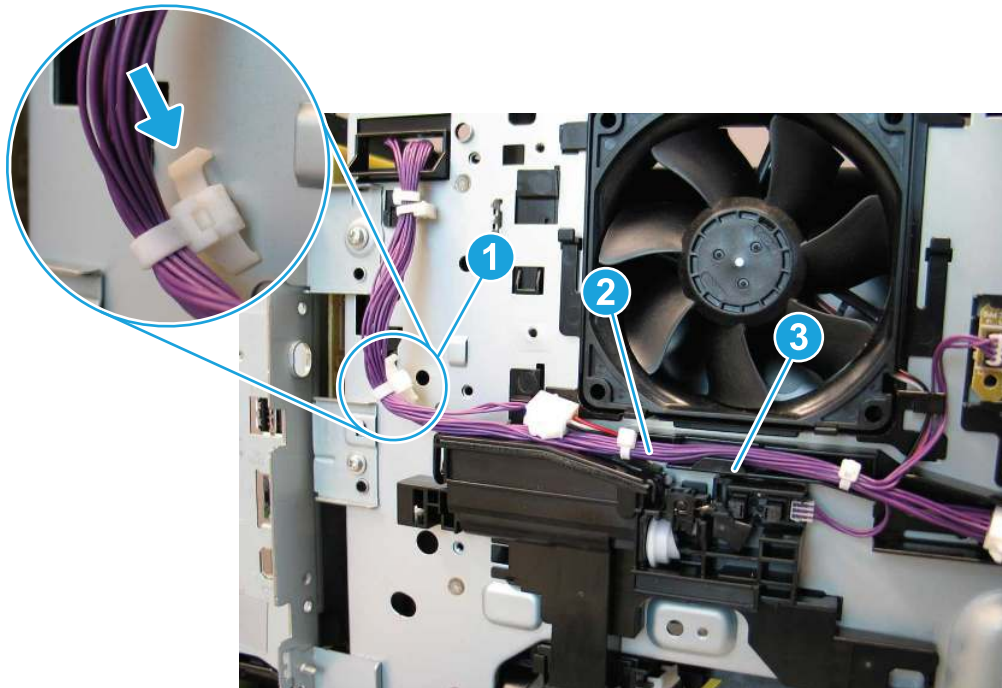
- b. Remove the left door upper hinge.

Figure 1-2616 Remove the left door upper hinge



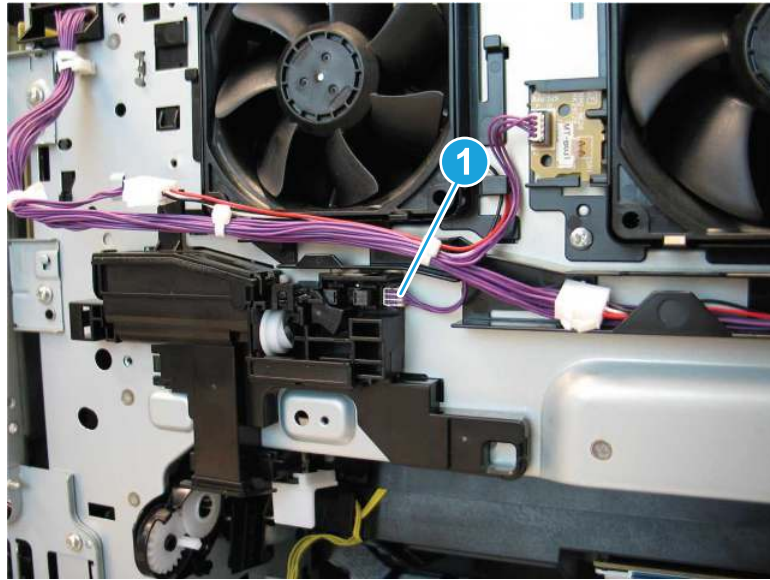
- c. Press the latch to release one retainer (callout 1) from the sheet metal. Remove the wire harness (callout 2) from the guides (callout 3).

Figure 1-2617 Release the wire harness from the guides



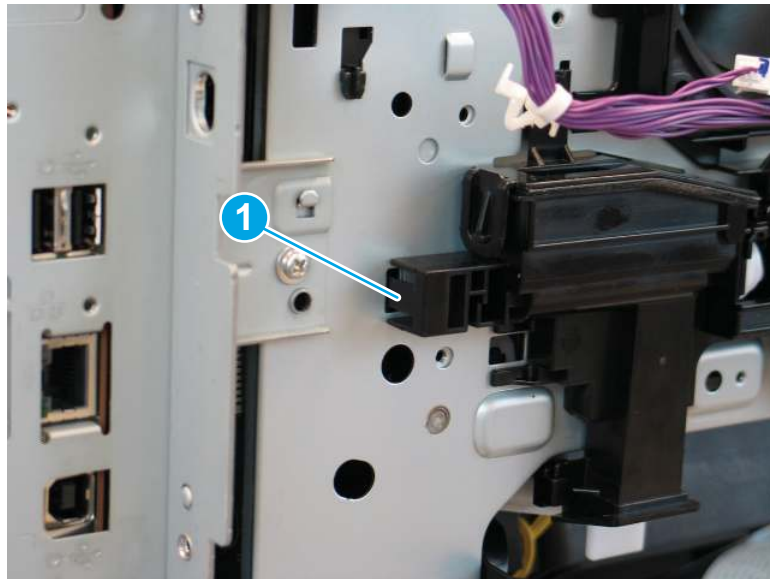
- d. Disconnect one connector (callout 1).

Figure 1-2618 Disconnect one connector



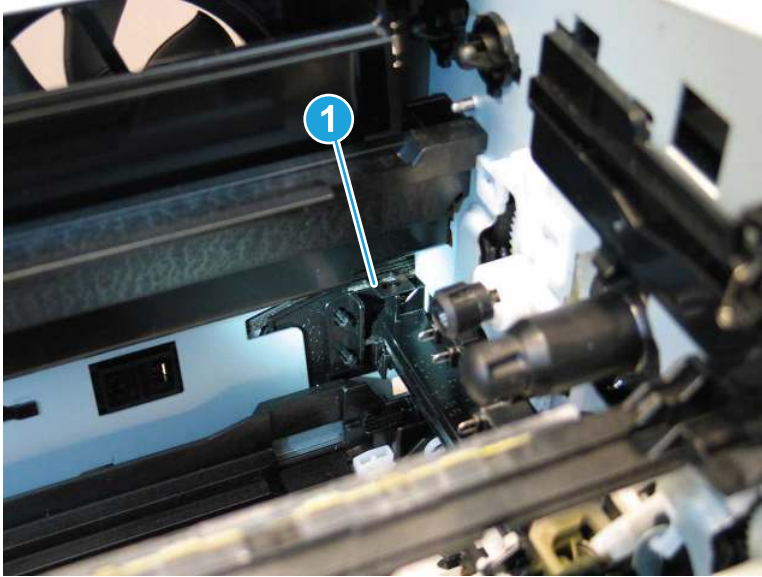
- e. Release one tab (callout 1).

Figure 1-2619 Release one tab



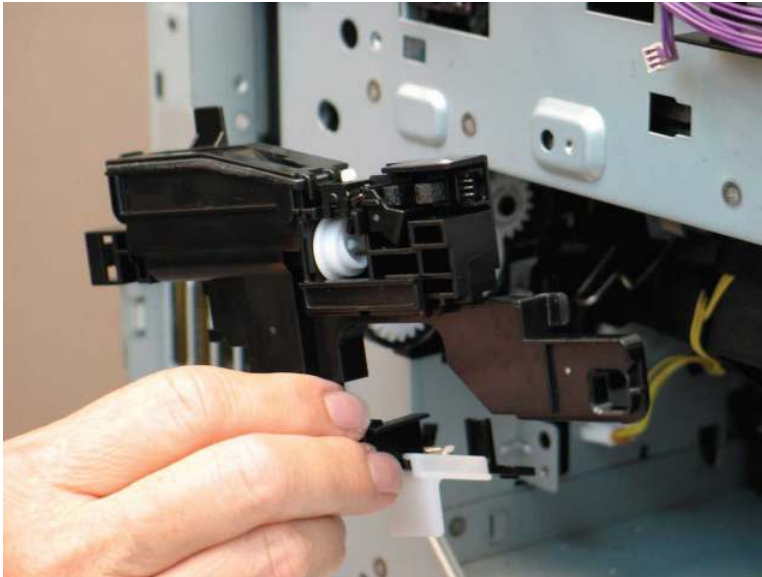
- f. Inside the printer, release one tab that connects to the primary auger (callout 1).

Figure 1-2620 Release one tab



- g. Remove the secondary auger assembly.

Figure 1-2621 Remove the secondary auger assembly

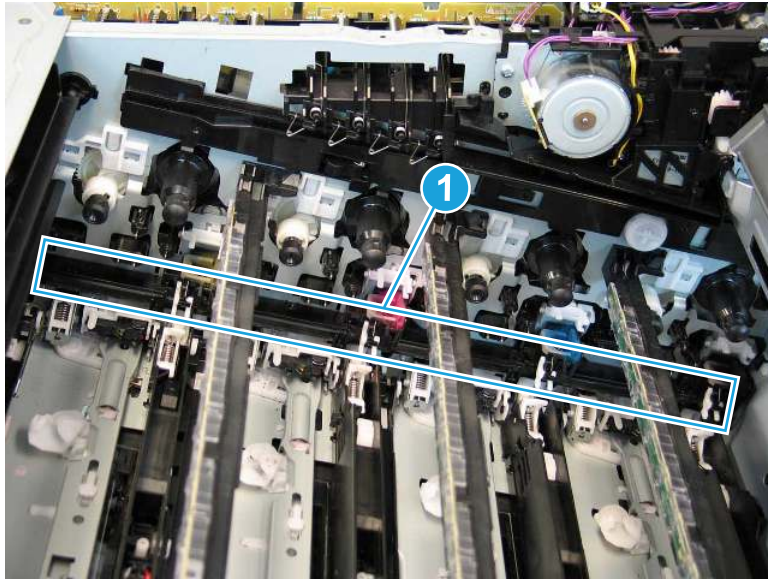


- 15. Remove the primary auger.

 **IMPORTANT:** Make sure that the front door is open before removing the primary auger.

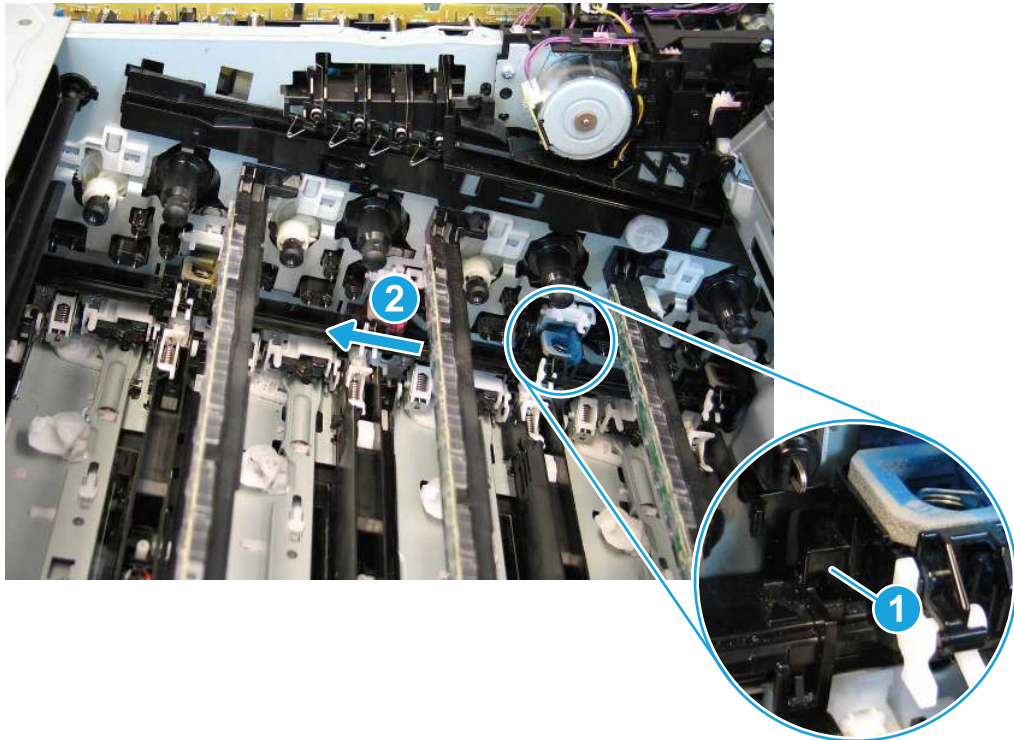
- a. Inside the printer, locate the primary auger (callout 1).

Figure 1-2622 Locate the primary auger



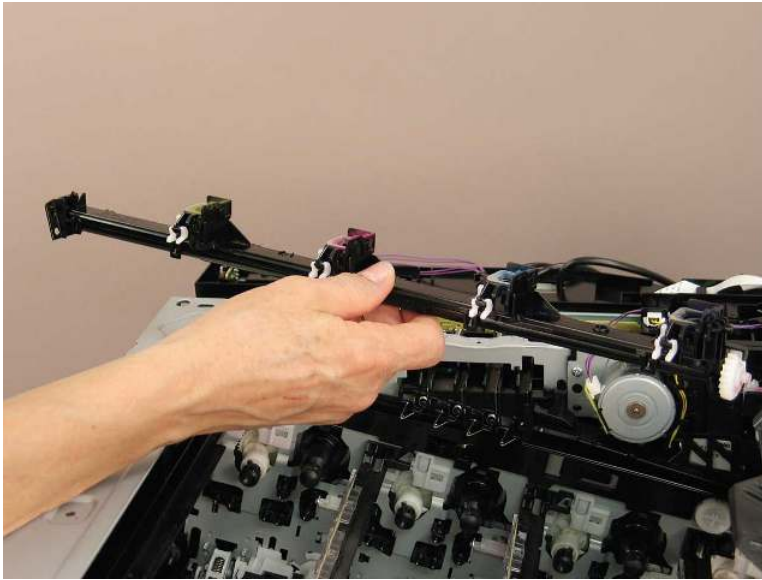
- b. Release one tab (callout 1) next to the cyan opening, and then slide the primary auger toward the left side of the printer (callout 2) to release it.

Figure 1-2623 Release the primary auger



- c. Turn the primary auger as needed to maneuver it out through the top of the printer.

Figure 1-2624 Remove the primary auger



16. Unpack the replacement assembly.

- a. Dispose of the defective part.



NOTE: HP recommends responsible disposal of the defective part.

<http://www8.hp.com/us/en/hp-information/environment/product-recycling.html>

- b. Unpack the replacement part from the packaging.



IMPORTANT: Make sure that all of the shipping materials (for example shipping tape) are removed from the replacement part prior to installation.

- c. To install an assembly, reverse the removal steps.



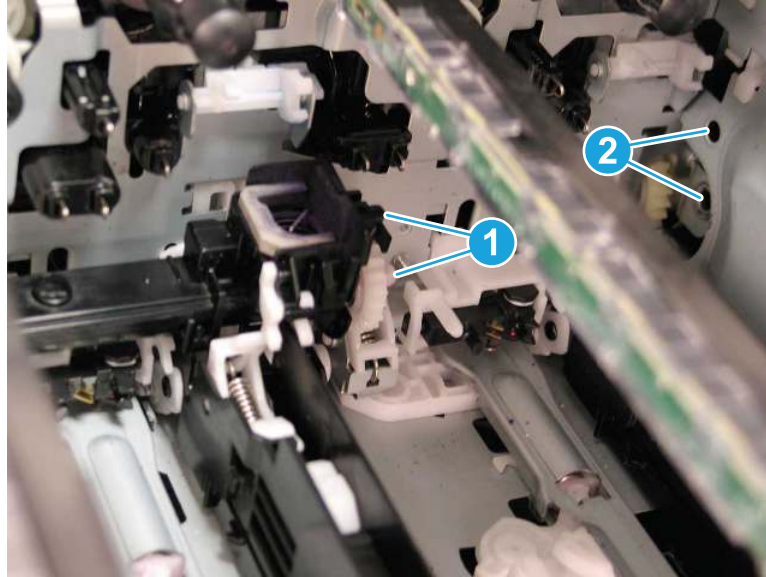
NOTE: When applicable, special installation instructions are provided for an assembly at the end of the removal procedure. Always completely read the removal instructions and follow all special installation instructions.

17. Reverse the removal steps to install the assembly. Also use the following **special installation instructions**.

Install the primary auger.

- ▲ When installing the primary auger, position the black boss and the center of the gear (callout 1) into the openings (callout 2) in the printer.

Figure 1-2625 Install the primary auger



Removal and replacement: Waste toner feed assembly (M776zs)

Learn how to remove and replace the waste toner feed assembly.

Mean time to repair: 18 minutes

Service level: Easy

Before performing service

Turn the printer power off

- Disconnect the power cable.

⚠ WARNING! To avoid damage to the printer, turn the printer off, wait 30 seconds, and then remove the power cord before attempting to service the printer.

Use the table below to identify the correct part number for your printer. To order the part, go to www.hp.com/buy/parts.

Table 1-130 Part information

Part number	Part description
RM2-1520-000CN	Waste toner feed assembly
RC5-0770-000CN	Hinge, left door, upper (if needed)

Required tools

- #2 Phillips screwdriver with a magnetic tip
- Small, flat-blade screwdriver

After performing service

Turn the printer power on

- Connect the power cable.
- Use the power switch to turn the power on.

Post service test

Make sure that the printer initializes to a **Ready** state.

Print a page to make sure that the printer is functioning correctly.

1. Remove the TCU.
 - a. Open the front door.

Figure 1-2626 Open the front door



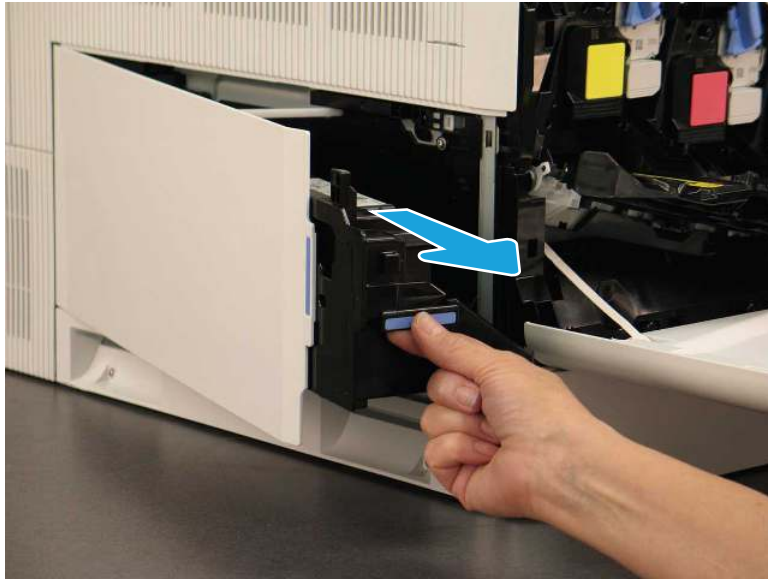
- b. Open the left door.

Figure 1-2627 Open the left door



- c. Grasp the front of the TCU, and then remove it from the printer.

Figure 1-2628 Remove the TCU



2. Remove the imaging drums.
 - a. Open the front door, if it is not already open. Rotate the blue lever in front of the imaging drum to the left.

Figure 1-2629 Rotate the blue lever



- b. Grasp the handle of the imaging drum and pull out to remove it. Repeat the process for the remaining imaging drums.

Figure 1-2630 Remove the imaging drum



3. Remove the toner cartridges.

- ▲ Open the front door, if it is not already open. Grasp the handle of the toner cartridge and pull out to remove it. Repeat the process for the remaining toner cartridges.

Figure 1-2631 Remove the toner cartridge



4. Remove the intermediate transfer belt (ITB).

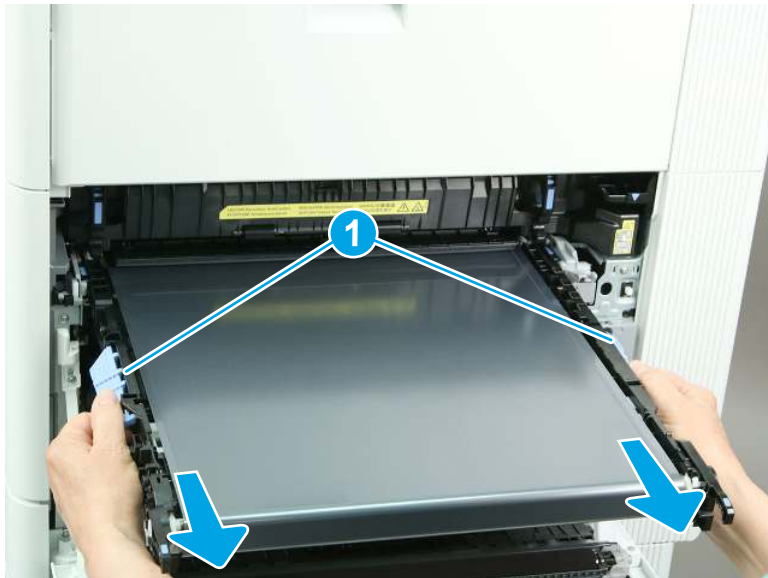
- a. Open the right door. Grasp the two blue handles on the ITB, and then pull the ITB partially out of the printer.

Figure 1-2632 Partially remove the ITB



- b. Grasp the blue handles on the side of the ITB (callout 1), and then remove the ITB from the printer.

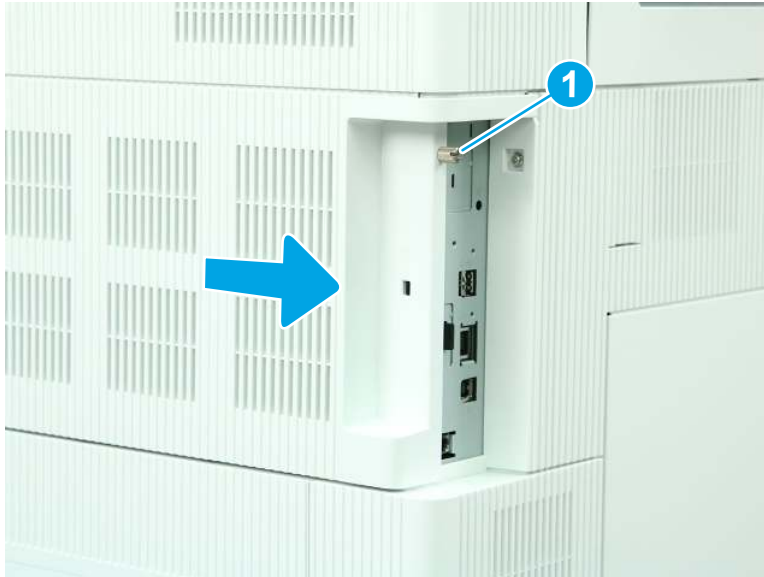
Figure 1-2633 Remove the ITB



5. Remove the formatter cover.

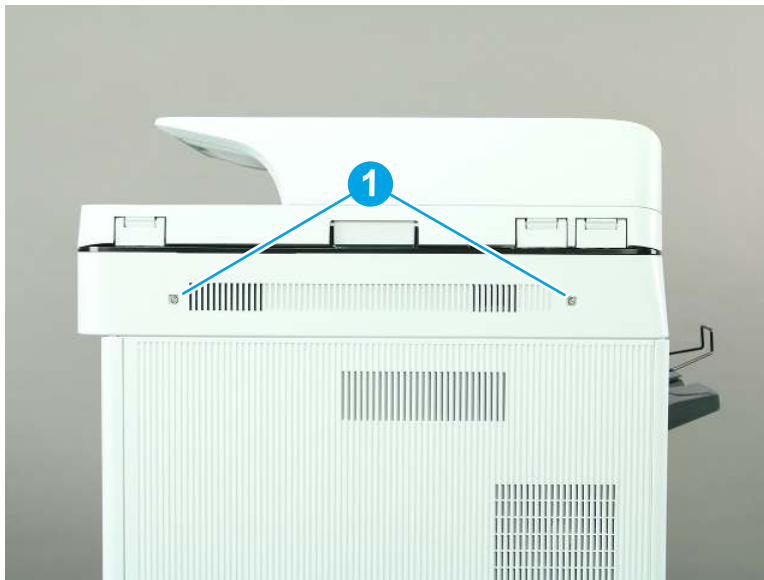
- ▲ Loosen one thumbscrew (callout 1), and then slide the formatter cover (callout 2) away from the printer to remove it.

Figure 1-2634 Remove the formatter cover



- 6. Remove the scanner control board (SCB) cover (M776).
 - a. Remove two screws (callout 1).

Figure 1-2635 Remove two screws



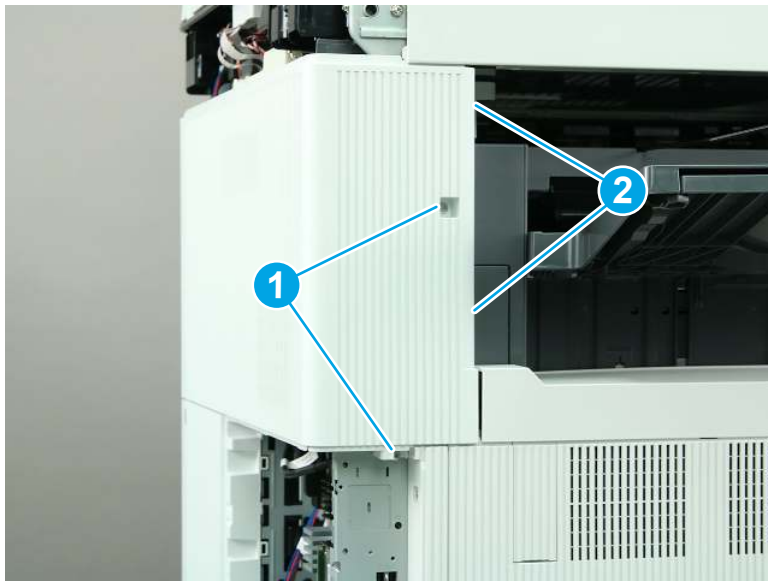
- b. Remove the SCB cover.

Figure 1-2636 Remove the SCB cover



7. Remove the rear upper cover and left rear upper cover (M776zs).
 - a. Remove two screws (callout 1), and then release two tabs (callout 2).

Figure 1-2637 Remove two screws and release two tabs



- b. Slide the cover to the right to remove it.

Figure 1-2638 Remove the rear upper and left rear upper cover



- 8. Remove the front cover (M776zs).

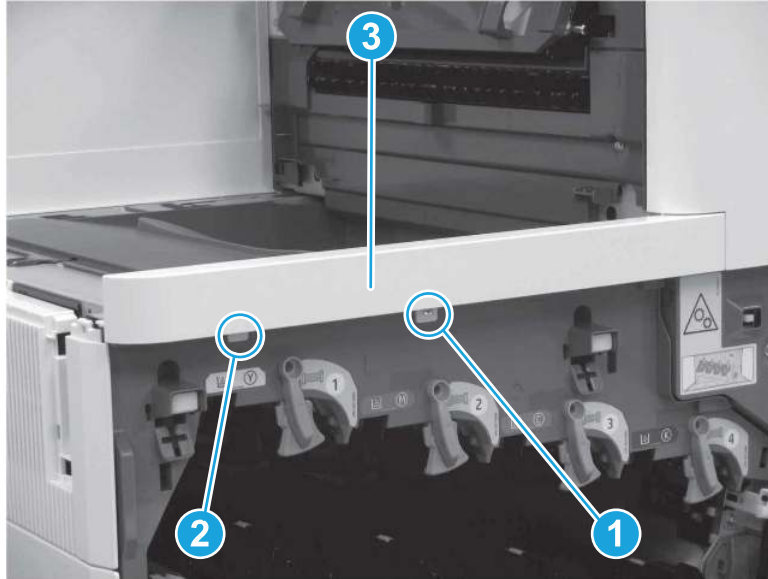
- a. Open the front door.

Figure 1-2639 Open the front door



- b. Remove one screw (callout 1), release one tab (callout 2), and then remove the front cover (callout 3).

Figure 1-2640 Remove the front cover



- 9. Remove the control panel (M776).

- a. Rotate the control panel to the fully raised position (callout 1), and then raise the document feeder (callout 2).

Figure 1-2641 Raise the control panel and document feeder



- b. Beginning at the right side of the control-panel cover, carefully release five tabs along the top edge of the cover.

 **NOTE:** The thin black-plastic cover will separate from the white-plastic control-panel base.

Figure 1-2642 Release the control panel cover



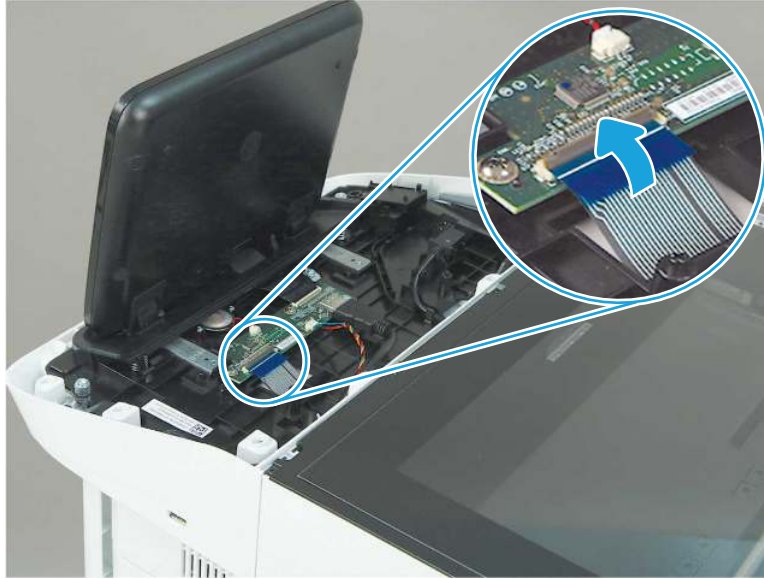
- c. Rotate the control panel cover slightly forward (callout 1), and then lift up to remove the cover (callout 2).

Figure 1-2643 Remove the control panel cover



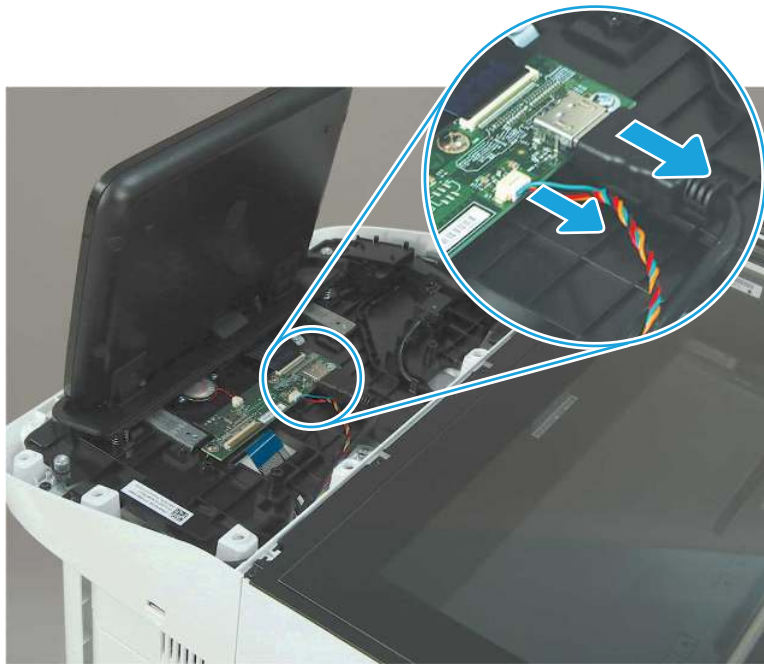
- d. **M776z or M776zs only:** Open the connector latch to release the keyboard flat cable.

Figure 1-2644 Release the keyboard flat cable (M776z/M776zs)



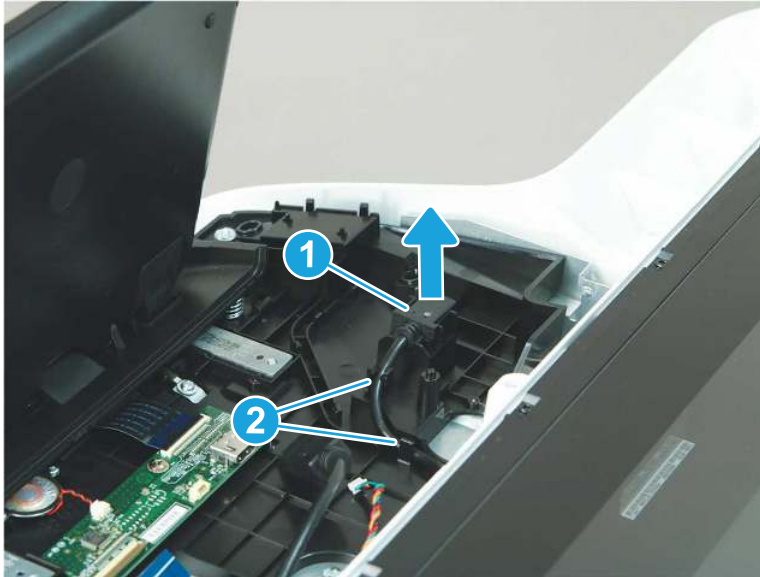
- e. Disconnect two connectors

Figure 1-2645 Disconnect two connectors



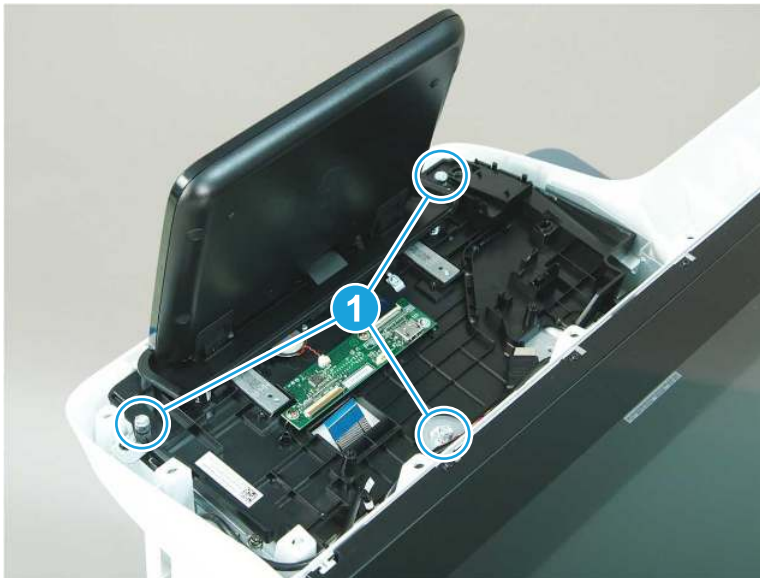
- f. Remove the USB cable (callout 1) from the holder, and then release the cable from two retainers (callout 2).

Figure 1-2646 Release the USB cable



- g. Remove three screws (callout 1).

Figure 1-2647 Remove three screws



- h. Lift the front of the control panel off of the printer (callout 1), and then slide it towards the front of the printer (callout 2) to remove it.

Figure 1-2648 Remove the control panel



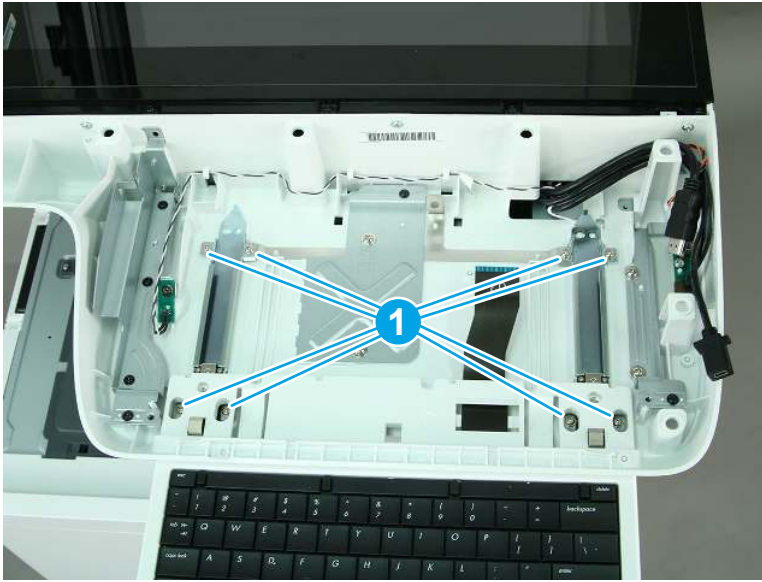
- 10. Remove the keyboard (M776z/M776zs).
 - a. Pull the keyboard out to its extended position.

Figure 1-2649 Pull the keyboard out



- b. Remove eight screws (callout 1).

Figure 1-2650 Remove eight screws



- c. Remove the keyboard and rails.

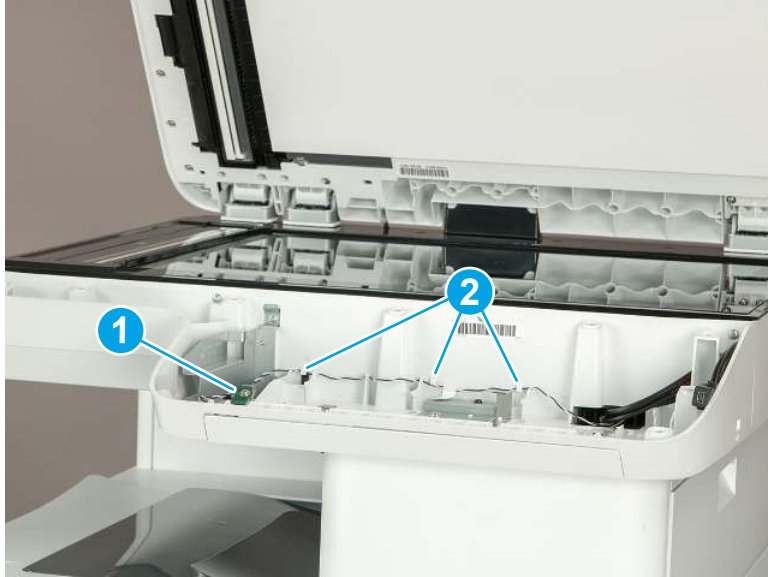
Figure 1-2651 Remove the keyboard and rails



- 11. Remove the nose cone (M776).

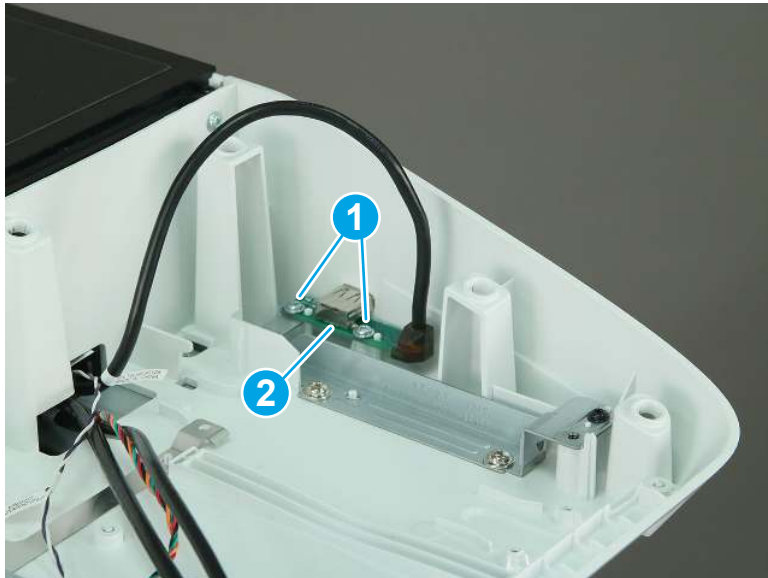
- a. Remove one screw (callout 1) to release the light PCA. Release the cable from three retainers (callout 2), and then move the light PCA out of the way.

Figure 1-2652 Release the light PCA



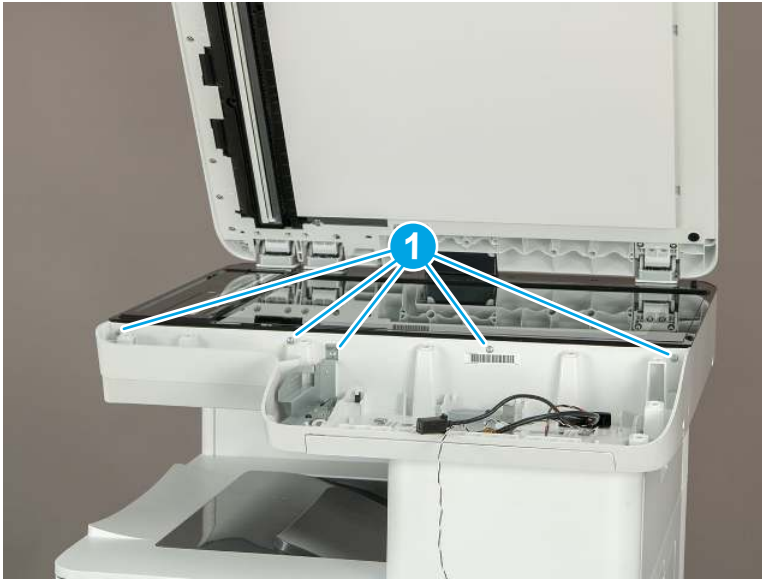
- b. Remove two screws (callout 1), and then move the USB port PCA (callout 2) out of the way.

Figure 1-2653 Release the USB port PCA



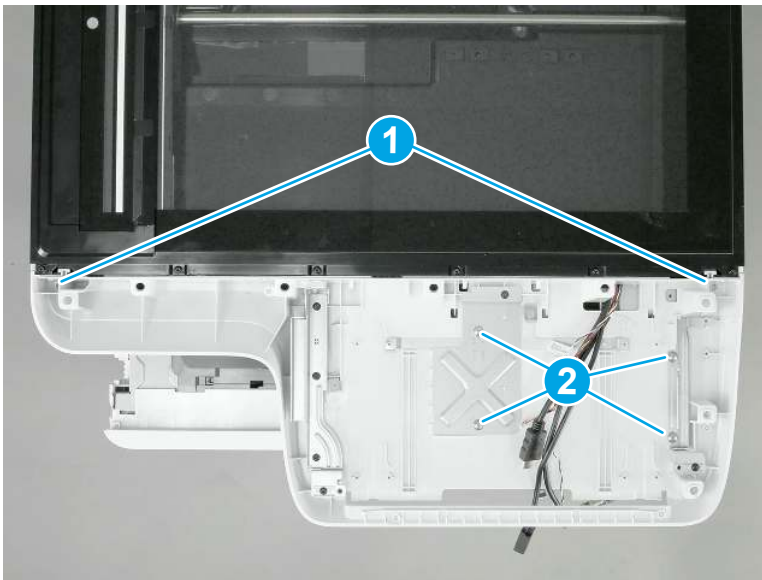
- c. Remove five screws (callout 1).

Figure 1-2654 Remove four screws



- d. Remove two small, self-tapping screws (callout 1), and then remove four larger machine screws (callout 2).

Figure 1-2655 Remove six screws

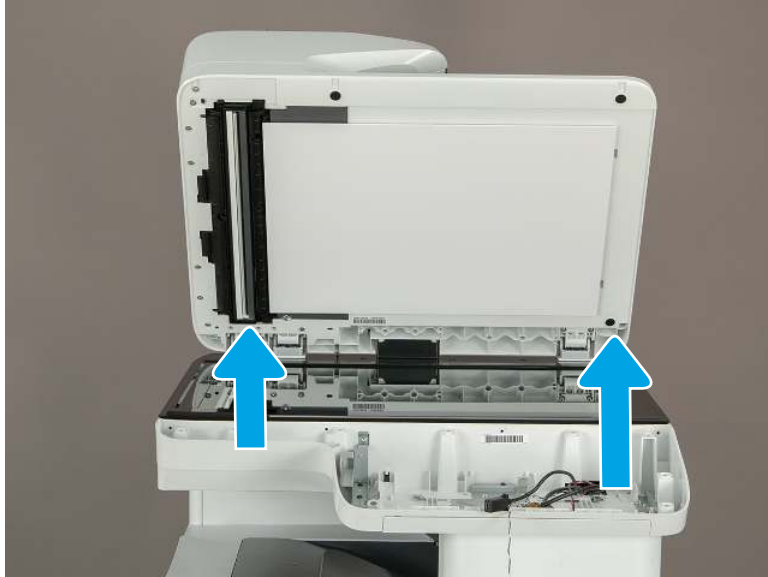


- e. Lift the nose cone up and off of the printer to remove it.



NOTE: Pass the wire harnesses and cables through the opening in the nose cone when removing it.

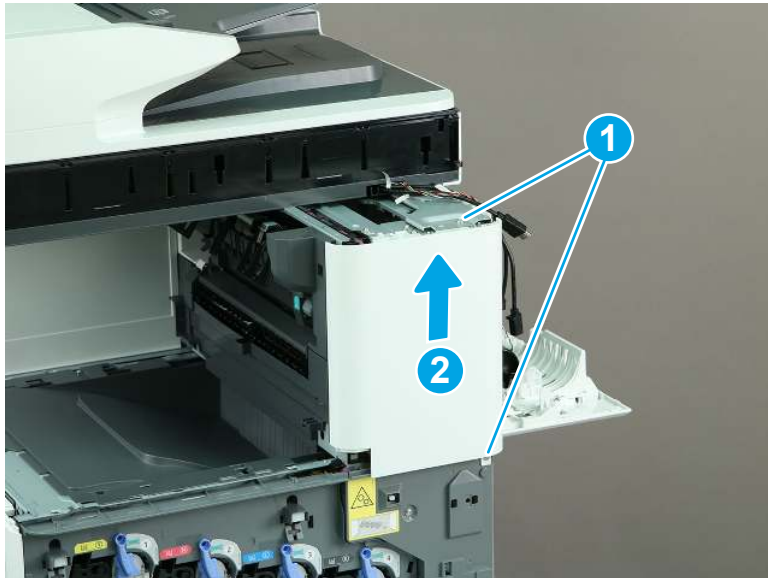
Figure 1-2656 Remove the nose cone



12. Remove the right front cover (M776zs).

- ▲ Remove two screws (callout 1), release one tab (callout 2), and then slide the right front cover up (callout 2) to remove it.

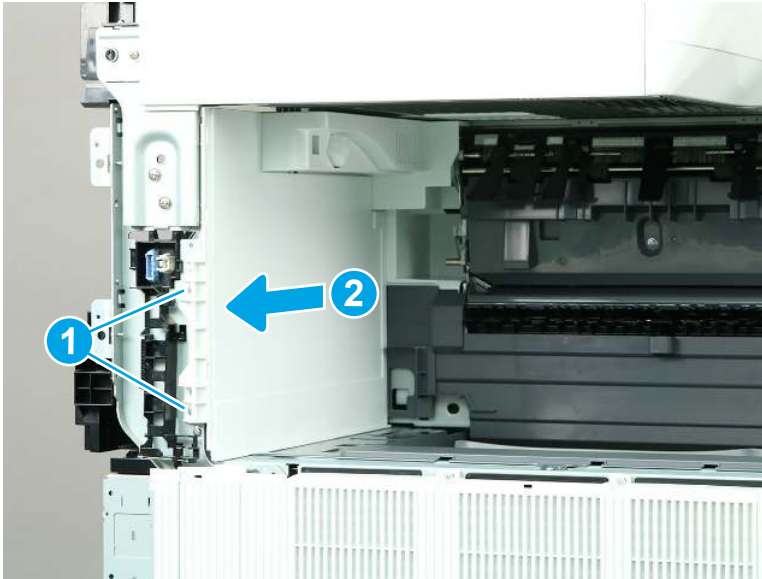
Figure 1-2657 Remove the right front cover



13. Remove the main cover (M776zs).

- ▲ Remove two screws (callout 1), and then slide the main cover away from the printer to remove it (callout 2).

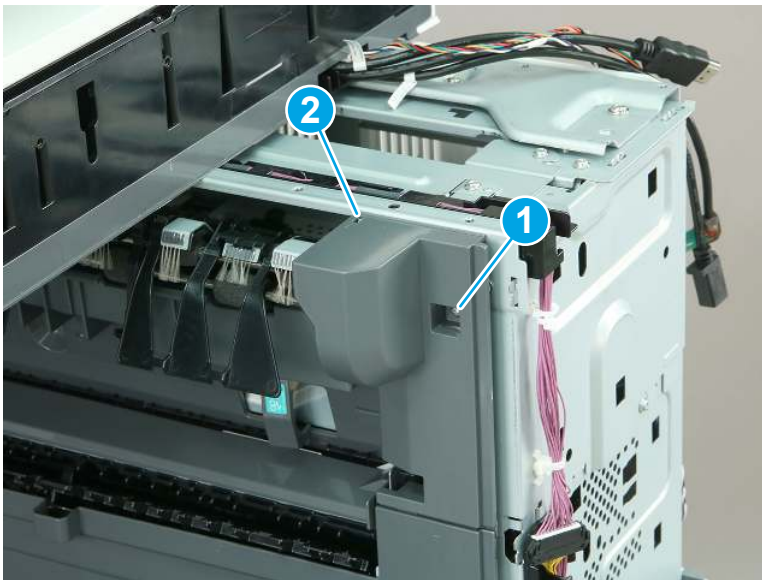
Figure 1-2658 Remove the main cover



14. Remove the delivery front cover (M776zs).

- ▲ Remove one screw (callout 1), and then remove the delivery front cover (callout 2).

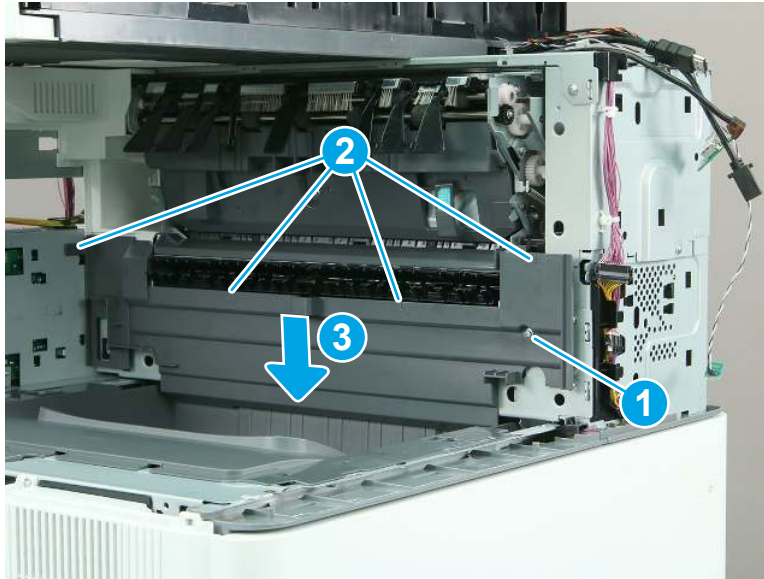
Figure 1-2659 Remove the delivery front cover



15. Remove the delivery cover (M776zs).

- ▲ Remove one screw (callout 1), release four tabs (callout 2), and then slide the delivery cover down (callout 3) to remove it.

Figure 1-2660 Remove the delivery cover

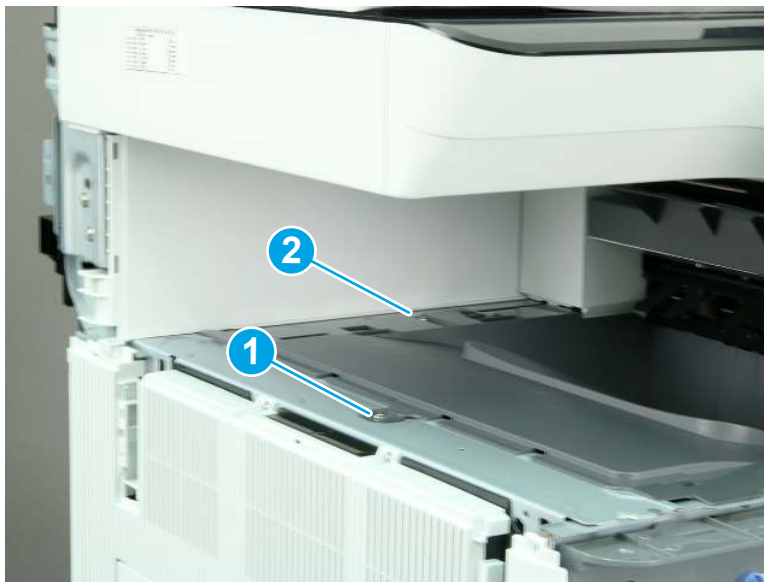


16. Remove the output bin (M856/E85055/M776).

 **NOTE:** The following figures show the M776z printer. The procedure is correct for all referenced models.

- a. Remove one washer-head machine screw (callout 1), remove one self-tapping screw (callout 2).

Figure 1-2661 Remove two screws



- b. Remove the output bin.

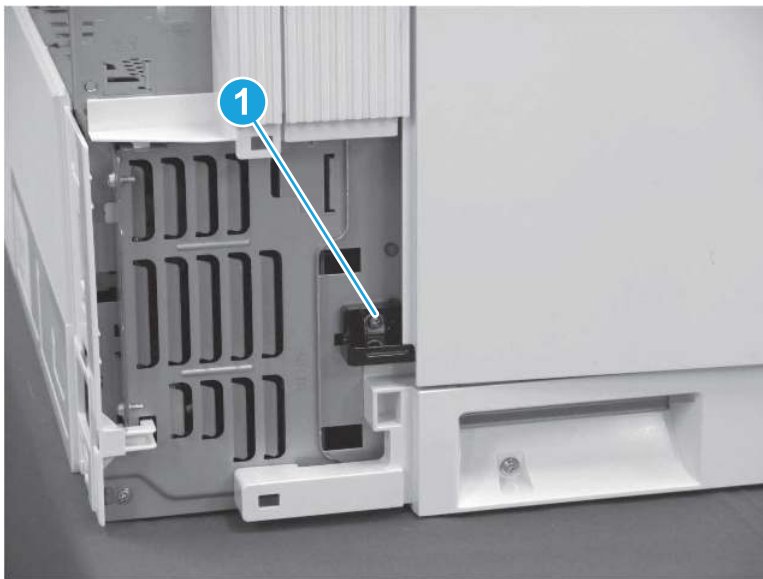
Figure 1-2662 Remove the output bin



- 17. Remove the left door.

- a. Remove one screw (callout 1).

Figure 1-2663 Remove one screw



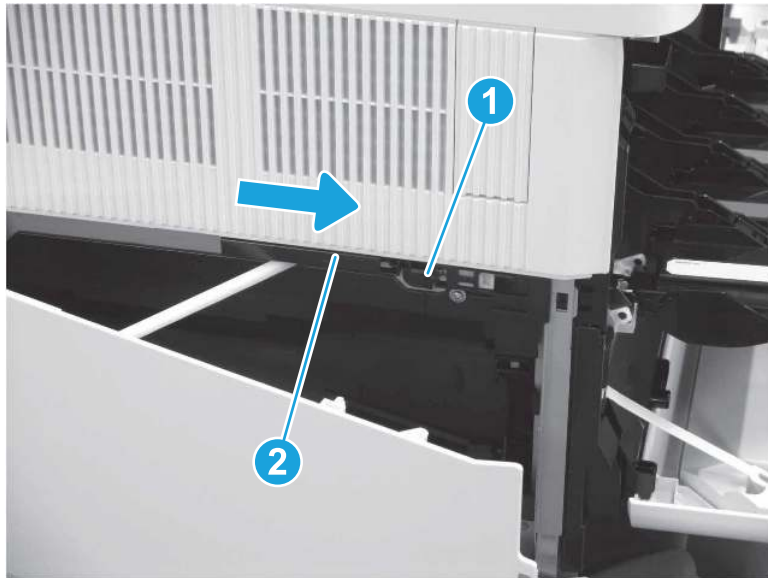
- b. Release the holder, and then remove it from the printer.

Figure 1-2664 Remove the holder



- c. Open the left door, and release one tab (callout 1). Slide the holder (callout 2) toward the front of the printer.

Figure 1-2665 Slide the holder



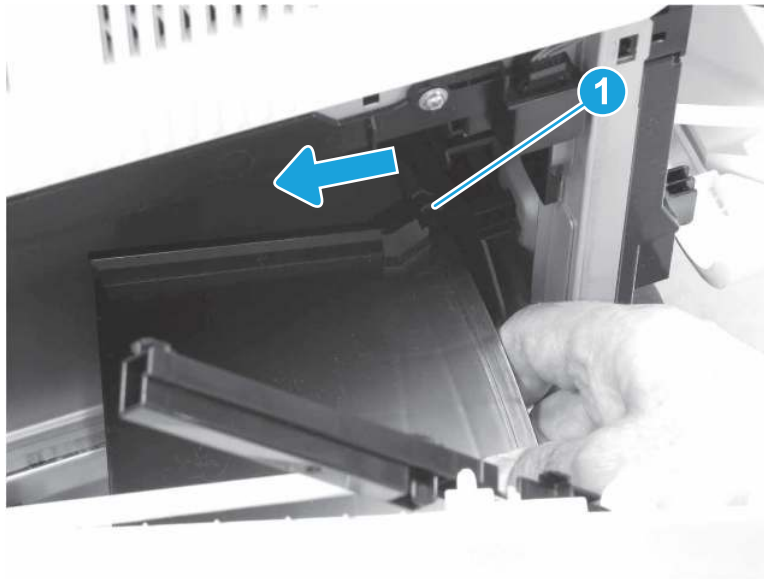
- d. Release the holder (callout 1) from the printer, but leave it attached to the hinge.

Figure 1-2666 Release the holder



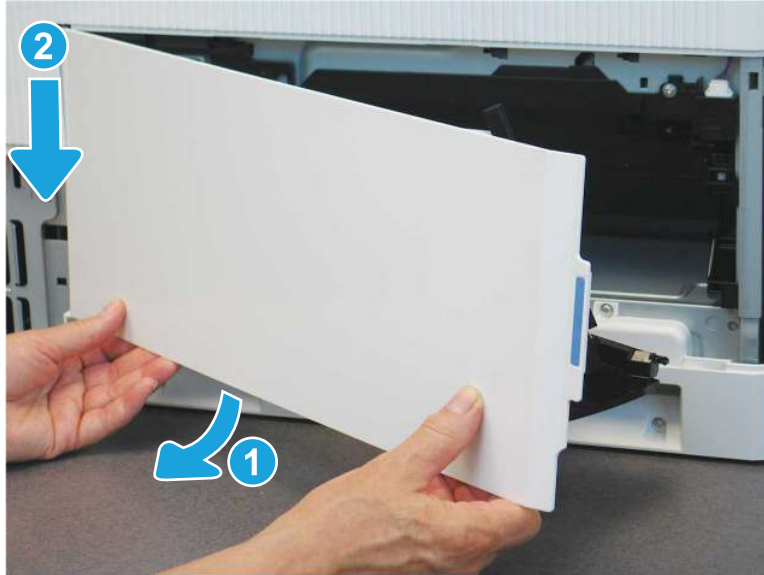
- e. Press the stopper (callout 1) on the bottom of the door to the left to release it from the track.

Figure 1-2667 Release the stopper



- f. Rotate the left, lower edge of the door away from the printer (callout 1), and then lower the door to remove it (callout 2).

Figure 1-2668 Remove the left door



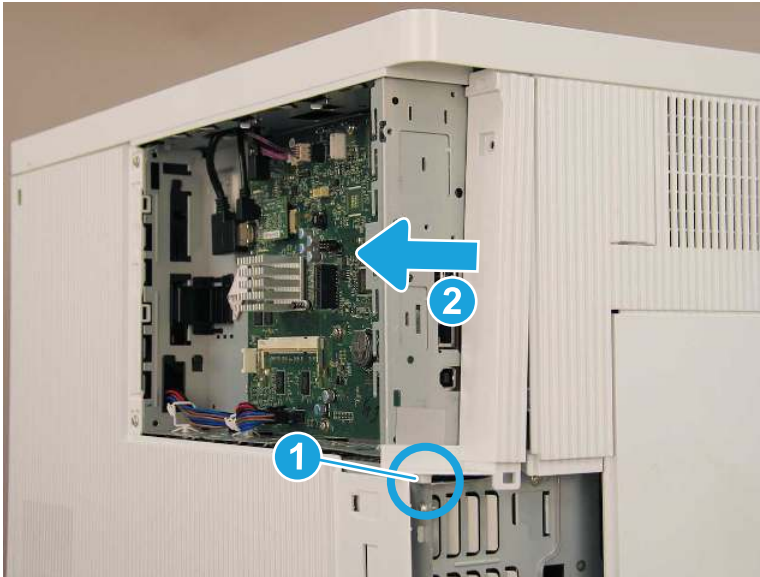
18. Remove the left rear cover (M751/E75245/M856/E85055/M776).
 - a. Remove one screw (callout 1).

Figure 1-2669 Remove one screw



- b. Release one boss (callout 1), and then slide the cover toward the back of the printer (callout 2) to remove it.

Figure 1-2670 Remove the left rear cover

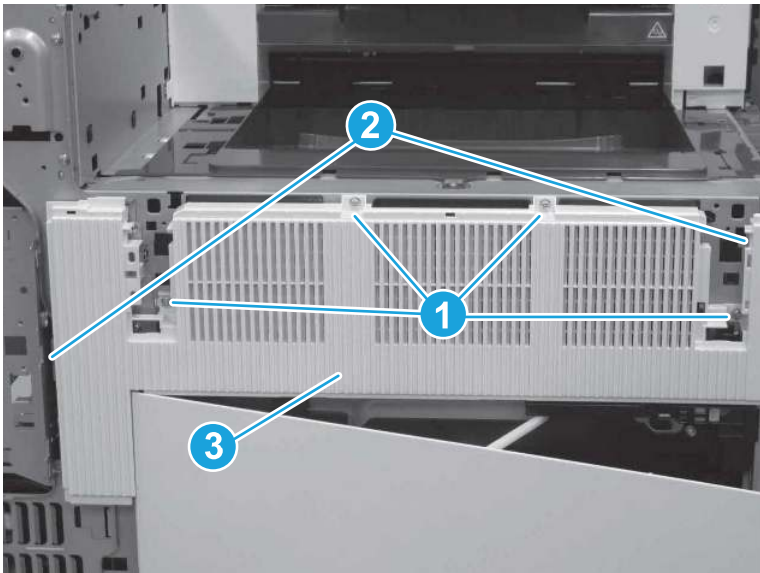


- 19. Remove the left upper cover (M856/E85055/M776).

 **NOTE:** The following figures show the M776z printer. The procedure is correct for all referenced models.

- ▲ Remove four screws (callout 1), release two tabs (callout 2), and then remove the left upper cover (callout 3).

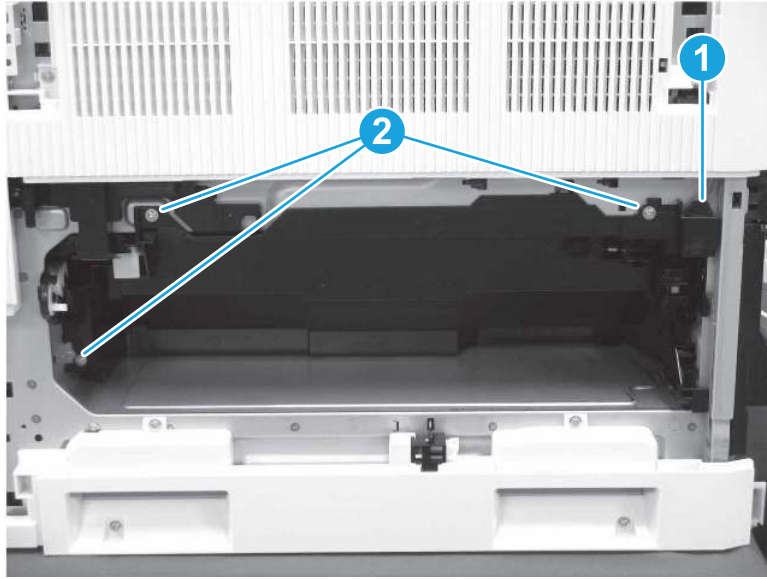
Figure 1-2671 Remove the left upper cover



- 20. Remove the scanner cover.

- a. Disconnect one connector (callout 1), and then remove three screws (callout 2).

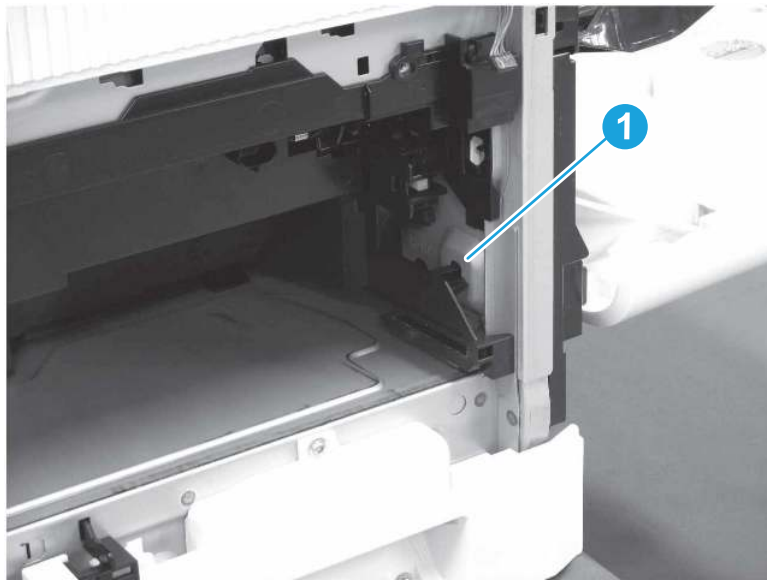
Figure 1-2672 Disconnect one connector and remove three screws



 **TIP:** Connect the connector before reinstalling the screws.

- b. Release one tab (callout 1), and then flex the scanner cover to remove it.

Figure 1-2673 Remove the scanner cover



21. Remove the secondary auger.

- a. Remove one screw (callout 1).

Figure 1-2674 Remove one screws



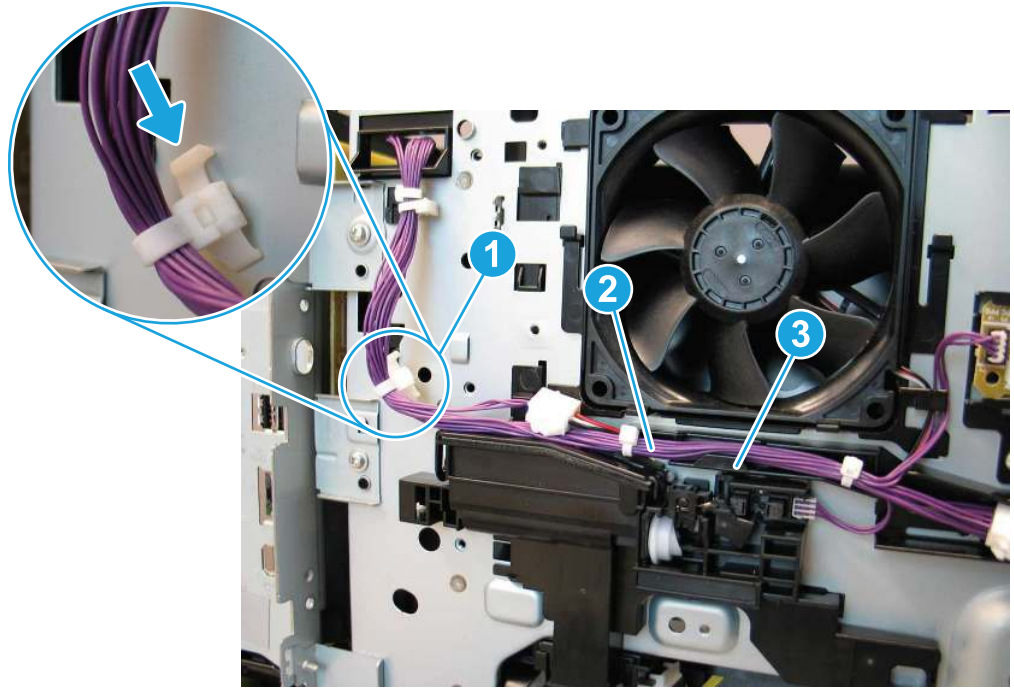
- b. Remove the left door upper hinge.

Figure 1-2675 Remove the left door upper hinge



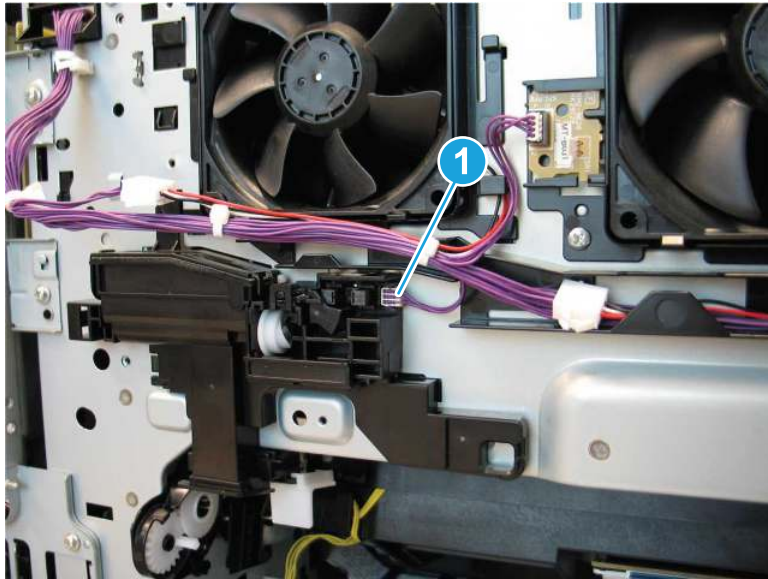
- c. Press the latch to release one retainer (callout 1) from the sheet metal. Remove the wire harness (callout 2) from the guides (callout 3).

Figure 1-2676 Release the wire harness from the guides



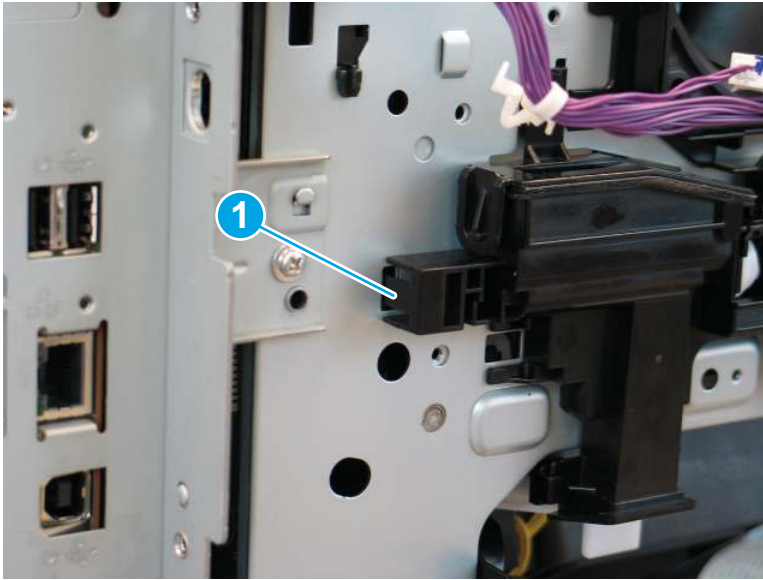
- d. Disconnect one connector (callout 1).

Figure 1-2677 Disconnect one connector



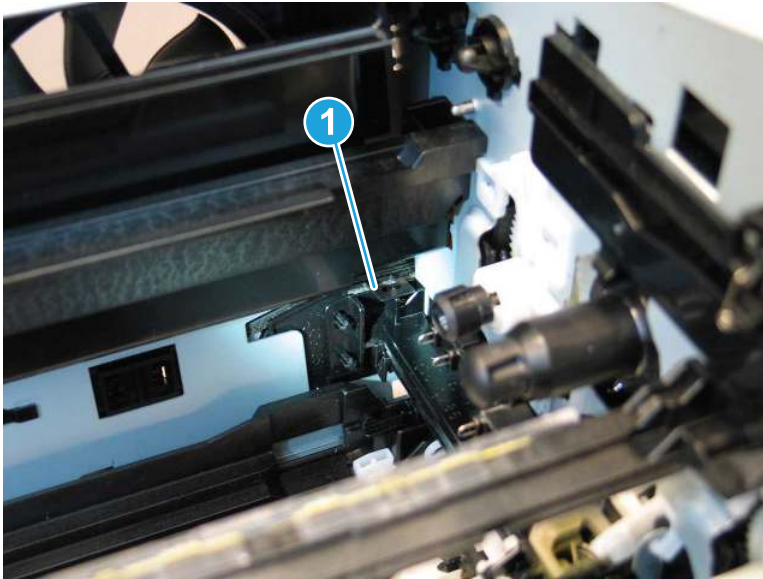
- e. Release one tab (callout 1).

Figure 1-2678 Release one tab



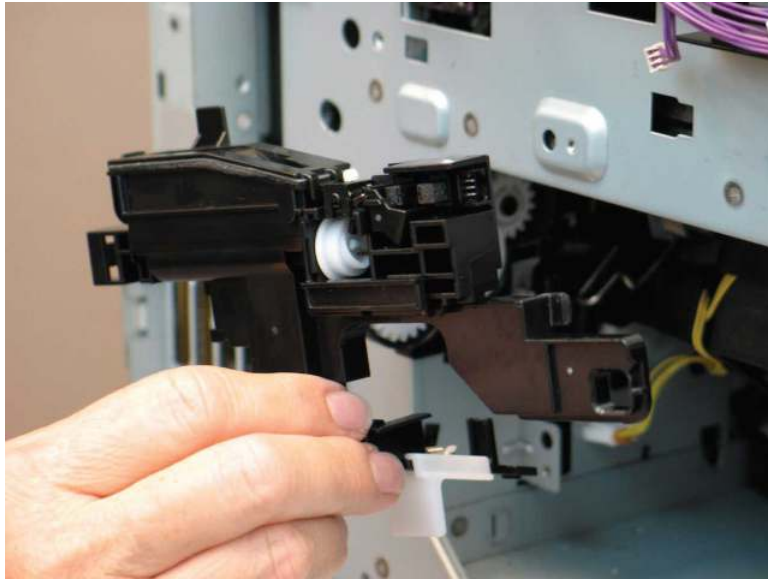
- f. Inside the printer, release one tab that connects to the primary auger (callout 1).

Figure 1-2679 Release one tab



- g. Remove the secondary auger assembly.

Figure 1-2680 Remove the secondary auger assembly

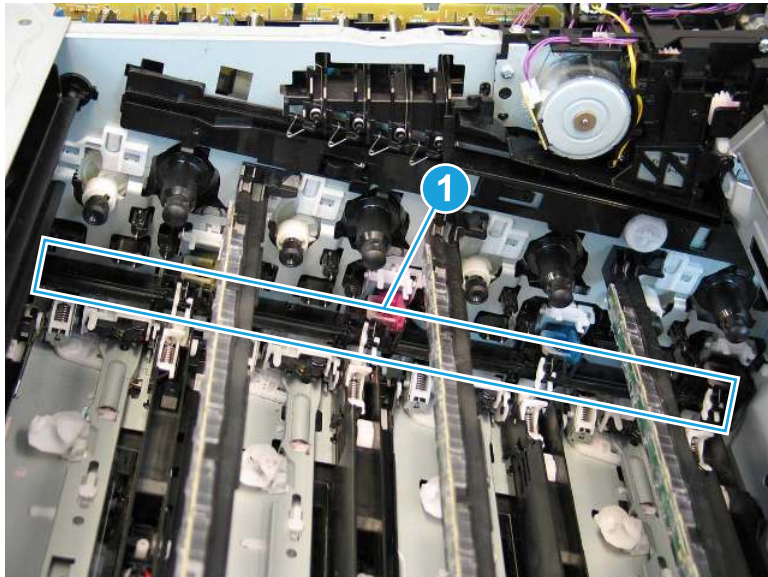


- 22. Remove the primary auger.

 **IMPORTANT:** Make sure that the front door is open before removing the primary auger.

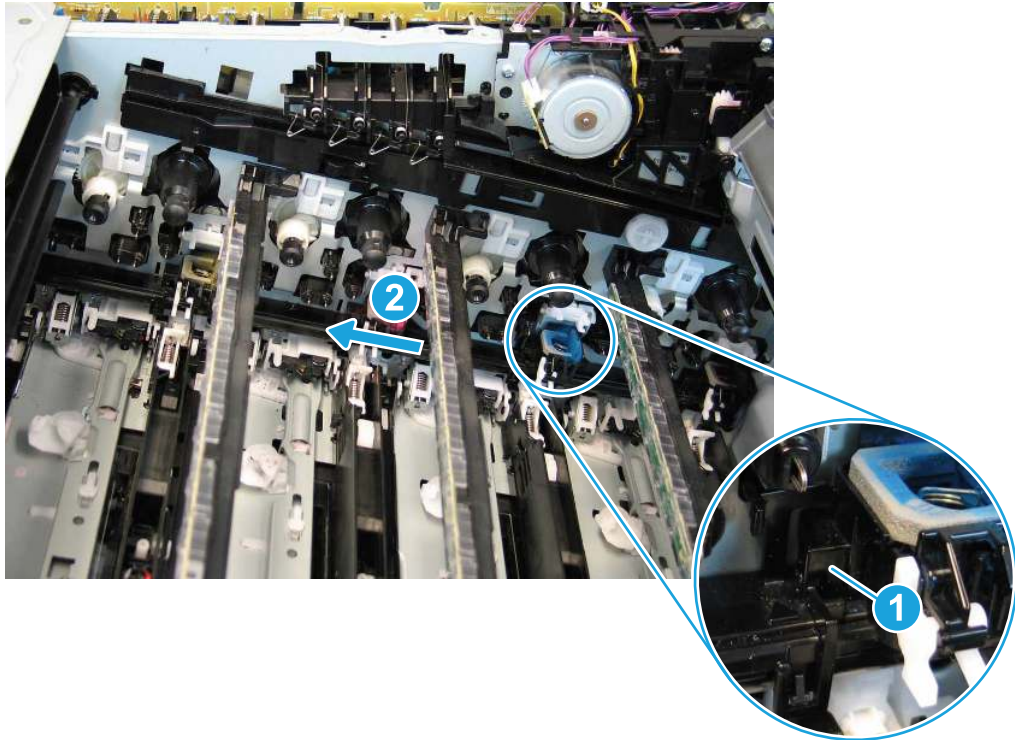
- a. Inside the printer, locate the primary auger (callout 1).

Figure 1-2681 Locate the primary auger



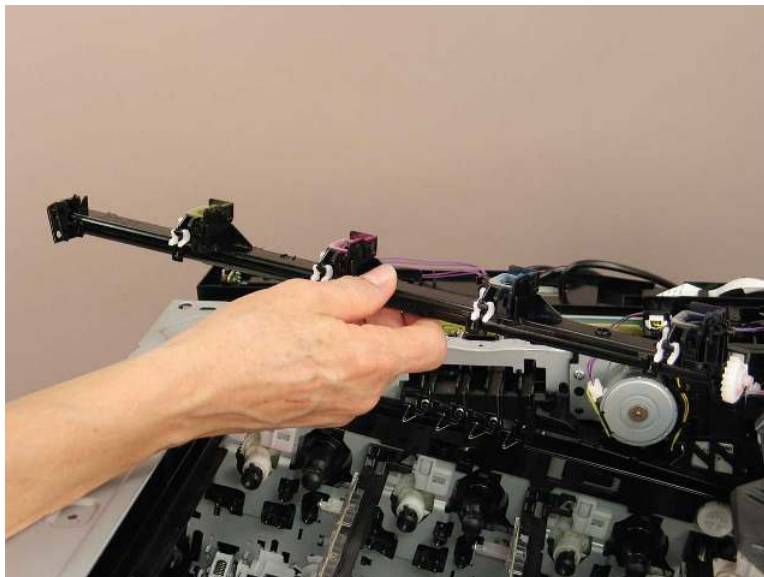
- b. Release one tab (callout 1) next to the cyan opening, and then slide the primary auger toward the left side of the printer (callout 2) to release it.

Figure 1-2682 Release the primary auger



- c. Turn the primary auger as needed to maneuver it out through the top of the printer.


Figure 1-2683 Remove the primary auger




23. Unpack the replacement assembly.
 - a. Dispose of the defective part.

 **NOTE:** HP recommends responsible disposal of the defective part.

- b. Unpack the replacement part from the packaging.

 **IMPORTANT:** Make sure that all of the shipping materials (for example shipping tape) are removed from the replacement part prior to installation.

- c. To install an assembly, reverse the removal steps.

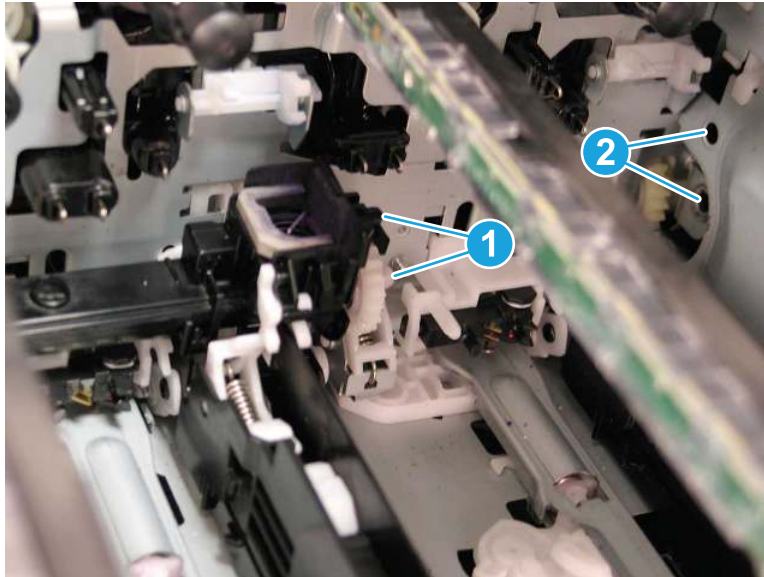
 **NOTE:** When applicable, special installation instructions are provided for an assembly at the end of the removal procedure. Always completely read the removal instructions and follow all special installation instructions.

- 24. Reverse the removal steps to install the assembly. Also use the following **special installation instructions**.

Install the primary auger.

- ▲ When installing the primary auger, position the black boss and the center of the gear (callout 1) into the openings (callout 2) in the printer.

Figure 1-2684 Install the primary auger



Removal and replacement: Waste toner gear base assembly (M751/E75245)

Learn how to remove and replace the waste toner gear base assembly.

[View a video of how to remove and replace the waste toner gear base assembly.](#)

Mean time to repair: 45 minutes

Service level: Difficult

Before performing service

Turn the printer power off

- Disconnect the power cable.

⚠ WARNING! To avoid damage to the printer, turn the printer off, wait 30 seconds, and then remove the power cord before attempting to service the printer.

Use the table below to identify the correct part number for your printer. To order the part, go to www.hp.com/buy/parts.

Table 1-131 Part information

Part number	Part description
RM2-1364-000CN	Waste toner gear base assembly

Required tools

- #2 Phillips screwdriver with a magnetic tip
- Small, flat-blade screwdriver

After performing service

Turn the printer power on

- Connect the power cable.
- Use the power switch to turn the power on.

Post service test

Make sure that the printer initializes to a **Ready** state.

Print a page to make sure that the printer is functioning correctly.

1. Remove the toner cartridges.

- ▲ Open the front door, if it is not already open. Grasp the handle of the toner cartridge and pull out to remove it. Repeat the process for the remaining toner cartridges.

Figure 1-2685 Remove the toner cartridge



- 2. Remove the imaging drums.
 - a. Open the front door, if it is not already open. Rotate the blue lever in front of the imaging drum to the left.

Figure 1-2686 Rotate the blue lever



- b. Grasp the handle of the imaging drum and pull out to remove it. Repeat the process for the remaining imaging drums.

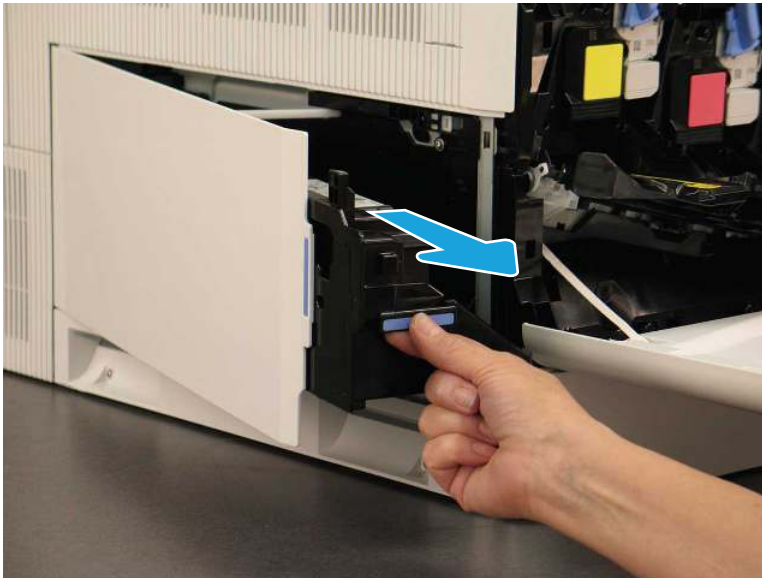
Figure 1-2687 Remove the imaging drum



3. Remove the TCU.

- ▲ Open the front door, and then open the left door. Grasp the front of the toner-collection unit, and then remove it from the printer.

Figure 1-2688 Remove the TCU



4. Remove the intermediate transfer belt (ITB).

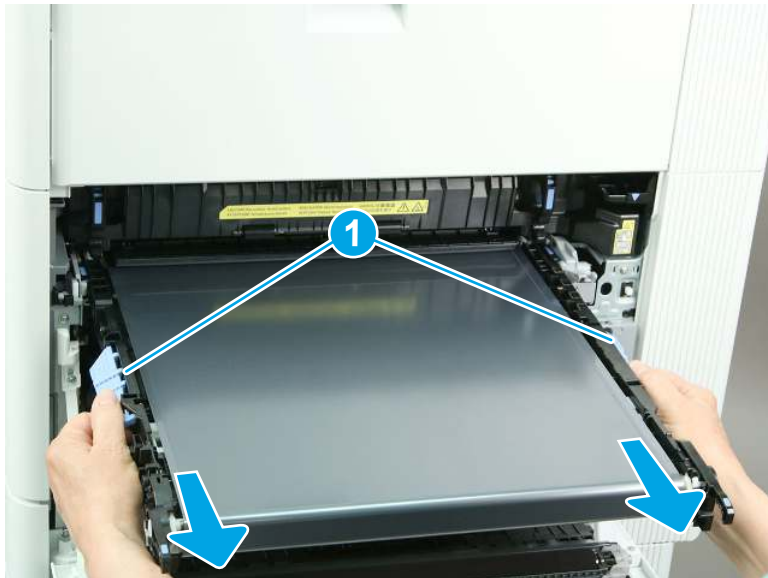
- a. Open the right door. Grasp the two blue handles on the ITB, and then pull the ITB partially out of the printer.

Figure 1-2689 Partially remove the ITB



- b. Grasp the blue handles on the side of the ITB (callout 1), and then remove the ITB from the printer.

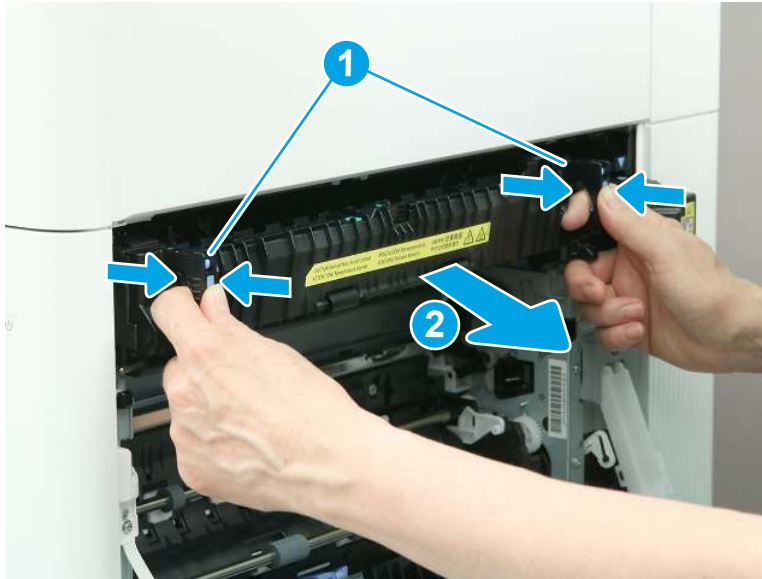
Figure 1-2690 Remove the ITB



5. Remove the fuser.

- ▲ Grasp the fuser handles, and then squeeze the release levers (callout 1). Lift up slightly, and then pull straight out to remove the fuser (callout 2).

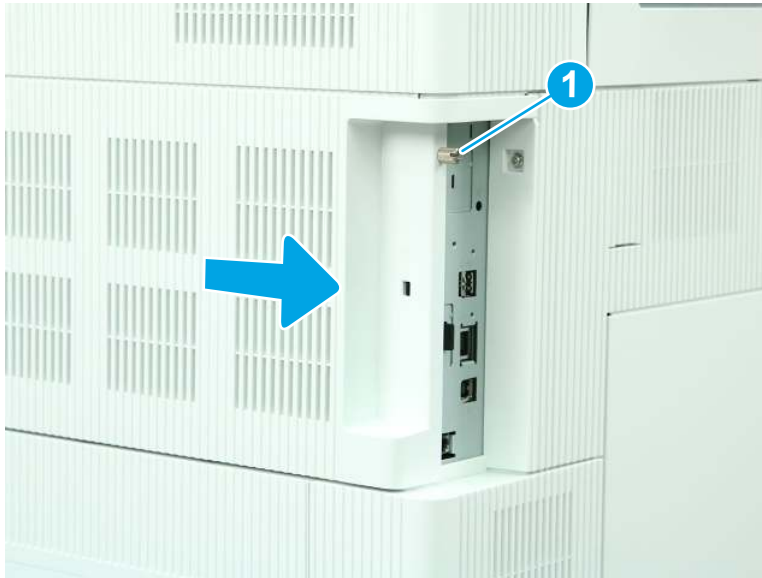
Figure 1-2691



6. Remove the formatter cover.

- ▲ Loosen one thumbscrew (callout 1), and then slide the formatter cover (callout 2) away from the printer to remove it.

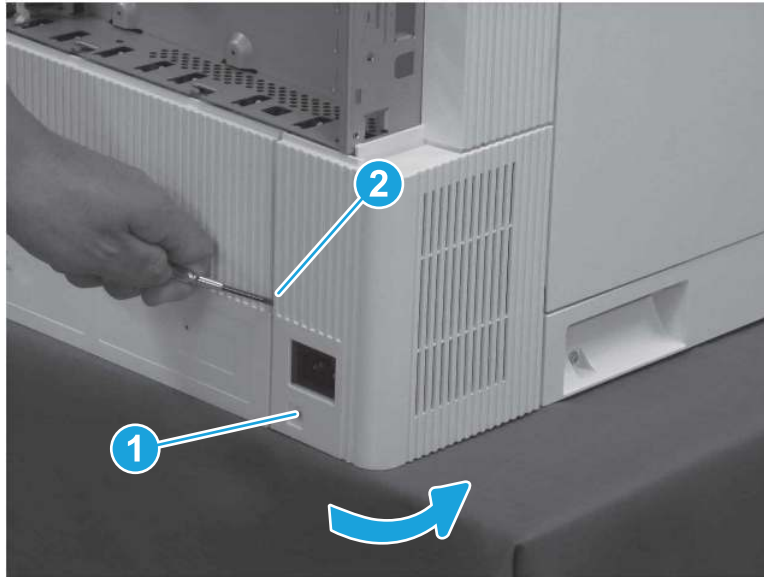
Figure 1-2692 Remove the formatter cover



7. Remove the left lower cover (M751/E75245).

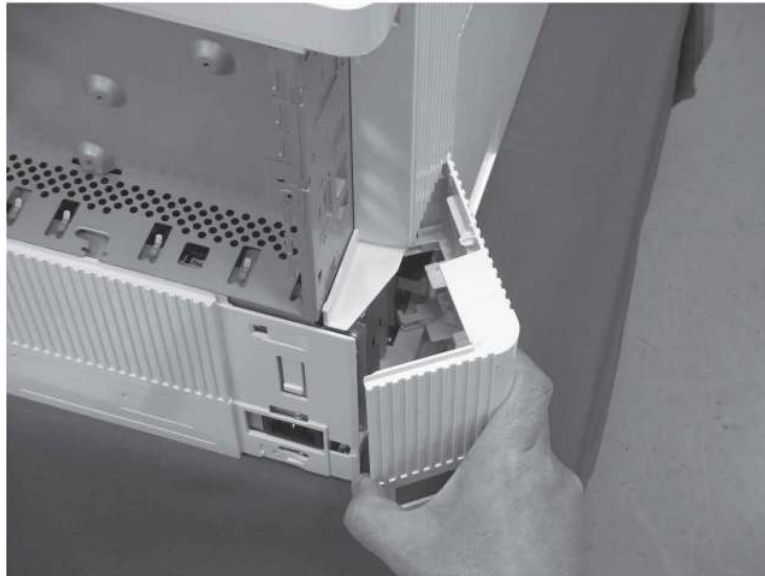
- a. Remove one screw (callout 1), release one tab (callout 2), and then rotate the cover away from the printer.

Figure 1-2693 Remove one screw and release one tab



- b. Remove the left lower cover.

Figure 1-2694 Remove the left lower cover



8. Remove the left rear cover (M751/E75245/M856/E85055/M776).

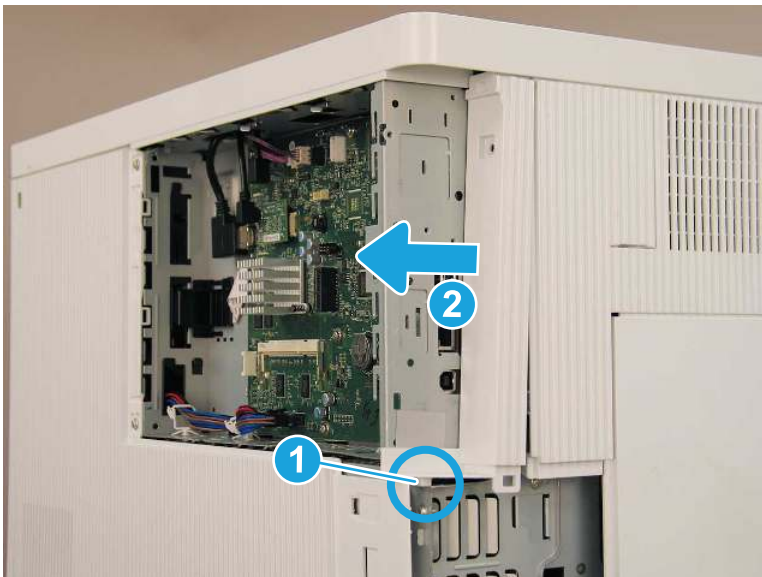
- a. Remove one screw (callout 1).

Figure 1-2695 Remove one screw



- b. Release one boss (callout 1), and then slide the cover toward the back of the printer (callout 2) to remove it.

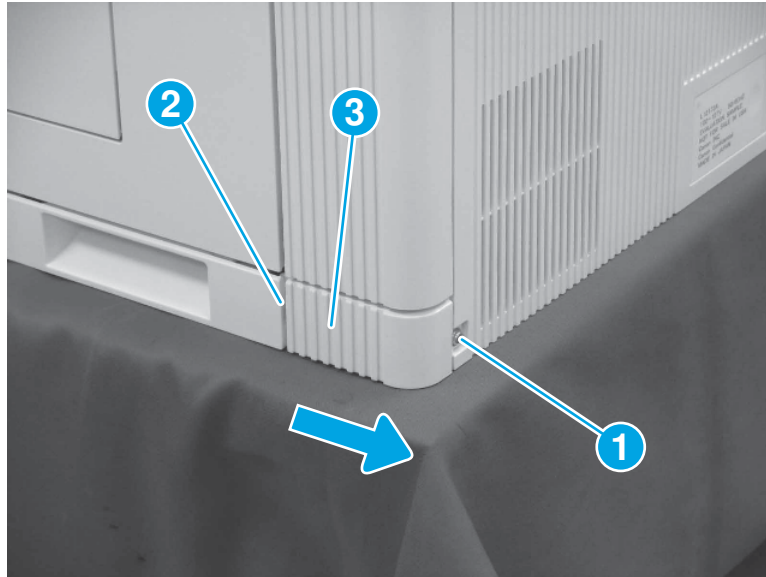
Figure 1-2696 Remove the left rear cover



9. Remove the right rear lower cover (M751/E75245/M856/E85055/M776).

- ▲ Remove one screw (callout 1), release one tab (callout 2), and then slide the right rear lower cover (callout 3) toward the back of the printer to remove it.

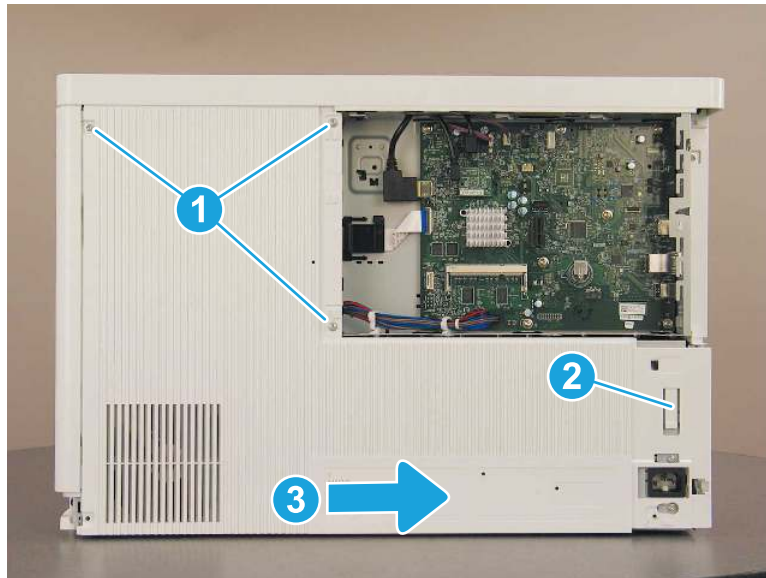
Figure 1-2697 Remove the right rear lower cover



10. Remove the rear cover (M751/E75245).

- ▲ Remove three screws (callout 1), release one tab (callout 2), and then slide the rear cover to the right (callout 3) to remove it.

Figure 1-2698 Remove the rear cover

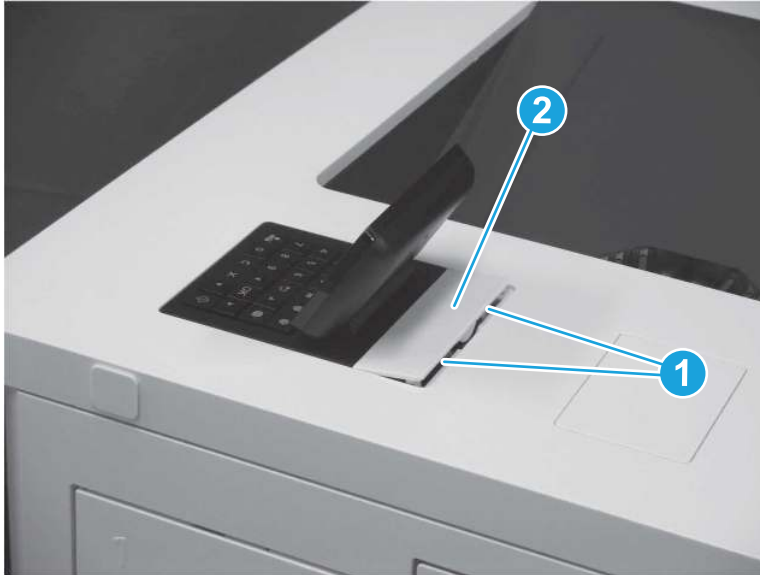


11. Remove the control panel.

 **NOTE:** A screwdriver is included in the control panel kit. The screwdriver has a reversible shaft. Simply pull the shaft out of the handle, and then reinstall it with the desired end facing out.

- a. Use a small, flat-blade screwdriver to release two tabs (callout 1), and then remove the control panel cover (callout 2).

Figure 1-2699 Remove the control panel cover



- b. Remove one screw (callout 1).

Figure 1-2700 Remove one screw



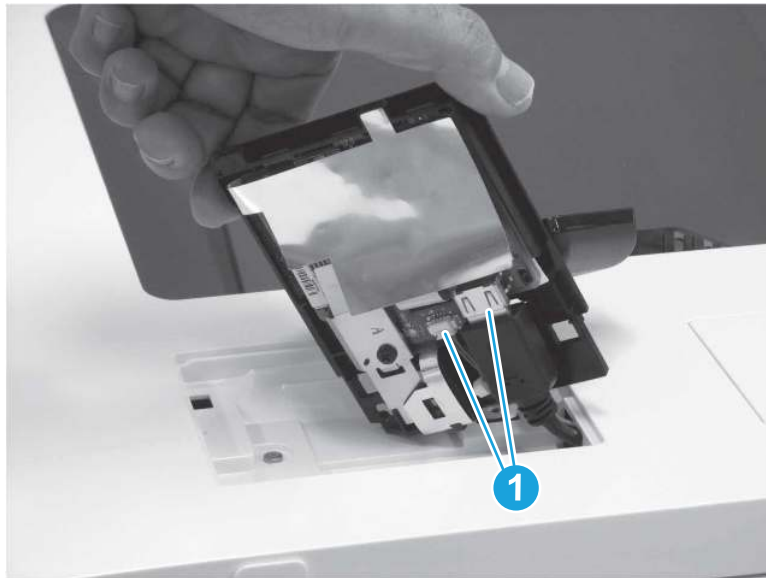
- c. Lift the back edge of the control panel up (callout 1), and then slide the control panel toward the back of the printer (callout 2).

Figure 1-2701 Slide the control panel back



- d. Turn the control panel so that the bottom is facing up, and then disconnect two connectors (callout 1) to remove the control panel.

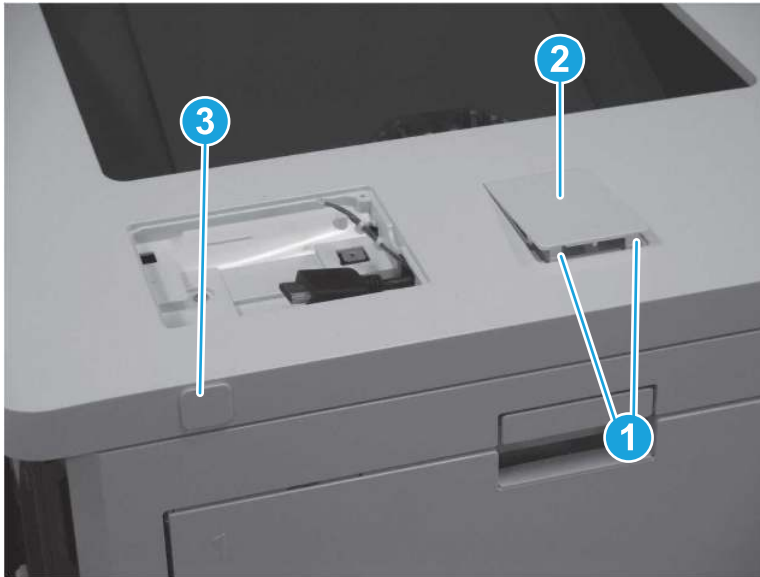
Figure 1-2702 Disconnect two connectors



- 12. Remove the top cover (M751/E75245).

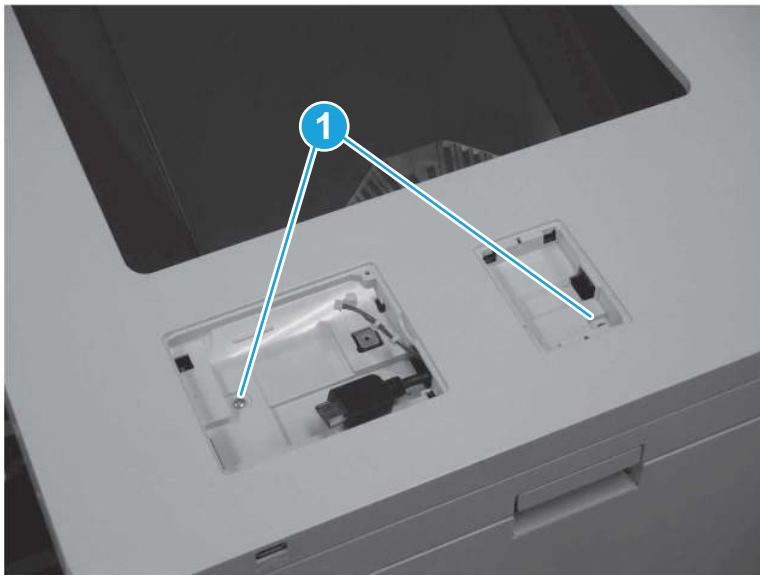
- a. Release two tabs (callout 1), and then remove the HIP cover (callout 2). Pull the USB cap (callout 3) away from the printer to remove it.

Figure 1-2703 Remove the HIP cover and USB cap



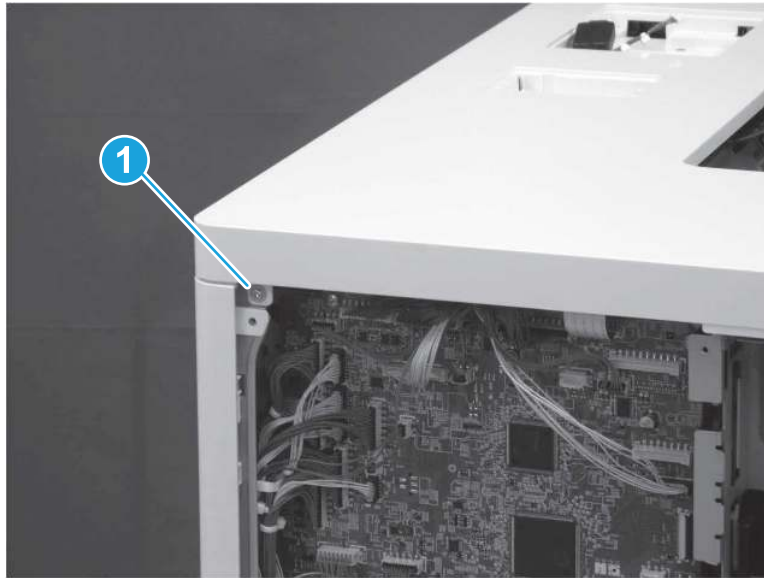
- b. At the top of the printer, remove two screws (callout 1).

Figure 1-2704 Remove two screws




- c. At the back of the printer, remove one screw (callout 1).

Figure 1-2705 Remove one screw

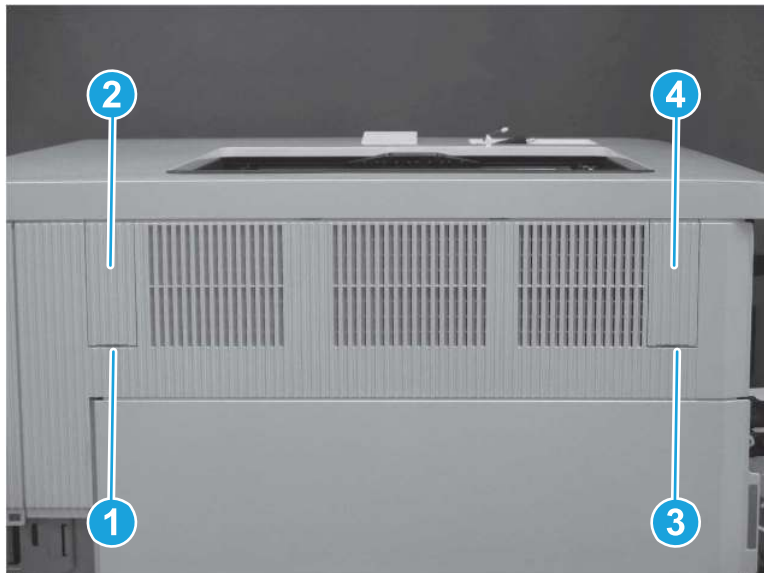


- d. Use a small, flat-blade screwdriver to release one tab (callout 1) and remove the left blanking cover (callout 2). Release one tab (callout 3) and remove the right blanking cover (callout 4).

 **TIP:** These covers are not identical. Make sure to reinstall the correct cover on the correct side.

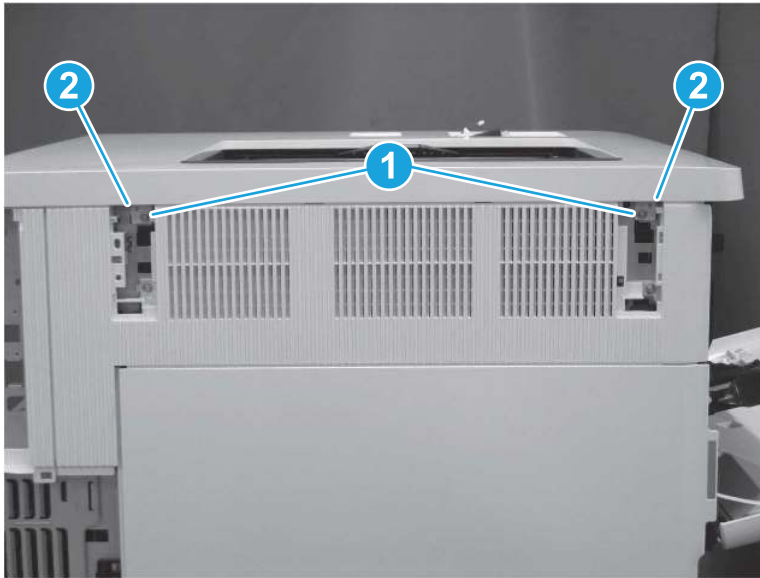
 **NOTE:** The screw under the left blanking cover is a self-tapping screw. Make sure this screw is reinstalled in the correct location.

Figure 1-2706 Remove the left and right blanking covers



- e. Remove two screws (callout 1), and then release two tabs (callout 2).

Figure 1-2707 Remove two screws and release two tabs



- f. At the front of the printer, remove one washer-head screw (callout 1) and one self-tapping screw (callout 2). Release one tab (callout 3).


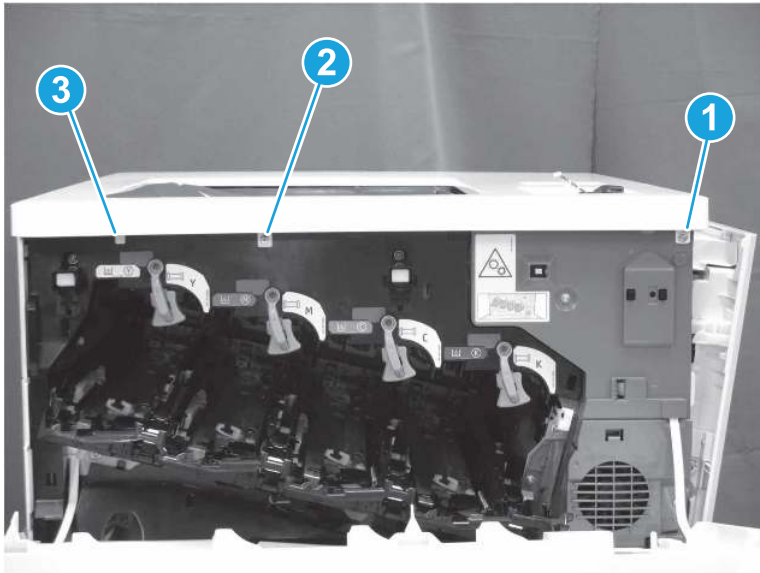
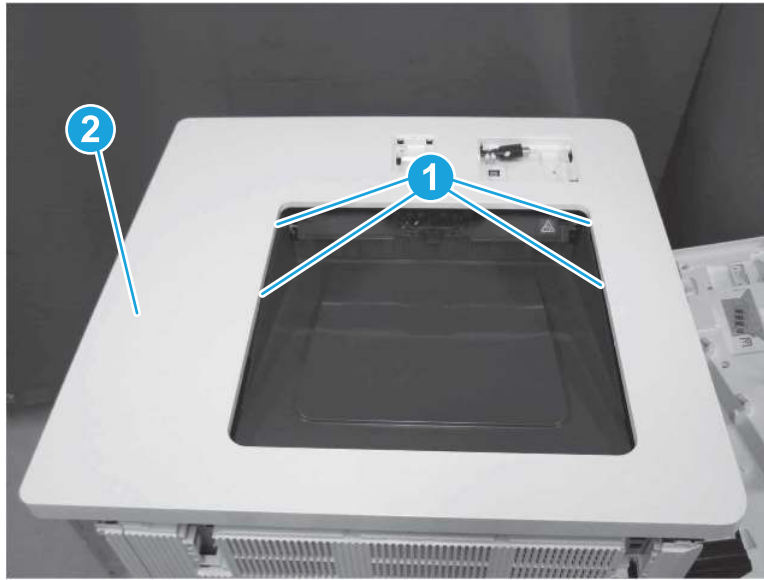
 **TIP:** Make sure to install the correct type of screw in the correct location.


Figure 1-2708 Remove two screws and release one tab

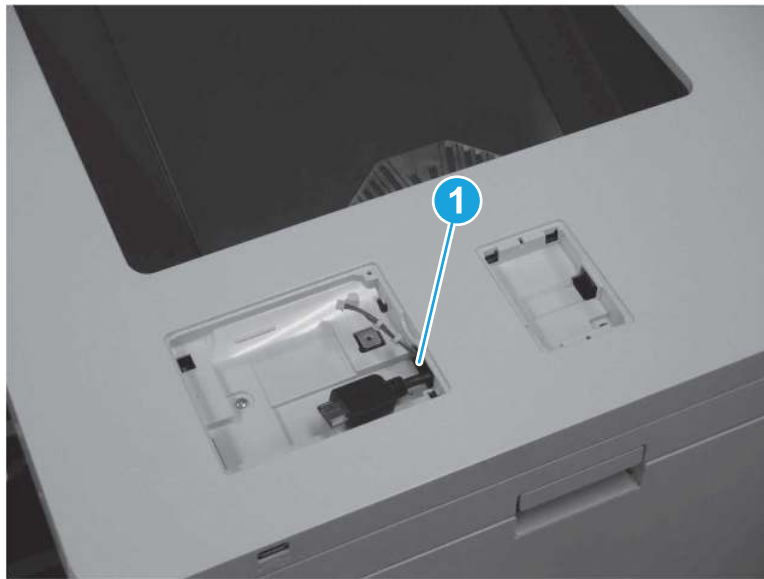


- g. At the top of the printer, release four tabs (callout 1), and then remove the top cover (callout 2).

Figure 1-2709 Remove the top cover



 **NOTE:** When removing the top cover, make sure to release the control panel cables (callout 1) through the opening.

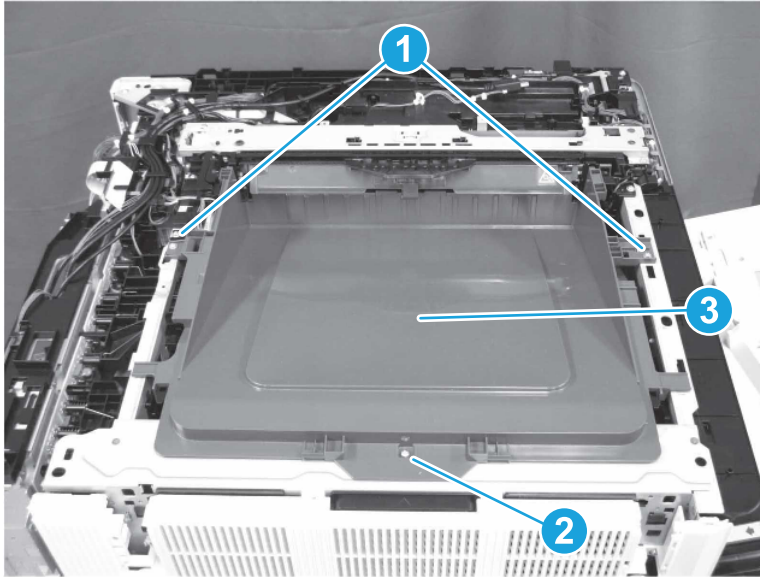


13. Remove the output bin (M751/E75245).

- ▲ Remove two washer-head machine screws (callout 1), remove one self-tapping screw (callout 2), and then remove the output bin (callout 3).

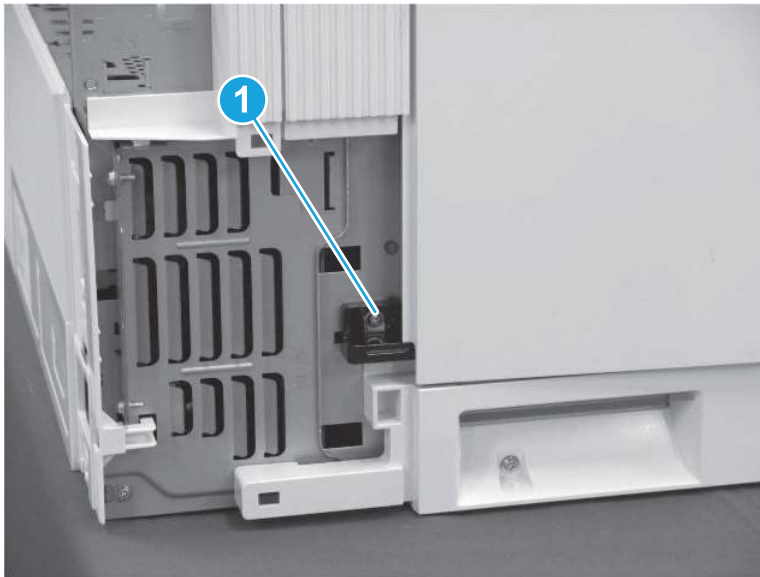
 **NOTE:** When reinstalling the output bin, make sure to install the correct type of screw in the correct location.

Figure 1-2710 Remove the output bin



14. Remove the left door.
 - a. Remove one screw (callout 1).

Figure 1-2711 Remove one screw



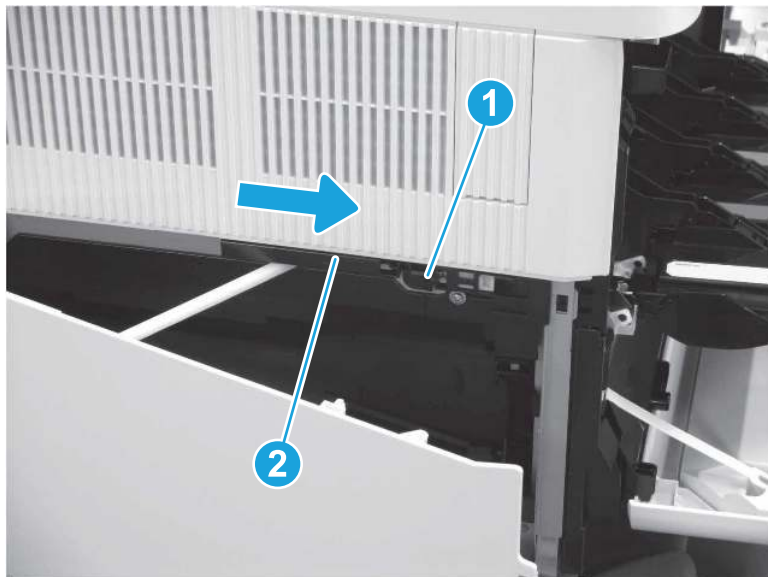
- b. Release the holder, and then remove it from the printer.

Figure 1-2712 Remove the holder



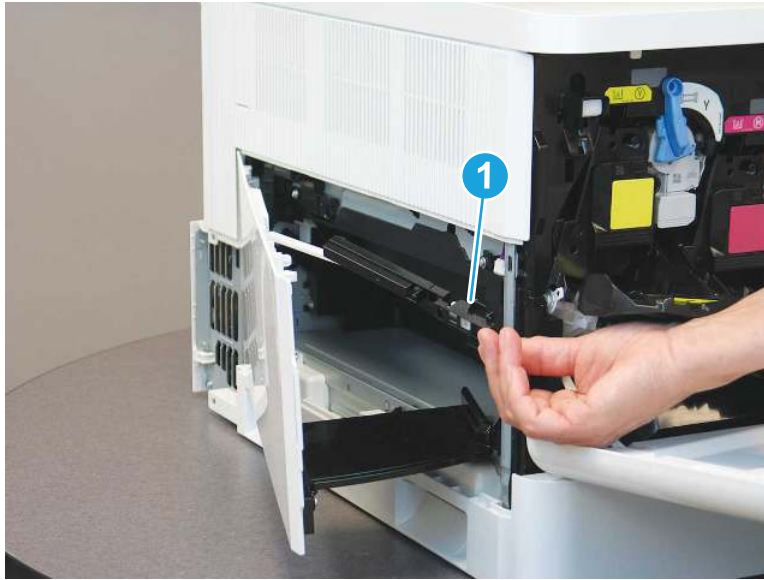
- c. Open the left door, and release one tab (callout 1). Slide the holder (callout 2) toward the front of the printer.

Figure 1-2713 Slide the holder



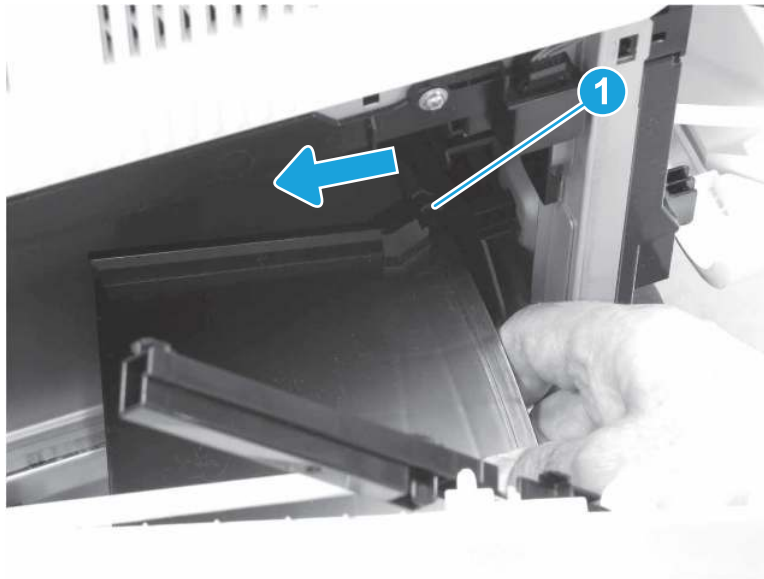
- d. Release the holder (callout 1) from the printer, but leave it attached to the hinge.

Figure 1-2714 Release the holder



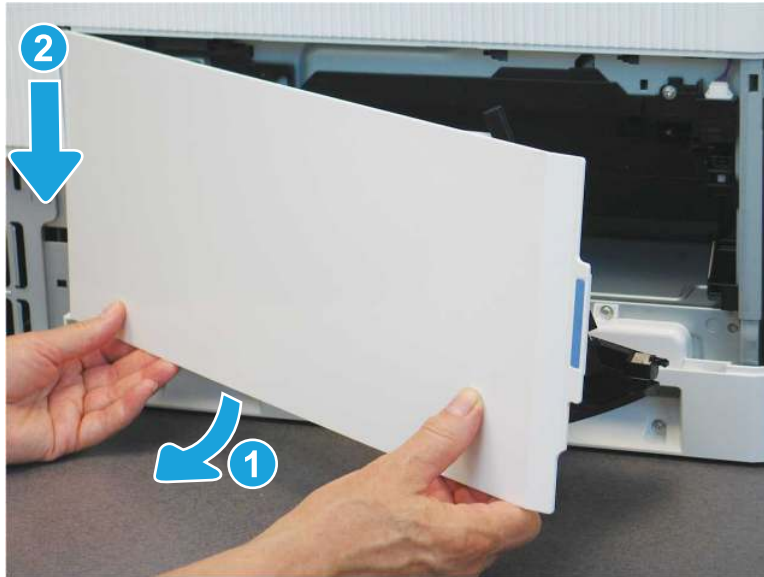
- e. Press the stopper (callout 1) on the bottom of the door to the left to release it from the track.

Figure 1-2715 Release the stopper



- f. Rotate the left, lower edge of the door away from the printer (callout 1), and then lower the door to remove it (callout 2).

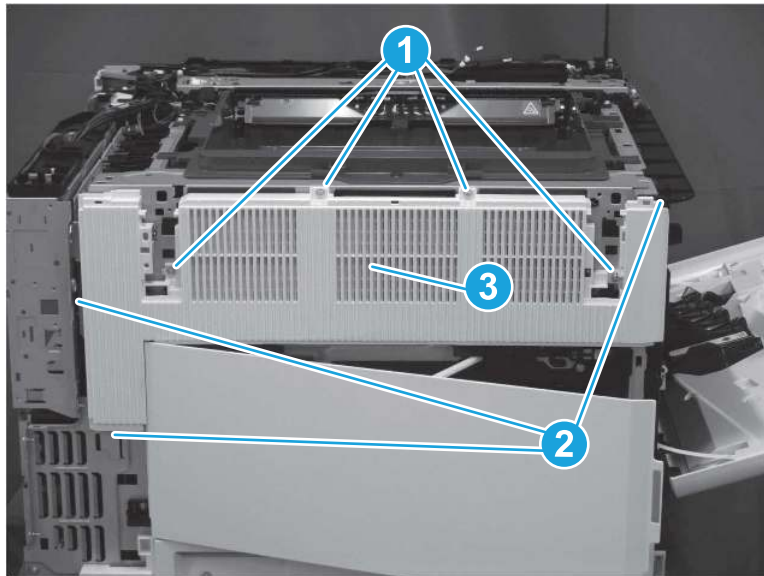
Figure 1-2716 Remove the left door



15. Remove the left upper cover (M751/E75245).

- ▲ Remove four screws (callout 1), release three tabs (callout 2), and then remove the left upper cover (callout 3).

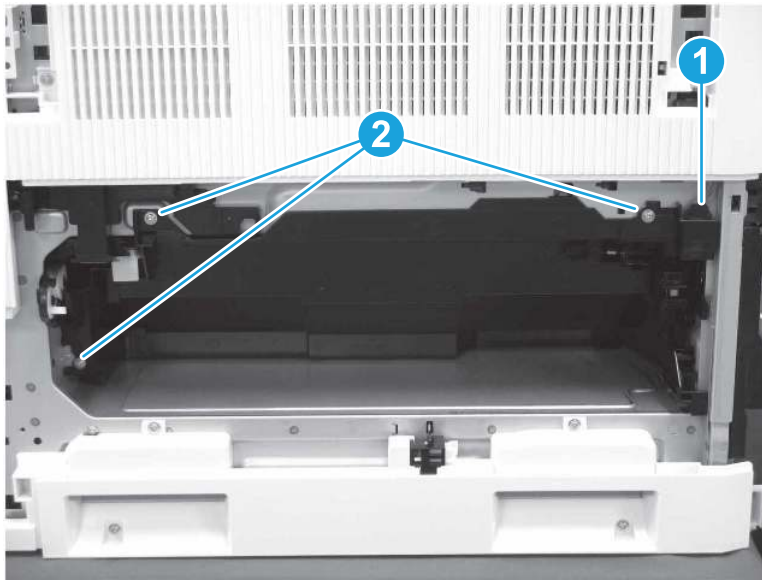
Figure 1-2717 Remove the left upper cover



16. Remove the scanner cover.

- a. Disconnect one connector (callout 1), and then remove three screws (callout 2).

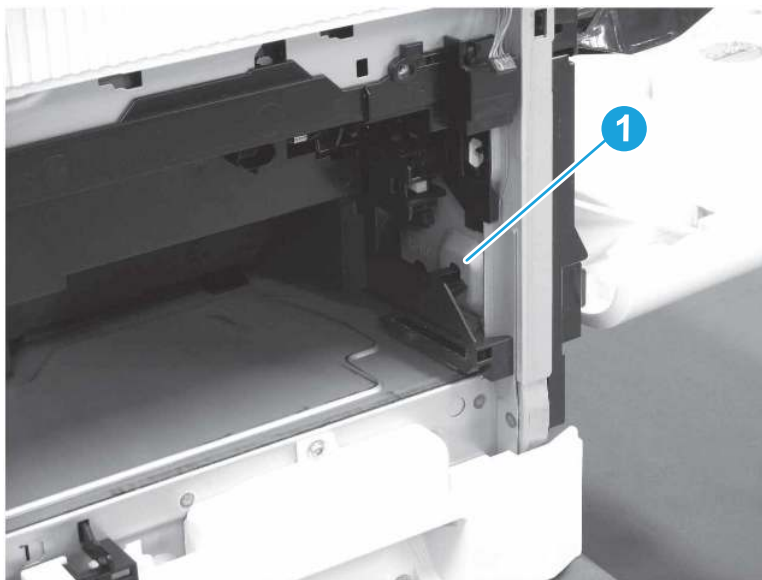
Figure 1-2718 Disconnect one connector and remove three screws



 **TIP:** Connect the connector before reinstalling the screws.

- b. Release one tab (callout 1), and then flex the scanner cover to remove it.

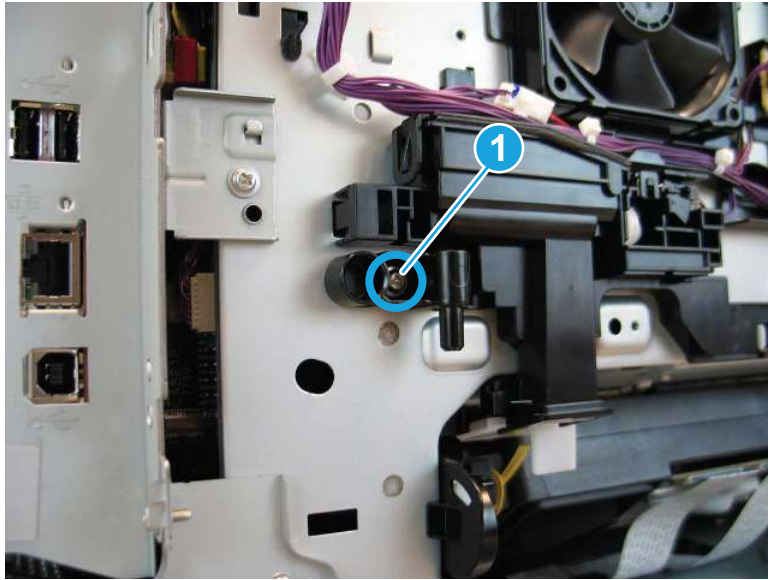
Figure 1-2719 Remove the scanner cover



17. Remove the secondary auger.

- a. Remove one screw (callout 1).

Figure 1-2720 Remove one screws



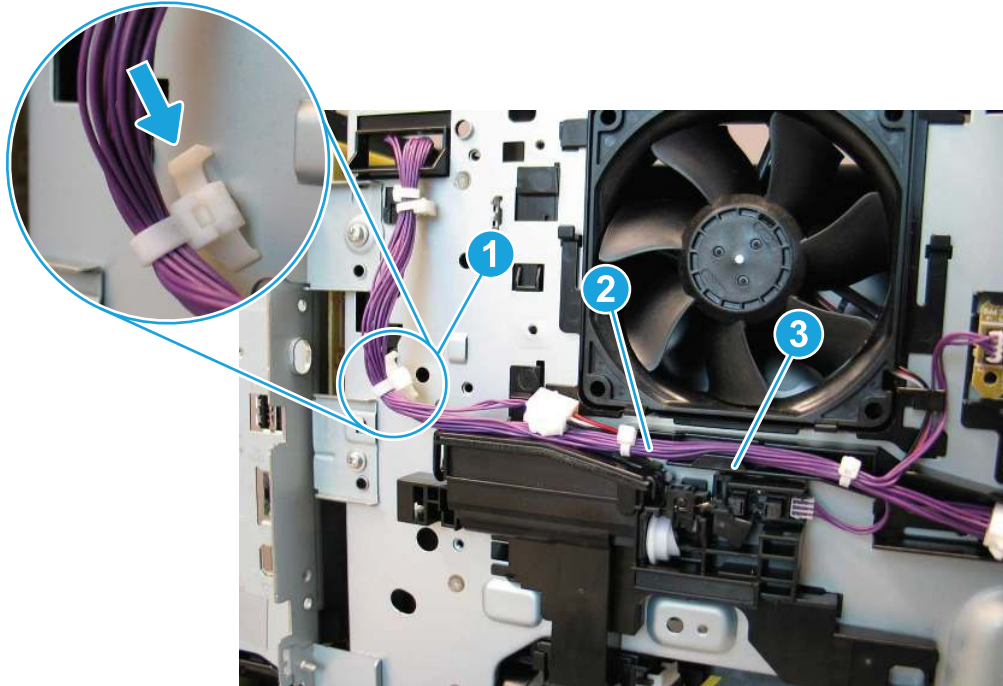
- b. Remove the left door upper hinge.

Figure 1-2721 Remove the left door upper hinge



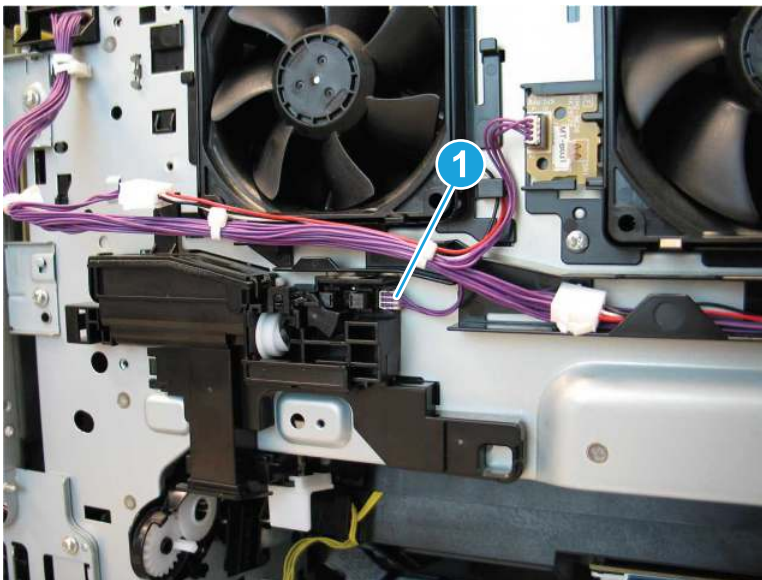
- c. Press the latch to release one retainer (callout 1) from the sheet metal. Remove the wire harness (callout 2) from the guides (callout 3).

Figure 1-2722 Release the wire harness from the guides



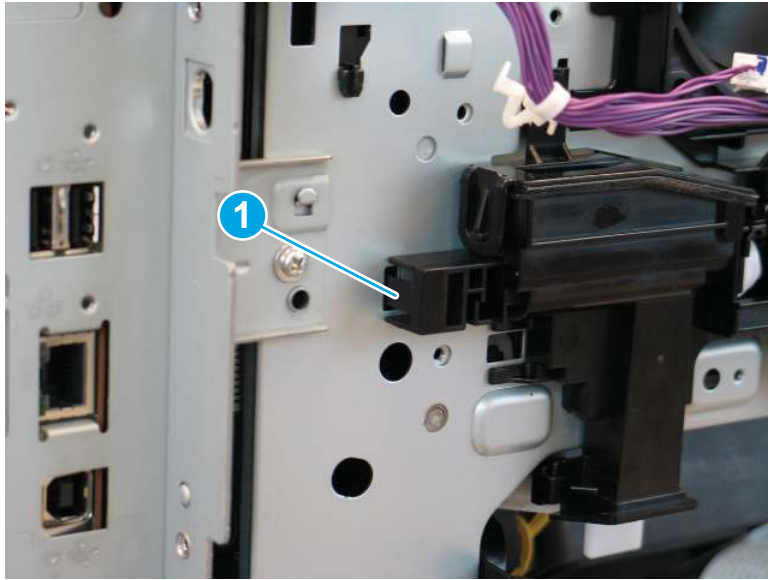
- d. Disconnect one connector (callout 1).

Figure 1-2723 Disconnect one connector



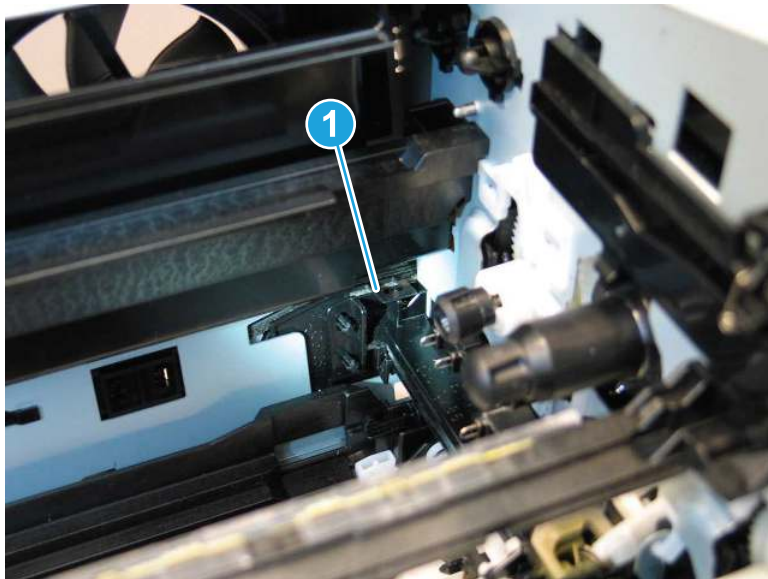
- e. Release one tab (callout 1).

Figure 1-2724 Release one tab



- f. Inside the printer, release one tab that connects to the primary auger (callout 1).

Figure 1-2725 Release one tab




- g. Remove the secondary auger assembly.

Figure 1-2726 Remove the secondary auger assembly

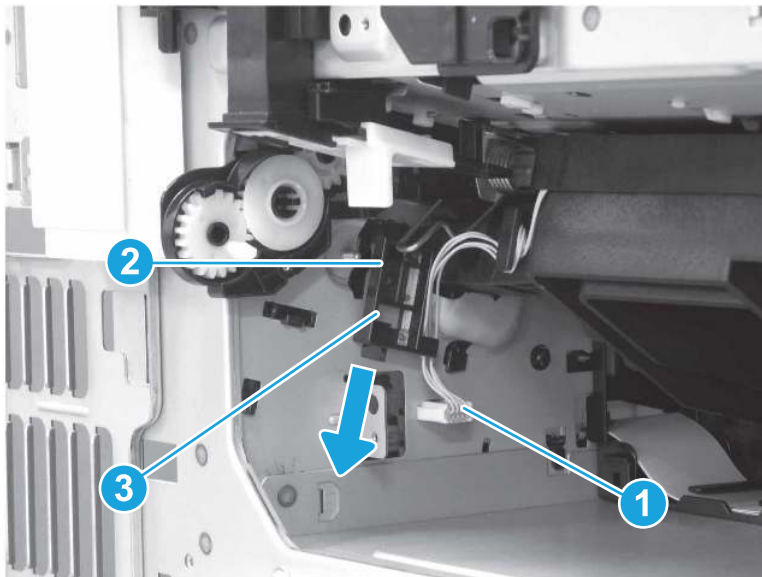


- 18. Remove the laser scanner.

 **IMPORTANT:** The front door must be open while removing and installing the laser scanner to avoid damaging the laser scanner cleaning pads.

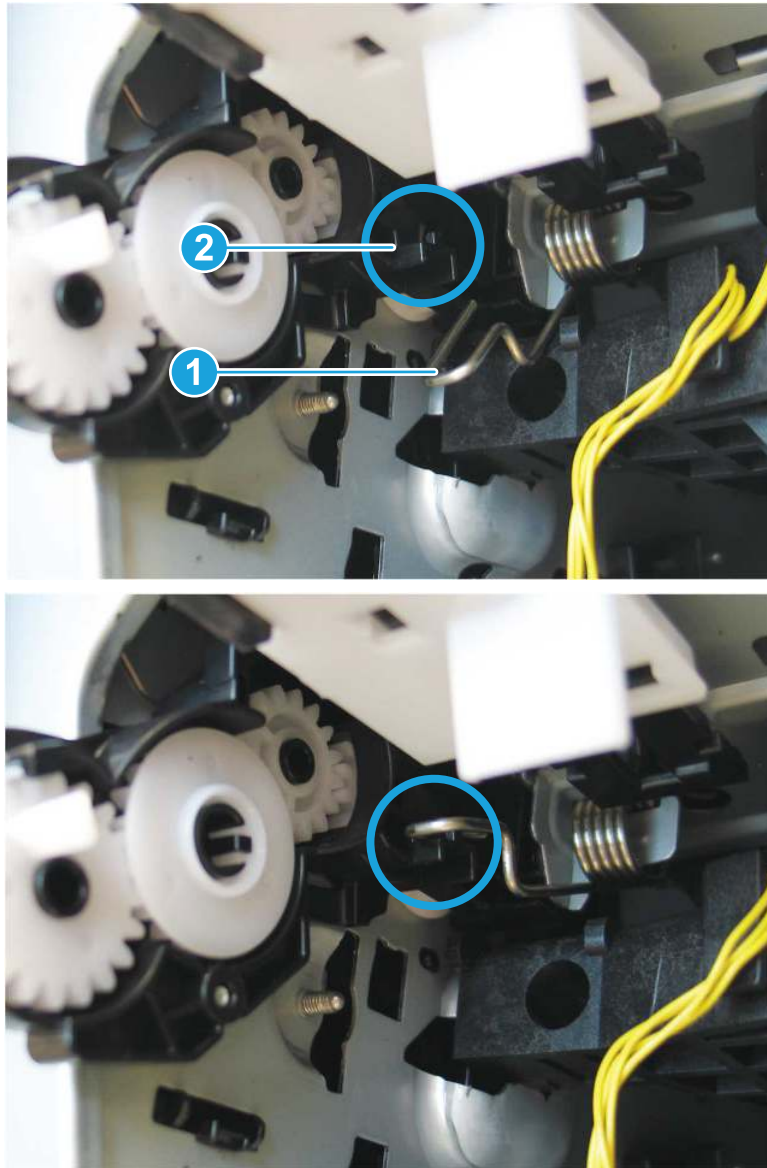
- a. Disconnect one connector (callout 1), release one tab (callout 2), and then slide the stopper (callout 3) down to remove it.


Figure 1-2727 Remove the stopper

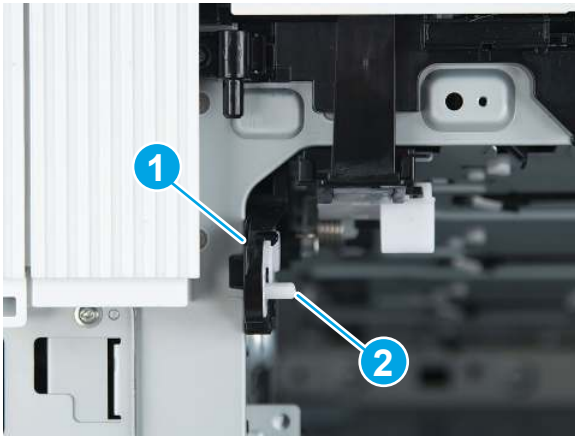


- b. Hook the spring (callout 1) on the hook (callout 2).

Figure 1-2728 Hook the spring

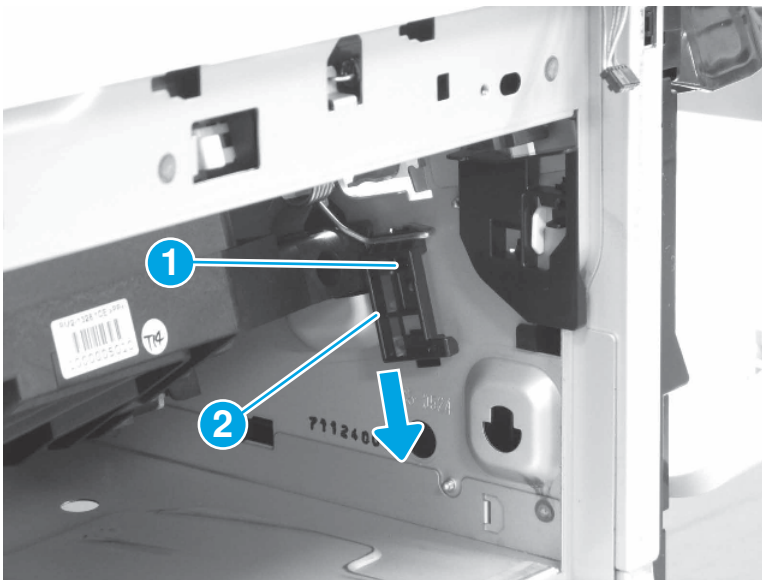


 **TIP:** When the laser scanner is installed, make sure that the gear case is flat against the printer chassis (callout 1). The pin on the gear (callout 2) might need to be rotated out of the way when the assembly is installed.



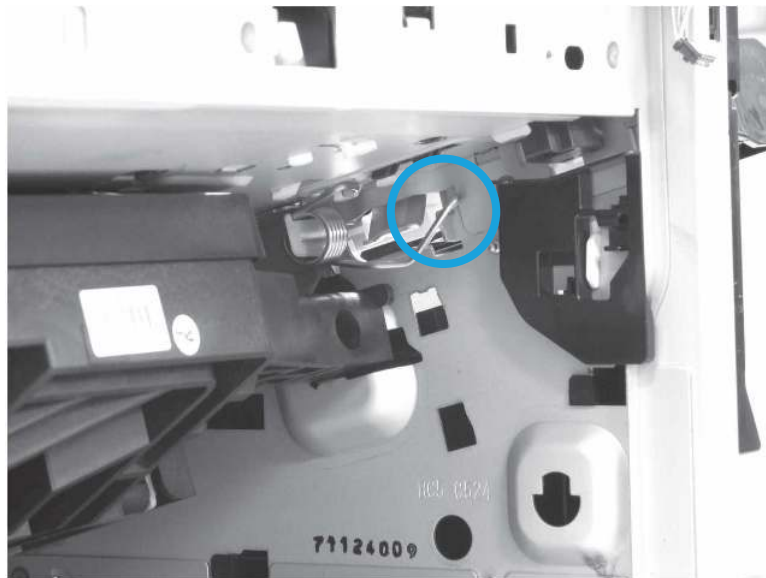
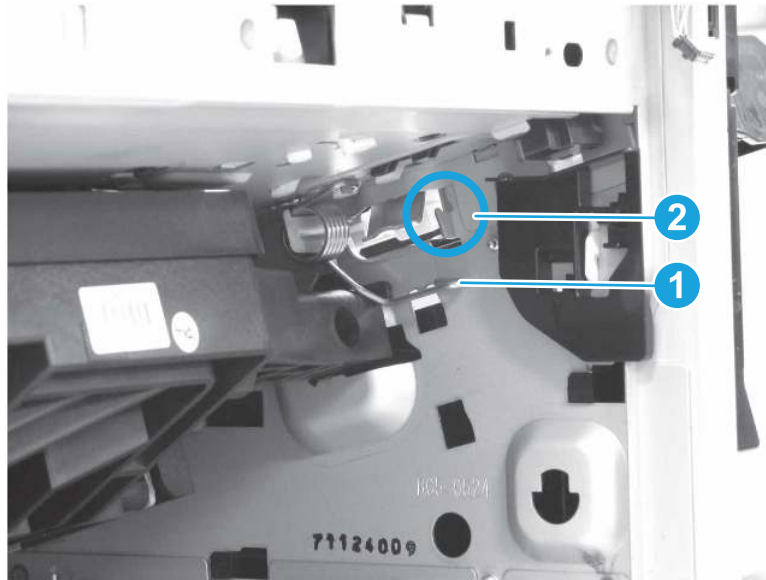
- c. On the right side of the laser scanner, release one tab (callout 1), and then slide the stopper (callout 2) down to remove it.

Figure 1-2729 Remove the stopper



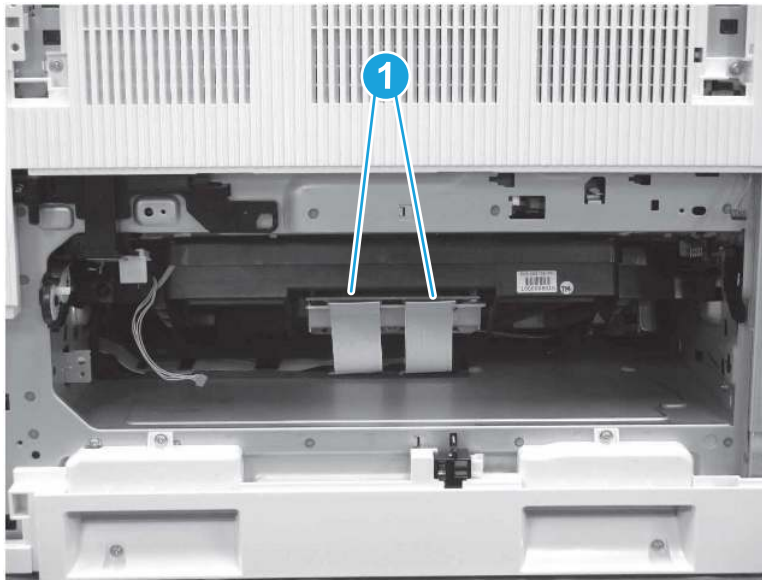
- d. Hook the spring (callout 1) on the hook (callout 2).

Figure 1-2730 Hook the spring



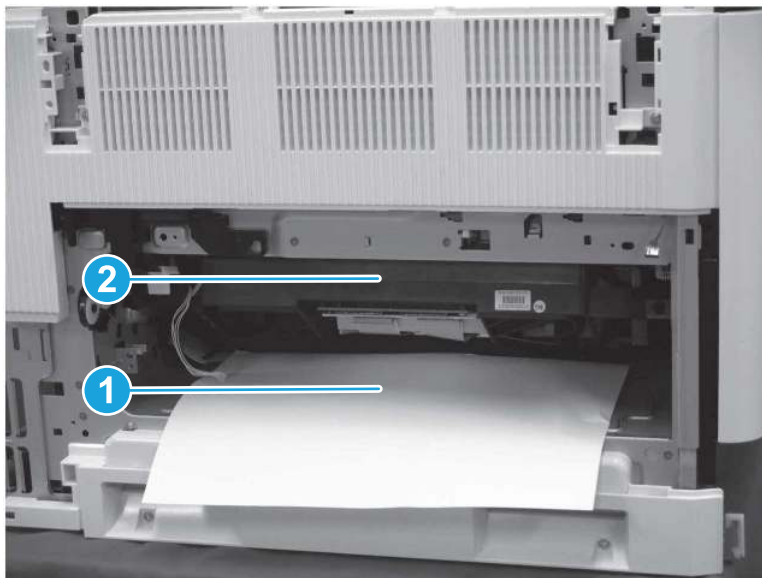
- e. Disconnect two flat cables (callout 1).


Figure 1-2731 Disconnect two flat cables




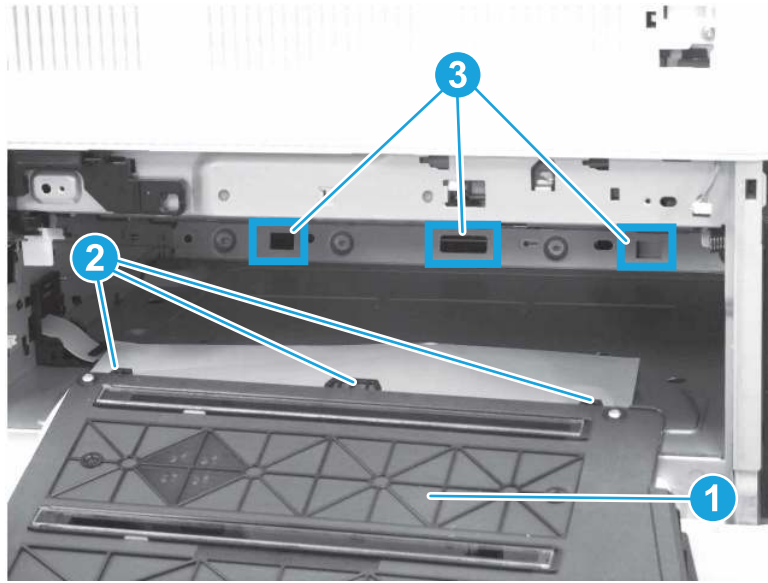
- f. Lay a sheet of paper on top of the flat cables (callout 1) to protect them. Pull the laser scanner (callout 2) out of the printer to remove it.

Figure 1-2732 Remove the laser scanner



 **IMPORTANT:** The front door must be open while removing and installing the laser scanner to avoid damaging the laser scanner cleaning pads.

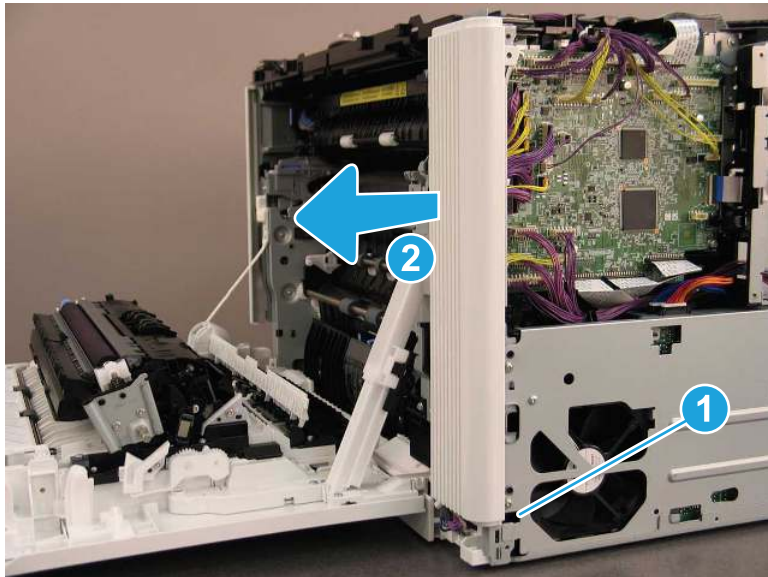
 **TIP:** When installing the laser scanner (callout 1), position the pins (callout 2) on the laser scanner into the openings (callout 3) inside the printer.



19. Remove the right rear cover (M751/E75245).

- ▲ Release one tab (callout 1), and then slide the right rear cover (callout 2) away from the printer to remove it.

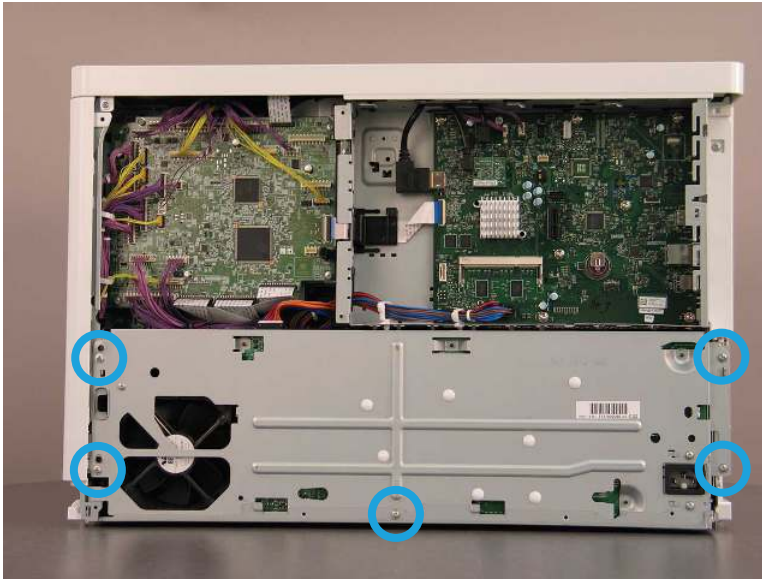
Figure 1-2733 Remove the right rear cover



20. Remove the low-voltage power supply (LVPS).

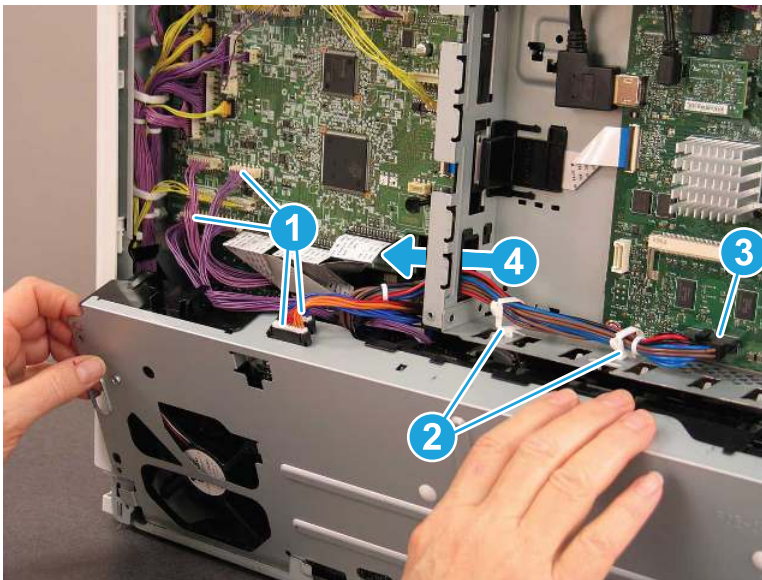
- a. Remove five screws.

Figure 1-2734 Remove five screws



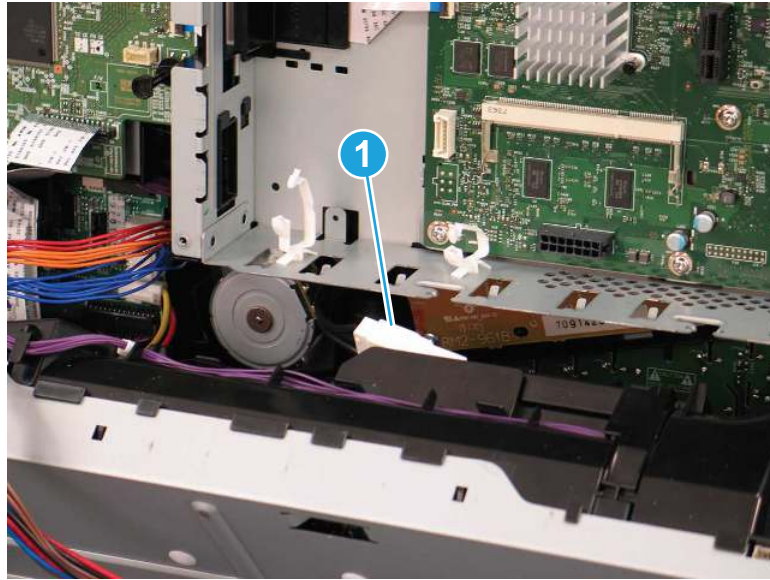
- b. Lift up on the LVPS, and then slightly rotate the top away from the printer. Disconnect four connectors (callout 1), and then release two retainers (callout 2). Press down on the latch to disconnect one connector (callout 3), and then release the wires through the hole (callout 4) in the formatter case.

Figure 1-2735 Disconnect five connectors



- c. Press down on the latch to disconnect one connector (callout 1), and then lift up to remove the LVPS.

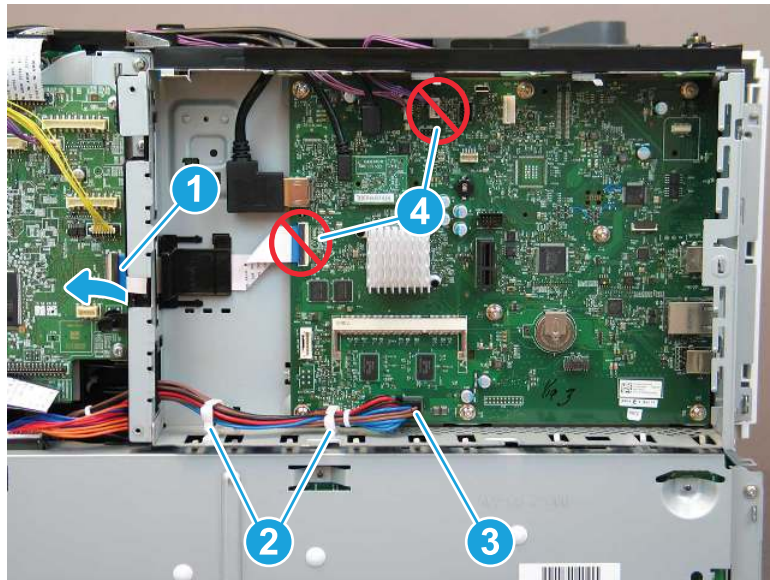
Figure 1-2736 Remove the LVPS



- 21. Remove the formatter and case.

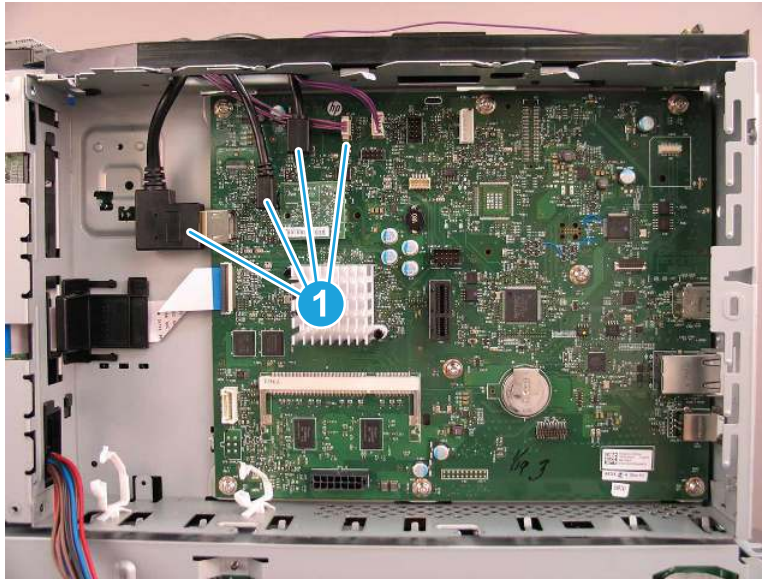
- a. Open the retainer (callout 1) to release the flat cable. Release the cables from two retainers (callout 2). Squeeze the latch to disconnect the connector (callout 3) at the lower edge of the formatter. It is not necessary to disconnect two connectors (callout 4).

Figure 1-2737 Disconnect the connectors



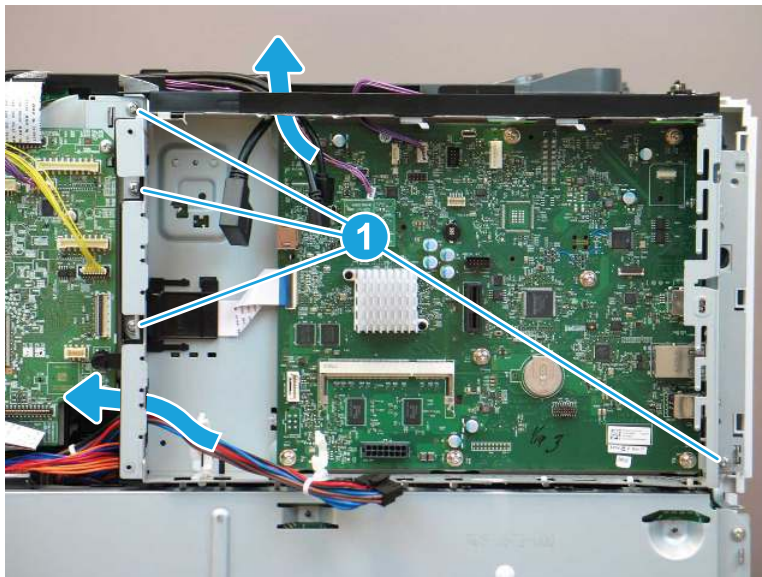
- b. Disconnect all of the remaining connectors on the formatter (callout 1).

Figure 1-2738 Disconnect the connectors



- c. Release the cables through the opening on top and on the left side of the formatter case. Remove four screws (callout 1), and then remove the formatter and case.

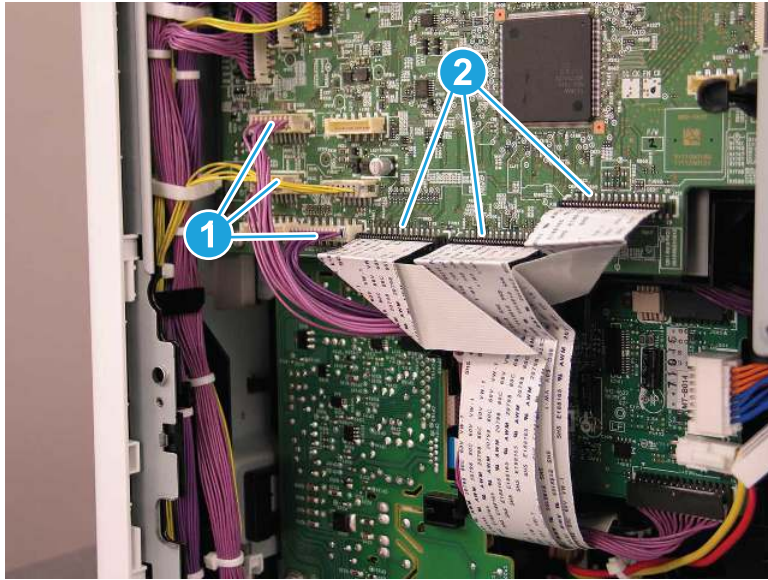
Figure 1-2739 Remove the formatter and case



- 22. Remove the T2 connecting PCA.

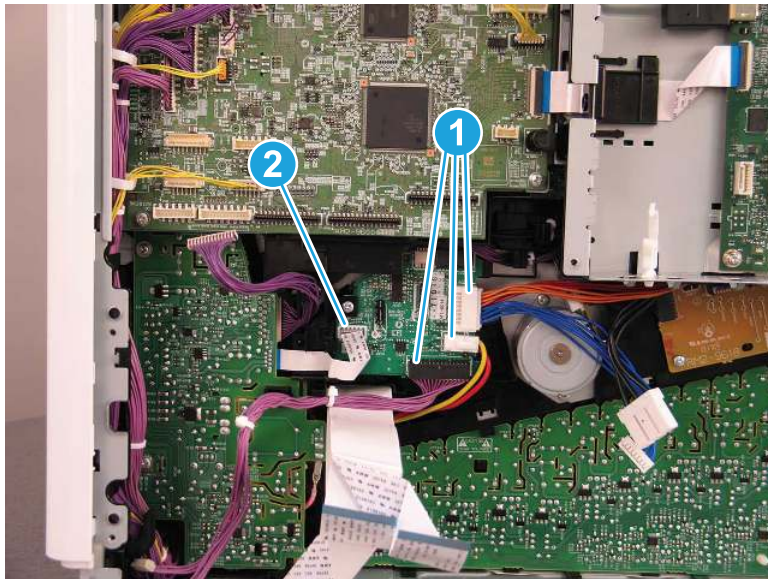
- a. Disconnect three connectors (callout 1), and then disconnect three flat cables (callout 2).

Figure 1-2740 Disconnect six connectors



- b. Disconnect three connectors (callout 1), and then disconnect one flat cable (callout 2).

Figure 1-2741 Disconnect three connectors and one flat cable



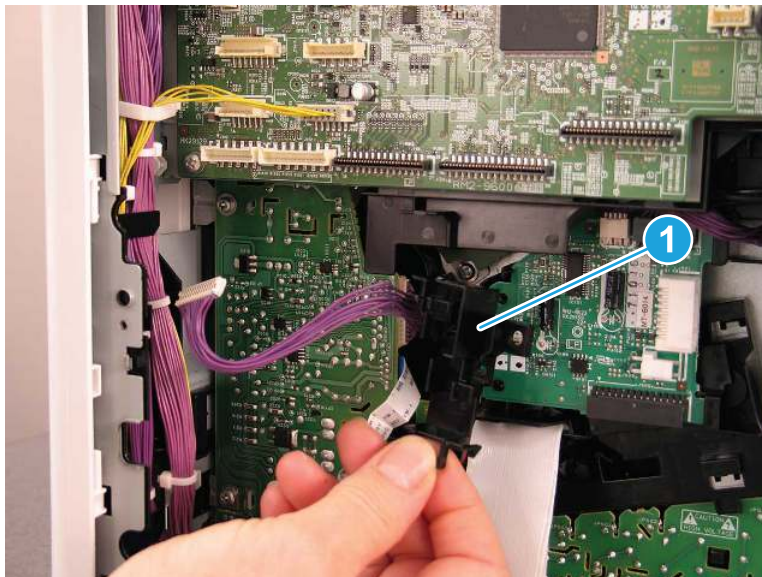
- c. Remove one screw (callout 1).

Figure 1-2742 Remove one screw



- d. Remove the cable guide (callout 1). If the cable guide is lost or damaged during the repair procedure, order a replacement part and install it along with the replacement T2 connecting PCA.

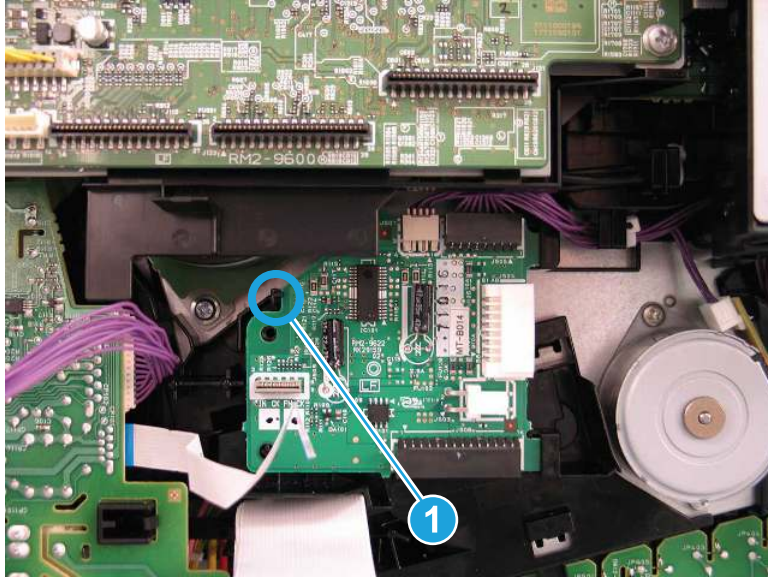
Figure 1-2743 Remove the cable guide



- e. Release one tab (callout 1), and then pull the T2 connecting PCA slightly away from the printer.

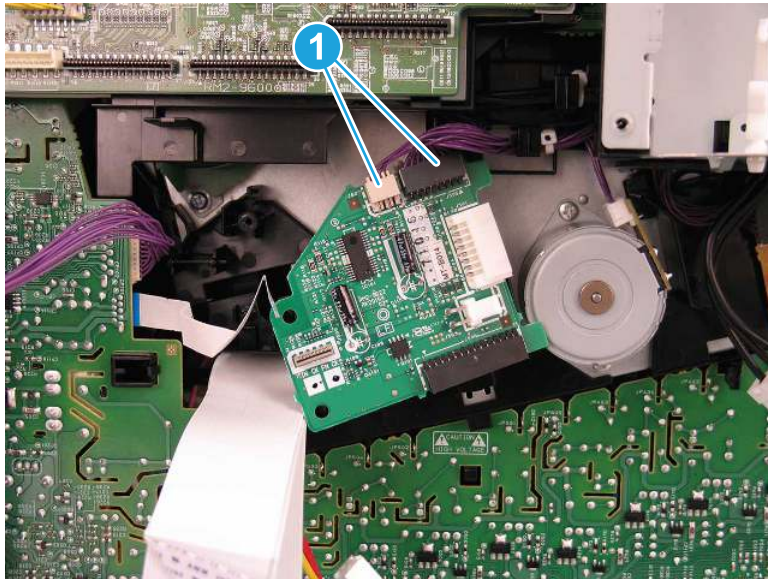
⚠ CAUTION: The T2 connecting PCA is still attached to the printer. Do not attempt to remove it completely.

Figure 1-2744 Release one tab



- f. Disconnect two connectors (callout 1), and then remove the T2 connecting PCA (callout 2).

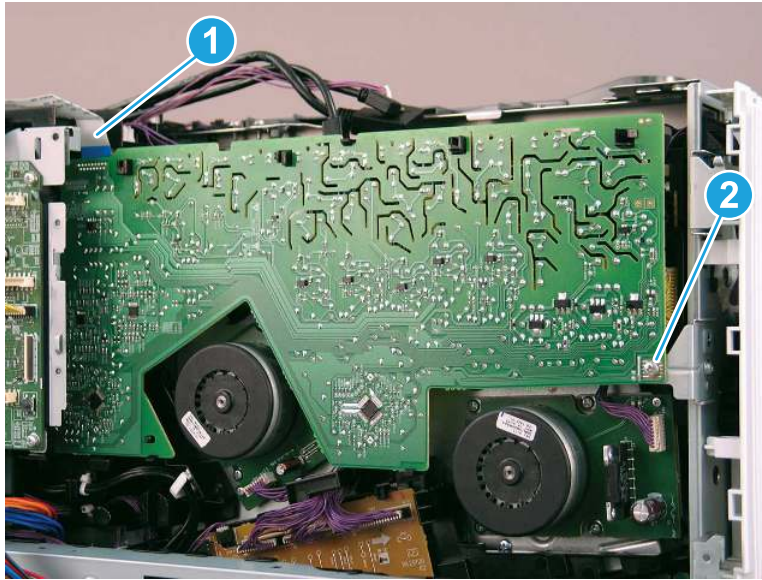
Figure 1-2745 Disconnect two connectors and remove the PCA



23. Remove the upper high-voltage power supply A (upper HVPS).

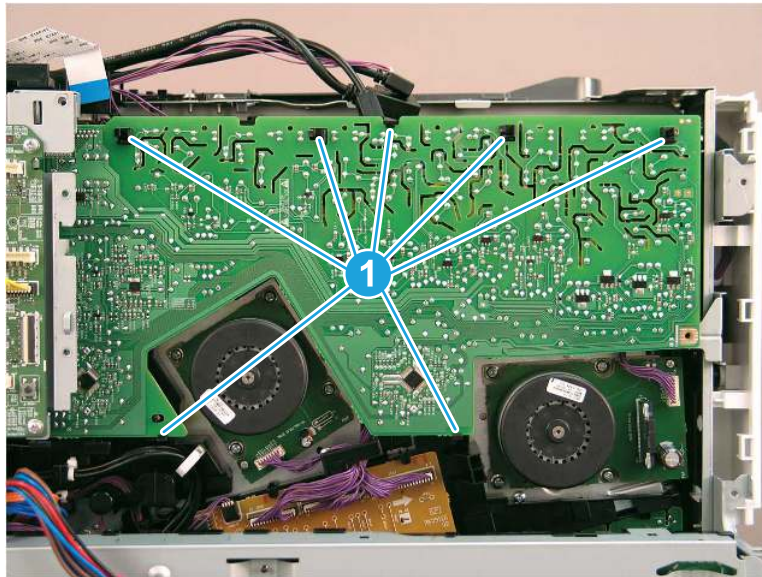
- a. Disconnect one flat cable (callout 1), and then remove one screw (callout 2).

Figure 1-2746 Disconnect one flat cable and remove one screw



- b. Release seven tabs (callout 1), and then remove the upper HVPS.

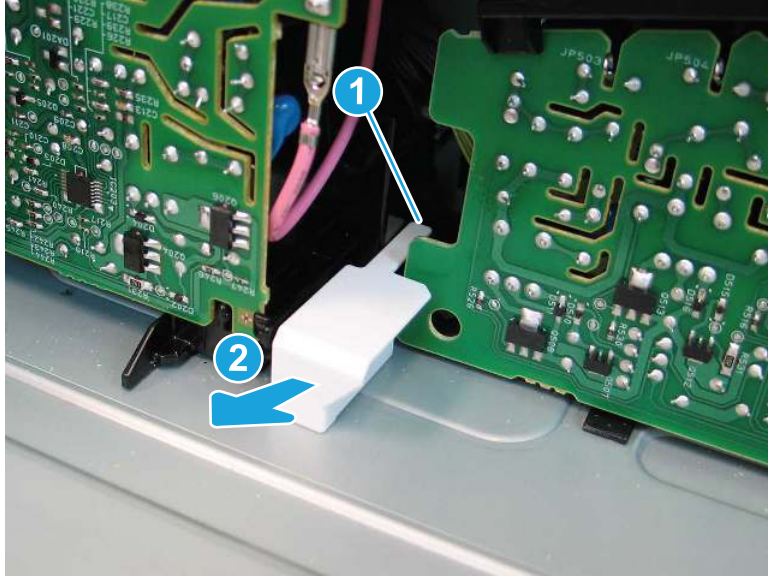
Figure 1-2747 Release seven tabs and remove the upper HVPS



24. Remove the lower high-voltage power supply (lower HVPS).

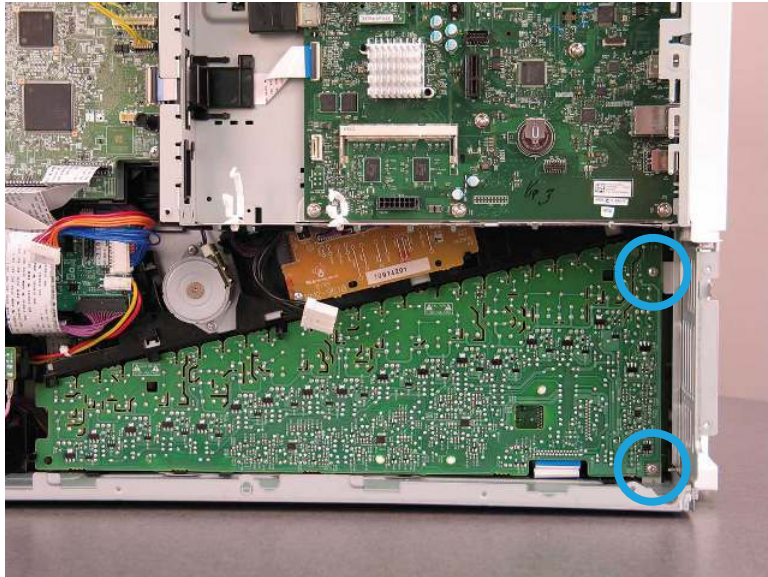
- a. Release one tab (callout 1) and then slide the stopper (callout 2) away from the printer to remove it.

Figure 1-2748 Remove the stopper



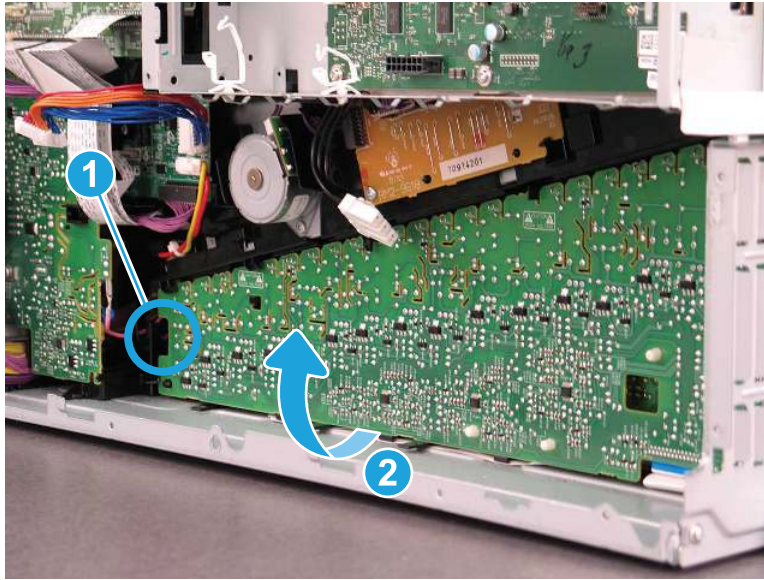
- b. Remove two screws (callout 1).

Figure 1-2749 Remove two screws



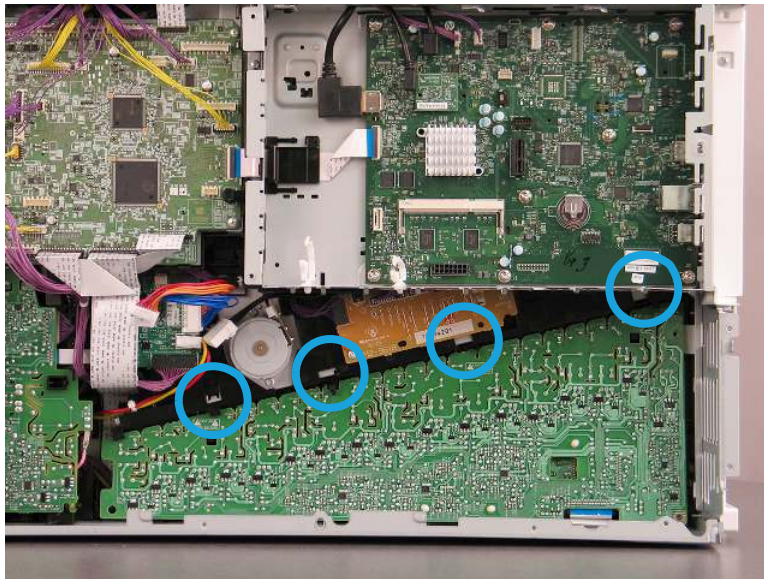
- c. Release one tab (callout 1), and then gently release the lower edge of the lower HVPS.

Figure 1-2750 Release the lower edge of the lower HVPS



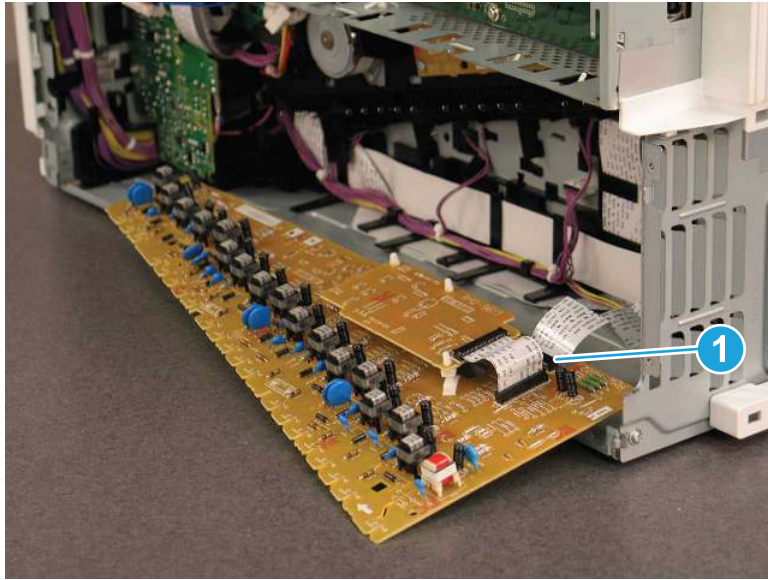
- d. Release the lower HVPS from four tabs.

Figure 1-2751 Release four tabs



- e. Disconnect one flat cable (callout 1) from the back of the lower HVPS.

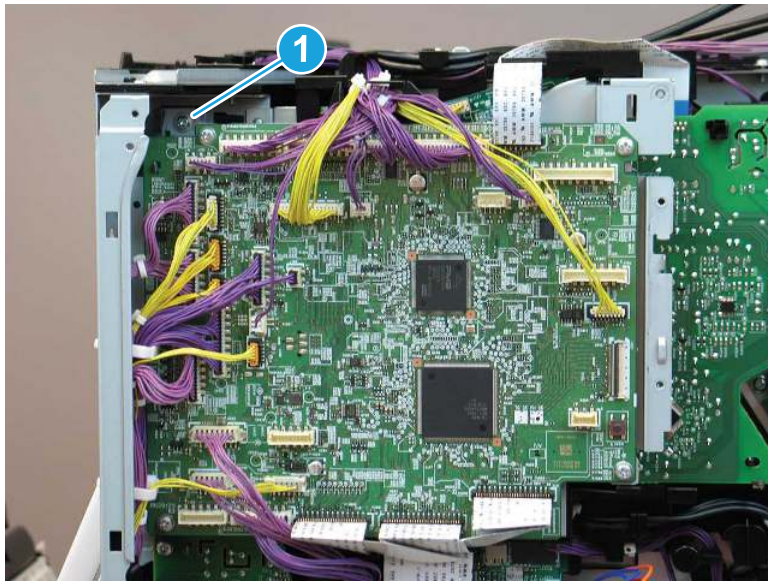
Figure 1-2752 Disconnect one flat cable



- 25. Remove the DC controller and case.

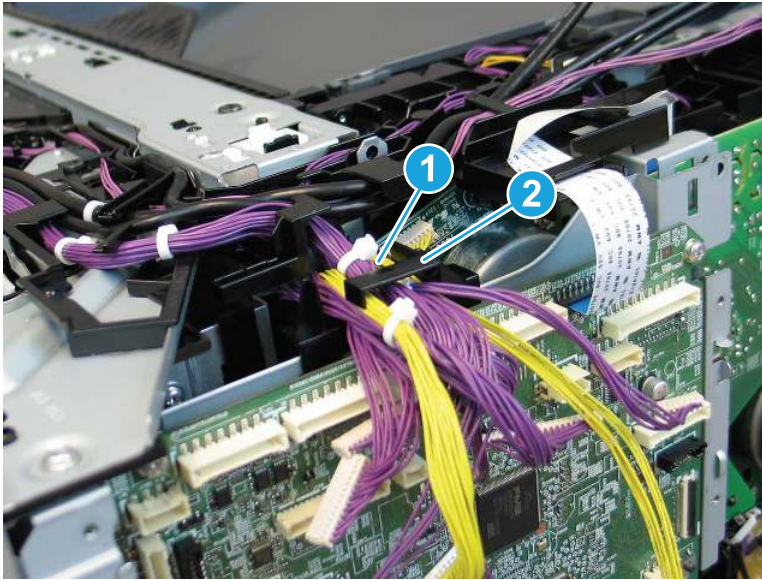
- a. Disconnect all of the connectors on the DC controller, and then remove one screw (callout 1).

Figure 1-2753 Disconnect connectors and remove one screw



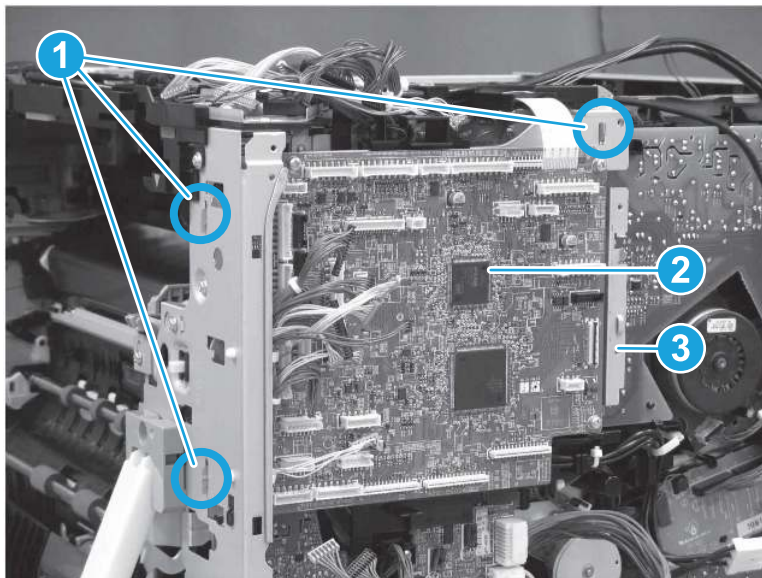
- b. Release the wire harnesses (callout 1) from the retainer (callout 2).

Figure 1-2754 Remove the wire harnesses from the retainer




- c. Lift up to release three tabs (callout 1), and then remove the DC controller (callout 2) together with the case (callout 3).

Figure 1-2755 Remove the DC controller and case



26. Remove the main drive assembly.

- a. Open the front door.

 **IMPORTANT:** The front door must remain open during removal and installation of the main drive assembly to prevent issues.

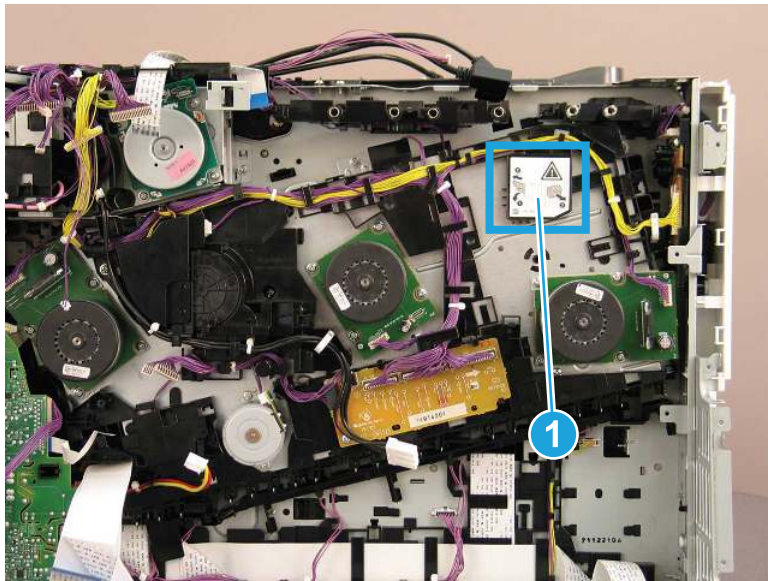
To prevent the front door from closing on its own, install one of the toner cartridges halfway.

Figure 1-2756 Open the front door



- b. Note the label (callout 1) on the main drive assembly indicating that the front door must be open and all toner cartridges and imaging drums removed before removing the main drive assembly.

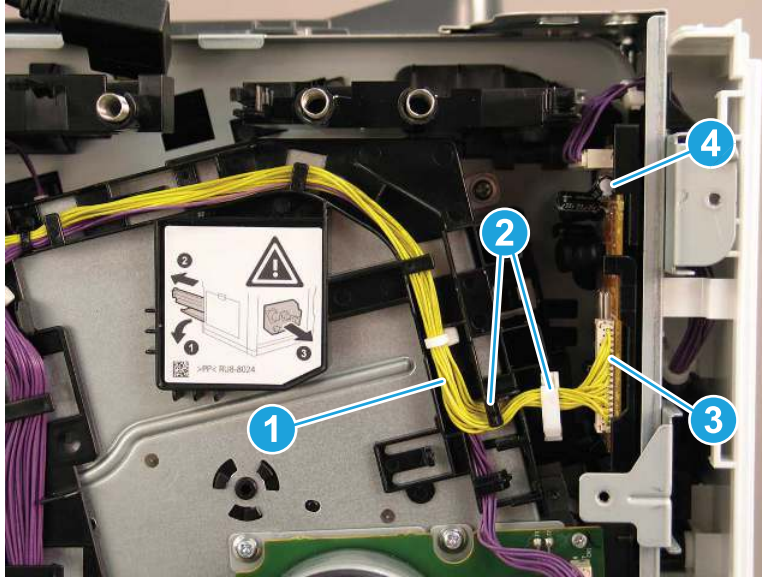
Figure 1-2757 Main drive assembly label



- c. Release the cable (callout 1) from the cable guide (callout 2), and then disconnect one connector (callout 3).

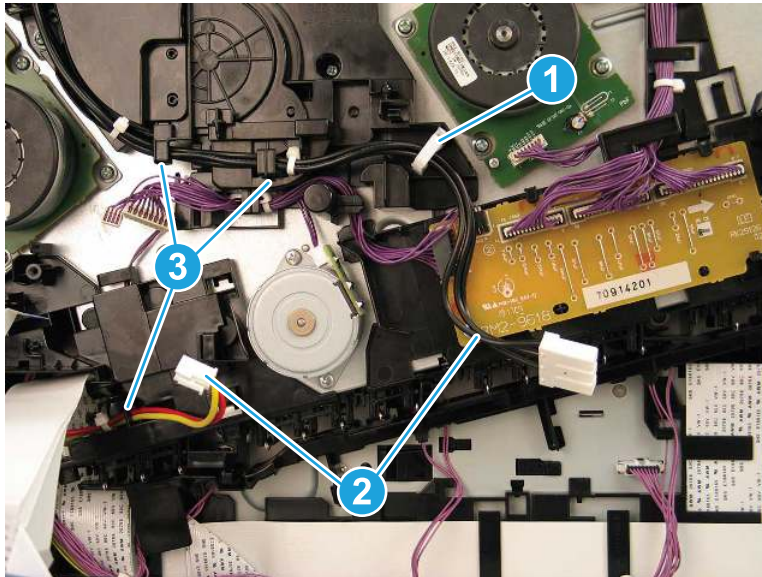
⚠ CAUTION: The capacitor on the PCA (callout 4) can rotate out and prevent the main drive assembly from reseating.

Figure 1-2758 Disconnect one connector



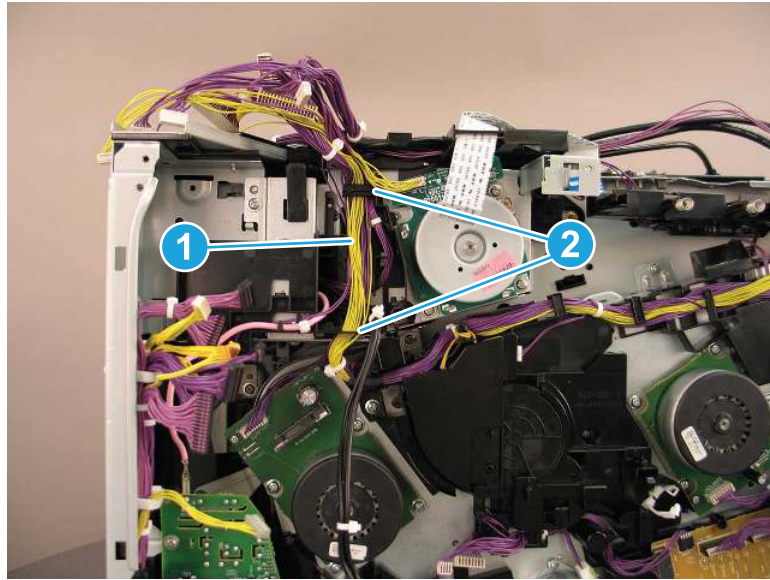
- d. Release the cables (callout 1) from the cable guides (callout 2).

Figure 1-2759 Release the cables from the guides



- e. Release the cables (callout 1) from the cable guides (callout 2).

Figure 1-2760 Release the cables from the guides

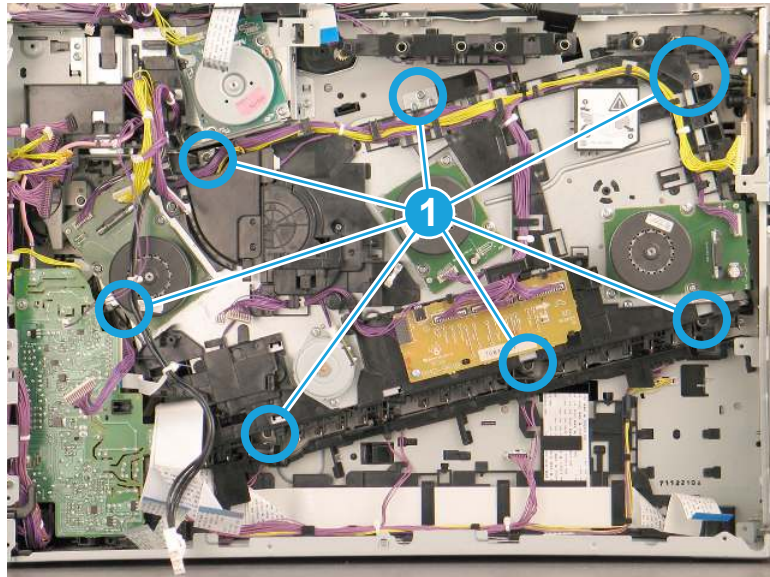


- f. Remove seven screws (callout 1), and then remove the main drive assembly.

IMPORTANT: When reinstalling the main drive assembly, make sure that the front door is open.

Partially reinstall one toner cartridge to prevent the front door from closing.

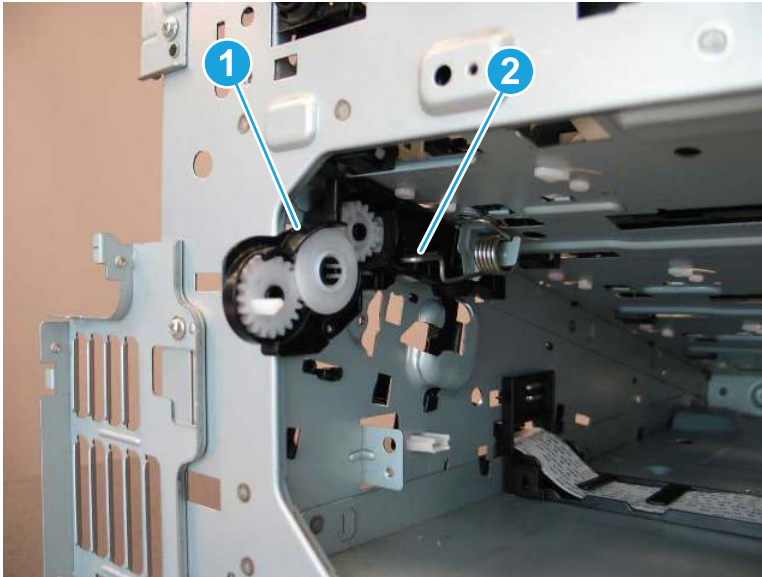
Figure 1-2761 Remove seven screws and the main drive assembly



- 27. Remove the waste toner gear base assembly.

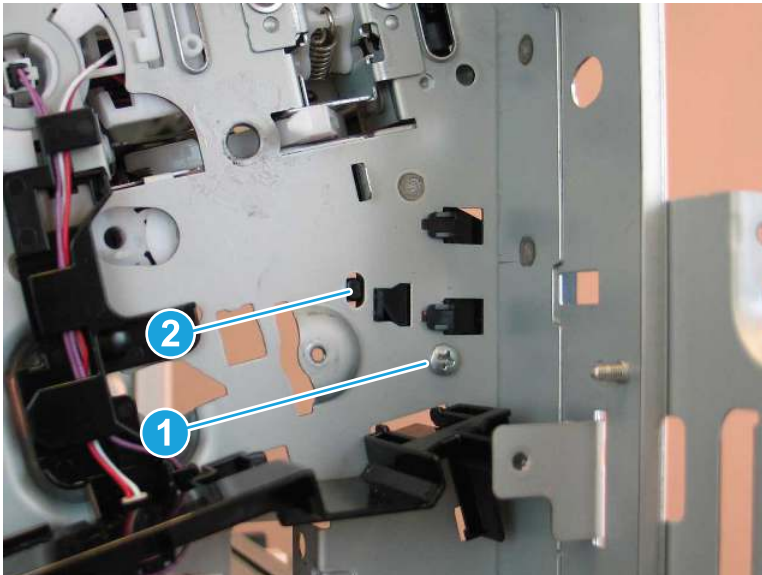
- a. Locate the waste toner gear base assembly (callout 1), and then release the laser scanner spring (callout 2).

Figure 1-2762 Release the laser scanner spring



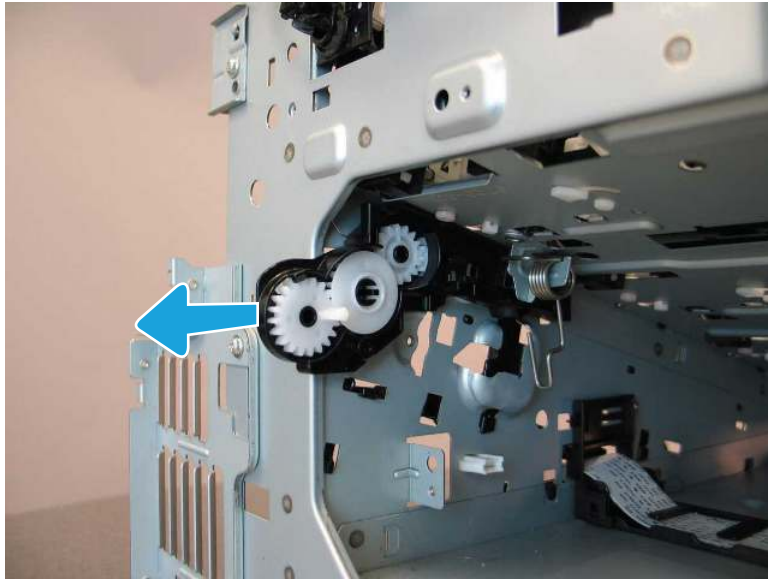
- b. At the back of the printer, remove one screw (callout 1), and then release one tab (callout 2).

Figure 1-2763 Remove one screw and release one tab



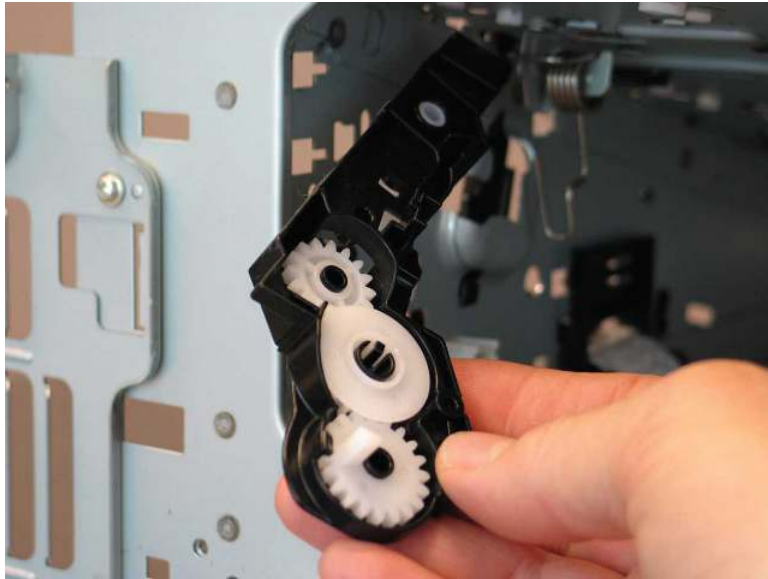
- c. Slide the waste toner gear base assembly away from the printer.

Figure 1-2764 Slide the waste toner gear base assembly



- d. Remove the waste toner gear base assembly.

Figure 1-2765 Remove the waste toner gear base assembly



28. Unpack the replacement assembly.



- a. Dispose of the defective part.




NOTE: HP recommends responsible disposal of the defective part.

<http://www8.hp.com/us/en/hp-information/environment/product-recycling.html>


- b. Unpack the replacement part from the packaging.

 **CAUTION:**  Some parts are sensitive to electrostatic discharge (ESD). Always perform service work at an ESD-protected workstation or mat. If an ESD workstation or mat is not available, touch the sheet-metal chassis to provide a static ground before touching an ESD-sensitive assembly. Protect the ESD-sensitive assemblies by placing them in ESD pouches when they are out of the printer.

If the replacement part is a roller or pad, avoid touching the spongy part of it. Skin oils on the roller or pad can cause paper pickup and/or print-quality problems. HP recommends using disposable gloves when handling rollers or pads or washing your hands before touching rollers or pads.

 **IMPORTANT:** Make sure that all of the shipping materials (for example shipping tape) are removed from the replacement part prior to installation.

- c. To install an assembly, reverse the removal steps.

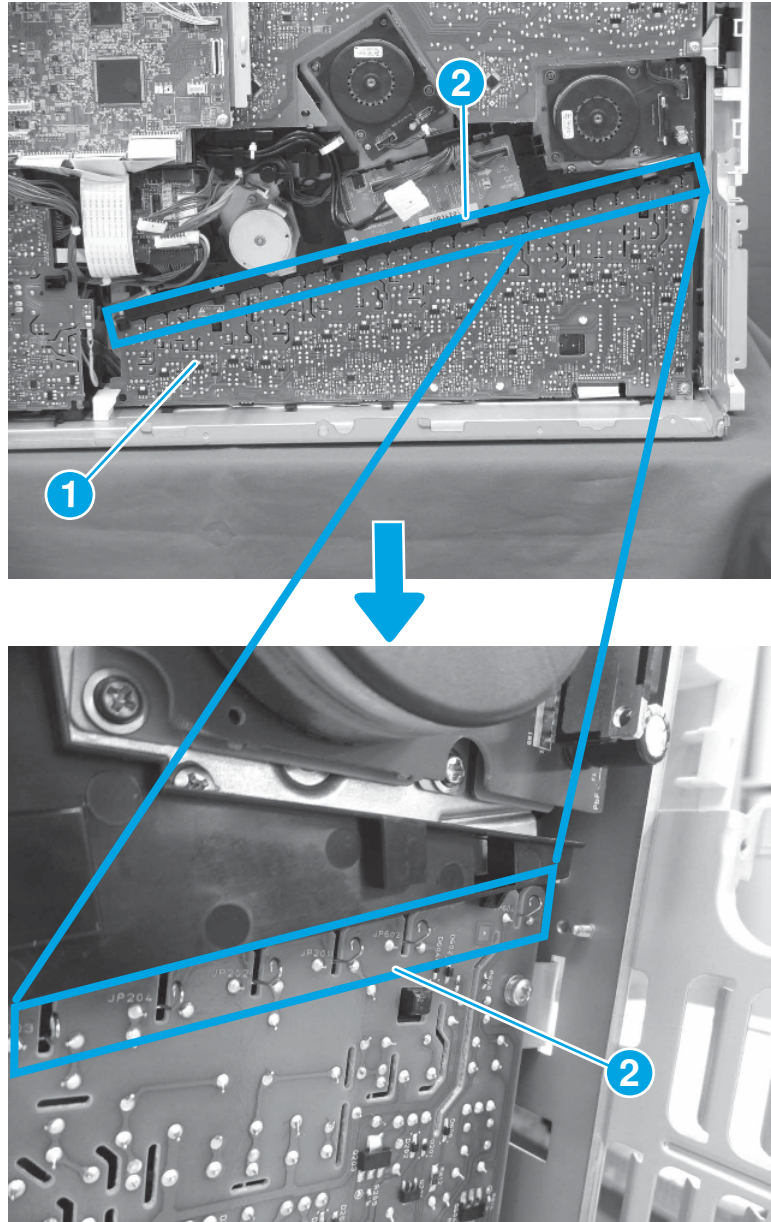
 **NOTE:** When applicable, special installation instructions are provided for an assembly at the end of the removal procedure. Always completely read the removal instructions and follow all special installation instructions.

- 29. Reverse the removal steps to install the assembly. Also use the following **special installation instructions**.

Install the lower HVPS.

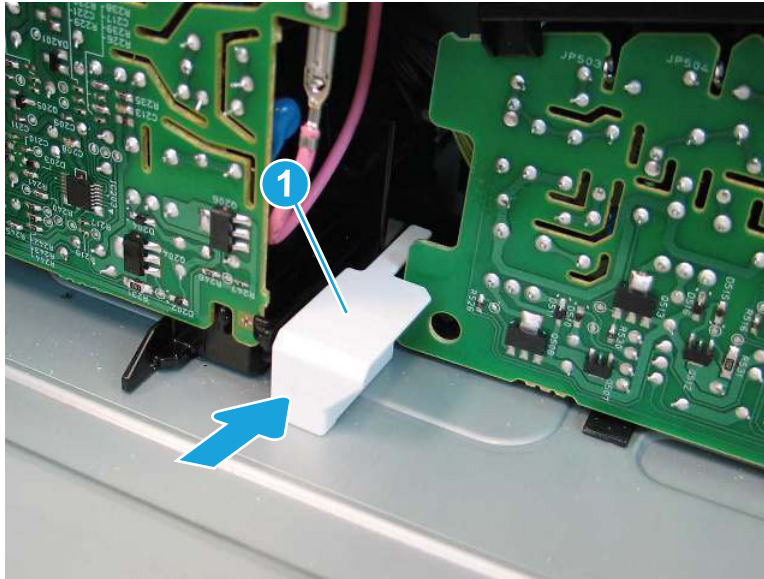
- a. When reinstalling the lower HVPS (callout 1), make sure that the top of the lower HVPS engages with the contact springs (callout 2) and that the springs are in the correct position.

Figure 1-2766 Check the springs



- b. Make sure that the stopper (callout 1) is reinstalled at the bottom of the lower HVPS.

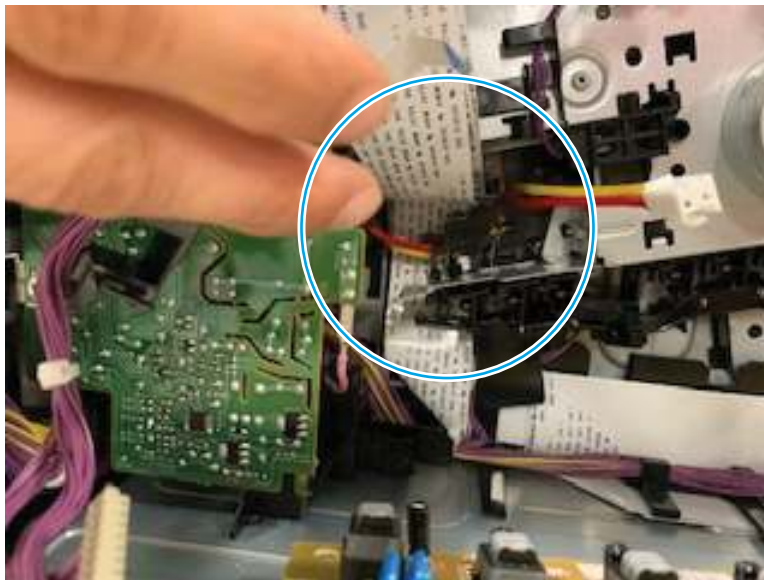
Figure 1-2767 Install the stopper



Install the main drive assembly.

- a. Route the red and yellow cables back into the main drive assembly guides prior to re-installation. This will prevent the cables from being pinched behind the main drive assembly.

Figure 1-2768 Main drive wire harness



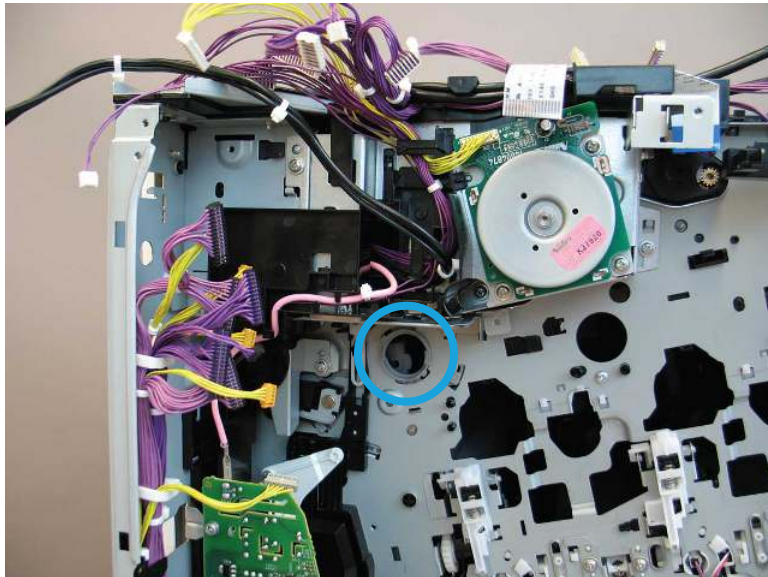
- b. If the coupling estrangement cam falls off of the printer or is broken or lost in the process of removing the main drive assembly, follow these steps to reinstall it.

Figure 1-2769 Coupling estrangement cam



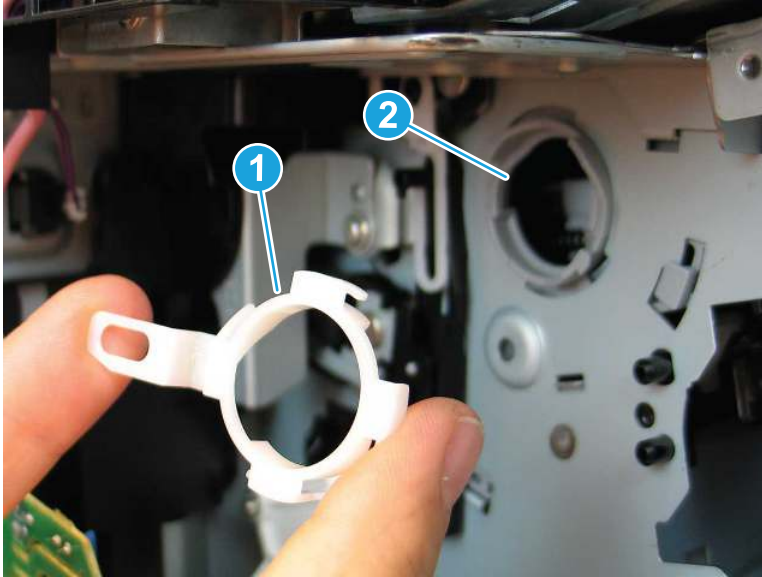
- c. Note the location where the cam will be installed.

Figure 1-2770 Cam location



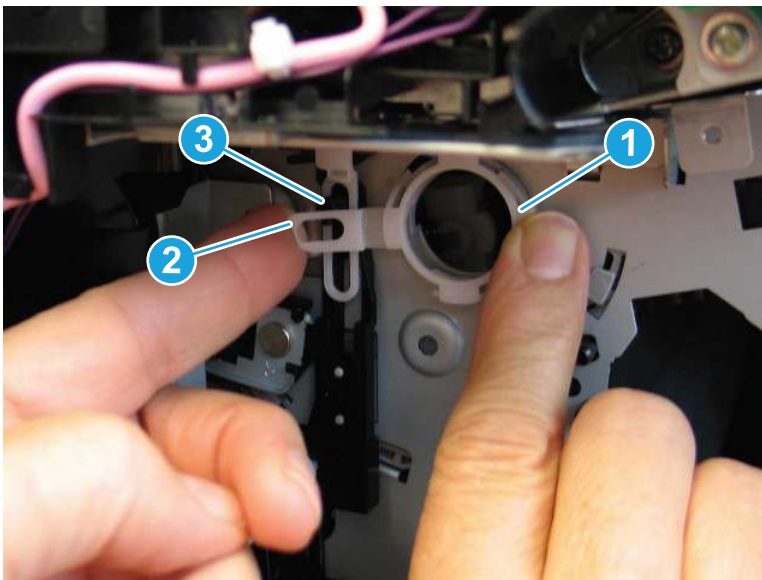
- d. Position the cam (callout 1) over the gray ring (callout 2) on the printer. The tabs on the cam fit into openings on the gray ring.

Figure 1-2771 Position the cam



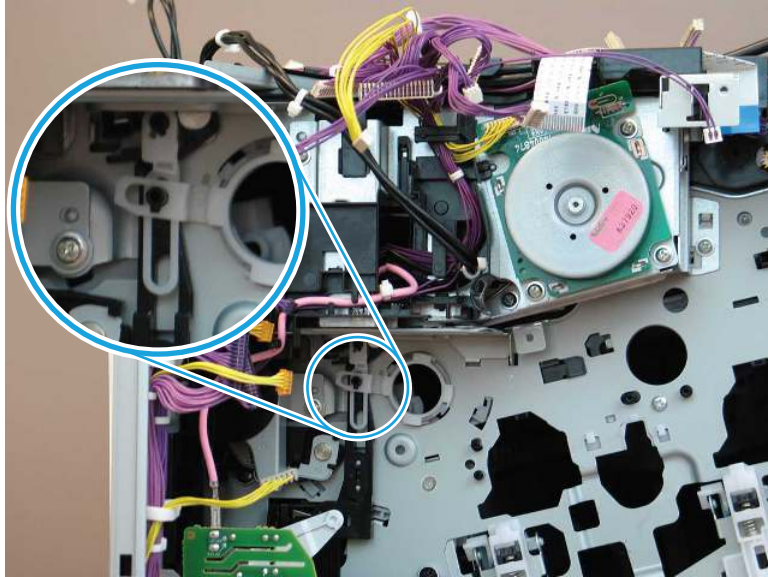
- e. Hold the cam in position (callout 1), and then position the opening in the left side of the cam (callout 2) over the boss (callout 3) on the black link arm on the printer.

Figure 1-2772 Install the cam



- f. When installed correctly, the cam engages with the black link arm on the printer.

Figure 1-2773 Cam correctly installed



Removal and replacement: Waste toner gear base assembly (M856/E85055/M776dn/M776z)

Learn how to remove and replace the waste toner gear base assembly.

[View a video of how to remove and replace the waste toner gear base assembly.](#)

Mean time to repair: 45 minutes

Service level: Difficult

Before performing service

Turn the printer power off

- Disconnect the power cable.

⚠ WARNING! To avoid damage to the printer, turn the printer off, wait 30 seconds, and then remove the power cord before attempting to service the printer.

Use the table below to identify the correct part number for your printer. To order the part, go to www.hp.com/buy/parts.

Table 1-132 Part information

Part number	Part description
RM2-1364-000CN	Waste toner gear base assembly

Required tools

- #2 Phillips screwdriver with a magnetic tip
- Small, flat-blade screwdriver

After performing service

Turn the printer power on

- Connect the power cable.
- Use the power switch to turn the power on.

Post service test

Make sure that the printer initializes to a **Ready** state.

Print a page to make sure that the printer is functioning correctly.

1. Remove the toner cartridges.
 - ▲ Open the front door, if it is not already open. Grasp the handle of the toner cartridge and pull out to remove it. Repeat the process for the remaining toner cartridges.

Figure 1-2774 Remove the toner cartridge



2. Remove the imaging drums.

- a. Open the front door, if it is not already open. Rotate the blue lever in front of the imaging drum to the left.

Figure 1-2775 Rotate the blue lever



- b. Grasp the handle of the imaging drum and pull out to remove it. Repeat the process for the remaining imaging drums.

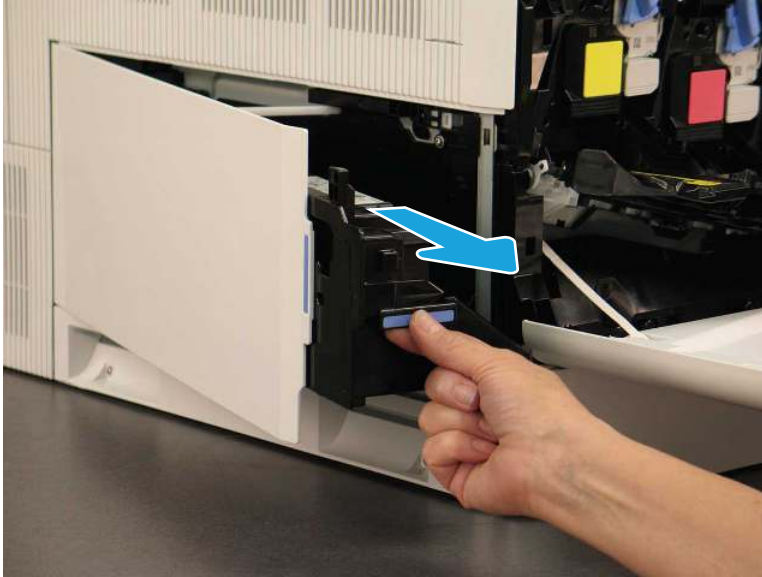
Figure 1-2776 Remove the imaging drum



3. Remove the TCU.

- ▲ Open the front door, and then open the left door. Grasp the front of the toner-collection unit, and then remove it from the printer.

Figure 1-2777 Remove the TCU



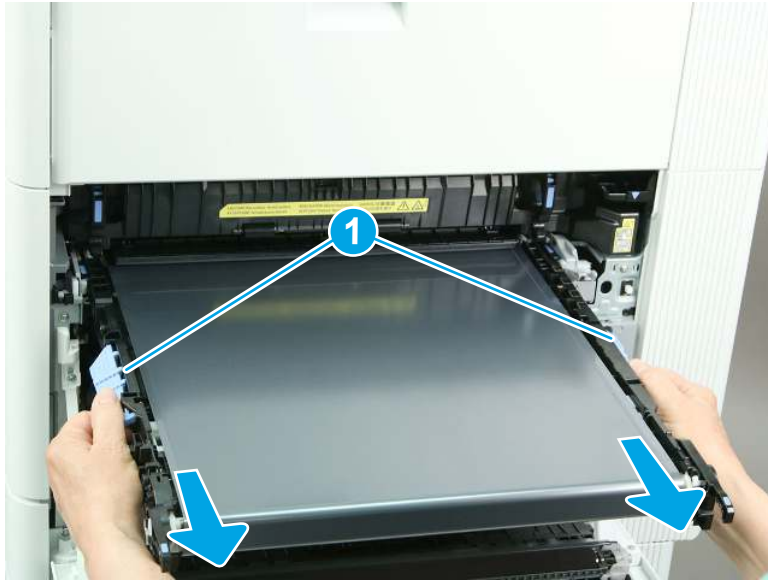
- 4. Remove the intermediate transfer belt (ITB).
 - a. Open the right door. Grasp the two blue handles on the ITB, and then pull the ITB partially out of the printer.

Figure 1-2778 Partially remove the ITB



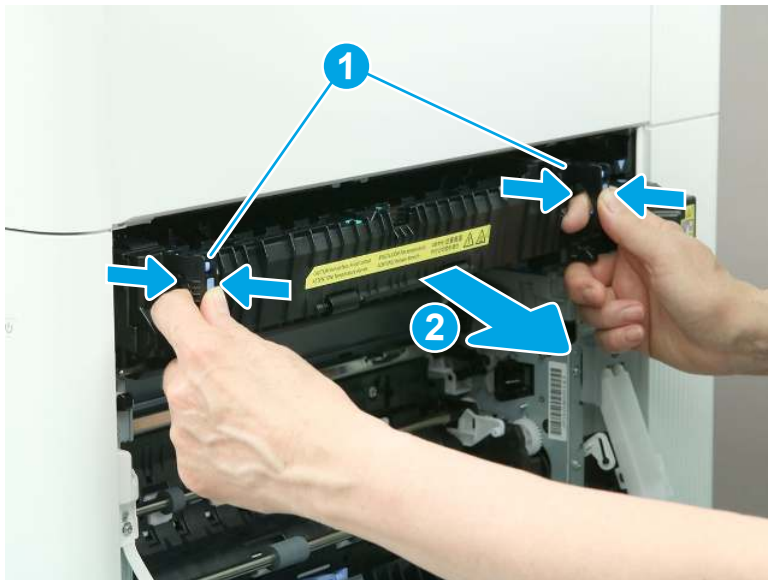
- b. Grasp the blue handles on the side of the ITB (callout 1), and then remove the ITB from the printer.

Figure 1-2779 Remove the ITB



5. Remove the fuser.
 - ▲ Grasp the fuser handles, and then squeeze the release levers (callout 1). Lift up slightly, and then pull straight out to remove the fuser (callout 2).

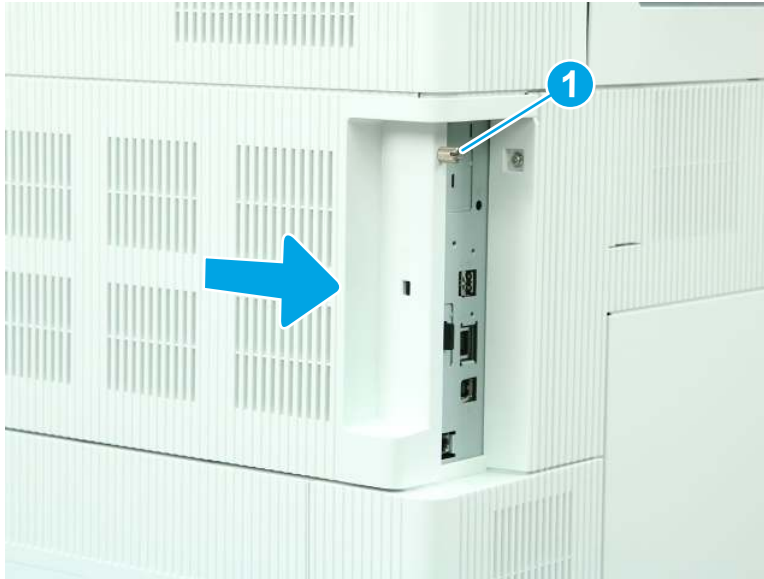
Figure 1-2780



6. Remove the formatter cover.

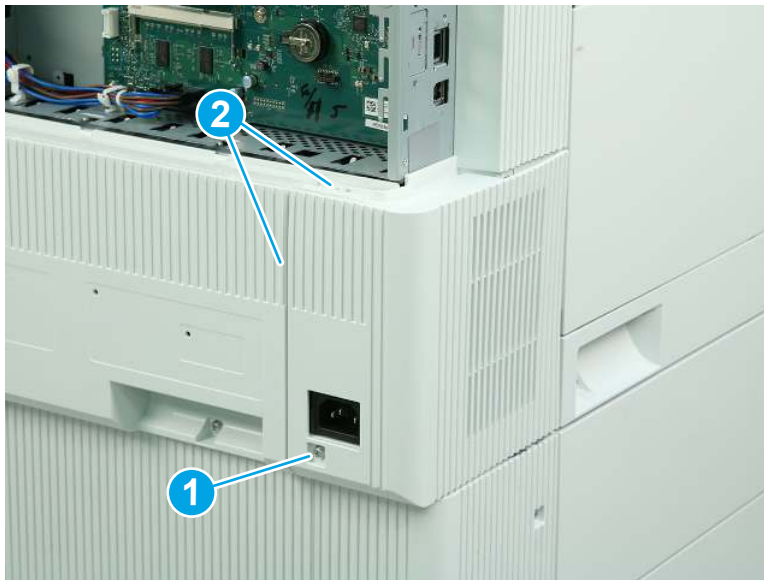
- ▲ Loosen one thumbscrew (callout 1), and then slide the formatter cover (callout 2) away from the printer to remove it.

Figure 1-2781 Remove the formatter cover



- 7. Remove the left lower cover (M856/E85055/M776).
 - a. Remove one screw (callout 1), and then release two tabs (callout 2).

Figure 1-2782 Remove one screw and release two tabs



- b. Rotate the cover away from the printer to remove it.

Figure 1-2783 Remove the left lower cover



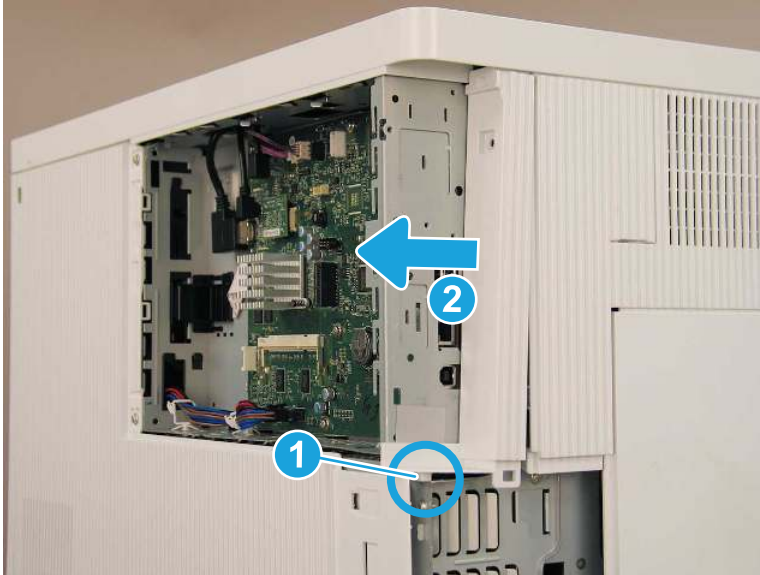
8. Remove the left rear cover (M751/E75245/M856/E85055/M776).
 - a. Remove one screw (callout 1).

Figure 1-2784 Remove one screw



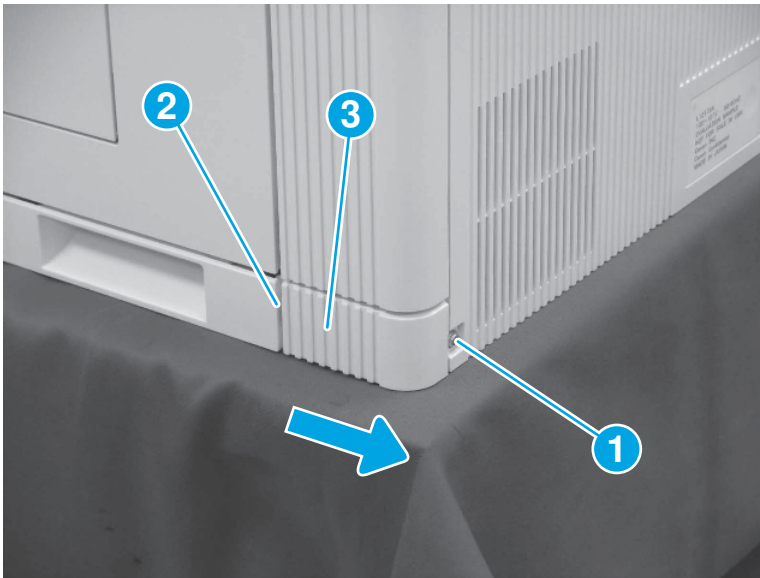
- b. Release one boss (callout 1), and then slide the cover toward the back of the printer (callout 2) to remove it.

Figure 1-2785 Remove the left rear cover



9. Remove the right rear lower cover (M751/E75245/M856/E85055/M776).
 - ▲ Remove one screw (callout 1), release one tab (callout 2), and then slide the right rear lower cover (callout 3) toward the back of the printer to remove it.

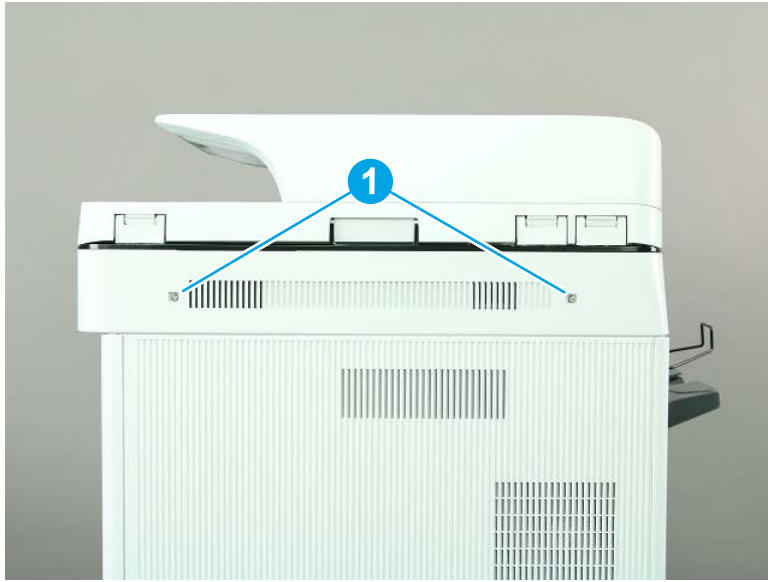
Figure 1-2786 Remove the right rear lower cover



10. Remove the scanner control board (SCB) cover (M776).

- a. Remove two screws (callout 1).

Figure 1-2787 Remove two screws



- b. Remove the SCB cover.

Figure 1-2788 Remove the SCB cover

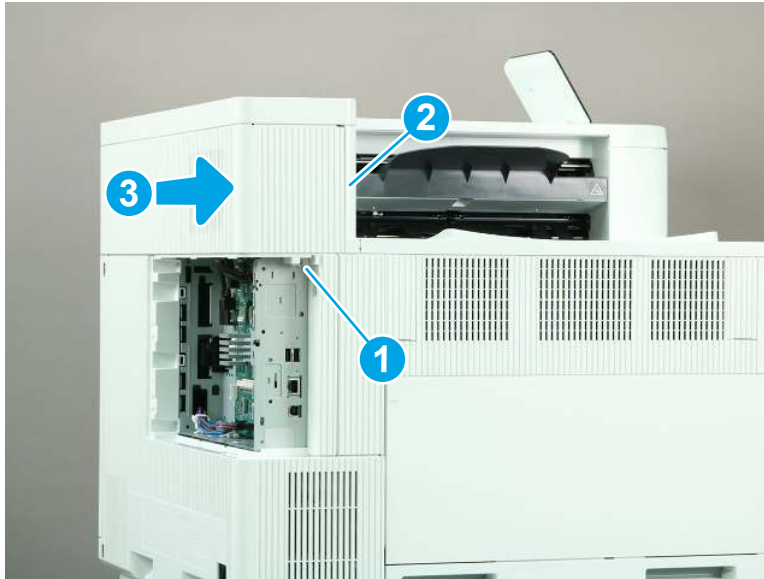


11. Remove the rear upper cover (M856/E85055/M776dn/M776z).

 **NOTE:** The following figure shows the M856 printer. The procedure is correct for all referenced models.

- ▲ Remove one screw (callout 1), release one tab (callout 2), and then slide the rear upper cover away from the printer to remove it (callout 3).

Figure 1-2789 Remove the rear upper cover

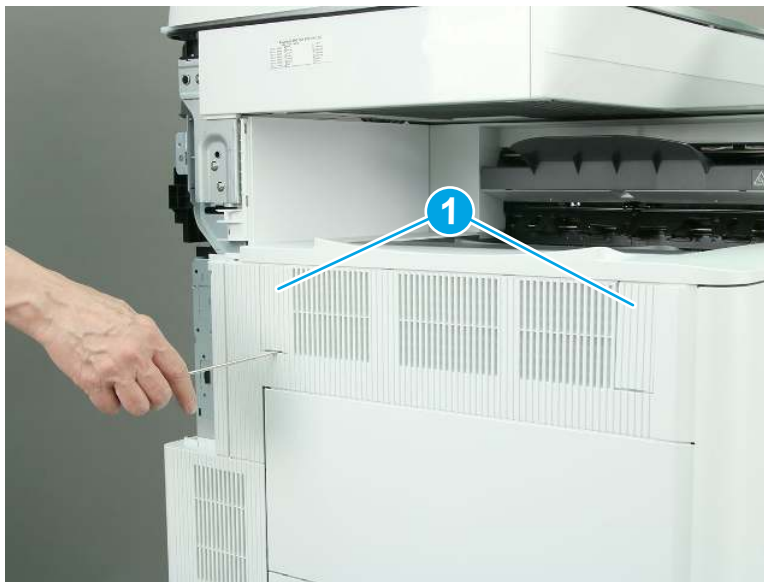


12. Remove the accessory upper cover (M856/E85055/M776dn/M776z).

 **NOTE:** The following figures show the M776z printer. The procedure is correct for all referenced models.

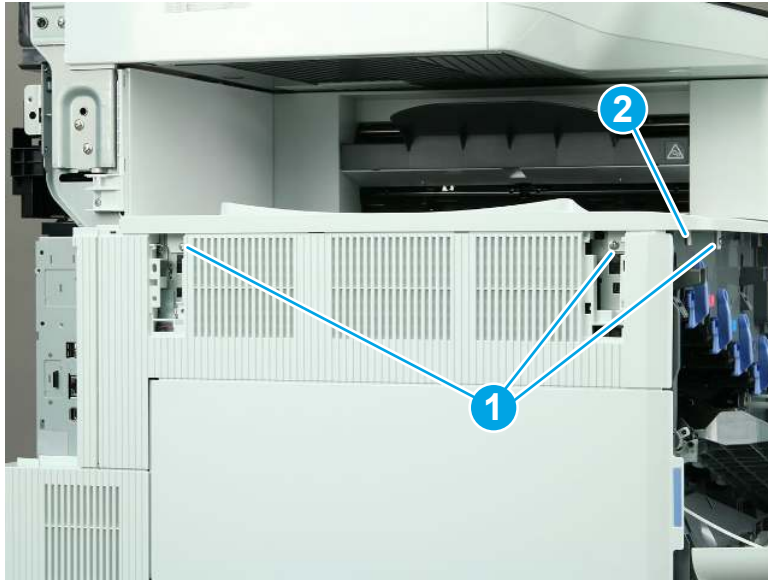
- a. Use a small, flat-blade screwdriver to remove two covers (callout 1).

Figure 1-2790 Remove two covers



- b. Remove three screws (callout 1), and then release one tab (callout 2).

Figure 1-2791 Remove three screws and release one tab



- c. Slide the accessory upper cover away from the printer to remove it.

Figure 1-2792 Remove the accessory upper cover

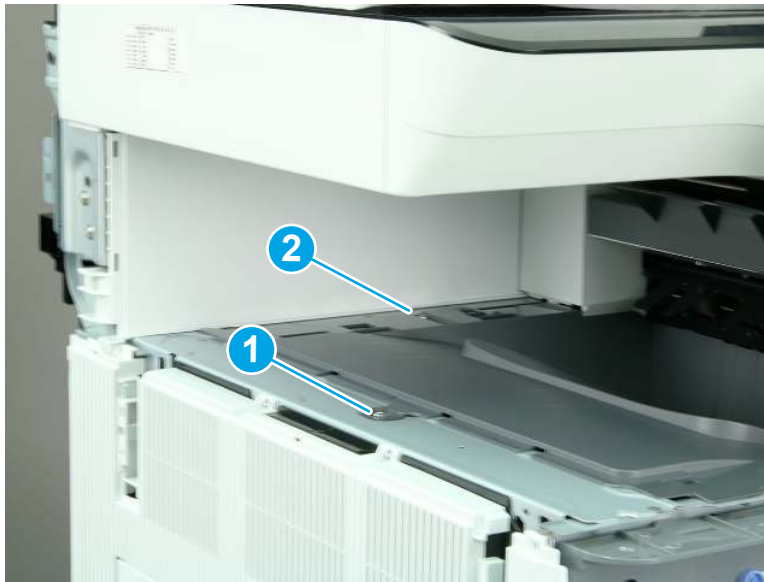


- 13. Remove the output bin (M856/E85055/M776).

 **NOTE:** The following figures show the M776z printer. The procedure is correct for all referenced models.

- a. Remove one washer-head machine screw (callout 1), remove one self-tapping screw (callout 2).

Figure 1-2793 Remove two screws



- b. Remove the output bin.

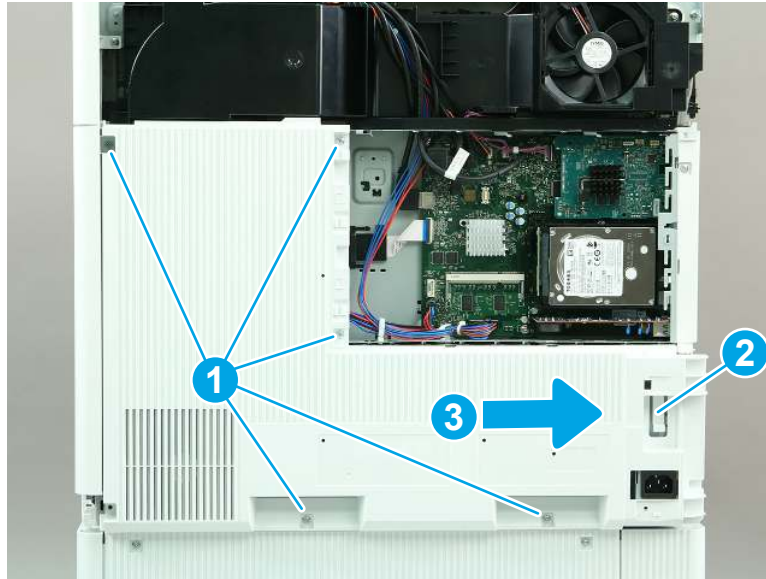
Figure 1-2794 Remove the output bin




14. Remove the rear cover (M856/E85055/M776).

- ▲ Remove five screws (callout 1), release one tab (callout 2), and then slide the rear cover to the right to remove it.

Figure 1-2795 Remove the rear cover (M856/E85055/M776)



15. **M856/E85055 only:** Remove the control panel and top cover.

 **NOTE:** This step applies to only the M856/E85055 models. Skip this step for all other models.

- a. Use a small, flat-blade screwdriver to release two tabs (callout 1), and then remove the control panel cover (callout 2).

Figure 1-2796 Remove the control panel cover



- b. Remove one screw (callout 1).

Figure 1-2797 Remove one screw



- c. Lift the back edge of the control panel up (callout 1), and then slide the control panel toward the back of the printer (callout 2).

Figure 1-2798 Slide the control panel back



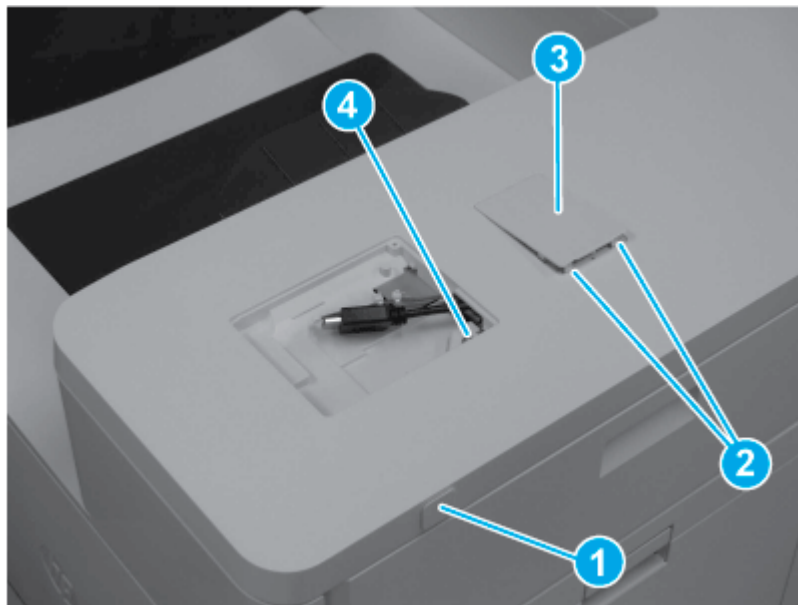
- d. Turn the control panel so that the bottom is facing up, and then disconnect two connectors to remove the control panel.

Figure 1-2799 Disconnect two connectors



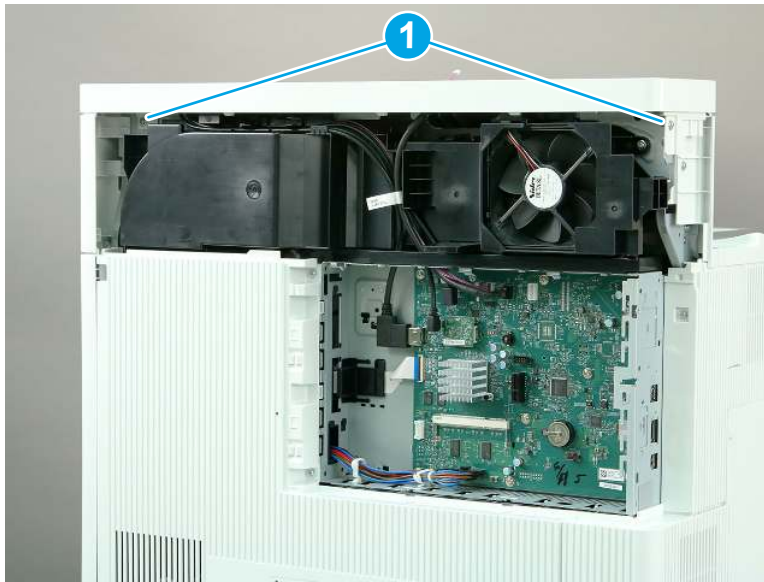
- e. Remove the USB cover (callout 1). Release two tabs (callout 2), and then remove the HIP cover (callout 3). Remove one screw (callout 4).

Figure 1-2800 Remove covers and one screw



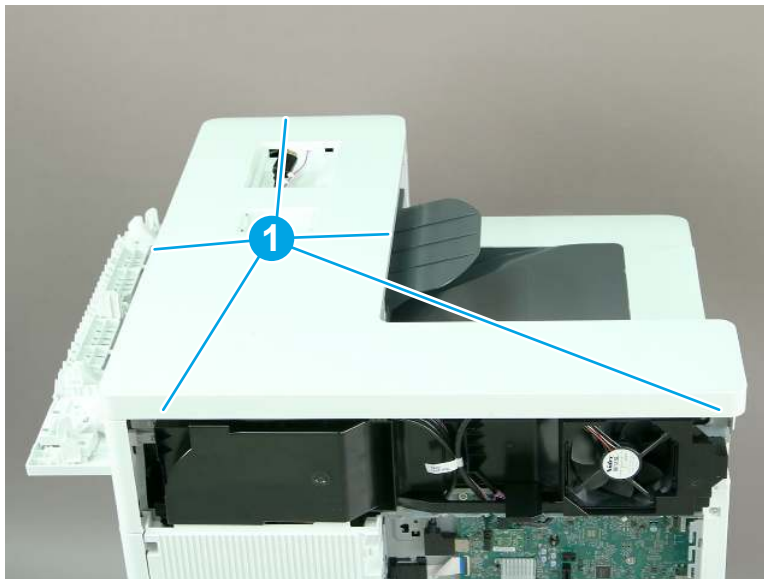
- f. Remove two screws (callout 1).

Figure 1-2801 Remove two screws



- g. Release five tabs (callout 1), and then remove the top cover.

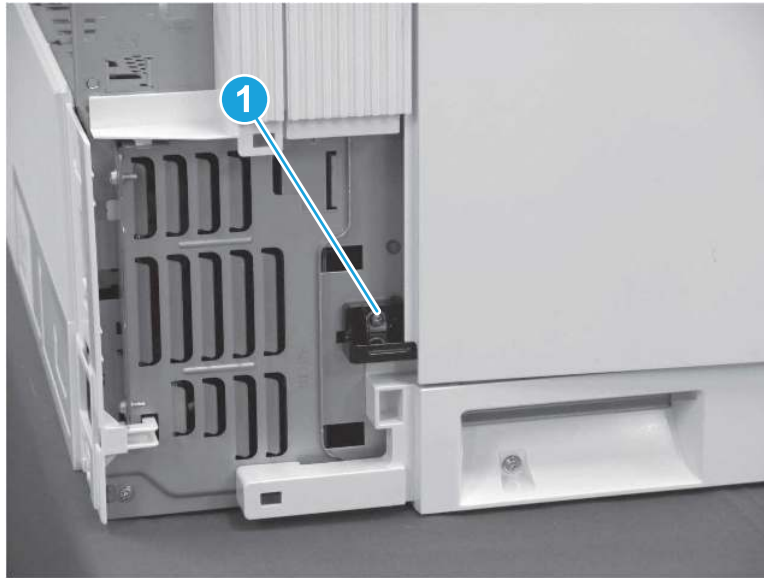
Figure 1-2802 Release five tabs



- 16. Remove the left door.

- a. Remove one screw (callout 1).

Figure 1-2803 Remove one screw



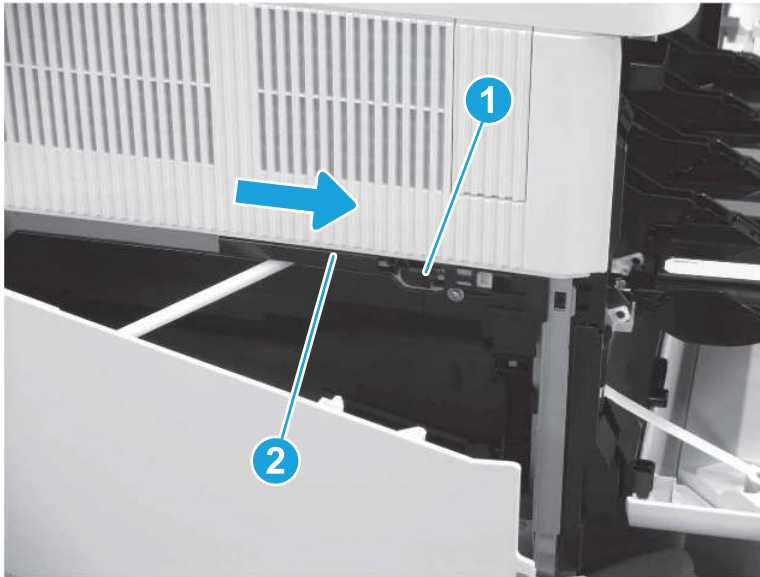
- b. Release the holder, and then remove it from the printer.

Figure 1-2804 Remove the holder



- c. Open the left door, and release one tab (callout 1). Slide the holder (callout 2) toward the front of the printer.

Figure 1-2805 Slide the holder



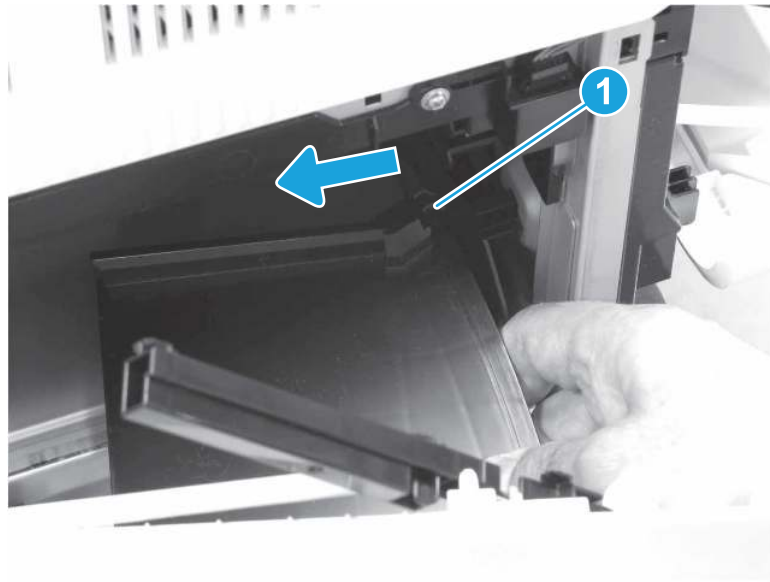
- d. Release the holder (callout 1) from the printer, but leave it attached to the hinge.

Figure 1-2806 Release the holder



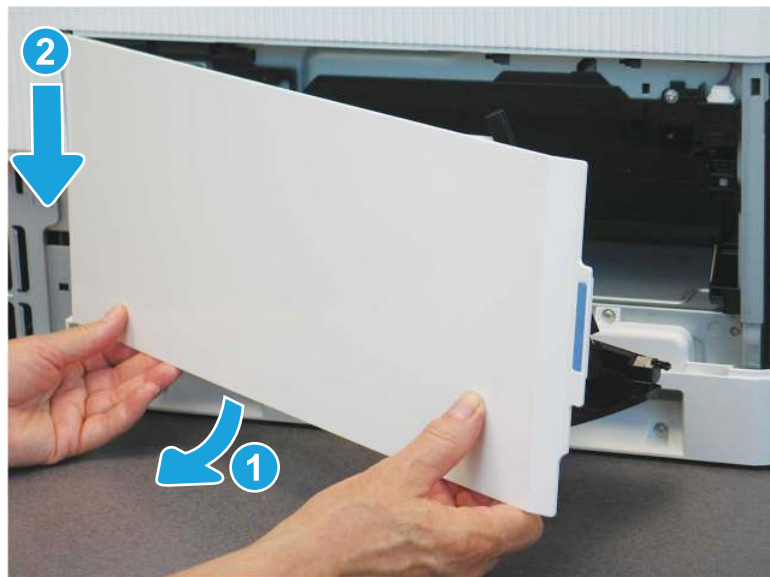
- e. Press the stopper (callout 1) on the bottom of the door to the left to release it from the track.

Figure 1-2807 Release the stopper



- f. Rotate the left, lower edge of the door away from the printer (callout 1), and then lower the door to remove it (callout 2).

Figure 1-2808 Remove the left door

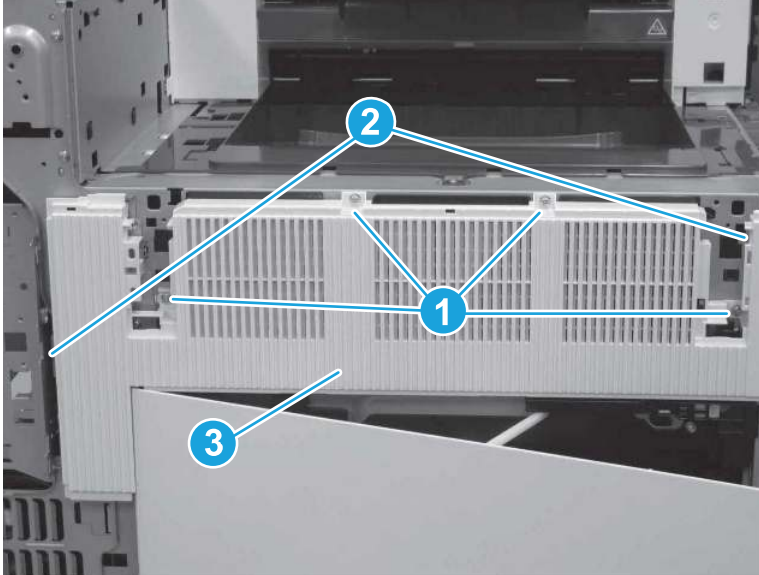


- 17. Remove the left upper cover (M856/E85055/M776).

 **NOTE:** The following figures show the M776z printer. The procedure is correct for all referenced models.

- ▲ Remove four screws (callout 1), release two tabs (callout 2), and then remove the left upper cover (callout 3).

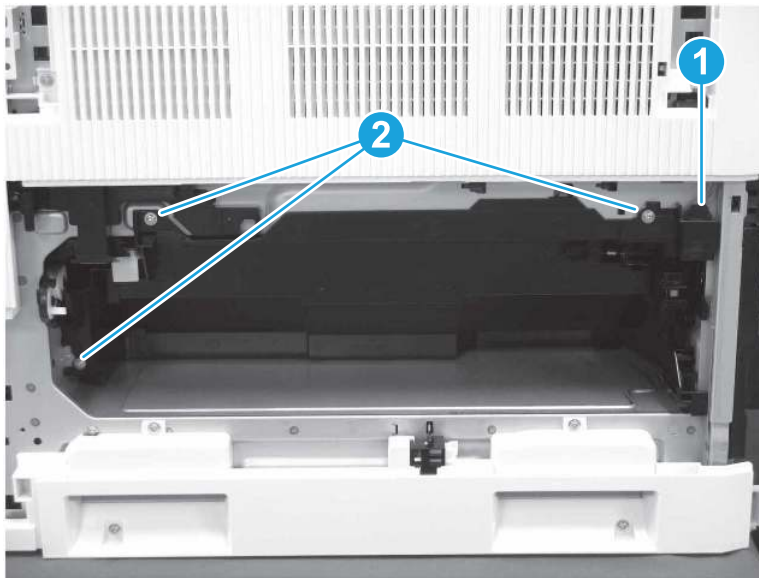
Figure 1-2809 Remove the left upper cover



- 18. Remove the scanner cover.

- a. Disconnect one connector (callout 1), and then remove three screws (callout 2).

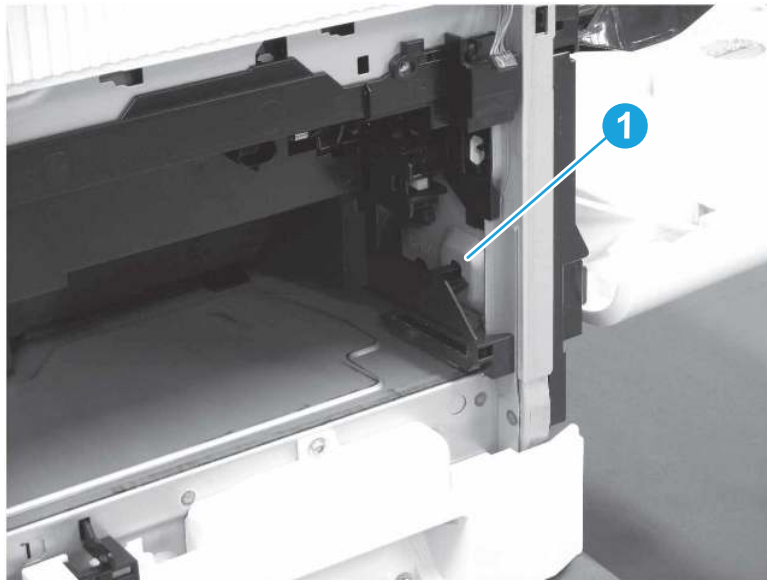
Figure 1-2810 Disconnect one connector and remove three screws



 **TIP:** Connect the connector before reinstalling the screws.

- b. Release one tab (callout 1), and then flex the scanner cover to remove it.

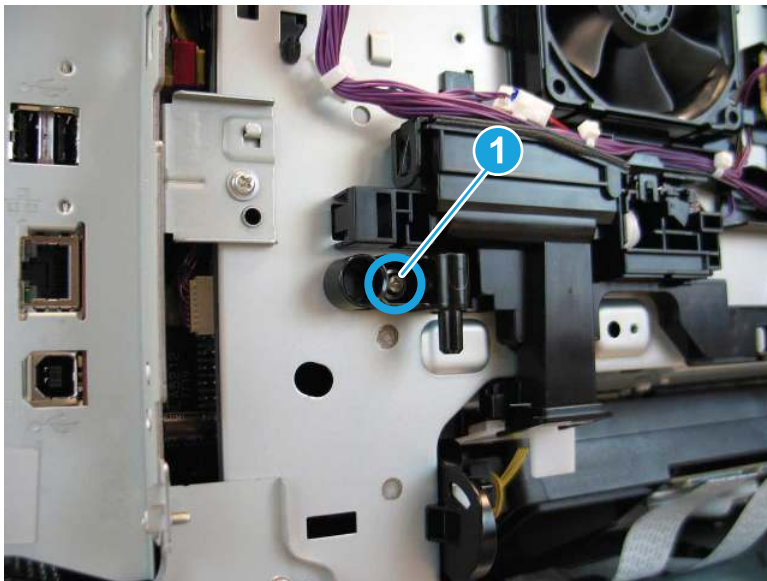
Figure 1-2811 Remove the scanner cover



- 19. Remove the secondary auger.

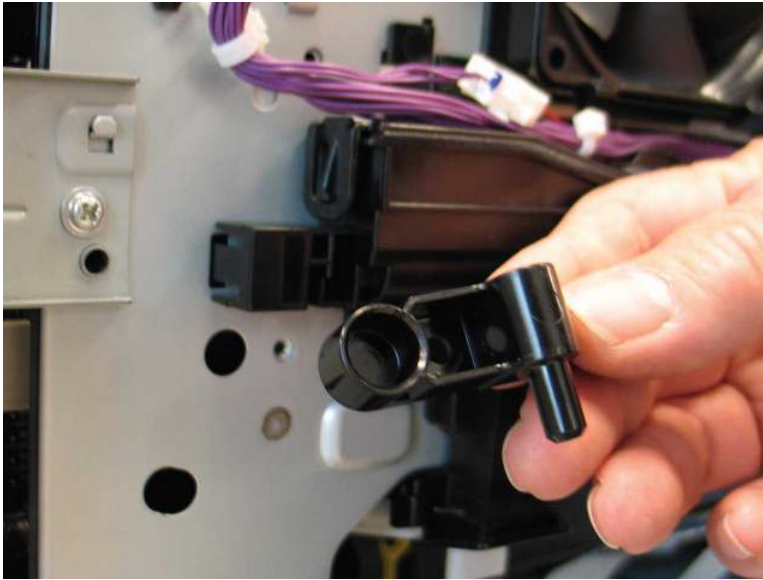
- a. Remove one screw (callout 1).

Figure 1-2812 Remove one screws



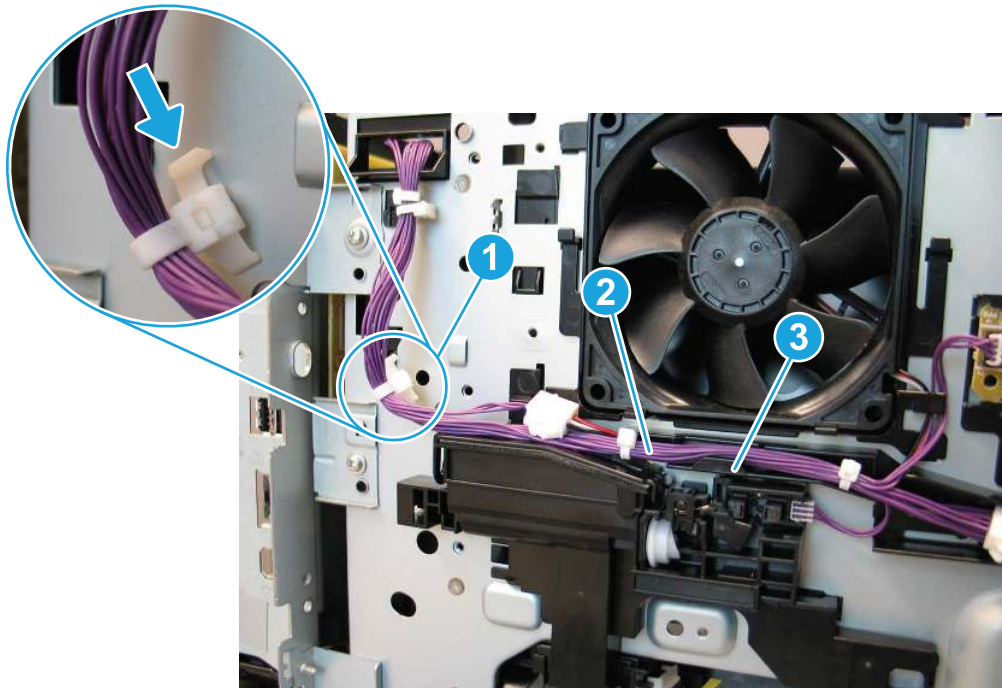
- b. Remove the left door upper hinge.

Figure 1-2813 Remove the left door upper hinge



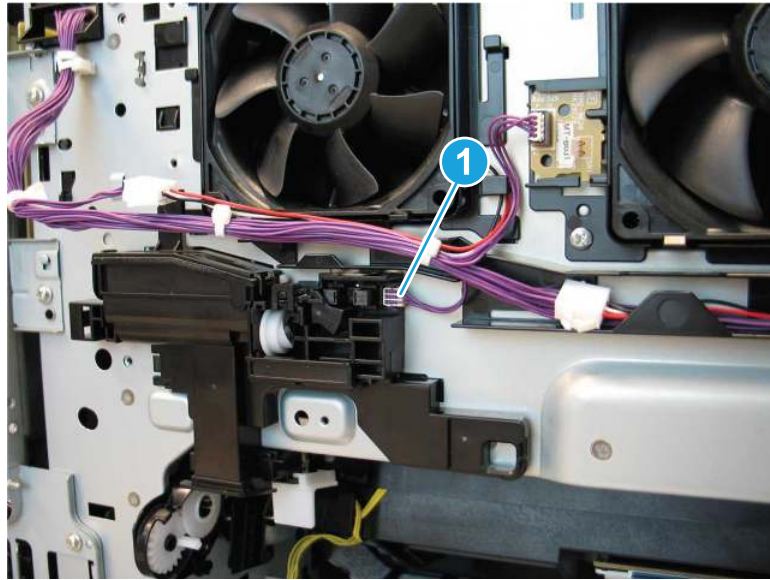
- c. Press the latch to release one retainer (callout 1) from the sheet metal. Remove the wire harness (callout 2) from the guides (callout 3).

Figure 1-2814 Release the wire harness from the guides



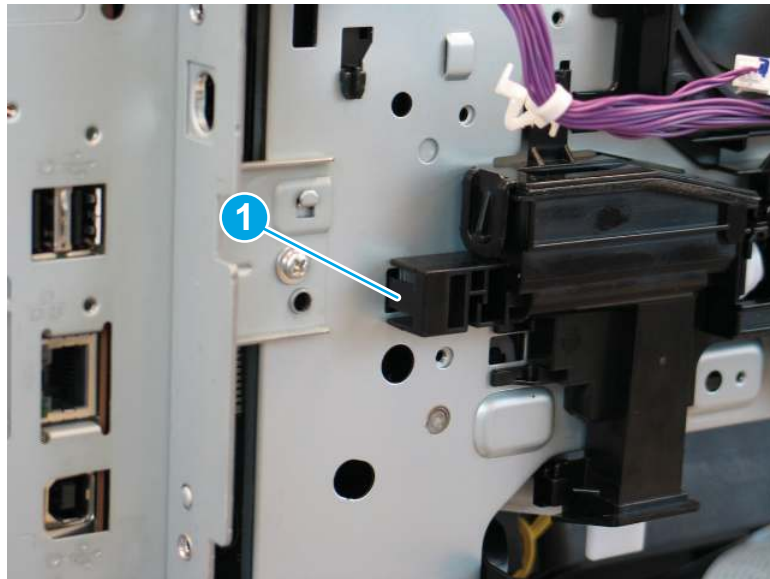
- d. Disconnect one connector (callout 1).

Figure 1-2815 Disconnect one connector



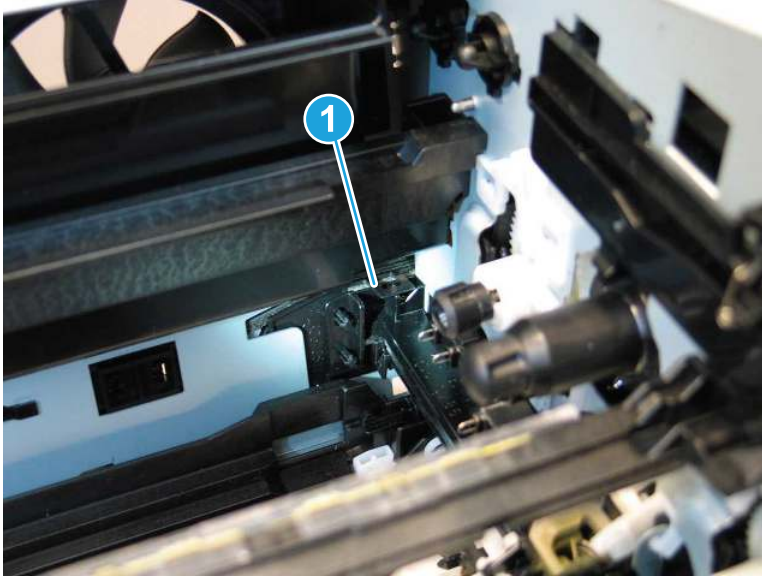
- e. Release one tab (callout 1).

Figure 1-2816 Release one tab



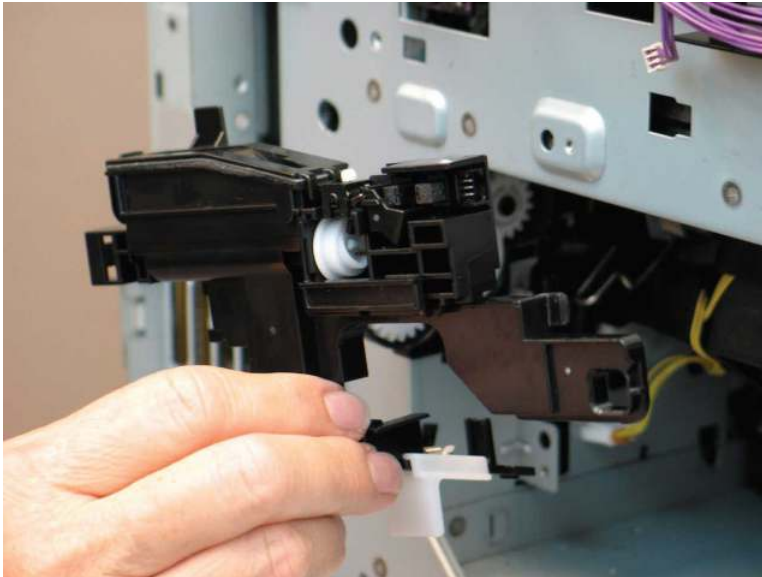
- f. Inside the printer, release one tab that connects to the primary auger (callout 1).

Figure 1-2817 Release one tab




- g. Remove the secondary auger assembly.

Figure 1-2818 Remove the secondary auger assembly

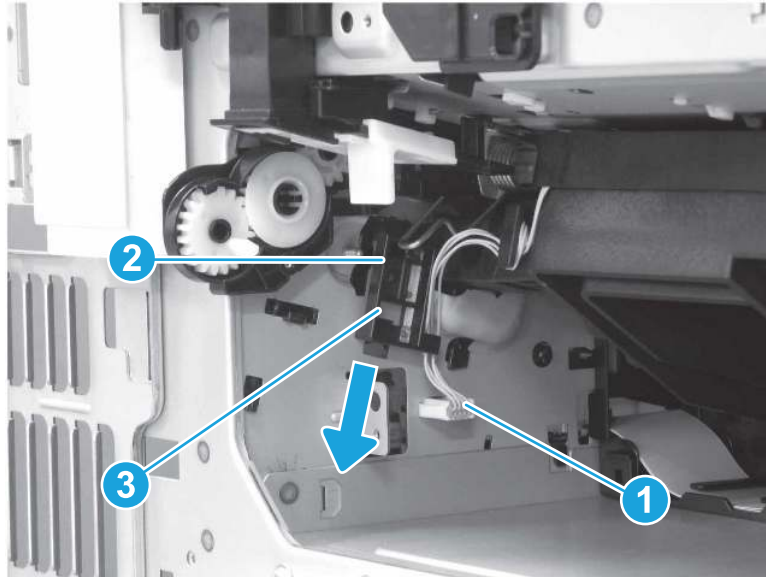


20. Remove the laser scanner.

 **IMPORTANT:** The front door must be open while removing and installing the laser scanner to avoid damaging the laser scanner cleaning pads.

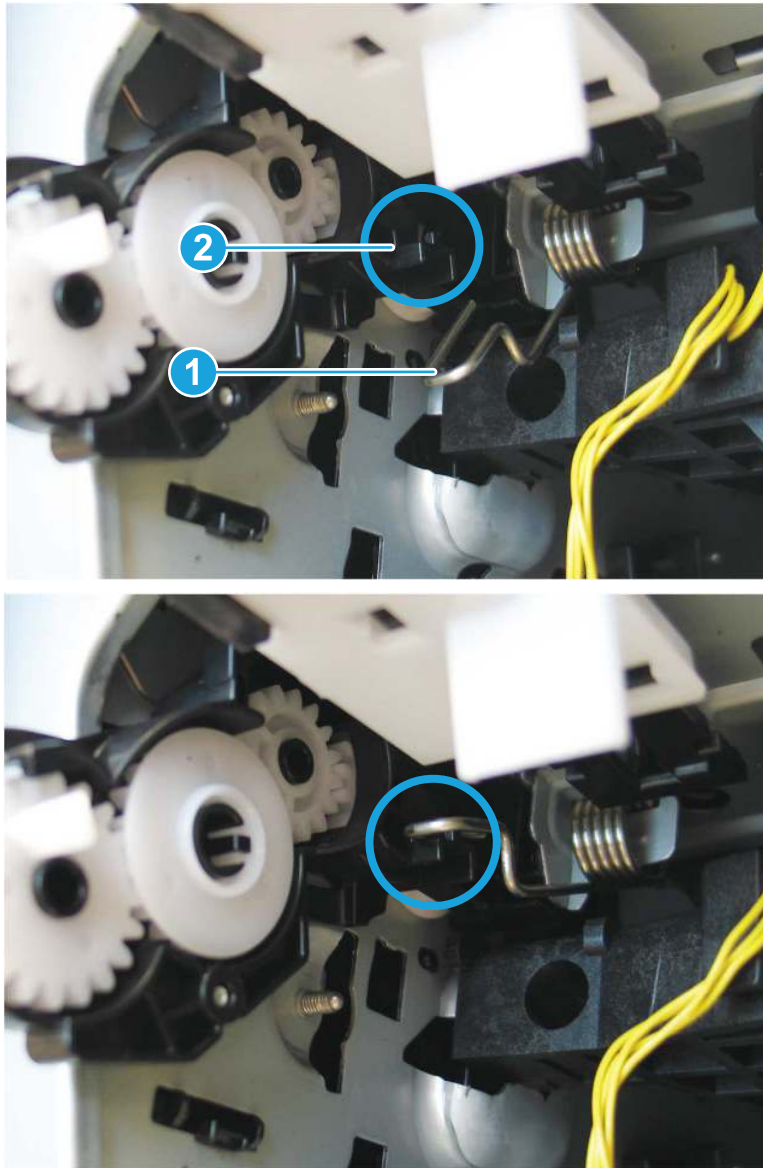
- a. Disconnect one connector (callout 1), release one tab (callout 2), and then slide the stopper (callout 3) down to remove it.


Figure 1-2819 Remove the stopper

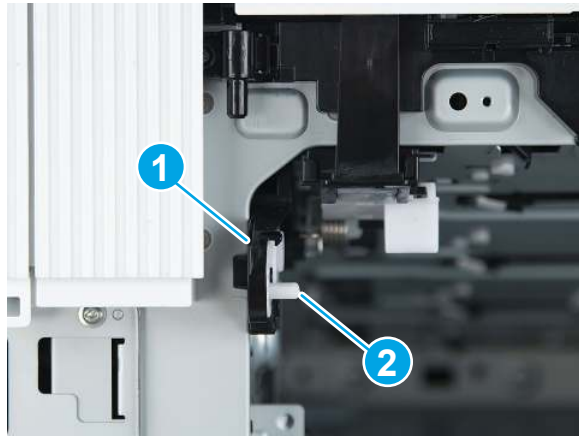


- b. Hook the spring (callout 1) on the hook (callout 2).

Figure 1-2820 Hook the spring

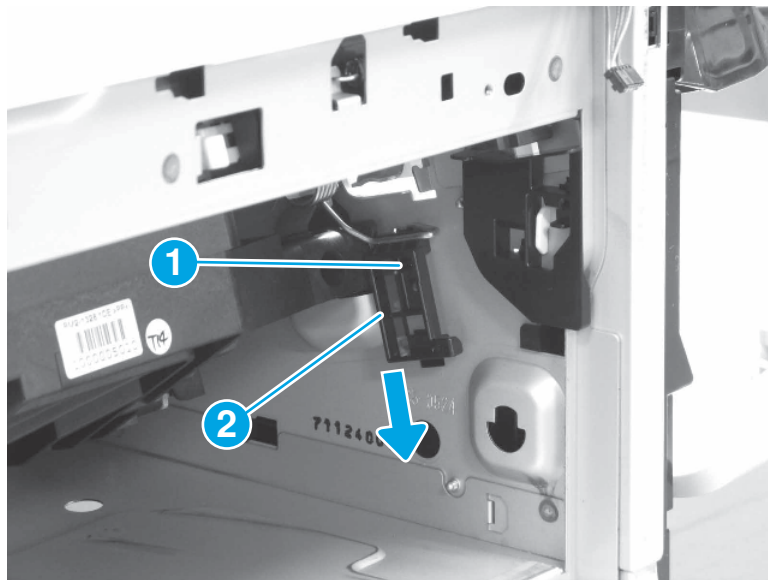


 **TIP:** When the laser scanner is installed, make sure that the gear case is flat against the printer chassis (callout 1). The pin on the gear (callout 2) might need to be rotated out of the way when the assembly is installed.



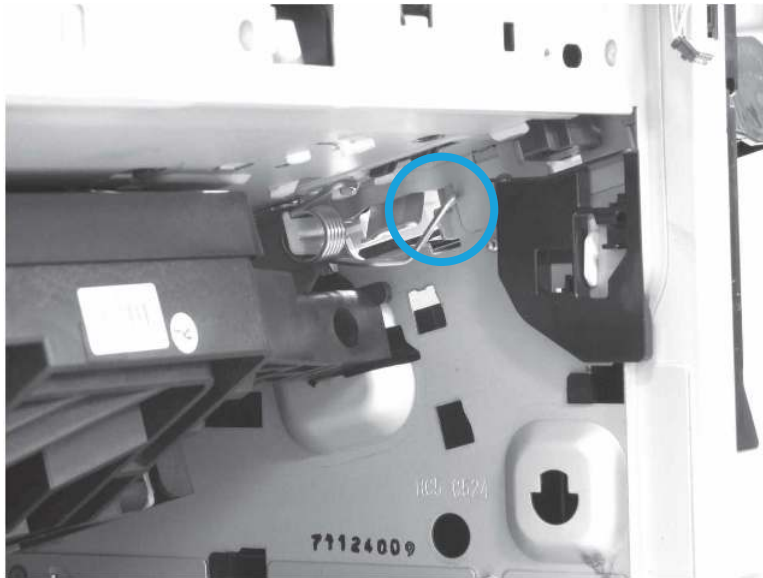
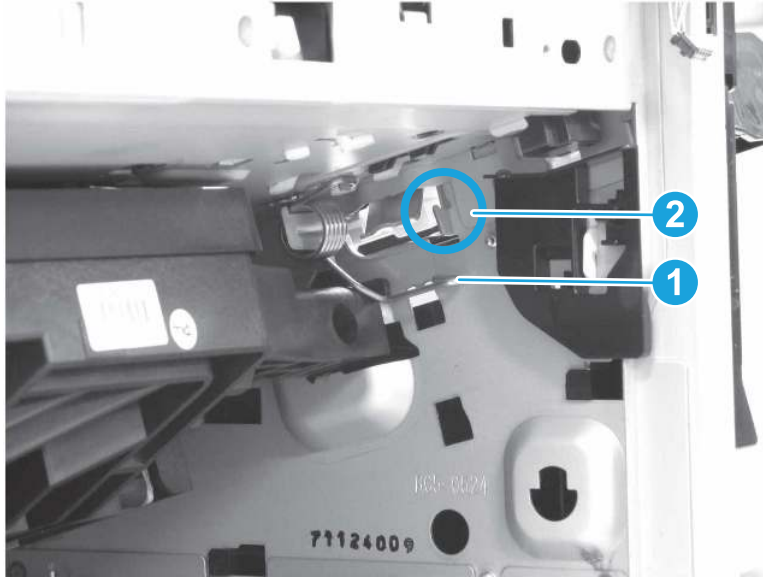
- c. On the right side of the laser scanner, release one tab (callout 1), and then slide the stopper (callout 2) down to remove it.

Figure 1-2821 Remove the stopper



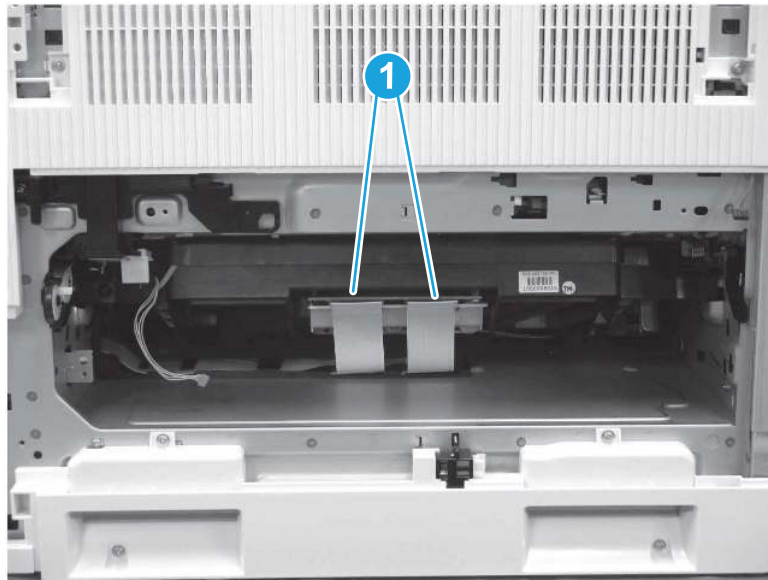
- d. Hook the spring (callout 1) on the hook (callout 2).

Figure 1-2822 Hook the spring



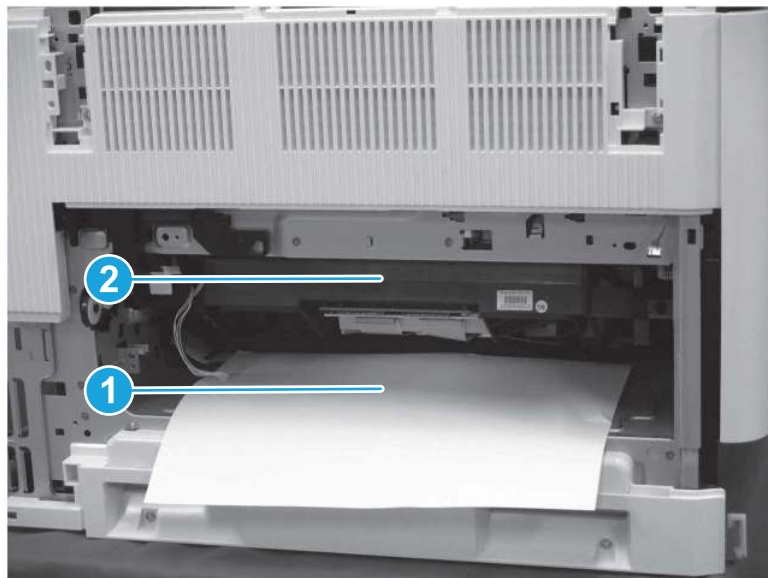
- e. Disconnect two flat cables (callout 1).


Figure 1-2823 Disconnect two flat cables




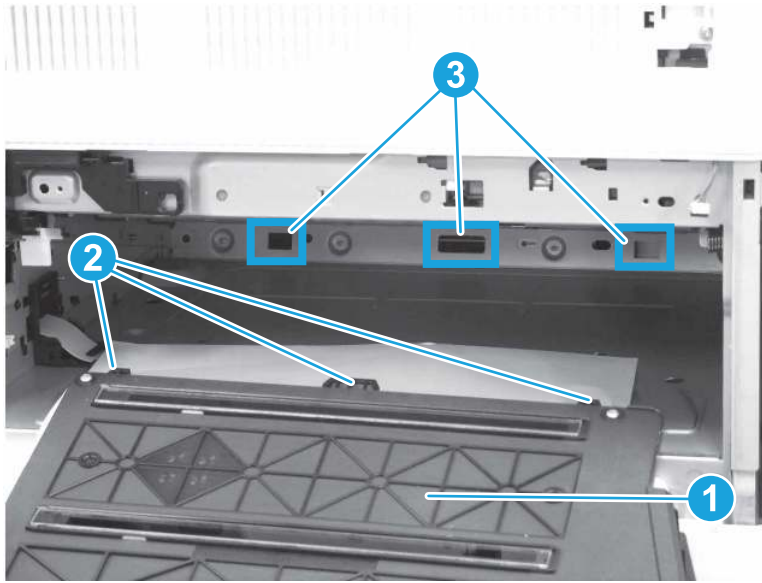
- f. Lay a sheet of paper on top of the flat cables (callout 1) to protect them. Pull the laser scanner (callout 2) out of the printer to remove it.

Figure 1-2824 Remove the laser scanner



 **IMPORTANT:** The front door must be open while removing and installing the laser scanner to avoid damaging the laser scanner cleaning pads.

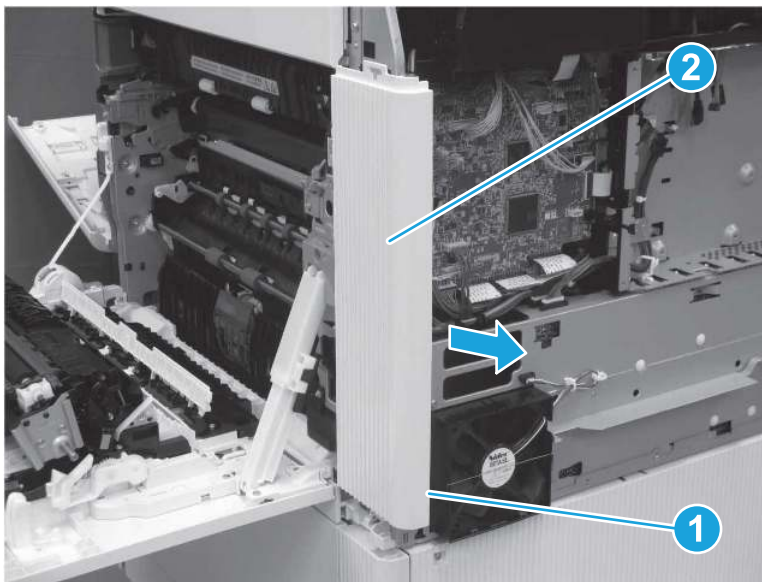
 **TIP:** When installing the laser scanner (callout 1), position the pins (callout 2) on the laser scanner into the openings (callout 3) inside the printer.



21. Remove the right rear cover (M856/E85055/M776).

- ▲ Release one tab (callout 1), and then slide the rear cover away from the printer to remove it.

Figure 1-2825 Remove right rear cover



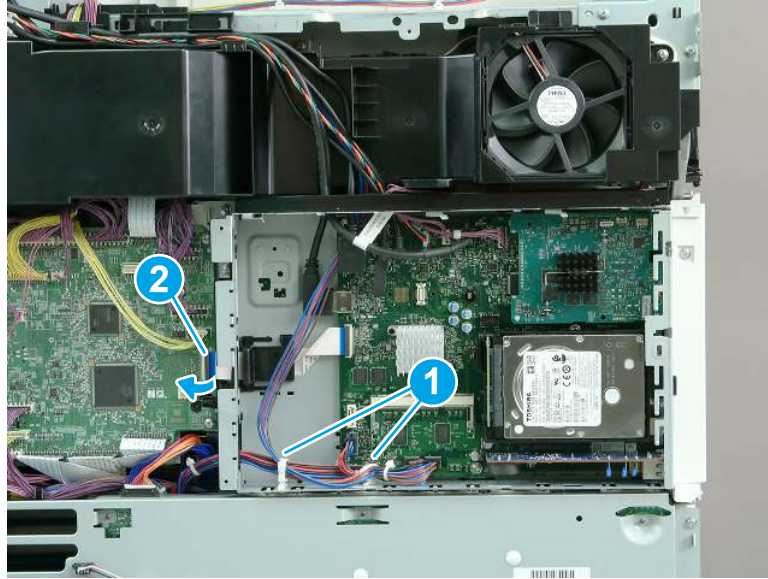
22. Remove the formatter and case (M856/E85055/M776).

 **NOTE:** The figures below show the M776zs formatter. The procedure is correct for all referenced models.

- a. Release two retainers (callout 1), and then open the retainer (callout 2) to release the flat cable. Disconnect all of the remaining connectors on the formatter board.

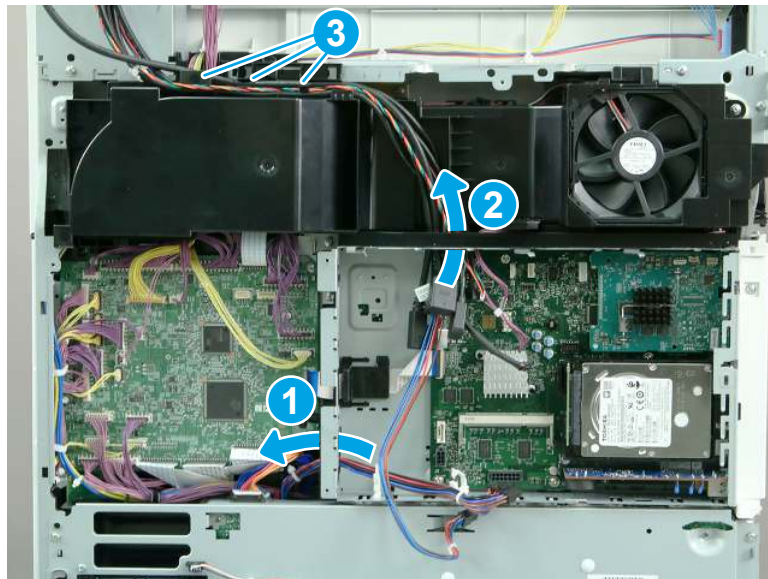
 **NOTE:** The figures below show the M776zs model. The procedures are correct for all of the referenced models.

Figure 1-2826 Disconnect the connectors



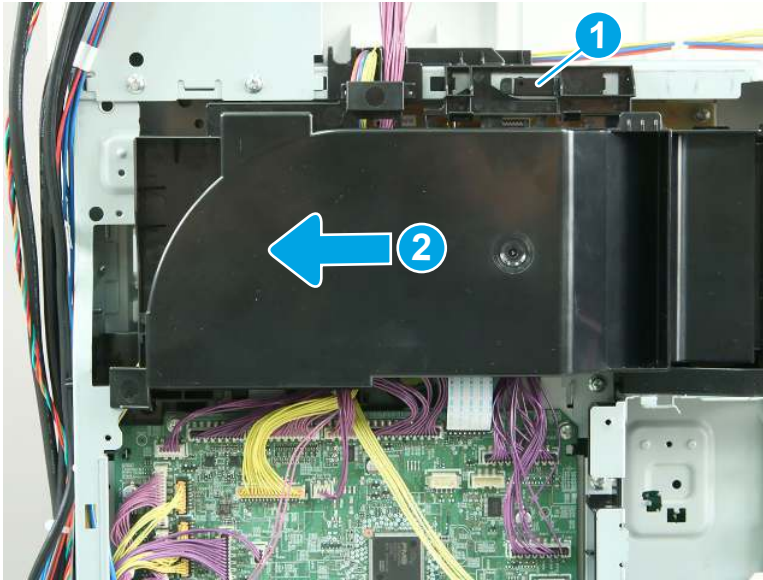
- b. Release one cable through the opening in the left side of the formatter case (callout 1). Release the remaining cables through the opening in the top of the formatter case (callout 2). Release the cables from the upper cable guide (callout 3).

Figure 1-2827 Release the cables



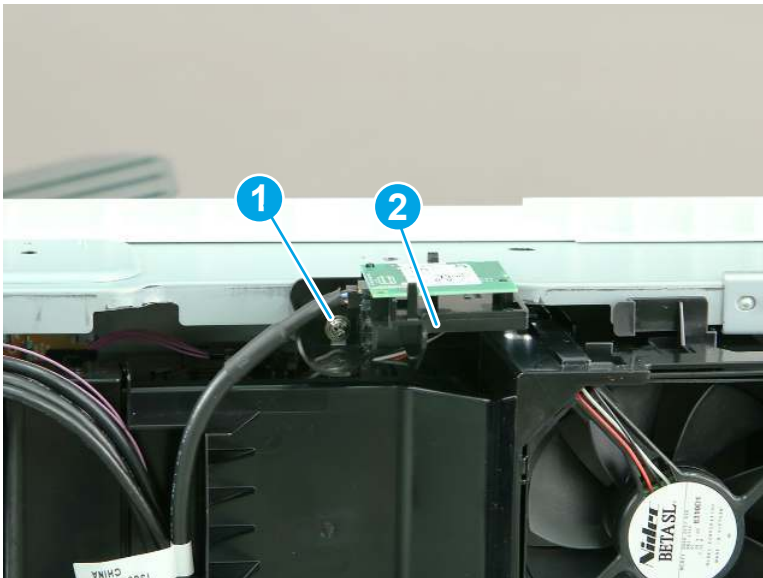
- c. Release one tab (callout 1), and then slide the fan duct to the left (callout 2) to remove it.

Figure 1-2828 Remove the fan duct



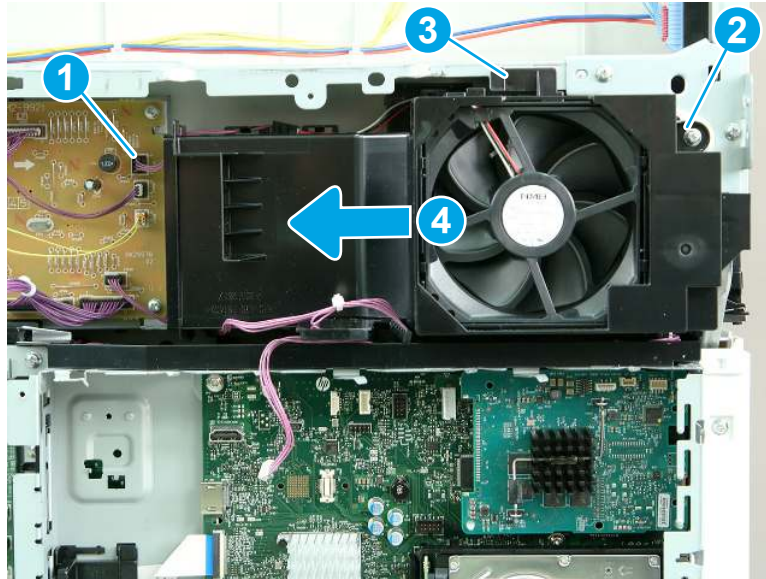
- d. **M856 and E85055 only:** Remove one screw (callout 1), and then remove the wireless card and bracket (callout 2).

Figure 1-2829 Remove the wireless card and bracket



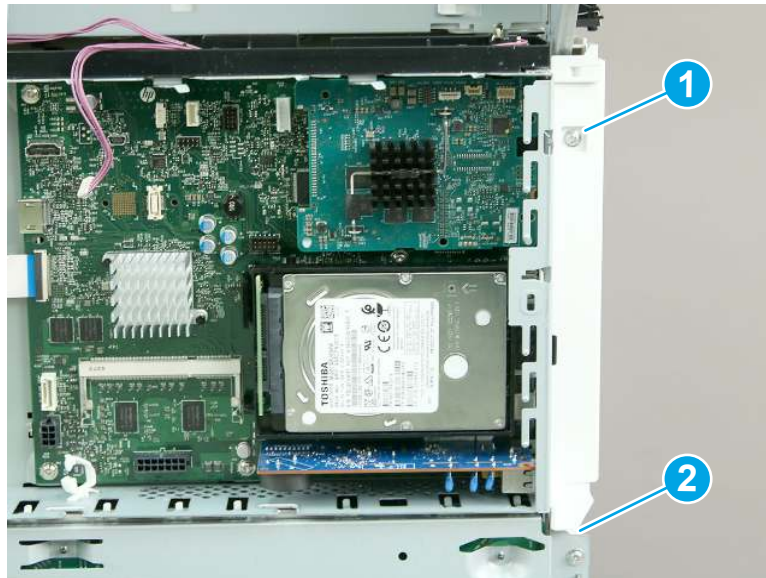
- e. Disconnect one connector (callout 1), and remove one screw (callout 2). Release one tab (callout 3), and then slide the fan assembly to the left (callout 4) to remove it.

Figure 1-2830 Remove the fan assembly



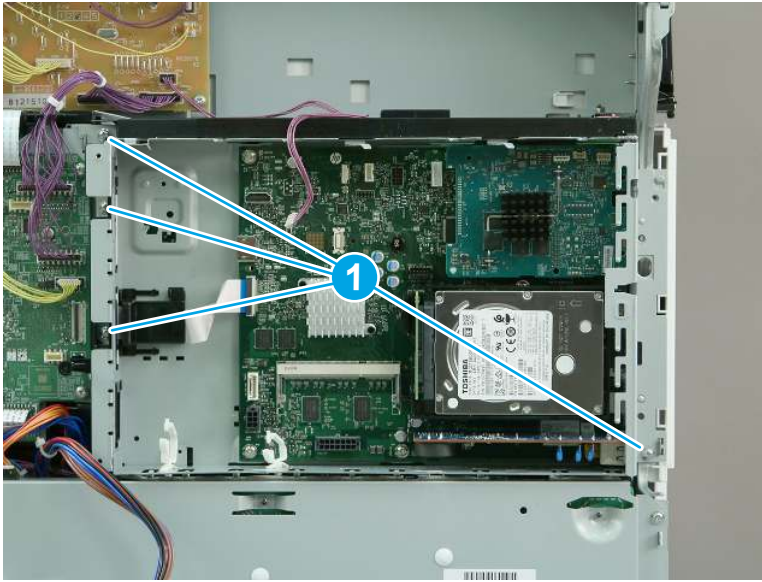
- f. Remove one screw (callout 1), release one tab (callout 2), and then remove the left rear cover.

Figure 1-2831 Remove the left rear cover



- g. Remove four screws (callout 1).

Figure 1-2832 Remove four screws



- h. Remove the formatter and case.

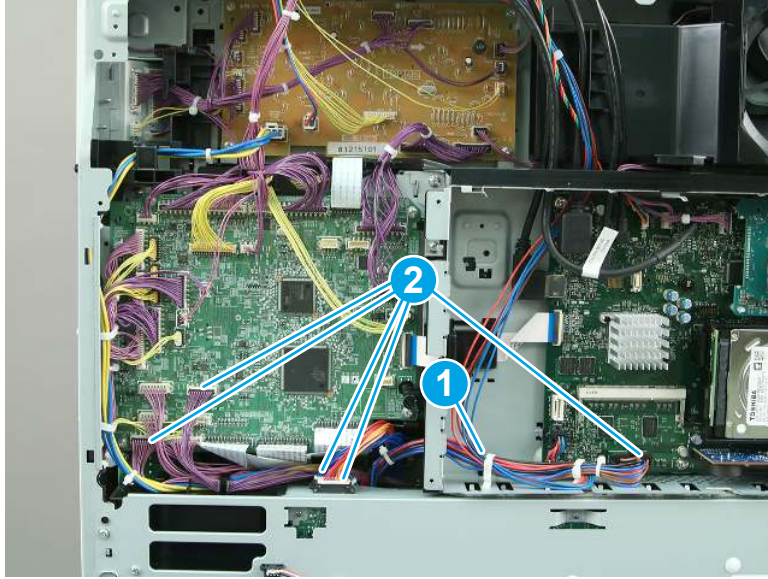
Figure 1-2833 Remove the formatter and case



- 23. Remove the low-voltage power supply (LVPS) (M856/E85055/M776).

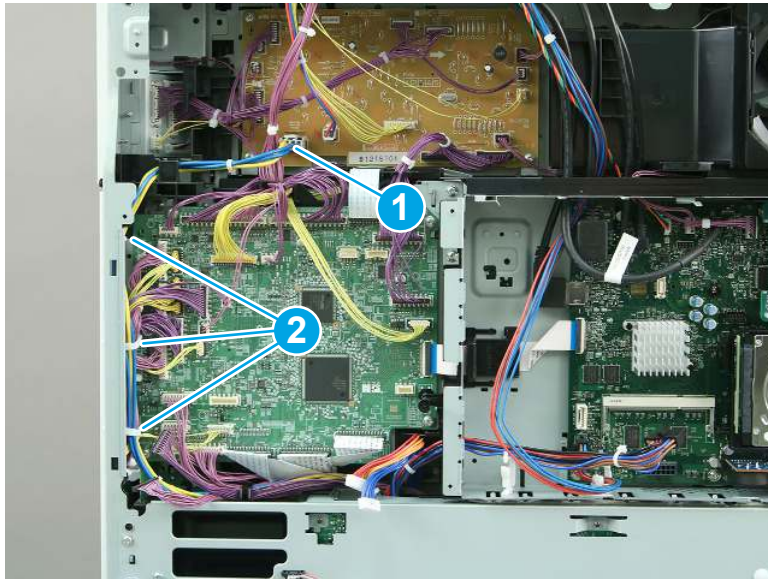
- a. Release one retainer (callout 1), and then disconnect five connectors (callout 2).

Figure 1-2834 Release the retainer and disconnect five connectors



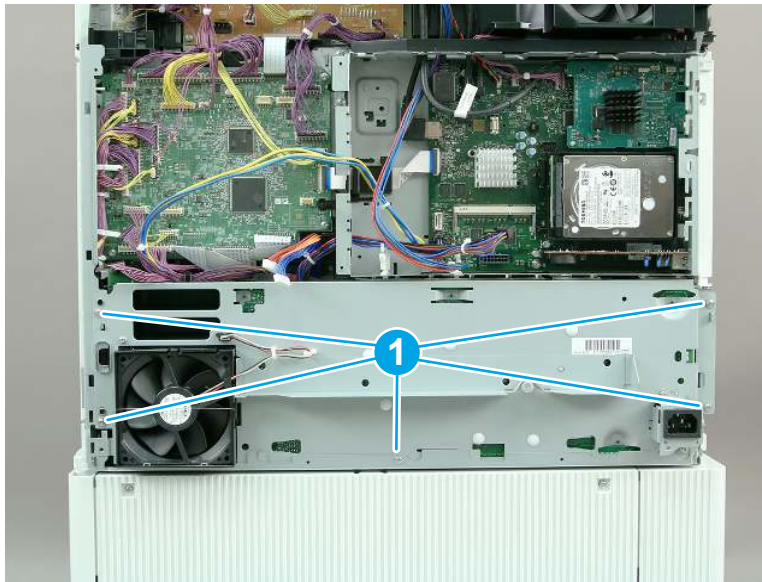
- b. Disconnect one connector (callout 1), and then release three retainers (callout 2).

Figure 1-2835 Disconnect one connector and release five retainers



- c. Remove five screws (callout 1).

Figure 1-2836 Remove five screws



- d. Tilt the LVPS away from the printer (callout 1). Thread the cable (callout 2) through the opening in the formatter case.

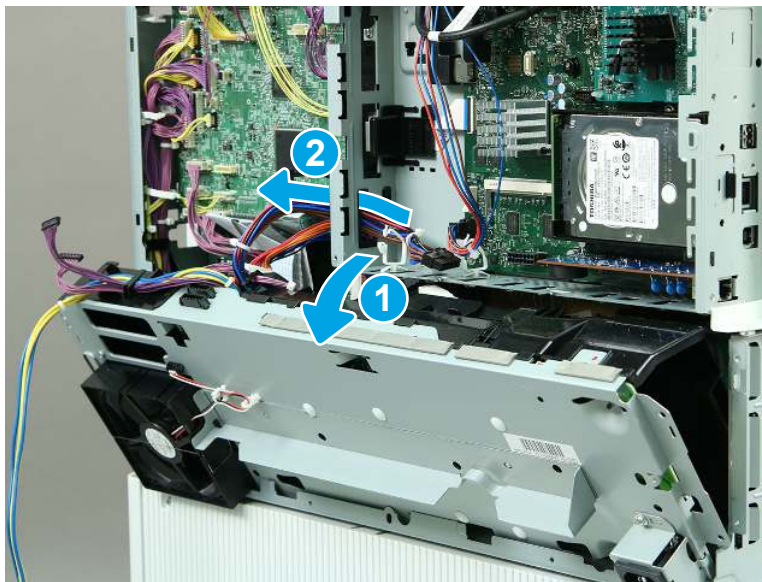


NOTE: Due to mechanical tolerances on the formatter cage, rotating the LVPS out might be difficult.



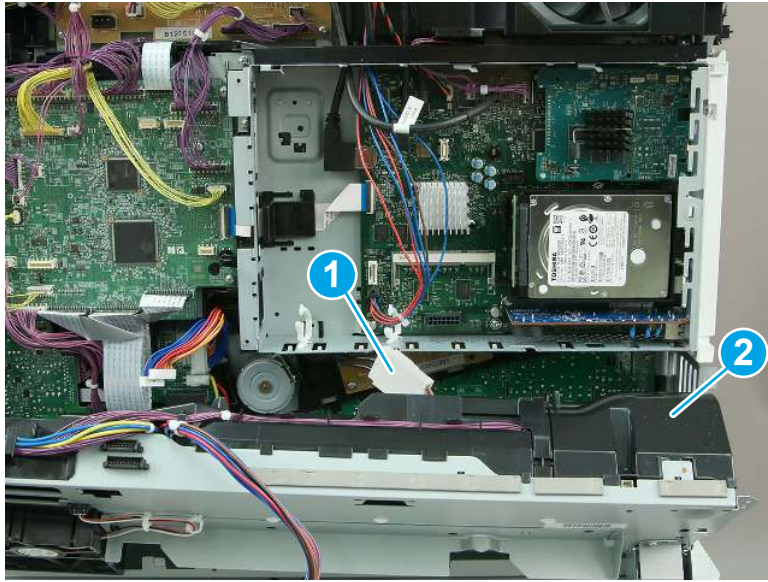
CAUTION: One connector is still connected, so tilt the LVPS carefully.

Figure 1-2837 Thread the cable



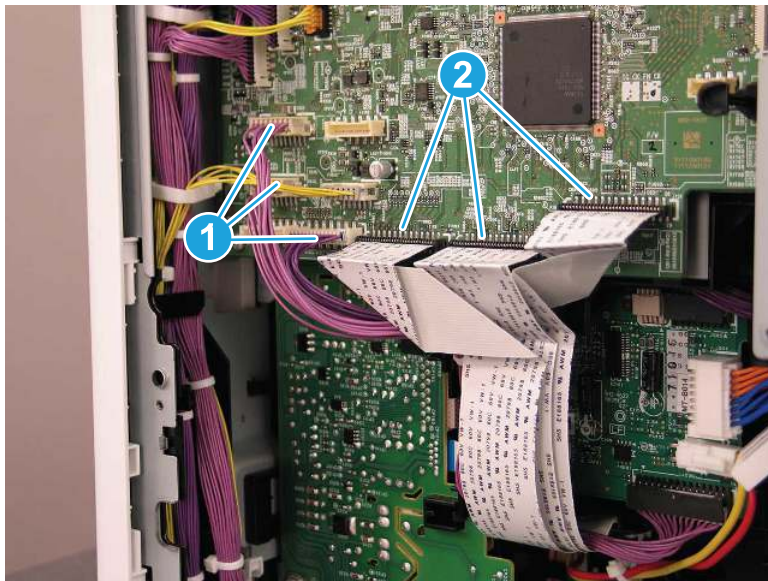
- e. Disconnect one connector (callout 1), and then lift up to remove the LVPS (callout 2).

Figure 1-2838 Remove the LVPS



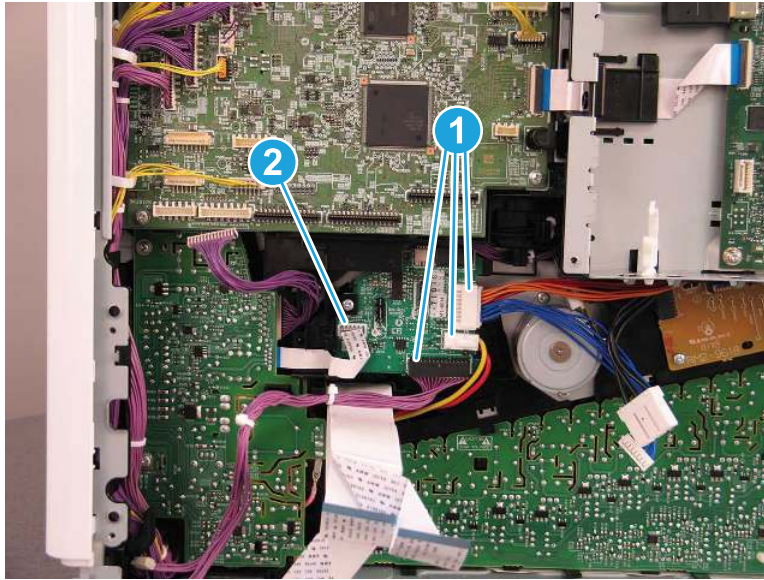
- 24. Remove the T2 connecting PCA.
 - a. Disconnect three connectors (callout 1), and then disconnect three flat cables (callout 2).

Figure 1-2839 Disconnect six connectors



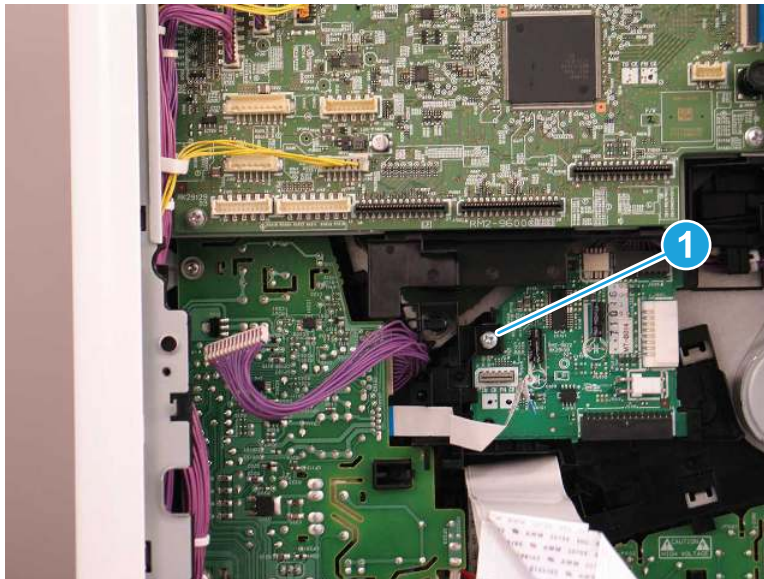
- b. Disconnect three connectors (callout 1), and then disconnect one flat cable (callout 2).

Figure 1-2840 Disconnect three connectors and one flat cable



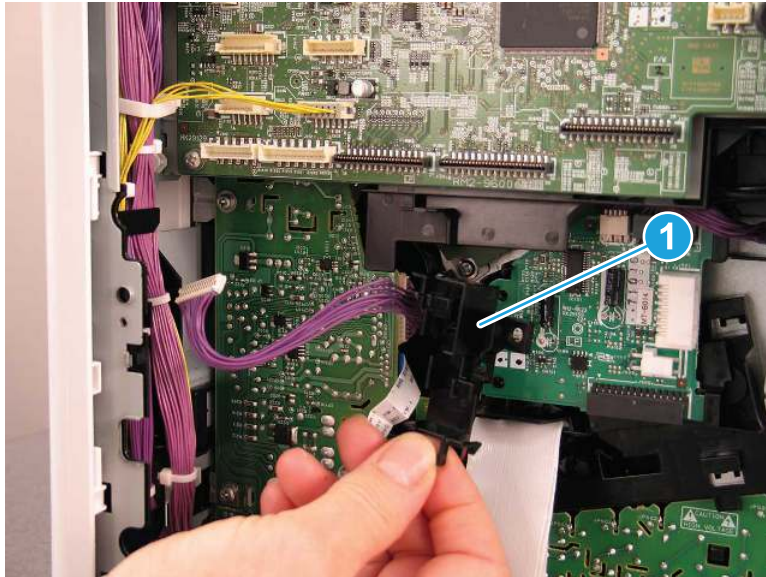
- c. Remove one screw (callout 1).

Figure 1-2841 Remove one screw



- d. Remove the cable guide (callout 1). If the cable guide is lost or damaged during the repair procedure, order a replacement part and install it along with the replacement T2 connecting PCA.

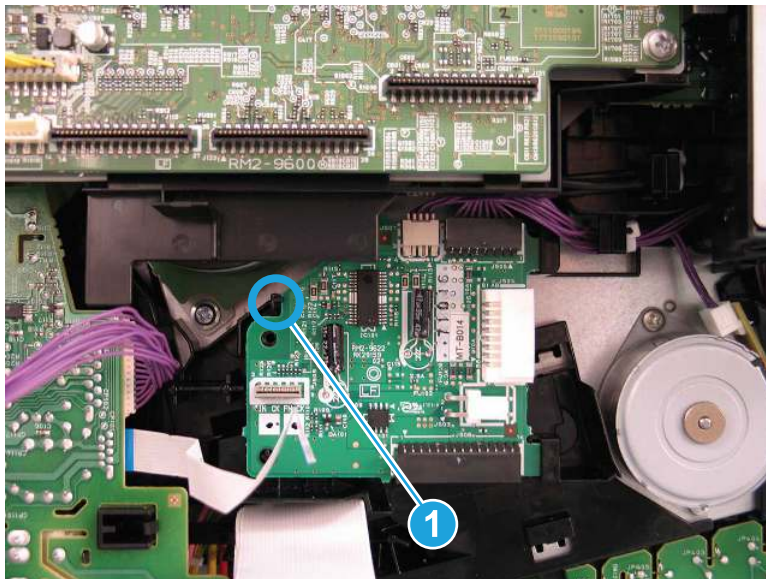
Figure 1-2842 Remove the cable guide



- e. Release one tab (callout 1), and then pull the T2 connecting PCA slightly away from the printer.

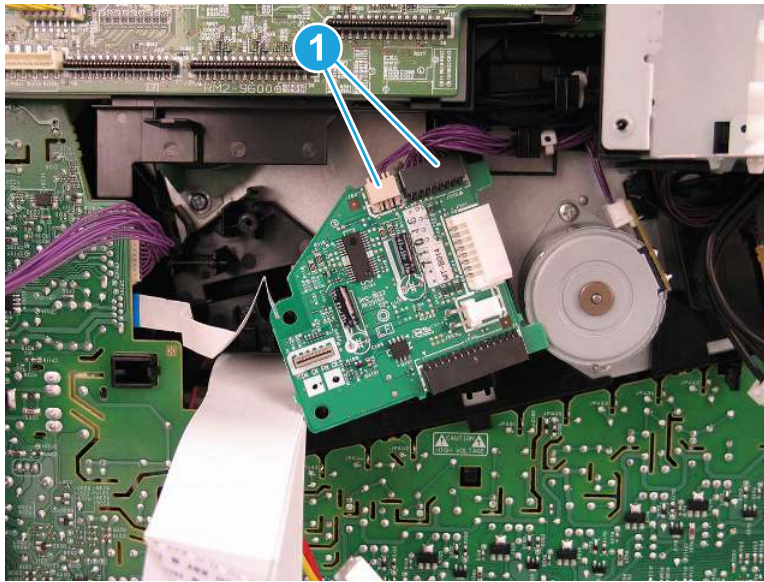
⚠ CAUTION: The T2 connecting PCA is still attached to the printer. Do not attempt to remove it completely.

Figure 1-2843 Release one tab



- f. Disconnect two connectors (callout 1), and then remove the T2 connecting PCA (callout 2).

Figure 1-2844 Disconnect two connectors and remove the PCA



- 25. Remove the upper high-voltage power supply (HVPS) (M856/E85055/M776).

- a. Disconnect one connector (callout 1), and then remove one screw (callout 2).

Figure 1-2845 Disconnect one connector and remove one screw



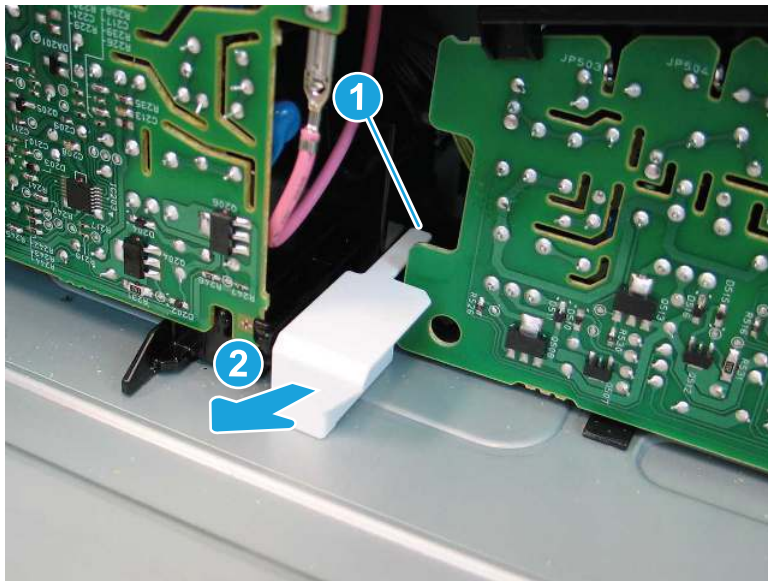
- b. Release six tabs (callout 1), and then remove the upper HVPS.

Figure 1-2846 Release six tabs



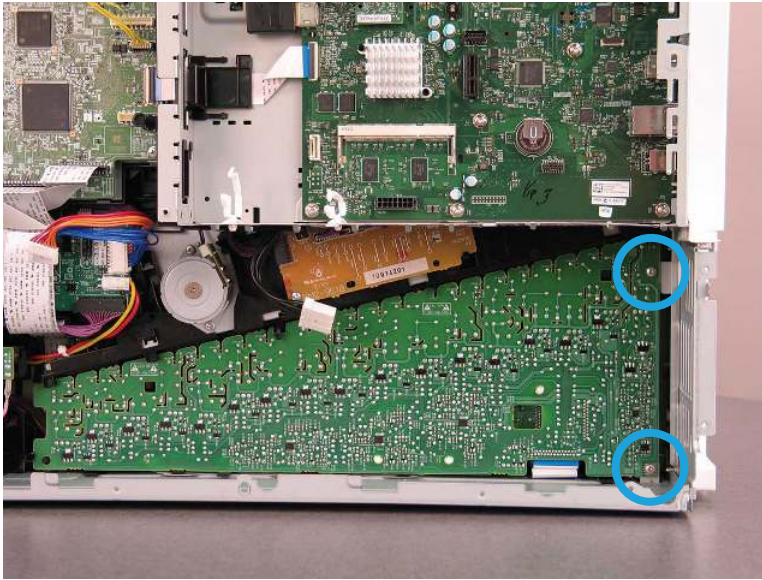
- 26. Remove the lower high-voltage power supply (lower HVPS).
 - a. Release one tab (callout 1) and then slide the stopper (callout 2) away from the printer to remove it.

Figure 1-2847 Remove the stopper



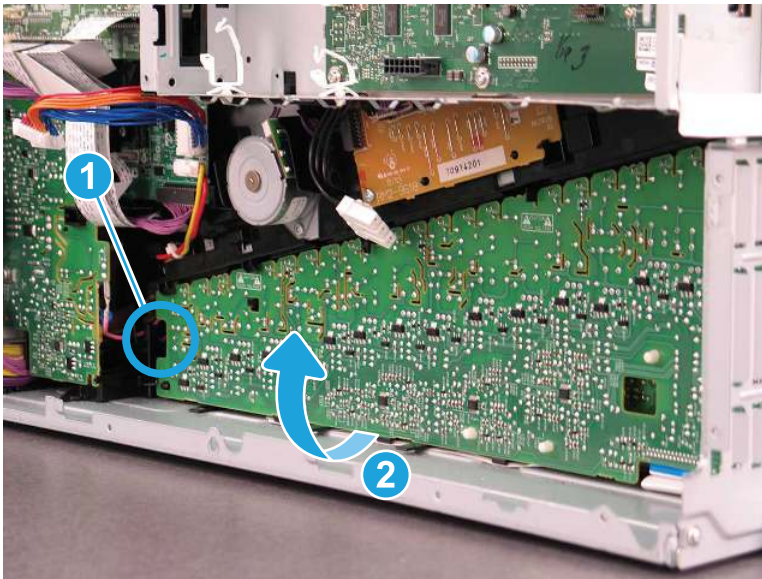
- b. Remove two screws (callout 1).

Figure 1-2848 Remove two screws



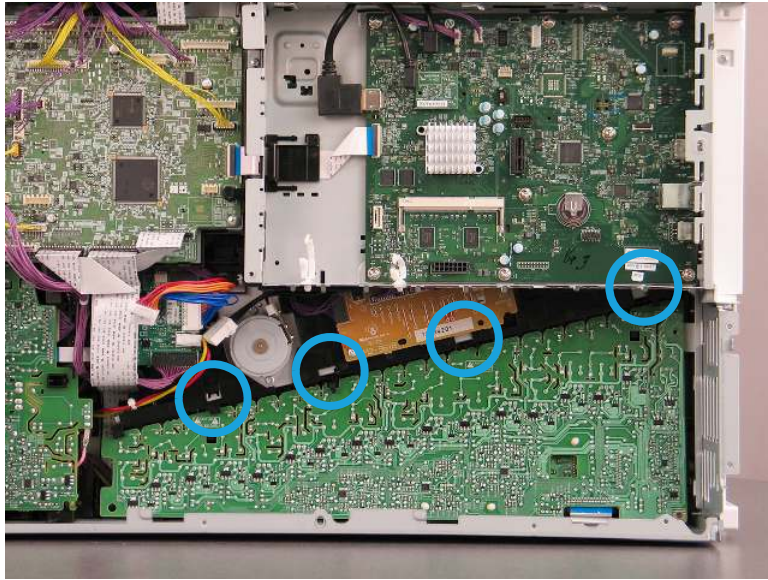
- c. Release one tab (callout 1), and then gently release the lower edge of the lower HVPS.

Figure 1-2849 Release the lower edge of the lower HVPS



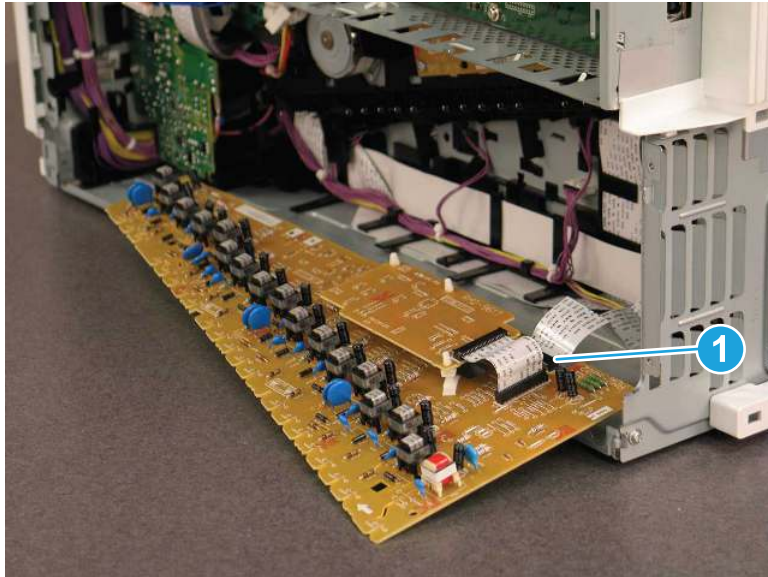
- d. Release the lower HVPS from four tabs.

Figure 1-2850 Release four tabs



- e. Disconnect one flat cable (callout 1) from the back of the lower HVPS.

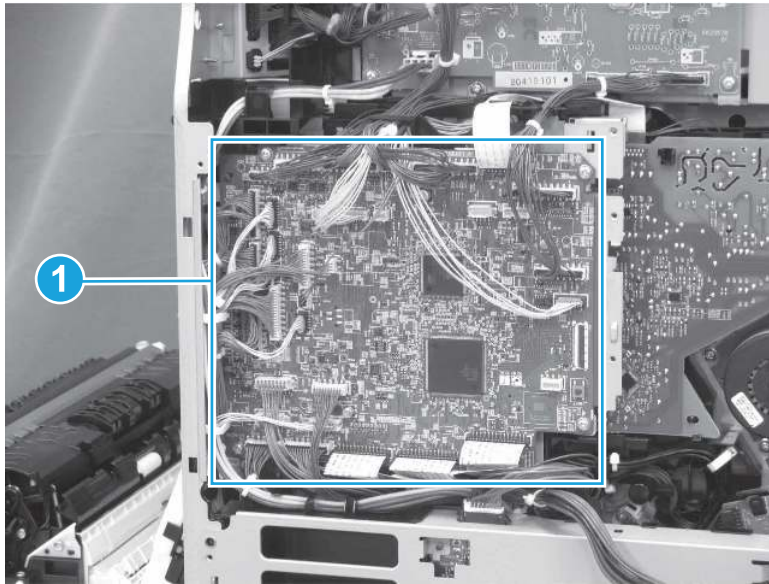
Figure 1-2851 Disconnect one flat cable



- 27. Remove the DC controller and case (M856/E85055/M776).

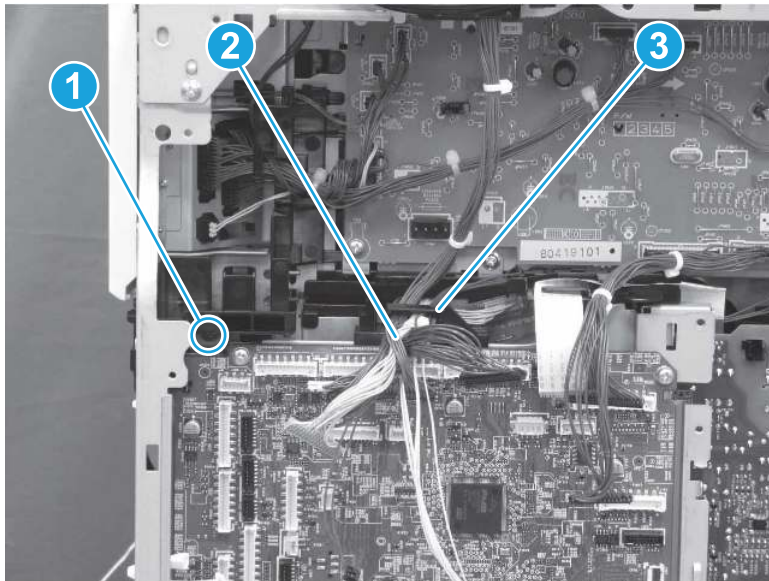
- a. Disconnect all of the connectors on the DC controller.

Figure 1-2852 Disconnect the connectors



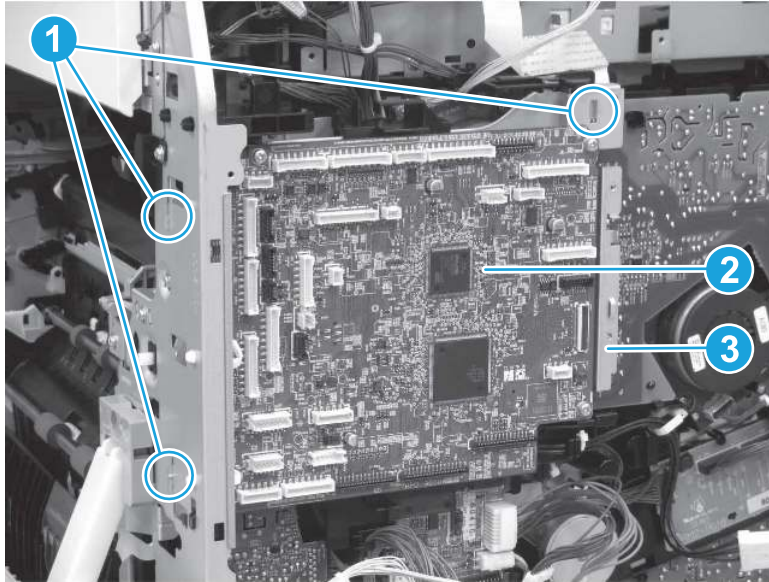
- b. Remove one screw (callout 1), and then release the cables (callout 2) from the cable guide (callout 3).

Figure 1-2853 Remove one screw and release the cables




- c. Remove one screw (callout 1), and then remove the DC controller (callout 2) together with the metal case (callout 3).

Figure 1-2854 Remove the DC controller and case



28. Remove the main drive assembly.

- a. Open the front door.

 **IMPORTANT:** The front door must remain open during removal and installation of the main drive assembly to prevent issues.

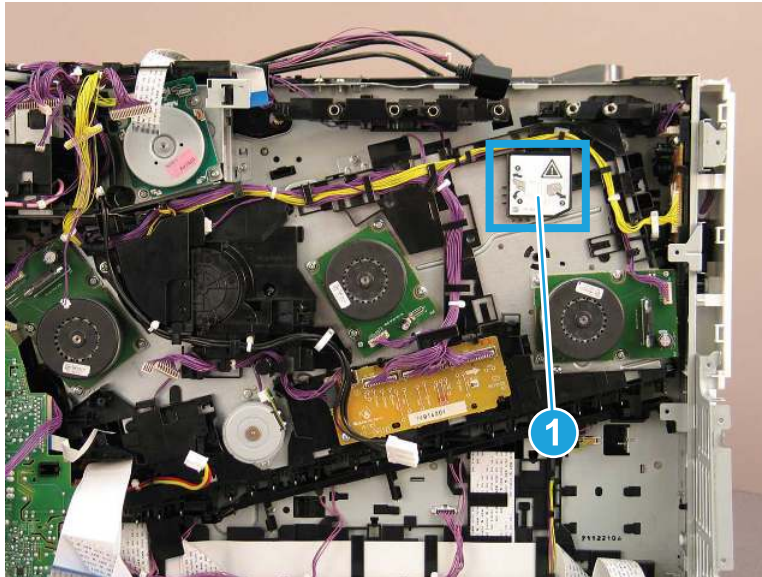
To prevent the front door from closing on its own, install one of the toner cartridges halfway.

Figure 1-2855 Open the front door



- b. Note the label (callout 1) on the main drive assembly indicating that the front door must be open and all toner cartridges and imaging drums removed before removing the main drive assembly.

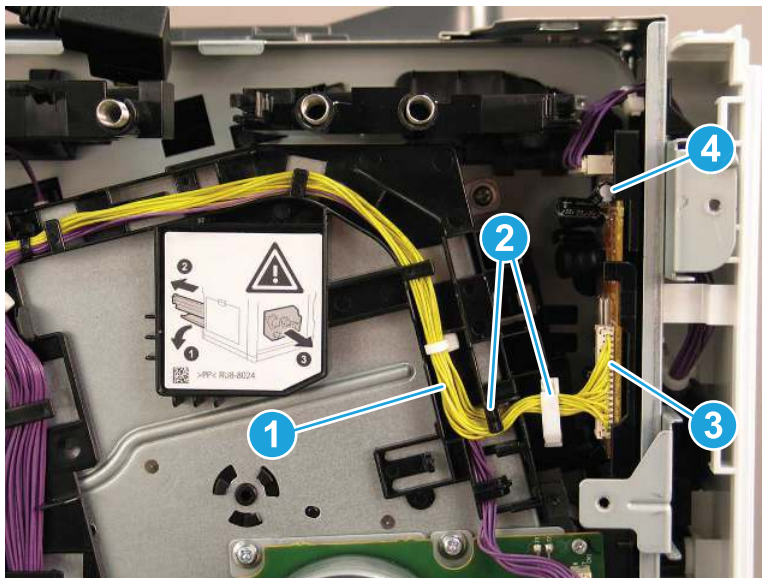
Figure 1-2856 Main drive assembly label



- c. Release the cable (callout 1) from the cable guide (callout 2), and then disconnect one connector (callout 3).

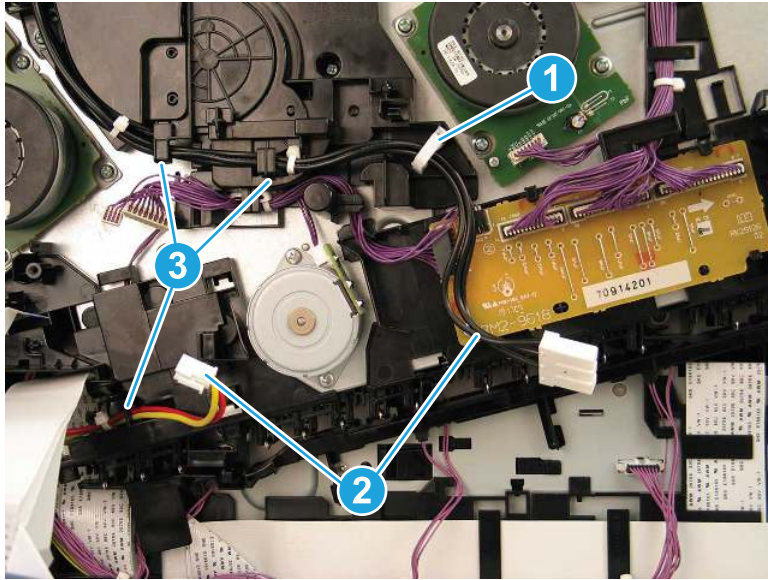
⚠ CAUTION: The capacitor on the PCA (callout 4) can rotate out and prevent the main drive assembly from reseating.

Figure 1-2857 Disconnect one connector



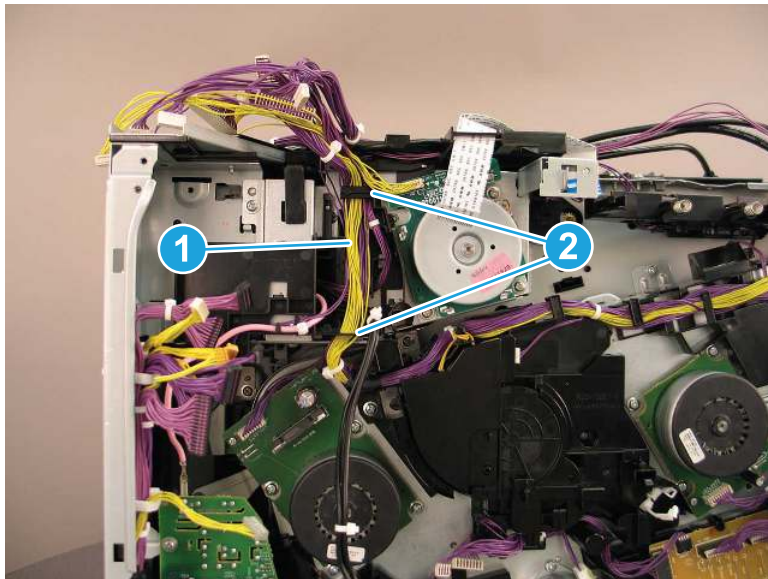
- d. Release the cables (callout 1) from the cable guides (callout 2).

Figure 1-2858 Release the cables from the guides



- e. Release the cables (callout 1) from the cable guides (callout 2).

Figure 1-2859 Release the cables from the guides

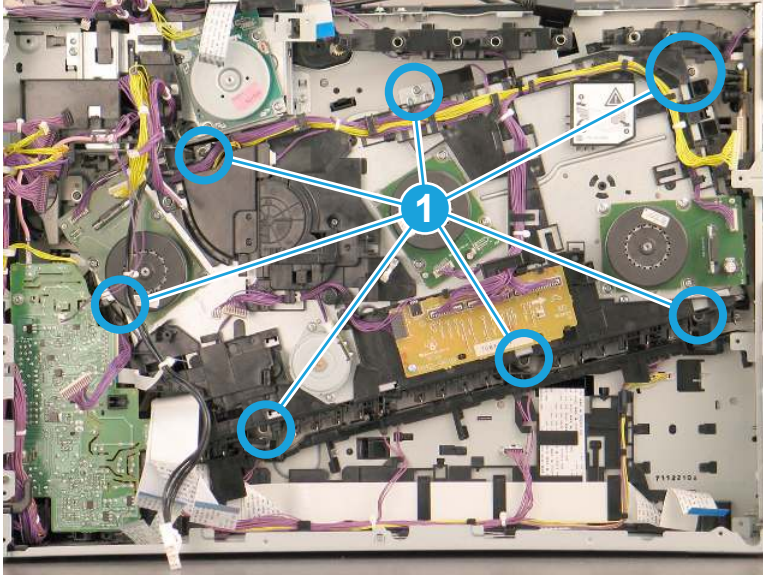


- f. Remove seven screws (callout 1), and then remove the main drive assembly.

 **IMPORTANT:** When reinstalling the main drive assembly, make sure that the front door is open.

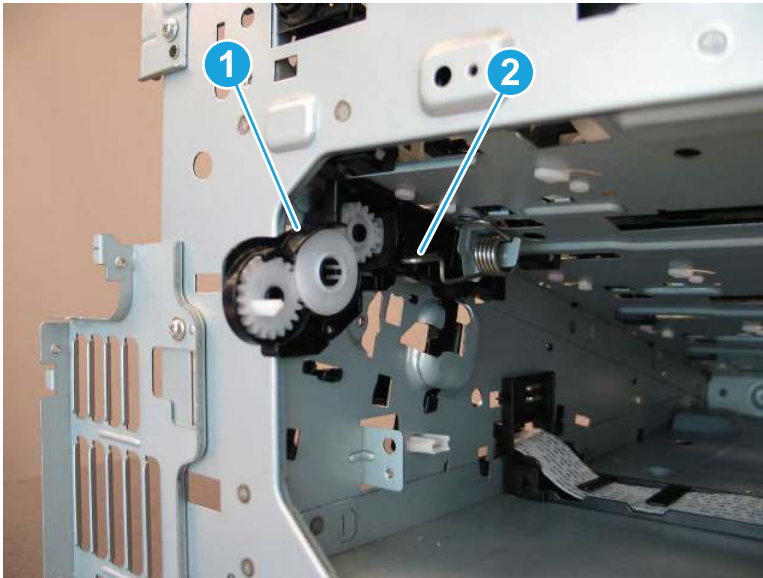
Partially reinstall one toner cartridge to prevent the front door from closing.

Figure 1-2860 Remove seven screws and the main drive assembly



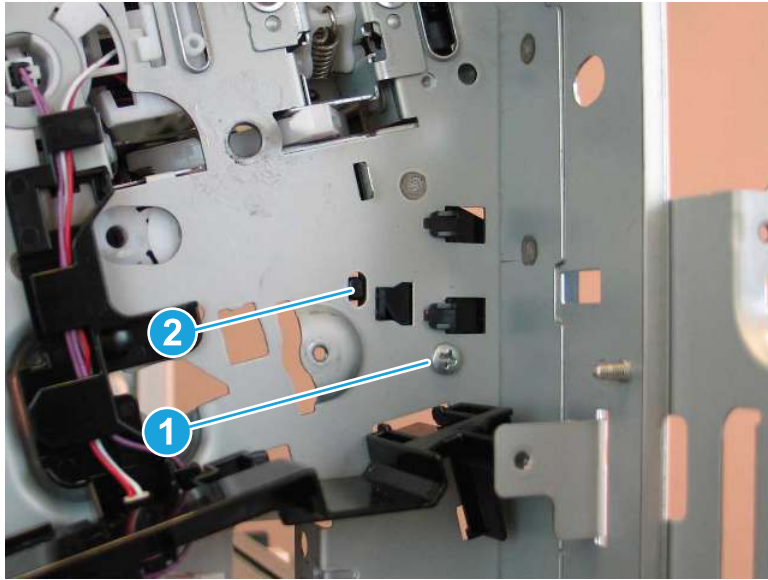
29. Remove the waste toner gear base assembly.
 - a. Locate the waste toner gear base assembly (callout 1), and then release the laser scanner spring (callout 2).

Figure 1-2861 Release the laser scanner spring



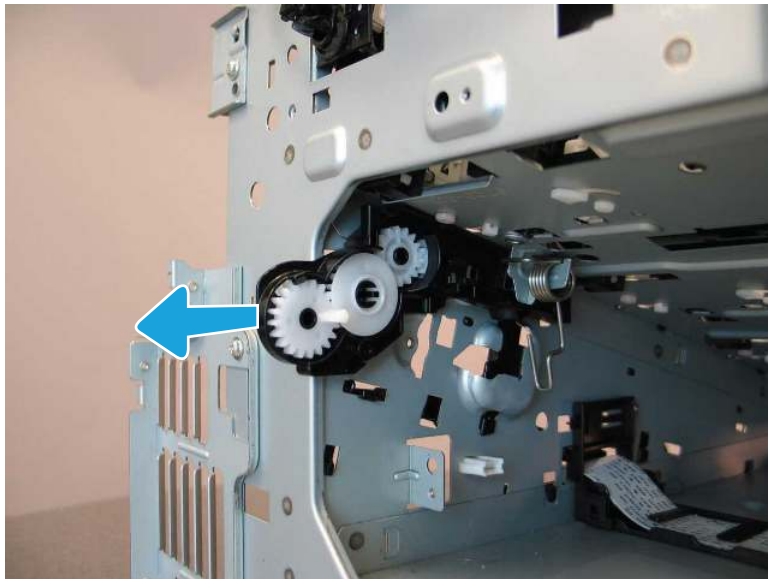
- b. At the back of the printer, remove one screw (callout 1), and then release one tab (callout 2).

Figure 1-2862 Remove one screw and release one tab



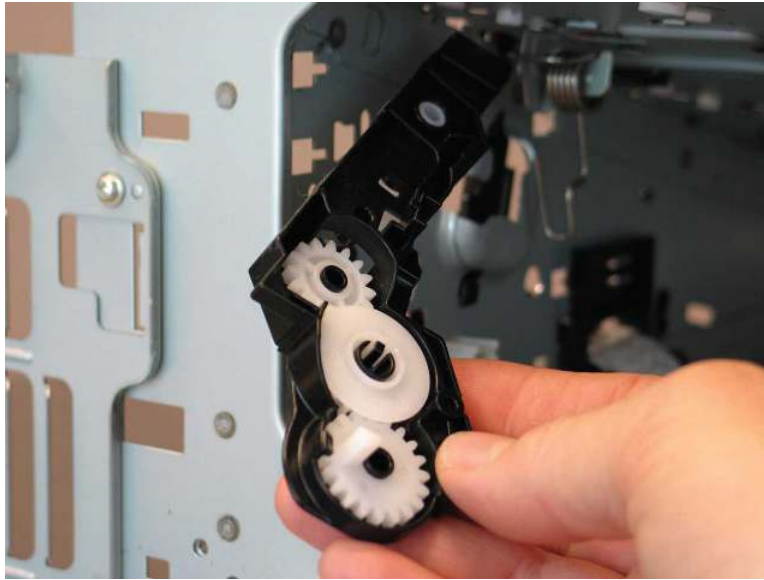
- c. Slide the waste toner gear base assembly away from the printer.

Figure 1-2863 Slide the waste toner gear base assembly



- d. Remove the waste toner gear base assembly.

Figure 1-2864 Remove the waste toner gear base assembly



30. Unpack the replacement assembly.

- a. Dispose of the defective part.




NOTE: HP recommends responsible disposal of the defective part.

<http://www8.hp.com/us/en/hp-information/environment/product-recycling.html>

- b. Unpack the replacement part from the packaging.



CAUTION:  Some parts are sensitive to electrostatic discharge (ESD). Always perform service work at an ESD-protected workstation or mat. If an ESD workstation or mat is not available, touch the sheet-metal chassis to provide a static ground before touching an ESD-sensitive assembly. Protect the ESD-sensitive assemblies by placing them in ESD pouches when they are out of the printer.

If the replacement part is a roller or pad, avoid touching the spongy part of it. Skin oils on the roller or pad can cause paper pickup and/or print-quality problems. HP recommends using disposable gloves when handling rollers or pads or washing your hands before touching rollers or pads.



IMPORTANT: Make sure that all of the shipping materials (for example shipping tape) are removed from the replacement part prior to installation.

- c. To install an assembly, reverse the removal steps.



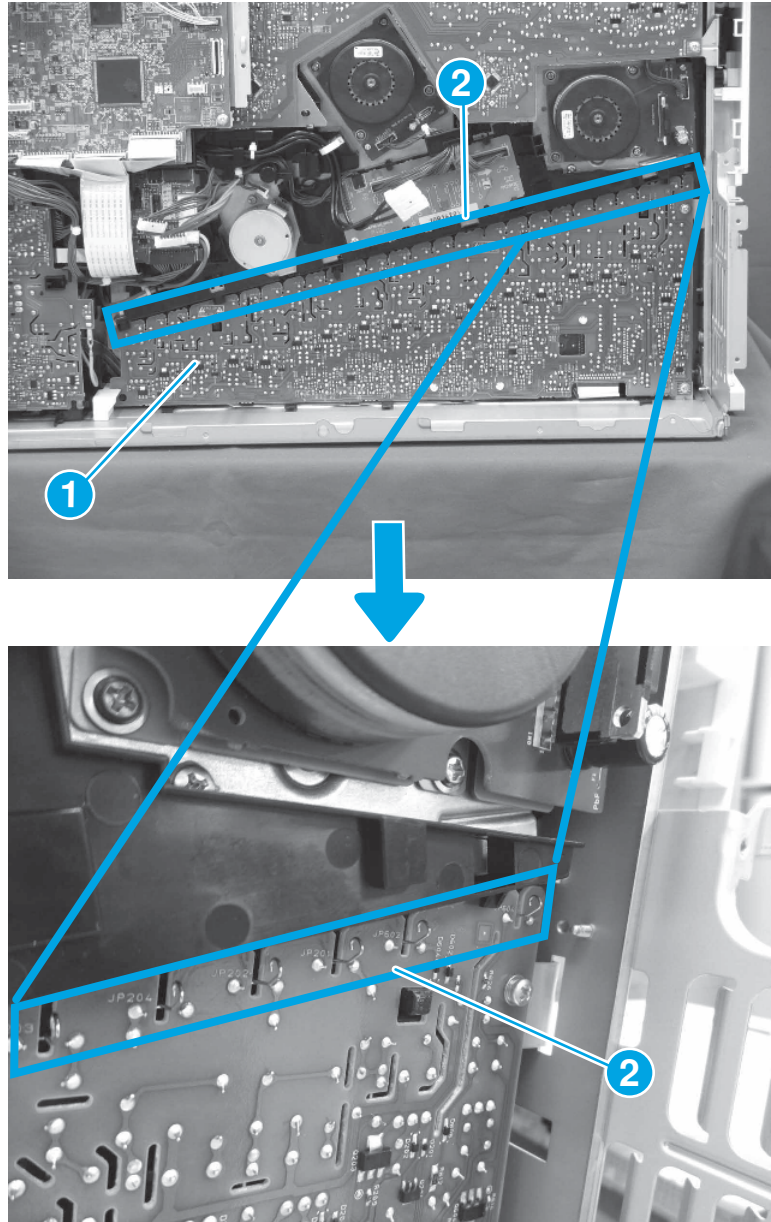
NOTE: When applicable, special installation instructions are provided for an assembly at the end of the removal procedure. Always completely read the removal instructions and follow all special installation instructions.

31. Reverse the removal steps to install the assembly. Also use the following **special installation instructions**.

Install the lower HVPS.

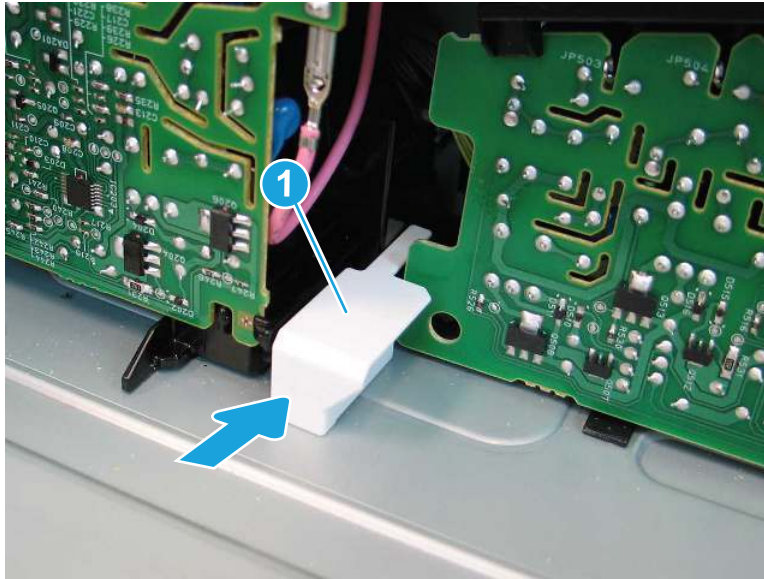
- a. When reinstalling the lower HVPS (callout 1), make sure that the top of the lower HVPS engages with the contact springs (callout 2) and that the springs are in the correct position.

Figure 1-2865 Check the springs



- b. Make sure that the stopper (callout 1) is reinstalled at the bottom of the lower HVPS.

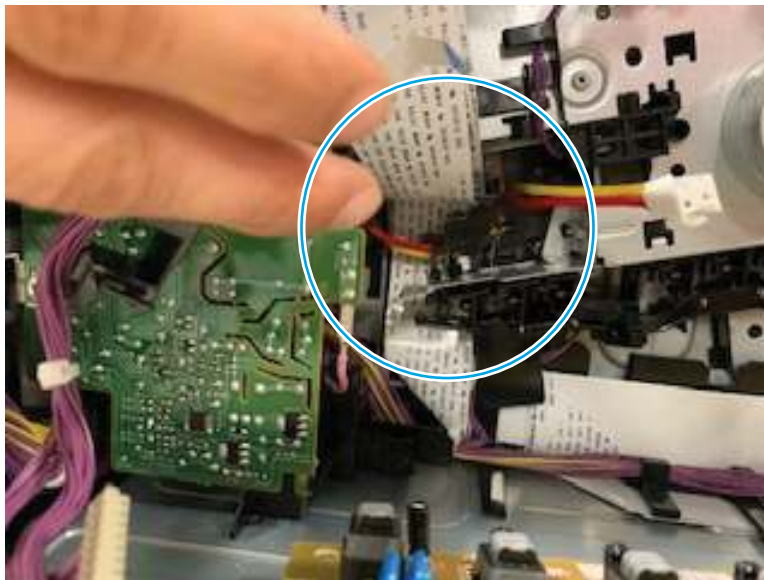
Figure 1-2866 Install the stopper



Install the main drive assembly.

- a. Route the red and yellow cables back into the main drive assembly guides prior to re-installation. This will prevent the cables from being pinched behind the main drive assembly.

Figure 1-2867 Main drive wire harness



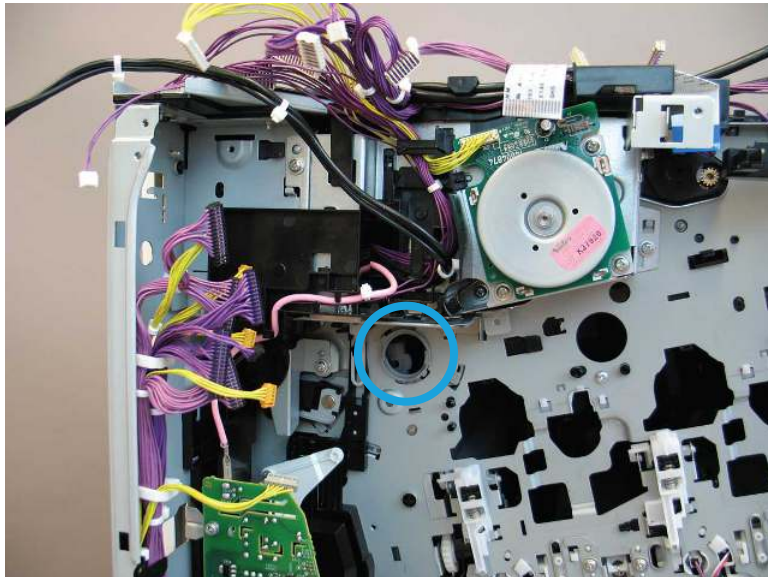
- b. If the coupling estrangement cam falls off of the printer or is broken or lost in the process of removing the main drive assembly, follow these steps to reinstall it.

Figure 1-2868 Coupling estrangement cam



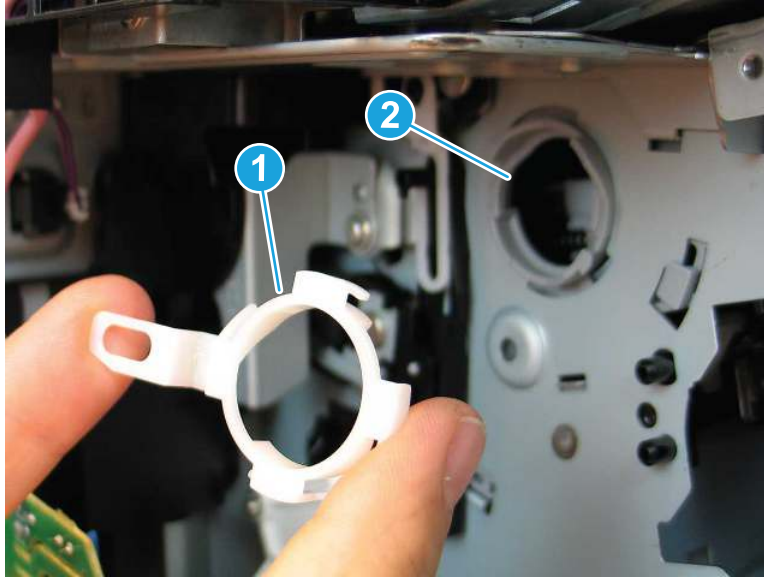
- c. Note the location where the cam will be installed.

Figure 1-2869 Cam location



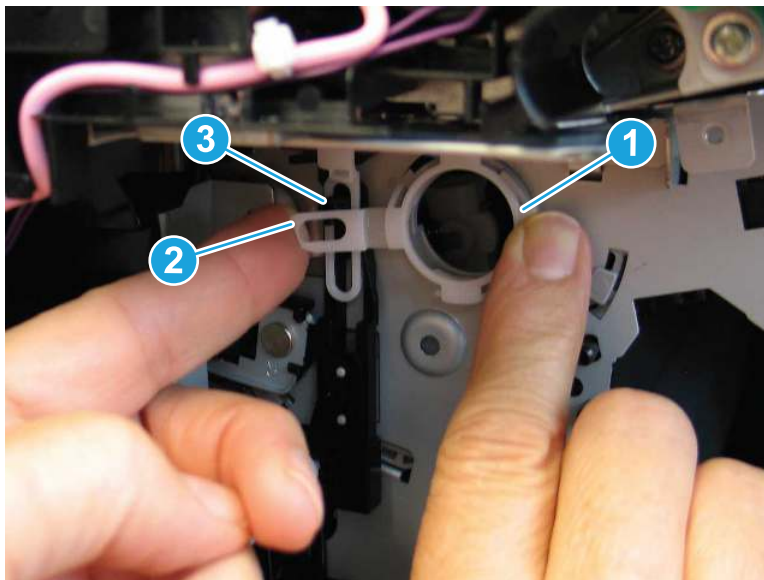
- d. Position the cam (callout 1) over the gray ring (callout 2) on the printer. The tabs on the cam fit into openings on the gray ring.

Figure 1-2870 Position the cam



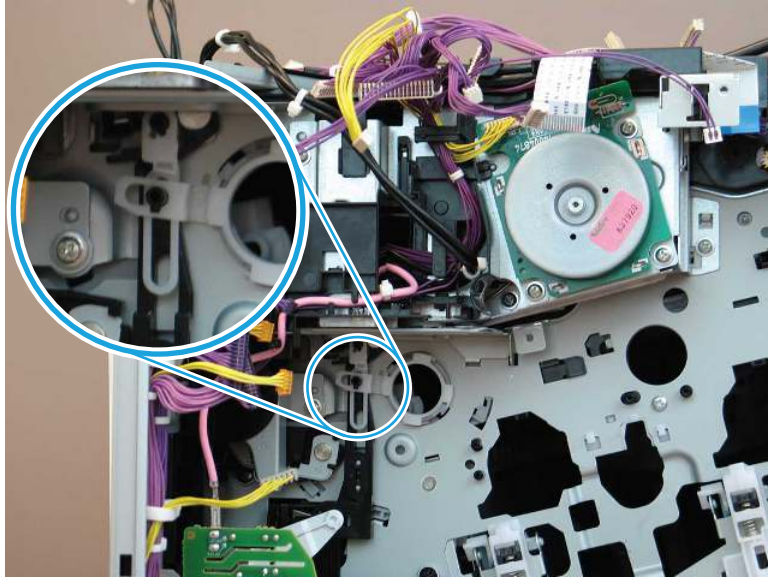
- e. Hold the cam in position (callout 1), and then position the opening in the left side of the cam (callout 2) over the boss (callout 3) on the black link arm on the printer.

Figure 1-2871 Install the cam



- f. When installed correctly, the cam engages with the black link arm on the printer.

Figure 1-2872 Cam correctly installed



Removal and replacement: Waste toner gear base assembly (M776zs)

Learn how to remove and replace the waste toner gear base assembly.

Mean time to repair: 45 minutes

Service level: Difficult

Before performing service

Turn the printer power off

- Disconnect the power cable.

⚠ WARNING! To avoid damage to the printer, turn the printer off, wait 30 seconds, and then remove the power cord before attempting to service the printer.

Use the table below to identify the correct part number for your printer. To order the part, go to www.hp.com/buy/parts.

Table 1-133 Part information

Part number	Part description
RM2-1364-000CN	Waste toner gear base assembly

Required tools

- #2 Phillips screwdriver with a magnetic tip
- Small, flat-blade screwdriver

After performing service

Turn the printer power on

- Connect the power cable.

- Use the power switch to turn the power on.

Post service test

Make sure that the printer initializes to a **Ready** state.

Print a page to make sure that the printer is functioning correctly.

1. Remove the toner cartridges.
 - ▲ Open the front door, if it is not already open. Grasp the handle of the toner cartridge and pull out to remove it. Repeat the process for the remaining toner cartridges.

Figure 1-2873 Remove the toner cartridge



2. Remove the imaging drums.

- a. Open the front door, if it is not already open. Rotate the blue lever in front of the imaging drum to the left.

Figure 1-2874 Rotate the blue lever



- b. Grasp the handle of the imaging drum and pull out to remove it. Repeat the process for the remaining imaging drums.

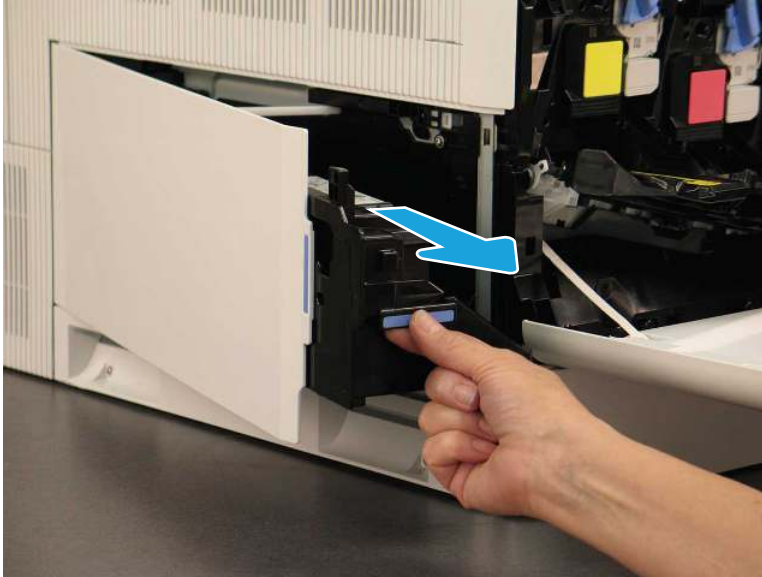
Figure 1-2875 Remove the imaging drum



3. Remove the TCU.

- ▲ Open the front door, and then open the left door. Grasp the front of the toner-collection unit, and then remove it from the printer.

Figure 1-2876 Remove the TCU



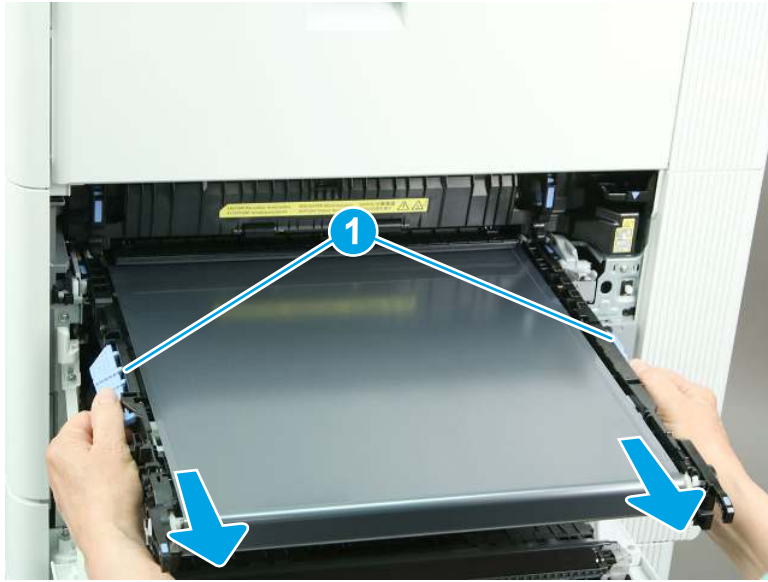
- 4. Remove the intermediate transfer belt (ITB).
 - a. Open the right door. Grasp the two blue handles on the ITB, and then pull the ITB partially out of the printer.

Figure 1-2877 Partially remove the ITB



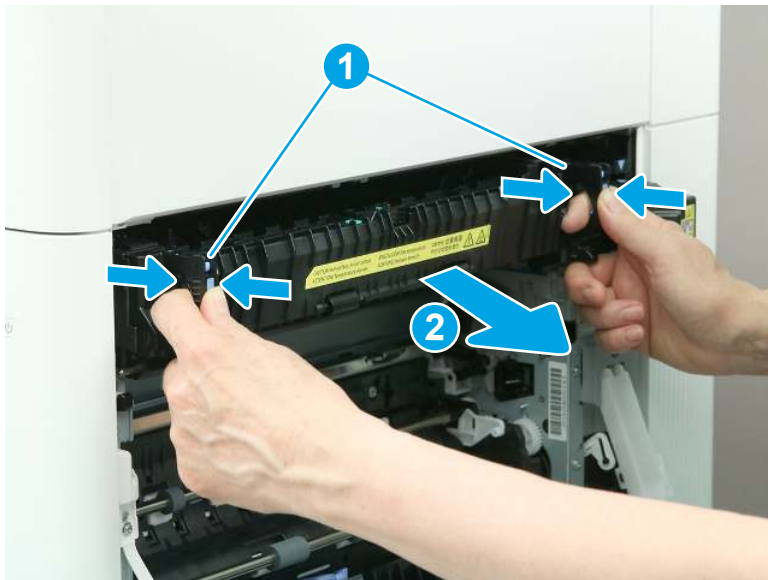
- b. Grasp the blue handles on the side of the ITB (callout 1), and then remove the ITB from the printer.

Figure 1-2878 Remove the ITB



5. Remove the fuser.
 - ▲ Grasp the fuser handles, and then squeeze the release levers (callout 1). Lift up slightly, and then pull straight out to remove the fuser (callout 2).

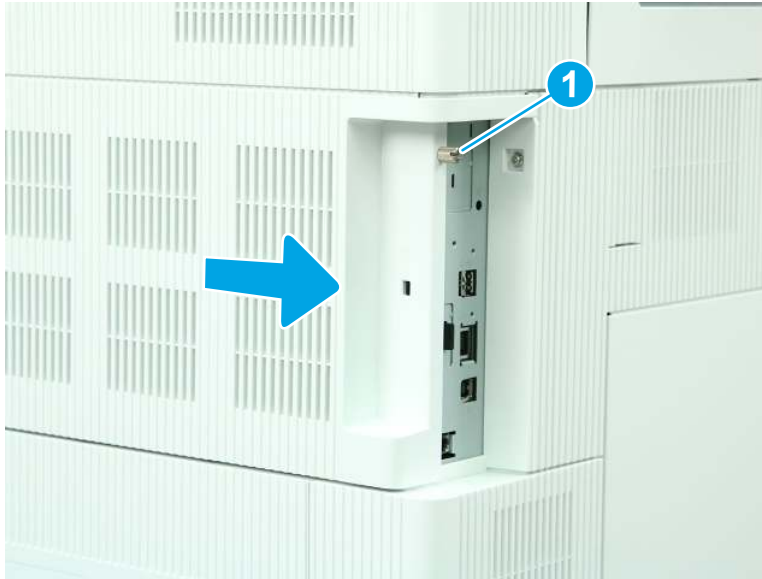
Figure 1-2879



6. Remove the formatter cover.

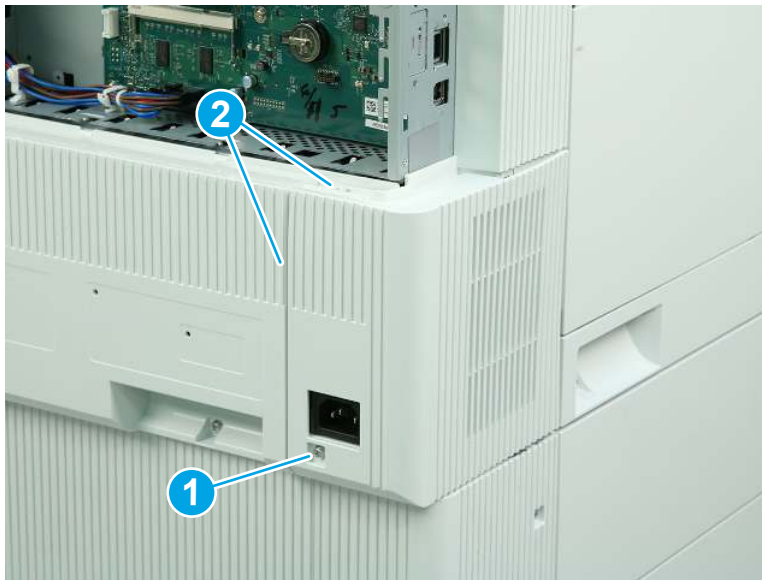
- ▲ Loosen one thumbscrew (callout 1), and then slide the formatter cover (callout 2) away from the printer to remove it.

Figure 1-2880 Remove the formatter cover



- 7. Remove the left lower cover (M856/E85055/M776).
 - a. Remove one screw (callout 1), and then release two tabs (callout 2).

Figure 1-2881 Remove one screw and release two tabs



- b. Rotate the cover away from the printer to remove it.

Figure 1-2882 Remove the left lower cover



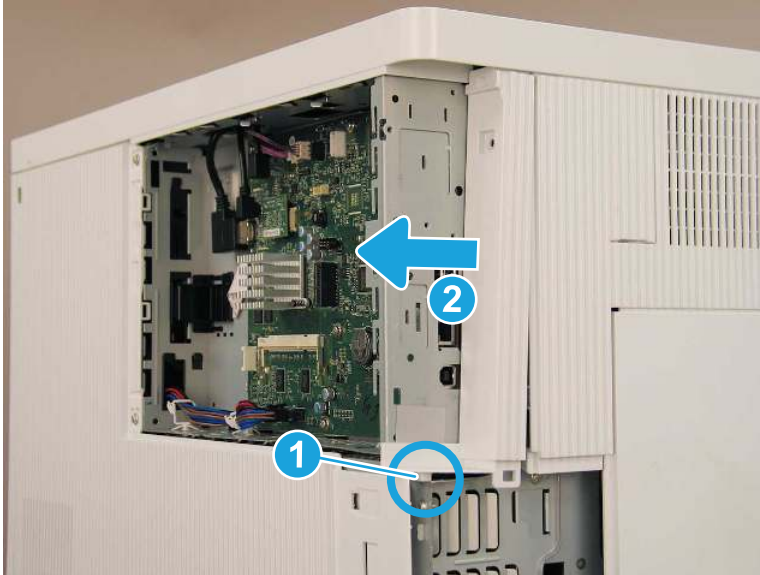
8. Remove the left rear cover (M751/E75245/M856/E85055/M776).
 - a. Remove one screw (callout 1).

Figure 1-2883 Remove one screw



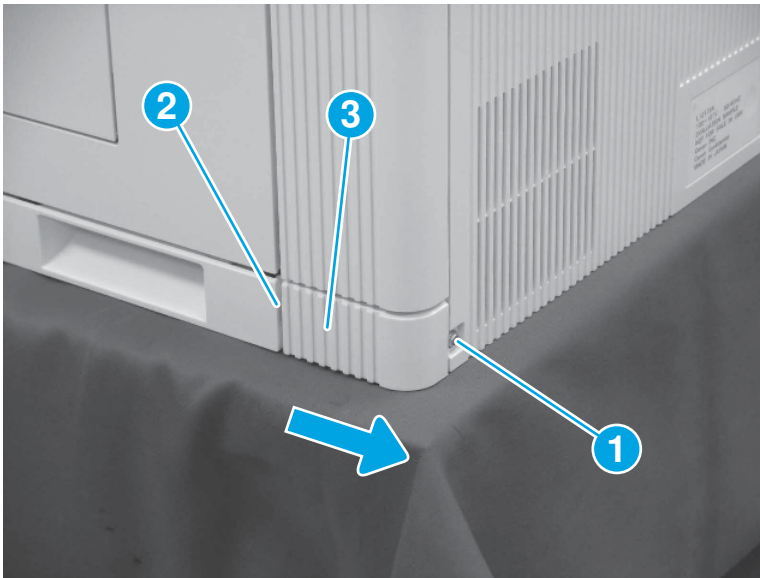
- b. Release one boss (callout 1), and then slide the cover toward the back of the printer (callout 2) to remove it.

Figure 1-2884 Remove the left rear cover



- 9. Remove the right rear lower cover (M751/E75245/M856/E85055/M776).
 - ▲ Remove one screw (callout 1), release one tab (callout 2), and then slide the right rear lower cover (callout 3) toward the back of the printer to remove it.

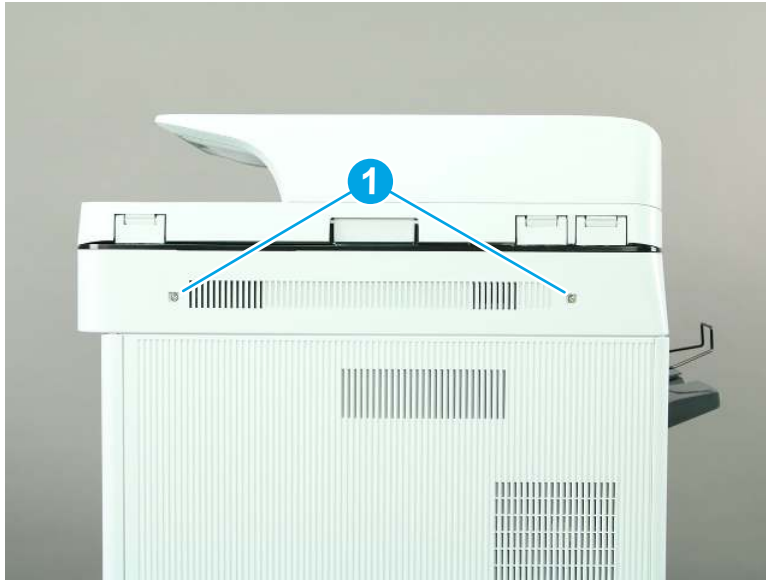
Figure 1-2885 Remove the right rear lower cover



- 10. Remove the scanner control board (SCB) cover (M776).

- a. Remove two screws (callout 1).

Figure 1-2886 Remove two screws



- b. Remove the SCB cover.

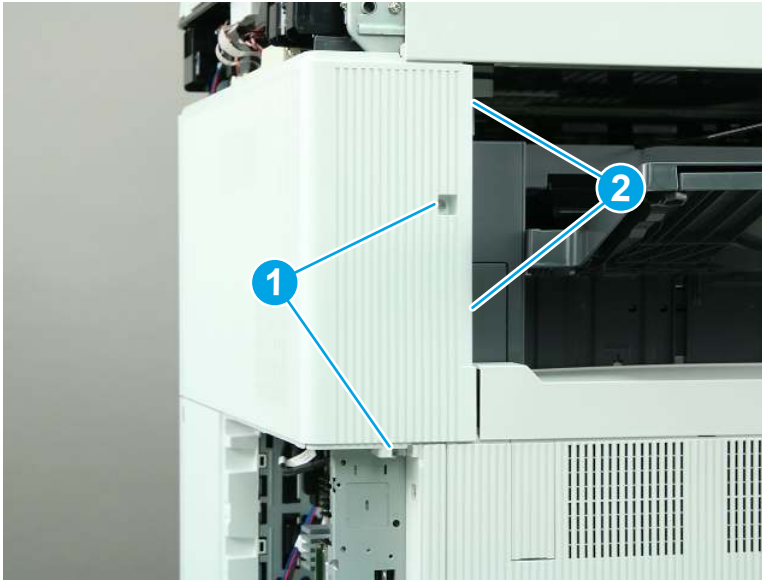
Figure 1-2887 Remove the SCB cover



11. Remove the rear upper cover and left rear upper cover (M776zs).

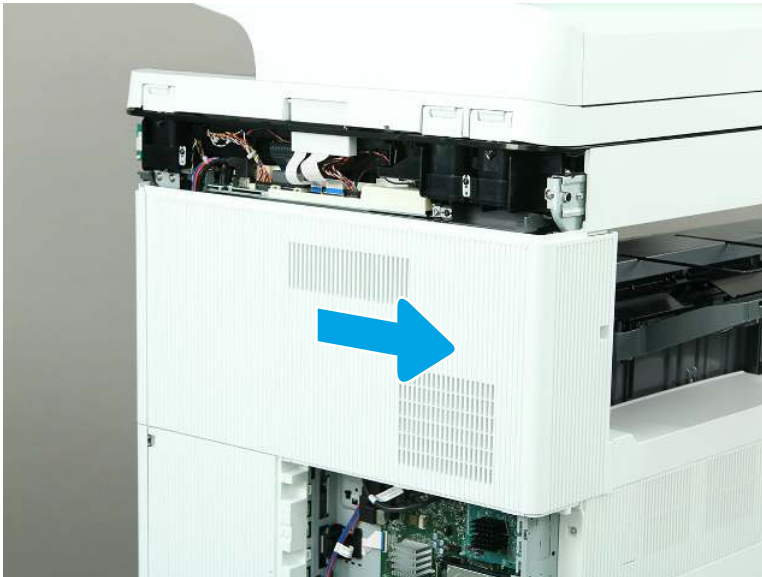
- a. Remove two screws (callout 1), and then release two tabs (callout 2).

Figure 1-2888 Remove two screws and release two tabs



- b. Slide the cover to the right to remove it.

Figure 1-2889 Remove the rear upper and left rear upper cover



12. Remove the front cover (M776zs).

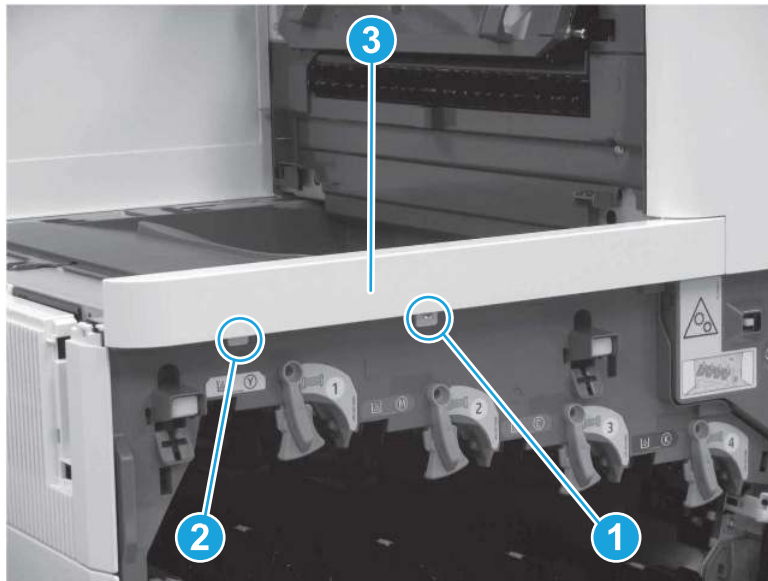
- a. Open the front door.

Figure 1-2890 Open the front door



- b. Remove one screw (callout 1), release one tab (callout 2), and then remove the front cover (callout 3).

Figure 1-2891 Remove the front cover



13. Remove the control panel (M776).

- a. Rotate the control panel to the fully raised position (callout 1), and then raise the document feeder (callout 2).

Figure 1-2892 Raise the control panel and document feeder



- b. Beginning at the right side of the control-panel cover, carefully release five tabs along the top edge of the cover.

 **NOTE:** The thin black-plastic cover will separate from the white-plastic control-panel base.

Figure 1-2893 Release the control panel cover



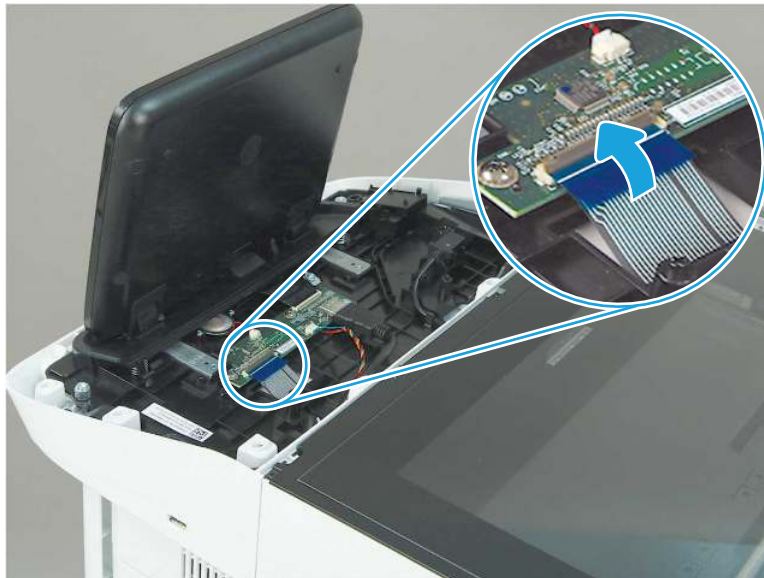
- c. Rotate the control panel cover slightly forward (callout 1), and then lift up to remove the cover (callout 2).

Figure 1-2894 Remove the control panel cover



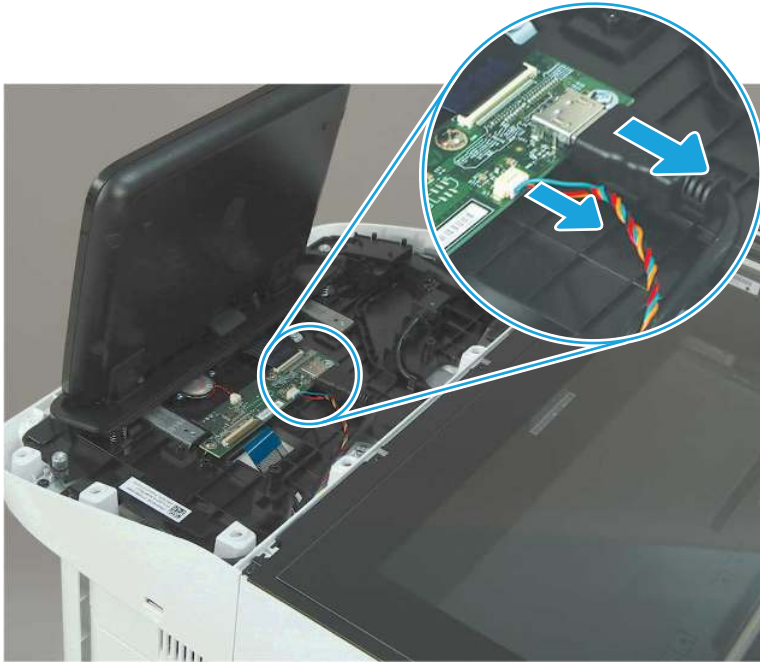
- d. **M776z or M776zs only:** Open the connector latch to release the keyboard flat cable.

Figure 1-2895 Release the keyboard flat cable (M776z/M776zs)



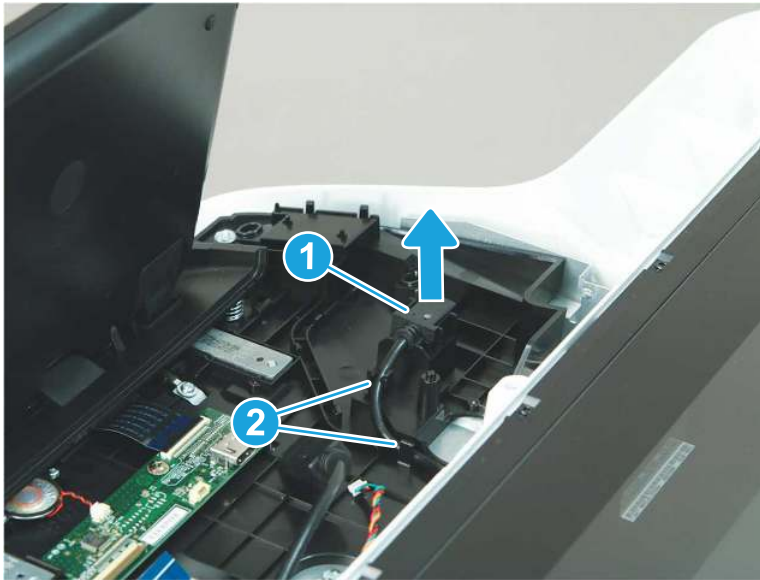
- e. Disconnect two connectors

Figure 1-2896 Disconnect two connectors



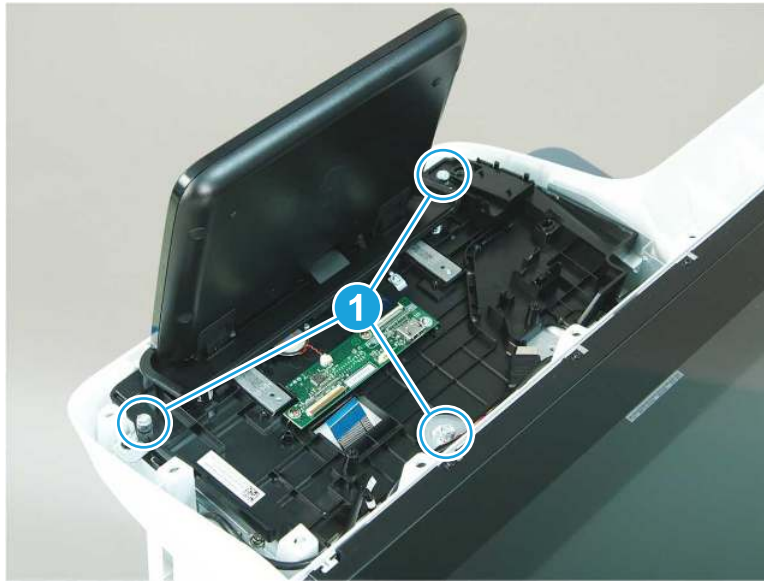
- f. Remove the USB cable (callout 1) from the holder, and then release the cable from two retainers (callout 2).

Figure 1-2897 Release the USB cable



- g. Remove three screws (callout 1).

Figure 1-2898 Remove three screws



- h. Lift the front of the control panel off of the printer (callout 1), and then slide it towards the front of the printer (callout 2) to remove it.

Figure 1-2899 Remove the control panel



- 14. Remove the keyboard (M776z/M776zs).

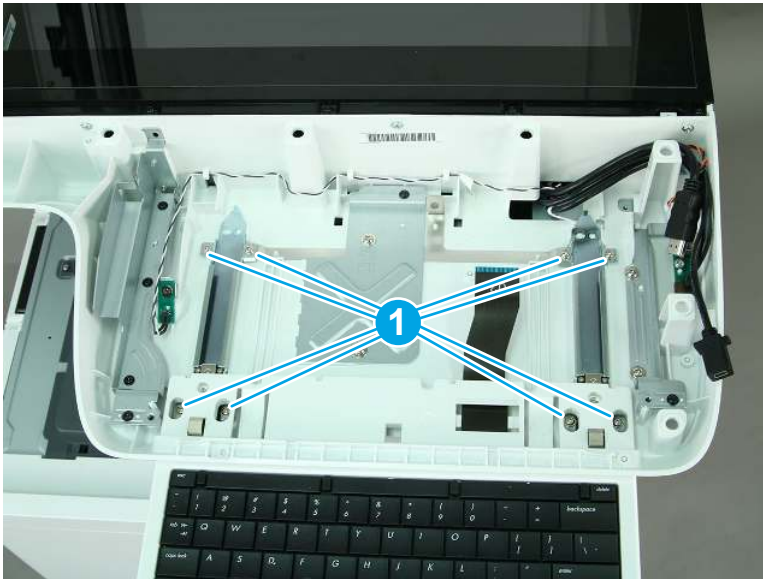
- a. Pull the keyboard out to its extended position.

Figure 1-2900 Pull the keyboard out



- b. Remove eight screws (callout 1).

Figure 1-2901 Remove eight screws



- c. Remove the keyboard and rails.

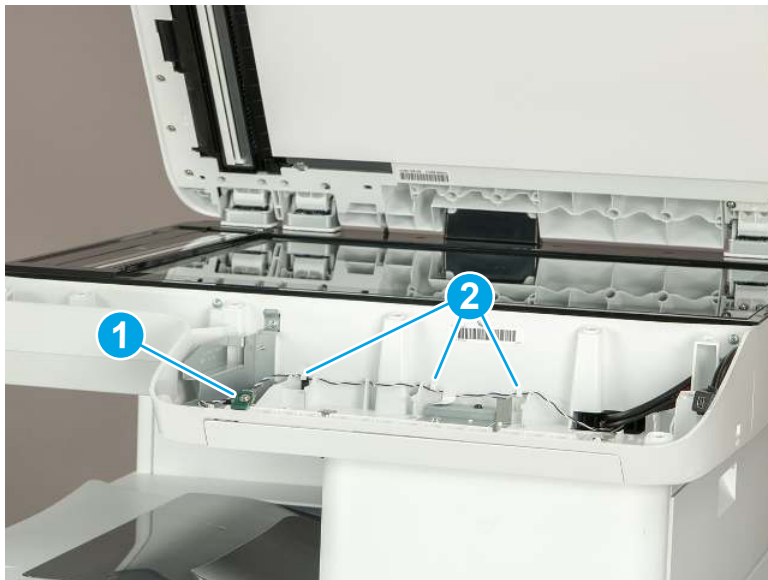
Figure 1-2902 Remove the keyboard and rails



- 15. Remove the nose cone (M776).

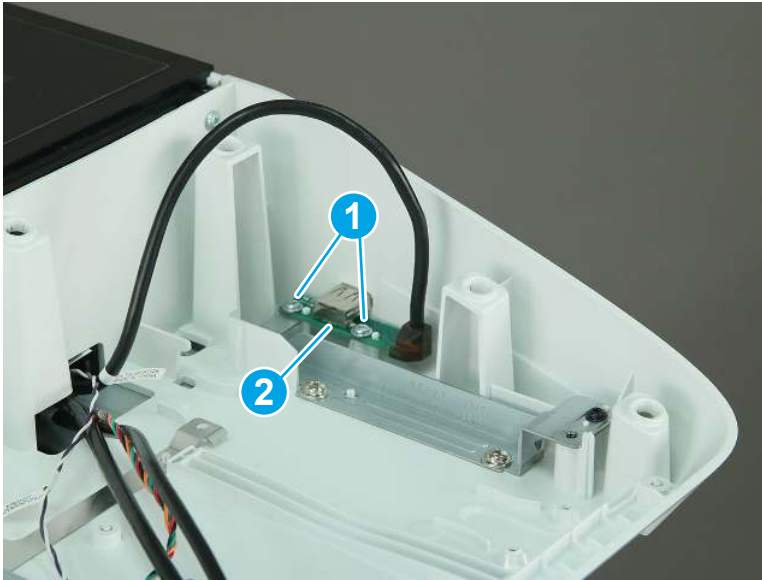
- a. Remove one screw (callout 1) to release the light PCA. Release the cable from three retainers (callout 2), and then move the light PCA out of the way.

Figure 1-2903 Release the light PCA



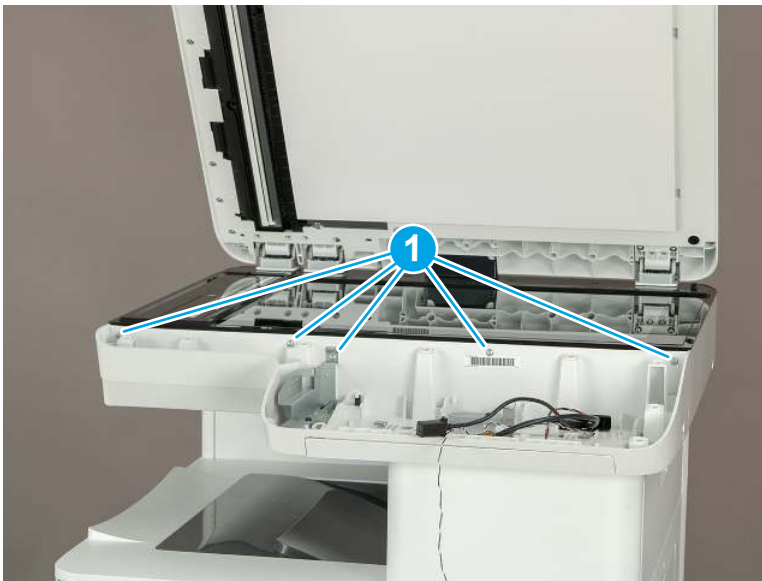
- b. Remove two screws (callout 1), and then move the USB port PCA (callout 2) out of the way.

Figure 1-2904 Release the USB port PCA



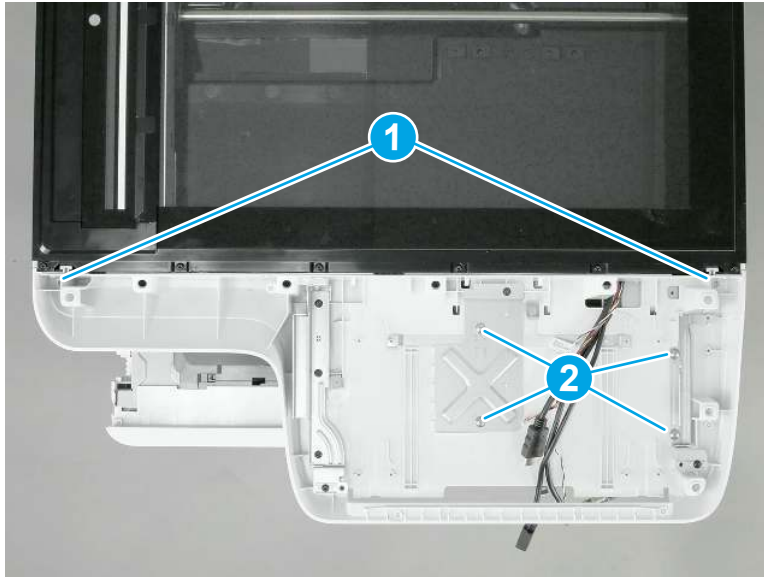
- c. Remove five screws (callout 1).

Figure 1-2905 Remove four screws



- d. Remove two small, self-tapping screws (callout 1), and then remove four larger machine screws (callout 2).

Figure 1-2906 Remove six screws



- e. Lift the nose cone up and off of the printer to remove it.


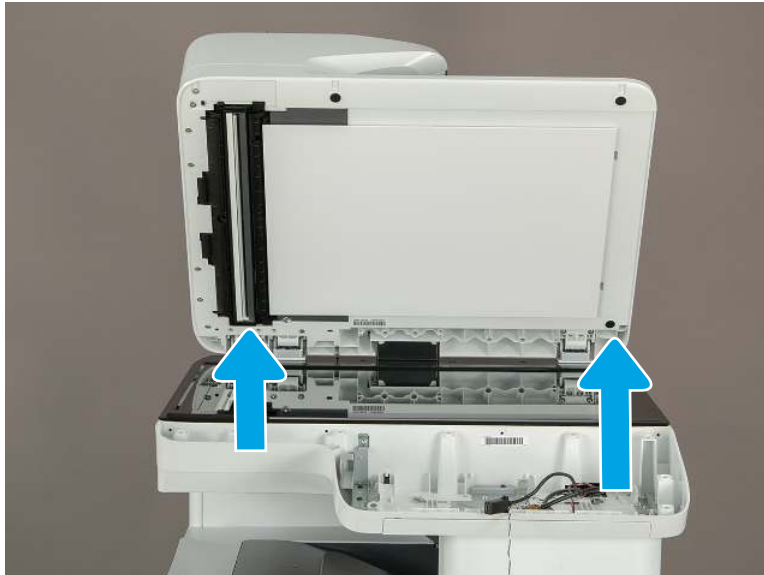
 **NOTE:** Pass the wire harnesses and cables through the opening in the nose cone when removing it.

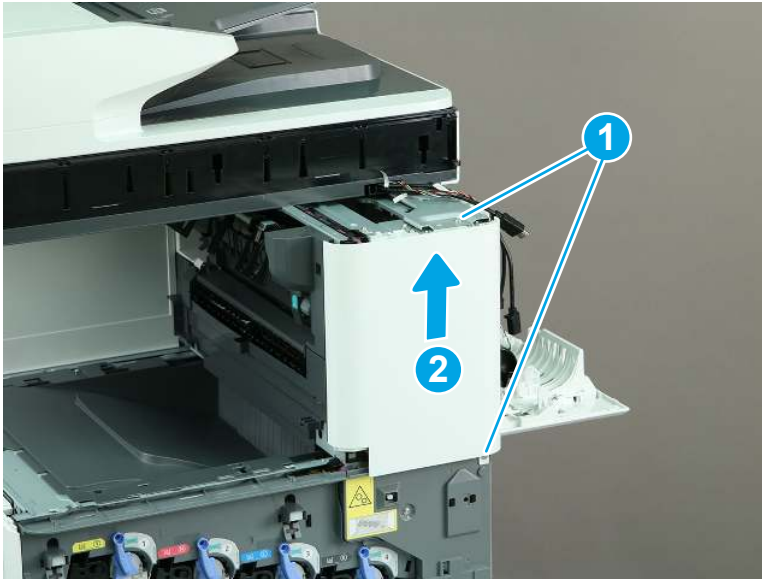
Figure 1-2907 Remove the nose cone



- 16. Remove the right front cover (M776zs).

- ▲ Remove two screws (callout 1), release one tab (callout 2), and then slide the right front cover up (callout 2) to remove it.

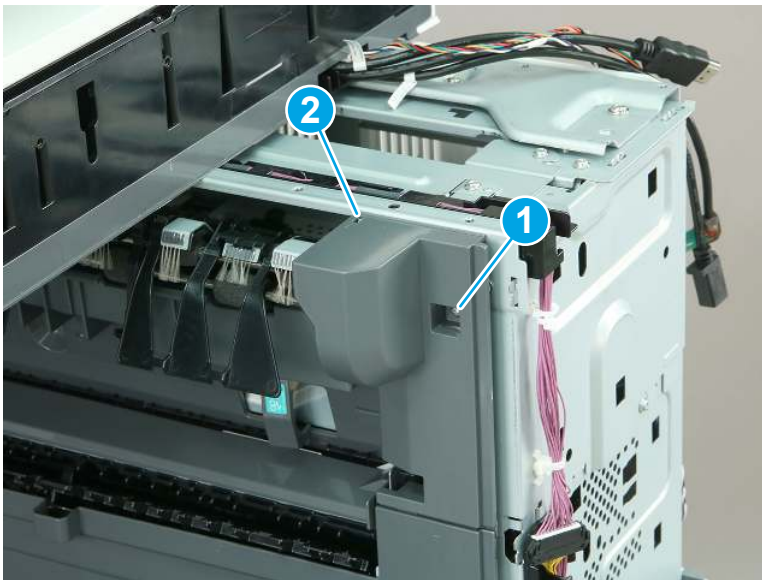
Figure 1-2908 Remove the right front cover



17. Remove the delivery front cover (M776zs).

- ▲ Remove one screw (callout 1), and then remove the delivery front cover (callout 2).

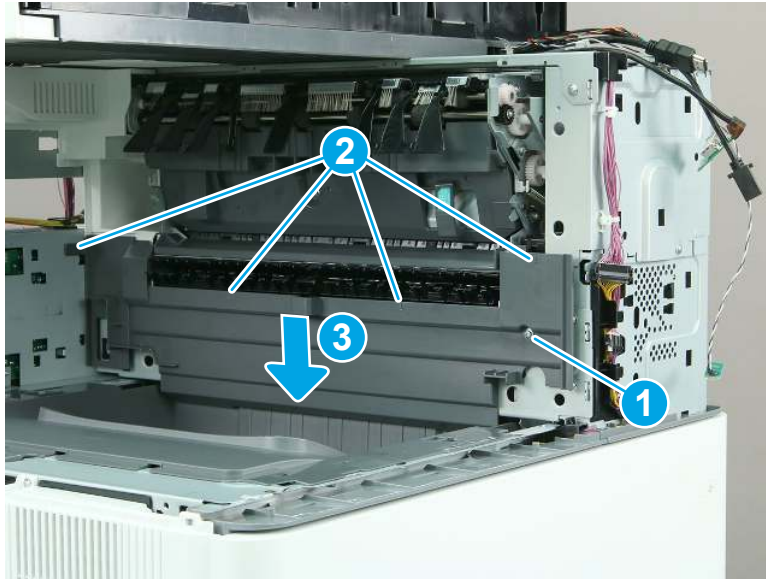
Figure 1-2909 Remove the delivery front cover



18. Remove the delivery cover (M776zs).

- ▲ Remove one screw (callout 1), release four tabs (callout 2), and then slide the delivery cover down (callout 3) to remove it.

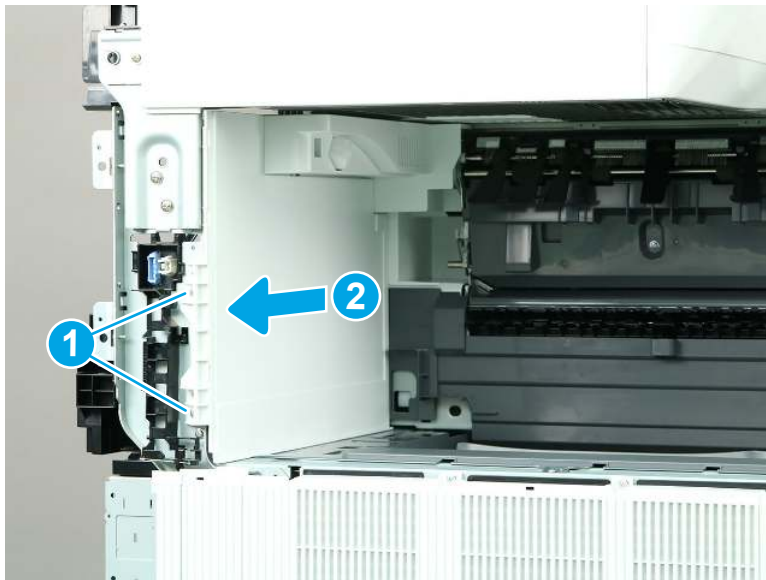
Figure 1-2910 Remove the delivery cover



19. Remove the main cover (M776zs).

- ▲ Remove two screws (callout 1), and then slide the main cover away from the printer to remove it (callout 2).

Figure 1-2911 Remove the main cover

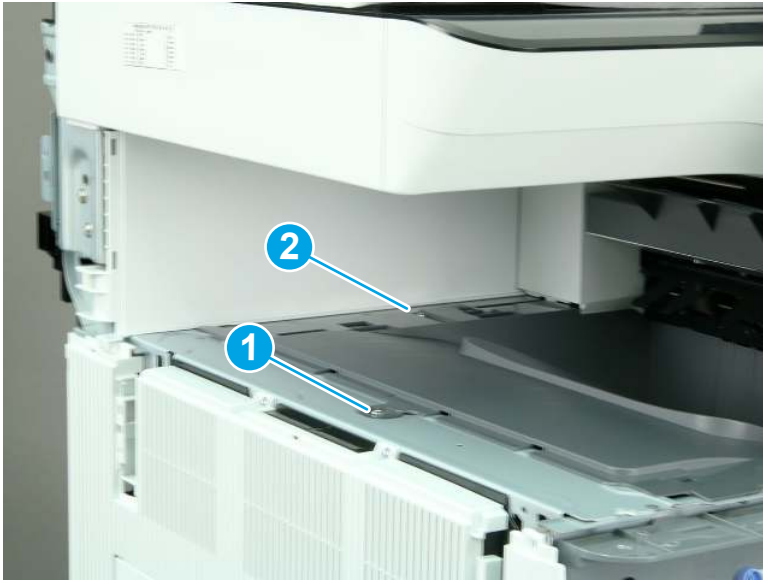


20. Remove the output bin (M856/E85055/M776).

 **NOTE:** The following figures show the M776z printer. The procedure is correct for all referenced models.

- a. Remove one washer-head machine screw (callout 1), remove one self-tapping screw (callout 2).

Figure 1-2912 Remove two screws



- b. Remove the output bin.

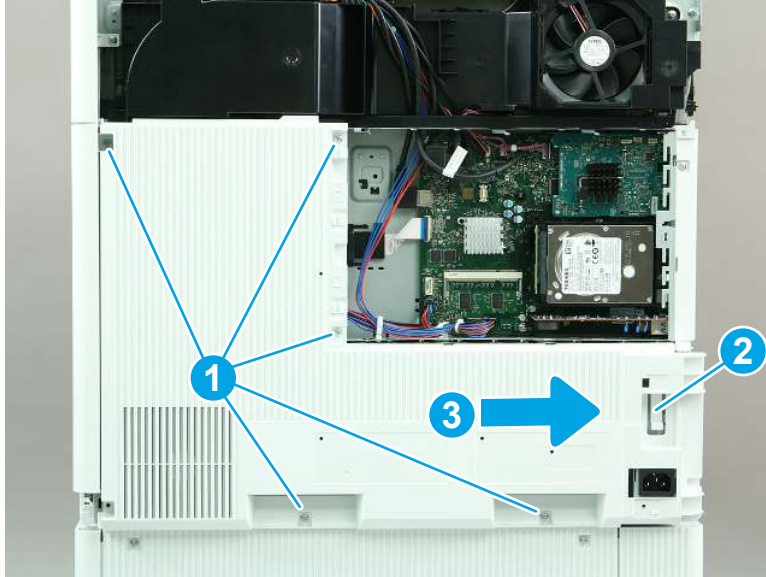
Figure 1-2913 Remove the output bin



21. Remove the rear cover (M856/E85055/M776).

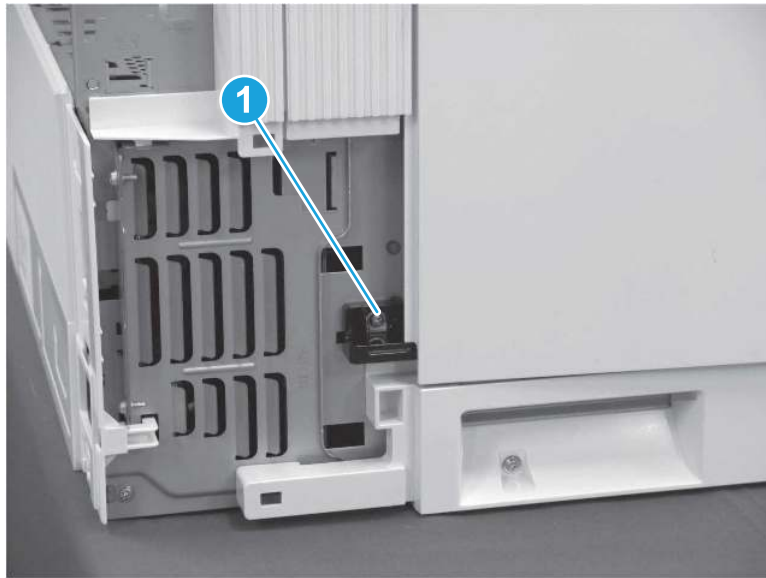
- ▲ Remove five screws (callout 1), release one tab (callout 2), and then slide the rear cover to the right to remove it.

Figure 1-2914 Remove the rear cover (M856/E85055/M776)



- 22. Remove the left door.
 - a. Remove one screw (callout 1).

Figure 1-2915 Remove one screw



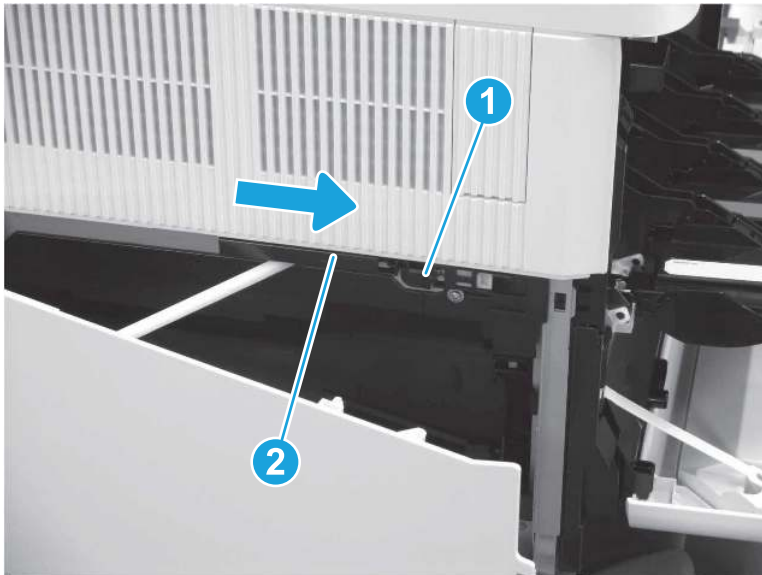
- b. Release the holder, and then remove it from the printer.

Figure 1-2916 Remove the holder



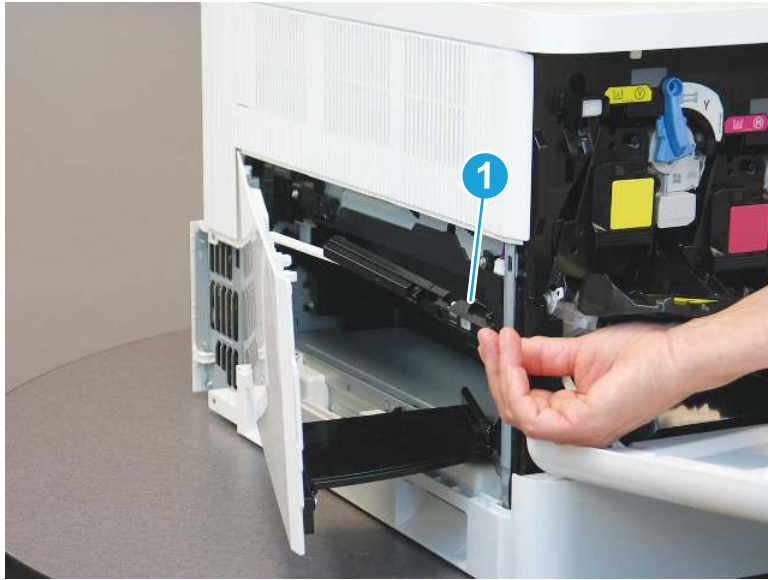
- c. Open the left door, and release one tab (callout 1). Slide the holder (callout 2) toward the front of the printer.

Figure 1-2917 Slide the holder



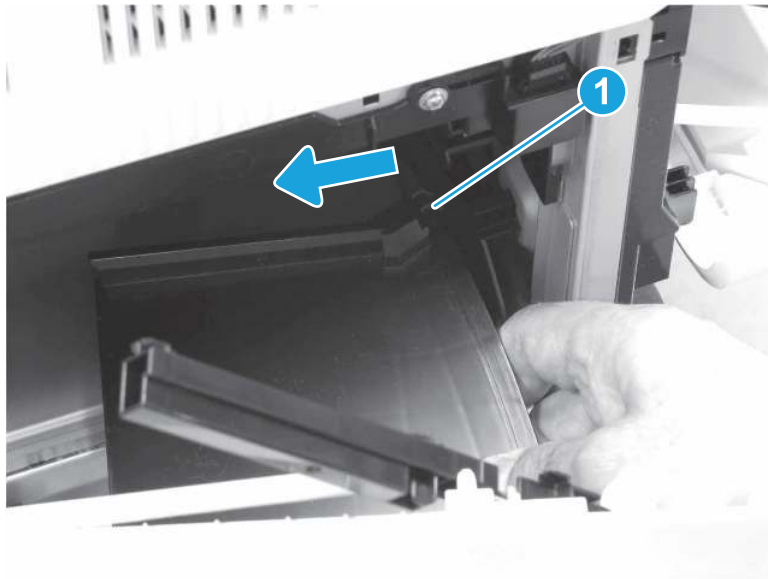
- d. Release the holder (callout 1) from the printer, but leave it attached to the hinge.

Figure 1-2918 Release the holder



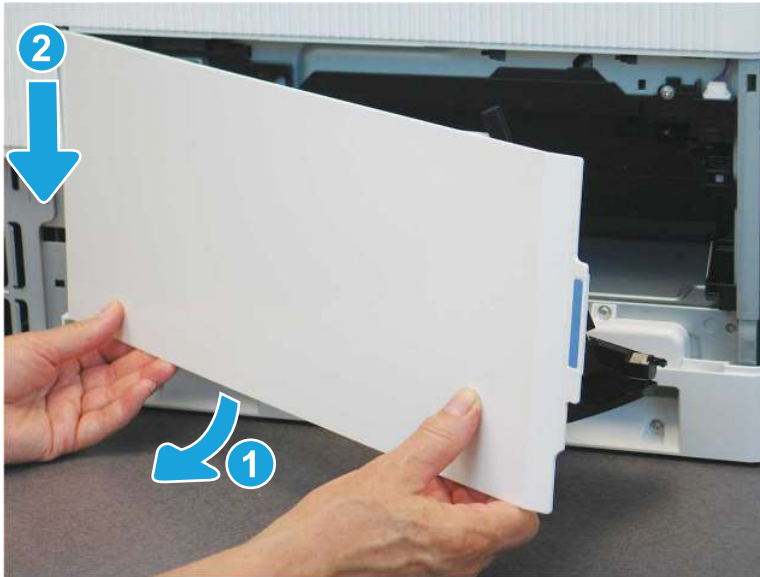
- e. Press the stopper (callout 1) on the bottom of the door to the left to release it from the track.

Figure 1-2919 Release the stopper



- f. Rotate the left, lower edge of the door away from the printer (callout 1), and then lower the door to remove it (callout 2).

Figure 1-2920 Remove the left door

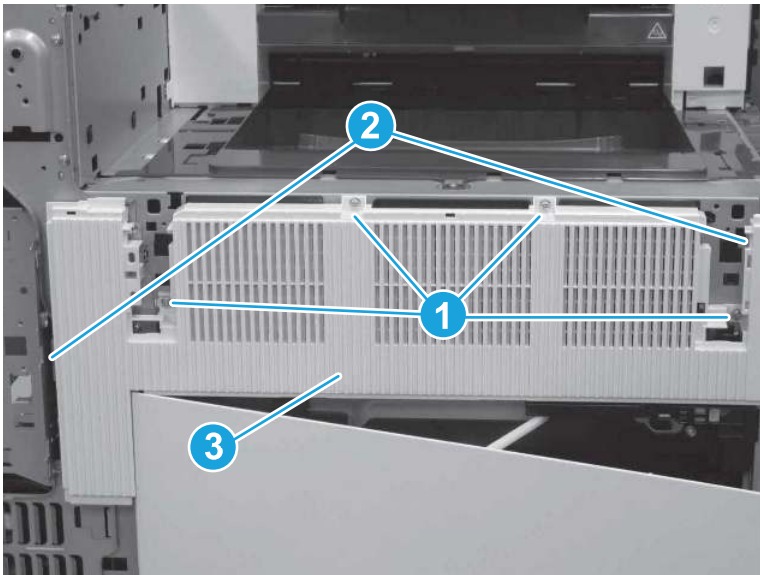


- 23. Remove the left upper cover (M856/E85055/M776).

 **NOTE:** The following figures show the M776z printer. The procedure is correct for all referenced models.

- ▲ Remove four screws (callout 1), release two tabs (callout 2), and then remove the left upper cover (callout 3).

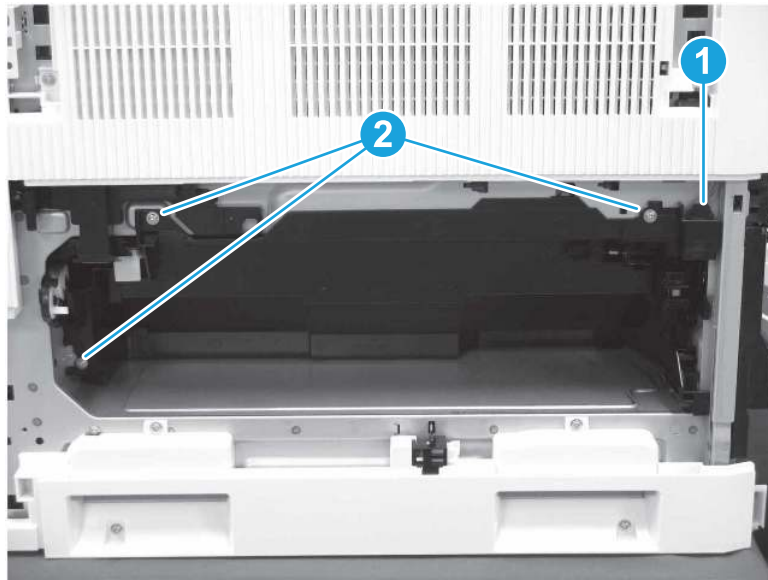
Figure 1-2921 Remove the left upper cover



- 24. Remove the scanner cover.

- a. Disconnect one connector (callout 1), and then remove three screws (callout 2).

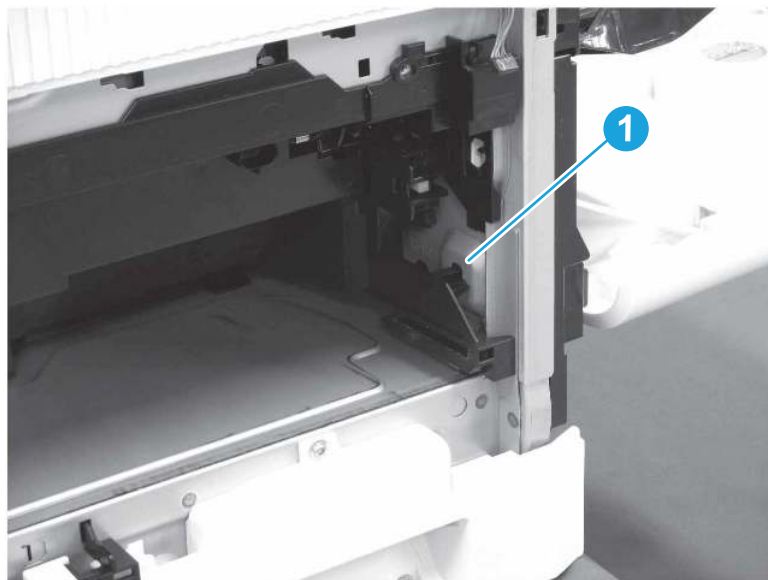
Figure 1-2922 Disconnect one connector and remove three screws



 **TIP:** Connect the connector before reinstalling the screws.

- b. Release one tab (callout 1), and then flex the scanner cover to remove it.

Figure 1-2923 Remove the scanner cover



25. Remove the secondary auger.

- a. Remove one screw (callout 1).

Figure 1-2924 Remove one screws



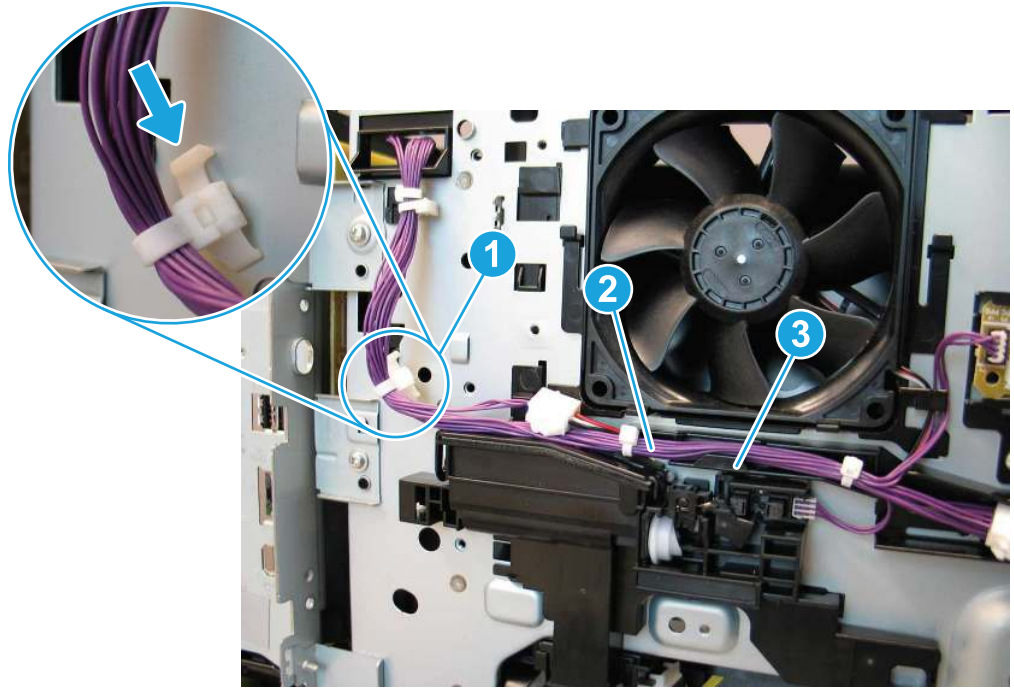
- b. Remove the left door upper hinge.

Figure 1-2925 Remove the left door upper hinge



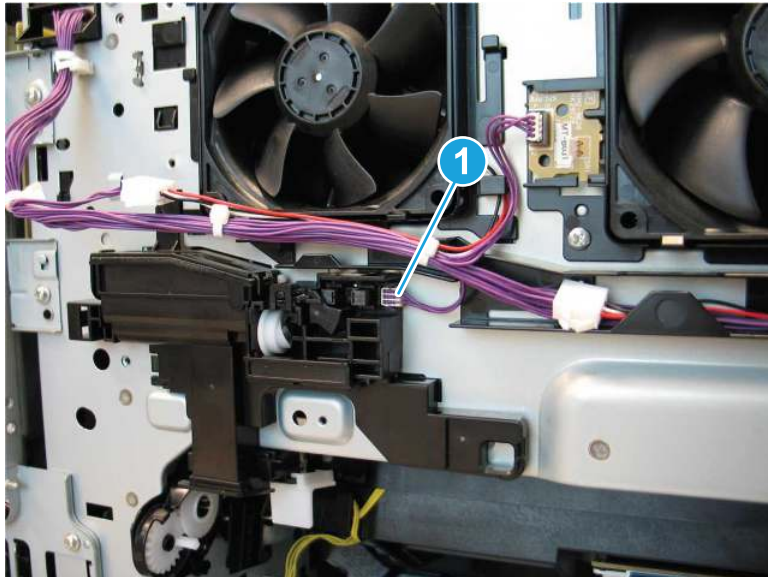
- c. Press the latch to release one retainer (callout 1) from the sheet metal. Remove the wire harness (callout 2) from the guides (callout 3).

Figure 1-2926 Release the wire harness from the guides



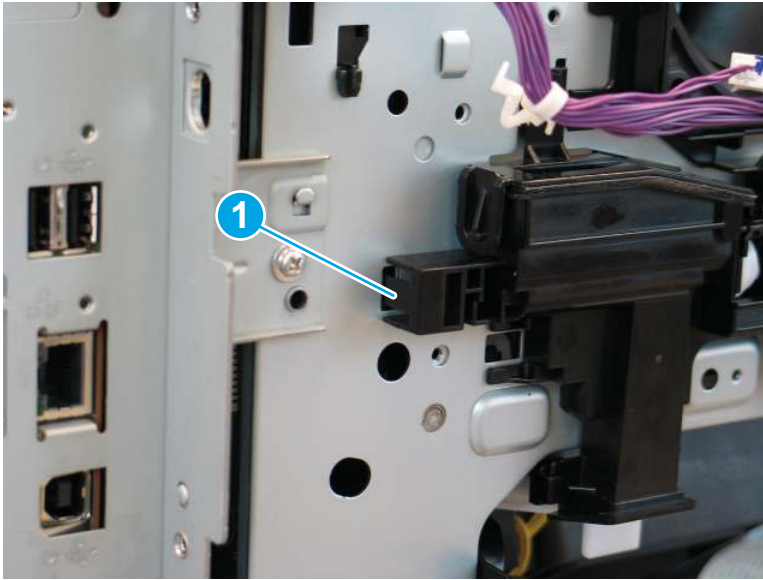
- d. Disconnect one connector (callout 1).

Figure 1-2927 Disconnect one connector



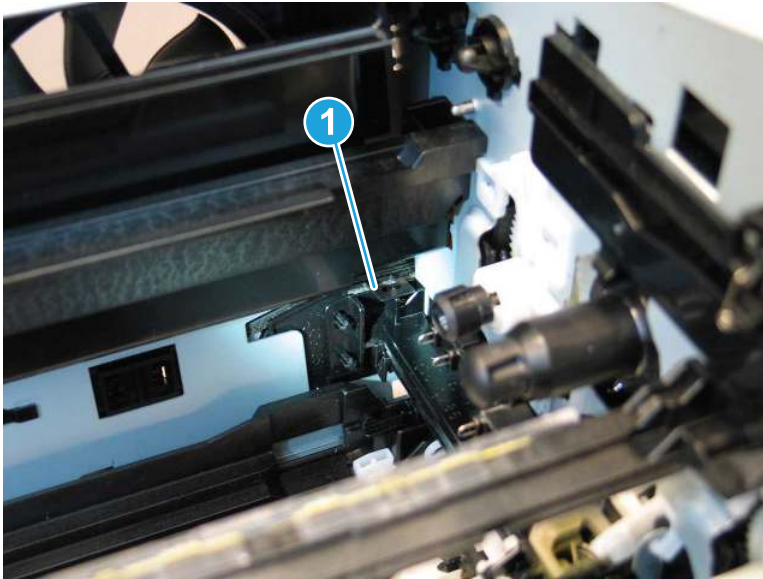
- e. Release one tab (callout 1).

Figure 1-2928 Release one tab



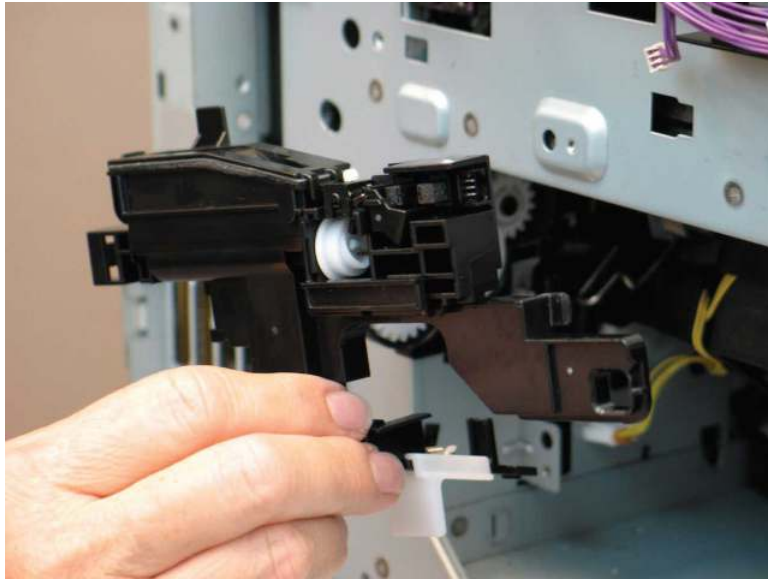
- f. Inside the printer, release one tab that connects to the primary auger (callout 1).

Figure 1-2929 Release one tab



- g. Remove the secondary auger assembly.

Figure 1-2930 Remove the secondary auger assembly

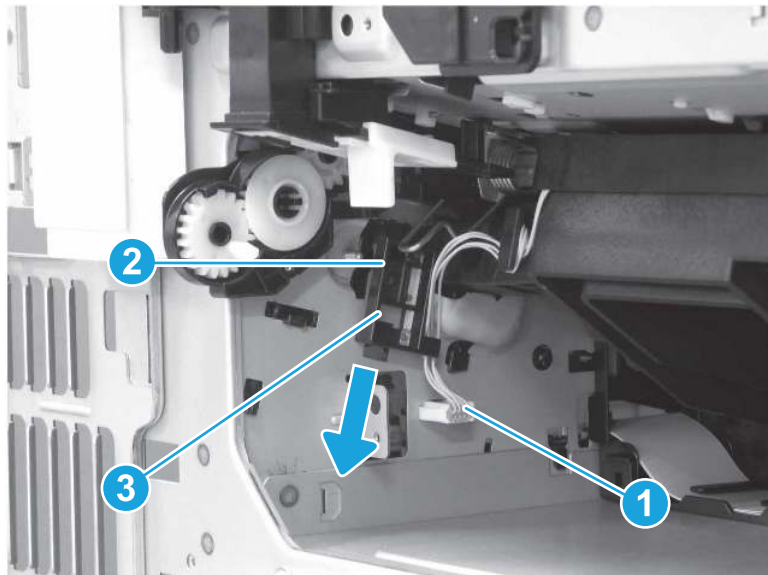


- 26. Remove the laser scanner.

IMPORTANT: The front door must be open while removing and installing the laser scanner to avoid damaging the laser scanner cleaning pads.

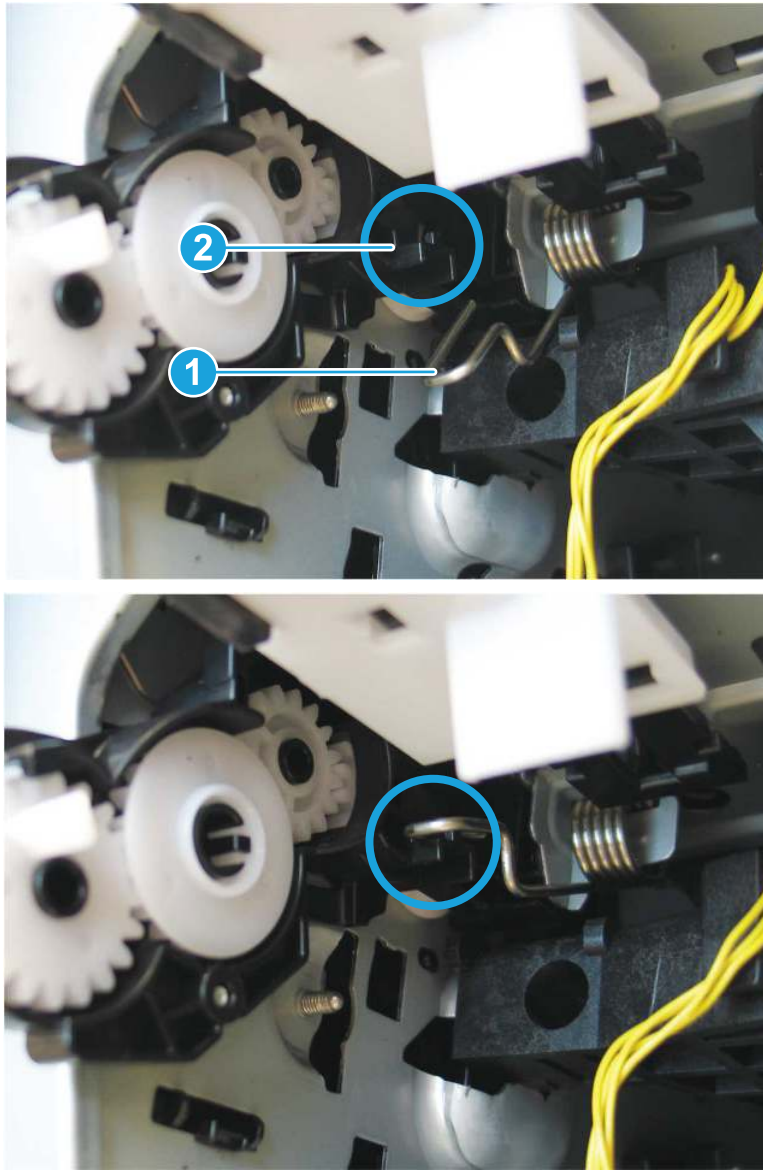
- a. Disconnect one connector (callout 1), release one tab (callout 2), and then slide the stopper (callout 3) down to remove it.


Figure 1-2931 Remove the stopper

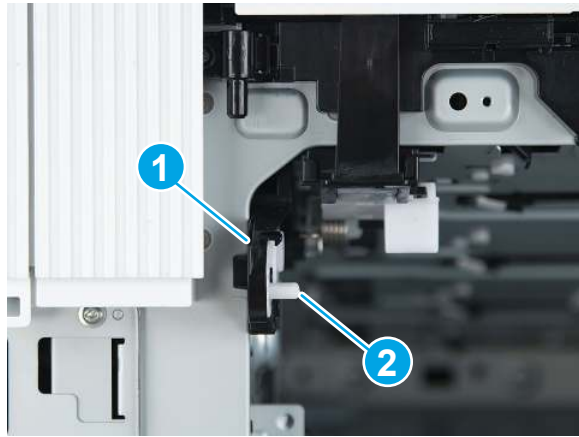


- b. Hook the spring (callout 1) on the hook (callout 2).

Figure 1-2932 Hook the spring

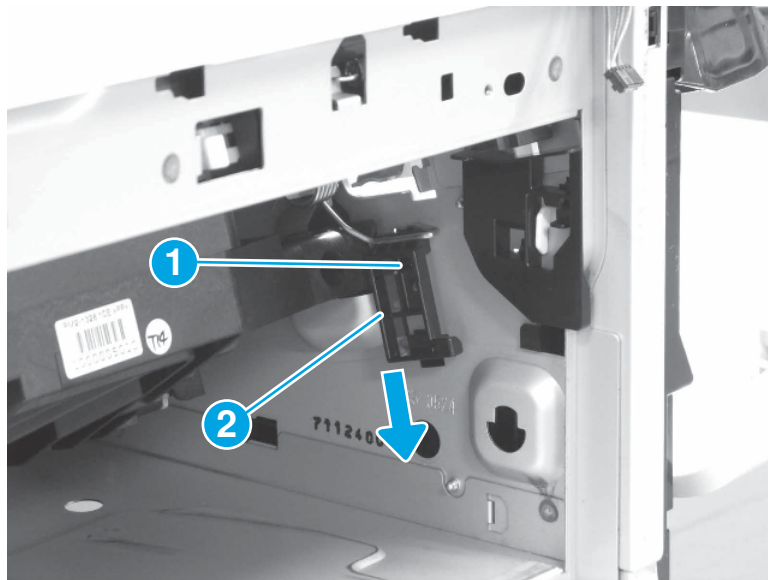


 **TIP:** When the laser scanner is installed, make sure that the gear case is flat against the printer chassis (callout 1). The pin on the gear (callout 2) might need to be rotated out of the way when the assembly is installed.



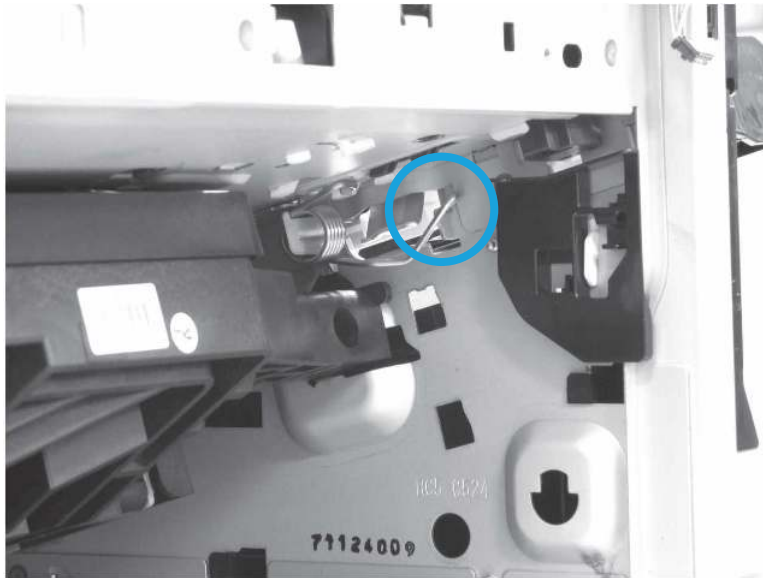
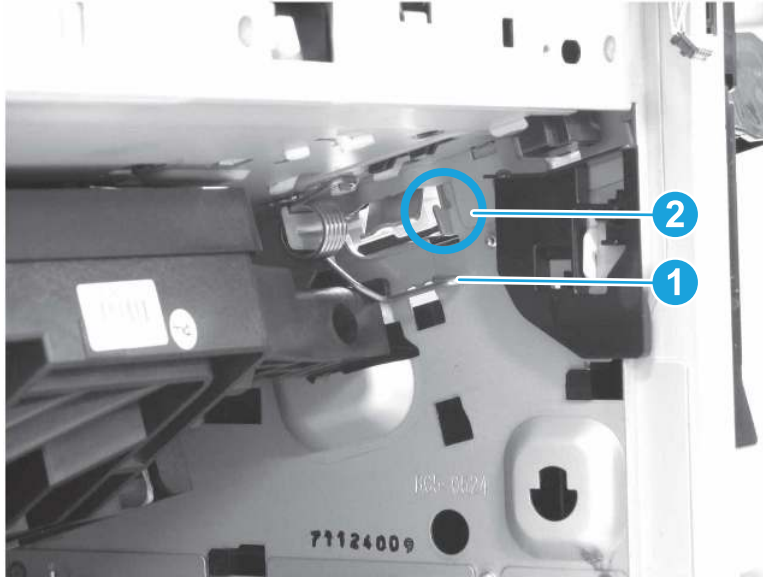
- c. On the right side of the laser scanner, release one tab (callout 1), and then slide the stopper (callout 2) down to remove it.

Figure 1-2933 Remove the stopper



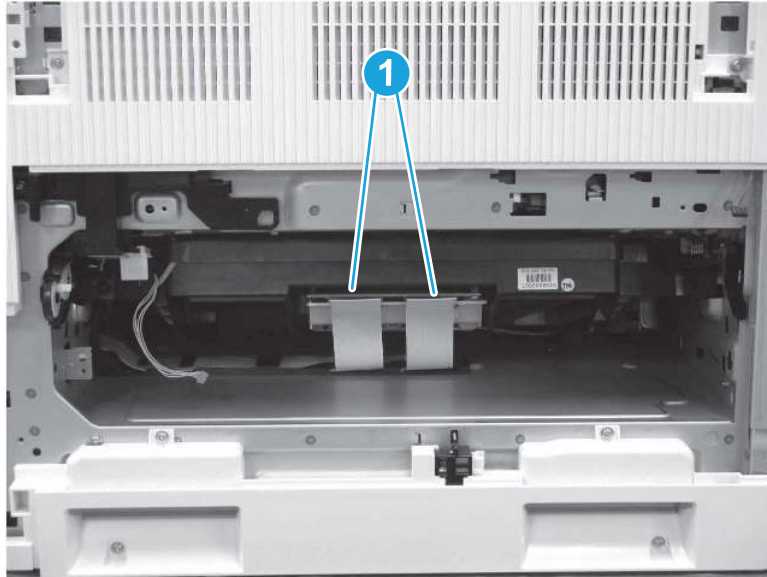
- d. Hook the spring (callout 1) on the hook (callout 2).

Figure 1-2934 Hook the spring



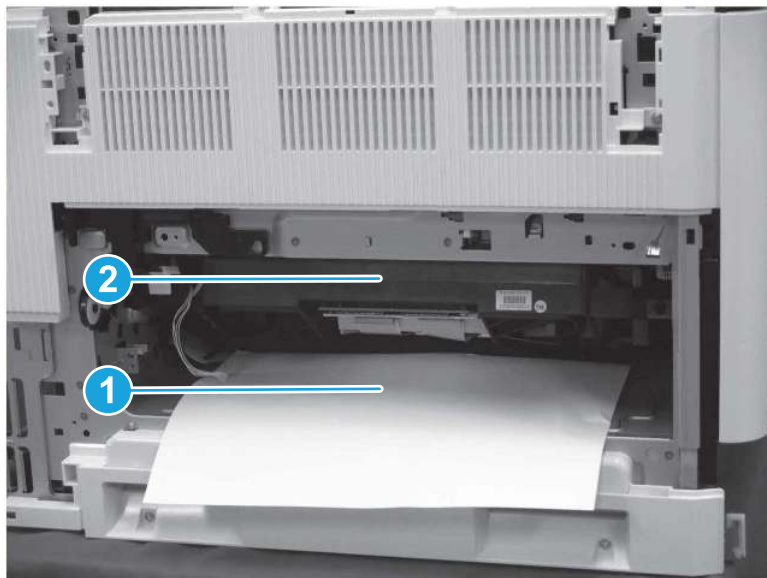
- e. Disconnect two flat cables (callout 1).


Figure 1-2935 Disconnect two flat cables




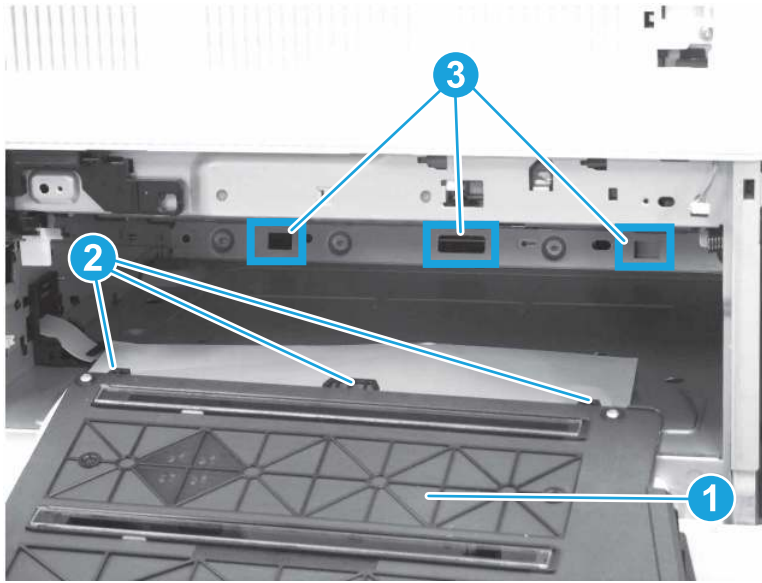
- f. Lay a sheet of paper on top of the flat cables (callout 1) to protect them. Pull the laser scanner (callout 2) out of the printer to remove it.

Figure 1-2936 Remove the laser scanner



 **IMPORTANT:** The front door must be open while removing and installing the laser scanner to avoid damaging the laser scanner cleaning pads.

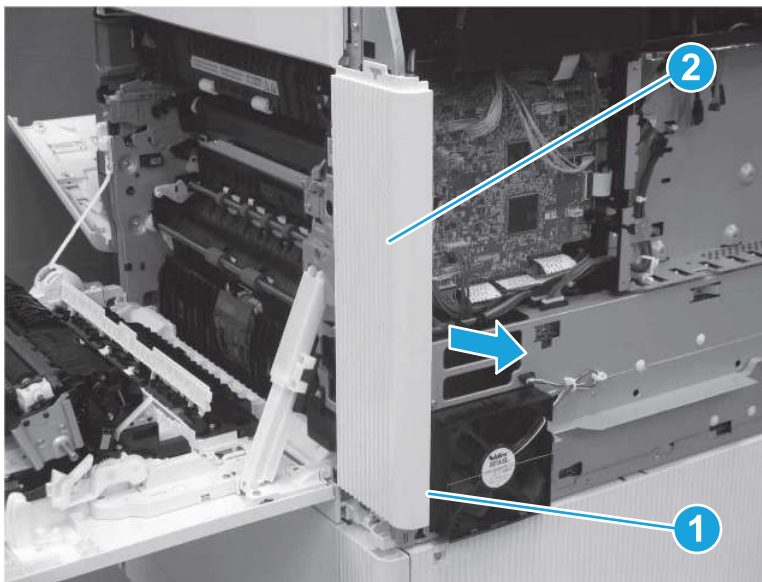
 **TIP:** When installing the laser scanner (callout 1), position the pins (callout 2) on the laser scanner into the openings (callout 3) inside the printer.



27. Remove the right rear cover (M856/E85055/M776).

- ▲ Release one tab (callout 1), and then slide the rear cover away from the printer to remove it.

Figure 1-2937 Remove right rear cover



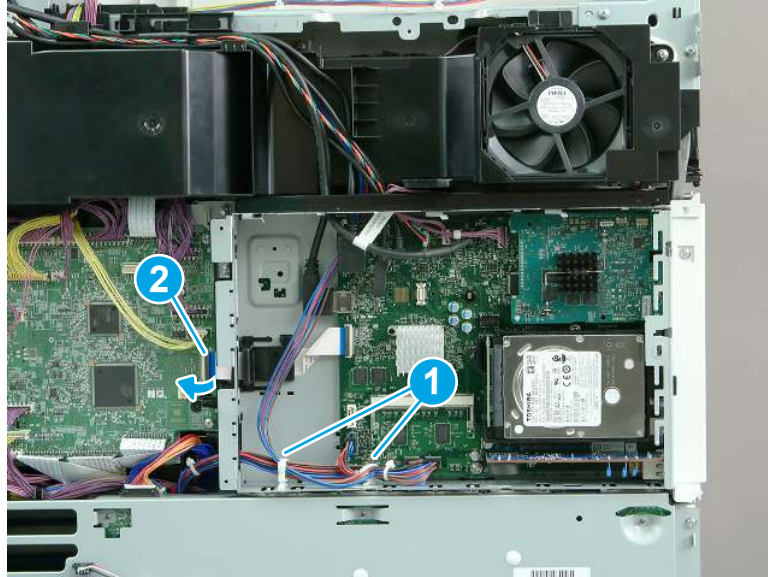
28. Remove the formatter and case (M856/E85055/M776).

 **NOTE:** The figures below show the M776zs formatter. The procedure is correct for all referenced models.

- a. Release two retainers (callout 1), and then open the retainer (callout 2) to release the flat cable. Disconnect all of the remaining connectors on the formatter board.

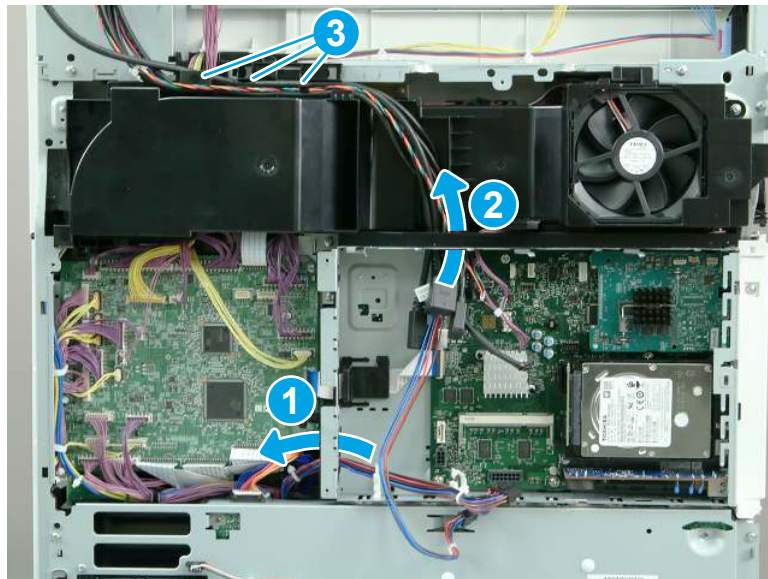
 **NOTE:** The figures below show the M776zs model. The procedures are correct for all of the referenced models.

Figure 1-2938 Disconnect the connectors



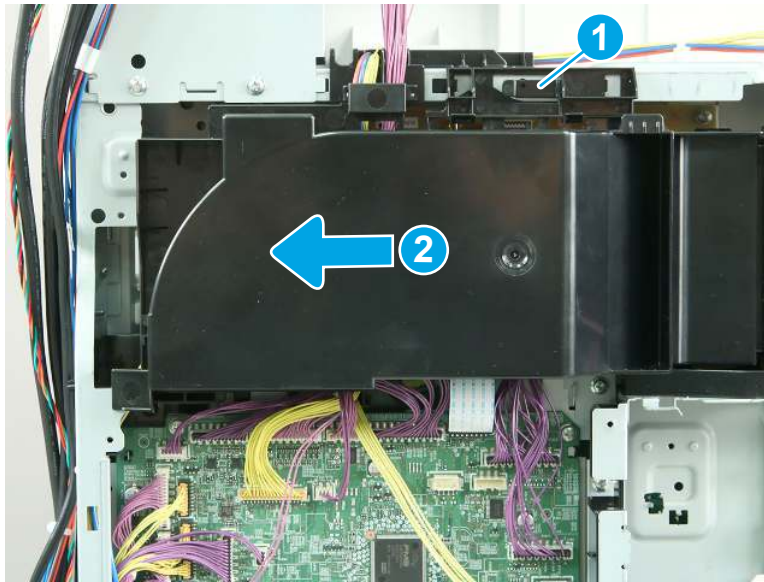
- b. Release one cable through the opening in the left side of the formatter case (callout 1). Release the remaining cables through the opening in the top of the formatter case (callout 2). Release the cables from the upper cable guide (callout 3).

Figure 1-2939 Release the cables



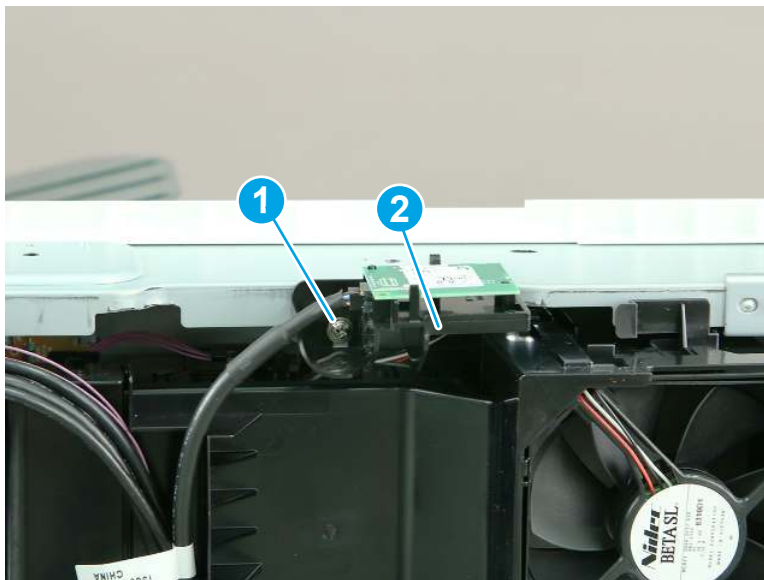
- c. Release one tab (callout 1), and then slide the fan duct to the left (callout 2) to remove it.

Figure 1-2940 Remove the fan duct



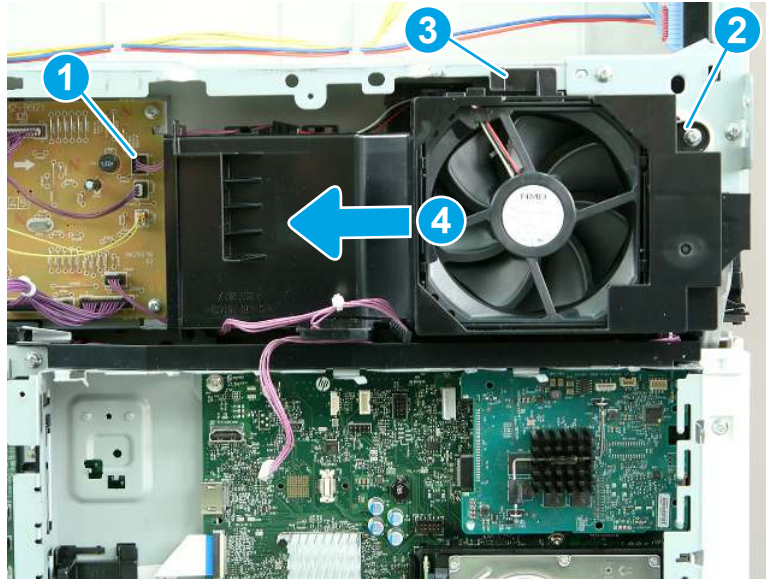
- d. **M856 and E85055 only:** Remove one screw (callout 1), and then remove the wireless card and bracket (callout 2).

Figure 1-2941 Remove the wireless card and bracket



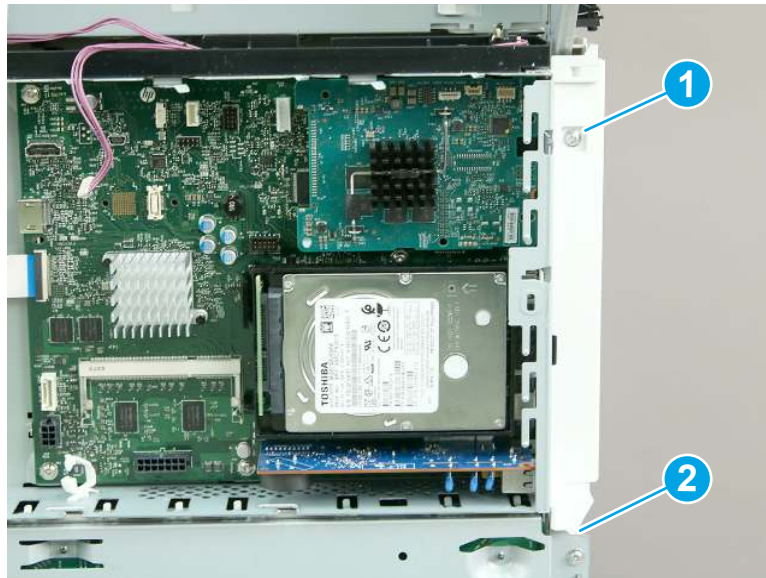
- e. Disconnect one connector (callout 1), and remove one screw (callout 2). Release one tab (callout 3), and then slide the fan assembly to the left (callout 4) to remove it.

Figure 1-2942 Remove the fan assembly



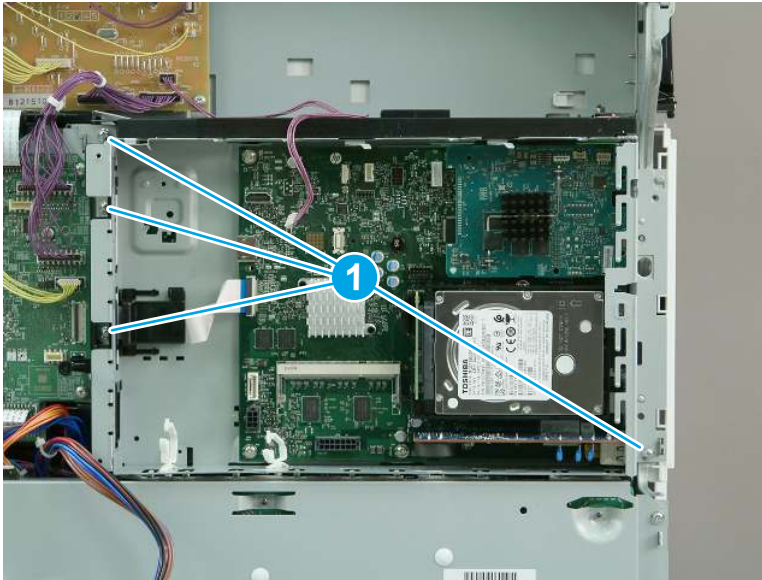
- f. Remove one screw (callout 1), release one tab (callout 2), and then remove the left rear cover.

Figure 1-2943 Remove the left rear cover



- g. Remove four screws (callout 1).

Figure 1-2944 Remove four screws



- h. Remove the formatter and case.

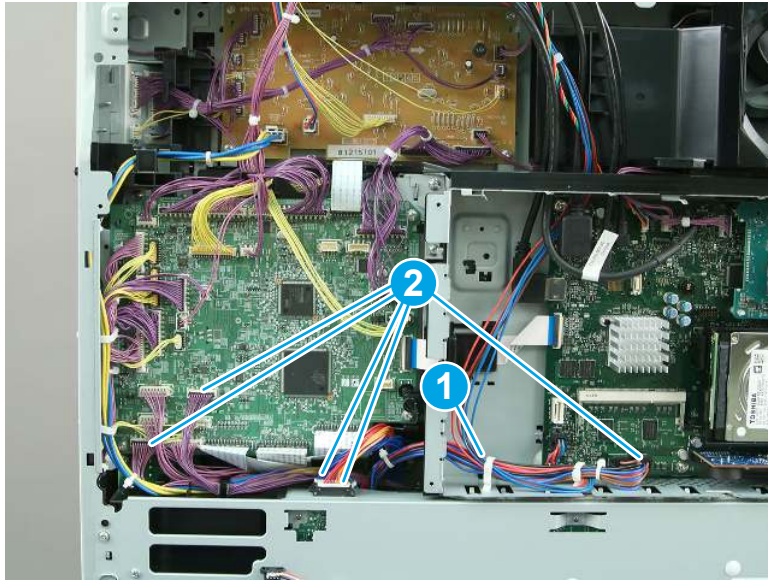
Figure 1-2945 Remove the formatter and case



- 29. Remove the low-voltage power supply (LVPS) (M856/E85055/M776).

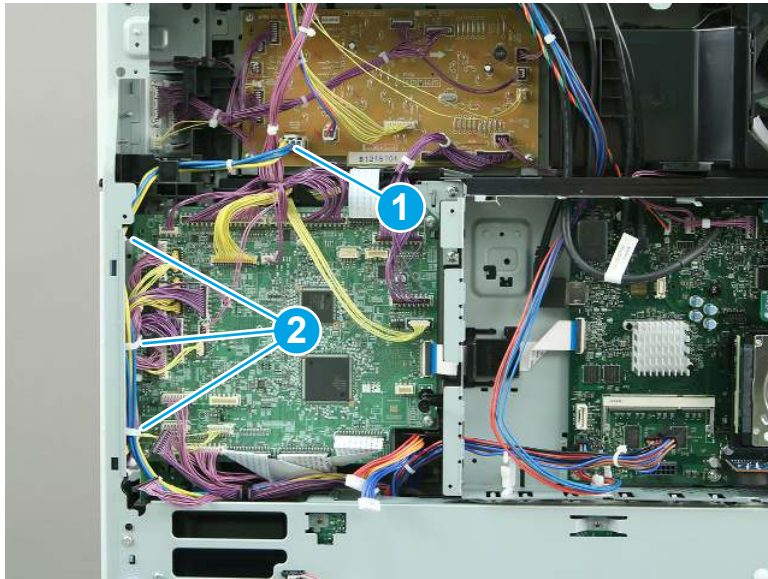
- a. Release one retainer (callout 1), and then disconnect five connectors (callout 2).

Figure 1-2946 Release the retainer and disconnect five connectors



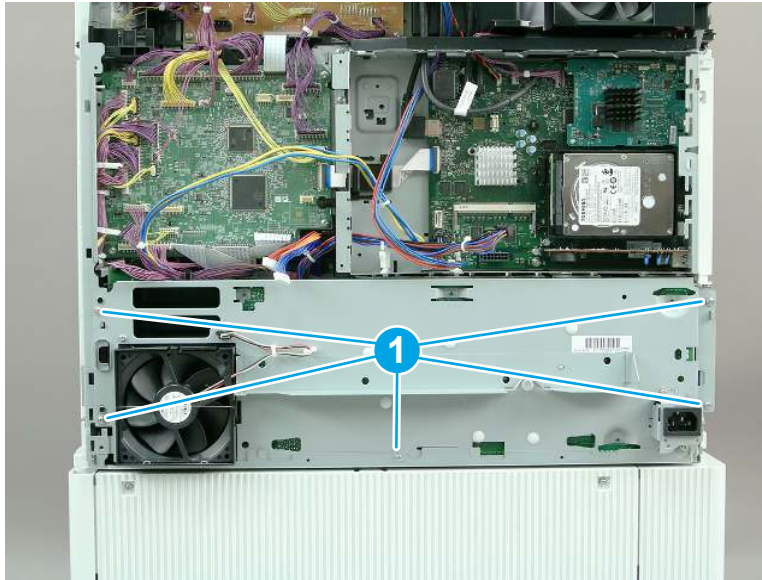
- b. Disconnect one connector (callout 1), and then release three retainers (callout 2).

Figure 1-2947 Disconnect one connector and release five retainers




- c. Remove five screws (callout 1).

Figure 1-2948 Remove five screws



- d. Tilt the LVPS away from the printer (callout 1). Thread the cable (callout 2) through the opening in the formatter case.

 **NOTE:** Due to mechanical tolerances on the formatter cage, rotating the LVPS out might be difficult.


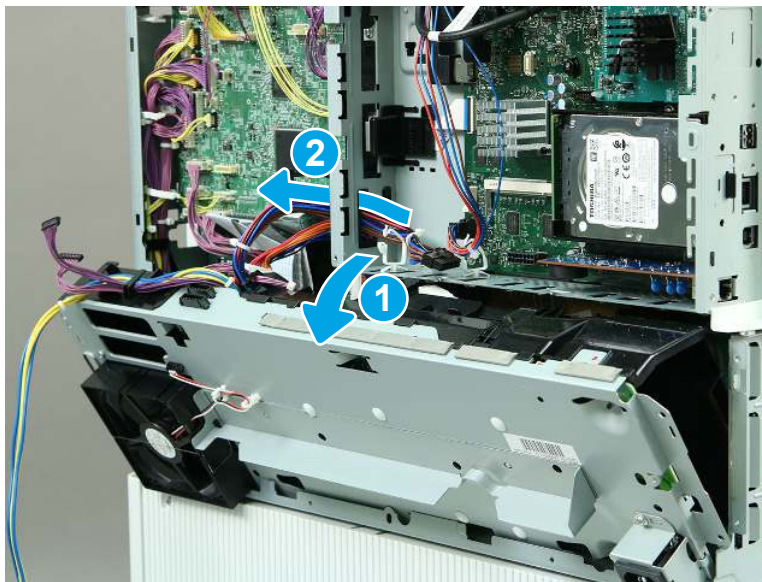
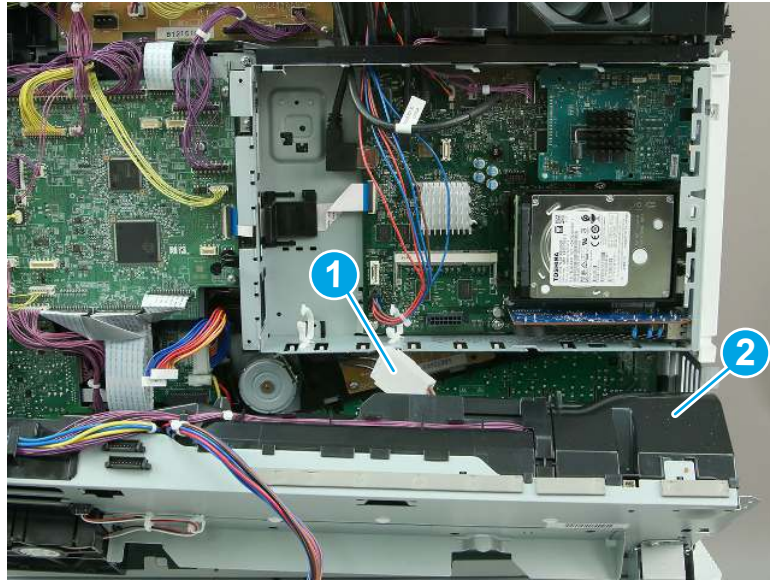
 **CAUTION:** One connector is still connected, so tilt the LVPS carefully.

Figure 1-2949 Thread the cable



- e. Disconnect one connector (callout 1), and then lift up to remove the LVPS (callout 2).

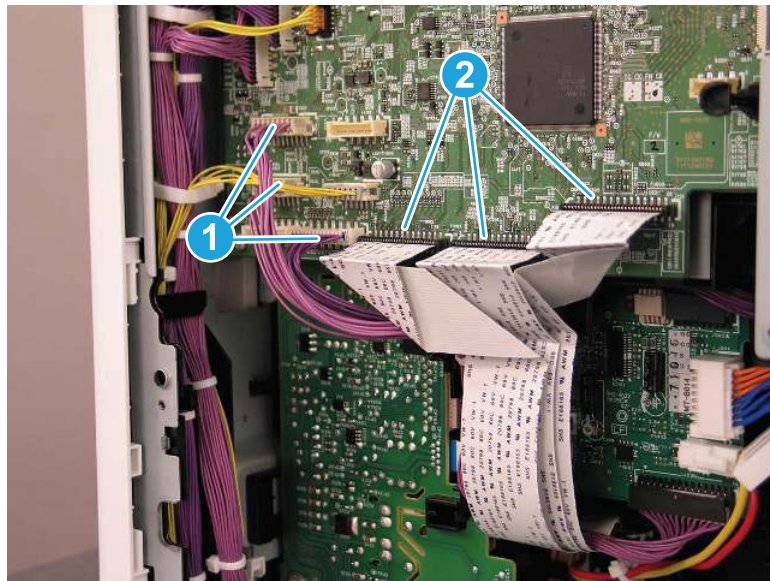
Figure 1-2950 Remove the LVPS



- 30. Remove the T2 connecting PCA.

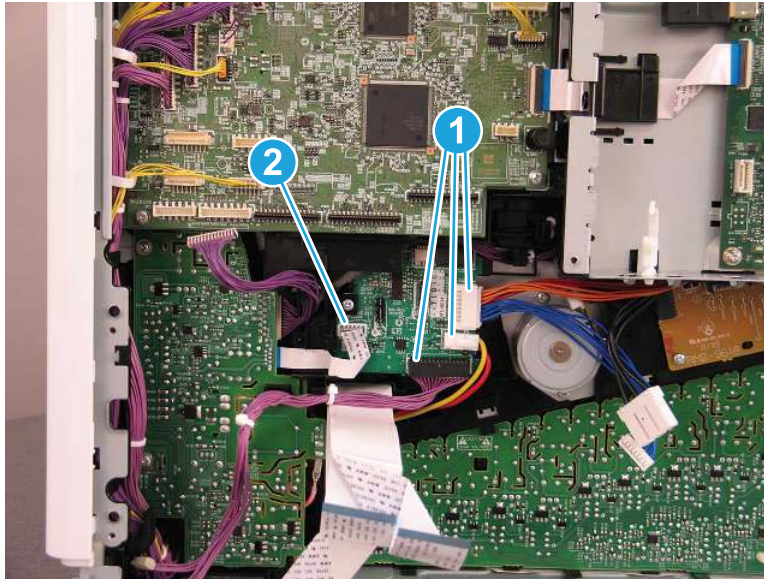
- a. Disconnect three connectors (callout 1), and then disconnect three flat cables (callout 2).

Figure 1-2951 Disconnect six connectors



- b. Disconnect three connectors (callout 1), and then disconnect one flat cable (callout 2).

Figure 1-2952 Disconnect three connectors and one flat cable



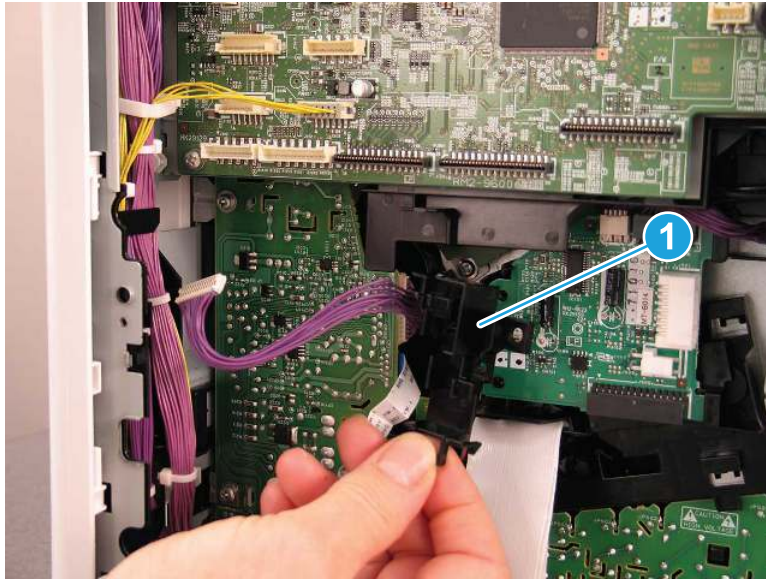
- c. Remove one screw (callout 1).

Figure 1-2953 Remove one screw



- d. Remove the cable guide (callout 1). If the cable guide is lost or damaged during the repair procedure, order a replacement part and install it along with the replacement T2 connecting PCA.

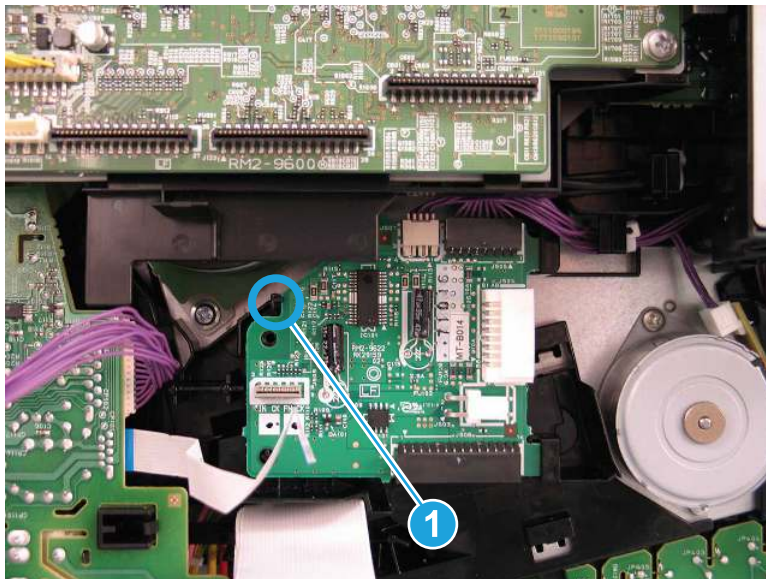
Figure 1-2954 Remove the cable guide



- e. Release one tab (callout 1), and then pull the T2 connecting PCA slightly away from the printer.

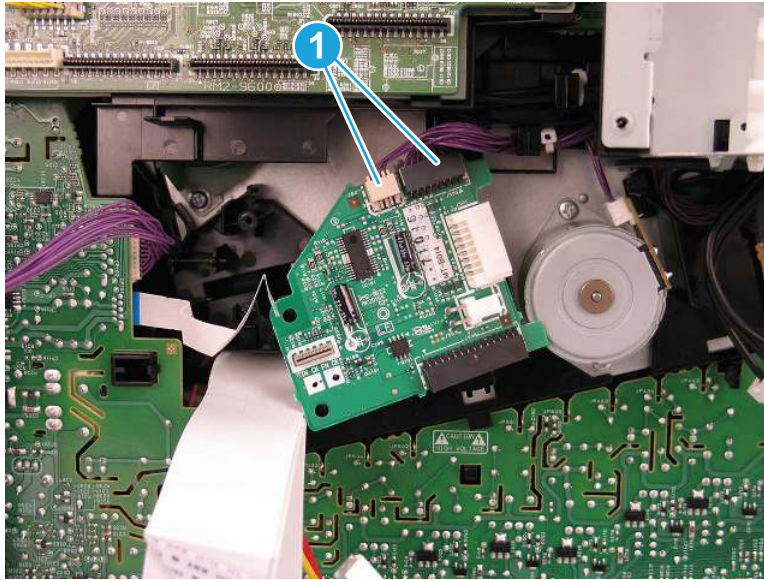
⚠ CAUTION: The T2 connecting PCA is still attached to the printer. Do not attempt to remove it completely.

Figure 1-2955 Release one tab



- f. Disconnect two connectors (callout 1), and then remove the T2 connecting PCA (callout 2).

Figure 1-2956 Disconnect two connectors and remove the PCA



- 31. Remove the upper high-voltage power supply (HVPS) (M856/E85055/M776).

- a. Disconnect one connector (callout 1), and then remove one screw (callout 2).

Figure 1-2957 Disconnect one connector and remove one screw



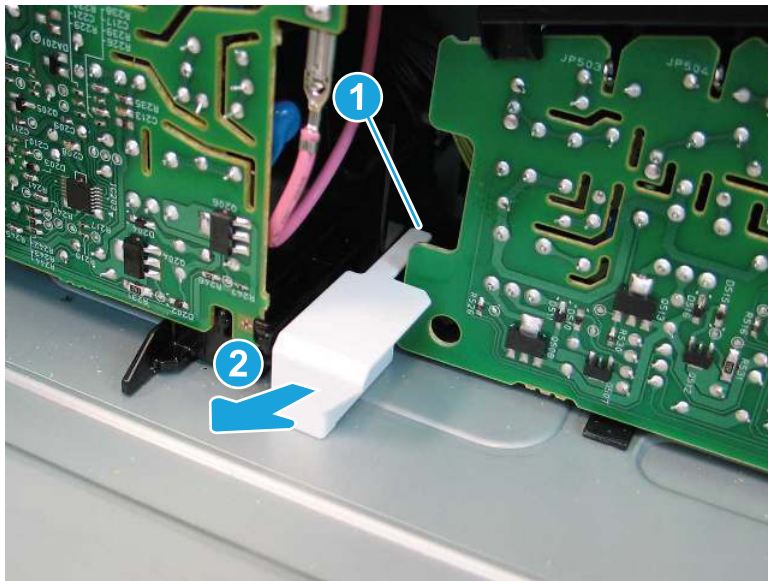
- b. Release six tabs (callout 1), and then remove the upper HVPS.

Figure 1-2958 Release six tabs



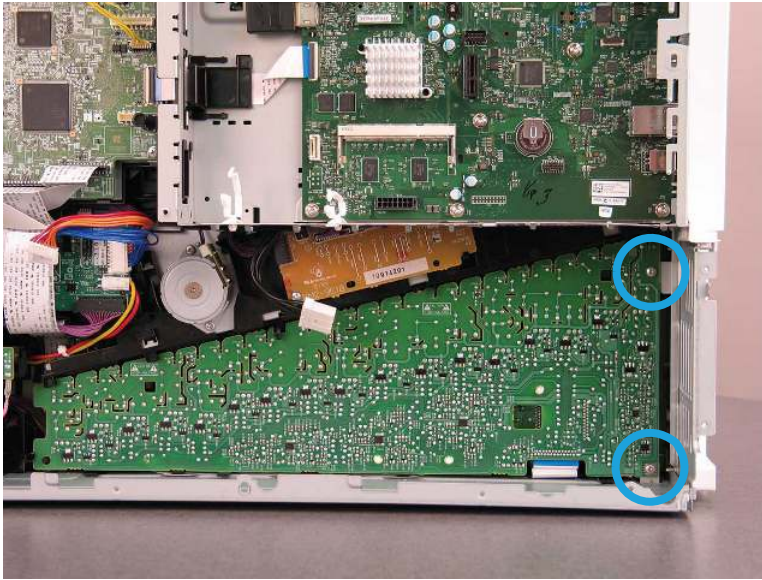
- 32. Remove the lower high-voltage power supply (lower HVPS).
 - a. Release one tab (callout 1) and then slide the stopper (callout 2) away from the printer to remove it.

Figure 1-2959 Remove the stopper



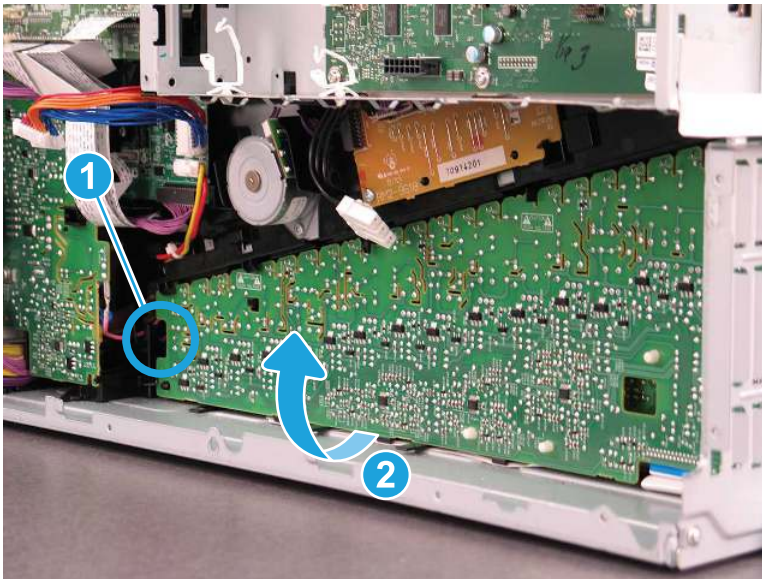
- b. Remove two screws (callout 1).

Figure 1-2960 Remove two screws



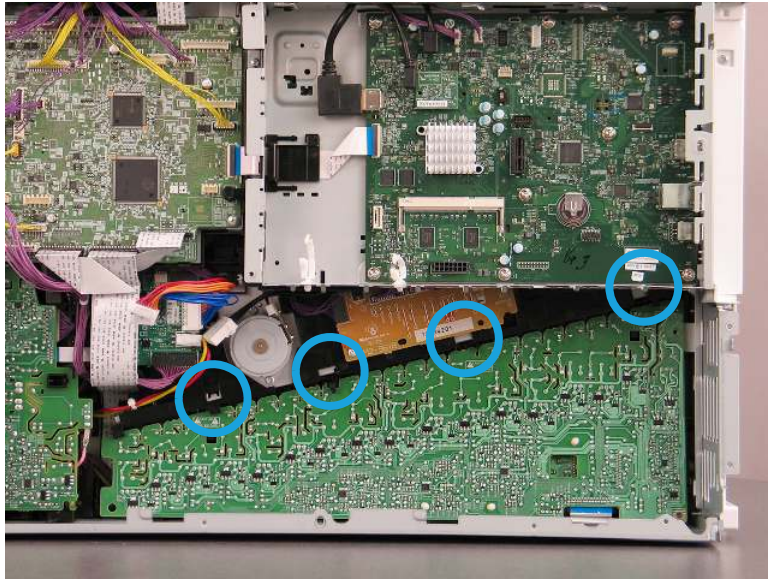
- c. Release one tab (callout 1), and then gently release the lower edge of the lower HVPS.

Figure 1-2961 Release the lower edge of the lower HVPS



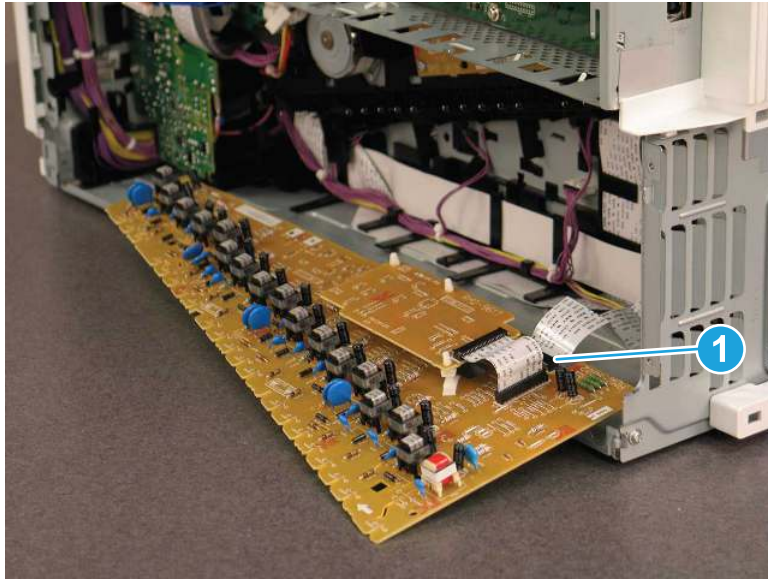
- d. Release the lower HVPS from four tabs.

Figure 1-2962 Release four tabs



- e. Disconnect one flat cable (callout 1) from the back of the lower HVPS.

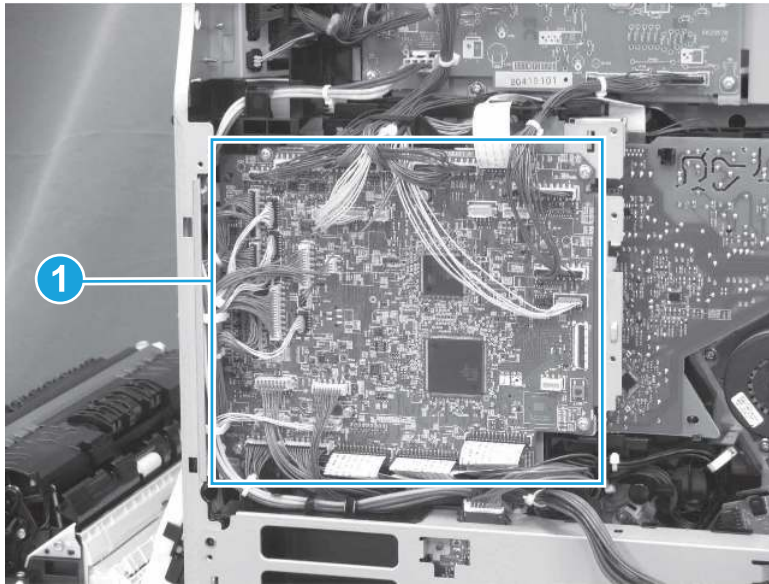
Figure 1-2963 Disconnect one flat cable



- 33. Remove the DC controller and case (M856/E85055/M776).

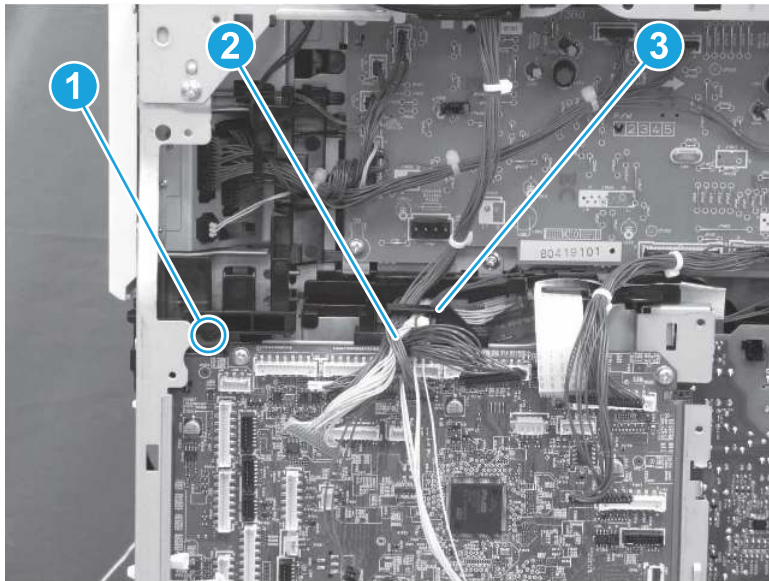
- a. Disconnect all of the connectors on the DC controller.

Figure 1-2964 Disconnect the connectors



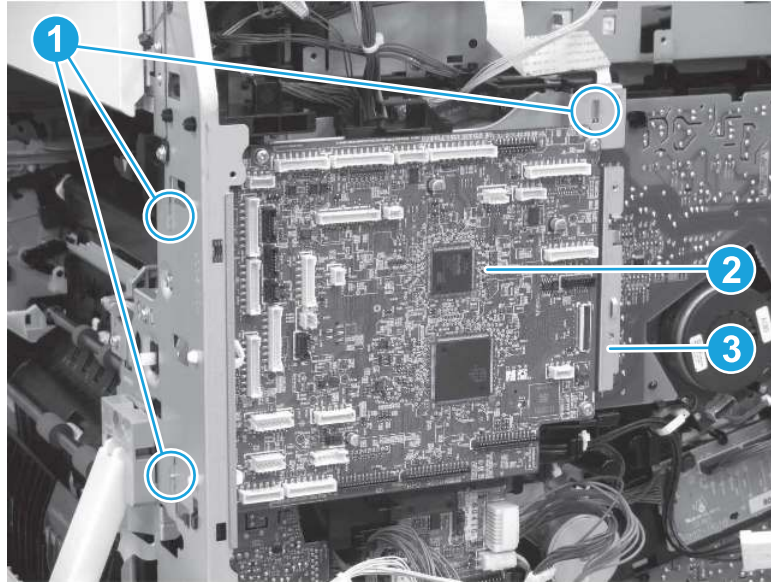
- b. Remove one screw (callout 1), and then release the cables (callout 2) from the cable guide (callout 3).

Figure 1-2965 Remove one screw and release the cables




- c. Remove one screw (callout 1), and then remove the DC controller (callout 2) together with the metal case (callout 3).

Figure 1-2966 Remove the DC controller and case



34. Remove the main drive assembly.

- a. Open the front door.

 **IMPORTANT:** The front door must remain open during removal and installation of the main drive assembly to prevent issues.

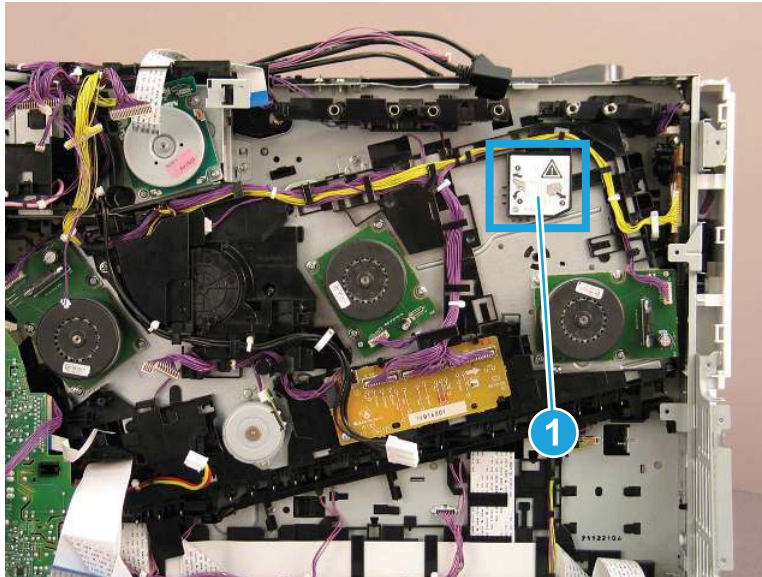
To prevent the front door from closing on its own, install one of the toner cartridges halfway.

Figure 1-2967 Open the front door



- b. Note the label (callout 1) on the main drive assembly indicating that the front door must be open and all toner cartridges and imaging drums removed before removing the main drive assembly.

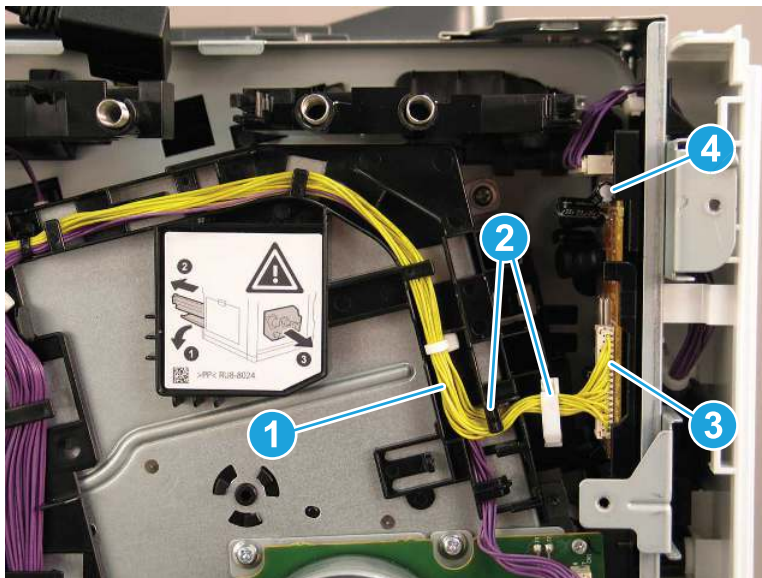
Figure 1-2968 Main drive assembly label



- c. Release the cable (callout 1) from the cable guide (callout 2), and then disconnect one connector (callout 3).

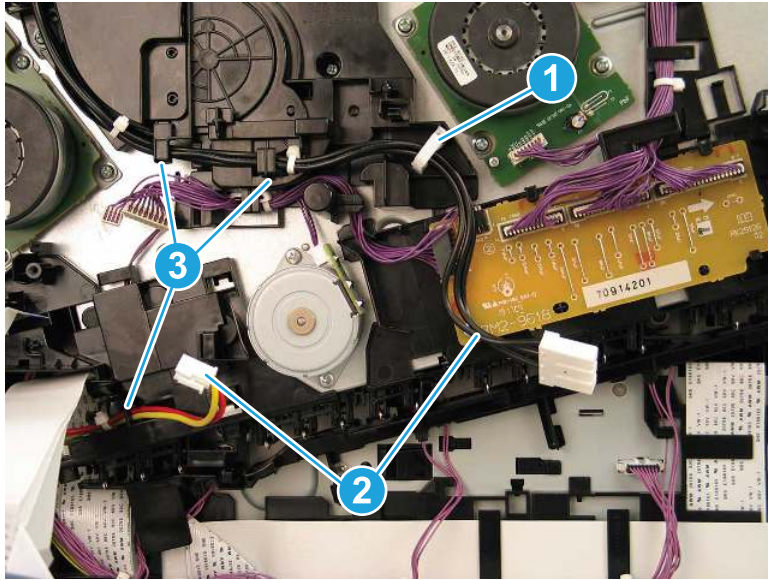
⚠ CAUTION: The capacitor on the PCA (callout 4) can rotate out and prevent the main drive assembly from reseating.

Figure 1-2969 Disconnect one connector



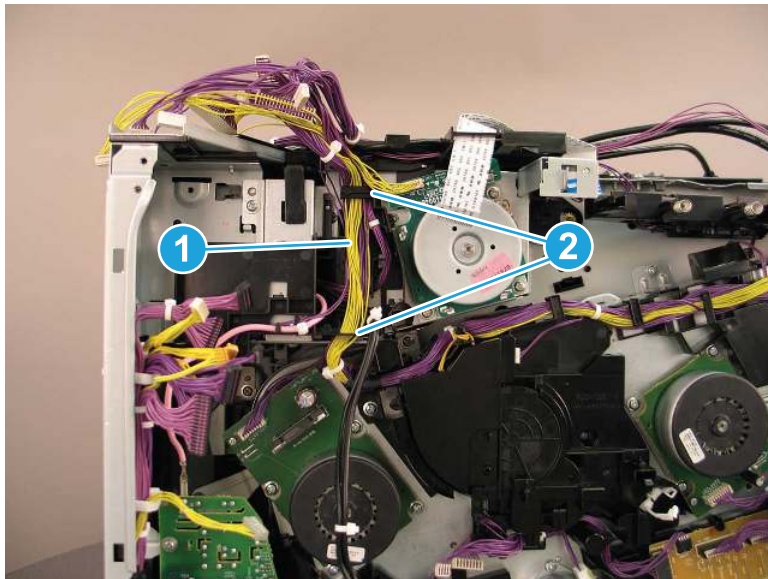
- d. Release the cables (callout 1) from the cable guides (callout 2).

Figure 1-2970 Release the cables from the guides



- e. Release the cables (callout 1) from the cable guides (callout 2).

Figure 1-2971 Release the cables from the guides

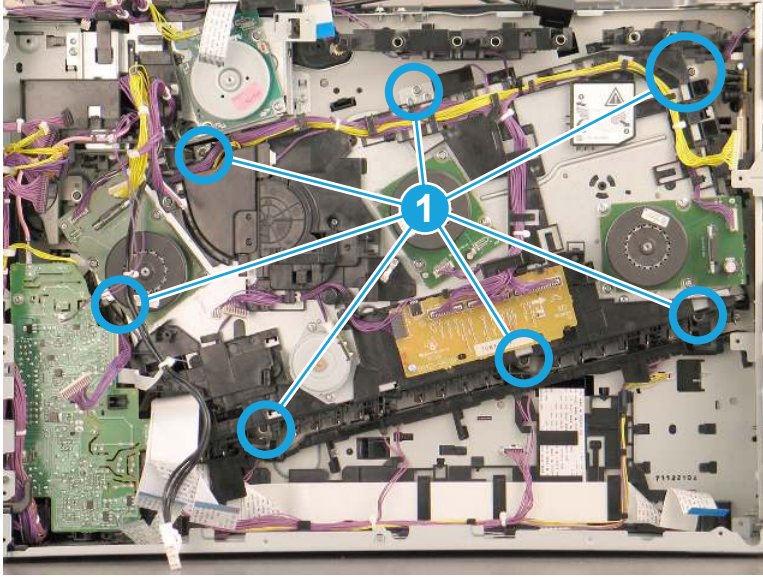


- f. Remove seven screws (callout 1), and then remove the main drive assembly.

 **IMPORTANT:** When reinstalling the main drive assembly, make sure that the front door is open.

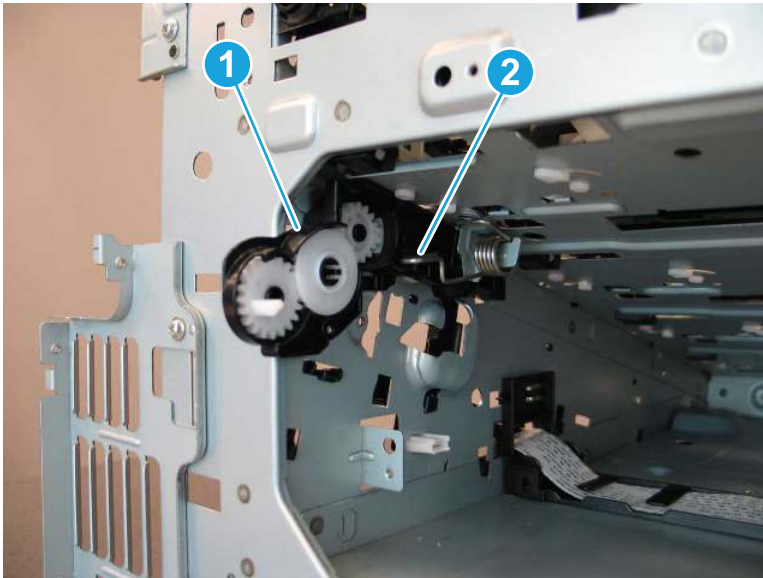
Partially reinstall one toner cartridge to prevent the front door from closing.

Figure 1-2972 Remove seven screws and the main drive assembly



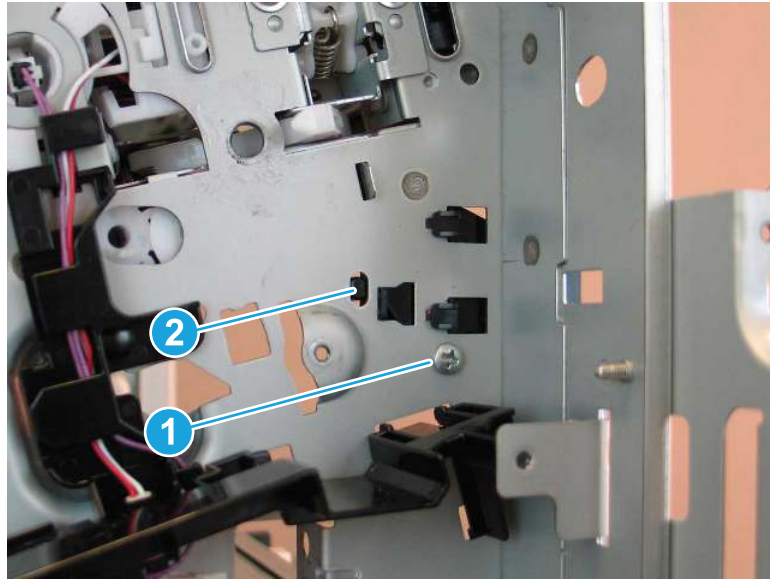
35. Remove the waste toner gear base assembly.
 - a. Locate the waste toner gear base assembly (callout 1), and then release the laser scanner spring (callout 2).

Figure 1-2973 Release the laser scanner spring



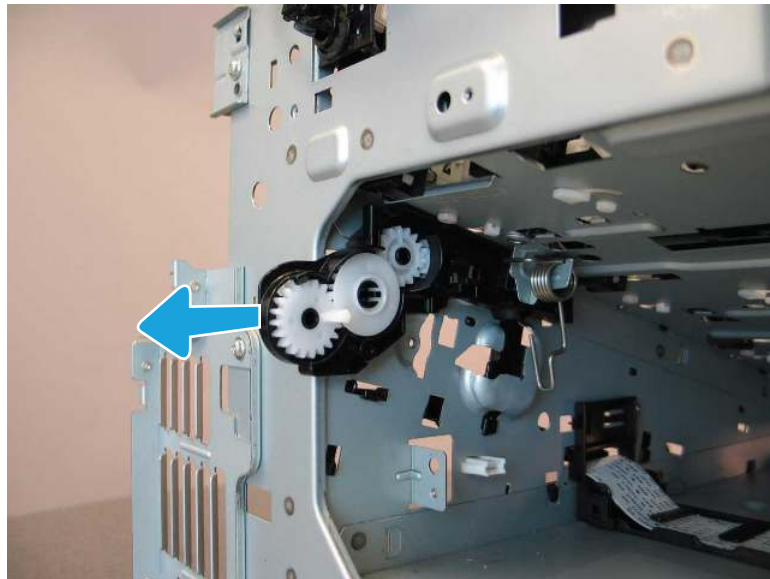
- b. At the back of the printer, remove one screw (callout 1), and then release one tab (callout 2).

Figure 1-2974 Remove one screw and release one tab



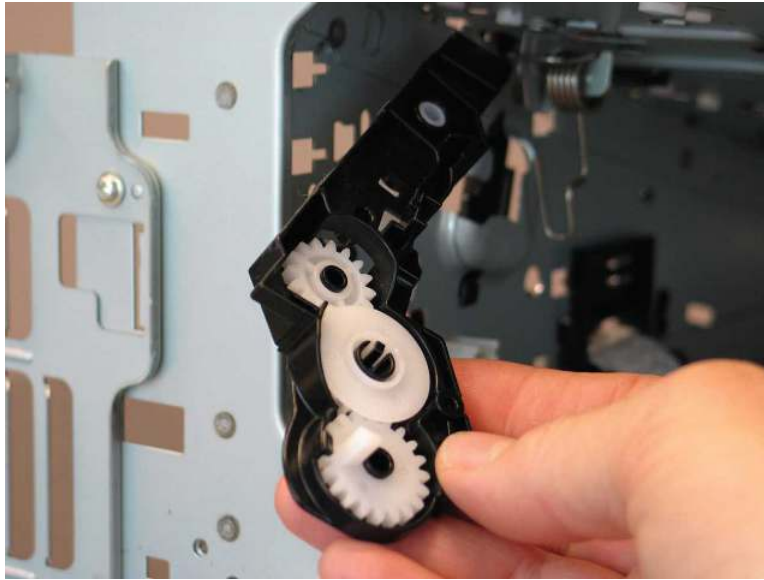
- c. Slide the waste toner gear base assembly away from the printer.

Figure 1-2975 Slide the waste toner gear base assembly



- d. Remove the waste toner gear base assembly.

Figure 1-2976 Remove the waste toner gear base assembly



36. Unpack the replacement assembly.

- a. Dispose of the defective part.




NOTE: HP recommends responsible disposal of the defective part.

<http://www8.hp.com/us/en/hp-information/environment/product-recycling.html>

- b. Unpack the replacement part from the packaging.



CAUTION:  Some parts are sensitive to electrostatic discharge (ESD). Always perform service work at an ESD-protected workstation or mat. If an ESD workstation or mat is not available, touch the sheet-metal chassis to provide a static ground before touching an ESD-sensitive assembly. Protect the ESD-sensitive assemblies by placing them in ESD pouches when they are out of the printer.

If the replacement part is a roller or pad, avoid touching the spongy part of it. Skin oils on the roller or pad can cause paper pickup and/or print-quality problems. HP recommends using disposable gloves when handling rollers or pads or washing your hands before touching rollers or pads.



IMPORTANT: Make sure that all of the shipping materials (for example shipping tape) are removed from the replacement part prior to installation.

- c. To install an assembly, reverse the removal steps.



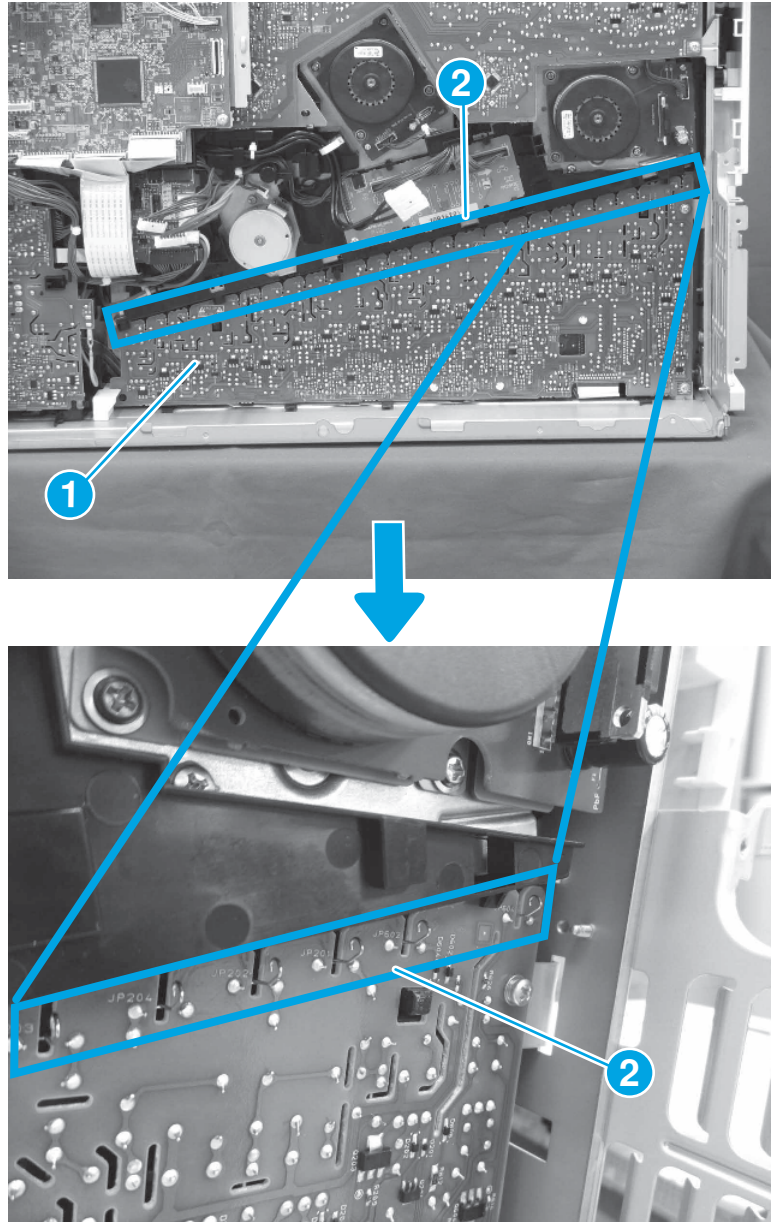
NOTE: When applicable, special installation instructions are provided for an assembly at the end of the removal procedure. Always completely read the removal instructions and follow all special installation instructions.

37. Reverse the removal steps to install the assembly. Also use the following **special installation instructions**.

Install the lower HVPS.

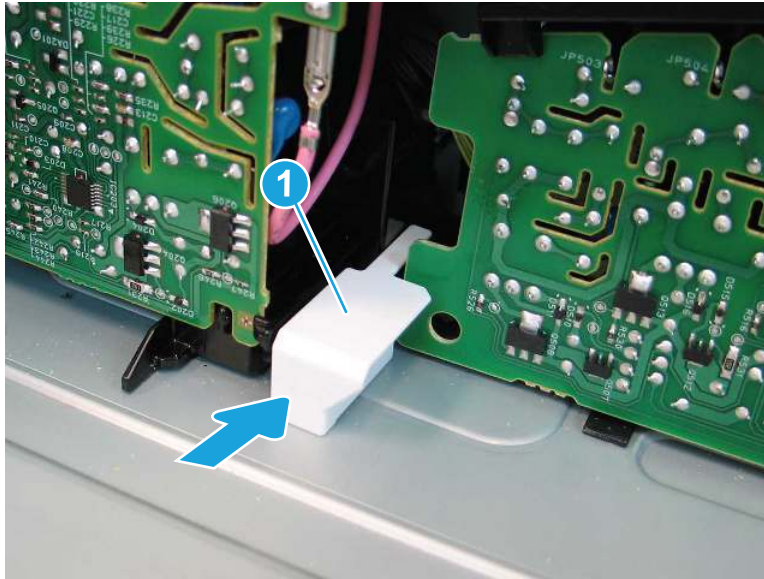
- a. When reinstalling the lower HVPS (callout 1), make sure that the top of the lower HVPS engages with the contact springs (callout 2) and that the springs are in the correct position.

Figure 1-2977 Check the springs



- b. Make sure that the stopper (callout 1) is reinstalled at the bottom of the lower HVPS.

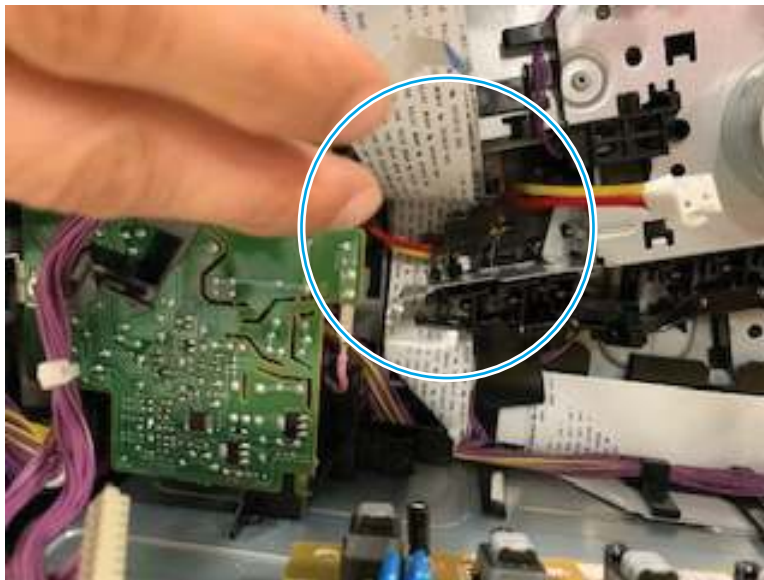
Figure 1-2978 Install the stopper



Install the main drive assembly.

- a. Route the red and yellow cables back into the main drive assembly guides prior to re-installation. This will prevent the cables from being pinched behind the main drive assembly.

Figure 1-2979 Main drive wire harness



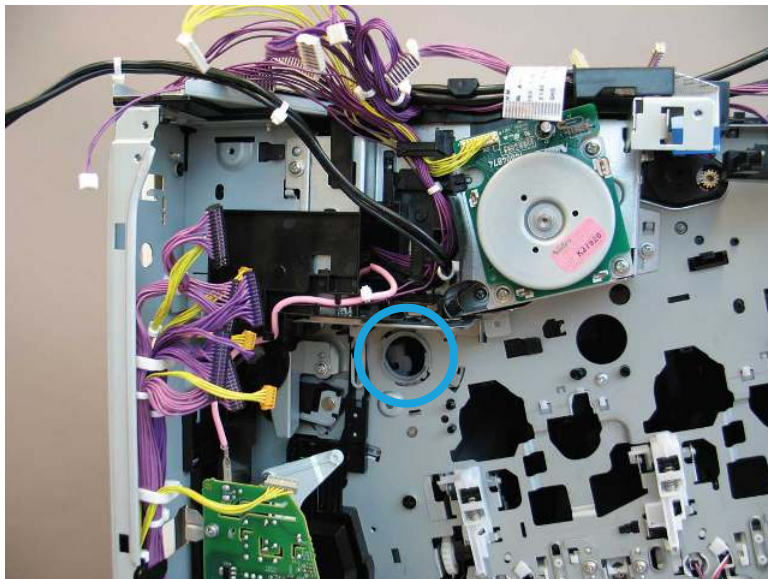
- b. If the coupling estrangement cam falls off of the printer or is broken or lost in the process of removing the main drive assembly, follow these steps to reinstall it.

Figure 1-2980 Coupling estrangement cam



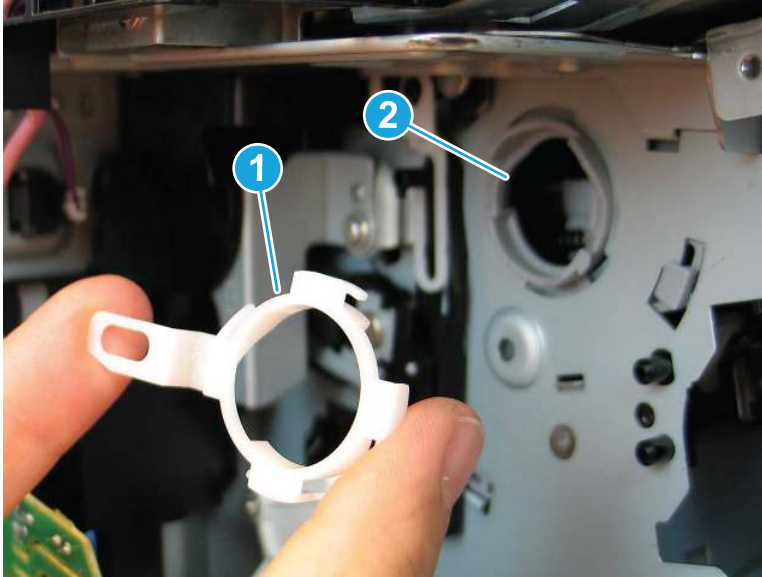
- c. Note the location where the cam will be installed.

Figure 1-2981 Cam location



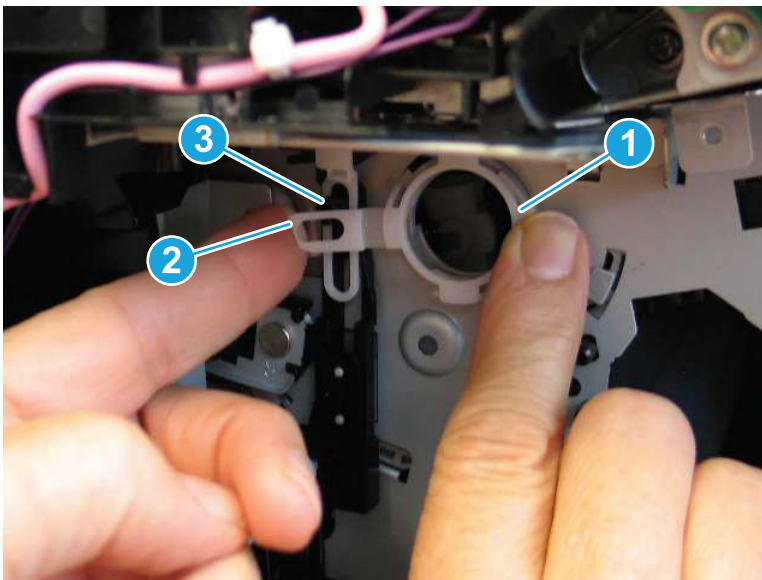
- d. Position the cam (callout 1) over the gray ring (callout 2) on the printer. The tabs on the cam fit into openings on the gray ring.

Figure 1-2982 Position the cam



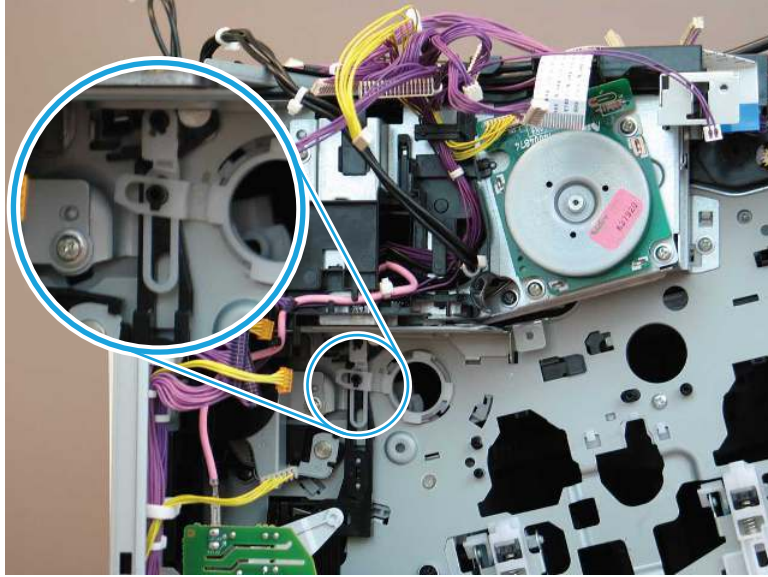
- e. Hold the cam in position (callout 1), and then position the opening in the left side of the cam (callout 2) over the boss (callout 3) on the black link arm on the printer.

Figure 1-2983 Install the cam



- f. When installed correctly, the cam engages with the black link arm on the printer.

Figure 1-2984 Cam correctly installed



Removal and replacement: Accessories

Learn how to remove and replace the accessories.

Removal and replacement: Inner finisher components

Learn how to remove and replace the component parts in the inner finisher.

Removal and replacement: Inner finisher (M776zs)

Learn how to remove and replace the inner finisher.

Mean time to repair: 6 minutes

Service level: Easy

Before performing service

Turn the printer power off

- Disconnect the power cable.

⚠ WARNING! To avoid damage to the printer, turn the printer off, wait 30 seconds, and then remove the power cord before attempting to service the printer.

Use the table below to identify the correct part number for your printer. To order the part, go to www.hp.com/buy/parts.

Table 1-134 Part information

Part number	Part description
T3U55-67901	Inner finisher

Required tools

- #2 Phillips screwdriver with a magnetic tip
- Small, flat-blade screwdriver

After performing service

Turn the printer power on

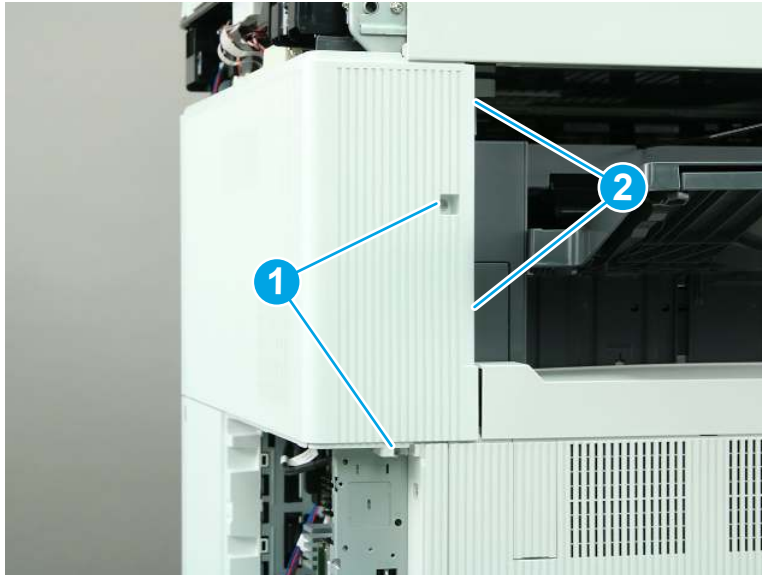
- Reinstall the inner finisher
- Connect the power cable.
- Use the power switch to turn the power on.

Post service test

Send a print job to the inner finisher and verify it is functioning correctly.

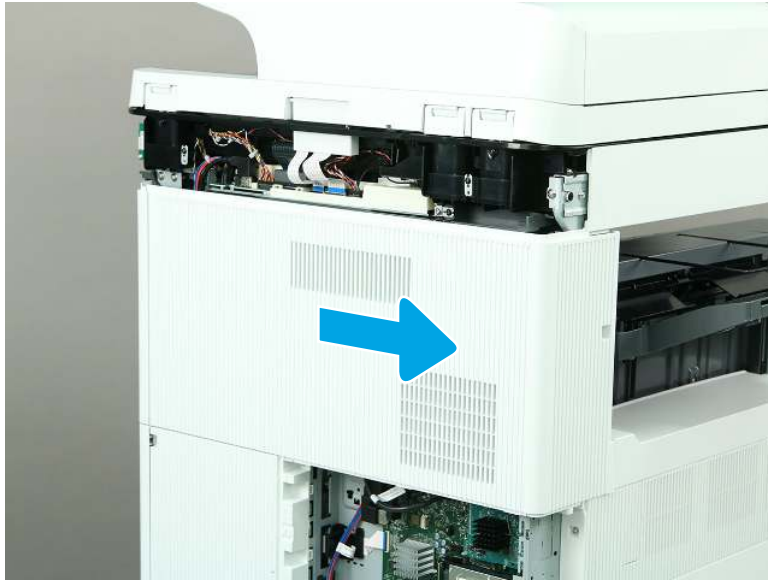
1. Remove the rear upper cover and left rear upper cover (M776zs).
 - a. Remove two screws (callout 1), and then release two tabs (callout 2).

Figure 1-2985 Remove two screws and release two tabs



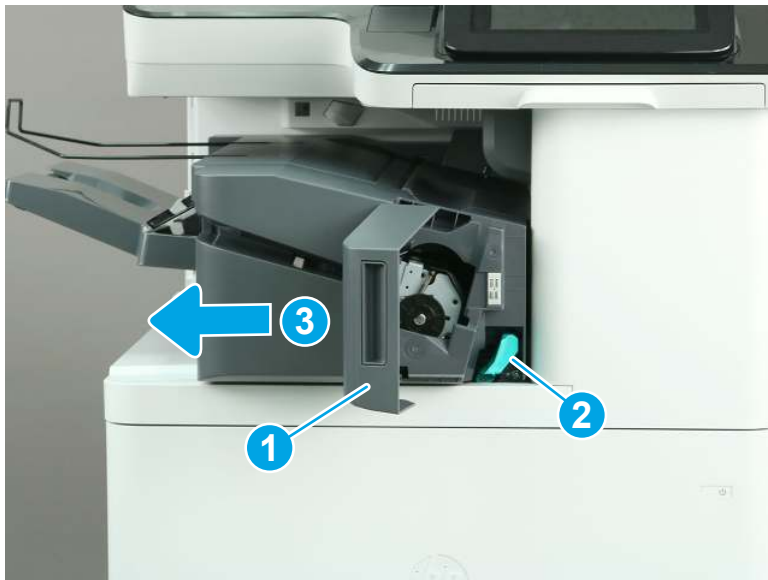
- b. Slide the cover to the right to remove it.

Figure 1-2986 Remove the rear upper and left rear upper cover



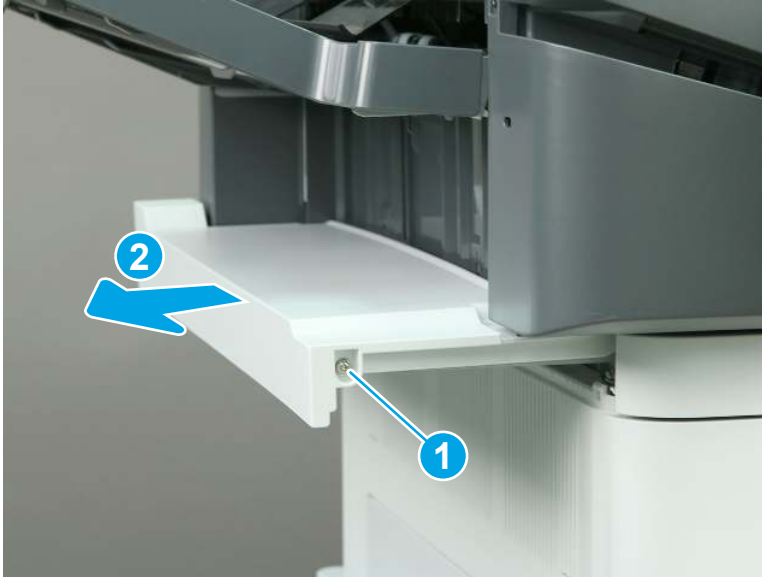
- 2. Remove the inner finisher rail cover (M776zs).
 - a. Open the inner finisher right door (callout 1). Release the latch (callout 2), and then slide the inner finisher toward the left side of the printer (callout 3).

Figure 1-2987 Slide the inner finisher



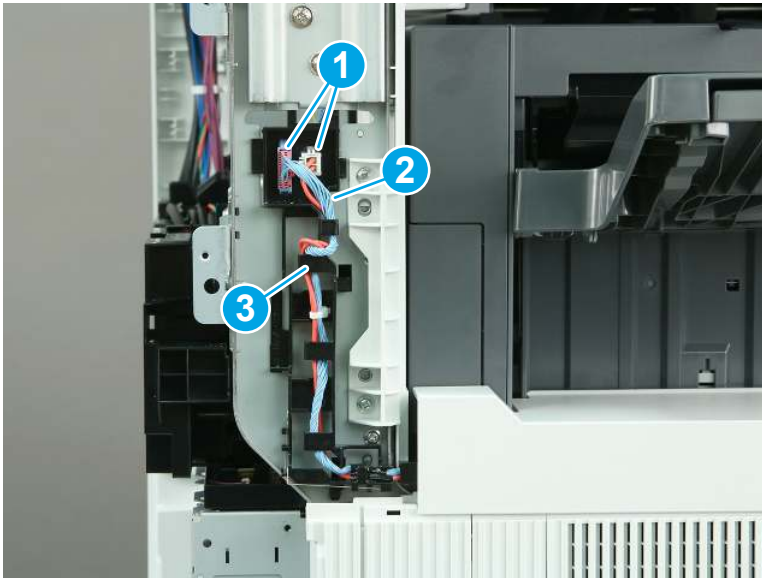
- b. Remove one screw (callout 1), and then slide the rail cover away from the finisher (callout 2) to remove it.

Figure 1-2988 Remove the rail cover



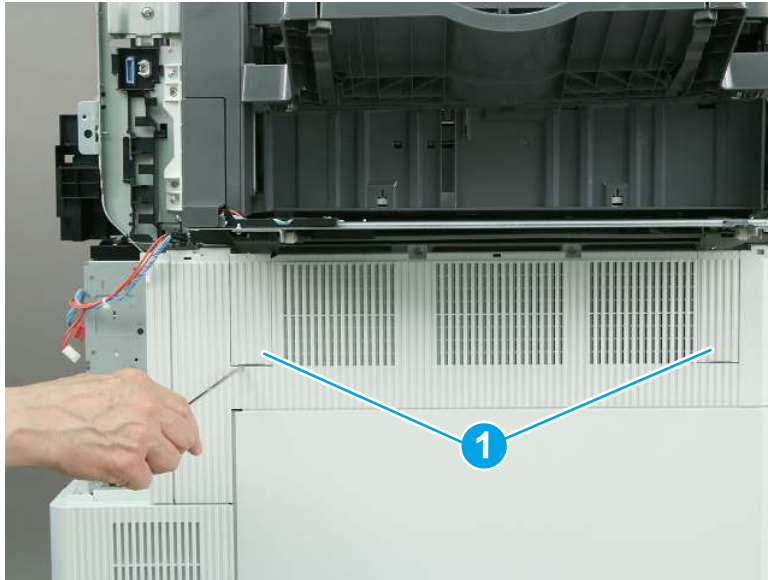
3. Remove the inner finisher (M776zs).
 - a. Disconnect two connectors (callout 1), and then remove the cables (callout 2) from the guide (callout 3).

Figure 1-2989 Disconnect two connectors



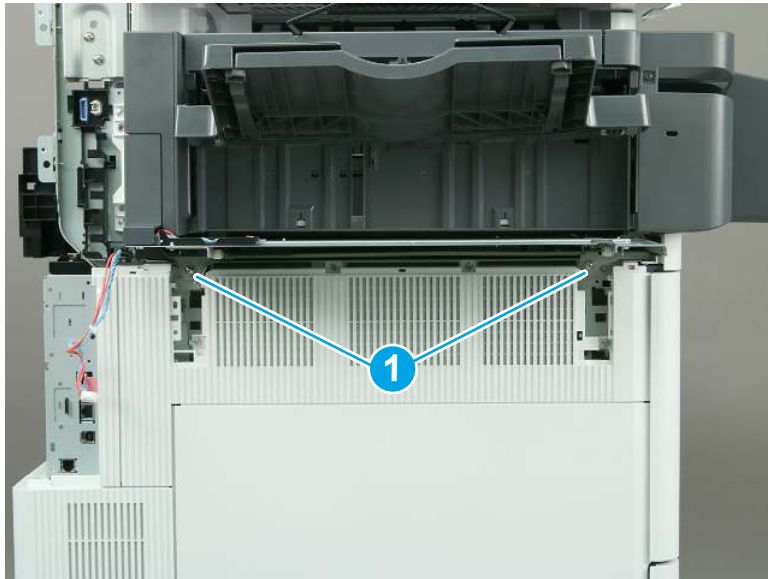
- b. Use a small, flat-blade screwdriver to remove two covers (callout 1).

Figure 1-2990 Remove two covers



- c. Remove two screws (callout 1).

Figure 1-2991 Remove two screws



- d. Slide the inner finisher away from the printer to remove it.

Figure 1-2992 Remove the inner finisher



4. Unpack the replacement assembly.
 - a. Dispose of the defective part.
 - b. Unpack the replacement part from the packaging.
 - c. To install an assembly, reverse the removal steps.



NOTE: HP recommends responsible disposal of the defective part.

<http://www8.hp.com/us/en/hp-information/environment/product-recycling.html>



IMPORTANT: Make sure that all of the shipping materials (for example shipping tape) are removed from the replacement part prior to installation.



NOTE: When applicable, special installation instructions are provided for an assembly at the end of the removal procedure. Always completely read the removal instructions and follow all special installation instructions.

Removal and replacement: Inner finisher connector cover (M776zs)

Learn how to remove and replace the inner finisher connector cover.

Mean time to repair: 2 minutes

Service level: Easy

Before performing service

Turn the printer power off

- Disconnect the power cable.

⚠ WARNING! To avoid damage to the printer, turn the printer off, wait 30 seconds, and then remove the power cord before attempting to service the printer.

- Remove the inner finisher from the printer.

Use the table below to identify the correct part number for your printer. To order the part, go to www.hp.com/buy/parts.

Table 1-135 Part information

Part number	Part description
RC5-4834-000CN	Cover, rear, small

Required tools

- Small, flat-blade screwdriver

After performing service

Turn the printer power on

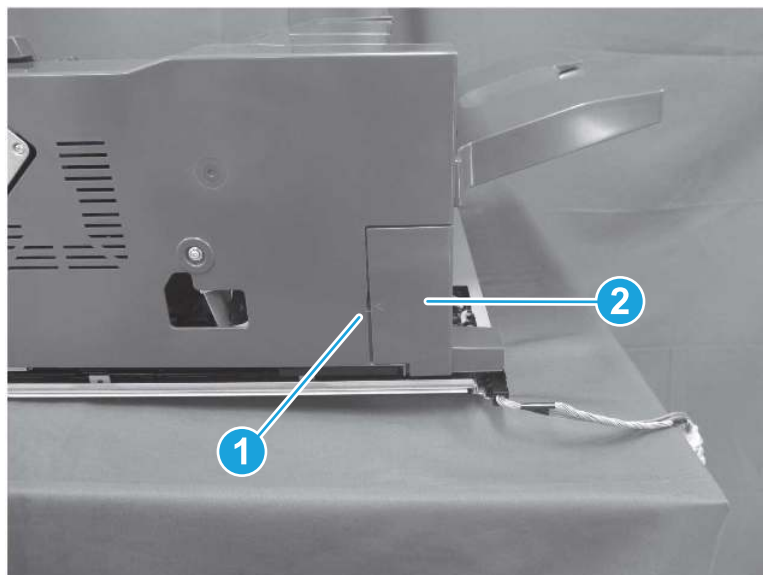
- Reinstall the inner finisher
- Connect the power cable.
- Use the power switch to turn the power on.

Post service test

No post service test is available for this assembly.

1. Remove the inner finisher connector cover (M776zs).
 - ▲ Release one tab (callout 1), and then remove the connector cover (callout 2).

Figure 1-2993 Remove the connector cover



2. Unpack the replacement assembly.

a. Dispose of the defective part.



NOTE: HP recommends responsible disposal of the defective part.

<http://www8.hp.com/us/en/hp-information/environment/product-recycling.html>

b. Unpack the replacement part from the packaging.



IMPORTANT: Make sure that all of the shipping materials (for example shipping tape) are removed from the replacement part prior to installation.

c. To install an assembly, reverse the removal steps.



NOTE: When applicable, special installation instructions are provided for an assembly at the end of the removal procedure. Always completely read the removal instructions and follow all special installation instructions.

Removal and replacement: Inner finisher front cover (M776zs)

Learn how to remove and replace the inner finisher front cover.

Mean time to repair: 5 minutes

Service level: Easy

Before performing service

Turn the printer power off

- Disconnect the power cable.



WARNING! To avoid damage to the printer, turn the printer off, wait 30 seconds, and then remove the power cord before attempting to service the printer.

- Remove the inner finisher from the printer.

Use the table below to identify the correct part number for your printer. To order the part, go to www.hp.com/buy/parts.

Table 1-136 Part information

Part number	Part description
RM2-2438-000CN	Front cover assembly

Required tools

- #2 Phillips screwdriver with a magnetic tip

After performing service

Turn the printer power on

- Reinstall the inner finisher
- Connect the power cable.

- Use the power switch to turn the power on.

Post service test

Send a print job to the inner finisher and verify it is functioning correctly.

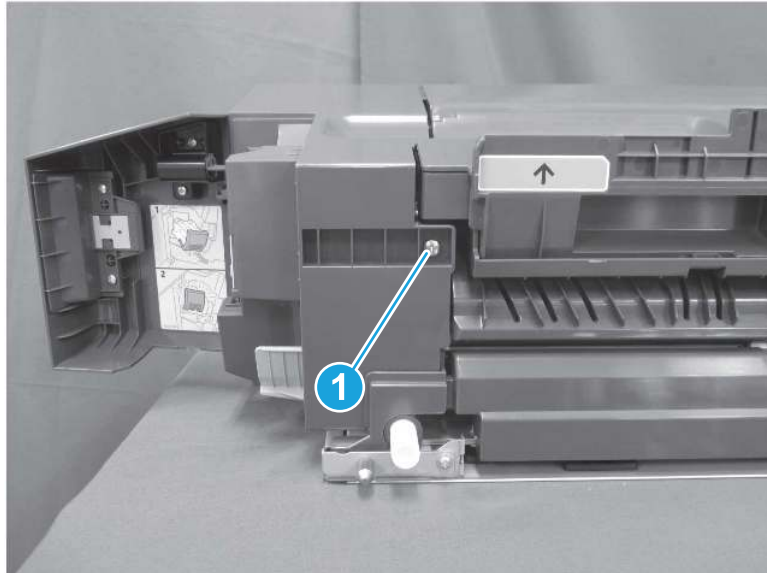
1. Remove the inner finisher front cover (M776zs).
 - a. Open the inner finisher front door, and then remove one screw (callout 1).

Figure 1-2994 Remove one screw



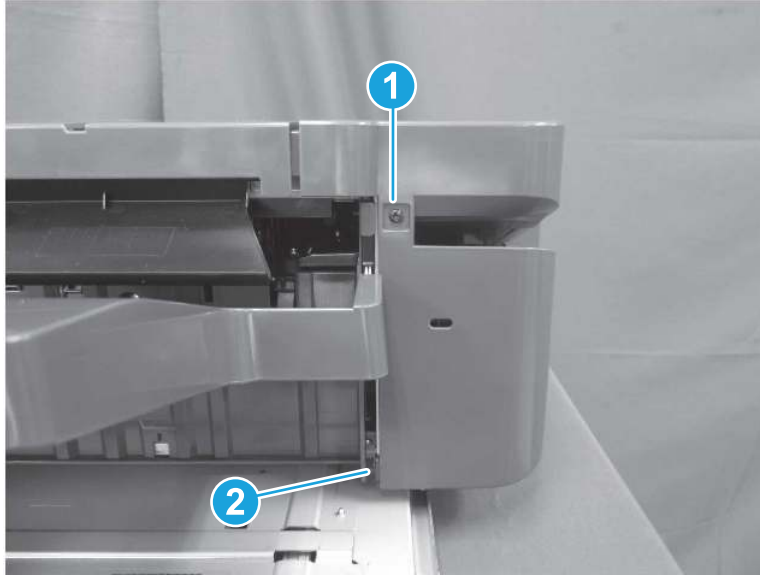
- b. Remove one screw (callout 1).

Figure 1-2995 Remove one screw



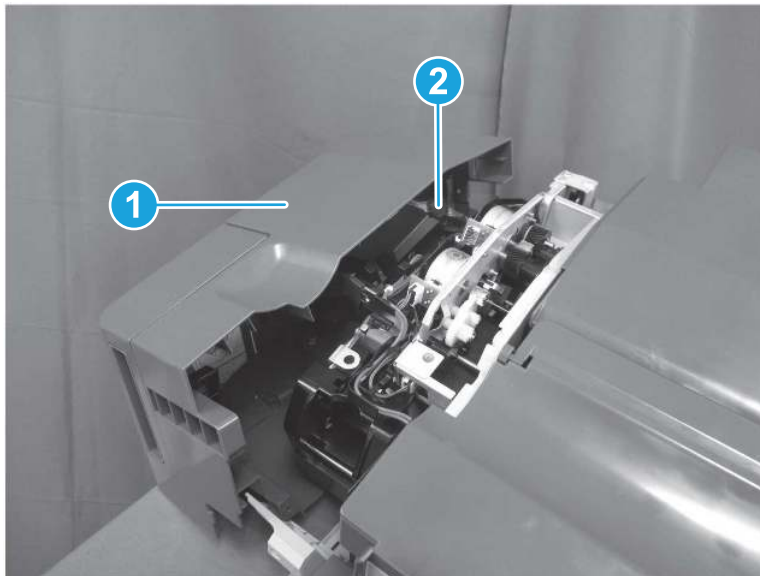
- c. Remove one screw (callout 1), and then release one tab (callout 2).

Figure 1-2996 Remove one screw and release one tab



- d. Pull the front cover (callout 1) slightly away from the finisher, disconnect one connector (callout 2), and then remove the front cover.

Figure 1-2997 Remove the front cover




2. Unpack the replacement assembly.
 - a. Dispose of the defective part.




NOTE: HP recommends responsible disposal of the defective part.

<http://www8.hp.com/us/en/hp-information/environment/product-recycling.html>

- b. Unpack the replacement part from the packaging.

 **IMPORTANT:** Make sure that all of the shipping materials (for example shipping tape) are removed from the replacement part prior to installation.

- c. To install an assembly, reverse the removal steps.

 **NOTE:** When applicable, special installation instructions are provided for an assembly at the end of the removal procedure. Always completely read the removal instructions and follow all special installation instructions.

Removal and replacement: Inner finisher stack tray (M776zs)

Learn how to remove and replace the inner finisher stack tray.


Mean time to repair: 2 minutes

Service level: Easy

Before performing service

Turn the printer power off

- Disconnect the power cable.

 **WARNING!** To avoid damage to the printer, turn the printer off, wait 30 seconds, and then remove the power cord before attempting to service the printer.

- Remove the inner finisher from the printer.

Use the table below to identify the correct part number for your printer. To order the part, go to www.hp.com/buy/parts.

Table 1-137 Part information

Part number	Part description
RM2-2450-000CN	Stack tray assembly

Required tools

- Small, flat-blade screwdriver

After performing service

Turn the printer power on

- Reinstall the inner finisher
- Connect the power cable.
- Use the power switch to turn the power on.

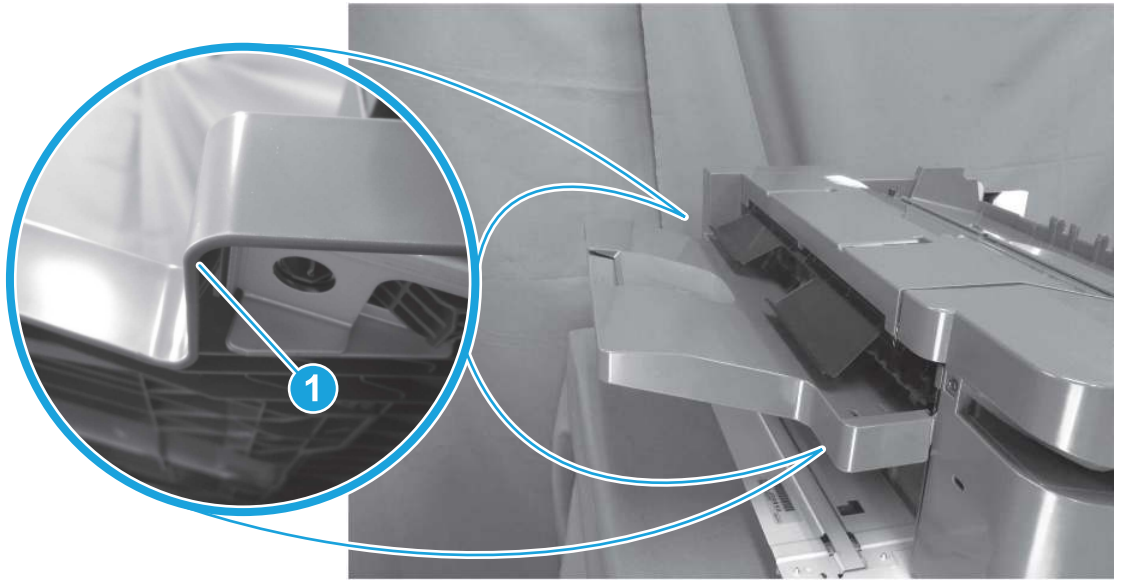
Post service test

Send a print job to the inner finisher and verify it is functioning correctly.

1. Remove the inner finisher stack tray assembly (M776zs).

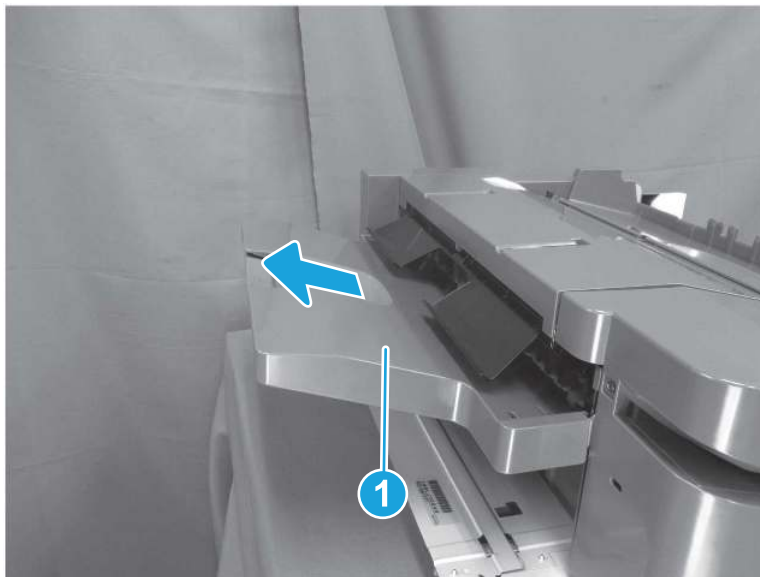
- a. Release two tabs (callout 1).

Figure 1-2998 Release two tabs



- b. Slide the stack tray assembly (callout 1) away from the finisher to remove it.

Figure 1-2999 Remove the stack tray assembly




2. Unpack the replacement assembly.
 - a. Dispose of the defective part.




NOTE: HP recommends responsible disposal of the defective part.

<http://www8.hp.com/us/en/hp-information/environment/product-recycling.html>

- b. Unpack the replacement part from the packaging.

 **IMPORTANT:** Make sure that all of the shipping materials (for example shipping tape) are removed from the replacement part prior to installation.

- c. To install an assembly, reverse the removal steps.

 **NOTE:** When applicable, special installation instructions are provided for an assembly at the end of the removal procedure. Always completely read the removal instructions and follow all special installation instructions.

Removal and replacement: Inner finisher rear small cover (M776zs)

Learn how to remove and replace the inner finisher rear small cover.


Mean time to repair: 3 minutes

Service level: Easy

Before performing service

Turn the printer power off

- Disconnect the power cable.

 **WARNING!** To avoid damage to the printer, turn the printer off, wait 30 seconds, and then remove the power cord before attempting to service the printer.

- Remove the inner finisher from the printer.

Use the table below to identify the correct part number for your printer. To order the part, go to www.hp.com/buy/parts.

Table 1-138 Part information

Part number	Part description
RC5-4834-000CN	Cover, rear, small

Required tools

- Small, flat-blade screwdriver

After performing service

Turn the printer power on

- Reinstall the inner finisher
- Connect the power cable.
- Use the power switch to turn the power on.

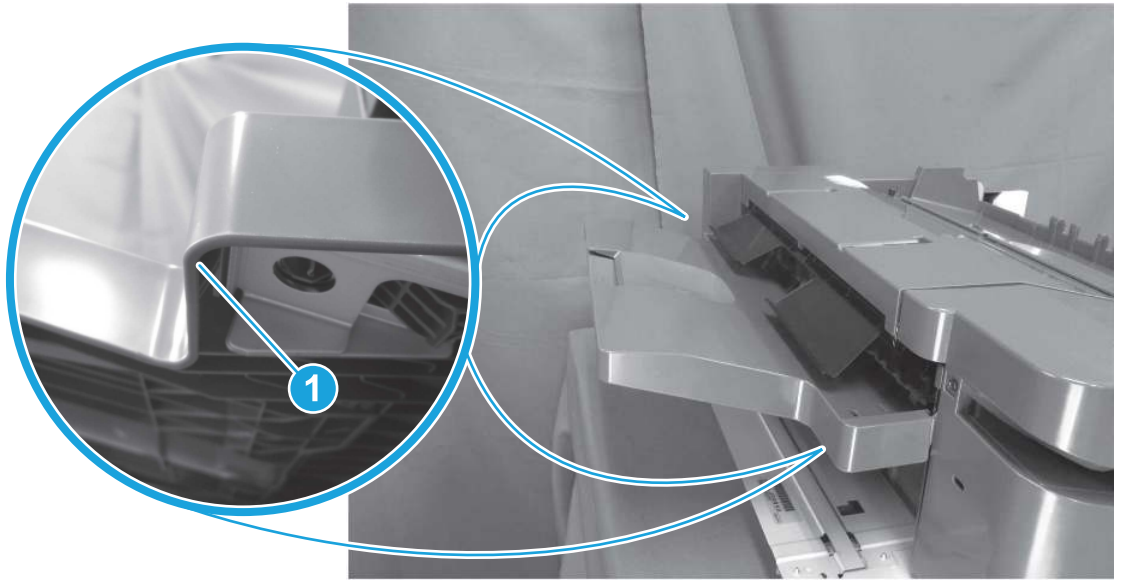
Post service test

Send a print job to the inner finisher and verify it is functioning correctly.

1. Remove the inner finisher stack tray assembly (M776zs).

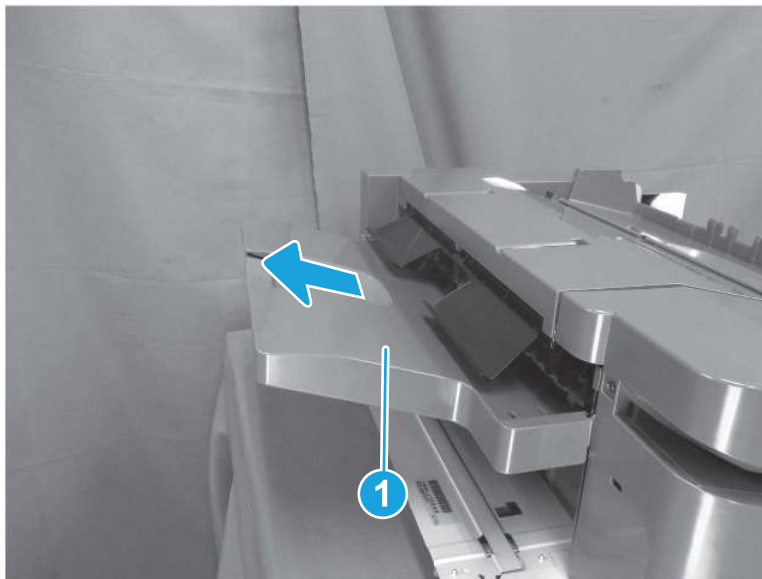
- a. Release two tabs (callout 1).

Figure 1-3000 Release two tabs



- b. Slide the stack tray assembly (callout 1) away from the finisher to remove it.

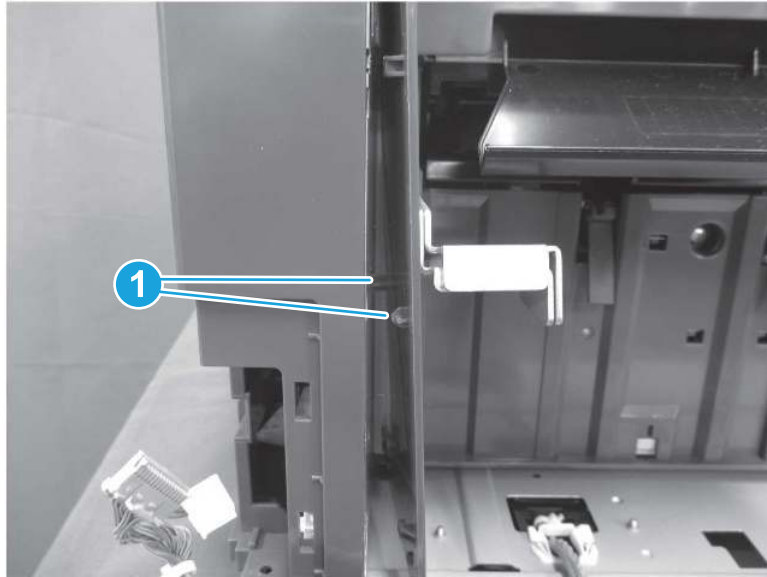
Figure 1-3001 Remove the stack tray assembly



2. Remove the inner finisher rear small cover (M776zs).

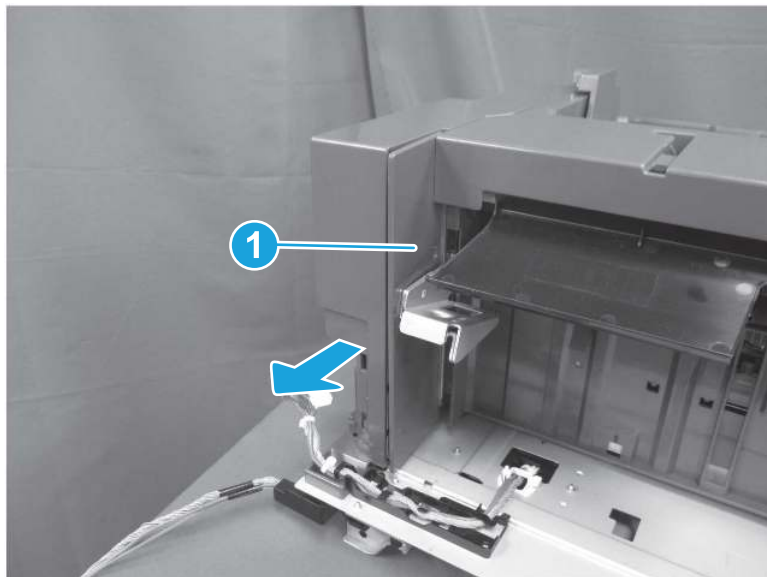
- a. Release two bosses (callout 1).

Figure 1-3002 Release two bosses



- b. Slide the rear small cover (callout 1) away from the finisher to remove it.

Figure 1-3003 Remove the rear small cover




3. Unpack the replacement assembly.
 - a. Dispose of the defective part.




NOTE: HP recommends responsible disposal of the defective part.

<http://www8.hp.com/us/en/hp-information/environment/product-recycling.html>

- b. Unpack the replacement part from the packaging.

 **IMPORTANT:** Make sure that all of the shipping materials (for example shipping tape) are removed from the replacement part prior to installation.

- c. To install an assembly, reverse the removal steps.

 **NOTE:** When applicable, special installation instructions are provided for an assembly at the end of the removal procedure. Always completely read the removal instructions and follow all special installation instructions.

Removal and replacement: Inner finisher latch cover (M776zs)

Learn how to remove and replace the inner finisher latch cover.


Mean time to repair: 5 minutes

Service level: Easy

Before performing service

Turn the printer power off

- Disconnect the power cable.

 **WARNING!** To avoid damage to the printer, turn the printer off, wait 30 seconds, and then remove the power cord before attempting to service the printer.

- Remove the inner finisher from the printer.

Use the table below to identify the correct part number for your printer. To order the part, go to www.hp.com/buy/parts.

Table 1-139 Part information

Part number	Part description
RC5-4840-000CN	Cover, latch

Required tools

- #2 Phillips screwdriver with a magnetic tip

After performing service

Turn the printer power on

- Reinstall the inner finisher
- Connect the power cable.
- Use the power switch to turn the power on.

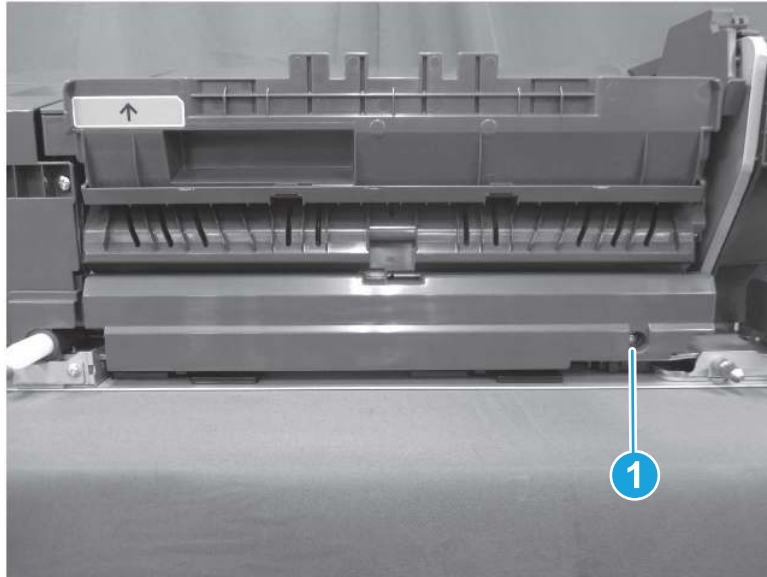
Post service test

Send a print job to the inner finisher and verify it is functioning correctly.

1. Remove the inner finisher latch cover (M776zs).

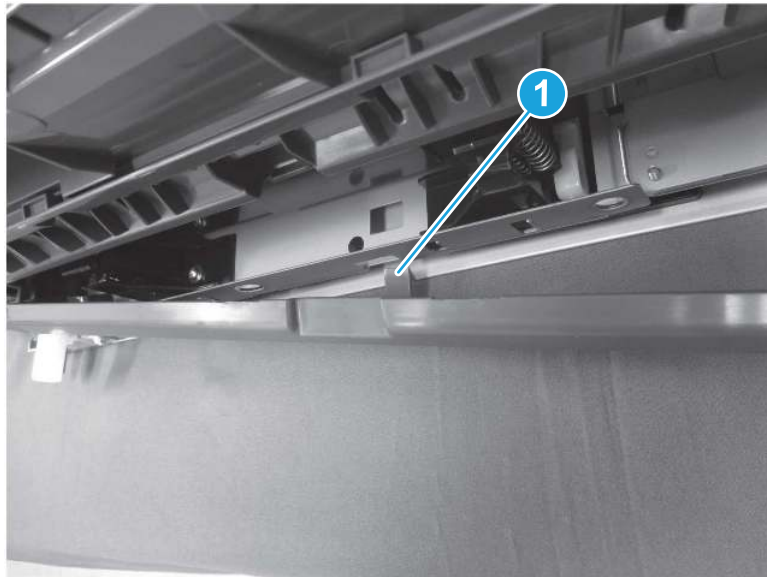
- a. Remove one screw (callout 1).

Figure 1-3004 Remove one screw



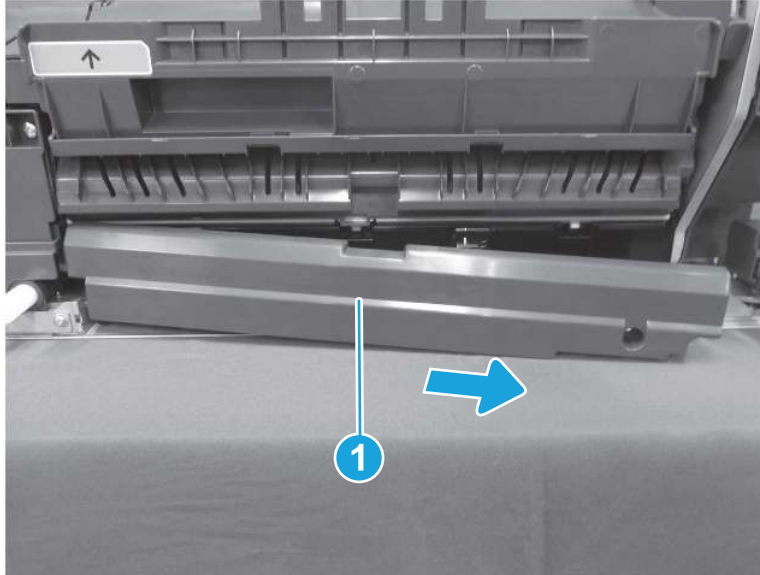
- b. Release one tab (callout 1).

Figure 1-3005 Release one tab



- c. Slide the latch cover (callout 1) to the right to remove it.

Figure 1-3006 Remove the latch cover



2. Unpack the replacement assembly.
 - a. Dispose of the defective part.
- b. Unpack the replacement part from the packaging.
- c. To install an assembly, reverse the removal steps.



NOTE: HP recommends responsible disposal of the defective part.

<http://www8.hp.com/us/en/hp-information/environment/product-recycling.html>



IMPORTANT: Make sure that all of the shipping materials (for example shipping tape) are removed from the replacement part prior to installation.



NOTE: When applicable, special installation instructions are provided for an assembly at the end of the removal procedure. Always completely read the removal instructions and follow all special installation instructions.

Removal and replacement: Inner finisher upper entrance guide (M776zs)

Learn how to remove and replace the inner finisher upper entrance guide.

Mean time to repair: 5 minutes

Service level: Easy

Before performing service

Turn the printer power off

- Disconnect the power cable.

⚠ WARNING! To avoid damage to the printer, turn the printer off, wait 30 seconds, and then remove the power cord before attempting to service the printer.

- Remove the inner finisher from the printer.

Use the table below to identify the correct part number for your printer. To order the part, go to www.hp.com/buy/parts.

Table 1-140 Part information

Part number	Part description
RM2-2434-000CN	Entrance guide assembly, upper

Required tools

- #2 Phillips screwdriver with a magnetic tip
- Small, flat-blade screwdriver

After performing service

Turn the printer power on

- Reinstall the inner finisher
- Connect the power cable.
- Use the power switch to turn the power on.

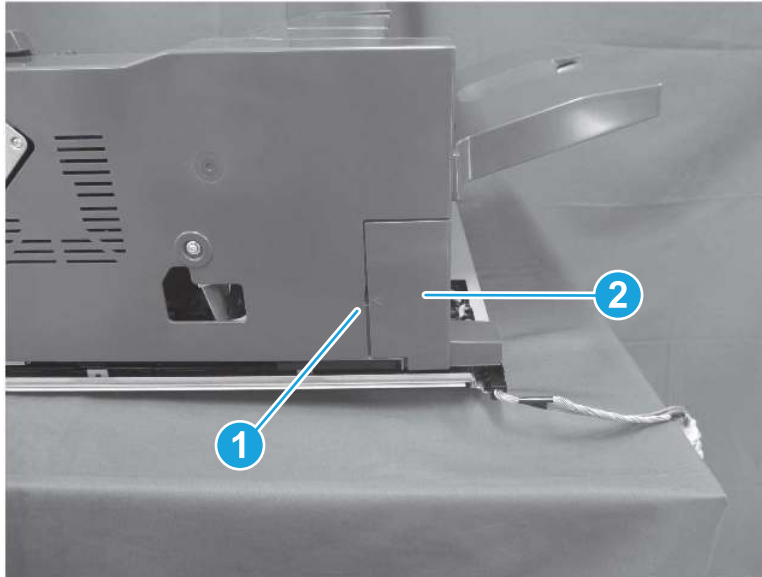
Post service test

Send a print job to the inner finisher and verify it is functioning correctly.

1. Remove the inner finisher connector cover (M776zs).

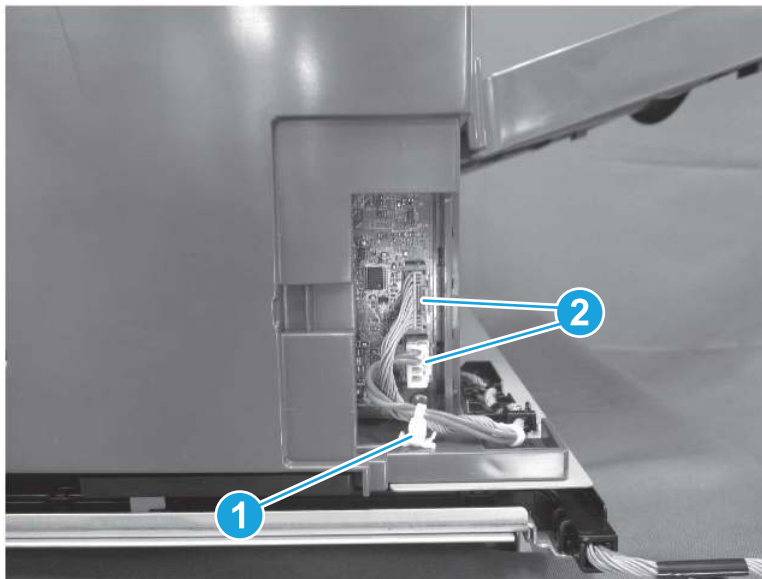
- ▲ Release one tab (callout 1), and then remove the connector cover (callout 2).

Figure 1-3007 Remove the connector cover



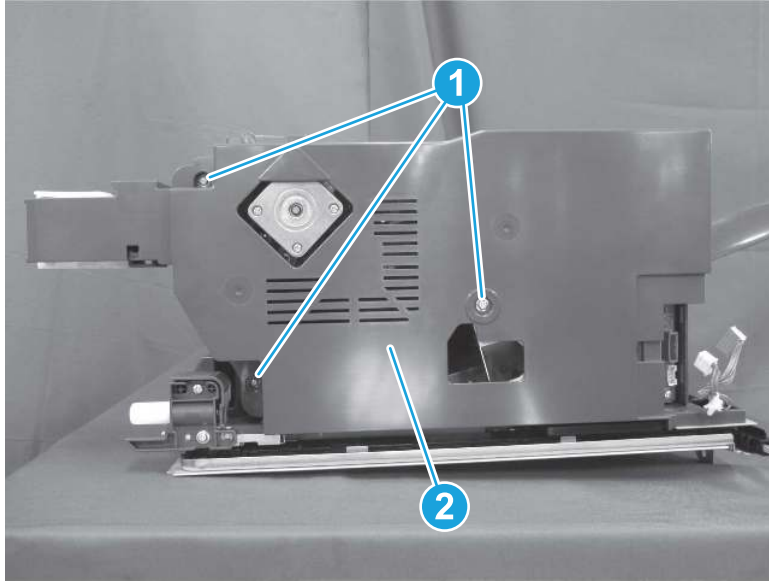
- 2. Remove the inner finisher rear cover (M776zs).
 - a. Release one retainer (callout 1), and then disconnect two connectors (callout 2).

Figure 1-3008 Disconnect two connectors



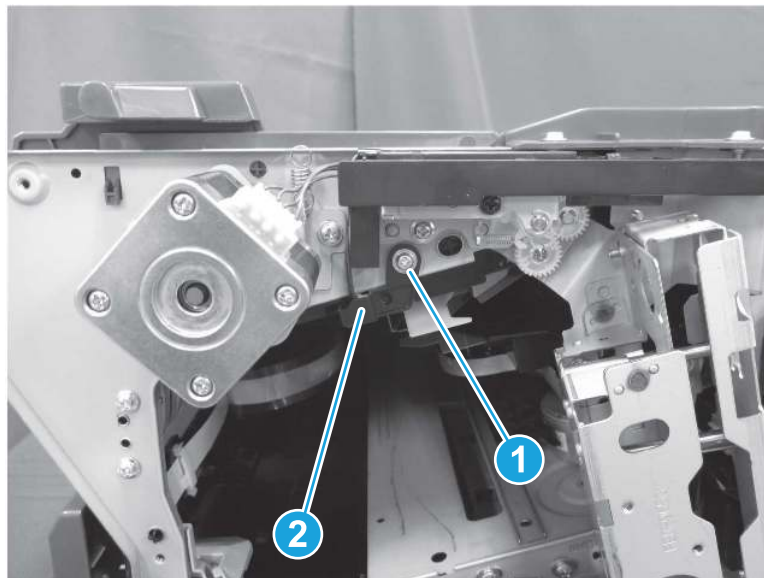
- b. Remove three screws (callout 1), and then remove the rear cover (callout 2).

Figure 1-3009 Remove the rear cover



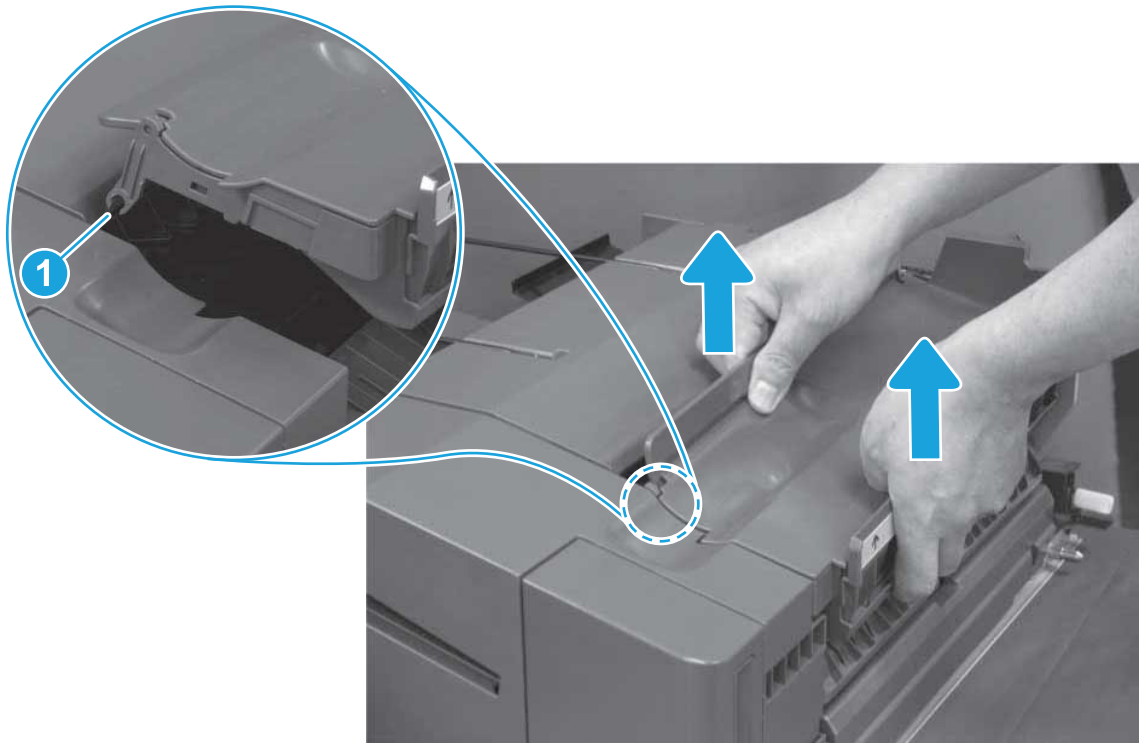
3. Remove the inner finisher upper entrance guide (M776zs).
 - a. Remove one screw (callout 1), and then remove the fixed pin (callout 2).

Figure 1-3010 Remove one screw and pin



- b. Lift up on the upper entrance guide to release the arm (callout 1) from the shaft.

Figure 1-3011 Remove the upper entrance guide



4. Unpack the replacement assembly.
 - a. Dispose of the defective part.



NOTE: HP recommends responsible disposal of the defective part.

<http://www8.hp.com/us/en/hp-information/environment/product-recycling.html>

- b. Unpack the replacement part from the packaging.



IMPORTANT: Make sure that all of the shipping materials (for example shipping tape) are removed from the replacement part prior to installation.

- c. To install an assembly, reverse the removal steps.



NOTE: When applicable, special installation instructions are provided for an assembly at the end of the removal procedure. Always completely read the removal instructions and follow all special installation instructions.

Removal and replacement: Inner finisher upper feed guide (Mc776zs)

Learn how to remove and replace the inner finisher upper feed guide.

Mean time to repair: 8 minutes

Service level: Easy

Before performing service

Turn the printer power off

- Disconnect the power cable.

⚠ WARNING! To avoid damage to the printer, turn the printer off, wait 30 seconds, and then remove the power cord before attempting to service the printer.

- Remove the inner finisher from the printer.

Use the table below to identify the correct part number for your printer. To order the part, go to www.hp.com/buy/parts.

Table 1-141 Part information

Part number	Part description
RM2-2432-000CN	Paper feed guide assembly, upper

Required tools

- #2 Phillips screwdriver with a magnetic tip
- Small, flat-blade screwdriver

After performing service

Turn the printer power on

- Reinstall the inner finisher
- Connect the power cable.
- Use the power switch to turn the power on.

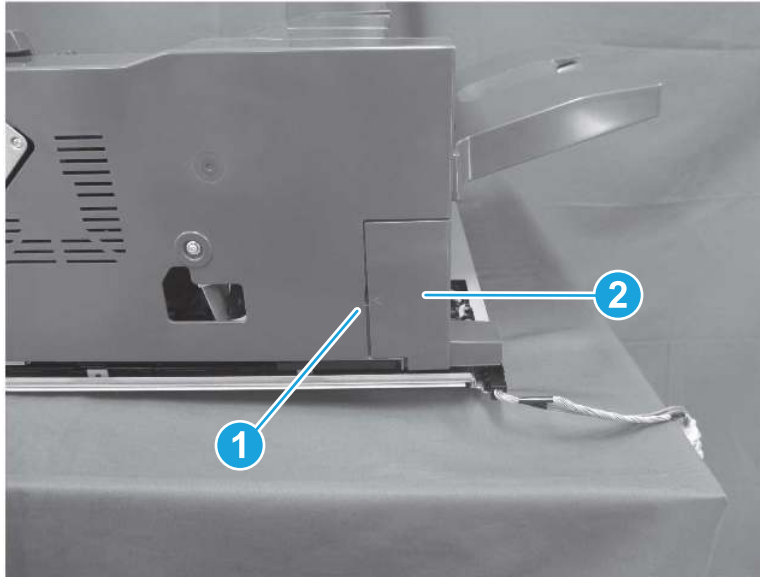
Post service test

Send a print job to the inner finisher and verify it is functioning correctly.

1. Remove the inner finisher connector cover (M776zs).

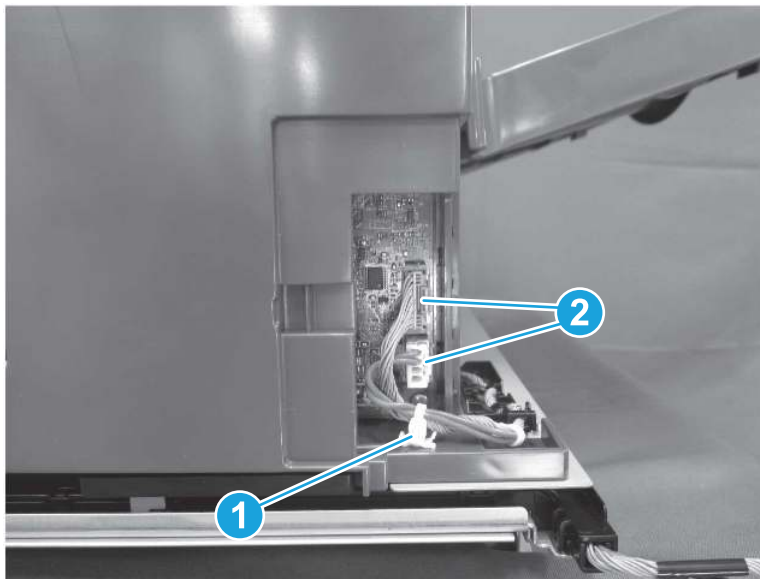
- ▲ Release one tab (callout 1), and then remove the connector cover (callout 2).

Figure 1-3012 Remove the connector cover



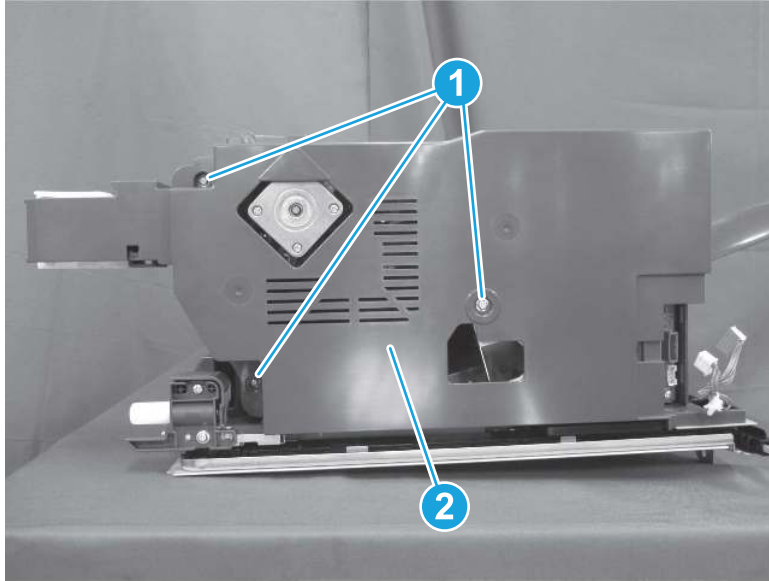
- 2. Remove the inner finisher rear cover (M776zs).
 - a. Release one retainer (callout 1), and then disconnect two connectors (callout 2).

Figure 1-3013 Disconnect two connectors



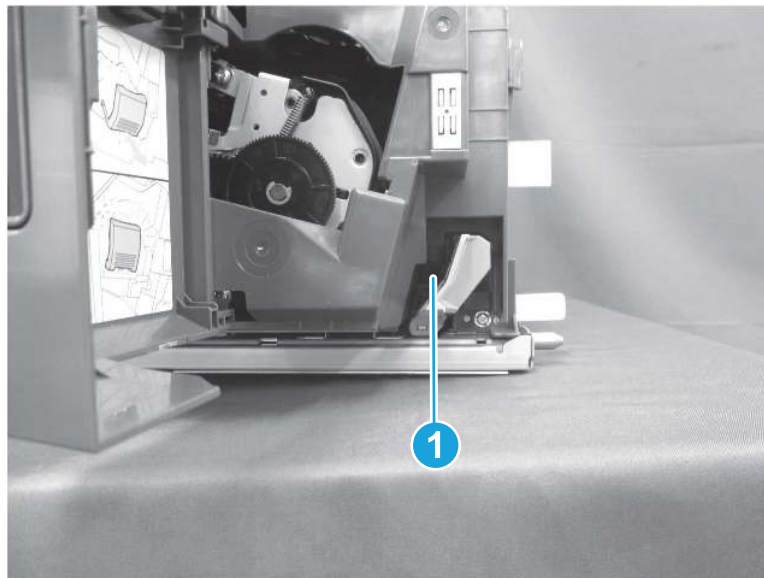
- b. Remove three screws (callout 1), and then remove the rear cover (callout 2).

Figure 1-3014 Remove the rear cover



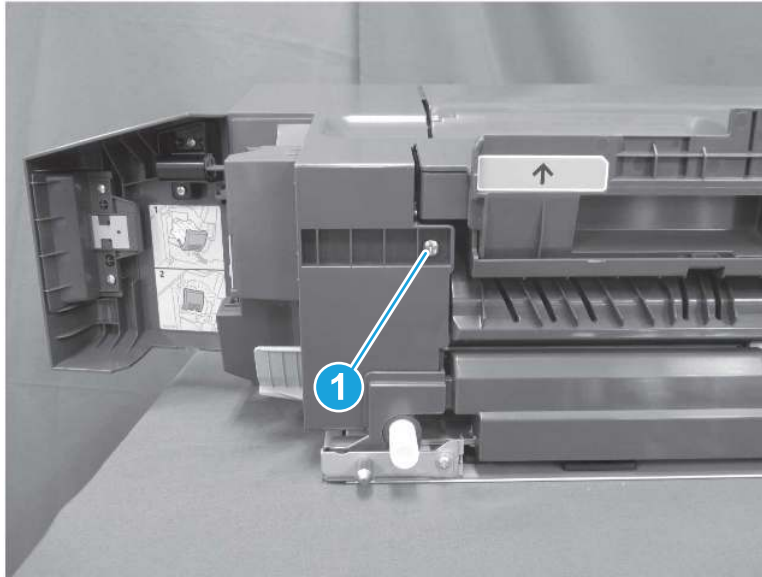
3. Remove the inner finisher front cover (M776zs).
 - a. Open the inner finisher front door, and then remove one screw (callout 1).

Figure 1-3015 Remove one screw



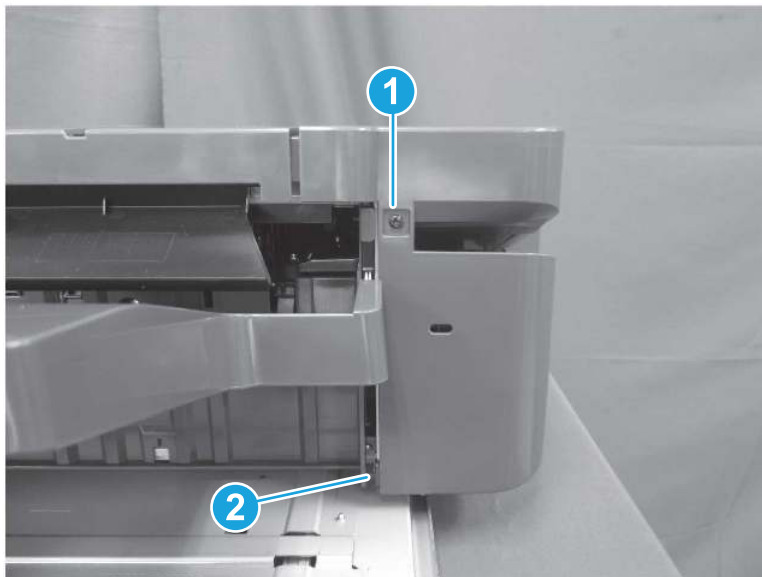
- b. Remove one screw (callout 1).

Figure 1-3016 Remove one screw



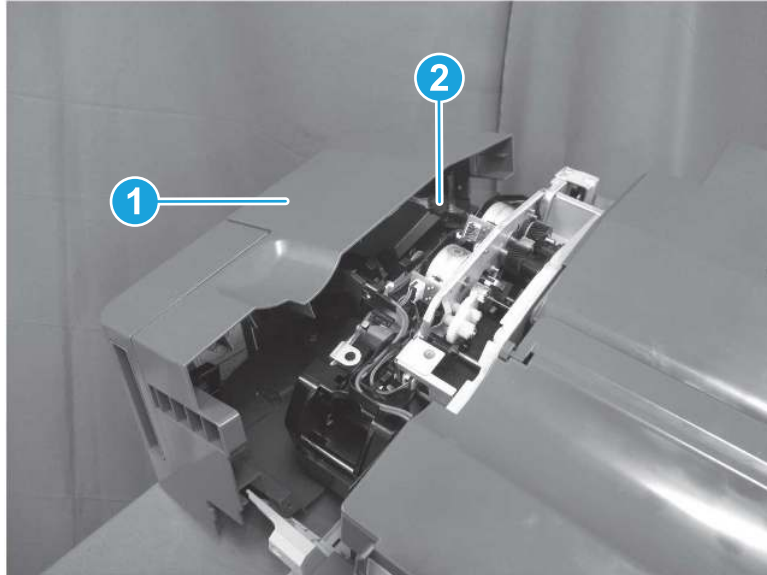
- c. Remove one screw (callout 1), and then release one tab (callout 2).

Figure 1-3017 Remove one screw and release one tab



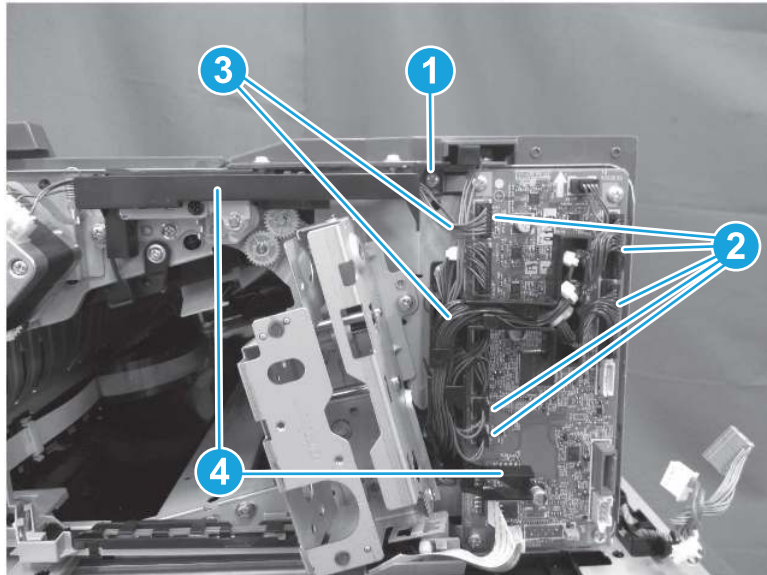
- d. Pull the front cover (callout 1) slightly away from the finisher, disconnect one connector (callout 2), and then remove the front cover.

Figure 1-3018 Remove the front cover



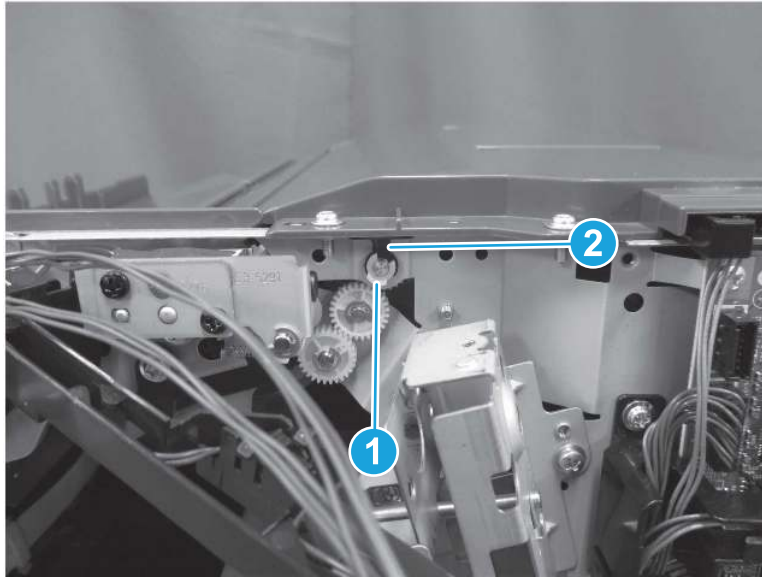
4. Remove the inner finisher upper feed guide (M776zs).
 - a. Remove one screw (callout 1), and then disconnect five connectors (callout 2). Release the cables (callout 3) from the guide (callout 4).

Figure 1-3019 Remove one screw and disconnect five connectors



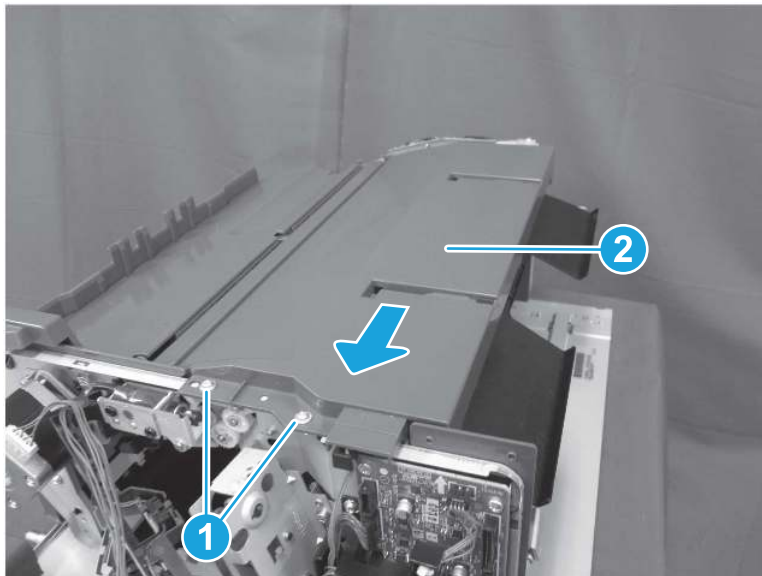
- b. Remove one e-clip (callout 1), and then remove the bushing (callout 2).

Figure 1-3020 Remove e-clip and bushing



- c. Remove one screw (callout 1). Lift the upper feed guide (callout 2), and then slide it towards the front of the finisher to remove it.

Figure 1-3021 Remove the upper feed guide




5. Unpack the replacement assembly.
 - a. Dispose of the defective part.




NOTE: HP recommends responsible disposal of the defective part.

<http://www8.hp.com/us/en/hp-information/environment/product-recycling.html>

- b. Unpack the replacement part from the packaging.

 **IMPORTANT:** Make sure that all of the shipping materials (for example shipping tape) are removed from the replacement part prior to installation.

- c. To install an assembly, reverse the removal steps.

 **NOTE:** When applicable, special installation instructions are provided for an assembly at the end of the removal procedure. Always completely read the removal instructions and follow all special installation instructions.

Removal and replacement: Inner finisher paddle assembly (M776zs)

Learn how to remove and replace the inner finisher paddle assembly.


Mean time to repair: 3 minutes

Service level: Easy

Before performing service

Turn the printer power off

- Disconnect the power cable.

 **WARNING!** To avoid damage to the printer, turn the printer off, wait 30 seconds, and then remove the power cord before attempting to service the printer.

- Remove the inner finisher from the printer.

Use the table below to identify the correct part number for your printer. To order the part, go to www.hp.com/buy/parts.

Table 1-142 Part information

Part number	Part description
FM1-C422-000CN	Paddle unit

Required tools

- Small, flat-blade screwdriver

After performing service

Turn the printer power on

- Reinstall the inner finisher
- Connect the power cable.
- Use the power switch to turn the power on.

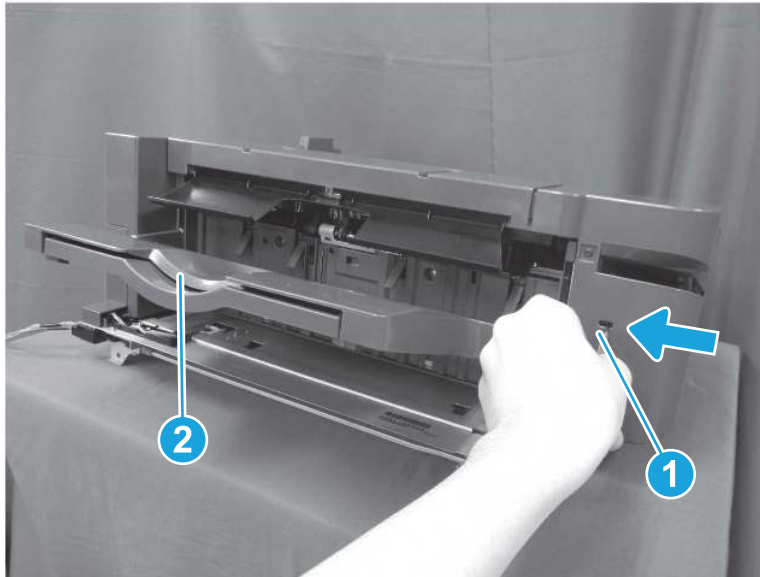
Post service test

Send a print job to the inner finisher and verify it is functioning correctly.

1. Remove the inner finisher paddle assembly (M776zs).

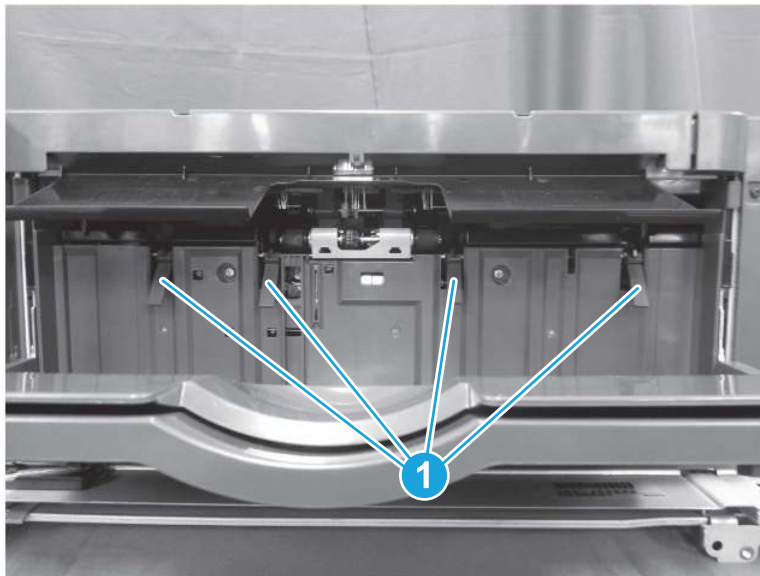
- a. Insert a small, flat-blade screwdriver into the opening (callout 1). Slide the screwdriver to the left to lower the stack tray assembly (callout 2).

Figure 1-3022 Lower the stack tray assembly



- b. Pull out on the paddle assembly (callout 1) to remove it.

Figure 1-3023 Remove the paddle assembly



2. Unpack the replacement assembly.


- a. Dispose of the defective part.




NOTE: HP recommends responsible disposal of the defective part.

<http://www8.hp.com/us/en/hp-information/environment/product-recycling.html>

- b. Unpack the replacement part from the packaging.

 **IMPORTANT:** Make sure that all of the shipping materials (for example shipping tape) are removed from the replacement part prior to installation.

- c. To install an assembly, reverse the removal steps.

 **NOTE:** When applicable, special installation instructions are provided for an assembly at the end of the removal procedure. Always completely read the removal instructions and follow all special installation instructions.

Removal and replacement: Inner finisher paddle drive assembly (M776zs)

Learn how to remove and replace the inner finisher paddle drive assembly.


Mean time to repair: 15 minutes

Service level: Medium

Before performing service

Turn the printer power off

- Disconnect the power cable.

 **WARNING!** To avoid damage to the printer, turn the printer off, wait 30 seconds, and then remove the power cord before attempting to service the printer.

- Remove the inner finisher from the printer.

Use the table below to identify the correct part number for your printer. To order the part, go to www.hp.com/buy/parts.

Table 1-143 Part information

Part number	Part description
FM1-C426-000CN	Paddle drive assembly

Required tools

- #2 Phillips screwdriver with a magnetic tip

After performing service

Turn the printer power on

- Reinstall the inner finisher
- Connect the power cable.
- Use the power switch to turn the power on.

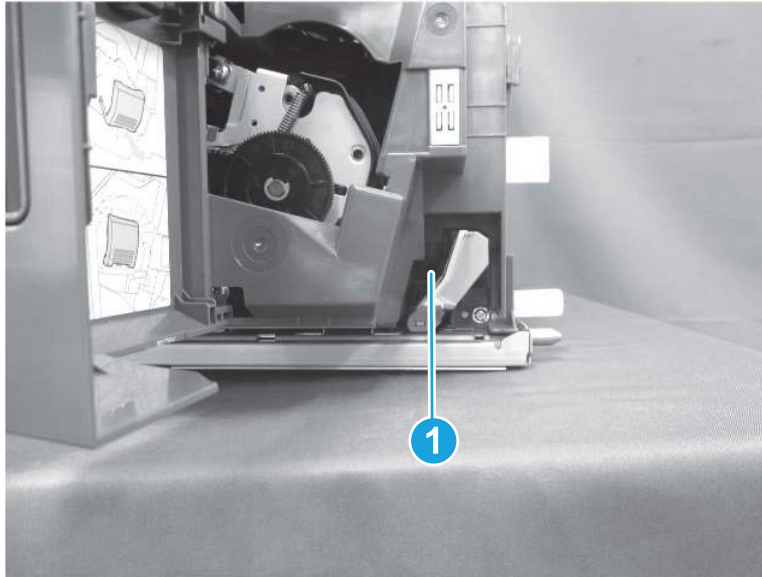
Post service test

Send a print job to the inner finisher and verify it is functioning correctly.

1. Remove the inner finisher front cover (M776zs).

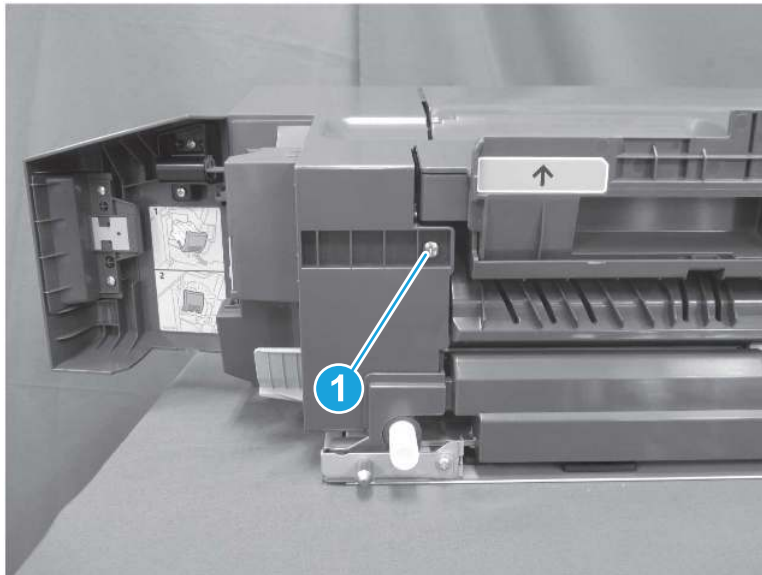
- a. Open the inner finisher front door, and then remove one screw (callout 1).

Figure 1-3024 Remove one screw



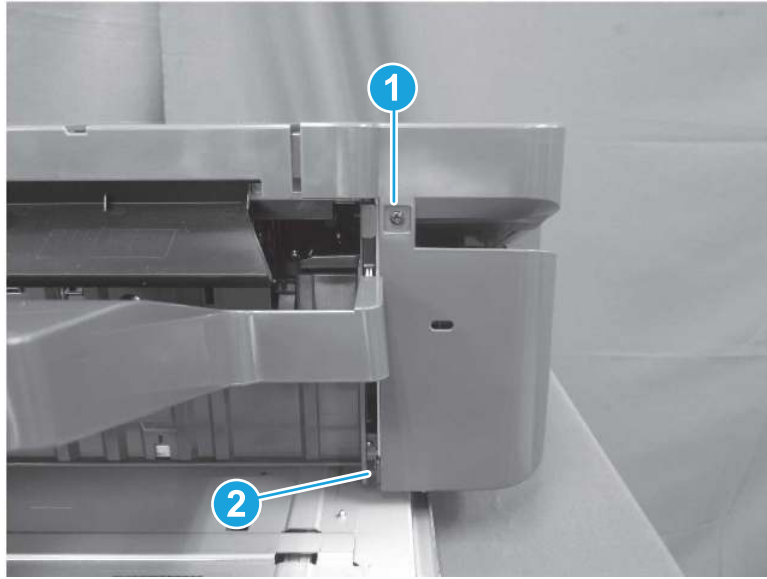
- b. Remove one screw (callout 1).

Figure 1-3025 Remove one screw



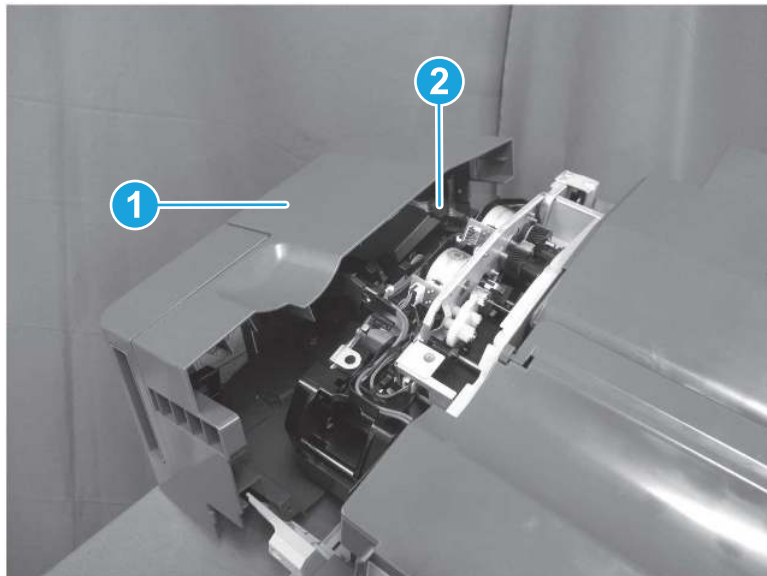
- c. Remove one screw (callout 1), and then release one tab (callout 2).

Figure 1-3026 Remove one screw and release one tab



- d. Pull the front cover (callout 1) slightly away from the finisher, disconnect one connector (callout 2), and then remove the front cover.

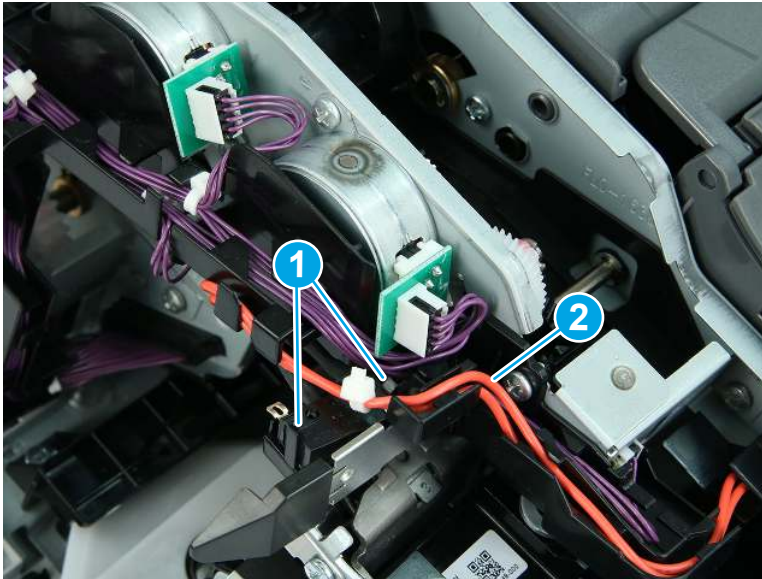
Figure 1-3027 Remove the front cover



2. Remove the inner finisher paddle drive assembly (M776zs).

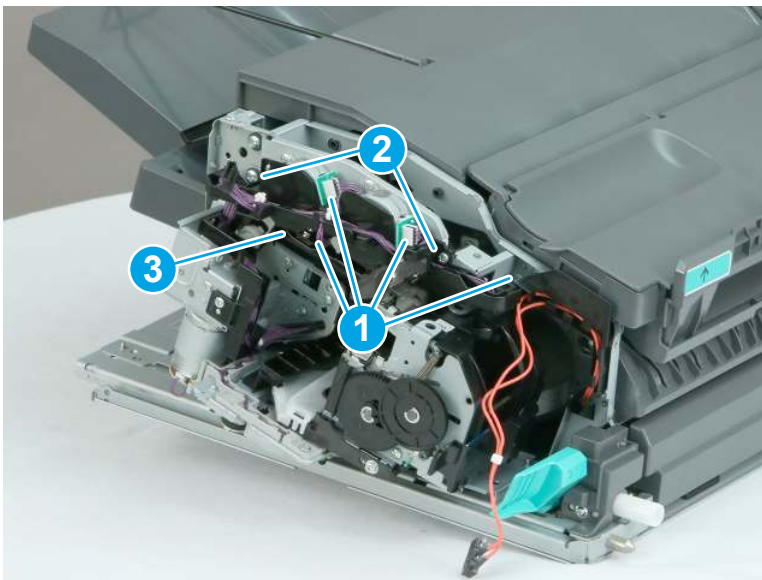
- a. Release two tabs (callout 1) to release the interlock switch, and then remove the cable (callout 2) from the guide.

Figure 1-3028 Release the interlock switch



- b. Disconnect four connectors (callout 1), remove two screws (callout 2), and then release the cables from the guide (callout 3).

Figure 1-3029 Disconnect four connectors and remove two screws



- c. Release one tab (callout 1), and then remove the guide (callout 2).

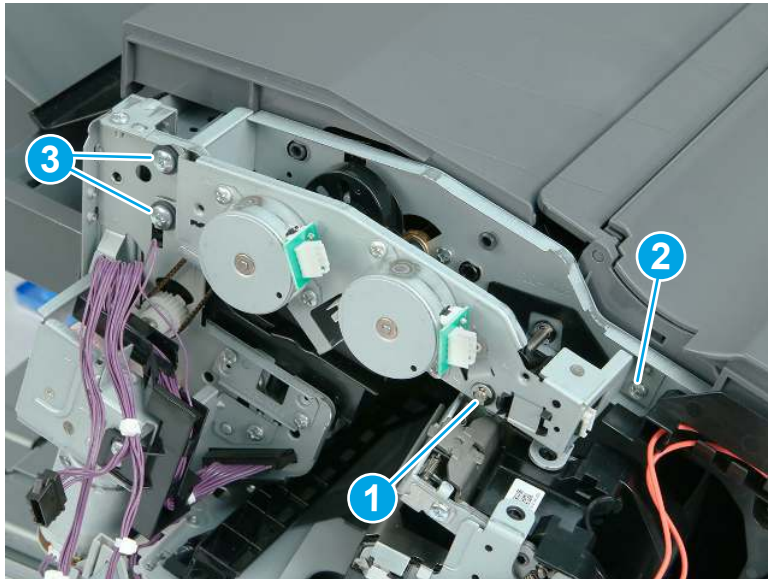
Figure 1-3030 Remove the guide



- d. Remove one e-ring and bushing (callout 1), remove one screw (callout 2), then remove two screws (callout 3).

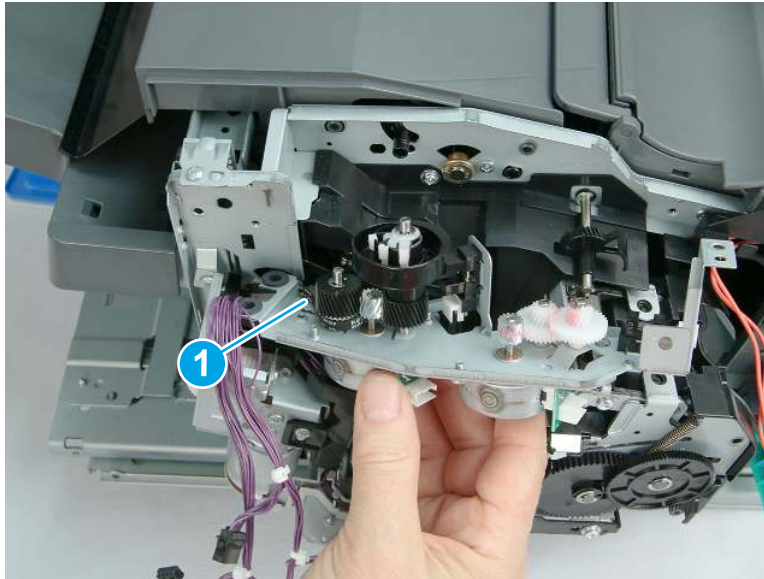
 **TIP:** One screw (callout 2) is smaller than the other two screws. Make sure this screw is installed in the correct position.

Figure 1-3031 Remove one e-ring and bushing and two screws



- e. Lift the paddle drive assembly slightly away from the finisher, and then release one belt from the gear (callout 1). Remove the paddle drive assembly.

Figure 1-3032 Release the belt and remove the paddle drive assembly



3. Unpack the replacement assembly.
 - a. Dispose of the defective part.
- b. Unpack the replacement part from the packaging.
 - c. To install an assembly, reverse the removal steps.



NOTE: HP recommends responsible disposal of the defective part.

<http://www8.hp.com/us/en/hp-information/environment/product-recycling.html>



IMPORTANT: Make sure that all of the shipping materials (for example shipping tape) are removed from the replacement part prior to installation.



NOTE: When applicable, special installation instructions are provided for an assembly at the end of the removal procedure. Always completely read the removal instructions and follow all special installation instructions.

Removal and replacement: Inner finisher latch assembly (M776zs)

Learn how to remove and replace the inner finisher latch assembly.

Mean time to repair: 17 minutes

Service level: Medium

Before performing service

Turn the printer power off

- Disconnect the power cable.

⚠ WARNING! To avoid damage to the printer, turn the printer off, wait 30 seconds, and then remove the power cord before attempting to service the printer.

- Remove the inner finisher from the printer.

Use the table below to identify the correct part number for your printer. To order the part, go to www.hp.com/buy/parts.

Table 1-144 Part information

Part number	Part description
RM2-2442-000CN	Latch assembly

Required tools

- #2 Phillips screwdriver with a magnetic tip

After performing service

Turn the printer power on

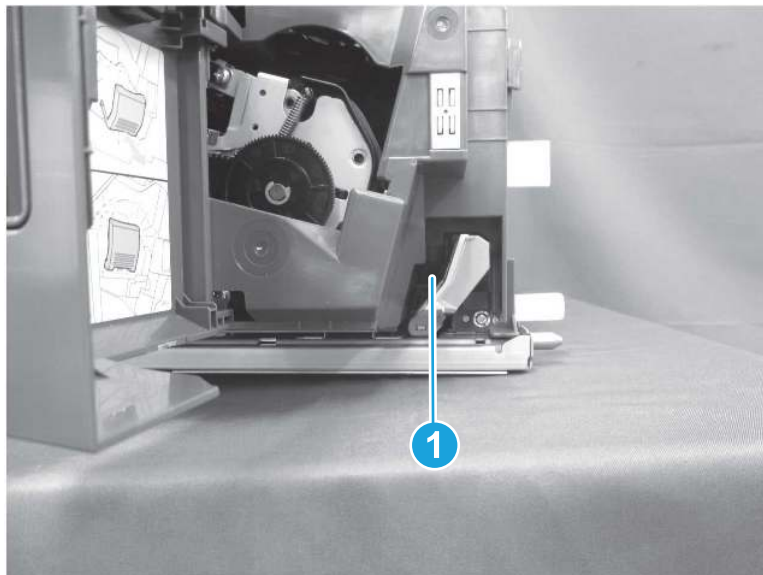
- Reinstall the inner finisher
- Connect the power cable.
- Use the power switch to turn the power on.

Post service test

Send a print job to the inner finisher and verify it is functioning correctly.

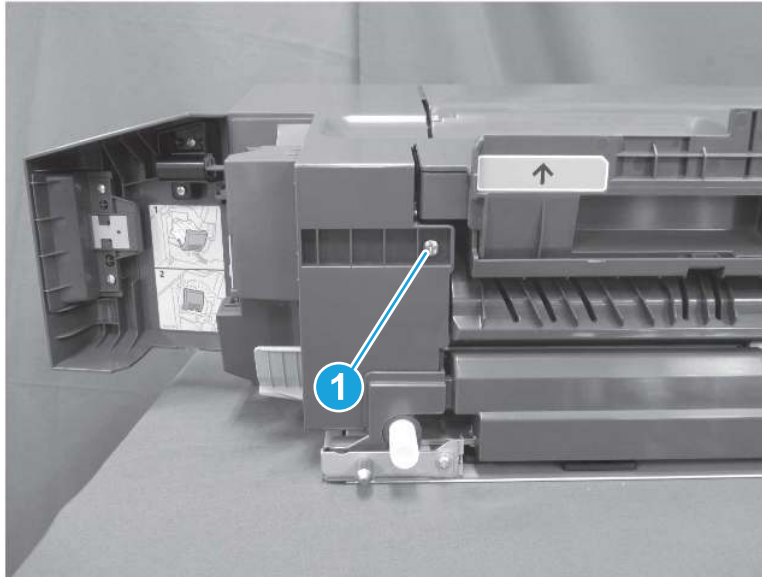
1. Remove the inner finisher front cover (M776zs).
 - a. Open the inner finisher front door, and then remove one screw (callout 1).

Figure 1-3033 Remove one screw



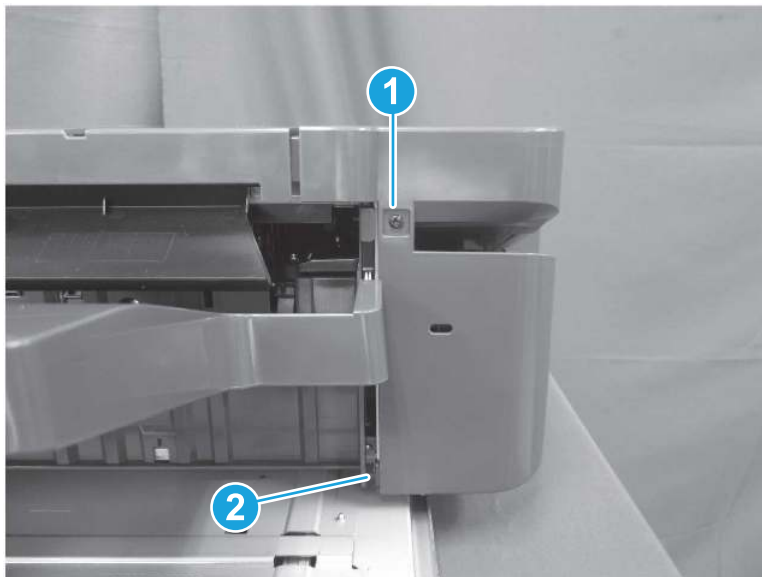
- b. Remove one screw (callout 1).

Figure 1-3034 Remove one screw



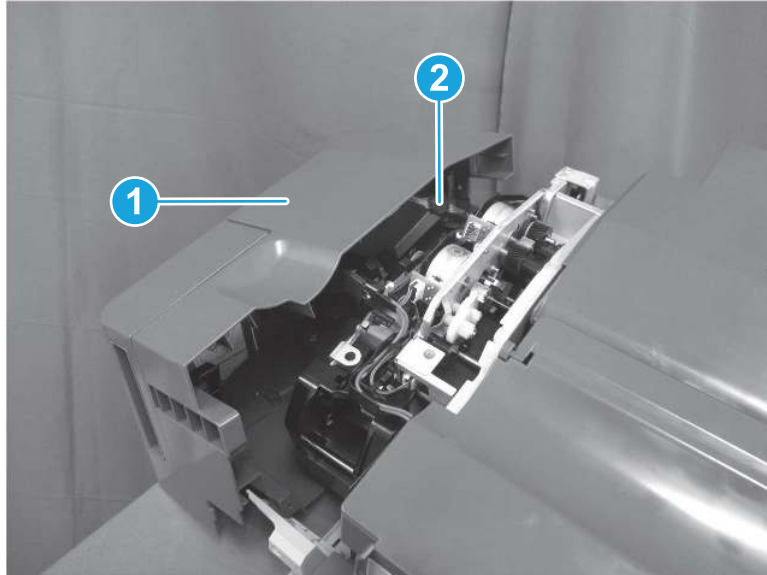
- c. Remove one screw (callout 1), and then release one tab (callout 2).

Figure 1-3035 Remove one screw and release one tab



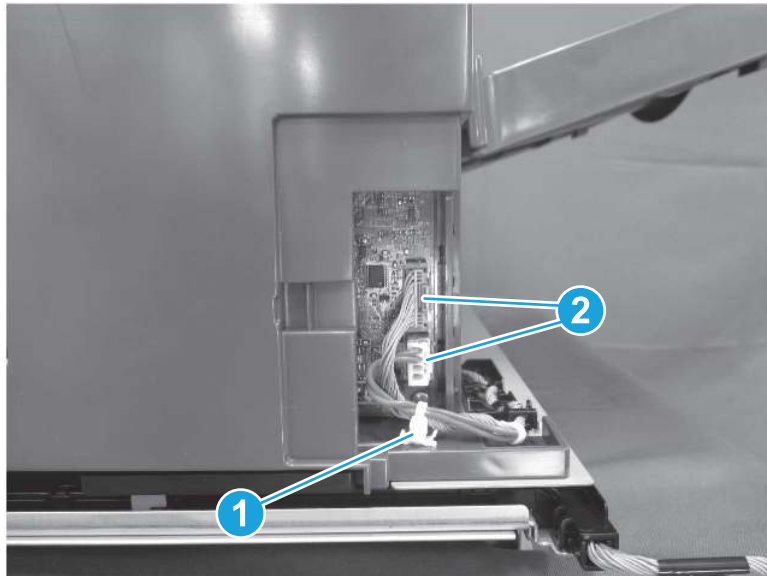
- d. Pull the front cover (callout 1) slightly away from the finisher, disconnect one connector (callout 2), and then remove the front cover.

Figure 1-3036 Remove the front cover



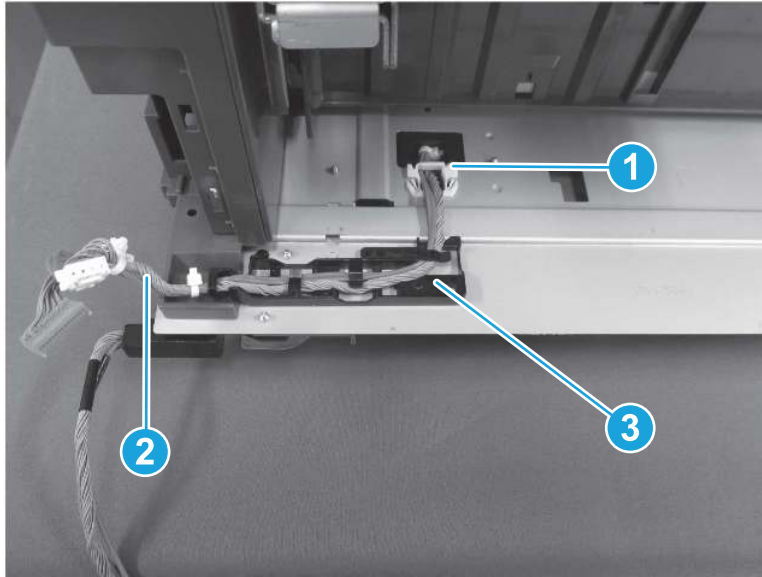
2. Remove the inner finisher latch assembly (M776zs).
 - a. Release one retainer (callout 1), and then disconnect two connectors (callout 2).

Figure 1-3037 Disconnect two connectors



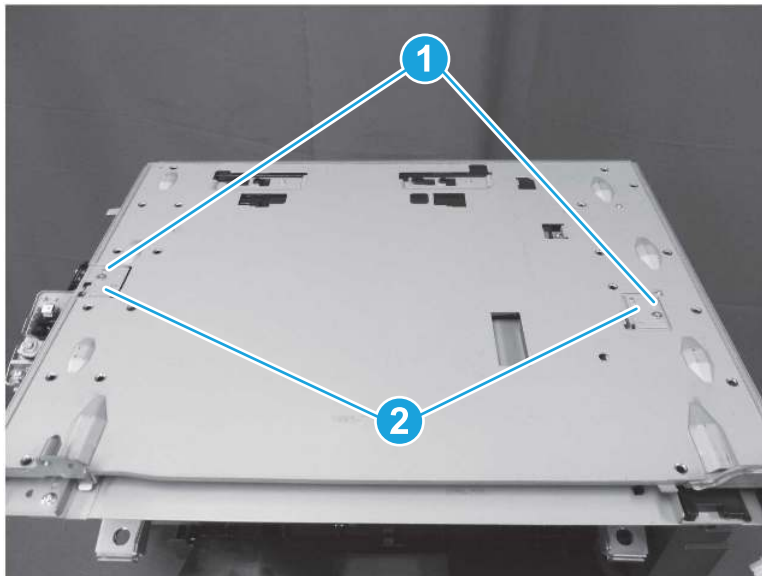
- b. Open one retainer (callout 1), and then release the cables (callout 2) from the cable guides (callout 3).

Figure 1-3038 Release the cables



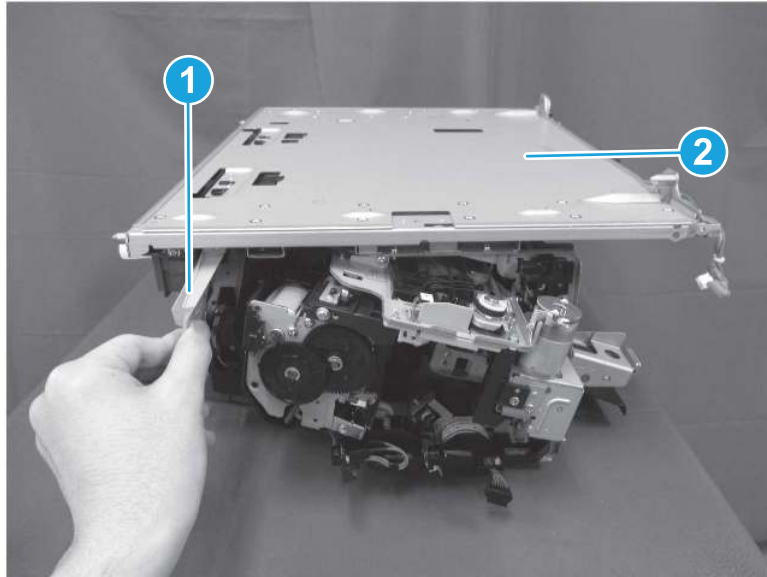
- c. Place the finisher face-down. Remove two screws (callout 1), and then remove two stoppers (callout 2).

Figure 1-3039 Remove two screws and stoppers



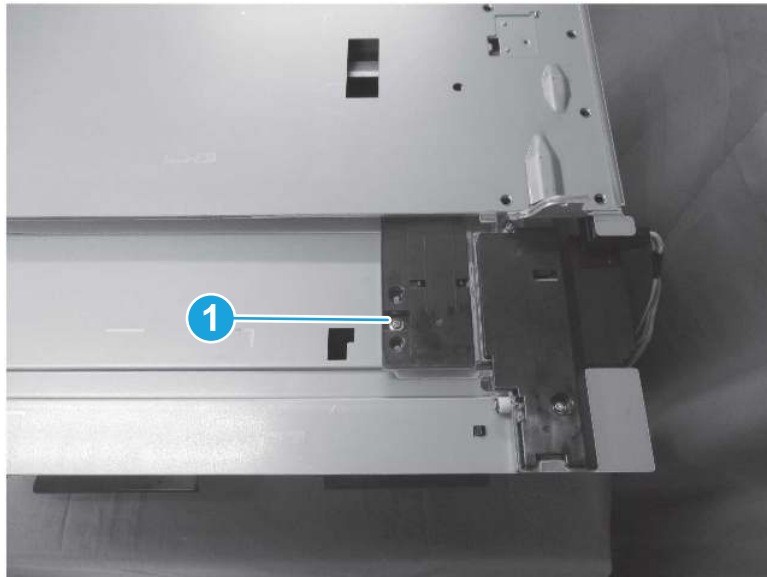
- d. Tilt the release lever (callout 1), and then slide the bottom slide assembly (callout 2) to the right.

Figure 1-3040 Release the latch and slide the assembly



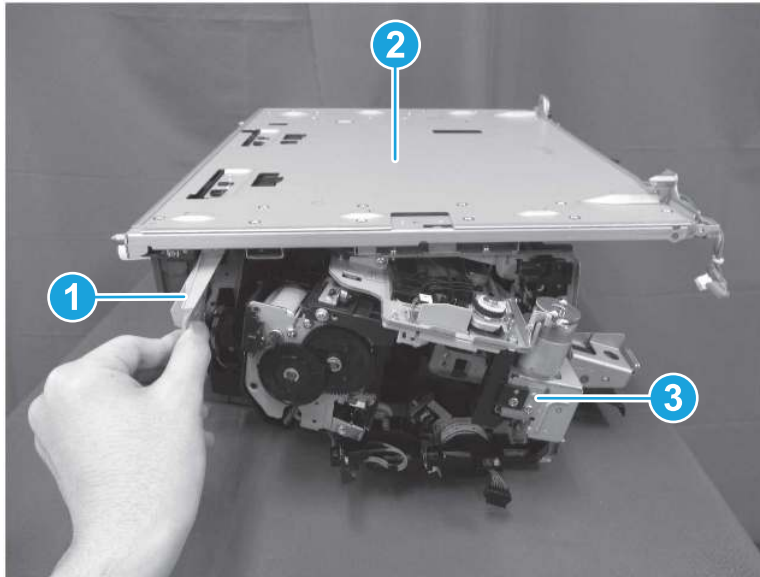
- e. Remove one screw (callout 1).

Figure 1-3041 Remove one screw



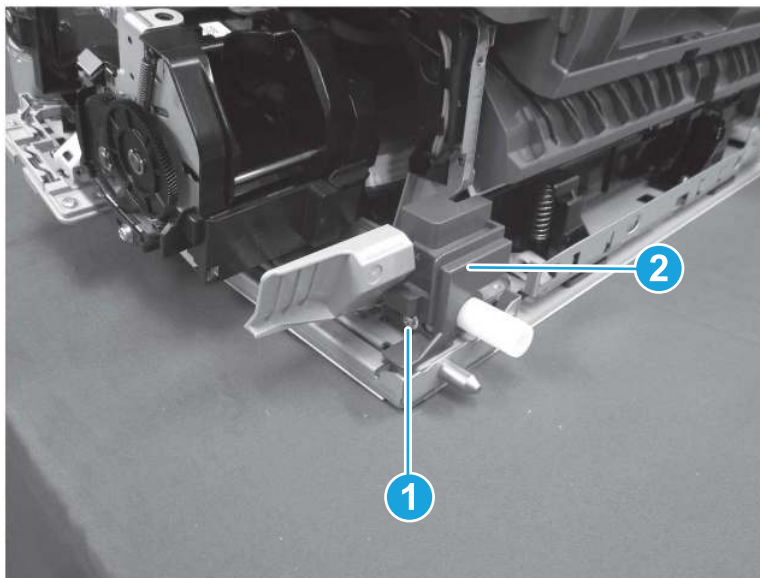
- f. Tilt the release lever (callout 1), and then slide the bottom slide assembly (callout 2) to remove it from the inner finisher (callout 3).

Figure 1-3042 Remove the bottom slide assembly



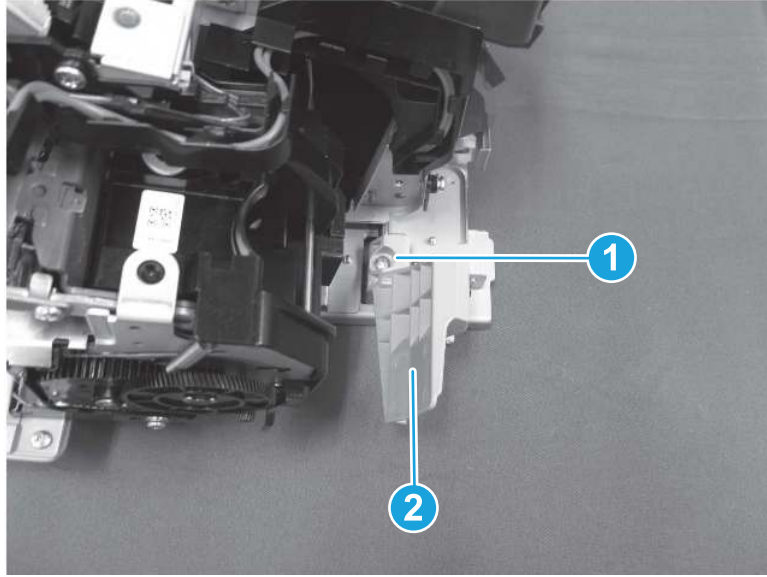
- g. Place the inner finisher face-up. Remove one screw (callout 1), and then remove the push assembly (callout 2)

Figure 1-3043 Remove the push assembly



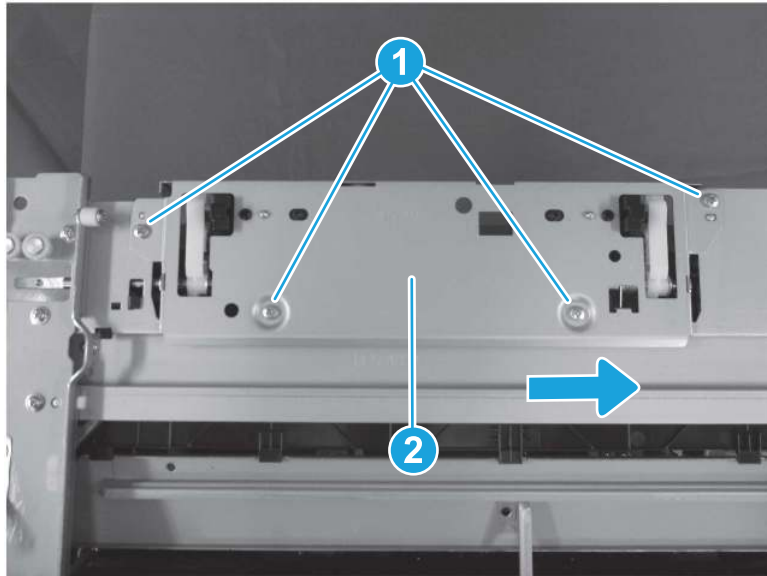
- h. Remove one screw (callout 1), and then remove the release lever (callout 2)

Figure 1-3044 Remove the release lever



- i. Place the finisher face-down. Remove four screws (callout 1). Slide the latch assembly (callout 2) to the right to remove it.

Figure 1-3045 Remove the latch assembly



- 3. Unpack the replacement assembly.


- a. Dispose of the defective part.




NOTE: HP recommends responsible disposal of the defective part.

<http://www8.hp.com/us/en/hp-information/environment/product-recycling.html>

- b. Unpack the replacement part from the packaging.

 **IMPORTANT:** Make sure that all of the shipping materials (for example shipping tape) are removed from the replacement part prior to installation.

- c. To install an assembly, reverse the removal steps.

 **NOTE:** When applicable, special installation instructions are provided for an assembly at the end of the removal procedure. Always completely read the removal instructions and follow all special installation instructions.

Removal and replacement: Inner finisher stapler assembly (M776zs)

Learn how to remove and replace the inner finisher stapler assembly.


Mean time to repair: 15 minutes

Service level: Medium

Before performing service

Turn the printer power off

- Disconnect the power cable.

 **WARNING!** To avoid damage to the printer, turn the printer off, wait 30 seconds, and then remove the power cord before attempting to service the printer.

- Remove the inner finisher from the printer.

Use the table below to identify the correct part number for your printer. To order the part, go to www.hp.com/buy/parts.

Table 1-145 Part information

Part number	Part description
RM2-2453-000CN	Staple assembly

Required tools

- #2 Phillips screwdriver with a magnetic tip
- Small, flat-blade screwdriver

After performing service

Turn the printer power on

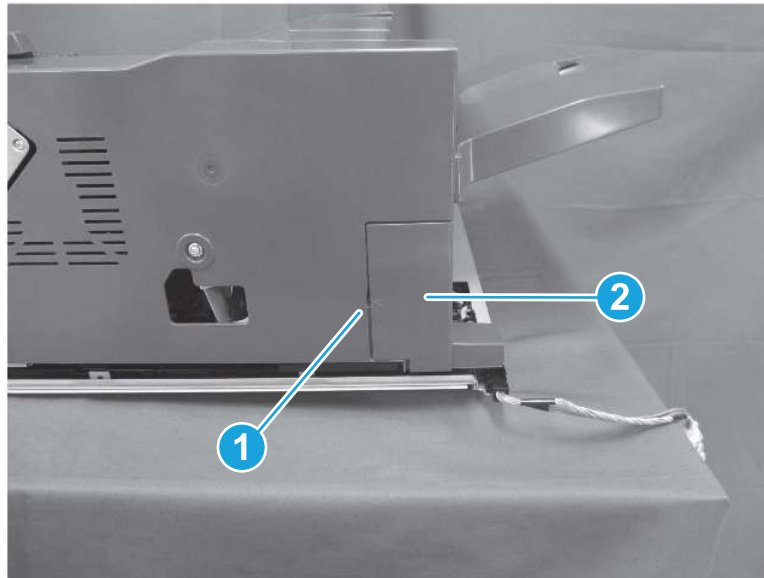
- Reinstall the inner finisher
- Connect the power cable.
- Use the power switch to turn the power on.

Post service test

Send a print job to the inner finisher and verify it is functioning correctly.

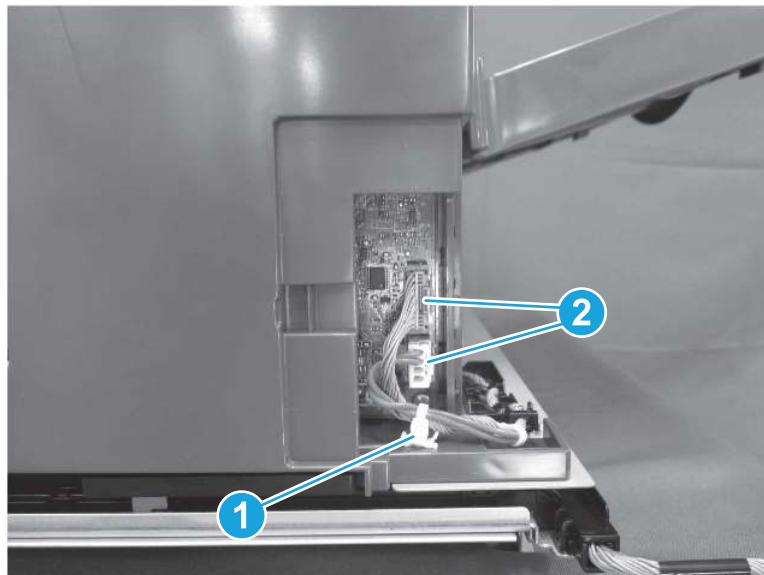
1. Remove the inner finisher connector cover (M776zs).
 - ▲ Release one tab (callout 1), and then remove the connector cover (callout 2).

Figure 1-3046 Remove the connector cover



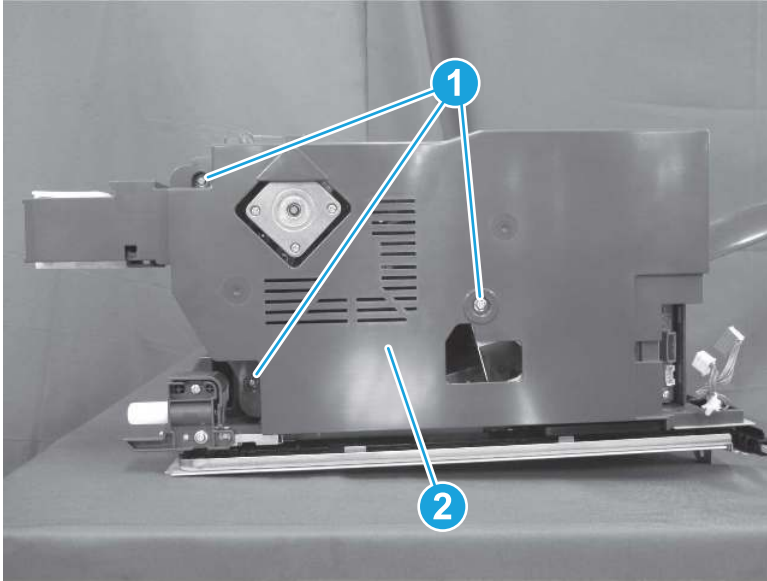
2. Remove the inner finisher rear cover (M776zs).
 - a. Release one retainer (callout 1), and then disconnect two connectors (callout 2).

Figure 1-3047 Disconnect two connectors



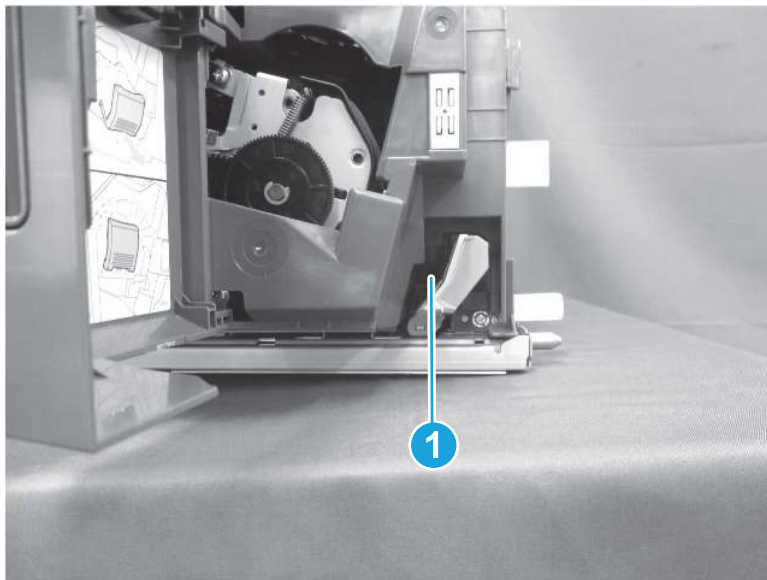
- b. Remove three screws (callout 1), and then remove the rear cover (callout 2).

Figure 1-3048 Remove the rear cover



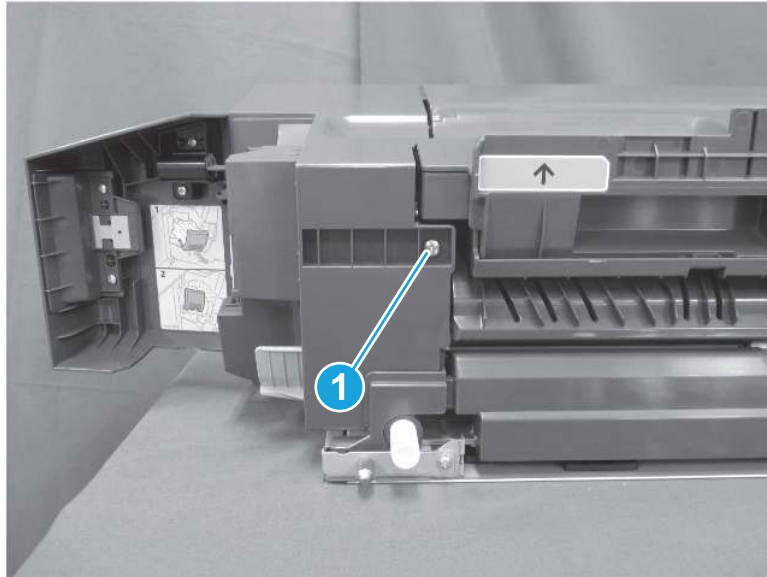
3. Remove the inner finisher front cover (M776zs).
 - a. Open the inner finisher front door, and then remove one screw (callout 1).

Figure 1-3049 Remove one screw



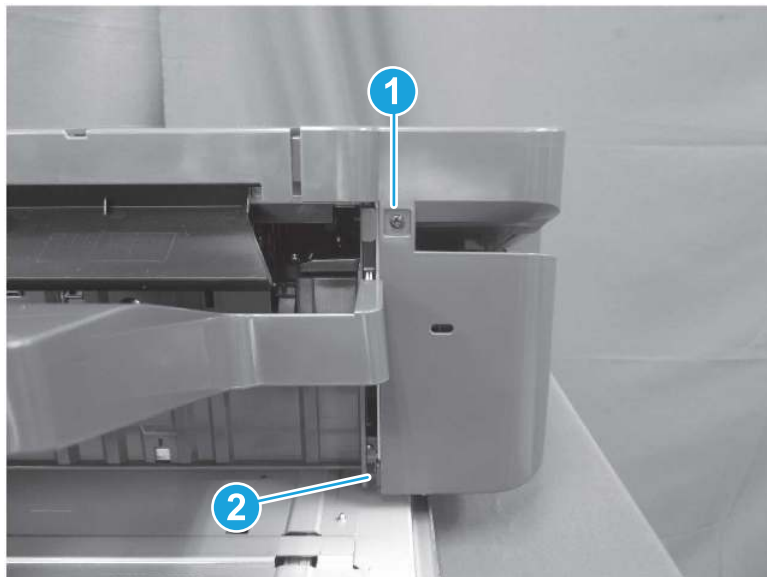
- b. Remove one screw (callout 1).

Figure 1-3050 Remove one screw



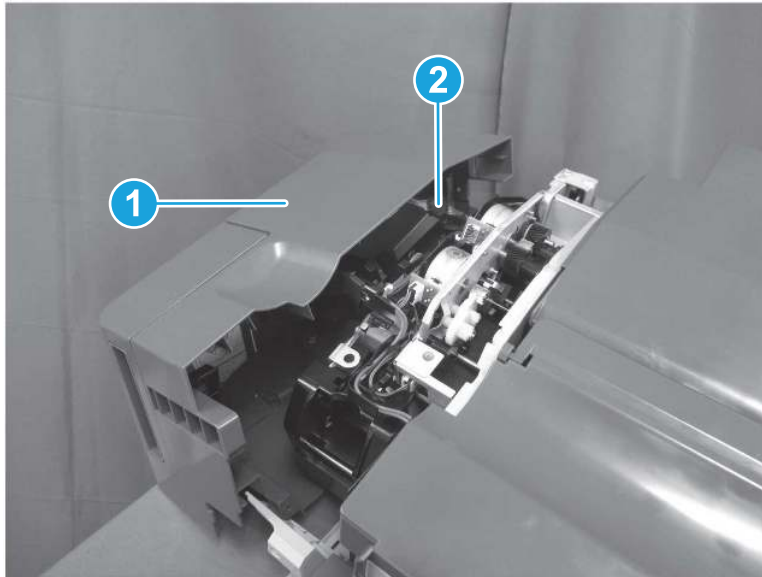
- c. Remove one screw (callout 1), and then release one tab (callout 2).

Figure 1-3051 Remove one screw and release one tab



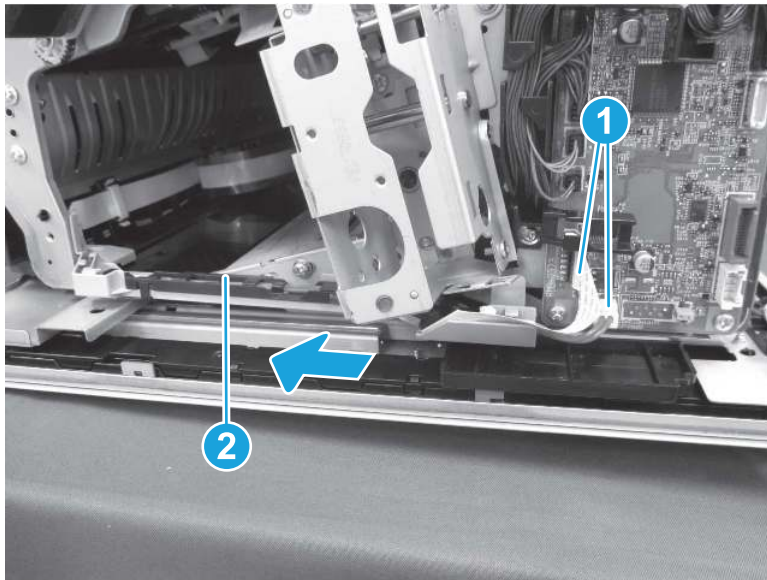
- d. Pull the front cover (callout 1) slightly away from the finisher, disconnect one connector (callout 2), and then remove the front cover.

Figure 1-3052 Remove the front cover



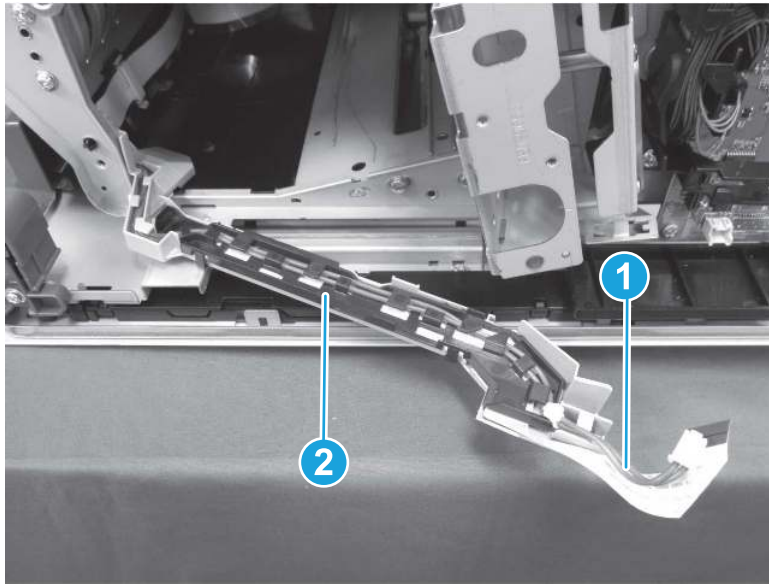
4. Remove the inner finisher stapler assembly (M776zs).
 - a. Disconnect two connectors (callout 1), and then slide the cable guide (callout 2) to the left to remove it.

Figure 1-3053 Disconnect two connectors and remove the cable guide



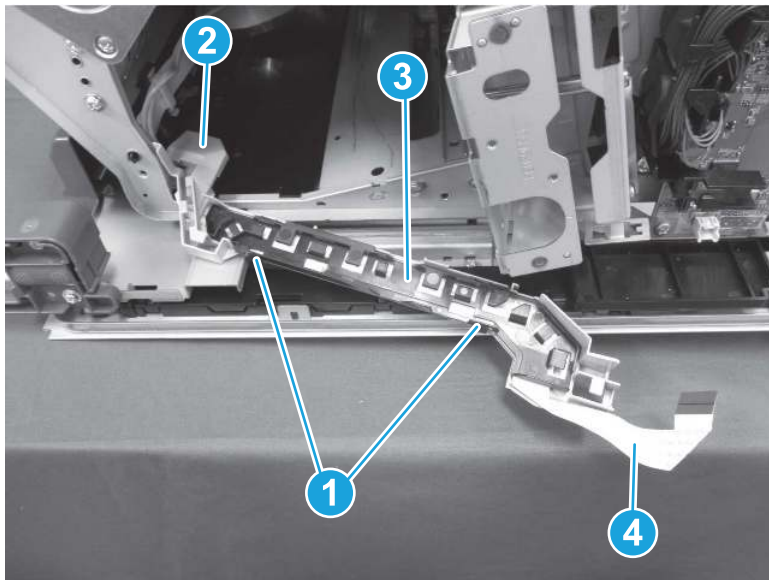
- b. Release the cable (callout 1), from the cable guide (callout 2).

Figure 1-3054 Release the cable from the cable guide



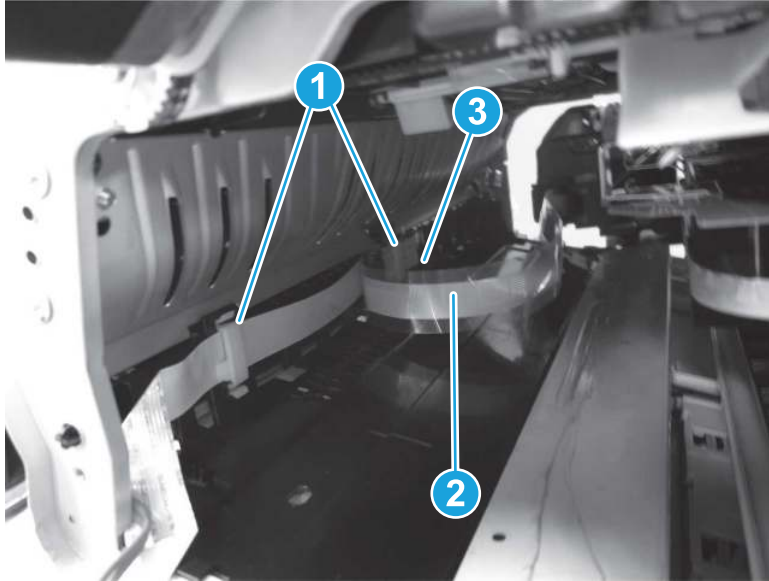
- c. Release two tabs (callout 1). Release the outer cable guide (callout 2) from the inner cable guide (callout 3). Remove the flat cable (callout 4) from the cable guide.

Figure 1-3055 Release the cable guides



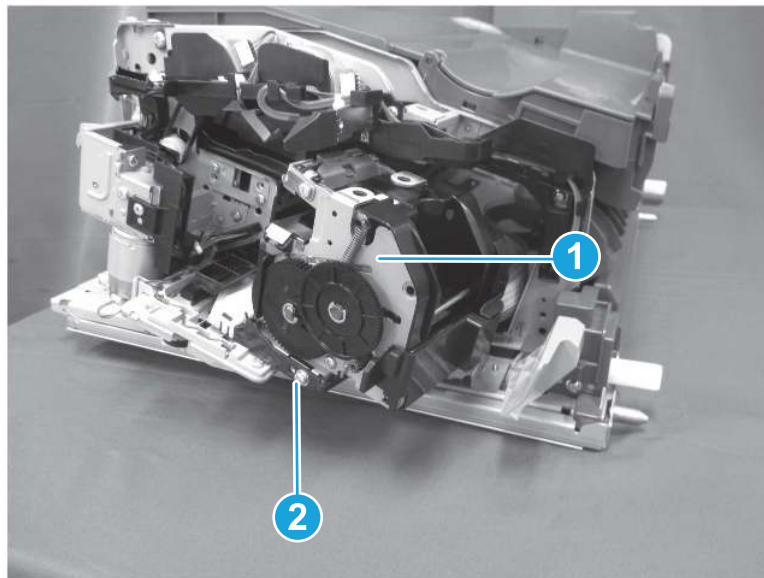
- d. Release two retainers (callout 1), and then release the flat cable (callout 2) from the guide (callout 3).

Figure 1-3056 Release the flat cable



- e. Slide the staple assembly (callout 1) out to the edge of the finisher. Remove one screw (callout 2), and then remove the staple assembly.

Figure 1-3057 Remove the staple assembly




5. Unpack the replacement assembly.
 - a. Dispose of the defective part.




NOTE: HP recommends responsible disposal of the defective part.

<http://www8.hp.com/us/en/hp-information/environment/product-recycling.html>

- b. Unpack the replacement part from the packaging.

 **IMPORTANT:** Make sure that all of the shipping materials (for example shipping tape) are removed from the replacement part prior to installation.

- c. To install an assembly, reverse the removal steps.

 **NOTE:** When applicable, special installation instructions are provided for an assembly at the end of the removal procedure. Always completely read the removal instructions and follow all special installation instructions.

Removal and replacement: Inner finisher stack wall assembly (M776zs)

Learn how to remove and replace the inner finisher stack wall assembly.


Mean time to repair: 10 minutes

Service level: Easy

Before performing service

Turn the printer power off

- Disconnect the power cable.

 **WARNING!** To avoid damage to the printer, turn the printer off, wait 30 seconds, and then remove the power cord before attempting to service the printer.

- Remove the inner finisher from the printer.

Use the table below to identify the correct part number for your printer. To order the part, go to www.hp.com/buy/parts.

Table 1-146 Part information

Part number	Part description
RM2-2452-000CN	Height wall assembly

Required tools

- #2 Phillips screwdriver with a magnetic tip
- Small, flat-blade screwdriver

After performing service

Turn the printer power on

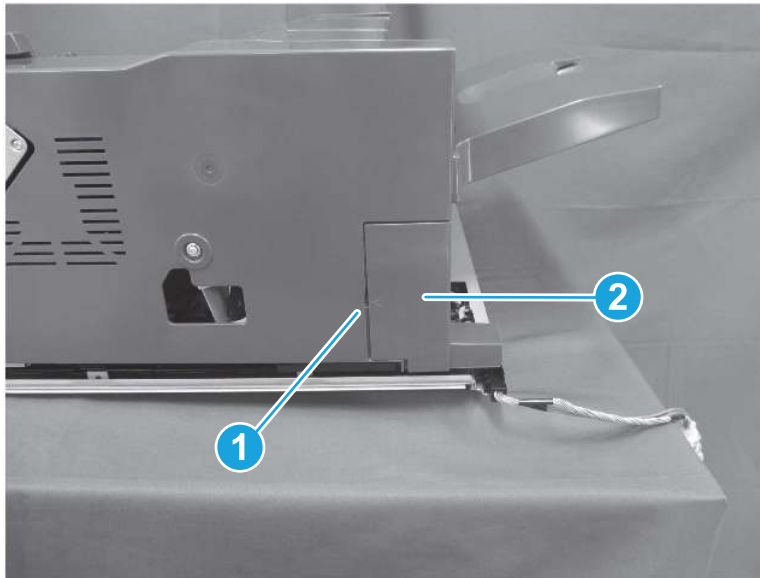
- Reinstall the inner finisher
- Connect the power cable.
- Use the power switch to turn the power on.

Post service test

Send a print job to the inner finisher and verify it is functioning correctly.

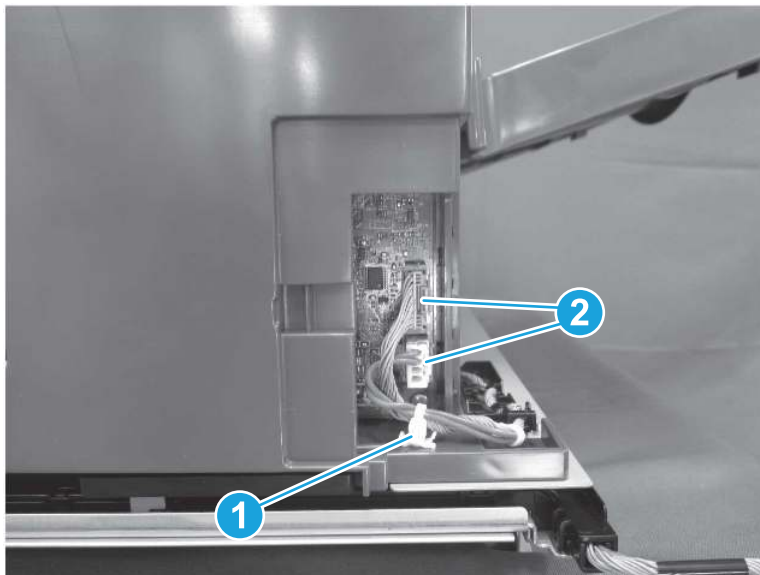
1. Remove the inner finisher connector cover (M776zs).
 - ▲ Release one tab (callout 1), and then remove the connector cover (callout 2).

Figure 1-3058 Remove the connector cover



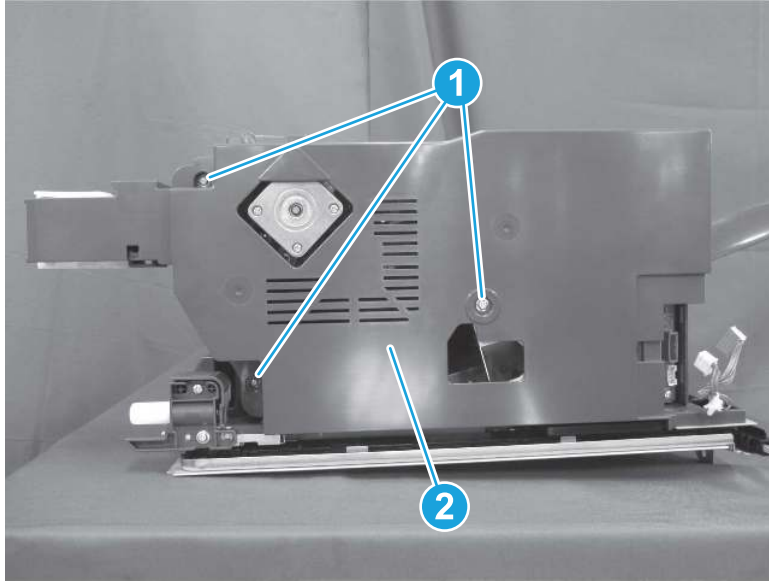
2. Remove the inner finisher rear cover (M776zs).
 - a. Release one retainer (callout 1), and then disconnect two connectors (callout 2).

Figure 1-3059 Disconnect two connectors



- b. Remove three screws (callout 1), and then remove the rear cover (callout 2).

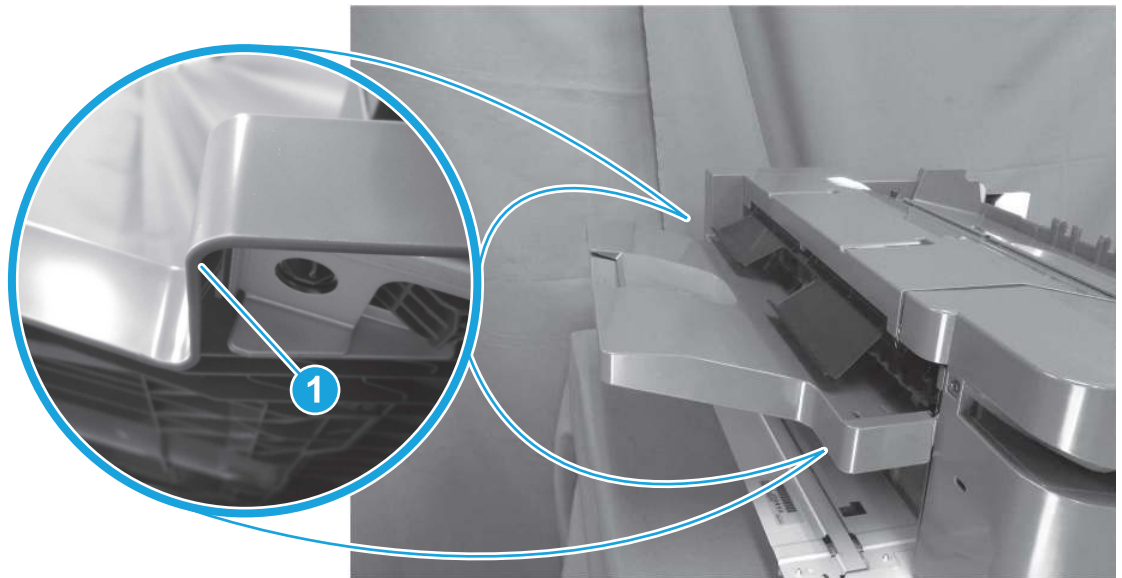
Figure 1-3060 Remove the rear cover



3. Remove the inner finisher stack tray assembly (M776zs).

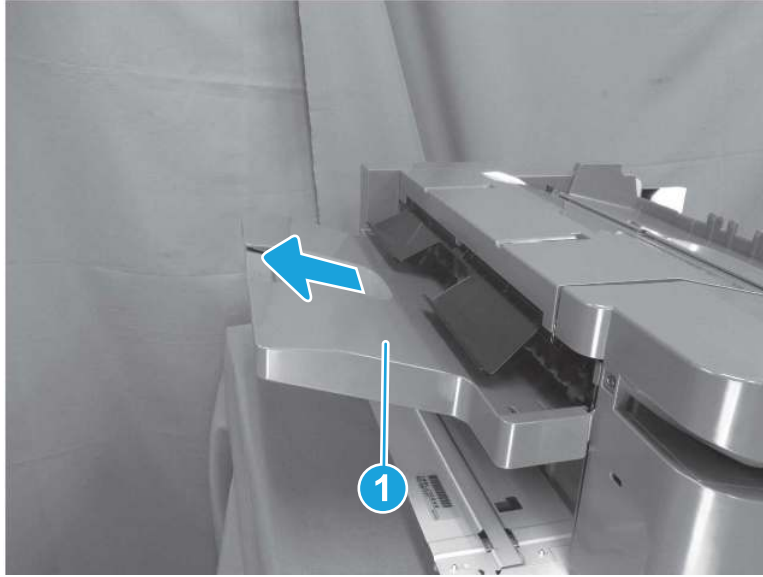
- a. Release two tabs (callout 1).

Figure 1-3061 Release two tabs



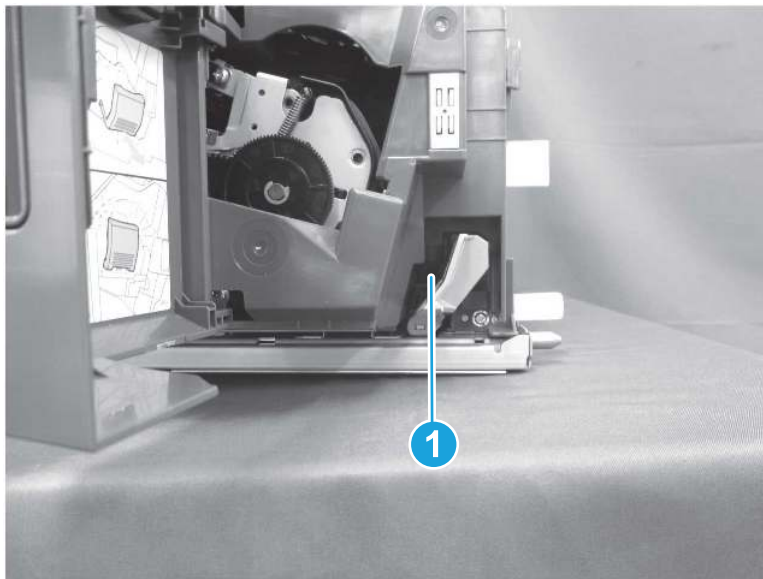
- b. Slide the stack tray assembly (callout 1) away from the finisher to remove it.

Figure 1-3062 Remove the stack tray assembly



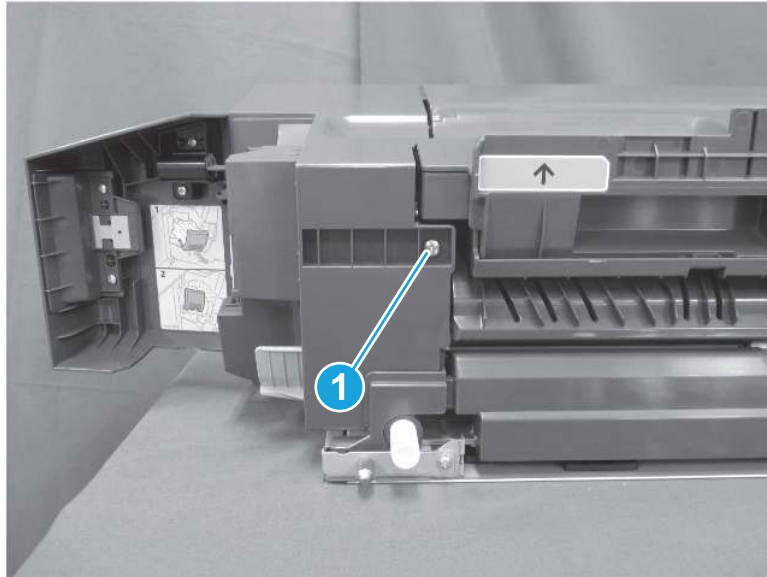
- 4. Remove the inner finisher front cover (M776zs).
 - a. Open the inner finisher front door, and then remove one screw (callout 1).

Figure 1-3063 Remove one screw



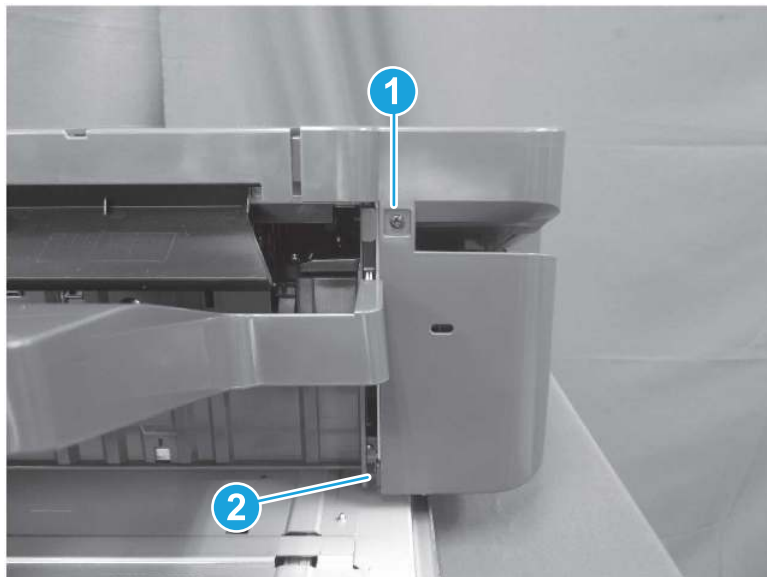
- b. Remove one screw (callout 1).

Figure 1-3064 Remove one screw



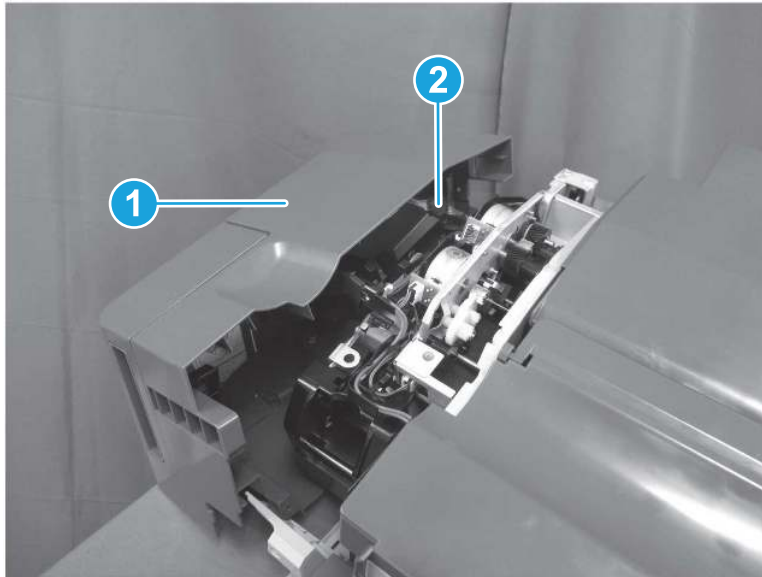
- c. Remove one screw (callout 1), and then release one tab (callout 2).

Figure 1-3065 Remove one screw and release one tab



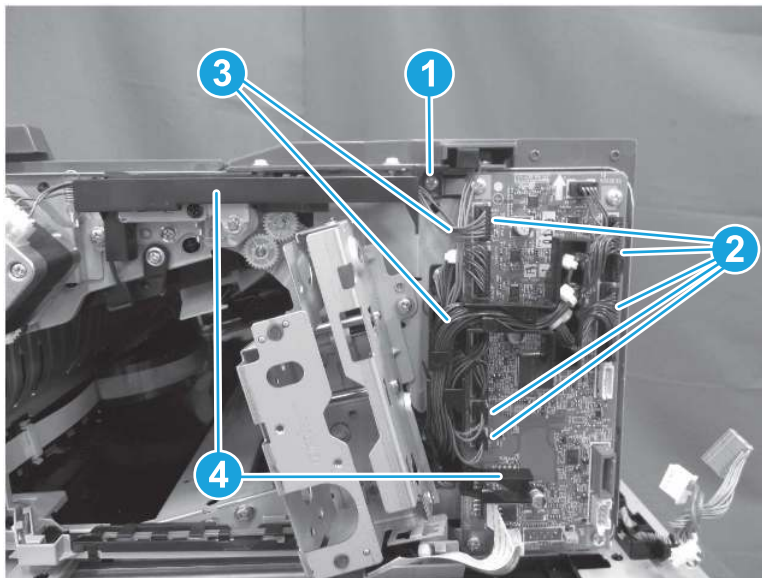
- d. Pull the front cover (callout 1) slightly away from the finisher, disconnect one connector (callout 2), and then remove the front cover.

Figure 1-3066 Remove the front cover



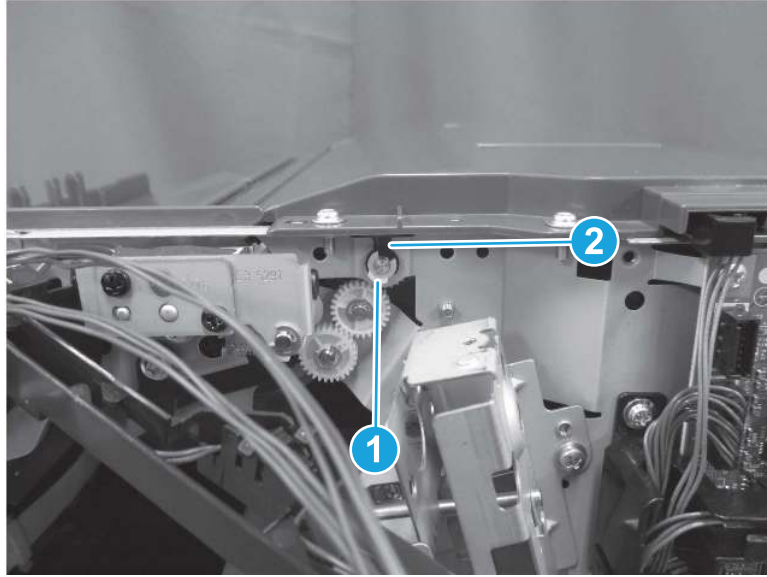
5. Remove the inner finisher upper feed guide (M776zs).
 - a. Remove one screw (callout 1), and then disconnect five connectors (callout 2). Release the cables (callout 3) from the guide (callout 4).

Figure 1-3067 Remove one screw and disconnect five connectors



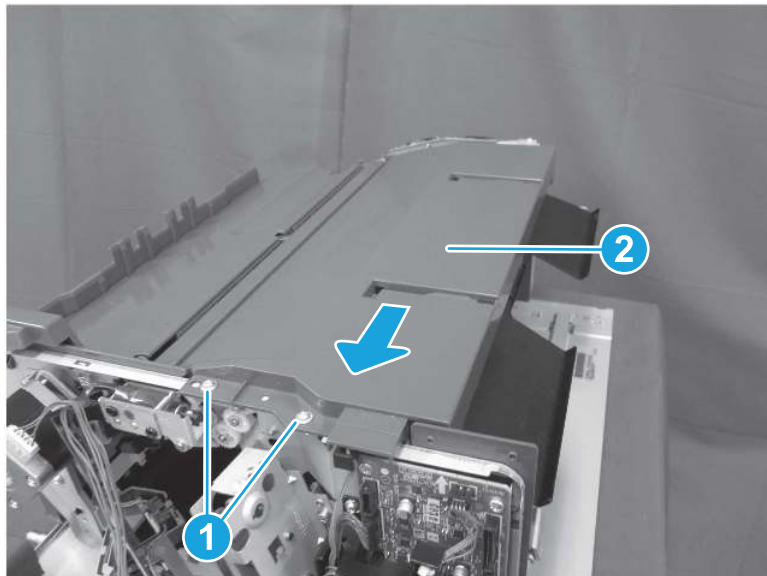
- b. Remove one e-clip (callout 1), and then remove the bushing (callout 2).

Figure 1-3068 Remove e-clip and bushing



- c. Remove one screw (callout 1). Lift the upper feed guide (callout 2), and then slide it towards the front of the finisher to remove it.

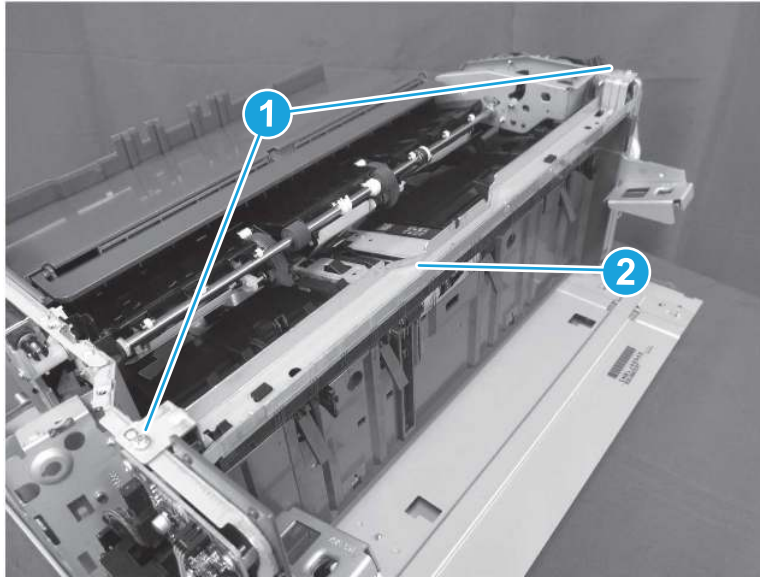
Figure 1-3069 Remove the upper feed guide



- 6. Remove the inner finisher stack wall assembly (M776zs).

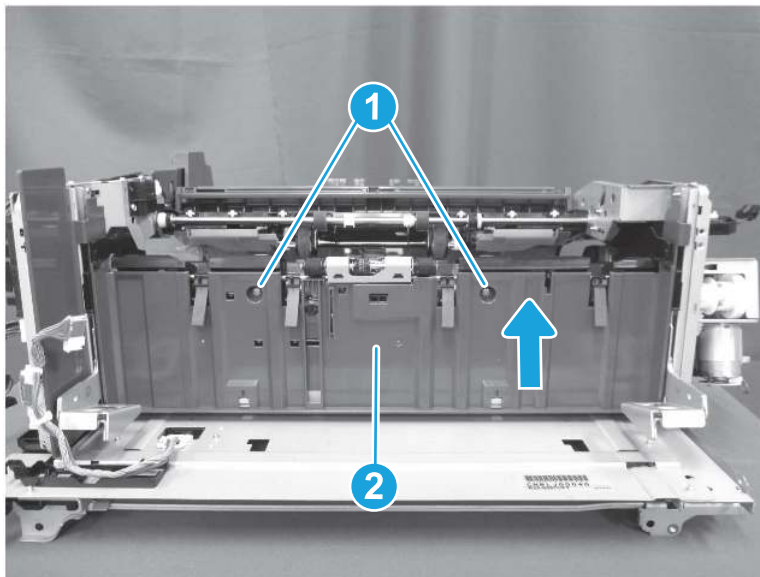
- a. Remove two screws (callout 1), and then remove the upper stay (callout 2).

Figure 1-3070 Remove two screws and the upper stay



- b. Remove two screws (callout 1), and then slide the stack wall assembly (callout 2) up to remove it.

Figure 1-3071 Remove the stack wall assembly




7. Unpack the replacement assembly.
 - a. Dispose of the defective part.




NOTE: HP recommends responsible disposal of the defective part.

<http://www8.hp.com/us/en/hp-information/environment/product-recycling.html>

- b. Unpack the replacement part from the packaging.

 **IMPORTANT:** Make sure that all of the shipping materials (for example shipping tape) are removed from the replacement part prior to installation.

- c. To install an assembly, reverse the removal steps.

 **NOTE:** When applicable, special installation instructions are provided for an assembly at the end of the removal procedure. Always completely read the removal instructions and follow all special installation instructions.

Removal and replacement: Inner finisher return belt assembly (M776zs)

Learn how to remove and replace the inner finisher return belt assembly.


Mean time to repair: 20 minutes

Service level: Medium

Before performing service

Turn the printer power off

- Disconnect the power cable.

 **WARNING!** To avoid damage to the printer, turn the printer off, wait 30 seconds, and then remove the power cord before attempting to service the printer.

- Remove the inner finisher from the printer.

Use the table below to identify the correct part number for your printer. To order the part, go to www.hp.com/buy/parts.

Table 1-147 Part information

Part number	Part description
FM1-H670-000CN	Return belt unit

Required tools

- #2 Phillips screwdriver with a magnetic tip
- Small, flat-blade screwdriver

After performing service

Turn the printer power on

- Reinstall the inner finisher
- Connect the power cable.
- Use the power switch to turn the power on.

 **IMPORTANT:** After replacement, the following adjustments need to be performed.

- Return belt tension

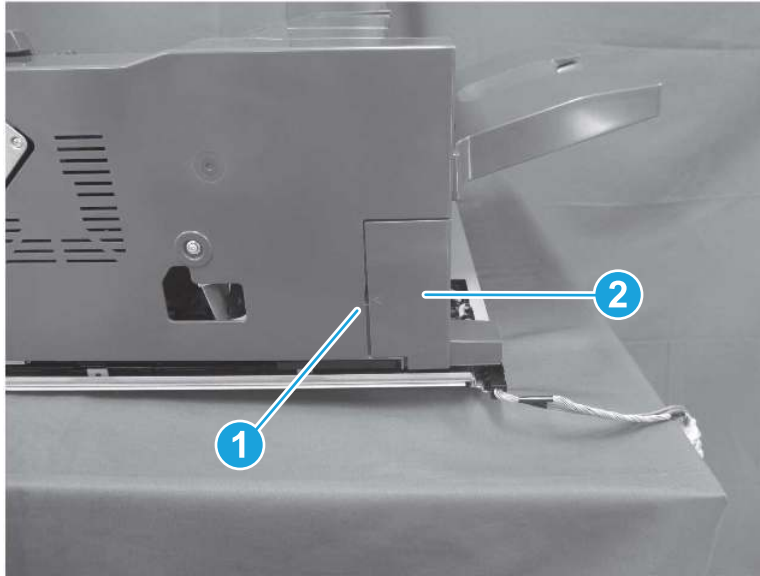
For adjustment procedure, refer to Solve problems / Solve paper handling problems / Inner finisher adjustments section in the Troubleshooting service manual.

Post service test

Send a print job to the inner finisher and verify it is functioning correctly.

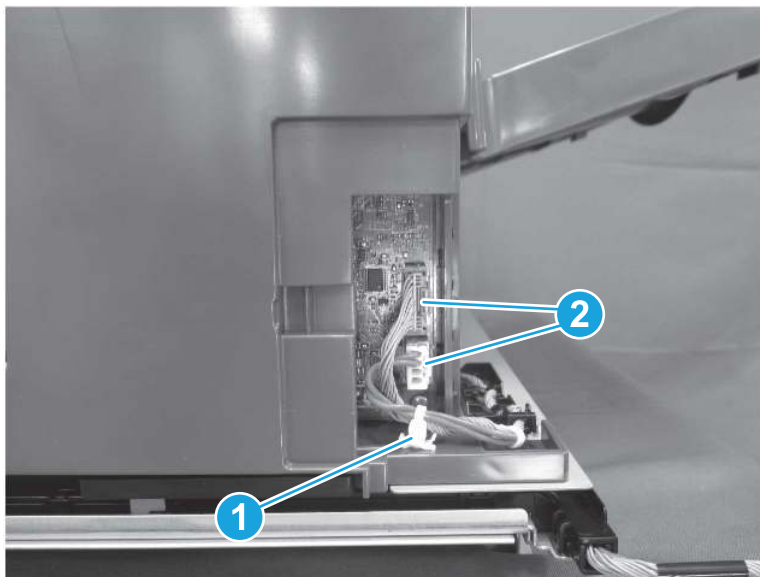
1. Remove the inner finisher connector cover (M776zs).
 - ▲ Release one tab (callout 1), and then remove the connector cover (callout 2).

Figure 1-3072 Remove the connector cover



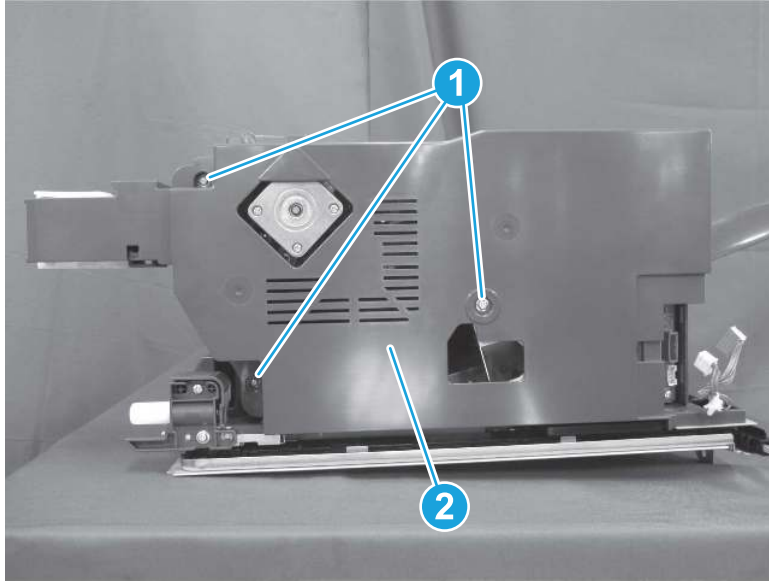
2. Remove the inner finisher rear cover (M776zs).
 - a. Release one retainer (callout 1), and then disconnect two connectors (callout 2).

Figure 1-3073 Disconnect two connectors



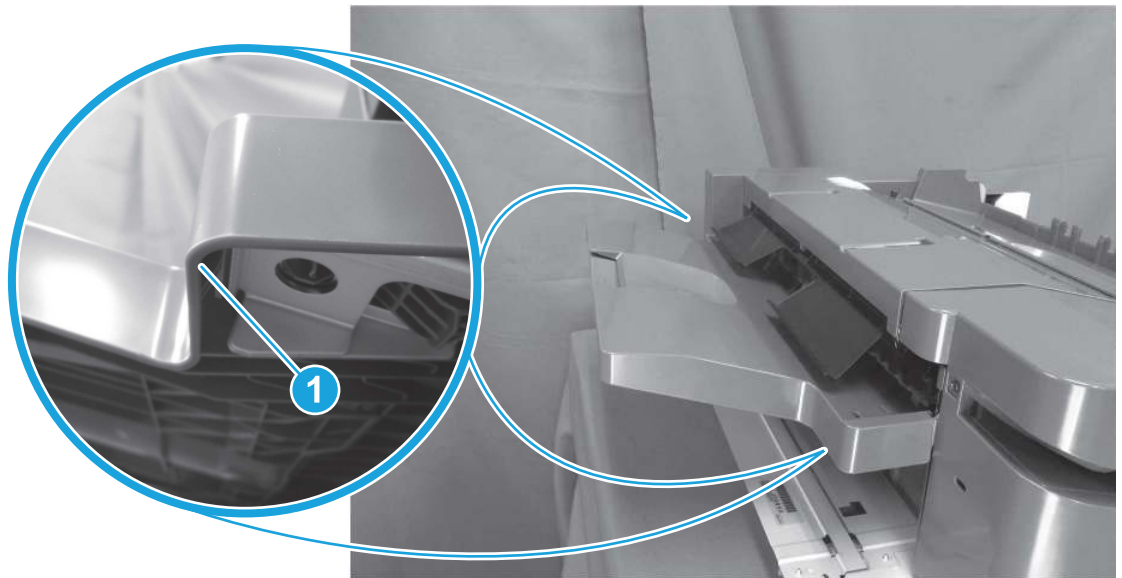
- b. Remove three screws (callout 1), and then remove the rear cover (callout 2).

Figure 1-3074 Remove the rear cover



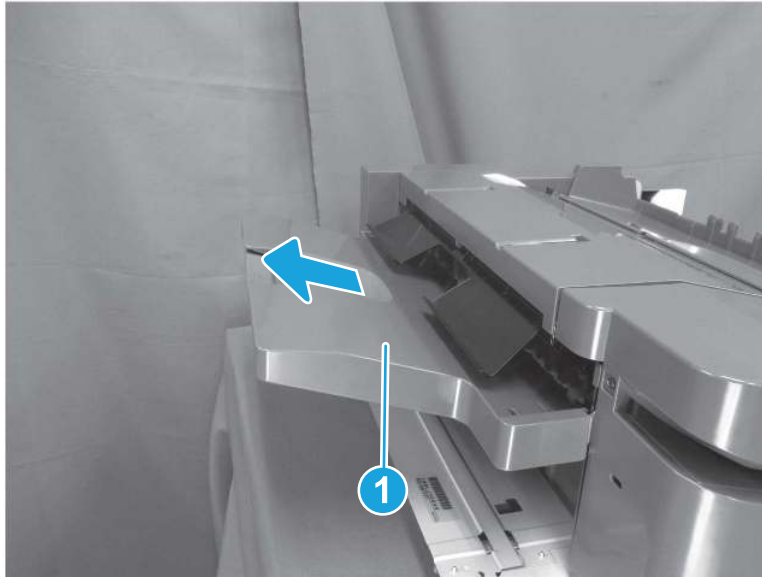
3. Remove the inner finisher stack tray assembly (M776zs).
 - a. Release two tabs (callout 1).

Figure 1-3075 Release two tabs



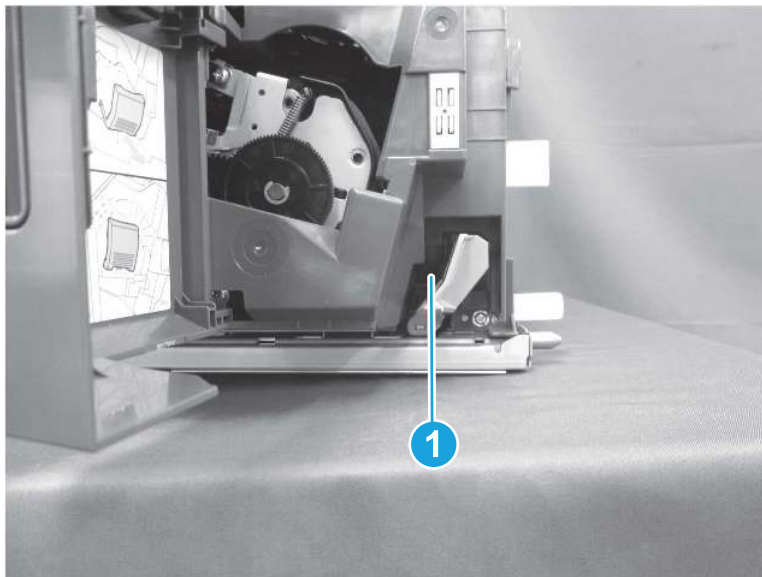
- b. Slide the stack tray assembly (callout 1) away from the finisher to remove it.

Figure 1-3076 Remove the stack tray assembly



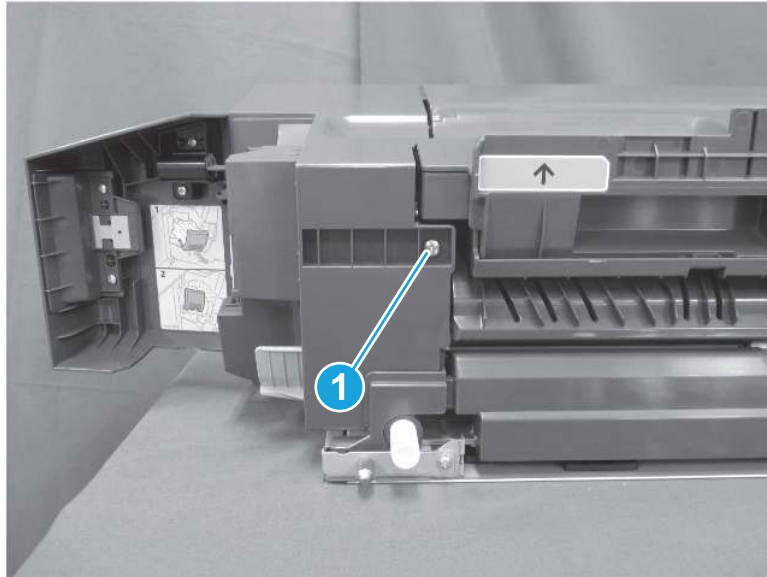
- 4. Remove the inner finisher front cover (M776zs).
 - a. Open the inner finisher front door, and then remove one screw (callout 1).

Figure 1-3077 Remove one screw



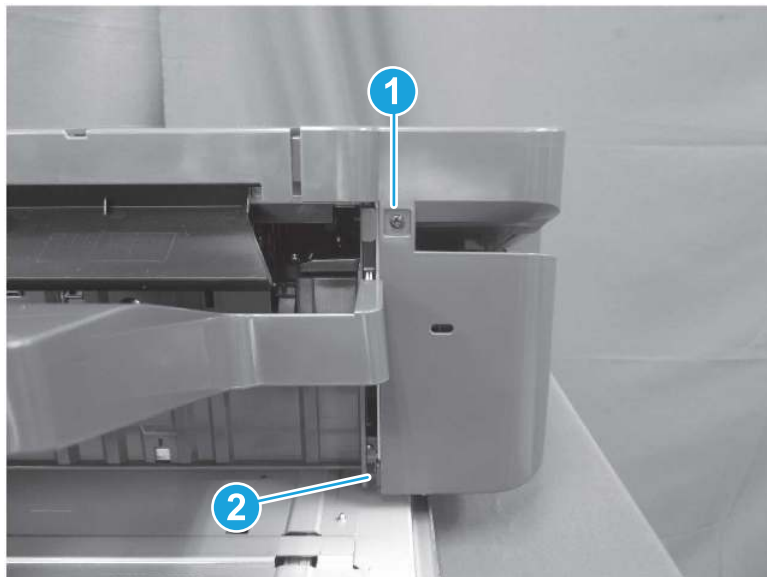
- b. Remove one screw (callout 1).

Figure 1-3078 Remove one screw



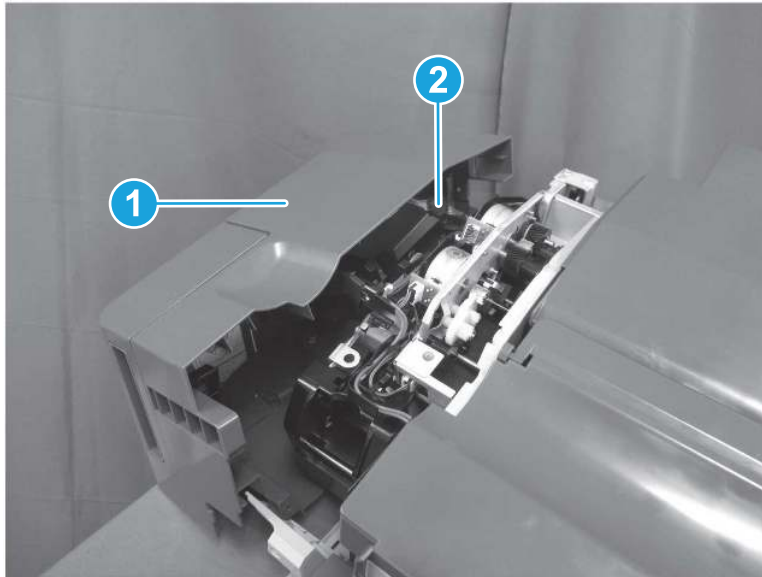
- c. Remove one screw (callout 1), and then release one tab (callout 2).

Figure 1-3079 Remove one screw and release one tab



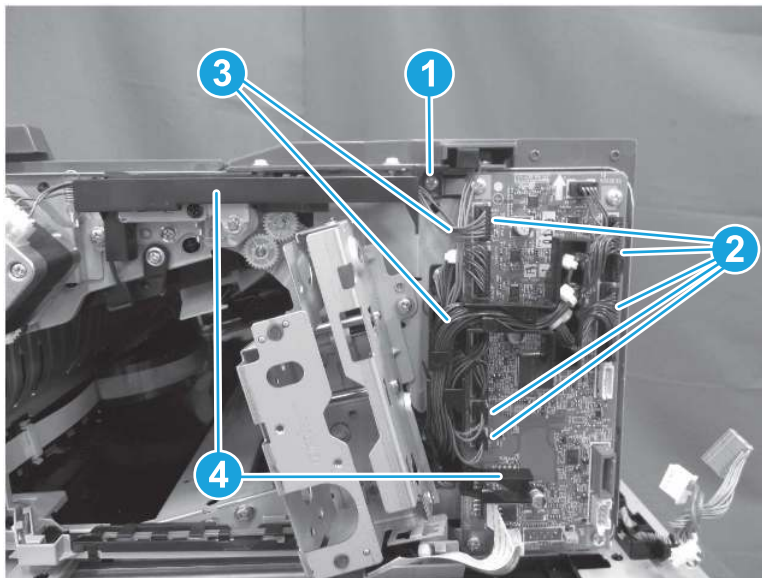
- d. Pull the front cover (callout 1) slightly away from the finisher, disconnect one connector (callout 2), and then remove the front cover.

Figure 1-3080 Remove the front cover



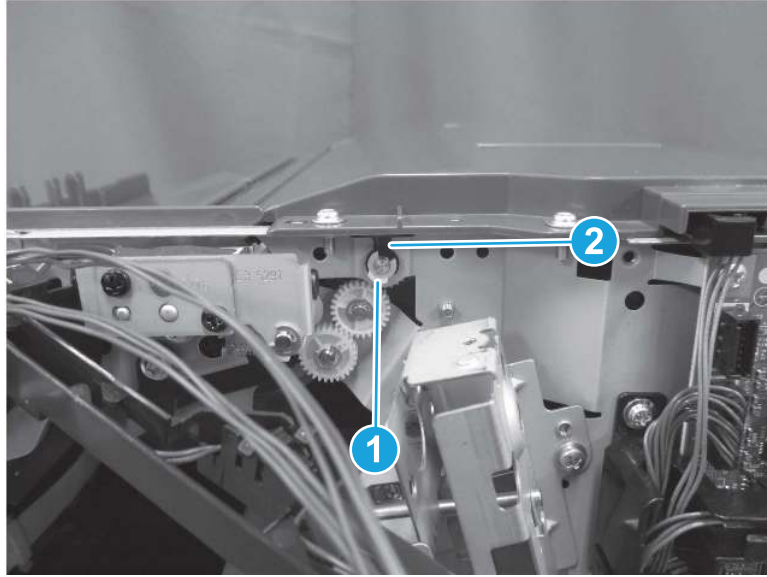
- 5. Remove the inner finisher upper feed guide (M776zs).
 - a. Remove one screw (callout 1), and then disconnect five connectors (callout 2). Release the cables (callout 3) from the guide (callout 4).

Figure 1-3081 Remove one screw and disconnect five connectors



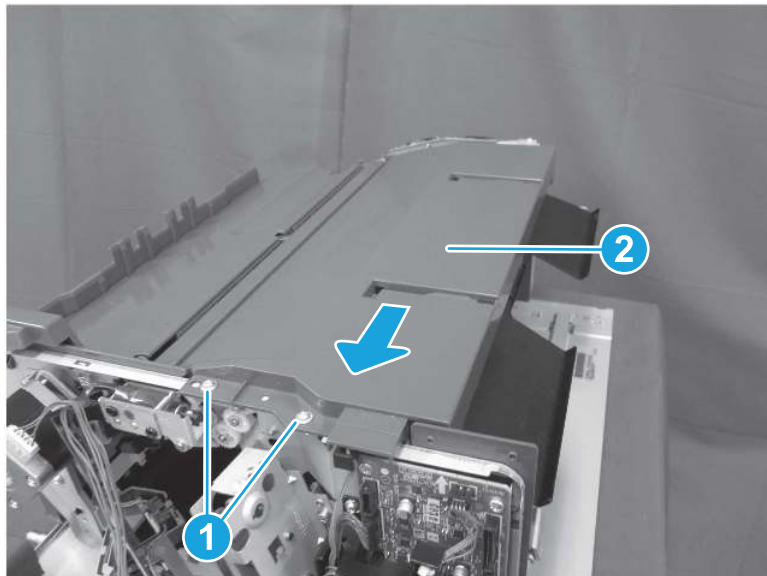
- b. Remove one e-clip (callout 1), and then remove the bushing (callout 2).

Figure 1-3082 Remove e-clip and bushing



- c. Remove one screw (callout 1). Lift the upper feed guide (callout 2), and then slide it towards the front of the finisher to remove it.

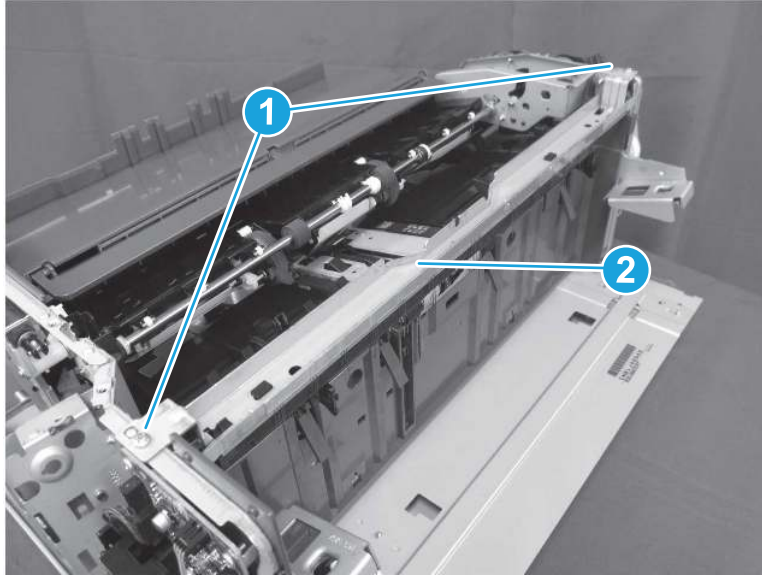
Figure 1-3083 Remove the upper feed guide



- 6. Remove the inner finisher return belt assembly (M776zs).

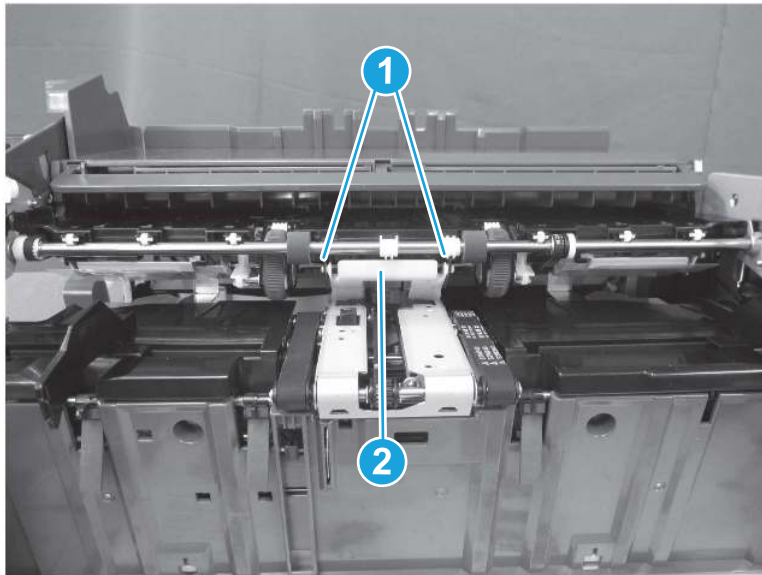
- a. Remove two screws (callout 1), and then remove the upper stay (callout 2).

Figure 1-3084 Remove two screws and the upper stay



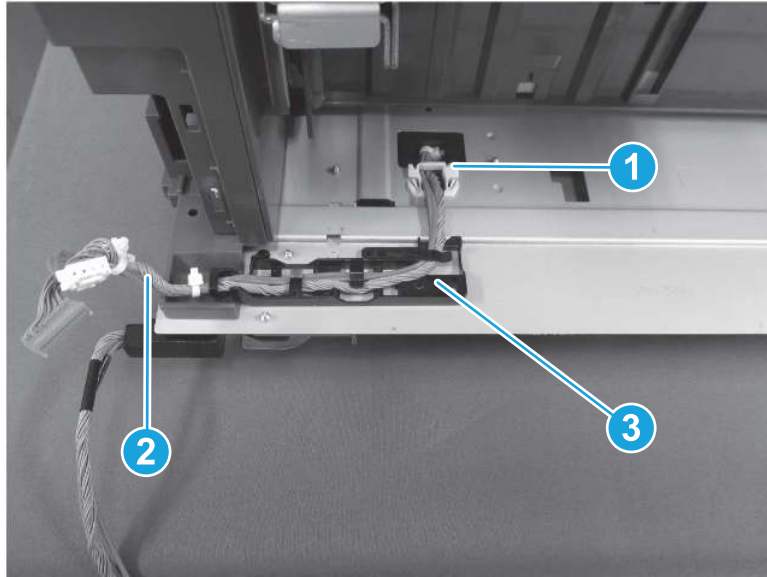
- b. Release two bosses (callout 1), and then remove the guide (callout 2).

Figure 1-3085 Remove the guide



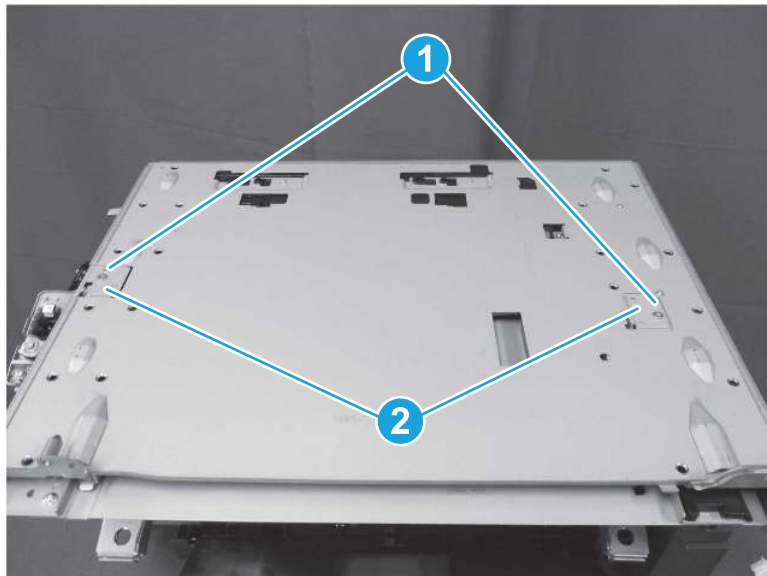
- c. Open one retainer (callout 1), and then release the cables (callout 2) from the cable guides (callout 3).

Figure 1-3086 Release the cables



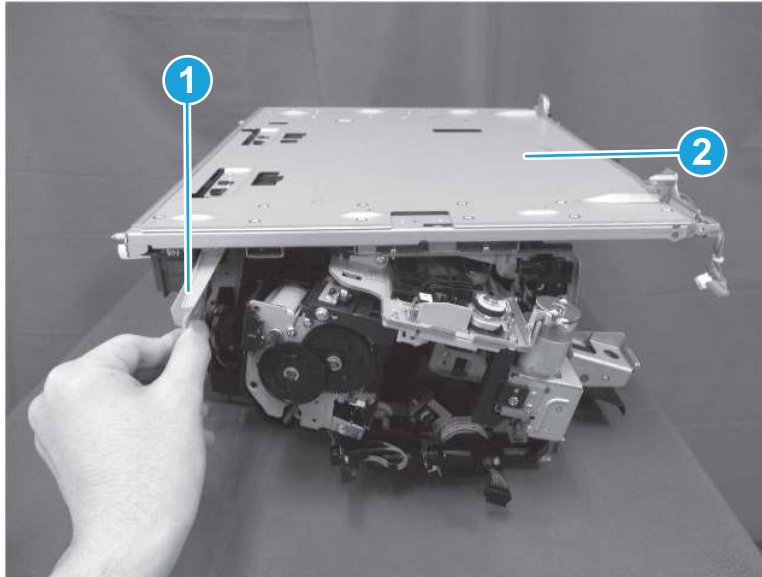
- d. Place the finisher face-down. Remove two screws (callout 1), and then remove two stoppers (callout 2).

Figure 1-3087 Remove two screws and stoppers



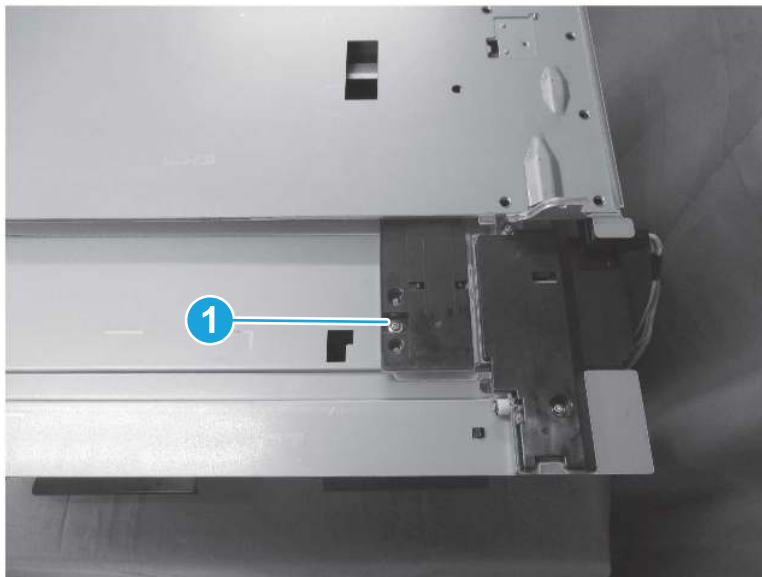
- e. Tilt the release lever (callout 1), and then slide the bottom slide assembly (callout 2) to the right.

Figure 1-3088 Release the latch and slide the assembly



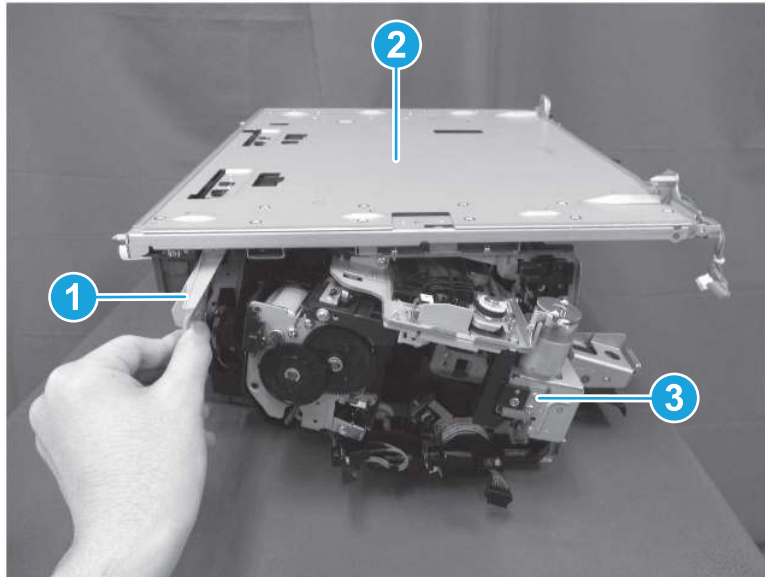
- f. Remove one screw (callout 1).

Figure 1-3089 Remove one screw



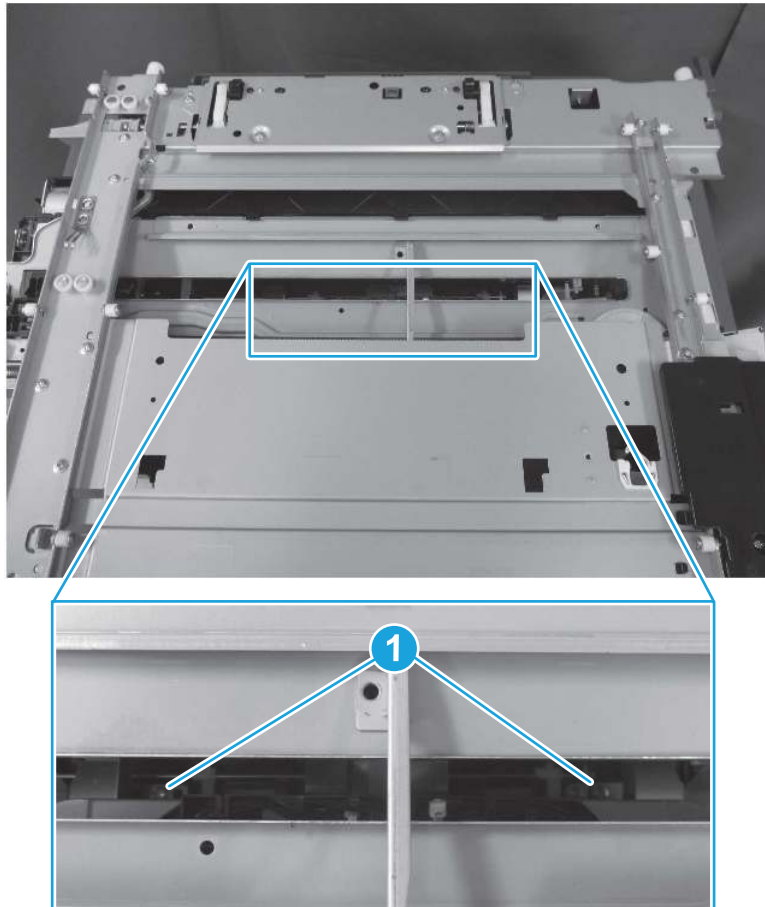
- g. Tilt the release lever (callout 1), and then slide the bottom slide assembly (callout 2) to remove it from the inner finisher (callout 3).

Figure 1-3090 Remove the bottom slide assembly



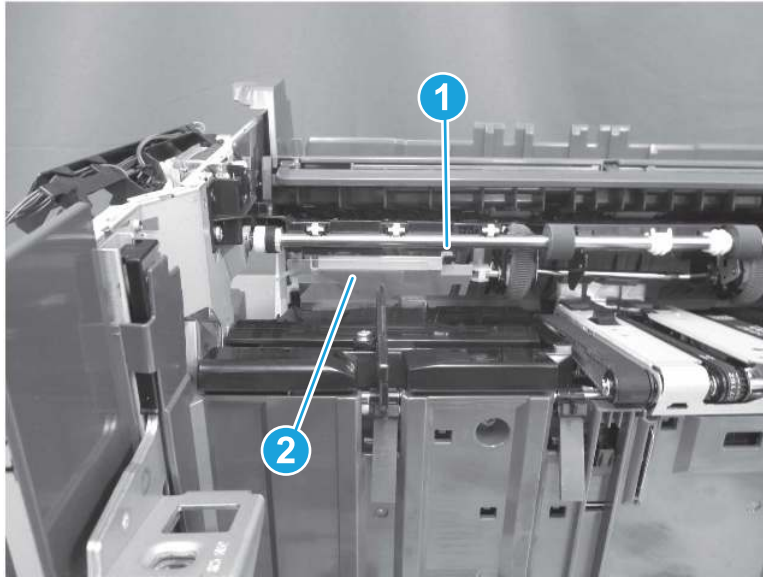
- h. Remove two screws (callout 1)

Figure 1-3091 Remove two screws



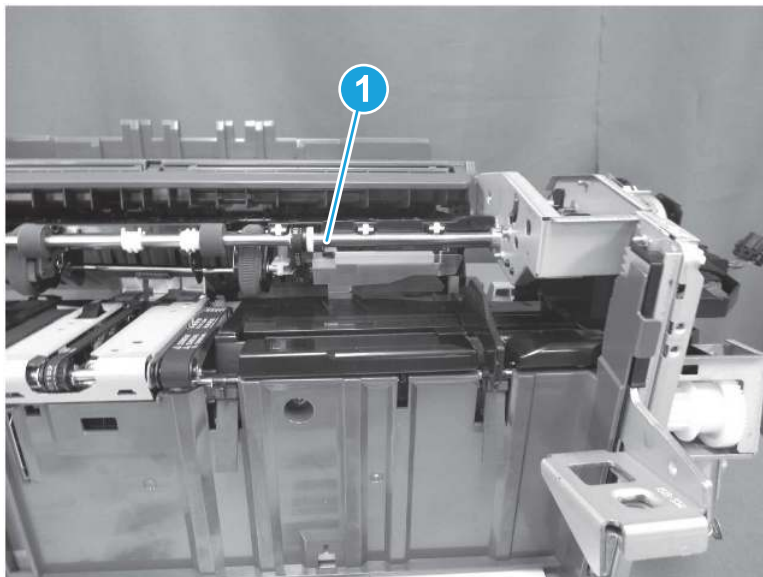
- i. Place the finisher face-up. Release one boss (callout 1), and then remove the guide (callout 2).

Figure 1-3092 Remove the guide



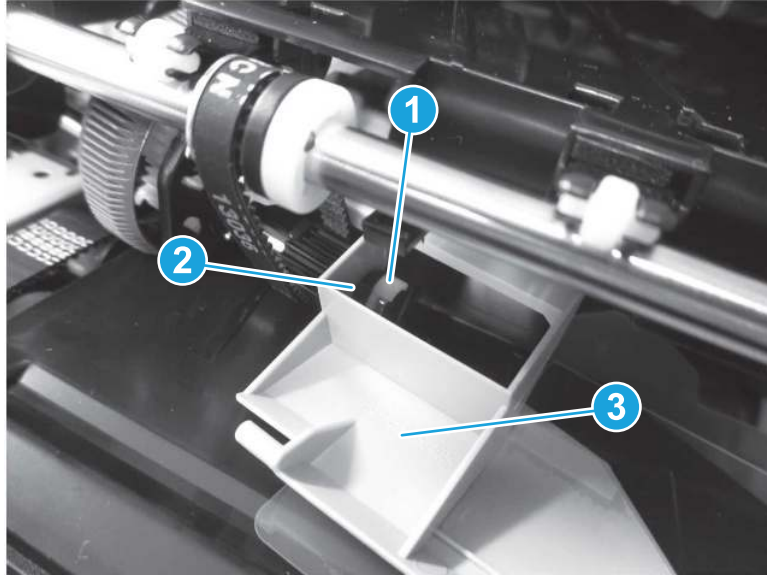
- j. Release one boss (callout 1).

Figure 1-3093 Release one boss



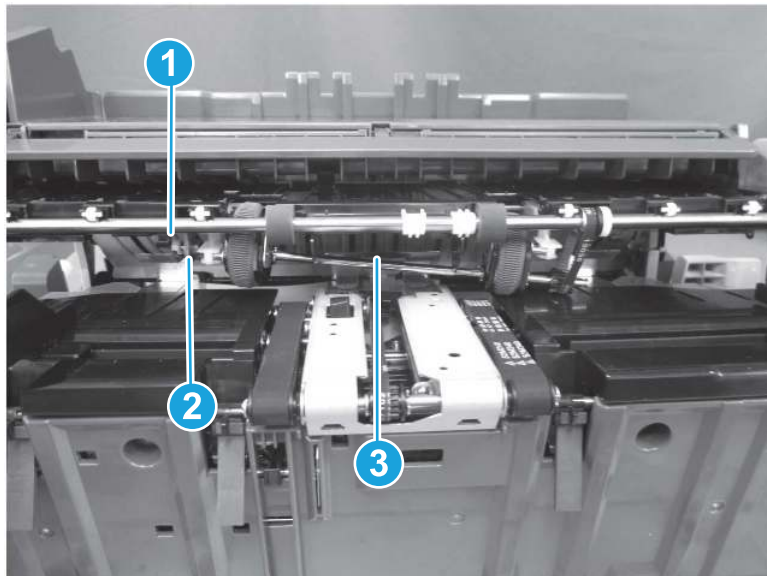
- k. Remove one ring (callout 1), remove one bushing (callout 2), and then remove the guide (callout 3).

Figure 1-3094 Remove the guide



- l. Remove one ring (callout 1), remove one bushing (callout 2), and then remove the return belt assembly (callout 3).

Figure 1-3095 Remove the return belt assembly



- 7. Unpack the replacement assembly.


- a. Dispose of the defective part.




NOTE: HP recommends responsible disposal of the defective part.

<http://www8.hp.com/us/en/hp-information/environment/product-recycling.html>

- b. Unpack the replacement part from the packaging.

 **IMPORTANT:** Make sure that all of the shipping materials (for example shipping tape) are removed from the replacement part prior to installation.

- c. To install an assembly, reverse the removal steps.

 **NOTE:** When applicable, special installation instructions are provided for an assembly at the end of the removal procedure. Always completely read the removal instructions and follow all special installation instructions.

Removal and replacement: Inner finisher processing tray assembly (M776zs)

Learn how to remove and replace the inner finisher processing tray assembly.


Mean time to repair: 45 minutes

Service level: Hard

Before performing service

Turn the printer power off

- Disconnect the power cable.

 **WARNING!** To avoid damage to the printer, turn the printer off, wait 30 seconds, and then remove the power cord before attempting to service the printer.

- Remove the inner finisher from the printer.

Use the table below to identify the correct part number for your printer. To order the part, go to www.hp.com/buy/parts.

Table 1-148 Part information

Part number	Part description
RM2-2458-000CN	Processing tray assembly

Required tools

- #2 Phillips screwdriver with a magnetic tip
- Small, flat-blade screwdriver

After performing service

Turn the printer power on

- Reinstall the inner finisher
- Connect the power cable.
- Use the power switch to turn the power on.

 **IMPORTANT:** After replacement, the following adjustments need to be performed.

- Jogger alignment

- Return belt tension
- Stapler alignment

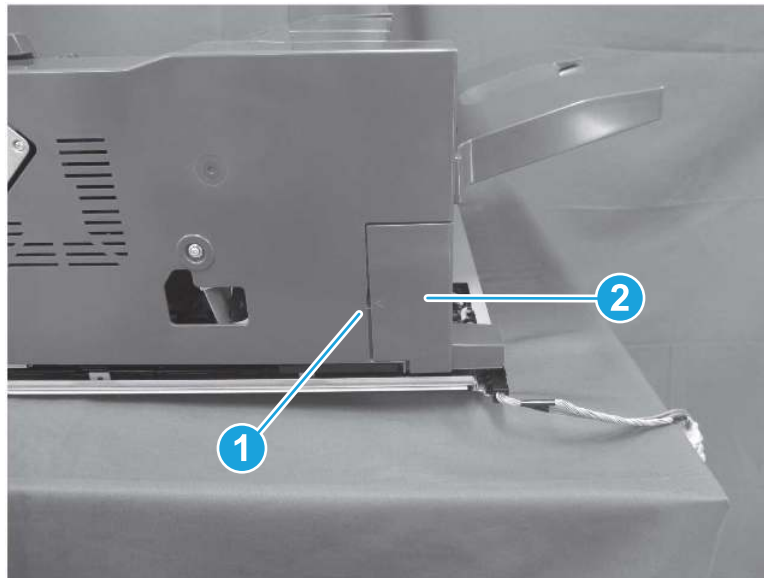
For adjustment procedure, refer to Solve problems / Solve paper handling problems / Inner finisher adjustments section in the Troubleshooting service manual.

Post service test

Send a print job to the inner finisher and verify it is functioning correctly.

1. Remove the inner finisher connector cover (M776zs).
 - ▲ Release one tab (callout 1), and then remove the connector cover (callout 2).

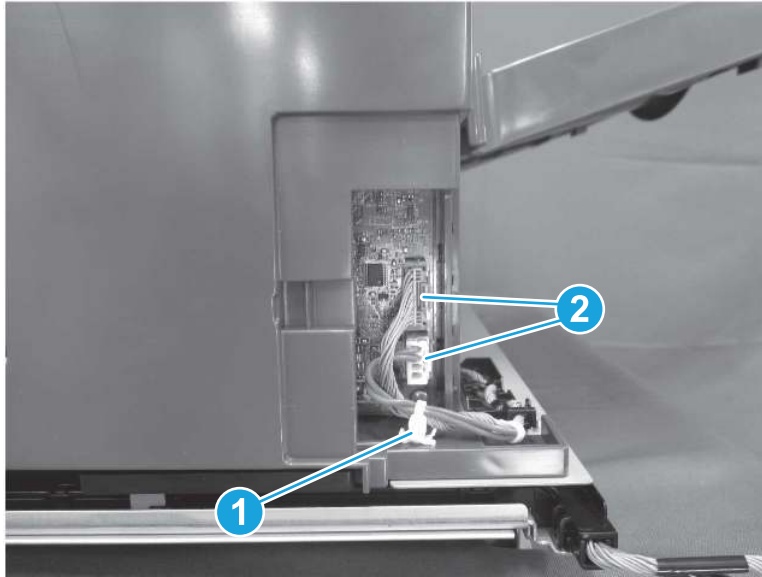
Figure 1-3096 Remove the connector cover



2. Remove the inner finisher rear cover (M776zs).

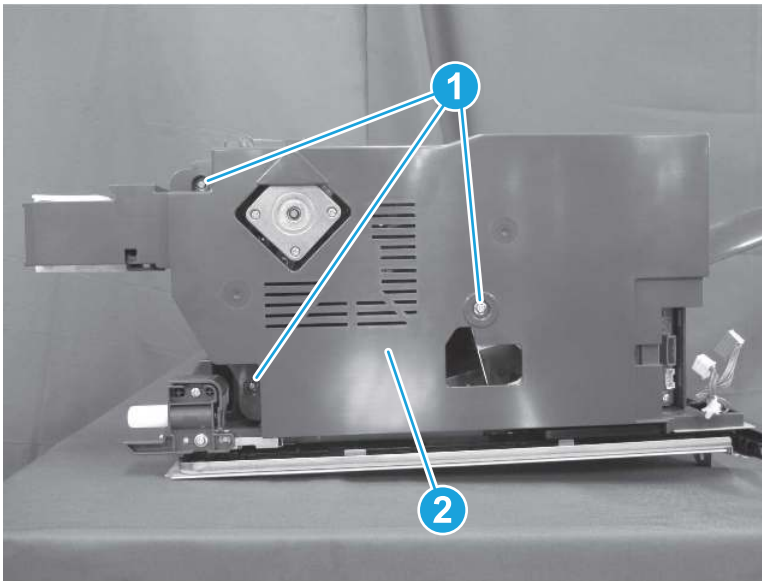
- a. Release one retainer (callout 1), and then disconnect two connectors (callout 2).

Figure 1-3097 Disconnect two connectors



- b. Remove three screws (callout 1), and then remove the rear cover (callout 2).

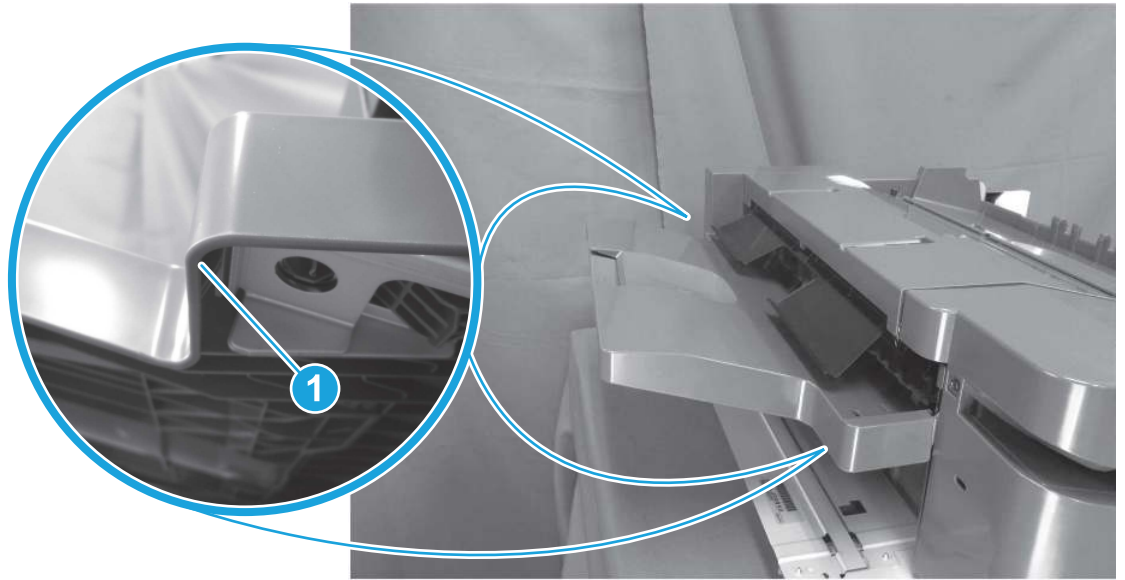
Figure 1-3098 Remove the rear cover



3. Remove the inner finisher stack tray assembly (M776zs).

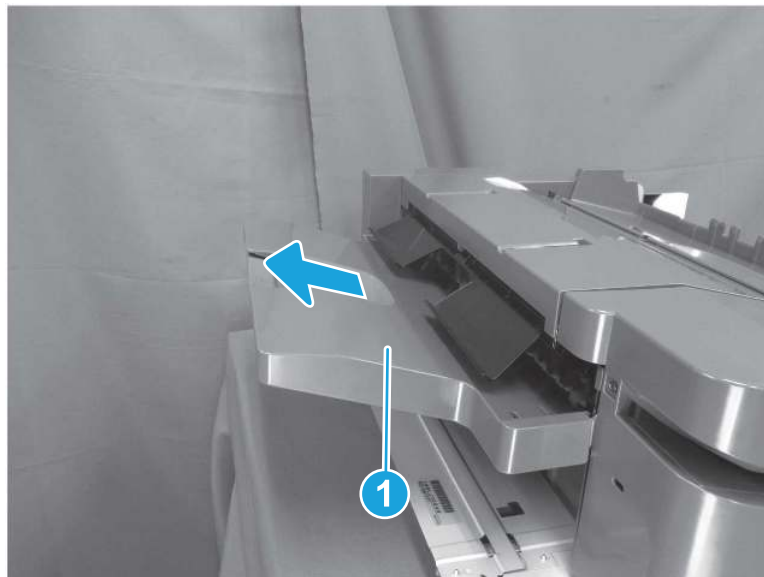
- a. Release two tabs (callout 1).

Figure 1-3099 Release two tabs



- b. Slide the stack tray assembly (callout 1) away from the finisher to remove it.

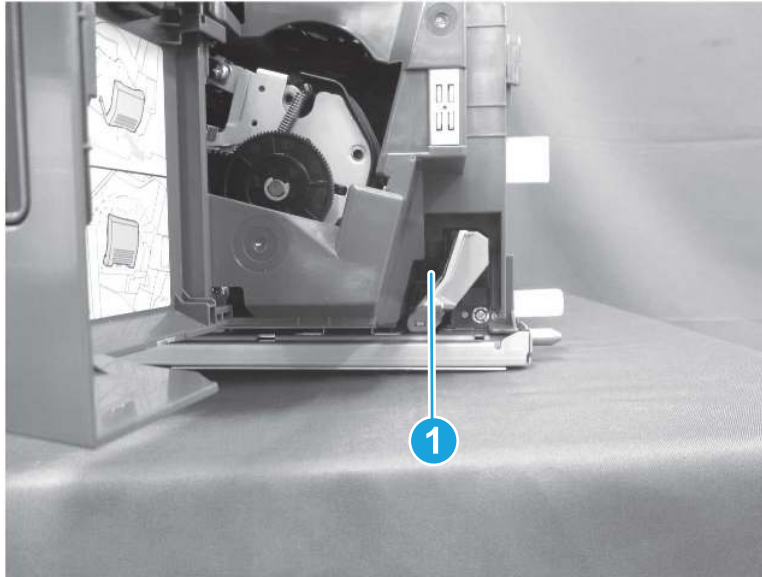
Figure 1-3100 Remove the stack tray assembly



4. Remove the inner finisher front cover (M776zs).

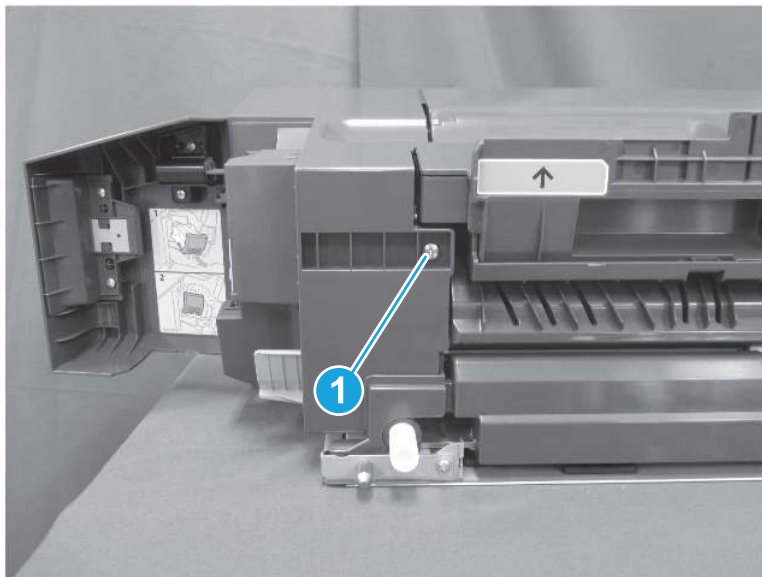
- a. Open the inner finisher front door, and then remove one screw (callout 1).

Figure 1-3101 Remove one screw



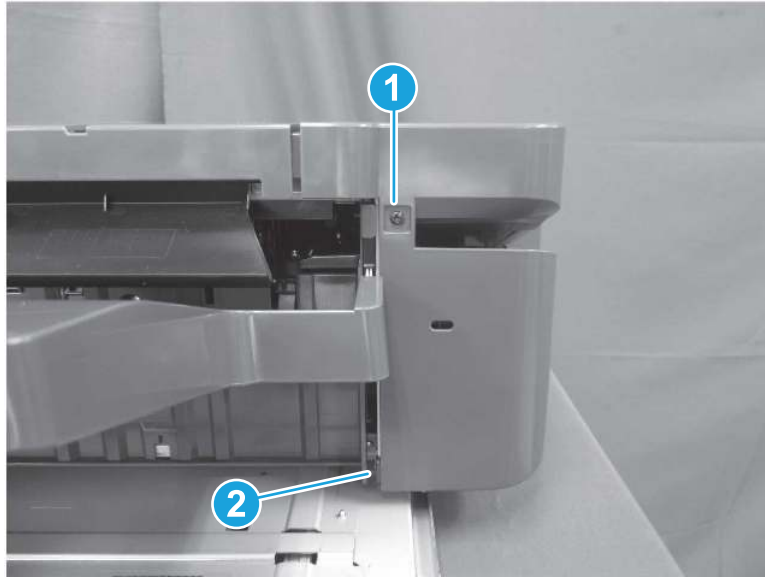
- b. Remove one screw (callout 1).

Figure 1-3102 Remove one screw



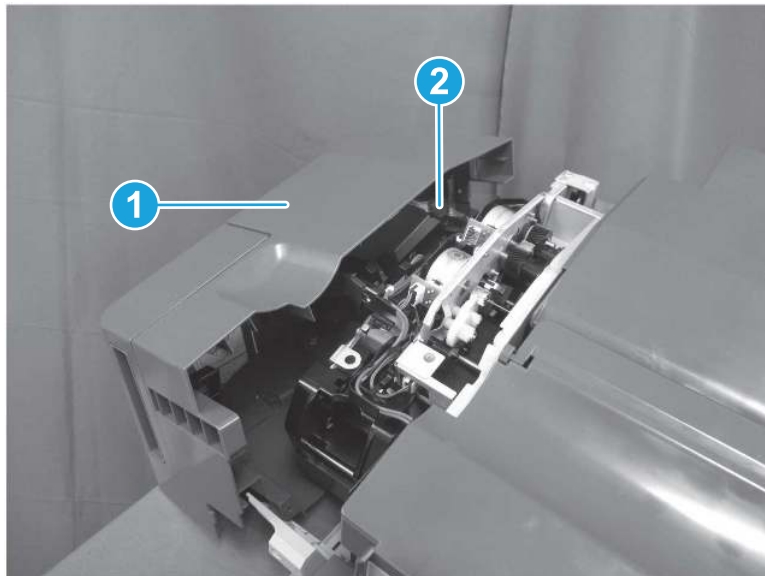
- c. Remove one screw (callout 1), and then release one tab (callout 2).

Figure 1-3103 Remove one screw and release one tab



- d. Pull the front cover (callout 1) slightly away from the finisher, disconnect one connector (callout 2), and then remove the front cover.

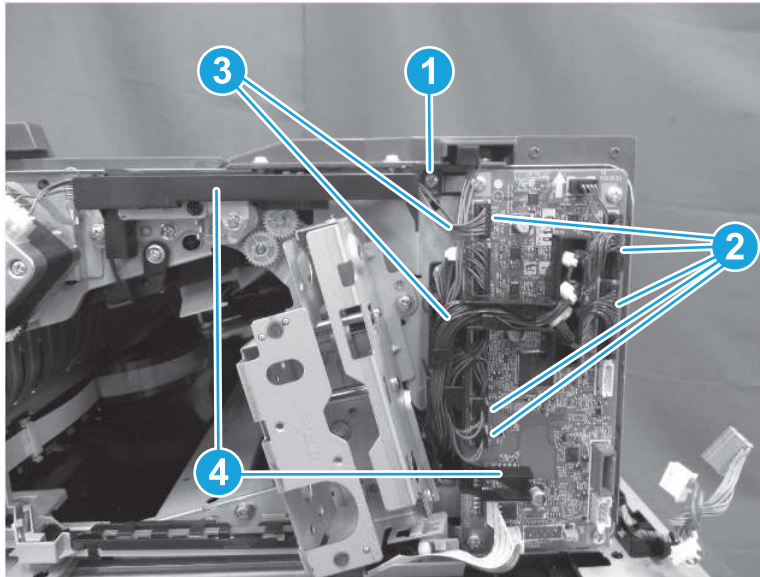
Figure 1-3104 Remove the front cover



5. Remove the inner finisher upper feed guide (M776zs).

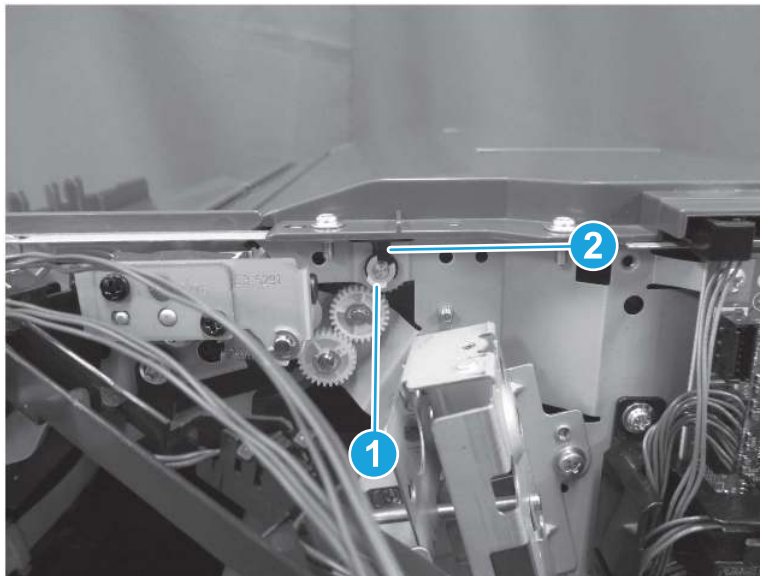
- a. Remove one screw (callout 1), and then disconnect five connectors (callout 2). Release the cables (callout 3) from the guide (callout 4).

Figure 1-3105 Remove one screw and disconnect five connectors



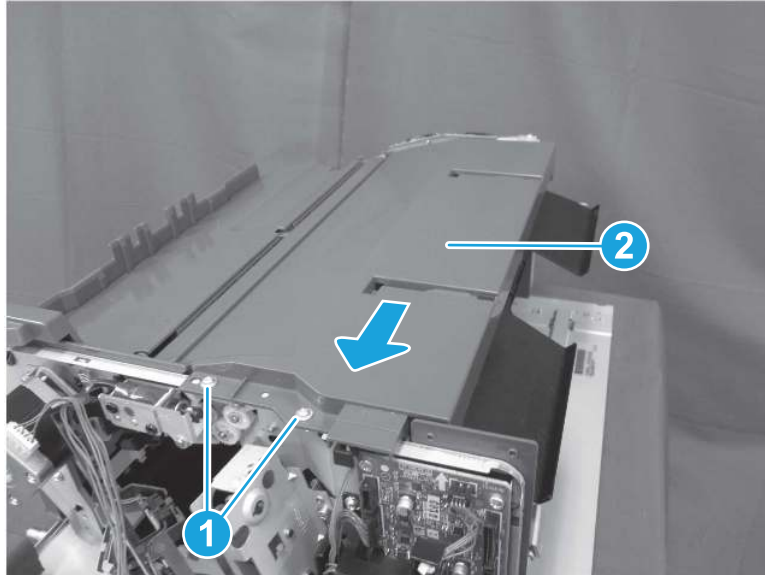
- b. Remove one e-clip (callout 1), and then remove the bushing (callout 2).

Figure 1-3106 Remove e-clip and bushing



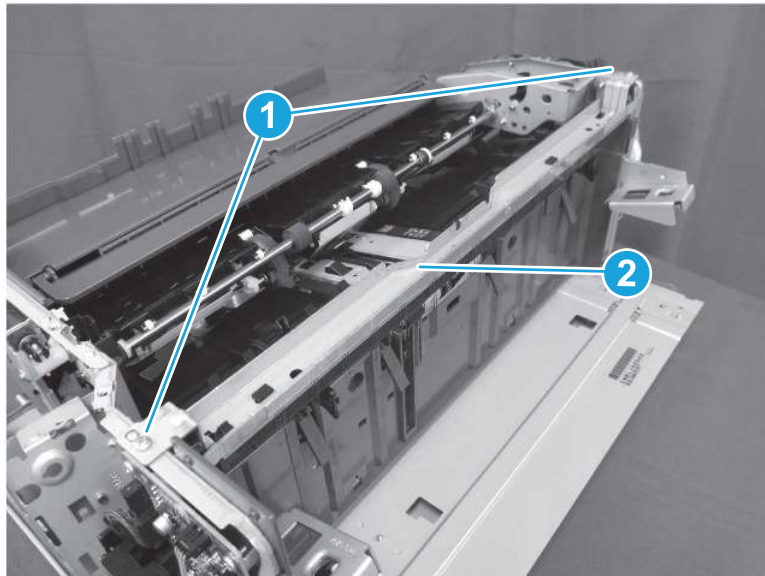
- c. Remove one screw (callout 1). Lift the upper feed guide (callout 2), and then slide it towards the front of the finisher to remove it.

Figure 1-3107 Remove the upper feed guide



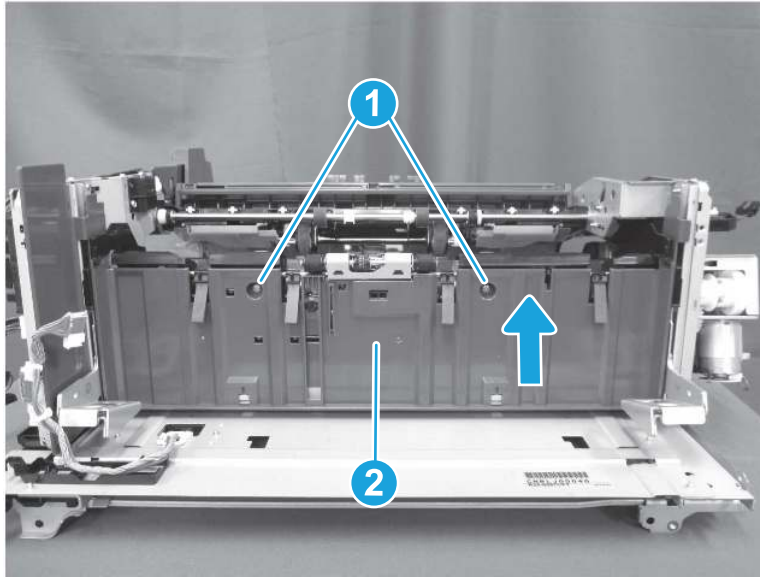
6. Remove the inner finisher stack wall assembly (M776zs).
 - a. Remove two screws (callout 1), and then remove the upper stay (callout 2).

Figure 1-3108 Remove two screws and the upper stay



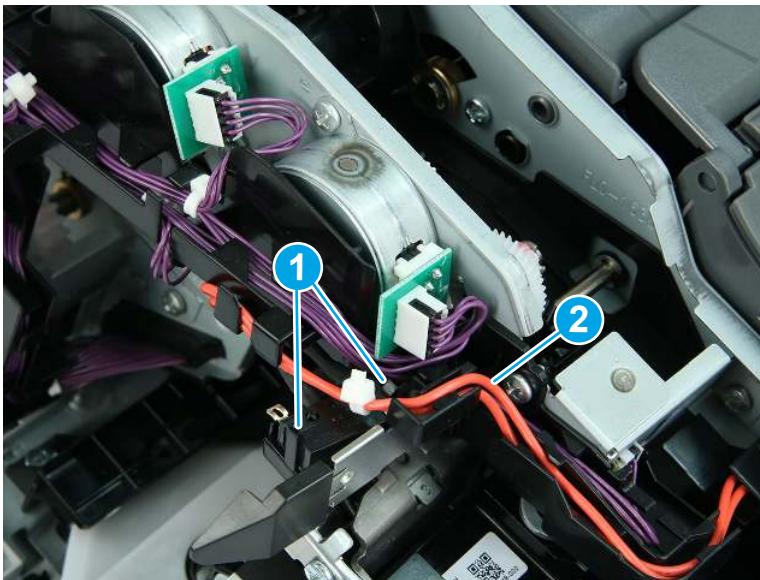
- b. Remove two screws (callout 1), and then slide the stack wall assembly (callout 2) up to remove it.

Figure 1-3109 Remove the stack wall assembly



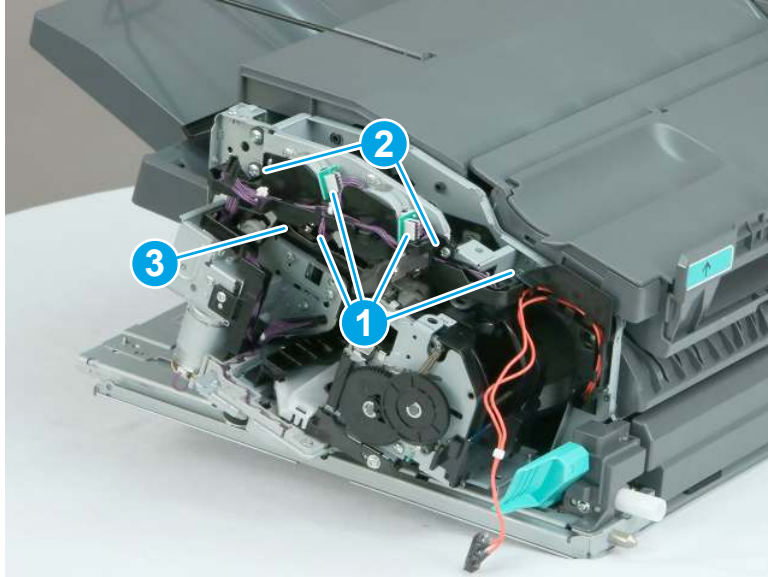
- 7. Remove the inner finisher paddle drive assembly (M776zs).
 - a. Release two tabs (callout 1) to release the interlock switch, and then remove the cable (callout 2) from the guide.

Figure 1-3110 Release the interlock switch



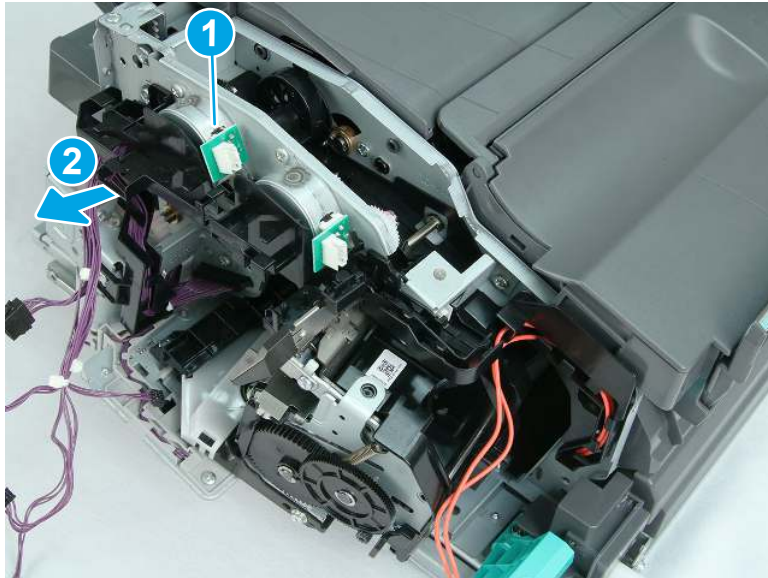
- b. Disconnect four connectors (callout 1), remove two screws (callout 2), and then release the cables from the guide (callout 3).

Figure 1-3111 Disconnect four connectors and remove two screws



- c. Release one tab (callout 1), and then remove the guide (callout 2).

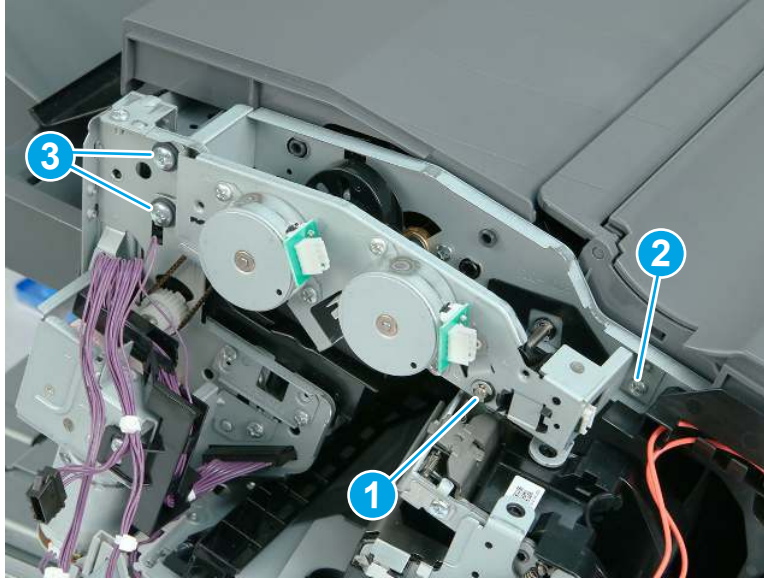
Figure 1-3112 Remove the guide



- d. Remove one e-ring and bushing (callout 1), remove one screw (callout 2), then remove two screws (callout 3).

 **TIP:** One screw (callout 2) is smaller than the other two screws. Make sure this screw is installed in the correct position.

Figure 1-3113 Remove one e-ring and bushing and two screws



- e. Lift the paddle drive assembly slightly away from the finisher, and then release one belt from the gear (callout 1). Remove the paddle drive assembly.

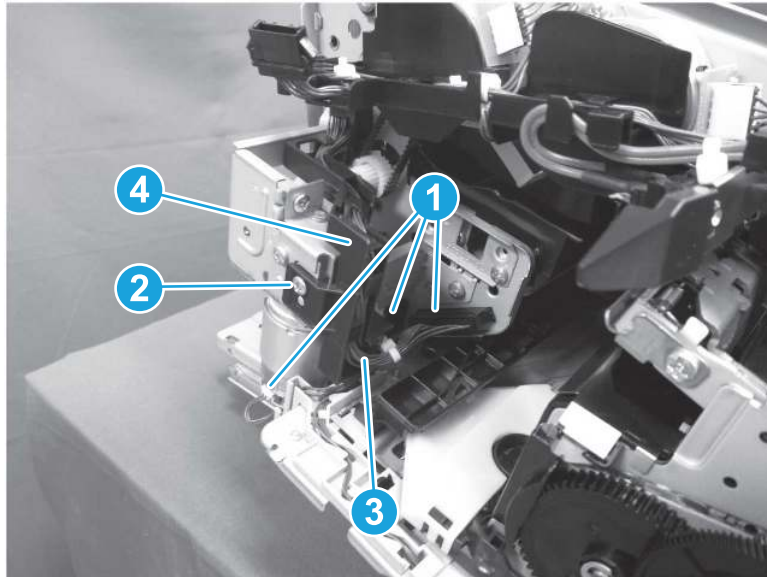
Figure 1-3114 Release the belt and remove the paddle drive assembly



- 8. Remove the inner finisher tray lifting motor (M776zs).

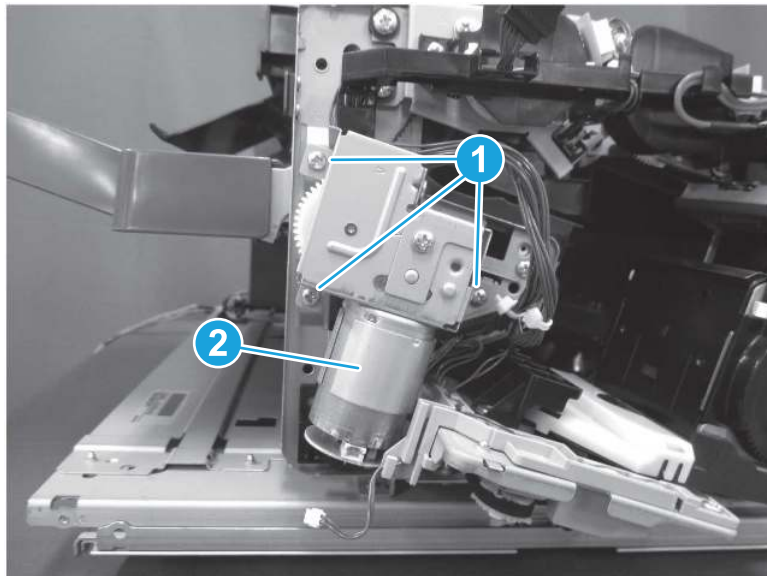
- a. Disconnect three connectors (callout 1), and then remove one screw (callout 2). Release the cable (callout 3) from the guide (callout 4), and then remove the guide (callout 4).

Figure 1-3115 Disconnect three connectors and remove one screw



- b. Remove three screws (callout 1), and then remove the tray lifting motor (callout 2).

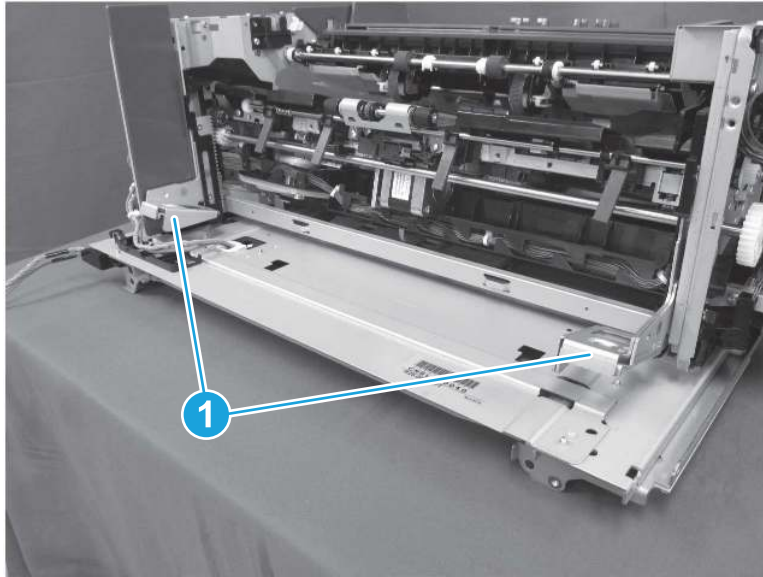
Figure 1-3116 Remove three screws and the tray lifting motor



9. Remove the inner finisher processing tray assembly (M776zs).

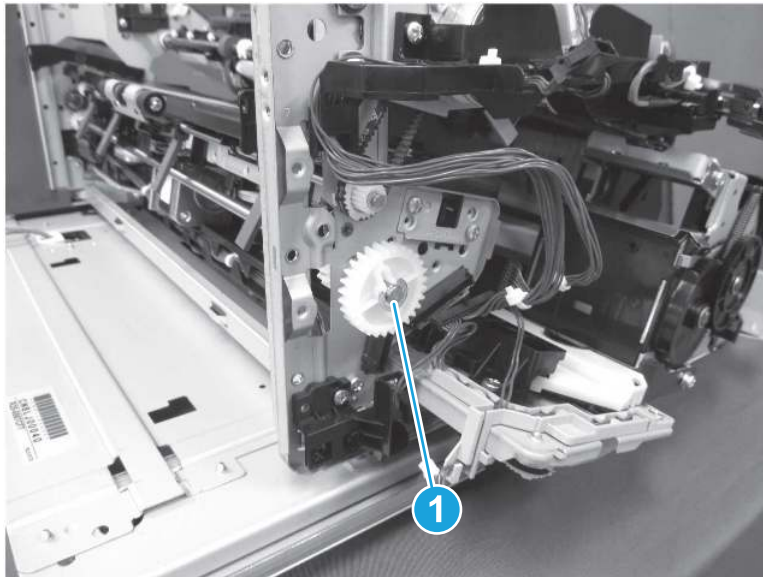
- a. Slide two locks (callout 1) up to remove them.

Figure 1-3117 Remove two locks



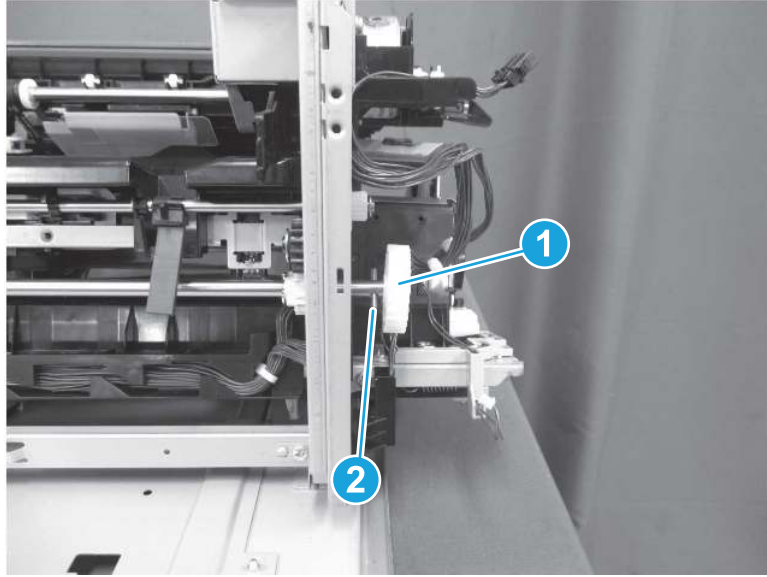
- b. Remove one e-ring (callout 1).

Figure 1-3118 Remove one e-ring



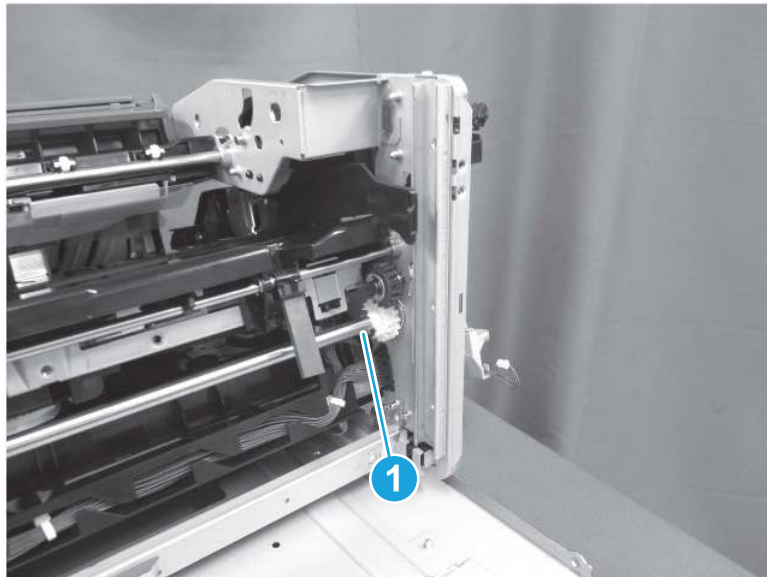
- c. Remove one gear (callout 1), and then remove one dowel pin (callout 2).

Figure 1-3119 Remove one gear and dowel pin



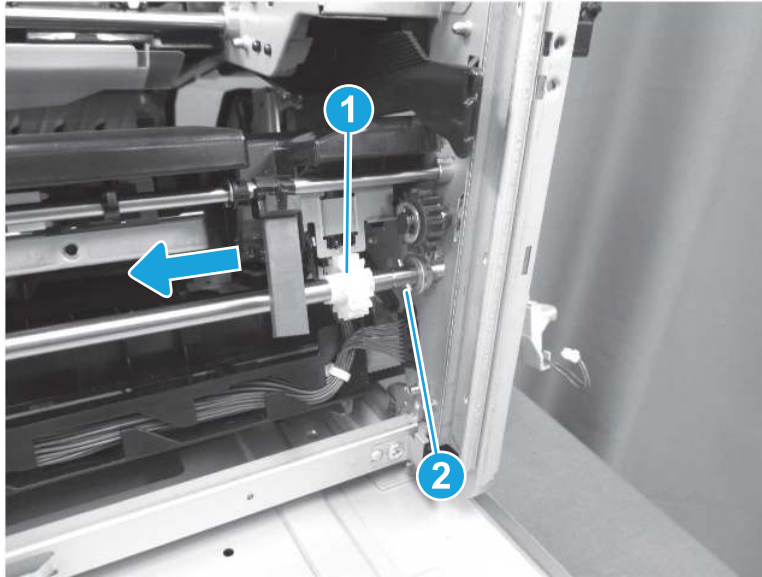
- d. Remove one e-ring (callout 1).

Figure 1-3120 Remove one e-ring



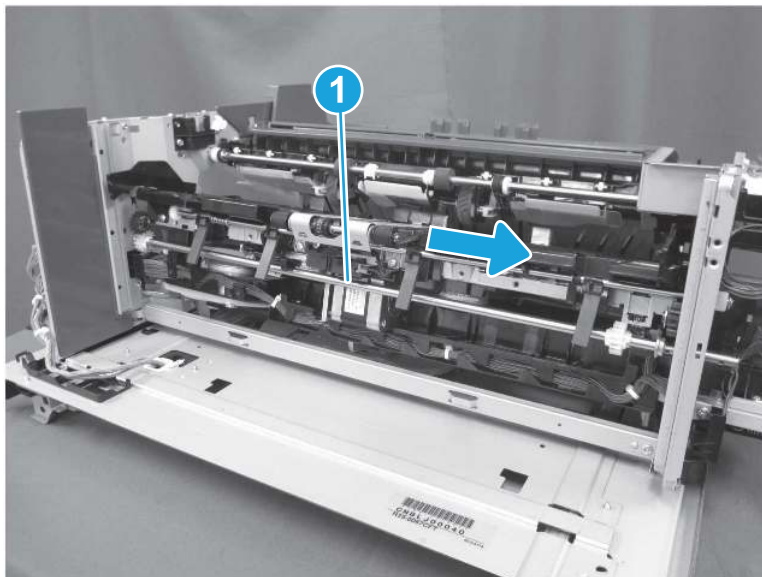
- e. Slide the gear (callout 1) to the left, and then remove one dowel pin (callout 2).

Figure 1-3121 Remove one dowel pin



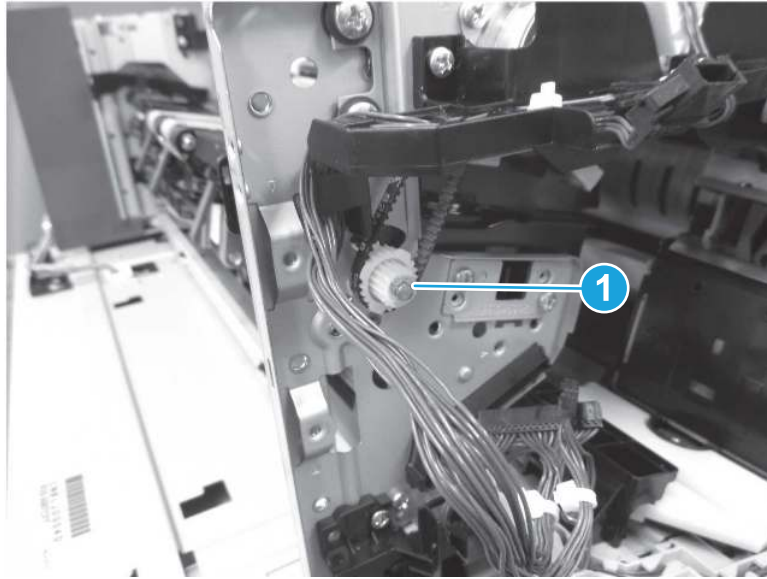
- f. Slide the tray drive shaft (callout 1) to the left, and then pull it away from the finisher to remove it.

Figure 1-3122 Remove the tray drive shaft



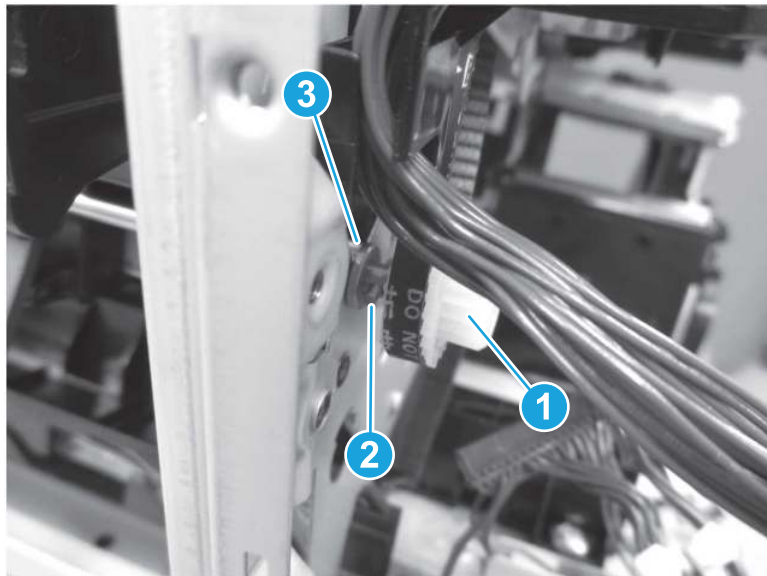
- g. Remove one e-ring (callout 1).

Figure 1-3123 Remove one e-ring



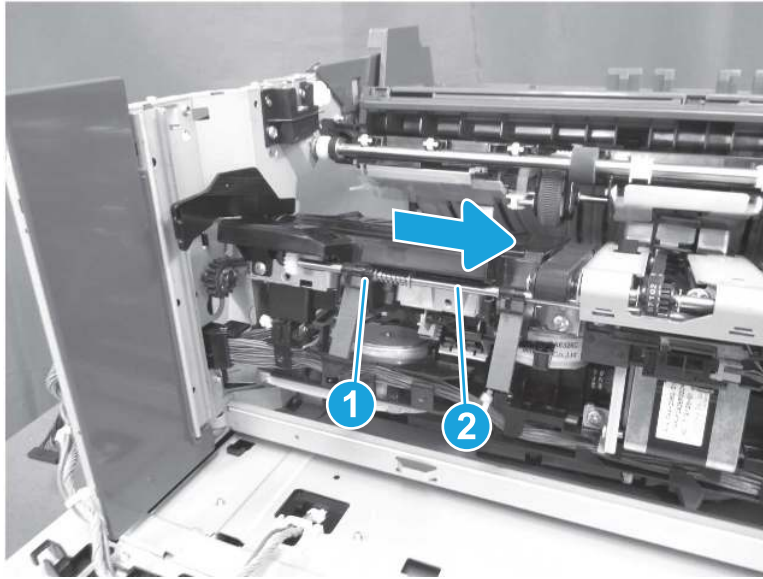
- h. Remove one gear (callout 1), remove one dowel pin (callout 2), and then remove the bushing (callout 3).

Figure 1-3124 Remove gear, dowel pin, and bushing



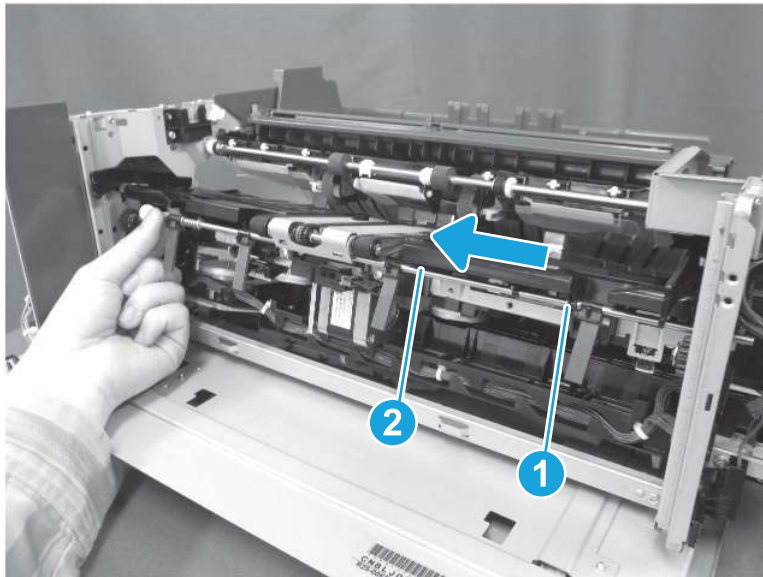
- i. Slide the bushing (callout 1) to the right, and then release the paper holder (callout 2).

Figure 1-3125 Release the paper holder



- j. Slide the bushing (callout 1) to the left, and then remove the paper holder (callout 2).

Figure 1-3126 Remove the paper holder

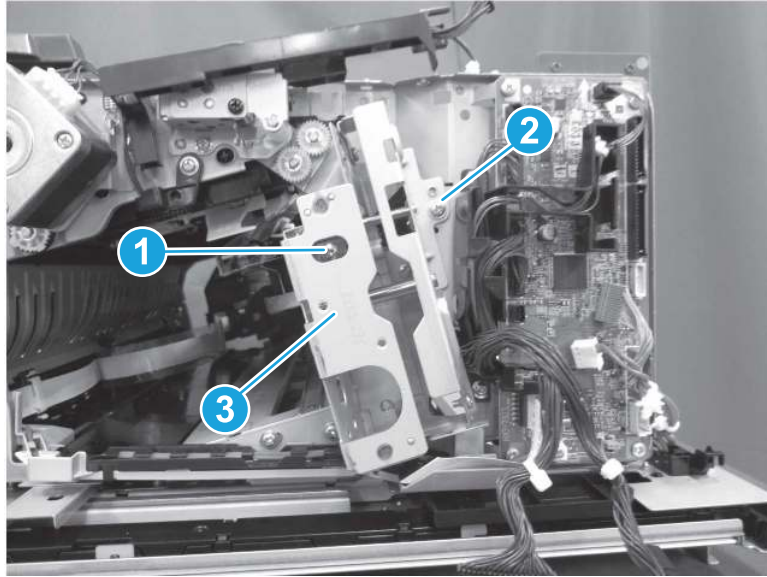


- k. Remove one screw (callout 1), remove two screws (callout 2), and then slide the stay assembly (callout 3) up to remove it.



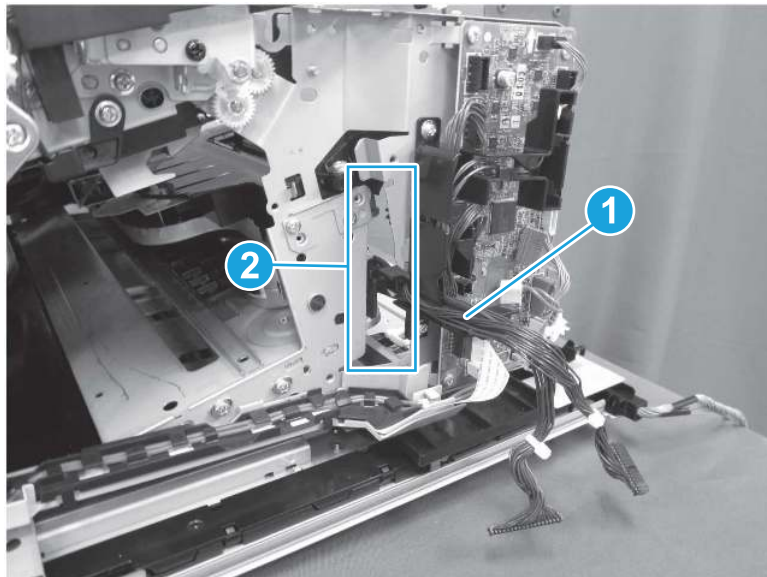
NOTE: One screw (callout 1) is larger than the other two. Make sure this screw is reinstalled in the correct position.

Figure 1-3127 Remove the stay assembly



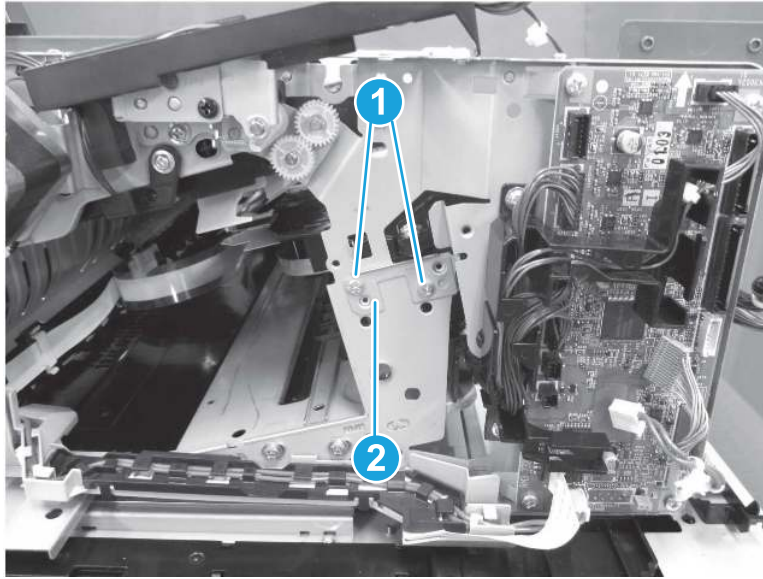
- l. Pass the cable (callout 1) through the opening (callout 2) in the frame.

Figure 1-3128 Pass the cable through the opening



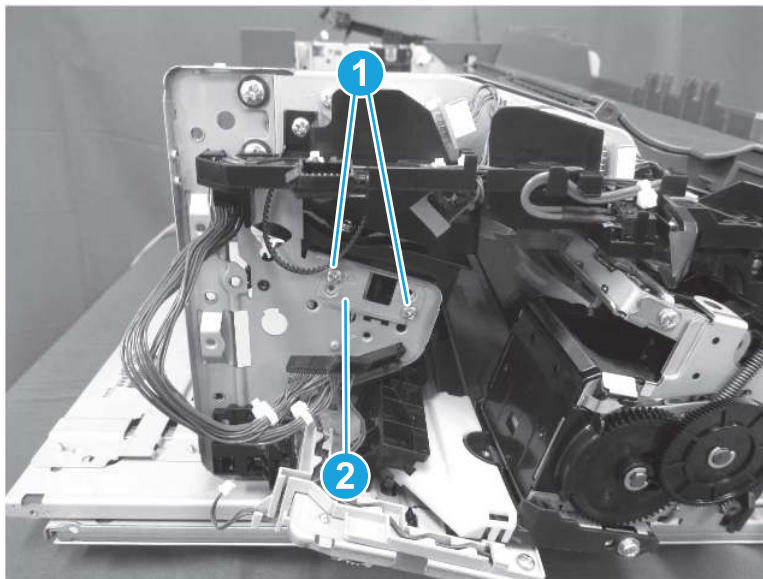
- m. Remove two screws (callout 1), and then remove the fixing plate (callout 2).

Figure 1-3129 Remove the fixing plate



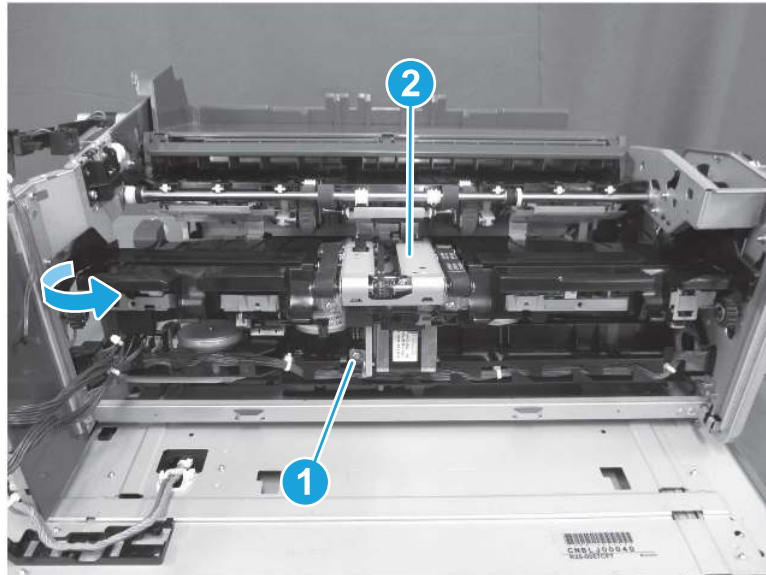
- n. Remove two screws (callout 1), and then remove the fixing plate (callout 2).

Figure 1-3130 Remove the fixing plate



- o. Remove one screw (callout 1). Rotate the processing tray (callout 2) away from the finisher to remove it.

Figure 1-3131 Remove the processing tray



10. Unpack the replacement assembly.
 - a. Dispose of the defective part.
- b. Unpack the replacement part from the packaging.
- c. To install an assembly, reverse the removal steps.



NOTE: HP recommends responsible disposal of the defective part.

<http://www8.hp.com/us/en/hp-information/environment/product-recycling.html>



IMPORTANT: Make sure that all of the shipping materials (for example shipping tape) are removed from the replacement part prior to installation.



NOTE: When applicable, special installation instructions are provided for an assembly at the end of the removal procedure. Always completely read the removal instructions and follow all special installation instructions.

Removal and replacement: Inner finisher staple mount assembly (M776zs)

Learn how to remove and replace the inner finisher staple mount assembly.


Mean time to repair: 45 minutes

Service level: Hard

Before performing service

Turn the printer power off

- Disconnect the power cable.

 **WARNING!** To avoid damage to the printer, turn the printer off, wait 30 seconds, and then remove the power cord before attempting to service the printer.

- Remove the inner finisher from the printer.

Use the table below to identify the correct part number for your printer. To order the part, go to www.hp.com/buy/parts.

Table 1-149 Part information

Part number	Part description
FM1-D645-000CN	Staple mount assembly

Required tools

- #2 Phillips screwdriver with a magnetic tip
- Small, flat-blade screwdriver

After performing service

Turn the printer power on

- Reinstall the inner finisher
- Connect the power cable.
- Use the power switch to turn the power on.

 **IMPORTANT:** After replacement, the following adjustments need to be performed.

- Jogger alignment
- Return belt tension
- Stapler alignment

For adjustment procedure, refer to Solve problems / Solve paper handling problems / Inner finisher adjustments section in the Troubleshooting service manual.

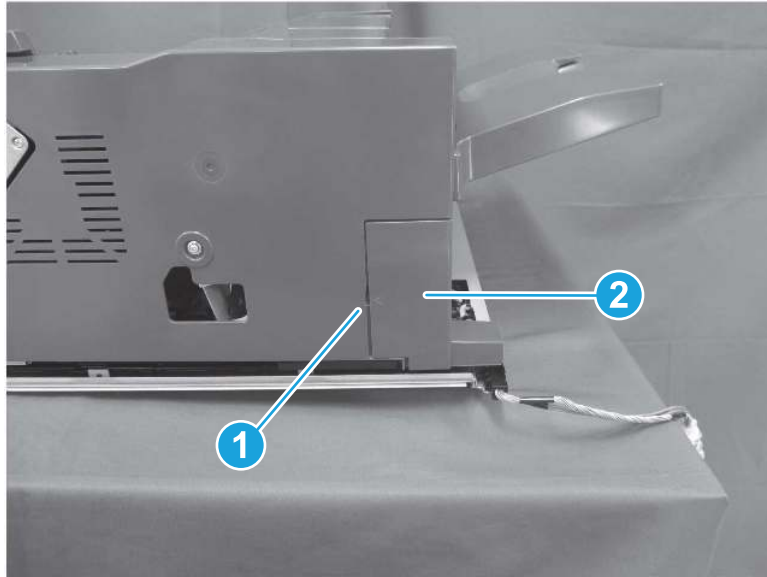
Post service test

Send a print job to the inner finisher and verify it is functioning correctly.

1. Remove the inner finisher connector cover (M776zs).

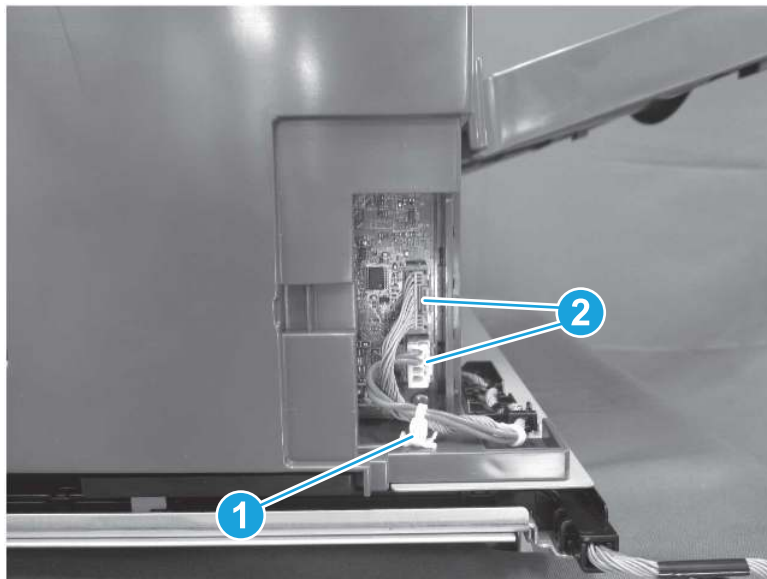
- ▲ Release one tab (callout 1), and then remove the connector cover (callout 2).

Figure 1-3132 Remove the connector cover



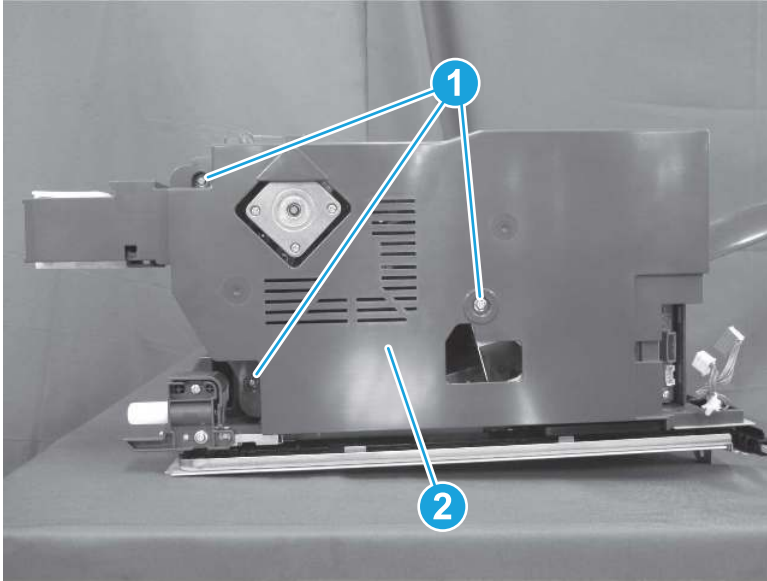
- 2. Remove the inner finisher rear cover (M776zs).
 - a. Release one retainer (callout 1), and then disconnect two connectors (callout 2).

Figure 1-3133 Disconnect two connectors



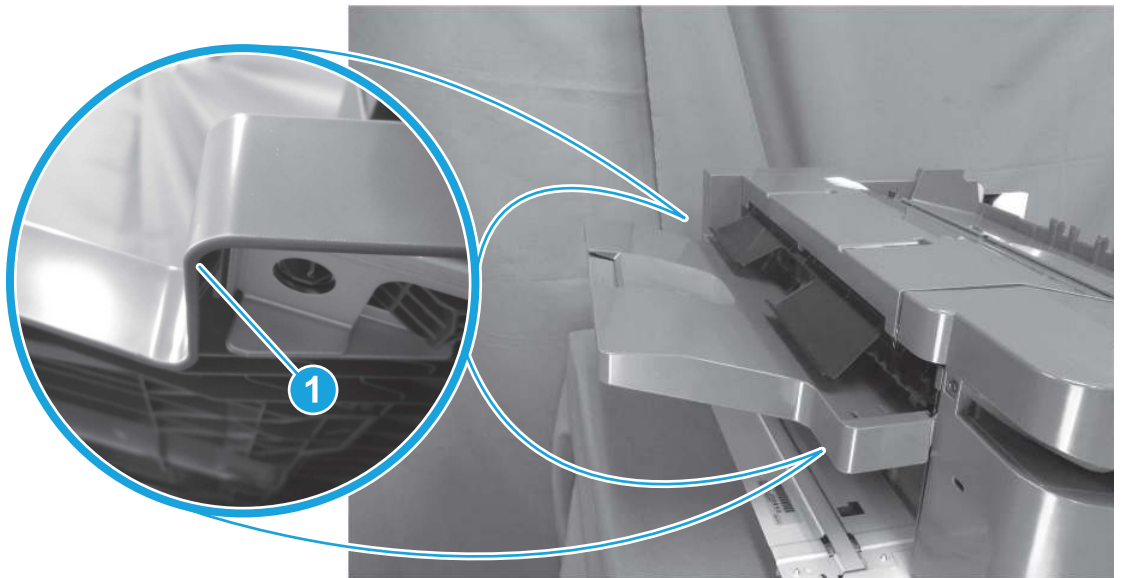
- b. Remove three screws (callout 1), and then remove the rear cover (callout 2).

Figure 1-3134 Remove the rear cover



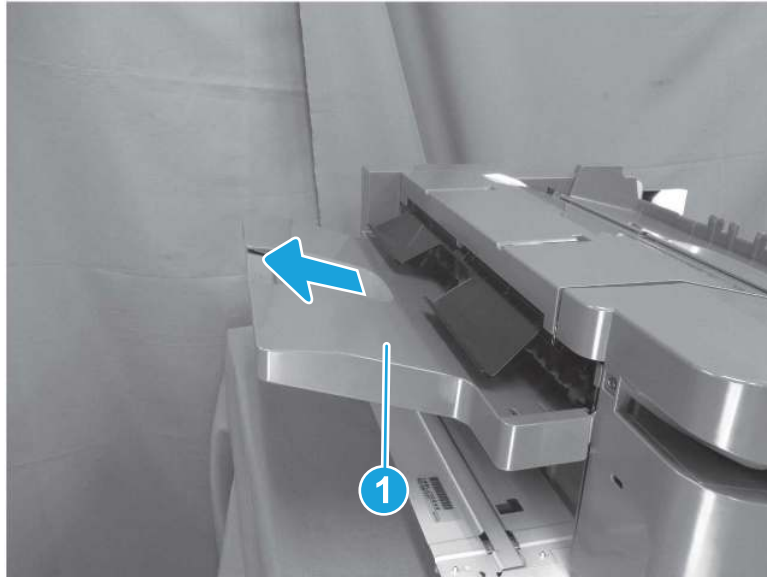
3. Remove the inner finisher stack tray assembly (M776zs).
 - a. Release two tabs (callout 1).

Figure 1-3135 Release two tabs



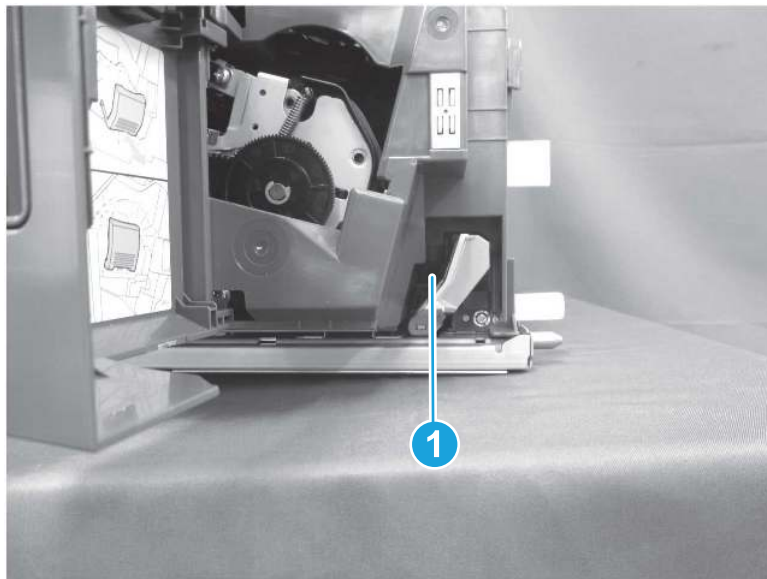
- b. Slide the stack tray assembly (callout 1) away from the finisher to remove it.

Figure 1-3136 Remove the stack tray assembly



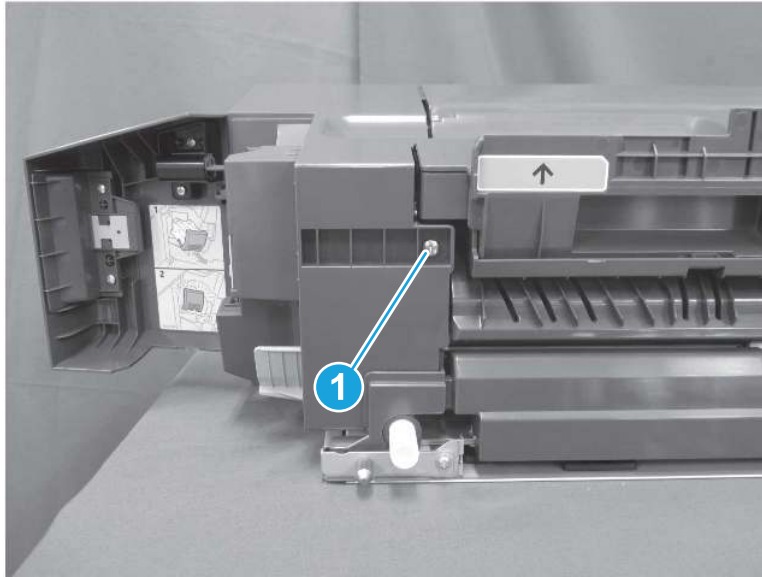
- 4. Remove the inner finisher front cover (M776zs).
 - a. Open the inner finisher front door, and then remove one screw (callout 1).

Figure 1-3137 Remove one screw



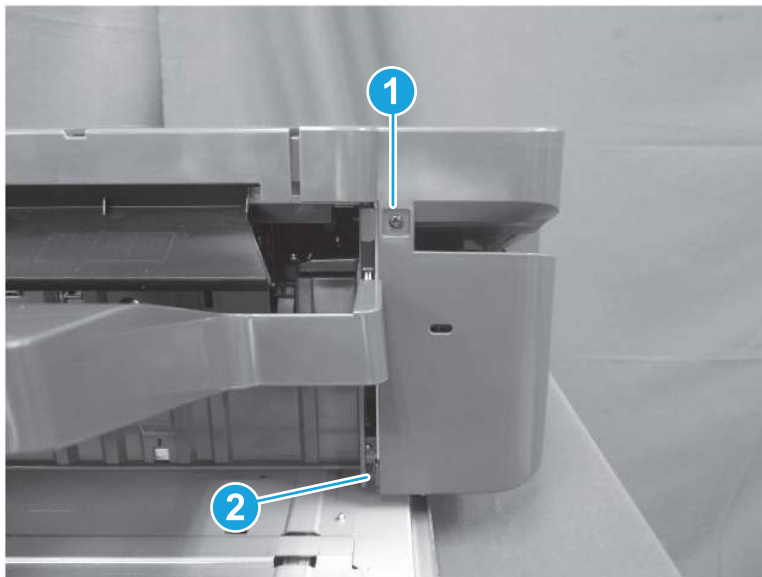
- b. Remove one screw (callout 1).

Figure 1-3138 Remove one screw



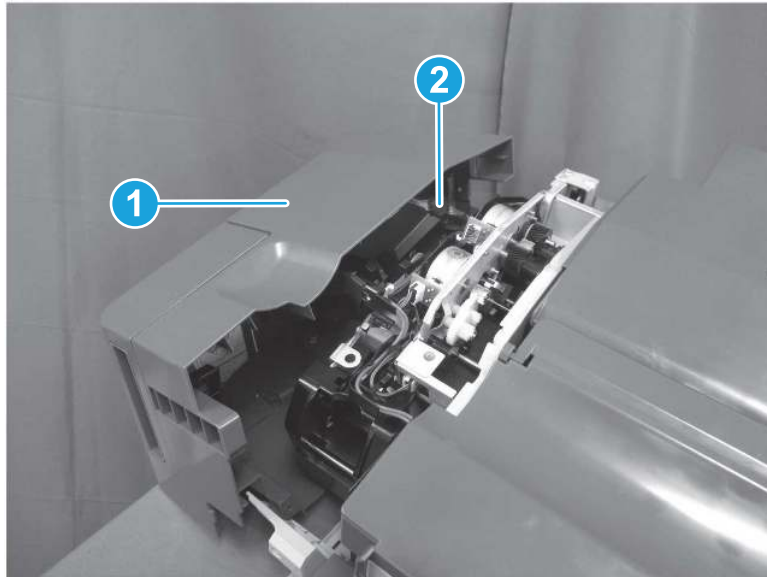
- c. Remove one screw (callout 1), and then release one tab (callout 2).

Figure 1-3139 Remove one screw and release one tab



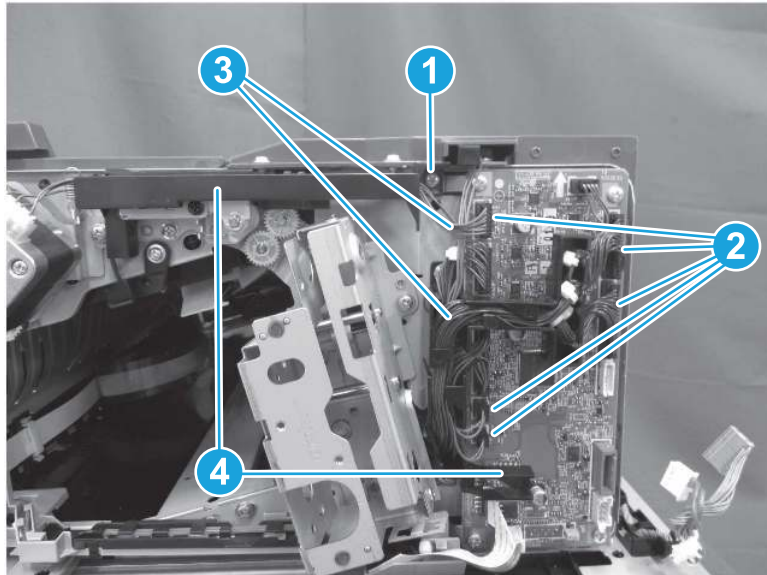
- d. Pull the front cover (callout 1) slightly away from the finisher, disconnect one connector (callout 2), and then remove the front cover.

Figure 1-3140 Remove the front cover



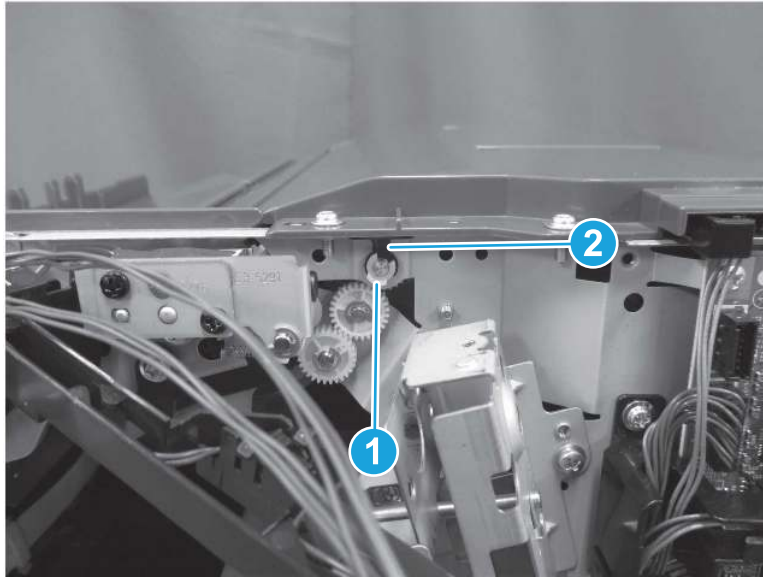
5. Remove the inner finisher upper feed guide (M776zs).
 - a. Remove one screw (callout 1), and then disconnect five connectors (callout 2). Release the cables (callout 3) from the guide (callout 4).

Figure 1-3141 Remove one screw and disconnect five connectors



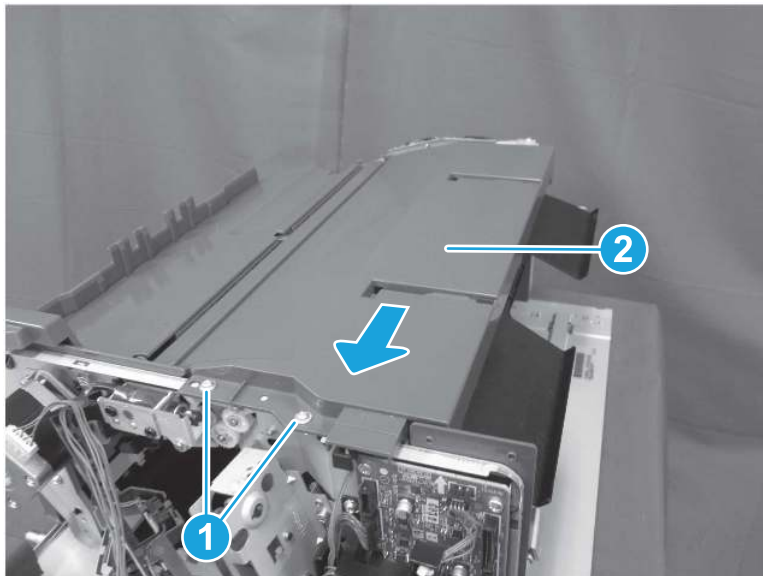
- b. Remove one e-clip (callout 1), and then remove the bushing (callout 2).

Figure 1-3142 Remove e-clip and bushing



- c. Remove one screw (callout 1). Lift the upper feed guide (callout 2), and then slide it towards the front of the finisher to remove it.

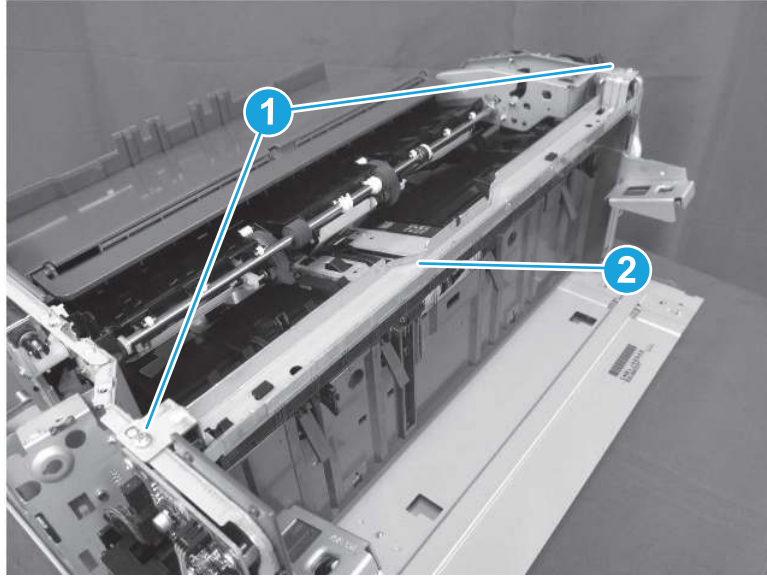
Figure 1-3143 Remove the upper feed guide



- 6.
- 7. Remove the inner finisher stack wall assembly (M776zs).

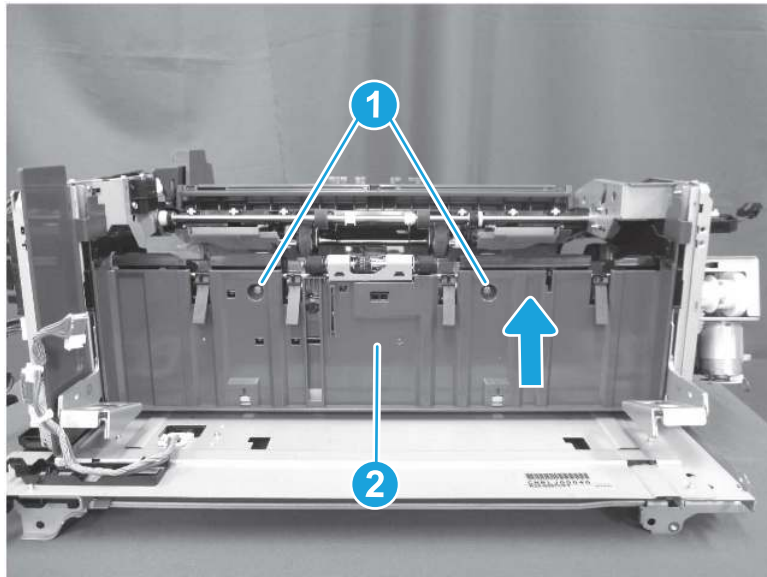
- a. Remove two screws (callout 1), and then remove the upper stay (callout 2).

Figure 1-3144 Remove two screws and the upper stay



- b. Remove two screws (callout 1), and then slide the stack wall assembly (callout 2) up to remove it.

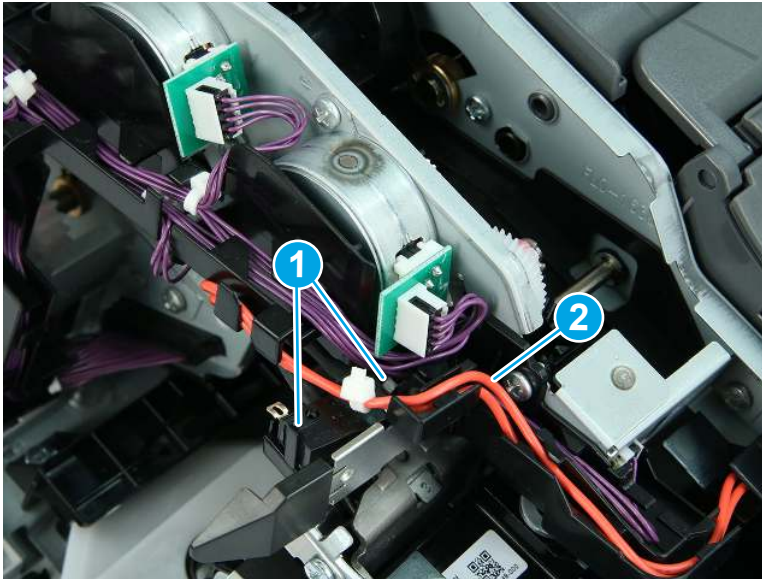
Figure 1-3145 Remove the stack wall assembly



- 8.
9. Remove the inner finisher paddle drive assembly (M776zs).

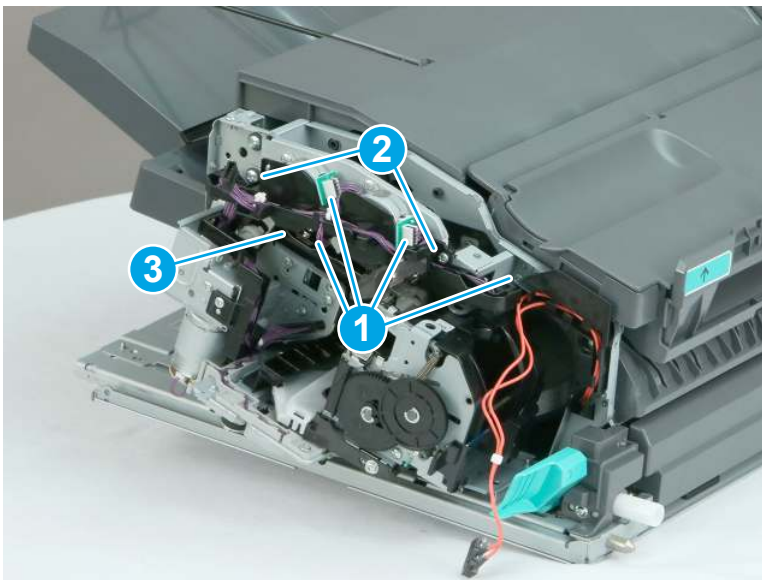
- a. Release two tabs (callout 1) to release the interlock switch, and then remove the cable (callout 2) from the guide.

Figure 1-3146 Release the interlock switch



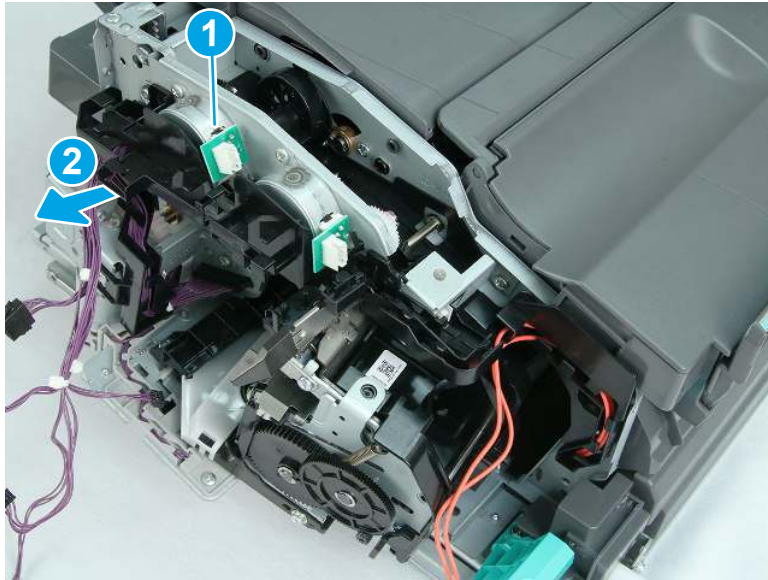
- b. Disconnect four connectors (callout 1), remove two screws (callout 2), and then release the cables from the guide (callout 3).

Figure 1-3147 Disconnect four connectors and remove two screws



- c. Release one tab (callout 1), and then remove the guide (callout 2).

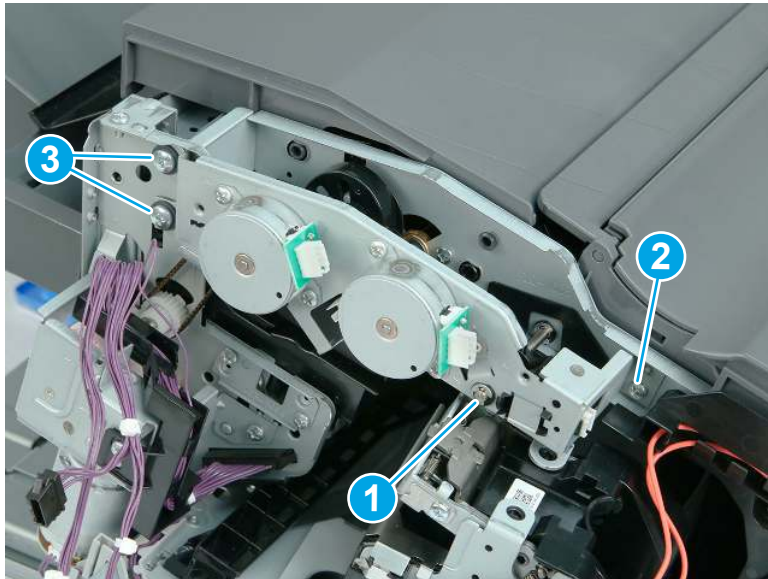
Figure 1-3148 Remove the guide



- d. Remove one e-ring and bushing (callout 1), remove one screw (callout 2), then remove two screws (callout 3).

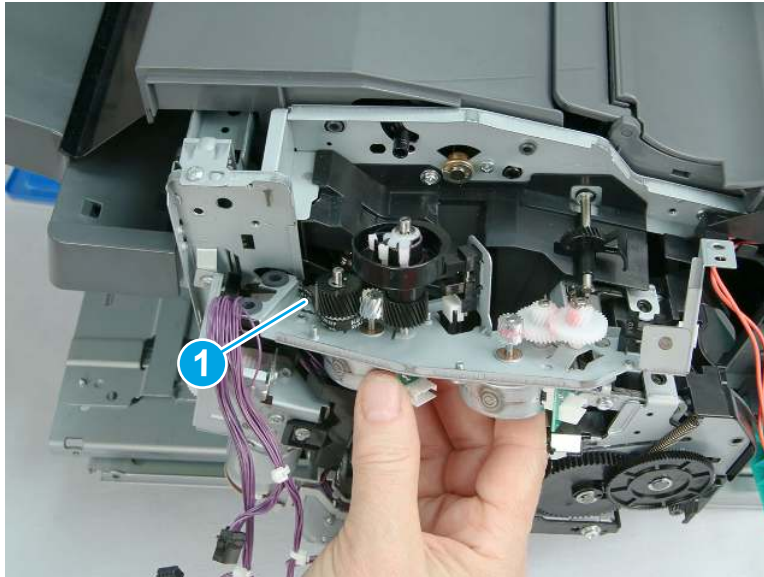
 **TIP:** One screw (callout 2) is smaller than the other two screws. Make sure this screw is installed in the correct position.

Figure 1-3149 Remove one e-ring and bushing and two screws



- e. Lift the paddle drive assembly slightly away from the finisher, and then release one belt from the gear (callout 1). Remove the paddle drive assembly.

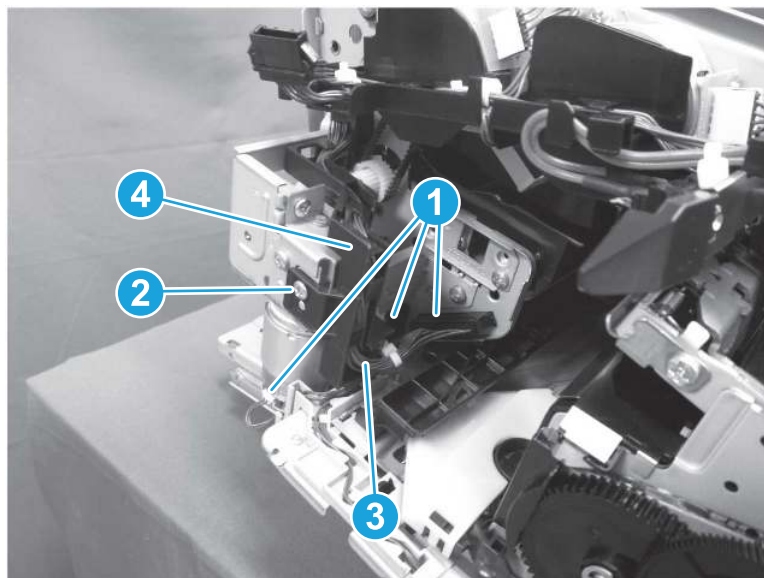
Figure 1-3150 Release the belt and remove the paddle drive assembly



- 10. Remove the inner finisher tray lifting motor (M776zs).

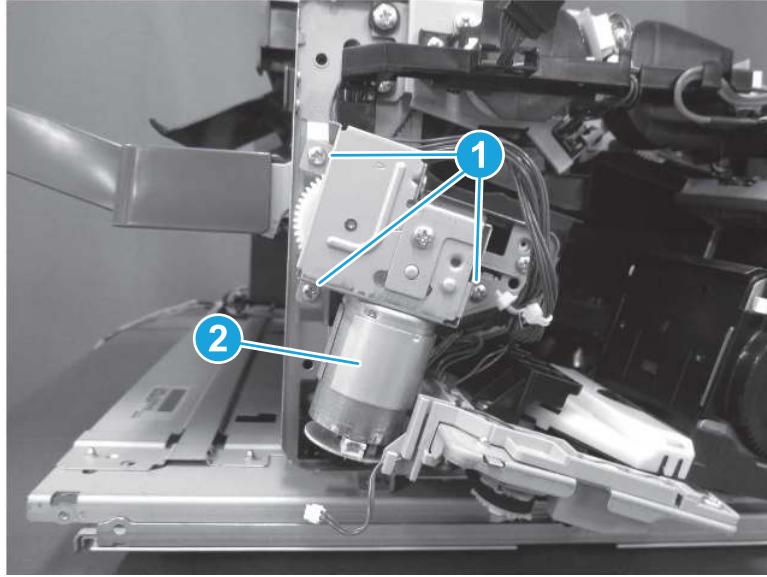
- a. Disconnect three connectors (callout 1), and then remove one screw (callout 2). Release the cable (callout 3) from the guide (callout 4), and then remove the guide (callout 4).

Figure 1-3151 Disconnect three connectors and remove one screw



- b. Remove three screws (callout 1), and then remove the tray lifting motor (callout 2).

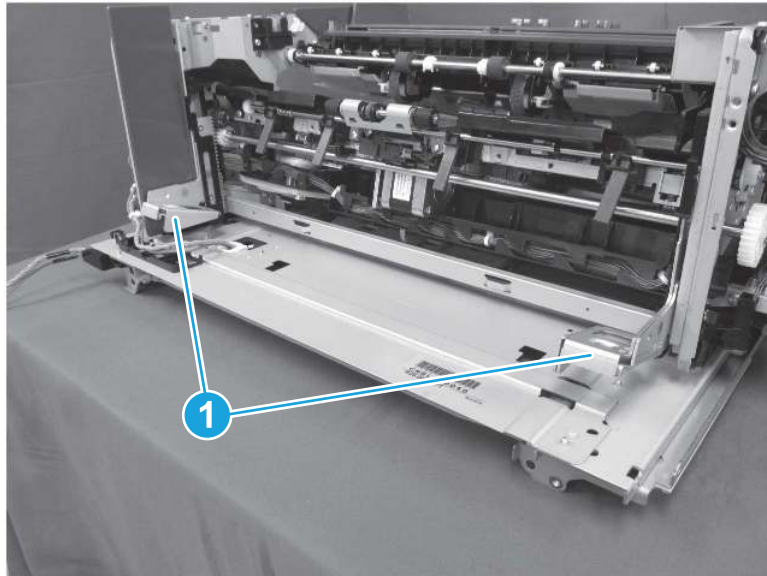
Figure 1-3152 Remove three screws and the tray lifting motor



- 11. Remove the inner finisher processing tray assembly (M776zs).

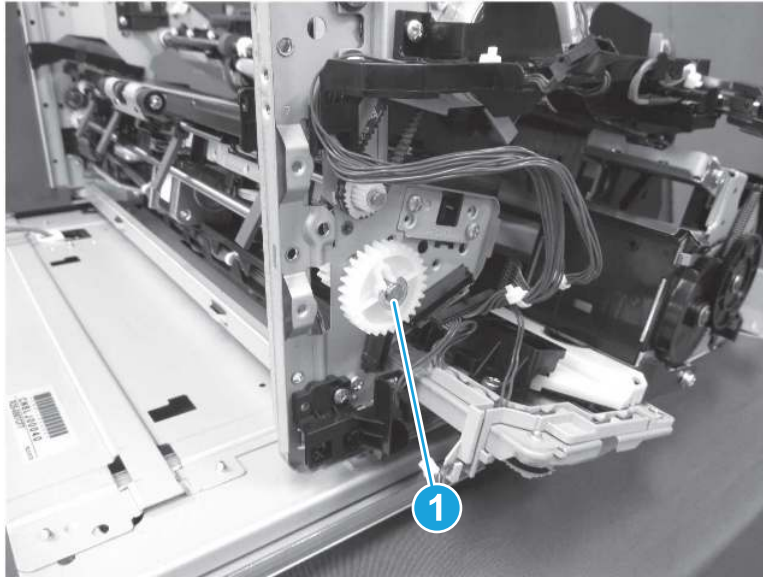
- a. Slide two locks (callout 1) up to remove them.

Figure 1-3153 Remove two locks



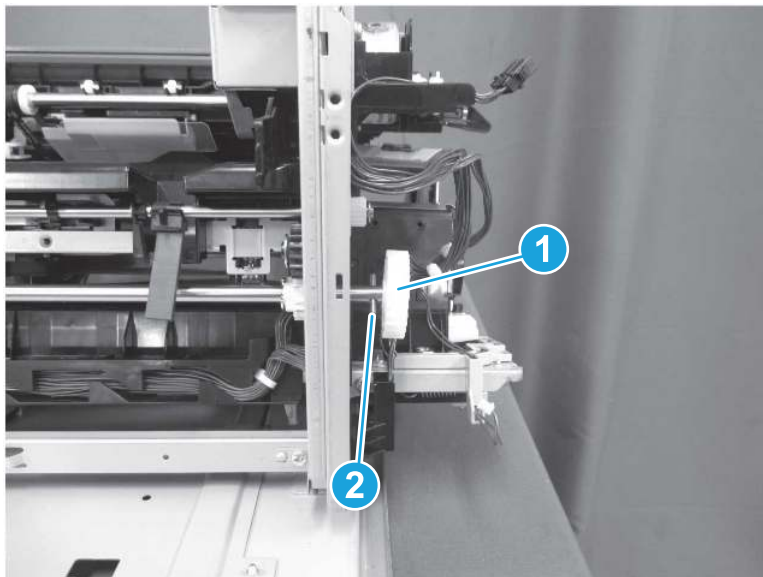
- b. Remove one e-ring (callout 1).

Figure 1-3154 Remove one e-ring



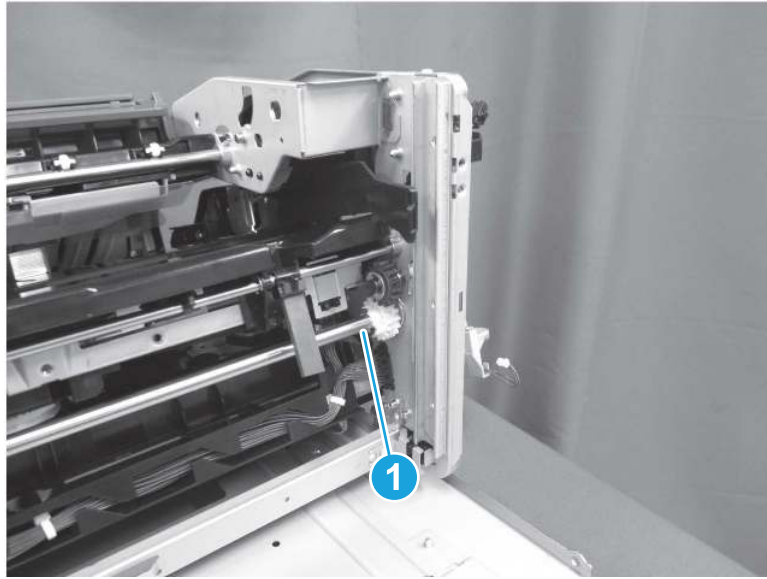
- c. Remove one gear (callout 1), and then remove one dowel pin (callout 2).

Figure 1-3155 Remove one gear and dowel pin



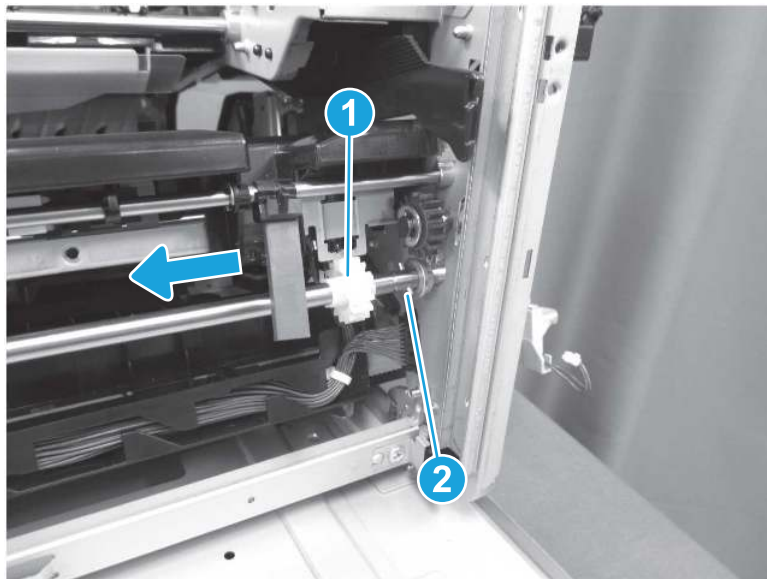
- d. Remove one e-ring (callout 1).

Figure 1-3156 Remove one e-ring



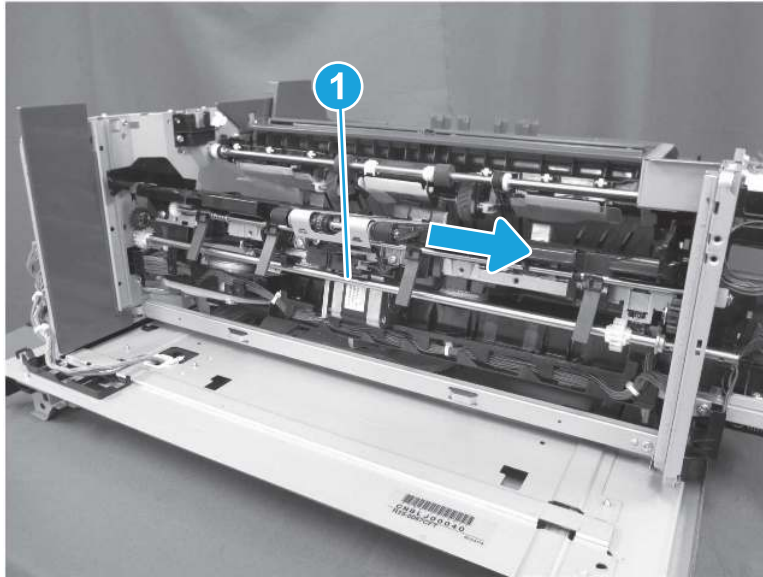
- e. Slide the gear (callout 1) to the left, and then remove one dowel pin (callout 2).

Figure 1-3157 Remove one dowel pin



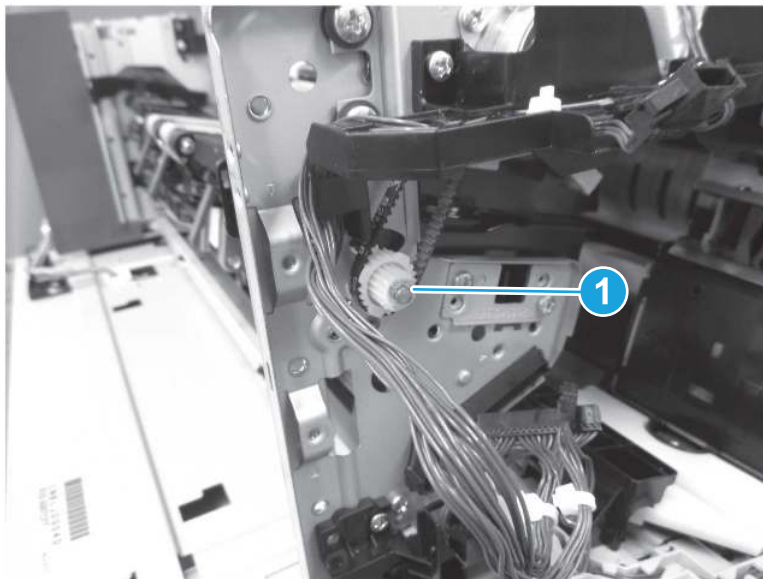
- f. Slide the tray drive shaft (callout 1) to the left, and then pull it away from the finisher to remove it.

Figure 1-3158 Remove the tray drive shaft



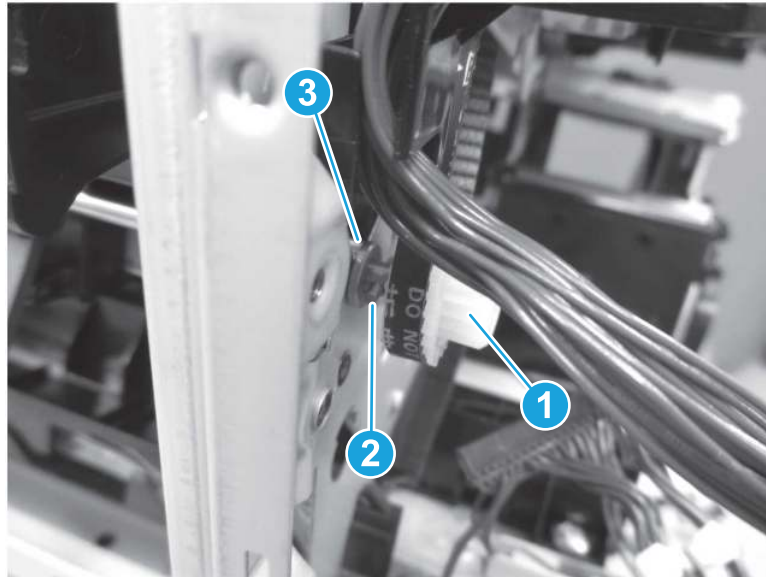
- g. Remove one e-ring (callout 1).

Figure 1-3159 Remove one e-ring



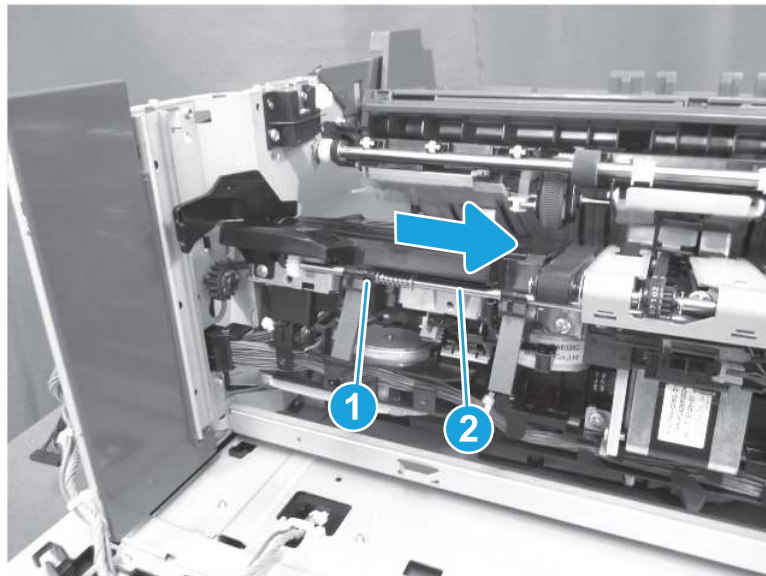
- h. Remove one gear (callout 1), remove one dowel pin (callout 2), and then remove the bushing (callout 3).

Figure 1-3160 Remove gear, dowel pin, and bushing



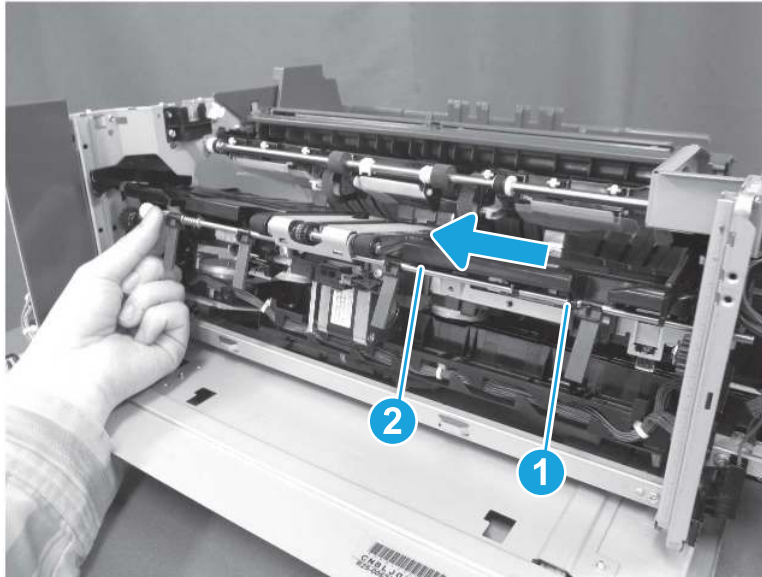
- i. Slide the bushing (callout 1) to the right, and then release the paper holder (callout 2).

Figure 1-3161 Release the paper holder



- j. Slide the bushing (callout 1) to the left, and then remove the paper holder (callout 2).

Figure 1-3162 Remove the paper holder



- k. Remove one screw (callout 1), remove two screws (callout 2), and then slide the stay assembly (callout 3) up to remove it.


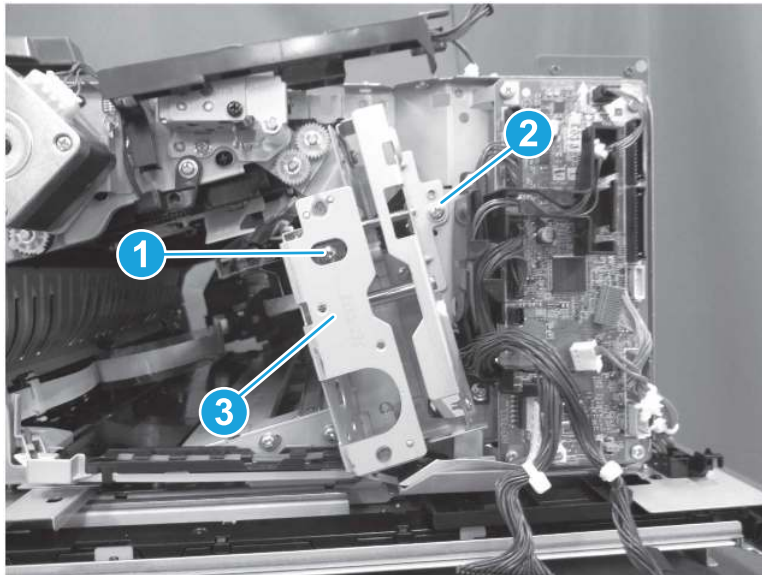
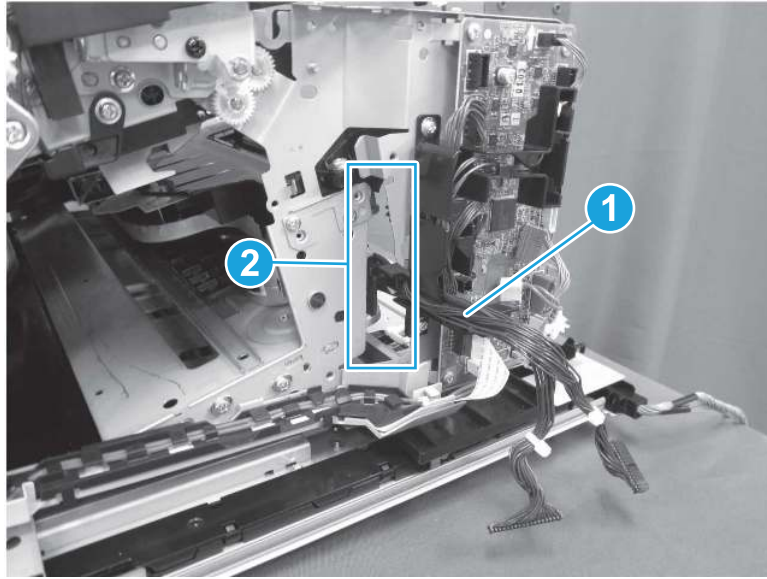
 **NOTE:** One screw (callout 1) is larger than the other two. Make sure this screw is reinstalled in the correct position.

Figure 1-3163 Remove the stay assembly



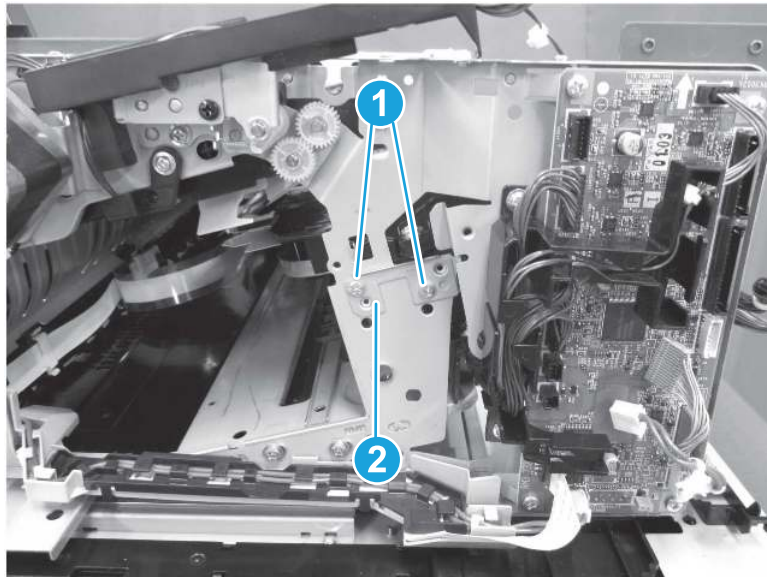
- l. Pass the cable (callout 1) through the opening (callout 2) in the frame.

Figure 1-3164 Pass the cable through the opening



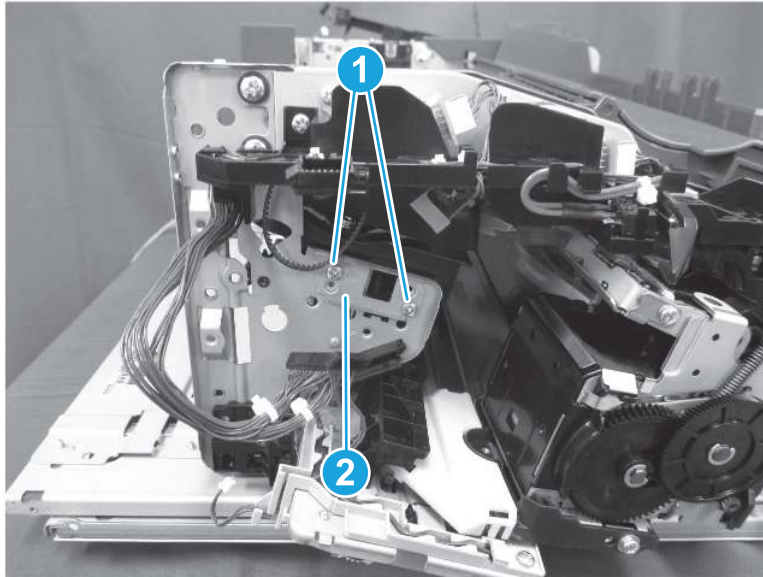
- m. Remove two screws (callout 1), and then remove the fixing plate (callout 2).

Figure 1-3165 Remove the fixing plate



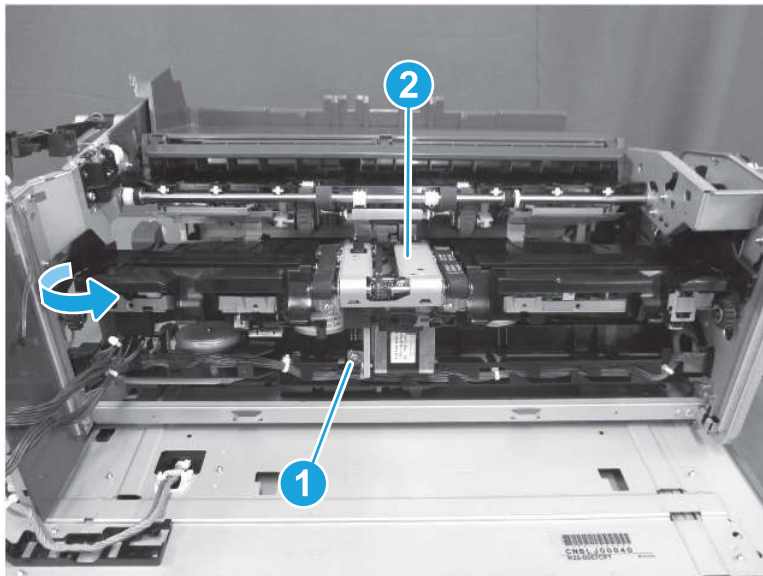
- n. Remove two screws (callout 1), and then remove the fixing plate (callout 2).

Figure 1-3166 Remove the fixing plate



- o. Remove one screw (callout 1). Rotate the processing tray (callout 2) away from the finisher to remove it.

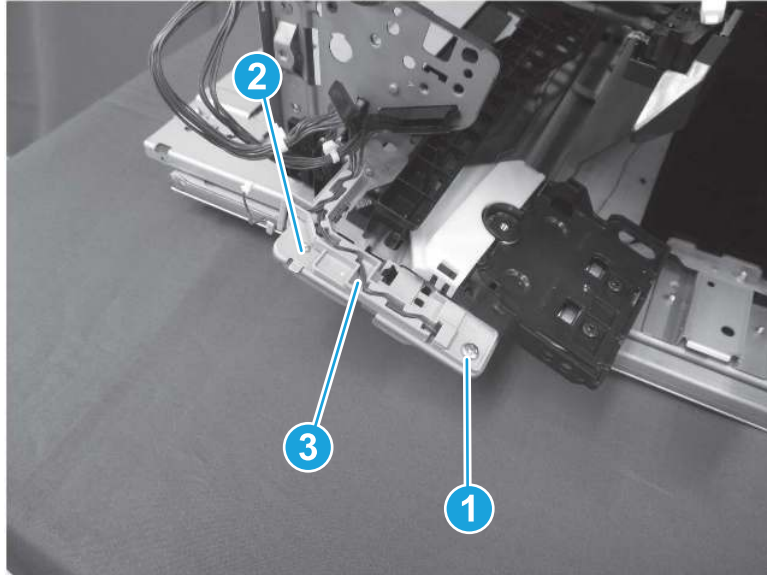
Figure 1-3167 Remove the processing tray



- 12. Remove the inner finisher staple mount assembly (M776zs).

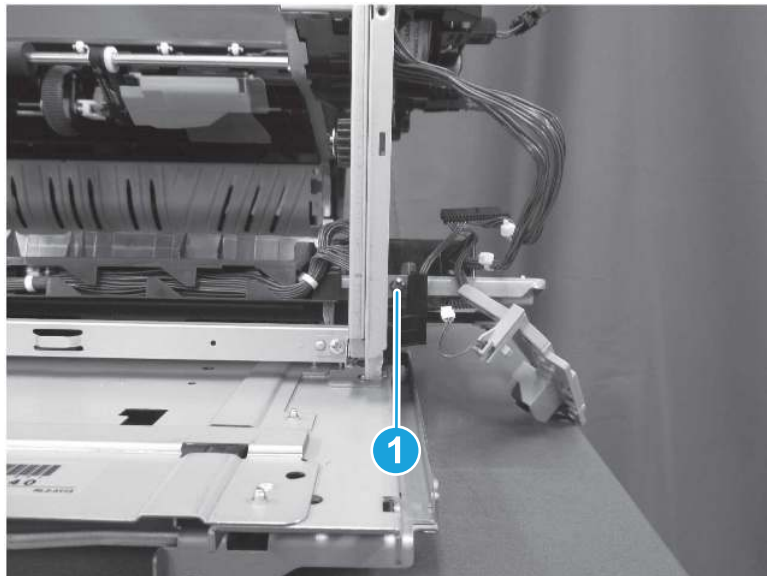
- a. Remove one screw (callout 1), and then remove the cable guide (callout 2) and the cable (callout 3) together.

Figure 1-3168 Remove the cable and guide



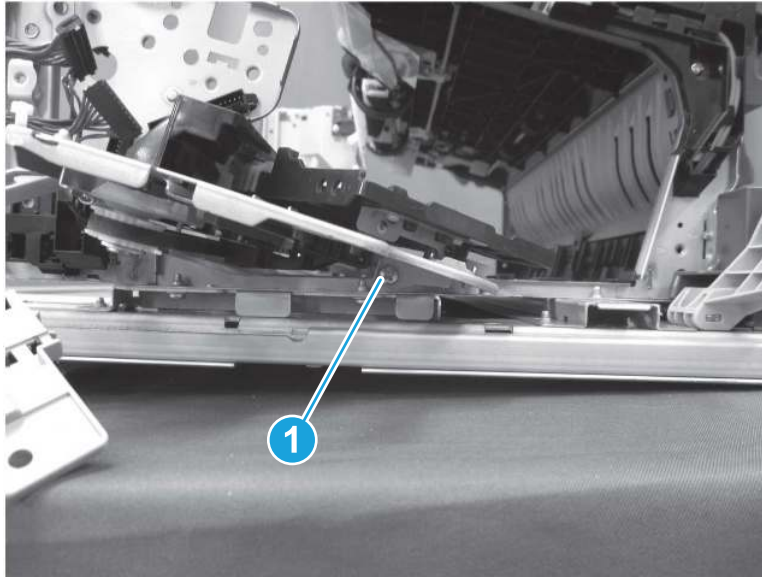
- b. Remove one screw (callout 1).

Figure 1-3169 Remove one screw



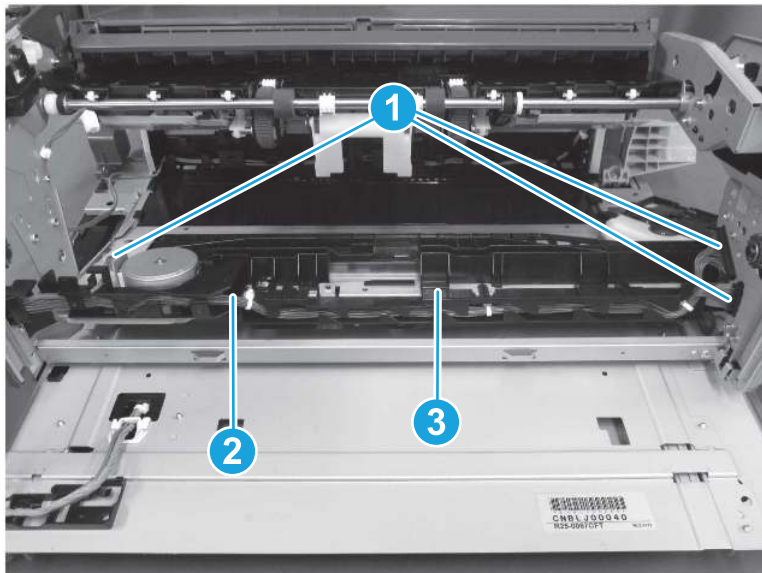
- c. Remove one screw (callout 1).

Figure 1-3170 Remove one screw



- d. Disconnect three connectors (callout 1), and then release the cable (callout 2) from the cable guide (callout 3).

Figure 1-3171 Disconnect three connectors and release the cable



- e. Remove two screws (callout 1), and then remove the staple mount assembly (callout 2).

Figure 1-3172 Remove the staple mount assembly

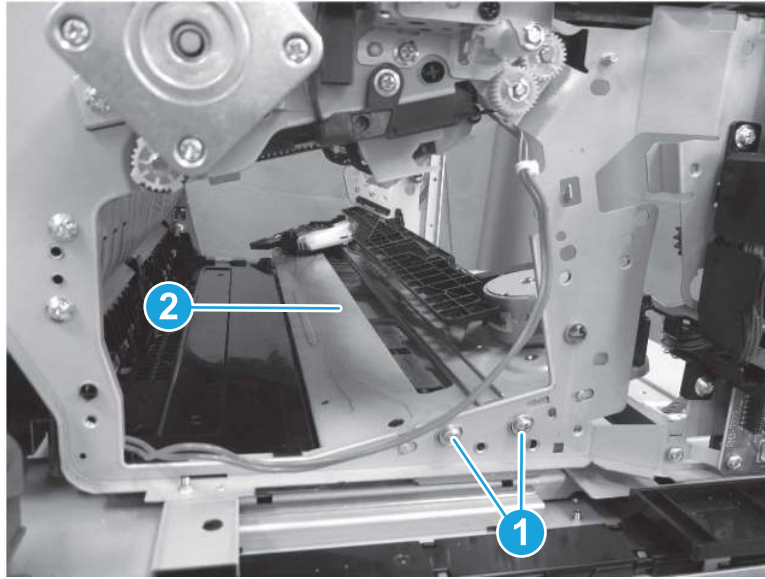
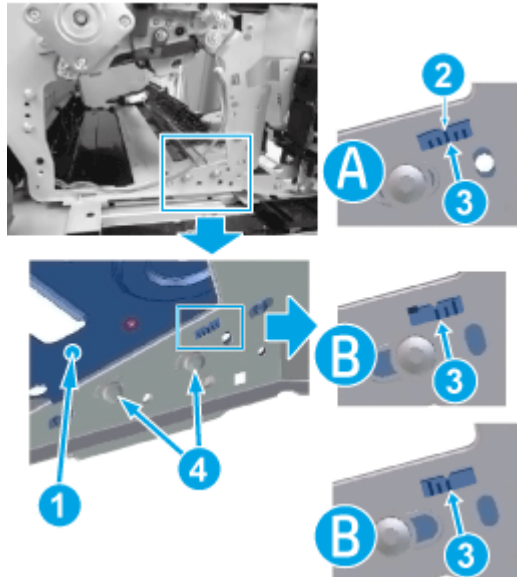



Figure 1-3173 Staple mount assembly install



Callout A: Correct alignment

Callout B: Incorrect alignments

 **NOTE:** When assembling the staple mount assembly (callout 1), first align the triangular indicator of the frame (callout 2) to the center marking of the staple mount assembly (callout 3), then screw using 2 screws (callout 4).


- 13. Unpack the replacement assembly.

- a. Dispose of the defective part.


 **NOTE:** HP recommends responsible disposal of the defective part.

<http://www8.hp.com/us/en/hp-information/environment/product-recycling.html>

- b. Unpack the replacement part from the packaging.

 **IMPORTANT:** Make sure that all of the shipping materials (for example shipping tape) are removed from the replacement part prior to installation.

- c. To install an assembly, reverse the removal steps.

 **NOTE:** When applicable, special installation instructions are provided for an assembly at the end of the removal procedure. Always completely read the removal instructions and follow all special installation instructions.

Removal and replacement: Inner finisher controller PCA (M776zs)

Learn how to remove and replace the inner finisher controller PCA.


Mean time to repair: 5 minutes

Service level: Easy

Before performing service

Turn the printer power off

- Disconnect the power cable.

 **WARNING!** To avoid damage to the printer, turn the printer off, wait 30 seconds, and then remove the power cord before attempting to service the printer.

- Remove the inner finisher from the printer.

Use the table below to identify the correct part number for your printer. To order the part, go to www.hp.com/buy/parts.

Table 1-150 Part information

Part number	Part description
RM3-7323-000CN	Staple stacker PCB assembly

Required tools

- #2 Phillips screwdriver with a magnetic tip

After performing service

Turn the printer power on

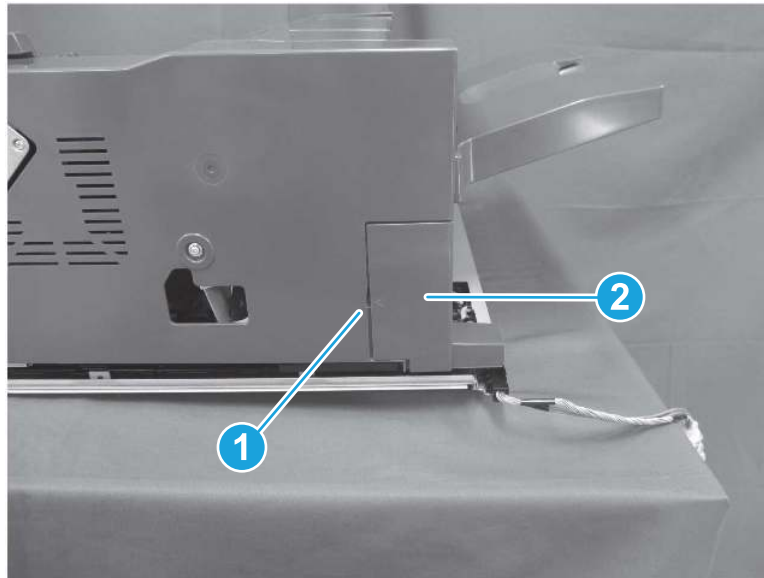
- Reinstall the inner finisher
- Connect the power cable.
- Use the power switch to turn the power on.

Post service test

Send a print job to the inner finisher and verify it is functioning correctly.

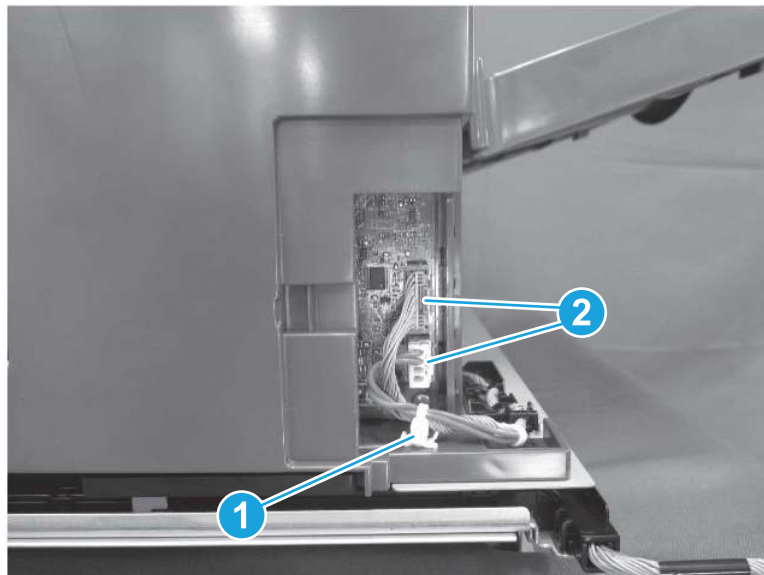
1. Remove the inner finisher connector cover (M776zs).
 - ▲ Release one tab (callout 1), and then remove the connector cover (callout 2).

Figure 1-3174 Remove the connector cover



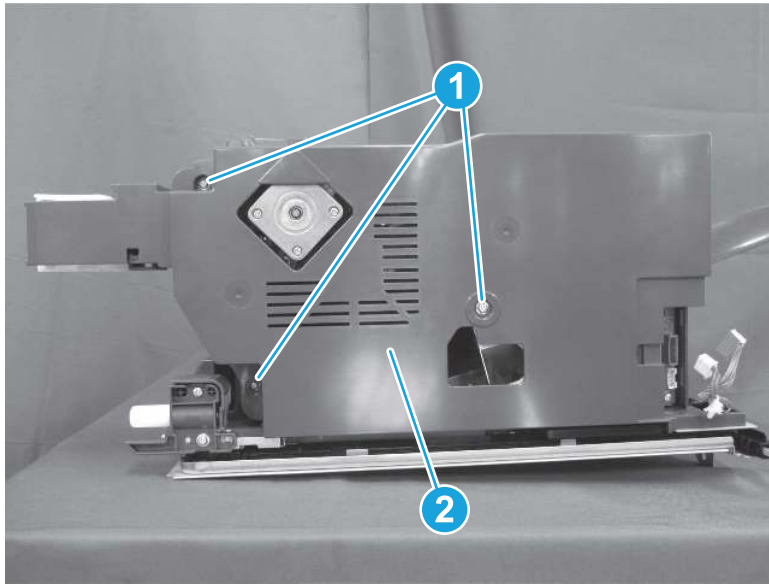
2. Remove the inner finisher rear cover (M776zs).
 - a. Release one retainer (callout 1), and then disconnect two connectors (callout 2).

Figure 1-3175 Disconnect two connectors



- b. Remove three screws (callout 1), and then remove the rear cover (callout 2).

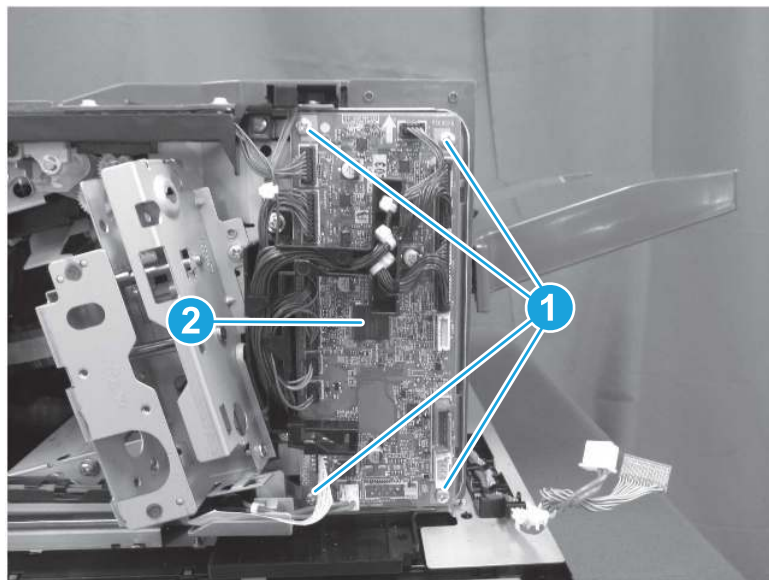
Figure 1-3176 Remove the rear cover



3. Remove the inner finisher controller PCA (M776zs).

- a. Disconnect all of the connectors on the controller PCA, remove four screws (callout 1), and then remove the controller PCA (callout 2).

Figure 1-3177 Remove the controller PCA





4. Unpack the replacement assembly.
 - a. Dispose of the defective part.




NOTE: HP recommends responsible disposal of the defective part.


<http://www8.hp.com/us/en/hp-information/environment/product-recycling.html>

- b. Unpack the replacement part from the packaging.

 **CAUTION:**  Some parts are sensitive to electrostatic discharge (ESD). Always perform service work at an ESD-protected workstation or mat. If an ESD workstation or mat is not available, touch the sheet-metal chassis to provide a static ground before touching an ESD-sensitive assembly. Protect the ESD-sensitive assemblies by placing them in ESD pouches when they are out of the printer.

 **IMPORTANT:** Make sure that all of the shipping materials (for example shipping tape) are removed from the replacement part prior to installation.

- c. To install an assembly, reverse the removal steps.

 **NOTE:** When applicable, special installation instructions are provided for an assembly at the end of the removal procedure. Always completely read the removal instructions and follow all special installation instructions.

Removal and replacement: Inner finisher feed motor (M776zs)

Learn how to remove and replace the inner finisher feed motor.


Mean time to repair: 5 minutes

Service level: Easy

Before performing service

Turn the printer power off

- Disconnect the power cable.

 **WARNING!** To avoid damage to the printer, turn the printer off, wait 30 seconds, and then remove the power cord before attempting to service the printer.

- Remove the inner finisher from the printer.

Use the table below to identify the correct part number for your printer. To order the part, go to www.hp.com/buy/parts.

Table 1-151 Part information

Part number	Part description
FK4-2060-000CN	Motor, stepping

Required tools

- #2 Phillips screwdriver with a magnetic tip

After performing service

Turn the printer power on

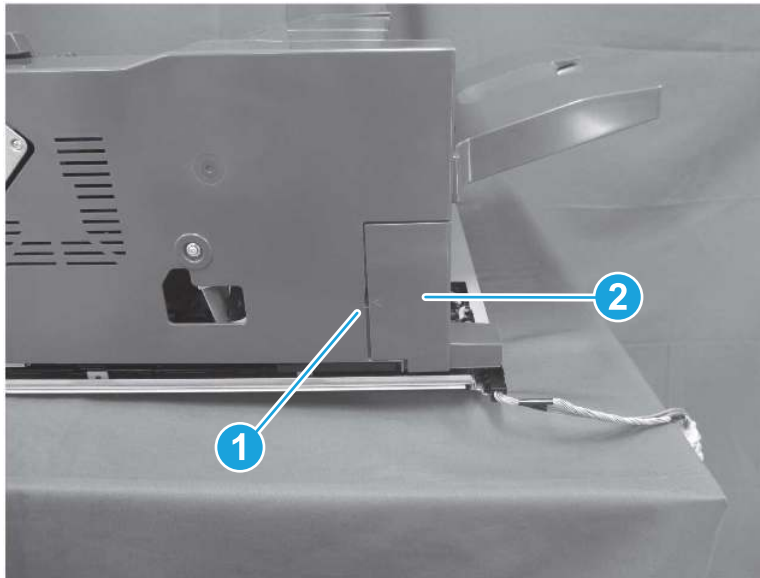
- Reinstall the inner finisher
- Connect the power cable.
- Use the power switch to turn the power on.

Post service test

Send a print job to the inner finisher and verify it is functioning correctly.

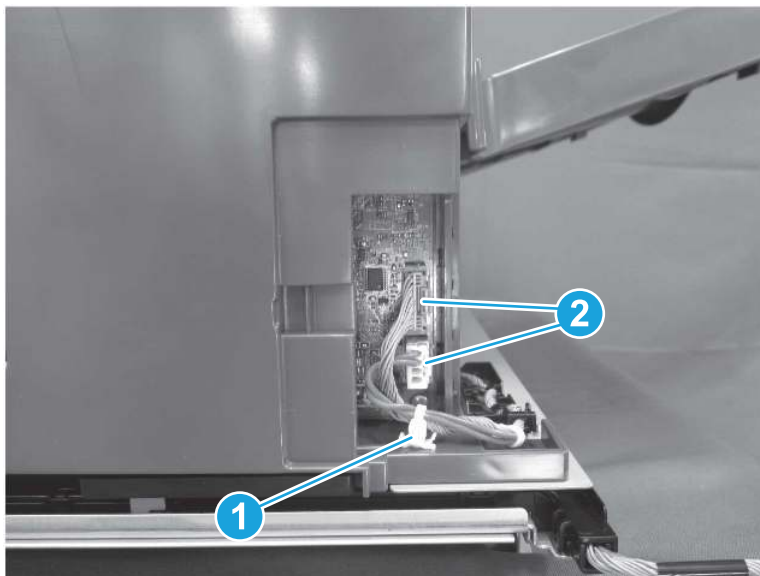
1. Remove the inner finisher connector cover (M776zs).
 - ▲ Release one tab (callout 1), and then remove the connector cover (callout 2).

Figure 1-3178 Remove the connector cover



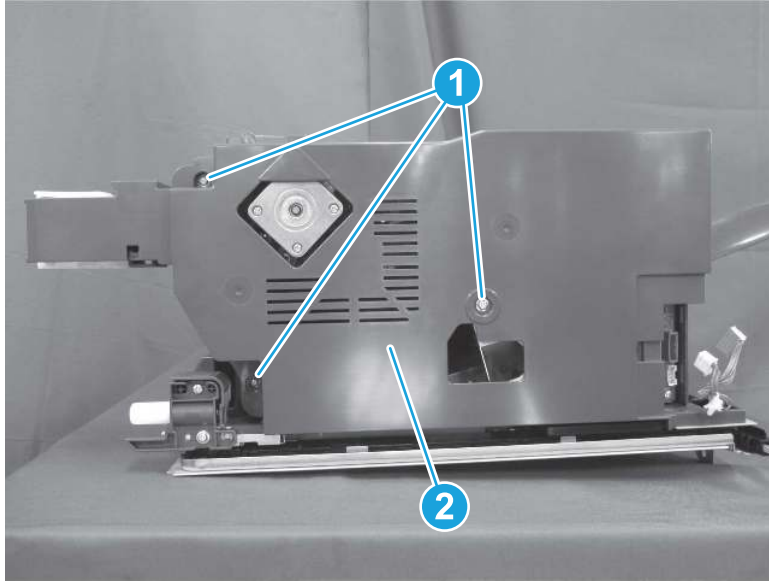
2. Remove the inner finisher rear cover (M776zs).
 - a. Release one retainer (callout 1), and then disconnect two connectors (callout 2).

Figure 1-3179 Disconnect two connectors



- b. Remove three screws (callout 1), and then remove the rear cover (callout 2).

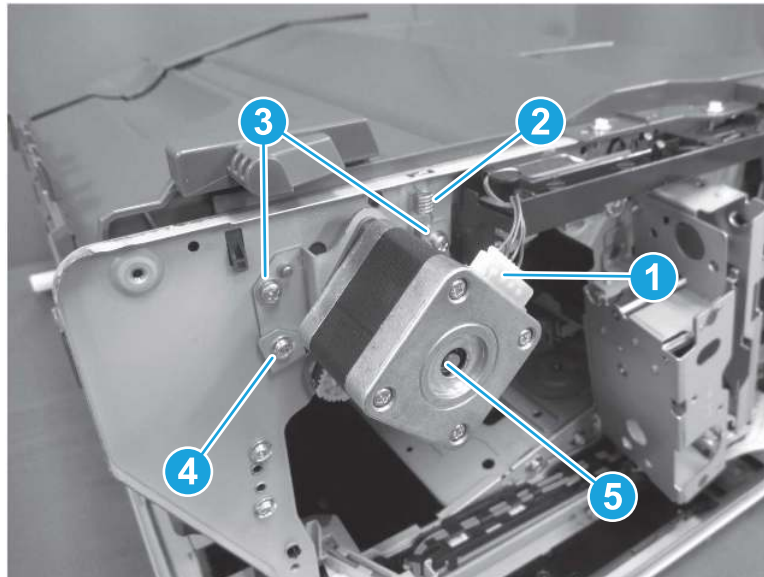
Figure 1-3180 Remove the rear cover



3. Remove the inner finisher feed motor (M776zs).

- a. Disconnect one connector (callout 1), and then unhook one spring (callout 2). Remove two screws with washers (callout 3), and then remove one machine screw (callout 4). Remove the feed motor (callout 5).

Figure 1-3181 Remove the feed motor




4. Unpack the replacement assembly.
 - a. Dispose of the defective part.




NOTE: HP recommends responsible disposal of the defective part.

<http://www8.hp.com/us/en/hp-information/environment/product-recycling.html>

- b. Unpack the replacement part from the packaging.

 **IMPORTANT:** Make sure that all of the shipping materials (for example shipping tape) are removed from the replacement part prior to installation.

- c. To install an assembly, reverse the removal steps.

 **NOTE:** When applicable, special installation instructions are provided for an assembly at the end of the removal procedure. Always completely read the removal instructions and follow all special installation instructions.

Removal and replacement: Inner finisher tray lifting motor (M776zs)

Learn how to remove and replace the inner finisher tray lifting motor.


Mean time to repair: 10 minutes

Service level: Easy

Before performing service

Turn the printer power off

- Disconnect the power cable.

 **WARNING!** To avoid damage to the printer, turn the printer off, wait 30 seconds, and then remove the power cord before attempting to service the printer.

- Remove the inner finisher from the printer.

Use the table below to identify the correct part number for your printer. To order the part, go to www.hp.com/buy/parts.

Table 1-152 Part information

Part number	Part description
FM1-C439-000CN	Height tray motor assembly

Required tools

- #2 Phillips screwdriver with a magnetic tip

After performing service

Turn the printer power on

- Reinstall the inner finisher
- Connect the power cable.
- Use the power switch to turn the power on.

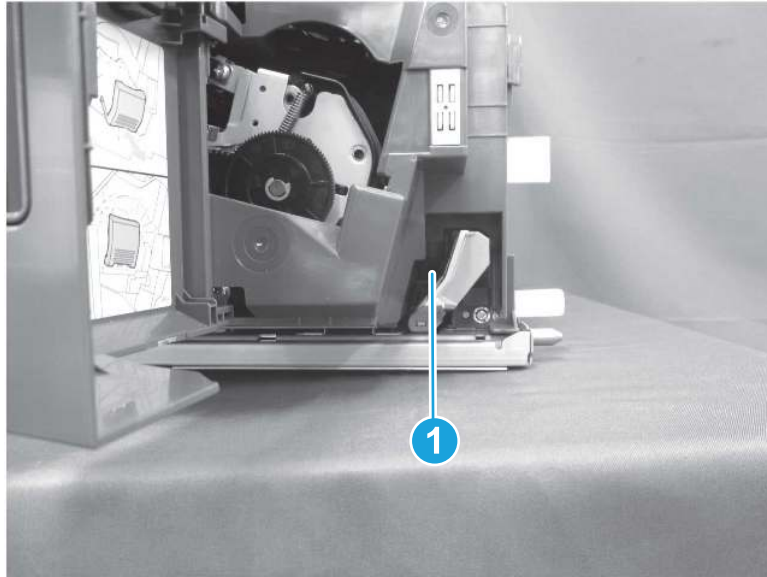
Post service test

Send a print job to the inner finisher and verify it is functioning correctly.

1. Remove the inner finisher front cover (M776zs).

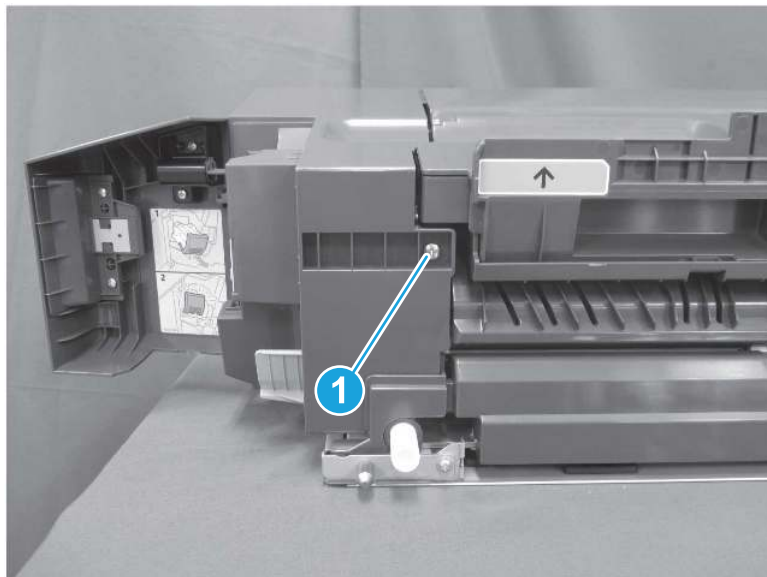
- a. Open the inner finisher front door, and then remove one screw (callout 1).

Figure 1-3182 Remove one screw



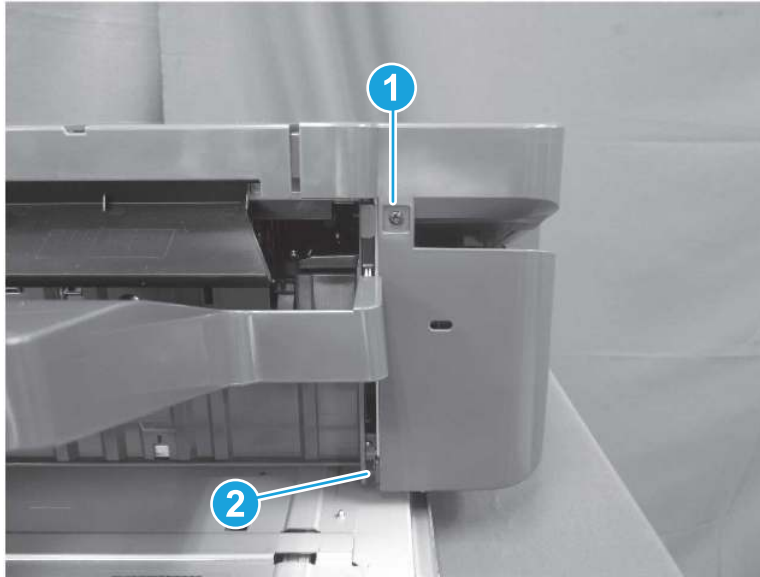
- b. Remove one screw (callout 1).

Figure 1-3183 Remove one screw



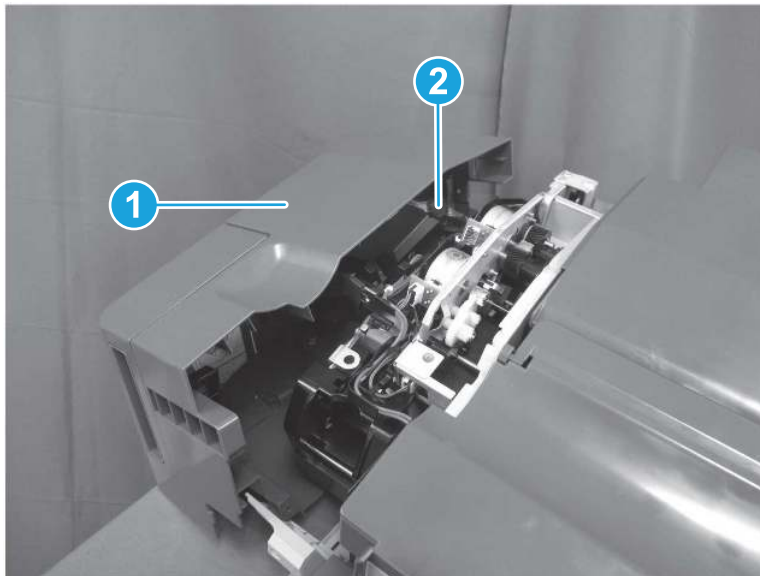
- c. Remove one screw (callout 1), and then release one tab (callout 2).

Figure 1-3184 Remove one screw and release one tab



- d. Pull the front cover (callout 1) slightly away from the finisher, disconnect one connector (callout 2), and then remove the front cover.

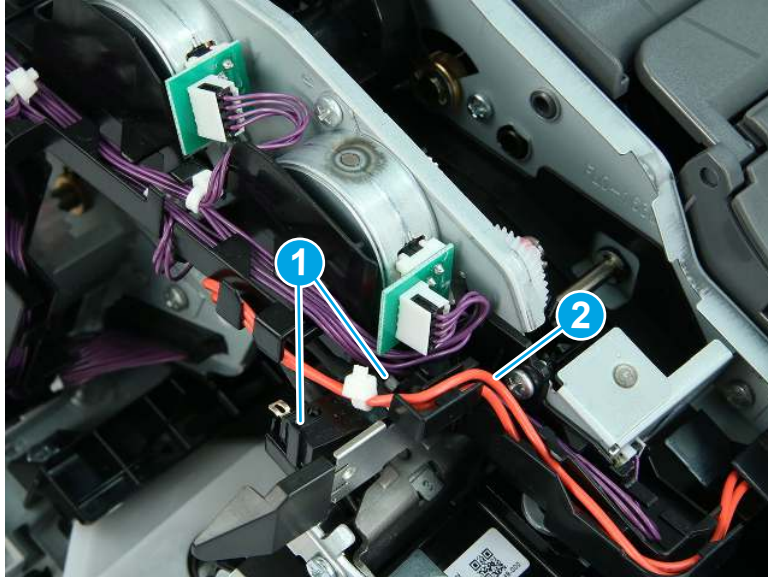
Figure 1-3185 Remove the front cover



2. Remove the inner finisher paddle drive assembly (M776zs).

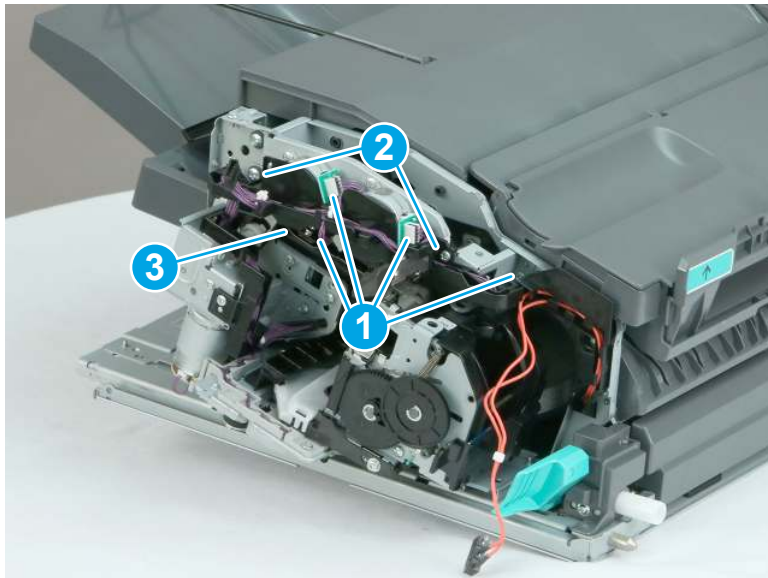
- a. Release two tabs (callout 1) to release the interlock switch, and then remove the cable (callout 2) from the guide.

Figure 1-3186 Release the interlock switch



- b. Disconnect four connectors (callout 1), remove two screws (callout 2), and then release the cables from the guide (callout 3).

Figure 1-3187 Disconnect four connectors and remove two screws



- c. Release one tab (callout 1), and then remove the guide (callout 2).

Figure 1-3188 Remove the guide



- d. Remove one e-ring and bushing (callout 1), remove one screw (callout 2), then remove two screws (callout 3).


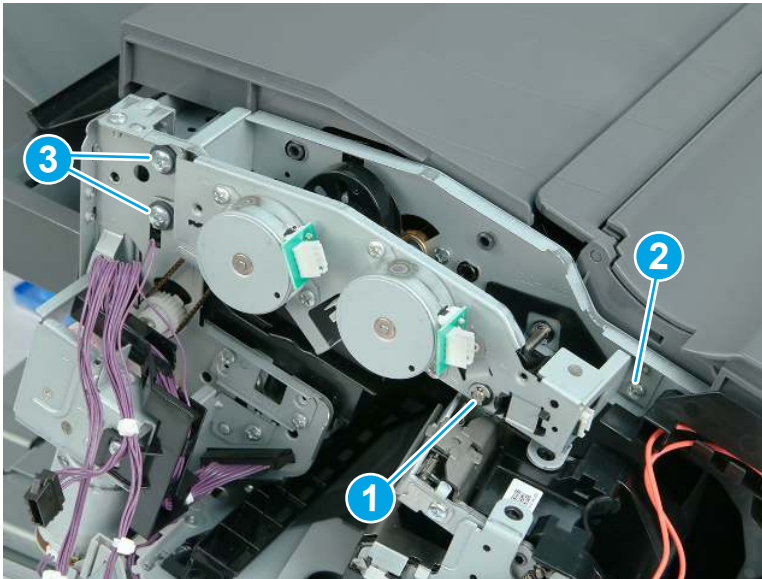
 **TIP:** One screw (callout 2) is smaller than the other two screws. Make sure this screw is installed in the correct position.

Figure 1-3189 Remove one e-ring and bushing and two screws



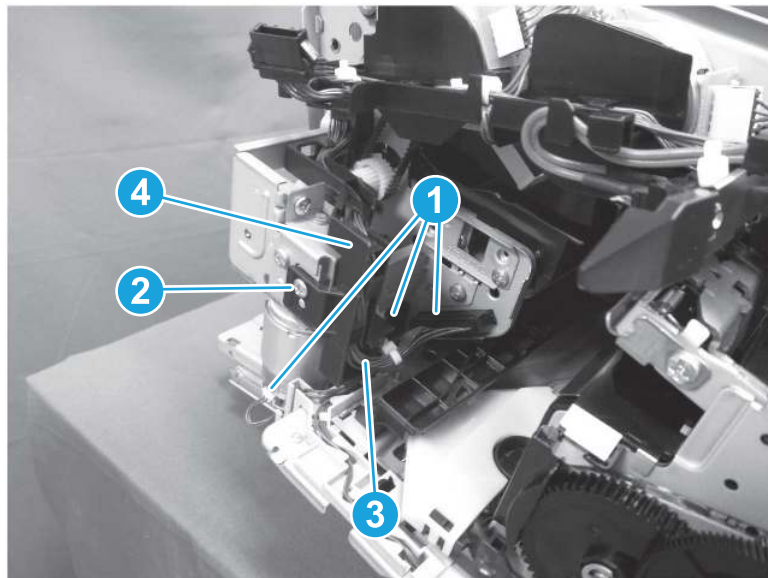
- e. Lift the paddle drive assembly slightly away from the finisher, and then release one belt from the gear (callout 1). Remove the paddle drive assembly.

Figure 1-3190 Release the belt and remove the paddle drive assembly



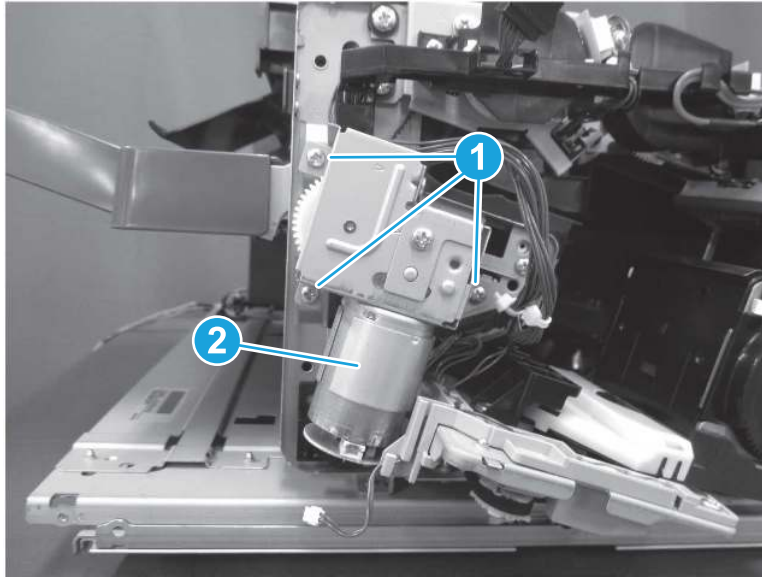
- 3. Remove the inner finisher tray lifting motor (M776zs).
 - a. Disconnect three connectors (callout 1), and then remove one screw (callout 2). Release the cable (callout 3) from the guide (callout 4), and then remove the guide (callout 4).

Figure 1-3191 Disconnect three connectors and remove one screw



- b. Remove three screws (callout 1), and then remove the tray lifting motor (callout 2).

Figure 1-3192 Remove three screws and the tray lifting motor



4. Unpack the replacement assembly.

- a. Dispose of the defective part.



NOTE: HP recommends responsible disposal of the defective part.

<http://www8.hp.com/us/en/hp-information/environment/product-recycling.html>

- b. Unpack the replacement part from the packaging.



IMPORTANT: Make sure that all of the shipping materials (for example shipping tape) are removed from the replacement part prior to installation.

- c. To install an assembly, reverse the removal steps.



NOTE: When applicable, special installation instructions are provided for an assembly at the end of the removal procedure. Always completely read the removal instructions and follow all special installation instructions.

Removal and replacement: Inner finisher trailing edge dropping solenoid (M776zs)

Learn how to remove and replace the inner finisher trailing edge dropping solenoid.

Mean time to repair: 10 minutes

Service level: Easy

Before performing service

Turn the printer power off

- Disconnect the power cable.

⚠ WARNING! To avoid damage to the printer, turn the printer off, wait 30 seconds, and then remove the power cord before attempting to service the printer.

- Remove the inner finisher from the printer.

Use the table below to identify the correct part number for your printer. To order the part, go to www.hp.com/buy/parts.

Table 1-153 Part information

Part number	Part description
FM1-F201-000CN	Estrangement solenoid assembly

Required tools

- #2 Phillips screwdriver with a magnetic tip

After performing service

Turn the printer power on

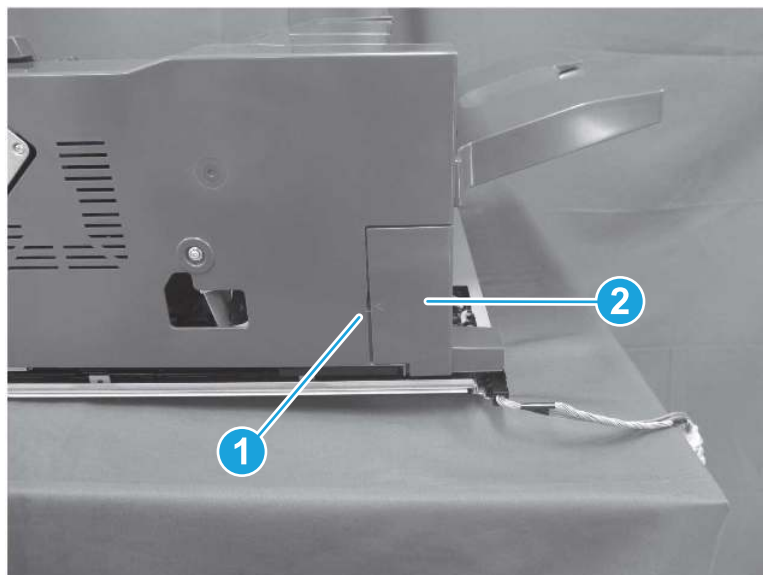
- Reinstall the inner finisher
- Connect the power cable.
- Use the power switch to turn the power on.

Post service test

Send a print job to the inner finisher and verify it is functioning correctly.

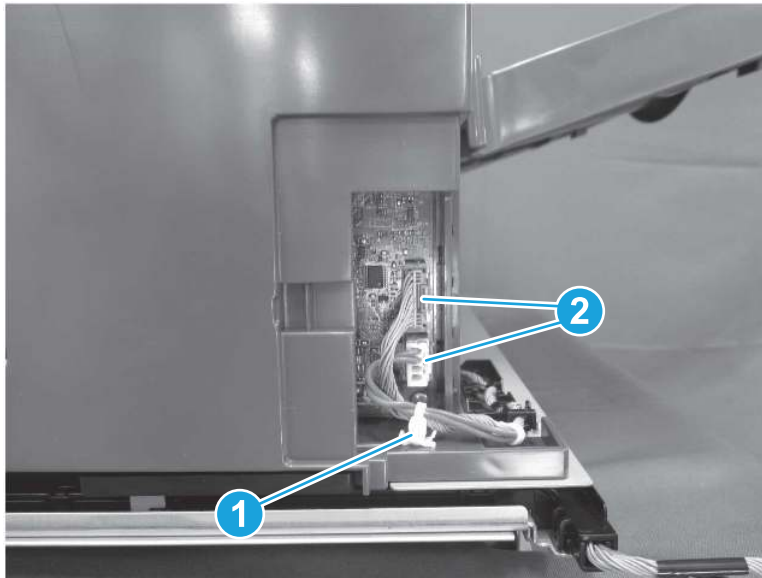
1. Remove the inner finisher connector cover (M776zs).
 - ▲ Release one tab (callout 1), and then remove the connector cover (callout 2).

Figure 1-3193 Remove the connector cover



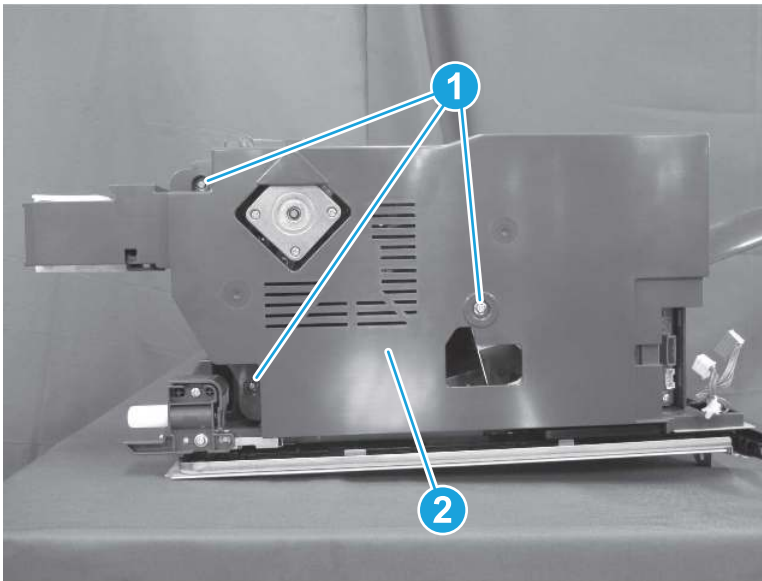
2. Remove the inner finisher rear cover (M776zs).
 - a. Release one retainer (callout 1), and then disconnect two connectors (callout 2).

Figure 1-3194 Disconnect two connectors



- b. Remove three screws (callout 1), and then remove the rear cover (callout 2).

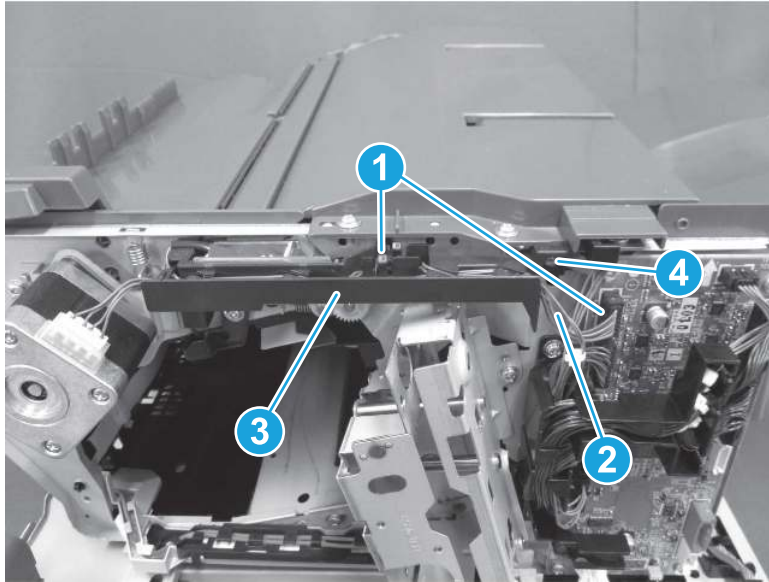
Figure 1-3195 Remove the rear cover



3. Remove the inner finisher trailing edge dropping solenoid (M776zs).

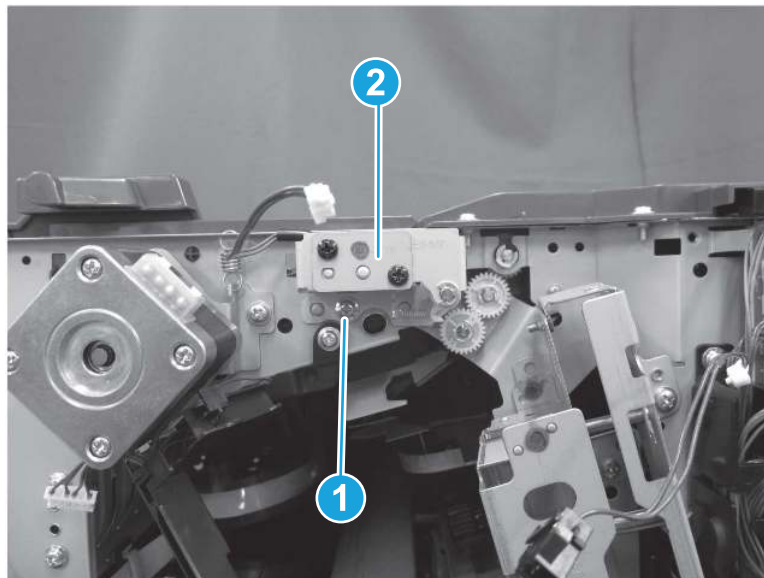
- a. Disconnect two connectors (callout 1), and then release the cable (callout 2) from the guide (callout 3). Remove one screw (callout 4), and then remove the cable guide (callout 3).

Figure 1-3196 Disconnect two connectors and remove the cable guide



- b. Remove one screw (callout 1), and then remove the trailing edge dropping solenoid (callout 2).

Figure 1-3197 Remove the trailing edge dropping solenoid



4. Unpack the replacement assembly.


- a. Dispose of the defective part.




NOTE: HP recommends responsible disposal of the defective part.

<http://www8.hp.com/us/en/hp-information/environment/product-recycling.html>

- b. Unpack the replacement part from the packaging.

 **IMPORTANT:** Make sure that all of the shipping materials (for example shipping tape) are removed from the replacement part prior to installation.

- c. To install an assembly, reverse the removal steps.

 **NOTE:** When applicable, special installation instructions are provided for an assembly at the end of the removal procedure. Always completely read the removal instructions and follow all special installation instructions.

Removal and replacement: Inner finisher cable duct assembly (M776zs)

Learn how to remove and replace the inner finisher cable duct assembly.


Mean time to repair: 15 minutes

Service level: Medium

Before performing service

Turn the printer power off

- Disconnect the power cable.

 **WARNING!** To avoid damage to the printer, turn the printer off, wait 30 seconds, and then remove the power cord before attempting to service the printer.

- Remove the inner finisher from the printer.

Use the table below to identify the correct part number for your printer. To order the part, go to www.hp.com/buy/parts.

Table 1-154 Part information

Part number	Part description
RM2-2444-000CN	Cable duct assembly

Required tools

- #2 Phillips screwdriver with a magnetic tip

After performing service

Turn the printer power on

- Reinstall the inner finisher
- Connect the power cable.
- Use the power switch to turn the power on.

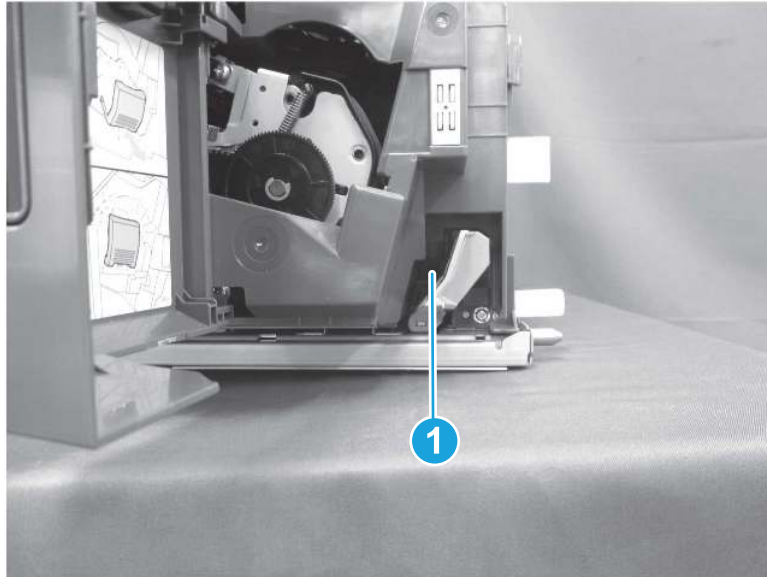
Post service test

Send a print job to the inner finisher and verify it is functioning correctly.

1. Remove the inner finisher front cover (M776zs).

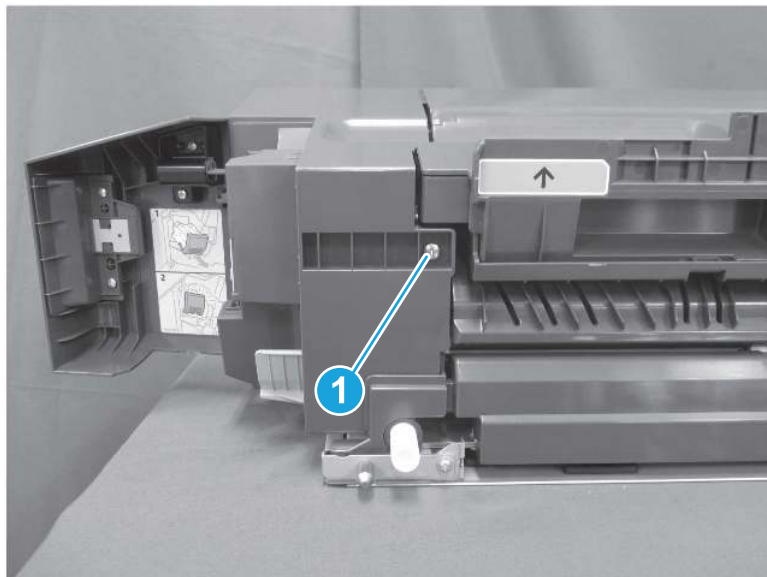
- a. Open the inner finisher front door, and then remove one screw (callout 1).

Figure 1-3198 Remove one screw



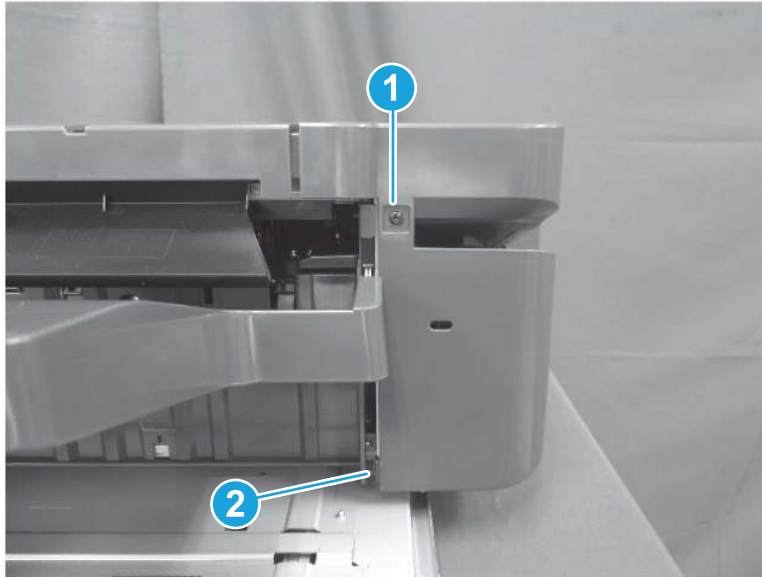
- b. Remove one screw (callout 1).

Figure 1-3199 Remove one screw



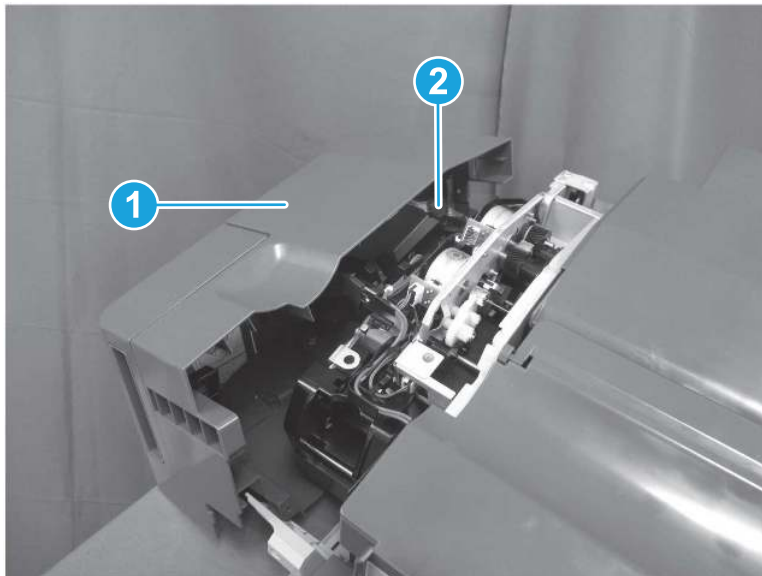
- c. Remove one screw (callout 1), and then release one tab (callout 2).

Figure 1-3200 Remove one screw and release one tab



- d. Pull the front cover (callout 1) slightly away from the finisher, disconnect one connector (callout 2), and then remove the front cover.

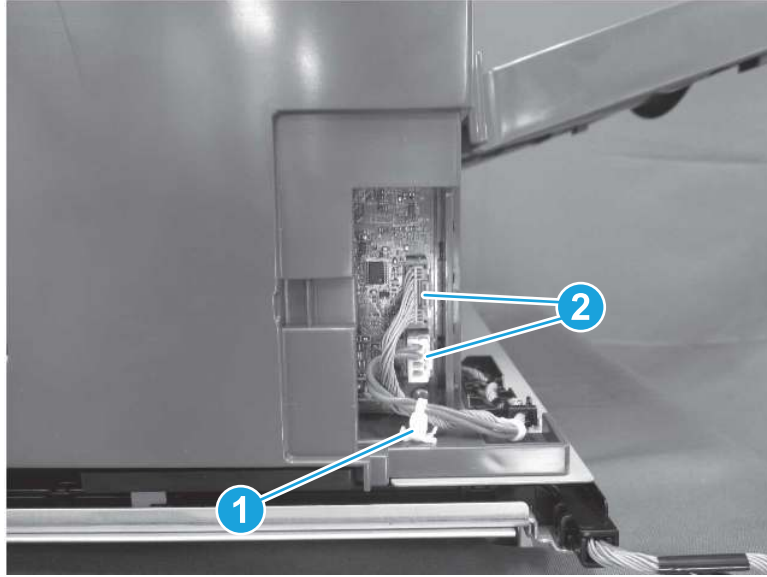
Figure 1-3201 Remove the front cover



- 2. Remove the inner finisher cable duct assembly (M776zs).

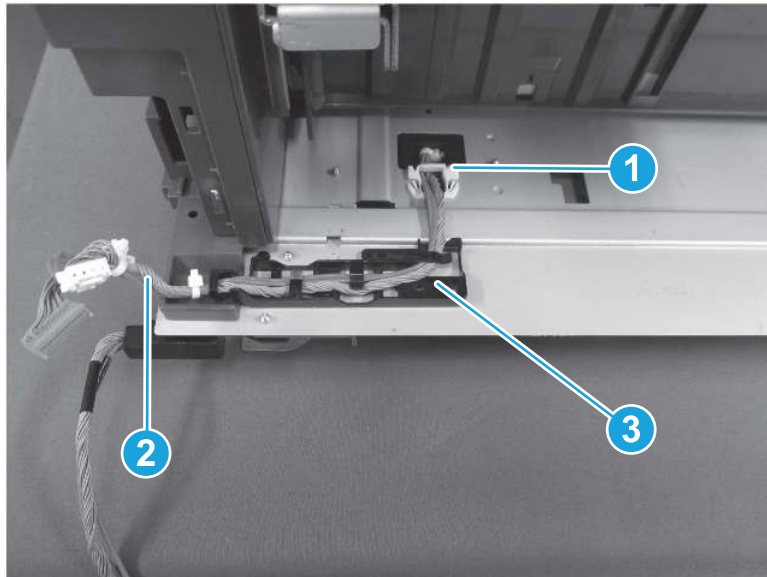
- a. Release one retainer (callout 1), and then disconnect two connectors (callout 2).

Figure 1-3202 Disconnect two connectors



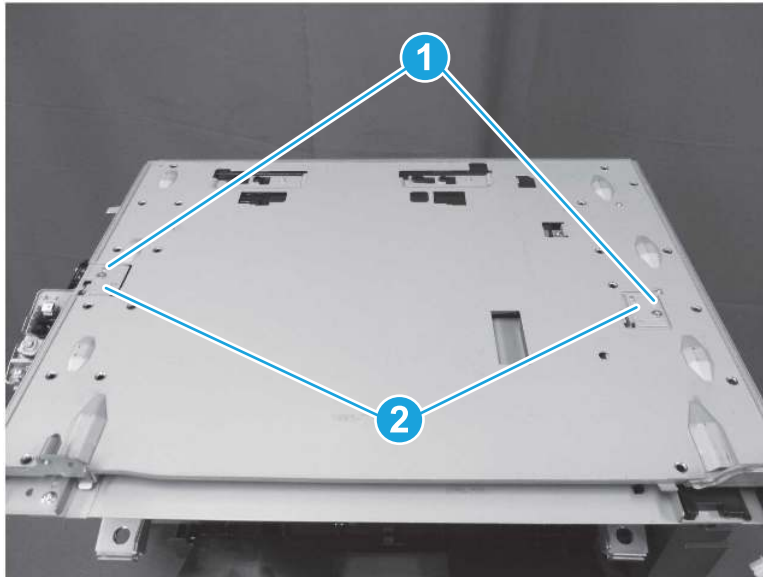
- b. Open one retainer (callout 1), and then release the cables (callout 2) from the cable guides (callout 3).

Figure 1-3203 Release the cables



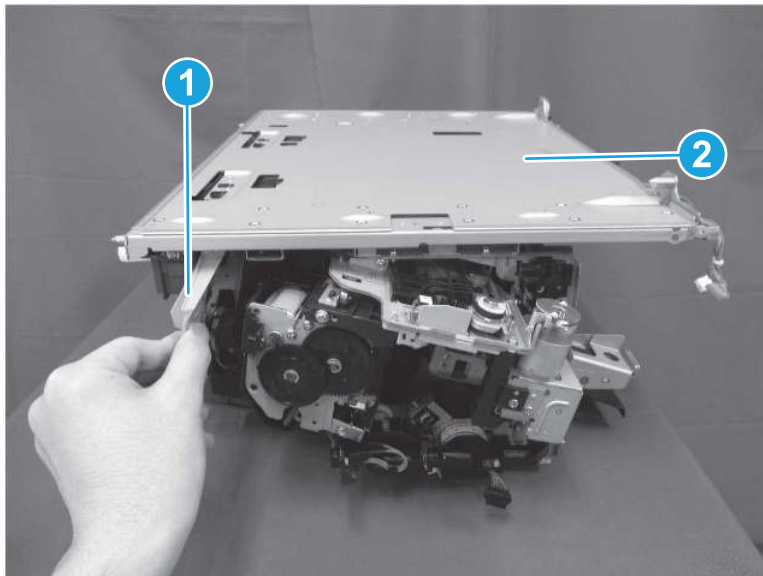
- c. Place the finisher face-down. Remove two screws (callout 1), and then remove two stoppers (callout 2).

Figure 1-3204 Remove two screws and stoppers



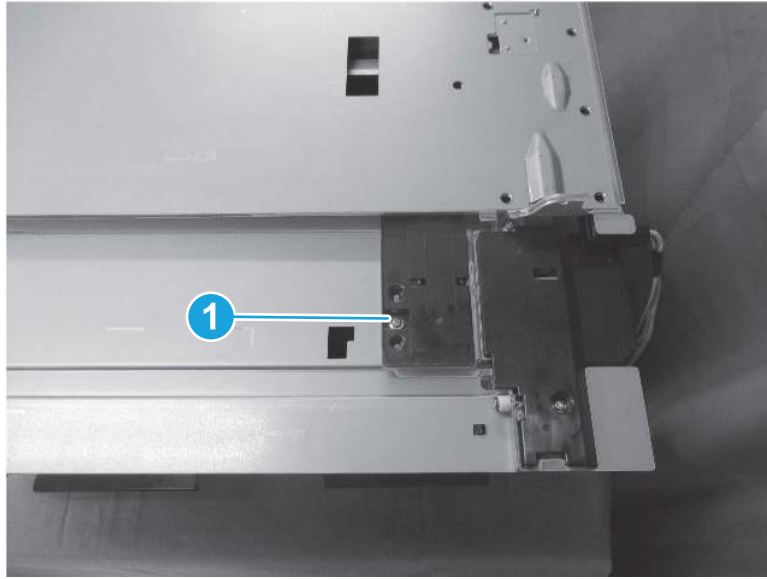
- d. Tilt the release lever (callout 1), and then slide the bottom slide assembly (callout 2) to the right.

Figure 1-3205 Release the latch and slide the assembly



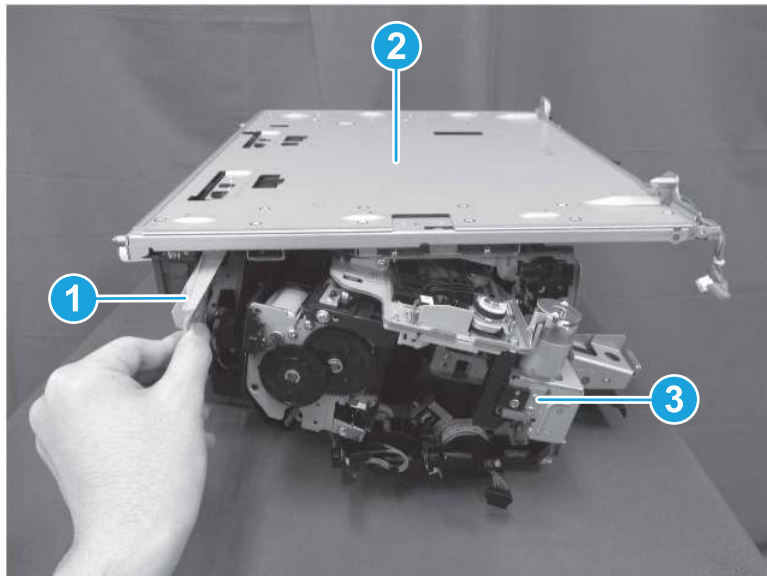
- e. Remove one screw (callout 1).

Figure 1-3206 Remove one screw



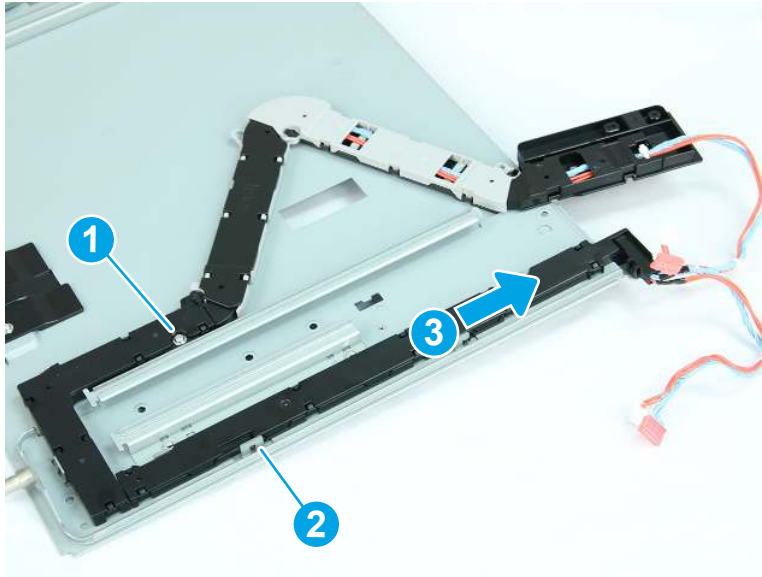
- f. Tilt the release lever (callout 1), and then slide the bottom slide assembly (callout 2) to remove it from the inner finisher (callout 3).

Figure 1-3207 Remove the bottom slide assembly



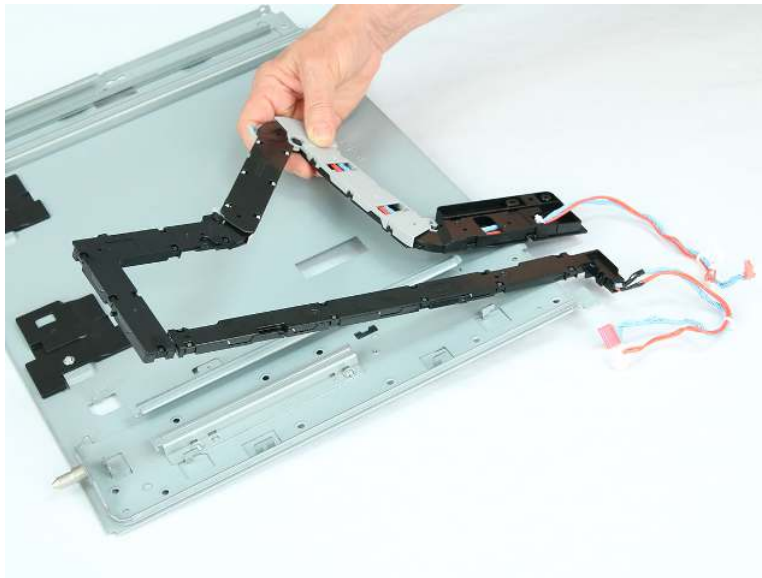
- g. Remove one screw (callout 1), release one tab (callout 2), and then slide the cable assembly to the right to release it.

Figure 1-3208 Remove one screw and release one tab



- h. Remove the cable duct assembly.

Figure 1-3209 Remove the cable duct assembly



Removal and replacement: Inner finisher front push assembly (M776zs)

Learn how to remove and replace the inner finisher front push assembly.

Mean time to repair: 5 minutes

Service level: Easy

Before performing service

Turn the printer power off

- Disconnect the power cable.

⚠ WARNING! To avoid damage to the printer, turn the printer off, wait 30 seconds, and then remove the power cord before attempting to service the printer.

- Remove the inner finisher from the printer.

Use the table below to identify the correct part number for your printer. To order the part, go to www.hp.com/buy/parts.

Table 1-155 Part information

Part number	Part description
RM2-2460-000CN	Push assembly, front

Required tools

- #2 Phillips screwdriver with a magnetic tip

After performing service

Turn the printer power on

- Reinstall the inner finisher
- Connect the power cable.
- Use the power switch to turn the power on.

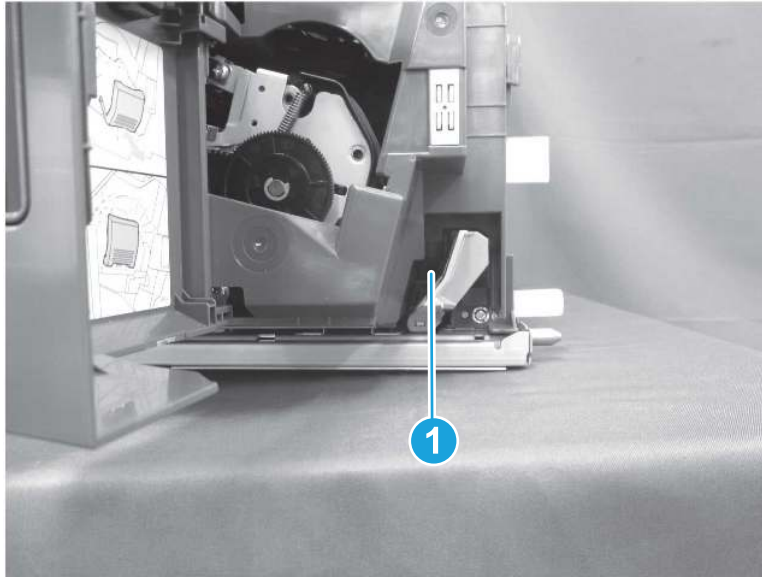
Post service test

Send a print job to the inner finisher and verify it is functioning correctly.

1. Remove the inner finisher front cover (M776zs).

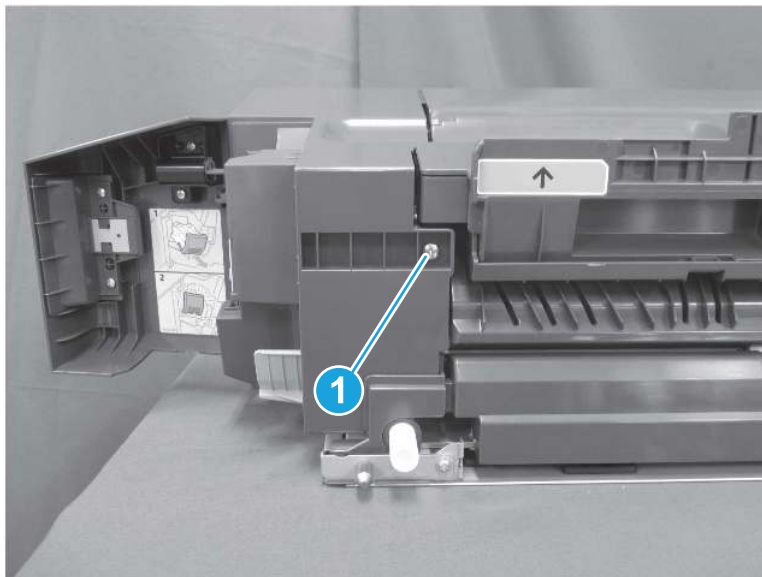
- a. Open the inner finisher front door, and then remove one screw (callout 1).

Figure 1-3210 Remove one screw



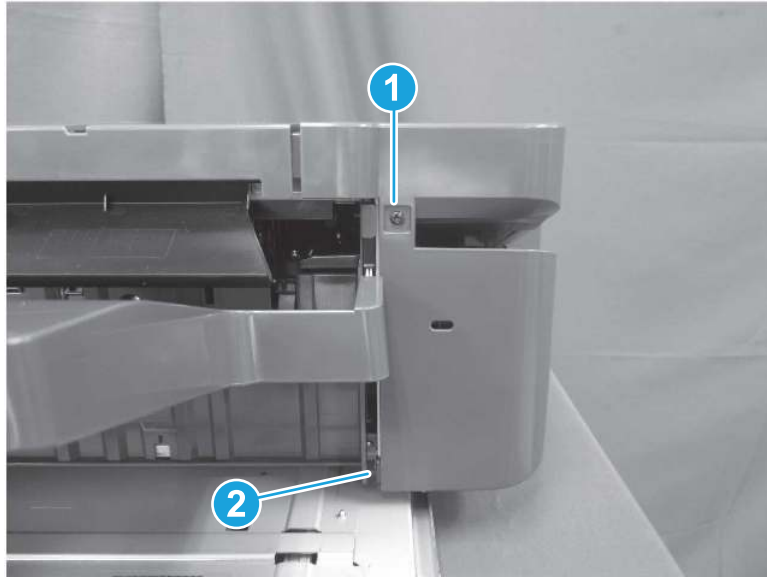
- b. Remove one screw (callout 1).

Figure 1-3211 Remove one screw



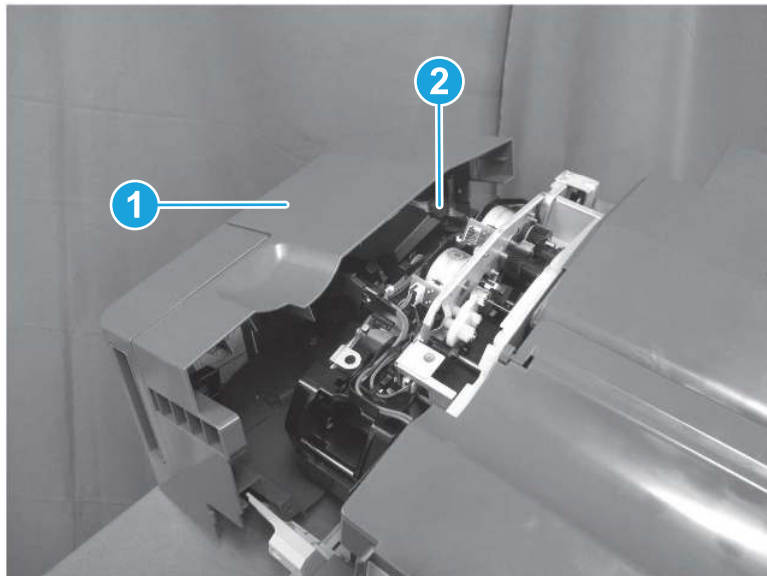
- c. Remove one screw (callout 1), and then release one tab (callout 2).

Figure 1-3212 Remove one screw and release one tab



- d. Pull the front cover (callout 1) slightly away from the finisher, disconnect one connector (callout 2), and then remove the front cover.

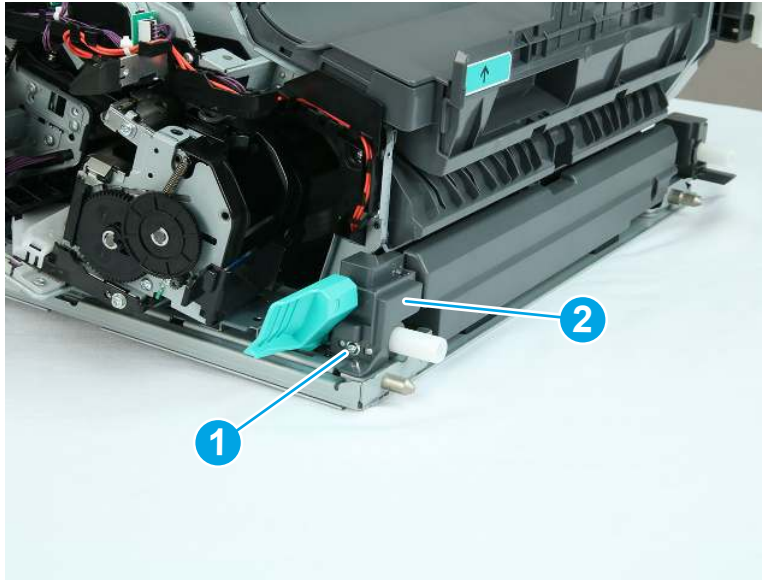
Figure 1-3213 Remove the front cover



2. Remove the inner finisher front push assembly (M776zs).

- ▲ Remove one screw (callout 1), and then remove the front push assembly (callout 2).

Figure 1-3214 Remove the front push assembly



3. Unpack the replacement assembly.
 - a. Dispose of the defective part.



NOTE: HP recommends responsible disposal of the defective part.

<http://www8.hp.com/us/en/hp-information/environment/product-recycling.html>

- b. Unpack the replacement part from the packaging.



IMPORTANT: Make sure that all of the shipping materials (for example shipping tape) are removed from the replacement part prior to installation.

- c. To install an assembly, reverse the removal steps.



NOTE: When applicable, special installation instructions are provided for an assembly at the end of the removal procedure. Always completely read the removal instructions and follow all special installation instructions.

Removal and replacement: Inner finisher release handle (M776zs)

Learn how to remove and replace the inner finisher release handle.

Mean time to repair: 10 minutes

Service level: Easy

Before performing service

Turn the printer power off

- Disconnect the power cable.

⚠ WARNING! To avoid damage to the printer, turn the printer off, wait 30 seconds, and then remove the power cord before attempting to service the printer.

- Remove the inner finisher from the printer.

Use the table below to identify the correct part number for your printer. To order the part, go to www.hp.com/buy/parts.

Table 1-156 Part information

Part number	Part description
RC5-4839-000CN	Handle, release

Required tools

- #2 Phillips screwdriver with a magnetic tip

After performing service

Turn the printer power on

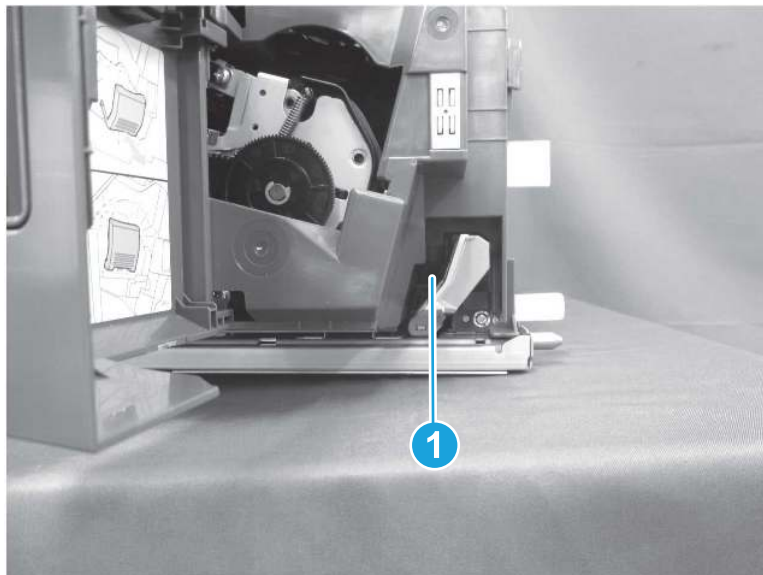
- Reinstall the inner finisher
- Connect the power cable.
- Use the power switch to turn the power on.

Post service test

Send a print job to the inner finisher and verify it is functioning correctly.

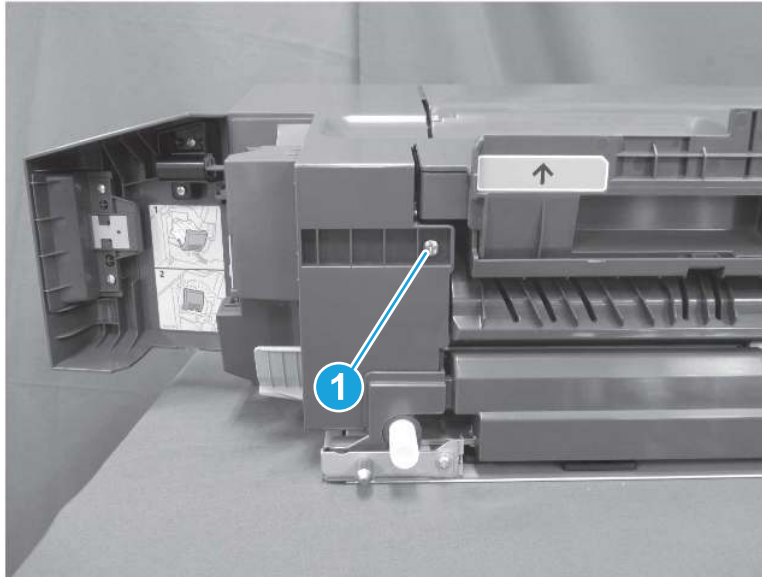
1. Remove the inner finisher front cover (M776zs).
 - a. Open the inner finisher front door, and then remove one screw (callout 1).

Figure 1-3215 Remove one screw



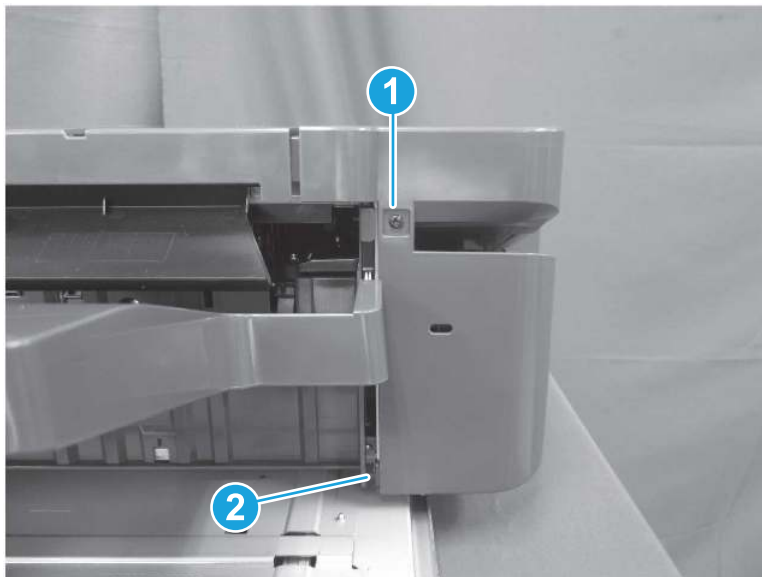
- b. Remove one screw (callout 1).

Figure 1-3216 Remove one screw



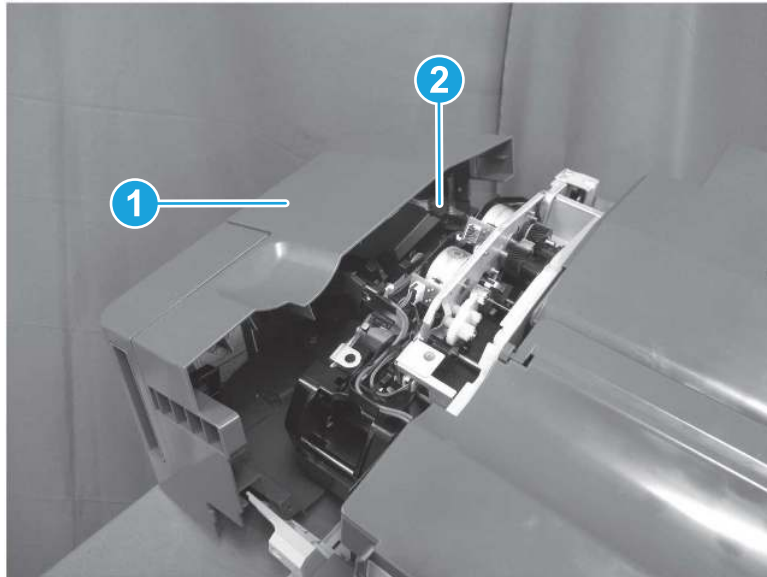
- c. Remove one screw (callout 1), and then release one tab (callout 2).

Figure 1-3217 Remove one screw and release one tab



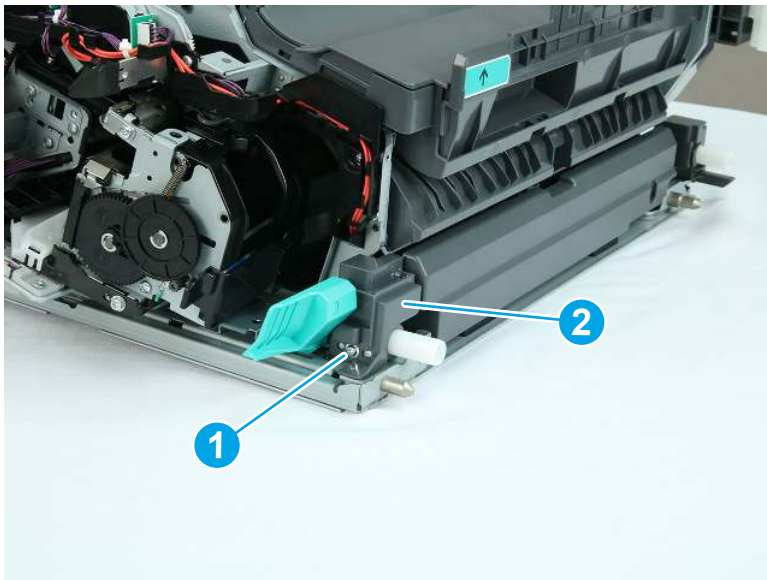
- d. Pull the front cover (callout 1) slightly away from the finisher, disconnect one connector (callout 2), and then remove the front cover.

Figure 1-3218 Remove the front cover



2. Remove the inner finisher front push assembly (M776zs).
 - ▲ Remove one screw (callout 1), and then remove the front push assembly (callout 2).

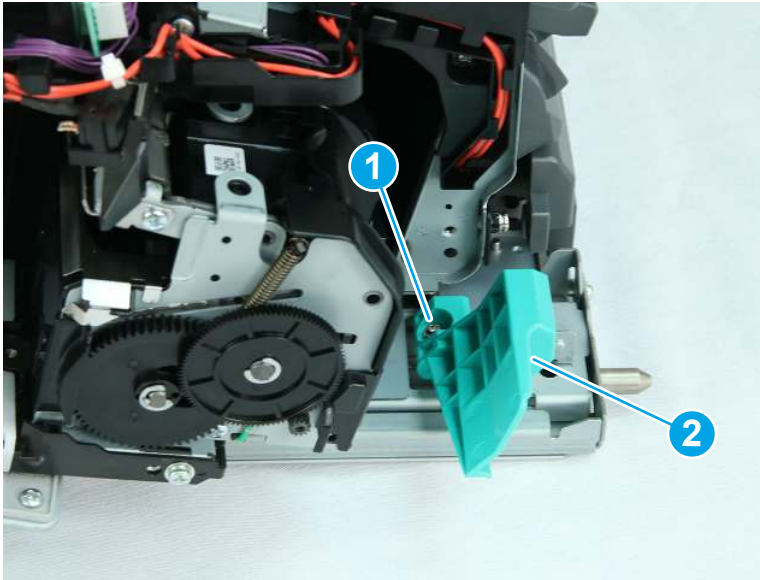
Figure 1-3219 Remove the front push assembly



3. Remove the inner finisher release handle (M776zs).

- ▲ Remove one screw (callout 1), and then remove the release handle (callout 2).

Figure 1-3220 Remove the release handle



4. Unpack the replacement assembly.
 - a. Dispose of the defective part.



NOTE: HP recommends responsible disposal of the defective part.

<http://www8.hp.com/us/en/hp-information/environment/product-recycling.html>

- b. Unpack the replacement part from the packaging.



IMPORTANT: Make sure that all of the shipping materials (for example shipping tape) are removed from the replacement part prior to installation.

- c. To install an assembly, reverse the removal steps.



NOTE: When applicable, special installation instructions are provided for an assembly at the end of the removal procedure. Always completely read the removal instructions and follow all special installation instructions.

Removal and replacement: Inner finisher rear push assembly (M776zs)

Learn how to remove and replace the inner finisher rear push assembly.

Mean time to repair: 2 minutes

Service level: Easy

Before performing service

Turn the printer power off

- Disconnect the power cable.

⚠ WARNING! To avoid damage to the printer, turn the printer off, wait 30 seconds, and then remove the power cord before attempting to service the printer.

- Remove the inner finisher from the printer.

Use the table below to identify the correct part number for your printer. To order the part, go to www.hp.com/buy/parts.

Table 1-157 Part information

Part number	Part description
RM2-2526-000CN	Push assembly, rear

Required tools

- #2 Phillips screwdriver with a magnetic tip

After performing service

Turn the printer power on

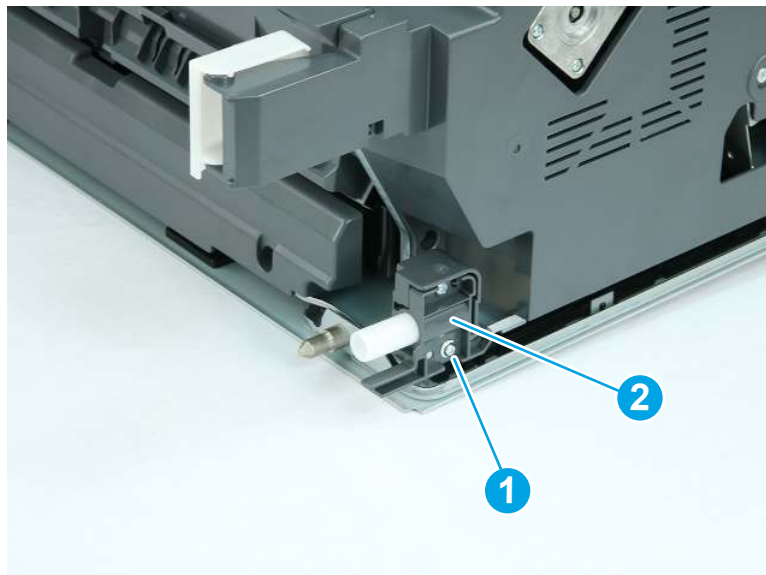
- Reinstall the inner finisher
- Connect the power cable.
- Use the power switch to turn the power on.

Post service test

Send a print job to the inner finisher and verify it is functioning correctly.

1. Remove the inner finisher rear push assembly (M776zs).
 - ▲ Remove one screw (callout 1), and then remove the rear push assembly (callout 2).

Figure 1-3221 Remove the rear push assembly



2. Unpack the replacement assembly.
 - a. Dispose of the defective part.



NOTE: HP recommends responsible disposal of the defective part.

<http://www8.hp.com/us/en/hp-information/environment/product-recycling.html>

- b. Unpack the replacement part from the packaging.



IMPORTANT: Make sure that all of the shipping materials (for example shipping tape) are removed from the replacement part prior to installation.

- c. To install an assembly, reverse the removal steps.



NOTE: When applicable, special installation instructions are provided for an assembly at the end of the removal procedure. Always completely read the removal instructions and follow all special installation instructions.

Removal and replacement: Inner finisher wire sub-tray (M776zs)

Learn how to remove and replace the inner finisher wire sub-tray.

Mean time to repair: 2 minutes

Service level: Easy

Before performing service

Turn the printer power off

- Disconnect the power cable.



WARNING! To avoid damage to the printer, turn the printer off, wait 30 seconds, and then remove the power cord before attempting to service the printer.

- Remove the inner finisher from the printer.

Use the table below to identify the correct part number for your printer. To order the part, go to www.hp.com/buy/parts.

Table 1-158 Part information

Part number	Part description
RC5-4905-000CN	Tray, wire sub

Required tools

- No special tools are required to remove or install this assembly.

After performing service

Turn the printer power on

- Reinstall the inner finisher
- Connect the power cable.

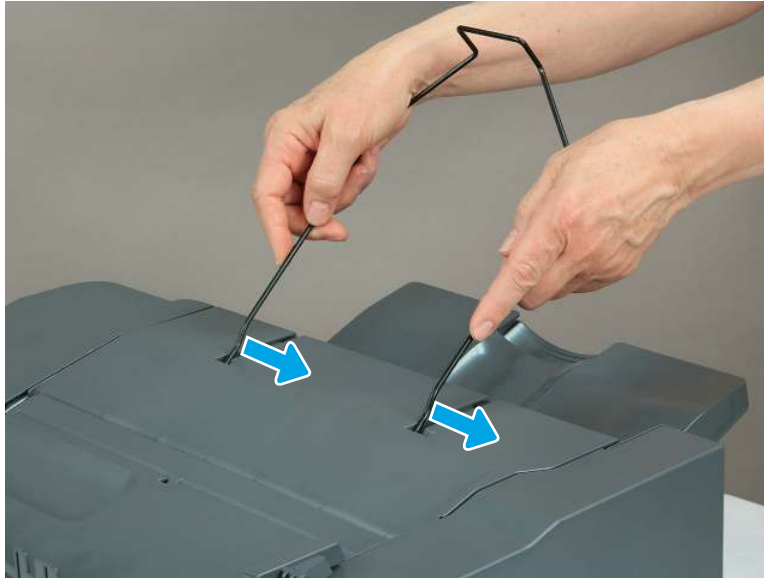
- Use the power switch to turn the power on.

Post service test

No post service test is available for this assembly.

1. Remove the inner finisher wire sub-tray (M776zs).
 - ▲ Slide the wire sub-tray to the left to release it, and then remove it from the inner finisher.

Figure 1-3222 Remove the wire sub-tray



2. Unpack the replacement assembly.
 - a. Dispose of the defective part.
 - b. Unpack the replacement part from the packaging.
 - c. To install an assembly, reverse the removal steps.



NOTE: HP recommends responsible disposal of the defective part.

<http://www8.hp.com/us/en/hp-information/environment/product-recycling.html>



IMPORTANT: Make sure that all of the shipping materials (for example shipping tape) are removed from the replacement part prior to installation.



NOTE: When applicable, special installation instructions are provided for an assembly at the end of the removal procedure. Always completely read the removal instructions and follow all special installation instructions.

Removal and replacement: 550-sheet paper tray components

Learn how to remove and replace the component parts in the 550-sheet paper tray.

Removal and replacement: 550-sheet paper tray

Learn how to remove and replace the paper tray for the 550-sheet paper tray.

[View a video of how to remove and replace the 550-sheet paper tray.](#)

Mean time to repair: 2 minutes

Service level: CSR A

Before performing service

Turn the printer power off

- Disconnect the power cable.

⚠ WARNING! To avoid damage to the printer, turn the printer off, wait 30 seconds, and then remove the power cord before attempting to service the printer.

Use the table below to identify the correct part number for your printer. To order the part, go to www.hp.com/buy/parts.

Table 1-159 Part information

Part number	Part description
RM2-1706-000CN	Cassette assembly

Required tools

- No special tools are required to remove or install this assembly.

After performing service

Turn the printer power on

- Connect the power cable.
- Use the power switch to turn the power on.

Post service test

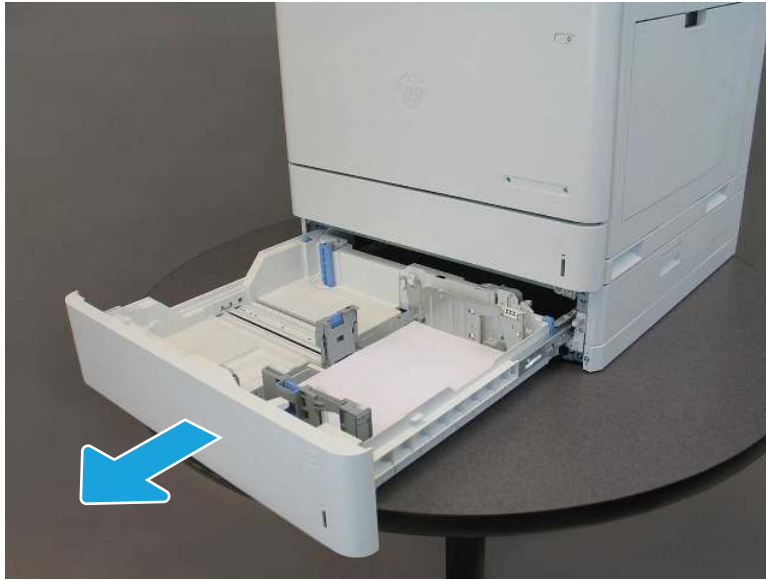
Make sure that the printer initializes to a **Ready** state.

Print a page from the 550-sheet tray to make sure that the printer is functioning correctly.

1. Remove the 550-sheet paper tray.

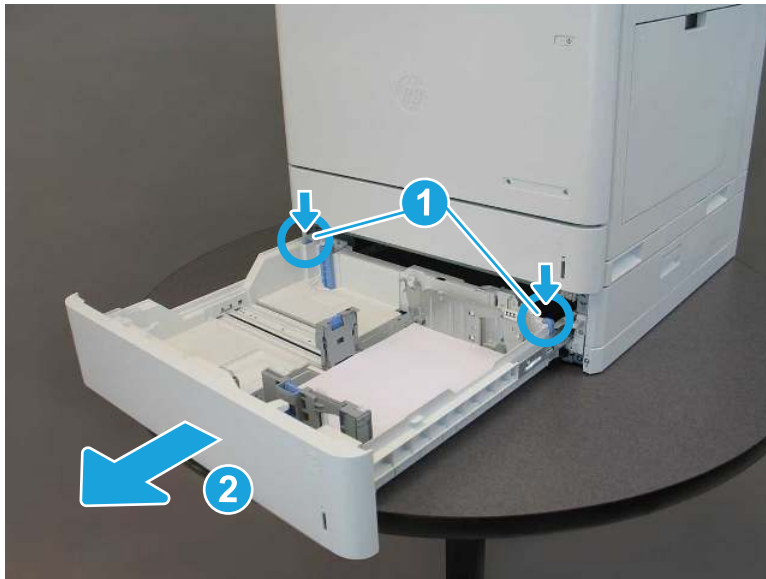
- a. Pull the tray away from the printer until it stops.

Figure 1-3223 Pull the tray out



- b. Push down to release two tabs (callout 1), and then remove the tray (callout 2).

Figure 1-3224 Remove the tray




2. Unpack the replacement assembly.
 - a. Dispose of the defective part.




NOTE: HP recommends responsible disposal of the defective part.

<http://www8.hp.com/us/en/hp-information/environment/product-recycling.html>

- b. Unpack the replacement part from the packaging.

 **IMPORTANT:** Make sure that all of the shipping materials (for example shipping tape) are removed from the replacement part prior to installation.

- c. To install an assembly, reverse the removal steps.

 **NOTE:** When applicable, special installation instructions are provided for an assembly at the end of the removal procedure. Always completely read the removal instructions and follow all special installation instructions.

Removal and replacement: 550-sheet paper tray pickup and separation rollers

Learn how to remove and replace the 550-sheet paper tray pickup and separation rollers.

[View a video of how to remove and replace the 550-sheet paper tray pickup and separation rollers.](#)


Mean time to repair: 2 minutes

Service level: CSR A

Before performing service

Turn the printer power off

- Disconnect the power cable.

 **WARNING!** To avoid damage to the printer, turn the printer off, wait 30 seconds, and then remove the power cord before attempting to service the printer.

Use the table below to identify the correct part number for your printer. To order the part, go to www.hp.com/buy/parts.

Table 1-160 Part information

Part number	Part description
RM2-1526-000CN	Tray 2-x pickup and separation rollers

Required tools

- No special tools are required to remove or install this assembly.

After performing service

Turn the printer power on

- Connect the power cable.
- Use the power switch to turn the power on.

Post service test

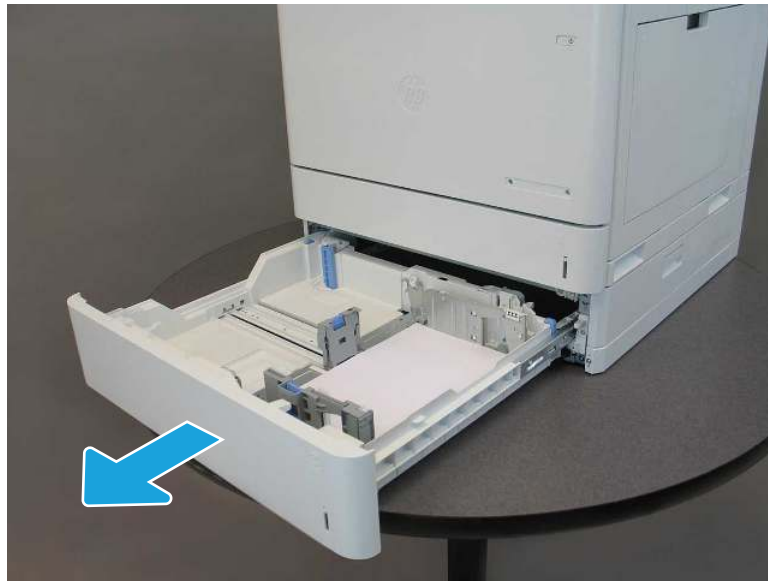
Make sure that the printer initializes to a **Ready** state.

Print a page from the 550-sheet tray to make sure that the printer is functioning correctly.

1. Remove the 550-sheet paper tray separation roller.

- a. Open the tray.

Figure 1-3225 Open the tray



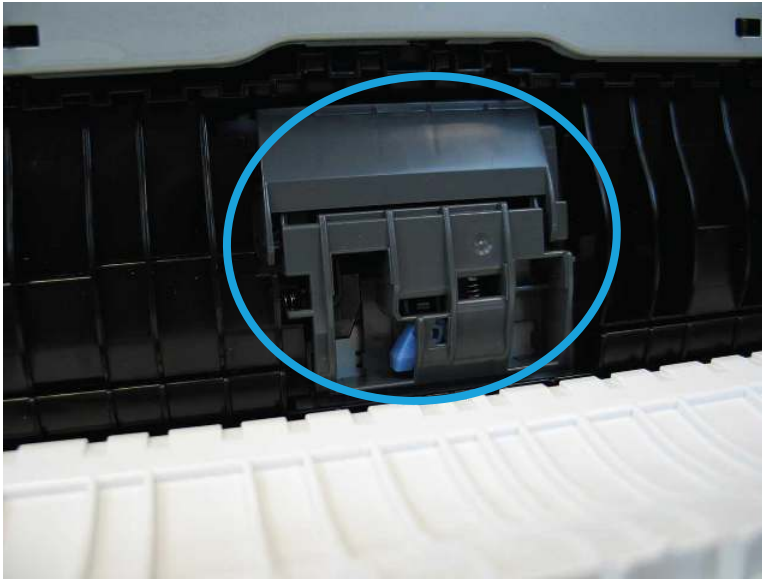
- b. Open the right door.

Figure 1-3226 Open the right door



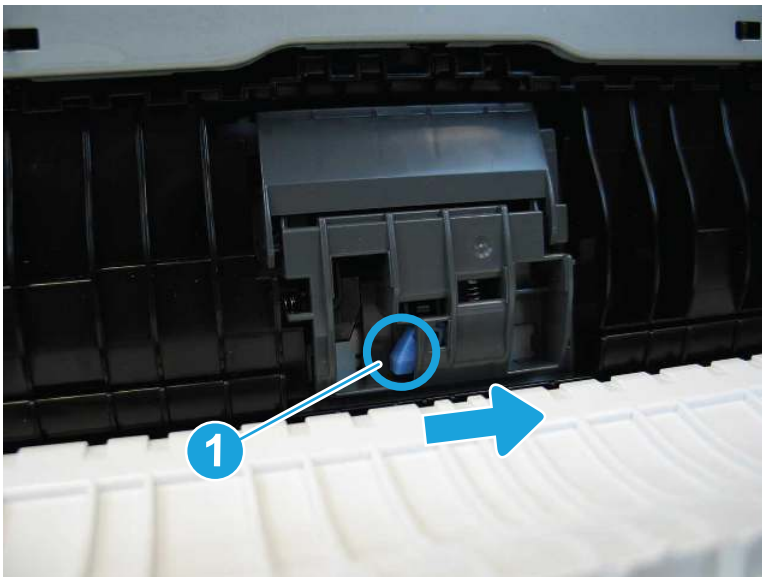
- c. Locate the separation roller

Figure 1-3227 Locate the separation roller



- d. Press the release button (callout 1), slide the separation roller assembly to the right, and then pull it away from the printer to remove it.

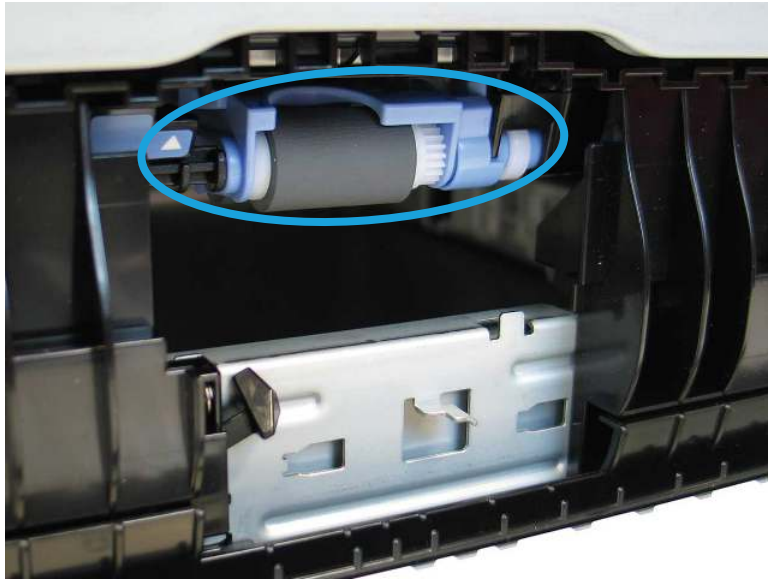
Figure 1-3228 Remove the separation roller



- 2. Remove the 550-sheet paper tray pickup roller.

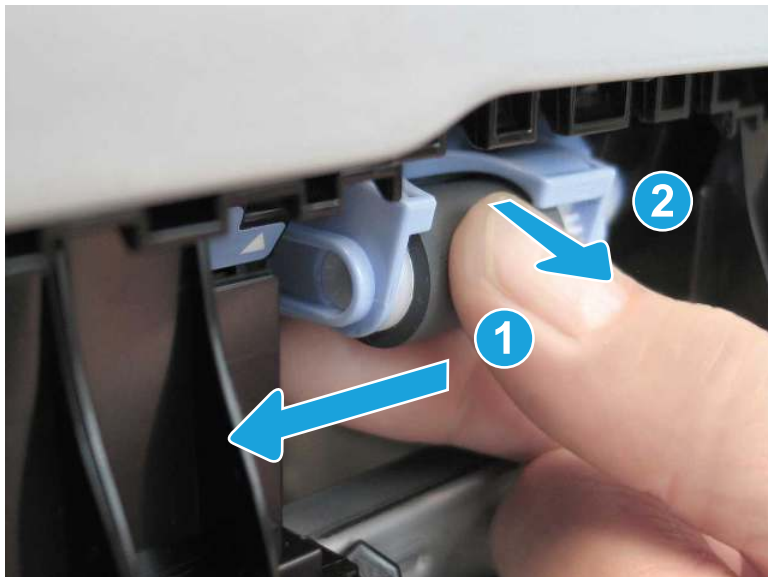
- a. Locate the pickup roller.

Figure 1-3229 Locate the pickup roller



- b. Slide the pickup roller assembly to the left (callout 1), and then pull it away from the printer (callout 2) to remove it.

Figure 1-3230 Release the pickup roller



3. Unpack the replacement assembly.


- a. Dispose of the defective part.




NOTE: HP recommends responsible disposal of the defective part.

<http://www8.hp.com/us/en/hp-information/environment/product-recycling.html>

- b. Unpack the replacement part from the packaging.

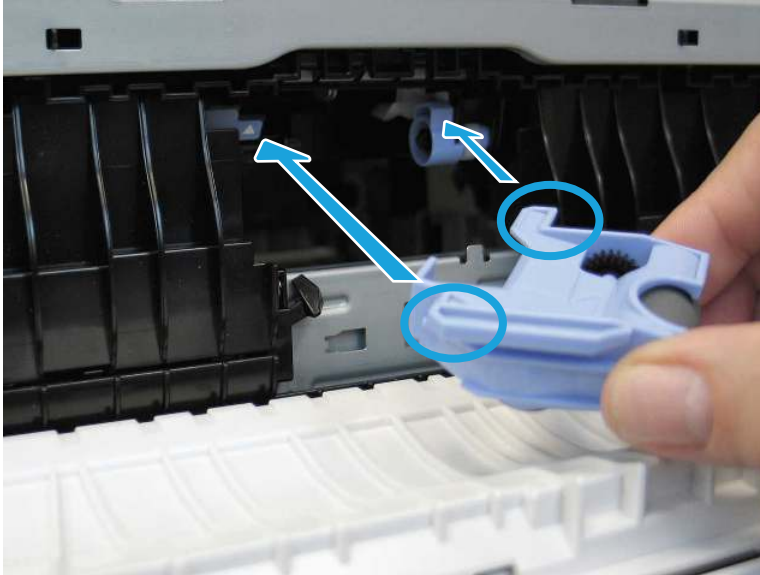
 **IMPORTANT:** Make sure that all of the shipping materials (for example shipping tape) are removed from the replacement part prior to installation.

4. Install the 550-sheet paper tray pickup roller.

 **NOTE:** Make sure that the tray is open before installing the roller.

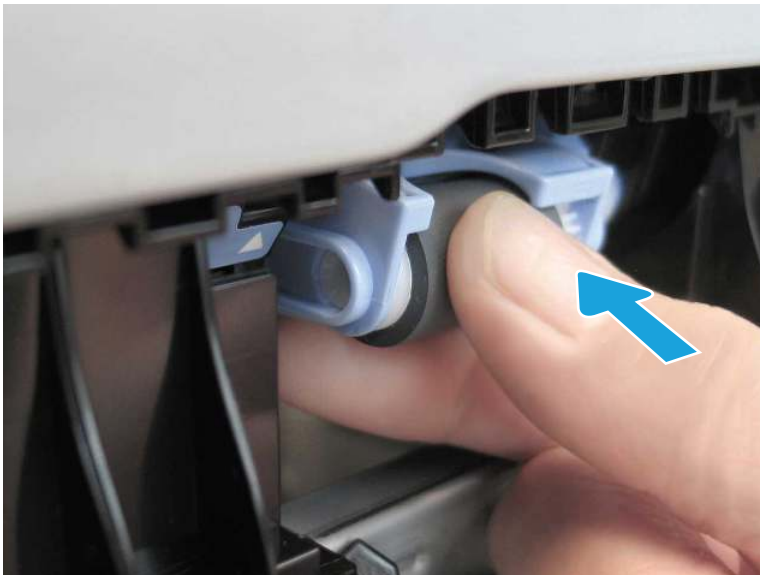
- a. Align the edges of the pickup roller assembly with the slots in the printer.

Figure 1-3231 Position the pickup roller




- b. Slide the roller assembly into the printer until it stops.

Figure 1-3232 Install the pickup roller



5. Install the 550-sheet paper tray separation roller.

 **NOTE:** Make sure that the tray is open before installing the roller.

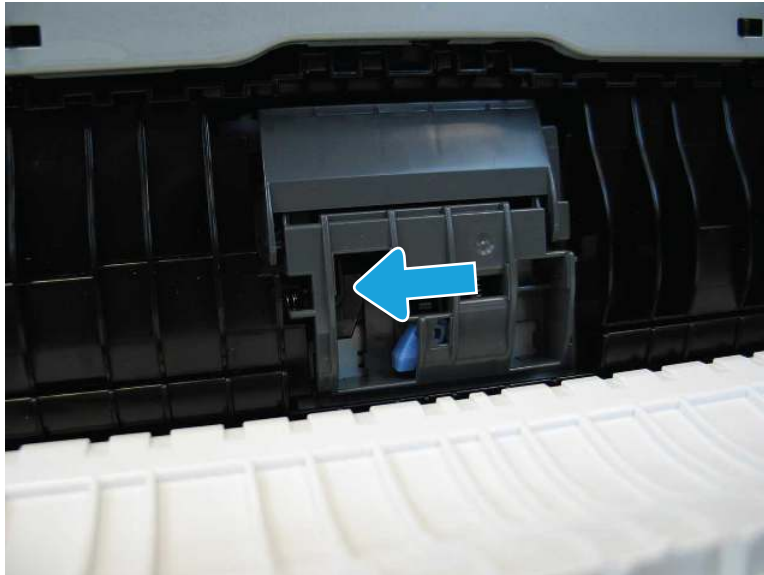
- a. Position the tabs on the roller assembly into the slots on the printer.

Figure 1-3233 Position the separation roller assembly



- b. Slide the roller assembly to the left until it snaps into place.

Figure 1-3234 Install the separation roller assembly



Removal and replacement: 550-sheet paper tray right door

Learn how to remove and replace the right door for the 550-sheet paper tray.

[View a video of how to remove and replace the 550-sheet paper tray right door.](#)

Mean time to repair: 8 minutes

Service level: Easy

Before performing service

Turn the printer power off

- Disconnect the power cable.

⚠ WARNING! To avoid damage to the printer, turn the printer off, wait 30 seconds, and then remove the power cord before attempting to service the printer.

Use the table below to identify the correct part number for your printer. To order the part, go to www.hp.com/buy/parts.

Table 1-161 Part information

Part number	Part description
RM2-1716-000CN	Right door assembly

Required tools

- #2 Phillips screwdriver with a magnetic tip

After performing service

Turn the printer power on

- Connect the power cable.
- Use the power switch to turn the power on.

Post service test

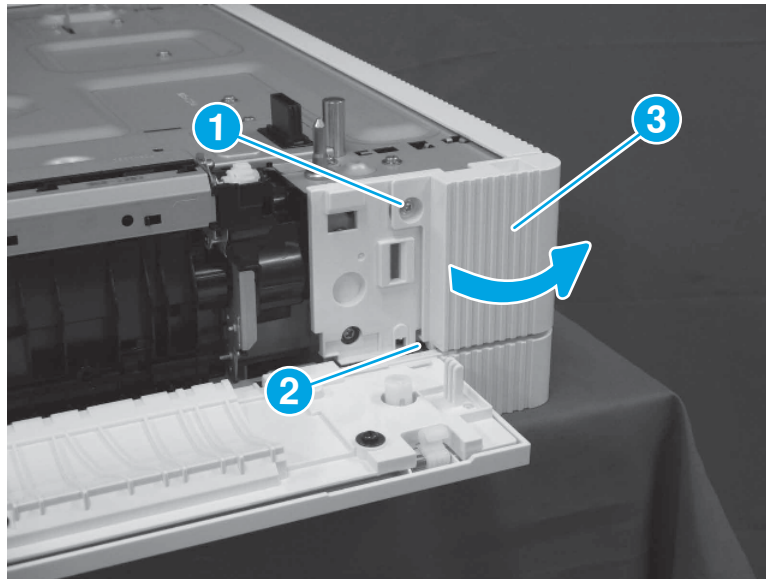
Make sure that the printer initializes to a **Ready** state.

Print a page from the 550-sheet tray to make sure that the printer is functioning correctly.

1. Remove the 550-sheet paper tray right rear cover.

- ▲ Open the right door. Remove one screw (callout 1), release one tab (callout 2), and then remove the right rear cover (callout 3).

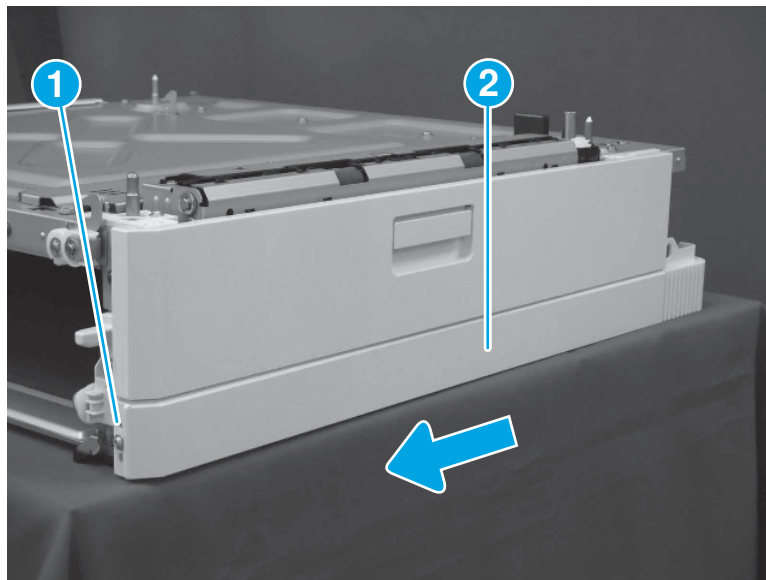
Figure 1-3235 Remove the right rear cover



2. Remove the 550-sheet paper tray right lower cover.

- ▲ Remove one screw (callout 1), and then slide the right lower cover (callout 2) toward the front of the feeder to remove it.

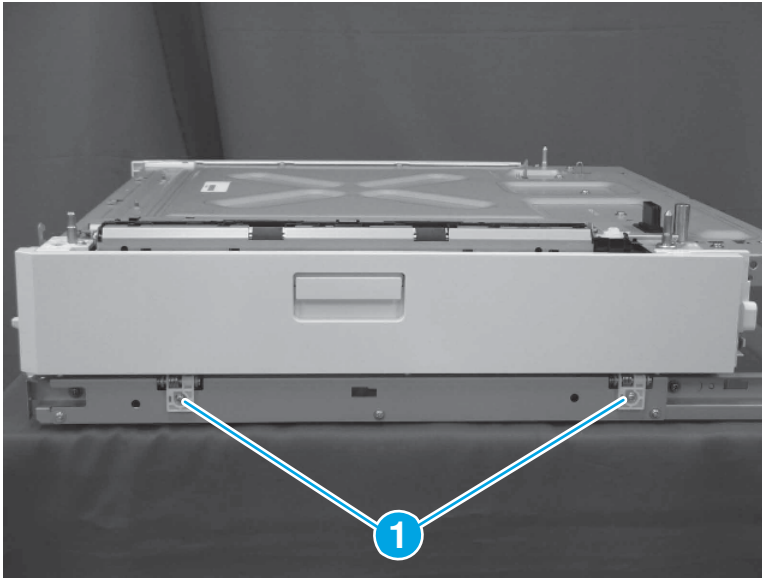
Figure 1-3236 Remove the right lower cover



3. Remove the 550-sheet paper tray right door.

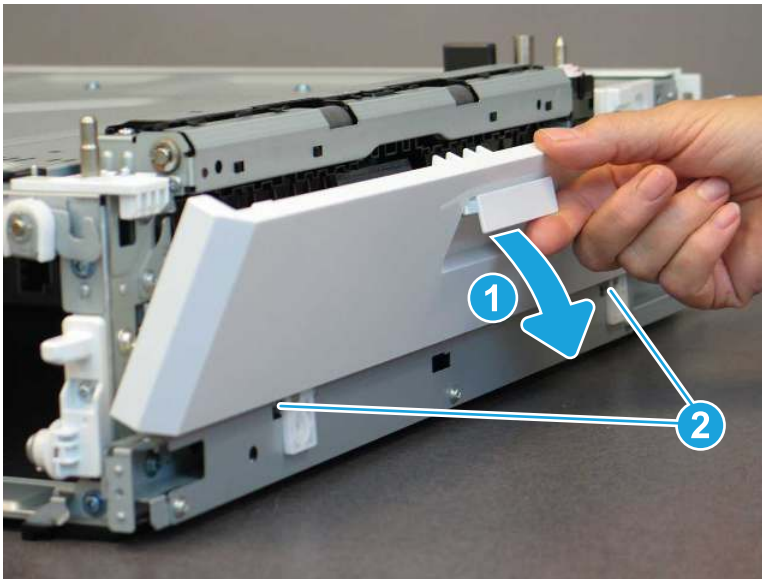
- a. Close the right door, and then remove two screws (callout 1).

Figure 1-3237 Remove two screws



- b. Open the right door (callout 1), and then release two bosses (callout 2) to remove the door.

Figure 1-3238 Remove the right door




4. Unpack the replacement assembly.
 - a. Dispose of the defective part.




NOTE: HP recommends responsible disposal of the defective part.

<http://www8.hp.com/us/en/hp-information/environment/product-recycling.html>

- b. Unpack the replacement part from the packaging.

 **IMPORTANT:** Make sure that all of the shipping materials (for example shipping tape) are removed from the replacement part prior to installation.

- c. To install an assembly, reverse the removal steps.

 **NOTE:** When applicable, special installation instructions are provided for an assembly at the end of the removal procedure. Always completely read the removal instructions and follow all special installation instructions.

Removal and replacement: 550-sheet paper tray pickup motor

Learn how to remove and replace the pickup motor for the 550-sheet paper tray.

[View a video of how to remove and replace the 550-sheet paper tray pickup motor.](#)


Mean time to repair: 4 minutes

Service level: Easy

Before performing service

Turn the printer power off

- Disconnect the power cable.

 **WARNING!** To avoid damage to the printer, turn the printer off, wait 30 seconds, and then remove the power cord before attempting to service the printer.

Use the table below to identify the correct part number for your printer. To order the part, go to www.hp.com/buy/parts.

Table 1-162 Part information

Part number	Part description
RK2-9410-000CN	Motor, stepping, DC

Required tools

- #2 Phillips screwdriver with a magnetic tip

After performing service

Turn the printer power on

- Connect the power cable.
- Use the power switch to turn the power on.

Post service test

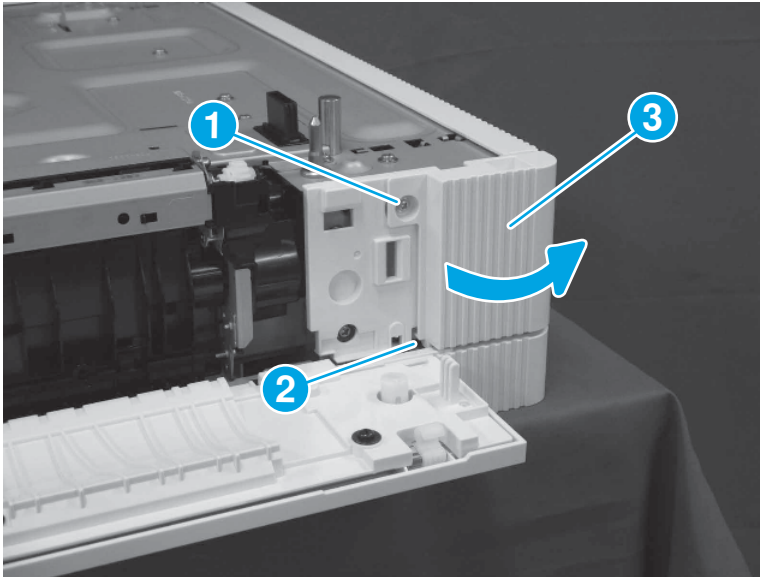
Make sure that the printer initializes to a **Ready** state.

Print a page from the 550-sheet tray to make sure that the printer is functioning correctly.

1. Remove the 550-sheet paper tray right rear cover.

- ▲ Open the right door. Remove one screw (callout 1), release one tab (callout 2), and then remove the right rear cover (callout 3).

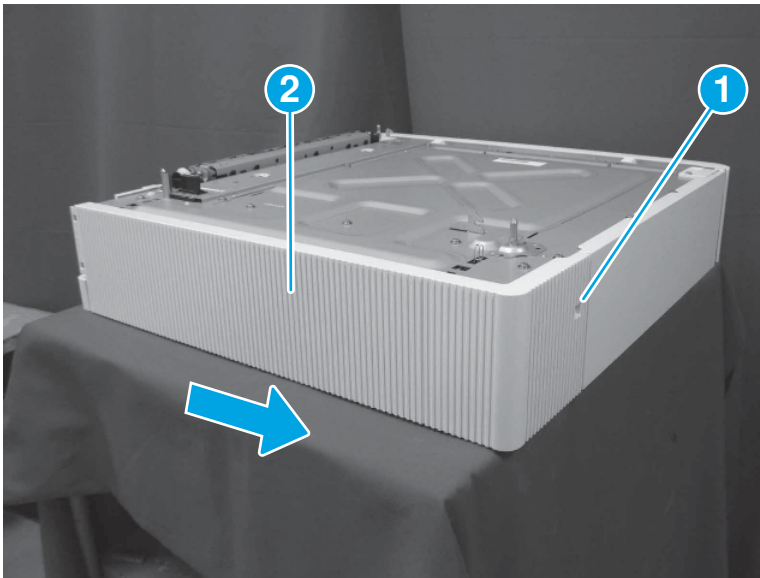
Figure 1-3239 Remove the right rear cover



2. Remove the 550-sheet paper tray rear cover.

- ▲ Remove one screw (callout 1), and then slide the rear cover (callout 2) toward the left side of the feeder to remove it.

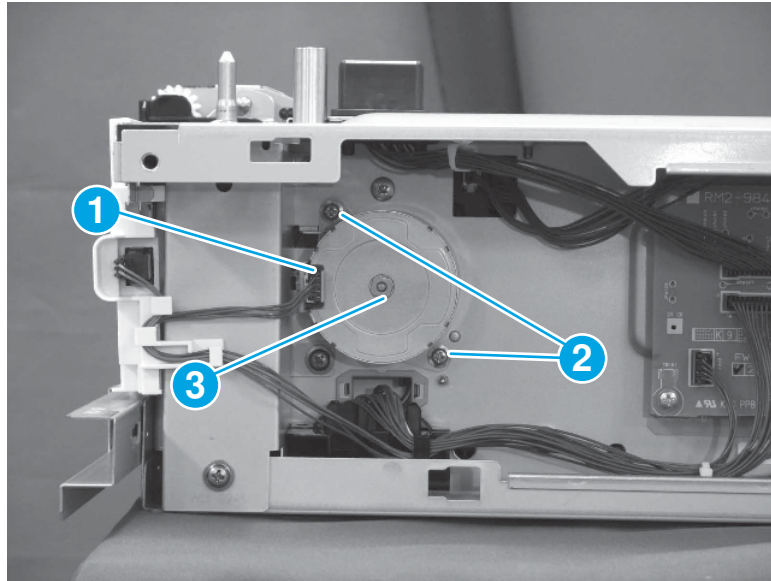
Figure 1-3240 Remove the rear cover



3. Remove the 550-sheet paper tray pickup motor.

- ▲ Disconnect one connector (callout 1), remove two screws (callout 2), and then remove the pickup motor (callout 3).

Figure 1-3241 Remove the pickup motor



4. Unpack the replacement assembly.
 - a. Dispose of the defective part.



NOTE: HP recommends responsible disposal of the defective part.

<http://www8.hp.com/us/en/hp-information/environment/product-recycling.html>

- b. Unpack the replacement part from the packaging.



IMPORTANT: Make sure that all of the shipping materials (for example shipping tape) are removed from the replacement part prior to installation.

- c. To install an assembly, reverse the removal steps.



NOTE: When applicable, special installation instructions are provided for an assembly at the end of the removal procedure. Always completely read the removal instructions and follow all special installation instructions.

Removal and replacement: 550-sheet paper tray pickup assembly

Learn how to remove and replace the 550-sheet paper tray pickup assembly.

[View a video of how to remove and replace the 550-sheet paper tray pickup assembly.](#)

Mean time to repair: 15 minutes

Service level: Easy

Before performing service

Turn the printer power off

- Disconnect the power cable.

⚠ WARNING! To avoid damage to the printer, turn the printer off, wait 30 seconds, and then remove the power cord before attempting to service the printer.

Use the table below to identify the correct part number for your printer. To order the part, go to www.hp.com/buy/parts.

Table 1-163 Part information

Part number	Part description
RM2-1717-000CN	Paper pickup assembly

Required tools

- #2 Phillips screwdriver with a magnetic tip

After performing service

Turn the printer power on

- Connect the power cable.
- Use the power switch to turn the power on.

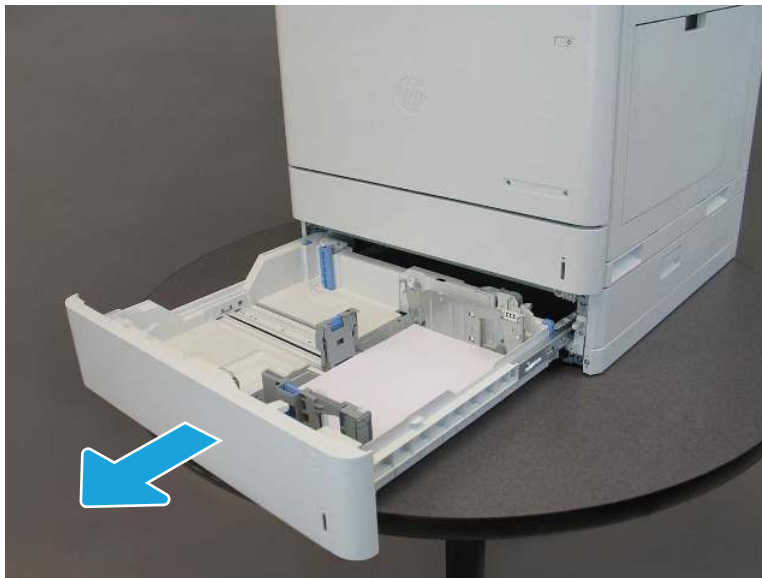
Post service test

Make sure that the printer initializes to a **Ready** state.

Print a page from the 550-sheet tray to make sure that the printer is functioning correctly.

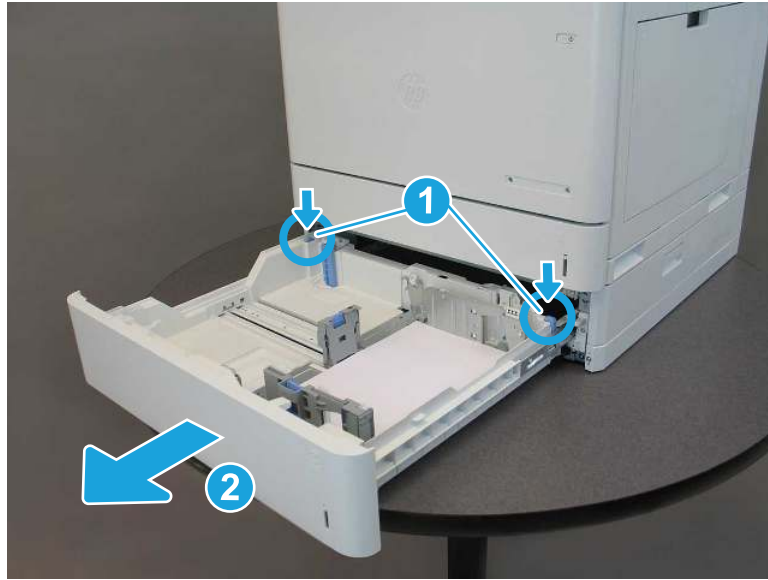
1. Remove the 550-sheet paper tray.
 - a. Pull the tray away from the printer until it stops.

Figure 1-3242 Pull the tray out



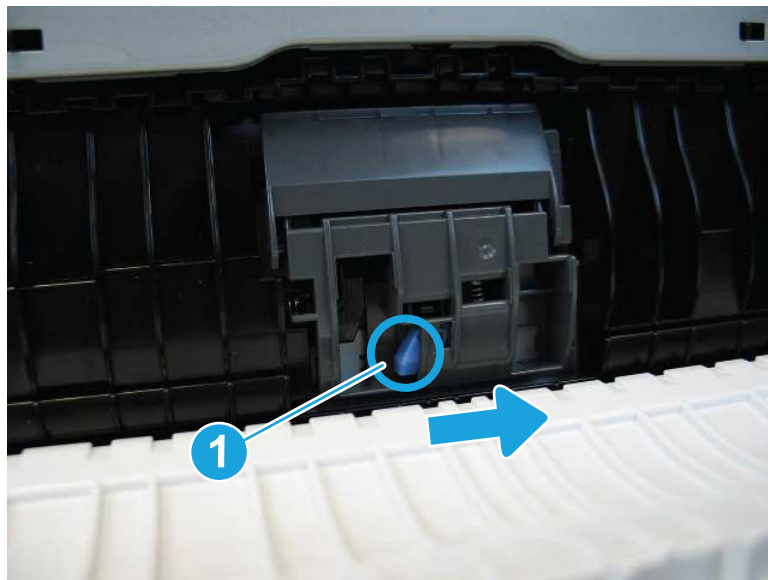
- b. Push down to release two tabs (callout 1), and then remove the tray (callout 2).

Figure 1-3243 Remove the tray



2. Remove the 550-sheet paper tray separation roller.
- ▲ Open the right door. Press the release button (callout 1), slide the separation roller assembly to the right, and then pull it away from the printer to remove it.

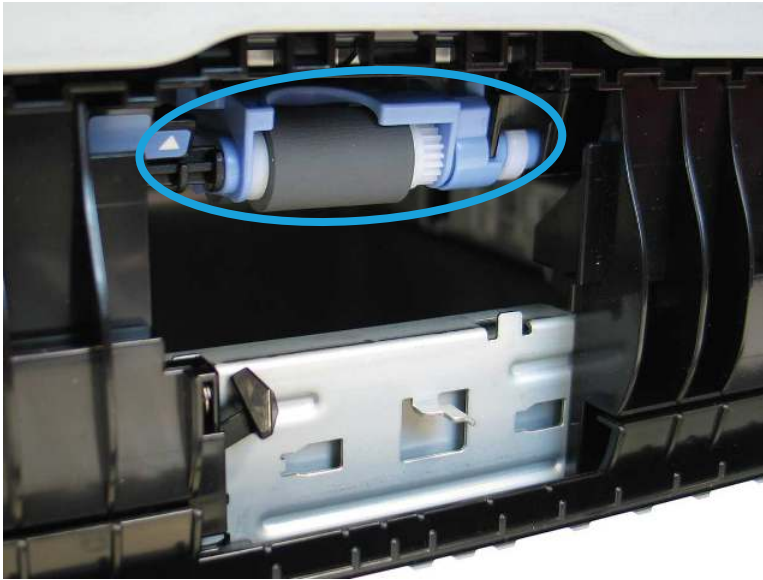
Figure 1-3244 Remove the separation roller



3. Remove the 550-sheet paper tray pickup roller.

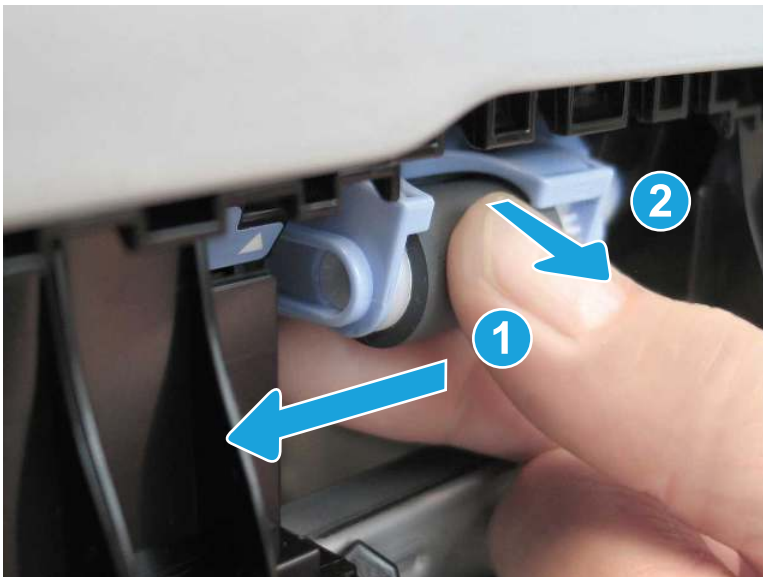
- a. Locate the pickup roller.

Figure 1-3245 Locate the pickup roller



- b. Slide the pickup roller assembly to the left (callout 1), and then pull it away from the printer (callout 2) to remove it.

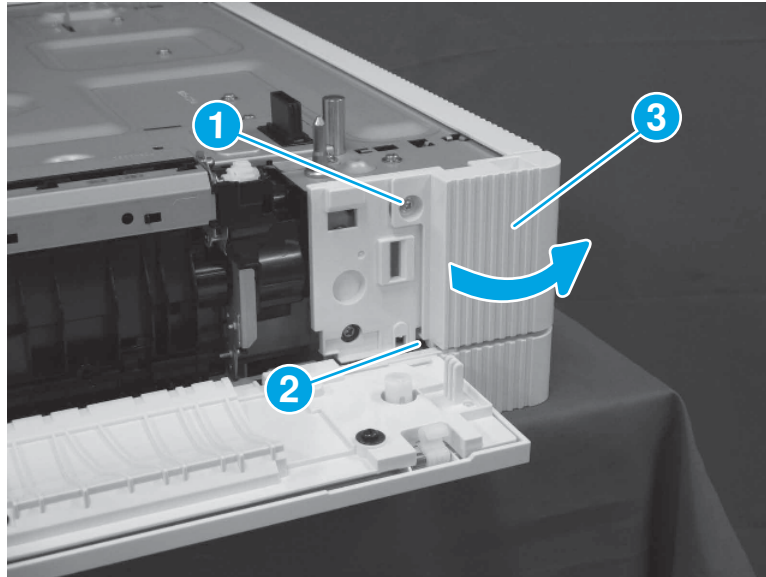
Figure 1-3246 Release the pickup roller



4. Remove the 550-sheet paper tray right rear cover.

- ▲ Open the right door. Remove one screw (callout 1), release one tab (callout 2), and then remove the right rear cover (callout 3).

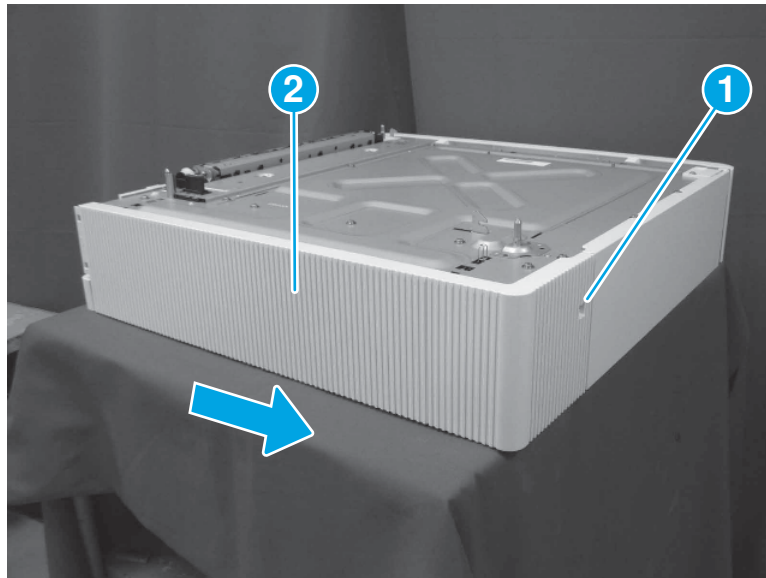
Figure 1-3247 Remove the right rear cover



5. Remove the 550-sheet paper tray rear cover.

- ▲ Remove one screw (callout 1), and then slide the rear cover (callout 2) toward the left side of the feeder to remove it.

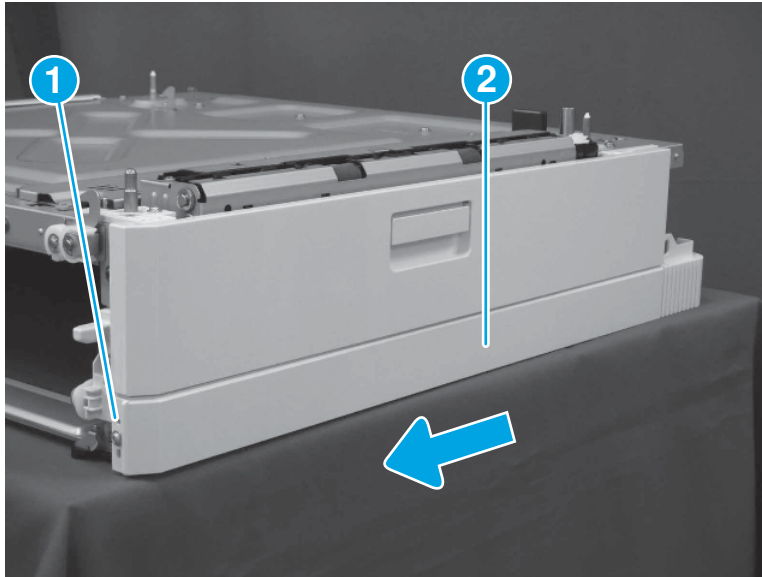
Figure 1-3248 Remove the rear cover



6. Remove the 550-sheet paper tray right lower cover.

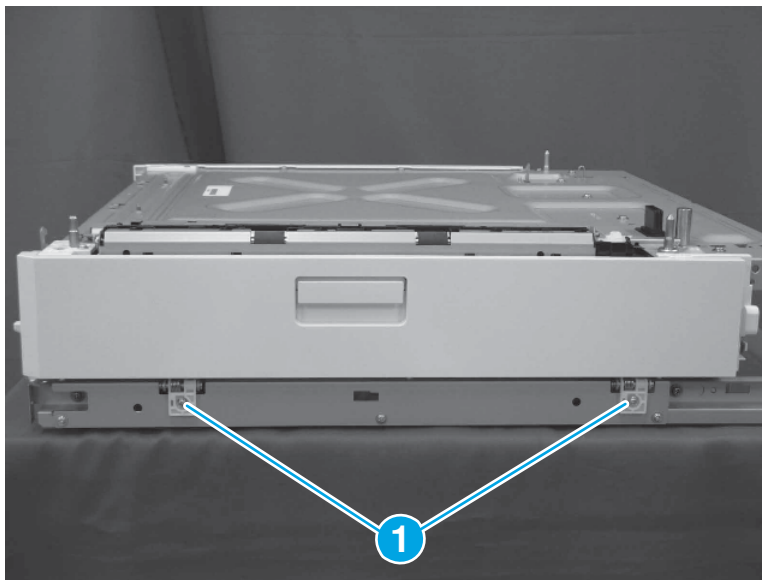
- ▲ Remove one screw (callout 1), and then slide the right lower cover (callout 2) toward the front of the feeder to remove it.

Figure 1-3249 Remove the right lower cover



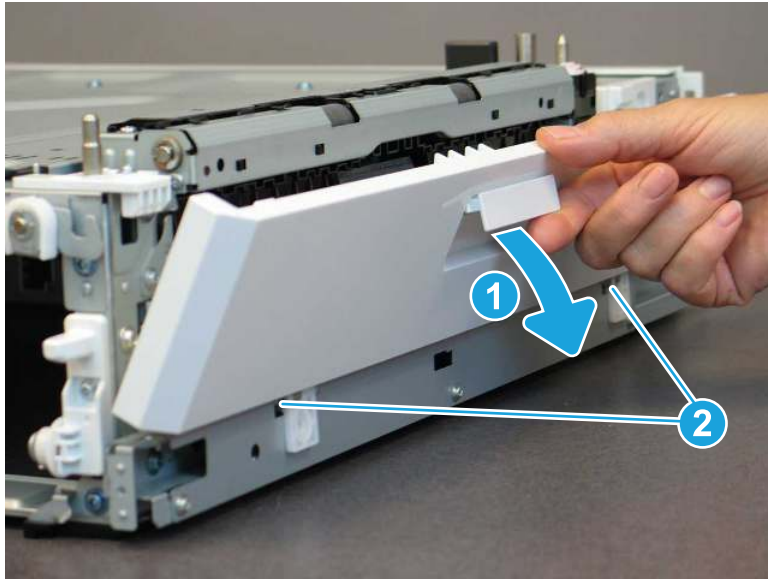
- 7. Remove the 550-sheet paper tray right door.
 - a. Close the right door, and then remove two screws (callout 1).

Figure 1-3250 Remove two screws



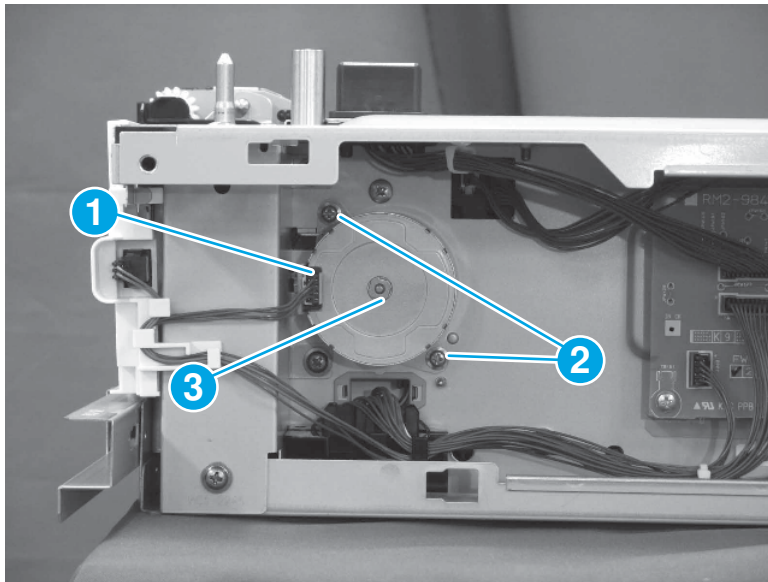
- b. Open the right door (callout 1), and then release two bosses (callout 2) to remove the door.

Figure 1-3251 Remove the right door



8. Remove the 550-sheet paper tray pickup motor.
 - ▲ Disconnect one connector (callout 1), remove two screws (callout 2), and then remove the pickup motor (callout 3).

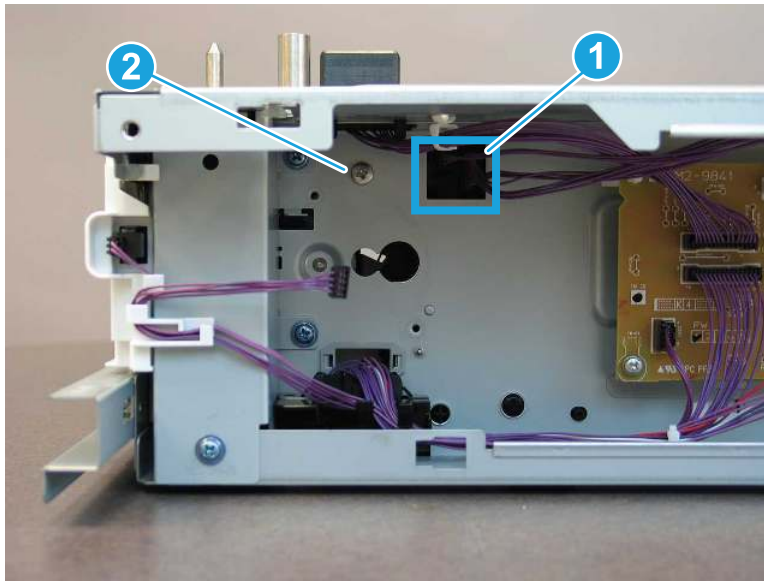
Figure 1-3252 Remove the pickup motor



9. Remove the 550-sheet paper tray pickup assembly.

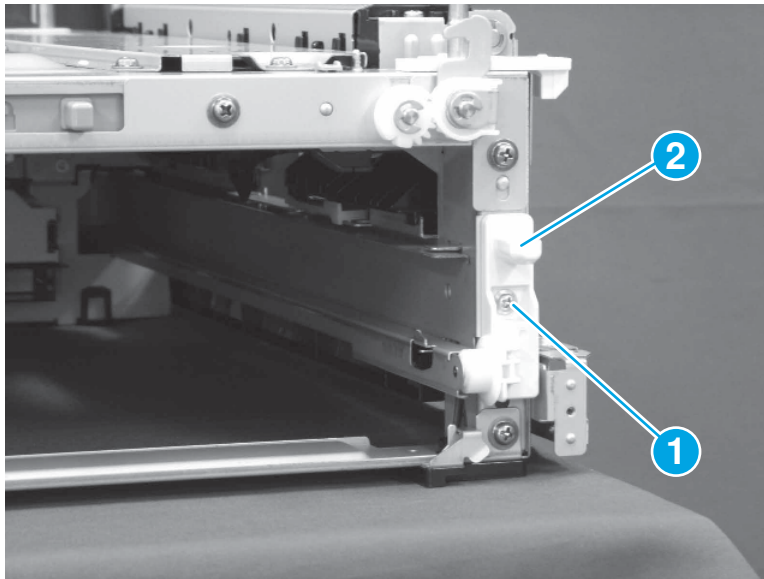
- a. Disconnect two connectors (callout 1), and then remove one screw (callout 2).

Figure 1-3253 Disconnect two connectors and remove one screw



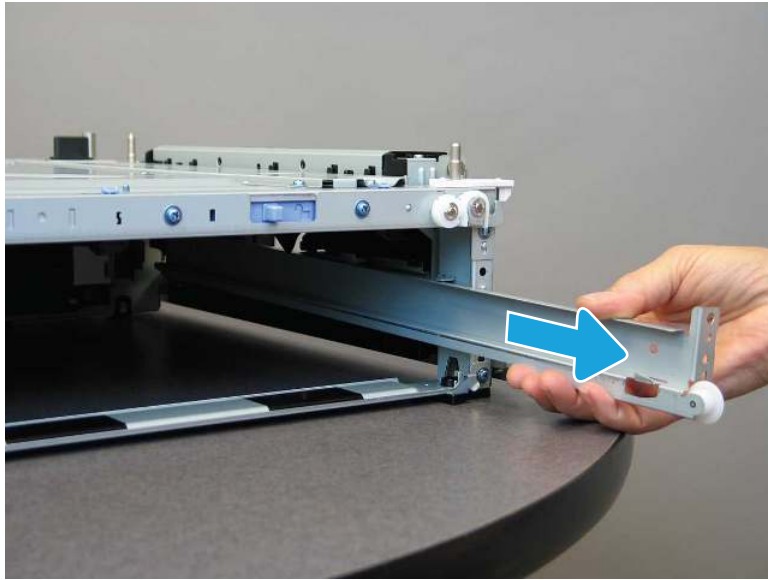
- b. At the front of the feeder, remove one screw (callout 1), and then remove the cover (callout 2).

Figure 1-3254 Remove one screw and the cover



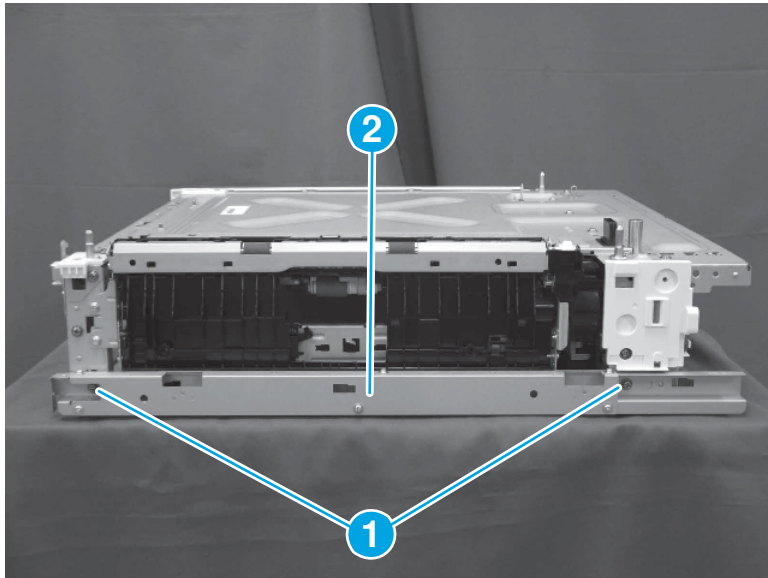
- c. Slide the cassette rail away from the printer to remove it.

Figure 1-3255 Remove the cassette rail



- d. On the right side of the feeder, remove two screws (callout 1), and then pull the right lower frame (callout 2) away from the printer to remove it.

Figure 1-3256 Remove the right lower frame

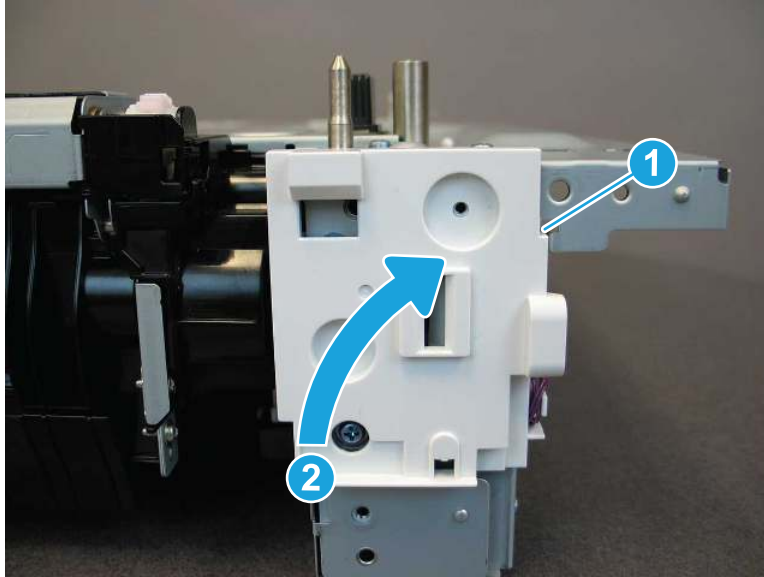


- e. Release one tab (callout 1), and then rotate the right rear inner cover away from the feeder.



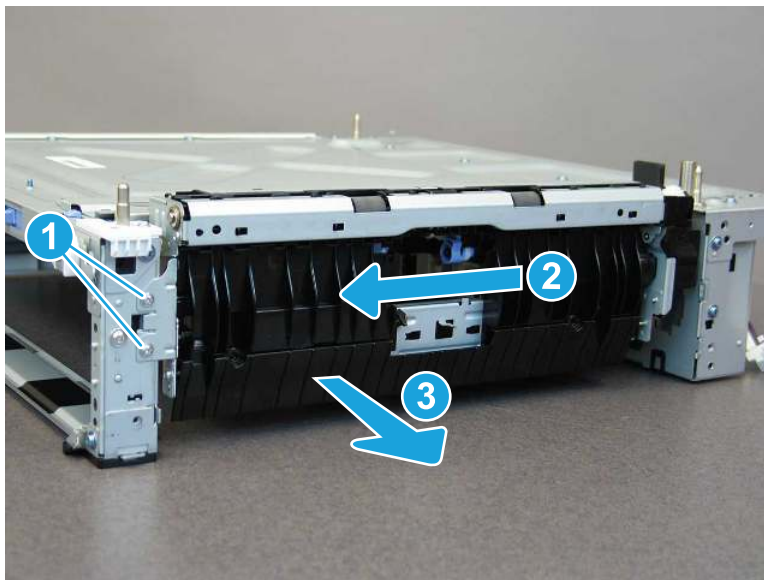
NOTE: The cover is still attached to the feeder. Do not attempt to remove it completely.

Figure 1-3257 Release the right rear inner cover



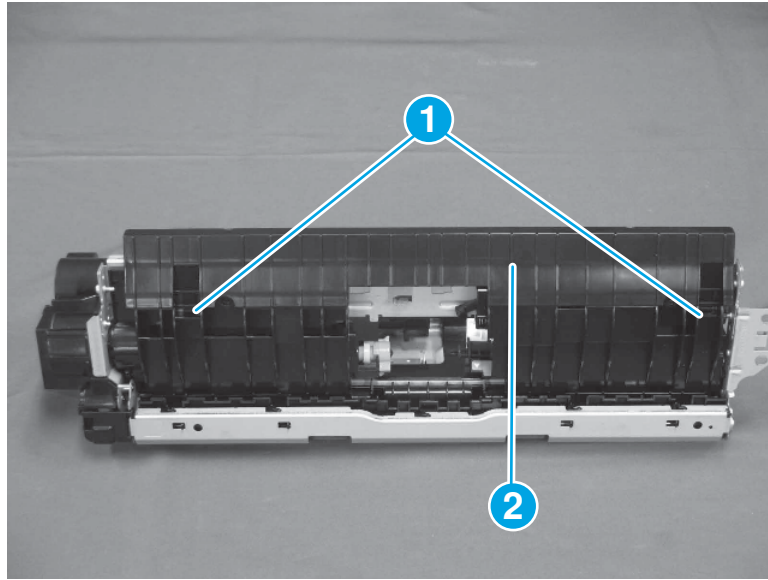
- f. Remove two screws (callout 1). Slide the pickup assembly (callout 2) toward the front of the feeder, and then pull it away from the feeder (callout 3) to remove it.

Figure 1-3258 Remove the pickup assembly



- g. Release two tabs (callout 1), and then remove the guide (callout 2).

Figure 1-3259 Remove the guide



10. Unpack the replacement assembly.

- a. Dispose of the defective part.



NOTE: HP recommends responsible disposal of the defective part.

<http://www8.hp.com/us/en/hp-information/environment/product-recycling.html>

- b. Unpack the replacement part from the packaging.



IMPORTANT: Make sure that all of the shipping materials (for example shipping tape) are removed from the replacement part prior to installation.

- c. To install an assembly, reverse the removal steps.



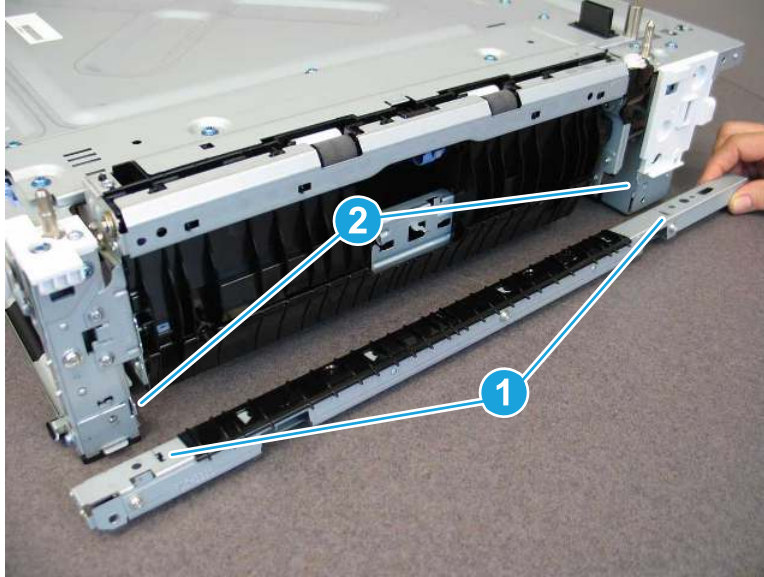
NOTE: When applicable, special installation instructions are provided for an assembly at the end of the removal procedure. Always completely read the removal instructions and follow all special installation instructions.

11. Reverse the removal steps to install the assembly. Also use the following **special installation instructions**.

Install the 550-sheet paper tray pickup assembly.

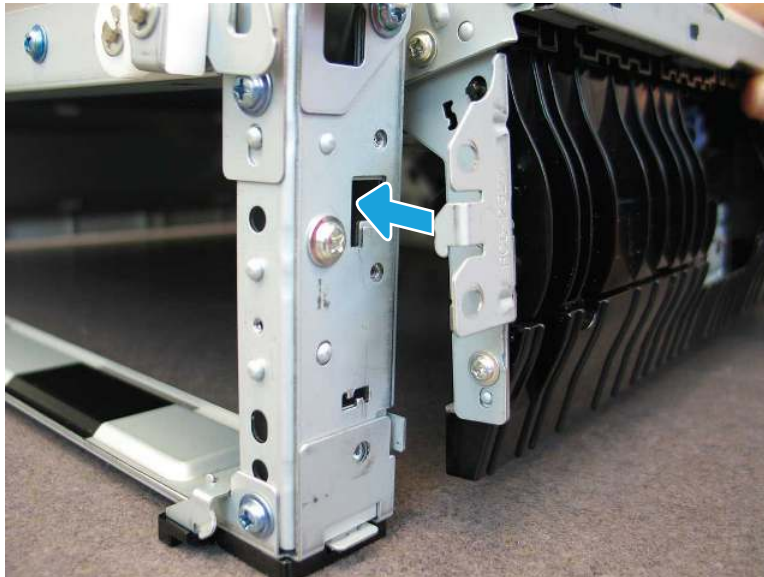
- a. When reinstalling the right lower frame, position the slots (callout 1) on the frame over the tabs (callout 2) on the feeder.

Figure 1-3260 Install the right lower frame



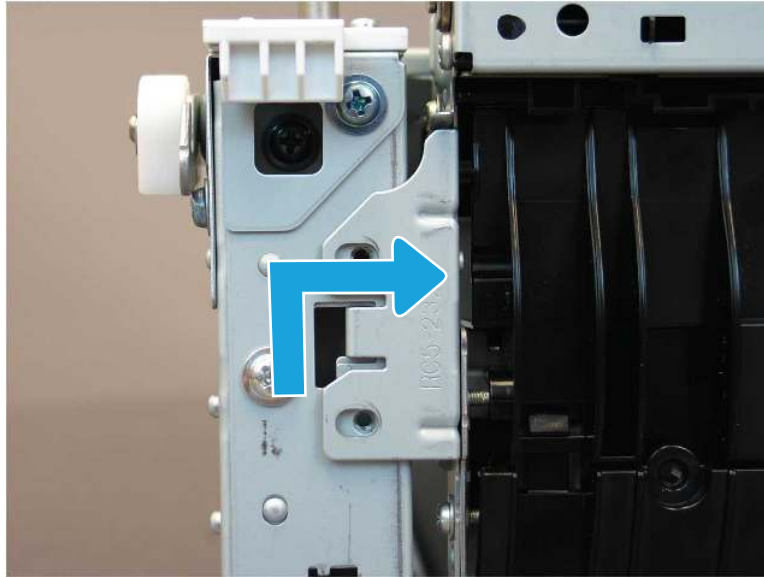
- b. When reinstalling the pickup assembly, install the tab in the slot.

Figure 1-3261 Install the tab



- c. Lift the pickup assembly up, and then slide to the right.

Figure 1-3262 Install the pickup assembly



Removal and replacement: 550-sheet paper tray lifter drive

Learn how to remove and replace the 550-sheet paper tray lifter drive.

[View a video of how to remove and replace the 550-sheet paper tray lifter drive.](#)

Mean time to repair: 18 minutes

Service level: Easy

Before performing service

Turn the printer power off

- Disconnect the power cable.

⚠ WARNING! To avoid damage to the printer, turn the printer off, wait 30 seconds, and then remove the power cord before attempting to service the printer.

Use the table below to identify the correct part number for your printer. To order the part, go to www.hp.com/buy/parts.

Table 1-164 Part information

Part number	Part description
RM2-1703-000CN	Lifter drive assembly

Required tools

- #2 Phillips screwdriver with a magnetic tip

After performing service

Turn the printer power on

- Connect the power cable.
- Use the power switch to turn the power on.

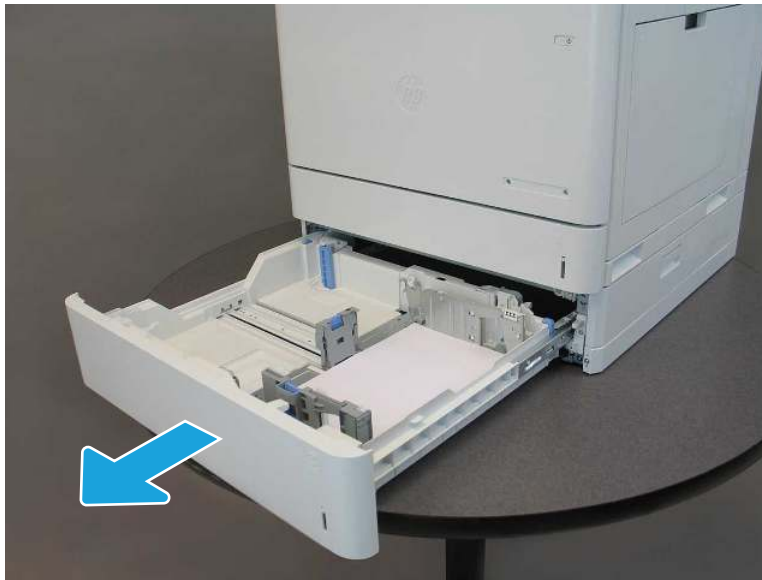
Post service test

Make sure that the printer initializes to a **Ready** state.

Print a page from the 550-sheet tray to make sure that the printer is functioning correctly.

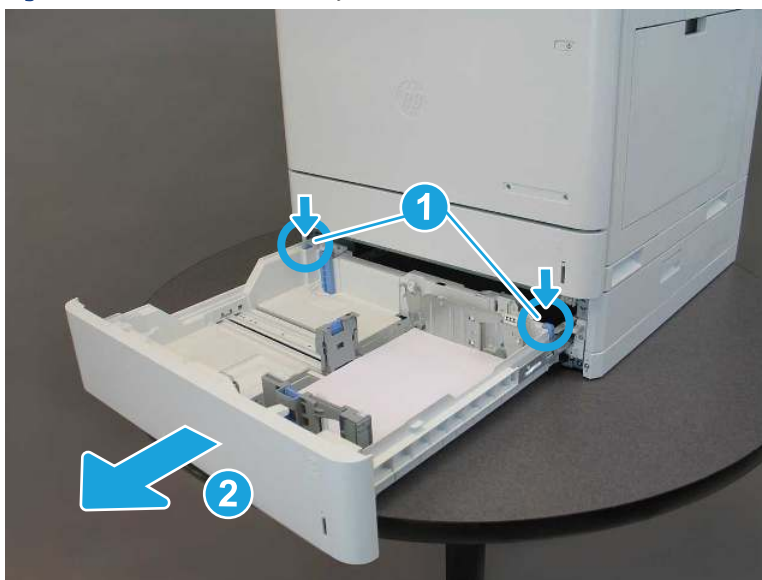
1. Remove the 550-sheet paper tray.
 - a. Pull the tray away from the printer until it stops.

Figure 1-3263 Pull the tray out



- b. Push down to release two tabs (callout 1), and then remove the tray (callout 2).

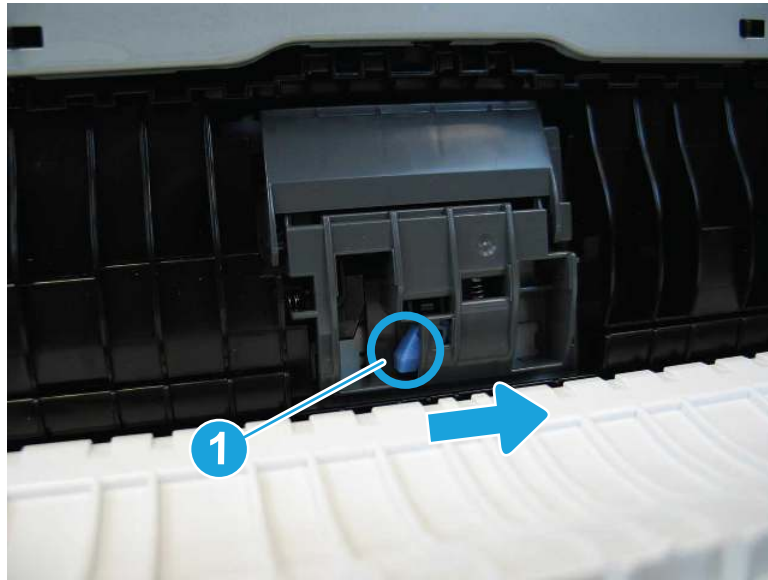
Figure 1-3264 Remove the tray



2. Remove the 550-sheet paper tray separation roller.

- ▲ Open the right door. Press the release button (callout 1), slide the separation roller assembly to the right, and then pull it away from the printer to remove it.

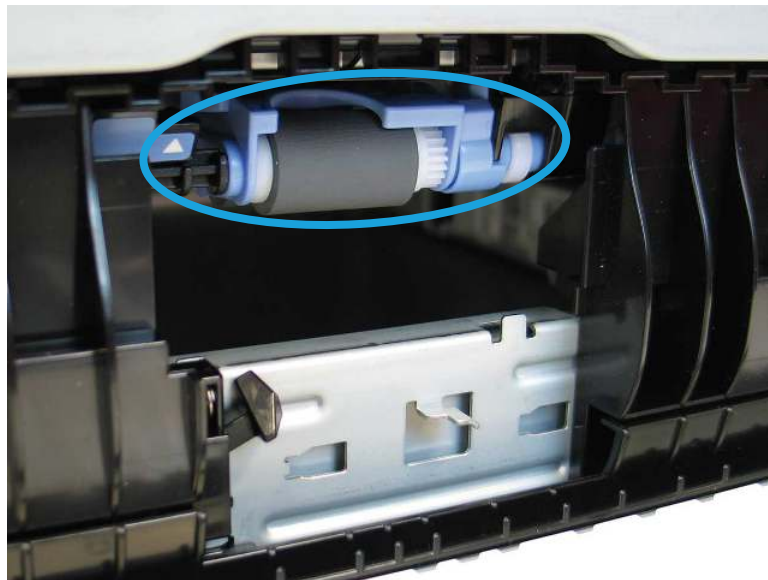
Figure 1-3265 Remove the separation roller



3. Remove the 550-sheet paper tray pickup roller.

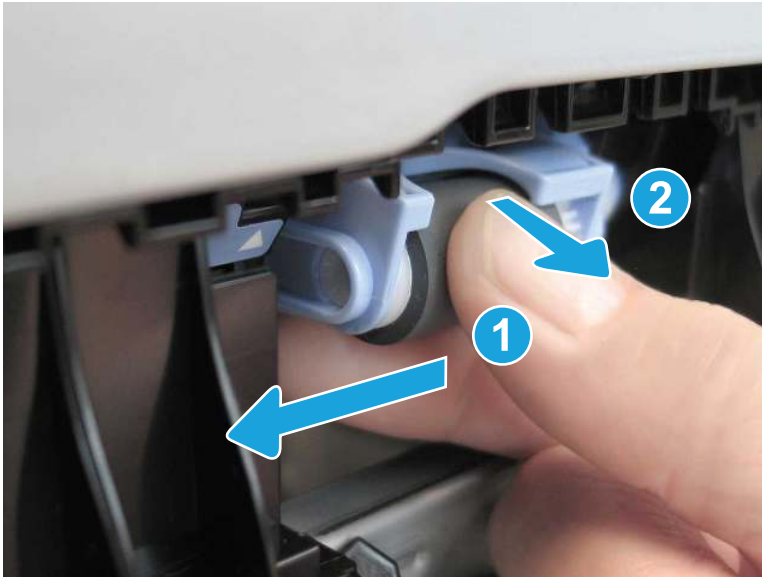
- a. Locate the pickup roller.

Figure 1-3266 Locate the pickup roller



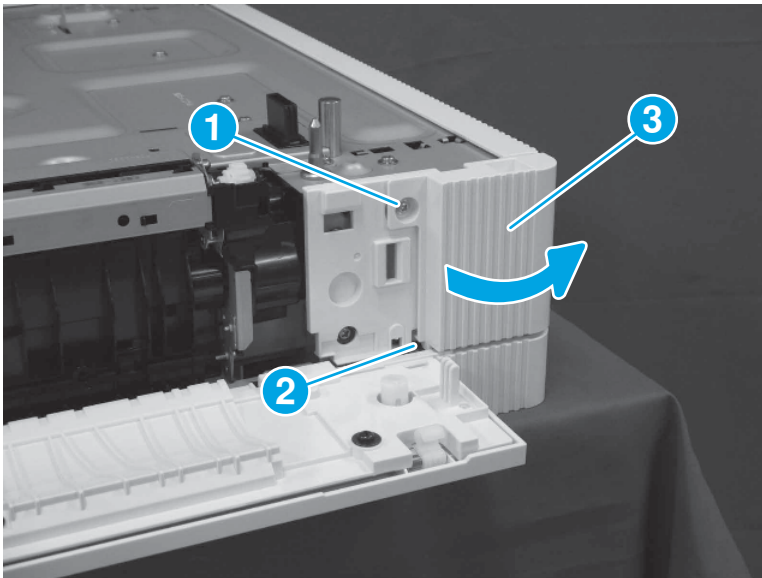
- b. Slide the pickup roller assembly to the left (callout 1), and then pull it away from the printer (callout 2) to remove it.

Figure 1-3267 Release the pickup roller



4. Remove the 550-sheet paper tray right rear cover.
 - ▲ Open the right door. Remove one screw (callout 1), release one tab (callout 2), and then remove the right rear cover (callout 3).

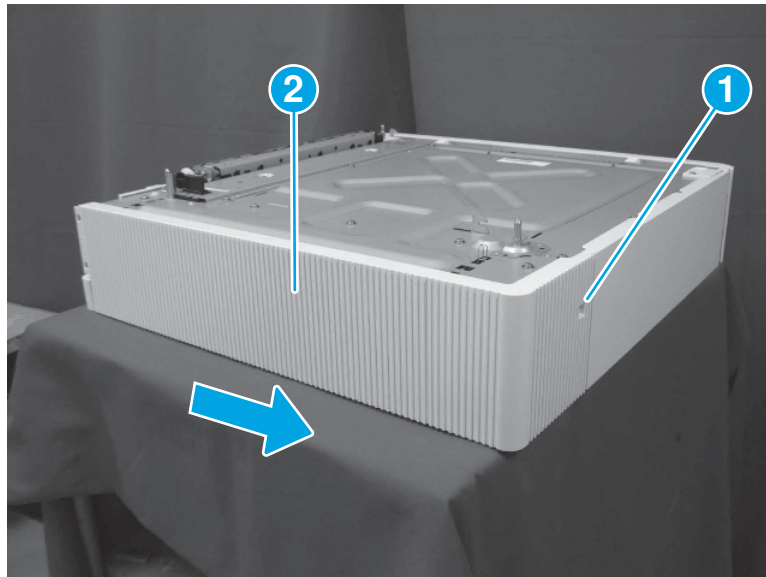
Figure 1-3268 Remove the right rear cover



5. Remove the 550-sheet paper tray rear cover.

- ▲ Remove one screw (callout 1), and then slide the rear cover (callout 2) toward the left side of the feeder to remove it.

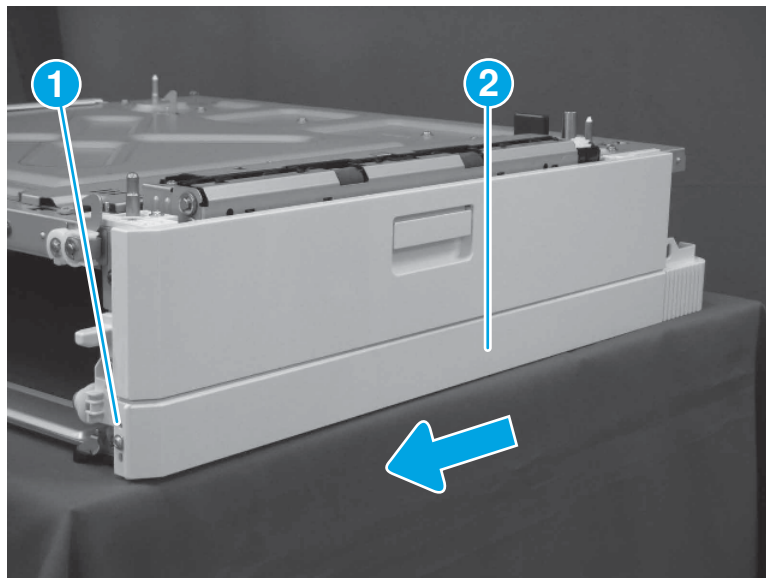
Figure 1-3269 Remove the rear cover



6. Remove the 550-sheet paper tray right lower cover.

- ▲ Remove one screw (callout 1), and then slide the right lower cover (callout 2) toward the front of the feeder to remove it.

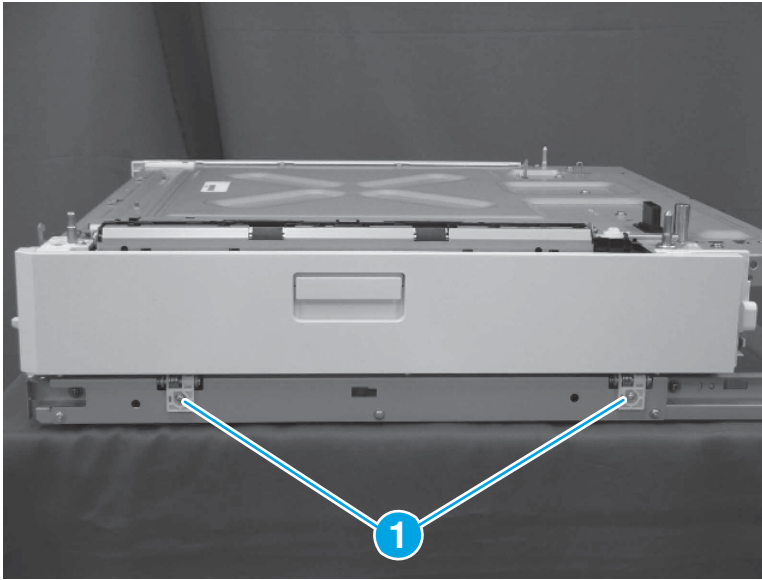
Figure 1-3270 Remove the right lower cover



7. Remove the 550-sheet paper tray right door.

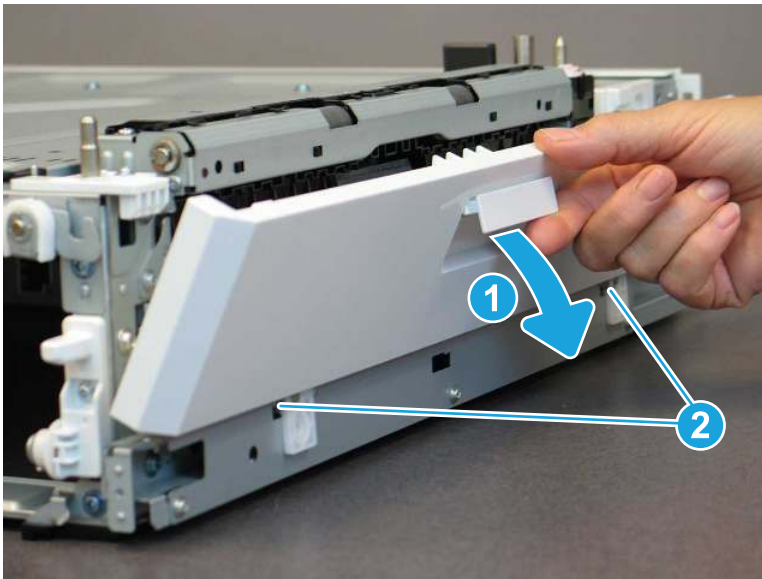
- a. Close the right door, and then remove two screws (callout 1).

Figure 1-3271 Remove two screws



- b. Open the right door (callout 1), and then release two bosses (callout 2) to remove the door.

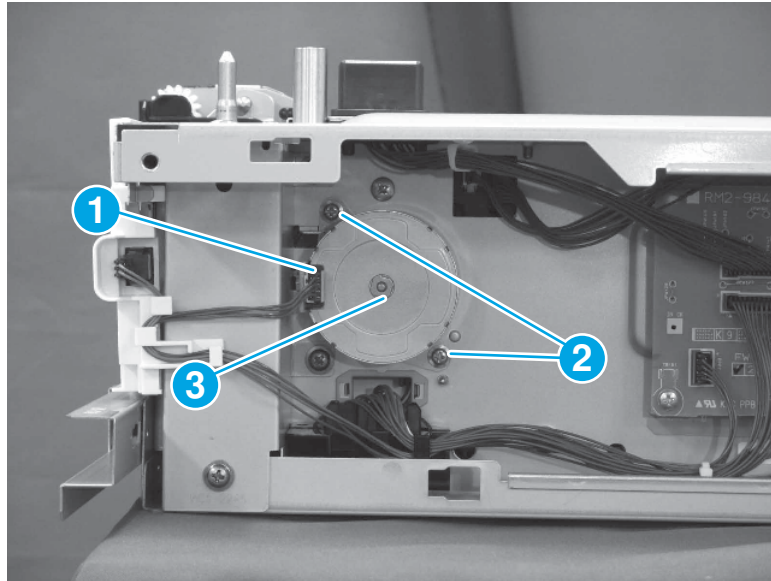
Figure 1-3272 Remove the right door



8. Remove the 550-sheet paper tray pickup motor.

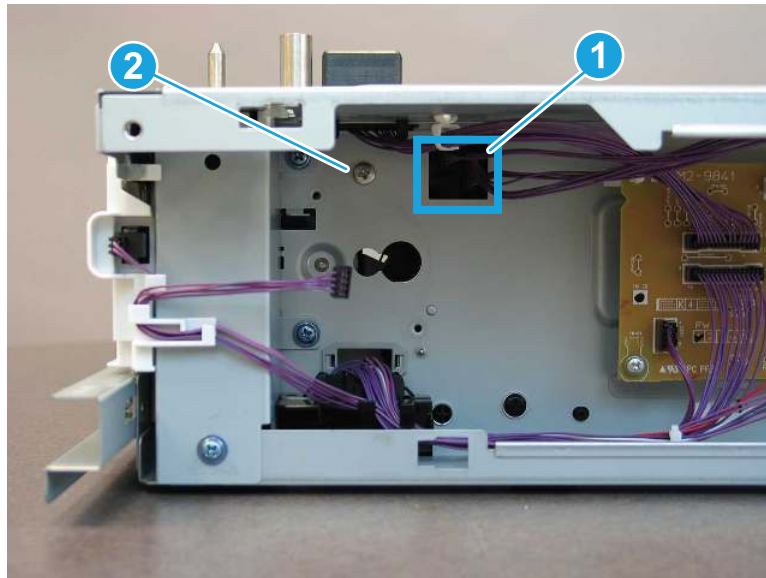
- ▲ Disconnect one connector (callout 1), remove two screws (callout 2), and then remove the pickup motor (callout 3).

Figure 1-3273 Remove the pickup motor



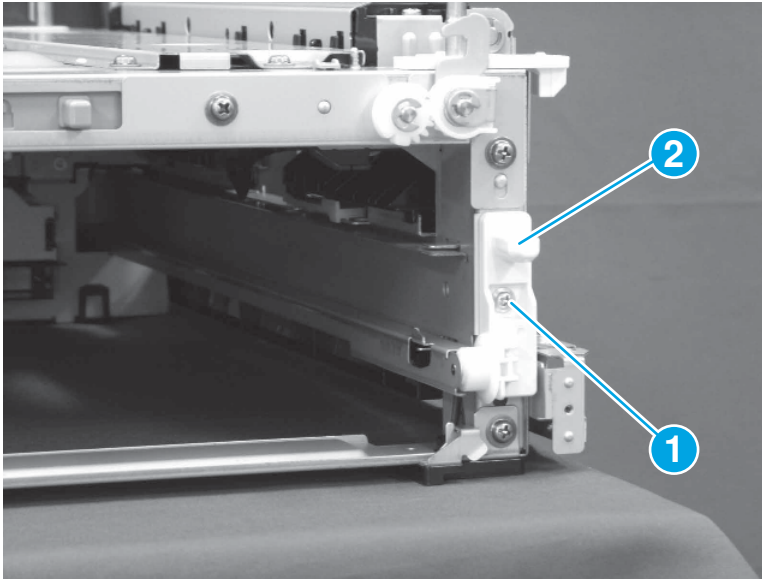
- 9. Remove the 550-sheet paper tray pickup assembly.
 - a. Disconnect two connectors (callout 1), and then remove one screw (callout 2).

Figure 1-3274 Disconnect two connectors and remove one screw



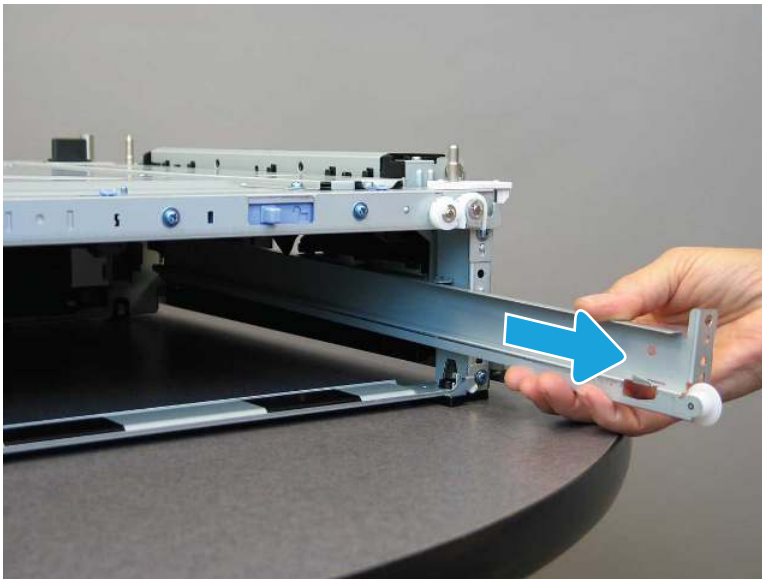
- b. At the front of the feeder, remove one screw (callout 1), and then remove the cover (callout 2).

Figure 1-3275 Remove one screw and the cover



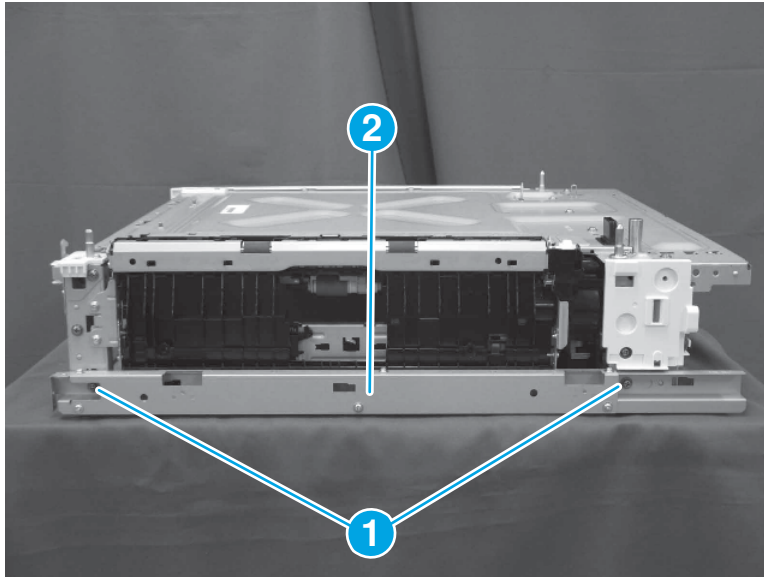
- c. Slide the cassette rail away from the printer to remove it.

Figure 1-3276 Remove the cassette rail



- d. On the right side of the feeder, remove two screws (callout 1), and then pull the right lower frame (callout 2) away from the printer to remove it.

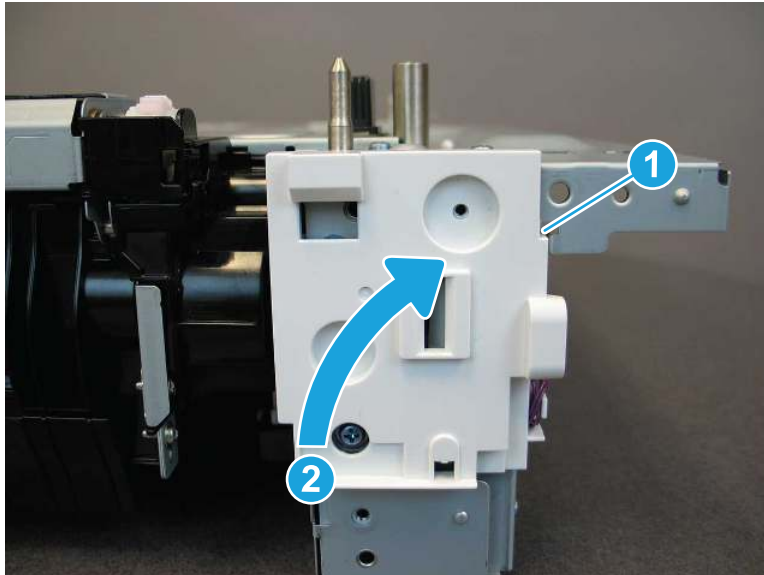
Figure 1-3277 Remove the right lower frame



- e. Release one tab (callout 1), and then rotate the right rear inner cover away from the feeder.

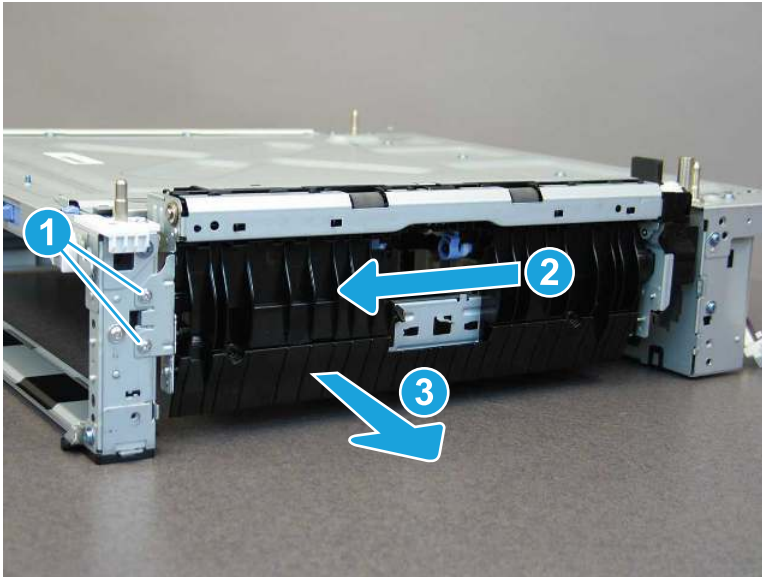
CAUTION: The cover is still attached to the feeder. Do not attempt to remove it completely.

Figure 1-3278 Release the right rear inner cover



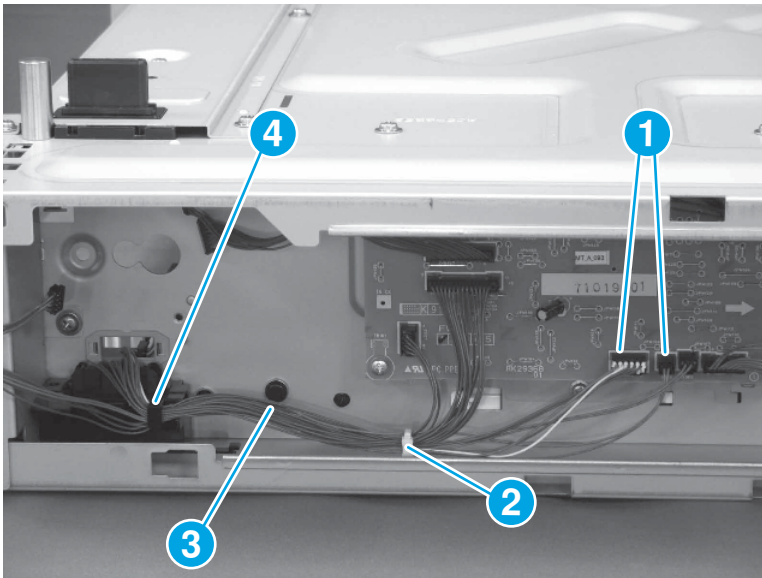
- f. Remove two screws (callout 1). Slide the pickup assembly (callout 2) toward the front of the feeder, and then pull it away from the feeder (callout 3) to remove it.

Figure 1-3279 Remove the pickup assembly



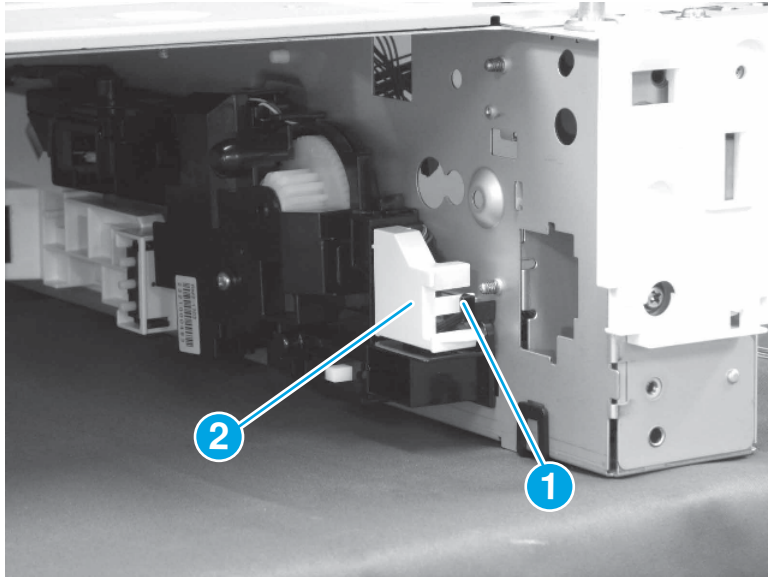
10. Remove the 550-sheet paper tray lifter drive assembly.
 - a. Disconnect two connectors (callout 1). Open one retainer (callout 2), and then remove the cables (callout 3) from the guide (callout 4).

Figure 1-3280 Disconnect two connectors and release cables



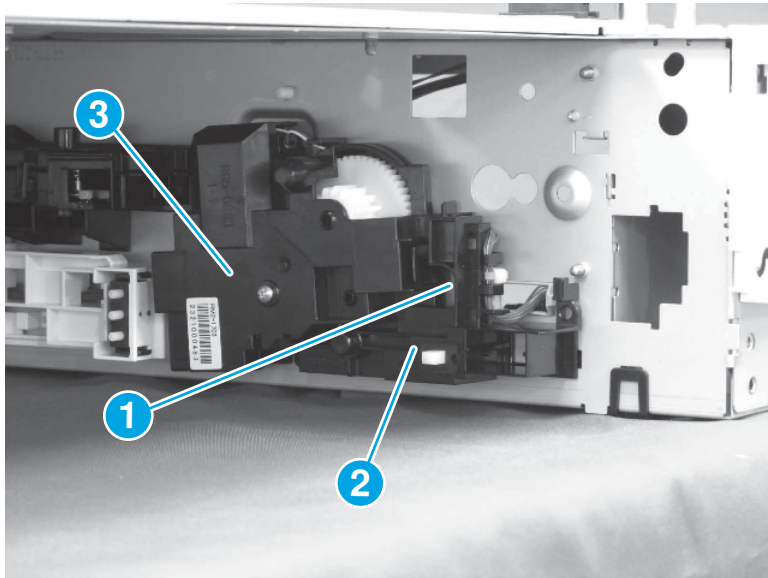
- b. On the right side of the feeder, release one tab (callout 1), and then remove the connector cover (callout 2).

Figure 1-3281 Remove the connector cover



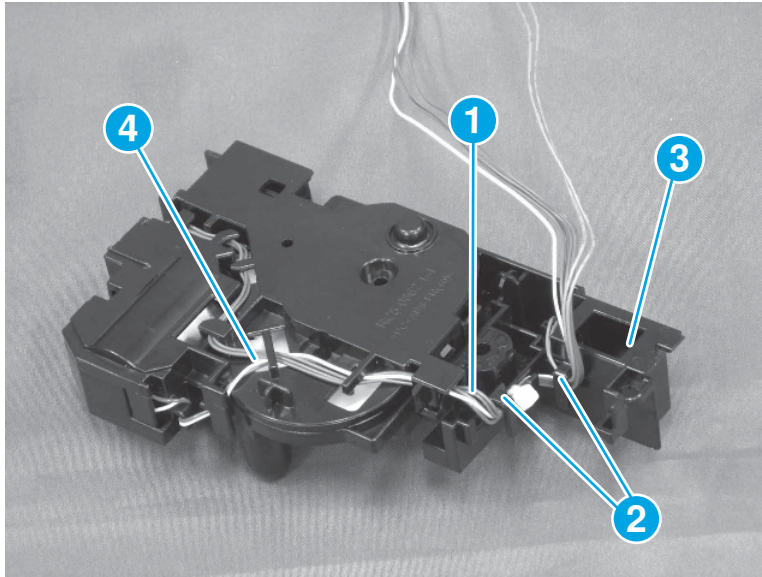
- c. Remove one screw (callout 1), and then remove the holder (callout 2) and the lifter drive (callout 3) together.

Figure 1-3282 Remove the lifter drive and holder



- d. Release the cables (callout 1) from the guides (callout 2). Remove the holder (callout 3) from the lifter drive (callout 4).

Figure 1-3283 Remove the holder from the lifter drive



11. Unpack the replacement assembly.

- a. Dispose of the defective part.



NOTE: HP recommends responsible disposal of the defective part.

<http://www8.hp.com/us/en/hp-information/environment/product-recycling.html>

- b. Unpack the replacement part from the packaging.



IMPORTANT: Make sure that all of the shipping materials (for example shipping tape) are removed from the replacement part prior to installation.

- c. To install an assembly, reverse the removal steps.



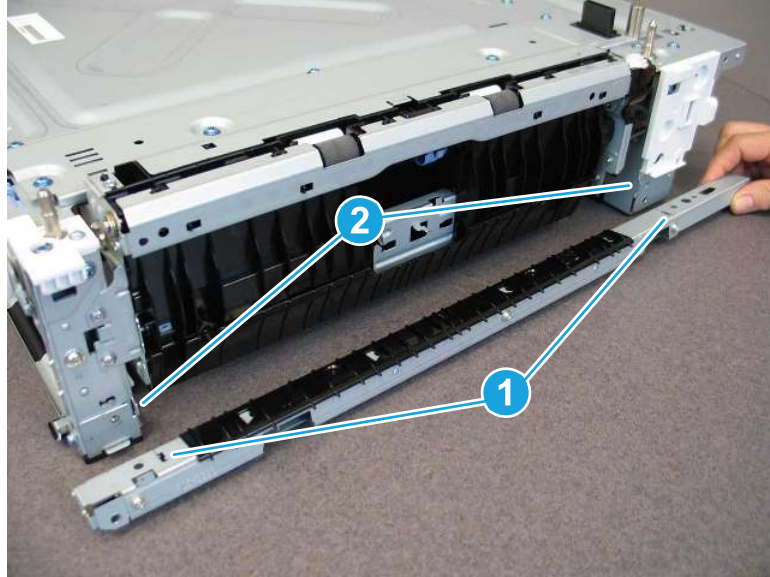
NOTE: When applicable, special installation instructions are provided for an assembly at the end of the removal procedure. Always completely read the removal instructions and follow all special installation instructions.

12. Reverse the removal steps to install the assembly. Also use the following **special installation instructions**.

Install the 550-sheet paper tray pickup assembly.

- a. When reinstalling the right lower frame, position the slots (callout 1) on the frame over the tabs (callout 2) on the feeder.

Figure 1-3284 Install the right lower frame



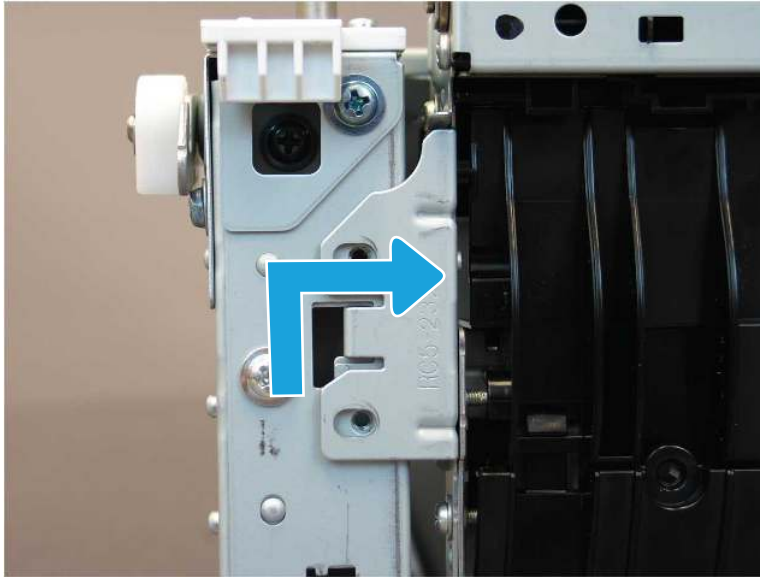
- b. When reinstalling the pickup assembly, install the tab in the slot.

Figure 1-3285 Install the tab



- c. Lift the pickup assembly up, and then slide to the right.

Figure 1-3286 Install the pickup assembly



Removal and replacement: 550-sheet paper tray auto close assembly

Learn how to remove and replace the 550-sheet tray auto close assembly.

[View a video of how to remove and replace the 550-sheet paper tray auto close assembly.](#)

Mean time to repair: 15 minutes

Service level: Medium

Before performing service

Turn the printer power off

- Disconnect the power cable.

⚠ WARNING! To avoid damage to the printer, turn the printer off, wait 30 seconds, and then remove the power cord before attempting to service the printer.

Use the table below to identify the correct part number for your printer. To order the part, go to www.hp.com/buy/parts.

Table 1-165 Part information

Part number	Part description
RM2-1760-000CN	Auto close assembly

Required tools

- #2 Phillips screwdriver with a magnetic tip

After performing service

Turn the printer power on

- Connect the power cable.
- Use the power switch to turn the power on.

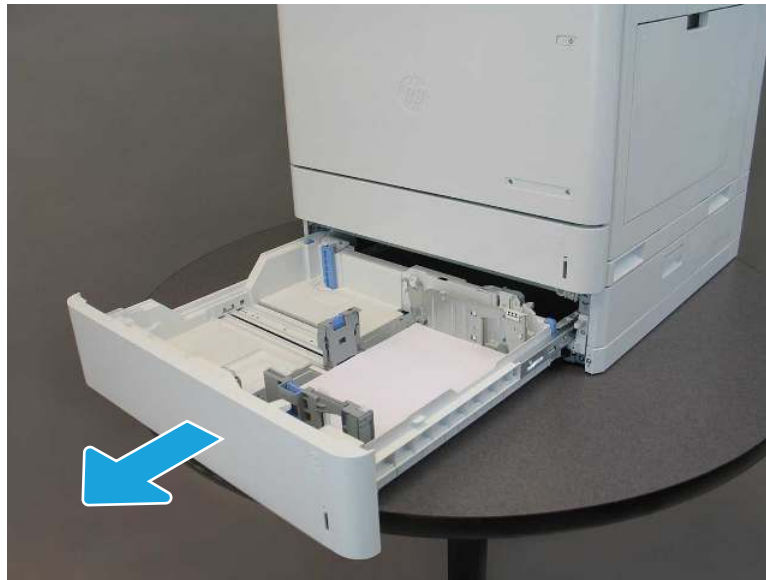
Post service test

Make sure that the printer initializes to a **Ready** state.

Print a page from the 550-sheet tray to make sure that the printer is functioning correctly.

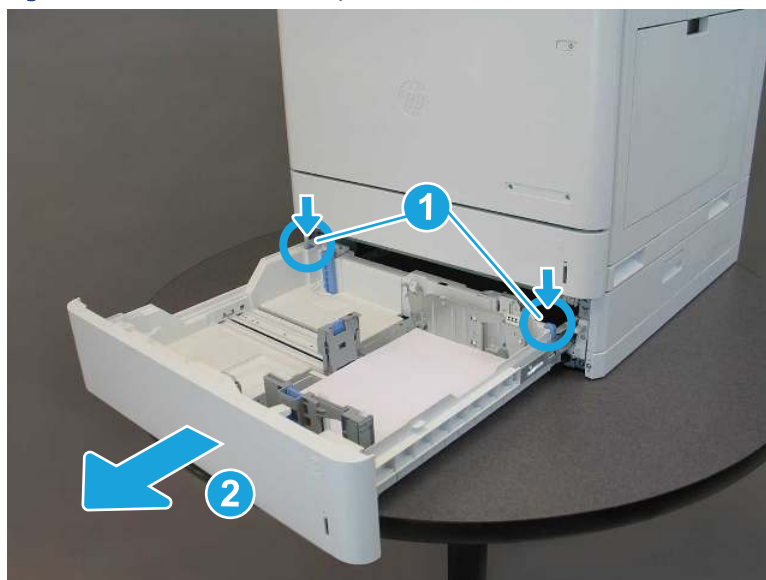
1. Remove the 550-sheet paper tray.
 - a. Pull the tray away from the printer until it stops.

Figure 1-3287 Pull the tray out



- b. Push down to release two tabs (callout 1), and then remove the tray (callout 2).

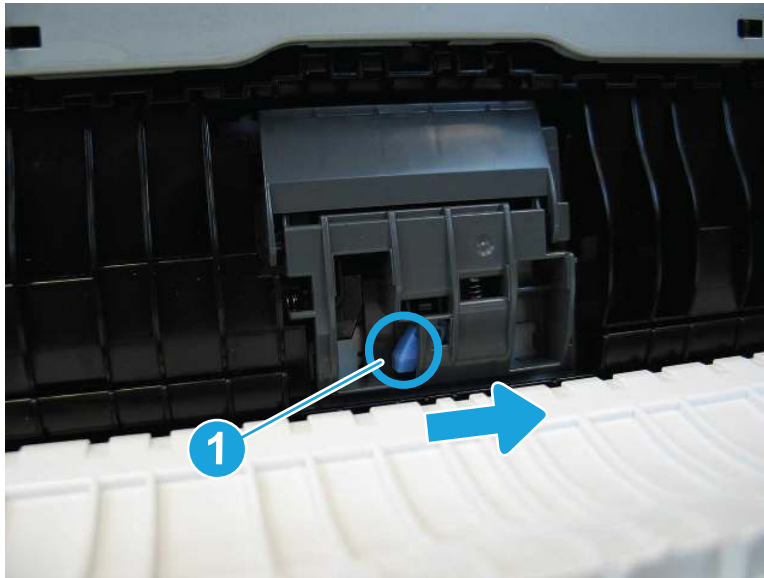
Figure 1-3288 Remove the tray



2. Remove the 550-sheet paper tray separation roller.

- ▲ Open the right door. Press the release button (callout 1), slide the separation roller assembly to the right, and then pull it away from the printer to remove it.

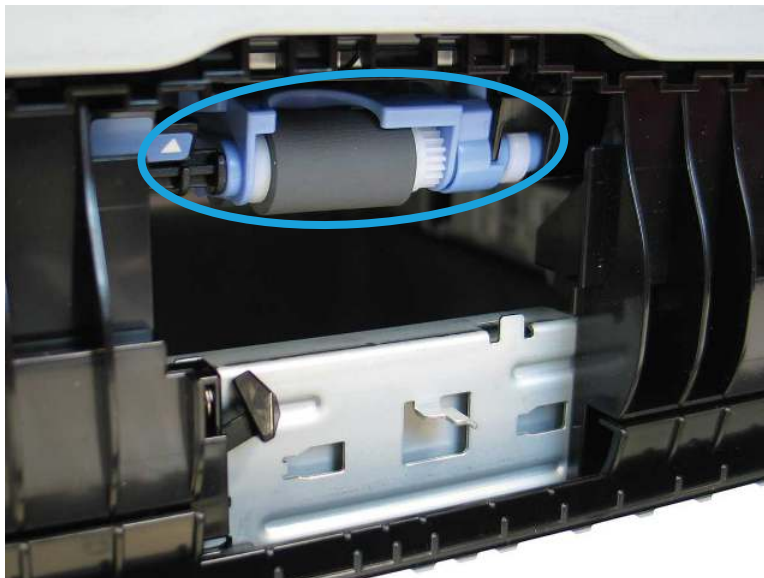
Figure 1-3289 Remove the separation roller



3. Remove the 550-sheet paper tray pickup roller.

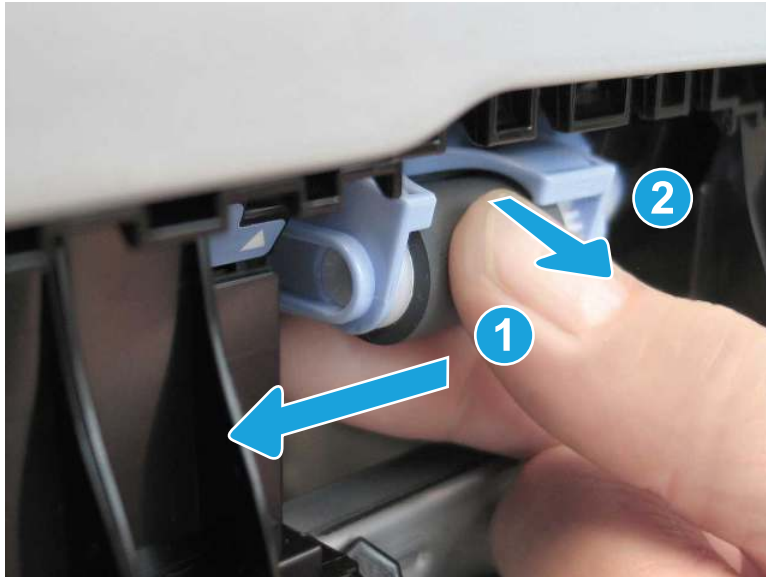
- a. Locate the pickup roller.

Figure 1-3290 Locate the pickup roller



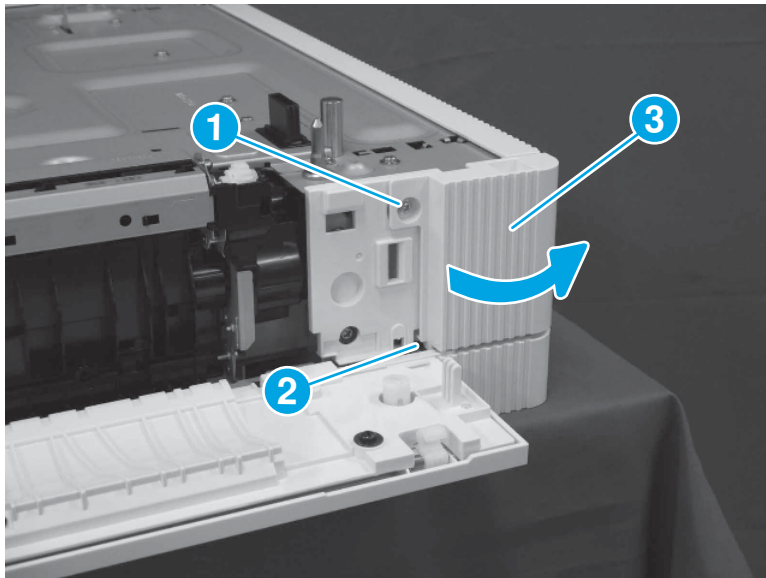
- b. Slide the pickup roller assembly to the left (callout 1), and then pull it away from the printer (callout 2) to remove it.

Figure 1-3291 Release the pickup roller



4. Remove the 550-sheet paper tray right rear cover.
 - ▲ Open the right door. Remove one screw (callout 1), release one tab (callout 2), and then remove the right rear cover (callout 3).

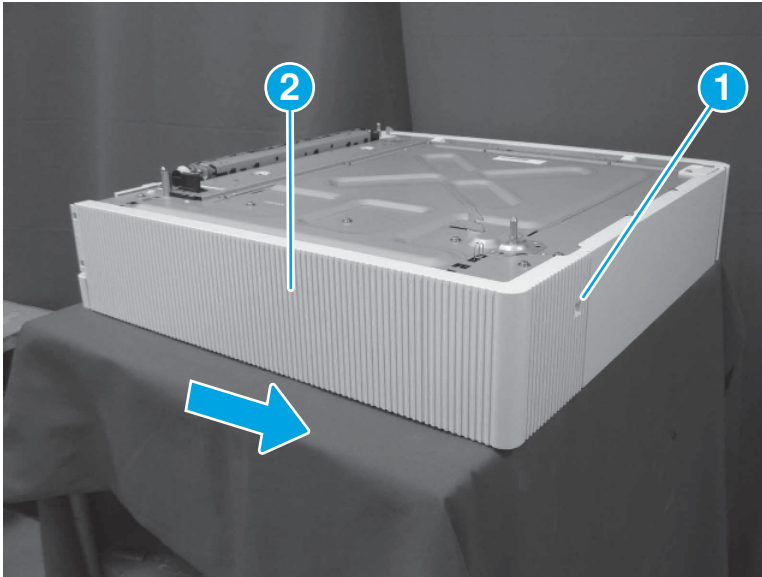
Figure 1-3292 Remove the right rear cover



5. Remove the 550-sheet paper tray rear cover.

- ▲ Remove one screw (callout 1), and then slide the rear cover (callout 2) toward the left side of the feeder to remove it.

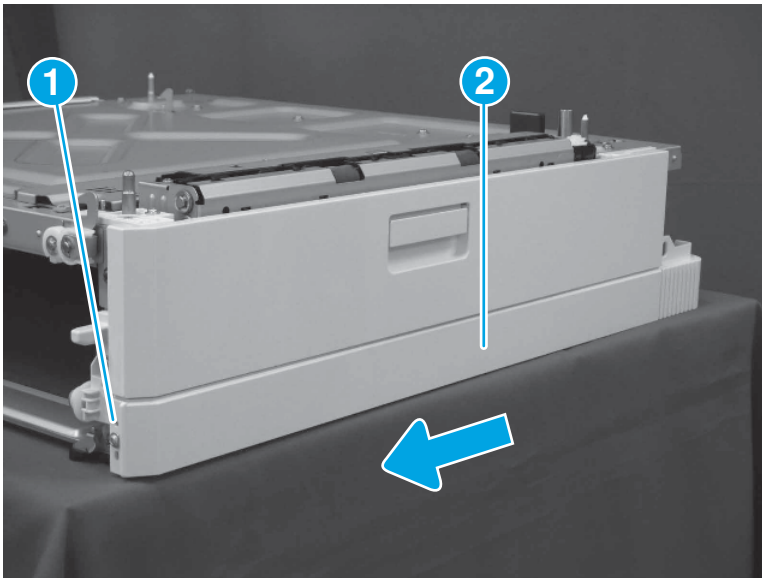
Figure 1-3293 Remove the rear cover



6. Remove the 550-sheet paper tray right lower cover.

- ▲ Remove one screw (callout 1), and then slide the right lower cover (callout 2) toward the front of the feeder to remove it.

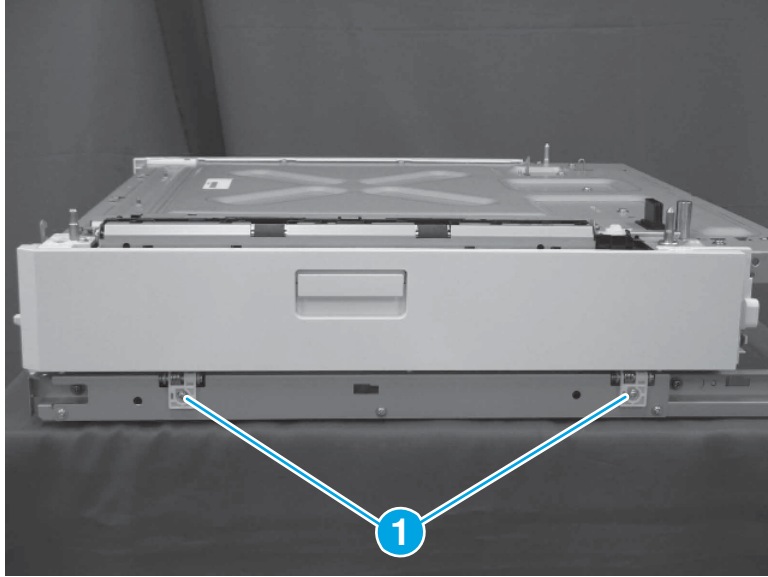
Figure 1-3294 Remove the right lower cover



7. Remove the 550-sheet paper tray right door.

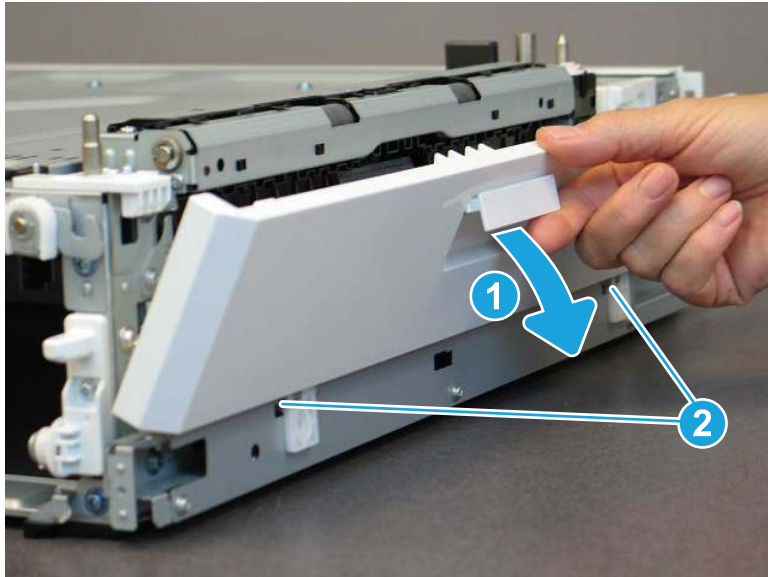
- a. Close the right door, and then remove two screws (callout 1).

Figure 1-3295 Remove two screws



- b. Open the right door (callout 1), and then release two bosses (callout 2) to remove the door.

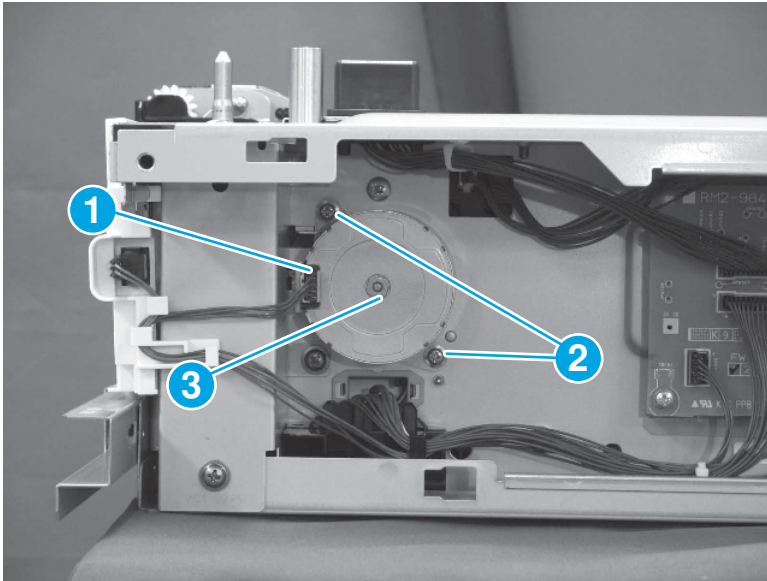
Figure 1-3296 Remove the right door



8. Remove the 550-sheet paper tray pickup motor.

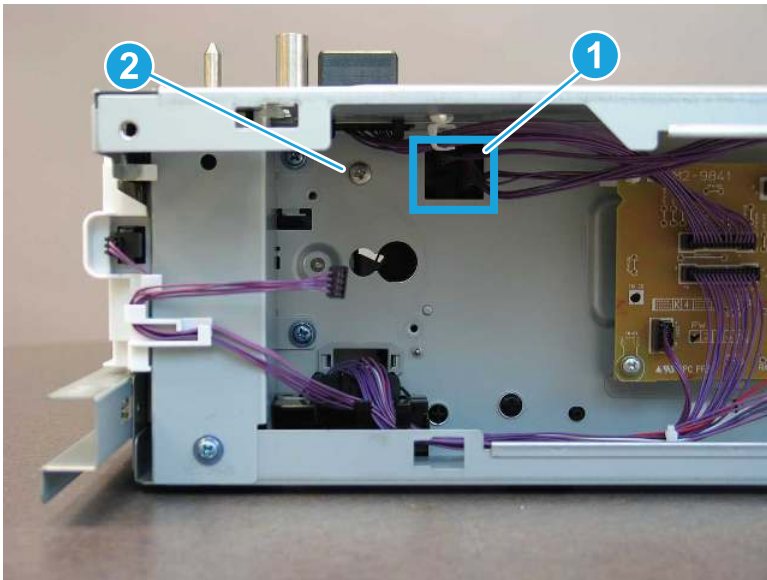
- ▲ Disconnect one connector (callout 1), remove two screws (callout 2), and then remove the pickup motor (callout 3).

Figure 1-3297 Remove the pickup motor



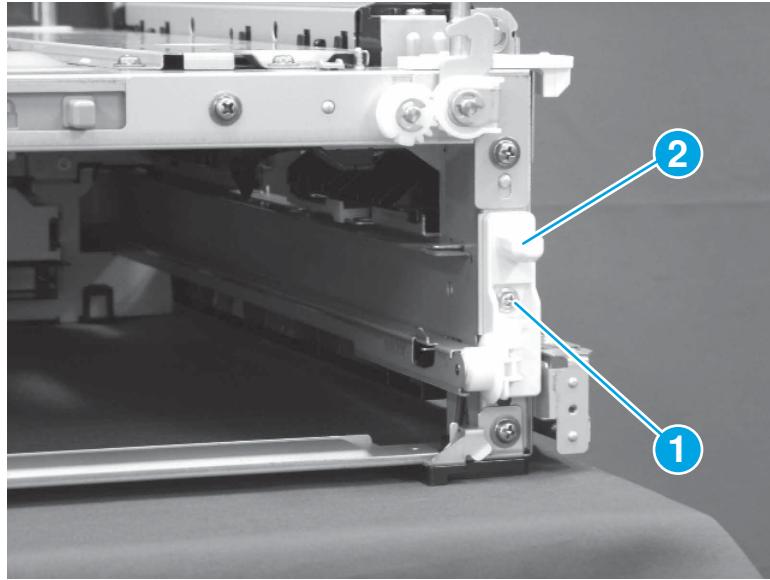
- 9. Remove the 550-sheet paper tray pickup assembly.
 - a. Disconnect two connectors (callout 1), and then remove one screw (callout 2).

Figure 1-3298 Disconnect two connectors and remove one screw



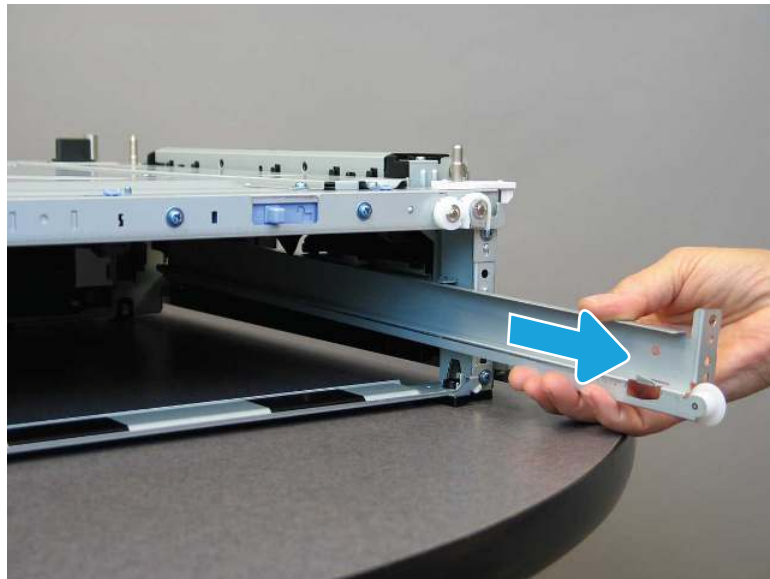
- b. At the front of the feeder, remove one screw (callout 1), and then remove the cover (callout 2).

Figure 1-3299 Remove one screw and the cover



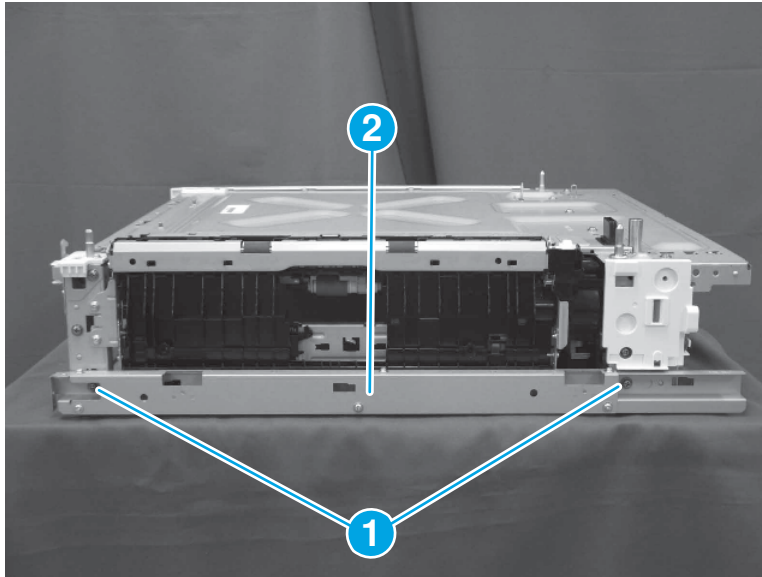
- c. Slide the cassette rail away from the printer to remove it.

Figure 1-3300 Remove the cassette rail



- d. On the right side of the feeder, remove two screws (callout 1), and then pull the right lower frame (callout 2) away from the printer to remove it.

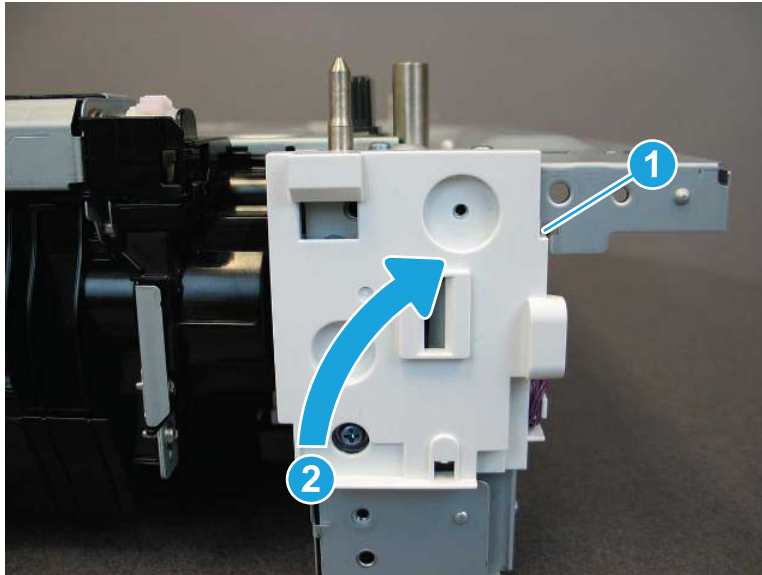
Figure 1-3301 Remove the right lower frame



- e. Release one tab (callout 1), and then rotate the right rear inner cover away from the feeder.

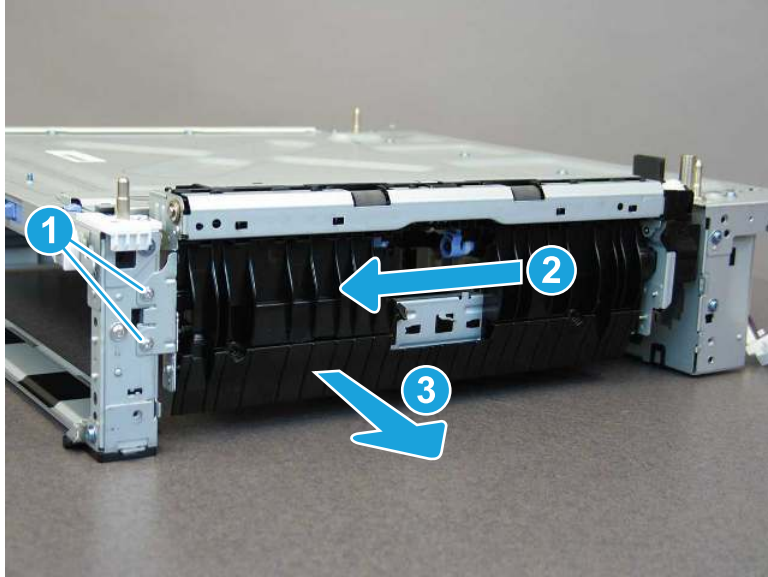
CAUTION: The cover is still attached to the feeder. Do not attempt to remove it completely.

Figure 1-3302 Release the right rear inner cover



- f. Remove two screws (callout 1). Slide the pickup assembly (callout 2) toward the front of the feeder, and then pull it away from the feeder (callout 3) to remove it.

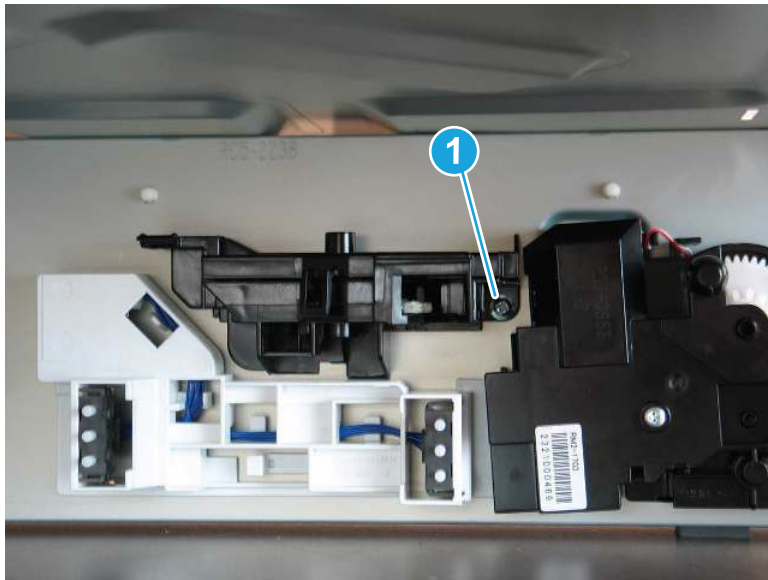
Figure 1-3303 Remove the pickup assembly



10. Remove the 550-sheet paper tray auto close assembly.

- ▲ Remove one screw (callout 1), and then slide the auto close assembly to the right to remove it.

Figure 1-3304 Remove the auto close assembly



11. Unpack the replacement assembly.

- a. Dispose of the defective part.



NOTE: HP recommends responsible disposal of the defective part.

<http://www8.hp.com/us/en/hp-information/environment/product-recycling.html>

- b. Unpack the replacement part from the packaging.



IMPORTANT: Make sure that all of the shipping materials (for example shipping tape) are removed from the replacement part prior to installation.

- c. To install an assembly, reverse the removal steps.



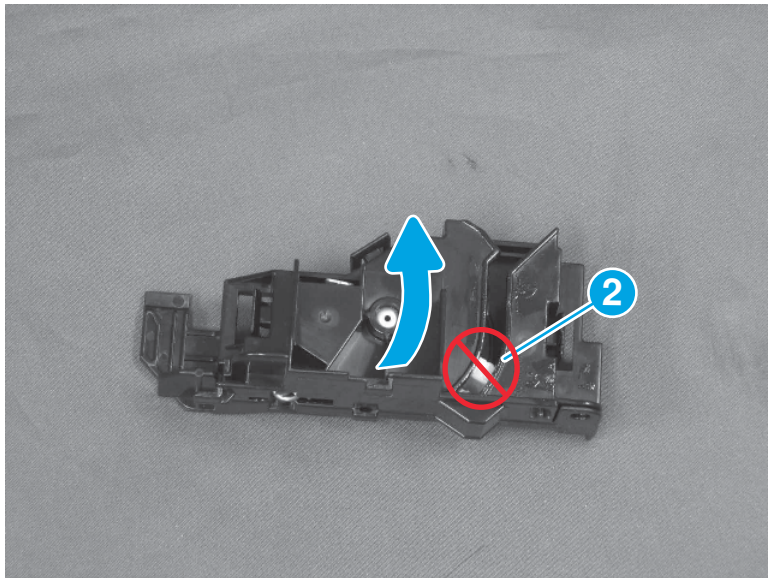
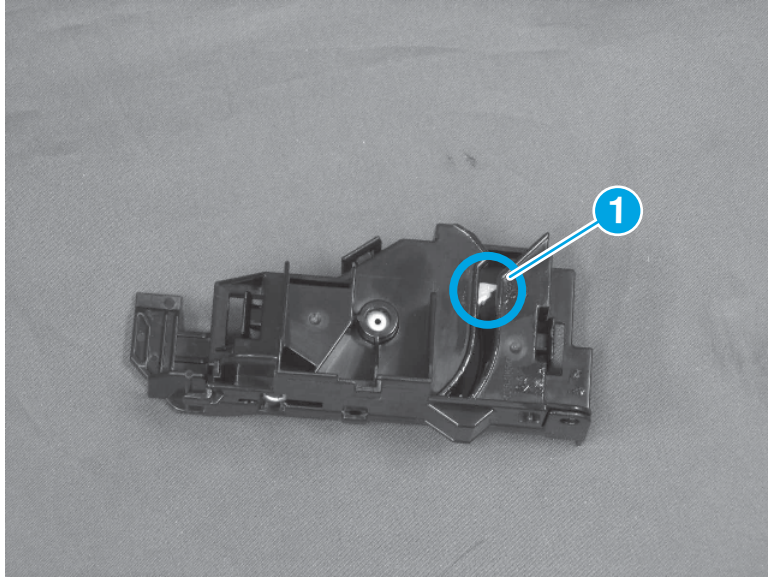
NOTE: When applicable, special installation instructions are provided for an assembly at the end of the removal procedure. Always completely read the removal instructions and follow all special installation instructions.

- 12. Reverse the removal steps to install the assembly. Also use the following **special installation instructions**.

Check the auto close toggle position

- ▲ Confirm the position of the toggle when installing the auto close assembly. The correct position of the toggle is toward the top of the auto close assembly (callout 1). If the toggle is in the wrong position (callout 2), use a small, flat-blade screwdriver to rotate it up to the correct position.

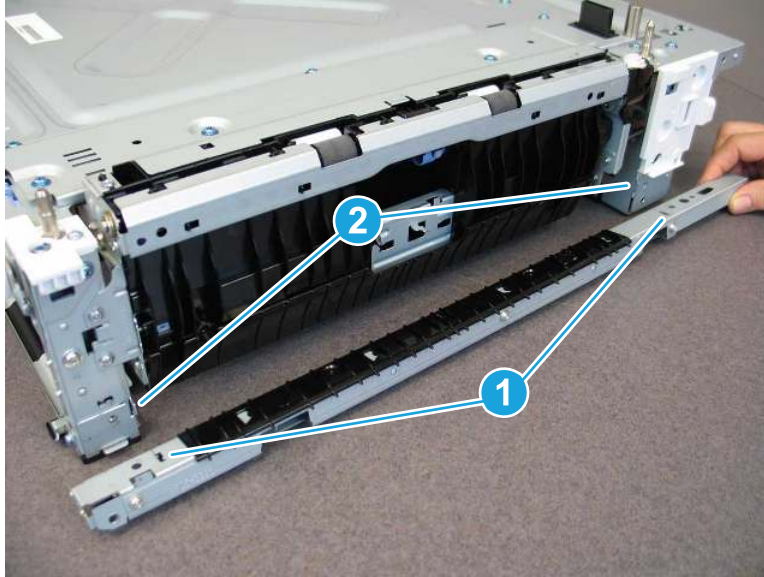
Figure 1-3305 Check the toggle position



Install the 550-sheet paper tray pickup assembly

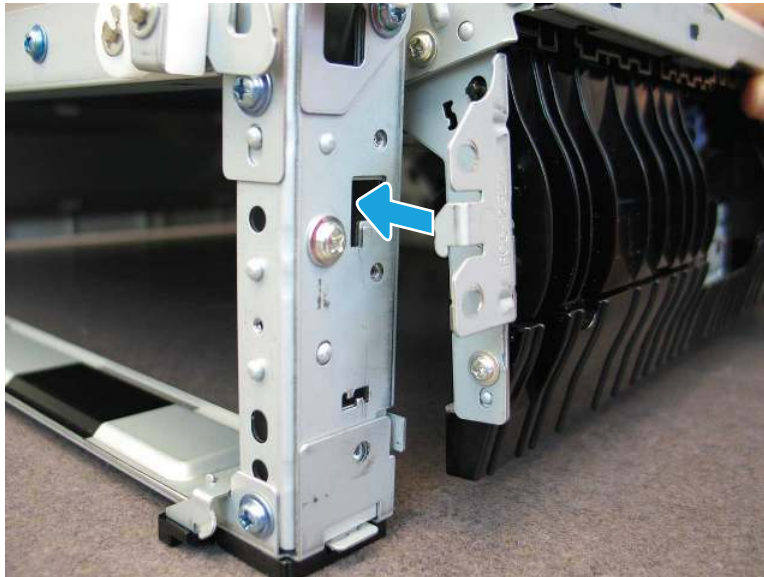
- a. When reinstalling the right lower frame, position the slots (callout 1) on the frame over the tabs (callout 2) on the feeder.

Figure 1-3306 Install the right lower frame



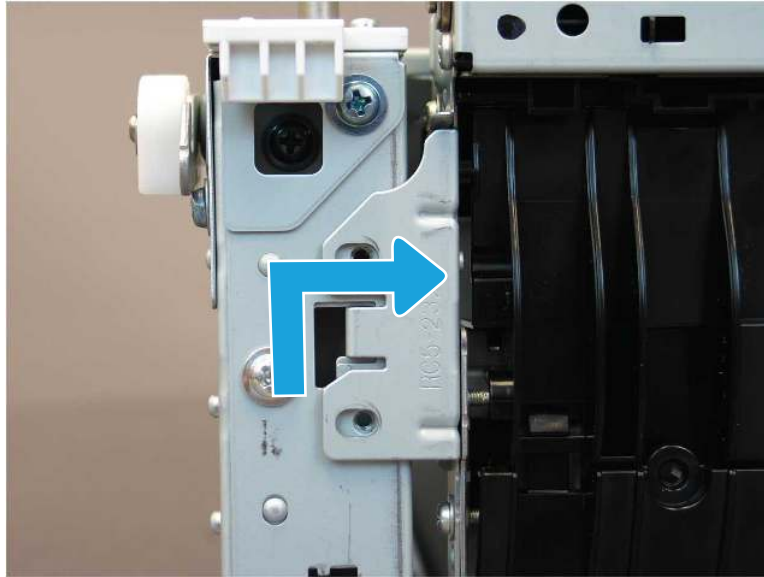
- b. When reinstalling the pickup assembly, install the tab in the slot.

Figure 1-3307 Install the tab



- c. Lift the pickup assembly up, and then slide to the right.

Figure 1-3308 Install the pickup assembly



Removal and replacement: 550-sheet paper tray size detect switch

Learn how to remove and replace the 550-sheet paper tray size detect switch.

[View a video of how to remove and replace the 550-sheet paper tray size detect switch.](#)

Mean time to repair: 3 minutes

Service level: Easy

Before performing service

Turn the printer power off

- Disconnect the power cable.

⚠ WARNING! To avoid damage to the printer, turn the printer off, wait 30 seconds, and then remove the power cord before attempting to service the printer.

Use the table below to identify the correct part number for your printer. To order the part, go to www.hp.com/buy/parts.

Table 1-166 Part information

Part number	Part description
RM2-1711-000CN	Size detect switch assembly

Required tools

- #2 Phillips screwdriver with a magnetic tip

After performing service

Turn the printer power on

- Connect the power cable.
- Use the power switch to turn the power on.

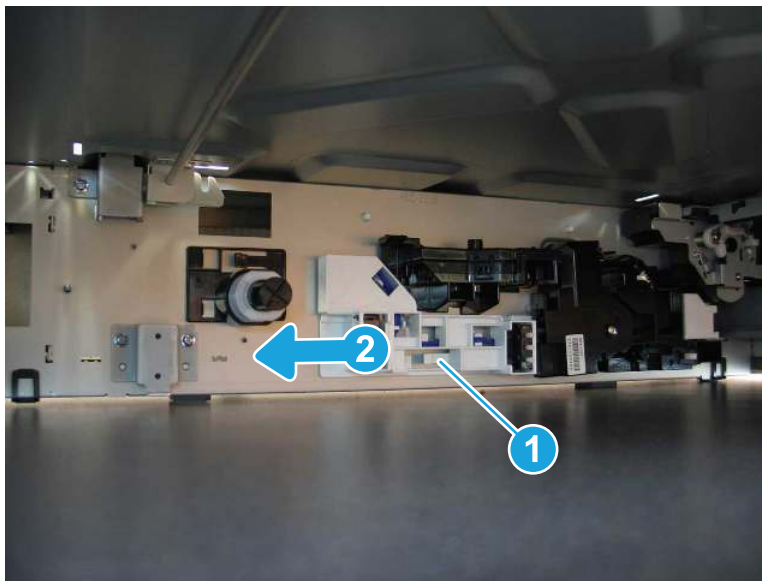
Post service test

Make sure that the printer initializes to a **Ready** state.

Print a page from the 550-sheet tray to make sure that the printer is functioning correctly.

1. Remove the 550-sheet paper tray size detect switch.
 - a. Remove the 550-sheet paper tray.
 - b. Inside the tray opening, release one tab (callout 1), and then slide the switch assembly to the left (callout 2) to release it.

Figure 1-3309 Release one tab and slide the switch assembly



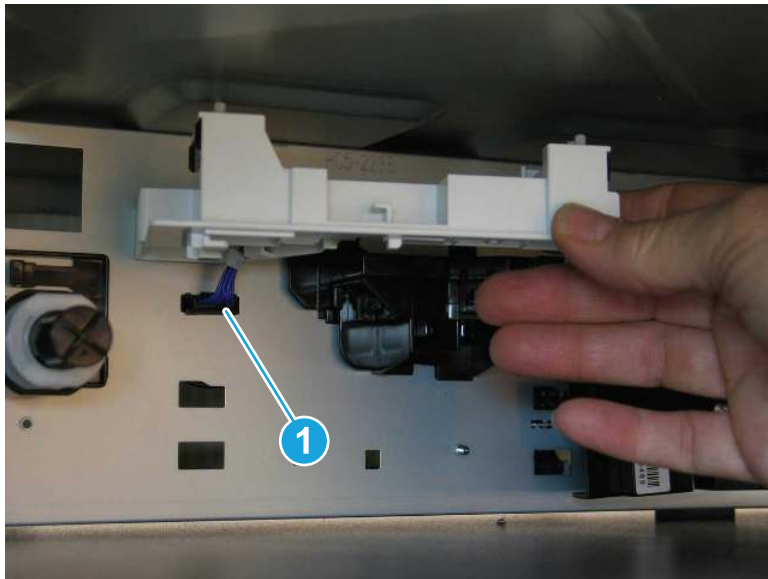
- c. Rotate the switch assembly up.

Figure 1-3310 Rotate the switch assembly up



- d. Disconnect one connector (callout 1), and then remove the size detect switch.

Figure 1-3311 Disconnect one connector and remove the switch




2. Unpack the replacement assembly.
 - a. Dispose of the defective part.




NOTE: HP recommends responsible disposal of the defective part.

<http://www8.hp.com/us/en/hp-information/environment/product-recycling.html>

- b. Unpack the replacement part from the packaging.

 **IMPORTANT:** Make sure that all of the shipping materials (for example shipping tape) are removed from the replacement part prior to installation.

- c. To install an assembly, reverse the removal steps.

 **NOTE:** When applicable, special installation instructions are provided for an assembly at the end of the removal procedure. Always completely read the removal instructions and follow all special installation instructions.

Removal and replacement: 2x550-sheet paper tray and stand components

Learn how to remove and replace the component parts in the 2x550-sheet paper tray and stand.

Removal and replacement: 2x550-sheet paper tray and stand paper tray

Learn how to remove and replace the paper tray for the 2x550-sheet paper tray and stand.

[View a video of how to remove and replace the 2x550-sheet paper tray and stand paper tray.](#)


Mean time to repair: 2 minutes

Service level: CSR A

Before performing service

Turn the printer power off

- Disconnect the power cable.

 **WARNING!** To avoid damage to the printer, turn the printer off, wait 30 seconds, and then remove the power cord before attempting to service the printer.

Use the table below to identify the correct part number for your printer. To order the part, go to www.hp.com/buy/parts.

Table 1-167 Part information

Part number	Part description
RM2-1706-000CN	Cassette assembly (upper tray)
RM2-1720-000CN	Cassette assembly (lower tray)

Required tools

- No special tools are required to remove or install this assembly.

After performing service

Turn the printer power on

- Connect the power cable.
- Use the power switch to turn the power on.

Post service test

Make sure that the printer initializes to a **Ready** state.

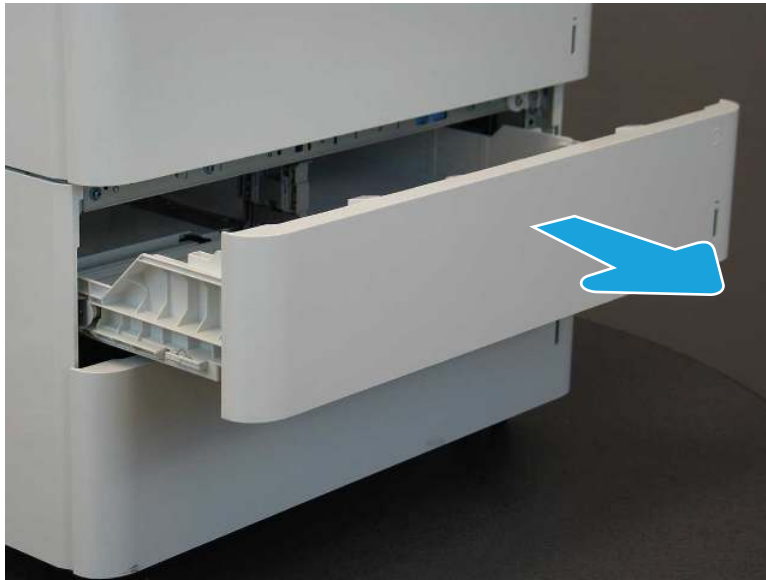
Print a page from the 2x550-sheet paper tray and stand to make sure that the printer is functioning correctly.

1. Remove the 2x550-sheet paper tray and stand tray.

 **NOTE:** The upper tray is shown in the steps below. The procedure is the same for the lower tray.

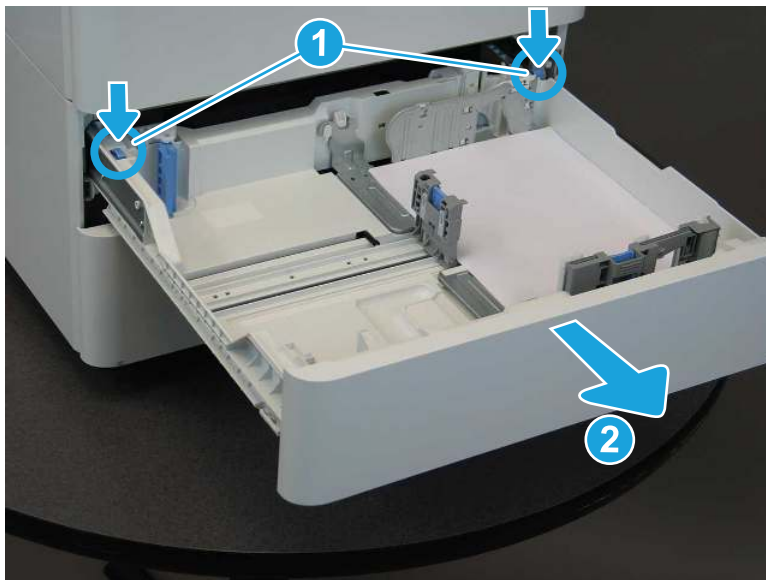
- a. Pull the tray away from the printer until it stops.

Figure 1-3312 Pull the tray out



- b. Push down to release two tabs (callout 1), and then remove the tray (callout 2).

Figure 1-3313 Remove the tray



2. Unpack the replacement assembly.

- a. Dispose of the defective part.



NOTE: HP recommends responsible disposal of the defective part.

<http://www8.hp.com/us/en/hp-information/environment/product-recycling.html>

- b. Unpack the replacement part from the packaging.



IMPORTANT: Make sure that all of the shipping materials (for example shipping tape) are removed from the replacement part prior to installation.

- c. To install an assembly, reverse the removal steps.



NOTE: When applicable, special installation instructions are provided for an assembly at the end of the removal procedure. Always completely read the removal instructions and follow all special installation instructions.

Removal and replacement: 2x550-sheet paper tray and stand pickup and separation rollers

Learn how to remove and replace the 2x550-sheet paper tray and stand pickup and separation rollers.

[View a video of how to remove and replace the 2x550-sheet paper tray and stand pickup and separation rollers.](#)

Mean time to repair: 2 minutes

Service level: CSR A

Before performing service

Turn the printer power off

- Disconnect the power cable.

⚠ WARNING! To avoid damage to the printer, turn the printer off, wait 30 seconds, and then remove the power cord before attempting to service the printer.

Use the table below to identify the correct part number for your printer. To order the part, go to www.hp.com/buy/parts.

Table 1-168 Part information

Part number	Part description
RM2-1526-000CN	Tray 2-x pickup and separation rollers

Required tools

- No special tools are required to remove or install this assembly.

After performing service

Turn the printer power on


- Connect the power cable.
- Use the power switch to turn the power on.

Post service test

Make sure that the printer initializes to a **Ready** state.

Print a page from the 2x550-sheet paper tray and stand to make sure that the printer is functioning correctly.

1. Remove the 2x550-sheet paper tray and stand separation roller.

 **NOTE:** The upper tray is shown in the figures below. The procedure is the same for the lower tray.

- a. Open the tray.

Figure 1-3314 Open the tray



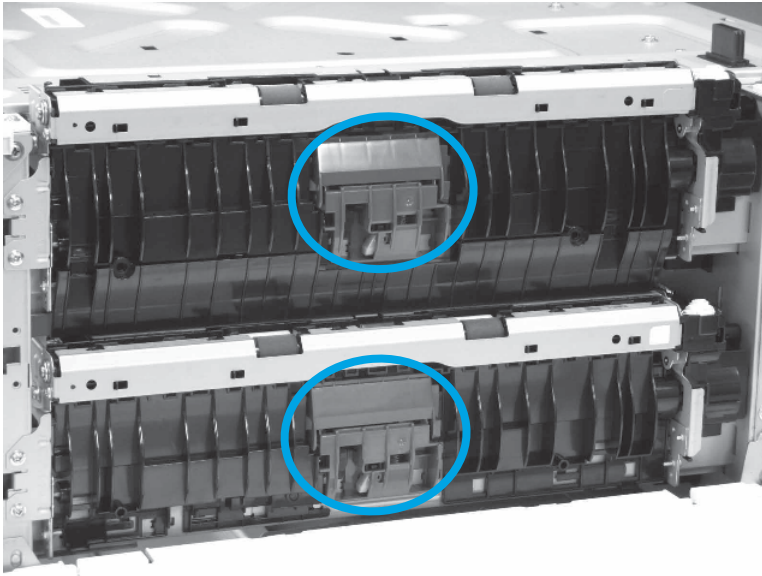
- b. Open the right door.

Figure 1-3315 Open the right door



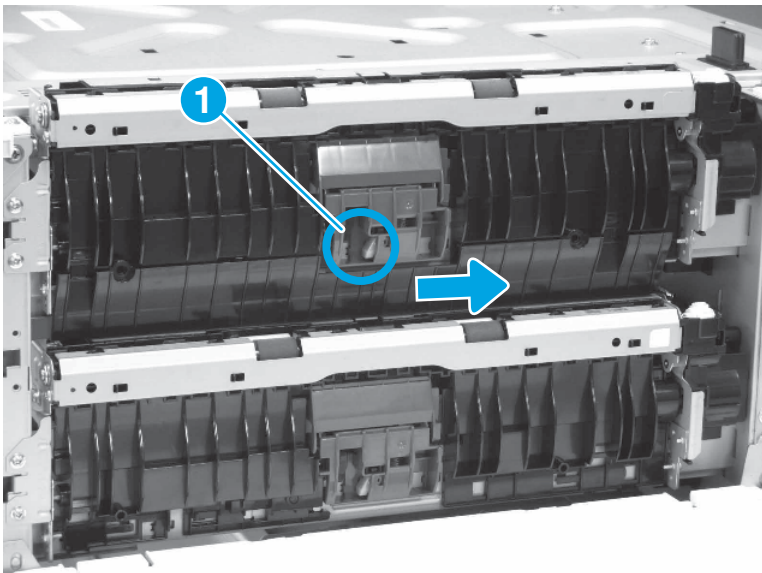
- c. Locate the separation roller.

Figure 1-3316 Locate the separation roller



- d. Press the release button (callout 1), slide the separation roller assembly to the right, and then pull it away from the printer to remove it .

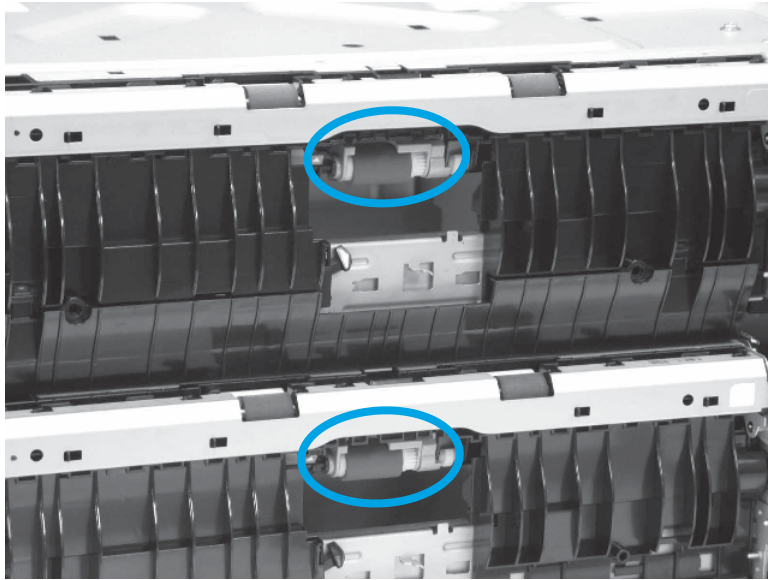
Figure 1-3317 Remove the separation roller



- 2. Remove the 2x550-sheet paper tray and stand tray pickup roller.

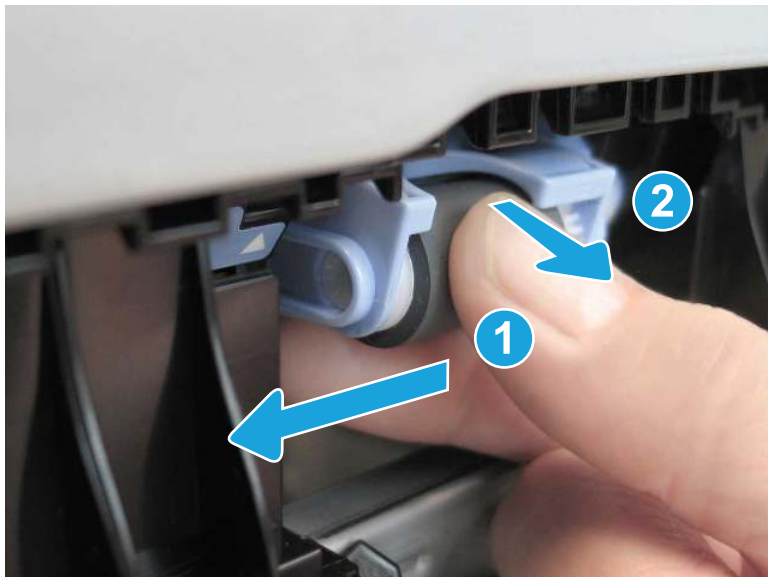
- a. Locate the pickup roller.

Figure 1-3318 Locate the pickup roller



- b. Slide the pickup roller assembly to the left (callout 1), and then pull it away from the printer (callout 2) to remove it.

Figure 1-3319 Remove the pickup roller



3. Unpack the replacement assembly.


- a. Dispose of the defective part.



NOTE: HP recommends responsible disposal of the defective part.

<http://www8.hp.com/us/en/hp-information/environment/product-recycling.html>

- b. Unpack the replacement part from the packaging.

 **IMPORTANT:** Make sure that all of the shipping materials (for example shipping tape) are removed from the replacement part prior to installation.

4. Install the 2x550-sheet paper tray and stand pickup roller.

 **NOTE:** Make sure that the tray is open before installing the roller.

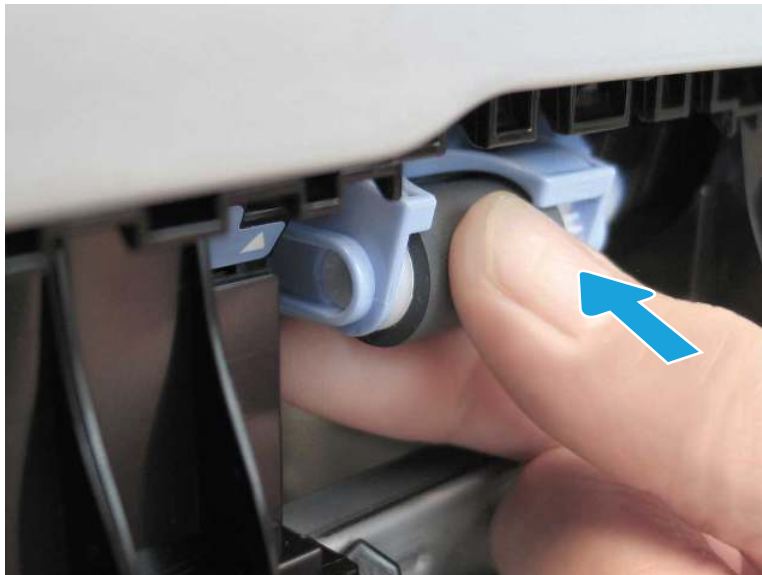
- a. Align the edges of the pickup roller assembly with the slots in the printer.

Figure 1-3320 Position the pickup roller




- b. Slide the roller assembly into the printer until it stops.

Figure 1-3321 Install the pickup roller

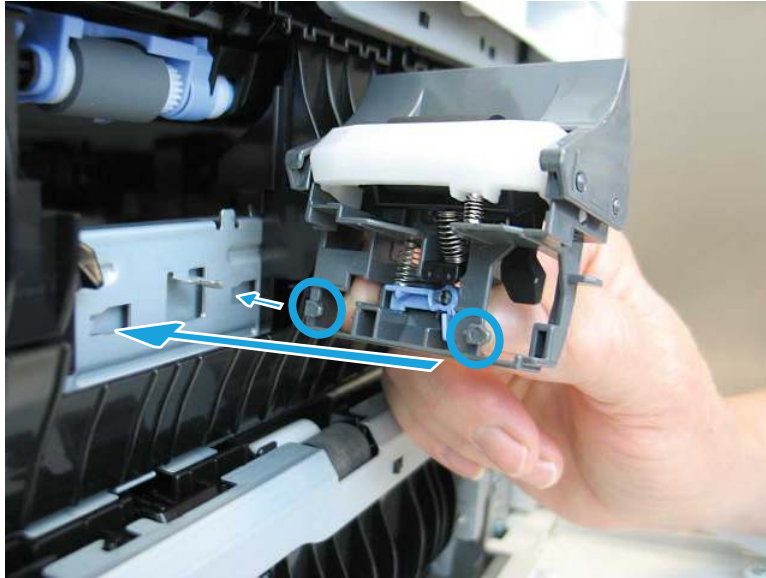


5. Install the 2x550-sheet paper tray and stand separation roller.

 **NOTE:** Make sure that the tray is open before installing the roller.

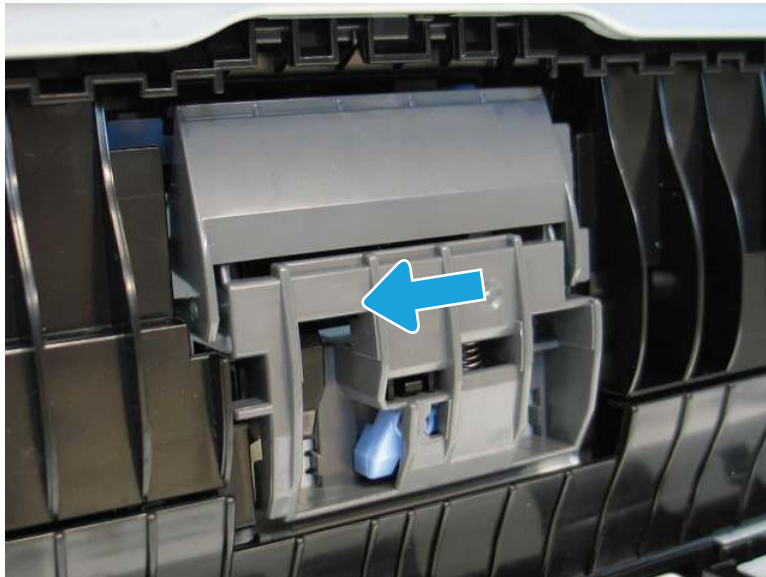
- a. Position the tabs on the separation roller into the slots on the feeder.

Figure 1-3322 Position the separation roller



- b. Slide the roller assembly to the left until it snaps into place.

Figure 1-3323 Install the separation roller



- c. Close the right door.

Figure 1-3324 Close the right door



- d. Close the tray.

Figure 1-3325 Close the tray



Removal and replacement: 2x550-sheet paper tray and stand right lower cover

Learn how to remove and replace the 2x550-sheet paper tray and stand right lower cover.

[View a video of how to remove and replace the 2x550-sheet paper tray and stand right lower cover.](#)


Mean time to repair: 2 minutes

Service level: Easy

Before performing service

Turn the printer power off

- Disconnect the power cable.

 **WARNING!** To avoid damage to the printer, turn the printer off, wait 30 seconds, and then remove the power cord before attempting to service the printer.

Use the table below to identify the correct part number for your printer. To order the part, go to www.hp.com/buy/parts.

Table 1-169 Part information

Part number	Part description
RC5-2064-000CN	Cover, right, lower

Required tools

- #2 Phillips screwdriver with a magnetic tip

After performing service

Turn the printer power on


- Connect the power cable.
- Use the power switch to turn the power on.

Post service test

Make sure that the printer initializes to a **Ready** state.

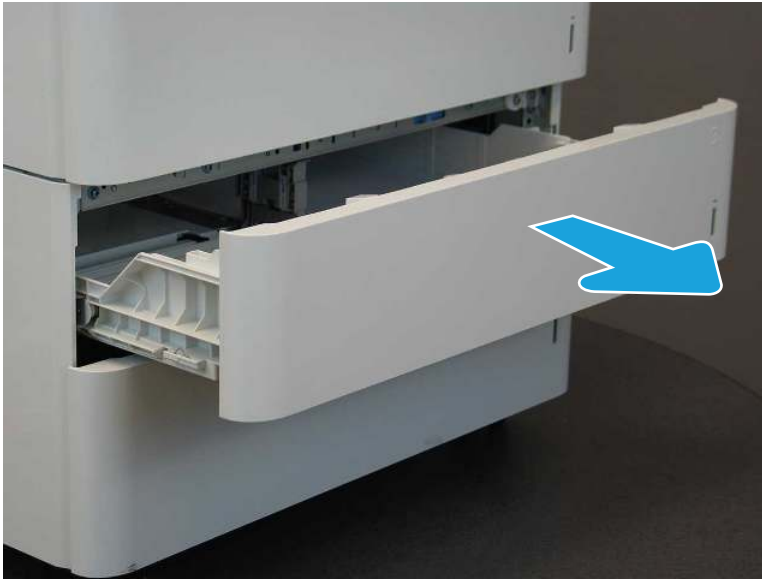
Print a page from the 2x550-sheet paper tray and stand to make sure that the printer is functioning correctly.

1. Remove both of the 2x550-sheet paper tray and stand trays.

 **NOTE:** The upper tray is shown in the steps below. Follow the same procedure to remove the lower tray.

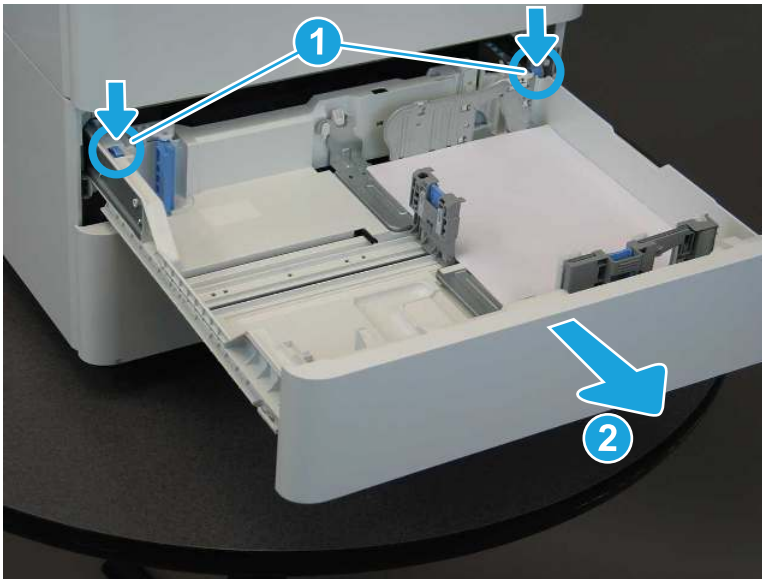
- a. Pull the tray away from the printer until it stops.

Figure 1-3326 Pull the tray out



- b. Push down to release two tabs (callout 1), and then remove the tray (callout 2).

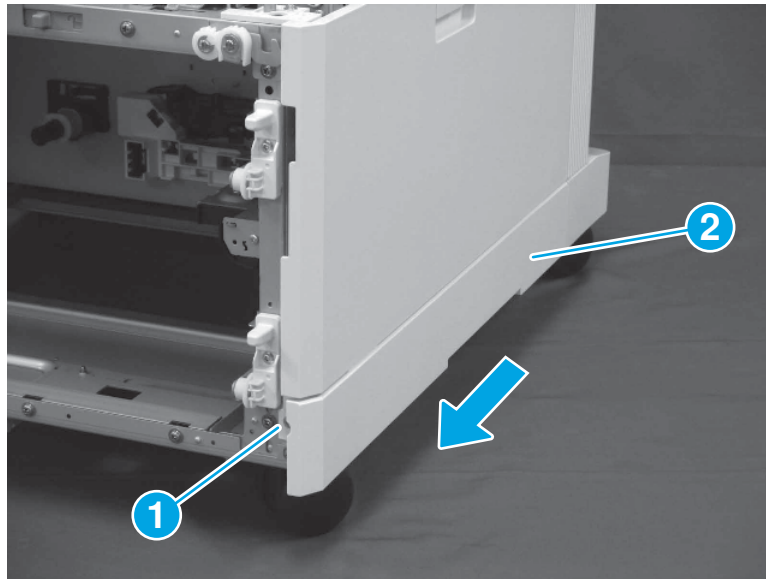
Figure 1-3327 Remove the tray



2. Remove the 2x550-sheet paper tray and stand right lower cover.

- ▲ Remove one screw (callout 1), and then slide the right lower cover (callout 2) toward the front of the feeder to remove it.

Figure 1-3328 Remove the right lower cover



3. Unpack the replacement assembly.

- a. Dispose of the defective part.



NOTE: HP recommends responsible disposal of the defective part.

<http://www8.hp.com/us/en/hp-information/environment/product-recycling.html>

- b. Unpack the replacement part from the packaging.



IMPORTANT: Make sure that all of the shipping materials (for example shipping tape) are removed from the replacement part prior to installation.

- c. To install an assembly, reverse the removal steps.



NOTE: When applicable, special installation instructions are provided for an assembly at the end of the removal procedure. Always completely read the removal instructions and follow all special installation instructions.

Removal and replacement: 2x550-sheet paper tray and stand right door

Learn how to remove and replace the 2x550-sheet paper tray and stand right door.

[View a video of how to remove and replace the 2x550-sheet paper tray and stand right door.](#)

Mean time to repair: 10 minutes

Service level: Easy

Before performing service

Turn the printer power off

- Disconnect the power cable.

⚠ WARNING! To avoid damage to the printer, turn the printer off, wait 30 seconds, and then remove the power cord before attempting to service the printer.

Use the table below to identify the correct part number for your printer. To order the part, go to www.hp.com/buy/parts.

Table 1-170 Part information

Part number	Part description
RM2-1729-000CN	Right door assembly

Required tools

- #2 Phillips screwdriver with a magnetic tip

After performing service

Turn the printer power on

- Connect the power cable.
- Use the power switch to turn the power on.

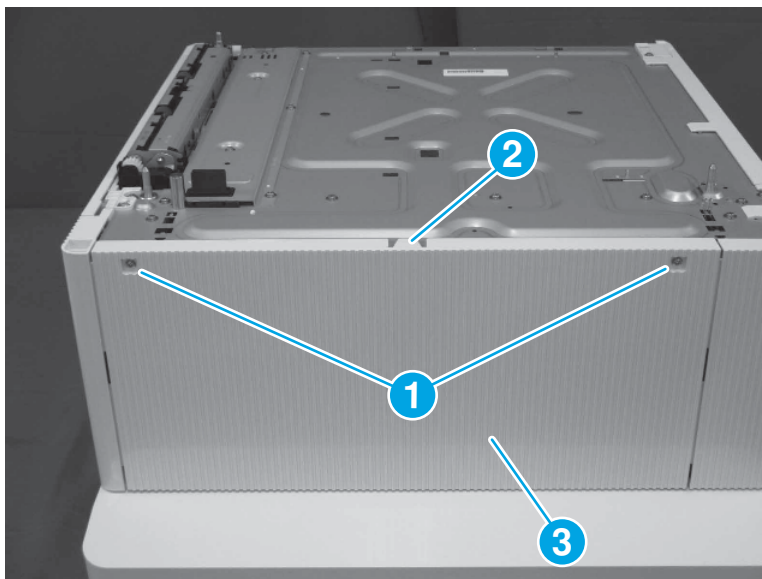
Post service test

Make sure that the printer initializes to a **Ready** state.

Print a page from the 2x550-sheet paper tray and stand to make sure that the printer is functioning correctly.

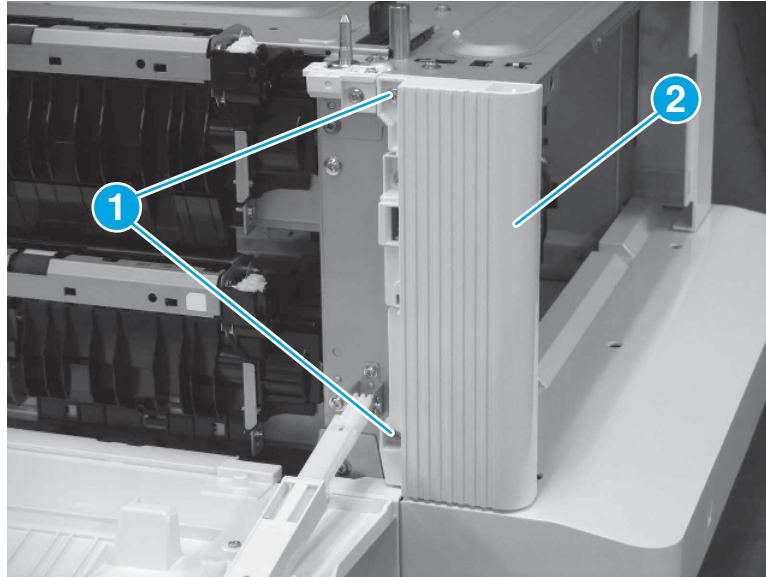
1. Remove the 2x550-sheet paper tray and stand rear upper cover.
 - ▲ Remove two screws (callout 1), release one tab (callout 2), and then lift up to remove the rear upper cover (callout 3).

Figure 1-3329 Remove the rear upper cover




2. Remove the 2x550-sheet paper tray and stand right rear cover.
 - a. Open the right door.
 - b. Remove two screws (callout 1), and then remove the right rear cover (callout 2).

Figure 1-3330 Remove the right rear cover

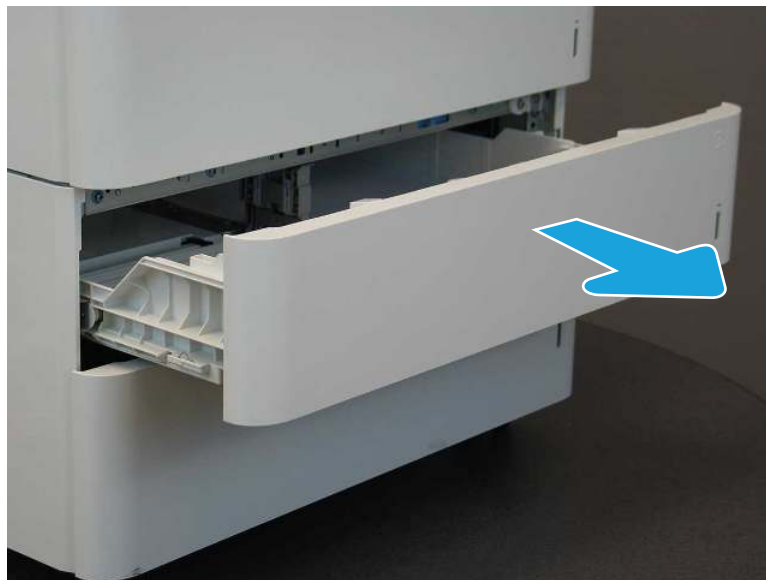


3. Remove both of the 2x550-sheet paper tray and stand trays.

 **NOTE:** The upper tray is shown in the steps below. Follow the same procedure to remove the lower tray.

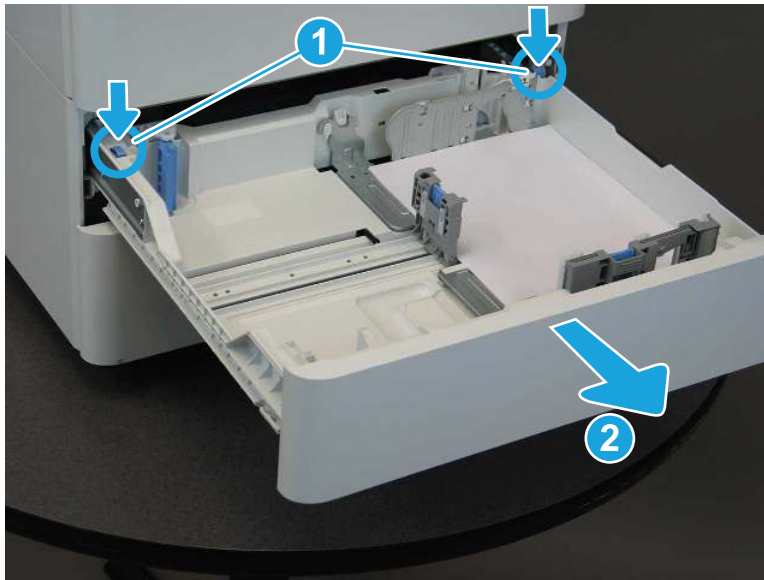
- a. Pull the tray away from the printer until it stops.

Figure 1-3331 Pull the tray out



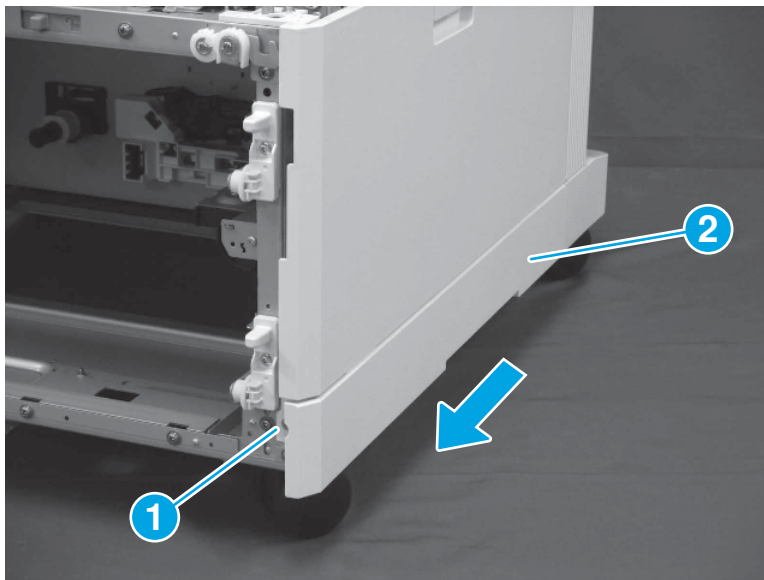
- b. Push down to release two tabs (callout 1), and then remove the tray (callout 2).

Figure 1-3332 Remove the tray



4. Remove the 2x550-sheet paper tray and stand right lower cover.
 - ▲ Remove one screw (callout 1), and then slide the right lower cover (callout 2) toward the front of the feeder to remove it.

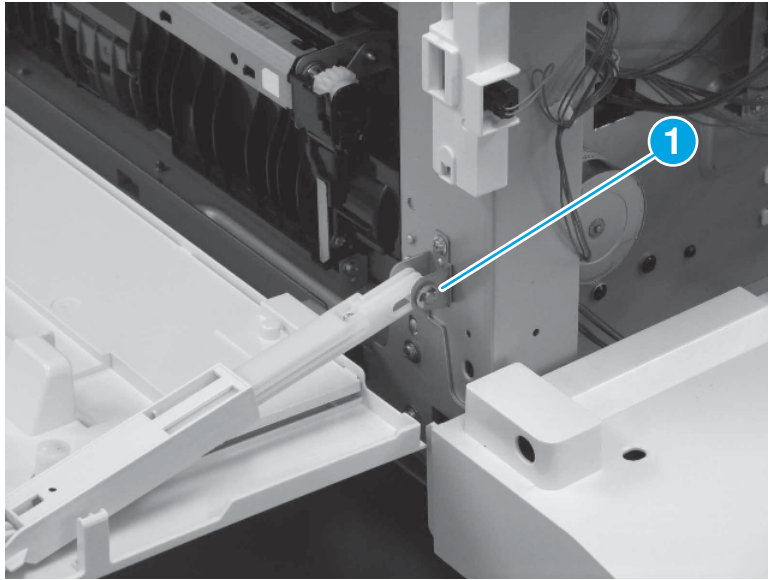
Figure 1-3333 Remove the right lower cover



5. Remove the 2x550-sheet paper tray and stand right door.

- a. Remove one E-ring (callout 1).

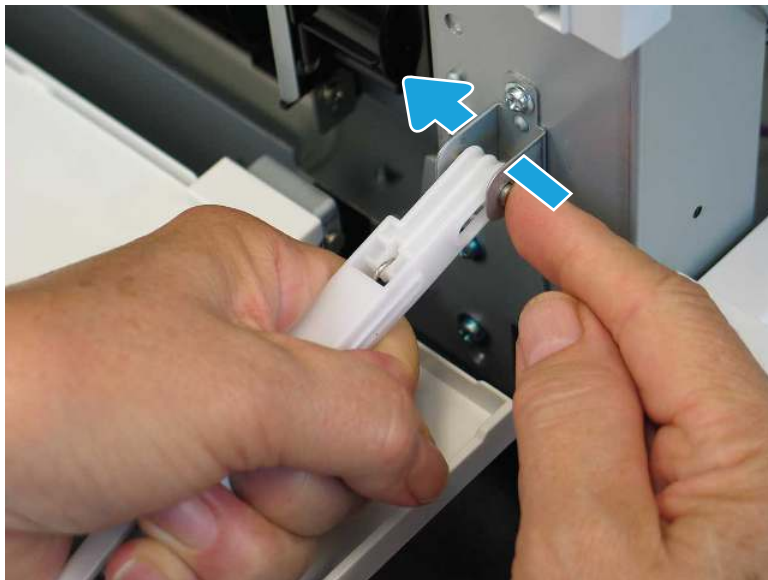
Figure 1-3334 Remove one E-ring



- b. Hold the hinge arm securely, and then slide the shaft to the left to remove it.

⚠ CAUTION: The hinge arm is spring-loaded and may snap back suddenly when the shaft is removed.

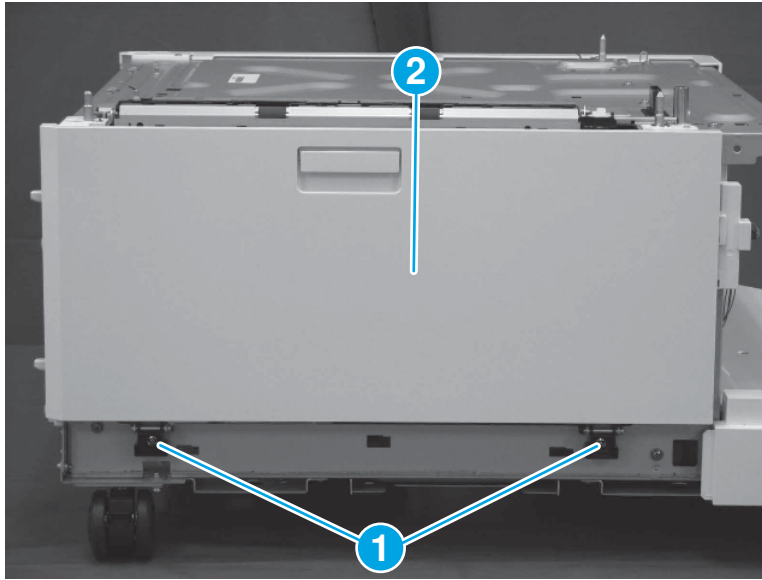
Figure 1-3335 Release the hinge arm



- c. Close the right door assembly.

- d. Remove two screws (callout 1), and then remove the right door assembly (callout 2).

Figure 1-3336 Remove two screws and the right door



6. Unpack the replacement assembly.
 - a. Dispose of the defective part.
 - b. Unpack the replacement part from the packaging.
 - c. To install an assembly, reverse the removal steps.



NOTE: HP recommends responsible disposal of the defective part.

<http://www8.hp.com/us/en/hp-information/environment/product-recycling.html>



IMPORTANT: Make sure that all of the shipping materials (for example shipping tape) are removed from the replacement part prior to installation.



NOTE: When applicable, special installation instructions are provided for an assembly at the end of the removal procedure. Always completely read the removal instructions and follow all special installation instructions.

Removal and replacement: 2x550-sheet paper tray and stand tray 1 pickup motor

Learn how to remove and replace the 2x550-sheet paper tray and stand tray 1 pickup motor.

[View a video of how to remove and replace the 2x550-sheet paper tray and stand tray 1 pickup motor.](#)

Mean time to repair: 3 minutes

Service level: Easy

Before performing service

Turn the printer power off

- Disconnect the power cable.

⚠ WARNING! To avoid damage to the printer, turn the printer off, wait 30 seconds, and then remove the power cord before attempting to service the printer.

Use the table below to identify the correct part number for your printer. To order the part, go to www.hp.com/buy/parts.

Table 1-171 Part information

Part number	Part description
RK2-9410-000CN	Motor, stepping, DC

Required tools

- #2 Phillips screwdriver with a magnetic tip

After performing service

Turn the printer power on

- Connect the power cable.
- Use the power switch to turn the power on.

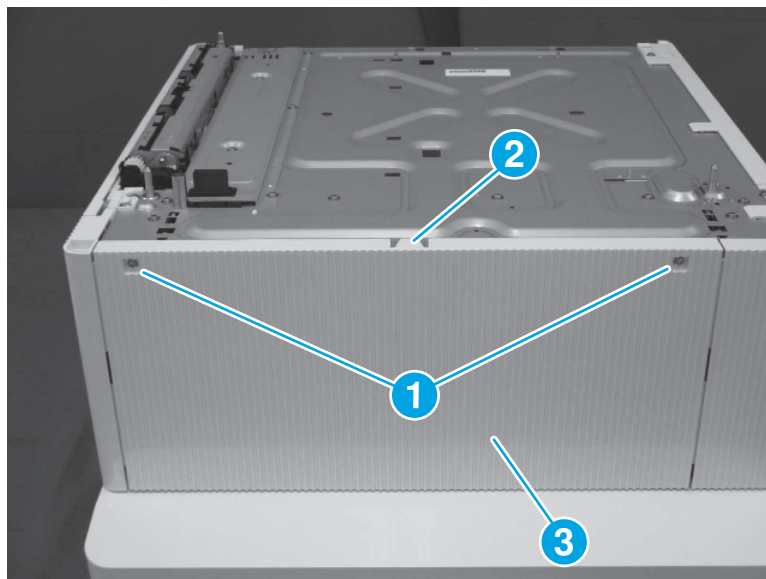
Post service test

Make sure that the printer initializes to a **Ready** state.

Print a page from the 2x550-sheet paper tray and stand to make sure that the printer is functioning correctly.

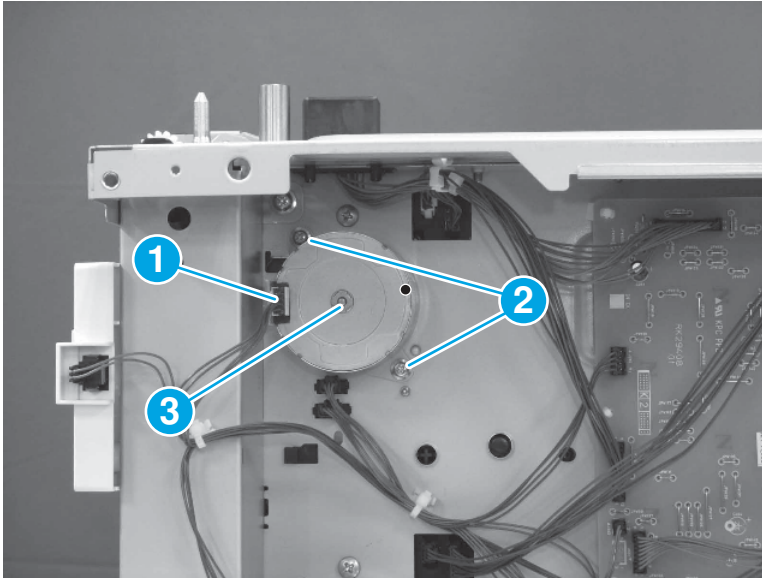
1. Remove the 2x550-sheet paper tray and stand rear upper cover.
 - ▲ Remove two screws (callout 1), release one tab (callout 2), and then lift up to remove the rear upper cover (callout 3).

Figure 1-3337 Remove the rear upper cover



2. Remove the 2x550-sheet paper tray and stand tray 1 pickup motor.
 - ▲ Disconnect one connector (callout 1), remove two screws (callout 2), and then remove the pickup motor (callout 3).

Figure 1-3338 Remove the pickup motor




3. Unpack the replacement assembly.
 - a. Dispose of the defective part.
 - b. Unpack the replacement part from the packaging.



NOTE: HP recommends responsible disposal of the defective part.

<http://www8.hp.com/us/en/hp-information/environment/product-recycling.html>



CAUTION:  Some parts are sensitive to electrostatic discharge (ESD). Always perform service work at an ESD-protected workstation or mat. If an ESD workstation or mat is not available, touch the sheet-metal chassis to provide a static ground before touching an ESD-sensitive assembly. Protect the ESD-sensitive assemblies by placing them in ESD pouches when they are out of the printer.



IMPORTANT: Make sure that all of the shipping materials (for example shipping tape) are removed from the replacement part prior to installation.

- c. To install an assembly, reverse the removal steps.



NOTE: When applicable, special installation instructions are provided for an assembly at the end of the removal procedure. Always completely read the removal instructions and follow all special installation instructions.

Removal and replacement: 2x550-sheet paper tray and stand tray 1 pickup assembly

Learn how to remove and replace the 2x550-sheet paper tray and stand tray 1 pickup assembly.

[View a video of how to remove and replace the 2x550-sheet paper tray and stand tray 1 pickup assembly.](#)


Mean time to repair: 18 minutes

Service level: Medium

Before performing service

Turn the printer power off

- Disconnect the power cable.

 **WARNING!** To avoid damage to the printer, turn the printer off, wait 30 seconds, and then remove the power cord before attempting to service the printer.

Use the table below to identify the correct part number for your printer. To order the part, go to www.hp.com/buy/parts.

Table 1-172 Part information

Part number	Part description
RM2-1717-000CN	Paper pickup assembly

Required tools

- #2 Phillips screwdriver with a magnetic tip

After performing service

Turn the printer power on

- Connect the power cable.
- Use the power switch to turn the power on.

Post service test

Make sure that the printer initializes to a **Ready** state.

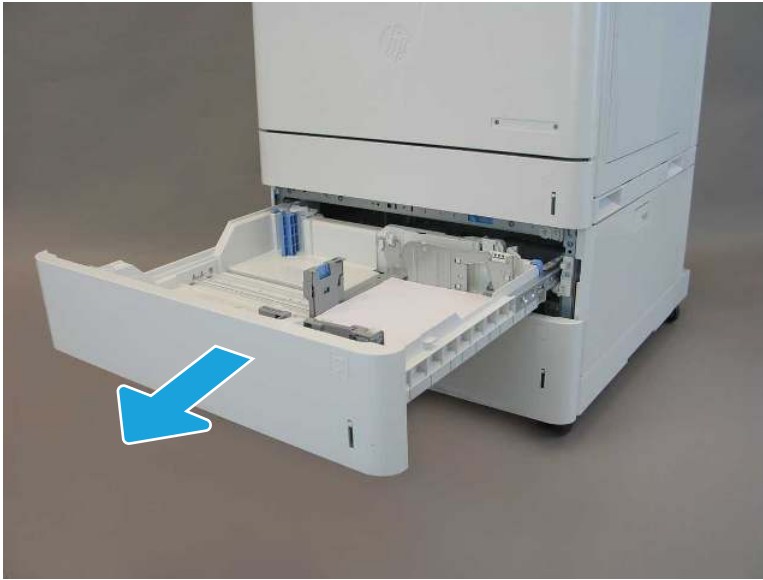
Print a page from the 2x550-sheet paper tray and stand to make sure that the printer is functioning correctly.

1. Remove the 2x550-sheet paper tray and stand separation roller.

 **NOTE:** The upper tray is shown in the figures below. The procedure is the same for the lower tray.

- a. Open the tray.

Figure 1-3339 Open the tray



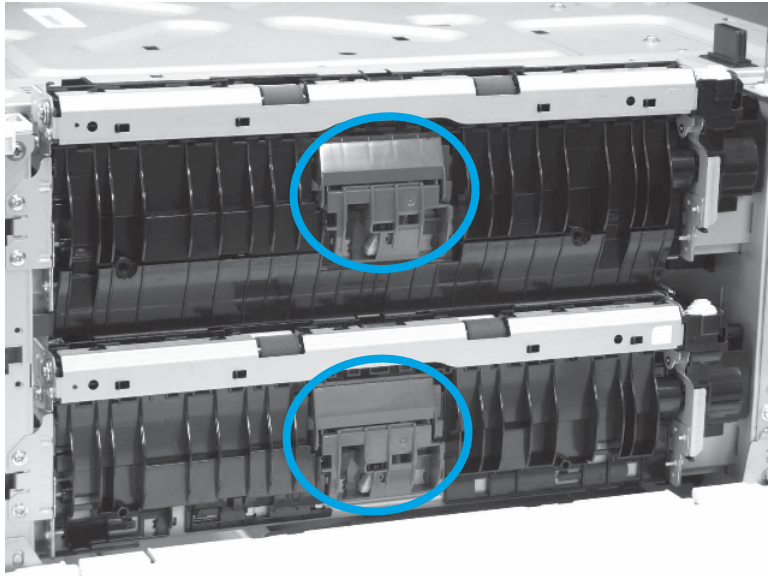
- b. Open the right door.

Figure 1-3340 Open the right door



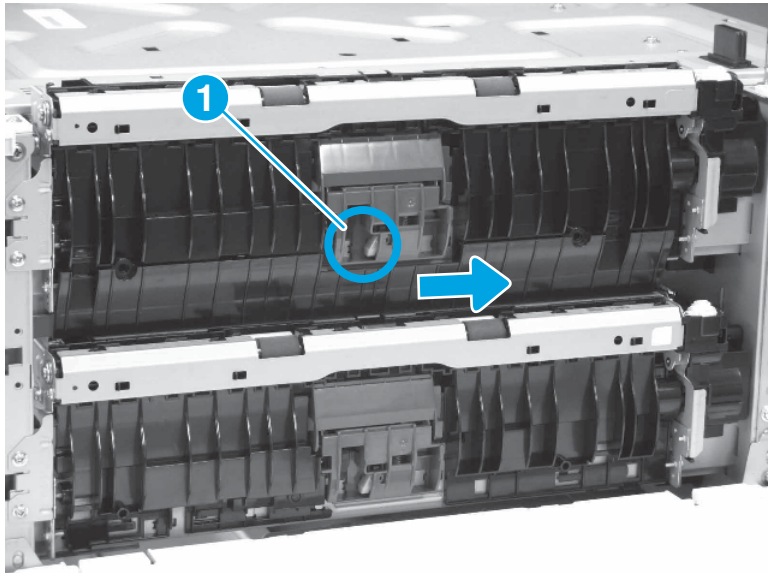
- c. Locate the separation roller.

Figure 1-3341 Locate the separation roller



- d. Press the release button (callout 1), slide the separation roller assembly to the right, and then pull it away from the printer to remove it.

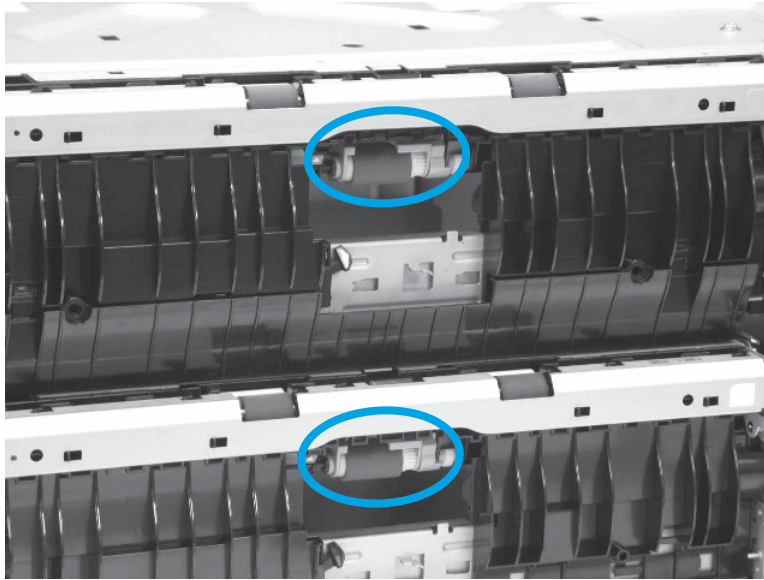
Figure 1-3342 Remove the separation roller



2. Remove the 2x550-sheet paper tray and stand tray pickup roller.

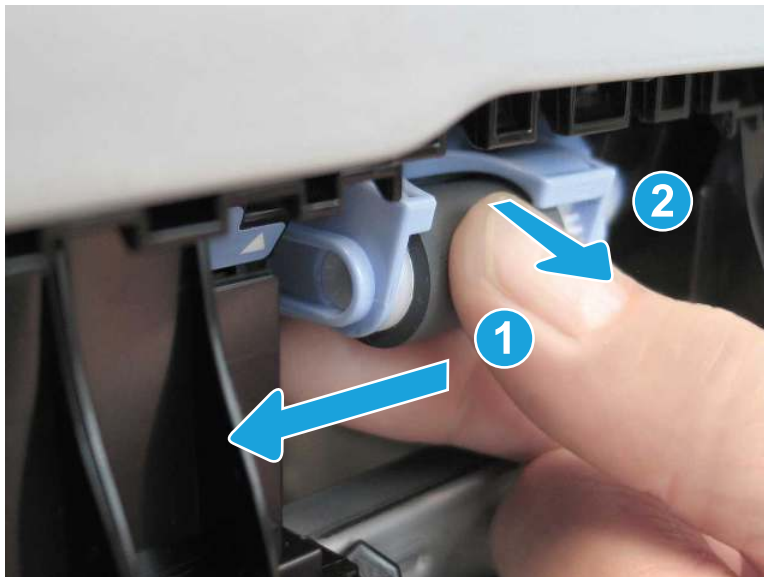
- a. Locate the pickup roller.

Figure 1-3343 Locate the pickup roller



- b. Slide the pickup roller assembly to the left (callout 1), and then pull it away from the printer (callout 2) to remove it.

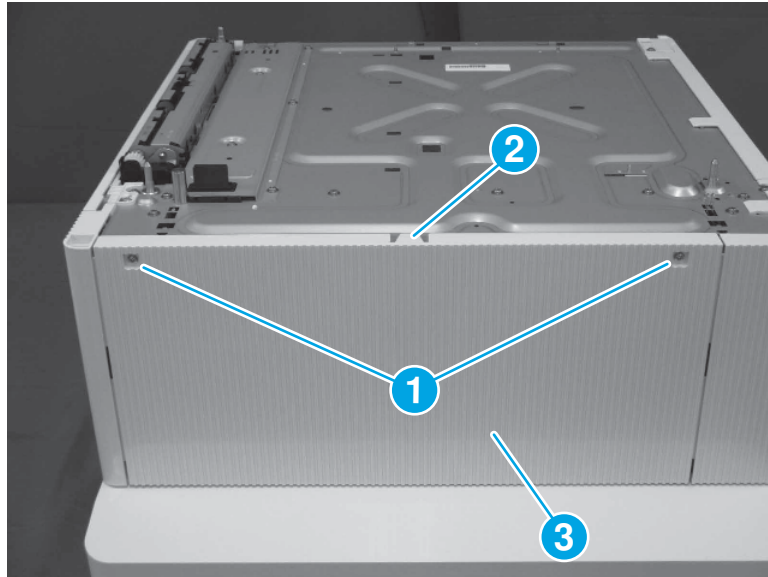
Figure 1-3344 Remove the pickup roller



3. Remove the 2x550-sheet paper tray and stand rear upper cover.

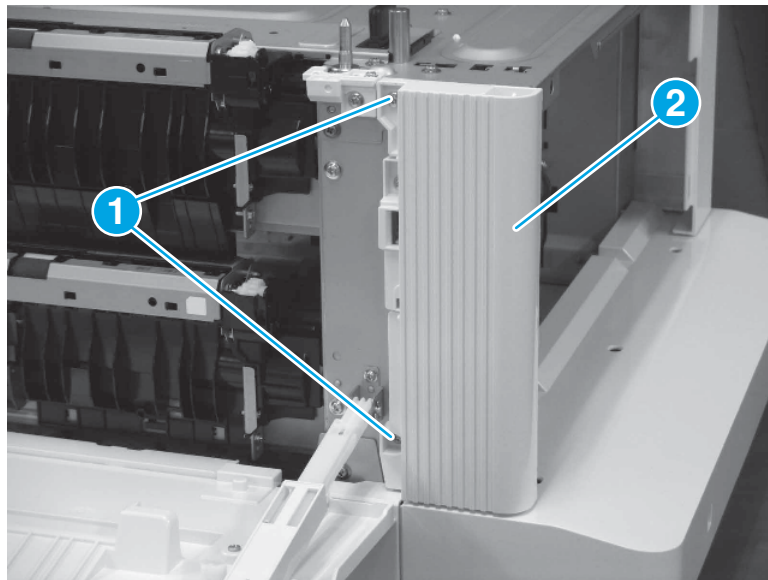
- ▲ Remove two screws (callout 1), release one tab (callout 2), and then lift up to remove the rear upper cover (callout 3).

Figure 1-3345 Remove the rear upper cover




- 4. Remove the 2x550-sheet paper tray and stand right rear cover.
 - a. Open the right door.
 - b. Remove two screws (callout 1), and then remove the right rear cover (callout 2).

Figure 1-3346 Remove the right rear cover

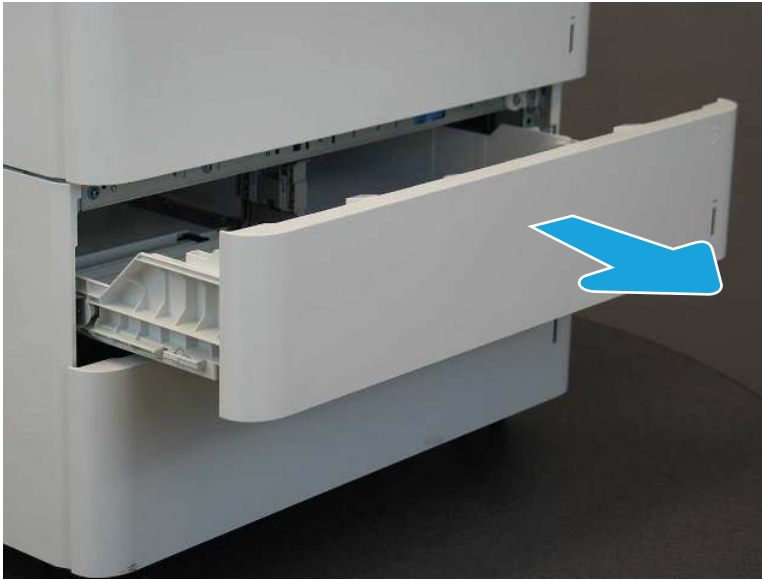


- 5. Remove both of the 2x550-sheet paper tray and stand trays.

 **NOTE:** The upper tray is shown in the steps below. Follow the same procedure to remove the lower tray.

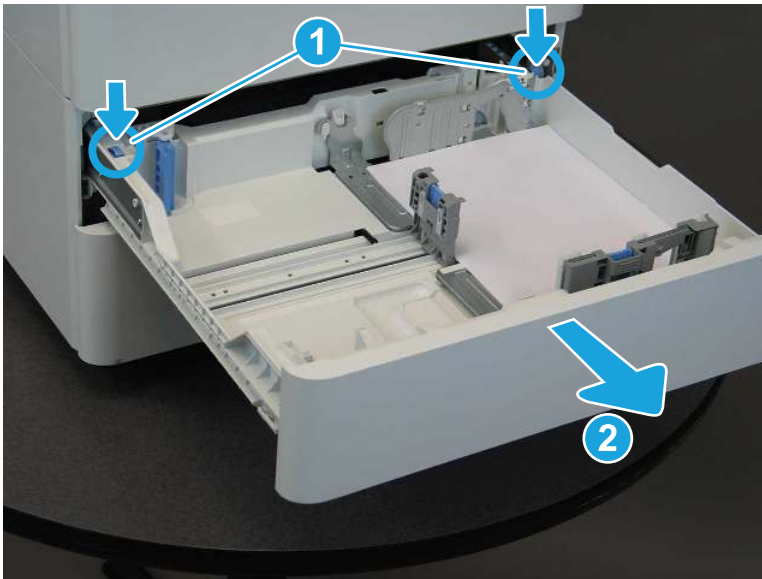
- a. Pull the tray away from the printer until it stops.

Figure 1-3347 Pull the tray out



- b. Push down to release two tabs (callout 1), and then remove the tray (callout 2).

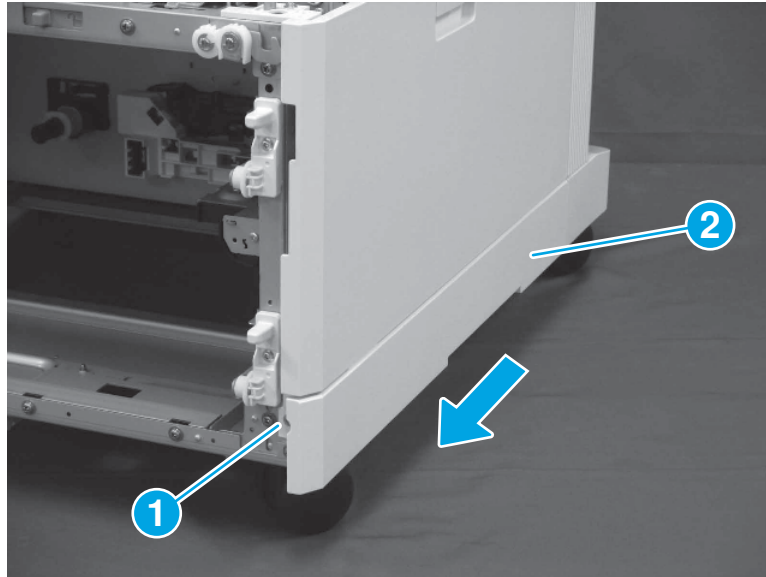
Figure 1-3348 Remove the tray



6. Remove the 2x550-sheet paper tray and stand right lower cover.

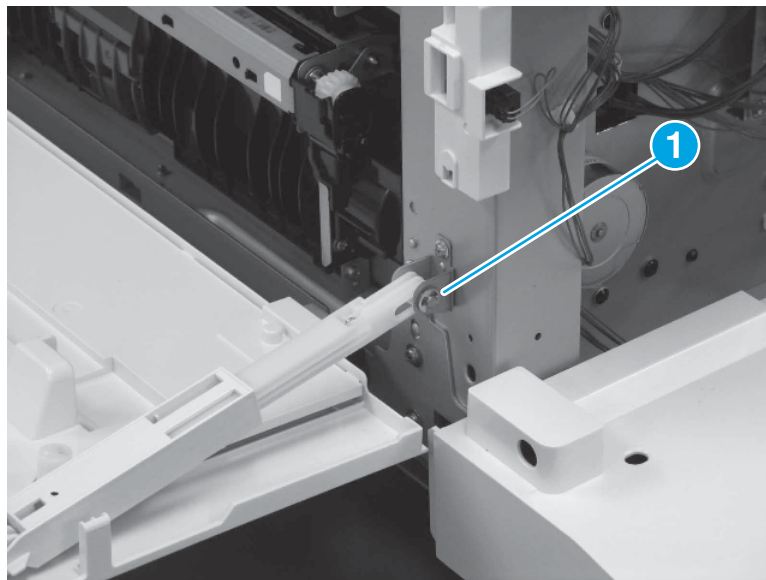
- ▲ Remove one screw (callout 1), and then slide the right lower cover (callout 2) toward the front of the feeder to remove it.

Figure 1-3349 Remove the right lower cover



- 7. Remove the 2x550-sheet paper tray and stand right door.
 - a. Remove one E-ring (callout 1).

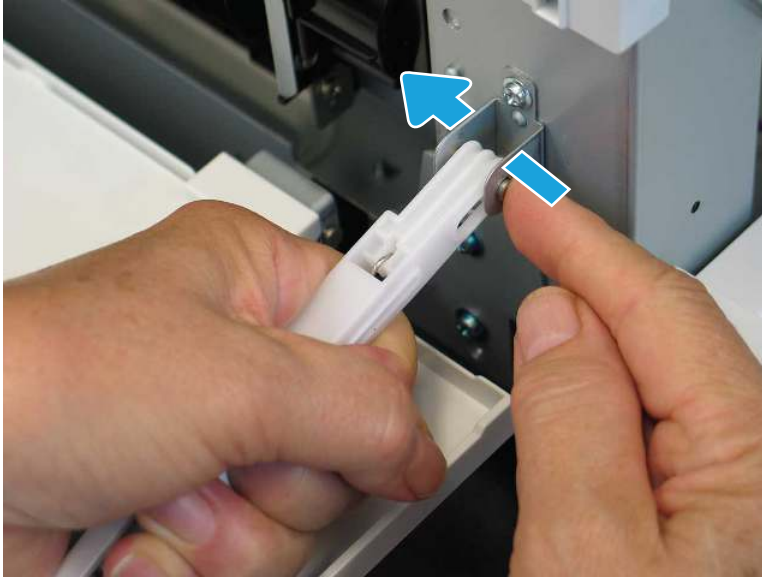
Figure 1-3350 Remove one E-ring



- b. Hold the hinge arm securely, and then slide the shaft to the left to remove it.

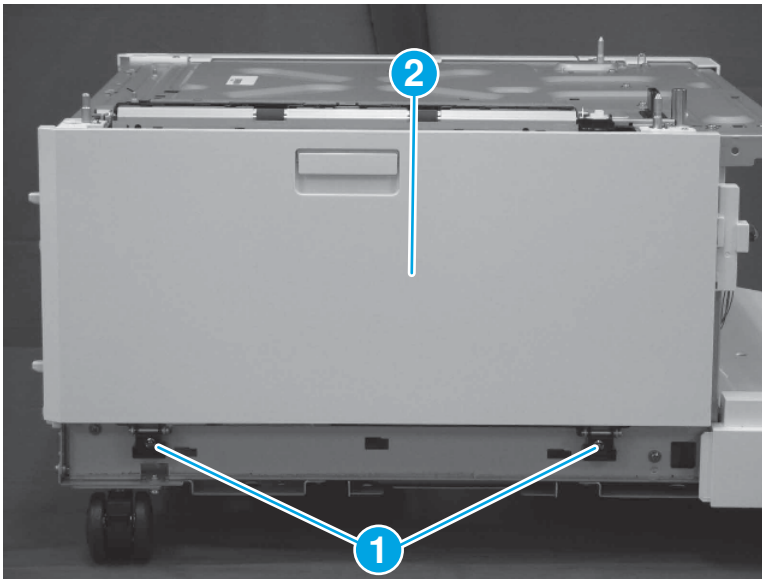
⚠ CAUTION: The hinge arm is spring-loaded and may snap back suddenly when the shaft is removed.

Figure 1-3351 Release the hinge arm



- c. Close the right door assembly.
- d. Remove two screws (callout 1), and then remove the right door assembly (callout 2).

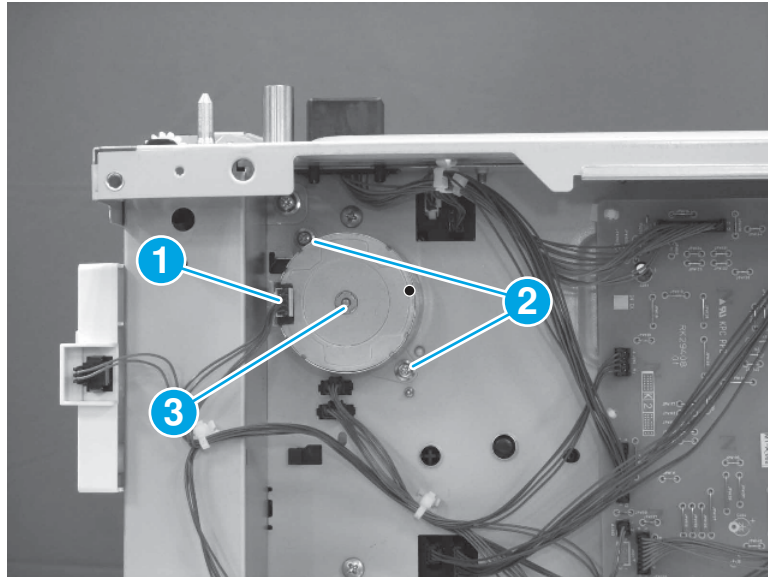
Figure 1-3352 Remove two screws and the right door



- 8. Remove the 2x550-sheet paper tray and stand tray 1 pickup motor.

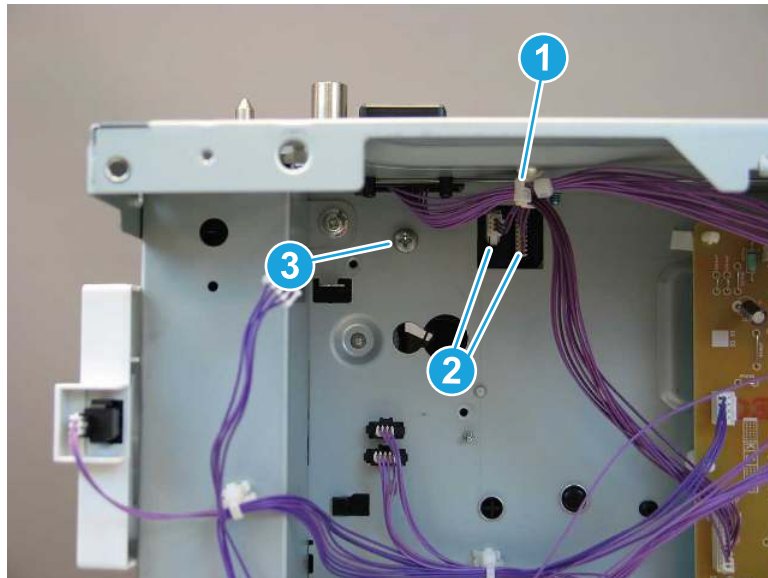
- ▲ Disconnect one connector (callout 1), remove two screws (callout 2), and then remove the pickup motor (callout 3).

Figure 1-3353 Remove the pickup motor



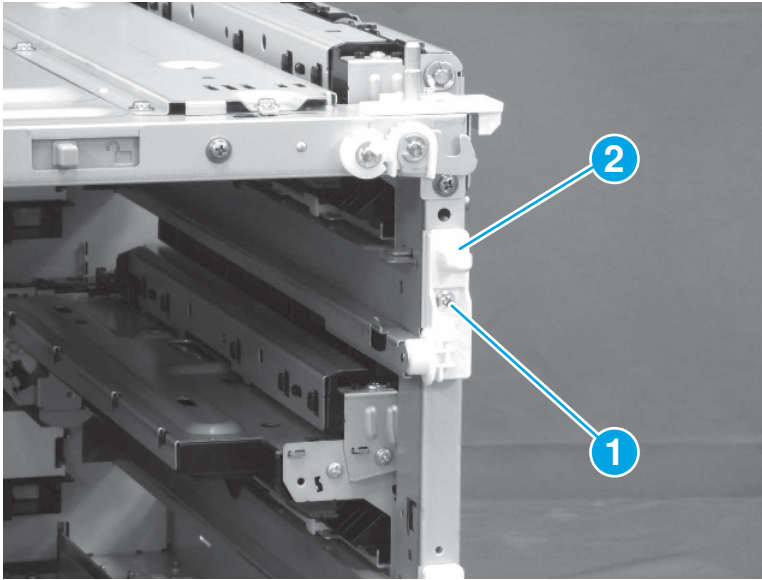
- 9. Remove the 2x550-sheet paper tray and stand tray 1 pickup assembly.
 - a. Release one retainer (callout 1). Disconnect two connectors (callout 2), and then remove one screw (callout 3).

Figure 1-3354 Disconnect two connectors and remove two screws



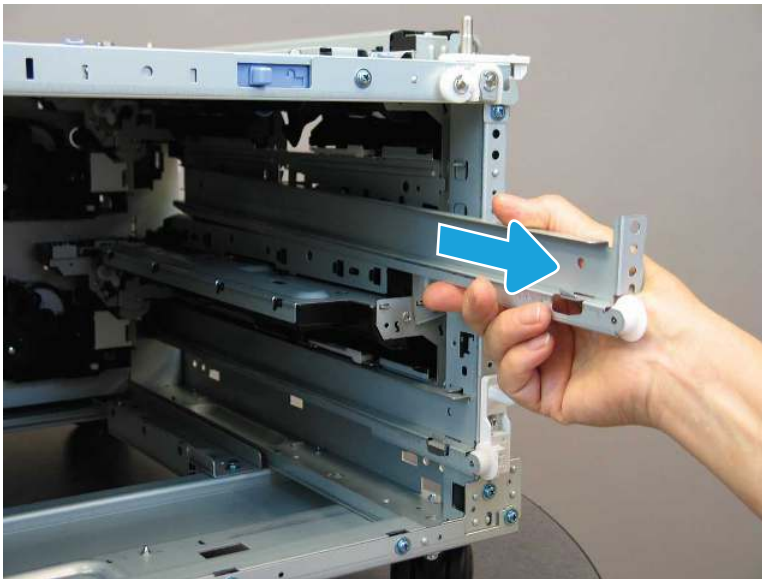
- b. Remove one screw (callout 1), and then remove the cover (callout 2).

Figure 1-3355 Remove the cover



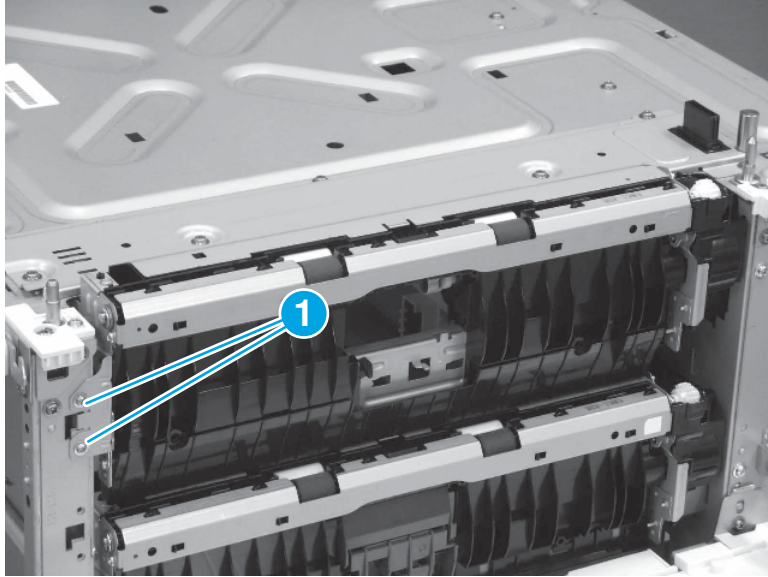
- c. Remove the cassette rail.

Figure 1-3356 Remove the cassette rail



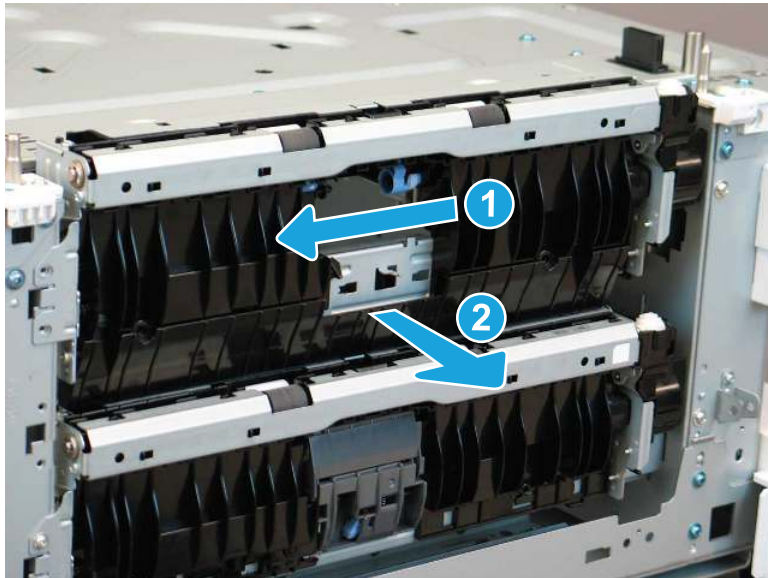
- d. Remove two screws (callout 1).

Figure 1-3357 Remove two screws



- e. Slide the pickup assembly toward the front of the feeder (callout 1), and then slide it away from the feeder (callout 2) to remove it.

Figure 1-3358 Remove the pickup assembly



10. Unpack the replacement assembly.


- a. Dispose of the defective part.




NOTE: HP recommends responsible disposal of the defective part.

<http://www8.hp.com/us/en/hp-information/environment/product-recycling.html>

- b. Unpack the replacement part from the packaging.

 **IMPORTANT:** Make sure that all of the shipping materials (for example shipping tape) are removed from the replacement part prior to installation.

- c. To install an assembly, reverse the removal steps.

 **NOTE:** When applicable, special installation instructions are provided for an assembly at the end of the removal procedure. Always completely read the removal instructions and follow all special installation instructions.

Removal and replacement: 2x550-sheet paper tray and stand tray 2 pickup motor

Learn how to remove and replace the 2x550-sheet paper tray and stand tray 2 pickup motor.

[View a video of how to remove and replace the 2x550-sheet paper tray and stand tray 2 pickup motor.](#)


Mean time to repair: 3 minutes

Service level: Easy

Before performing service

Turn the printer power off

- Disconnect the power cable.

 **WARNING!** To avoid damage to the printer, turn the printer off, wait 30 seconds, and then remove the power cord before attempting to service the printer.

Use the table below to identify the correct part number for your printer. To order the part, go to www.hp.com/buy/parts.

Table 1-173 Part information

Part number	Part description
RK2-9410-000CN	Motor, stepping, DC

Required tools

- #2 Phillips screwdriver with a magnetic tip

After performing service

Turn the printer power on

- Connect the power cable.
- Use the power switch to turn the power on.

Post service test

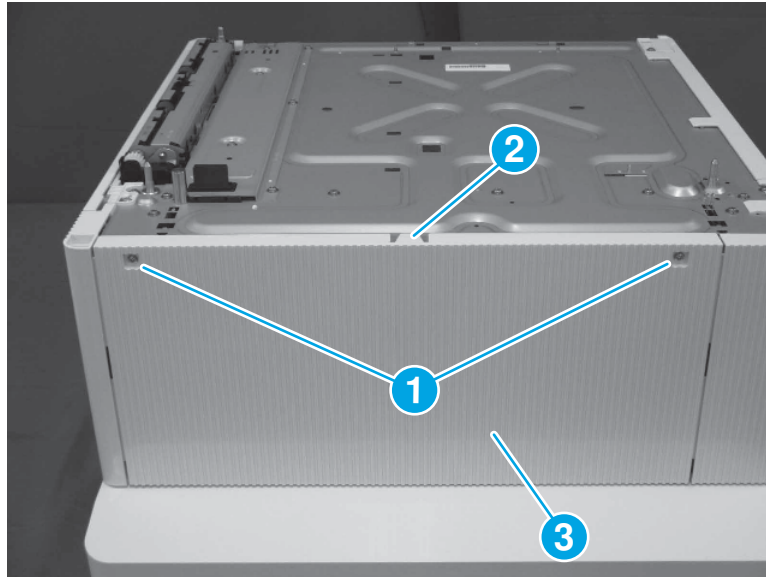
Make sure that the printer initializes to a **Ready** state.

Print a page from the 2x550-sheet paper tray and stand to make sure that the printer is functioning correctly.

1. Remove the 2x550-sheet paper tray and stand rear upper cover.

- ▲ Remove two screws (callout 1), release one tab (callout 2), and then lift up to remove the rear upper cover (callout 3).

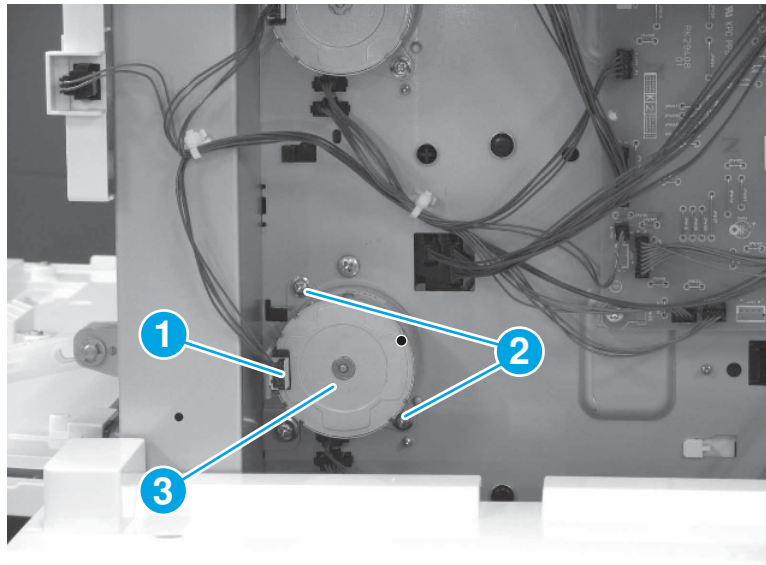
Figure 1-3359 Remove the rear upper cover



2. Remove the 2x550-sheet paper tray and stand tray 2 pickup motor.

- ▲ Disconnect one connector (callout 1), remove two screws (callout 2), and then remove the pickup motor (callout 3).

Figure 1-3360 Remove the pickup motor






3. Unpack the replacement assembly.
 - a. Dispose of the defective part.




NOTE: HP recommends responsible disposal of the defective part.

- b. Unpack the replacement part from the packaging.

 **CAUTION:**  Some parts are sensitive to electrostatic discharge (ESD). Always perform service work at an ESD-protected workstation or mat. If an ESD workstation or mat is not available, touch the sheet-metal chassis to provide a static ground before touching an ESD-sensitive assembly. Protect the ESD-sensitive assemblies by placing them in ESD pouches when they are out of the printer.

 **IMPORTANT:** Make sure that all of the shipping materials (for example shipping tape) are removed from the replacement part prior to installation.

- c. To install an assembly, reverse the removal steps.

 **NOTE:** When applicable, special installation instructions are provided for an assembly at the end of the removal procedure. Always completely read the removal instructions and follow all special installation instructions.

Removal and replacement: 2x550-sheet paper tray and stand tray 2 pickup assembly

Learn how to remove and replace the 2x550-sheet paper tray and stand tray 2 pickup assembly.

[View a video of how to remove and replace the 2x550-sheet paper tray and stand tray 2 pickup assembly.](#)


Mean time to repair: 18 minutes

Service level: Medium

Before performing service

Turn the printer power off

- Disconnect the power cable.

 **WARNING!** To avoid damage to the printer, turn the printer off, wait 30 seconds, and then remove the power cord before attempting to service the printer.

Use the table below to identify the correct part number for your printer. To order the part, go to www.hp.com/buy/parts.

Table 1-174 Part information

Part number	Part description
RM2-1717-000CN	Paper pickup assembly

Required tools

- #2 Phillips screwdriver with a magnetic tip

After performing service

Turn the printer power on

- Connect the power cable.


- Use the power switch to turn the power on.

Post service test

Make sure that the printer initializes to a **Ready** state.

Print a page from the 2x550-sheet paper tray and stand to make sure that the printer is functioning correctly.

1. Remove the 2x550-sheet paper tray and stand separation roller.

 **NOTE:** The upper tray is shown in the figures below. The procedure is the same for the lower tray.

- a. Open the tray.

Figure 1-3361 Open the tray



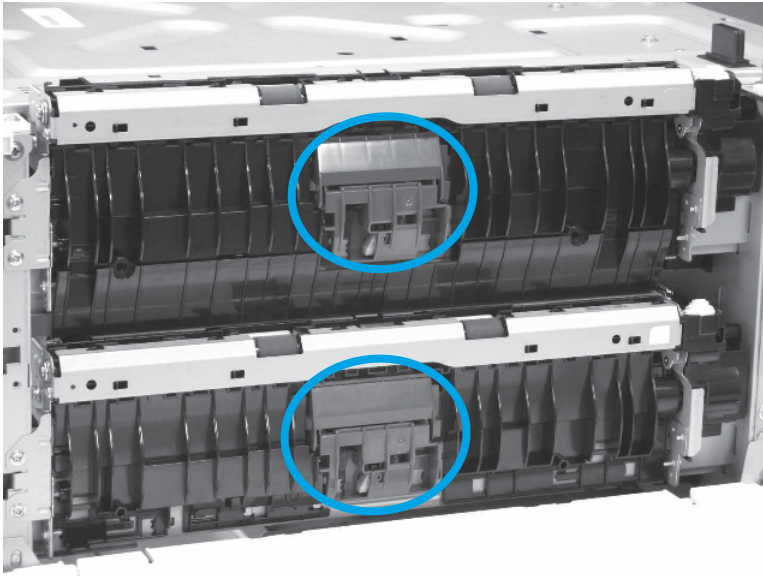
- b. Open the right door.

Figure 1-3362 Open the right door



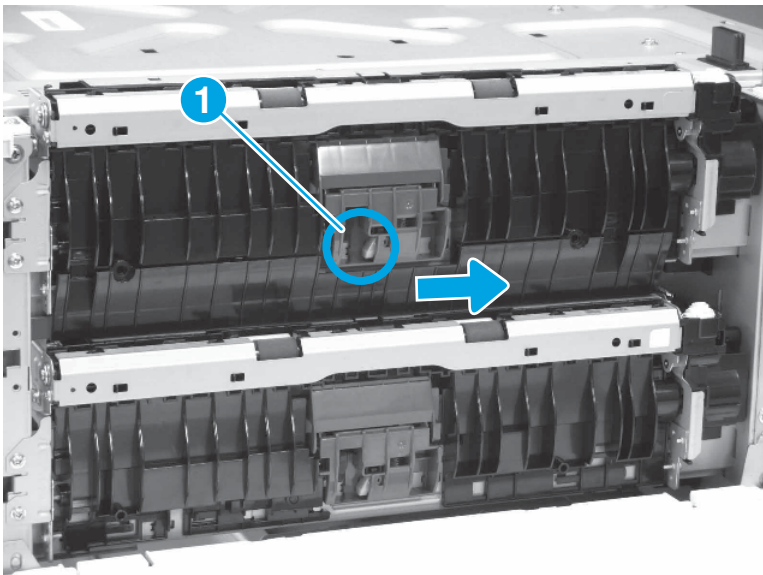
- c. Locate the separation roller.

Figure 1-3363 Locate the separation roller



- d. Press the release button (callout 1), slide the separation roller assembly to the right, and then pull it away from the printer to remove it .

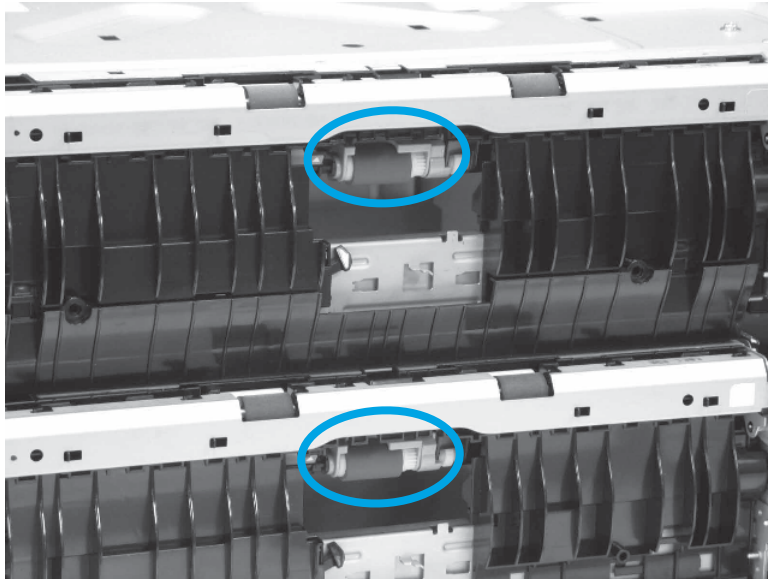
Figure 1-3364 Remove the separation roller



- 2. Remove the 2x550-sheet paper tray and stand tray pickup roller.

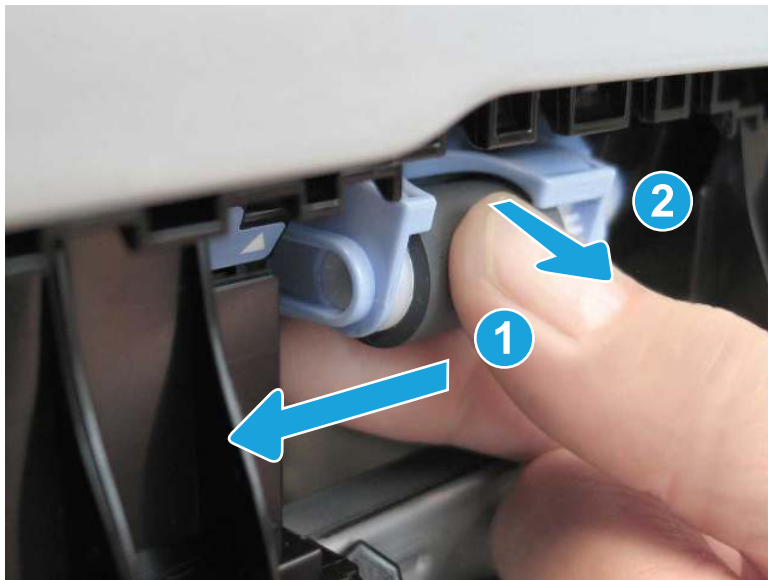
- a. Locate the pickup roller.

Figure 1-3365 Locate the pickup roller



- b. Slide the pickup roller assembly to the left (callout 1), and then pull it away from the printer (callout 2) to remove it.

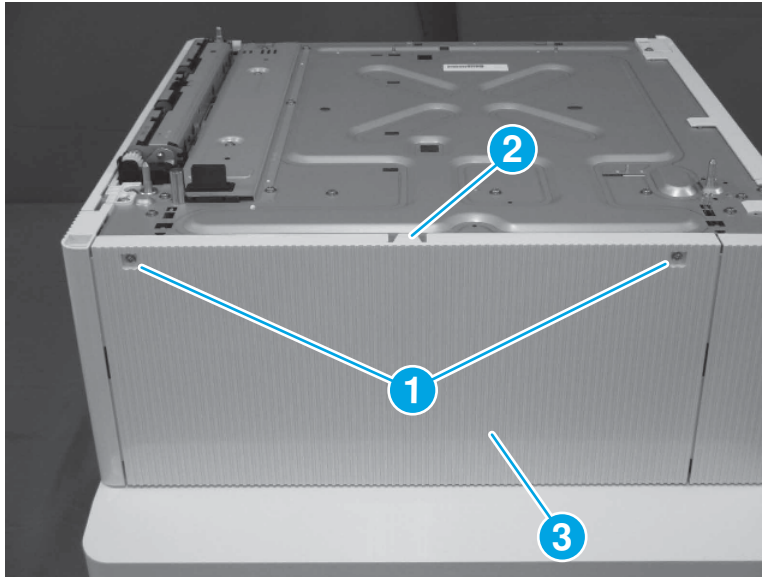
Figure 1-3366 Remove the pickup roller



3. Remove the 2x550-sheet paper tray and stand rear upper cover.

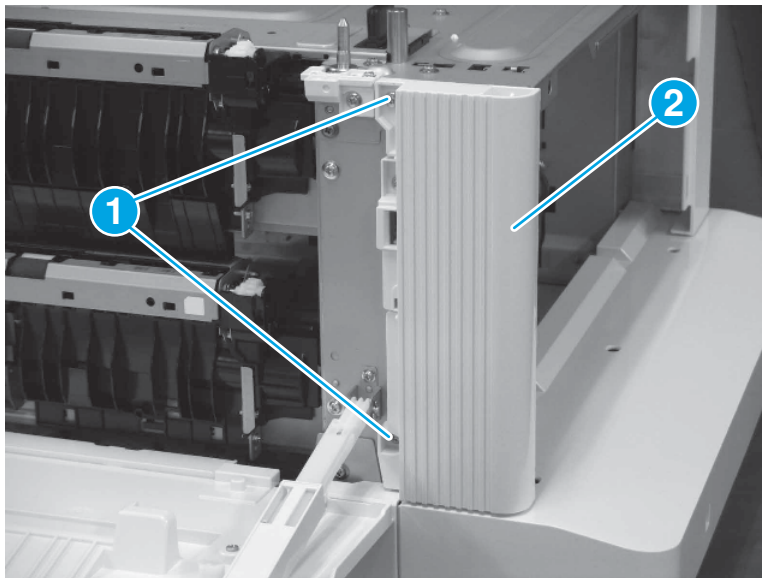
- ▲ Remove two screws (callout 1), release one tab (callout 2), and then lift up to remove the rear upper cover (callout 3).

Figure 1-3367 Remove the rear upper cover




- 4. Remove the 2x550-sheet paper tray and stand right rear cover.
 - a. Open the right door.
 - b. Remove two screws (callout 1), and then remove the right rear cover (callout 2).

Figure 1-3368 Remove the right rear cover

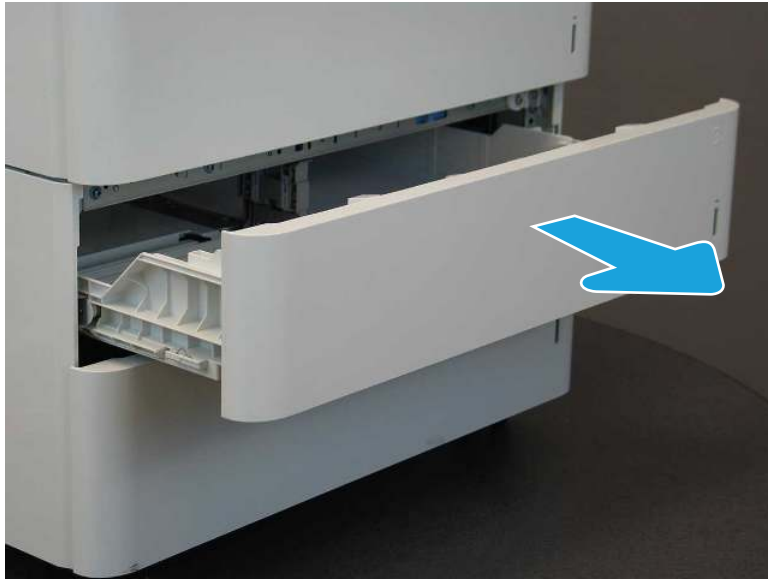


- 5. Remove both of the 2x550-sheet paper tray and stand trays.

 **NOTE:** The upper tray is shown in the steps below. Follow the same procedure to remove the lower tray.

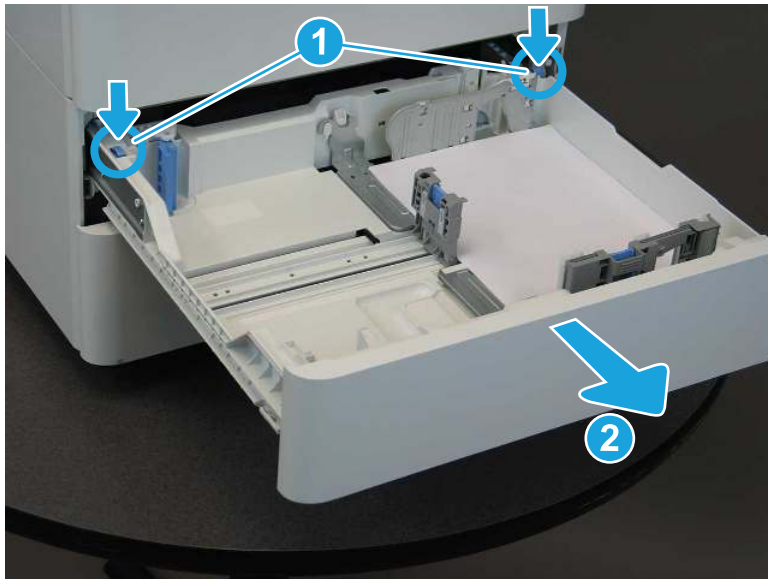
- a. Pull the tray away from the printer until it stops.

Figure 1-3369 Pull the tray out



- b. Push down to release two tabs (callout 1), and then remove the tray (callout 2).

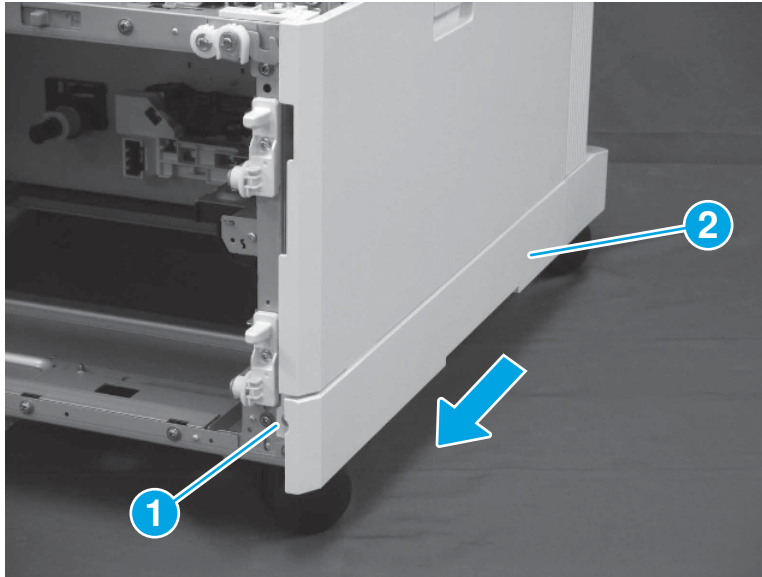
Figure 1-3370 Remove the tray



6. Remove the 2x550-sheet paper tray and stand right lower cover.

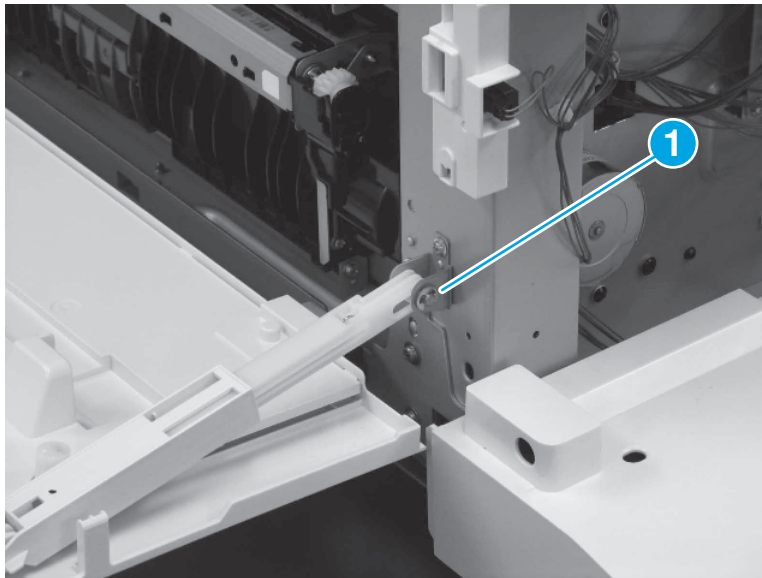
- ▲ Remove one screw (callout 1), and then slide the right lower cover (callout 2) toward the front of the feeder to remove it.

Figure 1-3371 Remove the right lower cover



- 7. Remove the 2x550-sheet paper tray and stand right door.
 - a. Remove one E-ring (callout 1).

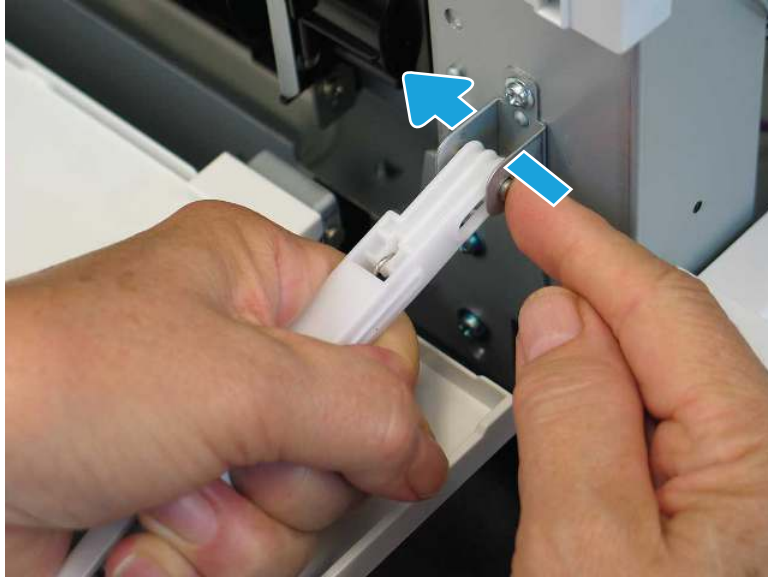
Figure 1-3372 Remove one E-ring



- b. Hold the hinge arm securely, and then slide the shaft to the left to remove it.

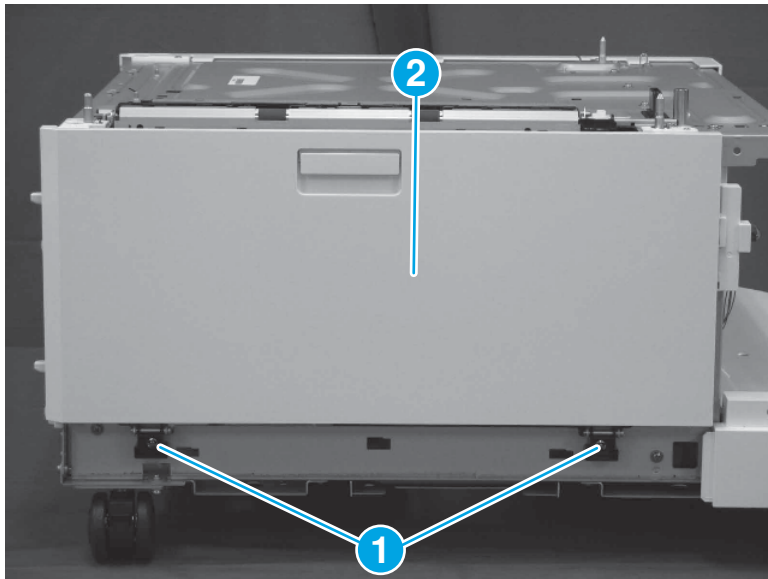
⚠ **CAUTION:** The hinge arm is spring-loaded and may snap back suddenly when the shaft is removed.

Figure 1-3373 Release the hinge arm



- c. Close the right door assembly.
- d. Remove two screws (callout 1), and then remove the right door assembly (callout 2).

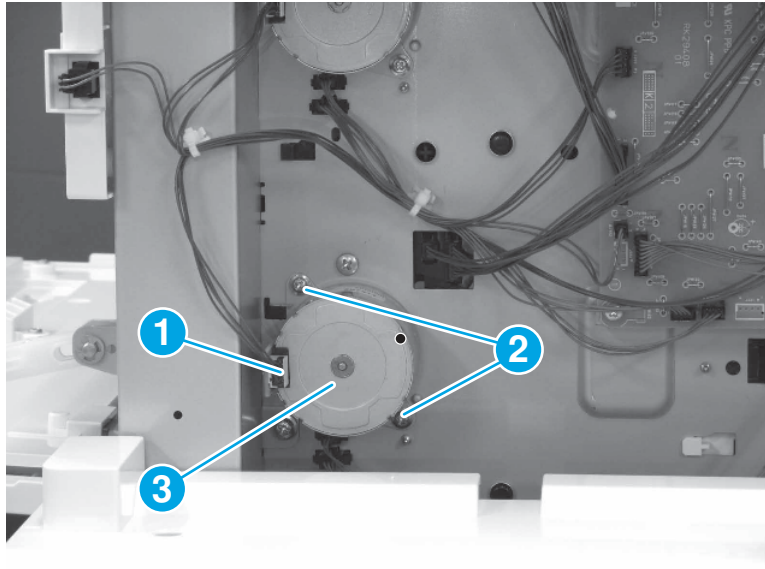
Figure 1-3374 Remove two screws and the right door



- 8. Remove the 2x550-sheet paper tray and stand tray 2 pickup motor.

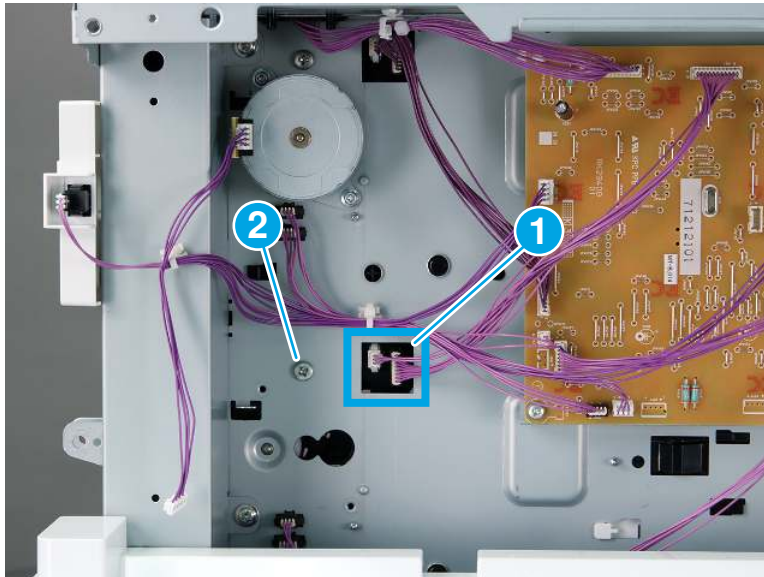
- ▲ Disconnect one connector (callout 1), remove two screws (callout 2), and then remove the pickup motor (callout 3).

Figure 1-3375 Remove the pickup motor



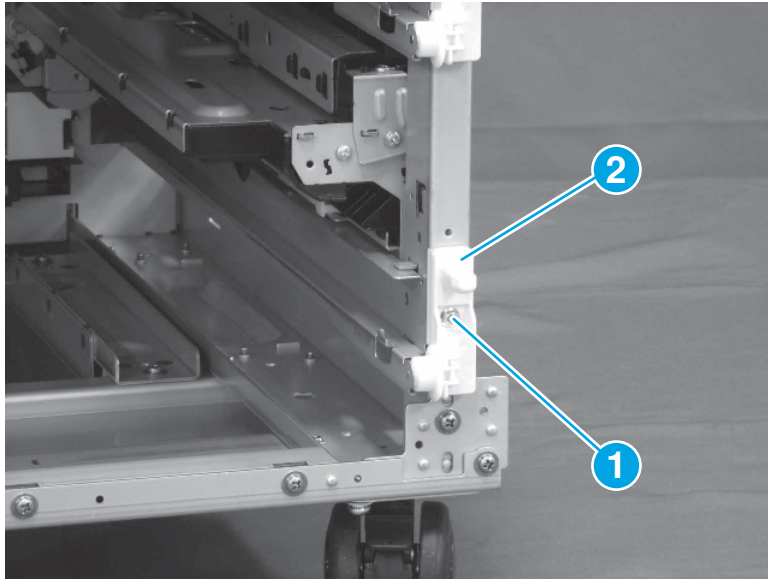
9. Remove the 2x550-sheet paper tray and stand tray 2 pickup assembly.
 - a. Disconnect two connectors (callout 1), and then remove one screw (callout 2).

Figure 1-3376 Disconnect two connectors and remove one screw



- b. Remove one screw (callout 1), and then remove the cover (callout 2).

Figure 1-3377 Remove the cover



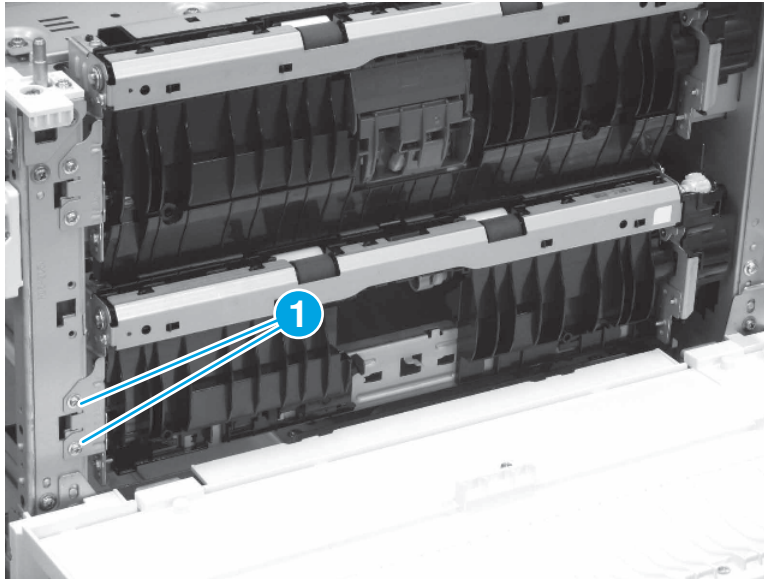
- c. Remove the cassette rail.

Figure 1-3378 Remove the rail



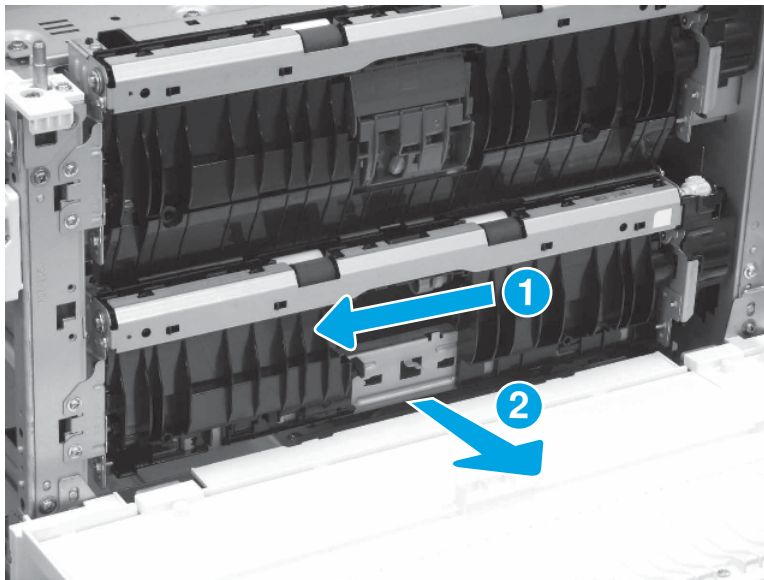
- d. Remove two screws (callout 1).

Figure 1-3379 Remove two screws



- e. Slide the pickup assembly toward the front of the feeder (callout 1), and then slide it away from the feeder (callout 2) to remove it.

Figure 1-3380 Remove the pickup assembly




10. Unpack the replacement assembly.
 - a. Dispose of the defective part.




NOTE: HP recommends responsible disposal of the defective part.

<http://www8.hp.com/us/en/hp-information/environment/product-recycling.html>

- b. Unpack the replacement part from the packaging.

 **IMPORTANT:** Make sure that all of the shipping materials (for example shipping tape) are removed from the replacement part prior to installation.

- c. To install an assembly, reverse the removal steps.

 **NOTE:** When applicable, special installation instructions are provided for an assembly at the end of the removal procedure. Always completely read the removal instructions and follow all special installation instructions.

Removal and replacement: 2x550-sheet paper tray and stand tray 1 lifter drive

Learn how to remove and replace the 2x550-sheet paper tray and stand tray 1 lifter drive.

[View a video of how to remove and replace the 2x550-sheet paper tray and stand tray 1 lifter drive.](#)


Mean time to repair: 18 minutes

Service level: Medium

Before performing service

Turn the printer power off

- Disconnect the power cable.

 **WARNING!** To avoid damage to the printer, turn the printer off, wait 30 seconds, and then remove the power cord before attempting to service the printer.

Use the table below to identify the correct part number for your printer. To order the part, go to www.hp.com/buy/parts.

Table 1-175 Part information

Part number	Part description
RM2-1704-000CN	Lifter drive assembly

Required tools

- #2 Phillips screwdriver with a magnetic tip

After performing service

Turn the printer power on


- Connect the power cable.
- Use the power switch to turn the power on.

Post service test

Make sure that the printer initializes to a **Ready** state.

Print a page from the 2x550-sheet paper tray and stand to make sure that the printer is functioning correctly.

1. Remove the 2x550-sheet paper tray and stand separation roller.

 **NOTE:** The upper tray is shown in the figures below. The procedure is the same for the lower tray.

- a. Open the tray.

Figure 1-3381 Open the tray



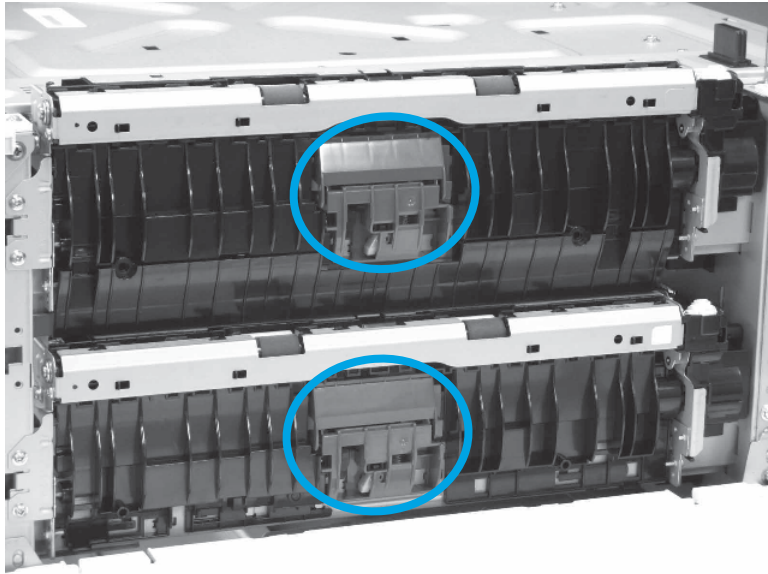
- b. Open the right door.

Figure 1-3382 Open the right door



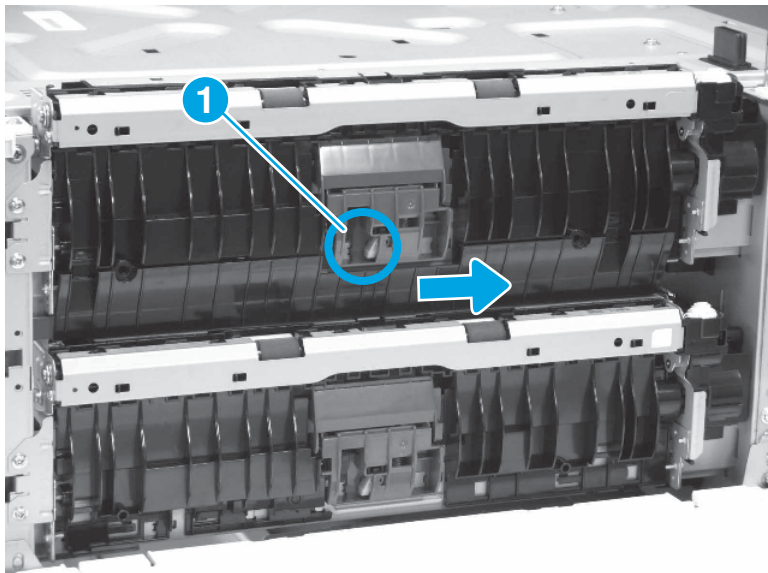
- c. Locate the separation roller.

Figure 1-3383 Locate the separation roller



- d. Press the release button (callout 1), slide the separation roller assembly to the right, and then pull it away from the printer to remove it.

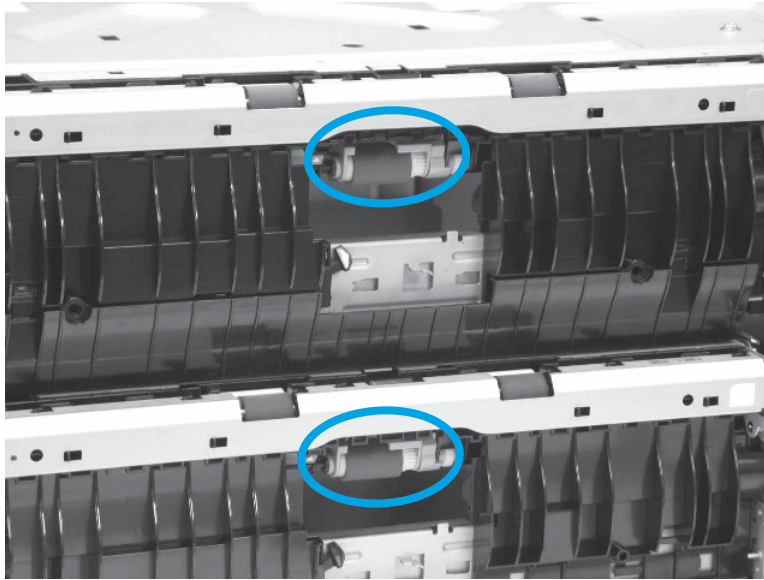
Figure 1-3384 Remove the separation roller



2. Remove the 2x550-sheet paper tray and stand tray pickup roller.

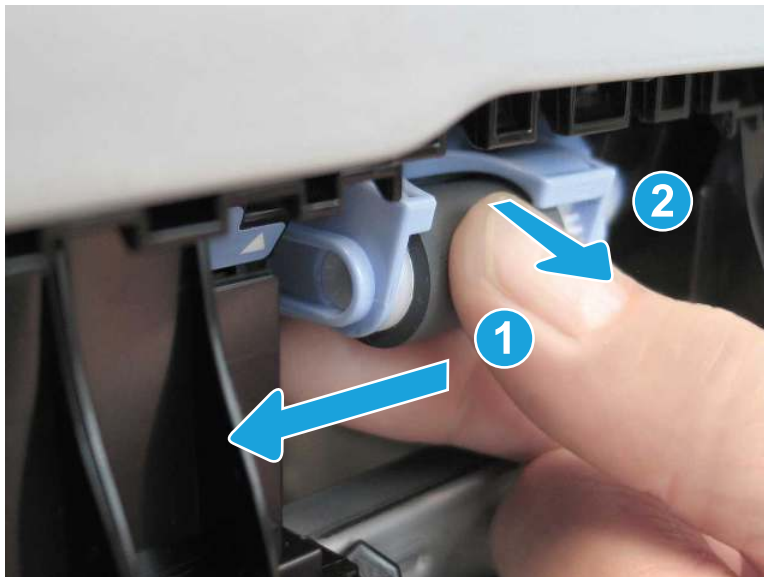
- a. Locate the pickup roller.

Figure 1-3385 Locate the pickup roller



- b. Slide the pickup roller assembly to the left (callout 1), and then pull it away from the printer (callout 2) to remove it.

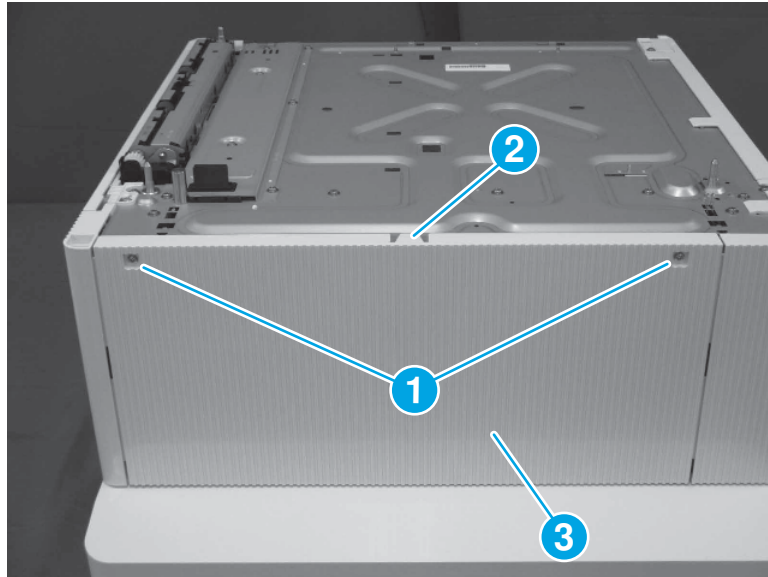
Figure 1-3386 Remove the pickup roller



3. Remove the 2x550-sheet paper tray and stand rear upper cover.

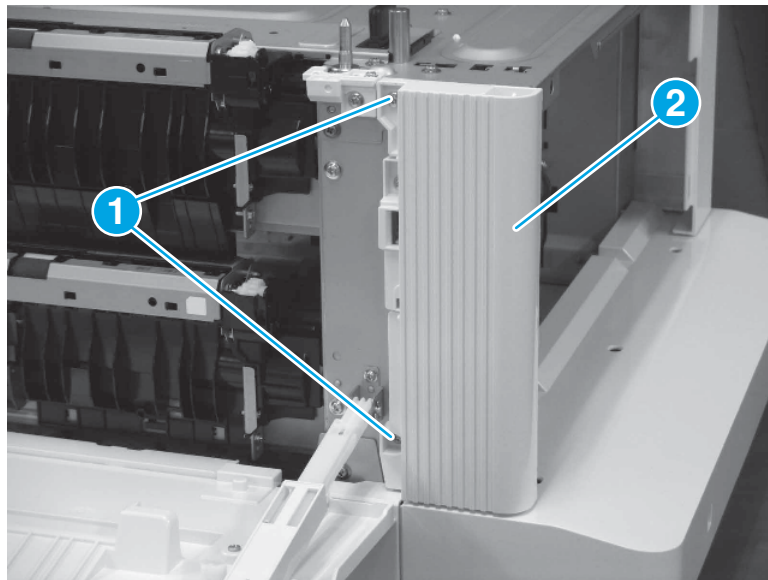
- ▲ Remove two screws (callout 1), release one tab (callout 2), and then lift up to remove the rear upper cover (callout 3).

Figure 1-3387 Remove the rear upper cover




- 4. Remove the 2x550-sheet paper tray and stand right rear cover.
 - a. Open the right door.
 - b. Remove two screws (callout 1), and then remove the right rear cover (callout 2).

Figure 1-3388 Remove the right rear cover

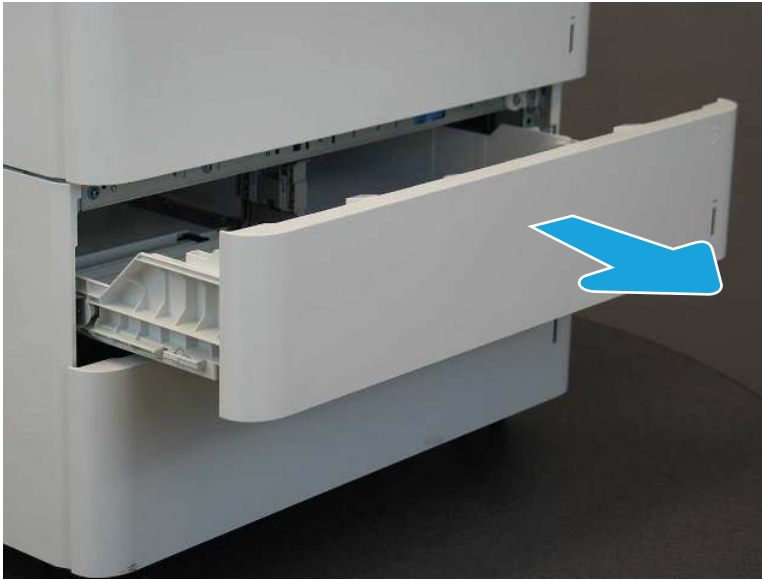


- 5. Remove both of the 2x550-sheet paper tray and stand trays.

 **NOTE:** The upper tray is shown in the steps below. Follow the same procedure to remove the lower tray.

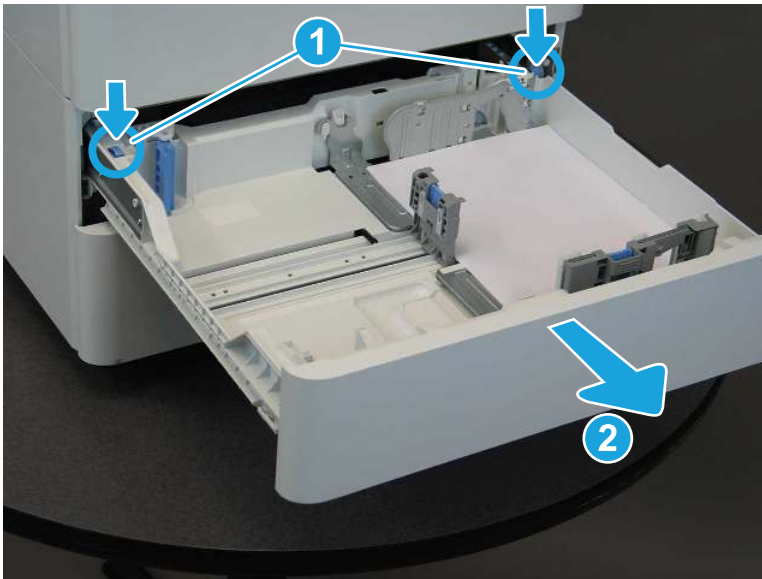
- a. Pull the tray away from the printer until it stops.

Figure 1-3389 Pull the tray out



- b. Push down to release two tabs (callout 1), and then remove the tray (callout 2).

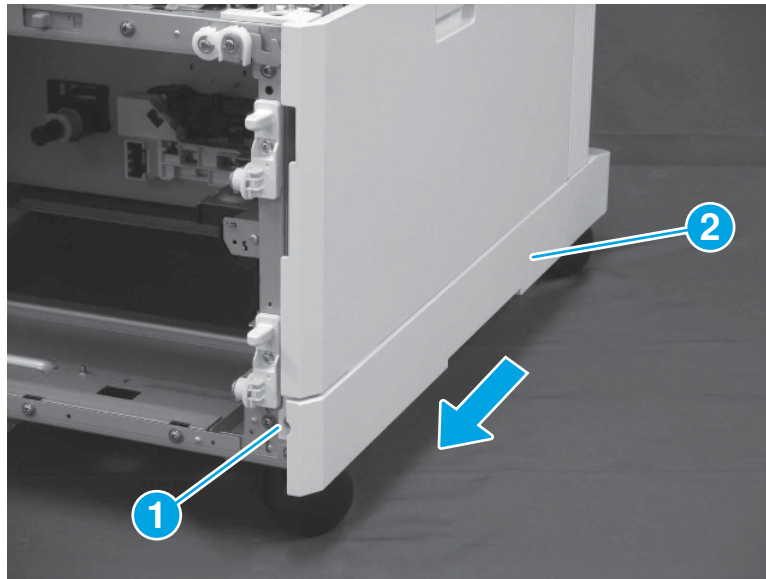
Figure 1-3390 Remove the tray



6. Remove the 2x550-sheet paper tray and stand right lower cover.

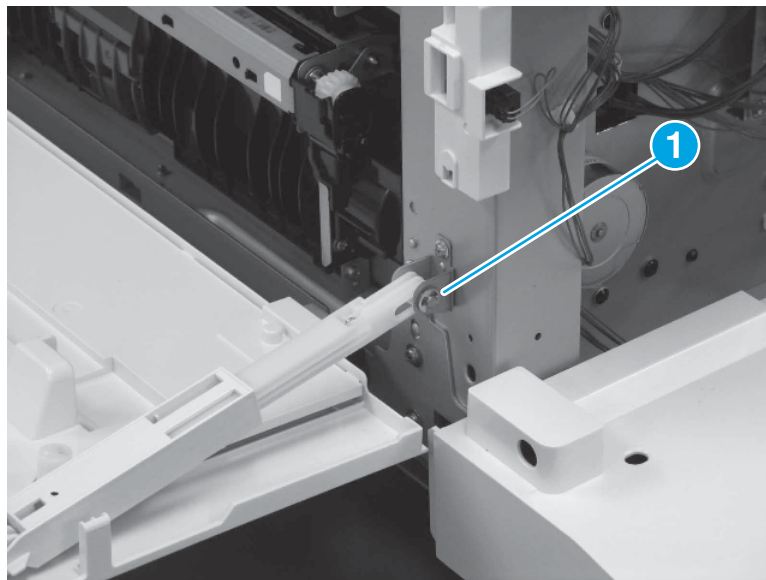
- ▲ Remove one screw (callout 1), and then slide the right lower cover (callout 2) toward the front of the feeder to remove it.

Figure 1-3391 Remove the right lower cover



- 7. Remove the 2x550-sheet paper tray and stand right door.
 - a. Remove one E-ring (callout 1).

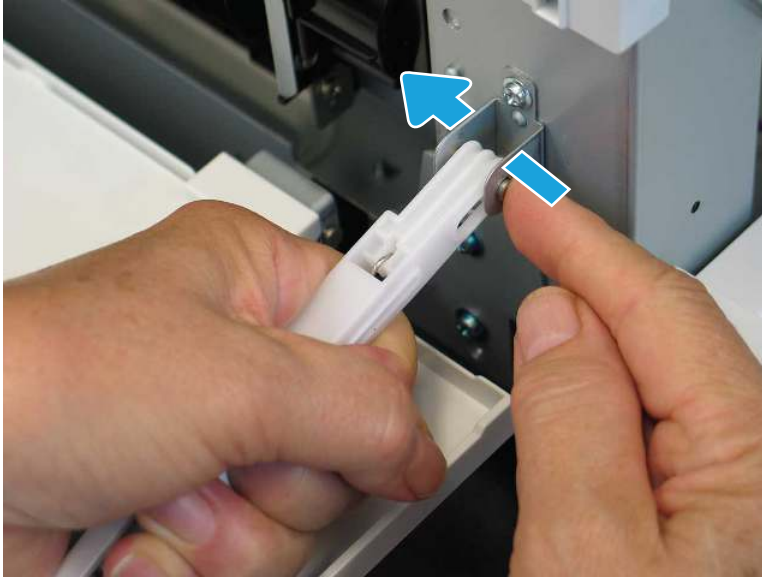
Figure 1-3392 Remove one E-ring



- b. Hold the hinge arm securely, and then slide the shaft to the left to remove it.

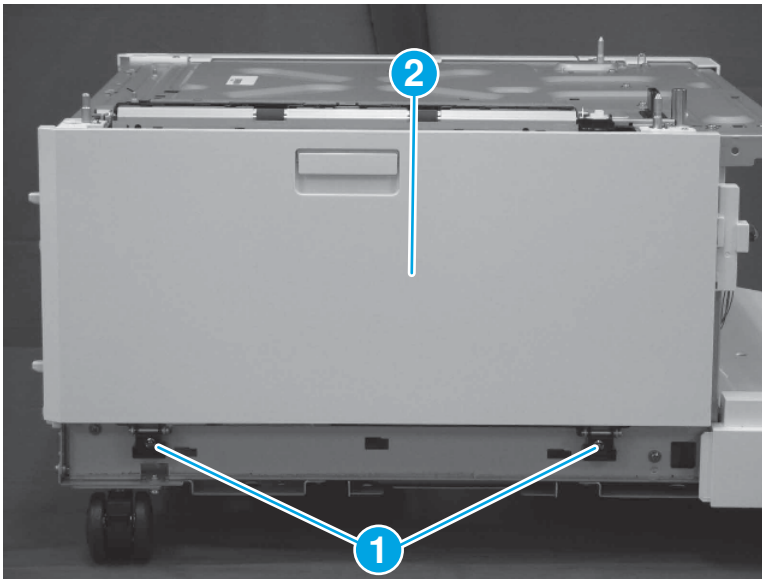
⚠ CAUTION: The hinge arm is spring-loaded and may snap back suddenly when the shaft is removed.

Figure 1-3393 Release the hinge arm



- c. Close the right door assembly.
- d. Remove two screws (callout 1), and then remove the right door assembly (callout 2).

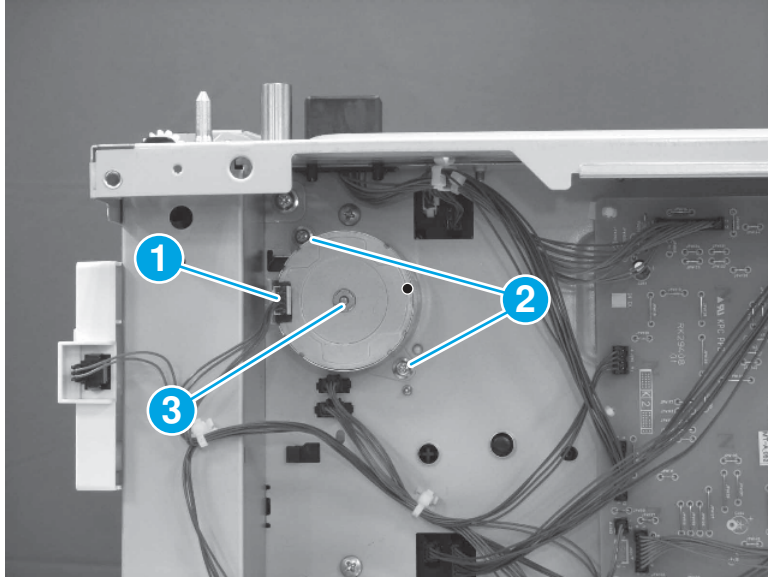
Figure 1-3394 Remove two screws and the right door



- 8. Remove the 2x550-sheet paper tray and stand tray 1 pickup motor.

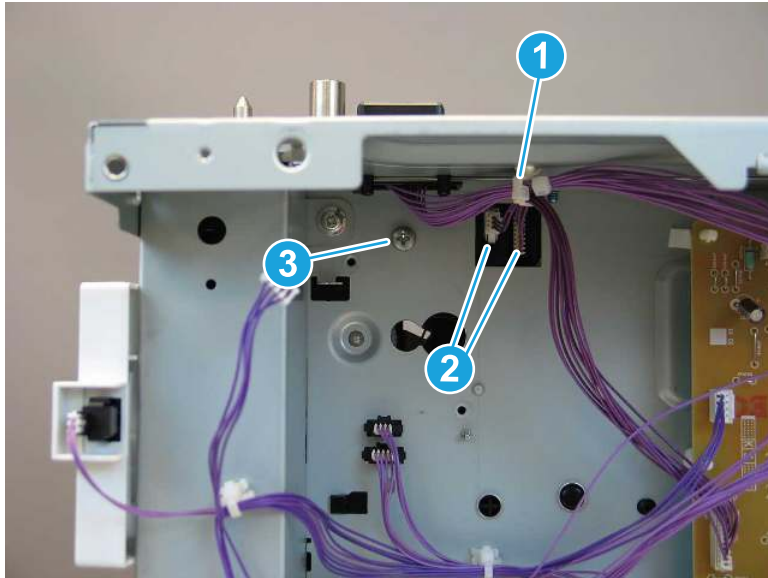
- ▲ Disconnect one connector (callout 1), remove two screws (callout 2), and then remove the pickup motor (callout 3).

Figure 1-3395 Remove the pickup motor



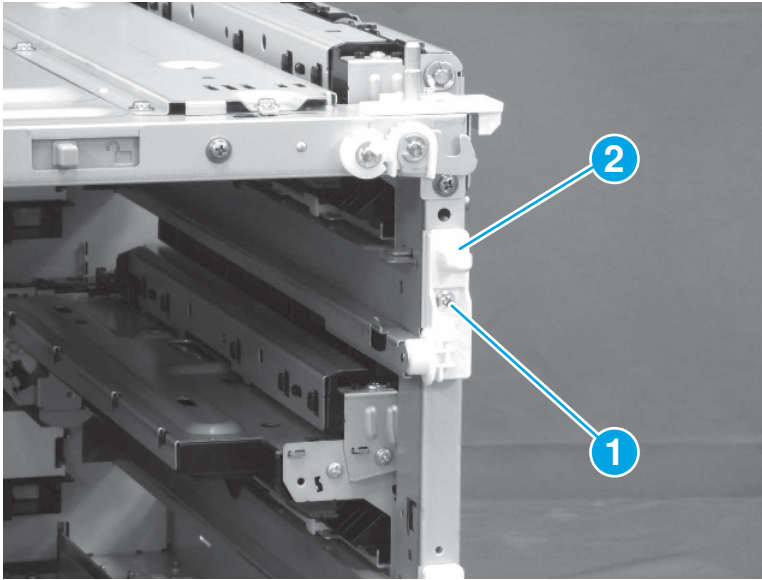
- 9. Remove the 2x550-sheet paper tray and stand tray 1 pickup assembly.
 - a. Release one retainer (callout 1). Disconnect two connectors (callout 2), and then remove one screw (callout 3).

Figure 1-3396 Disconnect two connectors and remove two screws



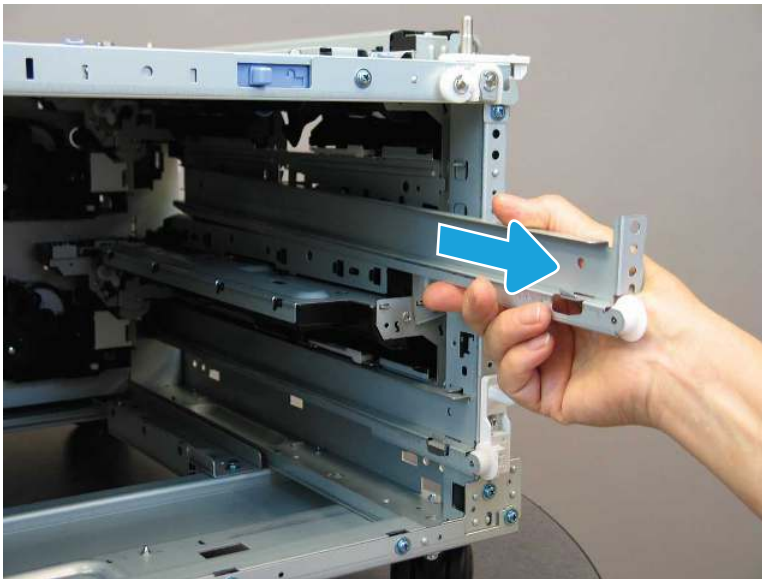
- b. Remove one screw (callout 1), and then remove the cover (callout 2).

Figure 1-3397 Remove the cover



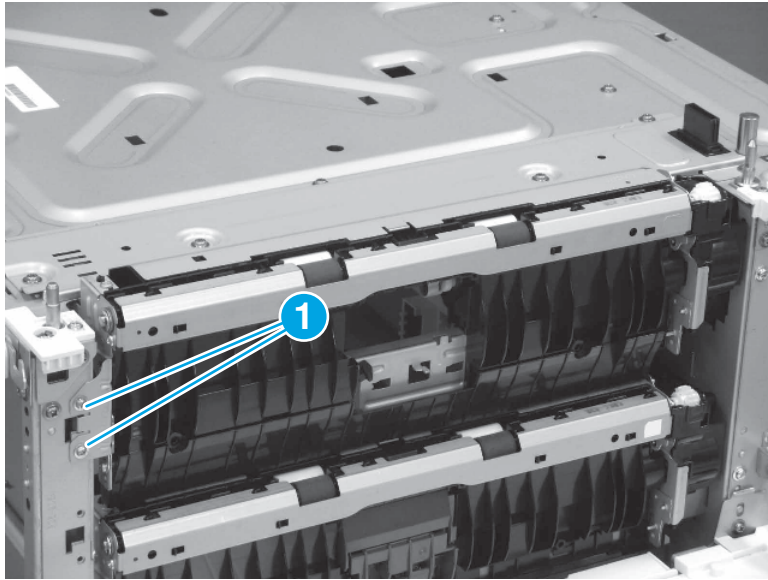
- c. Remove the cassette rail.

Figure 1-3398 Remove the cassette rail



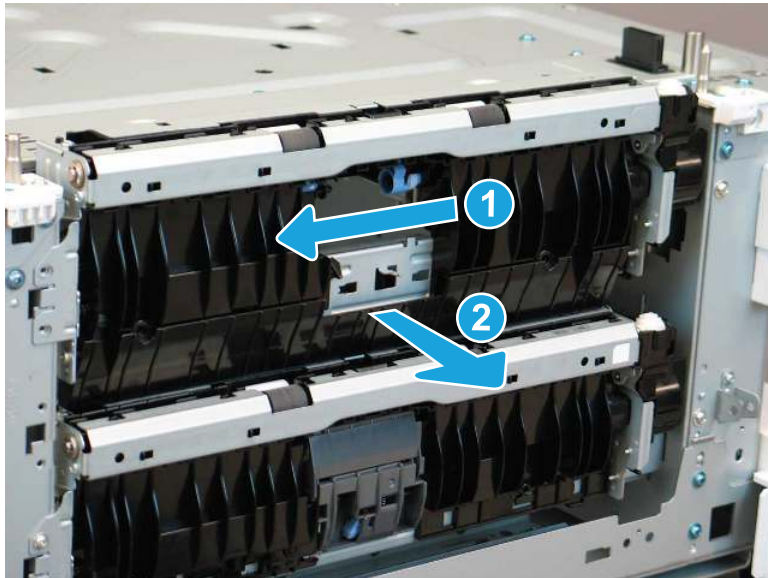
- d. Remove two screws (callout 1).

Figure 1-3399 Remove two screws



- e. Slide the pickup assembly toward the front of the feeder (callout 1), and then slide it away from the feeder (callout 2) to remove it.

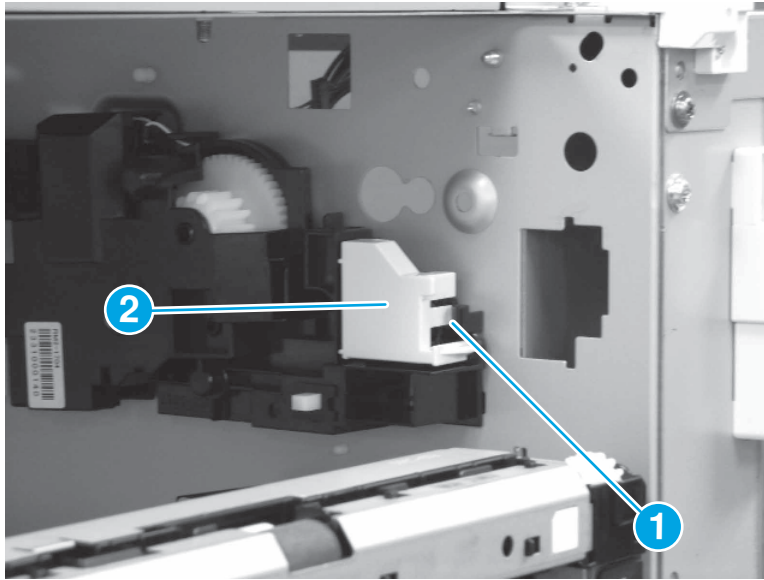
Figure 1-3400 Remove the pickup assembly



- 10. Remove the 2x550-sheet paper tray and stand tray 1 lifter drive.

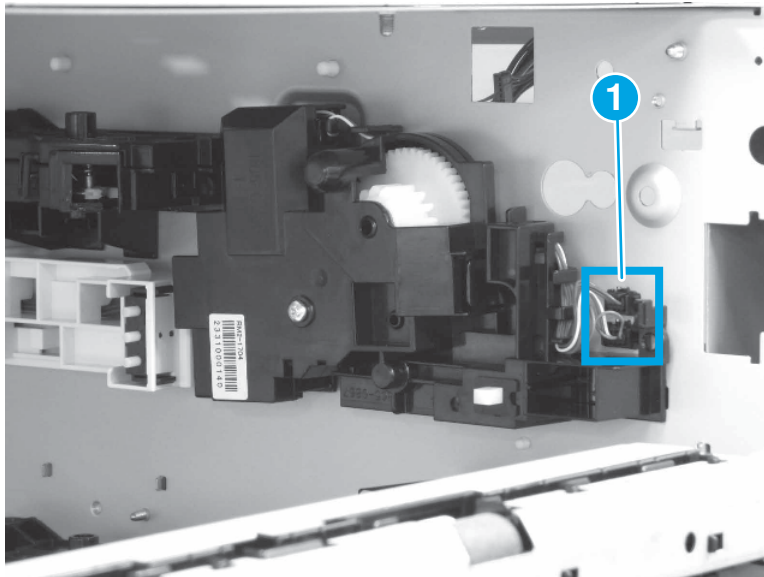
- a. Release one tab (callout 1), and then remove the connector cover (callout 2).

Figure 1-3401 Remove the connector cover



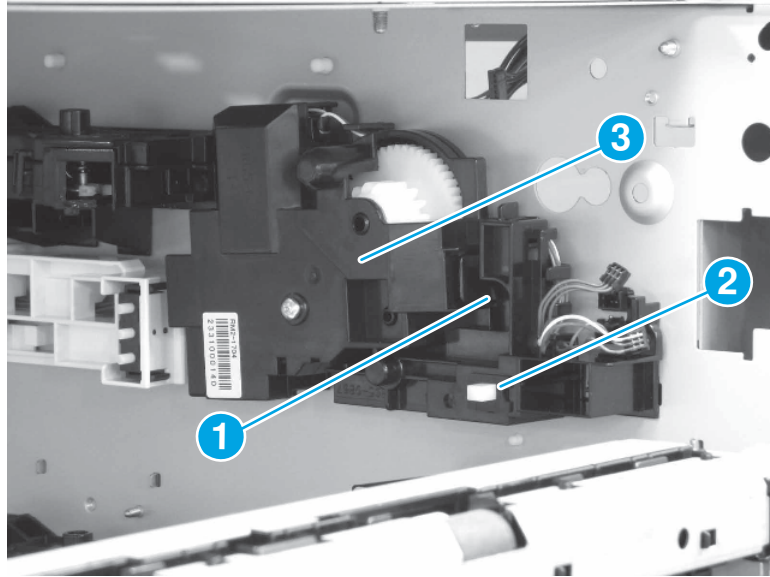
- b. Disconnect two connectors (callout 1).

Figure 1-3402 Disconnect two connectors



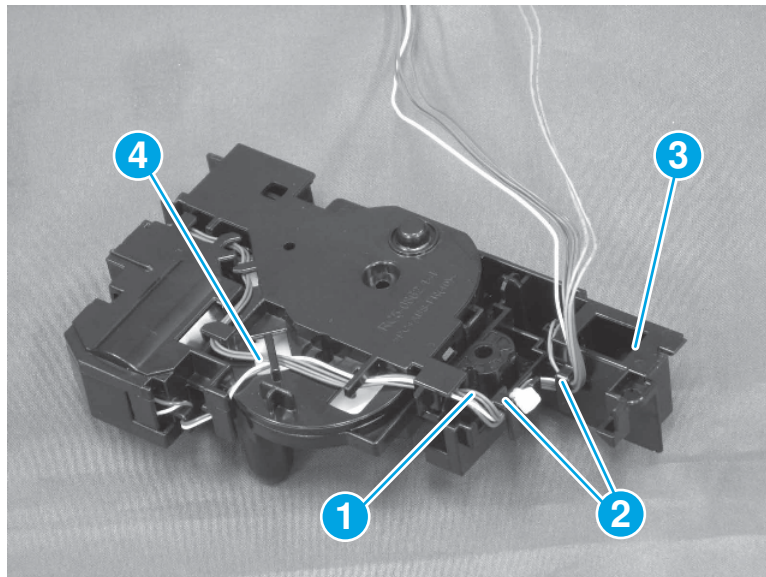
- c. Remove one screw (callout 1). Remove the holder (callout 2) and the lifter drive (callout 3) together.

Figure 1-3403 Remove the lifter drive and holder



- d. Release the cables (callout 1) from the cable guide (callout 2). Remove the holder (callout 3) from the lifter drive (callout 4).

Figure 1-3404 Remove the holder



- 11. Unpack the replacement assembly.


- a. Dispose of the defective part.




NOTE: HP recommends responsible disposal of the defective part.

<http://www8.hp.com/us/en/hp-information/environment/product-recycling.html>

- b. Unpack the replacement part from the packaging.

 **IMPORTANT:** Make sure that all of the shipping materials (for example shipping tape) are removed from the replacement part prior to installation.

- c. To install an assembly, reverse the removal steps.

 **NOTE:** When applicable, special installation instructions are provided for an assembly at the end of the removal procedure. Always completely read the removal instructions and follow all special installation instructions.

Removal and replacement: 2x550-sheet paper tray and stand tray 2 lifter drive

Learn how to remove and replace the 2x550-sheet paper tray and stand tray 2 lifter drive.

[View a video of how to remove and replace the 2x550-sheet paper tray and stand tray 2 lifter drive.](#)


Mean time to repair: 18 minutes

Service level: Medium

Before performing service

Turn the printer power off

- Disconnect the power cable.

 **WARNING!** To avoid damage to the printer, turn the printer off, wait 30 seconds, and then remove the power cord before attempting to service the printer.

Use the table below to identify the correct part number for your printer. To order the part, go to www.hp.com/buy/parts.

Table 1-176 Part information

Part number	Part description
RM2-1704-000CN	Lifter drive assembly

Required tools

- #2 Phillips screwdriver with a magnetic tip

After performing service

Turn the printer power on

- Connect the power cable.
- Use the power switch to turn the power on.

Post service test

Make sure that the printer initializes to a **Ready** state.

Print a page from the 2x550-sheet paper tray and stand to make sure that the printer is functioning correctly.

1. Remove the 2x550-sheet paper tray and stand separation roller.

 **NOTE:** The upper tray is shown in the figures below. The procedure is the same for the lower tray.

- a. Open the tray.

Figure 1-3405 Open the tray



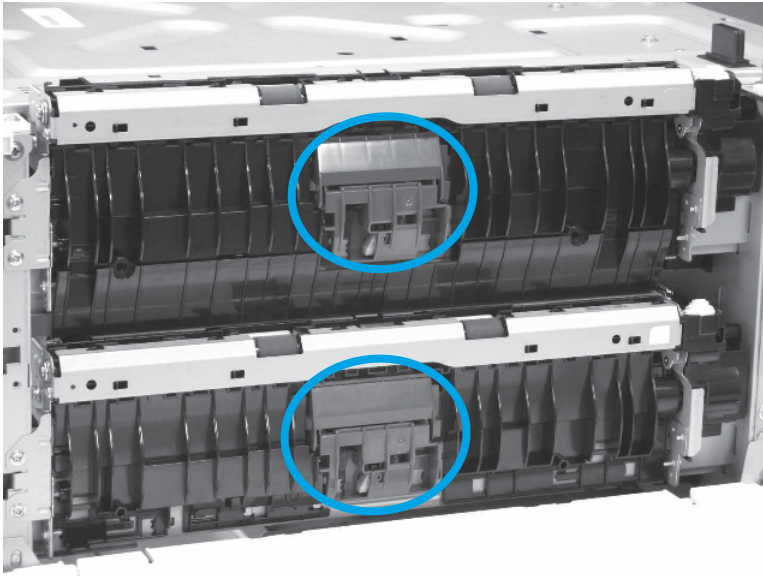
- b. Open the right door.

Figure 1-3406 Open the right door



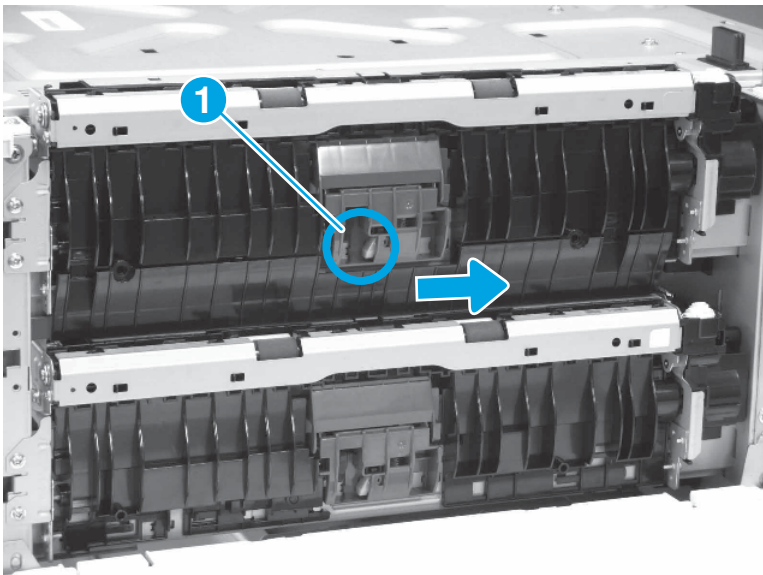
- c. Locate the separation roller.

Figure 1-3407 Locate the separation roller



- d. Press the release button (callout 1), slide the separation roller assembly to the right, and then pull it away from the printer to remove it .

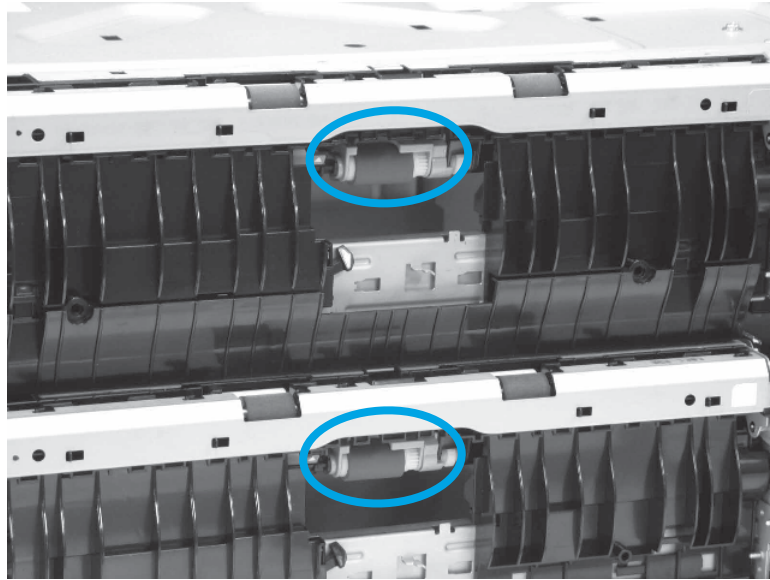
Figure 1-3408 Remove the separation roller



2. Remove the 2x550-sheet paper tray and stand tray pickup roller.

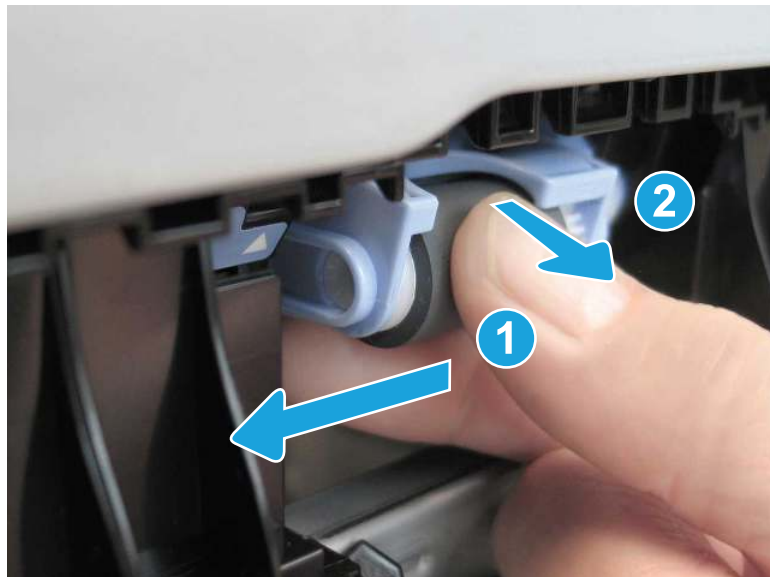
- a. Locate the pickup roller.

Figure 1-3409 Locate the pickup roller



- b. Slide the pickup roller assembly to the left (callout 1), and then pull it away from the printer (callout 2) to remove it.

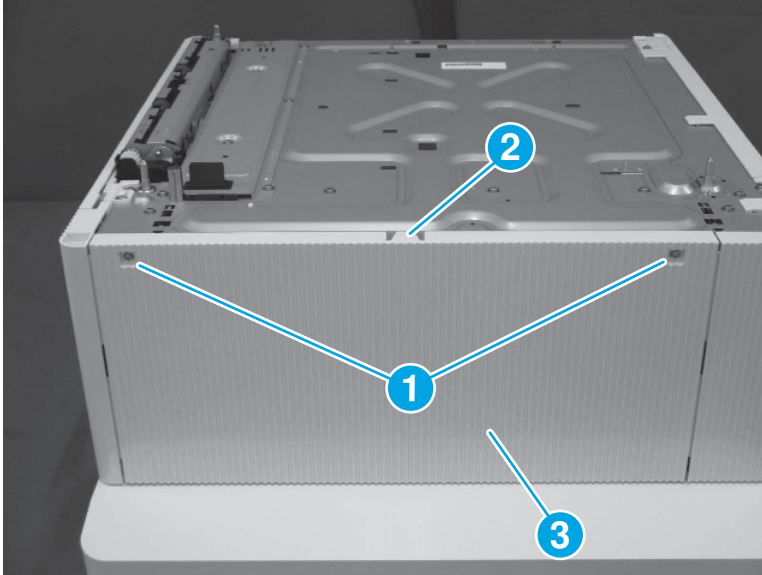
Figure 1-3410 Remove the pickup roller



3. Remove the 2x550-sheet paper tray and stand rear upper cover.

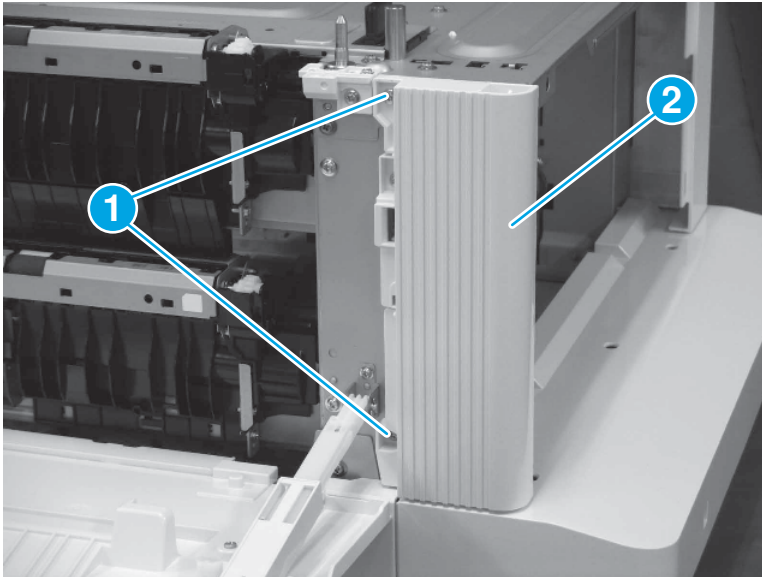
- ▲ Remove two screws (callout 1), release one tab (callout 2), and then lift up to remove the rear upper cover (callout 3).

Figure 1-3411 Remove the rear upper cover



- 4. Remove the 2x550-sheet paper tray and stand right rear cover.
 - a. Open the right door.
 - b. Remove two screws (callout 1), and then remove the right rear cover (callout 2).

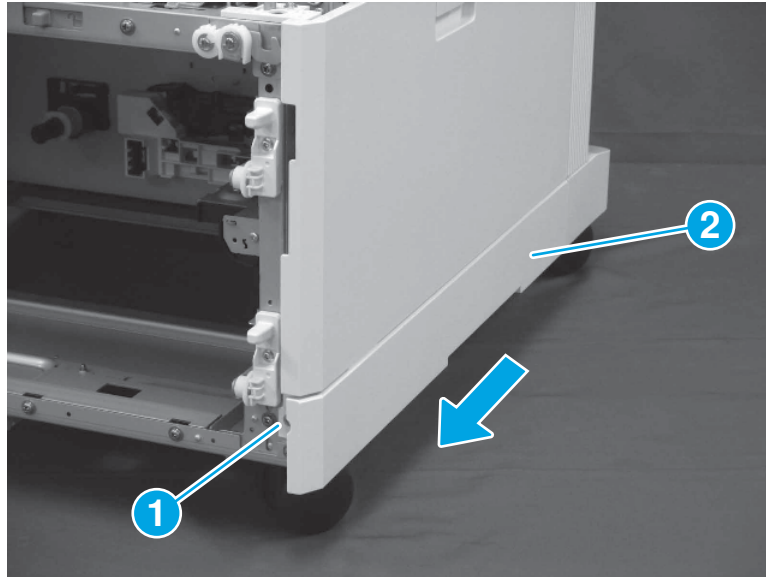
Figure 1-3412 Remove the right rear cover



- 5. Remove the 2x550-sheet paper tray and stand right lower cover.

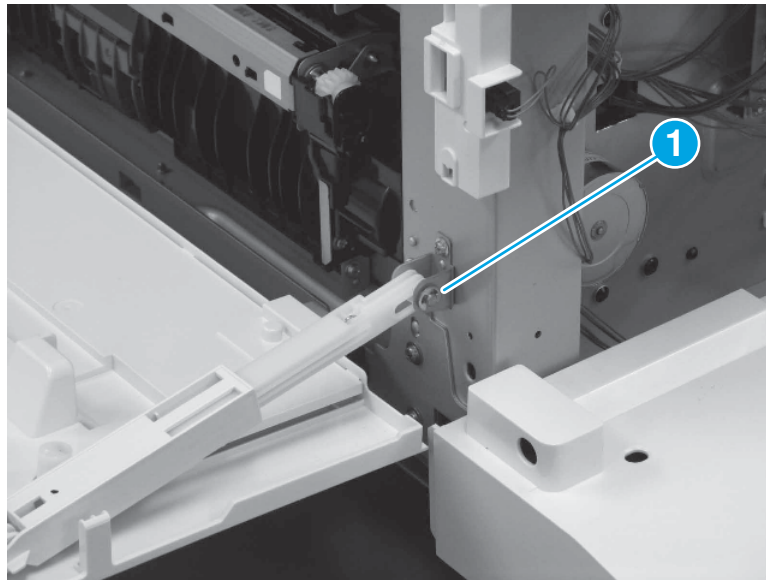
- ▲ Remove one screw (callout 1), and then slide the right lower cover (callout 2) toward the front of the feeder to remove it.

Figure 1-3413 Remove the right lower cover



- 6. Remove the 2x550-sheet paper tray and stand right door.
 - a. Remove one E-ring (callout 1).

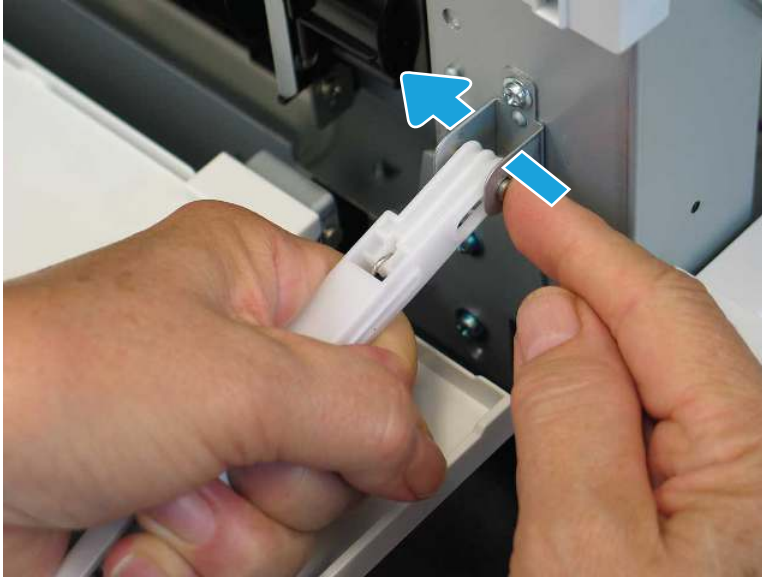
Figure 1-3414 Remove one E-ring



- b. Hold the hinge arm securely, and then slide the shaft to the left to remove it.

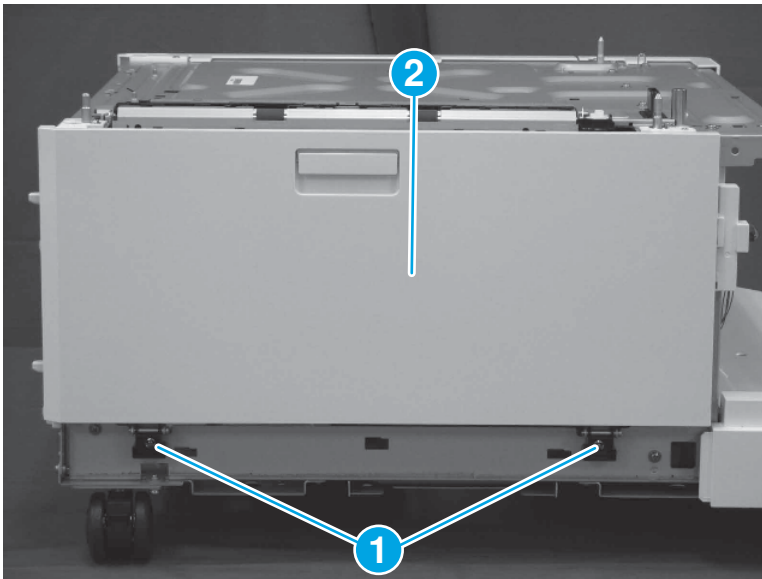
⚠ CAUTION: The hinge arm is spring-loaded and may snap back suddenly when the shaft is removed.

Figure 1-3415 Release the hinge arm



- c. Close the right door assembly.
- d. Remove two screws (callout 1), and then remove the right door assembly (callout 2).

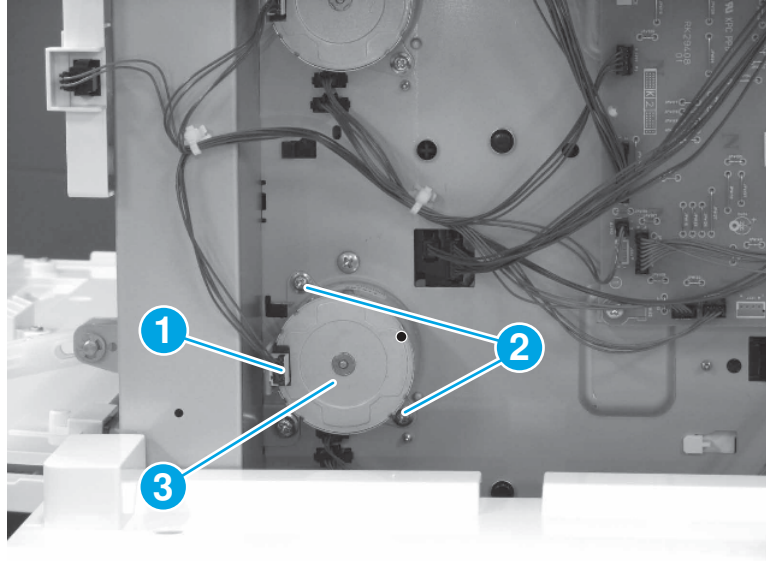
Figure 1-3416 Remove two screws and the right door



- 7. Remove the 2x550-sheet paper tray and stand tray 2 pickup motor.

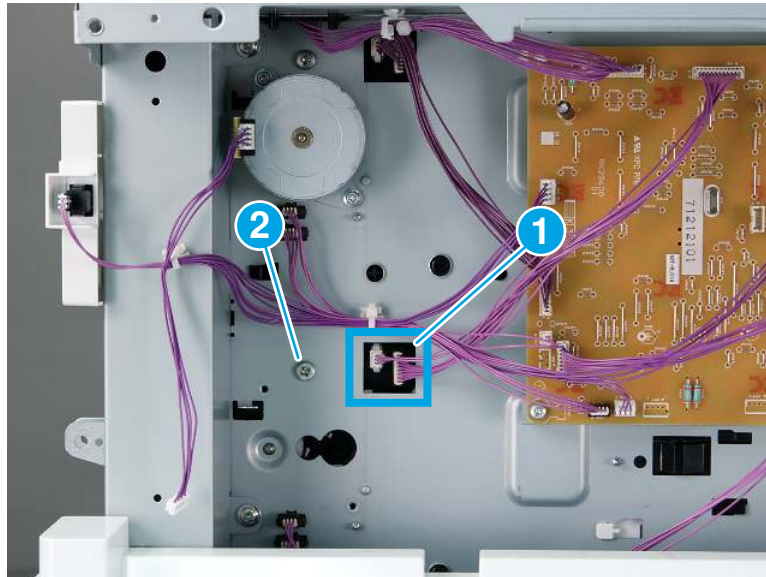
- ▲ Disconnect one connector (callout 1), remove two screws (callout 2), and then remove the pickup motor (callout 3).

Figure 1-3417 Remove the pickup motor



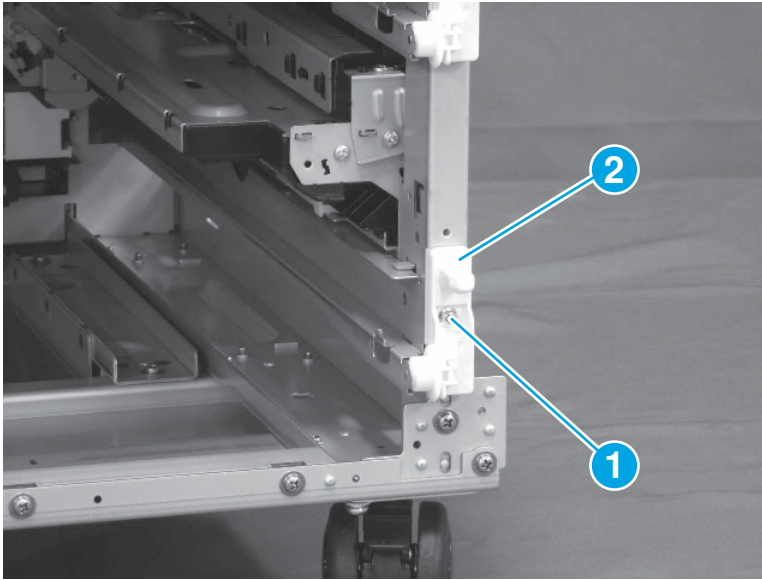
- 8. Remove the 2x550-sheet paper tray and stand tray 2 pickup assembly.
 - a. Disconnect two connectors (callout 1), and then remove one screw (callout 2).

Figure 1-3418 Disconnect two connectors and remove one screw



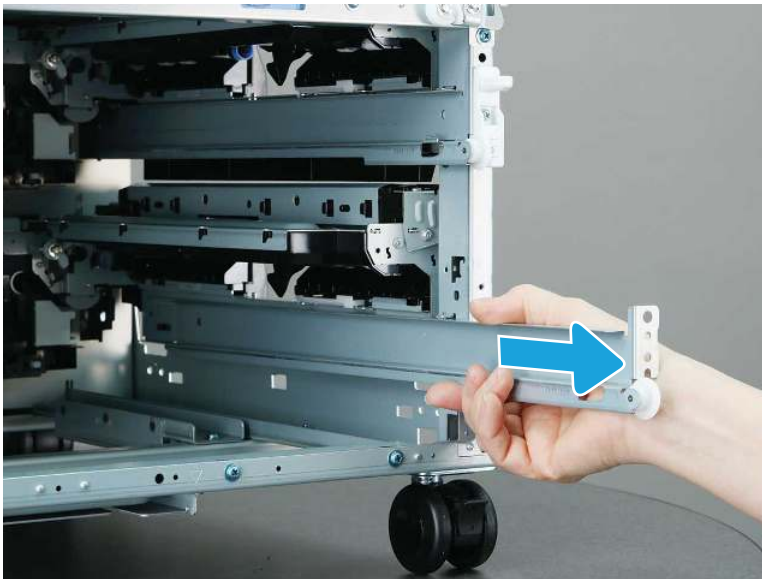
- b. Remove one screw (callout 1), and then remove the cover (callout 2).

Figure 1-3419 Remove the cover



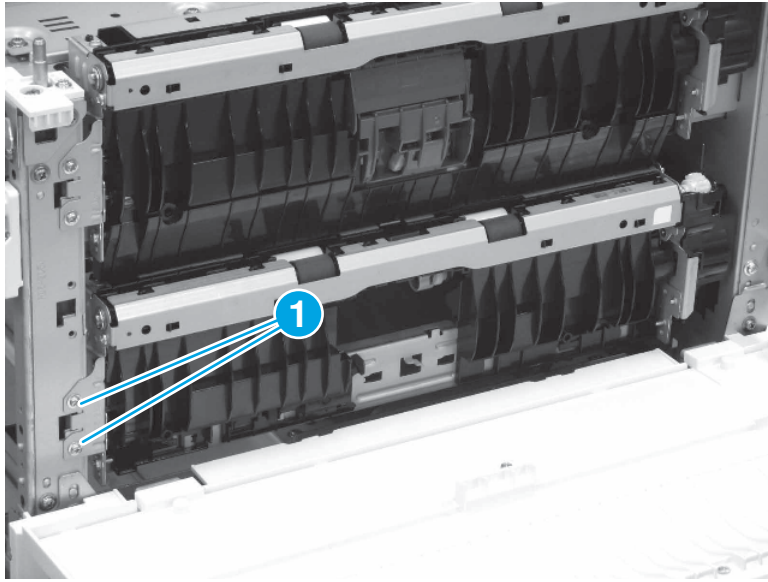
- c. Remove the cassette rail.

Figure 1-3420 Remove the rail



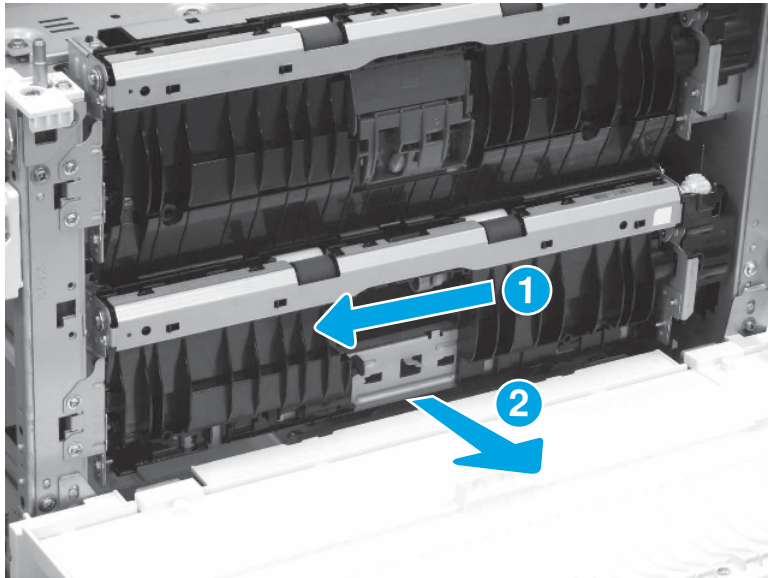
- d. Remove two screws (callout 1).

Figure 1-3421 Remove two screws



- e. Slide the pickup assembly toward the front of the feeder (callout 1), and then slide it away from the feeder (callout 2) to remove it.

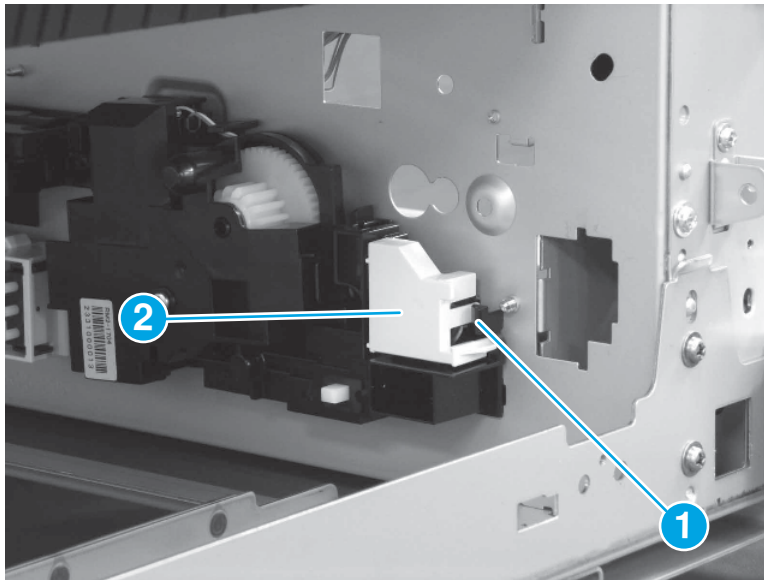
Figure 1-3422 Remove the pickup assembly



- 9. Remove the 2x550-sheet paper tray and stand tray 2 lifter drive.

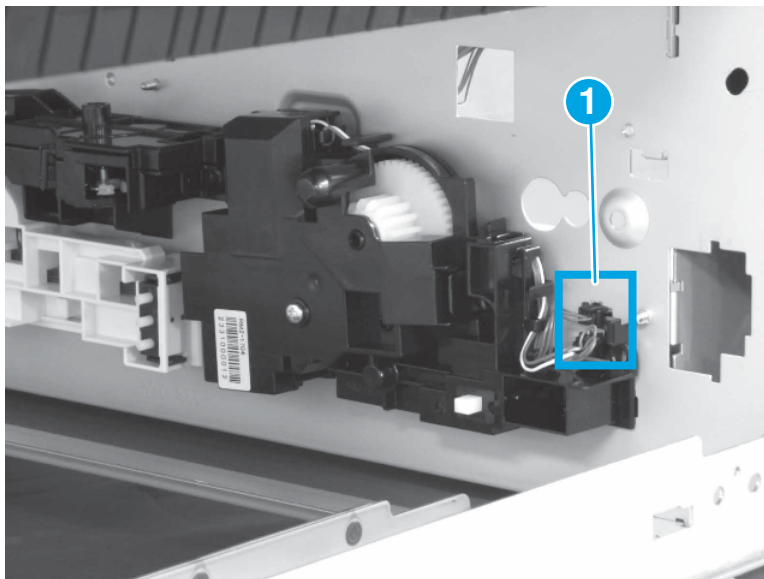
- a. Release one tab (callout 1), and then remove the connector cover (callout 2).

Figure 1-3423 Remove the connector cover



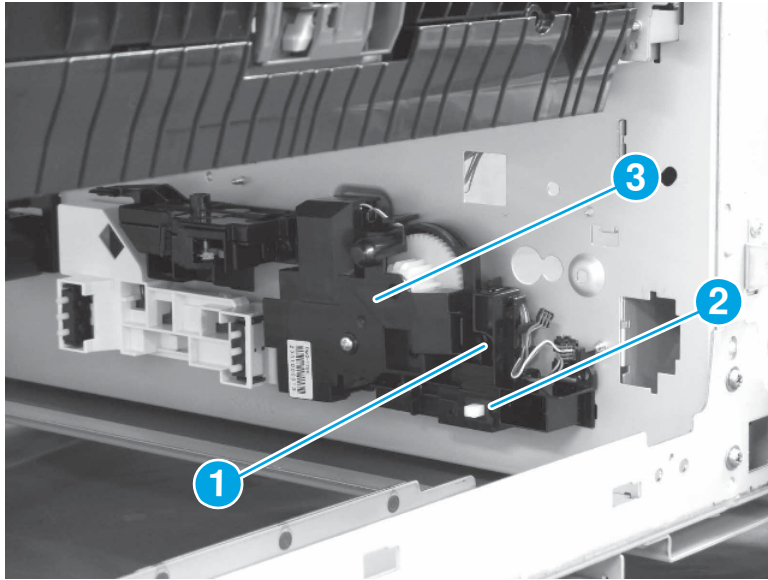
- b. Disconnect two connectors (callout 1).

Figure 1-3424 Disconnect two connectors



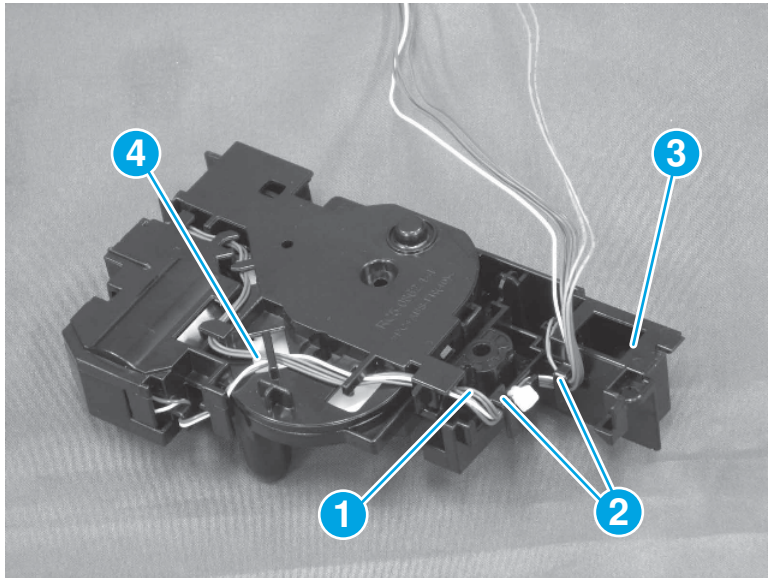
- c. Remove one screw (callout 1). Remove the holder (callout 2) and the lifter drive (callout 3) together.

Figure 1-3425 Remove the holder and lifter drive



- d. Release the cables (callout 1) from the cable guide (callout 2). Remove the holder (callout 3) from the lifter drive (callout 4).

Figure 1-3426 Remove the holder



- 10. Unpack the replacement assembly.


- a. Dispose of the defective part.




NOTE: HP recommends responsible disposal of the defective part.

<http://www8.hp.com/us/en/hp-information/environment/product-recycling.html>

- b. Unpack the replacement part from the packaging.

 **IMPORTANT:** Make sure that all of the shipping materials (for example shipping tape) are removed from the replacement part prior to installation.

- c. To install an assembly, reverse the removal steps.

 **NOTE:** When applicable, special installation instructions are provided for an assembly at the end of the removal procedure. Always completely read the removal instructions and follow all special installation instructions.

Removal and replacement: 2x550-sheet paper tray and stand tray 1 auto close assembly

Learn how to remove and replace the 2x550-sheet paper tray and stand tray 1 auto close assembly.

[View a video of how to remove and replace the 2x550-sheet paper tray and stand tray 1 auto close assembly.](#)


Mean time to repair: 18 minutes

Service level: Medium

Before performing service

Turn the printer power off

- Disconnect the power cable.

 **WARNING!** To avoid damage to the printer, turn the printer off, wait 30 seconds, and then remove the power cord before attempting to service the printer.

Use the table below to identify the correct part number for your printer. To order the part, go to www.hp.com/buy/parts.

Table 1-177 Part information

Part number	Part description
RM2-1760-000CN	Auto close assembly

Required tools

- #2 Phillips screwdriver with a magnetic tip

After performing service

Turn the printer power on

- Connect the power cable.
- Use the power switch to turn the power on.

Post service test

Make sure that the printer initializes to a **Ready** state.

Print a page from the 2x550-sheet paper tray and stand to make sure that the printer is functioning correctly.

1. Remove the 2x550-sheet paper tray and stand separation roller.

 **NOTE:** The upper tray is shown in the figures below. The procedure is the same for the lower tray.

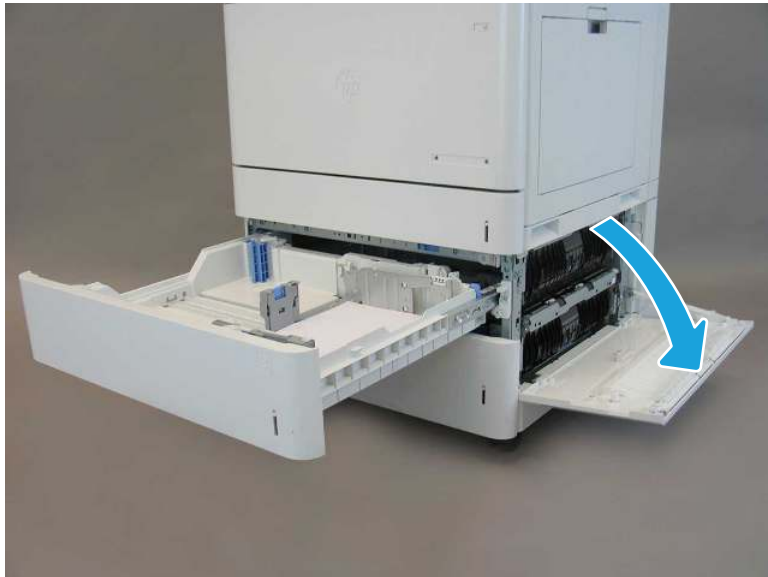
- a. Open the tray.

Figure 1-3427 Open the tray



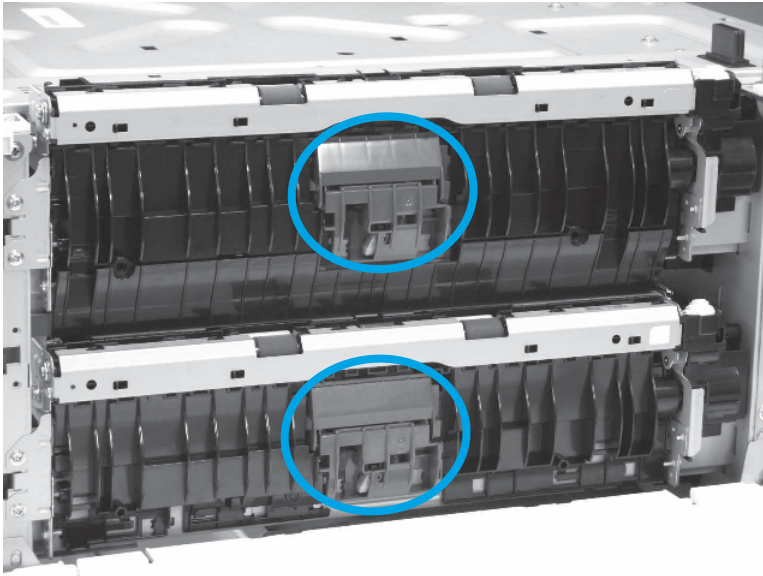
- b. Open the right door.

Figure 1-3428 Open the right door



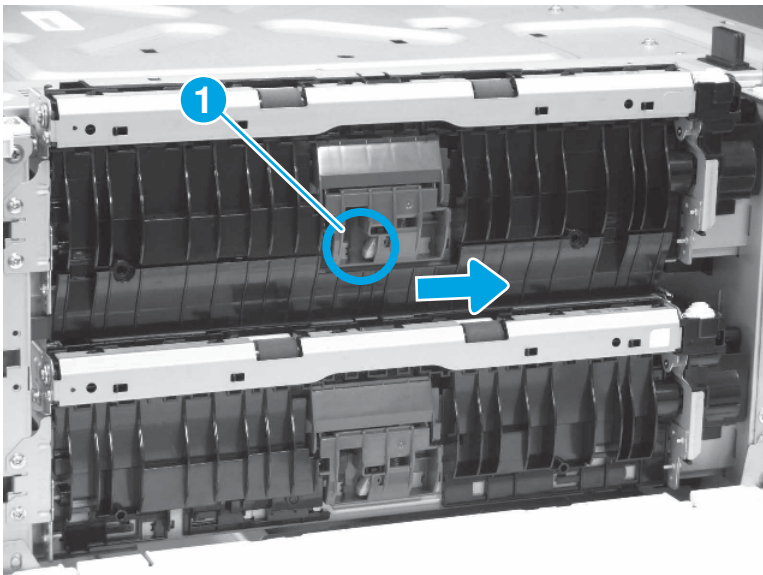
- c. Locate the separation roller.

Figure 1-3429 Locate the separation roller



- d. Press the release button (callout 1), slide the separation roller assembly to the right, and then pull it away from the printer to remove it .

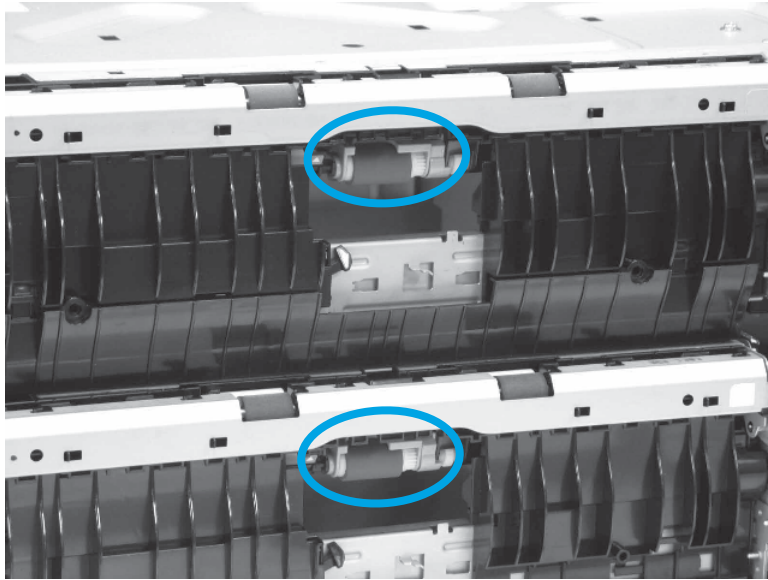
Figure 1-3430 Remove the separation roller



- 2. Remove the 2x550-sheet paper tray and stand tray pickup roller.

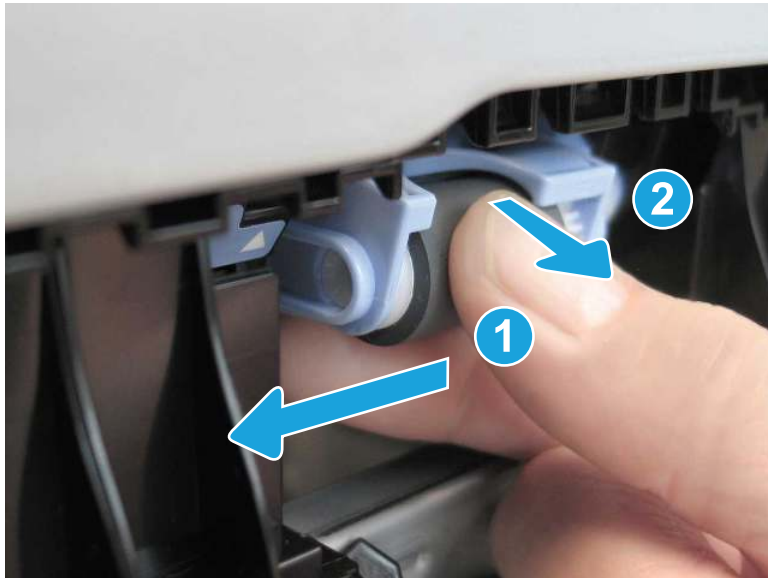
- a. Locate the pickup roller.

Figure 1-3431 Locate the pickup roller



- b. Slide the pickup roller assembly to the left (callout 1), and then pull it away from the printer (callout 2) to remove it.

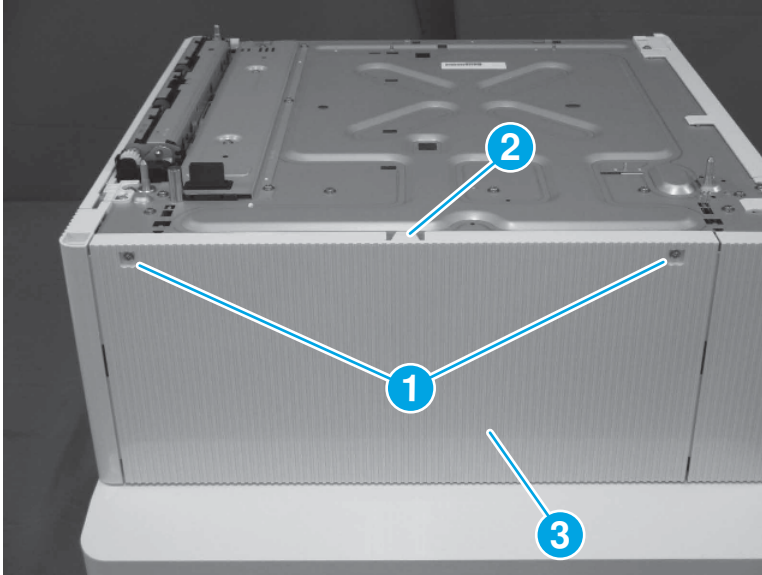
Figure 1-3432 Remove the pickup roller



3. Remove the 2x550-sheet paper tray and stand rear upper cover.

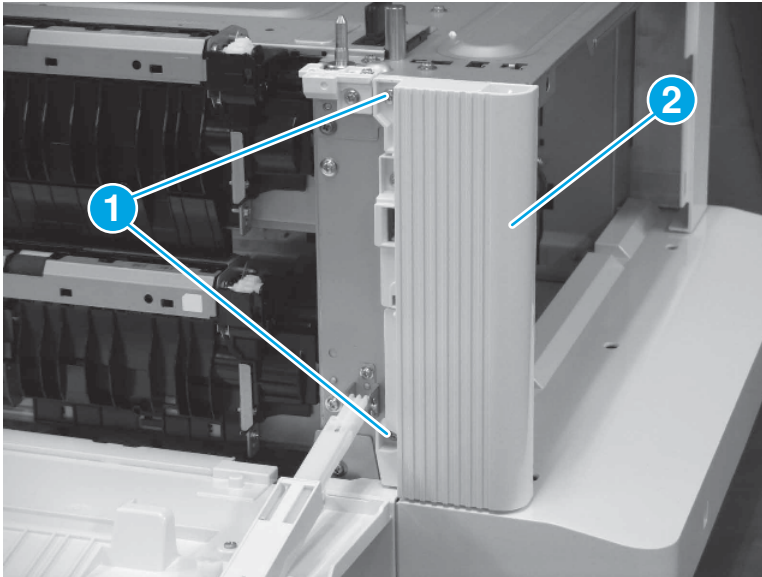
- ▲ Remove two screws (callout 1), release one tab (callout 2), and then lift up to remove the rear upper cover (callout 3).

Figure 1-3433 Remove the rear upper cover



- 4. Remove the 2x550-sheet paper tray and stand right rear cover.
 - a. Open the right door.
 - b. Remove two screws (callout 1), and then remove the right rear cover (callout 2).

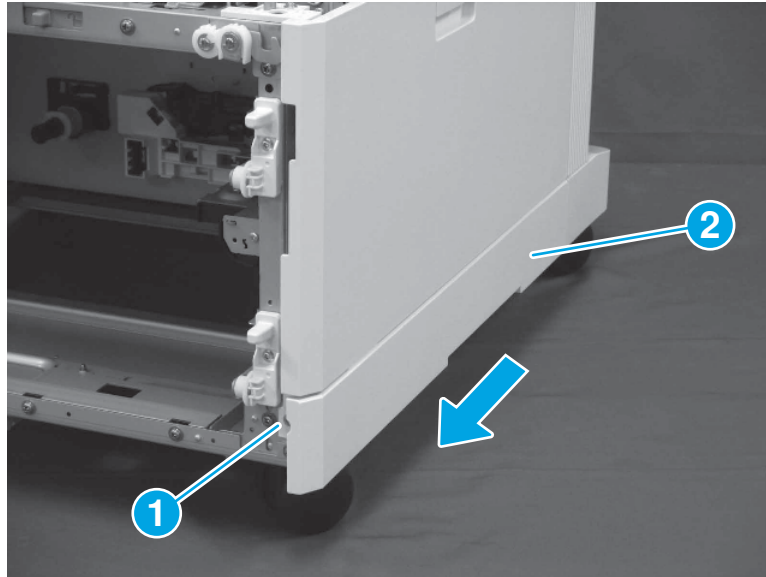
Figure 1-3434 Remove the right rear cover



- 5. Remove the 2x550-sheet paper tray and stand right lower cover.

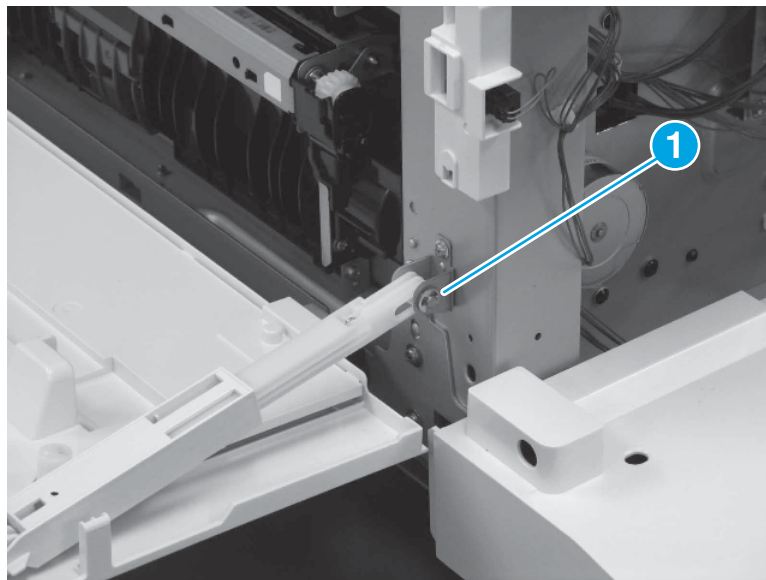
- ▲ Remove one screw (callout 1), and then slide the right lower cover (callout 2) toward the front of the feeder to remove it.

Figure 1-3435 Remove the right lower cover



- 6. Remove the 2x550-sheet paper tray and stand right door.
 - a. Remove one E-ring (callout 1).

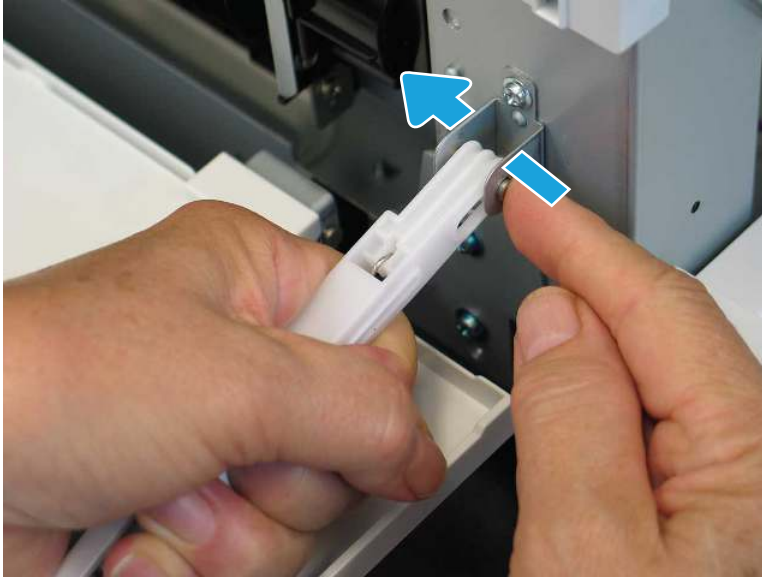
Figure 1-3436 Remove one E-ring



- b. Hold the hinge arm securely, and then slide the shaft to the left to remove it.

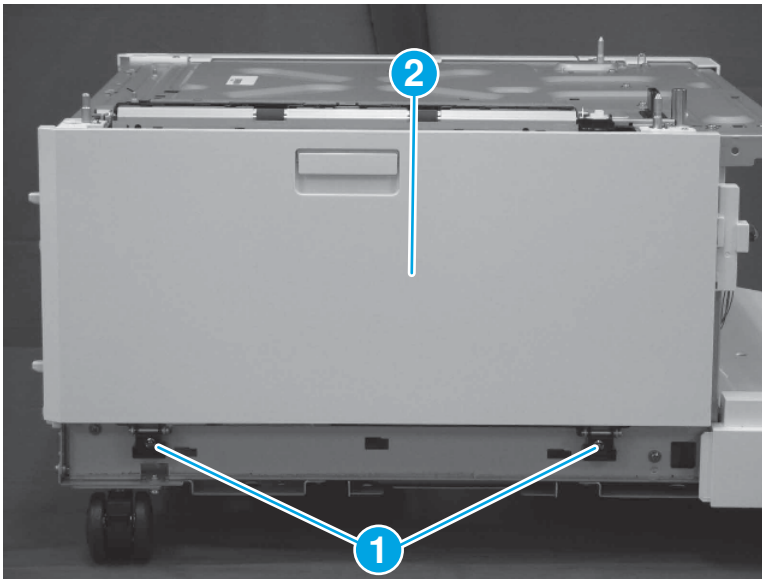
⚠ **CAUTION:** The hinge arm is spring-loaded and may snap back suddenly when the shaft is removed.

Figure 1-3437 Release the hinge arm



- c. Close the right door assembly.
- d. Remove two screws (callout 1), and then remove the right door assembly (callout 2).

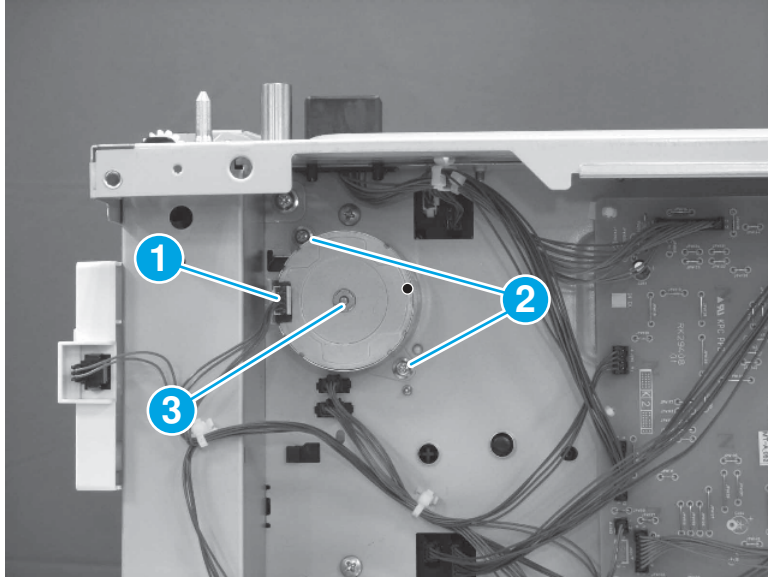
Figure 1-3438 Remove two screws and the right door



- 7. Remove the 2x550-sheet paper tray and stand tray 1 pickup motor.

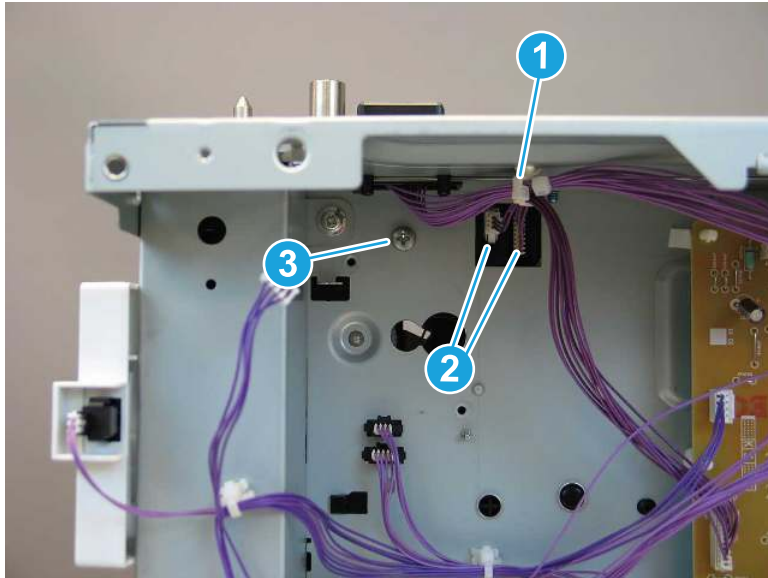
- ▲ Disconnect one connector (callout 1), remove two screws (callout 2), and then remove the pickup motor (callout 3).

Figure 1-3439 Remove the pickup motor



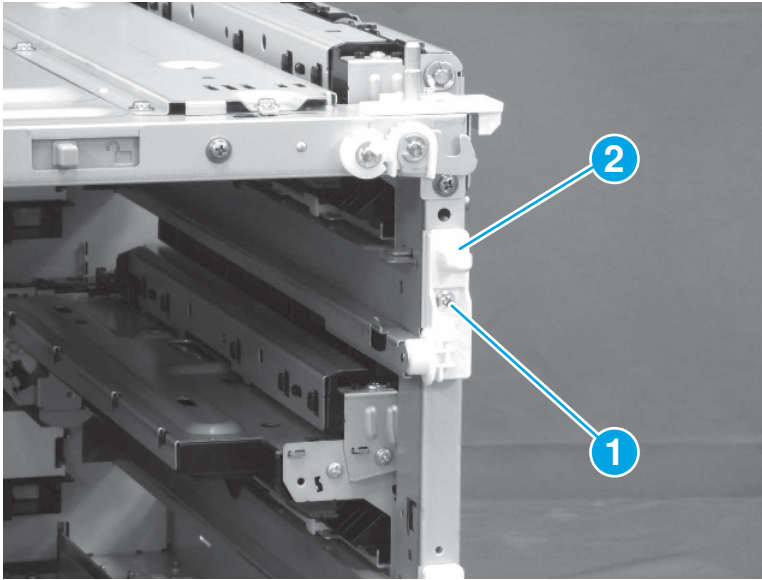
- 8. Remove the 2x550-sheet paper tray and stand tray 1 pickup assembly.
 - a. Release one retainer (callout 1). Disconnect two connectors (callout 2), and then remove one screw (callout 3).

Figure 1-3440 Disconnect two connectors and remove two screws



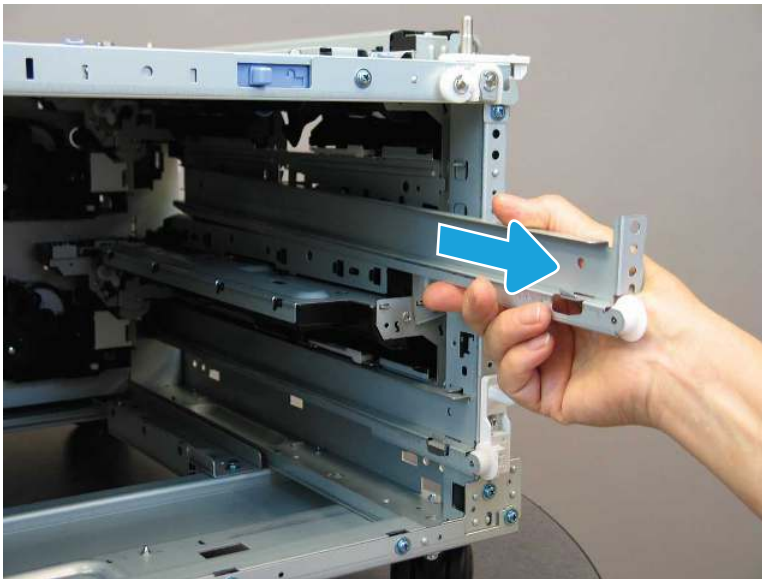
- b. Remove one screw (callout 1), and then remove the cover (callout 2).

Figure 1-3441 Remove the cover



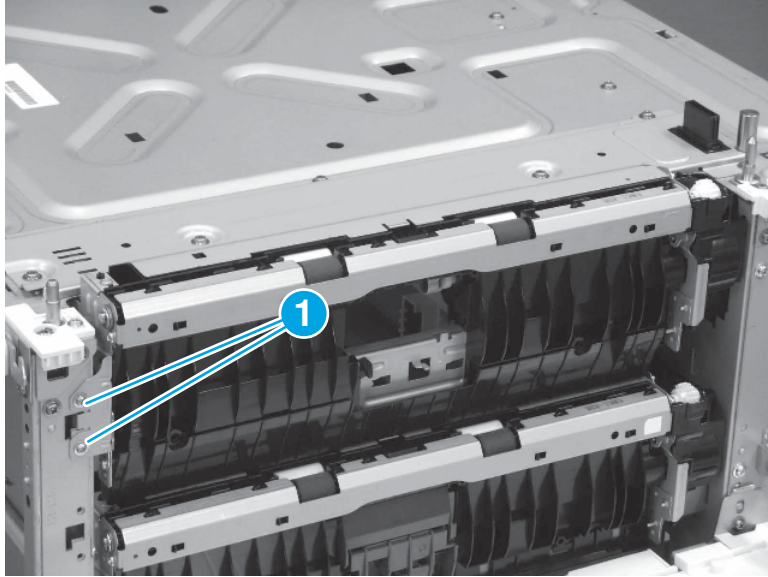
- c. Remove the cassette rail.

Figure 1-3442 Remove the cassette rail



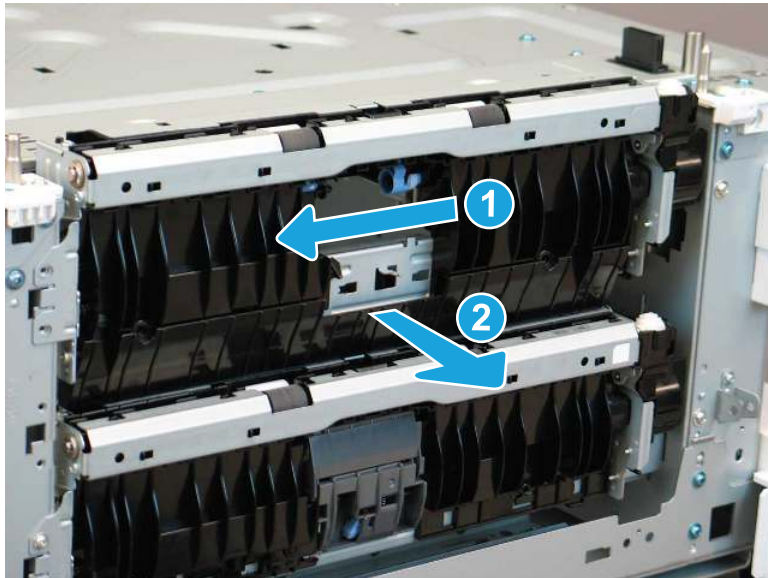
- d. Remove two screws (callout 1).

Figure 1-3443 Remove two screws



- e. Slide the pickup assembly toward the front of the feeder (callout 1), and then slide it away from the feeder (callout 2) to remove it.

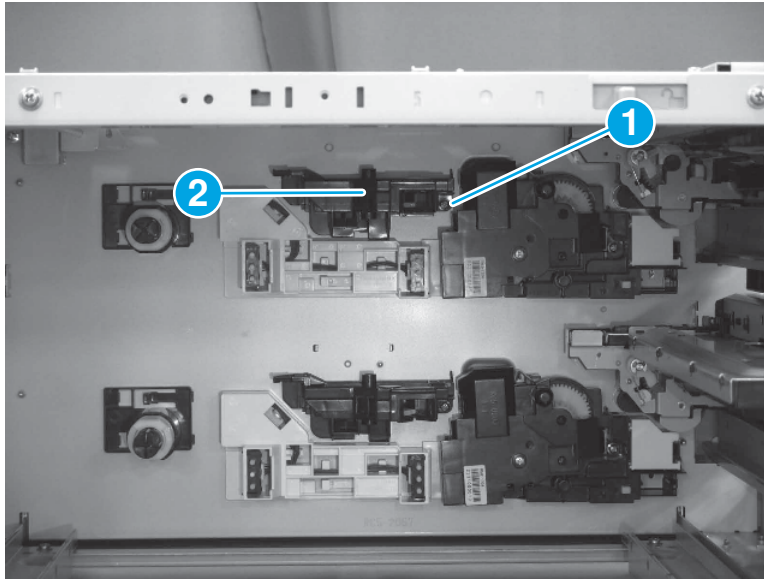
Figure 1-3444 Remove the pickup assembly



- 9. Remove the 2x550-sheet paper tray and stand tray 1 auto close assembly.

- ▲ Remove one screw (callout 1), and then remove the auto close assembly (callout 2).

Figure 1-3445 Remove the auto close assembly



10. Unpack the replacement assembly.

- a. Dispose of the defective part.



NOTE: HP recommends responsible disposal of the defective part.

<http://www8.hp.com/us/en/hp-information/environment/product-recycling.html>

- b. Unpack the replacement part from the packaging.



IMPORTANT: Make sure that all of the shipping materials (for example shipping tape) are removed from the replacement part prior to installation.

- c. To install an assembly, reverse the removal steps.



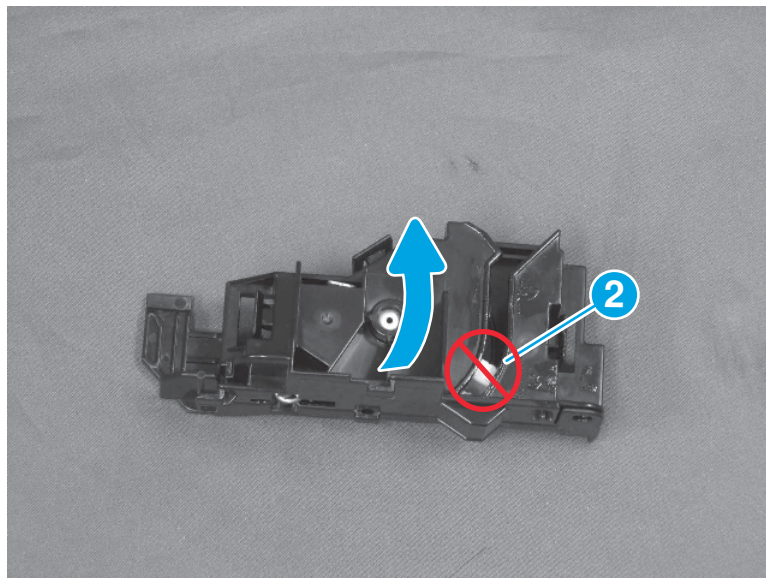
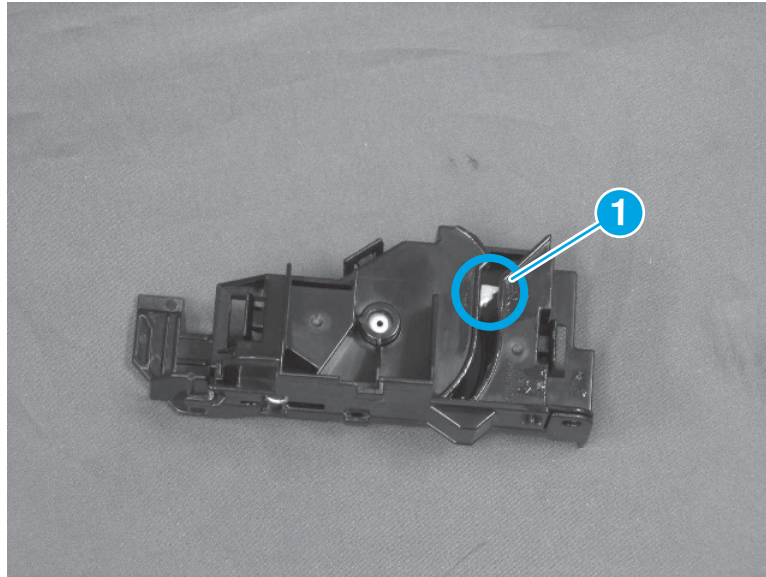
NOTE: When applicable, special installation instructions are provided for an assembly at the end of the removal procedure. Always completely read the removal instructions and follow all special installation instructions.

11. Reverse the removal steps to install the assembly. Also use the following **special installation instructions**.

Check the toggle position

- ▲ Confirm the position of the toggle when installing the auto close assembly. The correct position of the toggle is toward the top of the auto close assembly (callout 1). If the toggle is in the wrong position (callout 2), use a small, flat-blade screwdriver to rotate it up to the correct position.

Figure 1-3446 Check the toggle position



Removal and replacement: 2x550-sheet paper tray and stand tray 2 auto close assembly

Learn how to remove and replace the 2x550-sheet paper tray and stand tray 2 auto close assembly.

[View a video of how to remove and replace the 2x550-sheet paper tray and stand tray 2 auto close assembly.](#)


Mean time to repair: 18 minutes

Service level: Medium

Before performing service

Turn the printer power off

- Disconnect the power cable.

 **WARNING!** To avoid damage to the printer, turn the printer off, wait 30 seconds, and then remove the power cord before attempting to service the printer.

Use the table below to identify the correct part number for your printer. To order the part, go to www.hp.com/buy/parts.

Table 1-178 Part information

Part number	Part description
RM2-1760-000CN	Auto close assembly

Required tools

- #2 Phillips screwdriver with a magnetic tip

After performing service

Turn the printer power on

- Connect the power cable.
- Use the power switch to turn the power on.

Post service test

Make sure that the printer initializes to a **Ready** state.

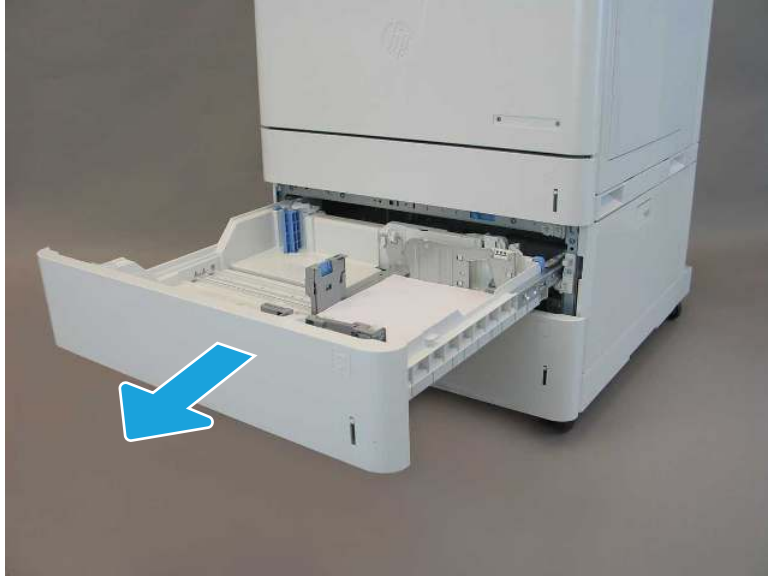
Print a page from the 2x550-sheet paper tray and stand to make sure that the printer is functioning correctly.

1. Remove the 2x550-sheet paper tray and stand separation roller.

 **NOTE:** The upper tray is shown in the figures below. The procedure is the same for the lower tray.

- a. Open the tray.

Figure 1-3447 Open the tray



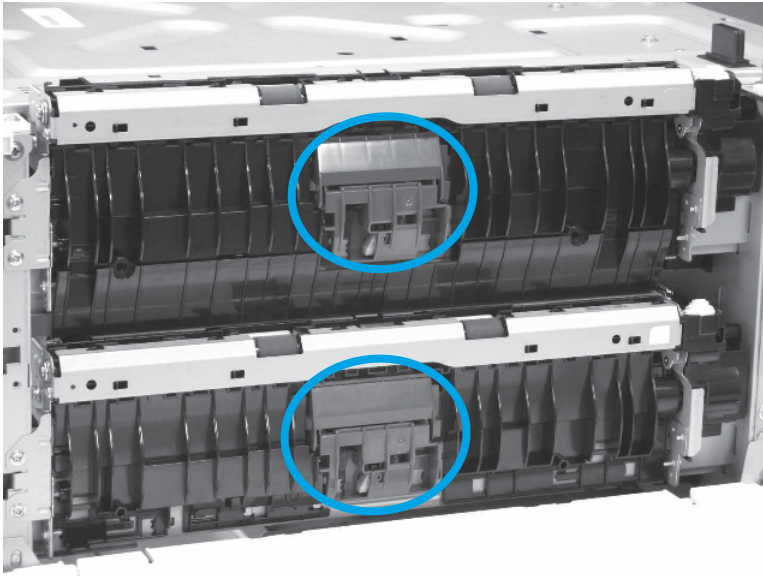
- b. Open the right door.

Figure 1-3448 Open the right door



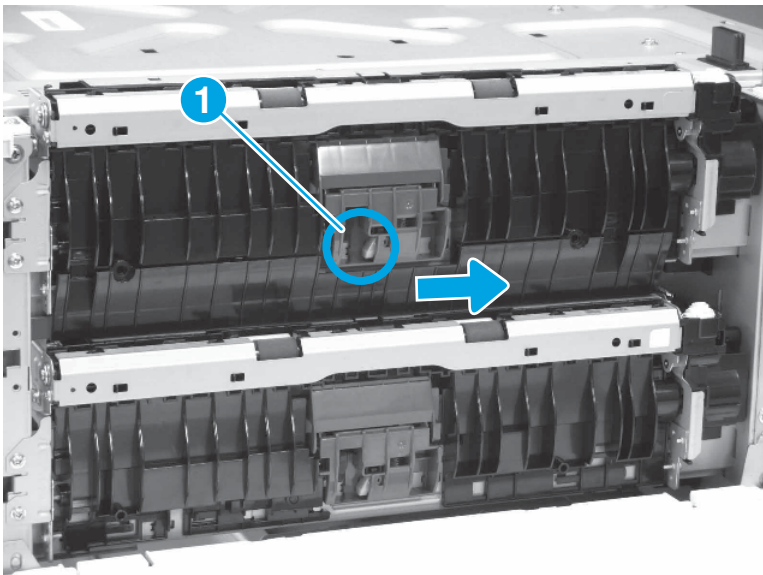
- c. Locate the separation roller.

Figure 1-3449 Locate the separation roller



- d. Press the release button (callout 1), slide the separation roller assembly to the right, and then pull it away from the printer to remove it .

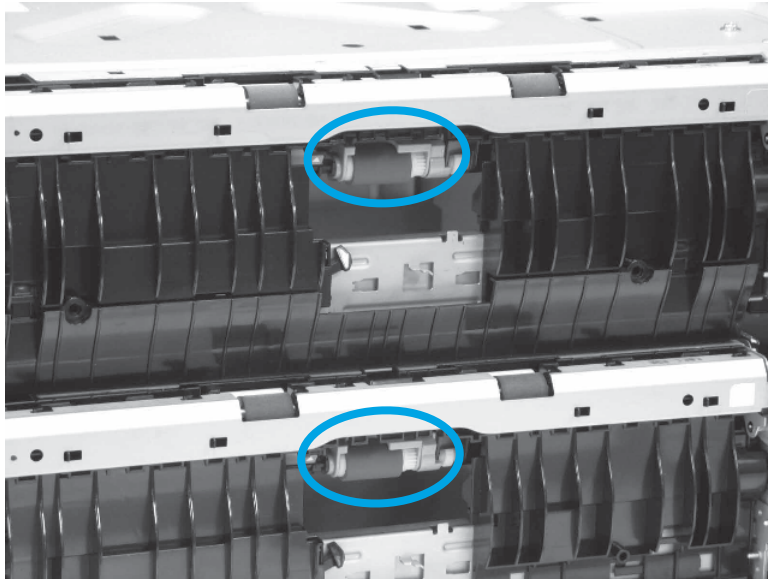
Figure 1-3450 Remove the separation roller



- 2. Remove the 2x550-sheet paper tray and stand tray pickup roller.

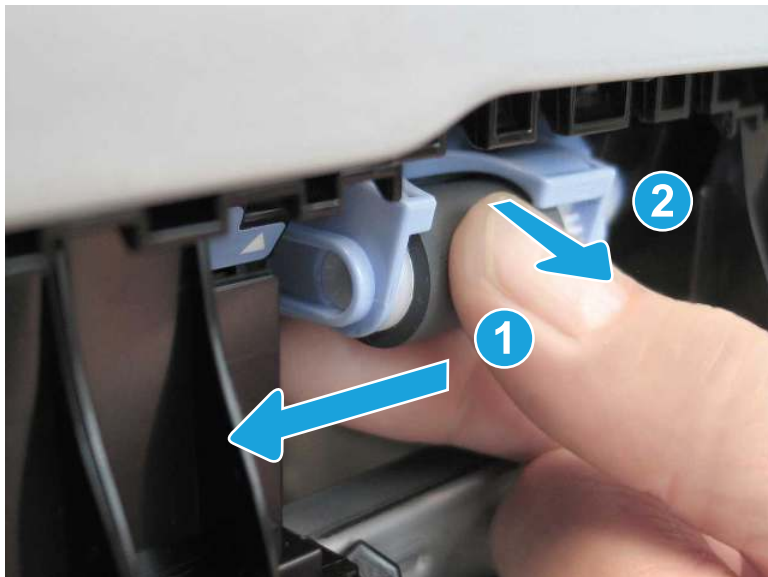
- a. Locate the pickup roller.

Figure 1-3451 Locate the pickup roller



- b. Slide the pickup roller assembly to the left (callout 1), and then pull it away from the printer (callout 2) to remove it.

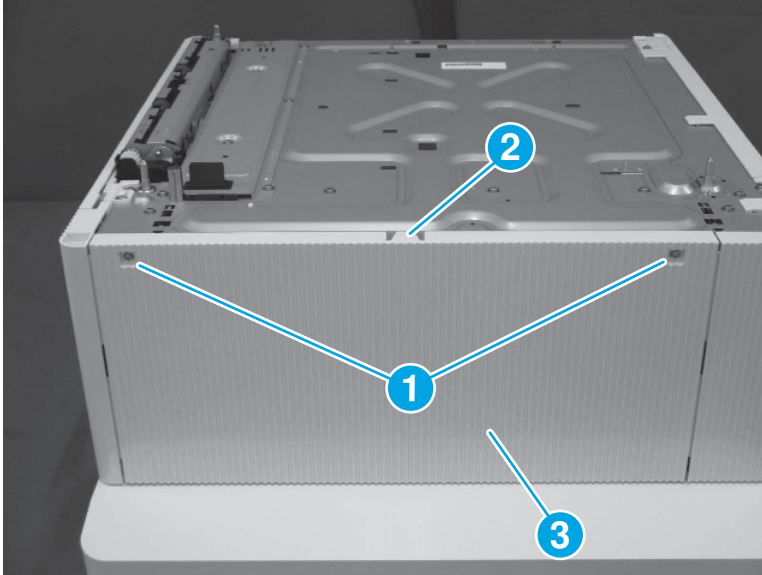
Figure 1-3452 Remove the pickup roller



3. Remove the 2x550-sheet paper tray and stand rear upper cover.

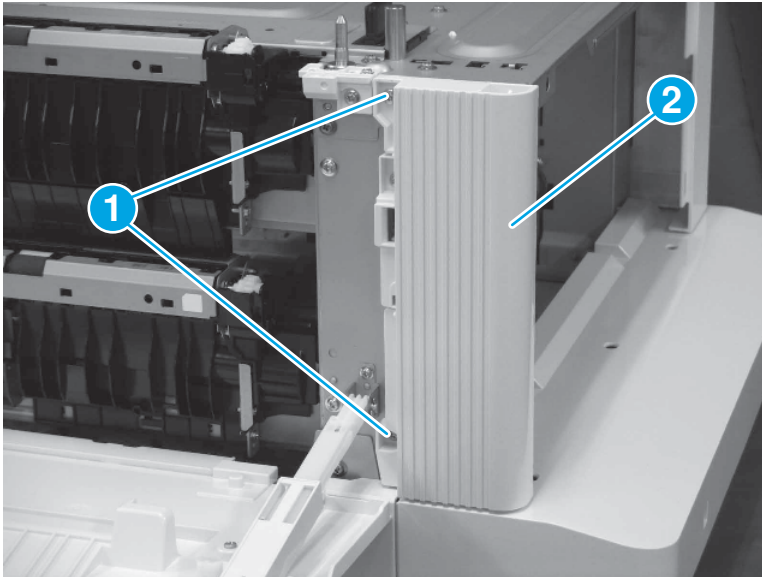
- ▲ Remove two screws (callout 1), release one tab (callout 2), and then lift up to remove the rear upper cover (callout 3).

Figure 1-3453 Remove the rear upper cover



- 4. Remove the 2x550-sheet paper tray and stand right rear cover.
 - a. Open the right door.
 - b. Remove two screws (callout 1), and then remove the right rear cover (callout 2).

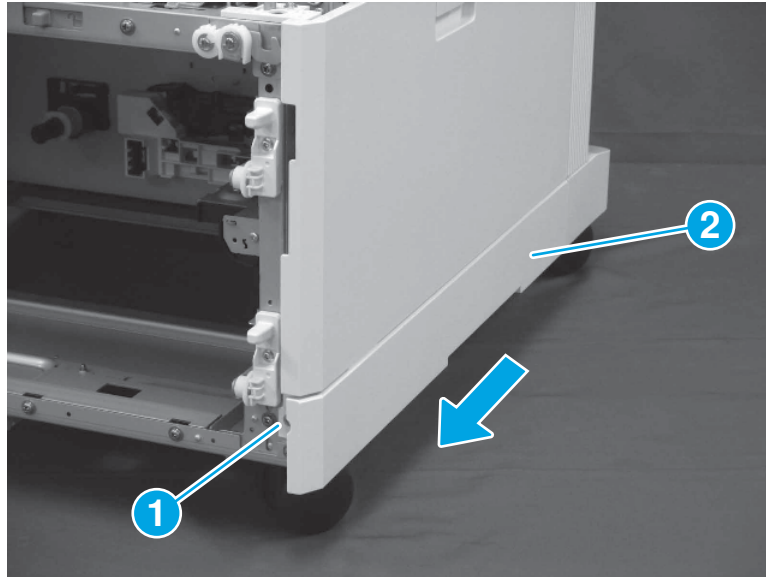
Figure 1-3454 Remove the right rear cover



- 5. Remove the 2x550-sheet paper tray and stand right lower cover.

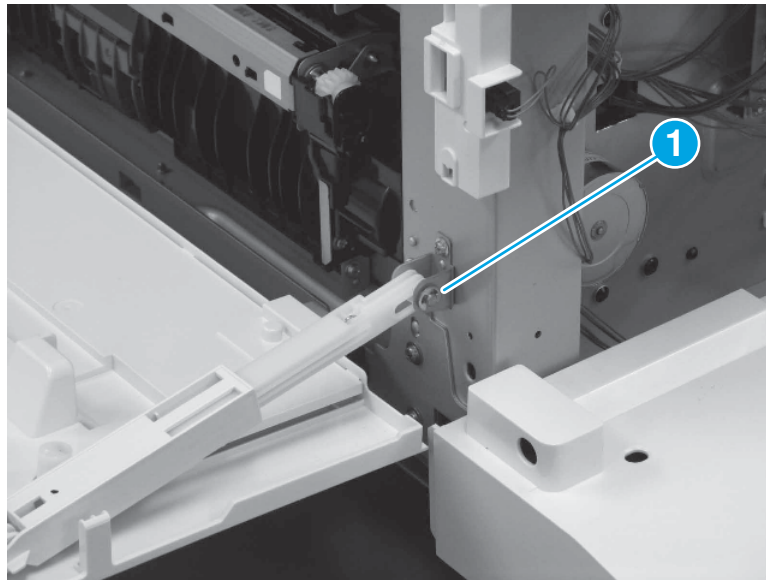
- ▲ Remove one screw (callout 1), and then slide the right lower cover (callout 2) toward the front of the feeder to remove it.

Figure 1-3455 Remove the right lower cover



- 6. Remove the 2x550-sheet paper tray and stand right door.
 - a. Remove one E-ring (callout 1).

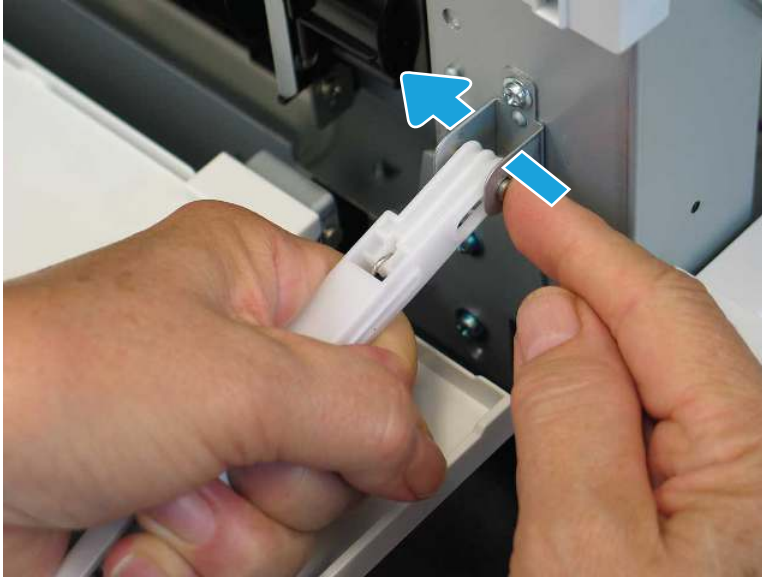
Figure 1-3456 Remove one E-ring



- b. Hold the hinge arm securely, and then slide the shaft to the left to remove it.

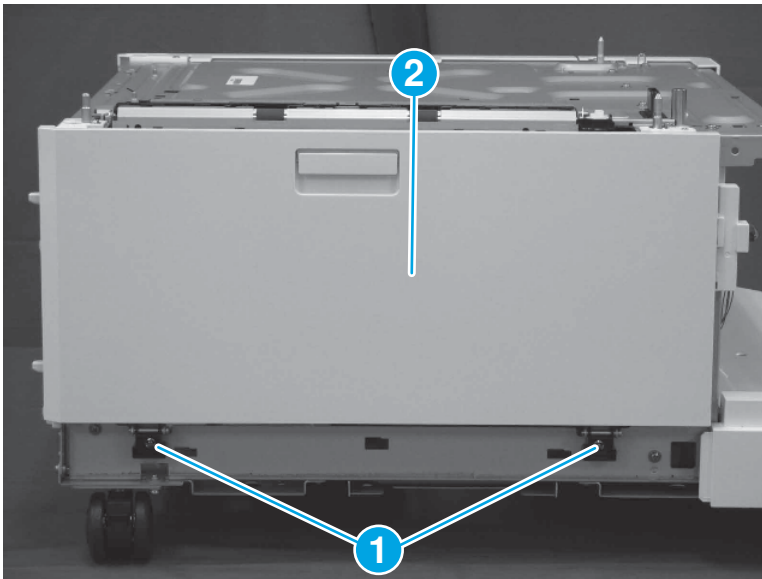
⚠ **CAUTION:** The hinge arm is spring-loaded and may snap back suddenly when the shaft is removed.

Figure 1-3457 Release the hinge arm



- c. Close the right door assembly.
- d. Remove two screws (callout 1), and then remove the right door assembly (callout 2).

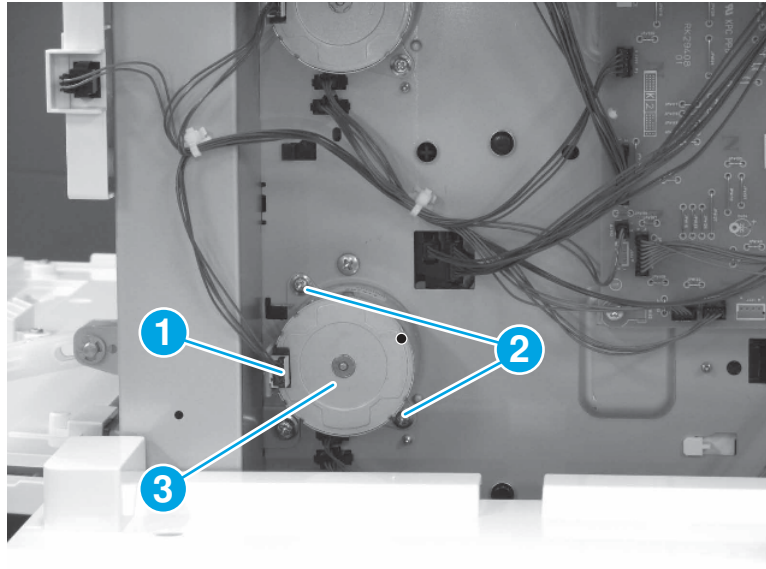
Figure 1-3458 Remove two screws and the right door



- 7. Remove the 2x550-sheet paper tray and stand tray 2 pickup motor.

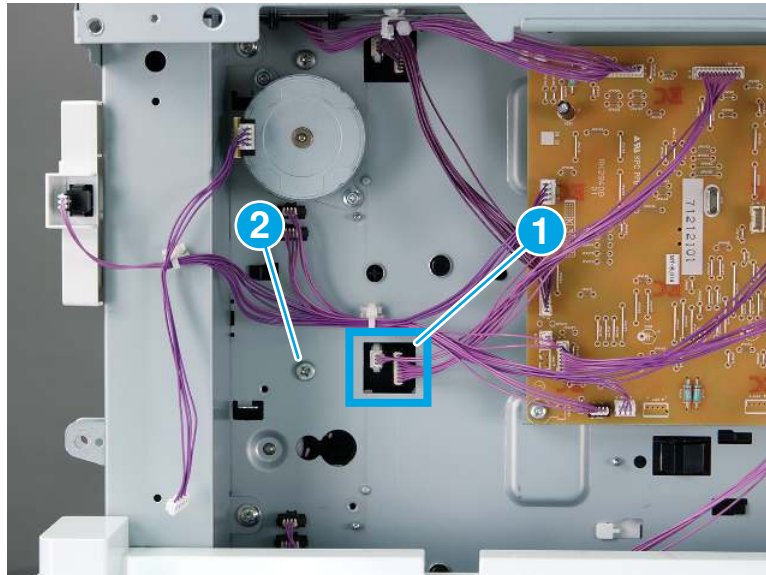
- ▲ Disconnect one connector (callout 1), remove two screws (callout 2), and then remove the pickup motor (callout 3).

Figure 1-3459 Remove the pickup motor



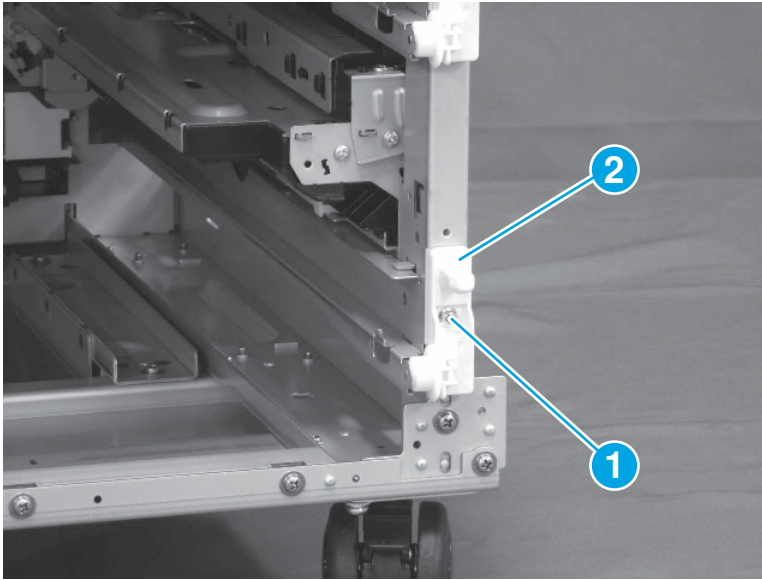
8. Remove the 2x550-sheet paper tray and stand tray 2 pickup assembly.
 - a. Disconnect two connectors (callout 1), and then remove one screw (callout 2).

Figure 1-3460 Disconnect two connectors and remove one screw



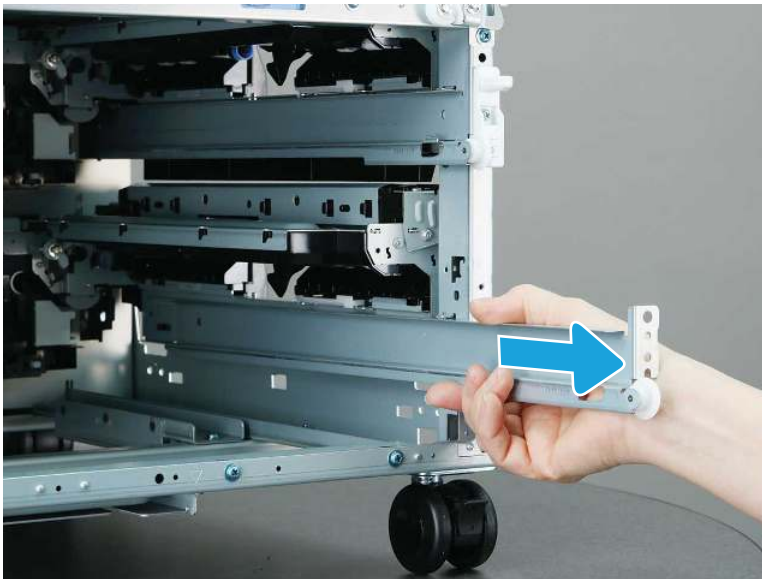
- b. Remove one screw (callout 1), and then remove the cover (callout 2).

Figure 1-3461 Remove the cover



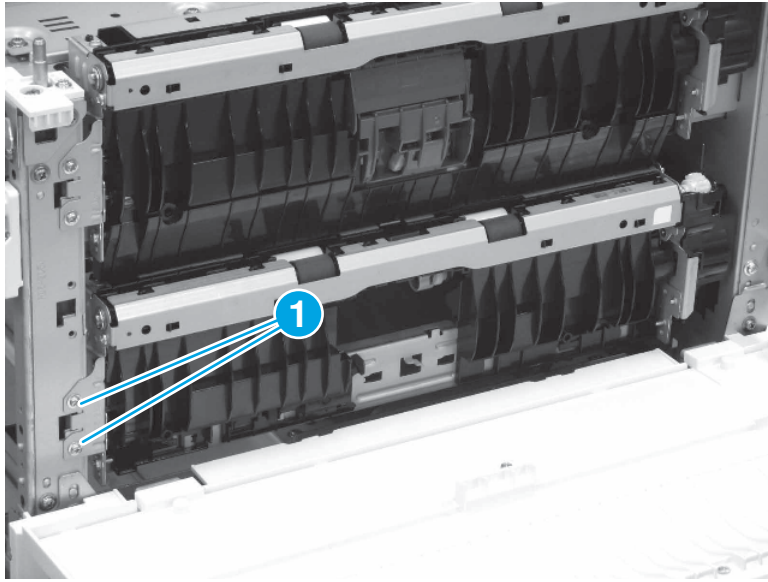
- c. Remove the cassette rail.

Figure 1-3462 Remove the rail



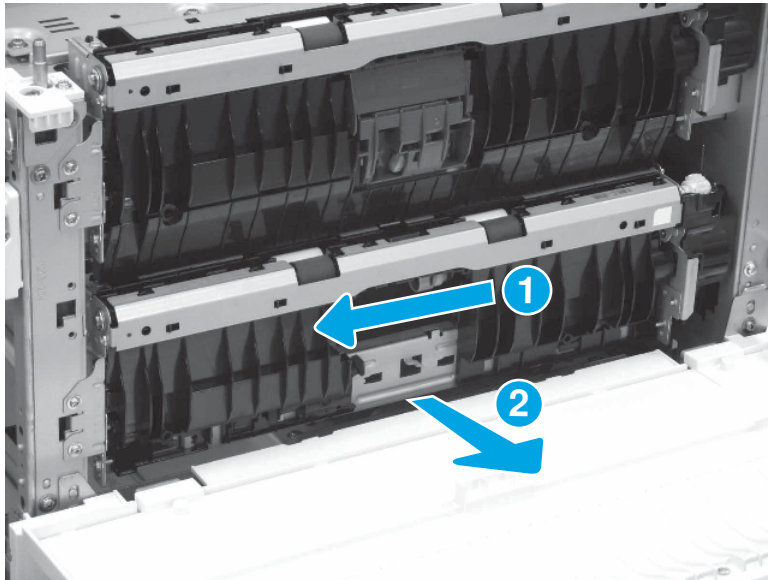
- d. Remove two screws (callout 1).

Figure 1-3463 Remove two screws



- e. Slide the pickup assembly toward the front of the feeder (callout 1), and then slide it away from the feeder (callout 2) to remove it.

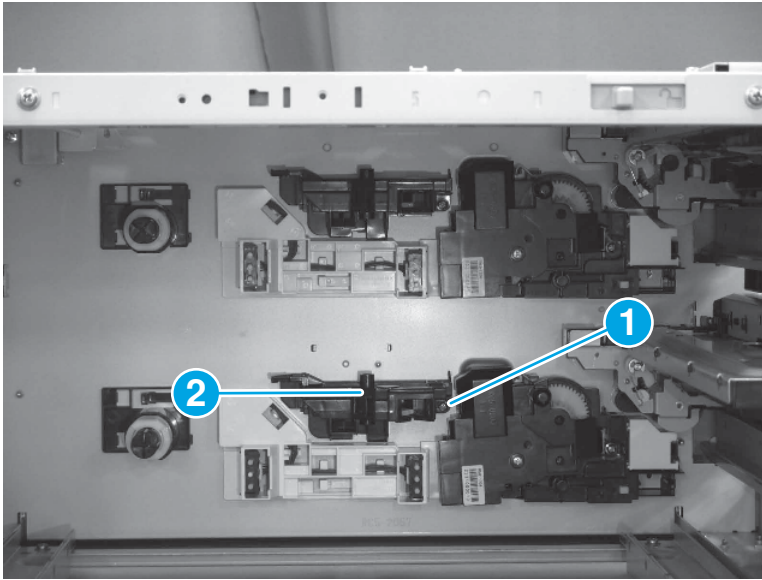
Figure 1-3464 Remove the pickup assembly



- 9. Remove the 2x550-sheet paper tray and stand tray 2 auto close assembly.

- ▲ Remove one screw (callout 1), and then remove the auto close assembly (callout 2).

Figure 1-3465 Remove the auto close assembly



10. Unpack the replacement assembly.

- a. Dispose of the defective part.



NOTE: HP recommends responsible disposal of the defective part.

<http://www8.hp.com/us/en/hp-information/environment/product-recycling.html>

- b. Unpack the replacement part from the packaging.



IMPORTANT: Make sure that all of the shipping materials (for example shipping tape) are removed from the replacement part prior to installation.

- c. To install an assembly, reverse the removal steps.



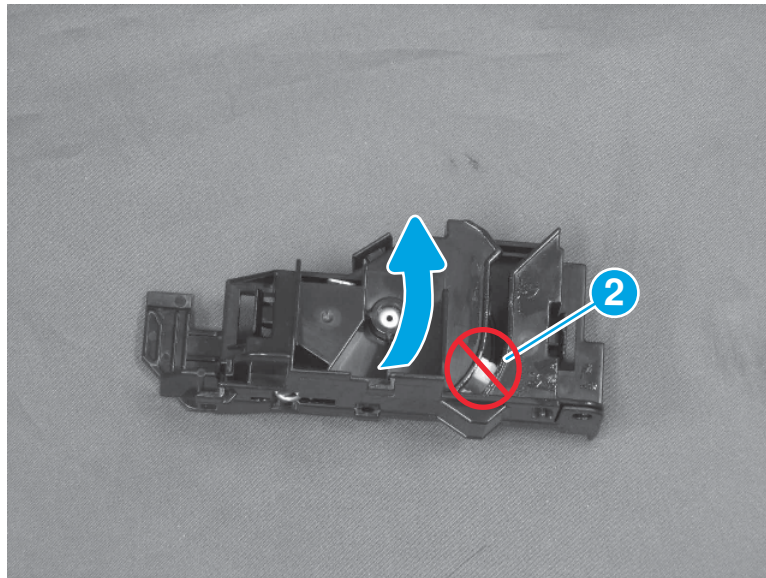
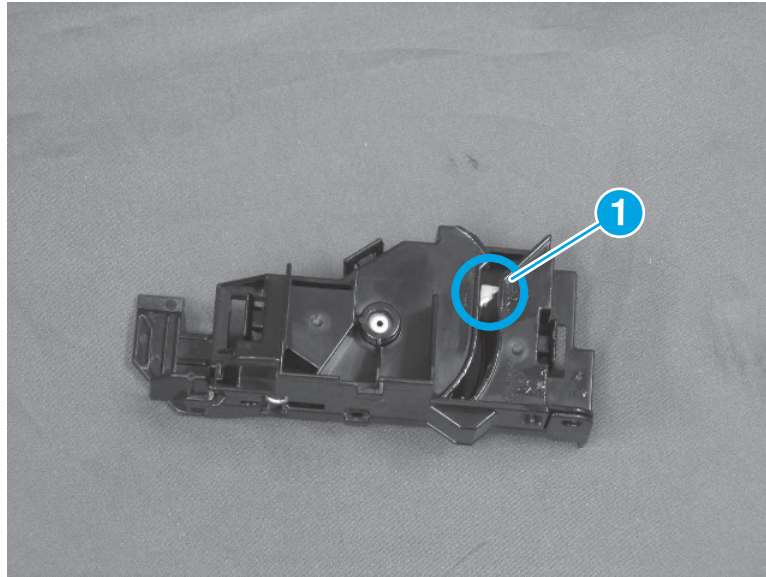
NOTE: When applicable, special installation instructions are provided for an assembly at the end of the removal procedure. Always completely read the removal instructions and follow all special installation instructions.

11. Reverse the removal steps to install the assembly. Also use the following **special installation instructions**.

Check the toggle position

- ▲ Confirm the position of the toggle when installing the auto close assembly. The correct position of the toggle is toward the top of the auto close assembly (callout 1). If the toggle is in the wrong position (callout 2), use a small, flat-blade screwdriver to rotate it up to the correct position.

Figure 1-3466 Check the toggle position



Removal and replacement: 2x550-sheet paper tray and stand controller PCA

Learn how to remove and replace the 2x550-sheet paper tray and stand controller PCA.

[View a video of how to remove and replace the 2x550-sheet paper tray and stand controller PCA.](#)

Mean time to repair: 5 Minutes

Service level: Easy

Before performing service

Turn the printer power off

- Disconnect the power cable.

⚠ WARNING! To avoid damage to the printer, turn the printer off, wait 30 seconds, and then remove the power cord before attempting to service the printer.

Use the table below to identify the correct part number for your printer. To order the part, go to www.hp.com/buy/parts.

Table 1-179 Part information

Part number	Part description
RM2-9885-000CN	Paper deck controller PCB assembly

Required tools

- #2 Phillips screwdriver with a magnetic tip
- Needle-nose pliers

After performing service

Turn the printer power on

- Connect the power cable.
- Use the power switch to turn the power on.

Post service test

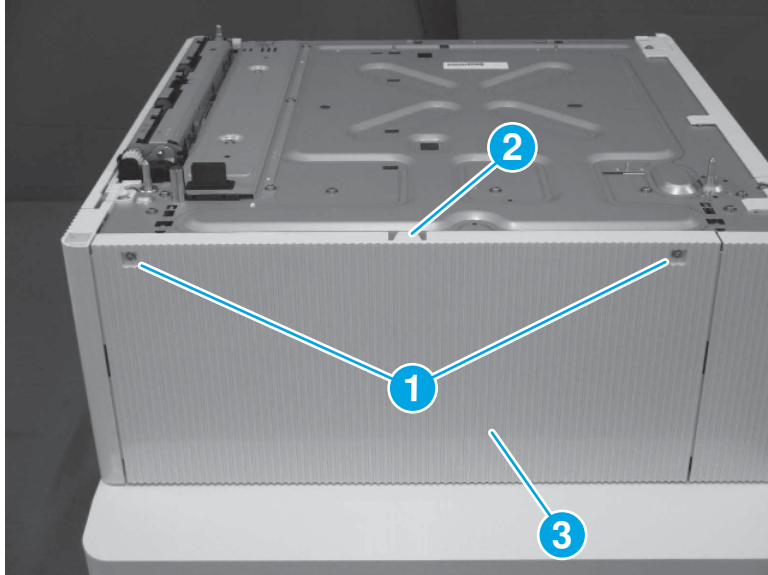
Make sure that the printer initializes to a **Ready** state.

Print a page from the 2x550-sheet paper tray and stand to make sure that the printer is functioning correctly.

1. Remove the 2x550-sheet paper tray and stand rear upper cover.

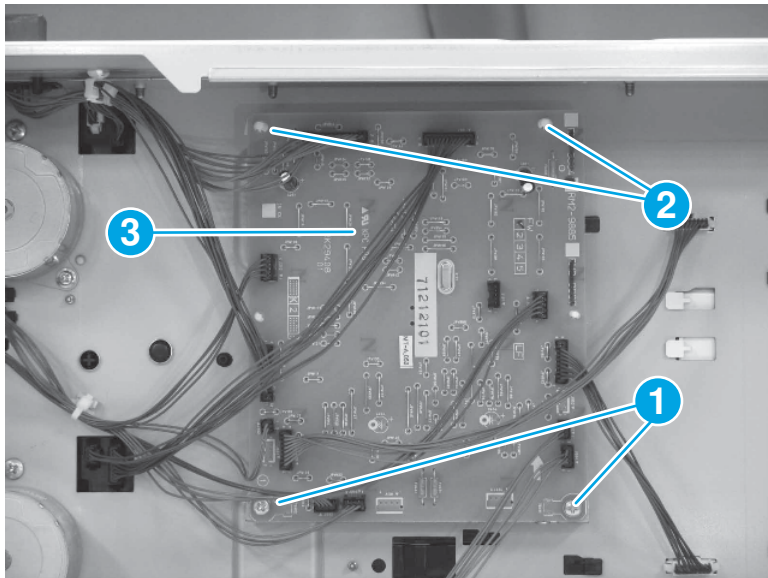
- ▲ Remove two screws (callout 1), release one tab (callout 2), and then lift up to remove the rear upper cover (callout 3).

Figure 1-3467 Remove the rear upper cover



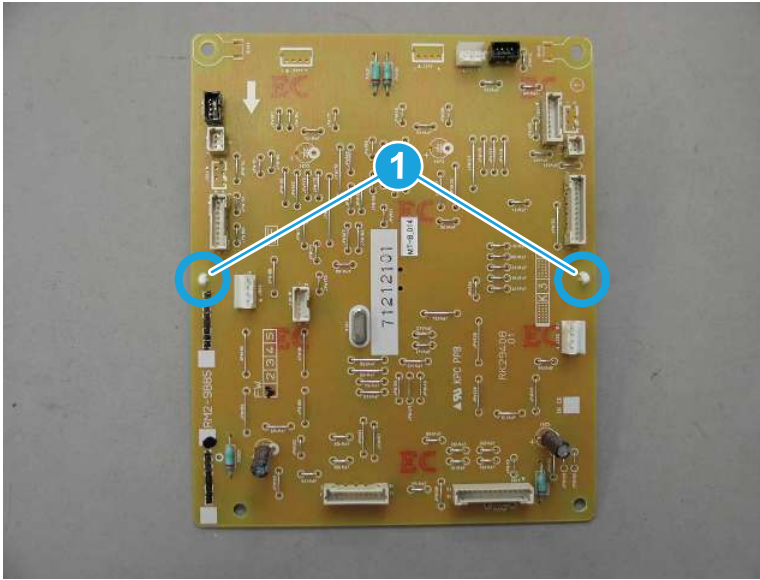
- 2. Remove the 2x550-sheet paper tray and stand controller PCA.
 - a. Disconnect all of the connectors on the controller PCA. Remove two screws (callout 1), release two tabs (callout 2), and then remove the controller PCA (callout 3).

Figure 1-3468 Remove the controller PCA



- b. Locate two supports (callout 1) on the controller PCA.

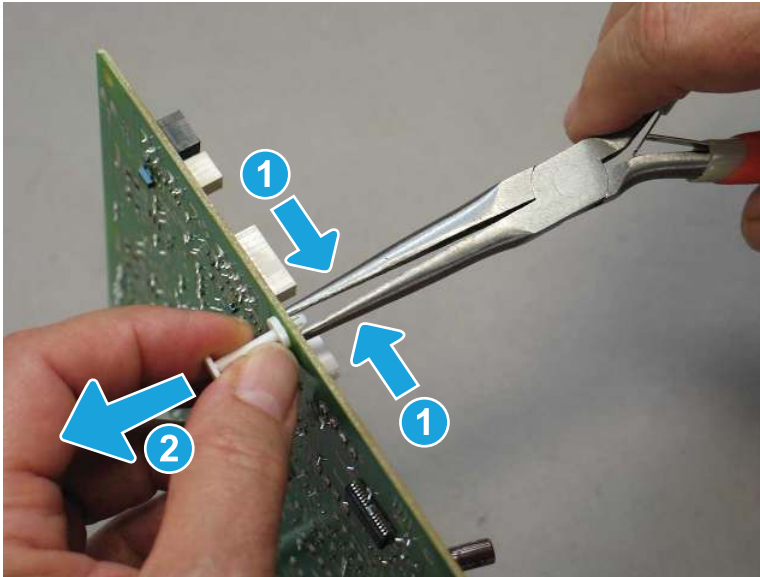
Figure 1-3469 Locate two supports



- c. For each support, use needle-nose pliers to compress two tabs on the front of the controller PCA (callout 1), and then slide the support (callout 2) away from the PCA.

 **NOTE:** Save these supports and install them on the replacement controller PCA.

Figure 1-3470 Remove the supports






3. Unpack the replacement assembly.
 - a. Dispose of the defective part.

 **NOTE:** HP recommends responsible disposal of the defective part.


<http://www8.hp.com/us/en/hp-information/environment/product-recycling.html>

- b. Unpack the replacement part from the packaging.

 **CAUTION:**  Some parts are sensitive to electrostatic discharge (ESD). Always perform service work at an ESD-protected workstation or mat. If an ESD workstation or mat is not available, touch the sheet-metal chassis to provide a static ground before touching an ESD-sensitive assembly. Protect the ESD-sensitive assemblies by placing them in ESD pouches when they are out of the printer.

 **IMPORTANT:** Make sure that all of the shipping materials (for example shipping tape) are removed from the replacement part prior to installation.

- c. To install an assembly, reverse the removal steps.

 **NOTE:** When applicable, special installation instructions are provided for an assembly at the end of the removal procedure. Always completely read the removal instructions and follow all special installation instructions.

Removal and replacement: 2,700-sheet HCl paper tray and stand components

Learn how to remove and replace the component parts in the 2,700-sheet HCl paper tray and stand.

Removal and replacement: 2,700-sheet HCl paper tray and stand right paper tray

Learn how to remove and replace the 2,700-sheet HCl paper tray and stand right paper tray.

[View a video of how to remove and replace the 2,700-sheet HCl paper tray and stand right paper tray.](#)


Mean time to repair: 2 minutes

Service level: CSR A

Before performing service

Turn the printer power off

- Disconnect the power cable.

 **WARNING!** To avoid damage to the printer, turn the printer off, wait 30 seconds, and then remove the power cord before attempting to service the printer.

Use the table below to identify the correct part number for your printer. To order the part, go to www.hp.com/buy/parts.

Table 1-180 Part information

Part number	Part description
RM2-1748-000CN	Right tray assembly

Required tools

- No special tools are required to remove or install this assembly.

After performing service

Turn the printer power on

- Connect the power cable.
- Use the power switch to turn the power on.

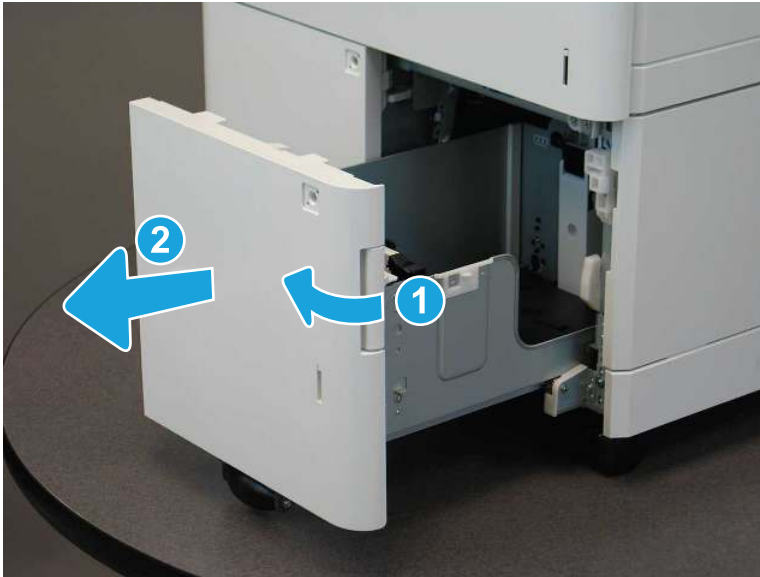
Post service test

Make sure that the printer initializes to a **Ready** state.

Print a page from the 2,700-sheet HCl paper tray and stand to make sure that the printer is functioning correctly.

1. Remove the 2,700-sheet HCl paper tray and stand right tray.
 - ▲ Release the handle (callout 1), pull the tray out away from the feeder (callout 2), and then lift up slightly to remove the tray.

Figure 1-3471 Remove the right tray



2. Unpack the replacement assembly.
 - a. Dispose of the defective part.



NOTE: HP recommends responsible disposal of the defective part.

<http://www8.hp.com/us/en/hp-information/environment/product-recycling.html>

- b. Unpack the replacement part from the packaging.



IMPORTANT: Make sure that all of the shipping materials (for example shipping tape) are removed from the replacement part prior to installation.

- c. To install an assembly, reverse the removal steps.



NOTE: When applicable, special installation instructions are provided for an assembly at the end of the removal procedure. Always completely read the removal instructions and follow all special installation instructions.

Removal and replacement: 2,700-sheet HCl paper tray and stand left paper tray

Learn how to remove and replace the 2,700-sheet HCl paper tray and stand left paper tray.

[View a video of how to remove and replace the 2,700-sheet HCl paper tray and stand left paper tray.](#)

Mean time to repair: 2 minutes

Service level: CSR A

Before performing service

Turn the printer power off

- Disconnect the power cable.

⚠ WARNING! To avoid damage to the printer, turn the printer off, wait 30 seconds, and then remove the power cord before attempting to service the printer.

Use the table below to identify the correct part number for your printer. To order the part, go to www.hp.com/buy/parts.

Table 1-181 Part information

Part number	Part description
RM2-1743-000CN	Left tray assembly

Required tools

- No special tools are required to remove or install this assembly.

After performing service

Turn the printer power on

- Connect the power cable.
- Use the power switch to turn the power on.

Post service test

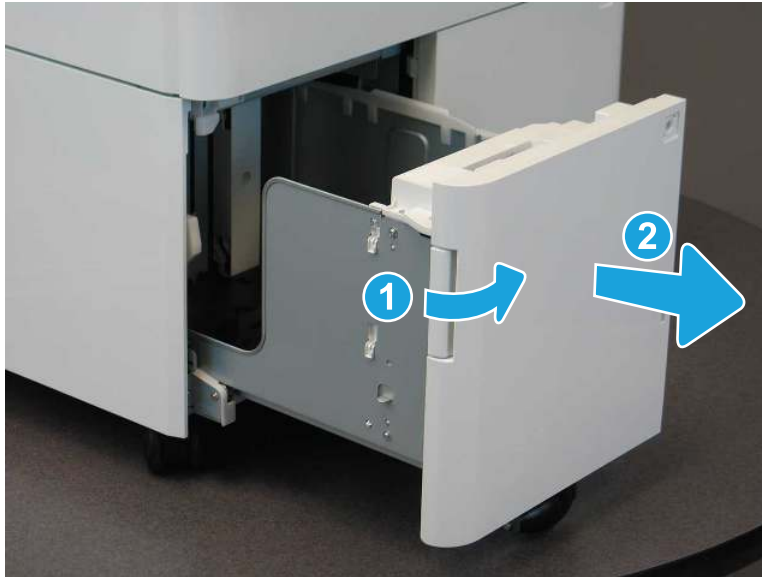
Make sure that the printer initializes to a **Ready** state.

Print a page from the 2,700-sheet HCl paper tray and stand to make sure that the printer is functioning correctly.

1. Remove the 2,700-sheet HCl paper tray and stand left tray.

- ▲ Release the handle (callout 1), pull the tray out away from the feeder (callout 2), and then lift up slightly to remove the tray.

Figure 1-3472 Remove the left tray



2. Unpack the replacement assembly.
 - a. Dispose of the defective part.



NOTE: HP recommends responsible disposal of the defective part.

<http://www8.hp.com/us/en/hp-information/environment/product-recycling.html>

- b. Unpack the replacement part from the packaging.



IMPORTANT: Make sure that all of the shipping materials (for example shipping tape) are removed from the replacement part prior to installation.

- c. To install an assembly, reverse the removal steps.



NOTE: When applicable, special installation instructions are provided for an assembly at the end of the removal procedure. Always completely read the removal instructions and follow all special installation instructions.

Removal and replacement: 2,700-sheet HCl paper tray and stand left tray pickup and separation rollers

Learn how to remove and replace the 2,700-sheet HCl paper tray and stand left tray pickup and separation rollers.

[View a video of how to remove and replace the 2,700-sheet HCl paper tray and stand left tray pickup and separation rollers.](#)

Mean time to repair: 2 minutes

Service level: CSR A

Before performing service

Turn the printer power off

- Disconnect the power cable.

⚠ WARNING! To avoid damage to the printer, turn the printer off, wait 30 seconds, and then remove the power cord before attempting to service the printer.

Use the table below to identify the correct part number for your printer. To order the part, go to www.hp.com/buy/parts.

Table 1-182 Part information

Part number	Part description
RM2-1526-000CN	Tray 2-x pickup and separation rollers

Required tools

- No special tools are required to remove or install this assembly.

After performing service

Turn the printer power on

- Connect the power cable.
- Use the power switch to turn the power on.

Post service test

Make sure that the printer initializes to a **Ready** state.

Print a page from the 2,700-sheet HCI paper tray and stand to make sure that the printer is functioning correctly.

1. Remove the 2,700-sheet HCI paper tray and stand left tray separation roller.

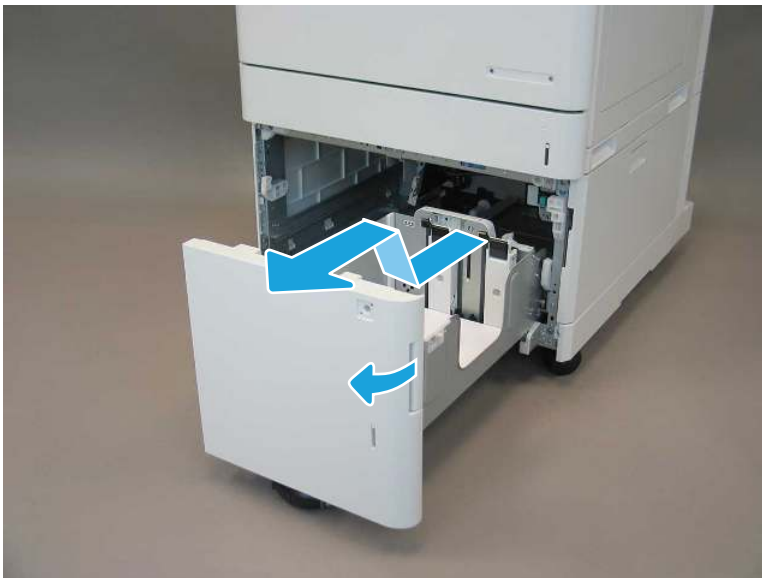
- a. Release the handle (callout 1) on the left tray, pull the tray out away from the feeder (callout 2), and then lift up slightly to remove the tray.

Figure 1-3473 Remove the left tray



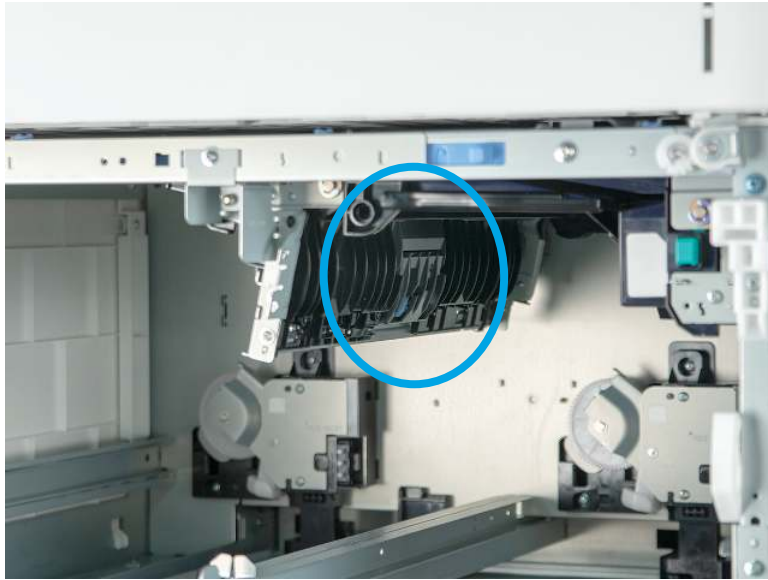
- b. Release the handle (callout 1) on the right tray, pull the tray out away from the feeder (callout 2), and then lift up slightly to remove the tray.

Figure 1-3474 Remove the right tray



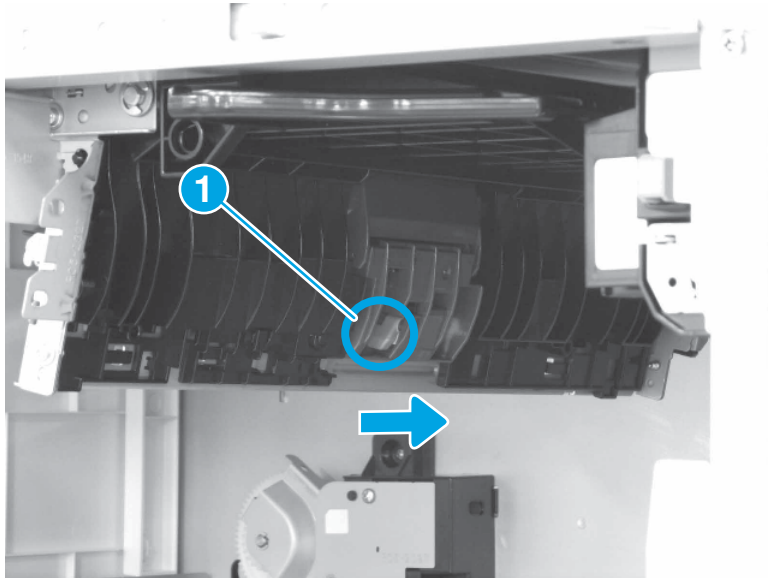
- c. Locate the left tray separation roller inside the right tray opening.

Figure 1-3475 Locate the left tray separation roller



- d. Press the release button (callout 1), slide the left tray separation roller assembly to the right, and then pull it away from the printer to remove it.

Figure 1-3476 Remove the left tray separation roller



2. Remove the 2,700-sheet HCl paper tray and stand left tray pickup roller.

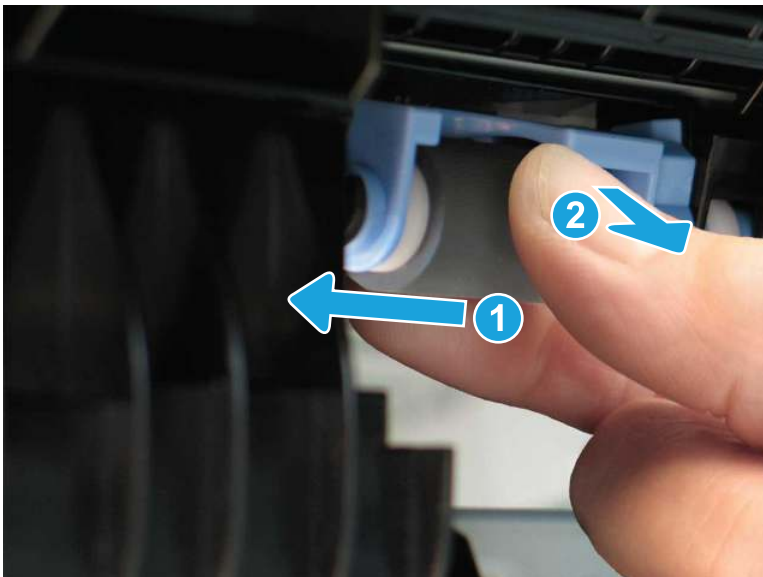
- a. Locate the left tray pickup roller inside the right tray opening.

Figure 1-3477 Locate the left tray pickup roller



- b. Slide the left tray pickup roller assembly to the left (callout 1), and then pull it away from the printer (callout 2) to remove it.

Figure 1-3478 Remove the left tray pickup roller




3. Unpack the replacement assembly.
 - a. Dispose of the defective part.



NOTE: HP recommends responsible disposal of the defective part.

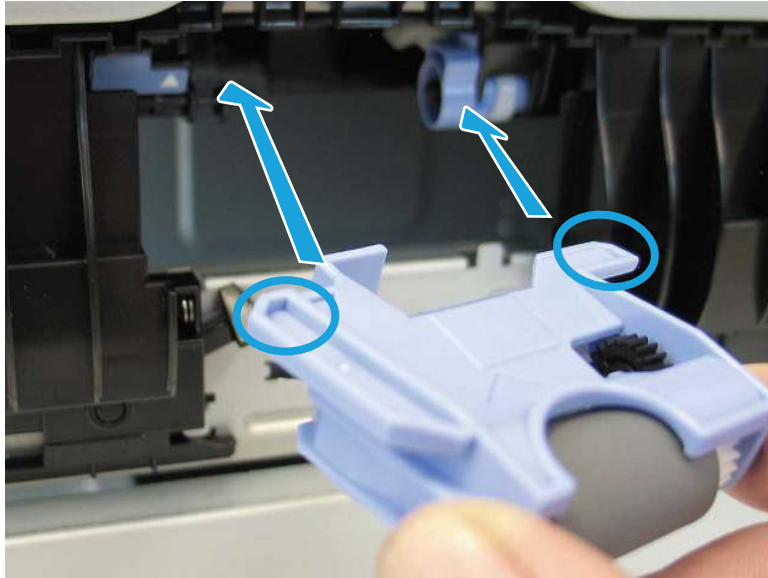
<http://www8.hp.com/us/en/hp-information/environment/product-recycling.html>

- b. Unpack the replacement part from the packaging.

 **IMPORTANT:** Make sure that all of the shipping materials (for example shipping tape) are removed from the replacement part prior to installation.

- 4. Install the 2,700-sheet HCl paper tray and stand left tray pickup roller.
 - a. Inside the printer opening, align the edges of the left tray pickup roller assembly with the slots in the printer.

Figure 1-3479 Position the left tray pickup roller



- b. Slide the roller assembly into the printer until it stops.

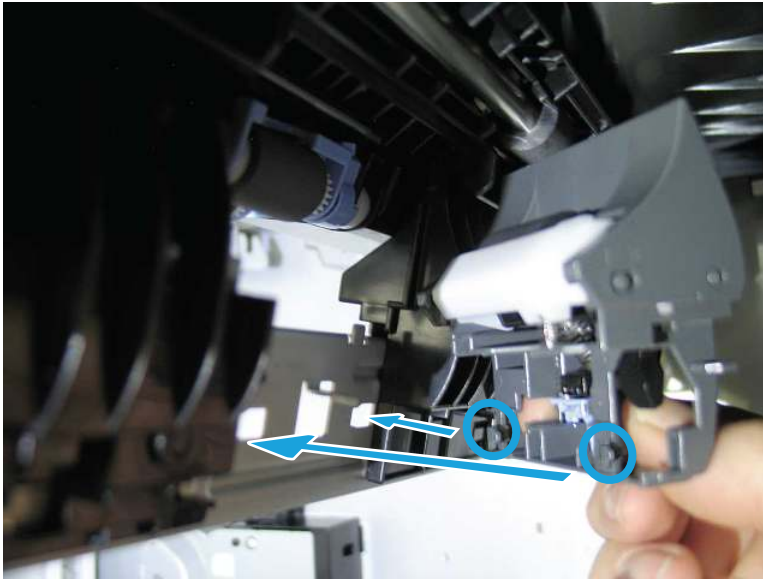
Figure 1-3480 Install the left tray pickup roller



- 5. Install the 2,700-sheet HCl paper tray and stand left tray separation roller.

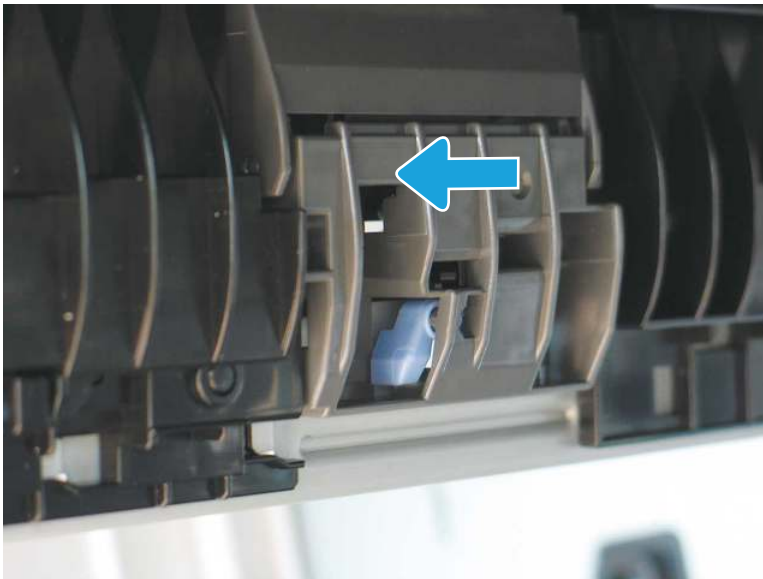
- a. Inside the tray opening, position the tabs on the separation roller into the slots on the feeder.

Figure 1-3481 Position the separation roller



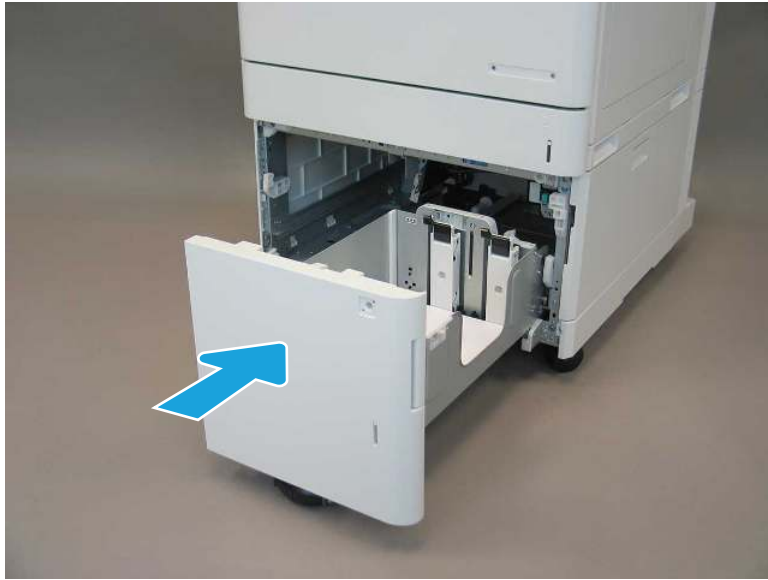
- b. Slide the roller assembly to the left until it snaps into place.

Figure 1-3482 Install the separation roller



- c. Install the right tray.

Figure 1-3483 Install the right tray



- d. Install the left tray.

Figure 1-3484 Install the left tray



Removal and replacement: 2,700-sheet HCl paper tray and stand right tray pickup and separation rollers

Learn how to remove and replace the 2,700-sheet HCl paper tray and stand right tray pickup and separation rollers.

[View a video of how to remove and replace the 2,700-sheet HCl paper tray and stand right tray pickup and separation rollers.](#)

Mean time to repair: 2 minutes

Service level: CSR A

Before performing service

Turn the printer power off

- Disconnect the power cable.

⚠ WARNING! To avoid damage to the printer, turn the printer off, wait 30 seconds, and then remove the power cord before attempting to service the printer.

Use the table below to identify the correct part number for your printer. To order the part, go to www.hp.com/buy/parts.

Table 1-183 Part information

Part number	Part description
RM2-1526-000CN	Tray 2-x pickup and separation rollers

Required tools

- No special tools are required to remove or install this assembly.

After performing service

Turn the printer power on

- Connect the power cable.
- Use the power switch to turn the power on.

Post service test

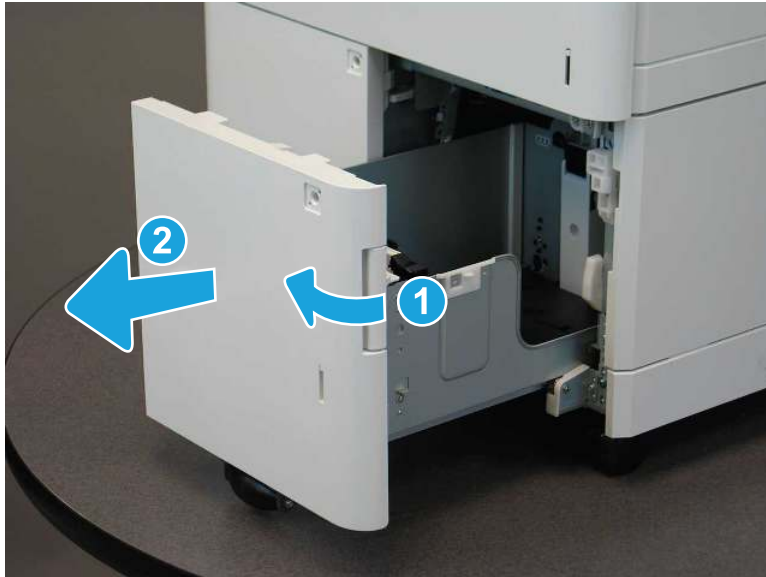
Make sure that the printer initializes to a **Ready** state.

Print a page from the 2,700-sheet HCl paper tray and stand to make sure that the printer is functioning correctly.

1. Remove the 2,700-sheet HCl paper tray and stand right tray separation roller

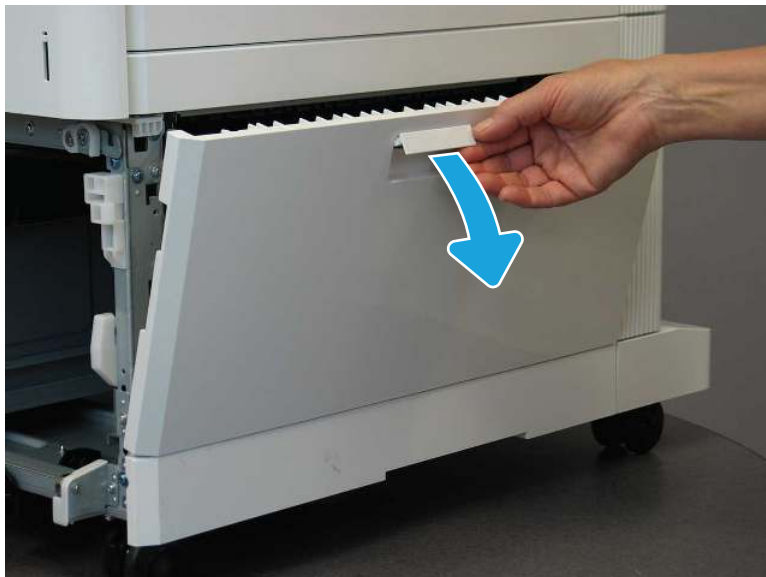
- a. Open the right tray by releasing the handle (callout 1) and pulling the tray out away from the feeder (callout 2).

Figure 1-3485 Open the right tray



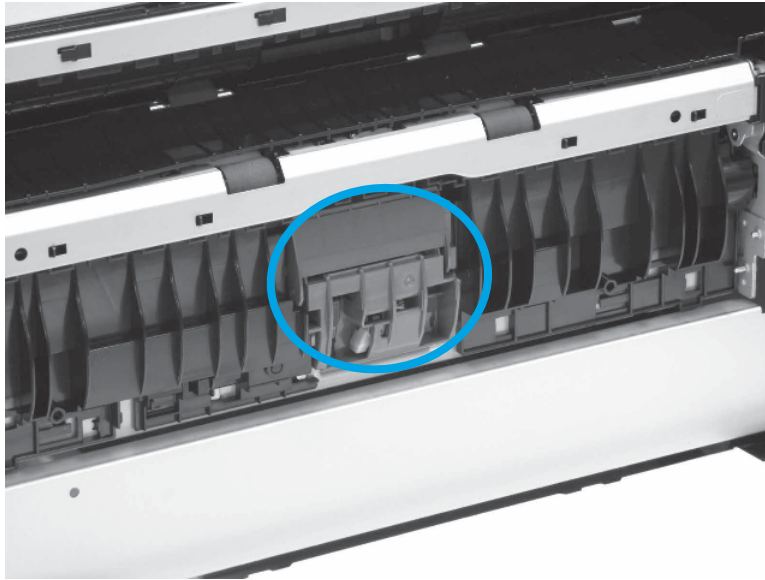
- b. Open the right door.

Figure 1-3486 Open the right door



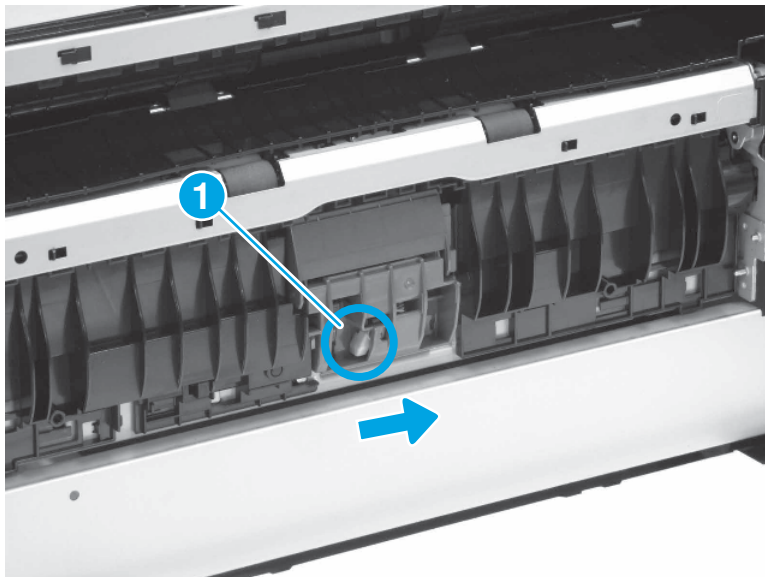
- c. Locate the right tray separation roller.

Figure 1-3487 Locate the separation roller



- d. Press the release button (callout 1), slide the right tray separation roller assembly to the right, and then pull it away from the printer to remove it.

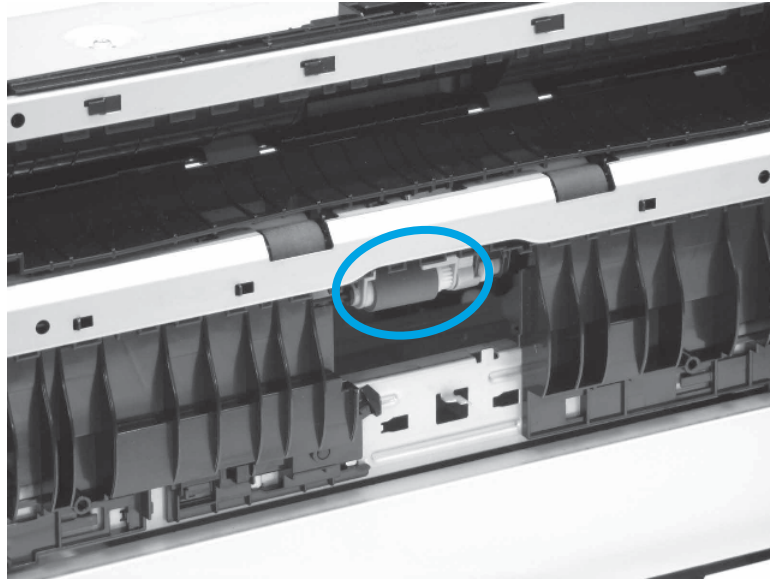
Figure 1-3488 Remove the separation roller assembly



2. Remove the 2,700-sheet HCl paper tray and stand right tray pickup roller.

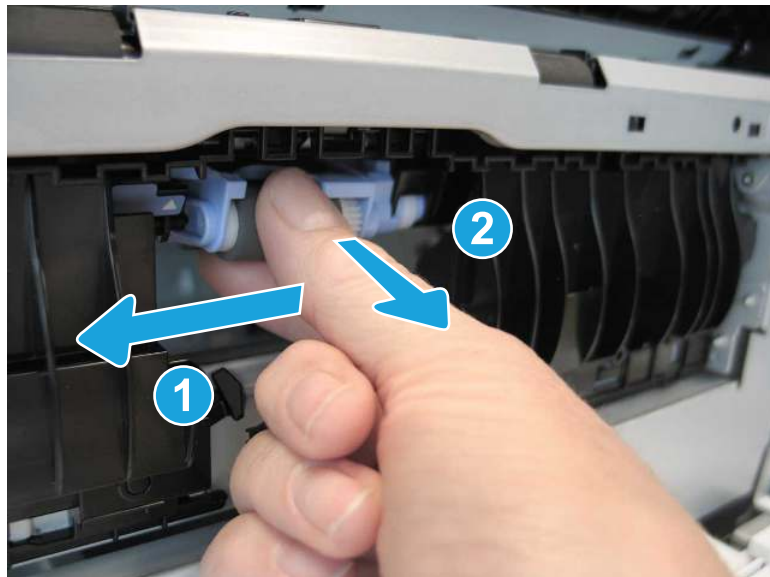
- a. Locate the right tray pickup roller on the right side of the feeder.

Figure 1-3489 Locate the pickup roller



- b. Slide the right tray pickup roller assembly to the left (callout 1), and then pull it away from the printer (callout 2) to remove it.

Figure 1-3490 Remove the right tray pickup roller



3. Unpack the replacement assembly.


- a. Dispose of the defective part.




NOTE: HP recommends responsible disposal of the defective part.

<http://www8.hp.com/us/en/hp-information/environment/product-recycling.html>

- b. Unpack the replacement part from the packaging.

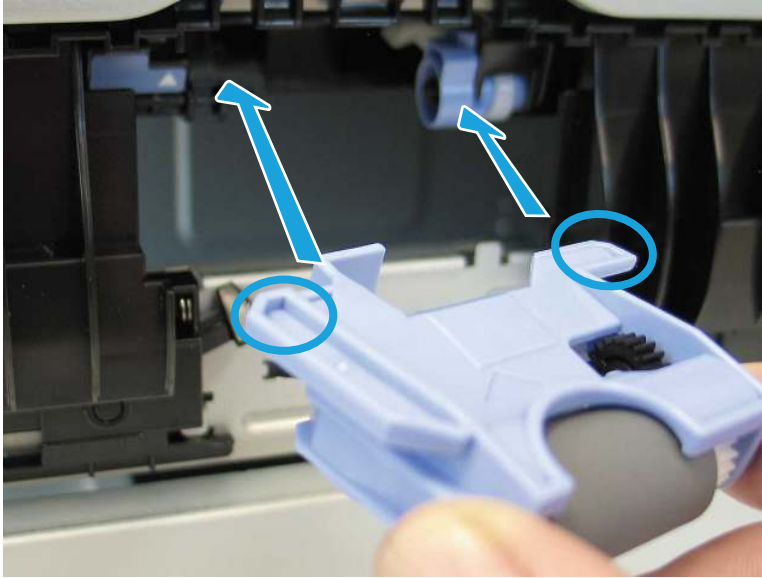
 **IMPORTANT:** Make sure that all of the shipping materials (for example shipping tape) are removed from the replacement part prior to installation.

4. Install the 2,700-sheet HCl paper tray and stand right tray pickup roller.

 **NOTE:** Make sure that the tray is open before installing the roller.

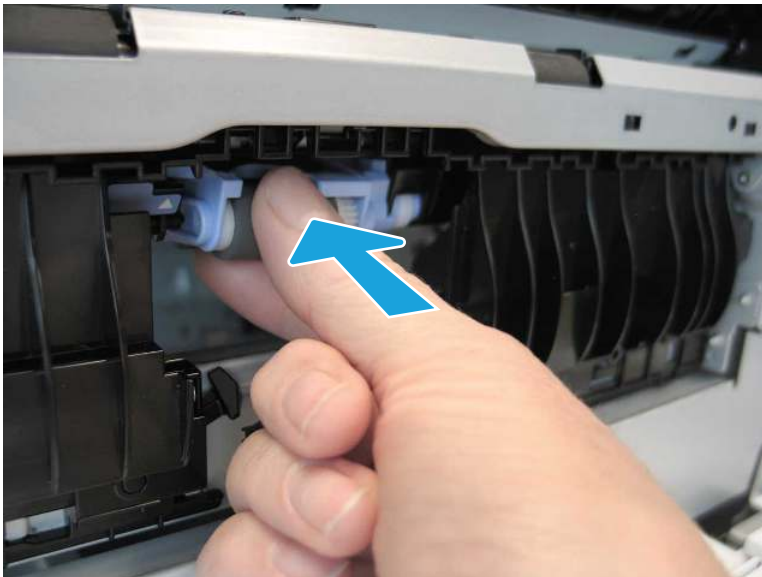
- a. On the right side of the printer, align the edges of the right tray pickup roller assembly with the slots in the printer.

Figure 1-3491 Position the right tray pickup roller




- b. Slide the roller assembly into the printer until it stops.

Figure 1-3492 Install the right tray pickup roller

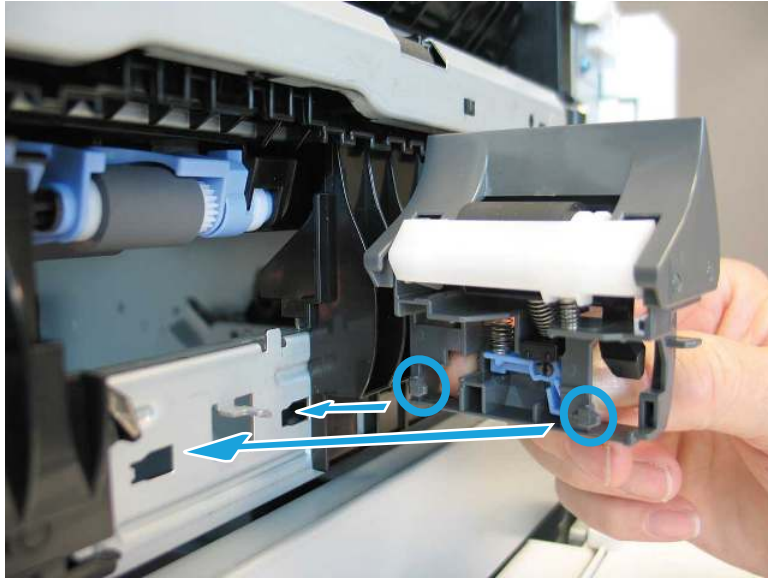


5. Install the 2,700-sheet HCl paper tray and stand right tray separation roller.

 **NOTE:** Make sure that the tray is open before installing the roller.

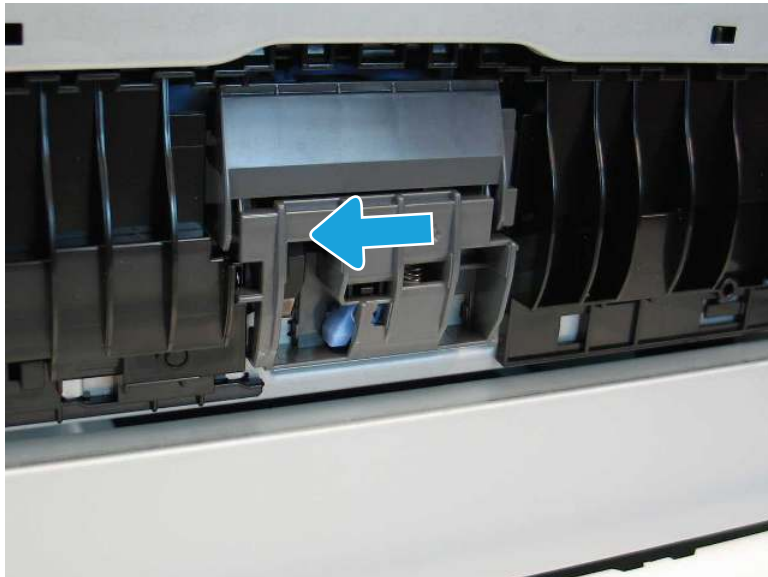
- a. On the right side of the feeder, position the tabs on the separation roller into the slots on the feeder.

Figure 1-3493 Position the separation roller



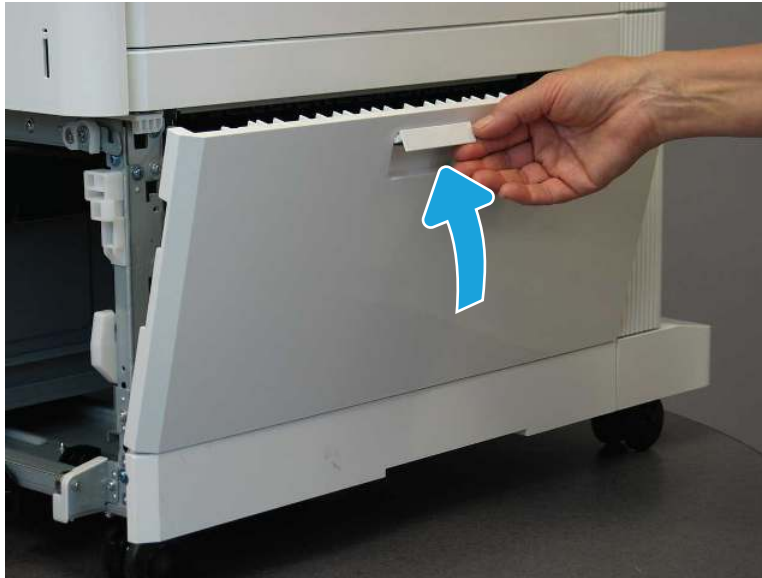
- b. Slide the roller assembly to the left until it snaps into place.

Figure 1-3494 Install the separation roller



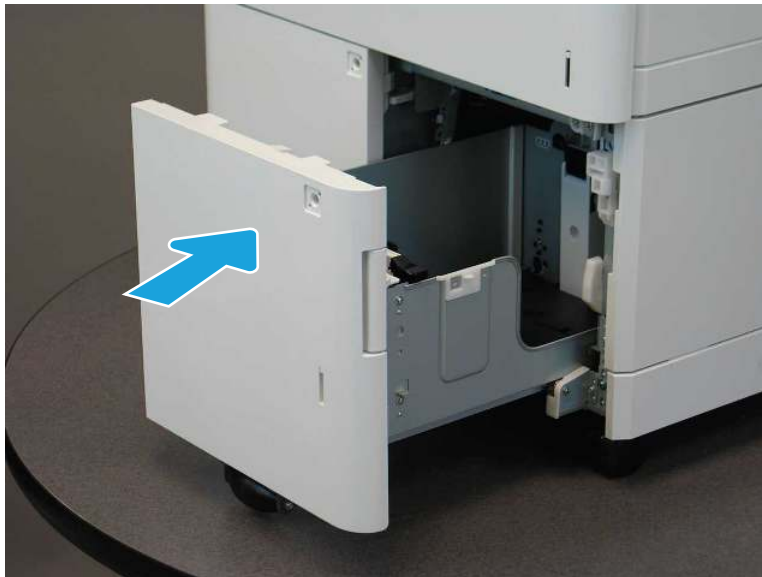
- c. Close the right door.

Figure 1-3495 Close the right door



- d. Close the right tray.

Figure 1-3496 Close the right tray



Removal and replacement: 2,700-sheet HCl paper tray and stand right lower cover

Learn how to remove and replace the 2,700-sheet HCl paper tray and stand right lower cover.

[View a video of how to remove and replace the 2,700-sheet HCl paper tray and stand right lower cover.](#)

Mean time to repair: 2 minutes

Service level: Easy

Before performing service

Turn the printer power off

- Disconnect the power cable.

⚠ WARNING! To avoid damage to the printer, turn the printer off, wait 30 seconds, and then remove the power cord before attempting to service the printer.

Use the table below to identify the correct part number for your printer. To order the part, go to www.hp.com/buy/parts.

Table 1-184 Part information

Part number	Part description
RC5-2064-000CN	Cover, right, lower

Required tools

- #2 Phillips screwdriver with a magnetic tip

After performing service

Turn the printer power on

- Connect the power cable.
- Use the power switch to turn the power on.

Post service test

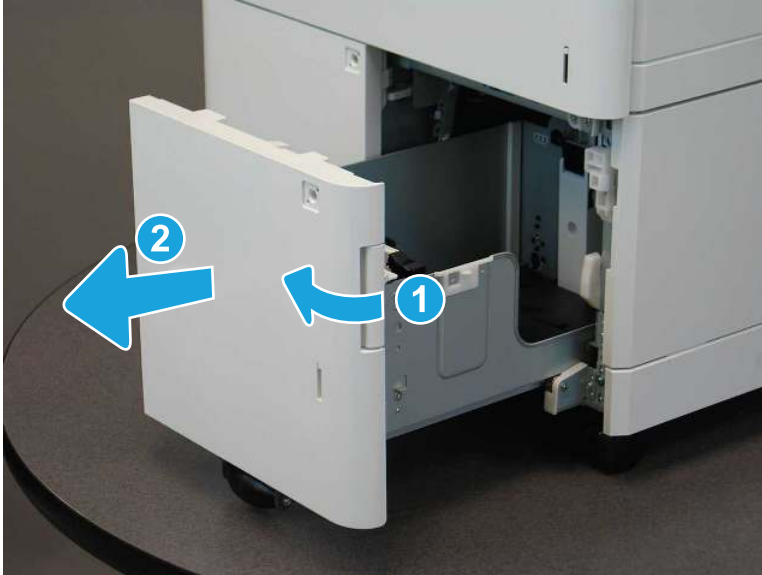
Make sure that the printer initializes to a **Ready** state.

Print a page from the 2,700-sheet HCI paper tray and stand to make sure that the printer is functioning correctly.

1. Remove the 2,700-sheet HCI paper tray and stand right tray.

- ▲ Release the handle (callout 1), pull the tray out away from the feeder (callout 2), and then lift up slightly to remove the tray.

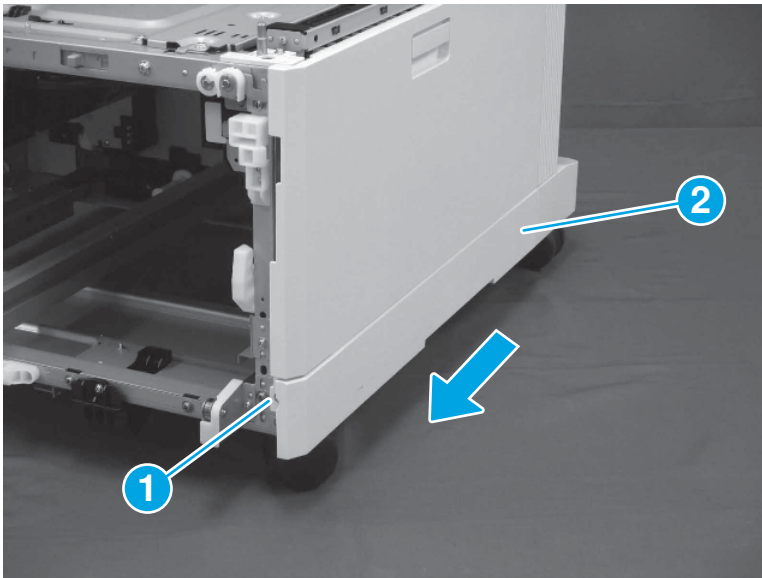
Figure 1-3497 Remove the right tray



2. Remove the 2,700-sheet HCI paper tray and stand right lower cover.

- ▲ Remove one screw (callout 1), and then slide the right lower cover (callout 2) toward the front of the feeder to remove it.

Figure 1-3498 Remove the right lower cover



3. Unpack the replacement assembly.


- a. Dispose of the defective part.




NOTE: HP recommends responsible disposal of the defective part.

<http://www8.hp.com/us/en/hp-information/environment/product-recycling.html>

- b. Unpack the replacement part from the packaging.

 **IMPORTANT:** Make sure that all of the shipping materials (for example shipping tape) are removed from the replacement part prior to installation.

- c. To install an assembly, reverse the removal steps.

 **NOTE:** When applicable, special installation instructions are provided for an assembly at the end of the removal procedure. Always completely read the removal instructions and follow all special installation instructions.

Removal and replacement: 2,700-sheet HCl paper tray and stand right door

Learn how to remove and replace the 2,700-sheet HCl paper tray and stand right door.

[View a video of how to remove and replace the 2,700-sheet HCl paper tray and stand right door.](#)


Mean time to repair: 10 minutes

Service level: Easy

Before performing service

Turn the printer power off

- Disconnect the power cable.

 **WARNING!** To avoid damage to the printer, turn the printer off, wait 30 seconds, and then remove the power cord before attempting to service the printer.

Use the table below to identify the correct part number for your printer. To order the part, go to www.hp.com/buy/parts.

Table 1-185 Part information

Part number	Part description
RM2-1740-000CN	Right door assembly

Required tools

- #2 Phillips screwdriver with a magnetic tip

After performing service

Turn the printer power on

- Connect the power cable.
- Use the power switch to turn the power on.

Post service test

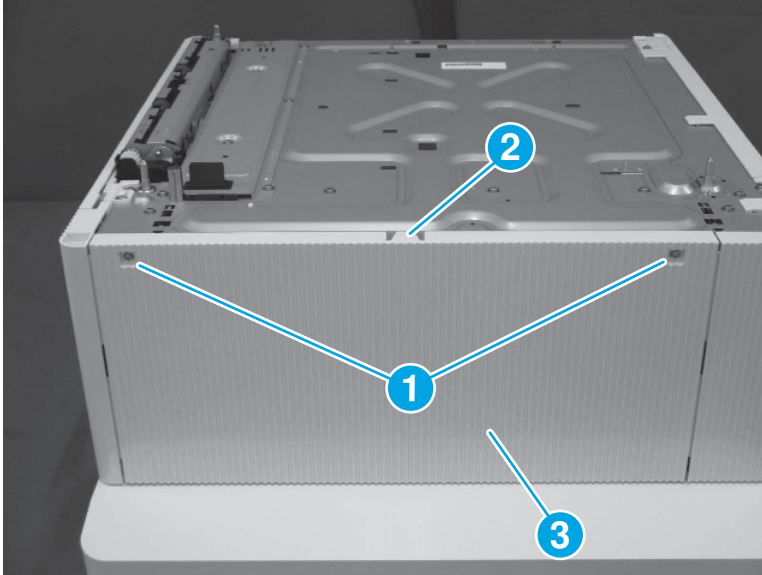
Make sure that the printer initializes to a **Ready** state.

Print a page from the 2,700-sheet HCl paper tray and stand to make sure that the printer is functioning correctly.

1. Remove the 2,700-sheet HCl paper tray and stand rear upper cover

- ▲ Remove two screws (callout 1), release one tab (callout 2), and then remove the rear upper cover (callout 3).

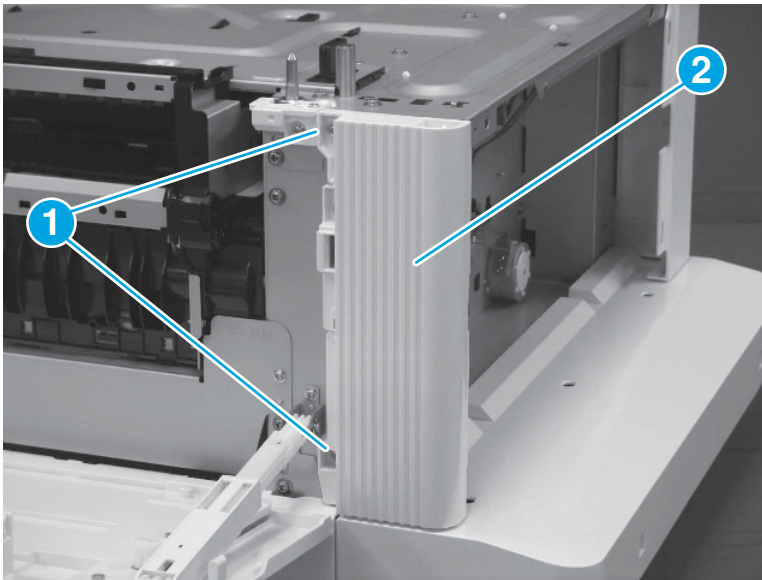
Figure 1-3499 Remove the rear upper cover



2. Remove the 2,700-sheet HCl paper tray and stand right rear cover.

- ▲ Remove two screws (callout 1), and then remove the right rear cover (callout 2).

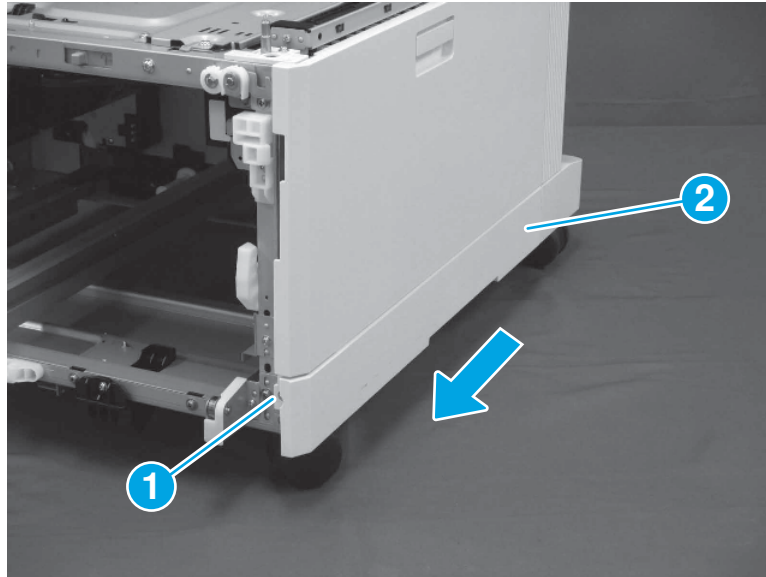
Figure 1-3500 Remove the right rear cover



3. Remove the 2,700-sheet HCl paper tray and stand right lower cover.

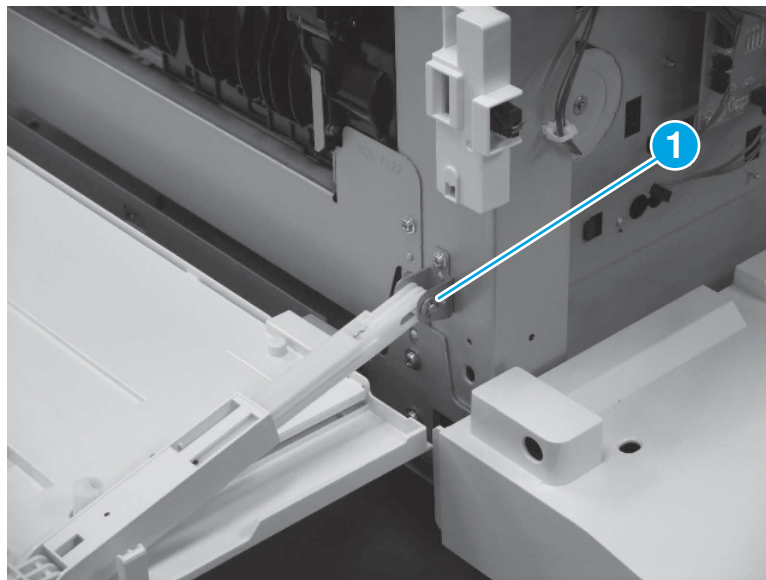
- ▲ Remove one screw (callout 1), and then slide the right lower cover (callout 2) toward the front of the feeder to remove it.

Figure 1-3501 Remove the right lower cover



- 4. Remove the 2,700-sheet HCl paper tray and stand right door.
 - a. Remove one E-ring (callout 1).

Figure 1-3502 Remove one E-ring



- b. Hold the hinge arm securely, and then slide the shaft to the left to remove it.



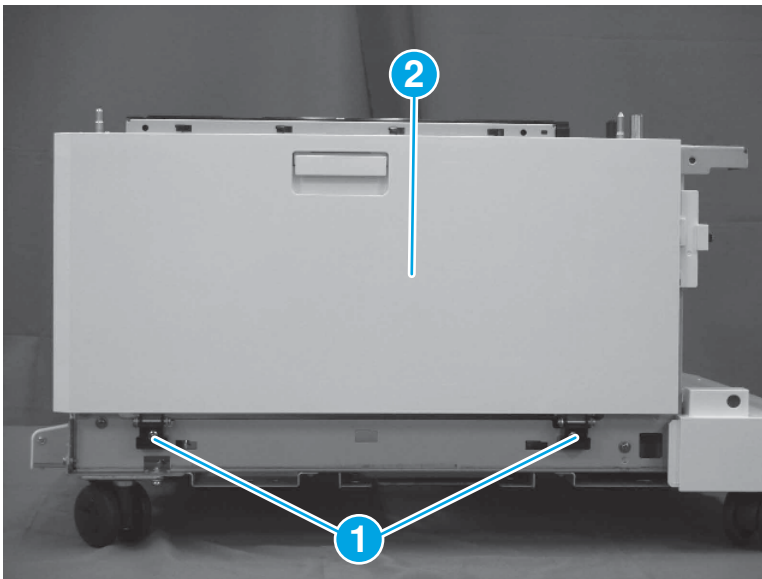
NOTE: The hinge arm is spring-loaded and may snap back suddenly when the shaft is removed.

Figure 1-3503 Release the hinge arm



- c. Remove two screws (callout 1), and then remove the right door assembly (callout 2).

Figure 1-3504 Remove the right door



- 5. Unpack the replacement assembly.
 - a. Dispose of the defective part.



NOTE: HP recommends responsible disposal of the defective part.

<http://www8.hp.com/us/en/hp-information/environment/product-recycling.html>

- b. Unpack the replacement part from the packaging.



IMPORTANT: Make sure that all of the shipping materials (for example shipping tape) are removed from the replacement part prior to installation.

- c. To install an assembly, reverse the removal steps.



NOTE: When applicable, special installation instructions are provided for an assembly at the end of the removal procedure. Always completely read the removal instructions and follow all special installation instructions.

Removal and replacement: 2,700-sheet HCl paper tray and stand right tray pickup motor

Learn how to remove and replace the 2,700-sheet HCl paper tray and stand right tray pickup motor.

[View a video of how to remove and replace the 2,700-sheet HCl paper tray and stand right tray pickup motor.](#)

Mean time to repair: 3 minutes

Service level: Easy

Before performing service

Turn the printer power off

- Disconnect the power cable.

⚠ WARNING! To avoid damage to the printer, turn the printer off, wait 30 seconds, and then remove the power cord before attempting to service the printer.

Use the table below to identify the correct part number for your printer. To order the part, go to www.hp.com/buy/parts.

Table 1-186 Part information

Part number	Part description
RK2-9410-000CN	Motor, stepping, DC

Required tools

- #2 Phillips screwdriver with a magnetic tip

After performing service

Turn the printer power on

- Connect the power cable.
- Use the power switch to turn the power on.

Post service test

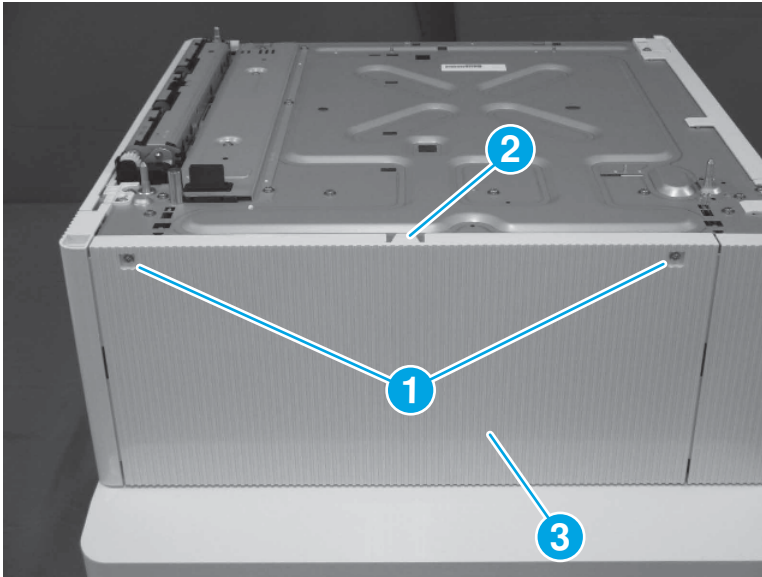
Make sure that the printer initializes to a **Ready** state.

Print a page from the 2,700-sheet HCl paper tray and stand to make sure that the printer is functioning correctly.

1. Remove the 2,700-sheet HCl paper tray and stand rear upper cover

- ▲ Remove two screws (callout 1), release one tab (callout 2), and then remove the rear upper cover (callout 3).

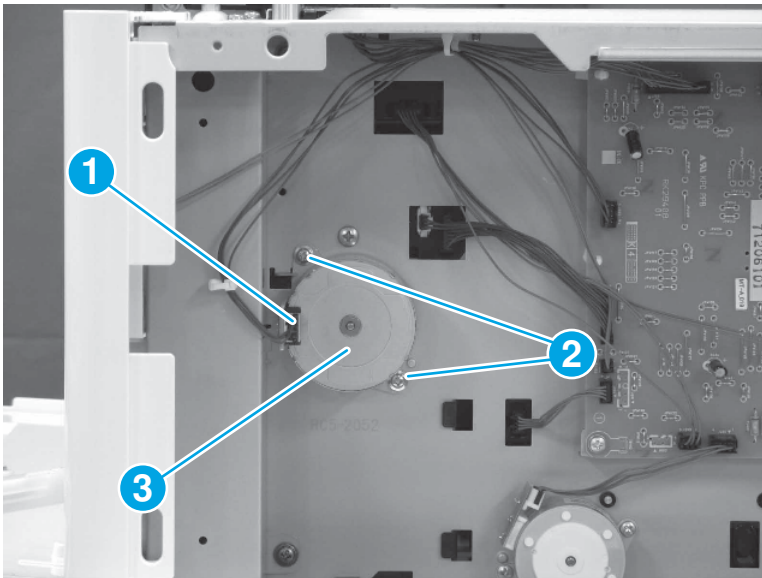
Figure 1-3505 Remove the rear upper cover



2. Remove the 2,700-sheet HCl paper tray and stand right tray pickup motor.

- ▲ Disconnect one connector (callout 1), remove two screws (callout 2), and then remove the HCl right tray pickup motor (callout 3).

Figure 1-3506 Remove the right tray pickup motor



3. Unpack the replacement assembly.



- a. Dispose of the defective part.




NOTE: HP recommends responsible disposal of the defective part.


<http://www8.hp.com/us/en/hp-information/environment/product-recycling.html>

- b. Unpack the replacement part from the packaging.

 **CAUTION:**  Some parts are sensitive to electrostatic discharge (ESD). Always perform service work at an ESD-protected workstation or mat. If an ESD workstation or mat is not available, touch the sheet-metal chassis to provide a static ground before touching an ESD-sensitive assembly. Protect the ESD-sensitive assemblies by placing them in ESD pouches when they are out of the printer.

 **IMPORTANT:** Make sure that all of the shipping materials (for example shipping tape) are removed from the replacement part prior to installation.

- c. To install an assembly, reverse the removal steps.

 **NOTE:** When applicable, special installation instructions are provided for an assembly at the end of the removal procedure. Always completely read the removal instructions and follow all special installation instructions.

Removal and replacement: 2,700-sheet HCl paper tray and stand right tray pickup assembly

Learn how to remove and replace the 2,700-sheet HCl paper tray and stand right tray pickup assembly.

[View a video of how to remove and replace the 2,700-sheet HCl paper tray and stand right tray pickup assembly.](#)


Mean time to repair: 18 minutes

Service level: Medium

Before performing service

Turn the printer power off

- Disconnect the power cable.

 **WARNING!** To avoid damage to the printer, turn the printer off, wait 30 seconds, and then remove the power cord before attempting to service the printer.

Use the table below to identify the correct part number for your printer. To order the part, go to www.hp.com/buy/parts.

Table 1-187 Part information

Part number	Part description
RM2-1717-000CN	Paper pickup assembly

Required tools

- #2 Phillips screwdriver with a magnetic tip

After performing service

Turn the printer power on

- Connect the power cable.
- Use the power switch to turn the power on.

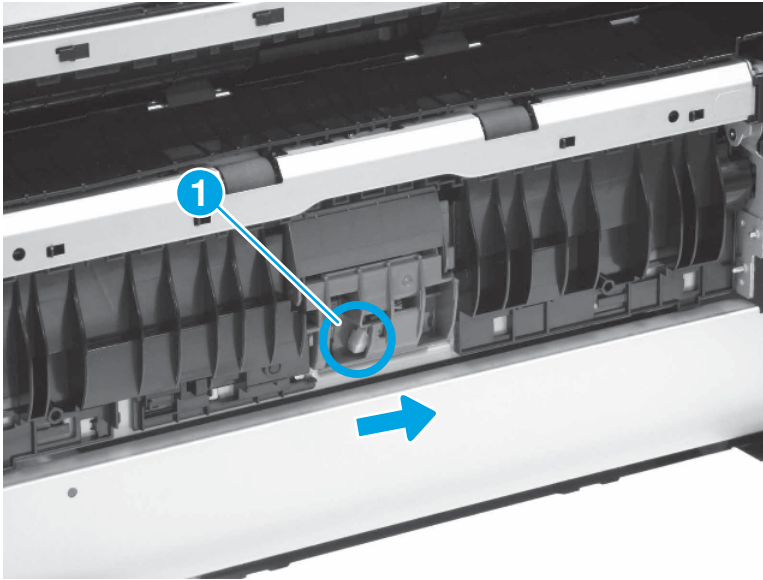
Post service test

Make sure that the printer initializes to a **Ready** state.

Print a page from the 2,700-sheet HCl paper tray and stand to make sure that the printer is functioning correctly.

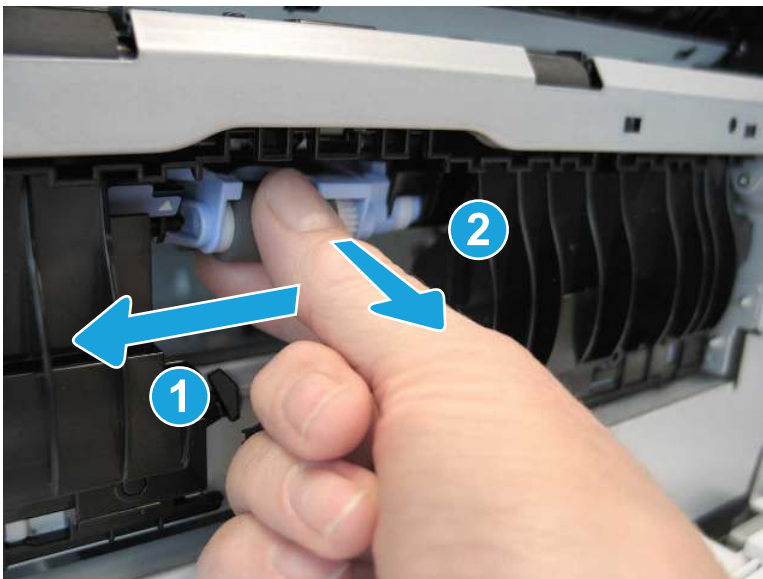
1. Remove the 2,700-sheet HCl paper tray and stand right tray separation roller.
 - ▲ Press the release button (callout 1), slide the right tray separation roller assembly to the right, and then pull it away from the printer to remove it.

Figure 1-3507 Remove the separation roller assembly



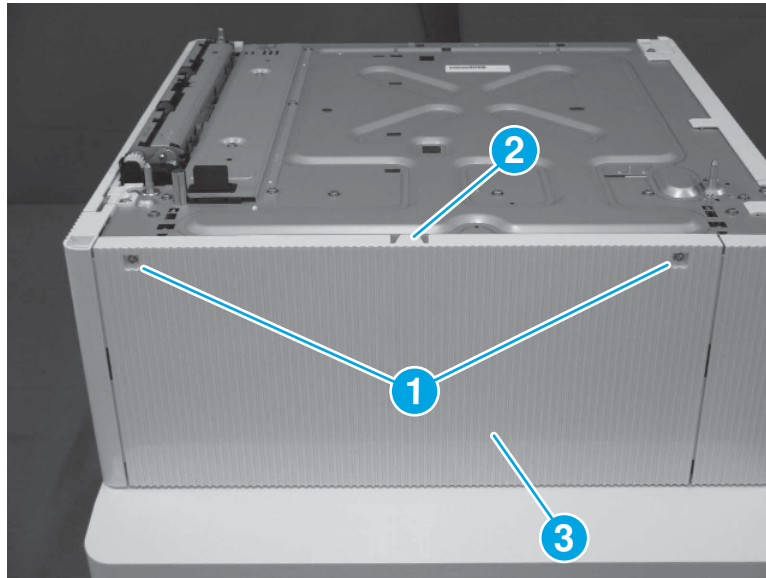
2. Remove the 2,700-sheet HCl paper tray and stand right tray pickup roller.
 - ▲ On the right side of the feeder, slide the right tray pickup roller assembly to the left (callout 1), and then pull it away from the printer (callout 2) to remove it.

Figure 1-3508 Remove the right tray pickup roller



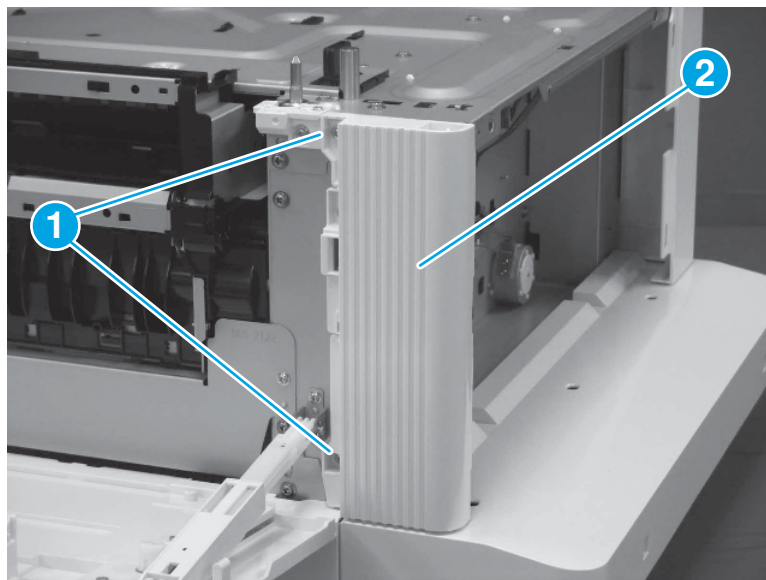
3. Remove the 2,700-sheet HCl paper tray and stand rear upper cover
 - ▲ Remove two screws (callout 1), release one tab (callout 2), and then remove the rear upper cover (callout 3).

Figure 1-3509 Remove the rear upper cover



4. Remove the 2,700-sheet HCl paper tray and stand right rear cover.
 - ▲ Remove two screws (callout 1), and then remove the right rear cover (callout 2).

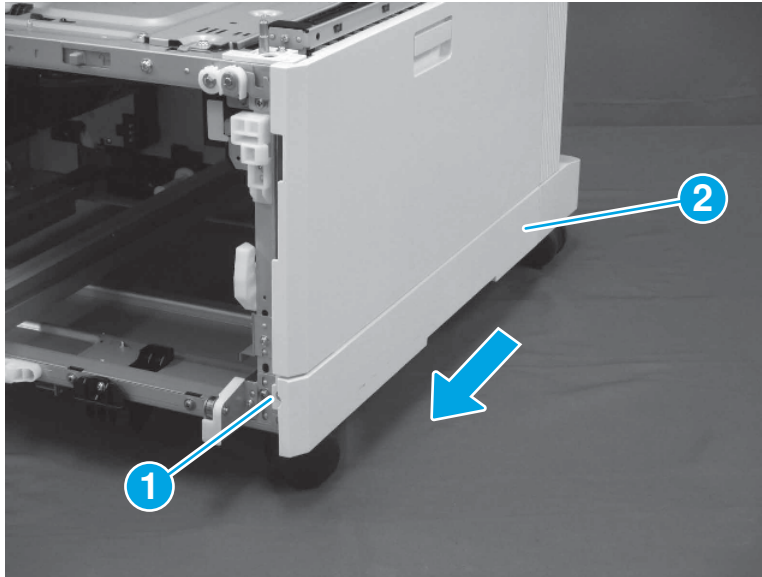
Figure 1-3510 Remove the right rear cover



5. Remove the 2,700-sheet HCl paper tray and stand right lower cover.

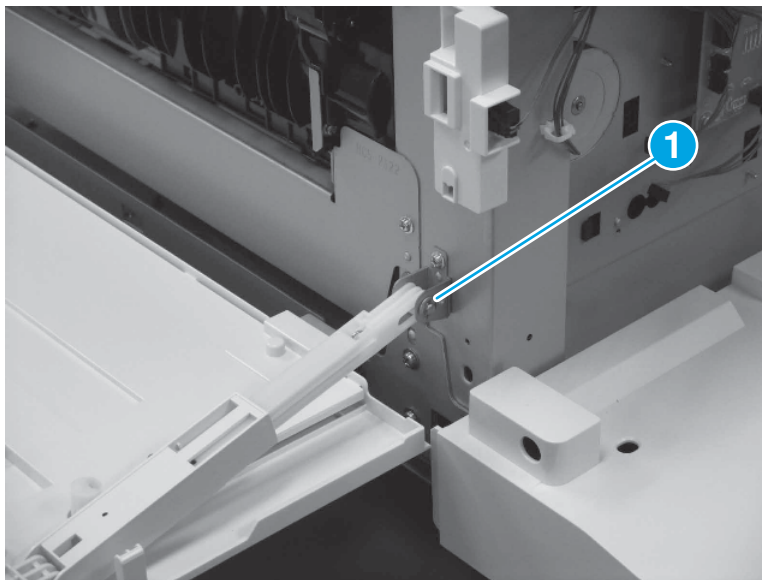
- ▲ Remove one screw (callout 1), and then slide the right lower cover (callout 2) toward the front of the feeder to remove it.

Figure 1-3511 Remove the right lower cover



- 6. Remove the 2,700-sheet HCI paper tray and stand right door.
 - a. Remove one E-ring (callout 1).

Figure 1-3512 Remove one E-ring



- b. Hold the hinge arm securely, and then slide the shaft to the left to remove it.

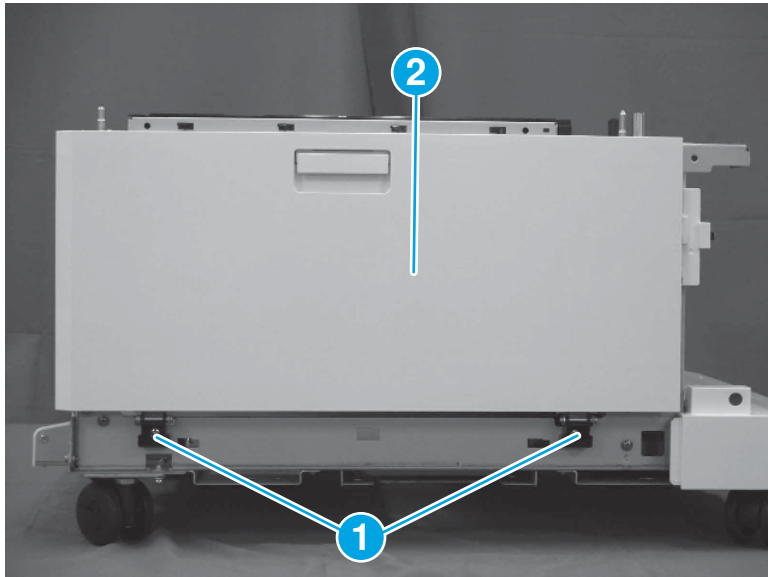
 **NOTE:** The hinge arm is spring-loaded and may snap back suddenly when the shaft is removed.

Figure 1-3513 Release the hinge arm



- c. Remove two screws (callout 1), and then remove the right door assembly (callout 2).

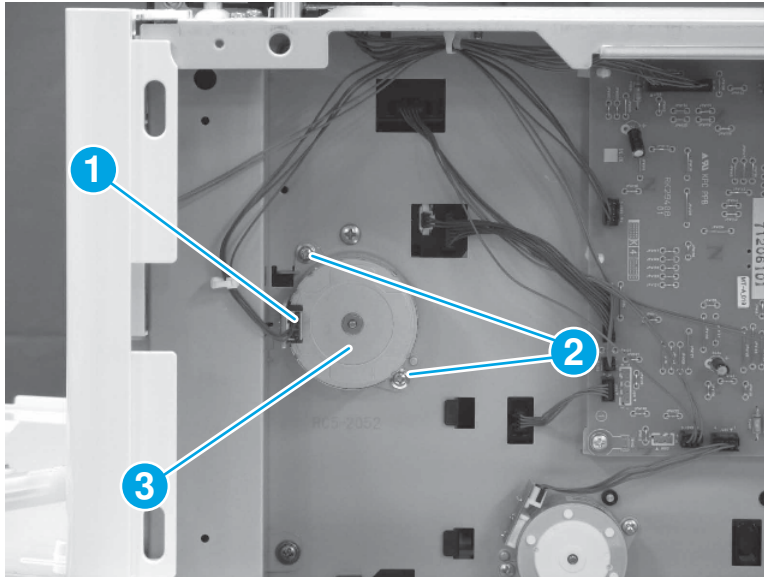
Figure 1-3514 Remove the right door



- 7. Remove the 2,700-sheet HCl paper tray and stand right tray pickup motor.

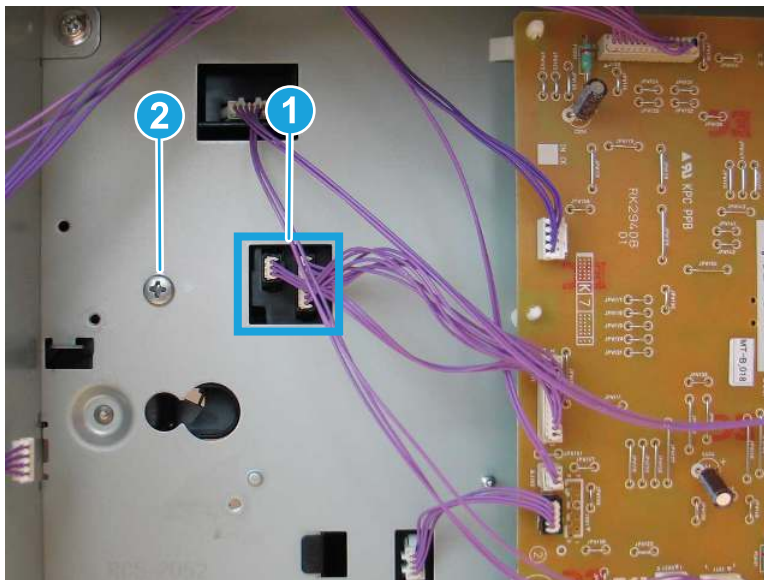
- ▲ Disconnect one connector (callout 1), remove two screws (callout 2), and then remove the HCI right tray pickup motor (callout 3).

Figure 1-3515 Remove the right tray pickup motor



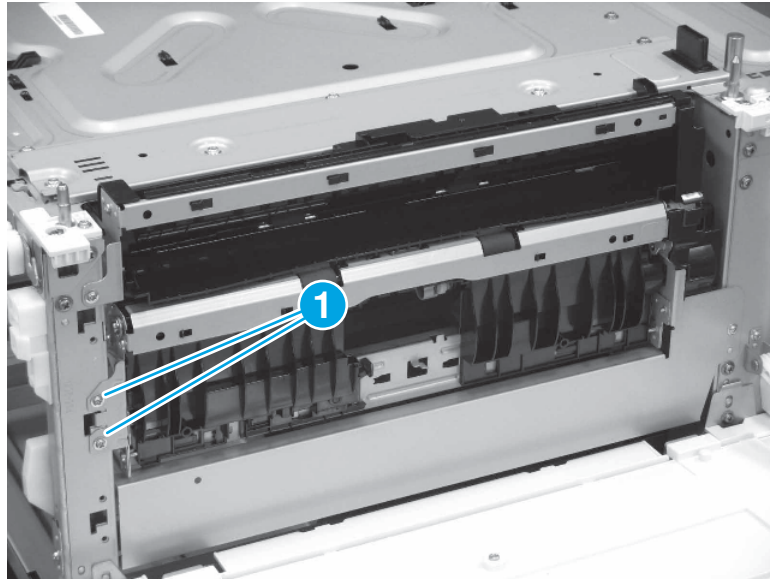
8. Remove the 2,700-sheet HCI paper tray and stand right tray pickup assembly.
 - a. Disconnect two connectors (callout 1), and then remove one screw (callout 2).

Figure 1-3516 Disconnect two connectors and remove one screw



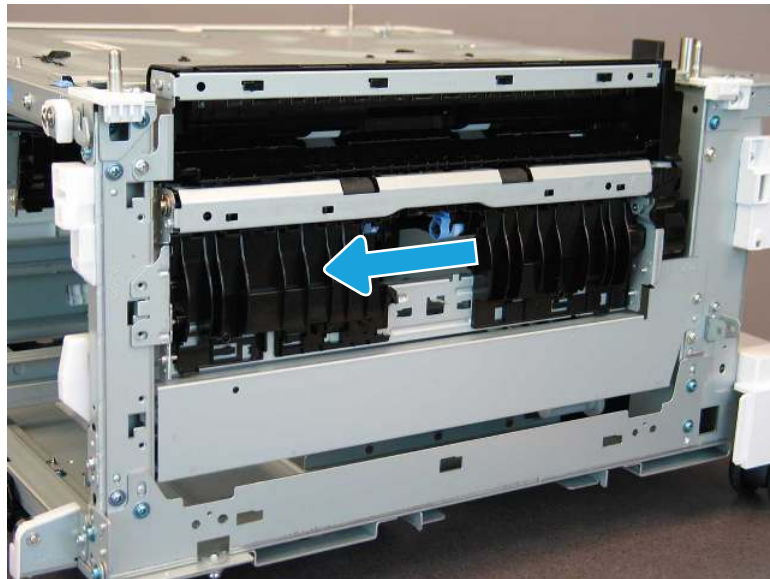
- b. Remove two screws (callout 1).

Figure 1-3517 Remove two screws



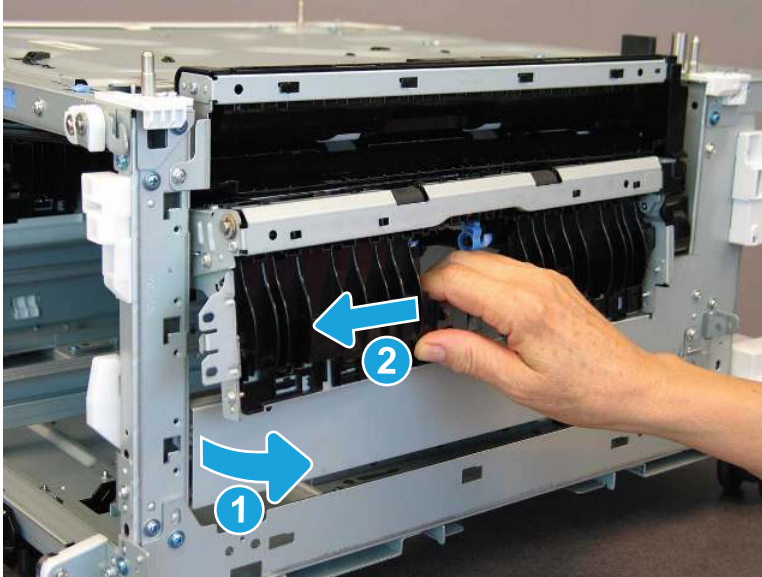
- c. Slide the pickup assembly toward the front of the feeder.

Figure 1-3518 Slide the pickup assembly



- d. Rotate the left side of the assembly away from the feeder (callout 1), and then slide it to the left (callout 2) to remove it.

Figure 1-3519 Remove the pickup assembly



9. Unpack the replacement assembly.

- a. Dispose of the defective part.



NOTE: HP recommends responsible disposal of the defective part.

<http://www8.hp.com/us/en/hp-information/environment/product-recycling.html>

- b. Unpack the replacement part from the packaging.



IMPORTANT: Make sure that all of the shipping materials (for example shipping tape) are removed from the replacement part prior to installation.

- c. To install an assembly, reverse the removal steps.



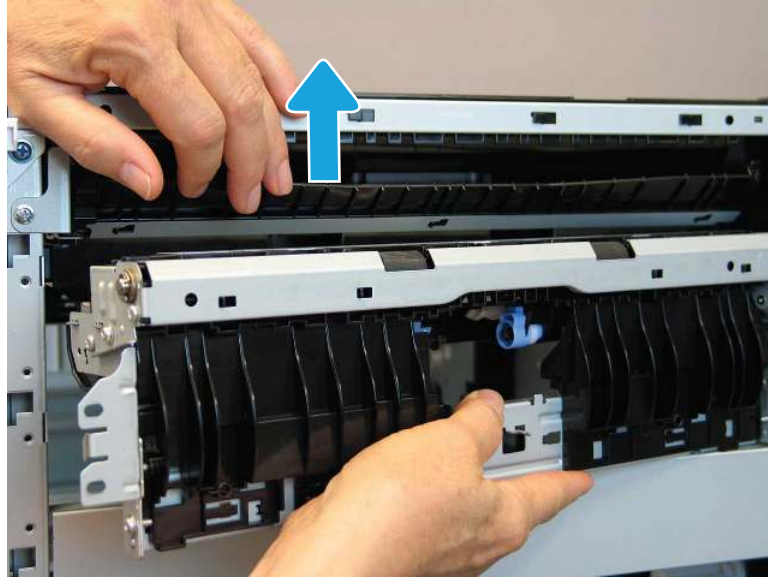
NOTE: When applicable, special installation instructions are provided for an assembly at the end of the removal procedure. Always completely read the removal instructions and follow all special installation instructions.

10. Reverse the removal steps to install the assembly. Also use the following **special installation instructions**.

Install the 2,700-sheet HCl paper tray and stand right tray pickup assembly

- ▲ Raise the flap on the feed assembly to install the right tray pickup assembly.

Figure 1-3520 Raise the feed assembly flap



Removal and replacement: 2,700-sheet HCl paper tray and stand feed assembly

Learn how to remove and replace the 2,700-sheet HCl paper tray and stand feed assembly.

[View a video of how to remove and replace the 2,700-sheet HCl paper tray and stand feed assembly.](#)

Mean time to repair: 21 minutes

Service level: Medium

Before performing service

Turn the printer power off

- Disconnect the power cable.

⚠ WARNING! To avoid damage to the printer, turn the printer off, wait 30 seconds, and then remove the power cord before attempting to service the printer.

Use the table below to identify the correct part number for your printer. To order the part, go to www.hp.com/buy/parts.

Table 1-188 Part information

Part number	Part description
RM2-1730-000CN	Paper feed assembly

Required tools

- #2 Phillips screwdriver with a magnetic tip

After performing service

Turn the printer power on

- Connect the power cable.

- Use the power switch to turn the power on.

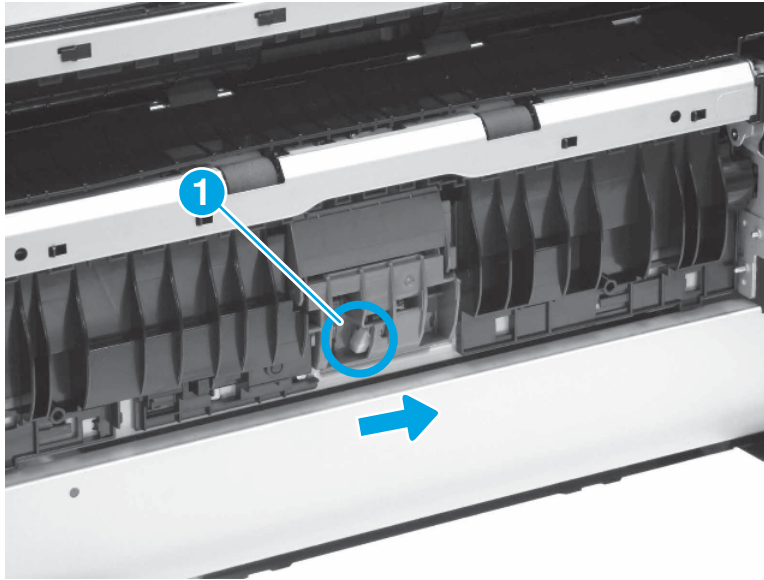
Post service test

Make sure that the printer initializes to a **Ready** state.

Print a page from the 2,700-sheet HCl paper tray and stand to make sure that the printer is functioning correctly.

1. Remove the 2,700-sheet HCl paper tray and stand right tray separation roller.
 - ▲ Press the release button (callout 1), slide the right tray separation roller assembly to the right, and then pull it away from the printer to remove it .

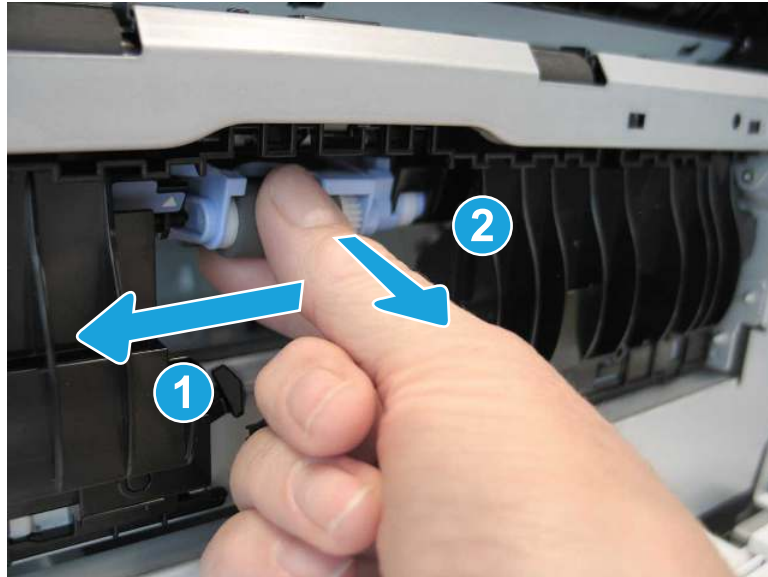
Figure 1-3521 Remove the separation roller assembly



2. Remove the 2,700-sheet HCl paper tray and stand right tray pickup roller.

- ▲ On the right side of the feeder, slide the right tray pickup roller assembly to the left (callout 1), and then pull it away from the printer (callout 2) to remove it.

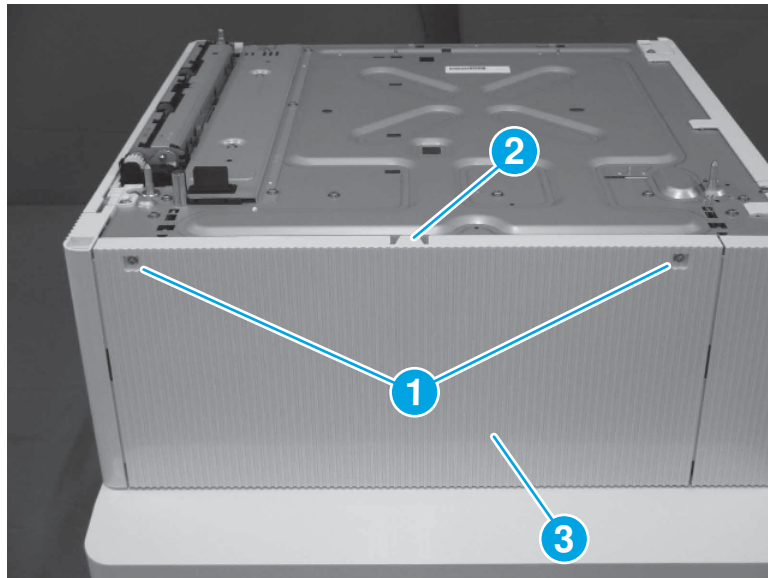
Figure 1-3522 Remove the right tray pickup roller



3. Remove the 2,700-sheet HCl paper tray and stand rear upper cover

- ▲ Remove two screws (callout 1), release one tab (callout 2), and then remove the rear upper cover (callout 3).

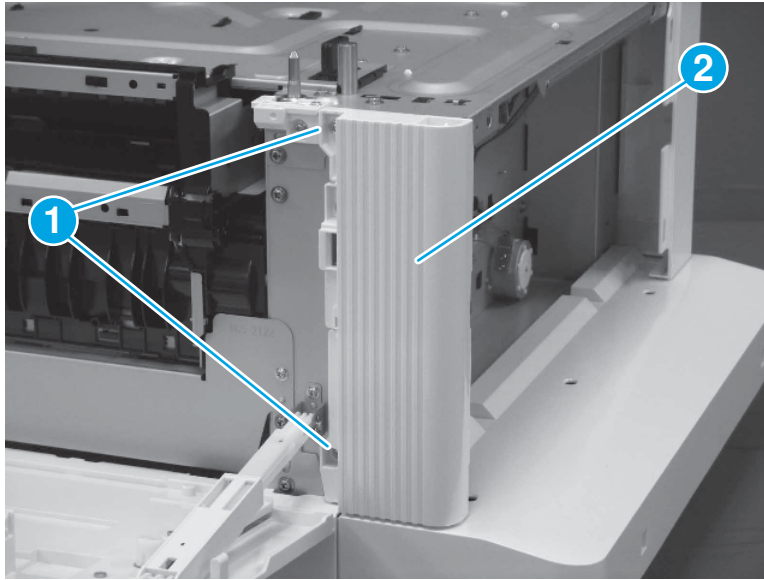
Figure 1-3523 Remove the rear upper cover



4. Remove the 2,700-sheet HCl paper tray and stand right rear cover.

- ▲ Remove two screws (callout 1), and then remove the right rear cover (callout 2).

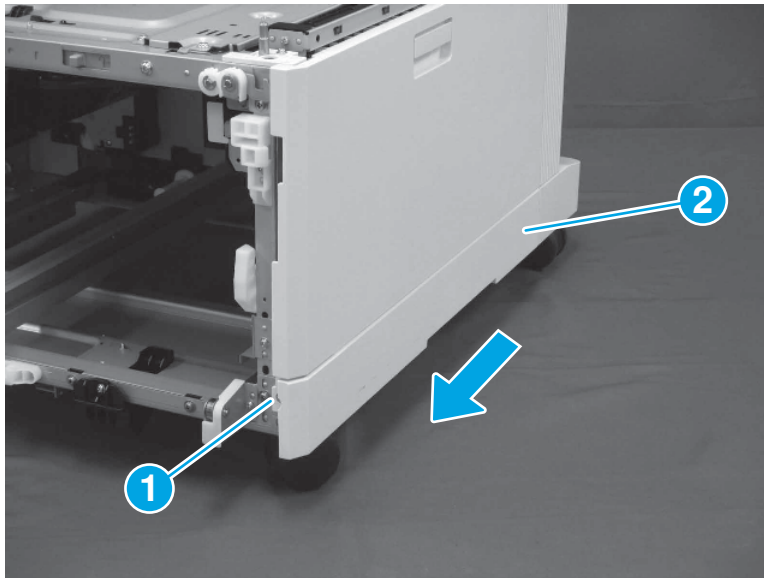
Figure 1-3524 Remove the right rear cover



5. Remove the 2,700-sheet HCl paper tray and stand right lower cover.

- ▲ Remove one screw (callout 1), and then slide the right lower cover (callout 2) toward the front of the feeder to remove it.

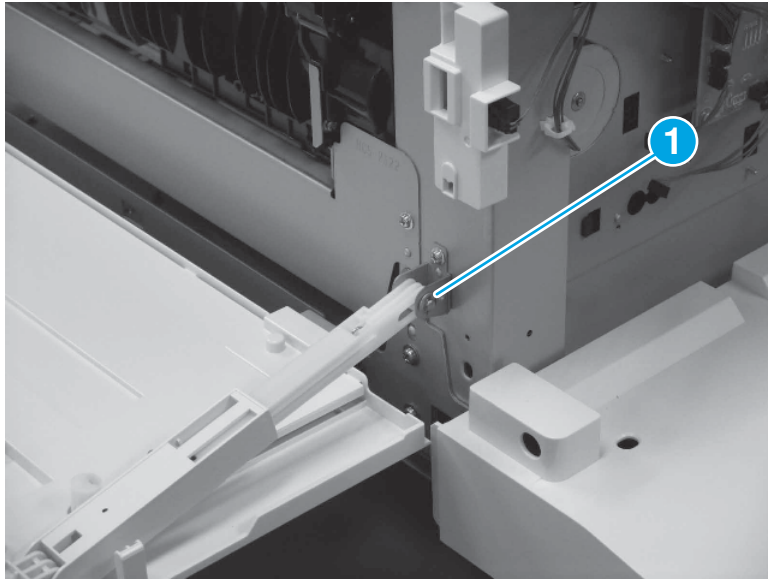
Figure 1-3525 Remove the right lower cover



6. Remove the 2,700-sheet HCl paper tray and stand right door.

- a. Remove one E-ring (callout 1).

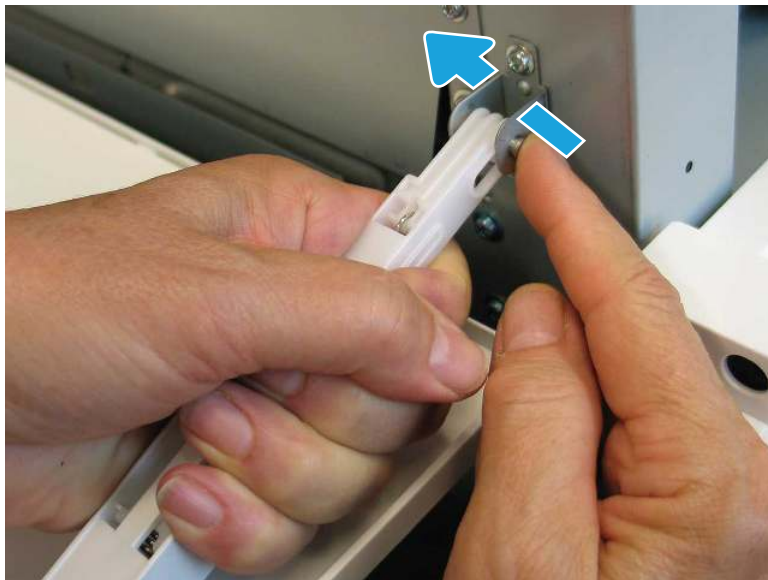
Figure 1-3526 Remove one E-ring



- b. Hold the hinge arm securely, and then slide the shaft to the left to remove it.

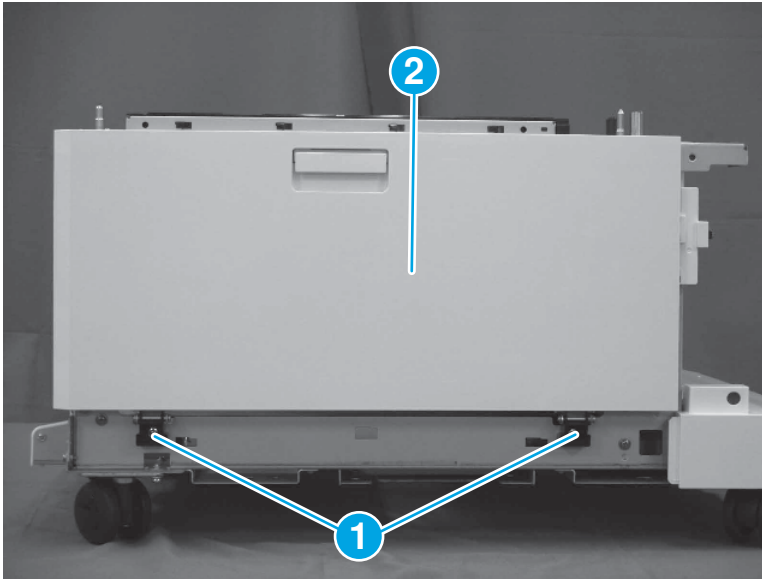
 **NOTE:** The hinge arm is spring-loaded and may snap back suddenly when the shaft is removed.

Figure 1-3527 Release the hinge arm



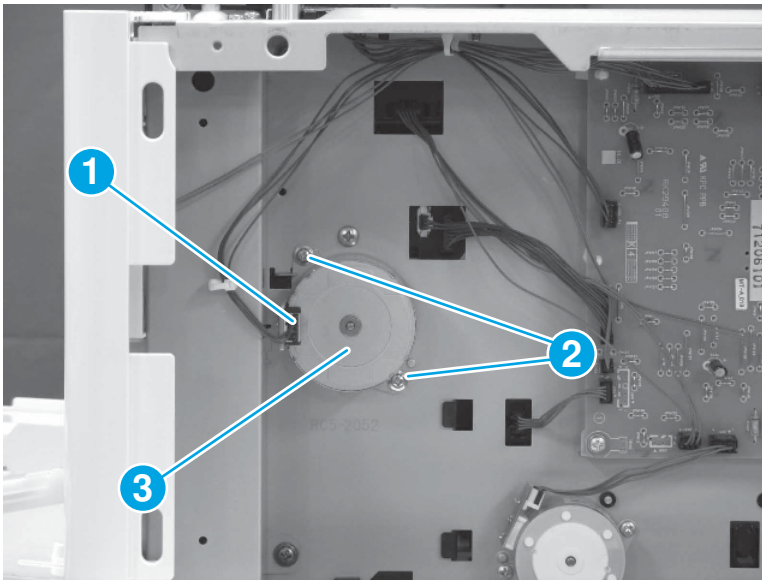
- c. Remove two screws (callout 1), and then remove the right door assembly (callout 2).

Figure 1-3528 Remove the right door



7. Remove the 2,700-sheet HCl paper tray and stand right tray pickup motor.
 - ▲ Disconnect one connector (callout 1), remove two screws (callout 2), and then remove the HCl right tray pickup motor (callout 3).

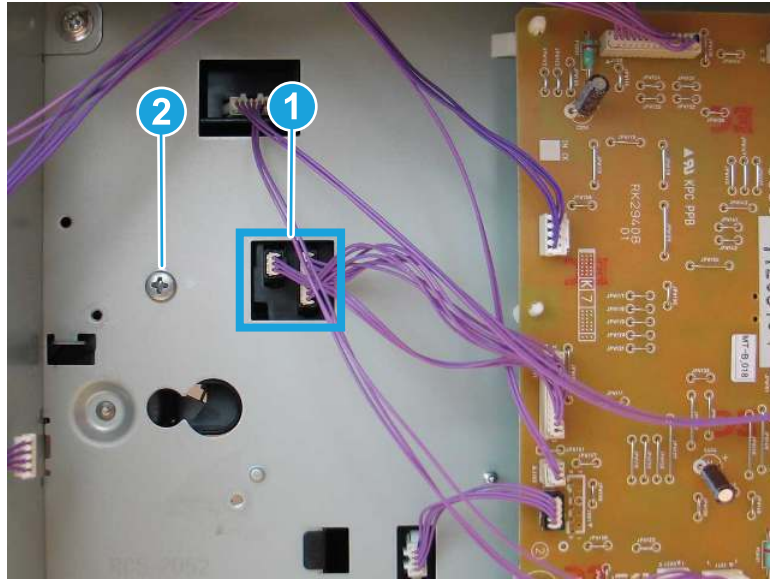
Figure 1-3529 Remove the right tray pickup motor



8. Remove the 2,700-sheet HCl paper tray and stand right tray pickup assembly.

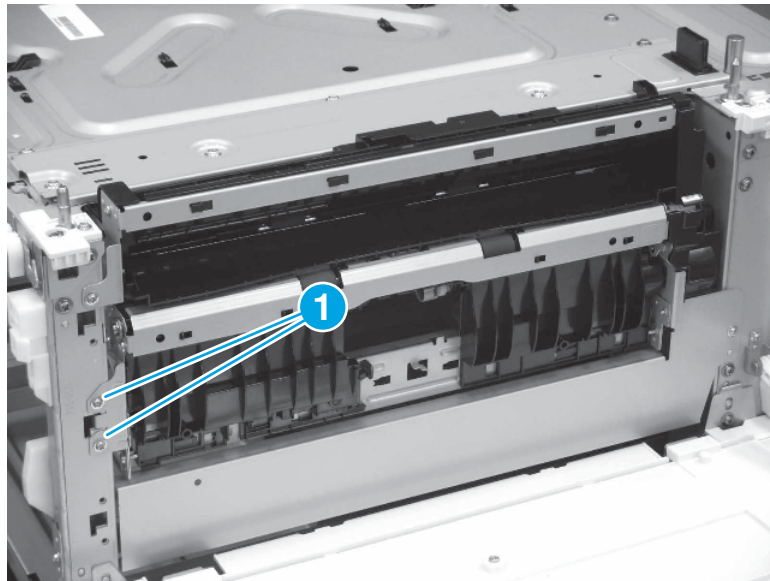
- a. Disconnect two connectors (callout 1), and then remove one screw (callout 2).

Figure 1-3530 Disconnect two connectors and remove one screw



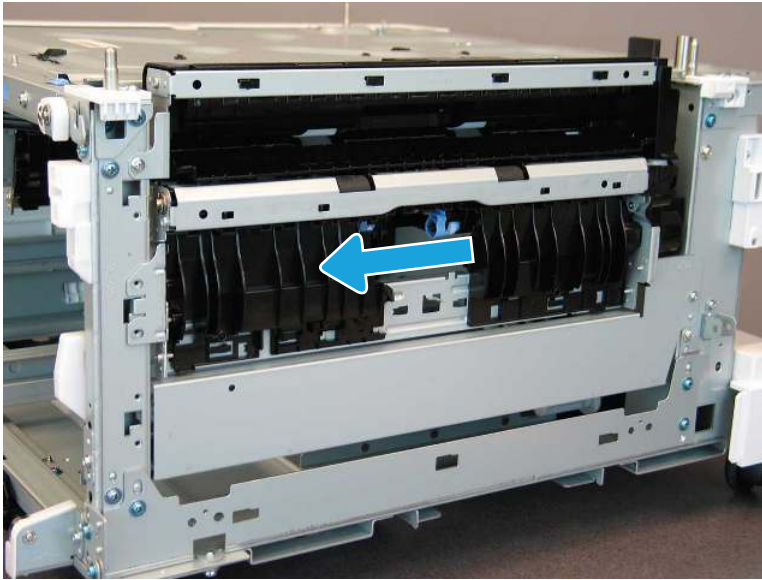
- b. Remove two screws (callout 1).

Figure 1-3531 Remove two screws



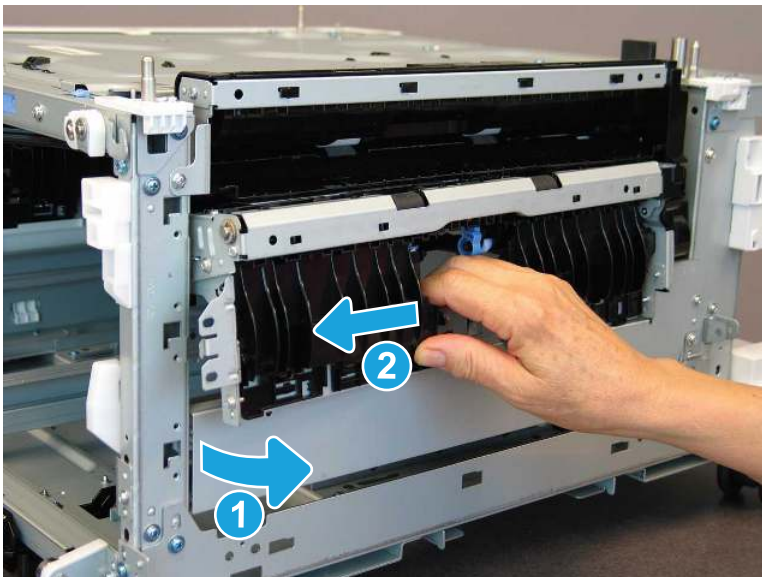
- c. Slide the pickup assembly toward the front of the feeder.

Figure 1-3532 Slide the pickup assembly



- d. Rotate the left side of the assembly away from the feeder (callout 1), and then slide it to the left (callout 2) to remove it.

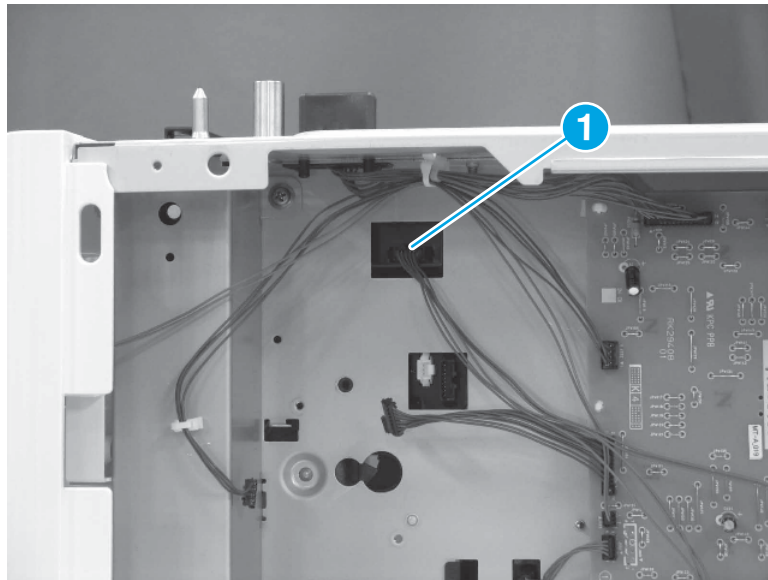
Figure 1-3533 Remove the pickup assembly



9. Remove the 2,700-sheet HCI paper tray and stand feed assembly.

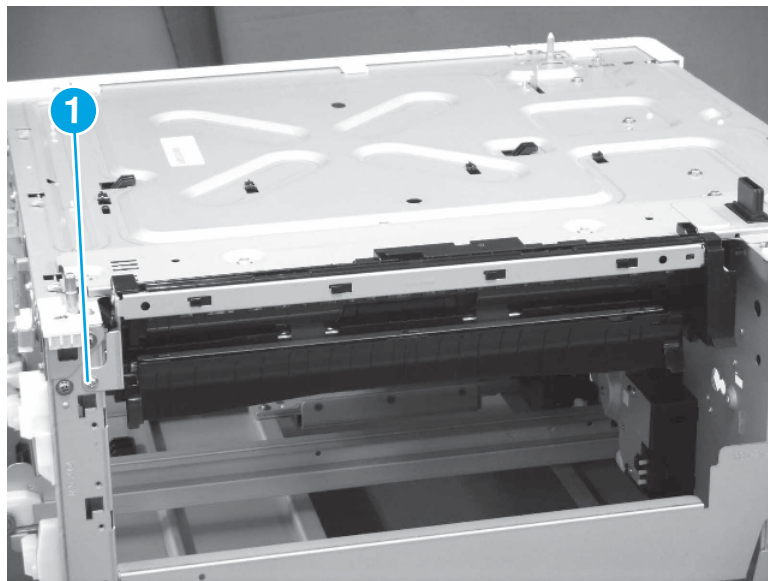
- a. Disconnect one connector (callout 1).

Figure 1-3534 Disconnect one connector



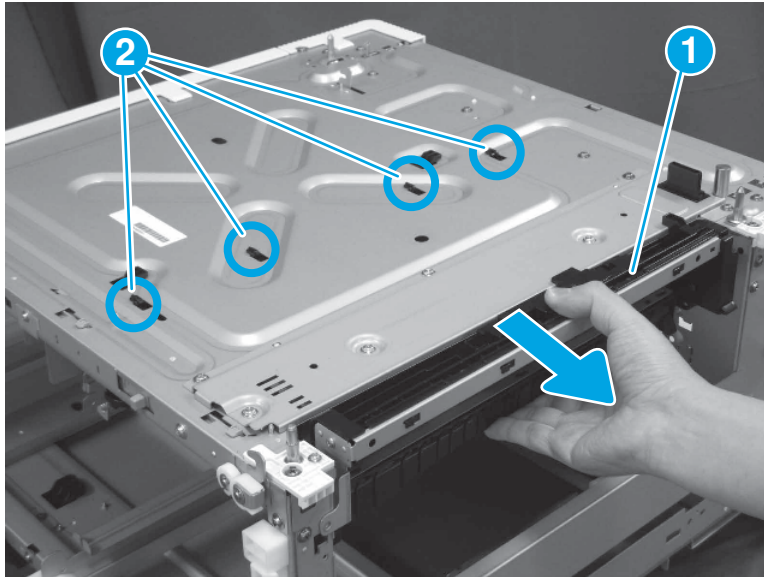
- b. Remove one screw.

Figure 1-3535 Remove one screw



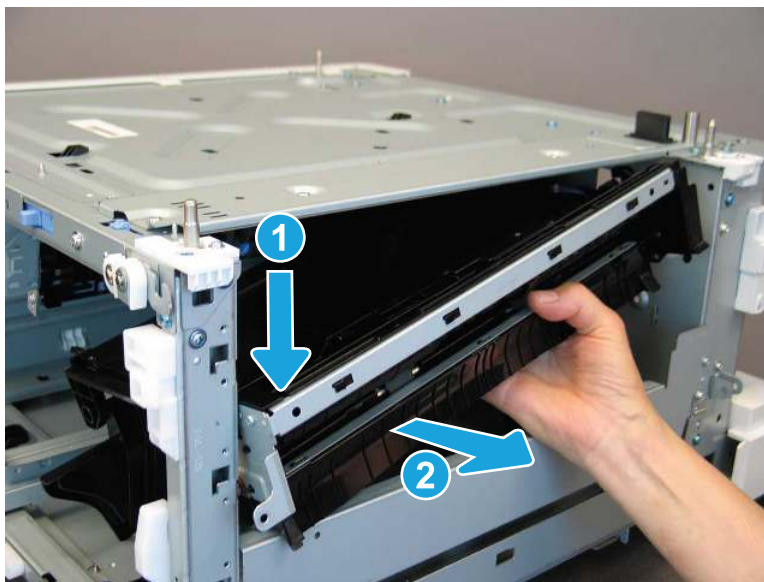
- c. Slide the feed assembly (callout 1) toward the front of the feeder to release four lugs (callout 2), and then lower the assembly.

Figure 1-3536 Release four lugs



- d. Rotate the left side of the feed assembly down (callout 1), and then pull the assembly away from the printer (callout 2) to remove it.

Figure 1-3537 Remove the feed assembly




10. Unpack the replacement assembly.
 - a. Dispose of the defective part.




NOTE: HP recommends responsible disposal of the defective part.

<http://www8.hp.com/us/en/hp-information/environment/product-recycling.html>

- b. Unpack the replacement part from the packaging.

 **IMPORTANT:** Make sure that all of the shipping materials (for example shipping tape) are removed from the replacement part prior to installation.

- c. To install an assembly, reverse the removal steps.

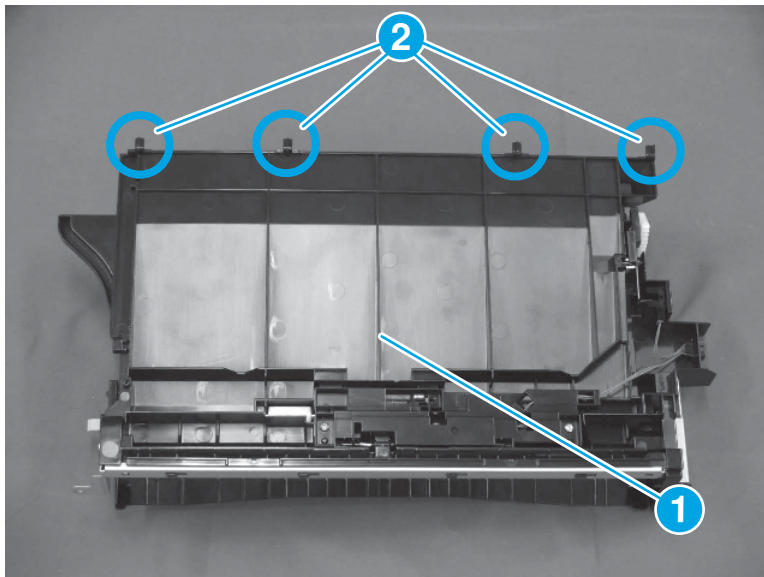
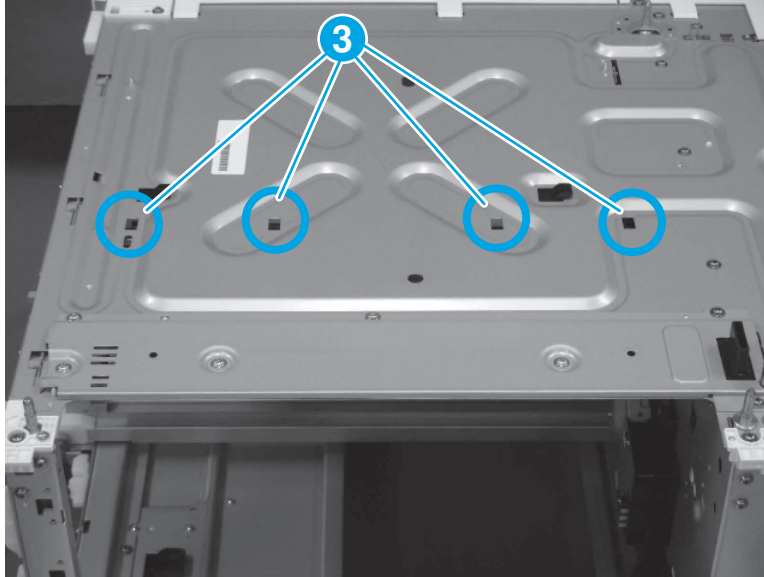
 **NOTE:** When applicable, special installation instructions are provided for an assembly at the end of the removal procedure. Always completely read the removal instructions and follow all special installation instructions.

- 11. Reverse the removal steps to install the assembly. Also use the following **special installation instructions**.

Install the 2,700-sheet HCI paper tray and stand feed assembly

- ▲ When installing the feed assembly (callout 1), make sure that the four hooks (callout 2) on the assembly fit into the openings (callout 3) on the feeder.

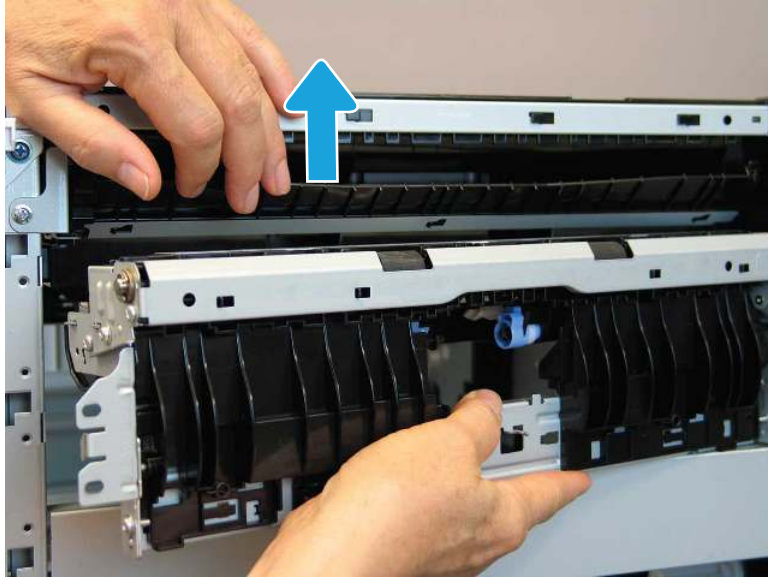
Figure 1-3538 Install the feed assembly



Install the 2,700-sheet HCI paper tray and stand right tray pickup assembly

- ▲ Raise the flap on the feed assembly to install the right tray pickup assembly.

Figure 1-3539 Raise the feed assembly flap



Removal and replacement: 2,700-sheet HCl paper tray and stand left tray pickup motor

Learn how to remove and replace the 2,700-sheet HCl paper tray and stand left tray pickup motor.

[View a video of how to remove and replace the 2,700-sheet HCl paper tray and stand left tray pickup motor.](#)

Mean time to repair: 3 minutes

Service level: Easy

Before performing service

Turn the printer power off

- Disconnect the power cable.

⚠ WARNING! To avoid damage to the printer, turn the printer off, wait 30 seconds, and then remove the power cord before attempting to service the printer.

Use the table below to identify the correct part number for your printer. To order the part, go to www.hp.com/buy/parts.

Table 1-189 Part information

Part number	Part description
RK2-9410-000CN	Motor, stepping, DC

Required tools

- #2 Phillips screwdriver with a magnetic tip

After performing service

Turn the printer power on

- Connect the power cable.

- Use the power switch to turn the power on.

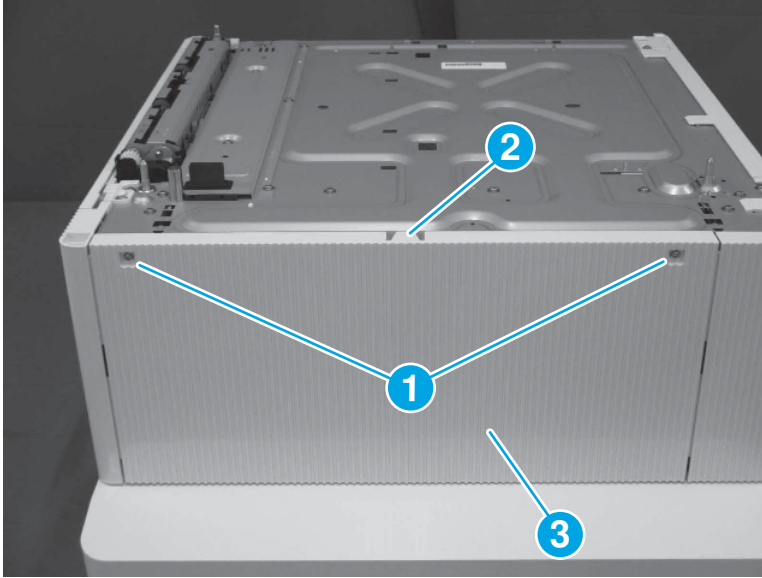
Post service test

Make sure that the printer initializes to a **Ready** state.

Print a page from the 2,700-sheet HCl paper tray and stand to make sure that the printer is functioning correctly.

1. Remove the 2,700-sheet HCl paper tray and stand rear upper cover
 - ▲ Remove two screws (callout 1), release one tab (callout 2), and then remove the rear upper cover (callout 3).

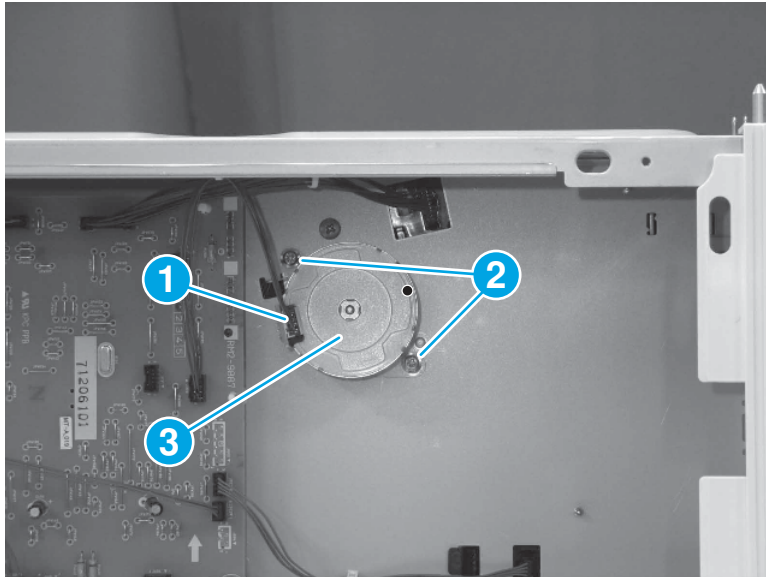
Figure 1-3540 Remove the rear upper cover



2. Remove the 2,700-sheet HCl paper tray and stand left tray pickup motor.

- ▲ Disconnect one connector (callout 1), remove two screws (callout 2), and then remove the HCI left tray pickup motor (callout 3).

Figure 1-3541 Remove the left tray pickup motor



- 3. Unpack the replacement assembly.

- a. Dispose of the defective part.




NOTE: HP recommends responsible disposal of the defective part.

<http://www8.hp.com/us/en/hp-information/environment/product-recycling.html>

- b. Unpack the replacement part from the packaging.



CAUTION:  Some parts are sensitive to electrostatic discharge (ESD). Always perform service work at an ESD-protected workstation or mat. If an ESD workstation or mat is not available, touch the sheet-metal chassis to provide a static ground before touching an ESD-sensitive assembly. Protect the ESD-sensitive assemblies by placing them in ESD pouches when they are out of the printer.



IMPORTANT: Make sure that all of the shipping materials (for example shipping tape) are removed from the replacement part prior to installation.

- c. To install an assembly, reverse the removal steps.



NOTE: When applicable, special installation instructions are provided for an assembly at the end of the removal procedure. Always completely read the removal instructions and follow all special installation instructions.

Removal and replacement: 2,700-sheet HCI paper tray and stand left tray pickup assembly

Learn how to remove and replace the 2,700-sheet HCI paper tray and stand left tray pickup assembly.

[View a video of how to remove and replace the 2,700-sheet HCI paper tray and stand left tray pickup assembly.](#)

Mean time to repair: 25 minutes

Service level: Medium

Before performing service

Turn the printer power off

- Disconnect the power cable.

⚠ WARNING! To avoid damage to the printer, turn the printer off, wait 30 seconds, and then remove the power cord before attempting to service the printer.

Use the table below to identify the correct part number for your printer. To order the part, go to www.hp.com/buy/parts.

Table 1-190 Part information

Part number	Part description
RM2-1741-000CN	Paper pickup assembly

Required tools

- #2 Phillips screwdriver with a magnetic tip

After performing service

Turn the printer power on

- Connect the power cable.
- Use the power switch to turn the power on.

Post service test

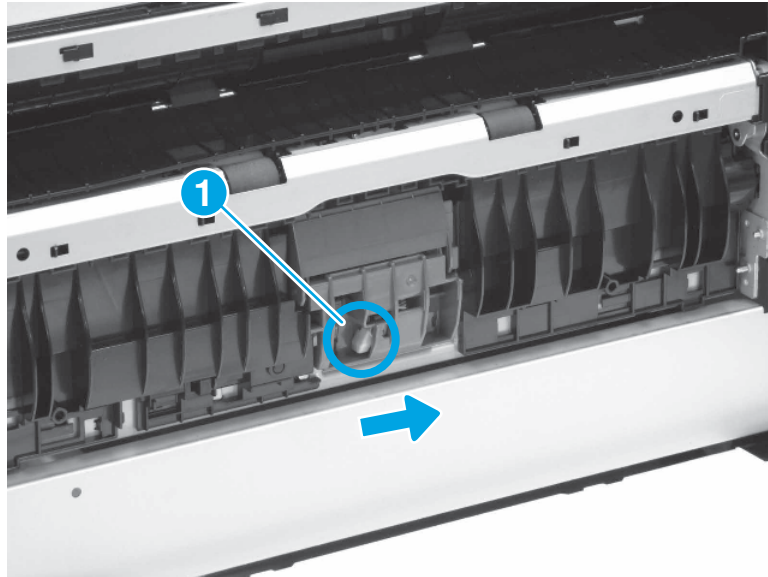
Make sure that the printer initializes to a **Ready** state.

Print a page from the 2,700-sheet HCl paper tray and stand to make sure that the printer is functioning correctly.

1. Remove the 2,700-sheet HCl paper tray and stand right tray separation roller.

- ▲ Press the release button (callout 1), slide the right tray separation roller assembly to the right, and then pull it away from the printer to remove it .

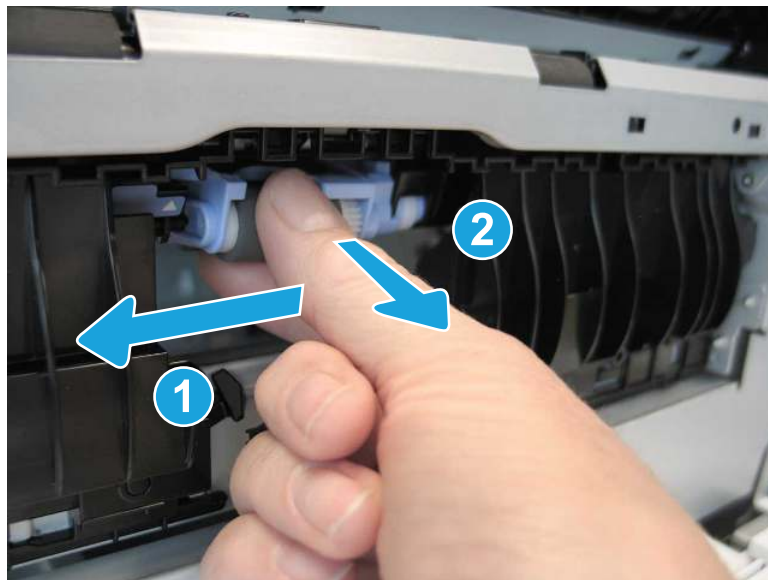
Figure 1-3542 Remove the separation roller assembly



2. Remove the 2,700-sheet HCl paper tray and stand right tray pickup roller.

- ▲ On the right side of the feeder, slide the right tray pickup roller assembly to the left (callout 1), and then pull it away from the printer (callout 2) to remove it.

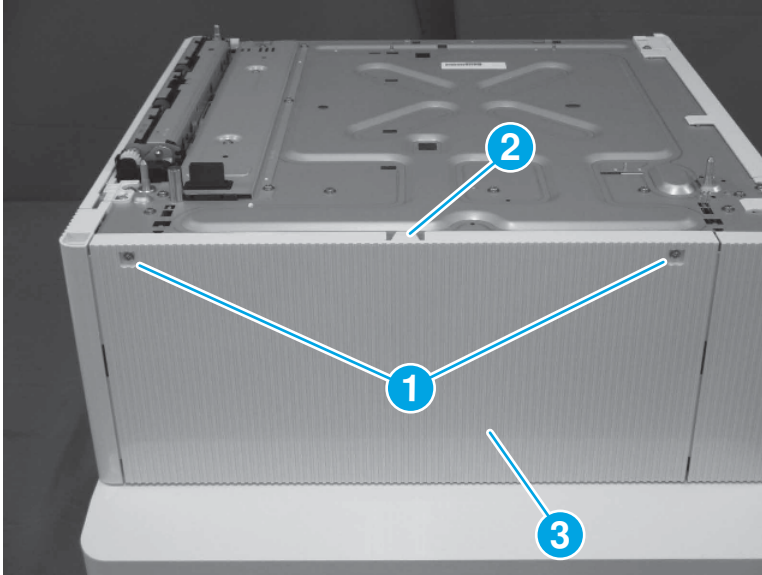
Figure 1-3543 Remove the right tray pickup roller



3. Remove the 2,700-sheet HCl paper tray and stand rear upper cover

- ▲ Remove two screws (callout 1), release one tab (callout 2), and then remove the rear upper cover (callout 3).

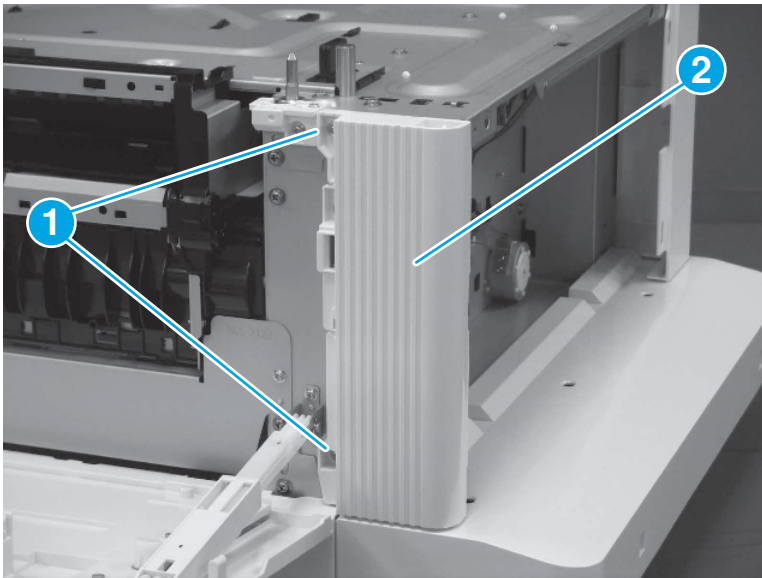
Figure 1-3544 Remove the rear upper cover



4. Remove the 2,700-sheet HCl paper tray and stand right rear cover.

- ▲ Remove two screws (callout 1), and then remove the right rear cover (callout 2).

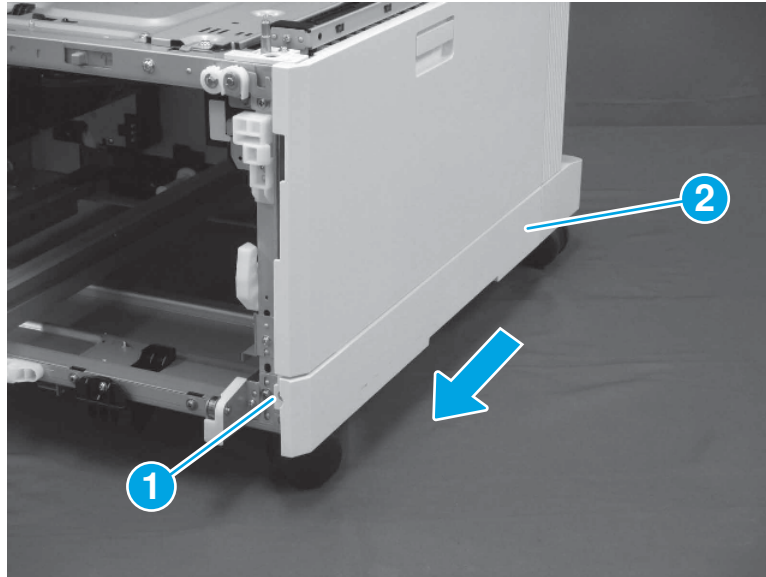
Figure 1-3545 Remove the right rear cover



5. Remove the 2,700-sheet HCl paper tray and stand right lower cover.

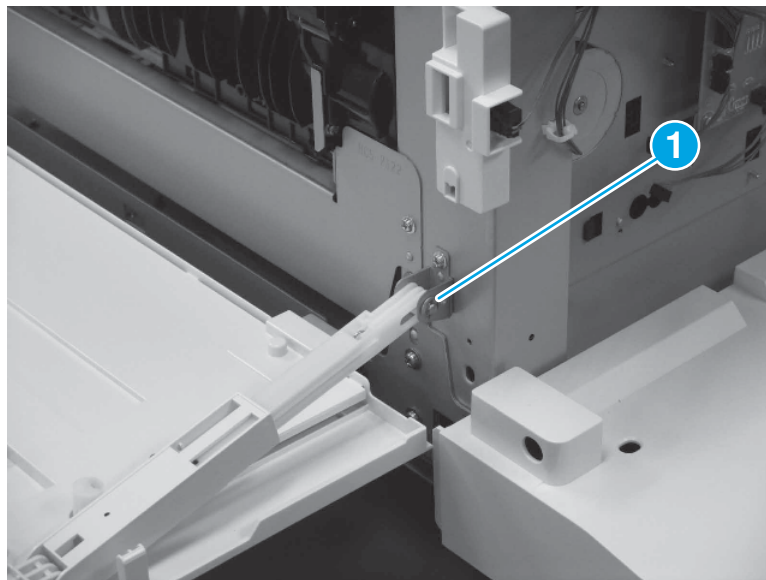
- ▲ Remove one screw (callout 1), and then slide the right lower cover (callout 2) toward the front of the feeder to remove it.

Figure 1-3546 Remove the right lower cover



- 6. Remove the 2,700-sheet HCl paper tray and stand right door.
 - a. Remove one E-ring (callout 1).

Figure 1-3547 Remove one E-ring



- b. Hold the hinge arm securely, and then slide the shaft to the left to remove it.



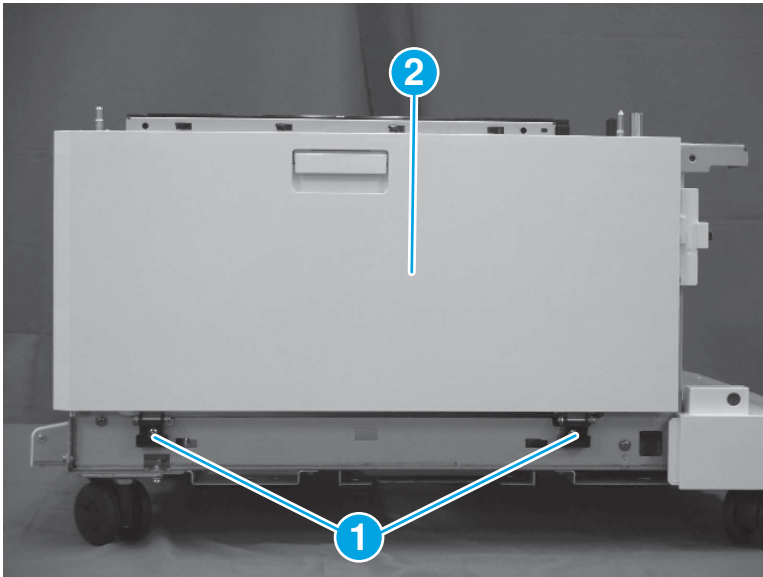
NOTE: The hinge arm is spring-loaded and may snap back suddenly when the shaft is removed.

Figure 1-3548 Release the hinge arm



- c. Remove two screws (callout 1), and then remove the right door assembly (callout 2).

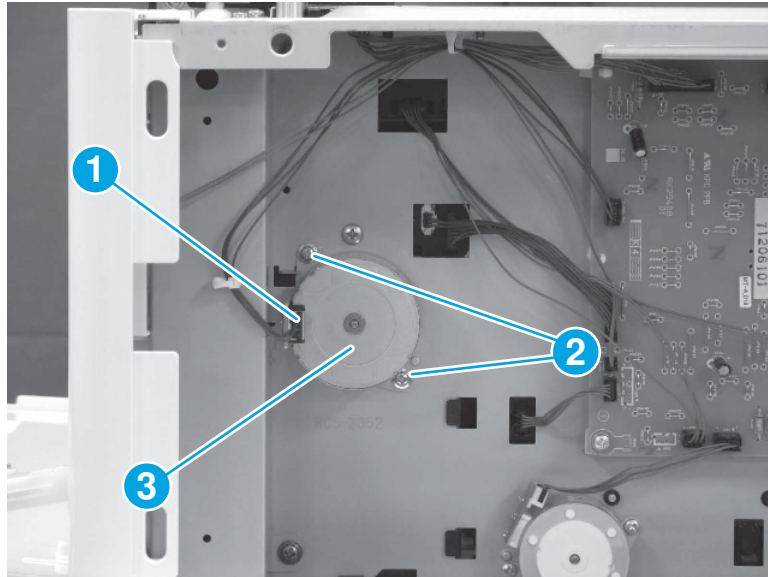
Figure 1-3549 Remove the right door



- 7. Remove the 2,700-sheet HCl paper tray and stand right tray pickup motor.

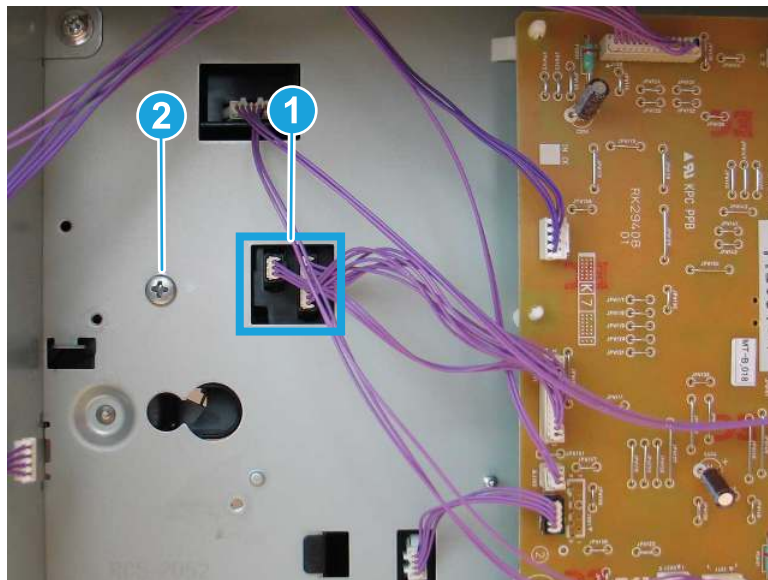
- ▲ Disconnect one connector (callout 1), remove two screws (callout 2), and then remove the HCI right tray pickup motor (callout 3).

Figure 1-3550 Remove the right tray pickup motor



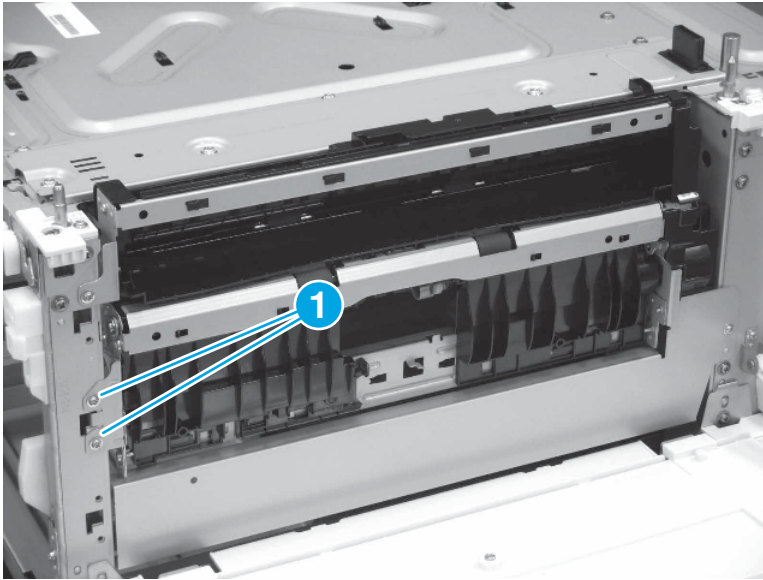
8. Remove the 2,700-sheet HCI paper tray and stand right tray pickup assembly.
 - a. Disconnect two connectors (callout 1), and then remove one screw (callout 2).

Figure 1-3551 Disconnect two connectors and remove one screw



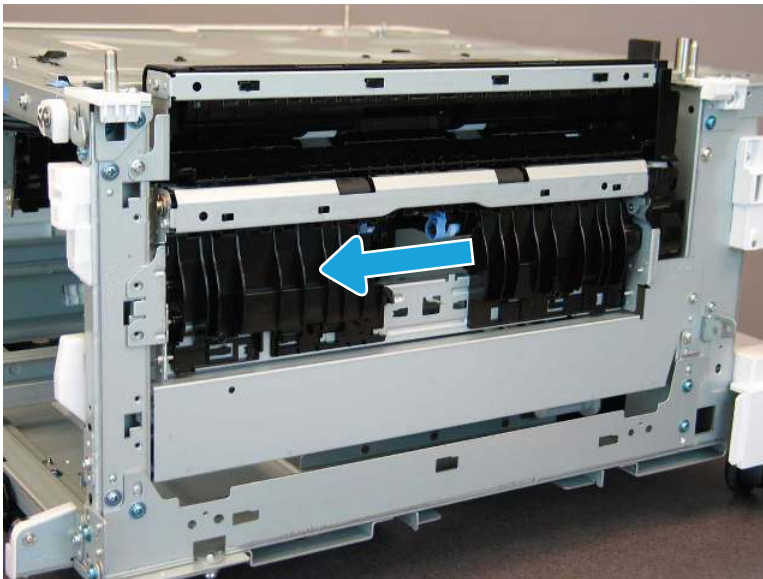
- b. Remove two screws (callout 1).

Figure 1-3552 Remove two screws



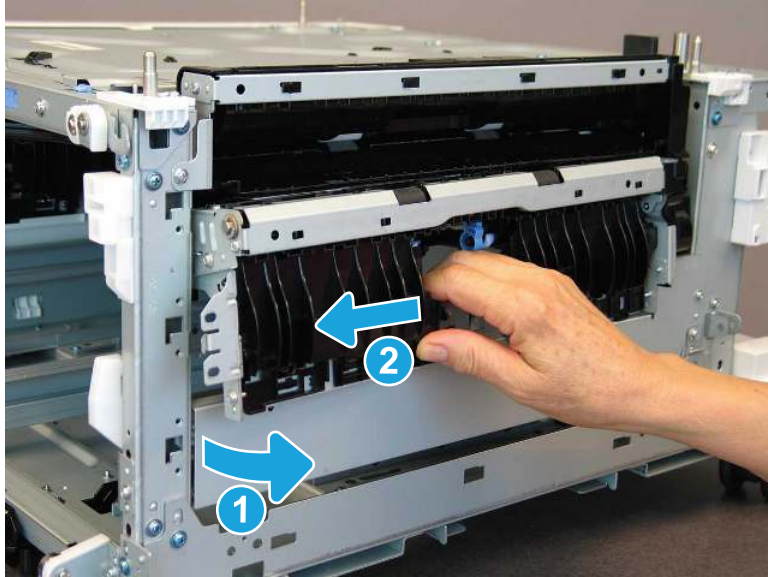
- c. Slide the pickup assembly toward the front of the feeder.

Figure 1-3553 Slide the pickup assembly



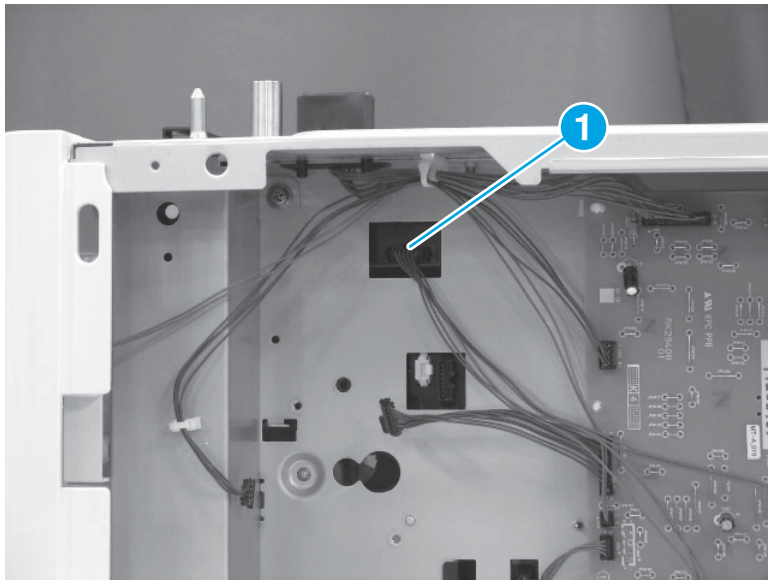
- d. Rotate the left side of the assembly away from the feeder (callout 1), and then slide it to the left (callout 2) to remove it.

Figure 1-3554 Remove the pickup assembly



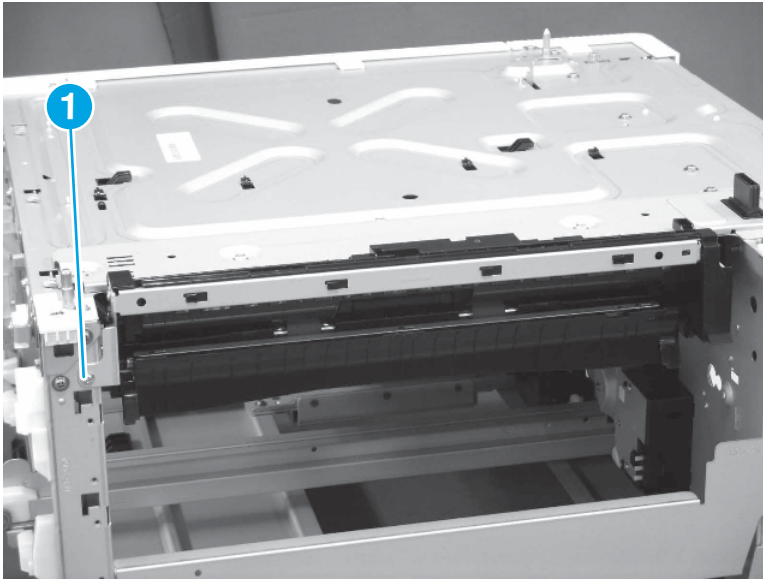
9. Remove the 2,700-sheet HCl paper tray and stand feed assembly.
 - a. Disconnect one connector (callout 1).

Figure 1-3555 Disconnect one connector



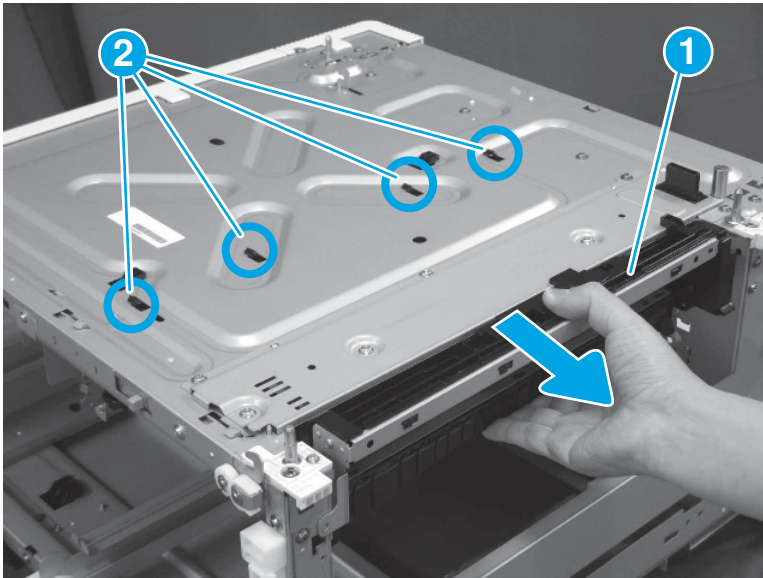
- b. Remove one screw.

Figure 1-3556 Remove one screw



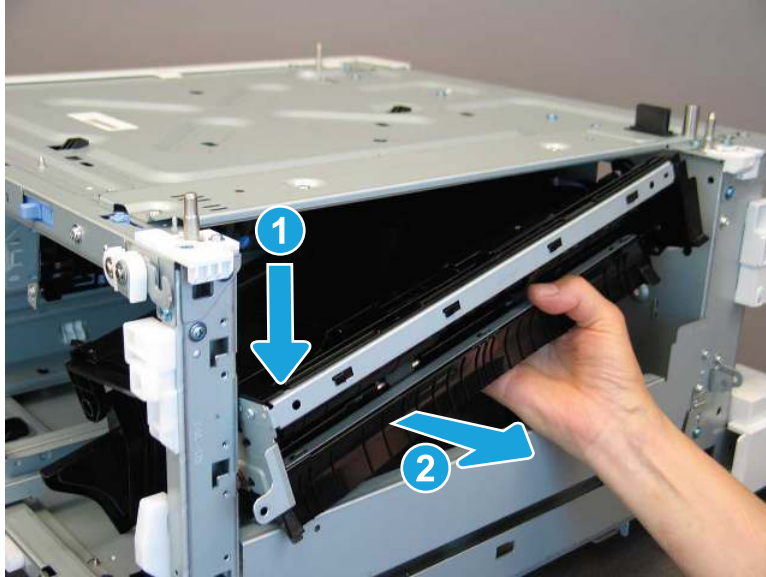
- c. Slide the feed assembly (callout 1) toward the front of the feeder to release four lugs (callout 2), and then lower the assembly.

Figure 1-3557 Release four lugs



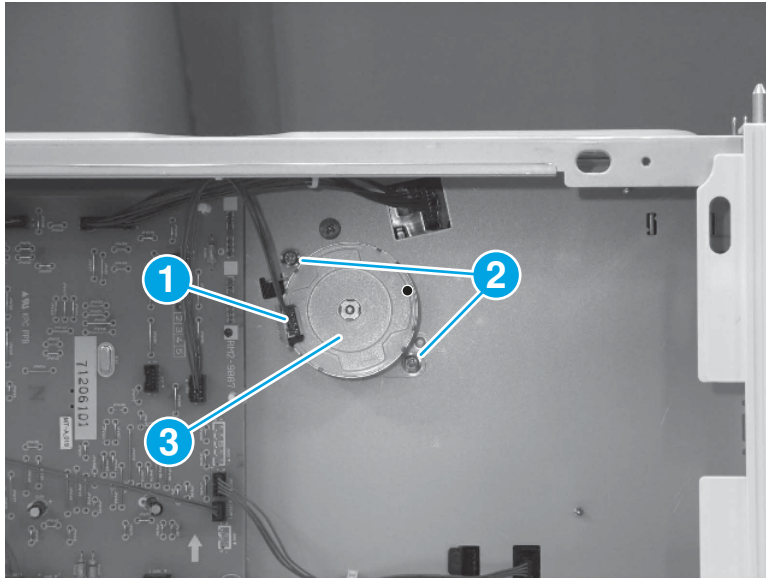
- d. Rotate the left side of the feed assembly down (callout 1), and then pull the assembly away from the printer (callout 2) to remove it.

Figure 1-3558 Remove the feed assembly



10. Remove the 2,700-sheet HCl paper tray and stand left tray pickup motor.
 - ▲ Disconnect one connector (callout 1), remove two screws (callout 2), and then remove the HCl left tray pickup motor (callout 3).

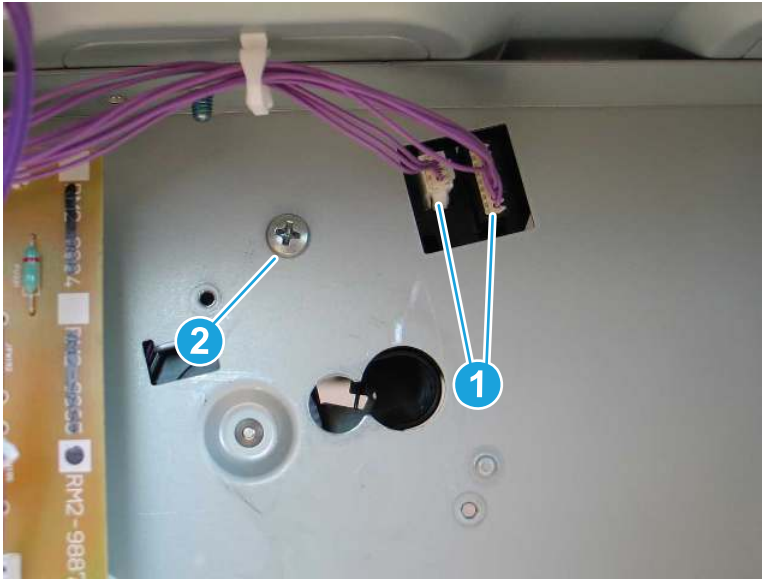
Figure 1-3559 Remove the left tray pickup motor



11. Remove the 2,700-sheet HCl paper tray and stand left tray pickup assembly.

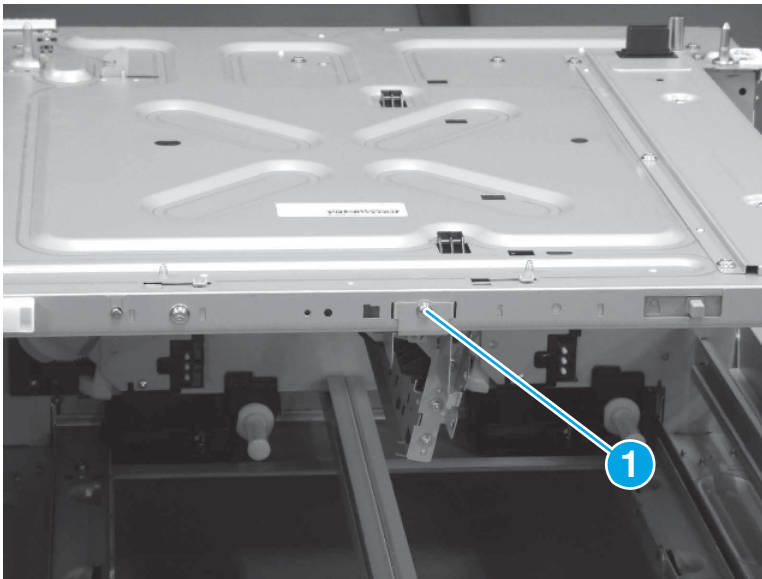
- a. Disconnect two connectors (callout 1), and then remove one screw (callout 2).

Figure 1-3560 Disconnect two connectors and remove one screw



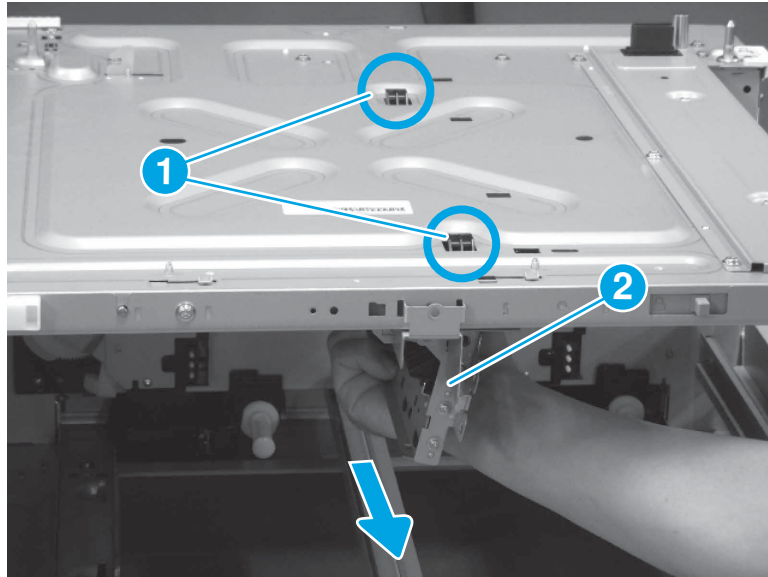
- b. Remove one screw (callout 1).

Figure 1-3561 Remove one screw



- c. Slide the pickup assembly away from the feeder to release two lugs (callout 1), and then remove the pickup assembly (callout 2).

Figure 1-3562 Remove the pickup assembly



12. Unpack the replacement assembly.

- a. Dispose of the defective part.



NOTE: HP recommends responsible disposal of the defective part.

<http://www8.hp.com/us/en/hp-information/environment/product-recycling.html>

- b. Unpack the replacement part from the packaging.



IMPORTANT: Make sure that all of the shipping materials (for example shipping tape) are removed from the replacement part prior to installation.

- c. To install an assembly, reverse the removal steps.



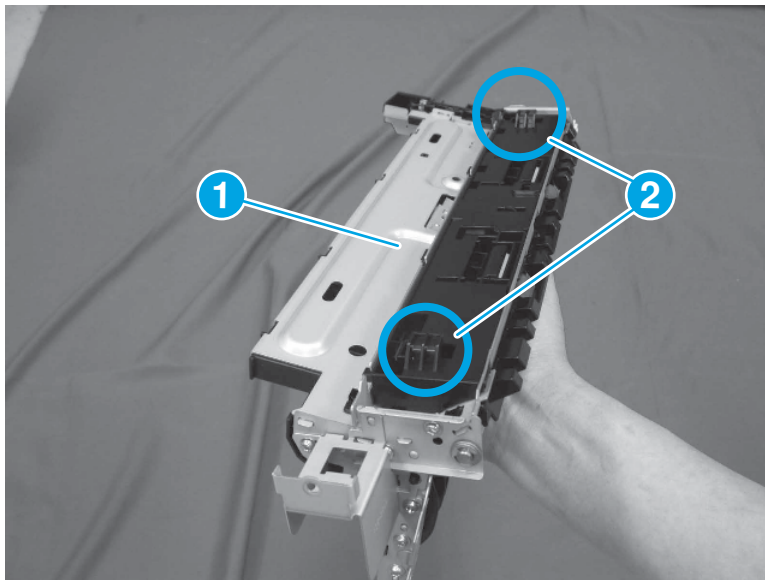
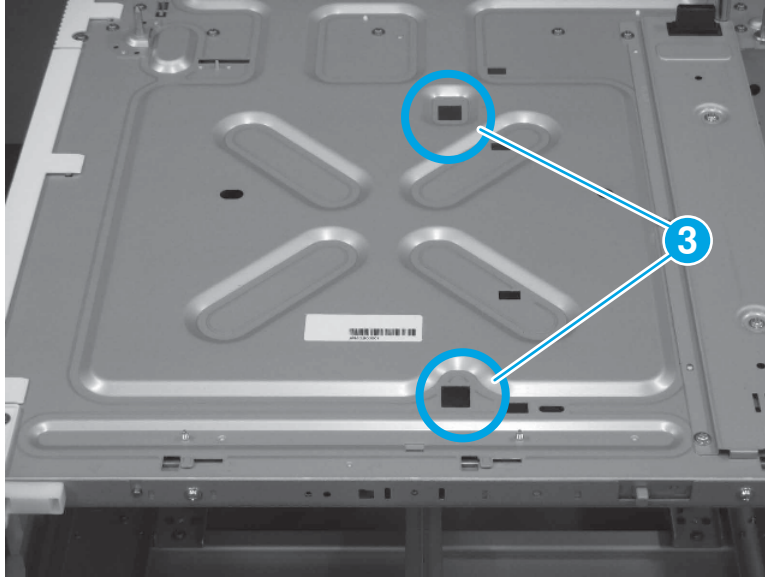
NOTE: When applicable, special installation instructions are provided for an assembly at the end of the removal procedure. Always completely read the removal instructions and follow all special installation instructions.

13. Reverse the removal steps to install the assembly. Also use the following **special installation instructions**.

Install the 2,700-sheet HCI paper tray and stand left tray pickup assembly

- ▲ When installing the HCI left tray pickup assembly (callout 1), make sure that two hooks (callout 2) on the pickup assembly engage with two openings (callout 3) on the feeder.

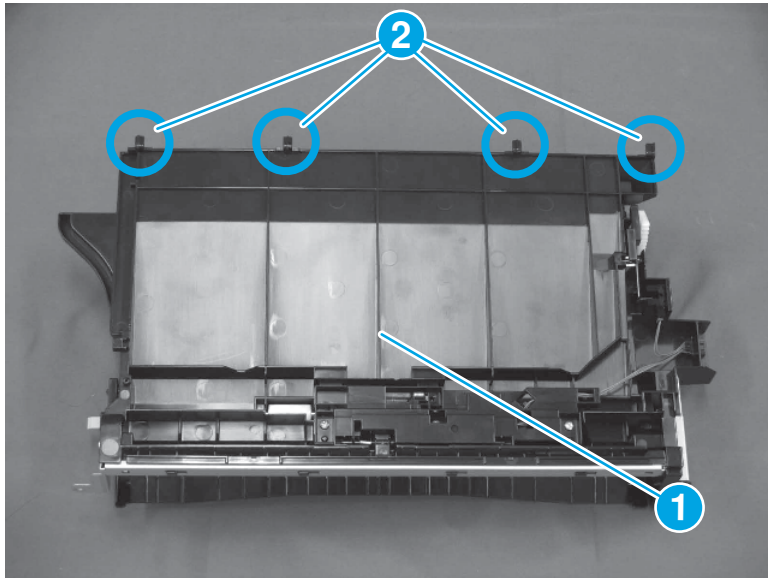
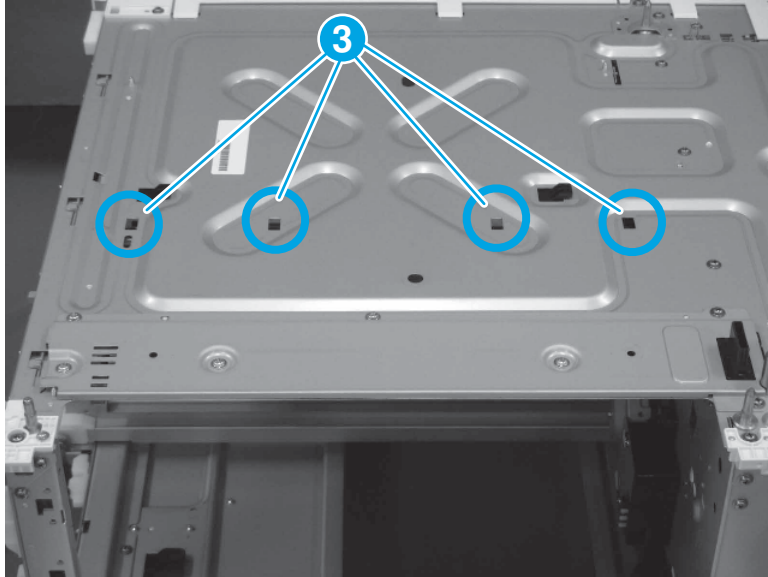
Figure 1-3563 Engage two hooks



Install the 2,700-sheet HCI paper tray and stand feed assembly

- ▲ When installing the feed assembly (callout 1), make sure that the four hooks (callout 2) on the assembly fit into the openings (callout 3) on the feeder.

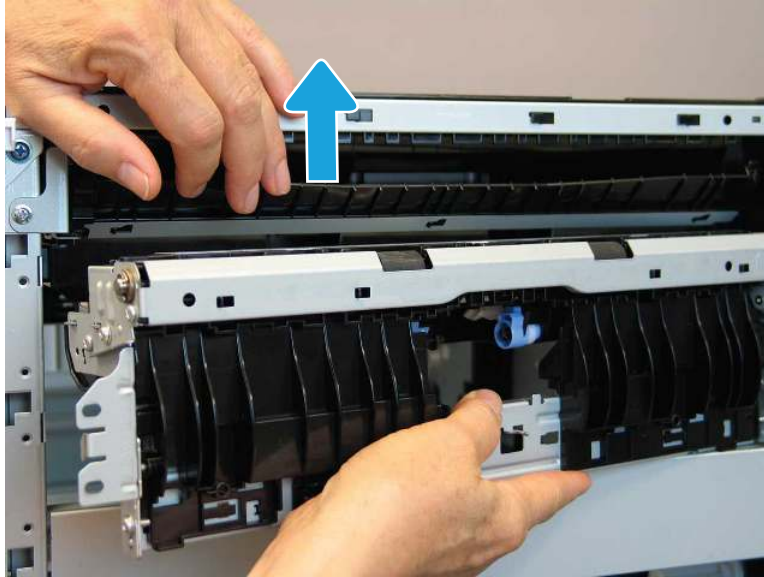
Figure 1-3564 Install the feed assembly



Install the 2,700-sheet HCI paper tray and stand right tray pickup assembly

- ▲ Raise the flap on the feed assembly to install the right tray pickup assembly.

Figure 1-3565 Raise the feed assembly flap



Removal and replacement: 2,700-sheet HCl paper tray and stand left tray lifter motor

Learn how to remove and replace the 2,700-sheet HCl paper tray and stand left tray lifter motor.

[View a video of how to remove and replace the 2,700-sheet HCl paper tray and stand left tray lifter motor.](#)

Mean time to repair: 3 minutes

Service level: Easy

Before performing service

Turn the printer power off

- Disconnect the power cable.

⚠ WARNING! To avoid damage to the printer, turn the printer off, wait 30 seconds, and then remove the power cord before attempting to service the printer.

Use the table below to identify the correct part number for your printer. To order the part, go to www.hp.com/buy/parts.

Table 1-191 Part information

Part number	Part description
RK2-7818-000CN	Motor, stepping, DC

Required tools

- #2 Phillips screwdriver with a magnetic tip

After performing service

Turn the printer power on

- Connect the power cable.

- Use the power switch to turn the power on.

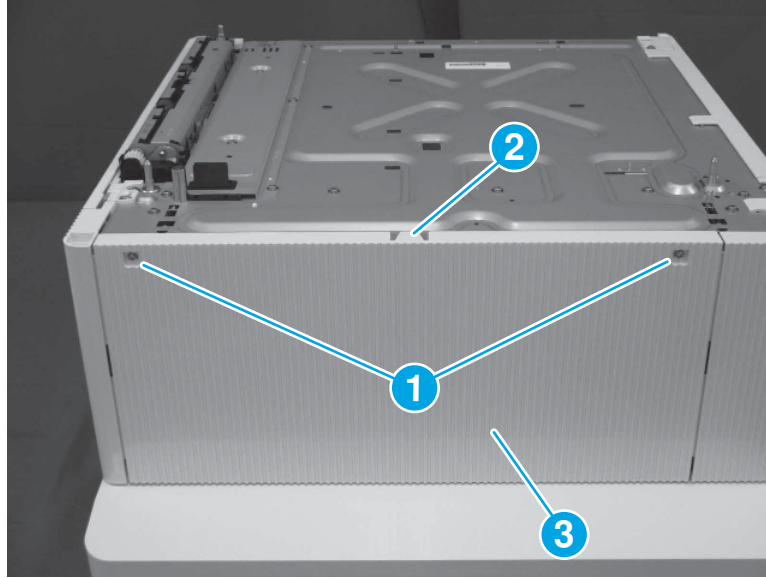
Post service test

Make sure that the printer initializes to a **Ready** state.

Print a page from the 2,700-sheet HCl paper tray and stand to make sure that the printer is functioning correctly.

1. Remove the 2,700-sheet HCl paper tray and stand rear upper cover
 - ▲ Remove two screws (callout 1), release one tab (callout 2), and then remove the rear upper cover (callout 3).

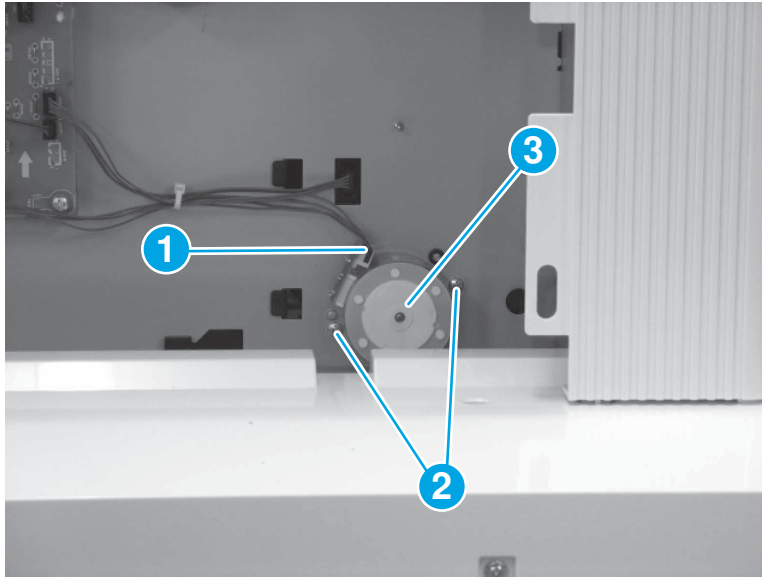
Figure 1-3566 Remove the rear upper cover



2. Remove the 2,700-sheet HCl paper tray and stand left tray lifter motor.

- ▲ Disconnect one connector (callout 1), remove two screws (callout 2), and then remove the lifter motor (callout 3).

Figure 1-3567 Remove the left tray lifter drive motor



3. Unpack the replacement assembly.

- a. Dispose of the defective part.




NOTE: HP recommends responsible disposal of the defective part.

<http://www8.hp.com/us/en/hp-information/environment/product-recycling.html>

- b. Unpack the replacement part from the packaging.



CAUTION:  Some parts are sensitive to electrostatic discharge (ESD). Always perform service work at an ESD-protected workstation or mat. If an ESD workstation or mat is not available, touch the sheet-metal chassis to provide a static ground before touching an ESD-sensitive assembly. Protect the ESD-sensitive assemblies by placing them in ESD pouches when they are out of the printer.



IMPORTANT: Make sure that all of the shipping materials (for example shipping tape) are removed from the replacement part prior to installation.

- c. To install an assembly, reverse the removal steps.



NOTE: When applicable, special installation instructions are provided for an assembly at the end of the removal procedure. Always completely read the removal instructions and follow all special installation instructions.

Removal and replacement: 2,700-sheet HCl paper tray and stand left tray lifter drive

Learn how to remove and replace the 2,700-sheet HCl paper tray and stand left tray lifter drive.

[View a video of how to remove and replace the 2,700-sheet HCl paper tray and stand left tray lifter drive.](#)

Mean time to repair: 5 minutes

Service level: Easy

Before performing service

Turn the printer power off

- Disconnect the power cable.

⚠ WARNING! To avoid damage to the printer, turn the printer off, wait 30 seconds, and then remove the power cord before attempting to service the printer.

Use the table below to identify the correct part number for your printer. To order the part, go to www.hp.com/buy/parts.

Table 1-192 Part information

Part number	Part description
RM2-1704-000CN	Lifter drive assembly

Required tools

- #2 Phillips screwdriver with a magnetic tip

After performing service

Turn the printer power on

- Connect the power cable.
- Use the power switch to turn the power on.

Post service test

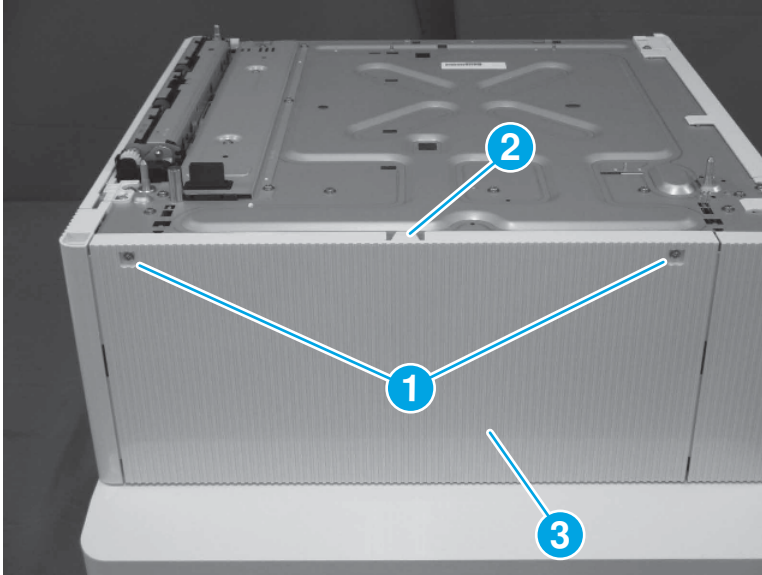
Make sure that the printer initializes to a **Ready** state.

Print a page from the 2,700-sheet HCl paper tray and stand to make sure that the printer is functioning correctly.

1. Remove the 2,700-sheet HCl paper tray and stand rear upper cover

- ▲ Remove two screws (callout 1), release one tab (callout 2), and then remove the rear upper cover (callout 3).

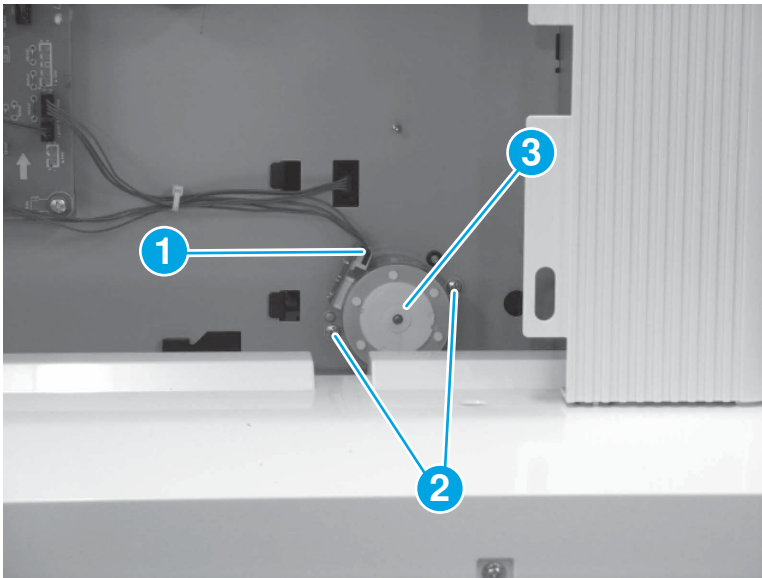
Figure 1-3568 Remove the rear upper cover



2. Remove the 2,700-sheet HCl paper tray and stand left tray lifter motor.

- ▲ Disconnect one connector (callout 1), remove two screws (callout 2), and then remove the lifter motor (callout 3).

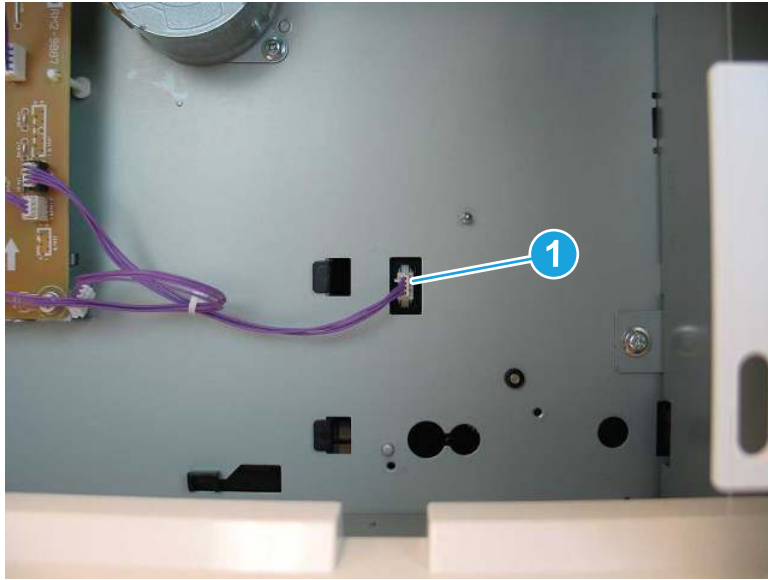
Figure 1-3569 Remove the left tray lifter drive motor



3. Remove the 2,700-sheet HCl paper tray and stand left tray lifter drive.

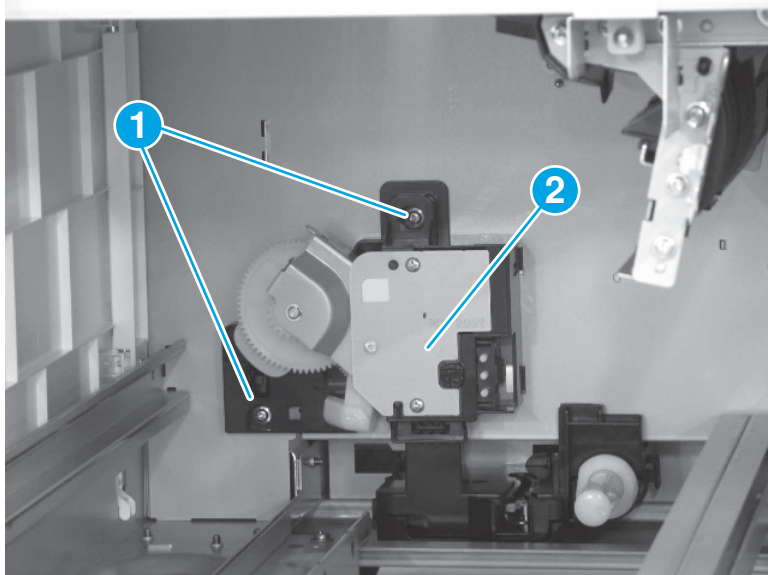
- a. Disconnect one connector (callout 1) on the back of the feeder.

Figure 1-3570 Disconnect one connector



- b. Remove two screws (callout 1), and then remove the lifter drive (callout 2).

Figure 1-3571 Remove the lifter drive




4. Unpack the replacement assembly.
 - a. Dispose of the defective part.




NOTE: HP recommends responsible disposal of the defective part.

<http://www8.hp.com/us/en/hp-information/environment/product-recycling.html>

- b. Unpack the replacement part from the packaging.

 **IMPORTANT:** Make sure that all of the shipping materials (for example shipping tape) are removed from the replacement part prior to installation.

- c. To install an assembly, reverse the removal steps.

 **NOTE:** When applicable, special installation instructions are provided for an assembly at the end of the removal procedure. Always completely read the removal instructions and follow all special installation instructions.

Removal and replacement: 2,700-sheet HCl paper tray and stand left tray auto close assembly

Learn how to remove and replace the 2,700-sheet HCl paper tray and stand left tray auto close assembly.

[View a video of how to remove and replace the 2,700-sheet HCl paper tray and stand left tray auto close assembly.](#)


Mean time to repair: 8 minutes

Service level: Easy

Before performing service

Turn the printer power off

- Disconnect the power cable.

 **WARNING!** To avoid damage to the printer, turn the printer off, wait 30 seconds, and then remove the power cord before attempting to service the printer.

Use the table below to identify the correct part number for your printer. To order the part, go to www.hp.com/buy/parts.

Table 1-193 Part information

Part number	Part description
RM2-1734-000CN	Auto close assembly

Required tools

- #2 Phillips screwdriver with a magnetic tip

After performing service

Turn the printer power on

- Connect the power cable.
- Use the power switch to turn the power on.

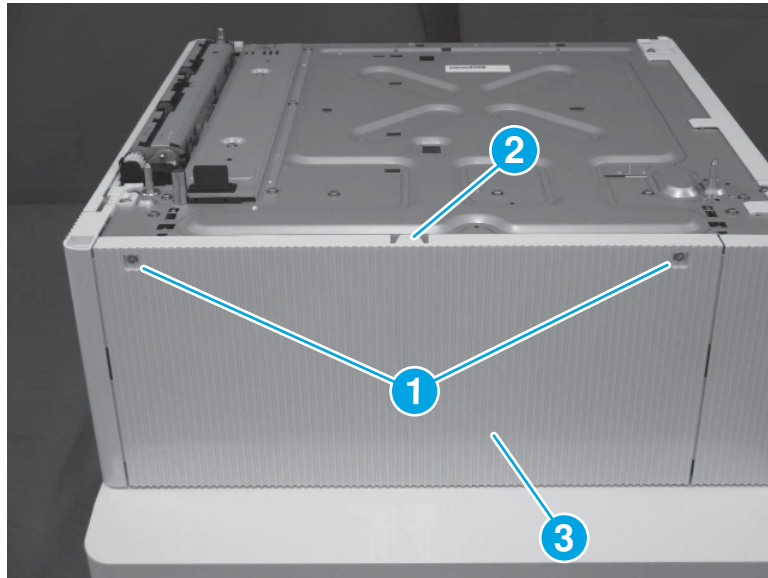
Post service test

Make sure that the printer initializes to a **Ready** state.

Print a page from the 2,700-sheet HCl paper tray and stand to make sure that the printer is functioning correctly.

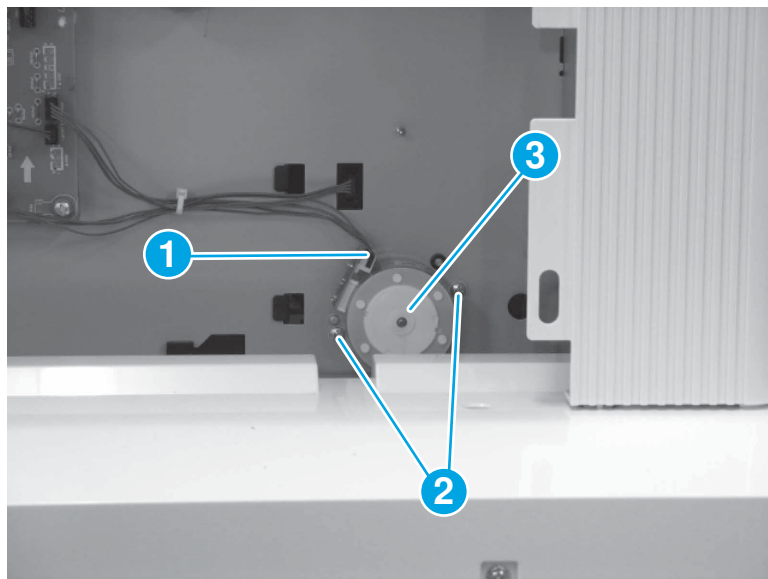
1. Remove the 2,700-sheet HCl paper tray and stand rear upper cover
 - ▲ Remove two screws (callout 1), release one tab (callout 2), and then remove the rear upper cover (callout 3).

Figure 1-3572 Remove the rear upper cover



2. Remove the 2,700-sheet HCl paper tray and stand left tray lifter motor.
 - ▲ Disconnect one connector (callout 1), remove two screws (callout 2), and then remove the lifter motor (callout 3).

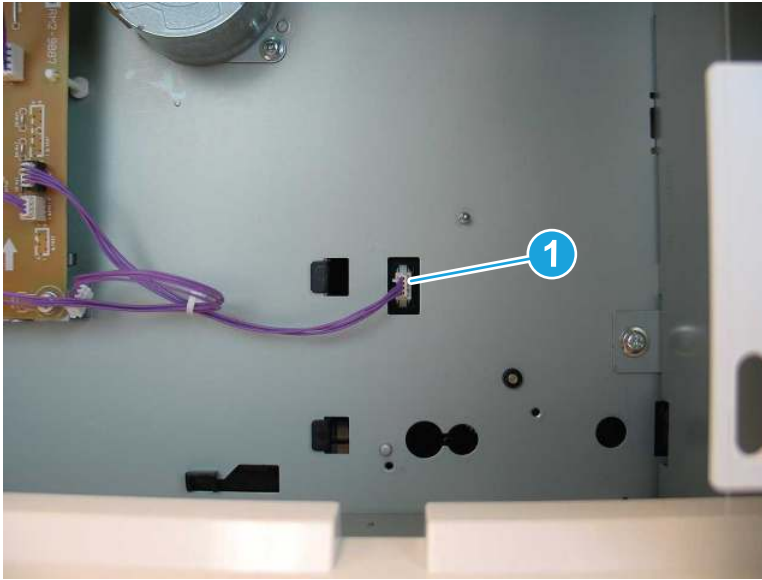
Figure 1-3573 Remove the left tray lifter drive motor



3. Remove the 2,700-sheet HCl paper tray and stand left tray lifter drive.

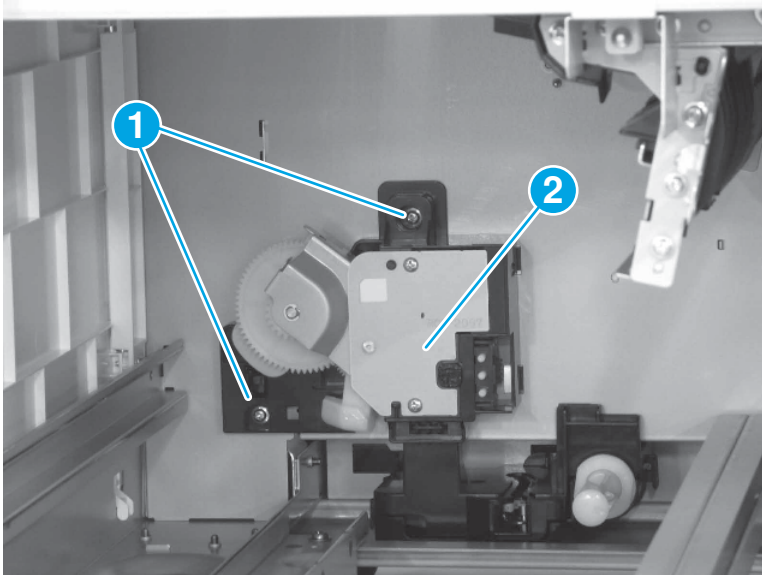
- a. Disconnect one connector (callout 1) on the back of the feeder.

Figure 1-3574 Disconnect one connector



- b. Remove two screws (callout 1), and then remove the lifter drive (callout 2).

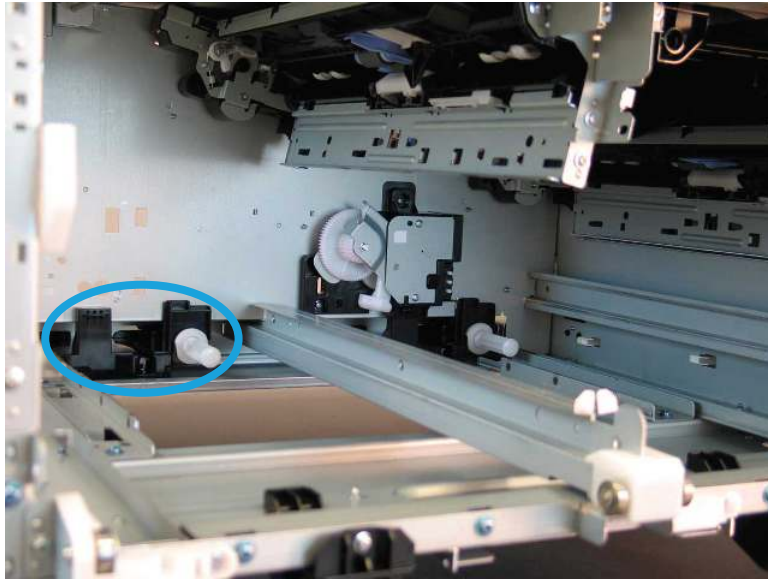
Figure 1-3575 Remove the lifter drive



4. Remove the 2,700-sheet HCI paper tray and stand left tray auto close assembly.

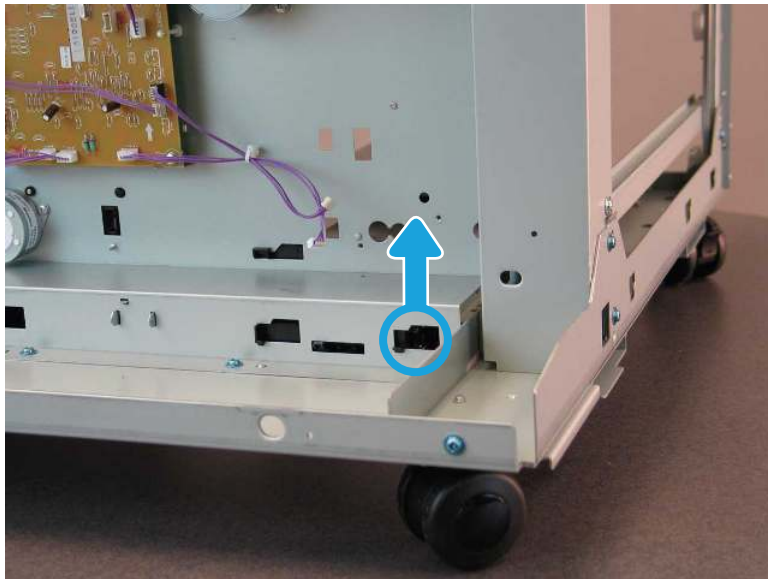
- a. Locate the left tray auto close assembly inside the tray opening.

Figure 1-3576 Locate the left tray auto close assembly



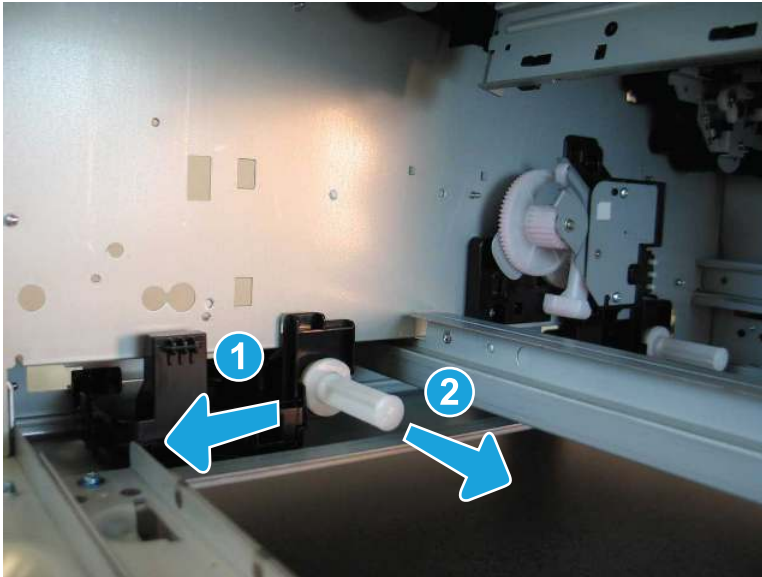
- b. On the back of the HCI, release one tab.

Figure 1-3577 Release one tab



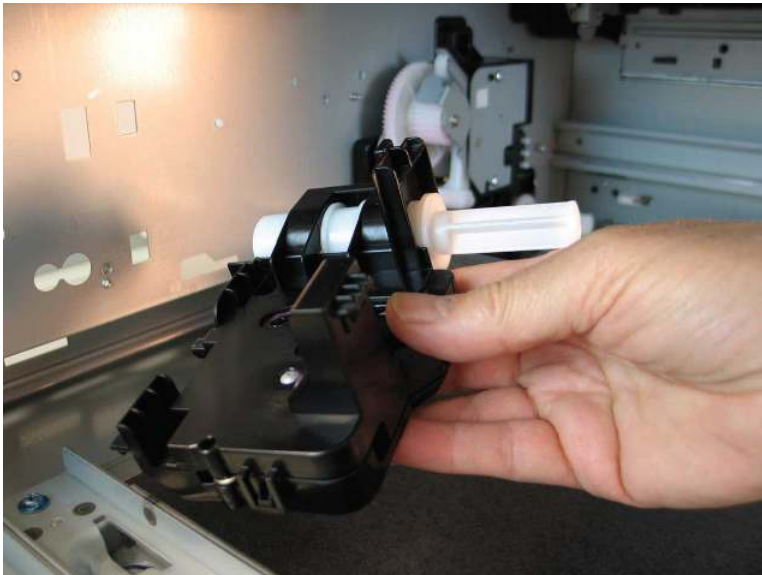
- c. Inside the tray opening, slide the auto close assembly to the left (callout 1), and then slide it toward the front of the HCI (callout 2).

Figure 1-3578 Slide the auto close assembly



- d. Remove the left tray auto close assembly.

Figure 1-3579 Remove the auto close assembly




5. Unpack the replacement assembly.
 - a. Dispose of the defective part.




NOTE: HP recommends responsible disposal of the defective part.

<http://www8.hp.com/us/en/hp-information/environment/product-recycling.html>

- b. Unpack the replacement part from the packaging.

 **IMPORTANT:** Make sure that all of the shipping materials (for example shipping tape) are removed from the replacement part prior to installation.

- c. To install an assembly, reverse the removal steps.

 **NOTE:** When applicable, special installation instructions are provided for an assembly at the end of the removal procedure. Always completely read the removal instructions and follow all special installation instructions.

Removal and replacement: 2,700-sheet HCl paper tray and stand right tray lifter motor

Learn how to remove and replace the 2,700-sheet HCl paper tray and stand right tray lifter motor.

[View a video of how to remove and replace the 2,700-sheet HCl paper tray and stand right tray lifter motor.](#)


Mean time to repair: 3 minutes

Service level: Easy

Before performing service

Turn the printer power off

- Disconnect the power cable.

 **WARNING!** To avoid damage to the printer, turn the printer off, wait 30 seconds, and then remove the power cord before attempting to service the printer.

Use the table below to identify the correct part number for your printer. To order the part, go to www.hp.com/buy/parts.

Table 1-194 Part information

Part number	Part description
RK2-7818-000CN	Motor, stepping, DC

Required tools

- #2 Phillips screwdriver with a magnetic tip

After performing service

Turn the printer power on

- Connect the power cable.
- Use the power switch to turn the power on.

Post service test

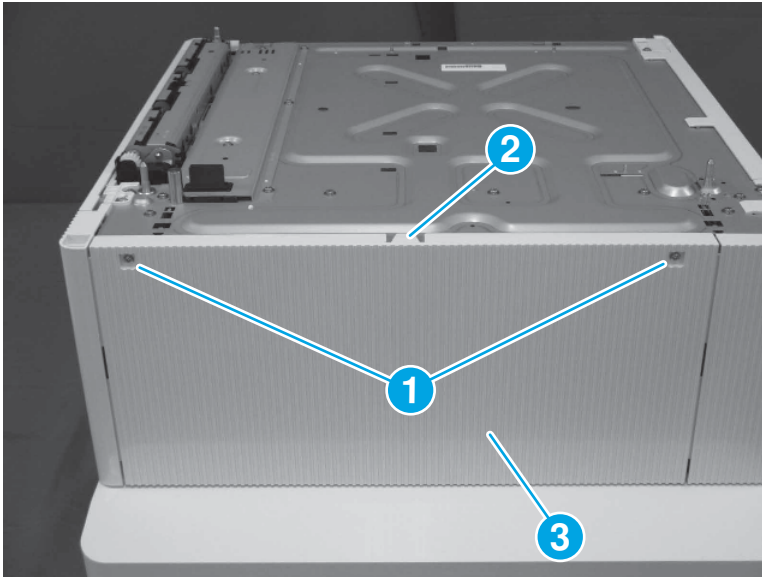
Make sure that the printer initializes to a **Ready** state.

Print a page from the 2,700-sheet HCl paper tray and stand to make sure that the printer is functioning correctly.

1. Remove the 2,700-sheet HCl paper tray and stand rear upper cover

- ▲ Remove two screws (callout 1), release one tab (callout 2), and then remove the rear upper cover (callout 3).

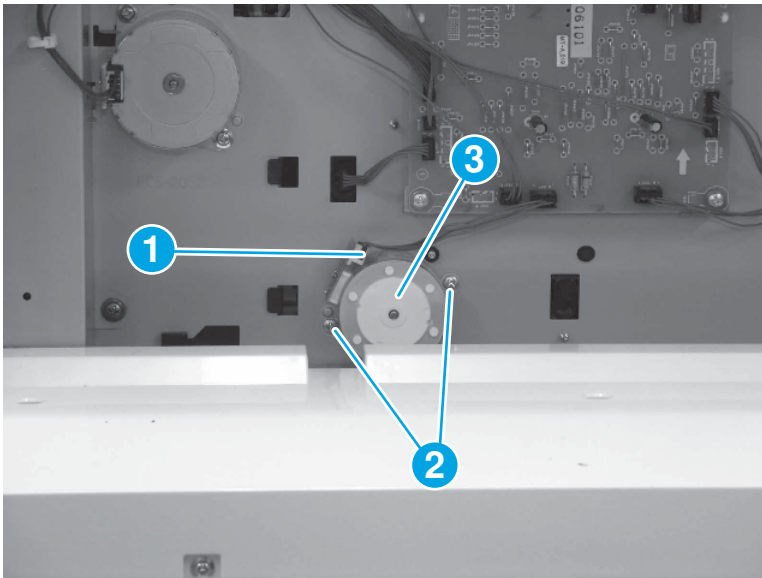
Figure 1-3580 Remove the rear upper cover



2. Remove the 2,700-sheet HCl paper tray and stand right tray lifter motor.

- ▲ Disconnect one connector (callout 1), remove two screws (callout 2), and then remove the lifter motor (callout 3).

Figure 1-3581 Remove the right tray lifter motor



3. Unpack the replacement assembly.



- a. Dispose of the defective part.




NOTE: HP recommends responsible disposal of the defective part.


<http://www8.hp.com/us/en/hp-information/environment/product-recycling.html>

- b. Unpack the replacement part from the packaging.

 **CAUTION:**  Some parts are sensitive to electrostatic discharge (ESD). Always perform service work at an ESD-protected workstation or mat. If an ESD workstation or mat is not available, touch the sheet-metal chassis to provide a static ground before touching an ESD-sensitive assembly. Protect the ESD-sensitive assemblies by placing them in ESD pouches when they are out of the printer.

 **IMPORTANT:** Make sure that all of the shipping materials (for example shipping tape) are removed from the replacement part prior to installation.

- c. To install an assembly, reverse the removal steps.

 **NOTE:** When applicable, special installation instructions are provided for an assembly at the end of the removal procedure. Always completely read the removal instructions and follow all special installation instructions.

Removal and replacement: 2,700-sheet HCl paper tray and stand right tray lifter drive

Learn how to remove and replace the 2,700-sheet HCl paper tray and stand right tray lifter drive.

[View a video of how to remove and replace the 2,700-sheet HCl paper tray and stand right tray lifter drive.](#)


Mean time to repair: 8 minutes

Service level: Easy

Before performing service

Turn the printer power off

- Disconnect the power cable.

 **WARNING!** To avoid damage to the printer, turn the printer off, wait 30 seconds, and then remove the power cord before attempting to service the printer.

Use the table below to identify the correct part number for your printer. To order the part, go to www.hp.com/buy/parts.

Table 1-195 Part information

Part number	Part description
RM2-1704-000CN	Lifter drive assembly

Required tools

- #2 Phillips screwdriver with a magnetic tip

After performing service

Turn the printer power on

- Connect the power cable.
- Use the power switch to turn the power on.

Post service test

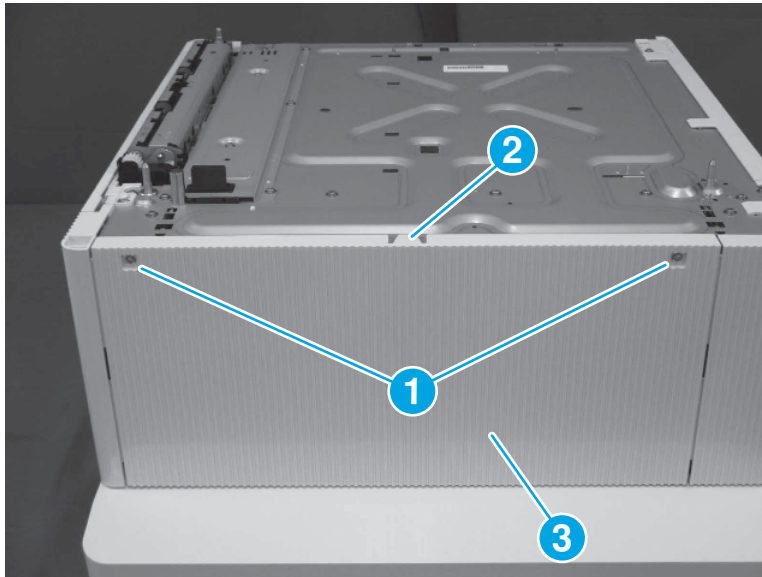
Make sure that the printer initializes to a **Ready** state.

Print a page from the 2,700-sheet HCl paper tray and stand to make sure that the printer is functioning correctly.

1. Remove the 2,700-sheet HCl paper tray and stand rear upper cover

- ▲ Remove two screws (callout 1), release one tab (callout 2), and then remove the rear upper cover (callout 3).

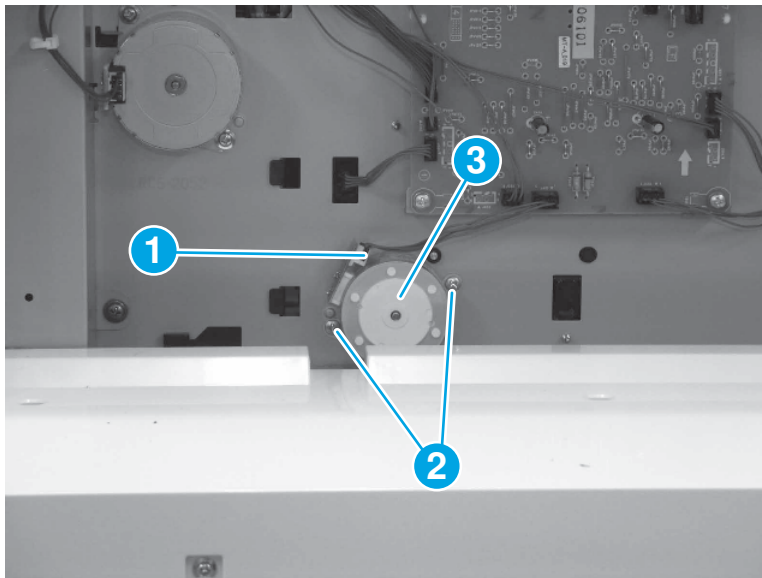
Figure 1-3582 Remove the rear upper cover



2. Remove the 2,700-sheet HCl paper tray and stand right tray lifter motor.

- ▲ Disconnect one connector (callout 1), remove two screws (callout 2), and then remove the lifter motor (callout 3).

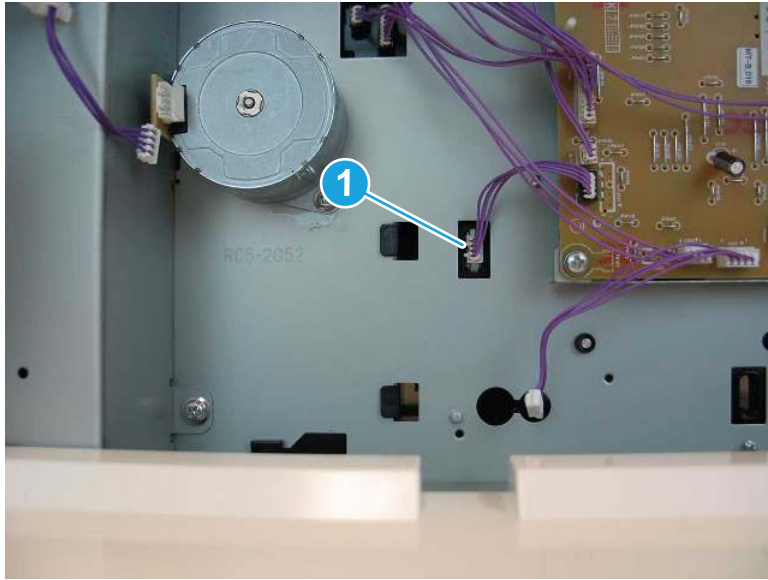
Figure 1-3583 Remove the right tray lifter motor



3. Remove the 2,700-sheet HCl paper tray and stand right tray lifter drive.

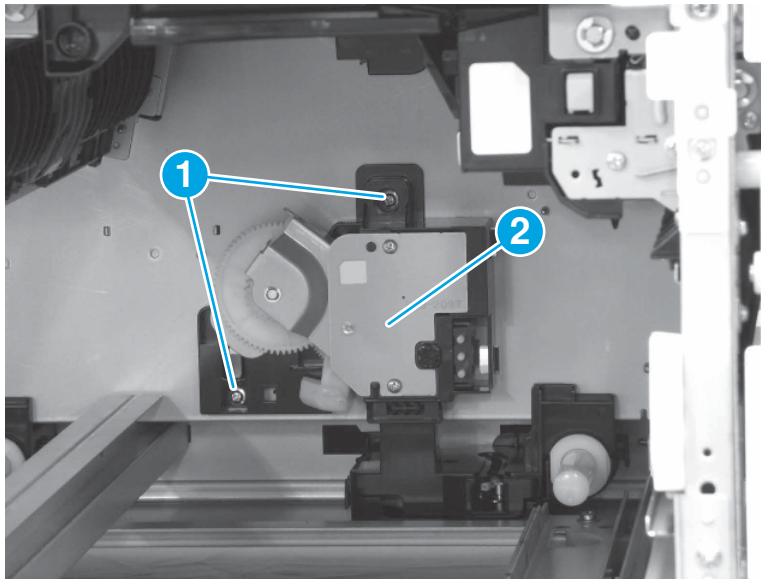
- a. Disconnect one connector (callout 1) on the back of the feeder.

Figure 1-3584 Disconnect one connector



- b. Remove two screws (callout 1), and then remove the lifter drive (callout 2).

Figure 1-3585 Remove the right tray lifter drive




4. Unpack the replacement assembly.
 - a. Dispose of the defective part.




NOTE: HP recommends responsible disposal of the defective part.

<http://www8.hp.com/us/en/hp-information/environment/product-recycling.html>

- b. Unpack the replacement part from the packaging.

 **IMPORTANT:** Make sure that all of the shipping materials (for example shipping tape) are removed from the replacement part prior to installation.

- c. To install an assembly, reverse the removal steps.

 **NOTE:** When applicable, special installation instructions are provided for an assembly at the end of the removal procedure. Always completely read the removal instructions and follow all special installation instructions.

Removal and replacement: 2,700-sheet HCl paper tray and stand right tray auto close assembly

Learn how to remove and replace the 2,700-sheet HCl paper tray and stand right tray auto close assembly.

[View a video of how to remove and replace the 2,700-sheet HCl paper tray and stand right tray auto close assembly.](#)


Mean time to repair: 8 minutes

Service level: Easy

Before performing service

Turn the printer power off

- Disconnect the power cable.

 **WARNING!** To avoid damage to the printer, turn the printer off, wait 30 seconds, and then remove the power cord before attempting to service the printer.

Use the table below to identify the correct part number for your printer. To order the part, go to www.hp.com/buy/parts.

Table 1-196 Part information

Part number	Part description
RM2-1734-000CN	Auto close assembly

Required tools

- #2 Phillips screwdriver with a magnetic tip

After performing service

Turn the printer power on

- Connect the power cable.
- Use the power switch to turn the power on.

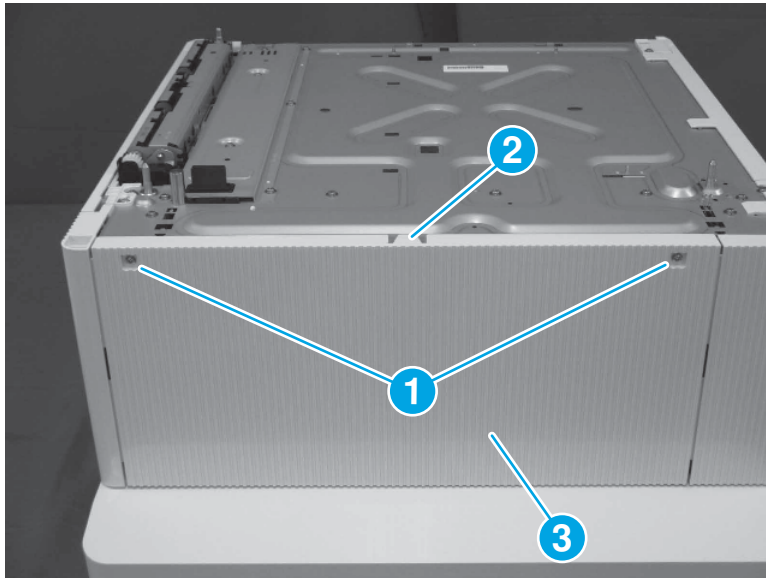
Post service test

Make sure that the printer initializes to a **Ready** state.

Print a page from the 2,700-sheet HCl paper tray and stand to make sure that the printer is functioning correctly.

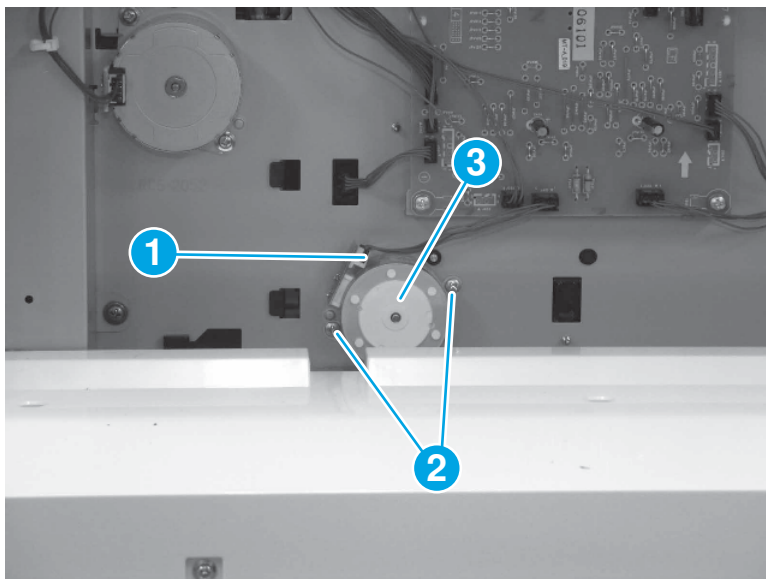
1. Remove the 2,700-sheet HCl paper tray and stand rear upper cover
 - ▲ Remove two screws (callout 1), release one tab (callout 2), and then remove the rear upper cover (callout 3).

Figure 1-3586 Remove the rear upper cover



2. Remove the 2,700-sheet HCl paper tray and stand right tray lifter motor.
 - ▲ Disconnect one connector (callout 1), remove two screws (callout 2), and then remove the lifter motor (callout 3).

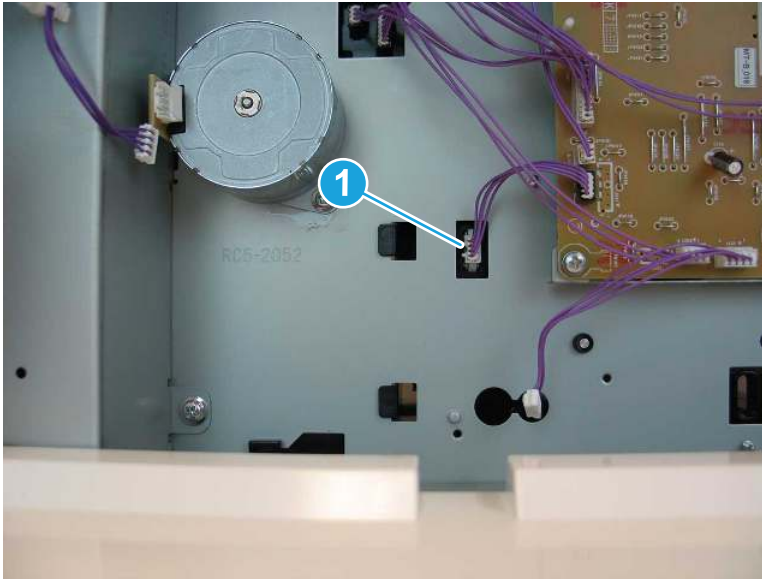
Figure 1-3587 Remove the right tray lifter motor



3. Remove the 2,700-sheet HCl paper tray and stand right tray lifter drive.

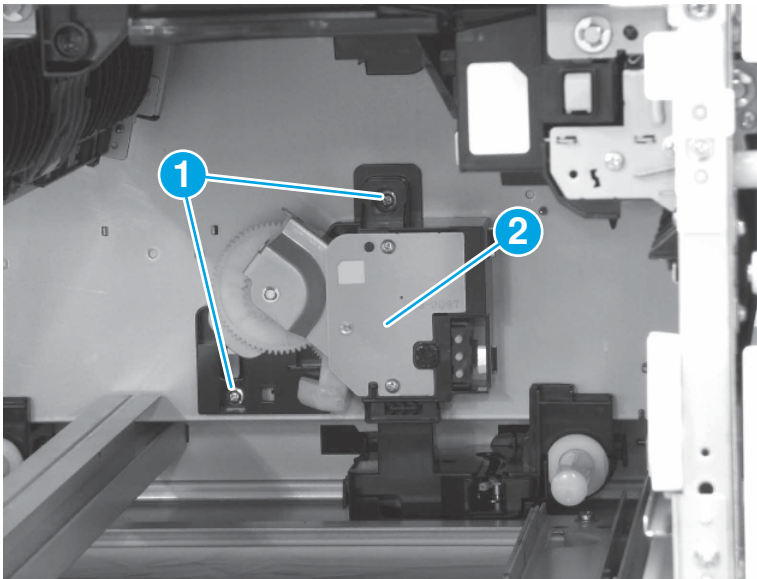
- a. Disconnect one connector (callout 1) on the back of the feeder.

Figure 1-3588 Disconnect one connector



- b. Remove two screws (callout 1), and then remove the lifter drive (callout 2).

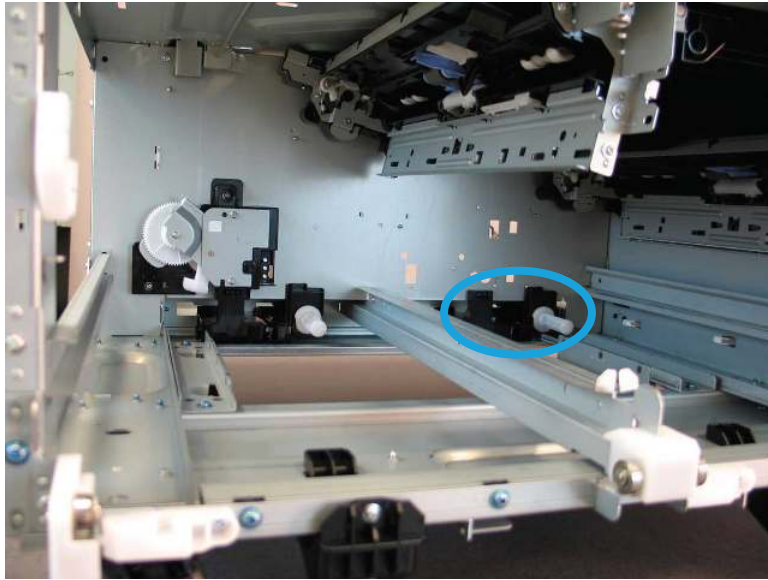
Figure 1-3589 Remove the right tray lifter drive



4. Remove the 2,700-sheet HCl paper tray and stand right tray auto close assembly.

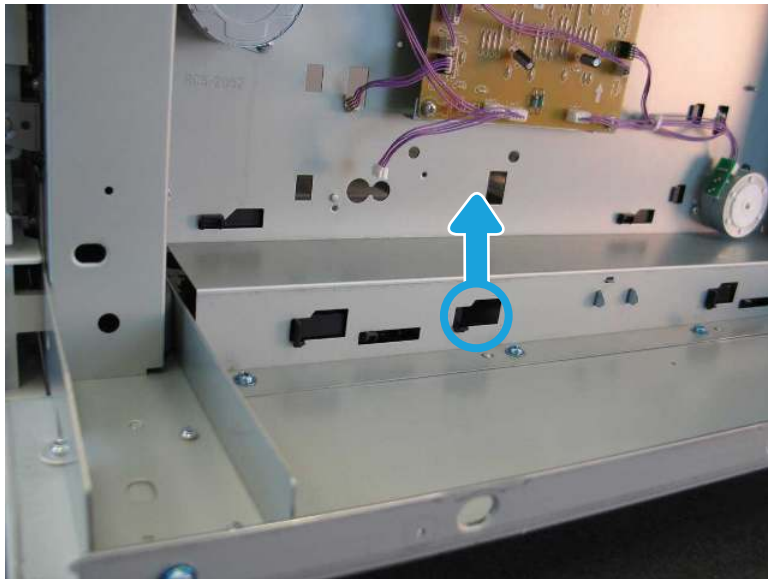
- a. Locate the right tray auto close assembly inside the tray opening.

Figure 1-3590 Locate the right tray auto close assembly



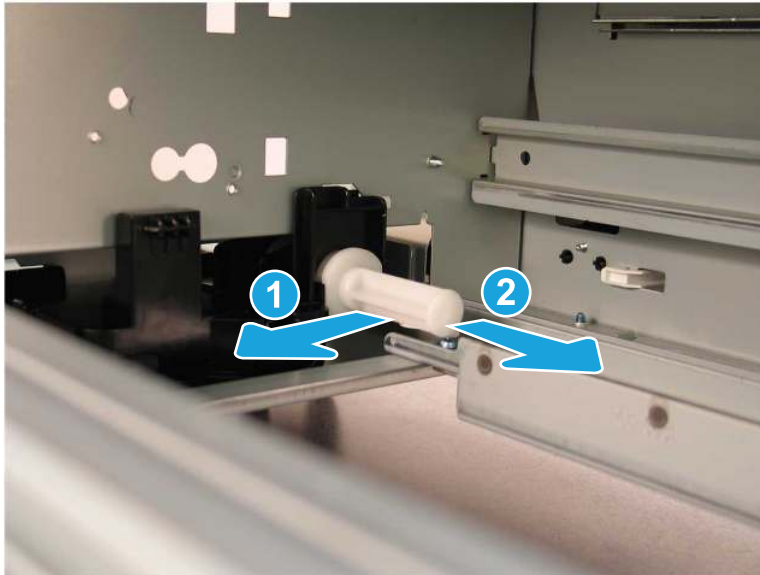
- b. On the back of the HCI, release one tab.

Figure 1-3591 Release one tab



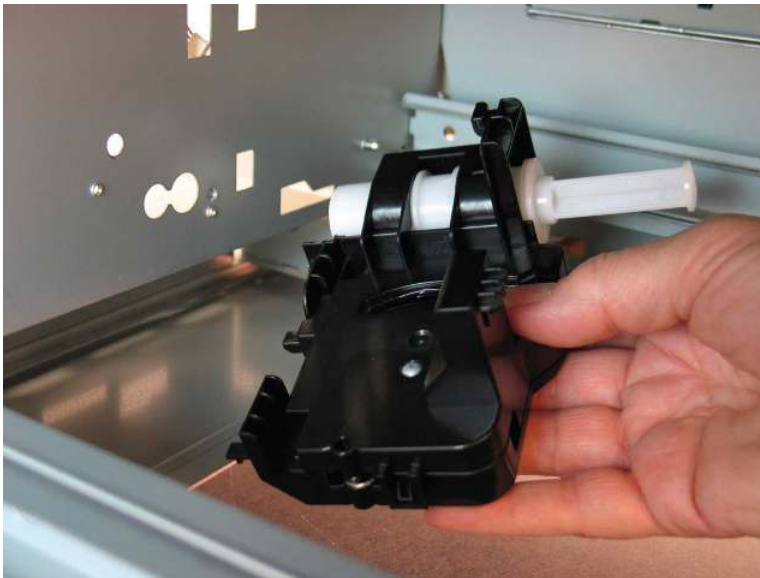
- c. Inside the tray opening, slide the auto close assembly to the left (callout 1), and then slide it toward the front of the HCI (callout 2).

Figure 1-3592 Slide the auto close assembly



- d. Remove the right tray auto close assembly.

Figure 1-3593 Remove the right tray auto close assembly




5. Unpack the replacement assembly.
 - a. Dispose of the defective part.




NOTE: HP recommends responsible disposal of the defective part.

<http://www8.hp.com/us/en/hp-information/environment/product-recycling.html>

- b. Unpack the replacement part from the packaging.

 **IMPORTANT:** Make sure that all of the shipping materials (for example shipping tape) are removed from the replacement part prior to installation.

- c. To install an assembly, reverse the removal steps.

 **NOTE:** When applicable, special installation instructions are provided for an assembly at the end of the removal procedure. Always completely read the removal instructions and follow all special installation instructions.

Removal and replacement: 2,700-sheet HCl paper tray and stand controller PCA

Learn how to remove and replace the 2,700-sheet HCl paper tray and stand controller PCA.

[View a video of how to remove and replace the 2,700-sheet HCl paper tray and stand controller PCA.](#)


Mean time to repair: 5 minutes

Service level: Easy

Before performing service

Turn the printer power off

- Disconnect the power cable.

 **WARNING!** To avoid damage to the printer, turn the printer off, wait 30 seconds, and then remove the power cord before attempting to service the printer.

Use the table below to identify the correct part number for your printer. To order the part, go to www.hp.com/buy/parts.

Table 1-197 Part information

Part number	Part description
RM2-9887-000CN	Paper deck controller PCB assembly

Required tools

- #2 Phillips screwdriver with a magnetic tip

After performing service

Turn the printer power on

- Connect the power cable.
- Use the power switch to turn the power on.

Post service test

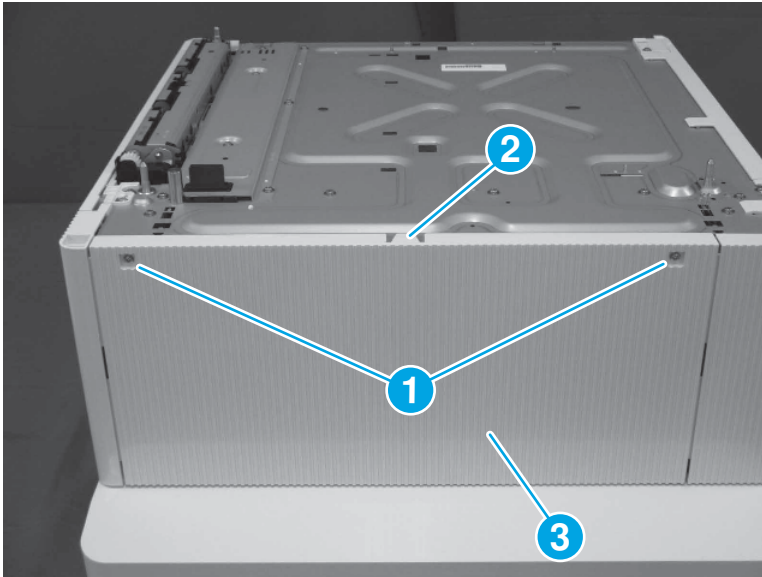
Make sure that the printer initializes to a **Ready** state.

Print a page from the 2,700-sheet HCl paper tray and stand to make sure that the printer is functioning correctly.

1. Remove the 2,700-sheet HCl paper tray and stand rear upper cover

- ▲ Remove two screws (callout 1), release one tab (callout 2), and then remove the rear upper cover (callout 3).

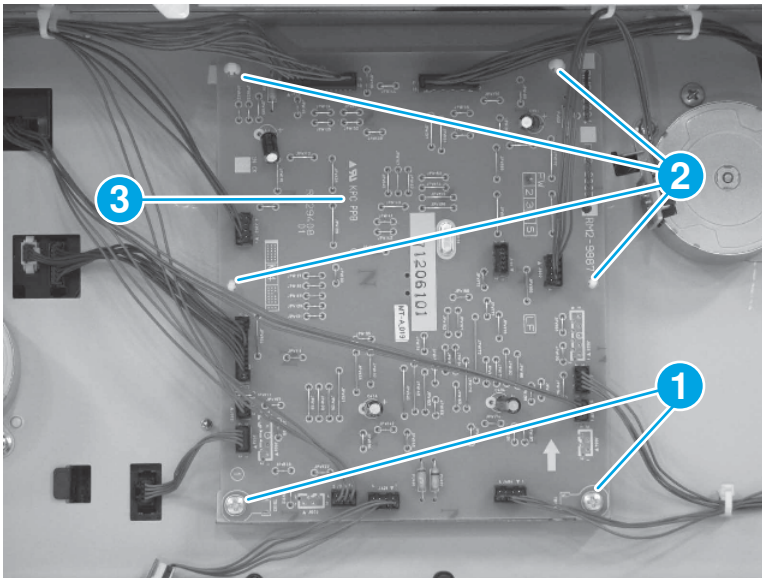
Figure 1-3594 Remove the rear upper cover



2. Remove the 2,700-sheet HCl paper tray and stand controller PCA.

- ▲ Disconnect all of the connectors on the PCA. Remove two screws (callout 1), release four tabs (callout 2), and then remove the PCA (callout 3).

Figure 1-3595 Remove the controller PCA



3. Unpack the replacement assembly.

- a. Dispose of the defective part.



NOTE: HP recommends responsible disposal of the defective part.

<http://www8.hp.com/us/en/hp-information/environment/product-recycling.html>

- b. Unpack the replacement part from the packaging.



CAUTION:



Some parts are sensitive to electrostatic discharge (ESD). Always perform service work at an ESD-protected workstation or mat. If an ESD workstation or mat is not available, touch the sheet-metal chassis to provide a static ground before touching an ESD-sensitive assembly. Protect the ESD-sensitive assemblies by placing them in ESD pouches when they are out of the printer.



IMPORTANT:

Make sure that all of the shipping materials (for example shipping tape) are removed from the replacement part prior to installation.

- c. To install an assembly, reverse the removal steps.



NOTE:

When applicable, special installation instructions are provided for an assembly at the end of the removal procedure. Always completely read the removal instructions and follow all special installation instructions.

2 Parts and diagrams

Printer parts information including exploded assembly diagrams and part number lists.

HP service and support

Learn about HP access to additional service and support information.

Additional service and support for channel partners

Channel partners go to partner.hp.com, and then use the steps below to access the HP Web-based Interactive Search Engine (WISE).

[View a video of how to use the HP Partner First Portal to access WISE.](#)

Access WISE for Channel partners

1. Select [Services & Support](#) (near the top of the screen).
2. Under [Services Delivery](#), select [Technical Support](#).
3. Select [Technical Documentation](#).

Find information about the following topics

- Service manuals
- Service advisories
- Up-to-date control panel message (CPMD) troubleshooting
- Solutions for printer issues and emerging issues
- Remove and replace part instructions and videos
- Install and configure
- Printer specifications
- Warranty and regulatory information

Additional service and support for HP internal personnel

HP internal personnel, go to one of the following Web-based Interactive Search Engine (WISE) sites:

[View a video of how to access WISE for internal HP users.](#)

Americas (AMS)

- [WISE - English](#)
- [WISE - Spanish](#)
- [WISE - Portuguese](#)
- [WISE - French](#)

Asia Pacific / Japan (APJ)

- [WISE - English](#)
- [WISE - Japanese](#)
- [WISE - Korean](#)
- [WISE - Chinese \(simplified\)](#)
- [WISE - Chinese \(traditional\)](#)
- [WISE - Thai](#)

Europe / Middle East / Africa (EMEA)

- [WISE - English](#)

Additional technical support WISE videos

The videos below provide additional ways to access printer information using WISE.

[View a video of how to use WISE to find technical support videos \(model number search\).](#)

[View a video of how to use WISE to find technical support videos \(Product detail page \[PDP\] search\).](#)

Order parts by authorized service providers

Find information about ordering parts and supplies for the printer.

Ordering

Order parts by authorized service providers.

Table 2-1 Ordering

Item or provider	Description
Order supplies and paper	www.hp.com/go/suresupply
Order parts from authorized service providers	www.hp.com/buy/parts or partsurfer.hp.com
Order through service or support providers	Contact an HP-authorized service or support provider.
Order using the HP Embedded Web Server (EWS)	To access, in a supported web browser on your computer, enter the printer IP address or host name in the address/URL field. The EWS contains a link to the HP SureSupply web site, which provides options for purchasing Original HP supplies.

Orderable parts

Not all of the parts shown in the exploded assembly diagrams are orderable parts.

Refer to the tables following the diagrams or the alphabetical/numerical parts lists to determine if a part is orderable.

Supplies and accessories

Following are the part numbers for the supplies and accessories that are available for the printers.

To order cartridges, visit <http://www.hp.com> (some portions of the HP Web site are available in English only). Ordering cartridges online is not supported in all countries/regions. However, many countries/regions have information about ordering by telephone, locating a local store, and printing a shopping list. In addition, go to hp.com/supplies to obtain information about purchasing HP products in your country/region.

Use only the replacement cartridges that have the same cartridge number as the cartridge that is being replaced. Find the cartridge number in the following places:

- On the label of the cartridge that is being replaced.
- On a sticker inside the printer. Open the cartridge door to locate the sticker.
- Open the printer software (**HP Printer Assistant**), and then click **Shop > Shop For Supplies Online**.
- Open the HP Embedded Web Server (EWS), and then click **Tools > Supply Status** (under the **Product Information** item).

Table 2-2 Supplies part numbers (M751)

Item	Description	Cartridge number	Part number
HP 660A Original LaserJet Imaging Drum	Replacement imaging drum	660A	W2004A (service: W2004-67901)
HP 658A Black Original LaserJet Toner Cartridge	Standard-yield replacement black toner cartridge	658A	W2000A (service: W2000-67901)
HP 658A Cyan Original LaserJet Toner Cartridge	Standard-yield replacement cyan toner cartridge	658A	W2001A (service: W2001-67901)
HP 658A Yellow Original LaserJet Toner Cartridge	Standard-yield replacement yellow toner cartridge	658A	W2002A (service: W2002-67901)
HP 658A Magenta Original LaserJet Toner Cartridge	Standard-yield replacement magenta toner cartridge	658A	W2003A (service: W2003-67901)
HP 658X High Yield Black Original LaserJet Toner Cartridge	High-yield replacement black toner cartridge	658X	W2000X (service: W2000-67902)
HP 658X High Yield Cyan Original LaserJet Toner Cartridge	High-yield replacement cyan toner cartridge	658X	W2001X (service: W2001-67902)
HP 658X High Yield Yellow Original LaserJet Toner Cartridge	High-yield replacement yellow toner cartridge	658X	W2002X (service: W2002-67902)
HP 658X High Yield Magenta Original LaserJet Toner Cartridge	High-yield replacement magenta toner cartridge	658X	W2003X (service: W2003-67902)

Table 2-3 Supplies part numbers (E75245)

Item	Description	Cartridge number	Part number
HP 660A Original LaserJet Imaging Drum	Replacement imaging drum	660A	W2004A (service: W2004-67901)
HP Black Managed LaserJet Toner Cartridge	Managed replacement black toner cartridge	N/A	W9020MC (service: W9020-67901)
HP Cyan Managed LaserJet Toner Cartridge	Managed replacement cyan toner cartridge	N/A	W9021MC (service: W9021-67901)
HP Yellow Managed LaserJet Toner Cartridge	Managed replacement yellow toner cartridge	N/A	W9022MC (service: W9022-67901)

Table 2-3 Supplies part numbers (E75245) (continued)

Item	Description	Cartridge number	Part number
HP Magenta Managed LaserJet Toner Cartridge	Managed replacement magenta toner cartridge	N/A	W9023MC (service: W9023-67901)

Table 2-4 Supplies part numbers (M856/M776)

Item	Description	Cartridge number	Part number
HP 660A Original LaserJet Imaging Drum	Replacement imaging drum	660A	W2004A (service: W2004-67901)
HP 659A Black Original LaserJet Toner Cartridge	Standard-yield replacement black toner cartridge	659A	W2000A (service: 5851-7901)
HP 659A Cyan Original LaserJet Toner Cartridge	Standard-yield replacement cyan toner cartridge	659A	W2001A (service: 5851-7902)
HP 659A Yellow Original LaserJet Toner Cartridge	Standard-yield replacement yellow toner cartridge	659A	W2002A (service: 5851-7903)
HP 659A Magenta Original LaserJet Toner Cartridge	Standard-yield replacement magenta toner cartridge	659A	W2003A (service: 5851-7904)
HP 659X High Yield Black Original LaserJet Toner Cartridge	High-yield replacement black toner cartridge	659X	W2000X (service: 5851-7905)
HP 659X High Yield Cyan Original LaserJet Toner Cartridge	High-yield replacement cyan toner cartridge	659X	W2001X (service: 5851-7906)
HP 659X High Yield Yellow Original LaserJet Toner Cartridge	High-yield replacement yellow toner cartridge	659X	W2002X (service: 5851-7907)
HP 659X High Yield Magenta Original LaserJet Toner Cartridge	High-yield replacement magenta toner cartridge	659X	W2003X (service: 5851-7908)

Table 2-5 Supplies part numbers (E85055)

Item	Description	Cartridge number	Part number
HP 660A Original LaserJet Imaging Drum	Replacement imaging drum	660A	W2004A (service: W2004-67901)
HP Black Managed LaserJet Toner Cartridge	Managed replacement black toner cartridge	N/A	W9020MC (service: 5851-7897)
HP Cyan Managed LaserJet Toner Cartridge	Managed replacement cyan toner cartridge	N/A	W9021MC (service: 5851-7898)
HP Yellow Managed LaserJet Toner Cartridge	Managed replacement yellow toner cartridge	N/A	W9022MC (service: 5851-7899)
HP Magenta Managed LaserJet Toner Cartridge	Managed replacement magenta toner cartridge	N/A	W9023MC (service: 5851-7900)

Table 2-6 Accessories

Item	Description	Part number
HP LaserJet 550-sheet Paper Tray	Optional 550-sheet paper tray NOTE: The printer supports up to two 550-sheet paper trays.	T3V27A (service: T3V27-67901)
HP LaserJet 2 x 550-sheet Paper Tray and Stand	Optional 2 x 550-sheet paper tray and stand to support the printer	T3V29A (service: T3V29-67901)
HP LaserJet 2,700-sheet HCI Paper Tray and Stand	Optional 2,700-sheet paper tray and stand to support the printer	T3V30A (service: T3V30-67901)
HP LaserJet Stand	Optional stand	T3V28A (service: T3V28-67901)
HP Jetdirect 2900nw Print Server	USB wireless print server accessory	J8031A (service: J8031-61001)
HP Jetdirect 3100w BLE/NFC/Wireless Accessory	Wi-Fi direct accessory for "touch" and Bluetooth printing from mobile devices	3JN69A (service: 3JN69-61001)
HP Internal USB Ports	Two optional USB ports for connecting third-party devices	B5L28A (service: B5L28-67902)
HP SmartCard NIPERNet Solution NOTE: Requires the B5L28A - HP Internal USB Ports accessory	HP SmartCard U.S. Government NIPRNet Solution for CAC and PIV tokens. Takes advantage of U.S. Government smartcard technology.	CC543B (service: CC543-69011)
HP SmartCard SIPERNet Solution NOTE: Requires the B5L28A - HP Internal USB Ports accessory	HP Smartcard U.S. Government SIPRNet Solution for SIPRNet tokens. Takes advantage of U.S. Government smartcard technology.	F8B30A (service: F8B30-69001)
HP Foreign Interface Harness	Optional port accessory for connecting third-party devices.	B5L31A (service: B5L31-67902)
Hard disk drive, 500GB 5400RPM SED	Optional hard disk drive.	L41606-011
Hard disk drive, 500GB 5400RPM FIPS/CCC OPAL2 7MM	Optional hard disk drive.	L42243-021
Hard disk drive, 500GB FIPS/CCC/TAA OPAL2 7MM	Optional hard disk drive.	L42244-031
HP 1GB DDR3 x32 144-Pin 800MHz SODIMM	Optional 1GB DIMM for expanding the memory	E5K48A (service: E5K48-67902)
HP 2GB DDR3 x32 144-Pin 800MHz SODIMM	Optional 2GB DIMM for expanding the memory	E5K49A (service: 5851-6581)

Customer self-repair kits

Following are the available customer self-repair kits part numbers.

Customer Self-Repair (CSR) parts are available for many HP LaserJet printers to reduce repair time. More information about the CSR program and benefits can be found at www.hp.com/go/csr-support and www.hp.com/go/csr-faq.

Genuine HP replacement parts can be ordered at www.hp.com/buy/parts or by contacting an HP-authorized service or support provider. When ordering, one of the following will be needed: part number, serial number (found on back of printer), printer number, or printer name.

- Parts listed as **A**: Easy
- Parts listed as **B**: Difficult and/or requires tools

Table 2-7 Customer self-repair kits

Kit	Description	CSR level	Part number
Control panel (M751/E75245)	Control panel and screwdriver	A	RM2-1267-010CN
Control panel (M856/E85055)	Control panel and screwdriver	A	K0Q15-67901
Control panel (M776)	Control panel and screwdriver	A	J7Z09-67928
HP 1GB DDR3 x32 144-pin 800MHz SODIMM	Optional DIMM for expanding the memory	A	E5K48-67902
HP 2GB DDR3 x32 144-pin 800MHz SODIMM	Optional DIMM for expanding the memory	A	5851-6581
Hard disk drive 500GB 5400RPM SED (Secure Encrypted Drive)	Replacement hard disk drive SED (Secure Encrypted Drive)	A	L41606-011
Hard disk drive 500GB 5400RPM FIPS/CCC OPAL2 7MM (higher level of security than SED)	Replacement hard disk drive (higher level of security than SED)	A	L42243-021
Hard disk drive 500GB FIPS/CCC/TAA OPAL2 7MM (for use in US government contracts)	Replacement hard disk drive (for use in US government contracts)	A	L42244-031
Tray 1 rollers	Replacement pickup and separation rollers for Tray 1	A	RM2-1525-000CN
Tray 2-x rollers	Replacement pickup and separation rollers for Trays 2-x	A	RM2-1526-000CN
Fuser	Replacement fuser	A	3WT87-67901 (M751/E75245; 110V) 3WT88-67901 (M751/E75245; 220V) 4YL16-67901 (M856/E85055/M776; 110V) 4YL17-67901 (M856/E85055/M776; 220V)
Intermediate transfer belt (ITB)	Replacement ITB	A	RM2-1504-000CN
Toner collection unit (TCU)	Replacement TCU	A	3WT90-67901
Secondary transfer roller	Replacement secondary transfer roller	A	RM2-1399-000CN

HP service and support

Learn about HP access to additional service and support information.

Additional service and support for channel partners

Channel partners go to partner.hp.com, and then use the steps below to access the HP Web-based Interactive Search Engine (WISE).

[View a video of how to use the HP Partner First Portal to access WISE.](#)

Access WISE for Channel partners

1. Select [Services & Support](#) (near the top of the screen).

2. Under *Services Delivery*, select *Technical Support*.
3. Select *Technical Documentation*.

Find information about the following topics

- Service manuals
- Service advisories
- Up-to-date control panel message (CPMD) troubleshooting
- Solutions for printer issues and emerging issues
- Remove and replace part instructions and videos
- Install and configure
- Printer specifications
- Warranty and regulatory information

Additional service and support for HP internal personnel

HP internal personnel, go to one of the following Web-based Interactive Search Engine (WISE) sites:

[View a video of how to access WISE for internal HP users.](#)

Americas (AMS)

- [WISE - English](#)
- [WISE - Spanish](#)
- [WISE - Portuguese](#)
- [WISE - French](#)

Asia Pacific / Japan (APJ)

- [WISE - English](#)
- [WISE - Japanese](#)
- [WISE - Korean](#)
- [WISE - Chinese \(simplified\)](#)
- [WISE - Chinese \(traditional\)](#)
- [WISE - Thai](#)

Europe / Middle East / Africa (EMEA)

- [WISE - English](#)

Additional technical support WISE videos

The videos below provide additional ways to access printer information using WISE.

[View a video of how to use WISE to find technical support videos \(model number search\).](#)

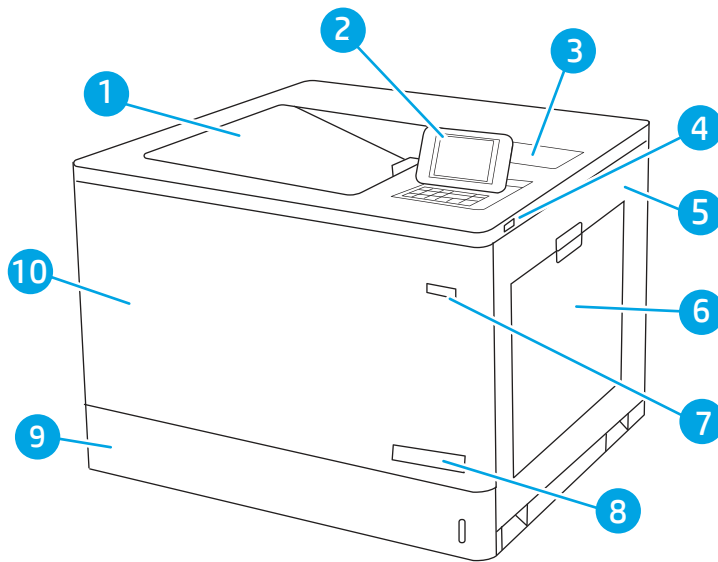
[View a video of how to use WISE to find technical support videos \(Product detail page \[PDP\] search\).](#)

Assembly locations

Learn about major printer assembly locations.

Printer front view (M751/E75245)

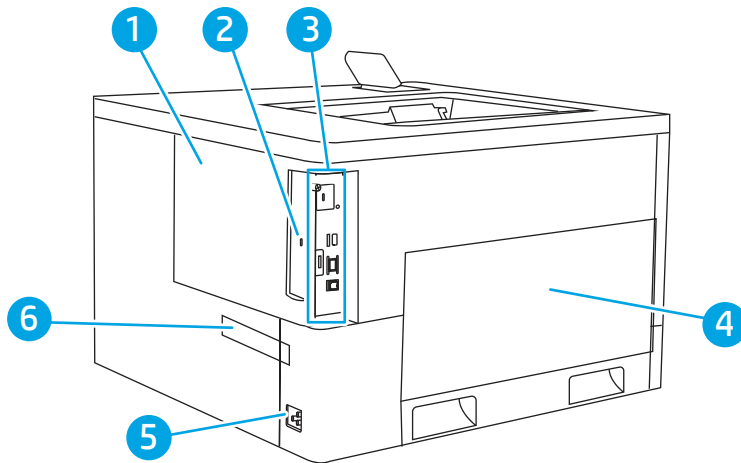
Locate features on the front of the printer (M751/E75245).



Callout	Description
1	Output bin
2	Control panel with color graphical display and keypad
3	Hardware integration pocket for connecting accessory and third-party devices
4	Easy-access USB port Insert a USB flash drive for printing without a computer or to update the printer firmware. NOTE: An administrator must enable this port before use.
5	Right door (access to the fuser and to clear jams)
6	Tray 1
7	On/off button
8	Model name
9	Tray 2
10	Front door (access to the toner cartridges and imaging drums)

Printer back view (M751/E75245)

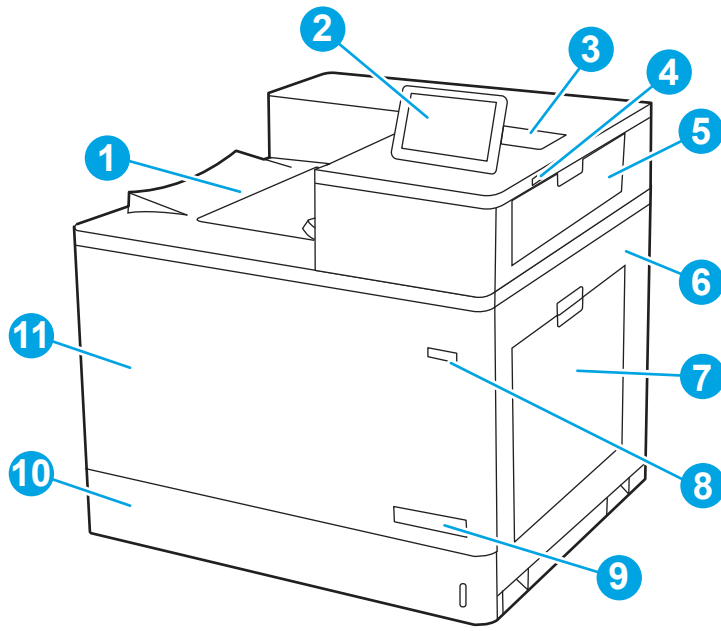
Locate features on the back of the printer (M751/E75245).



Callout	Description
1	Formatter cover
2	Slot for a cable-type security lock
3	Formatter (contains the interface ports)
4	Left door (access to the toner-collection unit)
	NOTE: The front door must be used in order to access the toner-collection unit.
5	Power connection
6	Serial number and product number label

Printer front view (M856/E85055)

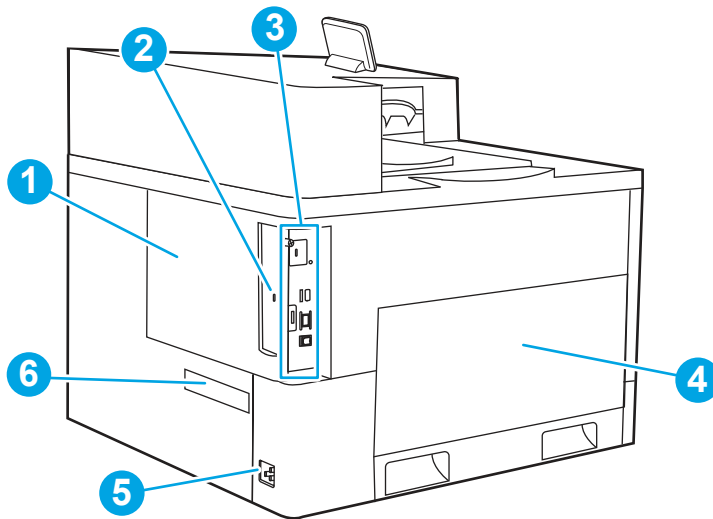
Locate features on the front of the printer (M856/E85055).



Number	Description
1	Output bin
2	Control panel
3	Hardware integration pocket for connecting accessory and third-party devices
4	Easy-access USB port Insert a USB flash drive for printing without a computer or to update the printer firmware. NOTE: An administrator must enable this port before use.
5	Upper-right door (access to clear jams)
6	Right door (access to the fuser and to clear jams)
7	Tray 1
8	On/off button
9	Model name
10	Tray 2
11	Front door (access to the toner cartridges, imaging drums, and waste toner collection unit)

Printer back view (M856/E85055)

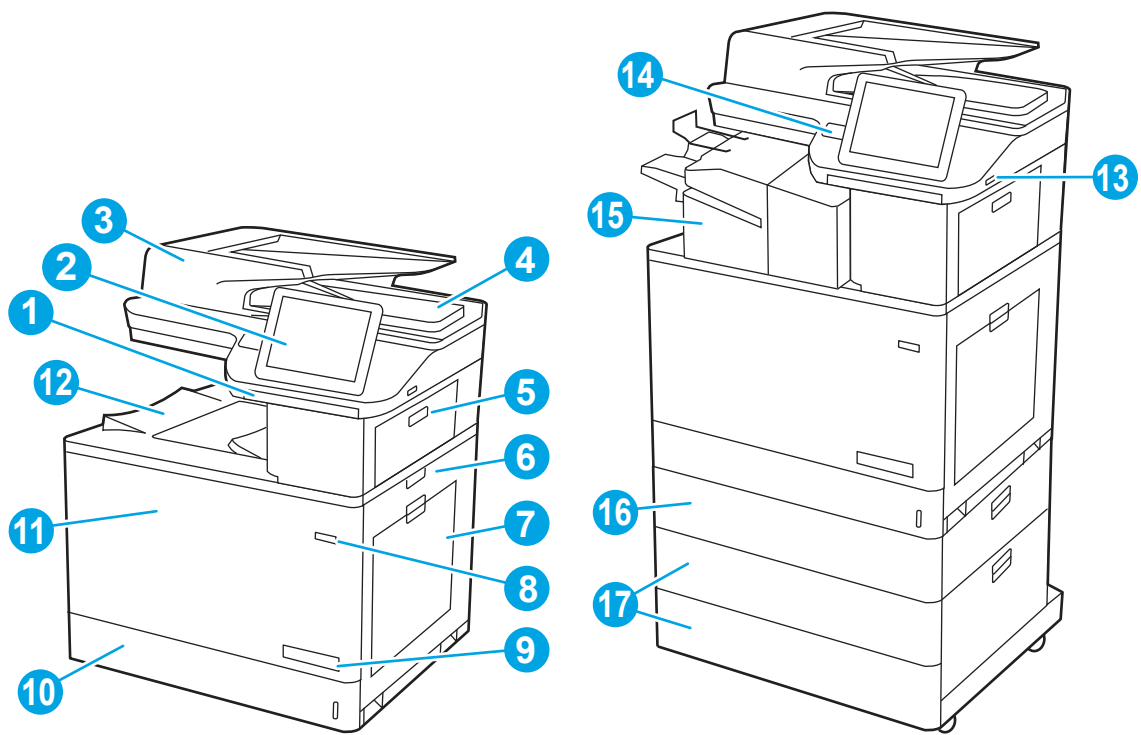
Locate features on the back of the printer (M856/E85055).



Number	Description
1	Formatter cover
2	Slot for a cable-type security lock
3	Formatter (contains the interface ports)
4	Left door (access to the toner-collection unit)
	NOTE: The front door also must be open in order to access the toner-collection unit.
5	Power connection
6	Serial number and product number label

Printer front view (M776)

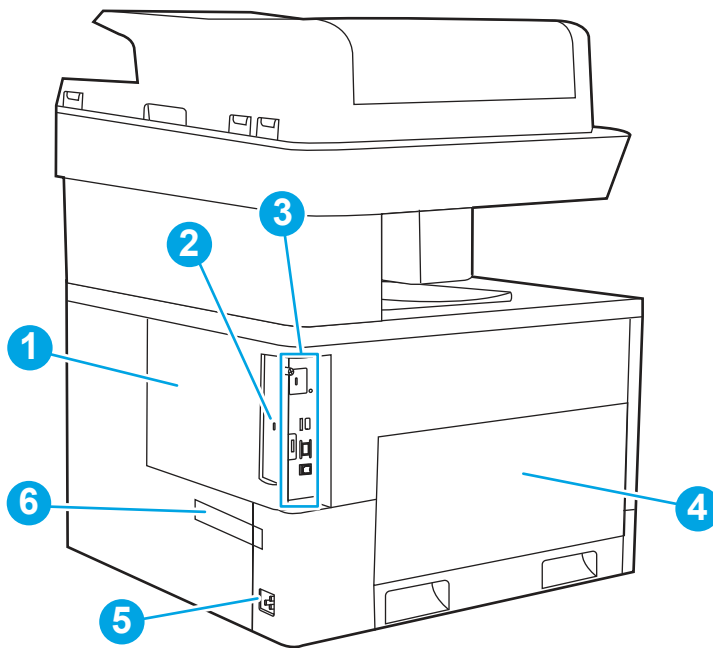
Locate features on the front of the printer (M776).



Number	Description
1	Retractable keyboard (Flow models)
2	Control panel
3	Document feeder cover
4	Document feeder output bin
5	Upper-right door (access to clear jams)
6	Right door (access to the fuser and to clear jams)
7	Tray 1
8	On/off button
9	Model name
10	Tray 2
11	Front door (access to the toner cartridges, imaging drums, and waste toner collection unit)
12	Output bin
13	Easy-access USB port Insert a USB flash drive for printing without a computer or to update the printer firmware. NOTE: An administrator must enable this port before use.
14	Hardware integration pocket for connecting accessory and third-party devices
15	Inline finisher (zs model only)
16	1 x 550 paper tray (included with the zs model; optional accessory for other models)
17	2 x 550 paper tray (included with the zs model; optional accessory for other models)

Printer back view (M776)

Locate features on the back of the printer (M776).




Number	Description
1	Formatter cover
2	Slot for a cable-type security lock
3	Formatter (contains the interface ports)
4	Left door (access to the toner-collection unit)
	NOTE: The front door also must be opened in order to access the toner-collection unit.
5	Power connection
6	Serial number and product number label

How to use the parts lists and diagrams

Learn how to use the parts lists and diagrams.

The figures in this chapter show the major sub-assemblies in the printer and their component parts. A parts list table follows each exploded view assembly diagram. The table lists the item number, the associated part number, and the description of each part. If a part is not listed in the table, then it is not a field replacement unit (FRU).

 **NOTE:** The abbreviation “PCA” stands for “printed circuit-board assembly.” Components described as a PCA might consist of a single circuit board or a circuit board plus other parts, such as cables and sensors.

Parts and diagrams: Document feeder and image scanner (M776)

Parts diagram and parts list for the internal printer assemblies.

Figure 2-1 Document feeder and image scanner (M776)

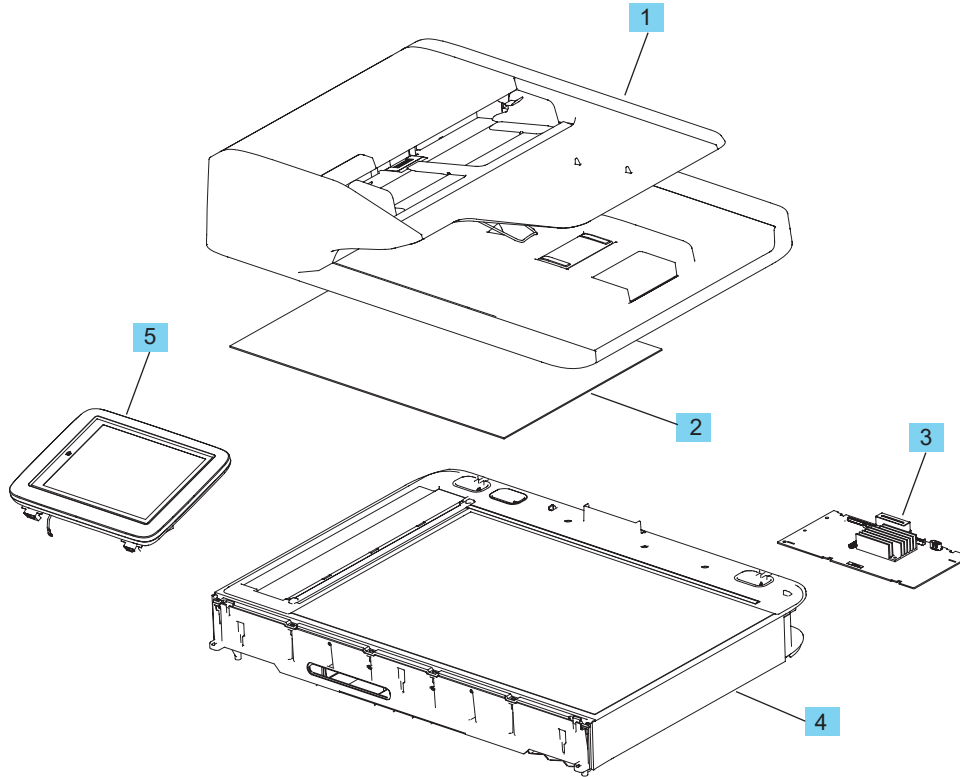


Table 2-8 Document feeder and image scanner (M776)

Ref	Part number	Description	Qty
1	5851-7930	ADF whole unit enterprise	1
1	5851-7931	ADF whole unit work flow	1
2	J7Z09-67926	White backing A3 kit	1
3	5851-7916	SCB enterprise	1
3	5851-7917	SCB work flow	1
4	5851-7915	Image scanner whole unit	1
5	J7Z09-67928	Control panel (M776)	1
Not shown	5851-7202	Document feeder roller kit	1
Not shown	J7Z09-67927	White backing retention clip kit	1
Not shown	J7Z09-67931	ADF hinges kit	1

Parts and diagrams: Discrete cables (M776)

Parts diagram and parts list for the discrete cables.

Figure 2-2 Discrete cables (M776)

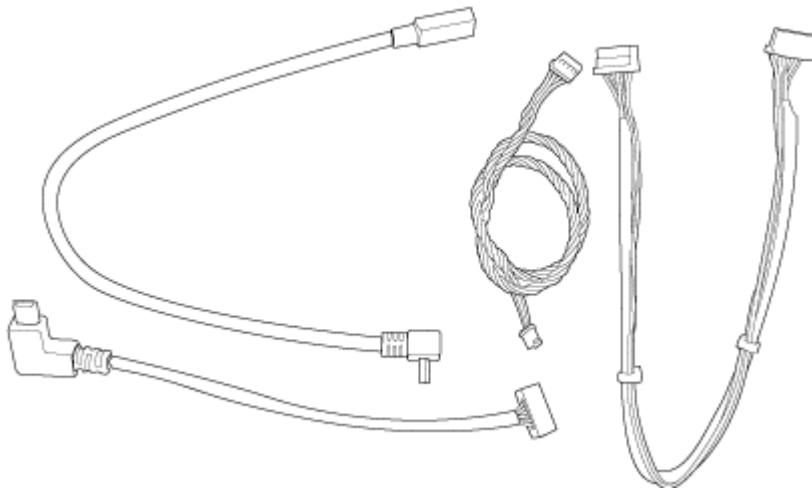


Table 2-9 Discrete cables (M776)

Ref No	Part number	Description	Qty
Not shown	5851-7918	Cable, HDMI control panel	1
Not shown	5851-7919	Cable, CP discrete power	1
Not shown	5851-7920	Cable, USB HIP2	1
Not shown	5851-7921	Cable, walk-up USB	1
Not shown	5851-7922	Cable, HDMI CP in-cave	1
Not shown	5851-7923	Cable, CP discrete power in-cave	1
Not shown	5851-7924	Cable, USB HIP2 in-cave	1
Not shown	5851-7925	Cable, walk-up USB in-cave	1
Not shown	5851-7926	HDMI engine to SCB in-cave	1
Not shown	5851-7927	HDMI engine to SCB base	1
Not shown	5851-7928	Power engine to SCB in-ave	1
Not shown	5851-7929	Power engine to SCB base	1

Parts and diagrams: Printer components

View parts diagrams and parts lists for printer components.

Parts and diagrams: Printer components (M751/E75245)

View parts diagrams and parts lists for the M751/E75245 printer components.

Parts and diagrams: Printer covers (M751/E75245)

Parts diagram and parts list for the printer covers (M751/E75245).

Figure 2-3 Printer covers (M751/E75245)

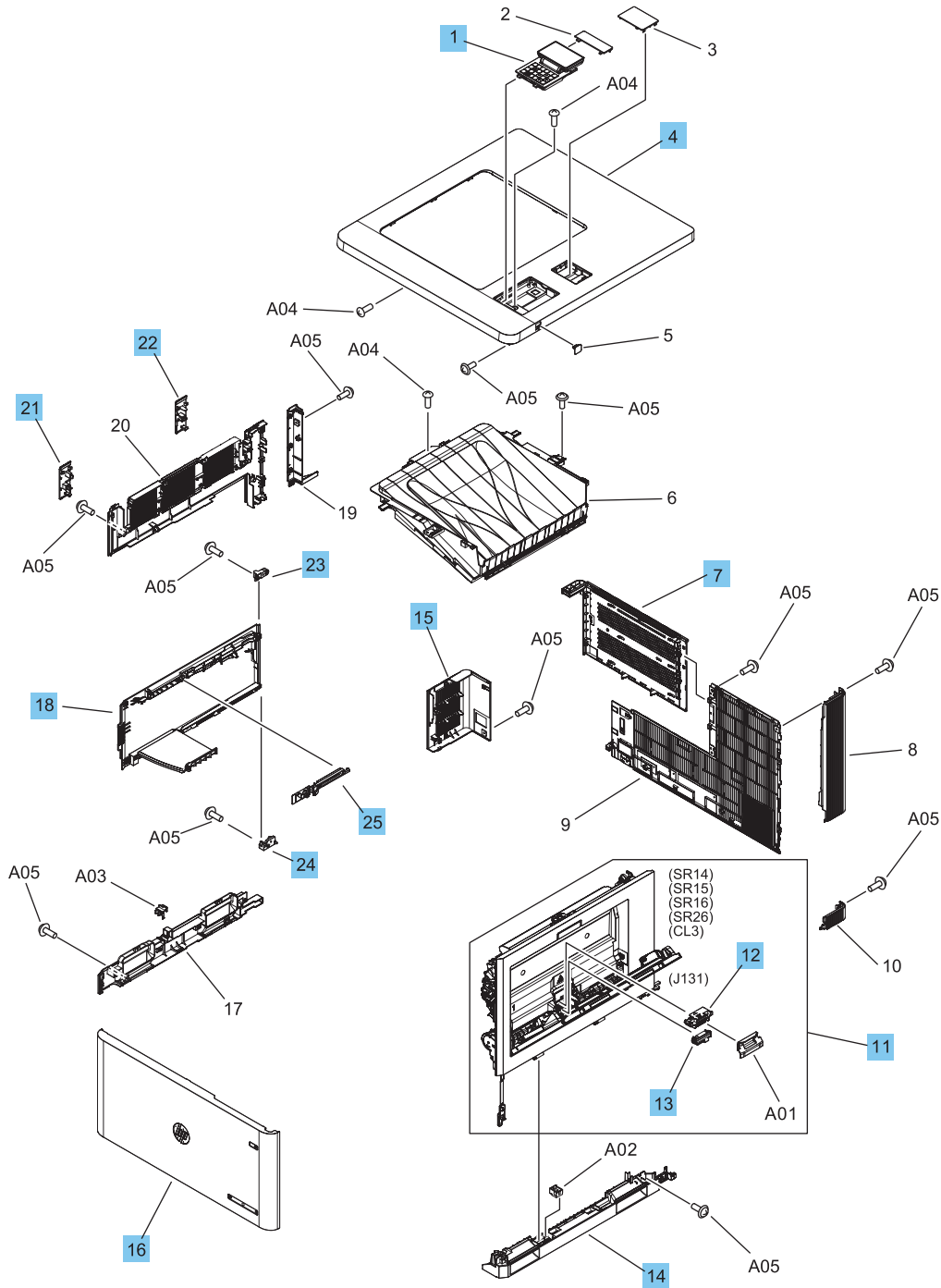


Table 2-10 Printer covers (M751/E75245)

Ref	Part number	Description	Qty
1	RM2-1267-010CN	Control panel (M751/E75245)	1
4	RC5-0658-000CN	Cover, upper	1
7	RM2-1346-000CN	Formatter cover assembly	1
11	RM2-1494-000CN	Right door assembly	1
12	RM2-1525-000CN	Tray 1 pickup roller	1
13	RM2-1525-000CN	Tray 1 separation roller	1
14	RM2-1376-000CN	Right handle assembly	1
15	RC5-1804-000CN	Cover, left rear	1
16	RM2-1368-000CN	Front door assembly	1
18	RM2-1351-000CN	Left door assembly	1
21	RC5-1805-000CN	Cover, left upper, F	1
22	RC5-1806-000CN	Cover, left upper, R	1
23	RC5-0770-000CN	Hinge, left door, upper	1
24	RC5-0801-000CN	Hinge, cover, left	1
25	RM2-1350-000CN	Left cover lock assembly	1

Parts and diagrams: Printer internal assemblies (M751/E75245; 1 of 7)

Parts diagram and parts list for the internal printer assemblies.

Figure 2-4 Printer internal assemblies (M751/E75245; 1 of 7)

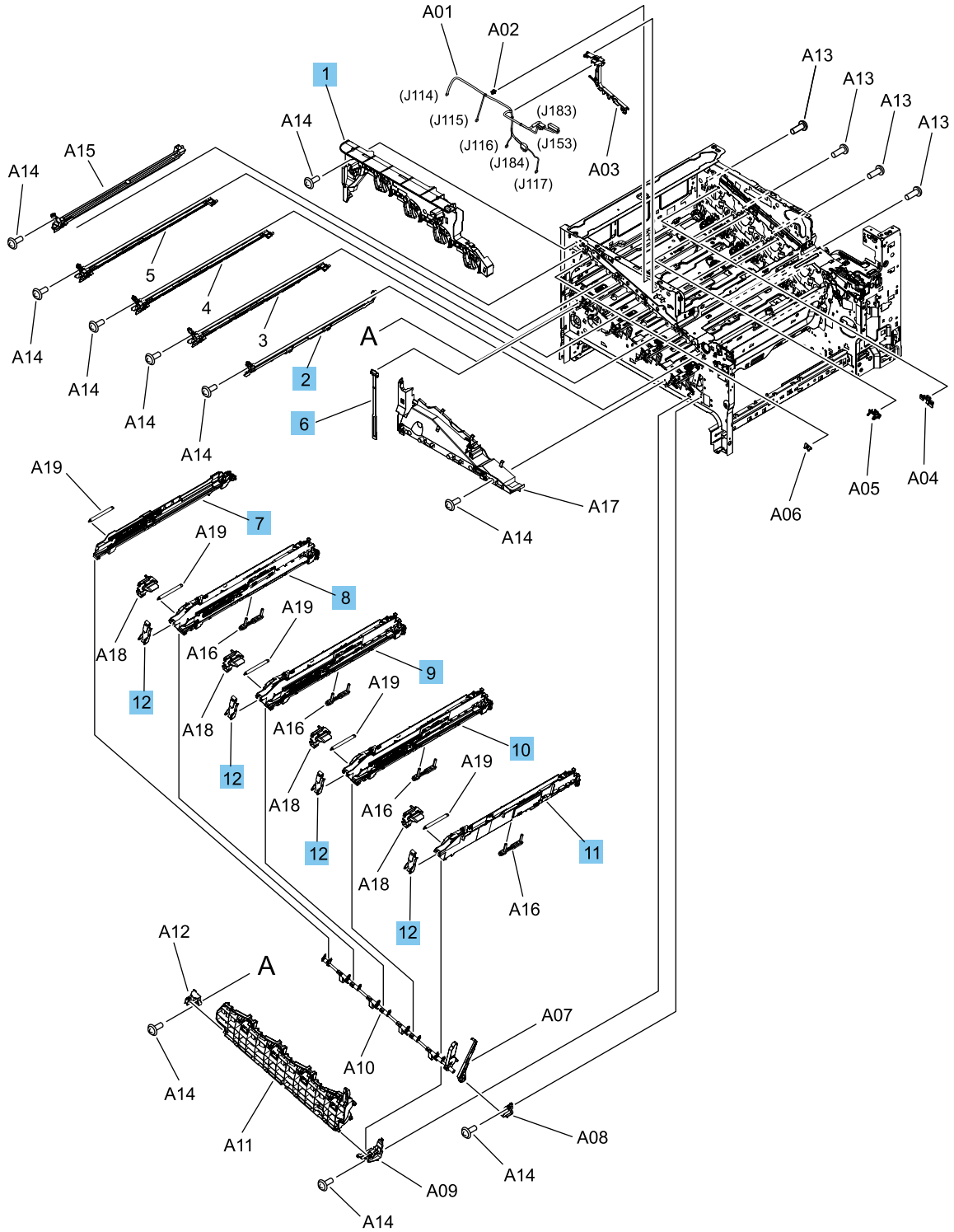


Table 2-11 Printer internal assemblies (M751/E75245; 1 of 7)

Ref	Part number	Description	Qty
1	RM2-1343-000CN	Cartridge upper guide assembly	1
2	RM2-1340-000CN	Black pre-exposure assembly	1
6	RC5-0722-000CN	Arm, front door, left	1
7	RM2-1357-000CN	DT cartridge rail assembly	1
8	RM2-1354-000CN	First cartridge rail assembly	1
9	RM2-1353-000CN	Second cartridge rail assembly	1
10	RM2-1355-000CN	Third cartridge rail assembly	1
11	RM2-1356-000CN	Black cartridge rail assembly	1
12	RL2-2091-000CN	Cartridge guide	4

Parts and diagrams: Printer internal assemblies (M751/E75245; 2 of 7)

Parts diagram and parts list for the internal printer assemblies.

Figure 2-5 Printer internal assemblies (M751/E75245; 2 of 7)

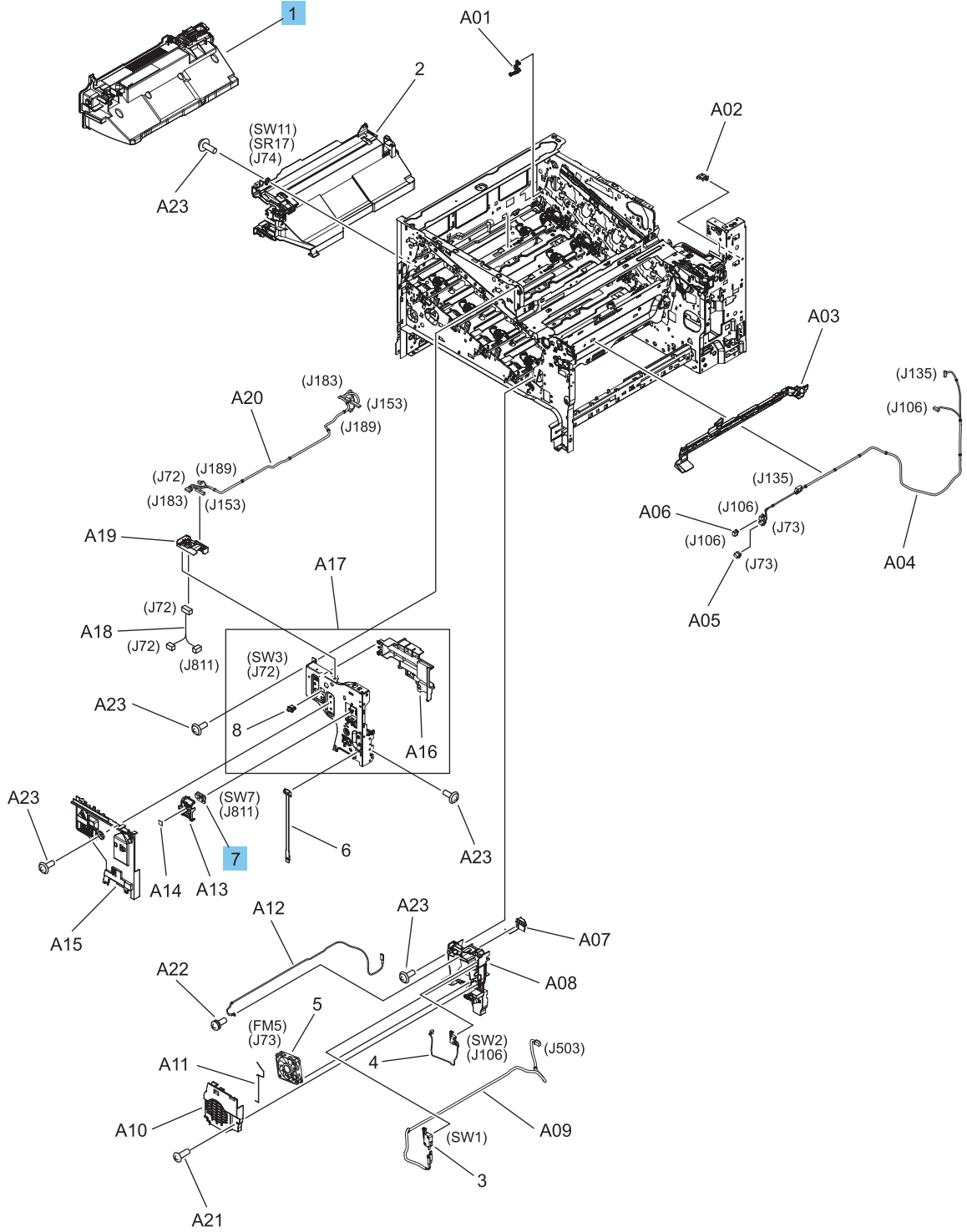


Table 2-12 Printer internal assemblies (M751/E75245; 2 of 7)

Ref	Part number	Description	Qty
1	3WT90-67901	Toner collection unit	1
7	RM2-9610-000CN	Power switch PCB assembly	1

Parts and diagrams: Printer internal assemblies (M751/E75245; 3 of 7)

Parts diagram and parts list for the internal printer assemblies.

Figure 2-6 Printer internal assemblies (M751/E75245; 3 of 7)

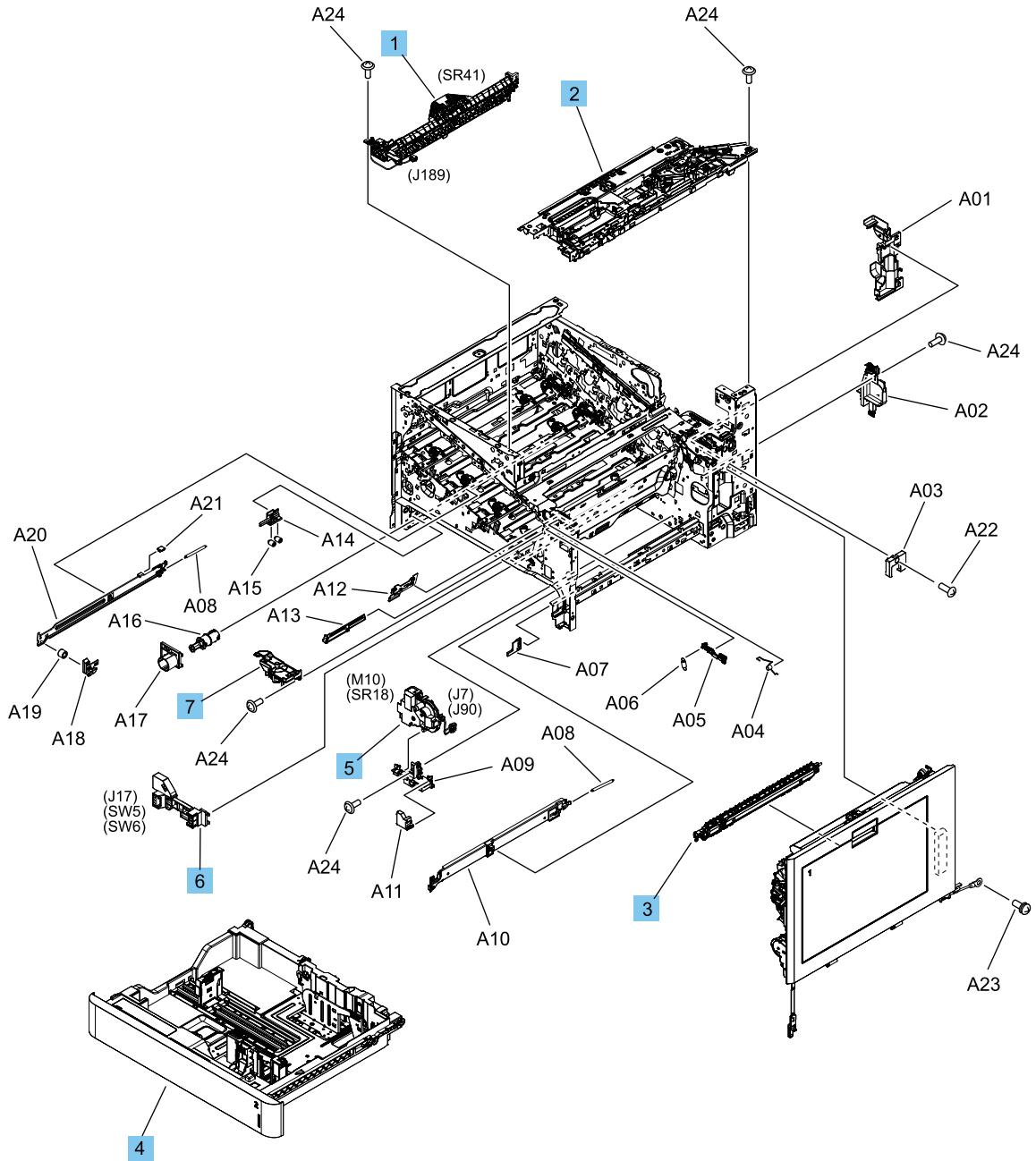


Table 2-13 Printer internal assemblies (M751/E75245; 3 of 7)

Ref	Part number	Description	Qty
1	RM2-1498-000CN	Paper delivery assembly	1
2	RM2-1521-000CN	Duplexing assembly	1
3	RM2-1399-010CN	Secondary transfer roller	1
4	RM2-1394-000CN	Cassette assembly	1

Table 2-13 Printer internal assemblies (M751/E75245; 3 of 7) (continued)

Ref	Part number	Description	Qty
5	RM2-1604-000CN	Lifter drive assembly	1
6	RM2-1436-000CN	Size detect switch assembly	1
7	RM2-1605-000CN	Auto close assembly	1

Parts and diagrams: Printer internal assemblies (M751/E75245; 4 of 7)

Parts diagram and parts list for the internal printer assemblies.

Figure 2-7 Printer internal assemblies (M751/E75245; 4 of 7)

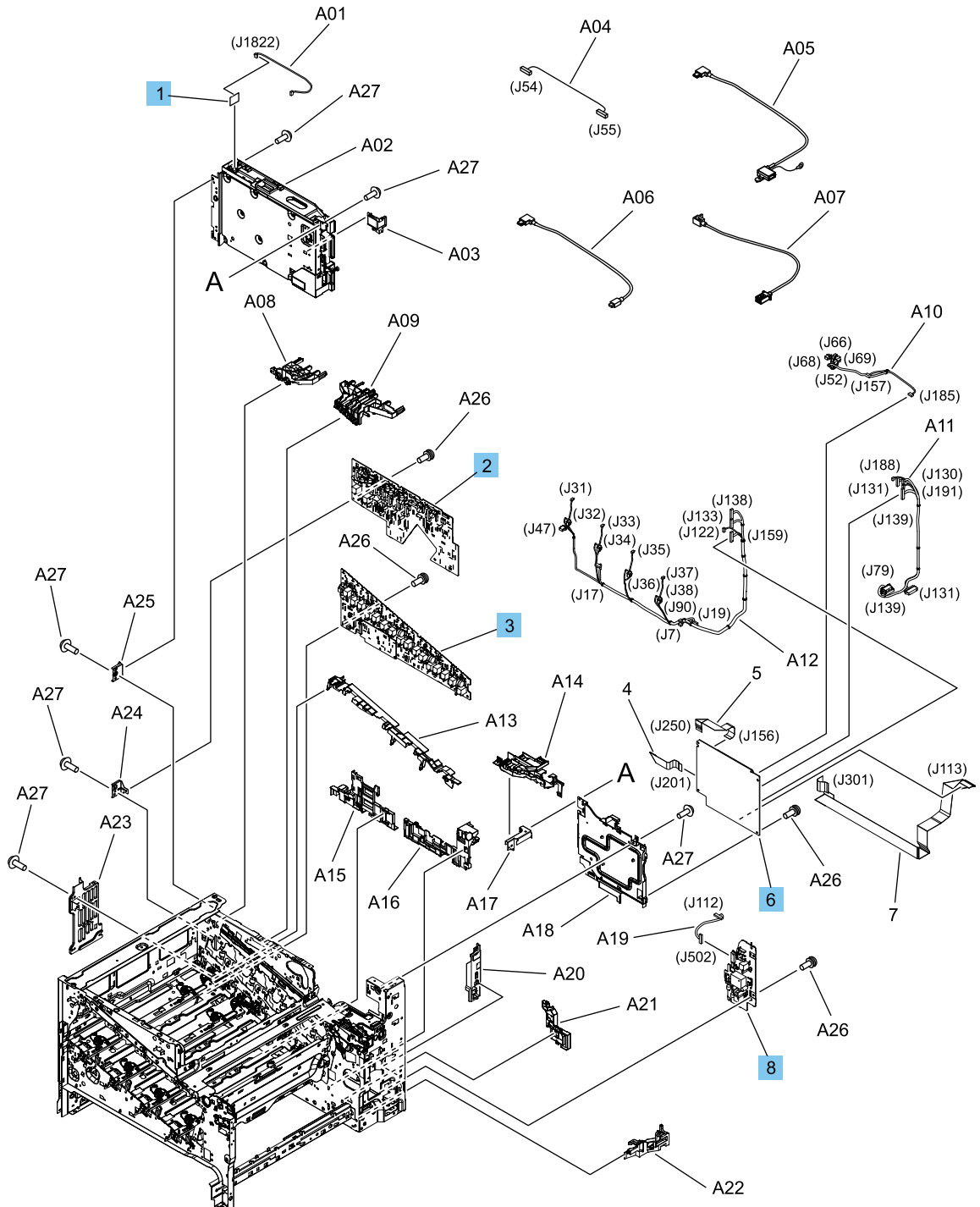


Table 2-14 Printer internal assemblies (M751/E75245; 4 of 7)

Ref	Part number	Description	Qty
1	RM3-7351-000CN	Memory PCB assembly	1

Table 2-14 Printer internal assemblies (M751/E75245; 4 of 7) (continued)

Ref	Part number	Description	Qty
2	RM2-9601-000CN	Upper high-voltage power supply PCB assembly	1
3	RM2-9624-000CN	Lower high-voltage power supply PCB assembly	1
6	RM2-9630-000CN	DC controller PCB assembly	1
8	RM2-9623-000CN	Second transfer high-voltage PCB assembly	1
Not shown	5851-7702	Formatter PCA (M751/E75245/M856/E85055) (sPAB - SFP)	1
Not shown	5851-7703	Formatter PCA (M751/E75245/M856/E85055) (sPAB - SFP; India/China)	1
Not shown	5851-7704	Formatter PCA + SDS (M751/E75245/M856/E85055) (sPAB - SFP)	1
Not shown	5851-7705	Formatter PCA + SDS (M751/E75245/M856/E85055) (sPAB - SFP; India/China)	1
Not shown	0960-3659	Wireless PCA board	1

Parts and diagrams: Printer internal assemblies (M751/E75245; 5 of 7)

Parts diagram and parts list for the internal printer assemblies.

Figure 2-8 Printer internal assemblies (M751/E75245; 5 of 7)

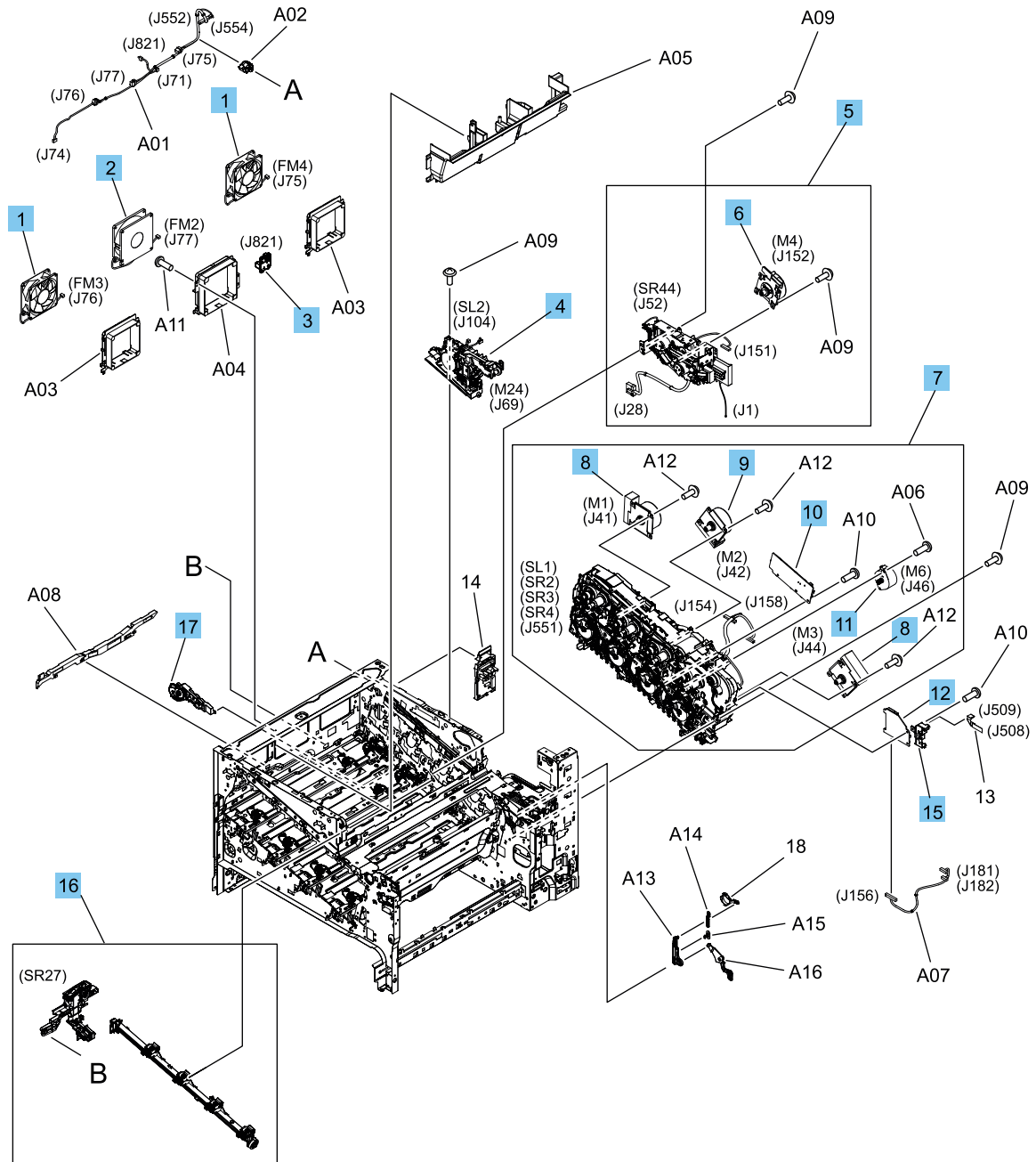


Table 2-15 Printer internal assemblies (M751/E75245; 5 of 7)

Ref	Part number	Description	Qty
1	RK2-2276-000CN	Fan	2
2	RK2-9148-000CN	Fan	1
3	RM2-9620-000CN	Environment sensor PCB assembly	1
4	RM2-1392-000CN	Duplexing drive assembly	1

Table 2-15 Printer internal assemblies (M751/E75245; 5 of 7) (continued)

Ref	Part number	Description	Qty
5	RM2-1391-000CN	Fuser drive assembly	1
6	RM2-1456-000CN	Fuser motor assembly	1
7	RM2-1614-000CN	Main drive assembly	1
8	RM2-1612-000CN	Main motor assembly	2
9	RM2-1613-000CN	Main motor assembly	1
10	RM2-9618-000CN	Main connecting PCB assembly	1
11	RK2-6027-000CN	Motor, stepping	1
12	RM2-9622-000CN	Connecting PCB assembly	1
15	RC5-1656-000CN	Guide, PCB cable	1
16	RM2-1520-000CN	Waste toner feed assembly	1
17	RM2-1364-000CN	Waste toner gear base assembly	1

Parts and diagrams: Printer internal assemblies (M751/E75245; 6 of 7)

Parts diagram and parts list for the internal printer assemblies.

Figure 2-9 Printer internal assemblies (M751/E75245; 6 of 7)

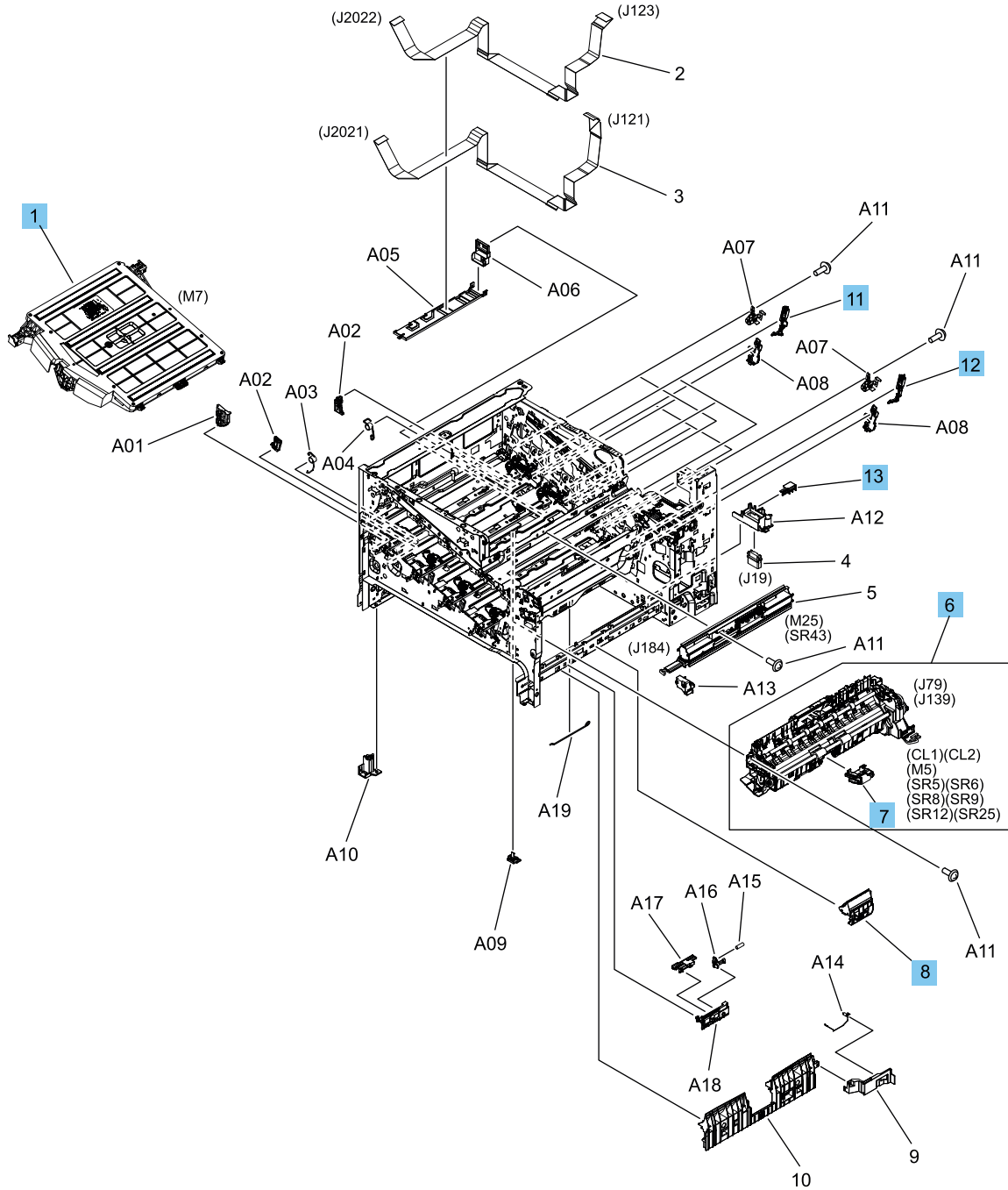


Table 2-16 Printer internal assemblies (M751/E75245; 6 of 7)

Ref	Part number	Description	Qty
1	RM2-1328-020CN	Laser scanner assembly	1
6	RM2-1393-010CN	Paper pickup assembly	1
7	RM2-1526-000CN	Paper pickup roller assembly	1

Table 2-16 Printer internal assemblies (M751/E75245; 6 of 7) (continued)

Ref	Part number	Description	Qty
8	RM2-1526-000CN	Separation roller holder assembly	1
11	RM2-1366-000CN	Waste toner feed link assembly	3
12	RM2-1367-000CN	Waste toner feed link assembly	1
13	RC5-1681-000CN	Spacer, drawer holder	1

Parts and diagrams: Printer internal assemblies (M751/E75245; 7 of 7)

Parts diagram and parts list for the internal printer assemblies.

Figure 2-10 Printer internal assemblies (M751/E75245; 7 of 7)

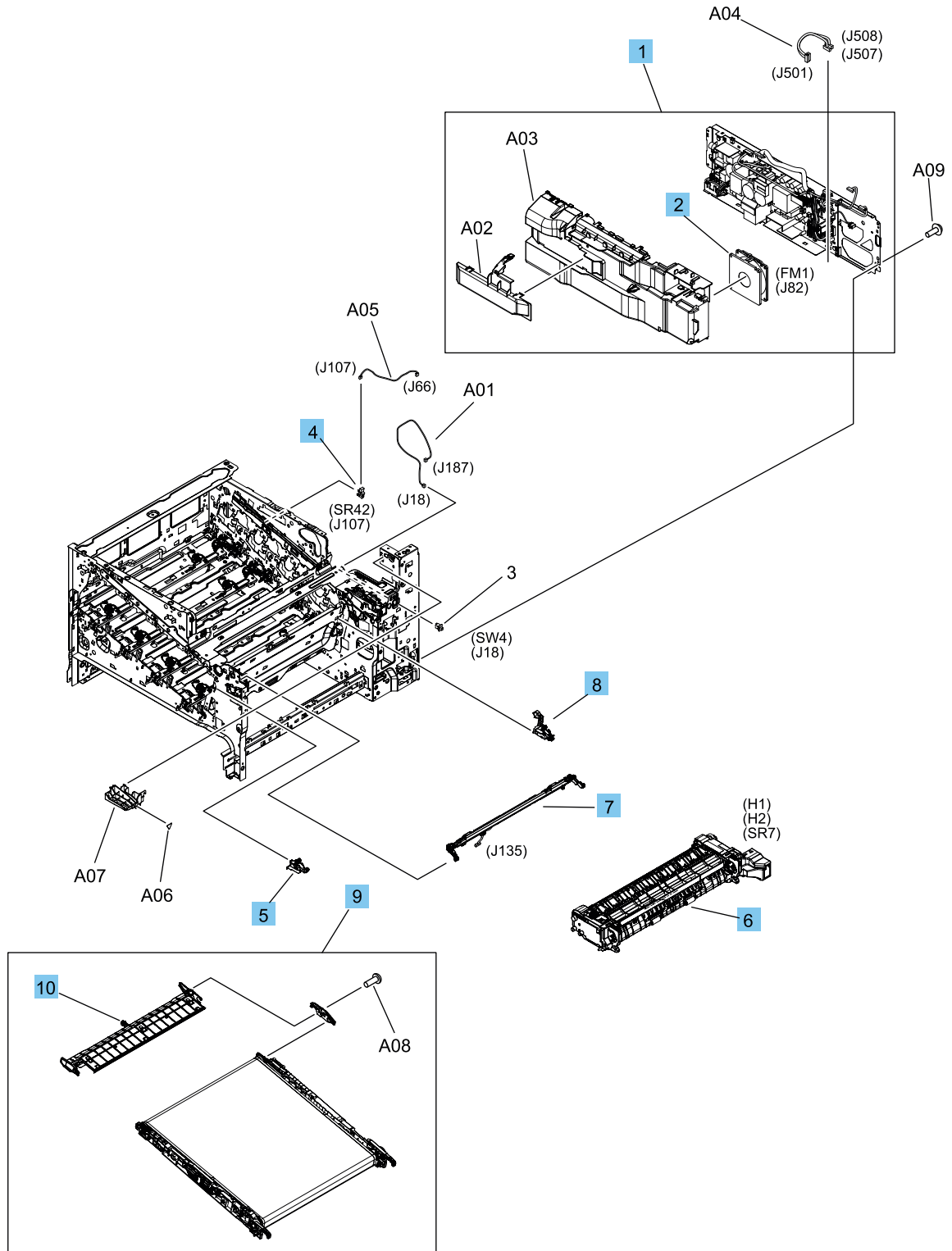


Table 2-17 Printer internal assemblies (M751/E75245; 7 of 7)

Ref	Part number	Description	Qty
1	RM2-1445-000CN	Low-voltage power supply (110V-127V)	1
1	RM2-1453-000CN	Low-voltage power supply (220V-240V)	1
2	RK2-9148-000CN	Fan	1
4	WG8-5935-000CN	IC, photointerrupter	2
5	RM2-1389-000CN	RD pressure link assembly, front	1
6	3WT87-67901	Fuser Kit (110V)	1
6	3WT88-67901	Fuser Kit (220V)	1
7	RM2-1501-000CN	Registration density sensor assembly	1
8	RM2-1390-000CN	RD pressure link assembly, rear	1
9	RM2-1504-000CN	Intermediate transfer belt	1
10	RM2-1490-000CN	Transfer cleaner assembly	1

Parts and diagrams: Printer components (M856/E85055/M776dn/M776z)

View parts diagrams and parts lists for the M856/E85055/M776dn/M776z printer components.

Parts and diagrams: Printer covers (M856/E85055)

Parts diagram and parts list for the printer covers (M856/E85055).

Figure 2-11 Printer covers (M856/E85055)

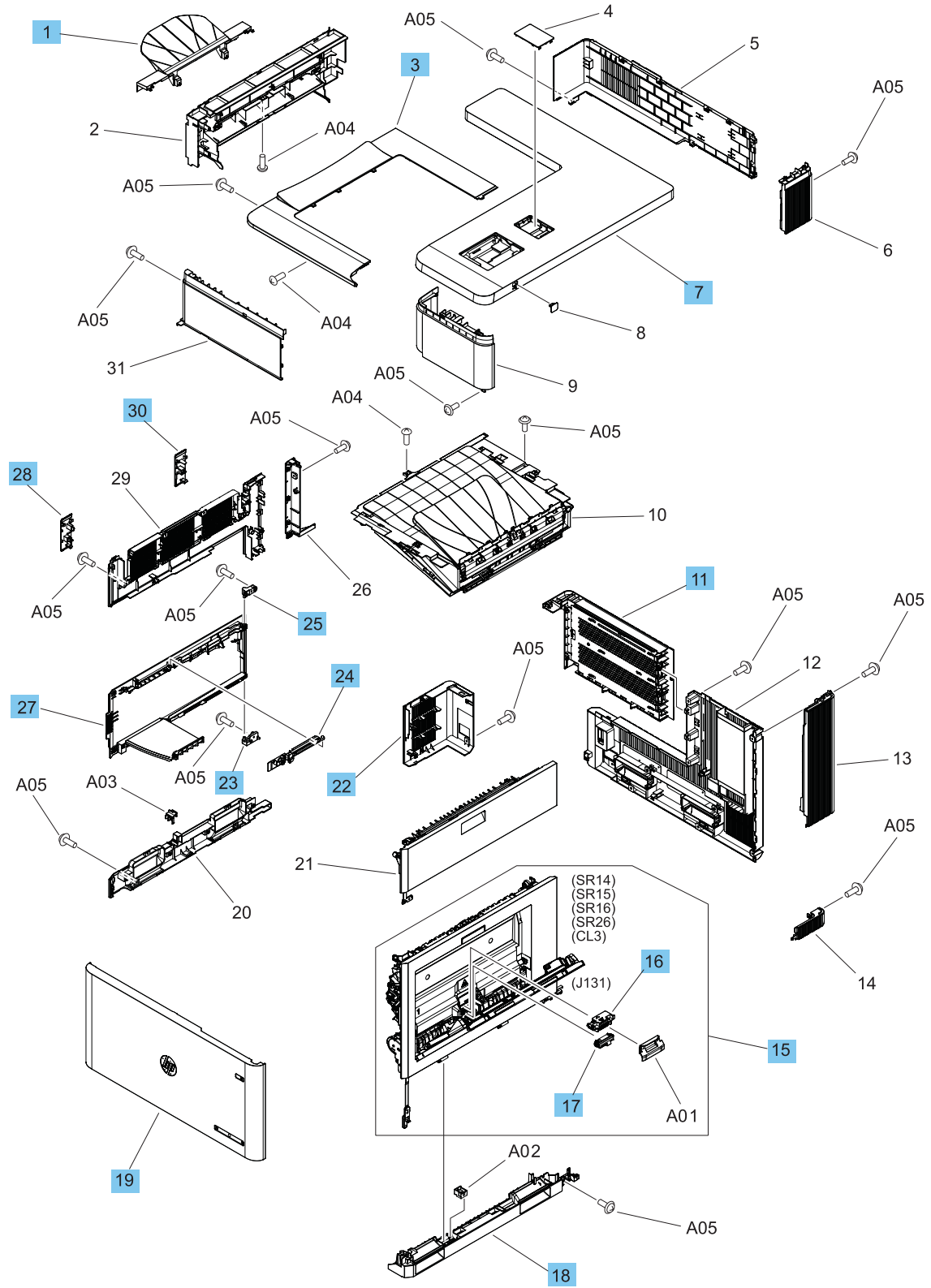


Table 2-18 Printer covers (M856/E85055)

Ref	Part number	Description	Qty
1	RL2-2563-000CN	Tray, reverse	1
3	RC5-2621-000CN	Cover, option, upper	1
7	RC5-2623-000CN	Cover, upper	1
11	RM2-2683-000CN	Formatter cover assembly	1
15	RM2-3434-000CN	Right door assembly	1
16	RM2-1525-000CN	Tray 1 pickup roller	1
17	RM2-1525-000CN	Tray 1 separation roller	1
18	RM2-1376-000CN	Right handle assembly	1
19	RM2-1368-000CN	Front door assembly	1
22	RC5-2632-000CN	Cover, left rear	1
23	RC5-0801-000CN	Hinge, cover, left	1
24	RM2-1350-000CN	Left cover lock assembly	1
25	RC5-0770-000CN	Hinge, left door, upper	1
27	RM2-1351-000CN	Left door assembly	1
28	RC5-1805-000CN	Cover, left upper, F	1
30	RC5-1806-000CN	Cover, left upper, R	1
Not shown	KOQ15-67901	Control panel (M856/E85055)	1

Parts and diagrams: Printer covers (M776dn/M776z)

Parts diagram and parts list for the printer covers (M776dn/M776z).

Figure 2-12 Printer covers (M776dn/M776z)

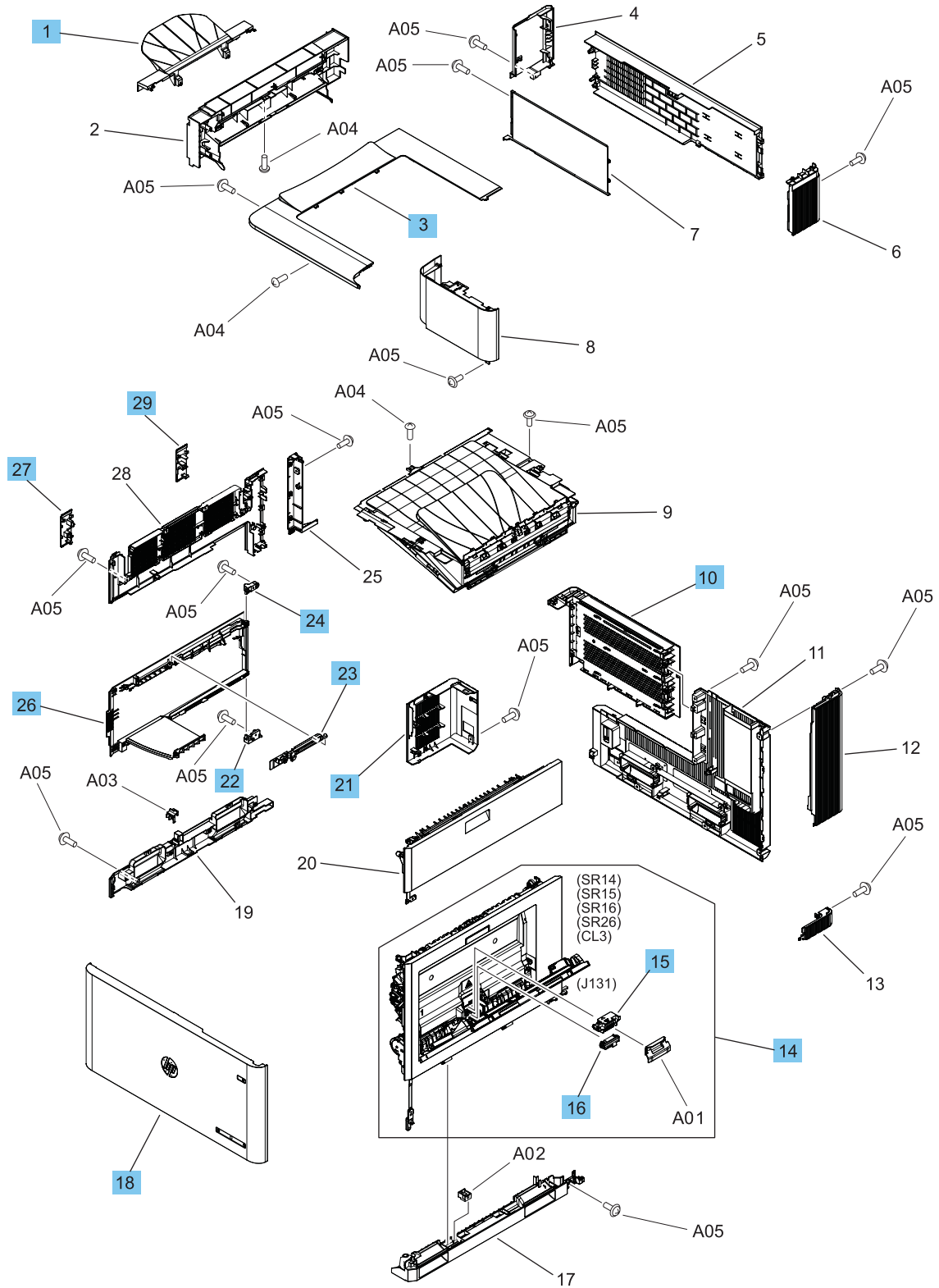


Table 2-19 Printer covers (M776dn/M776z)

Ref	Part number	Description	Qty
1	RL2-2563-000CN	Tray, reverse	1
3	RC5-2621-000CN	Cover, option, upper	1
10	RM2-2683-000CN	Formatter cover assembly	1
14	RM2-3434-000CN	Right door assembly	1
15	RM2-1525-000CN	Tray 1 pickup roller	1
16	RM2-1525-000CN	Tray 1 separation roller	1
18	RM2-1368-000CN	Front door assembly	1
21	RC5-2632-000CN	Cover, left rear	1
22	RC5-0801-000CN	Hinge, cover, left	1
23	RM2-1350-000CN	Left cover lock assembly	1
24	RC5-0770-000CN	Hinge, left door, upper	1
26	RM2-1351-000CN	Left door assembly	1
27	RC5-1805-000CN	Cover, left upper, F	1
29	RC5-1806-000CN	Cover, left upper, R	1

Parts and diagrams: Printer internal assemblies (M856/E85055, M776dn/M776z; 1 of 8)

Parts diagram and parts list for the internal printer assemblies.

Figure 2-13 Printer internal assemblies (M856/E85055, M776dn/M776z; 1 of 8)

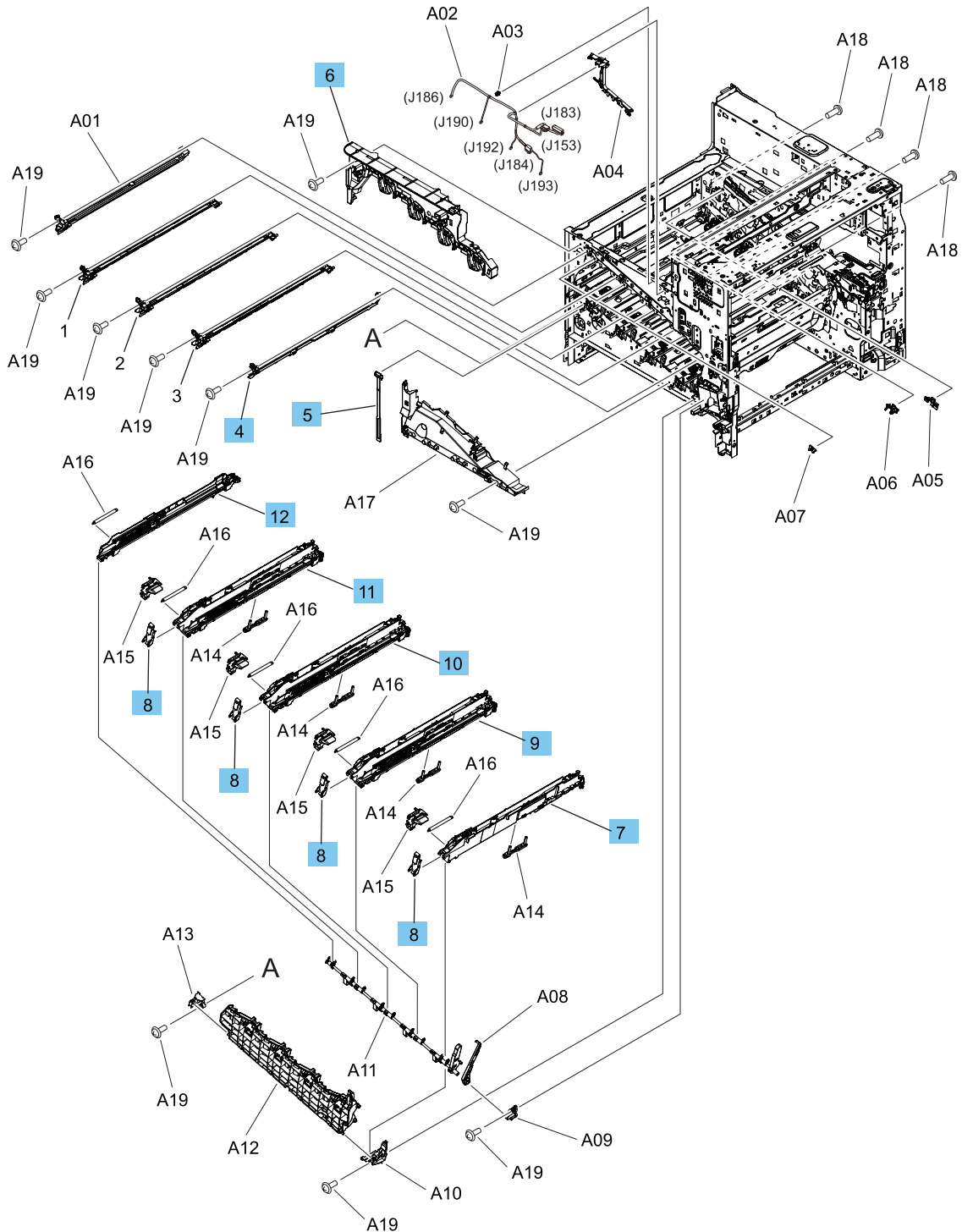


Table 2-20 Printer internal assemblies (M856/E85055, M776dn/M776z; 1 of 8)

Ref	Part number	Description	Qty
4	RM2-1340-000CN	Black pre-exposure assembly	1

Table 2-20 Printer internal assemblies (M856/E85055, M776dn/M776z; 1 of 8) (continued)

Ref	Part number	Description	Qty
5	RC5-0722-000CN	Arm, front door, left	1
6	RM2-1343-000CN	Cartridge upper guide assembly	1
7	RM2-1356-000CN	Black cartridge rail assembly	1
8	RL2-2091-000CN	Guide cartridge	4
9	RM2-2482-000CN	Third cartridge rail assembly	1
10	RM2-2480-000CN	Second cartridge rail assembly	1
11	RM2-2481-000CN	First cartridge rail assembly	1
12	RM2-2479-000CN	DT cartridge rail assembly	4

Parts and diagrams: Printer internal assemblies (M856/E85055, M776dn/M776z; 2 of 8)

Parts diagram and parts list for the internal printer assemblies.

Figure 2-14 Printer internal assemblies (M856/E85055, M776dn/M776z; 2 of 8)

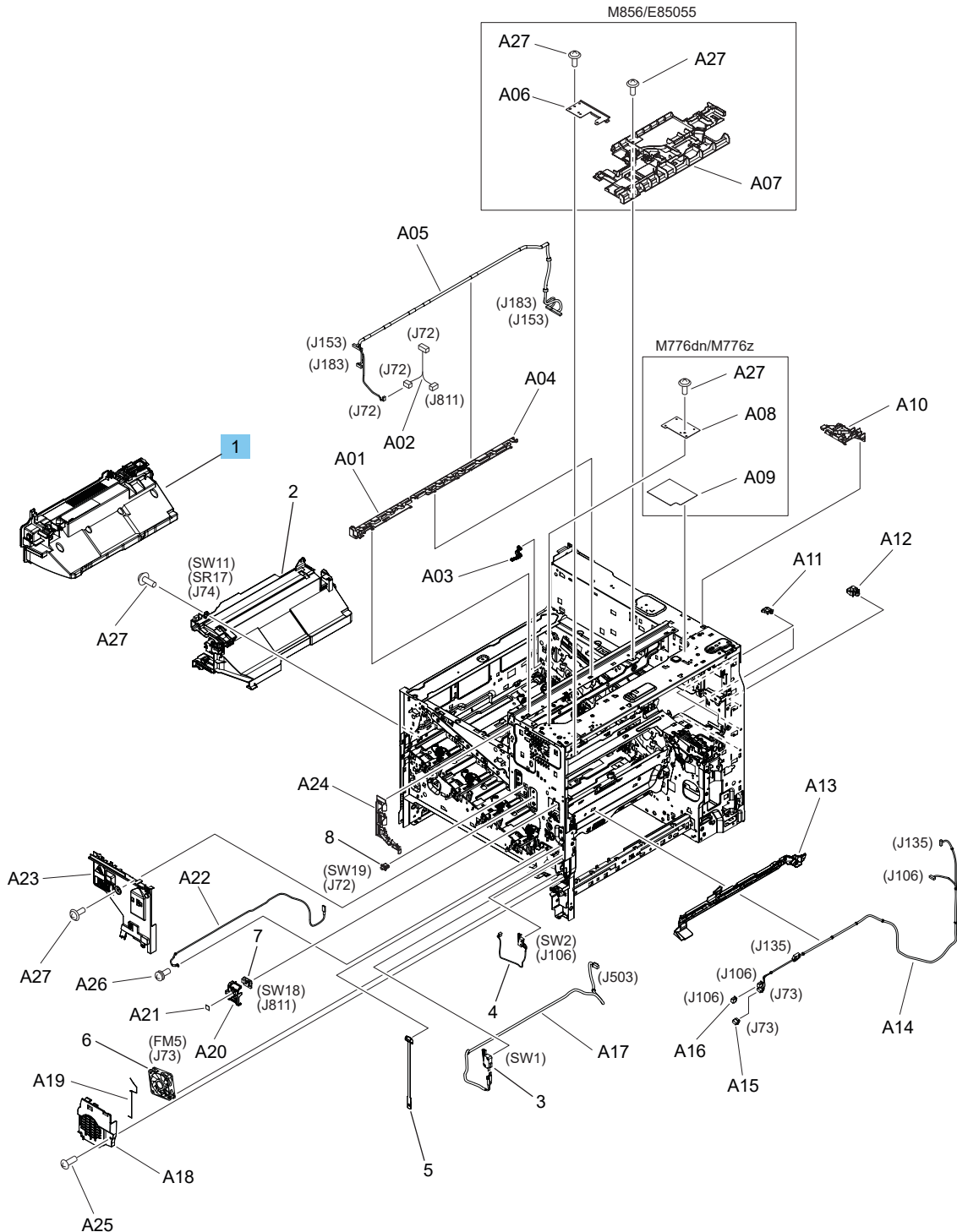


Table 2-21 Printer internal assemblies (M856/E85055, M776dn/M776z; 2 of 8)

Ref	Part number	Description	Qty
1	3WT90-67901	Toner collection unit	1

Parts and diagrams: Printer internal assemblies (M856/E85055, M776dn/M776z; 3 of 8)

Parts diagram and parts list for the internal printer assemblies.

Figure 2-15 Printer internal assemblies (M856/E85055, M776dn/M776z; 3 of 8)

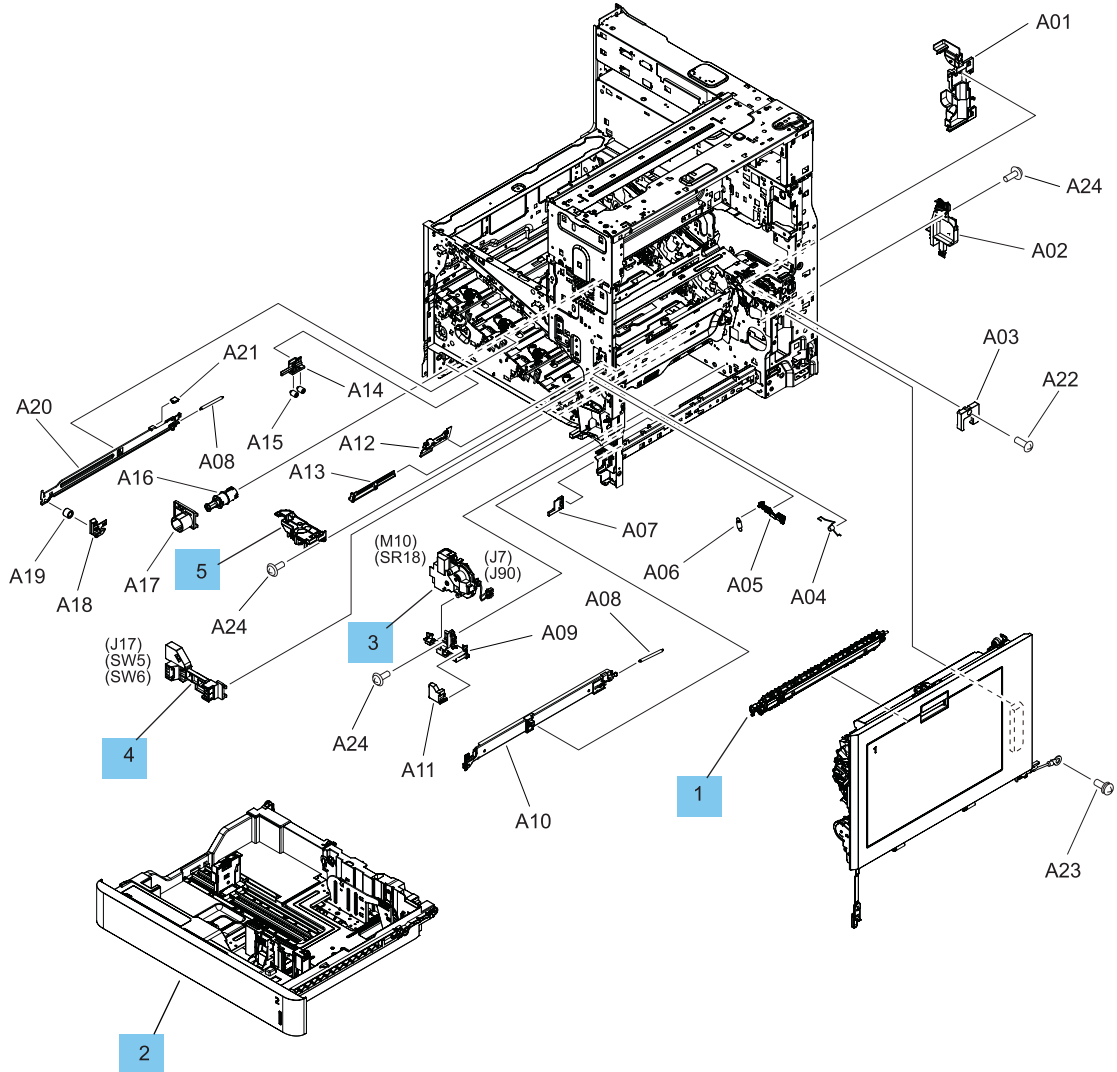


Table 2-22 Printer internal assemblies (M856/E85055, M776dn/M776z; 3 of 8)

Ref	Part number	Description	Qty
1	RM2-1399-010CN	Secondary transfer roller	1
2	RM2-1394-000CN	Cassette assembly	1
3	RM2-1604-000CN	Lifter drive assembly	1
4	RM2-1436-000CN	Size detect switch assembly	1
5	RM2-1605-000CN	Auto close assembly	1

Parts and diagrams: Printer internal assemblies (M856/E85055, M776dn/M776z; 4 of 8)

Parts diagram and parts list for the internal printer assemblies.

Figure 2-16 Printer internal assemblies (M856/E85055, M776dn/M776z; 4 of 8)

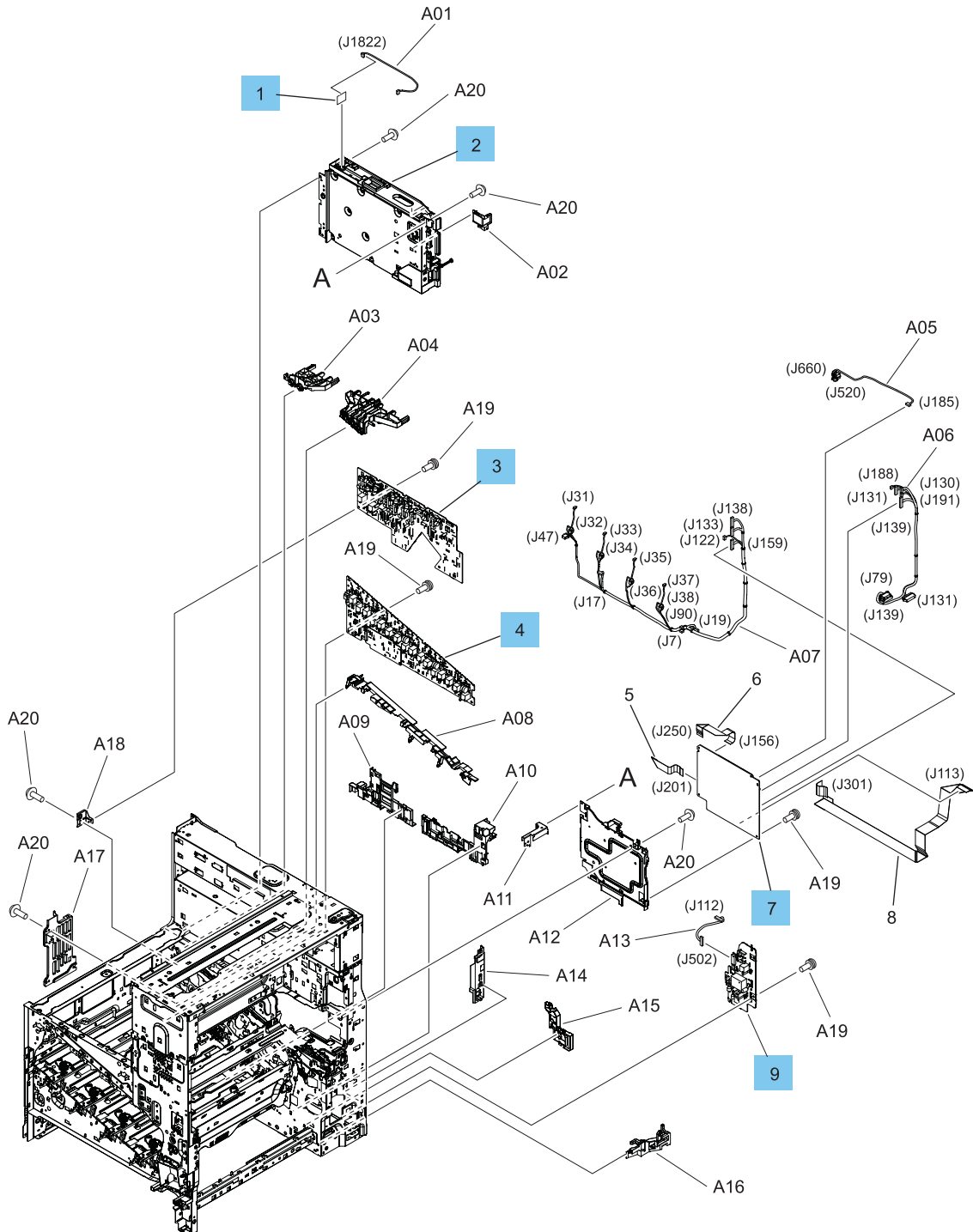


Table 2-23 Printer internal assemblies (M856/E85055, M776dn/M776z; 4 of 8)

Ref	Part number	Description	Qty
1	RM3-7351-000CN	Memory PCB assembly	1

Table 2-23 Printer internal assemblies (M856/E85055, M776dn/M776z; 4 of 8) (continued)

Ref	Part number	Description	Qty
2	RM2-2476-000CN	Formatter case assembly	1
3	RM2-9601-000CN	Upper high-voltage power supply PCB assembly	1
4	RM2-9624-000CN	Lower high-voltage power supply PCB assembly	1
7	RM2-9930-000CN	DC controller PCB assembly	1
9	RM2-9623-000CN	Second transfer H.V.T. PCB assembly	1
Not shown	5851-7702	Formatter PCA (M751/E75245/M856/E85055) (sPAB - SFP)	1
Not shown	5851-7703	Formatter PCA (M751/E75245/M856/E85055) (sPAB - SFP; India/China)	1
Not shown	5851-7704	Formatter PCA + SDS (M751/E75245/M856/E85055) (sPAB - SFP)	1
Not shown	5851-7705	Formatter PCA + SDS (M751/E75245/M856/E85055) (sPAB - SFP; India/China)	1
Not shown	5851-7913	Formatter PCA (M776) (sPAB - SFP)	1
Not shown	5851-7914	Formatter PCA (M776) (sPAB - SFP; India/China)	1
Not shown	0960-3659	Wireless PCA board	1

Parts and diagrams: Printer internal assemblies (M856/E85055, M776dn/M776z; 5 of 8)

Parts diagram and parts list for the internal printer assemblies.

Figure 2-17 Printer internal assemblies (M856/E85055, M776dn/M776z; 5 of 8)

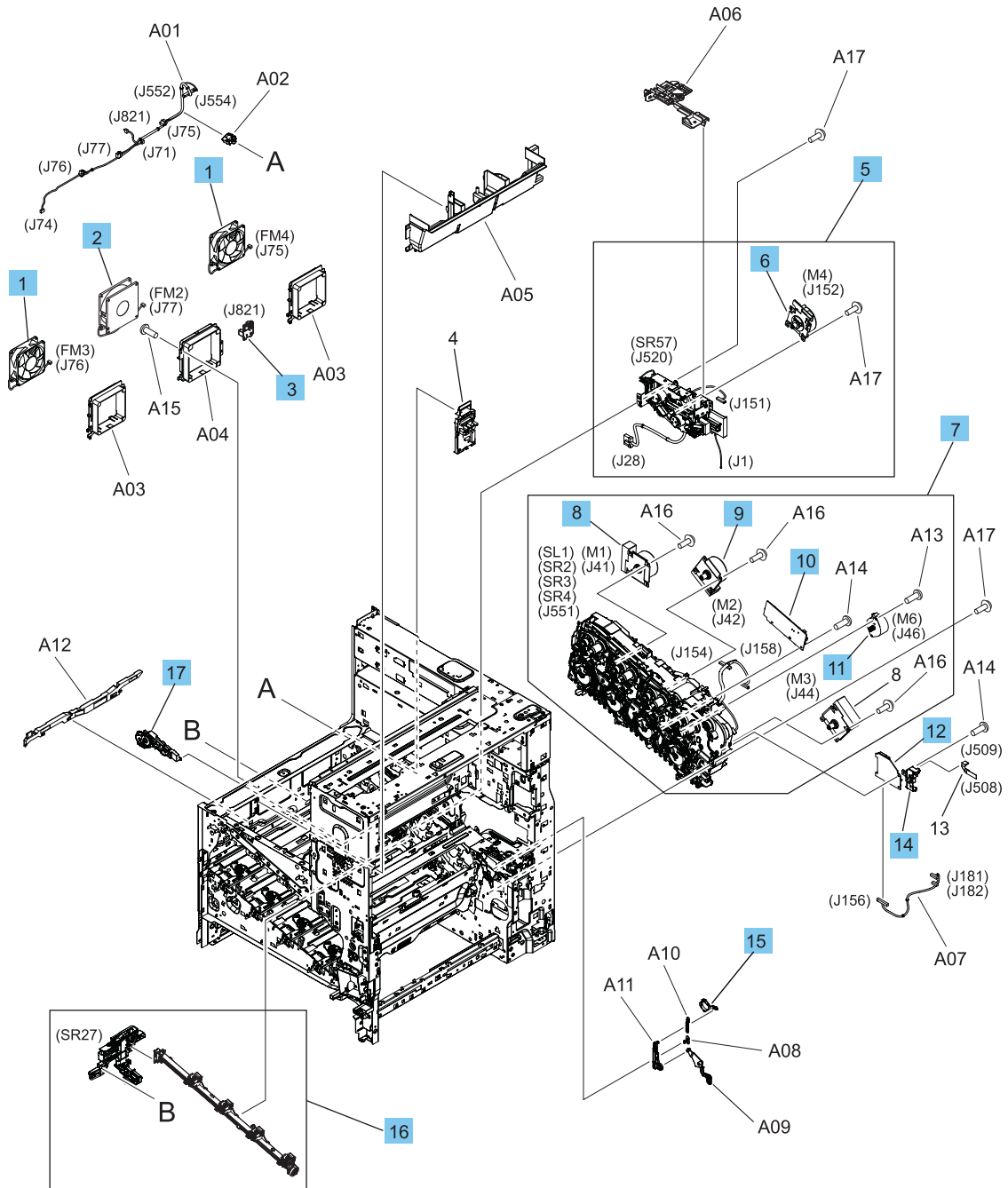


Table 2-24 Printer internal assemblies (M856/E85055, M776dn/M776z; 5 of 8)

Ref	Part number	Description	Qty
1	RK2-2276-000CN	Fan	2
2	RK2-9148-000CN	Fan	1
3	RM2-9620-000CN	Environment sensor PCB assembly	1

Table 2-24 Printer internal assemblies (M856/E85055, M776dn/M776z; 5 of 8) (continued)

Ref	Part number	Description	Qty
5	RM2-1391-000CN	Fuser drive assembly	1
6	RM2-1456-000CN	Fuser motor assembly	1
7	RM2-1614-000CN	Main drive assembly	1
8	RM2-1612-000CN	Main motor assembly	2
9	RM2-1613-000CN	Main motor assembly	1
10	RM2-9618-000CN	Connecting PCB assembly	1
11	RK2-6027-000CN	Motor, stepping	1
12	RM2-9622-000CN	Connecting PCB assembly	1
14	RC5-1656-000CN	Guide, PCB cable	1
15	RC5-1055-000CN	Cam, coupling estrangement	1
16	RM2-1520-000CN	Waste toner auger service kit	1
17	RM2-1364-000CN	Waste toner gear base assembly	1

Parts and diagrams: Printer internal assemblies (M856/E85055, M776dn/M776z; 6 of 8)

Parts diagram and parts list for the internal printer assemblies.

Figure 2-18 Printer internal assemblies (M856/E85055, M776dn/M776z; 6 of 8)

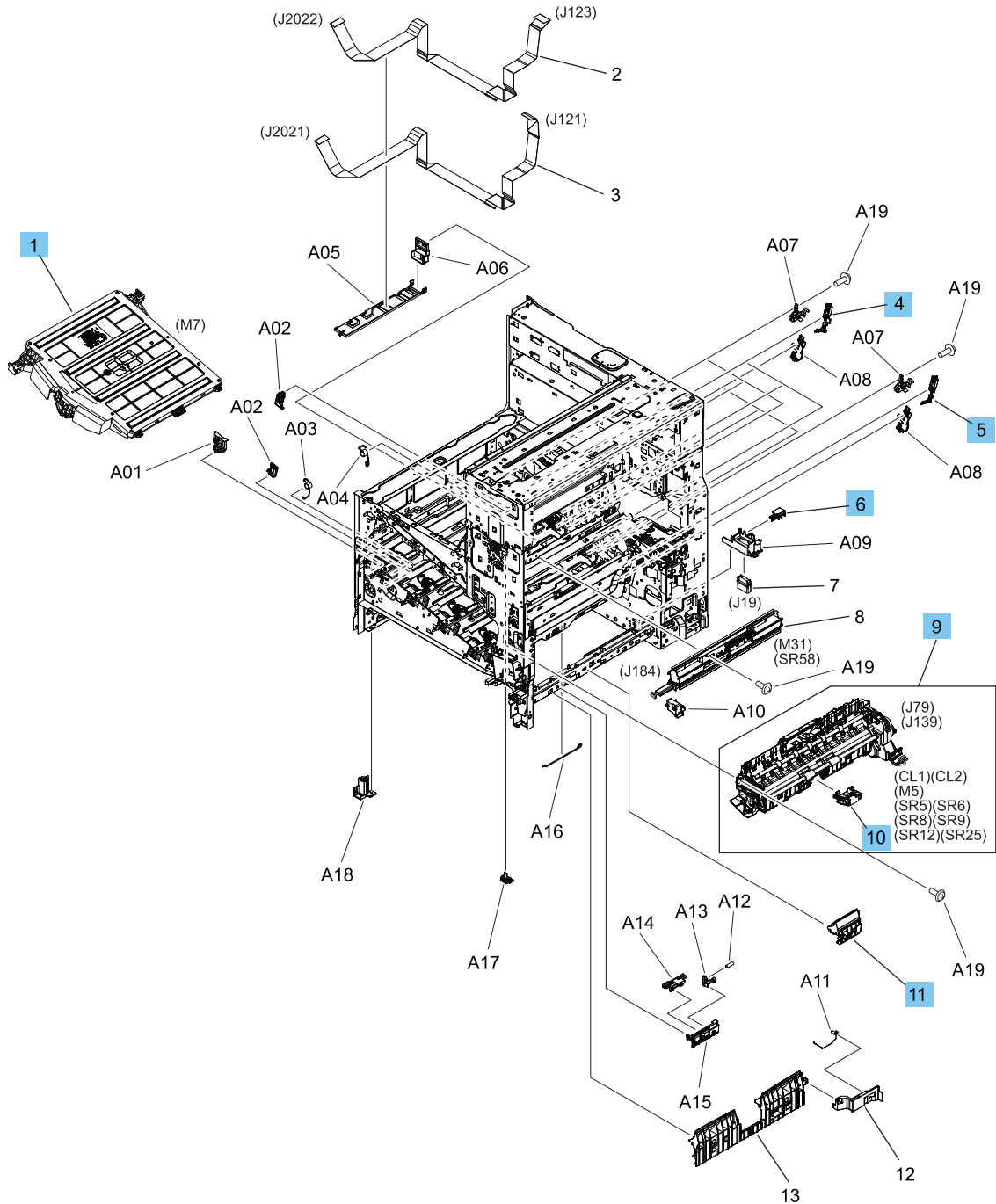


Table 2-25 Printer internal assemblies (M856/E85055, M776dn/M776z; 6 of 8)

Ref	Part number	Description	Qty
1	RM2-1328-020CN	Laser scanner assembly	1
4	RM2-1366-000CN	Waste toner feed link assembly	3

Table 2-25 Printer internal assemblies (M856/E85055, M776dn/M776z; 6 of 8) (continued)

Ref	Part number	Description	Qty
5	RM2-1367-000CN	Waste toner feed link assembly	1
6	RC5-1681-000CN	Spacer, drawer holder	1
9	RM2-3908-000CN	Paper pickup assembly	1
10	RM2-1526-000CN	Paper pickup roller assembly	1
11	RM2-1526-000CN	Separation roller holder assembly	1

Parts and diagrams: Printer internal assemblies (M856/E85055, M776dn/M776z; 7 of 8)

Parts diagram and parts list for the internal printer assemblies.

Figure 2-19 Printer internal assemblies (M856/E85055, M776dn/M776z; 7 of 8)

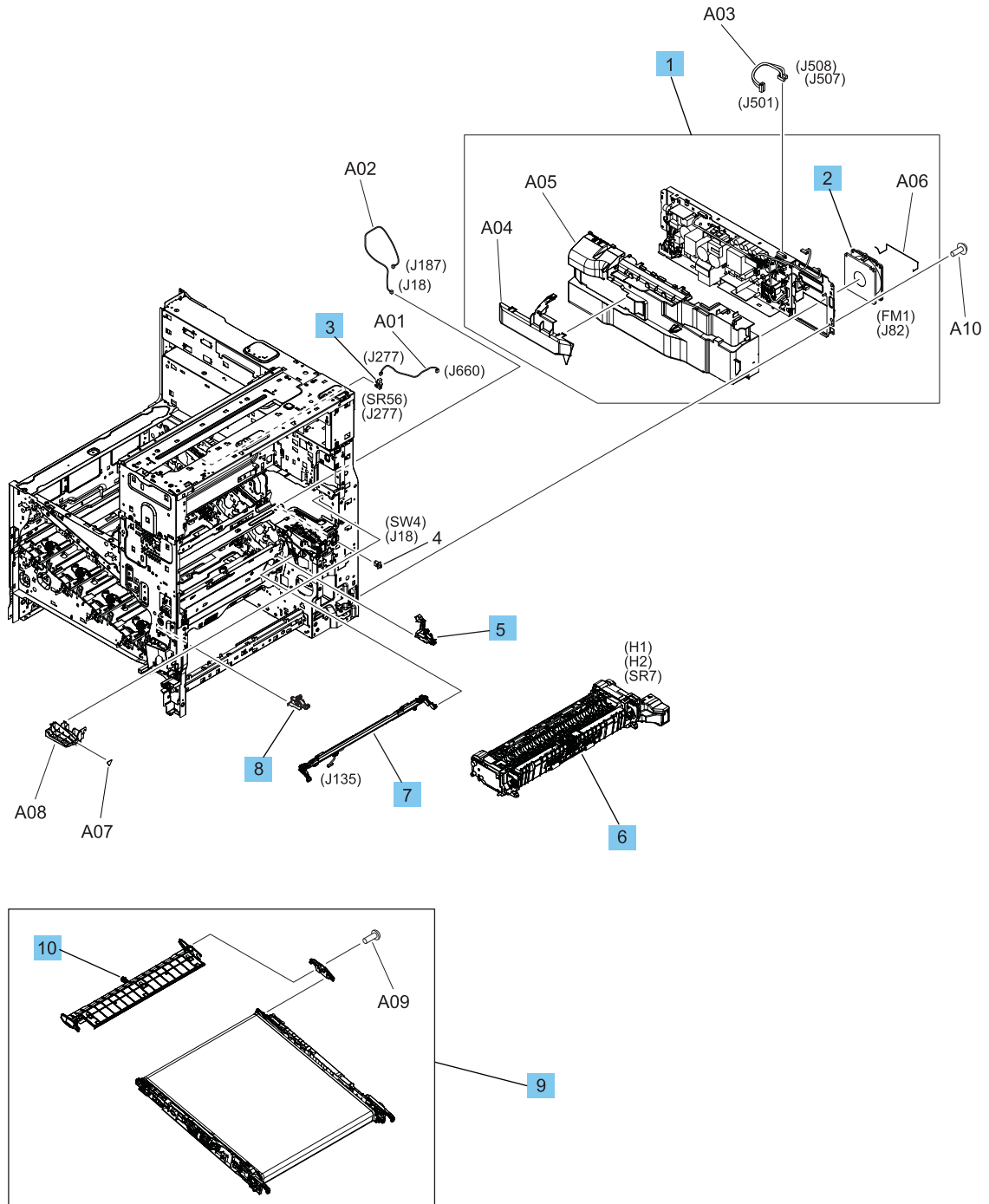


Table 2-26 Printer internal assemblies (M856/E85055, M776dn/M776z; 7 of 8)

Ref	Part number	Description	Qty
1	RM2-2473-000CN	Low-voltage power supply (110V-127V)	1
1	RM2-2474-000CN	Low-voltage power supply (220V-240V)	1

Table 2-26 Printer internal assemblies (M856/E85055, M776dn/M776z; 7 of 8) (continued)

Ref	Part number	Description	Qty
2	RK2-9148-000CN	Fan	1
3	WG8-5935-000CN	IC, photointerrupter	1
5	RM2-1390-000CN	RD pressure link assembly, rear	1
6	4YL16-67901	Fuser kit (110V)	1
6	4YL17-67901	Fuser kit (220V)	1
7	RM2-1501-000CN	Registration density sensor assembly, front	1
8	RM2-1389-000CN	RD pressure link assembly, front	1
9	RM2-1504-000CN	Intermediate transfer belt assembly	1
10	RM2-1490-000CN	Transfer cleaner assembly	1

Parts and diagrams: Printer internal assemblies (M856/E85055, M776dn/M776z; 8 of 8)

Parts diagram and parts list for the internal printer assemblies.

Figure 2-20 Printer internal assemblies (M856/E85055, M776dn/M776z; 8 of 8)

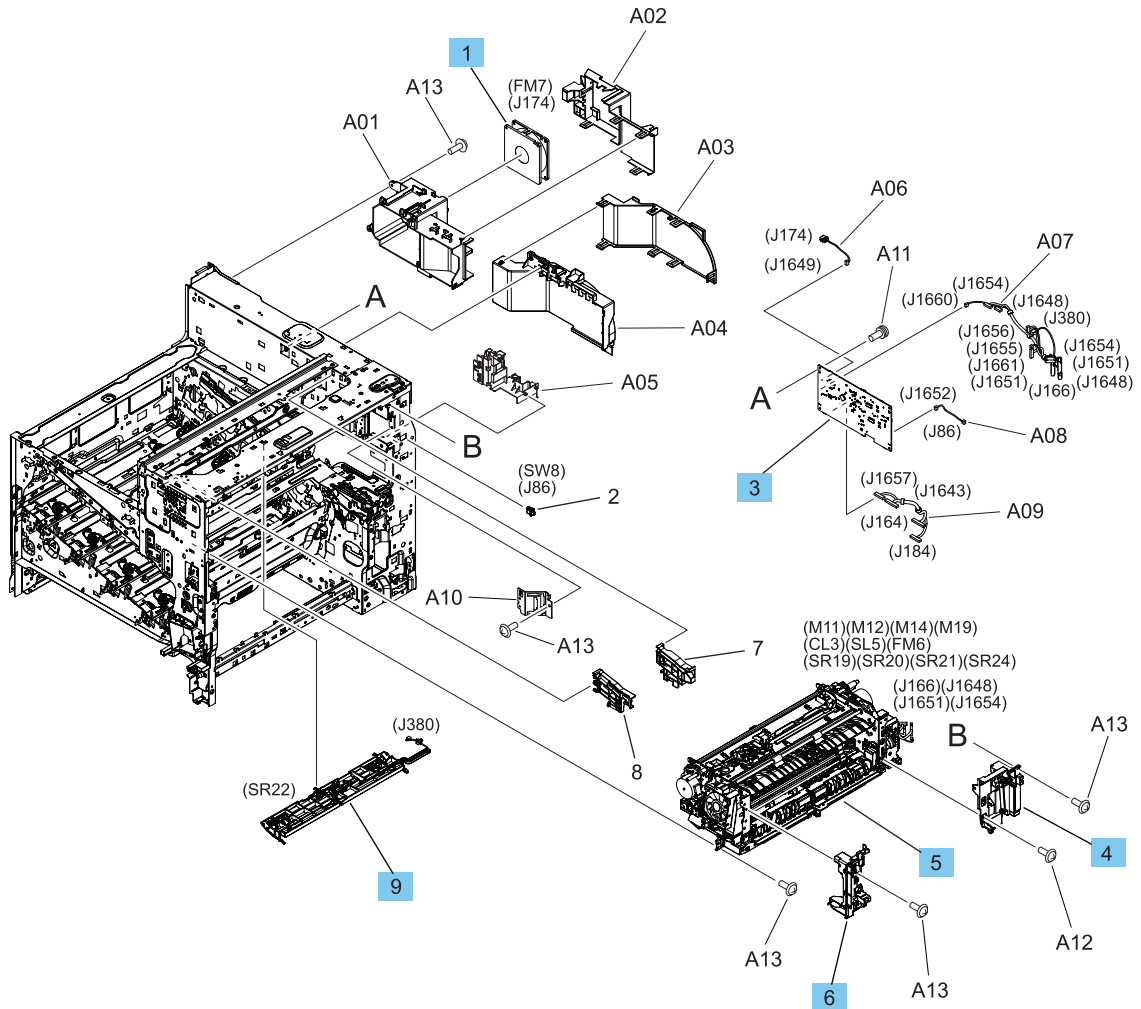


Table 2-27 Printer internal assemblies (M856/E85055, M776dn/M776z; 8 of 8)

Ref	Part number	Description	Qty
1	RK2-9148-000CN	Fan	1
3	RM2-9921-000CN	Duplexing controller PCB assembly	1
4	RM2-1763-000CN	Toggle rear assembly	1
5	RM2-1777-000CN	Paper delivery assembly	1
6	RM2-1764-000CN	Toggle front assembly	1
9	RM2-2690-000CN	Duplexing reverse guide assembly	1

Parts and diagrams: Printer components (M776zs)

View parts diagrams and parts lists for the M776zs printer components.

Parts and diagrams: Printer covers (M776zs)

Parts diagram and parts list for the internal printer assemblies.

Figure 2-21 Printer covers (M776zs)

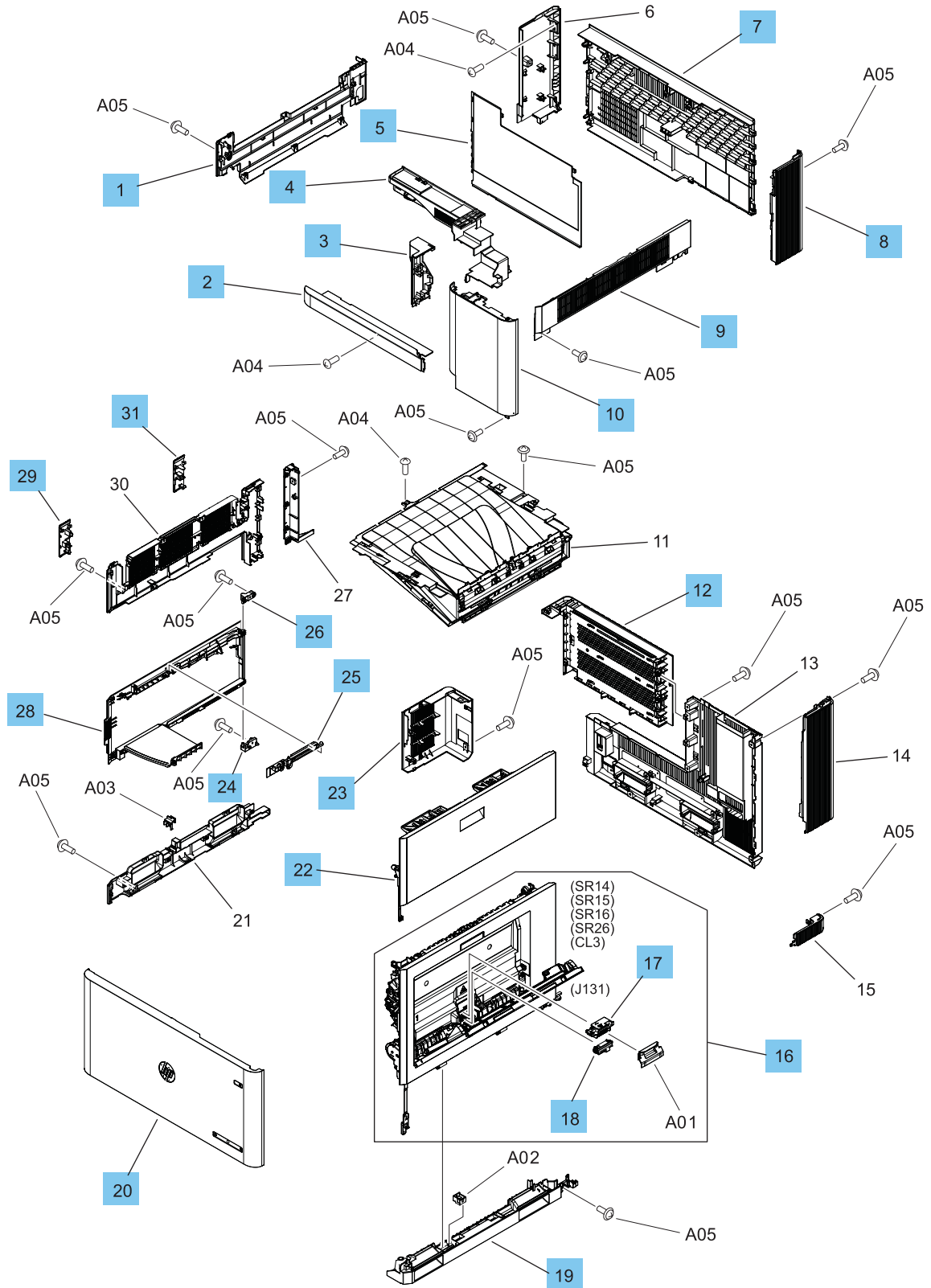


Table 2-28 Printer covers (M776zs)

Ref	Part number	Description	Qty
1	RC5-2734-000CN	Cover, paper delivery	1
2	RC5-2732-000CN	Cover, front	1
3	RC5-2728-000CN	Cover, paper delivery, front	1
4	RM2-1782-000CN	Rear delivery cover assembly	1
5	RC5-2731-000CN	Cover, main	1
7	RC5-2730-000CN	Cover, rear upper	1
8	RC5-2735-000CN	Cover, rear right, upper	1
9	RC5-2733-000CN	Cover, right upper	1
10	RM2-2661-000CN	Right front cover assembly	1
12	RM2-2683-000CN	Formatter cover assembly	1
16	RM2-3434-000CN	Right door assembly	1
17	RM2-1525-000CN	Tray 1 pickup roller	1
18	RM2-1525-000CN	Tray 1 separation roller	1
19	RM2-2660-000CN	Right handle assembly	1
20	RM2-1368-000CN	Front door assembly	1
22	RM2-1785-000CN	Right upper door assembly	1
23	RC5-2632-000CN	Cover, left rear	1
24	RC5-0801-000CN	Hinge, cover, left	1
25	RM2-1350-000CN	Left cover lock assembly	1
26	RC5-0770-000CN	Hinge, left door, upper	1
28	RM2-1351-000CN	Left door assembly	1
29	RC5-1805-000CN	Cover, left upper, F	1
31	RC5-1806-000CN	Cover, left upper, R	1

Parts and diagrams: Printer internal assemblies (M776zs; 1 of 9)

Parts diagram and parts list for the internal printer assemblies.

Figure 2-22 Printer internal assemblies (M776zs; 1 of 9)

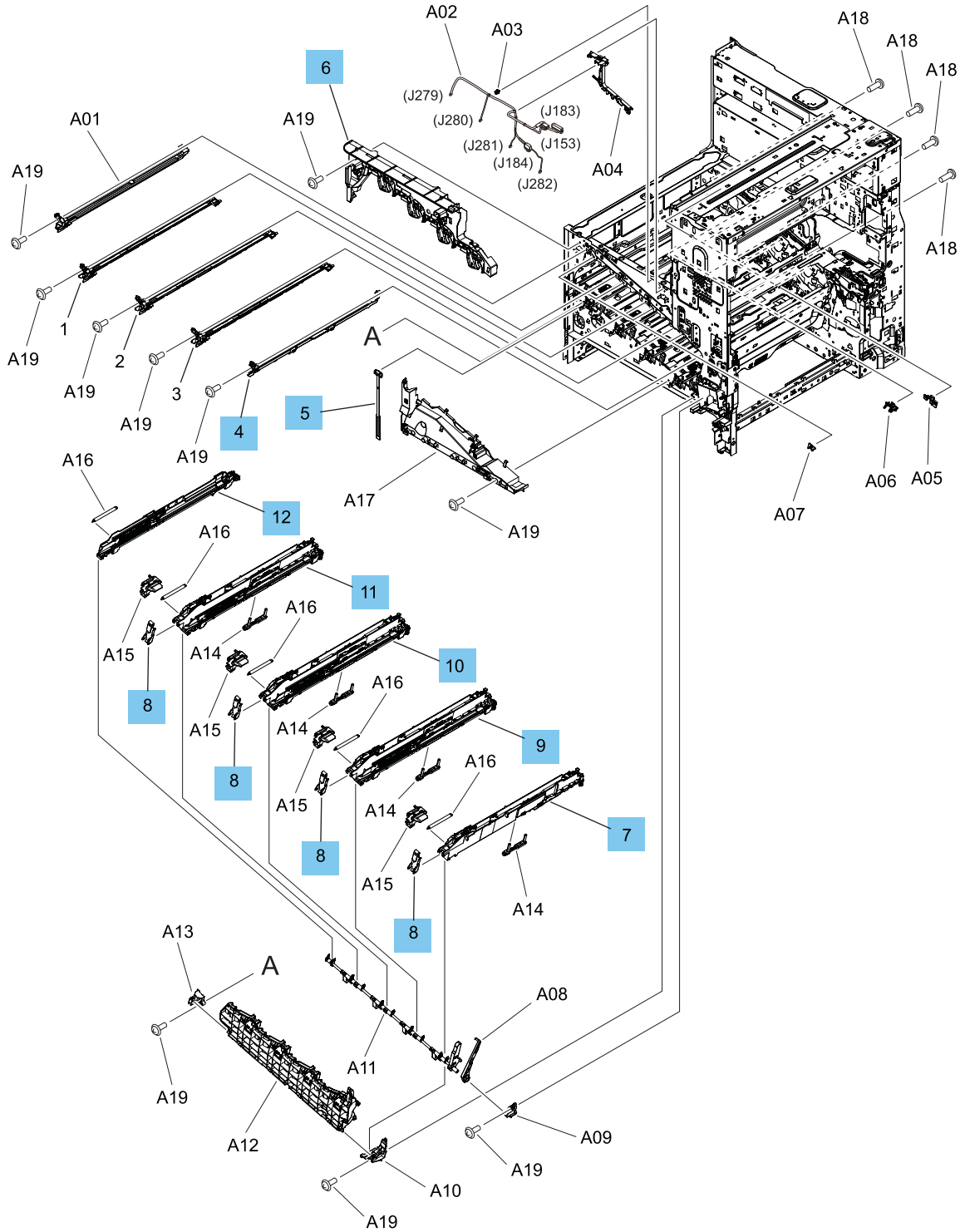


Table 2-29 Printer internal assemblies (M776zs; 1 of 9)

Ref	Part number	Description	Qty
4	RM2-1340-000CN	Black pre-exposure assembly	1
5	RC5-0722-000CN	Arm, front door, left	1
6	RM2-1343-000CN	Cartridge upper guide assembly	1
7	RM2-1356-000CN	Black cartridge rail assembly	1
8	RL2-2091-000CN	Guide, cartridge	4
9	RM2-2682-000CN	Third cartridge rail assembly	1
10	RM2-2480-000CN	Second cartridge rail assembly	1
11	RM2-2681-000CN	First cartridge rail assembly	1
12	RM2-2479-000CN	DT Cartridge rail assembly	1

Parts and diagrams: Printer internal assemblies (M776zs; 2 of 9)

Parts diagram and parts list for the internal printer assemblies.

Figure 2-23 Printer internal assemblies (M776zs; 2 of 9)

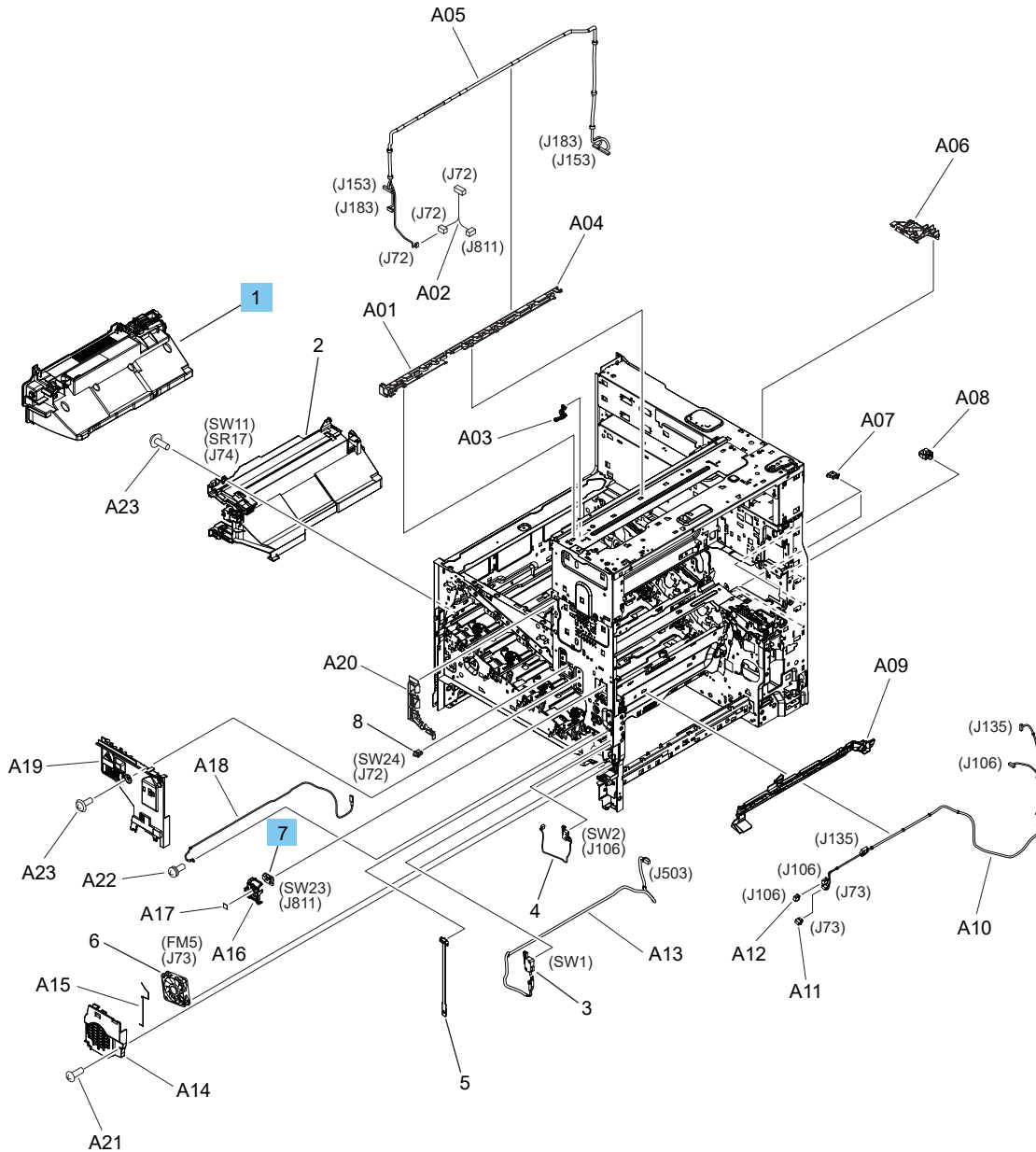


Table 2-30 Printer internal assemblies (M776zs; 2 of 9)

Ref	Part number	Description	Qty
1	3WT90-67901	Toner collection unit	1
7	RM2-9610-000CN	Power switch PCB assembly	1

Parts and diagrams: Printer internal assemblies (M776zs; 3 of 9)

Parts diagram and parts list for the internal printer assemblies.

Figure 2-24 Printer internal assemblies (M776zs; 3 of 9)

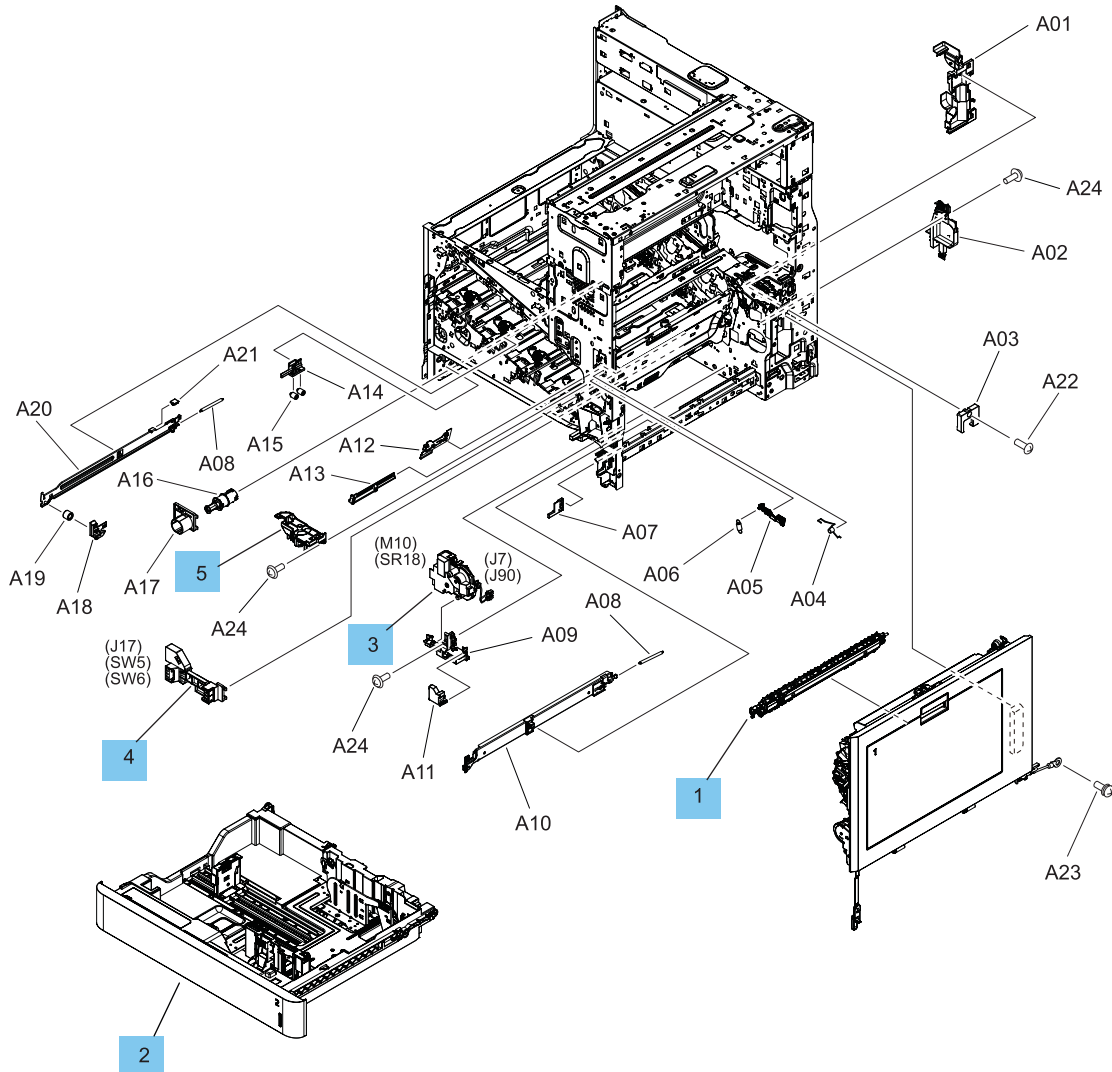


Table 2-31 Printer internal assemblies (M776zs; 3 of 9)

Ref	Part number	Description	Qty
1	RM2-1399-010CN	Second transfer, roller assembly	1
2	RM2-1394-000CN	Cassette Assembly	1
3	RM2-1604-000CN	Lifter drive assembly	1
4	RM2-1436-000CN	Size detect switch assembly	1
5	RM2-1605-000CN	Auto close assembly	1

Parts and diagrams: Printer internal assemblies (M776zs; 4 of 9)

Parts diagram and parts list for the internal printer assemblies.

Figure 2-25 Printer internal assemblies (M776zs; 4 of 9)

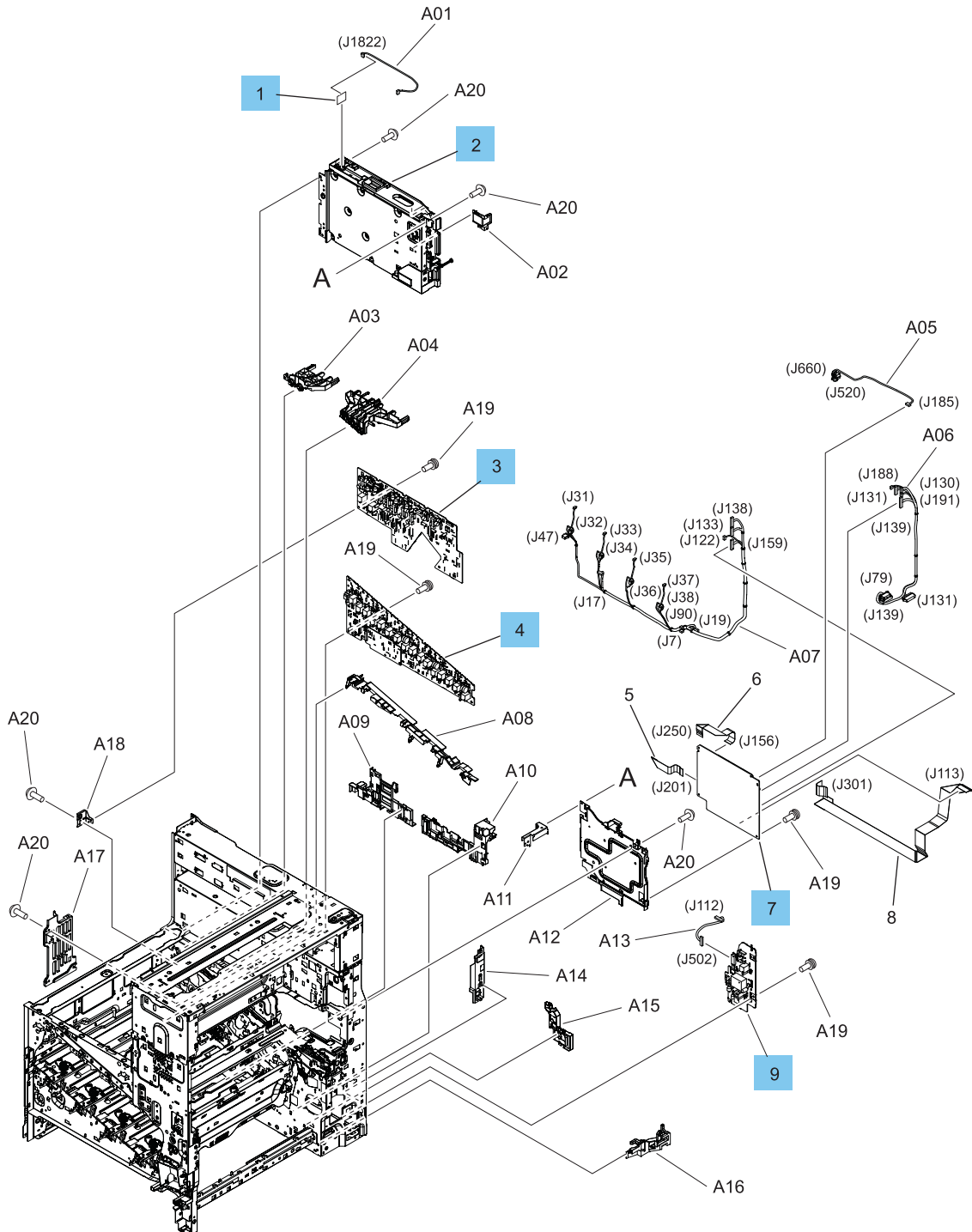


Table 2-32 Printer internal assemblies (M776zs; 4 of 9)

Ref	Part number	Description	Qty
1	RM3-7351-000CN	Memory PCB assembly	1

Table 2-32 Printer internal assemblies (M776zs; 4 of 9) (continued)

Ref	Part number	Description	Qty
2	RM2-2476-000CN	Formatter case assembly	1
3	RM2-9601-000CN	Upper high voltage power supply PCB assembly	1
4	RM2-9624-000CN	Lower high voltage power supply PCB assembly	1
7	RM2-9931-000CN	DC controller PCB assembly	1
9	RM2-9623-000CN	Second transfer H.V.T. PCB assembly	1
Not shown	5851-7913	Formatter PCA (M776) (sPAB - SFP)	1
Not shown	5851-7914	Formatter PCA (M776) (sPAB - SFP; India/China)	1
Not shown	0960-3659	Wireless PCA board	1

Parts and diagrams: Printer internal assemblies (M776zs; 5 of 9)

Parts diagram and parts list for the internal printer assemblies.

Figure 2-26 Printer internal assemblies (M776zs; 5 of 9)

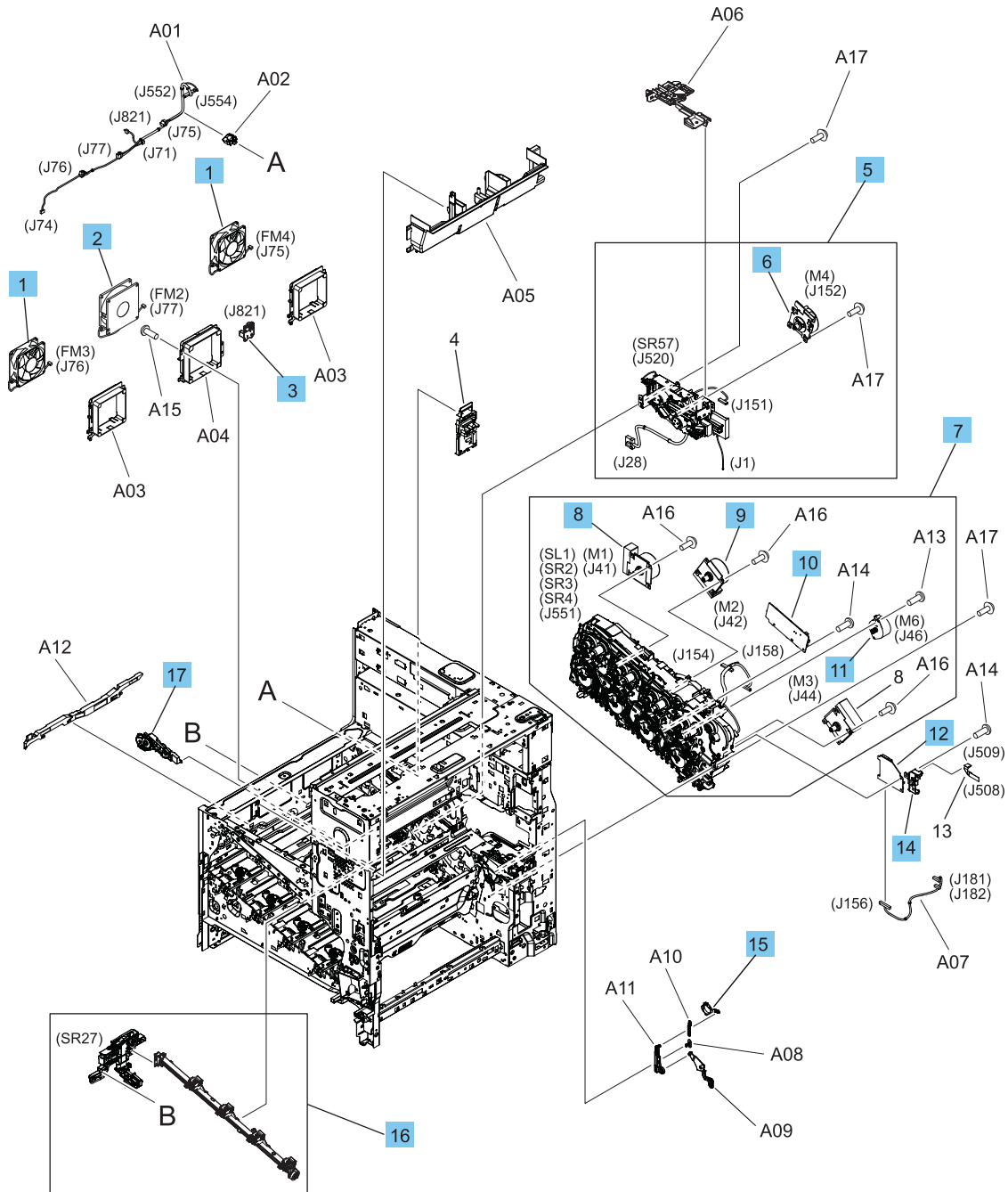


Table 2-33 Printer internal assemblies (M776zs; 5 of 9)

Ref	Part number	Description	Qty
1	RK2-2276-000CN	Fan	2
2	RK2-9148-000CN	Fan	1
3	RM2-9620-000CN	Environment sensor PCB assembly	1

Table 2-33 Printer internal assemblies (M776zs; 5 of 9) (continued)

Ref	Part number	Description	Qty
5	RM2-1391-000CN	Fuser drive assembly	1
6	RM2-1456-000CN	Fuser motor assembly	1
7	RM2-1614-000CN	Main drive assembly	1
8	RM2-1612-000CN	Main motor assembly	2
9	RM2-1613-000CN	Main motor assembly	1
10	RM2-9618-000CN	Main connecting PCB assembly	1
11	RK2-6027-000CN	Motor, stepping	1
12	RM2-9622-000CN	Connecting PCB assembly	1
14	RC5-1656-000CN	Guide, PCB cable	1
15	RC5-1055-000CN	Cam, coupling estrangement	1
16	RM2-1520-000CN	Waste toner auger service kit	1
17	RM2-1364-000CN	Waste toner gear base assembly	1

Parts and diagrams: Printer internal assemblies (M776zs; 6 of 9)

Parts diagram and parts list for the internal printer assemblies.

Figure 2-27 Printer internal assemblies (M776zs; 6 of 9)

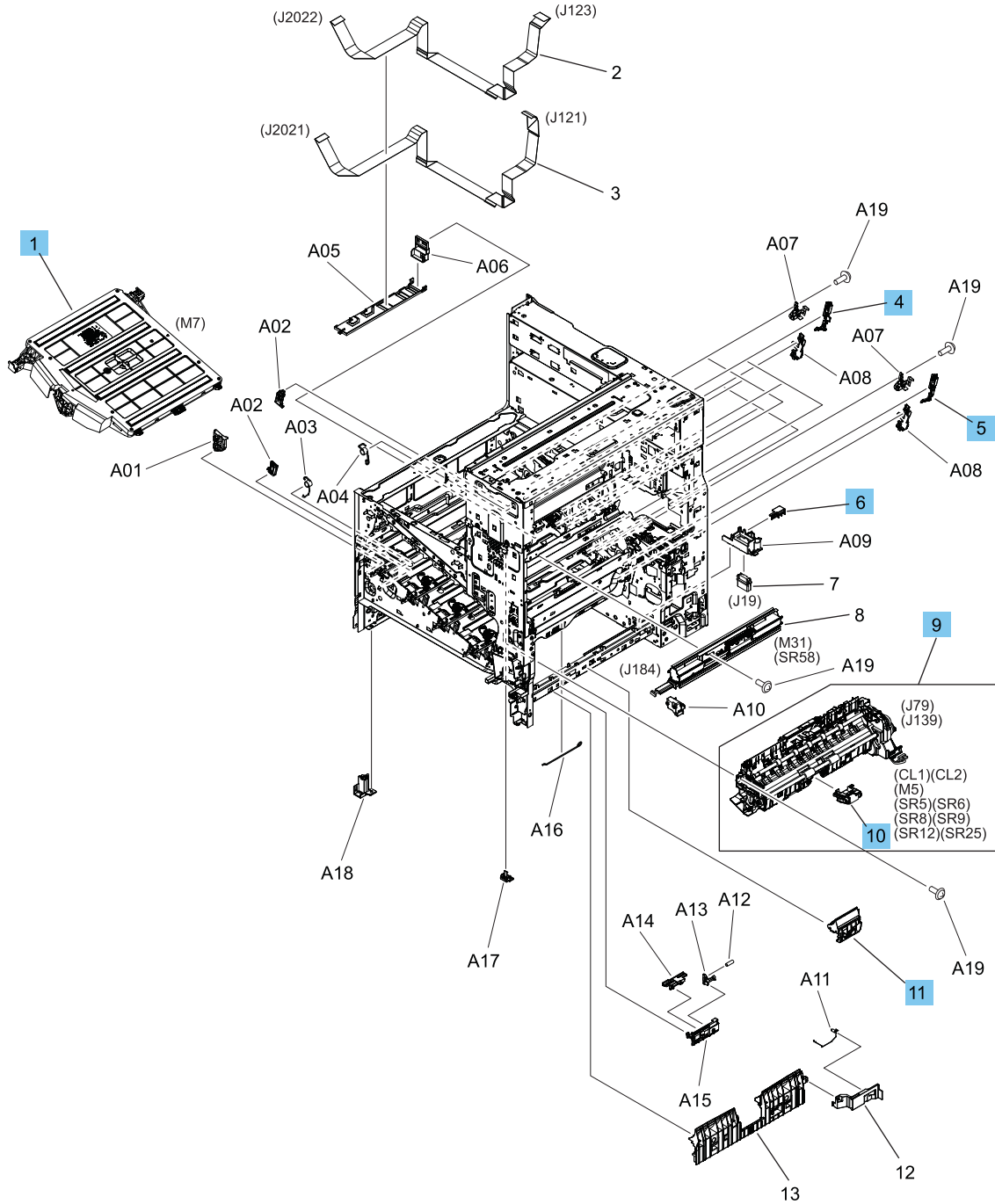


Table 2-34 Printer internal assemblies (M776zs; 6 of 9)

Ref	Part number	Description	Qty
1	RM2-1328-020CN	Laser scanner assembly	1
4	RM2-1366-000CN	Waste toner feed link assembly	3

Table 2-34 Printer internal assemblies (M776zs; 6 of 9) (continued)

Ref	Part number	Description	Qty
5	RM2-1367-000CN	Waste toner feed link assembly	1
6	RC5-1681-000CN	Spacer, drawer holder	1
9	RM2-3908-000CN	Paper pickup assembly	1
10	RM2-1526-000CN	Paper pickup roller assembly	1
11	RM2-1526-000CN	Separation roller holder assembly	1

Parts and diagrams: Printer internal assemblies (M776zs; 7 of 9)

Parts diagram and parts list for the internal printer assemblies.

Figure 2-28 Printer internal assemblies (M776zs; 7 of 9)

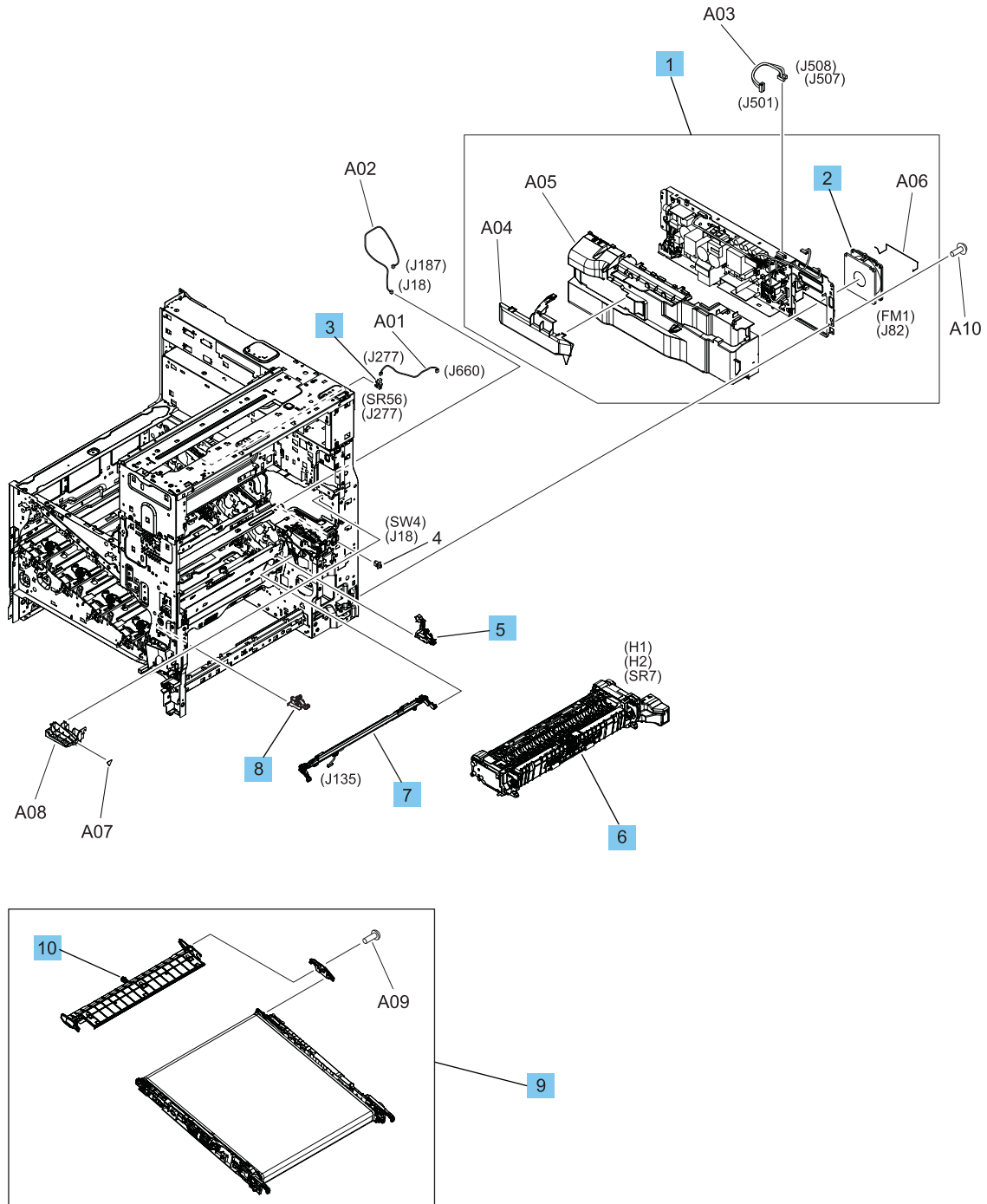


Table 2-35 Printer internal assemblies (M776zs; 7 of 9)

Ref	Part number	Description	Qty
1	RM2-2473-000CN	Low voltage power supply assembly	1
1	RM2-2474-000CN	Low voltage power supply assembly	1

Table 2-35 Printer internal assemblies (M776zs; 7 of 9) (continued)

Ref	Part number	Description	Qty
2	RK2-9148-000CN	Fan	1
3	WG8-5935-000CN	IC, photointerrupter	1
5	RM2-1390-000CN	RD pressure link assembly, rear	1
6	4YL16-67901	Fuser kit (110V)	1
6	4YL17-67901	Fuser kit (220V)	1
7	RM2-1501-000CN	Registration density sensor assembly	1
8	RM2-1389-000CN	RD pressure link assembly, front	1
9	RM2-1504-000CN	Intermediate transfer belt assembly	1
10	RM2-1490-000CN	Transfer cleaner assembly	1

Parts and diagrams: Printer internal assemblies (M776zs; 8 of 9)

Parts diagram and parts list for the internal printer assemblies.

Figure 2-29 Printer internal assemblies (M776zs; 8 of 9)

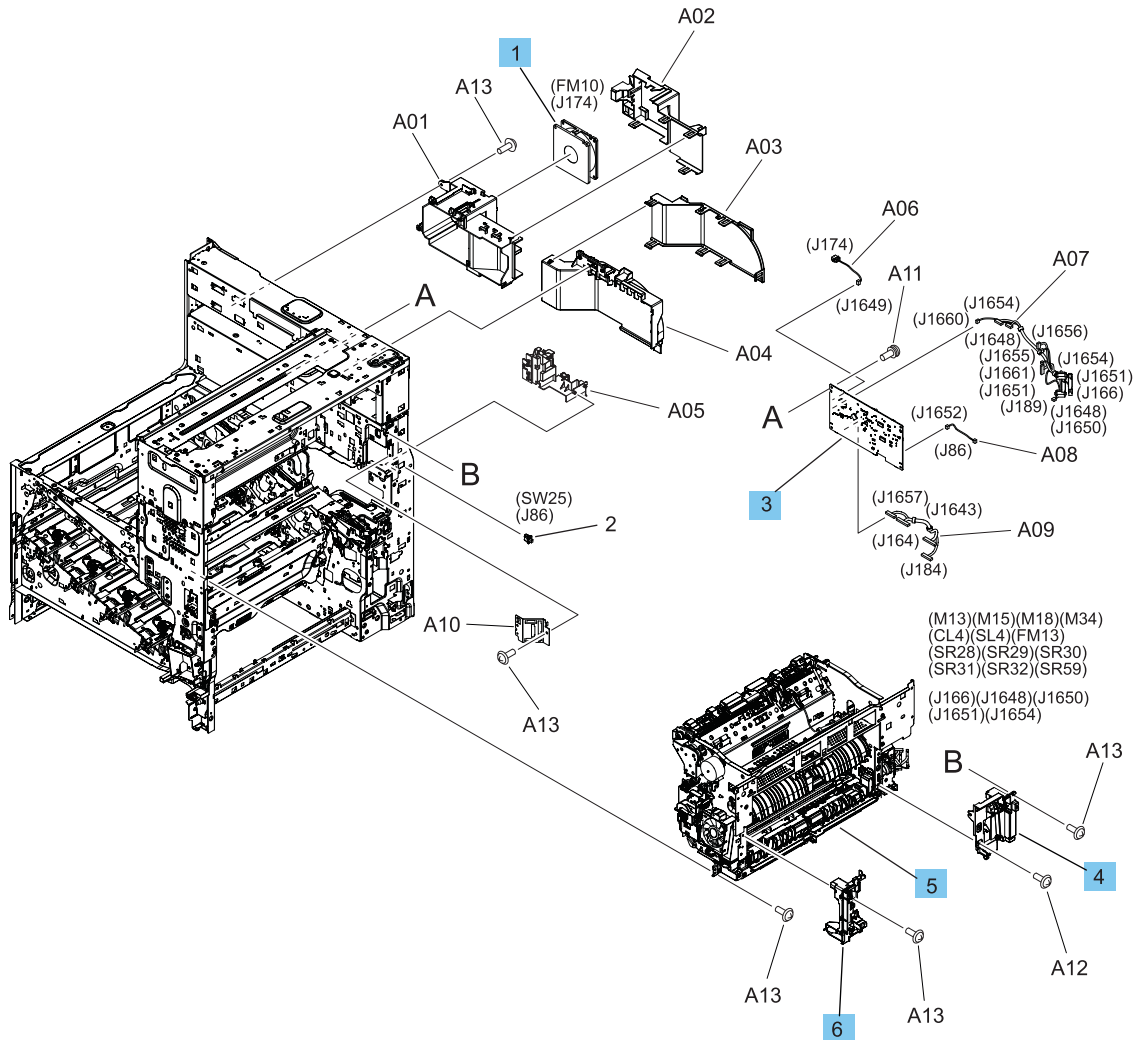


Table 2-36 Printer internal assemblies (M776zs; 8 of 9)

Ref	Part number	Description	Qty
1	RK2-9148-000CN	Fan	1
3	RM3-7380-000CN	Duplexing controller PCB assembly	1
4	RM2-1763-000CN	Toggle rear assembly	1
5	RM2-1786-000CN	Paper delivery assembly	1
6	RM2-1764-000CN	Toggle front assembly	1

Parts and diagrams: Printer internal assemblies (M776zs; 9 of 9)

Parts diagram and parts list for the internal printer assemblies.

Figure 2-30 Printer internal assemblies (M776zs; 9 of 9)

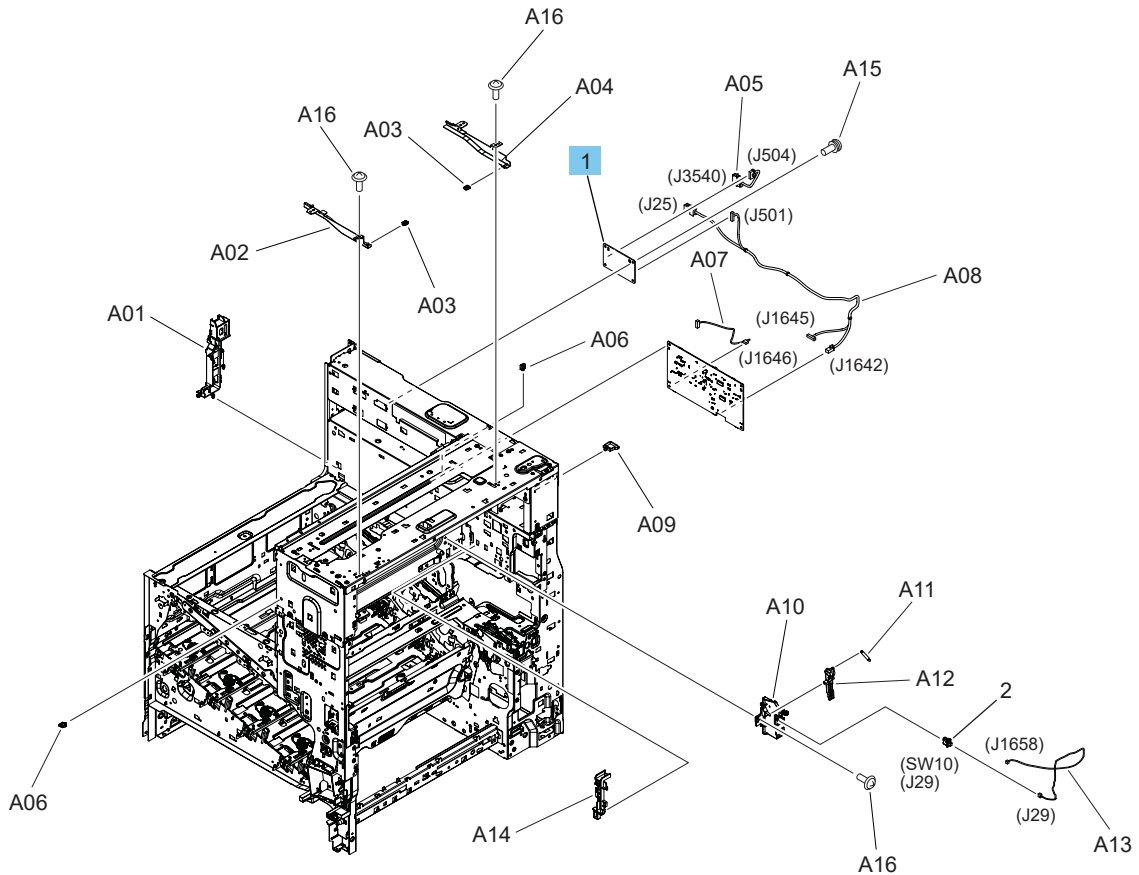


Table 2-37 Printer internal assemblies (M776zs; 9 of 9)

Ref	Part number	Description	Qty
1	RM3-7341-000CN	Communication PCB Assembly	1

Parts and diagrams: Inner finisher components

View parts diagrams and parts lists for the inner finisher components.

Parts and diagrams: Printer covers (Inner finisher)

Parts diagram and parts list for the inner finisher.

Figure 2-31 Inner finisher covers

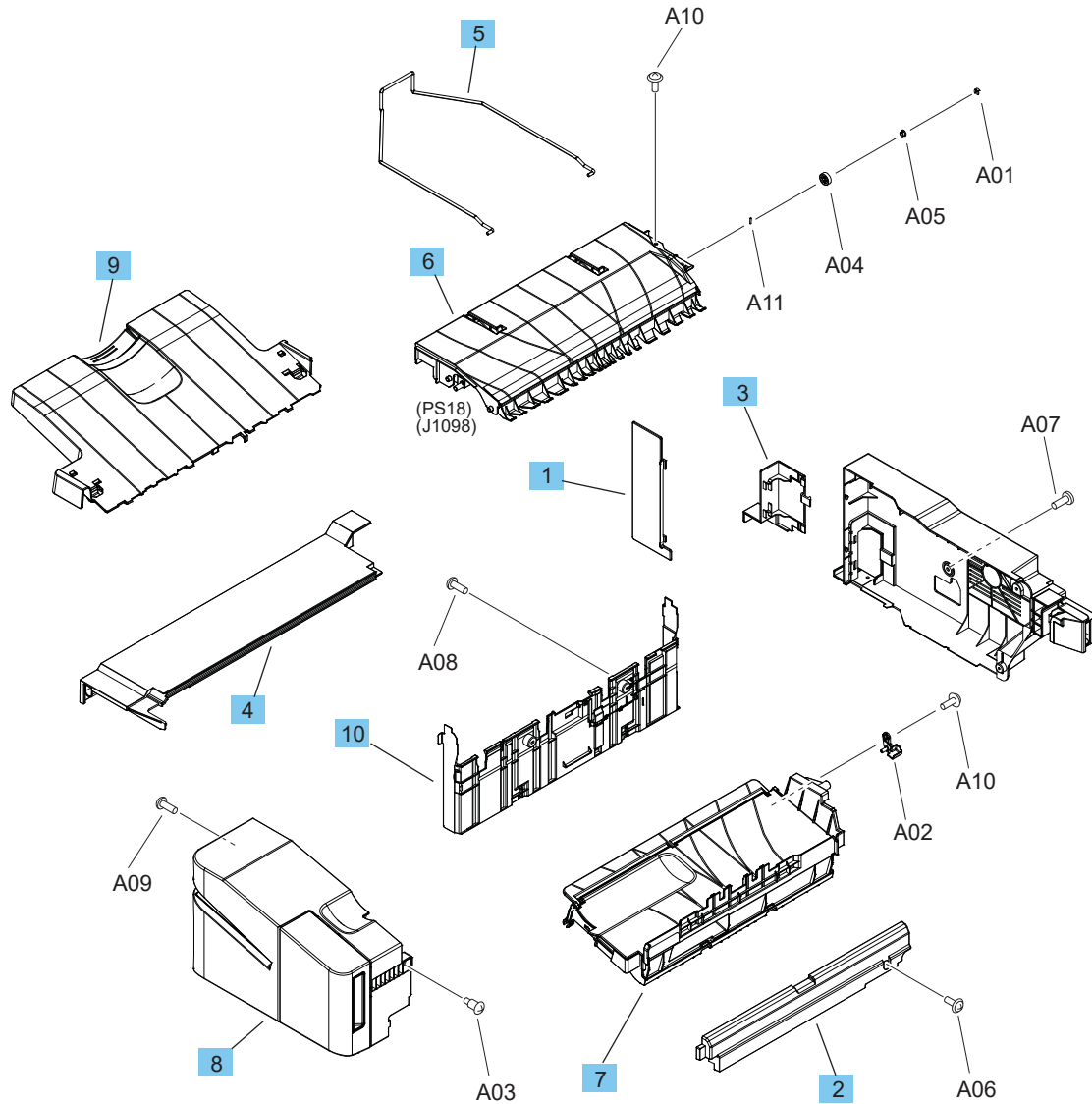


Table 2-38 Inner finisher covers

Ref	Part number	Description	Qty
All	T3U55-67901	Complete inner finisher	1
1	RC5-4834-000CN	Cover, rear, small	1
2	RC5-4840-000CN	Cover, latch	1
3	RC5-4842-000CN	Cap, cover, rear	1
4	RC5-4887-000CN	Cover, rail	1
5	RC5-4905-000CN	Tray, wire sub	1
6	RM2-2432-000CN	Paper feed guide assembly, upper	1
7	RM2-2434-000CN	Entrance guide assembly, upper	1
8	RM2-2438-000CN	Front cover assembly	1
9	RM2-2450-000CN	Stack tray assembly	1

Table 2-38 Inner finisher covers (continued)

Ref	Part number	Description	Qty
10	RM2-2452-000CN	Height wall assembly	1

Parts and diagrams: Printer internal assemblies (inner finisher; 1 of 3)

Parts diagram and parts list for the inner finisher.

Figure 2-32 Inner finisher internal assemblies (1 of 3)

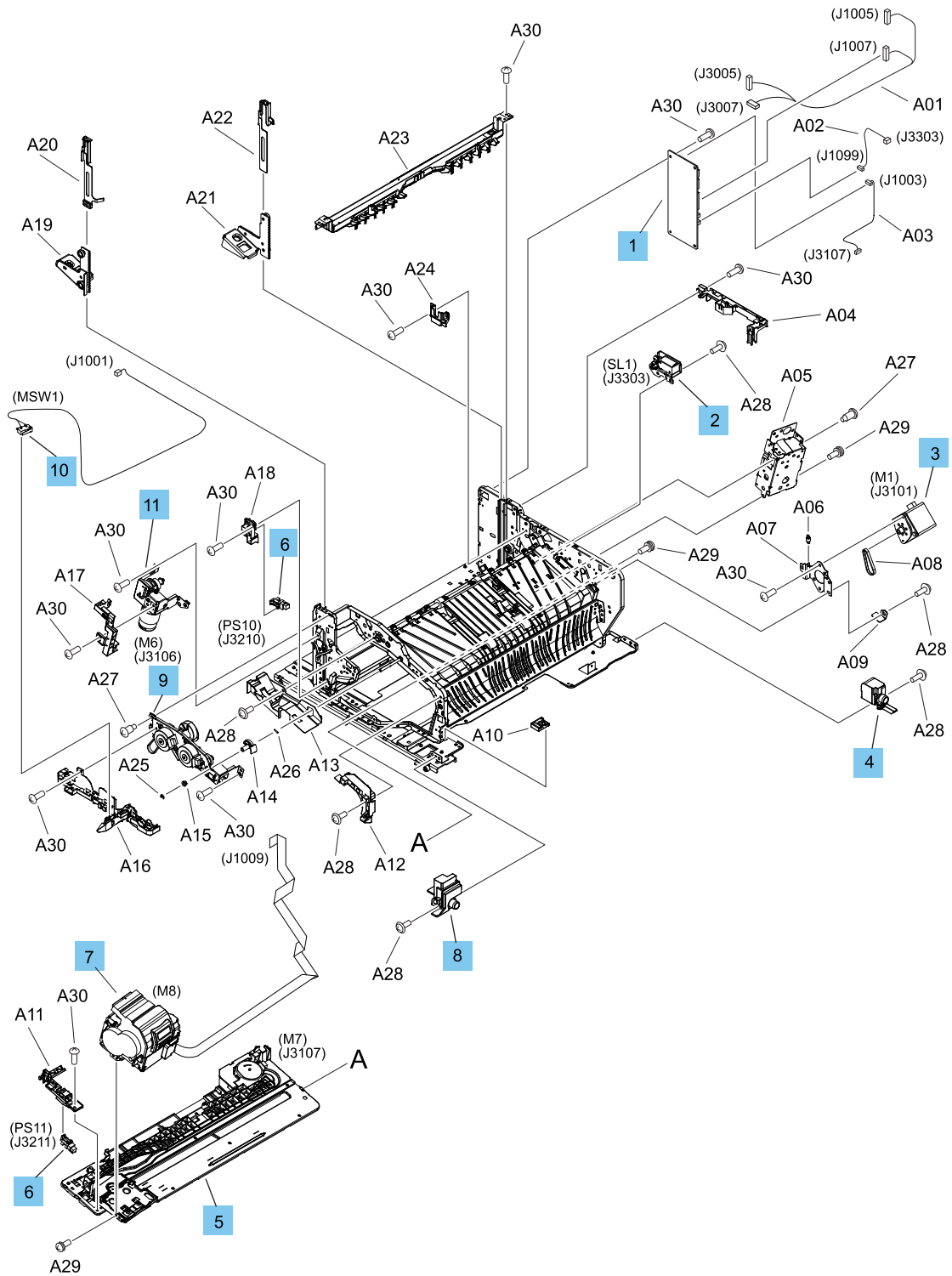


Table 2-39 Inner finisher internal assemblies (1 of 3)

Ref	Part number	Description	Qty
All	T3U55-67901	Complete inner finisher	1
1	RM3-7323-000CN	Staple stacker PCB assembly	1
2	FM1-F201-000CN	Estrangement solenoid assembly	1
3	FK4-2060-000CN	Motor stepping	1
4	RM2-2526-000CN	Push assembly, rear	1
5	FM1-D645-000CN	Staple mount assembly	1
6	WG8-5783-000CN	IC, photo-interrupter, LG248NL1A	2
7	RM2-2453-000CN	Staple assembly	1
8	RM2-2460-000CN	Push assembly, front	1
9	FM1-C426-000CN	Paddle drive assembly	1
10	FM1-E959-000CN	Cable, interlock	1
11	FM1-C439-000CN	Height tray motor assembly	1

Parts and diagrams: Printer internal assemblies (inner finisher; 2 of 3)

Parts diagram and parts list for the inner finisher.

Figure 2-33 Inner finisher internal assemblies (2 of 3)

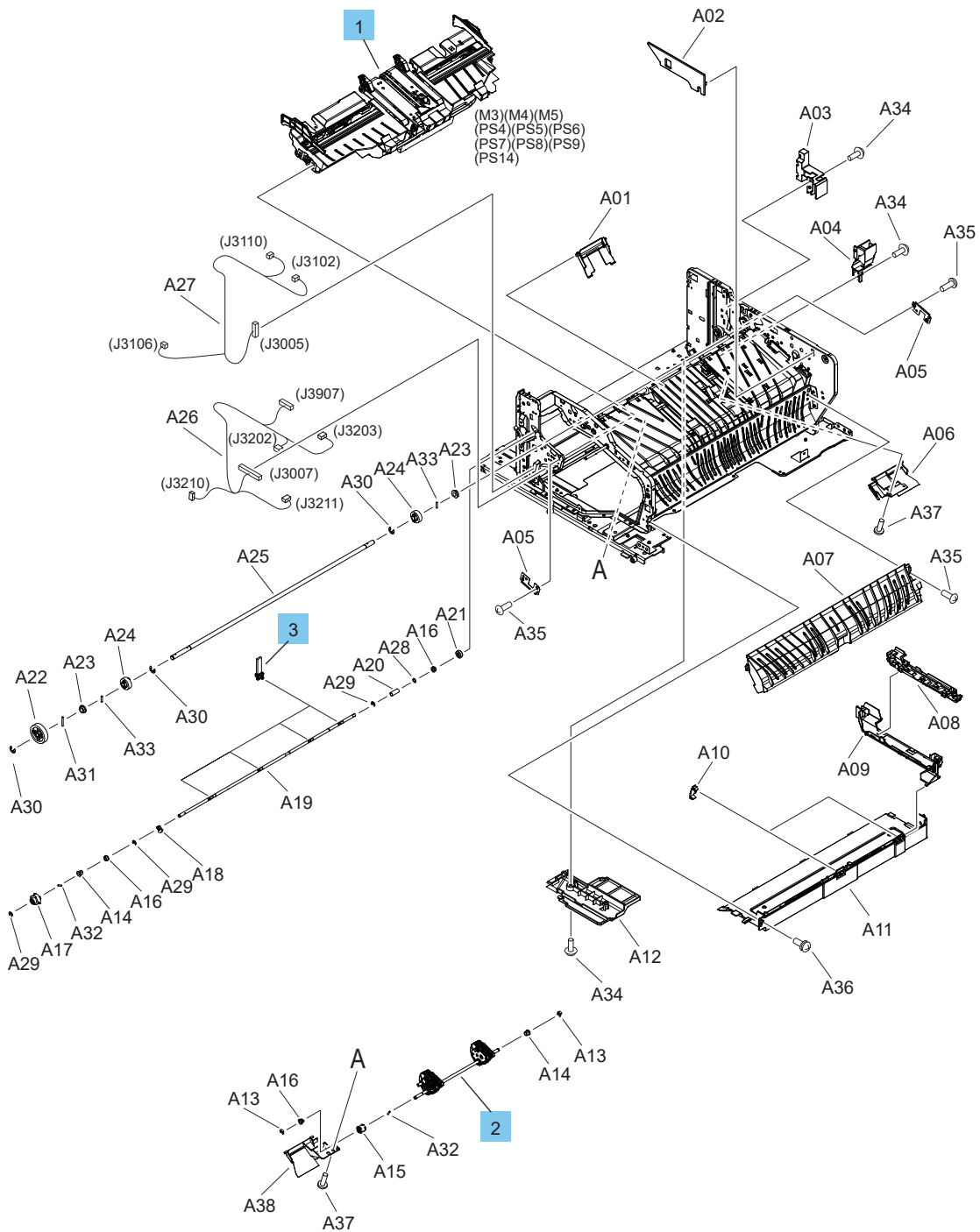


Table 2-40 Inner finisher internal assemblies (2 of 3)

Ref	Part number	Description	Qty
All	T3U55-67901	Complete inner finisher	1
1	RM2-2458-000CN	Processing tray assembly	1

Table 2-40 Inner finisher internal assemblies (2 of 3) (continued)

Ref	Part number	Description	Qty
2	FM1-H670-000CN	Return belt unit	1
3	FM1-C422-000CN	Paddle unit	4

Parts and diagrams: Printer internal assemblies (inner finisher; 3 of 3)

Parts diagram and parts list for the inner finisher.

Figure 2-34 Inner finisher internal assemblies (3 of 3)

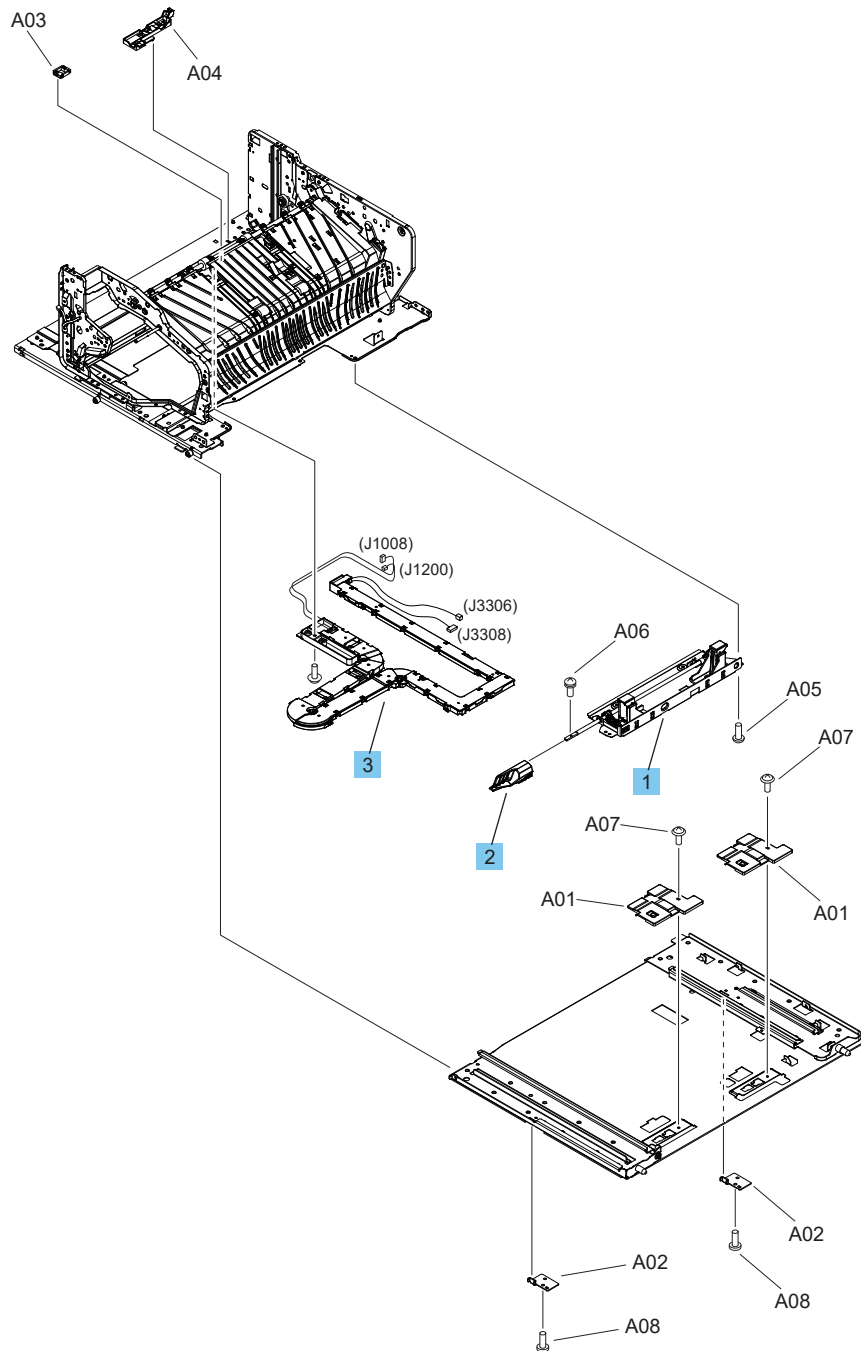


Table 2-41 Inner finisher internal assemblies (3 of 3)

Ref	Part number	Description	Qty
All	T3U55-67901	Complete inner finisher	1
1	RM2-2442-000CN	Latch assembly	1
2	RC5-4839-000CN	Handle, release	1

Table 2-41 Inner finisher internal assemblies (3 of 3) (continued)

Ref	Part number	Description	Qty
3	RM2-2444-000CN	Cable duct assembly	1

Parts and diagrams: 550-sheet tray components

View parts diagrams and parts lists for the 550-sheet tray components.

Parts and diagrams: 550-sheet tray covers

Parts diagram and parts list for the 550-sheet tray covers.

Figure 2-35 550-sheet tray covers

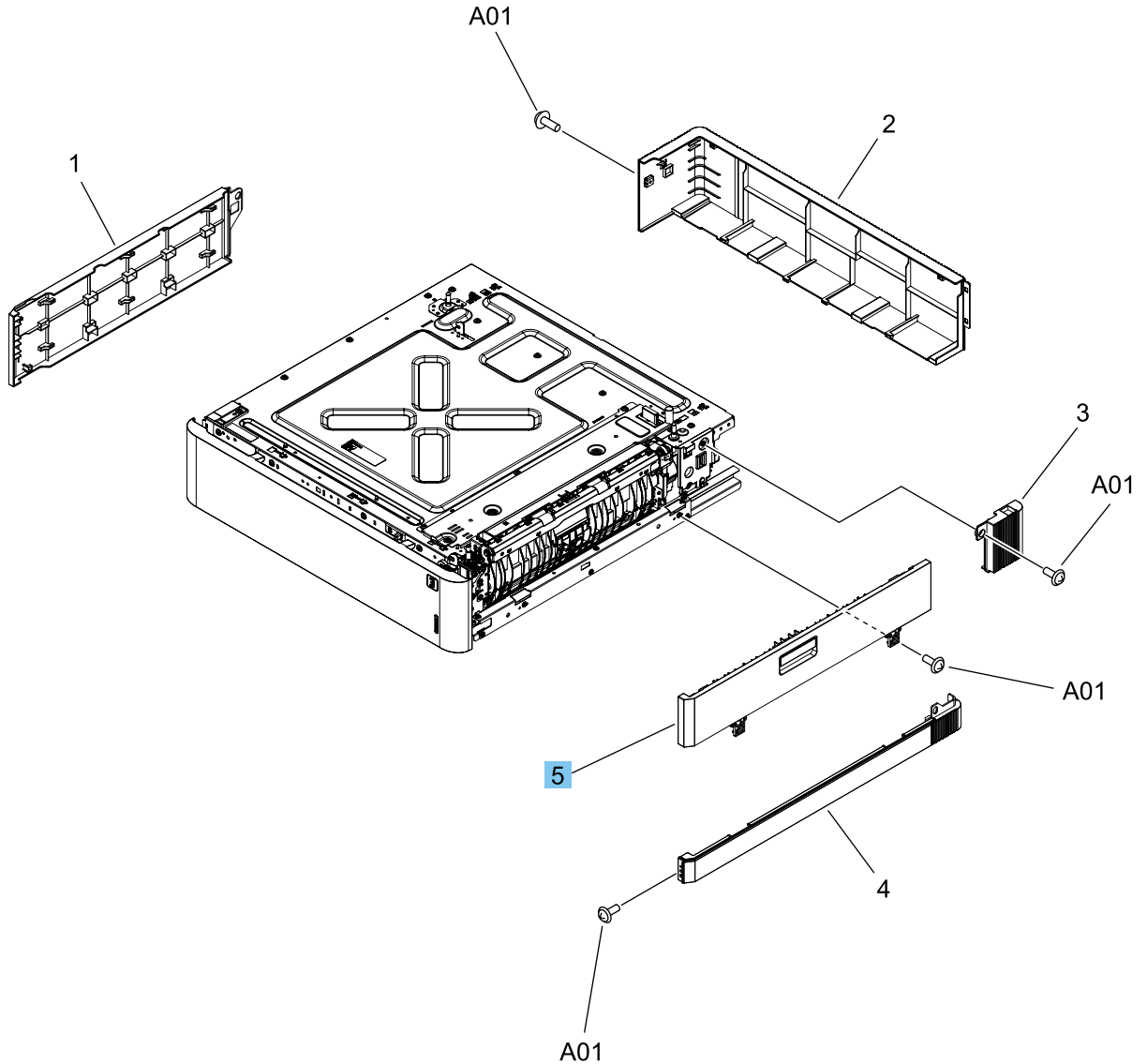


Table 2-42 550-sheet tray covers

Ref	Part number	Description	Qty
5	RM2-1716-000CN	Right door assembly	1

Parts and diagrams: 550-sheet paper tray internal assemblies

Parts diagram and parts list for the 550-sheet paper tray internal assemblies.

Figure 2-36 550-sheet paper tray internal assemblies

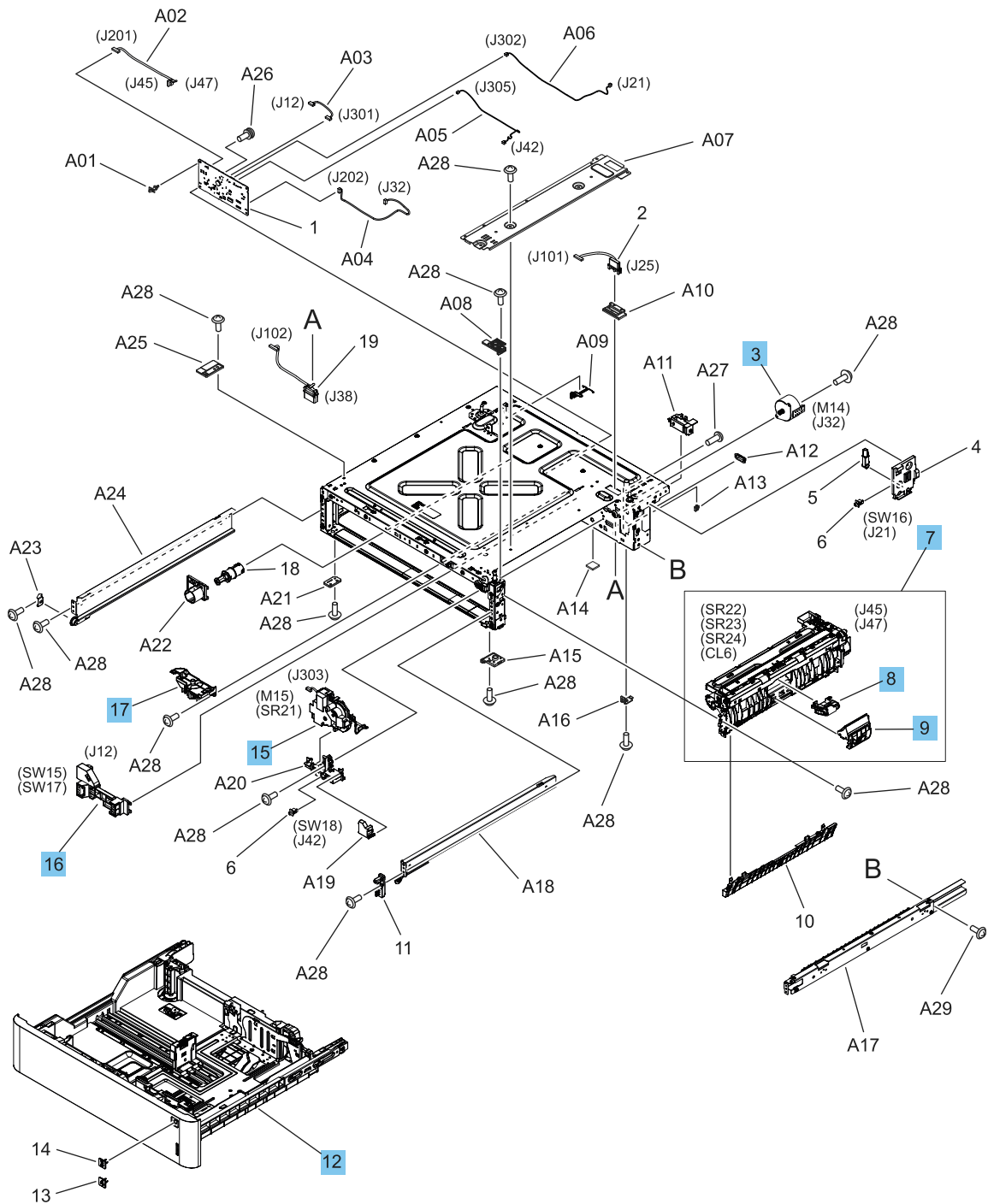


Table 2-43 550-sheet paper tray internal assemblies

Ref	Part number	Description	Qty
3	RK2-9410-000CN	Motor, stepping, DC	1
7	RM2-1717-000CN	Paper pickup assembly	1

Table 2-43 550-sheet paper tray internal assemblies (continued)

Ref	Part number	Description	Qty
8	RM2-1526-000CN	Paper pickup roller assembly	1
9	RM2-1526-000CN	Separation roller holder assembly	1
12	RM2-1706-000CN	Cassette assembly	1
15	RM2-1703-000CN	Lifter drive assembly	1
16	RM2-1711-000CN	Size detect switch assembly	1
17	RM2-1760-000CN	Auto-close assembly	1

Parts and diagrams: 2x550-sheet tray components

View parts diagrams and parts lists for the 2x550-sheet tray components.

Parts and diagrams: 2x550-sheet tray covers

Parts diagram and parts list for the 2x550-sheet tray covers.

Figure 2-37 2x550-sheet tray covers

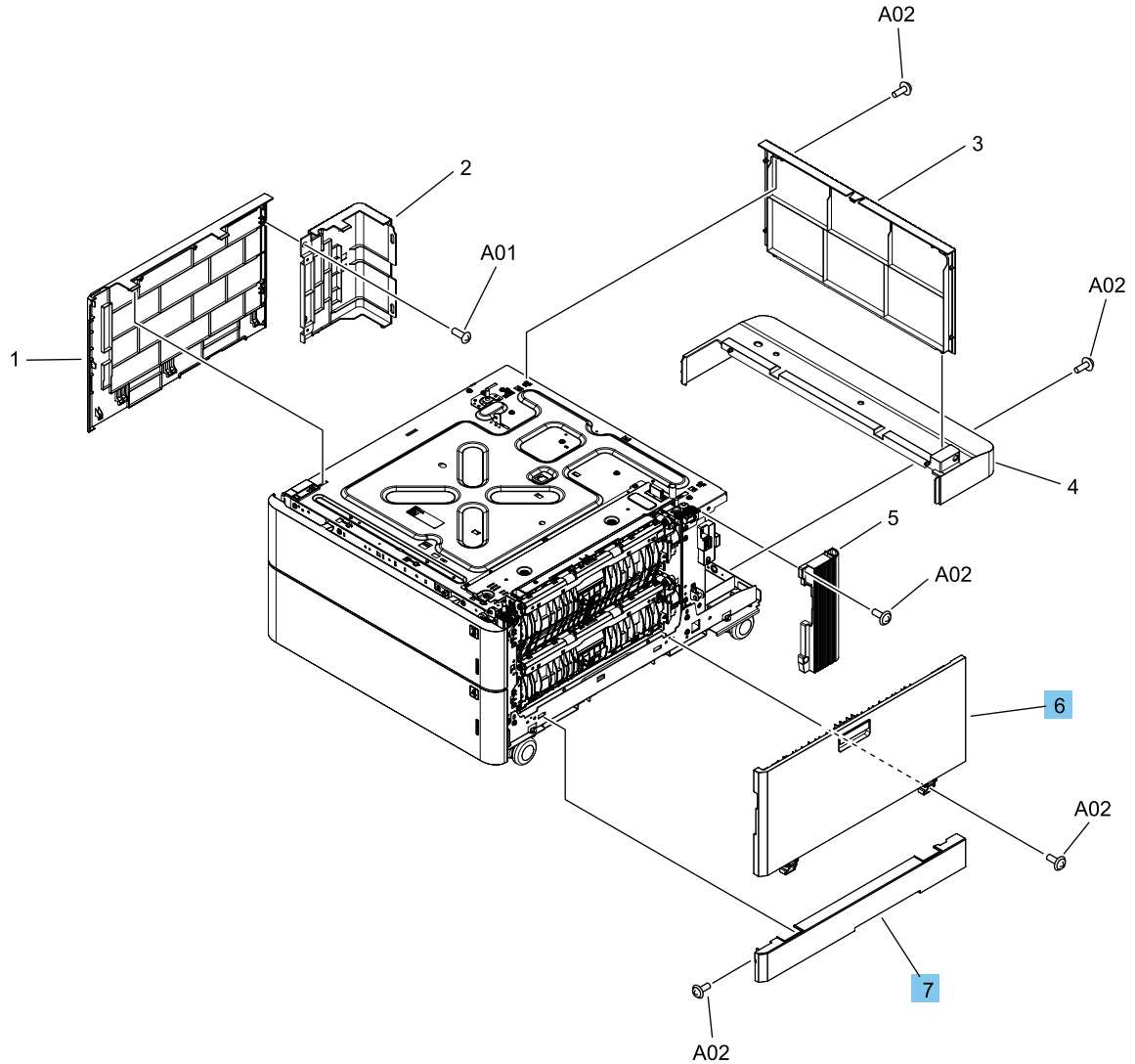


Table 2-44 2x550-sheet tray covers

Ref	Part number	Description	Qty
6	RM2-1729-000CN	Right door assembly	1
7	RC5-2064-000CN	Cover, right, lower	1

Parts and diagrams: 2x550-sheet paper tray internal assemblies (1 of 2)

Parts diagram and parts list for the 2x550-sheet paper tray internal assemblies.

Figure 2-38 2x550-sheet paper tray internal assemblies (1 of 2)

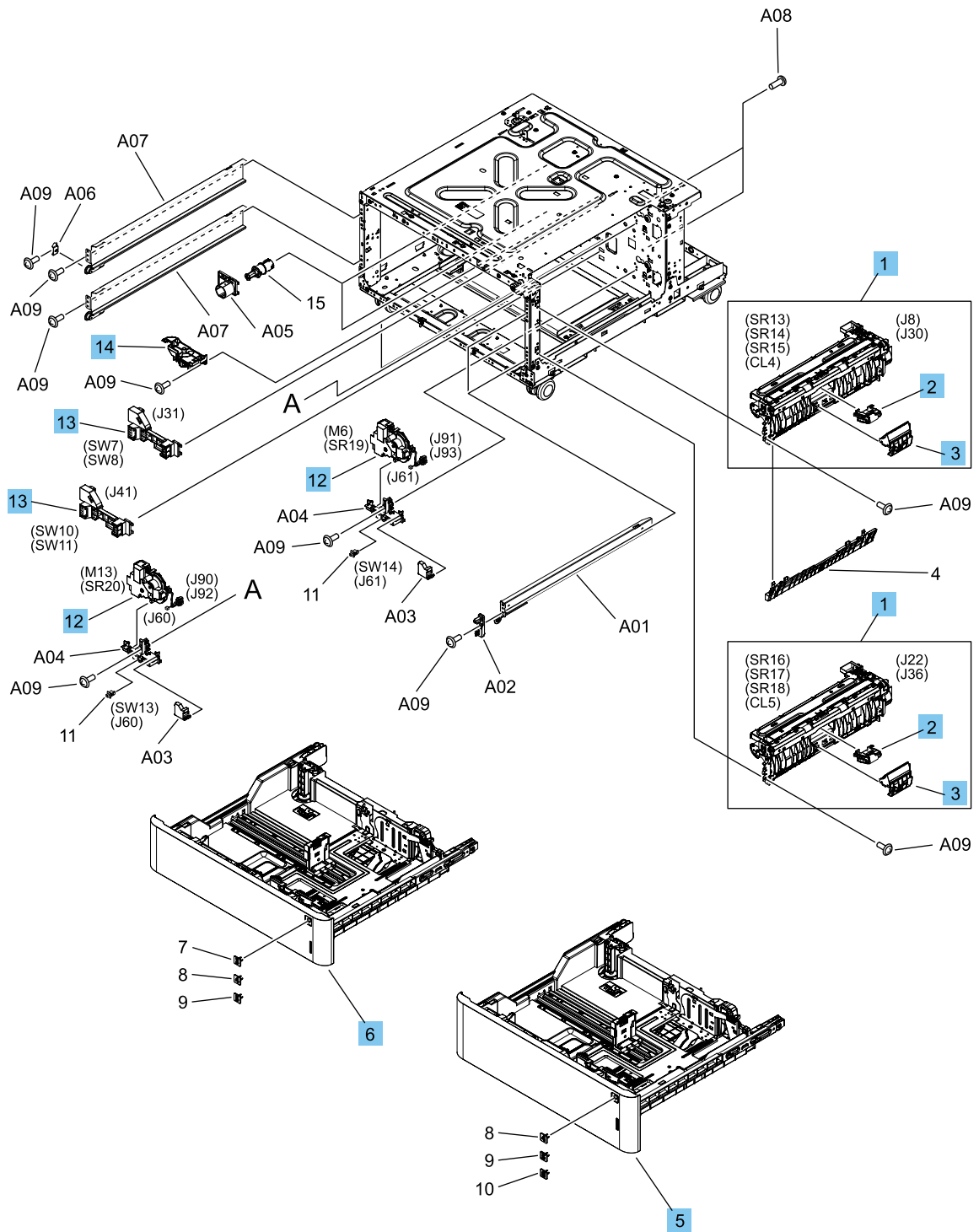


Table 2-45 2x550-sheet paper tray internal assemblies (1 of 2)

Ref	Part number	Description	Qty
1	RM2-1717-000CN	Paper pickup assembly	2

Table 2-45 2x550-sheet paper tray internal assemblies (1 of 2) (continued)

Ref	Part number	Description	Qty
2	RM2-1526-000CN	Paper pickup roller assembly	2
3	RM2-1526-000CN	Separation roller holder assembly	2
5	RM2-1720-000CN	Cassette assembly	1
6	RM2-1706-000CN	Cassette assembly	1
12	RM2-1704-000CN	Lifter drive assembly	2
13	RM2-1711-000CN	Size detect switch assembly	2
14	RM2-1760-000CN	Auto-close assembly	2

Parts and diagrams: 2x550-sheet paper tray internal assemblies (2 of 2)

Parts diagram and parts list for the 2x550-sheet paper tray internal assemblies.

Figure 2-39 2x550-sheet paper tray internal assemblies (2 of 2)

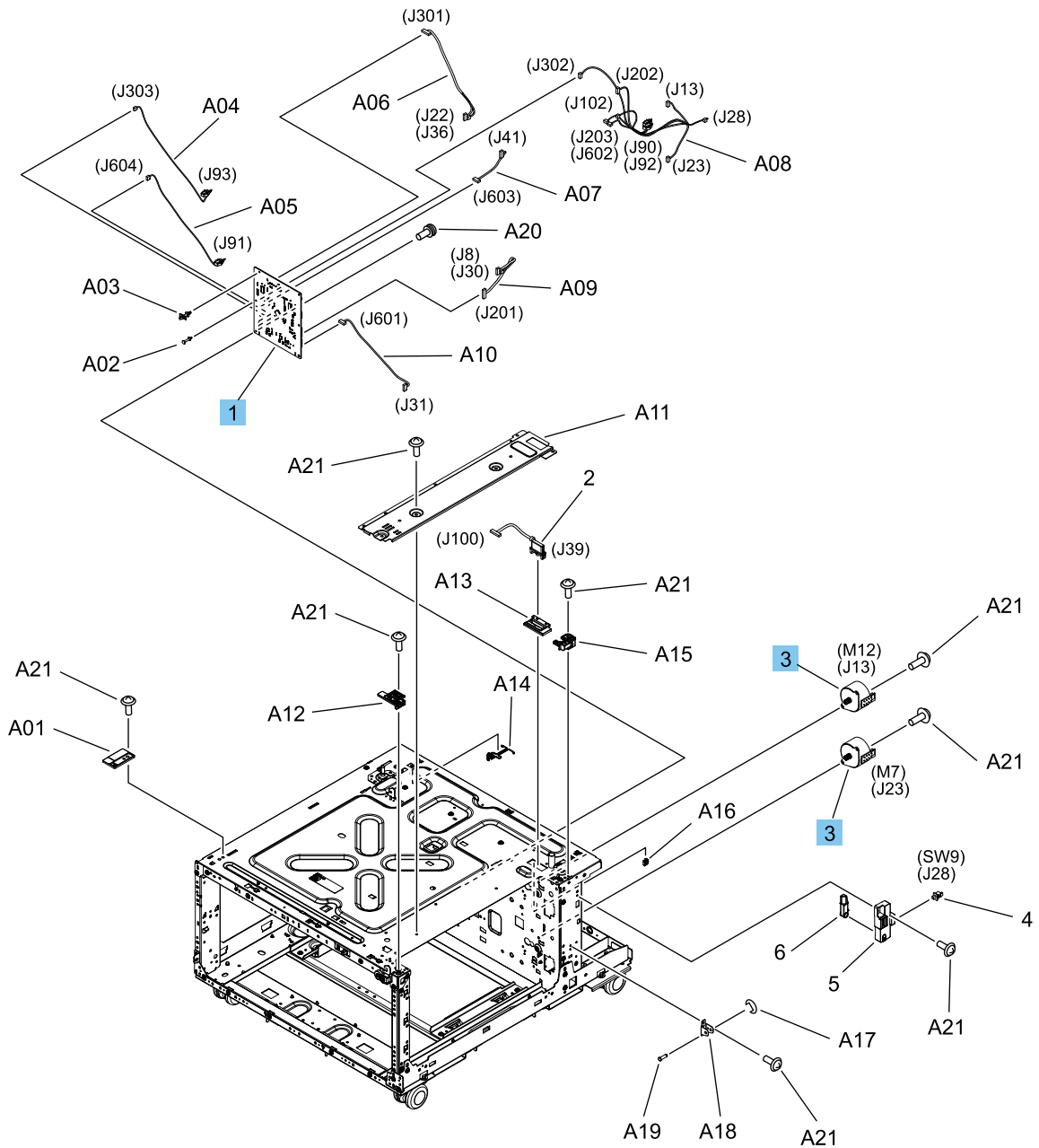


Table 2-46 2x550-sheet paper tray internal assemblies (2 of 2)

Ref	Part number	Description	Qty
1	RM2-9885-000CN	Paper deck controller PCB assembly	1
3	RK2-9410-000CN	Motor, stepping, DC	2

Parts and diagrams: High-capacity input (HCI) tray components

View parts diagrams and parts lists for the HCI tray components.

Parts and diagrams: High-capacity input (HCI) tray covers

Parts diagram and parts list for the HCI tray covers.

Figure 2-40 HCI tray covers

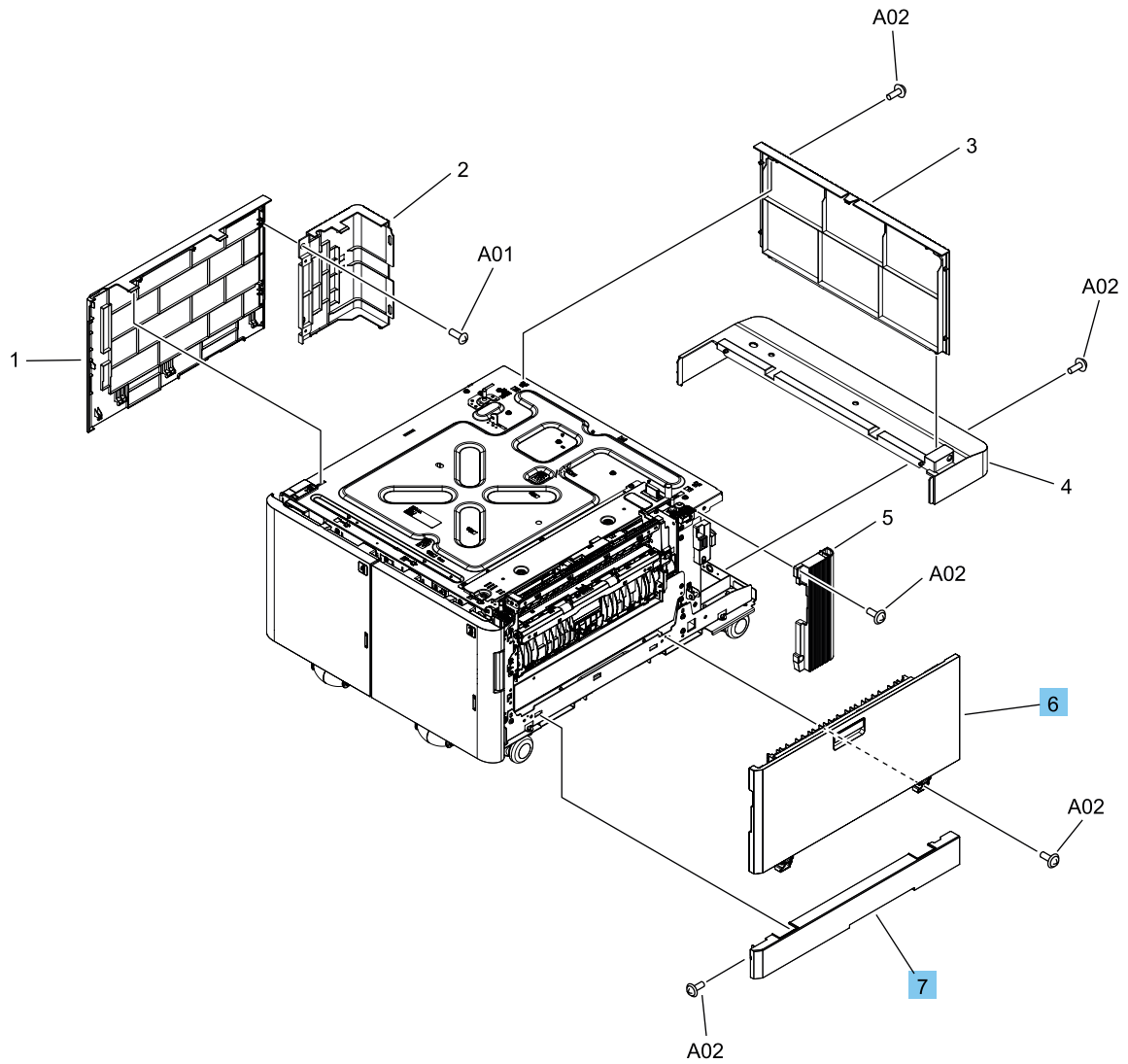


Table 2-47 HCI tray covers

Ref	Part number	Description	Qty
6	RM2-1740-000CN	Right door assembly	1
7	RC5-2064-000CN	Cover, right, lower	1

Parts and diagrams: High-capacity input (HCI) tray internal assemblies (1 of 2)

Parts diagram and parts list for the HCI tray internal assemblies.

Figure 2-41 HCI tray internal assemblies (1 of 2)

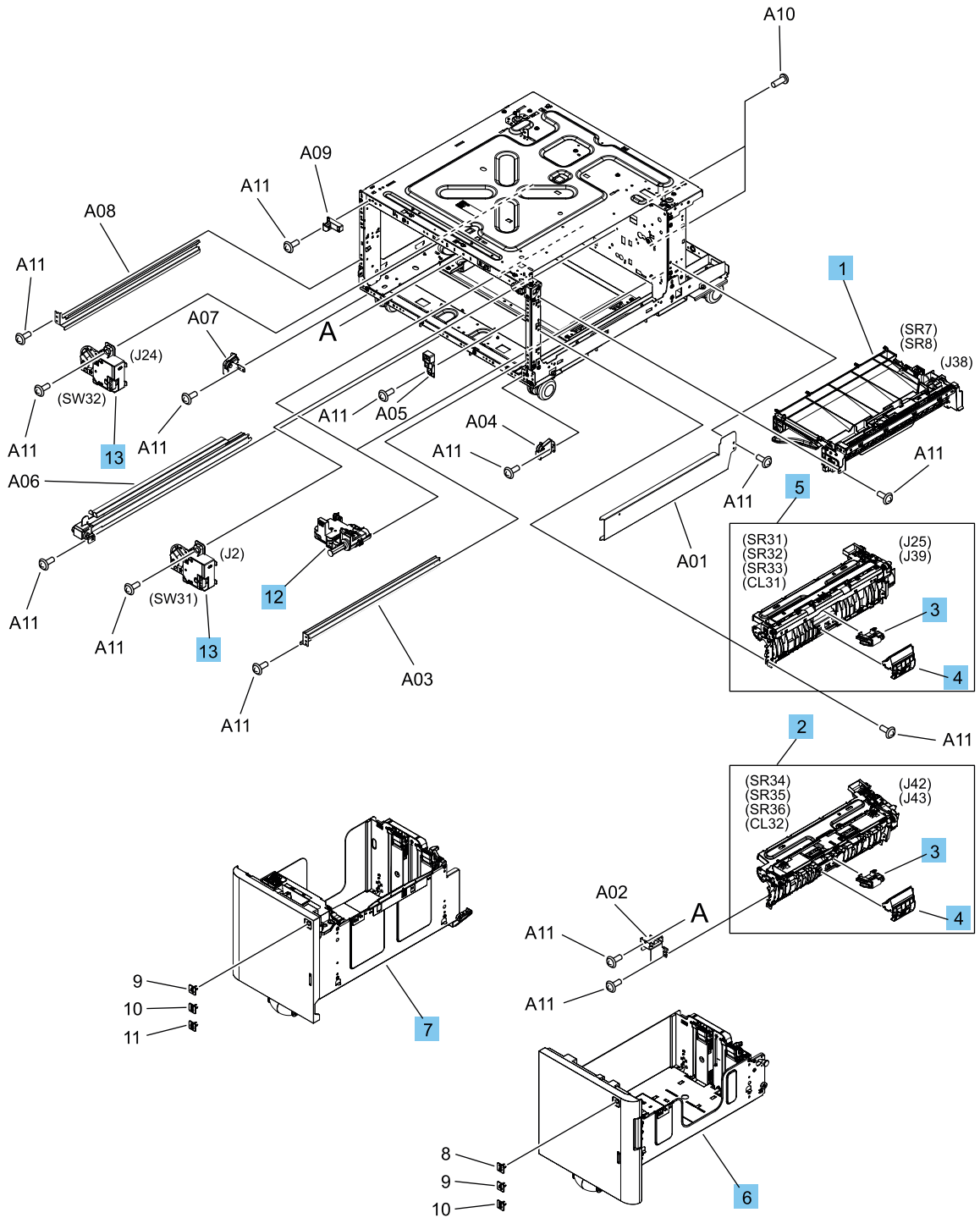


Table 2-48 HCI tray internal assemblies (1 of 2)

Ref	Part number	Description	Qty
1	RM2-1730-000CN	Paper feed assembly	1

Table 2-48 HCI tray internal assemblies (1 of 2) (continued)

Ref	Part number	Description	Qty
2	RM2-1741-000CN	Paper pickup assembly	1
3	RM2-1526-000CN	Paper pickup roller assembly	2
4	RM2-1526-000CN	Separation roller holder assembly	2
5	RM2-1717-000CN	Paper pickup assembly	1
6	RM2-1748-000CN	Right tray assembly	1
7	RM2-1743-000CN	Left tray assembly	1
12	RM2-1734-000CN	Auto-close assembly	2
13	RM2-1736-000CN	Lifter drive assembly	2

Parts and diagrams: High-capacity input (HCI) tray internal assemblies (2 of 2)

Parts diagram and parts list for the HCI tray internal assemblies.

Figure 2-42 HCI tray internal assemblies (2 of 2)

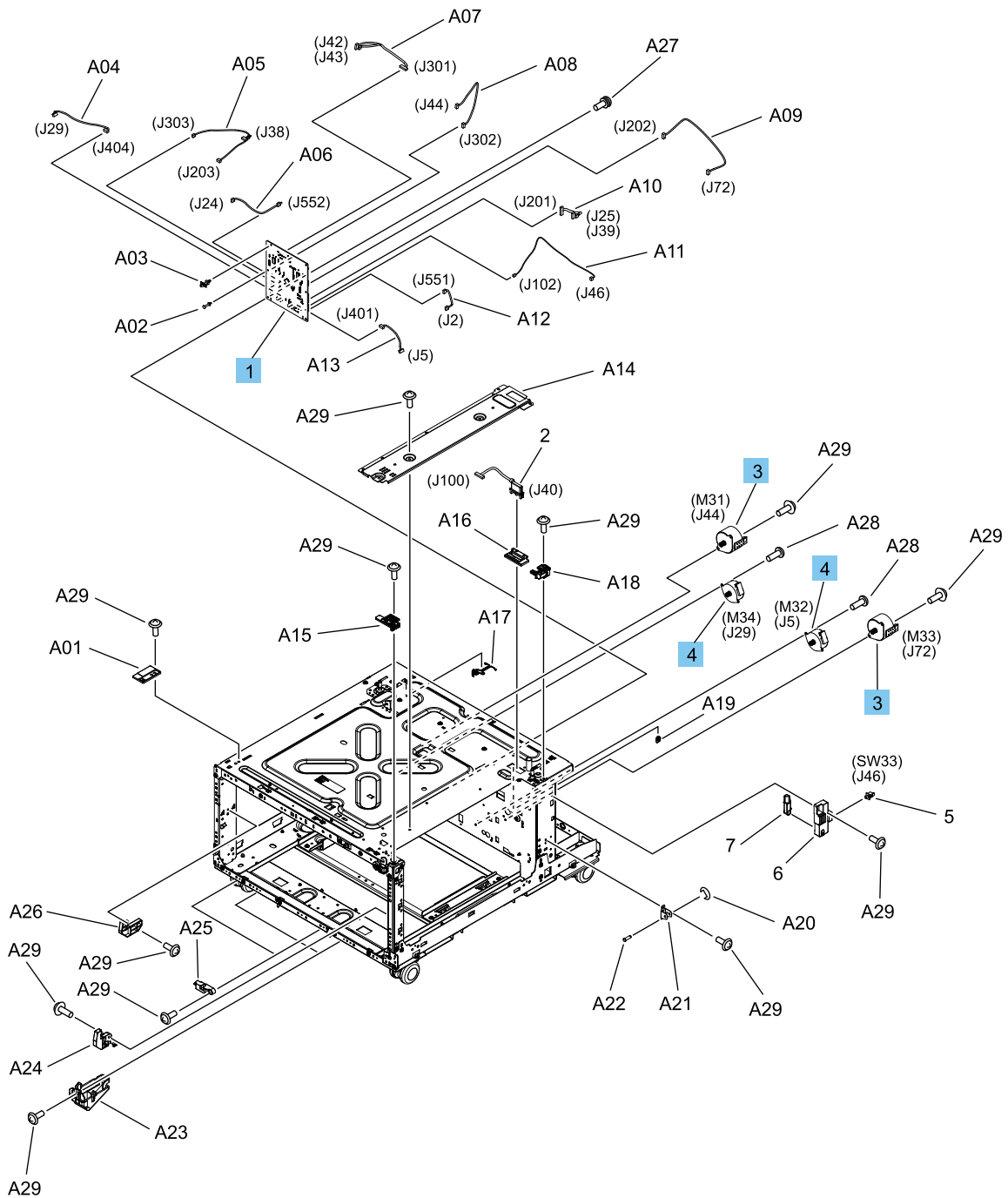


Table 2-49 HCI tray internal assemblies (2 of 2)

Ref	Part number	Description	Qty
1	RM2-9887-000CN	Paper deck controller PCB assembly	1
3	RK2-9410-000CN	Motor, stepping, DC	2

Table 2-49 HCI tray internal assemblies (2 of 2) (continued)

Ref	Part number	Description	Qty
4	RK2-7818-000CN	Motor, stepping, DC	2

Alphabetical parts list

Table 2-50 Alphabetical parts list

Description	Part number	Table and page
Arm, front door, left	RC5-0722-000CN	Printer internal assemblies (M751/E75245; 1 of 7) on page 2095
Auto close assembly	RM2-1605-000CN	Printer internal assemblies (M751/E75245; 3 of 7) on page 2098
Auto-close assembly	RM2-1734-000CN	HCI tray internal assemblies (1 of 2) on page 2158
Auto-close assembly	RM2-1760-000CN	550-sheet paper tray internal assemblies on page 2151
Auto-close assembly	RM2-1760-000CN	2x550-sheet paper tray internal assemblies (1 of 2) on page 2154
Black cartridge rail assembly	RM2-1356-000CN	Printer internal assemblies (M751/E75245; 1 of 7) on page 2095
Black pre-exposure assembly	RM2-1340-000CN	Printer internal assemblies (M751/E75245; 1 of 7) on page 2095
Cartridge guide	RL2-2091-000CN	Printer internal assemblies (M751/E75245; 1 of 7) on page 2095
Cartridge upper guide assembly	RM2-1343-000CN	Printer internal assemblies (M751/E75245; 1 of 7) on page 2095
Cassette assembly	RM2-1394-000CN	Printer internal assemblies (M751/E75245; 3 of 7) on page 2098
Cassette assembly	RM2-1706-000CN	550-sheet paper tray internal assemblies on page 2151
Cassette assembly	RM2-1706-000CN	2x550-sheet paper tray internal assemblies (1 of 2) on page 2154
Cassette assembly	RM2-1720-000CN	2x550-sheet paper tray internal assemblies (1 of 2) on page 2154
Connecting PCB assembly	RM2-9622-000CN	Printer internal assemblies (M751/E75245; 5 of 7) on page 2102
Control panel (M751/E75245)	RM2-1267-010CN	Printer covers (M751/E75245) on page 2093
Cover, left rear	RC5-1804-000CN	Printer covers (M751/E75245) on page 2093
Cover, left upper, F	RC5-1805-000CN	Printer covers (M751/E75245) on page 2093
Cover, left upper, R	RC5-1806-000CN	Printer covers (M751/E75245) on page 2093

Table 2-50 Alphabetical parts list (continued)

Description	Part number	Table and page
Cover, right, lower	RC5-2064-000CN	2x550-sheet tray covers on page 2153
Cover, right, lower	RC5-2064-000CN	HCI tray covers on page 2157
Cover, upper	RC5-0658-000CN	Printer covers (M751/E75245) on page 2093
DC controller PCB assembly	RM2-9630-000CN	Printer internal assemblies (M751/E75245; 4 of 7) on page 2100
DT cartridge rail assembly	RM2-1357-000CN	Printer internal assemblies (M751/E75245; 1 of 7) on page 2095
Duplexing assembly	RM2-1521-000CN	Printer internal assemblies (M751/E75245; 3 of 7) on page 2098
Duplexing drive assembly	RM2-1392-000CN	Printer internal assemblies (M751/E75245; 5 of 7) on page 2102
Environment sensor PCB assembly	RM2-9620-000CN	Printer internal assemblies (M751/E75245; 5 of 7) on page 2102
Fan	RK2-2276-000CN	Printer internal assemblies (M751/E75245; 5 of 7) on page 2102
Fan	RK2-9148-000CN	Printer internal assemblies (M751/E75245; 5 of 7) on page 2102
Fan	RK2-9148-000CN	Printer internal assemblies (M751/E75245; 7 of 7) on page 2107
First cartridge rail assembly	RM2-1354-000CN	Printer internal assemblies (M751/E75245; 1 of 7) on page 2095
Formatter PCA (M751/E75245/M856/E85055) (sPAB - SFP)	5851-7702	Printer internal assemblies (M751/E75245; 4 of 7) on page 2100
Formatter PCA (M751/E75245/M856/E85055) (sPAB - SFP; India/China)	5851-7703	Printer internal assemblies (M751/E75245; 4 of 7) on page 2100
Formatter PCA + SDS (M751/E75245/M856/E85055) (sPAB - SFP)	5851-7704	Printer internal assemblies (M751/E75245; 4 of 7) on page 2100
Formatter PCA + SDS (M751/E75245/M856/E85055) (sPAB - SFP; India/China)	5851-7705	Printer internal assemblies (M751/E75245; 4 of 7) on page 2100
Formatter cover assembly	RM2-1346-000CN	Printer covers (M751/E75245) on page 2093
Front door assembly	RM2-1368-000CN	Printer covers (M751/E75245) on page 2093

Table 2-50 Alphabetical parts list (continued)

Description	Part number	Table and page
Fuser Kit (110V)	3WT87-67901	Printer internal assemblies (M751/E75245; 7 of 7) on page 2107
Fuser Kit (220V)	3WT88-67901	Printer internal assemblies (M751/E75245; 7 of 7) on page 2107
Fuser drive assembly	RM2-1391-000CN	Printer internal assemblies (M751/E75245; 5 of 7) on page 2102
Fuser motor assembly	RM2-1456-000CN	Printer internal assemblies (M751/E75245; 5 of 7) on page 2102
Guide, PCB cable	RC5-1656-000CN	Printer internal assemblies (M751/E75245; 5 of 7) on page 2102
Hinge, cover, left	RC5-0801-000CN	Printer covers (M751/E75245) on page 2093
Hinge, left door, upper	RC5-0770-000CN	Printer covers (M751/E75245) on page 2093
IC, photointerrupter	WG8-5935-000CN	Printer internal assemblies (M751/E75245; 7 of 7) on page 2107
Intermediate transfer belt	RM2-1504-000CN	Printer internal assemblies (M751/E75245; 7 of 7) on page 2107
Laser scanner assembly	RM2-1328-020CN	Printer internal assemblies (M751/E75245; 6 of 7) on page 2104
Left cover lock assembly	RM2-1350-000CN	Printer covers (M751/E75245) on page 2093
Left door assembly	RM2-1351-000CN	Printer covers (M751/E75245) on page 2093
Left tray assembly	RM2-1743-000CN	HCI tray internal assemblies (1 of 2) on page 2158
Lifter drive assembly	RM2-1604-000CN	Printer internal assemblies (M751/E75245; 3 of 7) on page 2098
Lifter drive assembly	RM2-1703-000CN	550-sheet paper tray internal assemblies on page 2151
Lifter drive assembly	RM2-1704-000CN	2x550-sheet paper tray internal assemblies (1 of 2) on page 2154
Lifter drive assembly	RM2-1736-000CN	HCI tray internal assemblies (1 of 2) on page 2158
Low-voltage power supply (110V-127V)	RM2-1445-000CN	Printer internal assemblies (M751/E75245; 7 of 7) on page 2107

Table 2-50 Alphabetical parts list (continued)

Description	Part number	Table and page
Low-voltage power supply (220V-240V)	RM2-1453-000CN	Printer internal assemblies (M751/E75245; 7 of 7) on page 2107
Lower high-voltage power supply PCB assembly	RM2-9624-000CN	Printer internal assemblies (M751/E75245; 4 of 7) on page 2100
Main connecting PCB assembly	RM2-9618-000CN	Printer internal assemblies (M751/E75245; 5 of 7) on page 2102
Main drive assembly	RM2-1614-000CN	Printer internal assemblies (M751/E75245; 5 of 7) on page 2102
Main motor assembly	RM2-1612-000CN	Printer internal assemblies (M751/E75245; 5 of 7) on page 2102
Main motor assembly	RM2-1613-000CN	Printer internal assemblies (M751/E75245; 5 of 7) on page 2102
Memory PCB assembly	RM3-7351-000CN	Printer internal assemblies (M751/E75245; 4 of 7) on page 2100
Motor, stepping	RK2-6027-000CN	Printer internal assemblies (M751/E75245; 5 of 7) on page 2102
Motor, stepping, DC	RK2-7818-000CN	HCl tray internal assemblies (2 of 2) on page 2160
Motor, stepping, DC	RK2-9410-000CN	550-sheet paper tray internal assemblies on page 2151
Motor, stepping, DC	RK2-9410-000CN	2x550-sheet paper tray internal assemblies (2 of 2) on page 2156
Motor, stepping, DC	RK2-9410-000CN	HCl tray internal assemblies (2 of 2) on page 2160
Paper deck controller PCB assembly	RM2-9885-000CN	2x550-sheet paper tray internal assemblies (2 of 2) on page 2156
Paper deck controller PCB assembly	RM2-9887-000CN	HCl tray internal assemblies (2 of 2) on page 2160
Paper delivery assembly	RM2-1498-000CN	Printer internal assemblies (M751/E75245; 3 of 7) on page 2098
Paper feed assembly	RM2-1730-000CN	HCl tray internal assemblies (1 of 2) on page 2158
Paper pickup assembly	RM2-1393-010CN	Printer internal assemblies (M751/E75245; 6 of 7) on page 2104
Paper pickup assembly	RM2-1717-000CN	550-sheet paper tray internal assemblies on page 2151
Paper pickup assembly	RM2-1717-000CN	2x550-sheet paper tray internal assemblies (1 of 2) on page 2154

Table 2-50 Alphabetical parts list (continued)

Description	Part number	Table and page
Paper pickup assembly	RM2-1717-000CN	HCI tray internal assemblies (1 of 2) on page 2158
Paper pickup assembly	RM2-1741-000CN	HCI tray internal assemblies (1 of 2) on page 2158
Paper pickup roller assembly	RM2-1526-000CN	Printer internal assemblies (M751/E75245; 6 of 7) on page 2104
Paper pickup roller assembly	RM2-1526-000CN	550-sheet paper tray internal assemblies on page 2151
Paper pickup roller assembly	RM2-1526-000CN	2x550-sheet paper tray internal assemblies (1 of 2) on page 2154
Paper pickup roller assembly	RM2-1526-000CN	HCI tray internal assemblies (1 of 2) on page 2158
Power switch PCB assembly	RM2-9610-000CN	Printer internal assemblies (M751/E75245; 2 of 7) on page 2097
RD pressure link assembly, front	RM2-1389-000CN	Printer internal assemblies (M751/E75245; 7 of 7) on page 2107
RD pressure link assembly, rear	RM2-1390-000CN	Printer internal assemblies (M751/E75245; 7 of 7) on page 2107
Registration density sensor assembly	RM2-1501-000CN	Printer internal assemblies (M751/E75245; 7 of 7) on page 2107
Right door assembly	RM2-1494-000CN	Printer covers (M751/E75245) on page 2093
Right door assembly	RM2-1716-000CN	550-sheet tray covers on page 2150
Right door assembly	RM2-1729-000CN	2x550-sheet tray covers on page 2153
Right door assembly	RM2-1740-000CN	HCI tray covers on page 2157
Right handle assembly	RM2-1376-000CN	Printer covers (M751/E75245) on page 2093
Right tray assembly	RM2-1748-000CN	HCI tray internal assemblies (1 of 2) on page 2158
Second cartridge rail assembly	RM2-1353-000CN	Printer internal assemblies (M751/E75245; 1 of 7) on page 2095
Second transfer high-voltage PCB assembly	RM2-9623-000CN	Printer internal assemblies (M751/E75245; 4 of 7) on page 2100
Secondary transfer roller	RM2-1399-010CN	Printer internal assemblies (M751/E75245; 3 of 7) on page 2098

Table 2-50 Alphabetical parts list (continued)

Description	Part number	Table and page
Separation roller holder assembly	RM2-1526-000CN	Printer internal assemblies (M751/E75245; 6 of 7) on page 2104
Separation roller holder assembly	RM2-1526-000CN	550-sheet paper tray internal assemblies on page 2151
Separation roller holder assembly	RM2-1526-000CN	2x550-sheet paper tray internal assemblies (1 of 2) on page 2154
Separation roller holder assembly	RM2-1526-000CN	HCl tray internal assemblies (1 of 2) on page 2158
Size detect switch assembly	RM2-1436-000CN	Printer internal assemblies (M751/E75245; 3 of 7) on page 2098
Size detect switch assembly	RM2-1711-000CN	550-sheet paper tray internal assemblies on page 2151
Size detect switch assembly	RM2-1711-000CN	2x550-sheet paper tray internal assemblies (1 of 2) on page 2154
Spacer, drawer holder	RC5-1681-000CN	Printer internal assemblies (M751/E75245; 6 of 7) on page 2104
Third cartridge rail assembly	RM2-1355-000CN	Printer internal assemblies (M751/E75245; 1 of 7) on page 2095
Toner collection unit	3WT90-67901	Printer internal assemblies (M751/E75245; 2 of 7) on page 2097
Transfer cleaner assembly	RM2-1490-000CN	Printer internal assemblies (M751/E75245; 7 of 7) on page 2107
Tray 1 pickup roller	RM2-1525-000CN	Printer covers (M751/E75245) on page 2093
Tray 1 separation roller	RM2-1525-000CN	Printer covers (M751/E75245) on page 2093
Upper high-voltage power supply PCB assembly	RM2-9601-000CN	Printer internal assemblies (M751/E75245; 4 of 7) on page 2100
Waste toner feed assembly	RM2-1520-000CN	Printer internal assemblies (M751/E75245; 5 of 7) on page 2102
Waste toner feed link assembly	RM2-1366-000CN	Printer internal assemblies (M751/E75245; 6 of 7) on page 2104
Waste toner feed link assembly	RM2-1367-000CN	Printer internal assemblies (M751/E75245; 6 of 7) on page 2104
Waste toner gear base assembly	RM2-1364-000CN	Printer internal assemblies (M751/E75245; 5 of 7) on page 2102

Table 2-50 Alphabetical parts list (continued)

Description	Part number	Table and page
Wireless PCA board	0960-3659	Printer internal assemblies (M751/E75245; 4 of 7) on page 2100

Numerical parts list

Table 2-51 Numerical parts list

Part number	Description	Table and page
0960-3659	Wireless PCA board	Printer internal assemblies (M751/E75245; 4 of 7) on page 2100
3WT87-67901	Fuser Kit (110V)	Printer internal assemblies (M751/E75245; 7 of 7) on page 2107
3WT88-67901	Fuser Kit (220V)	Printer internal assemblies (M751/E75245; 7 of 7) on page 2107
3WT90-67901	Toner collection unit	Printer internal assemblies (M751/E75245; 2 of 7) on page 2097
5851-7702	Formatter PCA (M751/E75245/M856/E85055) (sPAB - SFP)	Printer internal assemblies (M751/E75245; 4 of 7) on page 2100
5851-7703	Formatter PCA (M751/E75245/M856/E85055) (sPAB - SFP; India/China)	Printer internal assemblies (M751/E75245; 4 of 7) on page 2100
5851-7704	Formatter PCA + SDS (M751/E75245/M856/E85055) (sPAB - SFP)	Printer internal assemblies (M751/E75245; 4 of 7) on page 2100
5851-7705	Formatter PCA + SDS (M751/E75245/M856/E85055) (sPAB - SFP; India/China)	Printer internal assemblies (M751/E75245; 4 of 7) on page 2100
RC5-0658-000CN	Cover, upper	Printer covers (M751/E75245) on page 2093
RC5-0722-000CN	Arm, front door, left	Printer internal assemblies (M751/E75245; 1 of 7) on page 2095
RC5-0770-000CN	Hinge, left door, upper	Printer covers (M751/E75245) on page 2093
RC5-0801-000CN	Hinge, cover, left	Printer covers (M751/E75245) on page 2093
RC5-1656-000CN	Guide, PCB cable	Printer internal assemblies (M751/E75245; 5 of 7) on page 2102
RC5-1681-000CN	Spacer, drawer holder	Printer internal assemblies (M751/E75245; 6 of 7) on page 2104
RC5-1804-000CN	Cover, left rear	Printer covers (M751/E75245) on page 2093
RC5-1805-000CN	Cover, left upper, F	Printer covers (M751/E75245) on page 2093
RC5-1806-000CN	Cover, left upper, R	Printer covers (M751/E75245) on page 2093

Table 2-51 Numerical parts list (continued)

Part number	Description	Table and page
RC5-2064-000CN	Cover, right, lower	2x550-sheet tray covers on page 2153
RC5-2064-000CN	Cover, right, lower	HCI tray covers on page 2157
RK2-2276-000CN	Fan	Printer internal assemblies (M751/E75245; 5 of 7) on page 2102
RK2-6027-000CN	Motor, stepping	Printer internal assemblies (M751/E75245; 5 of 7) on page 2102
RK2-7818-000CN	Motor, stepping, DC	HCI tray internal assemblies (2 of 2) on page 2160
RK2-9148-000CN	Fan	Printer internal assemblies (M751/E75245; 5 of 7) on page 2102
RK2-9148-000CN	Fan	Printer internal assemblies (M751/E75245; 7 of 7) on page 2107
RK2-9410-000CN	Motor, stepping, DC	550-sheet paper tray internal assemblies on page 2151
RK2-9410-000CN	Motor, stepping, DC	2x550-sheet paper tray internal assemblies (2 of 2) on page 2156
RK2-9410-000CN	Motor, stepping, DC	HCI tray internal assemblies (2 of 2) on page 2160
RL2-2091-000CN	Cartridge guide	Printer internal assemblies (M751/E75245; 1 of 7) on page 2095
RM2-1267-010CN	Control panel (M751/E75245)	Printer covers (M751/E75245) on page 2093
RM2-1328-020CN	Laser scanner assembly	Printer internal assemblies (M751/E75245; 6 of 7) on page 2104
RM2-1340-000CN	Black pre-exposure assembly	Printer internal assemblies (M751/E75245; 1 of 7) on page 2095
RM2-1343-000CN	Cartridge upper guide assembly	Printer internal assemblies (M751/E75245; 1 of 7) on page 2095
RM2-1346-000CN	Formatter cover assembly	Printer covers (M751/E75245) on page 2093
RM2-1350-000CN	Left cover lock assembly	Printer covers (M751/E75245) on page 2093
RM2-1351-000CN	Left door assembly	Printer covers (M751/E75245) on page 2093
RM2-1353-000CN	Second cartridge rail assembly	Printer internal assemblies (M751/E75245; 1 of 7) on page 2095

Table 2-51 Numerical parts list (continued)

Part number	Description	Table and page
RM2-1354-000CN	First cartridge rail assembly	Printer internal assemblies (M751/E75245; 1 of 7) on page 2095
RM2-1355-000CN	Third cartridge rail assembly	Printer internal assemblies (M751/E75245; 1 of 7) on page 2095
RM2-1356-000CN	Black cartridge rail assembly	Printer internal assemblies (M751/E75245; 1 of 7) on page 2095
RM2-1357-000CN	DT cartridge rail assembly	Printer internal assemblies (M751/E75245; 1 of 7) on page 2095
RM2-1364-000CN	Waste toner gear base assembly	Printer internal assemblies (M751/E75245; 5 of 7) on page 2102
RM2-1366-000CN	Waste toner feed link assembly	Printer internal assemblies (M751/E75245; 6 of 7) on page 2104
RM2-1367-000CN	Waste toner feed link assembly	Printer internal assemblies (M751/E75245; 6 of 7) on page 2104
RM2-1368-000CN	Front door assembly	Printer covers (M751/E75245) on page 2093
RM2-1376-000CN	Right handle assembly	Printer covers (M751/E75245) on page 2093
RM2-1389-000CN	RD pressure link assembly, front	Printer internal assemblies (M751/E75245; 7 of 7) on page 2107
RM2-1390-000CN	RD pressure link assembly, rear	Printer internal assemblies (M751/E75245; 7 of 7) on page 2107
RM2-1391-000CN	Fuser drive assembly	Printer internal assemblies (M751/E75245; 5 of 7) on page 2102
RM2-1392-000CN	Duplexing drive assembly	Printer internal assemblies (M751/E75245; 5 of 7) on page 2102
RM2-1393-010CN	Paper pickup assembly	Printer internal assemblies (M751/E75245; 6 of 7) on page 2104
RM2-1394-000CN	Cassette assembly	Printer internal assemblies (M751/E75245; 3 of 7) on page 2098
RM2-1399-010CN	Secondary transfer roller	Printer internal assemblies (M751/E75245; 3 of 7) on page 2098
RM2-1436-000CN	Size detect switch assembly	Printer internal assemblies (M751/E75245; 3 of 7) on page 2098

Table 2-51 Numerical parts list (continued)

Part number	Description	Table and page
RM2-1445-000CN	Low-voltage power supply (110V-127V)	Printer internal assemblies (M751/E75245; 7 of 7) on page 2107
RM2-1453-000CN	Low-voltage power supply (220V-240V)	Printer internal assemblies (M751/E75245; 7 of 7) on page 2107
RM2-1456-000CN	Fuser motor assembly	Printer internal assemblies (M751/E75245; 5 of 7) on page 2102
RM2-1490-000CN	Transfer cleaner assembly	Printer internal assemblies (M751/E75245; 7 of 7) on page 2107
RM2-1494-000CN	Right door assembly	Printer covers (M751/E75245) on page 2093
RM2-1498-000CN	Paper delivery assembly	Printer internal assemblies (M751/E75245; 3 of 7) on page 2098
RM2-1501-000CN	Registration density sensor assembly	Printer internal assemblies (M751/E75245; 7 of 7) on page 2107
RM2-1504-000CN	Intermediate transfer belt	Printer internal assemblies (M751/E75245; 7 of 7) on page 2107
RM2-1520-000CN	Waste toner feed assembly	Printer internal assemblies (M751/E75245; 5 of 7) on page 2102
RM2-1521-000CN	Duplexing assembly	Printer internal assemblies (M751/E75245; 3 of 7) on page 2098
RM2-1525-000CN	Tray 1 pickup roller	Printer covers (M751/E75245) on page 2093
RM2-1525-000CN	Tray 1 separation roller	Printer covers (M751/E75245) on page 2093
RM2-1526-000CN	Paper pickup roller assembly	Printer internal assemblies (M751/E75245; 6 of 7) on page 2104
RM2-1526-000CN	Paper pickup roller assembly	550-sheet paper tray internal assemblies on page 2151
RM2-1526-000CN	Paper pickup roller assembly	2x550-sheet paper tray internal assemblies (1 of 2) on page 2154
RM2-1526-000CN	Paper pickup roller assembly	HCI tray internal assemblies (1 of 2) on page 2158
RM2-1526-000CN	Separation roller holder assembly	Printer internal assemblies (M751/E75245; 6 of 7) on page 2104
RM2-1526-000CN	Separation roller holder assembly	550-sheet paper tray internal assemblies on page 2151

Table 2-51 Numerical parts list (continued)

Part number	Description	Table and page
RM2-1526-000CN	Separation roller holder assembly	2x550-sheet paper tray internal assemblies (1 of 2) on page 2154
RM2-1526-000CN	Separation roller holder assembly	HCI tray internal assemblies (1 of 2) on page 2158
RM2-1604-000CN	Lifter drive assembly	Printer internal assemblies (M751/E75245; 3 of 7) on page 2098
RM2-1605-000CN	Auto close assembly	Printer internal assemblies (M751/E75245; 3 of 7) on page 2098
RM2-1612-000CN	Main motor assembly	Printer internal assemblies (M751/E75245; 5 of 7) on page 2102
RM2-1613-000CN	Main motor assembly	Printer internal assemblies (M751/E75245; 5 of 7) on page 2102
RM2-1614-000CN	Main drive assembly	Printer internal assemblies (M751/E75245; 5 of 7) on page 2102
RM2-1703-000CN	Lifter drive assembly	550-sheet paper tray internal assemblies on page 2151
RM2-1704-000CN	Lifter drive assembly	2x550-sheet paper tray internal assemblies (1 of 2) on page 2154
RM2-1706-000CN	Cassette assembly	550-sheet paper tray internal assemblies on page 2151
RM2-1706-000CN	Cassette assembly	2x550-sheet paper tray internal assemblies (1 of 2) on page 2154
RM2-1711-000CN	Size detect switch assembly	550-sheet paper tray internal assemblies on page 2151
RM2-1711-000CN	Size detect switch assembly	2x550-sheet paper tray internal assemblies (1 of 2) on page 2154
RM2-1716-000CN	Right door assembly	550-sheet tray covers on page 2150
RM2-1717-000CN	Paper pickup assembly	550-sheet paper tray internal assemblies on page 2151
RM2-1717-000CN	Paper pickup assembly	2x550-sheet paper tray internal assemblies (1 of 2) on page 2154
RM2-1717-000CN	Paper pickup assembly	HCI tray internal assemblies (1 of 2) on page 2158
RM2-1720-000CN	Cassette assembly	2x550-sheet paper tray internal assemblies (1 of 2) on page 2154
RM2-1729-000CN	Right door assembly	2x550-sheet tray covers on page 2153
RM2-1730-000CN	Paper feed assembly	HCI tray internal assemblies (1 of 2) on page 2158

Table 2-51 Numerical parts list (continued)

Part number	Description	Table and page
RM2-1734-000CN	Auto-close assembly	HCI tray internal assemblies (1 of 2) on page 2158
RM2-1736-000CN	Lifter drive assembly	HCI tray internal assemblies (1 of 2) on page 2158
RM2-1740-000CN	Right door assembly	HCI tray covers on page 2157
RM2-1741-000CN	Paper pickup assembly	HCI tray internal assemblies (1 of 2) on page 2158
RM2-1743-000CN	Left tray assembly	HCI tray internal assemblies (1 of 2) on page 2158
RM2-1748-000CN	Right tray assembly	HCI tray internal assemblies (1 of 2) on page 2158
RM2-1760-000CN	Auto-close assembly	550-sheet paper tray internal assemblies on page 2151
RM2-1760-000CN	Auto-close assembly	2x550-sheet paper tray internal assemblies (1 of 2) on page 2154
RM2-9601-000CN	Upper high-voltage power supply PCB assembly	Printer internal assemblies (M751/E75245; 4 of 7) on page 2100
RM2-9610-000CN	Power switch PCB assembly	Printer internal assemblies (M751/E75245; 2 of 7) on page 2097
RM2-9618-000CN	Main connecting PCB assembly	Printer internal assemblies (M751/E75245; 5 of 7) on page 2102
RM2-9620-000CN	Environment sensor PCB assembly	Printer internal assemblies (M751/E75245; 5 of 7) on page 2102
RM2-9622-000CN	Connecting PCB assembly	Printer internal assemblies (M751/E75245; 5 of 7) on page 2102
RM2-9623-000CN	Second transfer high-voltage PCB assembly	Printer internal assemblies (M751/E75245; 4 of 7) on page 2100
RM2-9624-000CN	Lower high-voltage power supply PCB assembly	Printer internal assemblies (M751/E75245; 4 of 7) on page 2100
RM2-9630-000CN	DC controller PCB assembly	Printer internal assemblies (M751/E75245; 4 of 7) on page 2100
RM2-9885-000CN	Paper deck controller PCB assembly	2x550-sheet paper tray internal assemblies (2 of 2) on page 2156
RM2-9887-000CN	Paper deck controller PCB assembly	HCI tray internal assemblies (2 of 2) on page 2160
RM3-7351-000CN	Memory PCB assembly	Printer internal assemblies (M751/E75245; 4 of 7) on page 2100

Table 2-51 Numerical parts list (continued)

Part number	Description	Table and page
WG8-5935-000CN	IC, photointerrupter	Printer internal assemblies (M751/E75245; 7 of 7) on page 2107

Index

Symbols/Numerics

- 2,700-sheet HCI paper tray and stand parts, remove and replace..... 1989
- 2x550-sheet paper tray and stand controller PCA, removing and replacing..... 1985
- 2x550-sheet paper tray and stand parts, remove and replace..... 1894
- 2x550-sheet paper tray and stand right door, removing and replacing. 1905
- 2x550-sheet paper tray and stand right lower cover, removing and replacing..... 1902
- 2x550-sheet paper tray and stand rollers, removing and replacing..... 1896
- 2x550-sheet paper tray and stand tray 1 auto close assembly, removing and replacing..... 1962
- 2x550-sheet paper tray and stand tray 1 lifter drive, removing and replacing..... 1937
- 2x550-sheet paper tray and stand tray 1 pickup assembly, removing and replacing..... 1912
- 2x550-sheet paper tray and stand tray 1 pickup motor, removing and replacing..... 1910
- 2x550-sheet paper tray and stand tray 2 auto close assembly, removing and replacing..... 1973
- 2x550-sheet paper tray and stand tray 2 lifter drive, removing and replacing..... 1950
- 2x550-sheet paper tray and stand tray 2 pickup assembly, removing and replacing..... 1926
- 2x550-sheet paper tray and stand tray 2 pickup motor, removing and replacing..... 1924
- 2x550-sheet paper tray and stand, removing and replacing..... 1894
- 2x550-sheet tray components, parts. 2153
- 550-sheet paper tray auto close assembly, removing and replacing. 1878
- 550-sheet paper tray lifter drive, removing and replacing..... 1865
- 550-sheet paper tray parts, remove and replace..... 1839
- 550-sheet paper tray pickup assembly, removing and replacing. 1853
- 550-sheet paper tray pickup motor, removing and replacing..... 1851
- 550-sheet paper tray right door, removing and replacing..... 1847
- 550-sheet paper tray rollers, removing and replacing..... 1842
- 550-sheet paper tray size detect switch, removing and replacing..... 1891
- 550-sheet paper tray, removing and replacing..... 1839
- 550-sheet tray components, parts..... 2150
- A**
- accessories.....2078
- accessories, 2x550-sheet paper tray and stand remove and replace..... 1894
- accessories, 2x550-sheet paper tray and stand controller PCA remove and replace..... 1985
- accessories, 2x550-sheet paper tray and stand right door remove and replace..... 1905
- accessories, 2x550-sheet paper tray and stand right lower cover remove and replace..... 1902
- accessories, 2x550-sheet paper tray and stand rollers remove and replace..... 1896
- accessories, 2x550-sheet paper tray and stand tray 1 auto close assembly remove and replace..... 1962
- accessories, 2x550-sheet paper tray and stand tray 1 lifter drive remove and replace..... 1937
- accessories, 2x550-sheet paper tray and stand tray 1 pickup assembly remove and replace..... 1912
- accessories, 2x550-sheet paper tray and stand tray 1 pickup motor remove and replace..... 1910
- accessories, 2x550-sheet paper tray and stand tray 2 auto close assembly remove and replace..... 1973
- accessories, 2x550-sheet paper tray and stand tray 2 lifter drive remove and replace..... 1950
- accessories, 2x550-sheet paper tray and stand tray 2 pickup assembly remove and replace..... 1926
- accessories, 2x550-sheet paper tray and stand tray 2 pickup motor remove and replace..... 1924
- accessories, 550-sheet paper tray remove and replace..... 1839
- accessories, 550-sheet paper tray auto close assembly remove and replace..... 1878
- accessories, 550-sheet paper tray lifter drive remove and replace..... 1865
- accessories, 550-sheet paper tray pickup assembly remove and replace..... 1853
- accessories, 550-sheet paper tray pickup motor remove and replace..... 1851

accessories, 550-sheet paper tray right door remove and replace.....	1847	accessories, High capacity input (HCI) tray and stand right tray lifter drive remove and replace.....	2065	cartridge front fan (M751/E75245), removing and replacing.....	1258
accessories, 550-sheet paper tray rollers remove and replace.....	1842	accessories, High capacity input (HCI) tray and stand right tray lifter motor remove and replace.....	2063	cartridge front fan (M856/E85055/M776), removing and replacing.....	1270
accessories, 550-sheet paper tray size detect switch remove and replace.....	1891	accessories, High capacity input (HCI) tray and stand right tray pickup assembly remove and replace.....	2015	cartridge guide (M856/E85055/M776dn/M776z/M 776zs), removing and replacing.....	570
accessories, High capacity input (HCI) feeder paper tray and stand PCA remove and replace.....	2073	accessories, High capacity input (HCI) tray and stand right tray pickup motor remove and replace.....	2013	cartridge rail assembly (M751/E75245), removing and replacing.....	571
accessories, High capacity input (HCI) paper tray and stand feed assembly remove and replace.....	2023	accessories, High capacity input (HCI) tray and stand right tray rollers remove and replace.....	1999	cartridge rail assembly (M776zs), removing and replacing.....	605
accessories, High capacity input (HCI) paper tray and stand left tray auto close assembly remove and replace.....	2058	accessories, inner finisher remove and replace.....	1693	cartridge rail assembly (M856/E85055/M776dn/M776z), removing and replacing.....	591
accessories, High capacity input (HCI) paper tray and stand left tray lifter drive remove and replace.....	2054	accessories, internal USB ports remove and replace.....	6	cartridge rear fan (M751/E75245), removing and replacing.....	1283
accessories, High capacity input (HCI) tray and stand left paper tray remove and replace.....	1990	accessories, remove and replace	1693	cartridge rear fan (M856/E85055/M776), removing and replacing.....	1295
accessories, High capacity input (HCI) tray and stand left tray lifter motor remove and replace.....	2052	accessories, toner part numbers.	2078	cartridge upper guide (M751/E75245), removing and replacing.....	1308
accessories, High capacity input (HCI) tray and stand left tray pickup assembly remove and replace.....	2037	accessory upper cover (M856/E85055/M776dn/M776z), removing and replacing.....	155	cartridge upper guide (M776zs), removing and replacing.....	1332
accessories, High capacity input (HCI) tray and stand left tray pickup motor remove and replace.....	2035	assembly locations.....	2084	cartridge upper guide (M856/E85055/M776dn/M776z), removing and replacing.....	1323
accessories, High capacity input (HCI) tray and stand left tray rollers remove and replace.....	1992	authorized service providers, parts.....	2078	cartridges, toner part numbers... 2078	
accessories, High capacity input (HCI) tray and stand right door remove and replace.....	2009	auto close assembly for Tray 2 (M751/E75245/M856/E85055/M7 76dn/M776z/M776zs), removing and replacing.....	917	caution.....	1
accessories, High capacity input (HCI) tray and stand right lower cover remove and replace.....	2006			Channel partners WISE.....	1, 2077, 2082
accessories, High capacity input (HCI) tray and stand right paper tray remove and replace.....	1989			communication PCA (M776), removing and replacing.....	312
accessories, High capacity input (HCI) tray and stand right tray auto close assembly remove and replace.....	2068			control panel (M751/E75245) locating.....	2084

B	bin, output (M751/E75245) locating.....	2084	control panel (M776) locating.....	2087
	bin, output (M776) locating.....	2087	control panel (M776), removing and replacing.....	85
	bin, output (M856/E85055) locating.....	2085	control panel (M856/E85055) locating.....	2085
	black pre-exposure assembly (M751/E75245), removing and replacing.....	1352	control panel (M856/E85055), removing and replacing.....	79
	black pre-exposure assembly (M776zs), removing and replacing.	1374	control panel removing and replacing.	74
	black pre-exposure assembly (M856/E85055/M776dn/M776z), removing and replacing.....	1365	controller fan (M856/E85055/M776dn/M776z/M 776zs), removing and replacing.....	763

C	cables (discrete), parts.....	2091	conventions used.....	1
			covers 2x550-sheet tray, parts... 2153	
			covers 550-sheet tray, parts.....	2150

covers HCI tray, parts.....	2157	delivery cover (M776zs), removing and replacing.....	257	duplex reverse guide assembly (M776dn/M776z), removing and replacing.....	447
covers high-capacity input tray, parts..	2157	delivery front cover (M776zs), removing and replacing.....	246	duplex reverse guide assembly (M856/E85055), removing and replacing.....	433
covers printer, parts (M751/E75245)...	2092	delivery rear cover (M776zs), removing and replacing.....	272	duplexing controller PCA (M856/E85055/M776dn/M776z/M 776zs), removing and replacing.....	317
covers printer, parts (M776dn/M776z)	2110	developer alienation motor (M751/E75245), removing and replacing.....	1182		
covers printer, parts (M776zs).....	2126	developer alienation motor (M856/E85055/M776dn/M776z/M 776zs), removing and replacing.....	1197	E	
covers printer, parts (M856/E85055)...	2107	diagrams.....	2089	electrostatic discharge.....	4
covers, remove and replace.....	103	discrete cables, parts.....	2091	embedded Multi-Media Card (eMMC) removing and replacing.....	21
CSR		document feeder pickup and separation rollers, removing and replacing.....	39	eMMC) removing and replacing.....	21
control panel.....	74	document feeder reflector, removing and replacing.....	96	environmental sensor PCA (M751/E75245), removing and replacing.....	1055
document feeder pickup and separation rollers.....	39	document feeder, parts (M776)...	2090	environmental sensor PCA (M856/E85055/M776dn/M776z/M 776zs), removing and replacing.....	1066
embedded Multi-Media Card (eMMC).....	21	document feeder, removing and replacing.....	190	exploded views, parts and diagrams...	2089
eMMC.....	21	doors, remove and replace.....	103	external panel, remove and replace.....	103
fax PCA.....	26	drum motor 1 (M751/E75245), removing and replacing.....	1090		
fuser.....	58	drum motor 1 (M856/E85055/M776dn/M776z/M 776zs), removing and replacing.....	1103	F	
HDD.....	16	drum motor 2 (M751/E75245), removing and replacing.....	1119	fasteners used in this printer.....	5
imaging drum.....	33	drum motor 2 (M856/E85055/M776dn/M776z/M 776zs), removing and replacing.....	1131	fax PCA) removing and replacing.....	26
intermediate transfer belt (ITB)..	61	drum motor 3 (M751/E75245), removing and replacing.....	1147	field replaceable units.....	103
internal USB ports.....	6	drum motor 3 (M856/E85055/M776dn/M776z/M 776zs), removing and replacing.....	1163	formatter (M751/E75245) locating.....	2085
secondary transfer roller.....	70	DT cartridge rail assembly (M751/E75245), removing and replacing.....	629	formatter (M751/E75245), removing and replacing.....	702
SODIMM.....	11	DT cartridge rail assembly (M776zs), removing and replacing.....	663	formatter (M776) locating.....	2089
toner cartridge.....	29	DT cartridge rail assembly (M856/E85055/M776dn/M776z), removing and replacing.....	649	formatter (M856/E85055) locating.....	2086
toner collection unit (TCU).....	66	duplex.....	447	formatter case (M856/E85055/M776dn/M776z/M 776zs), removing and replacing.....	713
Tray 1 pickup and separation rollers.....	46	duplex drive assembly (M751/E75245), removing and replacing.....	815	formatter cover, removing and replacing.....	107
Tray 2.....	37			formatter, removing and replacing	707
Tray 2 pickup and separation rollers.....	52			front cover (M776zs), removing and replacing.....	234
CSR part numbers.....	2081			front door, removing and replacing.....	103
customer self-repair (CSR) A parts and accessories.....	6			FRUs, remove and replace.....	103
customer self-repair kits.....	2081				
D					
DC controller (M751/E75245), removing and replacing.....	931				
DC controller (M856/E85055/M776dn/M776z/M 776zs), removing and replacing.....	943				
delivery assembly (M751/E75245), removing and replacing.....	323				
delivery assembly (M776dn/M776z), removing and replacing.....	354				
delivery assembly (M776zs), removing and replacing.....	373				
delivery assembly (M856/E85055), removing and replacing.....	341				

fuser drive assembly (M751/E75245), removing and replacing..... 521

fuser drive assembly (M856/E85055/M776dn/M776z/M776zs), removing and replacing..... 545

fuser fan (M751/E75245), removing and replacing..... 1233

fuser fan (M856/E85055/M776), removing and replacing..... 1245

fuser motor (M856/E85055/M776dn/M776z/M776zs), removing and replacing..... 500

fuser, removing and replacing..... 58

H

hard-disk drive, HDD) removing and replacing..... 16

HCI tray components, parts..... 2157

HDD, remove and replace..... 16

High capacity input (HCI) paper tray and stand controller PCA, removing and replacing..... 2073

High capacity input (HCI) paper tray and stand feed assembly, removing and replacing..... 2023

High capacity input (HCI) paper tray and stand left tray auto close assembly, removing and replacing..... 2058

High capacity input (HCI) paper tray and stand left tray lifter drive, removing and replacing..... 2054

High capacity input (HCI) tray and stand left paper tray, removing and replacing..... 1990

High capacity input (HCI) tray and stand left tray lifter motor, removing and replacing..... 2052

High capacity input (HCI) tray and stand left tray pickup assembly, removing and replacing..... 2037

High capacity input (HCI) tray and stand left tray pickup motor, removing and replacing..... 2035

High capacity input (HCI) tray and stand left tray rollers, removing and replacing..... 1992

High capacity input (HCI) tray and stand right door, removing and replacing..... 2009

High capacity input (HCI) tray and stand right lower cover, removing and replacing..... 2006

High capacity input (HCI) tray and stand right paper tray, removing and replacing..... 1989

High capacity input (HCI) tray and stand right tray auto close assembly, removing and replacing..... 2068

High capacity input (HCI) tray and stand right tray lifter drive, removing and replacing..... 2065

High capacity input (HCI) tray and stand right tray lifter motor, removing and replacing..... 2063

High capacity input (HCI) tray and stand right tray pickup assembly, removing and replacing..... 2015

High capacity input (HCI) tray and stand right tray pickup motor, removing and replacing..... 2013

High capacity input (HCI) tray and stand right tray rollers, removing and replacing..... 1999

high-capacity input tray components, parts..... 2157

high-capacity input tray, remove and replace..... 1989

high-voltage power supply T2 (HVPS-T2; M751/E75245), removing and replacing..... 1017

high-voltage power supply T2 (HVPS-T2; M856/E85055/M776dn/M776z/M776zs), removing and replacing..... 1023

HP internal users WISE..... 1, 2077, 2082

I

image scanner, parts (M776)..... 2090

image scanner, removing and replacing..... 195

imaging drum, removing and replacing..... 33

inner finisher cable duct assembly, removing and replacing..... 1822

inner finisher components, parts 2141

inner finisher connector cover, removing and replacing..... 1698

inner finisher controller PCA, removing and replacing..... 1806

inner finisher feed motor, removing and replacing..... 1809

inner finisher front cover, removing and replacing..... 1700

inner finisher front push assembly, removing and replacing..... 1828

inner finisher latch assembly, removing and replacing..... 1728

inner finisher latch cover, removing and replacing..... 1708

inner finisher paddle assembly, removing and replacing..... 1721

inner finisher paddle drive assembly, removing and replacing..... 1723

inner finisher parts, remove and replace..... 1693

inner finisher processing tray assembly, removing and replacing..... 1764

inner finisher rear push assembly, removing and replacing..... 1836

inner finisher rear small cover, removing and replacing..... 1705

inner finisher release handle, removing and replacing..... 1832

inner finisher return belt assembly, removing and replacing..... 1751

inner finisher stack tray, removing and replacing..... 1703

inner finisher stack wall assembly, removing and replacing..... 1743

inner finisher staple mount assembly, removing and replacing..... 1783

inner finisher stapler assembly, removing and replacing..... 1736

inner finisher trailing edge dropping solenoid, removing and replacing..... 1818

inner finisher tray lifting motor, removing and replacing..... 1812

inner finisher upper entrance guide, removing and replacing..... 1710

inner finisher upper feed guide, removing and replacing..... 1714

inner finisher wire sub-tray, removing and replacing..... 1838

inner finisher, removing and replacing..... 1693

installing internal USB ports..... 6

intermediate transfer belt (ITB), removing and replacing..... 61

internal assemblies 2x550-sheet paper tray, parts..... 2154, 2156

- internal assemblies 550-sheet paper tray, parts..... 2151
 - internal assemblies HCI tray, parts..... 2158, 2160
 - internal assemblies high-capacity input tray, parts.....2158, 2160
 - internal assemblies printer (inner finisher; 1 of 3), parts..... 2144
 - internal assemblies printer (inner finisher; 2 of 3), parts..... 2146
 - internal assemblies printer (inner finisher; 3 of 3), parts..... 2148
 - internal assemblies printer (inner finisher), parts.....2141
 - internal assemblies printer (M751/E75245; 1 of 7), parts 2094
 - internal assemblies printer (M751/E75245; 2 of 7), parts 2096
 - internal assemblies printer (M751/E75245; 3 of 7), parts 2098
 - internal assemblies printer (M751/E75245; 4 of 7), parts 2100
 - internal assemblies printer (M751/E75245; 5 of 7), parts 2102
 - internal assemblies printer (M751/E75245; 6 of 7), parts 2104
 - internal assemblies printer (M751/E75245; 7 of 7), parts 2106
 - internal assemblies printer (M776zs; 1 of 9), parts..... 2128
 - internal assemblies printer (M776zs; 2 of 9), parts..... 2130
 - internal assemblies printer (M776zs; 3 of 9), parts..... 2131
 - internal assemblies printer (M776zs; 4 of 9), parts..... 2132
 - internal assemblies printer (M776zs; 5 of 9), parts..... 2134
 - internal assemblies printer (M776zs; 6 of 9), parts..... 2136
 - internal assemblies printer (M776zs; 7 of 9), parts..... 2138
 - internal assemblies printer (M776zs; 8 of 9), parts..... 2140
 - internal assemblies printer (M776zs; 9 of 9), parts..... 2141
 - internal assemblies printer (M856/E85055, M776dn/M776z; 1 of 8), parts..... 2112
 - internal assemblies printer (M856/E85055, M776dn/M776z; 2 of 8), parts..... 2114
 - internal assemblies printer (M856/E85055, M776dn/M776z; 3 of 8), parts..... 2116
 - internal assemblies printer (M856/E85055, M776dn/M776z; 4 of 8), parts..... 2117
 - internal assemblies printer (M856/E85055, M776dn/M776z; 5 of 8), parts..... 2119
 - internal assemblies printer (M856/E85055, M776dn/M776z; 6 of 8), parts..... 2121
 - internal assemblies printer (M856/E85055, M776dn/M776z; 7 of 8), parts..... 2123
 - internal assemblies printer (M856/E85055, M776dn/M776z; 8 of 8), parts..... 2125
 - internal parts and assemblies, remove and replace..... 292
 - internal USB ports installing..... 6
- K**
- keyboard (M776z/M776zs), removing and replacing.....292
 - keypad (M751/E75245), locating 2084
 - kits, customer self-repair..... 2081
- L**
- laser scanner (M751/E75245/M856/E85055/M776dn/M776z/M776zs), removing and replacing..... 771
 - left door (M776) locating..... 2089
 - left door (M856/E85055) locating..... 2086
 - left door, removing and replacing.. 109
 - left lower cover (M856/E85055/M776dn/M776z), removing and replacing..... 161
 - left upper front and rear covers, removing and replacing..... 159
 - lifter drive assembly (M751/E75245/M856/E85055/M776dn/M776z/M776zs), removing and replacing.....905
 - low-voltage power supply (LVPS; M751/E75245), removing and replacing..... 955
 - low-voltage power supply (LVPS) fan (M751/E75245), removing and replacing..... 1216
 - low-voltage power supply (M856/E85055/M776dn/M776z/M776zs), removing and replacing.....960
 - low-voltage power supply fan (M856/E85055/M776dn/M776z/M776zs), removing and replacing..... 1225
 - lower high-voltage power supply (lower HVPS; M751/E75245), removing and replacing.....970
 - lower high-voltage power supply (lower HVPS; M856/E85055/M776dn/M776z/M776zs), removing and replacing.....979
- LVPS**
- (M856/E85055/M776dn/M776z/M776zs), removing and replacing.....960
- LVPS fan**
- (M856/E85055/M776dn/M776z/M776zs), removing and replacing..... 1225
- M**
- main connecting PCA (M751/E75245), removing and replacing..... 734
 - main connecting PCA (M856/E85055/M776dn/M776z/M776zs), removing and replacing..... 748
 - main cover (M776zs), removing and replacing..... 230
 - main drive assembly (M751/E75245), removing and replacing.....835
 - main drive assembly (M856/E85055/M776dn/M776z/M776zs), removing and replacing.....868
 - memory PCA (M751/E75245), removing and replacing..... 1080
 - memory PCA (M856/E85055/M776dn/M776z/M776zs), removing and replacing..... 727
- N**
- note..... 1
- O**
- on/off button (M751/E75245) locating..... 2084
 - on/off button (M776) locating..... 2087

on/off button (M856/E85055)
 locating.....2085
 orderable parts.....2078
 output bin (M751/E75245)
 locating.....2084
 output bin (M776)
 locating.....2087
 output bin (M856/E85055)
 locating.....2085

P

parts.....2078, 2089
 parts and diagrams, using.....2089
 parts list and diagrams, how to use....
2089
 parts, 2x550-sheet tray components.
2153
 parts, 550-sheet tray components.....
2150
 parts, covers 2x550-sheet tray...2153
 parts, covers 550-sheet tray.....2150
 parts, covers HCl tray.....2157
 parts, covers high-capacity input tray..
2157
 parts, covers printer (M751/E75245)..
2092
 parts, covers printer (M776dn/M776z)
2110
 parts, covers printer (M776zs).....2126
 parts, covers printer (M856/E85055)..
2107
 parts, discrete cables.....2091
 parts, document feeder (M776)..2090
 parts, HCl tray components.....2157
 parts, high-capacity input tray
 components.....2157
 parts, image scanner (M776).....2090
 parts, inner finisher components2141
 parts, internal assemblies 2x550-
 sheet paper tray.....2154, 2156
 parts, internal assemblies 550-sheet
 paper tray.....2151
 parts, internal assemblies HCl tray.....
2158, 2160
 parts, internal assemblies high-
 capacity input tray.....2158, 2160
 parts, internal assemblies printer
 (inner finisher; 1 of 3).....2144
 parts, internal assemblies printer
 (inner finisher; 2 of 3).....2146
 parts, internal assemblies printer
 (inner finisher; 3 of 3).....2148
 parts, internal assemblies printer
 (inner finisher).....2141

parts, internal assemblies printer
 (M751/E75245; 1 of 7).....2094
 parts, internal assemblies printer
 (M751/E75245; 2 of 7).....2096
 parts, internal assemblies printer
 (M751/E75245; 3 of 7).....2098
 parts, internal assemblies printer
 (M751/E75245; 4 of 7).....2100
 parts, internal assemblies printer
 (M751/E75245; 5 of 7).....2102
 parts, internal assemblies printer
 (M751/E75245; 6 of 7).....2104
 parts, internal assemblies printer
 (M751/E75245; 7 of 7).....2106
 parts, internal assemblies printer
 (M776zs; 1 of 9).....2128
 parts, internal assemblies printer
 (M776zs; 2 of 9).....2130
 parts, internal assemblies printer
 (M776zs; 3 of 9).....2131
 parts, internal assemblies printer
 (M776zs; 4 of 9).....2132
 parts, internal assemblies printer
 (M776zs; 5 of 9).....2134
 parts, internal assemblies printer
 (M776zs; 6 of 9).....2136
 parts, internal assemblies printer
 (M776zs; 7 of 9).....2138
 parts, internal assemblies printer
 (M776zs; 8 of 9).....2140
 parts, internal assemblies printer
 (M776zs; 9 of 9).....2141
 parts, internal assemblies printer
 (M856/E85055, M776dn/M776z;
 1 of 8).....2112
 parts, internal assemblies printer
 (M856/E85055, M776dn/M776z;
 2 of 8).....2114
 parts, internal assemblies printer
 (M856/E85055, M776dn/M776z;
 3 of 8).....2116
 parts, internal assemblies printer
 (M856/E85055, M776dn/M776z;
 4 of 8).....2117
 parts, internal assemblies printer
 (M856/E85055, M776dn/M776z;
 5 of 8).....2119
 parts, internal assemblies printer
 (M856/E85055, M776dn/M776z;
 6 of 8).....2121
 parts, internal assemblies printer
 (M856/E85055, M776dn/M776z;
 7 of 8).....2123

parts, internal assemblies printer
 (M856/E85055, M776dn/M776z;
 8 of 8).....2125
 parts, order by authorized service
 providers.....2078
 parts, orderable.....2078
 parts, ordering.....2078
 parts, printer components.....2091
 parts, printer components
 (M751/E75245).....2092
 parts, printer components (M776zs)...
2125
 parts, printer components
 (M856/E85055/M776dn/M776z)...
2107
 PEFS board (E75245/E85055),
 removing and replacing.....699
 pickup assembly
 (M751/E75245/M856/E85055/M7
 76dn/M776z/M776zs), removing
 and replacing.....785
 post service tests
 print quality test.....6
 power connection (M751/E75245)
 locating.....2085
 power connection (M776)
 locating.....2089
 power connection (M856/E85055)
 locating.....2086
 power switch (M751/E75245)
 locating.....2084
 power switch (M776)
 locating.....2087
 power switch (M856/E85055)
 locating.....2085
 power switch PCA (M751/E75245),
 removing and replacing.....1392
 power switch PCA (M776dn/M776z),
 removing and replacing.....1419
 power switch PCA (M776zs),
 removing and replacing.....1434
 power switch PCA (M856/E85055),
 removing and replacing.....1407
 printer components (M751/E75245),
 parts.....2092
 printer components (M776zs), parts...
2125
 printer components
 (M856/E85055/M776dn/M776z),
 parts.....2107
 printer components, parts.....2091
 product number (M751/E75245)
 locating.....2085
 product number (M776)
 locating.....2089

product number (M856/E85055)
locating..... 2086

R

rear upper cover (M776zs), removing
and replacing.....226
registration density sensor
(M751/E75245/M856/E85055/M7
76dn/M776z/M776zs), removing
and replacing.....797
removal and replacement..... 1
considerations..... 3
removal and replacement procedures.
.....6
removal and replacement strategy....2
introduction.....2
remove and replace, 2,700-sheet HCl
paper tray and stand parts..... 1989
remove and replace, 2x550-sheet
paper tray and stand parts..... 1894
remove and replace, 550-sheet paper
tray parts..... 1839
remove and replace, accessories 1693
remove and replace, external panels,
covers, and doors..... 103
remove and replace, FRUs..... 103
remove and replace, HDD..... 16
remove and replace, high-capacity
input tray parts..... 1989
remove and replace, inner finisher
parts..... 1693
remove and replace, internal parts
and assemblies.....292
removing and replacing
2x550-sheet paper tray and stand
.....1894
2x550-sheet paper tray and stand
controller PCA..... 1985
2x550-sheet paper tray and stand
right door..... 1905
2x550-sheet paper tray and stand
right lower cover..... 1902
2x550-sheet paper tray and stand
rollers..... 1896
2x550-sheet paper tray and stand
tray 1 auto close assembly.....
.....1962
2x550-sheet paper tray and stand
tray 1 lifter drive..... 1937
2x550-sheet paper tray and stand
tray 1 pickup assembly..... 1912
2x550-sheet paper tray and stand
tray 1 pickup motor..... 1910

2x550-sheet paper tray and stand
tray 2 auto close assembly.....
.....1973
2x550-sheet paper tray and stand
tray 2 lifter drive..... 1950
2x550-sheet paper tray and stand
tray 2 pickup assembly..... 1926
2x550-sheet paper tray and stand
tray 2 pickup motor..... 1924
550-sheet paper tray..... 1839
550-sheet paper tray auto close
assembly..... 1878
550-sheet paper tray lifter drive....
.....1865
550-sheet paper tray pickup
assembly..... 1853
550-sheet paper tray pickup
motor..... 1851
550-sheet paper tray right door.....
.....1847
550-sheet paper tray rollers..1842
550-sheet paper tray size detect
switch..... 1891
accessory upper cover
(M856/E85055/M776dn/M776
z).....155
auto close assembly for Tray 2
(M751/E75245/M856/E85055
/M776dn/M776z/M776zs)..917
black pre-exposure assembly
(M751/E75245)..... 1352
black pre-exposure assembly
(M776zs)..... 1374
black pre-exposure assembly
(M856/E85055/M776dn/M776
z)..... 1365
cartridge front fan (M751/E75245)
.....1258
cartridge front fan
(M856/E85055/M776)..... 1270
cartridge guide
(M856/E85055/M776dn/M776
z/M776zs)..... 570
cartridge rail assembly
(M751/E75245)..... 571
cartridge rail assembly (M776zs)....
..... 605
cartridge rail assembly
(M856/E85055/M776dn/M776
z).....591
cartridge rear fan (M751/E75245).
.....1283
cartridge rear fan
(M856/E85055/M776)..... 1295

cartridge upper guide
(M751/E75245)..... 1308
cartridge upper guide (M776zs).....
.....1332
cartridge upper guide
(M856/E85055/M776dn/M776
z)..... 1323
communication PCA (M776)..... 312
control panel.....74
control panel (M776).....85
control panel (M856/E85055).... 79
controller fan
(M856/E85055/M776dn/M776
z/M776zs)..... 763
DC controller (M751/E75245).. 931
DC controller
(M856/E85055/M776dn/M776
z/M776zs).....943
delivery assembly (M751/E75245)
.....323
delivery assembly
(M776dn/M776z).....354
delivery assembly (M776zs).....373
delivery assembly (M856/E85055)
.....341
delivery cover (M776zs)..... 257
delivery front cover (M776zs).. 246
delivery rear cover (M776zs).... 272
developer alienation motor
(M751/E75245)..... 1182
developer alienation motor
(M856/E85055/M776dn/M776
z/M776zs)..... 1197
document feeder..... 190
document feeder pickup and
separation rollers..... 39
document feeder reflector..... 96
drum motor 1 (M751/E75245).....
.....1090
drum motor 1
(M856/E85055/M776dn/M776
z/M776zs)..... 1103
drum motor 2 (M751/E75245).....
.....1119
drum motor 2
(M856/E85055/M776dn/M776
z/M776zs)..... 1131
drum motor 3 (M751/E75245).....
.....1147
drum motor 3
(M856/E85055/M776dn/M776
z/M776zs)..... 1163
DT cartridge rail assembly
(M751/E75245)..... 629

DT cartridge rail assembly (M776zs).....	663	High capacity input (HCI) paper tray and stand left tray lifter drive.....	2054	inner finisher latch assembly.	1728
DT cartridge rail assembly (M856/E85055/M776dn/M776 z).....	649	High capacity input (HCI) tray and stand left paper tray.....	1990	inner finisher latch cover.....	1708
duplex drive assembly (M751/E75245).....	815	High capacity input (HCI) tray and stand left tray lifter motor	2052	inner finisher paddle assembly.....	1721
duplex reverse guide assembly (M776dn/M776z).....	447	High capacity input (HCI) tray and stand left tray pickup assembly	2037	inner finisher paddle drive assembly.....	1723
duplex reverse guide assembly (M856/E85055).....	433	High capacity input (HCI) tray and stand left tray pickup motor.....	2035	inner finisher processing tray assembly.....	1764
duplexing controller PCA (M856/E85055/M776dn/M776 z/M776zs).....	317	High capacity input (HCI) tray and stand left tray rollers.....	1992	inner finisher rear push assembly...	1836
embedded Multi-Media Card (eMMC).....	21	High capacity input (HCI) tray and stand right door.....	2009	inner finisher rear small cover	1705
eMMC.....	21	High capacity input (HCI) tray and stand right lower cover.....	2006	inner finisher release handle..	1832
environmental sensor PCA (M751/E75245).....	1055	High capacity input (HCI) tray and stand right paper tray.....	1989	inner finisher return belt assembly.	1751
environmental sensor PCA (M856/E85055/M776dn/M776 z/M776zs).....	1066	High capacity input (HCI) tray and stand right tray auto close assembly.....	2068	inner finisher stack tray.....	1703
fax PCA.....	26	High capacity input (HCI) tray and stand right tray lifter drive	2065	inner finisher stack wall assembly..	1743
formatter.....	707	High capacity input (HCI) tray and stand right tray pickup assembly.....	2015	inner finisher staple mount assembly.....	1783
formatter (M751/E75245).....	702	High capacity input (HCI) tray and stand right tray lifter motor.....	2063	inner finisher stapler assembly.....	1736
formatter case (M856/E85055/M776dn/M776 z/M776zs).....	713	High capacity input (HCI) tray and stand right tray pickup assembly.....	2015	inner finisher trailing edge dropping solenoid.....	1818
formatter cover.....	107	High capacity input (HCI) tray and stand right tray pickup assembly.....	2015	inner finisher tray lifting motor.....	1812
front cover (M776zs).....	234	High capacity input (HCI) tray and stand right tray rollers.....	1999	inner finisher upper entrance guide.....	1710
front door.....	103	high-voltage power supply T2 (HVPS-T2; M751/E75245)	1017	inner finisher upper feed guide.....	1714
fuser.....	58	high-voltage power supply T2 (HVPS-T2; M856/E85055/M776dn/M776z /M776zs).....	1023	inner finisher wire sub-tray....	1838
fuser drive assembly (M751/E75245).....	521	image scanner.....	195	intermediate transfer belt (ITB)..	61
fuser drive assembly (M856/E85055/M776dn/M776 z/M776zs).....	545	imaging drum.....	33	keyboard (M776z/M776zs).....	292
fuser fan (M751/E75245).....	1233	inner finisher.....	1693	laser scanner (M751/E75245/M856/E85055 /M776dn/M776z/M776zs)..	771
fuser fan (M856/E85055/M776)....	1245	inner finisher cable duct assembly.	1822	left door.....	109
fuser motor (M856/E85055/M776dn/M776 z/M776zs).....	500	inner finisher connector cover.....	1698	left lower cover (M856/E85055/M776dn/M776 z).....	161
hard-disk drive, HDD.....	16	inner finisher controller PCA..	1806	left upper front and rear covers.....	159
High capacity input (HCI) paper tray and stand controller PCA....	2073	inner finisher feed motor.....	1809	lifter drive assembly (M751/E75245/M856/E85055 /M776dn/M776z/M776zs)..	905
High capacity input (HCI) paper tray and stand feed assembly...	2023	inner finisher front cover.....	1700	low-voltage power supply (LVPS; M751/E75245).....	955
High capacity input (HCI) paper tray and stand left tray auto close assembly.....	2058	inner finisher front push assembly.	1828	low-voltage power supply (LVPS) fan (M751/E75245).....	1216

lower high-voltage power supply (lower HVPS; M751/E75245).....	secondary transfer roller..... 70	waste toner gear base assembly (M856/E85055/M776dn/M776 z)..... 1579
..... 970	SODIMM)..... 11	wireless PCA (M776)..... 309
lower high-voltage power supply (lower HVPS; M856/E85055/M776dn/M776z /M776zs)..... 979	T2 connecting PCA (M751/E75245)..... 1034	wireless PCA (M856/E85055)...303
LVPS (M856/E85055/M776dn/M776 z/M776zs)..... 960	T2 connecting PCA M856/E85055/M776dn/M776z /M776zs..... 1043	required tools..... 4
LVPS fan (M856/E85055/M776dn/M776 z/M776zs)..... 1225	toggle front assembly (M776zs).....	reverse tray (M856/E85055/M776dn/M776z), removing and replacing..... 163
main connecting PCA (M751/E75245)..... 734 468	revision history..... iii
main connecting PCA (M856/E85055/M776dn/M776 z/M776zs)..... 748	toggle front assembly (M856/E85055/M776dn/M776 z)..... 394	right door, removing and replacing.....
main cover (M776zs)..... 230	toggle rear assembly (M776zs)..... 125
main drive assembly (M751/E75245)..... 835 483	right front cover (M776zs), removing and replacing..... 236
main drive assembly (M856/E85055/M776dn/M776 z/M776zs)..... 868	toggle rear assembly (M856/E85055/M776dn/M776 z)..... 413	right handle, removing and replacing..
memory PCA (M751/E75245).....	toner cartridge..... 29 136
..... 1080	toner collection unit (TCU)..... 66	right rear upper cover (M776zs), removing and replacing..... 222
memory PCA (M856/E85055/M776dn/M776 z/M776zs)..... 727	top cover (M751/E75245)..... 116	right upper cover (M776zs), removing and replacing..... 205
PEFS board (E75245/E85055).699	top cover (M856/E85055)..... 149	right upper door (M776zs), removing and replacing..... 209
pickup assembly (M751/E75245/M856/E85055 /M776dn/M776z/M776zs)..785	transfer cleaner assembly (E75245/E85055)..... 687	
power switch PCA (M751/E75245).	Tray 1 pickup and separation	S
..... 1392	rollers..... 46	scanner control board (M776), removing and replacing..... 299
power switch PCA (M776dn/M776z)..... 1419	Tray 2..... 37	secondary transfer roller, removing and replacing..... 70
power switch PCA (M776zs)... 1434	Tray 2 pickup and separation	serial number (M751/E75245)
power switch PCA (M856/E85055).	rollers..... 52	locating..... 2085
..... 1407	Tray 2 size detect switch (M751/E75245/M856/E85055 /M776dn/M776z/M776zs)..... 2089
rear upper cover (M776zs)..... 226 1450	serial number (M856/E85055)
registration density sensor (M751/E75245/M856/E85055 /M776dn/M776z/M776zs)..797	upper high-voltage power supply (upper HVPS) Removal and replacement: Upper high- voltage power supply (M751/E75245)..... 992	locating..... 2086
reverse tray (M856/E85055/M776dn/M776 z)..... 163	upper high-voltage power supply (upper HVPS) Removal and replacement: Upper high- voltage power supply (M856/E85055/M776dn/M776 z/M776zs)..... 1005	service and support WISE..... 1, 2077, 2082
right door..... 125	waste toner feed assembly (M751/E75245)..... 1452	service approach..... 5
right front cover (M776zs)..... 236	waste toner feed assembly (M776zs)..... 1499	after performing service..... 6
right handle..... 136	waste toner feed assembly (M856/E85055/M776dn/M776 z)..... 1478	before performing service..... 5
right rear upper cover (M776zs).....	waste toner gear base assembly (M751/E75245)..... 1529	SODIMM removing and replacing..... 11
..... 222	waste toner gear base assembly (M776zs)..... 1633	supplies..... 2078
right upper cover (M776zs)..... 205		T
right upper door (M776zs)..... 209		T2 connecting PCA (M751/E75245), removing and replacing..... 1034
scanner control board (M776)..299		T2 connecting PCA M856/E85055/M776dn/M776z/M 776zs, removing and replacing.....
	 1043
		tip..... 1
		toggle front assembly (M776zs), removing and replacing..... 468

toggle front assembly (M856/E85055/M776dn/M776z), removing and replacing.....	394	waste toner feed assembly (M751/E75245), removing and replacing.....	1452
toggle rear assembly (M776zs), removing and replacing.....	483	waste toner feed assembly (M776zs), removing and replacing.....	1499
toggle rear assembly (M856/E85055/M776dn/M776z), removing and replacing.....	413	waste toner feed assembly (M856/E85055/M776dn/M776z), removing and replacing.....	1478
toner cartridge, removing and replacing.....	29	waste toner gear base assembly (776zs), removing and replacing....	1633
toner cartridges, part numbers...	2078	waste toner gear base assembly (M751/E75245), removing and replacing.....	1529
toner collection unit (TCU), removing and replacing.....	66	waste toner gear base assembly (M856/E85055/M776dn/M776z), removing and replacing.....	1579
top cover (M751/E75245), removing and replacing.....	116	Web-based Interactive Search Engine (WISE) HP internal users and Channel partners.....	1, 2077, 2082
top cover (M856/E85055), removing and replacing.....	149	wireless PCA (M776), removing and replacing.....	309
transfer cleaner assembly (E75245/E85055), removing and replacing.....	687	wireless PCA (M856/E85055), removing and replacing.....	303
Tray 1 pickup and separation rollers, removing and replacing.....	46	WISE HP internal users and Channel partners.....	1, 2077, 2082
Tray 2 pickup and separation rollers, removing and replacing.....	52		
Tray 2 size detect switch (M751/E75245/M856/E85055/M7 76dn/M776z/M776zs), removing and replacing.....	1450		
Tray 2, removing and replacing.....	37		
trays (M751/E75245) locating.....	2084		
trays (M776) locating.....	2087		
trays (M856/E85055) locating.....	2085		

U

upper high-voltage power supply (upper HVPS) Removal and replacement: Upper high-voltage power supply (M751/E75245), removing and replacing.....	992
upper high-voltage power supply (upper HVPS) Removal and replacement: Upper high-voltage power supply (M856/E85055/M776dn/M776z/M 776zs), removing and replacing.....	1005

W

warning.....	1
--------------	---