



Color LaserJet Enterprise M552, M553, M577

Color LaserJet Managed E55040

Color LaserJet Managed MFP E57540, Flow MFP E57540

Repair Manual

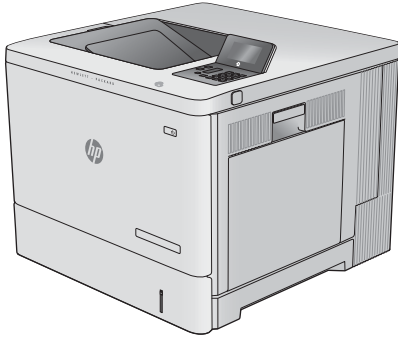

M553n

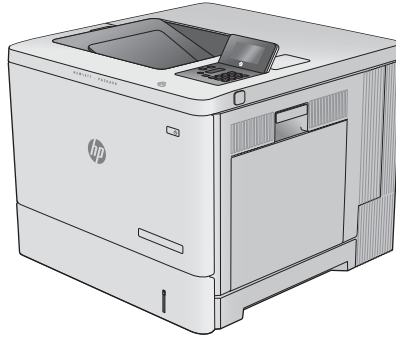

M552dn
M553dn
Managed M553dnm



M553x
Managed 553xm



M577dn
Managed MFP E57540dn



M577f



M577c
M577z
Managed MFP M577cm
Managed MFP E57540c

www.hp.com/support/colorlj552

www.hp.com/support/colorlj553

www.hp.com/support/colorljM577mfp

www.hp.com/support/colorljE55040

www.hp.com/support/colorljE57540mfp



For printer theory and troubleshooting information, see the Troubleshooting Manual.



HP Color LaserJet Enterprise M552, M553,
MFP M577, Managed M553, E55040, MFP
M577, MFP E57540, Managed Flow MFP
M577, MFP E57540

Repair Manual

Copyright and License

© Copyright 2017 HP Development Company, L.P.

Reproduction, adaptation, or translation without prior written permission is prohibited, except as allowed under the copyright laws.

The information contained herein is subject to change without notice.

The only warranties for HP products and services are set forth in the express warranty statements accompanying such products and services. Nothing herein should be construed as constituting an additional warranty. HP shall not be liable for technical or editorial errors or omissions contained herein.

Edition 3, 5/2018

Conventions used in this guide

 **TIP:** Helpful hints or shortcuts.

 **NOTE:** Information that explains a concept or how to complete a task.

 **Reinstallation tip:** Reinstallation helpful hints, shortcuts, or considerations.

 **IMPORTANT:** Information that help the user to avoid potential printer error conditions.

 **CAUTION:** Procedures that the user must follow to avoid losing data or damaging the printer.

 **WARNING!** Procedures that the user must follow to avoid personal injury, catastrophic loss of data, or extensive damage to the printer.

Related documentation and software

HP service personnel, go to one of the following Web-based Interactive Search Engines (WISE) sites:

AMS

- <https://support.hp.com/wise/home/ams-en>
- <https://support.hp.com/wise/home/ams-es>
- <https://support.hp.com/wise/home/ams-pt>

APJ

- <https://support.hp.com/wise/home/apj-en>
- <https://support.hp.com/wise/home/apj-ja>
- <https://support.hp.com/wise/home/apj-ko>
- <https://support.hp.com/wise/home/apj-zh-Hans>
- <https://support.hp.com/wise/home/apj-zh-Hant>

EMEA

- <https://support.hp.com/wise/home/emea-en>

Channel partners, go to HP Channel Services Network (CSN) at www.hp.com/partners/csn.

Channel partners, access training materials in the HP University and Partner Learning Center at <https://content.ext.hp.com/sites/LMS/HPU.page>.

Table of contents

1 Removal and replacement	1
For additional service and support	2
Removal and replacement strategy	2
Introduction	2
Considerations during removal and replacement	3
Electrostatic discharge	4
Required tools	4
Fasteners used in this printer	5
Service approach	6
Before performing service	6
After performing service	6
Post service tests	6
Print quality test	6
Copy-quality test (M577 models)	6
Fax-quality test (M577 models)	7
Parts removal orientation	7
Removal and replacement procedures	8
Customer self-repair (CSR) A parts and assemblies	8
Removal and replacement: Toner cartridges	9
Introduction	9
Step 1: Remove the toner cartridges	10
Step 2: Unpack the replacement assembly	11
Step 3: Install a toner cartridge	11
Removal and replacement: Toner collection unit (TCU)	14
Introduction	14
Step 1: Remove the TCU	14
Step 2: Unpack the replacement assembly	16
Step 3: Install the TCU	17
Removal and replacement: Staple cartridge (M577c/f/z)	19
Introduction	19
Step 1: Remove the staple cartridge	19
Step 2: Unpack the replacement assembly	20

Step 3: Install the staple cartridge	21
Removal and replacement: Fuser	23
Introduction	23
Step 1: Remove the fuser	23
Step 2: Unpack the replacement assembly	25
Step 3: Install the fuser	25
Step 4: Reset the fuser counter	27
Removal and replacement: Hard-disk drive (HDD) (M552 and M553)	28
Introduction	28
Step 1: Remove the formatter cover	29
Step 2: Remove the hard-disk drive (HDD)	30
Step 3: Unpack the replacement assembly	30
Step 4: Install the hard-disk drive (HDD)	31
Step 5: Install the formatter cover	32
Step 6: Reinstall the product firmware	33
Removal and replacement: Hard-disk drive (HDD) (M577)	28
Introduction	34
Step 1: Remove the formatter cover	35
Step 2: Remove the hard-disk drive (HDD)	36
Step 3: Unpack the replacement assembly	38
Step 4: Install the hard-disk drive (HDD)	39
Step 5: Install the formatter cover	42
Step 6: Reinstall the product firmware	43
Removal and replacement: Dual in-line memory module (DIMM; M552 and M553)	44
Introduction	44
Step 1: Remove the formatter cover	45
Step 2: Remove the hard-disk drive (HDD; M552 and M553)	46
Step 3: Remove the dual in-line memory module (DIMM)	47
Step 4: Unpack the replacement assembly	47
Step 5: Install the DIMM	48
Step 6: Install the HDD (M552 and M553)	49
Step 7: Install the formatter cover	50
Removal and replacement: Dual in-line memory module (DIMM; M577)	52
Introduction	52
Step 1: Remove the formatter cover	53
Step 2: Remove the hard-disk drive (HDD; M577)	54
Step 3: Remove the dual in-line memory module (DIMM)	44
Step 4: Unpack the replacement assembly	56
Step 5: Install the DIMM	56
Step 6: Install the HDD (M577)	58
Step 7: Install the formatter cover	59

Removal and replacement: embedded MultiMedia Card (eMMC; M552 and M553)	52
Introduction	60
Step 1: Remove the formatter cover	61
Step 2: Remove the embedded MultiMedia Card (eMMC)	62
Step 3: Unpack the replacement assembly	63
Step 4: Install the eMMC	63
Step 5: Install the formatter cover	64
Step 6: Reinstall the product firmware	64
Removal and replacement: Secondary transfer roller	66
Introduction	66
Step 1: Remove the transfer roller	66
Step 2: Unpack the replacement assembly	68
Step 3: Install the secondary transfer roller	69
Removal and replacement: Universal Serial Bus (USB) cover (M552 and M553)	71
Introduction	71
Step 1: Remove the USB cover	71
Step 2: Unpack the replacement assembly	72
Step 3: Install the USB cover	72
Removal and replacement: Hardware Integration Pocket (HIP) cover (M552 and M553)	74
Introduction	74
Step 1: Remove the HIP cover	74
Step 2: Unpack the replacement assembly	76
Step 3: Install the HIP cover	76
Removal and replacement: Hardware Integration Pocket (HIP) cover (M577)	78
Introduction	78
Step 1: Remove the HIP cover	78
Step 2: Unpack the replacement assembly	79
Step 3: Install the HIP cover	80
Removal and replacement: Control panel (M553x)	82
Introduction	82
Step 1: Remove the control panel	83
Step 2: Unpack the replacement assembly	87
Step 3: Install the control panel	87
Removal and replacement: Control panel (M577)	91
Introduction	91
Step 1: Remove the control-panel cover (M577)	91
Step 2: Remove the control panel (M577)	93
Step 3: Unpack the replacement assembly	96
Step 4: Install the control panel (M577)	96
Step 5: Install the control-panel cover (M577)	101

Removal and replacement: Keyboard (M577c/z)	103
Introduction	103
Step 1: Remove the control-panel cover (M577)	103
Step 2: Remove the keyboard	105
Step 3: Unpack the replacement assembly	107
Step 4: Install the keyboard	107
Step 5: Install the control-panel cover (M577)	110
Removal and replacement: White backing (M577)	112
Introduction	112
Step 1: Remove the white backing (M577)	112
Step 2: Unpack the replacement assembly	115
Step 3: Install the white backing (M577)	116
Removal and replacement: Retention clips (M577)	119
Introduction	119
Step 1: Remove the retention clips	119
Step 2: Unpack the replacement assembly	122
Step 3: Install the retention clips	122
Removal and replacement: Document feeder rollers (M577)	127
Introduction	127
Step 1: Remove the pickup and feed roller assembly	127
Step 2: Remove the separation roller	129
Step 3: Unpack the replacement assemblies	130
Step 4: Install the separation roller	131
Step 5: Install the pickup and feed roller assembly	133
Step 6: Reset the document feeder kit count	134
Customer self-repair (CSR) B parts and assemblies	136
Removal and replacement: Tray 2-X paper pickup roller and separation roller assemblies	137
Introduction	137
Step 1: Remove the Tray 2-X paper pickup roller assembly	138
Step 2: Remove the Tray 2-X separation roller	143
Step 3: Unpack the replacement assemblies	144
Step 4: Install the Tray 2-X separation roller	145
Step 5: Install the Tray 2-X paper pickup roller assembly	146
Removal and replacement: Intermediate transfer belt (ITB)	152
Introduction	82
Step 1: Remove the ITB	152
Step 2: Unpack the replacement assembly	157
Step 3: Install the ITB	158
Removal and replacement: Intermediate transfer belt (ITB) and secondary transfer roller	165

Introduction	165
Step 1: Remove the transfer roller	165
Step 2: Remove the ITB	167
Step 3: Unpack the replacement assemblies	172
Step 4: Install the ITB	172
Step 5: Install the transfer roller	178
Field replaceable units (FRUs)	180
Removal and replacement: External panels, covers, and doors	180
Removal and replacement: Stapler cover assembly (M577c/f/z)	181
Removal and replacement: Right front upper cover (M577dn)	186
Removal and replacement: Rear upper cover (M577)	191
Removal and replacement: Left upper cover (M577)	198
Removal and replacement: Right upper cover (M577)	208
Removal and replacement: Top rear cover (M577)	228
Removal and replacement: Paper feed cover (M577)	260
Removal and replacement: Top cover (M577)	294
Removal and replacement: Right door	338
Removal and replacement: Front door	347
Removal and replacement: Formatter cover	357
Removal and replacement: Rear cover (M552 and M553)	360
Removal and replacement: Rear cover (M577)	365
Removal and replacement: Left cover	375
Removal and replacement: Upper cover (M552 and M553)	393
Removal and replacement: Output bin	422
Removal and replacement: Right rear cover (M552 and M553)	489
Removal and replacement: Right rear cover (M577)	517
Removal and replacement: Control panel (M553n/dn and M552dn only) ...	540
Removal and replacement: Internal parts and assemblies	564
Removal and replacement: Tray 1 pickup and separation rollers	566
Removal and replacement: Secondary transfer assembly	578
Removal and replacement: Near field communication (NFC) PCA (M553x) .	584
Removal and replacement: Near field communication (NFC) PCA (M577z) .	611
Removal and replacement: Wireless PCA (M553 and M577)	619
Removal and replacement: Switch (SW4) PC board assembly	686
Removal and replacement: Stapler unit (M577c/f/z)	757
Removal and replacement: DC controller	767
Removal and replacement: Delivery assembly	782
Removal and replacement: Formatter (M552 and M553)	876
Removal and replacement: Formatter (M577)	891
Removal and replacement: Formatter case assembly	907
Removal and replacement: Fuser power supply	947

Removal and replacement: Low-voltage power supply (LVPS)	971
Removal and replacement: High-voltage power supply D (HVPSD)	1016
Removal and replacement: Drum motor 1 (M1)	1065
Removal and replacement: Power-supply fan (FM1)	1106
Removal and replacement: Developing disengagement motor (M6)	1180
Removal and replacement: Auto close assembly	1230
Removal and replacement: Lifter drive assembly	1280
Removal and replacement: Laser/scanner assembly	1332
Removal and replacement: Delivery fan (FM3)	1390
Removal and replacement: High-voltage power supply T (HVPST)	1475
Removal and replacement: Drum motor 2 (M2)	1563
Removal and replacement: Drum motor 3 (M3)	1652
Removal and replacement: Fuser motor (M4)	1741
Removal and replacement: Environmental sensor printed circuit assembly (PCA)	1830
Removal and replacement: Fuser drive assembly	1845
Removal and replacement: Duplex drive assembly and motor	1954
Removal and replacement: Pickup drive assembly and motor (M5)	2089
Removal and replacement: Registration assembly	2186
Removal and replacement: Paper pickup assembly	2307
Removal and replacement: Density-detect assembly	2444
Removal and replacement: Main drive assembly	2570
Removal and replacement: Document feeder and image scanner assemblies (M577)	2718
Removal and replacement: Document feeder (M577)	2719
Introduction	2719
Step 1: Remove the formatter cover	2720
Step 2: Remove the rear upper cover	2721
Step 3: Remove the left upper cover	2723
Step 4: Remove the document feeder	2724
Step 5: Unpack the replacement assembly	2728
Step 6: Install the document feeder	2728
Step 7: Install the left upper cover	2734
Step 8: Install the rear upper cover	2736
Step 9: Install the formatter cover	2738
Step 10: Reset the firmware counter	2739
Removal and replacement: Scanner control board (SCB) (M577)	2740
Introduction	2740
Step 1: Remove the formatter cover	2740
Step 2: Remove the rear upper cover	2741
Step 3: Remove the scanner control board (SCB)	2743
Step 4: Unpack the replacement assembly	2746

Step 5: Install the SCB	2746
Step 6: Install the rear upper cover	2749
Step 7: Install the formatter cover	2751
Removal and replacement: Image scanner (M577)	2753
Introduction	2753
Step 1: Remove the control-panel cover (M577)	2754
Step 2: Remove the white backing (M577)	2756
Step 3: Remove the keyboard (M577c/z)	2758
Step 4: Remove the control panel (M577)	2760
Step 5: Remove the formatter cover	2762
Step 6: Remove the fax PCA (M577c/f/z)	2763
Step 7: Remove the rear upper cover (M577)	2765
Step 8: Remove the left upper cover (M577)	2767
Step 9: Remove the right front upper cover (M577dn)	2769
Step 10: Remove the stapler cover assembly (M577c/f/z)	2770
Step 11: Remove the document feeder (M577)	2772
Step 12: Remove the scanner control board (SCB) (M577)	2776
Step 13: Remove the image scanner assembly (M577)	2778
Step 14: Unpack the replacement assembly	2781
Step 15: Install the image scanner assembly (M577)	2782
Step 16: Install the scanner control board (M577)	2786
Step 17: Install the document feeder (M577)	2788
Step 18: Install the stapler cover assembly (M577c/f/z)	2792
Step 19: Install the right front upper cover (M577dn)	2794
Step 20: Install the left upper cover (M577)	2795
Step 21: Install the rear upper cover (M577)	2797
Step 22: Install the fax PCA (M577c/f/z)	2799
Step 23: Install the formatter cover	2801
Step 24: Install the control panel (M577)	2801
Step 25: Install the keyboard (M577c/z)	2805
Step 26: Install the white backing (M577)	2807
Step 27: Install the control-panel cover (M577)	2808
Removal and replacement: Trays	2810
Removal and replacement: Tray 2	2811
Introduction	2811
Step 1: Remove the tray	2811
Step 2: Unpack the replacement assembly	2812
Step 3: Install the tray	2813
Removal and replacement: Tray 3, Tray 4, or Tray 5	2815
Introduction	2815
Step 1: Remove the tray	2815

Step 2: Unpack the replacement assembly	2816
Step 3: Install the tray	2817
Removal and replacement: Accessories	2819
Removal and replacement: 1x550-sheet paper feeder	2820
Removal and replacement: Rear cover (1x550-sheet paper feeder)	2821
Removal and replacement: Right door (1x550-sheet paper feeder)	2825
Removal and replacement: Right door hinge bracket (1x550-sheet paper feeder)	2834
Removal and replacement: Right-lower cover (1x550-sheet paper feeder)	2844
Removal and replacement: Right-door link (1x550-sheet paper feeder) .	2857
Removal and replacement: Left cover (1x550-sheet paper feeder)	2870
Removal and replacement: OP Drawer holder (1x550-sheet paper feeder)	2874
Removal and replacement: Auto close assembly (1x550-sheet paper feeder)	2880
Removal and replacement: Switch button (SW12) (1x550-sheet paper feeder)	2890
Removal and replacement: Drawer connector holder (1x550-sheet paper feeder)	2899
Removal and replacement: Paper-feeder drive PCA (1x550-sheet paper feeder)	2906
Removal and replacement: Paper feed assembly (1x550-sheet paper feeder)	2912
Removal and replacement: Paper pickup assembly (1x550-sheet paper feeder)	2935
Removal and replacement: Feeder drive assembly (1x550-sheet paper feeder)	2963
Removal and replacement: Lifter drive assembly (1x550-sheet paper feeder)	2988
Removal and replacement: Trusted platform module (M552 and M553)	3019
Introduction	3019
Step 1: Remove the formatter cover	3020
Step 2: Remove the hard-disk drive (HDD)	3021
Step 3: Remove the trusted platform module (TPM)	3022
Step 4: Unpack the replacement assembly	3023
Step 5: Install the TPM	3024
Step 6: Install the hard-disk drive (HDD)	3025
Step 7: Install the formatter cover	3026
Removal and replacement: Trusted platform module (M577)	3027
Introduction	3027
Step 1: Remove the formatter cover	3028

Step 2: Remove the hard-disk drive (HDD; M577)	3029
Step 3: Remove the trusted platform module (TPM)	3029
Step 4: Unpack the replacement assembly	3030
Step 5: Install the TPM	3024
Step 6: Install the hard-disk drive (HDD; M577)	3032
Step 7: Install the formatter cover	3026
Removal and replacement: Internal USB ports (M552 and M553)	52
Introduction	3034
Step 1: Remove the formatter cover	3035
Step 2: Remove the internal USB ports module (M552 and M553)	44
Step 3: Unpack the replacement assembly	3038
Step 4: Install the internal USB ports module (M552 and M553)	3039
Step 5: Install the formatter cover	59
Removal and replacement: Internal USB ports (M577)	52
Introduction	3043
Step 1: Remove the formatter cover	3044
Step 2: Remove the internal USB ports module (M577)	44
Step 3: Unpack the replacement assembly	3046
Step 4: Install the internal USB ports module (M577)	3047
Step 5: Install the formatter cover	59
Removal and replacement: Fax PCA (M577c/f/z)	52
Introduction	3050
Step 1: Remove the formatter cover	3051
Step 2: Remove the fax PCA	44
Step 3: Unpack the replacement assembly	3053
Step 4: Install the fax PCA	3054
Step 5: Install the formatter cover	59

2 Parts and diagrams 3057

For additional service and support	3058
Assembly locations	3059
Product front view (M552 and M553 models)	3059
Product back view (M552 and M553 models)	3060
Product front view (M577 models)	3061
Product back view (M577 models)	3062
Order parts, accessories, and supplies	3063
Ordering	3063
Orderable parts	3063
Supplies	3063
Accessories	3064
Customer self-repair kits	3067

Related documentation and software	3068
How to use the parts lists and diagrams	3069
Parts and diagrams: Document feeder and scanner whole units	3070
Parts and diagrams: Covers	3072
Covers (M552 and M553)	3072
Covers (M577)	3074
Parts and diagrams: Internal components	3076
Internal components (1 of 5)	3076
Internal components (2 of 5)	3078
Internal components (3 of 5)	3080
Internal components (4 of 5)	3082
Internal components (5 of 5)	3084
Parts and diagrams: 550-sheet paper feeder	3086
550-sheet paper feeder covers	3086
550-sheet paper feeder main body	3088
Alphabetical parts list	3090
Numerical parts list	3098

Index	3107
-------------	------

List of tables

Table 2-1	Supplies	3063
Table 2-2	Accessories (M552 and M553)	3064
Table 2-3	Accessories (M577)	3065
Table 2-4	Document feeder and scanner whole units (M577 only)	3071
Table 2-5	Covers (M552, M553)	3073
Table 2-6	Covers (M577)	3075
Table 2-7	Internal components (1 of 5)	3077
Table 2-8	Internal components (2 of 5)	3079
Table 2-9	Internal components (3 of 5)	3081
Table 2-10	Internal components (4 of 5)	3083
Table 2-11	Internal components (5 of 5)	3085
Table 2-12	550-sheet paper feeder covers	3087
Table 2-13	550-sheet paper feeder covers	3089

List of figures

Figure 1-1	Screwdrivers	4
Figure 1-2	Screw size chart	5
Figure 1-3	Open the front door	10
Figure 1-4	Remove the toner cartridge	11
Figure 1-5	Recycle and unpack	11
Figure 1-6	Rock the toner cartridge	12
Figure 1-7	Remove the protective shield	12
Figure 1-8	Install a toner cartridge	13
Figure 1-9	Close the front door	13
Figure 1-10	Open the front door	15
Figure 1-11	Open the TCU	15
Figure 1-12	Remove the TCU	16
Figure 1-13	Recycle and unpack	17
Figure 1-14	Verify that the toner collection hatch cover is closed	17
Figure 1-15	Install the TCU	18
Figure 1-16	Close the front door	18
Figure 1-17	Open the stapler door	20
Figure 1-18	Remove the staple cartridge	20
Figure 1-19	Recycle and unpack	21
Figure 1-20	Install the staple cartridge	21
Figure 1-21	Close the stapler door	22
Figure 1-22	Open the right door	24
Figure 1-23	Release the fuser	24
Figure 1-24	Remove the fuser	25
Figure 1-25	Recycle and unpack	25
Figure 1-26	Align the fuser with the opening	26
Figure 1-27	Install the fuser	26
Figure 1-28	Close the right door	27
Figure 1-29	Locate the formatter cover	29
Figure 1-30	Loosen the thumbscrews	29
Figure 1-31	Release the HDD	30
Figure 1-32	Remove the HDD	30

Figure 1-33	Recycle and unpack	31
Figure 1-34	Install the holder	32
Figure 1-35	Release the HDD	32
Figure 1-36	Install the cover	33
Figure 1-37	Locate the formatter cover	35
Figure 1-38	Loosen the thumbscrews	35
Figure 1-39	Release the HDD	36
Figure 1-40	Remove the HDD	36
Figure 1-41	Remove two screws	37
Figure 1-42	Remove the bracket	37
Figure 1-43	Remove the PCA	38
Figure 1-44	Recycle and unpack	38
Figure 1-45	Align the PCA	39
Figure 1-46	Install the PCA	39
Figure 1-47	Align the tabs on the bracket	40
Figure 1-48	Install the bracket	40
Figure 1-49	Install two screws	41
Figure 1-50	Install the holder	41
Figure 1-51	Release the HDD	42
Figure 1-52	Install the cover	42
Figure 1-53	Locate the formatter cover	45
Figure 1-54	Loosen the thumbscrews	45
Figure 1-55	Release the HDD	46
Figure 1-56	Remove the HDD	46
Figure 1-57	Locate the DIMM	47
Figure 1-58	Remove the DIMM	47
Figure 1-59	Recycle and unpack	48
Figure 1-60	The DIMM connector	48
Figure 1-61	Install the DIMM	49
Figure 1-62	Verify the installation	49
Figure 1-63	Install the holder	50
Figure 1-64	Release the HDD	50
Figure 1-65	Install the cover	51
Figure 1-66	Locate the formatter cover	53
Figure 1-67	Loosen the thumbscrews	53
Figure 1-68	Release the HDD	54
Figure 1-69	Remove the HDD	54
Figure 1-70	Locate the DIMM	55
Figure 1-71	Release the DIMM	55
Figure 1-72	Remove the DIMM (M527)	56
Figure 1-73	Recycle and unpack	56

Figure 1-74	Insert the DIMM	57
Figure 1-75	Install the DIMM	57
Figure 1-76	Snap the DIMM into place	58
Figure 1-77	Install the holder	58
Figure 1-78	Release the HDD	59
Figure 1-79	Install the cover	59
Figure 1-80	Locate the formatter cover	61
Figure 1-81	Loosen the thumbscrews	62
Figure 1-82	Remove the eMMC	62
Figure 1-83	Recycle and unpack	63
Figure 1-84	Install the eMMC	63
Figure 1-85	Verify the installation	64
Figure 1-86	Install the cover	64
Figure 1-87	Open the right door	67
Figure 1-88	Lower the secondary transfer roller assembly	67
Figure 1-89	Release the secondary transfer roller clip	68
Figure 1-90	Remove the secondary transfer roller	68
Figure 1-91	Recycle and unpack	69
Figure 1-92	Install the secondary transfer roller	69
Figure 1-93	Close the right door	70
Figure 1-94	Locate the USB cover	71
Figure 1-95	Remove the cover	72
Figure 1-96	Recycle and unpack	72
Figure 1-97	Install the cover	73
Figure 1-98	Check the installation	73
Figure 1-99	Locate the HIP cover	74
Figure 1-100	Note the mounting feet and tabs	75
Figure 1-101	Release the HIP cover tabs	75
Figure 1-102	Remove the cover	76
Figure 1-103	Recycle and unpack	76
Figure 1-104	Install the cover	77
Figure 1-105	Check the installation	77
Figure 1-106	Locate the HIP cover	78
Figure 1-107	Release the HIP cover tabs	79
Figure 1-108	Remove the cover	79
Figure 1-109	Recycle and unpack	80
Figure 1-110	Position the tabs	80
Figure 1-111	Rotate the cover down	81
Figure 1-112	Check the installation	81
Figure 1-113	Tilt the control panel up	83
Figure 1-114	Release the control-panel screws cover tabs	83

Figure 1-115	Remove the cover	84
Figure 1-116	Remove two screws	84
Figure 1-117	Rotate the control-panel base up	85
Figure 1-118	Turn the control panel over	85
Figure 1-119	Disconnect two connectors	86
Figure 1-120	Recycle and unpack	87
Figure 1-121	Place the control panel on the product	87
Figure 1-122	Connect two connectors	88
Figure 1-123	Turn the control panel over	88
Figure 1-124	Rotate the control-panel base down	89
Figure 1-125	Install two screws	89
Figure 1-126	Install the cover	90
Figure 1-127	Open the document feeder	92
Figure 1-128	Release five tabs	92
Figure 1-129	Remove the cover	93
Figure 1-130	Disconnect the keyboard flat cable (M577c/z)	93
Figure 1-131	Disconnect connectors	94
Figure 1-132	Disconnect connectors	94
Figure 1-133	Remove three screws	95
Figure 1-134	Remove the control panel	95
Figure 1-135	Recycle and unpack	96
Figure 1-136	Open the control panel	96
Figure 1-137	Feed the keyboard flat cable through opening	97
Figure 1-138	Locate hooks and grounding clip	97
Figure 1-139	Install the control-panel	98
Figure 1-140	Install three screws	99
Figure 1-141	Connect connectors	100
Figure 1-142	Install USB and NFC	100
Figure 1-143	Connect the keyboard flat cable (M577c/z)	101
Figure 1-144	Position the control-panel cover on the printer	101
Figure 1-145	Engage five tabs	102
Figure 1-146	Close the document feeder	102
Figure 1-147	Open the document feeder	104
Figure 1-148	Release five tabs	104
Figure 1-149	Remove the cover	105
Figure 1-150	Disconnect the keyboard flat cable	105
Figure 1-151	Slide the keyboard out	106
Figure 1-152	Release two tabs	106
Figure 1-153	Remove the keyboard	107
Figure 1-154	Recycle and unpack	107
Figure 1-155	Install the flat cable through the slot	108

Figure 1-156	Slide the keyboard into the slot	108
Figure 1-157	Check the flat cable	109
Figure 1-158	Connect the flat cable	109
Figure 1-159	Position the control-panel cover on the printer	110
Figure 1-160	Engage five tabs	110
Figure 1-161	Close the document feeder	111
Figure 1-162	Open the document feeder	113
Figure 1-163	Remove the white backing	113
Figure 1-164	Check the retention clips	114
Figure 1-165	Check the retention clip spring	114
Figure 1-166	Install the retention clip	115
Figure 1-167	Press the retention clip	115
Figure 1-168	Recycle and unpack	116
Figure 1-169	Install the white backing	116
Figure 1-170	Close the document feeder	117
Figure 1-171	Check the white backing	117
Figure 1-172	Close the document feeder	118
Figure 1-173	Open the document feeder	120
Figure 1-174	Remove the white backing	120
Figure 1-175	Check the retention clips	121
Figure 1-176	Loosen damaged clips	121
Figure 1-177	Remove the retention clip	122
Figure 1-178	Recycle and unpack	122
Figure 1-179	Check the retention clip spring	123
Figure 1-180	Install the retention clip	123
Figure 1-181	Press the retention clip	124
Figure 1-182	Install the white backing	124
Figure 1-183	Close the document feeder	125
Figure 1-184	Check the white backing	125
Figure 1-185	Close the document feeder	126
Figure 1-186	Open the document-feeder jam access door	128
Figure 1-187	Release the blue locking arm	128
Figure 1-188	Remove the roller assembly	129
Figure 1-189	Release the separation roller cover	129
Figure 1-190	Remove the cover	130
Figure 1-191	Remove the roller	130
Figure 1-192	Recycle and unpack	131
Figure 1-193	Install the roller	131
Figure 1-194	Position the separation roller cover	132
Figure 1-195	Close the separation roller cover	132
Figure 1-196	Snap the cover closed	133

Figure 1-197	Install the roller assembly	133
Figure 1-198	Close the blue locking arm	134
Figure 1-199	Close the document-feeder jam access door	134
Figure 1-200	Pull the tray out	138
Figure 1-201	Remove the tray	138
Figure 1-202	Open the right door	139
Figure 1-203	Raise the transfer roller assembly	139
Figure 1-204	Lower the paper guide	140
Figure 1-205	Locate the tray pickup roller	140
Figure 1-206	Open the Tray 3, 4, or 5 right door	141
Figure 1-207	Lower the Tray 3, 4, or 5 paper guide	141
Figure 1-208	Locate the Tray 3, 4, or 5 pickup roller assembly	142
Figure 1-209	Slide the assembly to the left	142
Figure 1-210	Remove the roller assembly	143
Figure 1-211	Locate the roller assembly	143
Figure 1-212	Push up on the blue label	144
Figure 1-213	Remove the roller assembly	144
Figure 1-214	Recycle and unpack	145
Figure 1-215	Install the roller assembly	145
Figure 1-216	Fully seat the roller assembly	146
Figure 1-217	Check the installation	146
Figure 1-218	Note the mounting tab	147
Figure 1-219	Position the roller assembly in the printer	147
Figure 1-220	Release the spring loaded shaft	148
Figure 1-221	Verify the roller installation	148
Figure 1-222	Raise the Tray 3, 4, or 5 paper guide	149
Figure 1-223	Close the Tray 3, 4, or 5 right door	149
Figure 1-224	Close the right door	150
Figure 1-225	Install the tray	150
Figure 1-226	Close the tray	151
Figure 1-227	Open the right door	153
Figure 1-228	Release the ITB drive coupling	153
Figure 1-229	Lower the secondary transfer roller assembly	154
Figure 1-230	Release the front-side ITB spring	154
Figure 1-231	Place the spring on the holder	155
Figure 1-232	Release the rear-side ITB spring	155
Figure 1-233	Place the spring on the holder	156
Figure 1-234	Grasp the ITB handles	157
Figure 1-235	Remove the ITB	157
Figure 1-236	Recycle and unpack	158
Figure 1-237	Handle the ITB by the edges	158

Figure 1-238	Align the ITB with the slots in the product	159
Figure 1-239	Orange handles stop	159
Figure 1-240	Release one tab	160
Figure 1-241	Remove the orange handle	160
Figure 1-242	Install the ITB	161
Figure 1-243	Remove the spring from the holder	161
Figure 1-244	Fasten the rear-side ITB spring	162
Figure 1-245	Remove the spring from the holder	162
Figure 1-246	Fasten the front-side ITB spring	163
Figure 1-247	Engage the ITB drive coupling	163
Figure 1-248	Close the right door	164
Figure 1-249	Open the right door	166
Figure 1-250	Lower the secondary transfer roller assembly	166
Figure 1-251	Release the secondary transfer roller clip	167
Figure 1-252	Remove the secondary transfer roller	167
Figure 1-253	Release the ITB drive coupling	168
Figure 1-254	Release the front-side ITB spring	168
Figure 1-255	Place the spring on the holder	169
Figure 1-256	Release the rear-side ITB spring	169
Figure 1-257	Place the spring on the holder	170
Figure 1-258	Grasp the ITB handles	171
Figure 1-259	Remove the ITB	171
Figure 1-260	Recycle and unpack	172
Figure 1-261	Handle the ITB by the edges	173
Figure 1-262	Align the ITB with the slots in the product	173
Figure 1-263	Orange handles stop	174
Figure 1-264	Release one tab	174
Figure 1-265	Remove the orange handle	175
Figure 1-266	Install the ITB	175
Figure 1-267	Remove the spring from the holder	176
Figure 1-268	Fasten the rear-side ITB spring	176
Figure 1-269	Remove the spring from the holder	177
Figure 1-270	Fasten the front-side ITB spring	177
Figure 1-271	Engage the ITB drive coupling	178
Figure 1-272	Install the secondary transfer roller right end	178
Figure 1-273	Close the right door	179
Figure 1-274	Remove one screw	182
Figure 1-275	Release two tabs	182
Figure 1-276	Release the back edge of the cover	183
Figure 1-277	Remove the cover	183
Figure 1-278	Recycle and unpack	184

Figure 1-279	Install two tabs	184
Figure 1-280	Install the cover assembly	185
Figure 1-281	Install one screw	185
Figure 1-282	Remove one screw	187
Figure 1-283	Release two tabs	187
Figure 1-284	Rotate the cover	188
Figure 1-285	Recycle and unpack	188
Figure 1-286	Install the cover	189
Figure 1-287	Press the cover	189
Figure 1-288	Install one screw	190
Figure 1-289	Locate the formatter cover	192
Figure 1-290	Loosen the thumbscrews	192
Figure 1-291	Remove two screws	193
Figure 1-292	Release the right edge	193
Figure 1-293	Slide the cover right	194
Figure 1-294	Remove the cover	194
Figure 1-295	Recycle and unpack	195
Figure 1-296	Align the cover	195
Figure 1-297	Rotate the top of the cover	196
Figure 1-298	Slide the cover	196
Figure 1-299	Install two screws	197
Figure 1-300	Install the cover	197
Figure 1-301	Locate the formatter cover	199
Figure 1-302	Loosen the thumbscrews	199
Figure 1-303	Remove two screws	200
Figure 1-304	Release the right edge	200
Figure 1-305	Slide the cover right	201
Figure 1-306	Remove the cover	201
Figure 1-307	Release one tab	202
Figure 1-308	Slide the cover back	202
Figure 1-309	Remove the left upper cover	203
Figure 1-310	Recycle and unpack	203
Figure 1-311	Position the tab	204
Figure 1-312	Slide the cover	204
Figure 1-313	Check the tab	205
Figure 1-314	Align the cover	205
Figure 1-315	Rotate the top of the cover	206
Figure 1-316	Slide the cover	206
Figure 1-317	Install two screws	207
Figure 1-318	Install the cover	207
Figure 1-319	Locate the formatter cover	209

Figure 1-320	Loosen the thumbscrews	209
Figure 1-321	Remove two screws	210
Figure 1-322	Release the right edge	210
Figure 1-323	Slide the cover right	211
Figure 1-324	Remove the cover	211
Figure 1-325	Remove one screw	212
Figure 1-326	Release two tabs	212
Figure 1-327	Rotate the cover	213
Figure 1-328	Remove one screw	213
Figure 1-329	Release two tabs	214
Figure 1-330	Release the back edge of the cover	214
Figure 1-331	Remove the cover	215
Figure 1-332	Remove two screws and one connector	215
Figure 1-333	Remove one screw and connector	216
Figure 1-334	Slide the cover	216
Figure 1-335	Remove the cover	217
Figure 1-336	Release two retainers	217
Figure 1-337	Remove the wire harness	218
Figure 1-338	Recycle and unpack	218
Figure 1-339	Install the wire harness	219
Figure 1-340	Install the cables	219
Figure 1-341	Position the hooks	220
Figure 1-342	Install the cover	220
Figure 1-343	Install one screw and connector	221
Figure 1-344	Install one screw and connector	221
Figure 1-345	Install two tabs	222
Figure 1-346	Install the cover assembly	222
Figure 1-347	Install one screw	223
Figure 1-348	Install the cover	223
Figure 1-349	Press the cover	224
Figure 1-350	Install one screw	224
Figure 1-351	Align the cover	225
Figure 1-352	Rotate the top of the cover	225
Figure 1-353	Slide the cover	226
Figure 1-354	Install two screws	226
Figure 1-355	Install the cover	227
Figure 1-356	Locate the formatter cover	229
Figure 1-357	Loosen the thumbscrews	230
Figure 1-358	Remove two screws	230
Figure 1-359	Release the right edge	231
Figure 1-360	Slide the cover right	231

Figure 1-361	Remove the cover	232
Figure 1-362	Release one tab	232
Figure 1-363	Slide the cover back	233
Figure 1-364	Remove the left upper cover	233
Figure 1-365	Remove one screw	234
Figure 1-366	Release two tabs	234
Figure 1-367	Rotate the cover	235
Figure 1-368	Remove one screw	235
Figure 1-369	Release two tabs	236
Figure 1-370	Release the back edge of the cover	236
Figure 1-371	Remove the cover	237
Figure 1-372	Remove one screw	237
Figure 1-373	Remove two screws	238
Figure 1-374	Remove one screw	238
Figure 1-375	Disconnect four connectors	239
Figure 1-376	Disconnect connectors	239
Figure 1-377	Slide the ISA towards the back of the printer	240
Figure 1-378	Remove the ISA	240
Figure 1-379	Remove two screws and one connector	241
Figure 1-380	Remove one screw and connector	241
Figure 1-381	Slide the cover	242
Figure 1-382	Remove the cover	242
Figure 1-383	Remove five screws	243
Figure 1-384	Release two tabs	243
Figure 1-385	Remove the top rear cover	244
Figure 1-386	Recycle and unpack	244
Figure 1-387	Align the locator tabs	245
Figure 1-388	Install the cover	245
Figure 1-389	Install five screws	246
Figure 1-390	Install the cables	246
Figure 1-391	Position the hooks	247
Figure 1-392	Install the cover	247
Figure 1-393	Install one screw and connector	248
Figure 1-394	Install one screw and connector	248
Figure 1-395	Locate the ISA mounting pins and slots	249
Figure 1-396	Install the ISA	249
Figure 1-397	Slide the ISA towards the front of the printer	250
Figure 1-398	Install one screw	250
Figure 1-399	Install two screws	251
Figure 1-400	Install one screw	251
Figure 1-401	Connect connectors	252

Figure 1-402	Connect four connectors	252
Figure 1-403	Install two tabs	253
Figure 1-404	Install the cover assembly	253
Figure 1-405	Install one screw	254
Figure 1-406	Install the cover	254
Figure 1-407	Press the cover	255
Figure 1-408	Install one screw	255
Figure 1-409	Position the tab	256
Figure 1-410	Slide the cover	256
Figure 1-411	Check the tab	257
Figure 1-412	Align the cover	257
Figure 1-413	Rotate the top of the cover	258
Figure 1-414	Slide the cover	258
Figure 1-415	Install two screws	259
Figure 1-416	Install the cover	259
Figure 1-417	Locate the formatter cover	261
Figure 1-418	Loosen the thumbscrews	262
Figure 1-419	Remove two screws	262
Figure 1-420	Release the right edge	263
Figure 1-421	Slide the cover right	263
Figure 1-422	Remove the cover	264
Figure 1-423	Release one tab	264
Figure 1-424	Slide the cover back	265
Figure 1-425	Remove the left upper cover	265
Figure 1-426	Remove one screw	266
Figure 1-427	Release two tabs	266
Figure 1-428	Rotate the cover	267
Figure 1-429	Remove one screw	267
Figure 1-430	Release two tabs	268
Figure 1-431	Release the back edge of the cover	268
Figure 1-432	Remove the cover	269
Figure 1-433	Remove one screw	269
Figure 1-434	Remove two screws	270
Figure 1-435	Remove one screw	270
Figure 1-436	Disconnect four connectors	271
Figure 1-437	Disconnect connectors	271
Figure 1-438	Slide the ISA towards the back of the printer	272
Figure 1-439	Remove the ISA	272
Figure 1-440	Remove two screws and one connector	273
Figure 1-441	Remove one screw and connector	273
Figure 1-442	Slide the cover	274

Figure 1-443	Remove the cover	274
Figure 1-444	Remove five screws	275
Figure 1-445	Release two tabs	275
Figure 1-446	Remove the top rear cover	276
Figure 1-447	Remove one screw	276
Figure 1-448	Remove the cover	277
Figure 1-449	Recycle and unpack	277
Figure 1-450	Install the cover	278
Figure 1-451	Install one screw	278
Figure 1-452	Align the locator tabs	279
Figure 1-453	Install the cover	279
Figure 1-454	Install five screws	280
Figure 1-455	Install the cables	280
Figure 1-456	Position the hooks	281
Figure 1-457	Install the cover	281
Figure 1-458	Install one screw and connector	282
Figure 1-459	Install one screw and connector	282
Figure 1-460	Locate the ISA mounting pins and slots	249
Figure 1-461	Install the ISA	283
Figure 1-462	Slide the ISA towards the front of the printer	284
Figure 1-463	Install one screw	284
Figure 1-464	Install two screws	285
Figure 1-465	Install one screw	285
Figure 1-466	Connect connectors	286
Figure 1-467	Connect four connectors	286
Figure 1-468	Install two tabs	287
Figure 1-469	Install the cover assembly	287
Figure 1-470	Install one screw	288
Figure 1-471	Install the cover	288
Figure 1-472	Press the cover	289
Figure 1-473	Install one screw	289
Figure 1-474	Position the tab	290
Figure 1-475	Slide the cover	290
Figure 1-476	Check the tab	291
Figure 1-477	Align the cover	291
Figure 1-478	Rotate the top of the cover	292
Figure 1-479	Slide the cover	292
Figure 1-480	Install two screws	293
Figure 1-481	Install the cover	293
Figure 1-482	Locate the formatter cover	295
Figure 1-483	Loosen the thumbscrews	296

Figure 1-484	Remove two screws	296
Figure 1-485	Release the right edge	297
Figure 1-486	Slide the cover right	297
Figure 1-487	Remove the cover	298
Figure 1-488	Release one tab	298
Figure 1-489	Slide the cover back	299
Figure 1-490	Remove the left upper cover	299
Figure 1-491	Remove one screw	300
Figure 1-492	Release two tabs	300
Figure 1-493	Rotate the cover	301
Figure 1-494	Remove one screw	301
Figure 1-495	Release two tabs	302
Figure 1-496	Release the back edge of the cover	302
Figure 1-497	Remove the cover	303
Figure 1-498	Remove one screw	303
Figure 1-499	Remove two screws	304
Figure 1-500	Remove one screw	304
Figure 1-501	Disconnect four connectors	305
Figure 1-502	Disconnect connectors	305
Figure 1-503	Slide the ISA towards the back of the printer	306
Figure 1-504	Remove the ISA	306
Figure 1-505	Disconnect connector and remove screws	307
Figure 1-506	Remove the stapler unit	307
Figure 1-507	Remove two screws and one connector	308
Figure 1-508	Remove one screw and connector	308
Figure 1-509	Slide the cover	309
Figure 1-510	Remove the cover	309
Figure 1-511	Remove five screws	310
Figure 1-512	Release two tabs	310
Figure 1-513	Remove the top rear cover	311
Figure 1-514	Remove one screw	311
Figure 1-515	Remove the cover	312
Figure 1-516	Open the front door	312
Figure 1-517	Open the TCU	313
Figure 1-518	Remove the TCU	314
Figure 1-519	Remove one screw	315
Figure 1-520	Remove one screw	315
Figure 1-521	Release one tab	316
Figure 1-522	Release two tabs	316
Figure 1-523	Recycle and unpack	317
Figure 1-524	Position the locator pins	317

Figure 1-525	Press down on the cover	318
Figure 1-526	Install one screw	318
Figure 1-527	Install one screw	319
Figure 1-528	Verify that the toner collection hatch cover is closed	319
Figure 1-529	Install the TCU	320
Figure 1-530	Close the front door	320
Figure 1-531	Install the cover	321
Figure 1-532	Install one screw	321
Figure 1-533	Align the locator tabs	322
Figure 1-534	Install the cover	322
Figure 1-535	Install five screws	323
Figure 1-536	Install the cables	323
Figure 1-537	Position the hooks	324
Figure 1-538	Install the cover	324
Figure 1-539	Install one screw and connector	325
Figure 1-540	Install one screw and connector	325
Figure 1-541	Position the hooks in the slots	326
Figure 1-542	Connect connector and install screws	326
Figure 1-543	Locate the ISA mounting pins and slots	249
Figure 1-544	Install the ISA	327
Figure 1-545	Slide the ISA towards the front of the printer	328
Figure 1-546	Install one screw	328
Figure 1-547	Install two screws	329
Figure 1-548	Install one screw	329
Figure 1-549	Connect connectors	330
Figure 1-550	Connect four connectors	330
Figure 1-551	Install two tabs	331
Figure 1-552	Install the cover assembly	331
Figure 1-553	Install one screw	332
Figure 1-554	Install the cover	332
Figure 1-555	Press the cover	333
Figure 1-556	Install one screw	333
Figure 1-557	Position the tab	334
Figure 1-558	Slide the cover	334
Figure 1-559	Check the tab	335
Figure 1-560	Align the cover	335
Figure 1-561	Rotate the top of the cover	336
Figure 1-562	Slide the cover	336
Figure 1-563	Install two screws	337
Figure 1-564	Install the cover	337
Figure 1-565	Open the right door	339

Figure 1-566	Rotate the secondary transfer assembly up	339
Figure 1-567	Release the door retainer straps	340
Figure 1-568	Release the connector cover	340
Figure 1-569	Remove the connector cover	341
Figure 1-570	Disconnect two connectors	341
Figure 1-571	Remove two screws	342
Figure 1-572	Remove the door	342
Figure 1-573	Recycle and unpack	343
Figure 1-574	Install the door	343
Figure 1-575	Rotate the door arm down	344
Figure 1-576	Install two screws	344
Figure 1-577	Connect two connectors	345
Figure 1-578	Install the connector cover	345
Figure 1-579	Install the door retainer straps	346
Figure 1-580	Close the right door	346
Figure 1-581	Pull the tray out	348
Figure 1-582	Remove the tray	348
Figure 1-583	Open the front door	349
Figure 1-584	Release the door retainer straps	349
Figure 1-585	Slide the door to the right	350
Figure 1-586	Remove the door	351
Figure 1-587	Recycle and unpack	352
Figure 1-588	Engage the inner door	352
Figure 1-589	Install the door	353
Figure 1-590	Engage the door retainer straps	354
Figure 1-591	Close the front door	354
Figure 1-592	Install nameplate and HP jewel	355
Figure 1-593	Install the tray	355
Figure 1-594	Close the tray	356
Figure 1-595	Locate the formatter cover	358
Figure 1-596	Loosen the thumbscrews	358
Figure 1-597	Recycle and unpack	359
Figure 1-598	Install the cover	359
Figure 1-599	Locate the formatter cover	361
Figure 1-600	Loosen the thumbscrews	361
Figure 1-601	Remove four screws	362
Figure 1-602	Remove the cover	362
Figure 1-603	Recycle and unpack	363
Figure 1-604	Install the cover	363
Figure 1-605	Install four screws cover	364
Figure 1-606	Install the cover	364

Figure 1-607	Locate the formatter cover	366
Figure 1-608	Loosen the thumbscrews	366
Figure 1-609	Remove two screws	367
Figure 1-610	Release the right edge	367
Figure 1-611	Slide the cover right	368
Figure 1-612	Remove the cover	368
Figure 1-613	Remove four screws	369
Figure 1-614	Remove the cover	369
Figure 1-615	Recycle and unpack	370
Figure 1-616	Position the hooks	370
Figure 1-617	Install the cover	371
Figure 1-618	Install four screws cover	371
Figure 1-619	Align the cover	372
Figure 1-620	Rotate the top of the cover	372
Figure 1-621	Slide the cover	373
Figure 1-622	Install two screws	373
Figure 1-623	Install the cover	374
Figure 1-624	Open the front door	376
Figure 1-625	Open the TCU	376
Figure 1-626	Remove the TCU	377
Figure 1-627	Locate the formatter cover	378
Figure 1-628	Loosen the thumbscrews	378
Figure 1-629	Remove four screws	379
Figure 1-630	Remove the cover	379
Figure 1-631	Remove two screws	380
Figure 1-632	Release the right edge	380
Figure 1-633	Slide the cover right	381
Figure 1-634	Remove the cover	381
Figure 1-635	Remove four screws	382
Figure 1-636	Remove the cover	382
Figure 1-637	Remove one screw	383
Figure 1-638	Release the cover	383
Figure 1-639	Remove the cover	384
Figure 1-640	Recycle and unpack	384
Figure 1-641	Install the cover	385
Figure 1-642	Engage the cover	385
Figure 1-643	Install one screw	386
Figure 1-644	Position the hooks	386
Figure 1-645	Install the cover	387
Figure 1-646	Install four screws cover	387
Figure 1-647	Align the cover	388

Figure 1-648	Rotate the top of the cover	388
Figure 1-649	Slide the cover	389
Figure 1-650	Install two screws	389
Figure 1-651	Install the cover	390
Figure 1-652	Install four screws cover	390
Figure 1-653	Install the cover	391
Figure 1-654	Verify that the toner collection hatch cover is closed	391
Figure 1-655	Install the TCU	392
Figure 1-656	Close the front door	392
Figure 1-657	Locate the USB cover	394
Figure 1-658	Remove the cover	395
Figure 1-659	Locate the HIP cover	395
Figure 1-660	Note the mounting feet and tabs	396
Figure 1-661	Release the HIP cover tabs	396
Figure 1-662	Remove the cover	397
Figure 1-663	Tilt the control panel up	398
Figure 1-664	Release the control-panel screws cover tabs	398
Figure 1-665	Remove the cover	399
Figure 1-666	Remove two screws	399
Figure 1-667	Rotate the control-panel base up	400
Figure 1-668	Turn the control panel over	400
Figure 1-669	Disconnect two connectors	401
Figure 1-670	Open the front door	401
Figure 1-671	Open the TCU	402
Figure 1-672	Remove the TCU	403
Figure 1-673	Locate the formatter cover	404
Figure 1-674	Loosen the thumbscrews	404
Figure 1-675	Remove four screws	405
Figure 1-676	Remove the cover	405
Figure 1-677	Remove one screw	406
Figure 1-678	Release the cover	406
Figure 1-679	Remove the cover	407
Figure 1-680	Remove three screws	407
Figure 1-681	Remove one screw and release one tab	408
Figure 1-682	Release the cover	408
Figure 1-683	Remove the cover	409
Figure 1-684	Recycle and unpack	409
Figure 1-685	Install the cover	410
Figure 1-686	Engage one tab	410
Figure 1-687	Engage one tab and install one screw	411
Figure 1-688	Install three screws	411

Figure 1-689	Install the cover	412
Figure 1-690	Engage the cover	412
Figure 1-691	Install one screw	413
Figure 1-692	Install the cover	413
Figure 1-693	Install four screws cover	414
Figure 1-694	Install the cover	414
Figure 1-695	Verify that the toner collection hatch cover is closed	415
Figure 1-696	Install the TCU	415
Figure 1-697	Close the front door	416
Figure 1-698	Place the control panel on the product	416
Figure 1-699	Connect two connectors	417
Figure 1-700	Turn the control panel over	417
Figure 1-701	Rotate the control-panel base down	418
Figure 1-702	Install two screws	418
Figure 1-703	Install the cover	419
Figure 1-704	Install the cover	419
Figure 1-705	Check the installation	420
Figure 1-706	Install the cover	420
Figure 1-707	Check the installation	421
Figure 1-708	Locate the formatter cover	424
Figure 1-709	Loosen the thumbscrews	424
Figure 1-710	Open the front door	425
Figure 1-711	Open the TCU	425
Figure 1-712	Remove the TCU	426
Figure 1-713	Locate the USB cover	427
Figure 1-714	Remove the cover	427
Figure 1-715	Tilt the control panel up	428
Figure 1-716	Release the control-panel screws cover tabs	428
Figure 1-717	Remove the cover	429
Figure 1-718	Remove two screws	429
Figure 1-719	Rotate the control-panel base up	430
Figure 1-720	Turn the control panel over	430
Figure 1-721	Disconnect two connectors	431
Figure 1-722	Remove four screws	431
Figure 1-723	Remove the cover	432
Figure 1-724	Remove two screws	432
Figure 1-725	Release the right edge	433
Figure 1-726	Slide the cover right	433
Figure 1-727	Remove the cover	434
Figure 1-728	Remove four screws	434
Figure 1-729	Remove the cover	435

Figure 1-730	Remove one screw	435
Figure 1-731	Release the cover	436
Figure 1-732	Remove the cover	436
Figure 1-733	Remove three screws	437
Figure 1-734	Remove one screw and release one tab	437
Figure 1-735	Release the cover	438
Figure 1-736	Remove the cover	438
Figure 1-737	Release one tab	439
Figure 1-738	Slide the cover back	439
Figure 1-739	Remove the left upper cover	440
Figure 1-740	Remove one screw	440
Figure 1-741	Release two tabs	441
Figure 1-742	Rotate the cover	441
Figure 1-743	Remove one screw	442
Figure 1-744	Release two tabs	442
Figure 1-745	Release the back edge of the cover	443
Figure 1-746	Remove the cover	443
Figure 1-747	Remove one screw	444
Figure 1-748	Remove two screws	444
Figure 1-749	Remove one screw	445
Figure 1-750	Disconnect four connectors	445
Figure 1-751	Disconnect connectors	446
Figure 1-752	Slide the ISA towards the back of the printer	446
Figure 1-753	Remove the ISA	447
Figure 1-754	Disconnect connector and remove screws	447
Figure 1-755	Remove the stapler unit	448
Figure 1-756	Remove two screws and one connector	448
Figure 1-757	Remove one screw and connector	449
Figure 1-758	Slide the cover	449
Figure 1-759	Remove the cover	450
Figure 1-760	Remove five screws	450
Figure 1-761	Release two tabs	451
Figure 1-762	Remove the top rear cover	451
Figure 1-763	Remove one screw	452
Figure 1-764	Remove the cover	452
Figure 1-765	Remove one screw	453
Figure 1-766	Remove one screw	453
Figure 1-767	Release one tab	454
Figure 1-768	Release two tabs	454
Figure 1-769	Release the cover	455
Figure 1-770	Remove the cover	455

Figure 1-771	Recycle and unpack	456
Figure 1-772	Install the cover	456
Figure 1-773	Align the tabs	457
Figure 1-774	Release the cover	457
Figure 1-775	Verify the installation	458
Figure 1-776	Position the locator pins	458
Figure 1-777	Press down on the cover	459
Figure 1-778	Install one screw	459
Figure 1-779	Install one screw	460
Figure 1-780	Install the cover	460
Figure 1-781	Install one screw	461
Figure 1-782	Align the locator tabs	461
Figure 1-783	Install the cover	462
Figure 1-784	Install five screws	462
Figure 1-785	Install the cables	463
Figure 1-786	Position the hooks	463
Figure 1-787	Install the cover	464
Figure 1-788	Install one screw and connector	464
Figure 1-789	Install one screw and connector	465
Figure 1-790	Position the hooks in the slots	465
Figure 1-791	Connect connector and install screws	466
Figure 1-792	Locate the ISA mounting pins and slots	249
Figure 1-793	Install the ISA	467
Figure 1-794	Slide the ISA towards the front of the printer	467
Figure 1-795	Install one screw	468
Figure 1-796	Install two screws	468
Figure 1-797	Install one screw	469
Figure 1-798	Connect connectors	469
Figure 1-799	Connect four connectors	470
Figure 1-800	Install two tabs	470
Figure 1-801	Install the cover assembly	471
Figure 1-802	Install one screw	471
Figure 1-803	Install the cover	472
Figure 1-804	Press the cover	472
Figure 1-805	Install one screw	473
Figure 1-806	Position the tab	473
Figure 1-807	Slide the cover	474
Figure 1-808	Check the tab	474
Figure 1-809	Install the cover	475
Figure 1-810	Engage one tab	475
Figure 1-811	Engage one tab and install one screw	476

Figure 1-812	Install three screws	476
Figure 1-813	Install the cover	477
Figure 1-814	Engage the cover	477
Figure 1-815	Install one screw	478
Figure 1-816	Position the hooks	478
Figure 1-817	Install the cover	479
Figure 1-818	Install four screws cover	479
Figure 1-819	Align the cover	480
Figure 1-820	Rotate the top of the cover	480
Figure 1-821	Slide the cover	481
Figure 1-822	Install two screws	481
Figure 1-823	Install the cover	482
Figure 1-824	Install four screws cover	482
Figure 1-825	Place the control panel on the product	483
Figure 1-826	Connect two connectors	483
Figure 1-827	Turn the control panel over	484
Figure 1-828	Rotate the control-panel base down	484
Figure 1-829	Install two screws	485
Figure 1-830	Install the cover	485
Figure 1-831	Install the cover	486
Figure 1-832	Check the installation	486
Figure 1-833	Verify that the toner collection hatch cover is closed	487
Figure 1-834	Install the TCU	487
Figure 1-835	Close the front door	488
Figure 1-836	Install the cover	488
Figure 1-837	Locate the USB cover	490
Figure 1-838	Remove the cover	491
Figure 1-839	Tilt the control panel up	492
Figure 1-840	Release the control-panel screws cover tabs	492
Figure 1-841	Remove the cover	493
Figure 1-842	Remove two screws	493
Figure 1-843	Rotate the control-panel base up	494
Figure 1-844	Turn the control panel over	494
Figure 1-845	Disconnect two connectors	495
Figure 1-846	Open the front door	495
Figure 1-847	Open the TCU	496
Figure 1-848	Remove the TCU	497
Figure 1-849	Locate the formatter cover	498
Figure 1-850	Loosen the thumbscrews	498
Figure 1-851	Remove four screws	499
Figure 1-852	Remove the cover	499

Figure 1-853	Remove one screw	500
Figure 1-854	Release the cover	500
Figure 1-855	Remove the cover	501
Figure 1-856	Remove three screws	501
Figure 1-857	Remove one screw and release one tab	502
Figure 1-858	Release the cover	502
Figure 1-859	Remove the cover	503
Figure 1-860	Release the cover	503
Figure 1-861	Remove the cover	504
Figure 1-862	Recycle and unpack	504
Figure 1-863	Install the cover	505
Figure 1-864	Install one screw	505
Figure 1-865	Install the cover	506
Figure 1-866	Engage one tab	506
Figure 1-867	Engage one tab and install one screw	507
Figure 1-868	Install three screws	507
Figure 1-869	Install the cover	508
Figure 1-870	Engage the cover	508
Figure 1-871	Install one screw	509
Figure 1-872	Install the cover	509
Figure 1-873	Install four screws cover	510
Figure 1-874	Install the cover	510
Figure 1-875	Verify that the toner collection hatch cover is closed	511
Figure 1-876	Install the TCU	511
Figure 1-877	Close the front door	512
Figure 1-878	Place the control panel on the product	512
Figure 1-879	Connect two connectors	513
Figure 1-880	Turn the control panel over	513
Figure 1-881	Rotate the control-panel base down	514
Figure 1-882	Install two screws	514
Figure 1-883	Install the cover	515
Figure 1-884	Install the cover	515
Figure 1-885	Check the installation	516
Figure 1-886	Locate the formatter cover	518
Figure 1-887	Loosen the thumbscrews	519
Figure 1-888	Remove two screws	519
Figure 1-889	Release the right edge	520
Figure 1-890	Slide the cover right	520
Figure 1-891	Remove the cover	521
Figure 1-892	Remove one screw	521
Figure 1-893	Release two tabs	522

Figure 1-894	Rotate the cover	522
Figure 1-895	Remove one screw	523
Figure 1-896	Release two tabs	523
Figure 1-897	Release the back edge of the cover	524
Figure 1-898	Remove the cover	524
Figure 1-899	Remove two screws and one connector	525
Figure 1-900	Remove one screw and connector	525
Figure 1-901	Slide the cover	526
Figure 1-902	Remove the cover	526
Figure 1-903	Remove four screws	527
Figure 1-904	Remove the cover	527
Figure 1-905	Release the cover	528
Figure 1-906	Remove the cover	528
Figure 1-907	Recycle and unpack	529
Figure 1-908	Install the cover	529
Figure 1-909	Install one screw	530
Figure 1-910	Position the hooks	530
Figure 1-911	Install the cover	531
Figure 1-912	Install four screws cover	531
Figure 1-913	Install the cables	532
Figure 1-914	Position the hooks	532
Figure 1-915	Install the cover	533
Figure 1-916	Install one screw and connector	533
Figure 1-917	Install one screw and connector	534
Figure 1-918	Install two tabs	534
Figure 1-919	Install the cover assembly	535
Figure 1-920	Install one screw	535
Figure 1-921	Install the cover	536
Figure 1-922	Press the cover	536
Figure 1-923	Install one screw	537
Figure 1-924	Align the cover	537
Figure 1-925	Rotate the top of the cover	538
Figure 1-926	Slide the cover	538
Figure 1-927	Install two screws	539
Figure 1-928	Install the cover	539
Figure 1-929	Locate the USB cover	541
Figure 1-930	Remove the cover	542
Figure 1-931	Open the front door	542
Figure 1-932	Open the TCU	543
Figure 1-933	Remove the TCU	544
Figure 1-934	Locate the formatter cover	545

Figure 1-935	Loosen the thumbscrews	545
Figure 1-936	Remove four screws	546
Figure 1-937	Remove the cover	546
Figure 1-938	Remove one screw	547
Figure 1-939	Release the cover	547
Figure 1-940	Remove the cover	548
Figure 1-941	Remove three screws	548
Figure 1-942	Remove one screw and release one tab	549
Figure 1-943	Release the cover	549
Figure 1-944	Remove the cover	550
Figure 1-945	Remove one screw	550
Figure 1-946	Remove the PCA holder	551
Figure 1-947	Remove one cable	551
Figure 1-948	Remove four screws	552
Figure 1-949	Remove the control panel	552
Figure 1-950	Recycle and unpack	553
Figure 1-951	Connect one connector	553
Figure 1-952	Install four screws	554
Figure 1-953	Place one cable in the guide	554
Figure 1-954	Install the tab	555
Figure 1-955	Install one screw	555
Figure 1-956	Install the cover	556
Figure 1-957	Engage one tab	556
Figure 1-958	Engage one tab and install one screw	557
Figure 1-959	Install three screws	557
Figure 1-960	Install the cover	558
Figure 1-961	Engage the cover	558
Figure 1-962	Install one screw	559
Figure 1-963	Install the cover	559
Figure 1-964	Install four screws cover	560
Figure 1-965	Install the cover	560
Figure 1-966	Verify that the toner collection hatch cover is closed	561
Figure 1-967	Install the TCU	561
Figure 1-968	Close the front door	562
Figure 1-969	Install the cover	562
Figure 1-970	Check the installation	563
Figure 1-971	Open Tray 1	567
Figure 1-972	Open the roller cover	567
Figure 1-973	Remove the cover	568
Figure 1-974	Release two tabs	568
Figure 1-975	Remove the roller	569

Figure 1-976	Release the tray retainers	569
Figure 1-977	Raise Tray 1 up	570
Figure 1-978	Open the roller cover	570
Figure 1-979	Release one tab	571
Figure 1-980	Remove the roller	571
Figure 1-981	Recycle and unpack	572
Figure 1-982	Locate the keyed end of the roller and the holder	572
Figure 1-983	Install the roller	573
Figure 1-984	Rotate the end of the roller into the holder	573
Figure 1-985	Close the roller cover	574
Figure 1-986	Lower Tray 1 down	574
Figure 1-987	Reconnect the tray retainers	575
Figure 1-988	Install the roller	575
Figure 1-989	Reconnect two tabs	576
Figure 1-990	Install the roller cover	576
Figure 1-991	Close the roller cover	577
Figure 1-992	Close Tray 1	577
Figure 1-993	Open the right door	579
Figure 1-994	Release the secondary transfer roller assembly	579
Figure 1-995	Carefully flex the top portion of the blue arm	580
Figure 1-996	Disengage the blue arm and pin	580
Figure 1-997	Remove the secondary transfer roller assembly	581
Figure 1-998	Recycle and unpack	581
Figure 1-999	Install the right hinge	582
Figure 1-1000	Install the left hinge	582
Figure 1-1001	Engage the blue arm with the pin	583
Figure 1-1002	Close the right door	583
Figure 1-1003	Locate the USB cover	585
Figure 1-1004	Remove the cover	586
Figure 1-1005	Tilt the control panel up	587
Figure 1-1006	Release the control-panel screws cover tabs	587
Figure 1-1007	Remove the cover	588
Figure 1-1008	Remove two screws	588
Figure 1-1009	Rotate the control-panel base up	589
Figure 1-1010	Turn the control panel over	589
Figure 1-1011	Disconnect two connectors	590
Figure 1-1012	Open the front door	590
Figure 1-1013	Open the TCU	591
Figure 1-1014	Remove the TCU	592
Figure 1-1015	Locate the formatter cover	593
Figure 1-1016	Loosen the thumbscrews	593

Figure 1-1017	Remove four screws	594
Figure 1-1018	Remove the cover	594
Figure 1-1019	Remove one screw	595
Figure 1-1020	Release the cover	595
Figure 1-1021	Remove the cover	596
Figure 1-1022	Remove three screws	596
Figure 1-1023	Remove one screw and release one tab	597
Figure 1-1024	Release the cover	597
Figure 1-1025	Remove the cover	598
Figure 1-1026	Remove the NFC PCA	598
Figure 1-1027	Recycle and unpack	599
Figure 1-1028	Install the NFC PCA	599
Figure 1-1029	Install the cover	600
Figure 1-1030	Engage one tab	600
Figure 1-1031	Engage one tab and install one screw	601
Figure 1-1032	Install three screws	601
Figure 1-1033	Install the cover	602
Figure 1-1034	Engage the cover	602
Figure 1-1035	Install one screw	603
Figure 1-1036	Install the cover	603
Figure 1-1037	Install four screws cover	604
Figure 1-1038	Install the cover	604
Figure 1-1039	Verify that the toner collection hatch cover is closed	605
Figure 1-1040	Install the TCU	605
Figure 1-1041	Close the front door	606
Figure 1-1042	Place the control panel on the product	606
Figure 1-1043	Connect two connectors	607
Figure 1-1044	Turn the control panel over	607
Figure 1-1045	Rotate the control-panel base down	608
Figure 1-1046	Install two screws	608
Figure 1-1047	Install the cover	609
Figure 1-1048	Install the cover	609
Figure 1-1049	Check the installation	610
Figure 1-1050	Open the document feeder	612
Figure 1-1051	Release five tabs	612
Figure 1-1052	Remove the cover	613
Figure 1-1053	Locate the NFC	613
Figure 1-1054	Release four tabs	614
Figure 1-1055	Disconnect one connector	614
Figure 1-1056	Recycle and unpack	615
Figure 1-1057	Connect one connector	615

Figure 1-1058	Position the NFC PCA	616
Figure 1-1059	Install four tabs	616
Figure 1-1060	Position the control-panel cover on the printer	617
Figure 1-1061	Engage five tabs	617
Figure 1-1062	Close the document feeder	618
Figure 1-1063	Locate the formatter cover	621
Figure 1-1064	Loosen the thumbscrews	622
Figure 1-1065	Open the front door	622
Figure 1-1066	Open the TCU	623
Figure 1-1067	Remove the TCU	624
Figure 1-1068	Locate the USB cover	625
Figure 1-1069	Remove the cover	625
Figure 1-1070	Tilt the control panel up	626
Figure 1-1071	Release the control-panel screws cover tabs	626
Figure 1-1072	Remove the cover	627
Figure 1-1073	Remove two screws	627
Figure 1-1074	Rotate the control-panel base up	628
Figure 1-1075	Turn the control panel over	628
Figure 1-1076	Disconnect two connectors	629
Figure 1-1077	Remove four screws	629
Figure 1-1078	Remove the cover	630
Figure 1-1079	Remove one screw	630
Figure 1-1080	Release the cover	631
Figure 1-1081	Remove the cover	631
Figure 1-1082	Remove three screws	632
Figure 1-1083	Remove one screw and release one tab	632
Figure 1-1084	Release the cover	633
Figure 1-1085	Remove the cover	633
Figure 1-1086	Remove two screws	634
Figure 1-1087	Release the right edge	634
Figure 1-1088	Slide the cover right	635
Figure 1-1089	Remove the cover	635
Figure 1-1090	Release one tab	636
Figure 1-1091	Slide the cover back	636
Figure 1-1092	Remove the left upper cover	637
Figure 1-1093	Remove one screw	637
Figure 1-1094	Release two tabs	638
Figure 1-1095	Rotate the cover	638
Figure 1-1096	Remove one screw	639
Figure 1-1097	Release two tabs	639
Figure 1-1098	Release the back edge of the cover	640

Figure 1-1099	Remove the cover	640
Figure 1-1100	Remove one screw	641
Figure 1-1101	Remove two screws	641
Figure 1-1102	Remove one screw	642
Figure 1-1103	Disconnect four connectors	642
Figure 1-1104	Disconnect connectors	643
Figure 1-1105	Slide the ISA towards the back of the printer	643
Figure 1-1106	Remove the ISA	644
Figure 1-1107	Disconnect connector and remove screws	644
Figure 1-1108	Remove the stapler unit	645
Figure 1-1109	Remove two screws and one connector	645
Figure 1-1110	Remove one screw and connector	646
Figure 1-1111	Slide the cover	646
Figure 1-1112	Remove the cover	647
Figure 1-1113	Remove five screws	647
Figure 1-1114	Release two tabs	648
Figure 1-1115	Remove the top rear cover	648
Figure 1-1116	Remove one screw	649
Figure 1-1117	Remove the cover	649
Figure 1-1118	Remove one screw	650
Figure 1-1119	Remove one screw	650
Figure 1-1120	Release one tab	651
Figure 1-1121	Release two tabs	651
Figure 1-1122	Release the cover	652
Figure 1-1123	Remove the cover	652
Figure 1-1124	Remove the wireless PCA	653
Figure 1-1125	Recycle and unpack	653
Figure 1-1126	Install the wireless PCA	654
Figure 1-1127	Install the cover	654
Figure 1-1128	Align the tabs	655
Figure 1-1129	Release the cover	655
Figure 1-1130	Verify the installation	656
Figure 1-1131	Position the locator pins	656
Figure 1-1132	Press down on the cover	657
Figure 1-1133	Install one screw	657
Figure 1-1134	Install one screw	658
Figure 1-1135	Install the cover	658
Figure 1-1136	Install one screw	659
Figure 1-1137	Align the locator tabs	659
Figure 1-1138	Install the cover	660
Figure 1-1139	Install five screws	660

Figure 1-1140	Install the cables	661
Figure 1-1141	Position the hooks	661
Figure 1-1142	Install the cover	662
Figure 1-1143	Install one screw and connector	662
Figure 1-1144	Install one screw and connector	663
Figure 1-1145	Position the hooks in the slots	663
Figure 1-1146	Connect connector and install screws	664
Figure 1-1147	Locate the ISA mounting pins and slots	249
Figure 1-1148	Install the ISA	665
Figure 1-1149	Slide the ISA towards the front of the printer	665
Figure 1-1150	Install one screw	666
Figure 1-1151	Install two screws	666
Figure 1-1152	Install one screw	667
Figure 1-1153	Connect connectors	667
Figure 1-1154	Connect four connectors	668
Figure 1-1155	Install two tabs	668
Figure 1-1156	Install the cover assembly	669
Figure 1-1157	Install one screw	669
Figure 1-1158	Install the cover	670
Figure 1-1159	Press the cover	670
Figure 1-1160	Install one screw	671
Figure 1-1161	Position the tab	671
Figure 1-1162	Slide the cover	672
Figure 1-1163	Check the tab	672
Figure 1-1164	Align the cover	673
Figure 1-1165	Rotate the top of the cover	673
Figure 1-1166	Slide the cover	674
Figure 1-1167	Install two screws	674
Figure 1-1168	Install the cover	675
Figure 1-1169	Engage one tab	675
Figure 1-1170	Engage one tab and install one screw	676
Figure 1-1171	Install three screws	676
Figure 1-1172	Install the cover	677
Figure 1-1173	Engage the cover	677
Figure 1-1174	Install one screw	678
Figure 1-1175	Install the cover	678
Figure 1-1176	Install four screws cover	679
Figure 1-1177	Place the control panel on the product	679
Figure 1-1178	Connect two connectors	680
Figure 1-1179	Turn the control panel over	680
Figure 1-1180	Rotate the control-panel base down	681

Figure 1-1181	Install two screws	681
Figure 1-1182	Install the cover	682
Figure 1-1183	Install the cover	682
Figure 1-1184	Check the installation	683
Figure 1-1185	Verify that the toner collection hatch cover is closed	683
Figure 1-1186	Install the TCU	684
Figure 1-1187	Close the front door	684
Figure 1-1188	Install the cover	685
Figure 1-1189	Locate the formatter cover	688
Figure 1-1190	Loosen the thumbscrews	689
Figure 1-1191	Open the front door	689
Figure 1-1192	Open the TCU	690
Figure 1-1193	Remove the TCU	691
Figure 1-1194	Locate the USB cover	692
Figure 1-1195	Remove the cover	692
Figure 1-1196	Tilt the control panel up	693
Figure 1-1197	Release the control-panel screws cover tabs	693
Figure 1-1198	Remove the cover	694
Figure 1-1199	Remove two screws	694
Figure 1-1200	Rotate the control-panel base up	695
Figure 1-1201	Turn the control panel over	695
Figure 1-1202	Disconnect two connectors	696
Figure 1-1203	Remove four screws	696
Figure 1-1204	Remove the cover	697
Figure 1-1205	Remove one screw	697
Figure 1-1206	Release the cover	698
Figure 1-1207	Remove the cover	698
Figure 1-1208	Remove three screws	699
Figure 1-1209	Remove one screw and release one tab	699
Figure 1-1210	Release the cover	700
Figure 1-1211	Remove the cover	700
Figure 1-1212	Remove two screws	701
Figure 1-1213	Release the right edge	701
Figure 1-1214	Slide the cover right	702
Figure 1-1215	Remove the cover	702
Figure 1-1216	Release one tab	703
Figure 1-1217	Slide the cover back	703
Figure 1-1218	Remove the left upper cover	704
Figure 1-1219	Remove one screw	704
Figure 1-1220	Release two tabs	705
Figure 1-1221	Rotate the cover	705

Figure 1-1222	Remove one screw	706
Figure 1-1223	Release two tabs	706
Figure 1-1224	Release the back edge of the cover	707
Figure 1-1225	Remove the cover	707
Figure 1-1226	Remove one screw	708
Figure 1-1227	Remove two screws	708
Figure 1-1228	Remove one screw	709
Figure 1-1229	Disconnect four connectors	709
Figure 1-1230	Disconnect connectors	710
Figure 1-1231	Slide the ISA towards the back of the printer	710
Figure 1-1232	Remove the ISA	711
Figure 1-1233	Disconnect connector and remove screws	711
Figure 1-1234	Remove the stapler unit	712
Figure 1-1235	Remove two screws and one connector	712
Figure 1-1236	Remove one screw and connector	713
Figure 1-1237	Slide the cover	713
Figure 1-1238	Remove the cover	714
Figure 1-1239	Remove five screws	714
Figure 1-1240	Release two tabs	715
Figure 1-1241	Remove the top rear cover	715
Figure 1-1242	Remove one screw	716
Figure 1-1243	Remove the cover	716
Figure 1-1244	Remove one screw	717
Figure 1-1245	Remove one screw	717
Figure 1-1246	Release one tab	718
Figure 1-1247	Release two tabs	718
Figure 1-1248	Remove the upper cover	719
Figure 1-1249	Remove the switch left-side cover	720
Figure 1-1250	Release the white strap	721
Figure 1-1251	Remove the switch	721
Figure 1-1252	Recycle and unpack	722
Figure 1-1253	Install the switch	723
Figure 1-1254	Install the switch right-side cover	724
Figure 1-1255	Connect the white strap	724
Figure 1-1256	Install the switch left-side cover	725
Figure 1-1257	Connect the door strap	725
Figure 1-1258	Tabs on the upper cover	726
Figure 1-1259	Install the upper cover	727
Figure 1-1260	Position the locator pins	727
Figure 1-1261	Press down on the cover	728
Figure 1-1262	Install one screw	728

Figure 1-1263	Install one screw	729
Figure 1-1264	Install the cover	729
Figure 1-1265	Install one screw	730
Figure 1-1266	Align the locator tabs	730
Figure 1-1267	Install the cover	731
Figure 1-1268	Install five screws	731
Figure 1-1269	Install the cables	732
Figure 1-1270	Position the hooks	732
Figure 1-1271	Install the cover	733
Figure 1-1272	Install one screw and connector	733
Figure 1-1273	Install one screw and connector	734
Figure 1-1274	Position the hooks in the slots	734
Figure 1-1275	Connect connector and install screws	735
Figure 1-1276	Locate the ISA mounting pins and slots	249
Figure 1-1277	Install the ISA	736
Figure 1-1278	Slide the ISA towards the front of the printer	736
Figure 1-1279	Install one screw	737
Figure 1-1280	Install two screws	737
Figure 1-1281	Install one screw	738
Figure 1-1282	Connect connectors	738
Figure 1-1283	Connect four connectors	739
Figure 1-1284	Install two tabs	739
Figure 1-1285	Install the cover assembly	740
Figure 1-1286	Install one screw	740
Figure 1-1287	Install the cover	741
Figure 1-1288	Press the cover	741
Figure 1-1289	Install one screw	742
Figure 1-1290	Position the tab	742
Figure 1-1291	Slide the cover	743
Figure 1-1292	Check the tab	743
Figure 1-1293	Align the cover	744
Figure 1-1294	Rotate the top of the cover	744
Figure 1-1295	Slide the cover	745
Figure 1-1296	Install two screws	745
Figure 1-1297	Install the cover	746
Figure 1-1298	Engage one tab	746
Figure 1-1299	Engage one tab and install one screw	747
Figure 1-1300	Install three screws	747
Figure 1-1301	Install the cover	748
Figure 1-1302	Engage the cover	748
Figure 1-1303	Install one screw	749

Figure 1-1304	Install the cover	749
Figure 1-1305	Install four screws cover	750
Figure 1-1306	Place the control panel on the product	750
Figure 1-1307	Connect two connectors	751
Figure 1-1308	Turn the control panel over	751
Figure 1-1309	Rotate the control-panel base down	752
Figure 1-1310	Install two screws	752
Figure 1-1311	Install the cover	753
Figure 1-1312	Install the cover	753
Figure 1-1313	Check the installation	754
Figure 1-1314	Verify that the toner collection hatch cover is closed	754
Figure 1-1315	Install the TCU	755
Figure 1-1316	Close the front door	755
Figure 1-1317	Install the cover	756
Figure 1-1318	Open the stapler door	758
Figure 1-1319	Remove the staple cartridge	758
Figure 1-1320	Close the stapler door	759
Figure 1-1321	Remove one screw	759
Figure 1-1322	Release two tabs	760
Figure 1-1323	Release the back edge of the cover	760
Figure 1-1324	Remove the cover	761
Figure 1-1325	Disconnect connector and remove screws	761
Figure 1-1326	Remove the stapler unit	762
Figure 1-1327	Recycle and unpack	762
Figure 1-1328	Position the hooks in the slots	763
Figure 1-1329	Connect connector and install screws	763
Figure 1-1330	Install two tabs	764
Figure 1-1331	Install the cover assembly	764
Figure 1-1332	Install one screw	765
Figure 1-1333	Open the stapler door	765
Figure 1-1334	Install the staple cartridge	766
Figure 1-1335	Close the stapler door	766
Figure 1-1336	Locate the formatter cover	768
Figure 1-1337	Loosen the thumbscrews	769
Figure 1-1338	Remove four screws	769
Figure 1-1339	Remove the cover	770
Figure 1-1340	Remove two screws	770
Figure 1-1341	Release the right edge	771
Figure 1-1342	Slide the cover right	771
Figure 1-1343	Remove the cover	772
Figure 1-1344	Remove four screws	772

Figure 1-1345	Remove the cover	773
Figure 1-1346	Disconnect 18 connectors	773
Figure 1-1347	Disconnect the flat cables	774
Figure 1-1348	Remove the DC controller	774
Figure 1-1349	Recycle and unpack	775
Figure 1-1350	Install the DC controller	775
Figure 1-1351	Connect the flat cables	776
Figure 1-1352	Connect all of the connectors	776
Figure 1-1353	Position the hooks	777
Figure 1-1354	Install the cover	777
Figure 1-1355	Install four screws cover	778
Figure 1-1356	Align the cover	778
Figure 1-1357	Rotate the top of the cover	779
Figure 1-1358	Slide the cover	779
Figure 1-1359	Install two screws	780
Figure 1-1360	Install the cover	780
Figure 1-1361	Install four screws cover	781
Figure 1-1362	Install the cover	781
Figure 1-1363	Locate the formatter cover	784
Figure 1-1364	Loosen the thumbscrews	785
Figure 1-1365	Open the front door	785
Figure 1-1366	Open the TCU	786
Figure 1-1367	Remove the TCU	787
Figure 1-1368	Locate the USB cover	788
Figure 1-1369	Remove the cover	788
Figure 1-1370	Open the right door	789
Figure 1-1371	Release the fuser	789
Figure 1-1372	Remove the fuser	790
Figure 1-1373	Release the ITB drive coupling	790
Figure 1-1374	Lower the secondary transfer roller assembly	791
Figure 1-1375	Release the front-side ITB spring	791
Figure 1-1376	Place the spring on the holder	792
Figure 1-1377	Release the rear-side ITB spring	792
Figure 1-1378	Place the spring on the holder	793
Figure 1-1379	Grasp the ITB handles	794
Figure 1-1380	Remove the ITB	794
Figure 1-1381	Tilt the control panel up	795
Figure 1-1382	Release the control-panel screws cover tabs	795
Figure 1-1383	Remove the cover	796
Figure 1-1384	Remove two screws	796
Figure 1-1385	Rotate the control-panel base up	797

Figure 1-1386	Turn the control panel over	797
Figure 1-1387	Disconnect two connectors	798
Figure 1-1388	Remove four screws	798
Figure 1-1389	Remove the cover	799
Figure 1-1390	Remove one screw	799
Figure 1-1391	Release the cover	800
Figure 1-1392	Remove the cover	800
Figure 1-1393	Remove three screws	801
Figure 1-1394	Remove one screw and release one tab	801
Figure 1-1395	Release the cover	802
Figure 1-1396	Remove the cover	802
Figure 1-1397	Remove one screw	803
Figure 1-1398	Remove the PCA holder	803
Figure 1-1399	Remove one cable	804
Figure 1-1400	Remove four screws	804
Figure 1-1401	Remove the control panel	805
Figure 1-1402	Remove two screws	805
Figure 1-1403	Release the right edge	806
Figure 1-1404	Slide the cover right	806
Figure 1-1405	Remove the cover	807
Figure 1-1406	Release one tab	807
Figure 1-1407	Slide the cover back	808
Figure 1-1408	Remove the left upper cover	808
Figure 1-1409	Remove one screw	809
Figure 1-1410	Release two tabs	809
Figure 1-1411	Rotate the cover	810
Figure 1-1412	Remove one screw	810
Figure 1-1413	Release two tabs	811
Figure 1-1414	Release the back edge of the cover	811
Figure 1-1415	Remove the cover	812
Figure 1-1416	Remove one screw	812
Figure 1-1417	Remove two screws	813
Figure 1-1418	Remove one screw	813
Figure 1-1419	Disconnect four connectors	814
Figure 1-1420	Disconnect connectors	814
Figure 1-1421	Slide the ISA towards the back of the printer	815
Figure 1-1422	Remove the ISA	815
Figure 1-1423	Disconnect connector and remove screws	816
Figure 1-1424	Remove the stapler unit	816
Figure 1-1425	Remove two screws and one connector	817
Figure 1-1426	Remove one screw and connector	817

Figure 1-1427	Slide the cover	818
Figure 1-1428	Remove the cover	818
Figure 1-1429	Remove five screws	819
Figure 1-1430	Release two tabs	819
Figure 1-1431	Remove the top rear cover	820
Figure 1-1432	Remove one screw	820
Figure 1-1433	Remove the cover	821
Figure 1-1434	Remove one screw	821
Figure 1-1435	Remove one screw	822
Figure 1-1436	Release one tab	822
Figure 1-1437	Release two tabs	823
Figure 1-1438	Remove three screws	823
Figure 1-1439	Remove two screws	824
Figure 1-1440	Remove the bracket	824
Figure 1-1441	Release the cover	825
Figure 1-1442	Remove the cover	825
Figure 1-1443	Remove two screws	826
Figure 1-1444	Remove the PCA	826
Figure 1-1445	Release two retainers and disconnect one connector	827
Figure 1-1446	Remove four screws	827
Figure 1-1447	Remove the assembly	828
Figure 1-1448	Recycle and unpack	829
Figure 1-1449	Locate the solenoid plunger	829
Figure 1-1450	Remove the arm	830
Figure 1-1451	Separate the solenoid plunger from the arm	830
Figure 1-1452	Install the solenoid plunger	831
Figure 1-1453	Install the assembly	831
Figure 1-1454	Install four screws	832
Figure 1-1455	Connect one connector	832
Figure 1-1456	Install the PCA holder	833
Figure 1-1457	Install one screw	833
Figure 1-1458	Connect one connector	834
Figure 1-1459	Install two screws	834
Figure 1-1460	Install the cover	835
Figure 1-1461	Align the tabs	835
Figure 1-1462	Release the cover	836
Figure 1-1463	Verify the installation	836
Figure 1-1464	Position the tabs in the slots	837
Figure 1-1465	Install two screws	837
Figure 1-1466	Install three screws	838
Figure 1-1467	Position the locator pins	838

Figure 1-1468	Press down on the cover	839
Figure 1-1469	Install one screw	839
Figure 1-1470	Install one screw	840
Figure 1-1471	Install the cover	840
Figure 1-1472	Install one screw	841
Figure 1-1473	Align the locator tabs	841
Figure 1-1474	Install the cover	842
Figure 1-1475	Install five screws	842
Figure 1-1476	Install the cables	843
Figure 1-1477	Position the hooks	843
Figure 1-1478	Install the cover	844
Figure 1-1479	Install one screw and connector	844
Figure 1-1480	Install one screw and connector	845
Figure 1-1481	Position the hooks in the slots	845
Figure 1-1482	Connect connector and install screws	846
Figure 1-1483	Locate the ISA mounting pins and slots	249
Figure 1-1484	Install the ISA	847
Figure 1-1485	Slide the ISA towards the front of the printer	847
Figure 1-1486	Install one screw	848
Figure 1-1487	Install two screws	848
Figure 1-1488	Install one screw	849
Figure 1-1489	Connect connectors	849
Figure 1-1490	Connect four connectors	850
Figure 1-1491	Install two tabs	850
Figure 1-1492	Install the cover assembly	851
Figure 1-1493	Install one screw	851
Figure 1-1494	Install the cover	852
Figure 1-1495	Press the cover	852
Figure 1-1496	Install one screw	853
Figure 1-1497	Position the tab	853
Figure 1-1498	Slide the cover	854
Figure 1-1499	Check the tab	854
Figure 1-1500	Align the cover	855
Figure 1-1501	Rotate the top of the cover	855
Figure 1-1502	Slide the cover	856
Figure 1-1503	Install two screws	856
Figure 1-1504	Connect one connector	857
Figure 1-1505	Install four screws	857
Figure 1-1506	Place one cable in the guide	858
Figure 1-1507	Install the tab	858
Figure 1-1508	Install one screw	859

Figure 1-1509	Install the cover	859
Figure 1-1510	Engage one tab	860
Figure 1-1511	Engage one tab and install one screw	860
Figure 1-1512	Install three screws	861
Figure 1-1513	Install the cover	861
Figure 1-1514	Engage the cover	862
Figure 1-1515	Install one screw	862
Figure 1-1516	Install the cover	863
Figure 1-1517	Install four screws cover	863
Figure 1-1518	Place the control panel on the product	864
Figure 1-1519	Connect two connectors	864
Figure 1-1520	Turn the control panel over	865
Figure 1-1521	Rotate the control-panel base down	865
Figure 1-1522	Install two screws	866
Figure 1-1523	Install the cover	866
Figure 1-1524	Handle the ITB by the edges	867
Figure 1-1525	Align the ITB with the slots in the product	867
Figure 1-1526	Install the ITB	868
Figure 1-1527	Remove the spring from the holder	868
Figure 1-1528	Fasten the rear-side ITB spring	869
Figure 1-1529	Remove the spring from the holder	869
Figure 1-1530	Fasten the front-side ITB spring	870
Figure 1-1531	Engage the ITB drive coupling	870
Figure 1-1532	Align the fuser with the opening	871
Figure 1-1533	Install the fuser	871
Figure 1-1534	Close the right door	872
Figure 1-1535	Install the cover	872
Figure 1-1536	Check the installation	873
Figure 1-1537	Verify that the toner collection hatch cover is closed	873
Figure 1-1538	Install the TCU	874
Figure 1-1539	Close the front door	874
Figure 1-1540	Install the cover	875
Figure 1-1541	Locate the formatter cover	877
Figure 1-1542	Loosen the thumbscrews	878
Figure 1-1543	Release the HDD	879
Figure 1-1544	Remove the HDD	879
Figure 1-1545	Remove the eMMC	880
Figure 1-1546	Locate the DIMM	880
Figure 1-1547	Remove the DIMM	881
Figure 1-1548	Locate the TPM	881
Figure 1-1549	Remove the TPM	882

Figure 1-1550	Disconnect all connectors	883
Figure 1-1551	Remove the formatter	883
Figure 1-1552	Recycle and unpack	884
Figure 1-1553	Install the formatter	884
Figure 1-1554	Connect all connectors	885
Figure 1-1555	The DIMM connector	886
Figure 1-1556	Install the DIMM	886
Figure 1-1557	Verify the installation	887
Figure 1-1558	Install the eMMC	887
Figure 1-1559	Verify the installation	888
Figure 1-1560	Install the TPM	888
Figure 1-1561	Verify that the TPM is fully seated	889
Figure 1-1562	Install the holder	889
Figure 1-1563	Release the HDD	890
Figure 1-1564	Install the cover	890
Figure 1-1565	Locate the formatter cover	892
Figure 1-1566	Loosen the thumbscrews	893
Figure 1-1567	Release the HDD	893
Figure 1-1568	Remove the HDD	894
Figure 1-1569	Locate the fax PCA	894
Figure 1-1570	Disconnect one connector	895
Figure 1-1571	Release one latch	895
Figure 1-1572	Remove the fax PCA	896
Figure 1-1573	Locate the DIMM	896
Figure 1-1574	Release the DIMM	897
Figure 1-1575	Remove the DIMM (M527)	897
Figure 1-1576	Disconnect all connectors	898
Figure 1-1577	Remove four screws	899
Figure 1-1578	Remove the formatter	899
Figure 1-1579	Recycle and unpack	900
Figure 1-1580	Install the formatter	900
Figure 1-1581	Install four screws	901
Figure 1-1582	Connect all connectors	902
Figure 1-1583	Insert the DIMM	902
Figure 1-1584	Install the DIMM	903
Figure 1-1585	Snap the DIMM into place	903
Figure 1-1586	Position the fax PCA	904
Figure 1-1587	Install the fax PCA	904
Figure 1-1588	Connect the connector	905
Figure 1-1589	Install the holder	905
Figure 1-1590	Release the HDD	906

Figure 1-1591	Install the cover	906
Figure 1-1592	Open the front door	909
Figure 1-1593	Open the TCU	909
Figure 1-1594	Remove the TCU	910
Figure 1-1595	Locate the formatter cover	911
Figure 1-1596	Loosen the thumbscrews	911
Figure 1-1597	Disconnect all connectors	913
Figure 1-1598	Remove the formatter	913
Figure 1-1599	Release the HDD	914
Figure 1-1600	Remove the HDD	914
Figure 1-1601	Locate the fax PCA	915
Figure 1-1602	Disconnect one connector	915
Figure 1-1603	Release one latch	916
Figure 1-1604	Remove the fax PCA	916
Figure 1-1605	Disconnect all connectors	917
Figure 1-1606	Remove four screws	918
Figure 1-1607	Remove the formatter	918
Figure 1-1608	Remove four screws	919
Figure 1-1609	Remove the cover	919
Figure 1-1610	Remove two screws	920
Figure 1-1611	Release the right edge	920
Figure 1-1612	Slide the cover right	921
Figure 1-1613	Remove the cover	921
Figure 1-1614	Remove four screws	922
Figure 1-1615	Remove the cover	922
Figure 1-1616	Remove one screw	923
Figure 1-1617	Release the cover	923
Figure 1-1618	Remove the cover	924
Figure 1-1619	Disconnect one connector	924
Figure 1-1620	Remove the bracket	925
Figure 1-1621	Remove the LVPS cover	925
Figure 1-1622	Release wire harnesses and flat cable	926
Figure 1-1623	Remove six screws	926
Figure 1-1624	Release the formatter case	927
Figure 1-1625	Remove the formatter case	927
Figure 1-1626	Recycle and unpack	928
Figure 1-1627	Pass the wire harnesses through the opening	928
Figure 1-1628	Install the formatter case	929
Figure 1-1629	Install six screws	929
Figure 1-1630	Install wire harnesses and flat cable	930
Figure 1-1631	Install the LVPS cover	930

Figure 1-1632	Attach the flat cable	931
Figure 1-1633	Position the bracket	931
Figure 1-1634	Connect one connector	932
Figure 1-1635	Install the cover	932
Figure 1-1636	Engage the cover	933
Figure 1-1637	Install one screw	933
Figure 1-1638	Position the hooks	934
Figure 1-1639	Install the cover	934
Figure 1-1640	Install four screws cover	935
Figure 1-1641	Align the cover	935
Figure 1-1642	Rotate the top of the cover	936
Figure 1-1643	Slide the cover	936
Figure 1-1644	Install two screws	937
Figure 1-1645	Install the cover	937
Figure 1-1646	Install four screws cover	938
Figure 1-1647	Install the formatter	938
Figure 1-1648	Install four screws	939
Figure 1-1649	Connect all connectors	940
Figure 1-1650	Position the fax PCA	940
Figure 1-1651	Install the fax PCA	941
Figure 1-1652	Connect the connector	941
Figure 1-1653	Install the holder	942
Figure 1-1654	Release the HDD	942
Figure 1-1655	Install the formatter	943
Figure 1-1656	Connect all connectors	944
Figure 1-1657	Install the cover	944
Figure 1-1658	Verify that the toner collection hatch cover is closed	945
Figure 1-1659	Install the TCU	945
Figure 1-1660	Close the front door	946
Figure 1-1661	Open the front door	948
Figure 1-1662	Open the TCU	949
Figure 1-1663	Remove the TCU	950
Figure 1-1664	Locate the formatter cover	951
Figure 1-1665	Loosen the thumbscrews	951
Figure 1-1666	Remove four screws	952
Figure 1-1667	Remove the cover	952
Figure 1-1668	Remove two screws	953
Figure 1-1669	Release the right edge	953
Figure 1-1670	Slide the cover right	954
Figure 1-1671	Remove the cover	954
Figure 1-1672	Remove four screws	955

Figure 1-1673	Remove the cover	955
Figure 1-1674	Remove one screw	956
Figure 1-1675	Release the cover	956
Figure 1-1676	Remove the cover	957
Figure 1-1677	Remove the LVPS cover	957
Figure 1-1678	Disconnect one connector	958
Figure 1-1679	Pass the wire harness through the opening	958
Figure 1-1680	Disconnect three connectors	959
Figure 1-1681	Remove the fuser power supply	959
Figure 1-1682	Recycle and unpack	960
Figure 1-1683	Remove the fuser power supply	960
Figure 1-1684	Connect three connectors	961
Figure 1-1685	Pass the wire harness through the opening	961
Figure 1-1686	Connect one connector	962
Figure 1-1687	Install the LVPS cover	962
Figure 1-1688	Install the cover	963
Figure 1-1689	Engage the cover	963
Figure 1-1690	Install one screw	964
Figure 1-1691	Position the hooks	964
Figure 1-1692	Install the cover	965
Figure 1-1693	Install four screws cover	965
Figure 1-1694	Align the cover	966
Figure 1-1695	Rotate the top of the cover	966
Figure 1-1696	Slide the cover	967
Figure 1-1697	Install two screws	967
Figure 1-1698	Install the cover	968
Figure 1-1699	Install four screws cover	968
Figure 1-1700	Install the cover	969
Figure 1-1701	Verify that the toner collection hatch cover is closed	969
Figure 1-1702	Install the TCU	970
Figure 1-1703	Close the front door	970
Figure 1-1704	Open the front door	973
Figure 1-1705	Open the TCU	973
Figure 1-1706	Remove the TCU	974
Figure 1-1707	Locate the formatter cover	975
Figure 1-1708	Loosen the thumbscrews	975
Figure 1-1709	Disconnect all connectors	977
Figure 1-1710	Remove the formatter	977
Figure 1-1711	Release the HDD	978
Figure 1-1712	Remove the HDD	978
Figure 1-1713	Locate the fax PCA	979

Figure 1-1714	Disconnect one connector	979
Figure 1-1715	Release one latch	980
Figure 1-1716	Remove the fax PCA	980
Figure 1-1717	Disconnect all connectors	981
Figure 1-1718	Remove four screws	982
Figure 1-1719	Remove the formatter	982
Figure 1-1720	Remove four screws	983
Figure 1-1721	Remove the cover	983
Figure 1-1722	Remove two screws	984
Figure 1-1723	Release the right edge	984
Figure 1-1724	Slide the cover right	985
Figure 1-1725	Remove the cover	985
Figure 1-1726	Remove four screws	986
Figure 1-1727	Remove the cover	986
Figure 1-1728	Remove one screw	987
Figure 1-1729	Release the cover	987
Figure 1-1730	Remove the cover	988
Figure 1-1731	Disconnect one connector	988
Figure 1-1732	Remove the bracket	989
Figure 1-1733	Remove the LVPS cover	989
Figure 1-1734	Release wire harnesses and flat cable	990
Figure 1-1735	Remove six screws	990
Figure 1-1736	Release the formatter case	991
Figure 1-1737	Remove the formatter case	991
Figure 1-1738	Disconnect one wire harness	992
Figure 1-1739	Disconnect seven connectors	992
Figure 1-1740	Pass the wire harnesses through the opening	993
Figure 1-1741	Remove three screws	993
Figure 1-1742	Remove the LVPS	994
Figure 1-1743	Recycle and unpack	994
Figure 1-1744	Install the LVPS	995
Figure 1-1745	Install three screws	995
Figure 1-1746	Pass the wire harnesses through the opening	996
Figure 1-1747	Connect seven connectors	996
Figure 1-1748	Connect one wire harness	997
Figure 1-1749	Pass the wire harnesses through the opening	997
Figure 1-1750	Install the formatter case	998
Figure 1-1751	Install six screws	998
Figure 1-1752	Install wire harnesses and flat cable	999
Figure 1-1753	Install the LVPS cover	999
Figure 1-1754	Attach the flat cable	1000

Figure 1-1755	Position the bracket	1000
Figure 1-1756	Connect one connector	1001
Figure 1-1757	Install the cover	1001
Figure 1-1758	Engage the cover	1002
Figure 1-1759	Install one screw	1002
Figure 1-1760	Position the hooks	1003
Figure 1-1761	Install the cover	1003
Figure 1-1762	Install four screws cover	1004
Figure 1-1763	Align the cover	1004
Figure 1-1764	Rotate the top of the cover	1005
Figure 1-1765	Slide the cover	1005
Figure 1-1766	Install two screws	1006
Figure 1-1767	Install the cover	1006
Figure 1-1768	Install four screws cover	1007
Figure 1-1769	Install the formatter	1007
Figure 1-1770	Install four screws	1008
Figure 1-1771	Connect all connectors	1009
Figure 1-1772	Position the fax PCA	1009
Figure 1-1773	Install the fax PCA	1010
Figure 1-1774	Connect the connector	1010
Figure 1-1775	Install the holder	1011
Figure 1-1776	Release the HDD	1011
Figure 1-1777	Install the formatter	1012
Figure 1-1778	Connect all connectors	1013
Figure 1-1779	Install the cover	1013
Figure 1-1780	Verify that the toner collection hatch cover is closed	1014
Figure 1-1781	Install the TCU	1014
Figure 1-1782	Close the front door	1015
Figure 1-1783	Open the front door	1018
Figure 1-1784	Open the TCU	1018
Figure 1-1785	Remove the TCU	1019
Figure 1-1786	Locate the formatter cover	1020
Figure 1-1787	Loosen the thumbscrews	1020
Figure 1-1788	Disconnect all connectors	1022
Figure 1-1789	Remove the formatter	1022
Figure 1-1790	Release the HDD	1023
Figure 1-1791	Remove the HDD	1023
Figure 1-1792	Locate the fax PCA	1024
Figure 1-1793	Disconnect one connector	1024
Figure 1-1794	Release one latch	1025
Figure 1-1795	Remove the fax PCA	1025

Figure 1-1796	Disconnect all connectors	1026
Figure 1-1797	Remove four screws	1027
Figure 1-1798	Remove the formatter	1027
Figure 1-1799	Remove four screws	1028
Figure 1-1800	Remove the cover	1028
Figure 1-1801	Remove two screws	1029
Figure 1-1802	Release the right edge	1029
Figure 1-1803	Slide the cover right	1030
Figure 1-1804	Remove the cover	1030
Figure 1-1805	Remove four screws	1031
Figure 1-1806	Remove the cover	1031
Figure 1-1807	Remove one screw	1032
Figure 1-1808	Release the cover	1032
Figure 1-1809	Remove the cover	1033
Figure 1-1810	Disconnect one connector	1033
Figure 1-1811	Remove the bracket	1034
Figure 1-1812	Remove the LVPS cover	1034
Figure 1-1813	Release wire harnesses and flat cable	1035
Figure 1-1814	Remove six screws	1035
Figure 1-1815	Release the formatter case	1036
Figure 1-1816	Remove the formatter case	1036
Figure 1-1817	Disconnect one wire harness	1037
Figure 1-1818	Disconnect seven connectors	1037
Figure 1-1819	Pass the wire harnesses through the opening	1038
Figure 1-1820	Remove three screws	1038
Figure 1-1821	Remove the LVPS	1039
Figure 1-1822	Disconnect one flat cable	1039
Figure 1-1823	Remove three screws	1040
Figure 1-1824	Remove the HVPSD	1040
Figure 1-1825	Recycle and unpack	1041
Figure 1-1826	Install the HVPSD	1041
Figure 1-1827	Press the tabs	1042
Figure 1-1828	Install three screws	1042
Figure 1-1829	Connect one flat cable	1043
Figure 1-1830	Install the LVPS	1043
Figure 1-1831	Install three screws	1044
Figure 1-1832	Pass the wire harnesses through the opening	1044
Figure 1-1833	Connect seven connectors	1045
Figure 1-1834	Connect one wire harness	1045
Figure 1-1835	Pass the wire harnesses through the opening	1046
Figure 1-1836	Install the formatter case	1046

Figure 1-1837	Install six screws	1047
Figure 1-1838	Install wire harnesses and flat cable	1047
Figure 1-1839	Install the LVPS cover	1048
Figure 1-1840	Attach the flat cable	1048
Figure 1-1841	Position the bracket	1049
Figure 1-1842	Connect one connector	1049
Figure 1-1843	Install the cover	1050
Figure 1-1844	Engage the cover	1050
Figure 1-1845	Install one screw	1051
Figure 1-1846	Position the hooks	1051
Figure 1-1847	Install the cover	1052
Figure 1-1848	Install four screws cover	1052
Figure 1-1849	Align the cover	1053
Figure 1-1850	Rotate the top of the cover	1053
Figure 1-1851	Slide the cover	1054
Figure 1-1852	Install two screws	1054
Figure 1-1853	Install the cover	1055
Figure 1-1854	Install four screws cover	1055
Figure 1-1855	Install the formatter	1056
Figure 1-1856	Install four screws	1056
Figure 1-1857	Connect all connectors	1057
Figure 1-1858	Position the fax PCA	1058
Figure 1-1859	Install the fax PCA	1058
Figure 1-1860	Connect the connector	1059
Figure 1-1861	Install the holder	1059
Figure 1-1862	Release the HDD	1060
Figure 1-1863	Install the formatter	1061
Figure 1-1864	Connect all connectors	1062
Figure 1-1865	Install the cover	1062
Figure 1-1866	Verify that the toner collection hatch cover is closed	1063
Figure 1-1867	Install the TCU	1063
Figure 1-1868	Close the front door	1064
Figure 1-1869	Open the front door	1067
Figure 1-1870	Open the TCU	1067
Figure 1-1871	Remove the TCU	1068
Figure 1-1872	Locate the formatter cover	1069
Figure 1-1873	Loosen the thumbscrews	1069
Figure 1-1874	Disconnect all connectors	1071
Figure 1-1875	Remove the formatter	1071
Figure 1-1876	Release the HDD	1072
Figure 1-1877	Remove the HDD	1072

Figure 1-1878	Locate the fax PCA	1073
Figure 1-1879	Disconnect one connector	1073
Figure 1-1880	Release one latch	1074
Figure 1-1881	Remove the fax PCA	1074
Figure 1-1882	Disconnect all connectors	1075
Figure 1-1883	Remove four screws	1076
Figure 1-1884	Remove the formatter	1076
Figure 1-1885	Remove four screws	1077
Figure 1-1886	Remove the cover	1077
Figure 1-1887	Remove two screws	1078
Figure 1-1888	Release the right edge	1078
Figure 1-1889	Slide the cover right	1079
Figure 1-1890	Remove the cover	1079
Figure 1-1891	Remove four screws	1080
Figure 1-1892	Remove the cover	1080
Figure 1-1893	Remove one screw	1081
Figure 1-1894	Release the cover	1081
Figure 1-1895	Remove the cover	1082
Figure 1-1896	Disconnect one connector	1082
Figure 1-1897	Remove the bracket	1083
Figure 1-1898	Remove the LVPS cover	1083
Figure 1-1899	Release wire harnesses and flat cable	1084
Figure 1-1900	Remove six screws	1084
Figure 1-1901	Release the formatter case	1085
Figure 1-1902	Remove the formatter case	1085
Figure 1-1903	Remove the motor	1086
Figure 1-1904	Recycle and unpack	1086
Figure 1-1905	Install the motor	1087
Figure 1-1906	Pass the wire harnesses through the opening	1087
Figure 1-1907	Install the formatter case	1088
Figure 1-1908	Install six screws	1088
Figure 1-1909	Install wire harnesses and flat cable	1089
Figure 1-1910	Install the LVPS cover	1089
Figure 1-1911	Attach the flat cable	1090
Figure 1-1912	Position the bracket	1090
Figure 1-1913	Connect one connector	1091
Figure 1-1914	Install the cover	1091
Figure 1-1915	Engage the cover	1092
Figure 1-1916	Install one screw	1092
Figure 1-1917	Position the hooks	1093
Figure 1-1918	Install the cover	1093

Figure 1-1919	Install four screws cover	1094
Figure 1-1920	Align the cover	1094
Figure 1-1921	Rotate the top of the cover	1095
Figure 1-1922	Slide the cover	1095
Figure 1-1923	Install two screws	1096
Figure 1-1924	Install the cover	1096
Figure 1-1925	Install four screws cover	1097
Figure 1-1926	Install the formatter	1097
Figure 1-1927	Install four screws	1098
Figure 1-1928	Connect all connectors	1099
Figure 1-1929	Position the fax PCA	1099
Figure 1-1930	Install the fax PCA	1100
Figure 1-1931	Connect the connector	1100
Figure 1-1932	Install the holder	1101
Figure 1-1933	Release the HDD	1101
Figure 1-1934	Install the formatter	1102
Figure 1-1935	Connect all connectors	1103
Figure 1-1936	Install the cover	1103
Figure 1-1937	Verify that the toner collection hatch cover is closed	1104
Figure 1-1938	Install the TCU	1104
Figure 1-1939	Close the front door	1105
Figure 1-1940	Locate the USB cover	1108
Figure 1-1941	Remove the cover	1108
Figure 1-1942	Tilt the control panel up	1109
Figure 1-1943	Release the control-panel screws cover tabs	1109
Figure 1-1944	Remove the cover	1110
Figure 1-1945	Remove two screws	1110
Figure 1-1946	Rotate the control-panel base up	1111
Figure 1-1947	Turn the control panel over	1111
Figure 1-1948	Disconnect two connectors	1112
Figure 1-1949	Open the front door	1112
Figure 1-1950	Open the TCU	1113
Figure 1-1951	Remove the TCU	1114
Figure 1-1952	Locate the formatter cover	1115
Figure 1-1953	Loosen the thumbscrews	1115
Figure 1-1954	Remove four screws	1116
Figure 1-1955	Remove the cover	1116
Figure 1-1956	Remove two screws	1117
Figure 1-1957	Release the right edge	1117
Figure 1-1958	Slide the cover right	1118
Figure 1-1959	Remove the cover	1118

Figure 1-1960	Remove four screws	1119
Figure 1-1961	Remove the cover	1119
Figure 1-1962	Remove one screw	1120
Figure 1-1963	Release the cover	1120
Figure 1-1964	Remove the cover	1121
Figure 1-1965	Remove three screws	1121
Figure 1-1966	Remove one screw and release one tab	1122
Figure 1-1967	Release the cover	1122
Figure 1-1968	Remove the cover	1123
Figure 1-1969	Remove one screw	1123
Figure 1-1970	Release two tabs	1124
Figure 1-1971	Rotate the cover	1124
Figure 1-1972	Remove one screw	1125
Figure 1-1973	Release two tabs	1125
Figure 1-1974	Release the back edge of the cover	1126
Figure 1-1975	Remove the cover	1126
Figure 1-1976	Remove two screws and one connector	1127
Figure 1-1977	Remove one screw and connector	1127
Figure 1-1978	Slide the cover	1128
Figure 1-1979	Remove the cover	1128
Figure 1-1980	Release the cover	1129
Figure 1-1981	Remove the cover	1129
Figure 1-1982	Disconnect all connectors	1130
Figure 1-1983	Remove the formatter	1131
Figure 1-1984	Release the HDD	1131
Figure 1-1985	Remove the HDD	1132
Figure 1-1986	Locate the fax PCA	1132
Figure 1-1987	Disconnect one connector	1133
Figure 1-1988	Release one latch	1133
Figure 1-1989	Remove the fax PCA	1134
Figure 1-1990	Disconnect all connectors	1135
Figure 1-1991	Remove four screws	1135
Figure 1-1992	Remove the formatter	1136
Figure 1-1993	Disconnect one connector	1136
Figure 1-1994	Remove the bracket	1137
Figure 1-1995	Remove the LVPS cover	1137
Figure 1-1996	Release wire harnesses and flat cable	1138
Figure 1-1997	Remove six screws	1138
Figure 1-1998	Release the formatter case	1139
Figure 1-1999	Remove the formatter case	1139
Figure 1-2000	Disconnect one wire harness	1140

Figure 1-2001	Disconnect seven connectors	1140
Figure 1-2002	Pass the wire harnesses through the opening	1141
Figure 1-2003	Remove three screws	1141
Figure 1-2004	Remove the LVPS	1142
Figure 1-2005	Remove one screw	1142
Figure 1-2006	Release the wire harnesses	1143
Figure 1-2007	Remove the fan	1143
Figure 1-2008	Recycle and unpack	1144
Figure 1-2009	Install the fan	1144
Figure 1-2010	Place the wire harnesses in the retainer	1145
Figure 1-2011	Install one screw	1145
Figure 1-2012	Install the LVPS	1146
Figure 1-2013	Install three screws	1146
Figure 1-2014	Pass the wire harnesses through the opening	1147
Figure 1-2015	Connect seven connectors	1147
Figure 1-2016	Connect one wire harness	1148
Figure 1-2017	Pass the wire harnesses through the opening	1148
Figure 1-2018	Install the formatter case	1149
Figure 1-2019	Install six screws	1149
Figure 1-2020	Install wire harnesses and flat cable	1150
Figure 1-2021	Install the LVPS cover	1150
Figure 1-2022	Attach the flat cable	1151
Figure 1-2023	Position the bracket	1151
Figure 1-2024	Connect one connector	1152
Figure 1-2025	Install the formatter	1152
Figure 1-2026	Install four screws	1153
Figure 1-2027	Connect all connectors	1154
Figure 1-2028	Position the fax PCA	1154
Figure 1-2029	Install the fax PCA	1155
Figure 1-2030	Connect the connector	1155
Figure 1-2031	Install the holder	1156
Figure 1-2032	Release the HDD	1156
Figure 1-2033	Install the formatter	1157
Figure 1-2034	Connect all connectors	1158
Figure 1-2035	Install the cover	1158
Figure 1-2036	Install one screw	1159
Figure 1-2037	Install the cables	1159
Figure 1-2038	Position the hooks	1160
Figure 1-2039	Install the cover	1160
Figure 1-2040	Install one screw and connector	1161
Figure 1-2041	Install one screw and connector	1161

Figure 1-2042	Install two tabs	1162
Figure 1-2043	Install the cover assembly	1162
Figure 1-2044	Install one screw	1163
Figure 1-2045	Install the cover	1164
Figure 1-2046	Press the cover	1164
Figure 1-2047	Install one screw	1165
Figure 1-2048	Install the cover	1165
Figure 1-2049	Engage one tab	1166
Figure 1-2050	Engage one tab and install one screw	1166
Figure 1-2051	Install three screws	1167
Figure 1-2052	Install the cover	1167
Figure 1-2053	Engage the cover	1168
Figure 1-2054	Install one screw	1168
Figure 1-2055	Position the hooks	1169
Figure 1-2056	Install the cover	1169
Figure 1-2057	Install four screws cover	1170
Figure 1-2058	Align the cover	1170
Figure 1-2059	Rotate the top of the cover	1171
Figure 1-2060	Slide the cover	1171
Figure 1-2061	Install two screws	1172
Figure 1-2062	Install the cover	1172
Figure 1-2063	Install four screws cover	1173
Figure 1-2064	Install the cover	1173
Figure 1-2065	Verify that the toner collection hatch cover is closed	1174
Figure 1-2066	Install the TCU	1174
Figure 1-2067	Close the front door	1175
Figure 1-2068	Place the control panel on the product	1175
Figure 1-2069	Connect two connectors	1176
Figure 1-2070	Turn the control panel over	1176
Figure 1-2071	Rotate the control-panel base down	1177
Figure 1-2072	Install two screws	1177
Figure 1-2073	Install the cover	1178
Figure 1-2074	Install the cover	1178
Figure 1-2075	Check the installation	1179
Figure 1-2076	Open the front door	1182
Figure 1-2077	Open the TCU	1182
Figure 1-2078	Remove the TCU	1183
Figure 1-2079	Locate the formatter cover	1184
Figure 1-2080	Loosen the thumbscrews	1184
Figure 1-2081	Disconnect all connectors	1186
Figure 1-2082	Remove the formatter	1186

Figure 1-2083	Release the HDD	1187
Figure 1-2084	Remove the HDD	1187
Figure 1-2085	Locate the fax PCA	1188
Figure 1-2086	Disconnect one connector	1188
Figure 1-2087	Release one latch	1189
Figure 1-2088	Remove the fax PCA	1189
Figure 1-2089	Disconnect all connectors	1190
Figure 1-2090	Remove four screws	1191
Figure 1-2091	Remove the formatter	1191
Figure 1-2092	Remove four screws	1192
Figure 1-2093	Remove the cover	1192
Figure 1-2094	Remove two screws	1193
Figure 1-2095	Release the right edge	1193
Figure 1-2096	Slide the cover right	1194
Figure 1-2097	Remove the cover	1194
Figure 1-2098	Remove four screws	1195
Figure 1-2099	Remove the cover	1195
Figure 1-2100	Remove one screw	1196
Figure 1-2101	Release the cover	1196
Figure 1-2102	Remove the cover	1197
Figure 1-2103	Disconnect one connector	1197
Figure 1-2104	Remove the bracket	1198
Figure 1-2105	Remove the LVPS cover	1198
Figure 1-2106	Release wire harnesses and flat cable	1199
Figure 1-2107	Remove six screws	1199
Figure 1-2108	Release the formatter case	1200
Figure 1-2109	Remove the formatter case	1200
Figure 1-2110	Disconnect one wire harness	1201
Figure 1-2111	Disconnect seven connectors	1201
Figure 1-2112	Pass the wire harnesses through the opening	1202
Figure 1-2113	Remove three screws	1202
Figure 1-2114	Remove the LVPS	1203
Figure 1-2115	Disconnect one flat cable	1203
Figure 1-2116	Remove three screws	1204
Figure 1-2117	Remove the HVPSD	1204
Figure 1-2118	Remove the motor	1205
Figure 1-2119	Recycle and unpack	1205
Figure 1-2120	Install the motor	1206
Figure 1-2121	Install the HVPSD	1206
Figure 1-2122	Press the tabs	1207
Figure 1-2123	Install three screws	1207

Figure 1-2124	Connect one flat cable	1208
Figure 1-2125	Install the LVPS	1208
Figure 1-2126	Install three screws	1209
Figure 1-2127	Pass the wire harnesses through the opening	1209
Figure 1-2128	Connect seven connectors	1210
Figure 1-2129	Connect one wire harness	1210
Figure 1-2130	Pass the wire harnesses through the opening	1211
Figure 1-2131	Install the formatter case	1211
Figure 1-2132	Install six screws	1212
Figure 1-2133	Install wire harnesses and flat cable	1212
Figure 1-2134	Install the LVPS cover	1213
Figure 1-2135	Attach the flat cable	1213
Figure 1-2136	Position the bracket	1214
Figure 1-2137	Connect one connector	1214
Figure 1-2138	Install the cover	1215
Figure 1-2139	Engage the cover	1215
Figure 1-2140	Install one screw	1216
Figure 1-2141	Position the hooks	1216
Figure 1-2142	Install the cover	1217
Figure 1-2143	Install four screws cover	1217
Figure 1-2144	Align the cover	1218
Figure 1-2145	Rotate the top of the cover	1218
Figure 1-2146	Slide the cover	1219
Figure 1-2147	Install two screws	1219
Figure 1-2148	Install the cover	1220
Figure 1-2149	Install four screws cover	1220
Figure 1-2150	Install the formatter	1221
Figure 1-2151	Install four screws	1221
Figure 1-2152	Connect all connectors	1222
Figure 1-2153	Position the fax PCA	1223
Figure 1-2154	Install the fax PCA	1223
Figure 1-2155	Connect the connector	1224
Figure 1-2156	Install the holder	1224
Figure 1-2157	Release the HDD	1225
Figure 1-2158	Install the formatter	1226
Figure 1-2159	Connect all connectors	1227
Figure 1-2160	Install the cover	1227
Figure 1-2161	Verify that the toner collection hatch cover is closed	1228
Figure 1-2162	Install the TCU	1228
Figure 1-2163	Close the front door	1229
Figure 1-2164	Open the front door	1232

Figure 1-2165	Open the TCU	1232
Figure 1-2166	Remove the TCU	1233
Figure 1-2167	Locate the formatter cover	1234
Figure 1-2168	Loosen the thumbscrews	1234
Figure 1-2169	Disconnect all connectors	1236
Figure 1-2170	Remove the formatter	1236
Figure 1-2171	Release the HDD	1237
Figure 1-2172	Remove the HDD	1237
Figure 1-2173	Locate the fax PCA	1238
Figure 1-2174	Disconnect one connector	1238
Figure 1-2175	Release one latch	1239
Figure 1-2176	Remove the fax PCA	1239
Figure 1-2177	Disconnect all connectors	1240
Figure 1-2178	Remove four screws	1241
Figure 1-2179	Remove the formatter	1241
Figure 1-2180	Remove four screws	1242
Figure 1-2181	Remove the cover	1242
Figure 1-2182	Remove two screws	1243
Figure 1-2183	Release the right edge	1243
Figure 1-2184	Slide the cover right	1244
Figure 1-2185	Remove the cover	1244
Figure 1-2186	Remove four screws	1245
Figure 1-2187	Remove the cover	1245
Figure 1-2188	Remove one screw	1246
Figure 1-2189	Release the cover	1246
Figure 1-2190	Remove the cover	1247
Figure 1-2191	Disconnect one connector	1247
Figure 1-2192	Remove the bracket	1248
Figure 1-2193	Remove the LVPS cover	1248
Figure 1-2194	Release wire harnesses and flat cable	1249
Figure 1-2195	Remove six screws	1249
Figure 1-2196	Release the formatter case	1250
Figure 1-2197	Remove the formatter case	1250
Figure 1-2198	Disconnect one wire harness	1251
Figure 1-2199	Disconnect seven connectors	1251
Figure 1-2200	Pass the wire harnesses through the opening	1252
Figure 1-2201	Remove three screws	1252
Figure 1-2202	Remove the LVPS	1253
Figure 1-2203	Disconnect one flat cable	1253
Figure 1-2204	Remove three screws	1254
Figure 1-2205	Remove the HVPSD	1254

Figure 1-2206	Remove the assembly	1255
Figure 1-2207	Recycle and unpack	1255
Figure 1-2208	Install the assembly	1256
Figure 1-2209	Install the HVPSD	1256
Figure 1-2210	Press the tabs	1257
Figure 1-2211	Install three screws	1257
Figure 1-2212	Connect one flat cable	1258
Figure 1-2213	Install the LVPS	1258
Figure 1-2214	Install three screws	1259
Figure 1-2215	Pass the wire harnesses through the opening	1259
Figure 1-2216	Connect seven connectors	1260
Figure 1-2217	Connect one wire harness	1260
Figure 1-2218	Pass the wire harnesses through the opening	1261
Figure 1-2219	Install the formatter case	1261
Figure 1-2220	Install six screws	1262
Figure 1-2221	Install wire harnesses and flat cable	1262
Figure 1-2222	Install the LVPS cover	1263
Figure 1-2223	Attach the flat cable	1263
Figure 1-2224	Position the bracket	1264
Figure 1-2225	Connect one connector	1264
Figure 1-2226	Install the cover	1265
Figure 1-2227	Engage the cover	1265
Figure 1-2228	Install one screw	1266
Figure 1-2229	Position the hooks	1266
Figure 1-2230	Install the cover	1267
Figure 1-2231	Install four screws cover	1267
Figure 1-2232	Align the cover	1268
Figure 1-2233	Rotate the top of the cover	1268
Figure 1-2234	Slide the cover	1269
Figure 1-2235	Install two screws	1269
Figure 1-2236	Install the cover	1270
Figure 1-2237	Install four screws cover	1270
Figure 1-2238	Install the formatter	1271
Figure 1-2239	Install four screws	1271
Figure 1-2240	Connect all connectors	1272
Figure 1-2241	Position the fax PCA	1273
Figure 1-2242	Install the fax PCA	1273
Figure 1-2243	Connect the connector	1274
Figure 1-2244	Install the holder	1274
Figure 1-2245	Release the HDD	1275
Figure 1-2246	Install the formatter	1276

Figure 1-2247	Connect all connectors	1277
Figure 1-2248	Install the cover	1277
Figure 1-2249	Verify that the toner collection hatch cover is closed	1278
Figure 1-2250	Install the TCU	1278
Figure 1-2251	Close the front door	1279
Figure 1-2252	Open the front door	1282
Figure 1-2253	Open the TCU	1282
Figure 1-2254	Remove the TCU	1283
Figure 1-2255	Locate the formatter cover	1284
Figure 1-2256	Loosen the thumbscrews	1284
Figure 1-2257	Disconnect all connectors	1286
Figure 1-2258	Remove the formatter	1286
Figure 1-2259	Release the HDD	1287
Figure 1-2260	Remove the HDD	1287
Figure 1-2261	Locate the fax PCA	1288
Figure 1-2262	Disconnect one connector	1288
Figure 1-2263	Release one latch	1289
Figure 1-2264	Remove the fax PCA	1289
Figure 1-2265	Disconnect all connectors	1290
Figure 1-2266	Remove four screws	1291
Figure 1-2267	Remove the formatter	1291
Figure 1-2268	Remove four screws	1292
Figure 1-2269	Remove the cover	1292
Figure 1-2270	Remove two screws	1293
Figure 1-2271	Release the right edge	1293
Figure 1-2272	Slide the cover right	1294
Figure 1-2273	Remove the cover	1294
Figure 1-2274	Remove four screws	1295
Figure 1-2275	Remove the cover	1295
Figure 1-2276	Remove one screw	1296
Figure 1-2277	Release the cover	1296
Figure 1-2278	Remove the cover	1297
Figure 1-2279	Disconnect one connector	1297
Figure 1-2280	Remove the bracket	1298
Figure 1-2281	Remove the LVPS cover	1298
Figure 1-2282	Release wire harnesses and flat cable	1299
Figure 1-2283	Remove six screws	1299
Figure 1-2284	Release the formatter case	1300
Figure 1-2285	Remove the formatter case	1300
Figure 1-2286	Disconnect one wire harness	1301
Figure 1-2287	Disconnect seven connectors	1301

Figure 1-2288	Pass the wire harnesses through the opening	1302
Figure 1-2289	Remove three screws	1302
Figure 1-2290	Remove the LVPS	1303
Figure 1-2291	Disconnect one flat cable	1303
Figure 1-2292	Remove three screws	1304
Figure 1-2293	Remove the HVPSD	1304
Figure 1-2294	Disconnect two connectors	1305
Figure 1-2295	Disconnect two flat cables	1305
Figure 1-2296	Remove the assembly	1306
Figure 1-2297	Recycle and unpack	1306
Figure 1-2298	Install the lifter drive	1307
Figure 1-2299	Connect two flat cables	1307
Figure 1-2300	Connect two connectors	1308
Figure 1-2301	Install the HVPSD	1308
Figure 1-2302	Press the tabs	1309
Figure 1-2303	Install three screws	1309
Figure 1-2304	Connect one flat cable	1310
Figure 1-2305	Install the LVPS	1310
Figure 1-2306	Install three screws	1311
Figure 1-2307	Pass the wire harnesses through the opening	1311
Figure 1-2308	Connect seven connectors	1312
Figure 1-2309	Connect one wire harness	1312
Figure 1-2310	Pass the wire harnesses through the opening	1313
Figure 1-2311	Install the formatter case	1313
Figure 1-2312	Install six screws	1314
Figure 1-2313	Install wire harnesses and flat cable	1314
Figure 1-2314	Install the LVPS cover	1315
Figure 1-2315	Attach the flat cable	1315
Figure 1-2316	Position the bracket	1316
Figure 1-2317	Connect one connector	1316
Figure 1-2318	Install the cover	1317
Figure 1-2319	Engage the cover	1317
Figure 1-2320	Install one screw	1318
Figure 1-2321	Position the hooks	1318
Figure 1-2322	Install the cover	1319
Figure 1-2323	Install four screws cover	1319
Figure 1-2324	Align the cover	1320
Figure 1-2325	Rotate the top of the cover	1320
Figure 1-2326	Slide the cover	1321
Figure 1-2327	Install two screws	1321
Figure 1-2328	Install the cover	1322

Figure 1-2329	Install four screws cover	1322
Figure 1-2330	Install the formatter	1323
Figure 1-2331	Install four screws	1323
Figure 1-2332	Connect all connectors	1324
Figure 1-2333	Position the fax PCA	1325
Figure 1-2334	Install the fax PCA	1325
Figure 1-2335	Connect the connector	1326
Figure 1-2336	Install the holder	1326
Figure 1-2337	Release the HDD	1327
Figure 1-2338	Install the formatter	1328
Figure 1-2339	Connect all connectors	1329
Figure 1-2340	Install the cover	1329
Figure 1-2341	Verify that the toner collection hatch cover is closed	1330
Figure 1-2342	Install the TCU	1330
Figure 1-2343	Close the front door	1331
Figure 1-2344	Open the front door	1334
Figure 1-2345	Open the TCU	1334
Figure 1-2346	Remove the TCU	1335
Figure 1-2347	Remove the toner cartridge	1336
Figure 1-2348	Locate the formatter cover	1336
Figure 1-2349	Loosen the thumbscrews	1337
Figure 1-2350	Disconnect all connectors	1338
Figure 1-2351	Remove the formatter	1338
Figure 1-2352	Release the HDD	1339
Figure 1-2353	Remove the HDD	1339
Figure 1-2354	Locate the fax PCA	1340
Figure 1-2355	Disconnect one connector	1340
Figure 1-2356	Release one latch	1341
Figure 1-2357	Remove the fax PCA	1341
Figure 1-2358	Disconnect all connectors	1342
Figure 1-2359	Remove four screws	1343
Figure 1-2360	Remove the formatter	1343
Figure 1-2361	Remove four screws	1344
Figure 1-2362	Remove the cover	1344
Figure 1-2363	Remove two screws	1345
Figure 1-2364	Release the right edge	1345
Figure 1-2365	Slide the cover right	1346
Figure 1-2366	Remove the cover	1346
Figure 1-2367	Remove four screws	1347
Figure 1-2368	Remove the cover	1347
Figure 1-2369	Remove one screw	1348

Figure 1-2370	Release the cover	1348
Figure 1-2371	Remove the cover	1349
Figure 1-2372	Disconnect one connector	1349
Figure 1-2373	Remove the bracket	1350
Figure 1-2374	Remove the LVPS cover	1350
Figure 1-2375	Release wire harnesses and flat cable	1351
Figure 1-2376	Remove six screws	1351
Figure 1-2377	Release the formatter case	1352
Figure 1-2378	Remove the formatter case	1352
Figure 1-2379	Disconnect one wire harness	1353
Figure 1-2380	Disconnect seven connectors	1353
Figure 1-2381	Pass the wire harnesses through the opening	1354
Figure 1-2382	Remove three screws	1354
Figure 1-2383	Remove the LVPS	1355
Figure 1-2384	Disconnect one flat cable	1355
Figure 1-2385	Remove three screws	1356
Figure 1-2386	Remove the HVPSD	1356
Figure 1-2387	Release one wire harness	1357
Figure 1-2388	Release two tabs	1357
Figure 1-2389	Remove the guide	1358
Figure 1-2390	Disconnect two flat cables	1358
Figure 1-2391	Disconnect two connectors	1359
Figure 1-2392	Remove one screw and the plate	1359
Figure 1-2393	Release the spring	1360
Figure 1-2394	Remove the spring	1360
Figure 1-2395	Release the wire harness	1361
Figure 1-2396	Remove the laser/scanner assembly	1361
Figure 1-2397	Recycle and unpack	1362
Figure 1-2398	Handle the laser/scanner assembly carefully	1362
Figure 1-2399	Install the laser/scanner assembly	1363
Figure 1-2400	Release the spring	1363
Figure 1-2401	Install the plate and one screw	1364
Figure 1-2402	Place the wire harness in the retainers	1364
Figure 1-2403	Connect two connectors	1365
Figure 1-2404	Connect two flat cables	1365
Figure 1-2405	Install the guide	1366
Figure 1-2406	Place one wire harness in the retainer	1366
Figure 1-2407	Install the HVPSD	1367
Figure 1-2408	Press the tabs	1367
Figure 1-2409	Install three screws	1368
Figure 1-2410	Connect one flat cable	1368

Figure 1-2411	Install the LVPS	1369
Figure 1-2412	Install three screws	1369
Figure 1-2413	Pass the wire harnesses through the opening	1370
Figure 1-2414	Connect seven connectors	1370
Figure 1-2415	Connect one wire harness	1371
Figure 1-2416	Pass the wire harnesses through the opening	1371
Figure 1-2417	Install the formatter case	1372
Figure 1-2418	Install six screws	1372
Figure 1-2419	Install wire harnesses and flat cable	1373
Figure 1-2420	Install the LVPS cover	1373
Figure 1-2421	Attach the flat cable	1374
Figure 1-2422	Position the bracket	1374
Figure 1-2423	Connect one connector	1375
Figure 1-2424	Install the cover	1375
Figure 1-2425	Engage the cover	1376
Figure 1-2426	Install one screw	1376
Figure 1-2427	Position the hooks	1377
Figure 1-2428	Install the cover	1377
Figure 1-2429	Install four screws cover	1378
Figure 1-2430	Align the cover	1378
Figure 1-2431	Rotate the top of the cover	1379
Figure 1-2432	Slide the cover	1379
Figure 1-2433	Install two screws	1380
Figure 1-2434	Install the cover	1380
Figure 1-2435	Install four screws cover	1381
Figure 1-2436	Install the formatter	1381
Figure 1-2437	Install four screws	1382
Figure 1-2438	Connect all connectors	1383
Figure 1-2439	Position the fax PCA	1383
Figure 1-2440	Install the fax PCA	1384
Figure 1-2441	Connect the connector	1384
Figure 1-2442	Install the holder	1385
Figure 1-2443	Release the HDD	1385
Figure 1-2444	Install the formatter	1386
Figure 1-2445	Connect all connectors	1387
Figure 1-2446	Install the cover	1387
Figure 1-2447	Install a toner cartridge	1388
Figure 1-2448	Verify that the toner collection hatch cover is closed	1388
Figure 1-2449	Install the TCU	1389
Figure 1-2450	Close the front door	1389
Figure 1-2451	Locate the USB cover	1392

Figure 1-2452	Remove the cover	1393
Figure 1-2453	Tilt the control panel up	1394
Figure 1-2454	Release the control-panel screws cover tabs	1394
Figure 1-2455	Remove the cover	1395
Figure 1-2456	Remove two screws	1395
Figure 1-2457	Rotate the control-panel base up	1396
Figure 1-2458	Turn the control panel over	1396
Figure 1-2459	Disconnect two connectors	1397
Figure 1-2460	Pull the tray out	1397
Figure 1-2461	Remove the tray	1398
Figure 1-2462	Open the front door	1398
Figure 1-2463	Open the TCU	1399
Figure 1-2464	Remove the TCU	1400
Figure 1-2465	Locate the formatter cover	1401
Figure 1-2466	Loosen the thumbscrews	1401
Figure 1-2467	Disconnect all connectors	1403
Figure 1-2468	Remove the formatter	1403
Figure 1-2469	Release the HDD	1404
Figure 1-2470	Remove the HDD	1404
Figure 1-2471	Locate the fax PCA	1405
Figure 1-2472	Disconnect one connector	1405
Figure 1-2473	Release one latch	1406
Figure 1-2474	Remove the fax PCA	1406
Figure 1-2475	Disconnect all connectors	1407
Figure 1-2476	Remove four screws	1408
Figure 1-2477	Remove the formatter	1408
Figure 1-2478	Remove four screws	1409
Figure 1-2479	Remove the cover	1409
Figure 1-2480	Remove two screws	1410
Figure 1-2481	Release the right edge	1410
Figure 1-2482	Slide the cover right	1411
Figure 1-2483	Remove the cover	1411
Figure 1-2484	Remove four screws	1412
Figure 1-2485	Remove the cover	1412
Figure 1-2486	Release one tab	1413
Figure 1-2487	Slide the cover back	1413
Figure 1-2488	Remove the left upper cover	1414
Figure 1-2489	Remove one screw	1414
Figure 1-2490	Release two tabs	1415
Figure 1-2491	Rotate the cover	1415
Figure 1-2492	Remove one screw	1416

Figure 1-2493	Release two tabs	1416
Figure 1-2494	Release the back edge of the cover	1417
Figure 1-2495	Remove the cover	1417
Figure 1-2496	Remove one screw	1418
Figure 1-2497	Remove two screws	1418
Figure 1-2498	Remove one screw	1419
Figure 1-2499	Disconnect connectors	1419
Figure 1-2500	Slide the ISA towards the back of the printer	1420
Figure 1-2501	Remove the ISA	1420
Figure 1-2502	Remove two screws and one connector	1421
Figure 1-2503	Remove one screw and connector	1421
Figure 1-2504	Slide the cover	1422
Figure 1-2505	Remove the cover	1422
Figure 1-2506	Remove one screw	1423
Figure 1-2507	Remove one screw	1423
Figure 1-2508	Release one tab	1424
Figure 1-2509	Release two tabs	1424
Figure 1-2510	Remove one screw	1425
Figure 1-2511	Release the cover	1425
Figure 1-2512	Remove the cover	1426
Figure 1-2513	Remove three screws	1426
Figure 1-2514	Remove one screw and release one tab	1427
Figure 1-2515	Release the cover	1427
Figure 1-2516	Remove the cover	1428
Figure 1-2517	Disconnect one connector	1428
Figure 1-2518	Remove the bracket	1429
Figure 1-2519	Remove the LVPS cover	1429
Figure 1-2520	Release wire harnesses and flat cable	1430
Figure 1-2521	Remove six screws	1430
Figure 1-2522	Release the formatter case	1431
Figure 1-2523	Remove the formatter case	1431
Figure 1-2524	Disconnect one connector	1432
Figure 1-2525	Remove one screw	1432
Figure 1-2526	Release the fan	1433
Figure 1-2527	Remove the fan	1433
Figure 1-2528	Recycle and unpack	1434
Figure 1-2529	Install the fan	1434
Figure 1-2530	Engage the fan with the chassis	1435
Figure 1-2531	Install one screw	1435
Figure 1-2532	Connect one connector	1436
Figure 1-2533	Pass the wire harnesses through the opening	1436

Figure 1-2534	Install the formatter case	1437
Figure 1-2535	Install six screws	1437
Figure 1-2536	Install wire harnesses and flat cable	1438
Figure 1-2537	Install the LVPS cover	1438
Figure 1-2538	Attach the flat cable	1439
Figure 1-2539	Position the bracket	1439
Figure 1-2540	Connect one connector	1440
Figure 1-2541	Install the cover	1440
Figure 1-2542	Engage one tab	1441
Figure 1-2543	Engage one tab and install one screw	1441
Figure 1-2544	Install three screws	1442
Figure 1-2545	Install the cover	1442
Figure 1-2546	Engage the cover	1443
Figure 1-2547	Install one screw	1443
Figure 1-2548	Position the locator pins	1444
Figure 1-2549	Press down on the cover	1444
Figure 1-2550	Install one screw	1445
Figure 1-2551	Install one screw	1445
Figure 1-2552	Install the cables	1446
Figure 1-2553	Position the hooks	1446
Figure 1-2554	Install the cover	1447
Figure 1-2555	Install one screw and connector	1447
Figure 1-2556	Install one screw and connector	1448
Figure 1-2557	Locate the ISA mounting pins and slots	249
Figure 1-2558	Install the ISA	1449
Figure 1-2559	Slide the ISA towards the front of the printer	1449
Figure 1-2560	Install one screw	1450
Figure 1-2561	Install two screws	1450
Figure 1-2562	Install one screw	1451
Figure 1-2563	Connect connectors	1451
Figure 1-2564	Install two tabs	1452
Figure 1-2565	Install the cover assembly	1452
Figure 1-2566	Install one screw	1453
Figure 1-2567	Install the cover	1454
Figure 1-2568	Press the cover	1454
Figure 1-2569	Install one screw	1455
Figure 1-2570	Position the tab	1455
Figure 1-2571	Slide the cover	1456
Figure 1-2572	Check the tab	1456
Figure 1-2573	Position the hooks	1457
Figure 1-2574	Install the cover	1457

Figure 1-2575	Install four screws cover	1458
Figure 1-2576	Align the cover	1458
Figure 1-2577	Rotate the top of the cover	1459
Figure 1-2578	Slide the cover	1459
Figure 1-2579	Install two screws	1460
Figure 1-2580	Install the cover	1460
Figure 1-2581	Install four screws cover	1461
Figure 1-2582	Install the formatter	1461
Figure 1-2583	Install four screws	1462
Figure 1-2584	Connect all connectors	1463
Figure 1-2585	Position the fax PCA	1463
Figure 1-2586	Install the fax PCA	1464
Figure 1-2587	Connect the connector	1464
Figure 1-2588	Install the holder	1465
Figure 1-2589	Release the HDD	1465
Figure 1-2590	Install the formatter	1466
Figure 1-2591	Connect all connectors	1467
Figure 1-2592	Install the cover	1467
Figure 1-2593	Verify that the toner collection hatch cover is closed	1468
Figure 1-2594	Install the TCU	1468
Figure 1-2595	Close the front door	1469
Figure 1-2596	Install the tray	1469
Figure 1-2597	Close the tray	1470
Figure 1-2598	Place the control panel on the product	1470
Figure 1-2599	Connect two connectors	1471
Figure 1-2600	Turn the control panel over	1471
Figure 1-2601	Rotate the control-panel base down	1472
Figure 1-2602	Install two screws	1472
Figure 1-2603	Install the cover	1473
Figure 1-2604	Install the cover	1473
Figure 1-2605	Check the installation	1474
Figure 1-2606	Locate the USB cover	1477
Figure 1-2607	Remove the cover	1478
Figure 1-2608	Tilt the control panel up	1479
Figure 1-2609	Release the control-panel screws cover tabs	1479
Figure 1-2610	Remove the cover	1480
Figure 1-2611	Remove two screws	1480
Figure 1-2612	Rotate the control-panel base up	1481
Figure 1-2613	Turn the control panel over	1481
Figure 1-2614	Disconnect two connectors	1482
Figure 1-2615	Pull the tray out	1482

Figure 1-2616	Remove the tray	1483
Figure 1-2617	Open the front door	1483
Figure 1-2618	Open the TCU	1484
Figure 1-2619	Remove the TCU	1485
Figure 1-2620	Locate the formatter cover	1486
Figure 1-2621	Loosen the thumbscrews	1486
Figure 1-2622	Disconnect all connectors	1488
Figure 1-2623	Remove the formatter	1488
Figure 1-2624	Release the HDD	1489
Figure 1-2625	Remove the HDD	1489
Figure 1-2626	Locate the fax PCA	1490
Figure 1-2627	Disconnect one connector	1490
Figure 1-2628	Release one latch	1491
Figure 1-2629	Remove the fax PCA	1491
Figure 1-2630	Disconnect all connectors	1492
Figure 1-2631	Remove four screws	1493
Figure 1-2632	Remove the formatter	1493
Figure 1-2633	Remove four screws	1494
Figure 1-2634	Remove the cover	1494
Figure 1-2635	Remove two screws	1495
Figure 1-2636	Release the right edge	1495
Figure 1-2637	Slide the cover right	1496
Figure 1-2638	Remove the cover	1496
Figure 1-2639	Remove four screws	1497
Figure 1-2640	Remove the cover	1497
Figure 1-2641	Release one tab	1498
Figure 1-2642	Slide the cover back	1498
Figure 1-2643	Remove the left upper cover	1499
Figure 1-2644	Remove one screw	1499
Figure 1-2645	Release two tabs	1500
Figure 1-2646	Rotate the cover	1500
Figure 1-2647	Remove one screw	1501
Figure 1-2648	Release two tabs	1501
Figure 1-2649	Release the back edge of the cover	1502
Figure 1-2650	Remove the cover	1502
Figure 1-2651	Remove one screw	1503
Figure 1-2652	Remove two screws	1503
Figure 1-2653	Remove one screw	1504
Figure 1-2654	Disconnect connectors	1504
Figure 1-2655	Slide the ISA towards the back of the printer	1505
Figure 1-2656	Remove the ISA	1505

Figure 1-2657	Remove two screws and one connector	1506
Figure 1-2658	Remove one screw and connector	1506
Figure 1-2659	Slide the cover	1507
Figure 1-2660	Remove the cover	1507
Figure 1-2661	Remove five screws	1508
Figure 1-2662	Release two tabs	1508
Figure 1-2663	Remove the top rear cover	1509
Figure 1-2664	Remove one screw	1509
Figure 1-2665	Release the cover	1510
Figure 1-2666	Remove the cover	1510
Figure 1-2667	Remove three screws	1511
Figure 1-2668	Remove one screw and release one tab	1511
Figure 1-2669	Release the cover	1512
Figure 1-2670	Remove the cover	1512
Figure 1-2671	Disconnect one connector	1513
Figure 1-2672	Remove the bracket	1513
Figure 1-2673	Remove the LVPS cover	1514
Figure 1-2674	Release wire harnesses and flat cable	1514
Figure 1-2675	Remove six screws	1515
Figure 1-2676	Release the formatter case	1515
Figure 1-2677	Remove the formatter case	1516
Figure 1-2678	Release the cover	1516
Figure 1-2679	Remove the cover	1517
Figure 1-2680	Remove two screws	1517
Figure 1-2681	Remove the plate	1518
Figure 1-2682	Disconnect five connectors and one flat cable	1518
Figure 1-2683	Remove one screw	1519
Figure 1-2684	Release the HVPST	1519
Figure 1-2685	Remove the HVPST	1520
Figure 1-2686	Recycle and unpack	1520
Figure 1-2687	Connect one ground wire	1521
Figure 1-2688	Install the HVPST	1521
Figure 1-2689	Install one screw	1522
Figure 1-2690	Connect five connectors and one flat cable	1522
Figure 1-2691	Install the plate	1523
Figure 1-2692	Install two screws	1523
Figure 1-2693	Install the cover	1524
Figure 1-2694	Install one screw	1524
Figure 1-2695	Pass the wire harnesses through the opening	1525
Figure 1-2696	Install the formatter case	1525
Figure 1-2697	Install six screws	1526

Figure 1-2698	Install wire harnesses and flat cable	1526
Figure 1-2699	Install the LVPS cover	1527
Figure 1-2700	Attach the flat cable	1527
Figure 1-2701	Position the bracket	1528
Figure 1-2702	Connect one connector	1528
Figure 1-2703	Install the cover	1529
Figure 1-2704	Engage one tab	1529
Figure 1-2705	Engage one tab and install one screw	1530
Figure 1-2706	Install three screws	1530
Figure 1-2707	Install the cover	1531
Figure 1-2708	Engage the cover	1531
Figure 1-2709	Install one screw	1532
Figure 1-2710	Align the locator tabs	1532
Figure 1-2711	Install the cover	1533
Figure 1-2712	Install five screws	1533
Figure 1-2713	Install the cables	1534
Figure 1-2714	Position the hooks	1534
Figure 1-2715	Install the cover	1535
Figure 1-2716	Install one screw and connector	1535
Figure 1-2717	Install one screw and connector	1536
Figure 1-2718	Locate the ISA mounting pins and slots	249
Figure 1-2719	Install the ISA	1537
Figure 1-2720	Slide the ISA towards the front of the printer	1537
Figure 1-2721	Install one screw	1538
Figure 1-2722	Install two screws	1538
Figure 1-2723	Install one screw	1539
Figure 1-2724	Connect connectors	1539
Figure 1-2725	Install two tabs	1540
Figure 1-2726	Install the cover assembly	1540
Figure 1-2727	Install one screw	1541
Figure 1-2728	Install the cover	1542
Figure 1-2729	Press the cover	1542
Figure 1-2730	Install one screw	1543
Figure 1-2731	Position the tab	1543
Figure 1-2732	Slide the cover	1544
Figure 1-2733	Check the tab	1544
Figure 1-2734	Position the hooks	1545
Figure 1-2735	Install the cover	1545
Figure 1-2736	Install four screws cover	1546
Figure 1-2737	Align the cover	1546
Figure 1-2738	Rotate the top of the cover	1547

Figure 1-2739	Slide the cover	1547
Figure 1-2740	Install two screws	1548
Figure 1-2741	Install the cover	1548
Figure 1-2742	Install four screws cover	1549
Figure 1-2743	Install the formatter	1549
Figure 1-2744	Install four screws	1550
Figure 1-2745	Connect all connectors	1551
Figure 1-2746	Position the fax PCA	1551
Figure 1-2747	Install the fax PCA	1552
Figure 1-2748	Connect the connector	1552
Figure 1-2749	Install the holder	1553
Figure 1-2750	Release the HDD	1553
Figure 1-2751	Install the formatter	1554
Figure 1-2752	Connect all connectors	1555
Figure 1-2753	Install the cover	1555
Figure 1-2754	Verify that the toner collection hatch cover is closed	1556
Figure 1-2755	Install the TCU	1556
Figure 1-2756	Close the front door	1557
Figure 1-2757	Install the tray	1557
Figure 1-2758	Close the tray	1558
Figure 1-2759	Place the control panel on the product	1558
Figure 1-2760	Connect two connectors	1559
Figure 1-2761	Turn the control panel over	1559
Figure 1-2762	Rotate the control-panel base down	1560
Figure 1-2763	Install two screws	1560
Figure 1-2764	Install the cover	1561
Figure 1-2765	Install the cover	1561
Figure 1-2766	Check the installation	1562
Figure 1-2767	Locate the USB cover	1565
Figure 1-2768	Remove the cover	1566
Figure 1-2769	Tilt the control panel up	1567
Figure 1-2770	Release the control-panel screws cover tabs	1567
Figure 1-2771	Remove the cover	1568
Figure 1-2772	Remove two screws	1568
Figure 1-2773	Rotate the control-panel base up	1569
Figure 1-2774	Turn the control panel over	1569
Figure 1-2775	Disconnect two connectors	1570
Figure 1-2776	Pull the tray out	1570
Figure 1-2777	Remove the tray	1571
Figure 1-2778	Open the front door	1571
Figure 1-2779	Open the TCU	1572

Figure 1-2780	Remove the TCU	1573
Figure 1-2781	Locate the formatter cover	1574
Figure 1-2782	Loosen the thumbscrews	1574
Figure 1-2783	Disconnect all connectors	1576
Figure 1-2784	Remove the formatter	1576
Figure 1-2785	Release the HDD	1577
Figure 1-2786	Remove the HDD	1577
Figure 1-2787	Locate the fax PCA	1578
Figure 1-2788	Disconnect one connector	1578
Figure 1-2789	Release one latch	1579
Figure 1-2790	Remove the fax PCA	1579
Figure 1-2791	Disconnect all connectors	1580
Figure 1-2792	Remove four screws	1581
Figure 1-2793	Remove the formatter	1581
Figure 1-2794	Remove four screws	1582
Figure 1-2795	Remove the cover	1582
Figure 1-2796	Remove two screws	1583
Figure 1-2797	Release the right edge	1583
Figure 1-2798	Slide the cover right	1584
Figure 1-2799	Remove the cover	1584
Figure 1-2800	Remove four screws	1585
Figure 1-2801	Remove the cover	1585
Figure 1-2802	Release one tab	1586
Figure 1-2803	Slide the cover back	1586
Figure 1-2804	Remove the left upper cover	1587
Figure 1-2805	Remove one screw	1587
Figure 1-2806	Release two tabs	1588
Figure 1-2807	Rotate the cover	1588
Figure 1-2808	Remove one screw	1589
Figure 1-2809	Release two tabs	1589
Figure 1-2810	Release the back edge of the cover	1590
Figure 1-2811	Remove the cover	1590
Figure 1-2812	Remove one screw	1591
Figure 1-2813	Remove two screws	1591
Figure 1-2814	Remove one screw	1592
Figure 1-2815	Disconnect connectors	1592
Figure 1-2816	Slide the ISA towards the back of the printer	1593
Figure 1-2817	Remove the ISA	1593
Figure 1-2818	Remove two screws and one connector	1594
Figure 1-2819	Remove one screw and connector	1594
Figure 1-2820	Slide the cover	1595

Figure 1-2821	Remove the cover	1595
Figure 1-2822	Remove five screws	1596
Figure 1-2823	Release two tabs	1596
Figure 1-2824	Remove the top rear cover	1597
Figure 1-2825	Remove one screw	1597
Figure 1-2826	Release the cover	1598
Figure 1-2827	Remove the cover	1598
Figure 1-2828	Remove three screws	1599
Figure 1-2829	Remove one screw and release one tab	1599
Figure 1-2830	Release the cover	1600
Figure 1-2831	Remove the cover	1600
Figure 1-2832	Disconnect one connector	1601
Figure 1-2833	Remove the bracket	1601
Figure 1-2834	Remove the LVPS cover	1602
Figure 1-2835	Release wire harnesses and flat cable	1602
Figure 1-2836	Remove six screws	1603
Figure 1-2837	Release the formatter case	1603
Figure 1-2838	Remove the formatter case	1604
Figure 1-2839	Release the cover	1604
Figure 1-2840	Remove the cover	1605
Figure 1-2841	Remove two screws	1605
Figure 1-2842	Remove the plate	1606
Figure 1-2843	Disconnect five connectors and one flat cable	1606
Figure 1-2844	Remove one screw	1607
Figure 1-2845	Release the HVPST	1607
Figure 1-2846	Remove the HVPST	1608
Figure 1-2847	Remove the motor	1608
Figure 1-2848	Recycle and unpack	1609
Figure 1-2849	Install the motor	1609
Figure 1-2850	Connect one ground wire	1610
Figure 1-2851	Install the HVPST	1610
Figure 1-2852	Install one screw	1611
Figure 1-2853	Connect five connectors and one flat cable	1611
Figure 1-2854	Install the plate	1612
Figure 1-2855	Install two screws	1612
Figure 1-2856	Install the cover	1613
Figure 1-2857	Install one screw	1613
Figure 1-2858	Pass the wire harnesses through the opening	1614
Figure 1-2859	Install the formatter case	1614
Figure 1-2860	Install six screws	1615
Figure 1-2861	Install wire harnesses and flat cable	1615

Figure 1-2862	Install the LVPS cover	1616
Figure 1-2863	Attach the flat cable	1616
Figure 1-2864	Position the bracket	1617
Figure 1-2865	Connect one connector	1617
Figure 1-2866	Install the cover	1618
Figure 1-2867	Engage one tab	1618
Figure 1-2868	Engage one tab and install one screw	1619
Figure 1-2869	Install three screws	1619
Figure 1-2870	Install the cover	1620
Figure 1-2871	Engage the cover	1620
Figure 1-2872	Install one screw	1621
Figure 1-2873	Align the locator tabs	1621
Figure 1-2874	Install the cover	1622
Figure 1-2875	Install five screws	1622
Figure 1-2876	Install the cables	1623
Figure 1-2877	Position the hooks	1623
Figure 1-2878	Install the cover	1624
Figure 1-2879	Install one screw and connector	1624
Figure 1-2880	Install one screw and connector	1625
Figure 1-2881	Locate the ISA mounting pins and slots	249
Figure 1-2882	Install the ISA	1626
Figure 1-2883	Slide the ISA towards the front of the printer	1626
Figure 1-2884	Install one screw	1627
Figure 1-2885	Install two screws	1627
Figure 1-2886	Install one screw	1628
Figure 1-2887	Connect connectors	1628
Figure 1-2888	Install two tabs	1629
Figure 1-2889	Install the cover assembly	1629
Figure 1-2890	Install one screw	1630
Figure 1-2891	Install the cover	1631
Figure 1-2892	Press the cover	1631
Figure 1-2893	Install one screw	1632
Figure 1-2894	Position the tab	1632
Figure 1-2895	Slide the cover	1633
Figure 1-2896	Check the tab	1633
Figure 1-2897	Position the hooks	1634
Figure 1-2898	Install the cover	1634
Figure 1-2899	Install four screws cover	1635
Figure 1-2900	Align the cover	1635
Figure 1-2901	Rotate the top of the cover	1636
Figure 1-2902	Slide the cover	1636

Figure 1-2903	Install two screws	1637
Figure 1-2904	Install the cover	1637
Figure 1-2905	Install four screws cover	1638
Figure 1-2906	Install the formatter	1638
Figure 1-2907	Install four screws	1639
Figure 1-2908	Connect all connectors	1640
Figure 1-2909	Position the fax PCA	1640
Figure 1-2910	Install the fax PCA	1641
Figure 1-2911	Connect the connector	1641
Figure 1-2912	Install the holder	1642
Figure 1-2913	Release the HDD	1642
Figure 1-2914	Install the formatter	1643
Figure 1-2915	Connect all connectors	1644
Figure 1-2916	Install the cover	1644
Figure 1-2917	Verify that the toner collection hatch cover is closed	1645
Figure 1-2918	Install the TCU	1645
Figure 1-2919	Close the front door	1646
Figure 1-2920	Install the tray	1646
Figure 1-2921	Close the tray	1647
Figure 1-2922	Place the control panel on the product	1647
Figure 1-2923	Connect two connectors	1648
Figure 1-2924	Turn the control panel over	1648
Figure 1-2925	Rotate the control-panel base down	1649
Figure 1-2926	Install two screws	1649
Figure 1-2927	Install the cover	1650
Figure 1-2928	Install the cover	1650
Figure 1-2929	Check the installation	1651
Figure 1-2930	Locate the USB cover	1654
Figure 1-2931	Remove the cover	1655
Figure 1-2932	Tilt the control panel up	1656
Figure 1-2933	Release the control-panel screws cover tabs	1656
Figure 1-2934	Remove the cover	1657
Figure 1-2935	Remove two screws	1657
Figure 1-2936	Rotate the control-panel base up	1658
Figure 1-2937	Turn the control panel over	1658
Figure 1-2938	Disconnect two connectors	1659
Figure 1-2939	Pull the tray out	1659
Figure 1-2940	Remove the tray	1660
Figure 1-2941	Open the front door	1660
Figure 1-2942	Open the TCU	1661
Figure 1-2943	Remove the TCU	1662

Figure 1-2944	Locate the formatter cover	1663
Figure 1-2945	Loosen the thumbscrews	1663
Figure 1-2946	Disconnect all connectors	1665
Figure 1-2947	Remove the formatter	1665
Figure 1-2948	Release the HDD	1666
Figure 1-2949	Remove the HDD	1666
Figure 1-2950	Locate the fax PCA	1667
Figure 1-2951	Disconnect one connector	1667
Figure 1-2952	Release one latch	1668
Figure 1-2953	Remove the fax PCA	1668
Figure 1-2954	Disconnect all connectors	1669
Figure 1-2955	Remove four screws	1670
Figure 1-2956	Remove the formatter	1670
Figure 1-2957	Remove four screws	1671
Figure 1-2958	Remove the cover	1671
Figure 1-2959	Remove two screws	1672
Figure 1-2960	Release the right edge	1672
Figure 1-2961	Slide the cover right	1673
Figure 1-2962	Remove the cover	1673
Figure 1-2963	Remove four screws	1674
Figure 1-2964	Remove the cover	1674
Figure 1-2965	Release one tab	1675
Figure 1-2966	Slide the cover back	1675
Figure 1-2967	Remove the left upper cover	1676
Figure 1-2968	Remove one screw	1676
Figure 1-2969	Release two tabs	1677
Figure 1-2970	Rotate the cover	1677
Figure 1-2971	Remove one screw	1678
Figure 1-2972	Release two tabs	1678
Figure 1-2973	Release the back edge of the cover	1679
Figure 1-2974	Remove the cover	1679
Figure 1-2975	Remove one screw	1680
Figure 1-2976	Remove two screws	1680
Figure 1-2977	Remove one screw	1681
Figure 1-2978	Disconnect connectors	1681
Figure 1-2979	Slide the ISA towards the back of the printer	1682
Figure 1-2980	Remove the ISA	1682
Figure 1-2981	Remove two screws and one connector	1683
Figure 1-2982	Remove one screw and connector	1683
Figure 1-2983	Slide the cover	1684
Figure 1-2984	Remove the cover	1684

Figure 1-2985	Remove five screws	1685
Figure 1-2986	Release two tabs	1685
Figure 1-2987	Remove the top rear cover	1686
Figure 1-2988	Remove one screw	1686
Figure 1-2989	Release the cover	1687
Figure 1-2990	Remove the cover	1687
Figure 1-2991	Remove three screws	1688
Figure 1-2992	Remove one screw and release one tab	1688
Figure 1-2993	Release the cover	1689
Figure 1-2994	Remove the cover	1689
Figure 1-2995	Disconnect one connector	1690
Figure 1-2996	Remove the bracket	1690
Figure 1-2997	Remove the LVPS cover	1691
Figure 1-2998	Release wire harnesses and flat cable	1691
Figure 1-2999	Remove six screws	1692
Figure 1-3000	Release the formatter case	1692
Figure 1-3001	Remove the formatter case	1693
Figure 1-3002	Release the cover	1693
Figure 1-3003	Remove the cover	1694
Figure 1-3004	Remove two screws	1694
Figure 1-3005	Remove the plate	1695
Figure 1-3006	Disconnect five connectors and one flat cable	1695
Figure 1-3007	Remove one screw	1696
Figure 1-3008	Release the HVPST	1696
Figure 1-3009	Remove the HVPST	1697
Figure 1-3010	Remove the motor	1697
Figure 1-3011	Recycle and unpack	1698
Figure 1-3012	Install the motor	1698
Figure 1-3013	Connect one ground wire	1699
Figure 1-3014	Install the HVPST	1699
Figure 1-3015	Install one screw	1700
Figure 1-3016	Connect five connectors and one flat cable	1700
Figure 1-3017	Install the plate	1701
Figure 1-3018	Install two screws	1701
Figure 1-3019	Install the cover	1702
Figure 1-3020	Install one screw	1702
Figure 1-3021	Pass the wire harnesses through the opening	1703
Figure 1-3022	Install the formatter case	1703
Figure 1-3023	Install six screws	1704
Figure 1-3024	Install wire harnesses and flat cable	1704
Figure 1-3025	Install the LVPS cover	1705

Figure 1-3026	Attach the flat cable	1705
Figure 1-3027	Position the bracket	1706
Figure 1-3028	Connect one connector	1706
Figure 1-3029	Install the cover	1707
Figure 1-3030	Engage one tab	1707
Figure 1-3031	Engage one tab and install one screw	1708
Figure 1-3032	Install three screws	1708
Figure 1-3033	Install the cover	1709
Figure 1-3034	Engage the cover	1709
Figure 1-3035	Install one screw	1710
Figure 1-3036	Align the locator tabs	1710
Figure 1-3037	Install the cover	1711
Figure 1-3038	Install five screws	1711
Figure 1-3039	Install the cables	1712
Figure 1-3040	Position the hooks	1712
Figure 1-3041	Install the cover	1713
Figure 1-3042	Install one screw and connector	1713
Figure 1-3043	Install one screw and connector	1714
Figure 1-3044	Locate the ISA mounting pins and slots	249
Figure 1-3045	Install the ISA	1715
Figure 1-3046	Slide the ISA towards the front of the printer	1715
Figure 1-3047	Install one screw	1716
Figure 1-3048	Install two screws	1716
Figure 1-3049	Install one screw	1717
Figure 1-3050	Connect connectors	1717
Figure 1-3051	Install two tabs	1718
Figure 1-3052	Install the cover assembly	1718
Figure 1-3053	Install one screw	1719
Figure 1-3054	Install the cover	1720
Figure 1-3055	Press the cover	1720
Figure 1-3056	Install one screw	1721
Figure 1-3057	Position the tab	1721
Figure 1-3058	Slide the cover	1722
Figure 1-3059	Check the tab	1722
Figure 1-3060	Position the hooks	1723
Figure 1-3061	Install the cover	1723
Figure 1-3062	Install four screws cover	1724
Figure 1-3063	Align the cover	1724
Figure 1-3064	Rotate the top of the cover	1725
Figure 1-3065	Slide the cover	1725
Figure 1-3066	Install two screws	1726

Figure 1-3067	Install the cover	1726
Figure 1-3068	Install four screws cover	1727
Figure 1-3069	Install the formatter	1727
Figure 1-3070	Install four screws	1728
Figure 1-3071	Connect all connectors	1729
Figure 1-3072	Position the fax PCA	1729
Figure 1-3073	Install the fax PCA	1730
Figure 1-3074	Connect the connector	1730
Figure 1-3075	Install the holder	1731
Figure 1-3076	Release the HDD	1731
Figure 1-3077	Install the formatter	1732
Figure 1-3078	Connect all connectors	1733
Figure 1-3079	Install the cover	1733
Figure 1-3080	Verify that the toner collection hatch cover is closed	1734
Figure 1-3081	Install the TCU	1734
Figure 1-3082	Close the front door	1735
Figure 1-3083	Install the tray	1735
Figure 1-3084	Close the tray	1736
Figure 1-3085	Place the control panel on the product	1736
Figure 1-3086	Connect two connectors	1737
Figure 1-3087	Turn the control panel over	1737
Figure 1-3088	Rotate the control-panel base down	1738
Figure 1-3089	Install two screws	1738
Figure 1-3090	Install the cover	1739
Figure 1-3091	Install the cover	1739
Figure 1-3092	Check the installation	1740
Figure 1-3093	Locate the USB cover	1743
Figure 1-3094	Remove the cover	1744
Figure 1-3095	Tilt the control panel up	1745
Figure 1-3096	Release the control-panel screws cover tabs	1745
Figure 1-3097	Remove the cover	1746
Figure 1-3098	Remove two screws	1746
Figure 1-3099	Rotate the control-panel base up	1747
Figure 1-3100	Turn the control panel over	1747
Figure 1-3101	Disconnect two connectors	1748
Figure 1-3102	Pull the tray out	1748
Figure 1-3103	Remove the tray	1749
Figure 1-3104	Open the front door	1749
Figure 1-3105	Open the TCU	1750
Figure 1-3106	Remove the TCU	1751
Figure 1-3107	Locate the formatter cover	1752

Figure 1-3108	Loosen the thumbscrews	1752
Figure 1-3109	Disconnect all connectors	1754
Figure 1-3110	Remove the formatter	1754
Figure 1-3111	Release the HDD	1755
Figure 1-3112	Remove the HDD	1755
Figure 1-3113	Locate the fax PCA	1756
Figure 1-3114	Disconnect one connector	1756
Figure 1-3115	Release one latch	1757
Figure 1-3116	Remove the fax PCA	1757
Figure 1-3117	Disconnect all connectors	1758
Figure 1-3118	Remove four screws	1759
Figure 1-3119	Remove the formatter	1759
Figure 1-3120	Remove four screws	1760
Figure 1-3121	Remove the cover	1760
Figure 1-3122	Remove two screws	1761
Figure 1-3123	Release the right edge	1761
Figure 1-3124	Slide the cover right	1762
Figure 1-3125	Remove the cover	1762
Figure 1-3126	Remove four screws	1763
Figure 1-3127	Remove the cover	1763
Figure 1-3128	Release one tab	1764
Figure 1-3129	Slide the cover back	1764
Figure 1-3130	Remove the left upper cover	1765
Figure 1-3131	Remove one screw	1765
Figure 1-3132	Release two tabs	1766
Figure 1-3133	Rotate the cover	1766
Figure 1-3134	Remove one screw	1767
Figure 1-3135	Release two tabs	1767
Figure 1-3136	Release the back edge of the cover	1768
Figure 1-3137	Remove the cover	1768
Figure 1-3138	Remove one screw	1769
Figure 1-3139	Remove two screws	1769
Figure 1-3140	Remove one screw	1770
Figure 1-3141	Disconnect connectors	1770
Figure 1-3142	Slide the ISA towards the back of the printer	1771
Figure 1-3143	Remove the ISA	1771
Figure 1-3144	Remove two screws and one connector	1772
Figure 1-3145	Remove one screw and connector	1772
Figure 1-3146	Slide the cover	1773
Figure 1-3147	Remove the cover	1773
Figure 1-3148	Remove five screws	1774

Figure 1-3149	Release two tabs	1774
Figure 1-3150	Remove the top rear cover	1775
Figure 1-3151	Remove one screw	1775
Figure 1-3152	Release the cover	1776
Figure 1-3153	Remove the cover	1776
Figure 1-3154	Remove three screws	1777
Figure 1-3155	Remove one screw and release one tab	1777
Figure 1-3156	Release the cover	1778
Figure 1-3157	Remove the cover	1778
Figure 1-3158	Disconnect one connector	1779
Figure 1-3159	Remove the bracket	1779
Figure 1-3160	Remove the LVPS cover	1780
Figure 1-3161	Release wire harnesses and flat cable	1780
Figure 1-3162	Remove six screws	1781
Figure 1-3163	Release the formatter case	1781
Figure 1-3164	Remove the formatter case	1782
Figure 1-3165	Release the cover	1782
Figure 1-3166	Remove the cover	1783
Figure 1-3167	Remove two screws	1783
Figure 1-3168	Remove the plate	1784
Figure 1-3169	Disconnect five connectors and one flat cable	1784
Figure 1-3170	Remove one screw	1785
Figure 1-3171	Release the HVPST	1785
Figure 1-3172	Remove the HVPST	1786
Figure 1-3173	Remove the motor	1786
Figure 1-3174	Recycle and unpack	1787
Figure 1-3175	Install the motor	1787
Figure 1-3176	Connect one ground wire	1788
Figure 1-3177	Install the HVPST	1788
Figure 1-3178	Install one screw	1789
Figure 1-3179	Connect five connectors and one flat cable	1789
Figure 1-3180	Install the plate	1790
Figure 1-3181	Install two screws	1790
Figure 1-3182	Install the cover	1791
Figure 1-3183	Install one screw	1791
Figure 1-3184	Pass the wire harnesses through the opening	1792
Figure 1-3185	Install the formatter case	1792
Figure 1-3186	Install six screws	1793
Figure 1-3187	Install wire harnesses and flat cable	1793
Figure 1-3188	Install the LVPS cover	1794
Figure 1-3189	Attach the flat cable	1794

Figure 1-3190	Position the bracket	1795
Figure 1-3191	Connect one connector	1795
Figure 1-3192	Install the cover	1796
Figure 1-3193	Engage one tab	1796
Figure 1-3194	Engage one tab and install one screw	1797
Figure 1-3195	Install three screws	1797
Figure 1-3196	Install the cover	1798
Figure 1-3197	Engage the cover	1798
Figure 1-3198	Install one screw	1799
Figure 1-3199	Align the locator tabs	1799
Figure 1-3200	Install the cover	1800
Figure 1-3201	Install five screws	1800
Figure 1-3202	Install the cables	1801
Figure 1-3203	Position the hooks	1801
Figure 1-3204	Install the cover	1802
Figure 1-3205	Install one screw and connector	1802
Figure 1-3206	Install one screw and connector	1803
Figure 1-3207	Locate the ISA mounting pins and slots	249
Figure 1-3208	Install the ISA	1804
Figure 1-3209	Slide the ISA towards the front of the printer	1804
Figure 1-3210	Install one screw	1805
Figure 1-3211	Install two screws	1805
Figure 1-3212	Install one screw	1806
Figure 1-3213	Connect connectors	1806
Figure 1-3214	Install two tabs	1807
Figure 1-3215	Install the cover assembly	1807
Figure 1-3216	Install one screw	1808
Figure 1-3217	Install the cover	1809
Figure 1-3218	Press the cover	1809
Figure 1-3219	Install one screw	1810
Figure 1-3220	Position the tab	1810
Figure 1-3221	Slide the cover	1811
Figure 1-3222	Check the tab	1811
Figure 1-3223	Position the hooks	1812
Figure 1-3224	Install the cover	1812
Figure 1-3225	Install four screws cover	1813
Figure 1-3226	Align the cover	1813
Figure 1-3227	Rotate the top of the cover	1814
Figure 1-3228	Slide the cover	1814
Figure 1-3229	Install two screws	1815
Figure 1-3230	Install the cover	1815

Figure 1-3231	Install four screws cover	1816
Figure 1-3232	Install the formatter	1816
Figure 1-3233	Install four screws	1817
Figure 1-3234	Connect all connectors	1818
Figure 1-3235	Position the fax PCA	1818
Figure 1-3236	Install the fax PCA	1819
Figure 1-3237	Connect the connector	1819
Figure 1-3238	Install the holder	1820
Figure 1-3239	Release the HDD	1820
Figure 1-3240	Install the formatter	1821
Figure 1-3241	Connect all connectors	1822
Figure 1-3242	Install the cover	1822
Figure 1-3243	Verify that the toner collection hatch cover is closed	1823
Figure 1-3244	Install the TCU	1823
Figure 1-3245	Close the front door	1824
Figure 1-3246	Install the tray	1824
Figure 1-3247	Close the tray	1825
Figure 1-3248	Place the control panel on the product	1825
Figure 1-3249	Connect two connectors	1826
Figure 1-3250	Turn the control panel over	1826
Figure 1-3251	Rotate the control-panel base down	1827
Figure 1-3252	Install two screws	1827
Figure 1-3253	Install the cover	1828
Figure 1-3254	Install the cover	1828
Figure 1-3255	Check the installation	1829
Figure 1-3256	Locate the formatter cover	1831
Figure 1-3257	Loosen the thumbscrews	1832
Figure 1-3258	Remove four screws	1832
Figure 1-3259	Remove the cover	1833
Figure 1-3260	Remove two screws	1833
Figure 1-3261	Release the right edge	1834
Figure 1-3262	Slide the cover right	1834
Figure 1-3263	Remove the cover	1835
Figure 1-3264	Remove four screws	1835
Figure 1-3265	Remove the cover	1836
Figure 1-3266	Remove the LVPS cover	1836
Figure 1-3267	Disconnect one connector	1837
Figure 1-3268	Remove the sensor	1837
Figure 1-3269	Recycle and unpack	1838
Figure 1-3270	Install the sensor	1838
Figure 1-3271	Connect one connector	1839

Figure 1-3272	Install the LVPS cover	1839
Figure 1-3273	Position the hooks	1840
Figure 1-3274	Install the cover	1840
Figure 1-3275	Install four screws cover	1841
Figure 1-3276	Align the cover	1841
Figure 1-3277	Rotate the top of the cover	1842
Figure 1-3278	Slide the cover	1842
Figure 1-3279	Install two screws	1843
Figure 1-3280	Install the cover	1843
Figure 1-3281	Install four screws cover	1844
Figure 1-3282	Install the cover	1844
Figure 1-3283	Locate the USB cover	1848
Figure 1-3284	Remove the cover	1848
Figure 1-3285	Open the right door	1849
Figure 1-3286	Release the fuser	1849
Figure 1-3287	Remove the fuser	1850
Figure 1-3288	Tilt the control panel up	1851
Figure 1-3289	Release the control-panel screws cover tabs	1851
Figure 1-3290	Remove the cover	1852
Figure 1-3291	Remove two screws	1852
Figure 1-3292	Rotate the control-panel base up	1853
Figure 1-3293	Turn the control panel over	1853
Figure 1-3294	Disconnect two connectors	1854
Figure 1-3295	Pull the tray out	1854
Figure 1-3296	Remove the tray	1855
Figure 1-3297	Open the front door	1855
Figure 1-3298	Open the TCU	1856
Figure 1-3299	Remove the TCU	1857
Figure 1-3300	Locate the formatter cover	1858
Figure 1-3301	Loosen the thumbscrews	1858
Figure 1-3302	Disconnect all connectors	1860
Figure 1-3303	Remove the formatter	1860
Figure 1-3304	Release the HDD	1861
Figure 1-3305	Remove the HDD	1861
Figure 1-3306	Locate the fax PCA	1862
Figure 1-3307	Disconnect one connector	1862
Figure 1-3308	Release one latch	1863
Figure 1-3309	Remove the fax PCA	1863
Figure 1-3310	Disconnect all connectors	1864
Figure 1-3311	Remove four screws	1865
Figure 1-3312	Remove the formatter	1865

Figure 1-3313	Remove four screws	1866
Figure 1-3314	Remove the cover	1866
Figure 1-3315	Remove two screws	1867
Figure 1-3316	Release the right edge	1867
Figure 1-3317	Slide the cover right	1868
Figure 1-3318	Remove the cover	1868
Figure 1-3319	Remove four screws	1869
Figure 1-3320	Remove the cover	1869
Figure 1-3321	Release one tab	1870
Figure 1-3322	Slide the cover back	1870
Figure 1-3323	Remove the left upper cover	1871
Figure 1-3324	Remove one screw	1871
Figure 1-3325	Release two tabs	1872
Figure 1-3326	Rotate the cover	1872
Figure 1-3327	Remove one screw	1873
Figure 1-3328	Release two tabs	1873
Figure 1-3329	Release the back edge of the cover	1874
Figure 1-3330	Remove the cover	1874
Figure 1-3331	Remove one screw	1875
Figure 1-3332	Remove two screws	1875
Figure 1-3333	Remove one screw	1876
Figure 1-3334	Disconnect connectors	1876
Figure 1-3335	Slide the ISA towards the back of the printer	1877
Figure 1-3336	Remove the ISA	1877
Figure 1-3337	Disconnect connector and remove screws	1878
Figure 1-3338	Remove the stapler unit	1878
Figure 1-3339	Remove two screws and one connector	1879
Figure 1-3340	Remove one screw and connector	1879
Figure 1-3341	Slide the cover	1880
Figure 1-3342	Remove the cover	1880
Figure 1-3343	Remove five screws	1881
Figure 1-3344	Release two tabs	1881
Figure 1-3345	Remove the top rear cover	1882
Figure 1-3346	Remove one screw	1882
Figure 1-3347	Remove the cover	1883
Figure 1-3348	Remove one screw	1883
Figure 1-3349	Remove one screw	1884
Figure 1-3350	Release one tab	1884
Figure 1-3351	Release two tabs	1885
Figure 1-3352	Remove three screws	1885
Figure 1-3353	Remove two screws	1886

Figure 1-3354	Remove the bracket	1886
Figure 1-3355	Remove one screw	1887
Figure 1-3356	Release the cover	1887
Figure 1-3357	Remove the cover	1888
Figure 1-3358	Remove three screws	1888
Figure 1-3359	Remove one screw and release one tab	1889
Figure 1-3360	Release the cover	1889
Figure 1-3361	Remove the cover	1890
Figure 1-3362	Disconnect one connector	1890
Figure 1-3363	Remove the bracket	1891
Figure 1-3364	Remove the LVPS cover	1891
Figure 1-3365	Release wire harnesses and flat cable	1892
Figure 1-3366	Remove six screws	1892
Figure 1-3367	Release the formatter case	1893
Figure 1-3368	Remove the formatter case	1893
Figure 1-3369	Release the cover	1894
Figure 1-3370	Remove the cover	1894
Figure 1-3371	Remove two screws	1895
Figure 1-3372	Remove the plate	1895
Figure 1-3373	Disconnect five connectors and one flat cable	1896
Figure 1-3374	Remove one screw	1896
Figure 1-3375	Release the HVPST	1897
Figure 1-3376	Remove the HVPST	1897
Figure 1-3377	Move the guide out of the way	1898
Figure 1-3378	Disconnect one connector	1898
Figure 1-3379	Remove one screw	1899
Figure 1-3380	Remove the guide	1899
Figure 1-3381	Remove three screws	1900
Figure 1-3382	Remove the assembly	1900
Figure 1-3383	Recycle and unpack	1901
Figure 1-3384	Check the gears on the assembly	1902
Figure 1-3385	Install three screws	1902
Figure 1-3386	Install the guide	1903
Figure 1-3387	Install one screw	1903
Figure 1-3388	Connect one connector	1904
Figure 1-3389	Install the guide	1904
Figure 1-3390	Connect one ground wire	1905
Figure 1-3391	Install the HVPST	1905
Figure 1-3392	Install one screw	1906
Figure 1-3393	Connect five connectors and one flat cable	1906
Figure 1-3394	Install the plate	1907

Figure 1-3395	Install two screws	1907
Figure 1-3396	Install the cover	1908
Figure 1-3397	Install one screw	1908
Figure 1-3398	Pass the wire harnesses through the opening	1909
Figure 1-3399	Install the formatter case	1909
Figure 1-3400	Install six screws	1910
Figure 1-3401	Install wire harnesses and flat cable	1910
Figure 1-3402	Install the LVPS cover	1911
Figure 1-3403	Attach the flat cable	1911
Figure 1-3404	Position the bracket	1912
Figure 1-3405	Connect one connector	1912
Figure 1-3406	Install the cover	1913
Figure 1-3407	Engage one tab	1913
Figure 1-3408	Engage one tab and install one screw	1914
Figure 1-3409	Install three screws	1914
Figure 1-3410	Install the cover	1915
Figure 1-3411	Engage the cover	1915
Figure 1-3412	Install one screw	1916
Figure 1-3413	Position the tabs in the slots	1916
Figure 1-3414	Install two screws	1917
Figure 1-3415	Install three screws	1917
Figure 1-3416	Position the locator pins	1918
Figure 1-3417	Press down on the cover	1918
Figure 1-3418	Install one screw	1919
Figure 1-3419	Install one screw	1919
Figure 1-3420	Install the cover	1920
Figure 1-3421	Install one screw	1920
Figure 1-3422	Align the locator tabs	1921
Figure 1-3423	Install the cover	1921
Figure 1-3424	Install five screws	1922
Figure 1-3425	Install the cables	1922
Figure 1-3426	Position the hooks	1923
Figure 1-3427	Install the cover	1923
Figure 1-3428	Install one screw and connector	1924
Figure 1-3429	Install one screw and connector	1924
Figure 1-3430	Position the hooks in the slots	1925
Figure 1-3431	Connect connector and install screws	1925
Figure 1-3432	Locate the ISA mounting pins and slots	249
Figure 1-3433	Install the ISA	1927
Figure 1-3434	Slide the ISA towards the front of the printer	1927
Figure 1-3435	Install one screw	1928

Figure 1-3436	Install two screws	1928
Figure 1-3437	Install one screw	1929
Figure 1-3438	Connect connectors	1929
Figure 1-3439	Install two tabs	1930
Figure 1-3440	Install the cover assembly	1930
Figure 1-3441	Install one screw	1931
Figure 1-3442	Install the cover	1932
Figure 1-3443	Press the cover	1932
Figure 1-3444	Install one screw	1933
Figure 1-3445	Position the tab	1933
Figure 1-3446	Slide the cover	1934
Figure 1-3447	Check the tab	1934
Figure 1-3448	Position the hooks	1935
Figure 1-3449	Install the cover	1935
Figure 1-3450	Install four screws cover	1936
Figure 1-3451	Align the cover	1936
Figure 1-3452	Rotate the top of the cover	1937
Figure 1-3453	Slide the cover	1937
Figure 1-3454	Install two screws	1938
Figure 1-3455	Install the cover	1938
Figure 1-3456	Install four screws cover	1939
Figure 1-3457	Install the formatter	1939
Figure 1-3458	Install four screws	1940
Figure 1-3459	Connect all connectors	1941
Figure 1-3460	Position the fax PCA	1941
Figure 1-3461	Install the fax PCA	1942
Figure 1-3462	Connect the connector	1942
Figure 1-3463	Install the holder	1943
Figure 1-3464	Release the HDD	1943
Figure 1-3465	Install the formatter	1944
Figure 1-3466	Connect all connectors	1945
Figure 1-3467	Install the cover	1945
Figure 1-3468	Verify that the toner collection hatch cover is closed	1946
Figure 1-3469	Install the TCU	1946
Figure 1-3470	Close the front door	1947
Figure 1-3471	Install the tray	1947
Figure 1-3472	Close the tray	1948
Figure 1-3473	Place the control panel on the product	1948
Figure 1-3474	Connect two connectors	1949
Figure 1-3475	Turn the control panel over	1949
Figure 1-3476	Rotate the control-panel base down	1950

Figure 1-3477	Install two screws	1950
Figure 1-3478	Install the cover	1951
Figure 1-3479	Align the fuser with the opening	1951
Figure 1-3480	Install the fuser	1952
Figure 1-3481	Close the right door	1952
Figure 1-3482	Install the cover	1953
Figure 1-3483	Check the installation	1953
Figure 1-3484	Open the right door	1957
Figure 1-3485	Release the fuser	1958
Figure 1-3486	Remove the fuser	1958
Figure 1-3487	Open the right door	1959
Figure 1-3488	Release the ITB drive coupling	1959
Figure 1-3489	Lower the secondary transfer roller assembly	1960
Figure 1-3490	Release the front-side ITB spring	1960
Figure 1-3491	Place the spring on the holder	1961
Figure 1-3492	Release the rear-side ITB spring	1961
Figure 1-3493	Place the spring on the holder	1962
Figure 1-3494	Grasp the ITB handles	1963
Figure 1-3495	Remove the ITB	1963
Figure 1-3496	Locate the USB cover	1964
Figure 1-3497	Remove the cover	1964
Figure 1-3498	Tilt the control panel up	1965
Figure 1-3499	Release the control-panel screws cover tabs	1965
Figure 1-3500	Remove the cover	1966
Figure 1-3501	Remove two screws	1966
Figure 1-3502	Rotate the control-panel base up	1967
Figure 1-3503	Turn the control panel over	1967
Figure 1-3504	Disconnect two connectors	1968
Figure 1-3505	Pull the tray out	1968
Figure 1-3506	Remove the tray	1969
Figure 1-3507	Open the front door	1969
Figure 1-3508	Open the TCU	1970
Figure 1-3509	Remove the TCU	1971
Figure 1-3510	Locate the formatter cover	1972
Figure 1-3511	Loosen the thumbscrews	1972
Figure 1-3512	Disconnect all connectors	1974
Figure 1-3513	Remove the formatter	1974
Figure 1-3514	Release the HDD	1975
Figure 1-3515	Remove the HDD	1975
Figure 1-3516	Locate the fax PCA	1976
Figure 1-3517	Disconnect one connector	1976

Figure 1-3518	Release one latch	1977
Figure 1-3519	Remove the fax PCA	1977
Figure 1-3520	Disconnect all connectors	1978
Figure 1-3521	Remove four screws	1979
Figure 1-3522	Remove the formatter	1979
Figure 1-3523	Remove four screws	1980
Figure 1-3524	Remove the cover	1980
Figure 1-3525	Remove two screws	1981
Figure 1-3526	Release the right edge	1981
Figure 1-3527	Slide the cover right	1982
Figure 1-3528	Remove the cover	1982
Figure 1-3529	Remove four screws	1983
Figure 1-3530	Remove the cover	1983
Figure 1-3531	Release one tab	1984
Figure 1-3532	Slide the cover back	1984
Figure 1-3533	Remove the left upper cover	1985
Figure 1-3534	Remove one screw	1985
Figure 1-3535	Release two tabs	1986
Figure 1-3536	Rotate the cover	1986
Figure 1-3537	Remove one screw	1987
Figure 1-3538	Release two tabs	1987
Figure 1-3539	Release the back edge of the cover	1988
Figure 1-3540	Remove the cover	1988
Figure 1-3541	Remove one screw	1989
Figure 1-3542	Remove two screws	1989
Figure 1-3543	Remove one screw	1990
Figure 1-3544	Disconnect connectors	1990
Figure 1-3545	Slide the ISA towards the back of the printer	1991
Figure 1-3546	Remove the ISA	1991
Figure 1-3547	Disconnect connector and remove screws	1992
Figure 1-3548	Remove the stapler unit	1992
Figure 1-3549	Remove two screws and one connector	1993
Figure 1-3550	Remove one screw and connector	1993
Figure 1-3551	Slide the cover	1994
Figure 1-3552	Remove the cover	1994
Figure 1-3553	Remove five screws	1995
Figure 1-3554	Release two tabs	1995
Figure 1-3555	Remove the top rear cover	1996
Figure 1-3556	Remove one screw	1996
Figure 1-3557	Remove the cover	1997
Figure 1-3558	Remove one screw	1997

Figure 1-3559	Remove one screw	1998
Figure 1-3560	Release one tab	1998
Figure 1-3561	Release two tabs	1999
Figure 1-3562	Remove three screws	1999
Figure 1-3563	Remove two screws	2000
Figure 1-3564	Remove the bracket	2000
Figure 1-3565	Remove one screw	2001
Figure 1-3566	Release the cover	2001
Figure 1-3567	Remove the cover	2002
Figure 1-3568	Remove three screws	2002
Figure 1-3569	Remove one screw and release one tab	2003
Figure 1-3570	Release the cover	2003
Figure 1-3571	Remove the cover	2004
Figure 1-3572	Remove one screw	2004
Figure 1-3573	Remove the PCA holder	2005
Figure 1-3574	Remove one cable	2005
Figure 1-3575	Remove four screws	2006
Figure 1-3576	Remove the control panel	2006
Figure 1-3577	Release the cover	2007
Figure 1-3578	Remove the cover	2007
Figure 1-3579	Disconnect one connector	2008
Figure 1-3580	Remove the bracket	2008
Figure 1-3581	Remove the LVPS cover	2009
Figure 1-3582	Release wire harnesses and flat cable	2009
Figure 1-3583	Remove six screws	2010
Figure 1-3584	Release the formatter case	2010
Figure 1-3585	Remove the formatter case	2011
Figure 1-3586	Release the cover	2011
Figure 1-3587	Remove the cover	2012
Figure 1-3588	Remove two screws	2012
Figure 1-3589	Remove the plate	2013
Figure 1-3590	Disconnect five connectors and one flat cable	2013
Figure 1-3591	Remove one screw	2014
Figure 1-3592	Release the HVPST	2014
Figure 1-3593	Remove the HVPST	2015
Figure 1-3594	Move the guide out of the way	2015
Figure 1-3595	Disconnect one connector	2016
Figure 1-3596	Remove one screw	2016
Figure 1-3597	Remove the guide	2017
Figure 1-3598	Remove three screws	2017
Figure 1-3599	Remove the assembly	2018

Figure 1-3600	Remove two screws	2018
Figure 1-3601	Remove the PCA	2019
Figure 1-3602	Release two retainers and disconnect one connector	2019
Figure 1-3603	Remove four screws	2020
Figure 1-3604	Remove the assembly	2021
Figure 1-3605	Remove two screws	2022
Figure 1-3606	Remove the duplex drive assembly	2022
Figure 1-3607	Recycle and unpack	2023
Figure 1-3608	Install the duplex drive assembly	2023
Figure 1-3609	Install two screws	2024
Figure 1-3610	Install the assembly	2024
Figure 1-3611	Install four screws	2025
Figure 1-3612	Connect one connector	2025
Figure 1-3613	Install the PCA holder	2026
Figure 1-3614	Install one screw	2026
Figure 1-3615	Connect one connector	2027
Figure 1-3616	Install two screws	2027
Figure 1-3617	Check the gears on the assembly	2028
Figure 1-3618	Install three screws	2028
Figure 1-3619	Install the guide	2029
Figure 1-3620	Install one screw	2029
Figure 1-3621	Connect one connector	2030
Figure 1-3622	Install the guide	2030
Figure 1-3623	Connect one ground wire	2031
Figure 1-3624	Install the HVPST	2031
Figure 1-3625	Install one screw	2032
Figure 1-3626	Connect five connectors and one flat cable	2032
Figure 1-3627	Install the plate	2033
Figure 1-3628	Install two screws	2033
Figure 1-3629	Install the cover	2034
Figure 1-3630	Install one screw	2034
Figure 1-3631	Pass the wire harnesses through the opening	2035
Figure 1-3632	Install the formatter case	2035
Figure 1-3633	Install six screws	2036
Figure 1-3634	Install wire harnesses and flat cable	2036
Figure 1-3635	Install the LVPS cover	2037
Figure 1-3636	Attach the flat cable	2037
Figure 1-3637	Position the bracket	2038
Figure 1-3638	Connect one connector	2038
Figure 1-3639	Install the cover	2039
Figure 1-3640	Align the tabs	2039

Figure 1-3641	Release the cover	2040
Figure 1-3642	Verify the installation	2040
Figure 1-3643	Connect one connector	2041
Figure 1-3644	Install four screws	2041
Figure 1-3645	Place one cable in the guide	2042
Figure 1-3646	Install the tab	2042
Figure 1-3647	Install one screw	2043
Figure 1-3648	Install the cover	2043
Figure 1-3649	Engage one tab	2044
Figure 1-3650	Engage one tab and install one screw	2044
Figure 1-3651	Install three screws	2045
Figure 1-3652	Install the cover	2045
Figure 1-3653	Engage the cover	2046
Figure 1-3654	Install one screw	2046
Figure 1-3655	Position the tabs in the slots	2047
Figure 1-3656	Install two screws	2047
Figure 1-3657	Install three screws	2048
Figure 1-3658	Position the locator pins	2048
Figure 1-3659	Press down on the cover	2049
Figure 1-3660	Install one screw	2049
Figure 1-3661	Install one screw	2050
Figure 1-3662	Install the cover	2050
Figure 1-3663	Install one screw	2051
Figure 1-3664	Align the locator tabs	2051
Figure 1-3665	Install the cover	2052
Figure 1-3666	Install five screws	2052
Figure 1-3667	Install the cables	2053
Figure 1-3668	Position the hooks	2053
Figure 1-3669	Install the cover	2054
Figure 1-3670	Install one screw and connector	2054
Figure 1-3671	Install one screw and connector	2055
Figure 1-3672	Position the hooks in the slots	2055
Figure 1-3673	Connect connector and install screws	2056
Figure 1-3674	Locate the ISA mounting pins and slots	249
Figure 1-3675	Install the ISA	2057
Figure 1-3676	Slide the ISA towards the front of the printer	2057
Figure 1-3677	Install one screw	2058
Figure 1-3678	Install two screws	2058
Figure 1-3679	Install one screw	2059
Figure 1-3680	Connect connectors	2059
Figure 1-3681	Install two tabs	2060

Figure 1-3682	Install the cover assembly	2060
Figure 1-3683	Install one screw	2061
Figure 1-3684	Install the cover	2062
Figure 1-3685	Press the cover	2062
Figure 1-3686	Install one screw	2063
Figure 1-3687	Position the tab	2063
Figure 1-3688	Slide the cover	2064
Figure 1-3689	Check the tab	2064
Figure 1-3690	Position the hooks	2065
Figure 1-3691	Install the cover	2065
Figure 1-3692	Install four screws cover	2066
Figure 1-3693	Align the cover	2066
Figure 1-3694	Rotate the top of the cover	2067
Figure 1-3695	Slide the cover	2067
Figure 1-3696	Install two screws	2068
Figure 1-3697	Install the cover	2068
Figure 1-3698	Install four screws cover	2069
Figure 1-3699	Install the formatter	2069
Figure 1-3700	Install four screws	2070
Figure 1-3701	Connect all connectors	2071
Figure 1-3702	Position the fax PCA	2071
Figure 1-3703	Install the fax PCA	2072
Figure 1-3704	Connect the connector	2072
Figure 1-3705	Install the holder	2073
Figure 1-3706	Release the HDD	2073
Figure 1-3707	Install the formatter	2074
Figure 1-3708	Connect all connectors	2075
Figure 1-3709	Install the cover	2075
Figure 1-3710	Verify that the toner collection hatch cover is closed	2076
Figure 1-3711	Install the TCU	2076
Figure 1-3712	Close the front door	2077
Figure 1-3713	Install the tray	2077
Figure 1-3714	Close the tray	2078
Figure 1-3715	Place the control panel on the product	2078
Figure 1-3716	Connect two connectors	2079
Figure 1-3717	Turn the control panel over	2079
Figure 1-3718	Rotate the control-panel base down	2080
Figure 1-3719	Install two screws	2080
Figure 1-3720	Install the cover	2081
Figure 1-3721	Install the cover	2081
Figure 1-3722	Check the installation	2082

Figure 1-3723	Handle the ITB by the edges	2082
Figure 1-3724	Align the ITB with the slots in the product	2083
Figure 1-3725	Install the ITB	2083
Figure 1-3726	Remove the spring from the holder	2084
Figure 1-3727	Fasten the rear-side ITB spring	2084
Figure 1-3728	Remove the spring from the holder	2085
Figure 1-3729	Fasten the front-side ITB spring	2085
Figure 1-3730	Engage the ITB drive coupling	2086
Figure 1-3731	Close the right door	2086
Figure 1-3732	Align the fuser with the opening	2087
Figure 1-3733	Install the fuser	2087
Figure 1-3734	Close the right door	2088
Figure 1-3735	Open the front door	2091
Figure 1-3736	Open the TCU	2092
Figure 1-3737	Remove the TCU	2093
Figure 1-3738	Locate the formatter cover	2094
Figure 1-3739	Loosen the thumbscrews	2094
Figure 1-3740	Locate the USB cover	2095
Figure 1-3741	Remove the cover	2095
Figure 1-3742	Tilt the control panel up	2096
Figure 1-3743	Release the control-panel screws cover tabs	2096
Figure 1-3744	Remove the cover	2097
Figure 1-3745	Remove two screws	2097
Figure 1-3746	Rotate the control-panel base up	2098
Figure 1-3747	Turn the control panel over	2098
Figure 1-3748	Disconnect two connectors	2099
Figure 1-3749	Disconnect all connectors	2100
Figure 1-3750	Remove the formatter	2100
Figure 1-3751	Release the HDD	2101
Figure 1-3752	Remove the HDD	2101
Figure 1-3753	Locate the fax PCA	2102
Figure 1-3754	Disconnect one connector	2102
Figure 1-3755	Release one latch	2103
Figure 1-3756	Remove the fax PCA	2103
Figure 1-3757	Disconnect all connectors	2104
Figure 1-3758	Remove four screws	2105
Figure 1-3759	Remove the formatter	2105
Figure 1-3760	Remove four screws	2106
Figure 1-3761	Remove the cover	2106
Figure 1-3762	Remove two screws	2107
Figure 1-3763	Release the right edge	2107

Figure 1-3764	Slide the cover right	2108
Figure 1-3765	Remove the cover	2108
Figure 1-3766	Remove four screws	2109
Figure 1-3767	Remove the cover	2109
Figure 1-3768	Release one tab	2110
Figure 1-3769	Slide the cover back	2110
Figure 1-3770	Remove the left upper cover	2111
Figure 1-3771	Remove one screw	2111
Figure 1-3772	Release two tabs	2112
Figure 1-3773	Rotate the cover	2112
Figure 1-3774	Remove one screw	2113
Figure 1-3775	Release two tabs	2113
Figure 1-3776	Release the back edge of the cover	2114
Figure 1-3777	Remove the cover	2114
Figure 1-3778	Remove one screw	2115
Figure 1-3779	Remove two screws	2115
Figure 1-3780	Remove one screw	2116
Figure 1-3781	Disconnect connectors	2116
Figure 1-3782	Slide the ISA towards the back of the printer	2117
Figure 1-3783	Remove the ISA	2117
Figure 1-3784	Remove two screws and one connector	2118
Figure 1-3785	Remove one screw and connector	2118
Figure 1-3786	Slide the cover	2119
Figure 1-3787	Remove the cover	2119
Figure 1-3788	Remove one screw	2120
Figure 1-3789	Release the cover	2120
Figure 1-3790	Remove the cover	2121
Figure 1-3791	Remove three screws	2121
Figure 1-3792	Remove one screw and release one tab	2122
Figure 1-3793	Release the cover	2122
Figure 1-3794	Remove the cover	2123
Figure 1-3795	Release the cover	2123
Figure 1-3796	Remove the cover	2124
Figure 1-3797	Disconnect one connector	2124
Figure 1-3798	Remove the bracket	2125
Figure 1-3799	Remove the LVPS cover	2125
Figure 1-3800	Release wire harnesses and flat cable	2126
Figure 1-3801	Remove six screws	2126
Figure 1-3802	Release the formatter case	2127
Figure 1-3803	Remove the formatter case	2127
Figure 1-3804	Disconnect one wire harness	2128

Figure 1-3805	Disconnect seven connectors	2128
Figure 1-3806	Pass the wire harnesses through the opening	2129
Figure 1-3807	Remove three screws	2129
Figure 1-3808	Remove the LVPS	2130
Figure 1-3809	Remove one screw	2130
Figure 1-3810	Release the wire harnesses	2131
Figure 1-3811	Remove the fan	2131
Figure 1-3812	Disconnect one flat cable	2132
Figure 1-3813	Remove three screws	2132
Figure 1-3814	Remove the HVPSD	2133
Figure 1-3815	Disconnect two connectors	2133
Figure 1-3816	Disconnect two flat cables	2134
Figure 1-3817	Remove the assembly	2134
Figure 1-3818	Remove two screws	2135
Figure 1-3819	Remove the plate	2135
Figure 1-3820	Move the guide out of the way	2136
Figure 1-3821	Remove three screws	2136
Figure 1-3822	Remove the assembly	2137
Figure 1-3823	Remove the gear if installed	2137
Figure 1-3824	Recycle and unpack	2138
Figure 1-3825	Check the gears for a gap	2139
Figure 1-3826	Adjust the gears	2139
Figure 1-3827	Install the assembly	2140
Figure 1-3828	Install three screws	2140
Figure 1-3829	Install the guide	2141
Figure 1-3830	Install the plate	2141
Figure 1-3831	Install two screws	2142
Figure 1-3832	Install the lifter drive	2142
Figure 1-3833	Connect two flat cables	2143
Figure 1-3834	Connect two connectors	2143
Figure 1-3835	Install the HVPSD	2144
Figure 1-3836	Press the tabs	2144
Figure 1-3837	Install three screws	2145
Figure 1-3838	Connect one flat cable	2145
Figure 1-3839	Install the fan	2146
Figure 1-3840	Place the wire harnesses in the retainer	2146
Figure 1-3841	Install one screw	2147
Figure 1-3842	Install the LVPS	2147
Figure 1-3843	Install three screws	2148
Figure 1-3844	Pass the wire harnesses through the opening	2148
Figure 1-3845	Connect seven connectors	2149

Figure 1-3846	Connect one wire harness	2149
Figure 1-3847	Pass the wire harnesses through the opening	2150
Figure 1-3848	Install the formatter case	2150
Figure 1-3849	Install six screws	2151
Figure 1-3850	Install wire harnesses and flat cable	2151
Figure 1-3851	Install the LVPS cover	2152
Figure 1-3852	Attach the flat cable	2152
Figure 1-3853	Position the bracket	2153
Figure 1-3854	Connect one connector	2153
Figure 1-3855	Install the cover	2154
Figure 1-3856	Install one screw	2154
Figure 1-3857	Install the cover	2155
Figure 1-3858	Engage one tab	2155
Figure 1-3859	Engage one tab and install one screw	2156
Figure 1-3860	Install three screws	2156
Figure 1-3861	Install the cover	2157
Figure 1-3862	Engage the cover	2157
Figure 1-3863	Install one screw	2158
Figure 1-3864	Install the cables	2158
Figure 1-3865	Position the hooks	2159
Figure 1-3866	Install the cover	2159
Figure 1-3867	Install one screw and connector	2160
Figure 1-3868	Install one screw and connector	2160
Figure 1-3869	Locate the ISA mounting pins and slots	249
Figure 1-3870	Install the ISA	2161
Figure 1-3871	Slide the ISA towards the front of the printer	2162
Figure 1-3872	Install one screw	2162
Figure 1-3873	Install two screws	2163
Figure 1-3874	Install one screw	2163
Figure 1-3875	Connect connectors	2164
Figure 1-3876	Install two tabs	2164
Figure 1-3877	Install the cover assembly	2165
Figure 1-3878	Install one screw	2165
Figure 1-3879	Install the cover	2166
Figure 1-3880	Press the cover	2166
Figure 1-3881	Install one screw	2167
Figure 1-3882	Position the tab	2167
Figure 1-3883	Slide the cover	2168
Figure 1-3884	Check the tab	2168
Figure 1-3885	Position the hooks	2169
Figure 1-3886	Install the cover	2169

Figure 1-3887	Install four screws cover	2170
Figure 1-3888	Align the cover	2170
Figure 1-3889	Rotate the top of the cover	2171
Figure 1-3890	Slide the cover	2171
Figure 1-3891	Install two screws	2172
Figure 1-3892	Install the cover	2172
Figure 1-3893	Install four screws cover	2173
Figure 1-3894	Install the formatter	2173
Figure 1-3895	Install four screws	2174
Figure 1-3896	Connect all connectors	2175
Figure 1-3897	Position the fax PCA	2175
Figure 1-3898	Install the fax PCA	2176
Figure 1-3899	Connect the connector	2176
Figure 1-3900	Install the holder	2177
Figure 1-3901	Release the HDD	2177
Figure 1-3902	Install the formatter	2178
Figure 1-3903	Connect all connectors	2179
Figure 1-3904	Place the control panel on the product	2179
Figure 1-3905	Connect two connectors	2180
Figure 1-3906	Turn the control panel over	2180
Figure 1-3907	Rotate the control-panel base down	2181
Figure 1-3908	Install two screws	2181
Figure 1-3909	Install the cover	2182
Figure 1-3910	Install the cover	2182
Figure 1-3911	Check the installation	2183
Figure 1-3912	Install the cover	2183
Figure 1-3913	Verify that the toner collection hatch cover is closed	2184
Figure 1-3914	Install the TCU	2184
Figure 1-3915	Close the front door	2185
Figure 1-3916	Open the right door	2189
Figure 1-3917	Release the secondary transfer roller assembly	2189
Figure 1-3918	Carefully flex the top portion of the blue arm	2190
Figure 1-3919	Disengage the blue arm and pin	2190
Figure 1-3920	Remove the secondary transfer roller assembly	2191
Figure 1-3921	Open the right door	2191
Figure 1-3922	Release the ITB drive coupling	2192
Figure 1-3923	Lower the secondary transfer roller assembly	2192
Figure 1-3924	Release the front-side ITB spring	2193
Figure 1-3925	Place the spring on the holder	2193
Figure 1-3926	Release the rear-side ITB spring	2194
Figure 1-3927	Place the spring on the holder	2194

Figure 1-3928	Grasp the ITB handles	2195
Figure 1-3929	Remove the ITB	2195
Figure 1-3930	Pull the tray out	2196
Figure 1-3931	Remove the tray	2196
Figure 1-3932	Open the front door	2197
Figure 1-3933	Open the TCU	2197
Figure 1-3934	Remove the TCU	2198
Figure 1-3935	Locate the formatter cover	2199
Figure 1-3936	Loosen the thumbscrews	2199
Figure 1-3937	Locate the USB cover	2200
Figure 1-3938	Remove the cover	2200
Figure 1-3939	Tilt the control panel up	2201
Figure 1-3940	Release the control-panel screws cover tabs	2201
Figure 1-3941	Remove the cover	2202
Figure 1-3942	Remove two screws	2202
Figure 1-3943	Rotate the control-panel base up	2203
Figure 1-3944	Turn the control panel over	2203
Figure 1-3945	Disconnect two connectors	2204
Figure 1-3946	Disconnect all connectors	2205
Figure 1-3947	Remove the formatter	2205
Figure 1-3948	Release the HDD	2206
Figure 1-3949	Remove the HDD	2206
Figure 1-3950	Locate the fax PCA	2207
Figure 1-3951	Disconnect one connector	2207
Figure 1-3952	Release one latch	2208
Figure 1-3953	Remove the fax PCA	2208
Figure 1-3954	Disconnect all connectors	2209
Figure 1-3955	Remove four screws	2210
Figure 1-3956	Remove the formatter	2210
Figure 1-3957	Remove four screws	2211
Figure 1-3958	Remove the cover	2211
Figure 1-3959	Remove two screws	2212
Figure 1-3960	Release the right edge	2212
Figure 1-3961	Slide the cover right	2213
Figure 1-3962	Remove the cover	2213
Figure 1-3963	Remove four screws	2214
Figure 1-3964	Remove the cover	2214
Figure 1-3965	Release one tab	2215
Figure 1-3966	Slide the cover back	2215
Figure 1-3967	Remove the left upper cover	2216
Figure 1-3968	Remove one screw	2216

Figure 1-3969	Release two tabs	2217
Figure 1-3970	Rotate the cover	2217
Figure 1-3971	Remove one screw	2218
Figure 1-3972	Release two tabs	2218
Figure 1-3973	Release the back edge of the cover	2219
Figure 1-3974	Remove the cover	2219
Figure 1-3975	Remove one screw	2220
Figure 1-3976	Remove two screws	2220
Figure 1-3977	Remove one screw	2221
Figure 1-3978	Disconnect connectors	2221
Figure 1-3979	Slide the ISA towards the back of the printer	2222
Figure 1-3980	Remove the ISA	2222
Figure 1-3981	Remove two screws and one connector	2223
Figure 1-3982	Remove one screw and connector	2223
Figure 1-3983	Slide the cover	2224
Figure 1-3984	Remove the cover	2224
Figure 1-3985	Remove one screw	2225
Figure 1-3986	Release the cover	2225
Figure 1-3987	Remove the cover	2226
Figure 1-3988	Remove three screws	2226
Figure 1-3989	Remove one screw and release one tab	2227
Figure 1-3990	Release the cover	2227
Figure 1-3991	Remove the cover	2228
Figure 1-3992	Release the cover	2228
Figure 1-3993	Remove the cover	2229
Figure 1-3994	Disconnect one connector	2229
Figure 1-3995	Remove the bracket	2230
Figure 1-3996	Remove the LVPS cover	2230
Figure 1-3997	Release wire harnesses and flat cable	2231
Figure 1-3998	Remove six screws	2231
Figure 1-3999	Release the formatter case	2232
Figure 1-4000	Remove the formatter case	2232
Figure 1-4001	Disconnect one wire harness	2233
Figure 1-4002	Disconnect seven connectors	2233
Figure 1-4003	Pass the wire harnesses through the opening	2234
Figure 1-4004	Remove three screws	2234
Figure 1-4005	Remove the LVPS	2235
Figure 1-4006	Remove one screw	2235
Figure 1-4007	Release the wire harnesses	2236
Figure 1-4008	Remove the fan	2236
Figure 1-4009	Disconnect one flat cable	2237

Figure 1-4010	Remove three screws	2237
Figure 1-4011	Remove the HVPSD	2238
Figure 1-4012	Disconnect two connectors	2238
Figure 1-4013	Disconnect two flat cables	2239
Figure 1-4014	Remove the assembly	2239
Figure 1-4015	Remove two screws	2240
Figure 1-4016	Remove the plate	2240
Figure 1-4017	Move the guide out of the way	2241
Figure 1-4018	Remove three screws	2241
Figure 1-4019	Remove the assembly	2242
Figure 1-4020	Remove the gear if installed	2242
Figure 1-4021	Release one tab	2243
Figure 1-4022	Remove the cover	2243
Figure 1-4023	Release the guide	2244
Figure 1-4024	Move the guide out of the way	2244
Figure 1-4025	Remove three screws	2245
Figure 1-4026	Locate the sheet metal portion of the assembly	2245
Figure 1-4027	Take note of the sheet-metal tabs	2246
Figure 1-4028	Rotate the top of the assembly away from the chassis	2246
Figure 1-4029	Release the bottom tabs	2247
Figure 1-4030	Remove the assembly	2247
Figure 1-4031	Recycle and unpack	2248
Figure 1-4032	Connect three connectors	2248
Figure 1-4033	Align the tabs on the assembly with the slots	2249
Figure 1-4034	Install the bottom tabs	2249
Figure 1-4035	Install the top tabs	2250
Figure 1-4036	Install three screws	2250
Figure 1-4037	Position the guide on the product	2251
Figure 1-4038	Install the guide	2251
Figure 1-4039	Position the cover on the product	2252
Figure 1-4040	Install the cover	2252
Figure 1-4041	Check the gears for a gap	2253
Figure 1-4042	Adjust the gears	2253
Figure 1-4043	Install the assembly	2254
Figure 1-4044	Install three screws	2254
Figure 1-4045	Install the guide	2255
Figure 1-4046	Install the plate	2255
Figure 1-4047	Install two screws	2256
Figure 1-4048	Install the lifter drive	2256
Figure 1-4049	Connect two flat cables	2257
Figure 1-4050	Connect two connectors	2257

Figure 1-4051	Install the HVPSD	2258
Figure 1-4052	Press the tabs	2258
Figure 1-4053	Install three screws	2259
Figure 1-4054	Connect one flat cable	2259
Figure 1-4055	Install the fan	2260
Figure 1-4056	Place the wire harnesses in the retainer	2260
Figure 1-4057	Install one screw	2261
Figure 1-4058	Install the LVPS	2261
Figure 1-4059	Install three screws	2262
Figure 1-4060	Pass the wire harnesses through the opening	2262
Figure 1-4061	Connect seven connectors	2263
Figure 1-4062	Connect one wire harness	2263
Figure 1-4063	Pass the wire harnesses through the opening	2264
Figure 1-4064	Install the formatter case	2264
Figure 1-4065	Install six screws	2265
Figure 1-4066	Install wire harnesses and flat cable	2265
Figure 1-4067	Install the LVPS cover	2266
Figure 1-4068	Attach the flat cable	2266
Figure 1-4069	Position the bracket	2267
Figure 1-4070	Connect one connector	2267
Figure 1-4071	Install the cover	2268
Figure 1-4072	Install one screw	2268
Figure 1-4073	Install the cover	2269
Figure 1-4074	Engage one tab	2269
Figure 1-4075	Engage one tab and install one screw	2270
Figure 1-4076	Install three screws	2270
Figure 1-4077	Install the cover	2271
Figure 1-4078	Engage the cover	2271
Figure 1-4079	Install one screw	2272
Figure 1-4080	Install the cables	2272
Figure 1-4081	Position the hooks	2273
Figure 1-4082	Install the cover	2273
Figure 1-4083	Install one screw and connector	2274
Figure 1-4084	Install one screw and connector	2274
Figure 1-4085	Locate the ISA mounting pins and slots	249
Figure 1-4086	Install the ISA	2275
Figure 1-4087	Slide the ISA towards the front of the printer	2276
Figure 1-4088	Install one screw	2276
Figure 1-4089	Install two screws	2277
Figure 1-4090	Install one screw	2277
Figure 1-4091	Connect connectors	2278

Figure 1-4092	Install two tabs	2278
Figure 1-4093	Install the cover assembly	2279
Figure 1-4094	Install one screw	2279
Figure 1-4095	Install the cover	2280
Figure 1-4096	Press the cover	2280
Figure 1-4097	Install one screw	2281
Figure 1-4098	Position the tab	2281
Figure 1-4099	Slide the cover	2282
Figure 1-4100	Check the tab	2282
Figure 1-4101	Position the hooks	2283
Figure 1-4102	Install the cover	2283
Figure 1-4103	Install four screws cover	2284
Figure 1-4104	Align the cover	2284
Figure 1-4105	Rotate the top of the cover	2285
Figure 1-4106	Slide the cover	2285
Figure 1-4107	Install two screws	2286
Figure 1-4108	Install the cover	2286
Figure 1-4109	Install four screws cover	2287
Figure 1-4110	Install the formatter	2287
Figure 1-4111	Install four screws	2288
Figure 1-4112	Connect all connectors	2289
Figure 1-4113	Position the fax PCA	2289
Figure 1-4114	Install the fax PCA	2290
Figure 1-4115	Connect the connector	2290
Figure 1-4116	Install the holder	2291
Figure 1-4117	Release the HDD	2291
Figure 1-4118	Install the formatter	2292
Figure 1-4119	Connect all connectors	2293
Figure 1-4120	Place the control panel on the product	2293
Figure 1-4121	Connect two connectors	2294
Figure 1-4122	Turn the control panel over	2294
Figure 1-4123	Rotate the control-panel base down	2295
Figure 1-4124	Install two screws	2295
Figure 1-4125	Install the cover	2296
Figure 1-4126	Install the cover	2296
Figure 1-4127	Check the installation	2297
Figure 1-4128	Install the cover	2297
Figure 1-4129	Verify that the toner collection hatch cover is closed	2298
Figure 1-4130	Install the TCU	2298
Figure 1-4131	Close the front door	2299
Figure 1-4132	Install the tray	2299

Figure 1-4133	Close the tray	2300
Figure 1-4134	Handle the ITB by the edges	2300
Figure 1-4135	Align the ITB with the slots in the product	2301
Figure 1-4136	Install the ITB	2301
Figure 1-4137	Remove the spring from the holder	2302
Figure 1-4138	Fasten the rear-side ITB spring	2302
Figure 1-4139	Remove the spring from the holder	2303
Figure 1-4140	Fasten the front-side ITB spring	2303
Figure 1-4141	Engage the ITB drive coupling	2304
Figure 1-4142	Close the right door	2304
Figure 1-4143	Install the right hinge	2305
Figure 1-4144	Install the left hinge	2305
Figure 1-4145	Engage the blue arm with the pin	2306
Figure 1-4146	Close the right door	2306
Figure 1-4147	Open the right door	2310
Figure 1-4148	Release the secondary transfer roller assembly	2310
Figure 1-4149	Carefully flex the top portion of the blue arm	2311
Figure 1-4150	Disengage the blue arm and pin	2311
Figure 1-4151	Remove the secondary transfer roller assembly	2312
Figure 1-4152	Open the right door	2312
Figure 1-4153	Release the ITB drive coupling	2313
Figure 1-4154	Lower the secondary transfer roller assembly	2313
Figure 1-4155	Release the front-side ITB spring	2314
Figure 1-4156	Place the spring on the holder	2314
Figure 1-4157	Release the rear-side ITB spring	2315
Figure 1-4158	Place the spring on the holder	2315
Figure 1-4159	Grasp the ITB handles	2316
Figure 1-4160	Remove the ITB	2316
Figure 1-4161	Pull the tray out	2317
Figure 1-4162	Remove the tray	2317
Figure 1-4163	Open the front door	2318
Figure 1-4164	Open the TCU	2318
Figure 1-4165	Remove the TCU	2319
Figure 1-4166	Locate the formatter cover	2320
Figure 1-4167	Loosen the thumbscrews	2320
Figure 1-4168	Locate the USB cover	2321
Figure 1-4169	Remove the cover	2321
Figure 1-4170	Tilt the control panel up	2322
Figure 1-4171	Release the control-panel screws cover tabs	2322
Figure 1-4172	Remove the cover	2323
Figure 1-4173	Remove two screws	2323

Figure 1-4174	Rotate the control-panel base up	2324
Figure 1-4175	Turn the control panel over	2324
Figure 1-4176	Disconnect two connectors	2325
Figure 1-4177	Disconnect all connectors	2326
Figure 1-4178	Remove the formatter	2326
Figure 1-4179	Release the HDD	2327
Figure 1-4180	Remove the HDD	2327
Figure 1-4181	Locate the fax PCA	2328
Figure 1-4182	Disconnect one connector	2328
Figure 1-4183	Release one latch	2329
Figure 1-4184	Remove the fax PCA	2329
Figure 1-4185	Disconnect all connectors	2330
Figure 1-4186	Remove four screws	2331
Figure 1-4187	Remove the formatter	2331
Figure 1-4188	Remove four screws	2332
Figure 1-4189	Remove the cover	2332
Figure 1-4190	Remove two screws	2333
Figure 1-4191	Release the right edge	2333
Figure 1-4192	Slide the cover right	2334
Figure 1-4193	Remove the cover	2334
Figure 1-4194	Remove four screws	2335
Figure 1-4195	Remove the cover	2335
Figure 1-4196	Release one tab	2336
Figure 1-4197	Slide the cover back	2336
Figure 1-4198	Remove the left upper cover	2337
Figure 1-4199	Remove one screw	2337
Figure 1-4200	Release two tabs	2338
Figure 1-4201	Rotate the cover	2338
Figure 1-4202	Remove one screw	2339
Figure 1-4203	Release two tabs	2339
Figure 1-4204	Release the back edge of the cover	2340
Figure 1-4205	Remove the cover	2340
Figure 1-4206	Remove one screw	2341
Figure 1-4207	Remove two screws	2341
Figure 1-4208	Remove one screw	2342
Figure 1-4209	Disconnect connectors	2342
Figure 1-4210	Slide the ISA towards the back of the printer	2343
Figure 1-4211	Remove the ISA	2343
Figure 1-4212	Remove two screws and one connector	2344
Figure 1-4213	Remove one screw and connector	2344
Figure 1-4214	Slide the cover	2345

Figure 1-4215	Remove the cover	2345
Figure 1-4216	Remove one screw	2346
Figure 1-4217	Release the cover	2346
Figure 1-4218	Remove the cover	2347
Figure 1-4219	Remove three screws	2347
Figure 1-4220	Remove one screw and release one tab	2348
Figure 1-4221	Release the cover	2348
Figure 1-4222	Remove the cover	2349
Figure 1-4223	Release the cover	2349
Figure 1-4224	Remove the cover	2350
Figure 1-4225	Disconnect one connector	2350
Figure 1-4226	Remove the bracket	2351
Figure 1-4227	Remove the LVPS cover	2351
Figure 1-4228	Release wire harnesses and flat cable	2352
Figure 1-4229	Remove six screws	2352
Figure 1-4230	Release the formatter case	2353
Figure 1-4231	Remove the formatter case	2353
Figure 1-4232	Disconnect one wire harness	2354
Figure 1-4233	Disconnect seven connectors	2354
Figure 1-4234	Pass the wire harnesses through the opening	2355
Figure 1-4235	Remove three screws	2355
Figure 1-4236	Remove the LVPS	2356
Figure 1-4237	Remove one screw	2356
Figure 1-4238	Release the wire harnesses	2357
Figure 1-4239	Remove the fan	2357
Figure 1-4240	Disconnect one flat cable	2358
Figure 1-4241	Remove three screws	2358
Figure 1-4242	Remove the HVPSD	2359
Figure 1-4243	Disconnect two connectors	2359
Figure 1-4244	Disconnect two flat cables	2360
Figure 1-4245	Remove the assembly	2360
Figure 1-4246	Remove two screws	2361
Figure 1-4247	Remove the plate	2361
Figure 1-4248	Move the guide out of the way	2362
Figure 1-4249	Remove three screws	2362
Figure 1-4250	Remove the assembly	2363
Figure 1-4251	Remove the gear if installed	2363
Figure 1-4252	Release one tab	2364
Figure 1-4253	Remove the cover	2364
Figure 1-4254	Release the guide	2365
Figure 1-4255	Move the guide out of the way	2365

Figure 1-4256	Remove three screws	2366
Figure 1-4257	Locate the sheet metal portion of the assembly	2366
Figure 1-4258	Take note of the sheet-metal tabs	2367
Figure 1-4259	Rotate the top of the assembly away from the chassis	2367
Figure 1-4260	Release the bottom tabs	2368
Figure 1-4261	Remove the assembly	2368
Figure 1-4262	Remove four screws	2369
Figure 1-4263	Release the left end of the assembly	2369
Figure 1-4264	Slide the assembly to the left	2370
Figure 1-4265	Remove the assembly	2370
Figure 1-4266	Disconnect one connector	2371
Figure 1-4267	Remove the tray pickup roller assembly	2371
Figure 1-4268	Locate the feed bushing	2372
Figure 1-4269	Release one tab and rotate the bushing	2372
Figure 1-4270	Remove the bushing	2373
Figure 1-4271	Slide the shaft out	2373
Figure 1-4272	Remove the gear	2374
Figure 1-4273	Recycle and unpack	2374
Figure 1-4274	Remove the tray pickup roller assembly	2375
Figure 1-4275	Locate the feed bushing	2375
Figure 1-4276	Release one tab and rotate the bushing	2376
Figure 1-4277	Remove the bushing	2376
Figure 1-4278	Slide the shaft out	2377
Figure 1-4279	Position the gear	2377
Figure 1-4280	Install the gear	2378
Figure 1-4281	Install the shaft	2378
Figure 1-4282	Check shaft alignment	2379
Figure 1-4283	Position the feed bushing	2379
Figure 1-4284	Install the feed bushing	2380
Figure 1-4285	Check shaft alignment	2380
Figure 1-4286	Position the roller assembly	2381
Figure 1-4287	Install the roller assembly	2381
Figure 1-4288	Release the spring loaded shaft	2382
Figure 1-4289	Remove three screws	2382
Figure 1-4290	Connect one connector	2383
Figure 1-4291	Position the assembly in the product	2383
Figure 1-4292	Slide the assembly to the right	2384
Figure 1-4293	Install the assembly	2384
Figure 1-4294	Install four screws	2385
Figure 1-4295	Connect three connectors	2385
Figure 1-4296	Align the tabs on the assembly with the slots	2386

Figure 1-4297	Install the bottom tabs	2386
Figure 1-4298	Install the top tabs	2387
Figure 1-4299	Install three screws	2387
Figure 1-4300	Position the guide on the product	2388
Figure 1-4301	Install the guide	2388
Figure 1-4302	Position the cover on the product	2389
Figure 1-4303	Install the cover	2389
Figure 1-4304	Check the gears for a gap	2390
Figure 1-4305	Adjust the gears	2390
Figure 1-4306	Install the assembly	2391
Figure 1-4307	Install three screws	2391
Figure 1-4308	Install the guide	2392
Figure 1-4309	Install the plate	2392
Figure 1-4310	Install two screws	2393
Figure 1-4311	Install the lifter drive	2393
Figure 1-4312	Connect two flat cables	2394
Figure 1-4313	Connect two connectors	2394
Figure 1-4314	Install the HVPSD	2395
Figure 1-4315	Press the tabs	2395
Figure 1-4316	Install three screws	2396
Figure 1-4317	Connect one flat cable	2396
Figure 1-4318	Install the fan	2397
Figure 1-4319	Place the wire harnesses in the retainer	2397
Figure 1-4320	Install one screw	2398
Figure 1-4321	Install the LVPS	2398
Figure 1-4322	Install three screws	2399
Figure 1-4323	Pass the wire harnesses through the opening	2399
Figure 1-4324	Connect seven connectors	2400
Figure 1-4325	Connect one wire harness	2400
Figure 1-4326	Pass the wire harnesses through the opening	2401
Figure 1-4327	Install the formatter case	2401
Figure 1-4328	Install six screws	2402
Figure 1-4329	Install wire harnesses and flat cable	2402
Figure 1-4330	Install the LVPS cover	2403
Figure 1-4331	Attach the flat cable	2403
Figure 1-4332	Position the bracket	2404
Figure 1-4333	Connect one connector	2404
Figure 1-4334	Install the cover	2405
Figure 1-4335	Install one screw	2405
Figure 1-4336	Install the cover	2406
Figure 1-4337	Engage one tab	2406

Figure 1-4338	Engage one tab and install one screw	2407
Figure 1-4339	Install three screws	2407
Figure 1-4340	Install the cover	2408
Figure 1-4341	Engage the cover	2408
Figure 1-4342	Install one screw	2409
Figure 1-4343	Install the cables	2409
Figure 1-4344	Position the hooks	2410
Figure 1-4345	Install the cover	2410
Figure 1-4346	Install one screw and connector	2411
Figure 1-4347	Install one screw and connector	2411
Figure 1-4348	Locate the ISA mounting pins and slots	249
Figure 1-4349	Install the ISA	2412
Figure 1-4350	Slide the ISA towards the front of the printer	2413
Figure 1-4351	Install one screw	2413
Figure 1-4352	Install two screws	2414
Figure 1-4353	Install one screw	2414
Figure 1-4354	Connect connectors	2415
Figure 1-4355	Install two tabs	2415
Figure 1-4356	Install the cover assembly	2416
Figure 1-4357	Install one screw	2416
Figure 1-4358	Install the cover	2417
Figure 1-4359	Press the cover	2417
Figure 1-4360	Install one screw	2418
Figure 1-4361	Position the tab	2418
Figure 1-4362	Slide the cover	2419
Figure 1-4363	Check the tab	2419
Figure 1-4364	Position the hooks	2420
Figure 1-4365	Install the cover	2420
Figure 1-4366	Install four screws cover	2421
Figure 1-4367	Align the cover	2421
Figure 1-4368	Rotate the top of the cover	2422
Figure 1-4369	Slide the cover	2422
Figure 1-4370	Install two screws	2423
Figure 1-4371	Install the cover	2423
Figure 1-4372	Install four screws cover	2424
Figure 1-4373	Install the formatter	2424
Figure 1-4374	Install four screws	2425
Figure 1-4375	Connect all connectors	2426
Figure 1-4376	Position the fax PCA	2426
Figure 1-4377	Install the fax PCA	2427
Figure 1-4378	Connect the connector	2427

Figure 1-4379	Install the holder	2428
Figure 1-4380	Release the HDD	2428
Figure 1-4381	Install the formatter	2429
Figure 1-4382	Connect all connectors	2430
Figure 1-4383	Place the control panel on the product	2430
Figure 1-4384	Connect two connectors	2431
Figure 1-4385	Turn the control panel over	2431
Figure 1-4386	Rotate the control-panel base down	2432
Figure 1-4387	Install two screws	2432
Figure 1-4388	Install the cover	2433
Figure 1-4389	Install the cover	2433
Figure 1-4390	Check the installation	2434
Figure 1-4391	Install the cover	2434
Figure 1-4392	Verify that the toner collection hatch cover is closed	2435
Figure 1-4393	Install the TCU	2435
Figure 1-4394	Close the front door	2436
Figure 1-4395	Install the tray	2436
Figure 1-4396	Close the tray	2437
Figure 1-4397	Handle the ITB by the edges	2437
Figure 1-4398	Align the ITB with the slots in the product	2438
Figure 1-4399	Install the ITB	2438
Figure 1-4400	Remove the spring from the holder	2439
Figure 1-4401	Fasten the rear-side ITB spring	2439
Figure 1-4402	Remove the spring from the holder	2440
Figure 1-4403	Fasten the front-side ITB spring	2440
Figure 1-4404	Engage the ITB drive coupling	2441
Figure 1-4405	Close the right door	2441
Figure 1-4406	Install the right hinge	2442
Figure 1-4407	Install the left hinge	2442
Figure 1-4408	Engage the blue arm with the pin	2443
Figure 1-4409	Close the right door	2443
Figure 1-4410	Open the right door	2447
Figure 1-4411	Release the secondary transfer roller assembly	2448
Figure 1-4412	Carefully flex the top portion of the blue arm	2448
Figure 1-4413	Disengage the blue arm and pin	2449
Figure 1-4414	Remove the secondary transfer roller assembly	2449
Figure 1-4415	Open the right door	2450
Figure 1-4416	Release the ITB drive coupling	2450
Figure 1-4417	Lower the secondary transfer roller assembly	2451
Figure 1-4418	Release the front-side ITB spring	2451
Figure 1-4419	Place the spring on the holder	2452

Figure 1-4420	Release the rear-side ITB spring	2452
Figure 1-4421	Place the spring on the holder	2453
Figure 1-4422	Grasp the ITB handles	2454
Figure 1-4423	Remove the ITB	2454
Figure 1-4424	Pull the tray out	2455
Figure 1-4425	Remove the tray	2455
Figure 1-4426	Open the front door	2456
Figure 1-4427	Open the TCU	2456
Figure 1-4428	Remove the TCU	2457
Figure 1-4429	Locate the formatter cover	2458
Figure 1-4430	Loosen the thumbscrews	2458
Figure 1-4431	Locate the USB cover	2459
Figure 1-4432	Remove the cover	2459
Figure 1-4433	Tilt the control panel up	2460
Figure 1-4434	Release the control-panel screws cover tabs	2460
Figure 1-4435	Remove the cover	2461
Figure 1-4436	Remove two screws	2461
Figure 1-4437	Rotate the control-panel base up	2462
Figure 1-4438	Turn the control panel over	2462
Figure 1-4439	Disconnect two connectors	2463
Figure 1-4440	Disconnect all connectors	2464
Figure 1-4441	Remove the formatter	2464
Figure 1-4442	Release the HDD	2465
Figure 1-4443	Remove the HDD	2465
Figure 1-4444	Locate the fax PCA	2466
Figure 1-4445	Disconnect one connector	2466
Figure 1-4446	Release one latch	2467
Figure 1-4447	Remove the fax PCA	2467
Figure 1-4448	Disconnect all connectors	2468
Figure 1-4449	Remove four screws	2469
Figure 1-4450	Remove the formatter	2469
Figure 1-4451	Remove four screws	2470
Figure 1-4452	Remove the cover	2470
Figure 1-4453	Remove two screws	2471
Figure 1-4454	Release the right edge	2471
Figure 1-4455	Slide the cover right	2472
Figure 1-4456	Remove the cover	2472
Figure 1-4457	Remove four screws	2473
Figure 1-4458	Remove the cover	2473
Figure 1-4459	Release one tab	2474
Figure 1-4460	Slide the cover back	2474

Figure 1-4461	Remove the left upper cover	2475
Figure 1-4462	Install the cover	2475
Figure 1-4463	Press the cover	2476
Figure 1-4464	Install one screw	2476
Figure 1-4465	Remove one screw	2477
Figure 1-4466	Release two tabs	2477
Figure 1-4467	Release the back edge of the cover	2478
Figure 1-4468	Remove the cover	2478
Figure 1-4469	Remove one screw	2479
Figure 1-4470	Remove two screws	2479
Figure 1-4471	Remove one screw	2480
Figure 1-4472	Disconnect connectors	2480
Figure 1-4473	Slide the ISA towards the back of the printer	2481
Figure 1-4474	Remove the ISA	2481
Figure 1-4475	Remove two screws and one connector	2482
Figure 1-4476	Remove one screw and connector	2482
Figure 1-4477	Slide the cover	2483
Figure 1-4478	Remove the cover	2483
Figure 1-4479	Remove one screw	2484
Figure 1-4480	Release the cover	2484
Figure 1-4481	Remove the cover	2485
Figure 1-4482	Remove three screws	2485
Figure 1-4483	Remove one screw and release one tab	2486
Figure 1-4484	Release the cover	2486
Figure 1-4485	Remove the cover	2487
Figure 1-4486	Release the cover	2487
Figure 1-4487	Remove the cover	2488
Figure 1-4488	Disconnect one connector	2488
Figure 1-4489	Remove the bracket	2489
Figure 1-4490	Remove the LVPS cover	2489
Figure 1-4491	Release wire harnesses and flat cable	2490
Figure 1-4492	Remove six screws	2490
Figure 1-4493	Release the formatter case	2491
Figure 1-4494	Remove the formatter case	2491
Figure 1-4495	Disconnect one wire harness	2492
Figure 1-4496	Disconnect seven connectors	2492
Figure 1-4497	Pass the wire harnesses through the opening	2493
Figure 1-4498	Remove three screws	2493
Figure 1-4499	Remove the LVPS	2494
Figure 1-4500	Remove one screw	2494
Figure 1-4501	Release the wire harnesses	2495

Figure 1-4502	Remove the fan	2495
Figure 1-4503	Disconnect one flat cable	2496
Figure 1-4504	Remove three screws	2496
Figure 1-4505	Remove the HVPSD	2497
Figure 1-4506	Disconnect two connectors	2497
Figure 1-4507	Disconnect two flat cables	2498
Figure 1-4508	Remove the assembly	2498
Figure 1-4509	Remove two screws	2499
Figure 1-4510	Remove the plate	2499
Figure 1-4511	Move the guide out of the way	2500
Figure 1-4512	Remove three screws	2500
Figure 1-4513	Remove the assembly	2501
Figure 1-4514	Remove the gear if installed	2501
Figure 1-4515	Release one tab	2502
Figure 1-4516	Remove the cover	2502
Figure 1-4517	Release the guide	2503
Figure 1-4518	Move the guide out of the way	2503
Figure 1-4519	Remove three screws	2504
Figure 1-4520	Locate the sheet metal portion of the assembly	2504
Figure 1-4521	Take note of the sheet-metal tabs	2505
Figure 1-4522	Rotate the top of the assembly away from the chassis	2505
Figure 1-4523	Release the bottom tabs	2506
Figure 1-4524	Remove the assembly	2506
Figure 1-4525	Remove one screw	2507
Figure 1-4526	Remove the cover	2507
Figure 1-4527	Remove the cover	2508
Figure 1-4528	Remove the assembly	2508
Figure 1-4529	Recycle and unpack	2509
Figure 1-4530	Install the assembly	2509
Figure 1-4531	Install the cover	2510
Figure 1-4532	Install the cover	2510
Figure 1-4533	Install one screw	2511
Figure 1-4534	Connect three connectors	2511
Figure 1-4535	Align the tabs on the assembly with the slots	2512
Figure 1-4536	Install the bottom tabs	2512
Figure 1-4537	Install the top tabs	2513
Figure 1-4538	Install three screws	2513
Figure 1-4539	Position the guide on the product	2514
Figure 1-4540	Install the guide	2514
Figure 1-4541	Position the cover on the product	2515
Figure 1-4542	Install the cover	2515

Figure 1-4543	Check the gears for a gap	2516
Figure 1-4544	Adjust the gears	2516
Figure 1-4545	Install the assembly	2517
Figure 1-4546	Install three screws	2517
Figure 1-4547	Install the guide	2518
Figure 1-4548	Install the plate	2518
Figure 1-4549	Install two screws	2519
Figure 1-4550	Install the lifter drive	2519
Figure 1-4551	Connect two flat cables	2520
Figure 1-4552	Connect two connectors	2520
Figure 1-4553	Install the HVPSD	2521
Figure 1-4554	Press the tabs	2521
Figure 1-4555	Install three screws	2522
Figure 1-4556	Connect one flat cable	2522
Figure 1-4557	Install the fan	2523
Figure 1-4558	Place the wire harnesses in the retainer	2523
Figure 1-4559	Install one screw	2524
Figure 1-4560	Install the LVPS	2524
Figure 1-4561	Install three screws	2525
Figure 1-4562	Pass the wire harnesses through the opening	2525
Figure 1-4563	Connect seven connectors	2526
Figure 1-4564	Connect one wire harness	2526
Figure 1-4565	Pass the wire harnesses through the opening	2527
Figure 1-4566	Install the formatter case	2527
Figure 1-4567	Install six screws	2528
Figure 1-4568	Install wire harnesses and flat cable	2528
Figure 1-4569	Install the LVPS cover	2529
Figure 1-4570	Attach the flat cable	2529
Figure 1-4571	Position the bracket	2530
Figure 1-4572	Connect one connector	2530
Figure 1-4573	Install the cover	2531
Figure 1-4574	Install one screw	2531
Figure 1-4575	Install the cover	2532
Figure 1-4576	Engage one tab	2532
Figure 1-4577	Engage one tab and install one screw	2533
Figure 1-4578	Install three screws	2533
Figure 1-4579	Install the cover	2534
Figure 1-4580	Engage the cover	2534
Figure 1-4581	Install one screw	2535
Figure 1-4582	Install the cables	2535
Figure 1-4583	Position the hooks	2536

Figure 1-4584	Install the cover	2536
Figure 1-4585	Install one screw and connector	2537
Figure 1-4586	Install one screw and connector	2537
Figure 1-4587	Locate the ISA mounting pins and slots	249
Figure 1-4588	Install the ISA	2538
Figure 1-4589	Slide the ISA towards the front of the printer	2539
Figure 1-4590	Install one screw	2539
Figure 1-4591	Install two screws	2540
Figure 1-4592	Install one screw	2540
Figure 1-4593	Connect connectors	2541
Figure 1-4594	Install two tabs	2541
Figure 1-4595	Install the cover assembly	2542
Figure 1-4596	Install one screw	2542
Figure 1-4597	Install the cover	2543
Figure 1-4598	Press the cover	2543
Figure 1-4599	Install one screw	2544
Figure 1-4600	Position the tab	2544
Figure 1-4601	Slide the cover	2545
Figure 1-4602	Check the tab	2545
Figure 1-4603	Position the hooks	2546
Figure 1-4604	Install the cover	2546
Figure 1-4605	Install four screws cover	2547
Figure 1-4606	Align the cover	2547
Figure 1-4607	Rotate the top of the cover	2548
Figure 1-4608	Slide the cover	2548
Figure 1-4609	Install two screws	2549
Figure 1-4610	Install the cover	2549
Figure 1-4611	Install four screws cover	2550
Figure 1-4612	Install the formatter	2550
Figure 1-4613	Install four screws	2551
Figure 1-4614	Connect all connectors	2552
Figure 1-4615	Position the fax PCA	2552
Figure 1-4616	Install the fax PCA	2553
Figure 1-4617	Connect the connector	2553
Figure 1-4618	Install the holder	2554
Figure 1-4619	Release the HDD	2554
Figure 1-4620	Install the formatter	2555
Figure 1-4621	Connect all connectors	2556
Figure 1-4622	Place the control panel on the product	2556
Figure 1-4623	Connect two connectors	2557
Figure 1-4624	Turn the control panel over	2557

Figure 1-4625	Rotate the control-panel base down	2558
Figure 1-4626	Install two screws	2558
Figure 1-4627	Install the cover	2559
Figure 1-4628	Install the cover	2559
Figure 1-4629	Check the installation	2560
Figure 1-4630	Install the cover	2560
Figure 1-4631	Verify that the toner collection hatch cover is closed	2561
Figure 1-4632	Install the TCU	2561
Figure 1-4633	Close the front door	2562
Figure 1-4634	Install the tray	2562
Figure 1-4635	Close the tray	2563
Figure 1-4636	Handle the ITB by the edges	2563
Figure 1-4637	Align the ITB with the slots in the product	2564
Figure 1-4638	Install the ITB	2564
Figure 1-4639	Remove the spring from the holder	2565
Figure 1-4640	Fasten the rear-side ITB spring	2565
Figure 1-4641	Remove the spring from the holder	2566
Figure 1-4642	Fasten the front-side ITB spring	2566
Figure 1-4643	Engage the ITB drive coupling	2567
Figure 1-4644	Close the right door	2567
Figure 1-4645	Install the right hinge	2568
Figure 1-4646	Install the left hinge	2568
Figure 1-4647	Engage the blue arm with the pin	2569
Figure 1-4648	Close the right door	2569
Figure 1-4649	Locate the USB cover	2574
Figure 1-4650	Remove the cover	2574
Figure 1-4651	Open the right door	2575
Figure 1-4652	Release the fuser	2575
Figure 1-4653	Remove the fuser	2576
Figure 1-4654	Release the ITB drive coupling	2576
Figure 1-4655	Lower the secondary transfer roller assembly	2577
Figure 1-4656	Release the front-side ITB spring	2577
Figure 1-4657	Place the spring on the holder	2578
Figure 1-4658	Release the rear-side ITB spring	2578
Figure 1-4659	Place the spring on the holder	2579
Figure 1-4660	Grasp the ITB handles	2580
Figure 1-4661	Remove the ITB	2580
Figure 1-4662	Tilt the control panel up	2581
Figure 1-4663	Release the control-panel screws cover tabs	2581
Figure 1-4664	Remove the cover	2582
Figure 1-4665	Remove two screws	2582

Figure 1-4666	Rotate the control-panel base up	2583
Figure 1-4667	Turn the control panel over	2583
Figure 1-4668	Disconnect two connectors	2584
Figure 1-4669	Pull the tray out	2584
Figure 1-4670	Remove the tray	2585
Figure 1-4671	Open the front door	2585
Figure 1-4672	Open the TCU	2586
Figure 1-4673	Remove the TCU	2587
Figure 1-4674	Locate the formatter cover	2588
Figure 1-4675	Loosen the thumbscrews	2588
Figure 1-4676	Disconnect all connectors	2590
Figure 1-4677	Remove the formatter	2590
Figure 1-4678	Release the HDD	2591
Figure 1-4679	Remove the HDD	2591
Figure 1-4680	Locate the fax PCA	2592
Figure 1-4681	Disconnect one connector	2592
Figure 1-4682	Release one latch	2593
Figure 1-4683	Remove the fax PCA	2593
Figure 1-4684	Disconnect all connectors	2594
Figure 1-4685	Remove four screws	2595
Figure 1-4686	Remove the formatter	2595
Figure 1-4687	Remove four screws	2596
Figure 1-4688	Remove the cover	2596
Figure 1-4689	Remove two screws	2597
Figure 1-4690	Release the right edge	2597
Figure 1-4691	Slide the cover right	2598
Figure 1-4692	Remove the cover	2598
Figure 1-4693	Remove four screws	2599
Figure 1-4694	Remove the cover	2599
Figure 1-4695	Release one tab	2600
Figure 1-4696	Slide the cover back	2600
Figure 1-4697	Remove the left upper cover	2601
Figure 1-4698	Remove one screw	2601
Figure 1-4699	Release two tabs	2602
Figure 1-4700	Rotate the cover	2602
Figure 1-4701	Remove one screw	2603
Figure 1-4702	Release two tabs	2603
Figure 1-4703	Release the back edge of the cover	2604
Figure 1-4704	Remove the cover	2604
Figure 1-4705	Remove one screw	2605
Figure 1-4706	Remove two screws	2605

Figure 1-4707	Remove one screw	2606
Figure 1-4708	Disconnect connectors	2606
Figure 1-4709	Slide the ISA towards the back of the printer	2607
Figure 1-4710	Remove the ISA	2607
Figure 1-4711	Disconnect connector and remove screws	2608
Figure 1-4712	Remove the stapler unit	2608
Figure 1-4713	Remove two screws and one connector	2609
Figure 1-4714	Remove one screw and connector	2609
Figure 1-4715	Slide the cover	2610
Figure 1-4716	Remove the cover	2610
Figure 1-4717	Remove five screws	2611
Figure 1-4718	Release two tabs	2611
Figure 1-4719	Remove the top rear cover	2612
Figure 1-4720	Remove one screw	2612
Figure 1-4721	Remove the cover	2613
Figure 1-4722	Remove one screw	2613
Figure 1-4723	Remove one screw	2614
Figure 1-4724	Release one tab	2614
Figure 1-4725	Release two tabs	2615
Figure 1-4726	Remove three screws	2615
Figure 1-4727	Remove two screws	2616
Figure 1-4728	Remove the bracket	2616
Figure 1-4729	Remove one screw	2617
Figure 1-4730	Release the cover	2617
Figure 1-4731	Remove the cover	2618
Figure 1-4732	Remove three screws	2618
Figure 1-4733	Remove one screw and release one tab	2619
Figure 1-4734	Release the cover	2619
Figure 1-4735	Remove the cover	2620
Figure 1-4736	Disconnect one connector	2620
Figure 1-4737	Remove the bracket	2621
Figure 1-4738	Remove the LVPS cover	2621
Figure 1-4739	Release wire harnesses and flat cable	2622
Figure 1-4740	Remove six screws	2622
Figure 1-4741	Release the formatter case	2623
Figure 1-4742	Remove the formatter case	2623
Figure 1-4743	Release the cover	2624
Figure 1-4744	Remove the cover	2624
Figure 1-4745	Disconnect one wire harness	2625
Figure 1-4746	Disconnect seven connectors	2625
Figure 1-4747	Pass the wire harnesses through the opening	2626

Figure 1-4748	Remove three screws	2626
Figure 1-4749	Remove the LVPS	2627
Figure 1-4750	Remove one screw	2627
Figure 1-4751	Release the wire harnesses	2628
Figure 1-4752	Remove the fan	2628
Figure 1-4753	Disconnect one flat cable	2629
Figure 1-4754	Remove three screws	2629
Figure 1-4755	Remove the HVPSD	2630
Figure 1-4756	Disconnect two connectors	2630
Figure 1-4757	Disconnect two flat cables	2631
Figure 1-4758	Remove the assembly	2631
Figure 1-4759	Remove two screws	2632
Figure 1-4760	Remove the plate	2632
Figure 1-4761	Disconnect five connectors and one flat cable	2633
Figure 1-4762	Remove one screw	2633
Figure 1-4763	Release the HVPST	2634
Figure 1-4764	Remove the HVPST	2634
Figure 1-4765	Move the guide out of the way	2635
Figure 1-4766	Disconnect one connector	2635
Figure 1-4767	Remove one screw	2636
Figure 1-4768	Remove the guide	2636
Figure 1-4769	Remove three screws	2637
Figure 1-4770	Remove the assembly	2637
Figure 1-4771	Remove one screw	2638
Figure 1-4772	Remove the cover	2638
Figure 1-4773	Release the wire harnesses	2639
Figure 1-4774	Disconnect two connectors	2639
Figure 1-4775	Release the wire harnesses	2640
Figure 1-4776	Disconnect one connector	2640
Figure 1-4777	Release the guide	2641
Figure 1-4778	Remove the guide	2641
Figure 1-4779	Release one wire harness	2642
Figure 1-4780	Release the guide	2642
Figure 1-4781	Remove the guide	2643
Figure 1-4782	Remove seven screws	2643
Figure 1-4783	Remove the main-drive assembly	2644
Figure 1-4784	Recycle and unpack	2644
Figure 1-4785	Main drive gear and cam locations	2645
Figure 1-4786	Main drive gear and cam alignment	2646
Figure 1-4787	Check the blue ITB drive handle	2647
Figure 1-4788	Install the main-drive assembly	2647

Figure 1-4789	Install seven screws	2648
Figure 1-4790	Verify that the assembly is correctly fastened	2648
Figure 1-4791	Install the guide	2649
Figure 1-4792	Install one wire harness	2649
Figure 1-4793	Install the guide	2650
Figure 1-4794	Connect one connector	2650
Figure 1-4795	Install the wire harnesses	2651
Figure 1-4796	Connect two connectors	2651
Figure 1-4797	Install the wire harnesses	2652
Figure 1-4798	Install the cover	2652
Figure 1-4799	Install one screw	2653
Figure 1-4800	Check the gears on the assembly	2653
Figure 1-4801	Install three screws	2654
Figure 1-4802	Install the guide	2654
Figure 1-4803	Install one screw	2655
Figure 1-4804	Connect one connector	2655
Figure 1-4805	Install the guide	2656
Figure 1-4806	Connect one ground wire	2656
Figure 1-4807	Install the HVPST	2657
Figure 1-4808	Install one screw	2657
Figure 1-4809	Connect five connectors and one flat cable	2658
Figure 1-4810	Install the plate	2658
Figure 1-4811	Install two screws	2659
Figure 1-4812	Install the lifter drive	2659
Figure 1-4813	Connect two flat cables	2660
Figure 1-4814	Connect two connectors	2660
Figure 1-4815	Install the HVPST	2661
Figure 1-4816	Press the tabs	2661
Figure 1-4817	Install three screws	2662
Figure 1-4818	Connect one flat cable	2662
Figure 1-4819	Install the fan	2663
Figure 1-4820	Place the wire harnesses in the retainer	2663
Figure 1-4821	Install one screw	2664
Figure 1-4822	Install the LVPS	2664
Figure 1-4823	Install three screws	2665
Figure 1-4824	Pass the wire harnesses through the opening	2665
Figure 1-4825	Connect seven connectors	2666
Figure 1-4826	Connect one wire harness	2666
Figure 1-4827	Install the cover	2667
Figure 1-4828	Install one screw	2667
Figure 1-4829	Pass the wire harnesses through the opening	2668

Figure 1-4830	Install the formatter case	2668
Figure 1-4831	Install six screws	2669
Figure 1-4832	Install wire harnesses and flat cable	2669
Figure 1-4833	Install the LVPS cover	2670
Figure 1-4834	Attach the flat cable	2670
Figure 1-4835	Position the bracket	2671
Figure 1-4836	Connect one connector	2671
Figure 1-4837	Install the cover	2672
Figure 1-4838	Engage one tab	2672
Figure 1-4839	Engage one tab and install one screw	2673
Figure 1-4840	Install three screws	2673
Figure 1-4841	Install the cover	2674
Figure 1-4842	Engage the cover	2674
Figure 1-4843	Install one screw	2675
Figure 1-4844	Position the tabs in the slots	2675
Figure 1-4845	Install two screws	2676
Figure 1-4846	Install three screws	2676
Figure 1-4847	Position the locator pins	2677
Figure 1-4848	Press down on the cover	2677
Figure 1-4849	Install one screw	2678
Figure 1-4850	Install one screw	2678
Figure 1-4851	Install the cover	2679
Figure 1-4852	Install one screw	2679
Figure 1-4853	Align the locator tabs	2680
Figure 1-4854	Install the cover	2680
Figure 1-4855	Install five screws	2681
Figure 1-4856	Install the cables	2681
Figure 1-4857	Position the hooks	2682
Figure 1-4858	Install the cover	2682
Figure 1-4859	Install one screw and connector	2683
Figure 1-4860	Install one screw and connector	2683
Figure 1-4861	Position the hooks in the slots	2684
Figure 1-4862	Connect connector and install screws	2684
Figure 1-4863	Locate the ISA mounting pins and slots	249
Figure 1-4864	Install the ISA	2686
Figure 1-4865	Slide the ISA towards the front of the printer	2686
Figure 1-4866	Install one screw	2687
Figure 1-4867	Install two screws	2687
Figure 1-4868	Install one screw	2688
Figure 1-4869	Connect connectors	2688
Figure 1-4870	Install two tabs	2689

Figure 1-4871	Install the cover assembly	2689
Figure 1-4872	Install one screw	2690
Figure 1-4873	Install the cover	2691
Figure 1-4874	Press the cover	2691
Figure 1-4875	Install one screw	2692
Figure 1-4876	Position the tab	2692
Figure 1-4877	Slide the cover	2693
Figure 1-4878	Check the tab	2693
Figure 1-4879	Position the hooks	2694
Figure 1-4880	Install the cover	2694
Figure 1-4881	Install four screws cover	2695
Figure 1-4882	Align the cover	2695
Figure 1-4883	Rotate the top of the cover	2696
Figure 1-4884	Slide the cover	2696
Figure 1-4885	Install two screws	2697
Figure 1-4886	Install the cover	2697
Figure 1-4887	Install four screws cover	2698
Figure 1-4888	Install the formatter	2698
Figure 1-4889	Install four screws	2699
Figure 1-4890	Connect all connectors	2700
Figure 1-4891	Position the fax PCA	2700
Figure 1-4892	Install the fax PCA	2701
Figure 1-4893	Connect the connector	2701
Figure 1-4894	Install the holder	2702
Figure 1-4895	Release the HDD	2702
Figure 1-4896	Install the formatter	2703
Figure 1-4897	Connect all connectors	2704
Figure 1-4898	Install the cover	2704
Figure 1-4899	Verify that the toner collection hatch cover is closed	2705
Figure 1-4900	Install the TCU	2705
Figure 1-4901	Close the front door	2706
Figure 1-4902	Install the tray	2706
Figure 1-4903	Close the tray	2707
Figure 1-4904	Place the control panel on the product	2707
Figure 1-4905	Connect two connectors	2708
Figure 1-4906	Turn the control panel over	2708
Figure 1-4907	Rotate the control-panel base down	2709
Figure 1-4908	Install two screws	2709
Figure 1-4909	Install the cover	2710
Figure 1-4910	Handle the ITB by the edges	2710
Figure 1-4911	Align the ITB with the slots in the product	2711

Figure 1-4912	Install the ITB	2711
Figure 1-4913	Remove the spring from the holder	2712
Figure 1-4914	Fasten the rear-side ITB spring	2712
Figure 1-4915	Remove the spring from the holder	2713
Figure 1-4916	Fasten the front-side ITB spring	2713
Figure 1-4917	Engage the ITB drive coupling	2714
Figure 1-4918	Align the fuser with the opening	2714
Figure 1-4919	Install the fuser	2715
Figure 1-4920	Close the right door	2715
Figure 1-4921	Install the cover	2716
Figure 1-4922	Check the installation	2716
Figure 1-4923	Locate the formatter cover	2720
Figure 1-4924	Loosen the thumbscrews	2721
Figure 1-4925	Remove two screws	2721
Figure 1-4926	Release the right edge	2722
Figure 1-4927	Slide the cover right	2722
Figure 1-4928	Remove the cover	2723
Figure 1-4929	Release one tab	2723
Figure 1-4930	Slide the cover back	2724
Figure 1-4931	Remove the left upper cover	2724
Figure 1-4932	Remove one screw	2725
Figure 1-4933	Remove the cover	2725
Figure 1-4934	Disconnect the flat cable, ground cable, and connectors	2726
Figure 1-4935	Open the document feeder	2726
Figure 1-4936	Raise the document feeder	2727
Figure 1-4937	Release two tabs	2727
Figure 1-4938	Remove the document feeder	2728
Figure 1-4939	Recycle and unpack	2728
Figure 1-4940	Install the document feeder	2729
Figure 1-4941	Lower the document feeder	2729
Figure 1-4942	Install the retention clip	2730
Figure 1-4943	Press the retention clip	2730
Figure 1-4944	Install the white backing	2731
Figure 1-4945	Attach the white backing	2731
Figure 1-4946	Check the white backing	2732
Figure 1-4947	Close the document feeder	2732
Figure 1-4948	Connect the flat cable, ground cable, and connectors	2733
Figure 1-4949	Position the tabs	2733
Figure 1-4950	Install the cover	2734
Figure 1-4951	Install one screw	2734
Figure 1-4952	Position the tab	2735

Figure 1-4953	Slide the cover	2735
Figure 1-4954	Check the tab	2736
Figure 1-4955	Align the cover	2736
Figure 1-4956	Rotate the top of the cover	2737
Figure 1-4957	Slide the cover	2737
Figure 1-4958	Install two screws	2738
Figure 1-4959	Install the cover	2738
Figure 1-4960	Locate the formatter cover	2741
Figure 1-4961	Loosen the thumbscrews	2741
Figure 1-4962	Remove two screws	2742
Figure 1-4963	Release the right edge	2742
Figure 1-4964	Slide the cover right	2743
Figure 1-4965	Remove the cover	2743
Figure 1-4966	Disconnect all of the connectors	2744
Figure 1-4967	Disconnect three connectors	2744
Figure 1-4968	Remove two screws	2745
Figure 1-4969	Slide the SCB out	2745
Figure 1-4970	Remove the SCB	2746
Figure 1-4971	Recycle and unpack	2746
Figure 1-4972	Install the SCB	2747
Figure 1-4973	Slide the SCB in	2747
Figure 1-4974	Raise the SCB and install cables	2748
Figure 1-4975	Install two screws	2748
Figure 1-4976	Connect three connectors	2749
Figure 1-4977	Connect all of the connectors	2749
Figure 1-4978	Align the cover	2750
Figure 1-4979	Rotate the top of the cover	2750
Figure 1-4980	Slide the cover	2751
Figure 1-4981	Install two screws	2751
Figure 1-4982	Install the cover	2752
Figure 1-4983	Open the document feeder	2755
Figure 1-4984	Release five tabs	2755
Figure 1-4985	Remove the cover	2756
Figure 1-4986	Remove the white backing	2756
Figure 1-4987	Check the retention clips	2757
Figure 1-4988	Check the retention clip spring	2757
Figure 1-4989	Install the retention clip	2758
Figure 1-4990	Press the retention clip	2758
Figure 1-4991	Disconnect the keyboard flat cable	2759
Figure 1-4992	Slide the keyboard out	2759
Figure 1-4993	Release two tabs	2760

Figure 1-4994	Remove the keyboard	2760
Figure 1-4995	Disconnect connectors	2761
Figure 1-4996	Disconnect connectors	2761
Figure 1-4997	Remove three screws	2762
Figure 1-4998	Remove the control panel	2762
Figure 1-4999	Locate the formatter cover	2763
Figure 1-5000	Loosen the thumbscrews	2763
Figure 1-5001	Locate the fax PCA	2764
Figure 1-5002	Disconnect one connector	2764
Figure 1-5003	Release one latch	2765
Figure 1-5004	Remove the fax PCA	2765
Figure 1-5005	Remove two screws	2766
Figure 1-5006	Release the right edge	2766
Figure 1-5007	Slide the cover right	2767
Figure 1-5008	Remove the cover	2767
Figure 1-5009	Release one tab	2768
Figure 1-5010	Slide the cover back	2768
Figure 1-5011	Remove the left upper cover	2769
Figure 1-5012	Remove one screw	2769
Figure 1-5013	Release two tabs	2770
Figure 1-5014	Rotate the cover	2770
Figure 1-5015	Remove one screw	2771
Figure 1-5016	Release two tabs	2771
Figure 1-5017	Release the back edge of the cover	2772
Figure 1-5018	Remove the cover	2772
Figure 1-5019	Remove one screw	2773
Figure 1-5020	Remove the cover	2773
Figure 1-5021	Disconnect the flat cable, ground cable, and connectors	2774
Figure 1-5022	Disconnect three connectors	2774
Figure 1-5023	Open the document feeder	2775
Figure 1-5024	Raise the document feeder	2775
Figure 1-5025	Release two tabs	2776
Figure 1-5026	Remove the document feeder	2776
Figure 1-5027	Remove two screws	2777
Figure 1-5028	Slide the SCB out	2777
Figure 1-5029	Remove the SCB	2778
Figure 1-5030	Disconnect cables and connectors	2778
Figure 1-5031	Remove one screw	2779
Figure 1-5032	Remove two screws	2779
Figure 1-5033	Remove one screw	2780
Figure 1-5034	Release the image scanner	2780

Figure 1-5035	Remove the image scanner	2781
Figure 1-5036	Recycle and unpack	2781
Figure 1-5037	Locate the image scanner mounting pins and slots	2782
Figure 1-5038	Install the image scanner	2782
Figure 1-5039	Engage the image scanner	2783
Figure 1-5040	Install one screw	2783
Figure 1-5041	Install two screws	2784
Figure 1-5042	Install one screw	2784
Figure 1-5043	Connect connectors	2785
Figure 1-5044	Keyboard cover mounting slots and tabs (M577dn and M577f)	2785
Figure 1-5045	Install the keyboard cover (M577dn and M577f)	2786
Figure 1-5046	Check the keyboard cover (M577dn and M577f)	2786
Figure 1-5047	Install the SCB	2787
Figure 1-5048	Slide the SCB in	2787
Figure 1-5049	Raise the SCB and install cables	2788
Figure 1-5050	Install two screws	2788
Figure 1-5051	Install the document feeder	2789
Figure 1-5052	Lower the document feeder	2789
Figure 1-5053	Close the document feeder	2790
Figure 1-5054	Connect three connectors	2790
Figure 1-5055	Connect the flat cable, ground cable, and connectors	2791
Figure 1-5056	Position the tabs	2791
Figure 1-5057	Install the cover	2792
Figure 1-5058	Install one screw	2792
Figure 1-5059	Install two tabs	2793
Figure 1-5060	Install the cover assembly	2793
Figure 1-5061	Install one screw	2794
Figure 1-5062	Install the cover	2794
Figure 1-5063	Press the cover	2795
Figure 1-5064	Install one screw	2795
Figure 1-5065	Position the tab	2796
Figure 1-5066	Slide the cover	2796
Figure 1-5067	Check the tab	2797
Figure 1-5068	Align the cover	2797
Figure 1-5069	Rotate the top of the cover	2798
Figure 1-5070	Slide the cover	2798
Figure 1-5071	Install two screws	2799
Figure 1-5072	Position the fax PCA	2800
Figure 1-5073	Install the fax PCA	2800
Figure 1-5074	Connect the connector	2801
Figure 1-5075	Install the cover	2801

Figure 1-5076	Open the control panel	2802
Figure 1-5077	Locate hooks and grounding clip	97
Figure 1-5078	Install the control-panel	2803
Figure 1-5079	Install three screws	2803
Figure 1-5080	Connect connectors	2804
Figure 1-5081	Connect connectors	2804
Figure 1-5082	Install the flat cable through the slot	2805
Figure 1-5083	Slide the keyboard into the slot	2805
Figure 1-5084	Check the flat cable	2806
Figure 1-5085	Connect the flat cable	2806
Figure 1-5086	Install the white backing	2807
Figure 1-5087	Close the document feeder	2807
Figure 1-5088	Check the white backing	2808
Figure 1-5089	Position the control-panel cover on the printer	2808
Figure 1-5090	Engage five tabs	2809
Figure 1-5091	Close the document feeder	2809
Figure 1-5092	Pull the tray out	2812
Figure 1-5093	Remove the tray	2812
Figure 1-5094	Recycle and unpack	2813
Figure 1-5095	Install the tray	2813
Figure 1-5096	Close the tray	2814
Figure 1-5097	Pull the tray out	2816
Figure 1-5098	Remove the tray	2816
Figure 1-5099	Recycle and unpack	2817
Figure 1-5100	Install the tray	2817
Figure 1-5101	Close the tray	2818
Figure 1-5102	Release three tabs	2821
Figure 1-5103	Remove the cover	2822
Figure 1-5104	Recycle and unpack	2822
Figure 1-5105	Position the cover on the chassis	2823
Figure 1-5106	Install the cover	2823
Figure 1-5107	Check the three tabs	2824
Figure 1-5108	Release three tabs	2826
Figure 1-5109	Remove the cover	2826
Figure 1-5110	Open the door	2827
Figure 1-5111	Release the hinge bracket	2827
Figure 1-5112	Remove the hinge bracket	2828
Figure 1-5113	Release the door link	2828
Figure 1-5114	Recycle and unpack	2829
Figure 1-5115	Install the door link	2829
Figure 1-5116	Position the door on the lower hinge	2830

Figure 1-5117	Engage the hinge bracket	2830
Figure 1-5118	Install the hinge bracket	2831
Figure 1-5119	Close the door	2831
Figure 1-5120	Position the cover on the chassis	2832
Figure 1-5121	Install the cover	2832
Figure 1-5122	Check the three tabs	2833
Figure 1-5123	Release three tabs	2835
Figure 1-5124	Remove the cover	2835
Figure 1-5125	Open the door	2836
Figure 1-5126	Release the hinge bracket	2836
Figure 1-5127	Remove the hinge bracket	2837
Figure 1-5128	Release the door link	2837
Figure 1-5129	Remove the hinge bracket	2838
Figure 1-5130	Recycle and unpack	2838
Figure 1-5131	Install the hinge bracket	2839
Figure 1-5132	Install the door link	2839
Figure 1-5133	Position the door on the lower hinge	2840
Figure 1-5134	Engage the hinge bracket	2840
Figure 1-5135	Install the hinge bracket	2841
Figure 1-5136	Close the door	2841
Figure 1-5137	Position the cover on the chassis	2842
Figure 1-5138	Install the cover	2842
Figure 1-5139	Check the three tabs	2843
Figure 1-5140	Release three tabs	2845
Figure 1-5141	Remove the cover	2845
Figure 1-5142	Open the door	2846
Figure 1-5143	Release the hinge bracket	2846
Figure 1-5144	Remove the hinge bracket	2847
Figure 1-5145	Release the door link	2847
Figure 1-5146	Cover mounting tabs	2848
Figure 1-5147	Release the cover	2848
Figure 1-5148	Remove the right-lower cover	2849
Figure 1-5149	Remove the right-door link	2849
Figure 1-5150	Recycle and unpack	2850
Figure 1-5151	Remove the right-door link	2850
Figure 1-5152	Cover mounting tabs	2851
Figure 1-5153	Install the right-lower cover	2851
Figure 1-5154	Engage the cover	2852
Figure 1-5155	Check the cover	2852
Figure 1-5156	Install the door link	2853
Figure 1-5157	Position the door on the lower hinge	2853

Figure 1-5158	Engage the hinge bracket	2854
Figure 1-5159	Install the hinge bracket	2854
Figure 1-5160	Close the door	2855
Figure 1-5161	Position the cover on the chassis	2855
Figure 1-5162	Install the cover	2856
Figure 1-5163	Check the three tabs	2856
Figure 1-5164	Release three tabs	2858
Figure 1-5165	Remove the cover	2858
Figure 1-5166	Open the door	2859
Figure 1-5167	Release the hinge bracket	2859
Figure 1-5168	Remove the hinge bracket	2860
Figure 1-5169	Release the door link	2860
Figure 1-5170	Cover mounting tabs	2861
Figure 1-5171	Release the cover	2861
Figure 1-5172	Remove the right-lower cover	2862
Figure 1-5173	Remove the right-door link	2862
Figure 1-5174	Recycle and unpack	2863
Figure 1-5175	Remove the right-door link	2863
Figure 1-5176	Cover mounting tabs	2864
Figure 1-5177	Install the right-lower cover	2864
Figure 1-5178	Engage the cover	2865
Figure 1-5179	Check the cover	2865
Figure 1-5180	Install the door link	2866
Figure 1-5181	Position the door on the lower hinge	2866
Figure 1-5182	Engage the hinge bracket	2867
Figure 1-5183	Install the hinge bracket	2867
Figure 1-5184	Close the door	2868
Figure 1-5185	Position the cover on the chassis	2868
Figure 1-5186	Install the cover	2869
Figure 1-5187	Check the three tabs	2869
Figure 1-5188	Release three tabs	2870
Figure 1-5189	Remove the cover	2871
Figure 1-5190	Recycle and unpack	2871
Figure 1-5191	Position the cover on the chassis	2872
Figure 1-5192	Install the cover	2872
Figure 1-5193	Check the three tabs	2873
Figure 1-5194	Release three tabs	2875
Figure 1-5195	Remove the cover	2875
Figure 1-5196	Disconnect one connector	2876
Figure 1-5197	Remove the drawer holder	2876
Figure 1-5198	Recycle and unpack	2877

Figure 1-5199	Install the drawer holder	2877
Figure 1-5200	Connect one connector	2878
Figure 1-5201	Position the cover on the chassis	2878
Figure 1-5202	Install the cover	2879
Figure 1-5203	Check the three tabs	2879
Figure 1-5204	Pull the tray out	2881
Figure 1-5205	Remove the tray	2881
Figure 1-5206	Release three tabs	2882
Figure 1-5207	Remove the cover	2882
Figure 1-5208	Disconnect one connector	2883
Figure 1-5209	Remove two screws	2883
Figure 1-5210	Release the assembly	2884
Figure 1-5211	Remove the assembly	2884
Figure 1-5212	Recycle and unpack	2885
Figure 1-5213	Install the assembly	2885
Figure 1-5214	Engage the assembly	2886
Figure 1-5215	Install two screws	2886
Figure 1-5216	Disconnect one connector	2887
Figure 1-5217	Position the cover on the chassis	2887
Figure 1-5218	Install the cover	2888
Figure 1-5219	Check the three tabs	2888
Figure 1-5220	Install the tray	2889
Figure 1-5221	Close the tray	2889
Figure 1-5222	Pull the tray out	2891
Figure 1-5223	Remove the tray	2891
Figure 1-5224	Release three tabs	2892
Figure 1-5225	Remove the cover	2892
Figure 1-5226	Disconnect one connector	2893
Figure 1-5227	Squeeze two tabs	2893
Figure 1-5228	Remove the switch button (SW12)	2894
Figure 1-5229	Recycle and unpack	2894
Figure 1-5230	Install the switch button (SW12)	2895
Figure 1-5231	Install the switch button (SW12)	2895
Figure 1-5232	Connect one connector	2896
Figure 1-5233	Position the cover on the chassis	2896
Figure 1-5234	Install the cover	2897
Figure 1-5235	Check the three tabs	2897
Figure 1-5236	Install the tray	2898
Figure 1-5237	Close the tray	2898
Figure 1-5238	Release three tabs	2900
Figure 1-5239	Remove the cover	2900

Figure 1-5240	Disconnect one connector	2901
Figure 1-5241	Release one tab	2901
Figure 1-5242	Remove the tray connector	2902
Figure 1-5243	Recycle and unpack	2902
Figure 1-5244	Place the tray connector on the accessory	2903
Figure 1-5245	Install the tray connector	2903
Figure 1-5246	Connect one connector	2904
Figure 1-5247	Position the cover on the chassis	2904
Figure 1-5248	Install the cover	2905
Figure 1-5249	Check the three tabs	2905
Figure 1-5250	Release three tabs	2907
Figure 1-5251	Remove the cover	2907
Figure 1-5252	Disconnect all of the connectors	2908
Figure 1-5253	Remove the PCA	2908
Figure 1-5254	Recycle and unpack	2909
Figure 1-5255	Install the PCA	2909
Figure 1-5256	Connect all of the connectors	2910
Figure 1-5257	Position the cover on the chassis	2910
Figure 1-5258	Install the cover	2911
Figure 1-5259	Check the three tabs	2911
Figure 1-5260	Pull the tray out	2913
Figure 1-5261	Remove the tray	2913
Figure 1-5262	Release three tabs	2914
Figure 1-5263	Remove the cover	2914
Figure 1-5264	Open the door	2915
Figure 1-5265	Release the hinge bracket	2915
Figure 1-5266	Remove the hinge bracket	2916
Figure 1-5267	Release the door link	2916
Figure 1-5268	Disconnect one connector	2917
Figure 1-5269	Release one tab	2917
Figure 1-5270	Remove the tray connector	2918
Figure 1-5271	Remove six screws	2918
Figure 1-5272	Remove the sheet-metal plate	2919
Figure 1-5273	Release the paper feed guide	2919
Figure 1-5274	Remove the cover	2920
Figure 1-5275	Disconnect one connector	2920
Figure 1-5276	Remove two springs	2921
Figure 1-5277	Remove three screws	2921
Figure 1-5278	Release two alignment pins	2922
Figure 1-5279	Remove the paper feed assembly	2922
Figure 1-5280	Recycle and unpack	2923

Figure 1-5281	Left side flag	2923
Figure 1-5282	Install the assembly	2924
Figure 1-5283	Check the alignment pins	2924
Figure 1-5284	Install three screws	2925
Figure 1-5285	Install two springs	2925
Figure 1-5286	Connect one connector	2926
Figure 1-5287	Install the cover	2926
Figure 1-5288	Raise the paper feed guide	2927
Figure 1-5289	Install the sheet-metal plate	2927
Figure 1-5290	Install six screws	2928
Figure 1-5291	Place the tray connector on the accessory	2928
Figure 1-5292	Install the tray connector	2929
Figure 1-5293	Connect one connector	2929
Figure 1-5294	Install the door link	2930
Figure 1-5295	Position the door on the lower hinge	2930
Figure 1-5296	Engage the hinge bracket	2931
Figure 1-5297	Install the hinge bracket	2931
Figure 1-5298	Close the door	2932
Figure 1-5299	Position the cover on the chassis	2932
Figure 1-5300	Install the cover	2933
Figure 1-5301	Check the three tabs	2933
Figure 1-5302	Install the tray	2934
Figure 1-5303	Close the tray	2934
Figure 1-5304	Pull the tray out	2936
Figure 1-5305	Remove the tray	2936
Figure 1-5306	Release three tabs	2937
Figure 1-5307	Remove the cover	2937
Figure 1-5308	Open the door	2938
Figure 1-5309	Release the hinge bracket	2938
Figure 1-5310	Remove the hinge bracket	2939
Figure 1-5311	Release the door link	2939
Figure 1-5312	Disconnect one connector	2940
Figure 1-5313	Release one tab	2940
Figure 1-5314	Remove the tray connector	2941
Figure 1-5315	Remove six screws	2941
Figure 1-5316	Remove the sheet-metal plate	2942
Figure 1-5317	Release the paper feed guide	2942
Figure 1-5318	Remove the cover	2943
Figure 1-5319	Disconnect one connector	2943
Figure 1-5320	Remove two springs	2944
Figure 1-5321	Remove three screws	2944

Figure 1-5322	Release two alignment pins	2945
Figure 1-5323	Remove the paper feed assembly	2945
Figure 1-5324	Disconnect one connector	2946
Figure 1-5325	Remove three screws	2946
Figure 1-5326	Lower the end of the assembly	2947
Figure 1-5327	Release the assembly from the drive gear	2947
Figure 1-5328	Remove the assembly	2948
Figure 1-5329	Recycle and unpack	2948
Figure 1-5330	Install the assembly	2949
Figure 1-5331	Raise the end of the assembly	2949
Figure 1-5332	Install three screws	2950
Figure 1-5333	Connect one connector	2950
Figure 1-5334	Left side flag	2951
Figure 1-5335	Install the assembly	2951
Figure 1-5336	Check the alignment pins	2952
Figure 1-5337	Install three screws	2952
Figure 1-5338	Install two springs	2953
Figure 1-5339	Connect one connector	2953
Figure 1-5340	Install the cover	2954
Figure 1-5341	Raise the paper feed guide	2954
Figure 1-5342	Install the sheet-metal plate	2955
Figure 1-5343	Install six screws	2955
Figure 1-5344	Place the tray connector on the accessory	2956
Figure 1-5345	Install the tray connector	2956
Figure 1-5346	Connect one connector	2957
Figure 1-5347	Install the door link	2957
Figure 1-5348	Position the door on the lower hinge	2958
Figure 1-5349	Engage the hinge bracket	2958
Figure 1-5350	Install the hinge bracket	2959
Figure 1-5351	Close the door	2959
Figure 1-5352	Position the cover on the chassis	2960
Figure 1-5353	Install the cover	2960
Figure 1-5354	Check the three tabs	2961
Figure 1-5355	Install the tray	2961
Figure 1-5356	Close the tray	2962
Figure 1-5357	Pull the tray out	2964
Figure 1-5358	Remove the tray	2964
Figure 1-5359	Release three tabs	2965
Figure 1-5360	Remove the cover	2965
Figure 1-5361	Open the door	2966
Figure 1-5362	Release the hinge bracket	2966

Figure 1-5363	Remove the hinge bracket	2967
Figure 1-5364	Release the door link	2967
Figure 1-5365	Cover mounting tabs	2968
Figure 1-5366	Release the cover	2968
Figure 1-5367	Remove the right-lower cover	2969
Figure 1-5368	Disconnect one connector	2969
Figure 1-5369	Release one tab	2970
Figure 1-5370	Remove the tray connector	2970
Figure 1-5371	Remove six screws	2971
Figure 1-5372	Remove the sheet-metal plate	2971
Figure 1-5373	Remove two screws	2972
Figure 1-5374	Remove the sheet-metal plate	2972
Figure 1-5375	Disconnect one connector	2973
Figure 1-5376	Remove one spring	2973
Figure 1-5377	Remove two screws	2974
Figure 1-5378	Remove the assembly	2974
Figure 1-5379	Recycle and unpack	2975
Figure 1-5380	Install the assembly	2975
Figure 1-5381	Install two screws	2976
Figure 1-5382	Install one spring	2976
Figure 1-5383	Connect one connector	2977
Figure 1-5384	Install the sheet-metal plate	2977
Figure 1-5385	Install two screws	2978
Figure 1-5386	Install the sheet-metal plate	2978
Figure 1-5387	Install six screws	2979
Figure 1-5388	Place the tray connector on the accessory	2979
Figure 1-5389	Install the tray connector	2980
Figure 1-5390	Connect one connector	2980
Figure 1-5391	Cover mounting tabs	2981
Figure 1-5392	Install the right-lower cover	2981
Figure 1-5393	Engage the cover	2982
Figure 1-5394	Check the cover	2982
Figure 1-5395	Install the door link	2983
Figure 1-5396	Position the door on the lower hinge	2983
Figure 1-5397	Engage the hinge bracket	2984
Figure 1-5398	Install the hinge bracket	2984
Figure 1-5399	Close the door	2985
Figure 1-5400	Position the cover on the chassis	2985
Figure 1-5401	Install the cover	2986
Figure 1-5402	Check the three tabs	2986
Figure 1-5403	Install the tray	2987

Figure 1-5404	Close the tray	2987
Figure 1-5405	Pull the tray out	2989
Figure 1-5406	Remove the tray	2989
Figure 1-5407	Release three tabs	2990
Figure 1-5408	Remove the cover	2990
Figure 1-5409	Open the door	2991
Figure 1-5410	Release the hinge bracket	2991
Figure 1-5411	Remove the hinge bracket	2992
Figure 1-5412	Release the door link	2992
Figure 1-5413	Cover mounting tabs	2993
Figure 1-5414	Release the cover	2993
Figure 1-5415	Remove the right-lower cover	2994
Figure 1-5416	Disconnect one connector	2994
Figure 1-5417	Release one tab	2995
Figure 1-5418	Remove the tray connector	2995
Figure 1-5419	Remove six screws	2996
Figure 1-5420	Remove the sheet-metal plate	2996
Figure 1-5421	Remove two screws	2997
Figure 1-5422	Remove the sheet-metal plate	2997
Figure 1-5423	Disconnect one connector	2998
Figure 1-5424	Remove one spring	2998
Figure 1-5425	Remove two screws	2999
Figure 1-5426	Remove the assembly	2999
Figure 1-5427	Disconnect one connector	3000
Figure 1-5428	Disconnect two connectors	3000
Figure 1-5429	Remove two screws	3001
Figure 1-5430	Release one tab	3001
Figure 1-5431	Release two tabs	3002
Figure 1-5432	Remove the assembly	3002
Figure 1-5433	Recycle and unpack	3003
Figure 1-5434	Install the assembly	3003
Figure 1-5435	Install the gear on the shaft	3004
Figure 1-5436	Install the assembly	3004
Figure 1-5437	Install two screws	3005
Figure 1-5438	Connect two connectors	3005
Figure 1-5439	Connect one connector	3006
Figure 1-5440	Install the assembly	3006
Figure 1-5441	Install two screws	3007
Figure 1-5442	Install one spring	3007
Figure 1-5443	Connect one connector	3008
Figure 1-5444	Install the sheet-metal plate	3008

Figure 1-5445	Install two screws	3009
Figure 1-5446	Install the sheet-metal plate	3009
Figure 1-5447	Install six screws	3010
Figure 1-5448	Place the tray connector on the accessory	3010
Figure 1-5449	Install the tray connector	3011
Figure 1-5450	Connect one connector	3011
Figure 1-5451	Cover mounting tabs	3012
Figure 1-5452	Install the right-lower cover	3012
Figure 1-5453	Engage the cover	3013
Figure 1-5454	Check the cover	3013
Figure 1-5455	Install the door link	3014
Figure 1-5456	Position the door on the lower hinge	3014
Figure 1-5457	Engage the hinge bracket	3015
Figure 1-5458	Install the hinge bracket	3015
Figure 1-5459	Close the door	3016
Figure 1-5460	Position the cover on the chassis	3016
Figure 1-5461	Install the cover	3017
Figure 1-5462	Check the three tabs	3017
Figure 1-5463	Install the tray	3018
Figure 1-5464	Close the tray	3018
Figure 1-5465	Locate the formatter cover	3020
Figure 1-5466	Loosen the thumbscrews	3020
Figure 1-5467	Release the HDD	3021
Figure 1-5468	Remove the HDD	3022
Figure 1-5469	Locate the TPM	3022
Figure 1-5470	Remove the TPM	3023
Figure 1-5471	Recycle and unpack	3023
Figure 1-5472	Install the TPM	3024
Figure 1-5473	Verify that the TPM is fully seated	3024
Figure 1-5474	Install the holder	3025
Figure 1-5475	Release the HDD	3025
Figure 1-5476	Install the cover	3026
Figure 1-5477	Locate the formatter cover	3028
Figure 1-5478	Loosen the thumbscrews	3028
Figure 1-5479	Release the HDD	3029
Figure 1-5480	Remove the HDD	3029
Figure 1-5481	Locate the TPM	3030
Figure 1-5482	Remove the TPM	3030
Figure 1-5483	Recycle and unpack	3031
Figure 1-5484	Install the TPM	3031
Figure 1-5485	Verify that the TPM is fully seated	3032

Figure 1-5486	Install the holder	3032
Figure 1-5487	Release the HDD	3033
Figure 1-5488	Install the cover	3033
Figure 1-5489	Locate the formatter cover	3035
Figure 1-5490	Loosen the thumbscrews	3035
Figure 1-5491	Locate the USB ports module	3036
Figure 1-5492	Disconnect one connector	3036
Figure 1-5493	Disconnect one connector	3037
Figure 1-5494	Disconnect one connector	3037
Figure 1-5495	Remove the module	3038
Figure 1-5496	Recycle and unpack	3038
Figure 1-5497	Install the PCA in the holder	3039
Figure 1-5498	Connect the cable harness	3039
Figure 1-5499	Install the internal USB ports module	3040
Figure 1-5500	Connect one connector	3040
Figure 1-5501	Connect one connector	3041
Figure 1-5502	Connect one connector	3041
Figure 1-5503	Install the cover	3042
Figure 1-5504	Locate the formatter cover	3044
Figure 1-5505	Loosen the thumbscrews	3044
Figure 1-5506	Locate the USB ports module	3045
Figure 1-5507	Disconnect one connector	3045
Figure 1-5508	Remove the module	3046
Figure 1-5509	Recycle and unpack	3046
Figure 1-5510	Install the PCA in the holder	3047
Figure 1-5511	Connect one cable	3047
Figure 1-5512	Position the internal USB ports module	3048
Figure 1-5513	Install the internal USB ports module	3048
Figure 1-5514	Connect one connector	3049
Figure 1-5515	Install the cover	3049
Figure 1-5516	Locate the formatter cover	3051
Figure 1-5517	Loosen the thumbscrews	3051
Figure 1-5518	Locate the fax PCA	3052
Figure 1-5519	Disconnect one connector	3052
Figure 1-5520	Release one latch	3053
Figure 1-5521	Remove the fax PCA	3053
Figure 1-5522	Recycle and unpack	3054
Figure 1-5523	Position the fax PCA	3054
Figure 1-5524	Install the fax PCA	3055
Figure 1-5525	Connect the connector	3055
Figure 1-5526	Install the cover	3056

Figure 2-1	Document feeder and scanner whole units (M577 only)	3070
Figure 2-2	Covers (M552, M553)	3072
Figure 2-3	Covers (M577)	3074
Figure 2-4	Internal components (1 of 5)	3076
Figure 2-5	Internal components (2 of 5)	3078
Figure 2-6	Internal components (3 of 5)	3080
Figure 2-7	Internal components (4 of 5)	3082
Figure 2-8	Internal components (5 of 5)	3084
Figure 2-9	550-sheet paper feeder covers	3086
Figure 2-10	550-sheet paper feeder main body	3088

1 Removal and replacement

- [For additional service and support](#)
- [Removal and replacement strategy](#)
- [Service approach](#)
- [Removal and replacement procedures](#)

For additional service and support

HP service personnel, go to one of the following Web-based Interactive Search Engines (WISE) sites:

AMS

- <https://support.hp.com/wise/home/ams-en>
- <https://support.hp.com/wise/home/ams-es>
- <https://support.hp.com/wise/home/ams-pt>

APJ

- <https://support.hp.com/wise/home/apj-en>
- <https://support.hp.com/wise/home/apj-ja>
- <https://support.hp.com/wise/home/apj-ko>
- <https://support.hp.com/wise/home/apj-zh-Hans>
- <https://support.hp.com/wise/home/apj-zh-Hant>

EMEA

- <https://support.hp.com/wise/home/emea-en>

Channel partners, go to HP Channel Services Network (CSN) at www.hp.com/partners/csn.

At these locations, find information on the following topics:

- Install and configure
- Printer specifications
- Up-to-date control panel message (CPMD) troubleshooting
- Solutions for printer issues and emerging issues
- Remove and replace part instructions and videos
- Service advisories
- Warranty and regulatory information

Channel partners, access training materials in the HP University and Partner Learning Center at <https://content.ext.hp.com/sites/LMS/HPU.page>.

To access HP PartSurfer information from any mobile device, go to <http://partsurfermobile.hp.com/>.

Removal and replacement strategy

Introduction

The printer uses a field repair strategy. Defective parts are diagnosed and replaced at the Field Replaceable Unit (FRU) assembly level. Repair normally begins by using the printer internal diagnostics and the following two-step process:

1. Isolate the problem to the major system (for example, the network, server, or printer).
2. Identify the cause of failures according to the printer troubleshooting service manual and follow the disassembly procedures to replace the defective parts or the consumable parts.

After locating a faulty part, the printer can usually be repaired at the assembly level by replacing FRUs. Some mechanical assemblies might need to be repaired at the subassembly level. HP does not support replacement of components on the printed circuit assemblies.

The user replaces toner cartridges as they are depleted. Additional instructions about other user-replaceable parts are provided in this section.

The printer tracks the amount of use on the user-replaceable supplies by keeping a page count. The printer prompts the user to replace certain items when a supply is depleted or a specific number of pages has been printed.

Swapping toner cartridges between products might cause a misrepresentation of supply life values and is not recommended.

Considerations during removal and replacement

This chapter describes the FRUs only.

Replacing FRUs is generally the reverse of removal. Notes are included to provide directions for difficult or critical replacement procedures.

HP does not support repairing individual subassemblies or troubleshooting to the printed-circuit assembly (PCA) component level.

 **WARNING!** Never operate or service the printer with the protective cover removed from the laser scanner assembly. The reflected beam, although invisible, can cause damage to the eyes.

The sheet-metal parts can have sharp edges. Be careful when handling sheet-metal parts.

Turn the printer off, wait 5 seconds, and then remove the power cord before attempting to service the printer. *If this warning is not followed, severe injury can result as well as damage to the printer.* The power must be on for certain functional checks during troubleshooting. However, the power cord must be disconnected during parts removal. AC voltage is still present inside the printer when the power switch is in the off position. The power cord must be *disconnected* before servicing the printer.

 **CAUTION:** Incorrectly routed or loose wire harnesses might interfere with other internal components or assemblies and be damaged, pinched, or frayed. Make sure that wire harnesses are correctly routed and retained when installing assemblies.

Do not bend or fold the flat flexible cables (FFCs) during removal or installation.

Do not expose the toner cartridge, or cartridges, to strong light even for a short time.

 **IMPORTANT:** When an assembly is removed that includes a rating plate or tag (or a printer code label), make sure to transfer the plate or tag (or code label) to the replacement assembly.

Do not replace the formatter, DC controller, and eMMC PCA or hard-disk drive simultaneously during a single printer servicing. Doing so might cause the printer to become unstable or inoperable.



 **NOTE:** During assembly removal and replacement, or if the printer is moved, remove the toner cartridge or cartridges.

Toner is a non-poisonous substance composed of plastic and a small number of colored components. If toner gets on the skin or clothing, wipe it off with dry tissue paper and wash in cold water. Hot water sets toner and it might be difficult, or impossible, to remove. Toner easily breaks down vinyl materials, so avoid letting toner contact vinyl.

 **NOTE:** The M553 model is pictured in procedures in this manual that might apply to the M552, M553 and M577 models. The procedures are correct for the indicated models.

 **TIP:** Some figures might show assemblies removed or installed that have not yet been removed or installed at that specific step. However, the procedures are correct for this printer and the target assembly. Always thoroughly read the instructions that accompany each figure.

Electrostatic discharge

 **CAUTION:**  Some parts are sensitive to electrostatic discharge (ESD). Look for the ESD reminder when removing printer parts. Always perform service work at an ESD-protected workstation or mat. If an ESD workstation or mat is not available, touch the sheet-metal chassis to provide a static ground *before* touching an ESD-sensitive assembly.

Protect the ESD-sensitive assemblies by placing them in ESD pouches when they are out of the printer.

Required tools

- #2 Phillips screwdriver with a magnetic tip and a 152-mm (6-in) shaft length
- Small, flat-blade screwdriver
- Needle-nose pliers
- ESD strap (if one is available)
- Penlight

 **CAUTION:** Always use a #2 Phillips screwdriver (callout 1). Do not use a Pozidriv screwdriver (callout 2) or any motorized screwdriver. These can damage screws or screw threads.

Figure 1-1 Screwdrivers



Fasteners used in this printer

⚠ WARNING! Make sure that assemblies are replaced with the correct screw type. Using the incorrect screw (for example, substituting a long screw for the correct shorter screw) can cause damage to the printer or interfere with printer operation. Do not intermix screws that are removed from one assembly with the screws that are removed from another assembly.

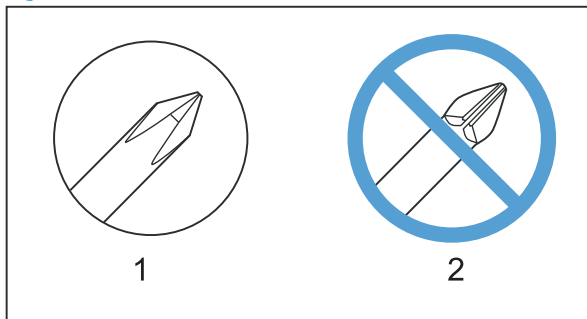
📝 NOTE: To install a self-tapping screw, first turn it counterclockwise to align it with the existing thread pattern, and then carefully turn it clockwise to tighten. Do not overtighten. If a self-tapping screw hole becomes stripped, repair the screw hole or replace the affected assembly.

Always take note of the length, diameter, color, type, and location of each removed screw. Make sure that screws are installed in their original location during reinstallation.

Fasteners used in the printer

- Screw, BH M3X10
- Screw, with washer, M3X8
- Screw, D M3X8
- Screw, machine, truss head, M3X6

Figure 1-2 Screw size chart

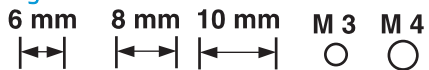

Service approach

Before performing service

 **WARNING!** Turn the printer off, wait 30 seconds, and then remove the power cord before attempting to service the printer. *If this warning is not followed, severe injury and damage to the printer can result.* The power must be on for certain functional checks during troubleshooting. However, the power to the printer should be disconnected during parts removal.

1. Remove all paper.
2. Place the printer on an ESD mat (if available). If an ESD workstation or mat is not available, touch the sheet-metal chassis to provide a static ground *before* touching an ESD-sensitive assembly.
3. Remove the toner cartridge or toner cartridges.
4. Remove the trays.

After performing service

1. Reinstall the toner cartridge or toner cartridges.
2. Reinstall the trays.
3. Return all paper to the trays.
4. Plug in the power cable and turn on the printer.
5. Perform print-quality tests by printing from a host computer.

Post service tests

Print quality test

Use the print-quality troubleshooting pages to help diagnose and solve print-quality problems. For more information, see the printer troubleshooting manual.

 **NOTE:** To get further assistance in print quality troubleshooting, go to www.hp.com/support/colorljM552, www.hp.com/support/colorljM553, www.hp.com/support/colorljM577MFP, www.hp.com/support/colorljE55040, www.hp.com/support/colorljE57540MFP and select PQ Troubleshooting Tools.

Copy-quality test (M577 models)

1. Verify that you have completed the necessary reassembly steps.
2. Ensure that the input tray contains clean, unmarked paper.
3. With the power cord attached, turn on the printer.
4. Verify that the expected start up sounds occur.
5. Print a configuration page, and then verify that the expected printing sounds occur.
6. Place the configuration page in the document feeder or on the flatbed glass.
7. Print a copy job, and then verify the results.

Fax-quality test (M577 models)

1. Place the configuration page in the document feeder.
2. Type a valid fax number, and send the fax job.
3. Verify that the send quality and the receive quality meet expectations.

Parts removal orientation

For procedures and/or steps that require identifying the right, left, or rear side of the printer, face the front of the printer for correct orientation.

Removal and replacement procedures

Customer self-repair (CSR) A parts and assemblies

- [Removal and replacement: Toner cartridges](#)
- [Removal and replacement: Toner collection unit \(TCU\)](#)
- [Removal and replacement: Staple cartridge \(M577c/f/z\)](#)
- [Removal and replacement: Fuser](#)
- [Removal and replacement: Hard-disk drive \(HDD\) \(M552 and M553\)](#)
- [Removal and replacement: Hard-disk drive \(HDD\) \(M577\)](#)
- [Removal and replacement: Dual in-line memory module \(DIMM; M552 and M553\)](#)
- [Removal and replacement: Dual in-line memory module \(DIMM; M577\)](#)
- [Removal and replacement: embedded MultiMedia Card \(eMMC; M552 and M553\)](#)
- [Removal and replacement: Secondary transfer roller](#)
- [Removal and replacement: Universal Serial Bus \(USB\) cover \(M552 and M553\)](#)
- [Removal and replacement: Hardware Integration Pocket \(HIP\) cover \(M552 and M553\)](#)
- [Removal and replacement: Hardware Integration Pocket \(HIP\) cover \(M577\)](#)
- [Removal and replacement: Control panel \(M553x\)](#)
- [Removal and replacement: Control panel \(M577\)](#)
- [Removal and replacement: Keyboard \(M577c/z\)](#)
- [Removal and replacement: White backing \(M577\)](#)
- [Removal and replacement: Retention clips \(M577\)](#)
- [Removal and replacement: Document feeder rollers \(M577\)](#)

The CSR level indicates the expected difficulty the customer will experience when removing and replacing an assembly. The CSR A assemblies in this section are easy for the customer to remove and replace.

Removal and replacement: Toner cartridges

- [Introduction](#)
- [Step 1: Remove the toner cartridges](#)
- [Step 2: Unpack the replacement assembly](#)
- [Step 3: Install a toner cartridge](#)

Introduction

This document provides instructions about removing and replacing toner cartridges.

Before performing service

⚠ CAUTION: To prevent damage to a toner cartridge, do not expose it to light for more than a few minutes. Cover the green imaging drum if the toner cartridge must be removed from the printer for an extended period of time.

If toner gets on the skin or clothing, wipe it off with dry tissue paper and wash in cold water. Hot water sets toner and it might be difficult, or impossible, to remove.

Use the table below to identify the correct part number for your printer. To order the part, go to www.hp.com/buy/parts.

Toner cartridge kit part numbers	
CF360-67901	Standard-capacity replacement black toner cartridge with instruction guide
CF360-67902	High-capacity replacement black toner cartridge with instruction guide
CF361-67901	Standard-capacity replacement cyan cartridge with instruction guide
CF361-67902	High-capacity replacement cyan toner cartridge with instruction guide
CF362-67901	Standard-capacity replacement yellow toner cartridge with instruction guide
CF362-67902	High-capacity replacement yellow toner cartridge with instruction guide
CF363-67901	Standard-capacity replacement magenta toner cartridge with instruction guide
CF363-67902	High-capacity replacement magenta toner cartridge with instruction guide
W9060-67901	SVC Cartridge LJ Black Managed Toner
W9061-67901	SVC Cartridge LJ Cyan Managed Toner
W9062-67901	SVC Cartridge LJ Yellow Managed Toner
W9063-67901	SVC Cartridge LJ Magenta Managed Toner

Required tools

No special tools are required to install this part.

After performing service

Make sure that the front door is fully closed after replacing a toner cartridge.

Post service test

The color-band test page shows bands of colors that can indicate whether the printer is producing colors correctly.

1. From the Home screen on the printer control panel, open the **Administration** menu.
2. Open the following menus:
 - Troubleshooting
 - Print Quality Pages
 - Color Band Test
3. Select the **Print** or **OK** button to print the pages.

Step 1: Remove the toner cartridges

1. Open the front door.

Figure 1-3 Open the front door

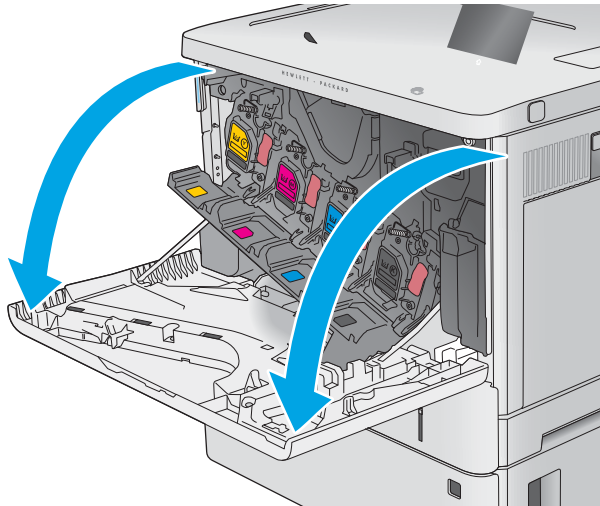

2. Grasp the handle of the used toner cartridge and pull out to remove it.

Figure 1-4 Remove the toner cartridge

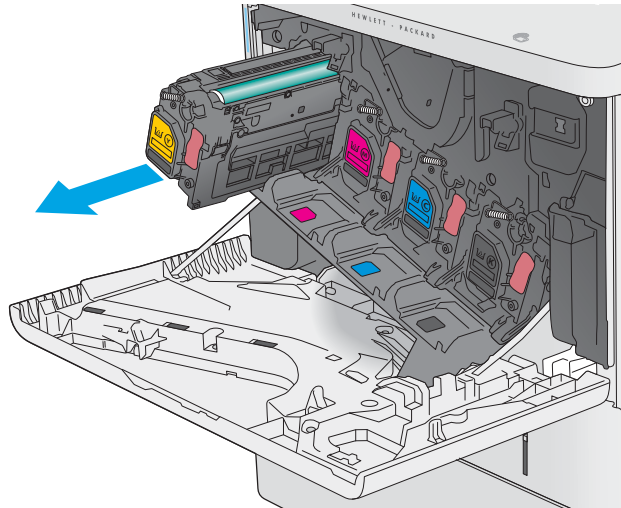

Step 2: Unpack the replacement assembly

Remove the new toner cartridge from its protective shell by tearing off the plastic strip and opening the package. Save all packaging for recycling the used toner cartridge.

For complete information on HP's recycling programs, go to [Product return and recycling](#).

CAUTION: To prevent damage to a replacement toner cartridge, do not expose it to light for more than a few minutes. Cover the green imaging drum if the toner cartridge must be removed from the printer for an extended period of time.

If toner gets on the skin or clothing, wipe it off with dry tissue paper and wash in cold water. Hot water sets toner and it might be difficult, or impossible, to remove.

NOTE: HP recommends responsible disposal of the defective assembly.

Figure 1-5 Recycle and unpack

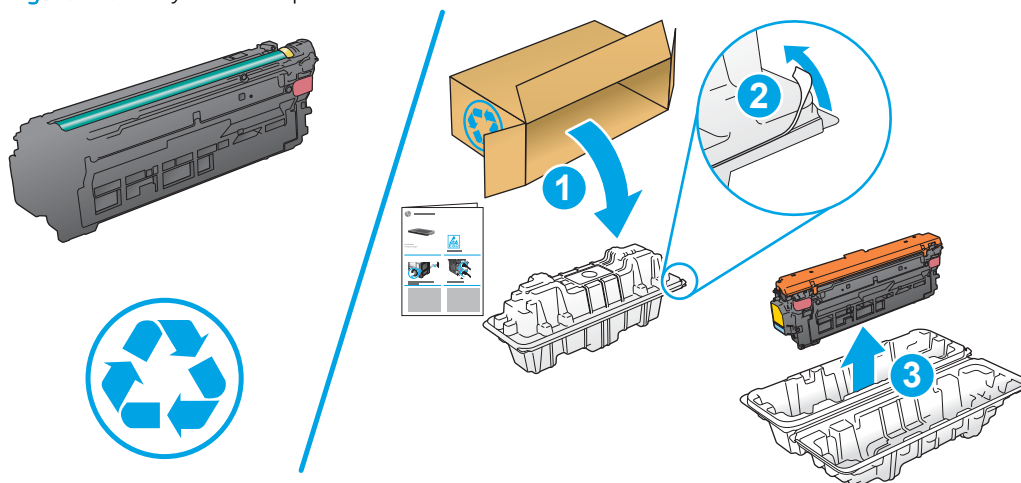

Step 3: Install a toner cartridge

1. Hold both ends of the toner cartridge and rock it 5-6 times.

Figure 1-6 Rock the toner cartridge

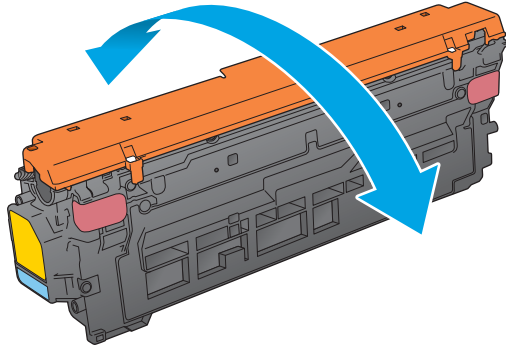

2. Remove the protective shield from the toner cartridge.

Figure 1-7 Remove the protective shield

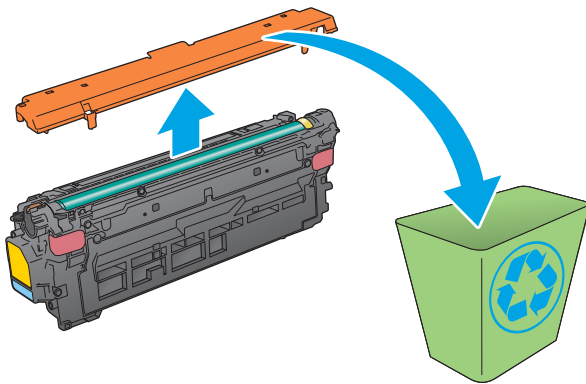

- Support the toner cartridge underneath with one hand while holding the cartridge handle with the other. Align the toner cartridge with its slot on the shelf, and then insert the toner cartridge into the printer.

 **NOTE:** Avoid touching the green imaging drum. Fingerprints on the imaging drum can cause print defects.

Figure 1-8 Install a toner cartridge

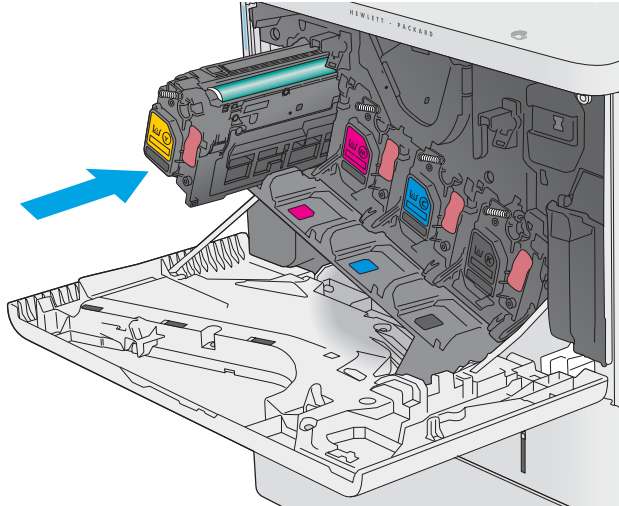

- Close the front door.

Figure 1-9 Close the front door

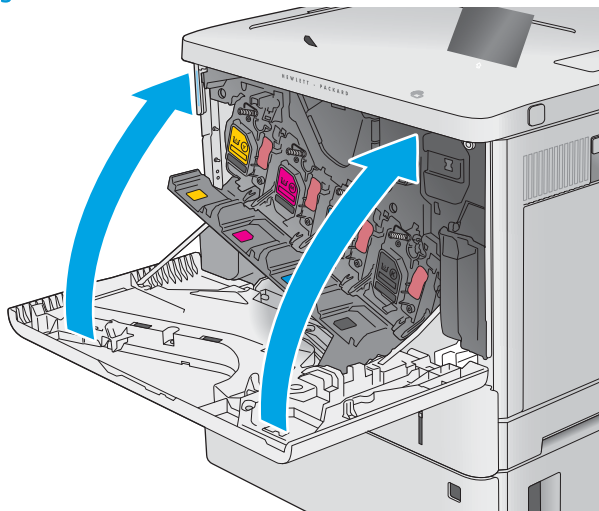

Removal and replacement: Toner collection unit (TCU)

- [Introduction](#)
- [Step 1: Remove the TCU](#)
- [Step 2: Unpack the replacement assembly](#)
- [Step 3: Install the TCU](#)

Introduction

This document provides the procedures to remove and replace the toner collection unit (TCU).

Before performing service

⚠ CAUTION: If toner gets on the skin or clothing, wipe it off with dry tissue paper and wash in cold water. Hot water sets toner and it might be difficult, or impossible, to remove.

Use the table below to identify the correct part number for your printer. To order the part, go to www.hp.com/buy/parts.

Toner collect unit (TCU) kit part number
--

B5L37-67901

Toner collection unit (TCU) with instruction guide
--

Required tools

No special tools are required to install this part.

After performing service

Make sure that the TCU is fully closed after replacing it.

Step 1: Remove the TCU

1. Open the front door.

Figure 1-10 Open the front door



2. Open the TCU.

 **NOTE:** The toner collection hatch cover automatically closes when the TCU is opened.

Figure 1-11 Open the TCU



3. Pull the TCU away from the printer at an angle to remove it.

⚠ CAUTION: Do not open the toner collection hatch cover when handling the TCU. If toner gets on the skin or clothing, wipe it off with dry tissue paper and wash in cold water. Hot water sets toner and it might be difficult, or impossible, to remove.

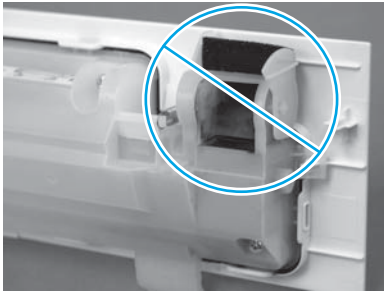
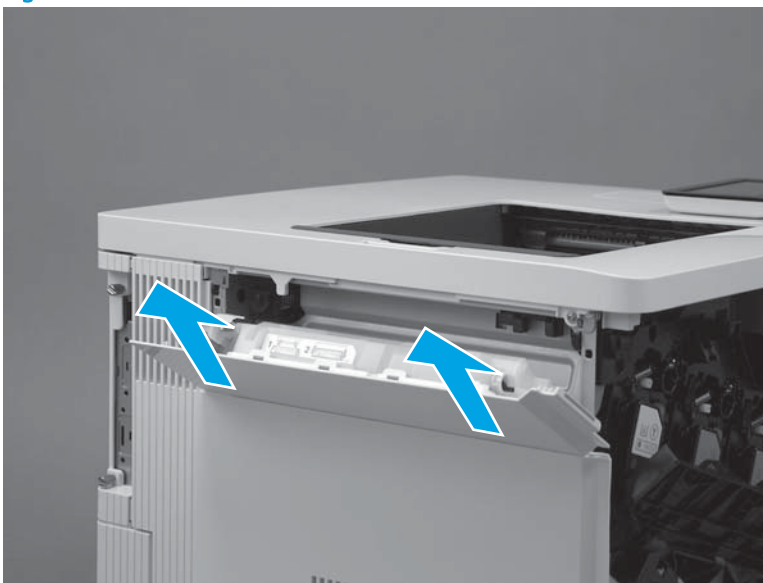

Figure 1-12 Remove the TCU



Step 2: Unpack the replacement assembly

Unpack the replacement assembly from the packaging.

For complete information on HP's recycling programs, go to [Product return and recycling](#).

📝 NOTE: HP recommends responsible disposal of the defective assembly.

Figure 1-13 Recycle and unpack

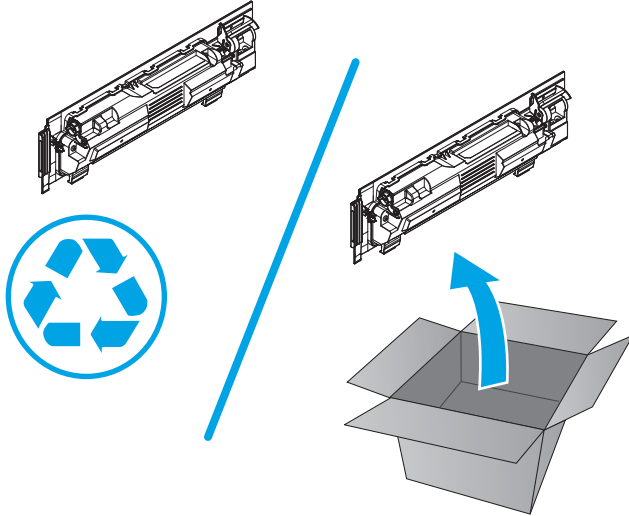

Step 3: Install the TCU

1. Verify that the toner collection hatch cover is in the closed position on the TCU.

Figure 1-14 Verify that the toner collection hatch cover is closed

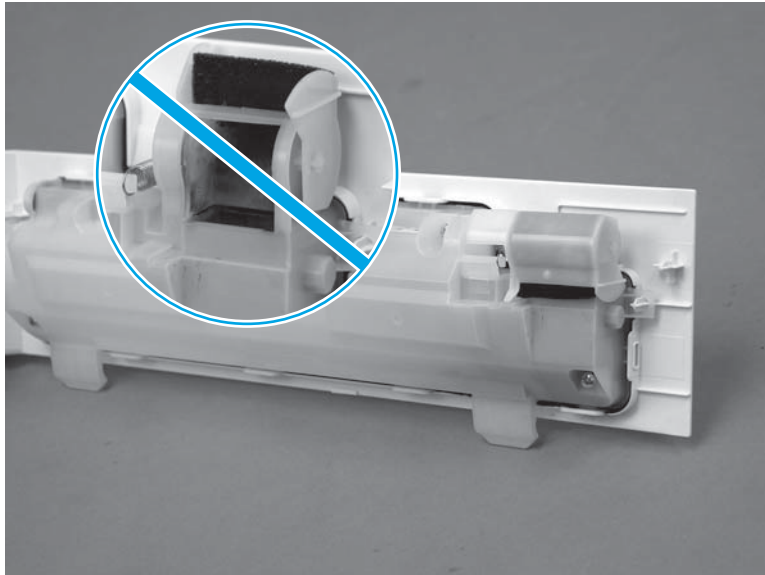

2. Position the TCU with the hinges in the slots provided in the printer (callout 1), and then rotate the TCU up and into the closed position.

 **NOTE:** The toner collection hatch cover automatically opens when the TCU is closed.

Figure 1-15 Install the TCU



3. Close the front door.

Figure 1-16 Close the front door

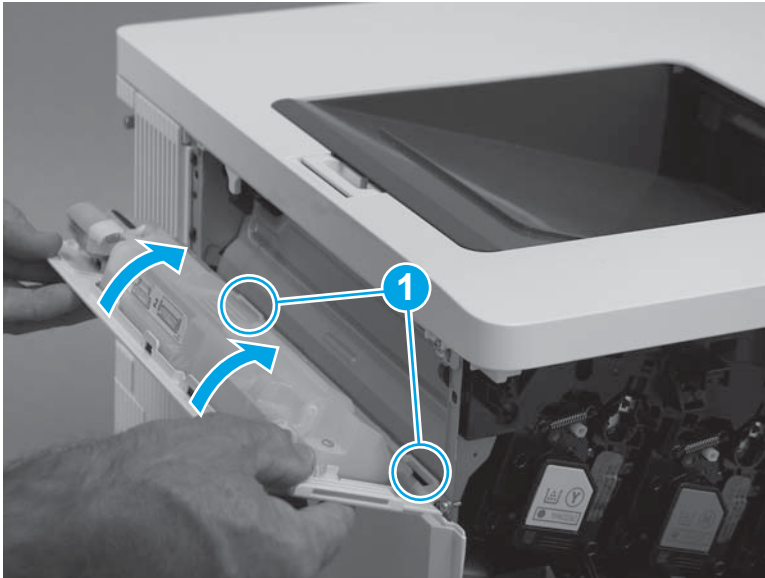

Removal and replacement: Staple cartridge (M577c/f/z)

- [Introduction](#)
- [Step 1: Remove the staple cartridge](#)
- [Step 2: Unpack the replacement assembly](#)
- [Step 3: Install the staple cartridge](#)

Introduction

This document provides the procedures to remove and replace the M577c/f/z staple cartridge.

Before performing service

Turn the printer power off

- Disconnect the power cable.

 **WARNING!** To avoid damage to the printer, turn the printer off, wait 30 seconds, and then remove the power cord before attempting to service the printer.

Use the table below to identify the correct part number for your printer. To order the part, go to www.hp.com/buy/parts.

Staple cartridge part number	
Q7432A	HP staple cartridge pack

Required tools

- No special tools are required to remove this part.

After performing service

Make sure that the stapler door is fully closed after replacing a staple cartridge.

Turn the printer power on

- Connect the power cable.
- Use the power switch to turn the power on.

Post service test

Make sure that the printer initializes to a **Ready** state.

Step 1: Remove the staple cartridge

1. Open the stapler door.

Figure 1-17 Open the stapler door



2. Pull the staple cartridge straight out of the printer to remove it.

Figure 1-18 Remove the staple cartridge



Step 2: Unpack the replacement assembly

Unpack the replacement assembly from the packaging.

For complete information on HP's recycling programs, go to [Product return and recycling](#).

 **NOTE:** HP recommends responsible disposal of the defective assembly.

Figure 1-19 Recycle and unpack

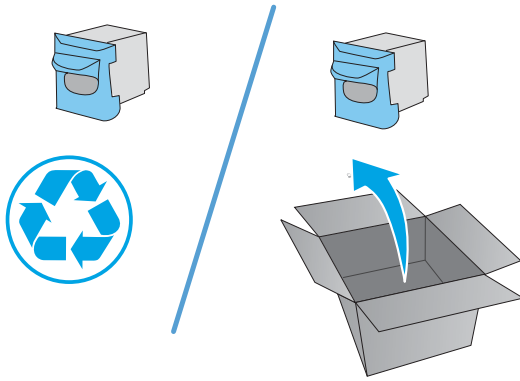

Step 3: Install the staple cartridge

1. Push the staple cartridge straight into the printer to install it.

Figure 1-20 Install the staple cartridge



2. Close the stapler door.

Figure 1-21 Close the stapler door



Removal and replacement: Fuser

- [Introduction](#)
- [Step 1: Remove the fuser](#)
- [Step 2: Unpack the replacement assembly](#)
- [Step 3: Install the fuser](#)
- [Step 4: Reset the fuser counter](#)

Introduction

This document provides the procedures to remove and replace the fuser.

Before performing service

Turn the printer power off

- Disconnect the power cable.

 **WARNING!** To avoid damage to the printer, turn the printer off, wait 30 seconds, and then remove the power cord before attempting to service the printer.

Use the table below to identify the correct part number for your printer. To order the part, go to www.hp.com/buy/parts.

Fuser kit part numbers	
B5L35-67902	Fuser (110V) with instruction guide
B5L36-67902	Fuser (220V) with instruction guide

Required tools

No special tools are required to install this part.

After performing service

Make sure that the right door is fully closed after replacing the fuser.

Turn the printer power on

- Connect the power cable.
- Use the power switch to turn the power on.

Post service test

Print a configuration page to make sure that the printer is functioning correctly.

Step 1: Remove the fuser

1. Open the right door.

⚠ CAUTION: The fuser is very hot. After turning the printer power off, allow the fuser to cool for at least 30 minutes before removing it.

Figure 1-22 Open the right door



2. Grasp the two fuser handles, and then squeeze the two blue triggers on the handles to release the fuser.

Figure 1-23 Release the fuser

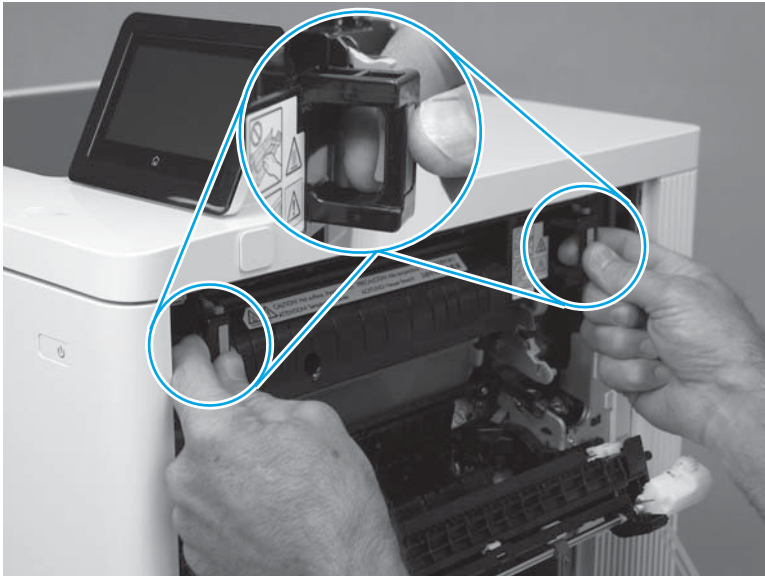

3. Slide the fuser straight out of the printer to remove it.

Figure 1-24 Remove the fuser



Step 2: Unpack the replacement assembly

Unpack the replacement assembly from the packaging.

For complete information on HP's recycling programs, go to [Product return and recycling](#).

 **NOTE:** HP recommends responsible disposal of the defective assembly.

Figure 1-25 Recycle and unpack

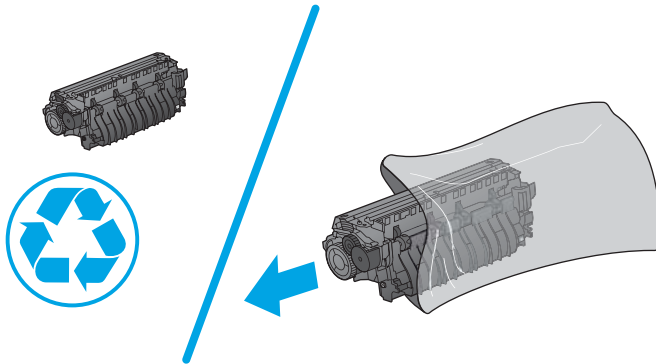

Step 3: Install the fuser

1. Align the fuser with the opening in the printer.

Figure 1-26 Align the fuser with the opening

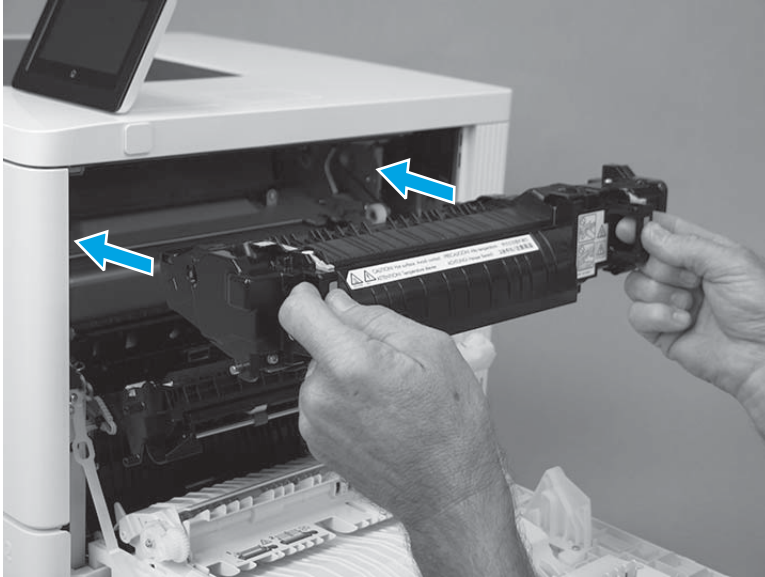

2. Slide the fuser into the printer, push in to install it, and then make sure that it is fully seated.

 **TIP:** When the fuser is fully seated, the two blue triggers on the handles make an audible click.

Figure 1-27 Install the fuser

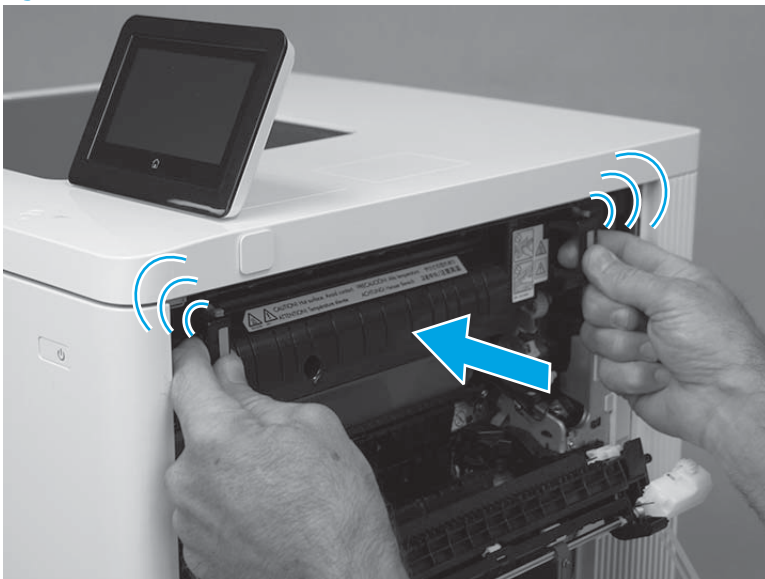

3. Close the right door.

Figure 1-28 Close the right door



Step 4: Reset the fuser counter

Reset the fuser counter from a touchscreen control panel

1. From the [Home](#) screen on the printer control panel, scroll to and touch the [Administration](#) button.
2. Open the following menus:
 - [Manage Supplies](#)
 - [Reset Supplies](#)
 - [New Fuser Kit](#)
3. Select the [Yes](#) item to reset the fuser counter.

Reset the fuser counter from an LCD control panel

1. From the [Home](#) screen on the printer control panel, use the down arrow ▼ button to scroll to [Administration](#), and then press the [OK](#) button.
2. Use the down arrow ▼ button to scroll to [Manage Supplies](#), and then press the [OK](#) button.
3. Use the down arrow ▼ button to scroll to [Reset Supplies](#), and then press the [OK](#) button.
4. Use the down arrow ▼ button to scroll to [New Fuser Kit](#), and then press the [OK](#) button to select it.
5. Use the down arrow ▼ button to scroll to [Yes](#), and then press the [OK](#) button to reset the fuser count.

Removal and replacement: Hard-disk drive (HDD) (M552 and M553)

- [Introduction](#)
- [Step 1: Remove the formatter cover](#)
- [Step 2: Remove the hard-disk drive \(HDD\)](#)
- [Step 3: Unpack the replacement assembly](#)
- [Step 4: Install the hard-disk drive \(HDD\)](#)
- [Step 5: Install the formatter cover](#)
- [Step 6: Reinstall the product firmware](#)

Introduction



This document provides the procedures to remove and replace the M553 hard-disk drive (HDD).

Before performing service

Turn the printer power off

- Disconnect the power cable.

 **WARNING!** To avoid damage to the printer, turn the printer off, wait 30 seconds, and then remove the power cord before attempting to service the printer.

 **CAUTION:**  This part contains components that are electrostatic discharge (ESD) sensitive. To reduce the possibility of ESD damage, always touch the sheet-metal chassis to ground yourself before touching an ESD sensitive part.

 **IMPORTANT:** Do not replace the formatter, DC controller, and eMMC PCA or hard-disk drive simultaneously during a single printer servicing. Doing so might cause the printer to become unstable or inoperable.

Use the table below to identify the correct part number for your printer. To order the part, go to www.hp.com/buy/parts.

Hard-disk drive (HDD) kit part number (M553)

B5L29-67903

Hard-disk drive (HDD) with instruction guide (M553)

Required tools

- No special tools are required to remove this part.

After performing service

Make sure that the formatter cover is fully seated, and that the thumbscrews are finger tight after replacing it.

Turn the printer power on

- Connect the power cable.
- Use the power switch to turn the power on.

Post service test

Print a configuration page to make sure that the printer is functioning correctly.

Step 1: Remove the formatter cover

1. Locate the formatter cover.

Figure 1-29 Locate the formatter cover

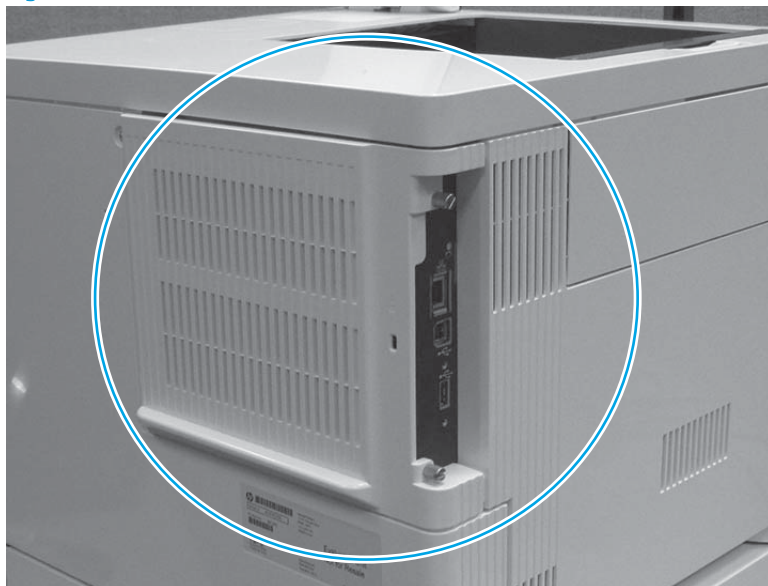

2. Loosen the two thumbscrews (callout 1). Grasp the two thumbscrews, and then slide the cover away from the printer (callout 2) to remove it.

 **TIP:** If needed, use the edge of a coin to turn the thumbscrews.

Figure 1-30 Loosen the thumbscrews

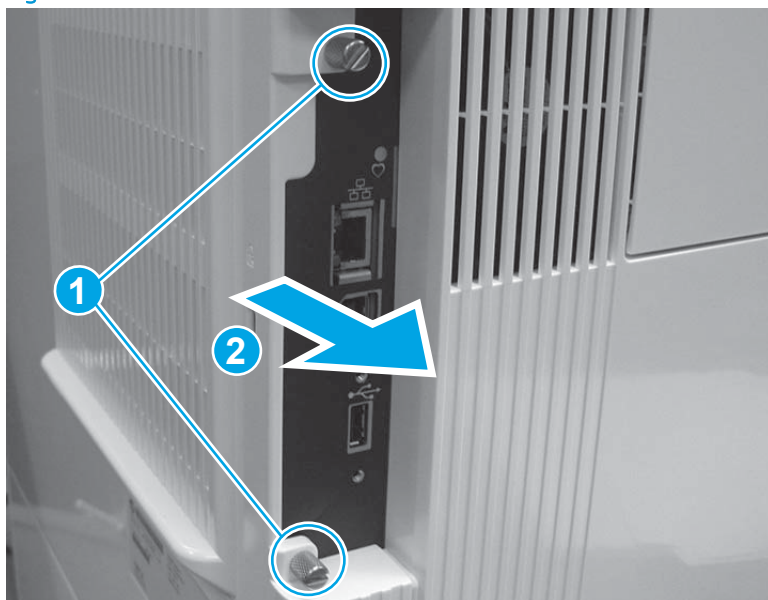

Step 2: Remove the hard-disk drive (HDD)

 **CAUTION:**  ESD-sensitive part.

1. Release one tab (callout 1), grasp the HDD mounting bracket, and then rotate the connector end of the bracket up (callout 2) and away from the formatter to release it.

Figure 1-31 Release the HDD

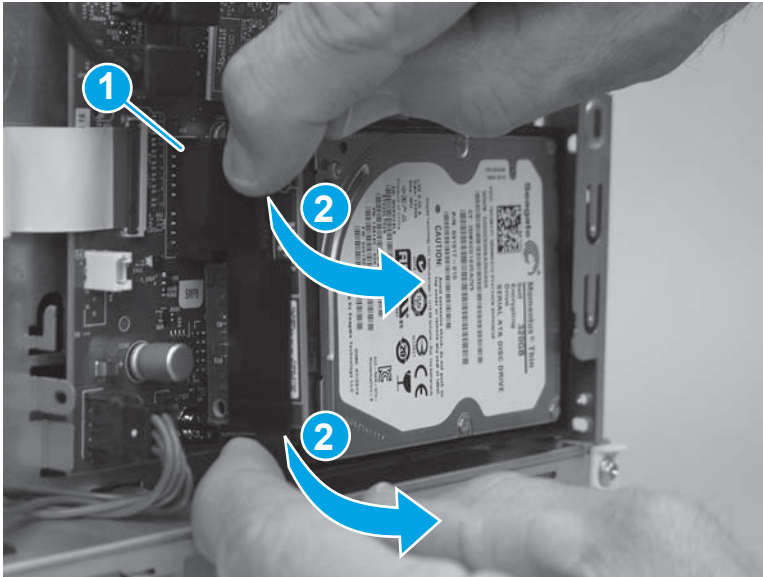

2. Slide the HDD away from the printer to remove it.

Figure 1-32 Remove the HDD

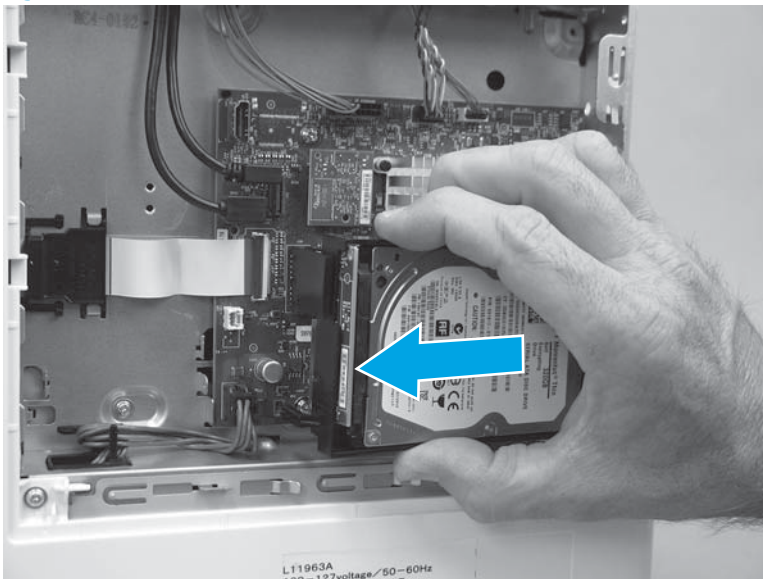

Step 3: Unpack the replacement assembly

Unpack the replacement assembly from the packaging.

 **CAUTION:**  ESD-sensitive part.

For complete information on HP's recycling programs, go to [Product return and recycling](#).

 **NOTE:** HP recommends responsible disposal of the defective assembly.

Figure 1-33 Recycle and unpack

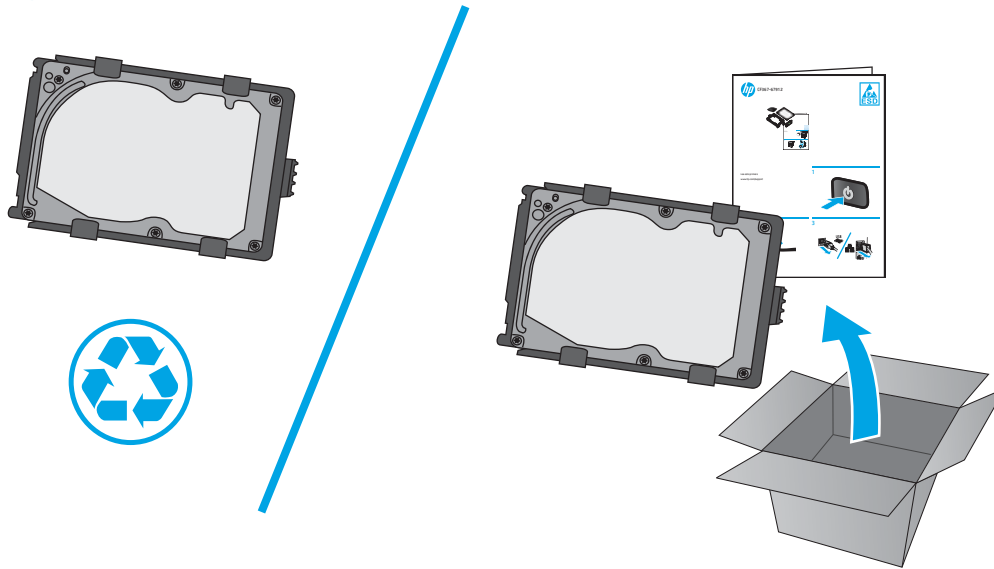

Step 4: Install the hard-disk drive (HDD)

 **CAUTION:**  ESD-sensitive part.

1. Align the end of the holder (callout 1) with the slot in the chassis (callout 2), and then slide the HDD into the printer (callout 3) to engage the holder with the chassis.

 **TIP:** If this is the first time the HDD is being installed, remove the pre-scored label that covers the slot in the chassis (callout 2).

Figure 1-34 Install the holder



2. Rotate the HDD connector (callout 1) down and into the connectors (callout 2) on the formatter to install it.

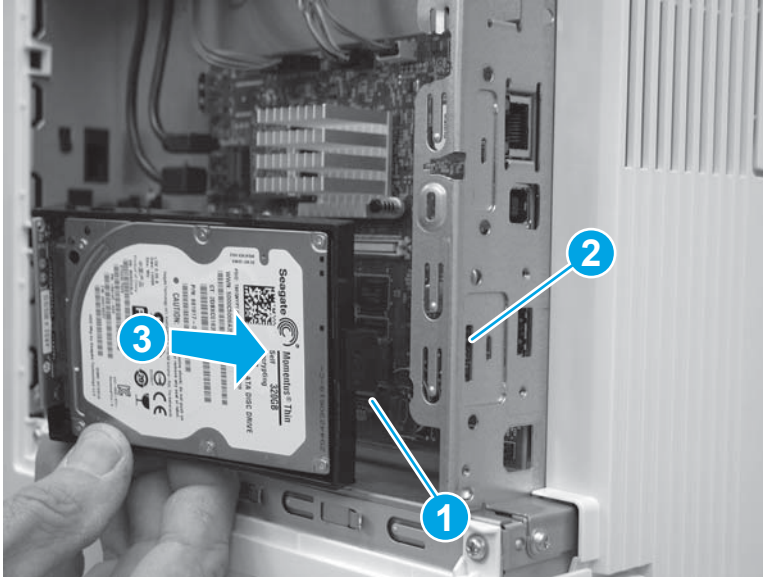

 **NOTE:** Make sure that the tabs (callout 2) snap into place, and that the HDD is securely installed.

Figure 1-35 Release the HDD

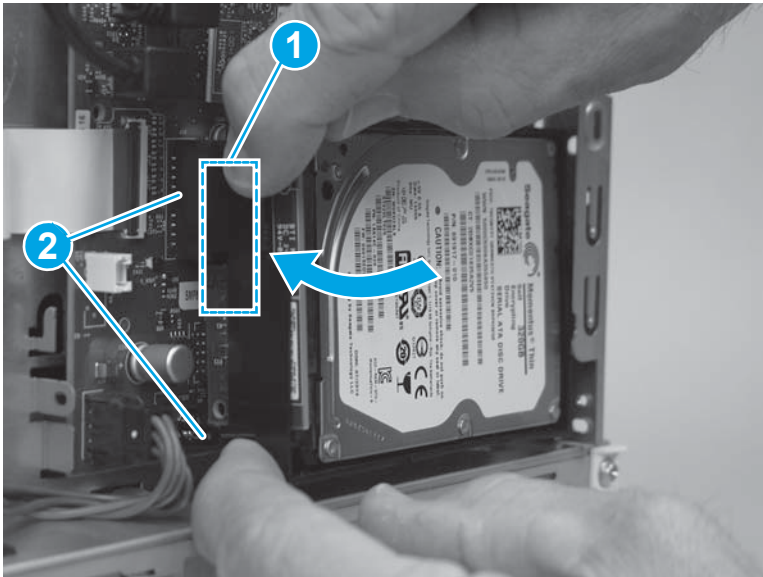

Step 5: Install the formatter cover

- ▲ Slide the cover onto the printer (callout 1) to install it.

 **NOTE:** Make sure that the tabs on the formatter cover align with the slots provided in the printer (callout 2). Tighten the two thumbscrews (callout 3).

 **TIP:** If needed, use the edge of a coin to turn the thumbscrews.

Figure 1-36 Install the cover



Step 6: Reinstall the product firmware

 **NOTE:** If this installation is a replacement HDD, use the following steps to reinstall the firmware.

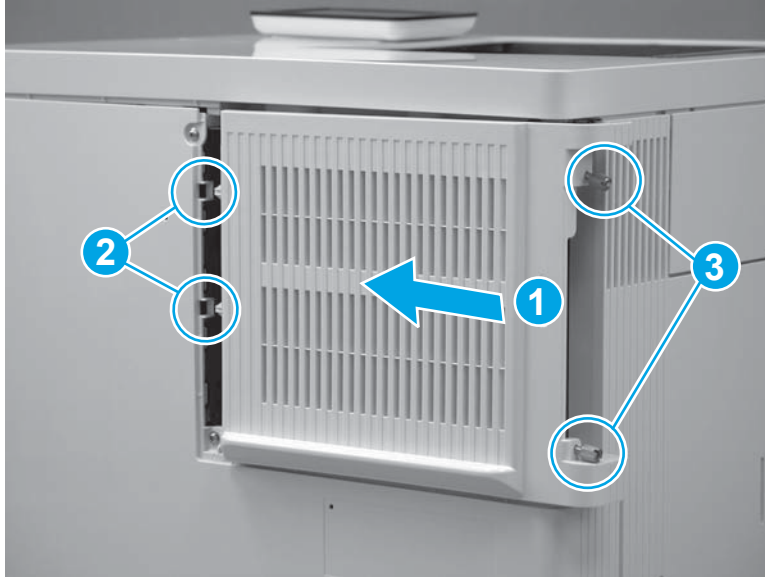
1. Go to www.hp.com/go/futuresmart.
2. Select **Upgrade now**.
3. Find your Enterprise printer model.
4. Select the link to open the firmware download page.
5. Select **OS Independent** from the list of operating systems.
6. Under the **Firmware** section, find the file for multiple operating systems.
7. Select **Download**.

 **NOTE:** To view installation instructions, go to www.hp.com/go/futuresmart. Select **Upgrade now**, and then select **How to perform a firmware update**.

Removal and replacement: Hard-disk drive (HDD) (M577)

- [Introduction](#)
- [Step 1: Remove the formatter cover](#)
- [Step 2: Remove the hard-disk drive \(HDD\)](#)
- [Step 3: Unpack the replacement assembly](#)
- [Step 4: Install the hard-disk drive \(HDD\)](#)
- [Step 5: Install the formatter cover](#)
- [Step 6: Reinstall the product firmware](#)

Introduction



This document provides the procedures to remove and replace the M557 hard-disk drive (HDD).

Before performing service

Turn the printer power off

- Disconnect the power cable.

 **WARNING!** To avoid damage to the printer, turn the printer off, wait 30 seconds, and then remove the power cord before attempting to service the printer.

 **CAUTION:**  This part contains components that are electrostatic discharge (ESD) sensitive. To reduce the possibility of ESD damage, always touch the sheet-metal chassis to ground yourself before touching an ESD sensitive part.

 **IMPORTANT:** Do not replace the formatter, DC controller, and eMMC PCA or hard-disk drive simultaneously during a single printer servicing. Doing so might cause the printer to become unstable or inoperable.

Use the table below to identify the correct part number for your printer. To order the part, go to www.hp.com/buy/parts.

Hard-disk drive (HDD) kit part number (M577)

5851-6712

Hard-disk drive (HDD) with instruction guide (M577)

Required tools

- No special tools are required to remove this part.

After performing service

Make sure that the formatter cover is fully seated, and that the thumbscrews are finger tight after replacing it.

Turn the printer power on

- Connect the power cable.
- Use the power switch to turn the power on.

Post service test

Print a configuration page to make sure that the printer is functioning correctly.

Step 1: Remove the formatter cover

1. Locate the formatter cover.

Figure 1-37 Locate the formatter cover

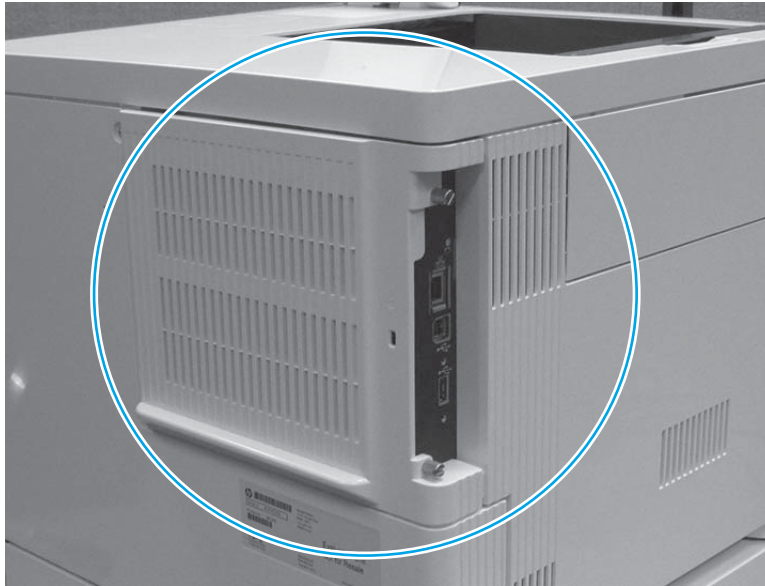

2. Loosen the two thumbscrews (callout 1). Grasp the two thumbscrews, and then slide the cover away from the printer (callout 2) to remove it.

 **TIP:** If needed, use the edge of a coin to turn the thumbscrews.

Figure 1-38 Loosen the thumbscrews

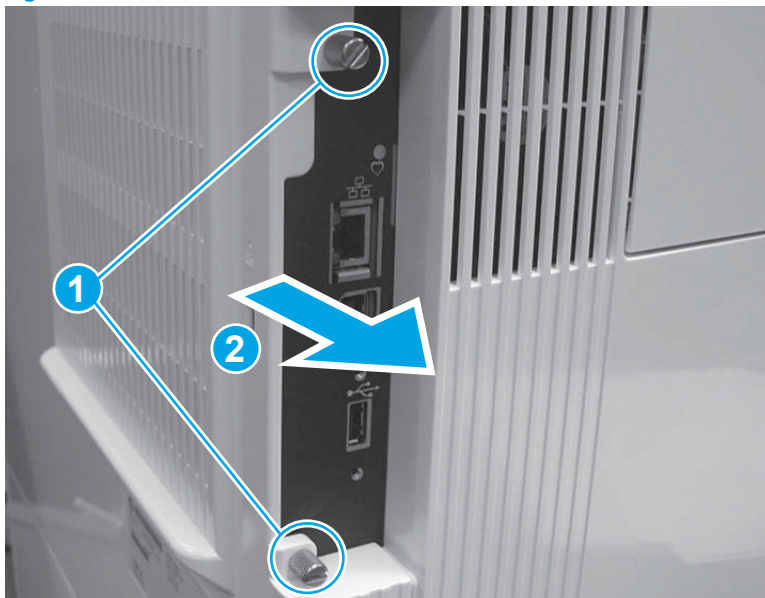

Step 2: Remove the hard-disk drive (HDD)

 **CAUTION:**  ESD-sensitive part.

1. Release two tabs (callout 1). Hold the tabs in the released position, and then rotate the hard disk drive (HDD) up (callout 2) to release the connector from the formatter.

Figure 1-39 Release the HDD

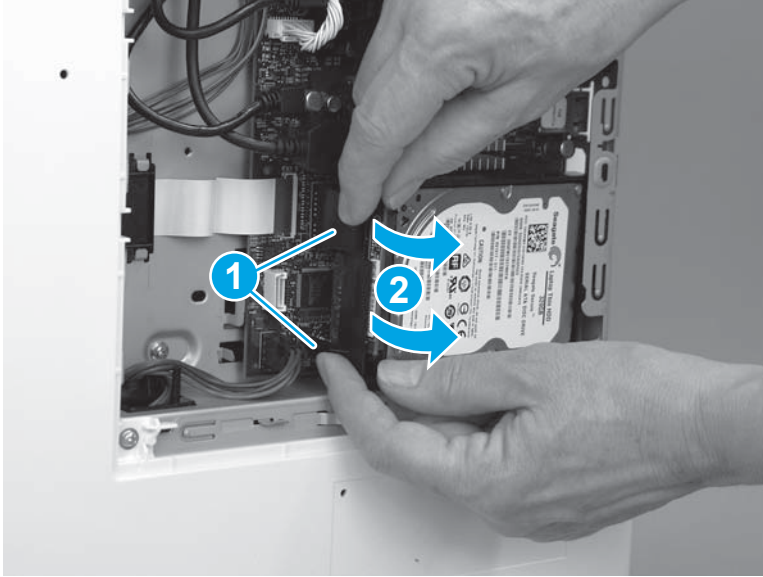

2. Slide the HDD away from the printer to remove it.

Figure 1-40 Remove the HDD

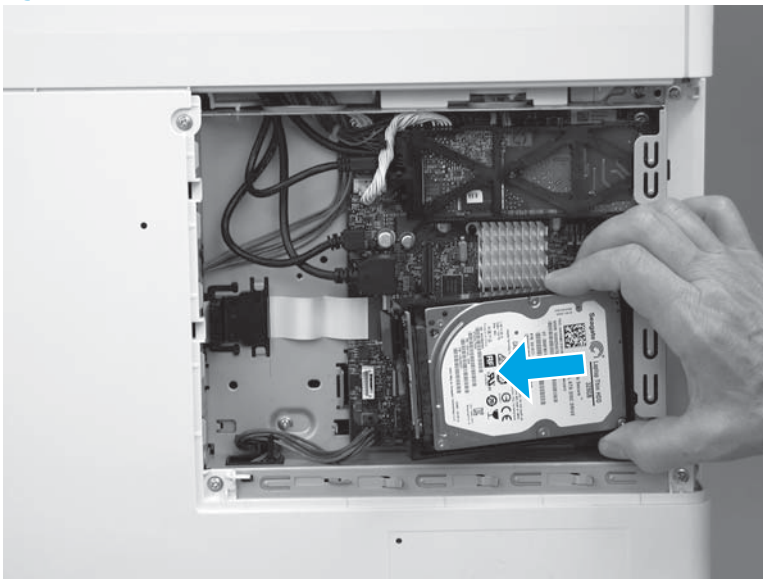

- Using the screwdriver provided with the replacement HDD, remove two screws (callout 1). Save these screws. They will be installed on the replacement HDD.

 **TIP:** The screwdriver has a reversible shaft. Simply pull the shaft out of the handle, and then reinstall it with the desired end facing out.

Figure 1-41 Remove two screws



- Lift the bracket (callout 1) up and off of the HDD. Save this bracket. It will be installed on the replacement HDD.

Figure 1-42 Remove the bracket

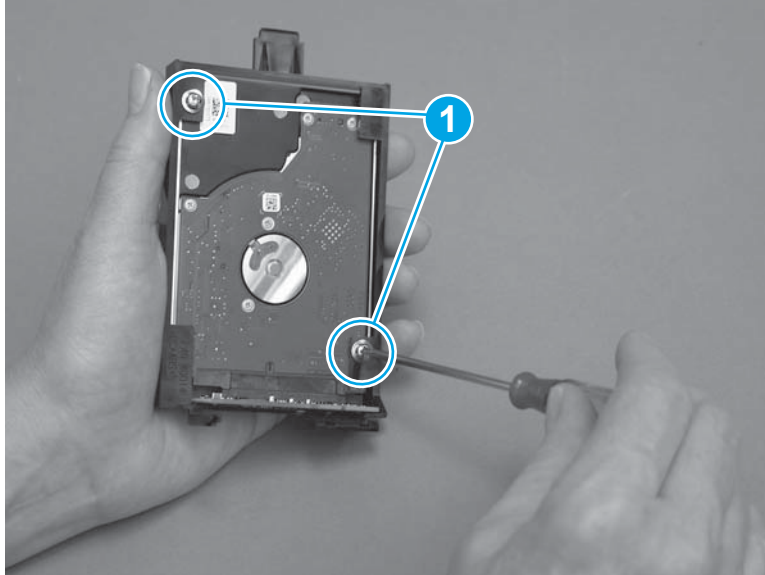
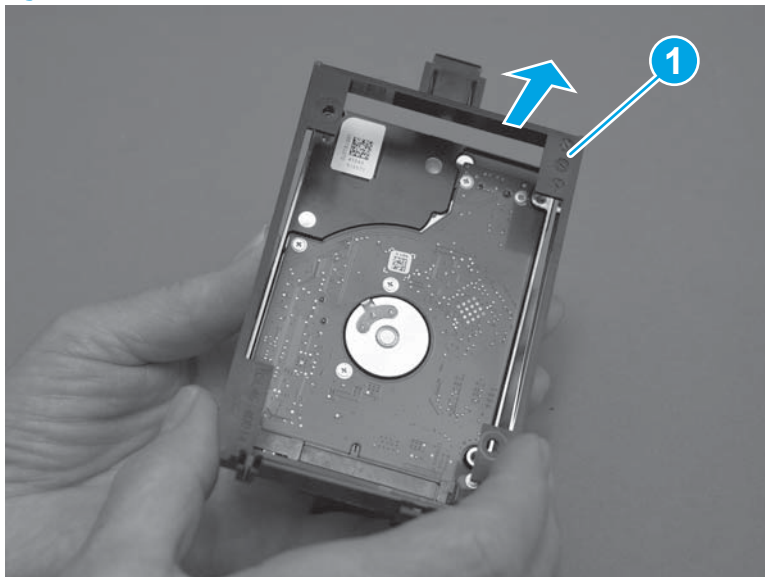

5. Grasp the PCA card (callout 1) attached to the end of the HDD and pull it away from the HDD to remove it. Save this PCA. It will be installed on the replacement HDD.

Figure 1-43 Remove the PCA

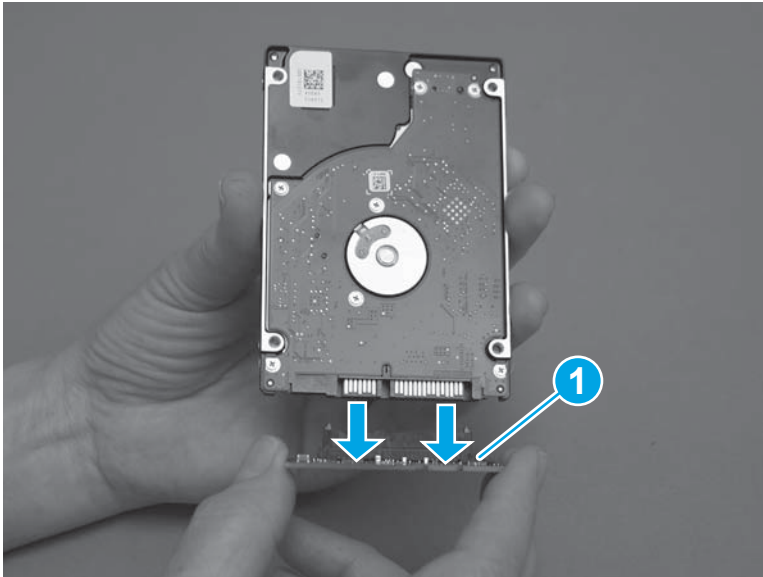

Step 3: Unpack the replacement assembly

 **CAUTION:**  ESD-sensitive part.

Unpack the replacement assembly from the packaging.

For complete information on HP's recycling programs, go to [Product return and recycling](#).

 **NOTE:** HP recommends responsible disposal of the defective assembly.

Figure 1-44 Recycle and unpack

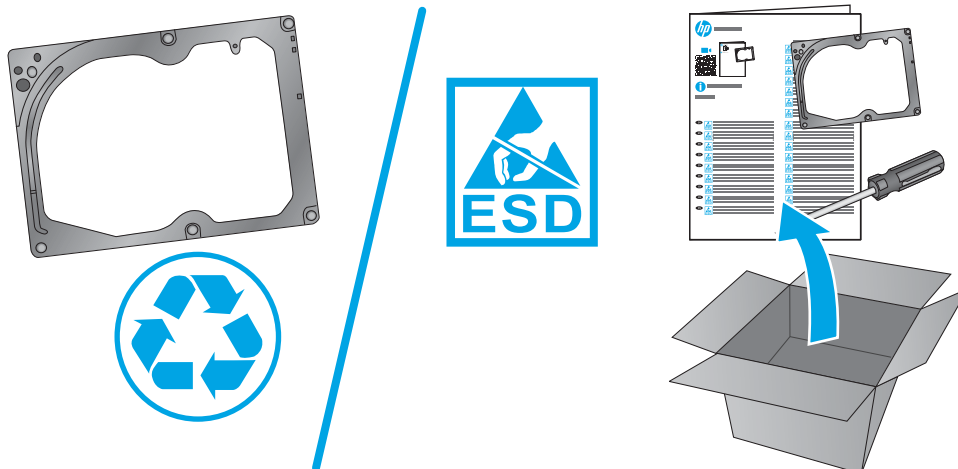

Step 4: Install the hard-disk drive (HDD)

 **CAUTION:**  ESD-sensitive part.

1. Align the slots (callout 1) on the PCA with the connectors (callout 2) on the replacement HDD.

Figure 1-45 Align the PCA

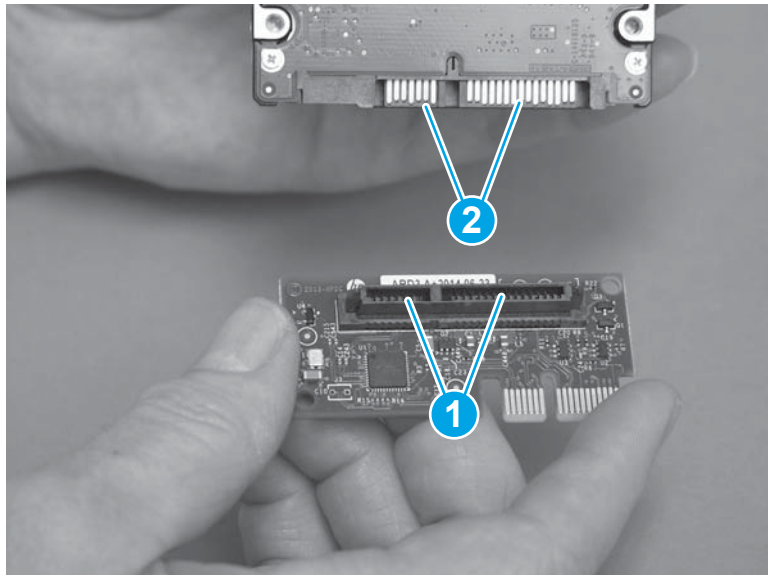

2. Press the PCA onto the HDD connectors. Make sure that the PCA is fully seated on the connectors.

Figure 1-46 Install the PCA

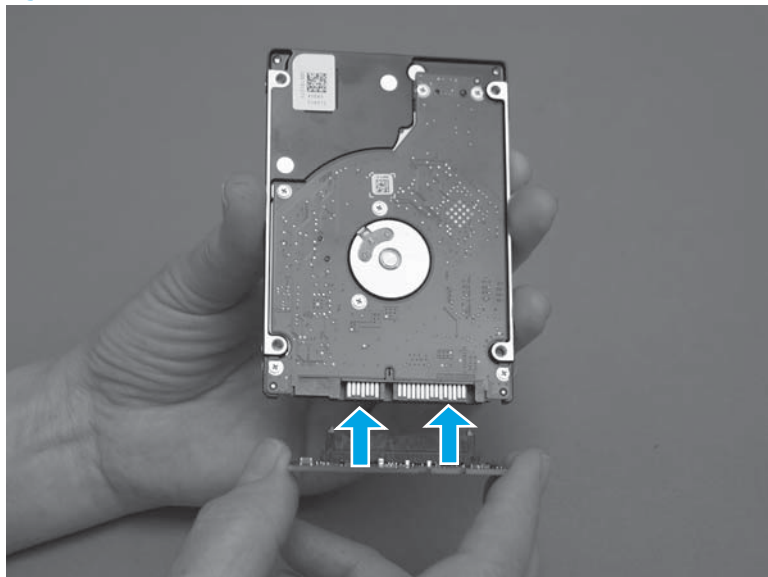

3. Align the tabs (callout 1) on the bracket with the holes (callout 2) in the back side of the HDD.

Figure 1-47 Align the tabs on the bracket

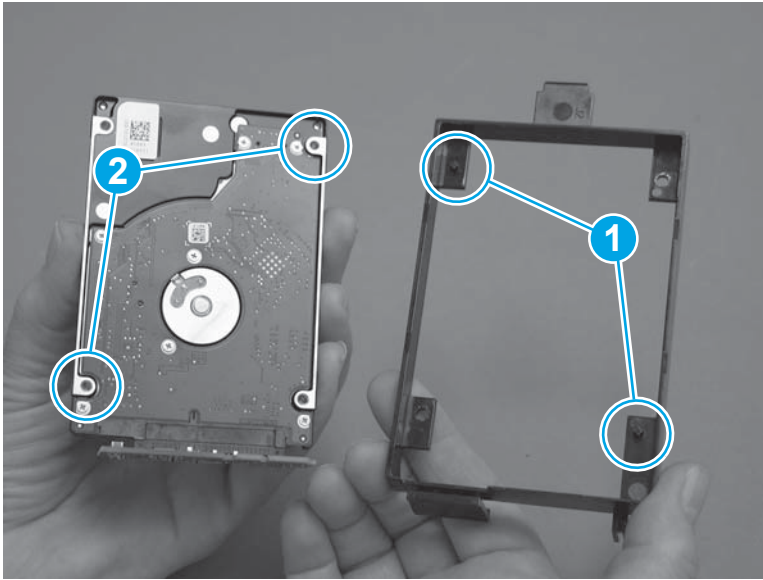

4. Install the bracket on the HDD.

 **NOTE:** If the bracket is difficult to install, make sure that the holes in the HDD are correctly aligned with the tabs on the bracket.

Figure 1-48 Install the bracket



5. Install two screws (callout 1).

CAUTION: Tighten the screws just enough to secure the HDD to the bracket. Do not over-tighten.

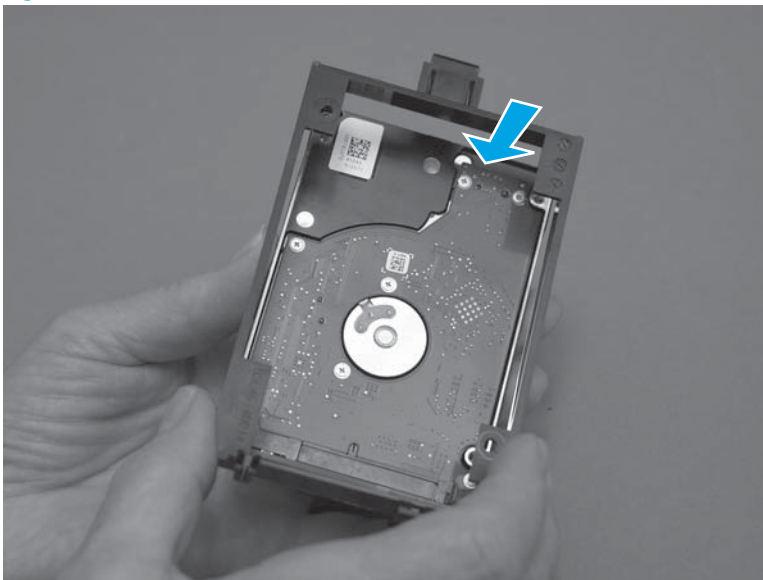
Figure 1-49 Install two screws

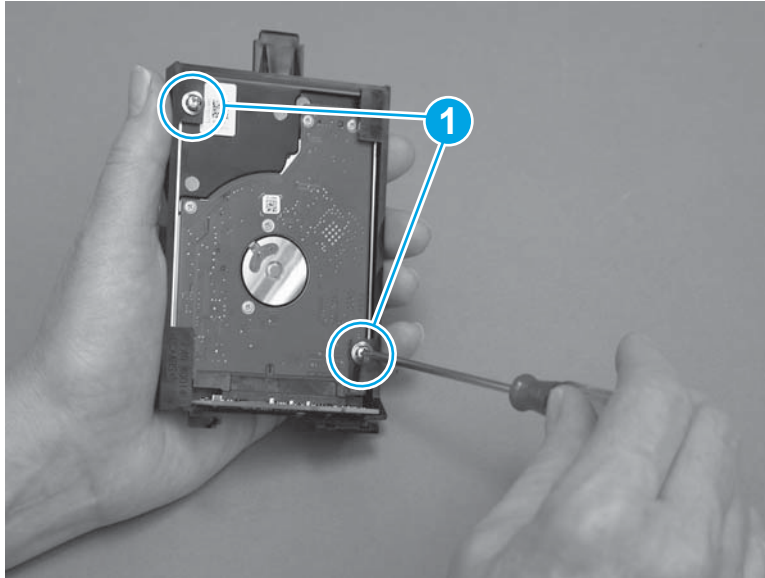

6. Align the end of the bracket (callout 1) with the slot in the chassis (callout 2), and then slide the HDD into the printer (callout 3) to engage the bracket with the chassis.

Figure 1-50 Install the holder

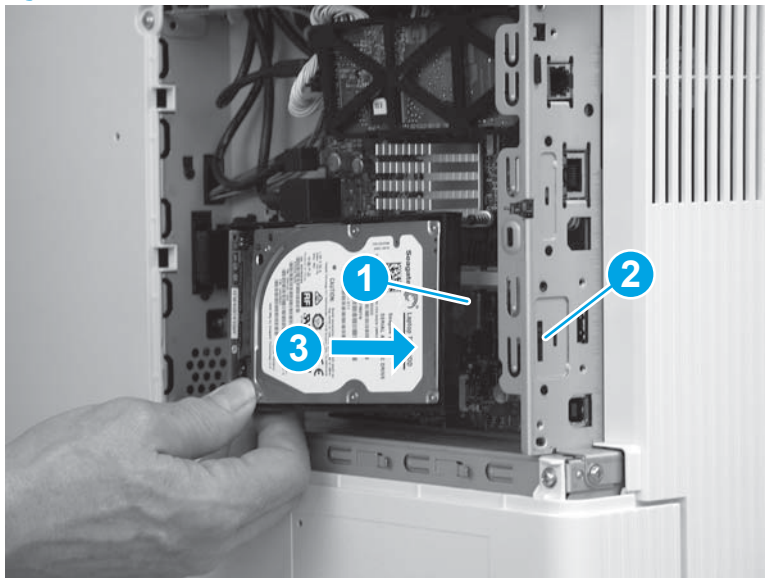

7. Hold the HDD connector latch (callout 1) in the released position, and then rotate the HDD down and into the connector on the formatter to install it.



 **NOTE:** Make sure that the tab (callout 2) snaps into place, and that the HDD is securely installed.

Figure 1-51 Release the HDD

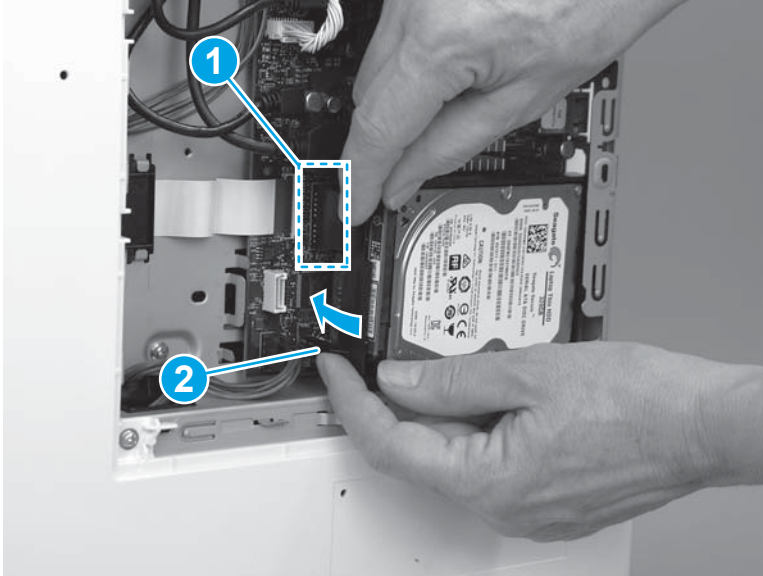

Step 5: Install the formatter cover

- ▲ Slide the cover onto the printer (callout 1) to install it.

 **NOTE:** Make sure that the tabs on the formatter cover align with the slots provided in the printer (callout 2). Tighten the two thumbscrews (callout 3).

 **TIP:** If needed, use the edge of a coin to turn the thumbscrews.

Figure 1-52 Install the cover



Step 6: Reinstall the product firmware

Use the following steps to reinstall the firmware.

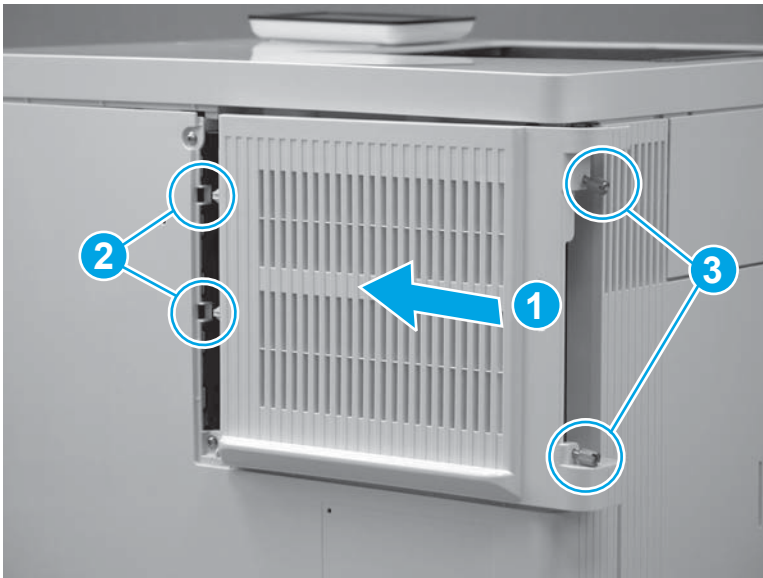
1. Go to www.hp.com/go/futuresmart.
2. Select **Upgrade now**.
3. Find your Enterprise printer model.
4. Select the link to open the firmware download page.
5. Select **OS Independent** from the list of operating systems.
6. Under the **Firmware** section, find the file for multiple operating systems.
7. Select **Download**.

 **NOTE:** To view installation instructions, go to www.hp.com/go/futuresmart. Select **Upgrade now**, and then select **How to perform a firmware update**.

Removal and replacement: Dual in-line memory module (DIMM; M552 and M553)

- [Introduction](#)
- [Step 1: Remove the formatter cover](#)
- [Step 2: Remove the hard-disk drive \(HDD; M552 and M553\)](#)
- [Step 3: Remove the dual in-line memory module \(DIMM\)](#)
- [Step 4: Unpack the replacement assembly](#)
- [Step 5: Install the DIMM](#)
- [Step 6: Install the HDD \(M552 and M553\)](#)
- [Step 7: Install the formatter cover](#)

Introduction



This document provides the procedures to remove and replace the M552 and M553 dual in-line memory module (DIMM).

Before performing service

Turn the printer power off

- Disconnect the power cable.

 **WARNING!** To avoid damage to the printer, turn the printer off, wait 30 seconds, and then remove the power cord before attempting to service the printer.

 **CAUTION:**  This part contains components that are electrostatic discharge (ESD) sensitive. To reduce the possibility of ESD damage, always touch the sheet-metal chassis to ground yourself before touching an ESD sensitive part.

Use the table below to identify the correct part number for your printer. To order the part, go to www.hp.com/buy/parts.

Dual in-line memory module (DIMM) kit part number	
---	--

5851-6422

Dual in-line memory module (DIMM) with instruction guide
--

Required tools

No special tools are required to install this part.

After performing service

Make sure that the formatter cover is fully seated, and that the thumbscrews are finger tight after replacing it.

Turn the printer power on

- Connect the power cable.
- Use the power switch to turn the power on.

Post service test

Print a configuration page to make sure that the printer is functioning correctly.

Step 1: Remove the formatter cover

1. Locate the formatter cover.

Figure 1-53 Locate the formatter cover

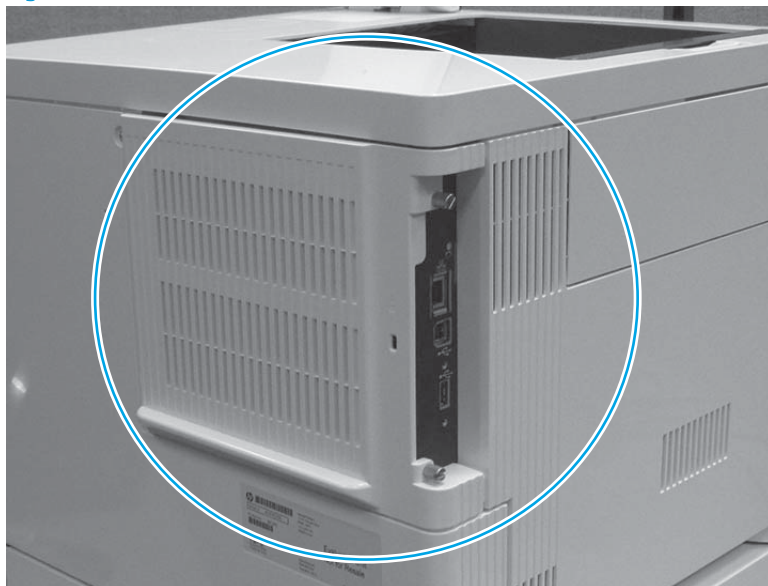

2. Loosen the two thumbscrews (callout 1). Grasp the two thumbscrews, and then slide the cover away from the printer (callout 2) to remove it.

 **TIP:** If needed, use the edge of a coin to turn the thumbscrews.

Figure 1-54 Loosen the thumbscrews

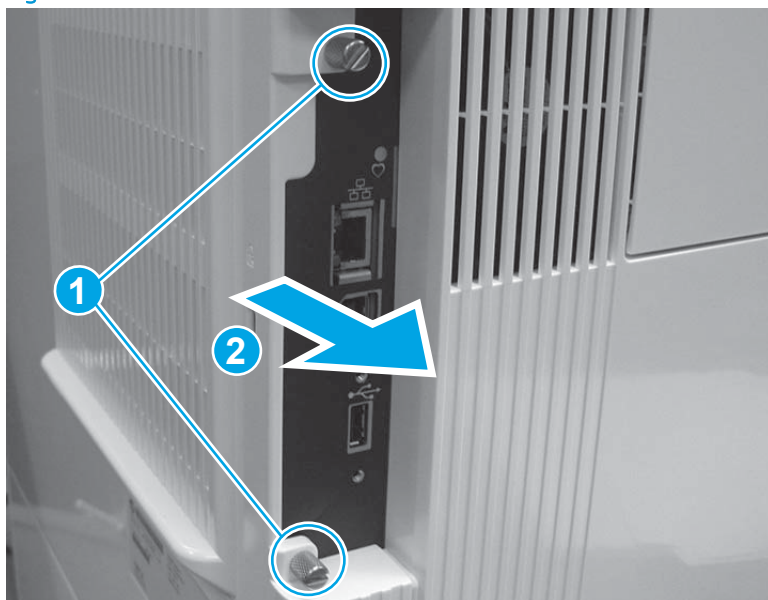

Step 2: Remove the hard-disk drive (HDD; M552 and M553)

 **NOTE:** If the optional HDD is not installed, skip this step and go to [Step 3: Remove the dual in-line memory module \(DIMM\) on page 47.](#)

 **CAUTION:**  ESD-sensitive part.

1. Release one tab (callout 1), grasp the HDD mounting bracket, and then rotate the connector end of the bracket up (callout 2) and away from the formatter to release it.

Figure 1-55 Release the HDD

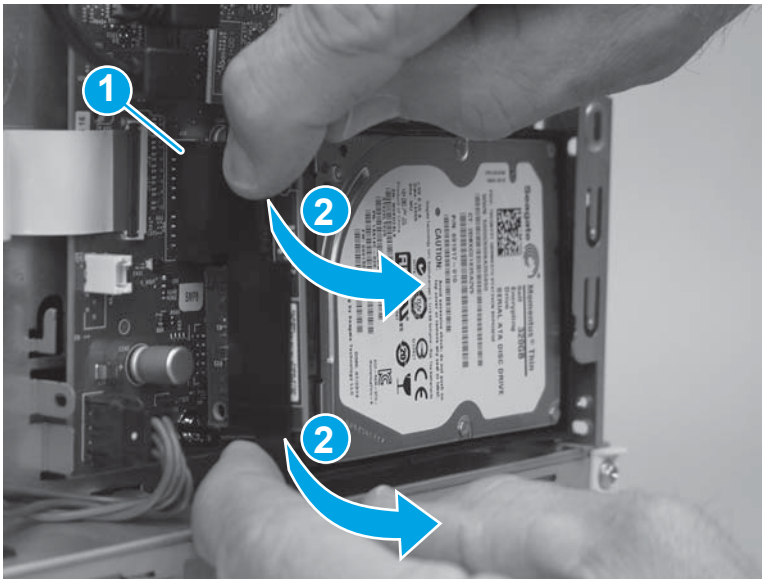

2. Slide the HDD away from the printer to remove it.

Figure 1-56 Remove the HDD

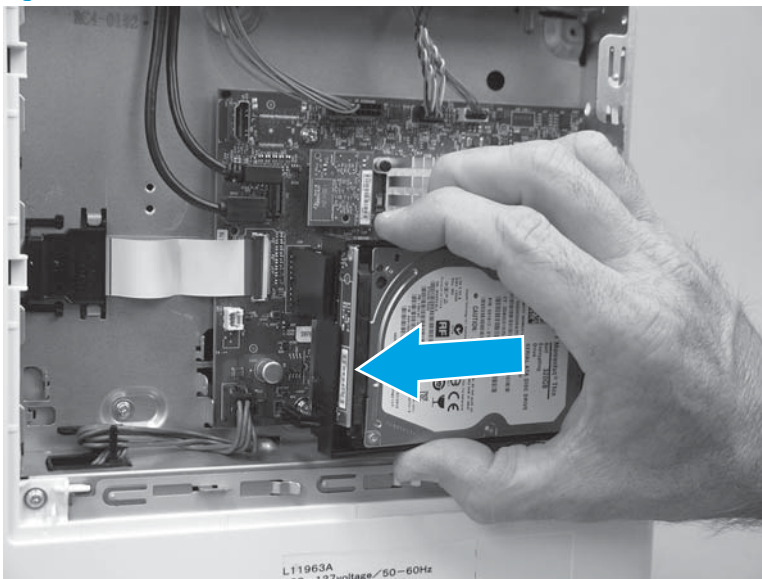

Step 3: Remove the dual in-line memory module (DIMM)

 **CAUTION:**  ESD-sensitive part.

1. Locate the DIMM component on the formatter.

Figure 1-57 Locate the DIMM

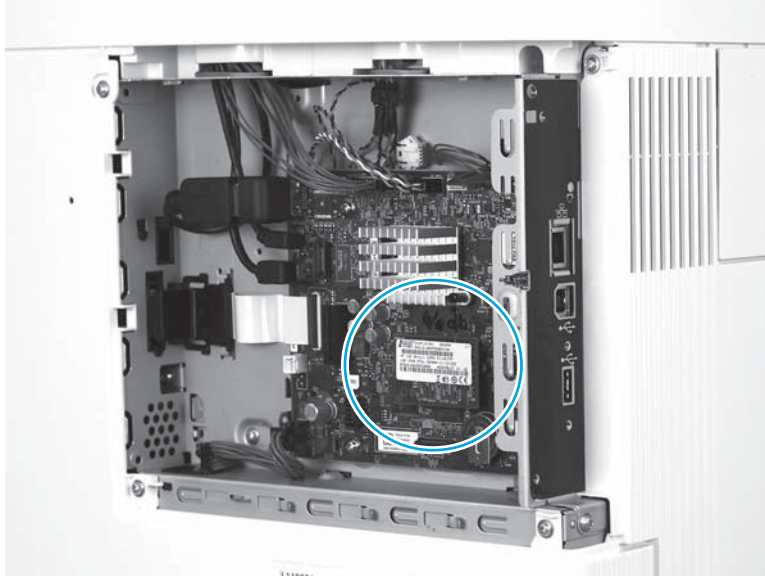

2. Pull the DIMM straight off of the formatter to remove it.

Figure 1-58 Remove the DIMM

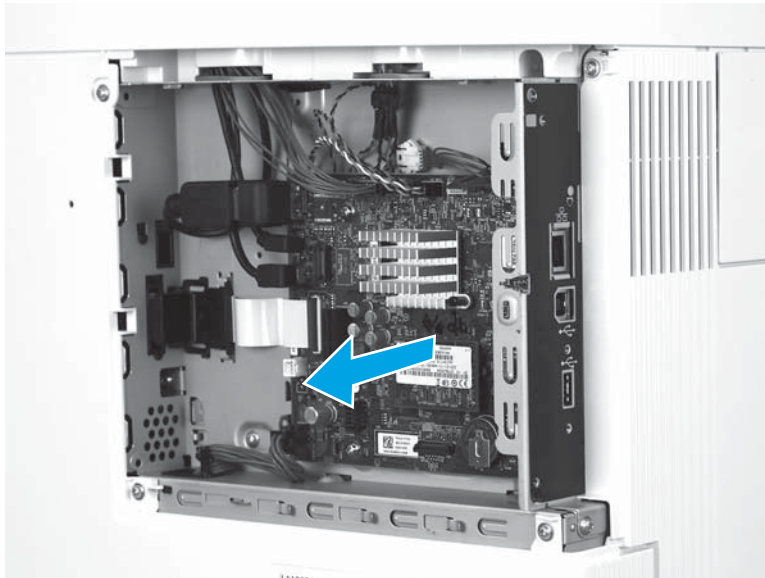

Step 4: Unpack the replacement assembly

Unpack the replacement assembly from the packaging.

 **CAUTION:**  ESD-sensitive part.

For complete information on HP's recycling programs, go to [Product return and recycling](#).

 **NOTE:** HP recommends responsible disposal of the defective assembly.

Figure 1-59 Recycle and unpack

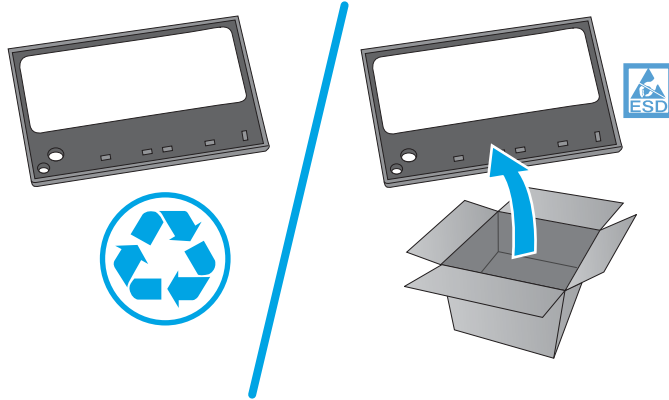

Step 5: Install the DIMM

 **CAUTION:**  ESD-sensitive part.

1. The DIMM connector (callout 1) is keyed, and can only be installed in one direction in the formatter connector (callout 2).

Figure 1-60 The DIMM connector

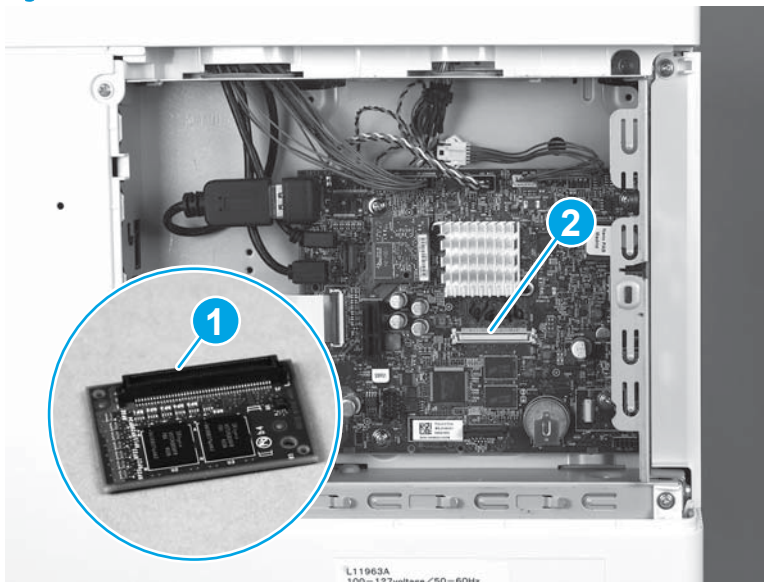

2. Align the connector on the DIMM with the connector on the formatter, and then push the DIMM onto the formatter to install it.

Figure 1-61 Install the DIMM

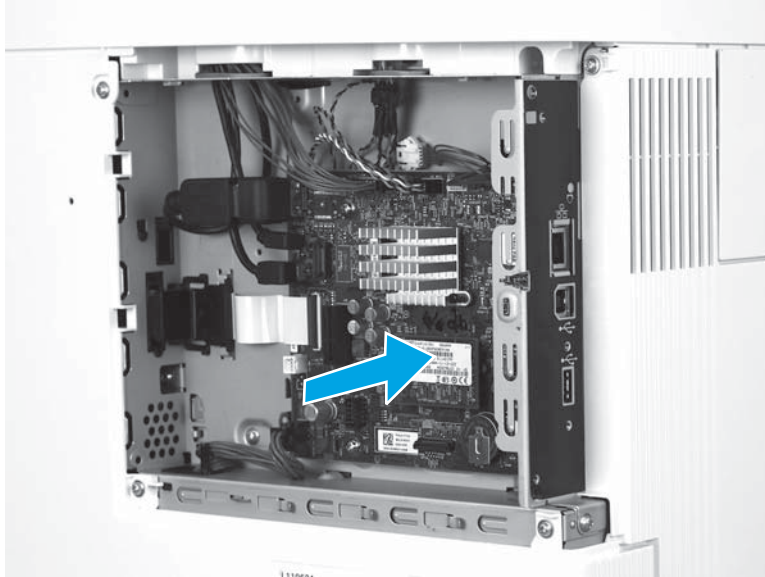

3. Verify that the DIMM is fully seated in the connector.

Figure 1-62 Verify the installation

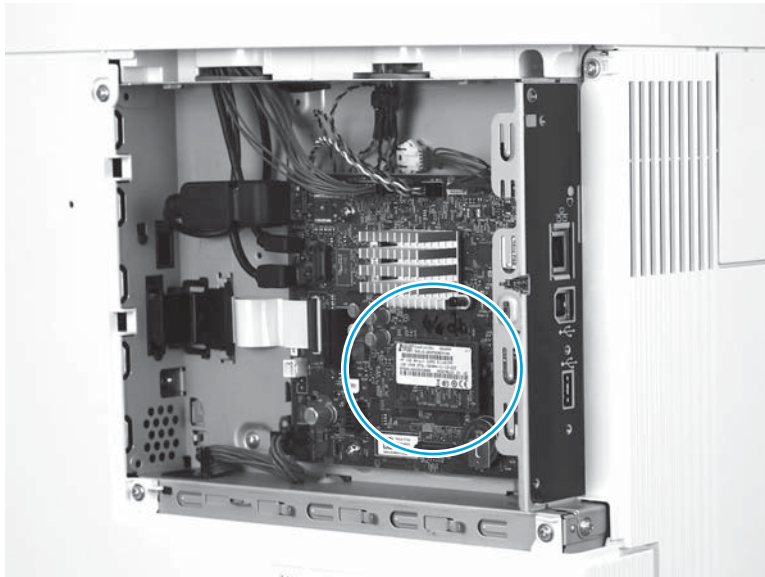

Step 6: Install the HDD (M552 and M553)

 **NOTE:** If the optional HDD is not installed, skip this step and go to [Step 7: Install the formatter cover on page 50](#).

 **CAUTION:**  ESD-sensitive part.

1. Align the end of the holder (callout 1) with the slot in the chassis (callout 2), and then slide the HDD into the printer (callout 3) to engage the holder with the chassis.

Figure 1-63 Install the holder

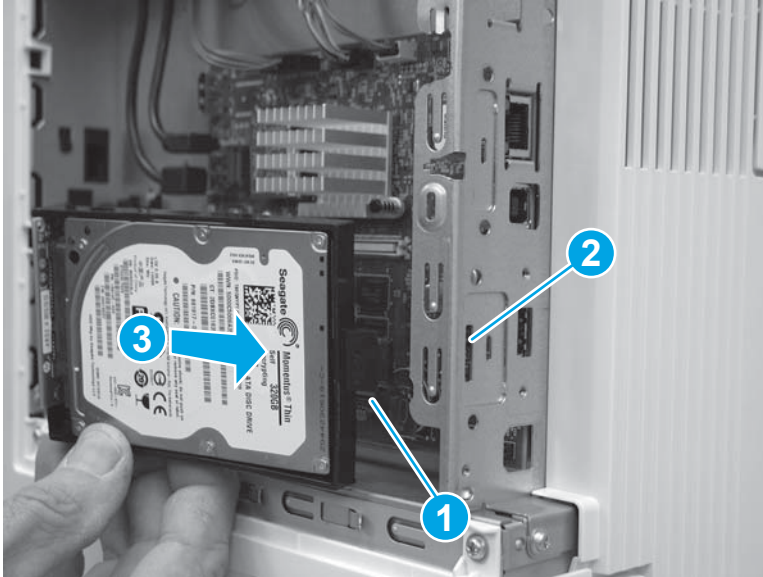

2. Rotate the HDD connector (callout 1) down and into the connector on the formatter to install it.

 **NOTE:** Make sure that the tabs (callout 2) snap into place, and that the HDD is securely installed.

Figure 1-64 Release the HDD



Step 7: Install the formatter cover

- ▲ Slide the cover onto the printer (callout 1) to install it.

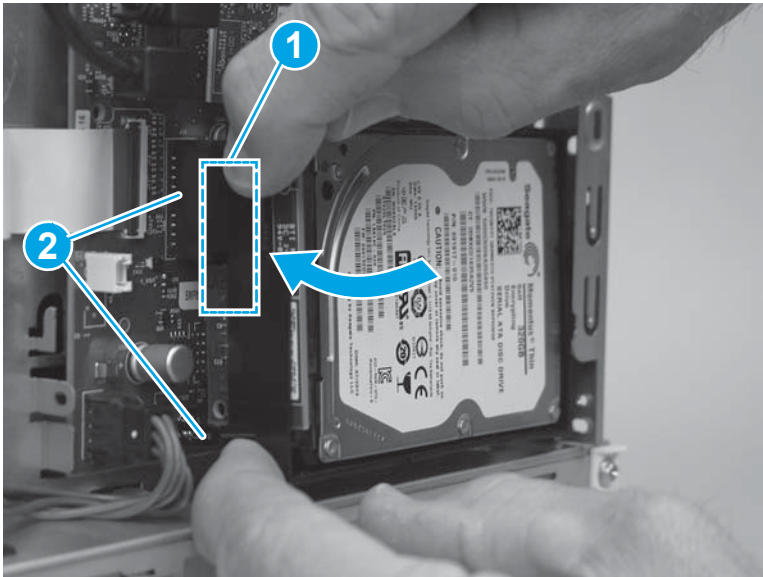
 **NOTE:** Make sure that the tabs on the formatter cover align with the slots provided in the printer (callout 2). Tighten the two thumbscrews (callout 3).

 **TIP:** If needed, use the edge of a coin to turn the thumbscrews.

Figure 1-65 Install the cover



Removal and replacement: Dual in-line memory module (DIMM; M577)

- [Introduction](#)
- [Step 1: Remove the formatter cover](#)
- [Step 2: Remove the hard-disk drive \(HDD; M577\)](#)
- [Step 3: Remove the dual in-line memory module \(DIMM\)](#)
- [Step 4: Unpack the replacement assembly](#)
- [Step 5: Install the DIMM](#)
- [Step 6: Install the HDD \(M577\)](#)
- [Step 7: Install the formatter cover](#)

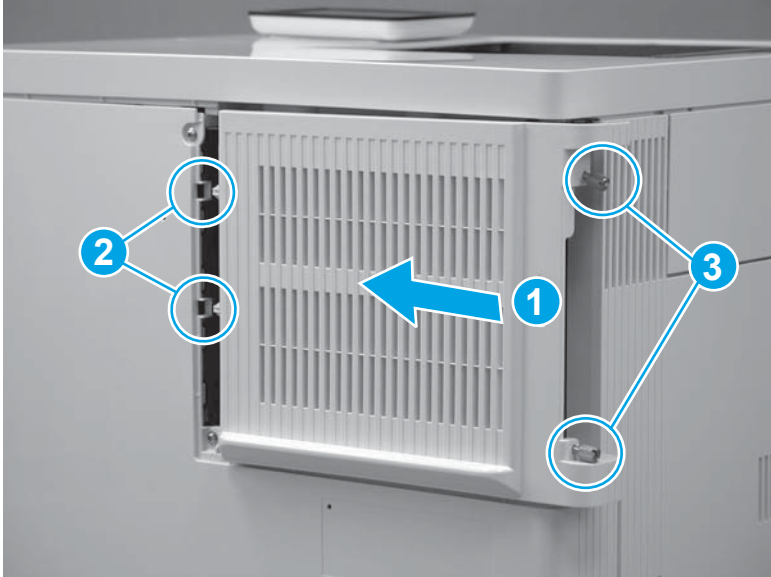
Introduction



This document provides the procedures to remove and replace the M577 dual in-line memory module (DIMM).

Before performing service

Turn the printer power off

- Disconnect the power cable.

 **WARNING!** To avoid damage to the printer, turn the printer off, wait 30 seconds, and then remove the power cord before attempting to service the printer.

 **CAUTION:**  This part contains components that are electrostatic discharge (ESD) sensitive. To reduce the possibility of ESD damage, always touch the sheet-metal chassis to ground yourself before touching an ESD sensitive part.

Use the table below to identify the correct part number for your printer. To order the part, go to www.hp.com/buy/parts.

Dual in-line memory module (DIMM) kit part number	
---	--

E5K49-67901

Dual in-line memory module (DIMM) with instruction guide (M577)

Required tools

No special tools are required to install this part.

After performing service

Turn the printer power on

- Connect the power cable.
- Use the power switch to turn the power on.

Post service test

Print a configuration page to make sure that the printer is functioning correctly.

Step 1: Remove the formatter cover

1. Locate the formatter cover.

Figure 1-66 Locate the formatter cover

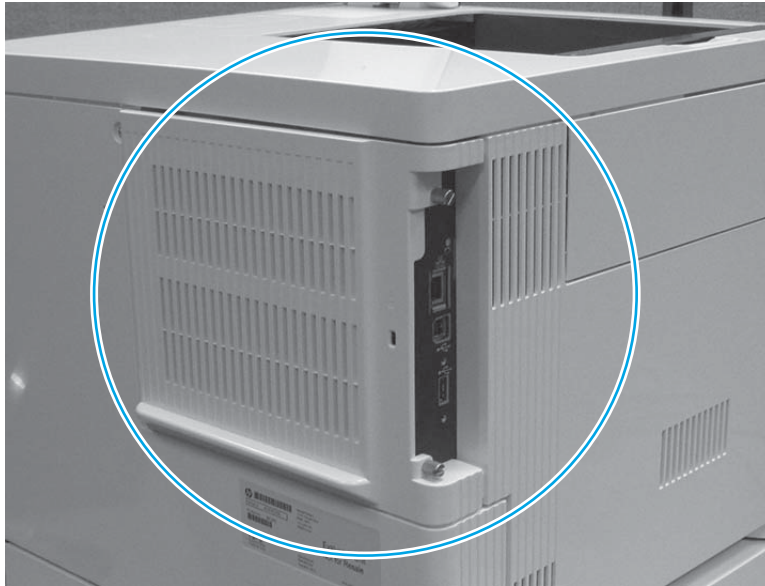

2. Loosen the two thumbscrews (callout 1). Grasp the two thumbscrews, and then slide the cover away from the printer (callout 2) to remove it.

 **TIP:** If needed, use the edge of a coin to turn the thumbscrews.

Figure 1-67 Loosen the thumbscrews

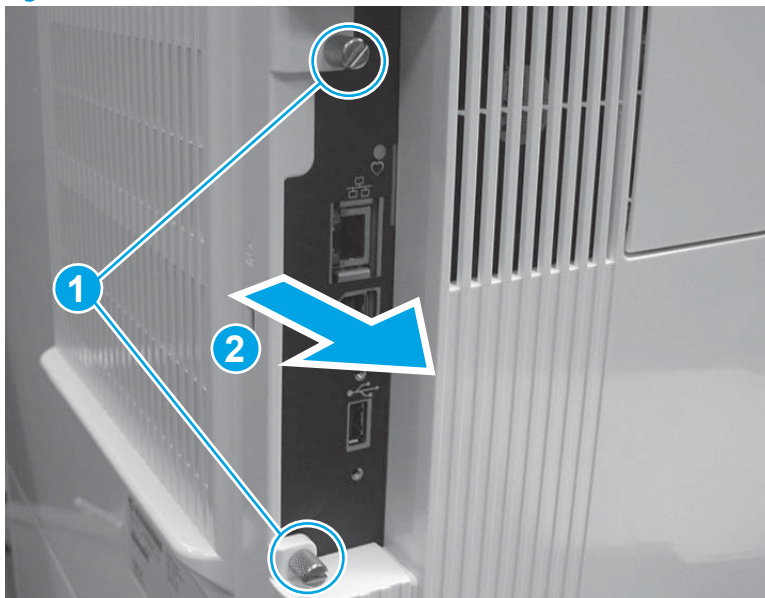

Step 2: Remove the hard-disk drive (HDD; M577)

 **CAUTION:**  ESD-sensitive part.

1. Release two tabs (callout 1). Hold the tabs in the released position, and then rotate the hard disk drive (HDD) up (callout 2) to release the connector from the formatter.

Figure 1-68 Release the HDD

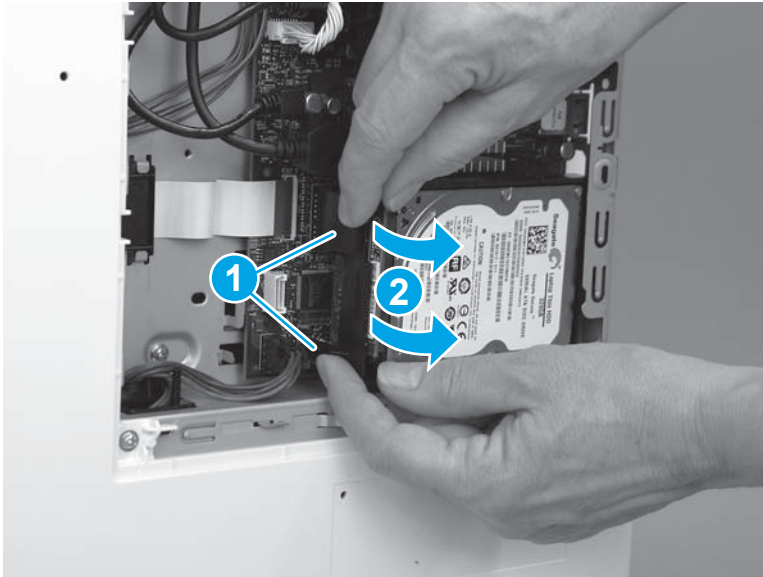

2. Slide the HDD away from the printer to remove it.

Figure 1-69 Remove the HDD

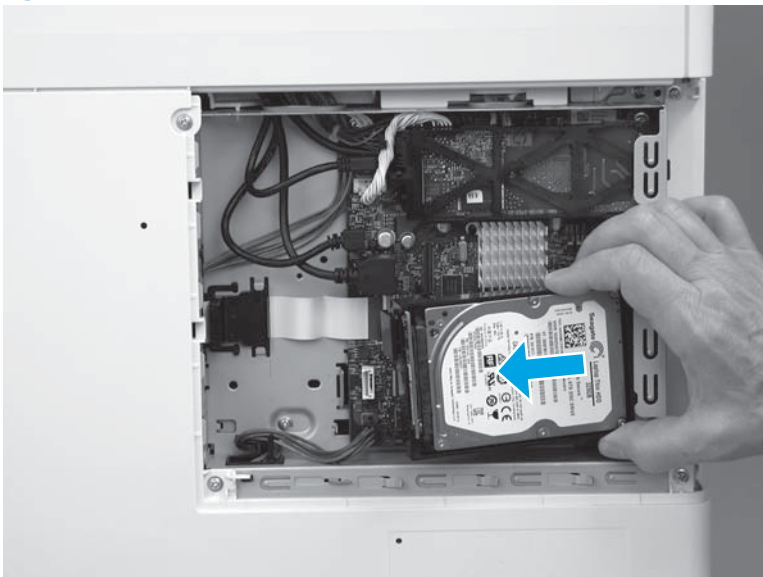

Step 3: Remove the dual in-line memory module (DIMM)

 **CAUTION:**  ESD-sensitive part.

1. Locate the DIMM component on the formatter.

Figure 1-70 Locate the DIMM

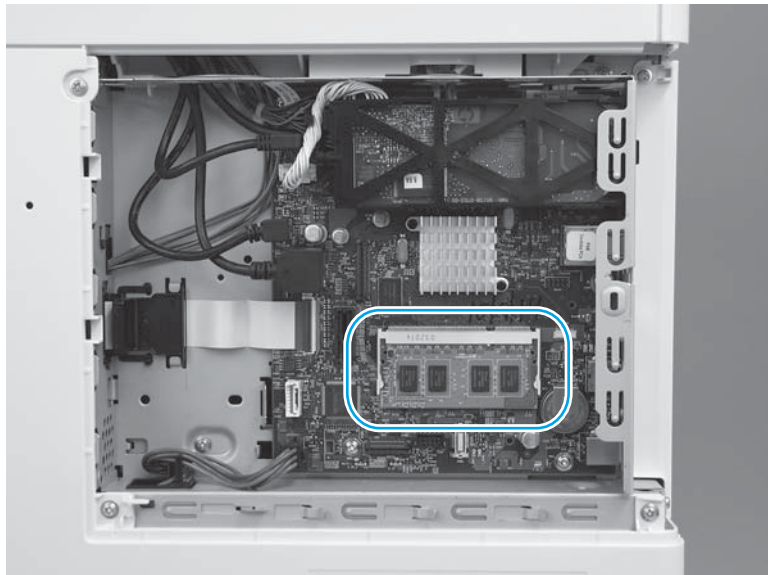

2. Do the following:
 - a. Release two locking arms (callout 1).

Figure 1-71 Release the DIMM

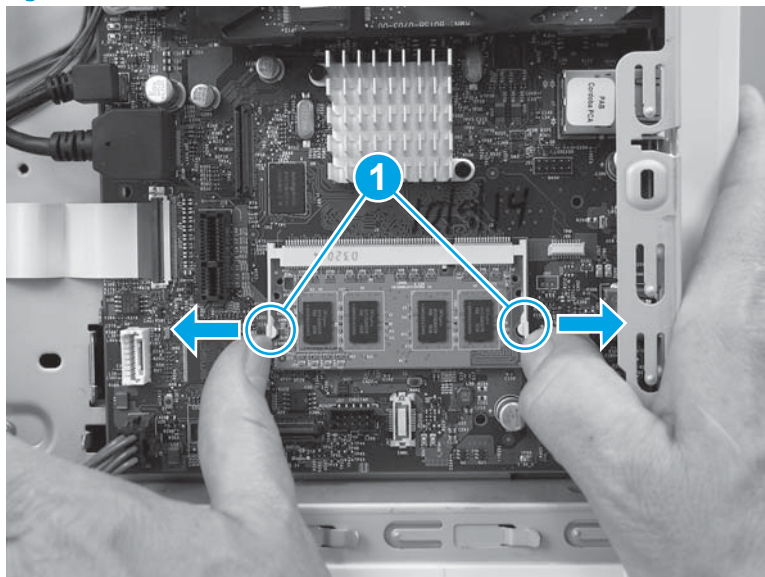

- b. Pull the DIMM down and away from the holder to remove it.

Figure 1-72 Remove the DIMM (M527)

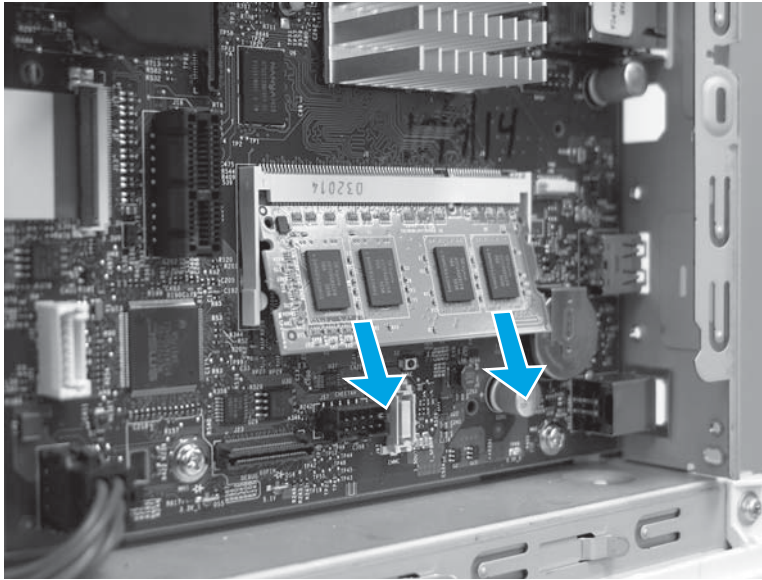

Step 4: Unpack the replacement assembly

Unpack the replacement assembly from the packaging.

CAUTION:  ESD-sensitive part.

For complete information on HP's recycling programs, go to [Product return and recycling](#).

NOTE:  HP recommends responsible disposal of the defective assembly.

Figure 1-73 Recycle and unpack

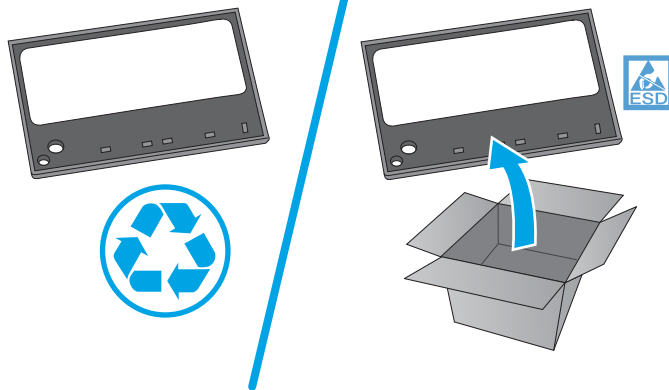

Step 5: Install the DIMM

CAUTION:  ESD-sensitive part.

1. Insert the top edge of the DIMM (callout 1) in the holder (callout 2).

Reinstallation tip:  The DIMM is keyed and can only be inserted in the holder one way.

Figure 1-74 Insert the DIMM

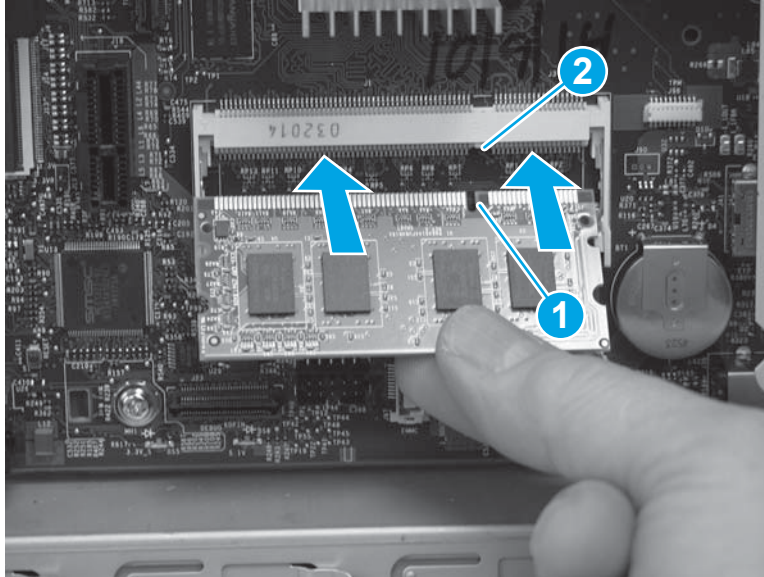

2. Make sure that the DIMM is fully installed in the holder (callout 1), and then rotate the bottom edge of the DIMM toward the holder (callout 2).

Figure 1-75 Install the DIMM

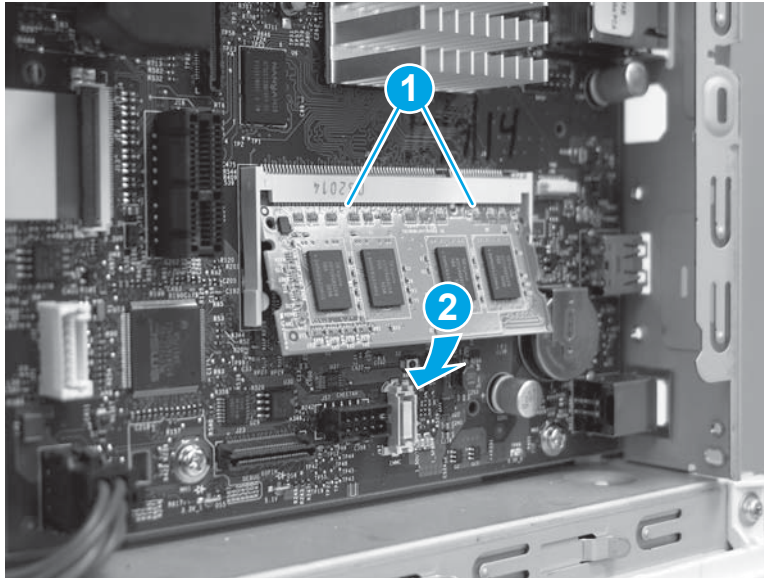

3. Make sure that the DIMM snaps into the locking arms (callout 1).

Figure 1-76 Snap the DIMM into place

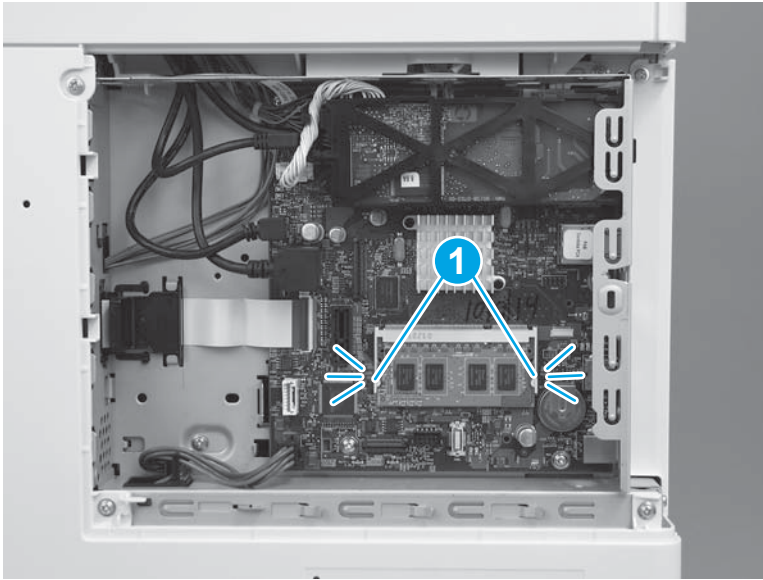

Step 6: Install the HDD (M577)

 **CAUTION:**  ESD-sensitive part.

1. Align the end of the bracket (callout 1) with the slot in the chassis (callout 2), and then slide the HDD into the printer (callout 3) to engage the bracket with the chassis.

Figure 1-77 Install the holder

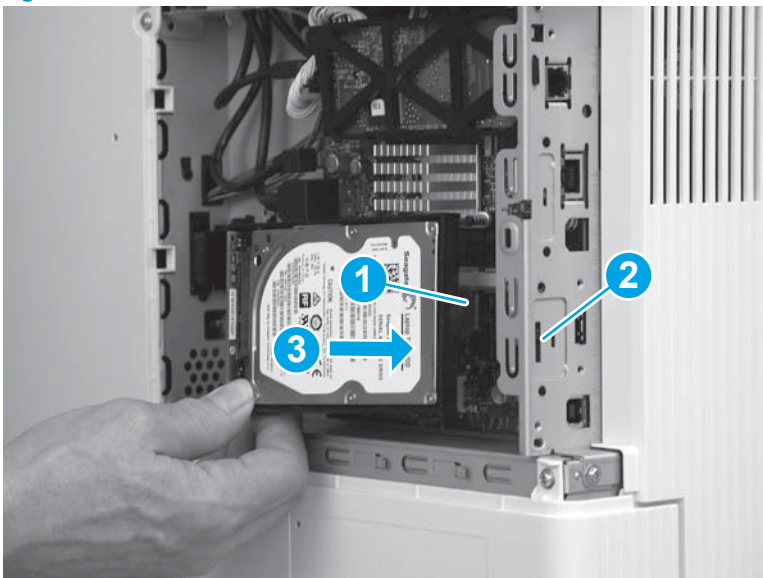

2. Hold the HDD connector latch (callout 1) in the released position, and then rotate the HDD down and into the connector on the formatter to install it.

 **NOTE:** Make sure that the tab (callout 2) snaps into place, and that the HDD is securely installed.

Figure 1-78 Release the HDD



Step 7: Install the formatter cover

- ▲ Slide the cover onto the printer (callout 1) to install it.

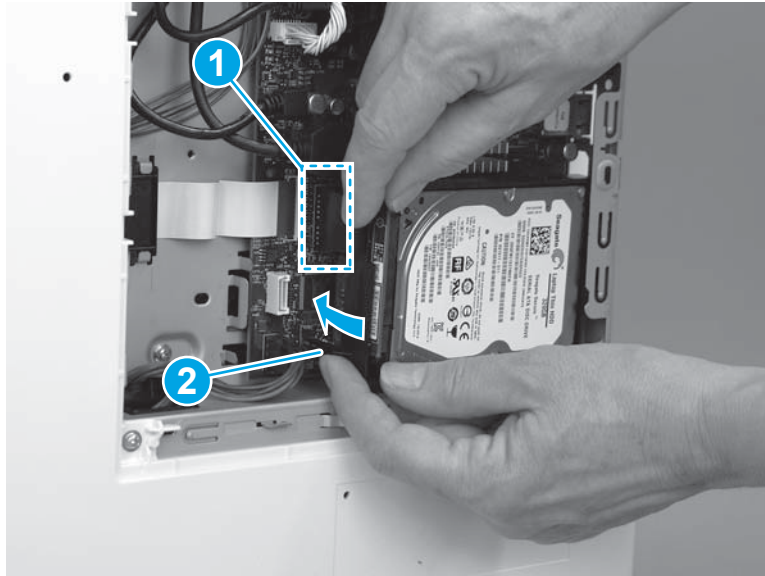
 **NOTE:** Make sure that the tabs on the formatter cover align with the slots provided in the printer (callout 2). Tighten the two thumbscrews (callout 3).

 **TIP:** If needed, use the edge of a coin to turn the thumbscrews.

Figure 1-79 Install the cover

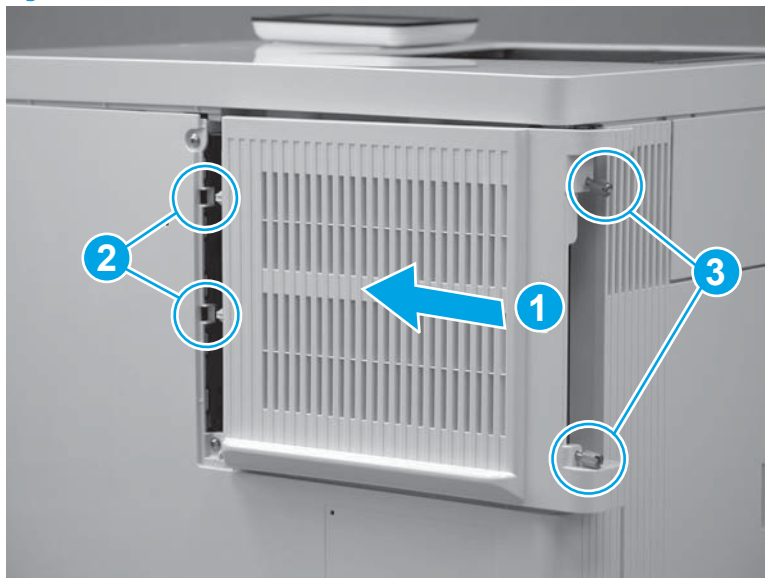

Removal and replacement: embedded MultiMedia Card (eMMC; M552 and M553)

- [Introduction](#)
- [Step 1: Remove the formatter cover](#)
- [Step 2: Remove the embedded MultiMedia Card \(eMMC\)](#)
- [Step 3: Unpack the replacement assembly](#)
- [Step 4: Install the eMMC](#)
- [Step 5: Install the formatter cover](#)
- [Step 6: Reinstall the product firmware](#)

Introduction



This document provides the procedures to remove and replace the M552 and M553 embedded MultiMedia Card (eMMC).

Before performing service

Turn the printer power off

- Disconnect the power cable.

 **WARNING!** To avoid damage to the printer, turn the printer off, wait 30 seconds, and then remove the power cord before attempting to service the printer.

 **CAUTION:**  This part contains components that are electrostatic discharge (ESD) sensitive. To reduce the possibility of ESD damage, always touch the sheet-metal chassis to ground yourself before touching an ESD sensitive part.

 **IMPORTANT:** Do not replace the formatter, DC controller, and eMMC PCA or hard-disk drive simultaneously during a single printer servicing. Doing so might cause the printer to become unstable or inoperable.

 **NOTE:** Data stored on the eMMC is not secure and cannot be encrypted.

Use the table below to identify the correct part number for your printer. To order the part, go to www.hp.com/buy/parts.

embedded MultiMedia Card (eMMC) kit part number	
---	--

5851-6436

embedded MultiMedia Card (eMMC) with instruction guide
--

Required tools

No special tools are required to install this part.

After performing service

Make sure that the formatter cover is fully seated, and that the thumbscrews are finger tight after replacing it.

Turn the printer power on

- Connect the power cable.
- Use the power switch to turn the power on.

Post service test

Print a configuration page to make sure that the printer is functioning correctly.

Step 1: Remove the formatter cover

1. Locate the formatter cover.

Figure 1-80 Locate the formatter cover

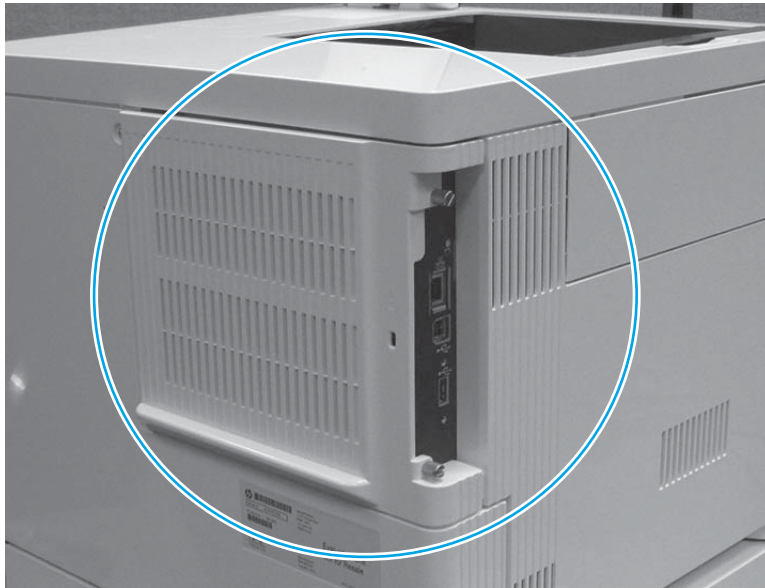

2. Loosen the two thumbscrews (callout 1). Grasp the two thumbscrews, and then slide the cover away from the printer (callout 2) to remove it.

 **TIP:** If needed, use the edge of a coin to turn the thumbscrews.

Figure 1-81 Loosen the thumbscrews



Step 2: Remove the embedded MultiMedia Card (eMMC)

 **CAUTION:**  ESD-sensitive part.

- ▲ Locate the eMMC component on the formatter, and then pull it straight off of the formatter to remove it.

Figure 1-82 Remove the eMMC

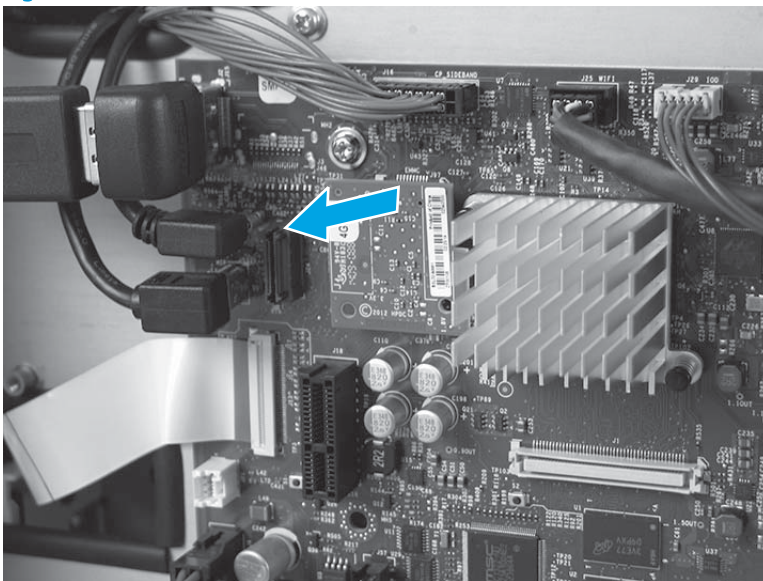

Step 3: Unpack the replacement assembly

Unpack the replacement assembly from the packaging.

 **CAUTION:**  ESD-sensitive part.

For complete information on HP's recycling programs, go to [Product return and recycling](#).

 **NOTE:** HP recommends responsible disposal of the defective assembly.

Figure 1-83 Recycle and unpack

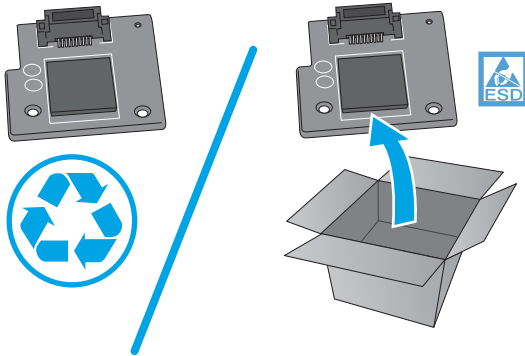

Step 4: Install the eMMC

 **CAUTION:**  ESD-sensitive part.

1. Align the connector on the replacement eMMC (callout 1) with the connector on the formatter (callout 2), and then push the eMMC onto the formatter to install it.

 **NOTE:** The eMMC can only be installed in one direction on the formatter.

Figure 1-84 Install the eMMC

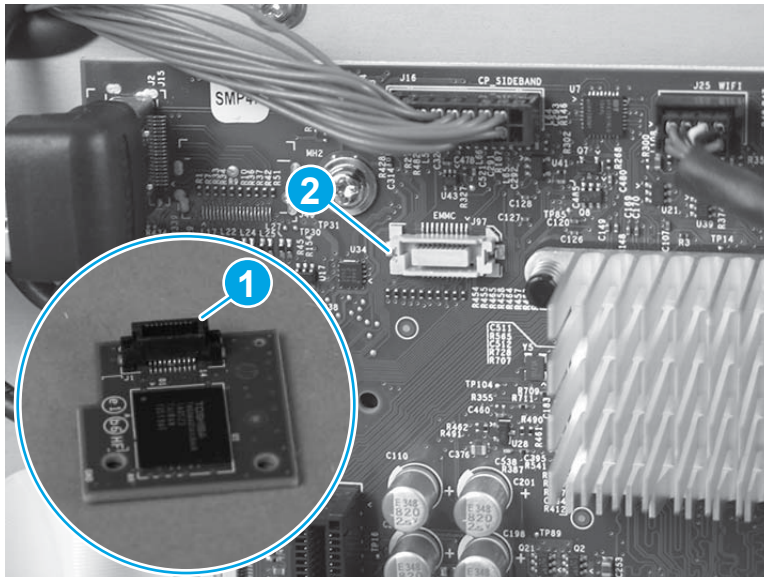

2. Push down on the eMMC to make sure that it is fully seated in the connector.

Figure 1-85 Verify the installation

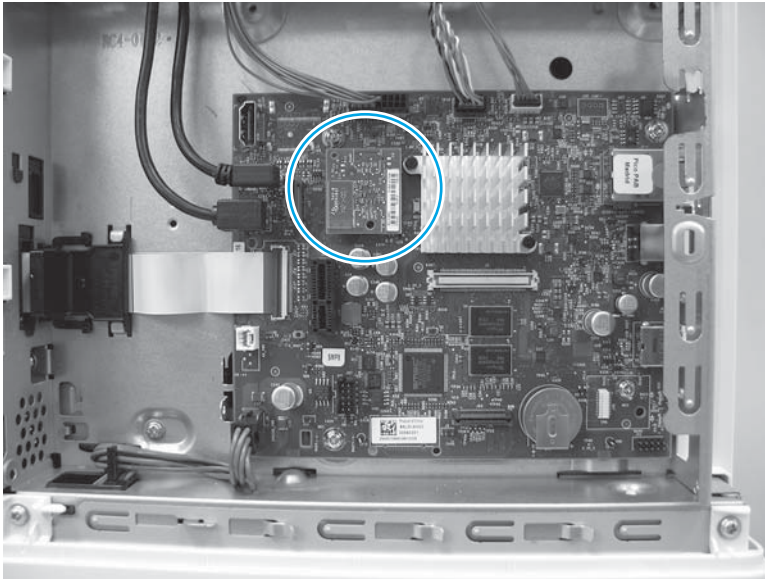

Step 5: Install the formatter cover

- ▲ Slide the cover onto the printer (callout 1) to install it.

 **NOTE:** Make sure that the tabs on the formatter cover align with the slots provided in the printer (callout 2). Tighten the two thumbscrews (callout 3).

 **TIP:** If needed, use the edge of a coin to turn the thumbscrews.

Figure 1-86 Install the cover



Step 6: Reinstall the product firmware

 **NOTE:** If this installation is a replacement eMMC, use the following steps to reinstall the firmware.

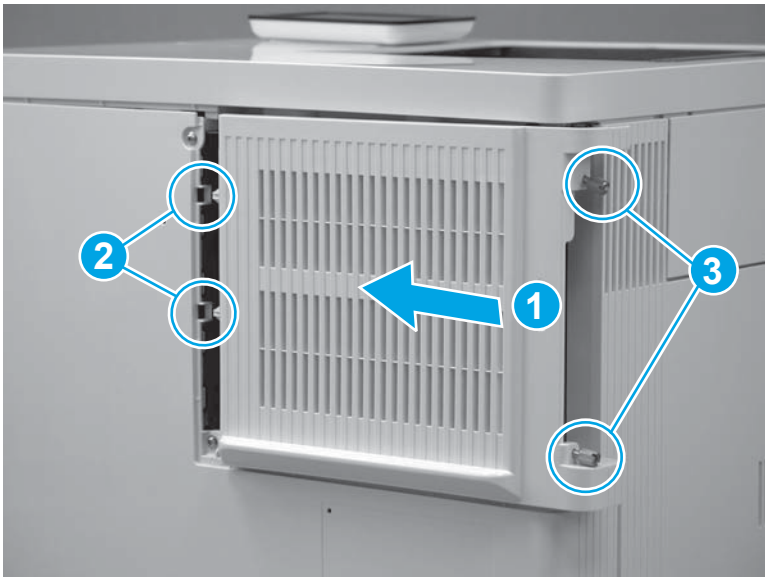
1. Go to www.hp.com/go/futuresmart.
2. Select **Upgrade now**.
3. Find your Enterprise printer model.
4. Select the link to open the firmware download page.
5. Select **OS Independent** from the list of operating systems.
6. Under the **Firmware** section, find the file for multiple operating systems.
7. Select **Download**.



NOTE: To view installation instructions, go to www.hp.com/go/futuresmart. Select **Upgrade now**, and then select **How to perform a firmware update**.

Removal and replacement: Secondary transfer roller

- [Introduction](#)
- [Step 1: Remove the transfer roller](#)
- [Step 2: Unpack the replacement assembly](#)
- [Step 3: Install the secondary transfer roller](#)

Introduction

This document provides the procedures to remove and replace the secondary transfer roller.

Before performing service

Turn the printer power off

- Disconnect the power cable.

⚠ WARNING! To avoid damage to the printer, turn the printer off, wait 30 seconds, and then remove the power cord before attempting to service the printer.

Use the table below to identify the correct part number for your printer. To order the part, go to www.hp.com/buy/parts.

Secondary transfer roller kit part number	
B5L24-67902	Secondary transfer roller with instruction guide

Required tools

No special tools are required to install this part.

After performing service

Make sure that the right door is fully closed after replacing the secondary transfer roller.

Turn the printer power on

- Connect the power cable.
- Use the power switch to turn the power on.

Post service test

Print a configuration page to make sure that the printer is functioning correctly.

Step 1: Remove the transfer roller

1. Open the right door.

Figure 1-87 Open the right door



2. Push in on the blue lever (callout 1) to release the secondary transfer roller assembly, and then lower the assembly (callout 2) to the service position.

Figure 1-88 Lower the secondary transfer roller assembly

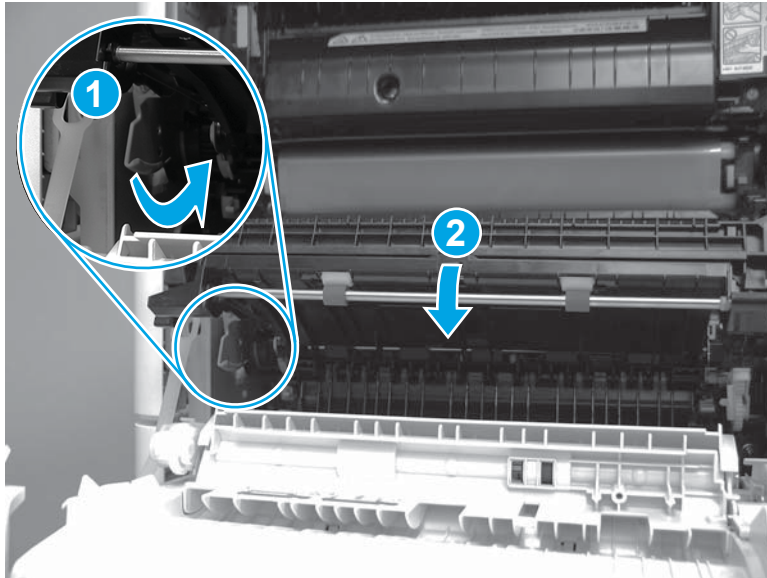

3. Slightly lift the left end of the roller shaft (callout 1; near the gear) to release the transfer roller clip.

Figure 1-89 Release the secondary transfer roller clip

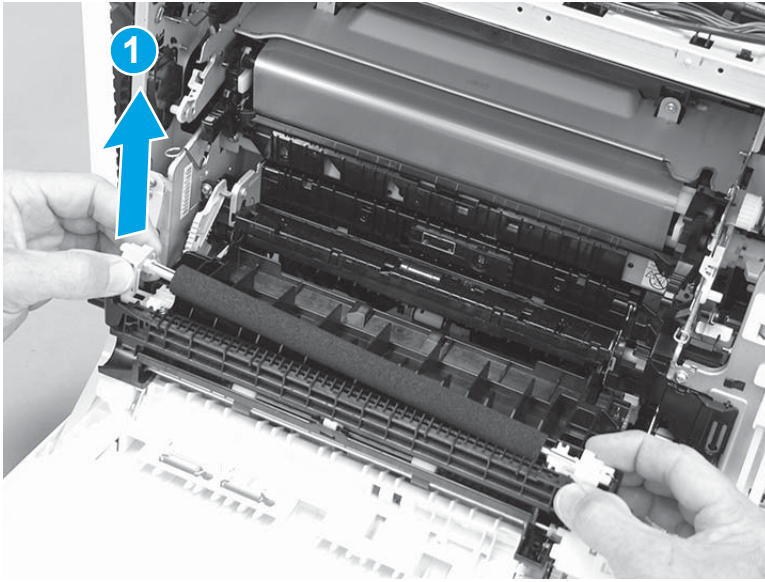

4. Slide the right end roller collar (callout 1) to the left to remove the transfer roller.

Figure 1-90 Remove the secondary transfer roller

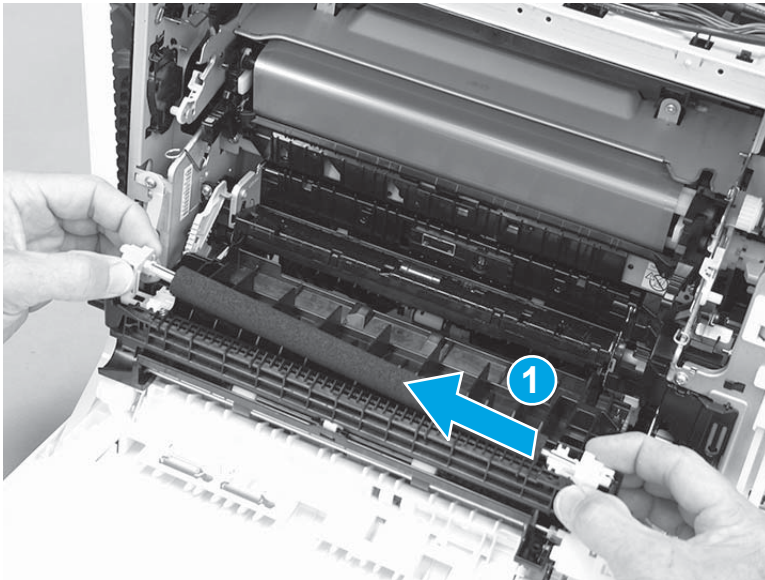

Step 2: Unpack the replacement assembly

Unpack the replacement assembly from the packaging.

CAUTION: Skin oils on the roller can cause print-quality problems. Avoid touching the black spongy roller on the assembly.

For complete information on HP's recycling programs, go to [Product return and recycling](#).

NOTE: HP recommends responsible disposal of the defective assembly.

Figure 1-91 Recycle and unpack

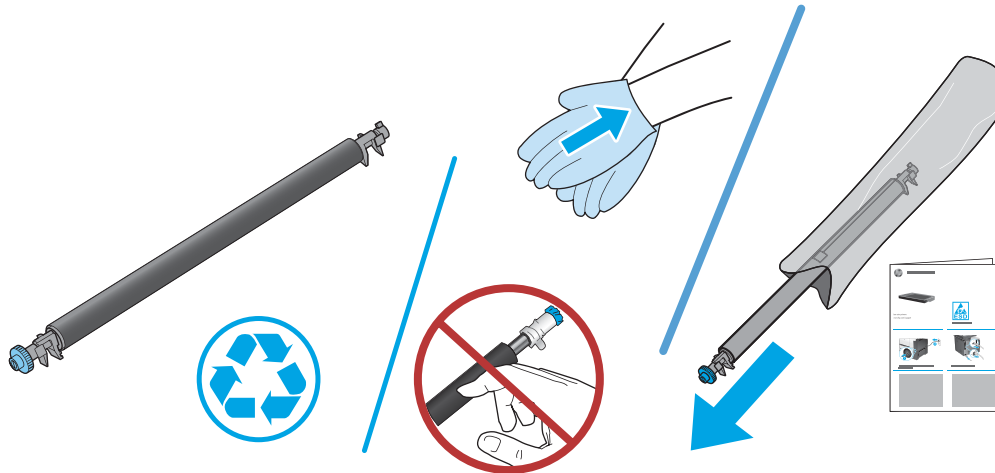

Step 3: Install the secondary transfer roller

1. Insert the right end (white plastic) of the replacement roller into the holder (callout 1), and then push down on the left end (blue plastic clip; callout 2) until the roller snaps into place.

 **IMPORTANT:** Make sure that both ends of the roller assembly are fully seated in the holders.

Figure 1-92 Install the secondary transfer roller

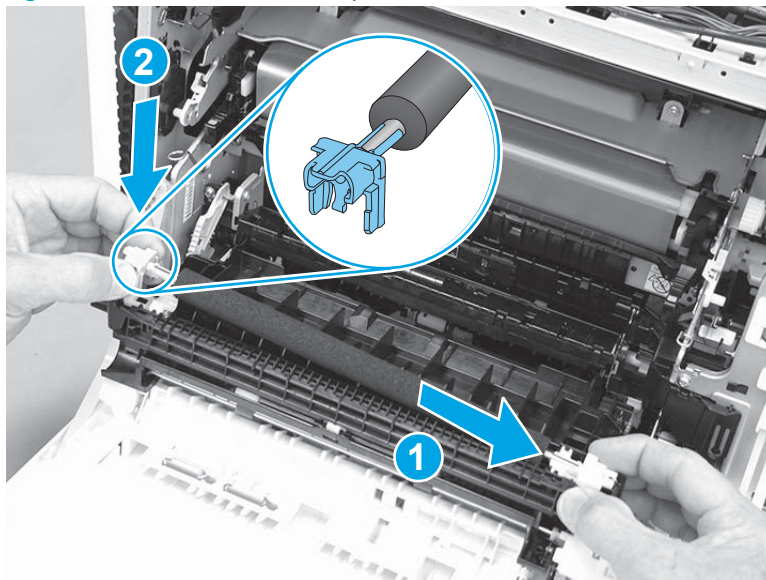

2. Close the right door.

Figure 1-93 Close the right door



Removal and replacement: Universal Serial Bus (USB) cover (M552 and M553)

- [Introduction](#)
- [Step 1: Remove the USB cover](#)
- [Step 2: Unpack the replacement assembly](#)
- [Step 3: Install the USB cover](#)

Introduction

This document provides the procedures to remove and replace the M552 and M553 USB cover.

Before performing service

Use the table below to identify the correct part number for your printer. To order the part, go to www.hp.com/buy/parts.

USB cover part number	
RC4-0214-000CN	USB cover

Required tools

No special tools are required to install this part.

After performing service

Make sure that the USB cover is fully seated after replacing it.

Step 1: Remove the USB cover

1. Locate the USB cover.

Figure 1-94 Locate the USB cover

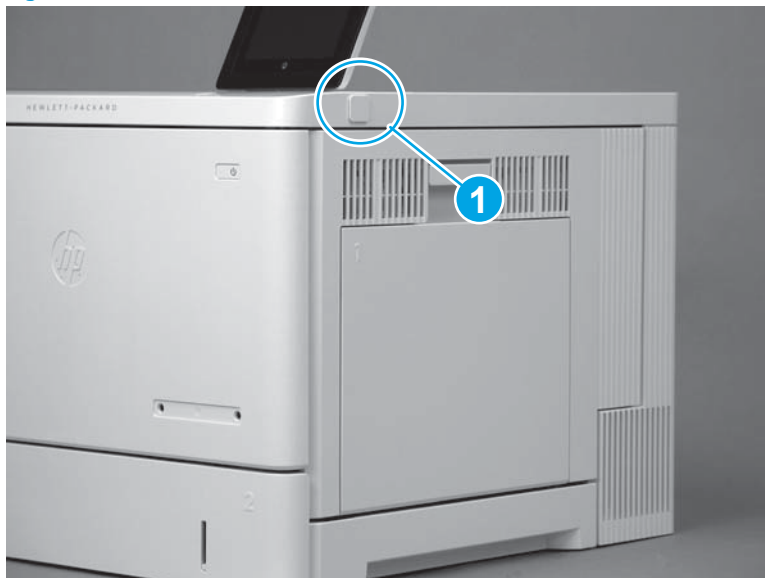

2. Pull the cover off of the printer to remove it.

Figure 1-95 Remove the cover



Step 2: Unpack the replacement assembly

Unpack the replacement assembly from the packaging.

For complete information on HP's recycling programs, go to [Product return and recycling](#).

 **NOTE:** HP recommends responsible disposal of the defective assembly.

Figure 1-96 Recycle and unpack

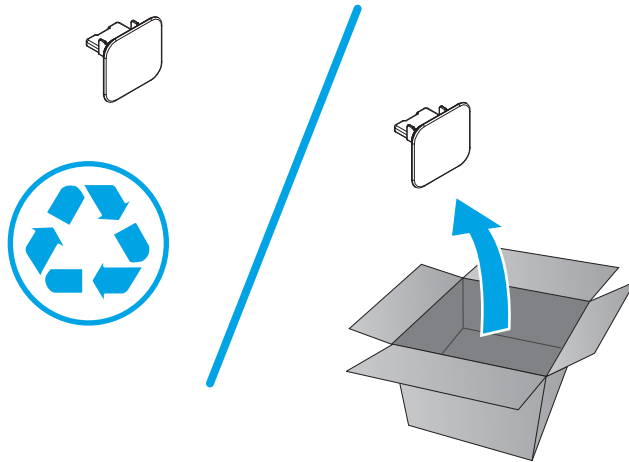

Step 3: Install the USB cover

1. Push the cover into the USB port to install it.

Figure 1-97 Install the cover



2. Make sure that the USB cover is fully seated after installing it.

Figure 1-98 Check the installation

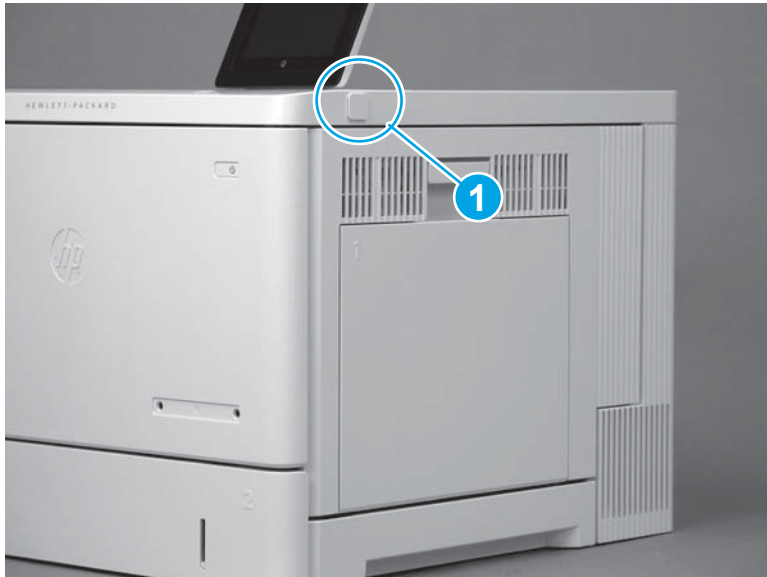

Removal and replacement: Hardware Integration Pocket (HIP) cover (M552 and M553)

- [Introduction](#)
- [Step 1: Remove the HIP cover](#)
- [Step 2: Unpack the replacement assembly](#)
- [Step 3: Install the HIP cover](#)

Introduction

This document provides the procedures to remove and replace the M552 and M553 HIP cover.

Before performing service

Use the table below to identify the correct part number for your printer. To order the part, go to www.hp.com/buy/parts.

HIP cover (M552 and M553) part number	
RC4-0213-000CN	HIP cover (M552 and M553)

Required tools

No special tools are required to install this part.

After performing service

Make sure that the HIP cover is fully seated after replacing it.

Step 1: Remove the HIP cover

1. Locate the HIP cover.

Figure 1-99 Locate the HIP cover



2. Before proceeding, take note of the mounting feet (callout 1) and tabs (callout 2) on the HIP cover.

Figure 1-100 Note the mounting feet and tabs

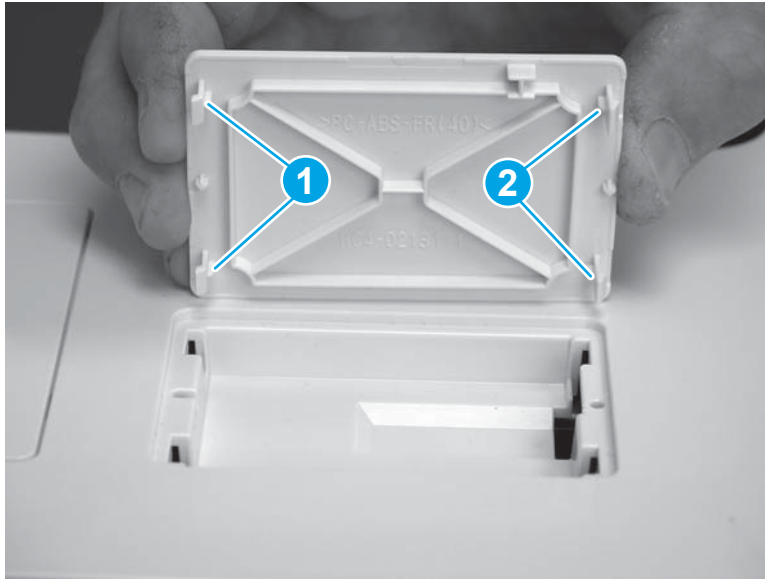

3. Use a small flat-blade screwdriver to release the tabs on the HIP cover.

Figure 1-101 Release the HIP cover tabs

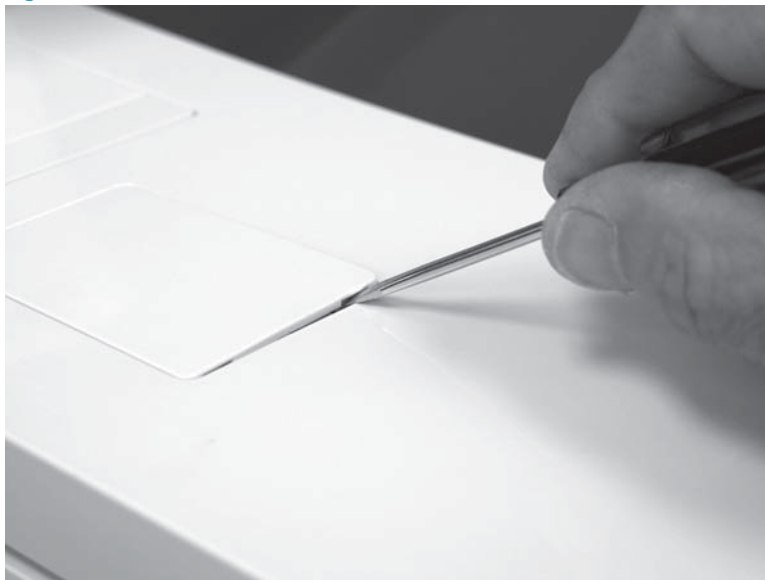

4. Rotate the cover up and off of the printer to remove it.

Figure 1-102 Remove the cover

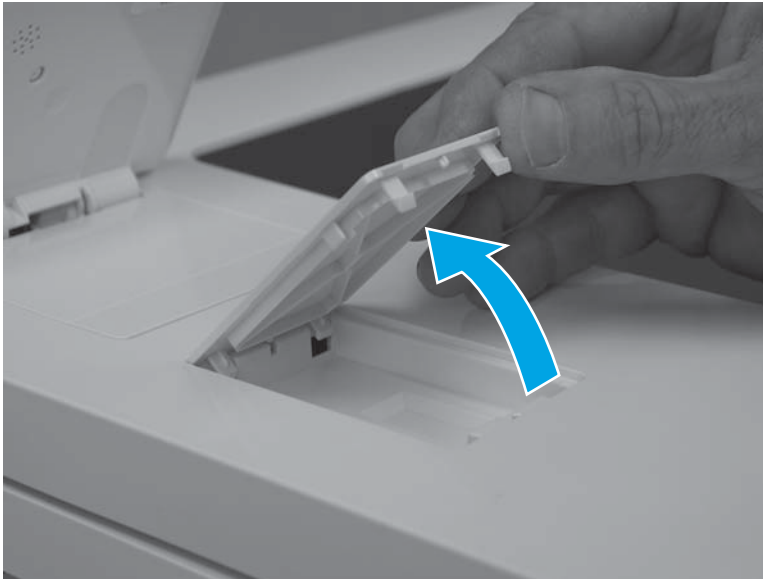

Step 2: Unpack the replacement assembly

Unpack the replacement assembly from the packaging.

For complete information on HP's recycling programs, go to [Product return and recycling](#).

 **NOTE:** HP recommends responsible disposal of the defective assembly.

Figure 1-103 Recycle and unpack

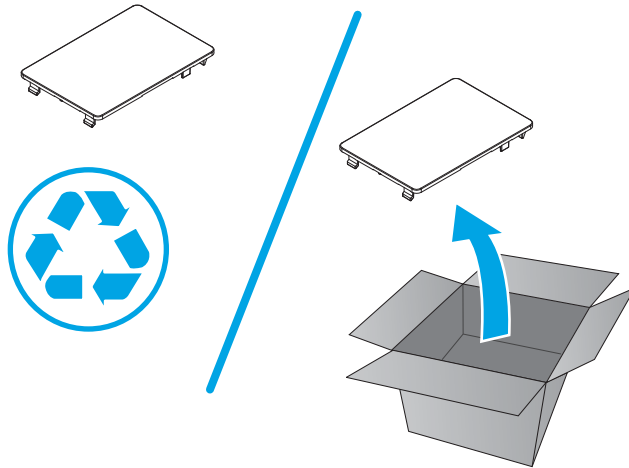

Step 3: Install the HIP cover

1. Position the HIP cover mounting feed in the slots (callout 1) provided in the top cover, and then rotate it down to install it.

 **NOTE:** Make sure that the tabs on the cover snap into place.

Figure 1-104 Install the cover

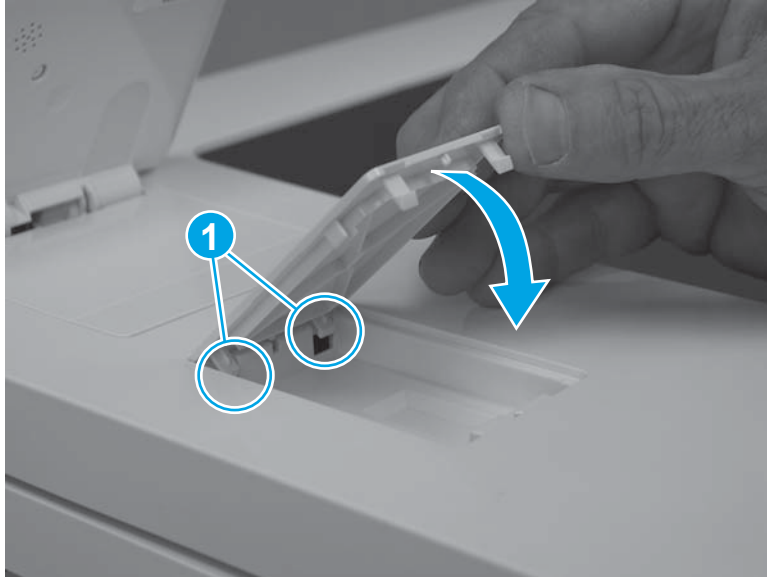

2. Make sure that the HIP cover is fully seated after installing it.

Figure 1-105 Check the installation



Removal and replacement: Hardware Integration Pocket (HIP) cover (M577)

- [Introduction](#)
- [Step 1: Remove the HIP cover](#)
- [Step 2: Unpack the replacement assembly](#)
- [Step 3: Install the HIP cover](#)

Introduction

This document provides the procedures to remove and replace the M577 HIP cover.

Before performing service

Use the table below to identify the correct part number for your printer. To order the part, go to www.hp.com/buy/parts.

HIP cover (M577) part number	
B5L46-40021	HIP cover (M577)

Required tools

No special tools are required to install this part.

After performing service

Make sure that the HIP cover is fully seated after replacing it.

Step 1: Remove the HIP cover

1. Locate the HIP cover.

Figure 1-106 Locate the HIP cover



2. Use a small flat-blade screwdriver to release the tabs on the HIP cover.

Figure 1-107 Release the HIP cover tabs



3. Rotate the cover up and off of the printer to remove it.

Figure 1-108 Remove the cover



Step 2: Unpack the replacement assembly

Unpack the replacement assembly from the packaging.

For complete information on HP's recycling programs, go to [Product return and recycling](#).

 **NOTE:** HP recommends responsible disposal of the defective assembly.

Figure 1-109 Recycle and unpack

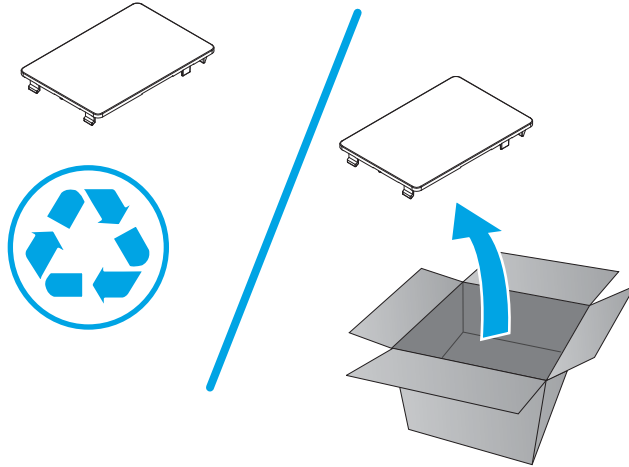

Step 3: Install the HIP cover

1. Position the tabs (callout 1) on the HIP cover in the slots (callout 2) in the printer.

Figure 1-110 Position the tabs

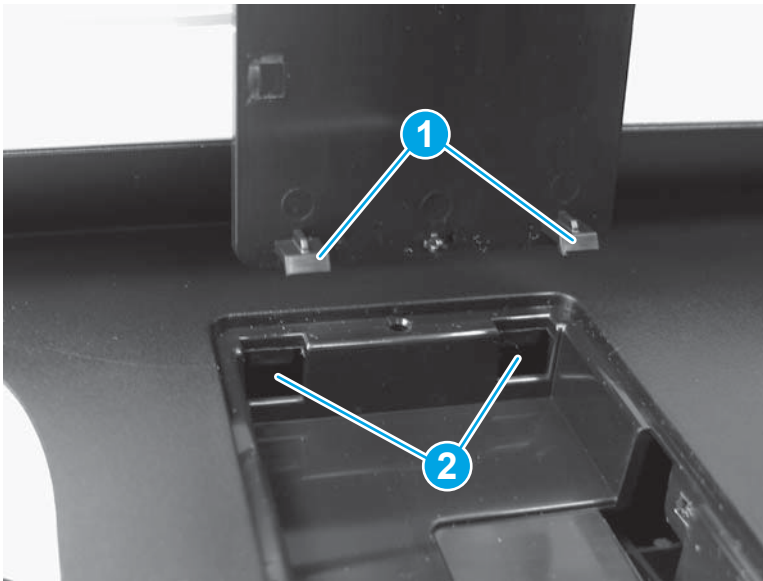

2. Rotate the cover down.

 **NOTE:** Make sure that the tabs on the cover snap into place.

Figure 1-111 Rotate the cover down



3. Make sure that the HIP cover is fully seated after installing it.

Figure 1-112 Check the installation



Removal and replacement: Control panel (M553x)

- [Introduction](#)
- [Step 1: Remove the control panel](#)
- [Step 2: Unpack the replacement assembly](#)
- [Step 3: Install the control panel](#)

Introduction

This document provides instructions about removing and replacing the M553x control panel.

Before performing service

Turn the printer power off

- Disconnect the power cable.

 **WARNING!** To avoid damage to the printer, turn the printer off, wait 30 seconds, and then remove the power cord before attempting to service the printer.

Use the table below to identify the correct part number for your printer. To order the part, go to www.hp.com/buy/parts.

Control panel (M553x) kit part number	
B5L24-67903	Control panel (M553x) and reversible screwdriver with instruction guide

Required tools

- Reversible small, flat-blade screwdriver and #2 Phillips screwdriver (included with the control panel)

After performing service

Turn the printer power on

- Connect the power cable.
- Use the power switch to turn the power on.

Post service test

The printer includes a diagnostic test mode for the control panel. For more information, see the control panel checks section of the printer troubleshooting manual.

Step 1: Remove the control panel

1. Tilt the control panel up.

Figure 1-113 Tilt the control panel up



2. Use the small flat-blade screwdriver supplied in this kit to release the control-panel screws cover tabs.

 **TIP:** The screwdriver has a reversible shaft. Simply pull the shaft out of the handle, and then reinstall it with the desired end facing out.

Figure 1-114 Release the control-panel screws cover tabs



3. Rotate the cover up to remove it.

Figure 1-115 Remove the cover



4. Use the small Phillips screwdriver supplied in this kit to remove two screws (callout 1).

 **IMPORTANT:** Store the screws in a secure place where they cannot fall down into the printer.

 **TIP:** The screwdriver has a reversible shaft. Simply pull the shaft out of the handle, and then reinstall it with the desired end facing out.

Figure 1-116 Remove two screws



5. Rotate the control-panel base toward the front of the printer.

Figure 1-117 Rotate the control-panel base up

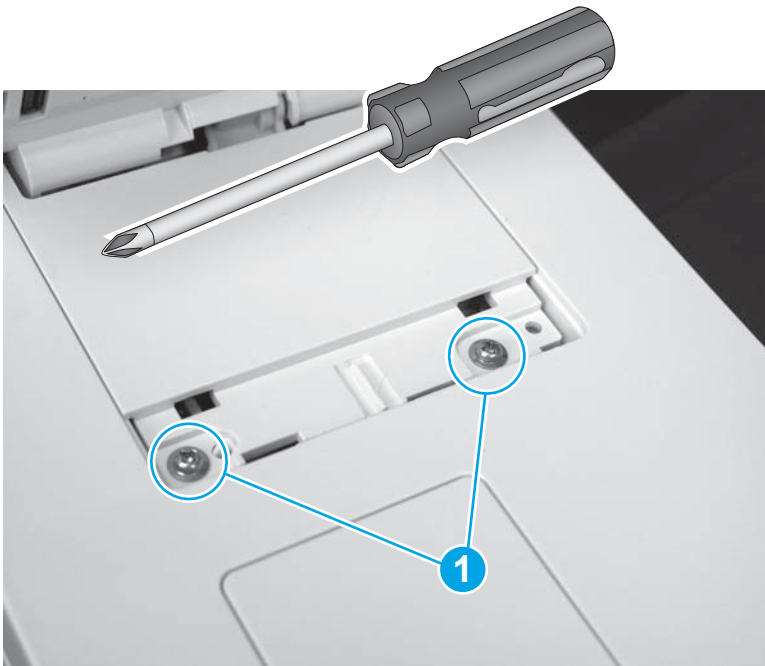

6. Slightly slide the control-panel base toward the rear of the printer (callout 1) to release it, and then turn the control panel over (callout 2) to access the bottom side.

⚠ CAUTION: The control panel is still attached to the printer. Do not attempt to completely remove the control panel.

Figure 1-118 Turn the control panel over

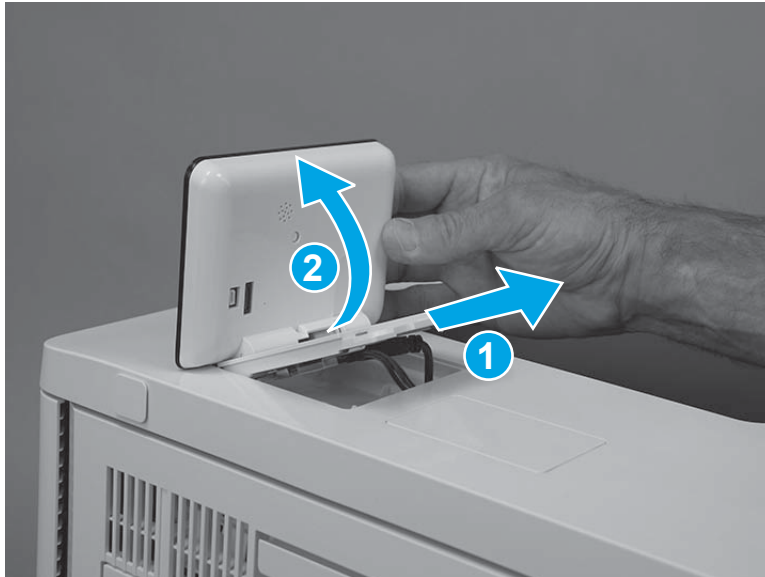

7. Disconnect one USB cable (callout 1), one connector (callout 2), and then remove the control panel.

Figure 1-119 Disconnect two connectors

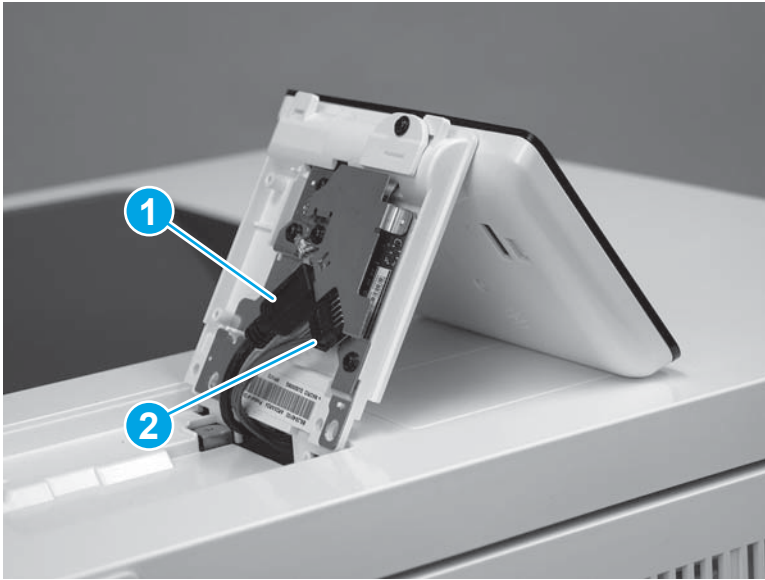

Step 2: Unpack the replacement assembly

Unpack the replacement assembly from the packaging.

For complete information on HP's recycling programs, go to [Product return and recycling](#).

 **NOTE:** HP recommends responsible disposal of the defective assembly.

 **TIP:** Don't forget to remove the protective film on the touchscreen of the replacement control panel.

Figure 1-120 Recycle and unpack



Step 3: Install the control panel

1. Place the control panel on the printer as shown.

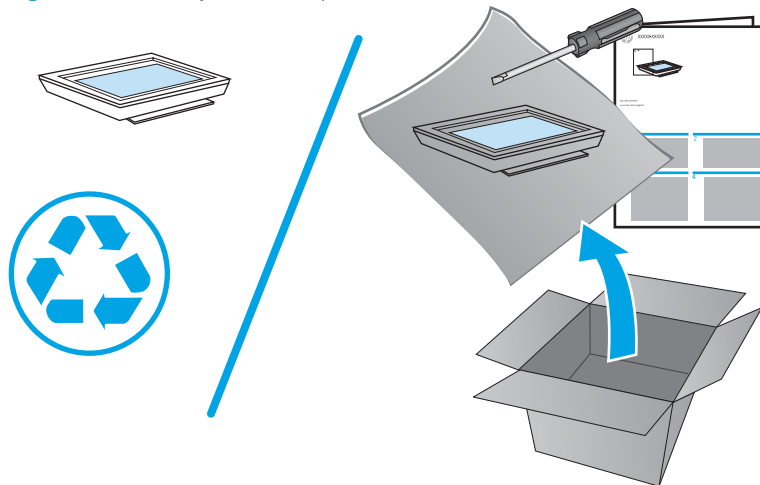
Figure 1-121 Place the control panel on the product

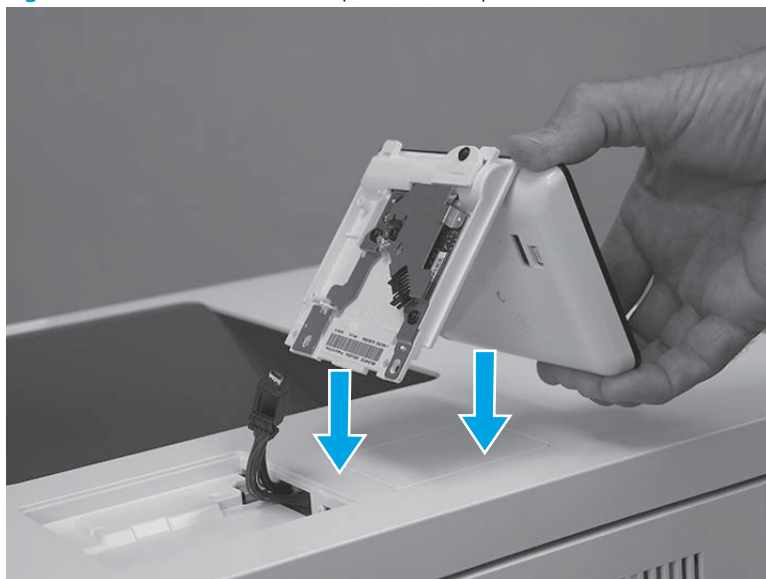

2. Connect one USB cable (callout 1), and one connector (callout 2).

 **IMPORTANT:** Take note of the location of the two mounting tabs (callout 3) on the control-panel assembly.

Figure 1-122 Connect two connectors



3. Turn the control panel over, and then position the front edge tabs in the slots in the top cover.

Figure 1-123 Turn the control panel over

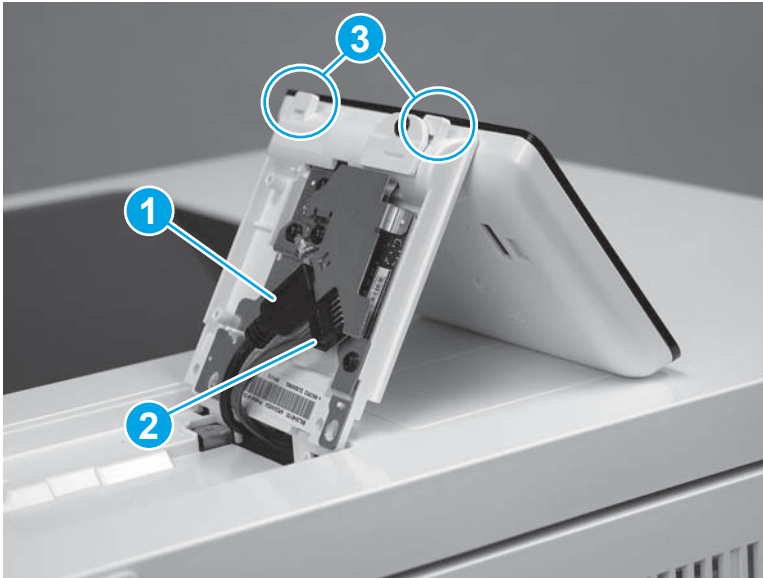
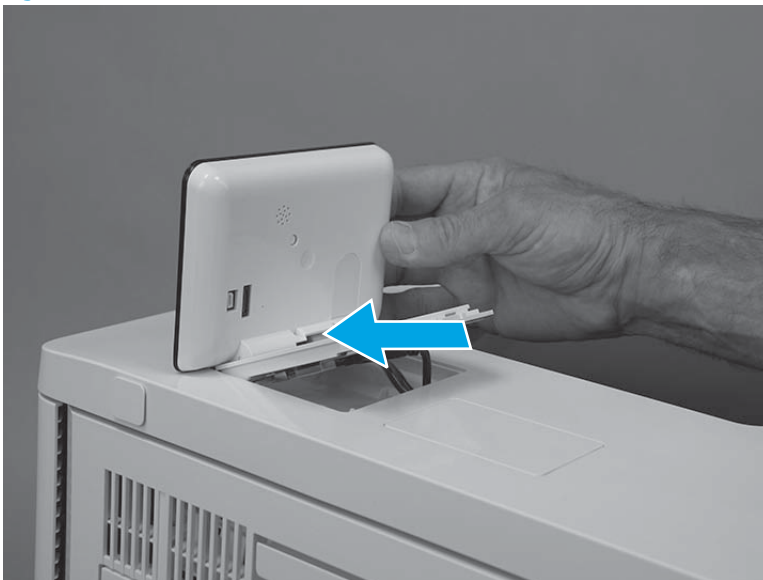

4. Rotate the control-panel base down onto the printer.

Figure 1-124 Rotate the control-panel base down



5. Use the small Phillips screwdriver supplied in this kit to install two screws (callout 1).

 **TIP:** The screwdriver has a reversible shaft. Simply pull the shaft out of the handle, and then reinstall it with the desired end facing out.

Figure 1-125 Install two screws



6. Position the screw cover mounting feet into the slots in the top cover (callout 1), and then rotate the cover down (callout 2) to install it.

 **NOTE:** Press down on the cover firmly to make sure that the tabs on the cover (callout 3) snap into place.

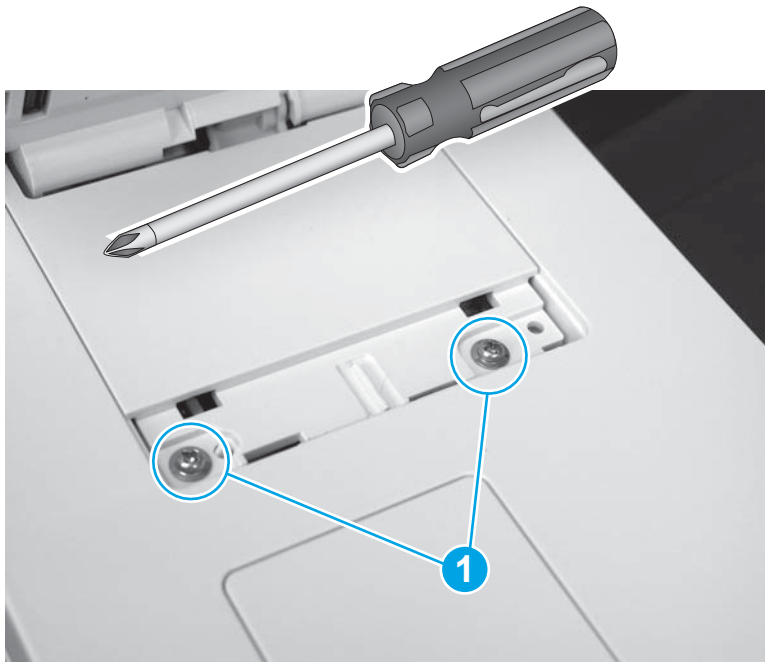
Figure 1-126 Install the cover



Removal and replacement: Control panel (M577)

- [Introduction](#)
- [Step 1: Remove the control-panel cover \(M577\)](#)
- [Step 2: Remove the control panel \(M577\)](#)
- [Step 3: Unpack the replacement assembly](#)
- [Step 4: Install the control panel \(M577\)](#)
- [Step 5: Install the control-panel cover \(M577\)](#)

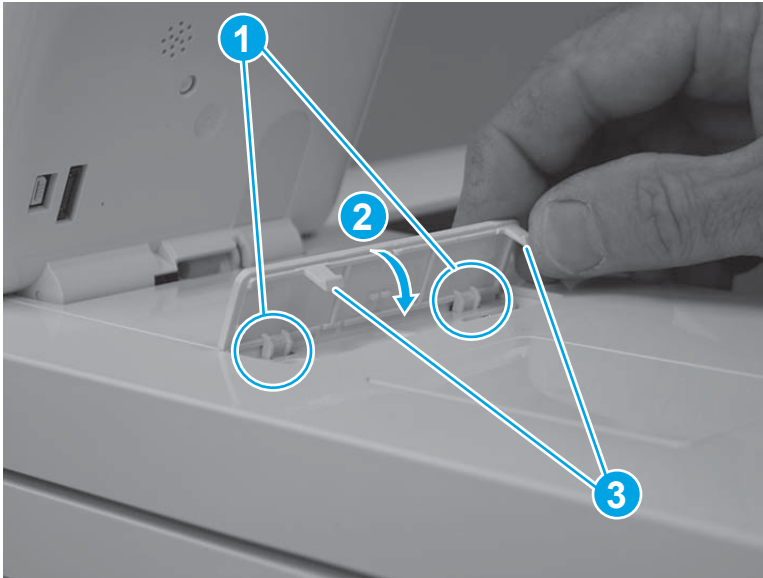
Introduction

This document provides the procedures to remove and replace the M577 control panel.

Before performing service

Turn the printer power off

- Disconnect the power cable.

 **WARNING!** To avoid damage to the printer, turn the printer off, wait 30 seconds, and then remove the power cord before attempting to service the printer.

Use the table below to identify the correct part number for your printer. To order the part, go to www.hp.com/buy/parts.

Control panel (M577) part number	
B5L47-67018	Control panel (M577) and reversible screwdriver with instruction guide

Required tools

- #2 Phillips screwdriver with a magnetic tip.

After performing service

Turn the printer power on

- Connect the power cable.
- Use the power switch to turn the power on.

Post service test

The printer includes a diagnostic test mode for the control panel. For more information, see the control panel checks section of the printer troubleshooting manual.

Step 1: Remove the control-panel cover (M577)

1. Open the document feeder (callout 1).

 **NOTE:** If the control panel is not fully tilted forward, tilt it forward now until it stops (callout 2).

Figure 1-127 Open the document feeder



2. Beginning at the right side of the control-panel cover, carefully release five tabs along the top edge of the cover.

 **NOTE:** The thin, black plastic cover will separate from the white plastic control-panel base.

Figure 1-128 Release five tabs

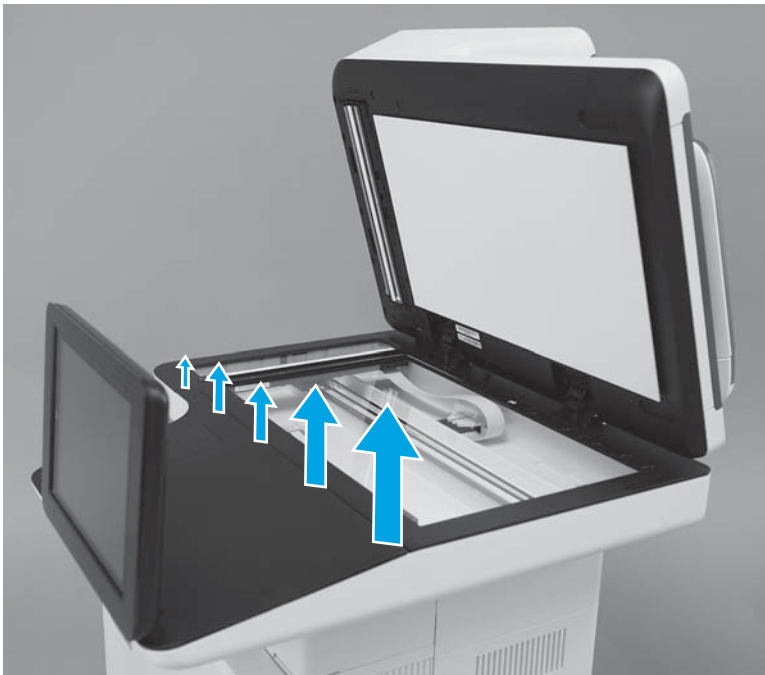

3. Continue to lift the top edge of the cover away from the printer, and then remove the cover.

Figure 1-129 Remove the cover



Step 2: Remove the control panel (M577)

1. **M577c/z only:** Open the latch (callout 1) to release the keyboard flat cable.

CAUTION: The latch must be opened to release the cable.

Figure 1-130 Disconnect the keyboard flat cable (M577c/z)

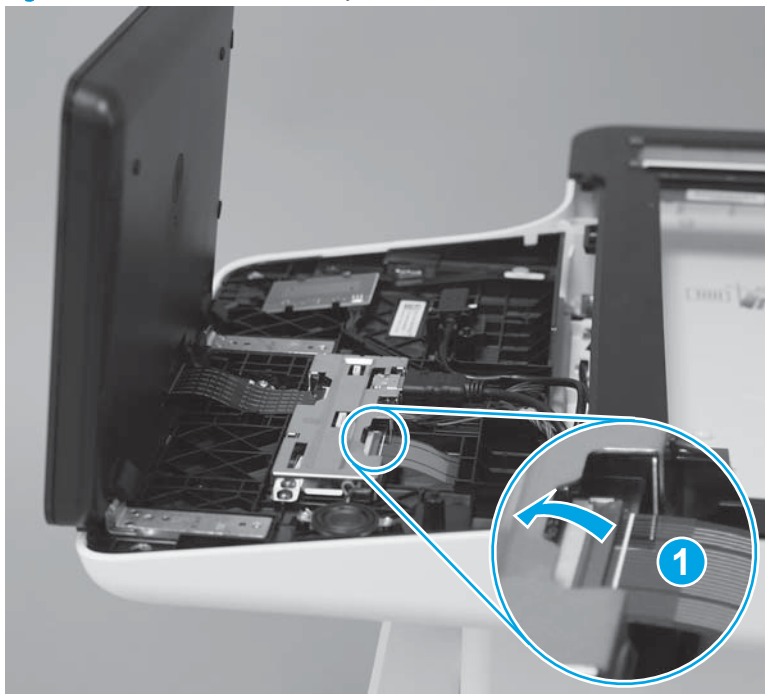

2. Disconnect one HDMI cable (callout 1) and one connector (callout 2).

Figure 1-131 Disconnect connectors



3. Remove the USB cable (callout 1) from the holder.

M577z only: Release four tabs (callout 2), and then remove the near-field communication (NFC) printed circuit board.

Figure 1-132 Disconnect connectors

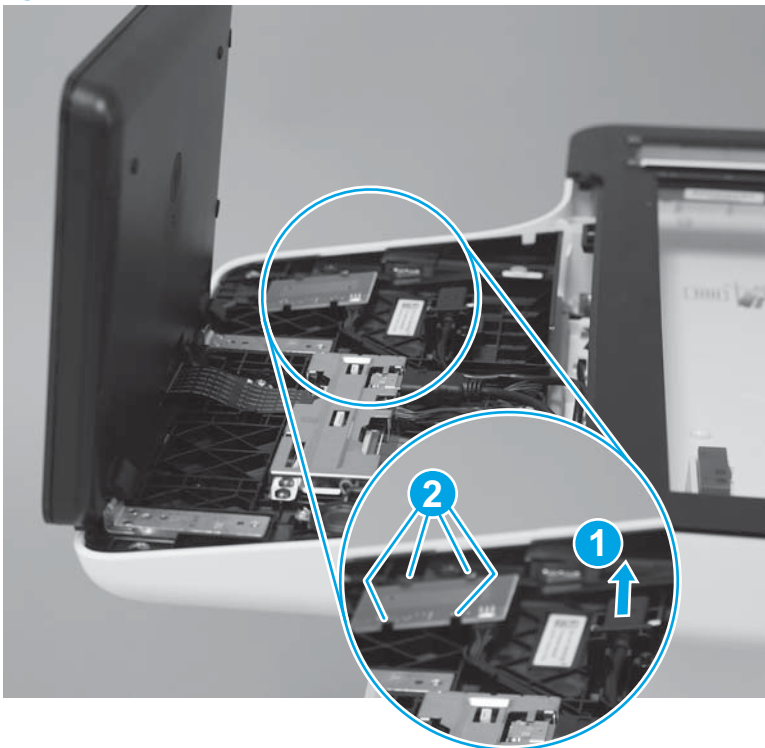

4. Remove three screws (callout 1).

 **TIP:** The screwdriver (supplied with the kit) has a reversible shaft. Simply pull the shaft out of the handle, and then reinstall it with the desired end facing out.

Figure 1-133 Remove three screws



5. Lift the front of the control panel off of the printer (callout 1), and then slide it towards the front of the printer (callout 2) to remove it.

Figure 1-134 Remove the control panel

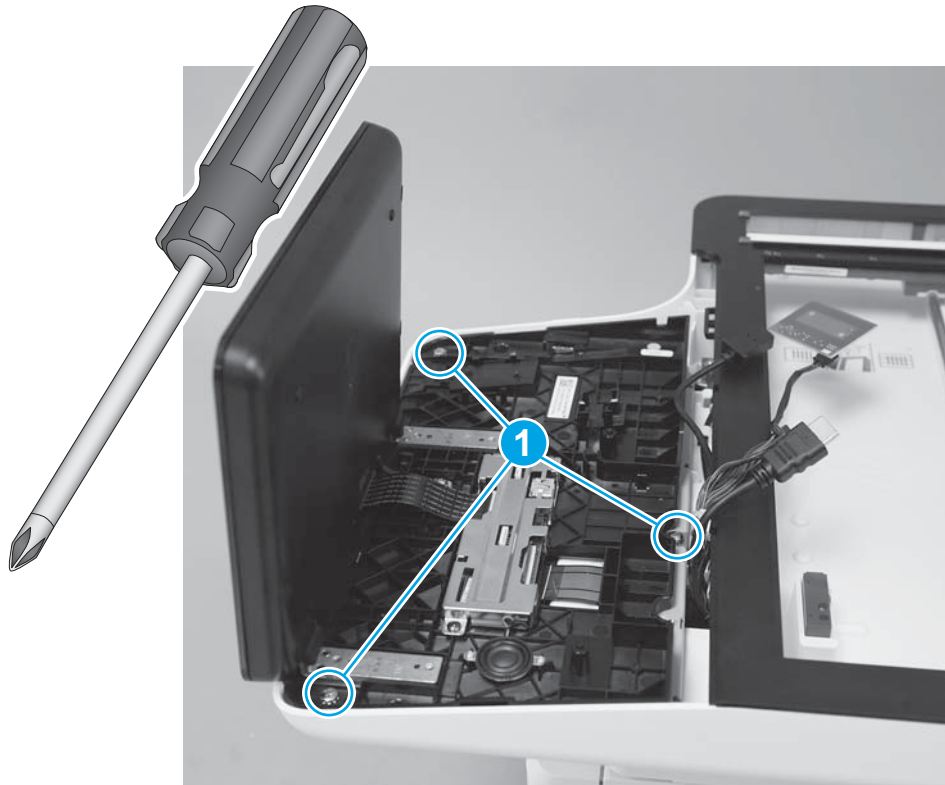

Step 3: Unpack the replacement assembly

Unpack the replacement assembly from the packaging.

For complete information on HP's recycling programs, go to [Product return and recycling](#).

 **NOTE:** HP recommends responsible disposal of the defective assembly.

 **TIP:** Don't forget to remove the protective film on the touchscreen of the replacement control panel.

Figure 1-135 Recycle and unpack



Step 4: Install the control panel (M577)

1. Tilt the replacement control panel away from the base plate.

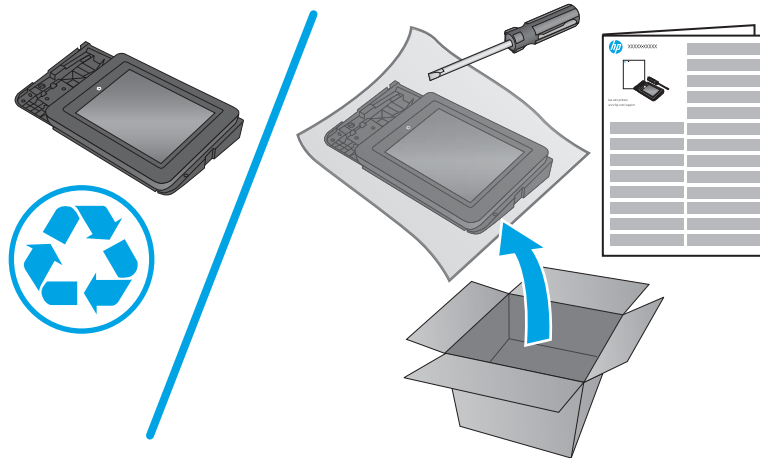
Figure 1-136 Open the control panel



2. **M577c/z only:** Make sure to feed the keyboard flat cable (callout 1) through the opening (callout 2) in the control-panel base when installing the control panel.

Figure 1-137 Feed the keyboard flat cable through opening

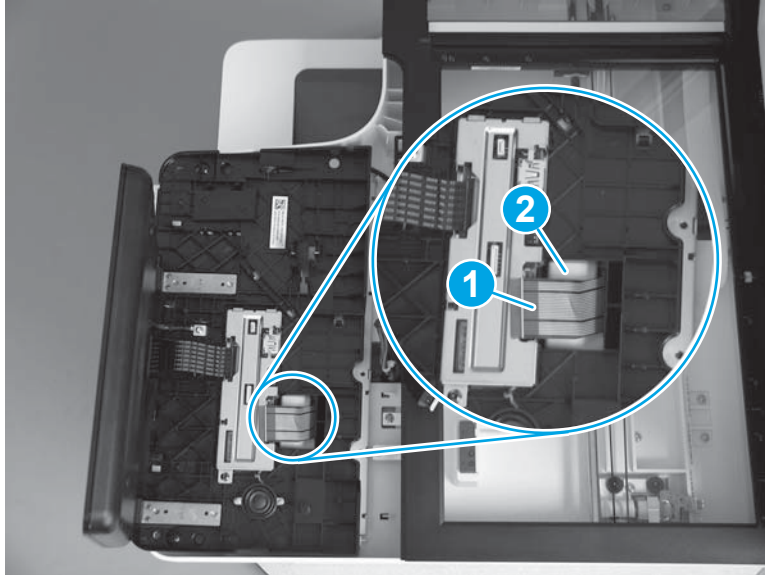

3. Locate the four hooks on the printer and matching slots in the control-panel base (callout 1). The hooks fit into the slots (callout 2) when the assembly is installed.

 **NOTE:** Make sure that the grounding clip (callout 3) is on top of the assembly base when it is installed.

Figure 1-138 Locate hooks and grounding clip

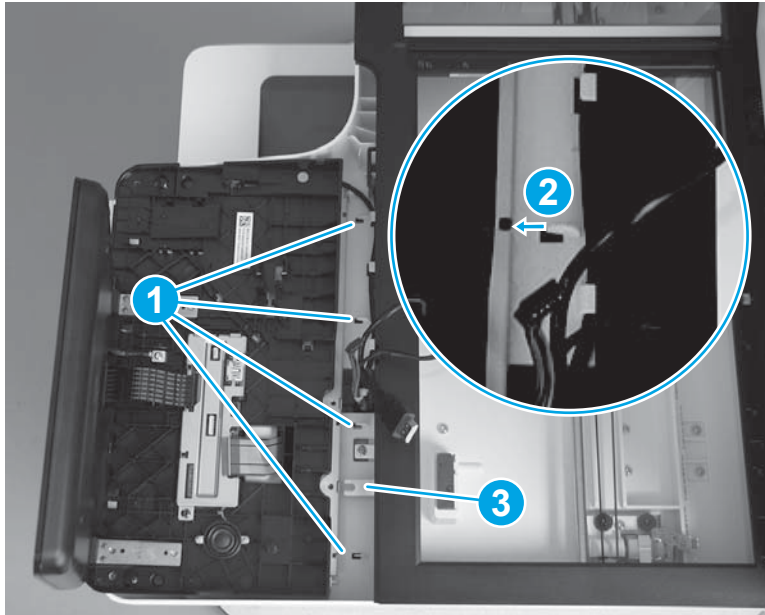

4. Position the rear edge of the control panel in the printer (callout 1), and then lower the front edge down (callout 2) to install it.

 **NOTE:** If the control panel is difficult to install, make sure that the hooks, slots, and grounding clip are correctly engaged. See [Figure 1-138 Locate hooks and grounding clip on page 97](#).

Figure 1-139 Install the control-panel



5. Install three screws (callout 1), making sure that the grounding clip is correctly installed (callout 2).

 **TIP:** The screwdriver (supplied with the kit) has a reversible shaft. Simply pull the shaft out of the handle, and then reinstall it with the desired end facing out.

Figure 1-140 Install three screws



6. Connect one HDMI cable (callout 1), and one connector (callout 2).

Figure 1-141 Connect connectors

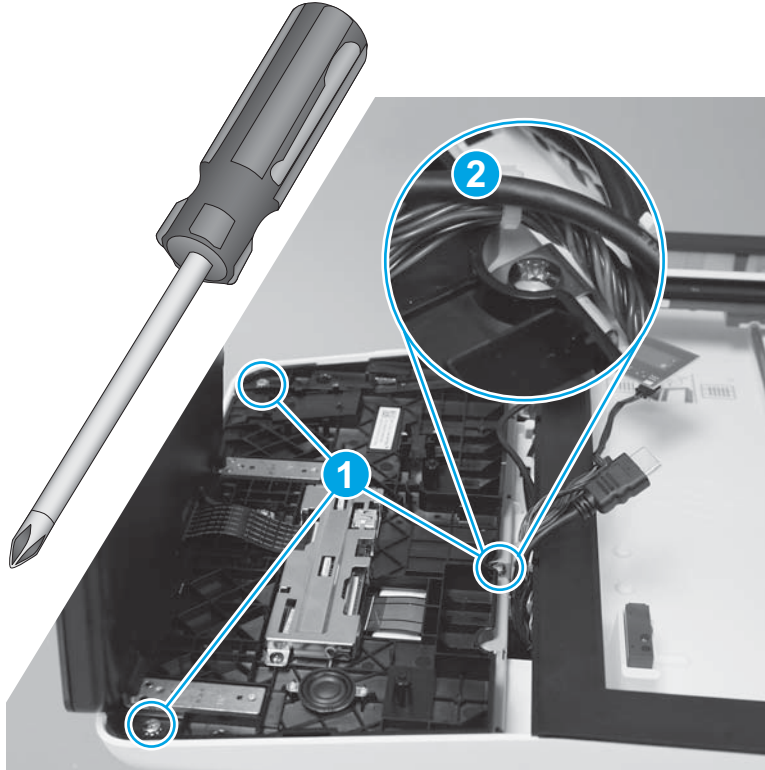

7. Install the USB cable (callout 1) in the holder.

M577z only: Install the near-field communication (NFC) printed circuit board under the four tabs (callout 2).

Figure 1-142 Install USB and NFC

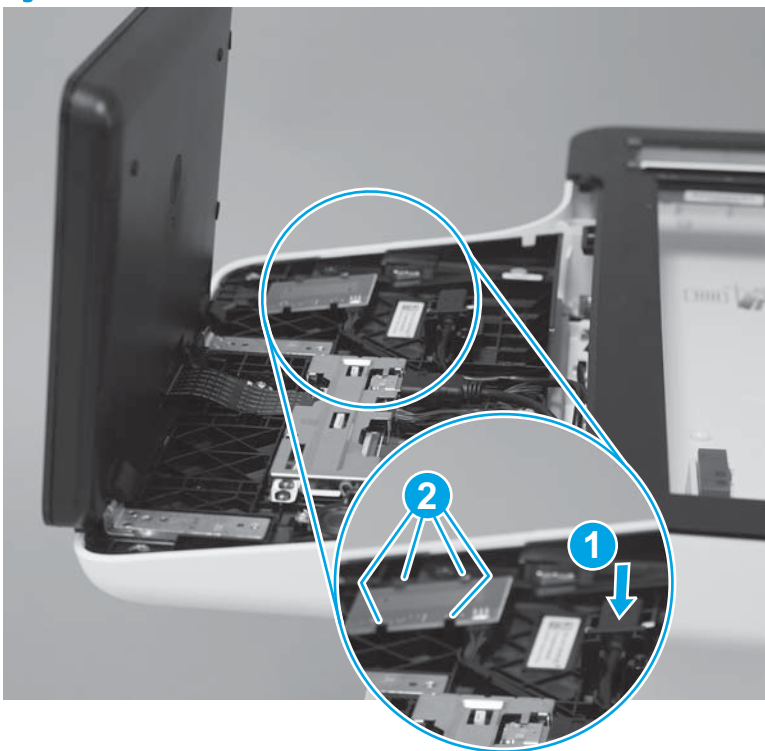

8. **M577c/z only:** Position the keyboard flat cable in the connector, and then close the latch (callout 1).

 **IMPORTANT:** Slightly tug on the cable to make sure that it is fully captured in the connector.

Figure 1-143 Connect the keyboard flat cable (M577c/z)



Step 5: Install the control-panel cover (M577)

1. Position the control-panel cover on the printer.

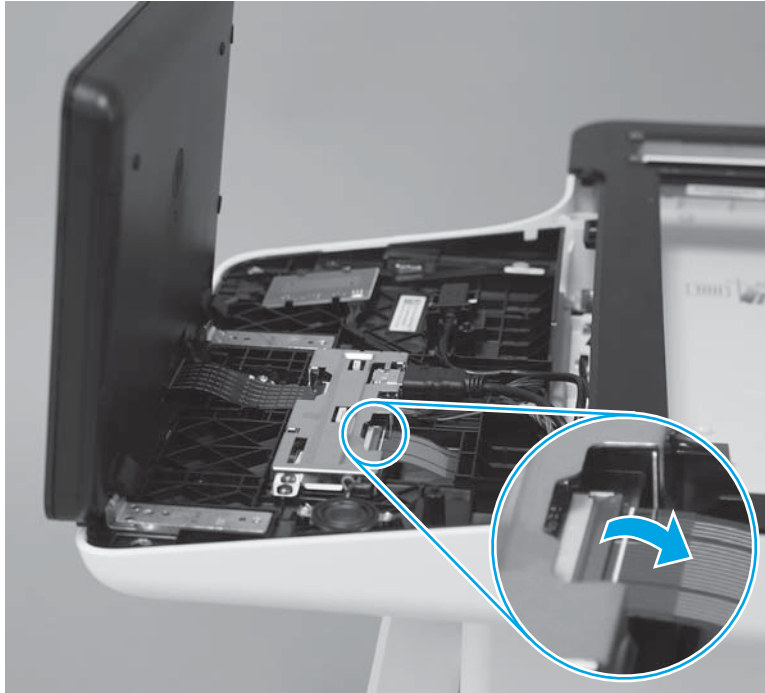
Figure 1-144 Position the control-panel cover on the printer



2. Beginning at the left side of the control-panel cover, carefully push down along the top edge of the cover to engage five tabs.

Figure 1-145 Engage five tabs

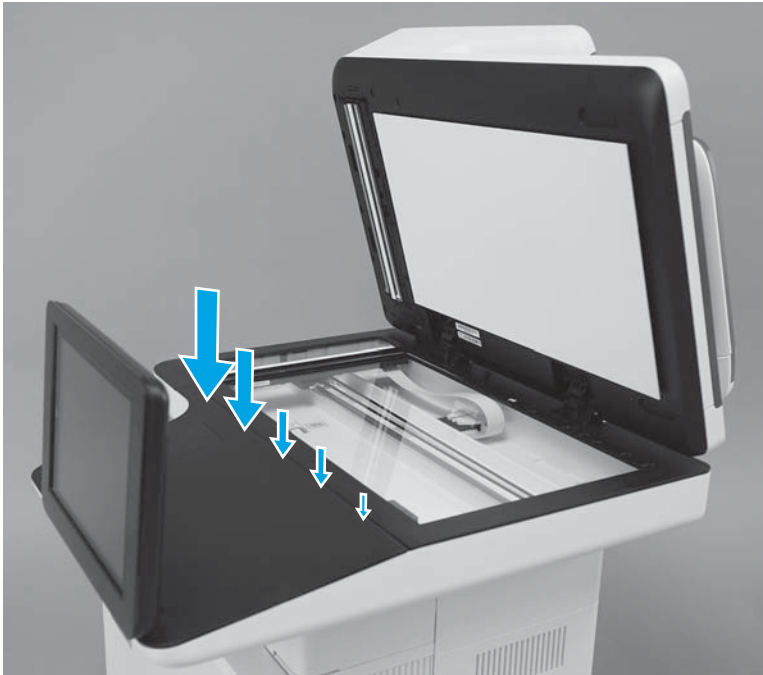

3. Close the document feeder.

 **NOTE:** Adjust the control panel to the desired angle.

Figure 1-146 Close the document feeder



Removal and replacement: Keyboard (M577c/z)

- [Introduction](#)
- [Step 1: Remove the control-panel cover \(M577\)](#)
- [Step 2: Remove the keyboard](#)
- [Step 3: Unpack the replacement assembly](#)
- [Step 4: Install the keyboard](#)
- [Step 5: Install the control-panel cover \(M577\)](#)

Introduction

This document provides the procedures to remove and replace the M577c/z keyboard.

Before performing service

Turn the printer power off

- Disconnect the power cable.

 **WARNING!** To avoid damage to the printer, turn the printer off, wait 30 seconds, and then remove the power cord before attempting to service the printer.

Use the table below to identify the correct part number for your printer. To order the part, go to www.hp.com/buy/parts.

Keyboard (M577z) part number	
B5L47-67019	US English Keyboard Kit
B5L47-67020	UK English Keyboard Kit

Required tools

- No special tools are required to replace this part.

After performing service

Turn the printer power on

- Connect the power cable.
- Use the power switch to turn the power on.

Post service test

Print a configuration page to make sure that the printer is functioning correctly.

Step 1: Remove the control-panel cover (M577)

1. Open the document feeder (callout 1).

 **NOTE:** If the control panel is not fully tilted forward, tilt it forward now until it stops (callout 2).

Figure 1-147 Open the document feeder



2. Beginning at the right side of the control-panel cover, carefully release five tabs along the top edge of the cover.

 **NOTE:** The thin, black plastic cover will separate from the white plastic control-panel base.

Figure 1-148 Release five tabs



3. Continue to lift the top edge of the cover away from the printer, and then remove the cover.

Figure 1-149 Remove the cover



Step 2: Remove the keyboard

1. Open the latch (callout 1) to release the keyboard flat cable.

CAUTION: The latch must be opened to release the cable.

Figure 1-150 Disconnect the keyboard flat cable

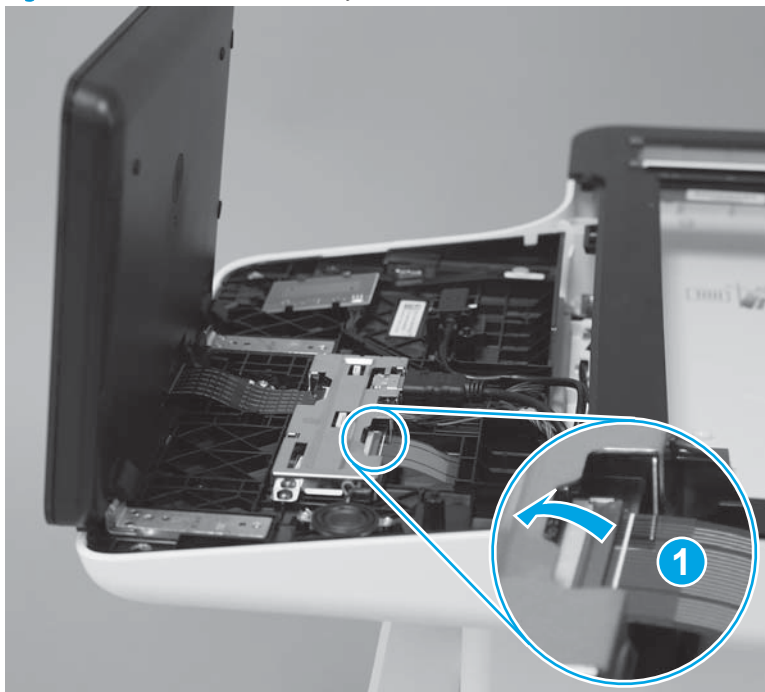

2. Slide the keyboard tray out until it stops.

Figure 1-151 Slide the keyboard out



3. Push up on the keyboard tray to release two tabs on the bottom of the tray, and then slide the tray toward the front of the printer to disengage the tabs.

Figure 1-152 Release two tabs

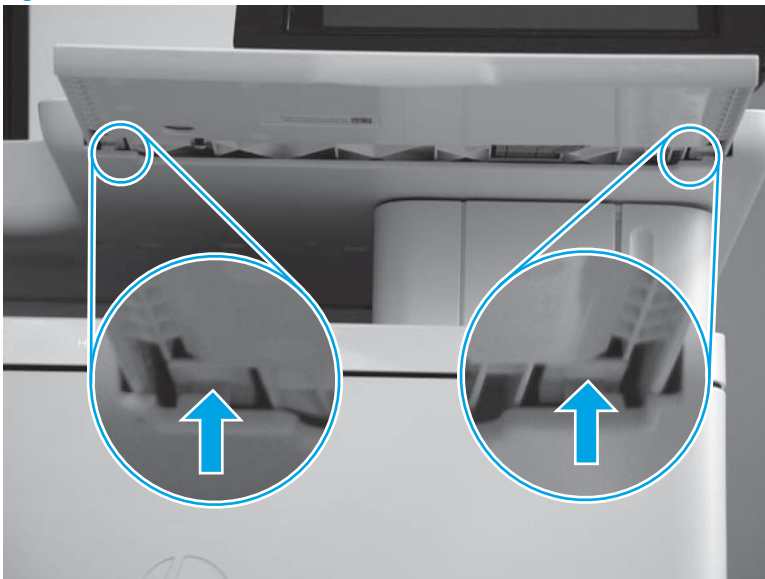

- Slide the keyboard (callout 1) all of the way out of the printer to remove it.

Figure 1-153 Remove the keyboard



Step 3: Unpack the replacement assembly

Unpack the replacement assembly from the packaging.

For complete information on HP's recycling programs, go to [Product return and recycling](#).

 **NOTE:** HP recommends responsible disposal of the defective assembly.

Figure 1-154 Recycle and unpack

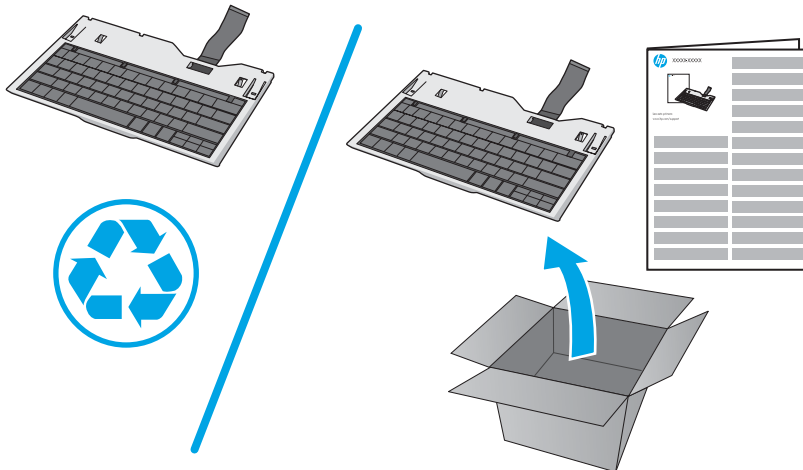

Step 4: Install the keyboard

- Position the flat cable (callout 1) on the keyboard into the keyboard slot (callout 2).

Figure 1-155 Install the flat cable through the slot



2. Slide the keyboard tray into the slot.

 **NOTE:** Only slide the tray halfway into the opening. This makes connecting the cable in the next step easier.

Figure 1-156 Slide the keyboard into the slot



3. If the flat cable (callout 1) is not in the opening (callout 2) in the control panel base, carefully reach in and thread the flat cable through the opening.

Figure 1-157 Check the flat cable

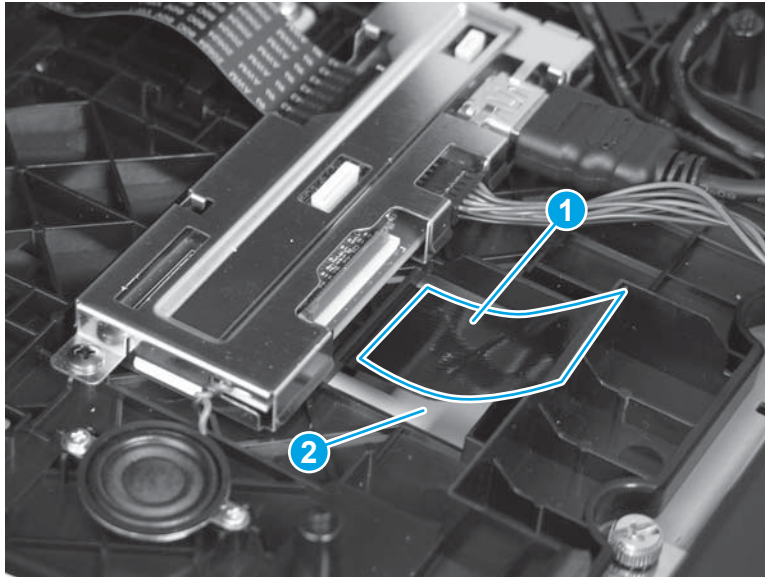

4. Position the keyboard flat cable in the connector, and then close the connector latch.

 **IMPORTANT:** Slightly tug on the cable to make sure that it is fully captured in the connector.

 **NOTE:** When the connector latch is closed and the cable is correctly installed, the white line on the cable is parallel to the connector latch.

Figure 1-158 Connect the flat cable

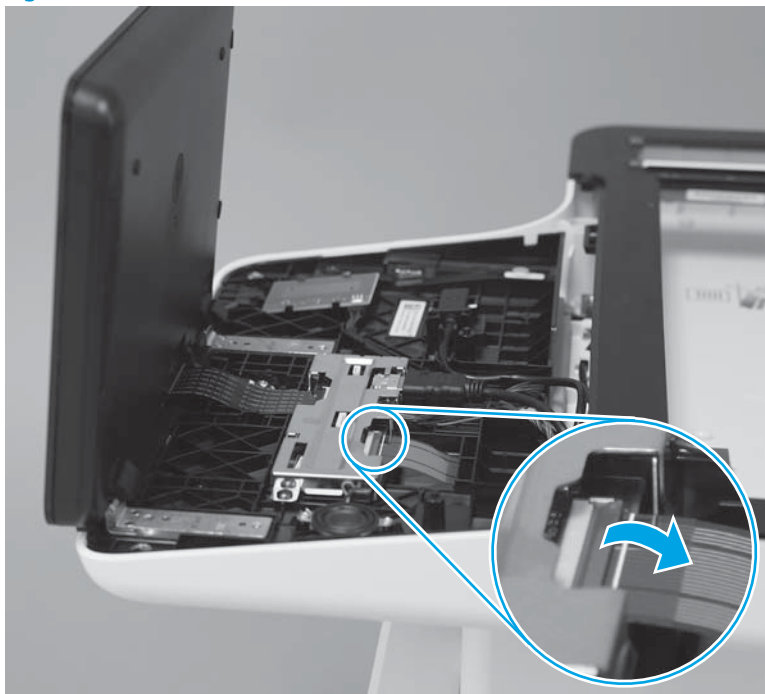

Step 5: Install the control-panel cover (M577)

1. Position the control-panel cover on the printer.

Figure 1-159 Position the control-panel cover on the printer



2. Beginning at the left side of the control-panel cover, carefully push down along the top edge of the cover to engage five tabs.

Figure 1-160 Engage five tabs

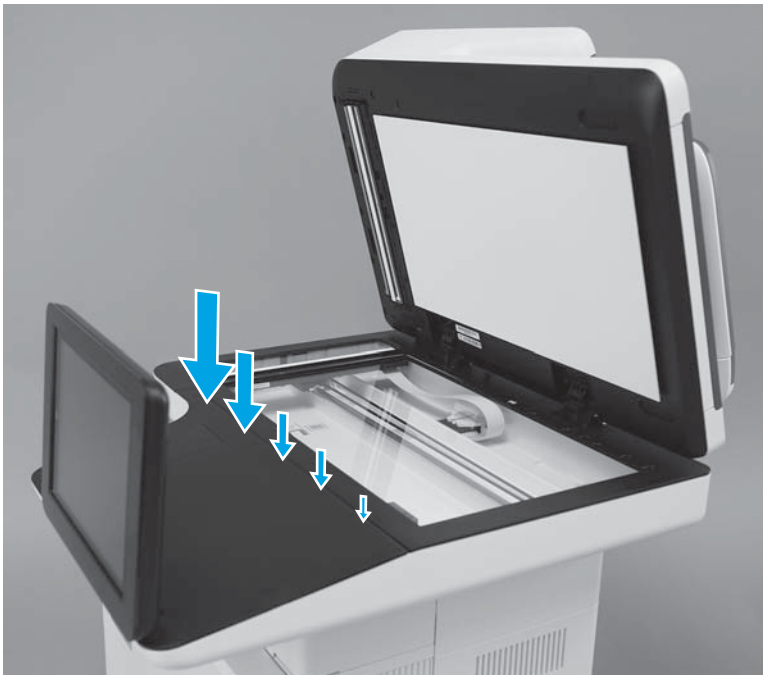

3. Close the document feeder.

 **NOTE:** Adjust the control panel to the desired angle.

Figure 1-161 Close the document feeder



Removal and replacement: White backing (M577)



NOTE: M577 printers only.

- [Introduction](#)
- [Step 1: Remove the white backing \(M577\)](#)
- [Step 2: Unpack the replacement assembly](#)
- [Step 3: Install the white backing \(M577\)](#)

Introduction

This document provides the procedures to remove and replace the M577 white backing.

Before performing service

Turn the printer power off

- Disconnect the power cable.



WARNING! To avoid damage to the printer, turn the printer off, wait 30 seconds, and then remove the power cord before attempting to service the printer.

Use the table below to identify the correct part number for your printer. To order the part, go to www.hp.com/buy/parts.

White backing (M577) part number	
5851-6570	White backing kit (M577) with instruction guide

Required tools

No special tools are required for this assembly.

After performing service

Turn the printer power on

- Connect the power cable.
- Use the power switch to turn the power on.

Step 1: Remove the white backing (M577)

1. Open the document feeder.

Figure 1-162 Open the document feeder



2. Remove the white backing.

Figure 1-163 Remove the white backing



3. One or more of the retention clips (callout 1) that fit in the openings (callout 2) in the document feeder might remain attached to the white backing when it is removed. If this happens, remove the clip from the white backing.

 **NOTE:** If none of the retention clips remain attached to the white backing, skip the remaining sub-steps in this removal procedure.

Figure 1-164 Check the retention clips



4. If a spring comes off of a retention clip, make sure that it is correctly repositioned on the clip.

 **NOTE:** If any of the retention clips or springs are damaged, replace them with the clips supplied in this kit.

Figure 1-165 Check the retention clip spring

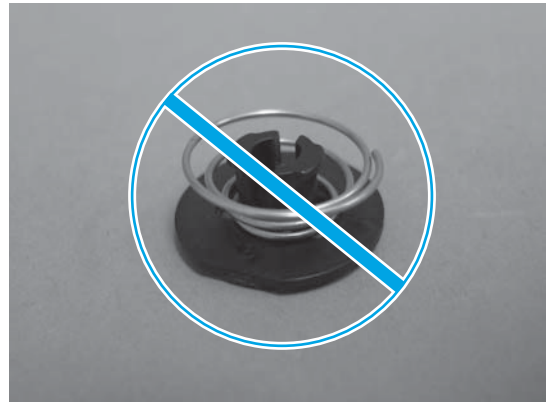

5. Install the clip (callout 1) in the opening (callout 2) in the document feeder.

Figure 1-166 Install the retention clip

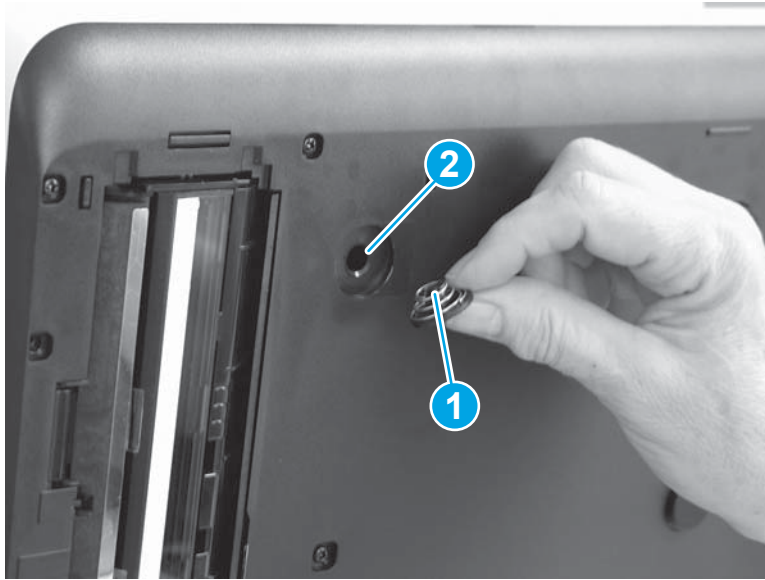

6. Press the clip to make sure it is securely installed.

Figure 1-167 Press the retention clip

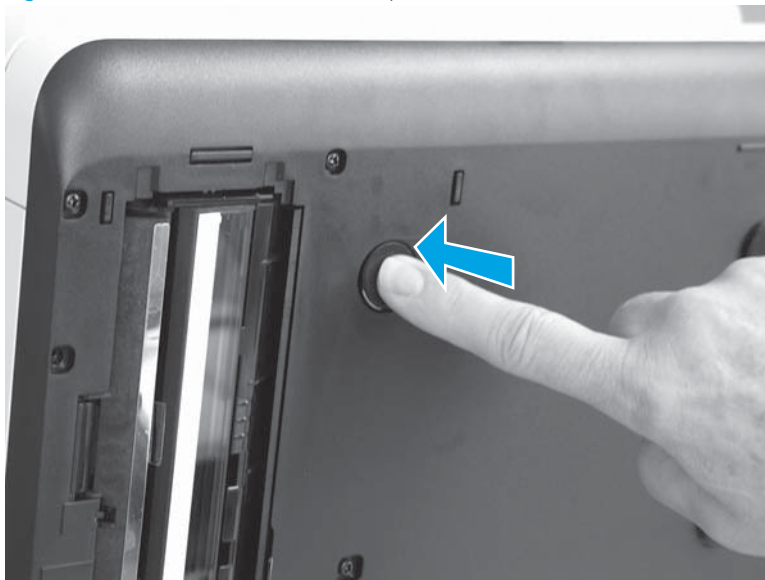

Step 2: Unpack the replacement assembly

Unpack the replacement assembly from the packaging.

For complete information on HP's recycling programs, go to [Product return and recycling](#)

 **NOTE:** HP recommends responsible disposal of the defective assembly.

Figure 1-168 Recycle and unpack

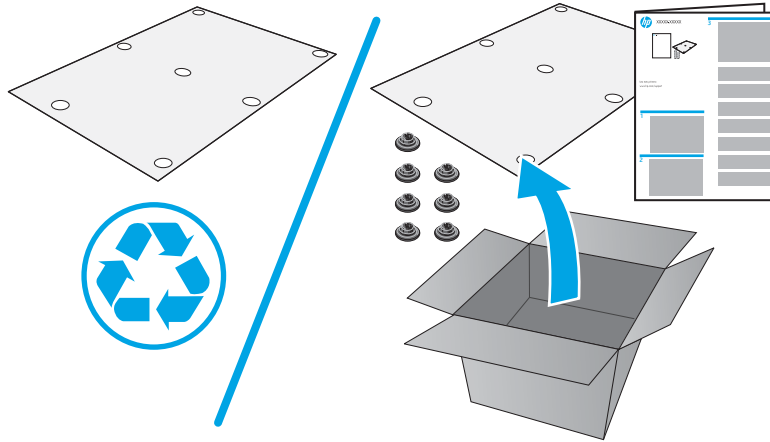

Step 3: Install the white backing (M577)

1. Open the document feeder, and then place the replacement white backing on the flatbed scanner glass, as shown.

 **NOTE:** Place the corner of the backing that does not have a hook-and-loop fastener in the upper-left corner of the scanner glass.

Figure 1-169 Install the white backing



2. Close the document feeder.

Figure 1-170 Close the document feeder

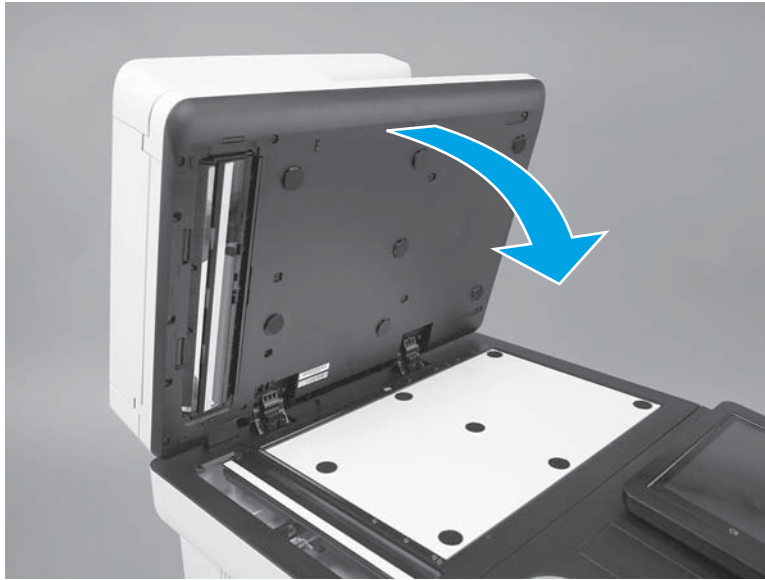

3. Open the document feeder and make sure that the white backing is securely attached.

Figure 1-171 Check the white backing



4. Close the document feeder.

Figure 1-172 Close the document feeder



Removal and replacement: Retention clips (M577)

- [Introduction](#)
- [Step 1: Remove the retention clips](#)
- [Step 2: Unpack the replacement assembly](#)
- [Step 3: Install the retention clips](#)

Introduction

This document provides the procedures to remove and replace the M577 retention clips.

Before performing service

Turn the printer power off

- Disconnect the power cable.

 **WARNING!** To avoid damage to the printer, turn the printer off, wait 30 seconds, and then remove the power cord before attempting to service the printer.

Use the table below to identify the correct part number for your printer. To order the part, go to www.hp.com/buy/parts.

Retention clips (M577) part number	
5851-6573	Retention clips kit (M577) with instruction guide

Required tools

No special tools are required for this assembly.

After performing service

Turn the printer power on

- Connect the power cable.
- Use the power switch to turn the power on.

Step 1: Remove the retention clips

1. Open the document feeder.

Figure 1-173 Open the document feeder



2. Remove the white backing.

Figure 1-174 Remove the white backing



3. If any of the retention clips (callout 1) remain attached to the white backing remove them.

 **NOTE:** If none of the retention clips remain attached to the white backing, skip to Step 4.

Figure 1-175 Check the retention clips



4. Remove any damaged retention clips from the document feeder.

 **TIP:** Use the edge of a coin to loosen the clip.

Figure 1-176 Loosen damaged clips



5. Remove the retention clip (callout 1).

Figure 1-177 Remove the retention clip

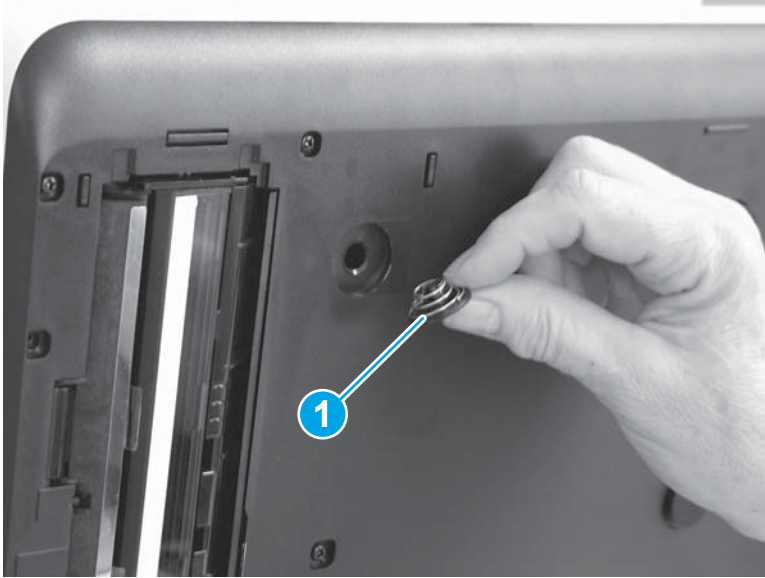

Step 2: Unpack the replacement assembly

Unpack the replacement assembly from the packaging.

For complete information on HP's recycling programs, go to [Product return and recycling](#).

 **NOTE:** HP recommends responsible disposal of the defective assembly.

Figure 1-178 Recycle and unpack

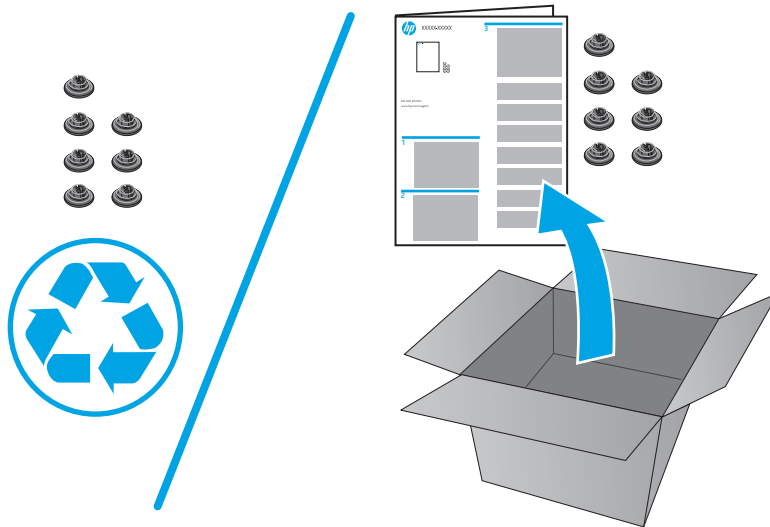

Step 3: Install the retention clips

1. If a spring comes off of a retention clip, make sure that it is correctly repositioned on the clip.

Figure 1-179 Check the retention clip spring



2. Install the clip (callout 1) in the opening (callout 2) in the document feeder. Repeat this step until all of the retention clips are installed.

Figure 1-180 Install the retention clip

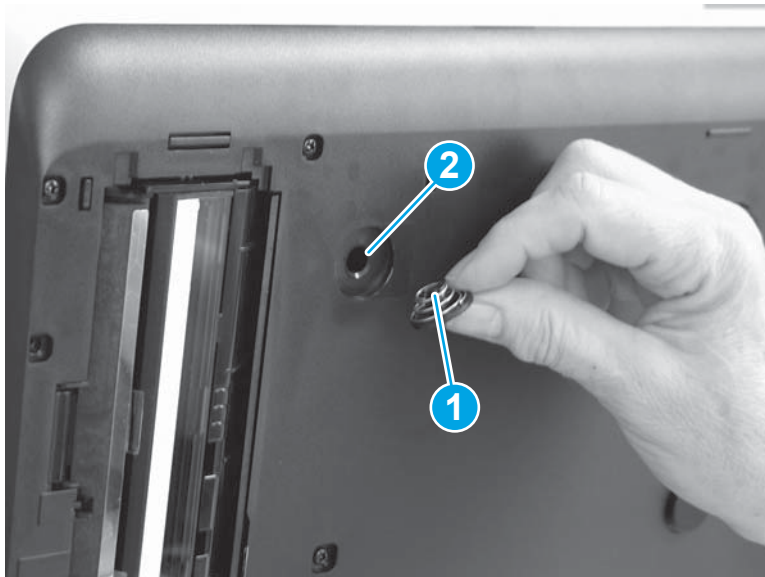

3. Press the clip to make sure it is securely installed. Repeat this step until all of the retention clips are secure.

Figure 1-181 Press the retention clip

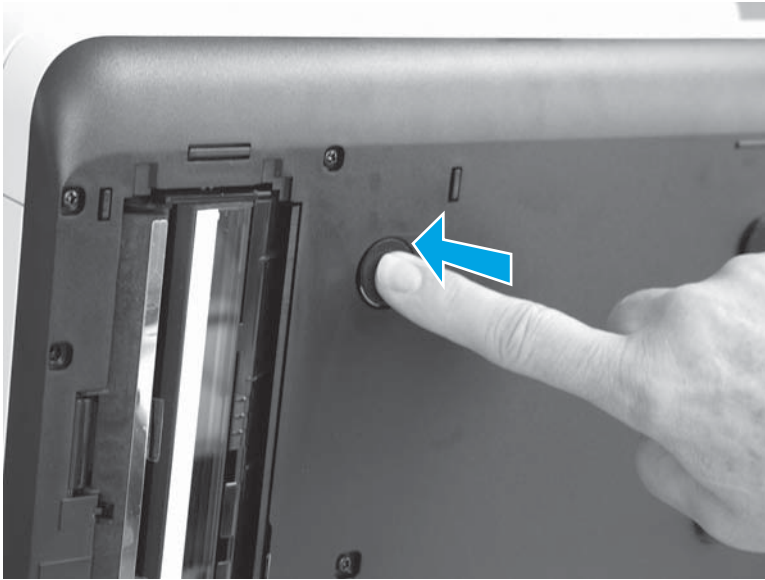

4. Place the white backing, on the flatbed scanner glass as shown.

 **NOTE:** Place the corner of the backing that does not have a hook-and-loop fastener in the upper-left corner of the scanner glass.

Figure 1-182 Install the white backing



5. Close the document feeder.

Figure 1-183 Close the document feeder

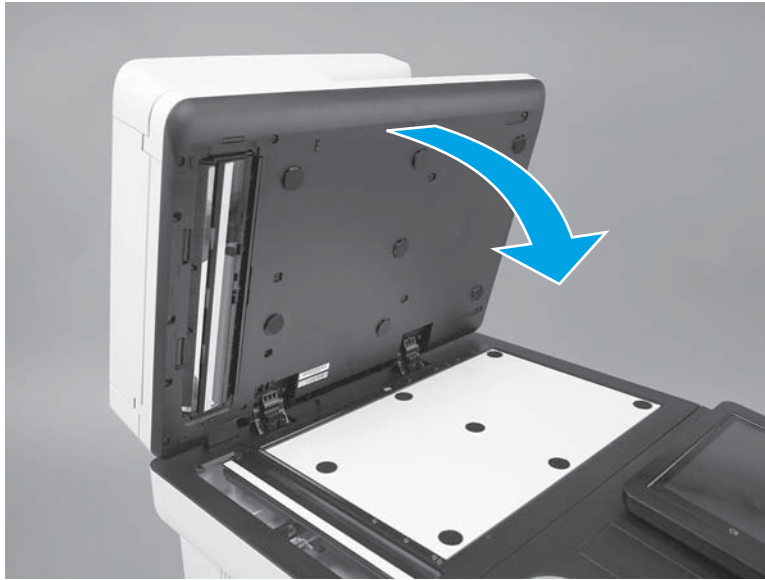

6. Open the document feeder and make sure that the white backing is securely attached.

Figure 1-184 Check the white backing



7. Close the document feeder.

Figure 1-185 Close the document feeder



Removal and replacement: Document feeder rollers (M577)

- [Introduction](#)
- [Step 1: Remove the pickup and feed roller assembly](#)
- [Step 2: Remove the separation roller](#)
- [Step 3: Unpack the replacement assemblies](#)
- [Step 4: Install the separation roller](#)
- [Step 5: Install the pickup and feed roller assembly](#)
- [Step 6: Reset the document feeder kit count](#)

Introduction

This document provides the procedures to remove and replace the document feeder rollers (M577).

Before performing service

Turn the printer power off

- Disconnect the power cable.

 **WARNING!** To avoid damage to the printer, turn the printer off, wait 30 seconds, and then remove the power cord before attempting to service the printer.

Use the table below to identify the correct part number for your printer. To order the part, go to www.hp.com/buy/parts.

Document feeder rollers (M527) part number	
B5L52-67903	ADF maintenance kit (M577) with instruction guide

Required tools

- No special tools are required to remove this part.

After performing service

Turn the printer power on

- Connect the power cable.
- Use the power switch to turn the power on.

Post service test

Copy a page from the document feeder to make sure that the printer is functioning correctly.

Step 1: Remove the pickup and feed roller assembly

1. Open the document-feeder jam access door.

Figure 1-186 Open the document-feeder jam access door



2. Release the blue locking arm.

Figure 1-187 Release the blue locking arm

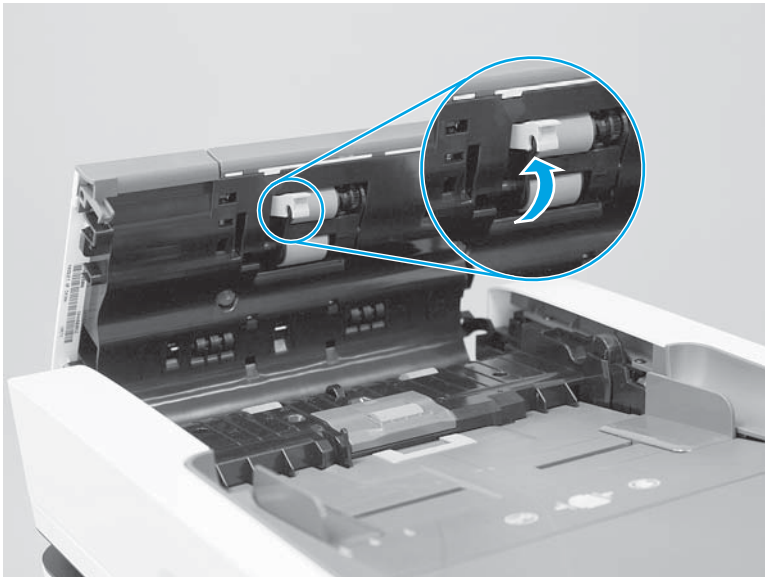

3. Slide the pickup and feed roller assembly to the left (callout 1), and then pull it away from the document feeder (callout 2) to remove it.

Figure 1-188 Remove the roller assembly

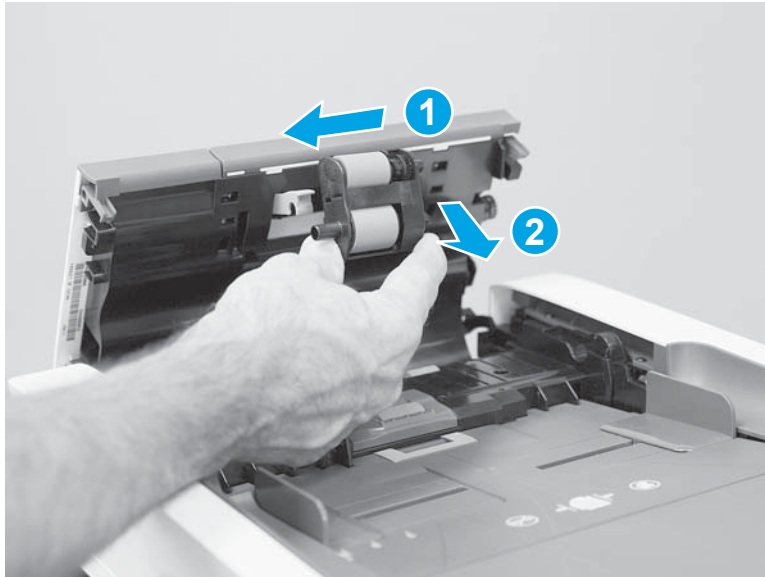

Step 2: Remove the separation roller

1. Rotate the top edge of the separation roller cover away from the printer to release it.

Figure 1-189 Release the separation roller cover



2. Remove the cover.

Figure 1-190 Remove the cover



3. Slide the separation roller to the left, and then lift it up and away from the document feeder to remove it.

Figure 1-191 Remove the roller



Step 3: Unpack the replacement assemblies

Unpack the replacement assemblies from the packaging.

For complete information on HP's recycling programs, go to [Product return and recycling](#).

CAUTION: Avoid touching the rollers. Skin oils deposited on the rollers might cause print quality problems. HP recommends washing your hands before handling the rollers.

NOTE: HP recommends responsible disposal of the defective assemblies.

Figure 1-192 Recycle and unpack

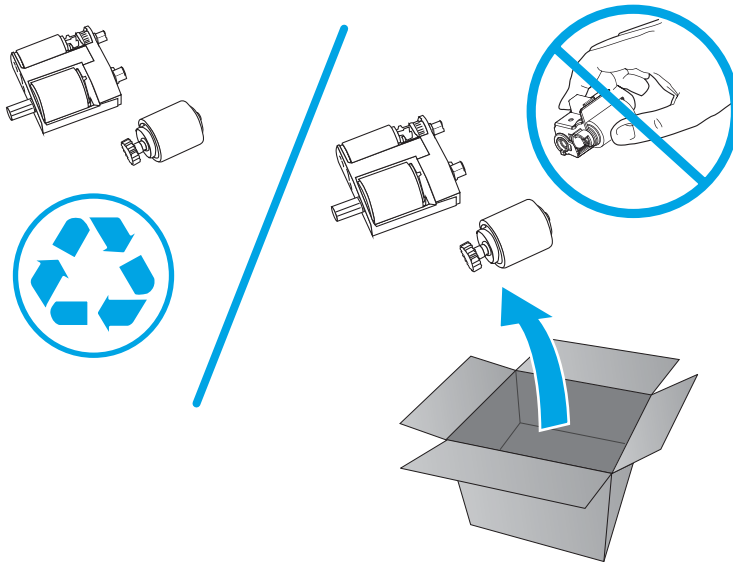

Step 4: Install the separation roller

1. Lower the separation roller into the document feeder, and then slide it to the right to install it.

Figure 1-193 Install the roller



2. Position the bottom edge of the separation roller cover on the printer.

Figure 1-194 Position the separation roller cover



3. Rotate the cover down to close it.

Figure 1-195 Close the separation roller cover

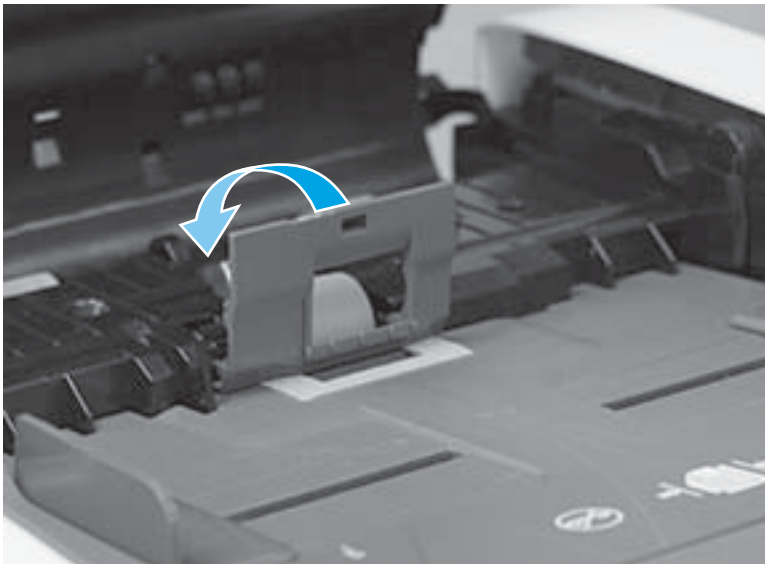

4. The roller might seem loose until the cover is snapped closed. The cover helps hold the roller in place.

Figure 1-196 Snap the cover closed



Step 5: Install the pickup and feed roller assembly

1. Position the pickup and feed roller assembly in the document feeder (callout 1), and then slide the assembly to the right (callout 2) to install it.

Figure 1-197 Install the roller assembly

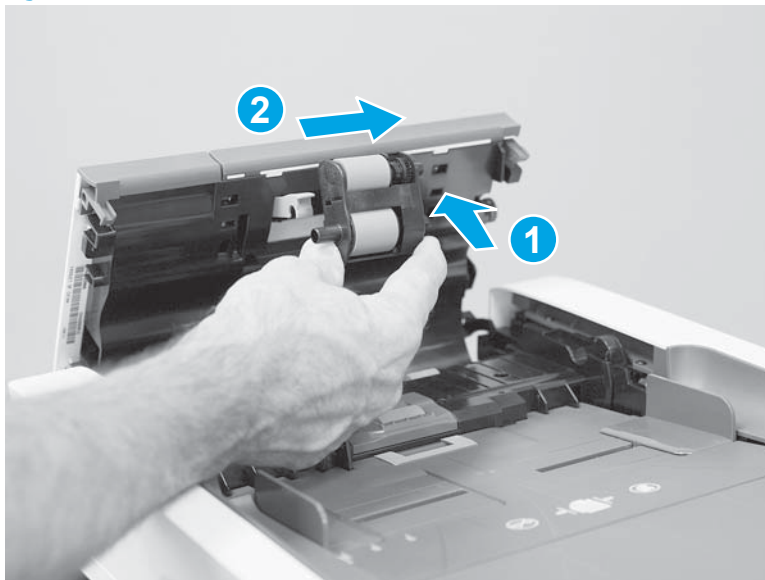

2. Close the blue locking arm.

Figure 1-198 Close the blue locking arm

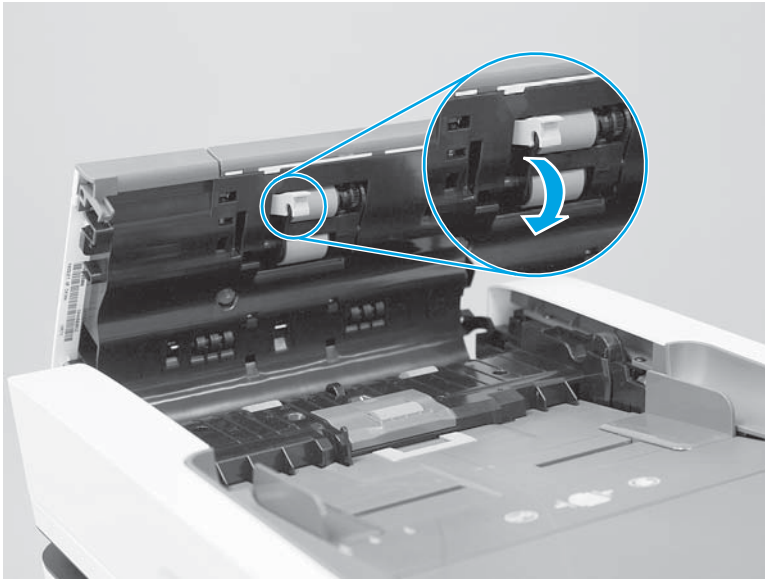

3. Close the document-feeder jam access door.

Figure 1-199 Close the document-feeder jam access door



Step 6: Reset the document feeder kit count

1. From the Home screen on the control panel, scroll to and touch the [Administration](#) button.
2. Open the following menus:

- [Manage Supplies](#)
 - [Reset Supplies](#)
 - [New Document Feeder Kit](#)
3. Select the [Reset](#) item to reset the firmware counter.

Customer self-repair (CSR) B parts and assemblies

- [Removal and replacement: Tray 2-X paper pickup roller and separation roller assemblies](#)
- [Removal and replacement: Intermediate transfer belt \(ITB\)](#)
- [Removal and replacement: Intermediate transfer belt \(ITB\) and secondary transfer roller](#)

The CSR level indicates the expected difficulty the customer will experience when removing and replacing an assembly. The CSR B assemblies in this section might be difficult for the customer to remove and replace.

Removal and replacement: Tray 2-X paper pickup roller and separation roller assemblies

- [Introduction](#)
- [Step 1: Remove the Tray 2-X paper pickup roller assembly](#)
- [Step 2: Remove the Tray 2-X separation roller](#)
- [Step 3: Unpack the replacement assemblies](#)
- [Step 4: Install the Tray 2-X separation roller](#)
- [Step 5: Install the Tray 2-X paper pickup roller assembly](#)

Introduction

This document provides the procedures to remove and replace the Tray 2/3/4/5 pickup, feed, and separation rollers.

Before performing service



NOTE: The procedure in this section shows Tray 2 in the figures. However, this procedure is also correct for Tray 3, Tray 4, or Tray 5.

Turn the printer power off

- Disconnect the power cable.



WARNING! To avoid damage to the printer, turn the printer off, wait 30 seconds, and then remove the power cord before attempting to service the printer.

Use the table below to identify the correct part number for your printer. To order the part, go to www.hp.com/buy/parts.

Tray 2 - X pickup, feed, and separation rollers kit part number	
B5L24-67904	Tray 2 - X pickup and feed rollers with instruction guide

Required tools

No special tools are required to install this part.

After performing service

Make sure that the tray is fully closed after replacing the rollers.

Turn the printer power on

- Connect the power cable.
- Use the power switch to turn the power on.

Post service test

Print a configuration page to make sure that the printer is functioning correctly.

Step 1: Remove the Tray 2-X paper pickup roller assembly

 **NOTE:** The procedure in this section shows Tray 2 in the figures. However, this procedure is also correct for Tray 3, Tray 4, or Tray 5.

1. Pull the tray out until it stops.

Figure 1-200 Pull the tray out



2. Lift the front of the tray, and then pull it out of the printer to remove it.

Figure 1-201 Remove the tray

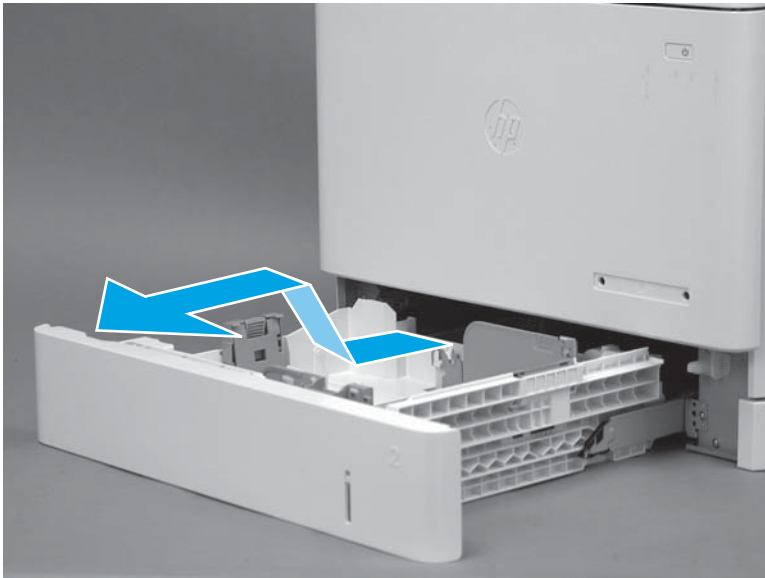

3. Open the right door.

Figure 1-202 Open the right door



4. Carefully raise the transfer roller assembly up and into the printer.

Figure 1-203 Raise the transfer roller assembly

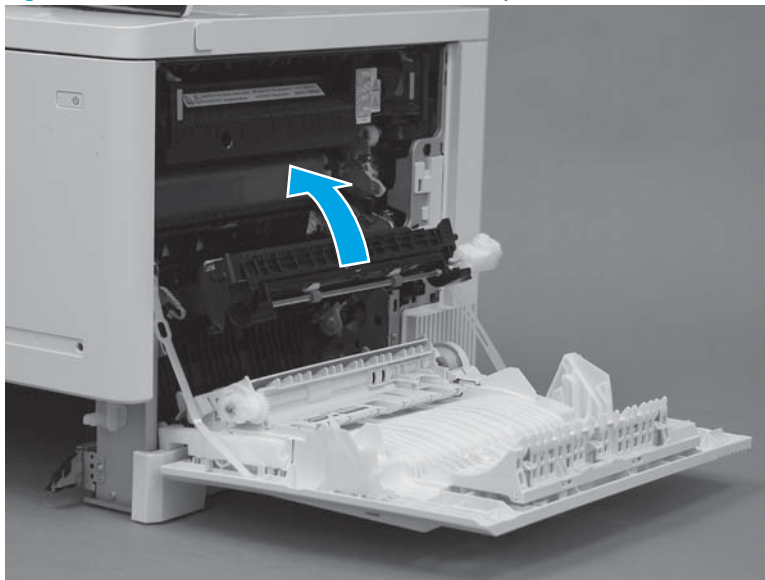

5. Release the green handle (callout 1), and then lower the paper guide (callout 2).

Figure 1-204 Lower the paper guide

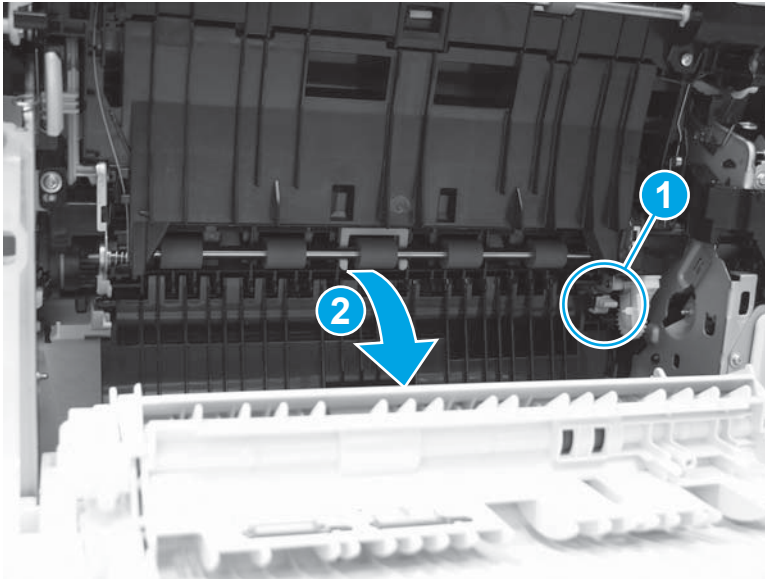

6. Locate the tray pickup roller assembly.

Figure 1-205 Locate the tray pickup roller

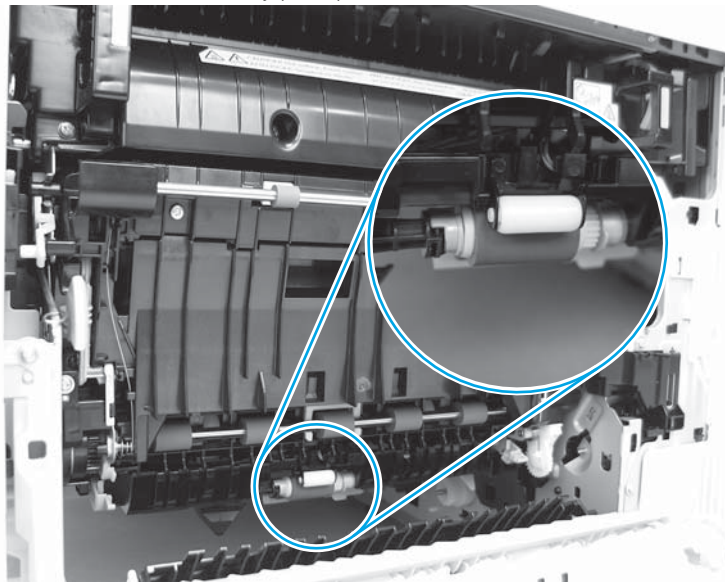

7. **Trays 3, 4, or 5 only:** Release the latch (callout 1), and then open the right door (callout 2).

Figure 1-206 Open the Tray 3, 4, or 5 right door

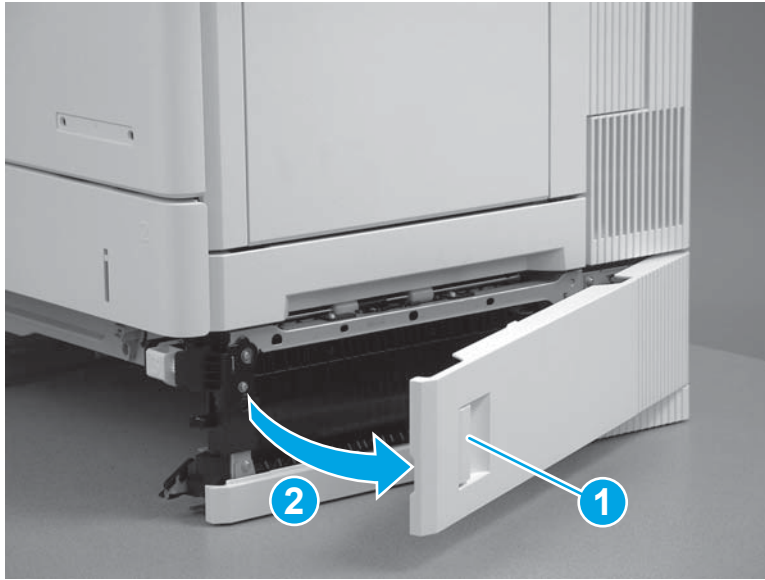

8. **Trays 3, 4, or 5 only:** Release the green handle (callout 1), and then lower the paper guide (callout 2).

Figure 1-207 Lower the Tray 3, 4, or 5 paper guide

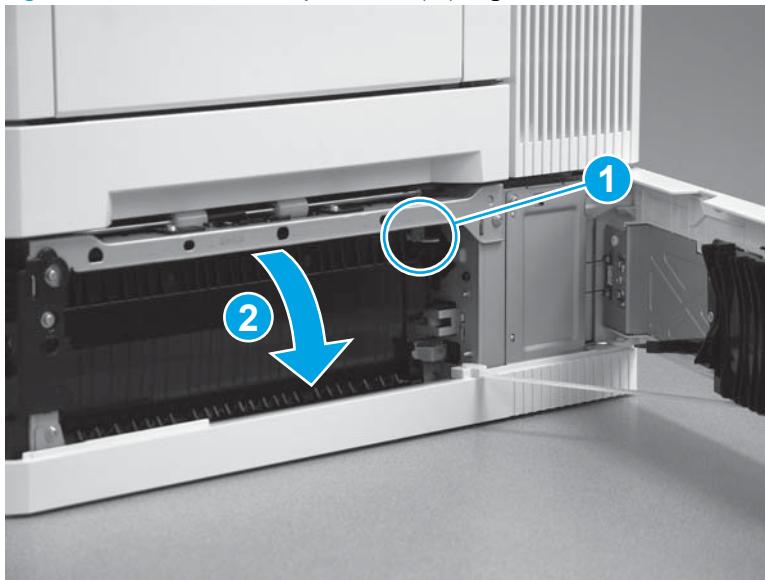

9. **Trays 3, 4, or 5 only:** Locate the tray pickup roller assembly.

Figure 1-208 Locate the Tray 3, 4, or 5 pickup roller assembly

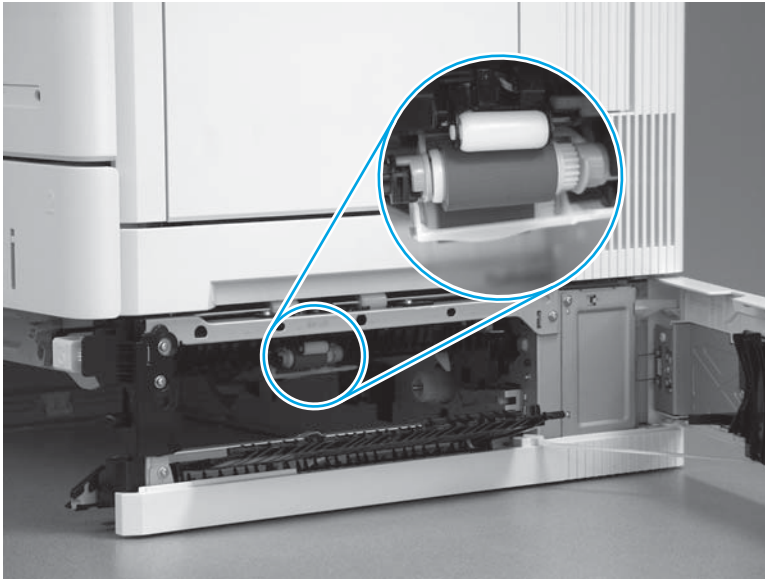

10. Slide the assembly to the left to compress the spring loaded shaft (callout 1), and then rotate the right end of the assembly down and away from the printer (callout 2).

 **TIP:** It might be easier to access the roller through the tray cavity, while viewing it through the right door opening.

Figure 1-209 Slide the assembly to the left



11. Remove the roller assembly.

Figure 1-210 Remove the roller assembly

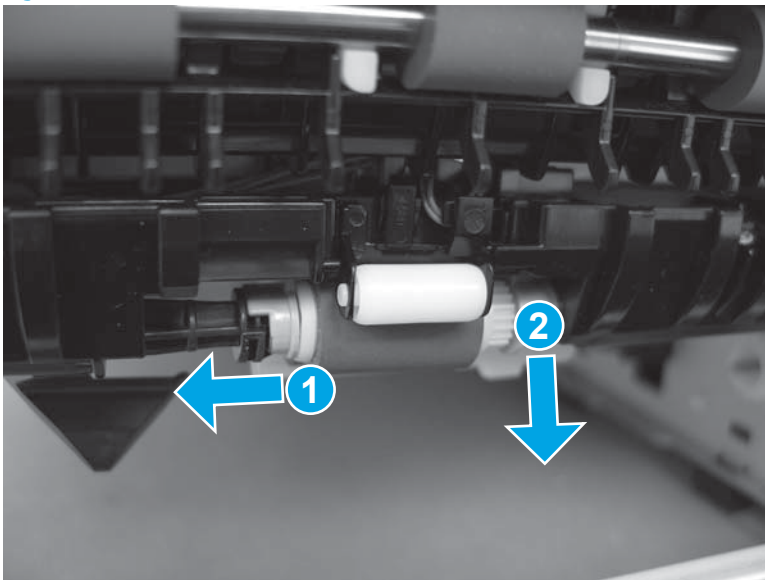
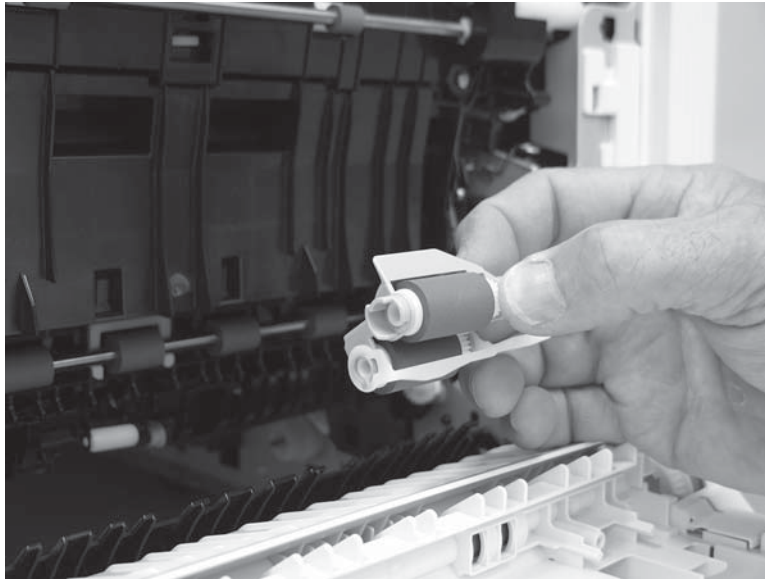

Step 2: Remove the Tray 2-X separation roller

1. Locate the tray separation roller.

Figure 1-211 Locate the roller assembly

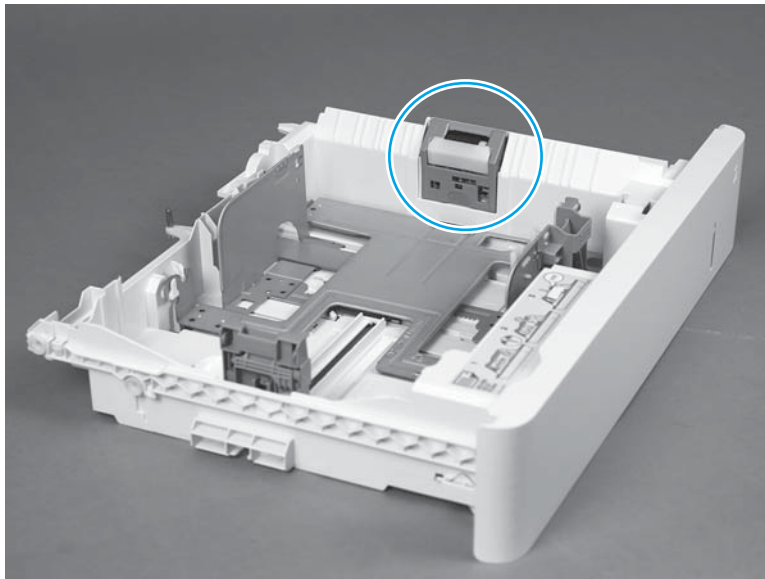

2. Push up on the blue label to release the roller assembly.

Figure 1-212 Push up on the blue label

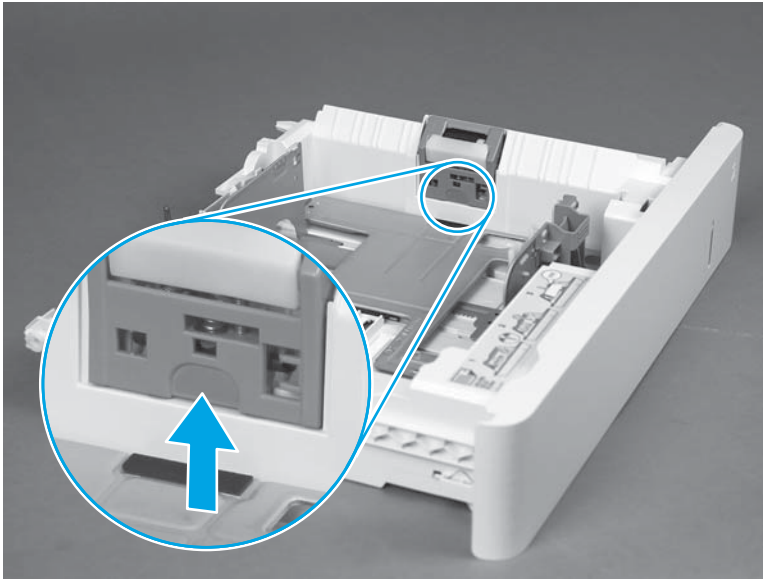

3. Slide the roller assembly straight up to remove it.

Figure 1-213 Remove the roller assembly

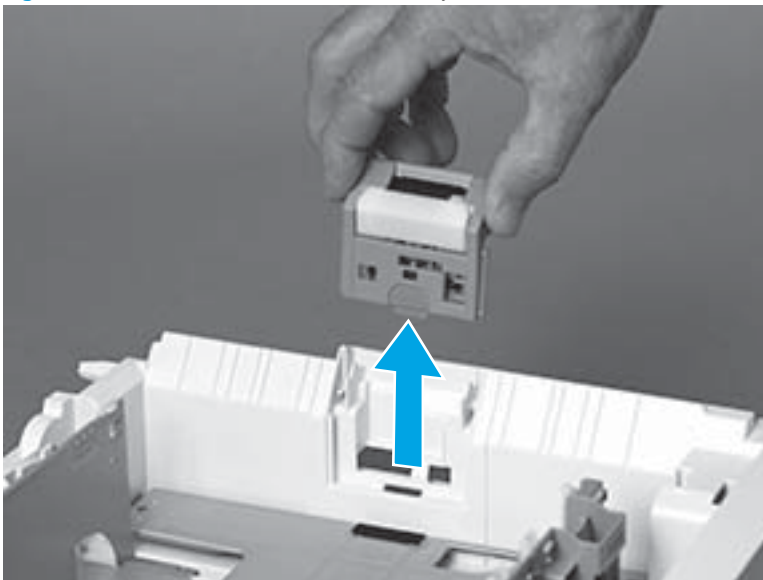

Step 3: Unpack the replacement assemblies

Unpack the replacement assemblies from the packaging.

CAUTION: Avoid touching the surface of the replacement rollers. Skin oils on the rollers can cause print-quality problems. Thoroughly wash your hands with soap and water to remove skin oils, and then completely dry them.

For complete information on HP's recycling programs, go to [Product return and recycling](#).

NOTE: HP recommends responsible disposal of the defective assemblies.

Figure 1-214 Recycle and unpack

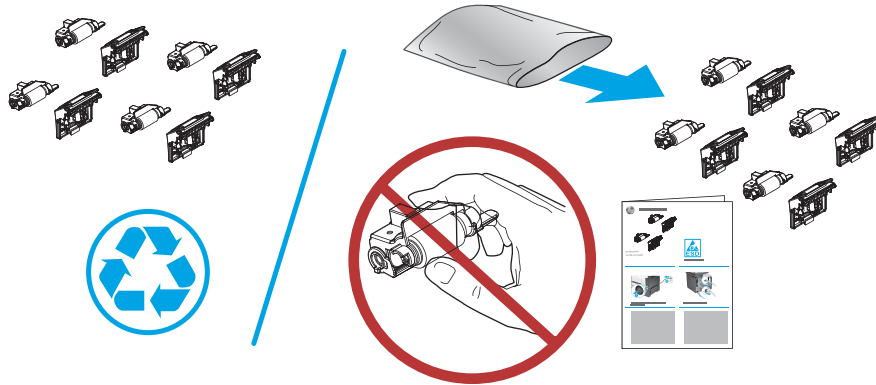

Step 4: Install the Tray 2-X separation roller

1. Slide the roller assembly straight into the tray to install it.

Figure 1-215 Install the roller assembly

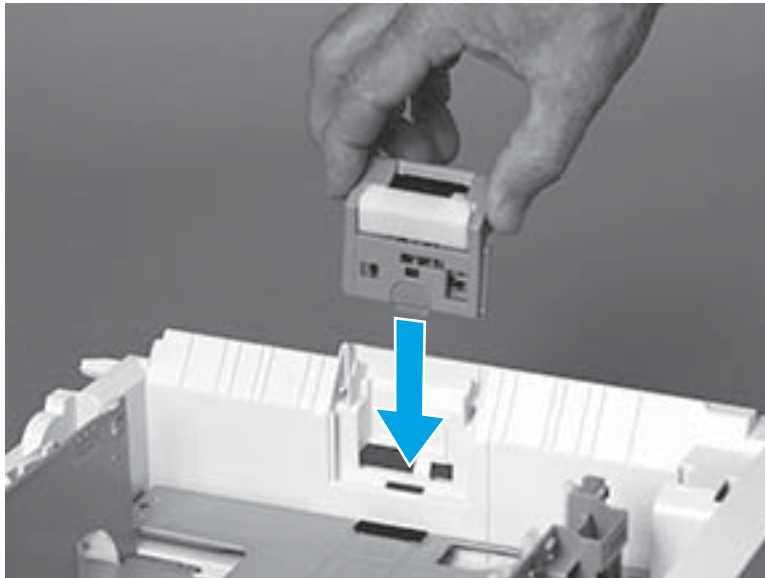

2. Make sure that the roller assembly is fully seated.

Figure 1-216 Fully seat the roller assembly

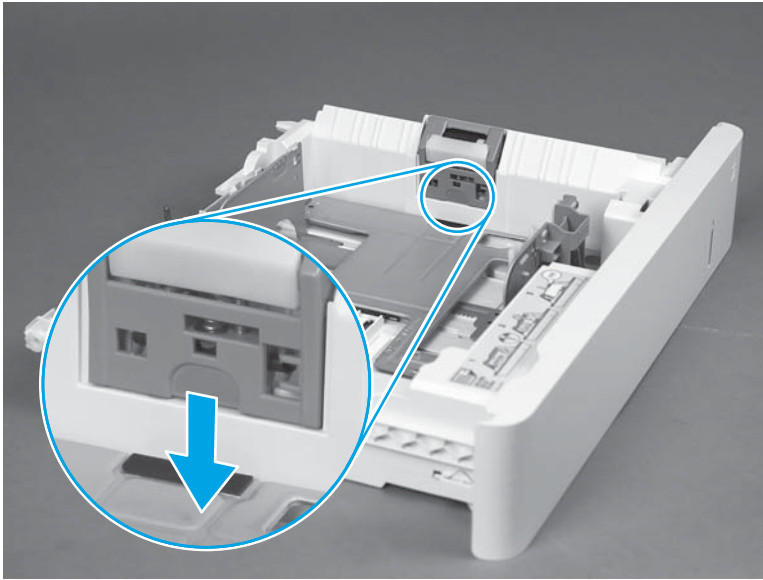

3. Verify that the roller assembly is correctly installed—it should be firmly attached to the tray.

Figure 1-217 Check the installation

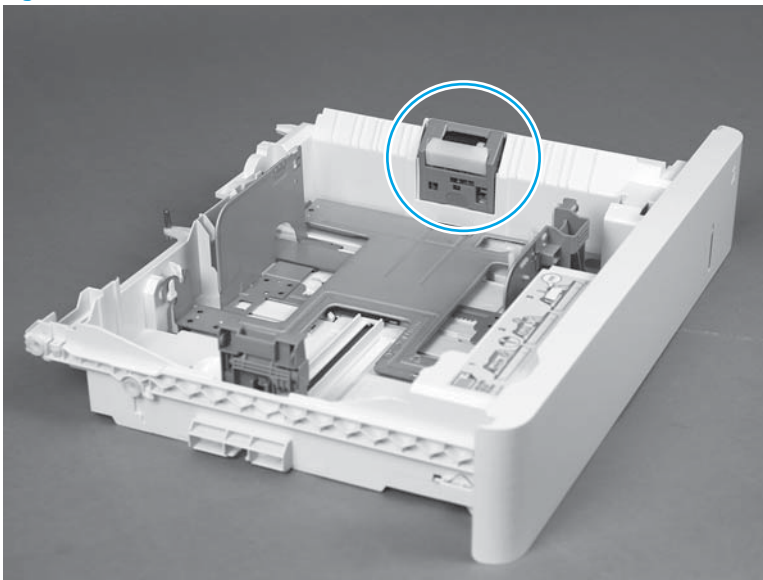

Step 5: Install the Tray 2-X paper pickup roller assembly

1. Before proceeding, take note of the mounting tab (callout 1) on the replacement roller assembly.

 **IMPORTANT:** When correctly installed, a black-plastic protrusion in the printer fits into this tab to hold the roller in the upright position.

Figure 1-218 Note the mounting tab

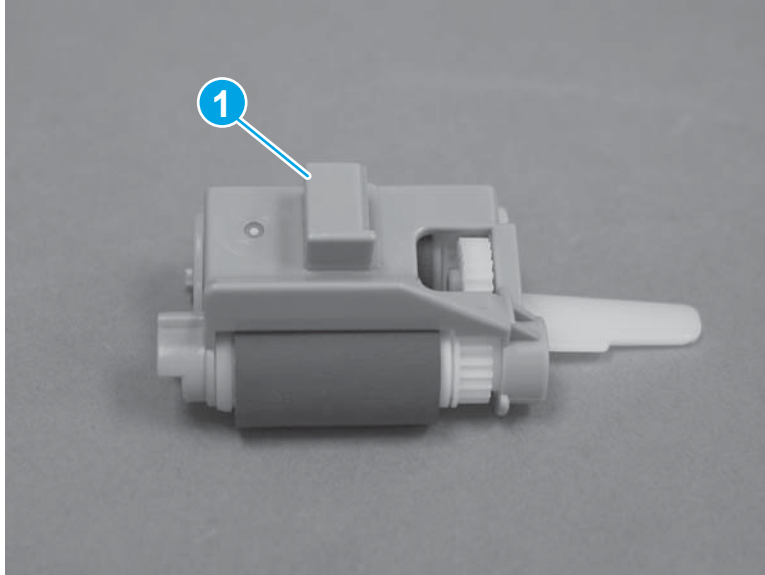

2. Position the roller assembly in the printer with the spring loaded shaft compressed (callout 1), and then rotate the right end of the assembly up and into the printer (callout 2).

 **TIP:** It might be easier to access the roller through the tray cavity, while viewing it through the right door opening.

Figure 1-219 Position the roller assembly in the printer



3. Carefully release the spring loaded shaft (callout 1) with the roller in place. The collar (callout 2) on the assembly fits over the bushing (callout 3) in the printer.

Figure 1-220 Release the spring loaded shaft

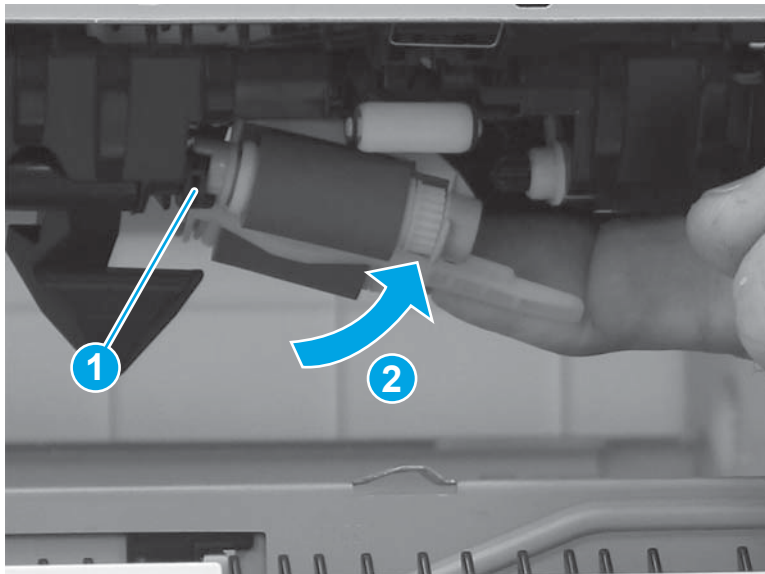
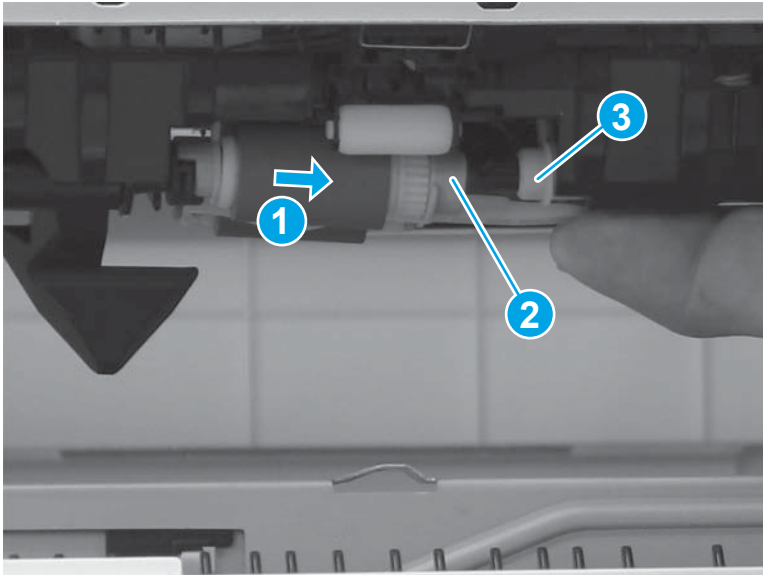

4. Make sure that the roller assembly is correctly installed. It must not hang down into the tray cavity. If the roller hangs down into the tray cavity, remove it, and then reinstall it.

CAUTION: If the roller assembly is not correctly installed, it will be damaged when the tray is installed.

Figure 1-221 Verify the roller installation

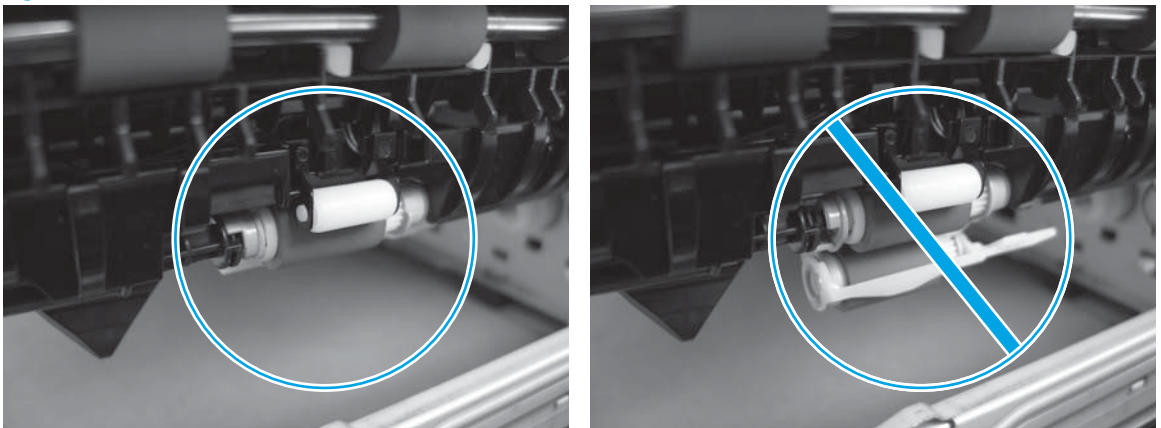

5. **Trays 3, 4, or 5 only:** Raise the paper guide.

Figure 1-222 Raise the Tray 3, 4, or 5 paper guide

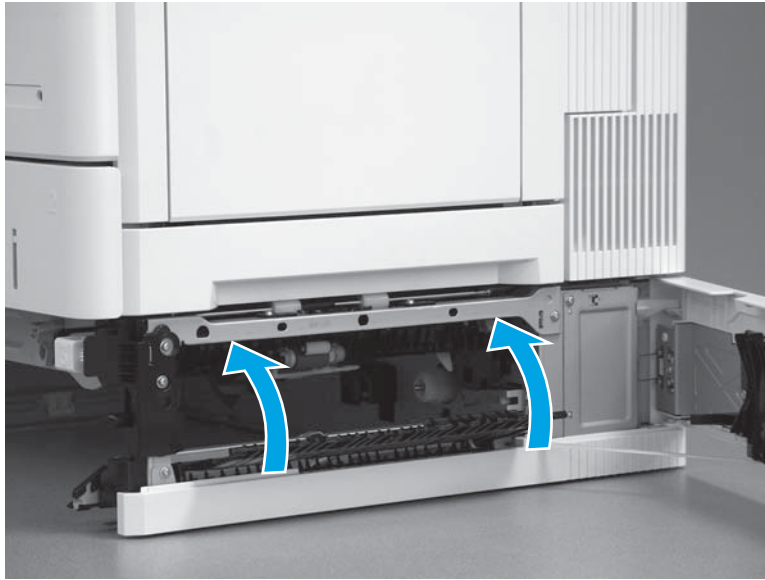

6. **Trays 3, 4, or 5 only:** Close the right door.

Figure 1-223 Close the Tray 3, 4, or 5 right door

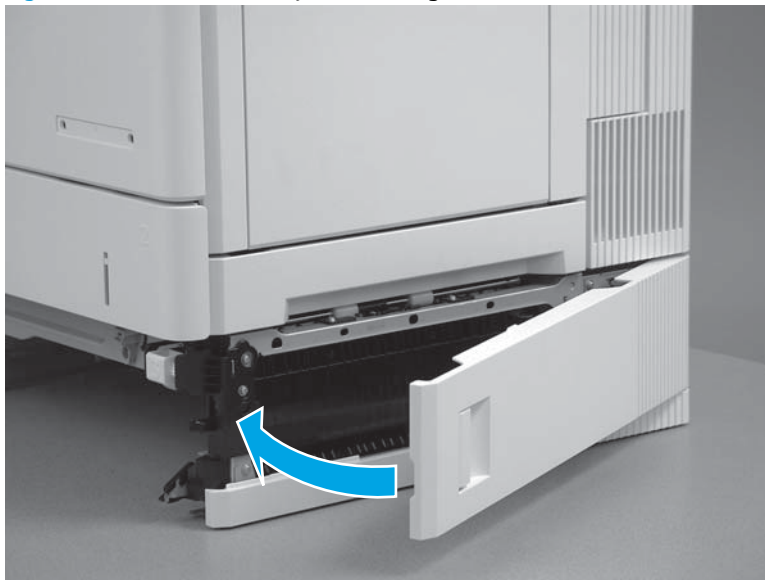

7. Close the right door.

Figure 1-224 Close the right door



8. With the front of the tray slightly lifted, align the sides of the tray with the rails in the printer, and then carefully slide the tray into the printer.

 **TIP:** As the tray slides into the printer, lower the front of it.

Figure 1-225 Install the tray



9. Close the tray.

Figure 1-226 Close the tray

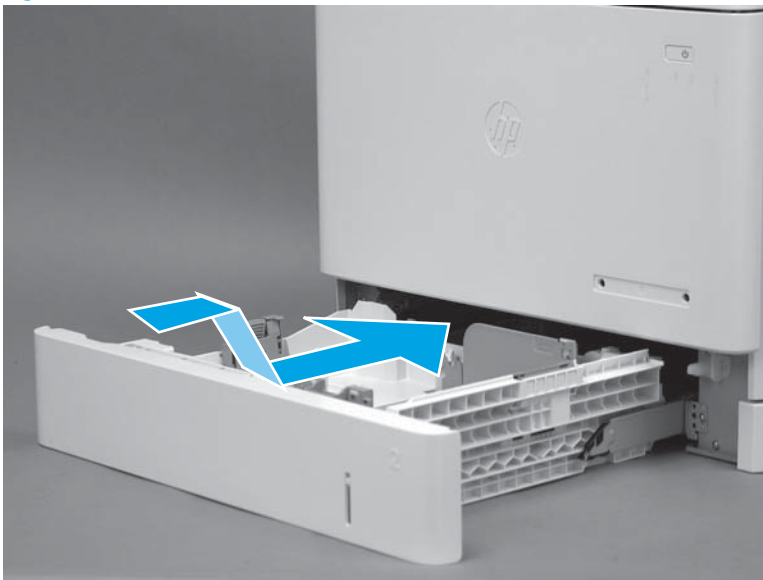

Removal and replacement: Intermediate transfer belt (ITB)

- [Introduction](#)
- [Step 1: Remove the ITB](#)
- [Step 2: Unpack the replacement assembly](#)
- [Step 3: Install the ITB](#)

Introduction

This document provides instructions about removing and replacing the intermediate transfer belt (ITB) assembly.

Before performing service

Turn the printer power off

- Disconnect the power cable.

⚠ WARNING! To avoid damage to the printer, turn the printer off, wait 30 seconds, and then remove the power cord before attempting to service the printer.

To order a replacement assembly, use the table below to identify the correct part number for your printer. To order the part, go to www.hp.com/buy/parts

Intermediate transfer belt part number	
--	--

RM2-6560-000CN

Intermediate transfer belt assembly

Required tools

No special tools are required to install this assembly.

After performing service

Make sure that the right door is fully closed after replacing the ITB.

Turn the printer power on

- Connect the power cable.
- Use the power switch to turn the power on.

Post service test

Print a configuration page to make sure that the printer is functioning correctly.

Step 1: Remove the ITB

⚠ CAUTION: Do not touch the grey-plastic belt. Skin oils and fingerprints on the belt can cause print-quality problems.

1. Open the right door.

Figure 1-227 Open the right door



2. Pull the blue lever to release the ITB drive coupling.

Figure 1-228 Release the ITB drive coupling

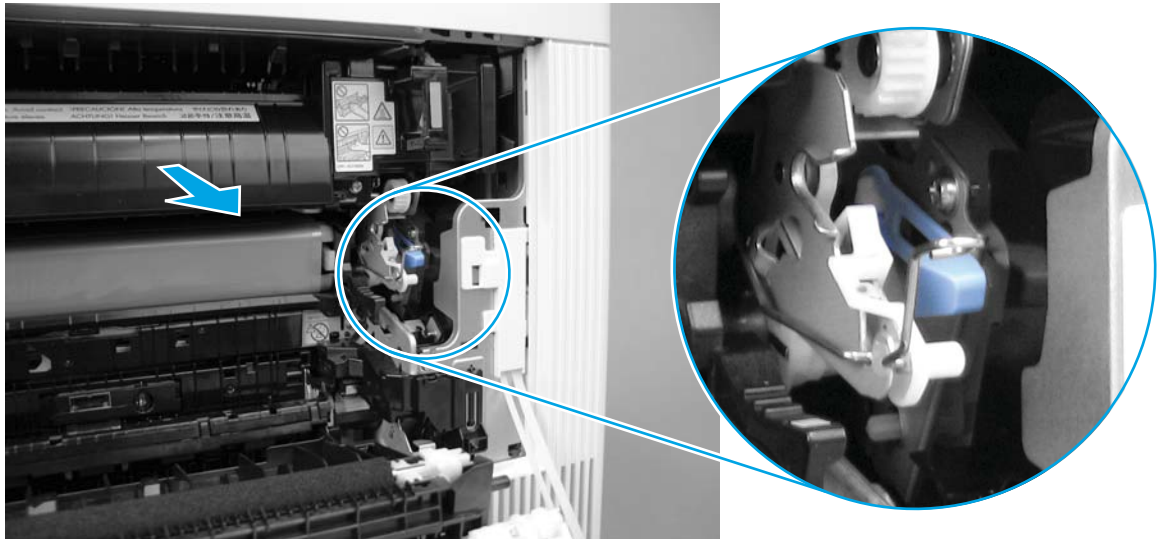

3. Push in on the blue arm to release the secondary transfer roller assembly, and then completely lower the assembly.

 **NOTE:** Press the blue arm on the secondary transfer roller assembly a second time to release the roller assembly when it stops at the halfway open position.

Figure 1-229 Lower the secondary transfer roller assembly



4. Release the left-side ITB spring (callout 1) from the tab (callout 2).

Figure 1-230 Release the front-side ITB spring

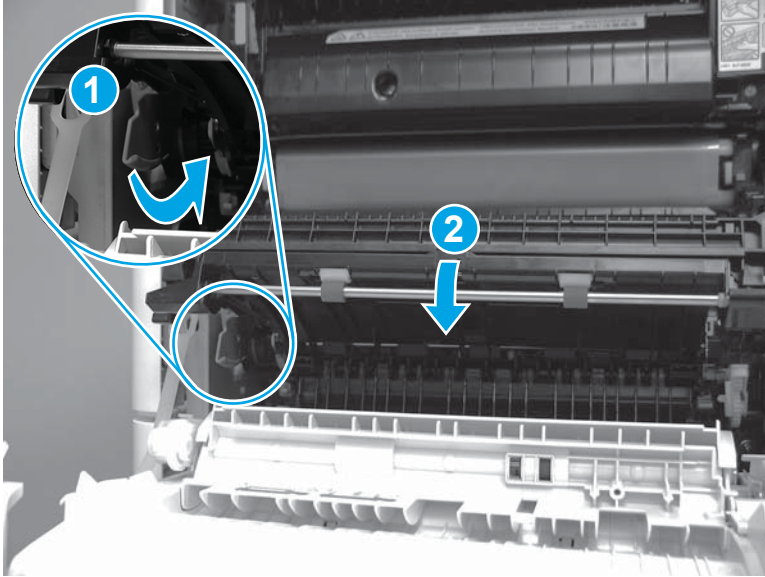
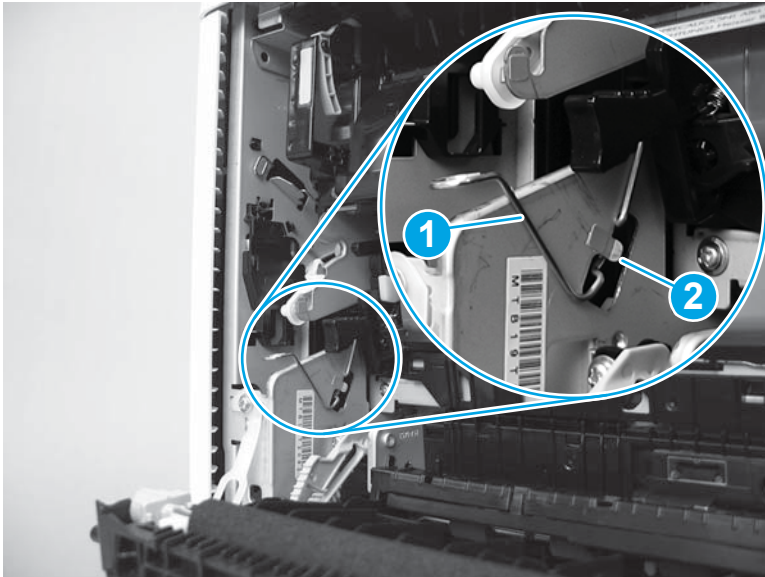

5. Place the left-side ITB spring on the holder to keep it out of the way.

 **TIP:** The holder is colored blue to help locate it.

Figure 1-231 Place the spring on the holder

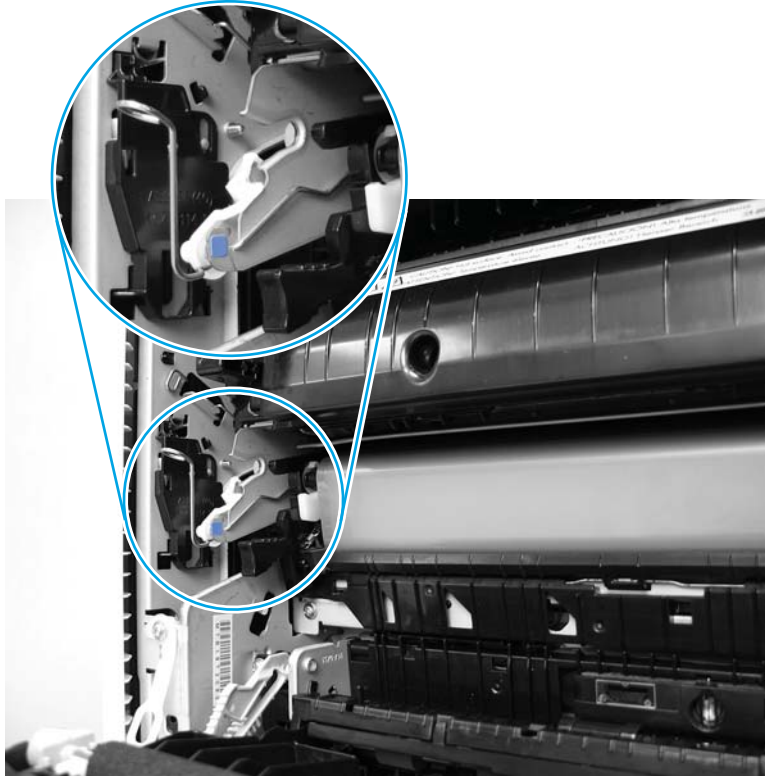

6. Release the right-side ITB spring (callout 1) from the tab (callout 2).

Figure 1-232 Release the rear-side ITB spring

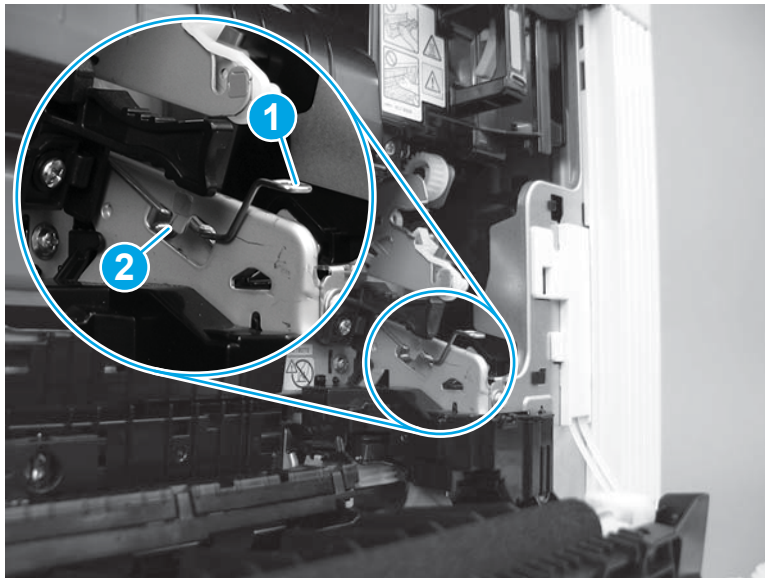

7. Place the right-side ITB spring on the holder to keep it out of the way.

 **TIP:** The holder is colored blue to help locate it.

Figure 1-233 Place the spring on the holder

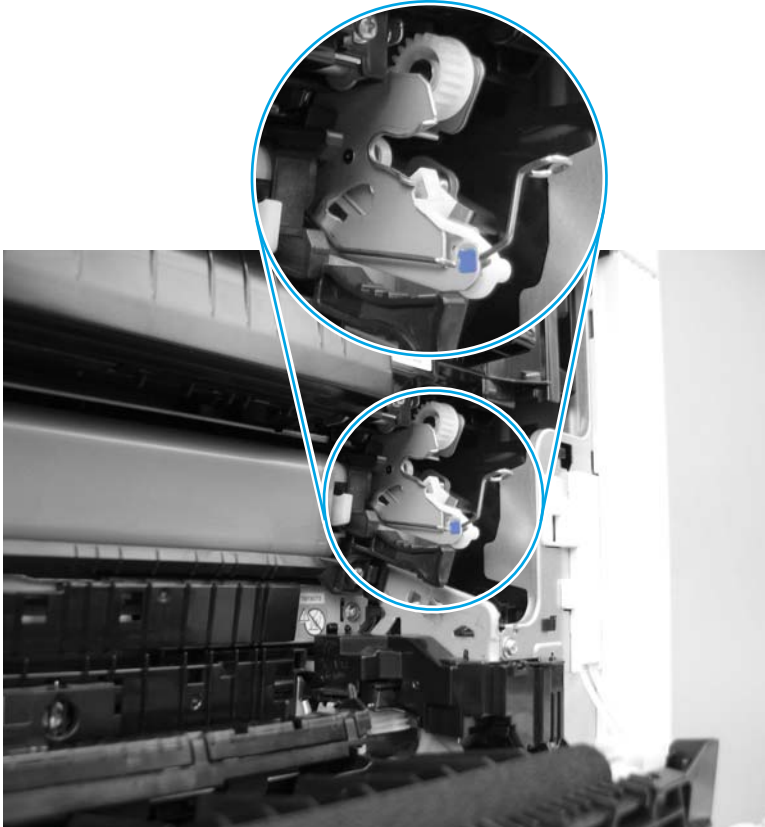

8. Grasp the two blue handles on the ITB.

⚠ CAUTION: If the ITB is removed to access other assemblies in the printer, use care. The ITB is a sensitive assembly. Be careful when handling the ITB so that it is not damaged. Always place the ITB in a safe and protected location.

Figure 1-234 Grasp the ITB handles

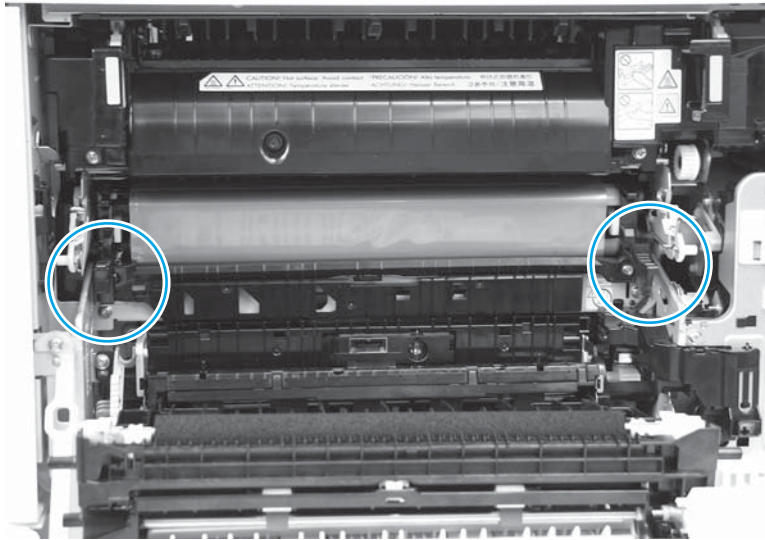

9. Pull the ITB out of the printer to remove it.

⚠ CAUTION: Do not touch the grey-plastic belt. Skin oils and fingerprints on the belt can cause print-quality problems.

Figure 1-235 Remove the ITB

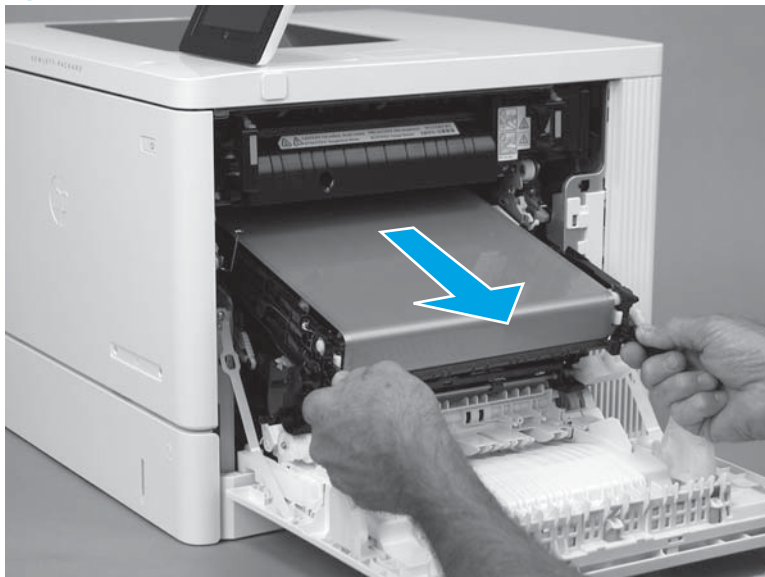

Step 2: Unpack the replacement assembly

Unpack the replacement assembly from the packaging.

CAUTION: Make sure that all of the packing materials and tape is removed from the replacement ITB. The ITB might be damaged if packing materials are in place when the printer power is turned on.

For complete information on HP's recycling programs, go to [Product return and recycling](#).

NOTE: HP recommends responsible disposal of the defective assembly.

Figure 1-236 Recycle and unpack

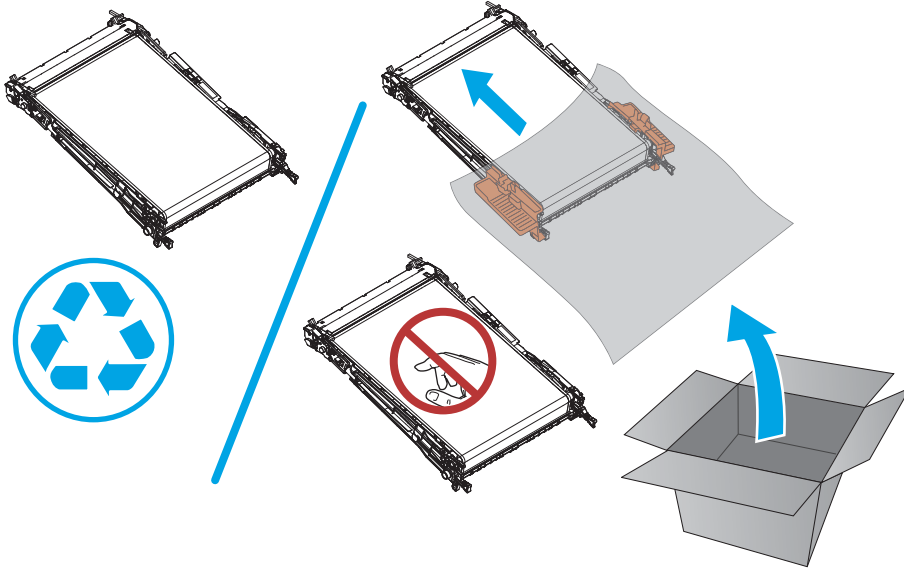

Step 3: Install the ITB

CAUTION: Do not touch the grey-plastic belt. Skin oils and fingerprints on the belt can cause print-quality problems.

1. Hold the ITB by the orange handles.

Figure 1-237 Handle the ITB by the edges

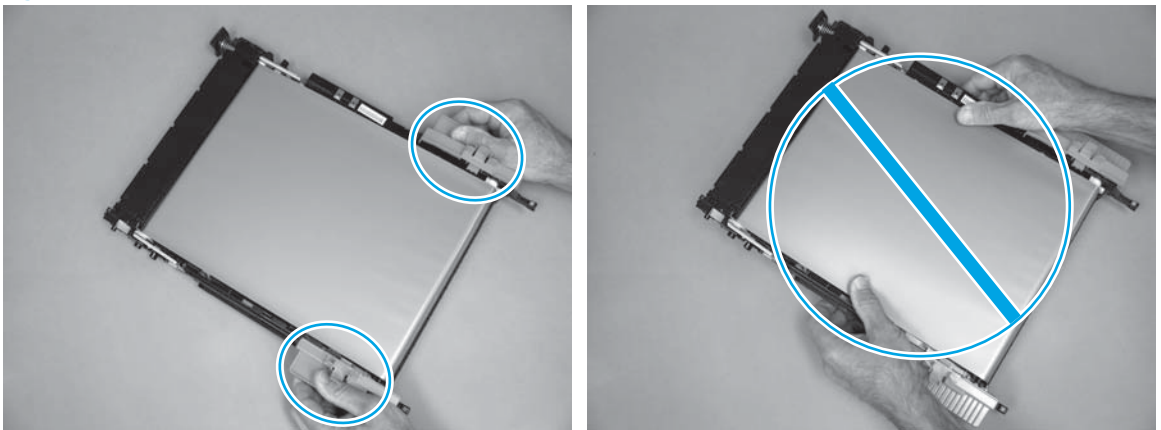

2. Align the ITB with the slots in the printer, and then carefully push it into the printer.

 **NOTE:** Be careful. Do not dislodge the ITB retainer springs from the holders on the chassis. The springs can interfere with installing the ITB.

Figure 1-238 Align the ITB with the slots in the product



3. Continue to carefully push the ITB into the printer until the orange handles stop it.

Figure 1-239 Orange handles stop

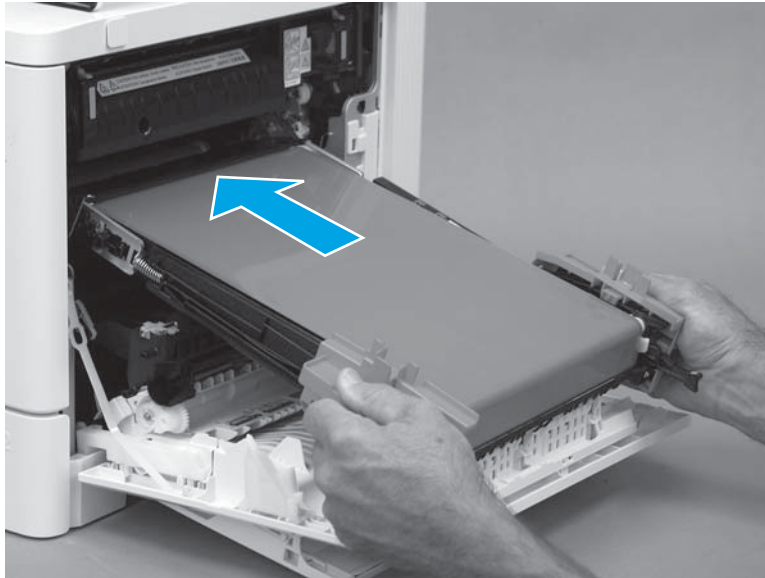
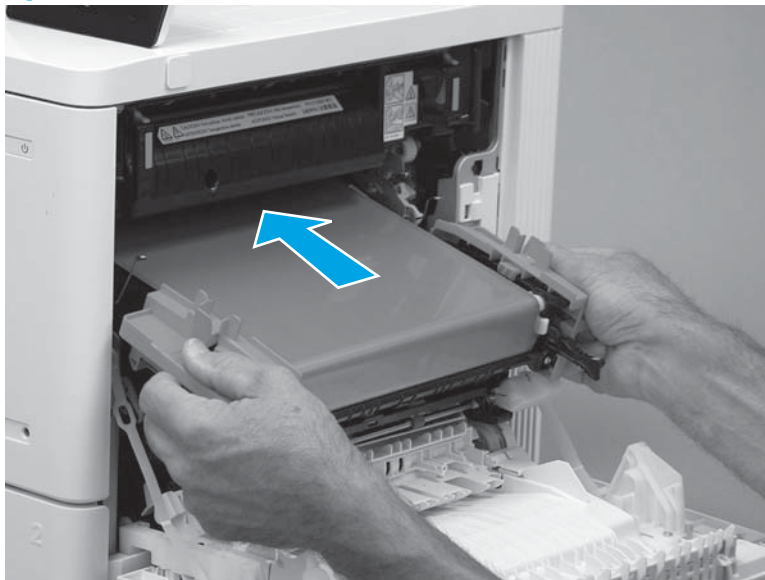

4. Release one tab (callout 1).

Figure 1-240 Release one tab

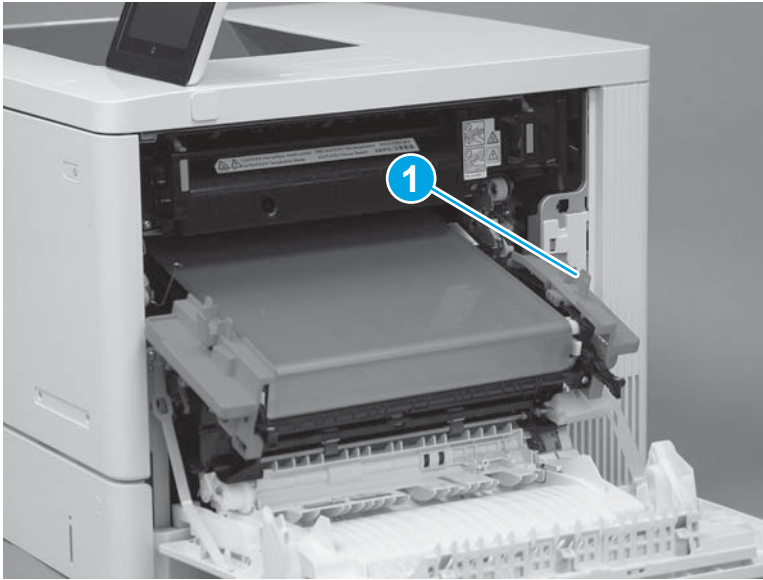

5. Remove the orange handle. Repeat this step for the remaining orange handle.

 **TIP:** HP recommends recycling the plastic handles.

Figure 1-241 Remove the orange handle



6. Continue to carefully push the ITB into the printer until it is fully installed.

Figure 1-242 Install the ITB

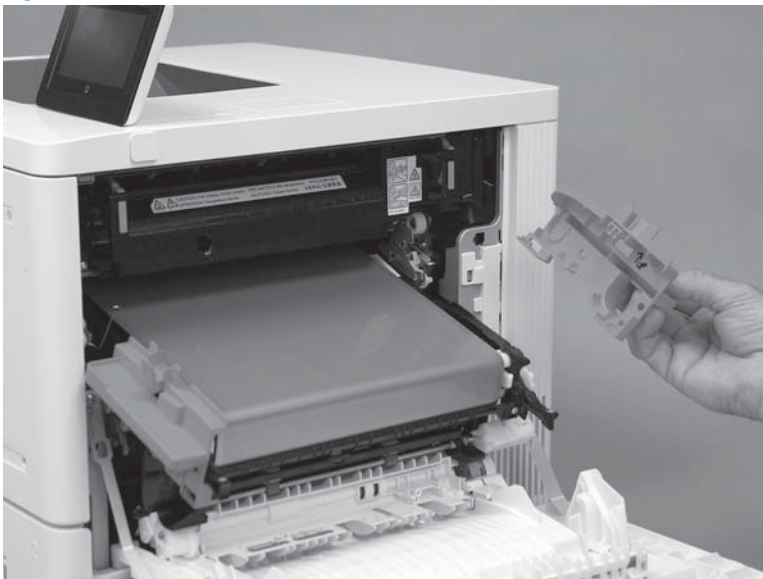
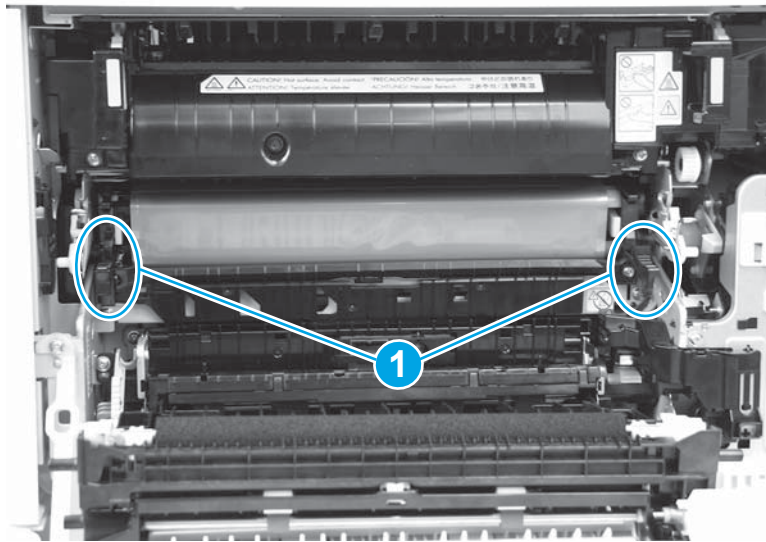

7. Remove the right-side ITB spring from the holder.

Figure 1-243 Remove the spring from the holder



8. Fasten the right-side ITB spring (callout 1) under the tab (callout 2).

Figure 1-244 Fasten the rear-side ITB spring

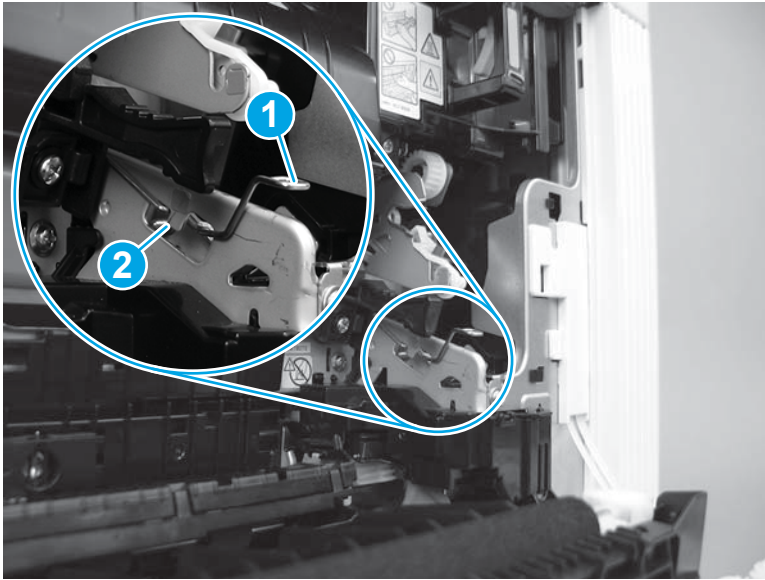

9. Remove the left-side ITB spring from the holder.

Figure 1-245 Remove the spring from the holder

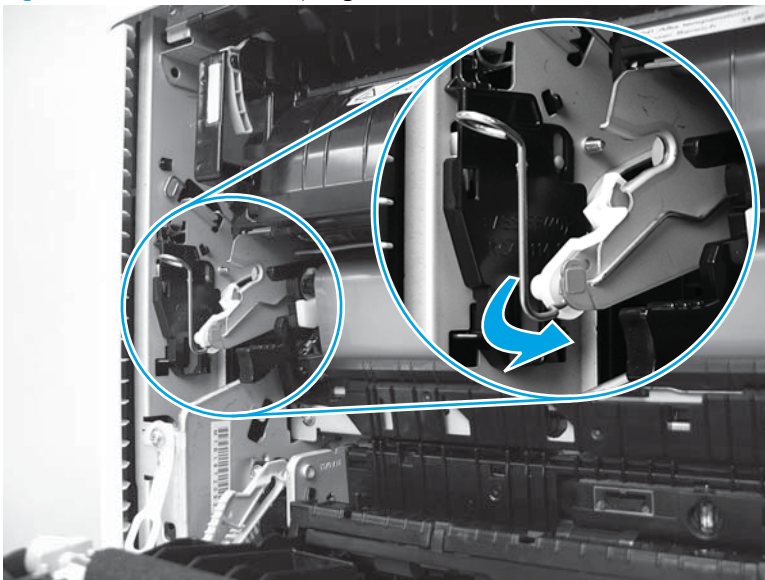

10. Fasten the left-side ITB spring (callout 1) under the tab (callout 2).

Figure 1-246 Fasten the front-side ITB spring

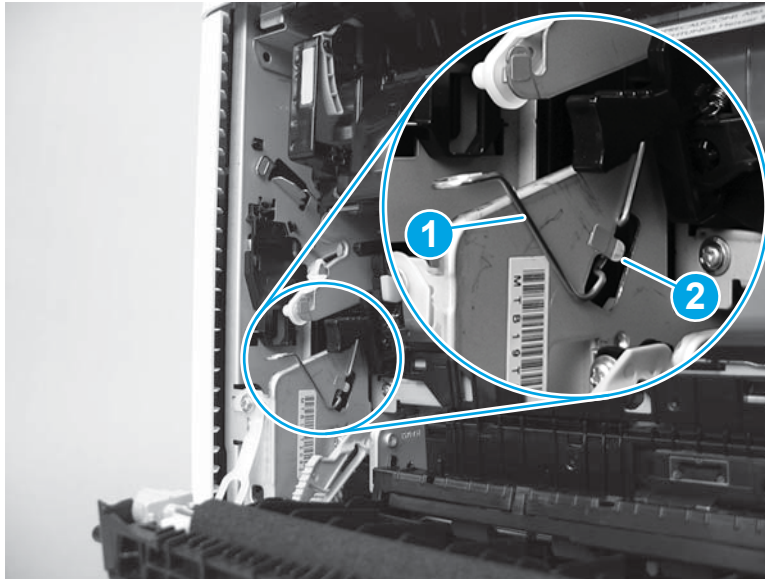

11. Push in the blue lever to engage the ITB drive coupling.

 **IMPORTANT:** If the ITB drive coupling is not fully engaged, the right door will not properly close.

Figure 1-247 Engage the ITB drive coupling

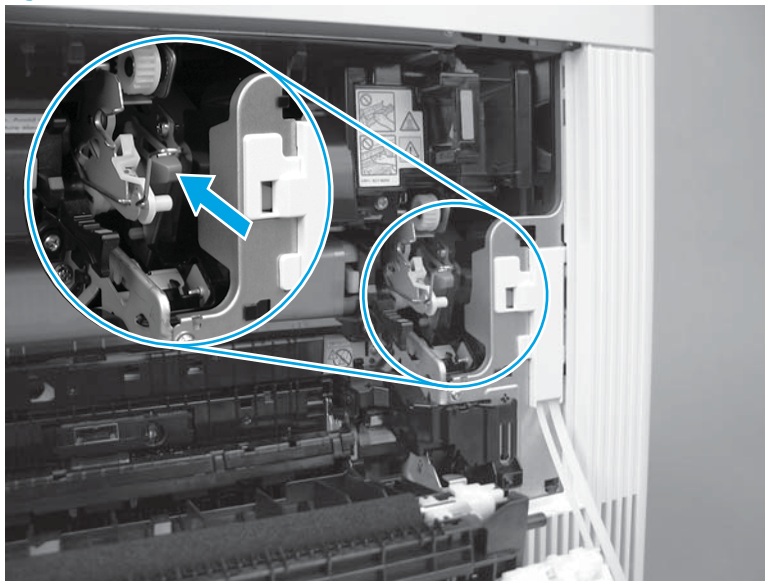

12. Close the right door.

 **TIP:** The right door should close easily if the ITB assembly is correctly installed.

Figure 1-248 Close the right door



Removal and replacement: Intermediate transfer belt (ITB) and secondary transfer roller

- [Introduction](#)
- [Step 1: Remove the transfer roller](#)
- [Step 2: Remove the ITB](#)
- [Step 3: Unpack the replacement assemblies](#)
- [Step 4: Install the ITB](#)
- [Step 5: Install the transfer roller](#)

Introduction

This document provides the procedures to remove and replace the secondary transfer roller and the intermediate transfer belt (ITB).

Before performing service

Turn the printer power off

- Disconnect the power cable.

 **WARNING!** To avoid damage to the printer, turn the printer off, wait 30 seconds, and then remove the power cord before attempting to service the printer.

Use the table below to identify the correct part number for your printer. To order the part, go to www.hp.com/buy/parts.

Secondary transfer roller kit part number	
B5L24-67901	Secondary transfer roller and intermediate transfer belt (ITB) with instruction guide

Required tools

No special tools are required to install this part.

After performing service

Make sure that the right door is fully closed after replacing the secondary transfer roller and ITB.

Turn the printer power on

- Connect the power cable.
- Use the power switch to turn the power on.

Post service test

Print a configuration page to make sure that the printer is functioning correctly.

Step 1: Remove the transfer roller

1. Open the right door.

Figure 1-249 Open the right door



2. Push in on the blue lever (callout 1) to release the secondary transfer roller assembly, and then lower the assembly (callout 2) to the service position.

Figure 1-250 Lower the secondary transfer roller assembly

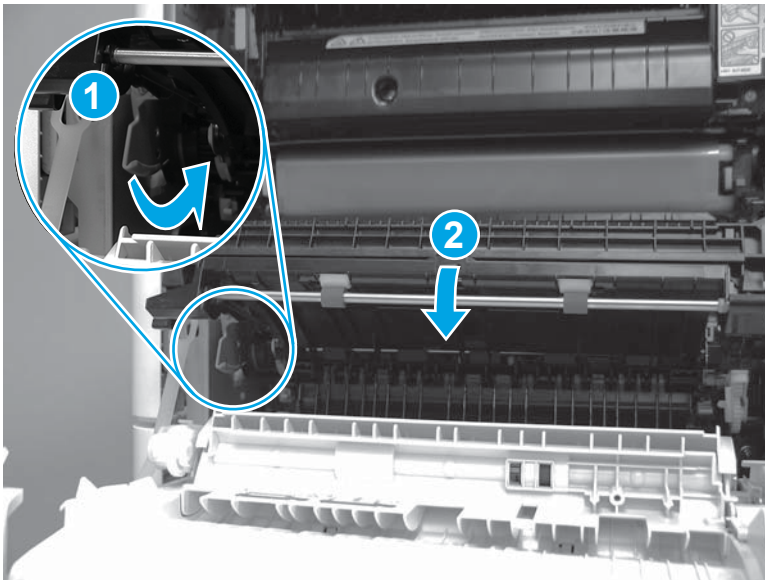

3. Slightly lift the left end of the roller shaft (callout 1; near the gear) to release the transfer roller clip.

Figure 1-251 Release the secondary transfer roller clip

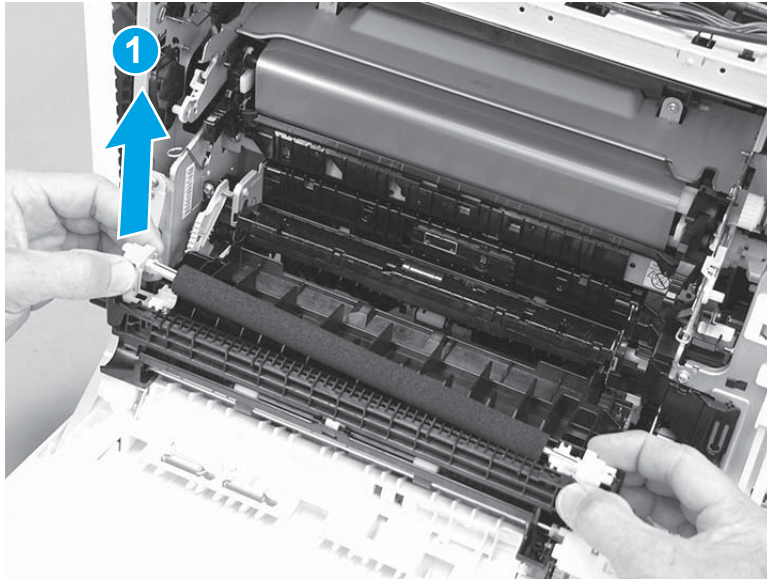

4. Slide the right end roller collar (callout 1) to the left to remove the transfer roller.

Figure 1-252 Remove the secondary transfer roller

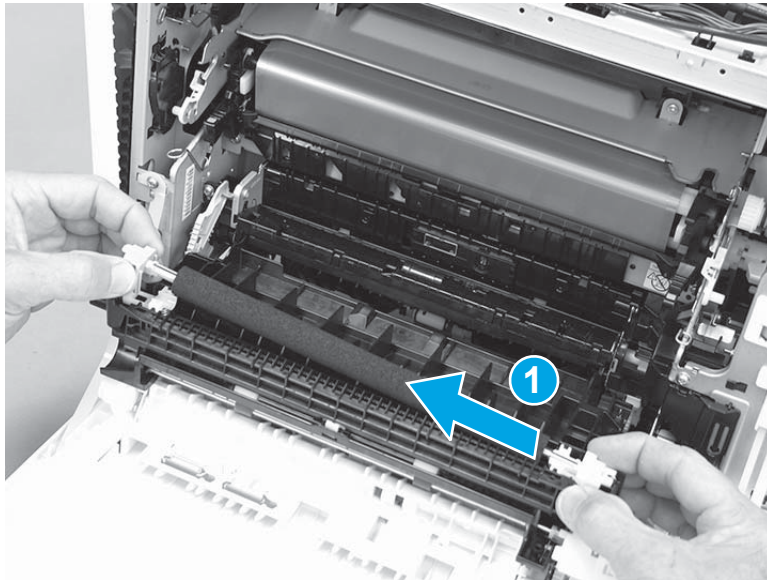

Step 2: Remove the ITB

CAUTION: Do not touch the grey-plastic belt. Skin oils and fingerprints on the belt can cause print-quality problems.

1. Pull the blue lever to release the ITB drive coupling.

Figure 1-253 Release the ITB drive coupling

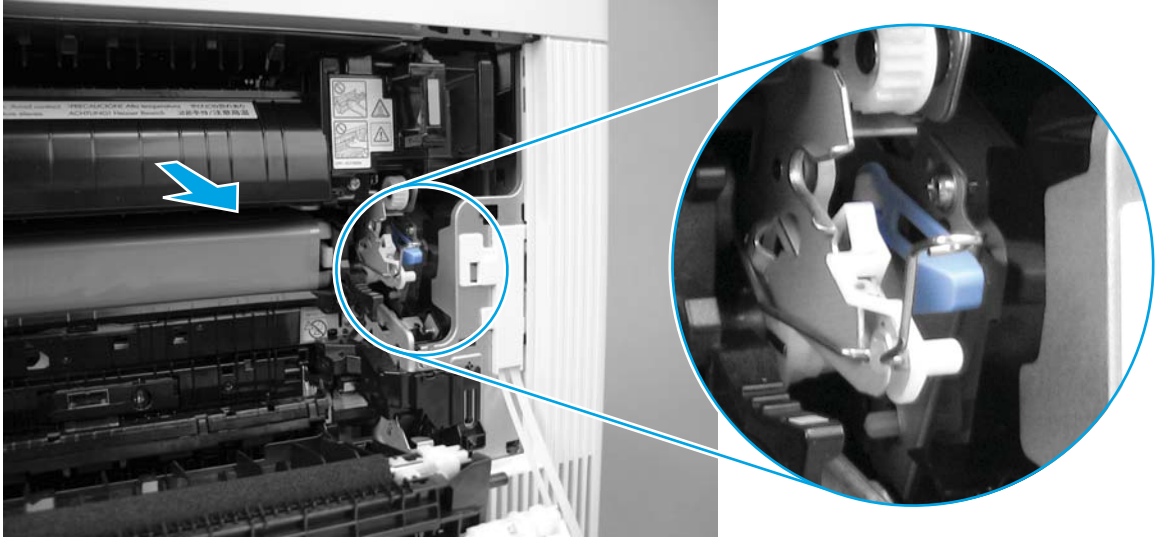

2. Release the left-side ITB spring (callout 1) from the tab (callout 2).

Figure 1-254 Release the front-side ITB spring

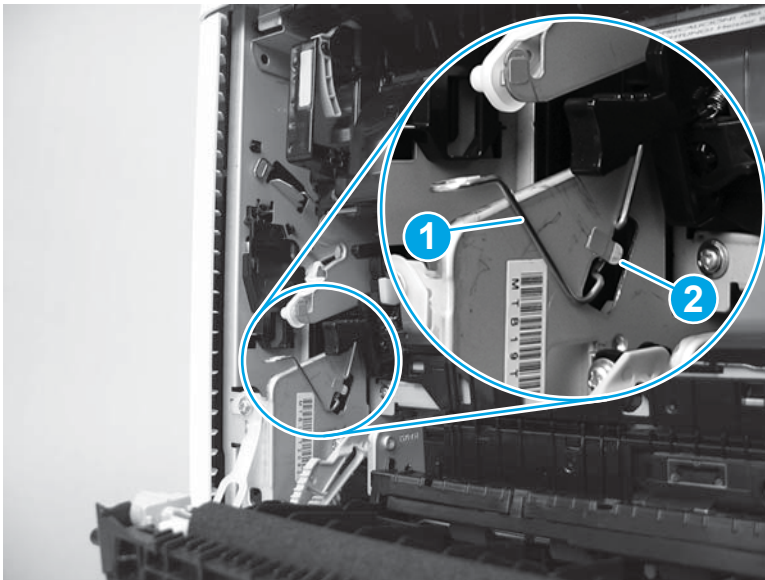

3. Place the left-side ITB spring on the holder to keep it out of the way.

 **TIP:** The holder is colored blue to help locate it.

Figure 1-255 Place the spring on the holder

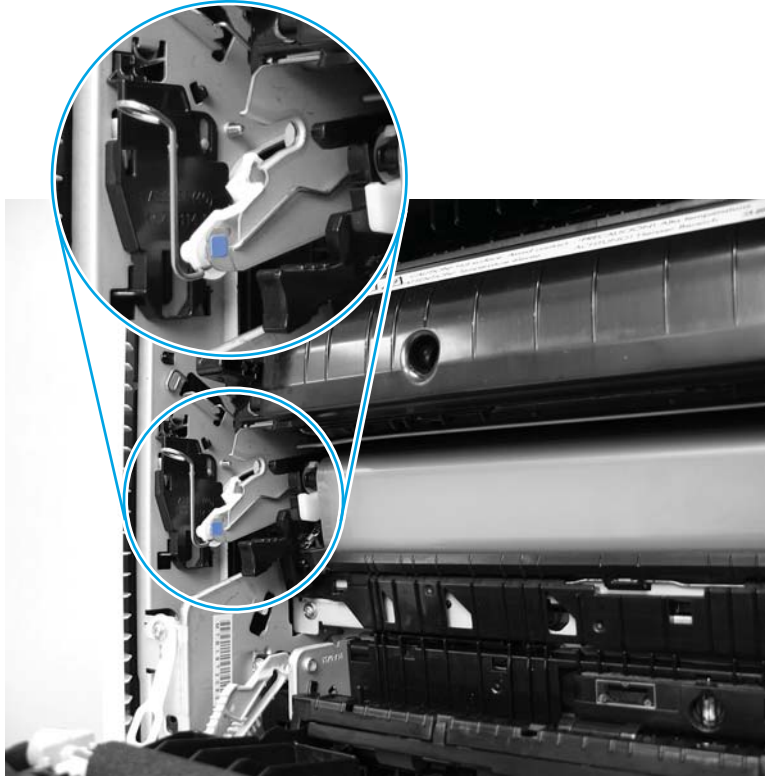

4. Release the right-side ITB spring (callout 1) from the tab (callout 2).

Figure 1-256 Release the rear-side ITB spring

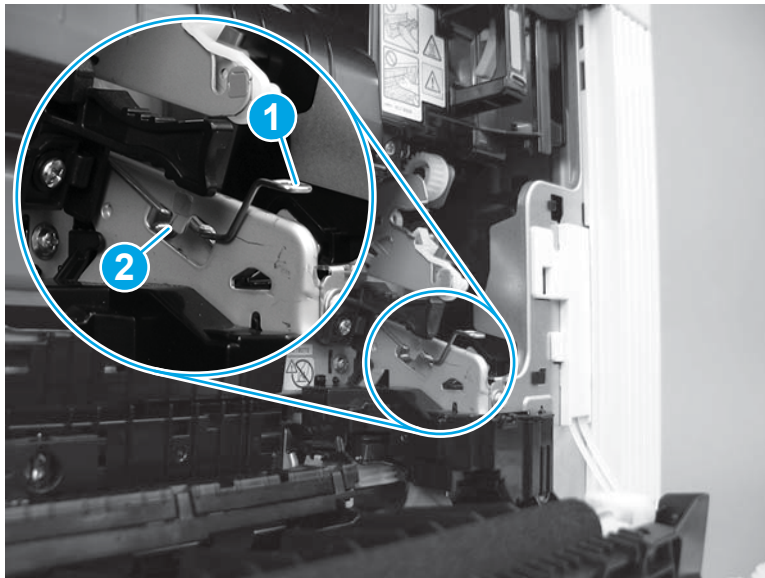

5. Place the right-side ITB spring on the holder to keep it out of the way.

 **TIP:** The holder is colored blue to help locate it.

Figure 1-257 Place the spring on the holder

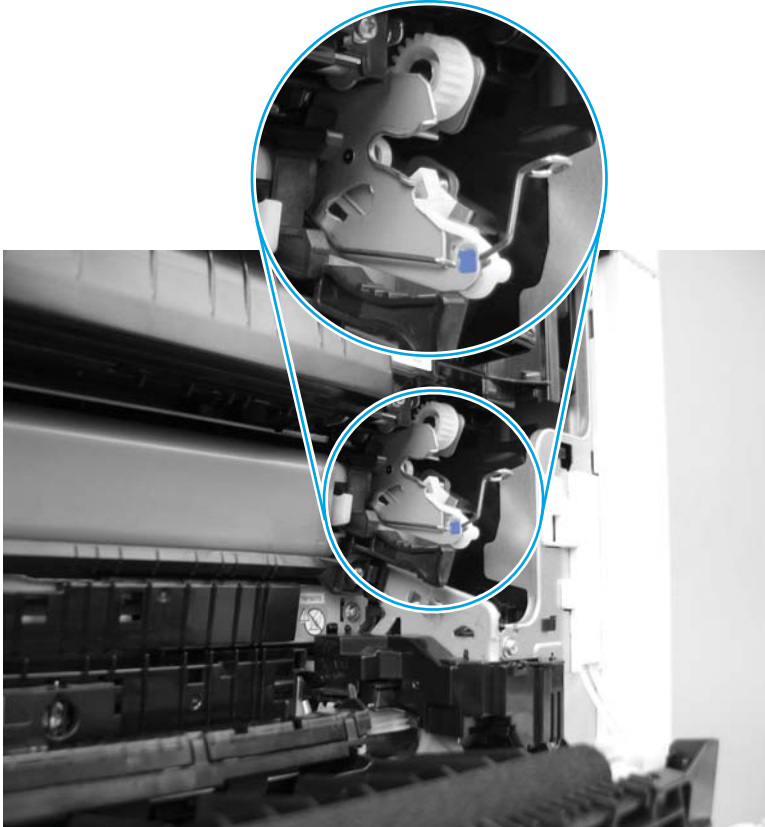

6. Grasp the two handles on the ITB.

CAUTION: If the ITB is removed to access other assemblies in the printer, use care. The ITB is a sensitive assembly. Be careful when handling the ITB so that it is not damaged. Always place the ITB in a safe and protected location.

NOTE: The two black handles have blue stickers on them to help you locate them.

Figure 1-258 Grasp the ITB handles

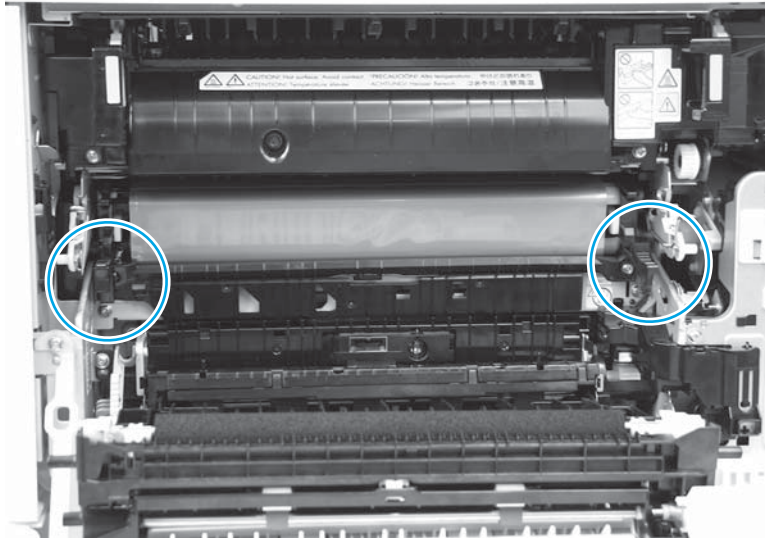

7. Pull the ITB out of the printer to remove it.

CAUTION: Do not touch the grey-plastic belt. Skin oils and fingerprints on the belt can cause print-quality problems.

NOTE: Be careful. Do not dislodge the ITB springs from the holders. The springs can interfere with removing the ITB.

Figure 1-259 Remove the ITB

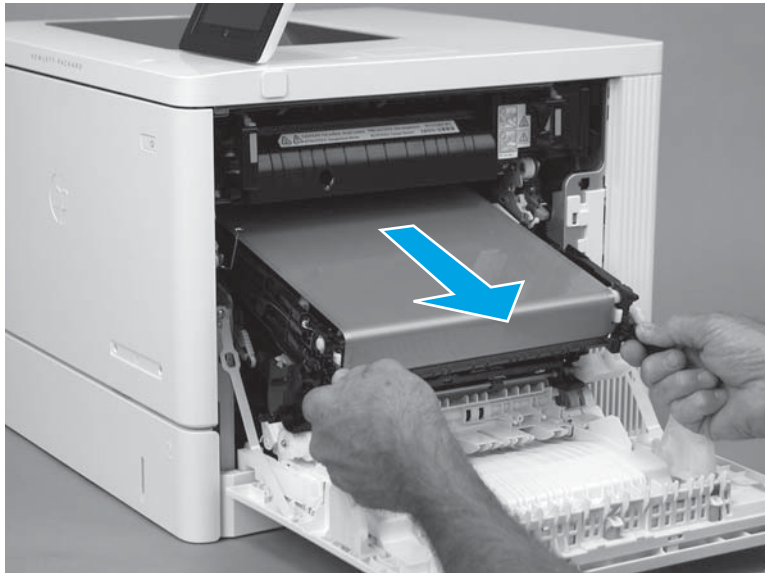

Step 3: Unpack the replacement assemblies

Unpack the replacement assemblies from the packaging.

CAUTION: Make sure that all of the packing materials and tape are removed from the replacement ITB. The ITB might be damaged if packing materials are in place when the printer power is turned on.

For complete information on HP's recycling programs, go to [Product return and recycling](#).

NOTE: HP recommends responsible disposal of the defective assemblies.

Figure 1-260 Recycle and unpack

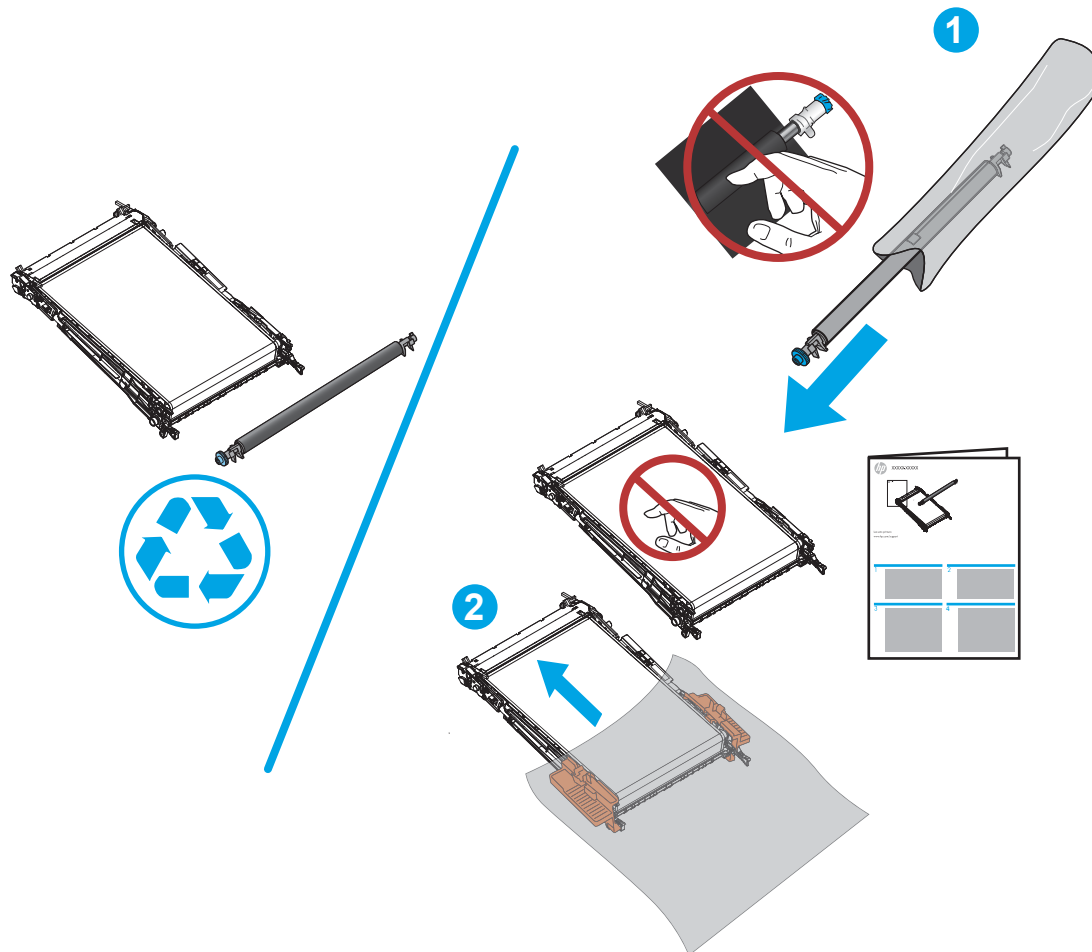

Step 4: Install the ITB

CAUTION: Do not touch the grey-plastic belt. Skin oils and fingerprints on the belt can cause print-quality problems.

1. Hold the ITB by the provided orange ITB service handles.

Figure 1-261 Handle the ITB by the edges

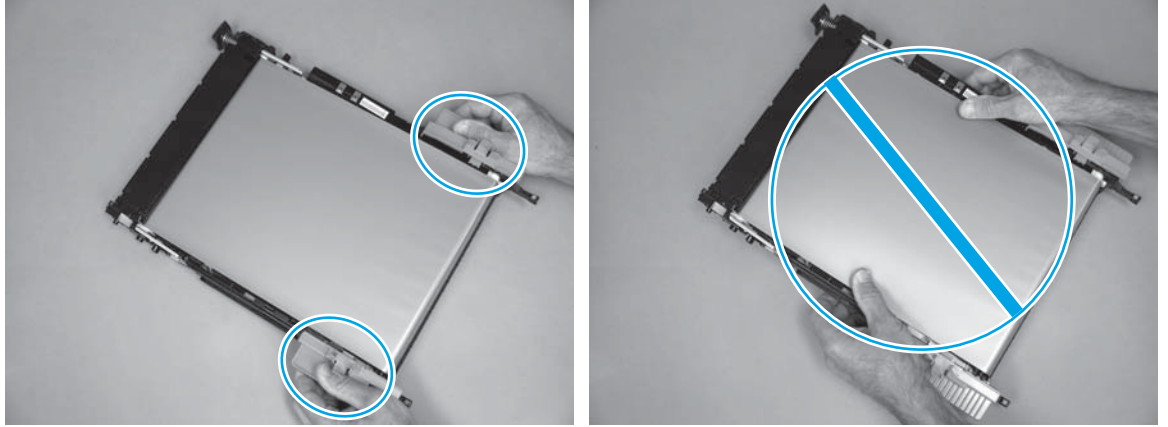

2. Align the ITB with the slots in the printer, and then carefully push it into the printer.

 **NOTE:** Be careful. Do not dislodge the ITB retainer springs from the holders on the chassis. The springs can interfere with installing the ITB.

Figure 1-262 Align the ITB with the slots in the product



3. Continue to carefully push the ITB into the printer until the orange handles stop it.

Figure 1-263 Orange handles stop

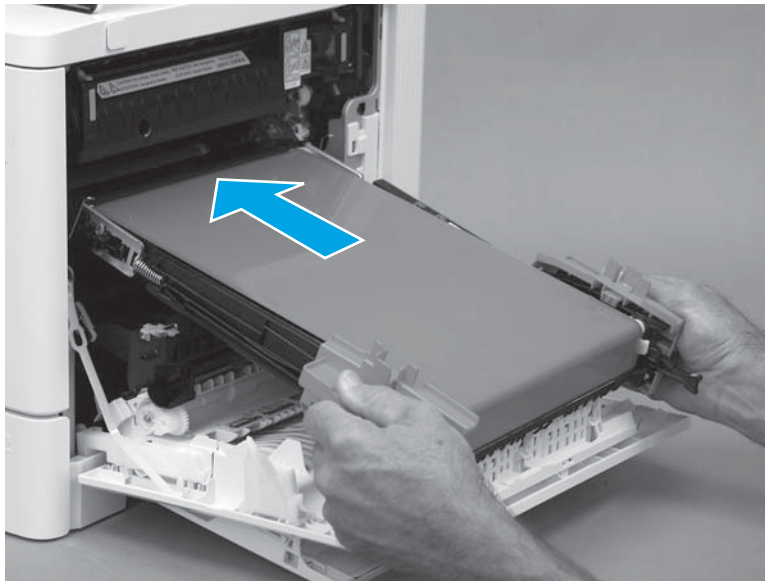
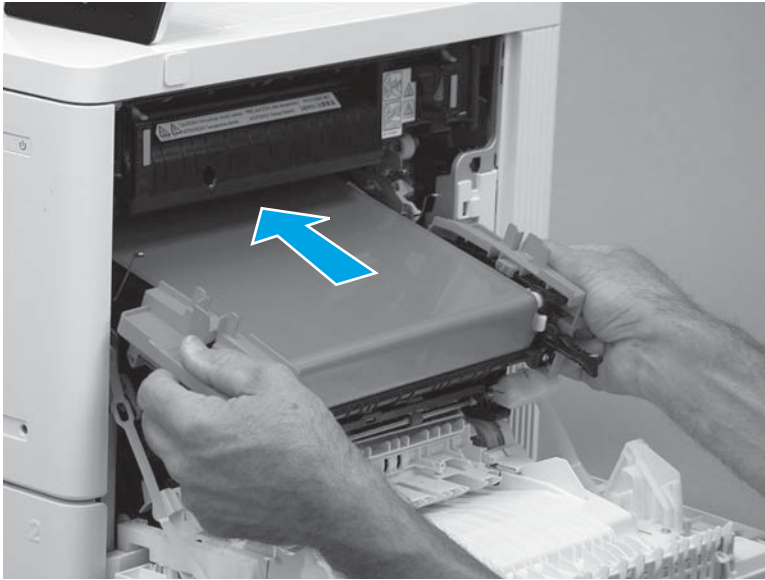

4. Release one tab (callout 1).

Figure 1-264 Release one tab

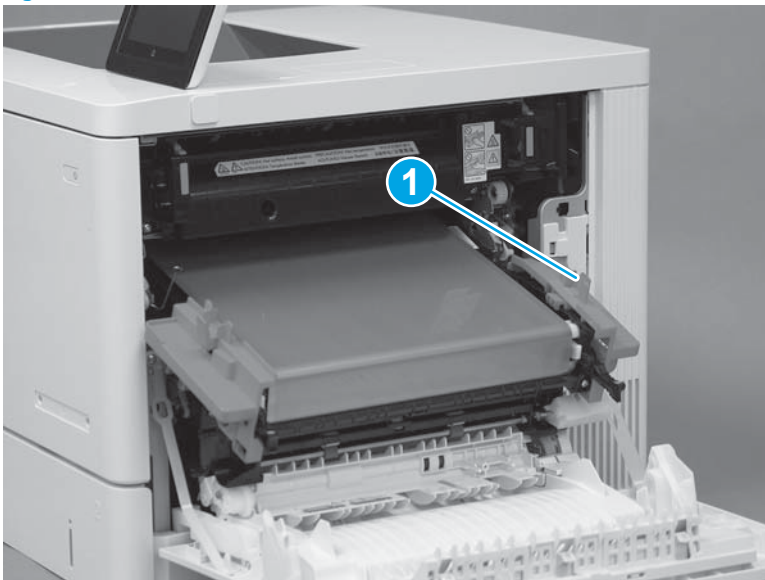

5. Remove the orange handle. Repeat this step for the remaining orange handle.

 **TIP:** HP recommends recycling the plastic handles.

Figure 1-265 Remove the orange handle



6. Use the black-plastic handles (callout 1) on the ITB to carefully push the ITB into the product until it is fully installed.

Figure 1-266 Install the ITB

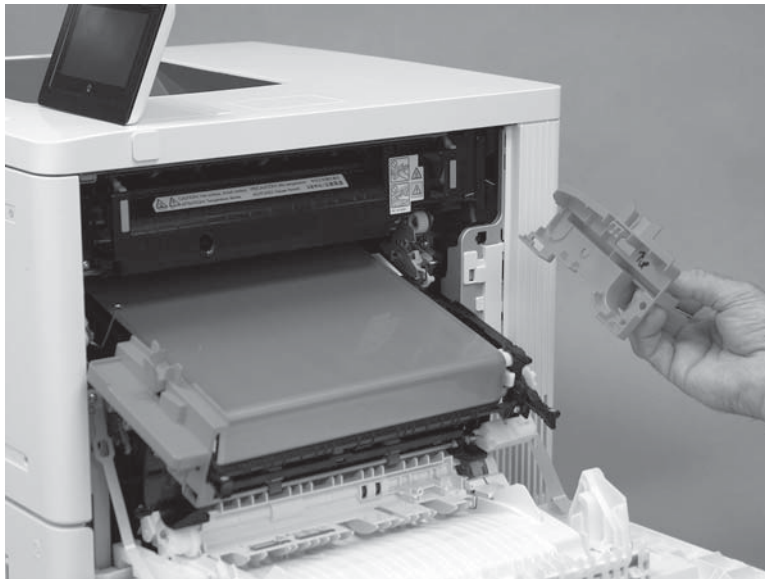
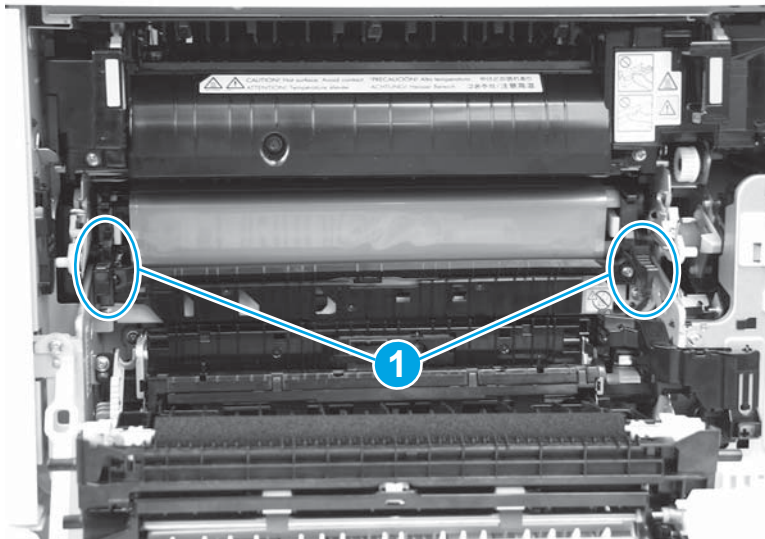

7. Remove the right-side ITB spring from the holder.

Figure 1-267 Remove the spring from the holder



8. Fasten the right-side ITB spring (callout 1) under the tab (callout 2).

Figure 1-268 Fasten the rear-side ITB spring

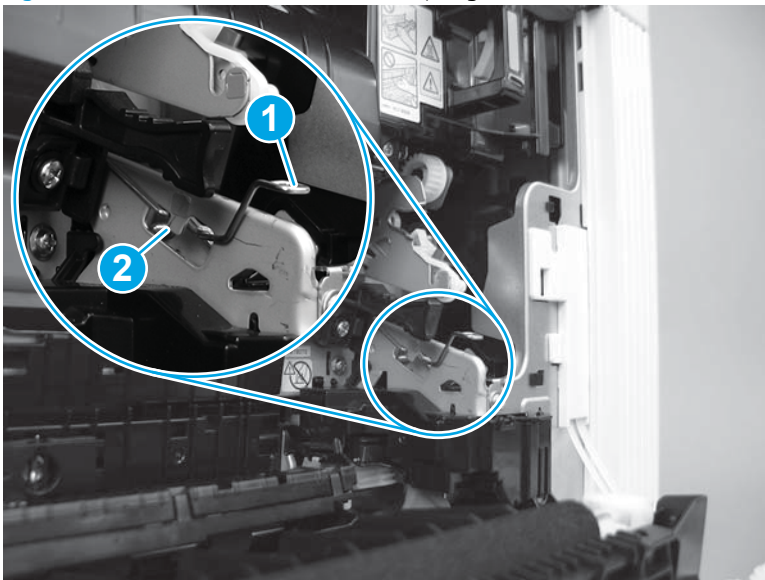

9. Remove the left-side ITB spring from the holder.

Figure 1-269 Remove the spring from the holder

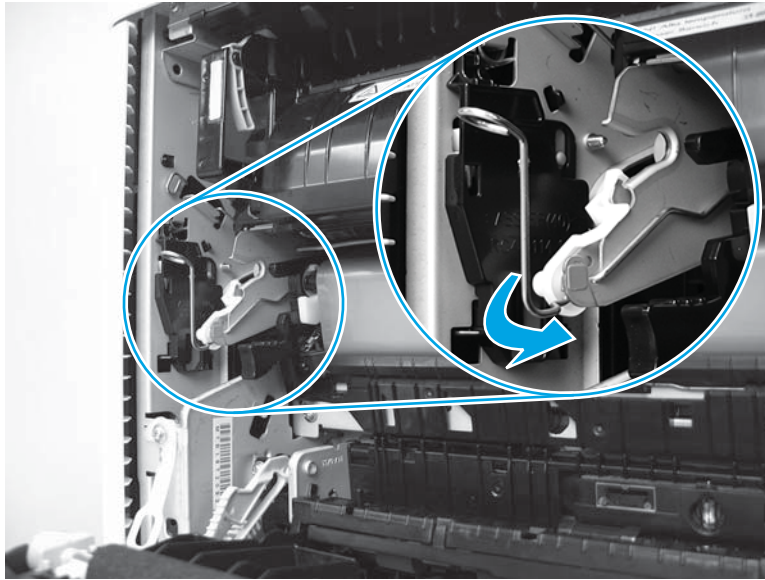

10. Fasten the left-side ITB spring (callout 1) under the tab (callout 2).

Figure 1-270 Fasten the front-side ITB spring

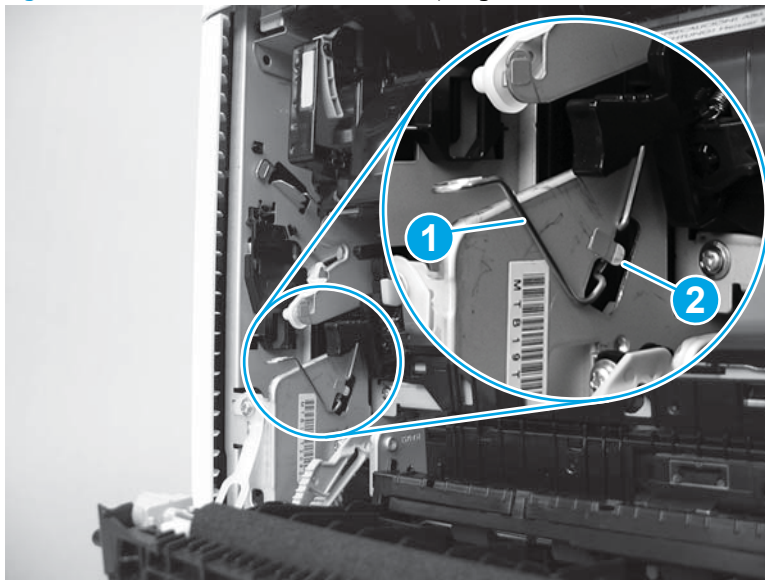

11. Push in the blue lever to engage the ITB drive coupling.

 **IMPORTANT:** If the ITB drive coupling is not fully engaged, the right door will not properly close.

Figure 1-271 Engage the ITB drive coupling

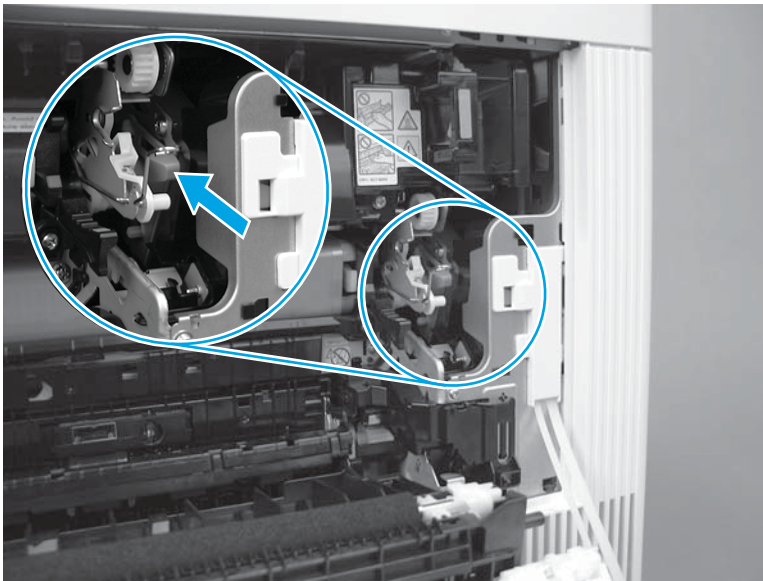

Step 5: Install the transfer roller

1. Insert the right end (white plastic) of the replacement roller into the holder (callout 1), and then push down on the left end (blue plastic clip; callout 2) until the roller snaps into place.

 **IMPORTANT:** Make sure that both ends of the roller assembly are fully seated in the holders.

Figure 1-272 Install the secondary transfer roller right end



2. Close the right door.

 **TIP:** The right door should close easily if the ITB assembly is correctly installed.

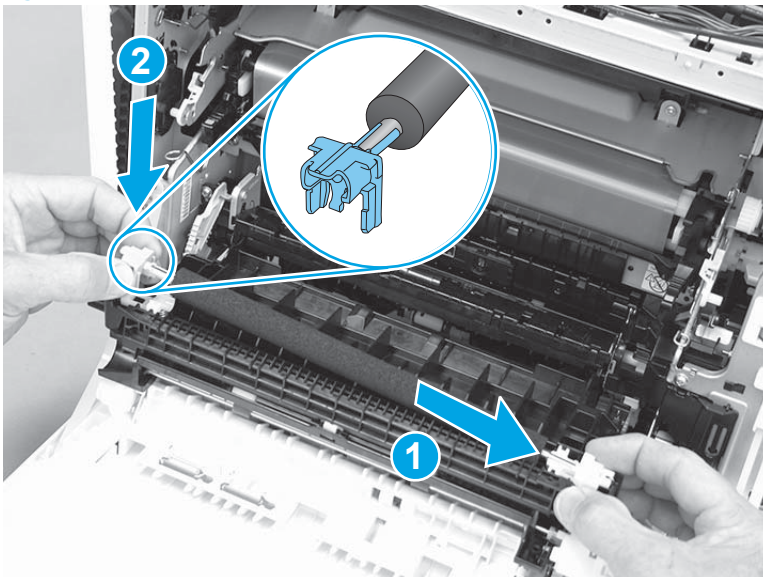
Figure 1-273 Close the right door



Field replaceable units (FRUs)

Removal and replacement: External panels, covers, and doors

- [Removal and replacement: Stapler cover assembly \(M577c/f/z\)](#)
- [Removal and replacement: Right front upper cover \(M577dn\)](#)
- [Removal and replacement: Rear upper cover \(M577\)](#)
- [Removal and replacement: Left upper cover \(M577\)](#)
- [Removal and replacement: Right upper cover \(M577\)](#)
- [Removal and replacement: Top rear cover \(M577\)](#)
- [Removal and replacement: Paper feed cover \(M577\)](#)
- [Removal and replacement: Top cover \(M577\)](#)
- [Removal and replacement: Right door](#)
- [Removal and replacement: Front door](#)
- [Removal and replacement: Formatter cover](#)
- [Removal and replacement: Rear cover \(M552 and M553\)](#)
- [Removal and replacement: Rear cover \(M577\)](#)
- [Removal and replacement: Left cover](#)
- [Removal and replacement: Upper cover \(M552 and M553\)](#)
- [Removal and replacement: Output bin](#)
- [Removal and replacement: Right rear cover \(M552 and M553\)](#)
- [Removal and replacement: Right rear cover \(M577\)](#)
- [Removal and replacement: Control panel \(M553n/dn and M552dn only\)](#)

Removal and replacement: Stapler cover assembly (M577c/f/z)

- [Introduction](#)
- [Step 1: Remove the stapler cover assembly](#)
- [Step 2: Unpack the replacement assembly](#)
- [Step 3: Install the stapler cover assembly](#)

Introduction

This document provides the procedures to remove and replace the M577c/f/z stapler cover assembly.

Before performing service

Turn the printer power off

- Disconnect the power cable.

 **WARNING!** To avoid damage to the printer, turn the printer off, wait 30 seconds, and then remove the power cord before attempting to service the printer.

Use the table below to identify the correct part number for your printer. To order the part, go to www.hp.com/buy/parts.

Stapler cover assembly (M577c/f/z) part number	
B5L46-60121	Stapler cover assembly (M577c/f/z)

Required tools

- Small flat blade screwdriver
- #2 Phillips screwdriver with a magnetic tip

After performing service

Make sure that the stapler cover is fully seated after replacing it.

Turn the printer power on

- Connect the power cable.
- Use the power switch to turn the power on.

Step 1: Remove the stapler cover assembly

1. Remove one screw (callout 1).

 **Reinstallation tip:** This is a self-tapping screw for plastic. When reinstalling, rotate the screw counterclockwise to align it with the existing thread pattern, and then carefully turn it clockwise to tighten. Do not overtighten. This will prevent stripping the threads inside the screw hole.

Figure 1-274 Remove one screw



2. Release two tabs at the front edge of the cover (callout 1).

Figure 1-275 Release two tabs

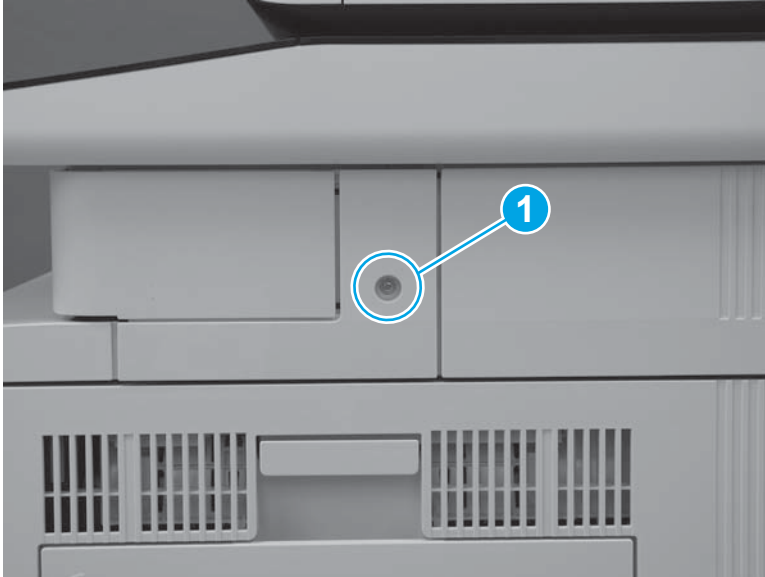

3. Release the back edge of the cover.

Figure 1-276 Release the back edge of the cover

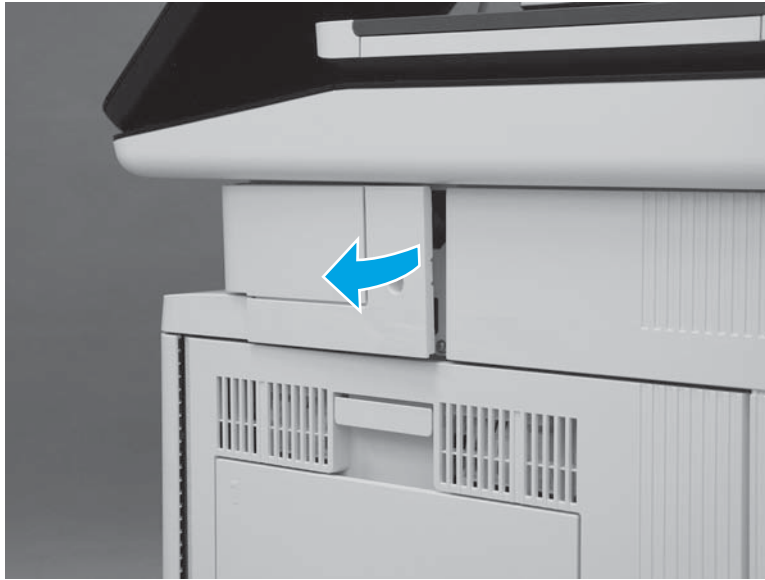

4. Rotate the cover away from the printer to remove it.

Figure 1-277 Remove the cover



Step 2: Unpack the replacement assembly

Unpack the replacement assembly from the packaging.

For complete information on HP's recycling programs, go to [Product return and recycling](#).

 **NOTE:** HP recommends responsible disposal of the defective assembly.

Figure 1-278 Recycle and unpack

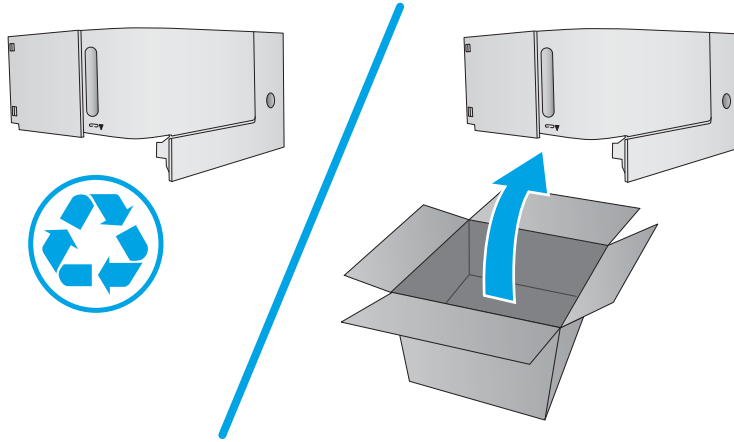

Step 3: Install the stapler cover assembly

1. Install the tabs (callout 1) on the cover in the slots (callout 2) in the printer.

Figure 1-279 Install two tabs



2. Press the cover toward the left side of the printer until it snaps into place.

Figure 1-280 Install the cover assembly



3. Install one screw (callout 1).

 **IMPORTANT:** This is a self-tapping screw for plastic. Rotate it counterclockwise to align it with the existing thread pattern, and then carefully turn it clockwise to tighten. Do not overtighten. This will prevent stripping the threads inside the screw hole.

Figure 1-281 Install one screw



Removal and replacement: Right front upper cover (M577dn)

- [Introduction](#)
- [Step 1: Remove the right front upper cover](#)
- [Step 2: Unpack the replacement assembly](#)
- [Step 3: Install the right front upper cover](#)

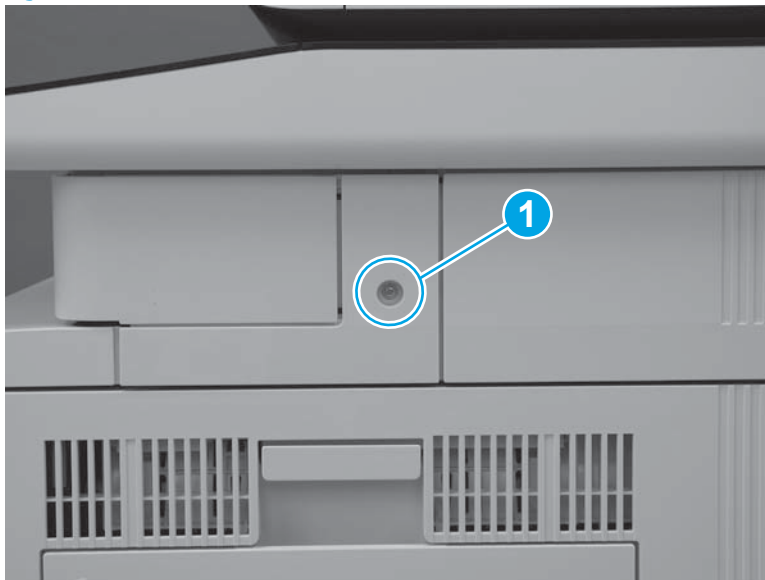
Introduction

This document provides the procedures to remove and replace the M577dn right front upper cover.

Before performing service

Turn the printer power off

- Disconnect the power cable.

 **WARNING!** To avoid damage to the printer, turn the printer off, wait 30 seconds, and then remove the power cord before attempting to service the printer.

Use the table below to identify the correct part number for your printer. To order the part, go to www.hp.com/buy/parts.

Right front upper cover (M577dn) part number	
B5L46-40024	Right front upper cover (M577dn)

Required tools

- Small flat blade screwdriver
- #2 Phillips screwdriver with a magnetic tip

After performing service

Make sure that the right front upper cover is fully seated after replacing it.

Turn the printer power on

- Connect the power cable.
- Use the power switch to turn the power on.

Step 1: Remove the right front upper cover

1. Remove one screw (callout 1).

Figure 1-282 Remove one screw

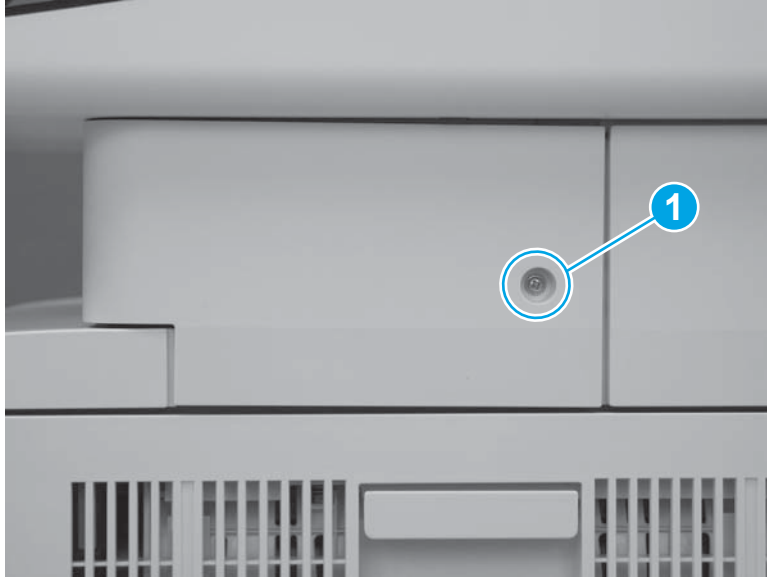

2. Release two tabs at the front edge of the cover (callout 1).

Figure 1-283 Release two tabs



3. Rotate the front of the cover to the right to remove it.

Figure 1-284 Rotate the cover



Step 2: Unpack the replacement assembly

Unpack the replacement assembly from the packaging.

For complete information on HP's recycling programs, go to [Product return and recycling](#).

 **NOTE:** HP recommends responsible disposal of the defective assembly.

Figure 1-285 Recycle and unpack

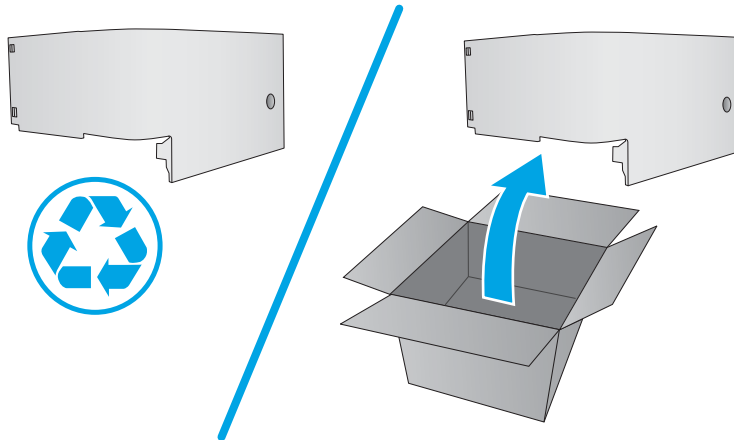

Step 3: Install the right front upper cover

1. Slide the cover toward the left side of the printer to install it. Make sure that the slots (callout 1) in the cover fit over the tabs (callout 2) on the inside of the paper feeder cover.

Figure 1-286 Install the cover



2. Press the right front upper cover (callout 1) and the paper feeder cover (callout 2) together until the tabs on the inside of the covers snap into place.

Figure 1-287 Press the cover



3. Install one screw (callout 1).

Figure 1-288 Install one screw

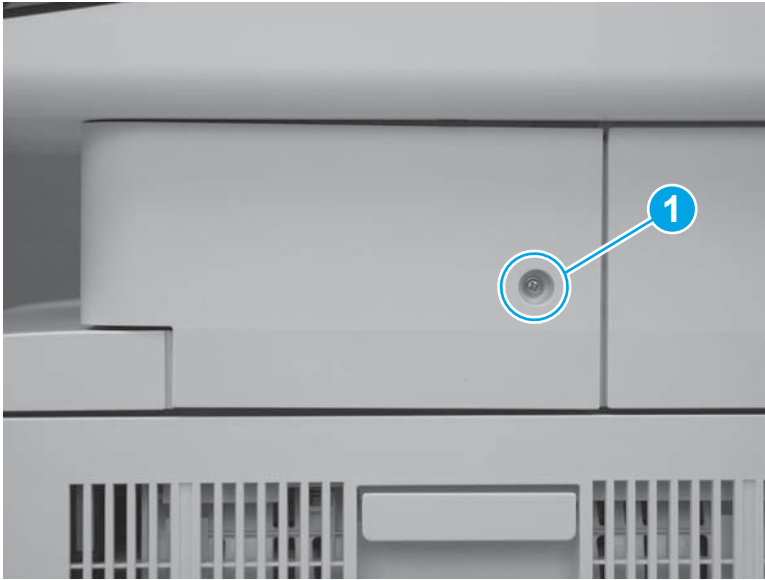

Removal and replacement: Rear upper cover (M577)

- [Introduction](#)
- [Step 1: Remove the formatter cover](#)
- [Step 2: Remove the rear upper cover](#)
- [Step 3: Unpack the replacement assembly](#)
- [Step 4: Install the rear upper cover](#)
- [Step 5: Install the formatter cover](#)

Introduction

This document provides the procedures to remove and replace the M577 rear upper cover.

Before performing service

Turn the printer power off

- Disconnect the power cable.

⚠ WARNING! To avoid damage to the printer, turn the printer off, wait 30 seconds, and then remove the power cord before attempting to service the printer.

Use the table below to identify the correct part number for your printer. To order the part, go to www.hp.com/buy/parts.

Rear upper cover (M577) part number	
RC4-3385-000CN	Rear upper cover (M577)

Required tools

- Small flat blade screwdriver
- #2 Phillips screwdriver with a magnetic tip

After performing service

Make sure that the rear upper cover is fully seated after replacing it.

Turn the printer power on

- Connect the power cable.
- Use the power switch to turn the power on.

Step 1: Remove the formatter cover

1. Locate the formatter cover.

Figure 1-289 Locate the formatter cover

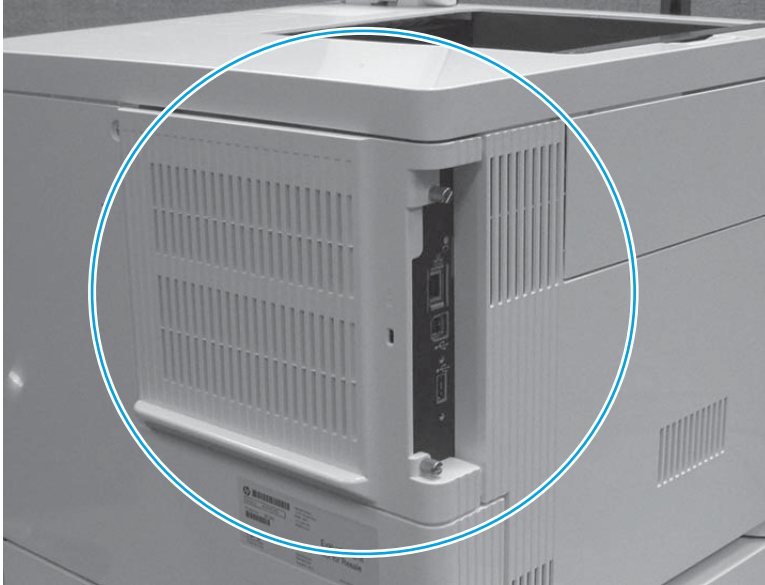

2. Loosen the two thumbscrews (callout 1). Grasp the two thumbscrews, and then slide the cover away from the printer (callout 2) to remove it.

 **TIP:** If needed, use the edge of a coin to turn the thumbscrews.

Figure 1-290 Loosen the thumbscrews

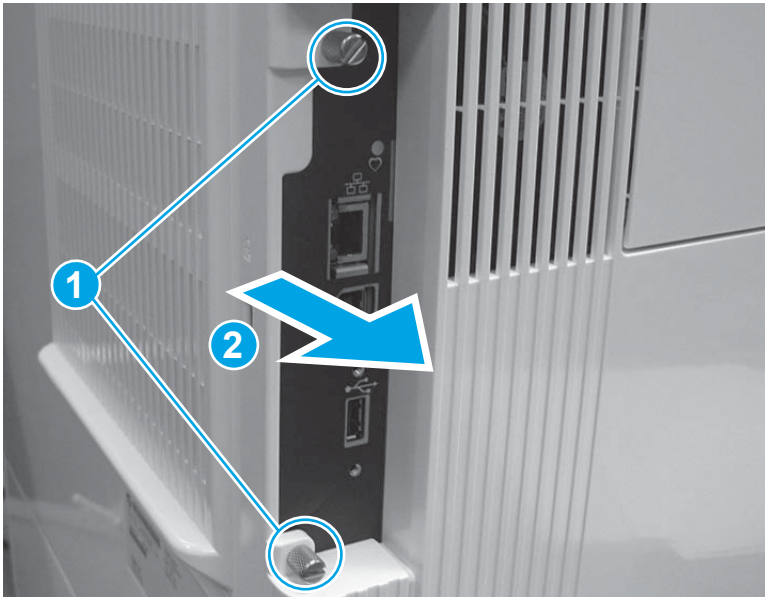

Step 2: Remove the rear upper cover

1. Remove two screws (callout 1).

 **Reinstallation tip:** These two screws are self-tapping screws for plastic. When reinstalling them, rotate the screws counterclockwise to align them with the existing thread pattern, and then carefully turn them clockwise to tighten. Do not overtighten. This will prevent stripping the threads inside the screw holes.

Figure 1-291 Remove two screws



2. Use a small, flat blade screwdriver to release the right edge of the cover.

Figure 1-292 Release the right edge

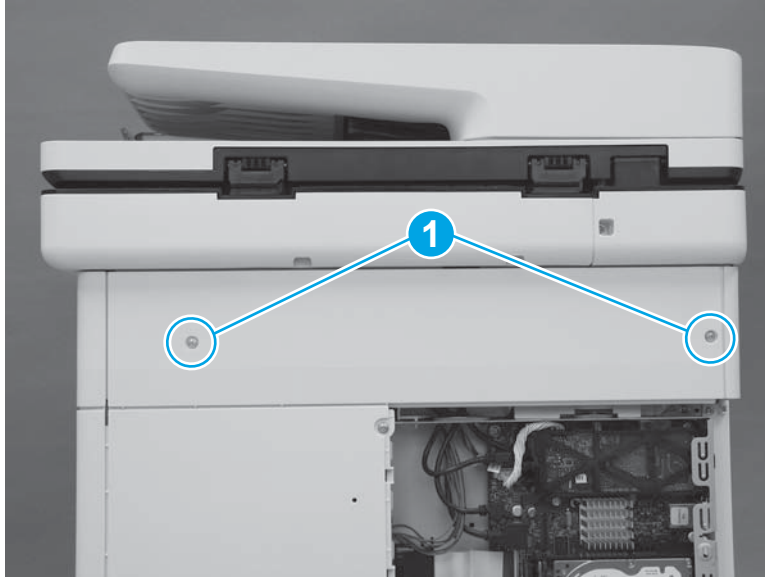
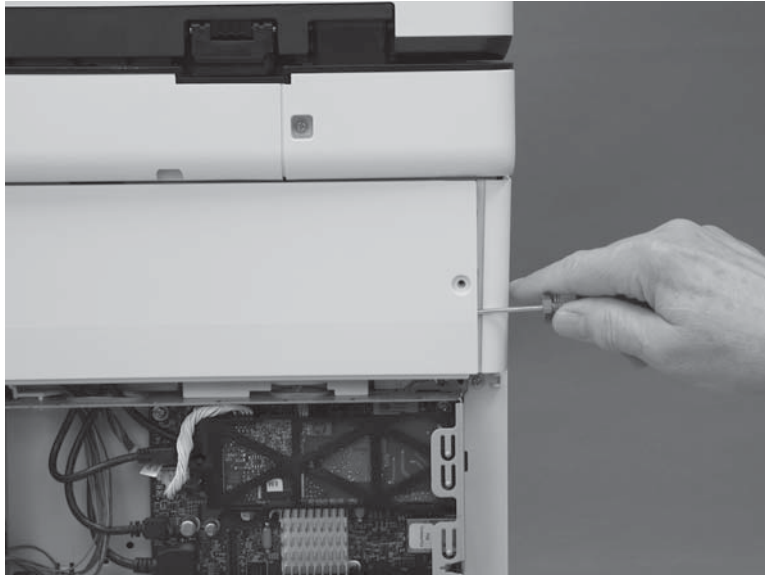

3. Pull the right edge of the cover (callout 1) away from the printer, and then slide the cover to the right (callout 2).

Figure 1-293 Slide the cover right

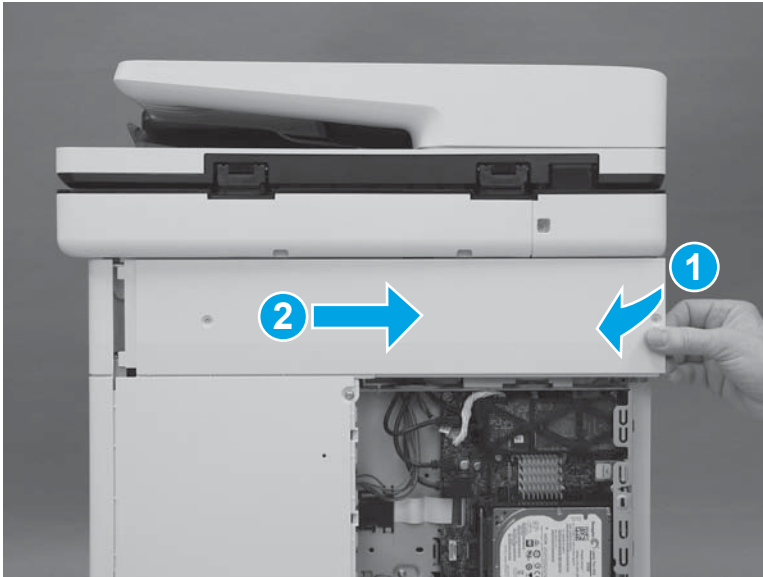

4. Remove the cover.

Figure 1-294 Remove the cover

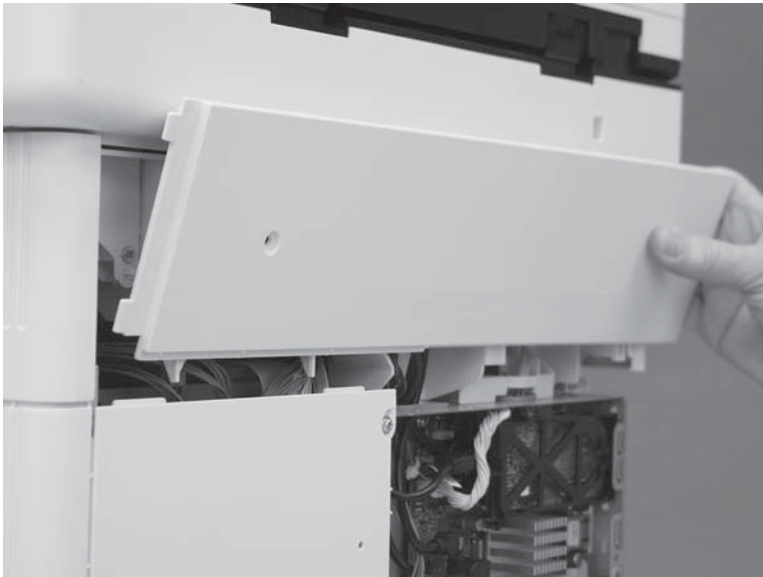

Step 3: Unpack the replacement assembly

Unpack the replacement assembly from the packaging.

For complete information on HP's recycling programs, go to [Product return and recycling](#).



NOTE: HP recommends responsible disposal of the defective assembly.

Figure 1-295 Recycle and unpack

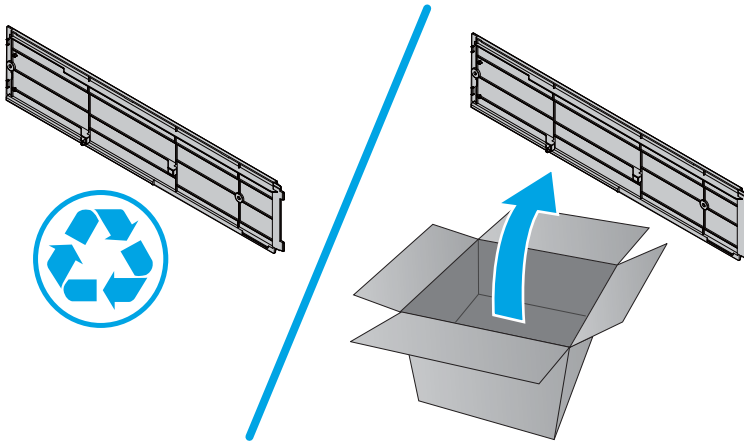

Step 4: Install the rear upper cover

1. Align the ridge (callout 1) on the lower edge of the rear upper cover in front of the tabs (callout 2) on the top edge of the rear cover.

Figure 1-296 Align the cover

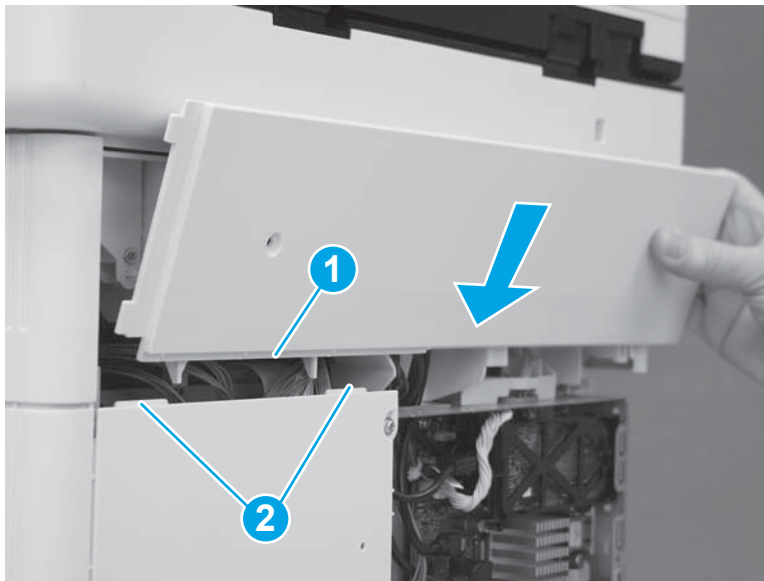

2. Rotate the top of the cover toward the printer.

Figure 1-297 Rotate the top of the cover

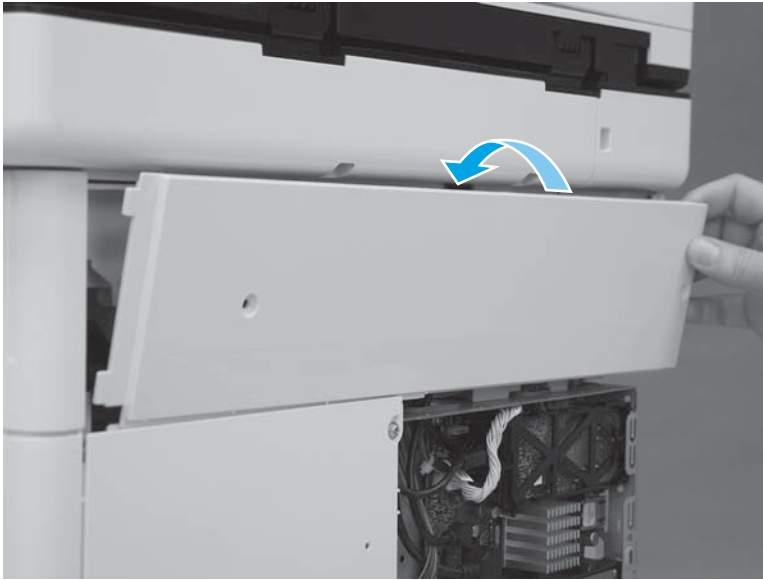

3. Slide the cover to the left (callout 1). Make sure that the tabs (callout 2) on the upper rear cover slide behind the edge (callout 3) of the right upper cover. Make sure that the cover is fully seated.

Figure 1-298 Slide the cover

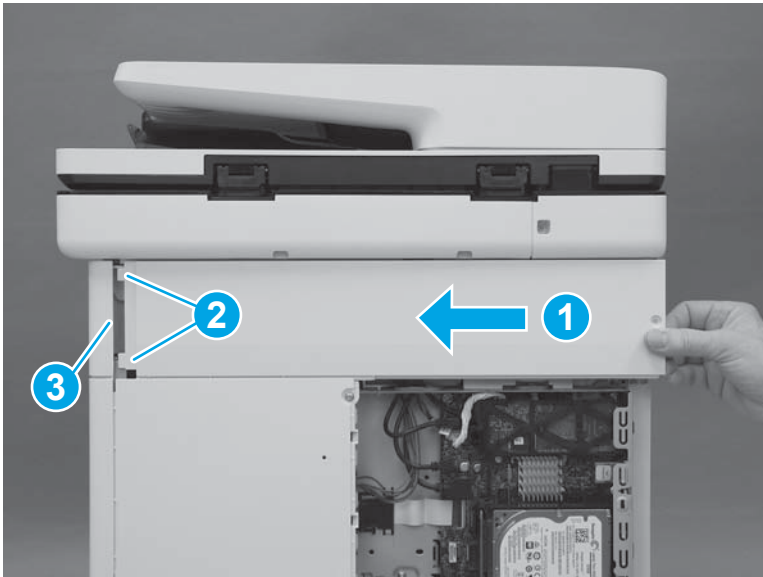

4. Install two screws (callout 1).



 **IMPORTANT:** These two screws are self-tapping screws for plastic. Rotate them counterclockwise to align them with the existing thread pattern, and then carefully turn them clockwise to tighten. Do not overtighten. This will prevent stripping the threads inside the screw holes.

Figure 1-299 Install two screws

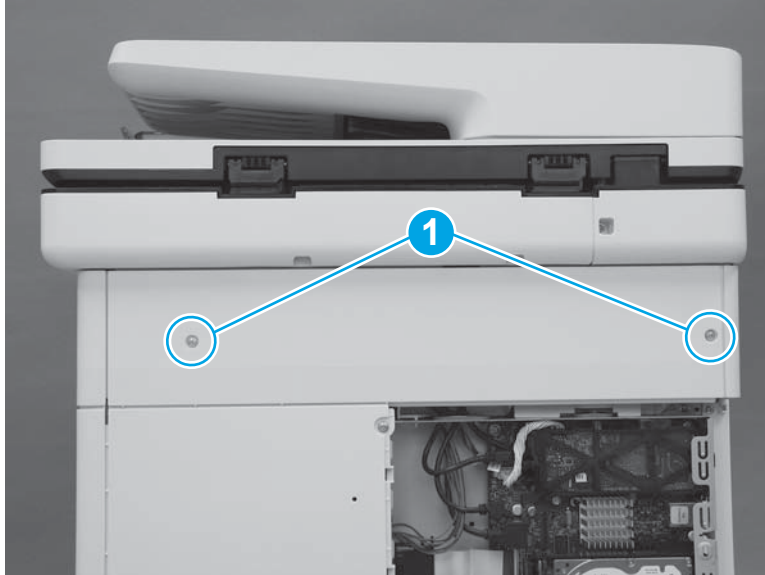

Step 5: Install the formatter cover

- ▲ Slide the cover onto the printer (callout 1) to install it.

 **NOTE:** Make sure that the tabs on the formatter cover align with the slots provided in the printer (callout 2). Tighten the two thumbscrews (callout 3).

 **TIP:** If needed, use the edge of a coin to turn the thumbscrews.

Figure 1-300 Install the cover

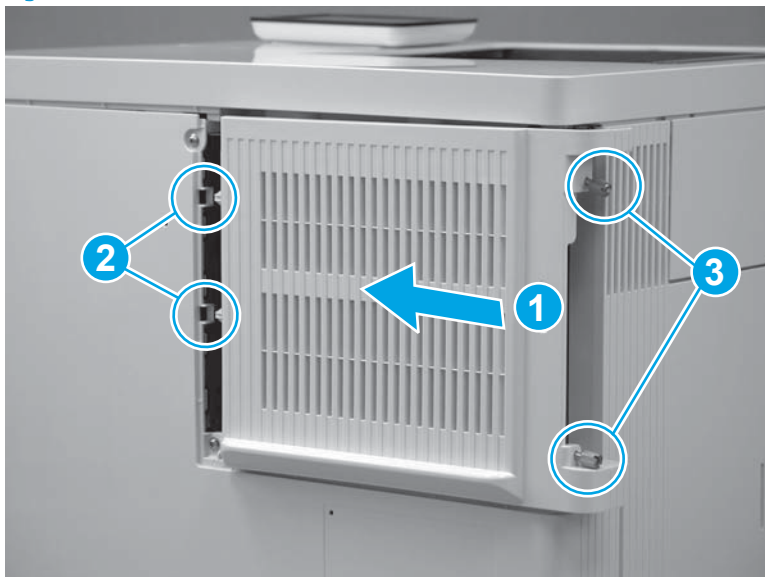

Removal and replacement: Left upper cover (M577)

- [Introduction](#)
- [Step 1: Remove the formatter cover](#)
- [Step 2: Remove the rear upper cover](#)
- [Step 3: Remove the left upper cover](#)
- [Step 4: Unpack the replacement assembly](#)
- [Step 5: Install the left upper cover](#)
- [Step 6: Install the rear upper cover](#)
- [Step 7: Install the formatter cover](#)

Introduction

This document provides the procedures to remove and replace the M577 left upper cover.

Before performing service

Turn the printer power off

- Disconnect the power cable.

 **WARNING!** To avoid damage to the printer, turn the printer off, wait 30 seconds, and then remove the power cord before attempting to service the printer.

Use the table below to identify the correct part number for your printer. To order the part, go to www.hp.com/buy/parts.

Left upper cover (M577) part number	
RC4-3384-000CN	Left upper cover (M577)

Required tools

- Small flat blade screwdriver
- #2 Phillips screwdriver with a magnetic tip

After performing service

Make sure that the left upper cover is fully seated after replacing it.

Turn the printer power on

- Connect the power cable.
- Use the power switch to turn the power on.

Step 1: Remove the formatter cover

1. Locate the formatter cover.

Figure 1-301 Locate the formatter cover

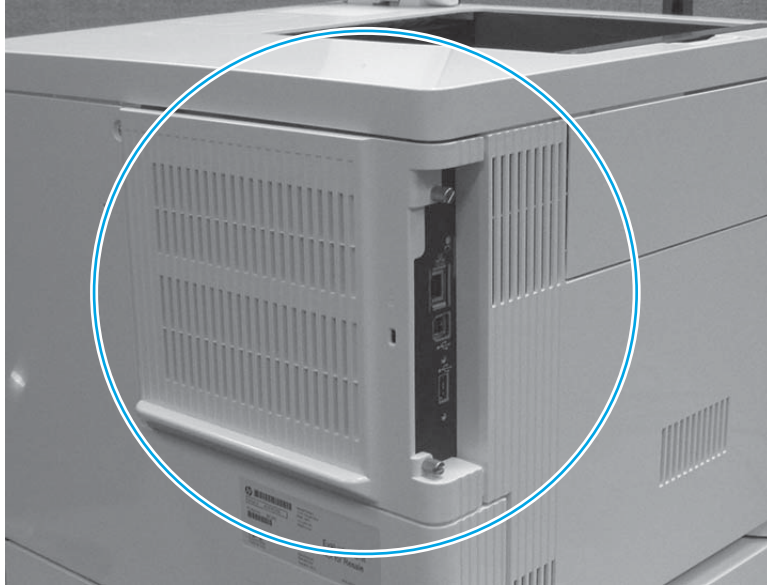

2. Loosen the two thumbscrews (callout 1). Grasp the two thumbscrews, and then slide the cover away from the printer (callout 2) to remove it.

 **TIP:** If needed, use the edge of a coin to turn the thumbscrews.

Figure 1-302 Loosen the thumbscrews

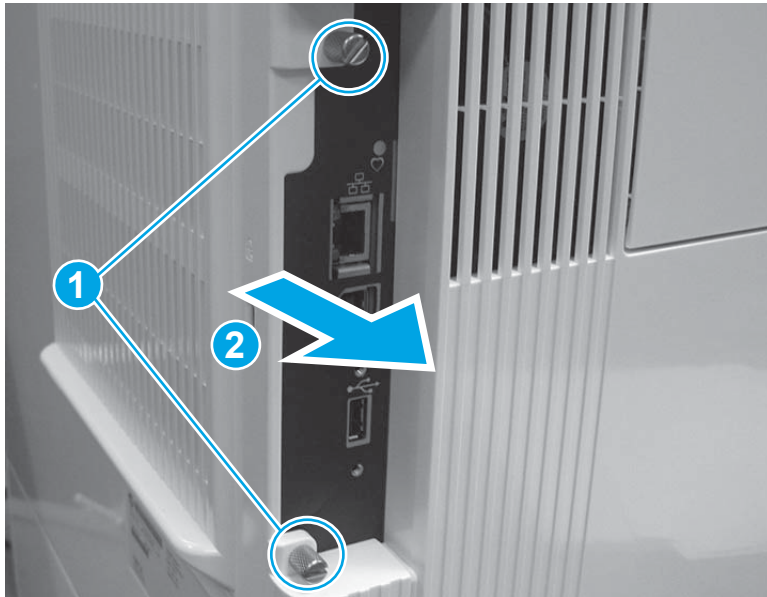

Step 2: Remove the rear upper cover

1. Remove two screws (callout 1).

 **Reinstallation tip:** These two screws are self-tapping screws for plastic. When reinstalling them, rotate the screws counterclockwise to align them with the existing thread pattern, and then carefully turn them clockwise to tighten. Do not overtighten. This will prevent stripping the threads inside the screw holes.

Figure 1-303 Remove two screws



2. Use a small, flat blade screwdriver to release the right edge of the cover.

Figure 1-304 Release the right edge

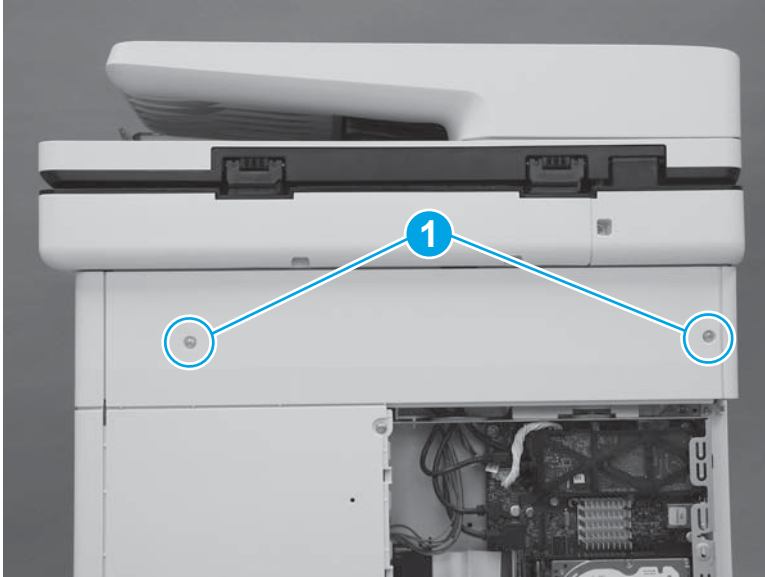
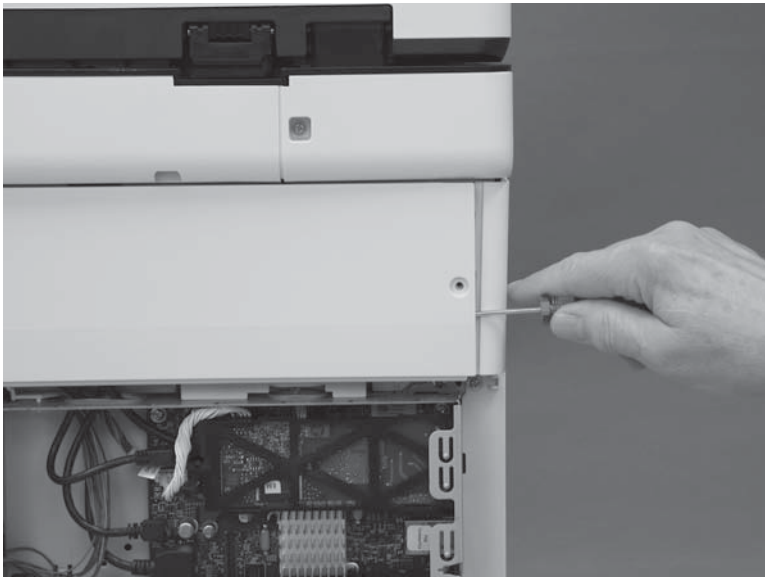

3. Pull the right edge of the cover (callout 1) away from the printer, and then slide the cover to the right (callout 2).

Figure 1-305 Slide the cover right

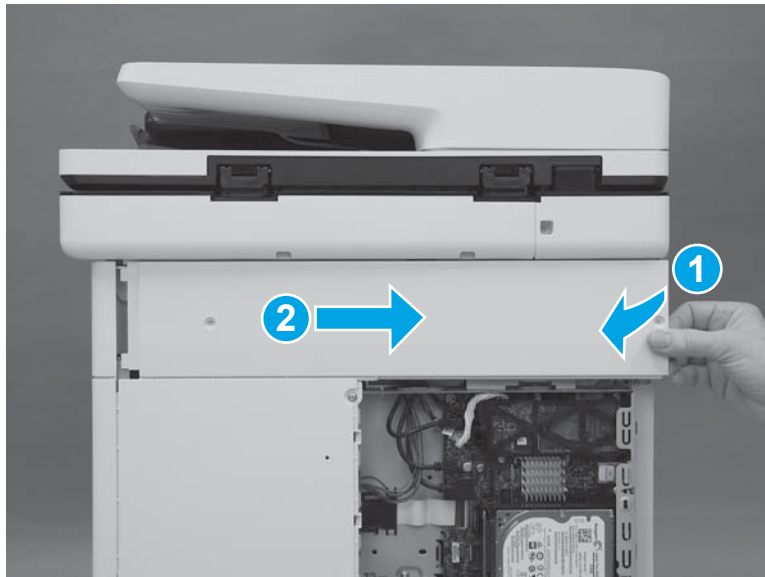

4. Remove the cover.

Figure 1-306 Remove the cover

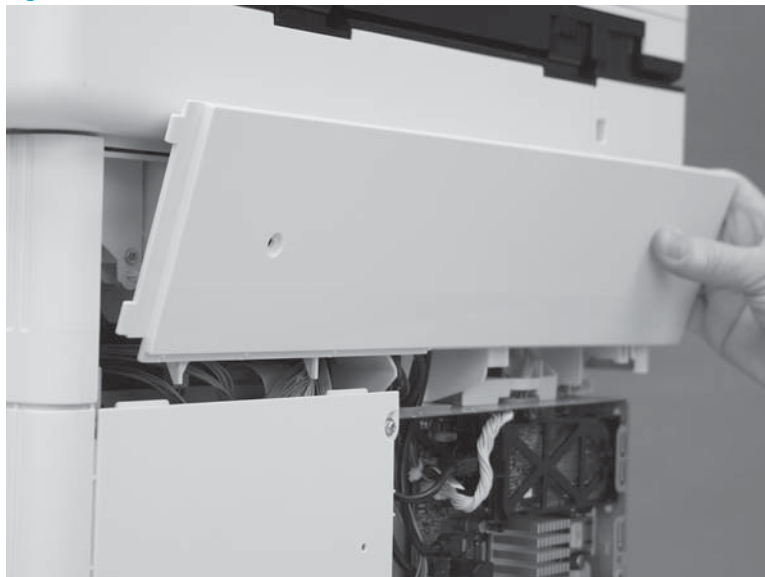

Step 3: Remove the left upper cover

1. At the left side of the printer, release one tab (callout 1).

Figure 1-307 Release one tab

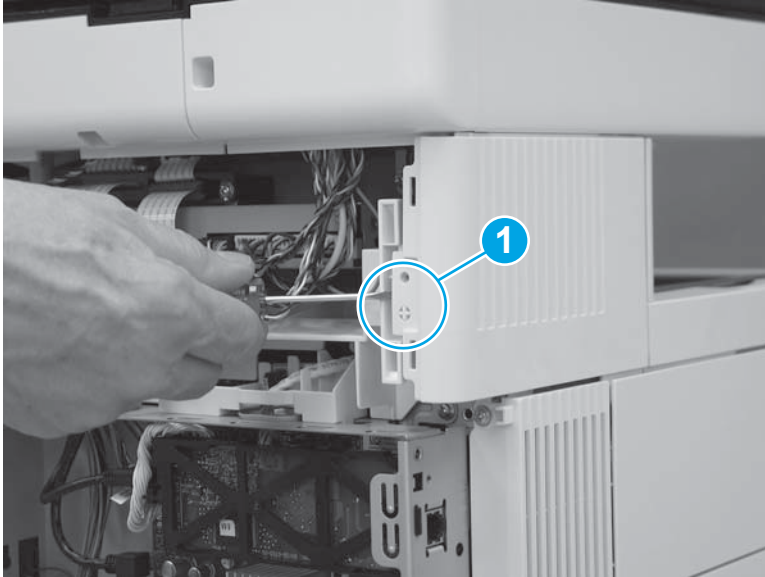

2. Slide the left upper cover toward the back of the printer.

Figure 1-308 Slide the cover back

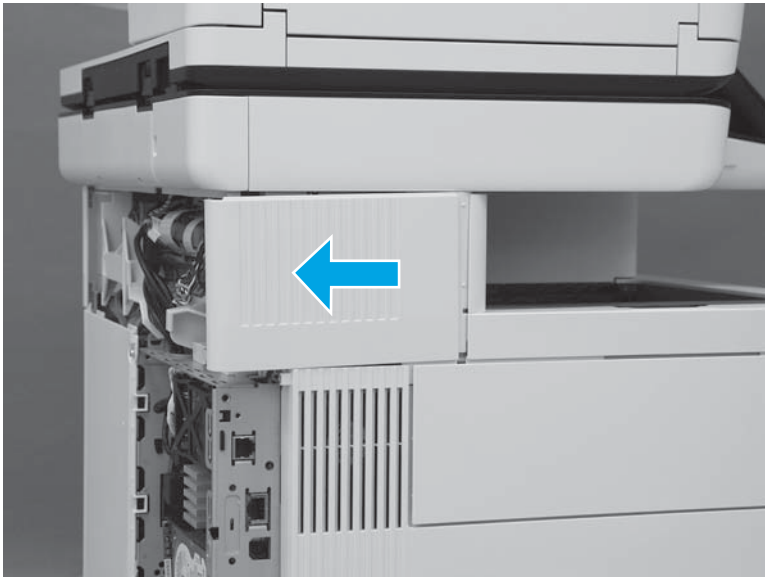

3. Rotate the cover up to remove it.

Figure 1-309 Remove the left upper cover



Step 4: Unpack the replacement assembly

Unpack the replacement assembly from the packaging.

For complete information on HP's recycling programs, go to [Product return and recycling](#).

 **NOTE:** HP recommends responsible disposal of the defective assembly.

Figure 1-310 Recycle and unpack

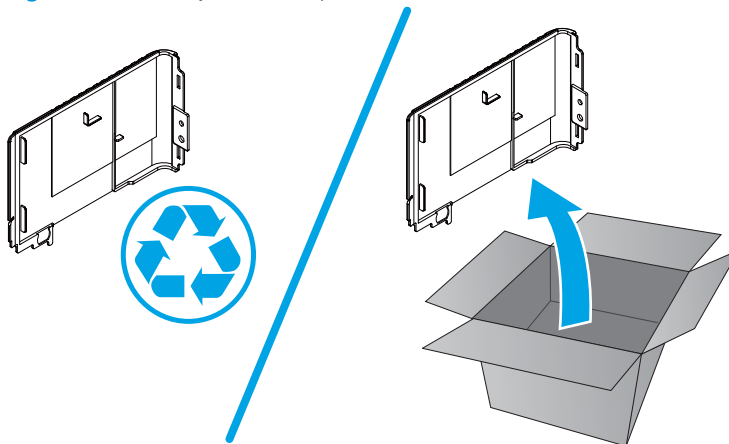

Step 5: Install the left upper cover

1. Position the tab (callout 1) on the lower edge of the cover behind the left cover (callout 2).

Figure 1-311 Position the tab

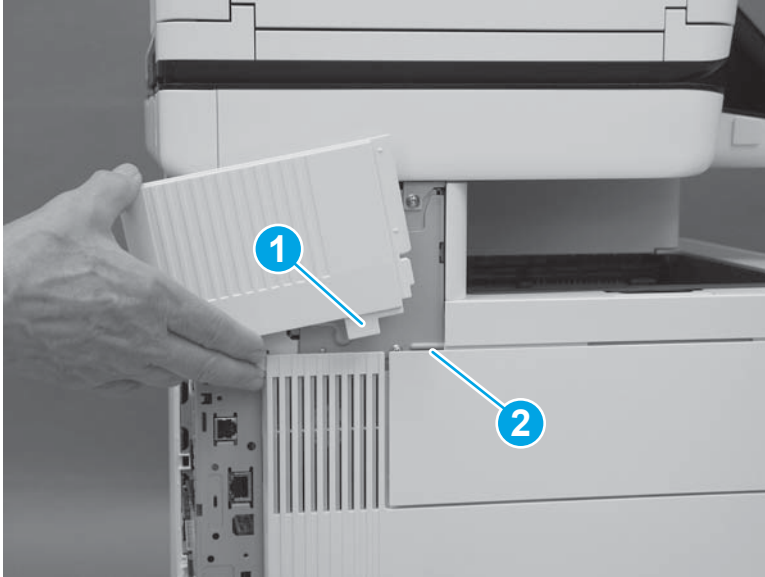

2. Slide the cover toward the front of the printer to install it. Make sure that the edge (callout 1) of the cover fits behind the edge (callout 2) of the top rear cover.

Figure 1-312 Slide the cover

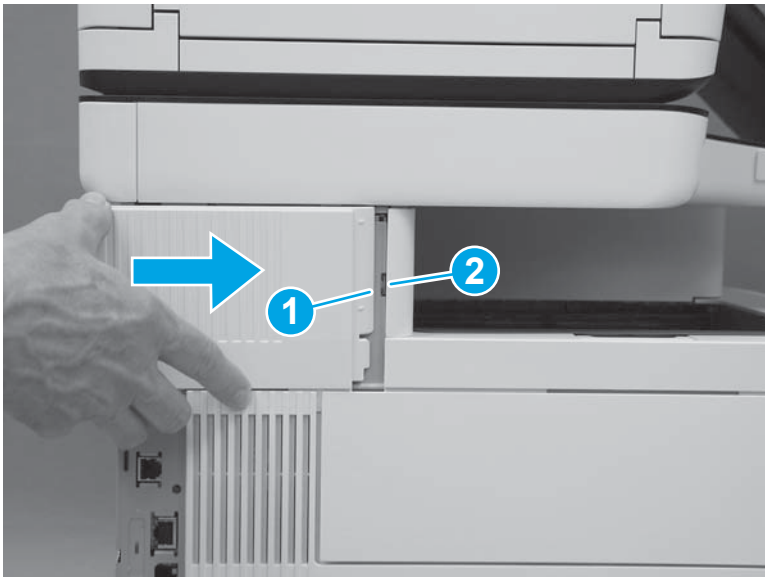

3. Make sure that the tab (callout 1) is fully installed.

Figure 1-313 Check the tab

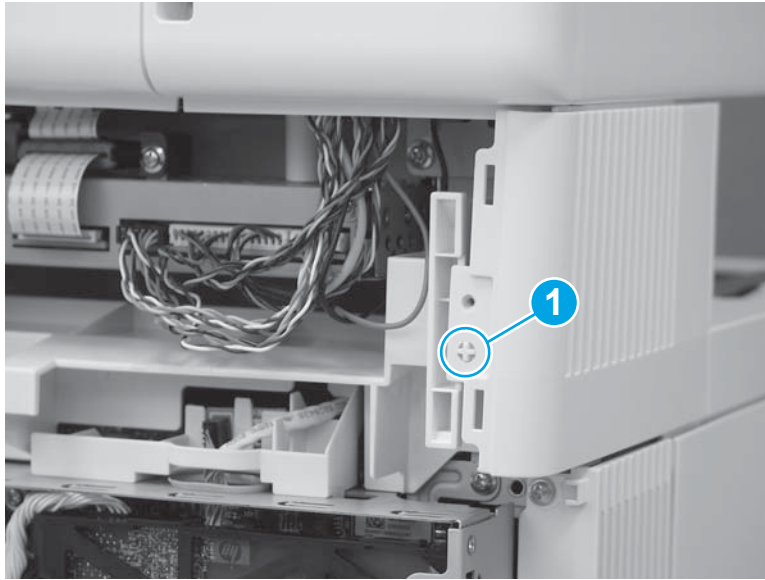

Step 6: Install the rear upper cover

1. Align the ridge (callout 1) on the lower edge of the rear upper cover in front of the tabs (callout 2) on the top edge of the rear cover.

Figure 1-314 Align the cover

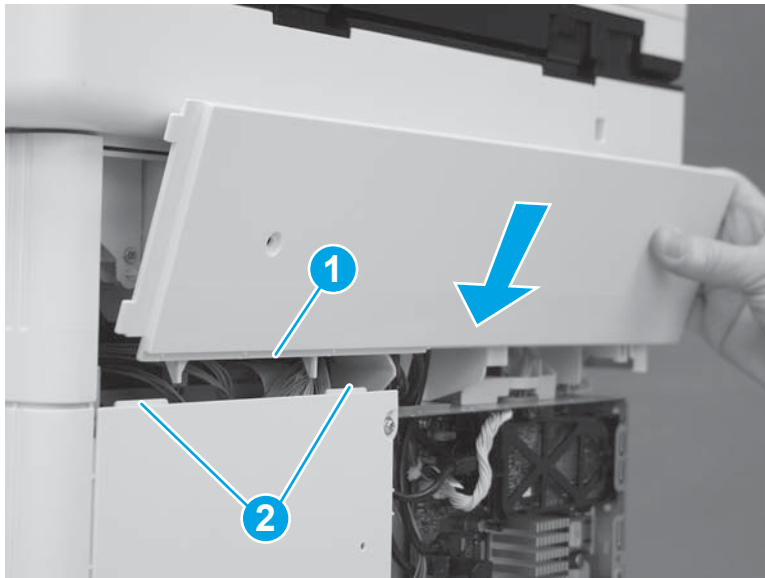

2. Rotate the top of the cover toward the printer.

Figure 1-315 Rotate the top of the cover

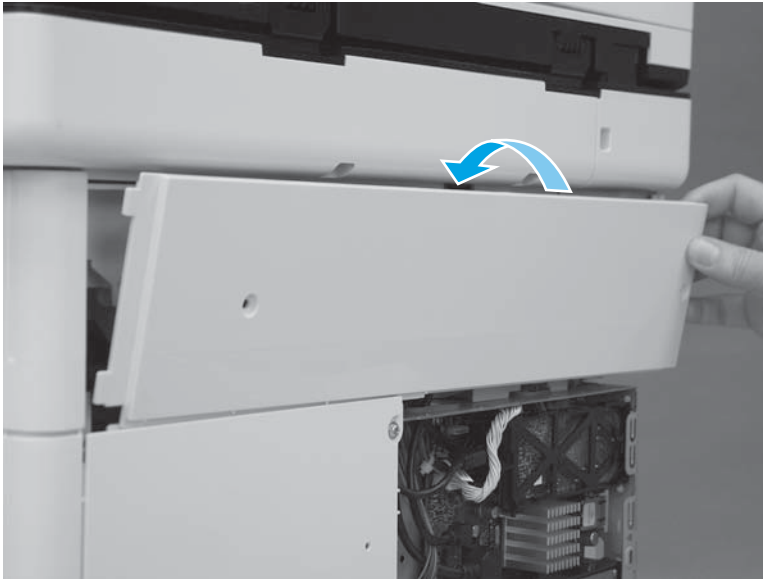

3. Slide the cover to the left (callout 1). Make sure that the tabs (callout 2) on the upper rear cover slide behind the edge (callout 3) of the right upper cover. Make sure that the cover is fully seated.

Figure 1-316 Slide the cover

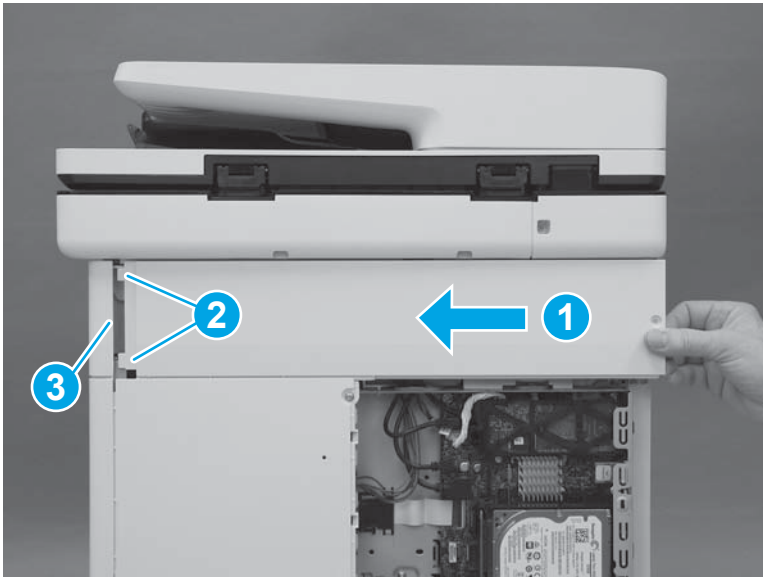

4. Install two screws (callout 1).

 **IMPORTANT:** These two screws are self-tapping screws for plastic. Rotate them counterclockwise to align them with the existing thread pattern, and then carefully turn them clockwise to tighten. Do not overtighten. This will prevent stripping the threads inside the screw holes.

Figure 1-317 Install two screws



Step 7: Install the formatter cover

- ▲ Slide the cover onto the printer (callout 1) to install it.

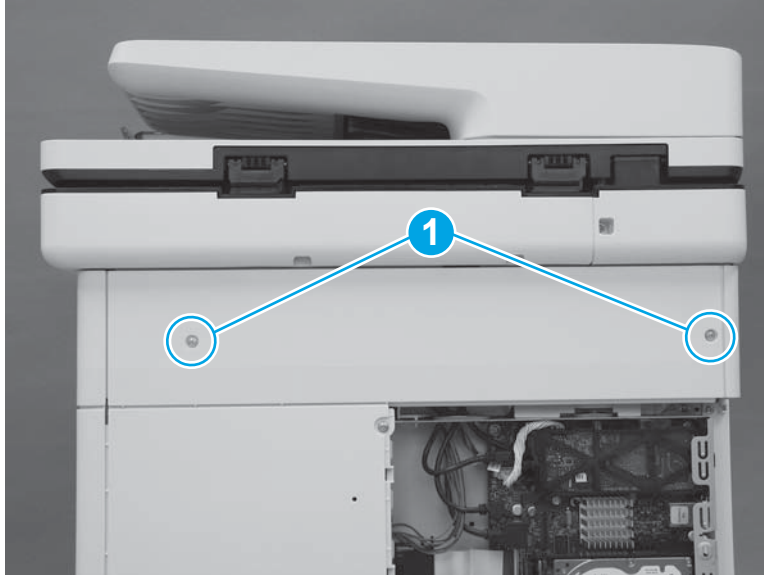
 **NOTE:** Make sure that the tabs on the formatter cover align with the slots provided in the printer (callout 2). Tighten the two thumbscrews (callout 3).

 **TIP:** If needed, use the edge of a coin to turn the thumbscrews.

Figure 1-318 Install the cover

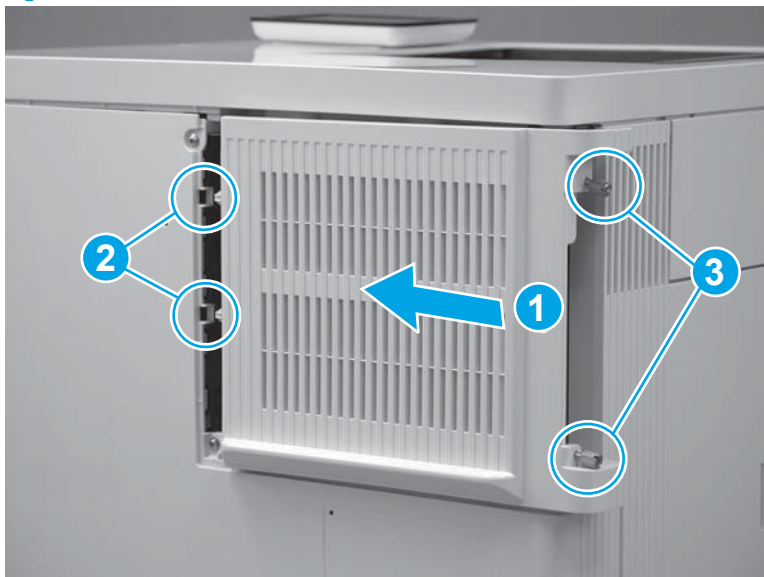

Removal and replacement: Right upper cover (M577)

- [Introduction](#)
- [Step 1: Remove the formatter cover](#)
- [Step 2: Remove the rear upper cover](#)
- [Step 3: Remove the right front upper cover \(M577dn\)](#)
- [Step 4: Remove the stapler cover assembly \(M577c/f/z\)](#)
- [Step 5: Remove the right upper cover \(M577\)](#)
- [Step 6: Unpack the replacement assembly](#)
- [Step 7: Install the right upper cover \(M577\)](#)
- [Step 8: Install the stapler cover assembly \(M577c/f/z\)](#)
- [Step 9: Install the right front upper cover \(M577dn\)](#)
- [Step 10: Install the rear upper cover](#)
- [Step 11: Install the formatter cover](#)

Introduction

This document provides the procedures to remove and replace the M577 right upper cover.

Before performing service

Turn the printer power off

- Disconnect the power cable.

 **WARNING!** To avoid damage to the printer, turn the printer off, wait 30 seconds, and then remove the power cord before attempting to service the printer.

Use the table below to identify the correct part number for your printer. To order the part, go to www.hp.com/buy/parts.

Right upper cover (M577) part number	
RC4-3386-000CN	Right upper cover (M577)

Required tools

- Small flat blade screwdriver
- #2 Phillips screwdriver with a magnetic tip

After performing service

Make sure that the right upper cover is fully seated after replacing it.

Turn the printer power on

- Connect the power cable.
- Use the power switch to turn the power on.

Step 1: Remove the formatter cover

1. Locate the formatter cover.

Figure 1-319 Locate the formatter cover

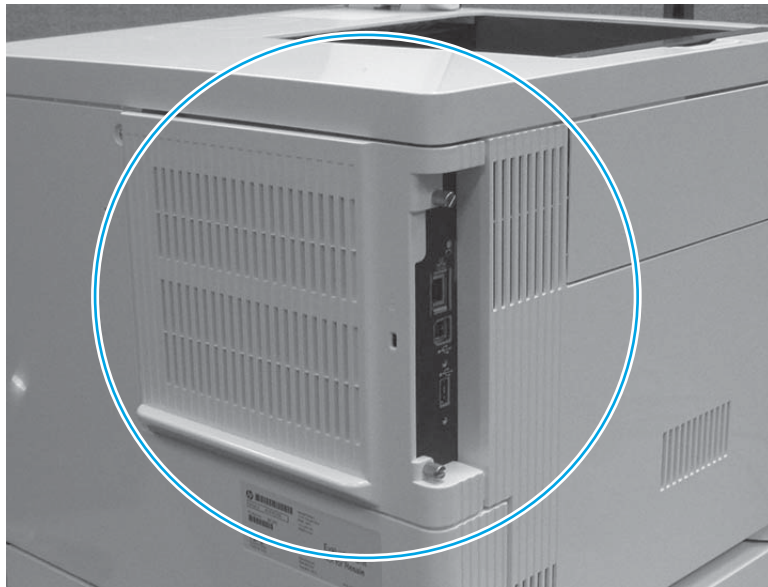

2. Loosen the two thumbscrews (callout 1). Grasp the two thumbscrews, and then slide the cover away from the printer (callout 2) to remove it.

 **TIP:** If needed, use the edge of a coin to turn the thumbscrews.

Figure 1-320 Loosen the thumbscrews

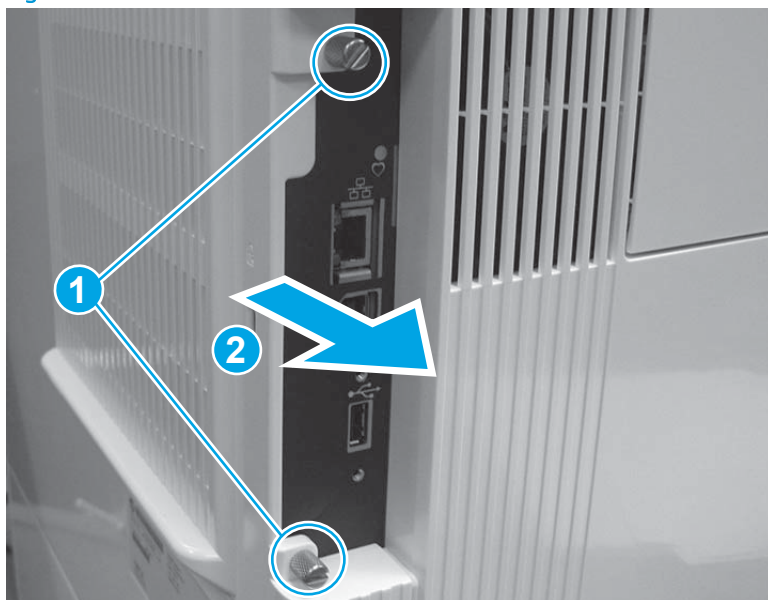

Step 2: Remove the rear upper cover

1. Remove two screws (callout 1).

 **Reinstallation tip:** These two screws are self-tapping screws for plastic. When reinstalling them, rotate the screws counterclockwise to align them with the existing thread pattern, and then carefully turn them clockwise to tighten. Do not overtighten. This will prevent stripping the threads inside the screw holes.

Figure 1-321 Remove two screws



2. Use a small, flat blade screwdriver to release the right edge of the cover.

Figure 1-322 Release the right edge

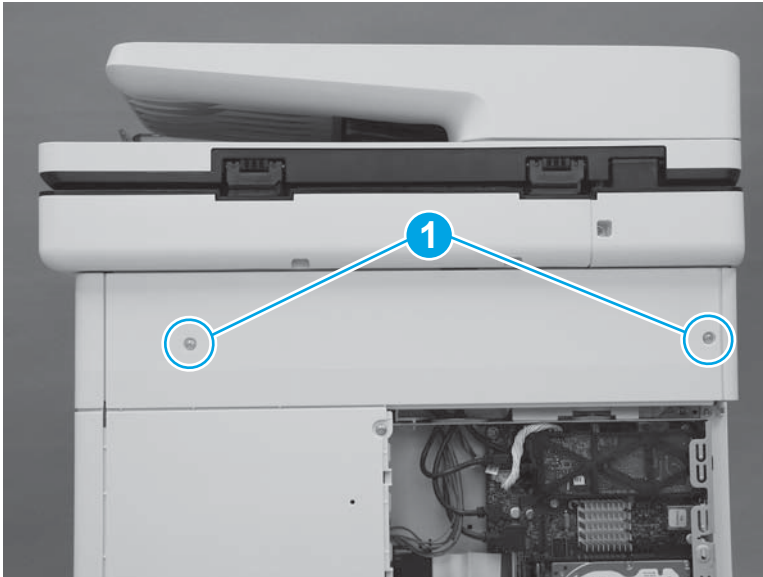
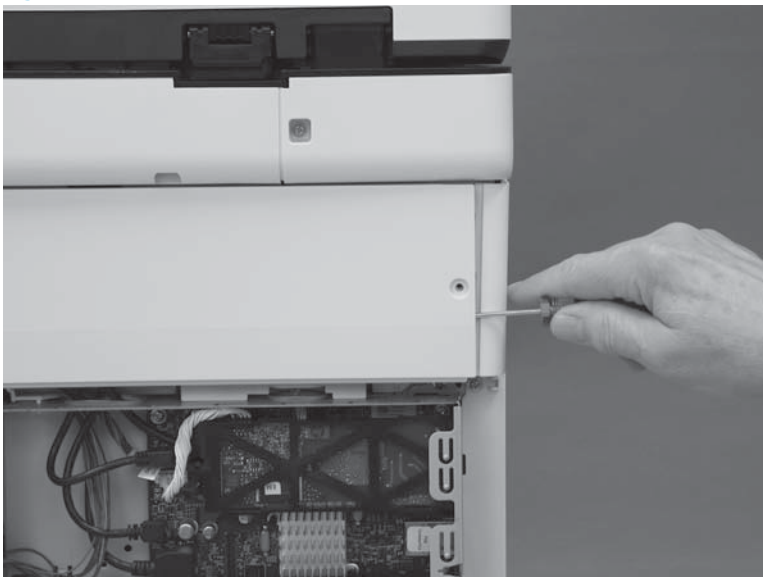

3. Pull the right edge of the cover (callout 1) away from the printer, and then slide the cover to the right (callout 2).

Figure 1-323 Slide the cover right

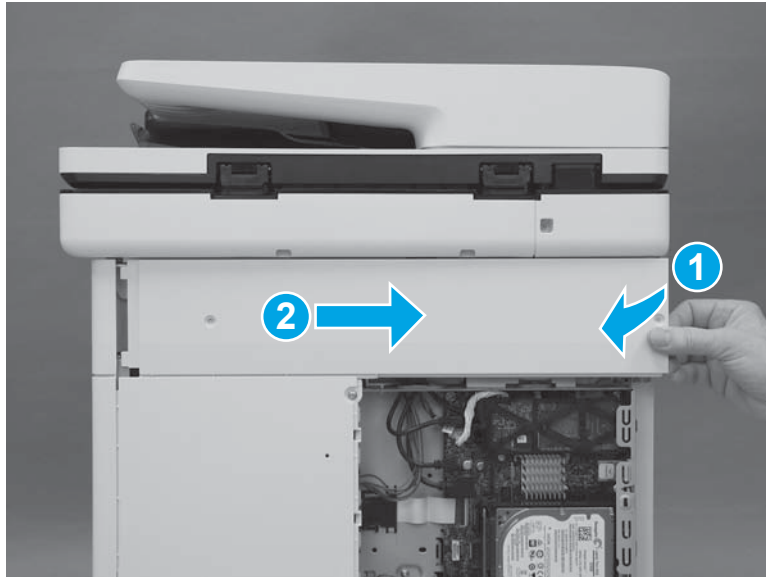

4. Remove the cover.

Figure 1-324 Remove the cover

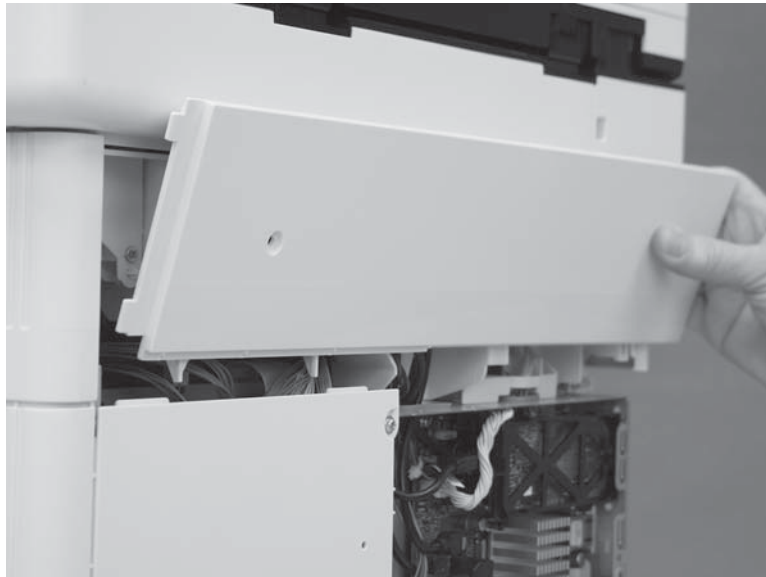

Step 3: Remove the right front upper cover (M577dn)

 **NOTE:** This step is for the M577dn model. For the M577c/f/z models, skip this step and to go [Step 4: Remove the stapler cover assembly \(M577c/f/z\) on page 213](#).

1. Remove one screw (callout 1).

Figure 1-325 Remove one screw

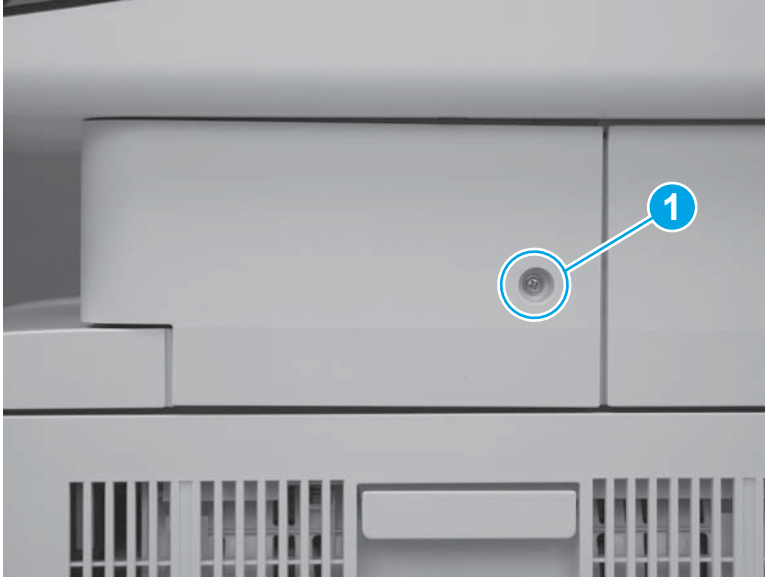

2. Release two tabs at the front edge of the cover (callout 1).

Figure 1-326 Release two tabs



3. Rotate the front of the cover to the right to remove it.

Figure 1-327 Rotate the cover



Step 4: Remove the stapler cover assembly (M577c/f/z)

 **NOTE:** This step is for the M577c/f/z models. For the M577dn model, skip this step and to go [Step 5: Remove the right upper cover \(M577\) on page 215](#).

1. Remove one screw (callout 1).

 **Reinstallation tip:** This is a self-tapping screw for plastic. When reinstalling, rotate the screw counterclockwise to align it with the existing thread pattern, and then carefully turn it clockwise to tighten. Do not overtighten. This will prevent stripping the threads inside the screw hole.

Figure 1-328 Remove one screw



2. Release two tabs at the front edge of the cover (callout 1).

Figure 1-329 Release two tabs

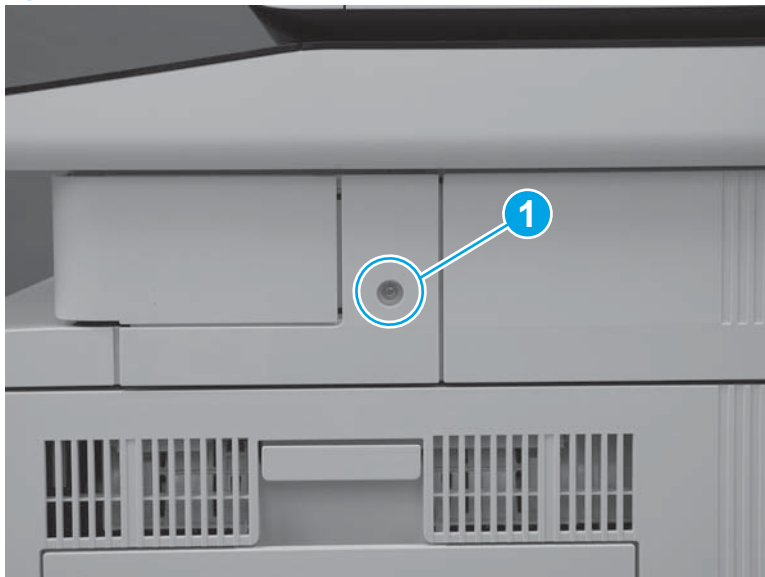

3. Release the back edge of the cover.

Figure 1-330 Release the back edge of the cover

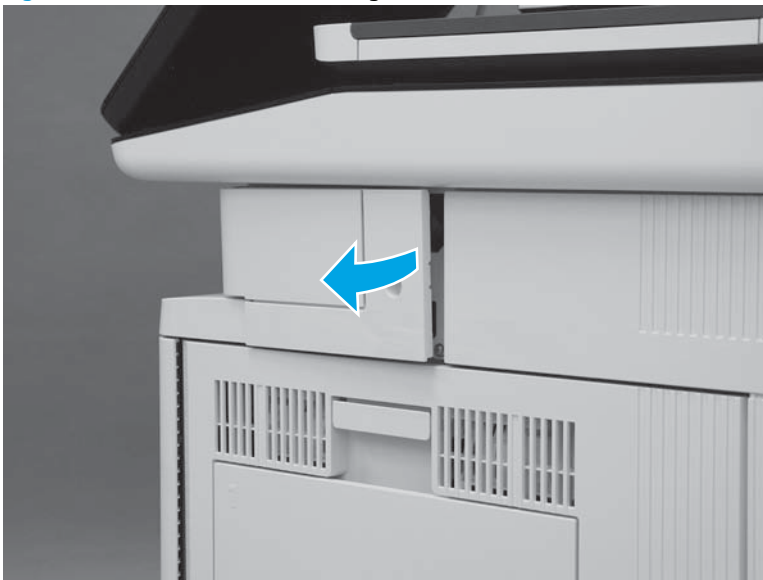

4. Rotate the cover away from the printer to remove it.

Figure 1-331 Remove the cover



Step 5: Remove the right upper cover (M577)

1. At the right side of the printer, remove two screws (callout 1).

M577c/f/z only: Disconnect one connector (callout 2).

Figure 1-332 Remove two screws and one connector

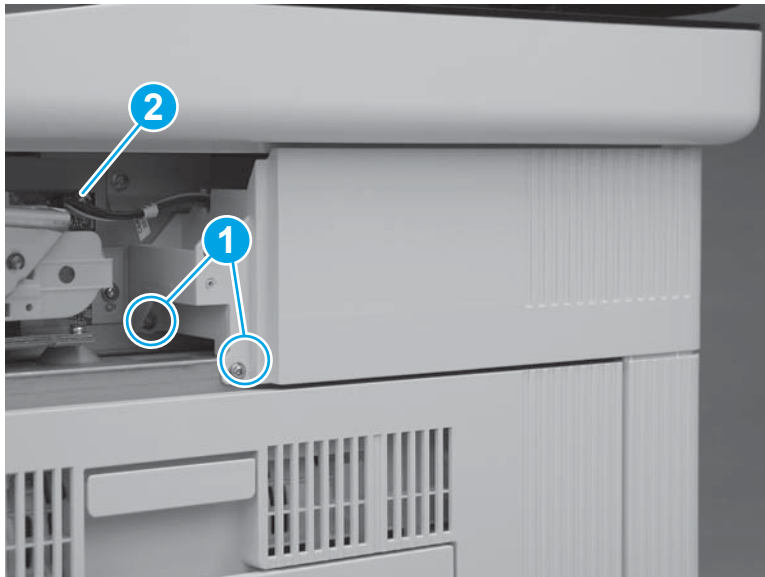

2. At the back of the printer, remove one screw (callout 1).

M577c/f/z only: Disconnect one connector (callout 2).

 **Reinstallation tip:** This screw is smaller than the screws removed in the previous step. When reinstalling the right upper cover, make sure that this screw is installed in the correct position.

Figure 1-333 Remove one screw and connector



3. Slide the cover toward the back of the printer.

Figure 1-334 Slide the cover

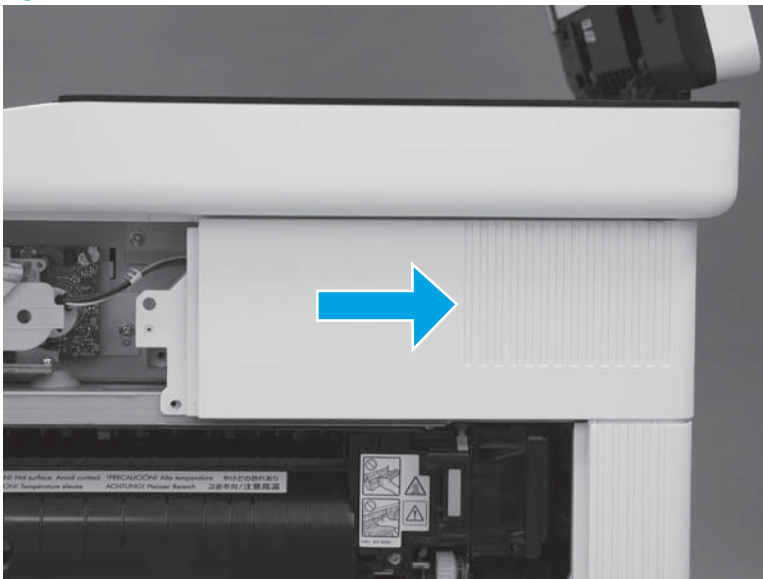

4. Lift the cover away from the printer to remove it.

M577c/f/z only: Release the cables (callout 1) through the slot (callout 2) in the printer.

Figure 1-335 Remove the cover

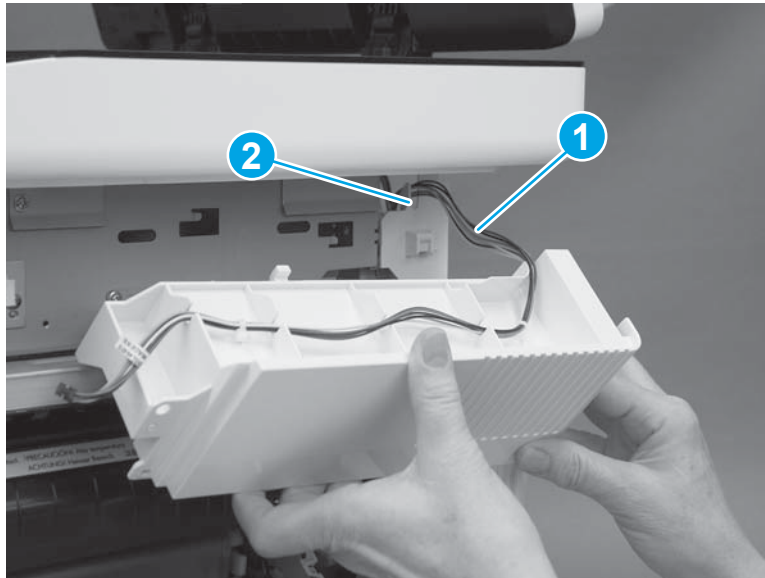

5. **M577c/f/z only:** Release two retainers on the bottom side of the cover.

Figure 1-336 Release two retainers

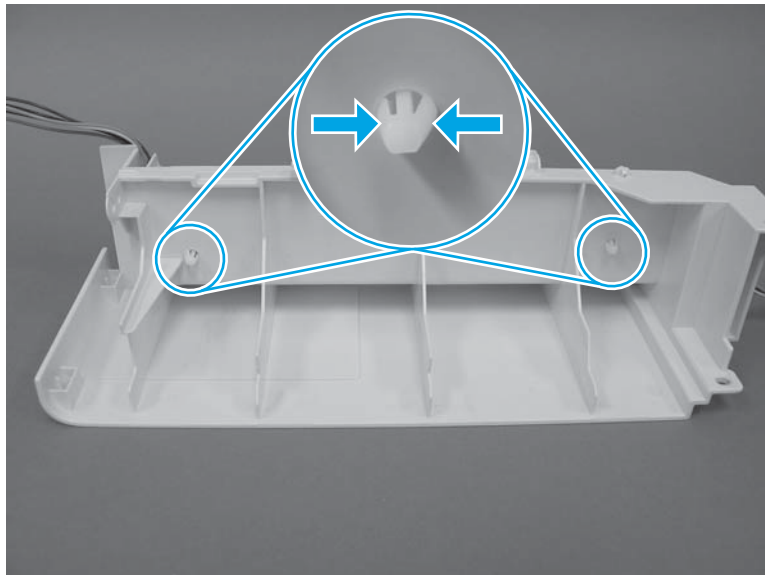

- M577c/f/z only:** On the top of the cover, release the wires (callout 1) from the guides (callout 2) in the right upper cover.

 **TIP:** Set the wire harness aside for installation on the replacement right upper cover.

Figure 1-337 Remove the wire harness

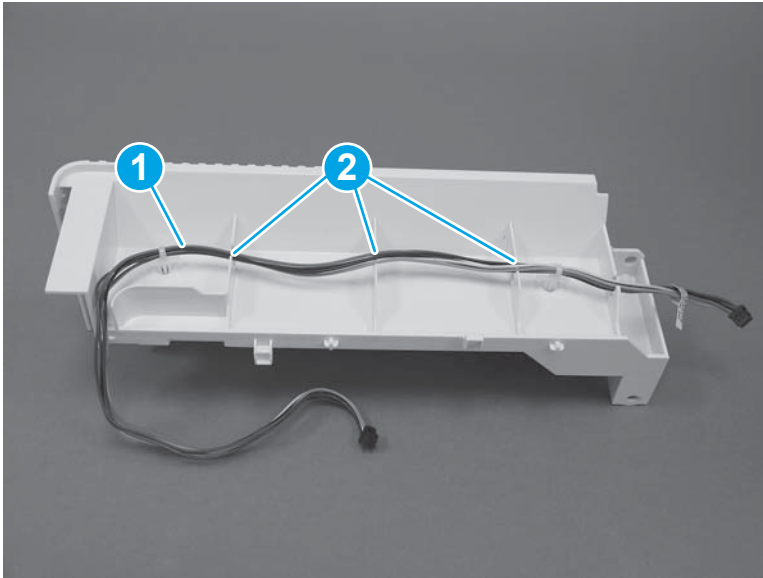

Step 6: Unpack the replacement assembly

Unpack the replacement assembly from the packaging.

For complete information on HP's recycling programs, go to [Product return and recycling](#).

 **NOTE:** HP recommends responsible disposal of the defective assembly.

Figure 1-338 Recycle and unpack

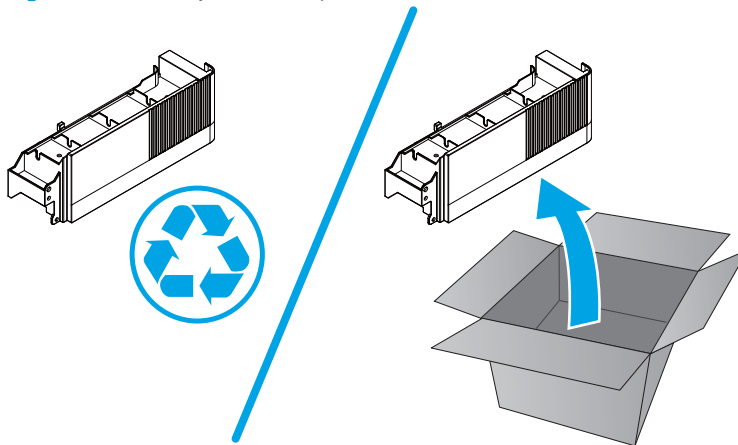

Step 7: Install the right upper cover (M577)

 **NOTE:** The M577z is shown in the figures below. The procedure is correct for all M577 models.

- M577c/f/z only:** Snap two retainers (callout 1) into place, and then install the wire harness (callout 2) in the guides (callout 3) in the cover.

Figure 1-339 Install the wire harness

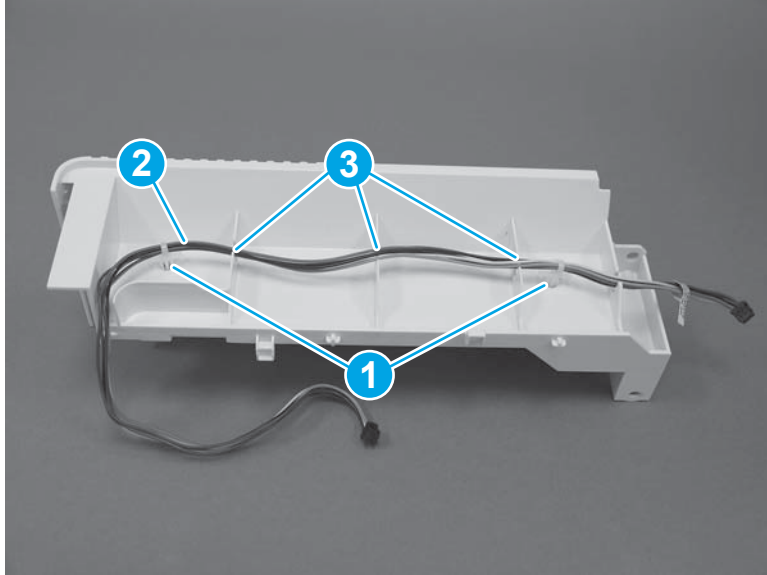

2. **M577c/f/z only:** Install the cables (callout 1) through the slot (callout 2) in the printer.

Figure 1-340 Install the cables

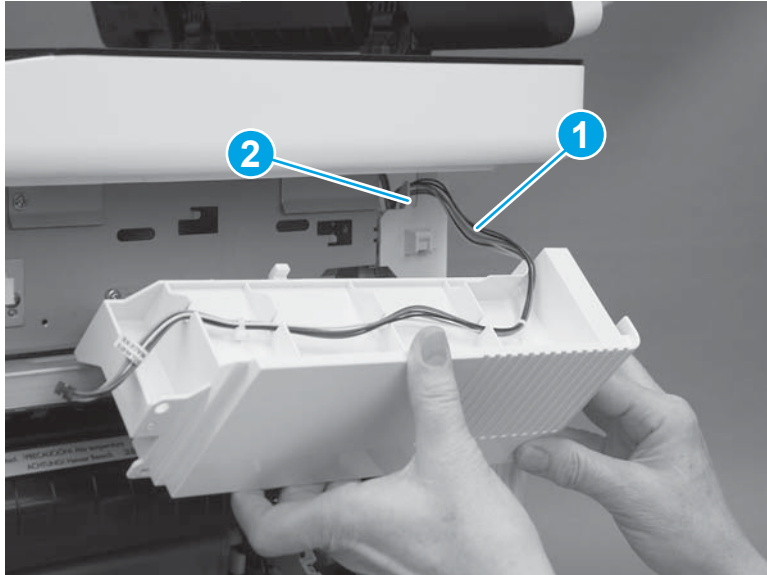

3. Position the hooks (callout 1) on the cover in the slots (callout 2) in the printer.

Figure 1-341 Position the hooks

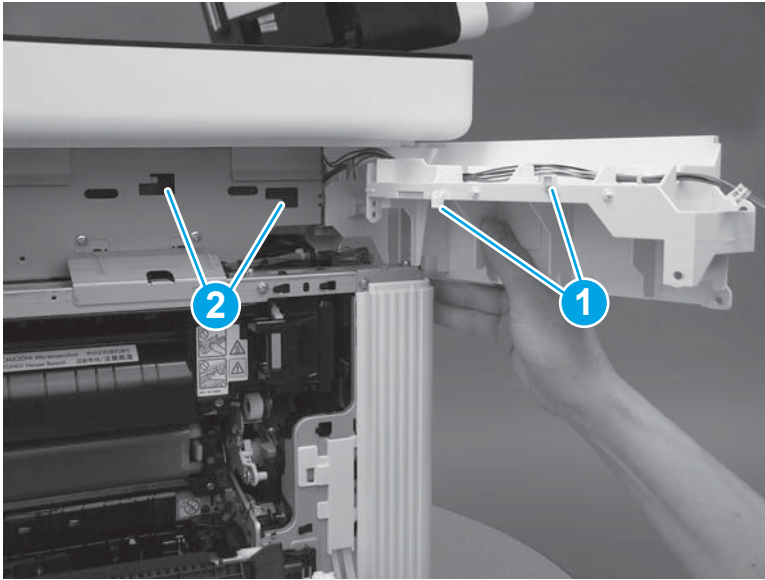

4. Slide the cover toward the front of the printer to install it.

Figure 1-342 Install the cover

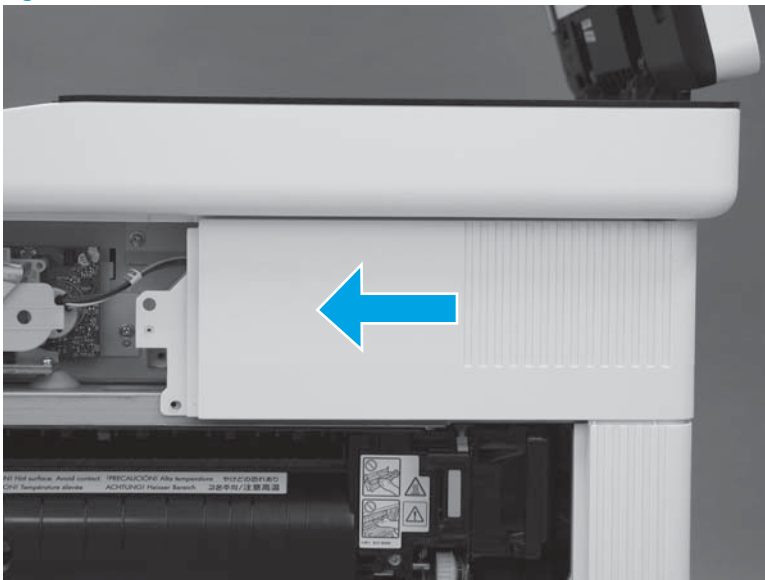

5. At the back of the printer, install one screw (callout 1).

M577c/f/z only: Connect one connector (callout 2).

 **TIP:** This screw is smaller than the screws installed in the next step. Make sure that this screw is installed in the correct position.

Figure 1-343 Install one screw and connector



6. At the right side of the printer, install two screws (callout 1).

M577c/f/z only: Connect one connector (callout 2).

Figure 1-344 Install one screw and connector

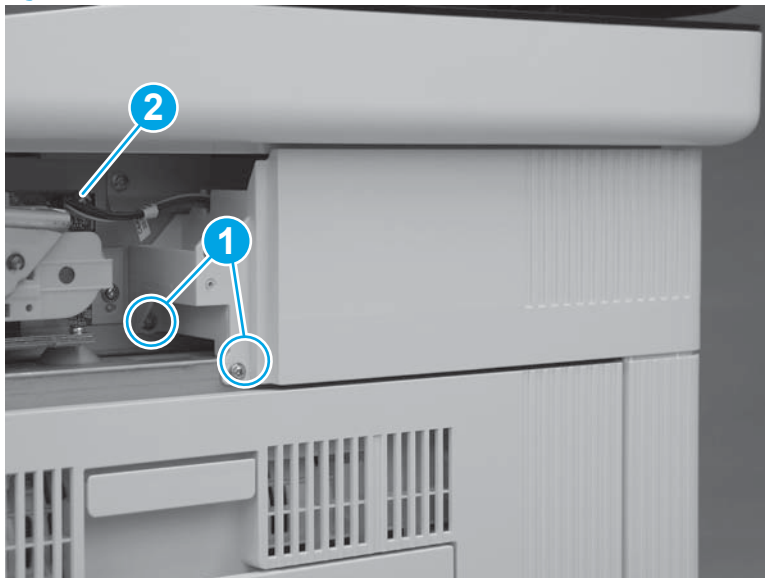

Step 8: Install the stapler cover assembly (M577c/f/z)

 **NOTE:** This step is for the M577c/f/z models only. For the M577dn model, skip this step and go to [Step 9: Install the right front upper cover \(M577dn\) on page 223](#).

1. Install the tabs (callout 1) on the cover in the slots (callout 2) in the printer.

Figure 1-345 Install two tabs



2. Press the cover toward the left side of the printer until it snaps into place.

Figure 1-346 Install the cover assembly



3. Install one screw (callout 1).

 **IMPORTANT:** This is a self-tapping screw for plastic. Rotate it counterclockwise to align it with the existing thread pattern, and then carefully turn it clockwise to tighten. Do not overtighten. This will prevent stripping the threads inside the screw hole.

Figure 1-347 Install one screw



Step 9: Install the right front upper cover (M577dn)

 **NOTE:** This step is for the M577dn model only. For the M577c/f/z models, skip this step and go to [Step 10: Install the rear upper cover on page 224](#).

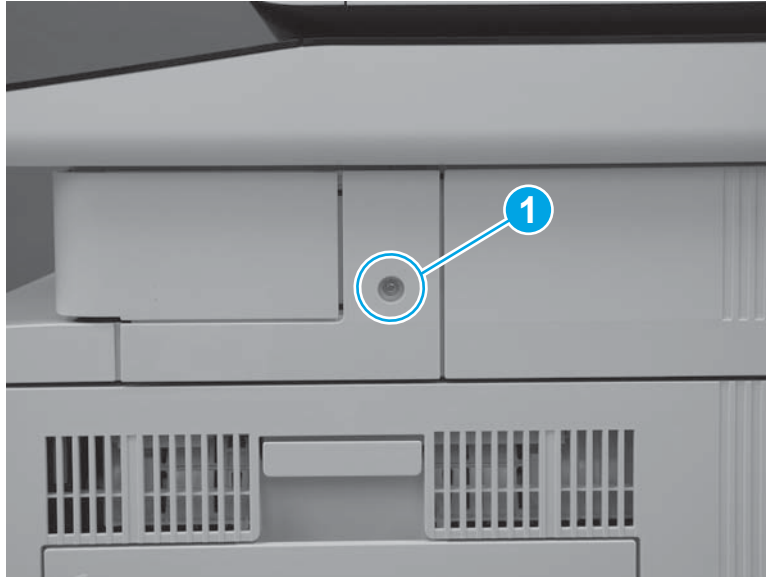
1. Slide the cover toward the left side of the printer to install it. Make sure that the slots (callout 1) in the cover fit over the tabs (callout 2) on the inside of the paper feeder cover.

Figure 1-348 Install the cover

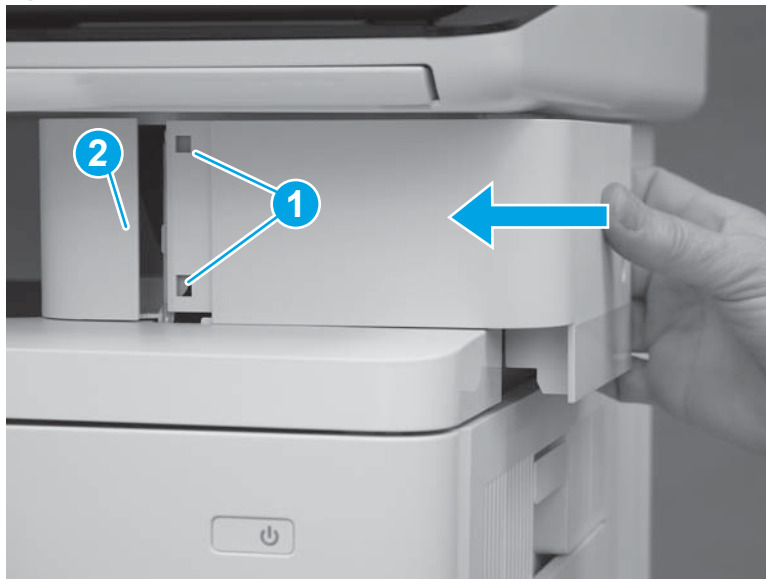

2. Press the right front upper cover (callout 1) and the paper feeder cover (callout 2) together until the tabs on the inside of the covers snap into place.

Figure 1-349 Press the cover



3. Install one screw (callout 1).

Figure 1-350 Install one screw

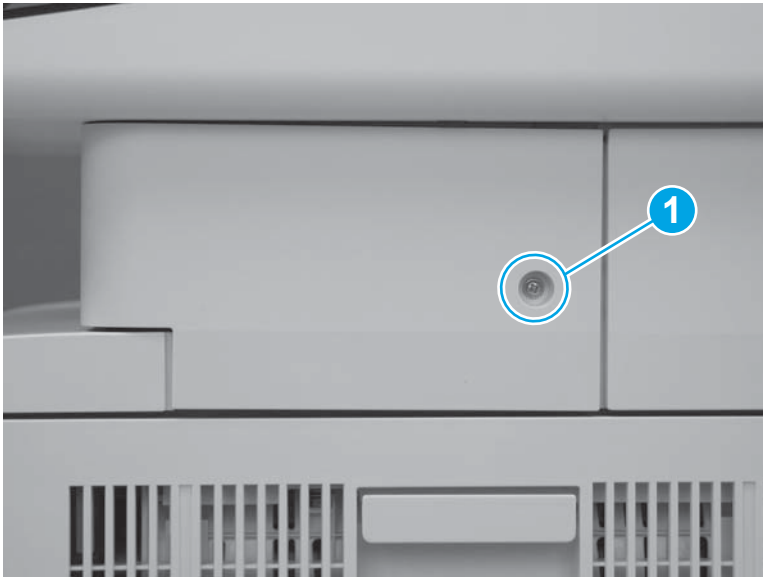

Step 10: Install the rear upper cover

1. Align the ridge (callout 1) on the lower edge of the rear upper cover in front of the tabs (callout 2) on the top edge of the rear cover.

Figure 1-351 Align the cover

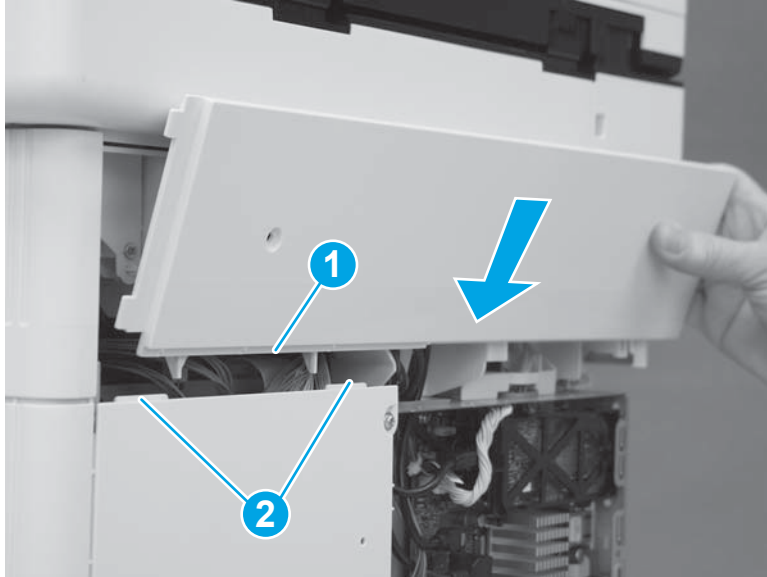

2. Rotate the top of the cover toward the printer.

Figure 1-352 Rotate the top of the cover

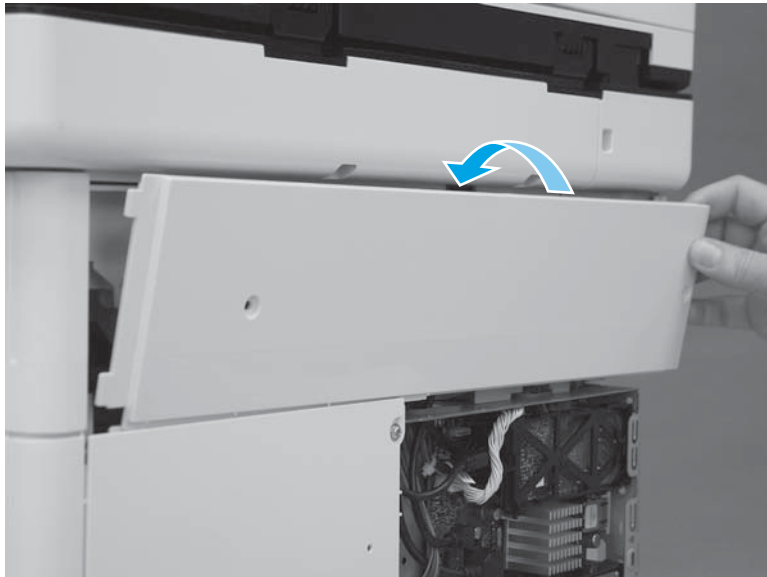

- Slide the cover to the left (callout 1). Make sure that the tabs (callout 2) on the upper rear cover slide behind the edge (callout 3) of the right upper cover. Make sure that the cover is fully seated.

Figure 1-353 Slide the cover

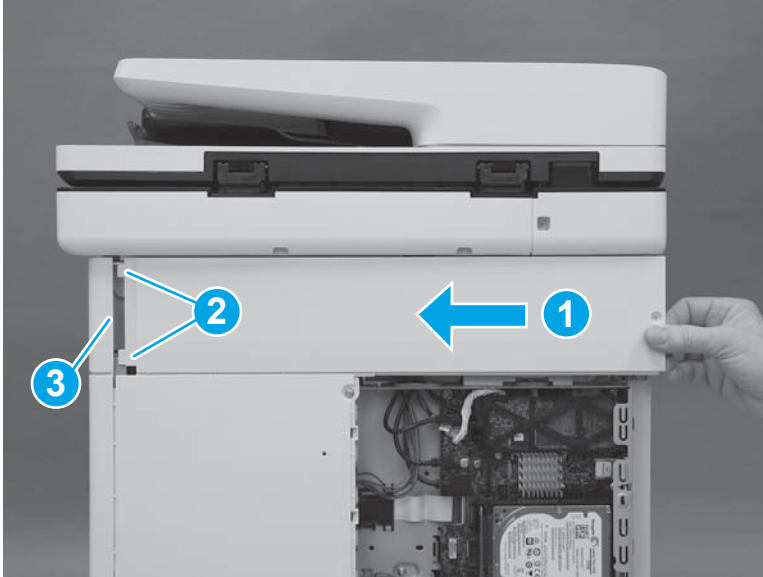

- Install two screws (callout 1).



 **IMPORTANT:** These two screws are self-tapping screws for plastic. Rotate them counterclockwise to align them with the existing thread pattern, and then carefully turn them clockwise to tighten. Do not overtighten. This will prevent stripping the threads inside the screw holes.

Figure 1-354 Install two screws

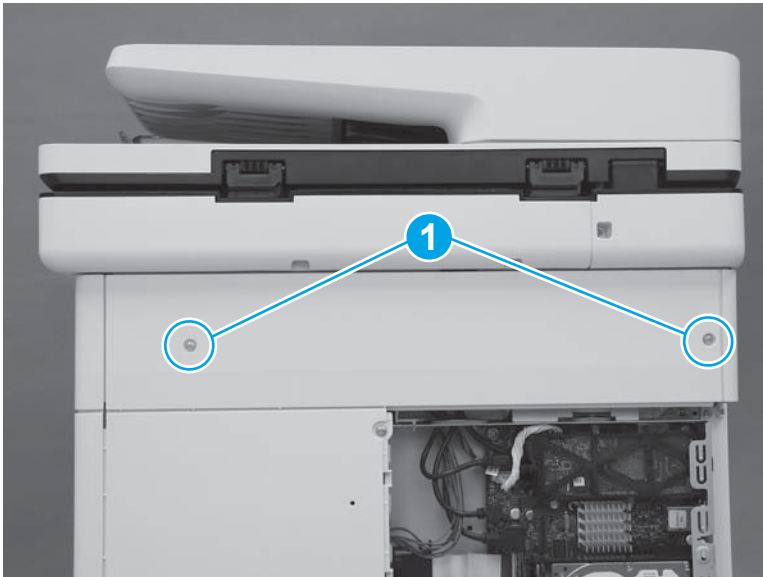

Step 11: Install the formatter cover

- ▲ Slide the cover onto the printer (callout 1) to install it.

 **NOTE:** Make sure that the tabs on the formatter cover align with the slots provided in the printer (callout 2). Tighten the two thumbscrews (callout 3).

 **TIP:** If needed, use the edge of a coin to turn the thumbscrews.

Figure 1-355 Install the cover

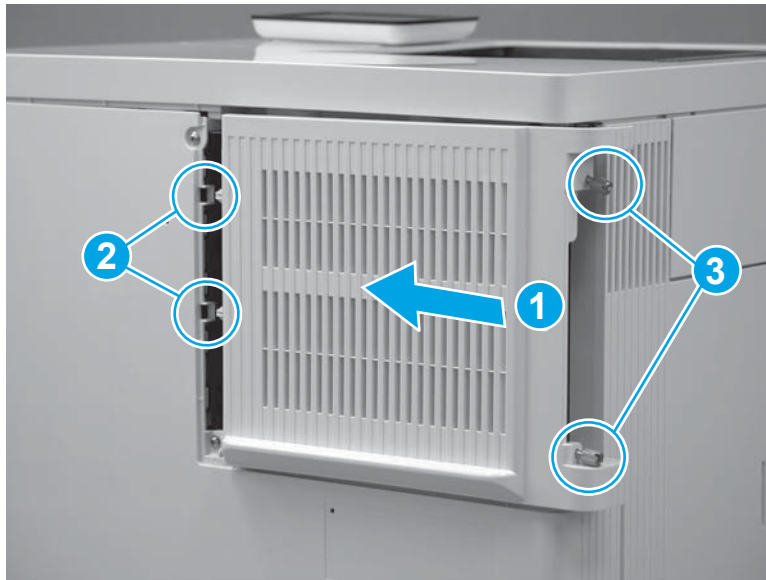

Removal and replacement: Top rear cover (M577)

- [Introduction](#)
- [Step 1: Remove the formatter cover](#)
- [Step 2: Remove the rear upper cover](#)
- [Step 3: Remove the left upper cover](#)
- [Step 4: Remove the right front upper cover \(M577dn\)](#)
- [Step 5: Remove the stapler cover assembly \(M577c/f/z\)](#)
- [Step 6: Remove the integrated scanner assembly \(ISA\) \(M577\)](#)
- [Step 7: Remove the right upper cover \(M577\)](#)
- [Step 8: Remove the top rear cover](#)
- [Step 9: Unpack the replacement assembly](#)
- [Step 10: Install the top rear cover](#)
- [Step 11: Install the right upper cover \(M577\)](#)
- [Step 12: Install the integrated scanner assembly \(ISA\) \(M577\)](#)
- [Step 13: Install the stapler cover assembly \(M577c/f/z\)](#)
- [Step 14: Install the right front upper cover \(M577dn\)](#)
- [Step 15: Install the left upper cover](#)
- [Step 16: Install the rear upper cover](#)
- [Step 17: Install the formatter cover](#)

Introduction

This document provides the procedures to remove and replace the M577 top rear cover.

Before performing service

Turn the printer power off

- Disconnect the power cable.

 **WARNING!** To avoid damage to the printer, turn the printer off, wait 30 seconds, and then remove the power cord before attempting to service the printer.

Use the table below to identify the correct part number for your printer. To order the part, go to www.hp.com/buy/parts.

Top rear cover (M577) part number

RC4-3383-000CN

Top rear cover (M577)

Required tools

- Small flat blade screwdriver
- #2 Phillips screwdriver with a magnetic tip

After performing service

Make sure that the top rear cover is fully seated after replacing it.

Turn the printer power on

- Connect the power cable.
- Use the power switch to turn the power on.

Step 1: Remove the formatter cover

1. Locate the formatter cover.

Figure 1-356 Locate the formatter cover

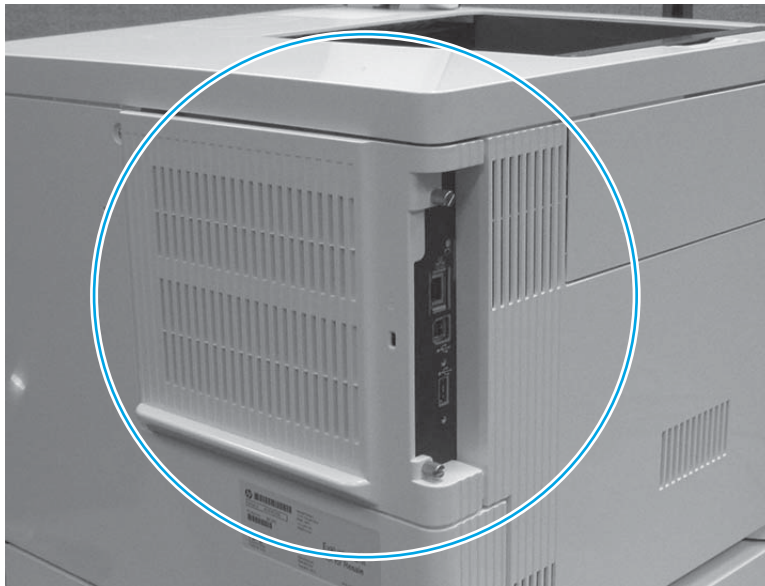

2. Loosen the two thumbscrews (callout 1). Grasp the two thumbscrews, and then slide the cover away from the printer (callout 2) to remove it.

 **TIP:** If needed, use the edge of a coin to turn the thumbscrews.

Figure 1-357 Loosen the thumbscrews

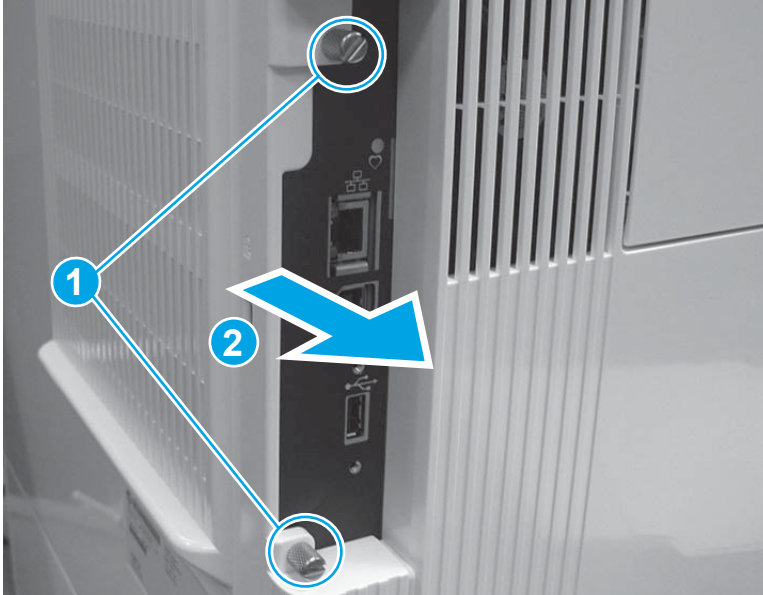

Step 2: Remove the rear upper cover

1. Remove two screws (callout 1).

 **Reinstallation tip:** These two screws are self-tapping screws for plastic. When reinstalling them, rotate the screws counterclockwise to align them with the existing thread pattern, and then carefully turn them clockwise to tighten. Do not overtighten. This will prevent stripping the threads inside the screw holes.

Figure 1-358 Remove two screws



2. Use a small, flat blade screwdriver to release the right edge of the cover.

Figure 1-359 Release the right edge

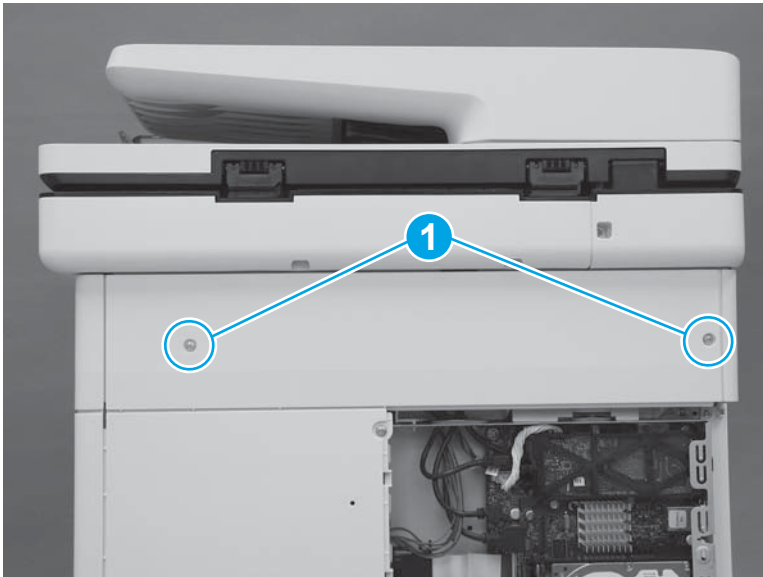
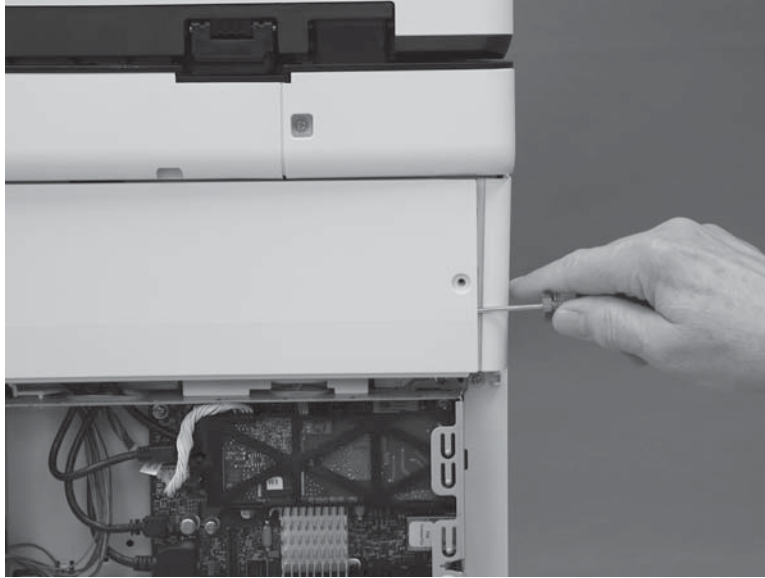

3. Pull the right edge of the cover (callout 1) away from the printer, and then slide the cover to the right (callout 2).

Figure 1-360 Slide the cover right

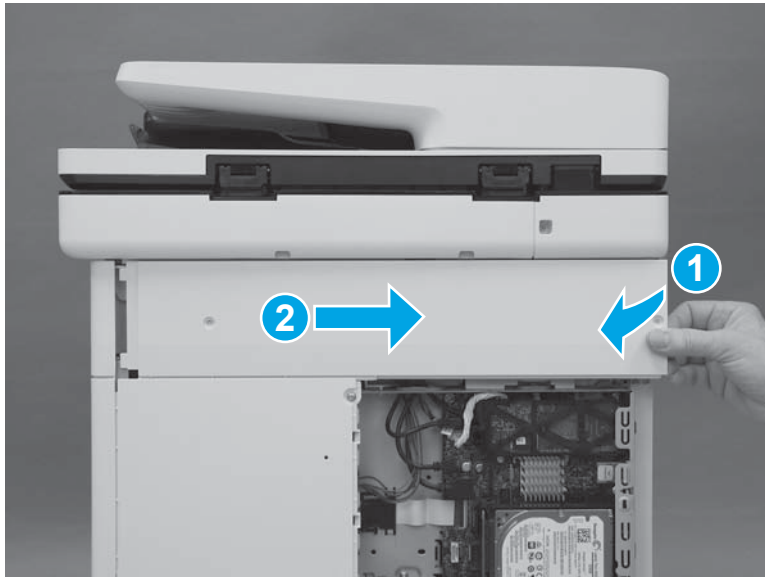

4. Remove the cover.

Figure 1-361 Remove the cover

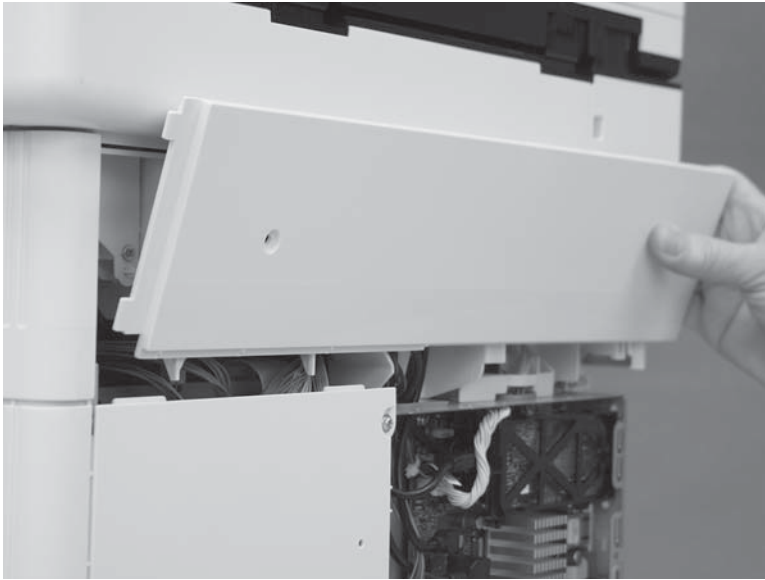

Step 3: Remove the left upper cover

1. At the left side of the printer, release one tab (callout 1).

Figure 1-362 Release one tab

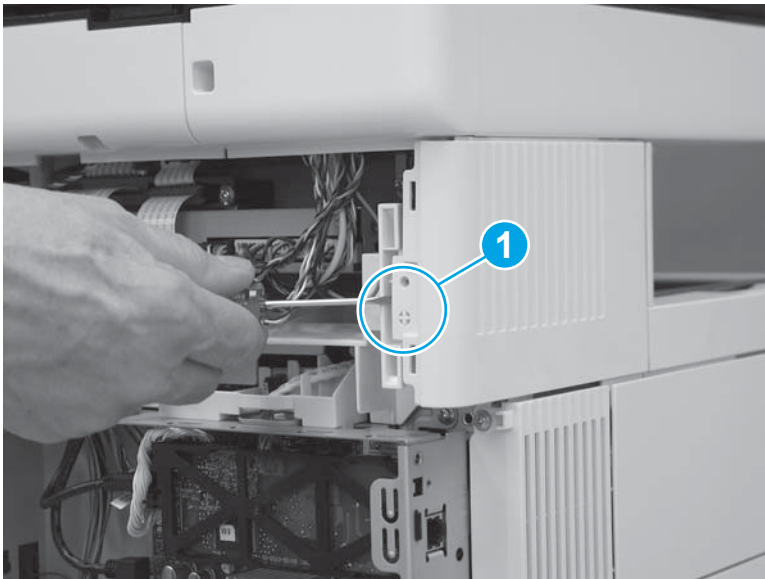

2. Slide the left upper cover toward the back of the printer.

Figure 1-363 Slide the cover back

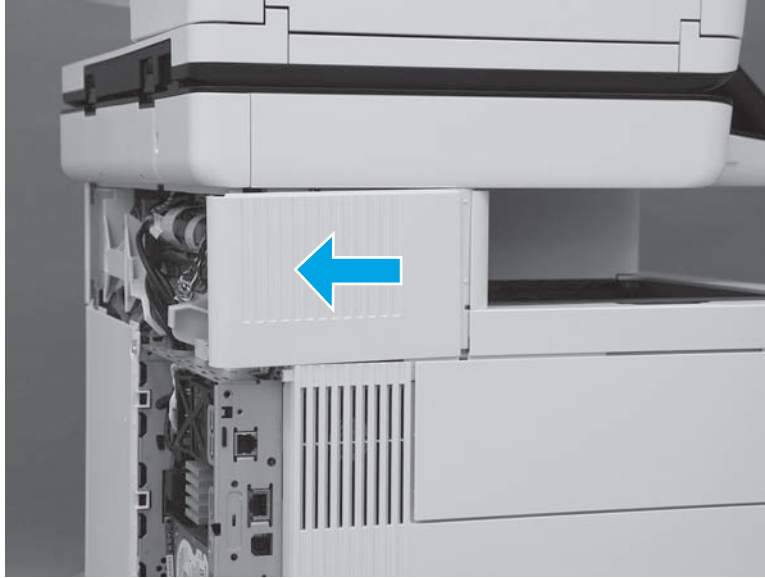

3. Rotate the cover up to remove it.

Figure 1-364 Remove the left upper cover

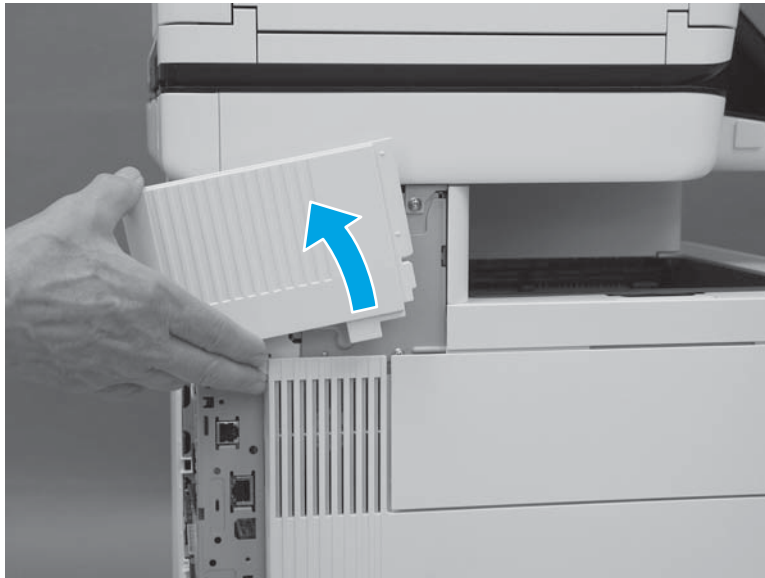

Step 4: Remove the right front upper cover (M577dn)

 **NOTE:** This step is for the M577dn model. For the M577c/f/z models, skip this step and to go [Step 5: Remove the stapler cover assembly \(M577c/f/z\) on page 235](#).

1. Remove one screw (callout 1).

Figure 1-365 Remove one screw

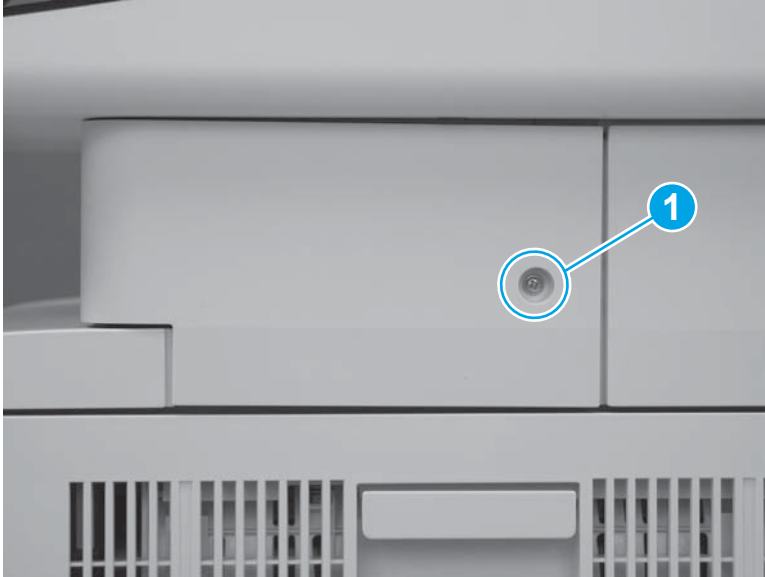

2. Release two tabs at the front edge of the cover (callout 1).

Figure 1-366 Release two tabs



3. Rotate the front of the cover to the right to remove it.

Figure 1-367 Rotate the cover



Step 5: Remove the stapler cover assembly (M577c/f/z)

 **NOTE:** This step is for the M577c/f/z models. For the M577dn model, skip this step and to go [Step 7: Remove the right upper cover \(M577\) on page 240](#).

1. Remove one screw (callout 1).

 **Reinstallation tip:** This is a self-tapping screw for plastic. When reinstalling, rotate the screw counterclockwise to align it with the existing thread pattern, and then carefully turn it clockwise to tighten. Do not overtighten. This will prevent stripping the threads inside the screw hole.

Figure 1-368 Remove one screw



2. Release two tabs at the front edge of the cover (callout 1).

Figure 1-369 Release two tabs

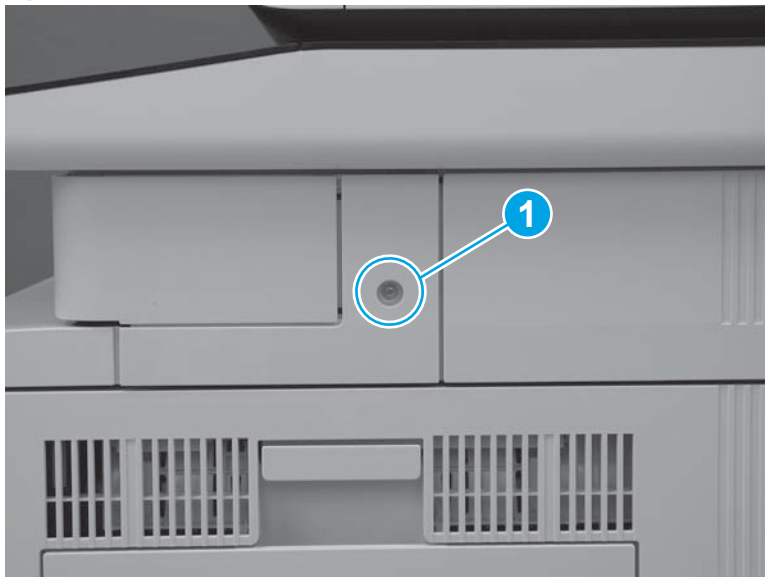

3. Release the back edge of the cover.

Figure 1-370 Release the back edge of the cover



4. Rotate the cover away from the printer to remove it.

Figure 1-371 Remove the cover



Step 6: Remove the integrated scanner assembly (ISA) (M577)

 **NOTE:** The ISA includes the document feeder, image scanner, scanner control board (SCB), control panel, keyboard (M577c/z) and NFC PCA (M577z).

1. At the left side of the printer, remove one screw (callout 1).

Figure 1-372 Remove one screw

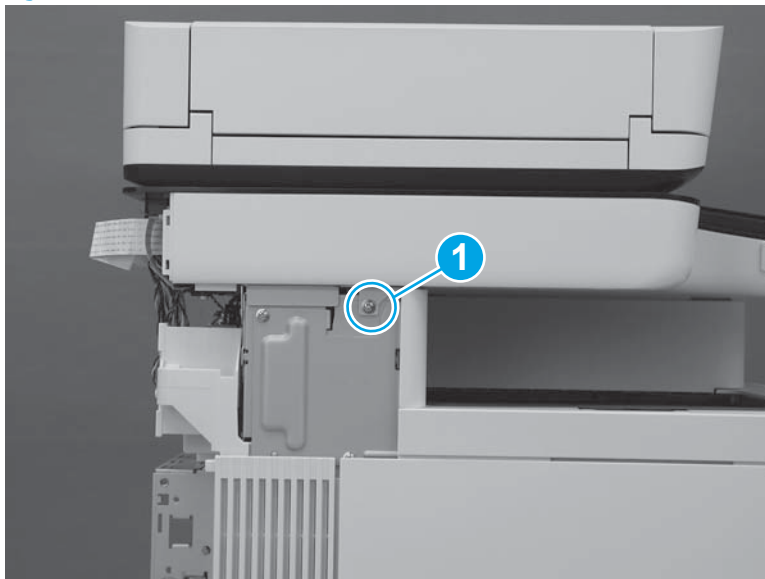

2. At the back side of the printer, remove two screws (callout 1).

Figure 1-373 Remove two screws

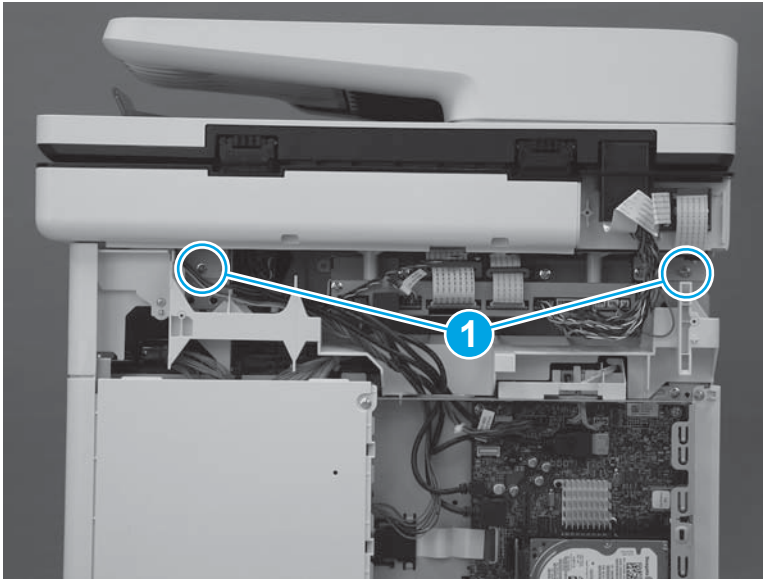

3. At the right side of the printer, remove one screw (callout 1).

Figure 1-374 Remove one screw

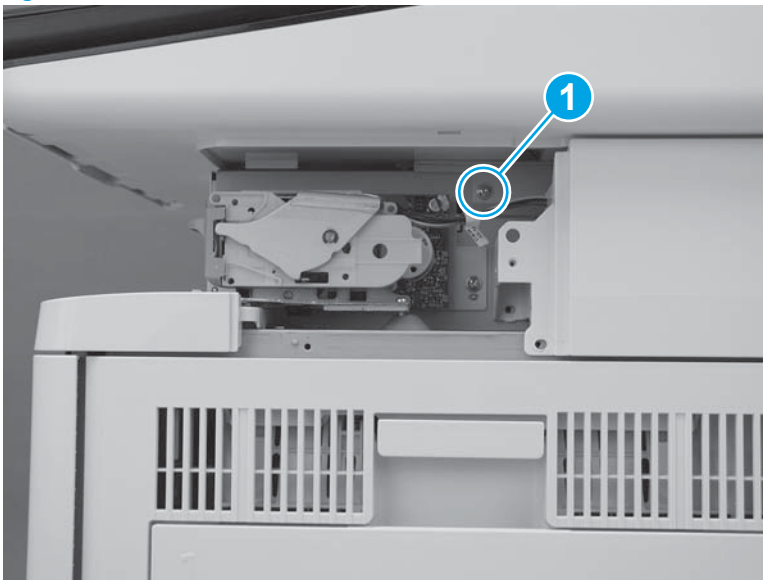

4. Disconnect four connectors on the formatter (callout 1), and then pass the wire harness and cables through the opening in the formatter case (callout 2).

Figure 1-375 Disconnect four connectors

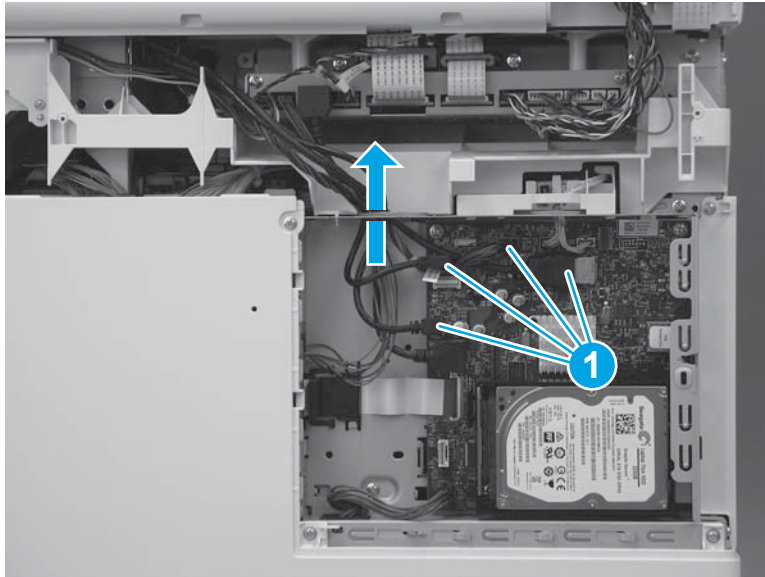

5. Disconnect two connectors on the scanner control board (callout 1).

M577c/f/z only: Disconnect one connector for the stapler on the scanner control board (callout 2).

Figure 1-376 Disconnect connectors

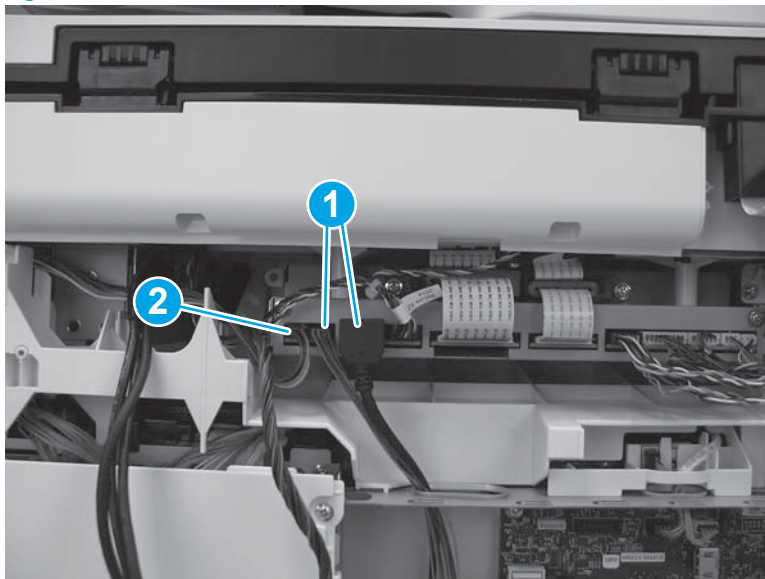

6. Slightly slide the ISA towards the back of the printer to release it.

Figure 1-377 Slide the ISA towards the back of the printer

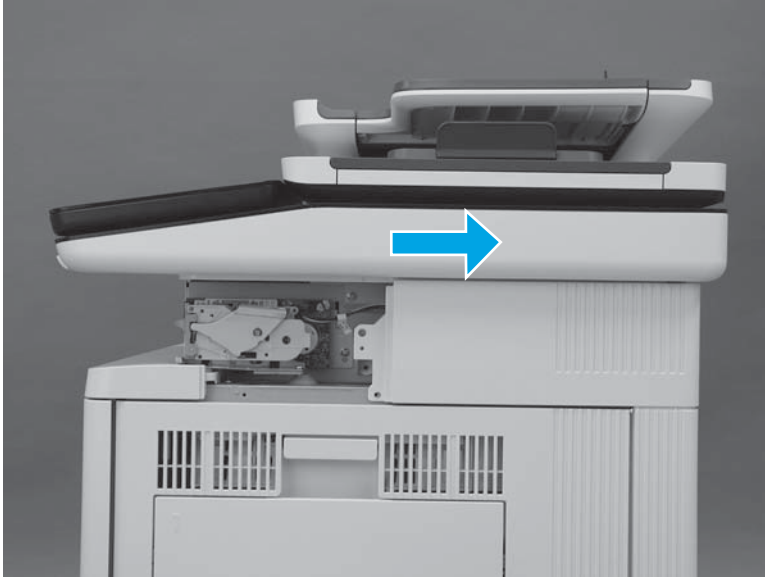

7. Lift the ISA up to remove it.

Figure 1-378 Remove the ISA



Step 7: Remove the right upper cover (M577)

 **NOTE:** The figures below show the image scanner installed. The procedures for removing and installing the right upper cover are the same whether the image scanner is installed or removed."

1. At the right side of the printer, remove two screws (callout 1).

M577c/f/z only: Disconnect one connector (callout 2), if it was not already disconnected in a previous step.

Figure 1-379 Remove two screws and one connector

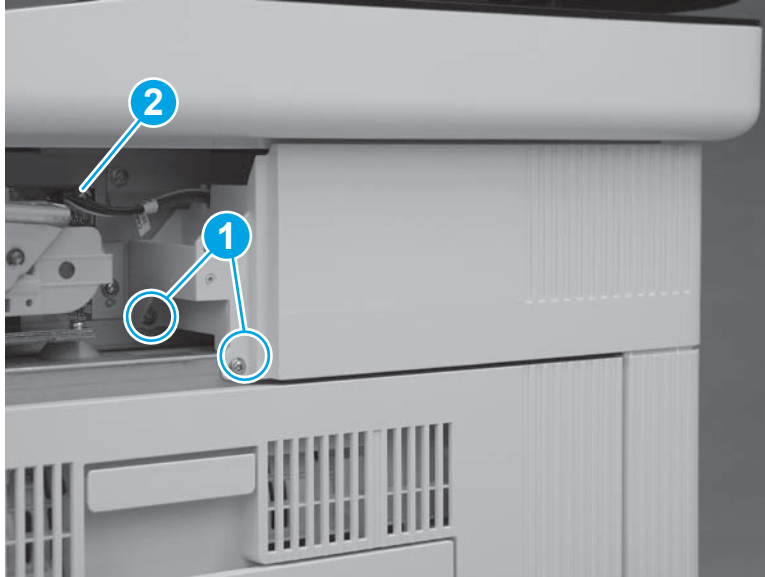

2. At the back of the printer, remove one screw (callout 1).

M577c/f/z only: Disconnect one connector (callout 2), if it was not already disconnected in a previous step.

 **Reinstallation tip:** This screw is smaller than the screws removed in the previous step. When reinstalling the right upper cover, make sure that this screw is installed in the correct position.

Figure 1-380 Remove one screw and connector



3. Slide the cover toward the back of the printer.

Figure 1-381 Slide the cover

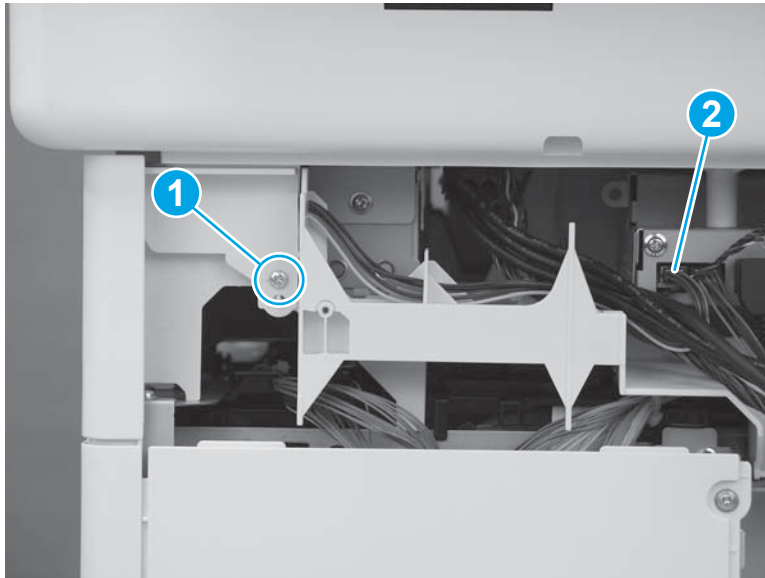
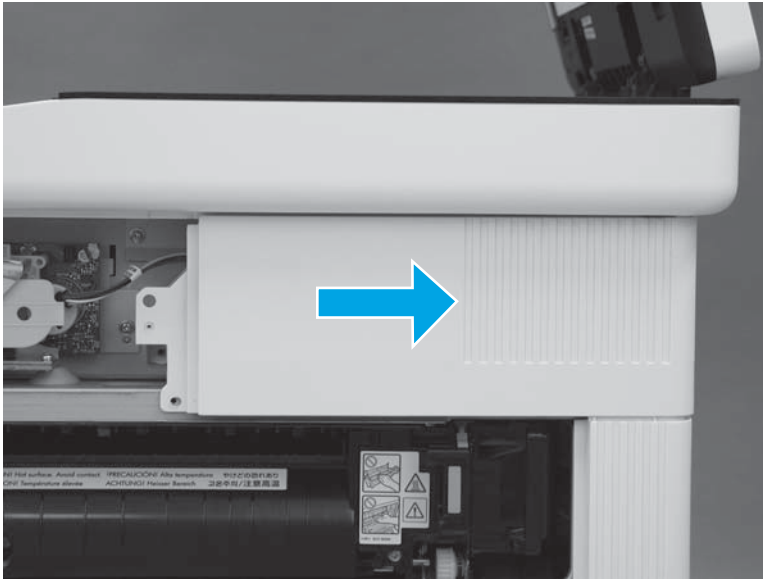

4. Lift the cover away from the printer to remove it.

M577c/f/z only: Release the cables (callout 1) through the slot (callout 2) in the printer.

Figure 1-382 Remove the cover

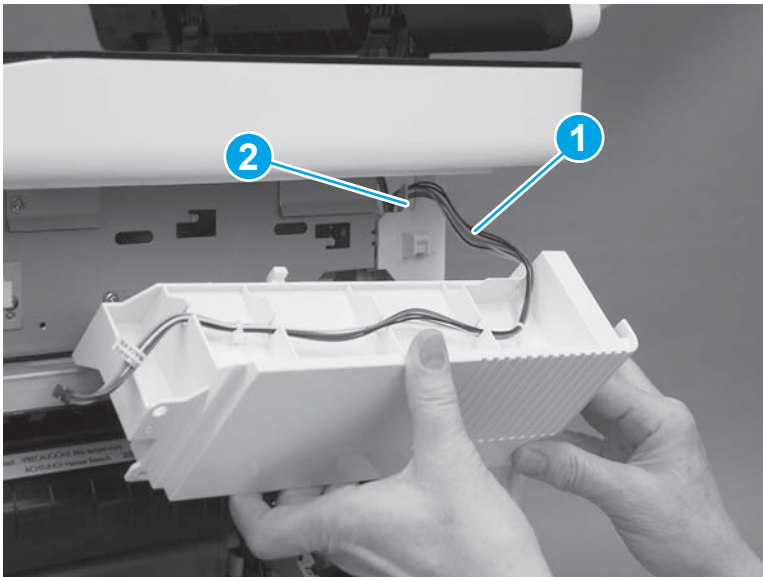

Step 8: Remove the top rear cover

1. At the top of the printer, remove five screws (callout 1).

Figure 1-383 Remove five screws

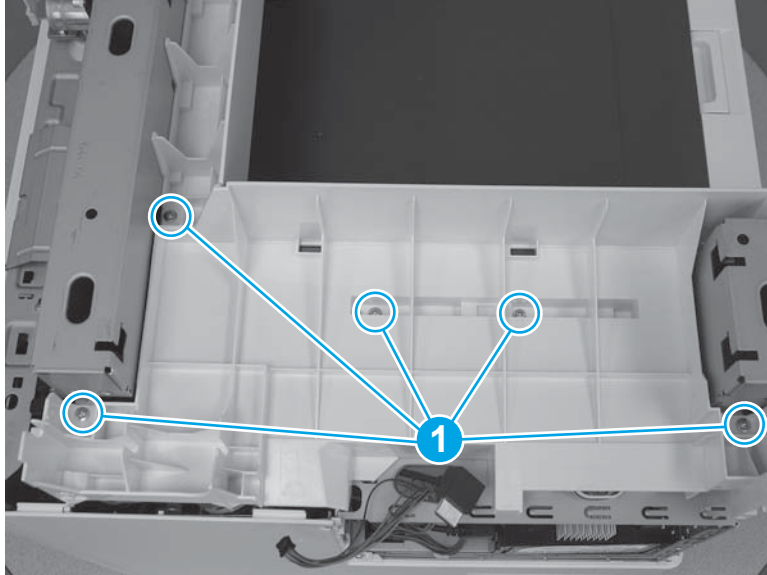

2. Release two tabs (callout 1) on the front edge of the cover.

Figure 1-384 Release two tabs

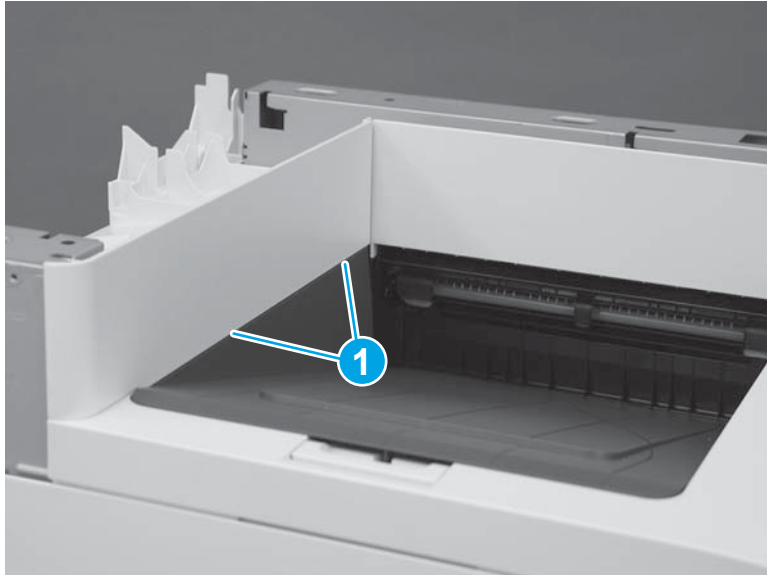

3. Remove the top rear cover.

Figure 1-385 Remove the top rear cover

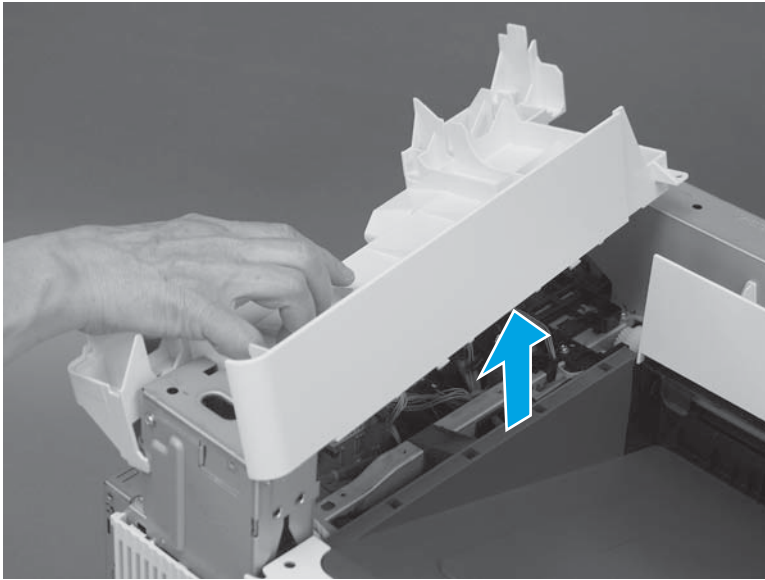

Step 9: Unpack the replacement assembly

Unpack the replacement assembly from the packaging.

For complete information on HP's recycling programs, go to [Product return and recycling](#).

 **NOTE:** HP recommends responsible disposal of the defective assembly.

Figure 1-386 Recycle and unpack

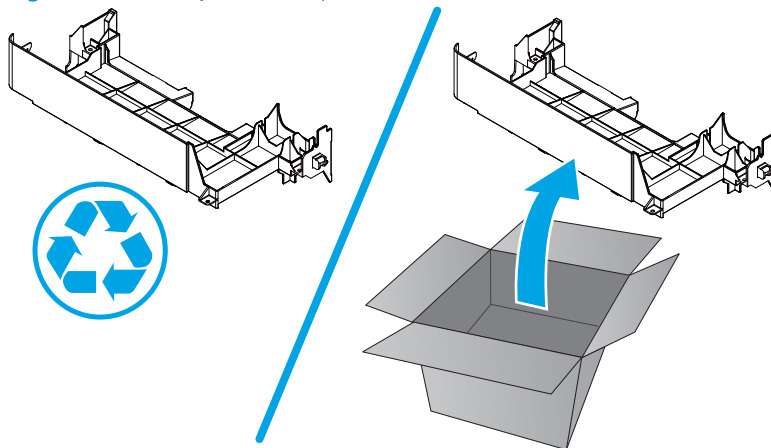

Step 10: Install the top rear cover

1. Align the locator tabs (callout 1) on the cover with the slots (callout 2) in the printer.

Figure 1-387 Align the locator tabs

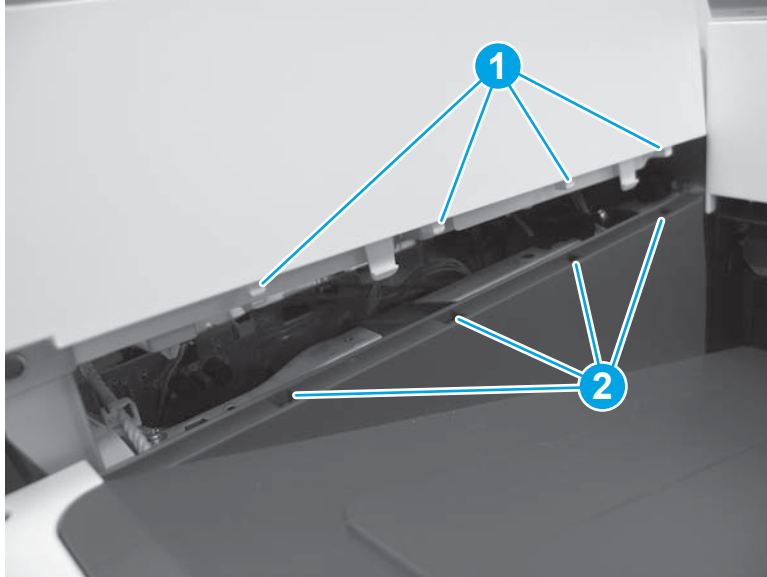

2. Press down to install the cover. Make sure that the tabs snap into place.

Figure 1-388 Install the cover

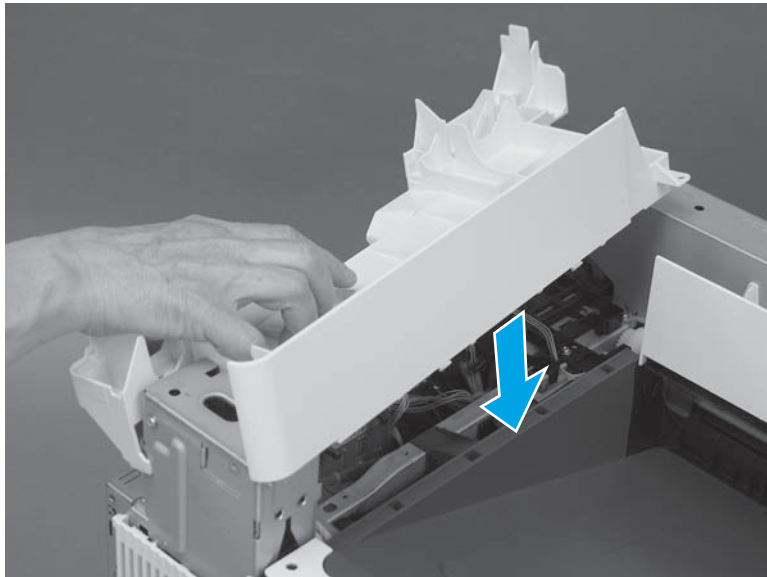

3. At the top of the printer, install five screws (callout 1).

Figure 1-389 Install five screws

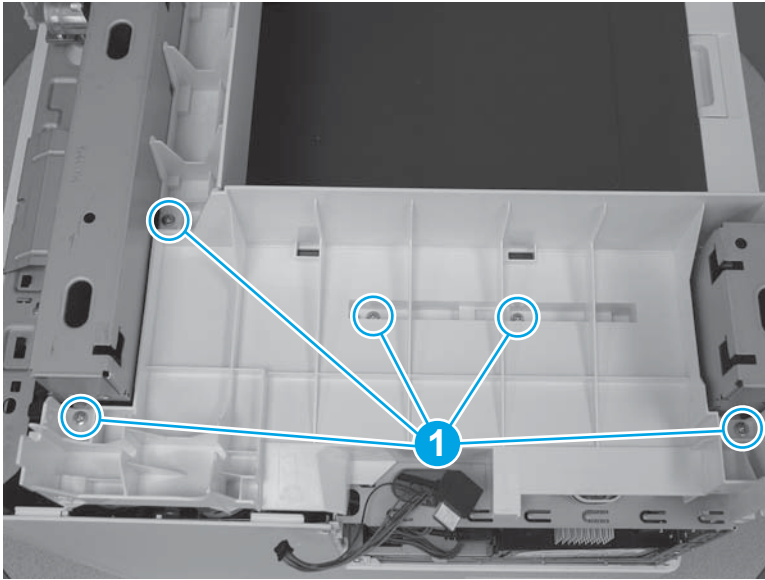

Step 11: Install the right upper cover (M577)

 **NOTE:** The figures below show the image scanner installed. The procedures for removing and installing the right upper cover are the same whether the image scanner is installed or removed."

1. **M577c/f/z only:** Install the cables (callout 1) through the slot (callout 2) in the printer.

Figure 1-390 Install the cables

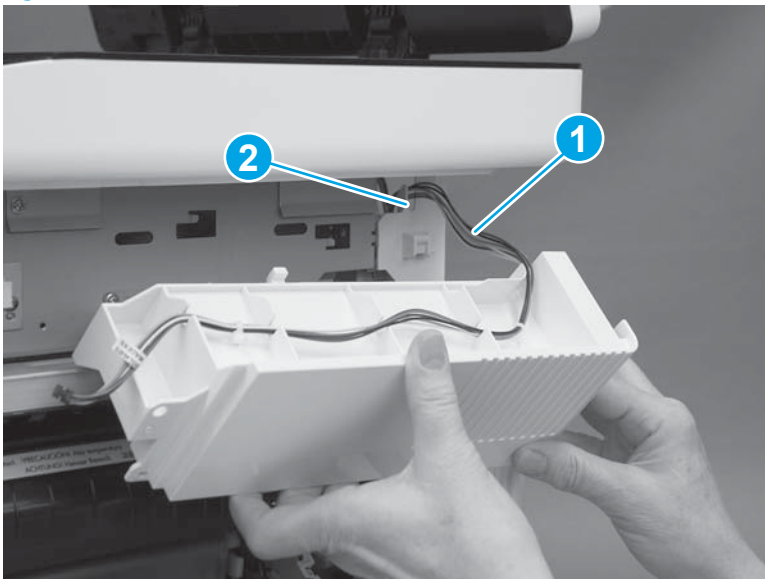

2. Position the hooks (callout 1) on the cover in the slots (callout 2) in the printer.

Figure 1-391 Position the hooks

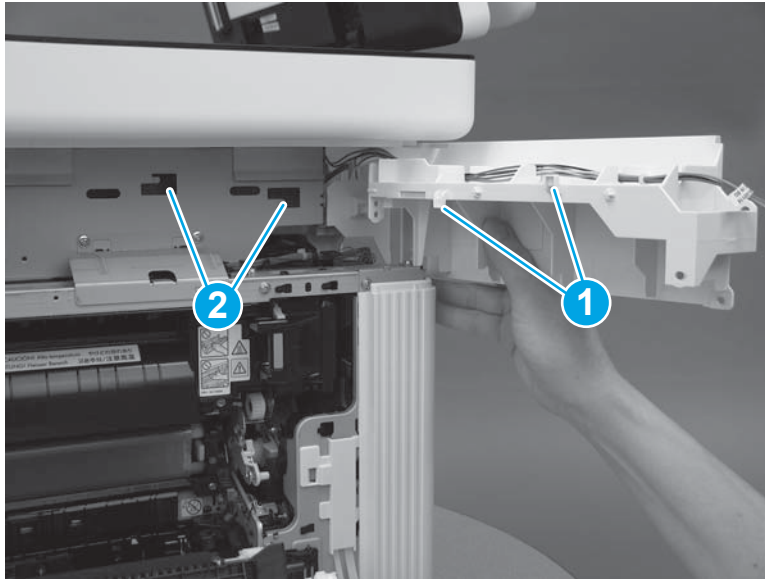

3. Slide the cover toward the front of the printer to install it.

Figure 1-392 Install the cover

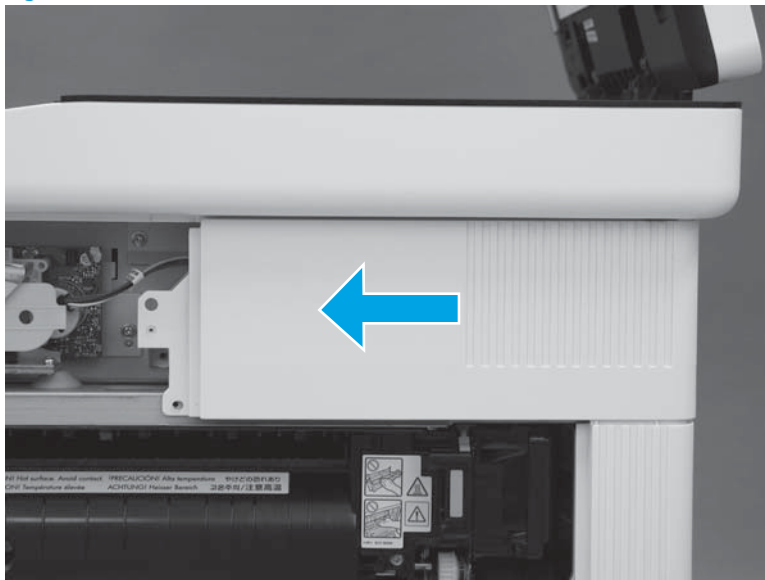

4. At the back of the printer, install one screw (callout 1).

M577c/f/z only: Connect one connector (callout 2), if the integrated scanner assembly is installed.

 **TIP:** This screw is smaller than the screws installed in the next step. Make sure that this screw is installed in the correct position.

Figure 1-393 Install one screw and connector



5. At the right side of the printer, install two screws (callout 1).

M577c/f/z only: Connect one connector (callout 2), if the stapler is installed.

Figure 1-394 Install one screw and connector

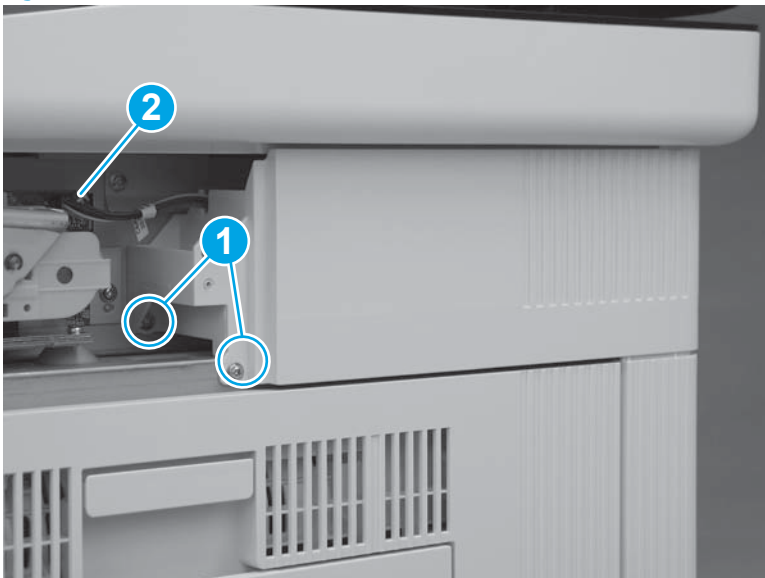

Step 12: Install the integrated scanner assembly (ISA) (M577)

 **NOTE:** The ISA includes the document feeder, image scanner, scanner control board (SCB), control panel, keyboard (M577c/z) and NFC PCA (M577z).

1. Before proceeding, locate the mounting pins (callout 1) on the bottom of the ISA and the slots (callout 2) on the printer base.

Figure 1-395 Locate the ISA mounting pins and slots

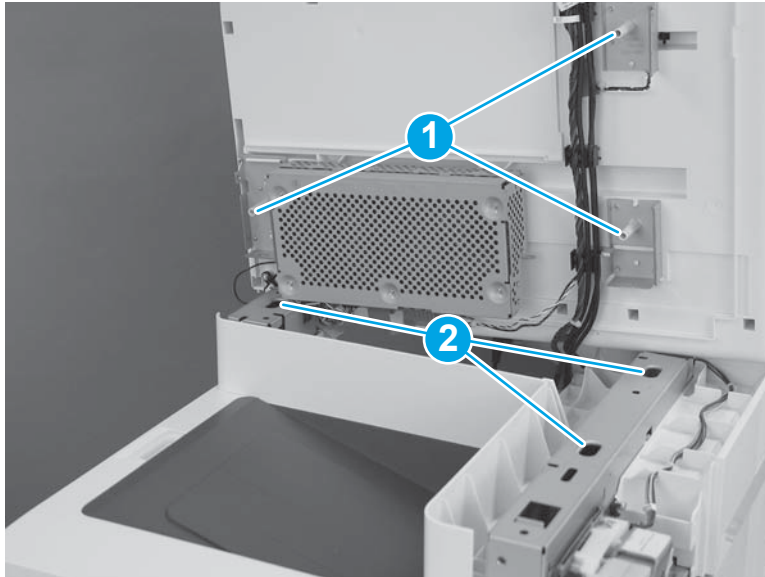

2. Position the ISA on the printer base with the pins in the slots.

 **NOTE:** To locate the pins and slots, see [Figure 1-395 Locate the ISA mounting pins and slots on page 249](#).

Figure 1-396 Install the ISA



3. Slightly slide the ISA towards the front of the printer to engage it.

Figure 1-397 Slide the ISA towards the front of the printer

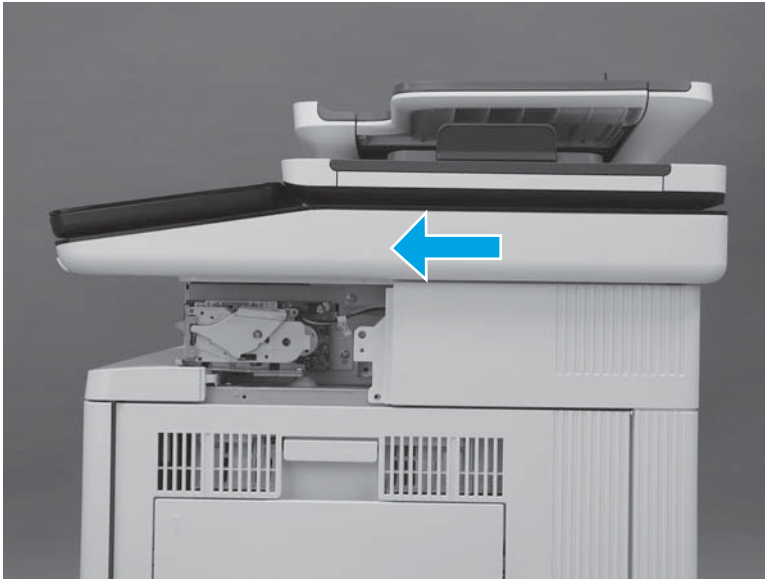

4. At the left side of the printer, install one screw (callout 1).

Figure 1-398 Install one screw

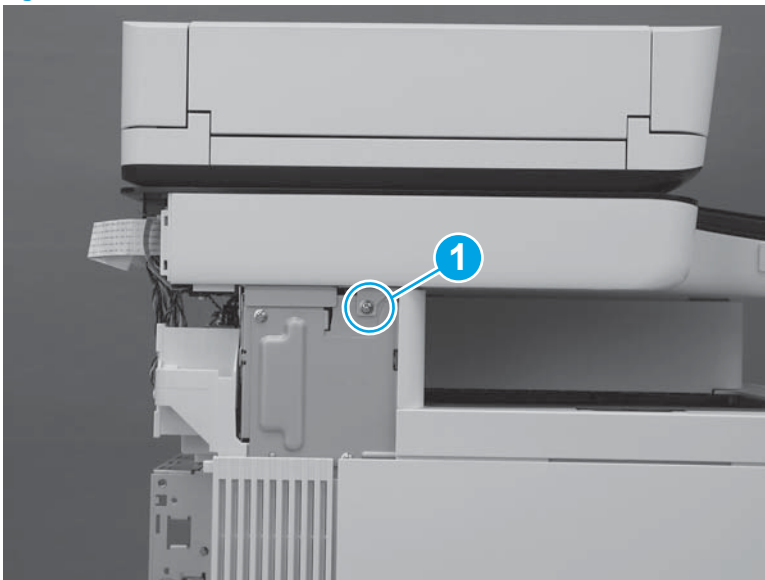

5. At the back of the printer, install two screws (callout 1).

Figure 1-399 Install two screws

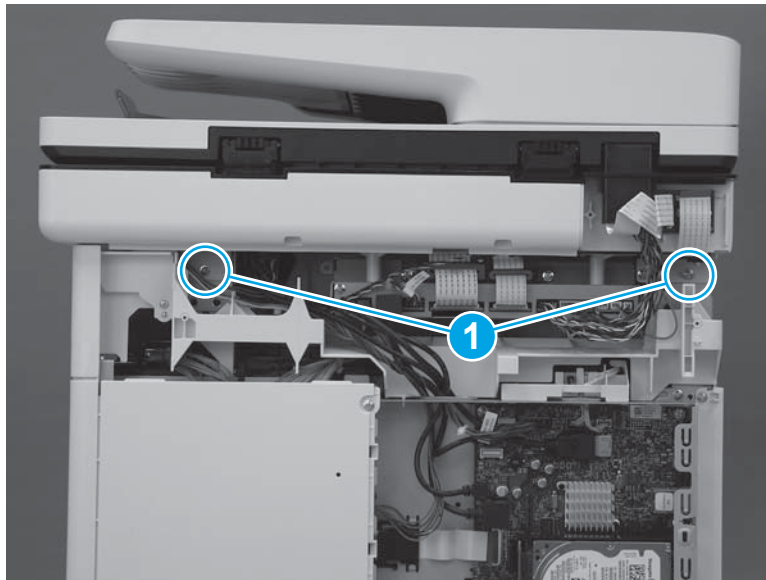

6. At the right side of the printer, install one screw (callout 1).

Figure 1-400 Install one screw

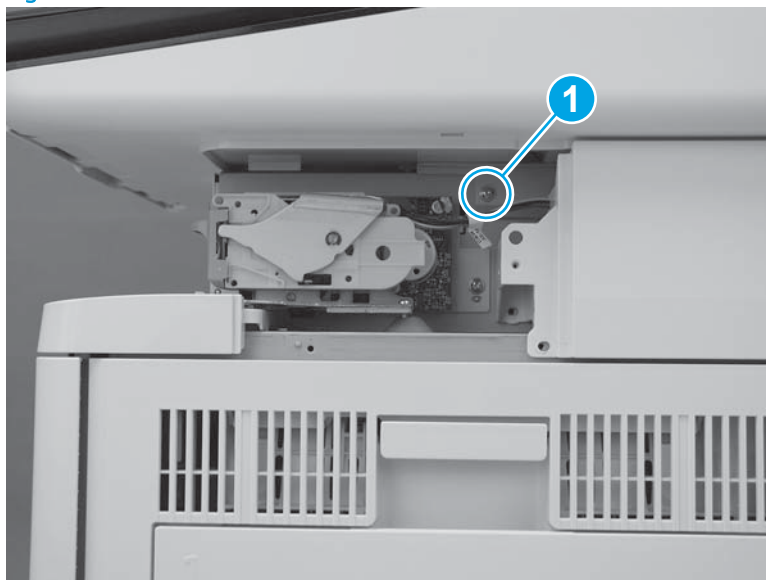

7. Connect two connectors on the scanner control board (callout 1).

M577c/f/z only: Connect one connector for the stapler on the scanner control board (callout 2).

Figure 1-401 Connect connectors

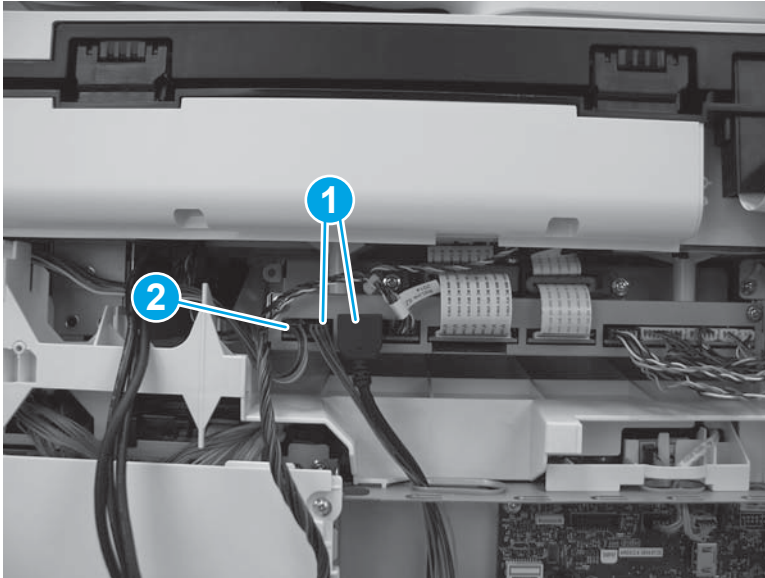

8. Install the wire harness and cables (callout 1) in the retainers (callout 2). Pass them through the opening in the top of the formatter cover (callout 3), and then connect four connectors (callout 4) on the formatter.

Figure 1-402 Connect four connectors

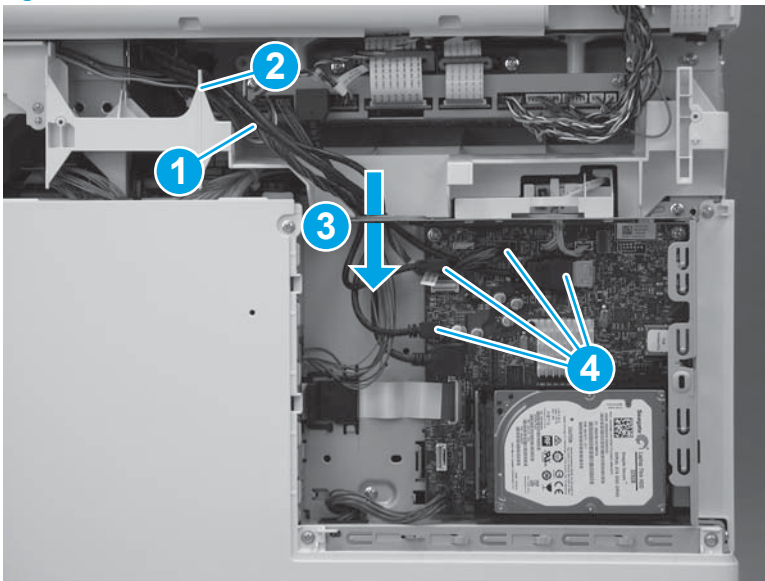

Step 13: Install the stapler cover assembly (M577c/f/z)

 **NOTE:** This step is for the M577c/f/z models only. For the M577dn model, skip this step and go to [Step 14: Install the right front upper cover \(M577dn\) on page 254.](#)

1. Install the tabs (callout 1) on the cover in the slots (callout 2) in the printer.

Figure 1-403 Install two tabs



2. Press the cover toward the left side of the printer until it snaps into place.

Figure 1-404 Install the cover assembly



3. Install one screw (callout 1).



 **IMPORTANT:** This is a self-tapping screw for plastic. Rotate it counterclockwise to align it with the existing thread pattern, and then carefully turn it clockwise to tighten. Do not overtighten. This will prevent stripping the threads inside the screw hole.

Figure 1-405 Install one screw

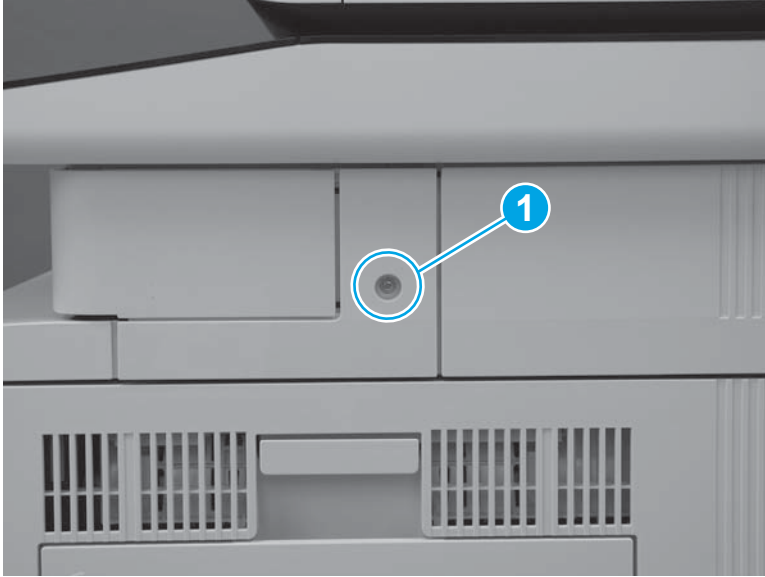

Step 14: Install the right front upper cover (M577dn)

 **NOTE:** This step is for the M577dn model only. For the M577c/f/z models, skip this step and go to [Step 15: Install the left upper cover on page 255](#).

1. Slide the cover toward the left side of the printer to install it. Make sure that the slots (callout 1) in the cover fit over the tabs (callout 2) on the inside of the paper feeder cover.

Figure 1-406 Install the cover

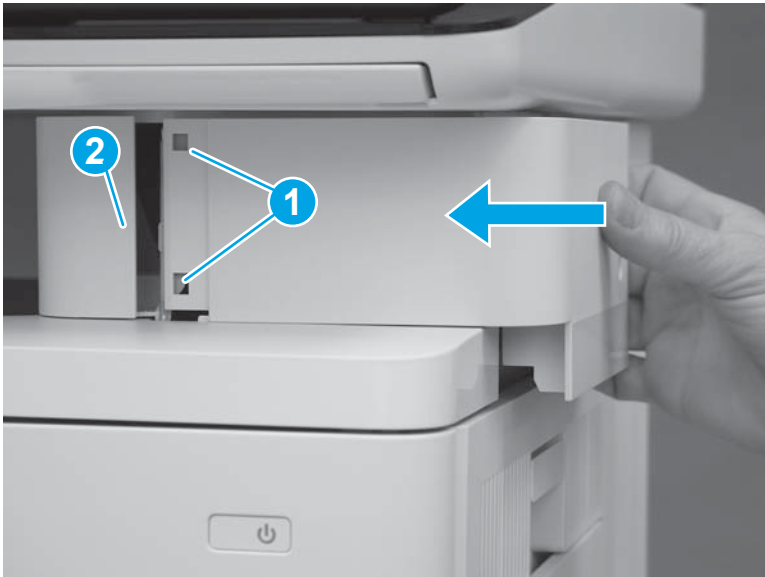

2. Press the right front upper cover (callout 1) and the paper feeder cover (callout 2) together until the tabs on the inside of the covers snap into place.

Figure 1-407 Press the cover



3. Install one screw (callout 1).

Figure 1-408 Install one screw

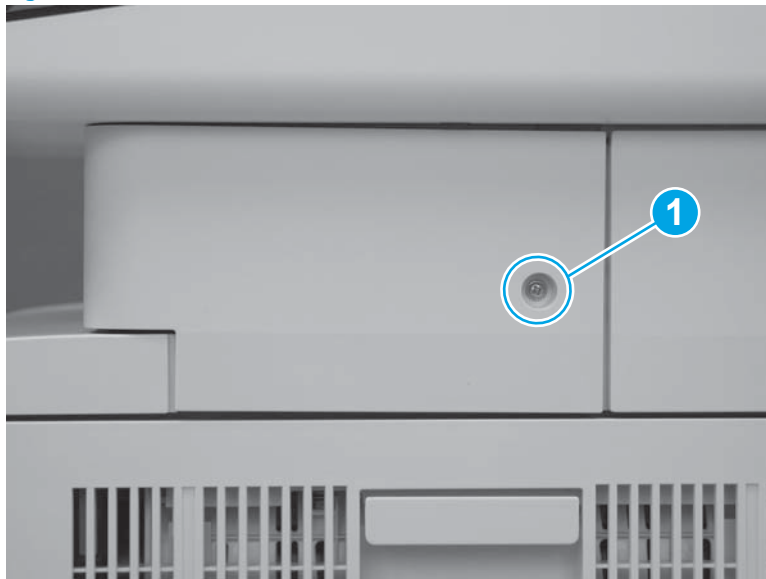

Step 15: Install the left upper cover

1. Position the tab (callout 1) on the lower edge of the cover behind the left cover (callout 2).

Figure 1-409 Position the tab

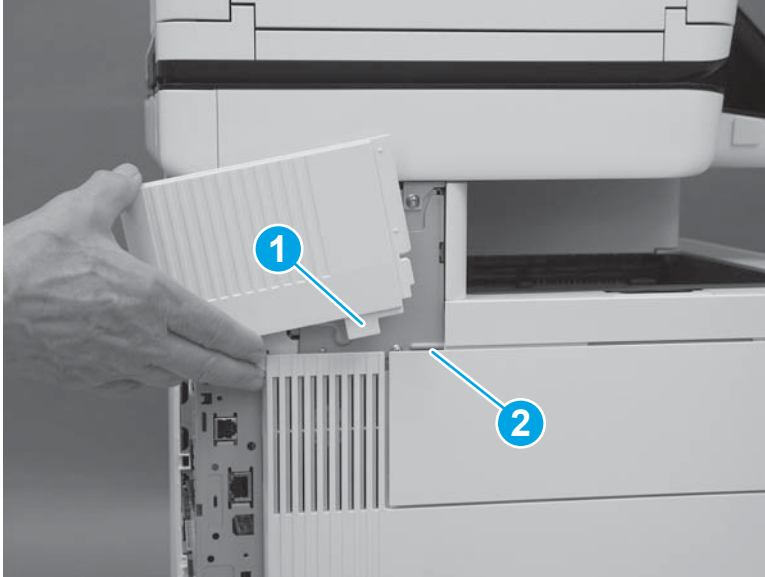

2. Slide the cover toward the front of the printer to install it. Make sure that the edge (callout 1) of the cover fits behind the edge (callout 2) of the top rear cover.

Figure 1-410 Slide the cover

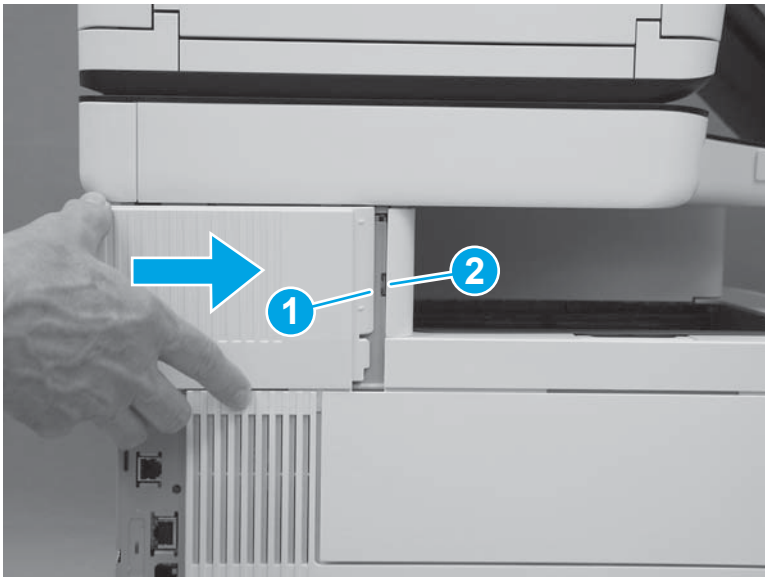

3. Make sure that the tab (callout 1) is fully installed.

Figure 1-411 Check the tab

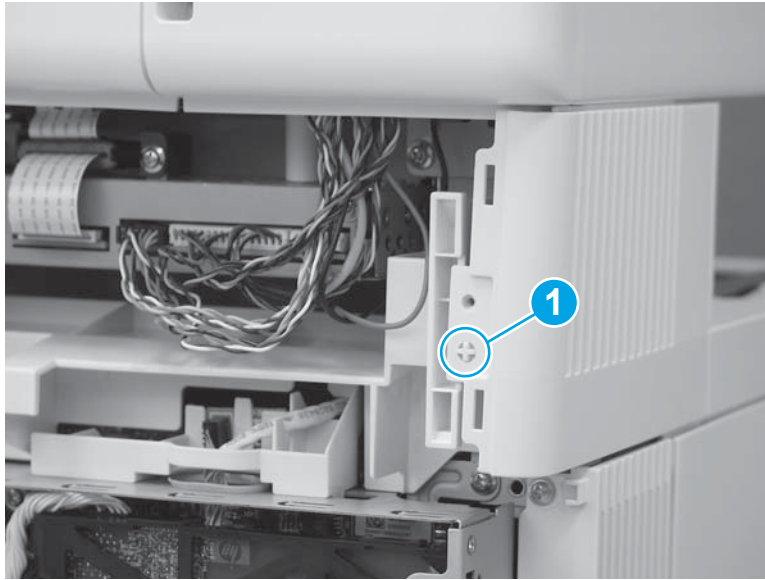

Step 16: Install the rear upper cover

1. Align the ridge (callout 1) on the lower edge of the rear upper cover in front of the tabs (callout 2) on the top edge of the rear cover.

Figure 1-412 Align the cover

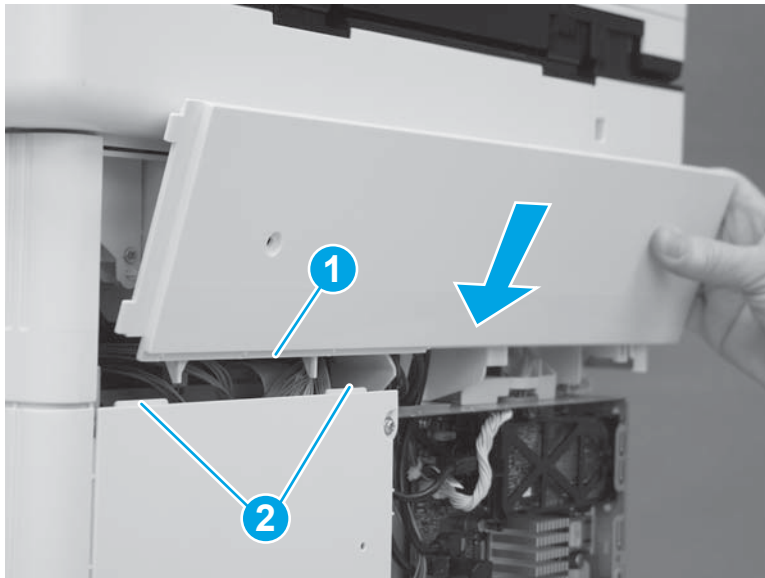

2. Rotate the top of the cover toward the printer.

Figure 1-413 Rotate the top of the cover

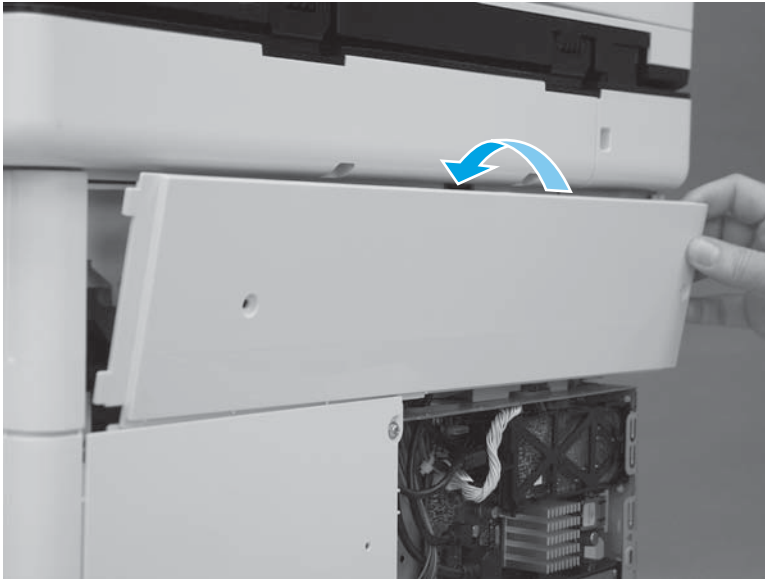

3. Slide the cover to the left (callout 1). Make sure that the tabs (callout 2) on the upper rear cover slide behind the edge (callout 3) of the right upper cover. Make sure that the cover is fully seated.

Figure 1-414 Slide the cover

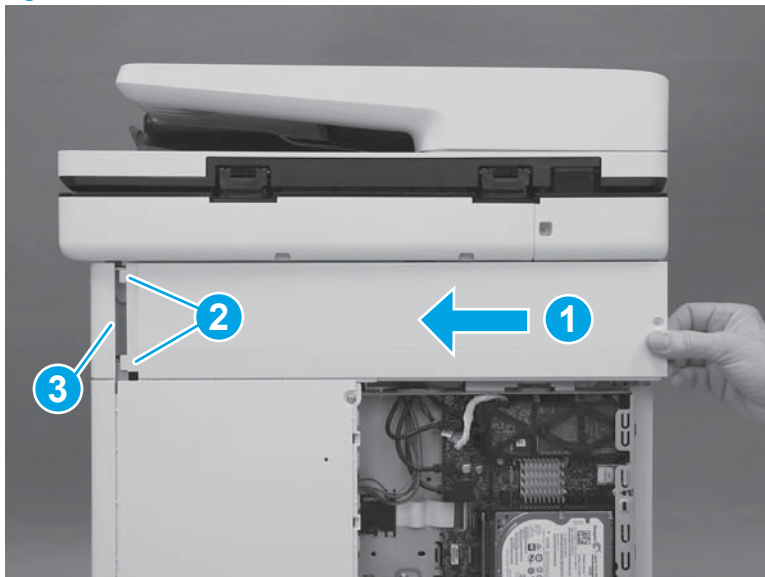

4. Install two screws (callout 1).



 **IMPORTANT:** These two screws are self-tapping screws for plastic. Rotate them counterclockwise to align them with the existing thread pattern, and then carefully turn them clockwise to tighten. Do not overtighten. This will prevent stripping the threads inside the screw holes.

Figure 1-415 Install two screws

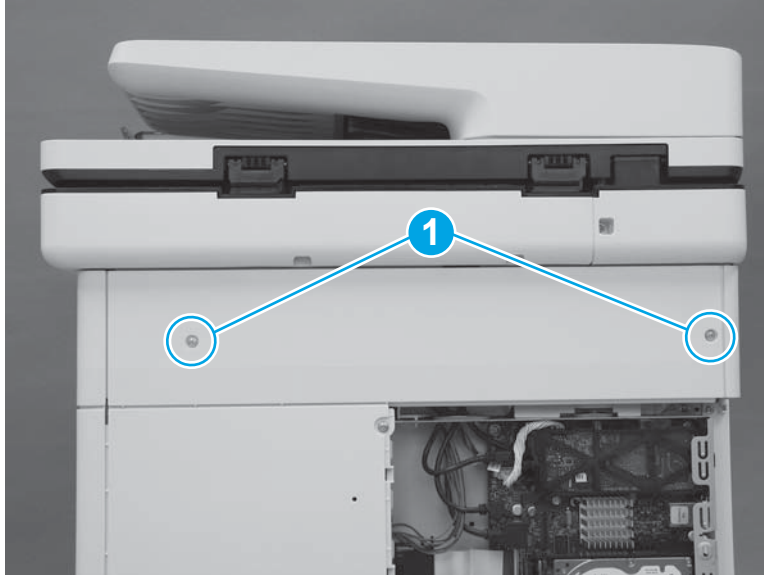

Step 17: Install the formatter cover

- ▲ Slide the cover onto the printer (callout 1) to install it.

 **NOTE:** Make sure that the tabs on the formatter cover align with the slots provided in the printer (callout 2). Tighten the two thumbscrews (callout 3).

 **TIP:** If needed, use the edge of a coin to turn the thumbscrews.

Figure 1-416 Install the cover

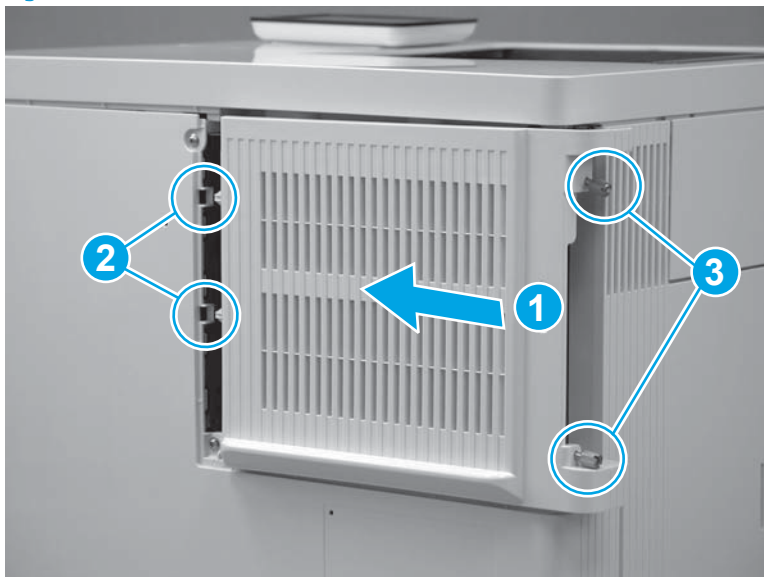

Removal and replacement: Paper feed cover (M577)

- [Introduction](#)
- [Step 1: Remove the formatter cover](#)
- [Step 2: Remove the rear upper cover](#)
- [Step 3: Remove the left upper cover](#)
- [Step 4: Remove the right front upper cover \(M577dn\)](#)
- [Step 5: Remove the stapler cover assembly \(M577c/f/z\)](#)
- [Step 6: Remove the integrated scanner assembly \(ISA\) \(M577\)](#)
- [Step 7: Remove the right upper cover \(M577\)](#)
- [Step 8: Remove the top rear cover](#)
- [Step 9: Remove the paper feed cover](#)
- [Step 10: Unpack the replacement assembly](#)
- [Step 11: Install the paper feed cover](#)
- [Step 12: Install the top rear cover](#)
- [Step 13: Install the right upper cover \(M577\)](#)
- [Step 14: Install the integrated scanner assembly \(ISA\) \(M577\)](#)
- [Step 15: Install the stapler cover assembly \(M577c/f/z\)](#)
- [Step 16: Install the right front upper cover \(M577dn\)](#)
- [Step 17: Install the left upper cover](#)
- [Step 18: Install the rear upper cover](#)
- [Step 19: Install the formatter cover](#)

Introduction

This document provides the procedures to remove and replace the M577 paper feed cover.

Before performing service

Turn the printer power off

- Disconnect the power cable.

 **WARNING!** To avoid damage to the printer, turn the printer off, wait 30 seconds, and then remove the power cord before attempting to service the printer.

Use the table below to identify the correct part number for your printer. To order the part, go to www.hp.com/buy/parts.

Paper feed cover (M577) part number

RC4-3382-000CN

Paper feed cover (M577)

Required tools

- Small flat blade screwdriver
- #2 Phillips screwdriver with a magnetic tip

After performing service

Make sure that the paper feed cover is fully seated after replacing it.

Turn the printer power on

- Connect the power cable.
- Use the power switch to turn the power on.

Step 1: Remove the formatter cover

1. Locate the formatter cover.

Figure 1-417 Locate the formatter cover

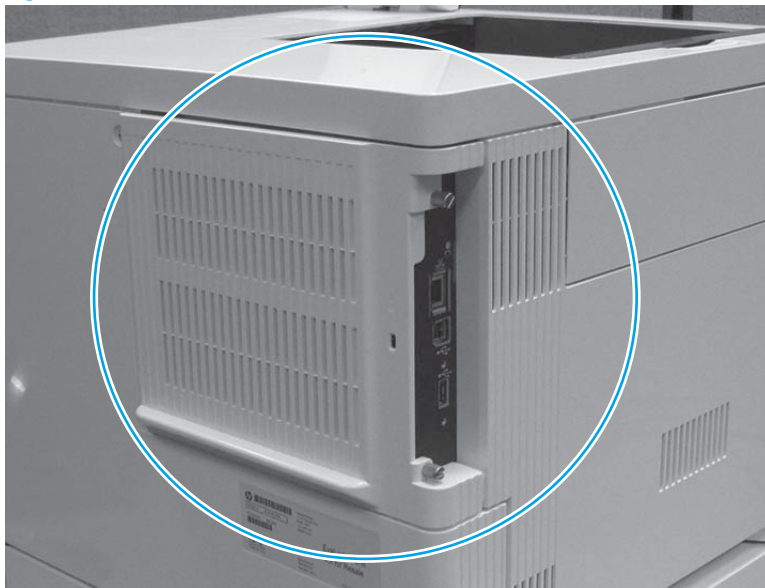

2. Loosen the two thumbscrews (callout 1). Grasp the two thumbscrews, and then slide the cover away from the printer (callout 2) to remove it.

 **TIP:** If needed, use the edge of a coin to turn the thumbscrews.

Figure 1-418 Loosen the thumbscrews

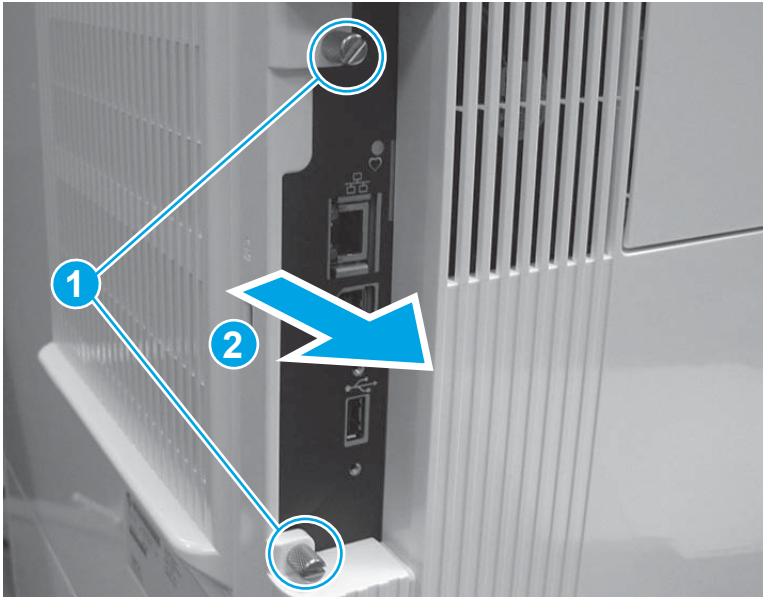

Step 2: Remove the rear upper cover

1. Remove two screws (callout 1).

 **Reinstallation tip:** These two screws are self-tapping screws for plastic. When reinstalling them, rotate the screws counterclockwise to align them with the existing thread pattern, and then carefully turn them clockwise to tighten. Do not overtighten. This will prevent stripping the threads inside the screw holes.

Figure 1-419 Remove two screws



2. Use a small, flat blade screwdriver to release the right edge of the cover.

Figure 1-420 Release the right edge

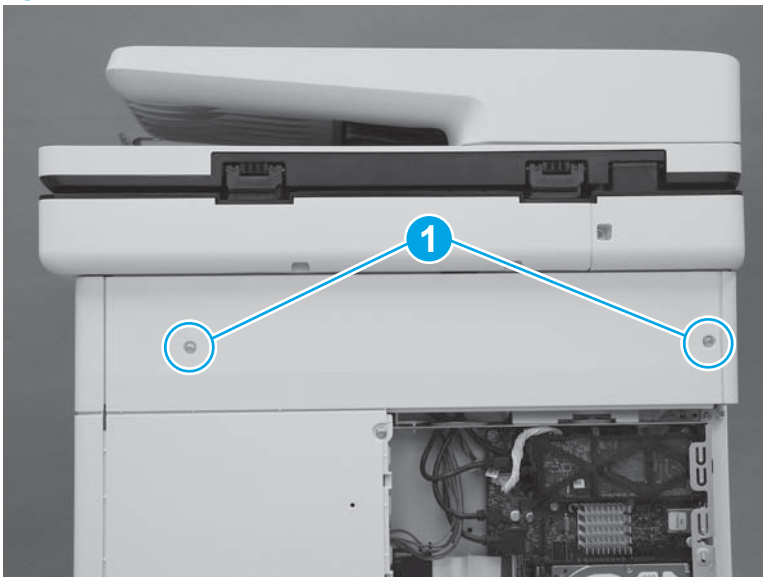
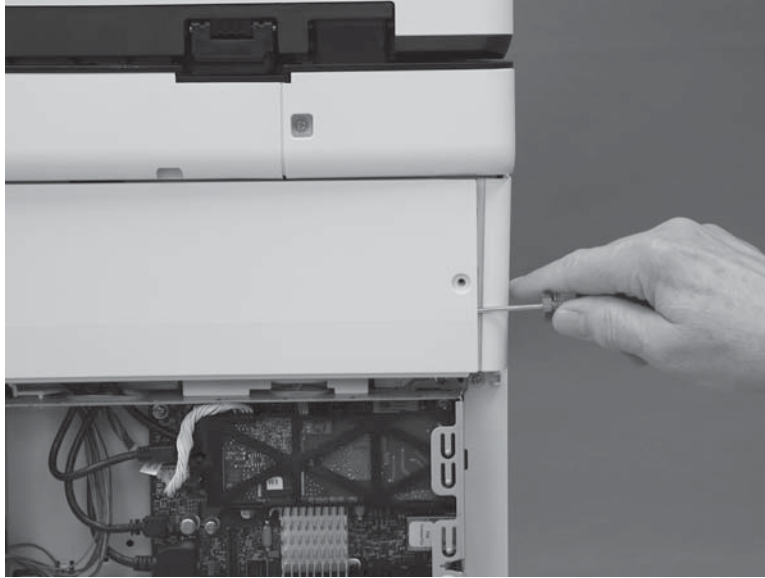

3. Pull the right edge of the cover (callout 1) away from the printer, and then slide the cover to the right (callout 2).

Figure 1-421 Slide the cover right

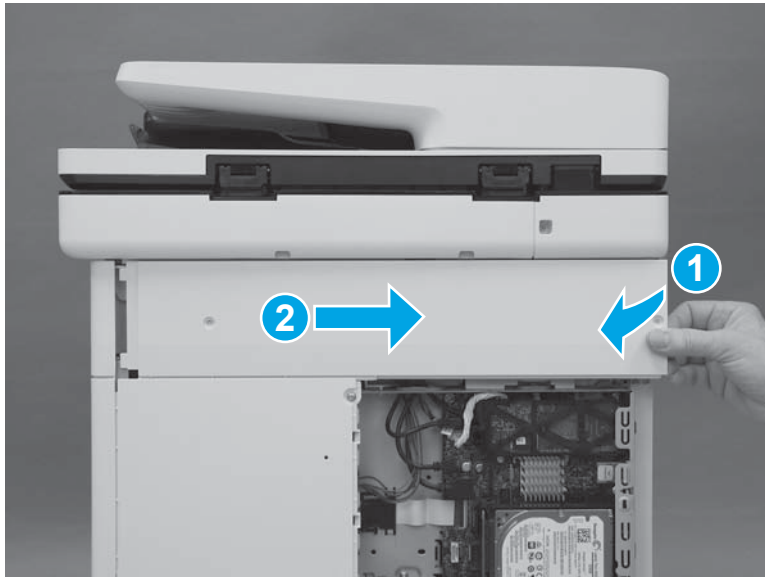

4. Remove the cover.

Figure 1-422 Remove the cover

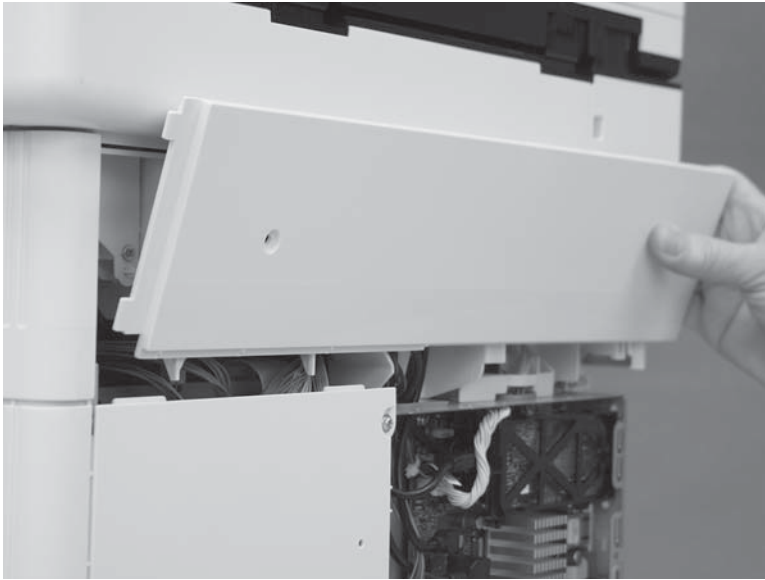

Step 3: Remove the left upper cover

1. At the left side of the printer, release one tab (callout 1).

Figure 1-423 Release one tab

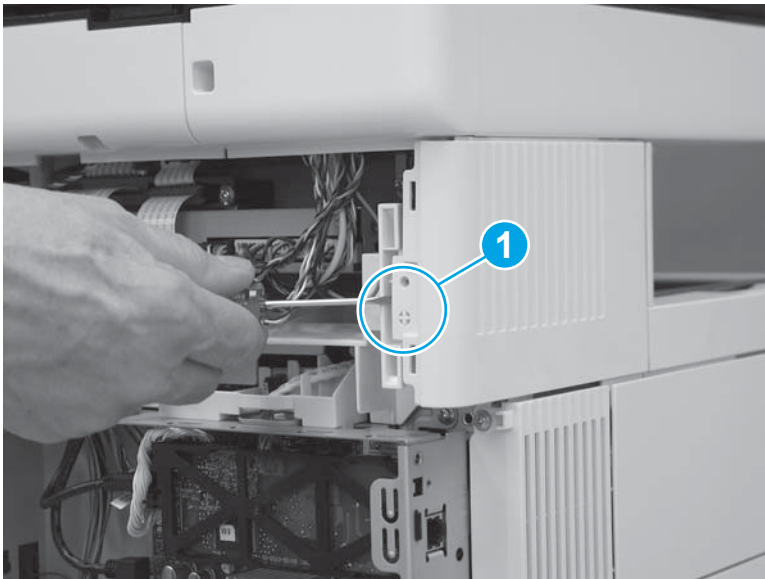

2. Slide the left upper cover toward the back of the printer.

Figure 1-424 Slide the cover back

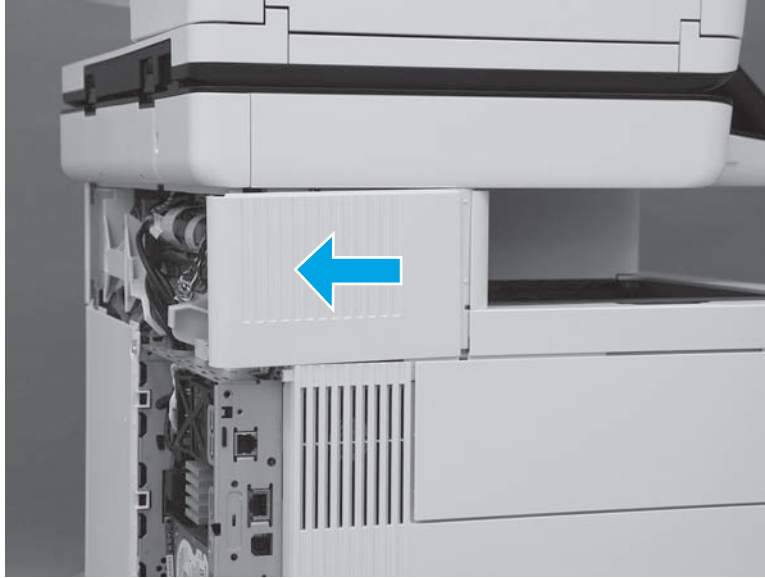

3. Rotate the cover up to remove it.

Figure 1-425 Remove the left upper cover



Step 4: Remove the right front upper cover (M577dn)

 **NOTE:** This step is for the M577dn model. For the M577c/f/z models, skip this step and to go [Step 5: Remove the stapler cover assembly \(M577c/f/z\) on page 267.](#)

1. Remove one screw (callout 1).

Figure 1-426 Remove one screw

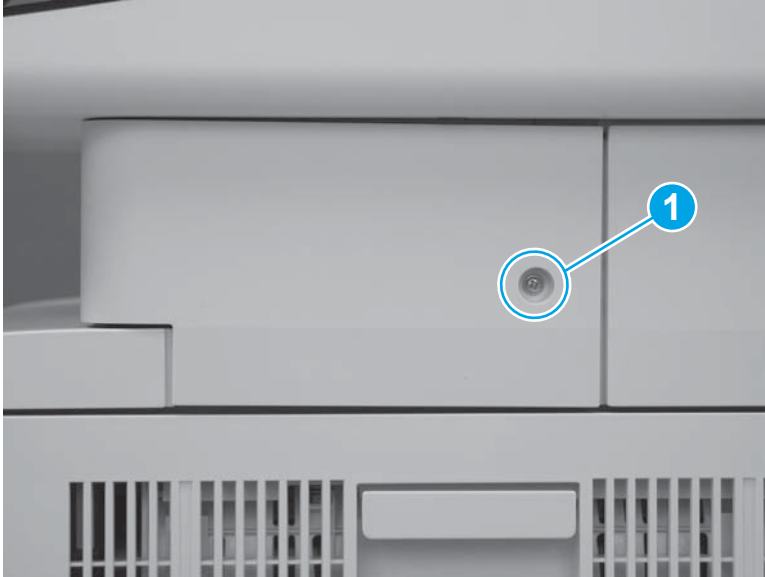

2. Release two tabs at the front edge of the cover (callout 1).

Figure 1-427 Release two tabs



3. Rotate the front of the cover to the right to remove it.

Figure 1-428 Rotate the cover



Step 5: Remove the stapler cover assembly (M577c/f/z)

 **NOTE:** This step is for the M577c/f/z models. For the M577dn model, skip this step and to go [Step 7: Remove the right upper cover \(M577\) on page 272](#).

1. Remove one screw (callout 1).

 **Reinstallation tip:** This is a self-tapping screw for plastic. When reinstalling, rotate the screw counterclockwise to align it with the existing thread pattern, and then carefully turn it clockwise to tighten. Do not overtighten. This will prevent stripping the threads inside the screw hole.

Figure 1-429 Remove one screw



2. Release two tabs at the front edge of the cover (callout 1).

Figure 1-430 Release two tabs

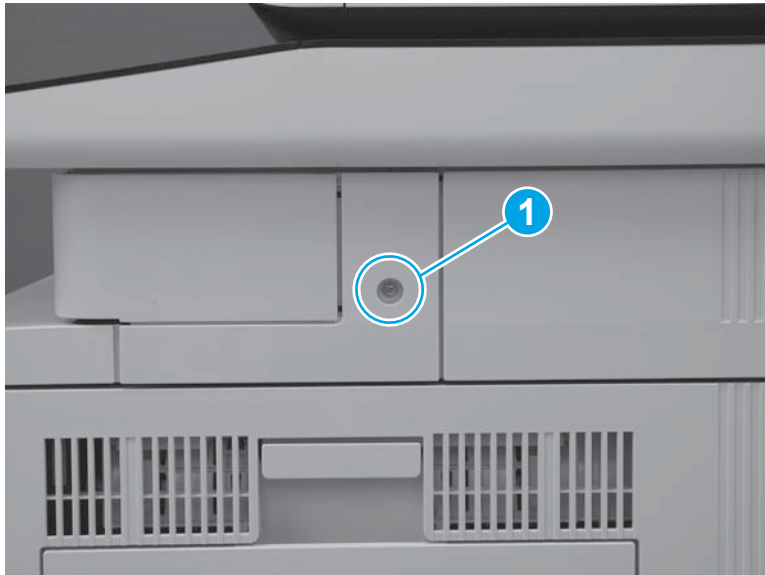

3. Release the back edge of the cover.

Figure 1-431 Release the back edge of the cover



4. Rotate the cover away from the printer to remove it.

Figure 1-432 Remove the cover



Step 6: Remove the integrated scanner assembly (ISA) (M577)

 **NOTE:** The ISA includes the document feeder, image scanner, scanner control board (SCB), control panel, keyboard (M577c/z) and NFC PCA (M577z).

1. At the left side of the printer, remove one screw (callout 1).

Figure 1-433 Remove one screw

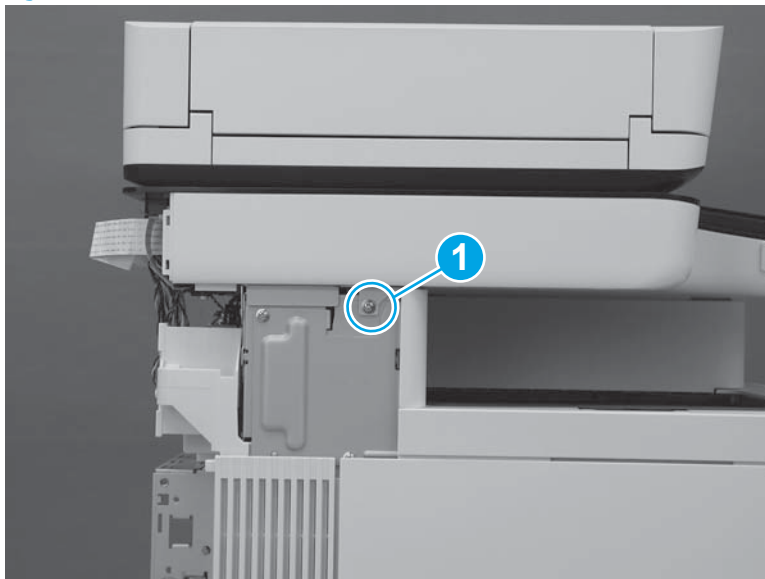

2. At the back side of the printer, remove two screws (callout 1).

Figure 1-434 Remove two screws

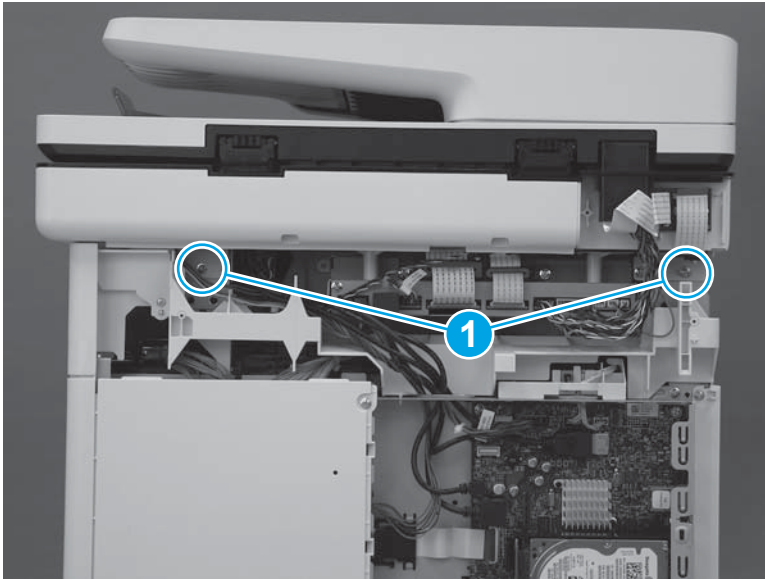

3. At the right side of the printer, remove one screw (callout 1).

Figure 1-435 Remove one screw

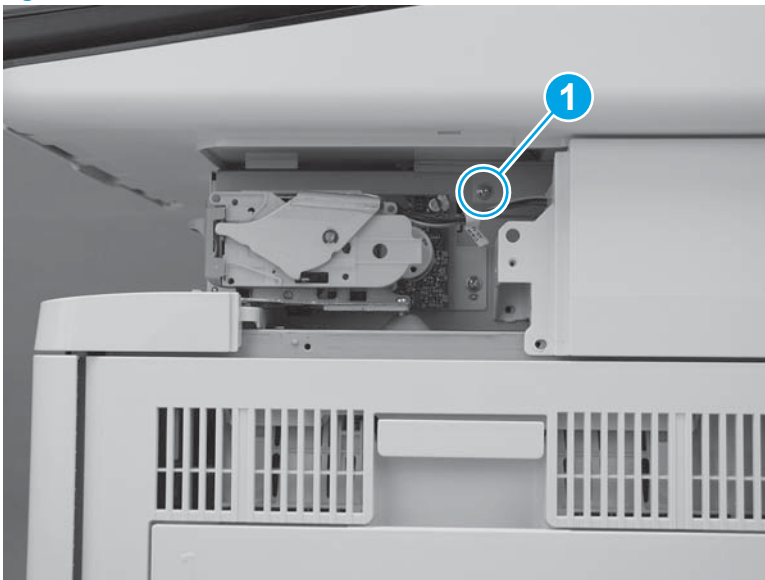

4. Disconnect four connectors on the formatter (callout 1), and then pass the wire harness and cables through the opening in the formatter case (callout 2).

Figure 1-436 Disconnect four connectors

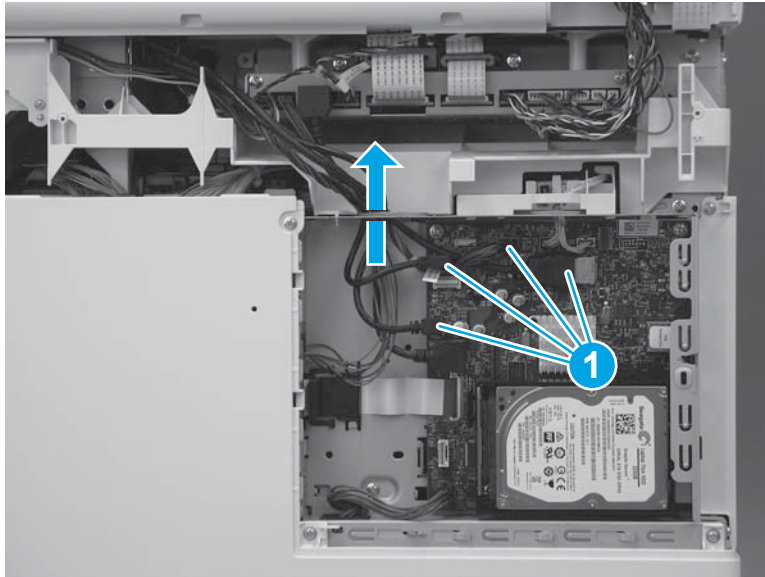

5. Disconnect two connectors on the scanner control board (callout 1).

M577c/f/z only: Disconnect one connector for the stapler on the scanner control board (callout 2).

Figure 1-437 Disconnect connectors

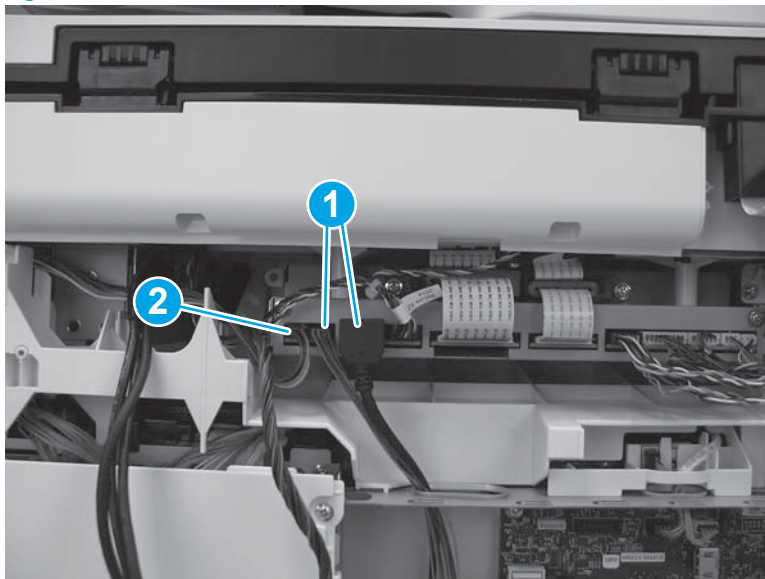

6. Slightly slide the ISA towards the back of the printer to release it.

Figure 1-438 Slide the ISA towards the back of the printer

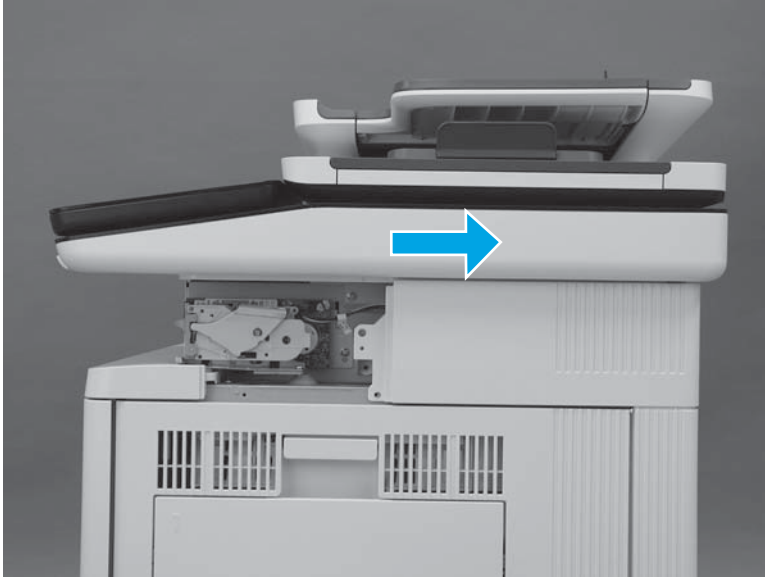

7. Lift the ISA up to remove it.

Figure 1-439 Remove the ISA

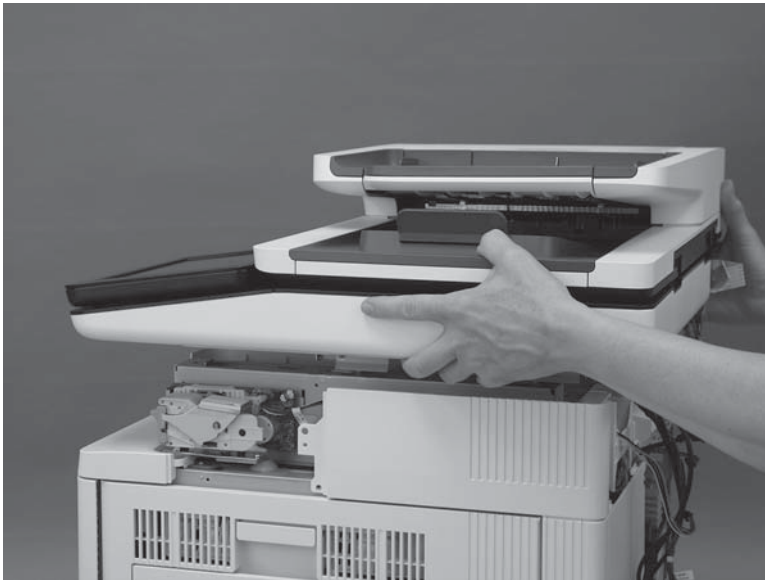

Step 7: Remove the right upper cover (M577)

 **NOTE:** The figures below show the image scanner installed. The procedures for removing and installing the right upper cover are the same whether the image scanner is installed or removed."

1. At the right side of the printer, remove two screws (callout 1).

M577c/f/z only: Disconnect one connector (callout 2), if it was not already disconnected in a previous step.

Figure 1-440 Remove two screws and one connector

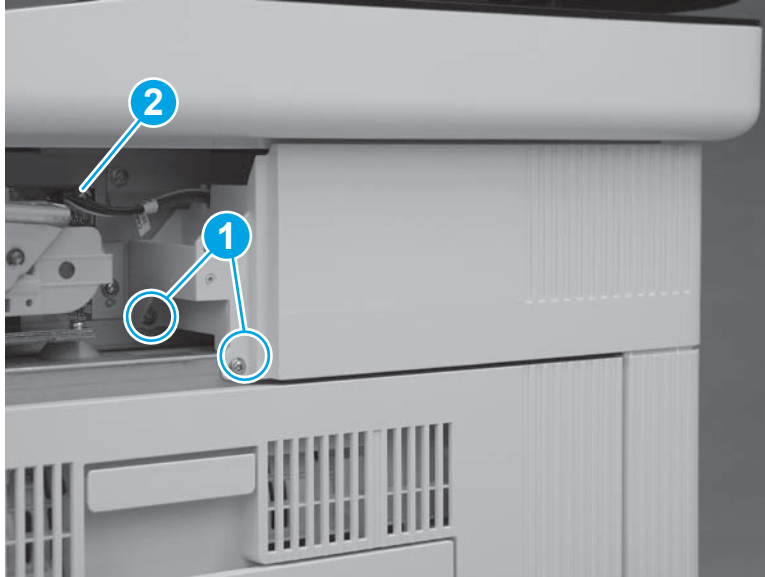

2. At the back of the printer, remove one screw (callout 1).

M577c/f/z only: Disconnect one connector (callout 2), if it was not already disconnected in a previous step.

 **Reinstallation tip:** This screw is smaller than the screws removed in the previous step. When reinstalling the right upper cover, make sure that this screw is installed in the correct position.

Figure 1-441 Remove one screw and connector



3. Slide the cover toward the back of the printer.

Figure 1-442 Slide the cover

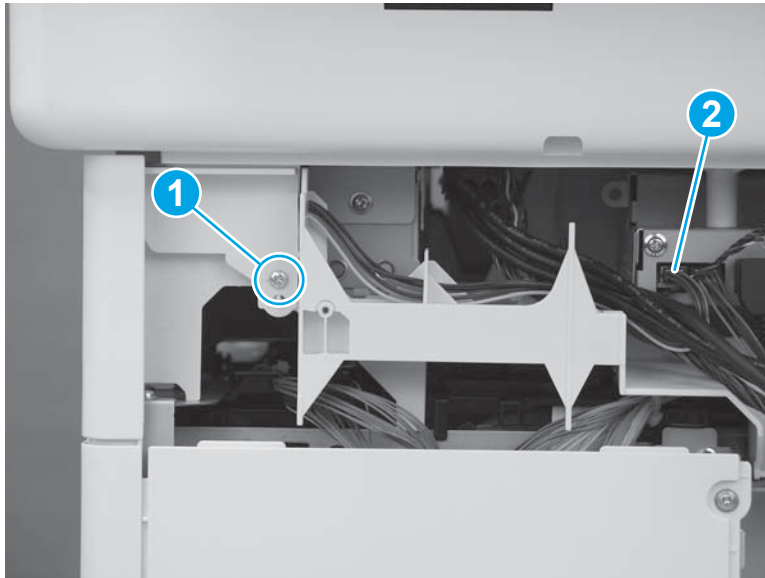
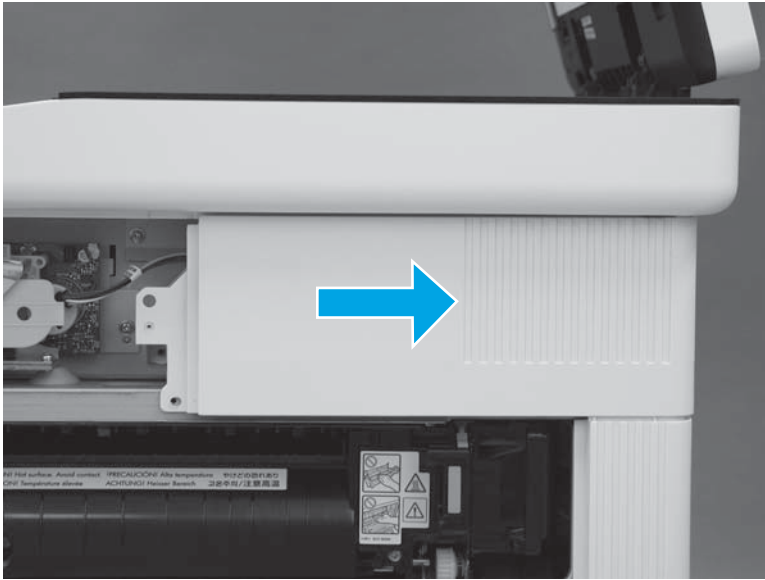

4. Lift the cover away from the printer to remove it.

M577c/f/z only: Release the cables (callout 1) through the slot (callout 2) in the printer.

Figure 1-443 Remove the cover

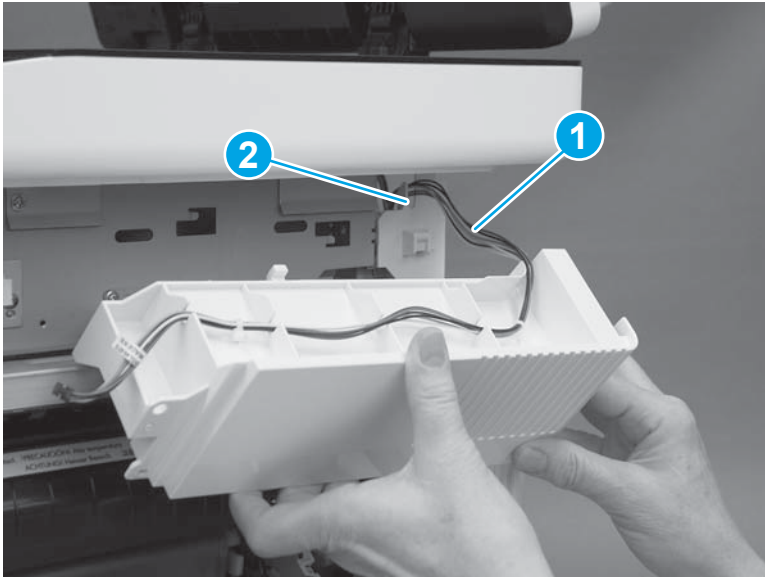

Step 8: Remove the top rear cover

1. At the top of the printer, remove five screws (callout 1).

Figure 1-444 Remove five screws

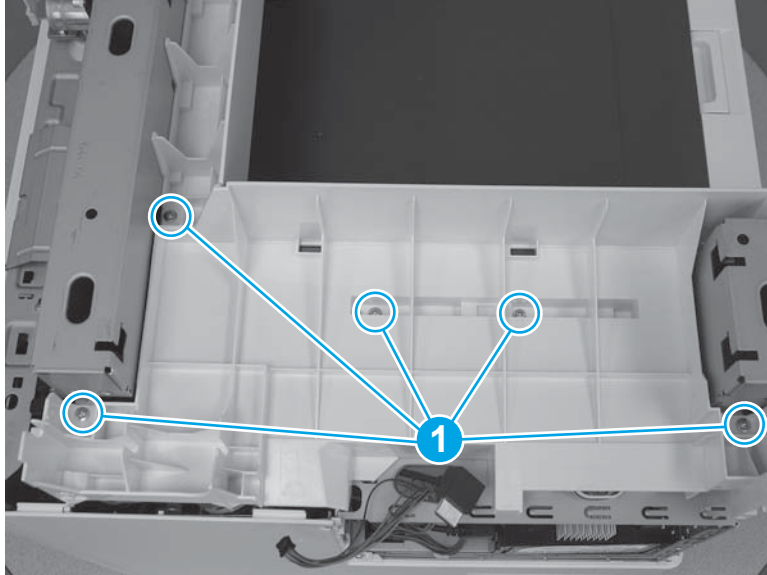

2. Release two tabs (callout 1) on the front edge of the cover.

Figure 1-445 Release two tabs

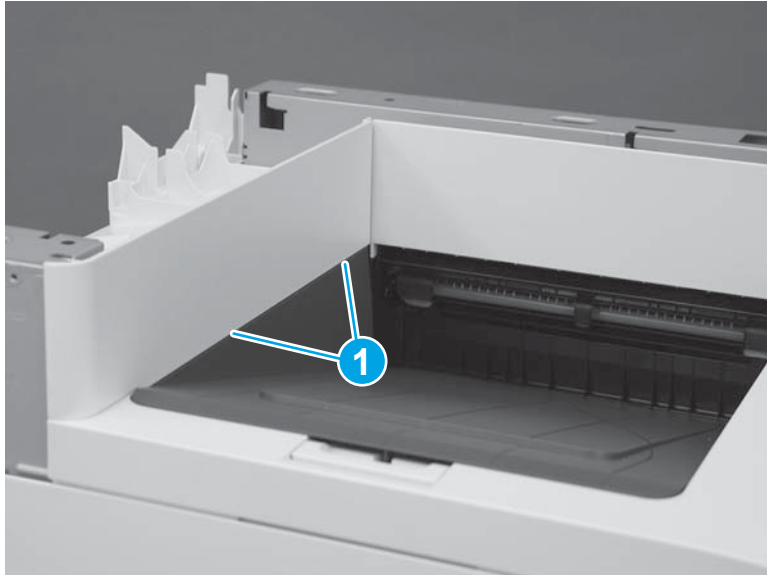

3. Remove the top rear cover.

Figure 1-446 Remove the top rear cover

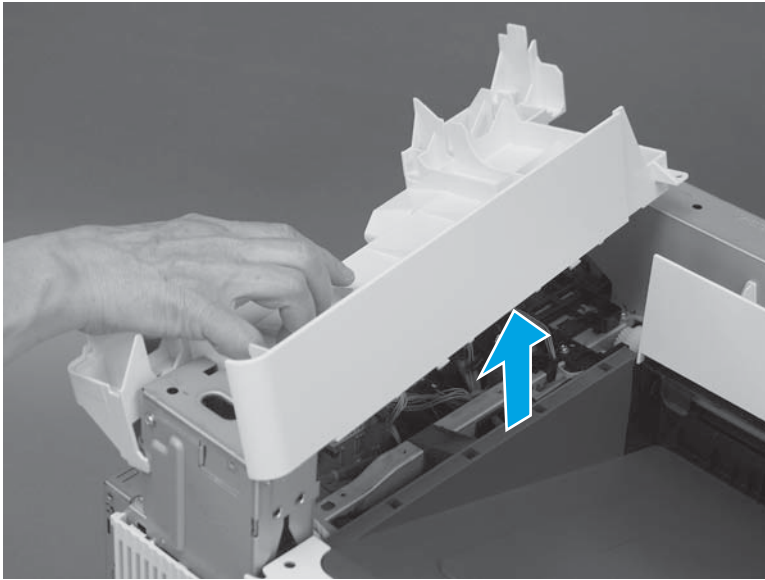

Step 9: Remove the paper feed cover

1. Remove one screw (callout 1).

Figure 1-447 Remove one screw

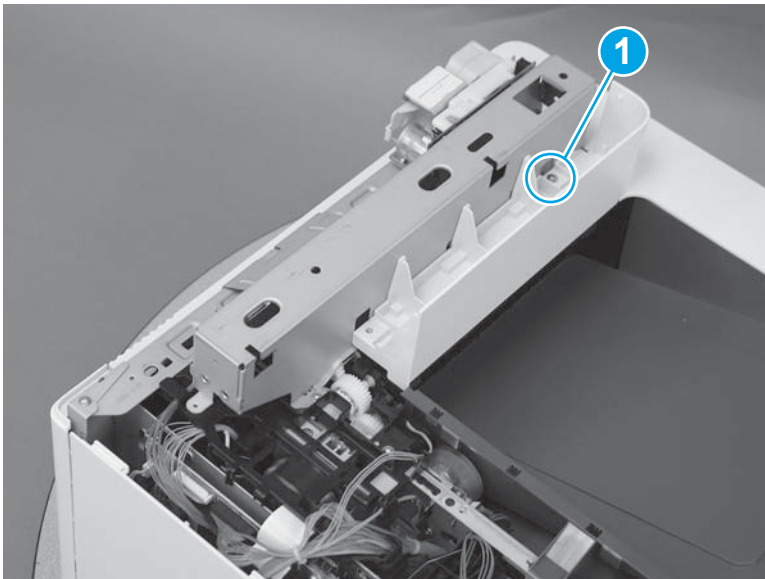

2. Lift the cover up to remove it.

Figure 1-448 Remove the cover

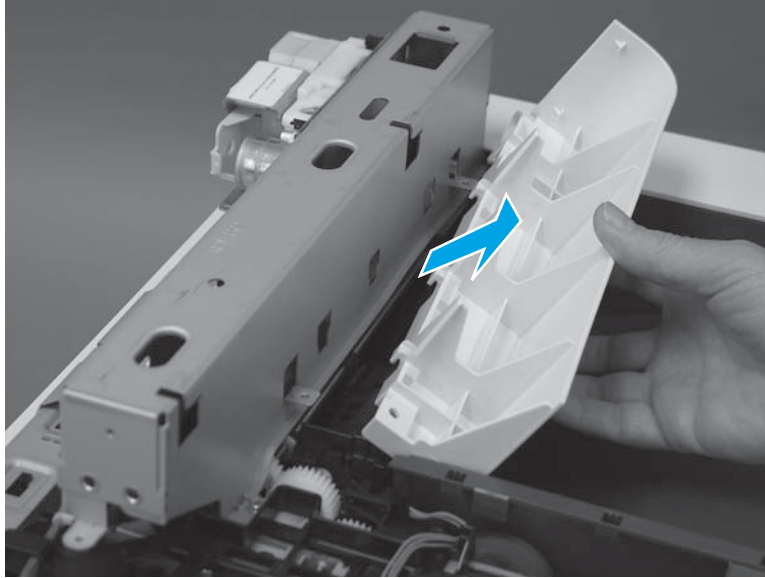

Step 10: Unpack the replacement assembly

Unpack the replacement assembly from the packaging.

For complete information on HP's recycling programs, go to [Product return and recycling](#).

 **NOTE:** HP recommends responsible disposal of the defective assembly.

Figure 1-449 Recycle and unpack

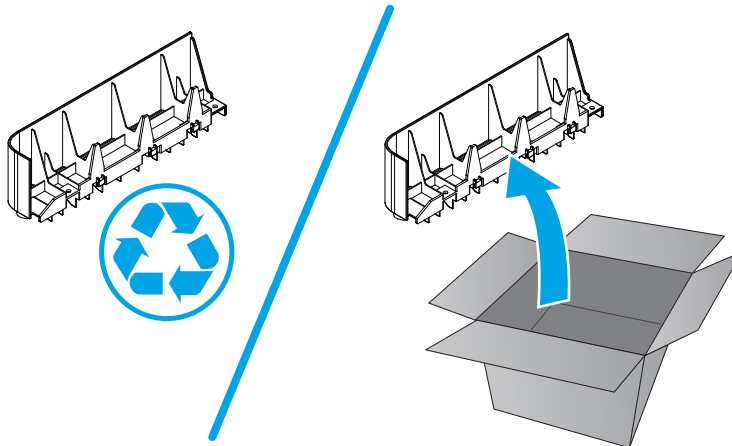

Step 11: Install the paper feed cover

1. Position the locator tabs (callout 1) on the cover in the slots (callout 2) in the printer. Press down until the cover snaps into place.

Figure 1-450 Install the cover

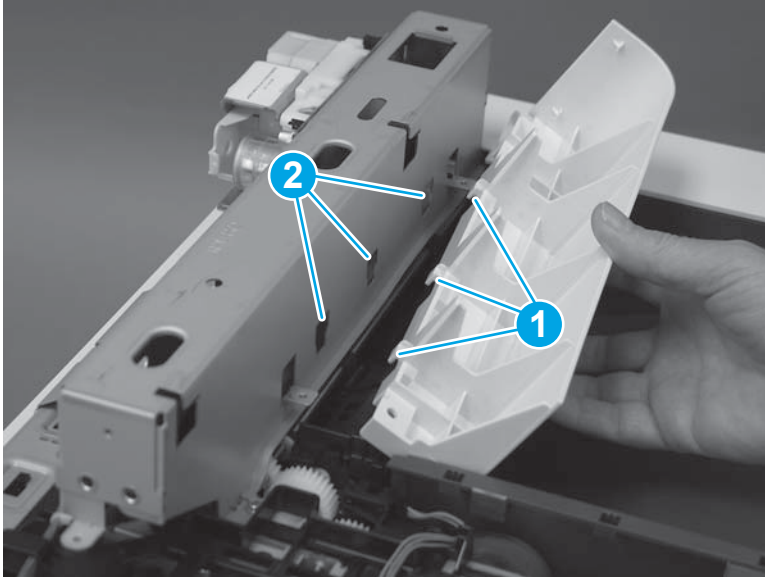

2. Install one screw (callout 1).

Figure 1-451 Install one screw

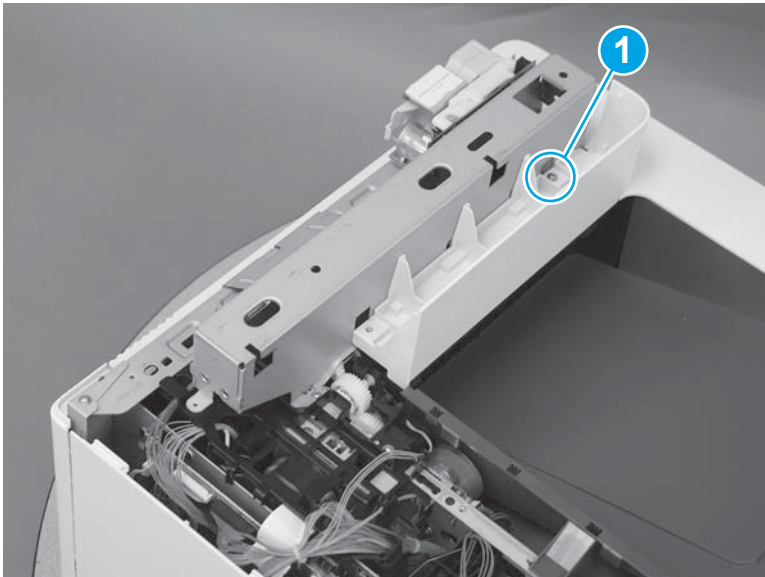

Step 12: Install the top rear cover

1. Align the locator tabs (callout 1) on the cover with the slots (callout 2) in the printer.

Figure 1-452 Align the locator tabs

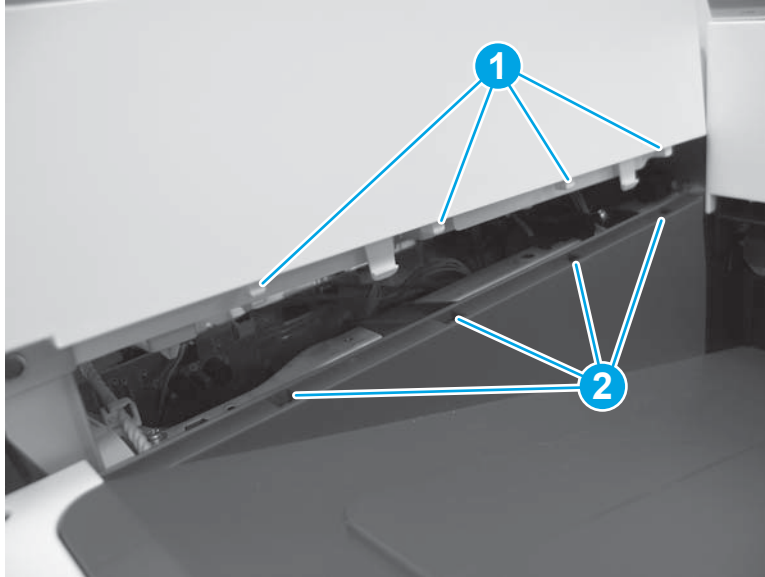

2. Press down to install the cover. Make sure that the tabs snap into place.

Figure 1-453 Install the cover

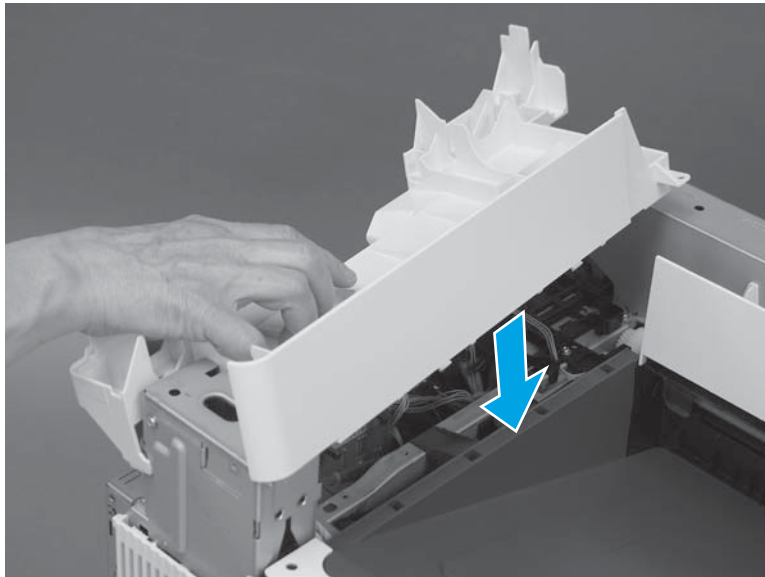

3. At the top of the printer, install five screws (callout 1).

Figure 1-454 Install five screws

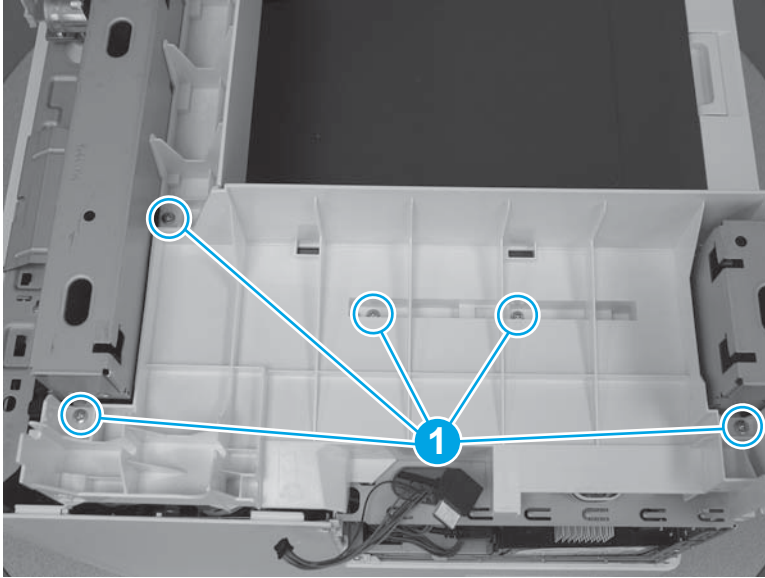

Step 13: Install the right upper cover (M577)

 **NOTE:** The figures below show the image scanner installed. The procedures for removing and installing the right upper cover are the same whether the image scanner is installed or removed."

1. **M577c/f/z only:** Install the cables (callout 1) through the slot (callout 2) in the printer.

Figure 1-455 Install the cables

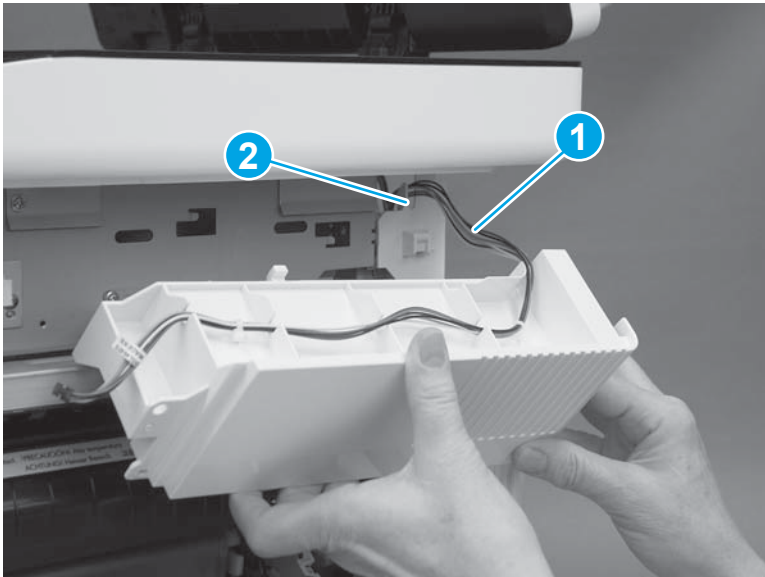

2. Position the hooks (callout 1) on the cover in the slots (callout 2) in the printer.

Figure 1-456 Position the hooks

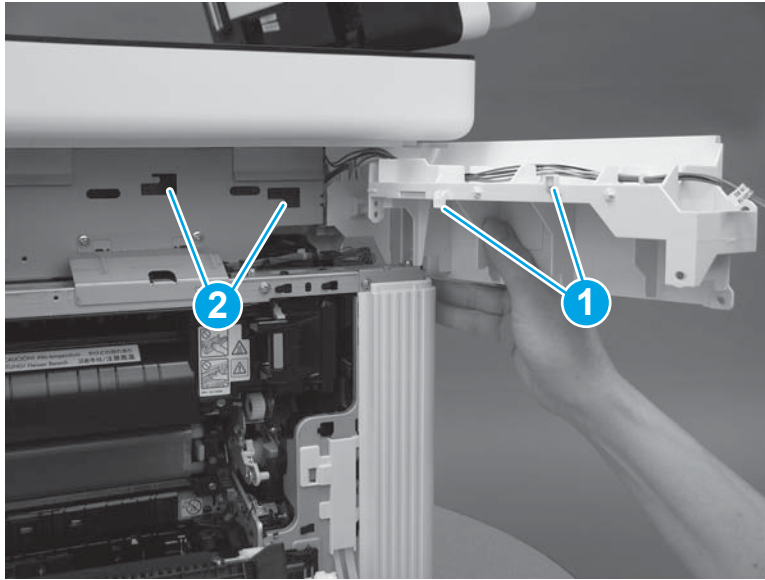

3. Slide the cover toward the front of the printer to install it.

Figure 1-457 Install the cover

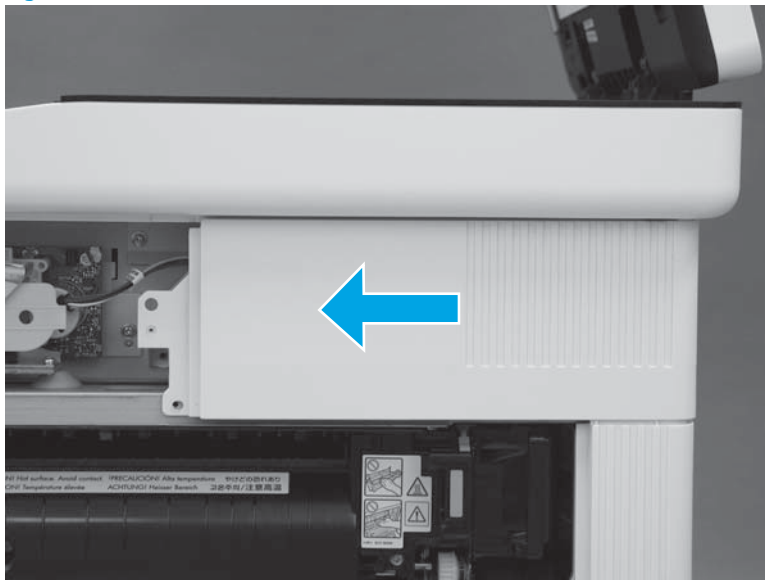

4. At the back of the printer, install one screw (callout 1).

M577c/f/z only: Connect one connector (callout 2), if the integrated scanner assembly is installed.

TIP: This screw is smaller than the screws installed in the next step. Make sure that this screw is installed in the correct position.

Figure 1-458 Install one screw and connector



5. At the right side of the printer, install two screws (callout 1).

M577c/f/z only: Connect one connector (callout 2), if the stapler is installed.

Figure 1-459 Install one screw and connector

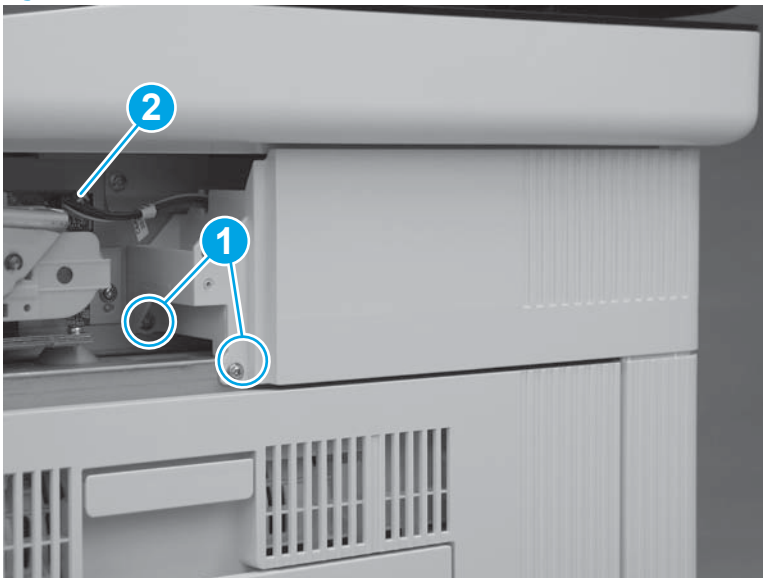

Step 14: Install the integrated scanner assembly (ISA) (M577)

 **NOTE:** The ISA includes the document feeder, image scanner, scanner control board (SCB), control panel, keyboard (M577c/z) and NFC PCA (M577z).

1. Before proceeding, locate the mounting pins (callout 1) on the bottom of the ISA and the slots (callout 2) on the printer base.

Figure 1-460 Locate the ISA mounting pins and slots

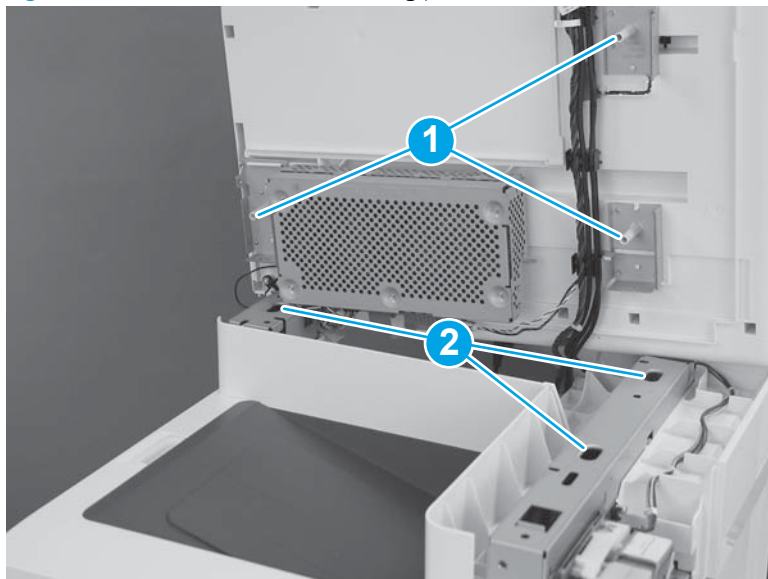

2. Position the ISA on the printer base with the pins in the slots.

 **NOTE:** To locate the pins and slots, see [Figure 1-395 Locate the ISA mounting pins and slots on page 249](#).

Figure 1-461 Install the ISA



3. Slightly slide the ISA towards the front of the printer to engage it.

Figure 1-462 Slide the ISA towards the front of the printer

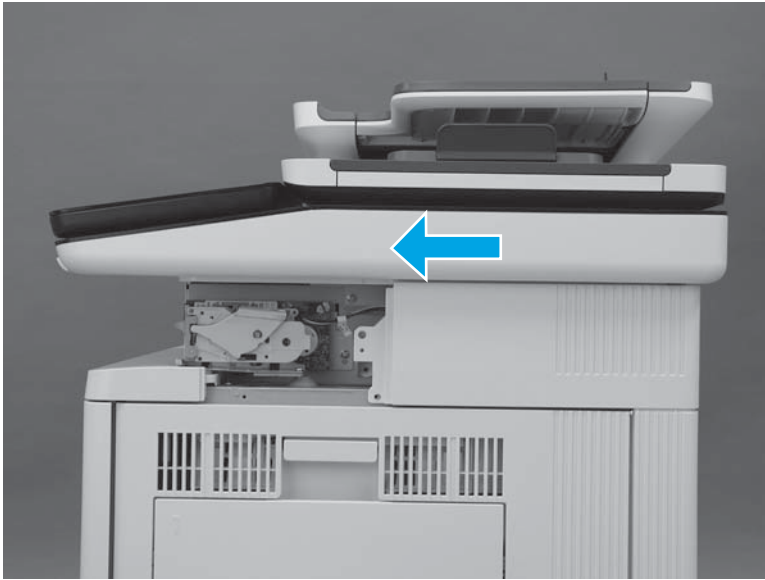

4. At the left side of the printer, install one screw (callout 1).

Figure 1-463 Install one screw

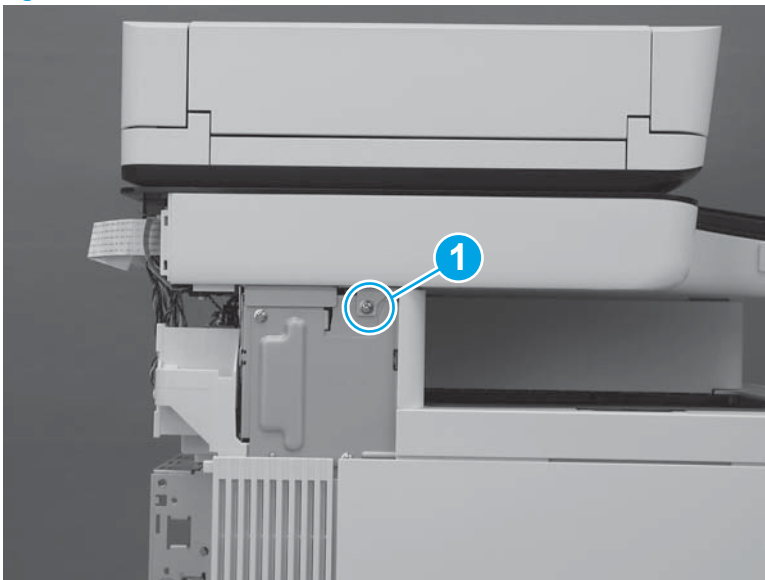

5. At the back of the printer, install two screws (callout 1).

Figure 1-464 Install two screws

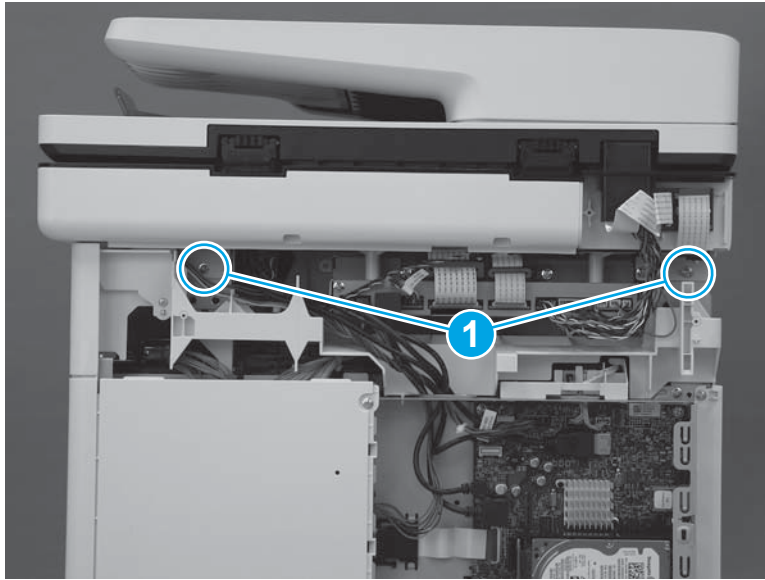

6. At the right side of the printer, install one screw (callout 1).

Figure 1-465 Install one screw

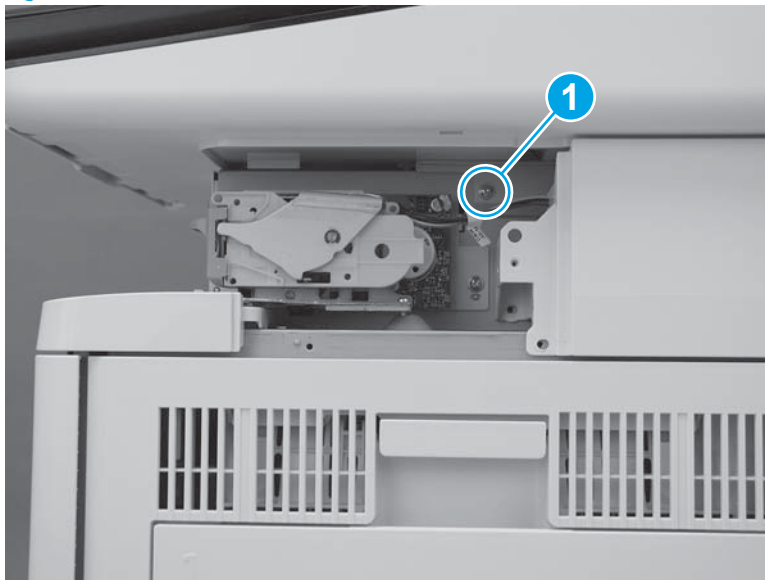

7. Connect two connectors on the scanner control board (callout 1).

M577c/f/z only: Connect one connector for the stapler on the scanner control board (callout 2).

Figure 1-466 Connect connectors

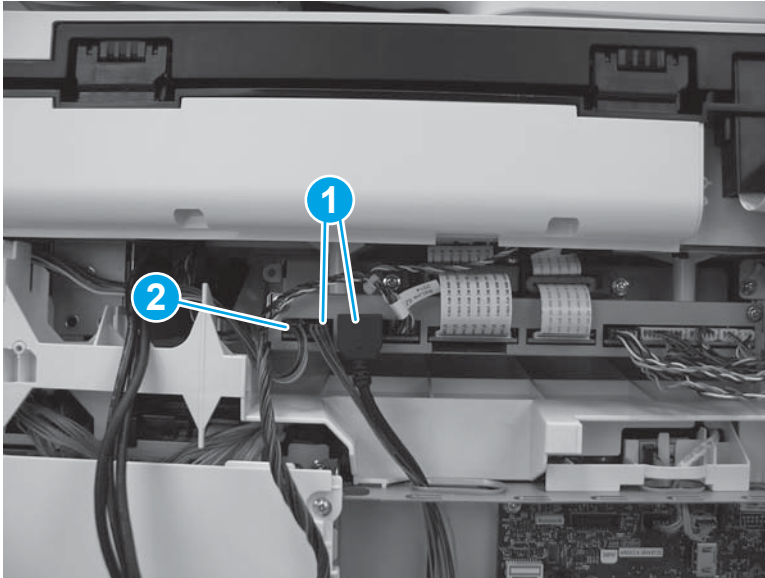

8. Install the wire harness and cables (callout 1) in the retainers (callout 2). Pass them through the opening in the top of the formatter cover (callout 3), and then connect four connectors (callout 4) on the formatter.

Figure 1-467 Connect four connectors

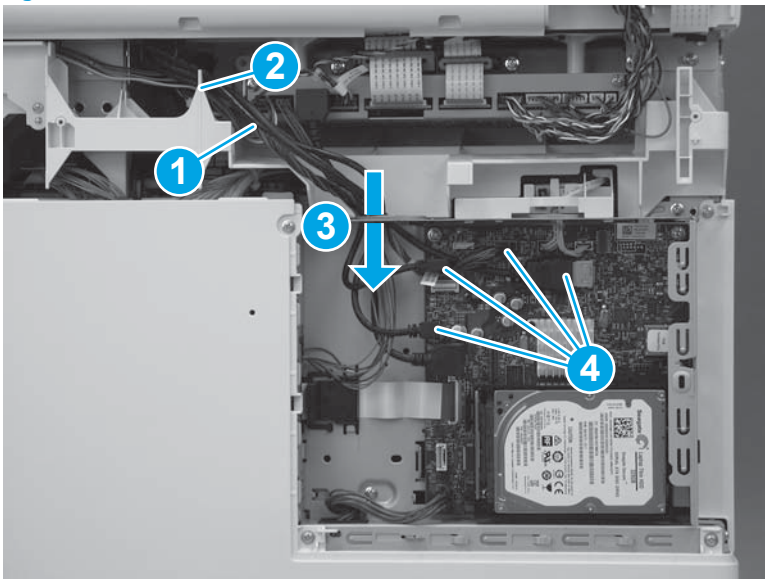

Step 15: Install the stapler cover assembly (M577c/f/z)

 **NOTE:** This step is for the M577c/f/z models only. For the M577dn model, skip this step and go to [Step 16: Install the right front upper cover \(M577dn\) on page 288.](#)

1. Install the tabs (callout 1) on the cover in the slots (callout 2) in the printer.

Figure 1-468 Install two tabs



2. Press the cover toward the left side of the printer until it snaps into place.

Figure 1-469 Install the cover assembly



3. Install one screw (callout 1).



 **IMPORTANT:** This is a self-tapping screw for plastic. Rotate it counterclockwise to align it with the existing thread pattern, and then carefully turn it clockwise to tighten. Do not overtighten. This will prevent stripping the threads inside the screw hole.

Figure 1-470 Install one screw

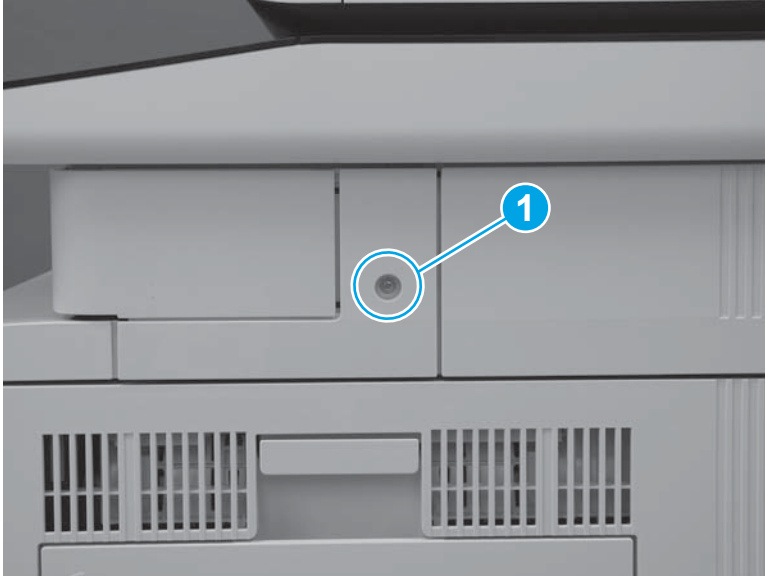

Step 16: Install the right front upper cover (M577dn)

 **NOTE:** This step is for the M577dn model only. For the M577c/f/z models, skip this step and go to [Step 17: Install the left upper cover on page 289](#).

1. Slide the cover toward the left side of the printer to install it. Make sure that the slots (callout 1) in the cover fit over the tabs (callout 2) on the inside of the paper feeder cover.

Figure 1-471 Install the cover

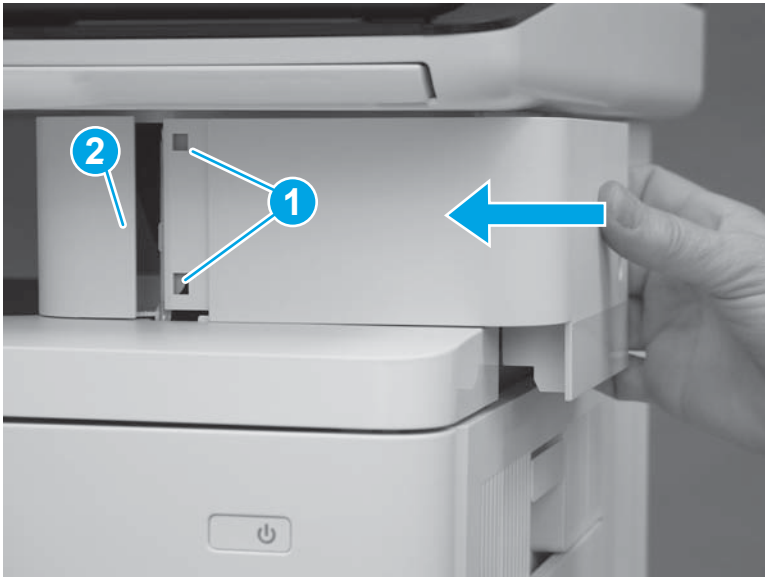

2. Press the right front upper cover (callout 1) and the paper feeder cover (callout 2) together until the tabs on the inside of the covers snap into place.

Figure 1-472 Press the cover



3. Install one screw (callout 1).

Figure 1-473 Install one screw

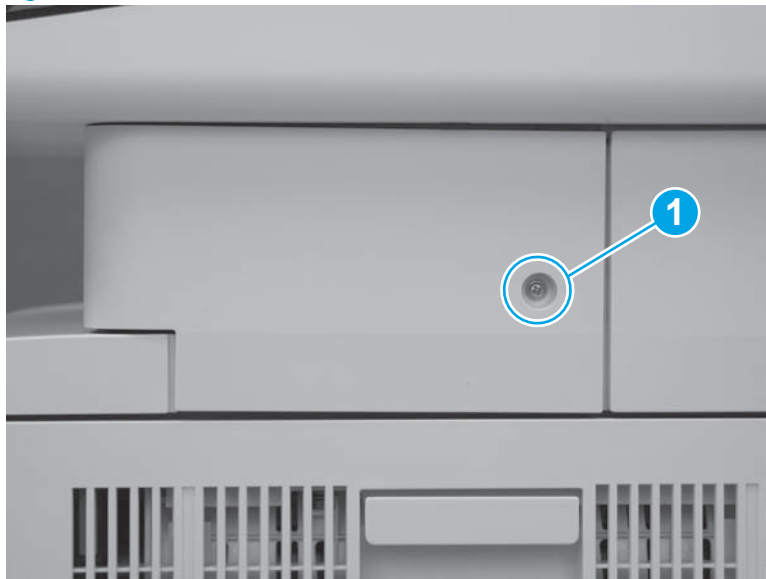

Step 17: Install the left upper cover

1. Position the tab (callout 1) on the lower edge of the cover behind the left cover (callout 2).

Figure 1-474 Position the tab

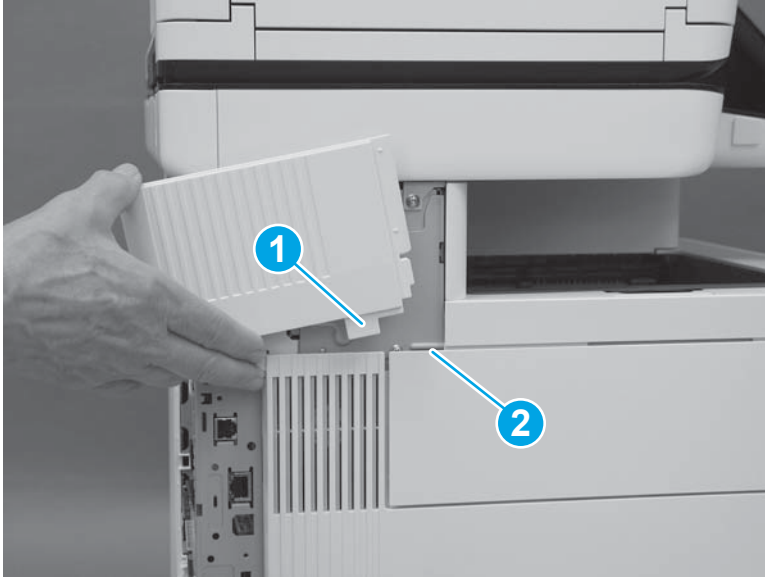

2. Slide the cover toward the front of the printer to install it. Make sure that the edge (callout 1) of the cover fits behind the edge (callout 2) of the top rear cover.

Figure 1-475 Slide the cover

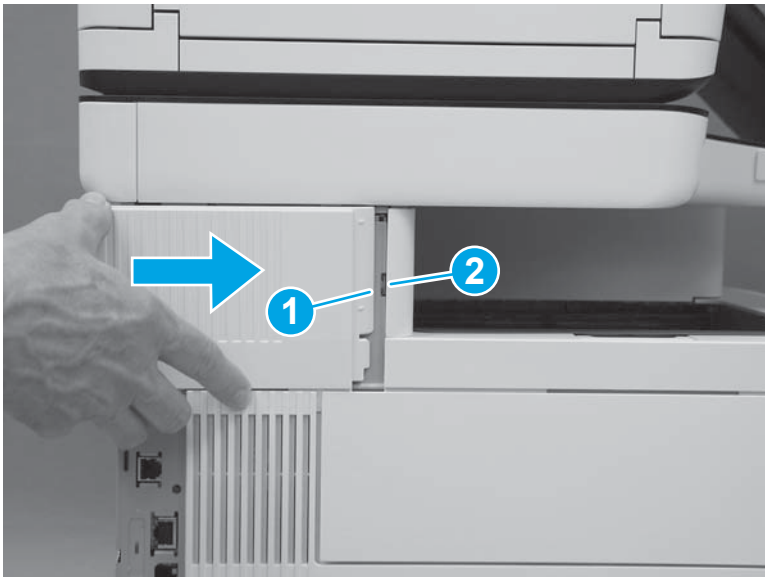

3. Make sure that the tab (callout 1) is fully installed.

Figure 1-476 Check the tab

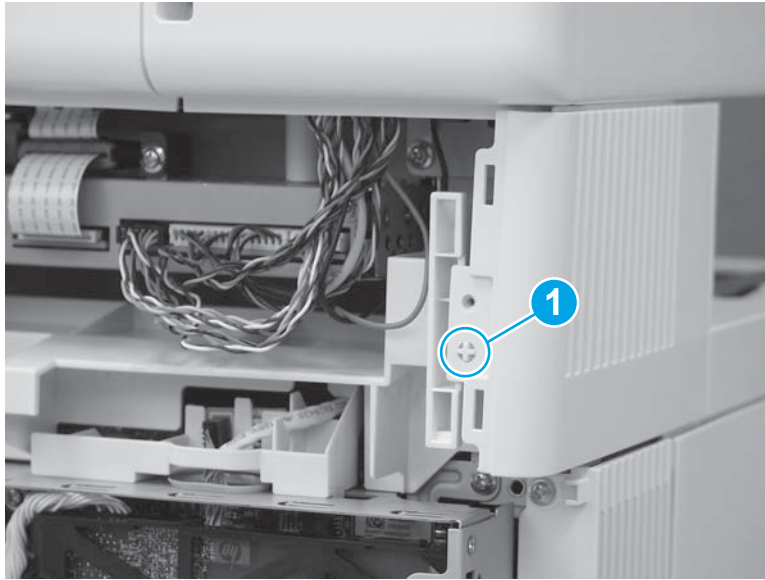

Step 18: Install the rear upper cover

1. Align the ridge (callout 1) on the lower edge of the rear upper cover in front of the tabs (callout 2) on the top edge of the rear cover.

Figure 1-477 Align the cover

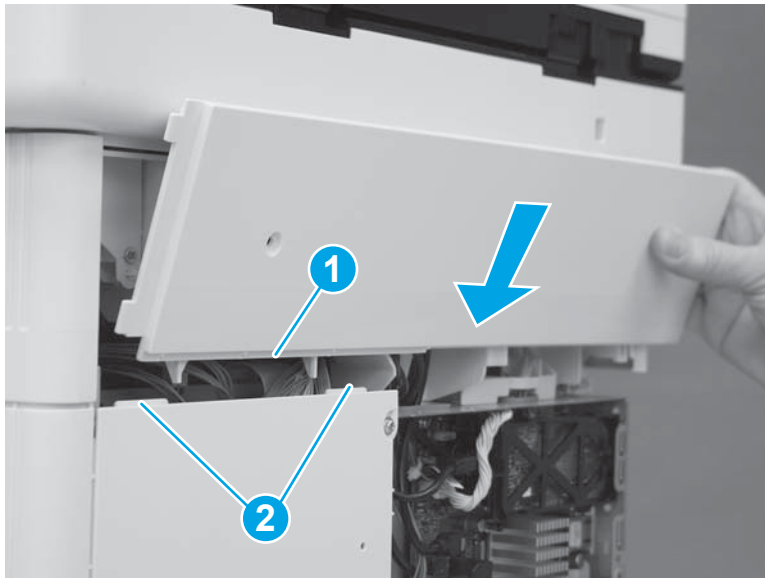

2. Rotate the top of the cover toward the printer.

Figure 1-478 Rotate the top of the cover

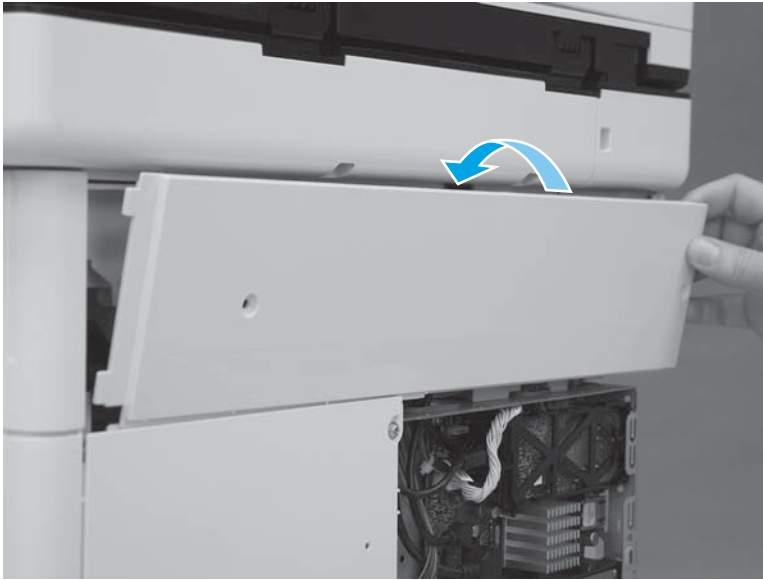

3. Slide the cover to the left (callout 1). Make sure that the tabs (callout 2) on the upper rear cover slide behind the edge (callout 3) of the right upper cover. Make sure that the cover is fully seated.

Figure 1-479 Slide the cover

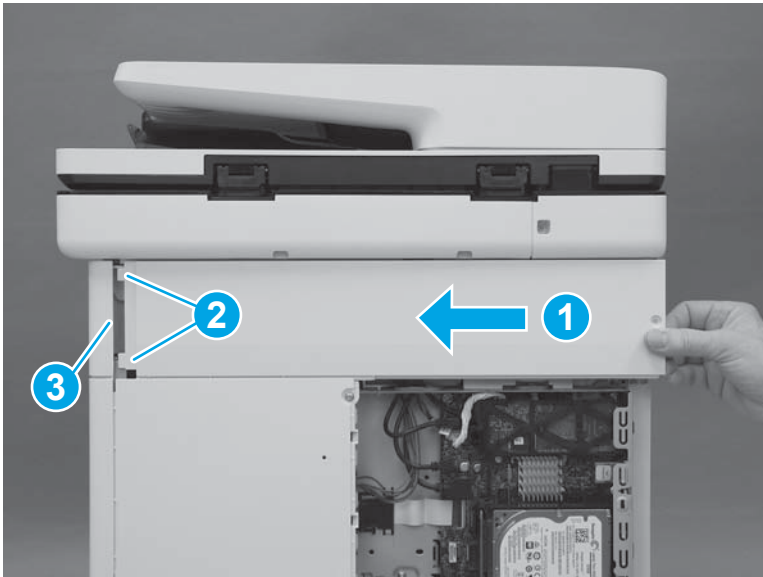

4. Install two screws (callout 1).



 **IMPORTANT:** These two screws are self-tapping screws for plastic. Rotate them counterclockwise to align them with the existing thread pattern, and then carefully turn them clockwise to tighten. Do not overtighten. This will prevent stripping the threads inside the screw holes.

Figure 1-480 Install two screws

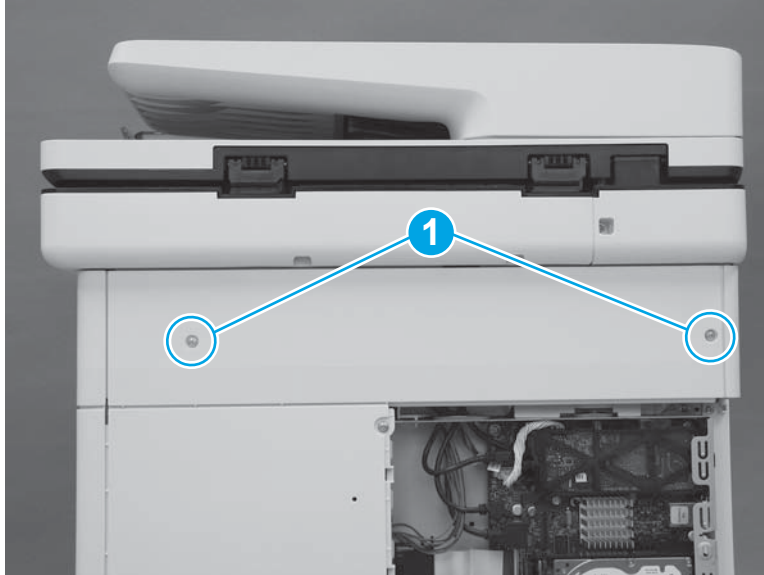

Step 19: Install the formatter cover

- ▲ Slide the cover onto the printer (callout 1) to install it.

 **NOTE:** Make sure that the tabs on the formatter cover align with the slots provided in the printer (callout 2). Tighten the two thumbscrews (callout 3).

 **TIP:** If needed, use the edge of a coin to turn the thumbscrews.

Figure 1-481 Install the cover

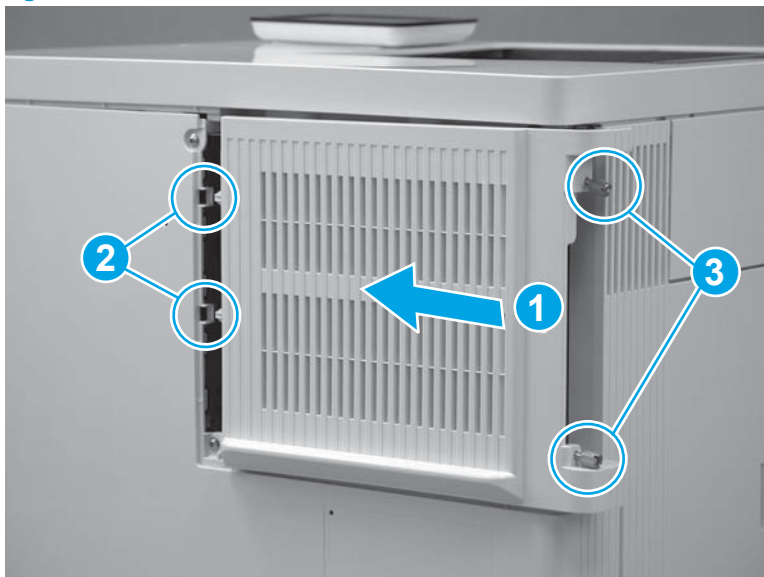

Removal and replacement: Top cover (M577)

- [Introduction](#)
- [Step 1: Remove the formatter cover](#)
- [Step 2: Remove the rear upper cover \(M577\)](#)
- [Step 3: Remove the left upper cover \(M577\)](#)
- [Step 4: Remove the right front upper cover \(M577dn\)](#)
- [Step 5: Remove the stapler cover assembly \(M577c/f/z\)](#)
- [Step 6: Remove the integrated scanner assembly \(ISA\) \(M577\)](#)
- [Step 7: Remove the stapler unit \(M577c/f/z\)](#)
- [Step 8: Remove the right upper cover \(M577\)](#)
- [Step 9: Remove the top rear cover \(M577\)](#)
- [Step 10: Remove the paper feed cover \(M577\)](#)
- [Step 11: Remove the toner collection unit \(TCU\)](#)
- [Step 12: Remove the top cover \(M577\)](#)
- [Step 13: Unpack the replacement assembly](#)
- [Step 14: Install the top cover](#)
- [Step 15: Install the toner collection unit \(TCU\)](#)
- [Step 16: Install the paper feed cover](#)
- [Step 17: Install the top rear cover](#)
- [Step 18: Install the right upper cover \(M577\)](#)
- [Step 19: Install the stapler unit \(M577c/f/z\)](#)
- [Step 20: Install the integrated scanner assembly \(ISA\) \(M577\)](#)
- [Step 21: Install the stapler cover assembly \(M577c/f/z\)](#)
- [Step 22: Install the right front upper cover \(M577dn\)](#)
- [Step 23: Install the left upper cover](#)
- [Step 24: Install the rear upper cover](#)
- [Step 25: Install the formatter cover](#)

Introduction

This document provides the procedures to remove and replace the M577 top cover.

Before performing service

Make sure that the top cover is fully seated after replacing it.

Turn the printer power off

- Disconnect the power cable.

⚠ WARNING! To avoid damage to the printer, turn the printer off, wait 30 seconds, and then remove the power cord before attempting to service the printer.

Use the table below to identify the correct part number for your printer. To order the part, go to www.hp.com/buy/parts.

Top cover (M577) part number	
RC4-3381-000CN	Top cover (M577)

Required tools

- Small flat blade screwdriver
- #2 Phillips screwdriver with a magnetic tip

After performing service

Turn the printer power on

- Connect the power cable.
- Use the power switch to turn the power on.

Step 1: Remove the formatter cover

1. Locate the formatter cover.

Figure 1-482 Locate the formatter cover

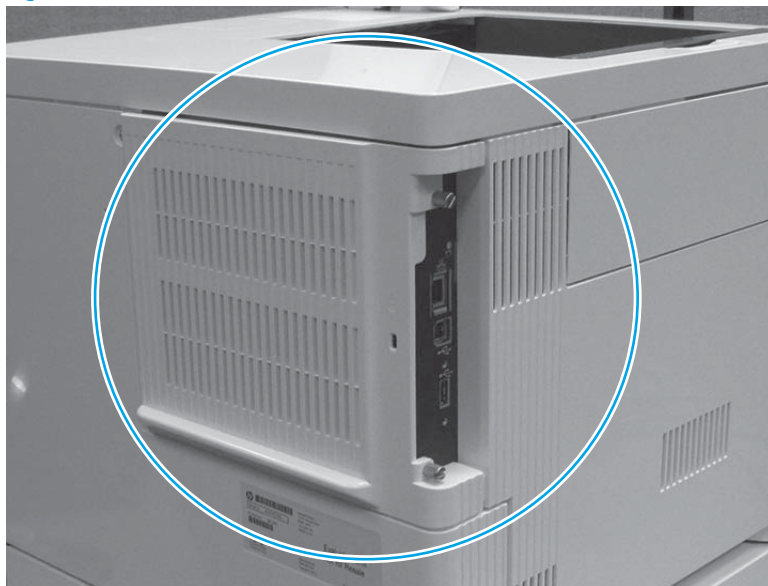

2. Loosen the two thumbscrews (callout 1). Grasp the two thumbscrews, and then slide the cover away from the printer (callout 2) to remove it.

 **TIP:** If needed, use the edge of a coin to turn the thumbscrews.

Figure 1-483 Loosen the thumbscrews

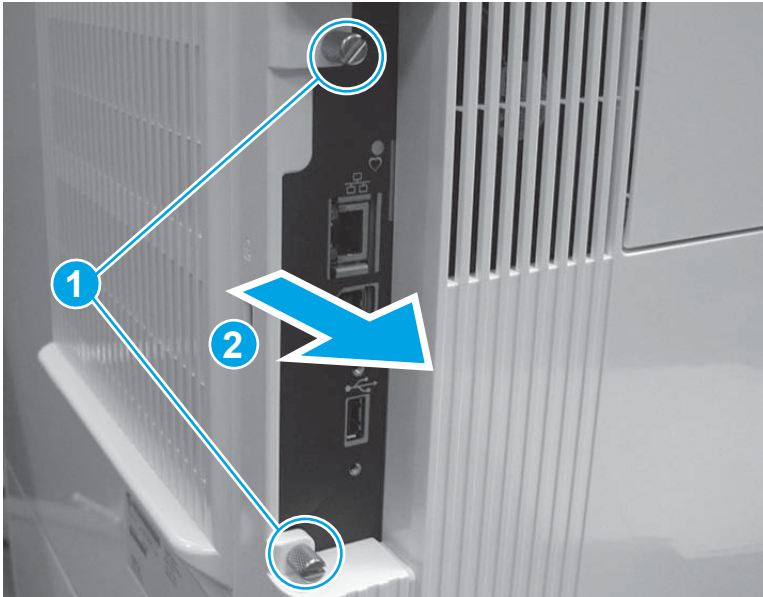

Step 2: Remove the rear upper cover (M577)

1. Remove two screws (callout 1).

 **Reinstallation tip:** These two screws are self-tapping screws for plastic. When reinstalling them, rotate the screws counterclockwise to align them with the existing thread pattern, and then carefully turn them clockwise to tighten. Do not overtighten. This will prevent stripping the threads inside the screw holes.

Figure 1-484 Remove two screws



2. Use a small, flat blade screwdriver to release the right edge of the cover.

Figure 1-485 Release the right edge

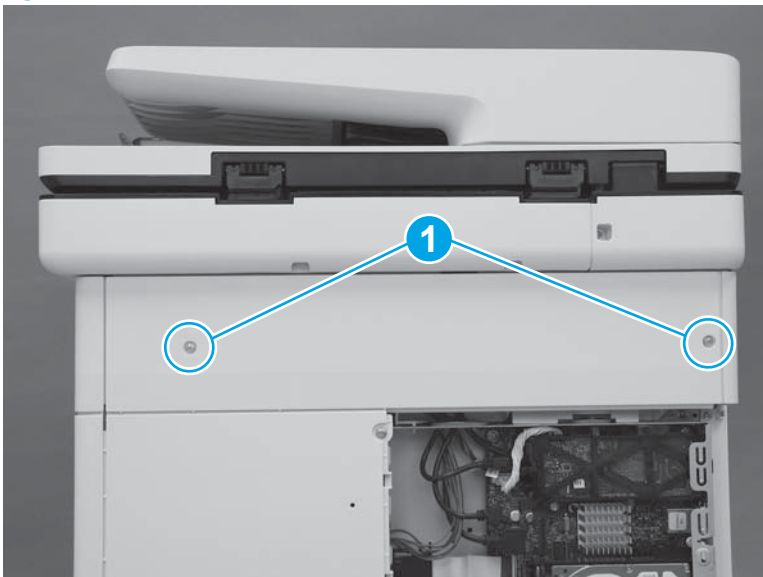
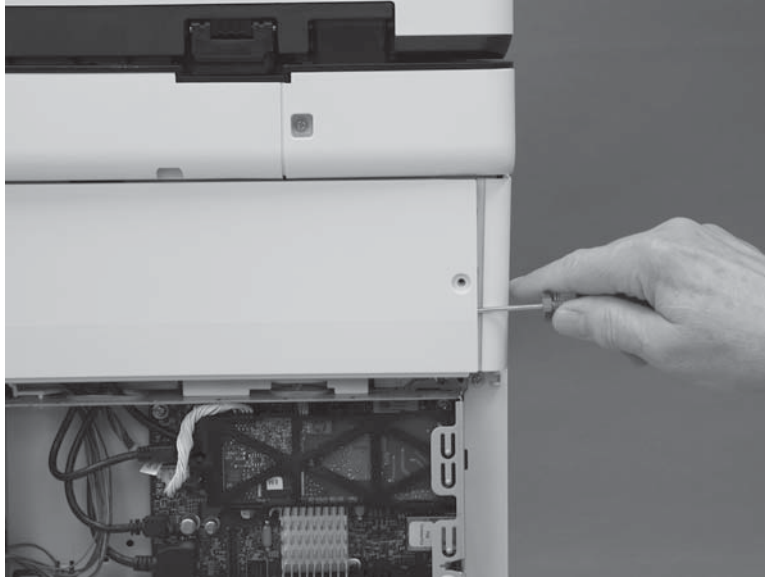

3. Pull the right edge of the cover (callout 1) away from the printer, and then slide the cover to the right (callout 2).

Figure 1-486 Slide the cover right

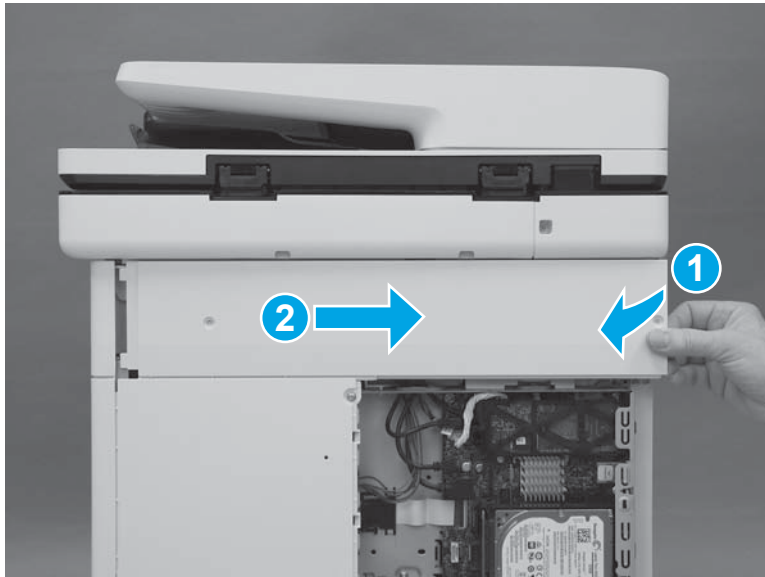

4. Remove the cover.

Figure 1-487 Remove the cover

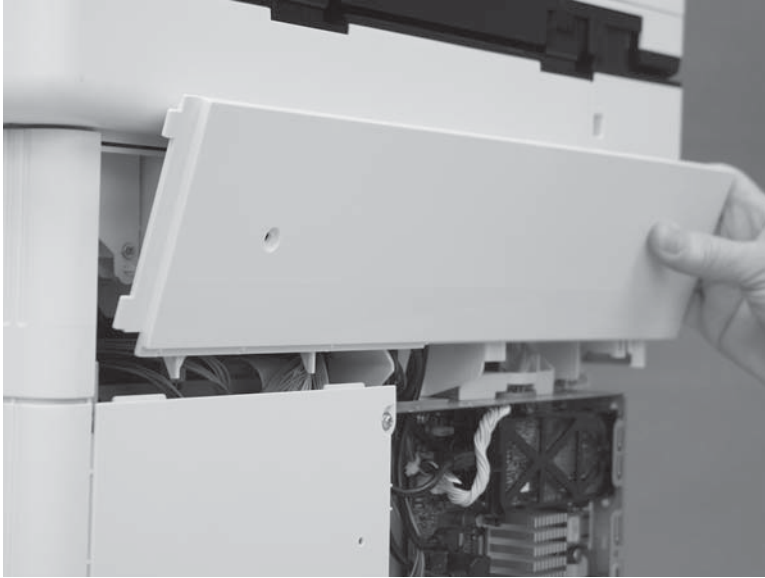

Step 3: Remove the left upper cover (M577)

1. At the left side of the printer, release one tab (callout 1).

Figure 1-488 Release one tab

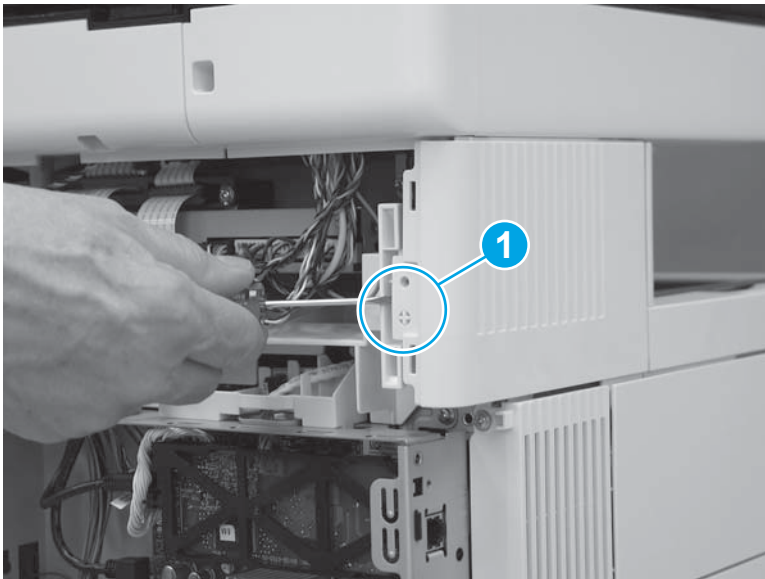

2. Slide the left upper cover toward the back of the printer.

Figure 1-489 Slide the cover back

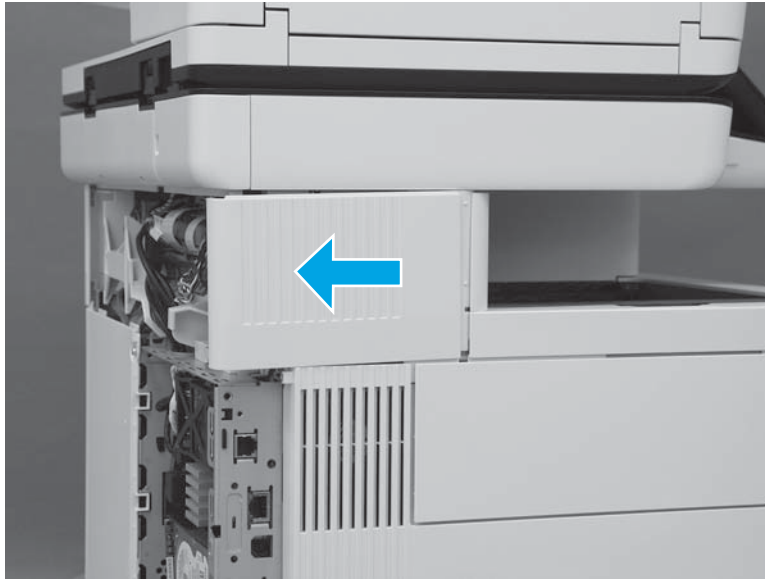

3. Rotate the cover up to remove it.

Figure 1-490 Remove the left upper cover



Step 4: Remove the right front upper cover (M577dn)

 **NOTE:** This step is for the M577dn model. For the M577c/f/z models, skip this step and to go [Step 5: Remove the stapler cover assembly \(M577c/f/z\) on page 301.](#)

1. Remove one screw (callout 1).

Figure 1-491 Remove one screw

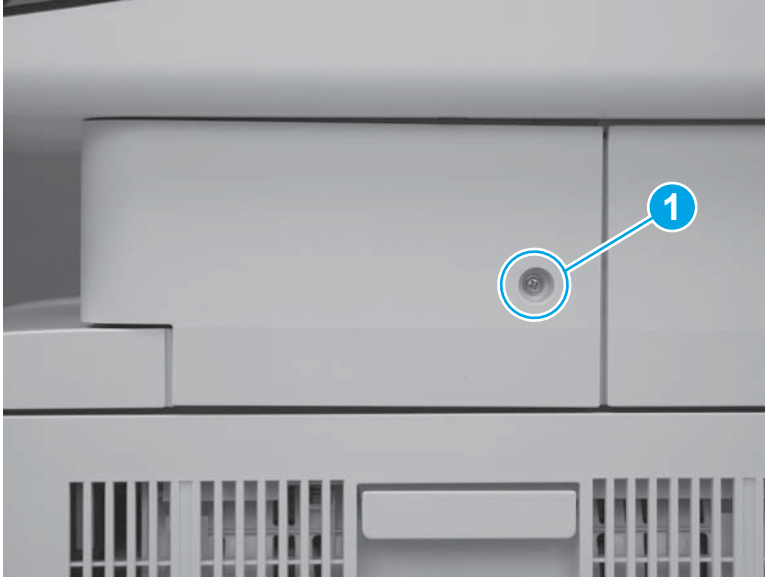

2. Release two tabs at the front edge of the cover (callout 1).

Figure 1-492 Release two tabs



3. Rotate the front of the cover to the right to remove it.

Figure 1-493 Rotate the cover



Step 5: Remove the stapler cover assembly (M577c/f/z)

 **NOTE:** This step is for the M577c/f/z models. For the M577dn model, skip this step and to go [Step 6: Remove the integrated scanner assembly \(ISA\) \(M577\) on page 303](#).

1. Remove one screw (callout 1).

 **Reinstallation tip:** This is a self-tapping screw for plastic. When reinstalling, rotate the screw counterclockwise to align it with the existing thread pattern, and then carefully turn it clockwise to tighten. Do not overtighten. This will prevent stripping the threads inside the screw hole.

Figure 1-494 Remove one screw



2. Release two tabs at the front edge of the cover (callout 1).

Figure 1-495 Release two tabs

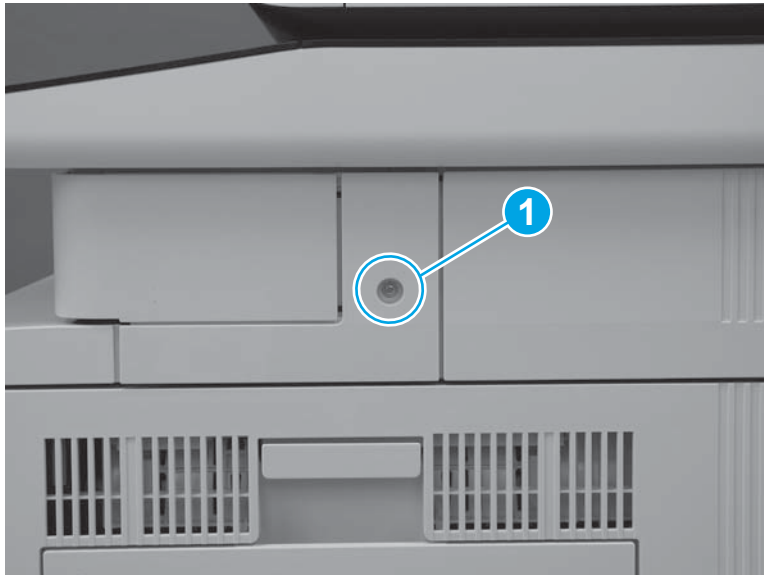

3. Release the back edge of the cover.

Figure 1-496 Release the back edge of the cover

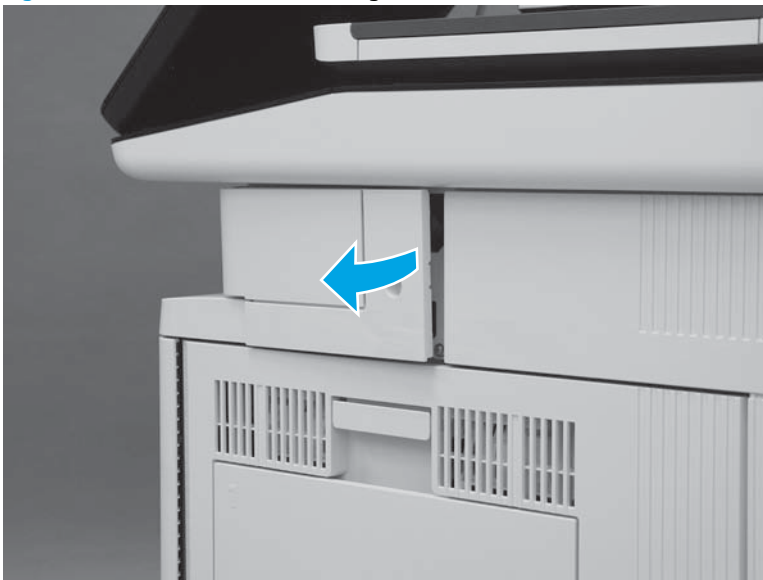

4. Rotate the cover away from the printer to remove it.

Figure 1-497 Remove the cover



Step 6: Remove the integrated scanner assembly (ISA) (M577)

 **NOTE:** The ISA includes the document feeder, image scanner, scanner control board (SCB), control panel, keyboard (M577c/z) and NFC PCA (M577z).

1. At the left side of the printer, remove one screw (callout 1).

Figure 1-498 Remove one screw

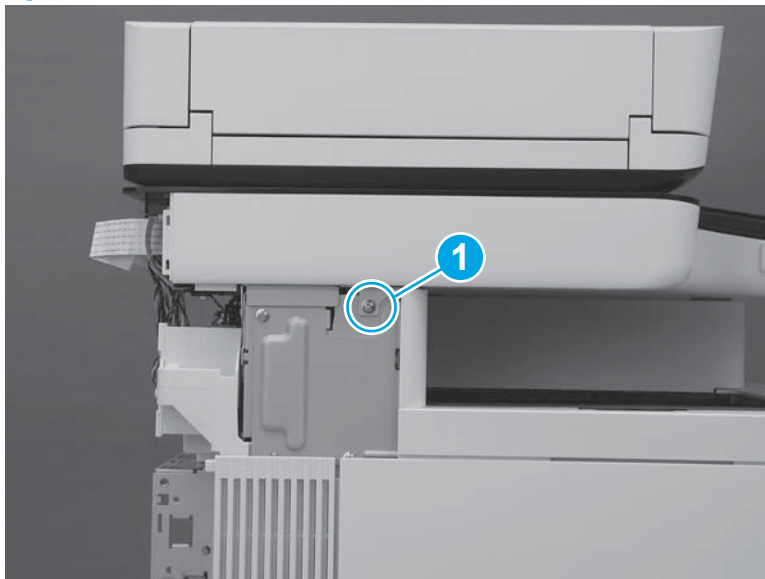

2. At the back side of the printer, remove two screws (callout 1).

Figure 1-499 Remove two screws

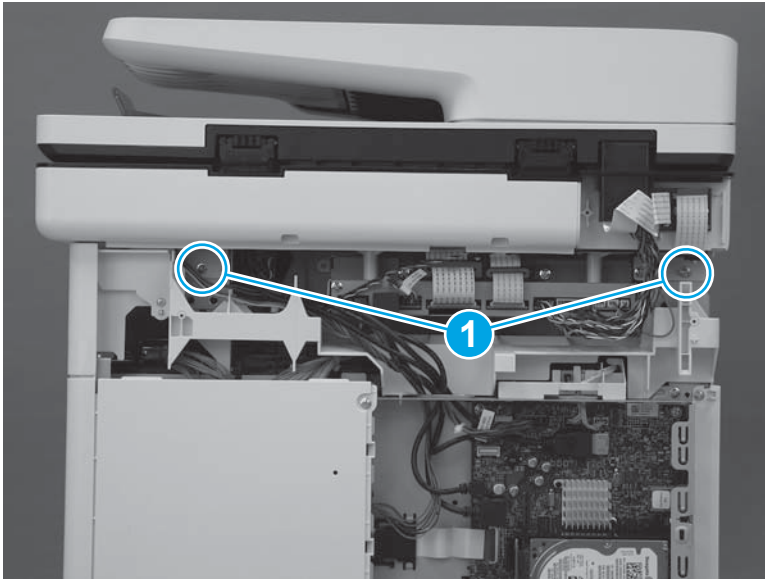

3. At the right side of the printer, remove one screw (callout 1).

Figure 1-500 Remove one screw

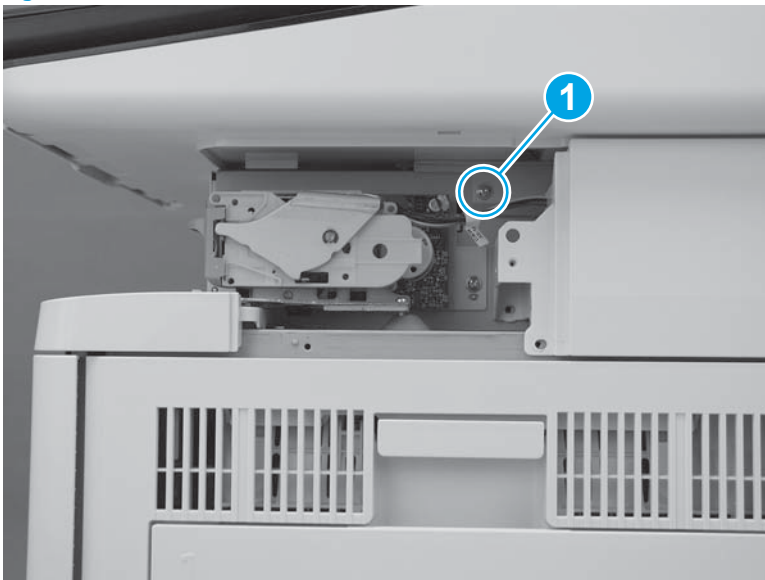

4. Disconnect four connectors on the formatter (callout 1), and then pass the wire harness and cables through the opening in the formatter case (callout 2).

Figure 1-501 Disconnect four connectors

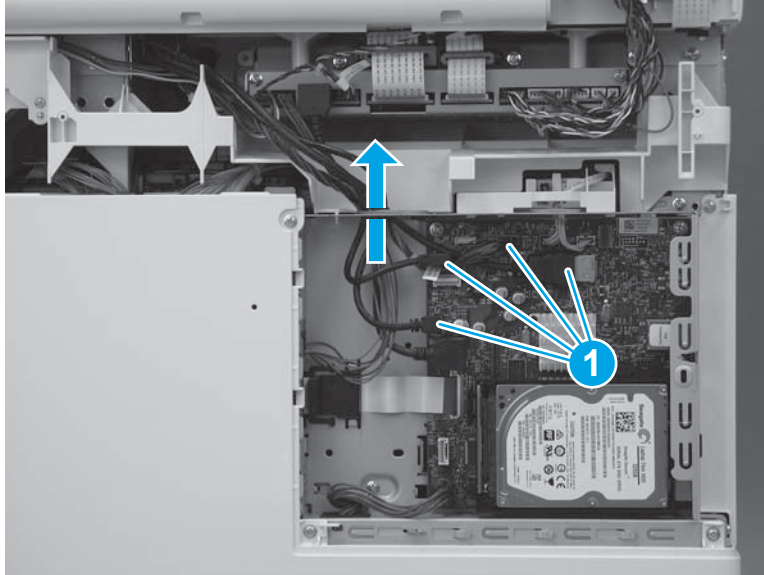

5. Disconnect two connectors on the scanner control board (callout 1).

M577c/f/z only: Disconnect one connector for the stapler on the scanner control board (callout 2).

Figure 1-502 Disconnect connectors

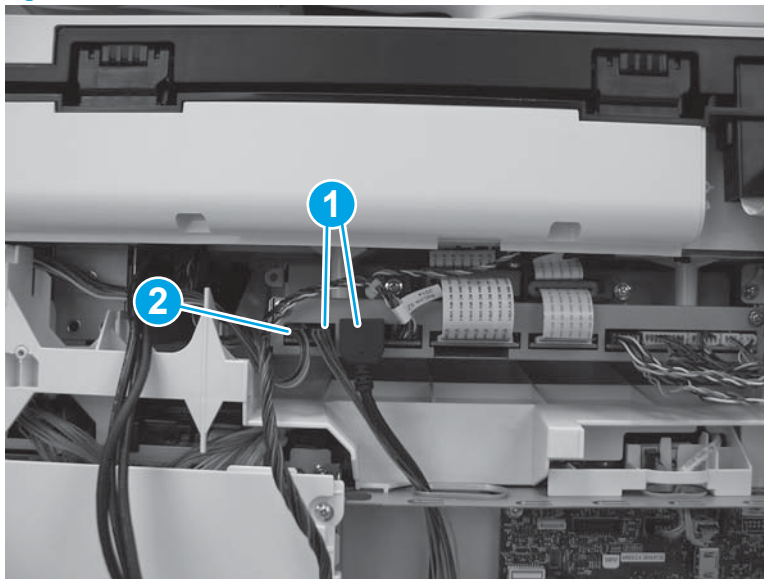

6. Slightly slide the ISA towards the back of the printer to release it.

Figure 1-503 Slide the ISA towards the back of the printer

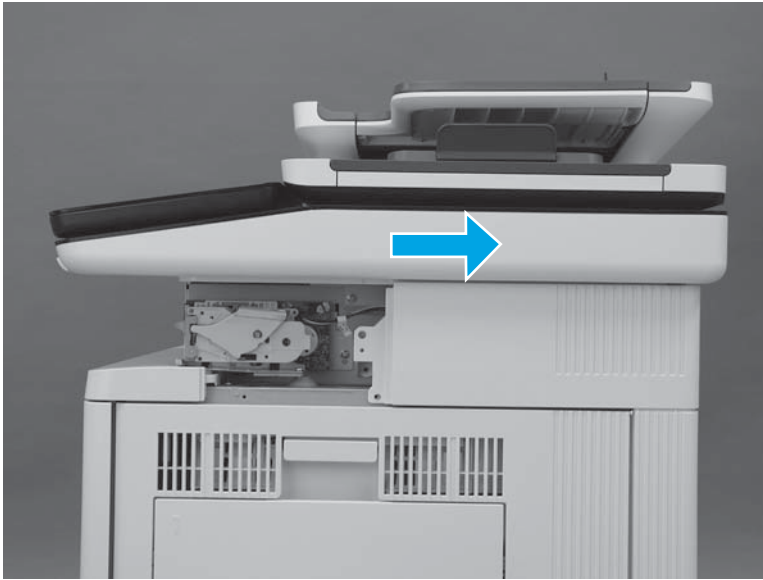

7. Lift the ISA up to remove it.

Figure 1-504 Remove the ISA

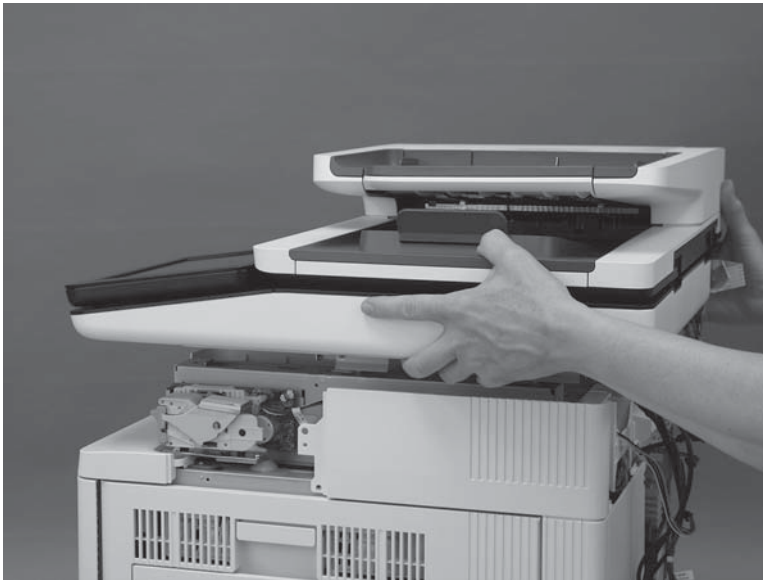

Step 7: Remove the stapler unit (M577c/f/z)

1. Disconnect one connector (callout 1), and then remove two screws (callout 2).

Figure 1-505 Disconnect connector and remove screws

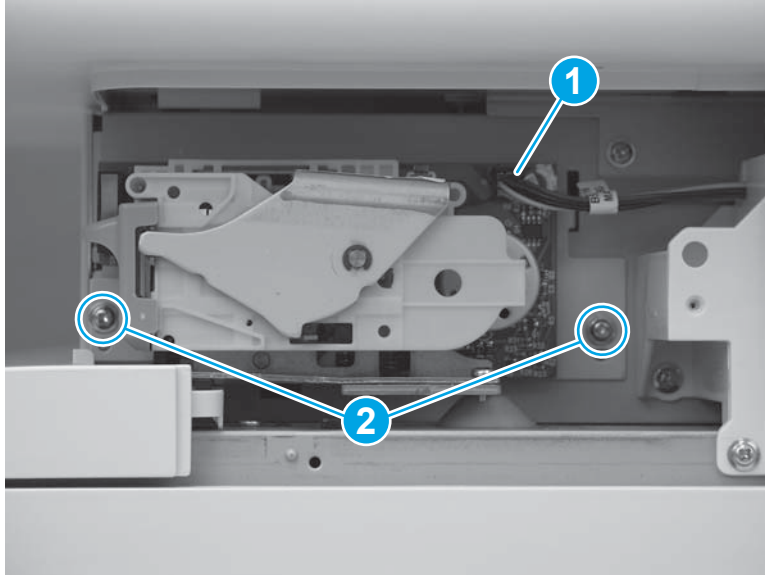

2. Slide the stapler unit up (callout 1), and then pull it away from the printer (callout 2) to remove it.

Figure 1-506 Remove the stapler unit

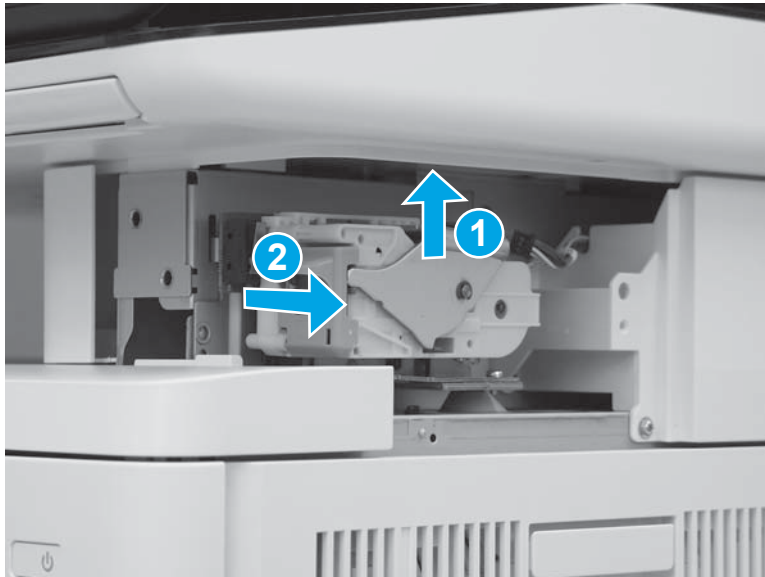

Step 8: Remove the right upper cover (M577)

 **NOTE:** The figures below show the image scanner installed. The procedures for removing and installing the right upper cover are the same whether the image scanner is installed or removed."

1. At the right side of the printer, remove two screws (callout 1).

M577c/f/z only: Disconnect one connector (callout 2), if it was not already disconnected in a previous step.

Figure 1-507 Remove two screws and one connector

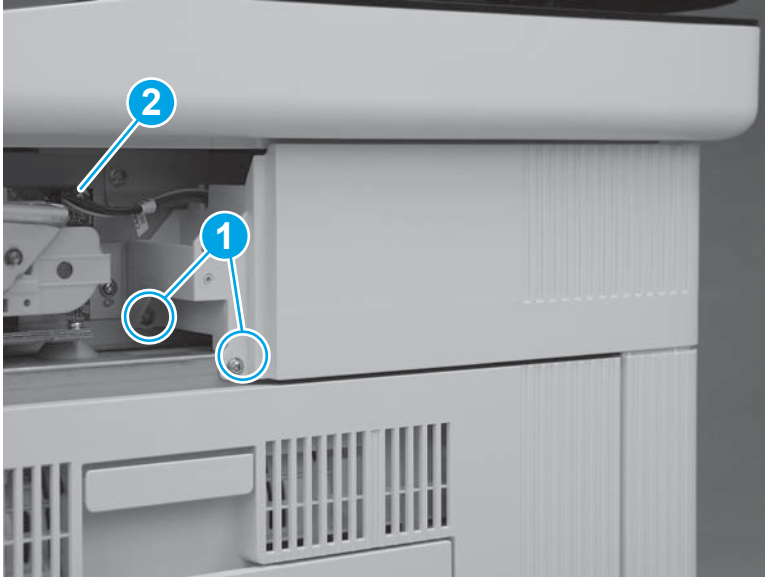

2. At the back of the printer, remove one screw (callout 1).

M577c/f/z only: Disconnect one connector (callout 2), if it was not already disconnected in a previous step.

 **Reinstallation tip:** This screw is smaller than the screws removed in the previous step. When reinstalling the right upper cover, make sure that this screw is installed in the correct position.

Figure 1-508 Remove one screw and connector



3. Slide the cover toward the back of the printer.

Figure 1-509 Slide the cover

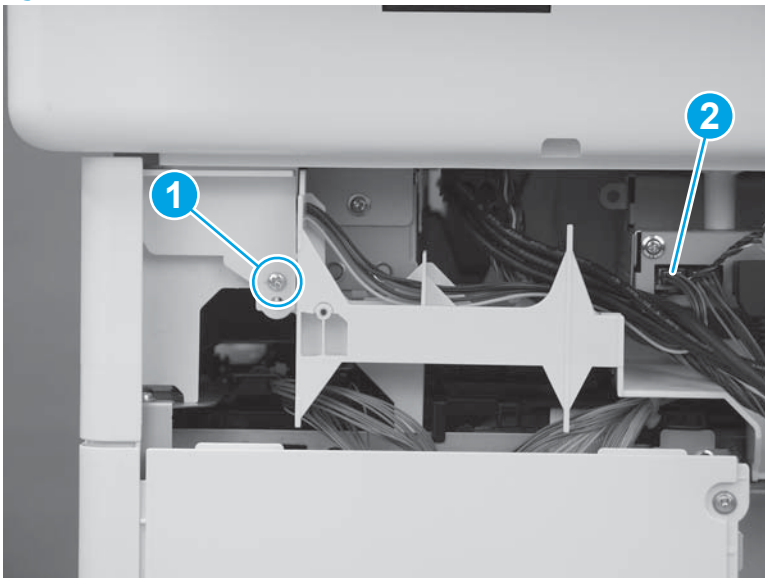
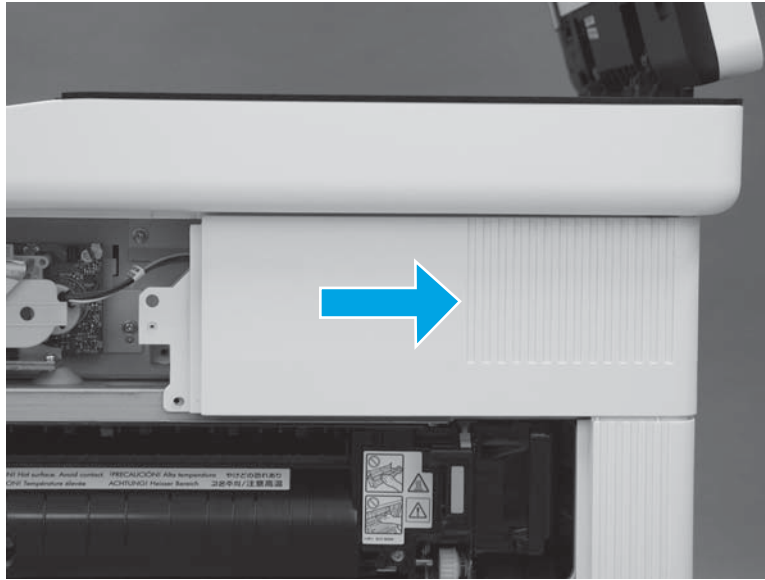

4. Lift the cover away from the printer to remove it.

M577c/f/z only: Release the cables (callout 1) through the slot (callout 2) in the printer.

Figure 1-510 Remove the cover

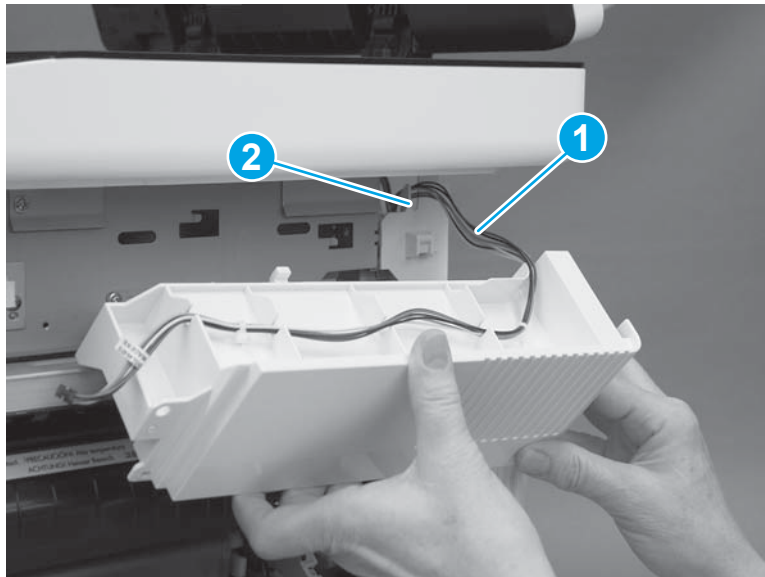

Step 9: Remove the top rear cover (M577)

1. At the top of the printer, remove five screws (callout 1).

Figure 1-511 Remove five screws

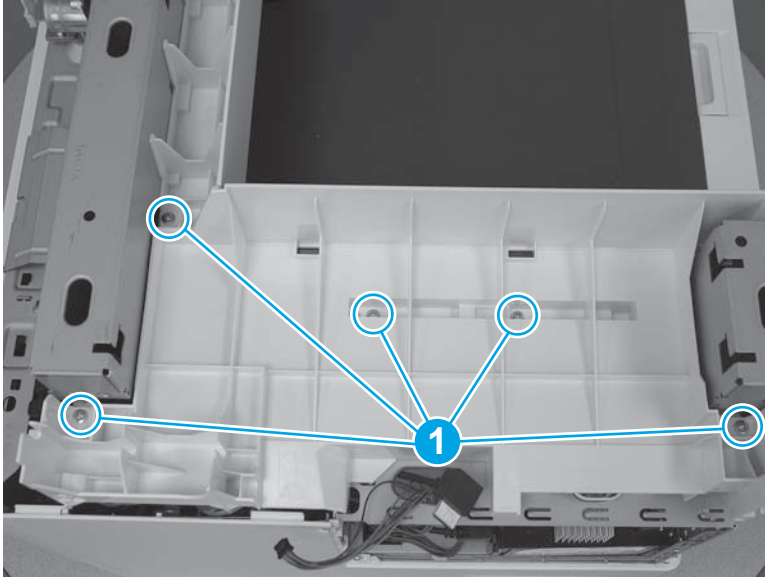

2. Release two tabs (callout 1) on the front edge of the cover.

Figure 1-512 Release two tabs

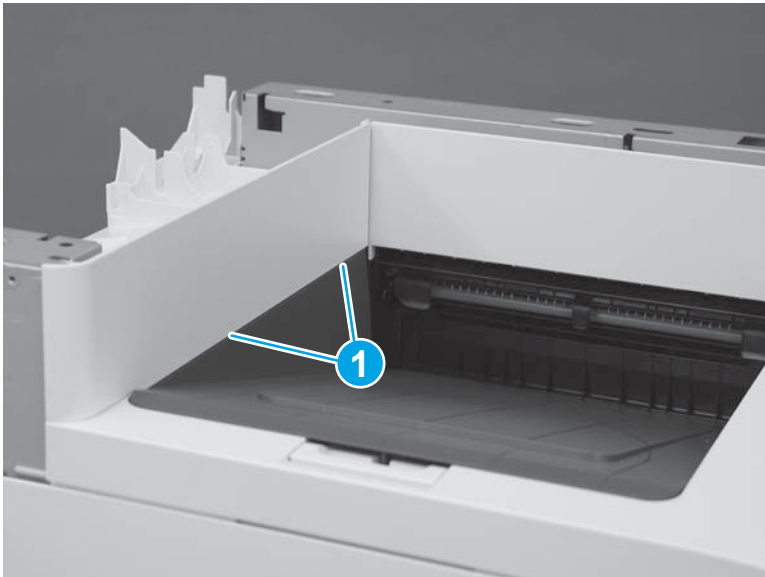

3. Remove the top rear cover.

Figure 1-513 Remove the top rear cover

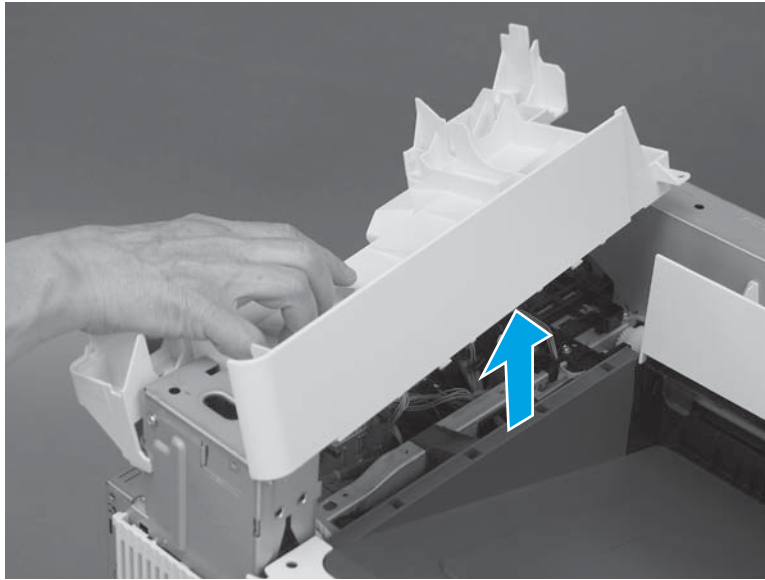

Step 10: Remove the paper feed cover (M577)

1. Remove one screw (callout 1).

Figure 1-514 Remove one screw

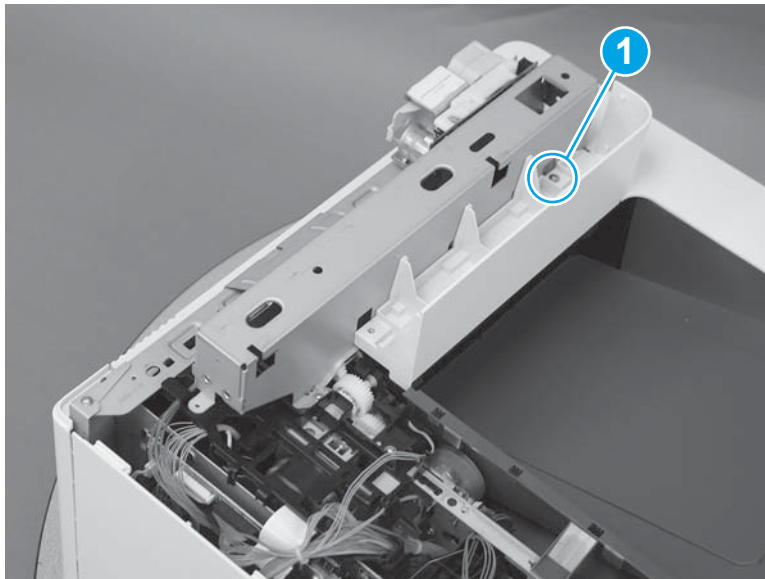

2. Lift the cover up to remove it.

Figure 1-515 Remove the cover

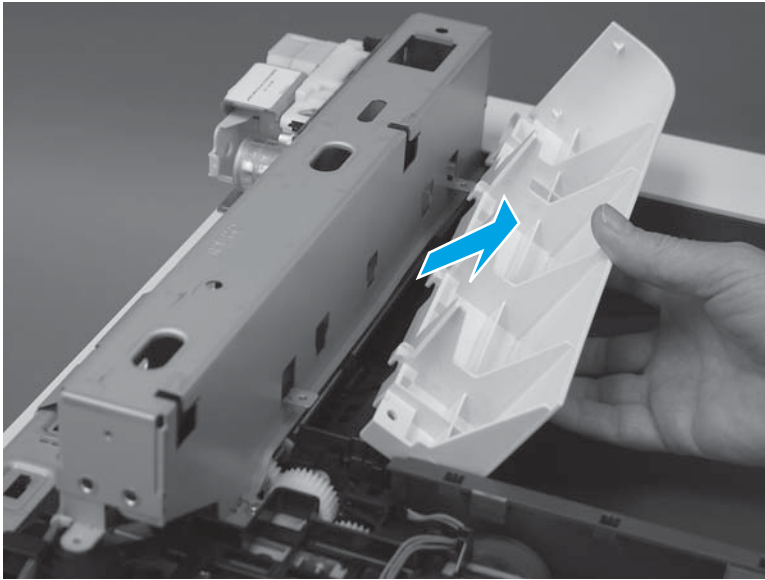

Step 11: Remove the toner collection unit (TCU)

1. Open the front door.

Figure 1-516 Open the front door



2. Open the TCU.

 **NOTE:** The toner collection hatch cover automatically closes when the TCU is opened.

Figure 1-517 Open the TCU



3. Pull the TCU away from the printer at an angle to remove it.

⚠ CAUTION: Do not open the toner collection hatch cover when handling the TCU. If toner gets on clothing, wipe it off by using a dry cloth and wash the clothes in cold water. Hot water sets toner into fabric.

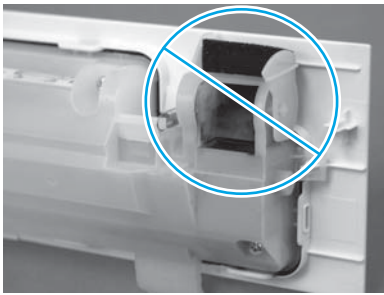
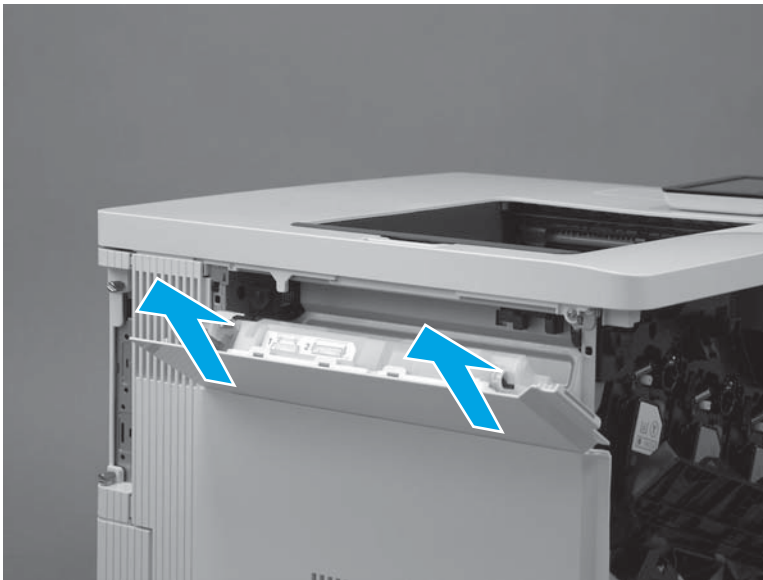

Figure 1-518 Remove the TCU



Step 12: Remove the top cover (M577)

1. At the front of the printer, remove one screw (callout 1).

💡 Reinstallation tip: This screw is longer and a different type of screw than the screw removed in the next step. When reinstalling the top cover, make sure that this screw is installed in the correct position.

Figure 1-519 Remove one screw

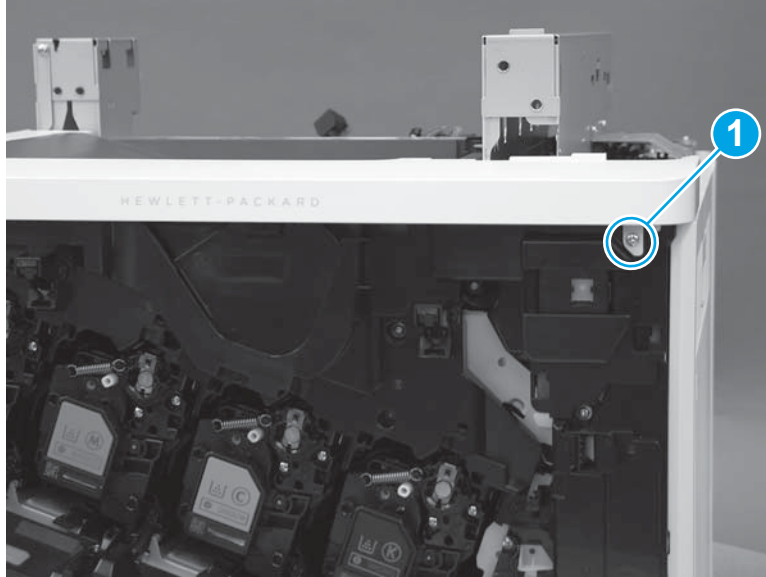

2. At the left side of the printer, remove one screw (callout 1).

Figure 1-520 Remove one screw

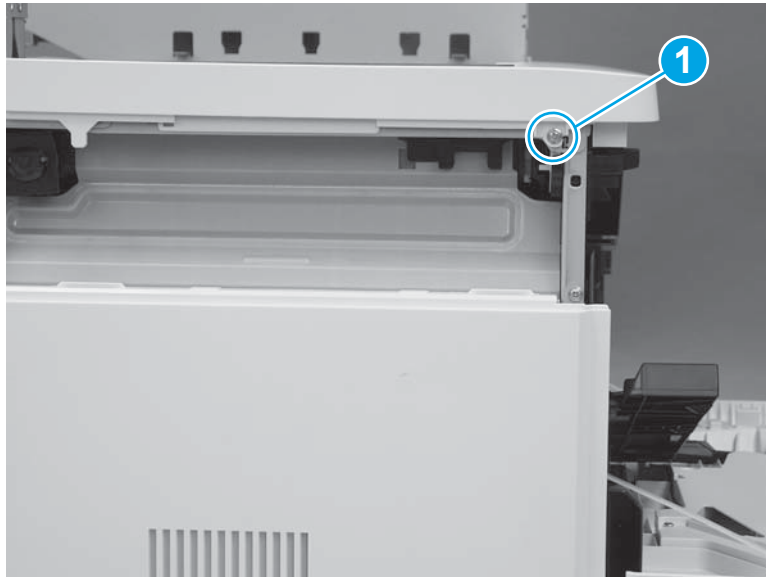

3. At the front of the printer, release one tab (callout 1).

Figure 1-521 Release one tab

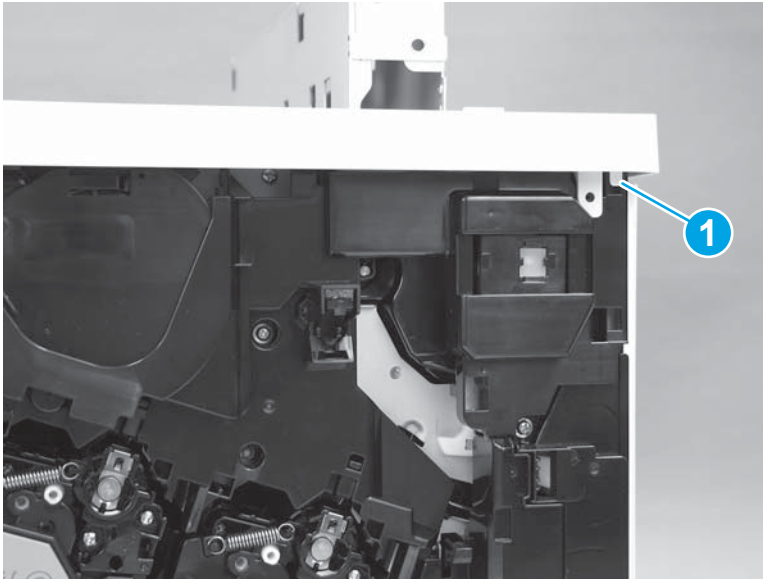

4. At the top of the printer, release two tabs (callout 1) next to the output bin, and then remove the top cover.

Figure 1-522 Release two tabs

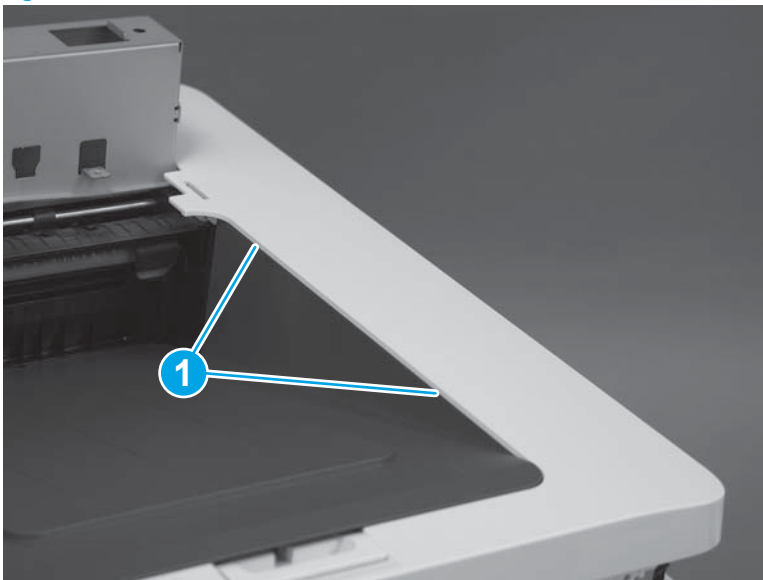

Step 13: Unpack the replacement assembly

Unpack the replacement assembly from the packaging.

For complete information on HP's recycling programs, go to [Product return and recycling](#).

 **NOTE:** HP recommends responsible disposal of the defective assembly.

Figure 1-523 Recycle and unpack

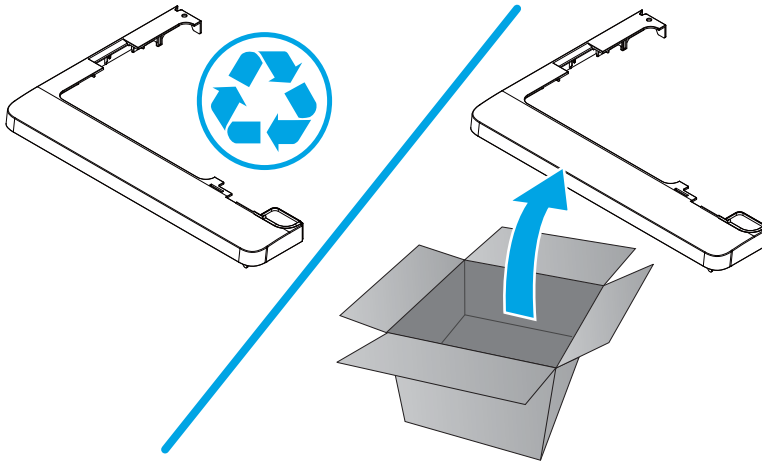

Step 14: Install the top cover

1. Position the locator pins (callout 1) on the cover in the slots (callout 2) in the printer.

Figure 1-524 Position the locator pins

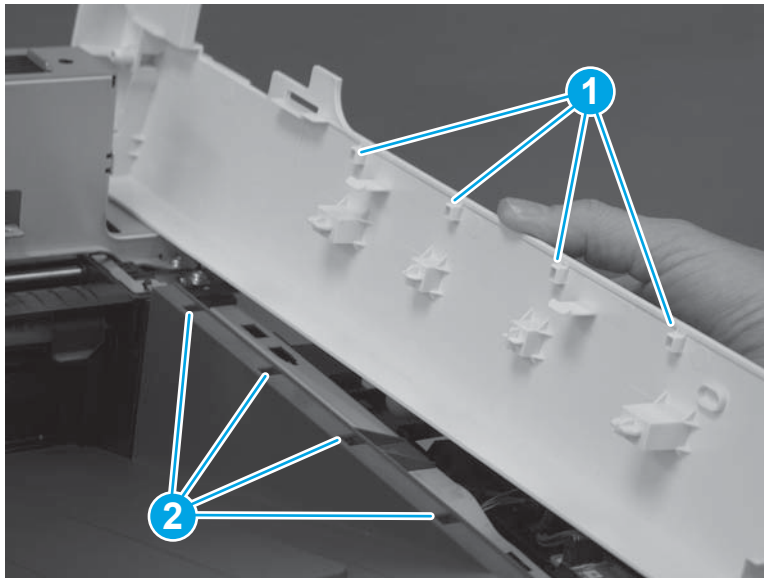

2. Press down on the cover to install it. Make sure that the tabs (callout 1) snap into place.

Figure 1-525 Press down on the cover

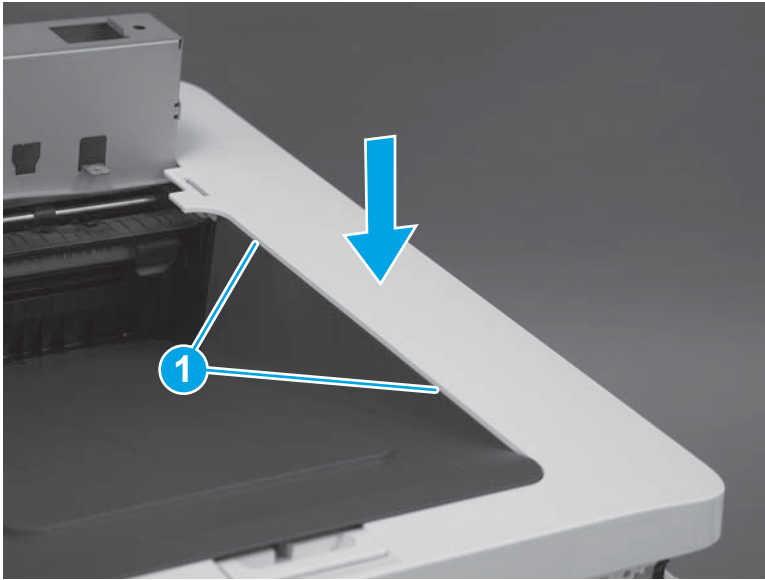

3. At the front of the printer, install one screw (callout 1).

 **Reinstallation tip:** This screw is longer and a different type of screw than the screw installed in the next step. Make sure that this screw is installed in the correct position.

Figure 1-526 Install one screw



4. At the left side of the printer, install one screw (callout 1).

Figure 1-527 Install one screw

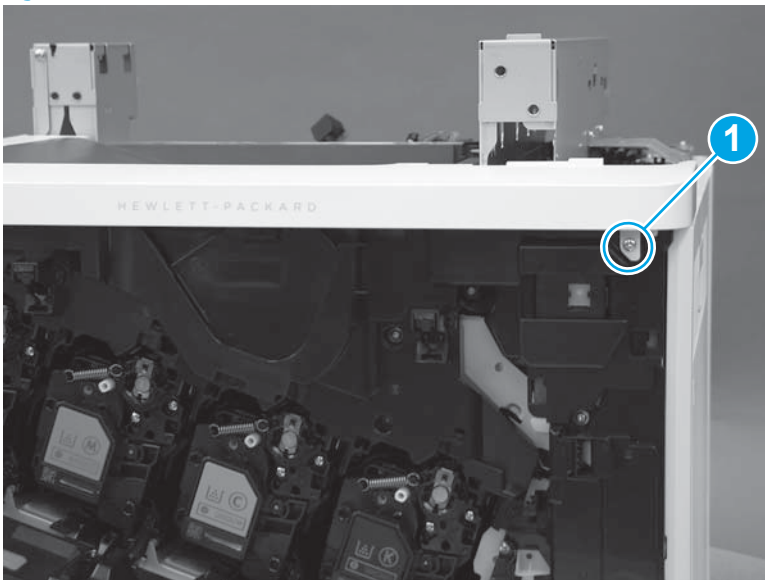
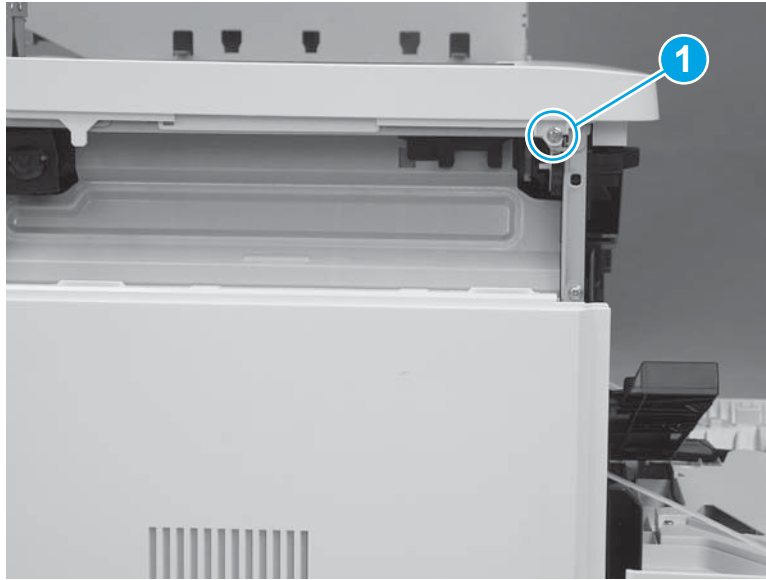

Step 15: Install the toner collection unit (TCU)

1. Verify that the toner collection hatch cover is in the closed position on the TCU.

Figure 1-528 Verify that the toner collection hatch cover is closed

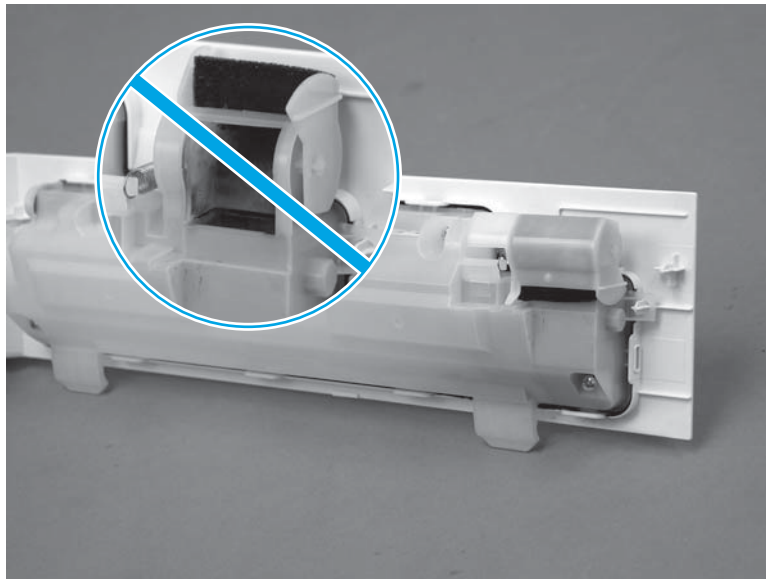

2. Position the TCU with the hinges in the slots provided in the printer (callout 1), and then rotate the TCU up and into the closed position.

 **NOTE:** The toner collection hatch cover automatically opens when the TCU is closed.

Figure 1-529 Install the TCU



3. Close the front door.

Figure 1-530 Close the front door

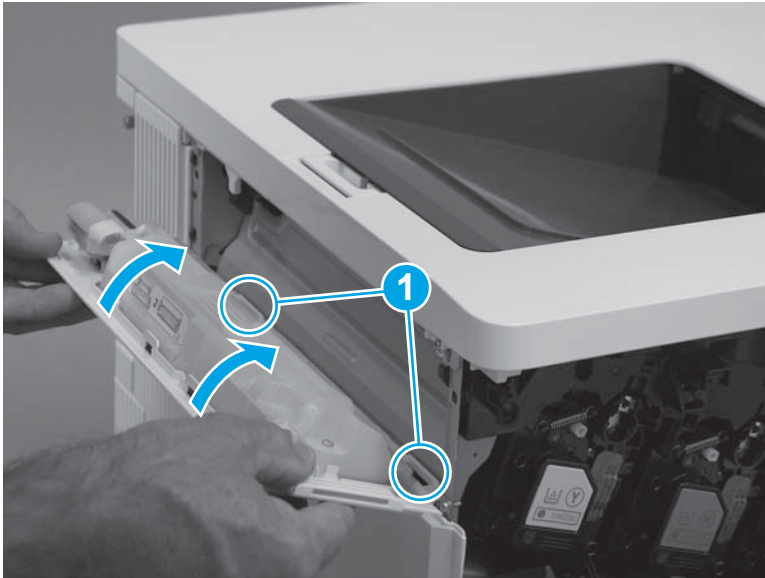

Step 16: Install the paper feed cover

1. Position the locator tabs (callout 1) on the cover in the slots (callout 2) in the printer. Press down until the cover snaps into place.

Figure 1-531 Install the cover

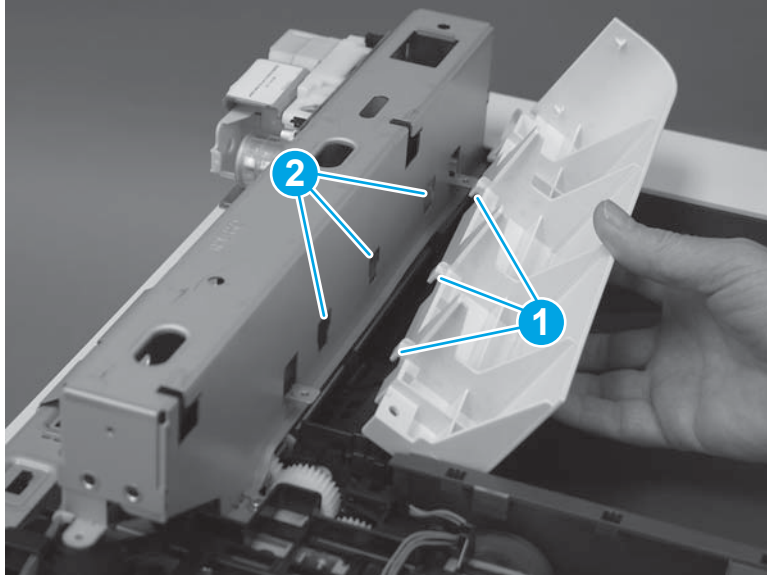

2. Install one screw (callout 1).

Figure 1-532 Install one screw

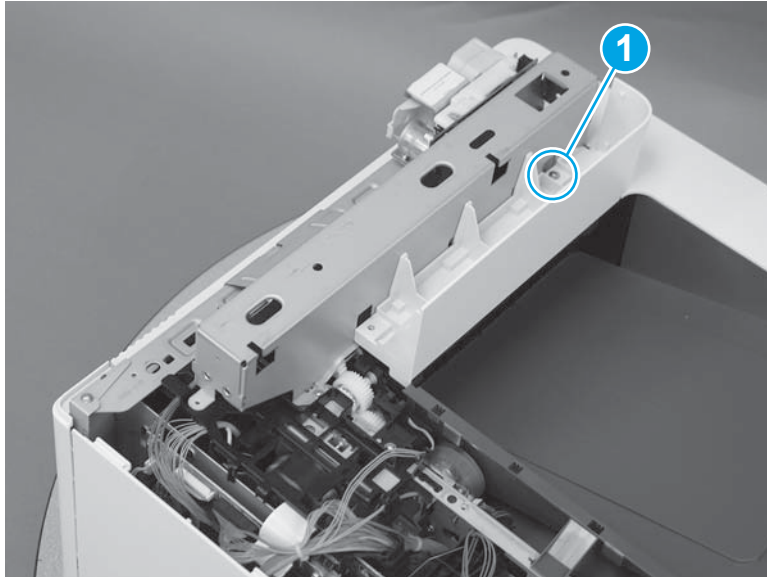

Step 17: Install the top rear cover

1. Align the locator tabs (callout 1) on the cover with the slots (callout 2) in the printer.

Figure 1-533 Align the locator tabs

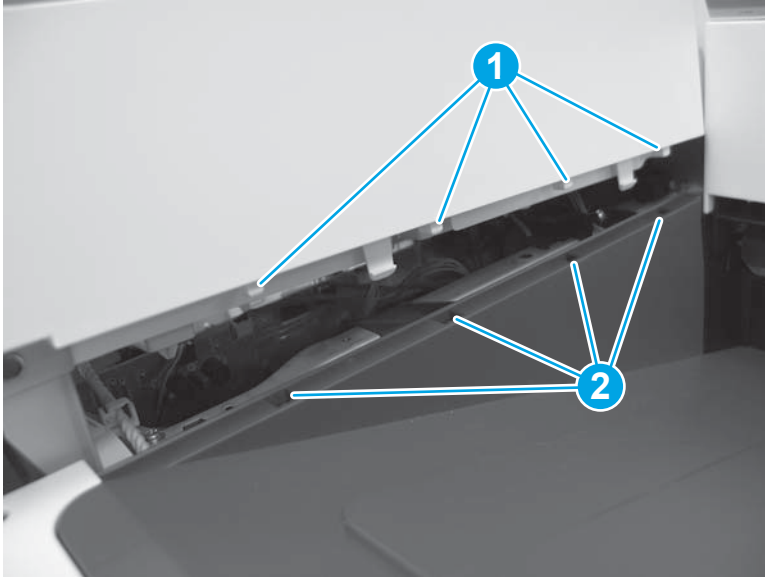

2. Press down to install the cover. Make sure that the tabs snap into place.

Figure 1-534 Install the cover

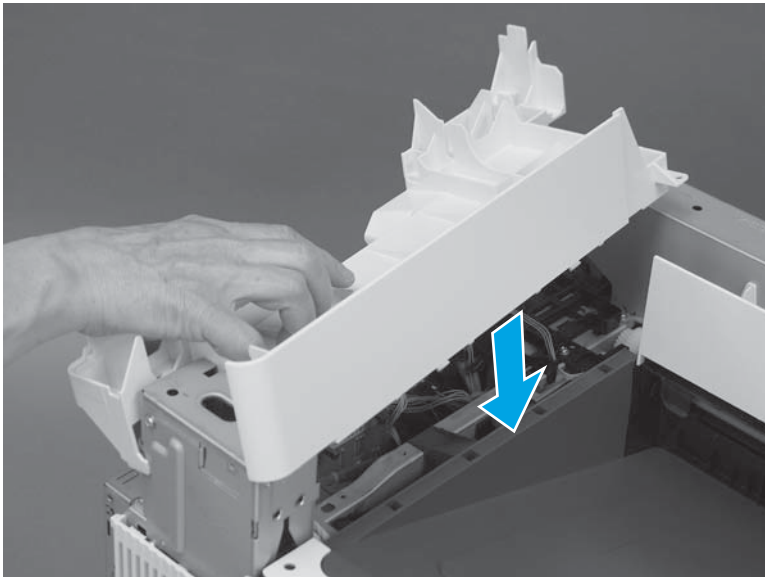

3. At the top of the printer, install five screws (callout 1).

Figure 1-535 Install five screws

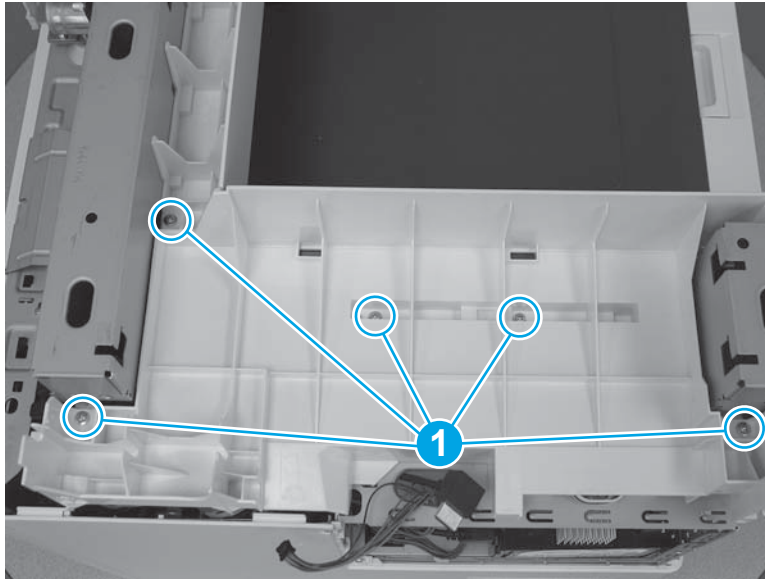

Step 18: Install the right upper cover (M577)

 **NOTE:** The figures below show the image scanner installed. The procedures for removing and installing the right upper cover are the same whether the image scanner is installed or removed."

1. **M577c/f/z only:** Install the cables (callout 1) through the slot (callout 2) in the printer.

Figure 1-536 Install the cables

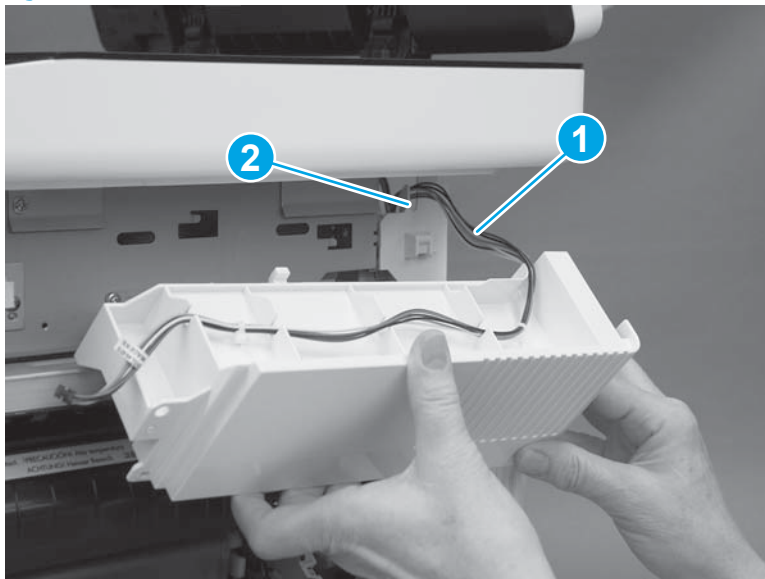

2. Position the hooks (callout 1) on the cover in the slots (callout 2) in the printer.

Figure 1-537 Position the hooks

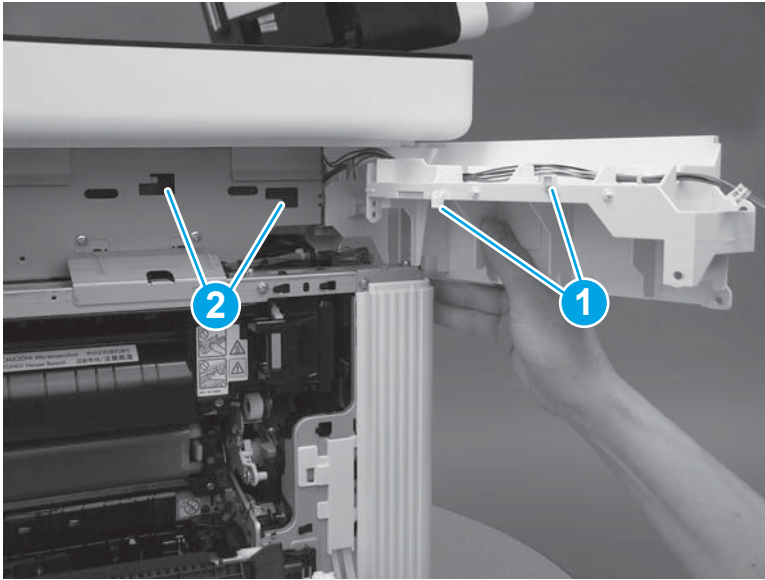

3. Slide the cover toward the front of the printer to install it.

Figure 1-538 Install the cover

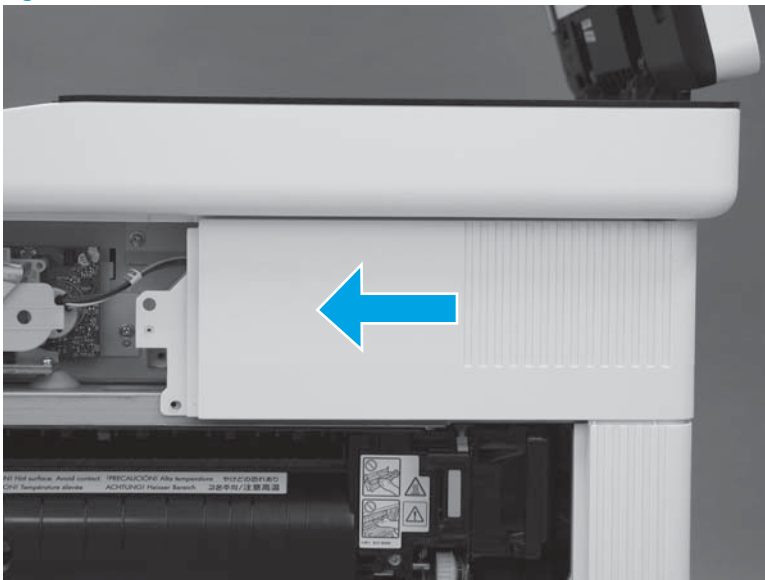

4. At the back of the printer, install one screw (callout 1).

M577c/f/z only: Connect one connector (callout 2), if the integrated scanner assembly is installed.

 **TIP:** This screw is smaller than the screws installed in the next step. Make sure that this screw is installed in the correct position.

Figure 1-539 Install one screw and connector



5. At the right side of the printer, install two screws (callout 1).

M577c/f/z only: Connect one connector (callout 2), if the stapler is installed.

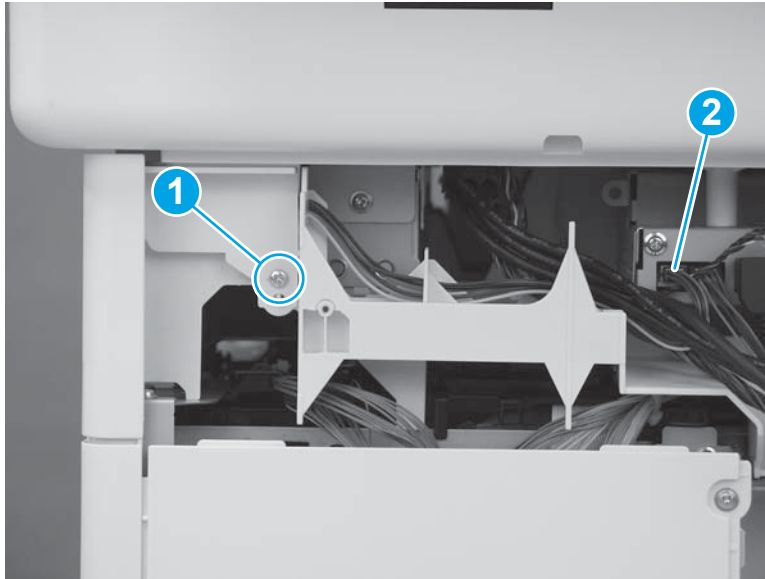
Figure 1-540 Install one screw and connector

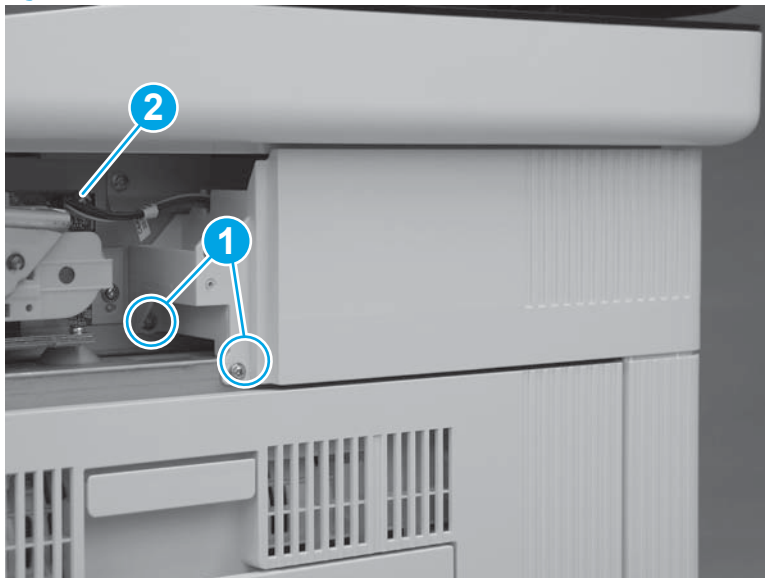

Step 19: Install the stapler unit (M577c/f/z)

1. Position the hooks (callout 1) on the stapler unit in the slots (callout 2) in the printer.

Figure 1-541 Position the hooks in the slots

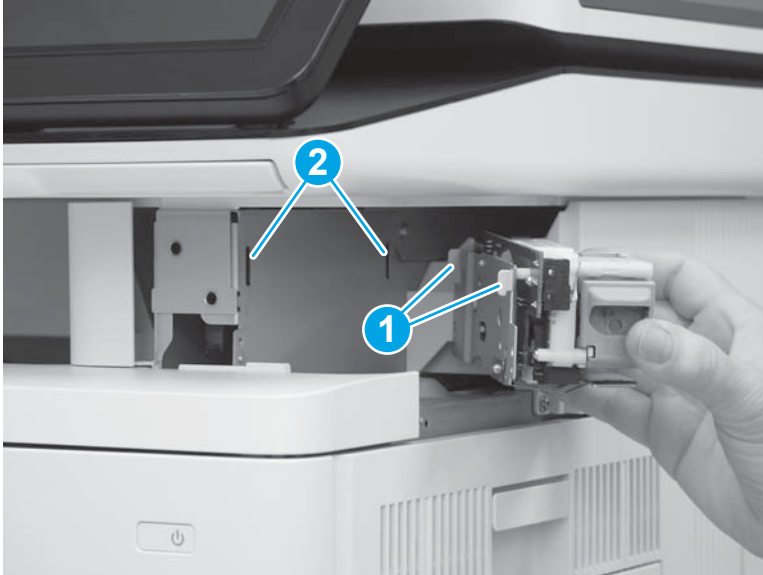

2. Connect one connector (callout 1), and then install two screws (callout 2).

Figure 1-542 Connect connector and install screws

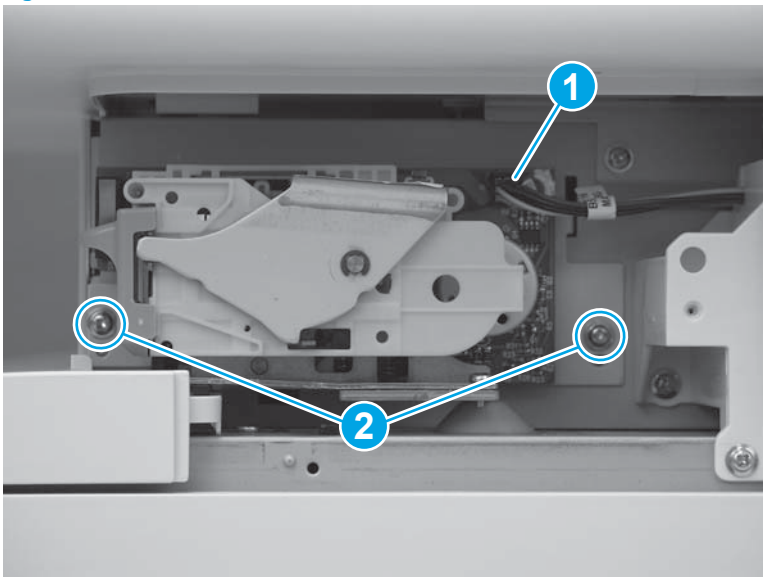

Step 20: Install the integrated scanner assembly (ISA) (M577)

 **NOTE:** The ISA includes the document feeder, image scanner, scanner control board (SCB), control panel, keyboard (M577c/z) and NFC PCA (M577z).

1. Before proceeding, locate the mounting pins (callout 1) on the bottom of the ISA and the slots (callout 2) on the printer base.

Figure 1-543 Locate the ISA mounting pins and slots

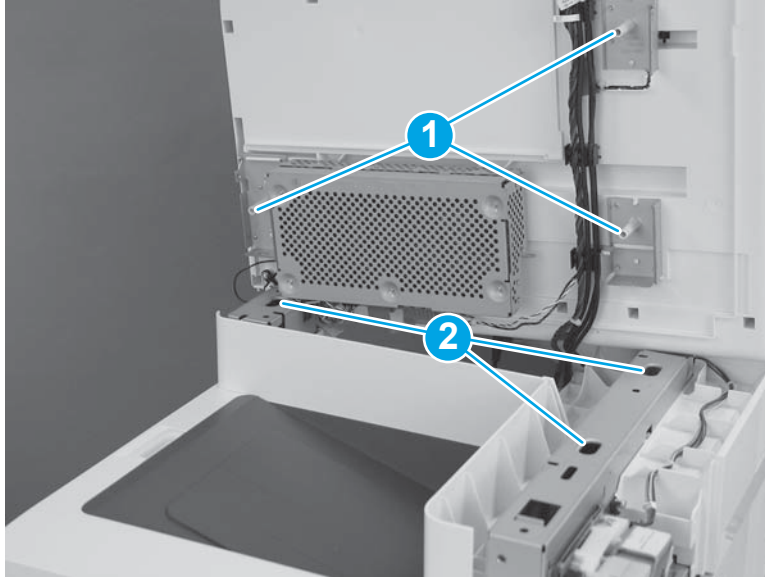

2. Position the ISA on the printer base with the pins in the slots.

 **NOTE:** To locate the pins and slots, see [Figure 1-395 Locate the ISA mounting pins and slots on page 249](#).

Figure 1-544 Install the ISA

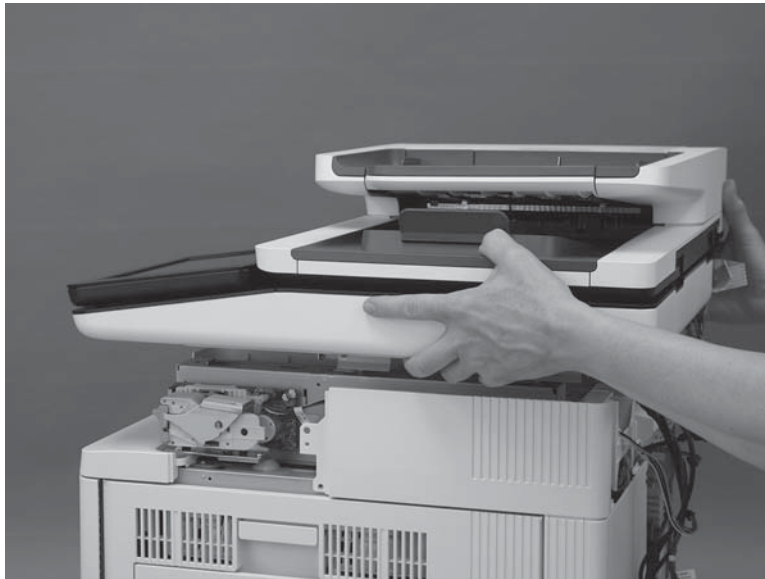

3. Slightly slide the ISA towards the front of the printer to engage it.

Figure 1-545 Slide the ISA towards the front of the printer

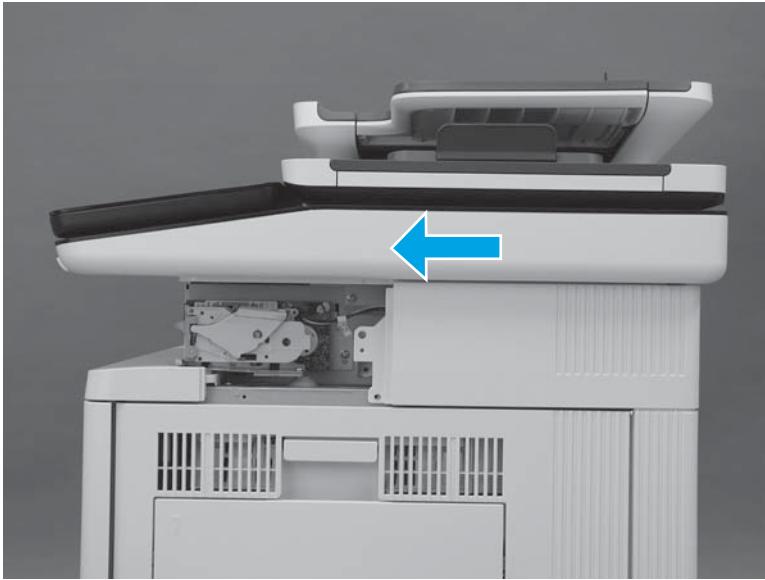

4. At the left side of the printer, install one screw (callout 1).

Figure 1-546 Install one screw

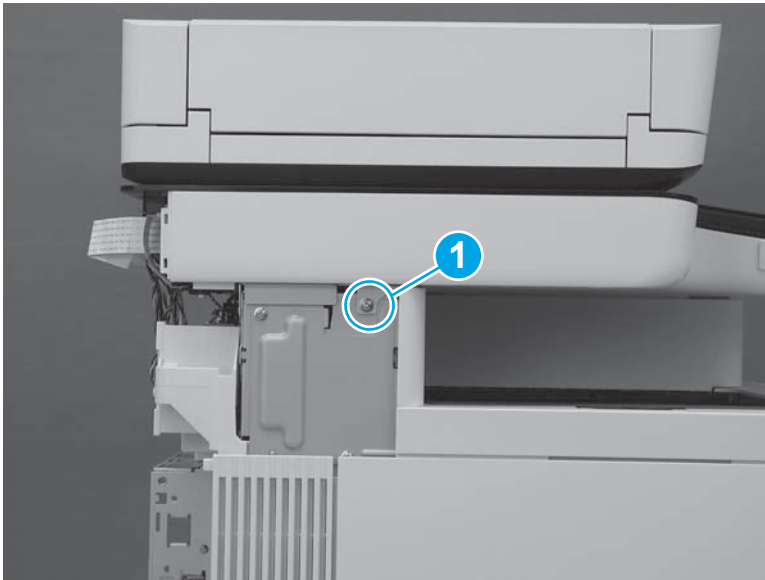

5. At the back of the printer, install two screws (callout 1).

Figure 1-547 Install two screws

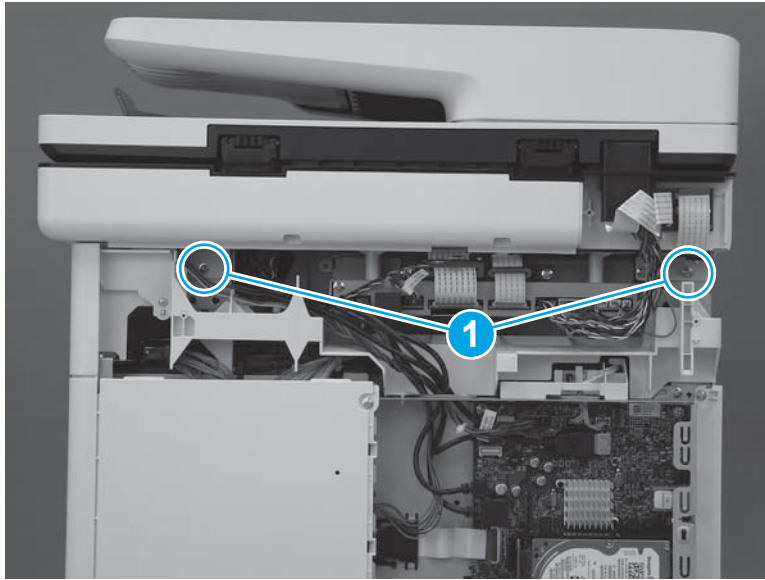

6. At the right side of the printer, install one screw (callout 1).

Figure 1-548 Install one screw

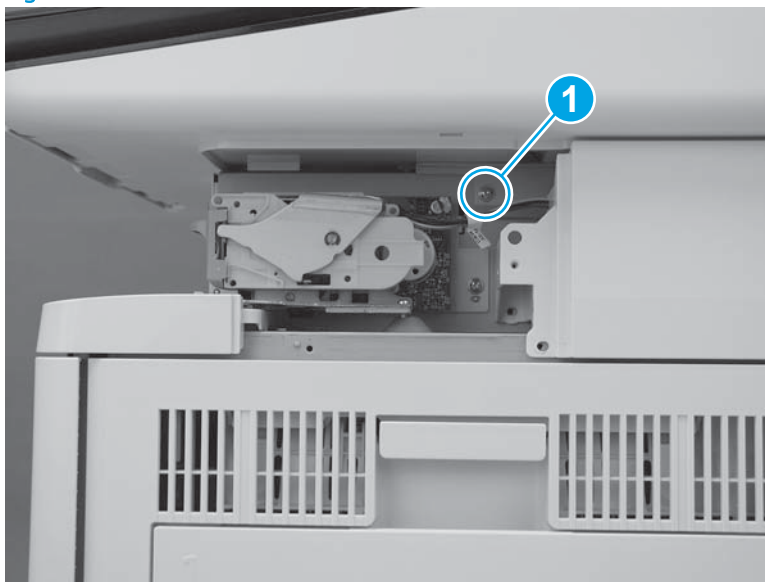

7. Connect two connectors on the scanner control board (callout 1).

M577c/f/z only: Connect one connector for the stapler on the scanner control board (callout 2).

Figure 1-549 Connect connectors

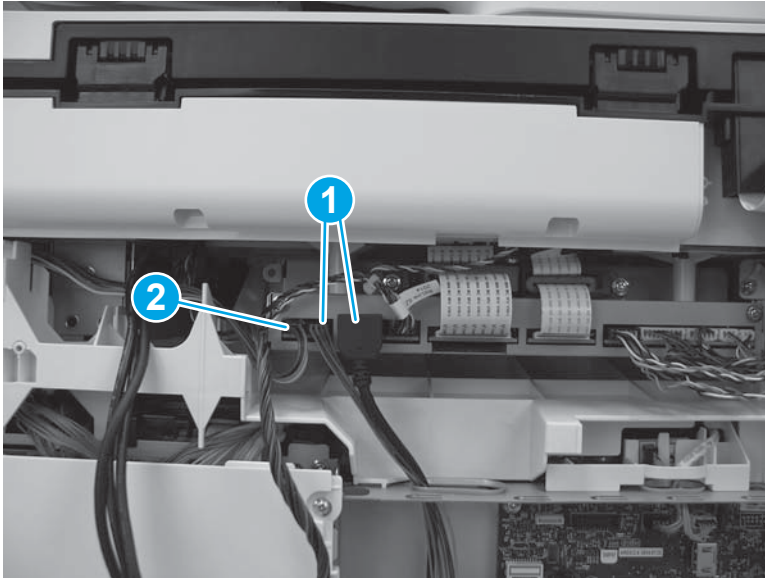

8. Install the wire harness and cables (callout 1) in the retainers (callout 2). Pass them through the opening in the top of the formatter cover (callout 3), and then connect four connectors (callout 4) on the formatter.

Figure 1-550 Connect four connectors

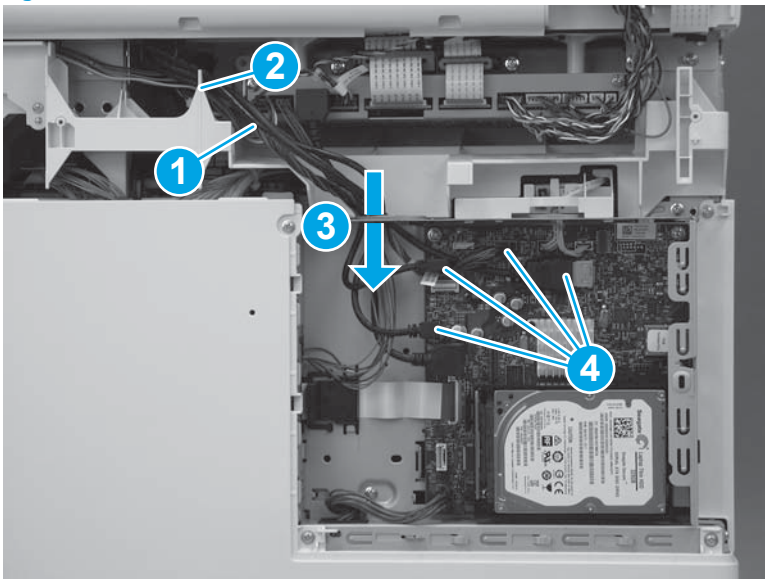

Step 21: Install the stapler cover assembly (M577c/f/z)

 **NOTE:** This step is for the M577c/f/z models only. For the M577dn model, skip this step and go to [Step 22: Install the right front upper cover \(M577dn\) on page 332](#).

1. Install the tabs (callout 1) on the cover in the slots (callout 2) in the printer.

Figure 1-551 Install two tabs



2. Press the cover toward the left side of the printer until it snaps into place.

Figure 1-552 Install the cover assembly



3. Install one screw (callout 1).



 **IMPORTANT:** This is a self-tapping screw for plastic. Rotate it counterclockwise to align it with the existing thread pattern, and then carefully turn it clockwise to tighten. Do not overtighten. This will prevent stripping the threads inside the screw hole.

Figure 1-553 Install one screw

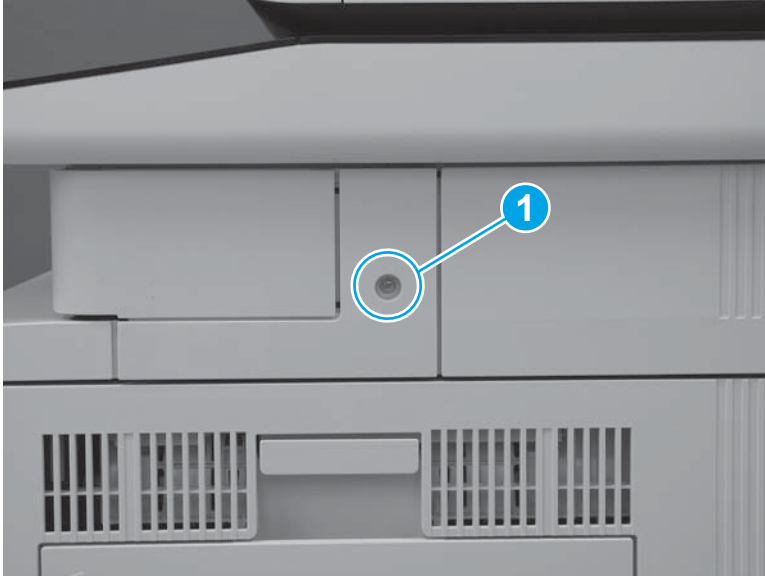

Step 22: Install the right front upper cover (M577dn)

 **NOTE:** This step is for the M577dn model only. For the M577c/f/z models, skip this step and go to [Step 23: Install the left upper cover on page 333](#).

1. Slide the cover toward the left side of the printer to install it. Make sure that the slots (callout 1) in the cover fit over the tabs (callout 2) on the inside of the paper feeder cover.

Figure 1-554 Install the cover

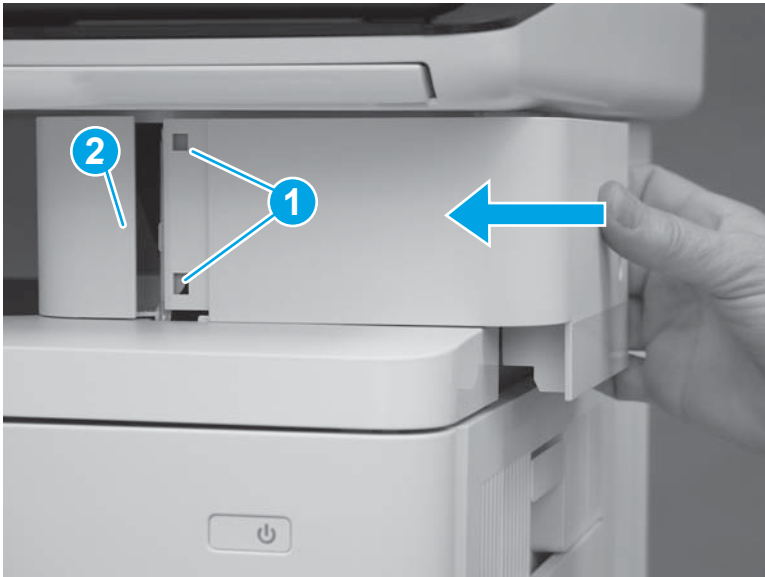

2. Press the right front upper cover (callout 1) and the paper feeder cover (callout 2) together until the tabs on the inside of the covers snap into place.

Figure 1-555 Press the cover



3. Install one screw (callout 1).

Figure 1-556 Install one screw

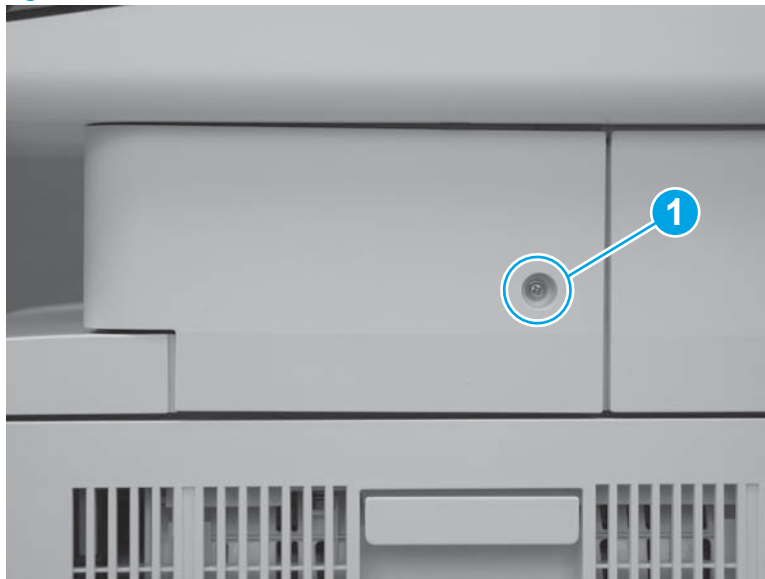

Step 23: Install the left upper cover

1. Position the tab (callout 1) on the lower edge of the cover behind the left cover (callout 2).

Figure 1-557 Position the tab

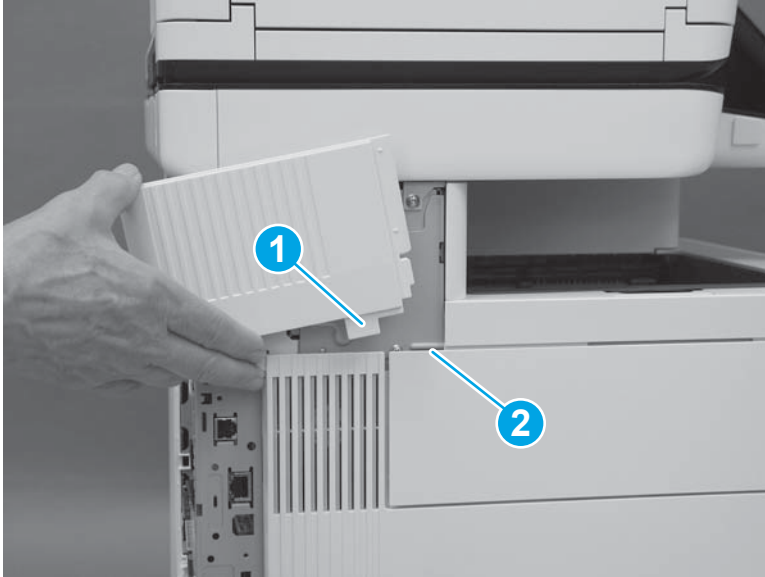

2. Slide the cover toward the front of the printer to install it. Make sure that the edge (callout 1) of the cover fits behind the edge (callout 2) of the top rear cover.

Figure 1-558 Slide the cover

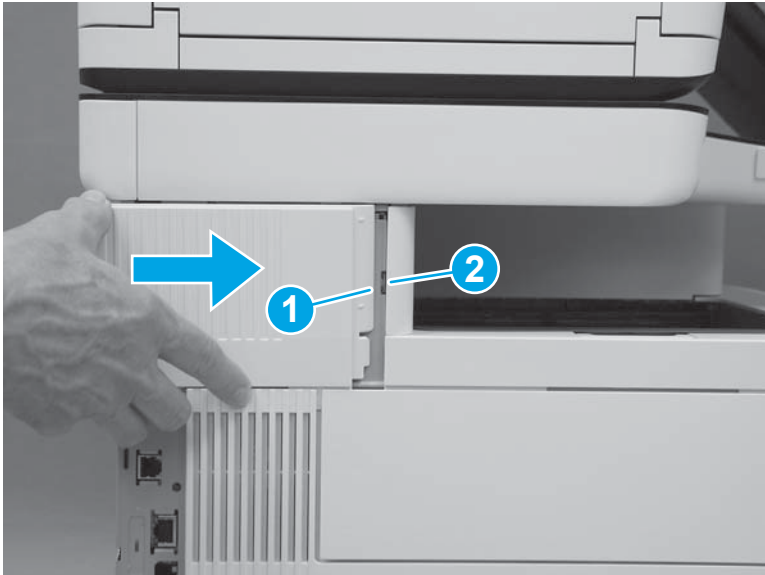

3. Make sure that the tab (callout 1) is fully installed.

Figure 1-559 Check the tab

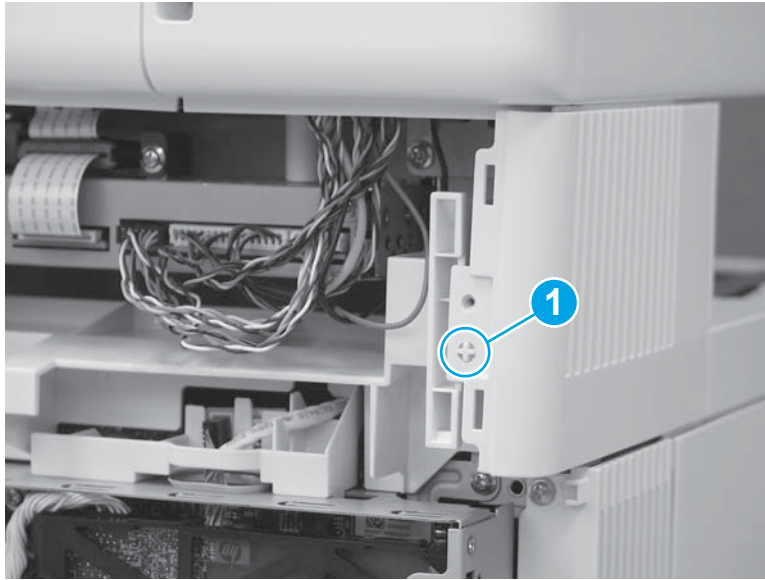

Step 24: Install the rear upper cover

1. Align the ridge (callout 1) on the lower edge of the rear upper cover in front of the tabs (callout 2) on the top edge of the rear cover.

Figure 1-560 Align the cover

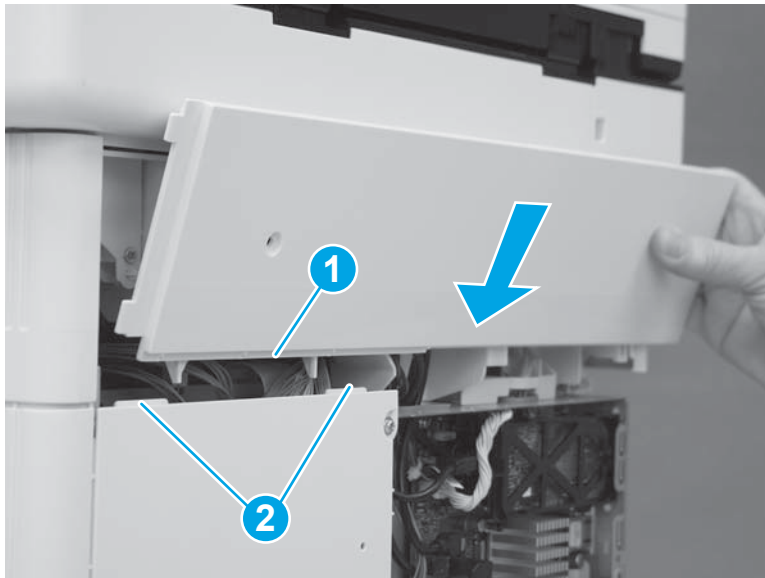

2. Rotate the top of the cover toward the printer.

Figure 1-561 Rotate the top of the cover

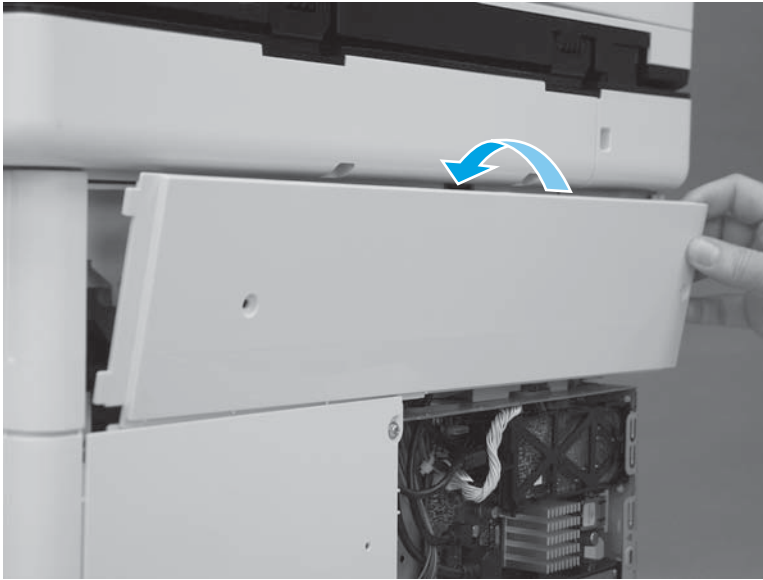

3. Slide the cover to the left (callout 1). Make sure that the tabs (callout 2) on the upper rear cover slide behind the edge (callout 3) of the right upper cover. Make sure that the cover is fully seated.

Figure 1-562 Slide the cover

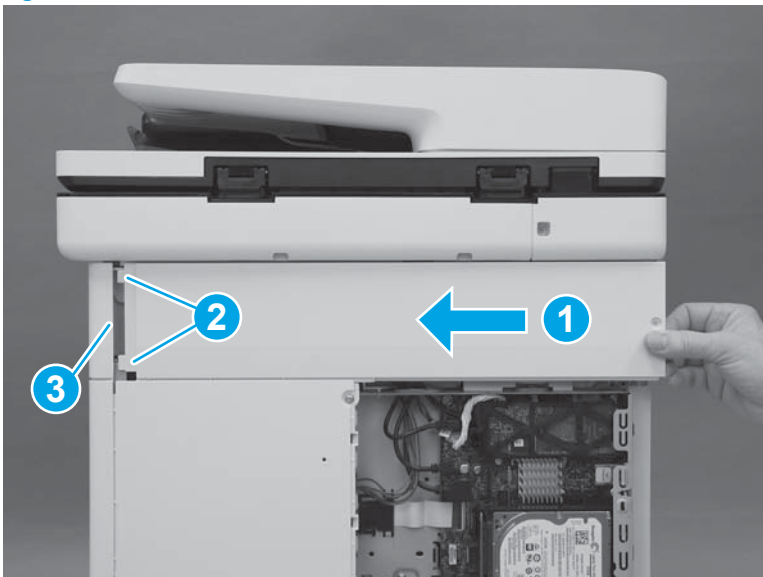

4. Install two screws (callout 1).

 **IMPORTANT:** These two screws are self-tapping screws for plastic. Rotate them counterclockwise to align them with the existing thread pattern, and then carefully turn them clockwise to tighten. Do not overtighten. This will prevent stripping the threads inside the screw holes.

Figure 1-563 Install two screws



Step 25: Install the formatter cover

- ▲ Slide the cover onto the printer (callout 1) to install it.

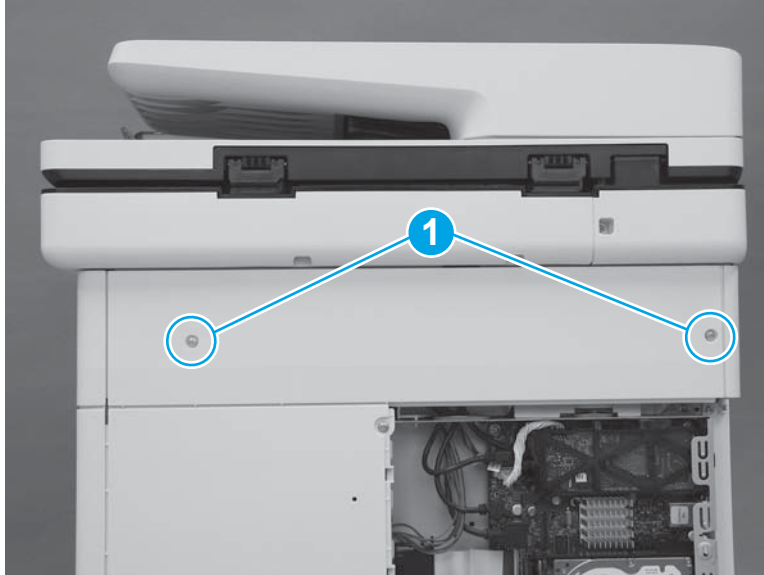
 **NOTE:** Make sure that the tabs on the formatter cover align with the slots provided in the printer (callout 2). Tighten the two thumbscrews (callout 3).

 **TIP:** If needed, use the edge of a coin to turn the thumbscrews.

Figure 1-564 Install the cover



Removal and replacement: Right door

- [Introduction](#)
- [Step 1: Remove the right door](#)
- [Step 2: Unpack the replacement assembly](#)
- [Step 3: Install the right door](#)

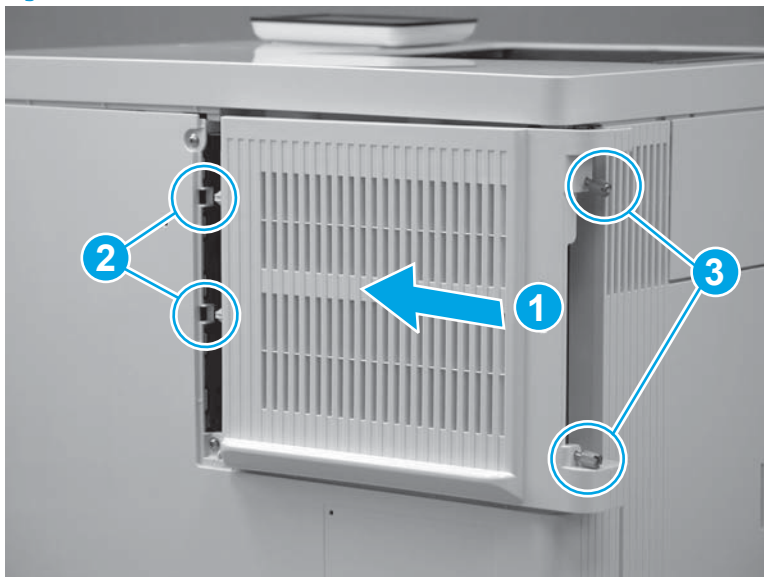
Introduction

This document provides the procedures to remove and replace the right door.

Before performing service

Turn the printer power off

- Disconnect the power cable.

 **WARNING!** To avoid damage to the printer, turn the printer off, wait 30 seconds, and then remove the power cord before attempting to service the printer.

Use the table below to identify the correct part number for your printer. To order the part, go to www.hp.com/buy/parts.

Right door part number	
RM2-0019-000CN	Right door

Required tools

- Small flat blade screwdriver
- #2 Phillips screwdriver with a magnetic tip

After performing service

Make sure that the right door closes correctly after replacing it.

Turn the printer power on

- Connect the power cable.
- Use the power switch to turn the power on.

Step 1: Remove the right door

1. Use the handle (callout 1) to open the right door.

Figure 1-565 Open the right door

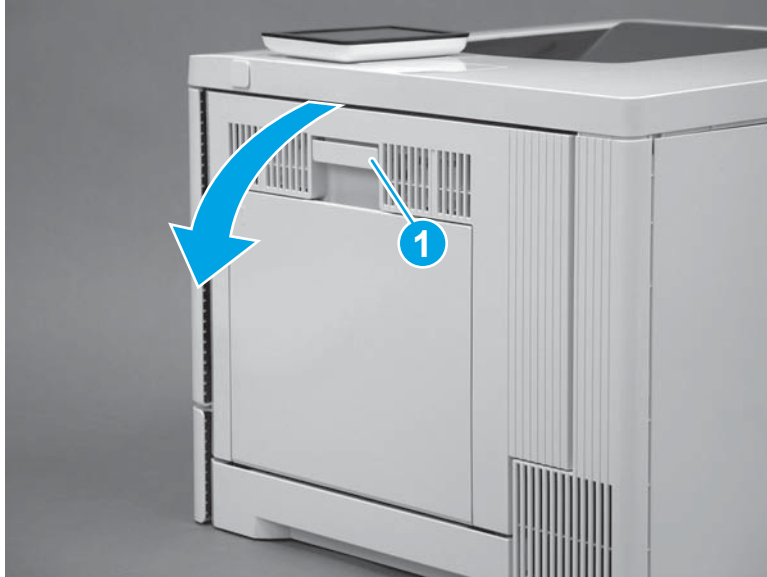

2. Rotate the secondary transfer assembly up and into the printer to move it out of the way.

Figure 1-566 Rotate the secondary transfer assembly up

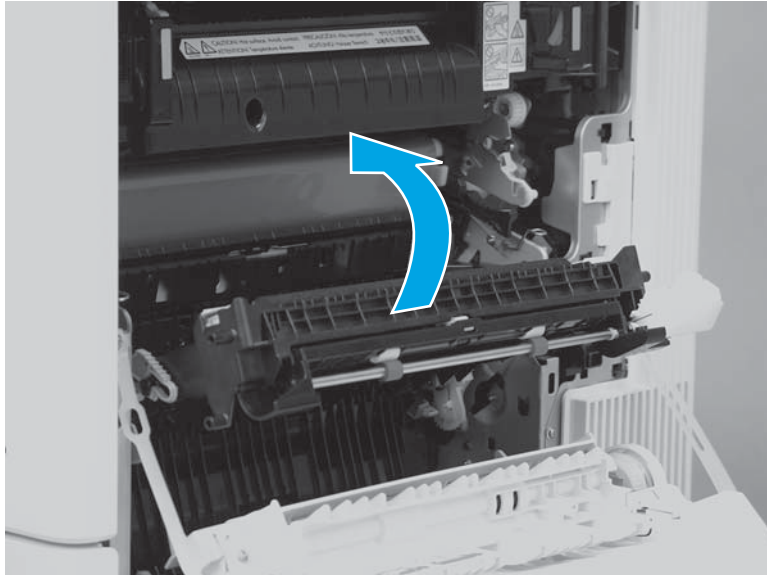

3. At the right- and left-side of the door, use a small flat blade screwdriver to release the door retainer straps (callout 1), and then pull them through the slot in the door.

Figure 1-567 Release the door retainer straps

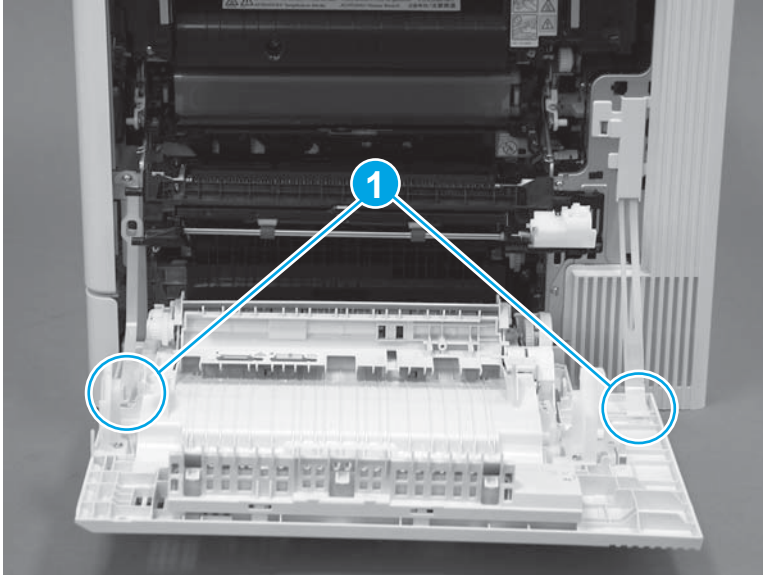

4. Locate a slot (callout 1) near the gear side of the door, push the blade of a small screwdriver into the slot (callout 2) to release one tab, and then rotate the end of the screwdriver down (callout 3) release the connector cover (callout 4).

Figure 1-568 Release the connector cover

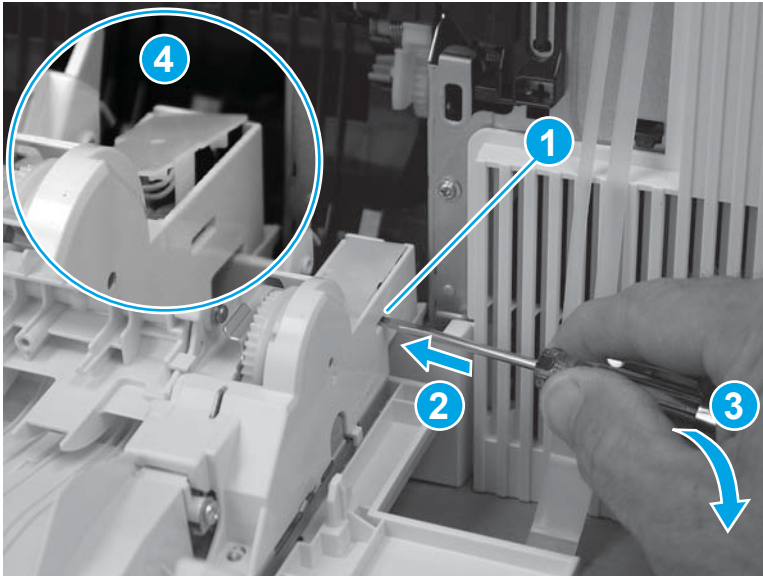

5. Remove the connector cover.

Figure 1-569 Remove the connector cover

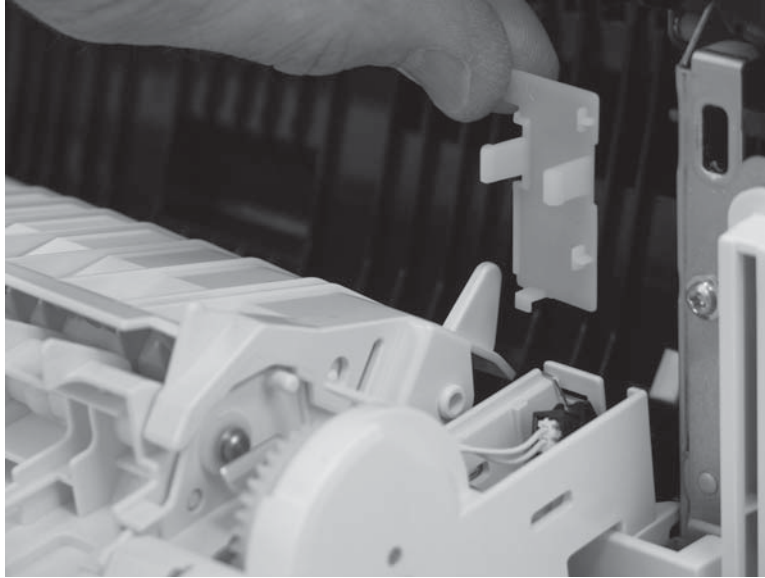

6. Disconnect two connectors (callout 1).

Figure 1-570 Disconnect two connectors

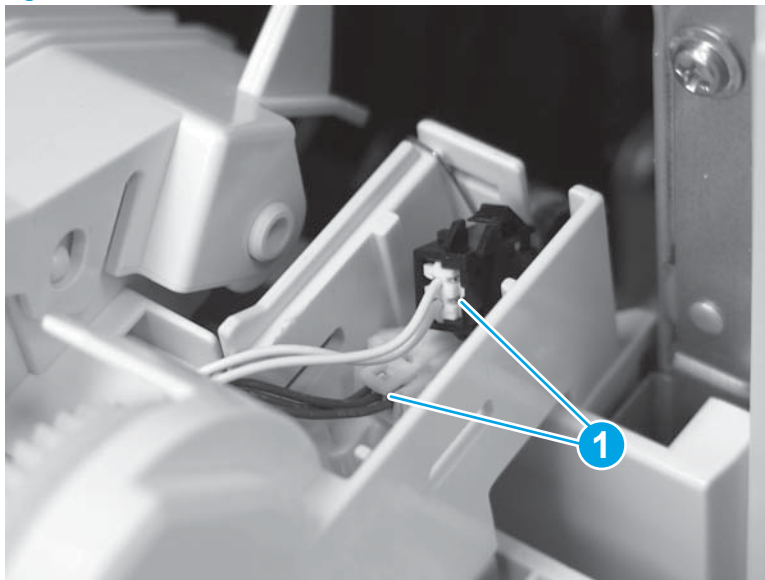

7. Remove two screws (callout 1) to release the door arm (callout 2).

 **NOTE:** The door arm is spring loaded. Keep a firm grip on it while removing the screws, and then carefully move it up and into the printer.

Figure 1-571 Remove two screws



8. Slide the door toward the front of the printer (callout 1) to release it, and then lift it up (callout 2) to remove it.

Figure 1-572 Remove the door

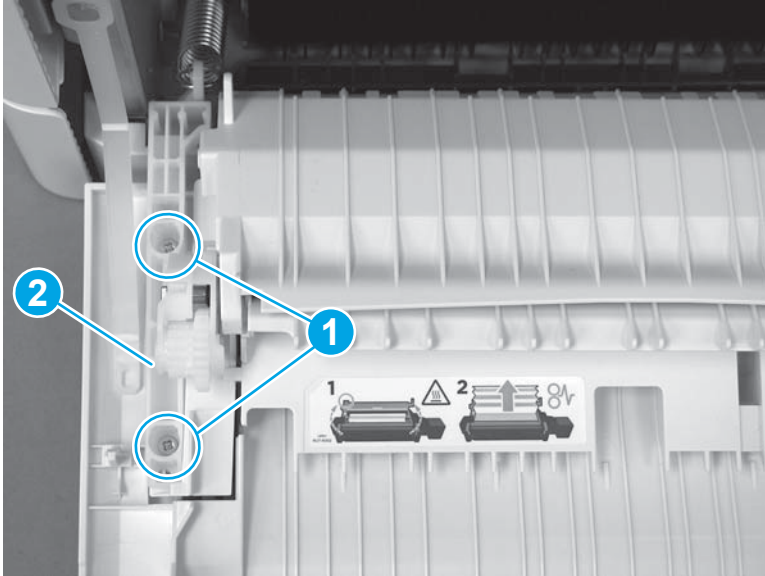
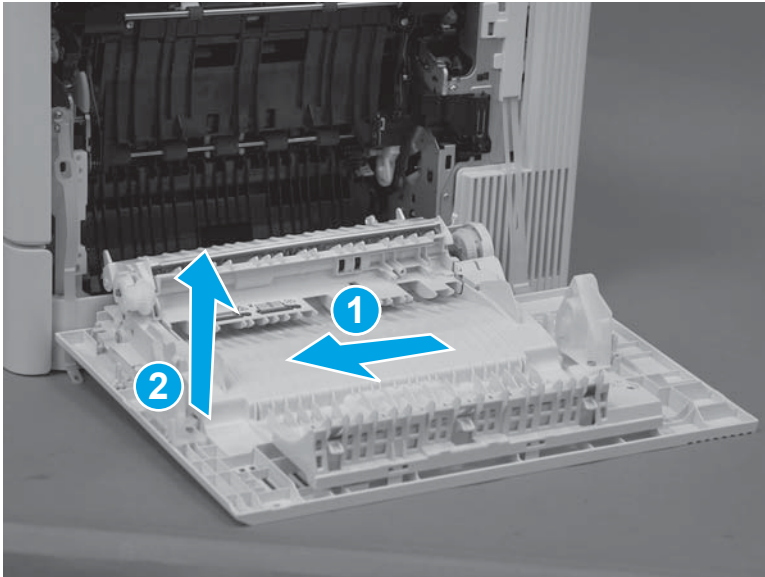

Step 2: Unpack the replacement assembly

Unpack the replacement assembly from the packaging.

For complete information on HP's recycling programs, go to [Product return and recycling](#).

 **NOTE:** HP recommends responsible disposal of the defective assembly.

Figure 1-573 Recycle and unpack

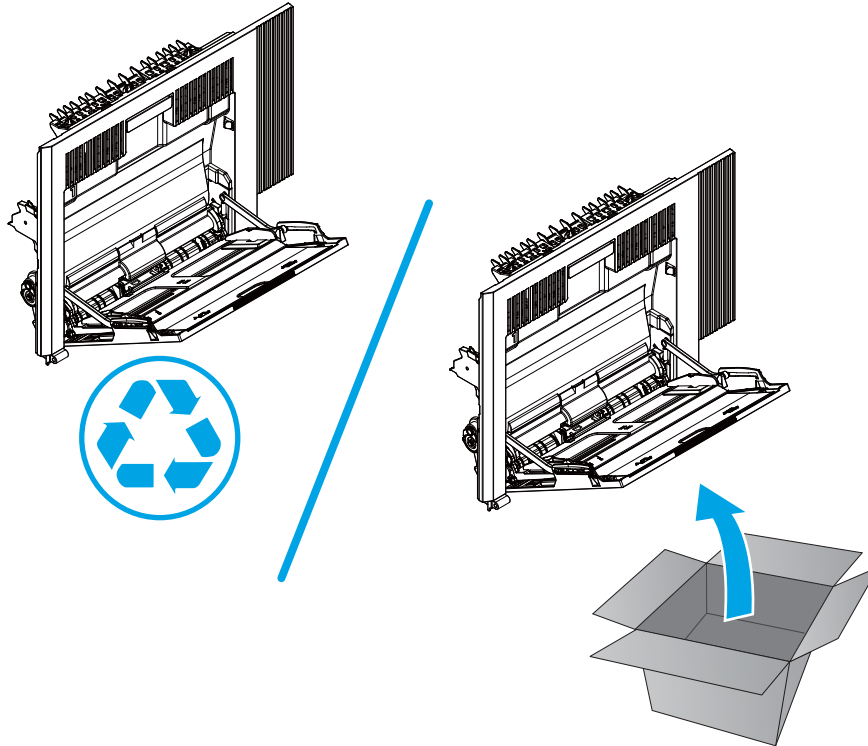

Step 3: Install the right door

1. Position the door on the printer, and then slide it toward the rear of the printer to engage the hinge pin (callout 1).

Figure 1-574 Install the door

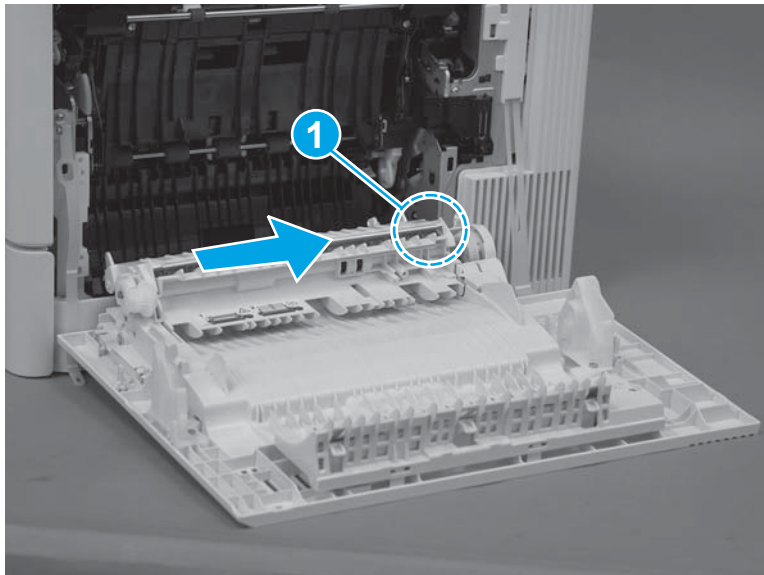

2. Rotate the door arm down onto the door.

 **NOTE:** The door arm is spring loaded. Keep a firm grip on it.

Figure 1-575 Rotate the door arm down



3. Install two screws (callout 1) to fasten the door arm (callout 2) to the door.

Figure 1-576 Install two screws

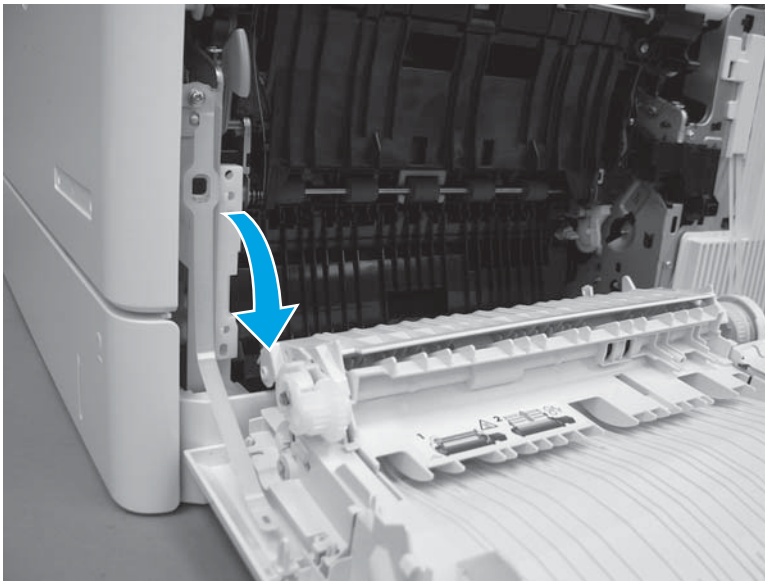
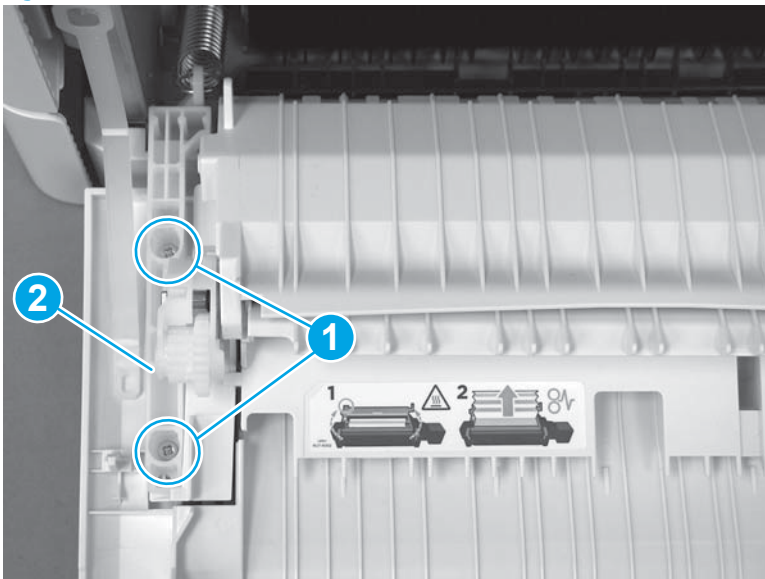

4. Connect two connectors (callout 1).

Figure 1-577 Connect two connectors

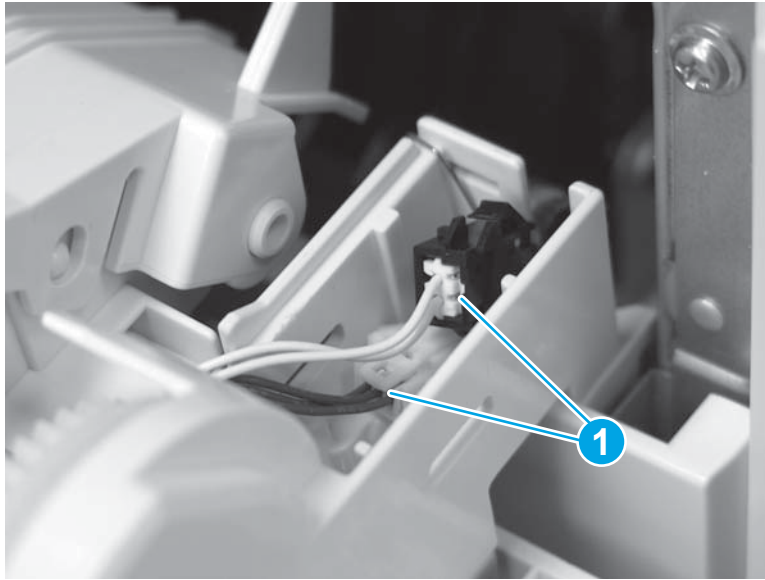

5. Install the connector cover. Position the mounting foot (callout 1) in the slot provided (callout 2), and then rotate the cover down to engage two tabs (callout 3) with the slots provided (callout 4).

 **IMPORTANT:** When correctly installed, the cover is flat against the door.

Figure 1-578 Install the connector cover

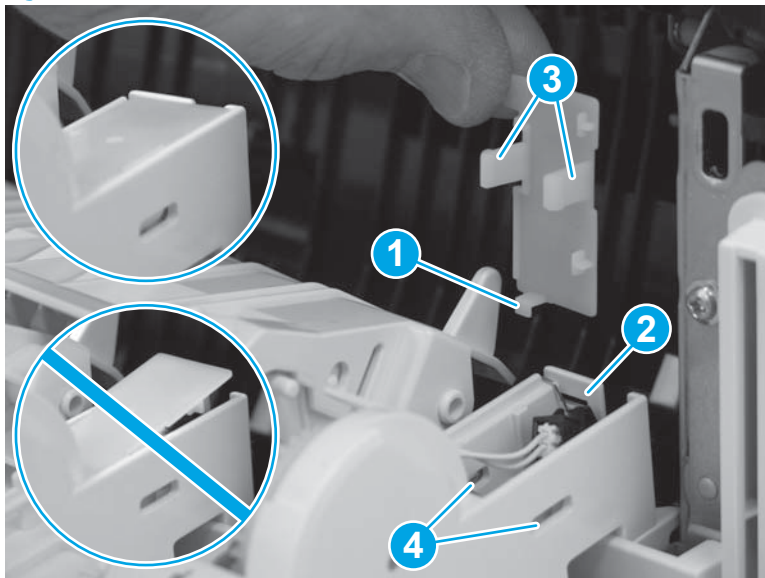

6. At the right- and left-side of the door, thread the door retainer straps (callout 1) through the holes in the door, and then secure them on the provided pins.

Figure 1-579 Install the door retainer straps

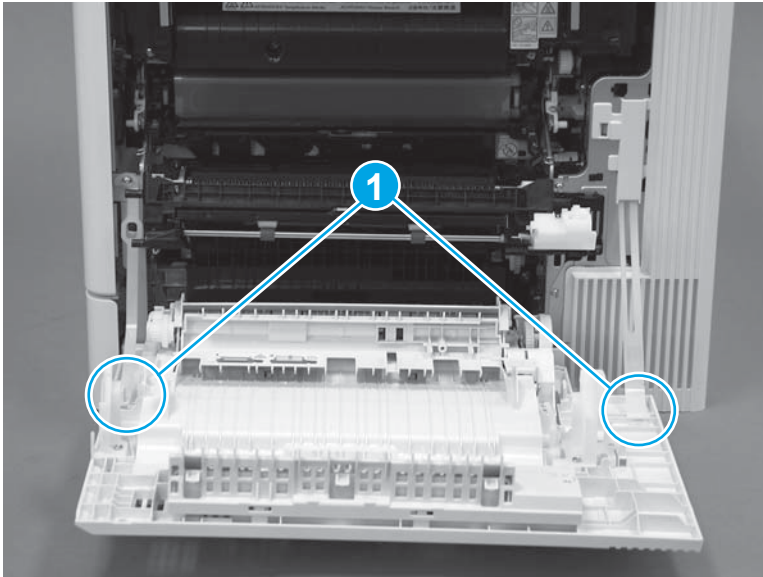

7. Close the right door.

Figure 1-580 Close the right door

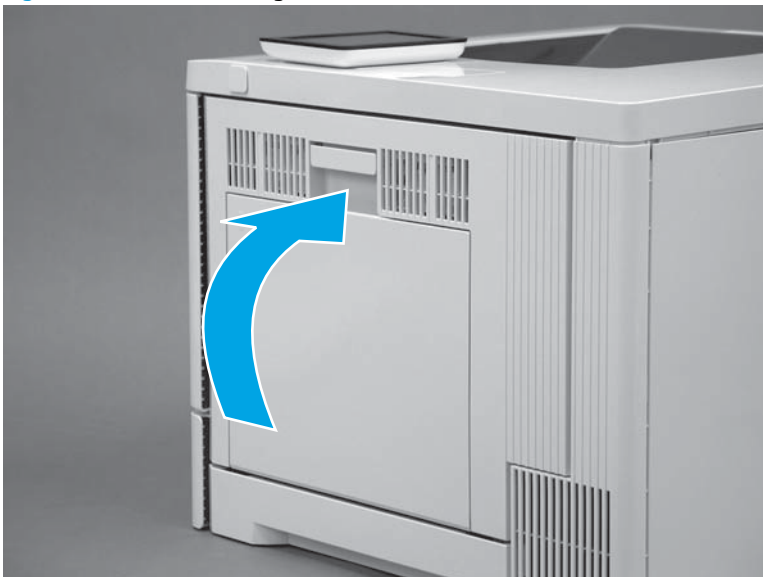

Removal and replacement: Front door

- [Introduction](#)
- [Step 1: Remove the tray](#)
- [Step 2: Remove the front door](#)
- [Step 3: Unpack the replacement front door](#)
- [Step 4: Install the front door](#)
- [Step 5: Install the tray](#)

Introduction

This document provides the procedures to remove and replace the front door.

Before performing service

Turn the printer power off

- Disconnect the power cable.

⚠ WARNING! To avoid damage to the printer, turn the printer off, wait 30 seconds, and then remove the power cord before attempting to service the printer.

Use the table below to identify the correct part number for your printer. To order the part, go to www.hp.com/buy/parts.

Front door kit part number	
B5L46-67906	Front door with instruction guide

Required tools

No special tools are required to install this part.

After performing service

Make sure that the front door closes correctly after replacing it.

Turn the printer power on

- Connect the power cable.
- Use the power switch to turn the power on.

Step 1: Remove the tray

1. Pull the tray out until it stops.

Figure 1-581 Pull the tray out



2. Lift the front of the tray, and then pull it out of the printer to remove it.

Figure 1-582 Remove the tray

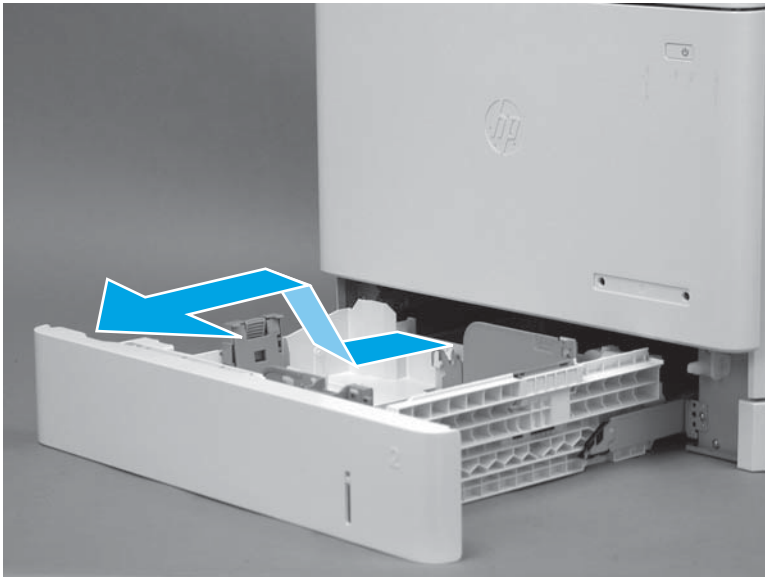

Step 2: Remove the front door

1. Open the front door.

Figure 1-583 Open the front door



2. At the right- and left-side of the door, release two tabs (callout 1), and then release the door retainer straps (callout 2).

 **TIP:** Use a pair of needle nose pliers to easily release the tabs.

Figure 1-584 Release the door retainer straps



- Carefully push down on the door to lower it until the keyed hinge pin (callout 1) is aligned with the slot in the flange, and then slide the door to the right (callout 2) to release the left and right hinge pins (callout 1 and callout 3).

⚠ CAUTION: The keyed hinge pin (callout 1) is fragile, and can easily be broken off.

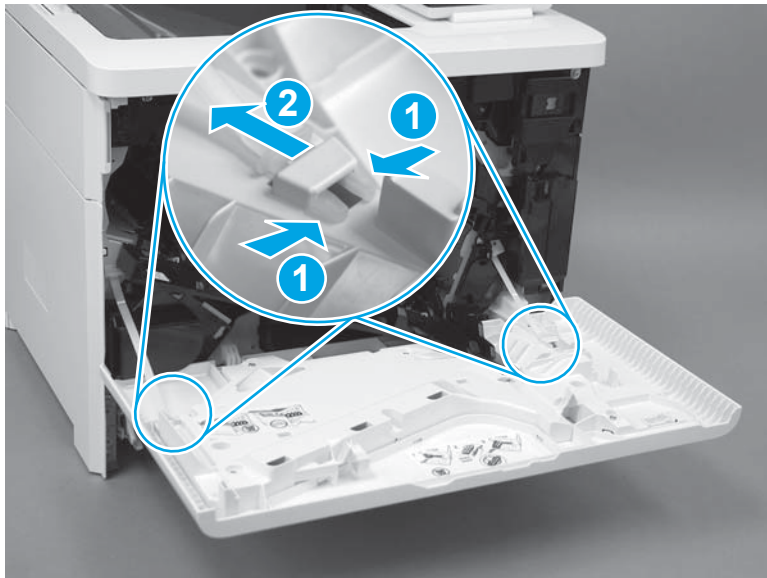
Make sure that it is correctly aligned with the slot in the flange before attempting to remove the front door from the printer.



Figure 1-585 Slide the door to the right

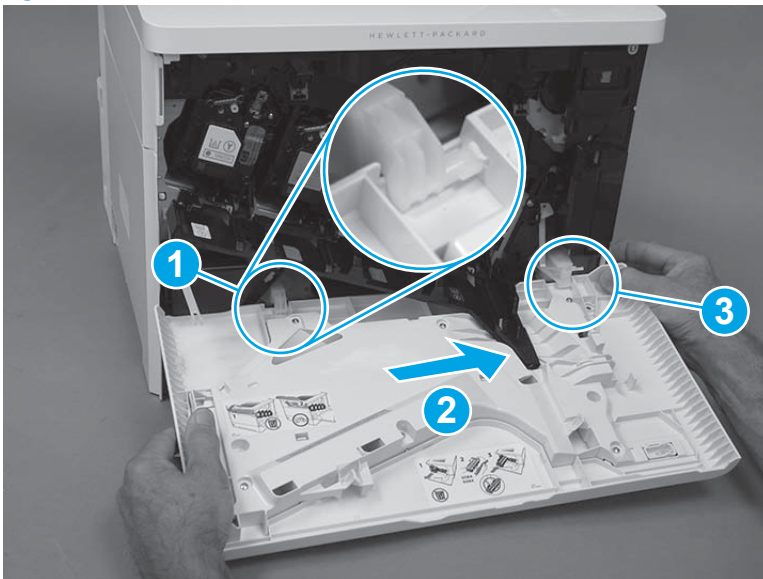

4. Pull the door toward you to release the inner door (callout 1), and then remove the front door.

⚠ CAUTION: Hold the inner door (callout 1) in place before releasing it. The inner door is spring loaded will abruptly close and be damaged if it is not held down.

Figure 1-586 Remove the door

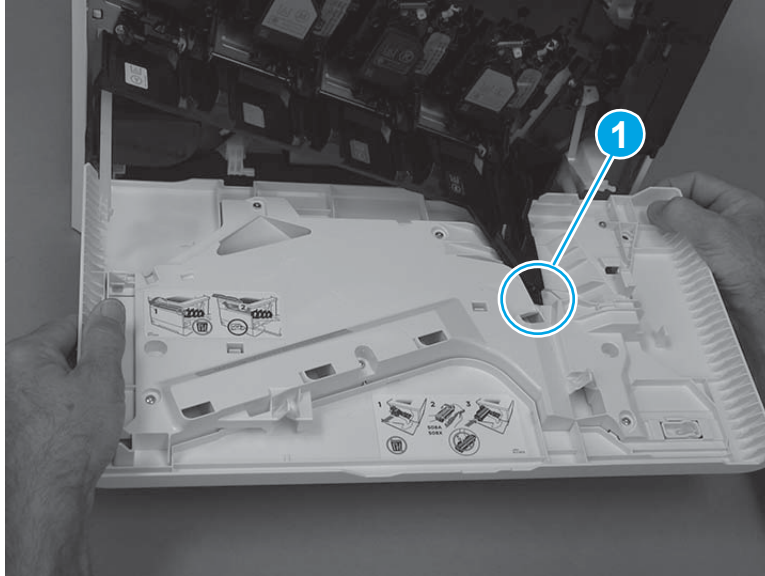

Step 3: Unpack the replacement front door

Unpack the replacement assembly from the packaging.

For complete information on HP's recycling programs, go to [Product return and recycling](#).

📄 NOTE: HP recommends responsible disposal of the defective assembly.

Figure 1-587 Recycle and unpack

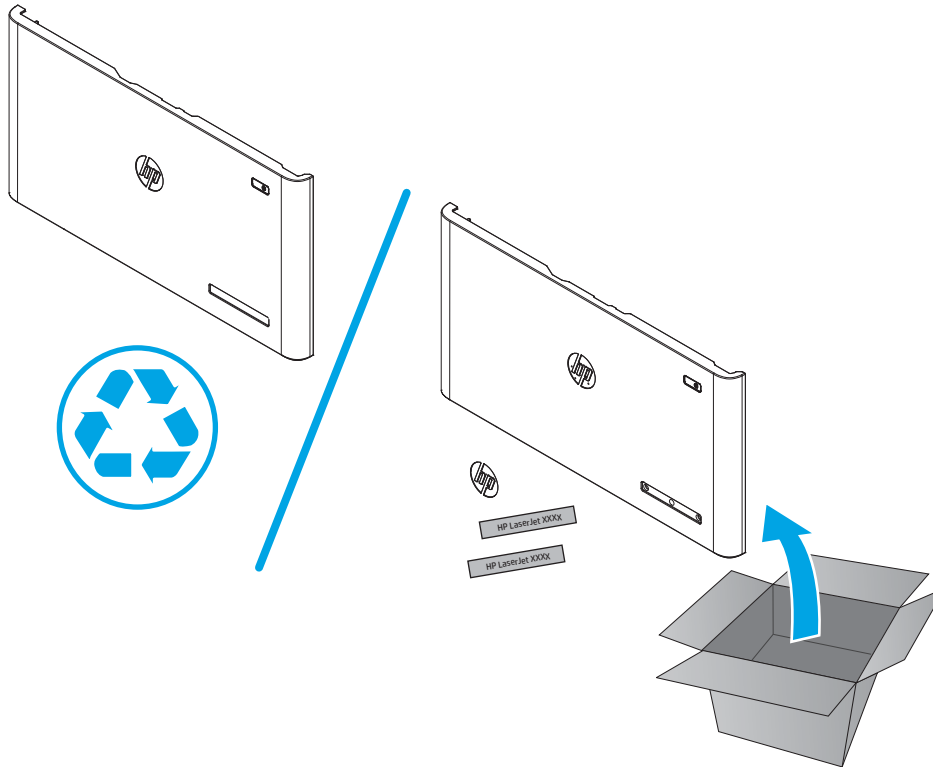

Step 4: Install the front door

1. Engage the tip of the inner door (callout 1) with the slot (callout 2) the front door.

Figure 1-588 Engage the inner door

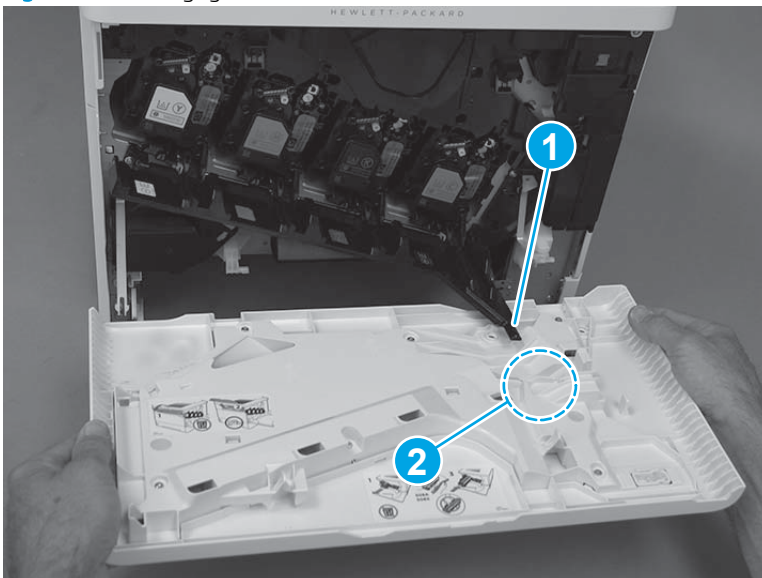

2. Position the door on the printer with the keyed hinge pin (callout 1) aligned with the slot in the flange, and then slide the door to the left (callout 2) to engage the left and right hinge pins (callout 1 and callout 3).

⚠ CAUTION: The keyed hinge pin (callout 1) is fragile, and can easily be broken off.

Make sure that it is correctly aligned with the slot in the flange before attempting to install the front door on the printer.



Figure 1-589 Install the door

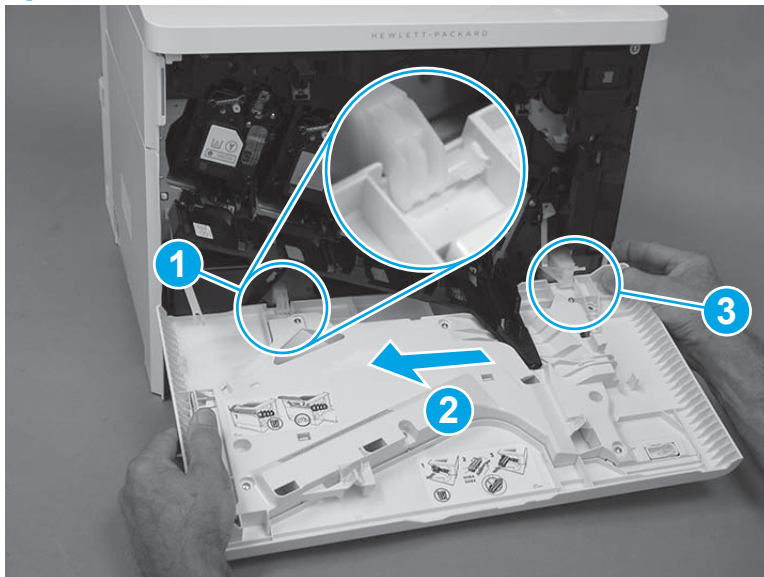

3. At the right- and left-side of the door, engage the door retainer straps with the holders on the door.

 **TIP:** Make sure that the tabs on the straps snap into place.

Figure 1-590 Engage the door retainer straps

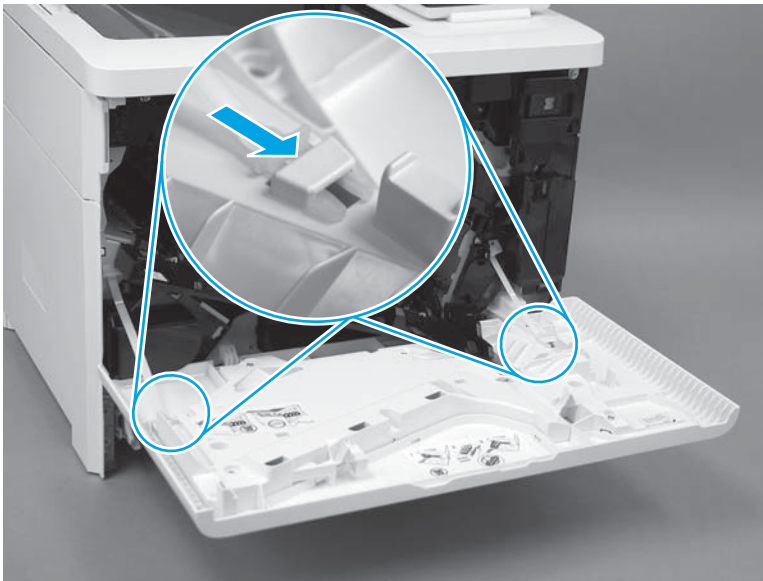

4. Close the front door.

Figure 1-591 Close the front door



5. If a replacement front door is installed, do the following:
 - a. Peel the adhesive backing away from the HP jewel, and then adhere the jewel to the front door (callout 1).
 - b. Press the nameplate mounting tabs through the holes provided in the door (callout 2) to install it.

Figure 1-592 Install nameplate and HP jewel



Step 5: Install the tray

1. With the front of the tray slightly lifted, align the sides of the tray with the rails in the printer, and then carefully slide the tray into the printer.

 **TIP:** As the tray slides into the printer, lower the front of it.

Figure 1-593 Install the tray



2. Close the tray.

Figure 1-594 Close the tray



Removal and replacement: Formatter cover

- [Introduction](#)
- [Step 1: Remove the formatter cover](#)
- [Step 2: Unpack the replacement formatter cover](#)
- [Step 3: Install the formatter cover](#)

Introduction

This document provides the procedures to remove and replace the formatter cover.

Before performing service

Turn the printer power off

- Disconnect the power cable.

⚠ WARNING! To avoid damage to the printer, turn the printer off, wait 30 seconds, and then remove the power cord before attempting to service the printer.

Use the table below to identify the correct part number for your printer. To order the part, go to www.hp.com/buy/parts.

Formatter cover part number	
RM2-0084-000CN	Formatter cover

Required tools

No special tools are required to install this part.

After performing service

Make sure that the formatter cover is fully seated, and that the thumbscrews are finger tight after replacing it.

Turn the printer power on

- Connect the power cable.
- Use the power switch to turn the power on.

Step 1: Remove the formatter cover

1. Locate the formatter cover.

Figure 1-595 Locate the formatter cover

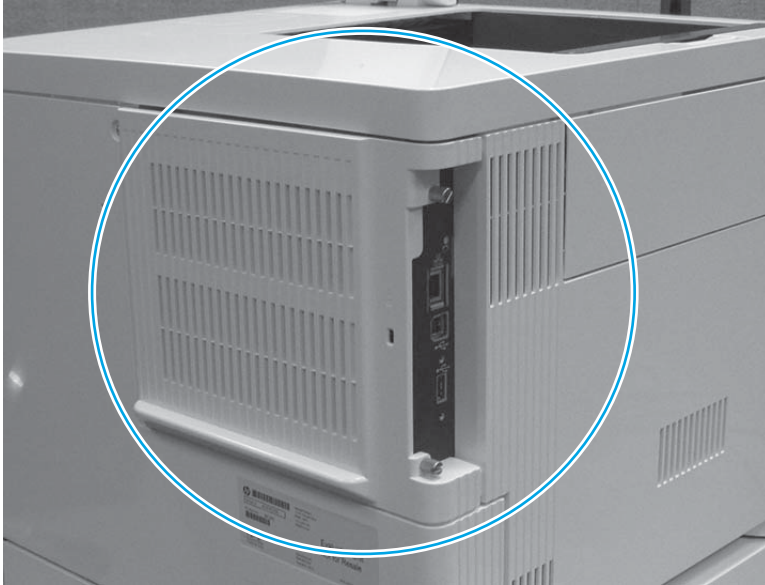

2. Loosen the two thumbscrews (callout 1). Grasp the two thumbscrews, and then slide the cover away from the printer (callout 2) to remove it.

 **TIP:** If needed, use the edge of a coin to turn the thumbscrews.

Figure 1-596 Loosen the thumbscrews

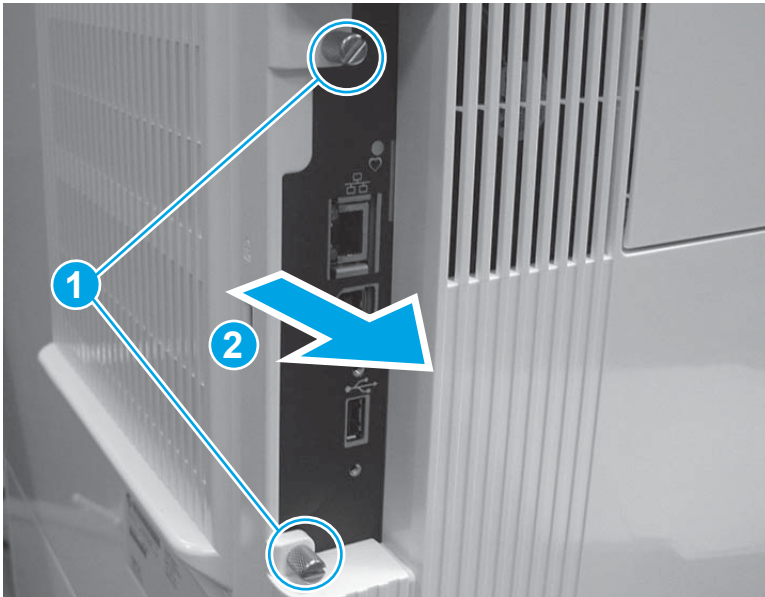

Step 2: Unpack the replacement formatter cover

Unpack the replacement assembly from the packaging.

For complete information on HP's recycling programs, go to [Product return and recycling](#).

 **NOTE:** HP recommends responsible disposal of the defective assembly.

Figure 1-597 Recycle and unpack

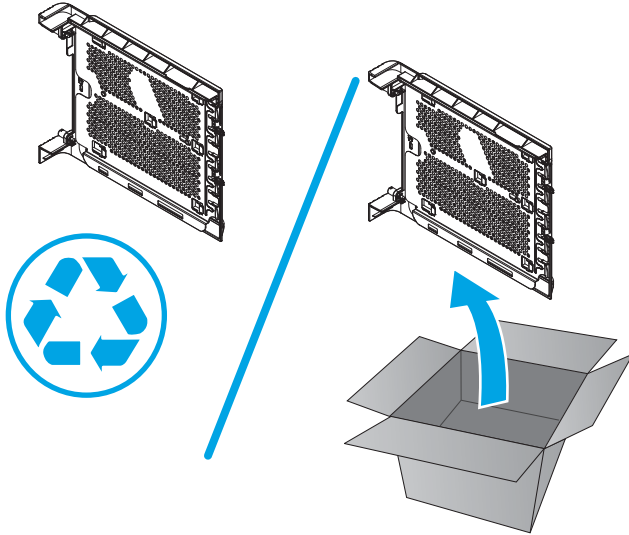

Step 3: Install the formatter cover

- ▲ Slide the cover onto the printer (callout 1) to install it.

 **NOTE:** Make sure that the tabs on the formatter cover align with the slots provided in the printer (callout 2). Tighten the two thumbscrews (callout 3).

 **TIP:** If needed, use the edge of a coin to turn the thumbscrews.

Figure 1-598 Install the cover

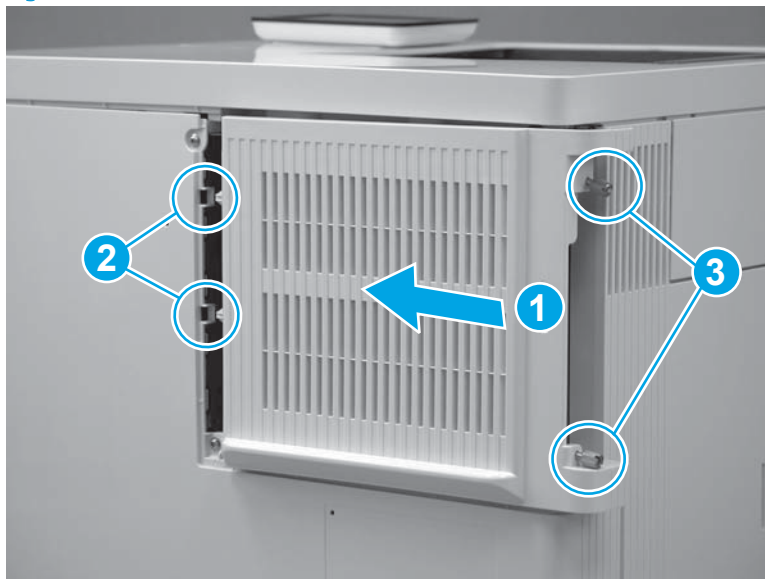

Removal and replacement: Rear cover (M552 and M553)

- [Introduction](#)
- [Step 1: Remove the formatter cover](#)
- [Step 2: Remove the rear cover](#)
- [Step 3: Unpack the replacement assembly](#)
- [Step 4: Install the rear cover](#)
- [Step 5: Install the formatter cover](#)

Introduction

This document provides the procedures to remove and replace the rear cover.

Before performing service

Turn the printer power off

- Disconnect the power cable.

 **WARNING!** To avoid damage to the printer, turn the printer off, wait 30 seconds, and then remove the power cord before attempting to service the printer.

Use the table below to identify the correct part number for your printer. To order the part, go to www.hp.com/buy/parts.

Rear cover part number	
RM2-0085-000CN	Rear cover

Required tools

- #2 Phillips screwdriver with a magnetic tip

After performing service

Make sure that the formatter cover is fully seated, and that the thumbscrews are finger tight after replacing it.

Turn the printer power on

- Connect the power cable.
- Use the power switch to turn the power on.

Step 1: Remove the formatter cover

1. Locate the formatter cover.

Figure 1-599 Locate the formatter cover

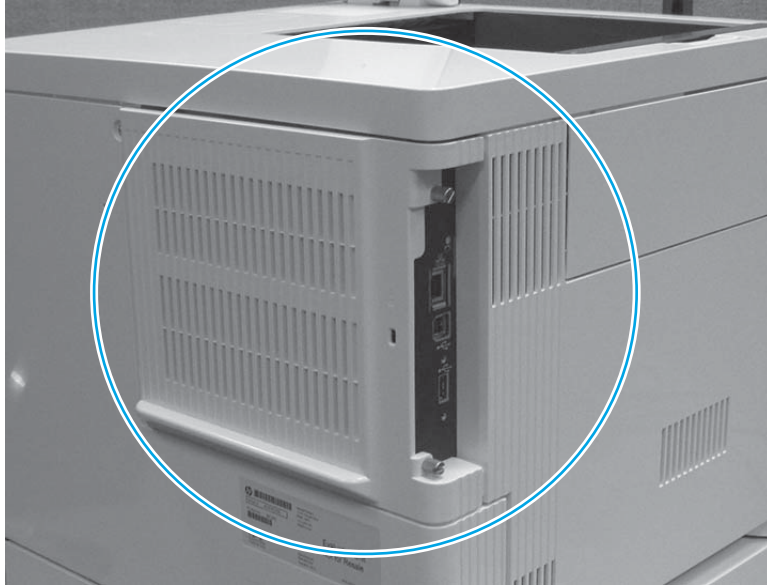

2. Loosen the two thumbscrews (callout 1). Grasp the two thumbscrews, and then slide the cover away from the printer (callout 2) to remove it.

 **TIP:** If needed, use the edge of a coin to turn the thumbscrews.

Figure 1-600 Loosen the thumbscrews

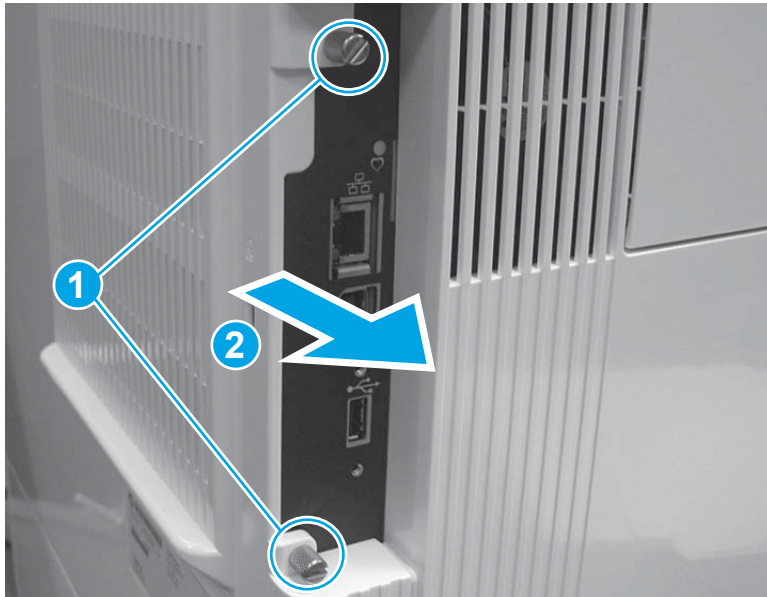

Step 2: Remove the rear cover

1. Remove four screws (callout 1).

Figure 1-601 Remove four screws

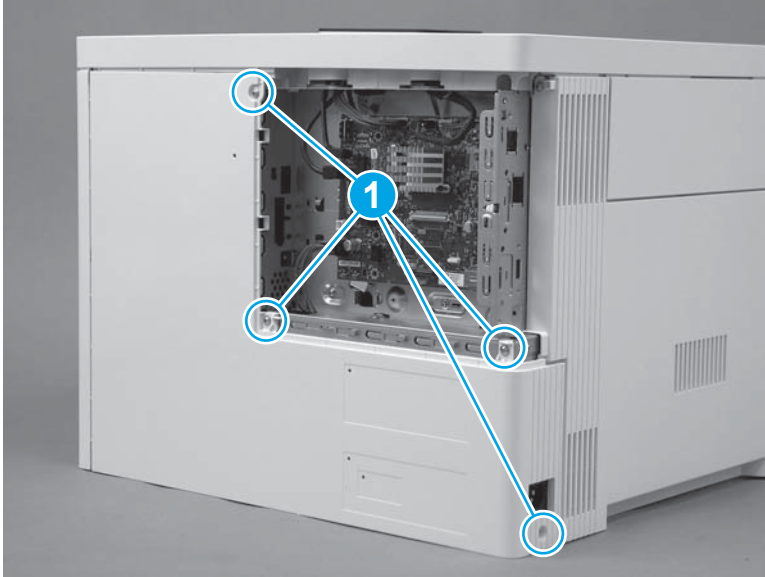

2. Slightly slide the cover to the right (callout 1), rotate the bottom of the cover away from the printer (callout 2), and then pull the top of the cover away from the printer (callout 3) to remove the cover.

Figure 1-602 Remove the cover

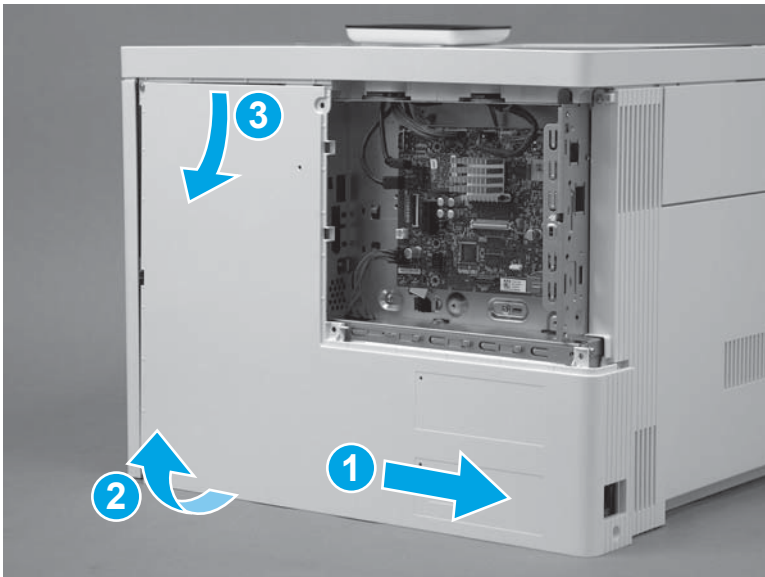

Step 3: Unpack the replacement assembly

Unpack the replacement assembly from the packaging.

For complete information on HP's recycling programs, go to [Product return and recycling](#).

 **NOTE:** HP recommends responsible disposal of the defective assembly.

Figure 1-603 Recycle and unpack

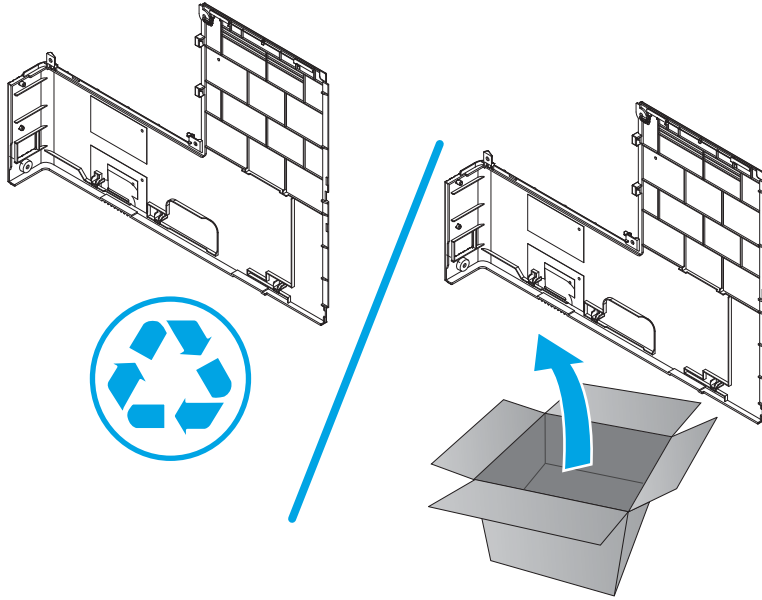

Step 4: Install the rear cover

1. Position the top of the cover under the upper cover (callout 1), rotate the bottom of the cover onto the chassis (callout 2), and then slide the cover to the left (callout 3) to install it.

Figure 1-604 Install the cover

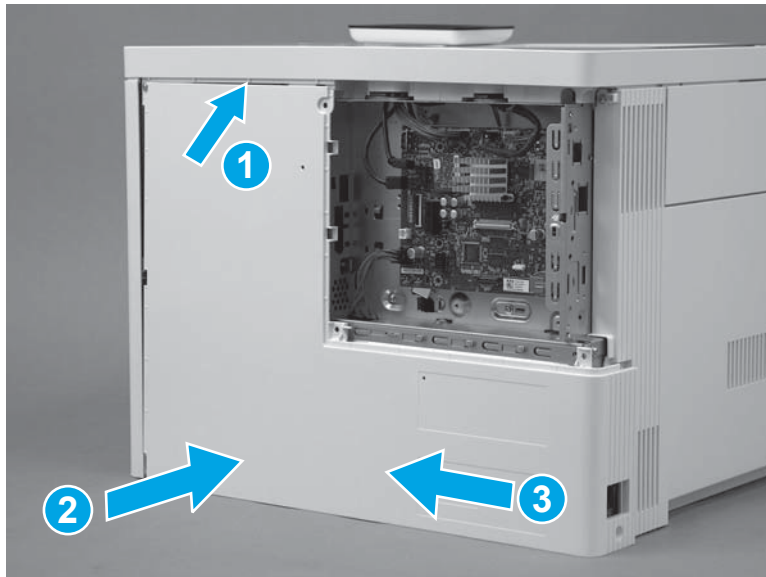

2. Install four screws (callout 1).

Figure 1-605 Install four screws cover

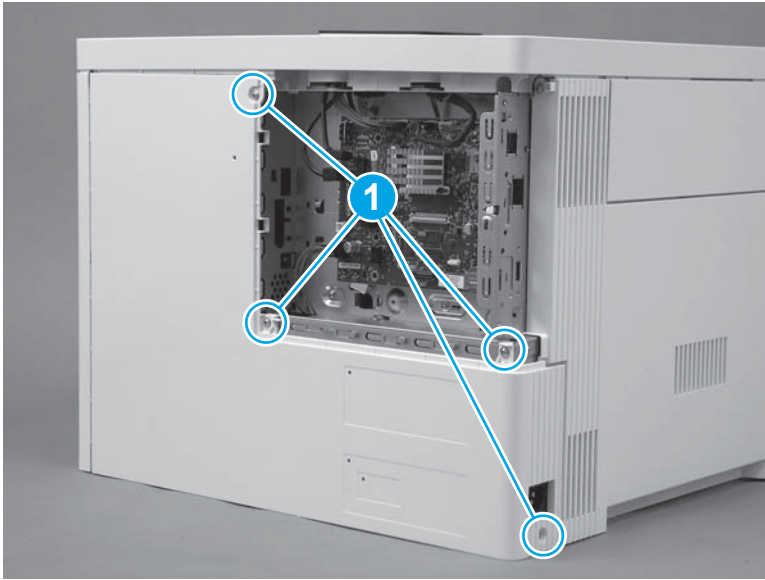

Step 5: Install the formatter cover

- ▲ Slide the cover onto the printer (callout 1) to install it.

 **NOTE:** Make sure that the tabs on the formatter cover align with the slots provided in the printer (callout 2). Tighten the two thumbscrews (callout 3).

 **TIP:** If needed, use the edge of a coin to turn the thumbscrews.

Figure 1-606 Install the cover

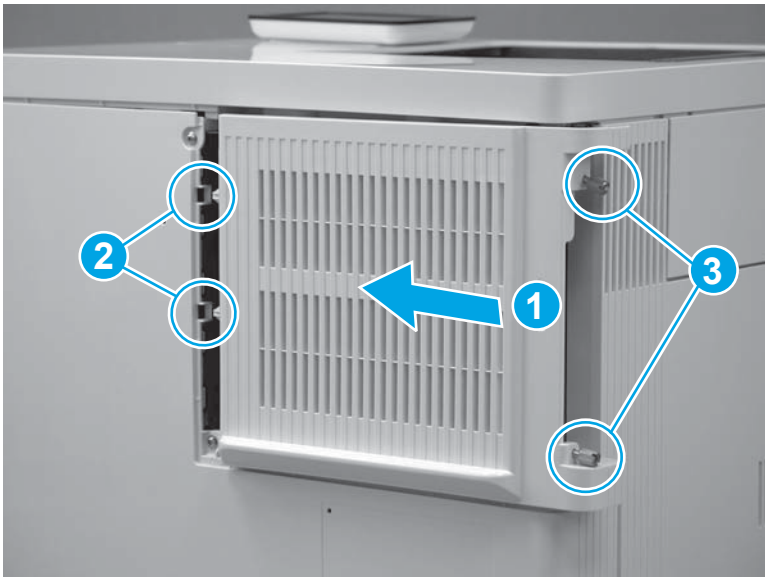

Removal and replacement: Rear cover (M577)

- [Introduction](#)
- [Step 1: Remove the formatter cover](#)
- [Step 2: Remove the rear upper cover](#)
- [Step 3: Remove the rear cover \(M577\)](#)
- [Step 4: Unpack the replacement assembly](#)
- [Step 5: Install the rear cover \(M577\)](#)
- [Step 6: Install the rear upper cover \(M577\)](#)
- [Step 7: Install the formatter cover](#)

Introduction

This document provides the procedures to remove and replace the rear cover.

Before performing service

Turn the printer power off

- Disconnect the power cable.

⚠ WARNING! To avoid damage to the printer, turn the printer off, wait 30 seconds, and then remove the power cord before attempting to service the printer.

Use the table below to identify the correct part number for your printer. To order the part, go to www.hp.com/buy/parts.

Rear cover part number	
RM2-0085-000CN	Rear cover

Required tools

- #2 Phillips screwdriver with a magnetic tip

After performing service

Make sure that the formatter cover is fully seated, and that the thumbscrews are finger tight after replacing it.

Turn the printer power on

- Connect the power cable.
- Use the power switch to turn the power on.

Step 1: Remove the formatter cover

1. Locate the formatter cover.

Figure 1-607 Locate the formatter cover

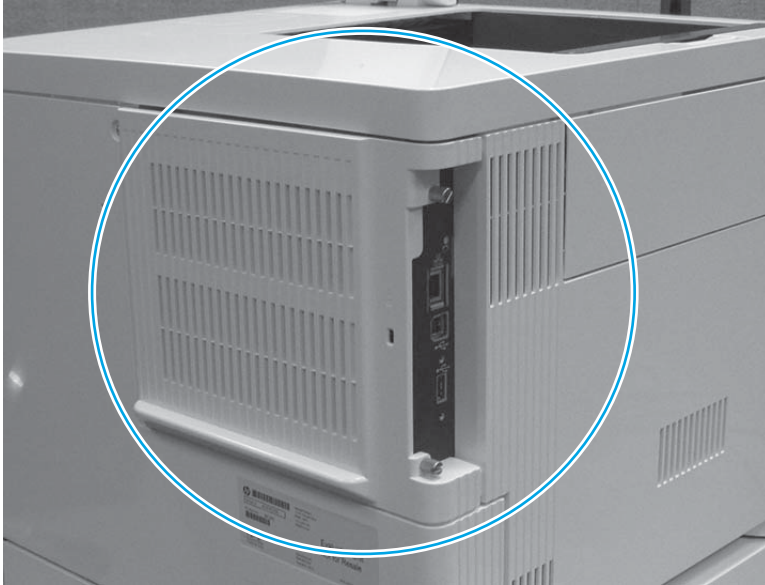

2. Loosen the two thumbscrews (callout 1). Grasp the two thumbscrews, and then slide the cover away from the printer (callout 2) to remove it.

 **TIP:** If needed, use the edge of a coin to turn the thumbscrews.

Figure 1-608 Loosen the thumbscrews

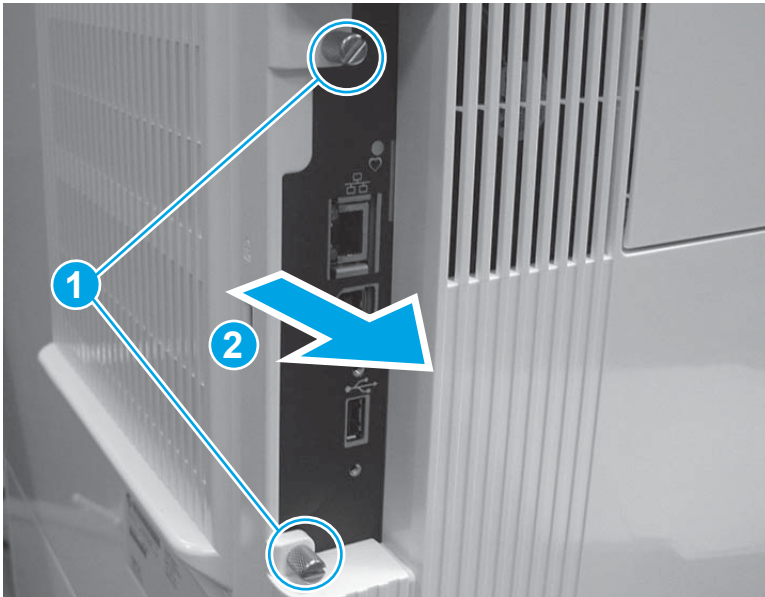

Step 2: Remove the rear upper cover

1. Remove two screws (callout 1).

 **Reinstallation tip:** These two screws are self-tapping screws for plastic. When reinstalling them, rotate the screws counterclockwise to align them with the existing thread pattern, and then carefully turn them clockwise to tighten. Do not overtighten. This will prevent stripping the threads inside the screw holes.

Figure 1-609 Remove two screws



2. Use a small, flat blade screwdriver to release the right edge of the cover.

Figure 1-610 Release the right edge

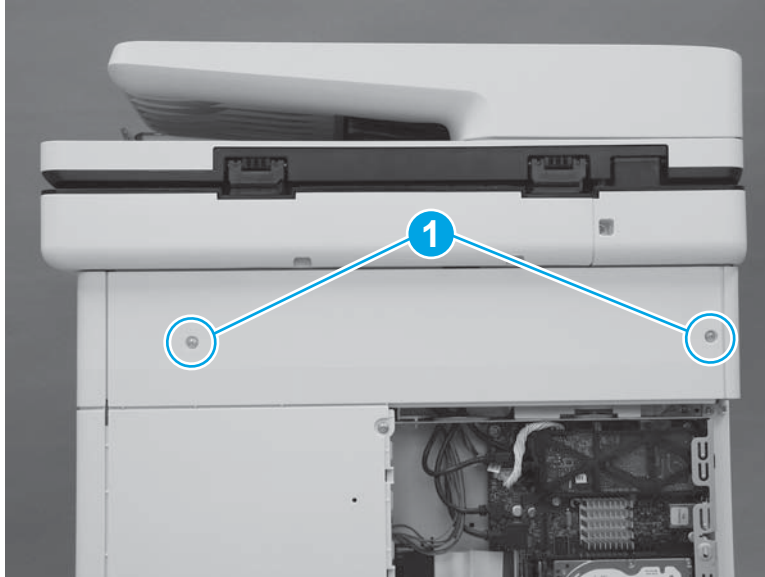
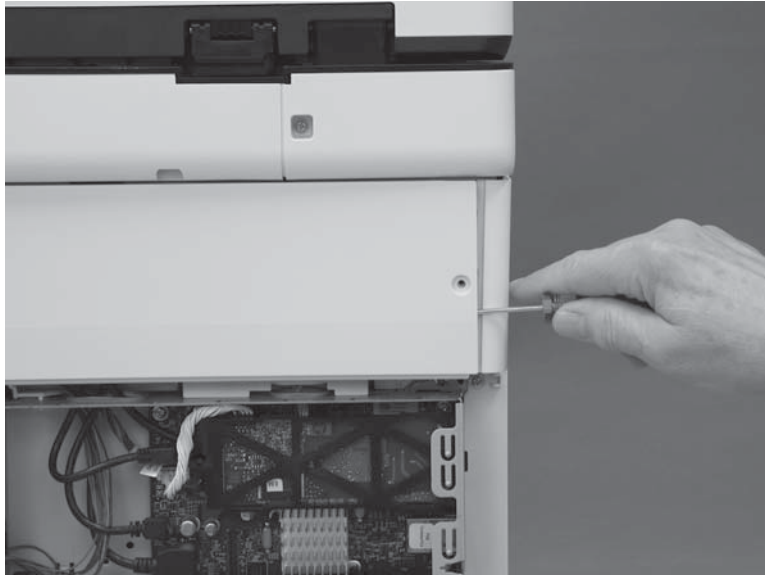

3. Pull the right edge of the cover (callout 1) away from the printer, and then slide the cover to the right (callout 2).

Figure 1-611 Slide the cover right

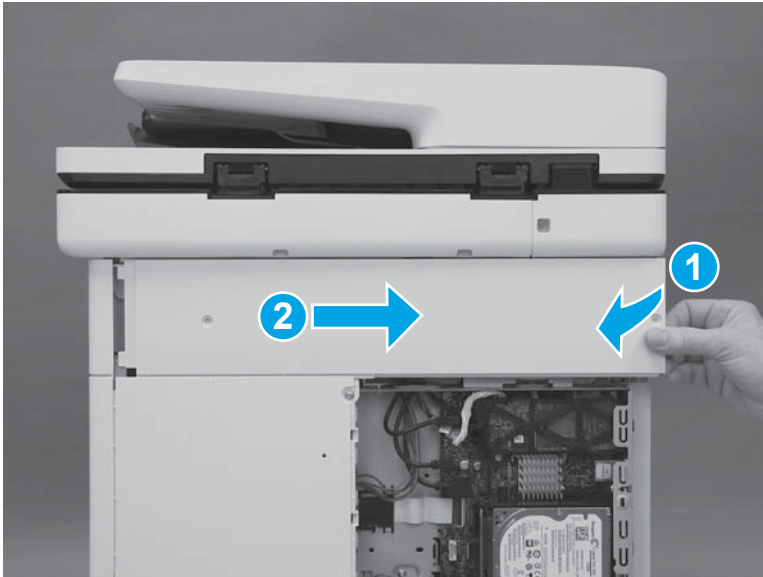

4. Remove the cover.

Figure 1-612 Remove the cover

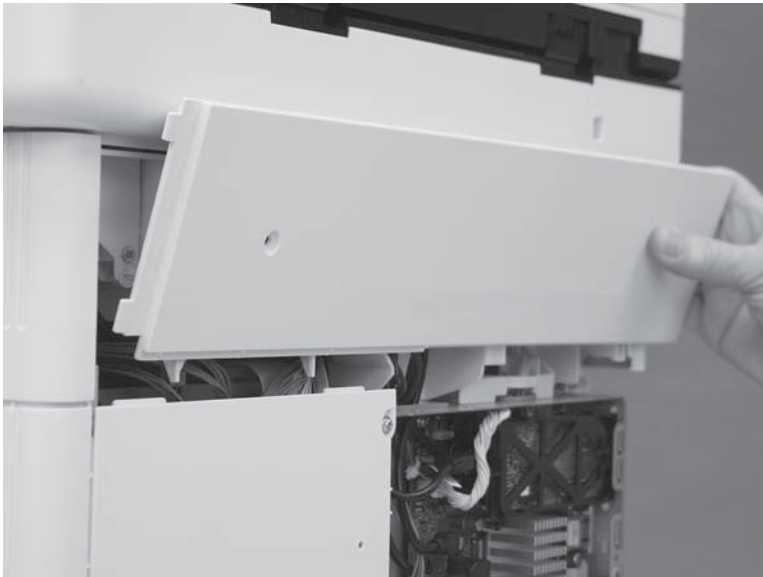

Step 3: Remove the rear cover (M577)

1. Remove four screws (callout 1).

Figure 1-613 Remove four screws

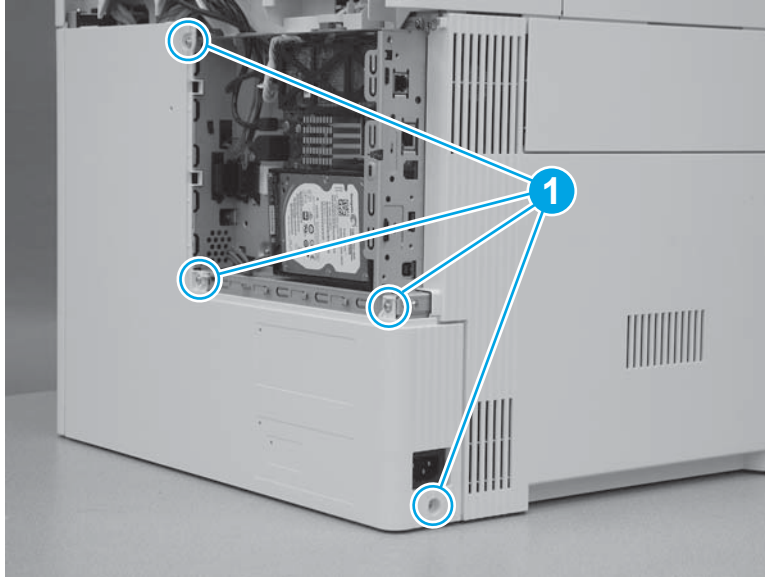

2. Slide the cover to the right to remove it.

Figure 1-614 Remove the cover

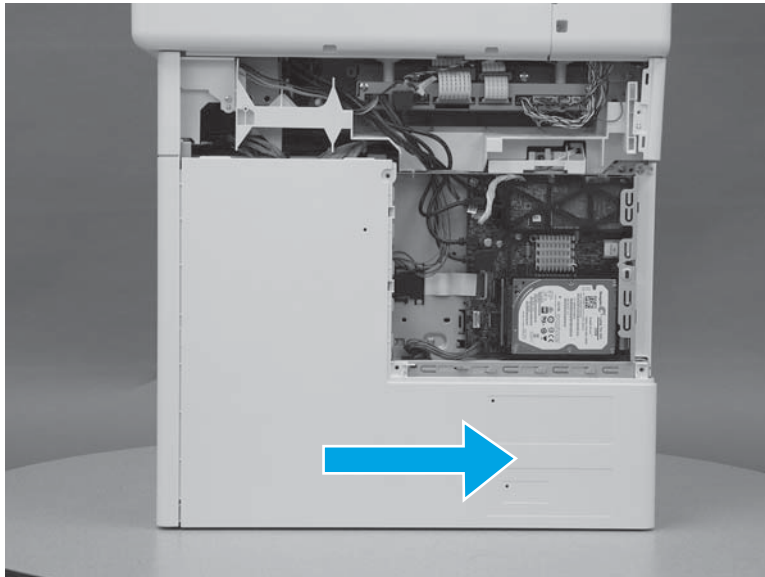

Step 4: Unpack the replacement assembly

Unpack the replacement assembly from the packaging.

For complete information on HP's recycling programs, go to [Product return and recycling](#).

 **NOTE:** HP recommends responsible disposal of the defective assembly.

Figure 1-615 Recycle and unpack

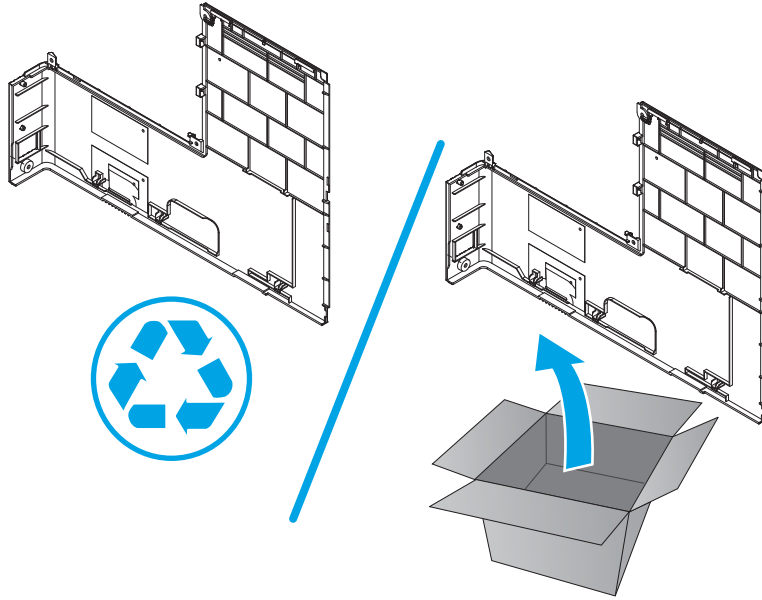

Step 5: Install the rear cover (M577)

1. Position the hooks (callout 1) on the cover in the slots (callout 2) in the printer.

Figure 1-616 Position the hooks

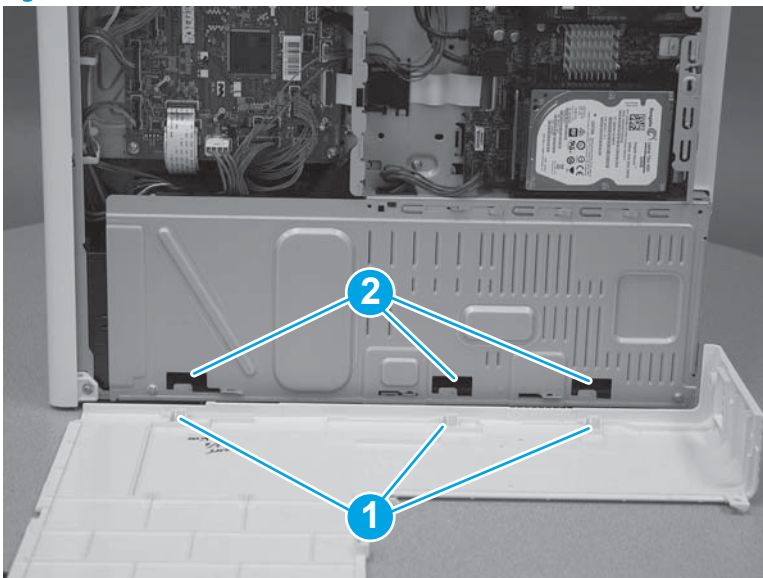

2. Position the back edge (callout 1) of the rear cover behind the edge (callout 2) of the right rear cover. Slide the cover to the left to install it.

Figure 1-617 Install the cover

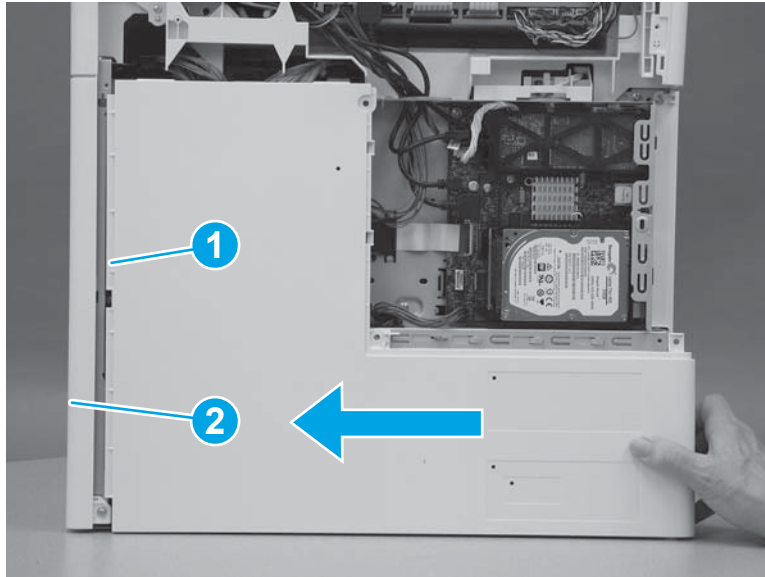

3. Install four screws (callout 1).

Figure 1-618 Install four screws cover

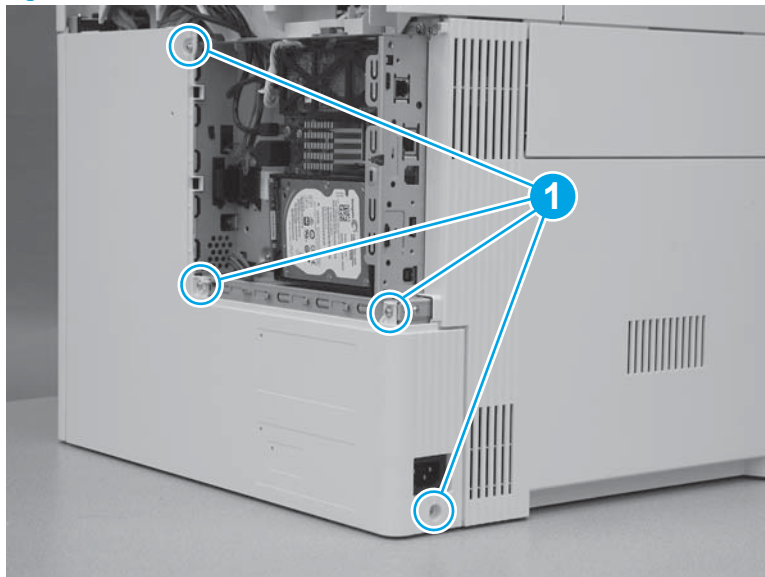

Step 6: Install the rear upper cover (M577)

1. Align the ridge (callout 1) on the lower edge of the rear upper cover in front of the tabs (callout 2) on the top edge of the rear cover.

Figure 1-619 Align the cover

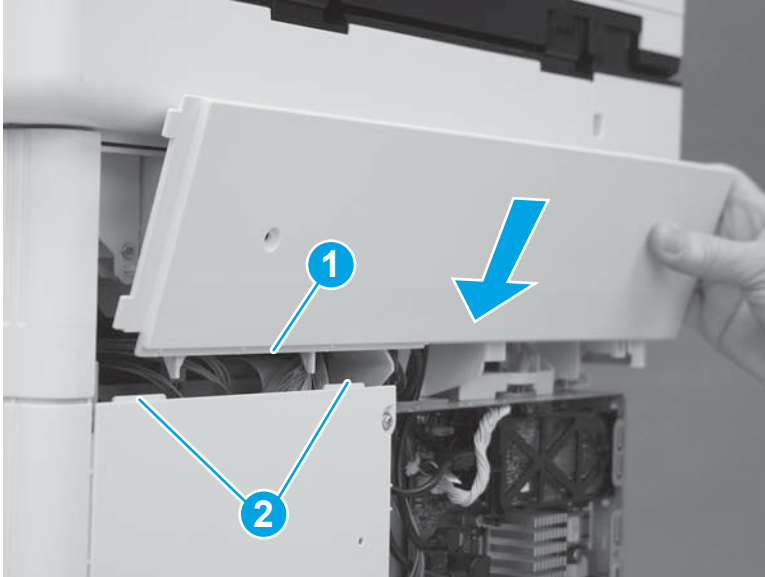

2. Rotate the top of the cover toward the printer.

Figure 1-620 Rotate the top of the cover



- Slide the cover to the left (callout 1). Make sure that the tabs (callout 2) on the upper rear cover slide behind the edge (callout 3) of the right upper cover. Make sure that the cover is fully seated.

Figure 1-621 Slide the cover

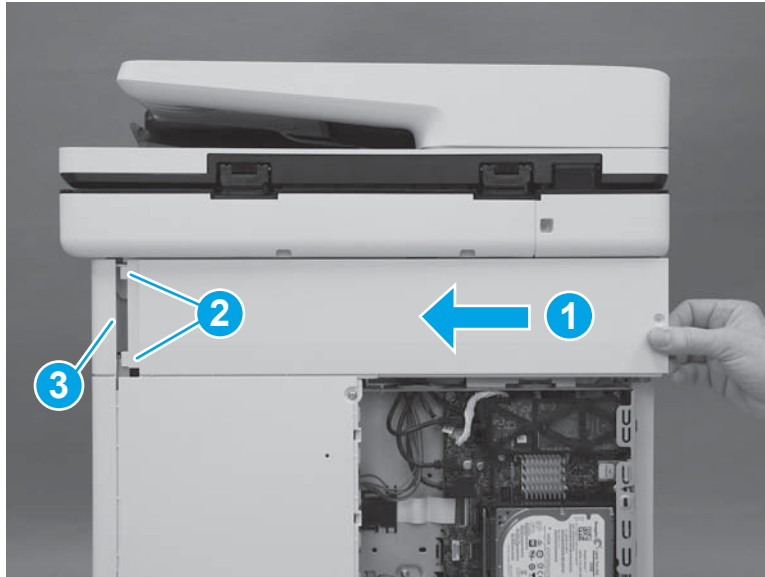

- Install two screws (callout 1).



 **IMPORTANT:** These two screws are self-tapping screws for plastic. Rotate them counterclockwise to align them with the existing thread pattern, and then carefully turn them clockwise to tighten. Do not overtighten. This will prevent stripping the threads inside the screw holes.

Figure 1-622 Install two screws

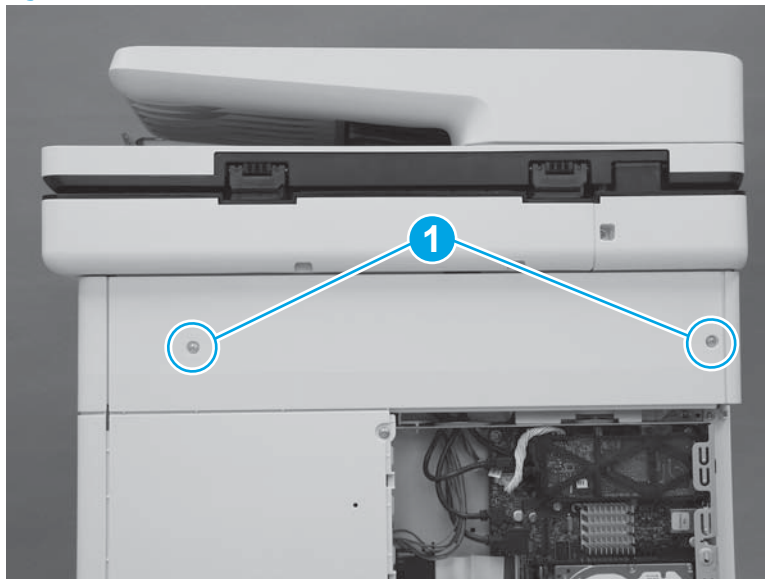

Step 7: Install the formatter cover

- ▲ Slide the cover onto the printer (callout 1) to install it.

 **NOTE:** Make sure that the tabs on the formatter cover align with the slots provided in the printer (callout 2). Tighten the two thumbscrews (callout 3).

 **TIP:** If needed, use the edge of a coin to turn the thumbscrews.

Figure 1-623 Install the cover



Removal and replacement: Left cover

- [Introduction](#)
- [Step 1: Remove the toner collection unit \(TCU\)](#)
- [Step 2: Remove the formatter cover](#)
- [Step 3: Remove the rear cover \(M552 and M553\)](#)
- [Step 4: Remove the rear upper cover \(M577\)](#)
- [Step 5: Remove the rear cover \(M577\)](#)
- [Step 6: Remove the left cover](#)
- [Step 7: Unpack the replacement assembly](#)
- [Step 8: Install the left cover](#)
- [Step 9: Install the rear cover \(M577\)](#)
- [Step 10: Install the rear upper cover \(M577\)](#)
- [Step 11: Install the rear cover \(M552 and M553\)](#)
- [Step 12: Install the formatter cover](#)
- [Step 13: Install the TCU](#)

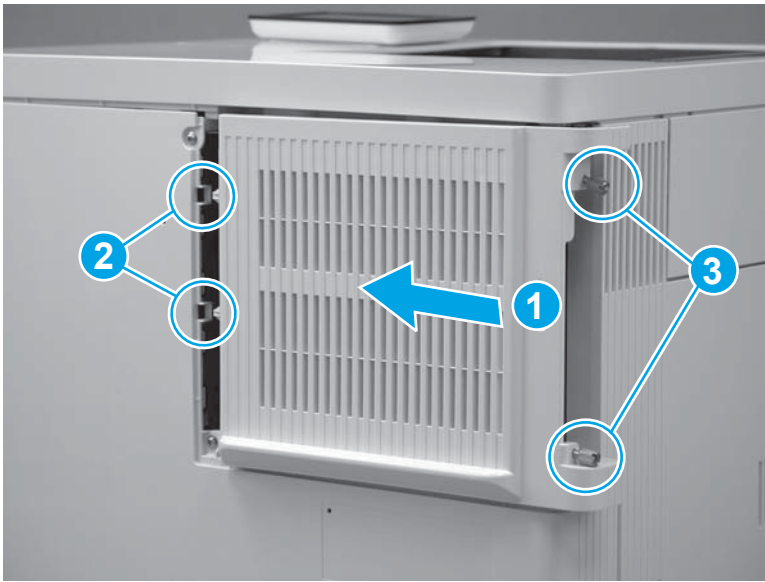
Introduction

This document provides the procedures to remove and replace the left cover.

Before performing service

Turn the printer power off

- Disconnect the power cable.

⚠ WARNING! To avoid damage to the printer, turn the printer off, wait 30 seconds, and then remove the power cord before attempting to service the printer.

Use the table below to identify the correct part number for your printer. To order the part, go to www.hp.com/buy/parts.

Left cover part number	
RC4-0179-000CN	Left cover

Required tools

- #2 Phillips screwdriver with a magnetic tip

After performing service

Make sure that the TCU is fully closed after replacing it.

Make sure that the formatter cover is fully seated, and that the thumbscrews are finger tight after replacing it.

Turn the printer power on

- Connect the power cable.
- Use the power switch to turn the power on.

Step 1: Remove the toner collection unit (TCU)

1. Open the front door.

Figure 1-624 Open the front door



2. Open the TCU.

 **NOTE:** The toner collection hatch cover automatically closes when the TCU is opened.

Figure 1-625 Open the TCU



3. Pull the TCU away from the printer at an angle to remove it.

⚠ CAUTION: Do not open the toner collection hatch cover when handling the TCU. If toner gets on clothing, wipe it off by using a dry cloth and wash the clothes in cold water. Hot water sets toner into fabric.

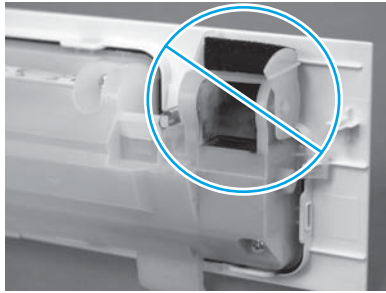
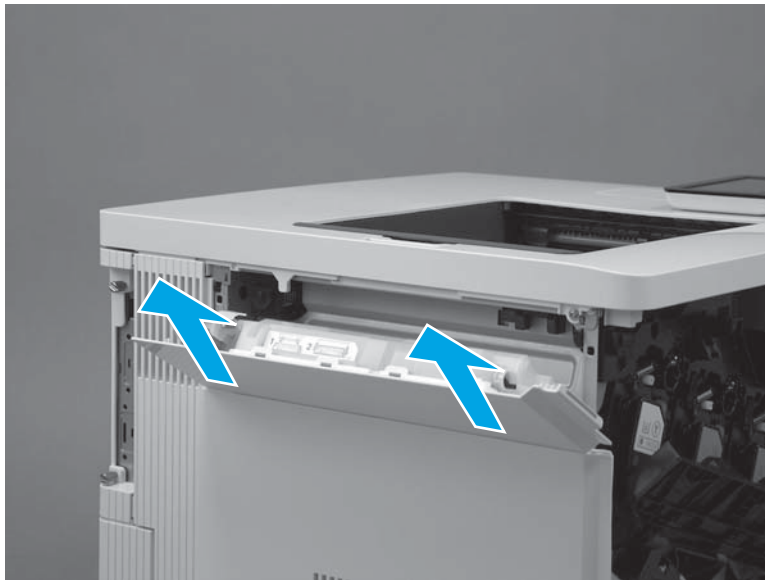

Figure 1-626 Remove the TCU



Step 2: Remove the formatter cover

1. Locate the formatter cover.

Figure 1-627 Locate the formatter cover

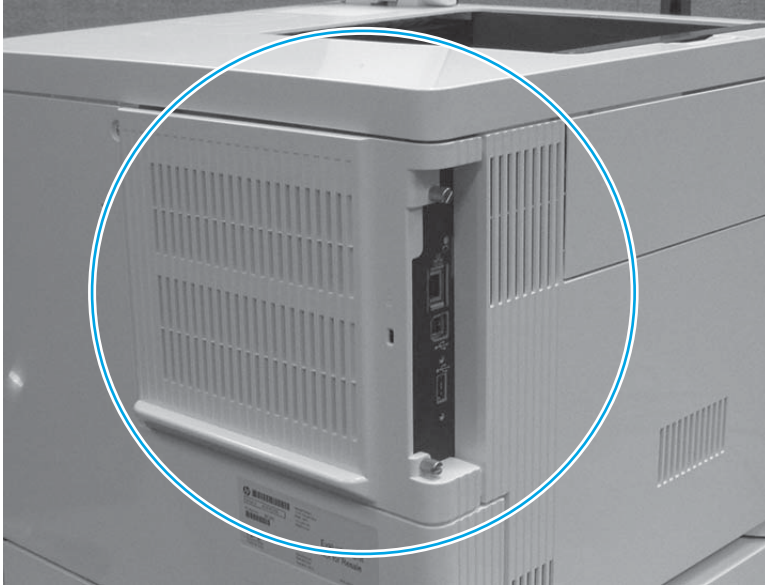

2. Loosen the two thumbscrews (callout 1). Grasp the two thumbscrews, and then slide the cover away from the printer (callout 2) to remove it.

 **TIP:** If needed, use the edge of a coin to turn the thumbscrews.

Figure 1-628 Loosen the thumbscrews

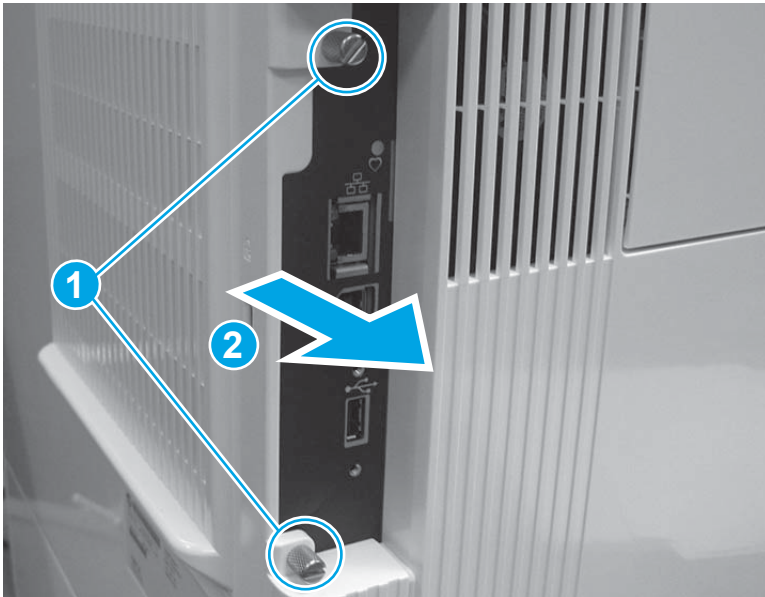

Step 3: Remove the rear cover (M552 and M553)

 **NOTE:** This step is for the M552 and M553 models. For the M577 models, skip this step and go to [Step 4: Remove the rear upper cover \(M577\) on page 379](#).

1. Remove four screws (callout 1).

Figure 1-629 Remove four screws

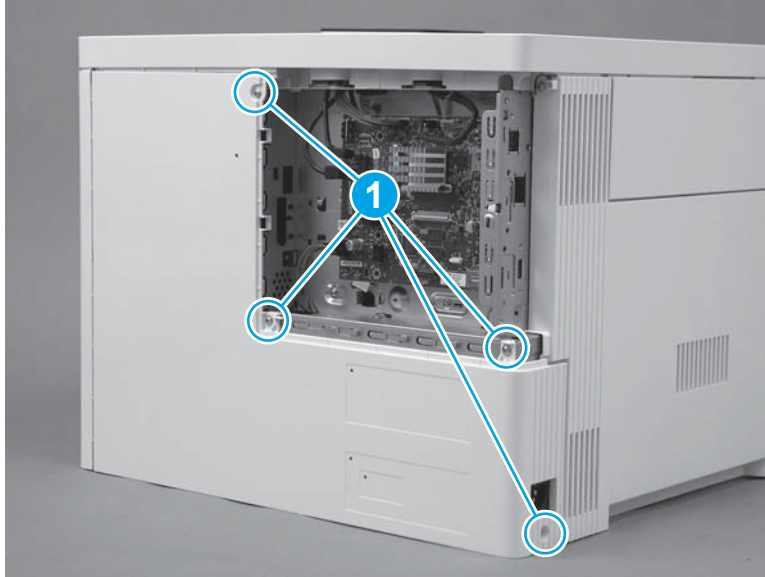

2. Slightly slide the cover to the right (callout 1), rotate the bottom of the cover away from the printer (callout 2), and then pull the top of the cover away from the printer (callout 3) to remove the cover.

Figure 1-630 Remove the cover

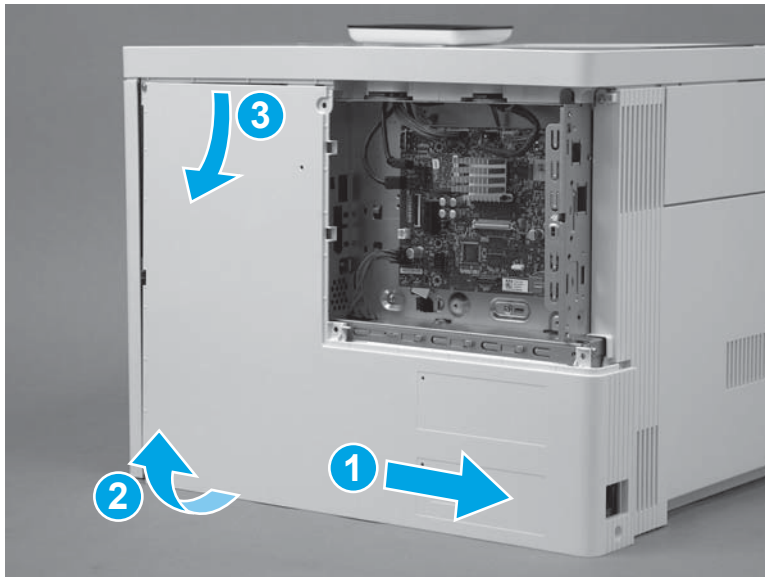

Step 4: Remove the rear upper cover (M577)

 **NOTE:** This step is for the M577 models. For the M552 and M553 models, skip this step and go to [Step 6: Remove the left cover on page 382](#).

1. Remove two screws (callout 1).

 **Reinstallation tip:** These two screws are self-tapping screws for plastic. When reinstalling them, rotate the screws counterclockwise to align them with the existing thread pattern, and then carefully turn them clockwise to tighten. Do not overtighten. This will prevent stripping the threads inside the screw holes.

Figure 1-631 Remove two screws



2. Use a small, flat blade screwdriver to release the right edge of the cover.

Figure 1-632 Release the right edge

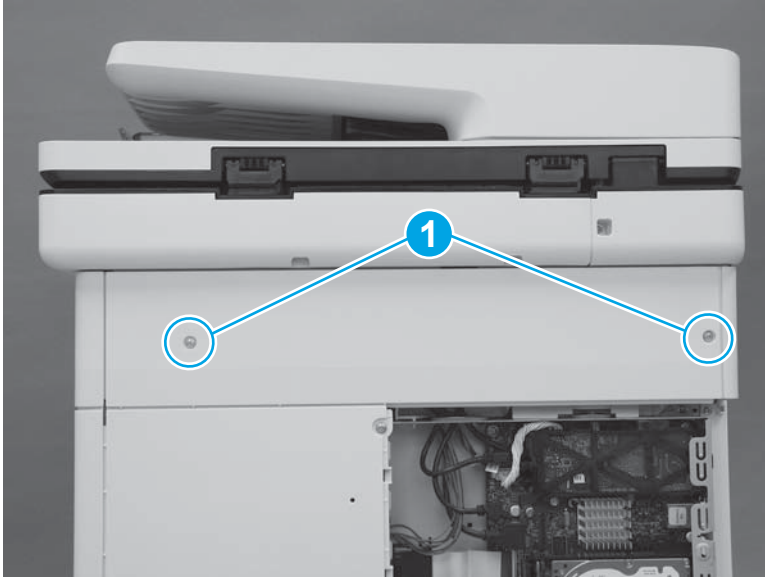
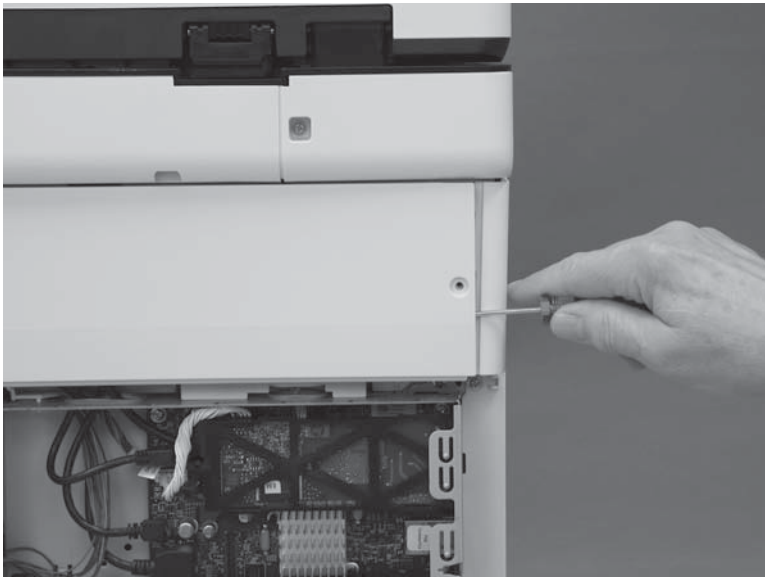

3. Pull the right edge of the cover (callout 1) away from the printer, and then slide the cover to the right (callout 2).

Figure 1-633 Slide the cover right

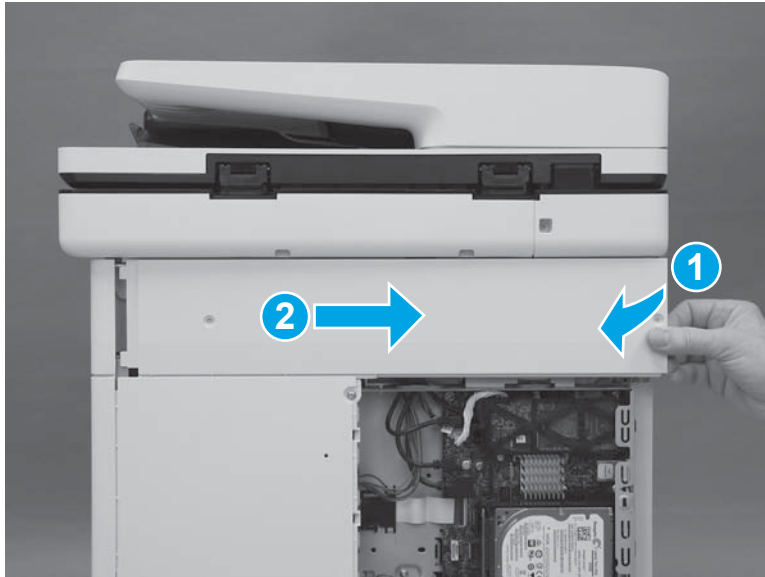

4. Remove the cover.

Figure 1-634 Remove the cover

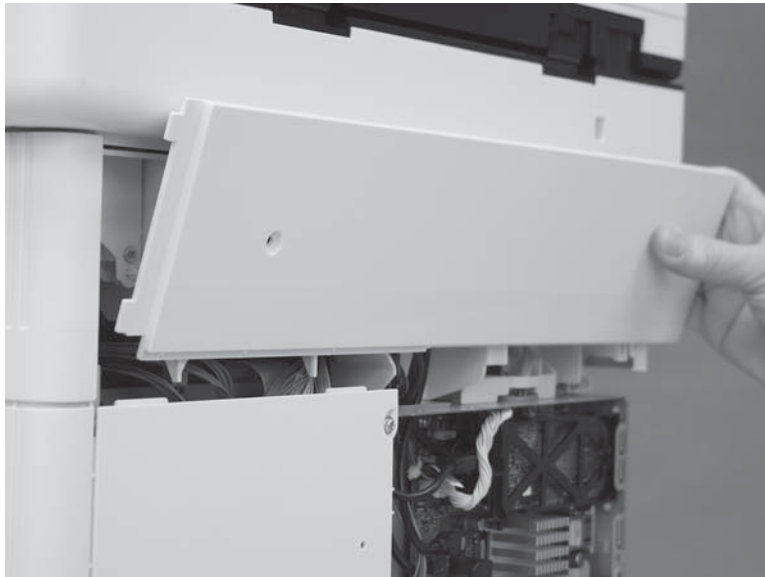

Step 5: Remove the rear cover (M577)

 **NOTE:** This step is for the M577 models. For the M552 and M553 models, skip this step and go to [Step 6: Remove the left cover on page 382.](#)

1. Remove four screws (callout 1).

Figure 1-635 Remove four screws

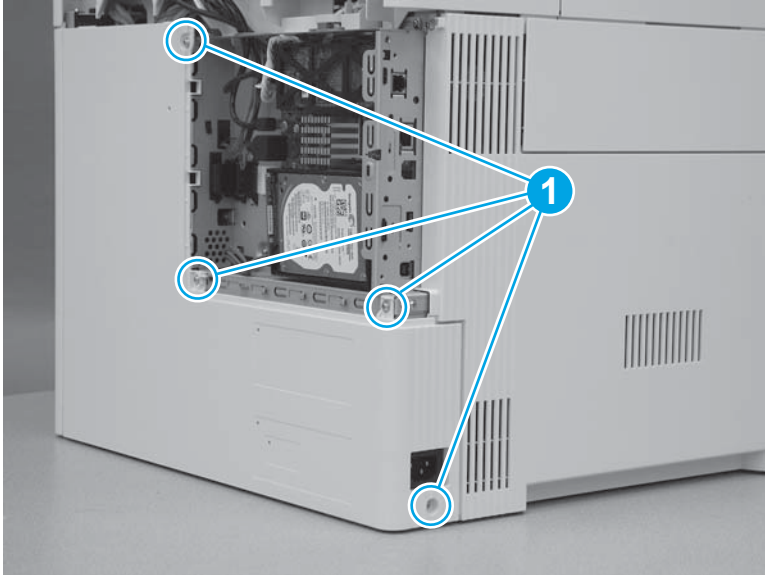

2. Slide the cover to the right to remove it.

Figure 1-636 Remove the cover

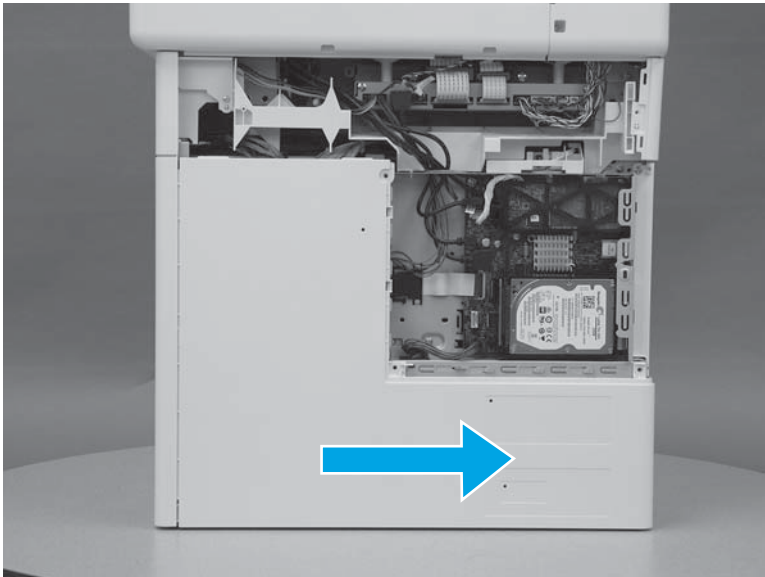

Step 6: Remove the left cover

1. At the left side of the printer, remove one screw (callout 1).

Figure 1-637 Remove one screw



2. Release one tab (callout 1), rotate the front edge of the cover away from the printer (callout 2), and then slide the cover (callout 3) toward the rear of the printer to release it.

Figure 1-638 Release the cover

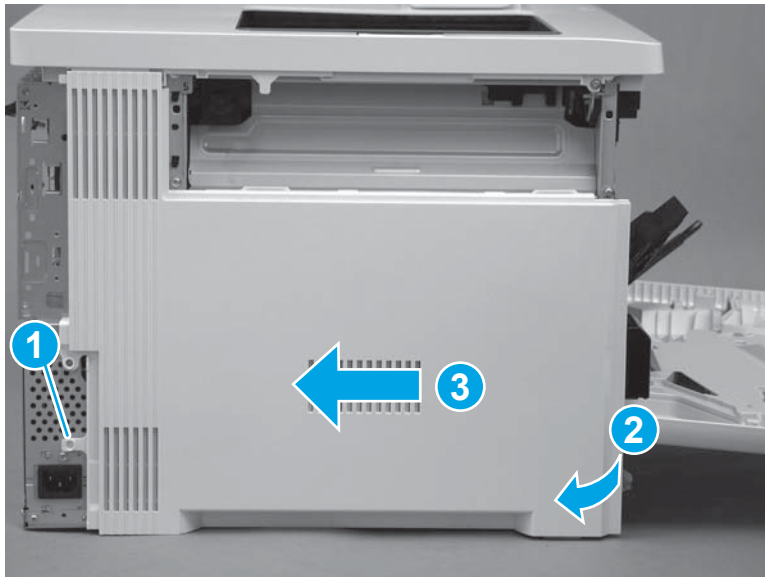

3. Remove the cover.

Figure 1-639 Remove the cover

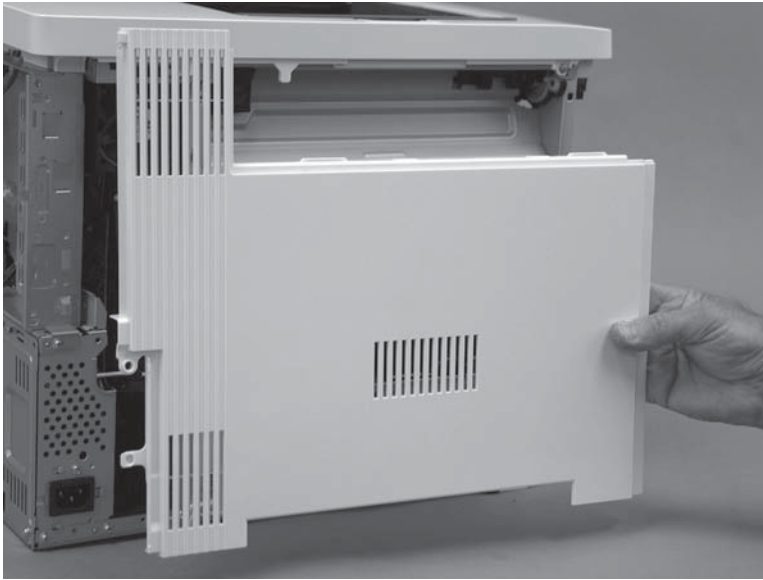

Step 7: Unpack the replacement assembly

Unpack the replacement assembly from the packaging.

For complete information on HP's recycling programs, go to [Product return and recycling](#).

 **NOTE:** HP recommends responsible disposal of the defective assembly.

Figure 1-640 Recycle and unpack

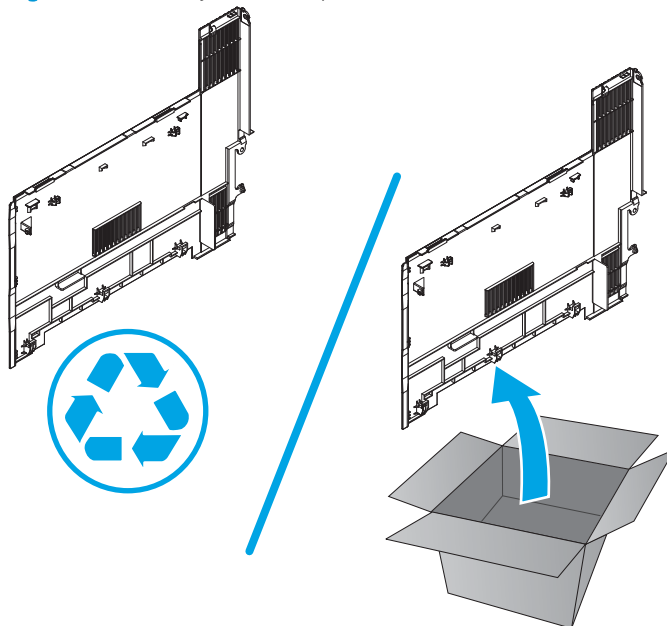

Step 8: Install the left cover

1. Position the cover on the printer.

 **NOTE:** Slightly offset the cover toward the rear of the printer.

Figure 1-641 Install the cover

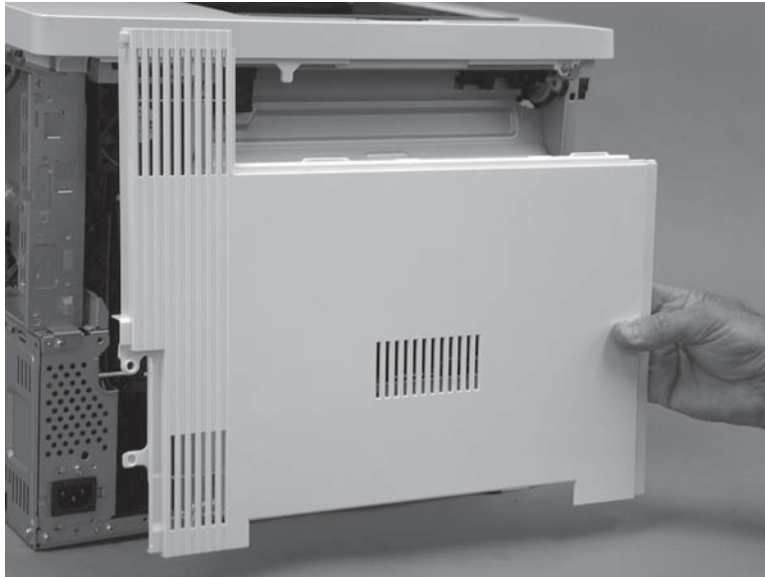

2. Slide the cover (callout 1) toward the front of the printer to engage it. Make sure that the tab (callout 2) snaps into place.

 **NOTE:** Locate the alignment pin (callout 3) on the cover from the front door side of the printer, and then make sure that it is fully engaged in the slot in the chassis.

 **TIP:** While sliding the cover into place, push in on the center of the cover (callout 1) to make sure that the hooks on the back of the cover engage with the slots in the chassis.

Figure 1-642 Engage the cover



3. At the left side of the printer, install one screw (callout 1).

Figure 1-643 Install one screw

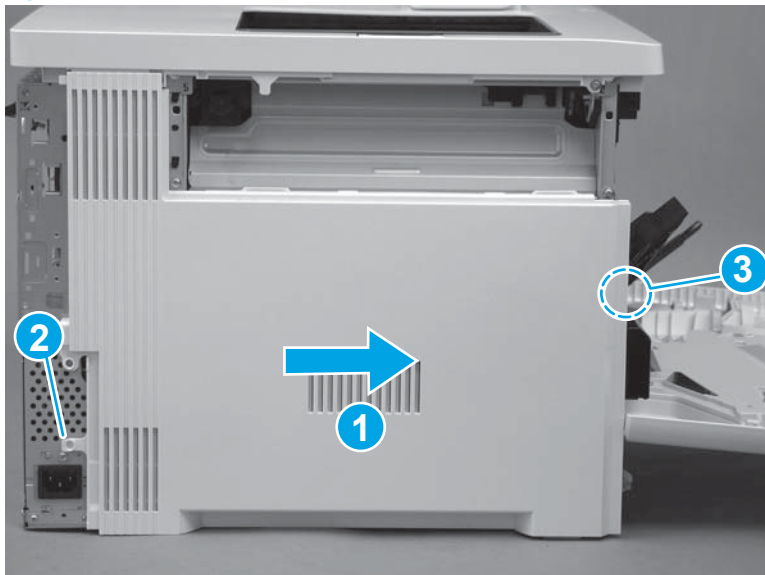

Step 9: Install the rear cover (M577)

 **NOTE:** This step is for the M577 models. For the M552 and M553 models, skip this step and go to [Step 11: Install the rear cover \(M552 and M553\) on page 389](#).

1. Position the hooks (callout 1) on the cover in the slots (callout 2) in the printer.

Figure 1-644 Position the hooks

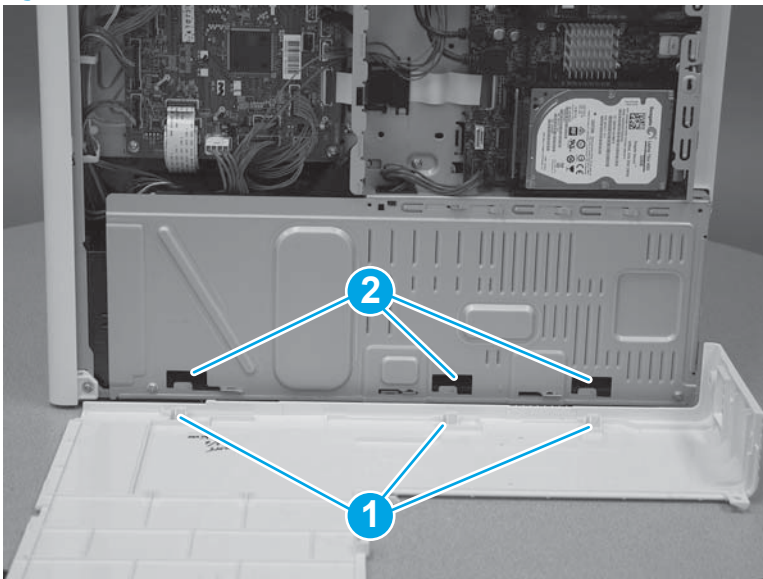

2. Position the back edge (callout 1) of the rear cover behind the edge (callout 2) of the right rear cover. Slide the cover to the left to install it.

Figure 1-645 Install the cover

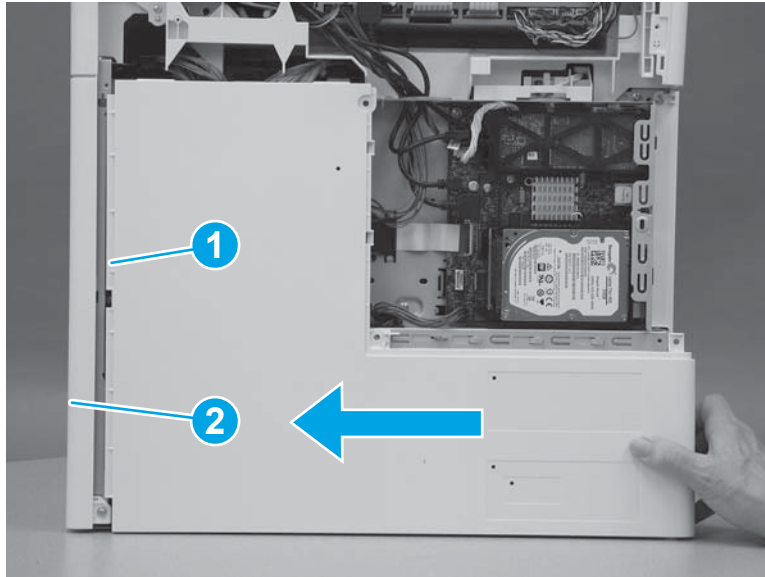

3. Install four screws (callout 1).

Figure 1-646 Install four screws cover

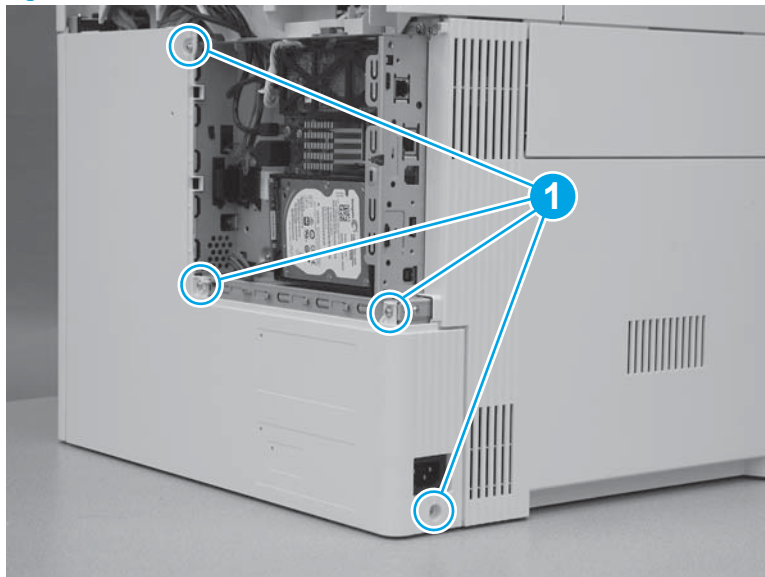

Step 10: Install the rear upper cover (M577)

 **NOTE:** This step is for the M577 models. For the M552 and M553 models, skip this step and go to [Step 11: Install the rear cover \(M552 and M553\) on page 389.](#)

1. Align the ridge (callout 1) on the lower edge of the rear upper cover in front of the tabs (callout 2) on the top edge of the rear cover.

Figure 1-647 Align the cover

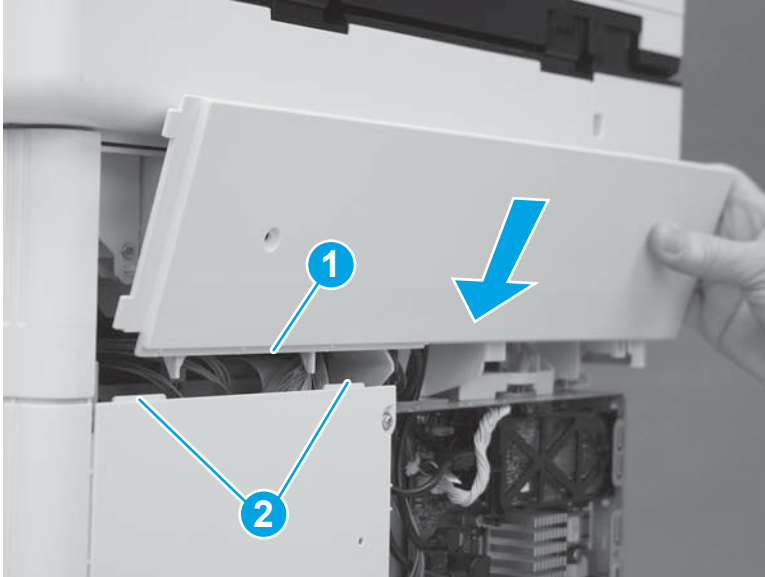

2. Rotate the top of the cover toward the printer.

Figure 1-648 Rotate the top of the cover



3. Slide the cover to the left (callout 1). Make sure that the tabs (callout 2) on the upper rear cover slide behind the edge (callout 3) of the right upper cover. Make sure that the cover is fully seated.

Figure 1-649 Slide the cover

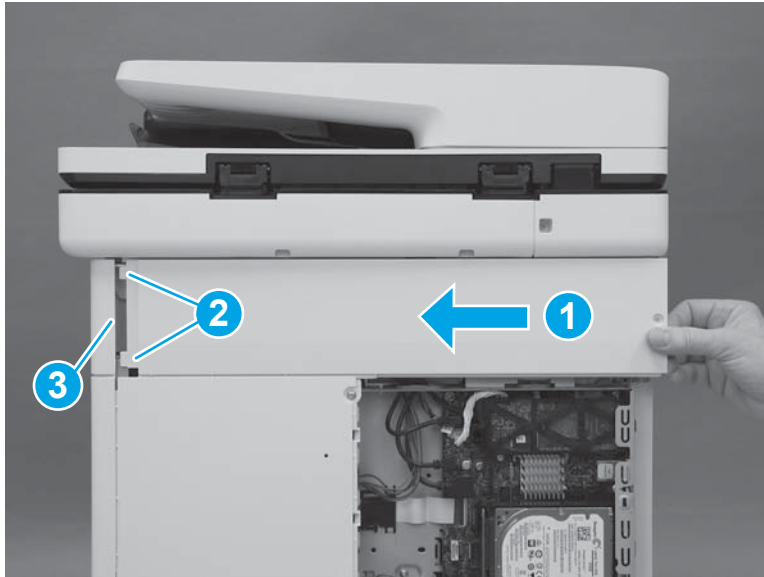

4. Install two screws (callout 1).



 **IMPORTANT:** These two screws are self-tapping screws for plastic. Rotate them counterclockwise to align them with the existing thread pattern, and then carefully turn them clockwise to tighten. Do not overtighten. This will prevent stripping the threads inside the screw holes.

Figure 1-650 Install two screws

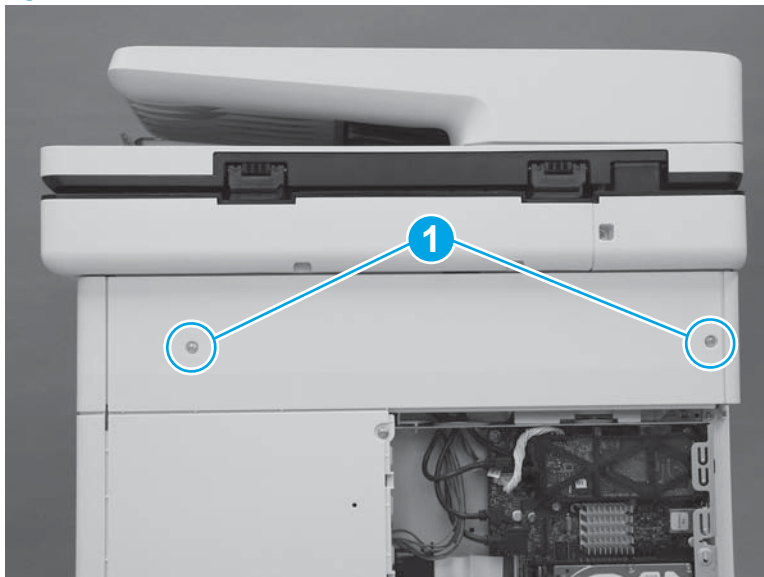

Step 11: Install the rear cover (M552 and M553)

 **NOTE:** This step is for the M552 and M553 models. For the M577 models, skip this step and go to [Step 12: Install the formatter cover on page 390](#).

1. Position the top of the cover under the upper cover (callout 1), rotate the bottom of the cover onto the chassis (callout 2), and then slide the cover to the left (callout 3) to install it.

Figure 1-651 Install the cover

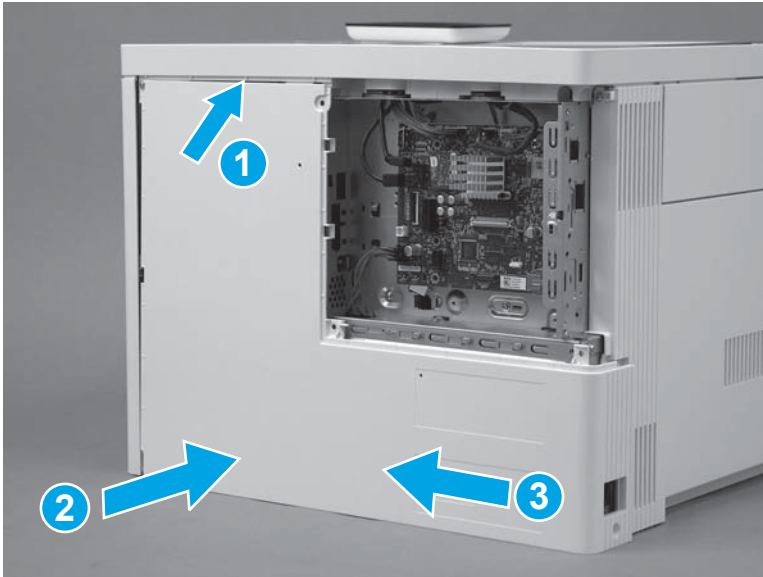

2. Install four screws (callout 1).

Figure 1-652 Install four screws cover

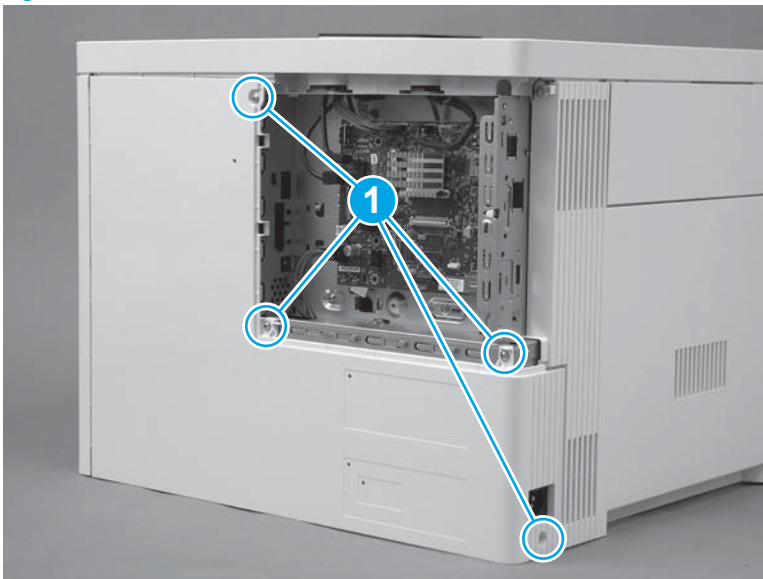

Step 12: Install the formatter cover

- ▲ Slide the cover onto the printer (callout 1) to install it.

 **NOTE:** Make sure that the tabs on the formatter cover align with the slots provided in the printer (callout 2). Tighten the two thumbscrews (callout 3).

 **TIP:** If needed, use the edge of a coin to turn the thumbscrews.

Figure 1-653 Install the cover

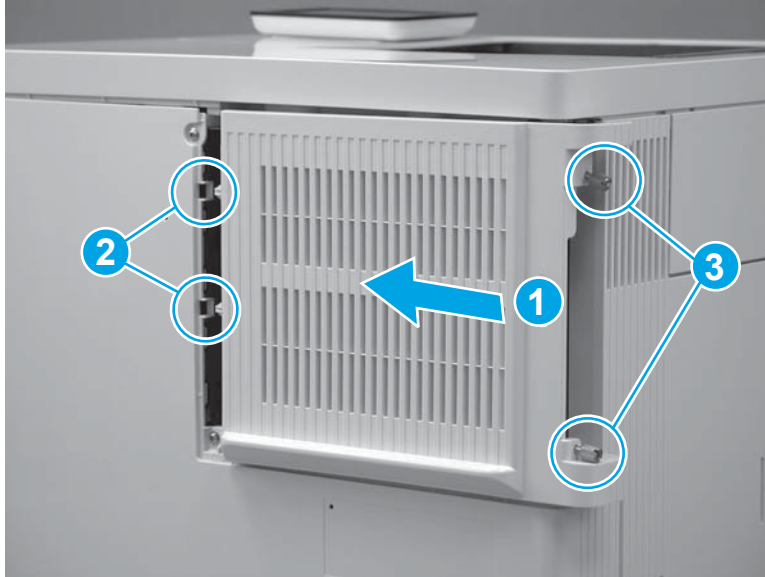

Step 13: Install the TCU

1. Verify that the toner collection hatch cover is in the closed position on the TCU.

Figure 1-654 Verify that the toner collection hatch cover is closed

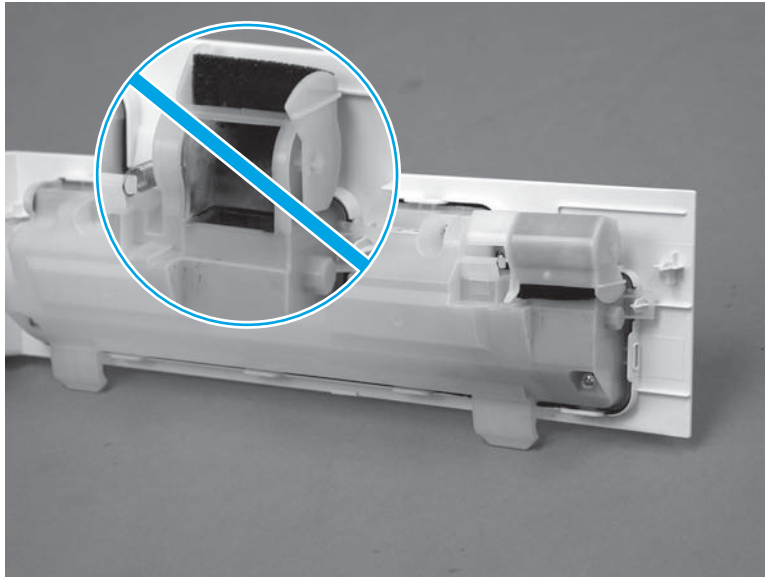

2. Position the TCU with the hinges in the slots provided in the printer (callout 1), and then rotate the TCU up and into the closed position.

 **NOTE:** The toner collection hatch cover automatically opens when the TCU is closed.

Figure 1-655 Install the TCU



3. Close the front door.

Figure 1-656 Close the front door

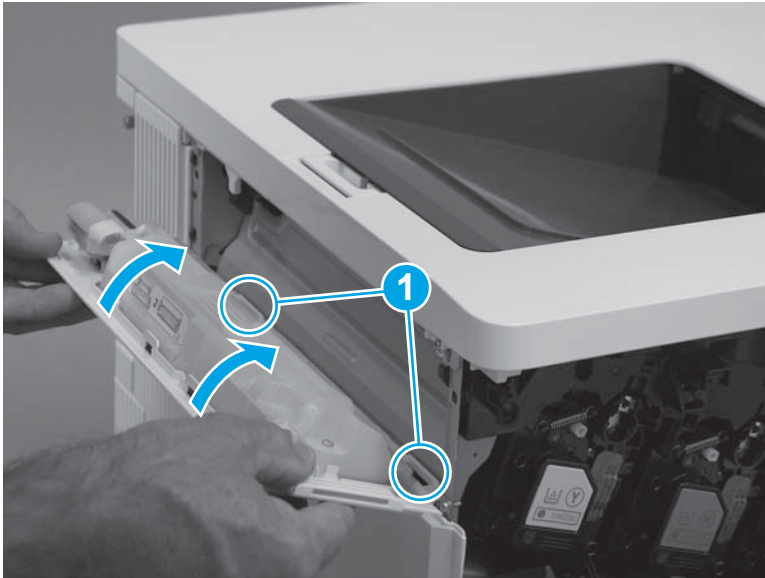

Removal and replacement: Upper cover (M552 and M553)

- [Introduction](#)
- [Step 1: Remove the USB cover](#)
- [Step 2: Remove the HIP cover](#)
- [Step 3: Remove the control panel \(M553x only\)](#)
- [Step 4: Remove the toner collection unit \(TCU\)](#)
- [Step 5: Remove the formatter cover](#)
- [Step 6: Remove the rear cover](#)
- [Step 7: Remove the left cover](#)
- [Step 8: Remove the upper cover](#)
- [Step 9: Unpack the replacement assembly](#)
- [Step 10: Install the upper cover](#)
- [Step 11: Install the left cover](#)
- [Step 12: Install the rear cover](#)
- [Step 13: Install the formatter cover](#)
- [Step 14: Install the TCU](#)
- [Step 15: Install the control-panel assembly \(M553x only\)](#)
- [Step 16: Install the HIP cover](#)
- [Step 17: Install the USB cover](#)

Introduction

This document provides the procedures to remove and replace the upper cover.

Before performing service

Turn the printer power off

- Disconnect the power cable.

⚠ WARNING! To avoid damage to the printer, turn the printer off, wait 30 seconds, and then remove the power cord before attempting to service the printer.

- Open the right door.

Use the table below to identify the correct part number for your printer. To order the part, go to www.hp.com/buy/parts.

Upper cover part number	
RL2-0097-000CN	Upper cover (M533x)
RL2-0098-000CN	Upper cover (M533n/dn and M552dn)

Required tools

- #2 Phillips screwdriver with a magnetic tip
- Small flat blade screwdriver

After performing service

Make sure that the USB cover is fully seated after replacing it.

Make sure that the TCU is fully closed after replacing it.

Make sure that the formatter cover is fully seated, and that the thumbscrews are finger tight after replacing it.

Turn the printer power on

- Connect the power cable.
- Use the power switch to turn the power on.

Step 1: Remove the USB cover

 **TIP:** Set this cover aside for installation on the replacement upper cover.

1. Locate the USB cover.

Figure 1-657 Locate the USB cover

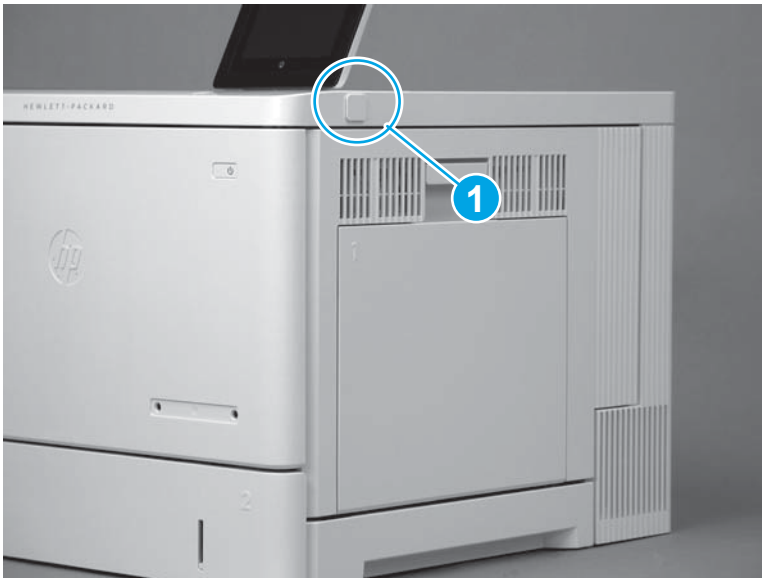

2. Pull the cover off of the printer to remove it.

Figure 1-658 Remove the cover



Step 2: Remove the HIP cover

 **TIP:** Set this cover aside for installation on the replacement upper cover.

1. Locate the HIP cover.

Figure 1-659 Locate the HIP cover



2. Before proceeding, take note of the mounting feet (callout 1) and tabs (callout 2) on the HIP cover.

Figure 1-660 Note the mounting feet and tabs

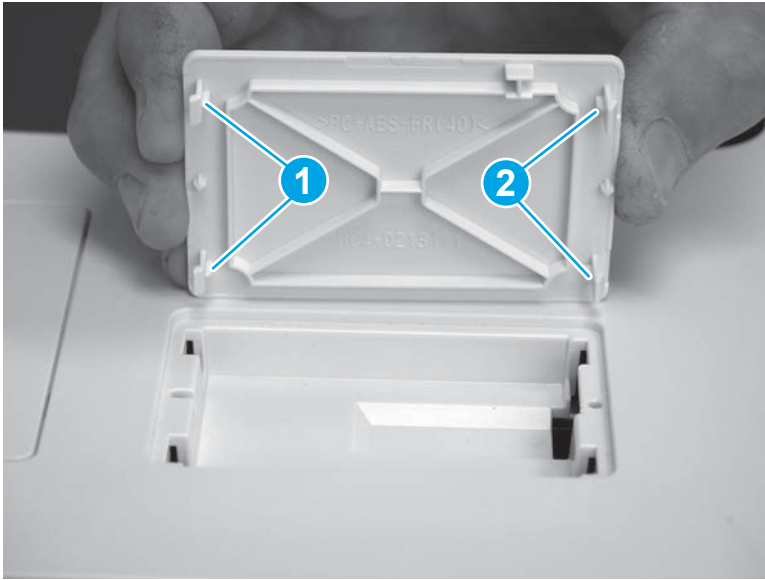

3. Use a small flat-blade screwdriver to release the tabs on the HIP cover.

Figure 1-661 Release the HIP cover tabs

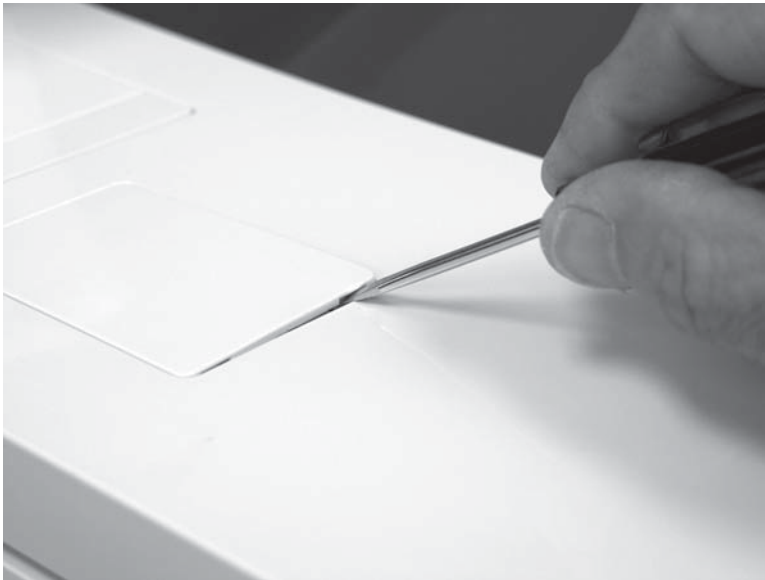

4. Rotate the cover up and off of the printer to remove it.

Figure 1-662 Remove the cover

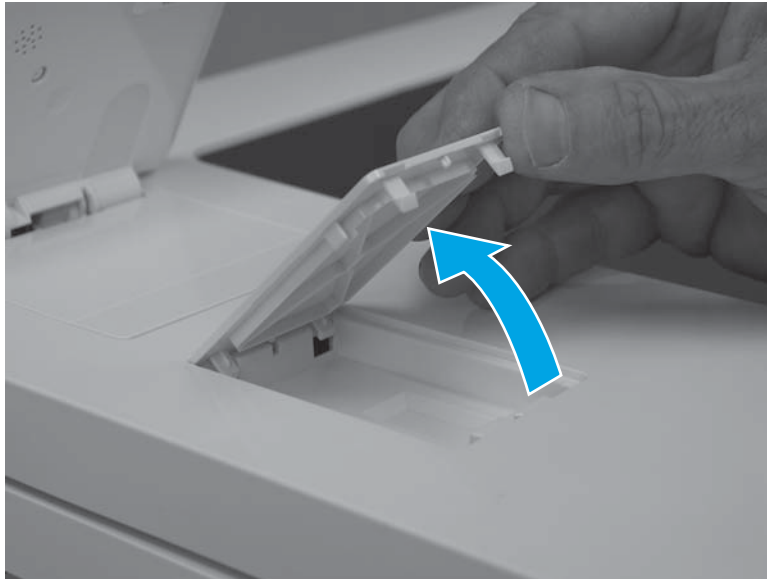

Step 3: Remove the control panel (M553x only)

 **NOTE:** For the M553n/dn and M552dn models, skip this step and go to [Step 4: Remove the toner collection unit \(TCU\) on page 401](#).

 **TIP:** Set the control panel aside for installation on the replacement upper cover.

1. Tilt the control panel up.

Figure 1-663 Tilt the control panel up



2. Use a small flat-blade screwdriver to release the control-panel screws cover tabs.

Figure 1-664 Release the control-panel screws cover tabs



3. Rotate the cover up to remove it.

Figure 1-665 Remove the cover



4. Use a small Phillips screwdriver to remove two screws (callout 1).

 **IMPORTANT:** Store the screws in a secure place where they cannot fall down into the printer.

Figure 1-666 Remove two screws

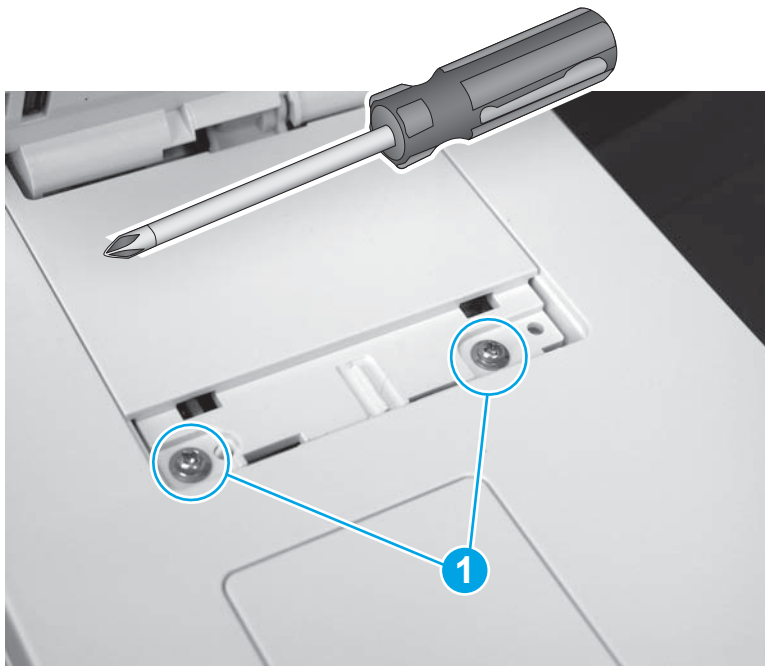

5. Rotate the control-panel base toward the front of the printer.

Figure 1-667 Rotate the control-panel base up



6. Slightly slide the control-panel base toward the rear of the printer (callout 1) to release it, and then turn the control panel over (callout 2) to access the bottom side.

⚠ CAUTION: The control panel is still attached to the printer. Do not attempt to completely remove the control panel.

Figure 1-668 Turn the control panel over

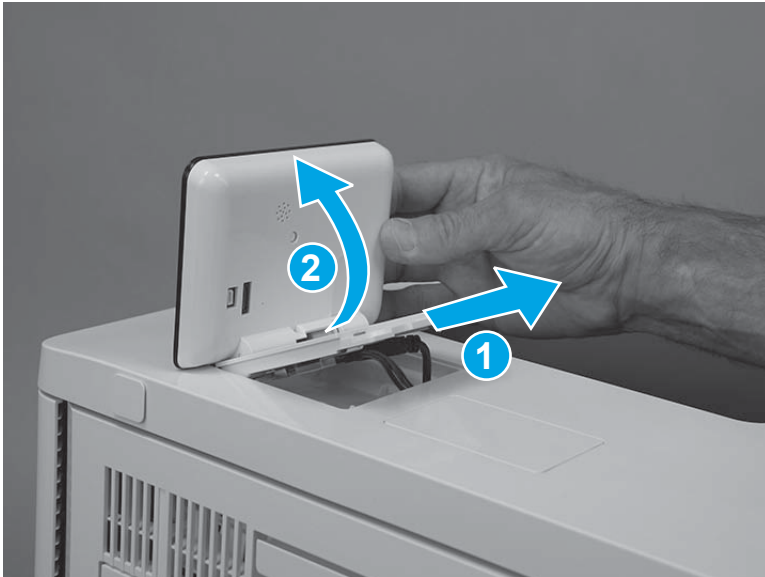

7. Disconnect one USB cable (callout 1), one connector (callout 2), and then remove the control panel.

Figure 1-669 Disconnect two connectors

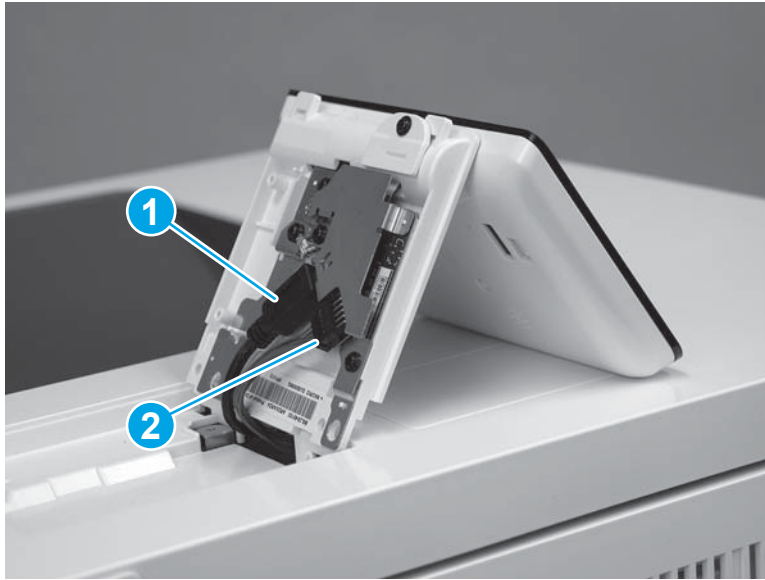

Step 4: Remove the toner collection unit (TCU)

1. Open the front door.

Figure 1-670 Open the front door



2. Open the TCU.

 **NOTE:** The toner collection hatch cover automatically closes when the TCU is opened.

Figure 1-671 Open the TCU



3. Pull the TCU away from the printer at an angle to remove it.

⚠ CAUTION: Do not open the toner collection hatch cover when handling the TCU. If toner gets on clothing, wipe it off by using a dry cloth and wash the clothes in cold water. Hot water sets toner into fabric.

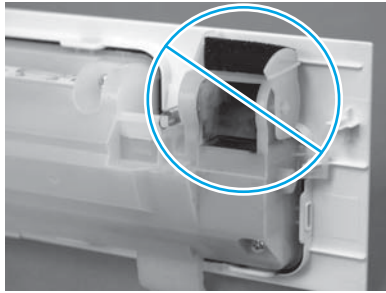
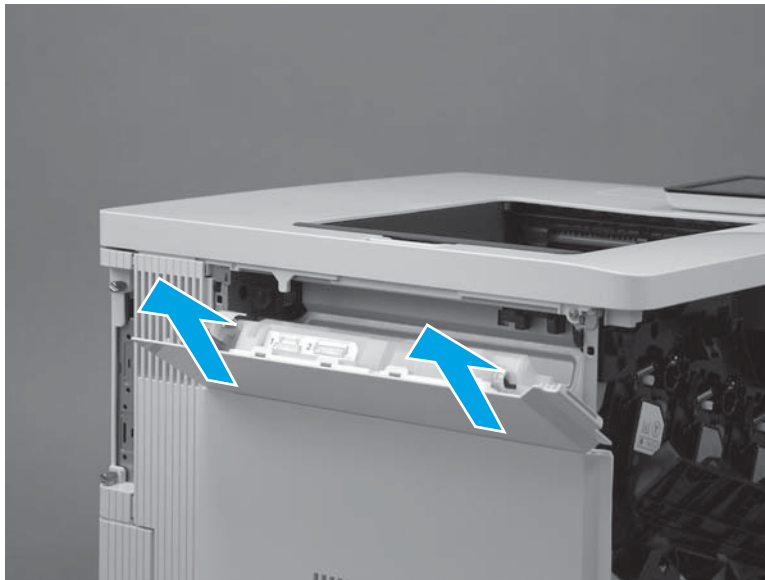

Figure 1-672 Remove the TCU



Step 5: Remove the formatter cover

1. Locate the formatter cover.

Figure 1-673 Locate the formatter cover

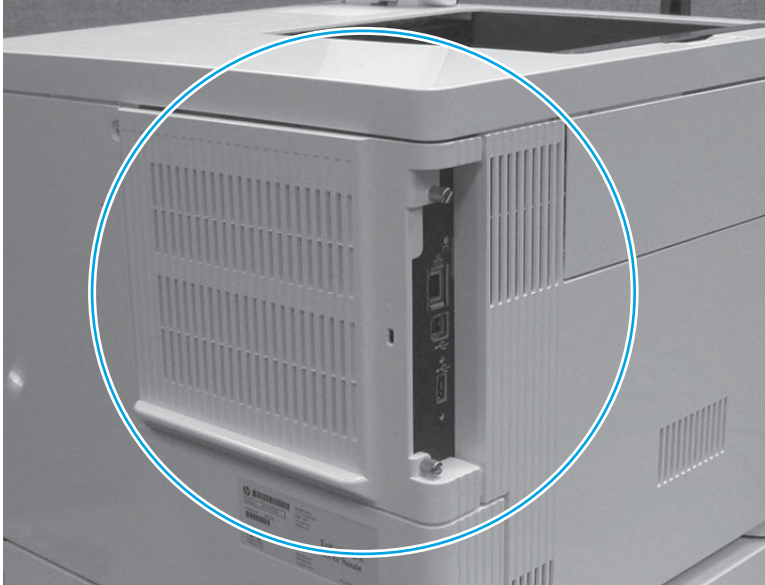

2. Loosen the two thumbscrews (callout 1). Grasp the two thumbscrews, and then slide the cover away from the printer (callout 2) to remove it.

 **TIP:** If needed, use the edge of a coin to turn the thumbscrews.

Figure 1-674 Loosen the thumbscrews

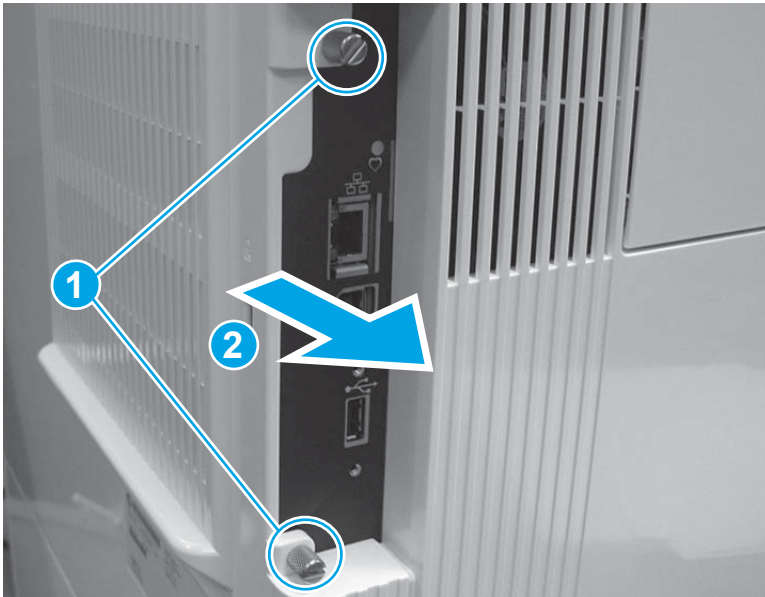

Step 6: Remove the rear cover

1. Remove four screws (callout 1).

Figure 1-675 Remove four screws

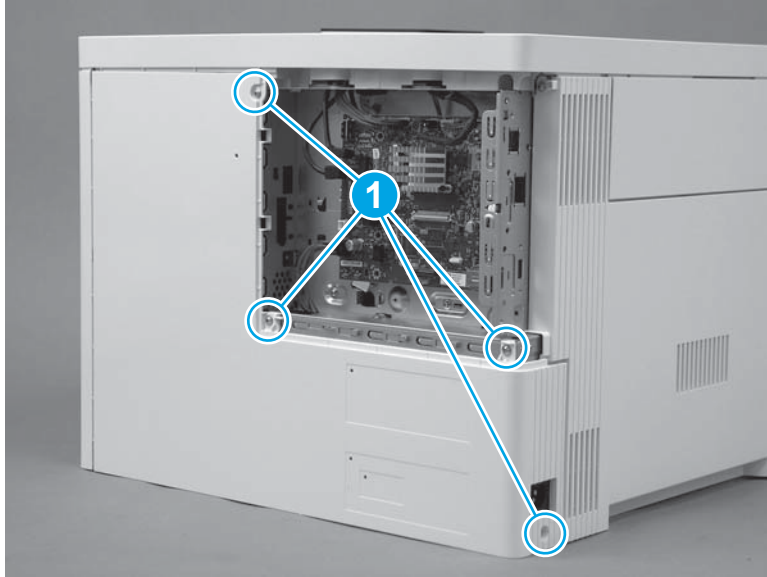

2. Slightly slide the cover to the right (callout 1), rotate the bottom of the cover away from the printer (callout 2), and then pull the top of the cover away from the printer (callout 3) to remove the cover.

Figure 1-676 Remove the cover

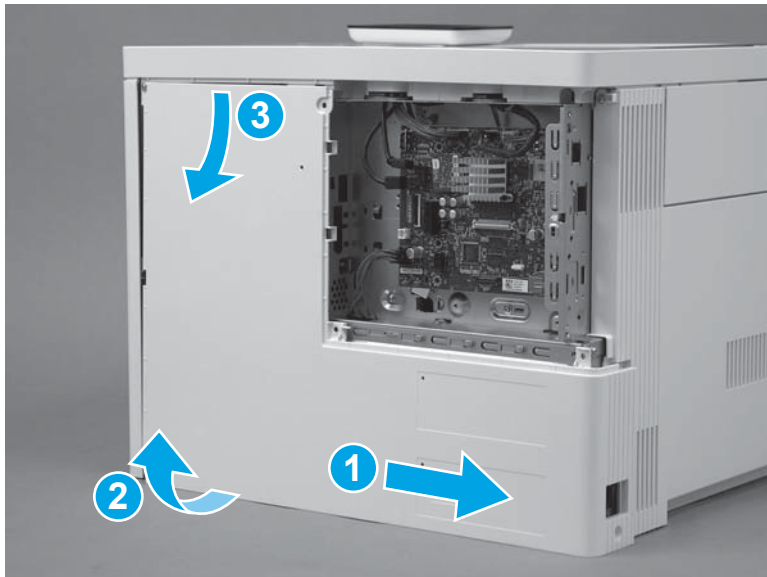

Step 7: Remove the left cover

1. At the left side of the printer, remove one screw (callout 1).

Figure 1-677 Remove one screw



2. Release one tab (callout 1), rotate the front edge of the cover away from the printer (callout 2), and then slide the cover (callout 3) toward the rear of the printer to release it.

Figure 1-678 Release the cover

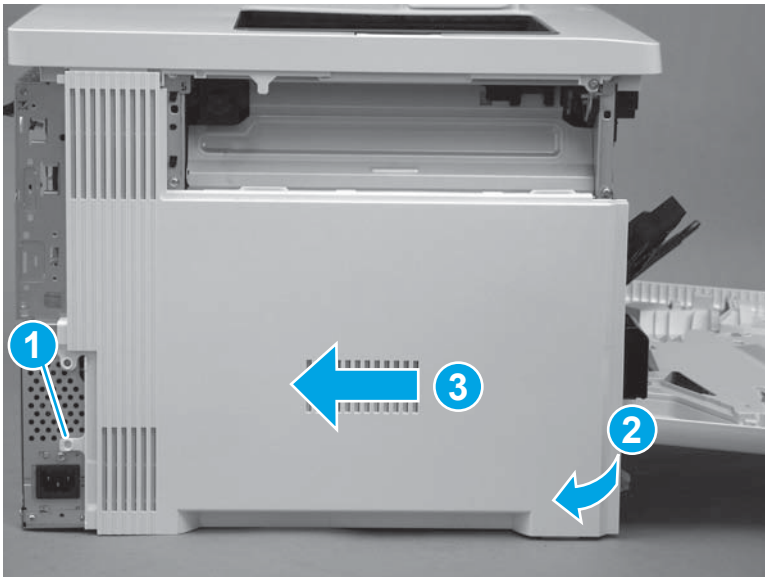

3. Remove the cover.

Figure 1-679 Remove the cover

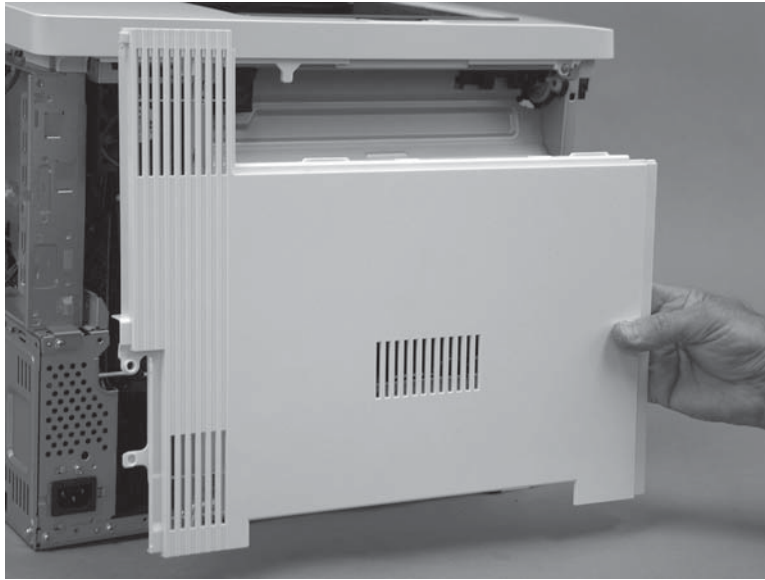

Step 8: Remove the upper cover

1. Remove three screws (callout 1).

Figure 1-680 Remove three screws

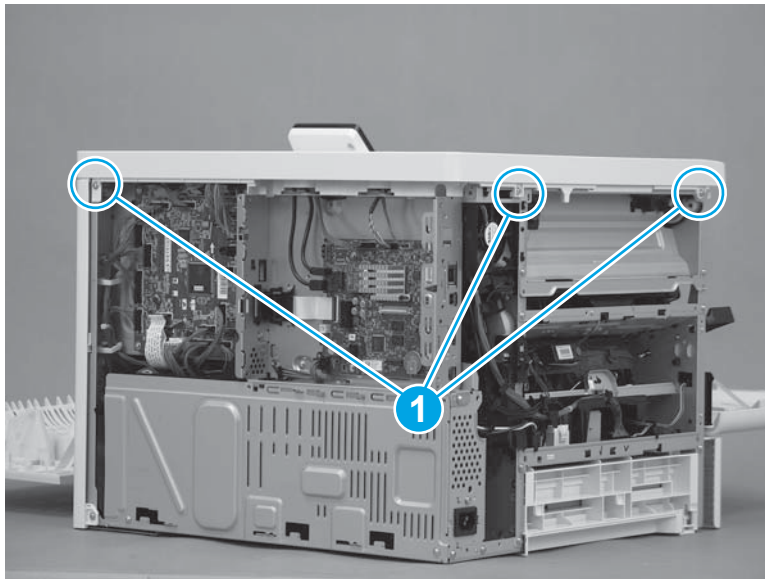

2. Remove one screw (callout 1), release one tab (callout 2), and then slightly separate the corner of the cover from the chassis.

 **NOTE:** This is a self-tapping plastic-thread screw. Make sure that this screw is used in this location when it is reinstalled.

Figure 1-681 Remove one screw and release one tab



3. Release one tab (callout 1), and then lift up on the cover to release it.

 **NOTE:** If the cover does not release, check for addition tabs by locating the triangles embossed in the cover at tab locations.

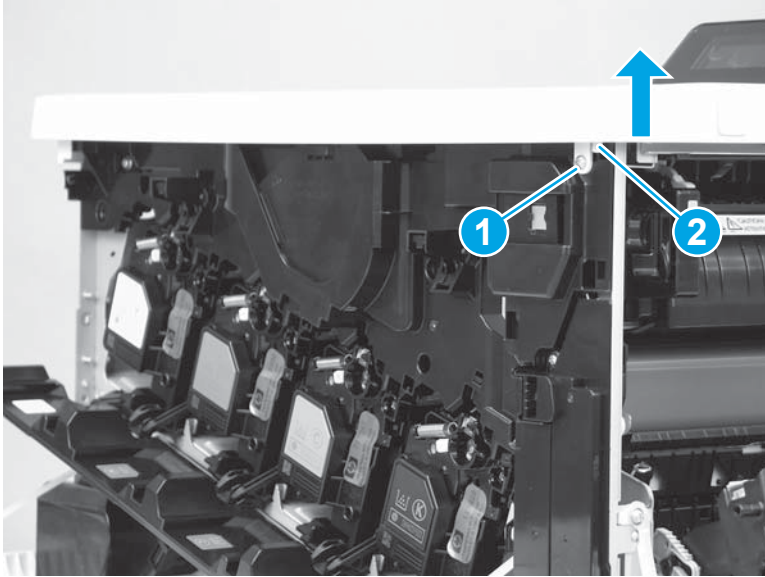
Figure 1-682 Release the cover



4. Remove the cover.

Figure 1-683 Remove the cover

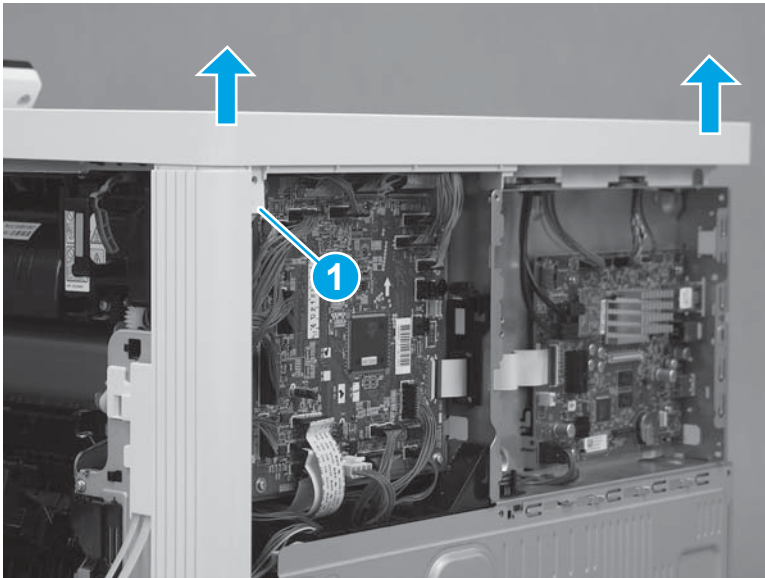
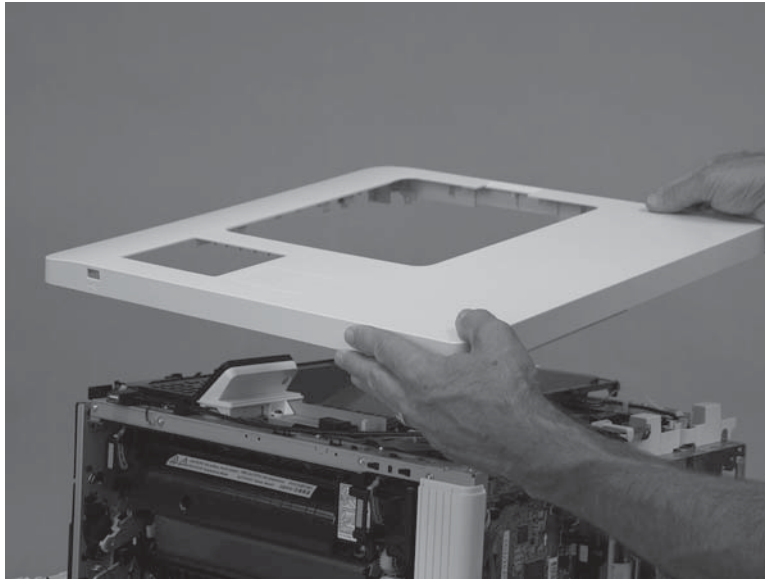

Step 9: Unpack the replacement assembly

Unpack the replacement assembly from the packaging.

For complete information on HP's recycling programs, go to [Product return and recycling](#).

 **NOTE:** HP recommends responsible disposal of the defective assembly.

Figure 1-684 Recycle and unpack

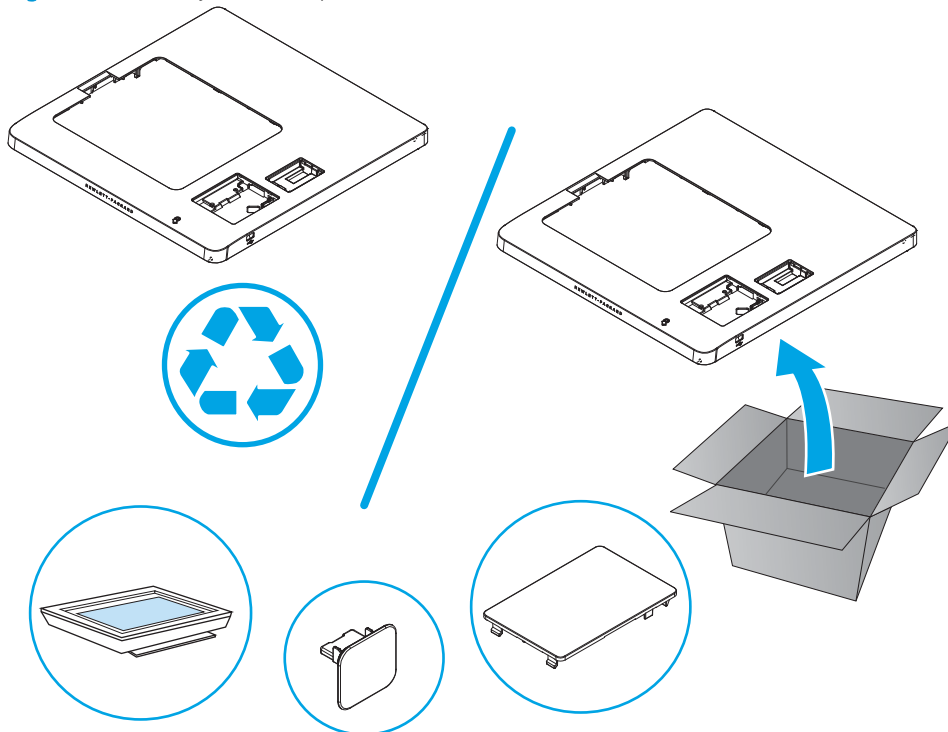

Step 10: Install the upper cover

1. Position the cover on the printer.

 **NOTE:** For the M553x model, do not forget to pass the control-panel wire harness and USB cable through the opening in the cover.

Figure 1-685 Install the cover



2. Push down on the rear corner of the cover to engage one tab (callout 1).

Figure 1-686 Engage one tab

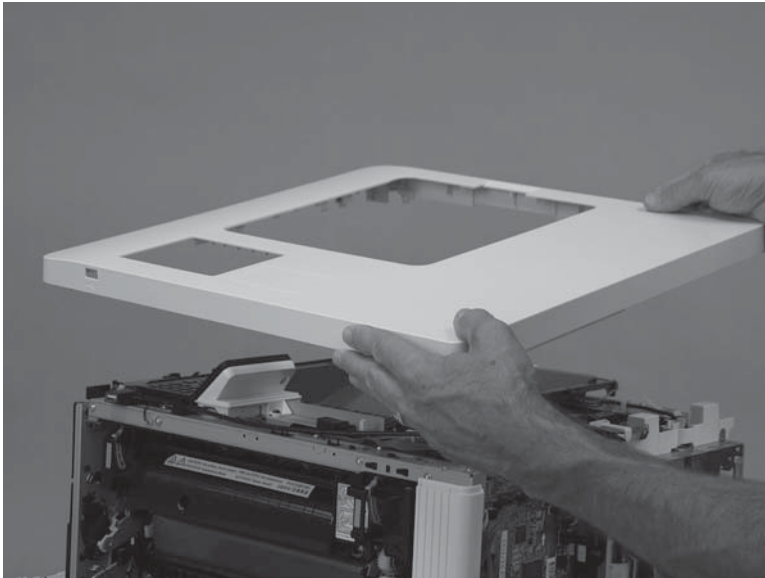
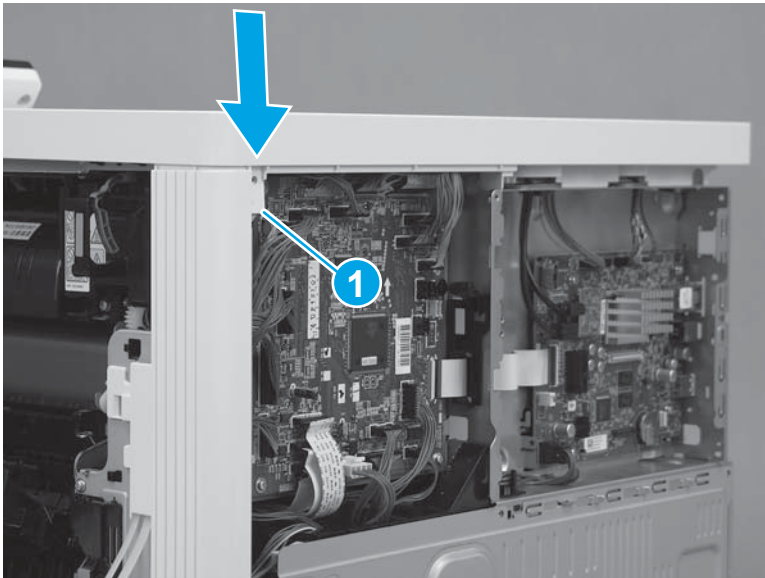

3. Push down on the front corner of the cover to engage one tab (callout 1), and then install one screw (callout 2).

 **NOTE:** This is a self-tapping plastic-thread screw. Make sure that this screw is used in this location when it is reinstalled.

Figure 1-687 Engage one tab and install one screw



4. Install three screws (callout 1).

Figure 1-688 Install three screws

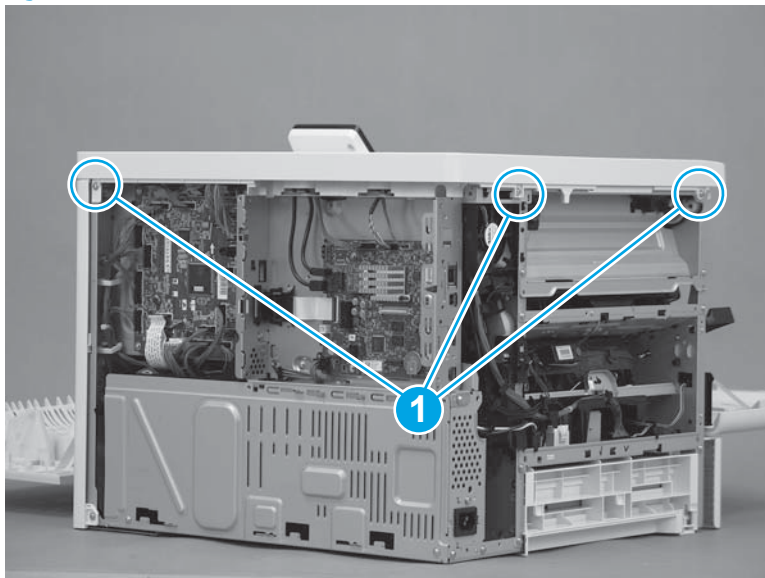

Step 11: Install the left cover

1. Position the cover on the printer.

 **NOTE:** Slightly offset the cover toward the rear of the printer.

Figure 1-689 Install the cover

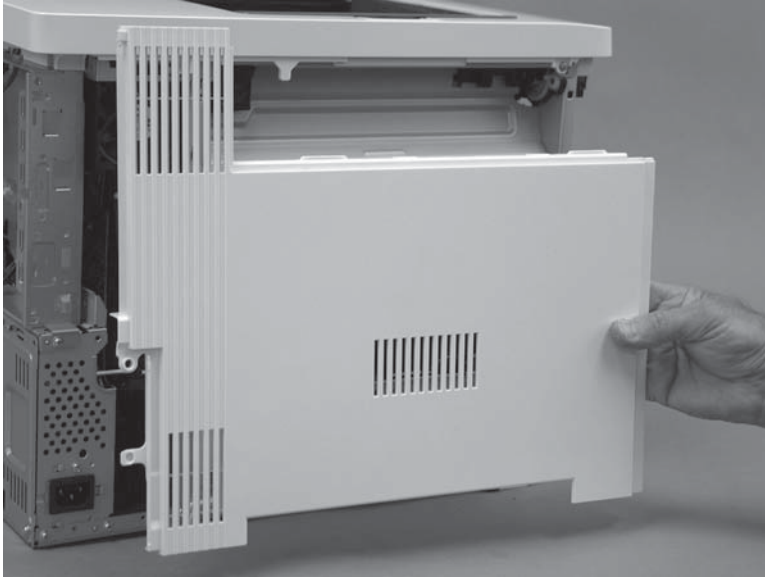

2. Slide the cover (callout 1) toward the front of the printer to engage it. Make sure that the tab (callout 2) snaps into place.

 **NOTE:** Locate the alignment pin (callout 3) on the cover from the front door side of the printer, and then make sure that it is fully engaged in the slot in the chassis.

 **TIP:** While sliding the cover into place, push in on the center of the cover (callout 1) to make sure that the hooks on the back of the cover engage with the slots in the chassis.

Figure 1-690 Engage the cover



3. At the left side of the printer, install one screw (callout 1).

Figure 1-691 Install one screw

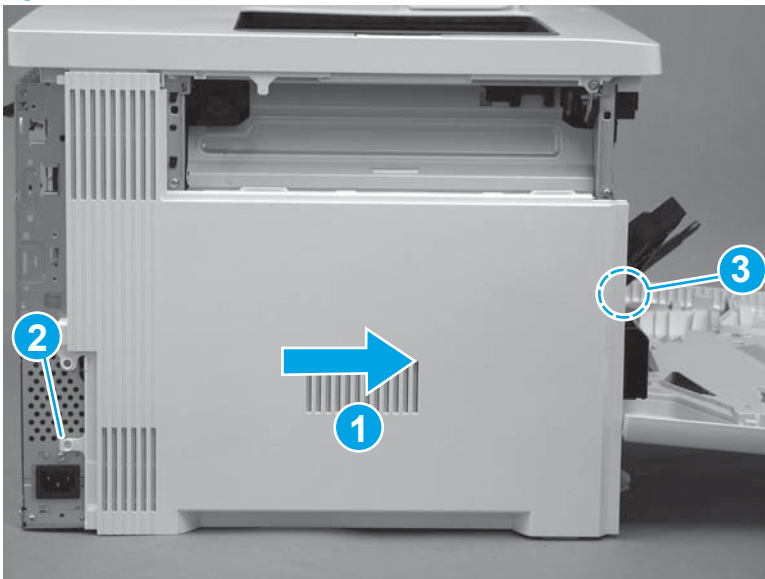

Step 12: Install the rear cover

1. Position the top of the cover under the upper cover (callout 1), rotate the bottom of the cover onto the chassis (callout 2), and then slide the cover to the left (callout 3) to install it.

Figure 1-692 Install the cover

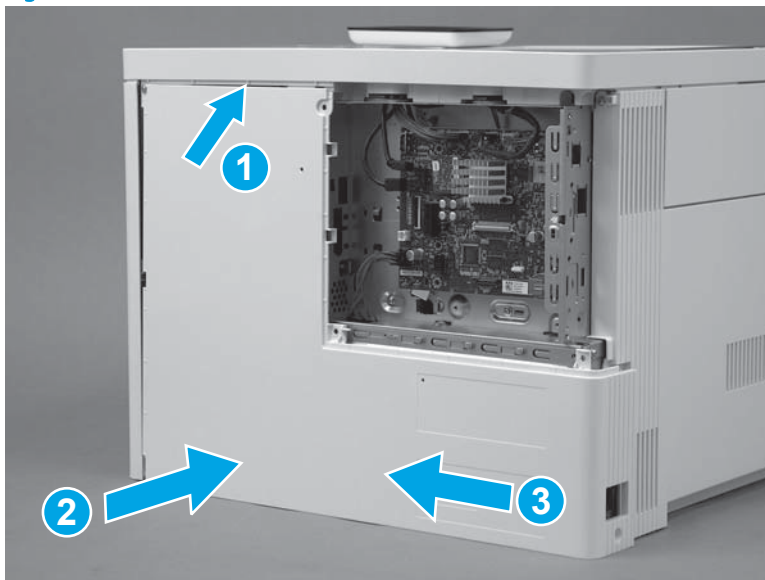

2. Install four screws (callout 1).

Figure 1-693 Install four screws cover

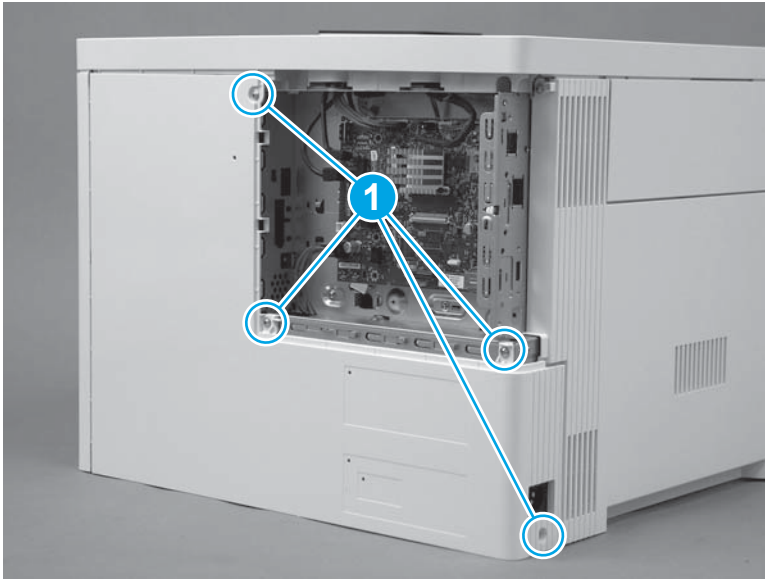

Step 13: Install the formatter cover

- ▲ Slide the cover onto the printer (callout 1) to install it.

 **NOTE:** Make sure that the tabs on the formatter cover align with the slots provided in the printer (callout 2). Tighten the two thumbscrews (callout 3).

 **TIP:** If needed, use the edge of a coin to turn the thumbscrews.

Figure 1-694 Install the cover

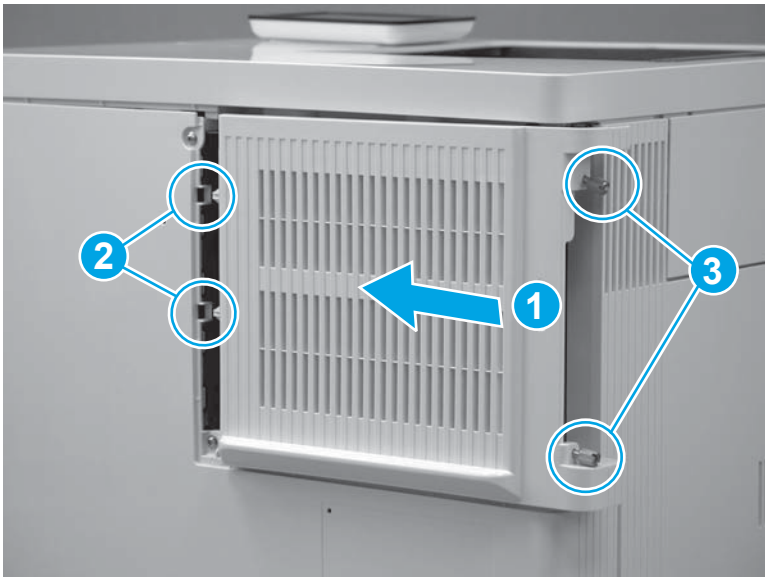

Step 14: Install the TCU

1. Verify that the toner collection hatch cover is in the closed position on the TCU.

Figure 1-695 Verify that the toner collection hatch cover is closed

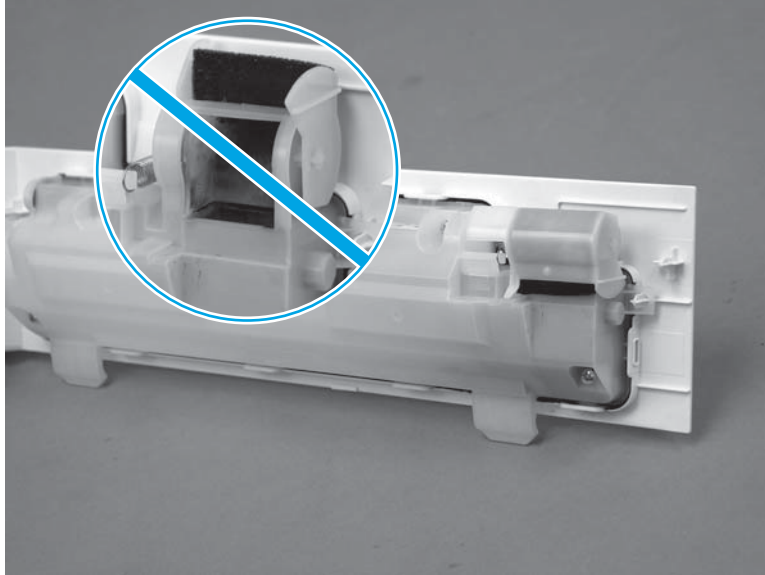

2. Position the TCU with the hinges in the slots provided in the printer (callout 1), and then rotate the TCU up and into the closed position.

 **NOTE:** The toner collection hatch cover automatically opens when the TCU is closed.

Figure 1-696 Install the TCU

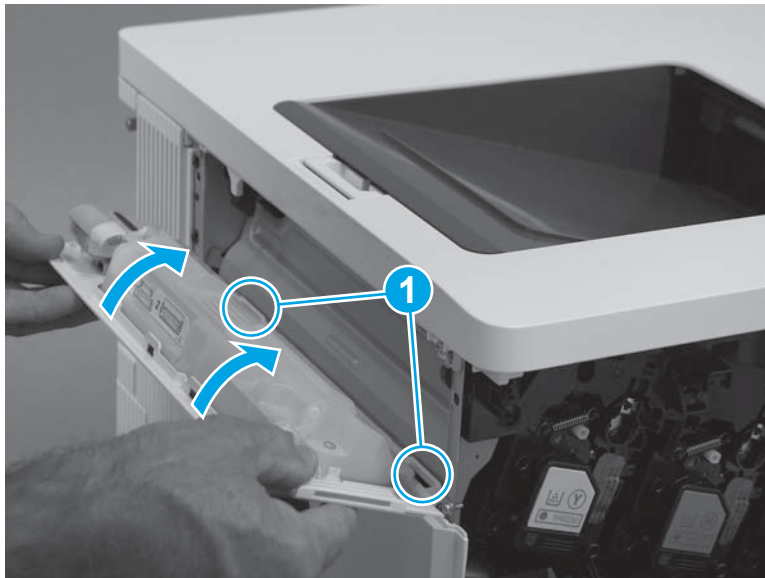

3. Close the front door.

Figure 1-697 Close the front door



Step 15: Install the control-panel assembly (M553x only)

 **NOTE:** For the M553n/dn and M552dn models, skip this step and go to [Step 16: Install the HIP cover on page 419](#).

1. Place the control panel on the printer as shown.

Figure 1-698 Place the control panel on the product

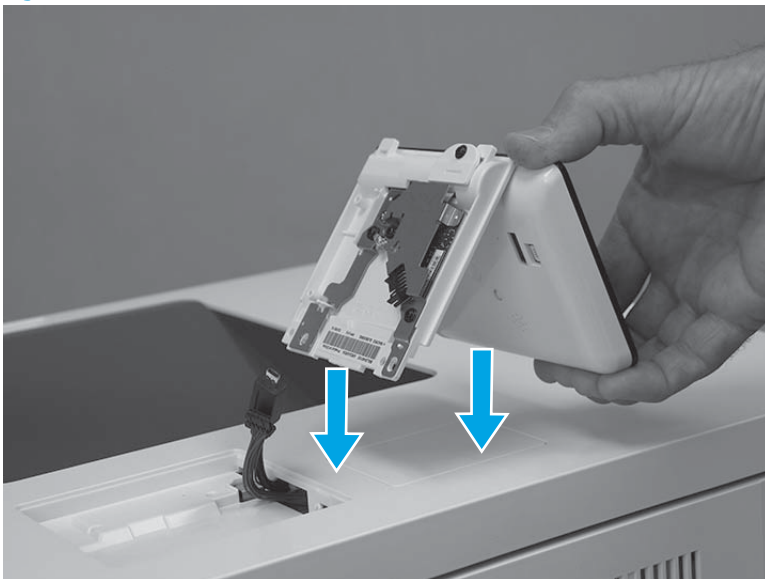

2. Connect one USB cable (callout 1), and one connector (callout 2).

 **IMPORTANT:** Take note of the location of the two mounting tabs (callout 3) on the control-panel assembly.

Figure 1-699 Connect two connectors



3. Turn the control panel over, and then position the front edge tabs in the slots in the top cover.

Figure 1-700 Turn the control panel over

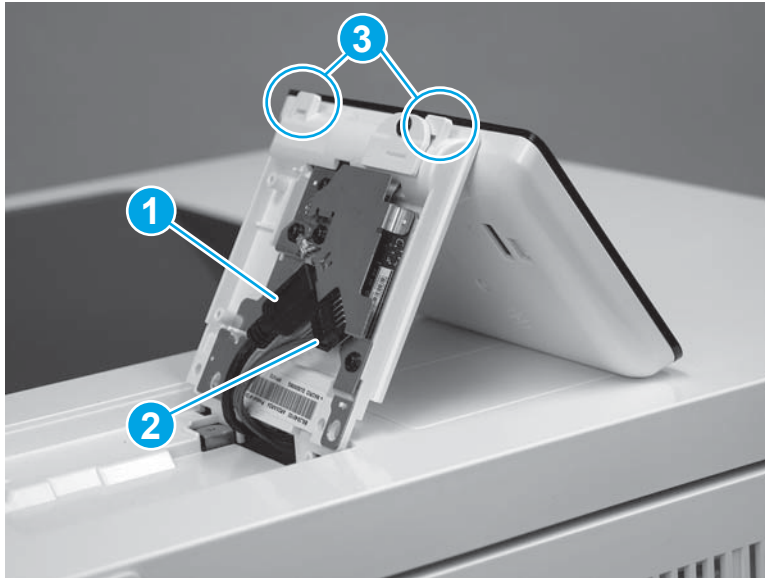
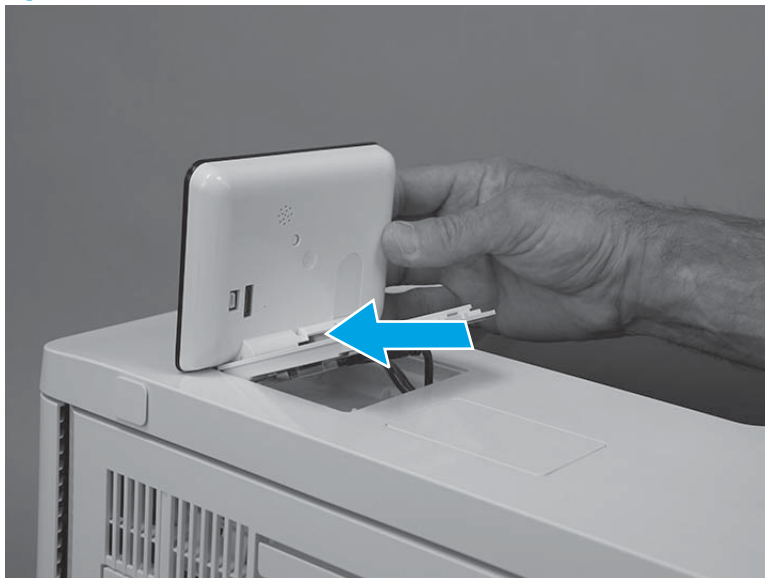

4. Rotate the control-panel base down onto the printer.

Figure 1-701 Rotate the control-panel base down



5. Use a small Phillips screwdriver to install two screws (callout 1).

Figure 1-702 Install two screws

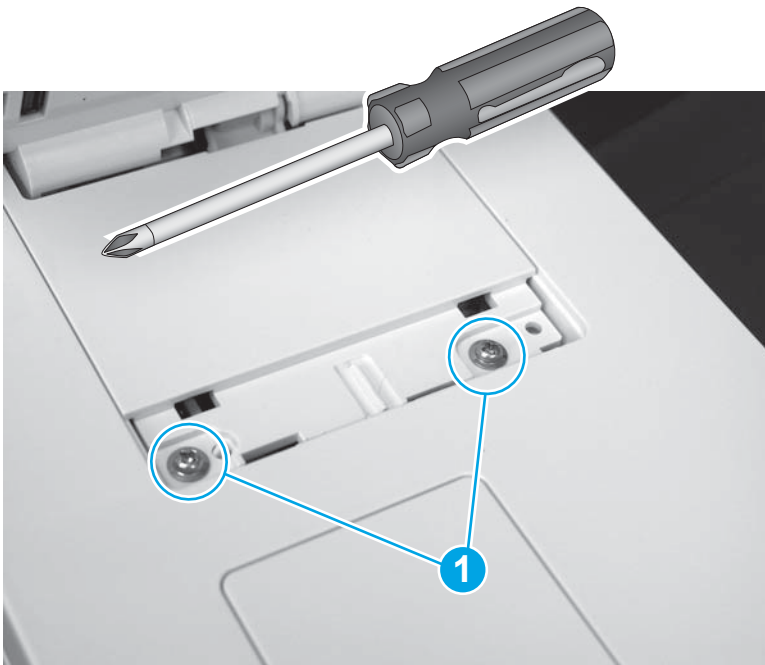

6. Position the screw cover mounting feet into the slots in the top cover (callout 1), and then rotate the cover down (callout 2) to install it.

 **NOTE:** Press down on the cover firmly to make sure that the tabs on the cover (callout 3) snap into place.

Figure 1-703 Install the cover



Step 16: Install the HIP cover

1. Position the HIP cover mounting feed in the slots (callout 1) provided in the top cover, and then rotate it down to install it.

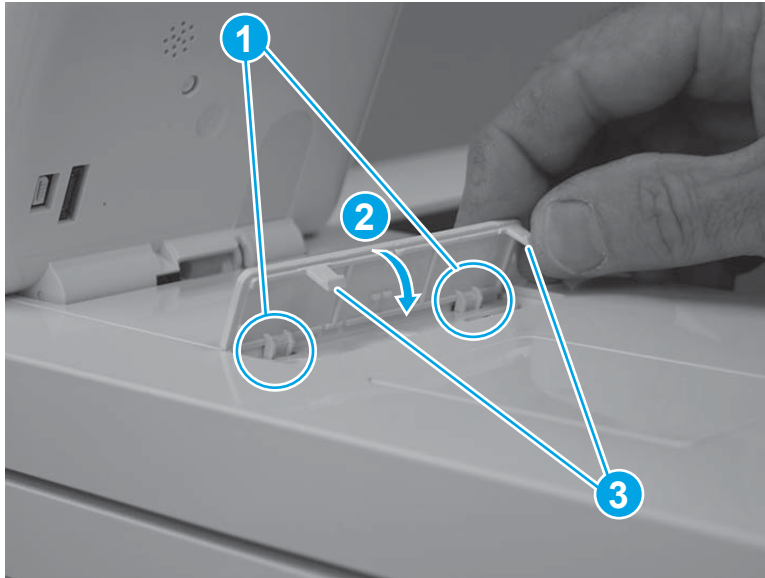
 **NOTE:** Make sure that the tabs on the cover snap into place.

Figure 1-704 Install the cover

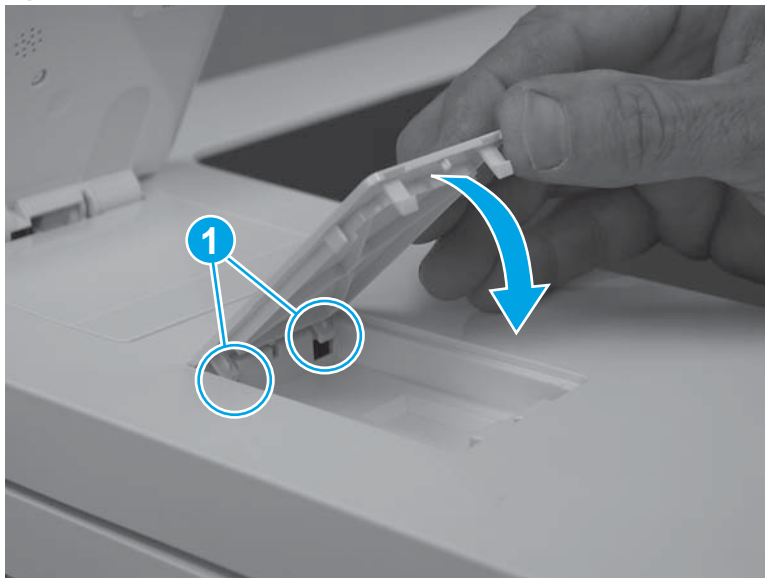

2. Make sure that the HIP cover is fully seated after installing it.

Figure 1-705 Check the installation



Step 17: Install the USB cover

1. Push the cover into the USB port to install it.

Figure 1-706 Install the cover



2. Make sure that the USB cover is fully seated after installing it.

Figure 1-707 Check the installation

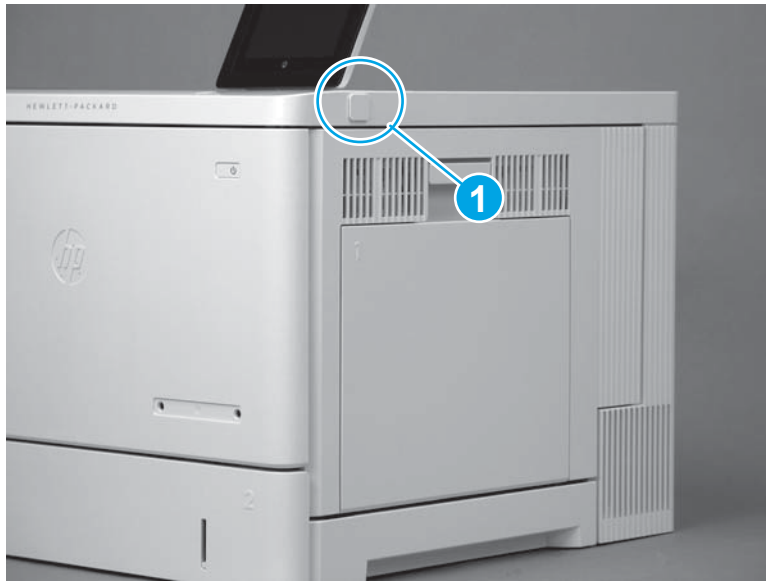

Removal and replacement: Output bin

- [Introduction](#)
- [Step 1: Remove the formatter cover](#)
- [Step 2: Remove the toner collection unit \(TCU\)](#)
- [Step 3: Remove the USB cover \(M552 and M553\)](#)
- [Step 4: Remove the control panel \(M553x only\)](#)
- [Step 5: Remove the rear cover \(M552 and M553\)](#)
- [Step 6: Remove the rear upper cover \(M577\)](#)
- [Step 7: Remove the rear cover \(M577\)](#)
- [Step 8: Remove the left cover](#)
- [Step 9: Remove the upper cover \(M552 and M553\)](#)
- [Step 10: Remove the left upper cover \(M577\)](#)
- [Step 11: Remove the right front upper cover \(M577dn\)](#)
- [Step 12: Remove the stapler cover assembly \(M577c/f/z\)](#)
- [Step 13: Remove the integrated scanner assembly \(M577\)](#)
- [Step 14: Remove the stapler \(M577c/f/z\)](#)
- [Step 15: Remove the right upper cover \(M577\)](#)
- [Step 16: Remove the top rear cover \(M577\)](#)
- [Step 17: Remove the paper feed cover \(M577\)](#)
- [Step 18: Remove the top cover \(M577\)](#)
- [Step 19: Remove the output bin](#)
- [Step 20: Unpack the replacement assembly](#)
- [Step 21: Install the output bin](#)
- [Step 22: Install the top cover \(M577\)](#)
- [Step 23: Install the paper feed cover \(M577\)](#)
- [Step 24: Install the top rear cover \(M577\)](#)
- [Step 25: Install the right upper cover \(M577\)](#)
- [Step 26: Install the stapler \(M577c/f/z\)](#)
- [Step 27: Install the integrated scanner assembly \(M577\)](#)
- [Step 28: Install the stapler cover assembly \(M577c/f/z\)](#)
- [Step 29: Install the right front upper cover \(M577dn\)](#)

- [Step 30: Install the left upper cover \(M577\)](#)
- [Step 31: Install the upper cover \(M552 and M553\)](#)
- [Step 32: Install the left cover](#)
- [Step 33: Install the rear cover \(M577\)](#)
- [Step 34: Install the rear upper cover \(M577\)](#)
- [Step 35: Install the rear cover \(M552 and M553\)](#)
- [Step 36: Install the control-panel assembly \(M553x only\)](#)
- [Step 37: Install the USB cover \(M552 and M553\)](#)
- [Step 38: Install the toner collection unit \(TCU\)](#)
- [Step 39: Install the formatter cover](#)

Introduction

This document provides the procedures to remove and replace the output bin.

Before performing service

Turn the printer power off

- Disconnect the power cable.

⚠ WARNING! To avoid damage to the printer, turn the printer off, wait 30 seconds, and then remove the power cord before attempting to service the printer.

- Open the right door.

Use the table below to identify the correct part number for your printer. To order the part, go to www.hp.com/buy/parts.

Output bin part number	
RM2-0044-000CN	Output bin

Required tools

- #2 Phillips screwdriver with a magnetic tip

After performing service

Make sure that the USB cover is fully seated after replacing it.

Make sure that the TCU is fully closed after replacing it.

Make sure that the formatter cover is fully seated, and that the thumbscrews are finger tight after replacing it.

Make sure that the output bin is flat against the chassis after replacing it.

Turn the printer power on

- Connect the power cable.
- Use the power switch to turn the power on.

Step 1: Remove the formatter cover

1. Locate the formatter cover.

Figure 1-708 Locate the formatter cover

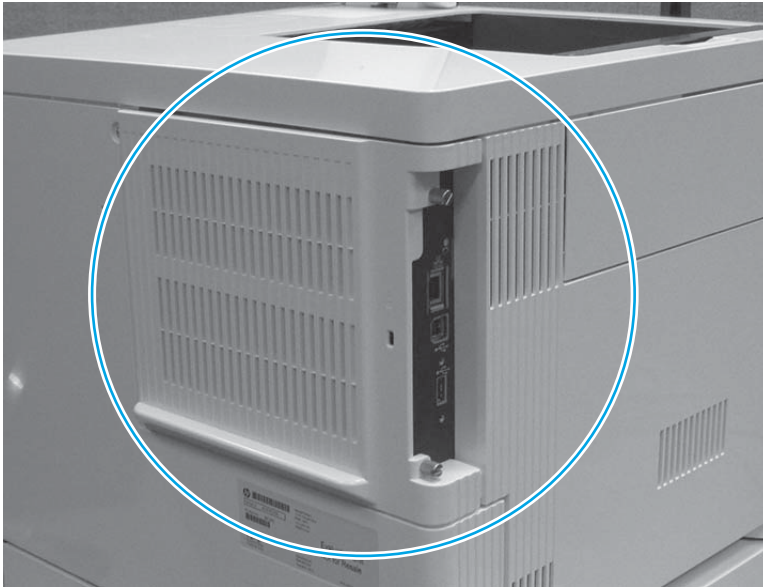

2. Loosen the two thumbscrews (callout 1). Grasp the two thumbscrews, and then slide the cover away from the printer (callout 2) to remove it.

 **TIP:** If needed, use the edge of a coin to turn the thumbscrews.

Figure 1-709 Loosen the thumbscrews

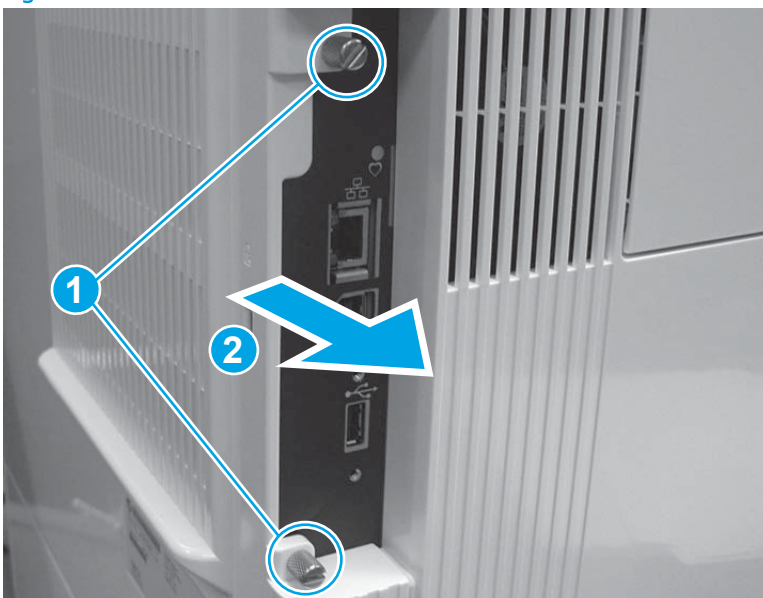

Step 2: Remove the toner collection unit (TCU)

1. Open the front door.

Figure 1-710 Open the front door



2. Open the TCU.

 **NOTE:** The toner collection hatch cover automatically closes when the TCU is opened.

Figure 1-711 Open the TCU



3. Pull the TCU away from the printer at an angle to remove it.

⚠ CAUTION: Do not open the toner collection hatch cover when handling the TCU. If toner gets on clothing, wipe it off by using a dry cloth and wash the clothes in cold water. Hot water sets toner into fabric.

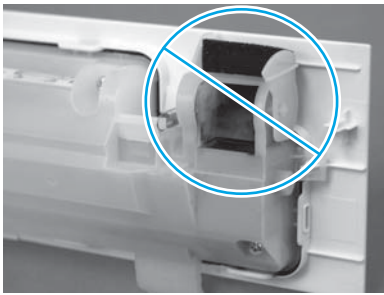
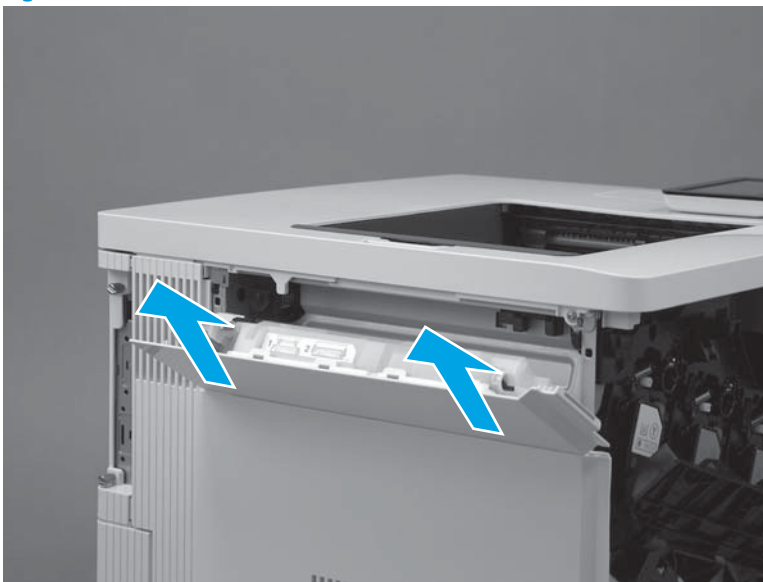

Figure 1-712 Remove the TCU



Step 3: Remove the USB cover (M552 and M553)

📝 NOTE: This step is for the M552 and M553 models. For the M577 models, skip this step and go to [Step 6: Remove the rear upper cover \(M577\) on page 432](#).

1. Locate the USB cover.

Figure 1-713 Locate the USB cover



2. Pull the cover off of the printer to remove it.

Figure 1-714 Remove the cover



Step 4: Remove the control panel (M553x only)

 **NOTE:** This step is for the M553x model only. For the M553n/dn and M552dn models, skip this step and go to [Step 5: Remove the rear cover \(M552 and M553\) on page 431](#).

For the M577 models, skip this step and go to [Step 6: Remove the rear upper cover \(M577\) on page 432](#).

1. Tilt the control panel up.

Figure 1-715 Tilt the control panel up



2. Use a small flat-blade screwdriver to release the control-panel screws cover tabs.

Figure 1-716 Release the control-panel screws cover tabs



3. Rotate the cover up to remove it.

Figure 1-717 Remove the cover



4. Use a small Phillips screwdriver to remove two screws (callout 1).

 **IMPORTANT:** Store the screws in a secure place where they cannot fall down into the printer.

Figure 1-718 Remove two screws

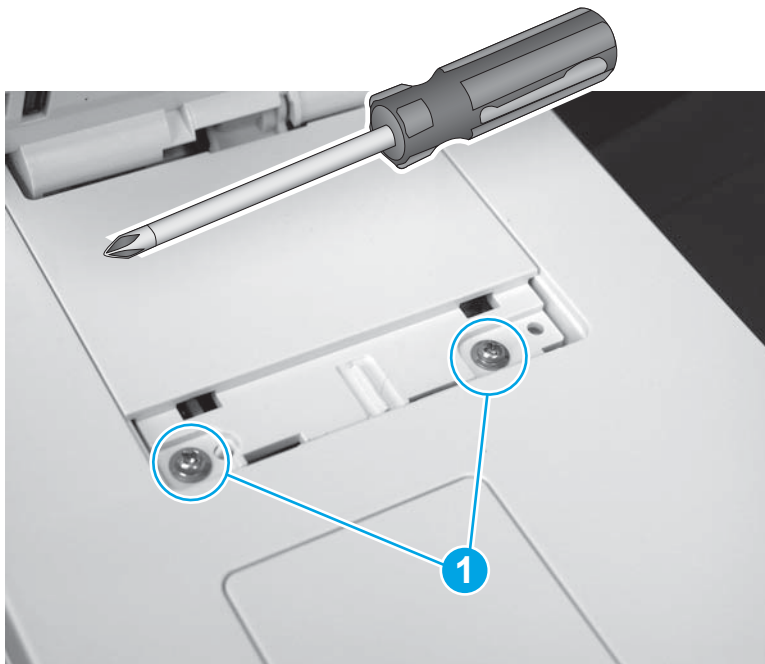

5. Rotate the control-panel base toward the front of the printer.

Figure 1-719 Rotate the control-panel base up



6. Slightly slide the control-panel base toward the rear of the printer (callout 1) to release it, and then turn the control panel over (callout 2) to access the bottom side.

⚠ CAUTION: The control panel is still attached to the printer. Do not attempt to completely remove the control panel.

Figure 1-720 Turn the control panel over

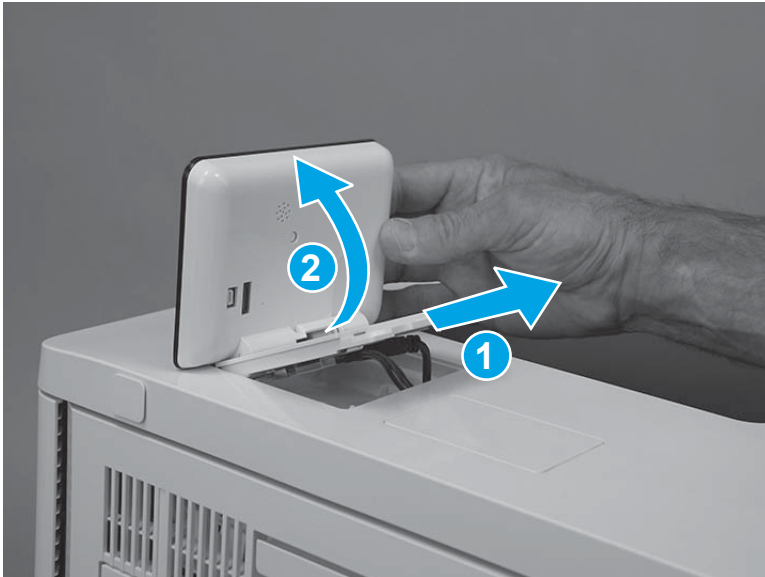

7. Disconnect one USB cable (callout 1), one connector (callout 2), and then remove the control panel.

Figure 1-721 Disconnect two connectors

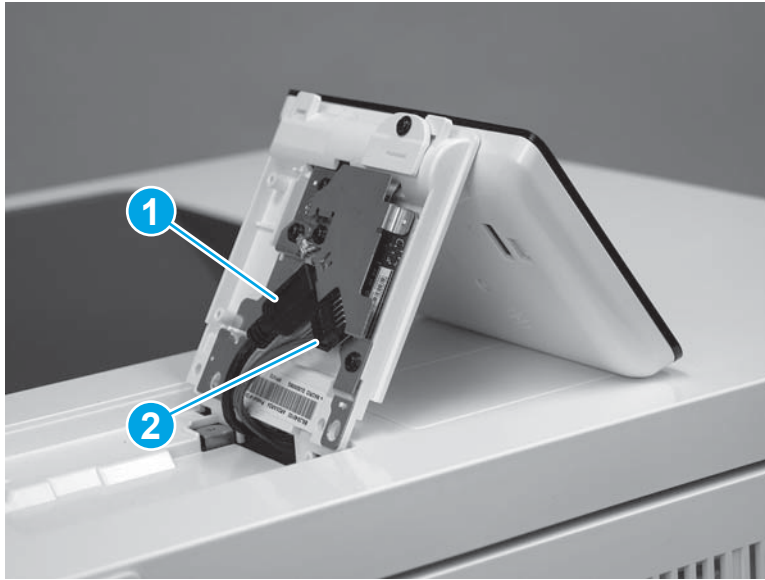

Step 5: Remove the rear cover (M552 and M553)

 **NOTE:** This step is for the M552 and M553 models. For the M577 models, skip this step and go to [Step 6: Remove the rear upper cover \(M577\) on page 432](#).

1. Remove four screws (callout 1).

Figure 1-722 Remove four screws

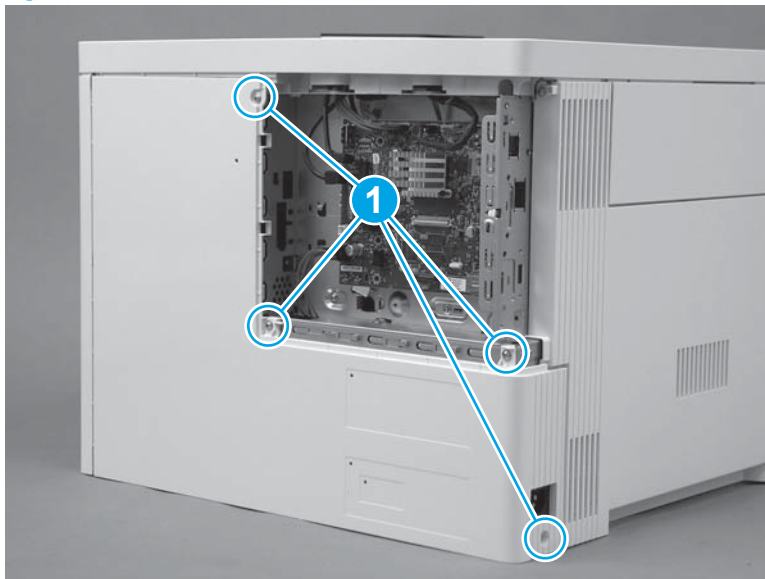

2. Slightly slide the cover to the right (callout 1), rotate the bottom of the cover away from the printer (callout 2), and then pull the top of the cover away from the printer (callout 3) to remove the cover.

Figure 1-723 Remove the cover

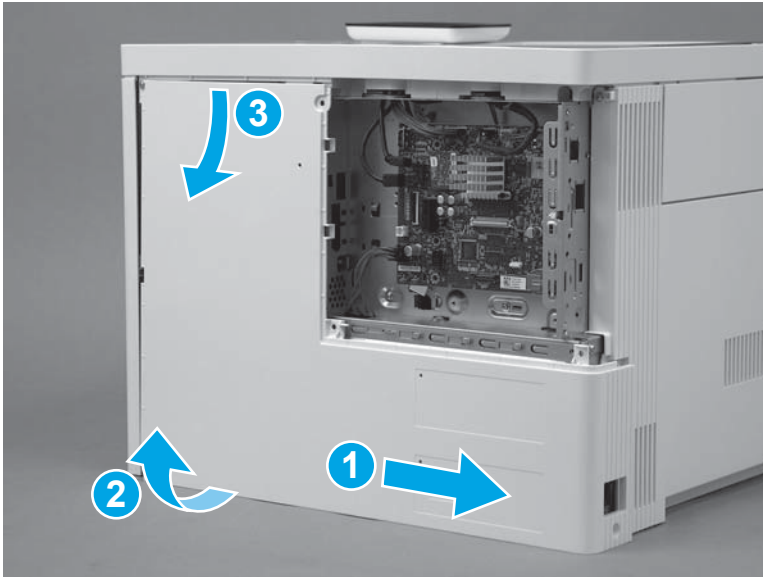

Step 6: Remove the rear upper cover (M577)

 **NOTE:** This step is for the M577 models. For the M552 and M553 models, skip this step and go to [Step 8: Remove the left cover on page 435](#).

1. Remove two screws (callout 1).

 **Reinstallation tip:** These two screws are self-tapping screws for plastic. When reinstalling them, rotate the screws counterclockwise to align them with the existing thread pattern, and then carefully turn them clockwise to tighten. Do not overtighten. This will prevent stripping the threads inside the screw holes.

Figure 1-724 Remove two screws



2. Use a small, flat blade screwdriver to release the right edge of the cover.

Figure 1-725 Release the right edge

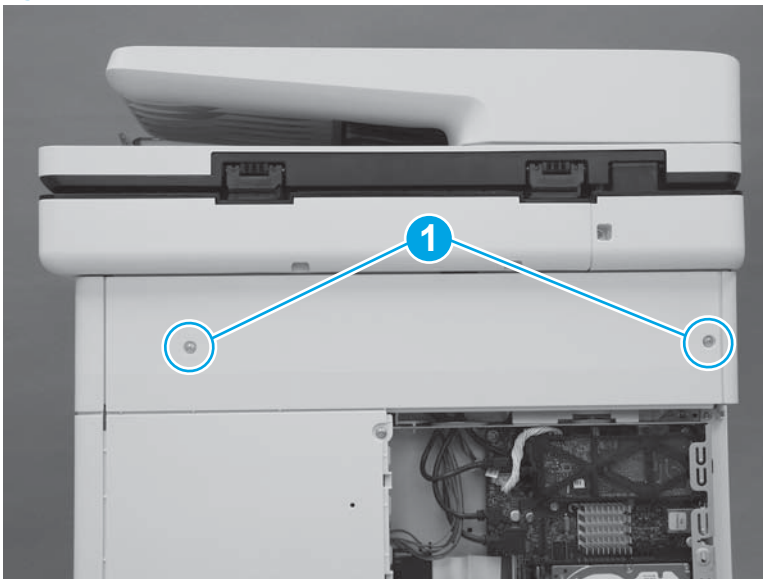
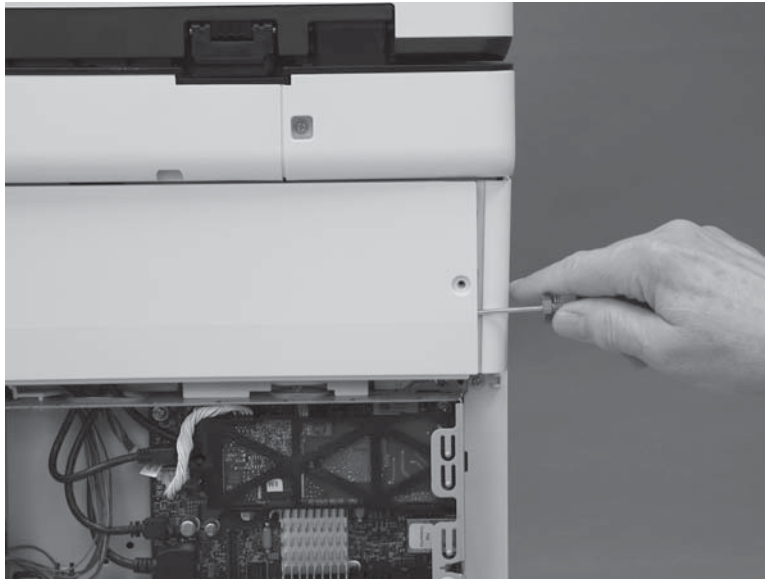

3. Pull the right edge of the cover (callout 1) away from the printer, and then slide the cover to the right (callout 2).

Figure 1-726 Slide the cover right

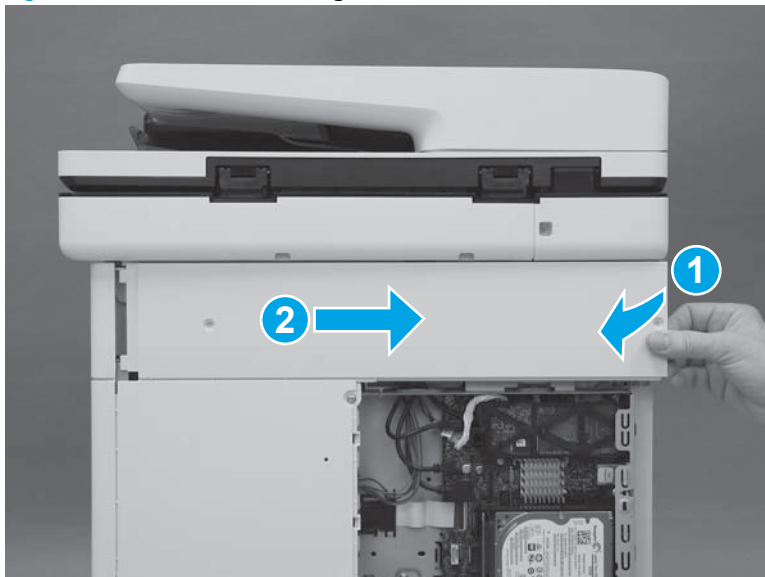

4. Remove the cover.

Figure 1-727 Remove the cover

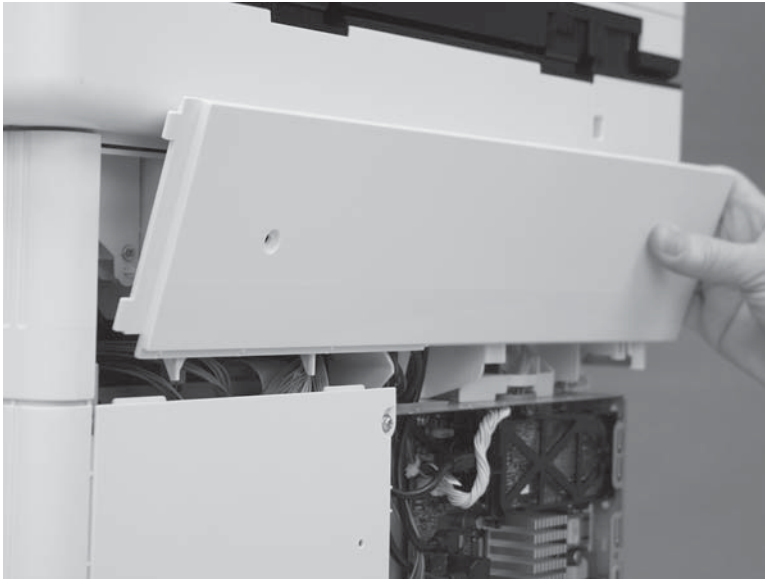

Step 7: Remove the rear cover (M577)

 **NOTE:** This step is for the M577 models. For the M552 and M553 models, skip this step and go to [Step 8: Remove the left cover on page 435](#).

1. Remove four screws (callout 1).

Figure 1-728 Remove four screws

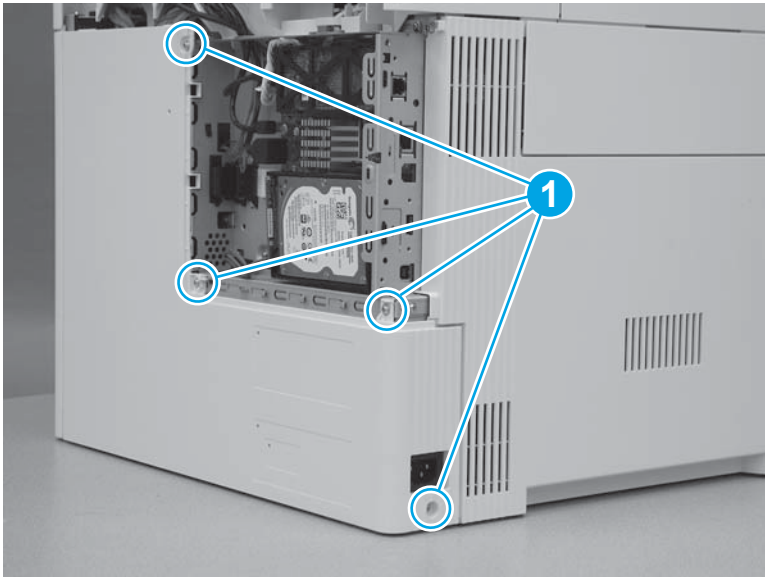

2. Slide the cover to the right to remove it.

Figure 1-729 Remove the cover

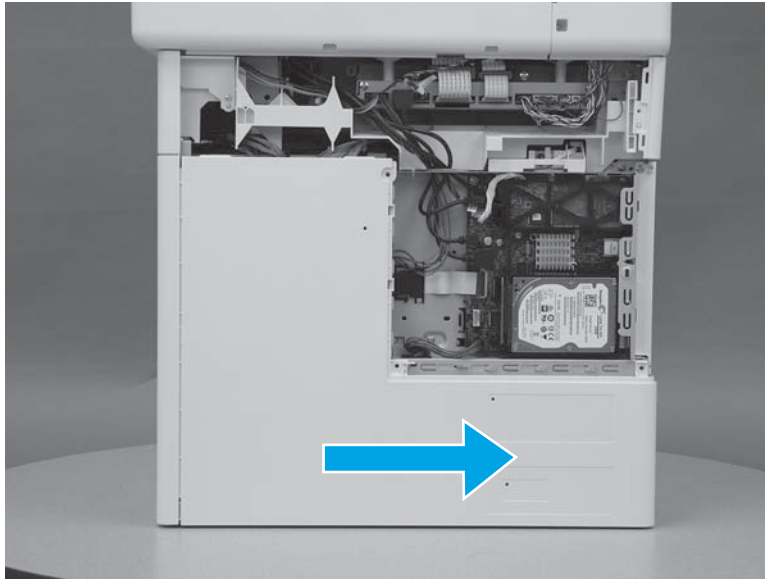

Step 8: Remove the left cover

1. At the left side of the printer, remove one screw (callout 1).

Figure 1-730 Remove one screw



2. Release one tab (callout 1), rotate the front edge of the cover away from the printer (callout 2), and then slide the cover (callout 3) toward the rear of the printer to release it.

Figure 1-731 Release the cover

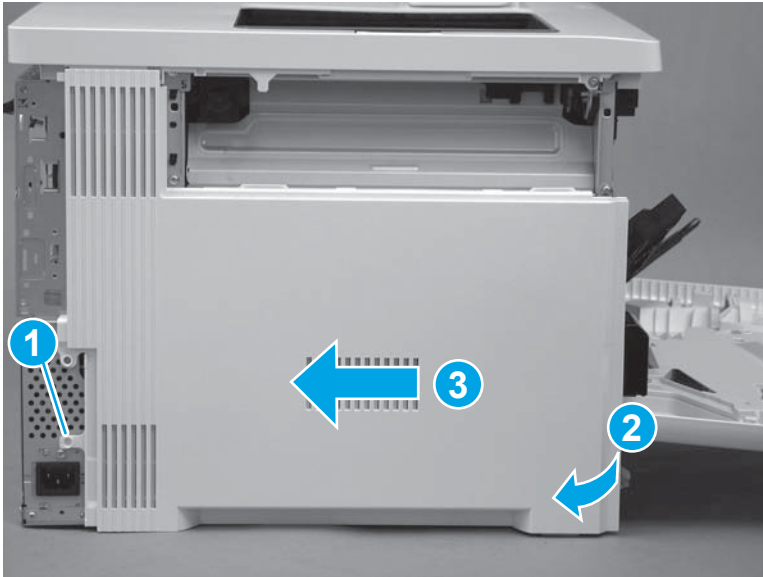

3. Remove the cover.

Figure 1-732 Remove the cover

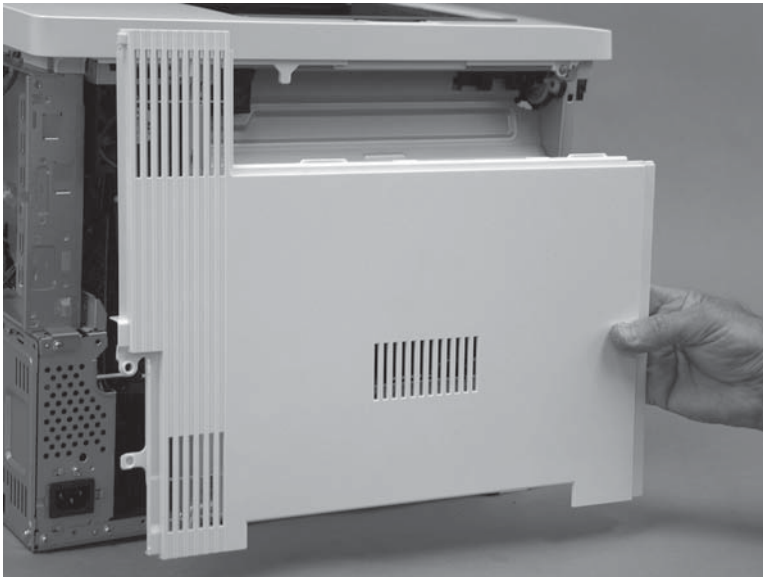

Step 9: Remove the upper cover (M552 and M553)

 **NOTE:** This step is for the M552 and M553 models. For the M577 models, skip this step and go to [Step 10: Remove the left upper cover \(M577\) on page 438.](#)

1. Remove three screws (callout 1).

Figure 1-733 Remove three screws

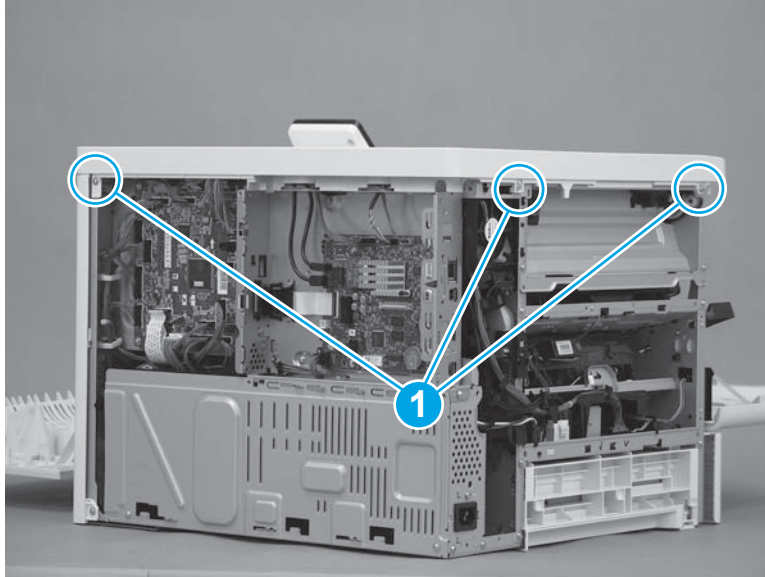

2. Remove one screw (callout 1), release one tab (callout 2), and then slightly separate the corner of the cover from the chassis.

 **NOTE:** This is a self-tapping plastic-thread screw. Make sure that this screw is used in this location when it is reinstalled.

Figure 1-734 Remove one screw and release one tab



3. Release one tab (callout 1), and then lift up on the cover to release it.

 **NOTE:** If the cover does not release, check for addition tabs by locating the triangles embossed in the cover at tab locations.

Figure 1-735 Release the cover



4. Remove the cover.

Figure 1-736 Remove the cover

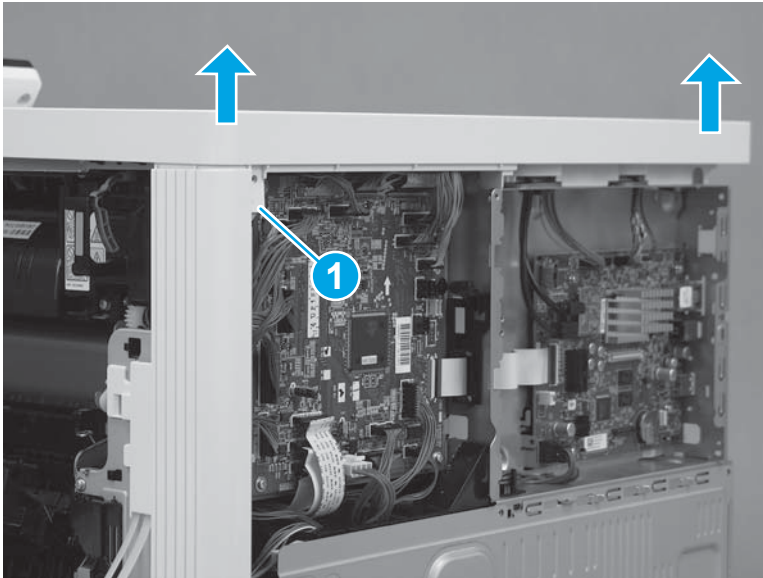
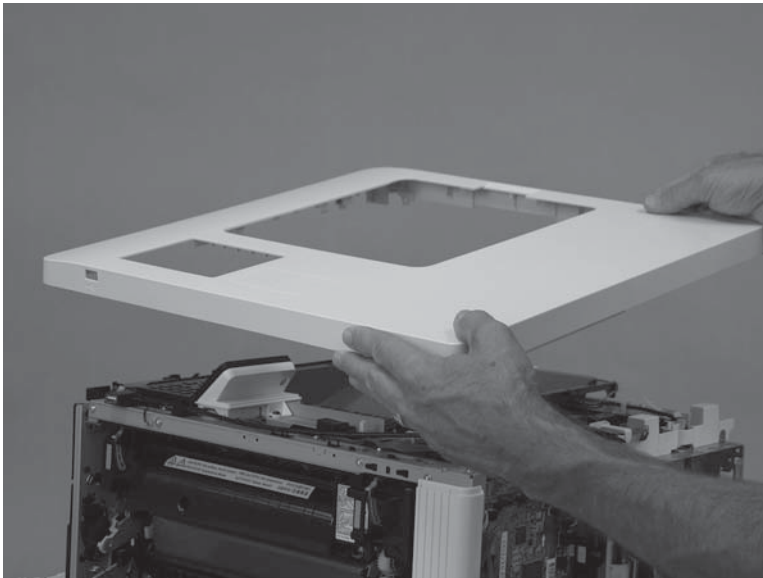

Step 10: Remove the left upper cover (M577)

 **NOTE:** This step is for the M577 models. For the M552 and M553 models, skip this step and go to [Step 19: Remove the output bin on page 454](#).

1. At the left side of the printer, release one tab (callout 1).

Figure 1-737 Release one tab

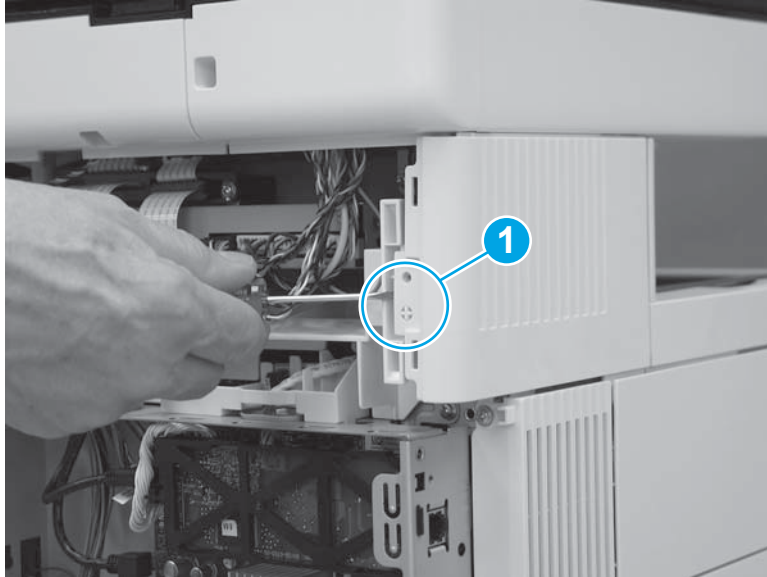

2. Slide the left upper cover toward the back of the printer.

Figure 1-738 Slide the cover back

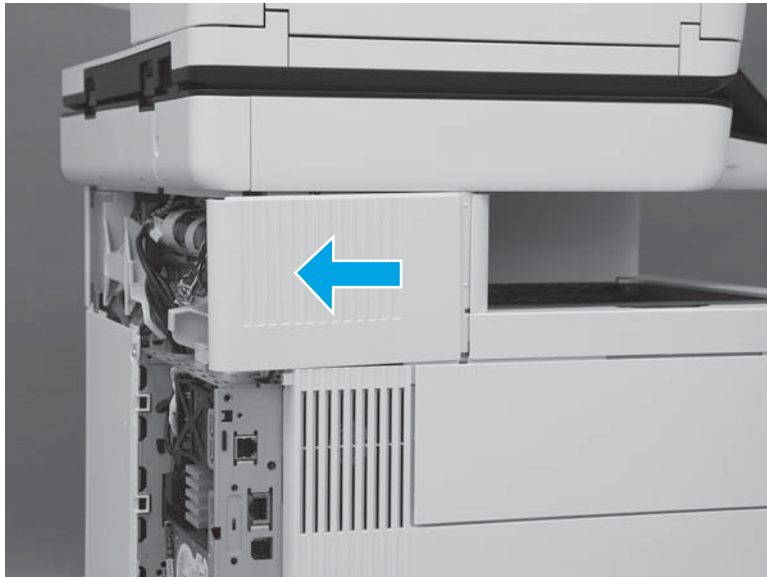

3. Rotate the cover up to remove it.

Figure 1-739 Remove the left upper cover



Step 11: Remove the right front upper cover (M577dn)



NOTE: This step is for the M577dn model. For the M577f and M577z models, skip this step and go to [Step 12: Remove the stapler cover assembly \(M577c/f/z\) on page 441](#).

For the M552 and M553 models, skip this step and go to [Step 19: Remove the output bin on page 454](#).

1. Remove one screw (callout 1).

Figure 1-740 Remove one screw

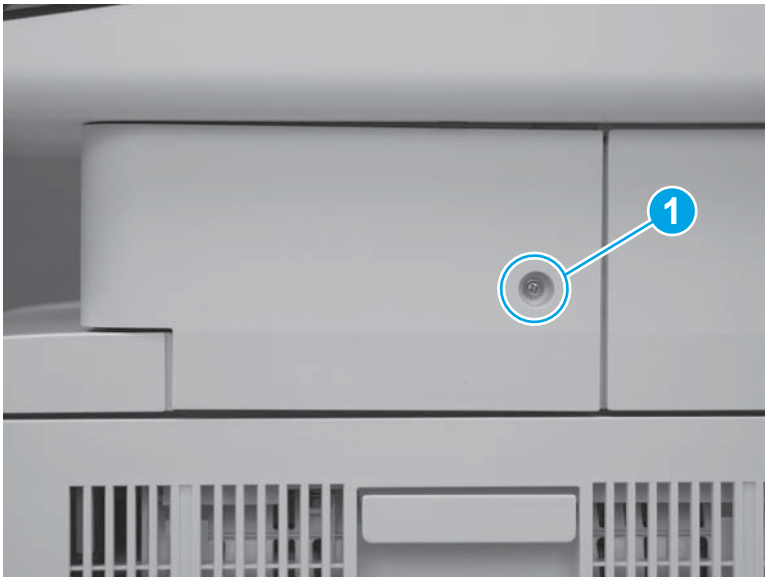

2. Release two tabs at the front edge of the cover (callout 1).

Figure 1-741 Release two tabs



3. Rotate the front of the cover to the right to remove it.

Figure 1-742 Rotate the cover



Step 12: Remove the stapler cover assembly (M577c/f/z)

 **NOTE:** This step is for the M577f and M577z models. For the M577dn model, skip this step and to go [Step 13: Remove the integrated scanner assembly \(M577\) on page 443.](#)

For the M552 and M553 models, skip this step and go to [Step 19: Remove the output bin on page 454.](#)

1. Remove one screw (callout 1).

 **Reinstallation tip:** This is a self-tapping screw for plastic. When reinstalling, rotate the screw counterclockwise to align it with the existing thread pattern, and then carefully turn it clockwise to tighten. Do not overtighten. This will prevent stripping the threads inside the screw hole.

Figure 1-743 Remove one screw

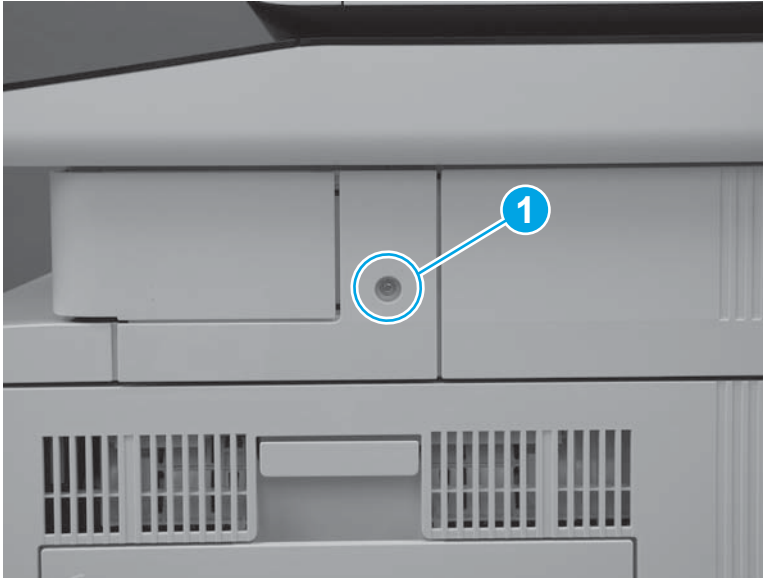

2. Release two tabs at the front edge of the cover (callout 1).

Figure 1-744 Release two tabs



3. Release the back edge of the cover.

Figure 1-745 Release the back edge of the cover

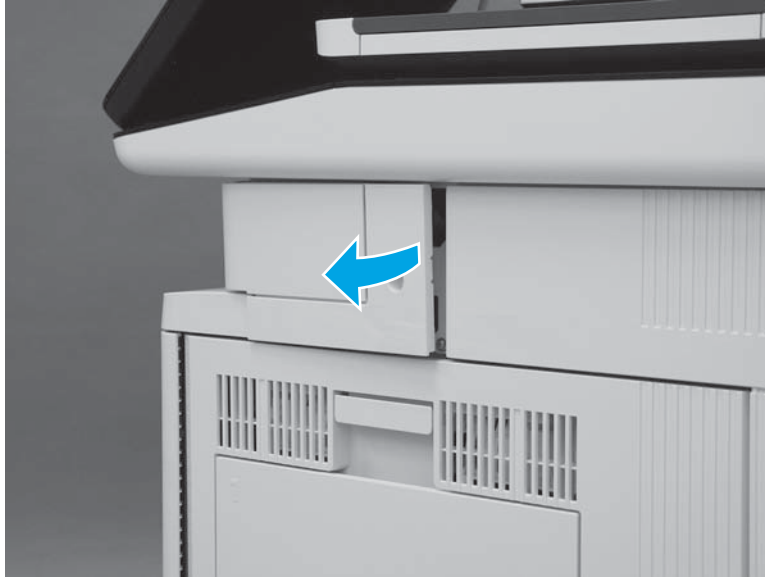



4. Rotate the cover away from the printer to remove it.

Figure 1-746 Remove the cover



Step 13: Remove the integrated scanner assembly (M577)

 **NOTE:** This step is for the M577 models. For the M552 and M553 models, skip this step and go to [Step 19: Remove the output bin on page 454](#).

 **NOTE:** The ISA includes the document feeder, image scanner, scanner control board (SCB), control panel, keyboard (M577c/z) and NFC PCA (M577z).

1. At the left side of the printer, remove one screw (callout 1).

Figure 1-747 Remove one screw

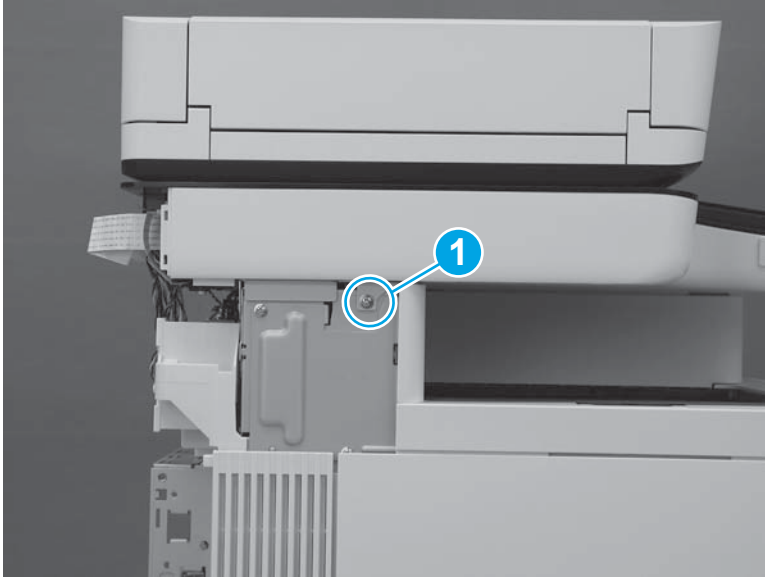

2. At the back side of the printer, remove two screws (callout 1).

Figure 1-748 Remove two screws

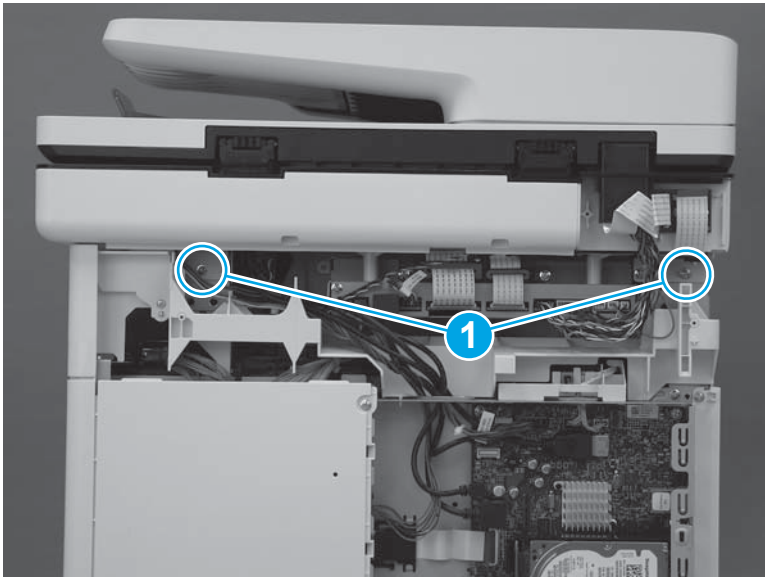

3. At the right side of the printer, remove one screw (callout 1).

Figure 1-749 Remove one screw

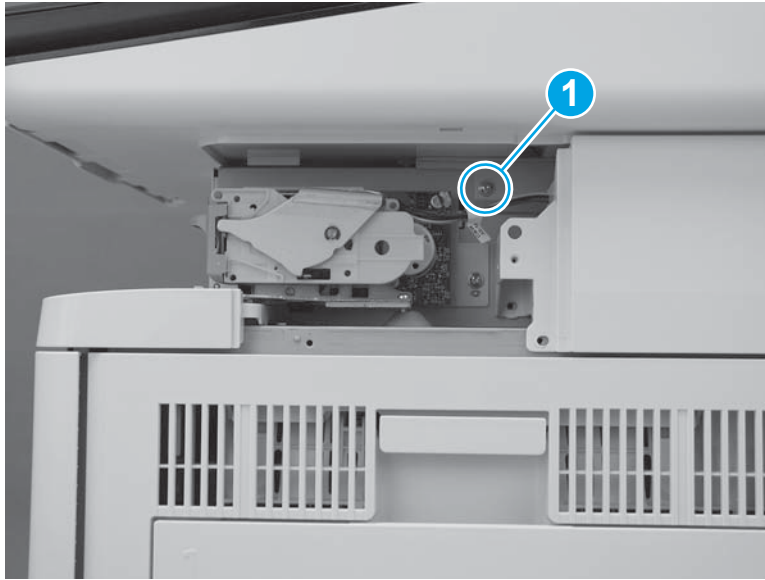

4. Disconnect four connectors on the formatter (callout 1), and then pass the wire harness and cables through the opening in the formatter case (callout 2).

Figure 1-750 Disconnect four connectors

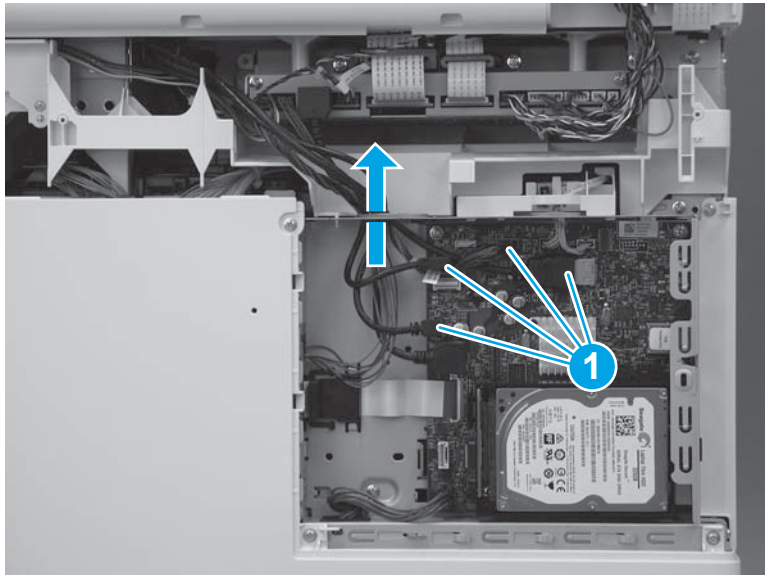

5. Disconnect two connectors on the scanner control board (callout 1).

M577c/f/z only: Disconnect one connector for the stapler on the scanner control board (callout 2).

Figure 1-751 Disconnect connectors

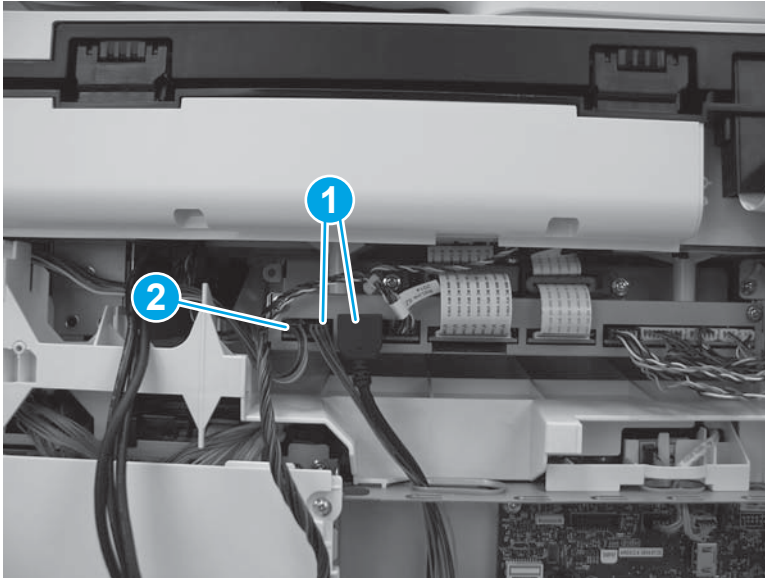

6. Slightly slide the ISA towards the back of the printer to release it.

Figure 1-752 Slide the ISA towards the back of the printer

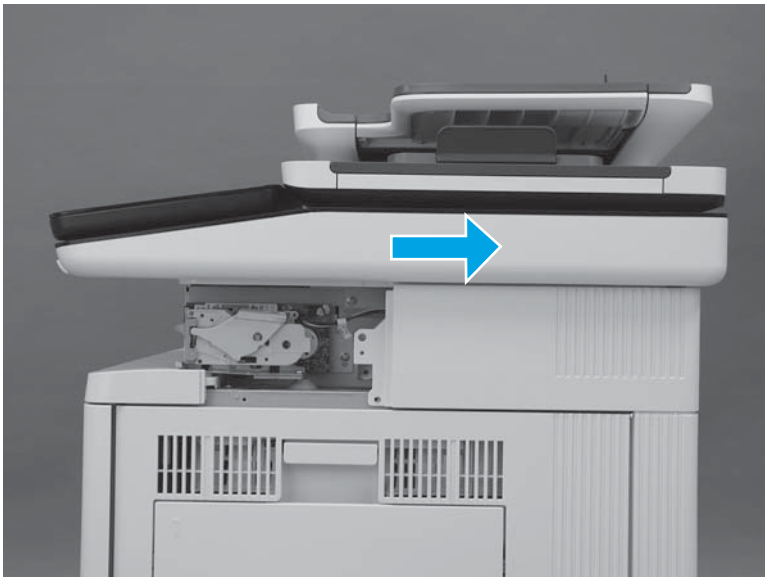

7. Lift the ISA up to remove it.

Figure 1-753 Remove the ISA

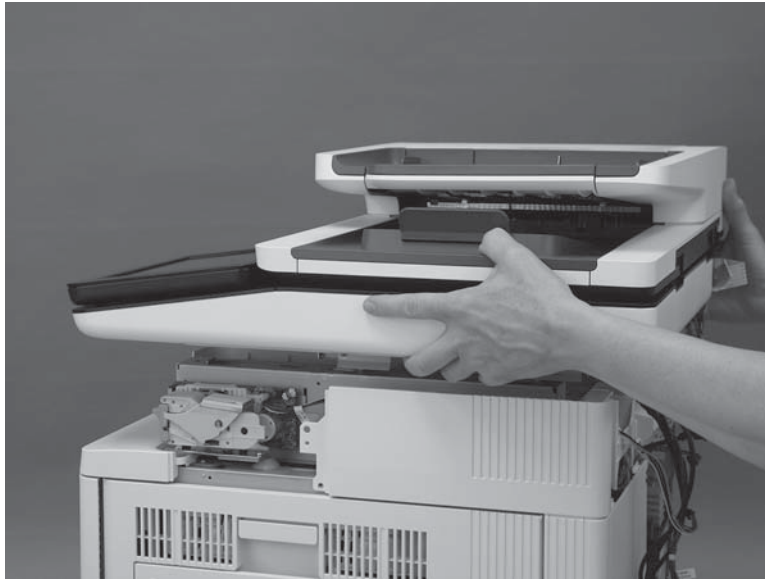

Step 14: Remove the stapler (M577c/f/z)

 **NOTE:** This step is for the M577c/f/z models. For the M577dn model, skip this step and go to [Step 15: Remove the right upper cover \(M577\) on page 448](#).

For the M552 and M553 models, skip this step and go to [Step 19: Remove the output bin on page 454](#).

1. Disconnect one connector (callout 1), and then remove two screws (callout 2).

Figure 1-754 Disconnect connector and remove screws

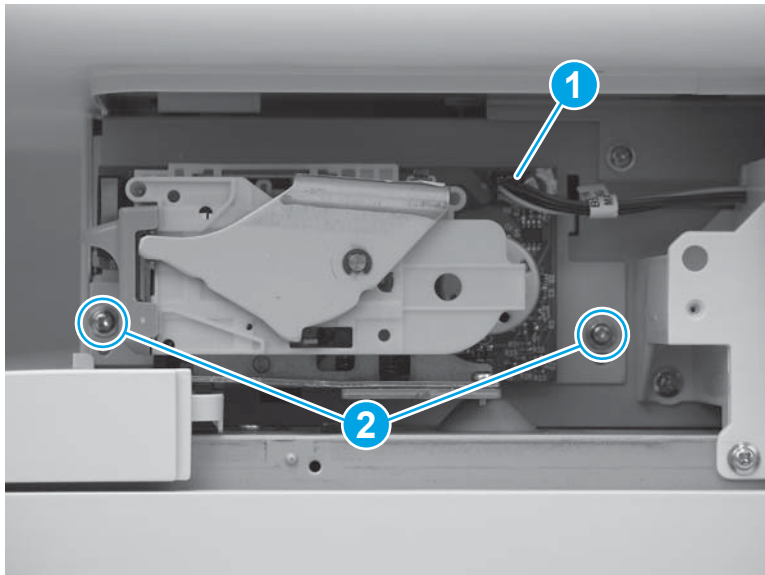

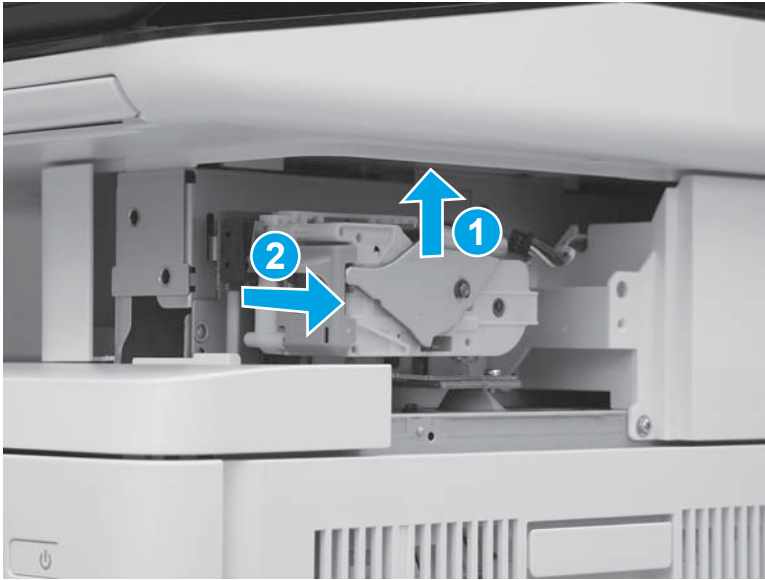

2. Slide the stapler unit up (callout 1), and then pull it away from the printer (callout 2) to remove it.

Figure 1-755 Remove the stapler unit



Step 15: Remove the right upper cover (M577)

 **NOTE:** This step is for the M577 models. For the M552 and M553 models, skip this step and go to [Step 19: Remove the output bin on page 454](#).

 **NOTE:** The figures below show the image scanner installed. The procedures for removing and installing the right upper cover are the same whether the image scanner is installed or removed."

1. At the right side of the printer, remove two screws (callout 1).

M577c/f/z only: Disconnect one connector (callout 2), if it was not already disconnected in a previous step.

Figure 1-756 Remove two screws and one connector

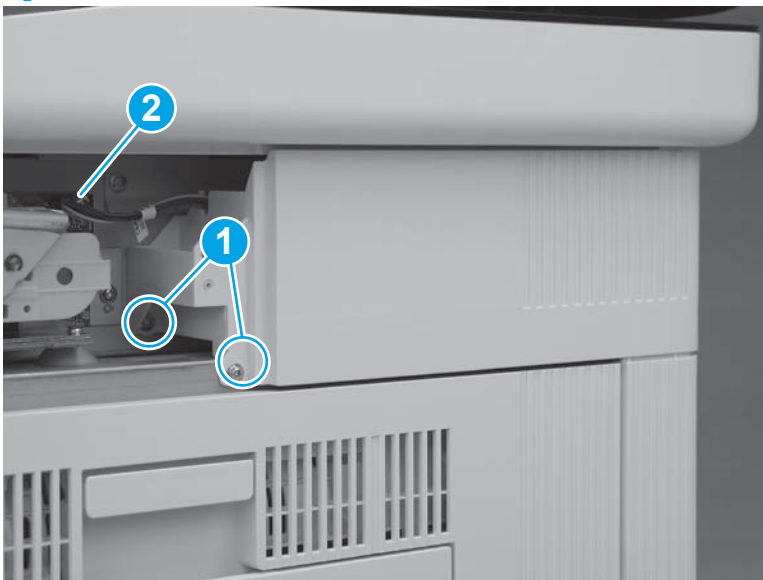

2. At the back of the printer, remove one screw (callout 1).

M577c/f/z only: Disconnect one connector (callout 2), if it was not already disconnected in a previous step.

 **Reinstallation tip:** This screw is smaller than the screws removed in the previous step. When reinstalling the right upper cover, make sure that this screw is installed in the correct position.

Figure 1-757 Remove one screw and connector



3. Slide the cover toward the back of the printer.

Figure 1-758 Slide the cover

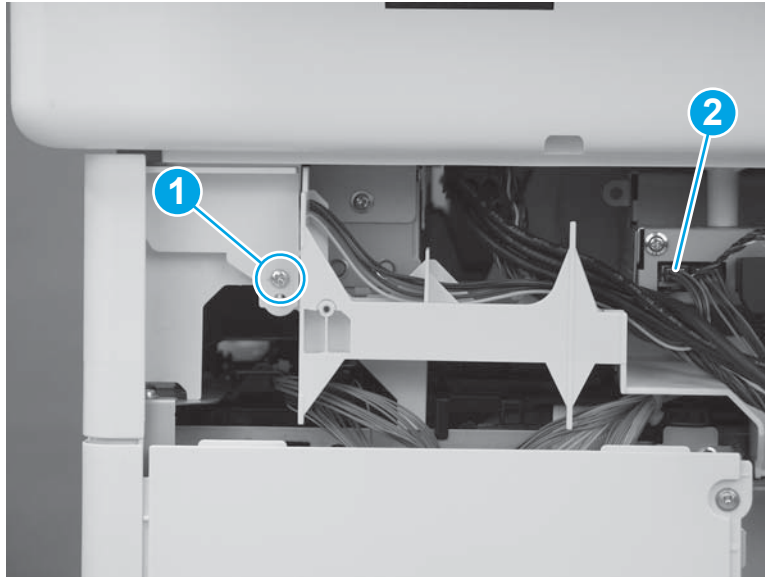
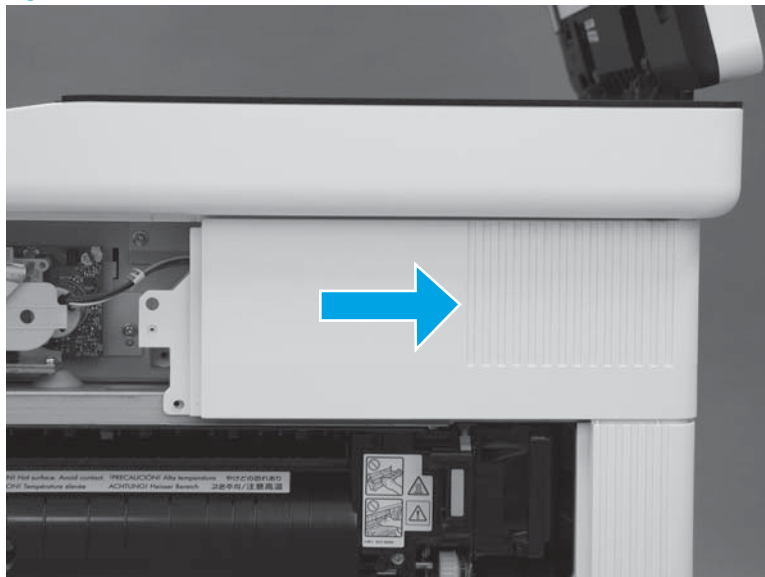

4. Lift the cover away from the printer to remove it.

M577c/f/z only: Release the cables (callout 1) through the slot (callout 2) in the printer.

Figure 1-759 Remove the cover

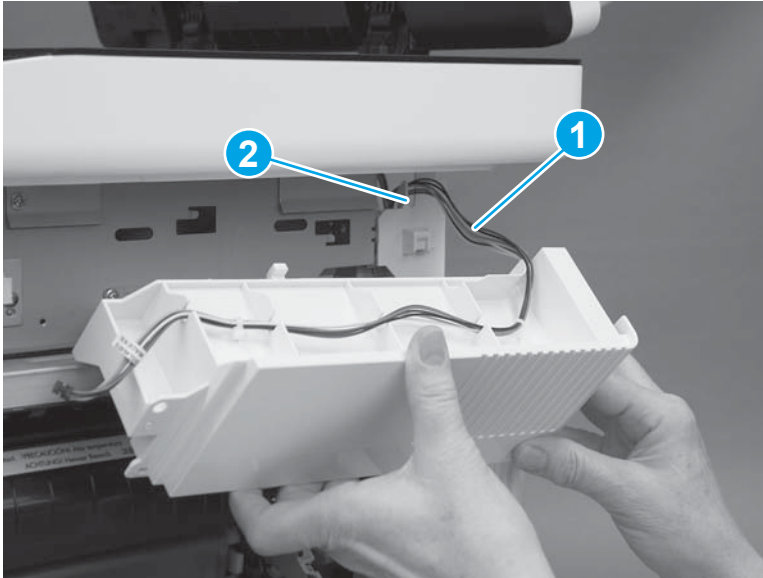

Step 16: Remove the top rear cover (M577)

 **NOTE:** This step is for the M577 models. For the M552 and M553 models, skip this step and go to [Step 19: Remove the output bin on page 454](#).

1. At the top of the printer, remove five screws (callout 1).

Figure 1-760 Remove five screws

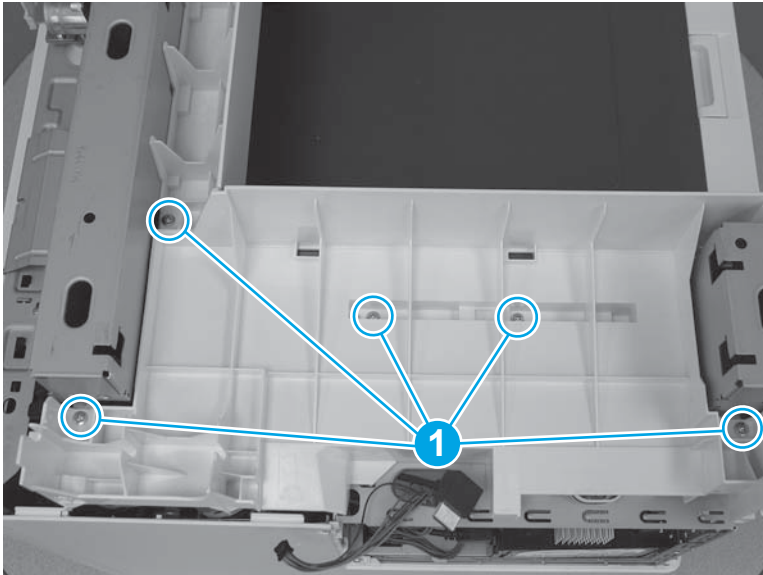

2. Release two tabs (callout 1) on the front edge of the cover.

Figure 1-761 Release two tabs

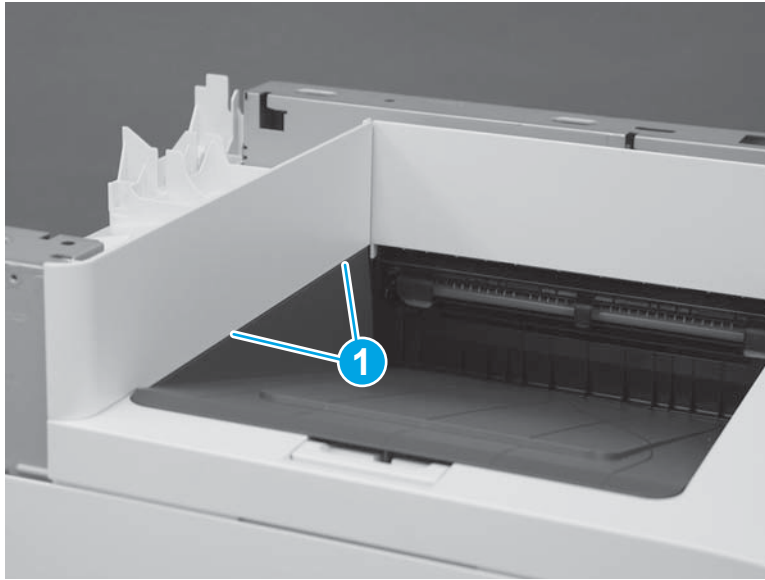

3. Remove the top rear cover.

Figure 1-762 Remove the top rear cover

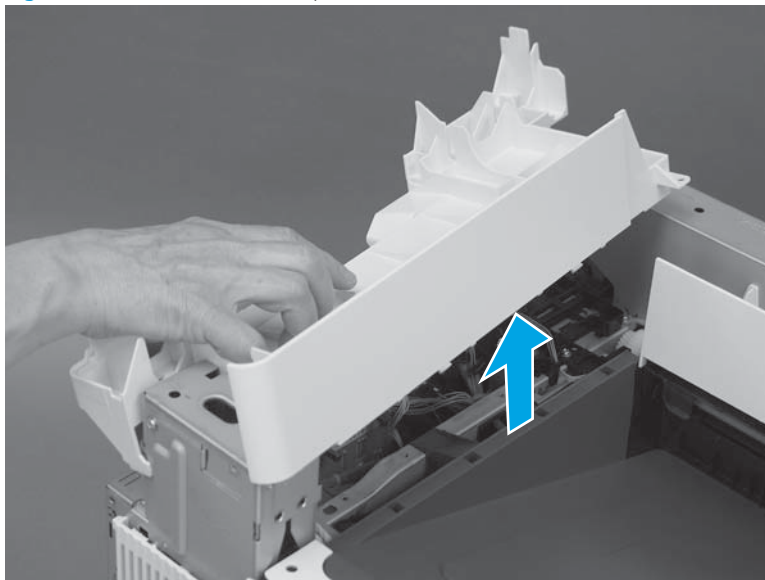

Step 17: Remove the paper feed cover (M577)

 **NOTE:** This step is for the M577 models. For the M552 and M553 models, skip this step and go to [Step 19: Remove the output bin on page 454.](#)

1. Remove one screw (callout 1).

Figure 1-763 Remove one screw

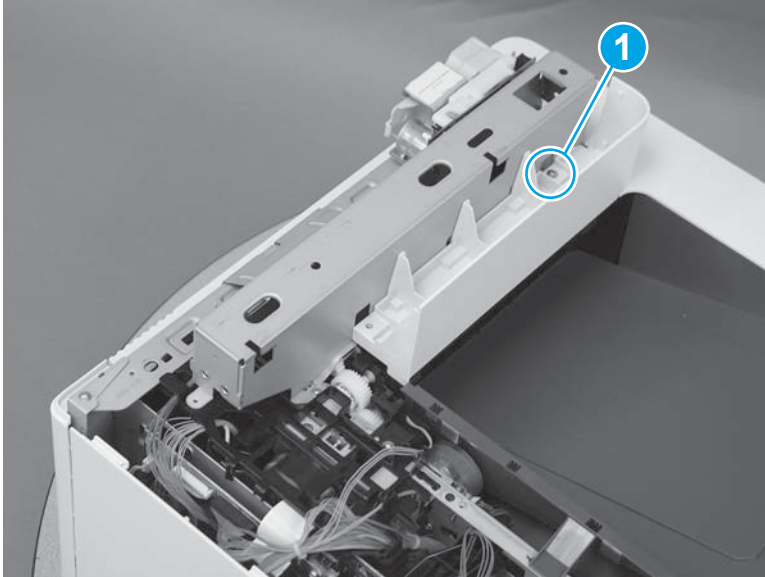

2. Lift the cover up to remove it.

Figure 1-764 Remove the cover

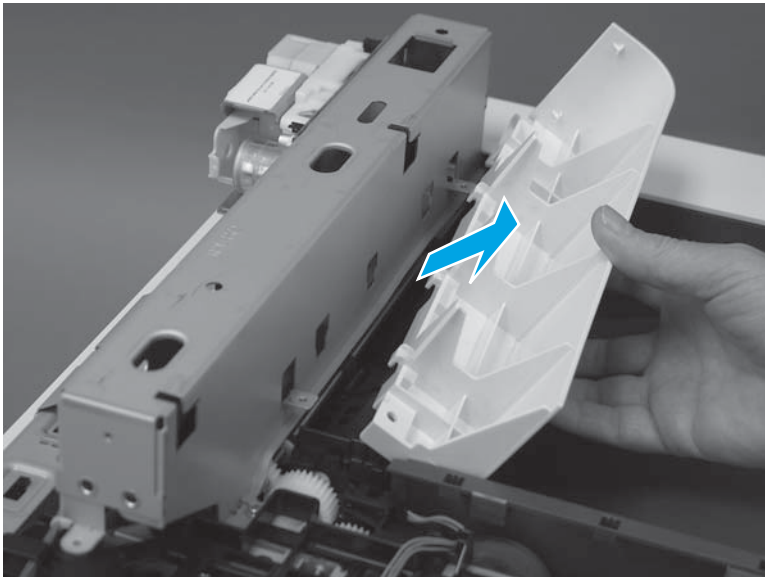

Step 18: Remove the top cover (M577)

 **NOTE:** This step is for the M577 models. For the M552 and M553 models, skip this step and go to [Step 19: Remove the output bin on page 454](#).

1. At the front of the printer, remove one screw (callout 1).

 **Reinstallation tip:** This screw is longer and a different type of screw than the screw removed in the next step. When reinstalling the top cover, make sure that this screw is installed in the correct position.

Figure 1-765 Remove one screw



2. At the left side of the printer, remove one screw (callout 1).

Figure 1-766 Remove one screw

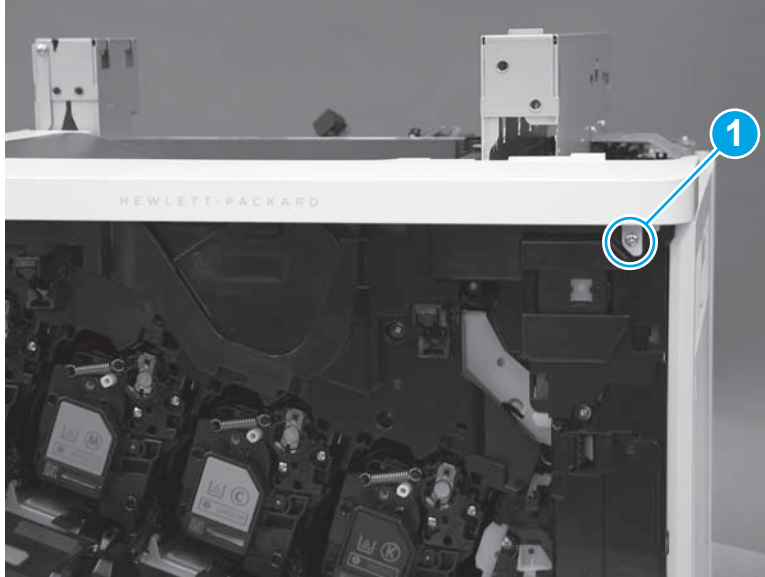
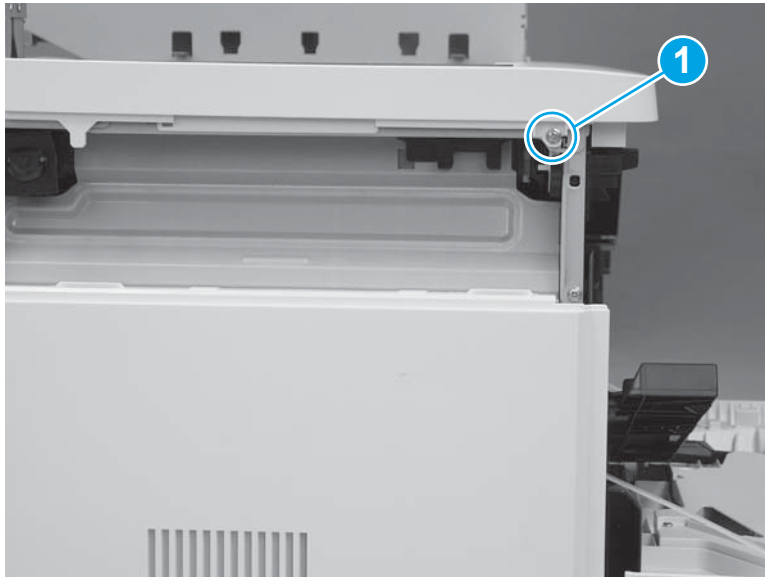

3. At the front of the printer, release one tab (callout 1).

Figure 1-767 Release one tab

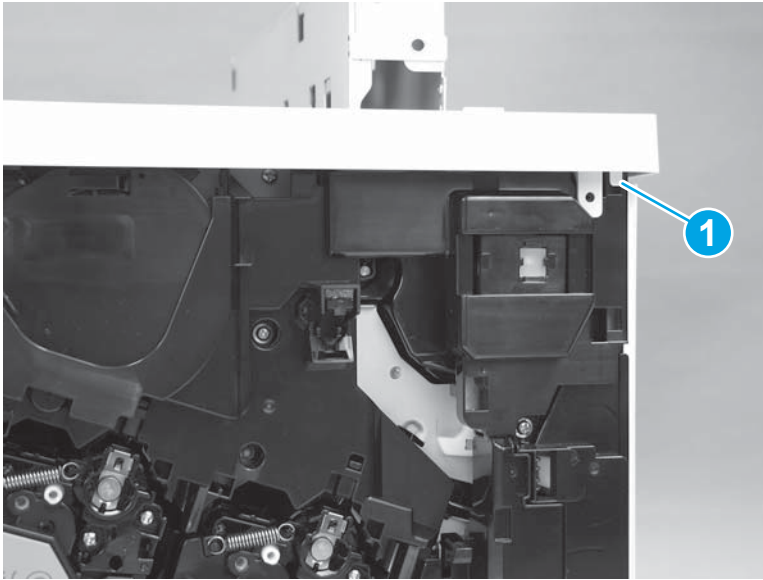

4. At the top of the printer, release two tabs (callout 1) next to the output bin, and then remove the top cover.

Figure 1-768 Release two tabs

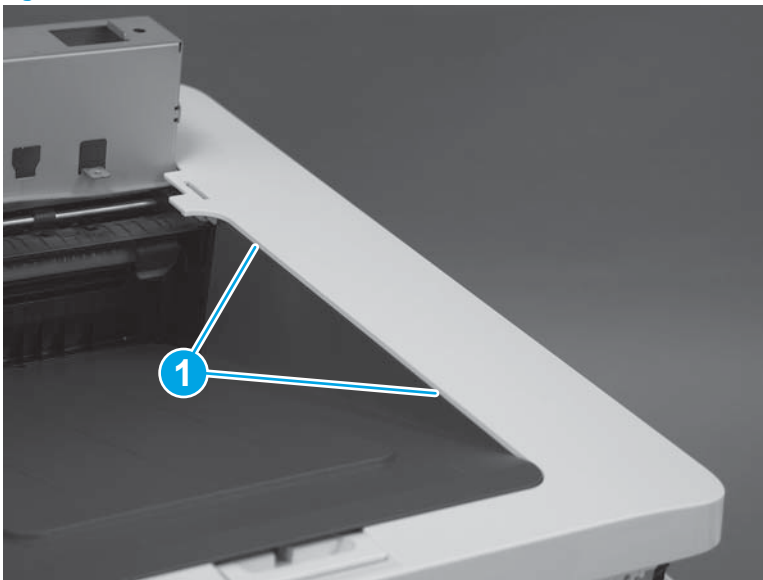

Step 19: Remove the output bin

1. Slightly slide and lift the cover to release it.

Figure 1-769 Release the cover

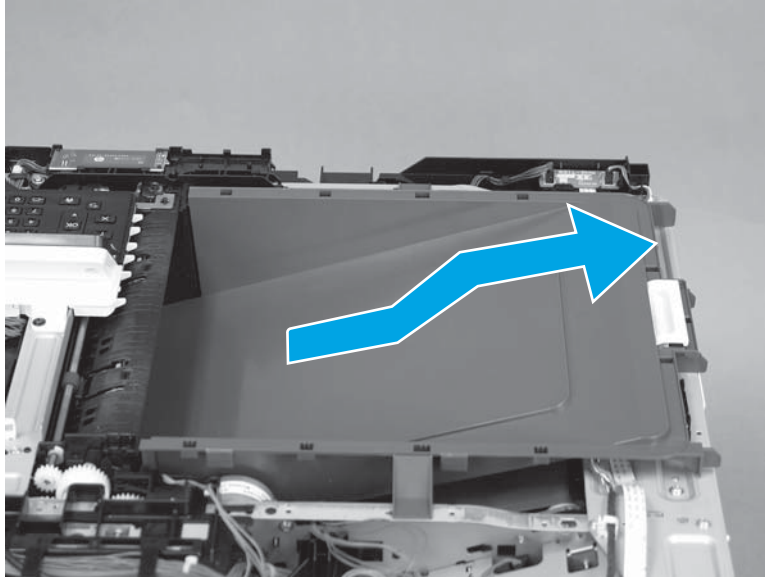

2. Remove the cover.

Figure 1-770 Remove the cover

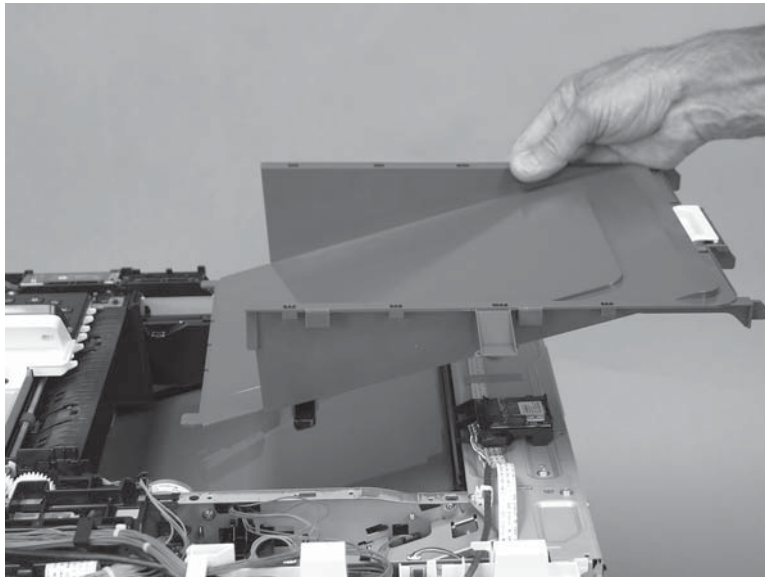

Step 20: Unpack the replacement assembly

Unpack the replacement assembly from the packaging.

For complete information on HP's recycling programs, go to [Product return and recycling](#).



NOTE: HP recommends responsible disposal of the defective assembly.

Figure 1-771 Recycle and unpack

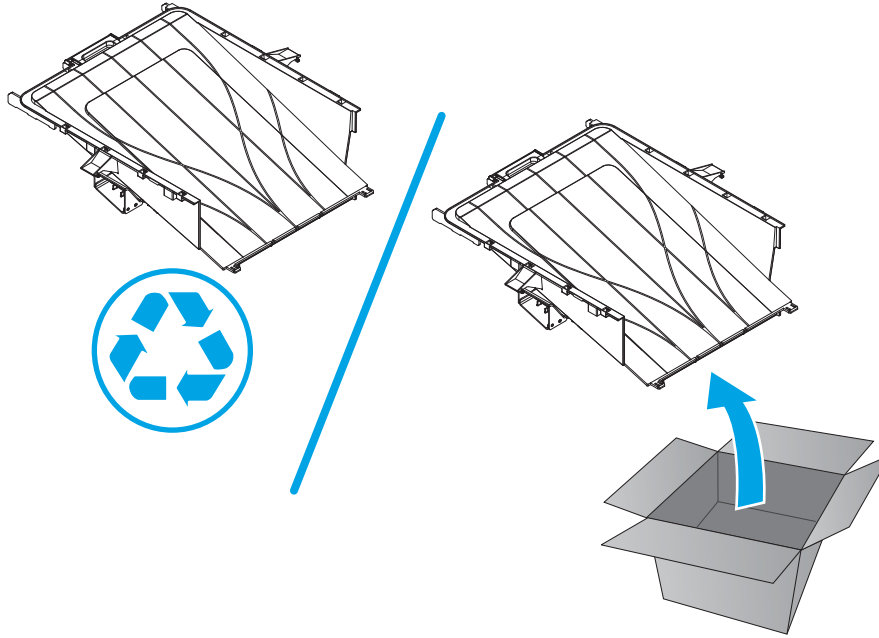

Step 21: Install the output bin

1. Position the cover near the printer.

Figure 1-772 Install the cover

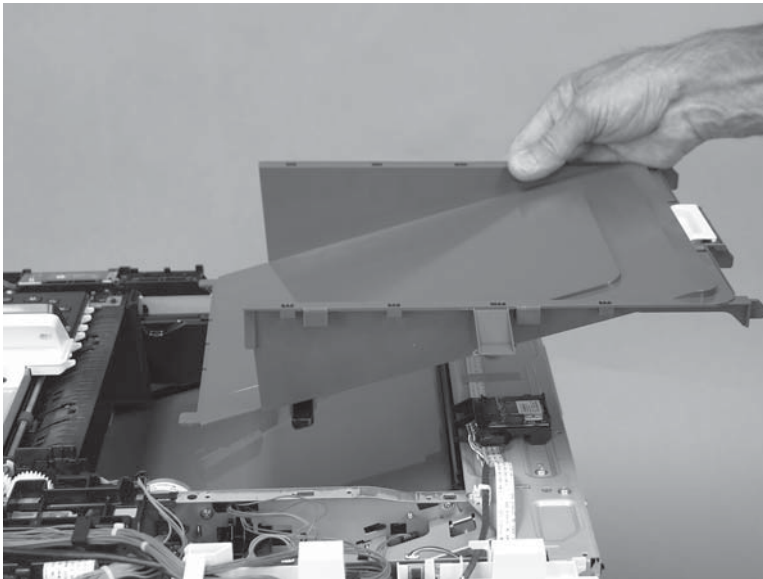

2. Align the tabs on the cover with the slots in the printer.

Figure 1-773 Align the tabs

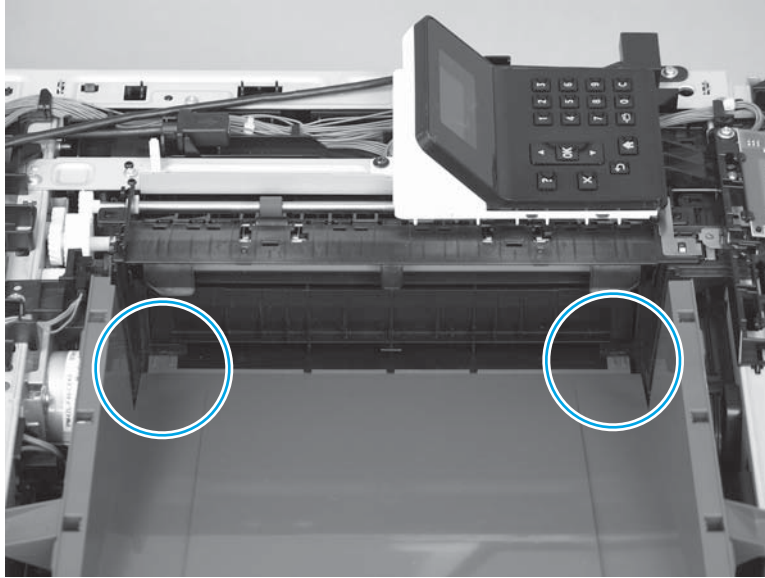

3. Slide and lower the cover onto the printer to install it.

Figure 1-774 Release the cover

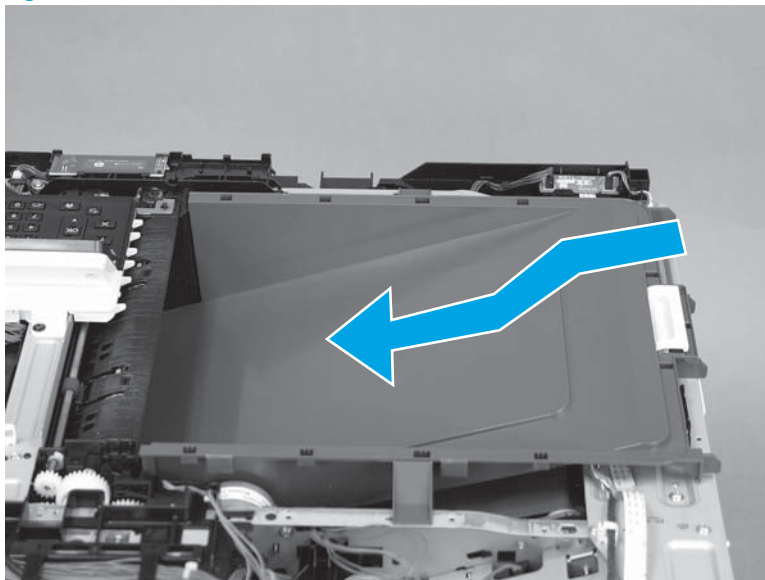

4. Verify that the tabs on the front- and rear-side of the cover are correctly installed in the slots in the chassis.

Figure 1-775 Verify the installation

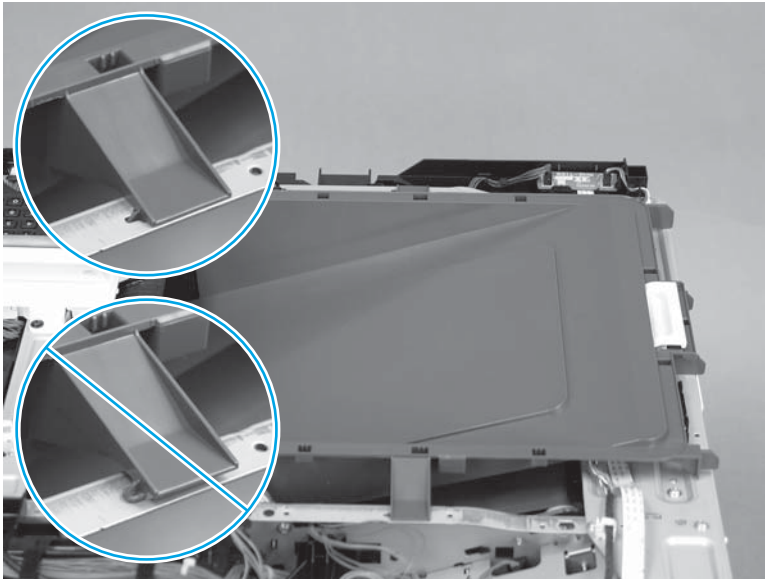

Step 22: Install the top cover (M577)

 **NOTE:** This step is for the M577 models. For the M552 and M553 models, skip this step and go to [Step 31: Install the upper cover \(M552 and M553\) on page 474](#).

1. Position the locator pins (callout 1) on the cover in the slots (callout 2) in the printer.

Figure 1-776 Position the locator pins

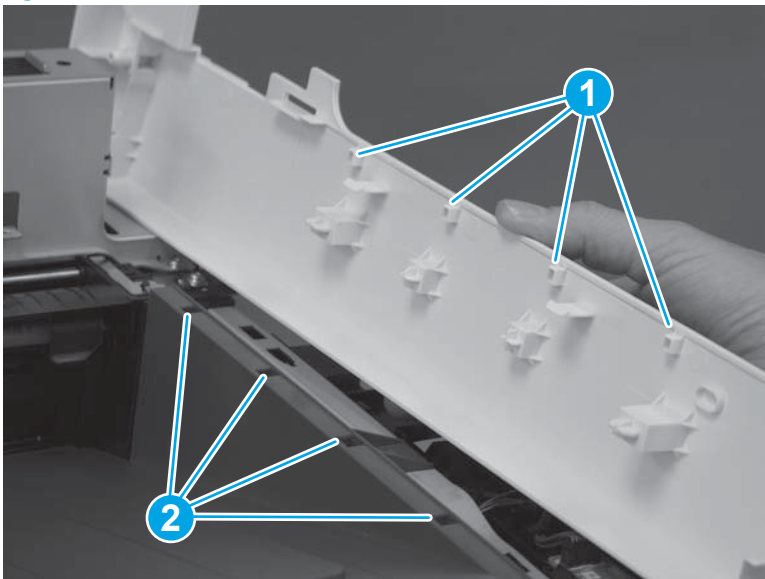

2. Press down on the cover to install it. Make sure that the tabs (callout 1) snap into place.

Figure 1-777 Press down on the cover

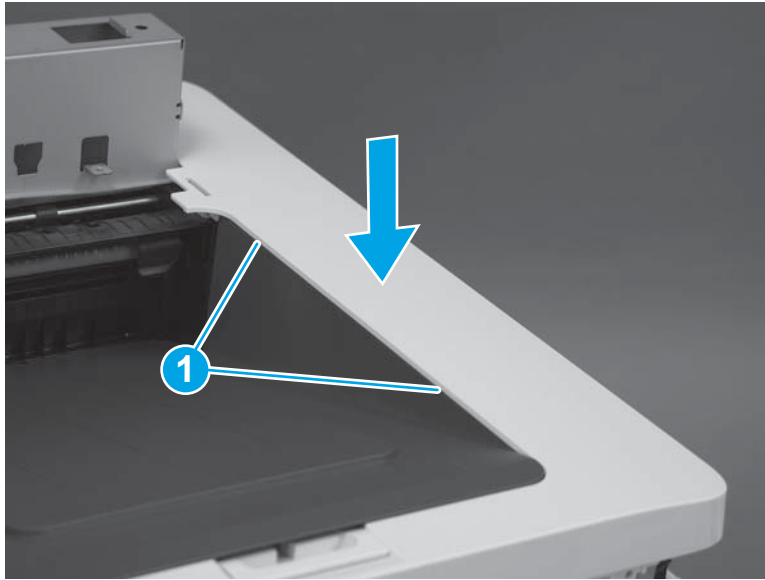

3. At the front of the printer, install one screw (callout 1).

 **Reinstallation tip:** This screw is longer and a different type of screw than the screw installed in the next step. Make sure that this screw is installed in the correct position.

Figure 1-778 Install one screw



4. At the left side of the printer, install one screw (callout 1).

Figure 1-779 Install one screw

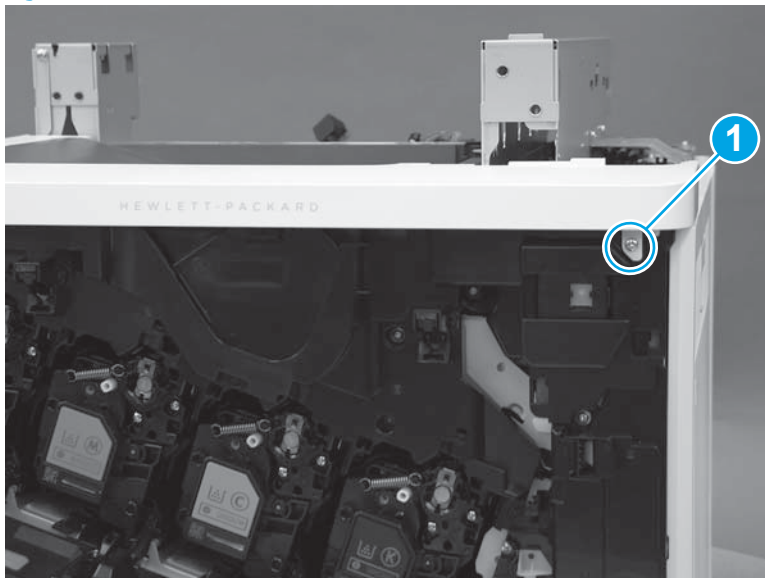
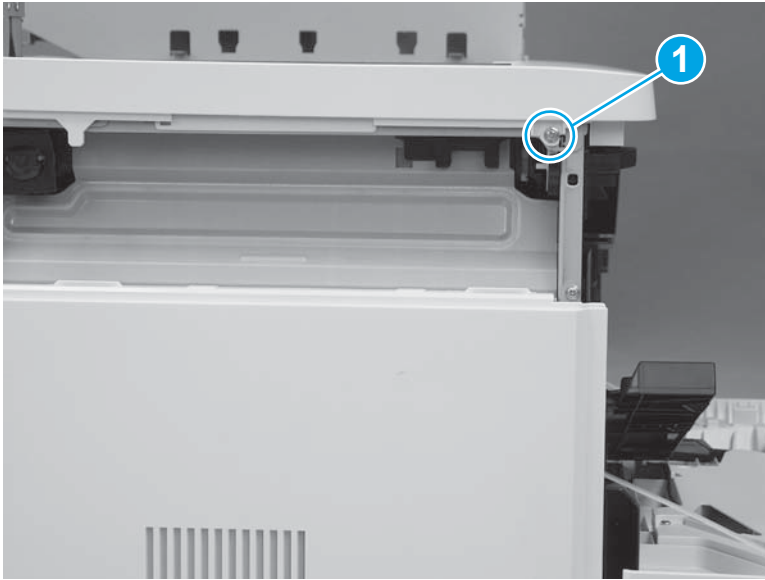

Step 23: Install the paper feed cover (M577)



NOTE: This step is for the M577 models. For the M552 and M553 models, skip this step and go to [Step 31: Install the upper cover \(M552 and M553\) on page 474](#).

1. Position the locator tabs (callout 1) on the cover in the slots (callout 2) in the printer. Press down until the cover snaps into place.

Figure 1-780 Install the cover

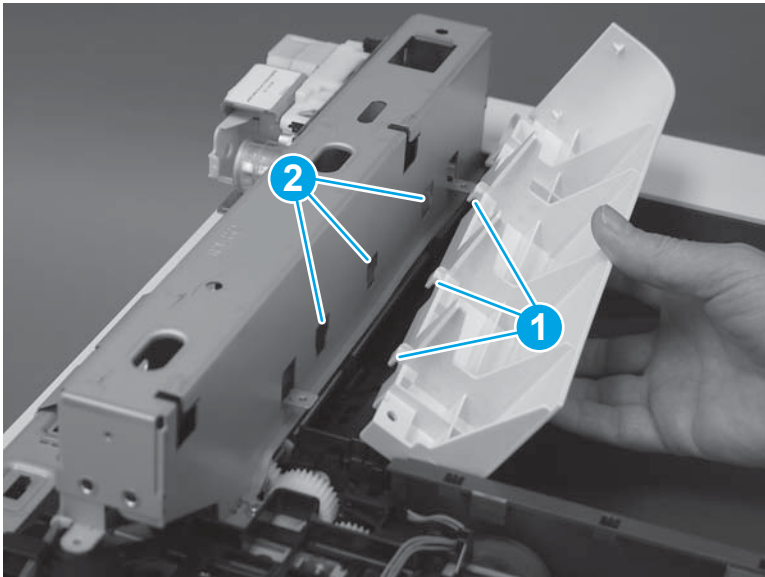

2. Install one screw (callout 1).

Figure 1-781 Install one screw

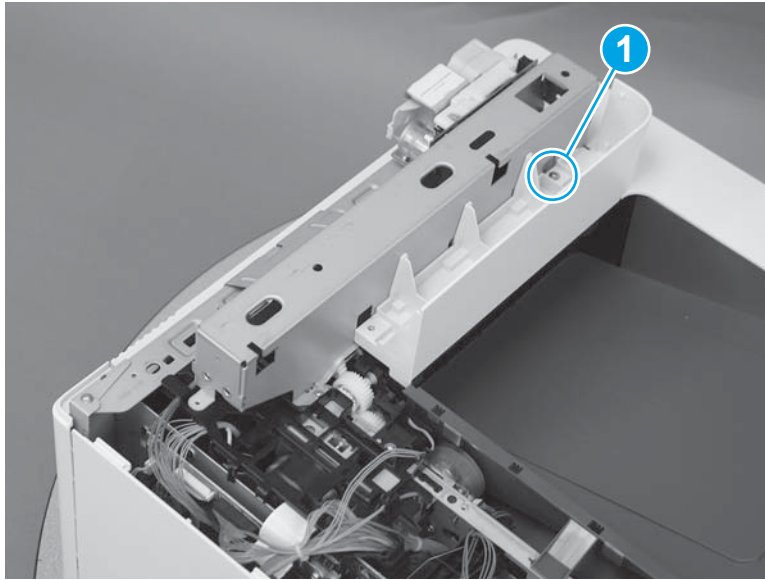

Step 24: Install the top rear cover (M577)

 **NOTE:** This step is for the M577 models. For the M552 and M553 models, skip this step and go to [Step 31: Install the upper cover \(M552 and M553\) on page 474](#).

1. Align the locator tabs (callout 1) on the cover with the slots (callout 2) in the printer.

Figure 1-782 Align the locator tabs

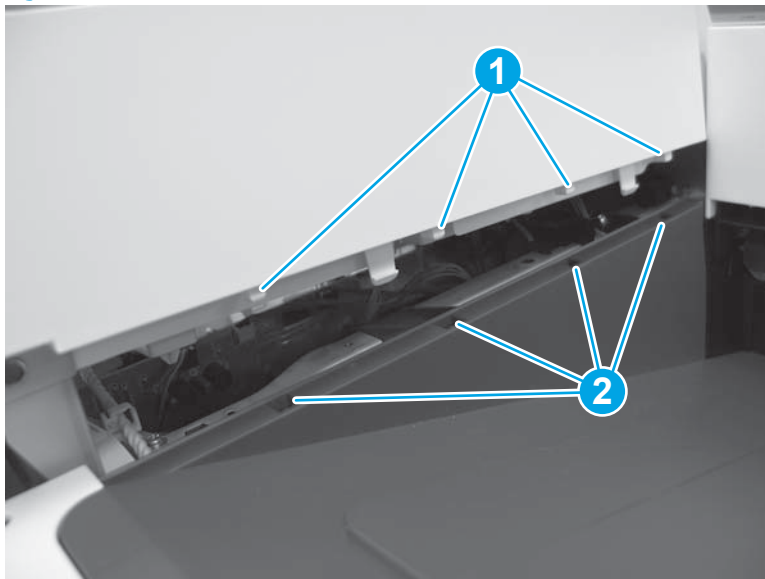

2. Press down to install the cover. Make sure that the tabs snap into place.

Figure 1-783 Install the cover

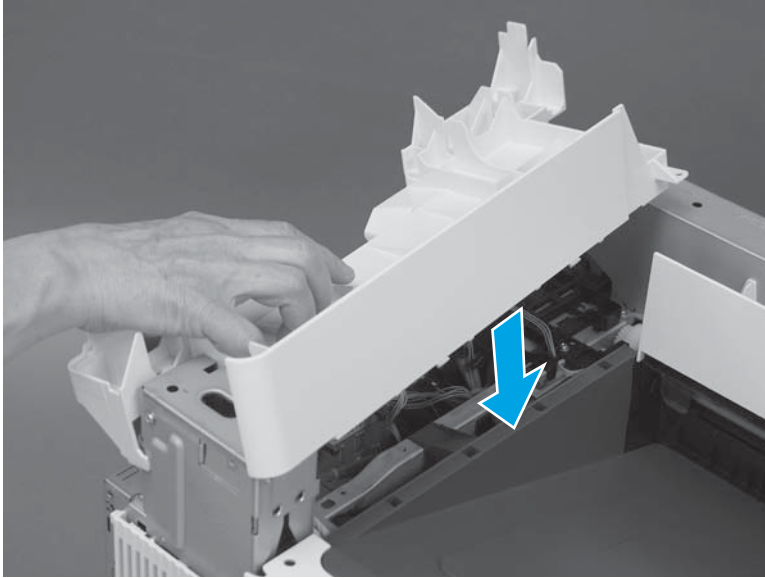

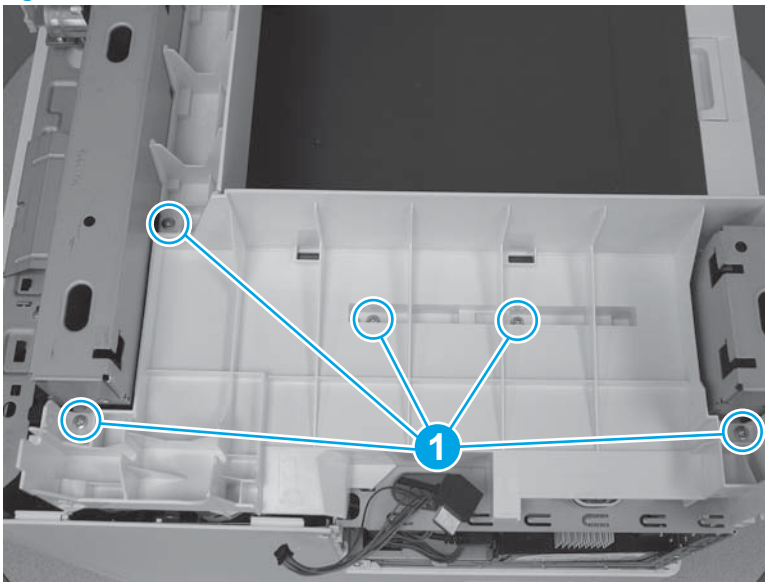

3. At the top of the printer, install five screws (callout 1).

Figure 1-784 Install five screws



Step 25: Install the right upper cover (M577)

 **NOTE:** This step is for the M577 models. For the M552 and M553 models, skip this step and go to [Step 31: Install the upper cover \(M552 and M553\) on page 474](#).

 **NOTE:** The figures below show the image scanner installed. The procedures for removing and installing the right upper cover are the same whether the image scanner is installed or removed."

1. **M577c/f/z only:** Install the cables (callout 1) through the slot (callout 2) in the printer.

Figure 1-785 Install the cables

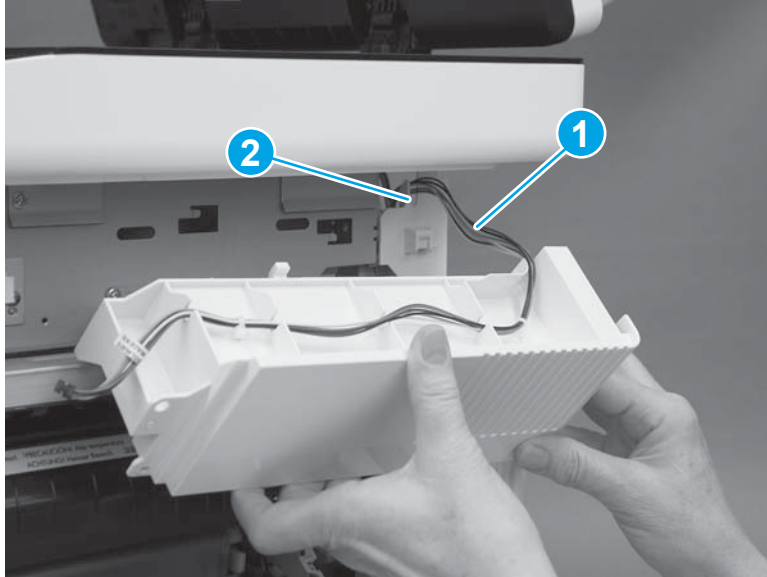

2. Position the hooks (callout 1) on the cover in the slots (callout 2) in the printer.

Figure 1-786 Position the hooks

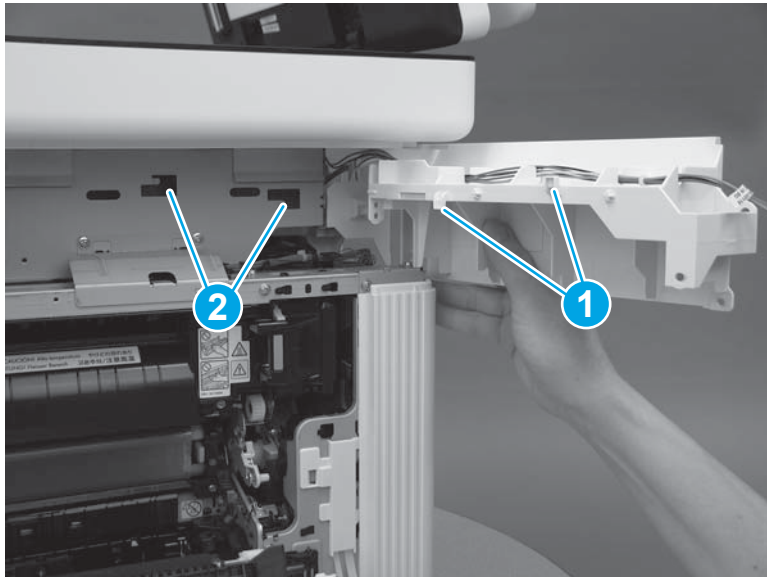

3. Slide the cover toward the front of the printer to install it.

Figure 1-787 Install the cover

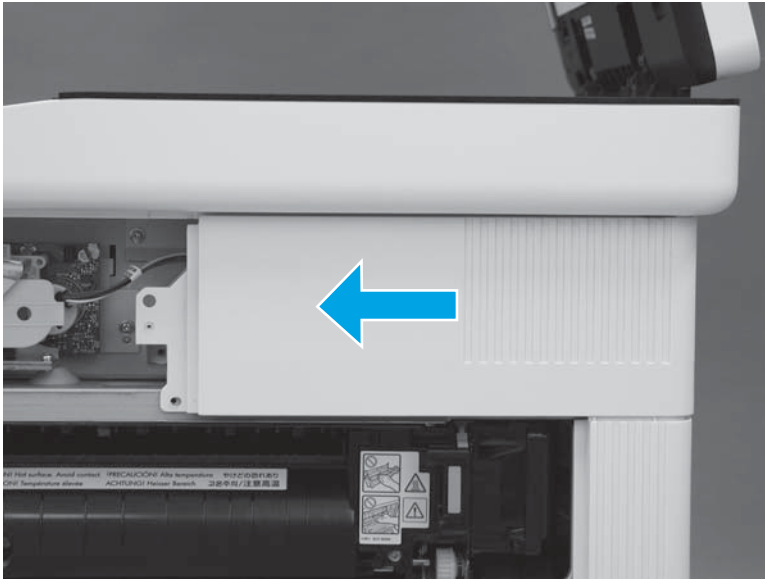

4. At the back of the printer, install one screw (callout 1).

M577c/f/z only: Connect one connector (callout 2), if the integrated scanner assembly is installed.

TIP: This screw is smaller than the screws installed in the next step. Make sure that this screw is installed in the correct position.

Figure 1-788 Install one screw and connector

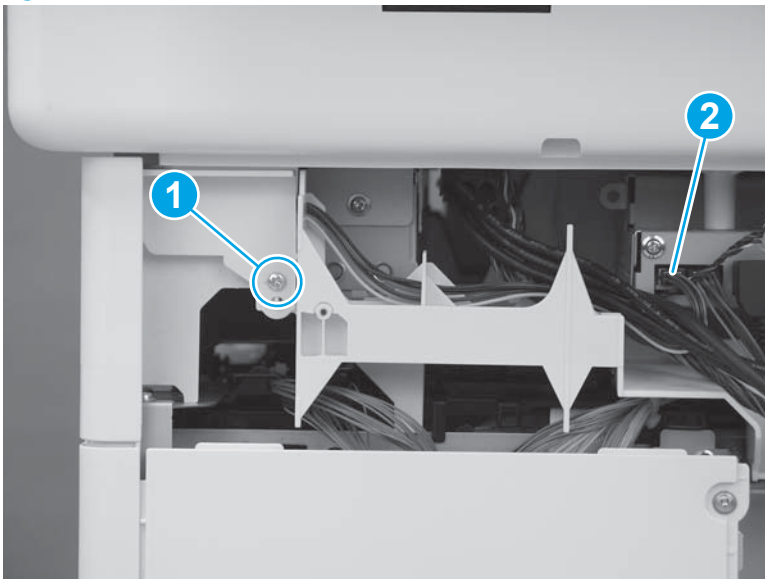

5. At the right side of the printer, install two screws (callout 1).

M577c/f/z only: Connect one connector (callout 2), if the stapler is installed.

Figure 1-789 Install one screw and connector

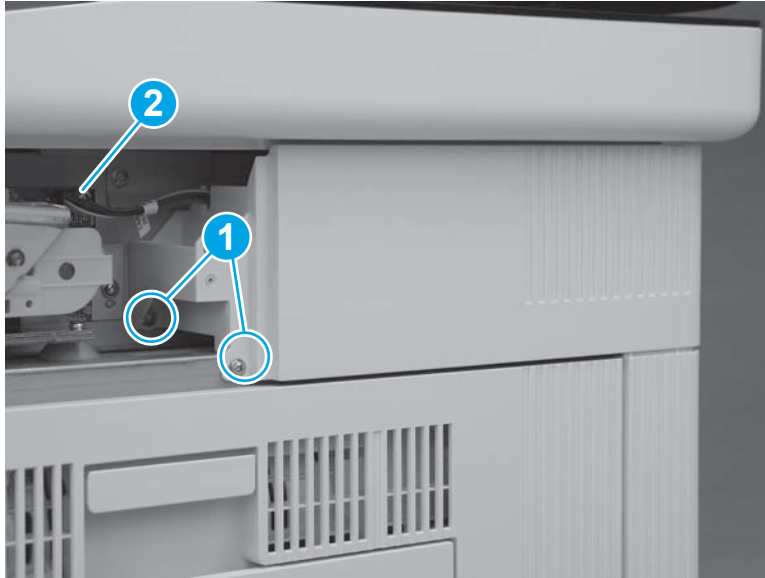

Step 26: Install the stapler (M577c/f/z)

 **NOTE:** This step is for the M577c/f/z models only. For the M577dn model, skip this step and go to [Step 27: Install the integrated scanner assembly \(M577\) on page 466.](#)

For the M552 and M553 models, skip this step and go to [Step 31: Install the upper cover \(M552 and M553\) on page 474.](#)

1. Position the hooks (callout 1) on the stapler unit in the slots (callout 2) in the printer.

Figure 1-790 Position the hooks in the slots

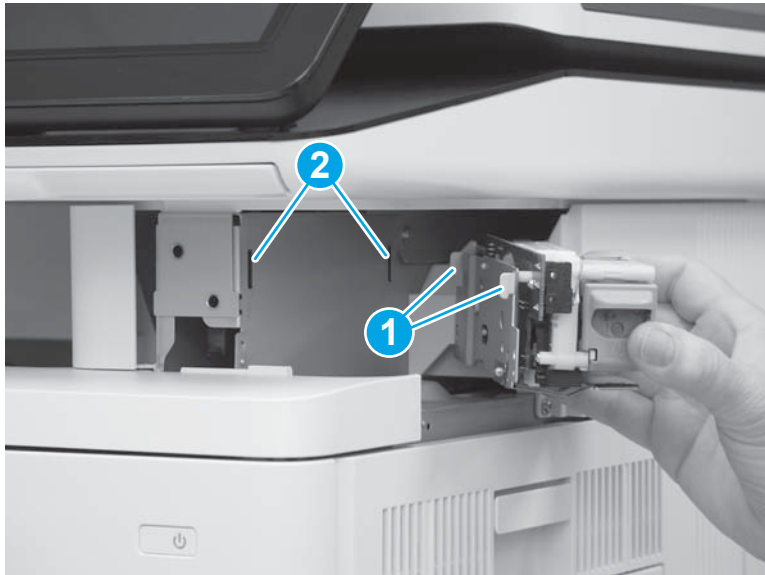

2. Connect one connector (callout 1), and then install two screws (callout 2).

Figure 1-791 Connect connector and install screws

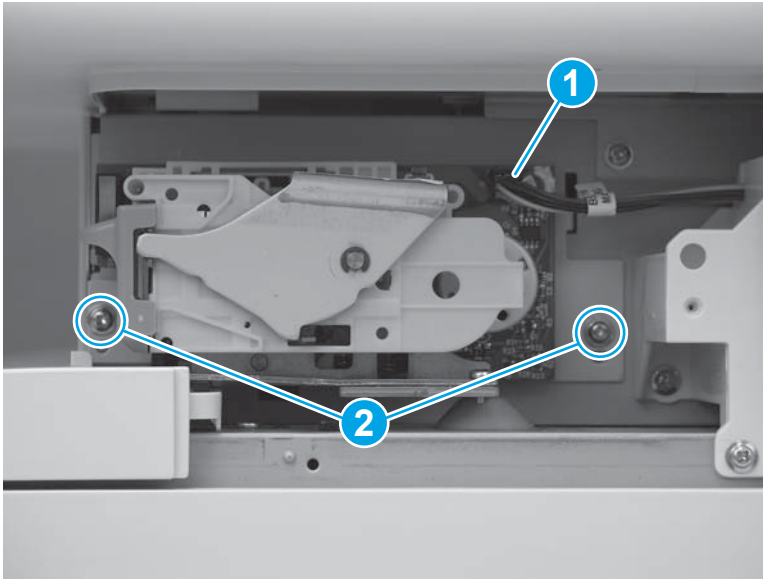

Step 27: Install the integrated scanner assembly (M577)

 **NOTE:** This step is for the M577 models. For the M552 and M553 models, skip this step and go to [Step 31: Install the upper cover \(M552 and M553\) on page 474](#).

 **NOTE:** The ISA includes the document feeder, image scanner, scanner control board (SCB), control panel, keyboard (M577c/z) and NFC PCA (M577z).

1. Before proceeding, locate the mounting pins (callout 1) on the bottom of the ISA and the slots (callout 2) on the printer base.

Figure 1-792 Locate the ISA mounting pins and slots

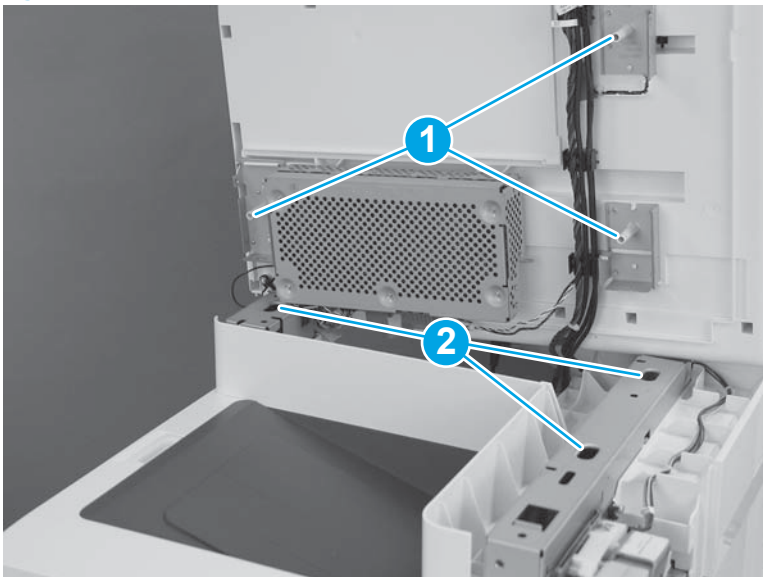

2. Position the ISA on the printer base with the pins in the slots.

 **NOTE:** To locate the pins and slots, see [Figure 1-395 Locate the ISA mounting pins and slots on page 249](#).

Figure 1-793 Install the ISA



3. Slightly slide the ISA towards the front of the printer to engage it.

Figure 1-794 Slide the ISA towards the front of the printer

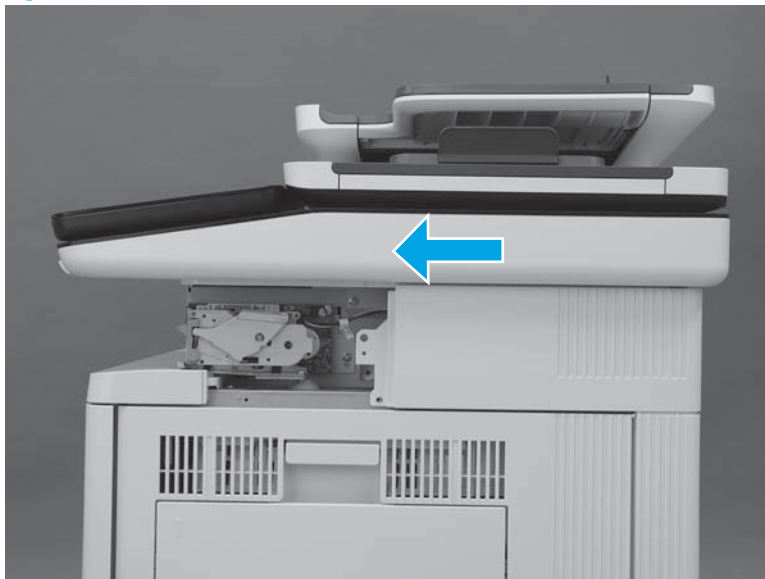

4. At the left side of the printer, install one screw (callout 1).

Figure 1-795 Install one screw

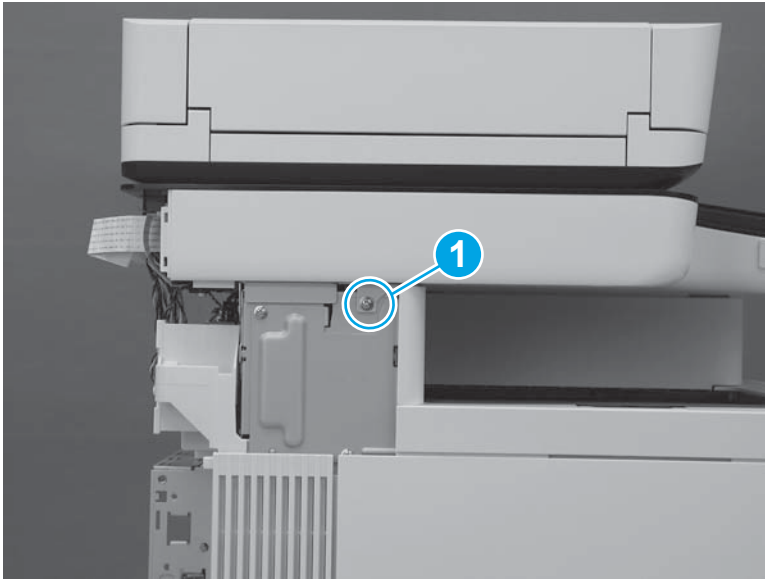

5. At the back of the printer, install two screws (callout 1).

Figure 1-796 Install two screws

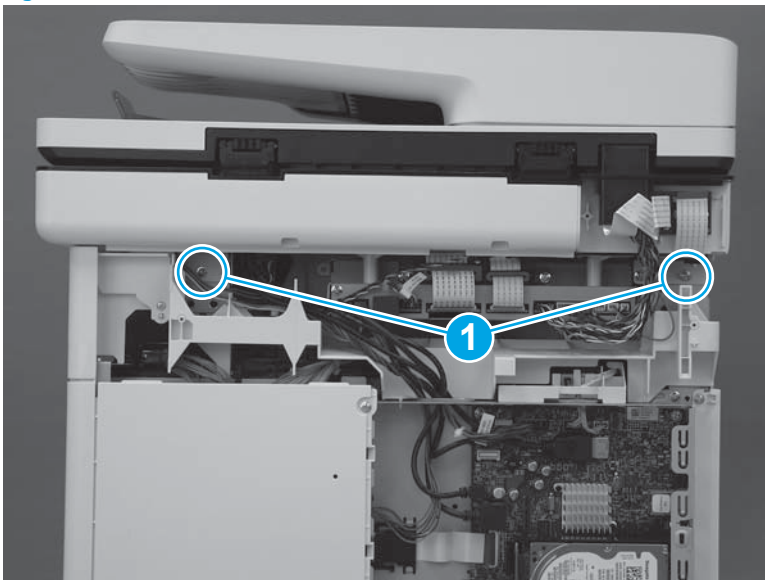

6. At the right side of the printer, install one screw (callout 1).

Figure 1-797 Install one screw

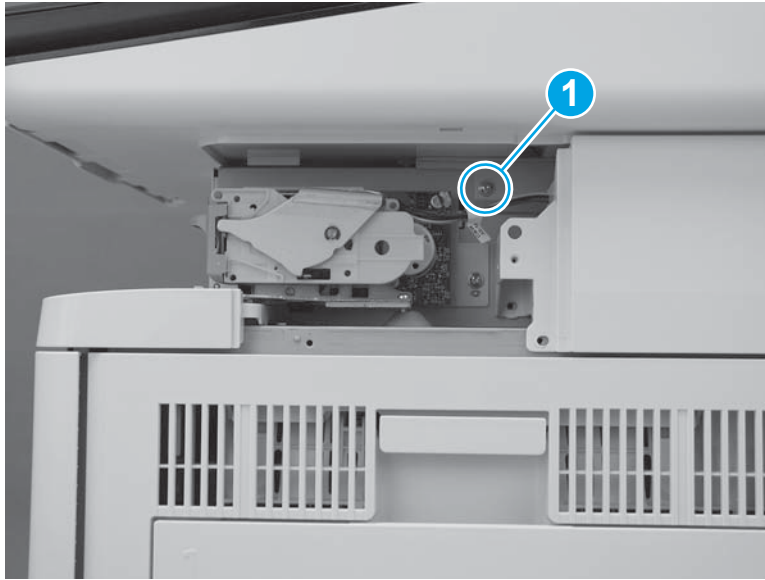

7. Connect two connectors on the scanner control board (callout 1).

M577c/f/z only: Connect one connector for the stapler on the scanner control board (callout 2).

Figure 1-798 Connect connectors

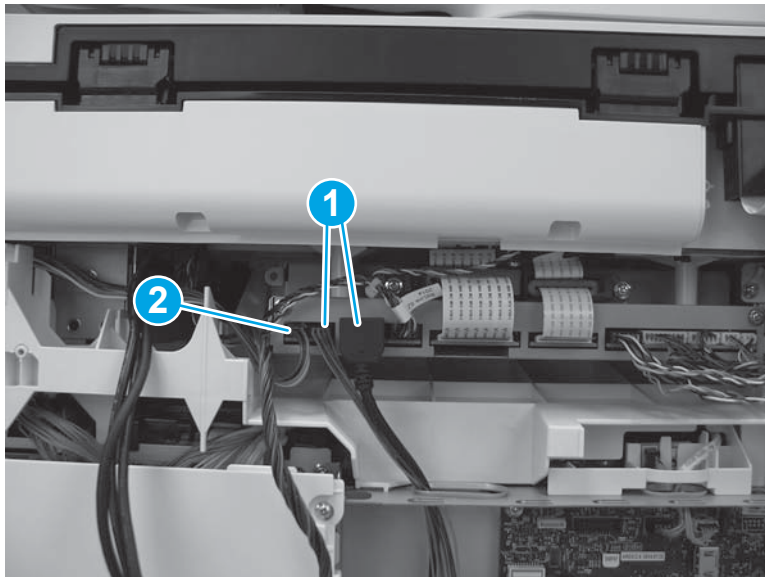

8. Install the wire harness and cables (callout 1) in the retainers (callout 2). Pass them through the opening in the top of the formatter cover (callout 3), and then connect four connectors (callout 4) on the formatter.

Figure 1-799 Connect four connectors

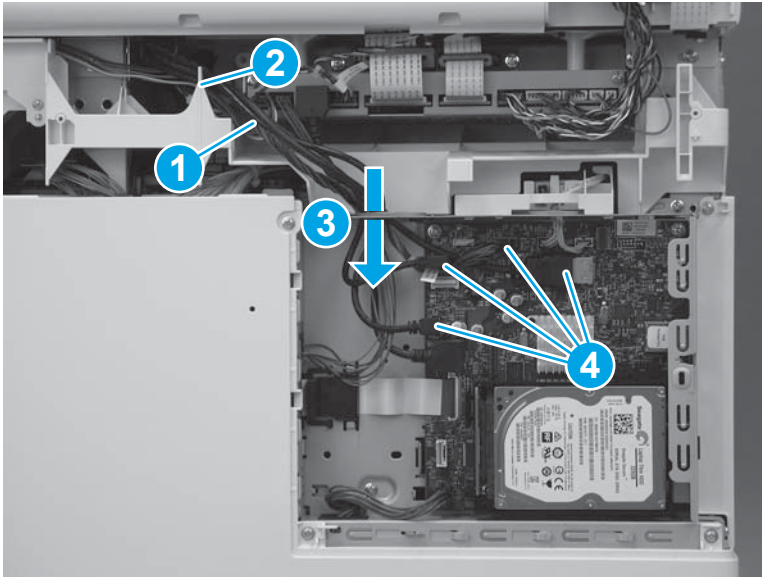

Step 28: Install the stapler cover assembly (M577c/f/z)

 **NOTE:** This step is for the M577c/f/z models only. For the M577dn model, skip this step and go to [Step 29: Install the right front upper cover \(M577dn\) on page 471](#).

For the M552 and M553 models, skip this step and go to [Step 31: Install the upper cover \(M552 and M553\) on page 474](#).

1. Install the tabs (callout 1) on the cover in the slots (callout 2) in the printer.

Figure 1-800 Install two tabs



2. Press the cover toward the left side of the printer until it snaps into place.

Figure 1-801 Install the cover assembly



3. Install one screw (callout 1).



 **IMPORTANT:** This is a self-tapping screw for plastic. Rotate it counterclockwise to align it with the existing thread pattern, and then carefully turn it clockwise to tighten. Do not overtighten. This will prevent stripping the threads inside the screw hole.

Figure 1-802 Install one screw

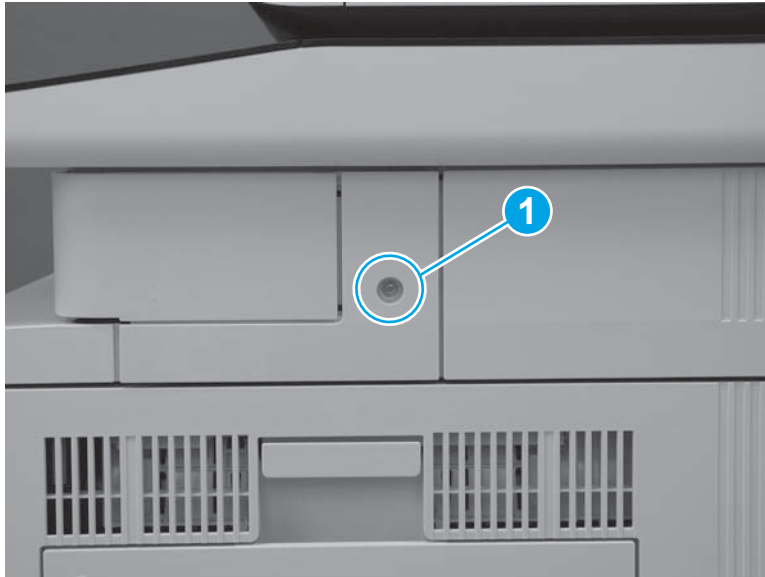

Step 29: Install the right front upper cover (M577dn)

 **NOTE:** This step is for the M577dn model only. For the M577f and M577z models, skip this step and go to [Step 30: Install the left upper cover \(M577\) on page 473](#).

For the M552 and M553 models, skip this step and go to [Step 31: Install the upper cover \(M552 and M553\) on page 474](#).

1. Slide the cover toward the left side of the printer to install it. Make sure that the slots (callout 1) in the cover fit over the tabs (callout 2) on the inside of the paper feeder cover.

Figure 1-803 Install the cover



2. Press the right front upper cover (callout 1) and the paper feeder cover (callout 2) together until the tabs on the inside of the covers snap into place.

Figure 1-804 Press the cover



3. Install one screw (callout 1).

Figure 1-805 Install one screw

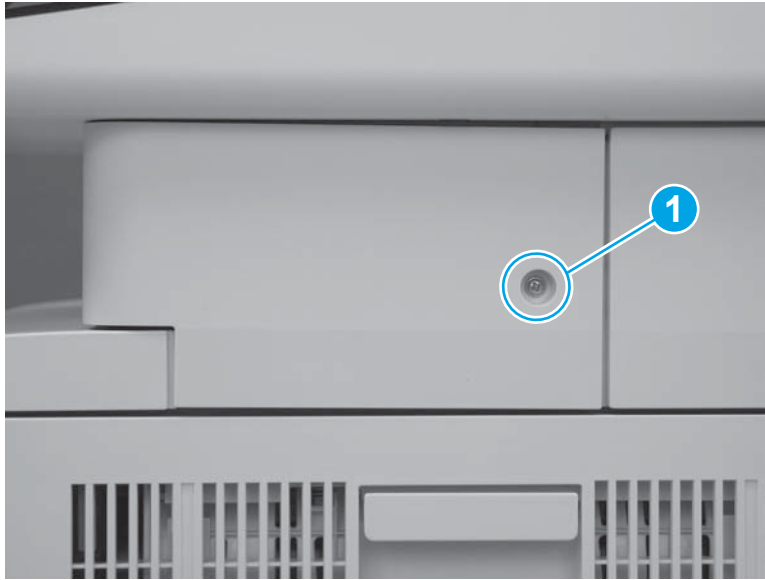

Step 30: Install the left upper cover (M577)

 **NOTE:** This step is for the M577 models. For the M552 and M553 models, skip this step and go to [Step 31: Install the upper cover \(M552 and M553\) on page 474](#).

1. Position the tab (callout 1) on the lower edge of the cover behind the left cover (callout 2).

Figure 1-806 Position the tab

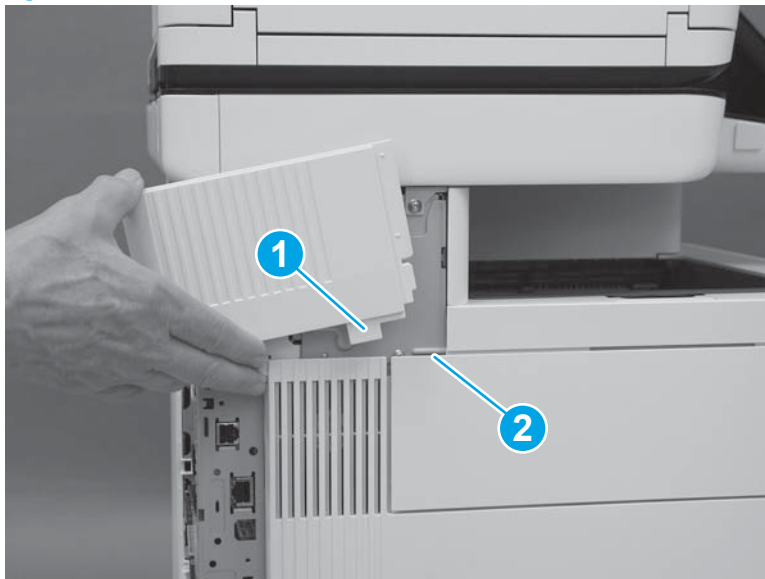

2. Slide the cover toward the front of the printer to install it. Make sure that the edge (callout 1) of the cover fits behind the edge (callout 2) of the top rear cover.

Figure 1-807 Slide the cover

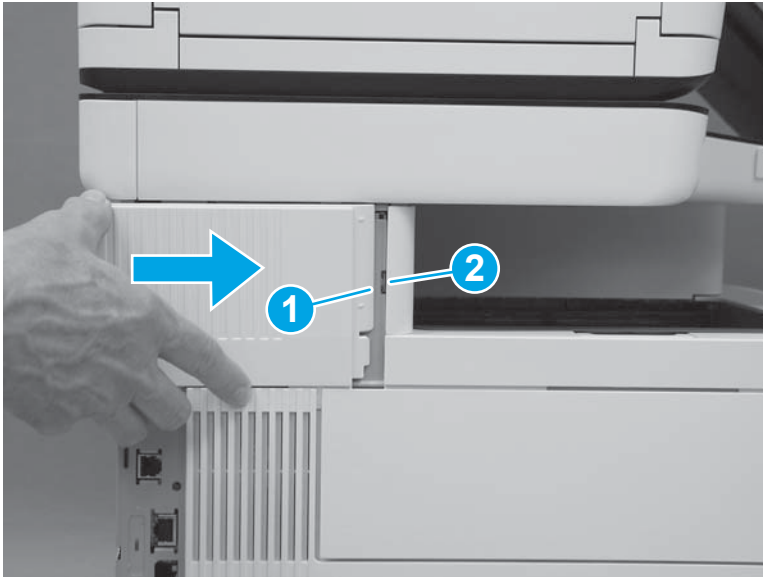

3. Make sure that the tab (callout 1) is fully installed.

Figure 1-808 Check the tab

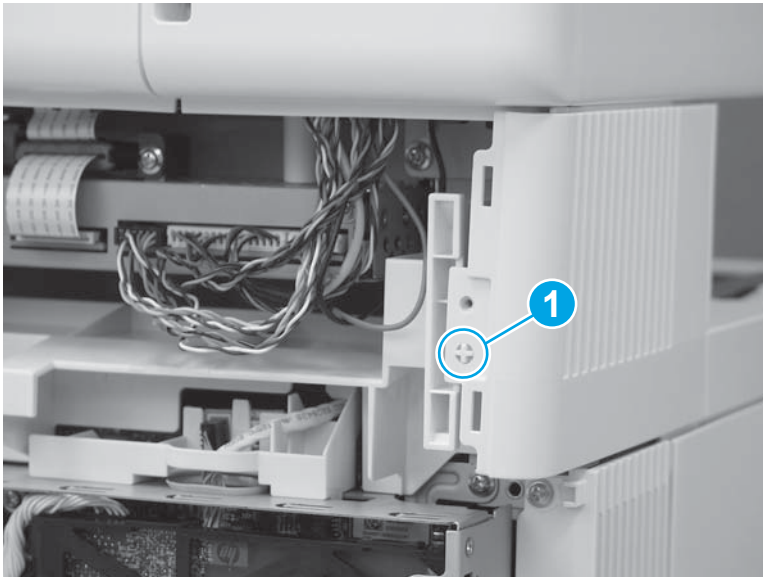

Step 31: Install the upper cover (M552 and M553)

 **NOTE:** This step is for the M552 and M553 models. For the M577 models, skip this step and go to [Step 32: Install the left cover on page 476](#).

1. Position the cover on the printer.

 **NOTE:** For the M553x model, do not forget to pass the control-panel wire harness and USB cable through the opening in the cover.

Figure 1-809 Install the cover



2. Push down on the rear corner of the cover to engage one tab (callout 1).

Figure 1-810 Engage one tab

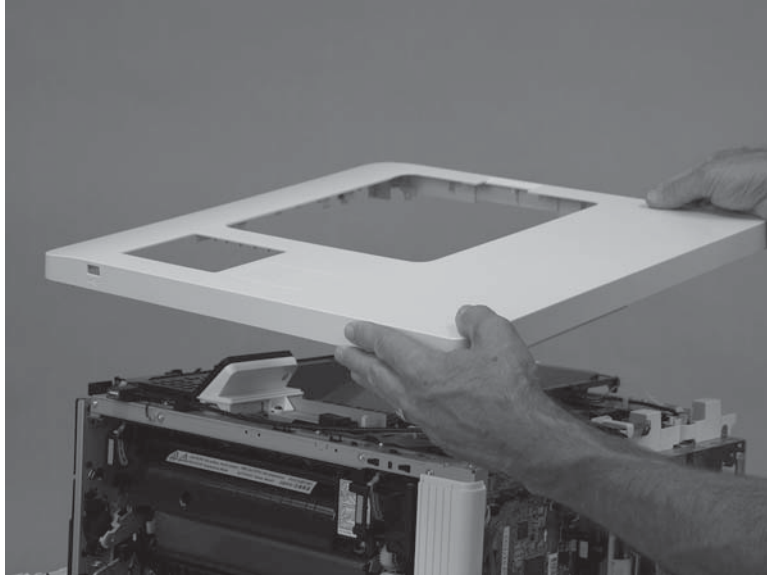
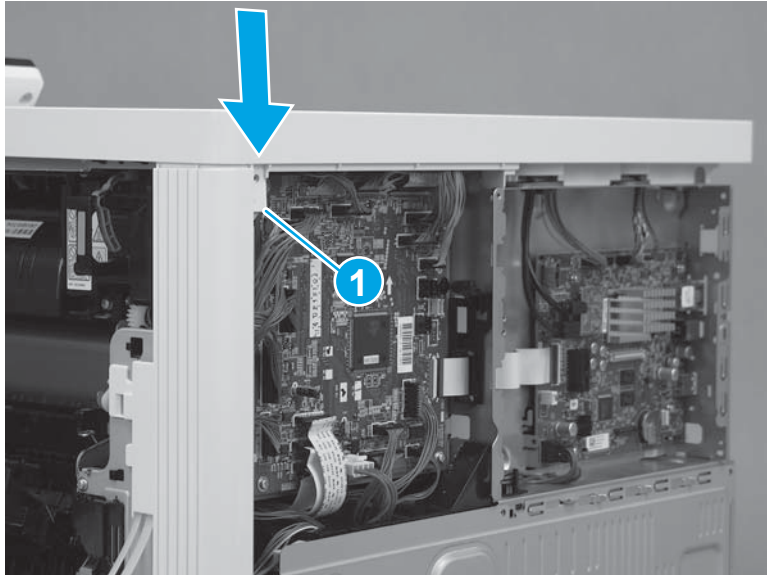

3. Push down on the front corner of the cover to engage one tab (callout 1), and then install one screw (callout 2).

 **NOTE:** This is a self-tapping plastic-thread screw. Make sure that this screw is used in this location when it is reinstalled.

Figure 1-811 Engage one tab and install one screw



4. Install three screws (callout 1).

Figure 1-812 Install three screws

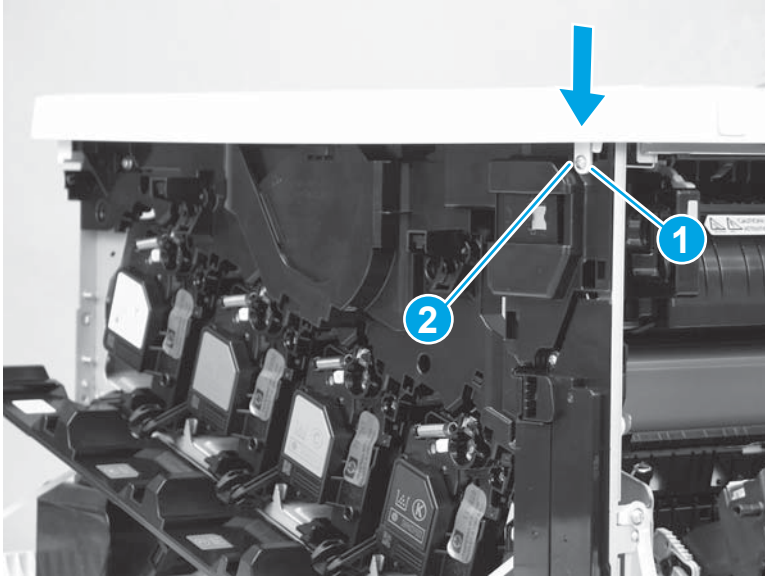
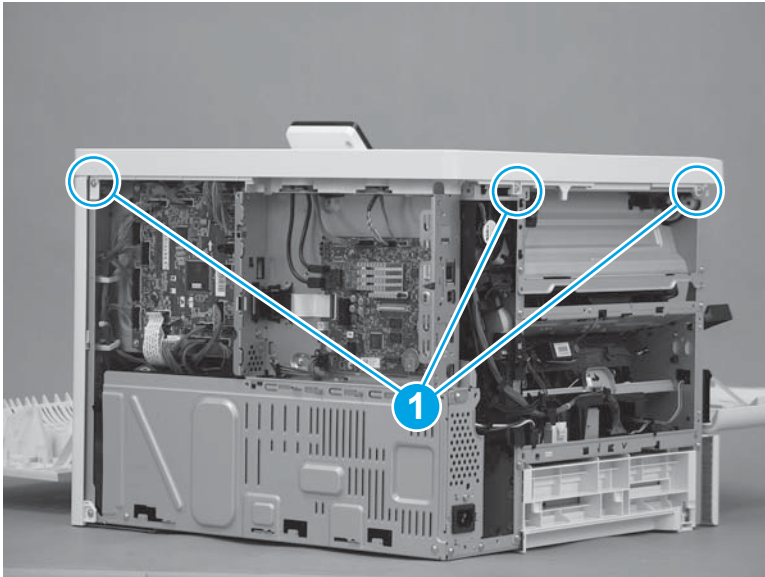

Step 32: Install the left cover

1. Position the cover on the printer.

 **NOTE:** Slightly offset the cover toward the rear of the printer.

Figure 1-813 Install the cover

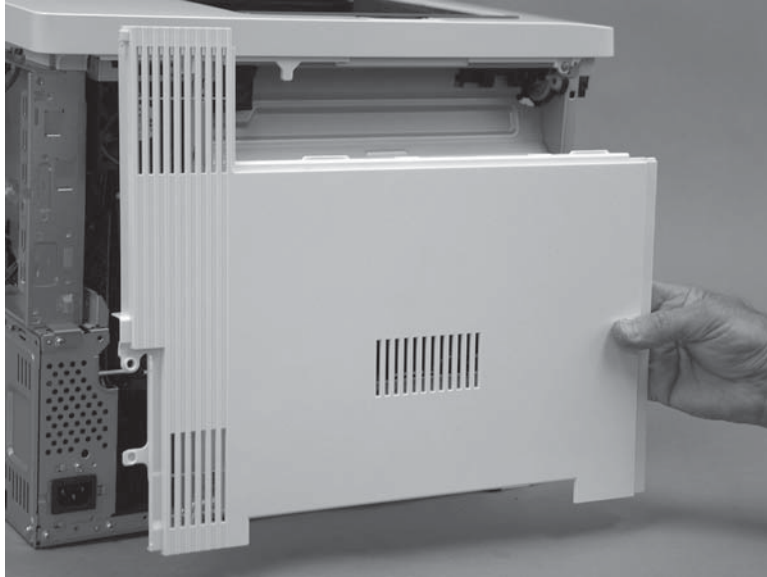

2. Slide the cover (callout 1) toward the front of the printer to engage it. Make sure that the tab (callout 2) snaps into place.

 **NOTE:** Locate the alignment pin (callout 3) on the cover from the front door side of the printer, and then make sure that it is fully engaged in the slot in the chassis.

 **TIP:** While sliding the cover into place, push in on the center of the cover (callout 1) to make sure that the hooks on the back of the cover engage with the slots in the chassis.

Figure 1-814 Engage the cover

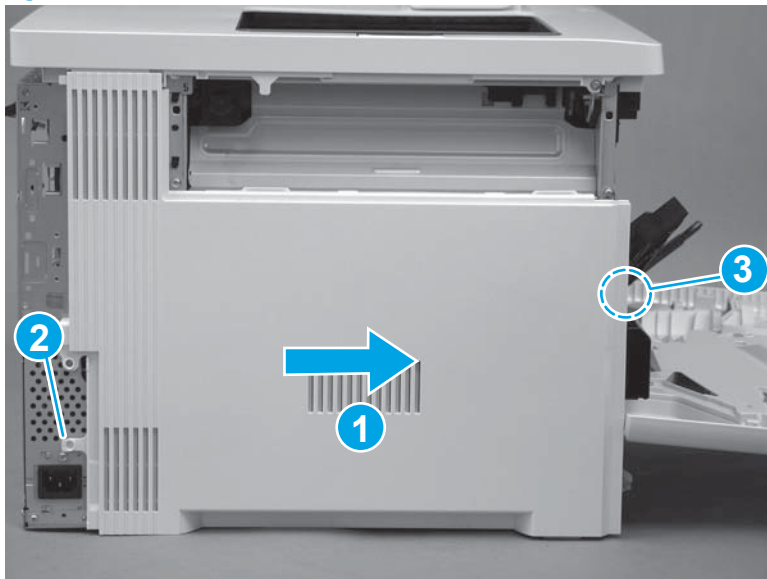

3. At the left side of the printer, install one screw (callout 1).

Figure 1-815 Install one screw



Step 33: Install the rear cover (M577)



NOTE: This step is for the M577 models. For the M552 and M553 models, skip this step and go to [Step 35: Install the rear cover \(M552 and M553\) on page 481](#).

1. Position the hooks (callout 1) on the cover in the slots (callout 2) in the printer.

Figure 1-816 Position the hooks

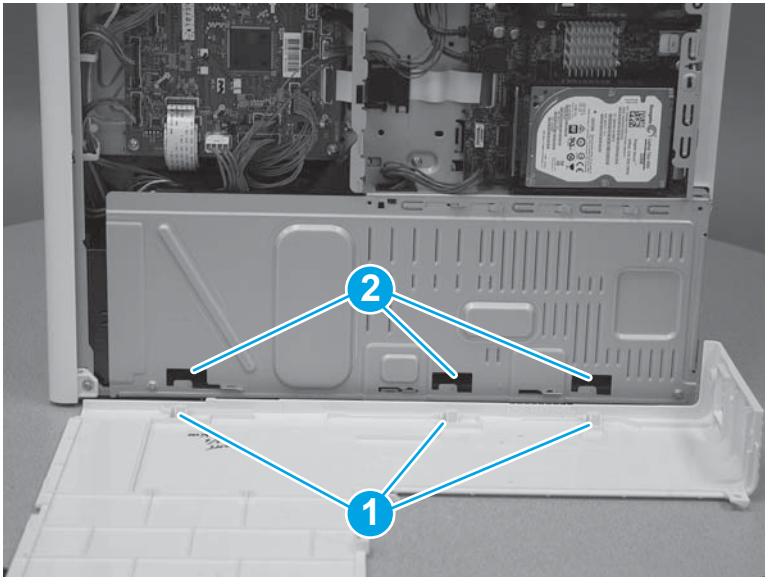

2. Position the back edge (callout 1) of the rear cover behind the edge (callout 2) of the right rear cover. Slide the cover to the left to install it.

Figure 1-817 Install the cover

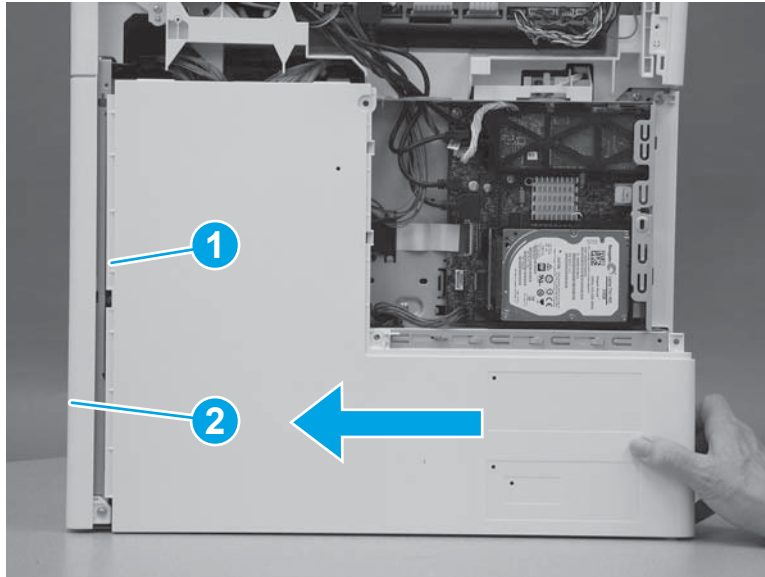

3. Install four screws (callout 1).

Figure 1-818 Install four screws cover

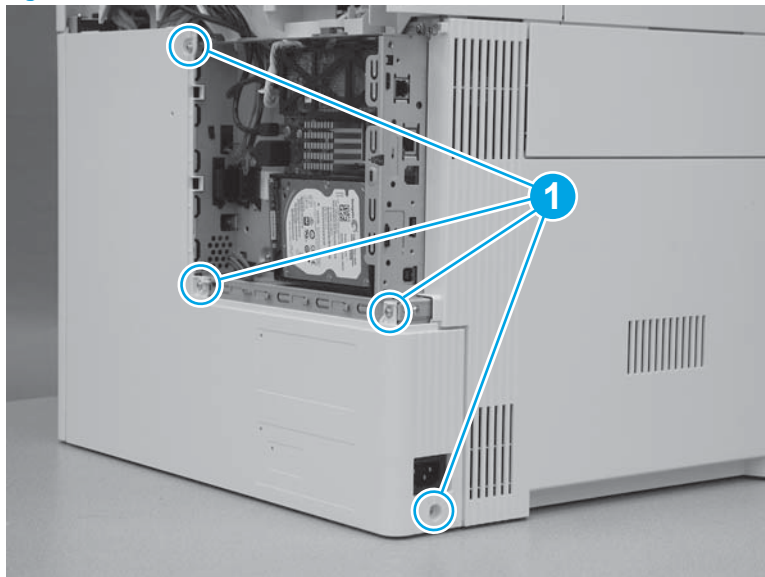

Step 34: Install the rear upper cover (M577)

 **NOTE:** This step is for the M577 models. For the M552 and M553 models, skip this step and go to [Step 35: Install the rear cover \(M552 and M553\) on page 481](#).

1. Align the ridge (callout 1) on the lower edge of the rear upper cover in front of the tabs (callout 2) on the top edge of the rear cover.

Figure 1-819 Align the cover

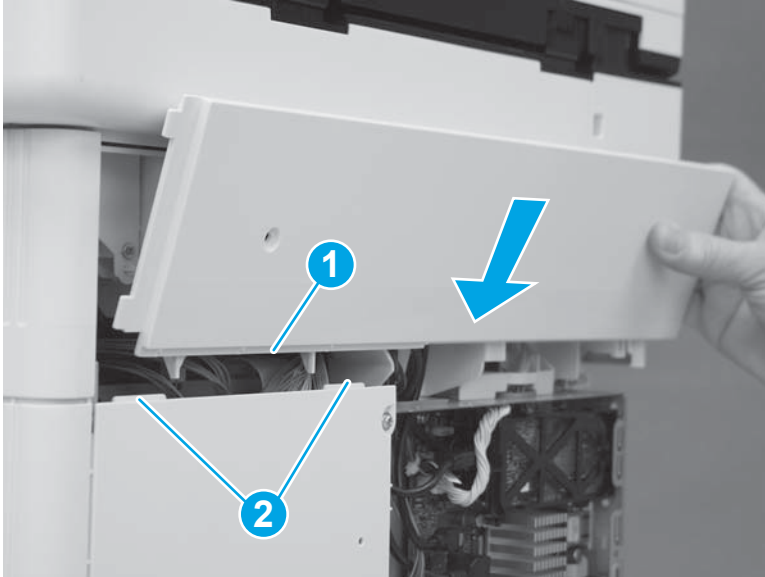

2. Rotate the top of the cover toward the printer.

Figure 1-820 Rotate the top of the cover

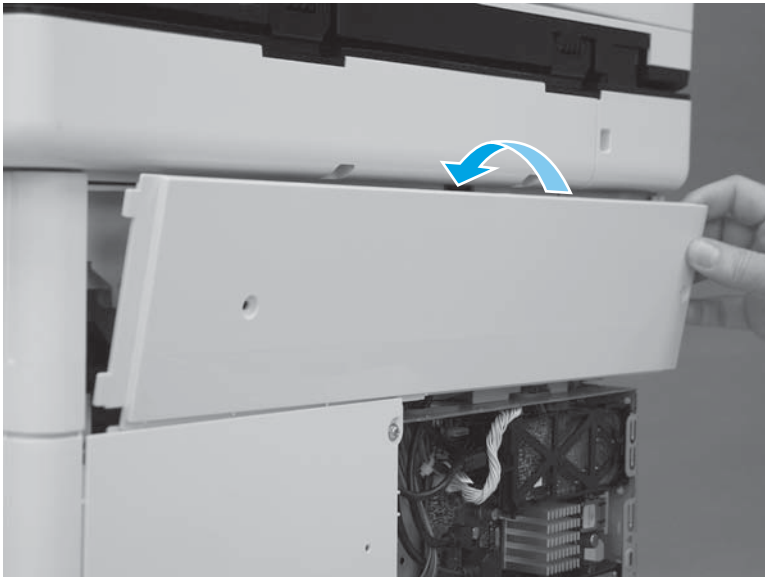

3. Slide the cover to the left (callout 1). Make sure that the tabs (callout 2) on the upper rear cover slide behind the edge (callout 3) of the right upper cover. Make sure that the cover is fully seated.

Figure 1-821 Slide the cover

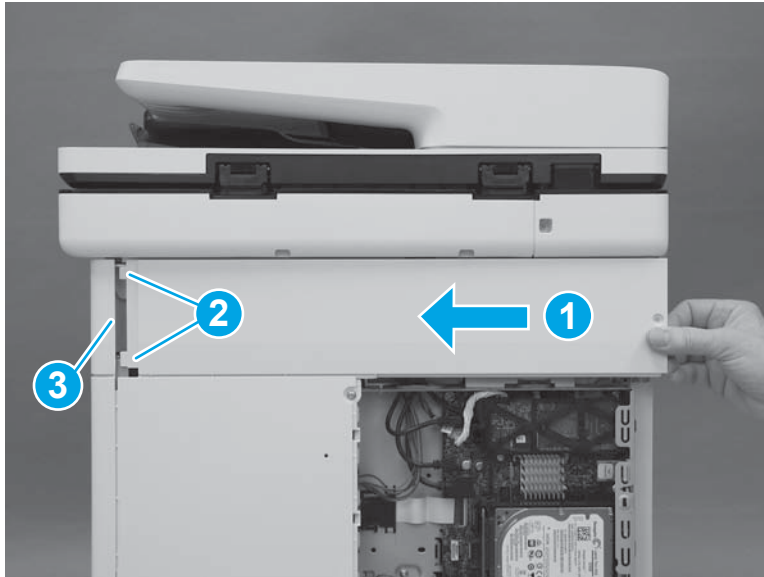

4. Install two screws (callout 1).



 **IMPORTANT:** These two screws are self-tapping screws for plastic. Rotate them counterclockwise to align them with the existing thread pattern, and then carefully turn them clockwise to tighten. Do not overtighten. This will prevent stripping the threads inside the screw holes.

Figure 1-822 Install two screws

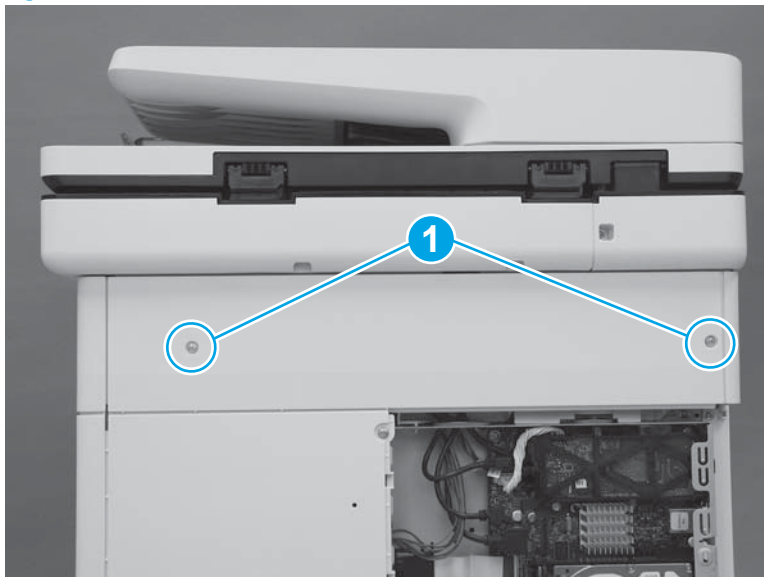

Step 35: Install the rear cover (M552 and M553)

 **NOTE:** This step is for the M552 and M553 models. For the M577 models, skip this step and go to [Step 38: Install the toner collection unit \(TCU\) on page 486](#).

1. Position the top of the cover under the upper cover (callout 1), rotate the bottom of the cover onto the chassis (callout 2), and then slide the cover to the left (callout 3) to install it.

Figure 1-823 Install the cover

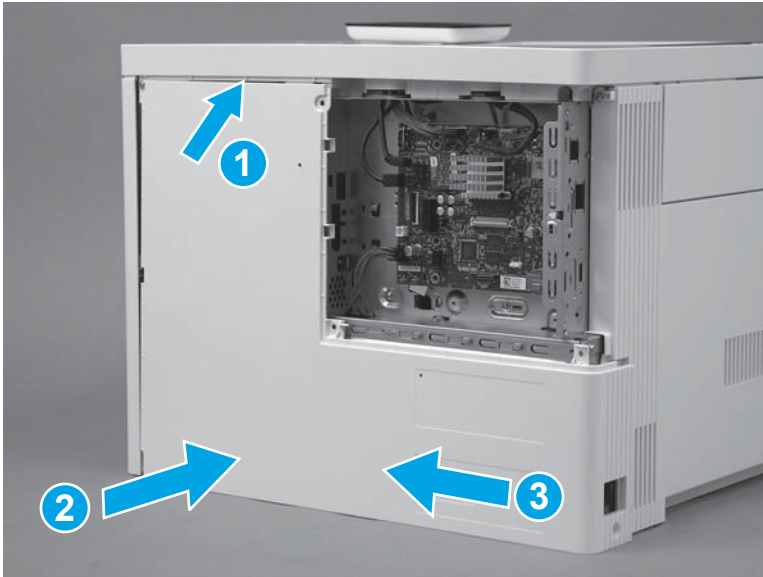

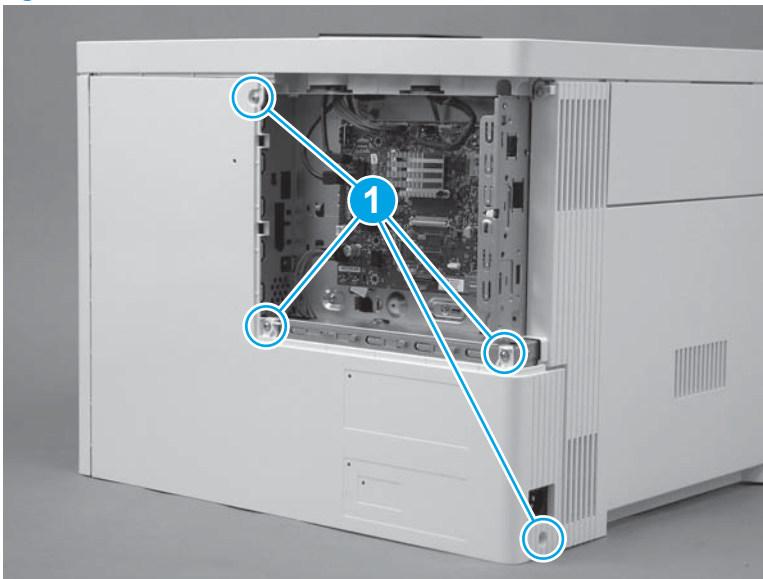

2. Install four screws (callout 1).

Figure 1-824 Install four screws cover



Step 36: Install the control-panel assembly (M553x only)

 **NOTE:** This step is for the M553x model. For the M553n/dn and M552dn models, skip this step and go to [Step 37: Install the USB cover \(M552 and M553\) on page 485](#).

 **NOTE:** For the M577 models, skip this step and go to [Step 38: Install the toner collection unit \(TCU\) on page 486](#).

1. Place the control panel on the printer as shown.

Figure 1-825 Place the control panel on the product

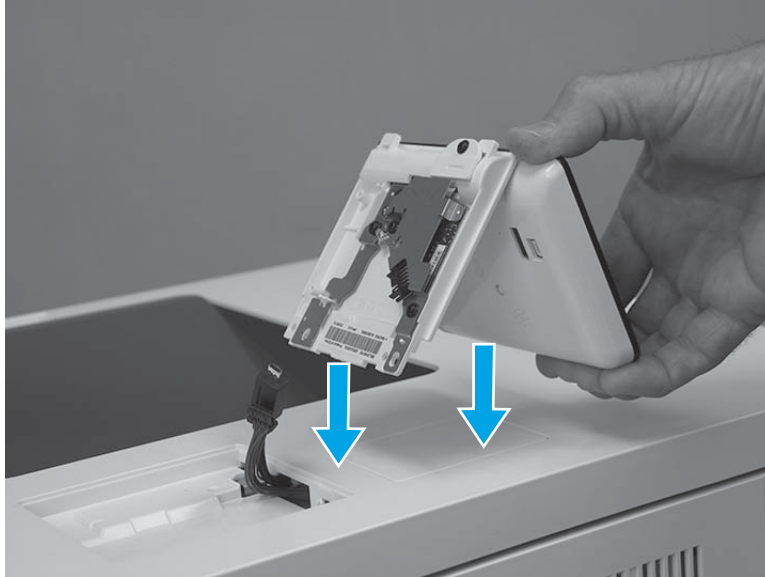

2. Connect one USB cable (callout 1), and one connector (callout 2).

 **IMPORTANT:** Take note of the location of the two mounting tabs (callout 3) on the control-panel assembly.

Figure 1-826 Connect two connectors



3. Turn the control panel over, and then position the front edge tabs in the slots in the top cover.

Figure 1-827 Turn the control panel over

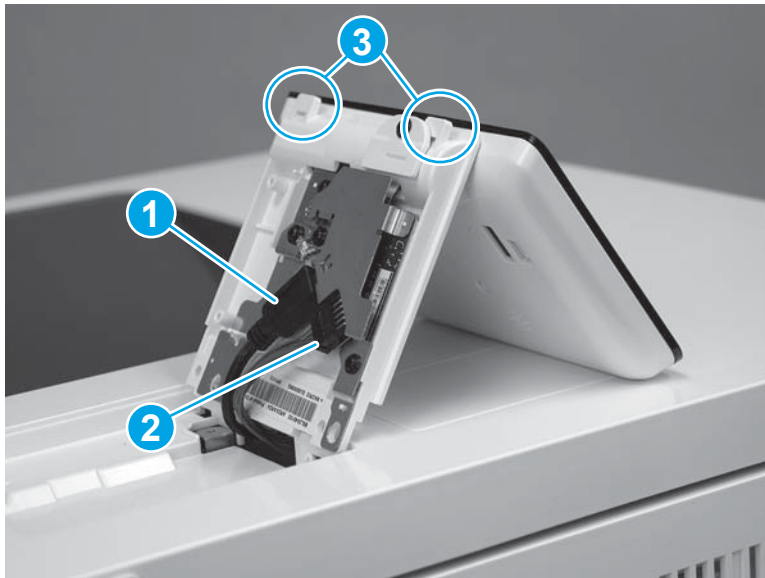
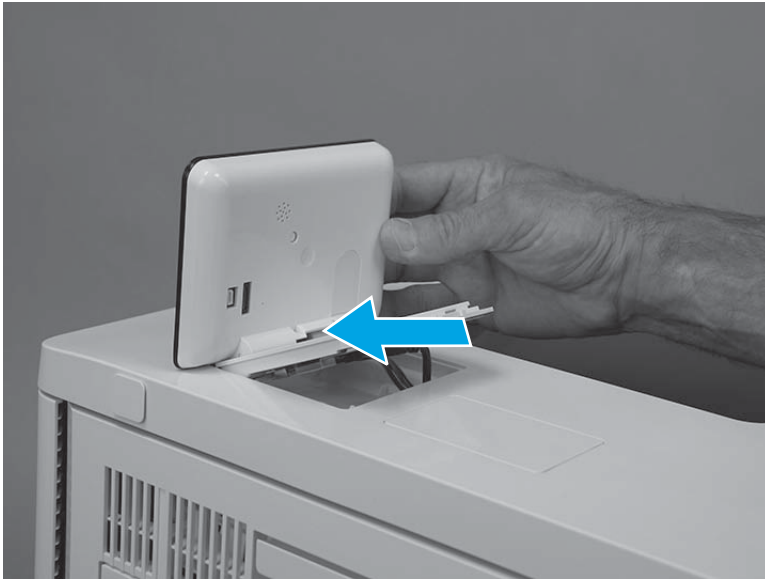

4. Rotate the control-panel base down onto the printer.

Figure 1-828 Rotate the control-panel base down



5. Use a small Phillips screwdriver to install two screws (callout 1).

Figure 1-829 Install two screws

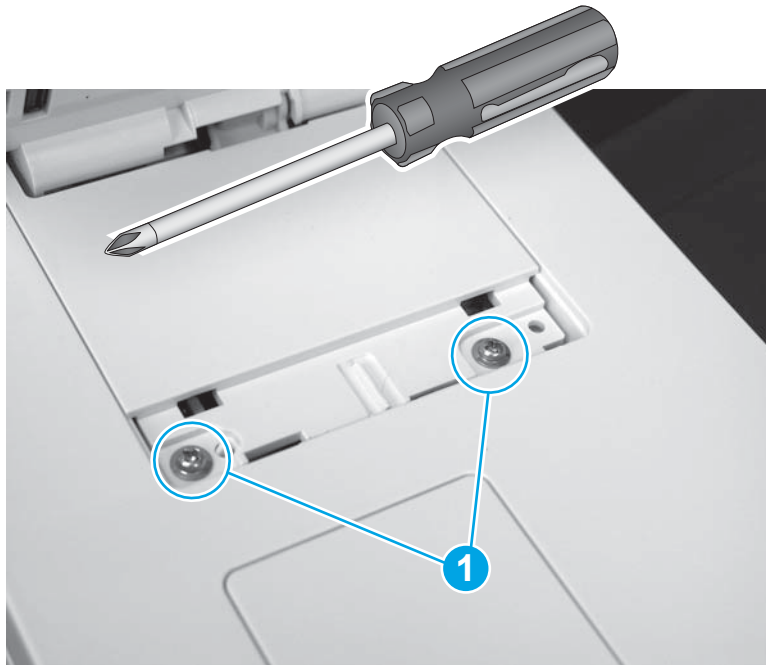

6. Position the screw cover mounting feet into the slots in the top cover (callout 1), and then rotate the cover down (callout 2) to install it.



 **NOTE:** Press down on the cover firmly to make sure that the tabs on the cover (callout 3) snap into place.

Figure 1-830 Install the cover

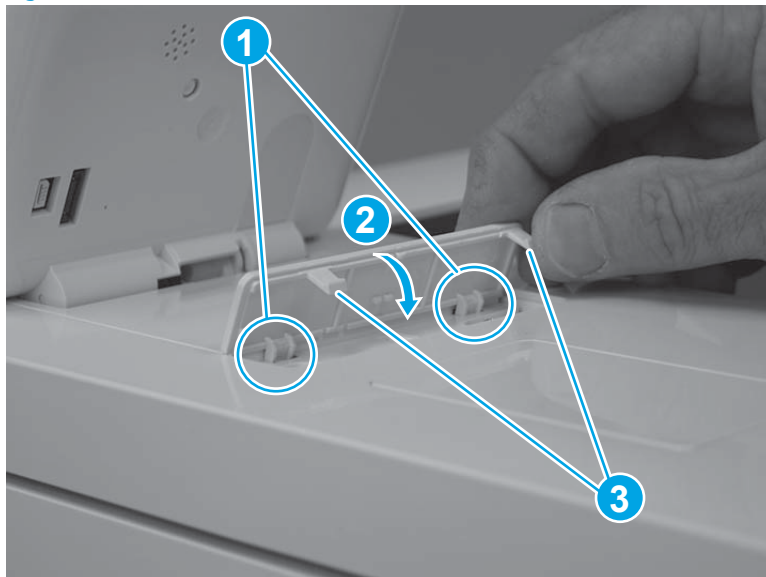

Step 37: Install the USB cover (M552 and M553)

 **NOTE:** This step is for the M552 and M553 models. For the M577 models, skip this step and go to [Step 38: Install the toner collection unit \(TCU\) on page 486.](#)

1. Push the cover into the USB port to install it.

Figure 1-831 Install the cover



2. Make sure that the USB cover is fully seated after installing it.

Figure 1-832 Check the installation

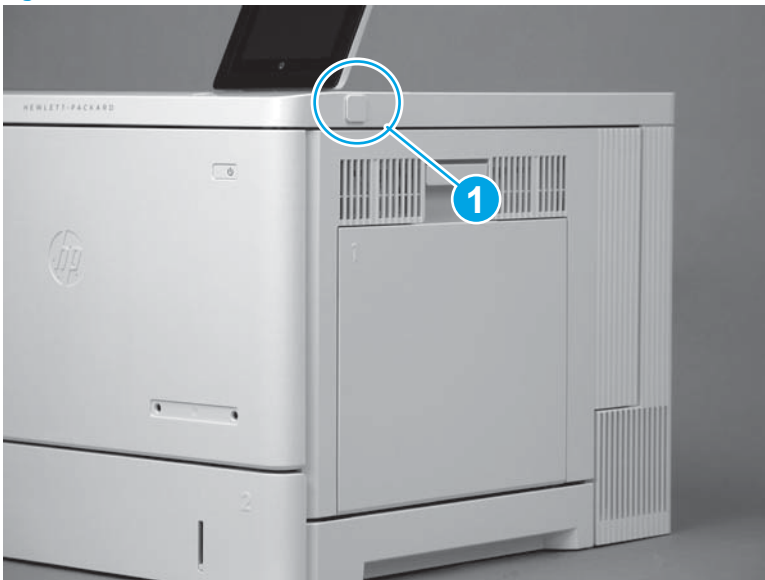

Step 38: Install the toner collection unit (TCU)

1. Verify that the toner collection hatch cover is in the closed position on the TCU.

Figure 1-833 Verify that the toner collection hatch cover is closed

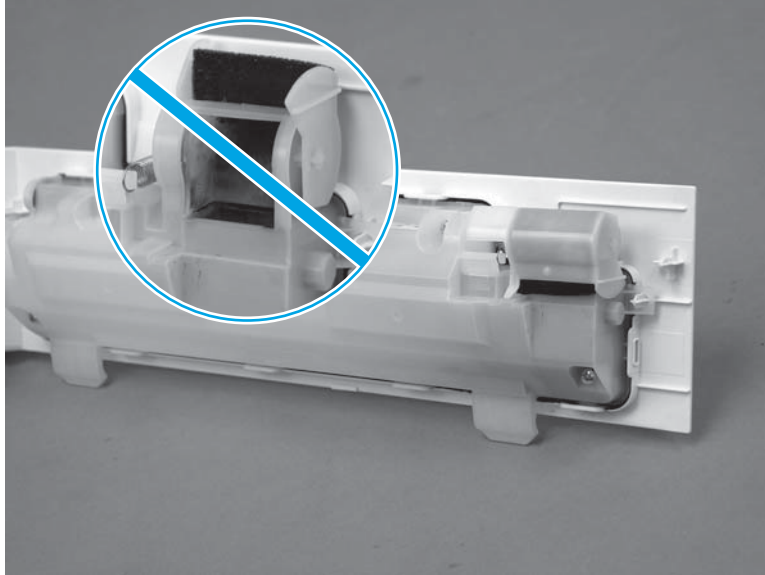

2. Position the TCU with the hinges in the slots provided in the printer (callout 1), and then rotate the TCU up and into the closed position.

 **NOTE:** The toner collection hatch cover automatically opens when the TCU is closed.

Figure 1-834 Install the TCU

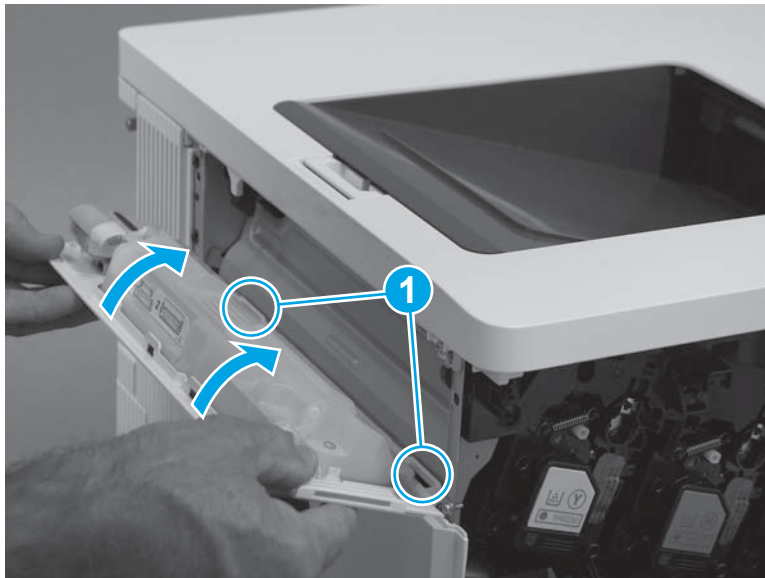

3. Close the front door.

Figure 1-835 Close the front door



Step 39: Install the formatter cover

- ▲ Slide the cover onto the printer (callout 1) to install it.

 **NOTE:** Make sure that the tabs on the formatter cover align with the slots provided in the printer (callout 2). Tighten the two thumbscrews (callout 3).

 **TIP:** If needed, use the edge of a coin to turn the thumbscrews.

Figure 1-836 Install the cover

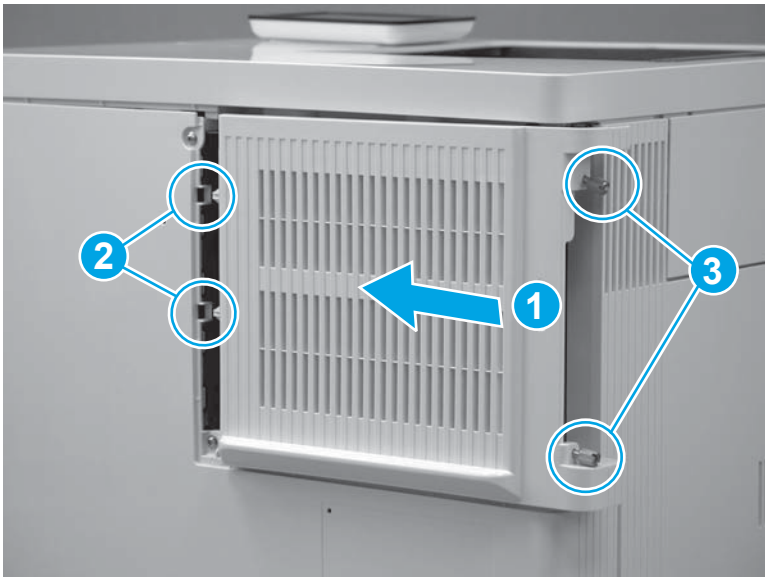

Removal and replacement: Right rear cover (M552 and M553)

- [Introduction](#)
- [Step 1: Remove the USB cover](#)
- [Step 2: Remove the control panel \(M553x only\)](#)
- [Step 3: Remove the toner collection unit \(TCU\)](#)
- [Step 4: Remove the formatter cover](#)
- [Step 5: Remove the rear cover](#)
- [Step 6: Remove the left cover](#)
- [Step 7: Remove the upper cover](#)
- [Step 8: Remove the right rear cover](#)
- [Step 9: Unpack the replacement assembly](#)
- [Step 10: Install the right rear cover](#)
- [Step 11: Install the upper cover](#)
- [Step 12: Install the left cover](#)
- [Step 13: Install the rear cover](#)
- [Step 14: Install the formatter cover](#)
- [Step 15: Install the TCU](#)
- [Step 16: Install the control-panel assembly \(M553x only\)](#)
- [Step 17: Install the USB cover](#)

Introduction

This document provides the procedures to remove and replace the right rear cover.

Before performing service

Turn the printer power off

- Disconnect the power cable.

⚠ WARNING! To avoid damage to the printer, turn the printer off, wait 30 seconds, and then remove the power cord before attempting to service the printer.

- Open the right door.

Use the table below to identify the correct part number for your printer, and then go to <http://h20141.www2.hp.com/hpparts> to order the part.

Right rear cover part number	
RC4-0178-000CN	Right rear cover

Required tools

- #2 Phillips screwdriver with a magnetic tip

After performing service

Make sure that the USB cover is fully seated after replacing it.

Make sure that the TCU is fully closed after replacing it.

Make sure that the formatter cover is fully seated, and that the thumbscrews are finger tight after replacing it.

Make sure that the output bin is flat against the chassis after replacing it.

Turn the printer power on

- Connect the power cable.
- Use the power switch to turn the power on.

Step 1: Remove the USB cover

1. Locate the USB cover.

Figure 1-837 Locate the USB cover

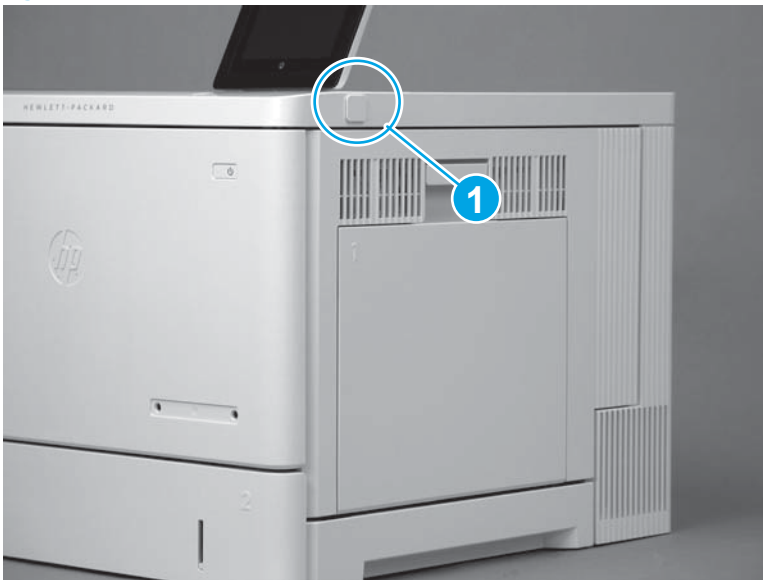

2. Pull the cover off of the printer to remove it.

Figure 1-838 Remove the cover



Step 2: Remove the control panel (M553x only)

 **NOTE:** For the M553n/dn and M552dn models, skip this step and go to [Step 3: Remove the toner collection unit \(TCU\) on page 495](#).

1. Tilt the control panel up.

Figure 1-839 Tilt the control panel up



2. Use a small flat-blade screwdriver to release the control-panel screws cover tabs.

Figure 1-840 Release the control-panel screws cover tabs



3. Rotate the cover up to remove it.

Figure 1-841 Remove the cover



4. Use a small Phillips screwdriver to remove two screws (callout 1).

 **IMPORTANT:** Store the screws in a secure place where they cannot fall down into the printer.

Figure 1-842 Remove two screws

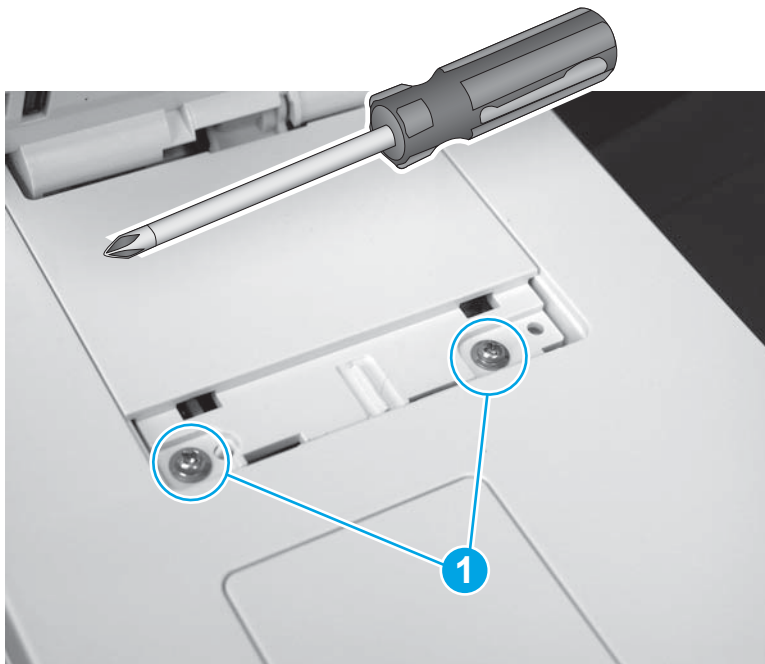

5. Rotate the control-panel base toward the front of the printer.

Figure 1-843 Rotate the control-panel base up



6. Slightly slide the control-panel base toward the rear of the printer (callout 1) to release it, and then turn the control panel over (callout 2) to access the bottom side.

⚠ CAUTION: The control panel is still attached to the printer. Do not attempt to completely remove the control panel.

Figure 1-844 Turn the control panel over

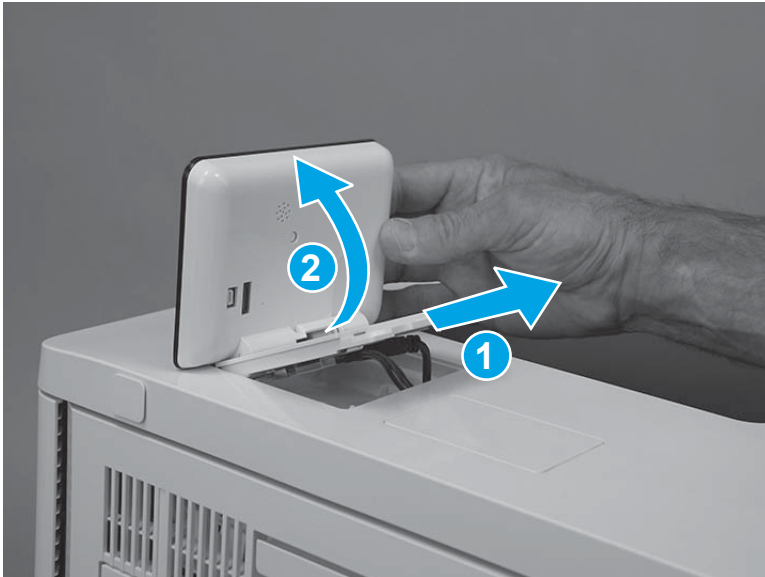

7. Disconnect one USB cable (callout 1), one connector (callout 2), and then remove the control panel.

Figure 1-845 Disconnect two connectors

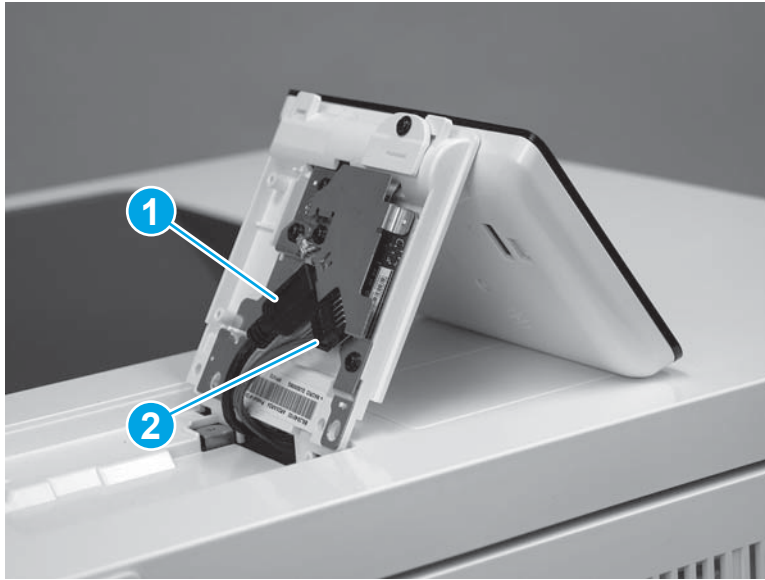

Step 3: Remove the toner collection unit (TCU)

1. Open the front door.

Figure 1-846 Open the front door



2. Open the TCU.

 **NOTE:** The toner collection hatch cover automatically closes when the TCU is opened.

Figure 1-847 Open the TCU



3. Pull the TCU away from the printer at an angle to remove it.

⚠ CAUTION: Do not open the toner collection hatch cover when handling the TCU. If toner gets on clothing, wipe it off by using a dry cloth and wash the clothes in cold water. Hot water sets toner into fabric.

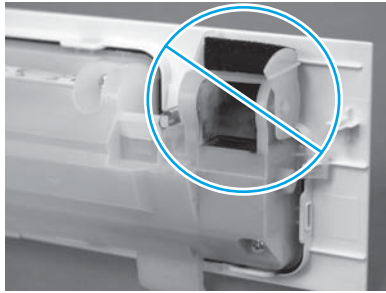
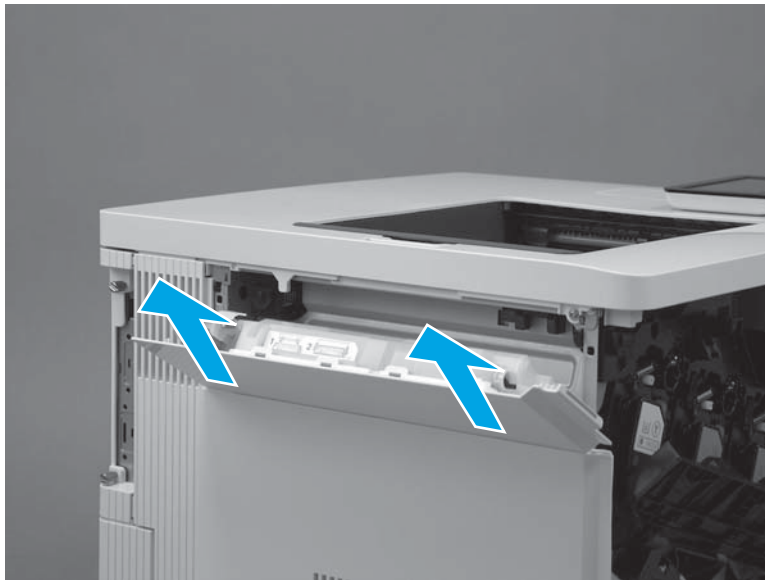

Figure 1-848 Remove the TCU



Step 4: Remove the formatter cover

1. Locate the formatter cover.

Figure 1-849 Locate the formatter cover

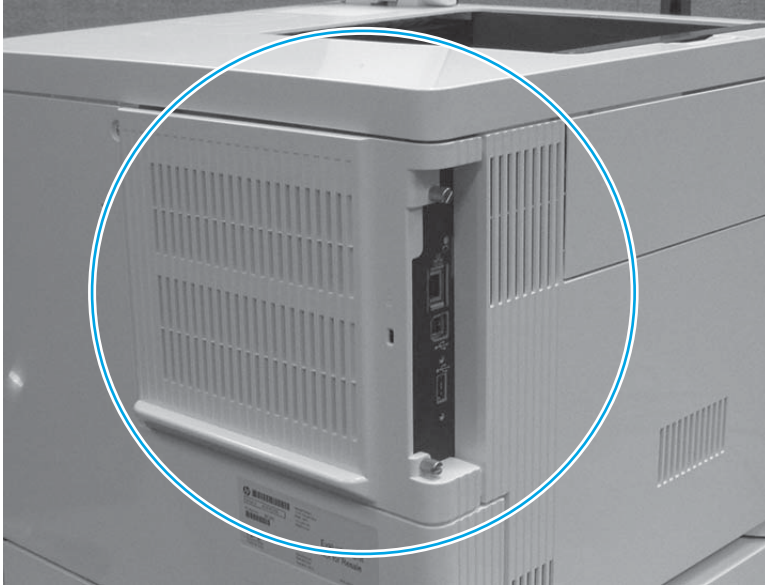

2. Loosen the two thumbscrews (callout 1). Grasp the two thumbscrews, and then slide the cover away from the printer (callout 2) to remove it.

 **TIP:** If needed, use the edge of a coin to turn the thumbscrews.

Figure 1-850 Loosen the thumbscrews

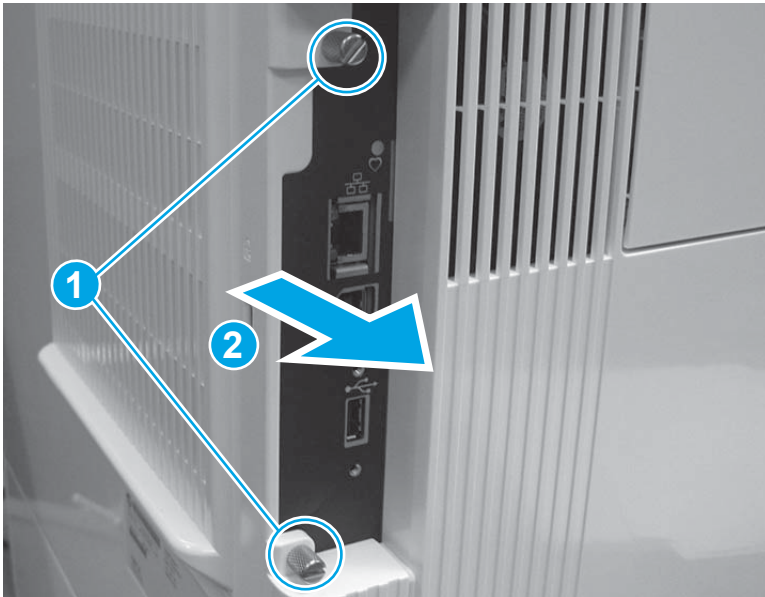

Step 5: Remove the rear cover

1. Remove four screws (callout 1).

Figure 1-851 Remove four screws

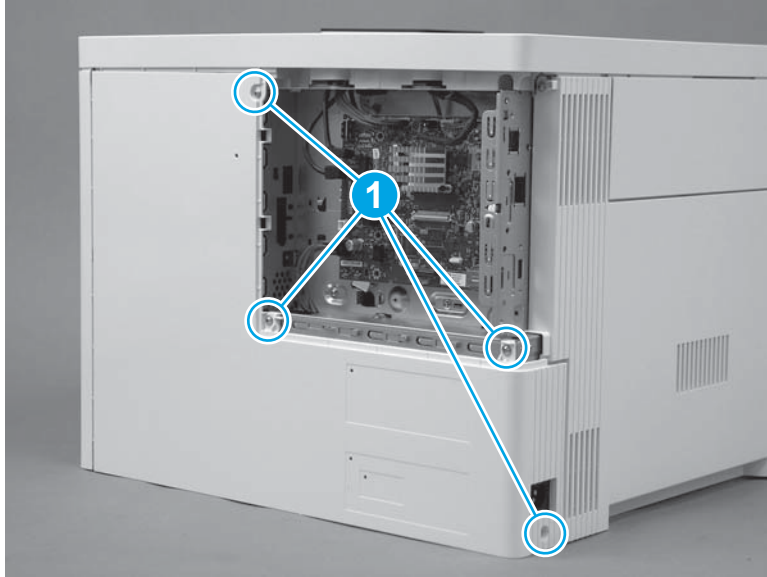

2. Slightly slide the cover to the right (callout 1), rotate the bottom of the cover away from the printer (callout 2), and then pull the top of the cover away from the printer (callout 3) to remove the cover.

Figure 1-852 Remove the cover

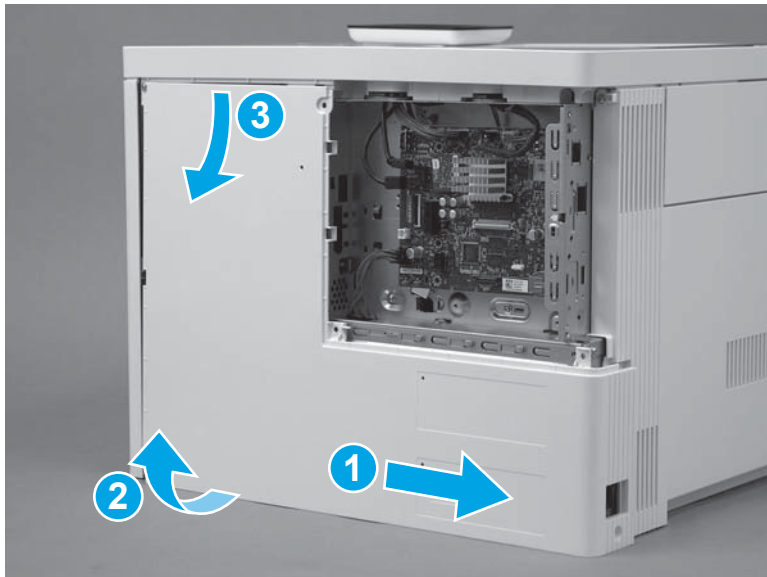

Step 6: Remove the left cover

1. At the left side of the printer, remove one screw (callout 1).

Figure 1-853 Remove one screw



2. Release one tab (callout 1), rotate the front edge of the cover away from the printer (callout 2), and then slide the cover (callout 3) toward the rear of the printer to release it.

Figure 1-854 Release the cover

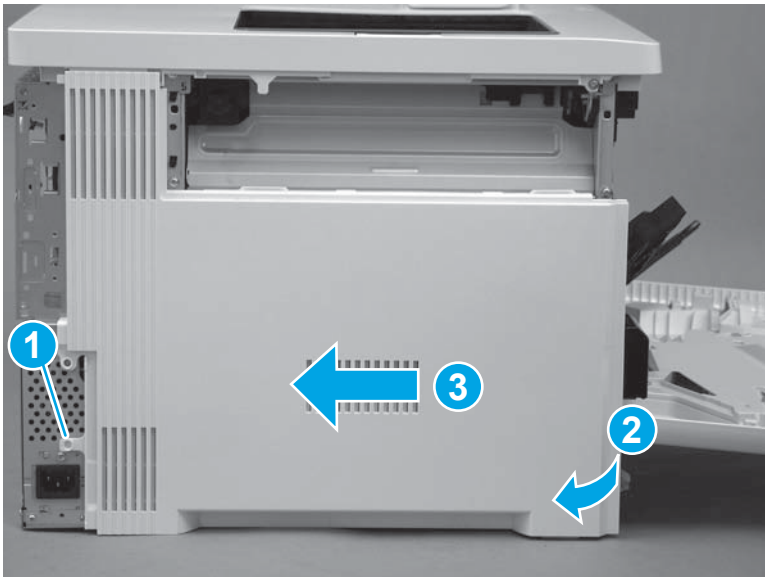

3. Remove the cover.

Figure 1-855 Remove the cover

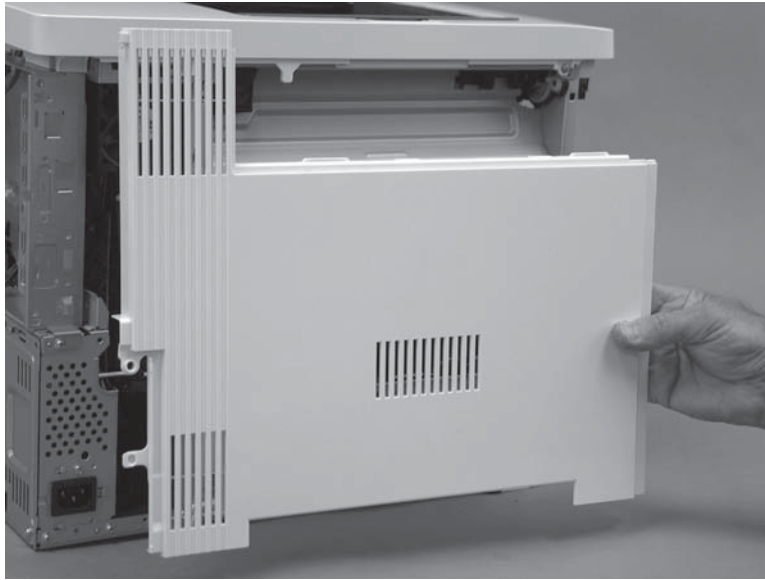

Step 7: Remove the upper cover

1. Remove three screws (callout 1).

Figure 1-856 Remove three screws

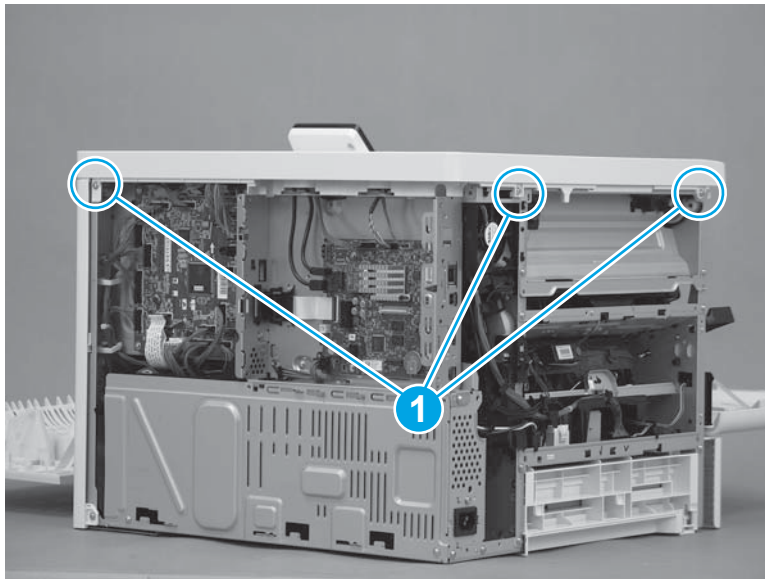

2. Remove one screw (callout 1), release one tab (callout 2), and then slightly separate the corner of the cover from the chassis.

 **NOTE:** This is a self-tapping plastic-thread screw. Make sure that this screw is used in this location when it is reinstalled.

Figure 1-857 Remove one screw and release one tab



3. Release one tab (callout 1), and then lift up on the cover to release it.

 **NOTE:** If the cover does not release, check for addition tabs by locating the triangles embossed in the cover at tab locations.

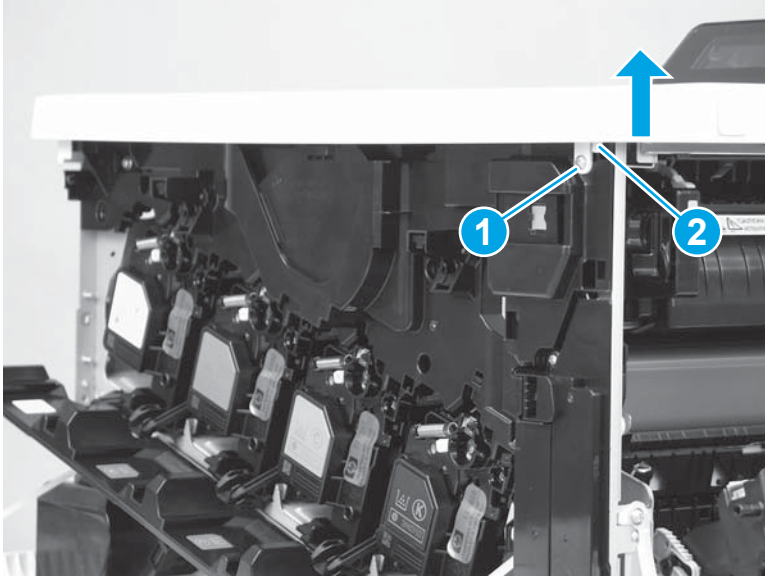
Figure 1-858 Release the cover



4. Remove the cover.

Figure 1-859 Remove the cover

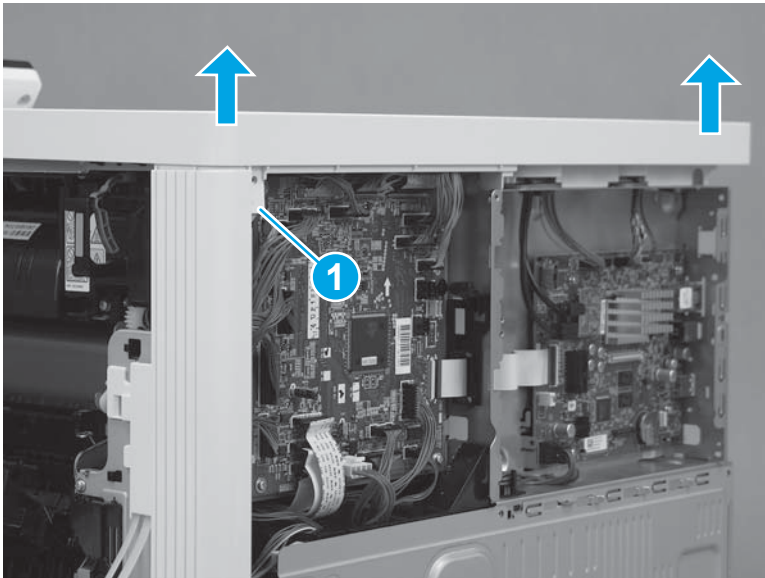
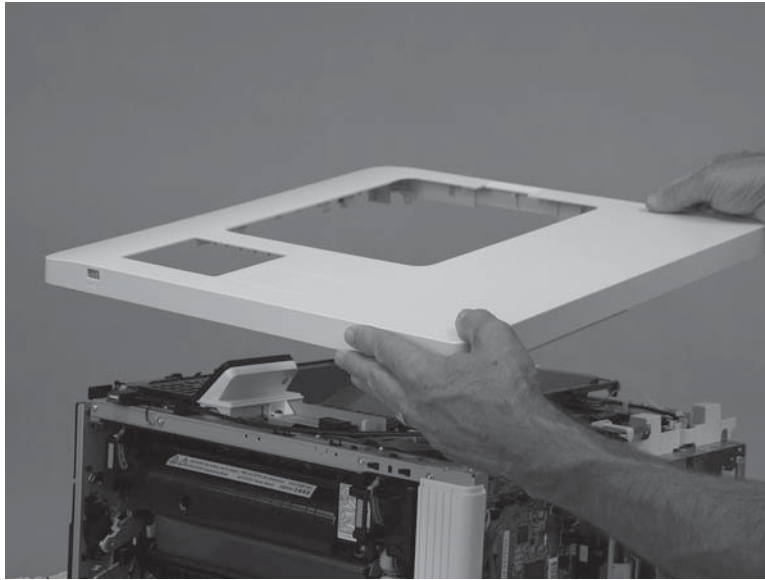

Step 8: Remove the right rear cover

1. Remove one screw (callout 1), and then slide the cover toward the rear of the printer (callout 2) to release it.

 **TIP:** If the right door is closed, open it now.

Figure 1-860 Release the cover



2. Remove the cover.

Figure 1-861 Remove the cover

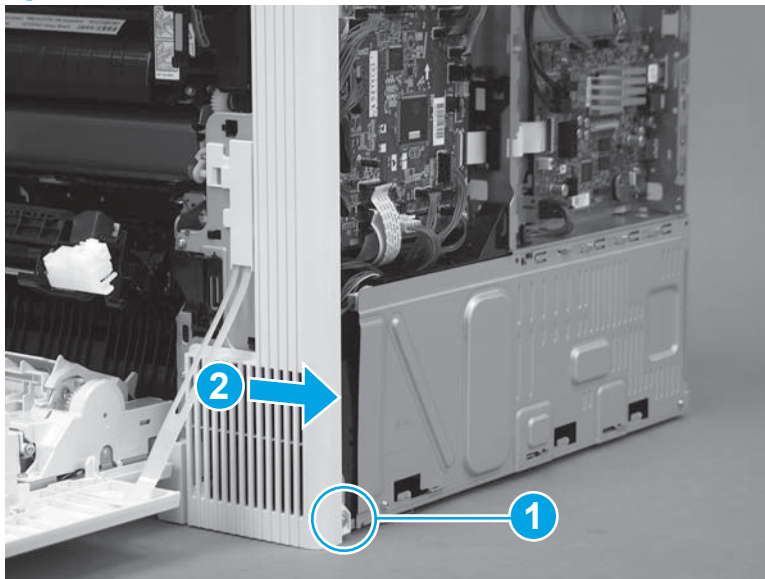
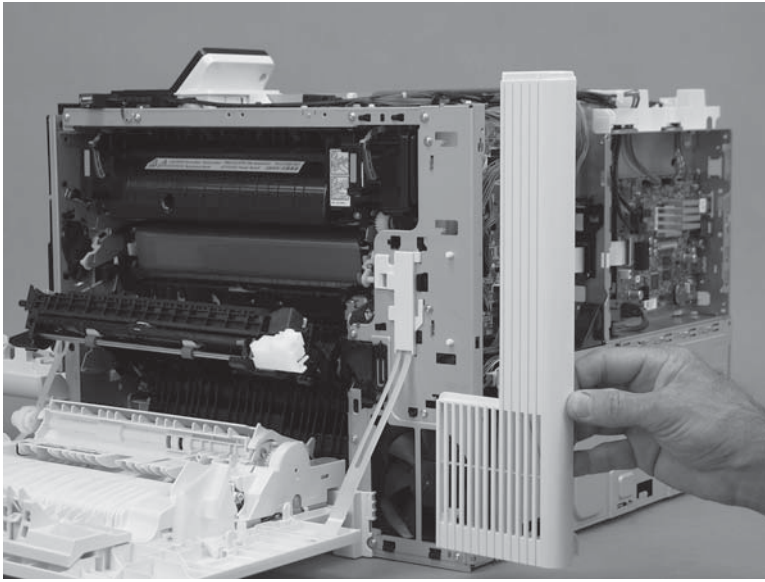

Step 9: Unpack the replacement assembly

Unpack the replacement assembly from the packaging.

For complete information on HP's recycling programs, go to [Product return and recycling](#).

 **NOTE:** HP recommends responsible disposal of the defective assembly.

Figure 1-862 Recycle and unpack

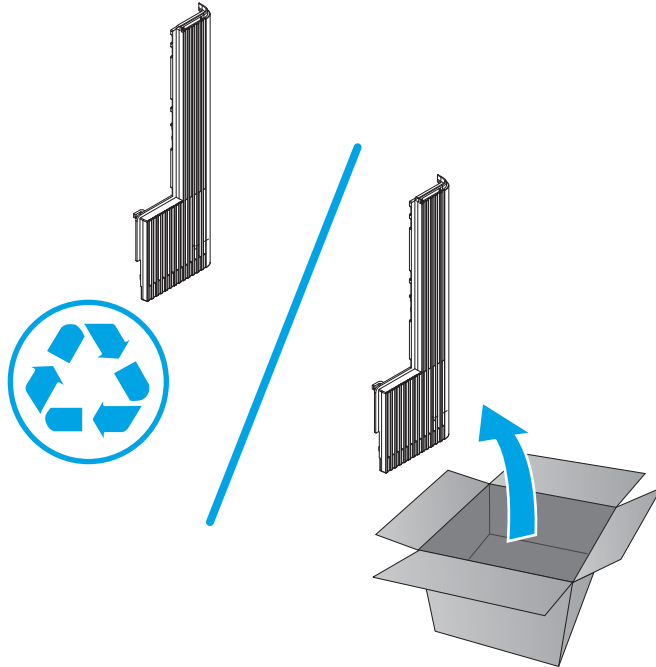

Step 10: Install the right rear cover

1. Position the cover on the printer.

Figure 1-863 Install the cover

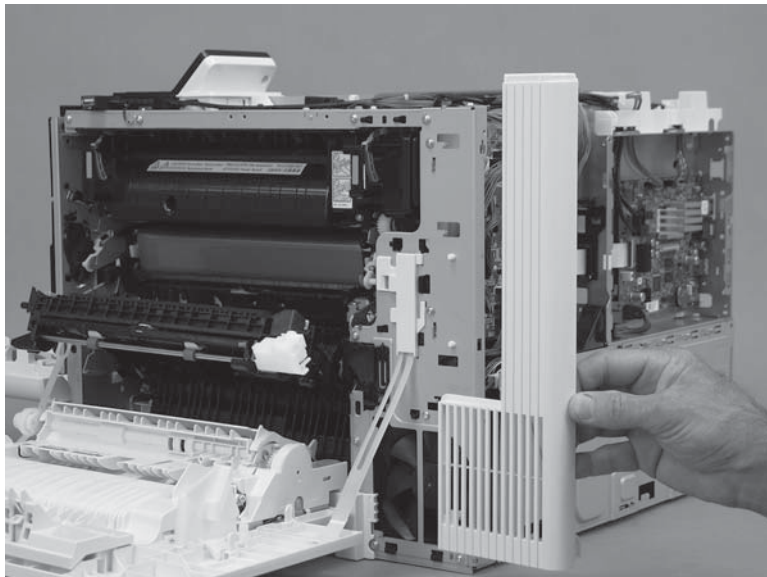

2. Slide the cover toward the right door (callout 1) to engage it with the printer, and then install one screw (callout 2).

Figure 1-864 Install one screw

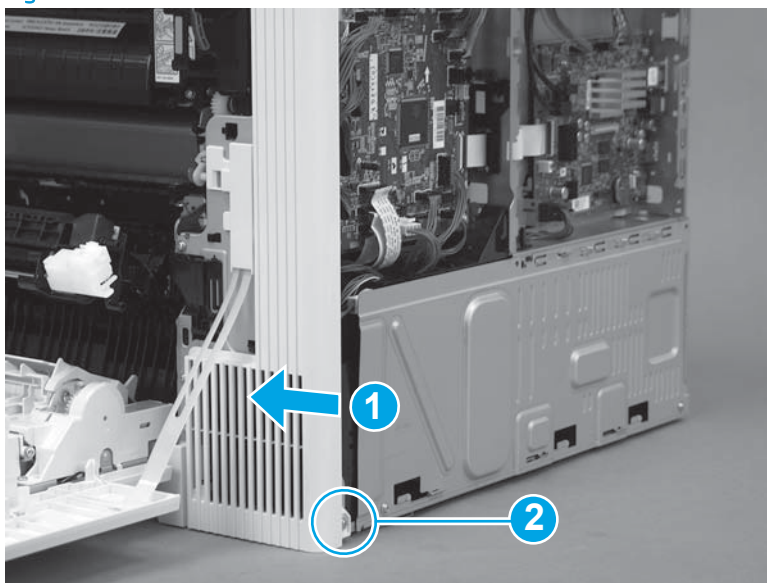

Step 11: Install the upper cover

1. Position the cover on the printer.

 **NOTE:** For the M553x model, do not forget to pass the control-panel wire harness and USB cable through the opening in the cover.

Figure 1-865 Install the cover



2. Push down on the rear corner of the cover to engage one tab (callout 1).

Figure 1-866 Engage one tab

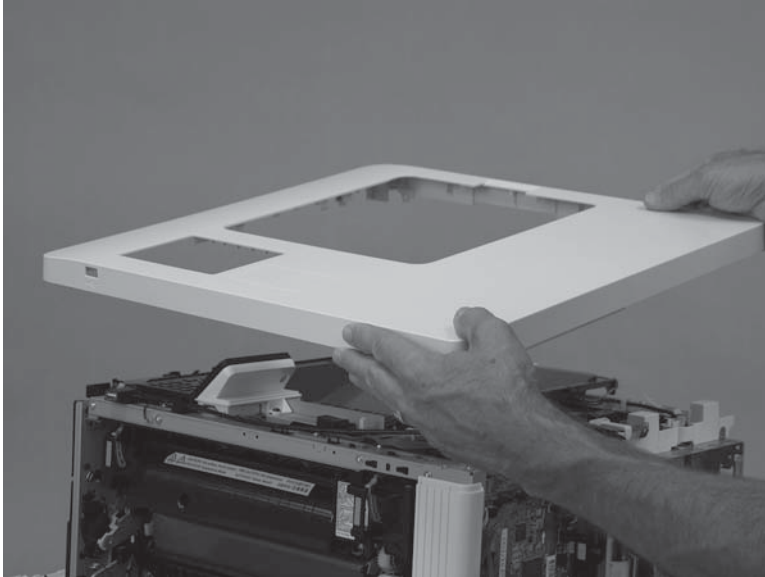
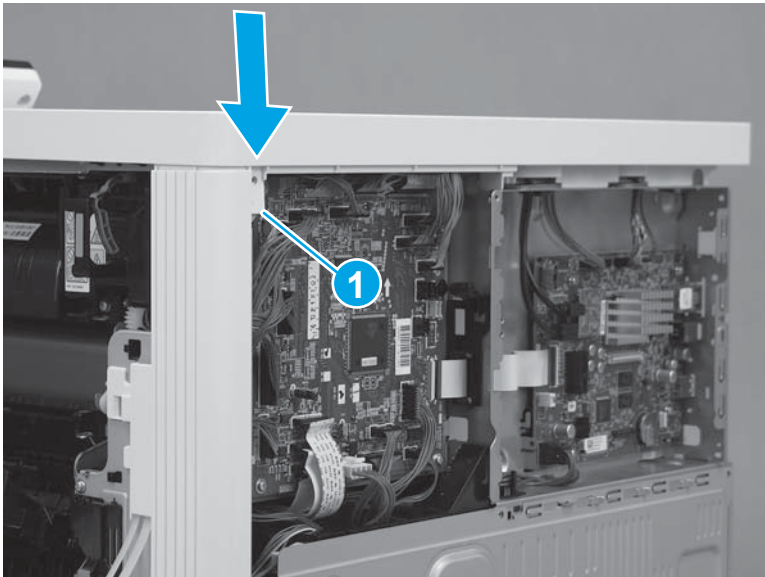

3. Push down on the front corner of the cover to engage one tab (callout 1), and then install one screw (callout 2).

 **NOTE:** This is a self-tapping plastic-thread screw. Make sure that this screw is used in this location when it is reinstalled.

Figure 1-867 Engage one tab and install one screw



4. Install three screws (callout 1).

Figure 1-868 Install three screws

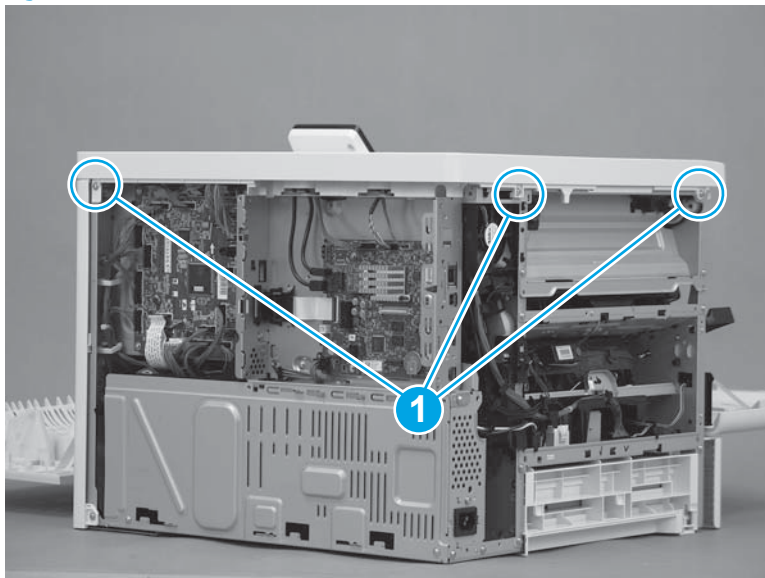

Step 12: Install the left cover

1. Position the cover on the printer.

 **NOTE:** Slightly offset the cover toward the rear of the printer.

Figure 1-869 Install the cover

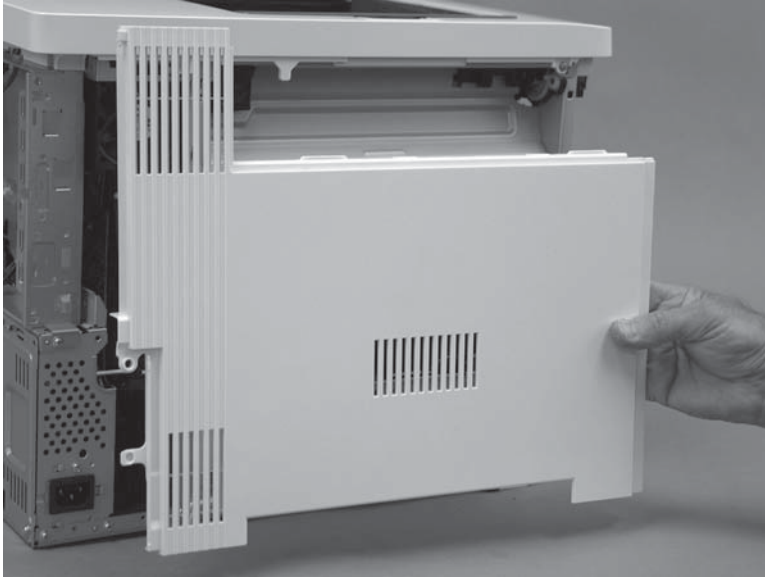

2. Slide the cover (callout 1) toward the front of the printer to engage it. Make sure that the tab (callout 2) snaps into place.

 **NOTE:** Locate the alignment pin (callout 3) on the cover from the front door side of the printer, and then make sure that it is fully engaged in the slot in the chassis.

 **TIP:** While sliding the cover into place, push in on the center of the cover (callout 1) to make sure that the hooks on the back of the cover engage with the slots in the chassis.

Figure 1-870 Engage the cover



3. At the left side of the printer, install one screw (callout 1).

Figure 1-871 Install one screw

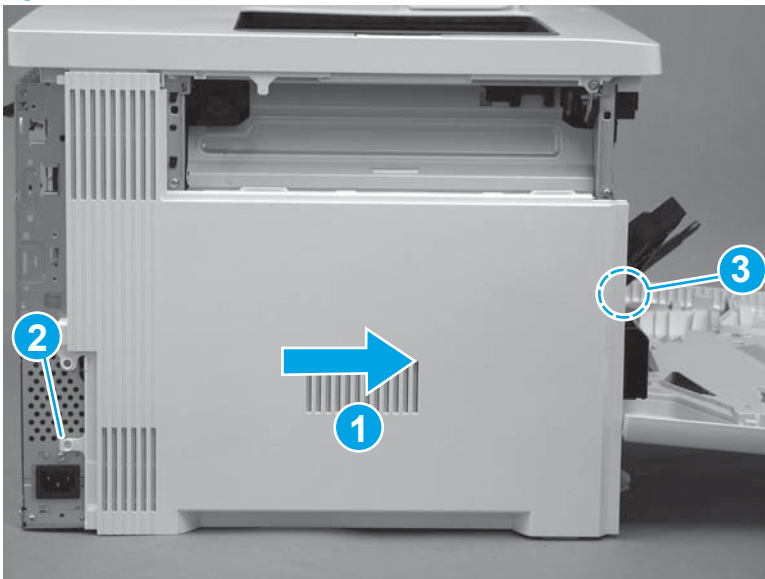

Step 13: Install the rear cover

1. Position the top of the cover under the upper cover (callout 1), rotate the bottom of the cover onto the chassis (callout 2), and then slide the cover to the left (callout 3) to install it.

Figure 1-872 Install the cover

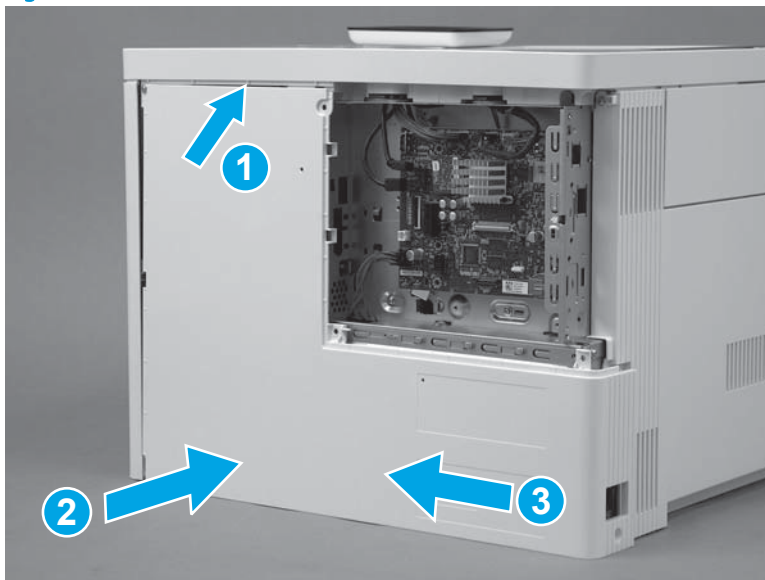

2. Install four screws (callout 1).

Figure 1-873 Install four screws cover

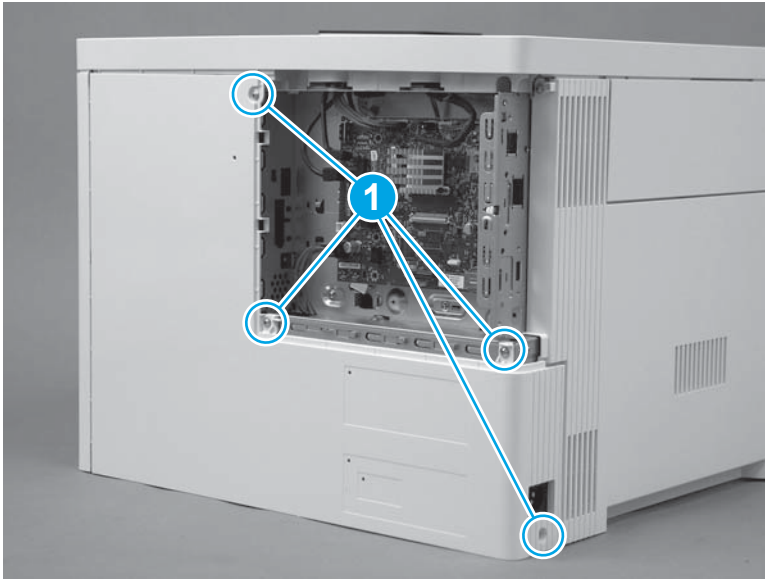

Step 14: Install the formatter cover

- ▲ Slide the cover onto the printer (callout 1) to install it.

 **NOTE:** Make sure that the tabs on the formatter cover align with the slots provided in the printer (callout 2). Tighten the two thumbscrews (callout 3).

 **TIP:** If needed, use the edge of a coin to turn the thumbscrews.

Figure 1-874 Install the cover

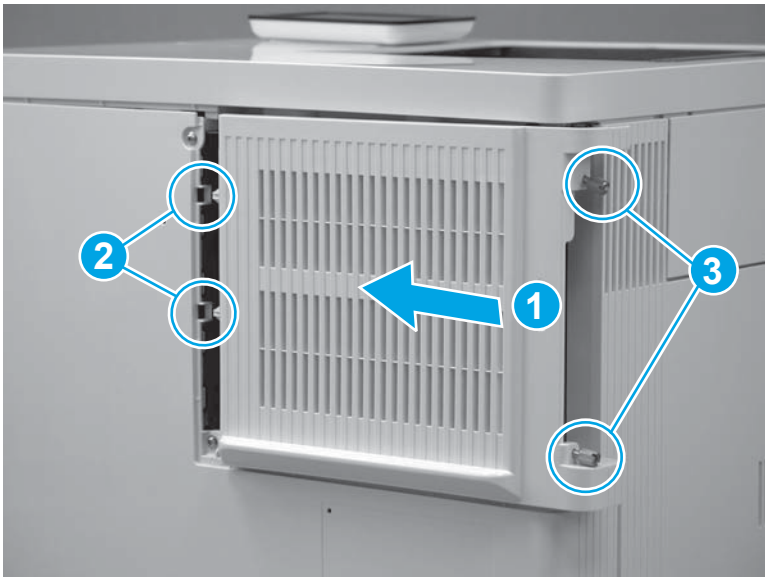

Step 15: Install the TCU

1. Verify that the toner collection hatch cover is in the closed position on the TCU.

Figure 1-875 Verify that the toner collection hatch cover is closed

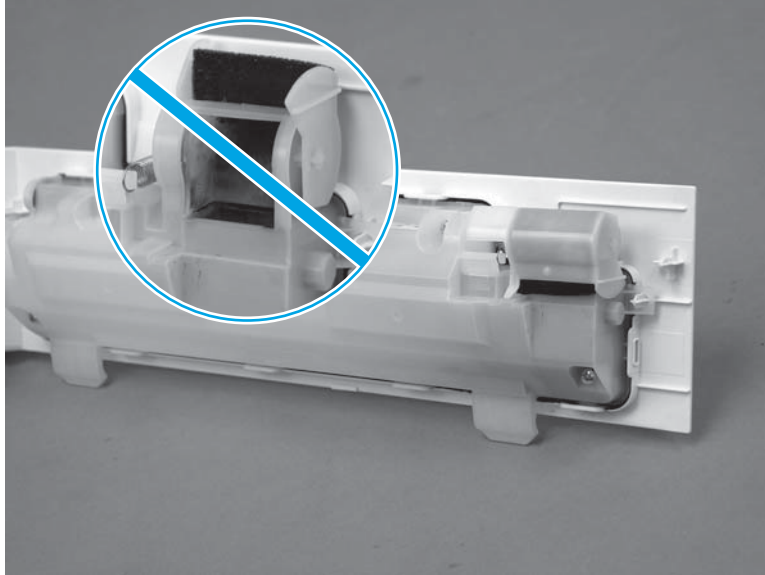

2. Position the TCU with the hinges in the slots provided in the printer (callout 1), and then rotate the TCU up and into the closed position.

 **NOTE:** The toner collection hatch cover automatically opens when the TCU is closed.

Figure 1-876 Install the TCU

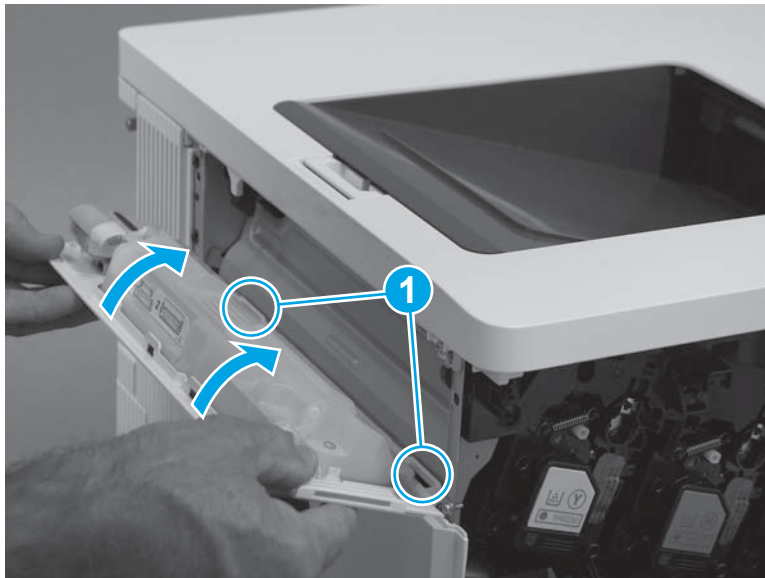

3. Close the front door.

Figure 1-877 Close the front door



Step 16: Install the control-panel assembly (M553x only)

 **NOTE:** For the M553n/dn and M552dn models, skip this step and go to [Step 17: Install the USB cover on page 515](#).

1. Place the control panel on the printer as shown.

Figure 1-878 Place the control panel on the product

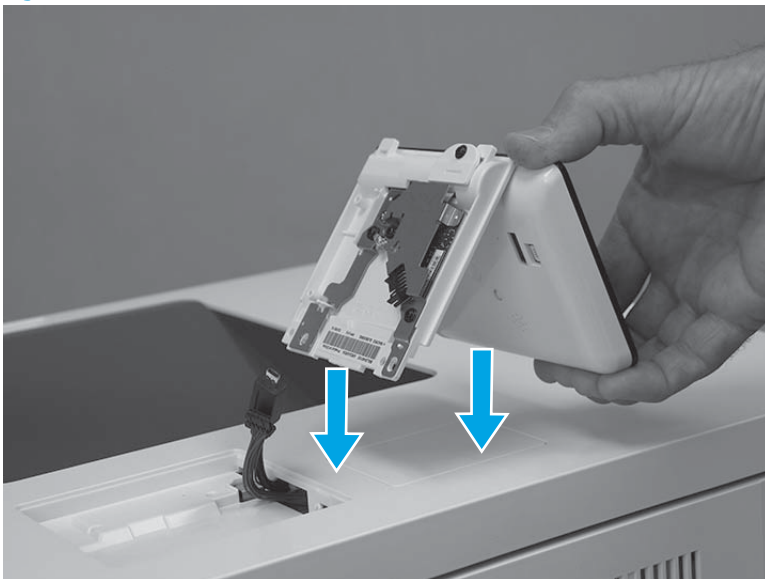

2. Connect one USB cable (callout 1), and one connector (callout 2).

 **IMPORTANT:** Take note of the location of the two mounting tabs (callout 3) on the control-panel assembly.

Figure 1-879 Connect two connectors



3. Turn the control panel over, and then position the front edge tabs in the slots in the top cover.

Figure 1-880 Turn the control panel over

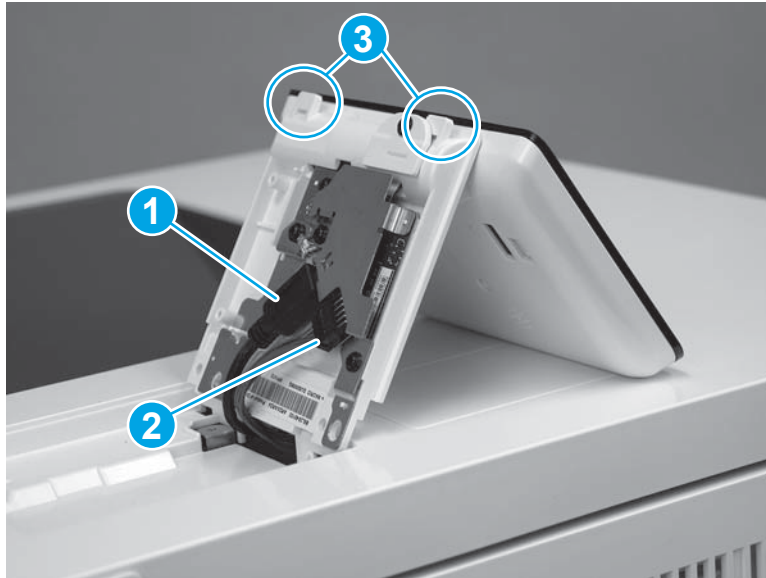
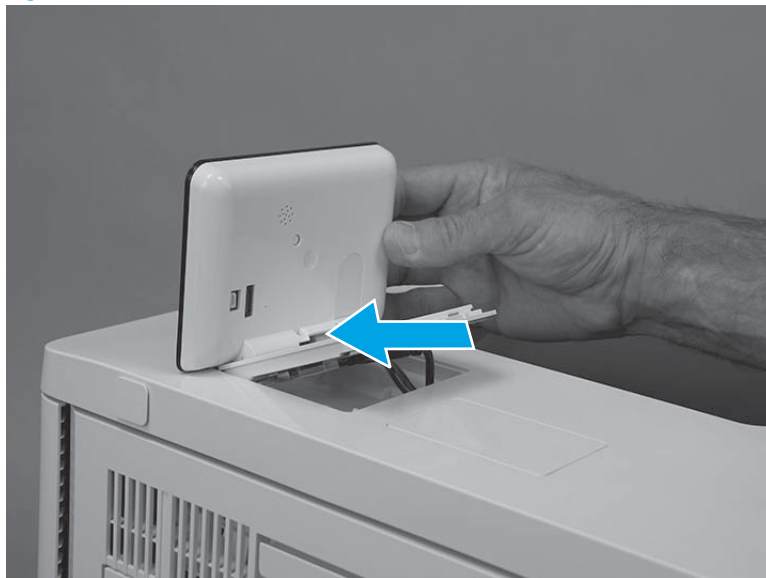

4. Rotate the control-panel base down onto the printer.

Figure 1-881 Rotate the control-panel base down



5. Use a small Phillips screwdriver to install two screws (callout 1).

Figure 1-882 Install two screws

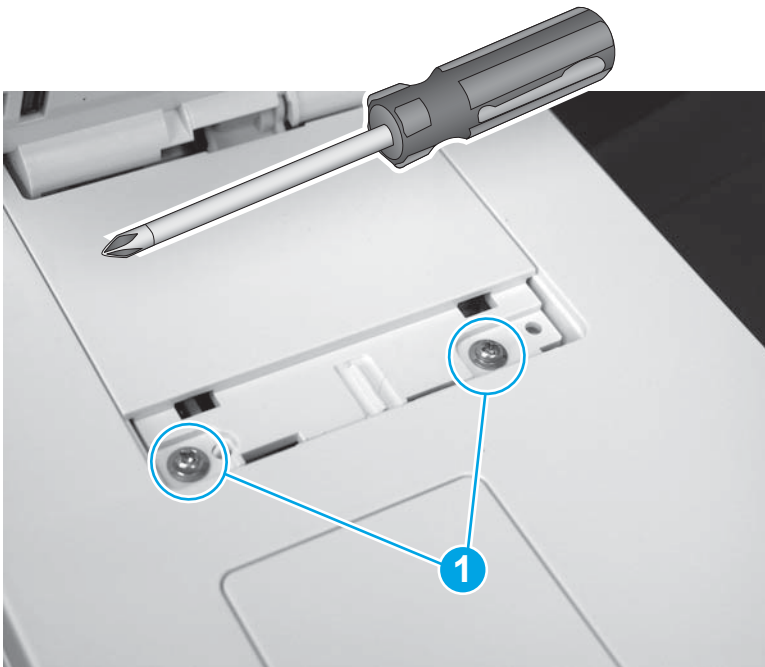

6. Position the screw cover mounting feet into the slots in the top cover (callout 1), and then rotate the cover down (callout 2) to install it.

 **NOTE:** Press down on the cover firmly to make sure that the tabs on the cover (callout 3) snap into place.

Figure 1-883 Install the cover



Step 17: Install the USB cover

1. Push the cover into the USB port to install it.

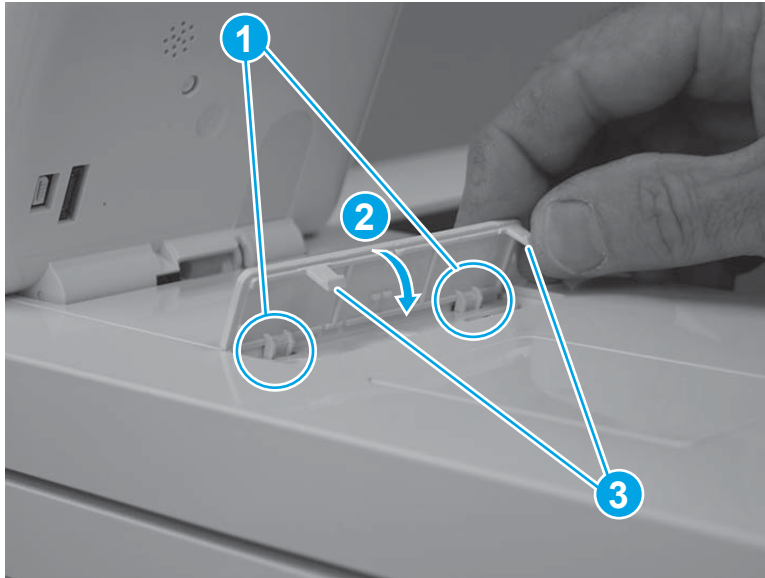
Figure 1-884 Install the cover



2. Make sure that the USB cover is fully seated after installing it.

Figure 1-885 Check the installation

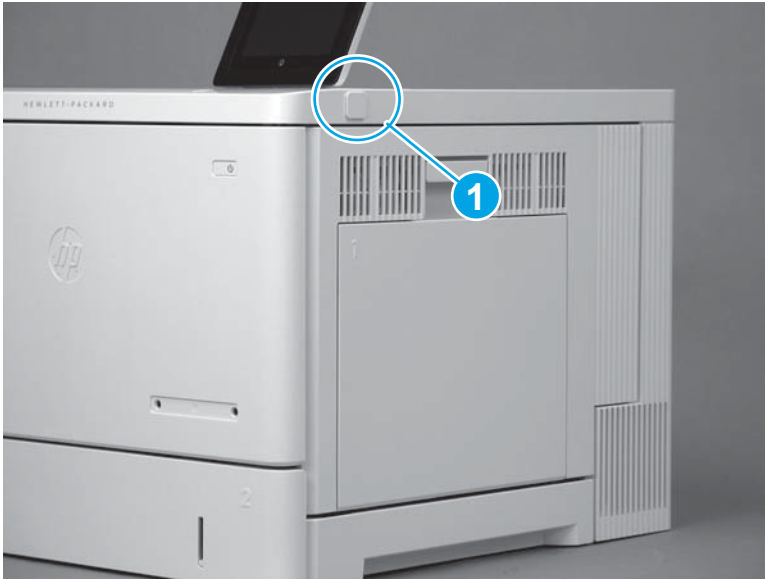

Removal and replacement: Right rear cover (M577)

- [Introduction](#)
- [Step 1: Remove the formatter cover](#)
- [Step 2: Remove the rear upper cover \(M577\)](#)
- [Step 3: Remove the right front upper cover \(M577dn\)](#)
- [Step 4: Remove the stapler cover assembly \(M577c/f/z\)](#)
- [Step 5: Remove the right upper cover \(M577\)](#)
- [Step 6: Remove the rear cover \(M577\)](#)
- [Step 7: Remove the right rear cover](#)
- [Step 9: Unpack the replacement assembly](#)
- [Step 9: Install the right rear cover](#)
- [Step 10: Install the rear cover \(M577\)](#)
- [Step 11: Install the right upper cover \(M577\)](#)
- [Step 12: Install the stapler cover assembly \(M577c/f/z\)](#)
- [Step 13: Install the right front upper cover \(M577dn\)](#)
- [Step 14: Install the rear upper cover \(M577\)](#)
- [Step 15: Install the formatter cover](#)

Introduction

This document provides the procedures to remove and replace the right rear cover on the M577.

Before performing service

Turn the printer power off

- Disconnect the power cable.

⚠ WARNING! To avoid damage to the printer, turn the printer off, wait 30 seconds, and then remove the power cord before attempting to service the printer.

- Open the right door.

Use the table below to identify the correct part number for your printer, and then go to <http://h20141.www2.hp.com/hpparts> to order the part.

Right rear cover part number	
RC4-0178-000CN	Right rear cover

Required tools

- #2 Phillips screwdriver with a magnetic tip

After performing service

Make sure that the right rear cover is fully seated after replacing it.

Make sure that the formatter cover is fully seated, and that the thumbscrews are finger tight after replacing it.

Turn the printer power on

- Connect the power cable.
- Use the power switch to turn the power on.

Step 1: Remove the formatter cover

1. Locate the formatter cover.

Figure 1-886 Locate the formatter cover

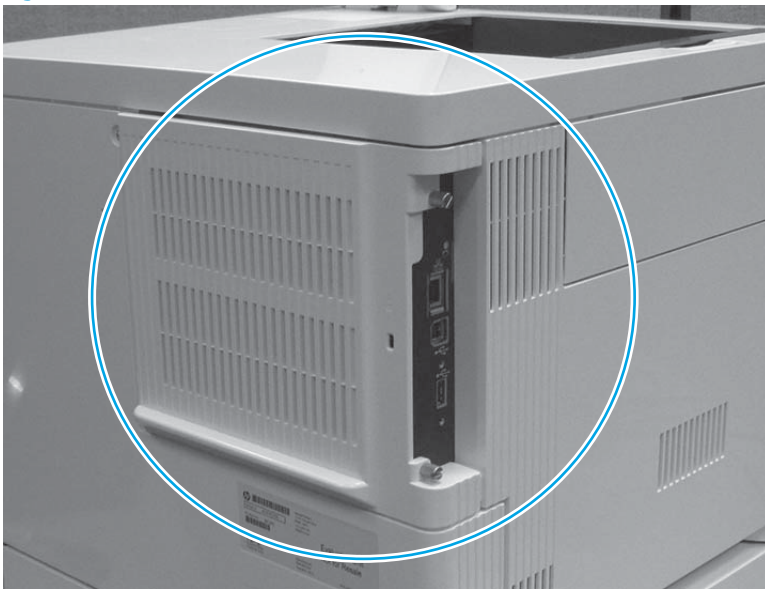

2. Loosen the two thumbscrews (callout 1). Grasp the two thumbscrews, and then slide the cover away from the printer (callout 2) to remove it.

 **TIP:** If needed, use the edge of a coin to turn the thumbscrews.

Figure 1-887 Loosen the thumbscrews

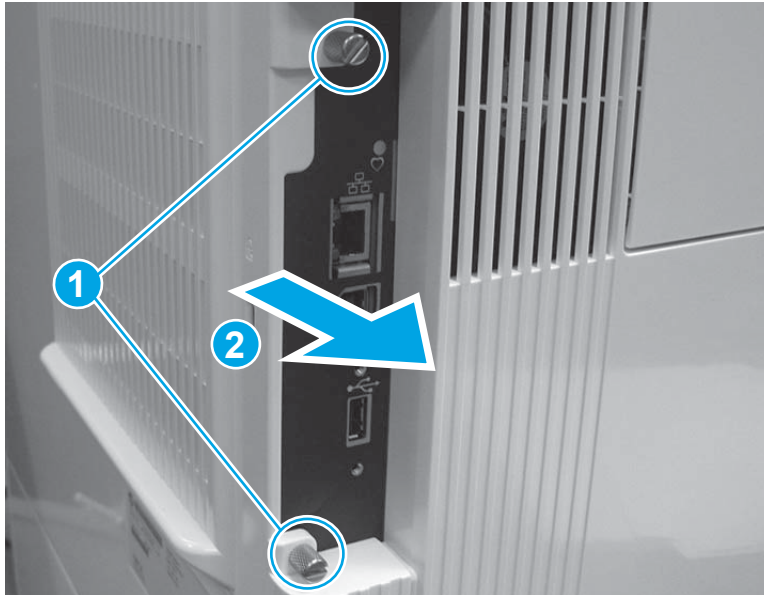

Step 2: Remove the rear upper cover (M577)

1. Remove two screws (callout 1).

 **Reinstallation tip:** These two screws are self-tapping screws for plastic. When reinstalling them, rotate the screws counterclockwise to align them with the existing thread pattern, and then carefully turn them clockwise to tighten. Do not overtighten. This will prevent stripping the threads inside the screw holes.

Figure 1-888 Remove two screws



2. Use a small, flat blade screwdriver to release the right edge of the cover.

Figure 1-889 Release the right edge

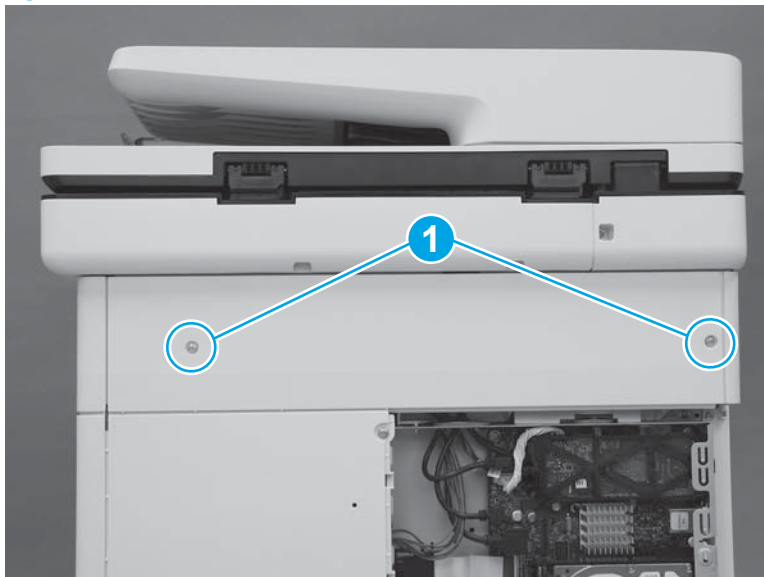
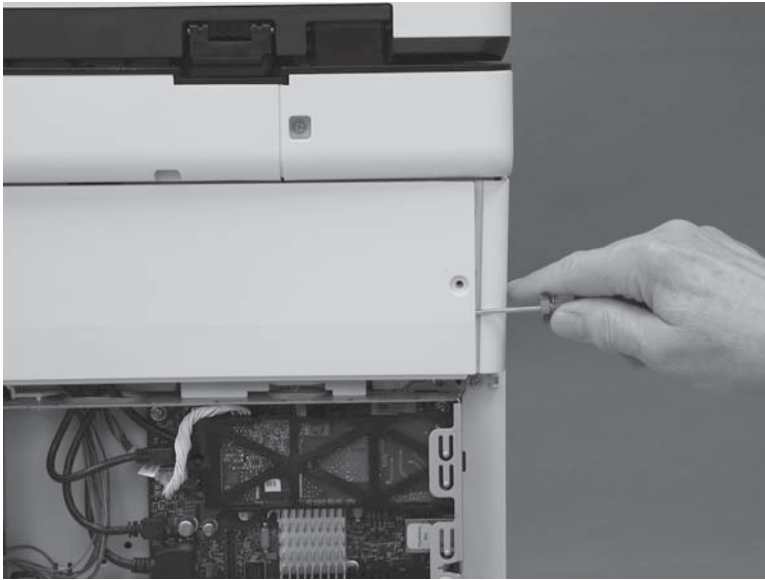

3. Pull the right edge of the cover (callout 1) away from the printer, and then slide the cover to the right (callout 2).

Figure 1-890 Slide the cover right

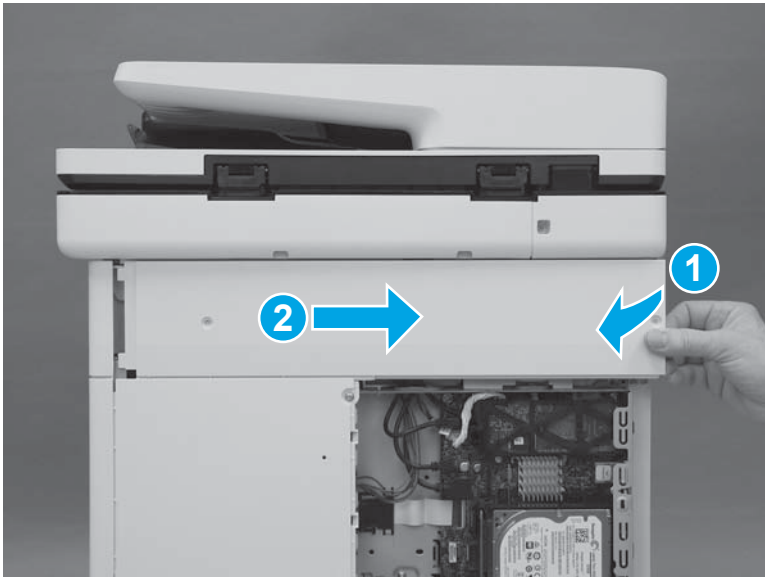

4. Remove the cover.

Figure 1-891 Remove the cover

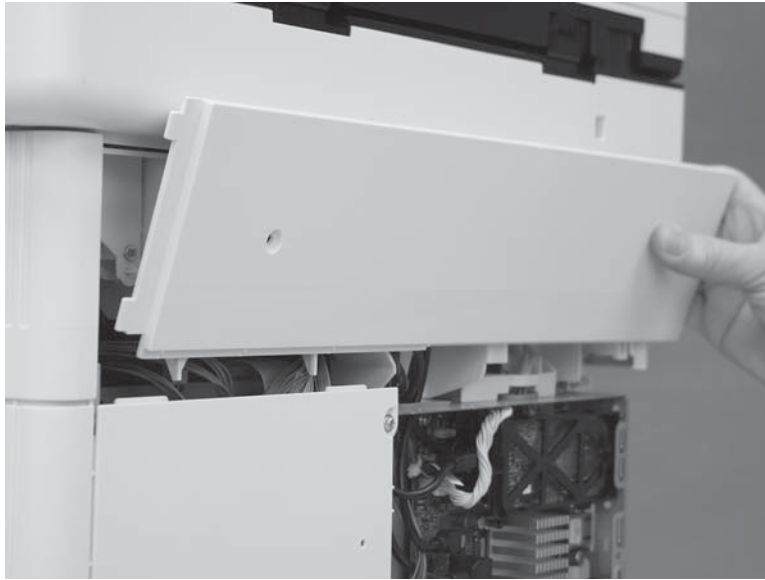

Step 3: Remove the right front upper cover (M577dn)

 **NOTE:** This step is for the M577dn model. For the M577c/f/z models, skip this step and to go [Step 4: Remove the stapler cover assembly \(M577c/f/z\) on page 522](#).

1. Remove one screw (callout 1).

Figure 1-892 Remove one screw

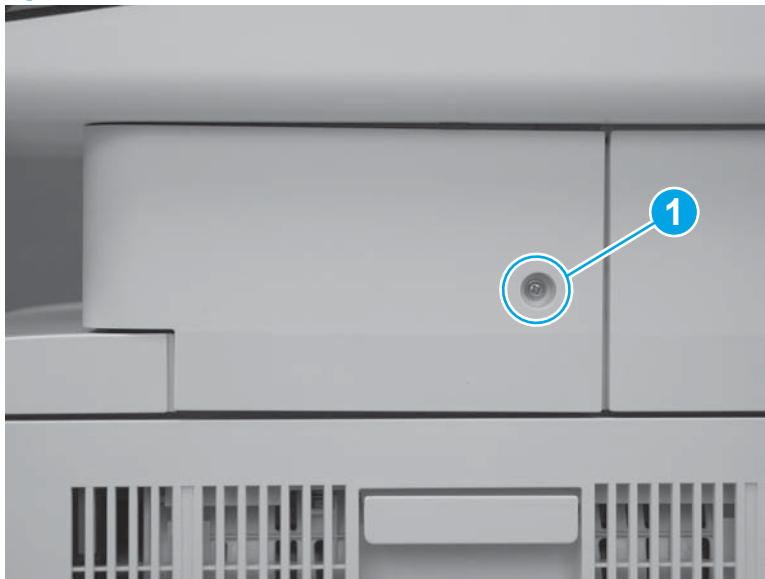

2. Release two tabs at the front edge of the cover (callout 1).

Figure 1-893 Release two tabs



3. Rotate the front of the cover to the right to remove it.

Figure 1-894 Rotate the cover



Step 4: Remove the stapler cover assembly (M577c/f/z)

 **NOTE:** This step is for the M577c/f/z models. For the M577dn model, skip this step and to go [Step 5: Remove the right upper cover \(M577\) on page 524](#).

1. Remove one screw (callout 1).

 **Reinstallation tip:** This is a self-tapping screw for plastic. When reinstalling, rotate the screw counterclockwise to align it with the existing thread pattern, and then carefully turn it clockwise to tighten. Do not overtighten. This will prevent stripping the threads inside the screw hole.

Figure 1-895 Remove one screw

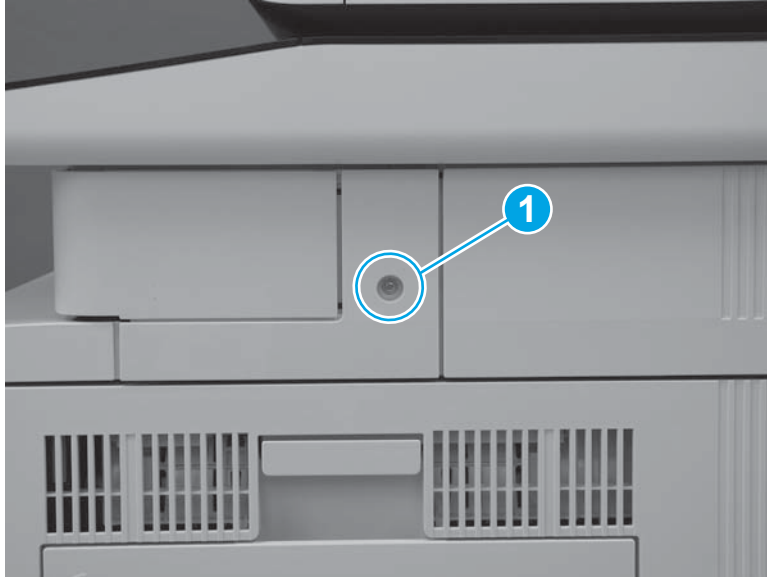

2. Release two tabs at the front edge of the cover (callout 1).

Figure 1-896 Release two tabs



3. Release the back edge of the cover.

Figure 1-897 Release the back edge of the cover

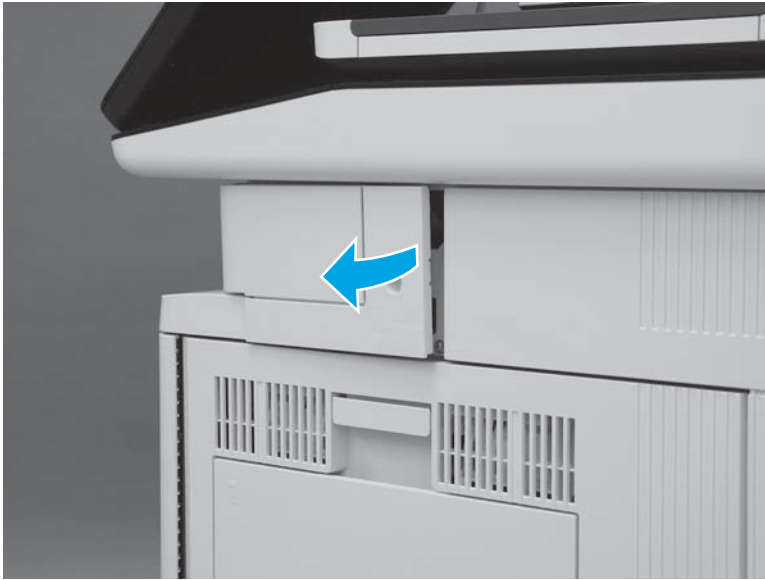

4. Rotate the cover away from the printer to remove it.

Figure 1-898 Remove the cover



Step 5: Remove the right upper cover (M577)

 **NOTE:** The figures below show the image scanner installed. The procedures for removing and installing the right upper cover are the same whether the image scanner is installed or removed."

1. At the right side of the printer, remove two screws (callout 1).

M577c/f/z only: Disconnect one connector (callout 2), if it was not already disconnected in a previous step.

Figure 1-899 Remove two screws and one connector

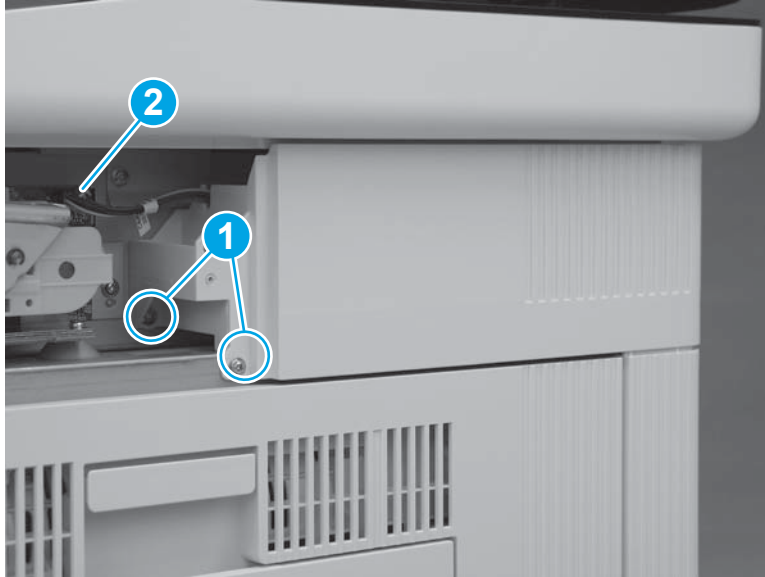

2. At the back of the printer, remove one screw (callout 1).

M577c/f/z only: Disconnect one connector (callout 2), if it was not already disconnected in a previous step.

 **Reinstallation tip:** This screw is smaller than the screws removed in the previous step. When reinstalling the right upper cover, make sure that this screw is installed in the correct position.

Figure 1-900 Remove one screw and connector



3. Slide the cover toward the back of the printer.

Figure 1-901 Slide the cover

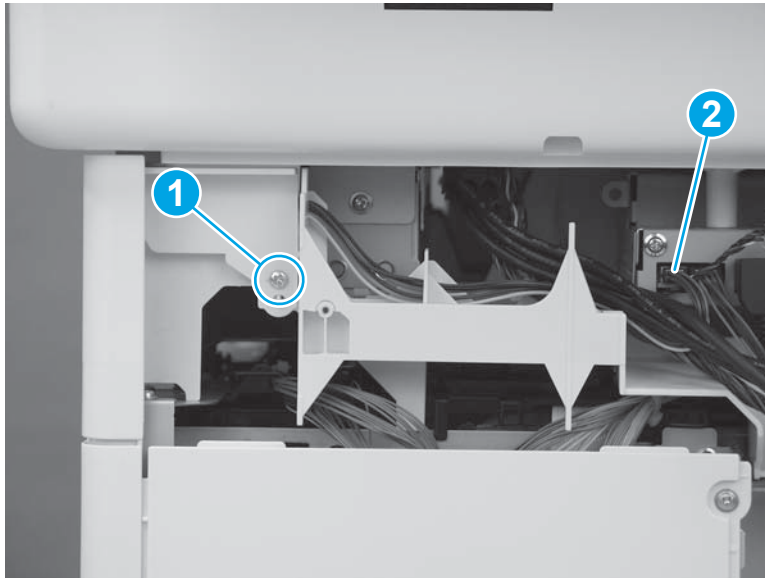
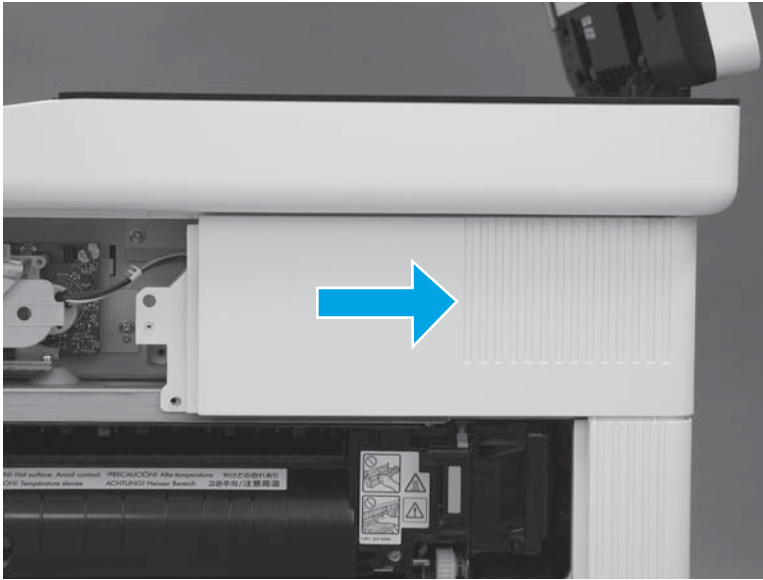

4. Lift the cover away from the printer to remove it.

M577c/f/z only: Release the cables (callout 1) through the slot (callout 2) in the printer.

Figure 1-902 Remove the cover

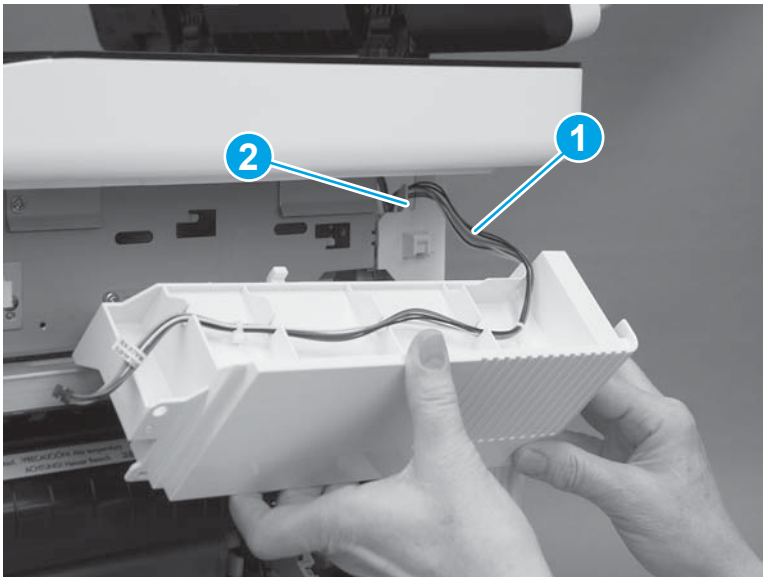

Step 6: Remove the rear cover (M577)

1. Remove four screws (callout 1).

Figure 1-903 Remove four screws

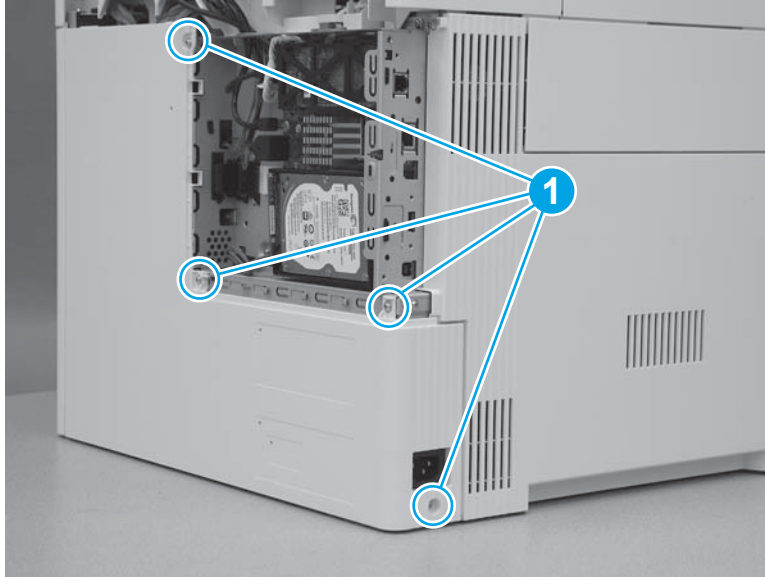

2. Slide the cover to the right to remove it.

Figure 1-904 Remove the cover

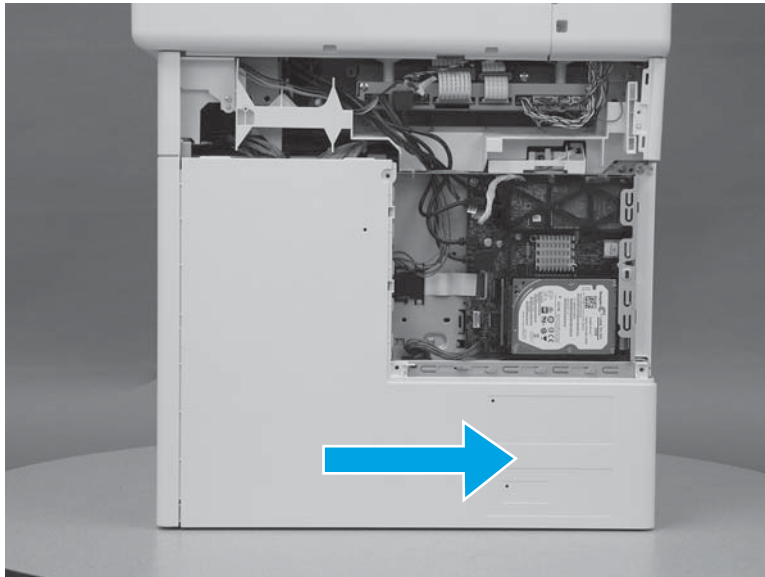

Step 7: Remove the right rear cover

1. Remove one screw (callout 1), and then slide the cover toward the rear of the printer (callout 2) to release it.

 **TIP:** If the right door is closed, open it now.

Figure 1-905 Release the cover



2. Remove the cover.

Figure 1-906 Remove the cover

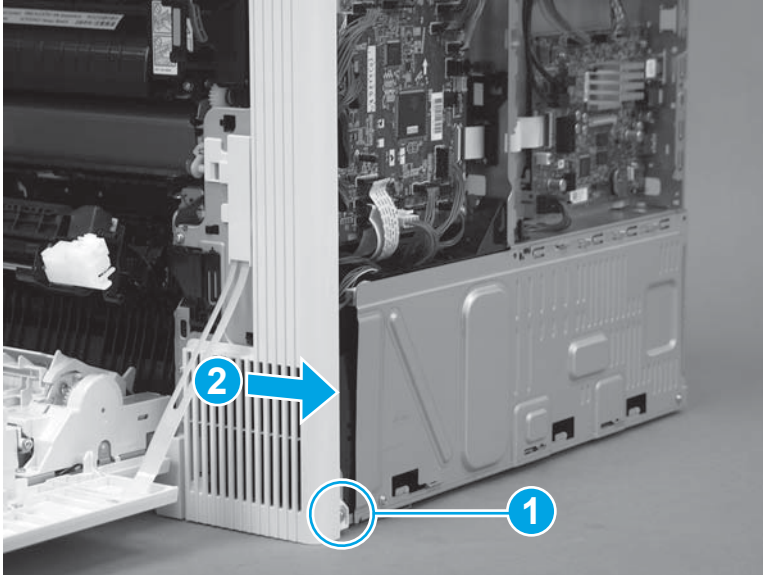
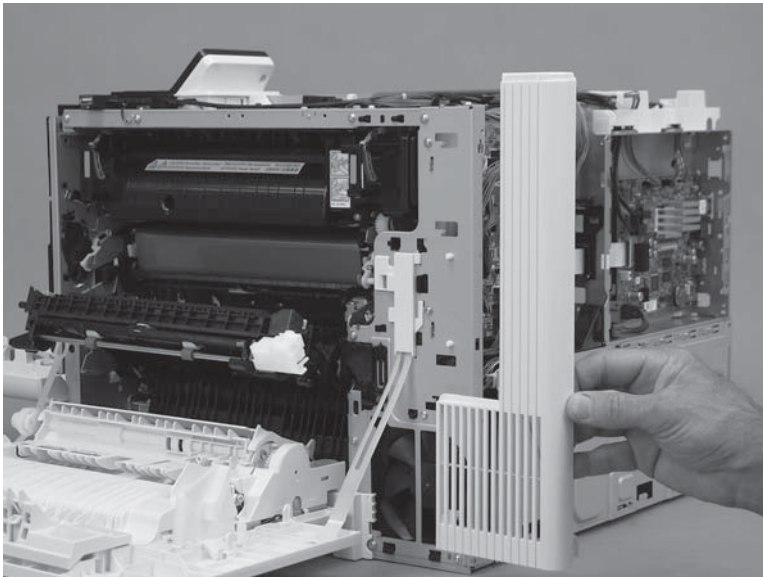

Step 9: Unpack the replacement assembly

Unpack the replacement assembly from the packaging.

For complete information on HP's recycling programs, go to [Product return and recycling](#).

 **NOTE:** HP recommends responsible disposal of the defective assembly.

Figure 1-907 Recycle and unpack

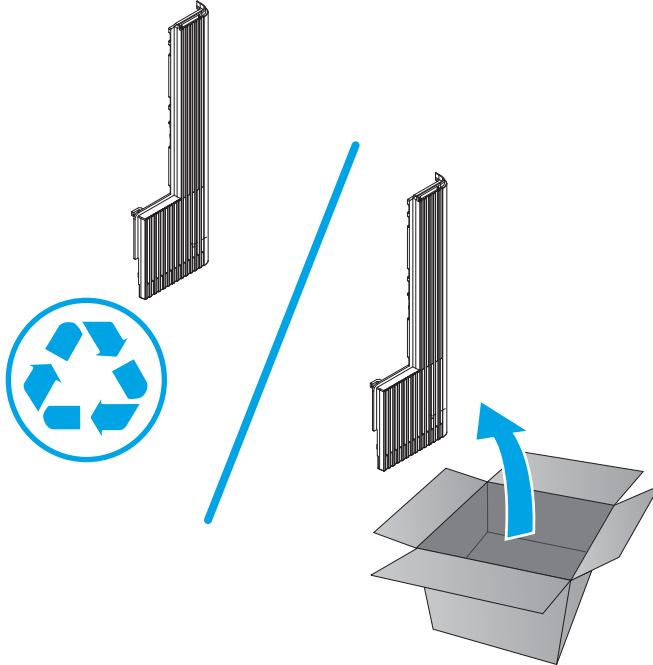

Step 9: Install the right rear cover

1. Position the cover on the printer.

Figure 1-908 Install the cover

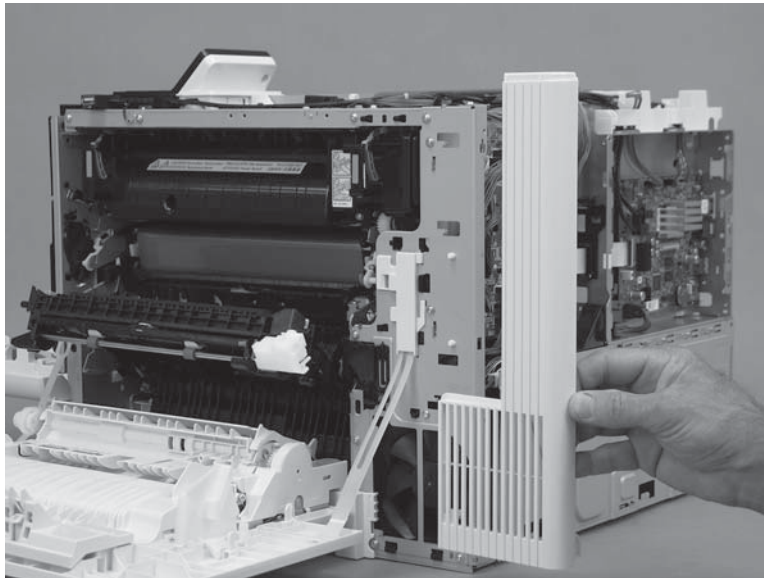

2. Slide the cover toward the right door (callout 1) to engage it with the printer, and then install one screw (callout 2).

Figure 1-909 Install one screw

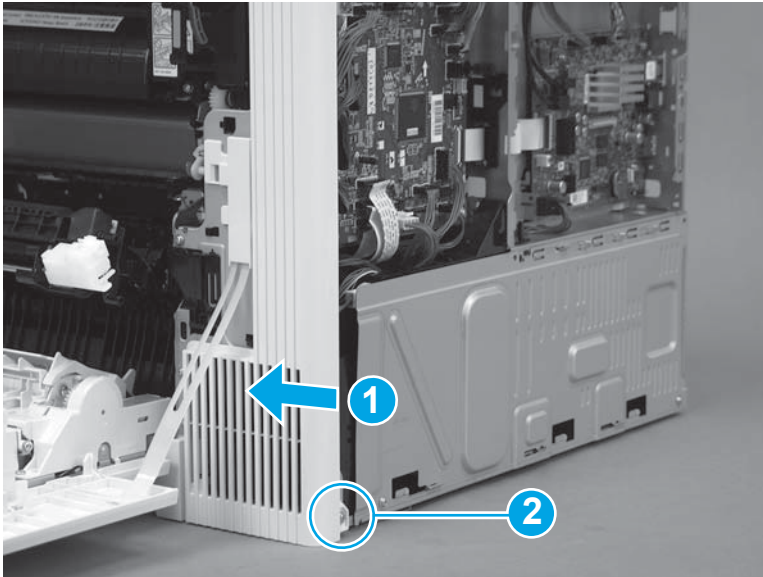

Step 10: Install the rear cover (M577)

1. Position the hooks (callout 1) on the cover in the slots (callout 2) in the printer.

Figure 1-910 Position the hooks

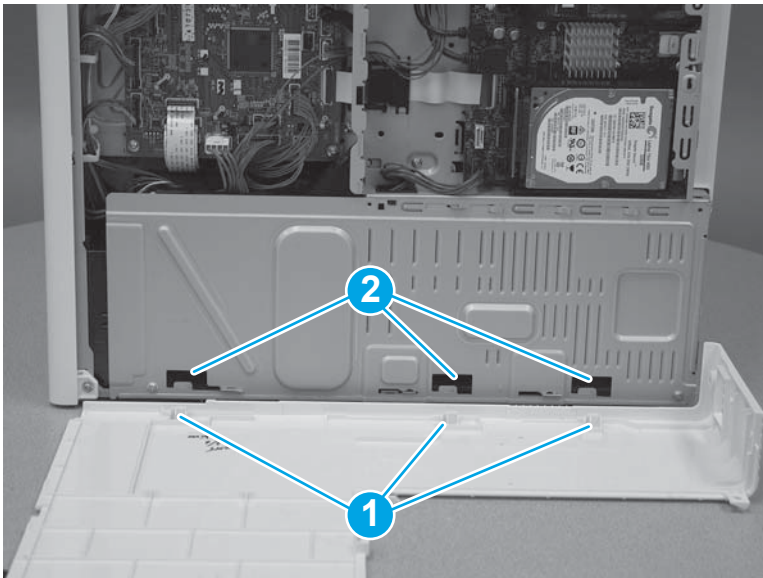

2. Position the back edge (callout 1) of the rear cover behind the edge (callout 2) of the right rear cover. Slide the cover to the left to install it.

Figure 1-911 Install the cover

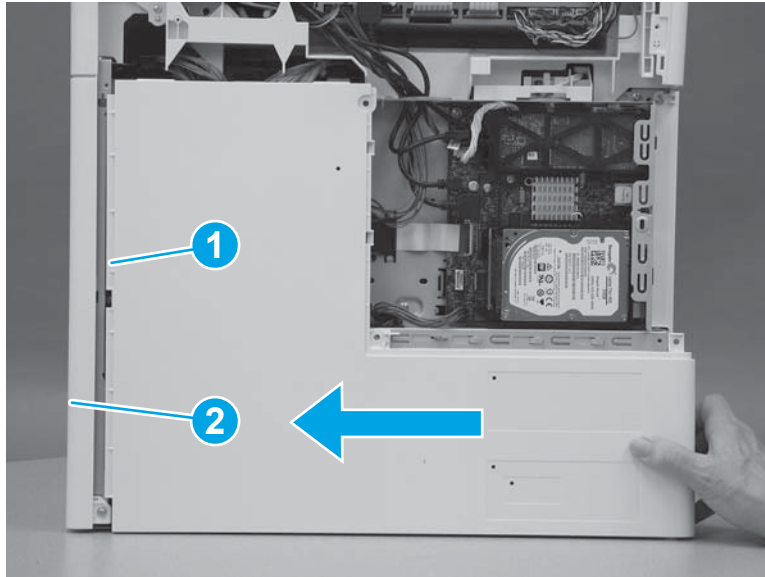

3. Install four screws (callout 1).

Figure 1-912 Install four screws cover

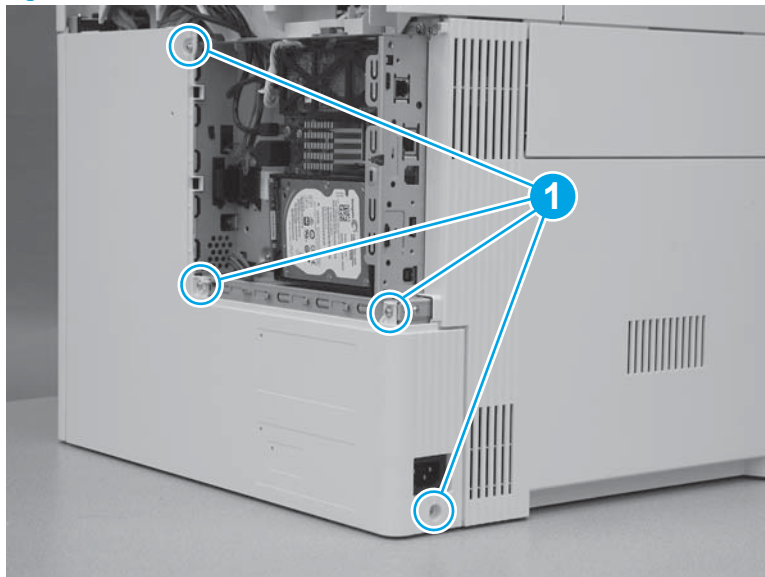

Step 11: Install the right upper cover (M577)

 **NOTE:** The figures below show the image scanner installed. The procedures for removing and installing the right upper cover are the same whether the image scanner is installed or removed."

1. **M577c/f/z only:** Install the cables (callout 1) through the slot (callout 2) in the printer.

Figure 1-913 Install the cables

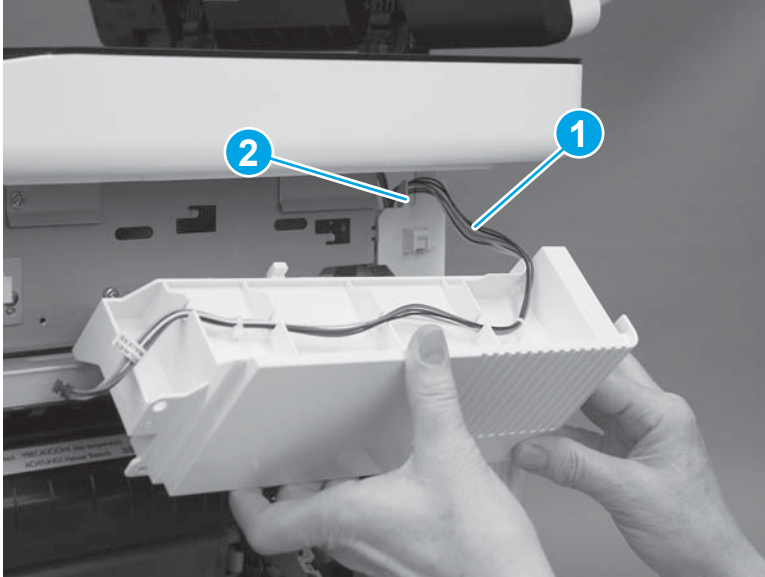

2. Position the hooks (callout 1) on the cover in the slots (callout 2) in the printer.

Figure 1-914 Position the hooks

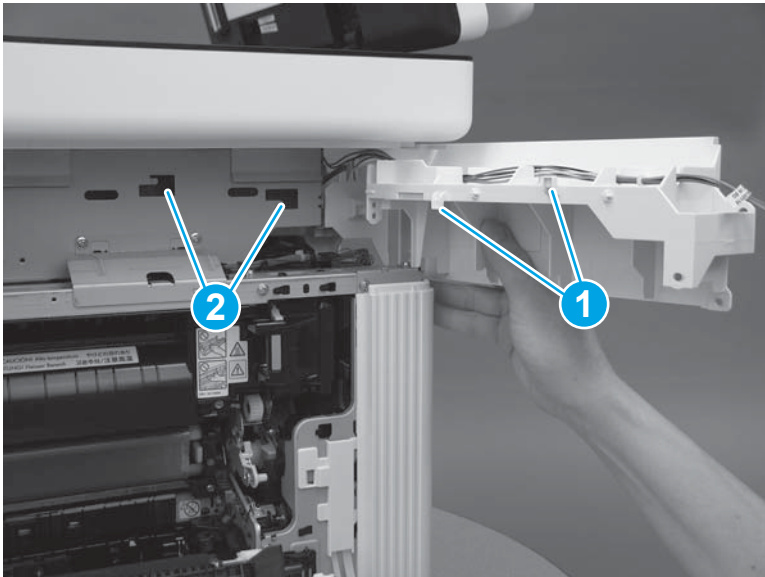

3. Slide the cover toward the front of the printer to install it.

Figure 1-915 Install the cover

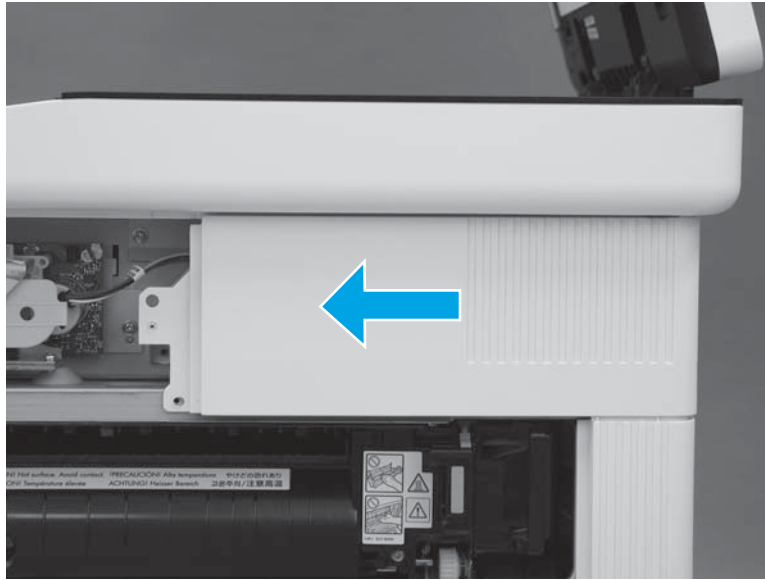

4. At the back of the printer, install one screw (callout 1).

M577c/f/z only: Connect one connector (callout 2), if the integrated scanner assembly is installed.

TIP: This screw is smaller than the screws installed in the next step. Make sure that this screw is installed in the correct position.

Figure 1-916 Install one screw and connector

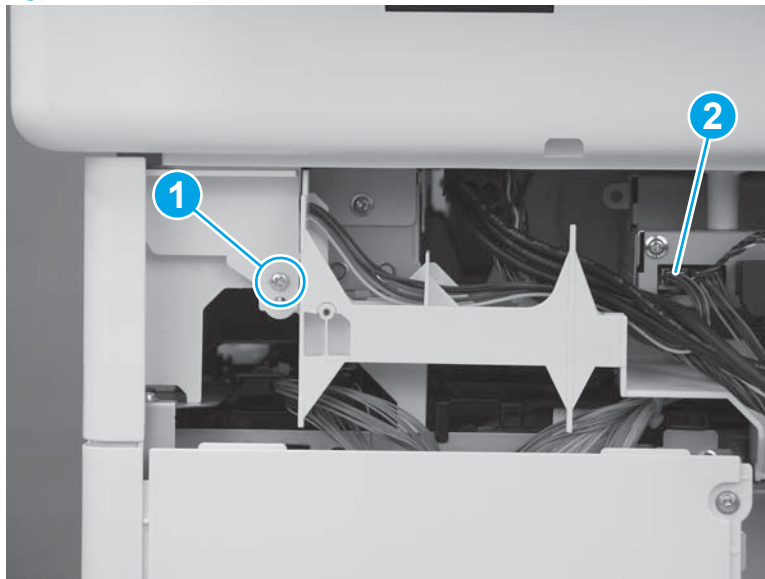

5. At the right side of the printer, install two screws (callout 1).
M577c/f/z only: Connect one connector (callout 2), if the stapler is installed.

Figure 1-917 Install one screw and connector

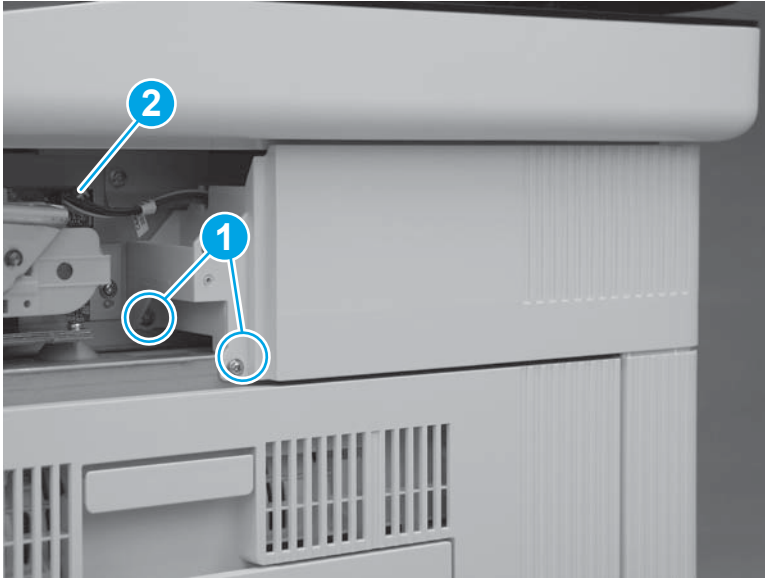

Step 12: Install the stapler cover assembly (M577c/f/z)

 **NOTE:** This step is for the M577c/f/z models only. For the M577dn model, skip this step and go to [Step 13: Install the right front upper cover \(M577dn\) on page 535.](#)

1. Install the tabs (callout 1) on the cover in the slots (callout 2) in the printer.

Figure 1-918 Install two tabs



2. Press the cover toward the left side of the printer until it snaps into place.

Figure 1-919 Install the cover assembly



3. Install one screw (callout 1).



 **IMPORTANT:** This is a self-tapping screw for plastic. Rotate it counterclockwise to align it with the existing thread pattern, and then carefully turn it clockwise to tighten. Do not overtighten. This will prevent stripping the threads inside the screw hole.

Figure 1-920 Install one screw

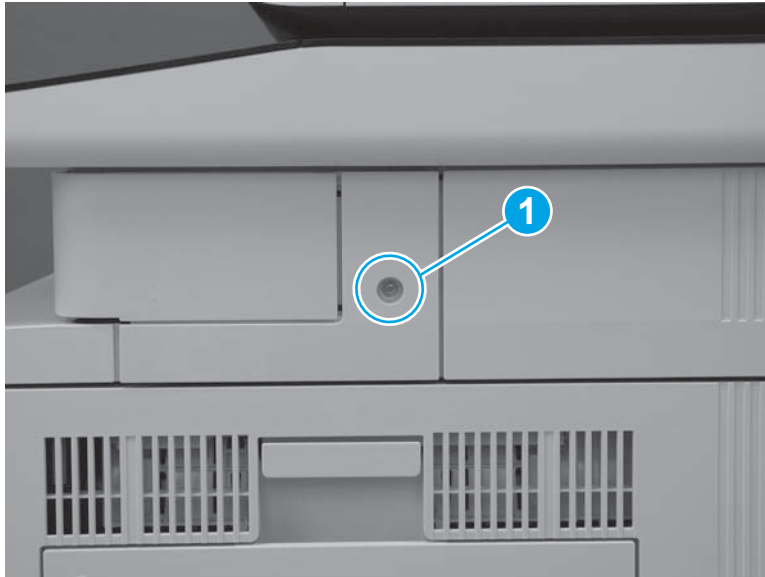

Step 13: Install the right front upper cover (M577dn)

 **NOTE:** This step is for the M577dn model only. For the M577c/f/z models, skip this step and go to [Step 14: Install the rear upper cover \(M577\) on page 537](#).

1. Slide the cover toward the left side of the printer to install it. Make sure that the slots (callout 1) in the cover fit over the tabs (callout 2) on the inside of the paper feeder cover.

Figure 1-921 Install the cover



2. Press the right front upper cover (callout 1) and the paper feeder cover (callout 2) together until the tabs on the inside of the covers snap into place.

Figure 1-922 Press the cover



3. Install one screw (callout 1).

Figure 1-923 Install one screw

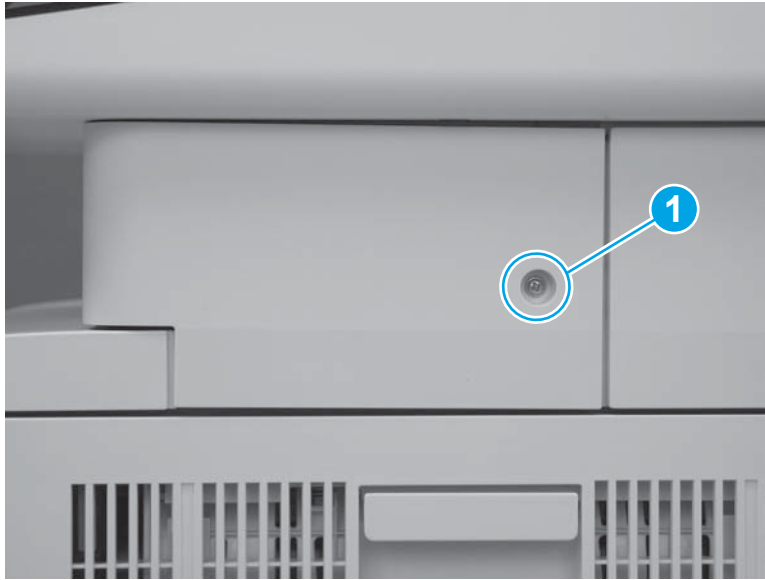

Step 14: Install the rear upper cover (M577)

1. Align the ridge (callout 1) on the lower edge of the rear upper cover in front of the tabs (callout 2) on the top edge of the rear cover.

Figure 1-924 Align the cover

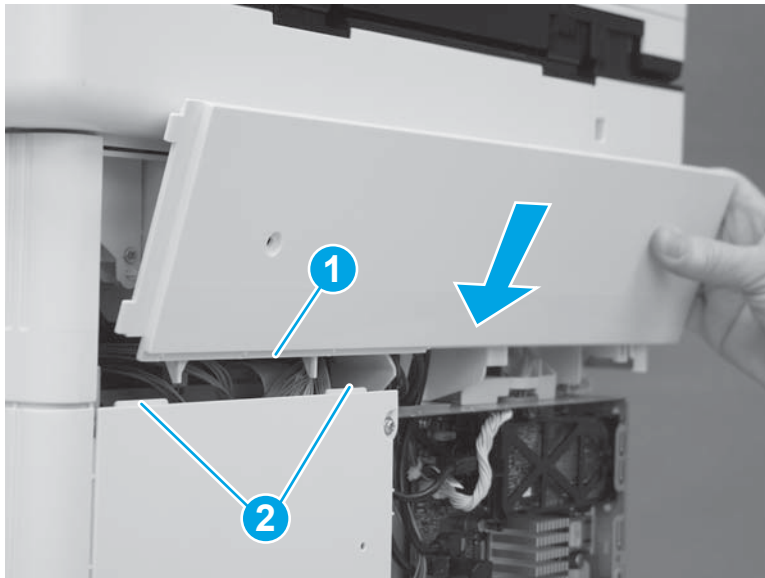

2. Rotate the top of the cover toward the printer.

Figure 1-925 Rotate the top of the cover

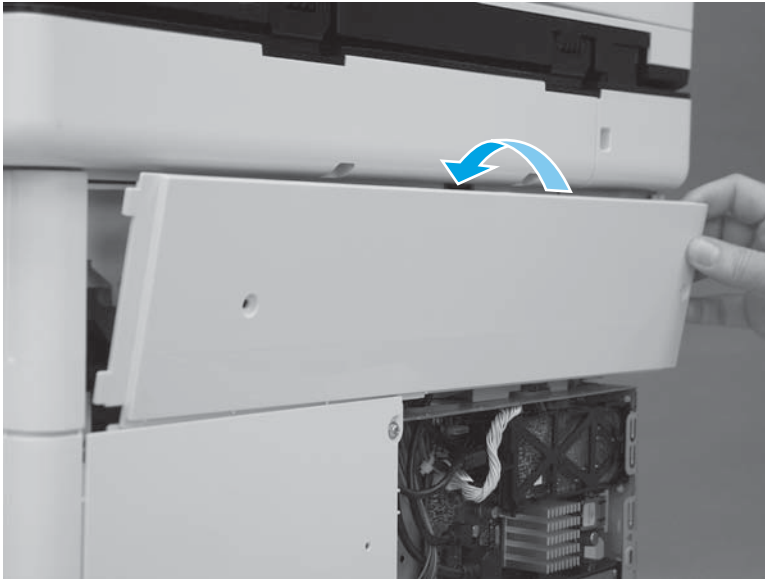

3. Slide the cover to the left (callout 1). Make sure that the tabs (callout 2) on the upper rear cover slide behind the edge (callout 3) of the right upper cover. Make sure that the cover is fully seated.

Figure 1-926 Slide the cover

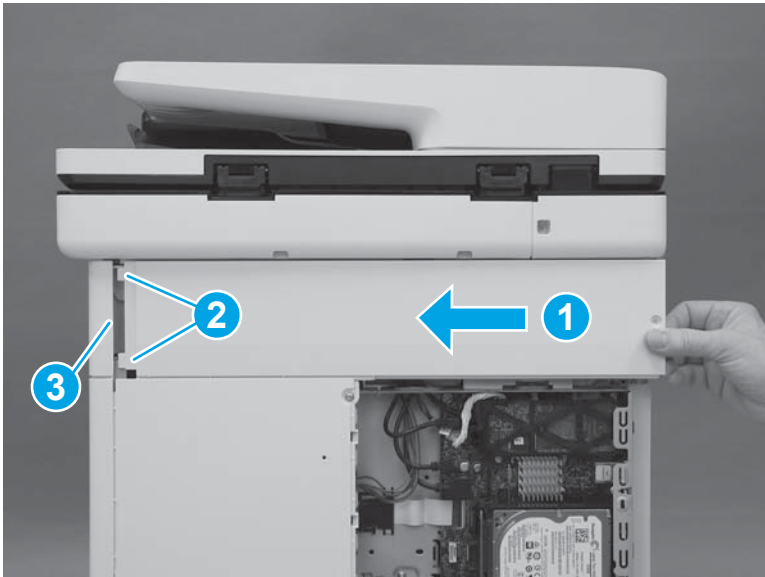

4. Install two screws (callout 1).



 **IMPORTANT:** These two screws are self-tapping screws for plastic. Rotate them counterclockwise to align them with the existing thread pattern, and then carefully turn them clockwise to tighten. Do not overtighten. This will prevent stripping the threads inside the screw holes.

Figure 1-927 Install two screws

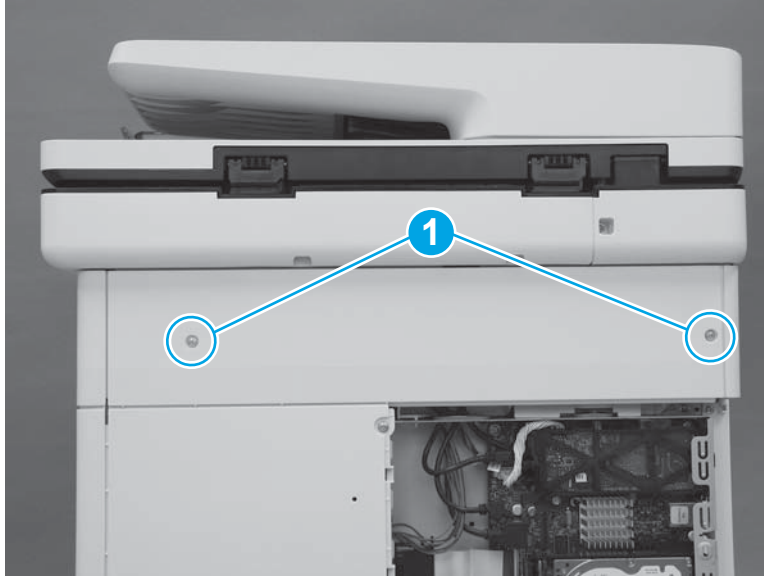

Step 15: Install the formatter cover

- ▲ Slide the cover onto the printer (callout 1) to install it.

 **NOTE:** Make sure that the tabs on the formatter cover align with the slots provided in the printer (callout 2). Tighten the two thumbscrews (callout 3).

 **TIP:** If needed, use the edge of a coin to turn the thumbscrews.

Figure 1-928 Install the cover

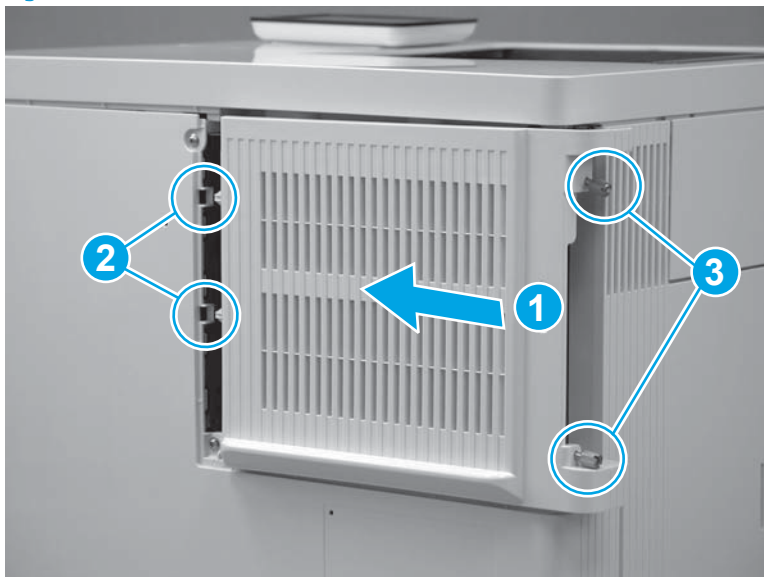

Removal and replacement: Control panel (M553n/dn and M552dn only)

- [Introduction](#)
- [Step 1: Remove the USB cover](#)
- [Step 2: Remove the toner collection unit \(TCU\)](#)
- [Step 3: Remove the formatter cover](#)
- [Step 4: Remove the rear cover](#)
- [Step 5: Remove the left cover](#)
- [Step 6: Remove the upper cover](#)
- [Step 7: Remove the control panel](#)
- [Step 8: Unpack the replacement assembly](#)
- [Step 9: Install the control panel](#)
- [Step 10: Install the upper cover](#)
- [Step 11: Install the left cover](#)
- [Step 12: Install the rear cover](#)
- [Step 13: Install the formatter cover](#)
- [Step 14: Install the TCU](#)
- [Step 15: Install the USB cover](#)

Introduction

This document provides the procedures to remove and replace the M553n/dn and M552dn control panel.

Before performing service

Turn the printer power off

- Disconnect the power cable.

⚠ WARNING! To avoid damage to the printer, turn the printer off, wait 30 seconds, and then remove the power cord before attempting to service the printer.

- Open the right door.

Use the table below to identify the correct part number for your printer. To order the part, go to www.hp.com/buy/parts.

Control panel (M553n/dn and M552dn) part number

RM2-7180-000CNControl panel (M553n/dn and M552dn)

Required tools

- #2 Phillips screwdriver with a magnetic tip

After performing service

Make sure that the USB cover is fully seated after replacing it.

Make sure that the TCU is fully closed after replacing it.

Make sure that the formatter cover is fully seated, and that the thumbscrews are finger tight after replacing it.

Turn the printer power on

- Connect the power cable.
- Use the power switch to turn the power on.

Step 1: Remove the USB cover

1. Locate the USB cover.

Figure 1-929 Locate the USB cover



2. Pull the cover off of the printer to remove it.

Figure 1-930 Remove the cover



Step 2: Remove the toner collection unit (TCU)

1. Open the front door.

Figure 1-931 Open the front door



2. Open the TCU.

 **NOTE:** The toner collection hatch cover automatically closes when the TCU is opened.

Figure 1-932 Open the TCU



3. Pull the TCU away from the printer at an angle to remove it.

⚠ CAUTION: Do not open the toner collection hatch cover when handling the TCU. If toner gets on clothing, wipe it off by using a dry cloth and wash the clothes in cold water. Hot water sets toner into fabric.

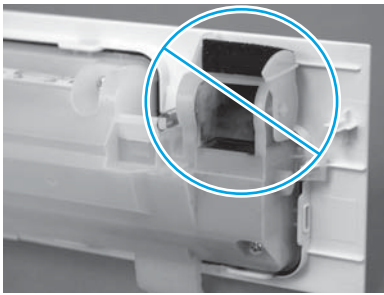
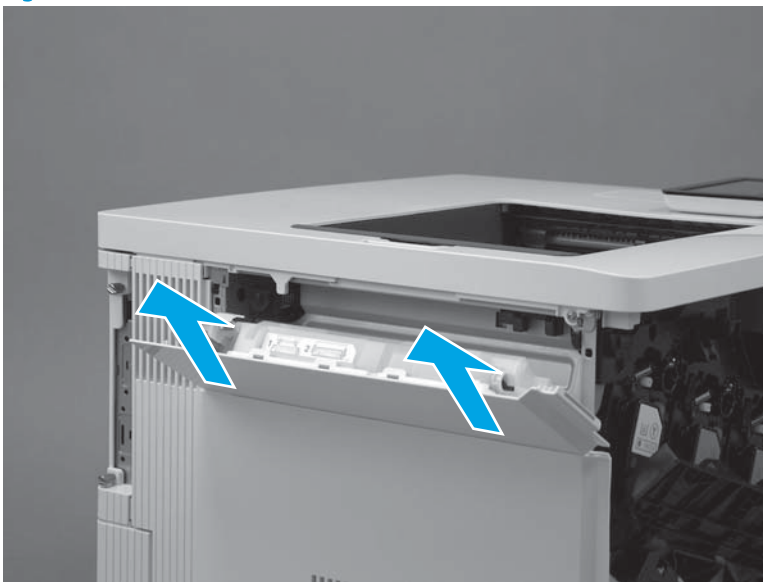

Figure 1-933 Remove the TCU



Step 3: Remove the formatter cover

1. Locate the formatter cover.

Figure 1-934 Locate the formatter cover

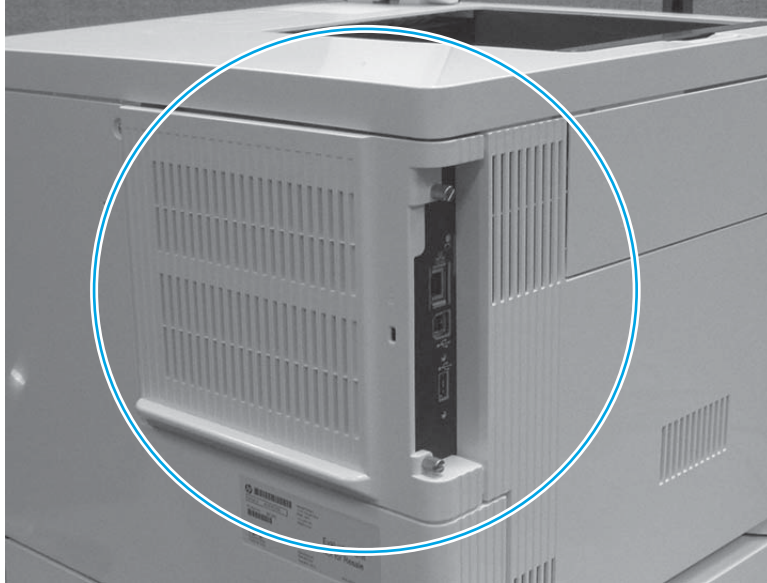

2. Loosen the two thumbscrews (callout 1). Grasp the two thumbscrews, and then slide the cover away from the printer (callout 2) to remove it.

 **TIP:** If needed, use the edge of a coin to turn the thumbscrews.

Figure 1-935 Loosen the thumbscrews

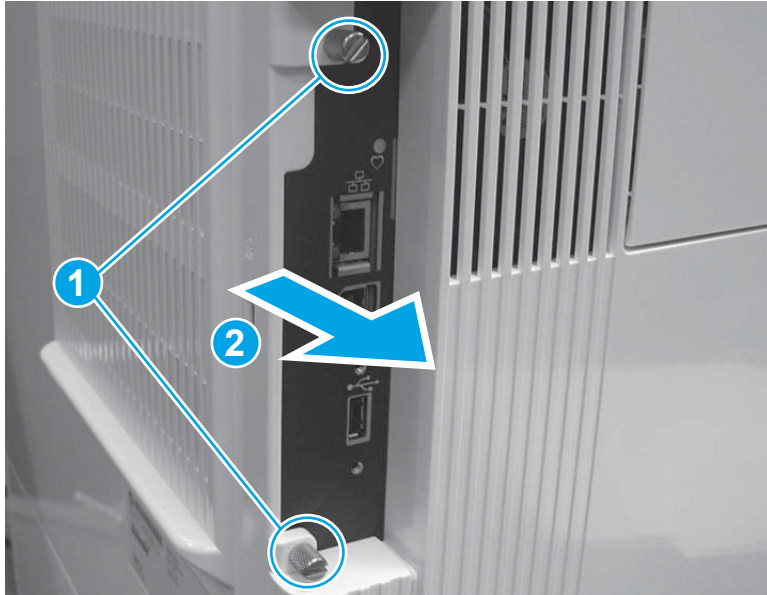

Step 4: Remove the rear cover

1. Remove four screws (callout 1).

Figure 1-936 Remove four screws

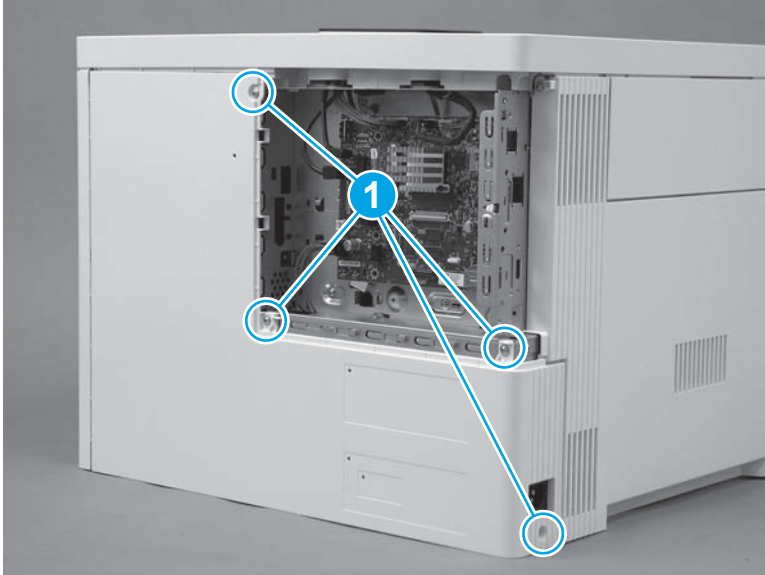

2. Slightly slide the cover to the right (callout 1), rotate the bottom of the cover away from the printer (callout 2), and then pull the top of the cover away from the printer (callout 3) to remove the cover.

Figure 1-937 Remove the cover

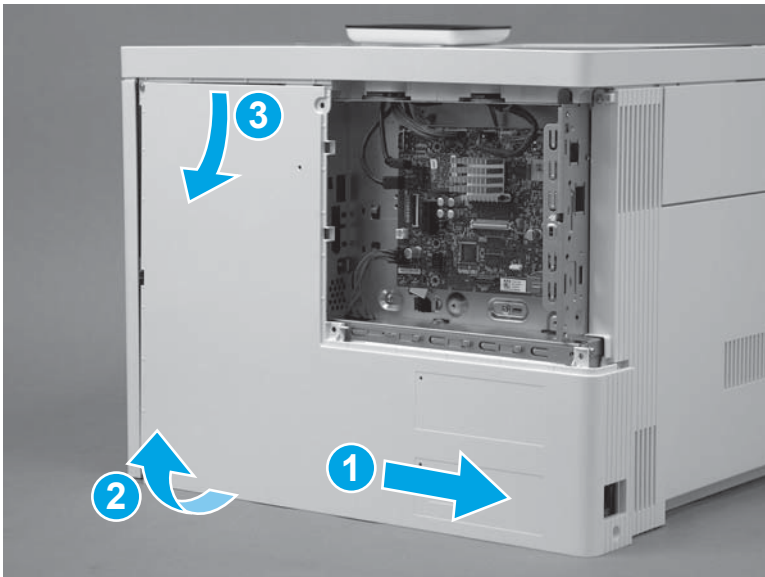

Step 5: Remove the left cover

1. At the left side of the printer, remove one screw (callout 1).

Figure 1-938 Remove one screw



2. Release one tab (callout 1), rotate the front edge of the cover away from the printer (callout 2), and then slide the cover (callout 3) toward the rear of the printer to release it.

Figure 1-939 Release the cover

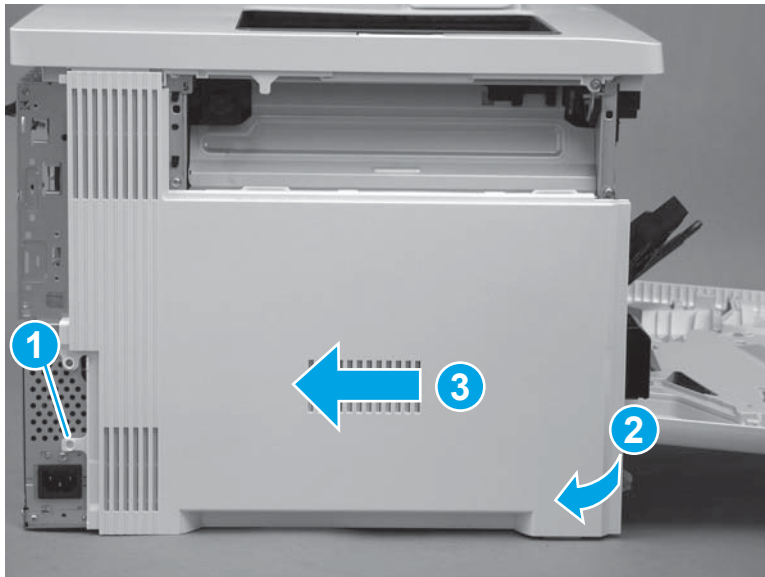

3. Remove the cover.

Figure 1-940 Remove the cover

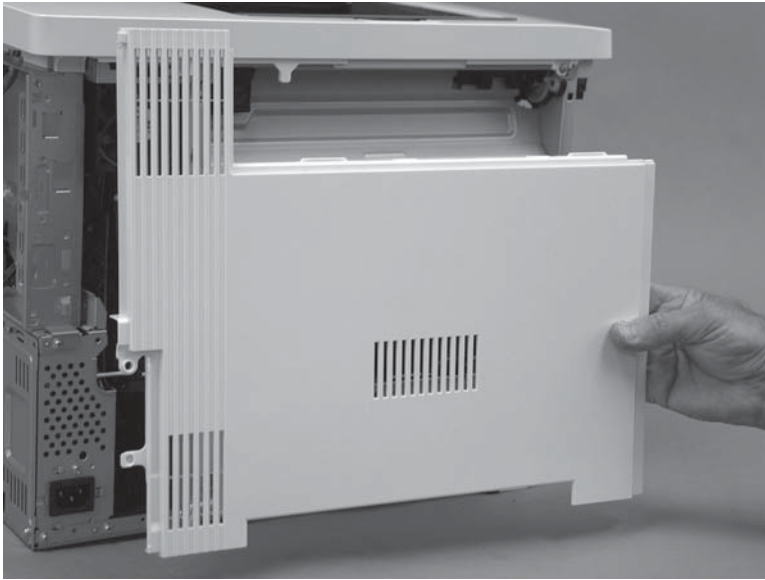

Step 6: Remove the upper cover

1. Remove three screws (callout 1).

Figure 1-941 Remove three screws

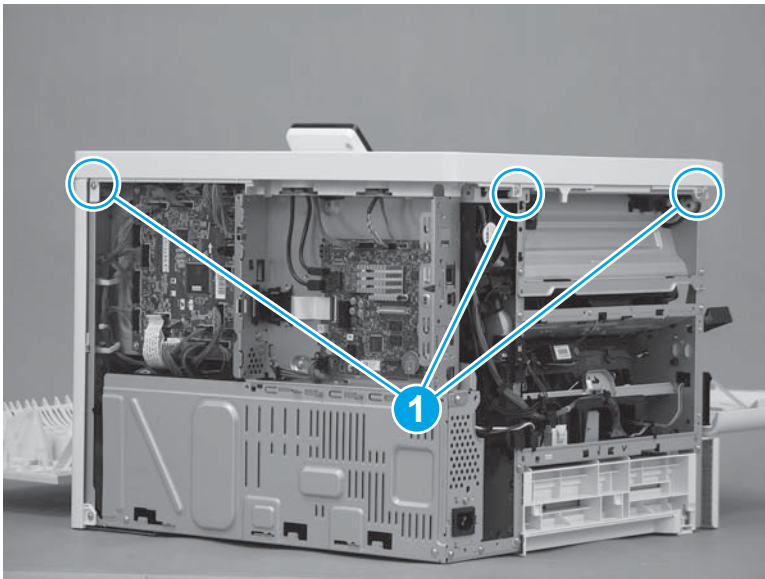

2. Remove one screw (callout 1), release one tab (callout 2), and then slightly separate the corner of the cover from the chassis.

 **NOTE:** This is a self-tapping plastic-thread screw. Make sure that this screw is used in this location when it is reinstalled.

Figure 1-942 Remove one screw and release one tab



3. Release one tab (callout 1), and then lift up on the cover to release it.

 **NOTE:** If the cover does not release, check for addition tabs by locating the triangles embossed in the cover at tab locations.

Figure 1-943 Release the cover



4. Remove the cover.

Figure 1-944 Remove the cover

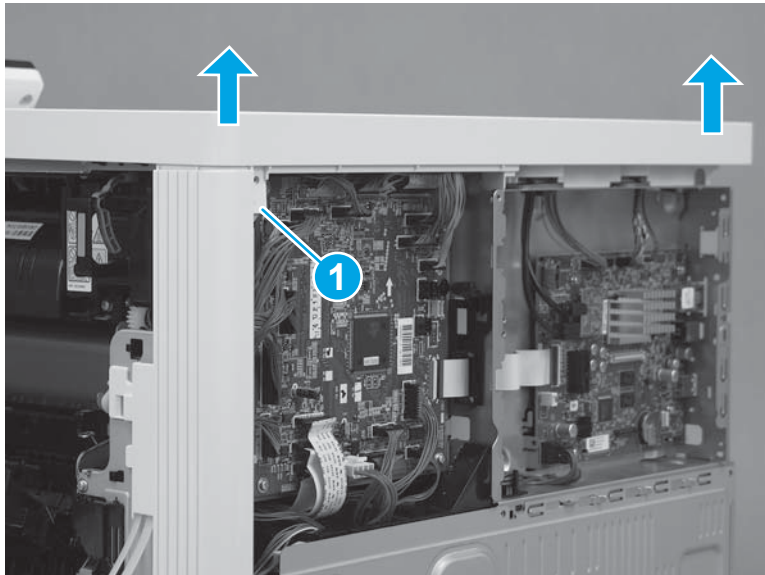
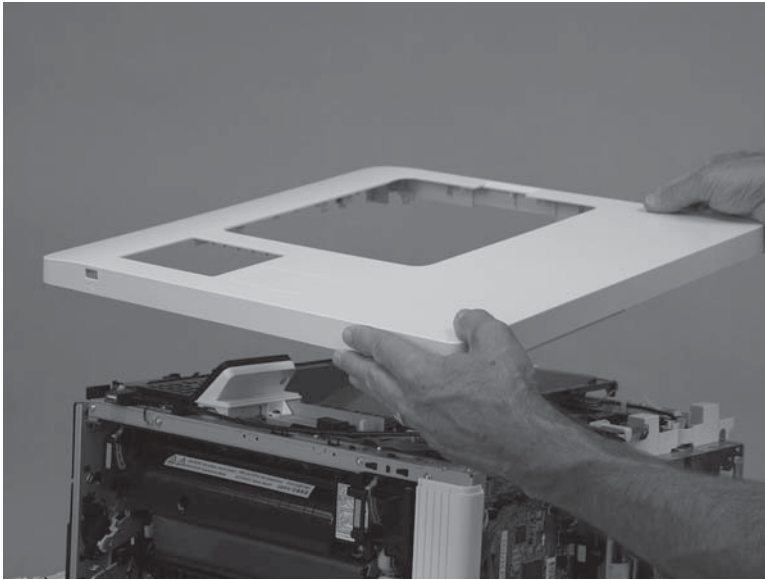

Step 7: Remove the control panel

1. Remove one screw (callout 1).

Figure 1-945 Remove one screw

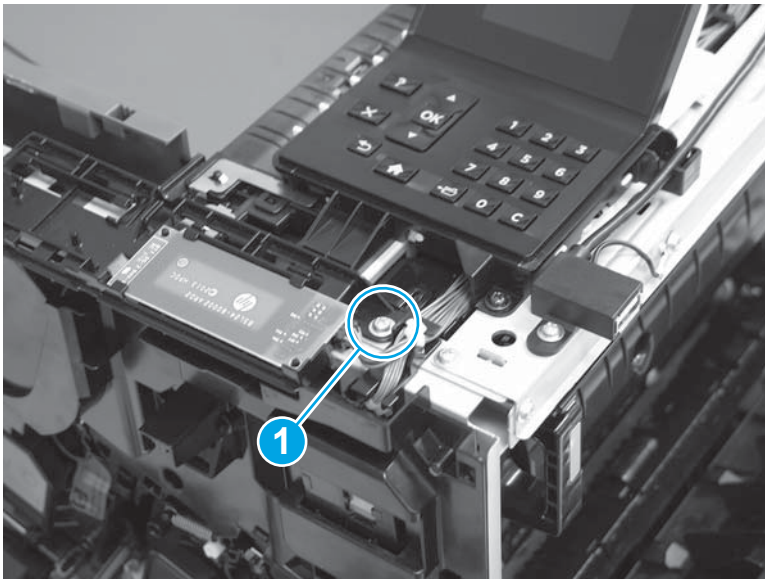

2. Disconnect one connector (callout 1). Rotate the near field communication (NFC) PCA holder up (callout 2), and then slide it to the right (callout 3) to remove it.

Figure 1-946 Remove the PCA holder

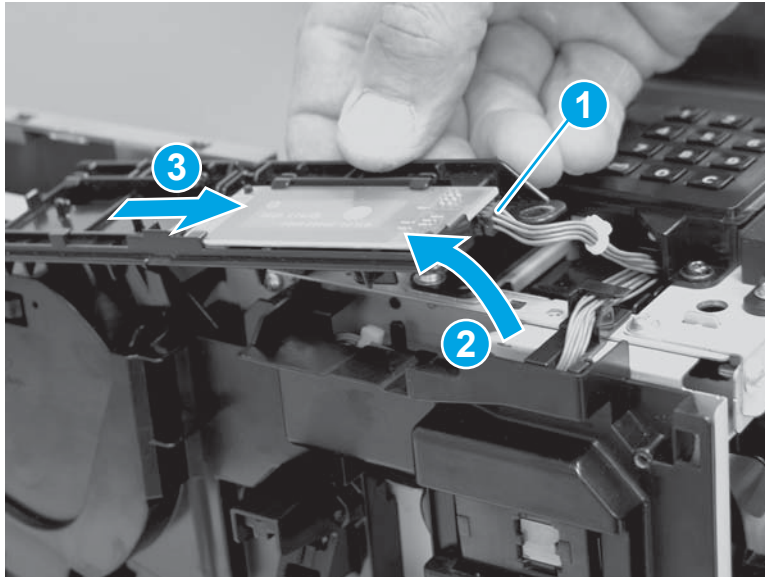

3. Remove one cable from the guide.

Figure 1-947 Remove one cable



4. Remove four screws (callout 1), and then turn the control panel over (callout 2) to access the bottom side.

⚠ CAUTION: The control panel is still attached to the printer. Do not attempt to completely remove the control panel.

Figure 1-948 Remove four screws

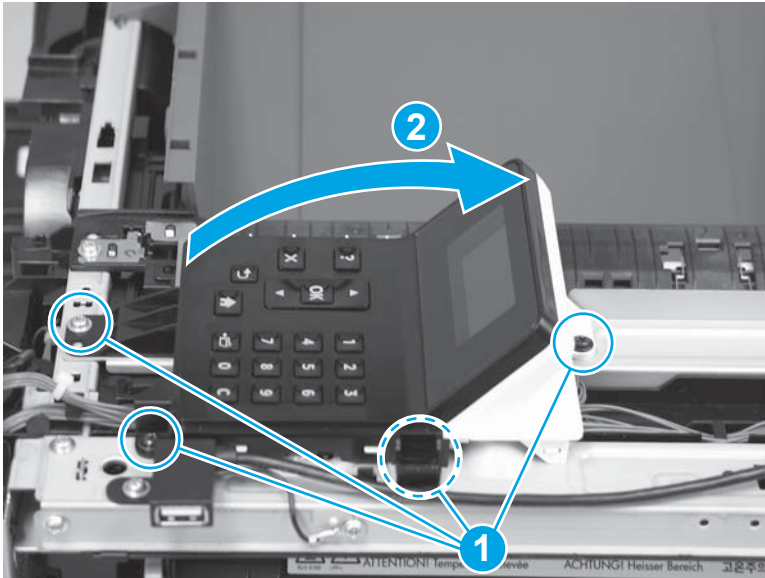

5. Disconnect one connector (callout 1), and then remove the control panel.

Figure 1-949 Remove the control panel

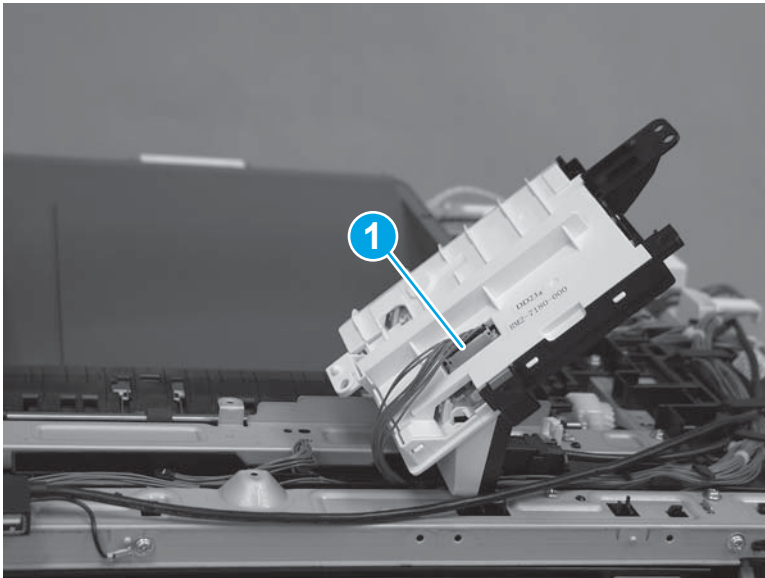

Step 8: Unpack the replacement assembly

Unpack the replacement assembly from the packaging.

For complete information on HP's recycling programs, go to [Product return and recycling](#).

📝 NOTE: HP recommends responsible disposal of the defective assembly.

Figure 1-950 Recycle and unpack

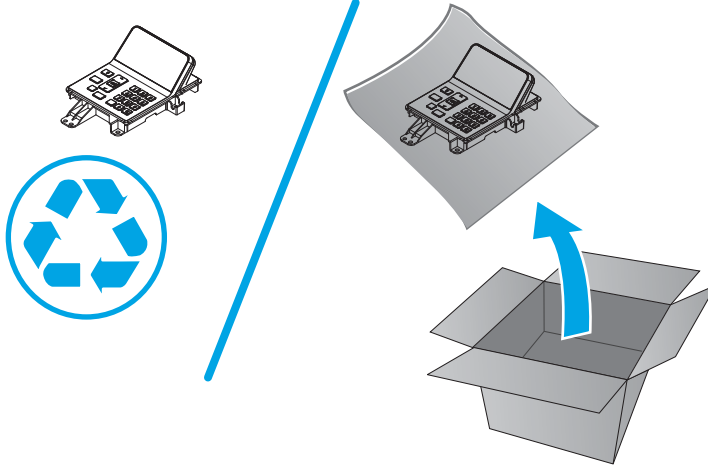

Step 9: Install the control panel

1. Position the control panel on the printer, and then connect one connector (callout 1).

Figure 1-951 Connect one connector

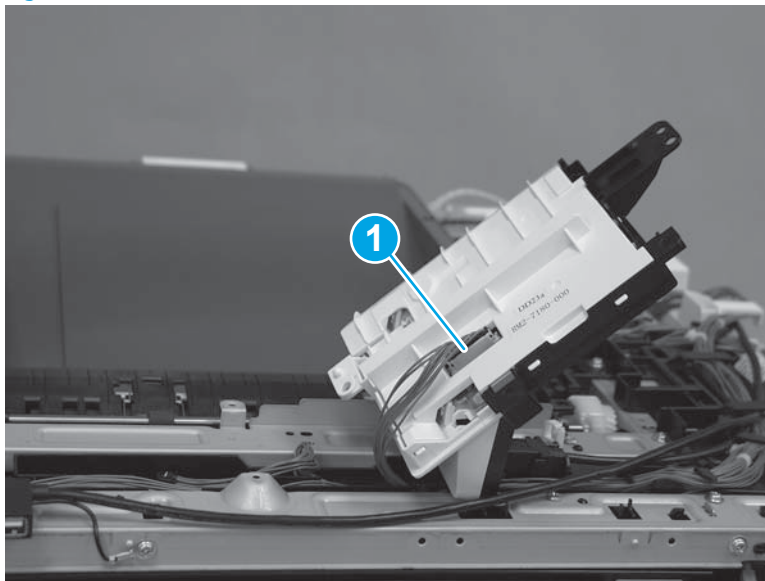

2. Turn the control panel over (callout 1), and then install four screws (callout 2).

Figure 1-952 Install four screws

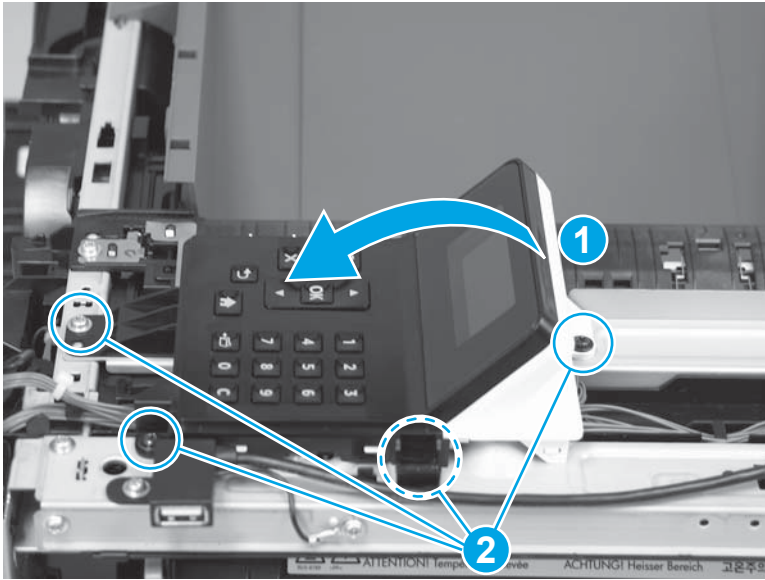

3. Place one cable in the guide.

Figure 1-953 Place one cable in the guide



4. Install the tab on the NFC PCA holder (callout 1) in the slot (callout 2) in the chassis.

Figure 1-954 Install the tab

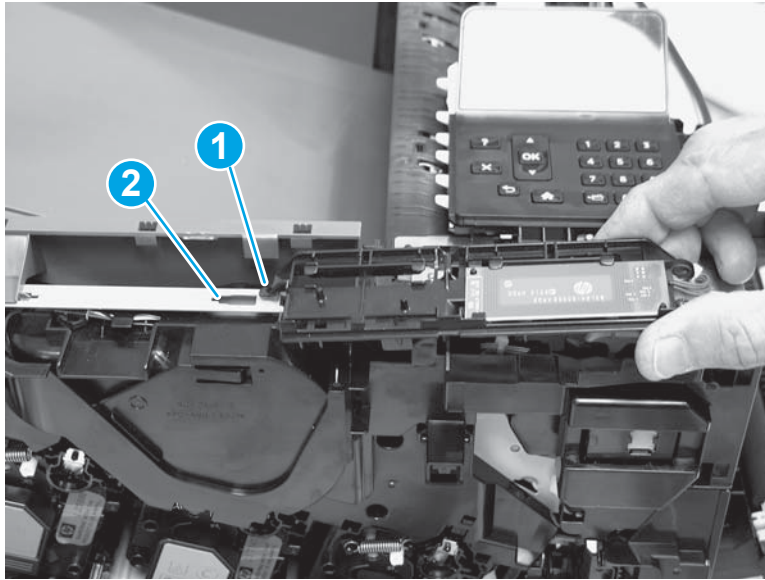

5. Rotate the NFC PCA holder down (callout 1) to install it, connect one connector (callout 2), and then install one screw (callout 3).

Figure 1-955 Install one screw

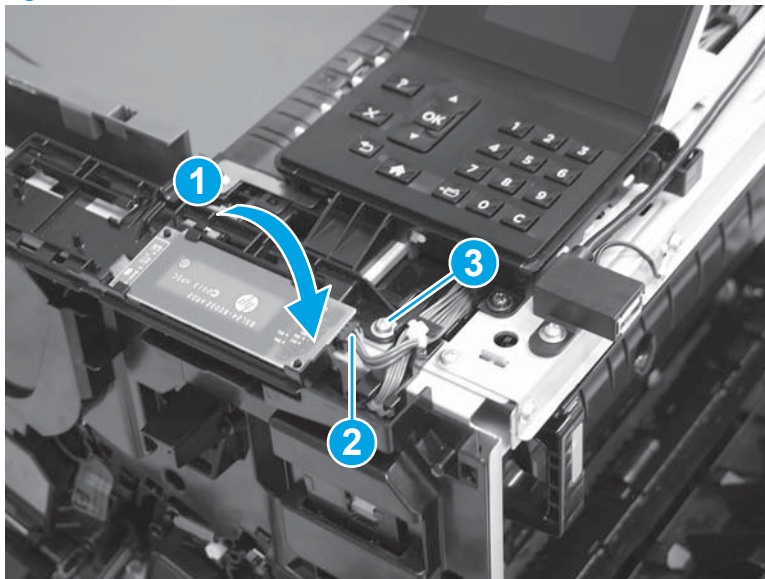

Step 10: Install the upper cover

1. Position the cover on the printer.

 **NOTE:** For the M553x model, do not forget to pass the control-panel wire harness and USB cable through the opening in the cover.

Figure 1-956 Install the cover



2. Push down on the rear corner of the cover to engage one tab (callout 1).

Figure 1-957 Engage one tab

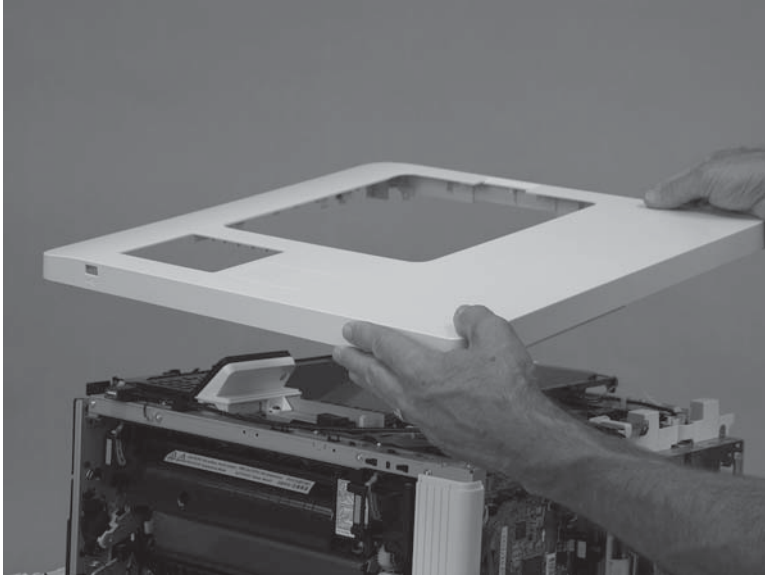
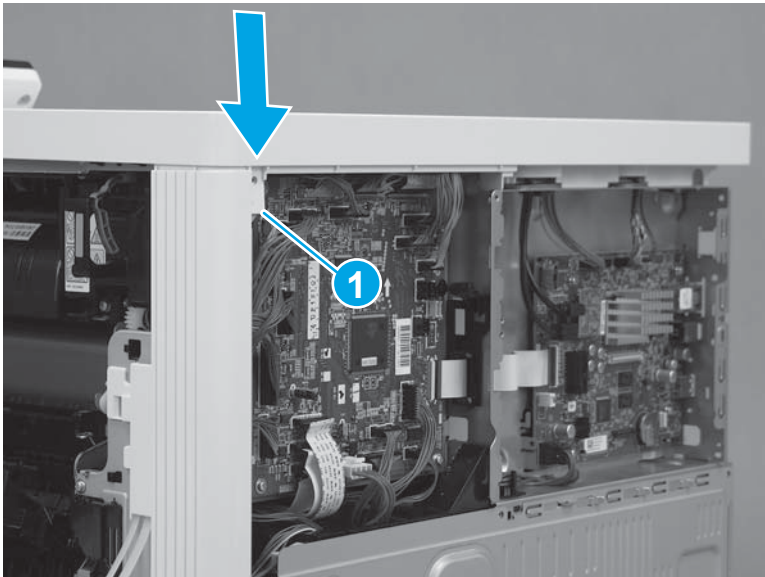

3. Push down on the front corner of the cover to engage one tab (callout 1), and then install one screw (callout 2).

 **NOTE:** This is a self-tapping plastic-thread screw. Make sure that this screw is used in this location when it is reinstalled.

Figure 1-958 Engage one tab and install one screw



4. Install three screws (callout 1).

Figure 1-959 Install three screws

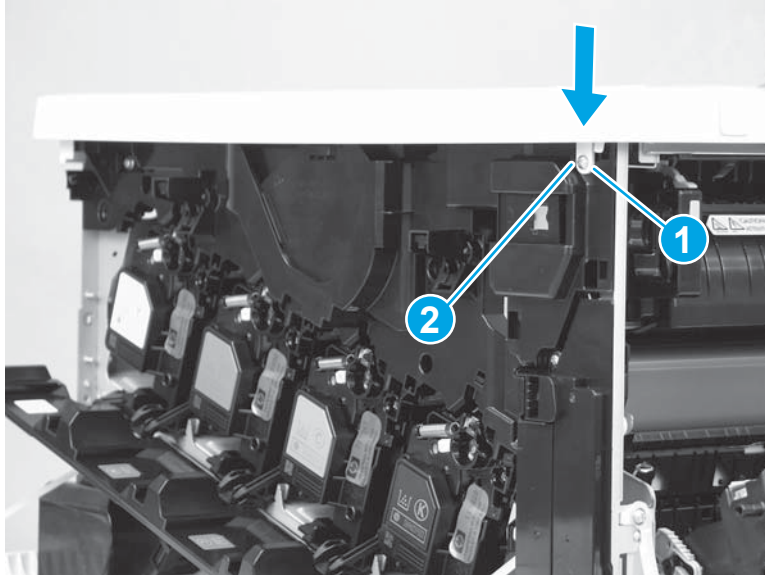
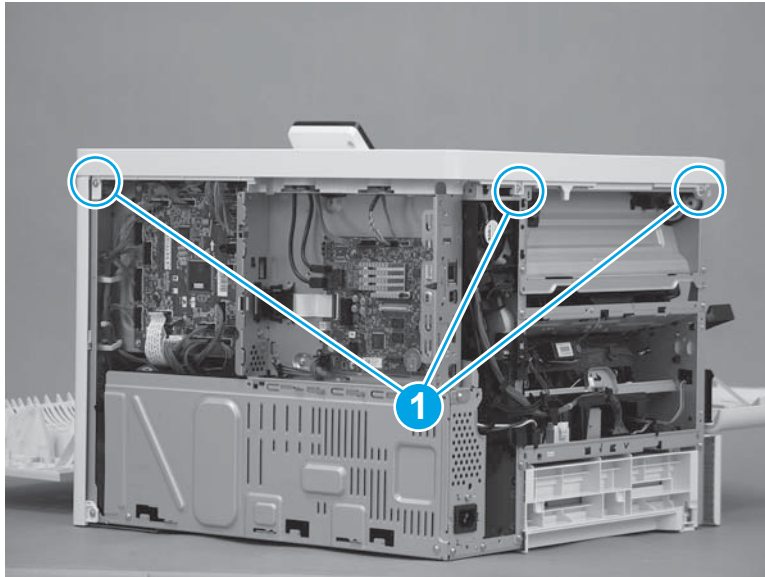

Step 11: Install the left cover

1. Position the cover on the printer.

 **NOTE:** Slightly offset the cover toward the rear of the printer.

Figure 1-960 Install the cover

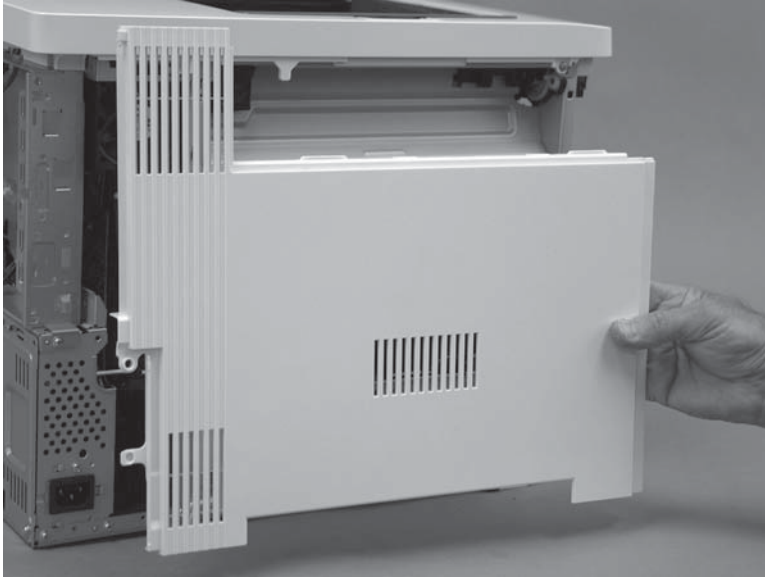

2. Slide the cover (callout 1) toward the front of the printer to engage it. Make sure that the tab (callout 2) snaps into place.

 **NOTE:** Locate the alignment pin (callout 3) on the cover from the front door side of the printer, and then make sure that it is fully engaged in the slot in the chassis.

 **TIP:** While sliding the cover into place, push in on the center of the cover (callout 1) to make sure that the hooks on the back of the cover engage with the slots in the chassis.

Figure 1-961 Engage the cover



3. At the left side of the printer, install one screw (callout 1).

Figure 1-962 Install one screw

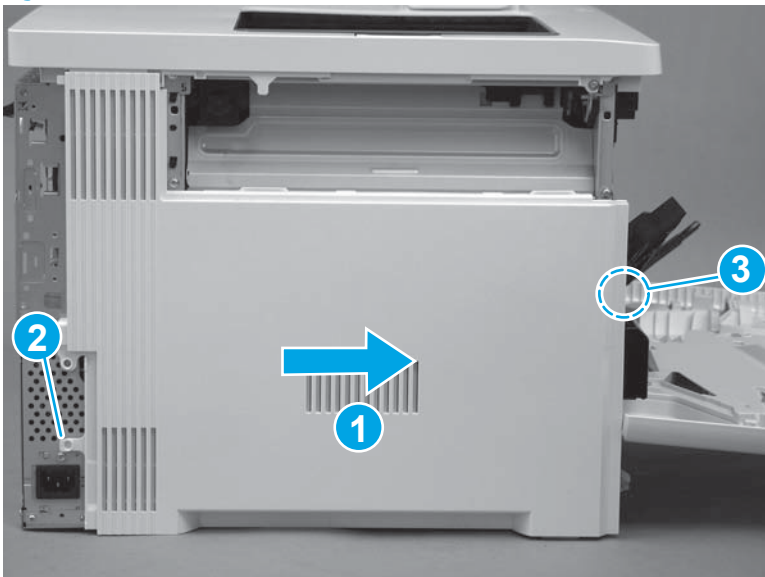

Step 12: Install the rear cover

1. Position the top of the cover under the upper cover (callout 1), rotate the bottom of the cover onto the chassis (callout 2), and then slide the cover to the left (callout 3) to install it.

Figure 1-963 Install the cover

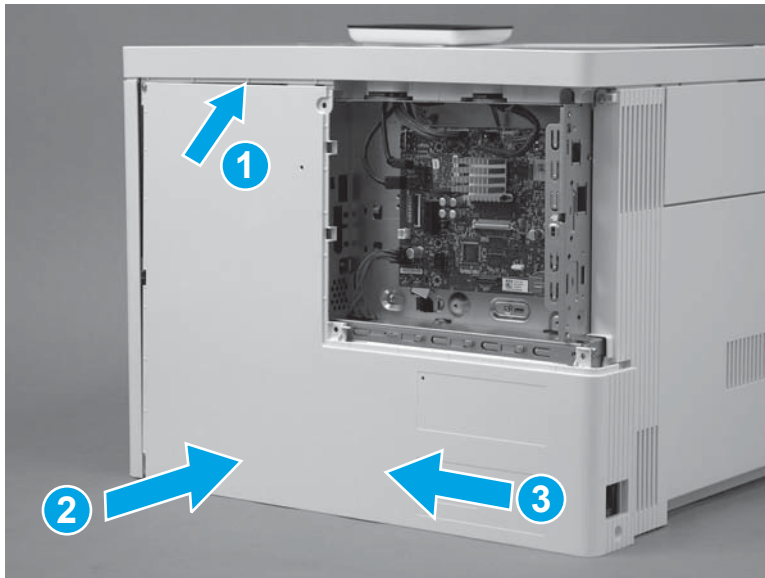

2. Install four screws (callout 1).

Figure 1-964 Install four screws cover

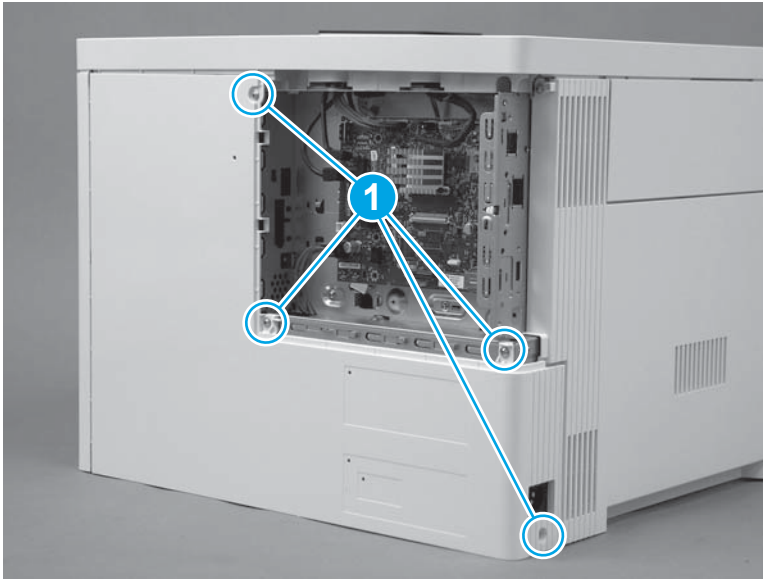

Step 13: Install the formatter cover

- ▲ Slide the cover onto the printer (callout 1) to install it.

 **NOTE:** Make sure that the tabs on the formatter cover align with the slots provided in the printer (callout 2). Tighten the two thumbscrews (callout 3).

 **TIP:** If needed, use the edge of a coin to turn the thumbscrews.

Figure 1-965 Install the cover

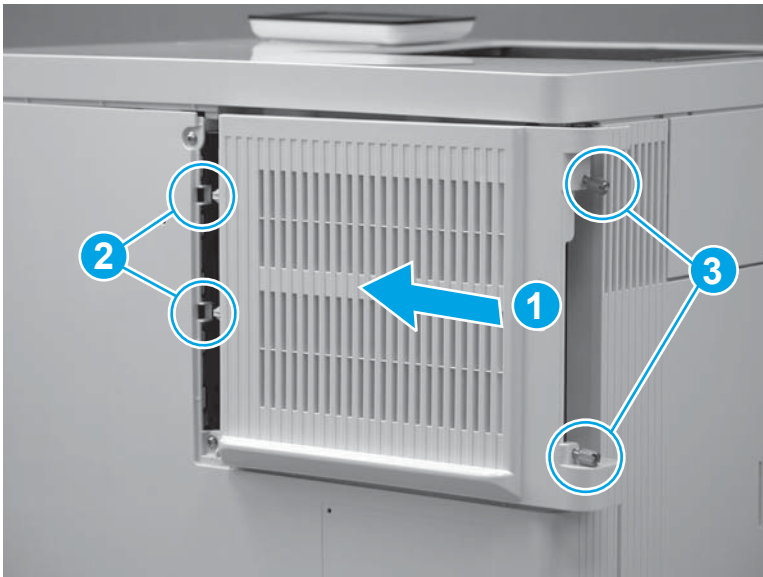

Step 14: Install the TCU

1. Verify that the toner collection hatch cover is in the closed position on the TCU.

Figure 1-966 Verify that the toner collection hatch cover is closed

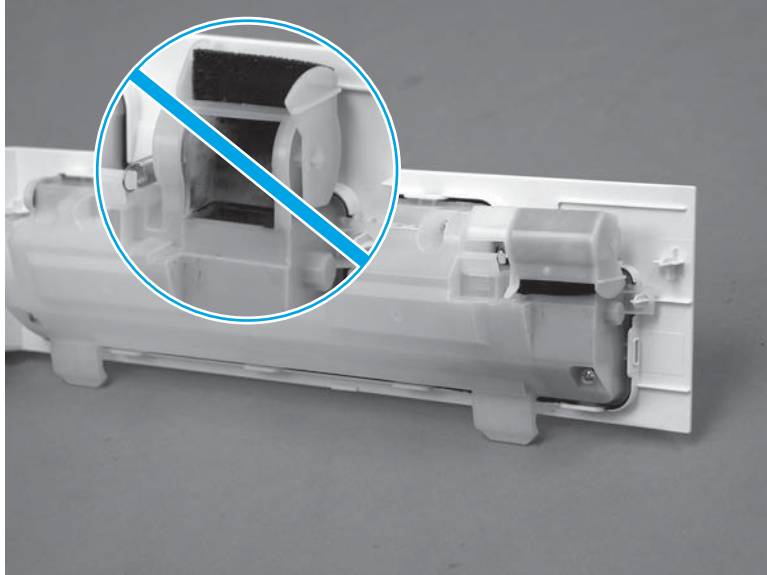

2. Position the TCU with the hinges in the slots provided in the printer (callout 1), and then rotate the TCU up and into the closed position.

 **NOTE:** The toner collection hatch cover automatically opens when the TCU is closed.

Figure 1-967 Install the TCU

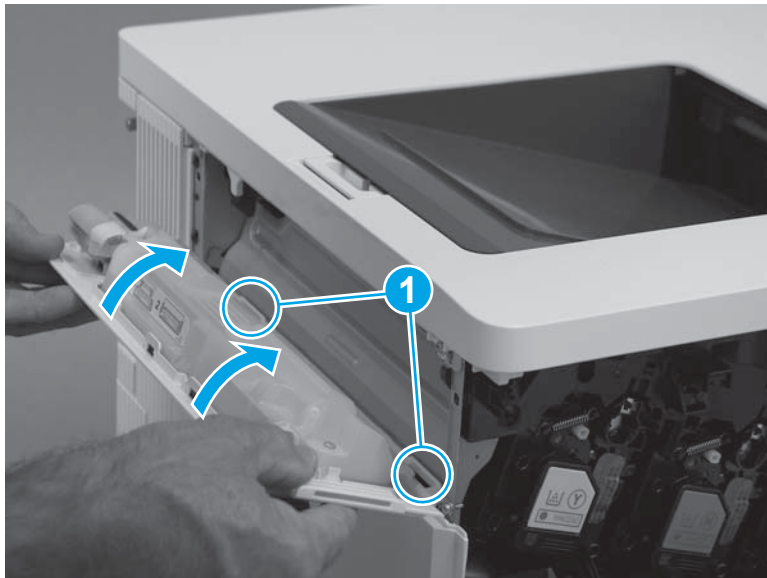

3. Close the front door.

Figure 1-968 Close the front door



Step 15: Install the USB cover

1. Push the cover into the USB port to install it.

Figure 1-969 Install the cover



2. Make sure that the USB cover is fully seated after installing it.

Figure 1-970 Check the installation

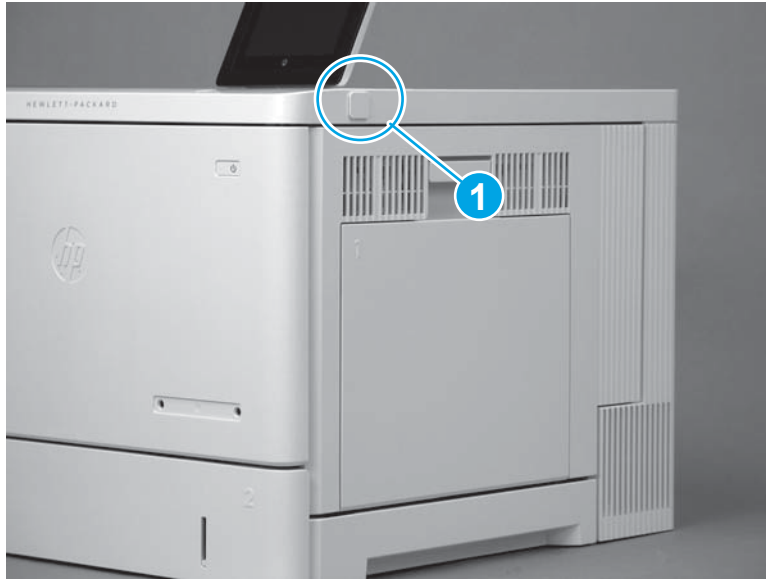

Removal and replacement: Internal parts and assemblies

- [Removal and replacement: Tray 1 pickup and separation rollers](#)
- [Removal and replacement: Secondary transfer assembly](#)
- [Removal and replacement: Near field communication \(NFC\) PCA \(M553x\)](#)
- [Removal and replacement: Near field communication \(NFC\) PCA \(M577z\)](#)
- [Removal and replacement: Wireless PCA \(M553 and M577\)](#)
- [Removal and replacement: Switch \(SW4\) PC board assembly](#)
- [Removal and replacement: Stapler unit \(M577c/f/z\)](#)
- [Removal and replacement: DC controller](#)
- [Removal and replacement: Delivery assembly](#)
- [Removal and replacement: Formatter \(M552 and M553\)](#)
- [Removal and replacement: Formatter \(M577\)](#)
- [Removal and replacement: Formatter case assembly](#)
- [Removal and replacement: Fuser power supply](#)
- [Removal and replacement: Low-voltage power supply \(LVPS\)](#)
- [Removal and replacement: High-voltage power supply D \(HVPSD\)](#)
- [Removal and replacement: Drum motor 1 \(M1\)](#)
- [Removal and replacement: Power-supply fan \(FM1\)](#)
- [Removal and replacement: Developing disengagement motor \(M6\)](#)
- [Removal and replacement: Auto close assembly](#)
- [Removal and replacement: Lifter drive assembly](#)
- [Removal and replacement: Laser/scanner assembly](#)
- [Removal and replacement: Delivery fan \(FM3\)](#)
- [Removal and replacement: High-voltage power supply T \(HVPST\)](#)
- [Removal and replacement: Drum motor 2 \(M2\)](#)
- [Removal and replacement: Drum motor 3 \(M3\)](#)
- [Removal and replacement: Fuser motor \(M4\)](#)
- [Removal and replacement: Environmental sensor printed circuit assembly \(PCA\)](#)
- [Removal and replacement: Fuser drive assembly](#)
- [Removal and replacement: Duplex drive assembly and motor](#)
- [Removal and replacement: Pickup drive assembly and motor \(M5\)](#)

- [Removal and replacement: Registration assembly](#)
- [Removal and replacement: Paper pickup assembly](#)
- [Removal and replacement: Density-detect assembly](#)
- [Removal and replacement: Main drive assembly](#)

Removal and replacement: Tray 1 pickup and separation rollers

- [Introduction](#)
- [Step 1: Remove the Tray 1 pickup roller](#)
- [Step 2: Remove the Tray 1 separation roller](#)
- [Step 3: Unpack the replacement assemblies](#)
- [Step 4: Install the Tray 1 separation roller](#)
- [Step 5: Install the Tray 1 pickup roller](#)

Introduction

This document provides the procedures to remove and replace the Tray 1 pickup and separation rollers.

Before performing service

Turn the printer power off

- Disconnect the power cable.

 **WARNING!** To avoid damage to the printer, turn the printer off, wait 30 seconds, and then remove the power cord before attempting to service the printer.

Use the table below to identify the correct part number for your printer. To order the part, go to www.hp.com/buy/parts.

Tray 1 pickup and separation rollers kit part number	
--	--

B5L24-67905

Tray 1 pickup and separation rollers with instruction guide

Required tools

No special tools are required to install this part.

After performing service

Make sure that Tray 1 is fully closed after replacing the rollers.

Turn the printer power on

- Connect the power cable.
- Use the power switch to turn the power on.

Post service test

Print a configuration page to make sure that the printer is functioning correctly.

Step 1: Remove the Tray 1 pickup roller

1. Open Tray 1.

Figure 1-971 Open Tray 1



2. Pull on the center of the cover to open it.

Figure 1-972 Open the roller cover

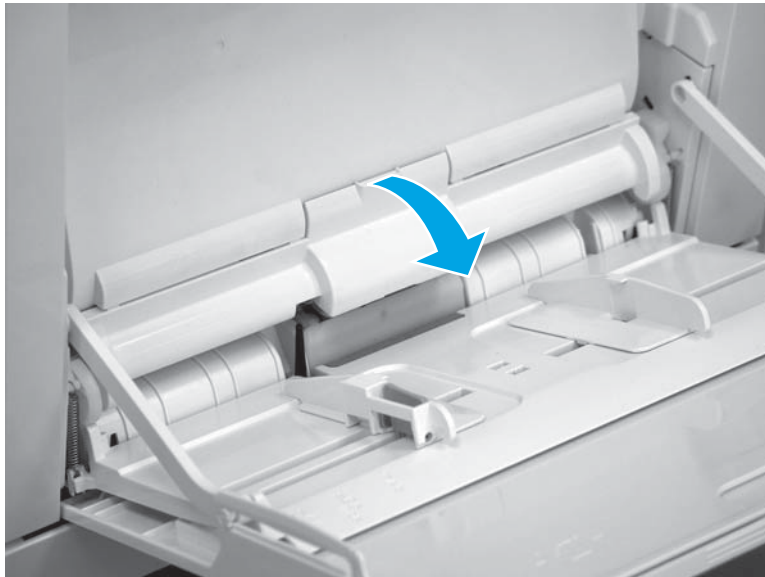

3. Pull the cover straight off of the printer to remove it.

Figure 1-973 Remove the cover

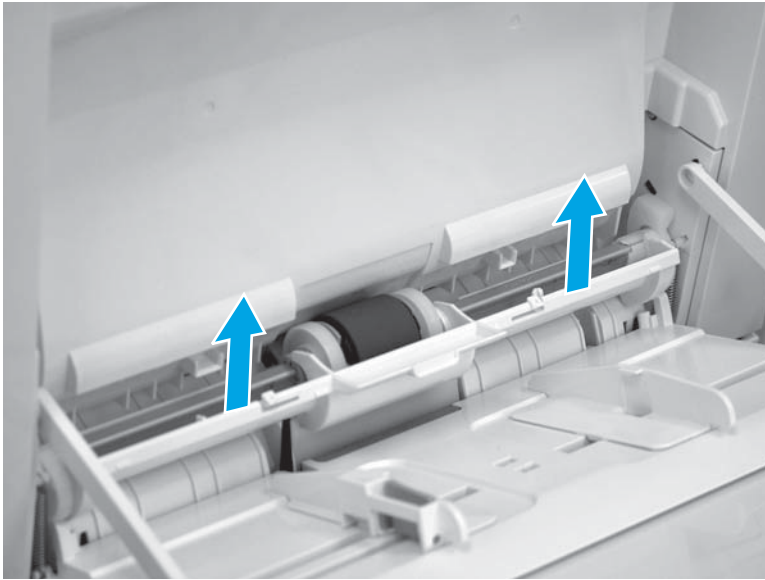

4. Release two tabs (callout 1) between the roller collar and roller, and then rotate the top of the roller (callout 2) out and away from the printer.

 **TIP:** Pushing down on the top of the roller might make it easier to release the tabs.

Figure 1-974 Release two tabs



5. Remove the roller.

Figure 1-975 Remove the roller

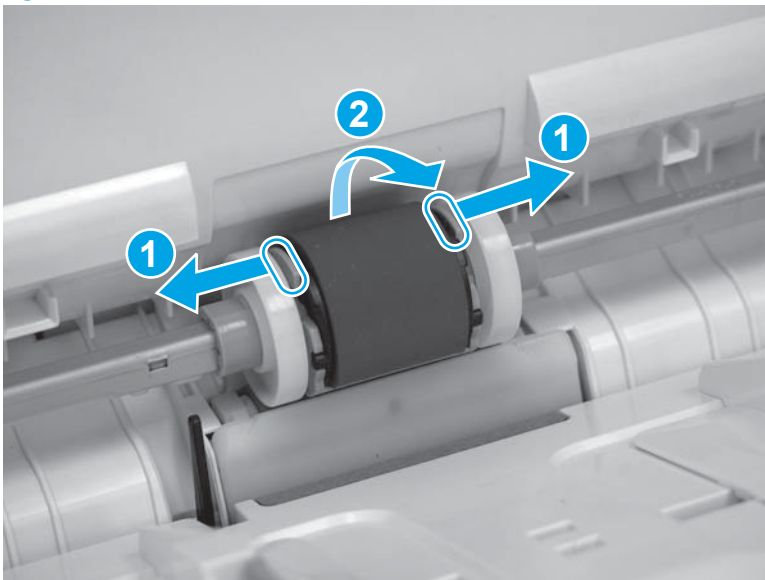
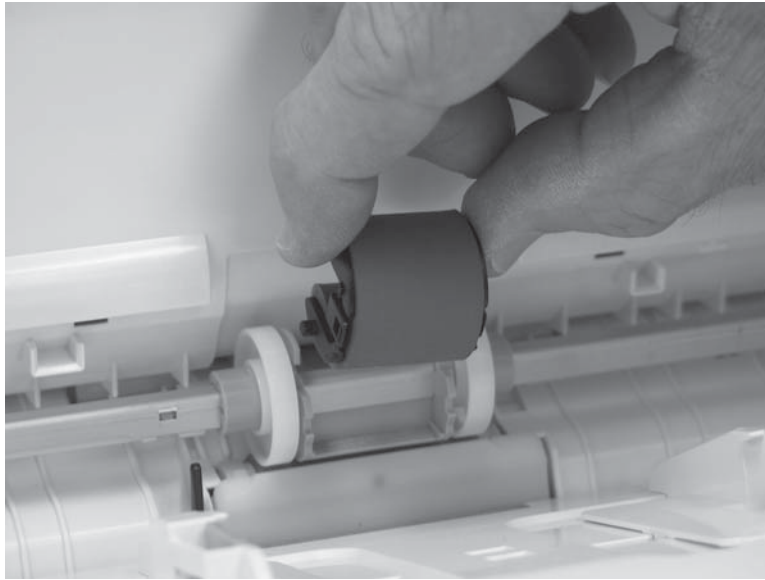

Step 2: Remove the Tray 1 separation roller

1. Carefully flex the right- and left-side tray retainers to release them.

 **TIP:** Raise the tray to the halfway closed position to make it is easier to release the retainers.

Figure 1-976 Release the tray retainers

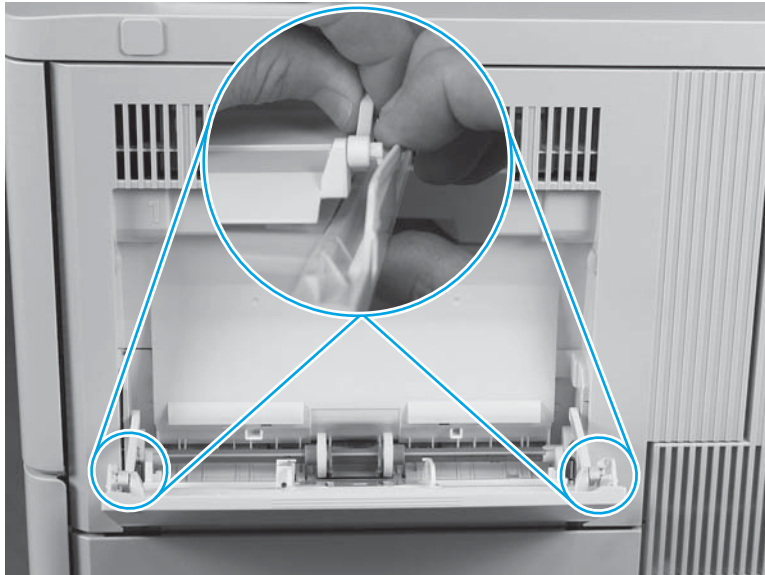

- Carefully raise Tray 1 up into the printer.

Figure 1-977 Raise Tray 1 up

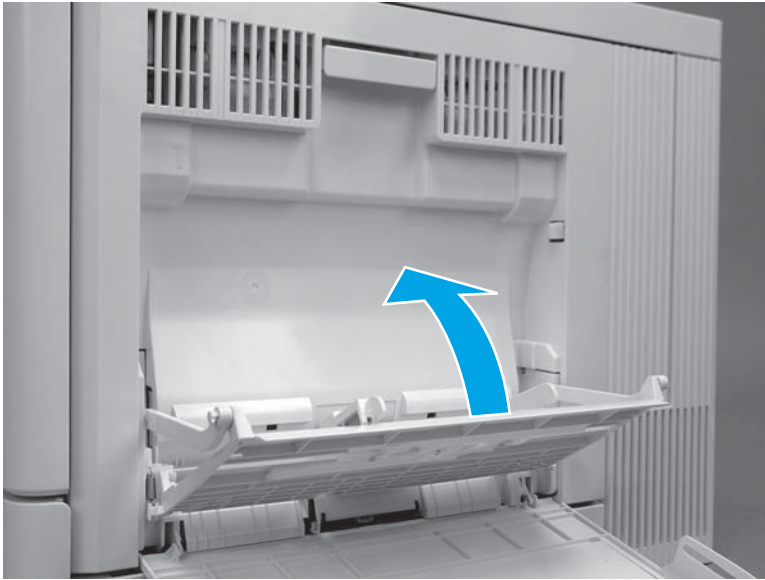

- Firmly grasp the corners of the separation roller cover, and then rotate it down and away from the printer to remove it.

Figure 1-978 Open the roller cover

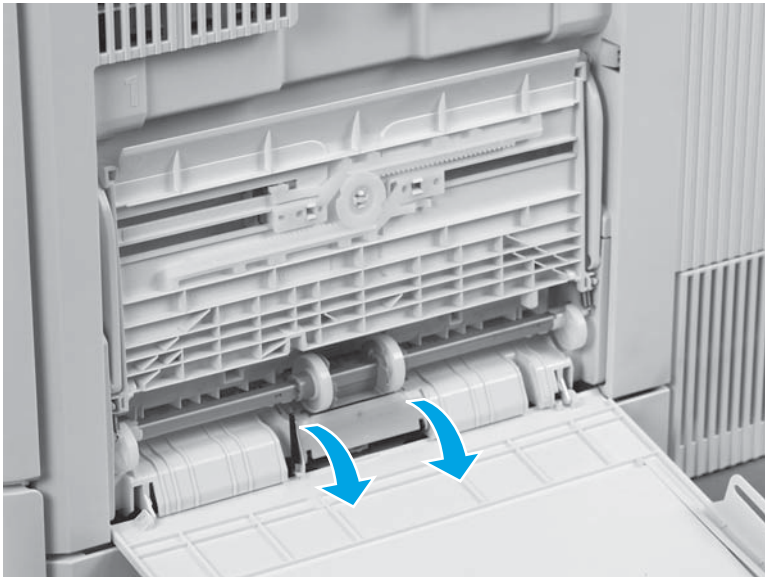

4. Release one tab (callout 1), and then rotate the end of the roller out and away from the holder (callout 2).

 **TIP:** It might be necessary to use a small flat-blade screwdriver to complete this step.

Figure 1-979 Release one tab



5. Slide the roller out of the holder to remove it.

Figure 1-980 Remove the roller

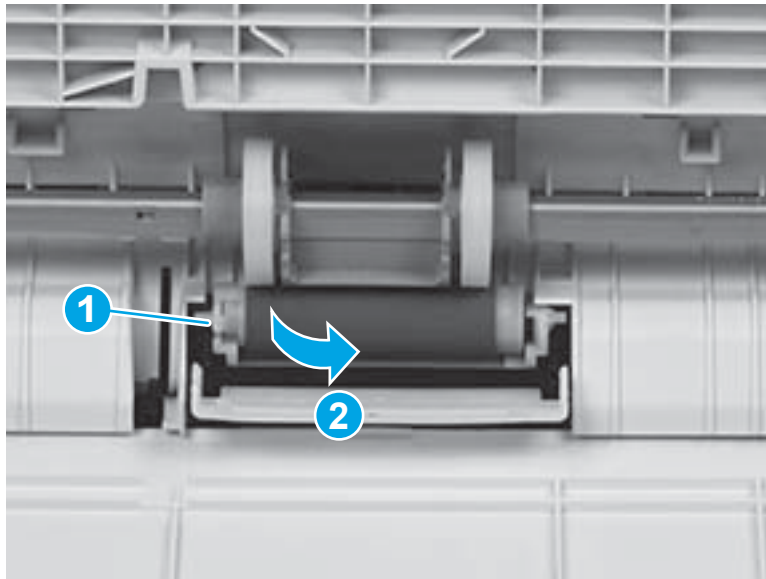
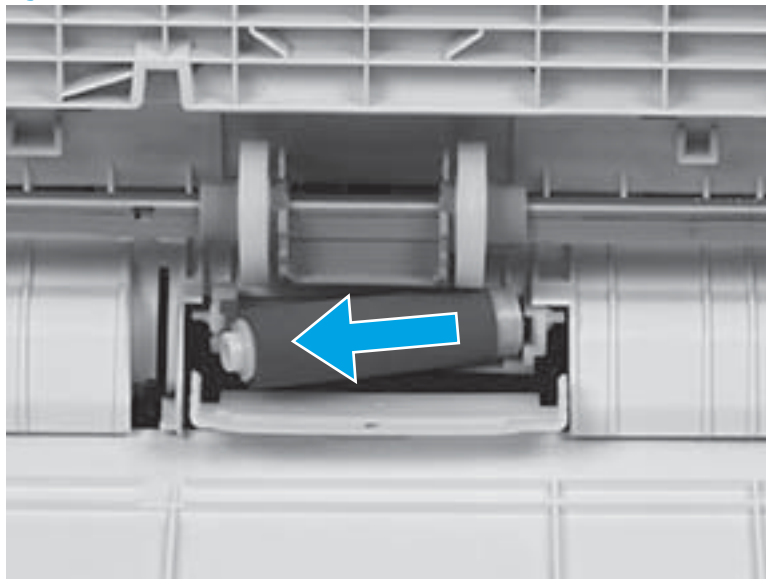

Step 3: Unpack the replacement assemblies

Unpack the replacement assemblies from the packaging.

 **CAUTION:** Avoid touching the surface of the replacement rollers. Skin oils on the rollers can cause print-quality problems. Thoroughly wash your hands with soap and water to remove skin oils, and then completely dry them.

For complete information on HP's recycling programs, go to [Product return and recycling](#).

 **NOTE:** HP recommends responsible disposal of the defective assemblies.

Figure 1-981 Recycle and unpack



Step 4: Install the Tray 1 separation roller

1. Before beginning, locate the keyed end of the replacement separation roller (callout 1) and the holder (callout 2).

Figure 1-982 Locate the keyed end of the roller and the holder

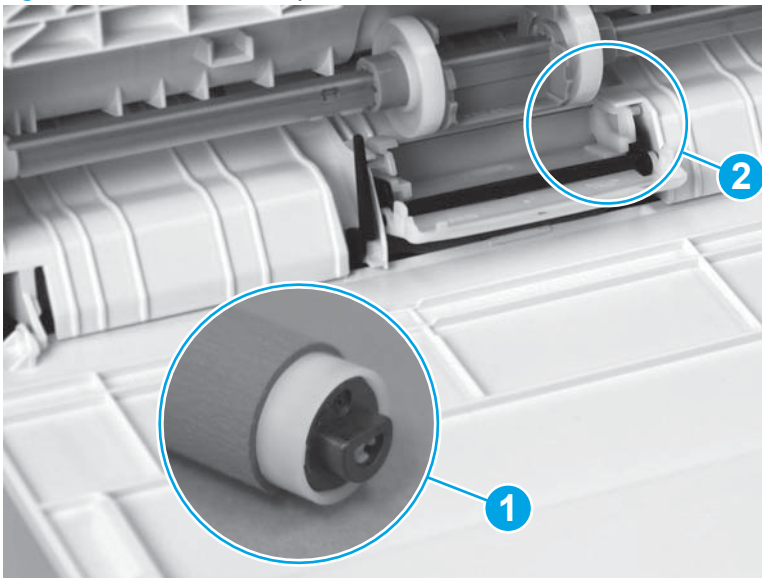

2. Slide the keyed end of the roller into the holder to install it.

Figure 1-983 Install the roller

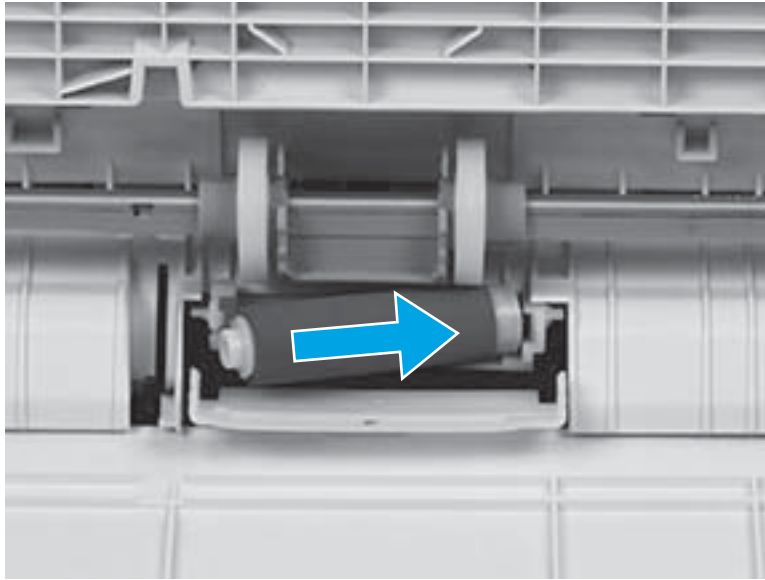

3. Rotate the end of the roller into the holder (callout 1) until the tab (callout 2) snaps into place.

Figure 1-984 Rotate the end of the roller into the holder

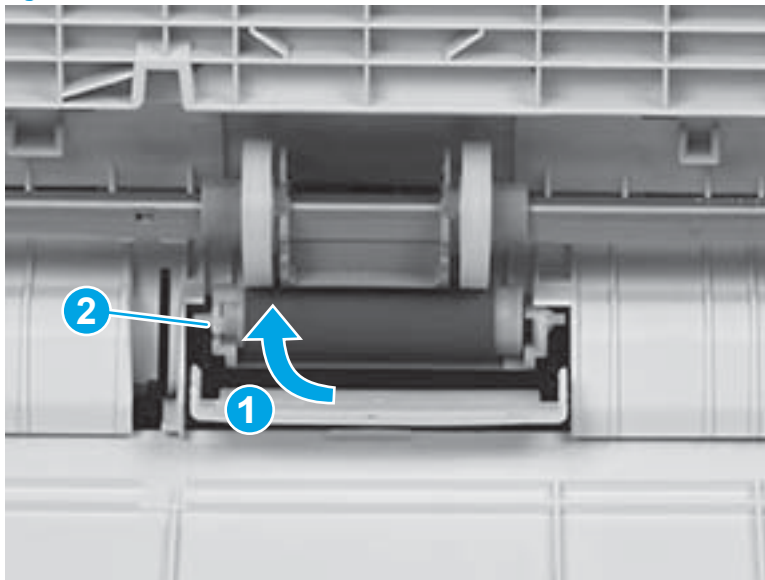

4. Position the separation roller cover on the printer, and then rotate it up and towards the printer to install it.

Figure 1-985 Close the roller cover

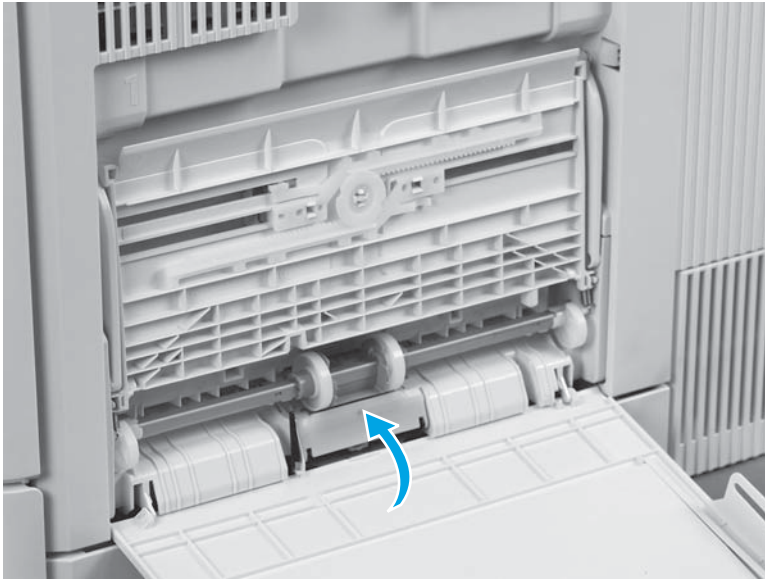

5. Carefully lower Tray 1 down.

Figure 1-986 Lower Tray 1 down

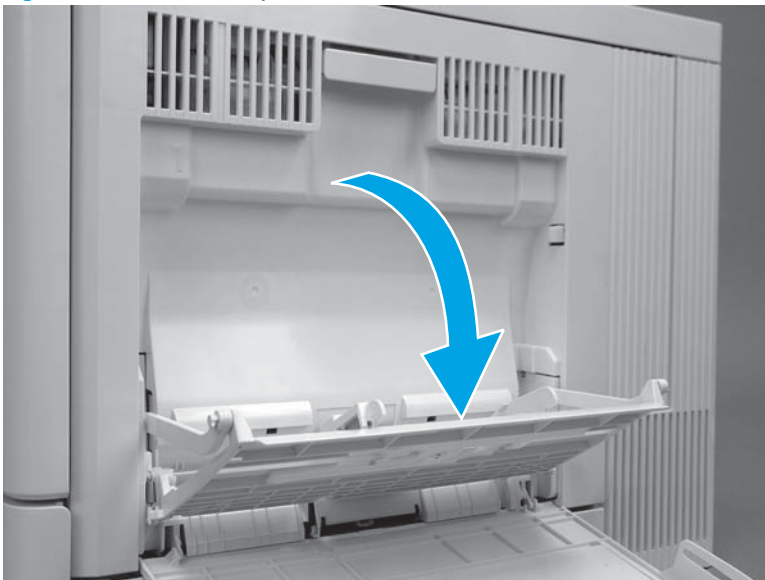

6. Carefully flex the right- and left-side tray retainers to reconnect them.

Figure 1-987 Reconnect the tray retainers

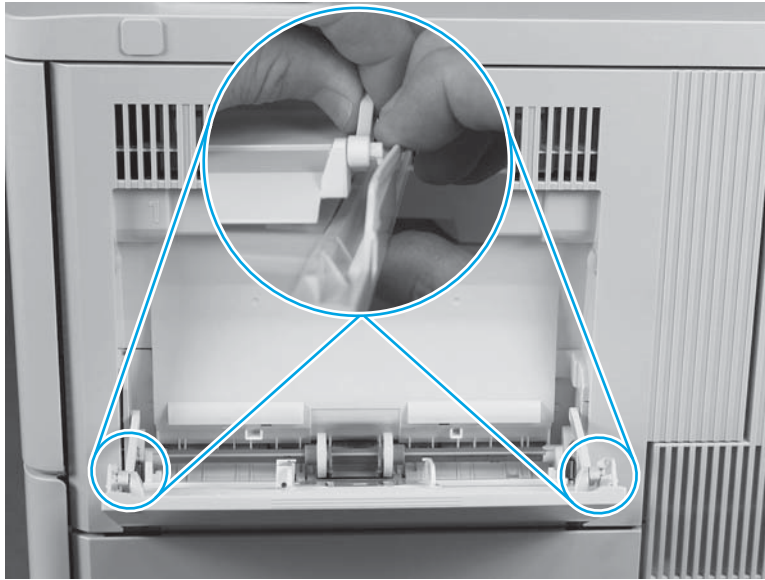

Step 5: Install the Tray 1 pickup roller

1. Position the replacement pickup roller with the pins in the provided slots on the holder, and then rotate the top of the roller up and toward the printer.

Figure 1-988 Install the roller

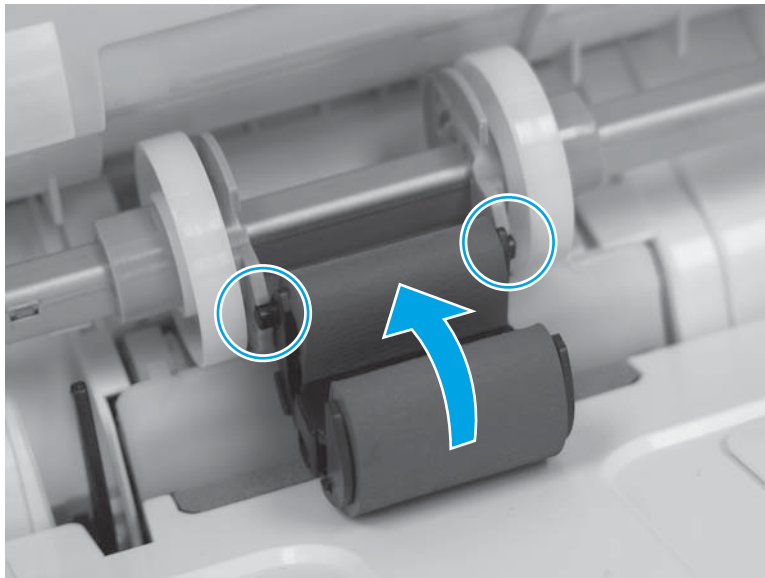

2. Continue to rotate the top of the roller toward the printer (callout 1), until two tabs (callout 2) snap into place.

Figure 1-989 Reconnect two tabs

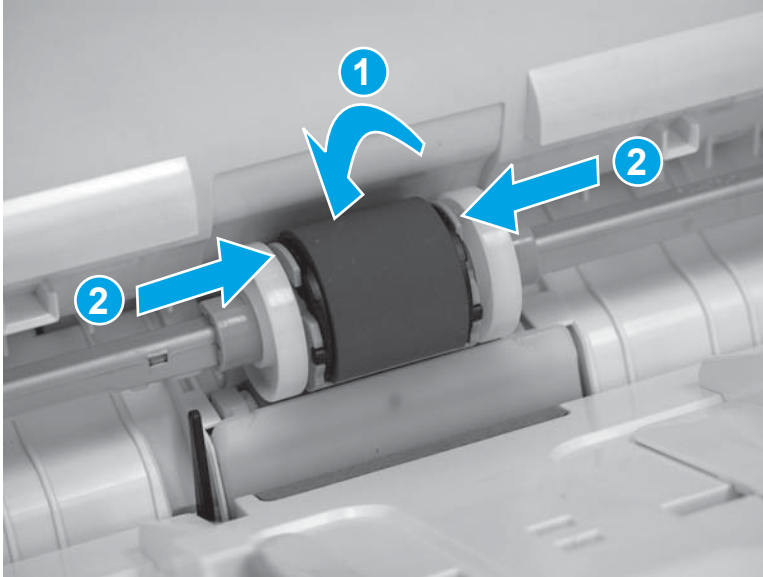

3. Install the roller cover.

Figure 1-990 Install the roller cover

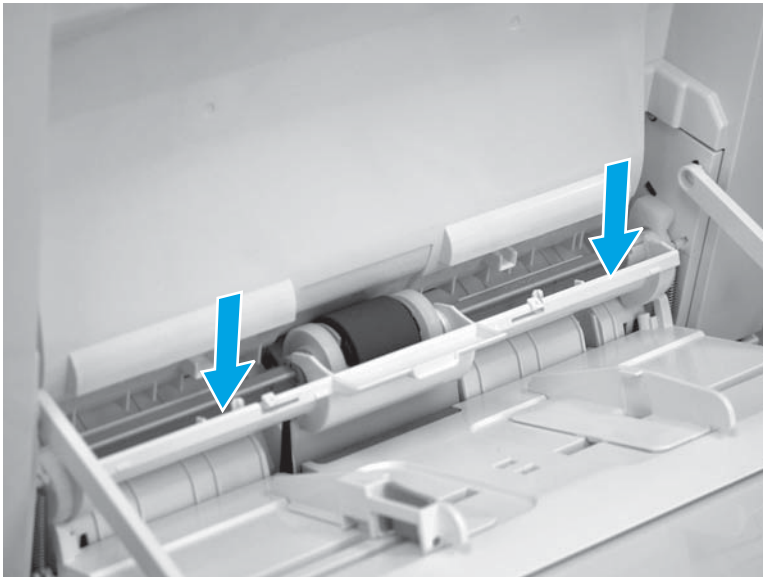

4. Close the roller cover.

Figure 1-991 Close the roller cover

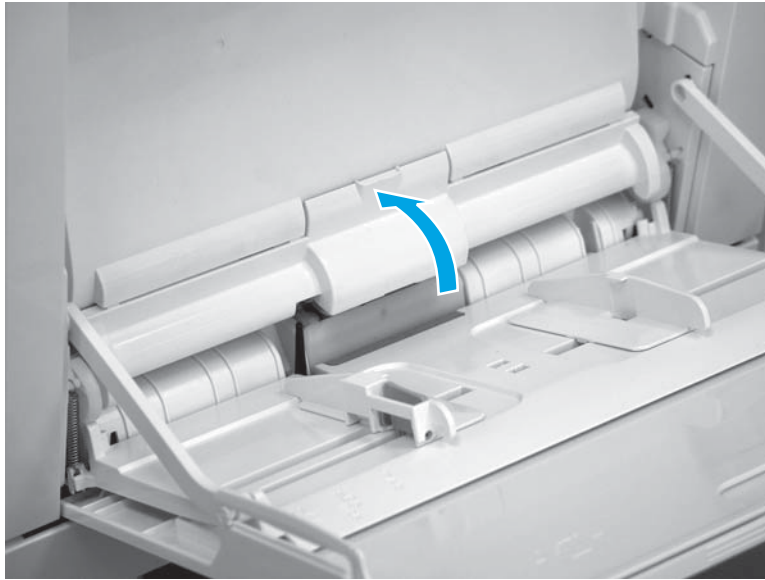

5. Close Tray 1.

Figure 1-992 Close Tray 1



Removal and replacement: Secondary transfer assembly

- [Introduction](#)
- [Step 1: Remove the secondary transfer assembly](#)
- [Step 2: Unpack the replacement assembly](#)
- [Step 3: Install the secondary transfer assembly](#)

Introduction

This document provides the procedures to remove and replace the secondary transfer assembly.

Before performing service

Turn the printer power off

- Disconnect the power cable.

 **WARNING!** To avoid damage to the printer, turn the printer off, wait 30 seconds, and then remove the power cord before attempting to service the printer.

Use the table below to identify the correct part number for your printer, and then go to <http://h20141.www2.hp.com/hpparts> to order the part.

Secondary transfer assembly part number	
RM2-0090-000CN	Secondary transfer assembly (M553n)
RM2-0022-000CN	Secondary transfer assembly (M552dn, M553dn, M553x, M577)

Required tools

- #2 Phillips screwdriver with a magnetic tip

After performing service

Make sure that the right door is fully closed after replacing the secondary transfer roller assembly.

Turn the printer power on

- Connect the power cable.
- Use the power switch to turn the power on.

Post service test

Print a configuration page to make sure that the printer is functioning correctly.

Step 1: Remove the secondary transfer assembly

1. Open the right door.

Figure 1-993 Open the right door



2. Release the blue arm, and then let the secondary transfer assembly rotate down to the half-way open position.

 **NOTE:** The assembly should stop at the halfway down point—the pin will stop at the notch in the slot in the blue arm.

Figure 1-994 Release the secondary transfer roller assembly



3. Carefully flex the top portion of the blue arm—as shown in the figure—to start to disengage it from the pin.

Figure 1-995 Carefully flex the top portion of the blue arm

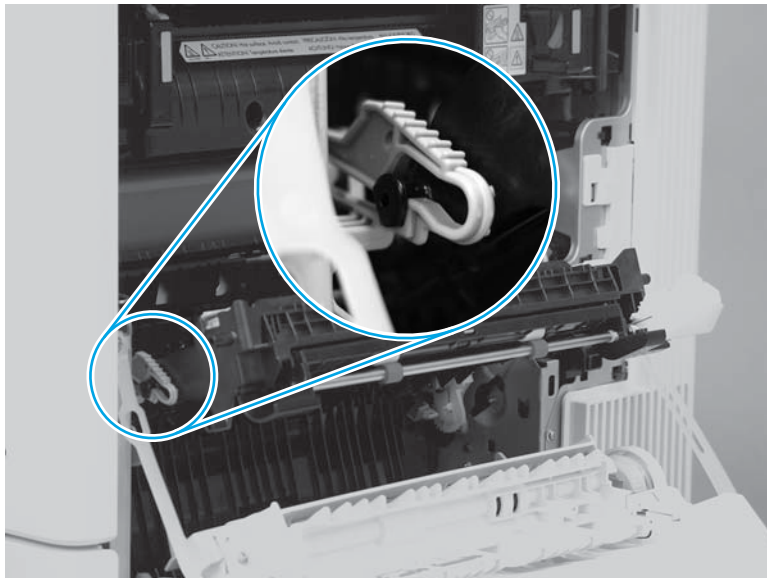

4. Continue to flex the blue arm until it disengages from the pin.

Figure 1-996 Disengage the blue arm and pin



5. Slide the assembly toward the front of the printer to release it (callout 1), and then rotate it down and away from the printer to remove it (callout 2).

 **Reinstallation tip:** Before removing the assembly, take note of where the assembly hinge pins fit into the holes provided in the printer.

Figure 1-997 Remove the secondary transfer roller assembly



Step 2: Unpack the replacement assembly

Unpack the replacement assembly from the packaging.

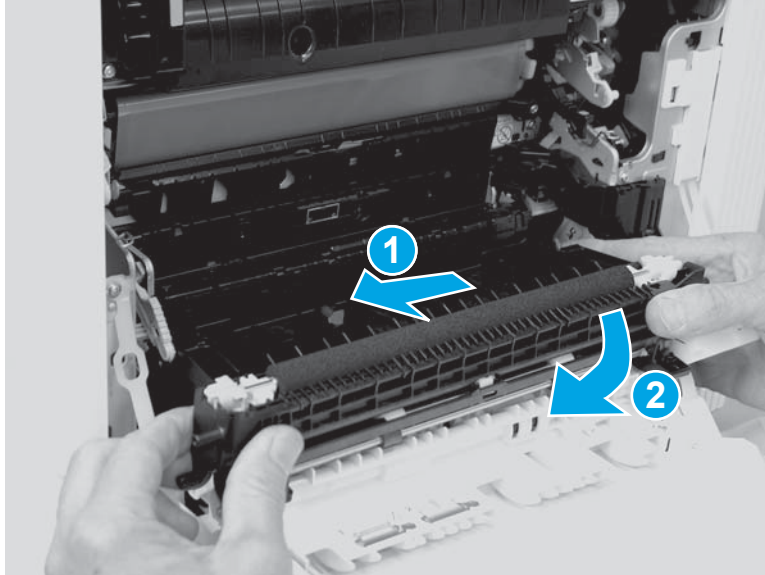
 **CAUTION:** Skin oils on the roller can cause print-quality problems. Avoid touching the black spongy roller on the assembly.

For complete information on HP's recycling programs, go to [Product return and recycling](#).

 **NOTE:** HP recommends responsible disposal of the defective assembly.

Figure 1-998 Recycle and unpack

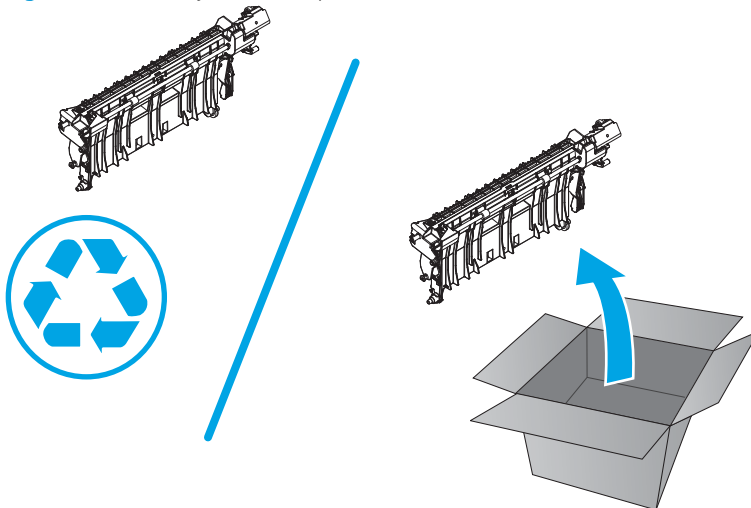

Step 3: Install the secondary transfer assembly

1. Move the registration sensor assembly (callout 1) out of the way, and then position the secondary transfer assembly right hinge (callout 2) into the hole provided in the printer.

Figure 1-999 Install the right hinge

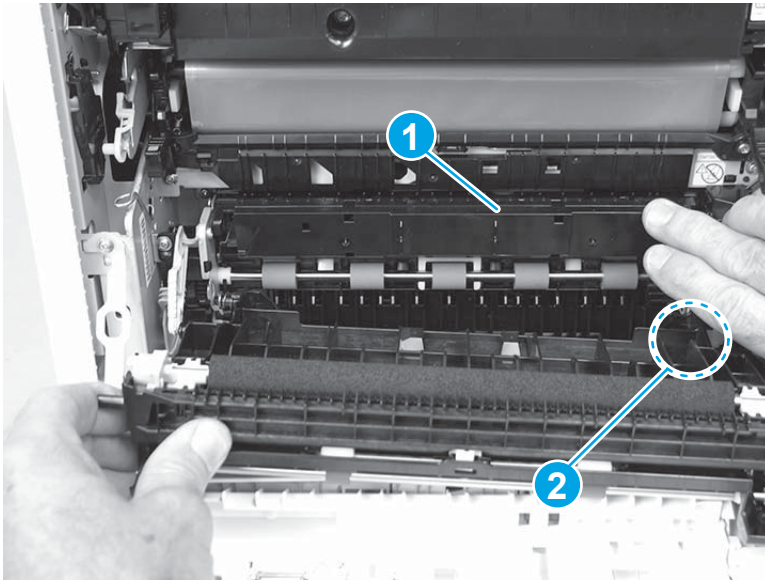

2. Position the assembly left-side hinge near the hole provided in the printer, and then slide the assembly toward the front of the printer to install the hinge in the hole.

Figure 1-1000 Install the left hinge

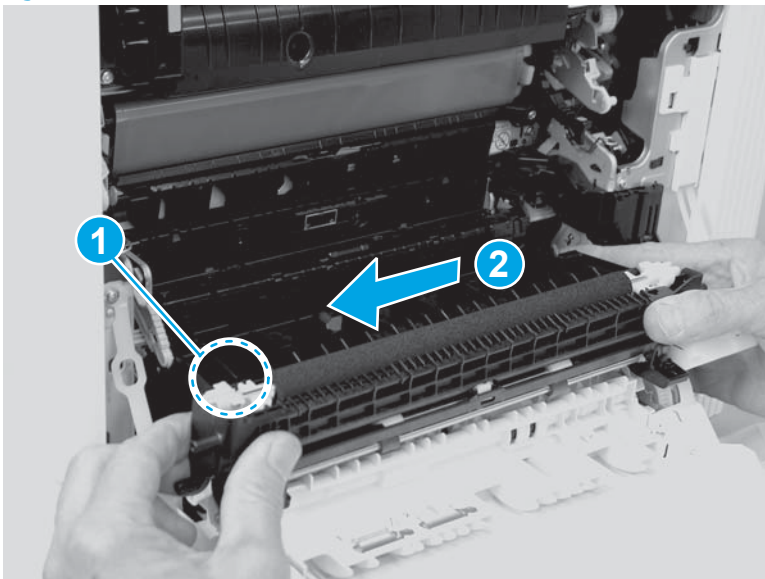

- Carefully flex the blue arm, and then push it over the pin on the assembly to engage it.

 **NOTE:** Make sure that the pin is correctly installed in the slot on the blue arm.

Figure 1-1001 Engage the blue arm with the pin



- Close the right door.

 **TIP:** The right door should close easily if the secondary transfer assembly is correctly installed.

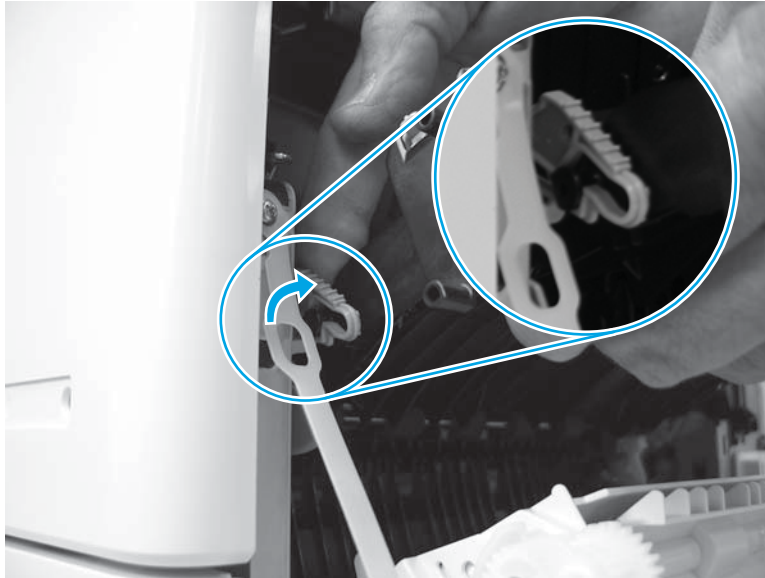
Figure 1-1002 Close the right door



Removal and replacement: Near field communication (NFC) PCA (M553x)

- [Introduction](#)
- [Step 1: Remove the USB cover](#)
- [Step 2: Remove the control panel \(M553x only\)](#)
- [Step 3: Remove the toner collection unit \(TCU\)](#)
- [Step 4: Remove the formatter cover](#)
- [Step 5: Remove the rear cover](#)
- [Step 6: Remove the left cover](#)
- [Step 7: Remove the upper cover](#)
- [Step 8: Remove the NFC PCA](#)
- [Step 9: Unpack the replacement assembly](#)
- [Step 10: Install the NFC PCA](#)
- [Step 11: Install the upper cover](#)
- [Step 12: Install the left cover](#)
- [Step 13: Install the rear cover](#)
- [Step 14: Install the formatter cover](#)
- [Step 15: Install the TCU](#)
- [Step 16: Install the control-panel assembly \(M553x only\)](#)
- [Step 17: Install the USB cover](#)

Introduction

This document provides the procedures to remove and replace the near field communication (NFC) printed circuit assembly (PCA).



Before performing service

Turn the printer power off

- Disconnect the power cable.

 **WARNING!** To avoid damage to the printer, turn the printer off, wait 30 seconds, and then remove the power cord before attempting to service the printer.

- Open the right door.

 **CAUTION:**  This part contains components that are electrostatic discharge (ESD) sensitive. To reduce the possibility of ESD damage, always touch the sheet-metal chassis to ground yourself before touching an ESD sensitive part.

Use the table below to identify the correct part number for your printer, and then go to <http://h20141.www2.hp.com/hpparts> to order the part.

NFC PCA part number	
B5L24-60002	NFC PCA

Required tools

- #2 Phillips screwdriver with a magnetic tip
- Small flat blade screwdriver

After performing service

Make sure that the USB cover is fully seated after replacing it.

Make sure that the TCU is fully closed after replacing it.

Make sure that the formatter cover is fully seated, and that the thumbscrews are finger tight after replacing it.

With the printer in the Ready state, send a print job using the NFC PCA.

Turn the printer power on

- Connect the power cable.
- Use the power switch to turn the power on.

Step 1: Remove the USB cover

1. Locate the USB cover.

Figure 1-1003 Locate the USB cover



2. Pull the cover off of the printer to remove it.

Figure 1-1004 Remove the cover



Step 2: Remove the control panel (M553x only)

 **NOTE:** For the M553n/dn and M552dn models, skip this step and go to [Step 3: Remove the toner collection unit \(TCU\) on page 590](#).

1. Tilt the control panel up.

Figure 1-1005 Tilt the control panel up



2. Use a small flat-blade screwdriver to release the control-panel screws cover tabs.

Figure 1-1006 Release the control-panel screws cover tabs

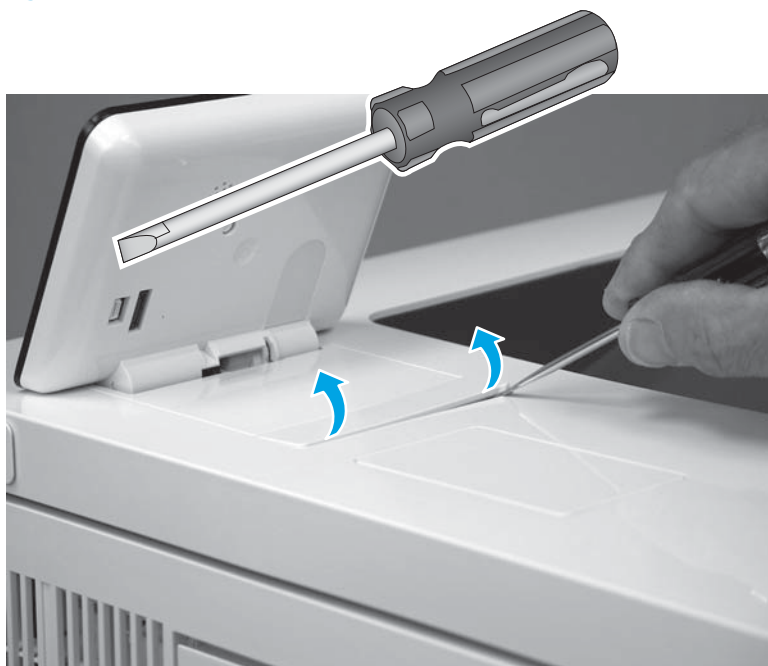

3. Rotate the cover up to remove it.

Figure 1-1007 Remove the cover



4. Use a small Phillips screwdriver to remove two screws (callout 1).

 **IMPORTANT:** Store the screws in a secure place where they cannot fall down into the printer.

Figure 1-1008 Remove two screws

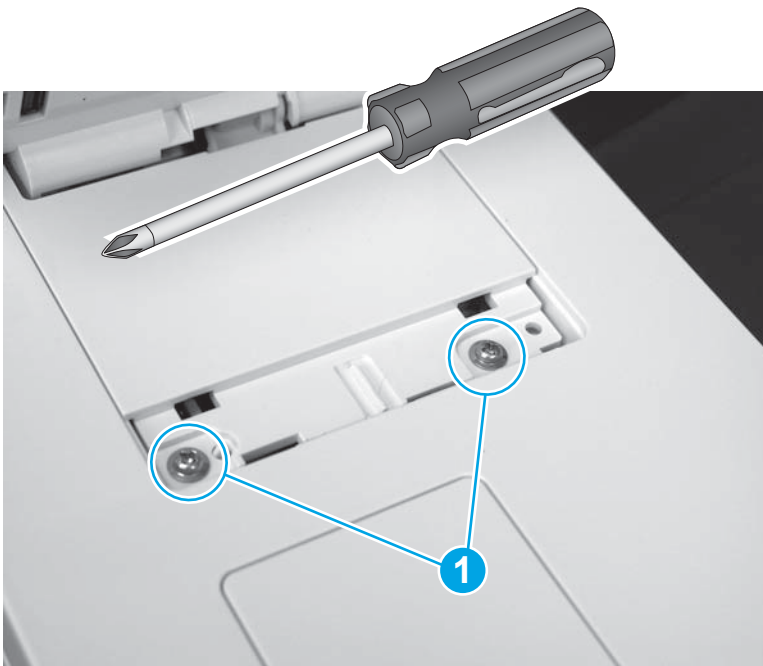

5. Rotate the control-panel base toward the front of the printer.

Figure 1-1009 Rotate the control-panel base up



6. Slightly slide the control-panel base toward the rear of the printer (callout 1) to release it, and then turn the control panel over (callout 2) to access the bottom side.

⚠ CAUTION: The control panel is still attached to the printer. Do not attempt to completely remove the control panel.

Figure 1-1010 Turn the control panel over

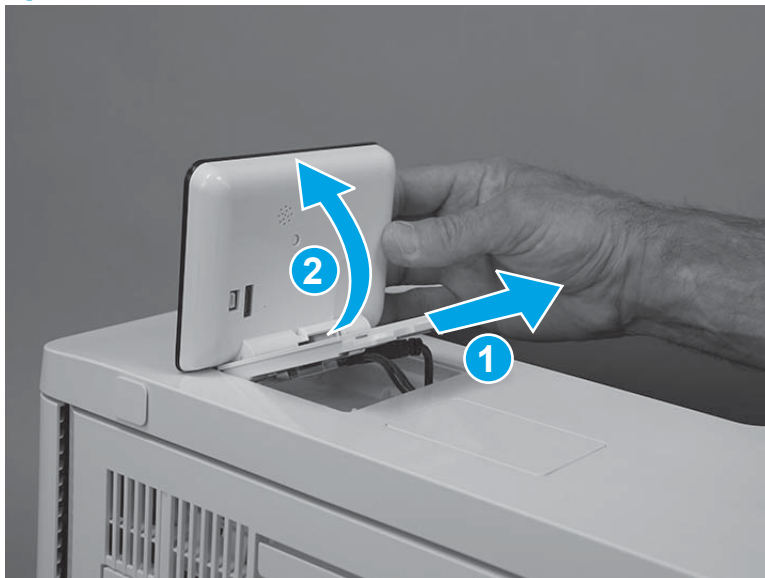

7. Disconnect one USB cable (callout 1), one connector (callout 2), and then remove the control panel.

Figure 1-1011 Disconnect two connectors

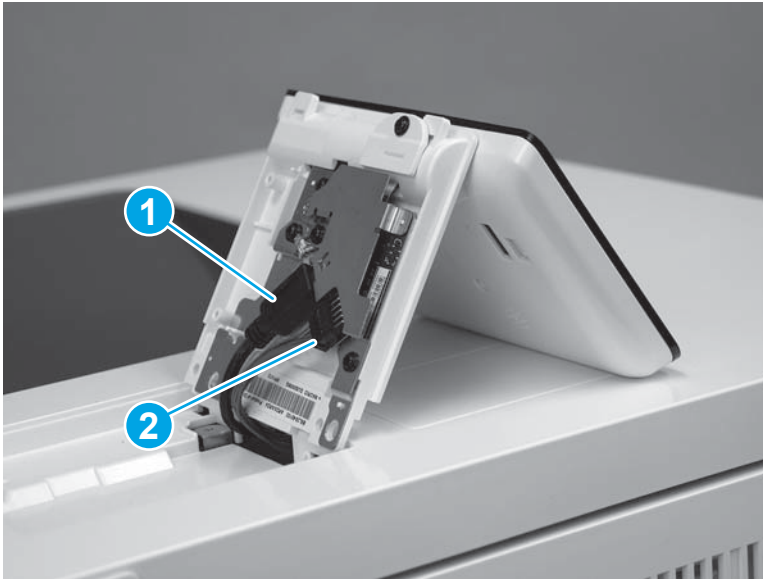

Step 3: Remove the toner collection unit (TCU)

1. Open the front door.

Figure 1-1012 Open the front door



2. Open the TCU.

 **NOTE:** The toner collection hatch cover automatically closes when the TCU is opened.

Figure 1-1013 Open the TCU



3. Pull the TCU away from the printer at an angle to remove it.

⚠ CAUTION: Do not open the toner collection hatch cover when handling the TCU. If toner gets on clothing, wipe it off by using a dry cloth and wash the clothes in cold water. Hot water sets toner into fabric.

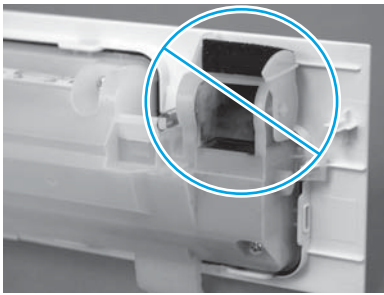
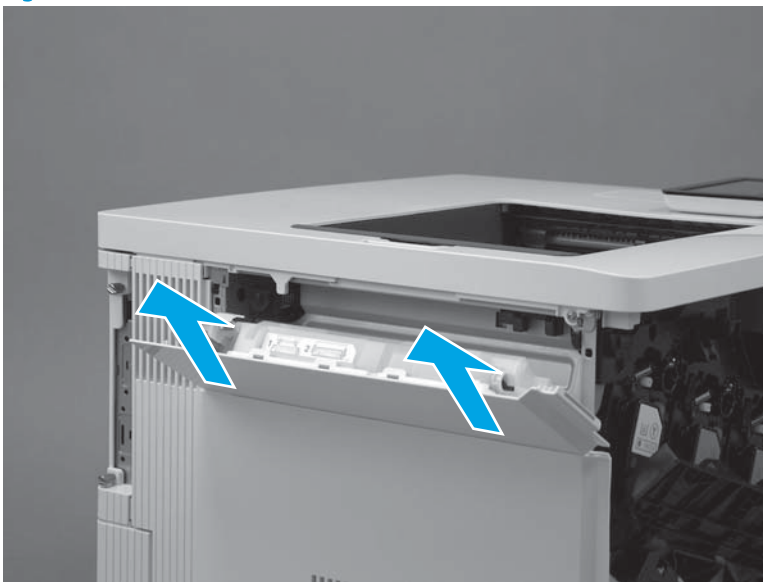

Figure 1-1014 Remove the TCU



Step 4: Remove the formatter cover

1. Locate the formatter cover.

Figure 1-1015 Locate the formatter cover

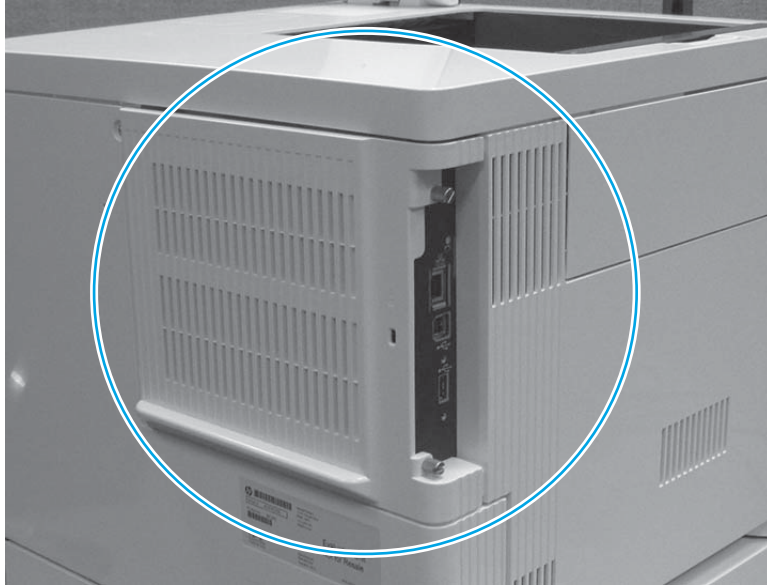

2. Loosen the two thumbscrews (callout 1). Grasp the two thumbscrews, and then slide the cover away from the printer (callout 2) to remove it.

 **TIP:** If needed, use the edge of a coin to turn the thumbscrews.

Figure 1-1016 Loosen the thumbscrews

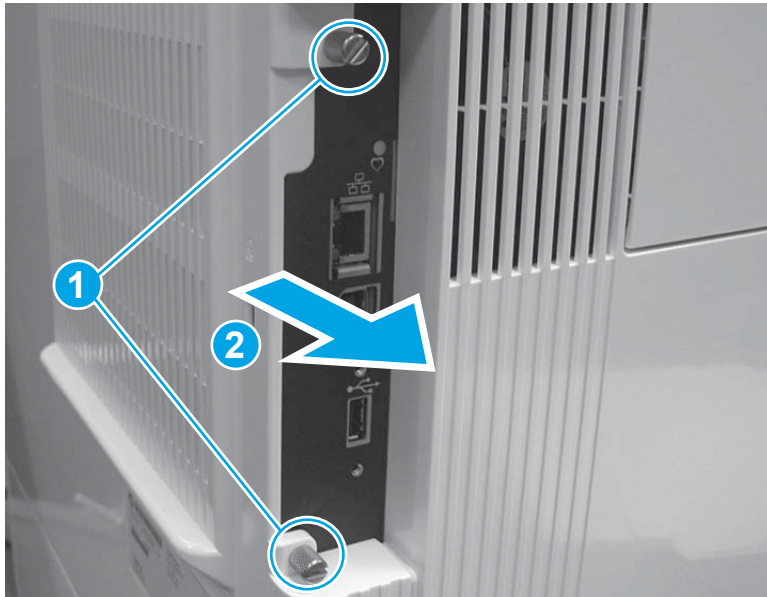

Step 5: Remove the rear cover

1. Remove four screws (callout 1).

Figure 1-1017 Remove four screws

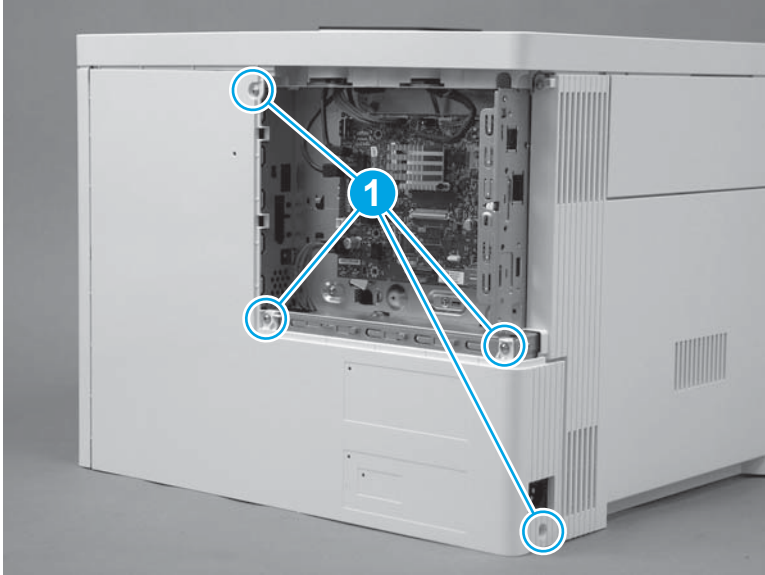

2. Slightly slide the cover to the right (callout 1), rotate the bottom of the cover away from the printer (callout 2), and then pull the top of the cover away from the printer (callout 3) to remove the cover.

Figure 1-1018 Remove the cover

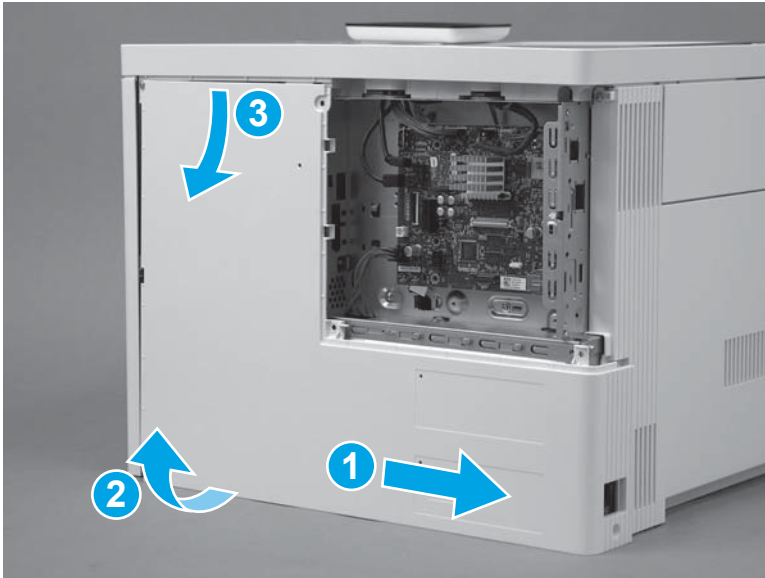

Step 6: Remove the left cover

1. At the left side of the printer, remove one screw (callout 1).

Figure 1-1019 Remove one screw



2. Release one tab (callout 1), rotate the front edge of the cover away from the printer (callout 2), and then slide the cover (callout 3) toward the rear of the printer to release it.

Figure 1-1020 Release the cover

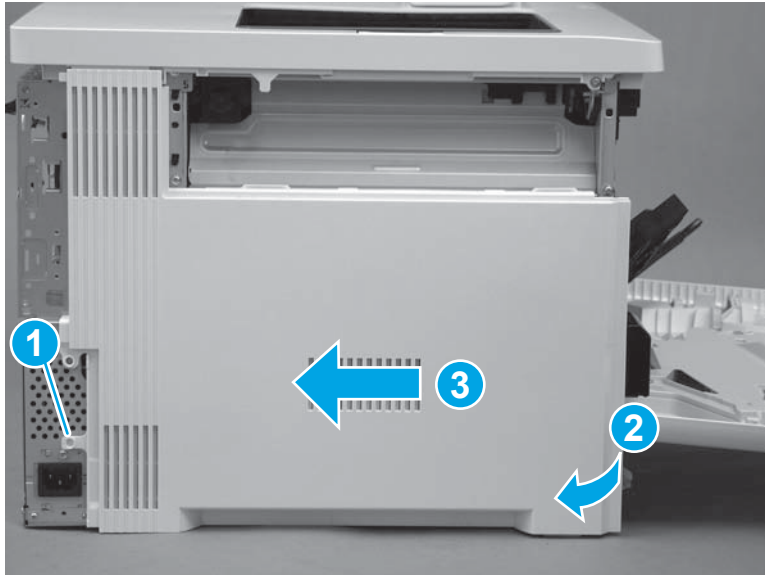

3. Remove the cover.

Figure 1-1021 Remove the cover

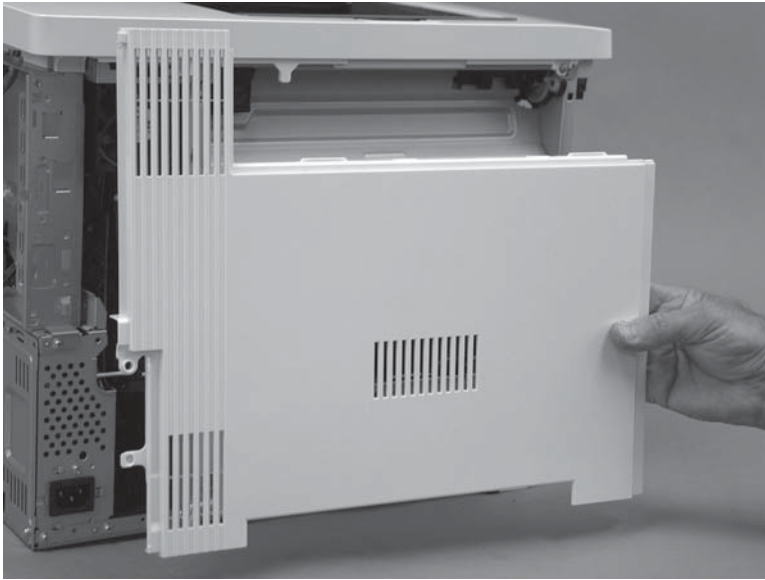

Step 7: Remove the upper cover

1. Remove three screws (callout 1).

Figure 1-1022 Remove three screws

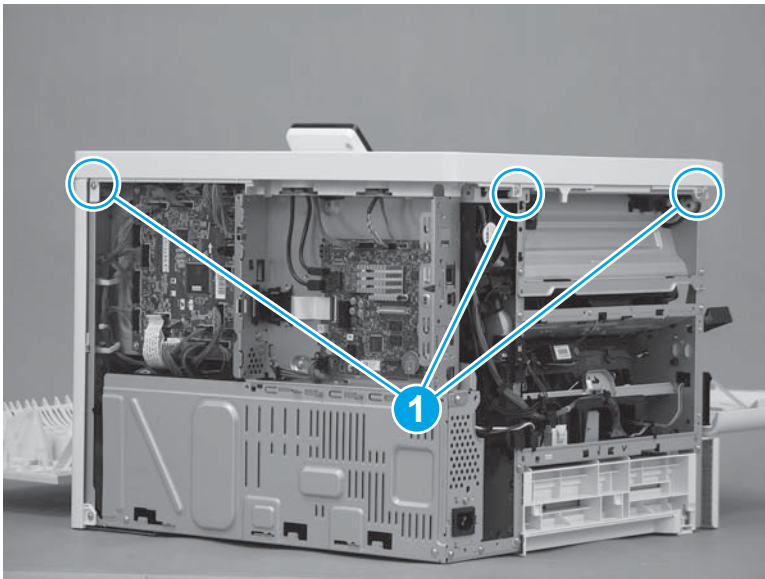

2. Remove one screw (callout 1), release one tab (callout 2), and then slightly separate the corner of the cover from the chassis.

 **NOTE:** This is a self-tapping plastic-thread screw. Make sure that this screw is used in this location when it is reinstalled.

Figure 1-1023 Remove one screw and release one tab



3. Release one tab (callout 1), and then lift up on the cover to release it.

 **NOTE:** If the cover does not release, check for additional tabs by locating the triangles embossed in the cover at tab locations.

Figure 1-1024 Release the cover



4. Remove the cover.

Figure 1-1025 Remove the cover

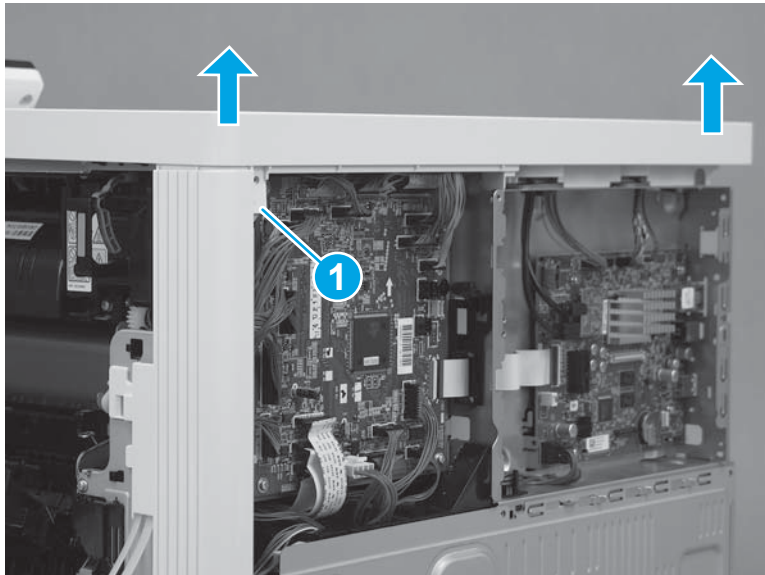
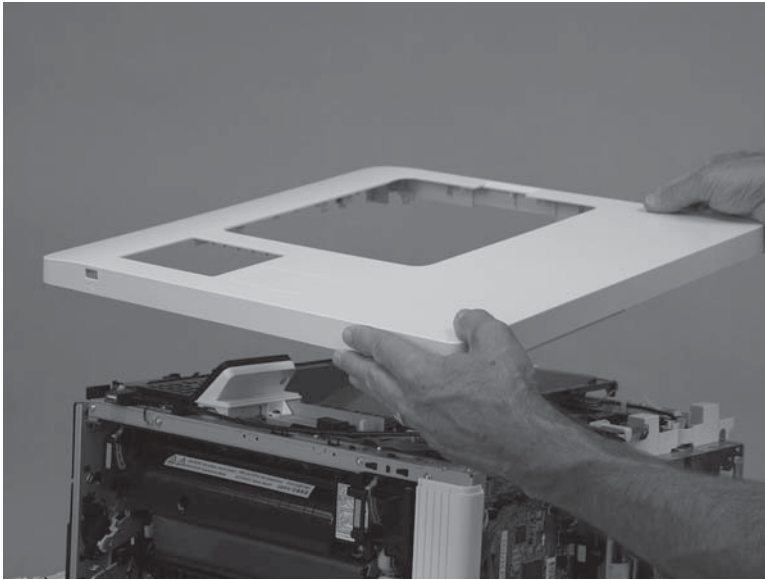

Step 8: Remove the NFC PCA

- ▲ Disconnect one connector (callout 1), release two tabs (callout 2), and then remove the NFC PCA (callout 3).

Figure 1-1026 Remove the NFC PCA

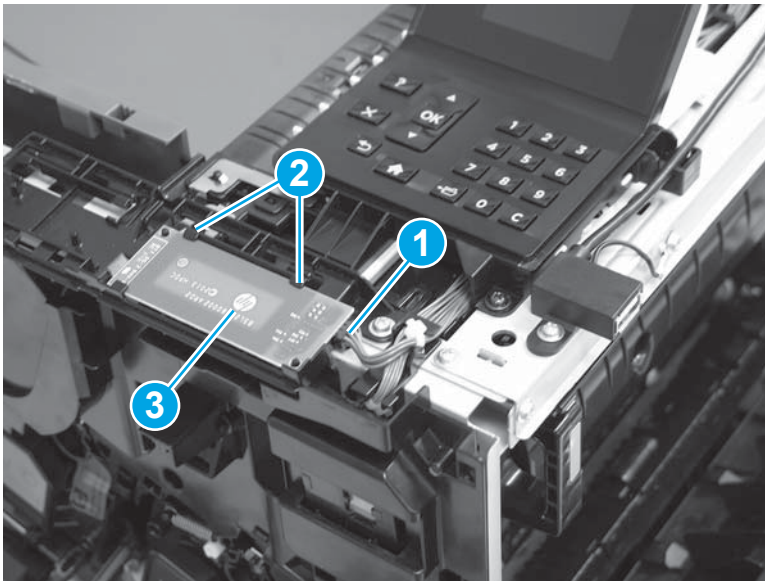

Step 9: Unpack the replacement assembly

Unpack the replacement assembly from the packaging.

For complete information on HP's recycling programs, go to [Product return and recycling](#).

 **CAUTION:**  ESD-sensitive part.

 **NOTE:** HP recommends responsible disposal of the defective assembly.

Figure 1-1027 Recycle and unpack

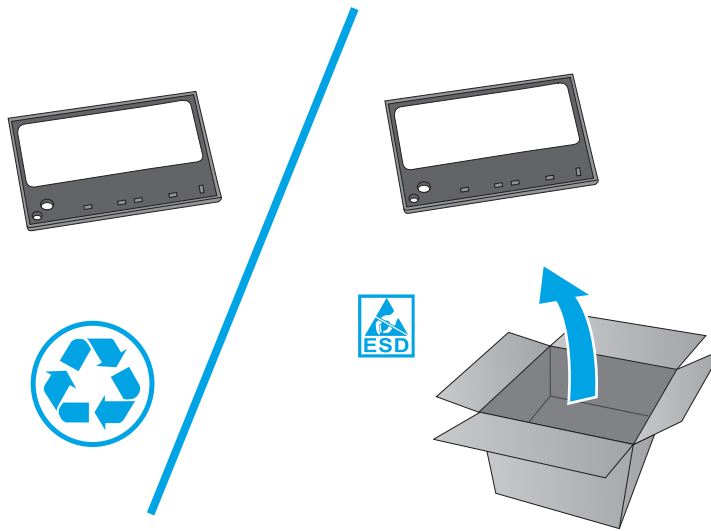

Step 10: Install the NFC PCA

- ▲ Position the NFC PCA (callout 1) on the printer, connect one connector (callout 2), and then make sure the two tabs (callout 3) are firmly holding the PCA in the holder.

Figure 1-1028 Install the NFC PCA

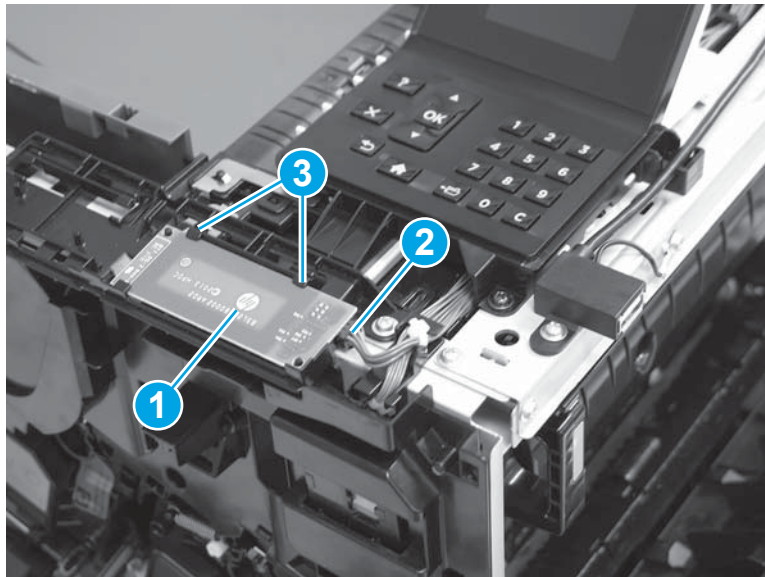

Step 11: Install the upper cover

1. Position the cover on the printer.

 **NOTE:** For the M553x model, do not forget to pass the control-panel wire harness and USB cable through the opening in the cover.

Figure 1-1029 Install the cover



2. Push down on the rear corner of the cover to engage one tab (callout 1).

Figure 1-1030 Engage one tab

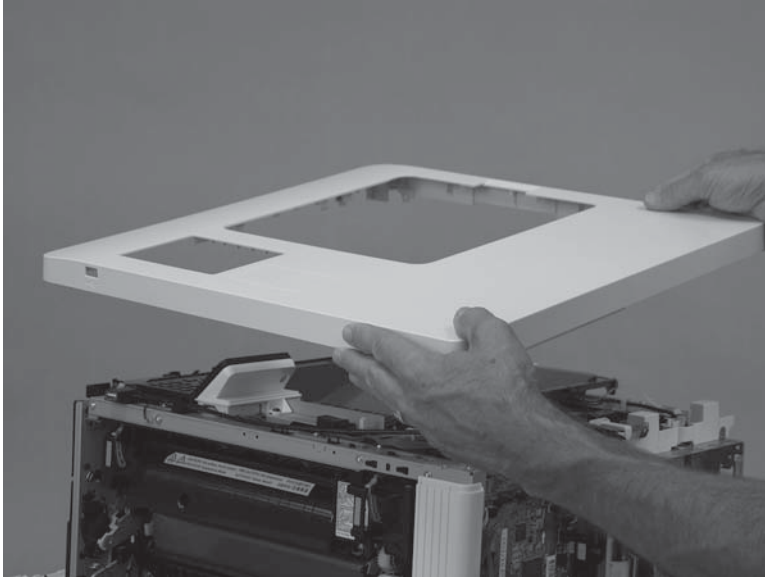
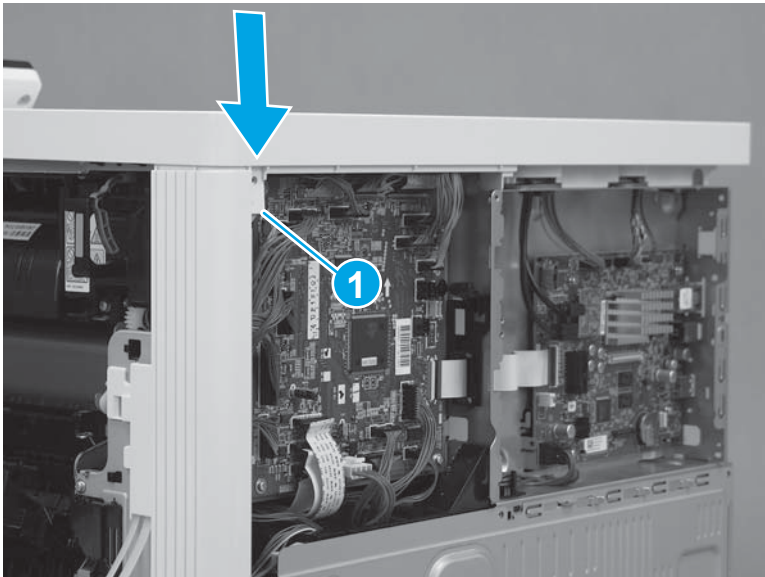

3. Push down on the front corner of the cover to engage one tab (callout 1), and then install one screw (callout 2).

 **NOTE:** This is a self-tapping plastic-thread screw. Make sure that this screw is used in this location when it is reinstalled.

Figure 1-1031 Engage one tab and install one screw



4. Install three screws (callout 1).

Figure 1-1032 Install three screws

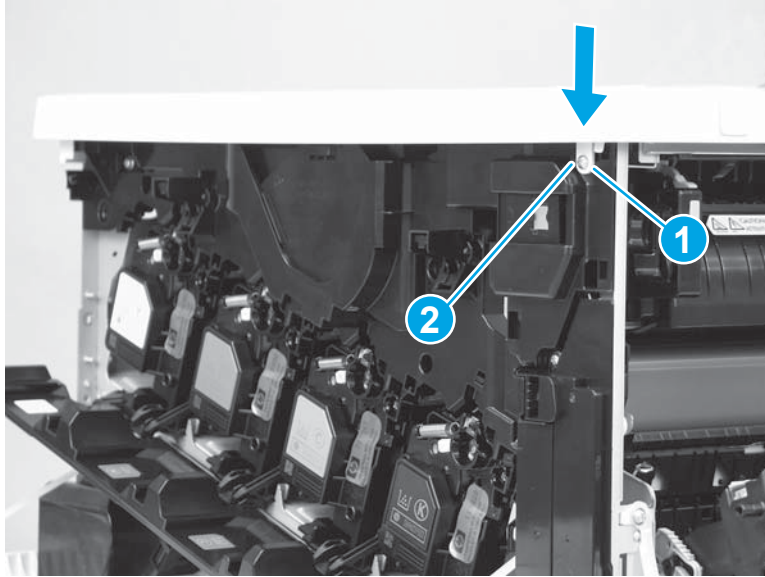
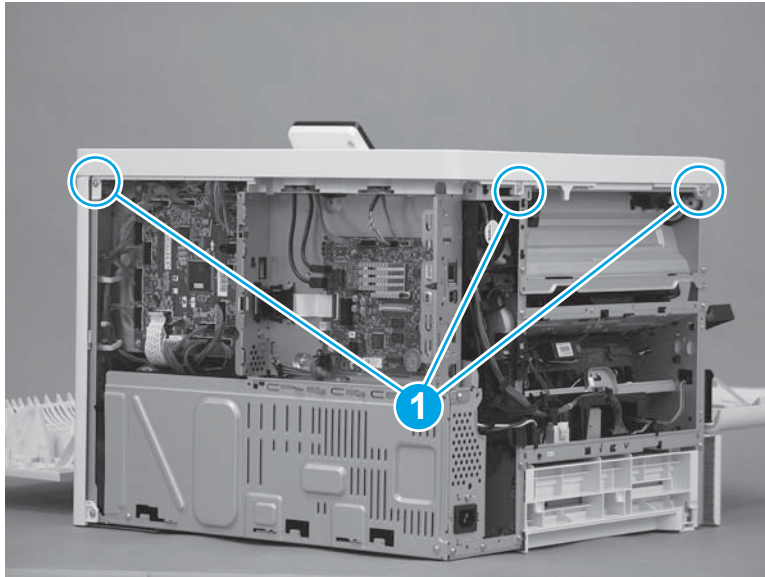

Step 12: Install the left cover

1. Position the cover on the printer.

 **NOTE:** Slightly offset the cover toward the rear of the printer.

Figure 1-1033 Install the cover

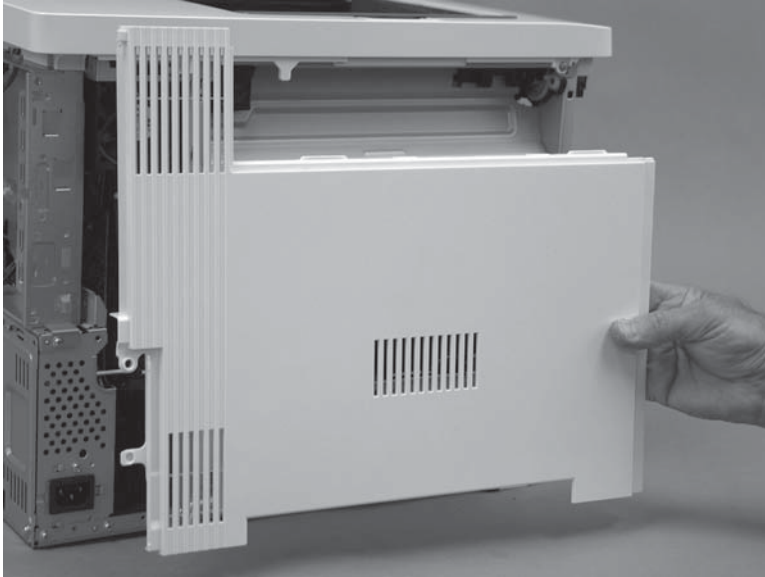

2. Slide the cover (callout 1) toward the front of the printer to engage it. Make sure that the tab (callout 2) snaps into place.

 **NOTE:** Locate the alignment pin (callout 3) on the cover from the front door side of the printer, and then make sure that it is fully engaged in the slot in the chassis.

 **TIP:** While sliding the cover into place, push in on the center of the cover (callout 1) to make sure that the hooks on the back of the cover engage with the slots in the chassis.

Figure 1-1034 Engage the cover



3. At the left side of the printer, install one screw (callout 1).

Figure 1-1035 Install one screw

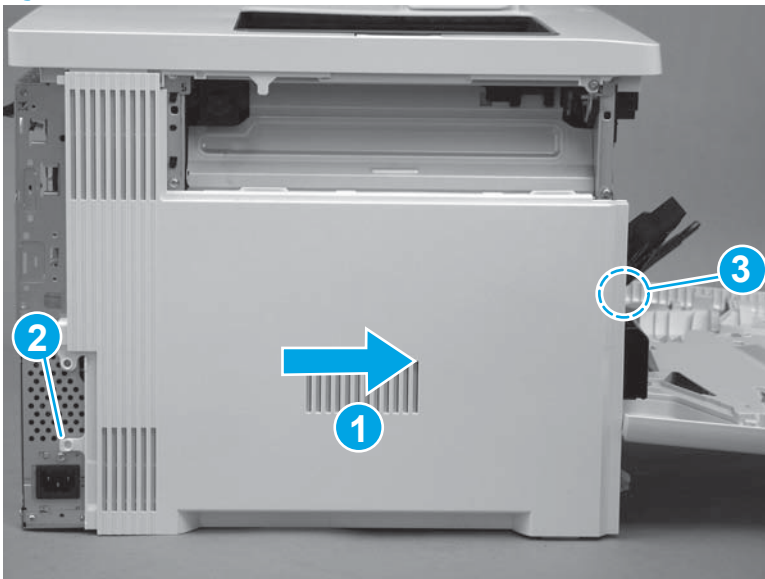

Step 13: Install the rear cover

1. Position the top of the cover under the upper cover (callout 1), rotate the bottom of the cover onto the chassis (callout 2), and then slide the cover to the left (callout 3) to install it.

Figure 1-1036 Install the cover

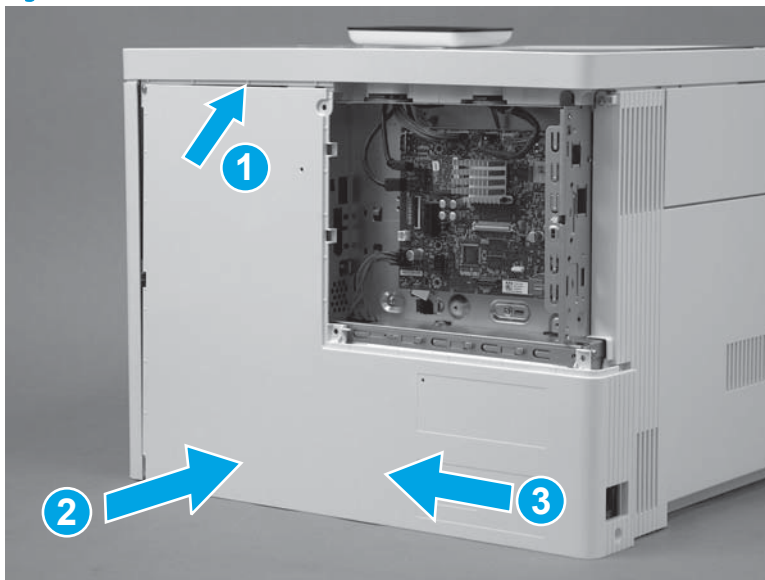

2. Install four screws (callout 1).

Figure 1-1037 Install four screws cover

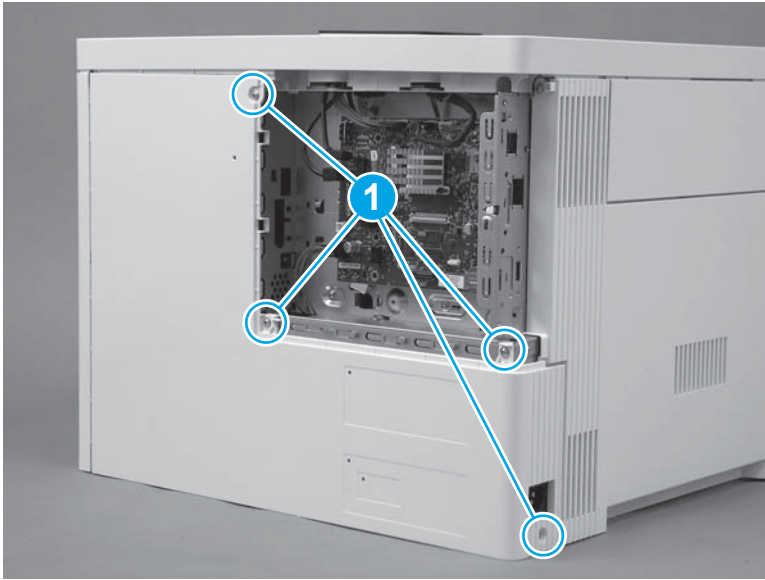

Step 14: Install the formatter cover

- ▲ Slide the cover onto the printer (callout 1) to install it.

 **NOTE:** Make sure that the tabs on the formatter cover align with the slots provided in the printer (callout 2). Tighten the two thumbscrews (callout 3).

 **TIP:** If needed, use the edge of a coin to turn the thumbscrews.

Figure 1-1038 Install the cover

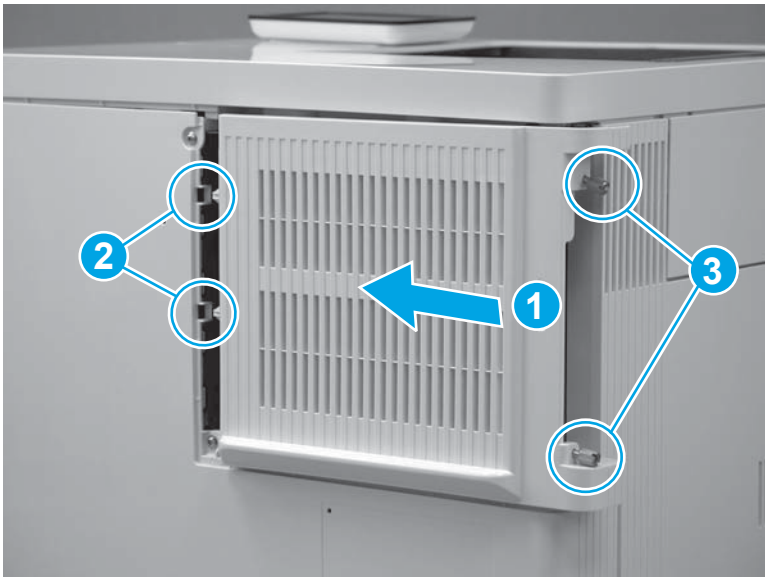

Step 15: Install the TCU

1. Verify that the toner collection hatch cover is in the closed position on the TCU.

Figure 1-1039 Verify that the toner collection hatch cover is closed

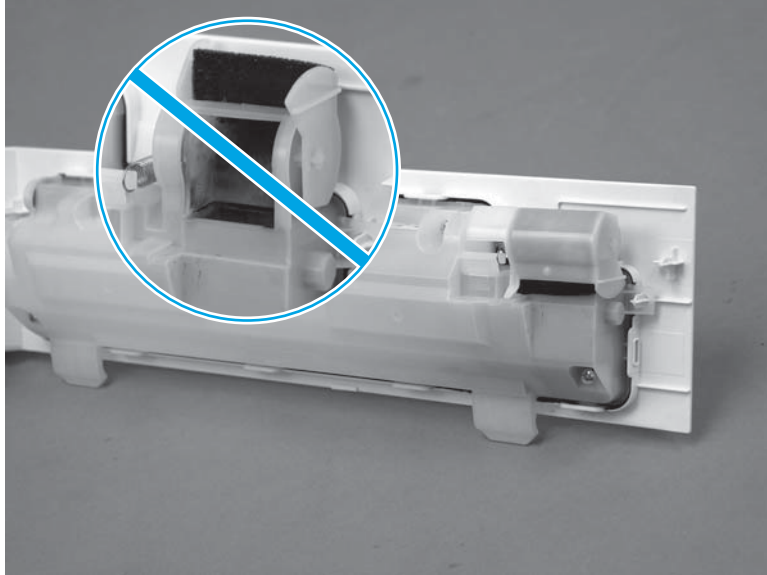

2. Position the TCU with the hinges in the slots provided in the printer (callout 1), and then rotate the TCU up and into the closed position.

 **NOTE:** The toner collection hatch cover automatically opens when the TCU is closed.

Figure 1-1040 Install the TCU

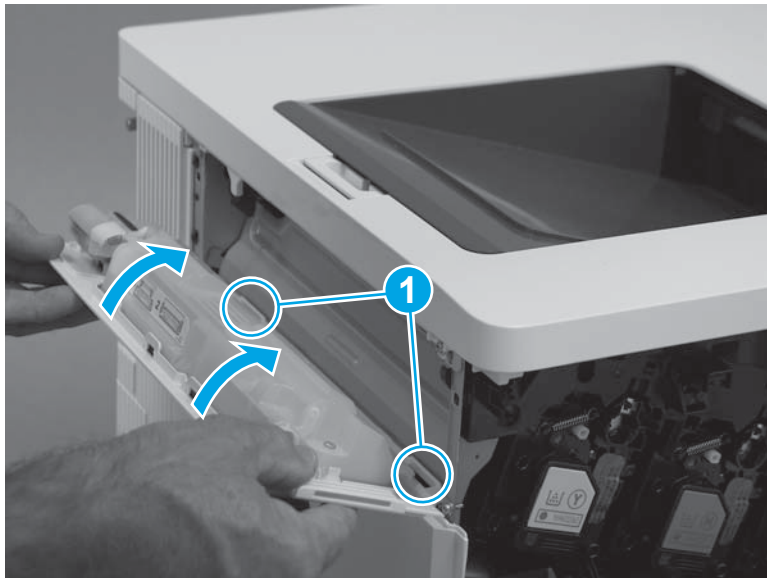

3. Close the front door.

Figure 1-1041 Close the front door



Step 16: Install the control-panel assembly (M553x only)

 **NOTE:** For the M553n/dn and M552dn models, skip this step and go to [Step 17: Install the USB cover on page 609](#).

1. Place the control panel on the printer as shown.

Figure 1-1042 Place the control panel on the product

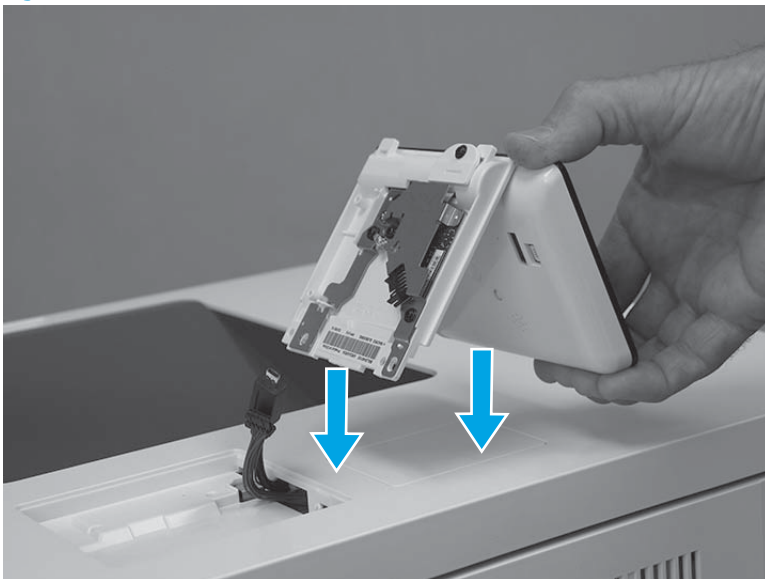

2. Connect one USB cable (callout 1), and one connector (callout 2).

 **IMPORTANT:** Take note of the location of the two mounting tabs (callout 3) on the control-panel assembly.

Figure 1-1043 Connect two connectors



3. Turn the control panel over, and then position the front edge tabs in the slots in the top cover.

Figure 1-1044 Turn the control panel over

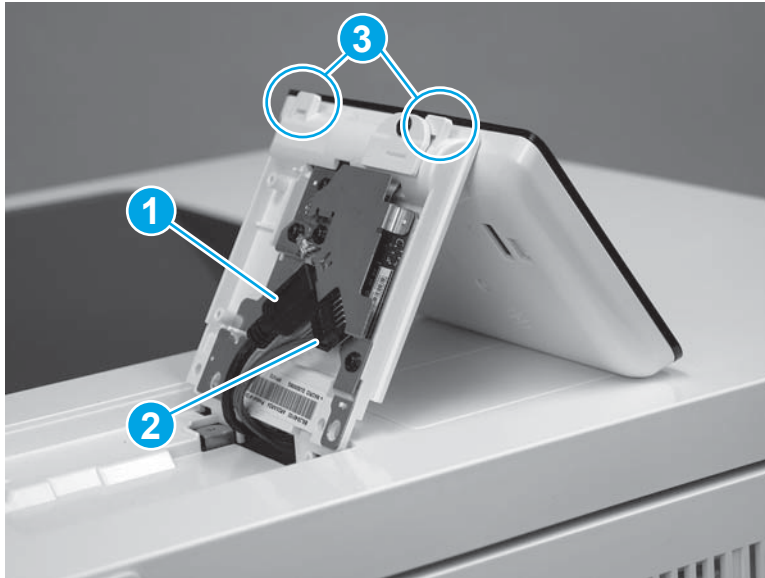
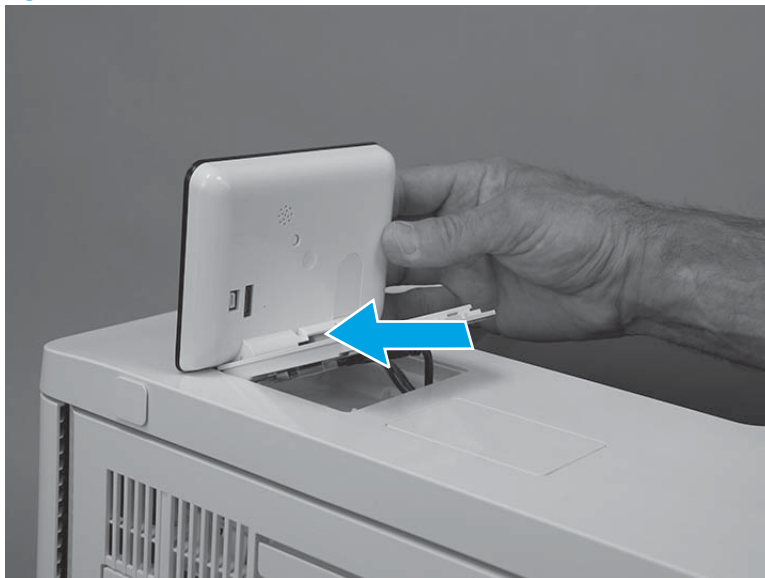

4. Rotate the control-panel base down onto the printer.

Figure 1-1045 Rotate the control-panel base down



5. Use a small Phillips screwdriver to install two screws (callout 1).

Figure 1-1046 Install two screws

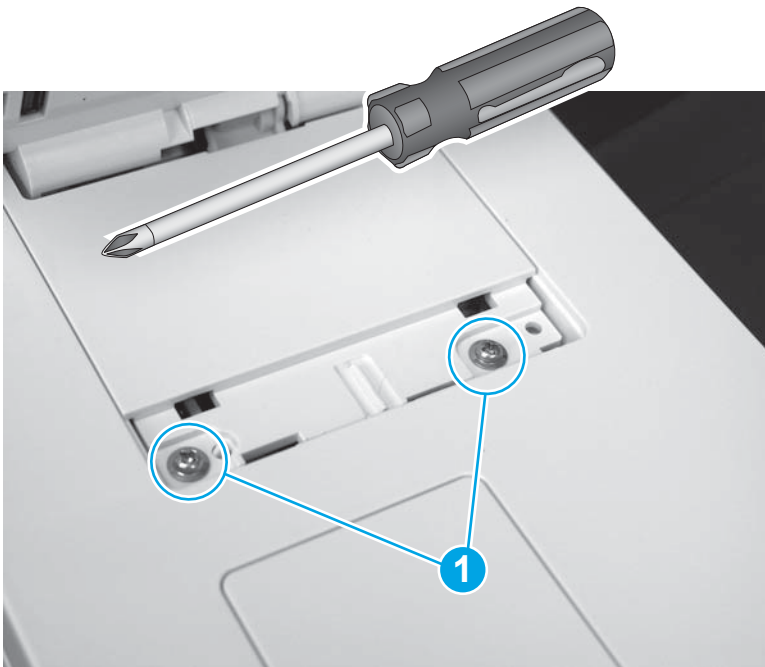

6. Position the screw cover mounting feet into the slots in the top cover (callout 1), and then rotate the cover down (callout 2) to install it.

 **NOTE:** Press down on the cover firmly to make sure that the tabs on the cover (callout 3) snap into place.

Figure 1-1047 Install the cover



Step 17: Install the USB cover

1. Push the cover into the USB port to install it.

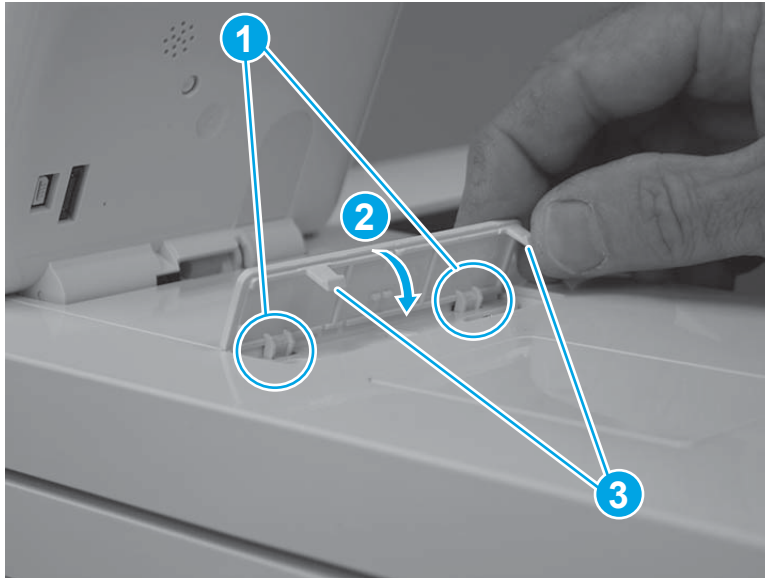
Figure 1-1048 Install the cover



2. Make sure that the USB cover is fully seated after installing it.

Figure 1-1049 Check the installation



Removal and replacement: Near field communication (NFC) PCA (M577z)

- [Introduction](#)
- [Step 1: Remove the NFC](#)
- [Step 2: Unpack the replacement assembly](#)
- [Step 3: Install the NFC PCA](#)

Introduction

This document provides the procedures to remove and replace the NFC PCA for the M577.

Before performing service

Turn the printer power off

- Disconnect the power cable.

 **WARNING!** To avoid damage to the printer, turn the printer off, wait 30 seconds, and then remove the power cord before attempting to service the printer.

Use the table below to identify the correct part number for your printer. To order the part, go to www.hp.com/buy/parts.

NFC PCA part number	
B5L24-60001	NFC PCA

Required tools

- No special tools are required to replace this part.

After performing service

Turn the printer power on

- Connect the power cable.
- Use the power switch to turn the power on.

Post service test

Print a configuration page to make sure that the printer is functioning correctly.

Step 1: Remove the NFC

1. Open the document feeder (callout 1).

 **NOTE:** If the control panel is not fully tilted forward, tilt it forward now until it stops (callout 2).

Figure 1-1050 Open the document feeder



2. Beginning at the right side of the control-panel cover, carefully release five tabs along the top edge of the cover.

Figure 1-1051 Release five tabs

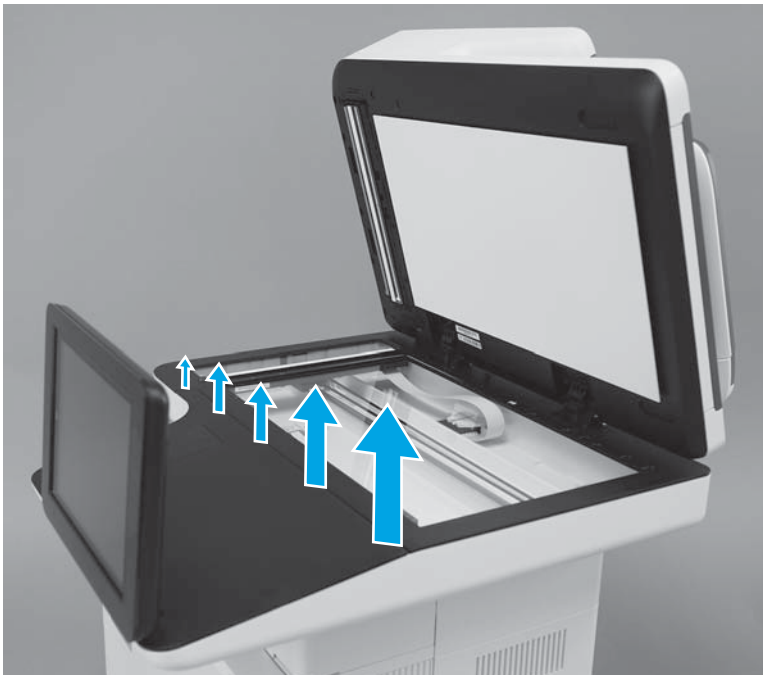

3. Continue to rotate the top edge of the cover away from the printer, and then remove the cover.

Figure 1-1052 Remove the cover



4. Locate the NFC.

Figure 1-1053 Locate the NFC



5. Release four tabs (callout 1).

Figure 1-1054 Release four tabs

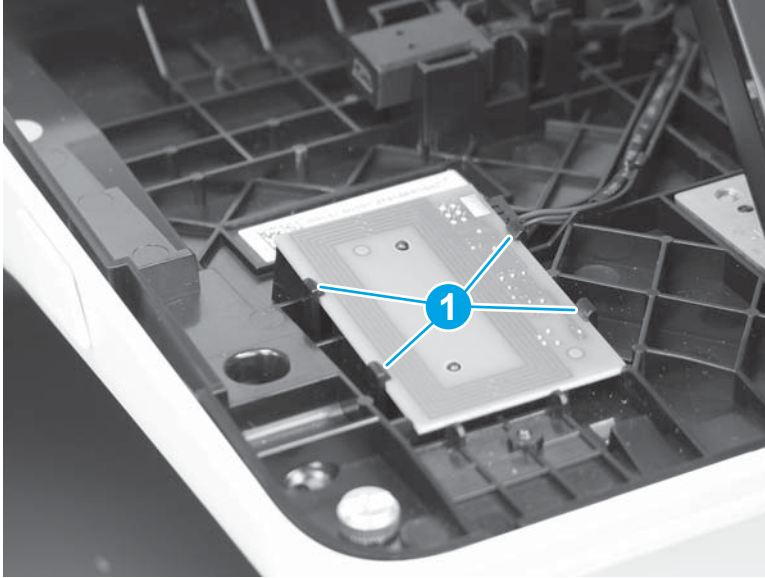

6. Lift the NFC PCA up, and then disconnect one connector (callout 1).

Figure 1-1055 Disconnect one connector

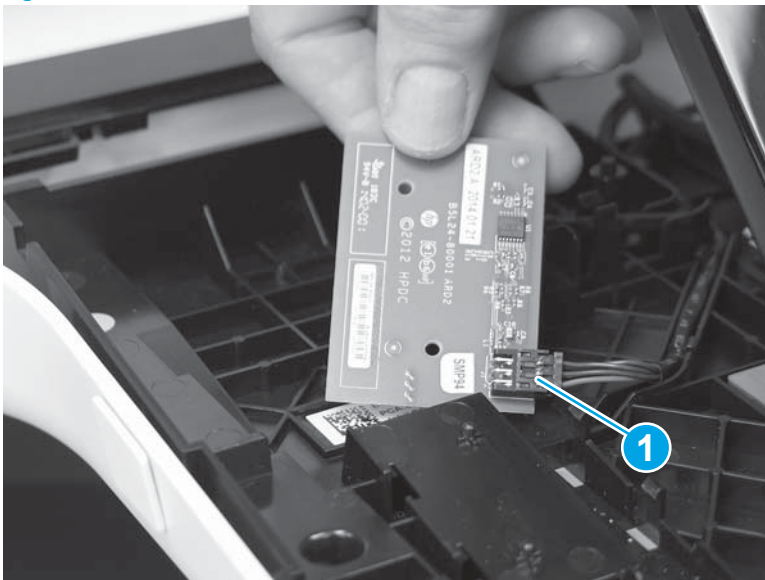

Step 2: Unpack the replacement assembly

Unpack the replacement assembly from the packaging.

For complete information on HP's recycling programs, go to [Product return and recycling](#).

 **NOTE:** HP recommends responsible disposal of the defective part.

Figure 1-1056 Recycle and unpack

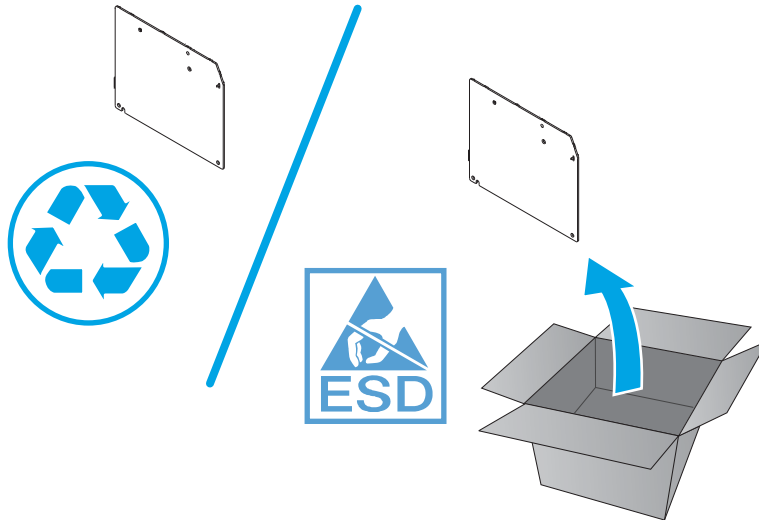

Step 3: Install the NFC PCA

1. Connect one connector (callout 1).

Figure 1-1057 Connect one connector

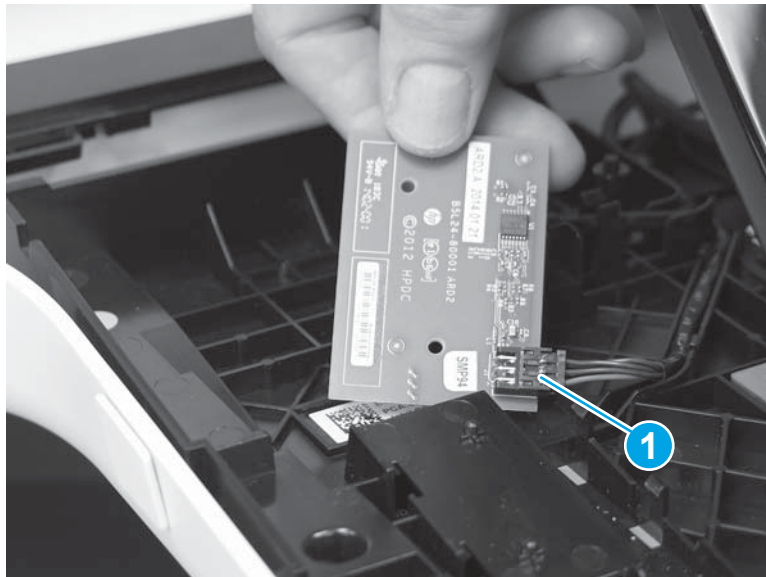

2. Position the holes in the NFC PCA (callout 1) over the posts (callout 2) on the printer.

Figure 1-1058 Position the NFC PCA

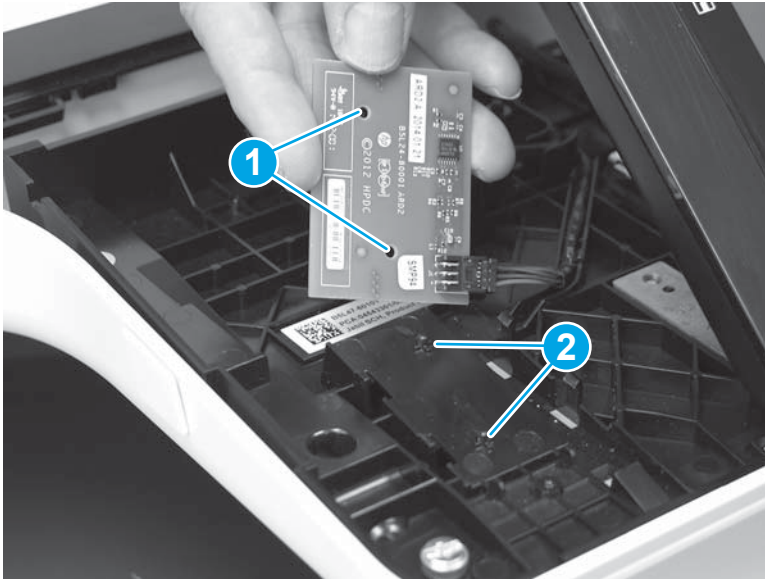

3. Install four tabs (callout 1) around the NFC PCA.

Figure 1-1059 Install four tabs

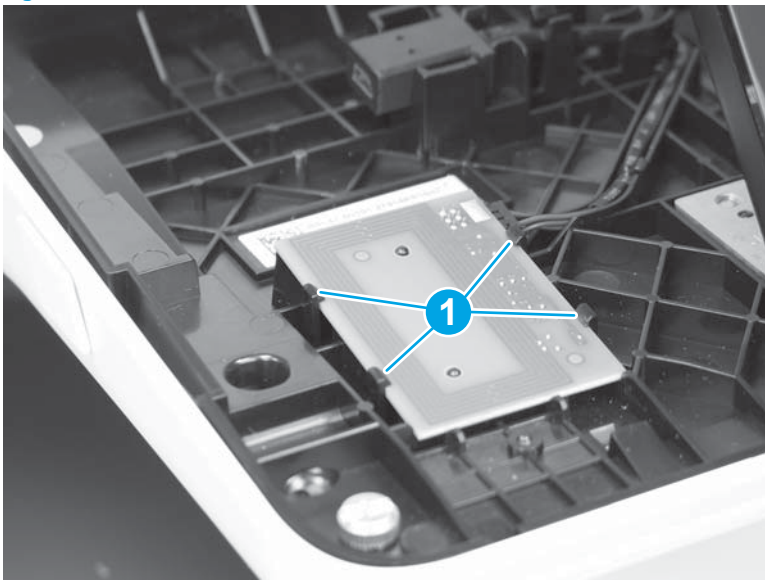

4. Position the control-panel cover on the printer.

Figure 1-1060 Position the control-panel cover on the printer



5. Beginning at the left side of the control-panel cover, carefully engage five tabs along the top edge of the cover.

Figure 1-1061 Engage five tabs

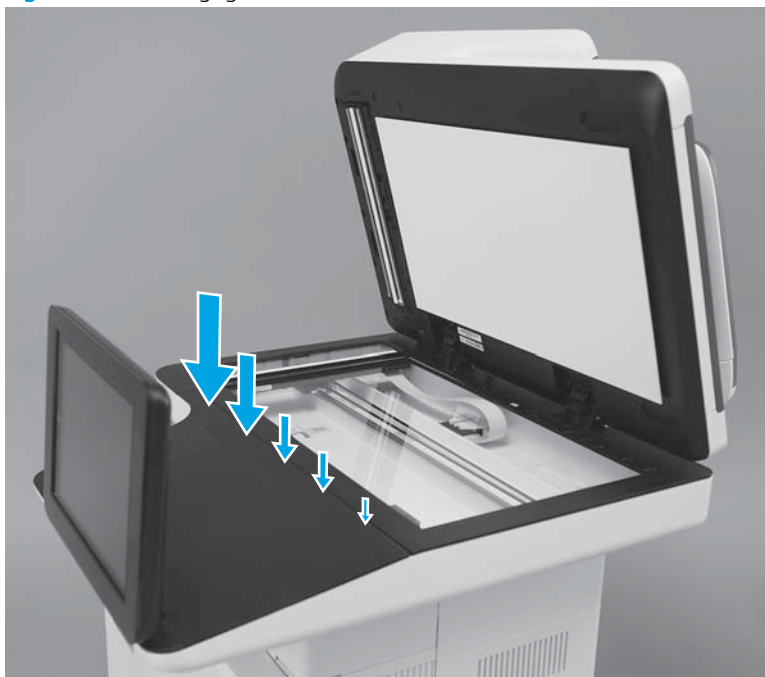

6. Close the document feeder.

 **NOTE:** Adjust the control panel to the desired angle.

Figure 1-1062 Close the document feeder



Removal and replacement: Wireless PCA (M553 and M577)

- [Introduction](#)
- [Step 1: Remove the formatter cover](#)
- [Step 2: Remove the toner collection unit \(TCU\)](#)
- [Step 3: Remove the USB cover \(M553\)](#)
- [Step 4: Remove the control panel \(M553x only\)](#)
- [Step 5: Remove the rear cover \(M553\)](#)
- [Step 6: Remove the left cover \(M553\)](#)
- [Step 7: Remove the upper cover \(M553\)](#)
- [Step 8: Remove the rear upper cover \(M577\)](#)
- [Step 9: Remove the left upper cover \(M577\)](#)
- [Step 10: Remove the right front upper cover \(M577dn\)](#)
- [Step 11: Remove the stapler cover assembly \(M577c/f/z\)](#)
- [Step 12: Remove the integrated scanner assembly \(M577\)](#)
- [Step 13: Remove the stapler unit \(M577f and M577z\)](#)
- [Step 14: Remove the right upper cover \(M577\)](#)
- [Step 15: Remove the top rear cover \(M577\)](#)
- [Step 16: Remove the paper feed cover \(M577\)](#)
- [Step 17: Remove the top cover \(M577\)](#)
- [Step 18: Remove the output bin](#)
- [Step 19: Remove the wireless PCA \(M553 and M577\)](#)
- [Step 19: Unpack the replacement assembly](#)
- [Step 21: Install the wireless PCA \(M553 and M577\)](#)
- [Step 22: Install the output bin](#)
- [Step 23: Install the top cover \(M577\)](#)
- [Step 24: Install the paper feed cover \(M577\)](#)
- [Step 25: Install the top rear cover \(M577\)](#)
- [Step 26: Install the right upper cover \(M577\)](#)
- [Step 27: Install the stapler unit \(M577f and M577z\)](#)
- [Step 28: Install the integrated scanner assembly \(M577\)](#)
- [Step 29: Install the stapler cover assembly \(M577c/f/z\)](#)

- [Step 30: Install the right front upper cover \(M577dn\)](#)
- [Step 31: Install the left upper cover \(M577\)](#)
- [Step 32: Install the rear upper cover \(M577\)](#)
- [Step 33: Install the upper cover \(M553\)](#)
- [Step 34: Install the left cover \(M553\)](#)
- [Step 35: Install the rear cover \(M553\)](#)
- [Step 36: Install the control-panel \(M553x only\)](#)
- [Step 37: Install the USB cover \(M553\)](#)
- [Step 38: Install the TCU](#)
- [Step 39: Install the formatter cover](#)

Introduction

This document provides the procedures to remove and replace the wireless printed circuit assembly (PCA).



Before performing service

Turn the printer power off

- Disconnect the power cable.

 **WARNING!** To avoid damage to the printer, turn the printer off, wait 30 seconds, and then remove the power cord before attempting to service the printer.

- Open the right door.

 **CAUTION:**  This part contains components that are electrostatic discharge (ESD) sensitive. To reduce the possibility of ESD damage, always touch the sheet-metal chassis to ground yourself before touching an ESD sensitive part.

Use the table below to identify the correct part number for your printer, and then go to <http://h20141.www2.hp.com/hpparts> to order the part.

Wireless PCA part number	
1150-7968	Wireless PCA

Required tools

- #2 Phillips screwdriver with a magnetic tip
- Small flat blade screwdriver

After performing service

Make sure that the USB cover is fully seated after replacing it.

Make sure that the TCU is fully closed after replacing it.

Make sure that the formatter cover is fully seated, and that the thumbscrews are finger tight after replacing it.

With the printer in the Ready state, send a print job using the wireless PCA.

Turn the printer power on

- Connect the power cable.
- Use the power switch to turn the power on.

Step 1: Remove the formatter cover

1. Locate the formatter cover.

Figure 1-1063 Locate the formatter cover

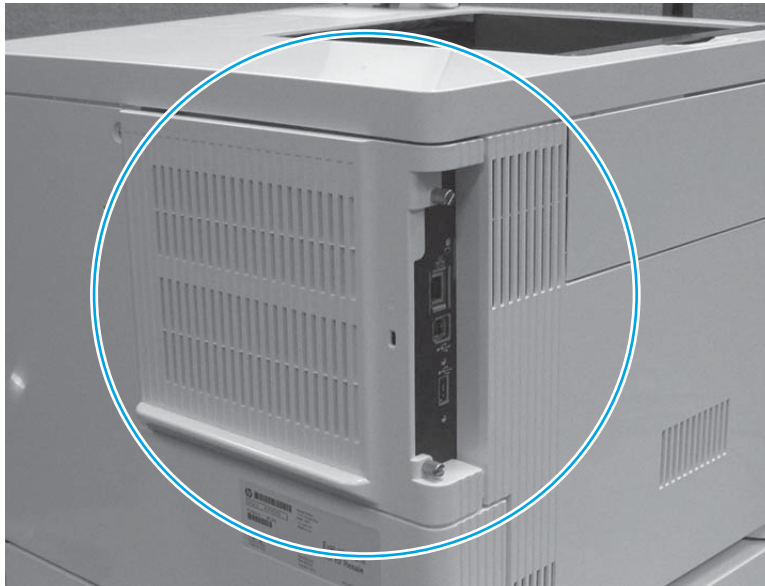

2. Loosen the two thumbscrews (callout 1). Grasp the two thumbscrews, and then slide the cover away from the printer (callout 2) to remove it.

 **TIP:** If needed, use the edge of a coin to turn the thumbscrews.

Figure 1-1064 Loosen the thumbscrews

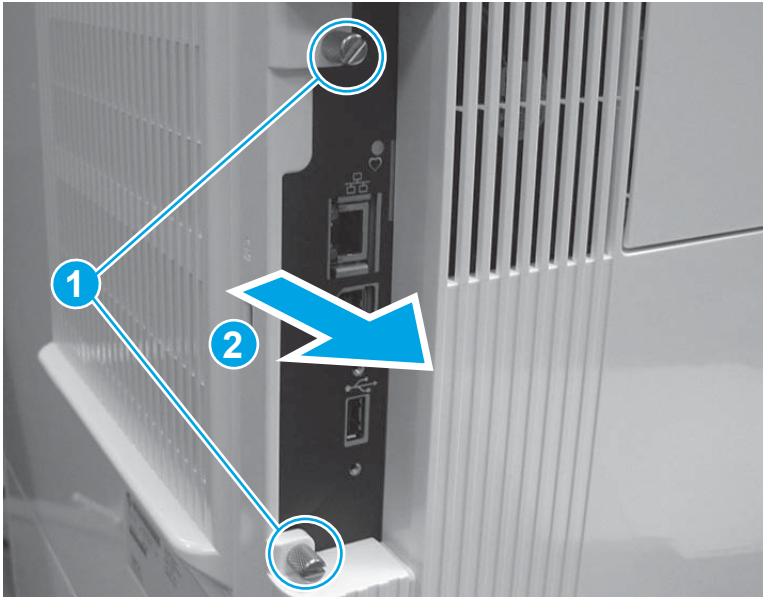

Step 2: Remove the toner collection unit (TCU)

1. Open the front door.

Figure 1-1065 Open the front door



2. Open the TCU.

 **NOTE:** The toner collection hatch cover automatically closes when the TCU is opened.

Figure 1-1066 Open the TCU



3. Pull the TCU away from the printer at an angle to remove it.

⚠ CAUTION: Do not open the toner collection hatch cover when handling the TCU. If toner gets on clothing, wipe it off by using a dry cloth and wash the clothes in cold water. Hot water sets toner into fabric.

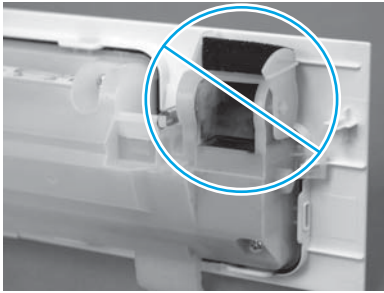
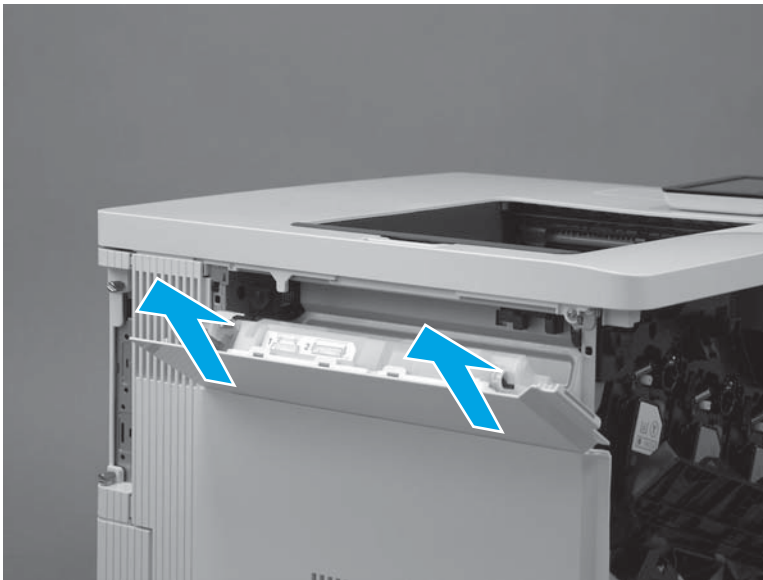

Figure 1-1067 Remove the TCU



Step 3: Remove the USB cover (M553)

📝 NOTE: This step is for the M552 and M553 models. For the M577 models, skip this step and go to [Step 8: Remove the rear upper cover \(M577\) on page 633](#).

1. Locate the USB cover.

Figure 1-1068 Locate the USB cover



2. Pull the cover off of the printer to remove it.

Figure 1-1069 Remove the cover



Step 4: Remove the control panel (M553x only)

 **NOTE:** For the M553n/dn and M552dn models, skip this step and go to [Step 5: Remove the rear cover \(M553\) on page 629](#).

For the M577, skip this step and go to [Step 8: Remove the rear upper cover \(M577\) on page 633](#).

1. Tilt the control panel up.

Figure 1-1070 Tilt the control panel up



2. Use a small flat-blade screwdriver to release the control-panel screws cover tabs.

Figure 1-1071 Release the control-panel screws cover tabs



3. Rotate the cover up to remove it.

Figure 1-1072 Remove the cover



4. Use a small Phillips screwdriver to remove two screws (callout 1).

 **IMPORTANT:** Store the screws in a secure place where they cannot fall down into the printer.

Figure 1-1073 Remove two screws

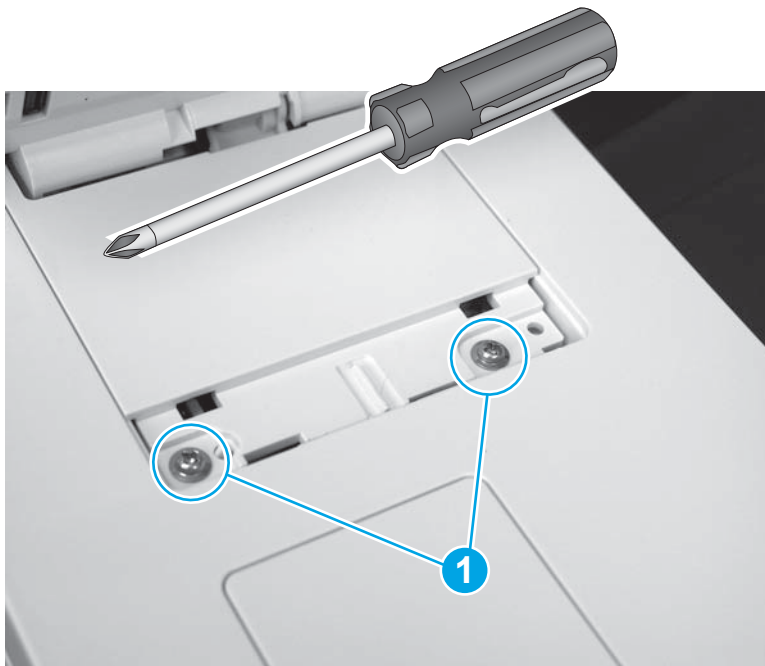

5. Rotate the control-panel base toward the front of the printer.

Figure 1-1074 Rotate the control-panel base up



6. Slightly slide the control-panel base toward the rear of the printer (callout 1) to release it, and then turn the control panel over (callout 2) to access the bottom side.

⚠ CAUTION: The control panel is still attached to the printer. Do not attempt to completely remove the control panel.

Figure 1-1075 Turn the control panel over

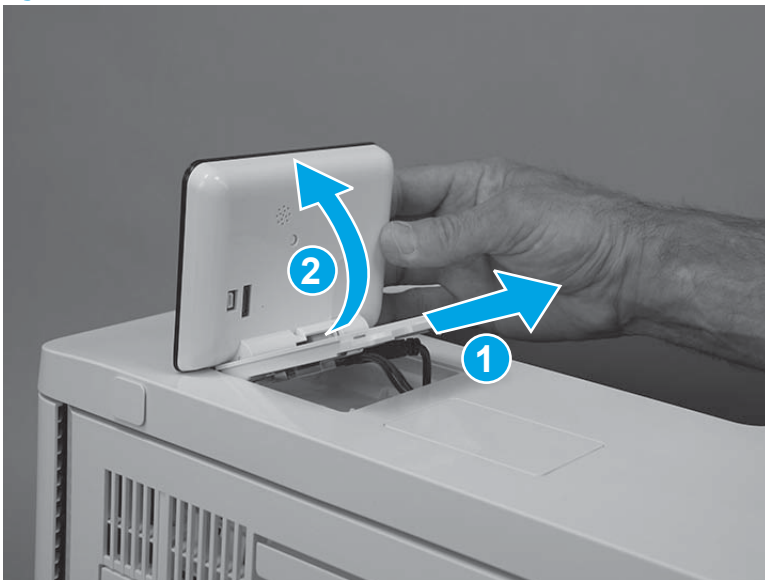

7. Disconnect one USB cable (callout 1), one connector (callout 2), and then remove the control panel.

Figure 1-1076 Disconnect two connectors

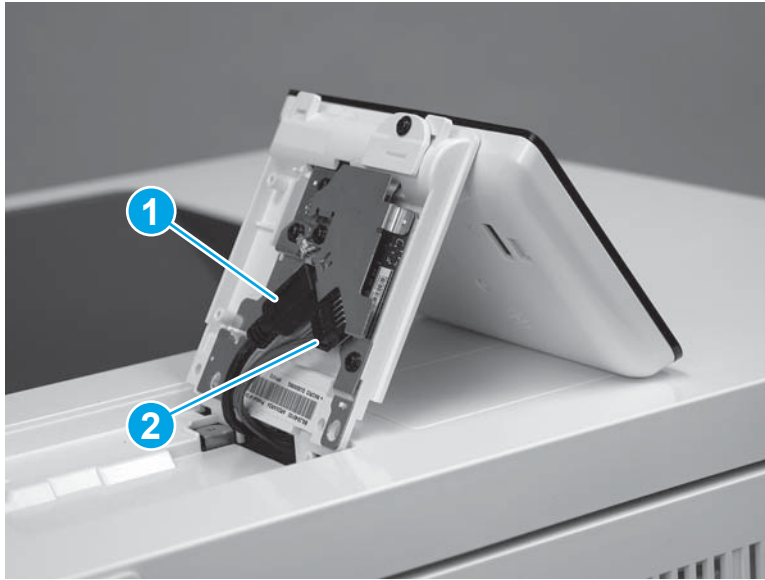

Step 5: Remove the rear cover (M553)

 **NOTE:** This step is for the M552 and M553 models. For the M577 models, skip this step and go to [Step 8: Remove the rear upper cover \(M577\) on page 633](#).

1. Remove four screws (callout 1).

Figure 1-1077 Remove four screws

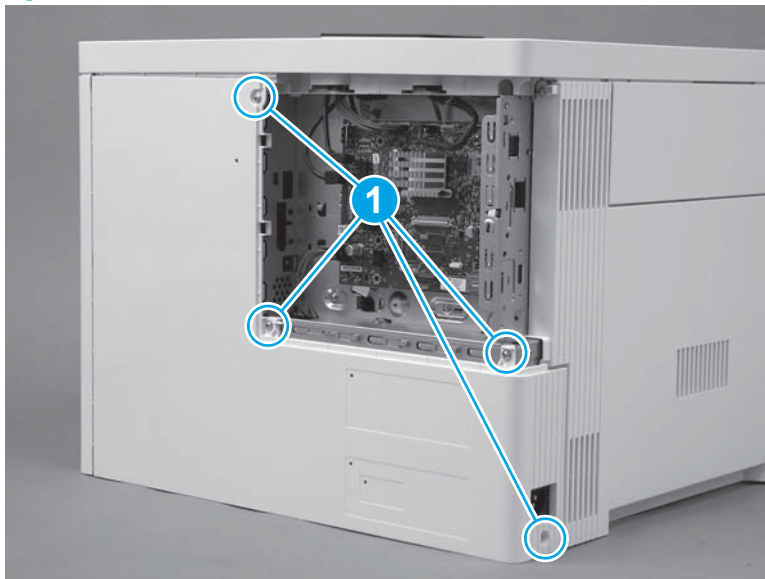

2. Slightly slide the cover to the right (callout 1), rotate the bottom of the cover away from the printer (callout 2), and then pull the top of the cover away from the printer (callout 3) to remove the cover.

Figure 1-1078 Remove the cover

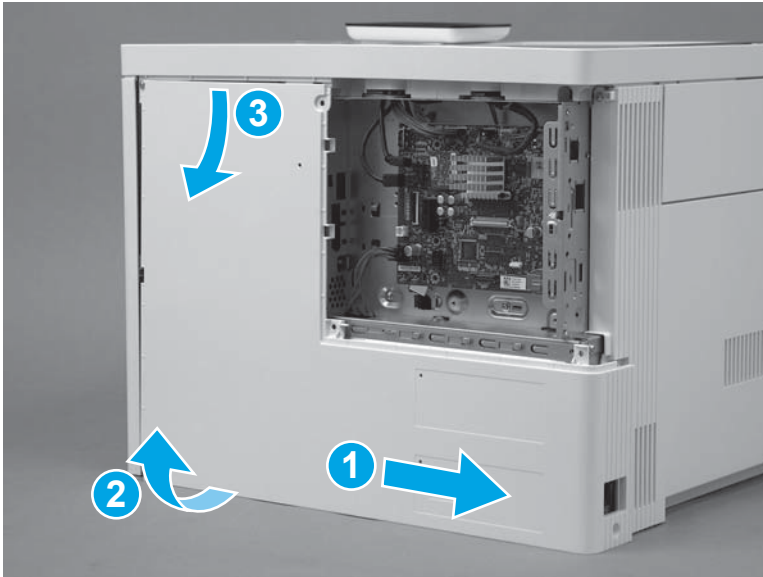

Step 6: Remove the left cover (M553)

 **NOTE:** This step is for the M552 and M553 models. For the M577 models, skip this step and go to [Step 8: Remove the rear upper cover \(M577\) on page 633](#).

1. At the left side of the printer, remove one screw (callout 1).

Figure 1-1079 Remove one screw

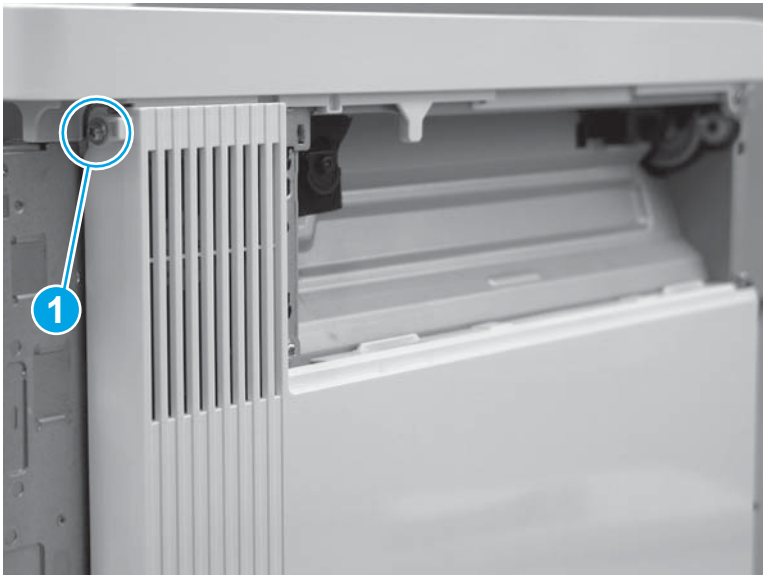

2. Release one tab (callout 1), rotate the front edge of the cover away from the printer (callout 2), and then slide the cover (callout 3) toward the rear of the printer to release it.

Figure 1-1080 Release the cover

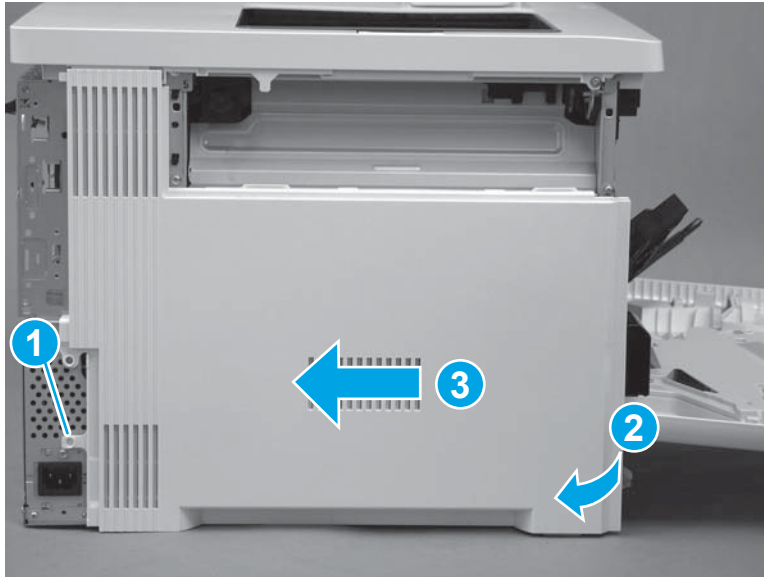

3. Remove the cover.

Figure 1-1081 Remove the cover

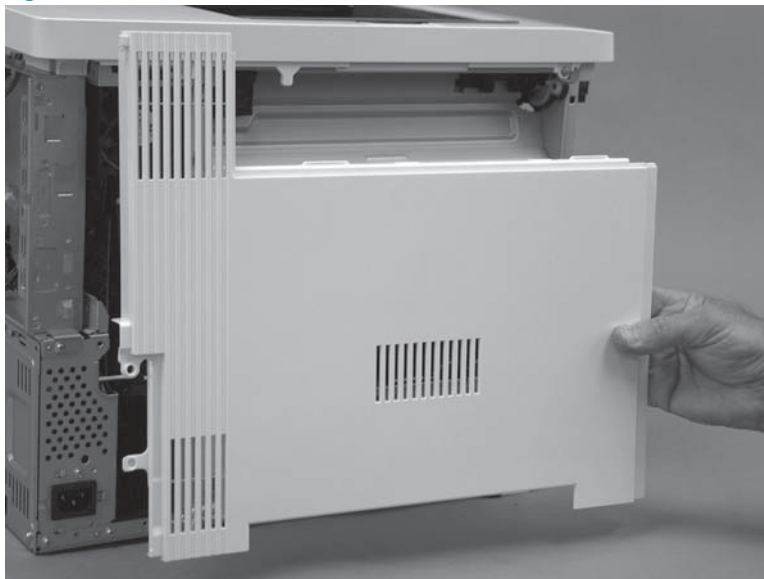

Step 7: Remove the upper cover (M553)

 **NOTE:** This step is for the M552 and M553 models. For the M577 models, skip this step and go to [Step 8: Remove the rear upper cover \(M577\) on page 633](#).

1. Remove three screws (callout 1).

Figure 1-1082 Remove three screws

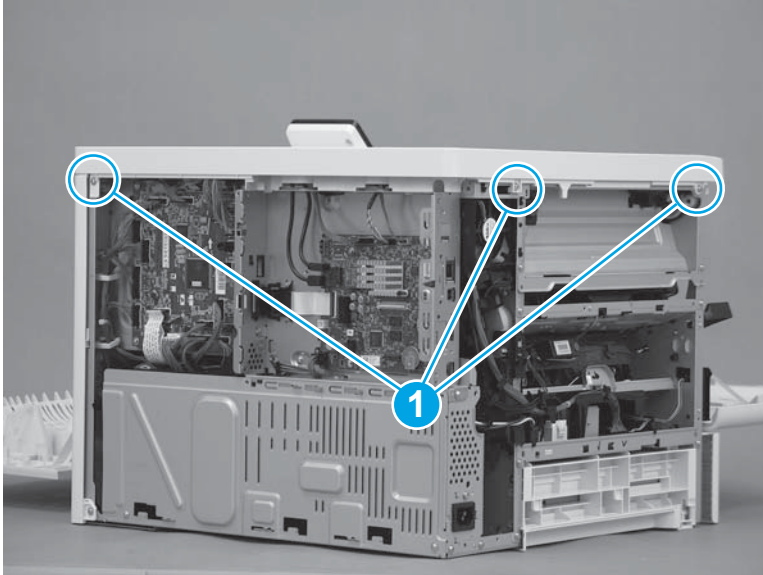

2. Remove one screw (callout 1), release one tab (callout 2), and then slightly separate the corner of the cover from the chassis.

 **NOTE:** This is a self-tapping plastic-thread screw. Make sure that this screw is used in this location when it is reinstalled.

Figure 1-1083 Remove one screw and release one tab



3. Release one tab (callout 1), and then lift up on the cover to release it.

 **NOTE:** If the cover does not release, check for addition tabs by locating the triangles embossed in the cover at tab locations.

Figure 1-1084 Release the cover



4. Remove the cover.

Figure 1-1085 Remove the cover

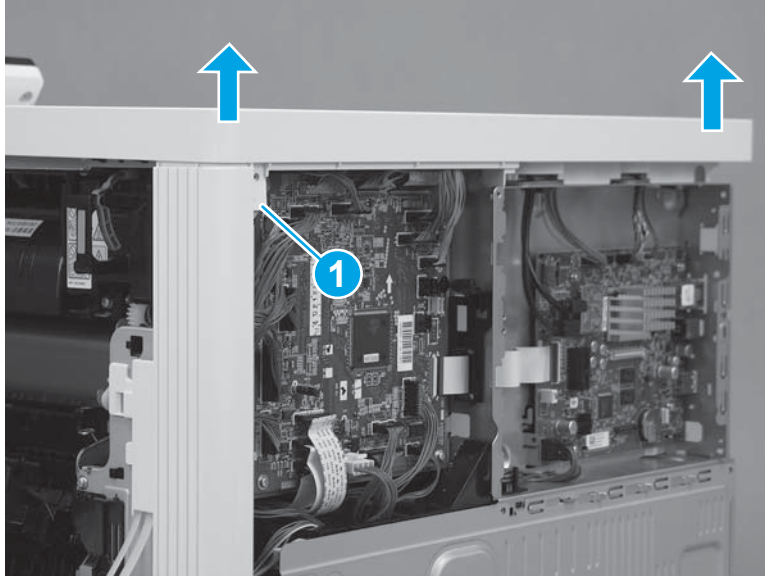
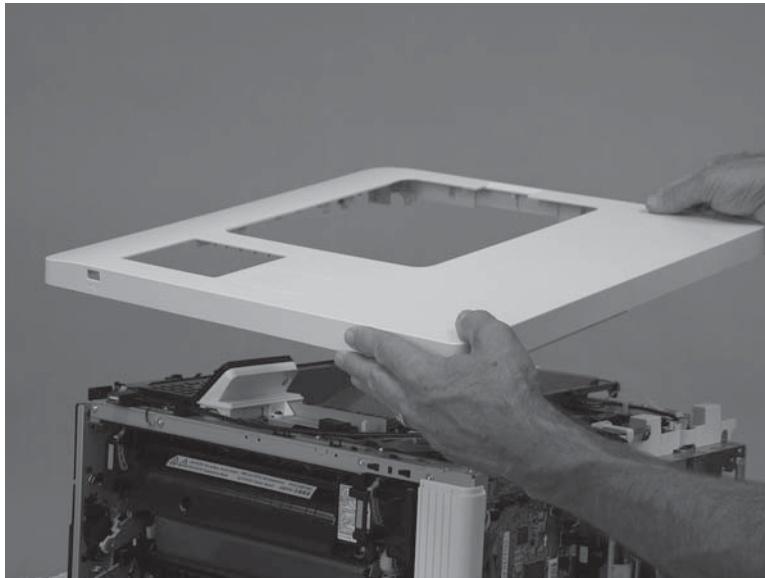

Step 8: Remove the rear upper cover (M577)

 **NOTE:** This step is for the M577 models. For the M552 and M553 models, skip this step and go to [Step 18: Remove the output bin on page 651](#).

1. Remove two screws (callout 1).

 **Reinstallation tip:** These two screws are self-tapping screws for plastic. When reinstalling them, rotate the screws counterclockwise to align them with the existing thread pattern, and then carefully turn them clockwise to tighten. Do not overtighten. This will prevent stripping the threads inside the screw holes.

Figure 1-1086 Remove two screws



2. Use a small, flat blade screwdriver to release the right edge of the cover.

Figure 1-1087 Release the right edge

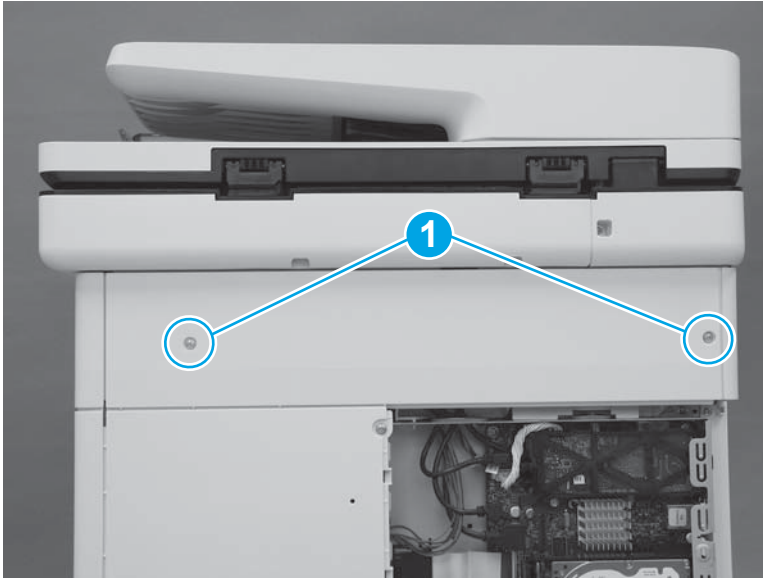
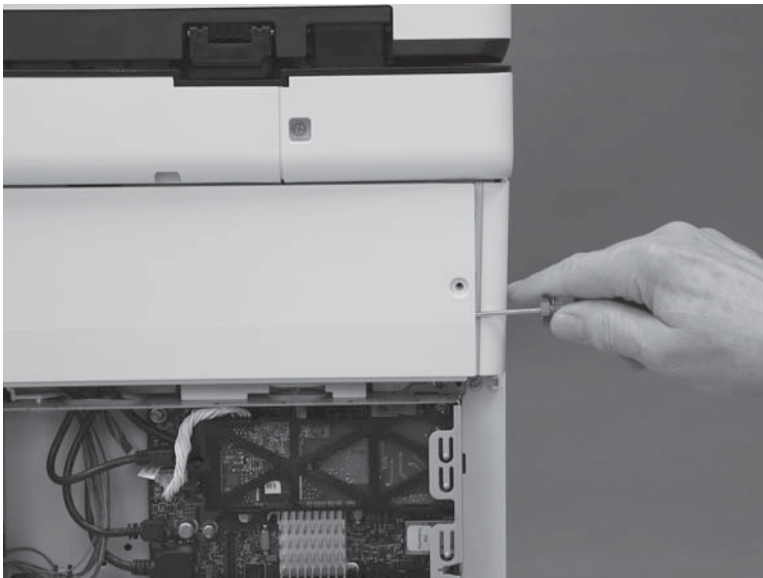

3. Pull the right edge of the cover (callout 1) away from the printer, and then slide the cover to the right (callout 2).

Figure 1-1088 Slide the cover right

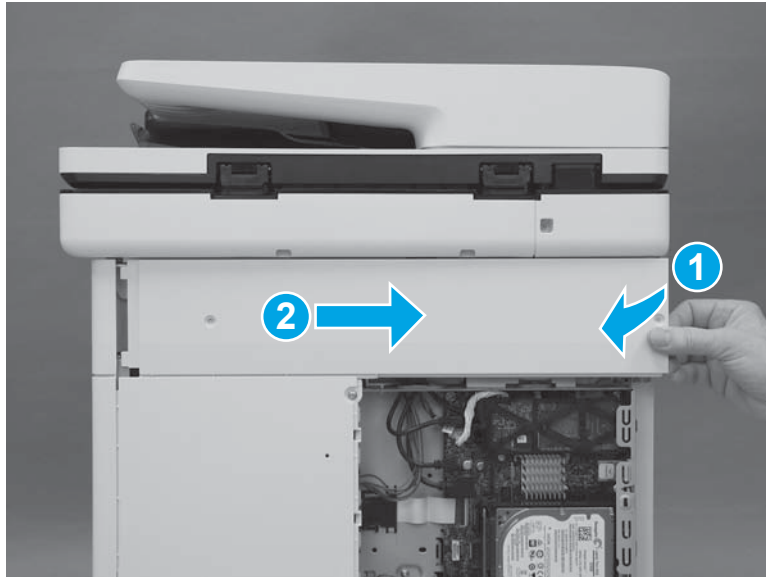

4. Remove the cover.

Figure 1-1089 Remove the cover

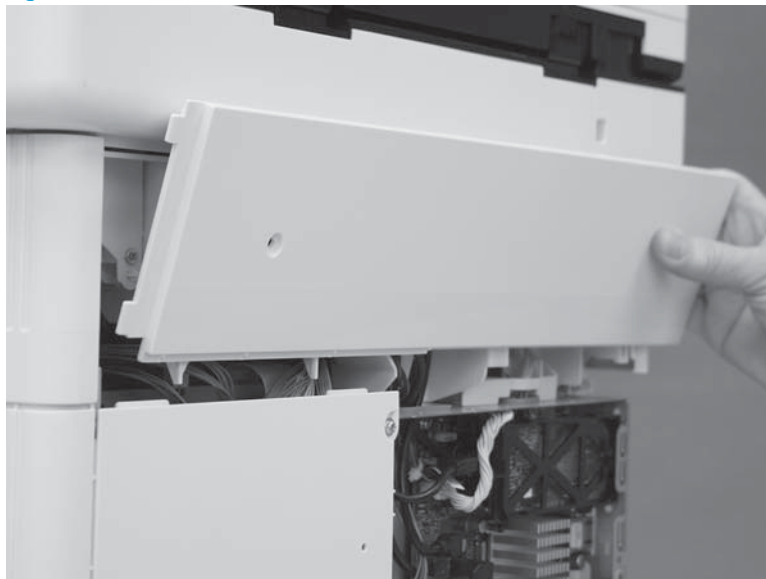

Step 9: Remove the left upper cover (M577)

 **NOTE:** This step is for the M577 models. For the M552 and M553 models, skip this step and go to [Step 18: Remove the output bin on page 651](#).

1. At the left side of the printer, release one tab (callout 1).

Figure 1-1090 Release one tab

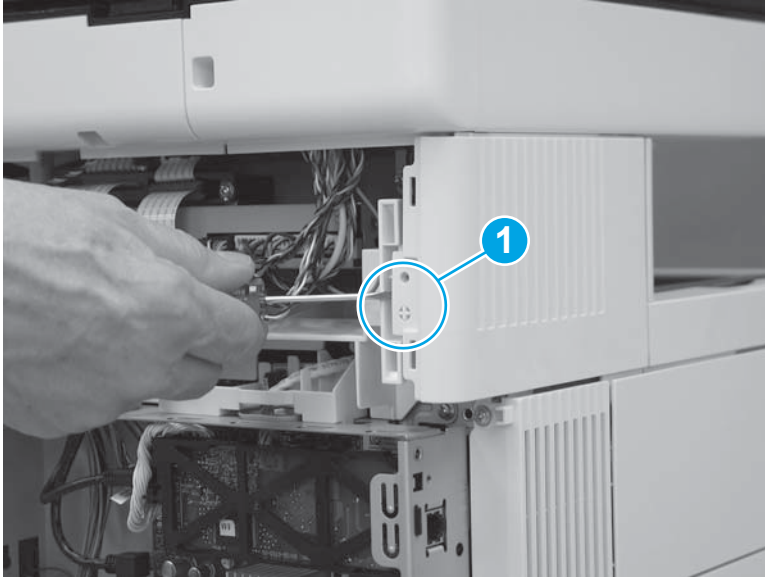

2. Slide the left upper cover toward the back of the printer.

Figure 1-1091 Slide the cover back

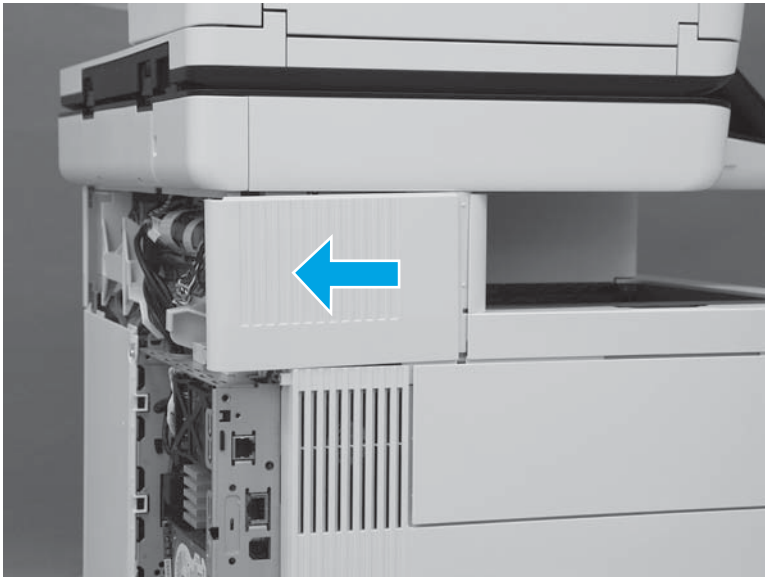

3. Rotate the cover up to remove it.

Figure 1-1092 Remove the left upper cover

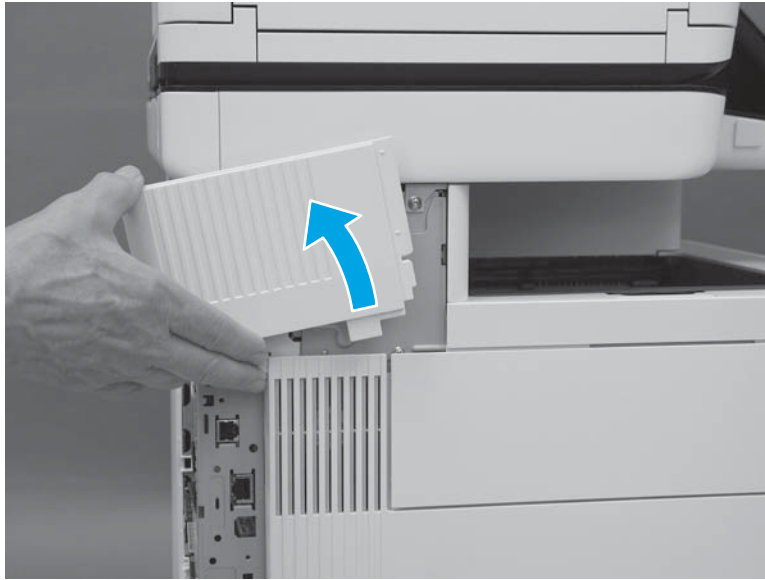

Step 10: Remove the right front upper cover (M577dn)

 **NOTE:** This step is for the M577dn model. For the M577c/f/z models, skip this step and to go [Step 11: Remove the stapler cover assembly \(M577c/f/z\) on page 638](#).

For the M552 and M553 models, skip this step and go to [Step 18: Remove the output bin on page 651](#).

1. Remove one screw (callout 1).

Figure 1-1093 Remove one screw

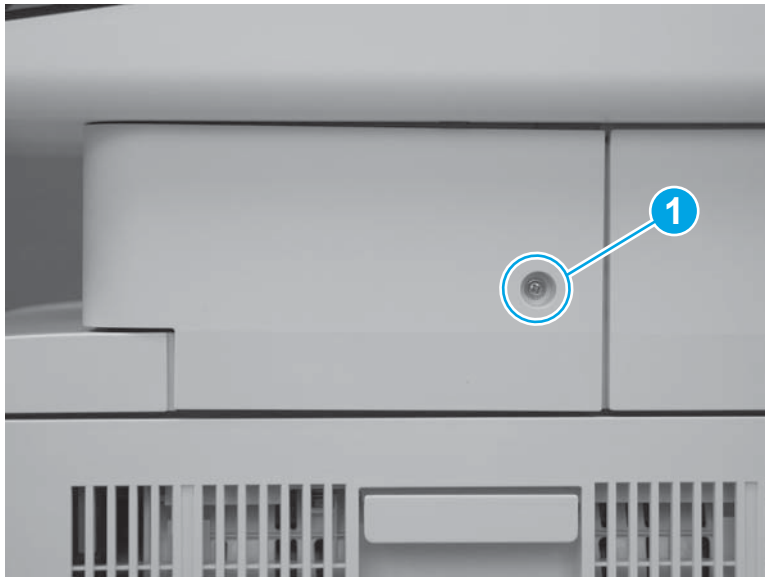

2. Release two tabs at the front edge of the cover (callout 1).

Figure 1-1094 Release two tabs



3. Rotate the front of the cover to the right to remove it.

Figure 1-1095 Rotate the cover



Step 11: Remove the stapler cover assembly (M577c/f/z)

 **NOTE:** This step is for the M577c/f/z models. For the M577dn model, skip this step and to go [Step 12: Remove the integrated scanner assembly \(M577\) on page 640.](#)

For the M552 and M553 models, skip this step and go to [Step 18: Remove the output bin on page 651.](#)

1. Remove one screw (callout 1).

 **Reinstallation tip:** This is a self-tapping screw for plastic. When reinstalling, rotate the screw counterclockwise to align it with the existing thread pattern, and then carefully turn it clockwise to tighten. Do not overtighten. This will prevent stripping the threads inside the screw hole.

Figure 1-1096 Remove one screw



2. Release two tabs at the front edge of the cover (callout 1).

Figure 1-1097 Release two tabs

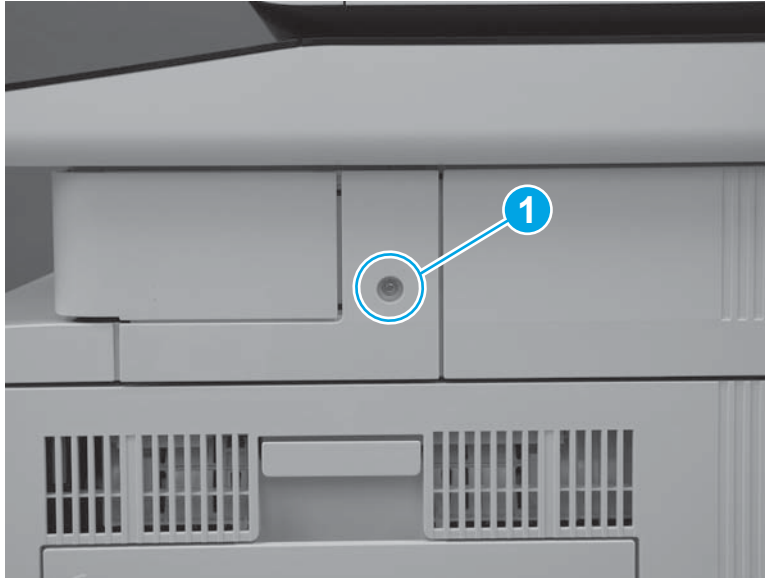

3. Release the back edge of the cover.

Figure 1-1098 Release the back edge of the cover

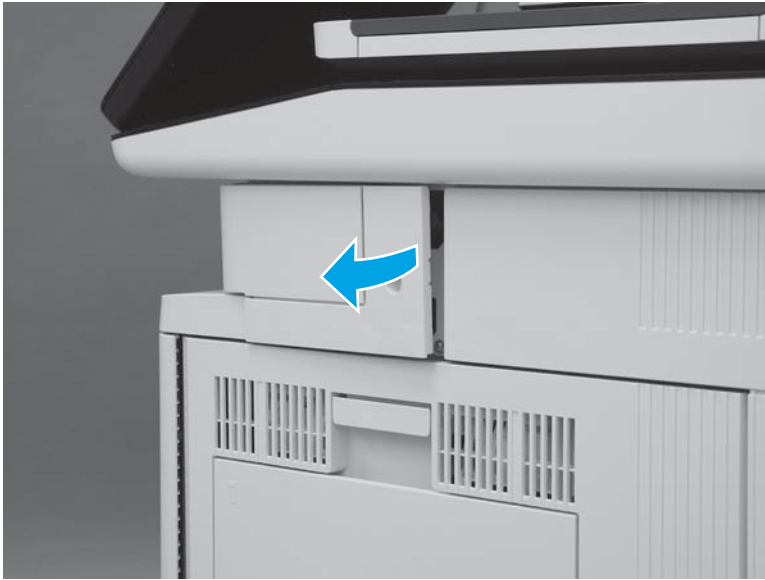

4. Rotate the cover away from the printer to remove it.

Figure 1-1099 Remove the cover



Step 12: Remove the integrated scanner assembly (M577)

 **NOTE:** This step is for the M577 models. For the M552 and M553 models, skip this step and go to [Step 18: Remove the output bin on page 651](#).

 **NOTE:** The ISA includes the document feeder, image scanner, scanner control board (SCB), control panel, keyboard (M577c/z) and NFC PCA (M577z).

1. At the left side of the printer, remove one screw (callout 1).

Figure 1-1100 Remove one screw

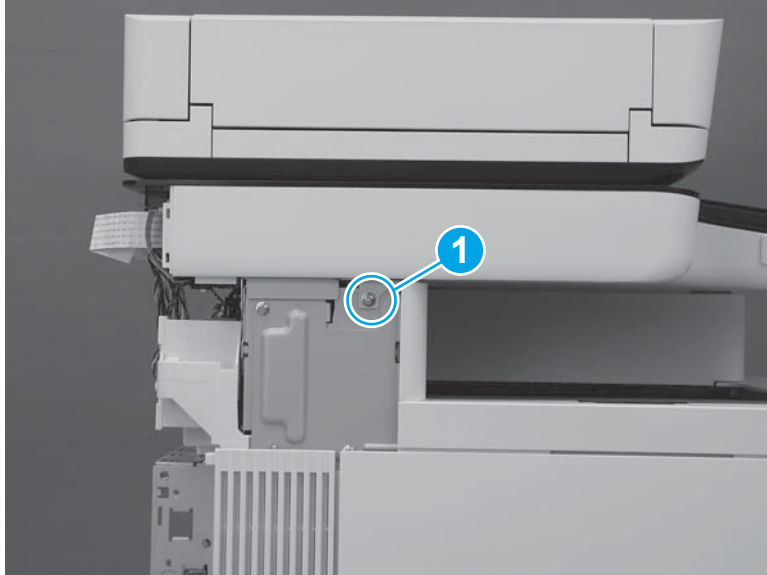

2. At the back side of the printer, remove two screws (callout 1).

Figure 1-1101 Remove two screws

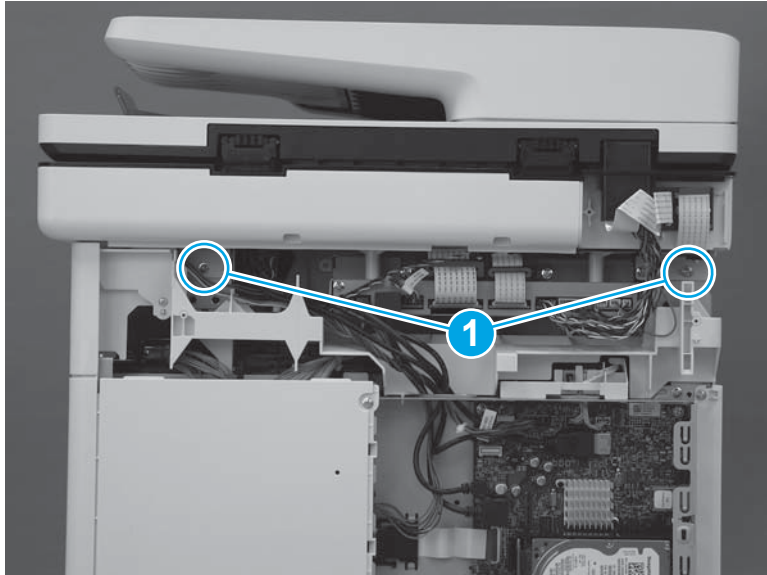

3. At the right side of the printer, remove one screw (callout 1).

Figure 1-1102 Remove one screw

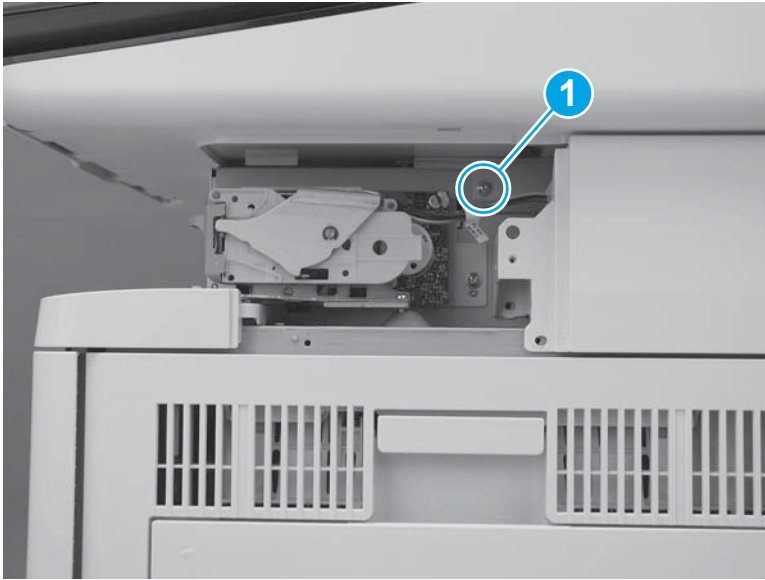

4. Disconnect four connectors on the formatter (callout 1), and then pass the wire harness and cables through the opening in the formatter case (callout 2).

Figure 1-1103 Disconnect four connectors

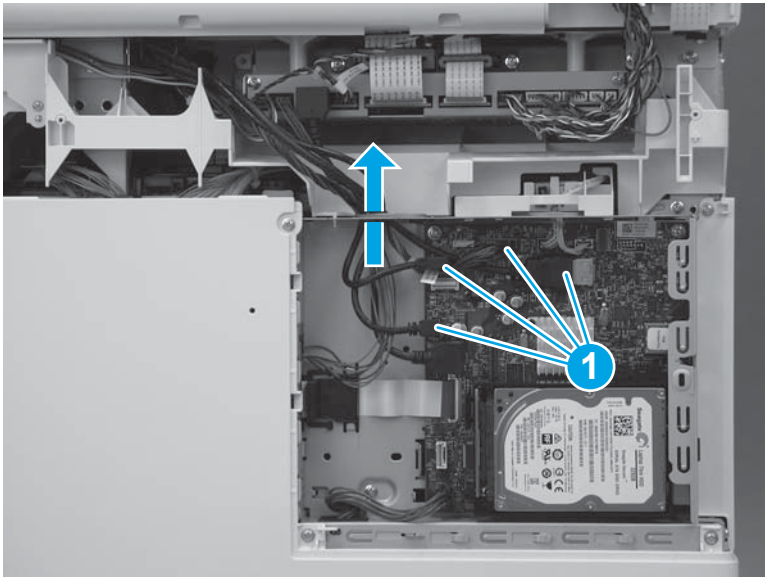

5. Disconnect two connectors on the scanner control board (callout 1).

M577c/f/z only: Disconnect one connector for the stapler on the scanner control board (callout 2).

Figure 1-1104 Disconnect connectors

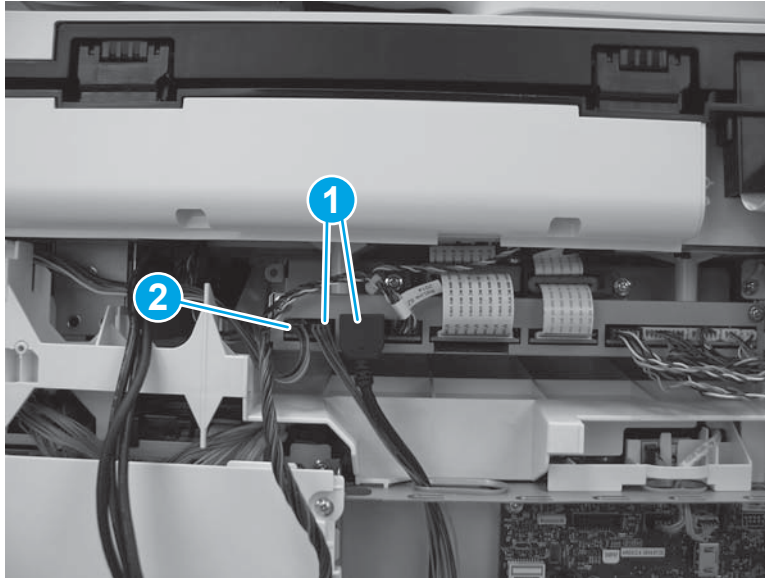

6. Slightly slide the ISA towards the back of the printer to release it.

Figure 1-1105 Slide the ISA towards the back of the printer

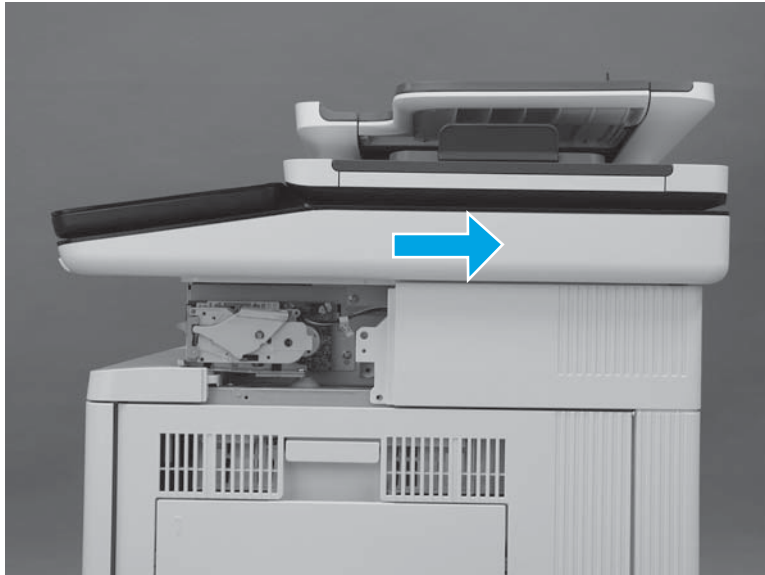

7. Lift the ISA up to remove it.

Figure 1-1106 Remove the ISA

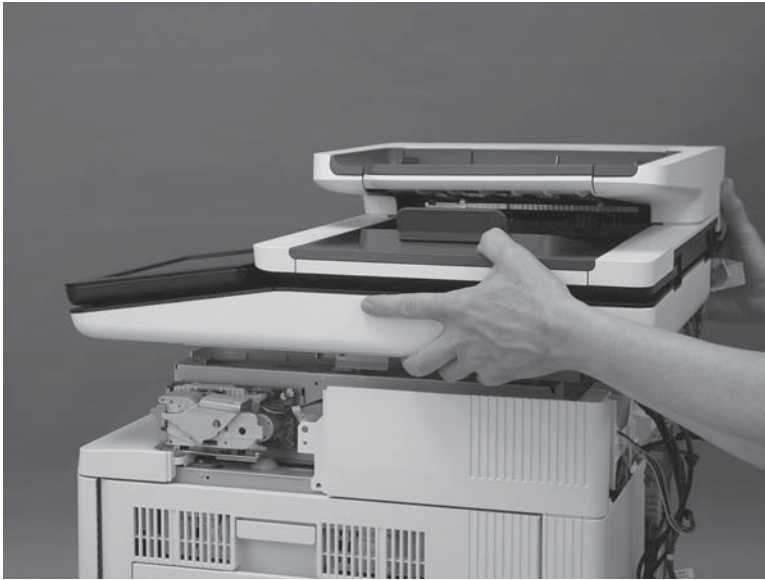

Step 13: Remove the stapler unit (M577f and M577z)

 **NOTE:** This step is for the M577f and M577z models. For the M577dn model, skip this step and to go [Step 14: Remove the right upper cover \(M577\) on page 645](#).

This step is for the M577 models. For the M552 and M553 models, skip this step and go to [Step 18: Remove the output bin on page 651](#).

1. Disconnect one connector (callout 1), and then remove two screws (callout 2).

Figure 1-1107 Disconnect connector and remove screws

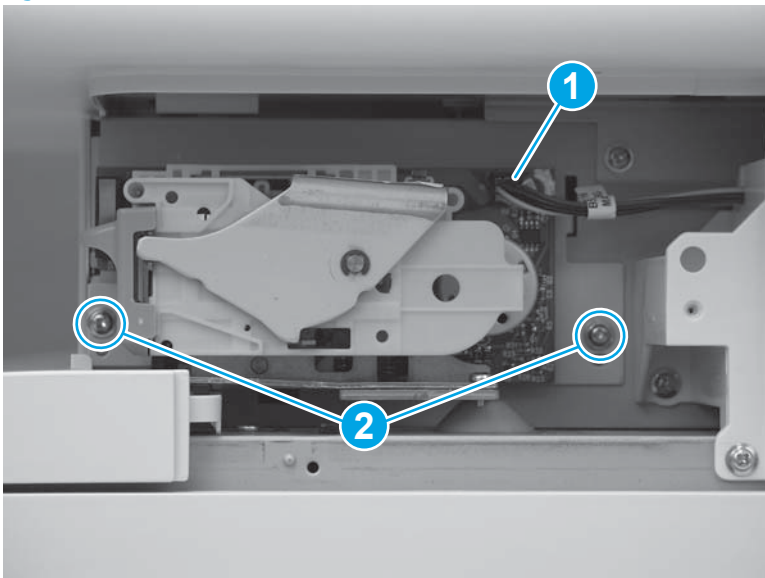

2. Slide the stapler unit up (callout 1), and then pull it away from the printer (callout 2) to remove it.

Figure 1-1108 Remove the stapler unit

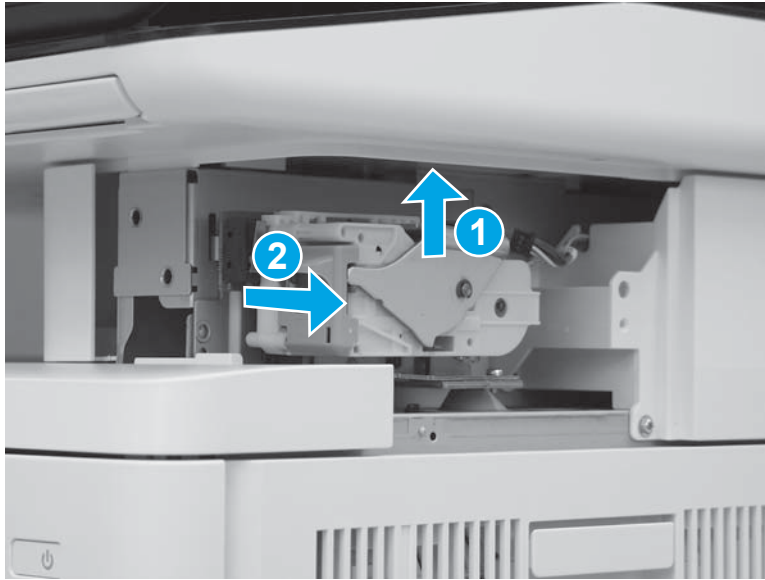

Step 14: Remove the right upper cover (M577)

 **NOTE:** This step is for the M577 models. For the M552 and M553 models, skip this step and go to [Step 18: Remove the output bin on page 651](#).

 **NOTE:** The figures below show the image scanner installed. The procedures for removing and installing the right upper cover are the same whether the image scanner is installed or removed."

1. At the right side of the printer, remove two screws (callout 1).

M577c/f/z only: Disconnect one connector (callout 2), if it was not already disconnected in a previous step.

Figure 1-1109 Remove two screws and one connector

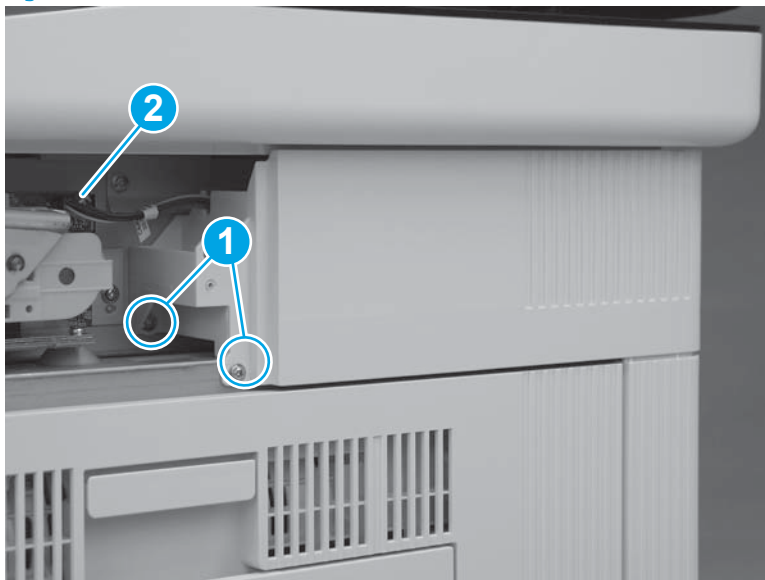

2. At the back of the printer, remove one screw (callout 1).

M577c/f/z only: Disconnect one connector (callout 2), if it was not already disconnected in a previous step.

 **Reinstallation tip:** This screw is smaller than the screws removed in the previous step. When reinstalling the right upper cover, make sure that this screw is installed in the correct position.

Figure 1-1110 Remove one screw and connector



3. Slide the cover toward the back of the printer.

Figure 1-1111 Slide the cover

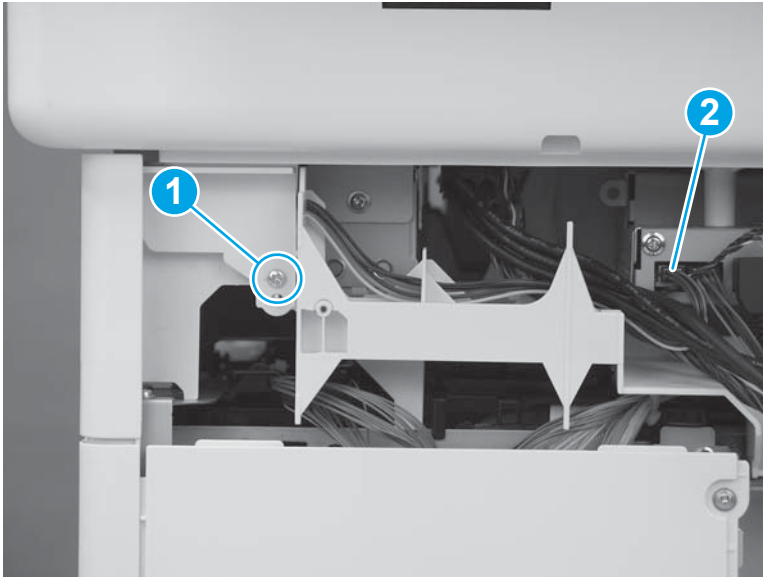
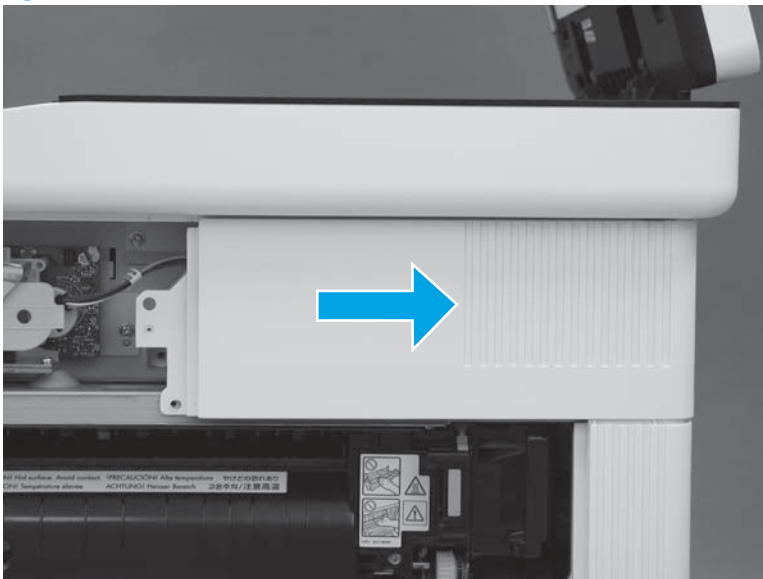

4. Lift the cover away from the printer to remove it.

M577c/f/z only: Release the cables (callout 1) through the slot (callout 2) in the printer.

Figure 1-1112 Remove the cover

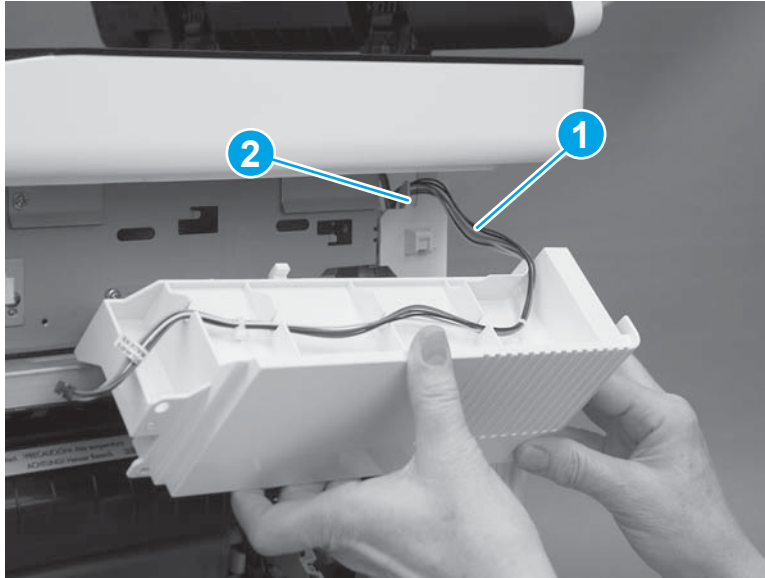

Step 15: Remove the top rear cover (M577)

 **NOTE:** This step is for the M577 models. For the M552 and M553 models, skip this step and go to [Step 18: Remove the output bin on page 651.](#)

1. At the top of the printer, remove five screws (callout 1).

Figure 1-1113 Remove five screws

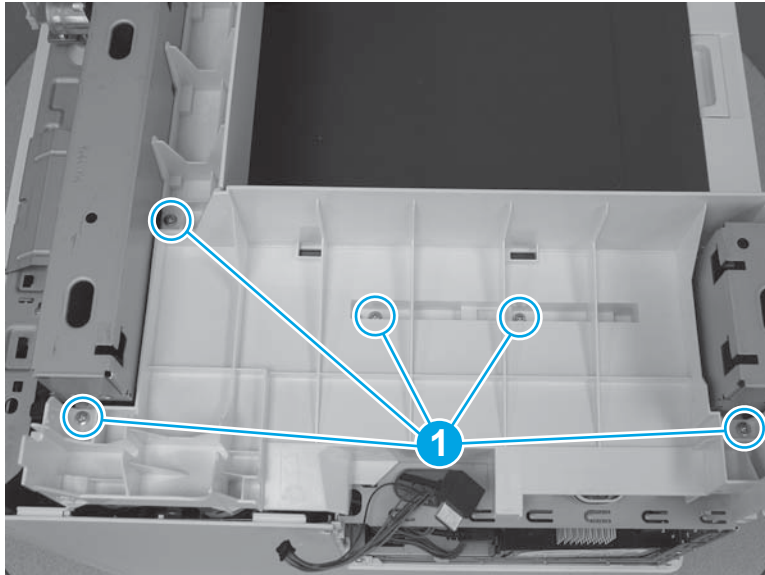

2. Release two tabs (callout 1) on the front edge of the cover.

Figure 1-1114 Release two tabs

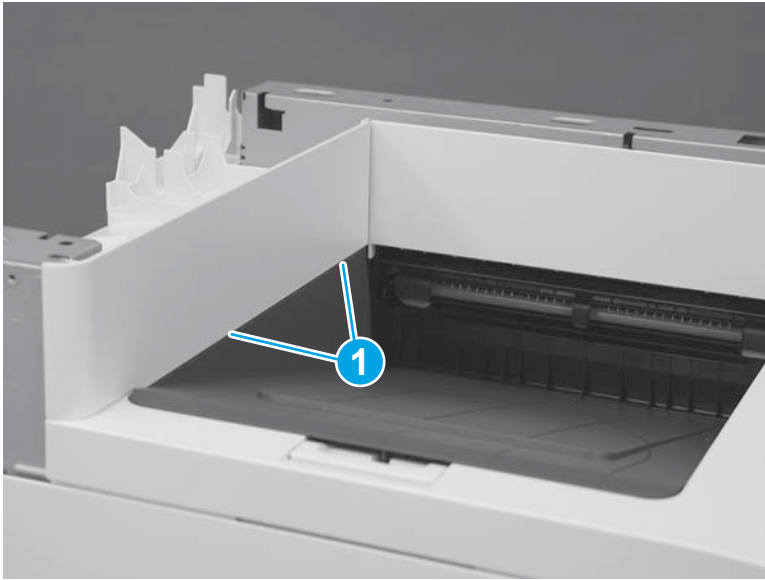

3. Remove the top rear cover.

Figure 1-1115 Remove the top rear cover

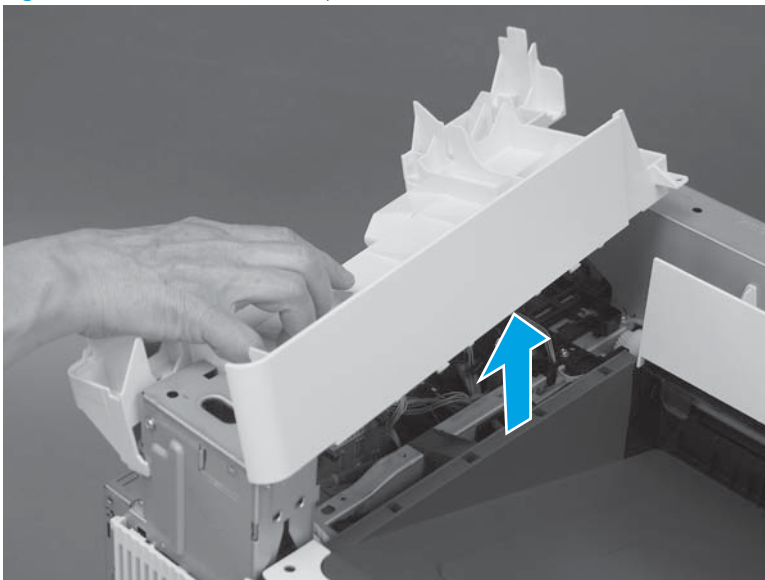

Step 16: Remove the paper feed cover (M577)

 **NOTE:** This step is for the M577 models. For the M552 and M553 models, skip this step and go to [Step 18: Remove the output bin on page 651.](#)

1. Remove one screw (callout 1).

Figure 1-1116 Remove one screw

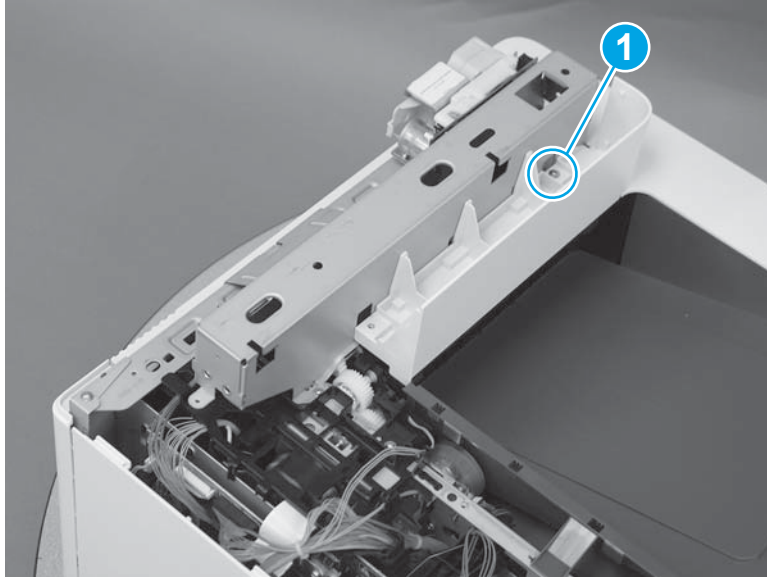

2. Lift the cover up to remove it.

Figure 1-1117 Remove the cover

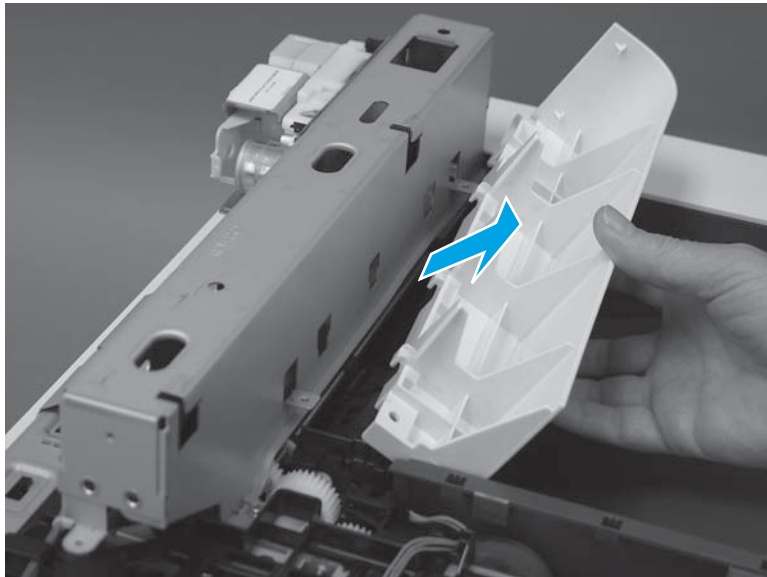

Step 17: Remove the top cover (M577)

 **NOTE:** This step is for the M577 models. For the M552 and M553 models, skip this step and go to [Step 18: Remove the output bin on page 651.](#)

1. At the front of the printer, remove one screw (callout 1).

 **Reinstallation tip:** This screw is longer and a different type of screw than the screw removed in the next step. When reinstalling the top cover, make sure that this screw is installed in the correct position.

Figure 1-1118 Remove one screw



2. At the left side of the printer, remove one screw (callout 1).

Figure 1-1119 Remove one screw

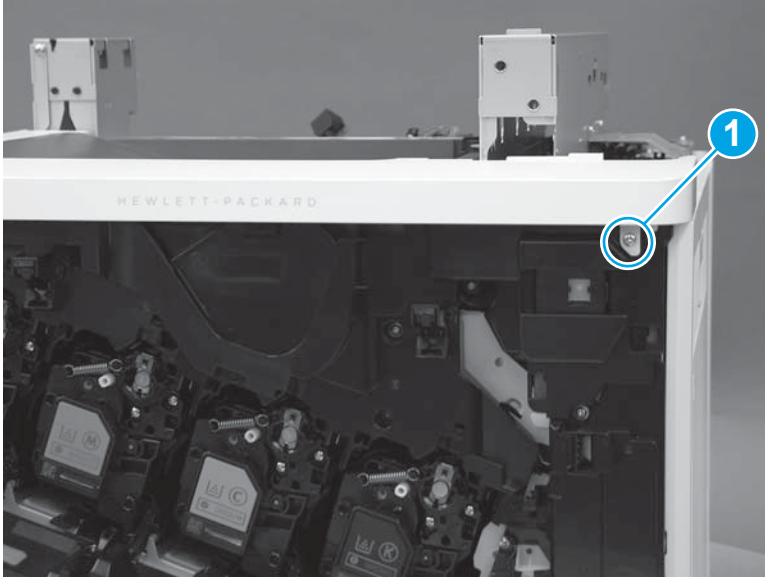
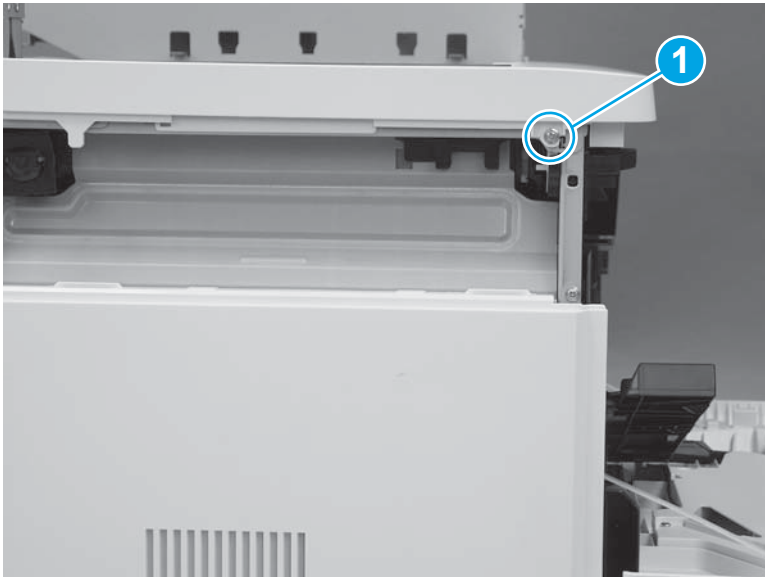

3. At the front of the printer, release one tab (callout 1).

Figure 1-1120 Release one tab

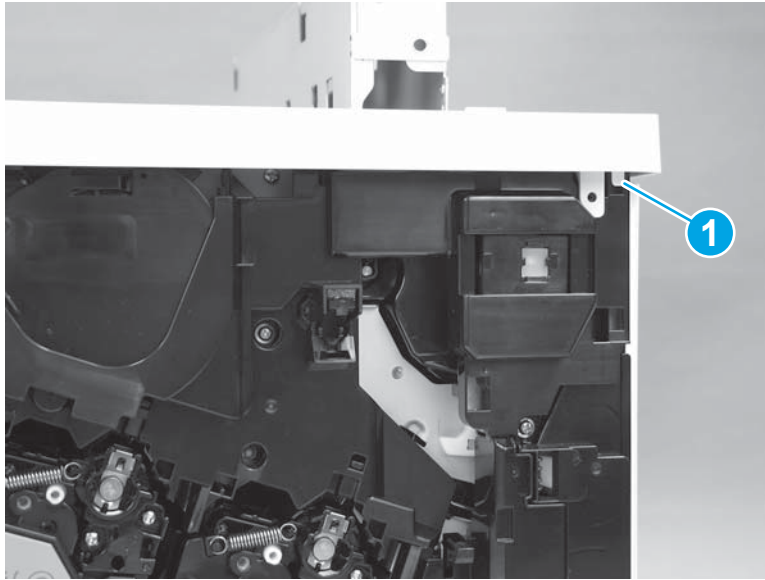

4. At the top of the printer, release two tabs (callout 1) next to the output bin, and then remove the top cover.

Figure 1-1121 Release two tabs

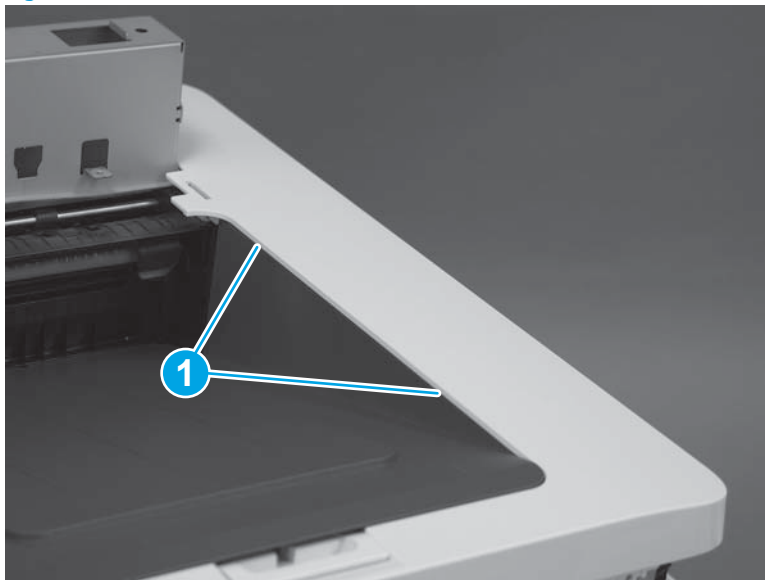

Step 18: Remove the output bin

1. Slightly slide and lift the cover to release it.

Figure 1-1122 Release the cover

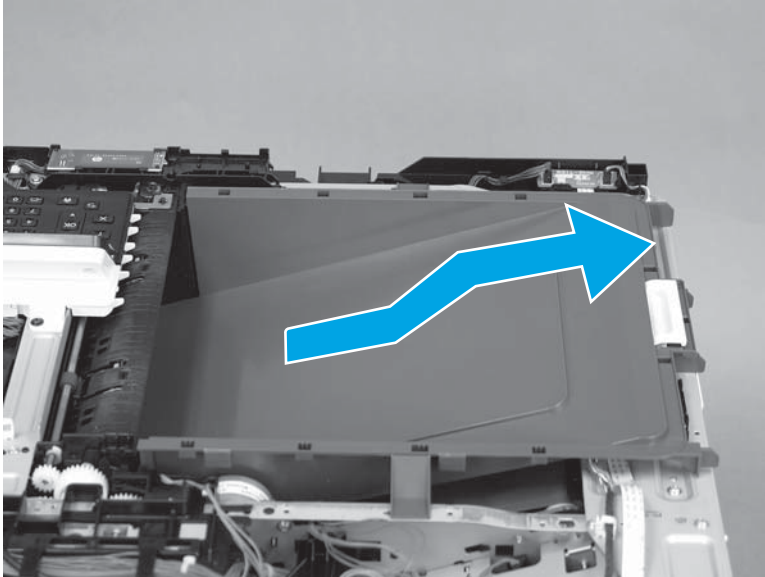

2. Remove the cover.

Figure 1-1123 Remove the cover

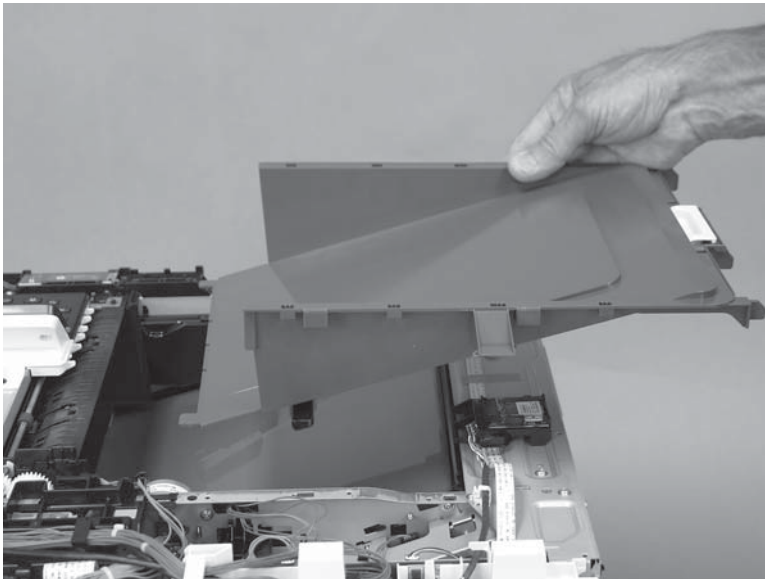

Step 19: Remove the wireless PCA (M553 and M577)

- ▲ Disconnect one connector (callout 1), release two tabs (callout 2), and then remove the wireless PCA (callout 3).

Figure 1-1124 Remove the wireless PCA

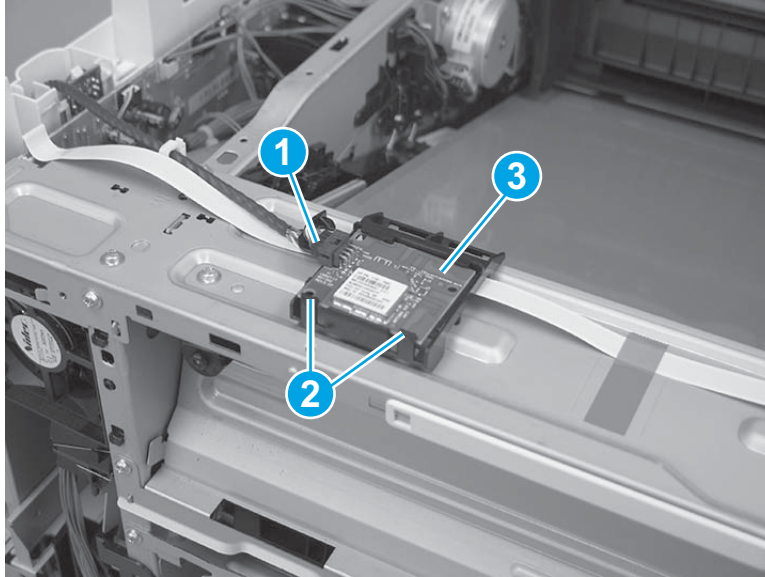

Step 19: Unpack the replacement assembly

Unpack the replacement assembly from the packaging.

For complete information on HP's recycling programs, go to [Product return and recycling](#).

 **CAUTION:**  ESD-sensitive part.

 **NOTE:** HP recommends responsible disposal of the defective assembly.

Figure 1-1125 Recycle and unpack

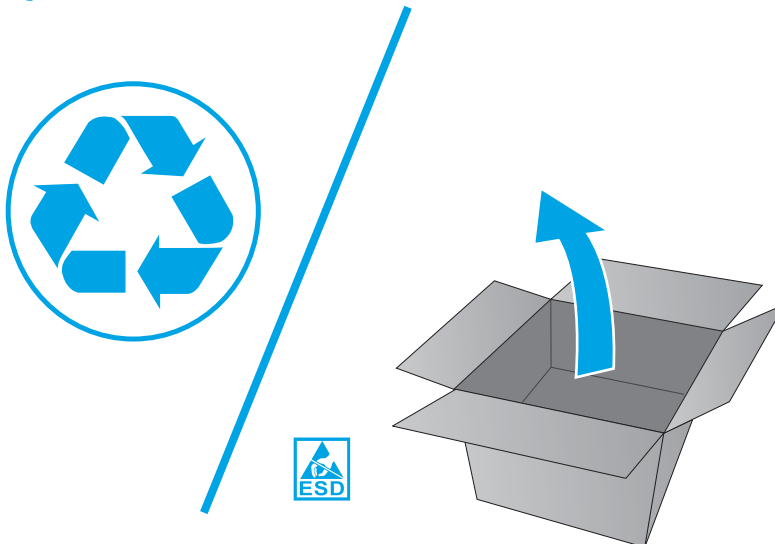

Step 21: Install the wireless PCA (M553 and M577)

- ▲ Position the wireless PCA (callout 1) on the printer, connect one connector (callout 2), and then make sure the two tabs (callout 3) are firmly holding the PCA in the holder.

Figure 1-1126 Install the wireless PCA

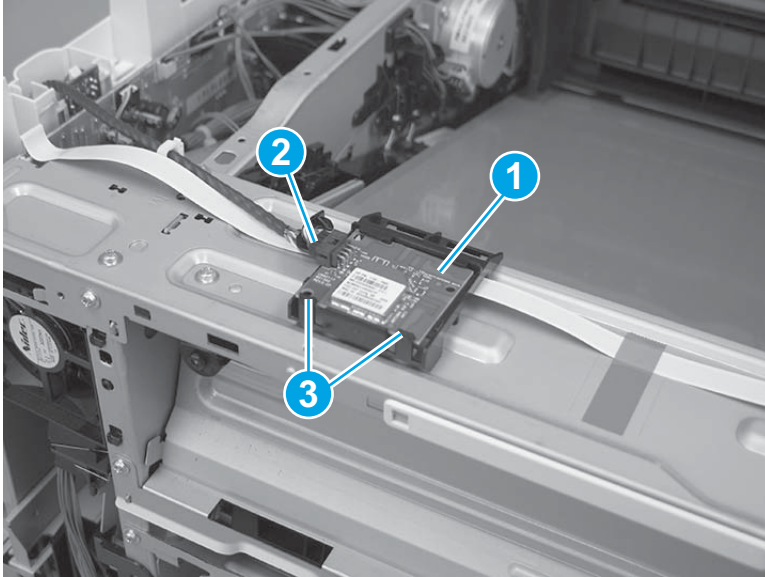

Step 22: Install the output bin

1. Position the cover near the printer.

Figure 1-1127 Install the cover

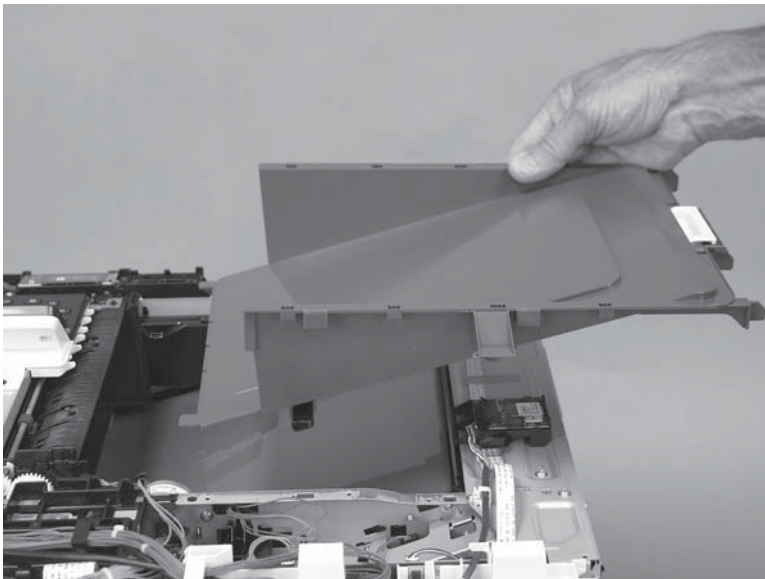

2. Align the tabs on the cover with the slots in the printer.

Figure 1-1128 Align the tabs

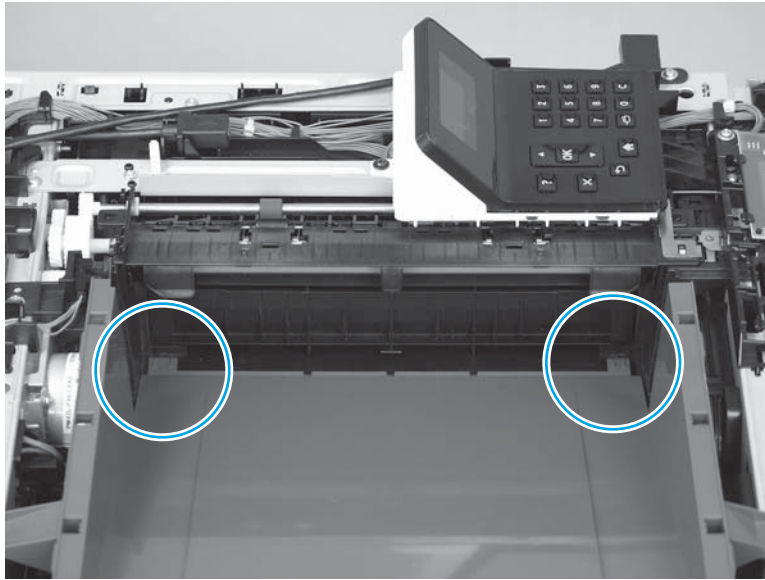

3. Slide and lower the cover onto the printer to install it.

Figure 1-1129 Release the cover

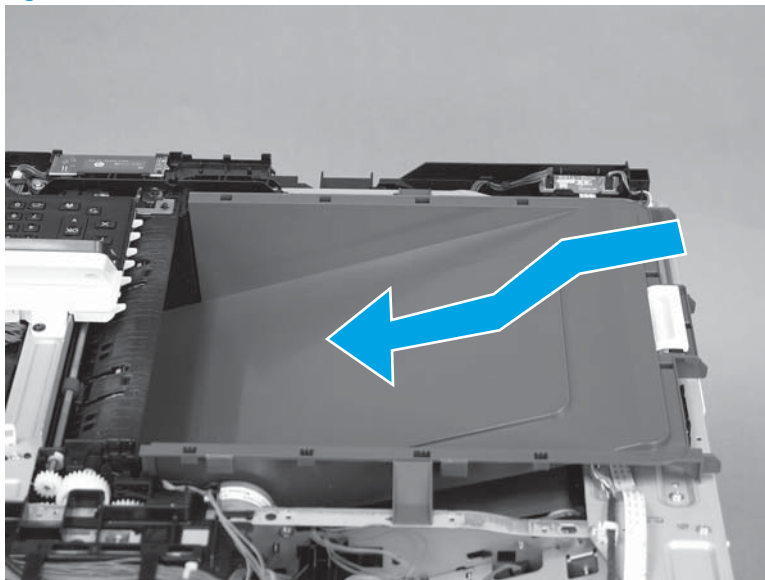

4. Verify that the tabs on the front- and rear-side of the cover are correctly installed in the slots in the chassis.

Figure 1-1130 Verify the installation

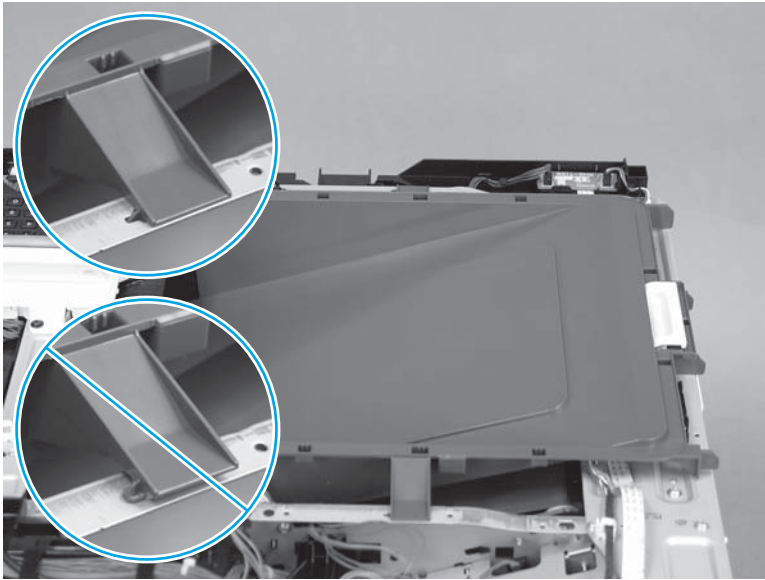

Step 23: Install the top cover (M577)

 **NOTE:** This step is for the M577 models. For the M552 and M553 models, skip this step and go to [Step 33: Install the upper cover \(M553\) on page 674](#).

1. Position the locator pins (callout 1) on the cover in the slots (callout 2) in the printer.

Figure 1-1131 Position the locator pins

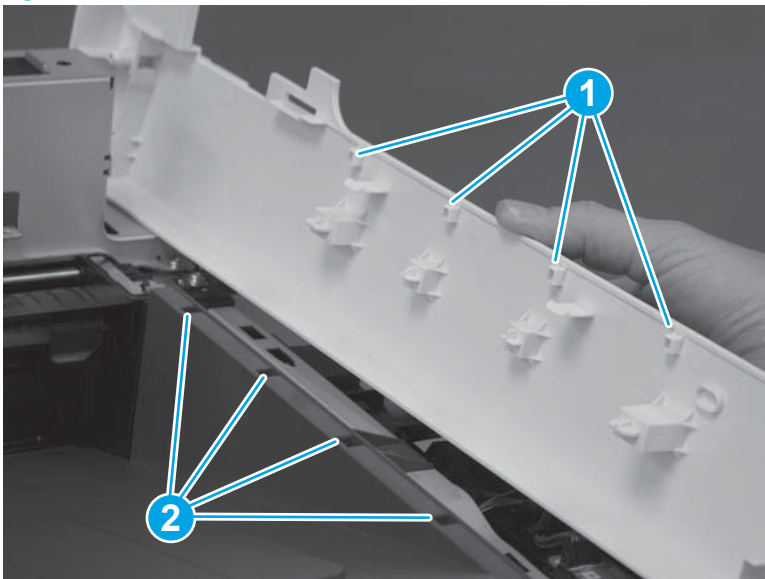

2. Press down on the cover to install it. Make sure that the tabs (callout 1) snap into place.

Figure 1-1132 Press down on the cover

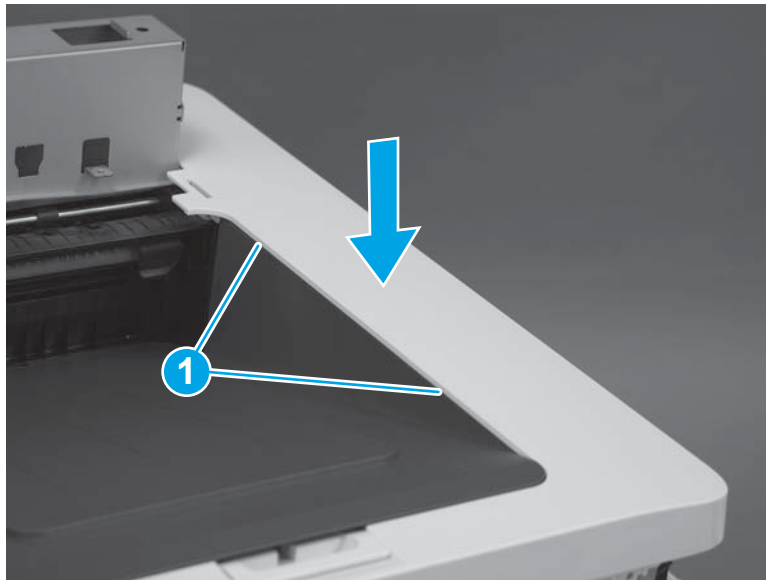

3. At the front of the printer, install one screw (callout 1).

 **Reinstallation tip:** This screw is longer and a different type of screw than the screw installed in the next step. Make sure that this screw is installed in the correct position.

Figure 1-1133 Install one screw



4. At the left side of the printer, install one screw (callout 1).

Figure 1-1134 Install one screw

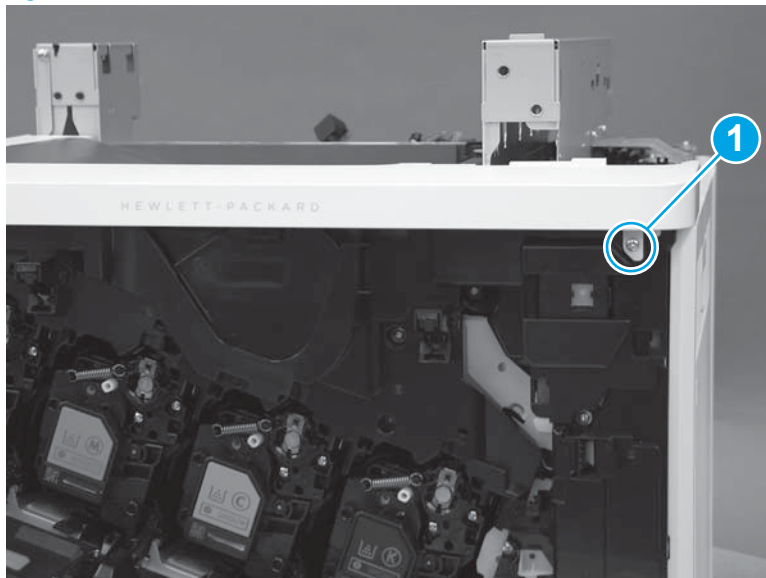
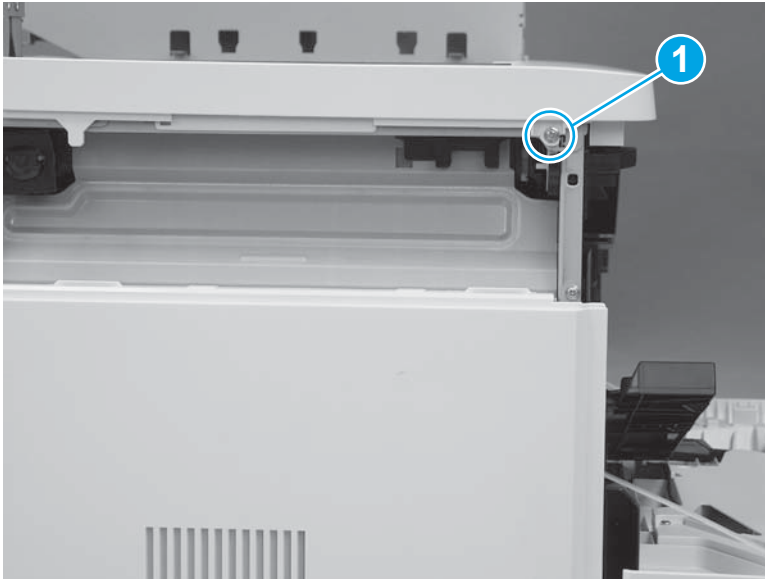

Step 24: Install the paper feed cover (M577)

 **NOTE:** This step is for the M577 models. For the M552 and M553 models, skip this step and go to [Step 33: Install the upper cover \(M553\) on page 674](#).

1. Position the locator tabs (callout 1) on the cover in the slots (callout 2) in the printer. Press down until the cover snaps into place.

Figure 1-1135 Install the cover

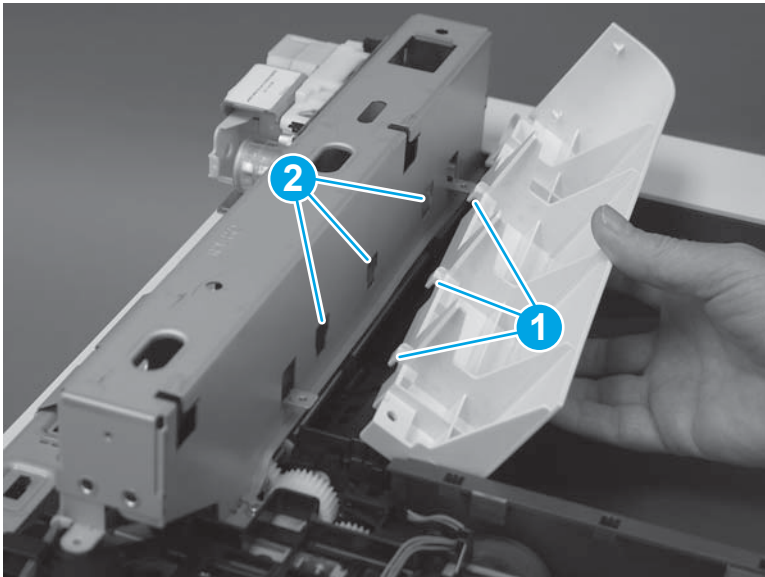

2. Install one screw (callout 1).

Figure 1-1136 Install one screw

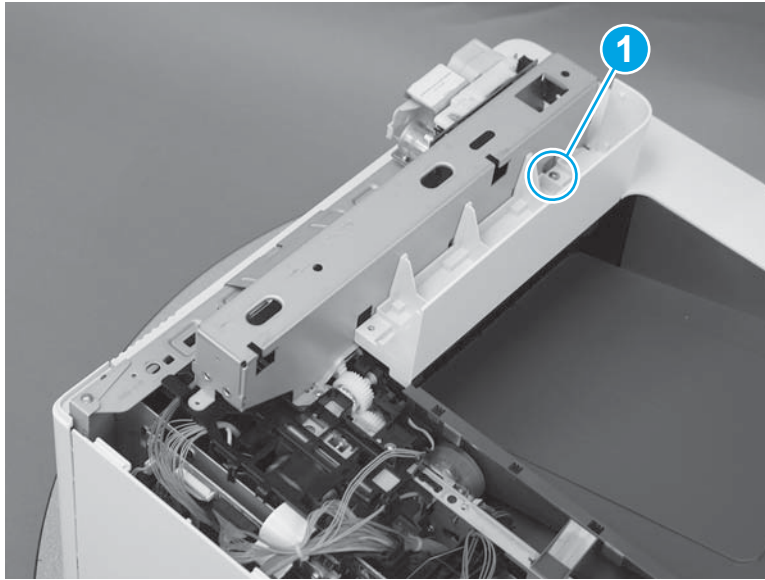

Step 25: Install the top rear cover (M577)

 **NOTE:** This step is for the M577 models. For the M552 and M553 models, skip this step and go to [Step 33: Install the upper cover \(M553\) on page 674](#).

1. Align the locator tabs (callout 1) on the cover with the slots (callout 2) in the printer.

Figure 1-1137 Align the locator tabs

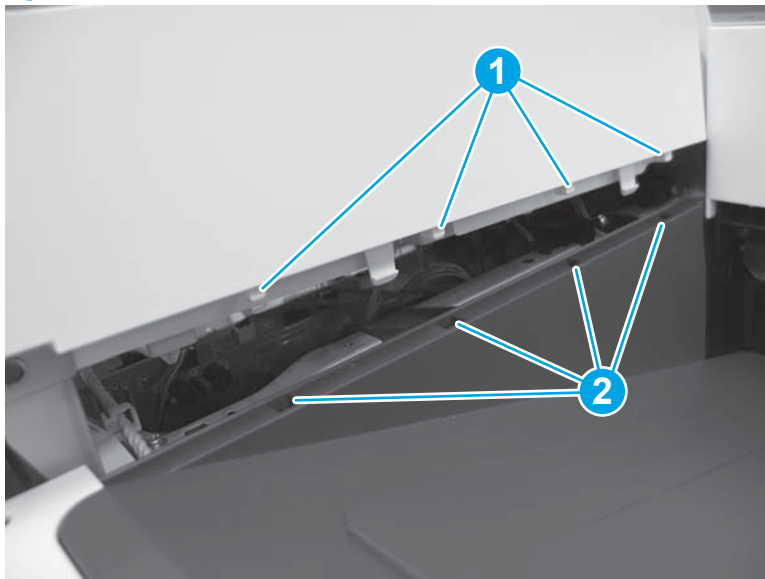

2. Press down to install the cover. Make sure that the tabs snap into place.

Figure 1-1138 Install the cover

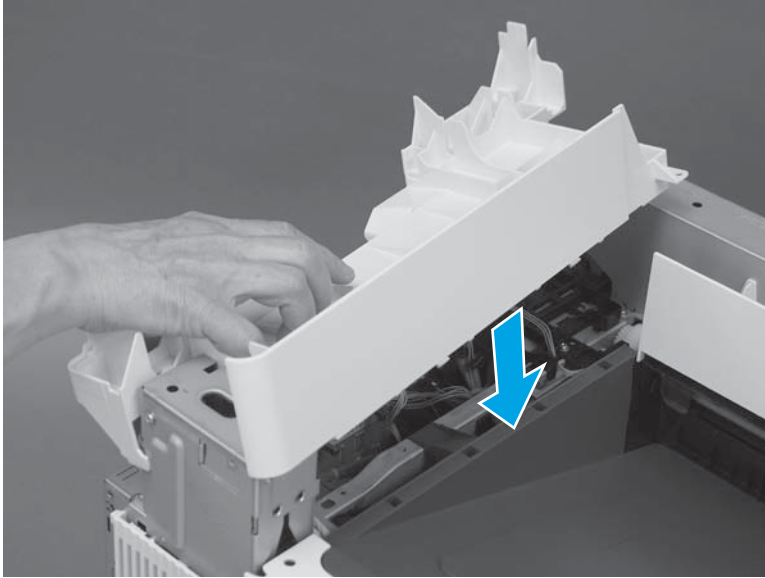

3. At the top of the printer, install five screws (callout 1).

Figure 1-1139 Install five screws

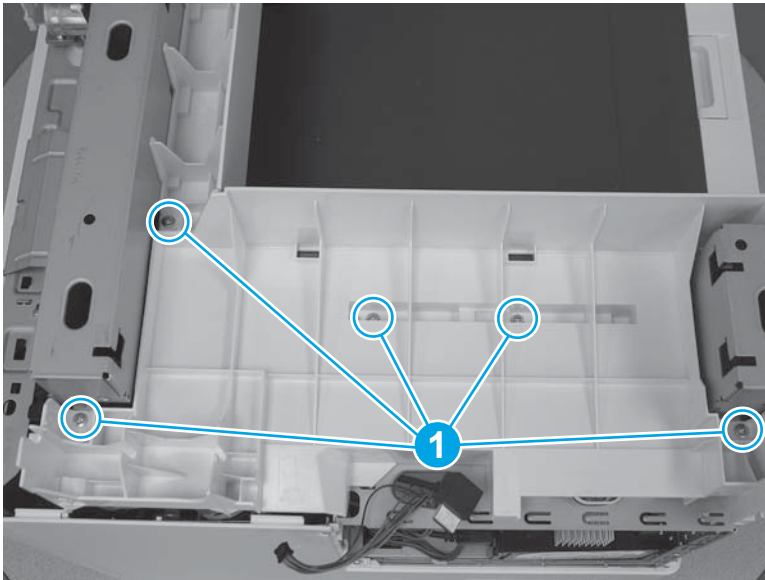

Step 26: Install the right upper cover (M577)

 **NOTE:** This step is for the M577 models. For the M552 and M553 models, skip this step and go to [Step 33: Install the upper cover \(M553\) on page 674](#).

 **NOTE:** The figures below show the image scanner installed. The procedures for removing and installing the right upper cover are the same whether the image scanner is installed or removed."

1. **M577c/f/z only:** Install the cables (callout 1) through the slot (callout 2) in the printer.

Figure 1-1140 Install the cables

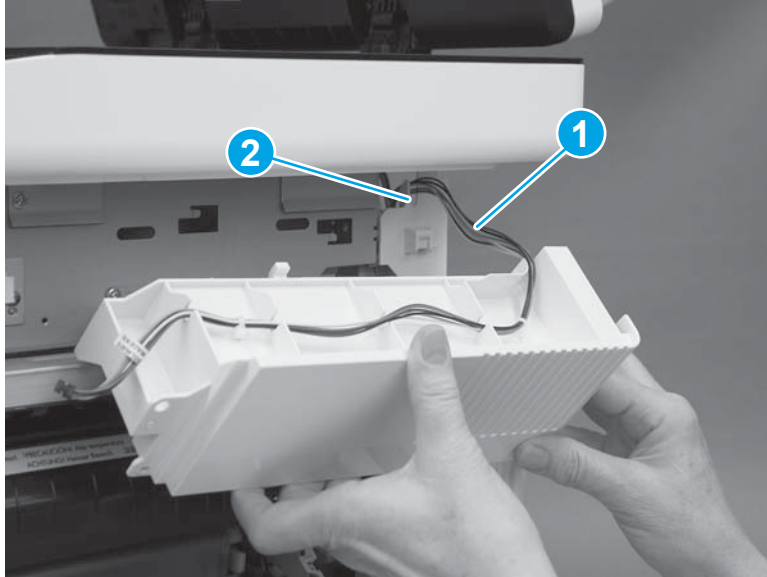

2. Position the hooks (callout 1) on the cover in the slots (callout 2) in the printer.

Figure 1-1141 Position the hooks

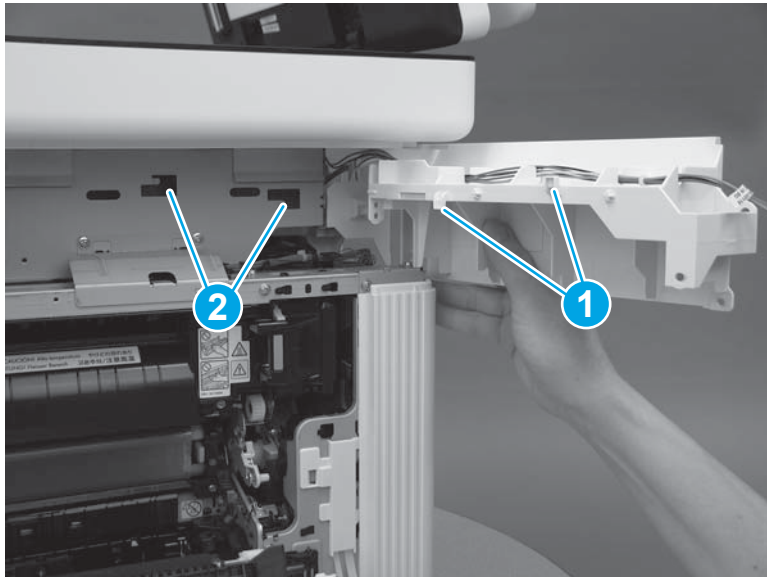

3. Slide the cover toward the front of the printer to install it.

Figure 1-1142 Install the cover

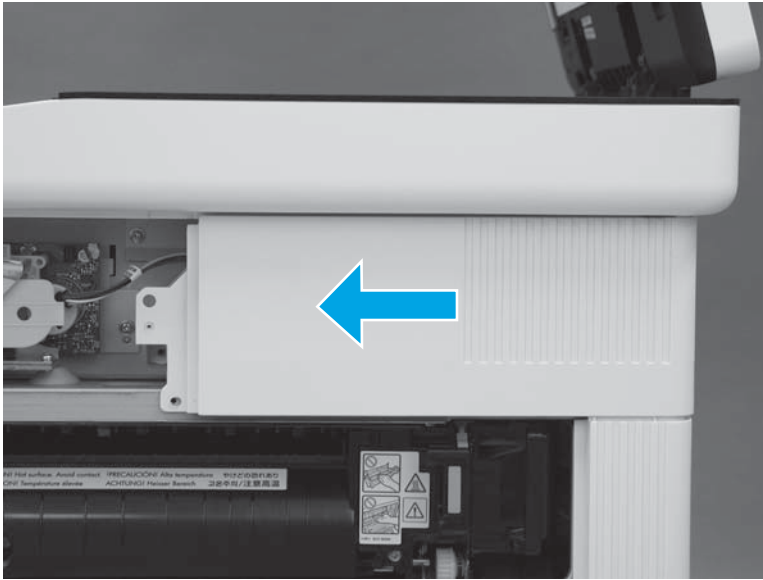

4. At the back of the printer, install one screw (callout 1).

M577c/f/z only: Connect one connector (callout 2), if the integrated scanner assembly is installed.

 **TIP:** This screw is smaller than the screws installed in the next step. Make sure that this screw is installed in the correct position.

Figure 1-1143 Install one screw and connector

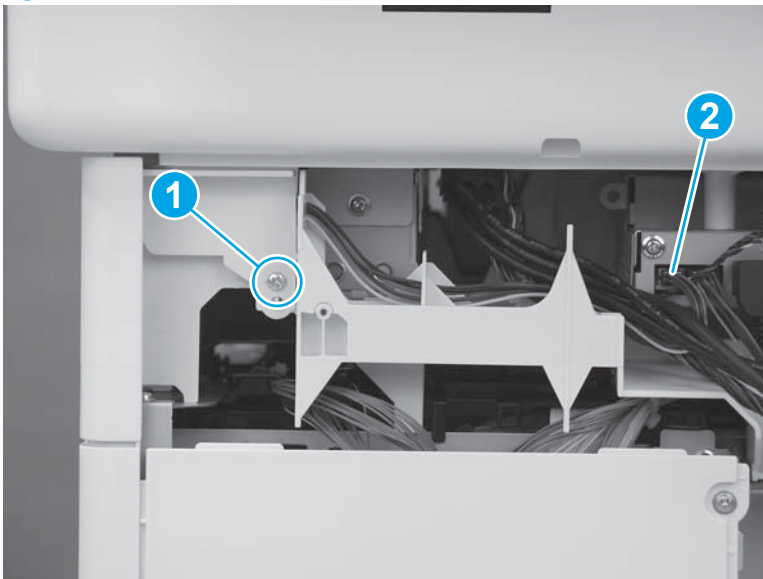

5. At the right side of the printer, install two screws (callout 1).

M577c/f/z only: Connect one connector (callout 2), if the stapler is installed.

Figure 1-1144 Install one screw and connector

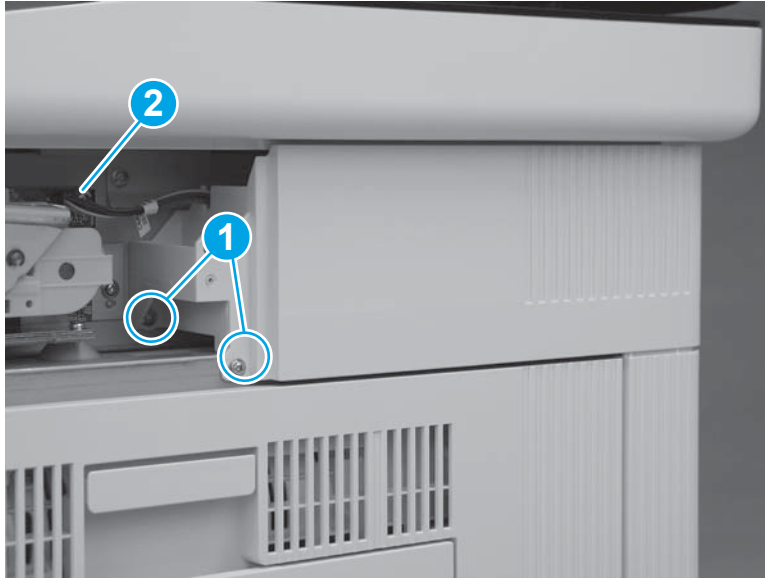

Step 27: Install the stapler unit (M577f and M577z)

 **NOTE:** This step is for the M577f and M577z models only. For the M577dn model, skip this step and go to [Step 28: Install the integrated scanner assembly \(M577\) on page 664](#).

For the M552 and M553 models, skip this step and go to [Step 33: Install the upper cover \(M553\) on page 674](#).

1. Position the hooks (callout 1) on the stapler unit in the slots (callout 2) in the printer.

Figure 1-1145 Position the hooks in the slots

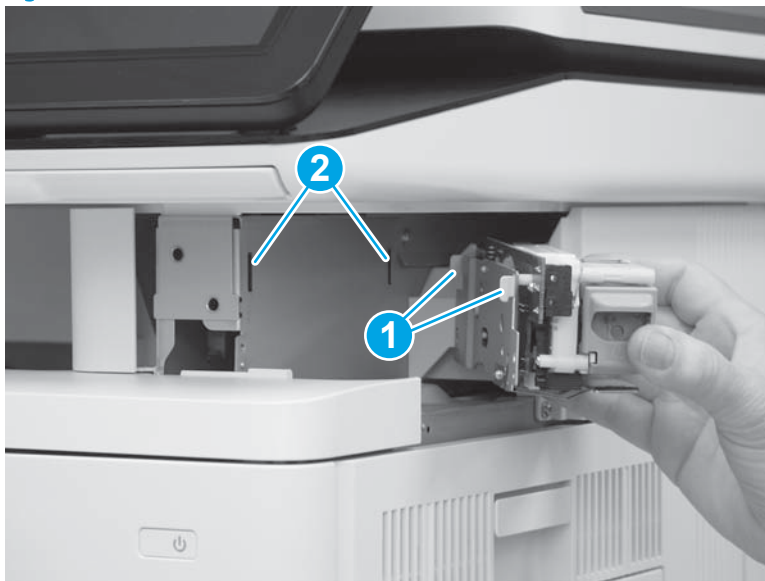

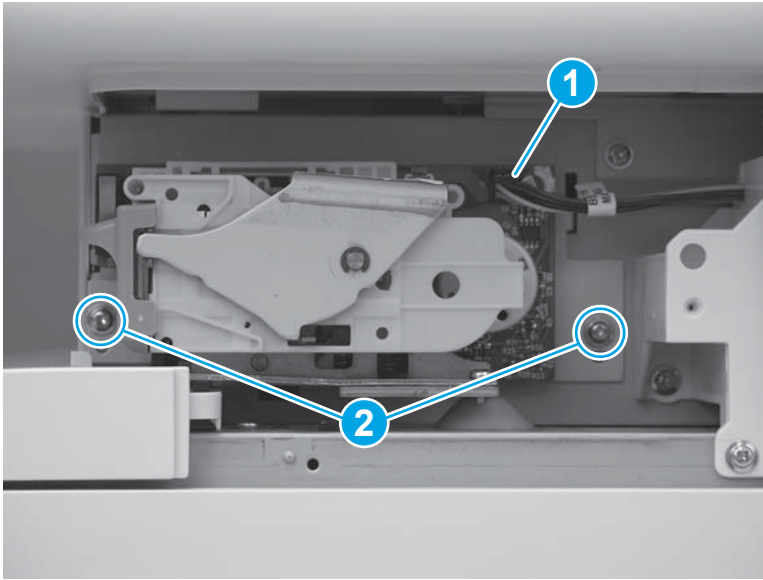

2. Connect one connector (callout 1), and then install two screws (callout 2).

Figure 1-1146 Connect connector and install screws



Step 28: Install the integrated scanner assembly (M577)

 **NOTE:** This step is for the M577 models. For the M552 and M553 models, skip this step and go to [Step 33: Install the upper cover \(M553\)](#) on page 674.

 **NOTE:** The ISA includes the document feeder, image scanner, scanner control board (SCB), control panel, keyboard (M577c/z) and NFC PCA (M577z).

1. Before proceeding, locate the mounting pins (callout 1) on the bottom of the ISA and the slots (callout 2) on the printer base.

Figure 1-1147 Locate the ISA mounting pins and slots

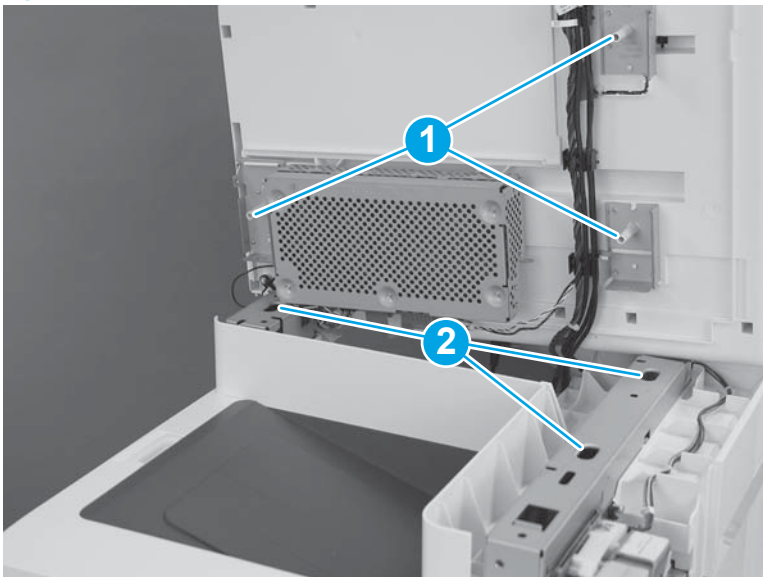

2. Position the ISA on the printer base with the pins in the slots.

 **NOTE:** To locate the pins and slots, see [Figure 1-395 Locate the ISA mounting pins and slots on page 249](#).

Figure 1-1148 Install the ISA



3. Slightly slide the ISA towards the front of the printer to engage it.

Figure 1-1149 Slide the ISA towards the front of the printer

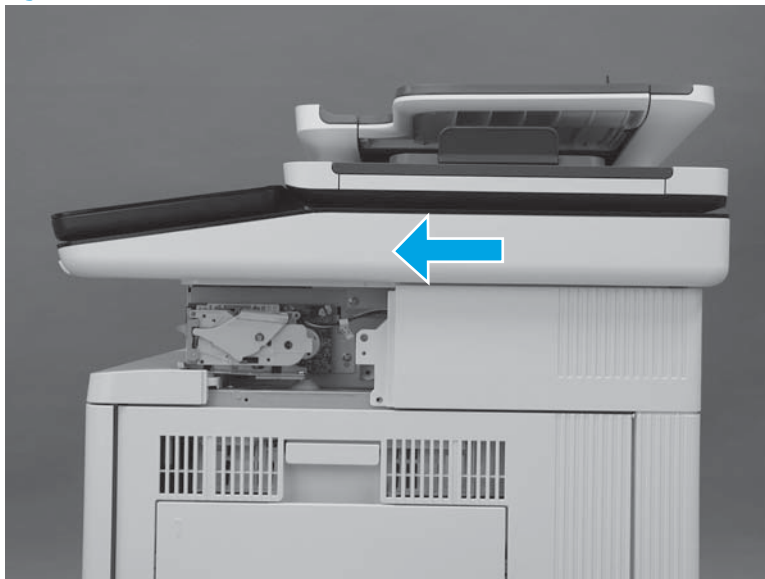

4. At the left side of the printer, install one screw (callout 1).

Figure 1-1150 Install one screw

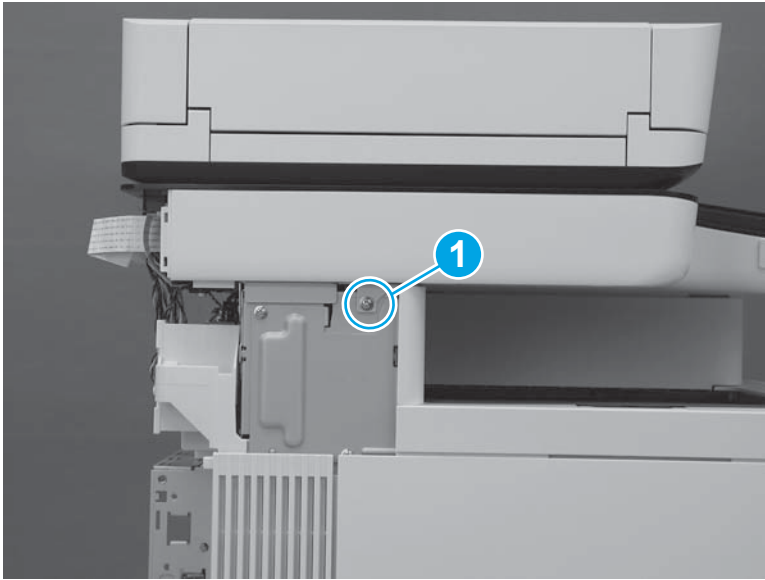

5. At the back of the printer, install two screws (callout 1).

Figure 1-1151 Install two screws

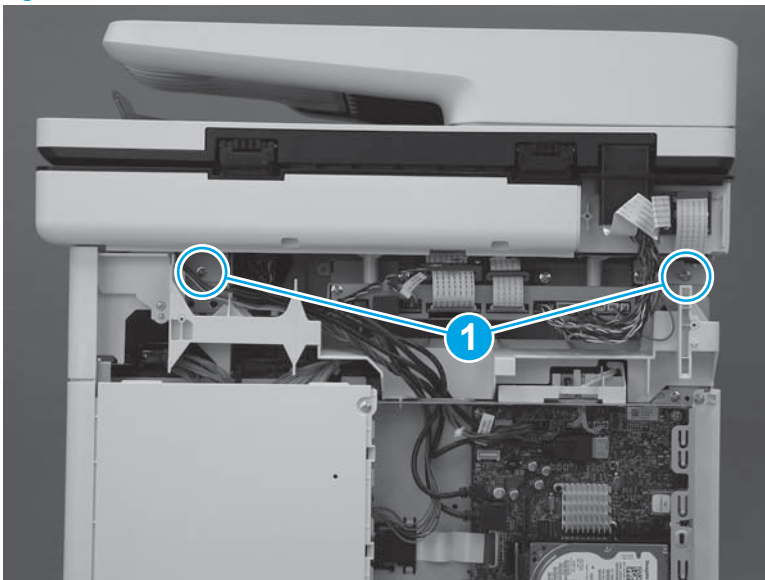

6. At the right side of the printer, install one screw (callout 1).

Figure 1-1152 Install one screw

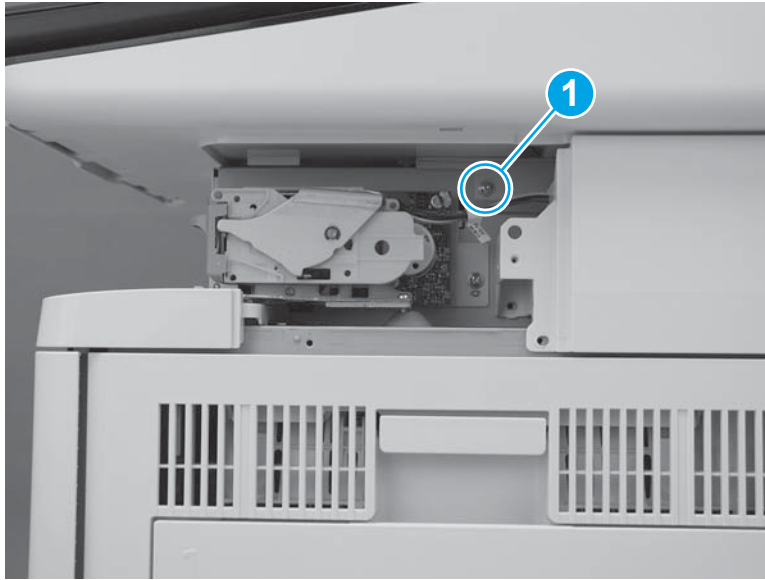

7. Connect two connectors on the scanner control board (callout 1).

M577c/f/z only: Connect one connector for the stapler on the scanner control board (callout 2).

Figure 1-1153 Connect connectors

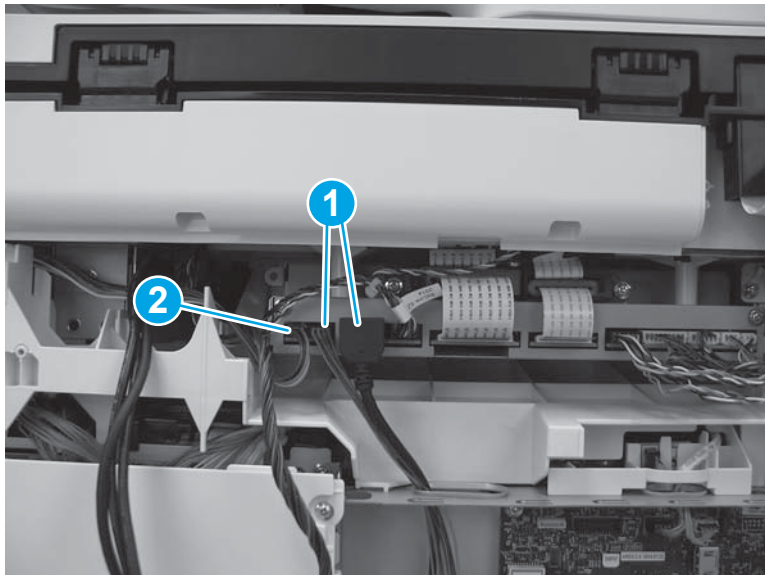

8. Install the wire harness and cables (callout 1) in the retainers (callout 2). Pass them through the opening in the top of the formatter cover (callout 3), and then connect four connectors (callout 4) on the formatter.

Figure 1-1154 Connect four connectors

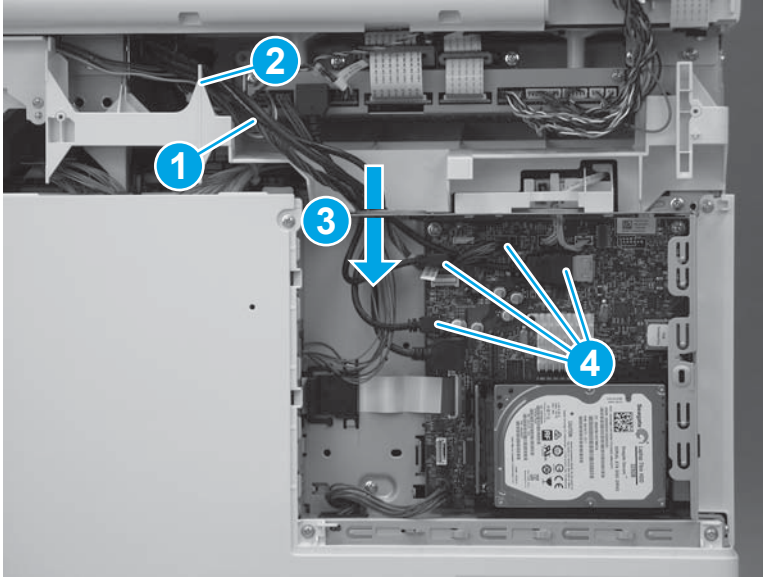

Step 29: Install the stapler cover assembly (M577c/f/z)

 **NOTE:** This step is for the M577c/f/z models only. For the M577dn model, skip this step and go to [Step 30: Install the right front upper cover \(M577dn\) on page 669](#).

For the M552 and M553 models, skip this step and go to [Step 33: Install the upper cover \(M553\) on page 674](#).

1. Install the tabs (callout 1) on the cover in the slots (callout 2) in the printer.

Figure 1-1155 Install two tabs



2. Press the cover toward the left side of the printer until it snaps into place.

Figure 1-1156 Install the cover assembly



3. Install one screw (callout 1).



 **IMPORTANT:** This is a self-tapping screw for plastic. Rotate it counterclockwise to align it with the existing thread pattern, and then carefully turn it clockwise to tighten. Do not overtighten. This will prevent stripping the threads inside the screw hole.

Figure 1-1157 Install one screw

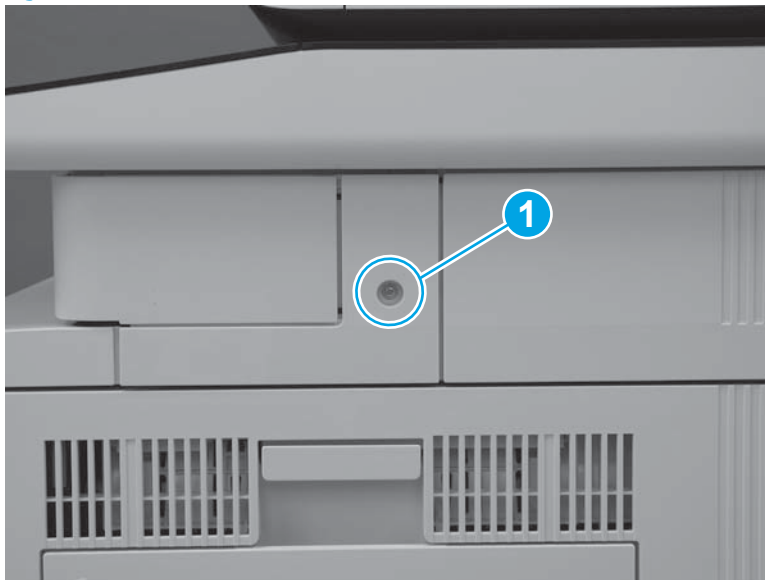

Step 30: Install the right front upper cover (M577dn)

 **NOTE:** This step is for the M577dn model only. For the M577c/f/z models, skip this step and go to [Step 31: Install the left upper cover \(M577\) on page 671.](#)

For the M552 and M553 models, skip this step and go to [Step 33: Install the upper cover \(M553\) on page 674.](#)

1. Slide the cover toward the left side of the printer to install it. Make sure that the slots (callout 1) in the cover fit over the tabs (callout 2) on the inside of the paper feeder cover.

Figure 1-1158 Install the cover



2. Press the right front upper cover (callout 1) and the paper feeder cover (callout 2) together until the tabs on the inside of the covers snap into place.

Figure 1-1159 Press the cover



3. Install one screw (callout 1).

Figure 1-1160 Install one screw

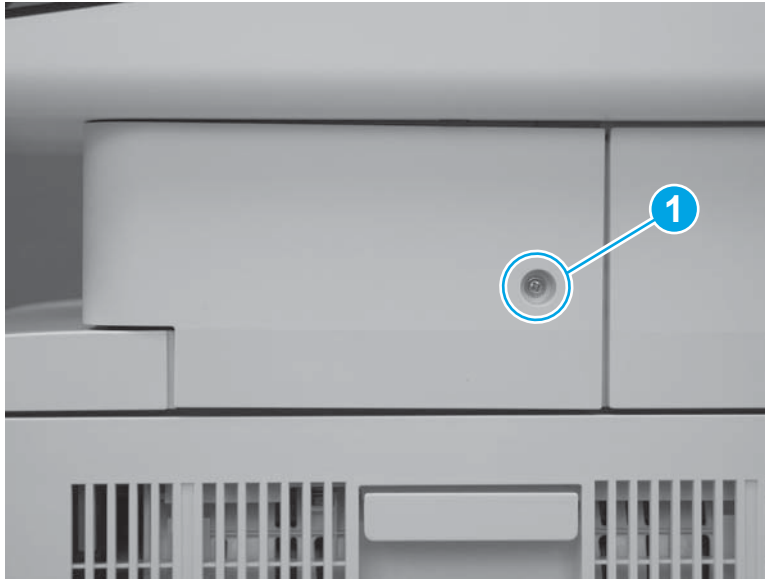

Step 31: Install the left upper cover (M577)

 **NOTE:** This step is for the M577 models. For the M552 and M553 models, skip this step and go to [Step 33: Install the upper cover \(M553\) on page 674](#).

1. Position the tab (callout 1) on the lower edge of the cover behind the left cover (callout 2).

Figure 1-1161 Position the tab

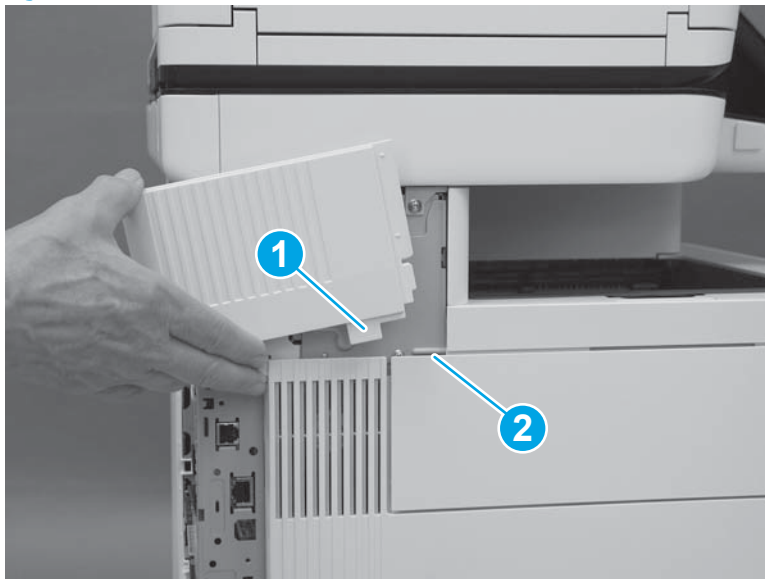

2. Slide the cover toward the front of the printer to install it. Make sure that the edge (callout 1) of the cover fits behind the edge (callout 2) of the top rear cover.

Figure 1-1162 Slide the cover

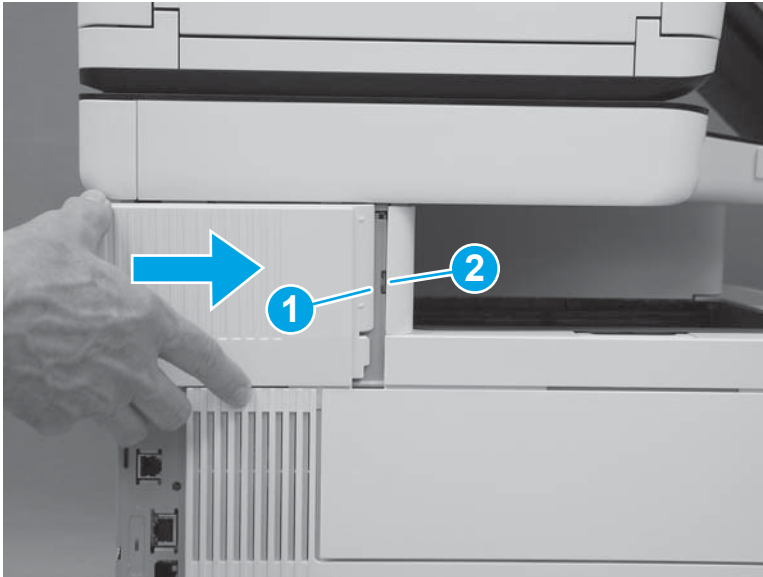

3. Make sure that the tab (callout 1) is fully installed.

Figure 1-1163 Check the tab

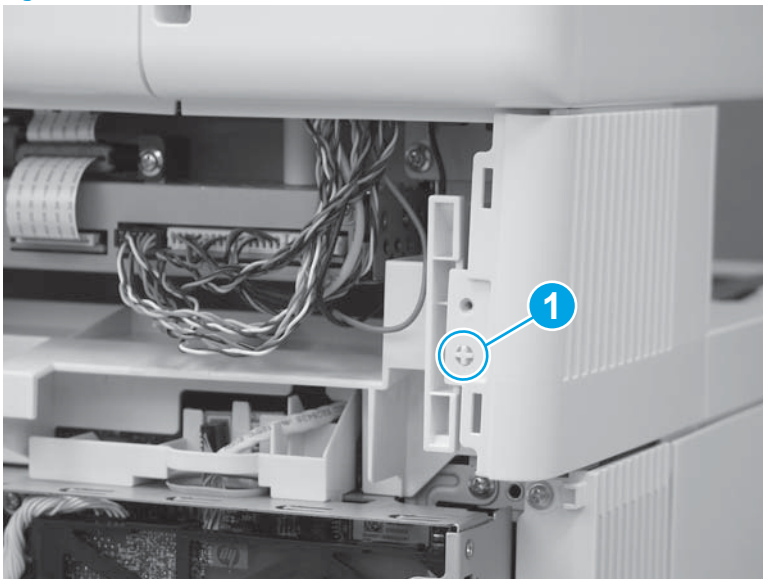

Step 32: Install the rear upper cover (M577)

 **NOTE:** This step is for the M577 models. For the M552 and M553 models, skip this step and go to [Step 33: Install the upper cover \(M553\) on page 674](#).

1. Align the ridge (callout 1) on the lower edge of the rear upper cover in front of the tabs (callout 2) on the top edge of the rear cover.

Figure 1-1164 Align the cover

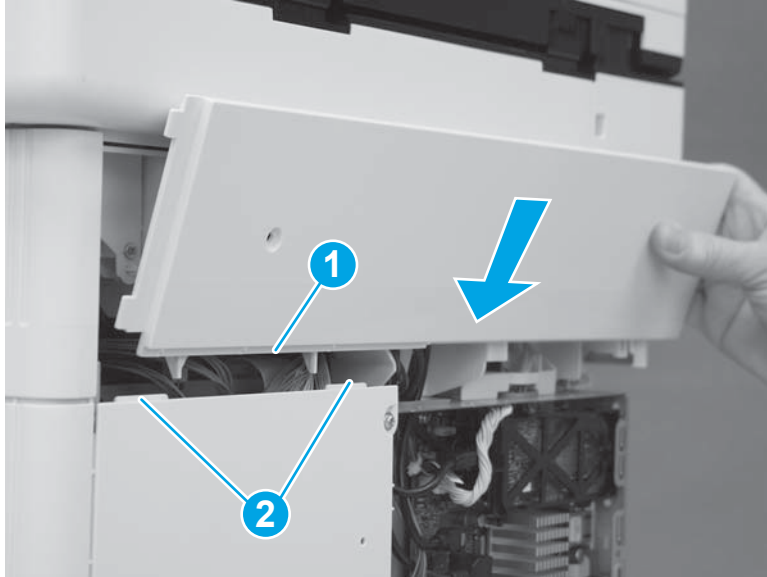

2. Rotate the top of the cover toward the printer.

Figure 1-1165 Rotate the top of the cover

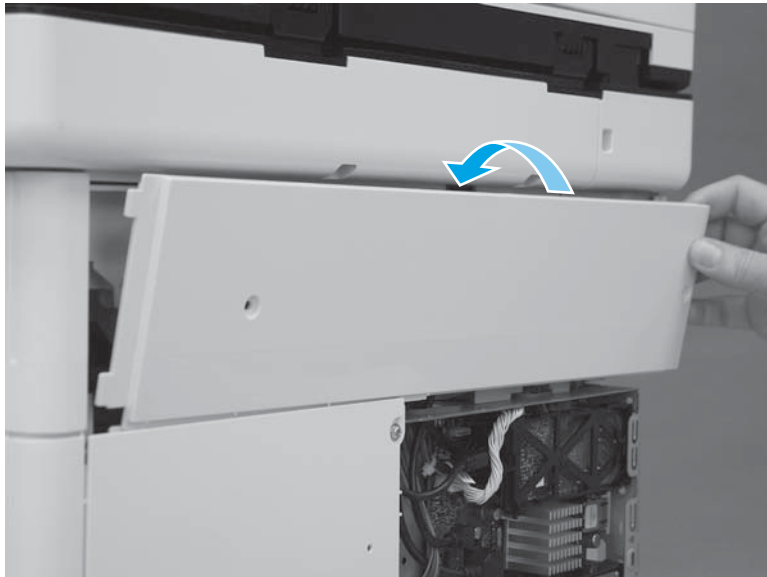

3. Slide the cover to the left (callout 1). Make sure that the tabs (callout 2) on the upper rear cover slide behind the edge (callout 3) of the right upper cover. Make sure that the cover is fully seated.

Figure 1-1166 Slide the cover

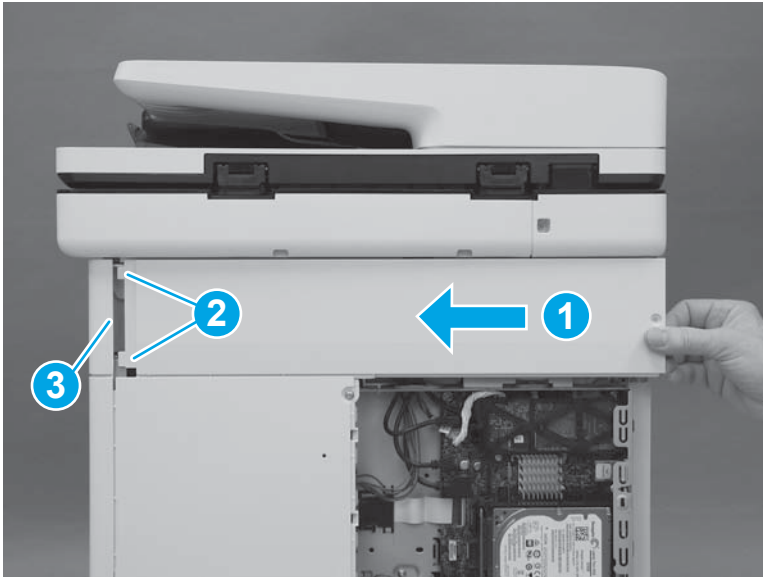

4. Install two screws (callout 1).



 **IMPORTANT:** These two screws are self-tapping screws for plastic. Rotate them counterclockwise to align them with the existing thread pattern, and then carefully turn them clockwise to tighten. Do not overtighten. This will prevent stripping the threads inside the screw holes.

Figure 1-1167 Install two screws

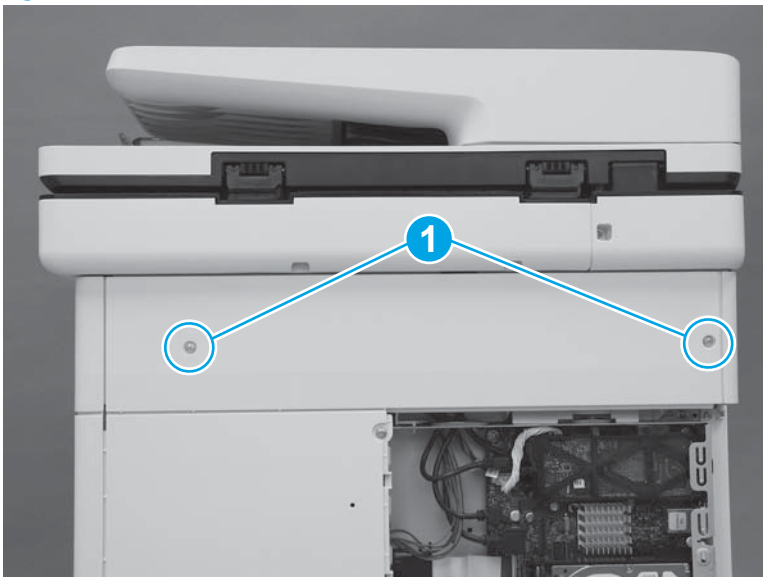

Step 33: Install the upper cover (M553)

 **NOTE:** This step is for the M552 and M553 models. For the M577 models, skip this step and go to [Step 38: Install the TCU on page 683](#).

1. Position the cover on the printer.

 **NOTE:** For the M553x model, do not forget to pass the control-panel wire harness and USB cable through the opening in the cover.

Figure 1-1168 Install the cover



2. Push down on the rear corner of the cover to engage one tab (callout 1).

Figure 1-1169 Engage one tab

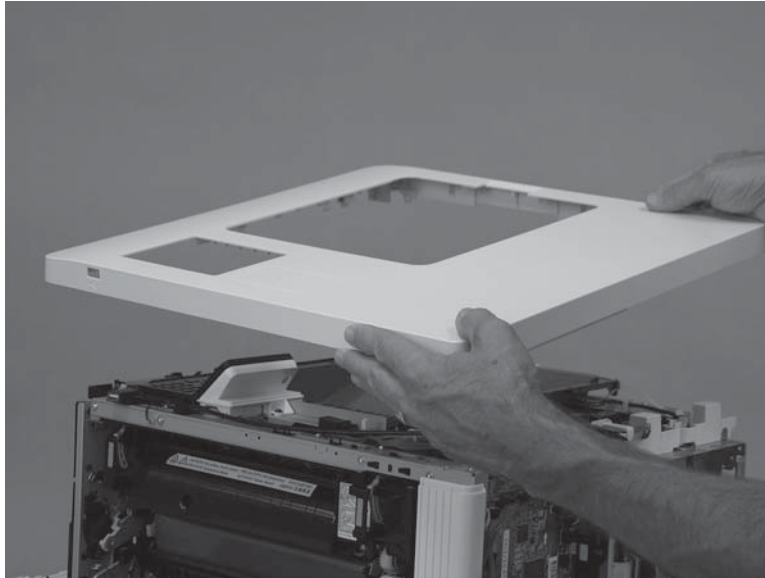
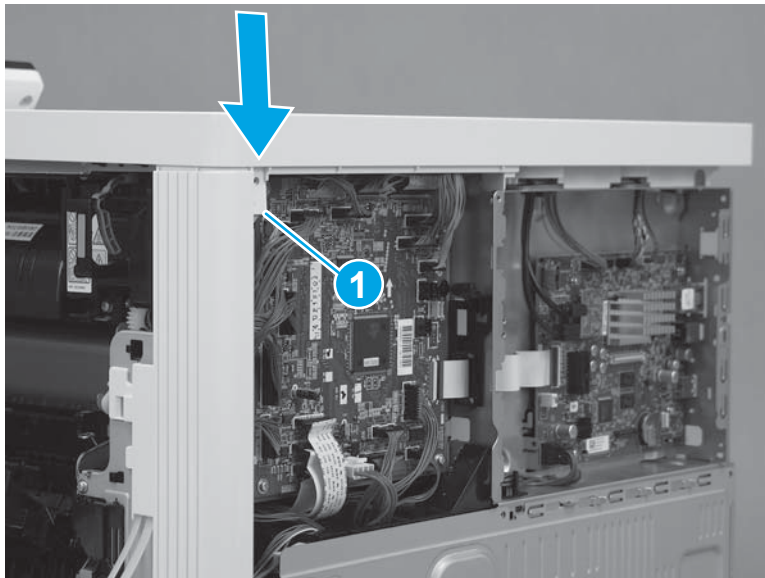

3. Push down on the front corner of the cover to engage one tab (callout 1), and then install one screw (callout 2).

 **NOTE:** This is a self-tapping plastic-thread screw. Make sure that this screw is used in this location when it is reinstalled.

Figure 1-1170 Engage one tab and install one screw



4. Install three screws (callout 1).

Figure 1-1171 Install three screws

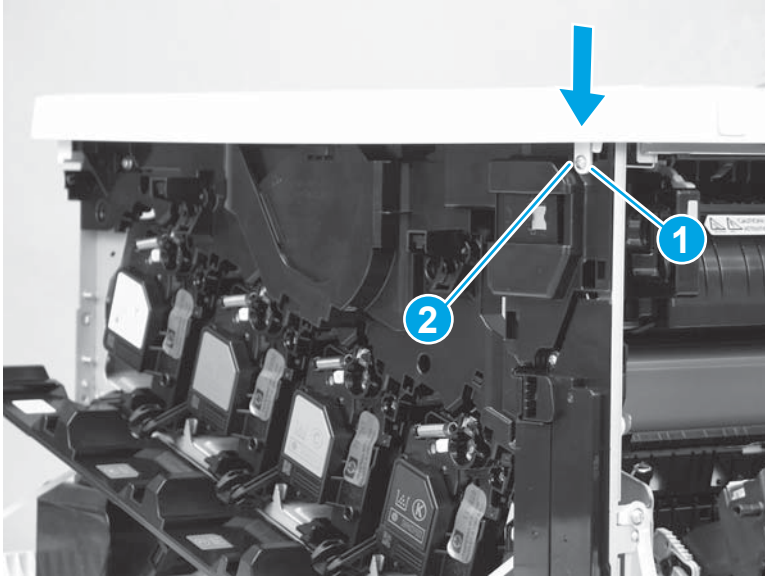
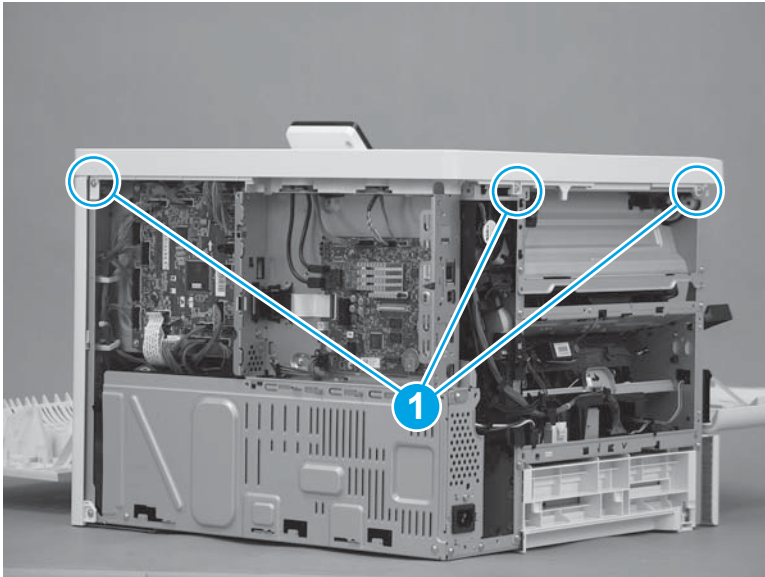

Step 34: Install the left cover (M553)

 **NOTE:** This step is for the M552 and M553 models. For the M577 models, skip this step and go to [Step 38: Install the TCU on page 683](#).

1. Position the cover on the printer.

 **NOTE:** Slightly offset the cover toward the rear of the printer.

Figure 1-1172 Install the cover

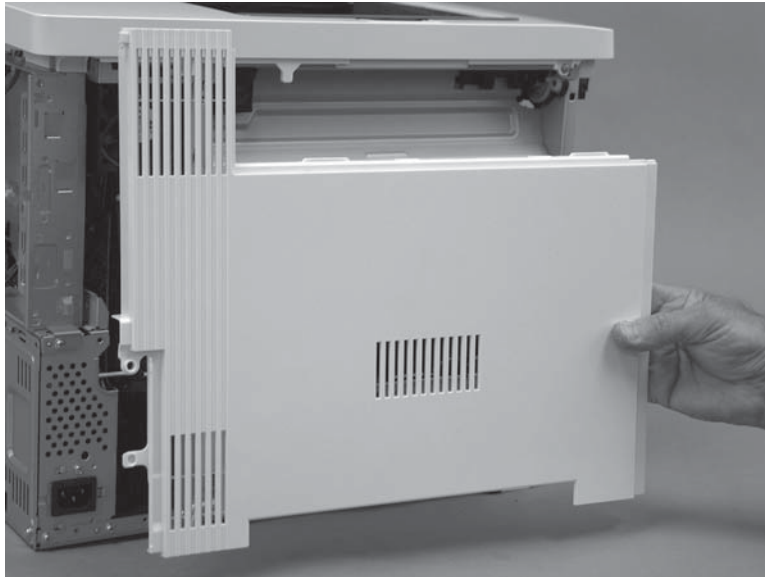

2. Slide the cover (callout 1) toward the front of the printer to engage it. Make sure that the tab (callout 2) snaps into place.

 **NOTE:** Locate the alignment pin (callout 3) on the cover from the front door side of the printer, and then make sure that it is fully engaged in the slot in the chassis.

 **TIP:** While sliding the cover into place, push in on the center of the cover (callout 1) to make sure that the hooks on the back of the cover engage with the slots in the chassis.

Figure 1-1173 Engage the cover

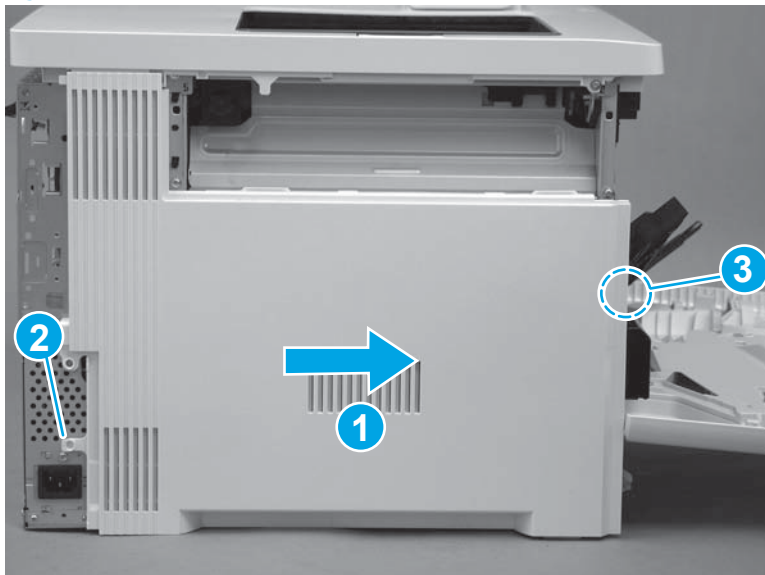

3. At the left side of the printer, install one screw (callout 1).

Figure 1-1174 Install one screw



Step 35: Install the rear cover (M553)



NOTE: This step is for the M552 and M553 models. For the M577 models, skip this step and go to [Step 38: Install the TCU on page 683](#).

1. Position the top of the cover under the upper cover (callout 1), rotate the bottom of the cover onto the chassis (callout 2), and then slide the cover to the left (callout 3) to install it.

Figure 1-1175 Install the cover

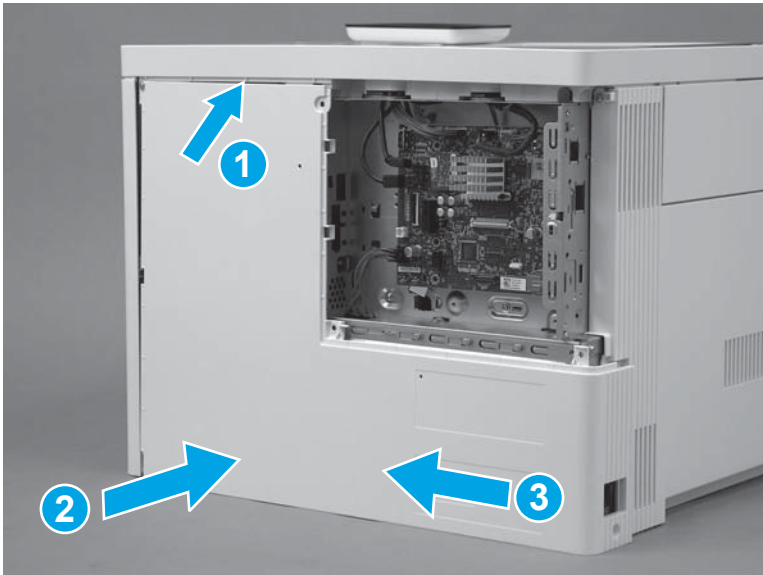

2. Install four screws (callout 1).

Figure 1-1176 Install four screws cover

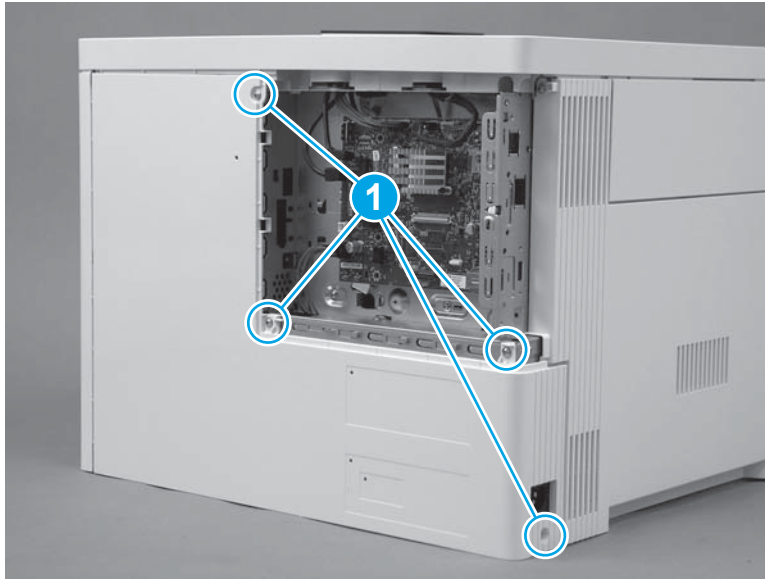

Step 36: Install the control-panel (M553x only)

 **NOTE:** For the M553n/dn and M552dn models, skip this step and go to [Step 37: Install the USB cover \(M553\) on page 682](#).

For the M577 models, skip this step and go to [Step 38: Install the TCU on page 683](#).

1. Place the control panel on the printer as shown.

Figure 1-1177 Place the control panel on the product

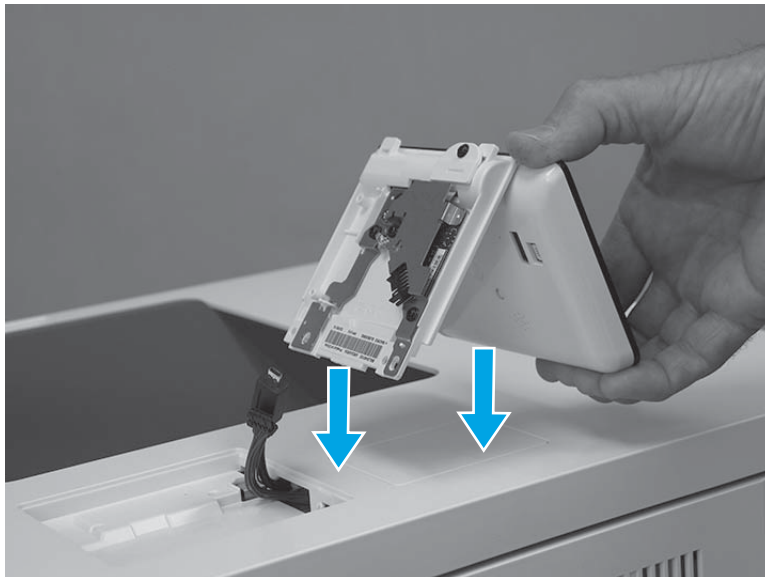

2. Connect one USB cable (callout 1), and one connector (callout 2).

 **IMPORTANT:** Take note of the location of the two mounting tabs (callout 3) on the control-panel assembly.

Figure 1-1178 Connect two connectors



3. Turn the control panel over, and then position the front edge tabs in the slots in the top cover.

Figure 1-1179 Turn the control panel over

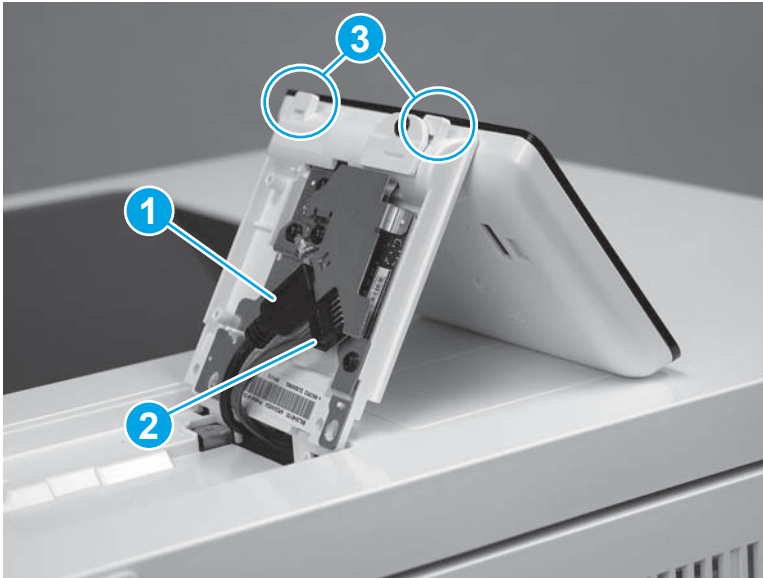
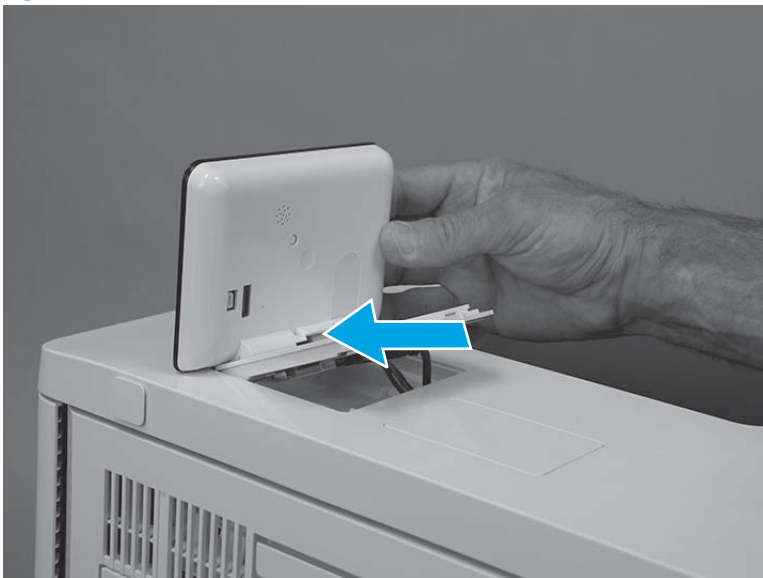

4. Rotate the control-panel base down onto the printer.

Figure 1-1180 Rotate the control-panel base down



5. Use a small Phillips screwdriver to install two screws (callout 1).

Figure 1-1181 Install two screws

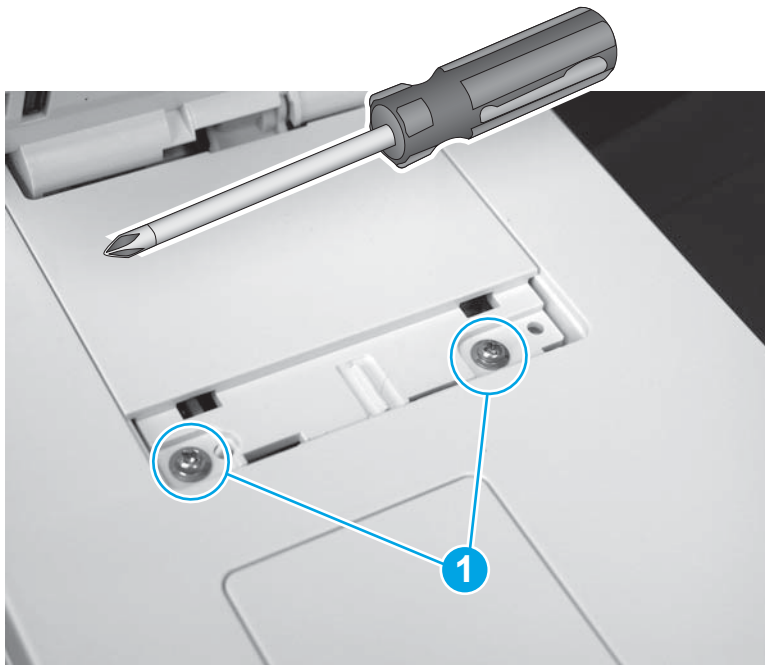

6. Position the screw cover mounting feet into the slots in the top cover (callout 1), and then rotate the cover down (callout 2) to install it.

 **NOTE:** Press down on the cover firmly to make sure that the tabs on the cover (callout 3) snap into place.

Figure 1-1182 Install the cover



Step 37: Install the USB cover (M553)

 **NOTE:** This step is for the M552 and M553 models. For the M577 models, skip this step and go to [Step 38: Install the TCU on page 683](#).

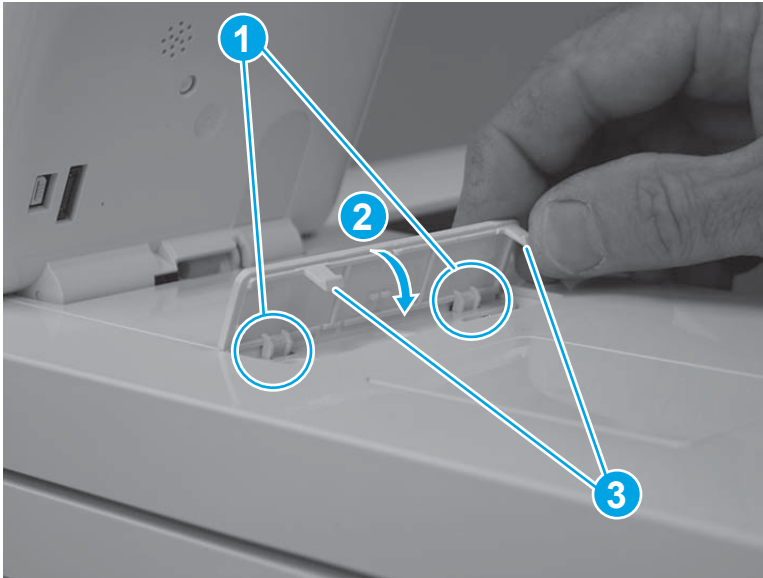
1. Push the cover into the USB port to install it.

Figure 1-1183 Install the cover



2. Make sure that the USB cover is fully seated after installing it.

Figure 1-1184 Check the installation



Step 38: Install the TCU

1. Verify that the toner collection hatch cover is in the closed position on the TCU.

Figure 1-1185 Verify that the toner collection hatch cover is closed

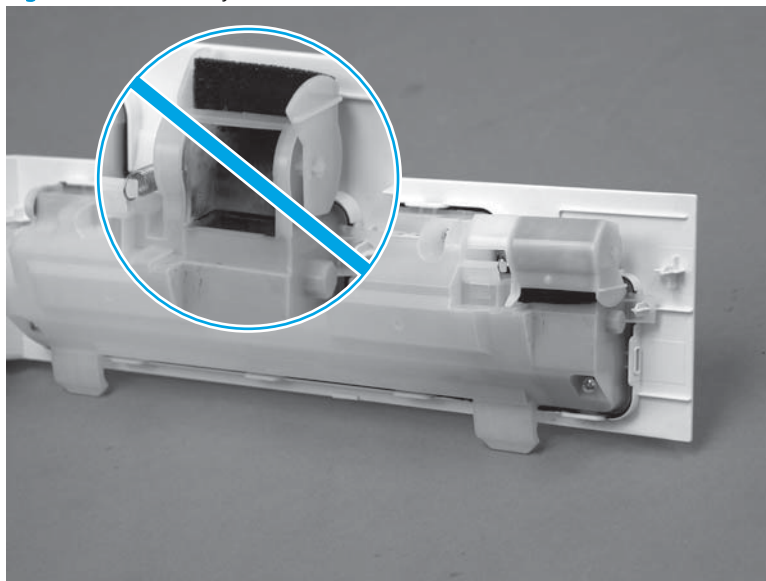

2. Position the TCU with the hinges in the slots provided in the printer (callout 1), and then rotate the TCU up and into the closed position.

 **NOTE:** The toner collection hatch cover automatically opens when the TCU is closed.

Figure 1-1186 Install the TCU



3. Close the front door.

Figure 1-1187 Close the front door

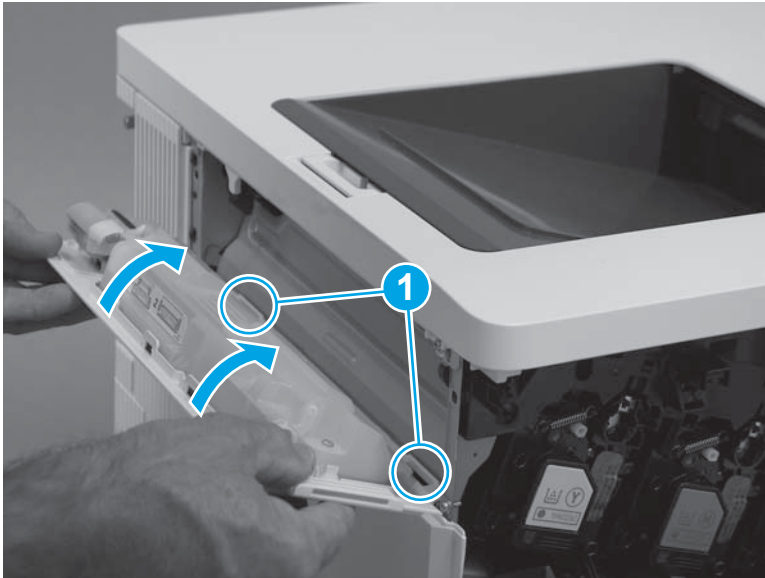

Step 39: Install the formatter cover

- ▲ Slide the cover onto the printer (callout 1) to install it.

 **NOTE:** Make sure that the tabs on the formatter cover align with the slots provided in the printer (callout 2). Tighten the two thumbscrews (callout 3).

 **TIP:** If needed, use the edge of a coin to turn the thumbscrews.

Figure 1-1188 Install the cover

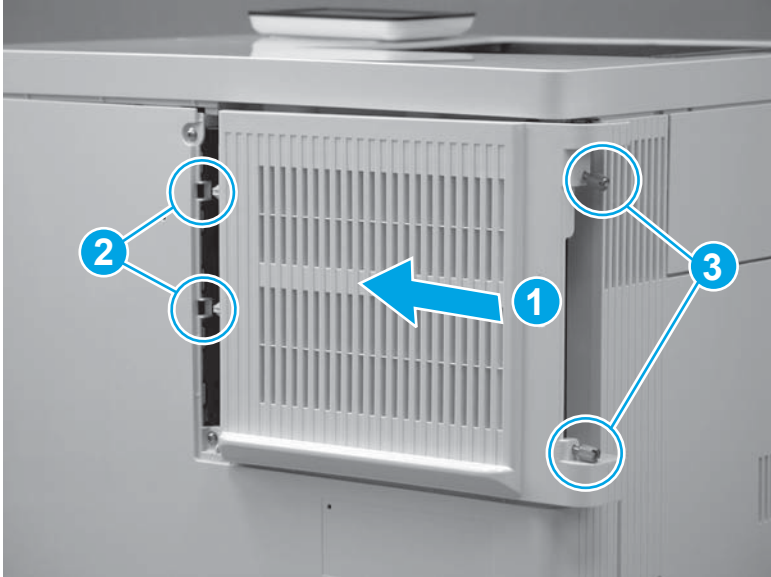

Removal and replacement: Switch (SW4) PC board assembly

- [Introduction](#)
- [Step 1: Remove the formatter cover](#)
- [Step 2: Remove the toner collection unit \(TCU\)](#)
- [Step 3: Remove the USB cover \(M553\)](#)
- [Step 4: Remove the control panel \(M553x only\)](#)
- [Step 5: Remove the rear cover \(M553\)](#)
- [Step 6: Remove the left cover \(M553\)](#)
- [Step 7: Remove the upper cover \(M553\)](#)
- [Step 8: Remove the rear upper cover \(M577\)](#)
- [Step 9: Remove the left upper cover \(M577\)](#)
- [Step 10: Remove the right front upper cover \(M577dn\)](#)
- [Step 11: Remove the stapler cover assembly \(M577c/f/z\)](#)
- [Step 12: Remove the integrated scanner assembly \(M577\)](#)
- [Step 13: Remove the stapler unit \(M577f and M577z\)](#)
- [Step 14: Remove the right upper cover \(M577\)](#)
- [Step 15: Remove the top rear cover \(M577\)](#)
- [Step 16: Remove the paper feed cover \(M577\)](#)
- [Step 17: Remove the top cover \(M577\)](#)
- [Step 18: Remove the switch \(SW4\) PC board assembly](#)
- [Step 19: Unpack the replacement assembly](#)
- [Step 20: Install the switch \(SW4\) PC board assembly](#)
- [Step 21: Install the top cover \(M577\)](#)
- [Step 22: Install the paper feed cover \(M577\)](#)
- [Step 23: Install the top rear cover \(M577\)](#)
- [Step 24: Install the right upper cover \(M577\)](#)
- [Step 25: Install the stapler unit \(M577f and M577z\)](#)
- [Step 26: Install the integrated scanner assembly \(M577\)](#)
- [Step 27: Install the stapler cover assembly \(M577c/f/z\)](#)
- [Step 28: Install the right front upper cover \(M577dn\)](#)
- [Step 29: Install the left upper cover \(M577\)](#)

- [Step 30: Install the rear upper cover \(M577\)](#)
- [Step 31: Install the upper cover \(M553\)](#)
- [Step 32: Install the left cover \(M553\)](#)
- [Step 33: Install the rear cover \(M553\)](#)
- [Step 34: Install the control-panel \(M553x only\)](#)
- [Step 35: Install the USB cover \(M553\)](#)
- [Step 36: Install the TCU](#)
- [Step 37: Install the formatter cover](#)

Introduction

This document provides the procedures to remove and replace the switch (SW4) PC board assembly.



Before performing service

Turn the printer power off

- Disconnect the power cable.

 **WARNING!** To avoid damage to the printer, turn the printer off, wait 30 seconds, and then remove the power cord before attempting to service the printer.

- Open the right door.

 **CAUTION:**  This part contains components that are electrostatic discharge (ESD) sensitive. To reduce the possibility of ESD damage, always touch the sheet-metal chassis to ground yourself before touching an ESD sensitive part.

Use the table below to identify the correct part number for your printer, and then go to <http://h20141.www2.hp.com/hpparts> to order the part.

Switch (SW4) PC board assembly part number	
RM2-7133-000CN	Switch (SW4) PC board assembly

Required tools

- #2 Phillips screwdriver with a magnetic tip
- Small flat blade screwdriver

After performing service

Make sure that the USB cover is fully seated after replacing it.

Make sure that the TCU is fully closed after replacing it.

Make sure that the formatter cover is fully seated, and that the thumbscrews are finger tight after replacing it.

Turn the printer power on

- Connect the power cable.
- Use the power switch to turn the power on.

 **NOTE:** The printer reaches the Ready state (without a **Close front door** error message appearing on the control-panel display).

Step 1: Remove the formatter cover

1. Locate the formatter cover.

Figure 1-1189 Locate the formatter cover

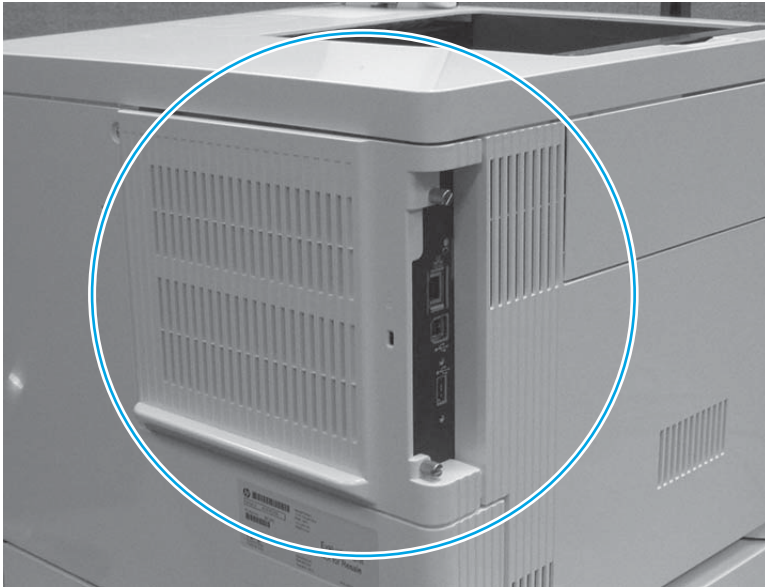

2. Loosen the two thumbscrews (callout 1). Grasp the two thumbscrews, and then slide the cover away from the printer (callout 2) to remove it.

 **TIP:** If needed, use the edge of a coin to turn the thumbscrews.

Figure 1-1190 Loosen the thumbscrews

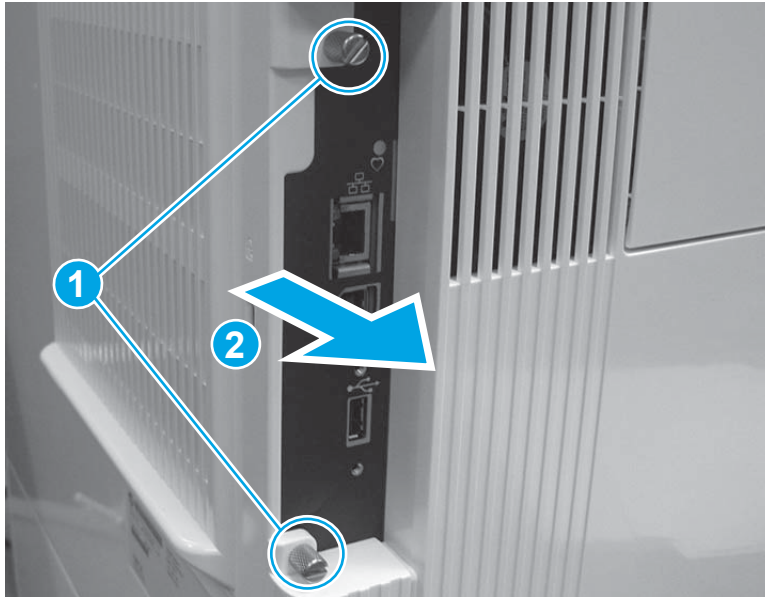

Step 2: Remove the toner collection unit (TCU)

1. Open the front door.

Figure 1-1191 Open the front door



2. Open the TCU.

 **NOTE:** The toner collection hatch cover automatically closes when the TCU is opened.

Figure 1-1192 Open the TCU



3. Pull the TCU away from the printer at an angle to remove it.

CAUTION: Do not open the toner collection hatch cover when handling the TCU. If toner gets on clothing, wipe it off by using a dry cloth and wash the clothes in cold water. Hot water sets toner into fabric.

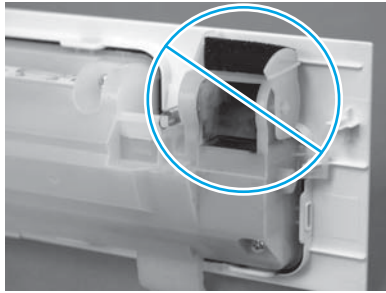
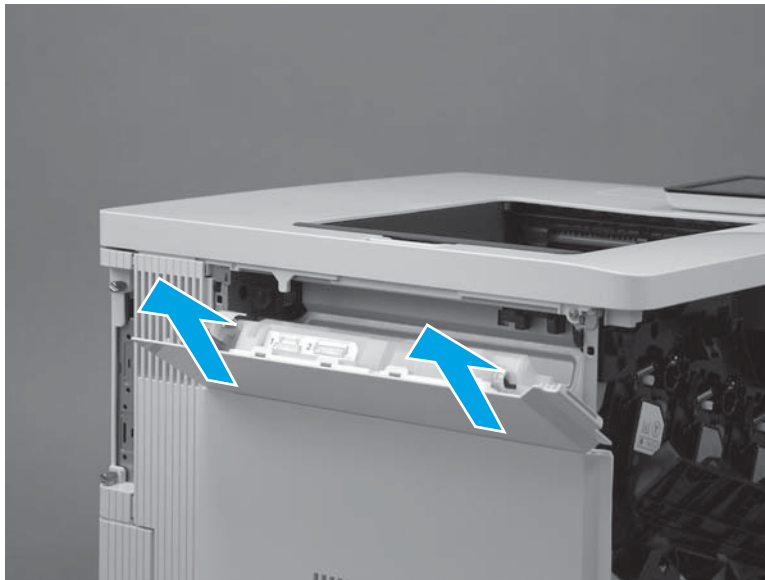

Figure 1-1193 Remove the TCU



Step 3: Remove the USB cover (M553)

NOTE: This step is for the M552 and M553 models. For the M577 models, skip this step and go to [Step 8: Remove the rear upper cover \(M577\) on page 700](#).

1. Locate the USB cover.

Figure 1-1194 Locate the USB cover



2. Pull the cover off of the printer to remove it.

Figure 1-1195 Remove the cover



Step 4: Remove the control panel (M553x only)

 **NOTE:** For the M553n/dn and M552dn models, skip this step and go to [Step 5: Remove the rear cover \(M553\) on page 696](#).

For the M577, skip this step and go to [Step 8: Remove the rear upper cover \(M577\) on page 700](#).

1. Tilt the control panel up.

Figure 1-1196 Tilt the control panel up



2. Use a small flat-blade screwdriver to release the control-panel screws cover tabs.

Figure 1-1197 Release the control-panel screws cover tabs



3. Rotate the cover up to remove it.

Figure 1-1198 Remove the cover

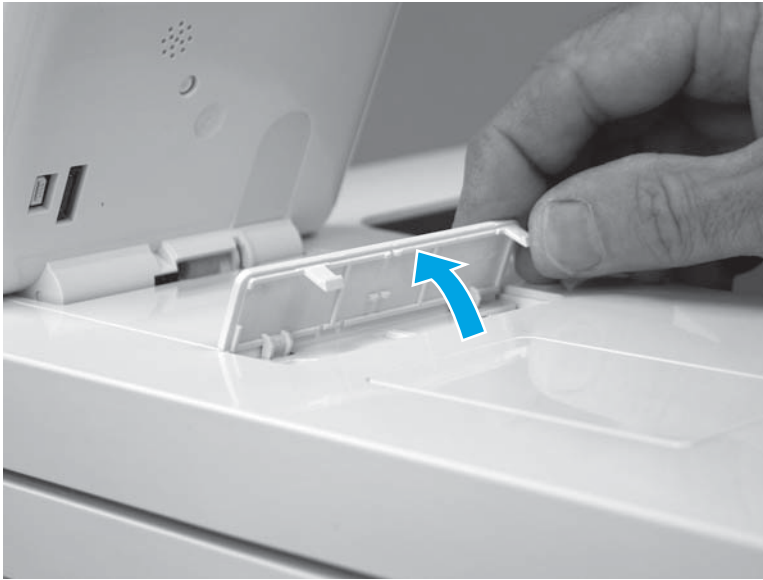

4. Use a small Phillips screwdriver to remove two screws (callout 1).

 **IMPORTANT:** Store the screws in a secure place where they cannot fall down into the printer.

Figure 1-1199 Remove two screws

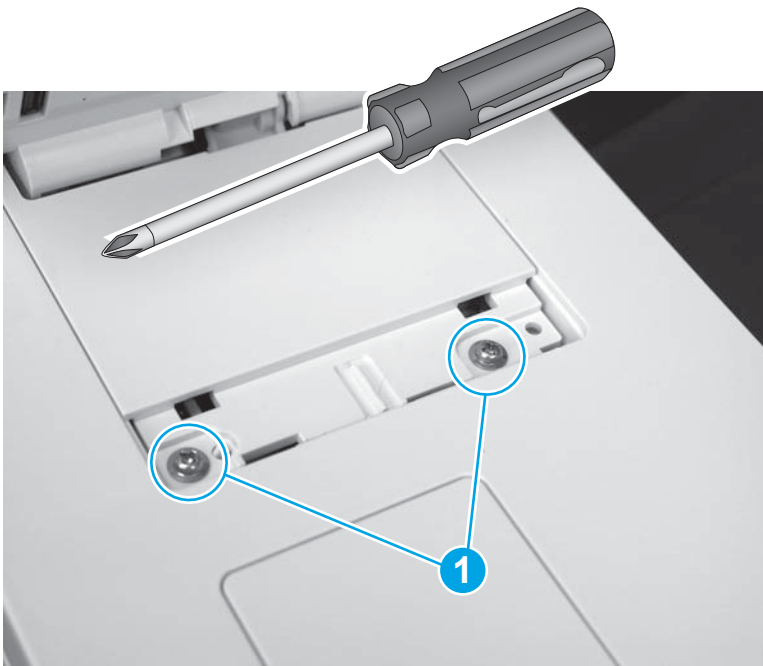

5. Rotate the control-panel base toward the front of the printer.

Figure 1-1200 Rotate the control-panel base up



6. Slightly slide the control-panel base toward the rear of the printer (callout 1) to release it, and then turn the control panel over (callout 2) to access the bottom side.

⚠ CAUTION: The control panel is still attached to the printer. Do not attempt to completely remove the control panel.

Figure 1-1201 Turn the control panel over

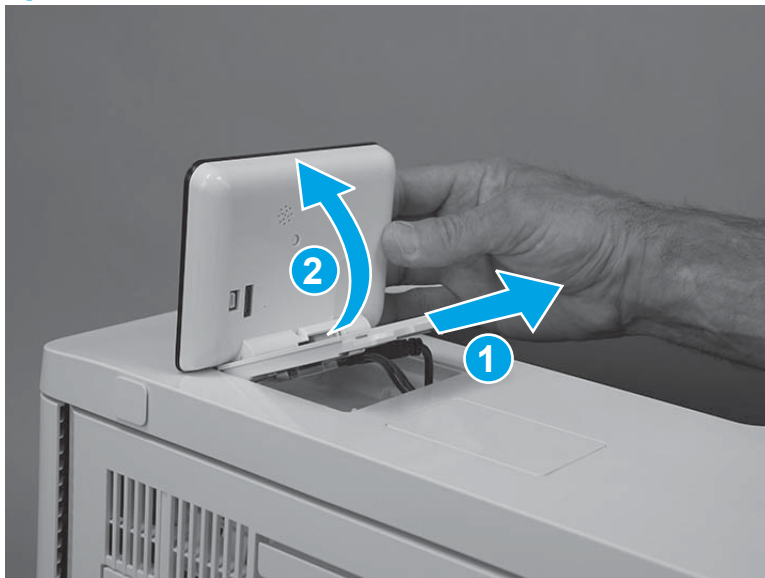

7. Disconnect one USB cable (callout 1), one connector (callout 2), and then remove the control panel.

Figure 1-1202 Disconnect two connectors

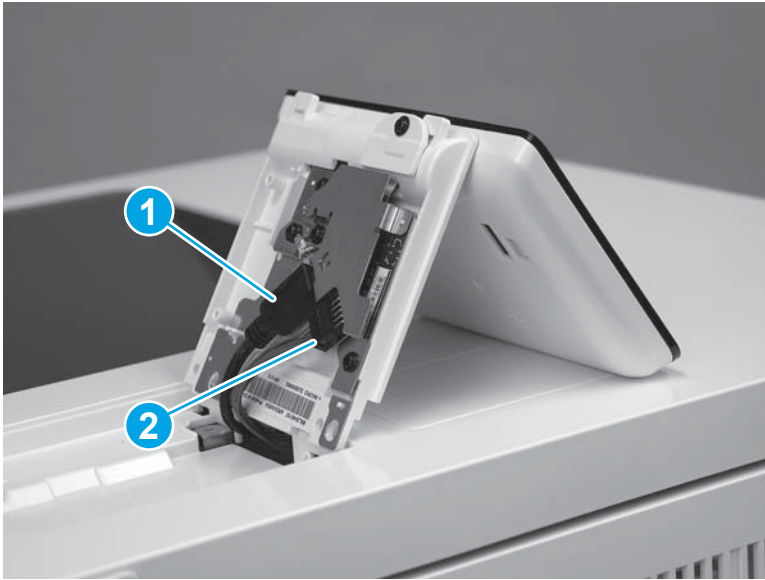

Step 5: Remove the rear cover (M553)



NOTE: This step is for the M552 and M553 models. For the M577 models, skip this step and go to [Step 8: Remove the rear upper cover \(M577\) on page 700](#).

1. Remove four screws (callout 1).

Figure 1-1203 Remove four screws

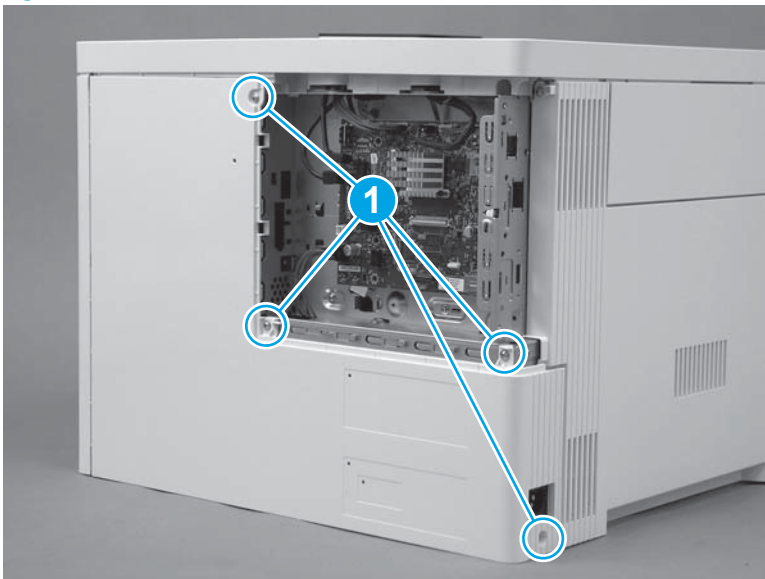

2. Slightly slide the cover to the right (callout 1), rotate the bottom of the cover away from the printer (callout 2), and then pull the top of the cover away from the printer (callout 3) to remove the cover.

Figure 1-1204 Remove the cover

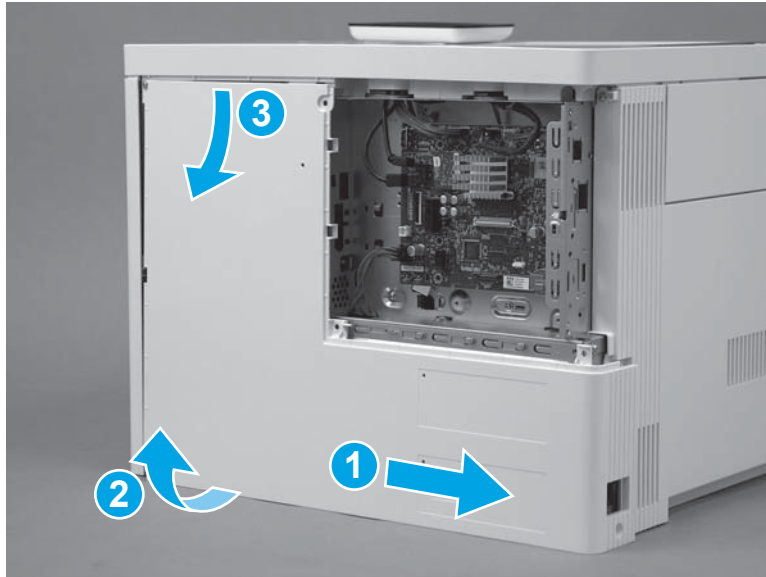

Step 6: Remove the left cover (M553)

 **NOTE:** This step is for the M552 and M553 models. For the M577 models, skip this step and go to [Step 8: Remove the rear upper cover \(M577\) on page 700](#).

1. At the left side of the printer, remove one screw (callout 1).

Figure 1-1205 Remove one screw



2. Release one tab (callout 1), rotate the front edge of the cover away from the printer (callout 2), and then slide the cover (callout 3) toward the rear of the printer to release it.

Figure 1-1206 Release the cover

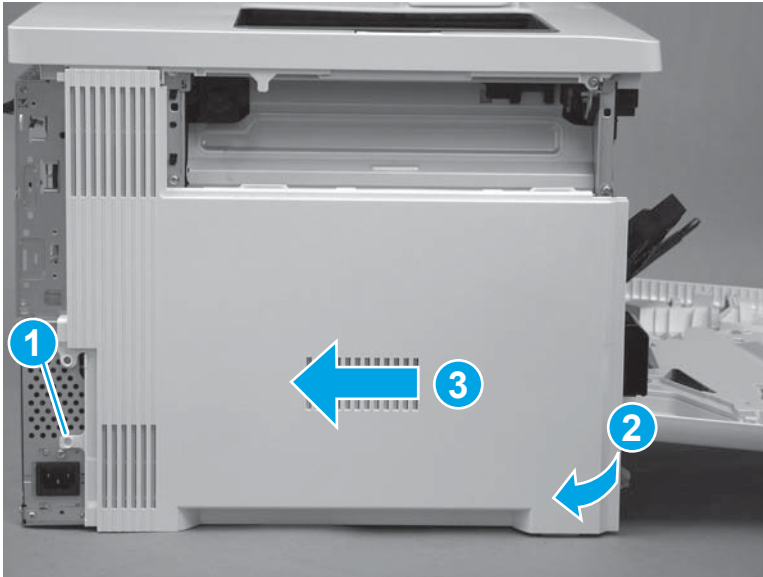

3. Remove the cover.

Figure 1-1207 Remove the cover

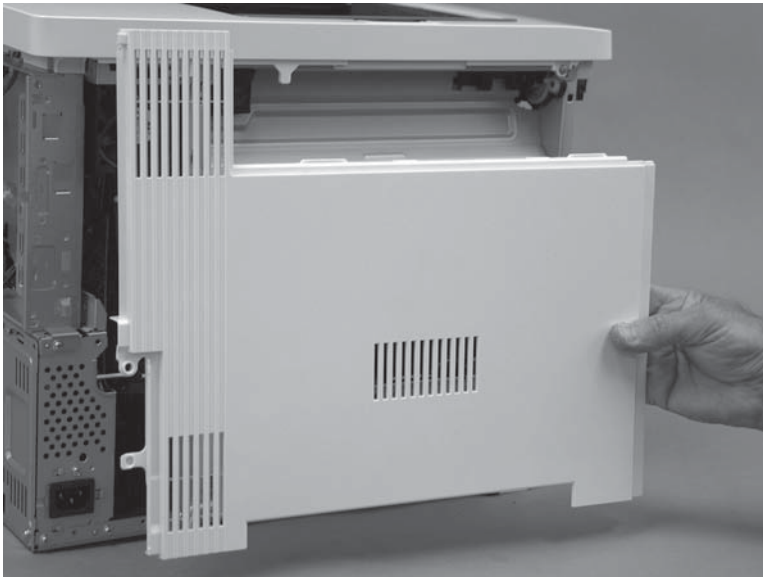

Step 7: Remove the upper cover (M553)

 **NOTE:** This step is for the M552 and M553 models. For the M577 models, skip this step and go to [Step 8: Remove the rear upper cover \(M577\) on page 700.](#)

1. Remove three screws (callout 1).

Figure 1-1208 Remove three screws

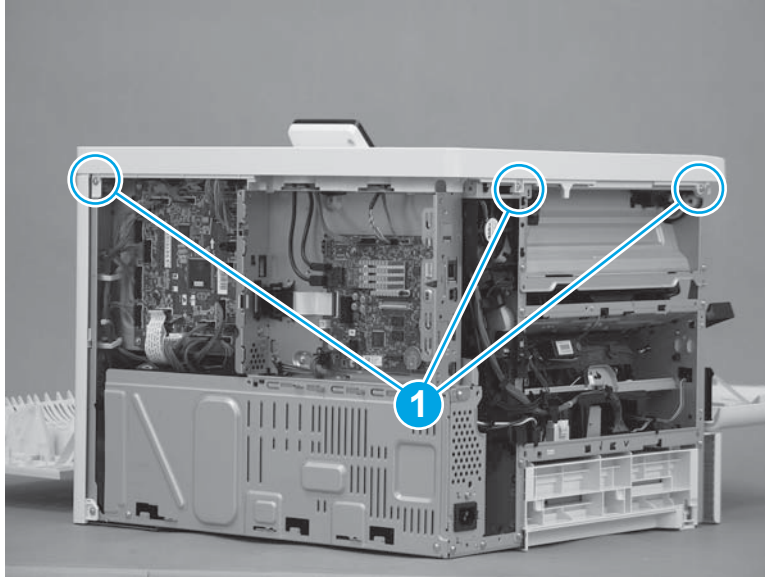

2. Remove one screw (callout 1), release one tab (callout 2), and then slightly separate the corner of the cover from the chassis.

 **NOTE:** This is a self-tapping plastic-thread screw. Make sure that this screw is used in this location when it is reinstalled.

Figure 1-1209 Remove one screw and release one tab



3. Release one tab (callout 1), and then lift up on the cover to release it.

 **NOTE:** If the cover does not release, check for addition tabs by locating the triangles embossed in the cover at tab locations.

Figure 1-1210 Release the cover



4. Remove the cover.

Figure 1-1211 Remove the cover

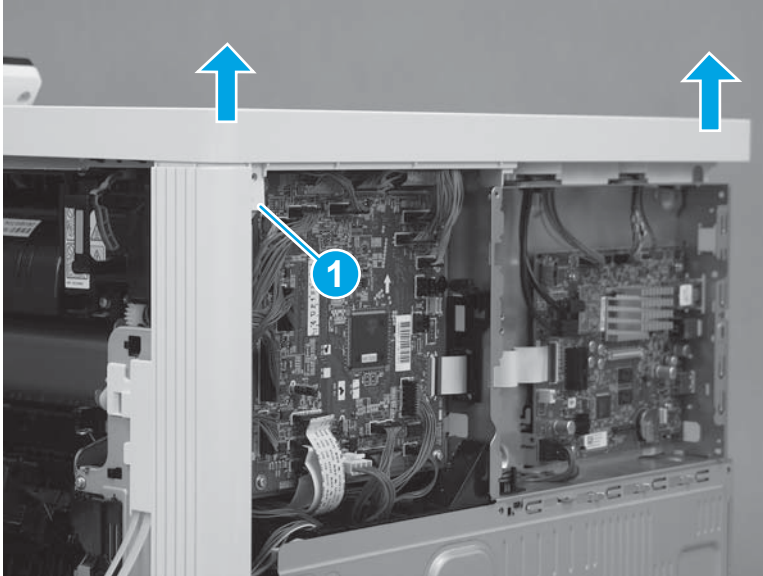
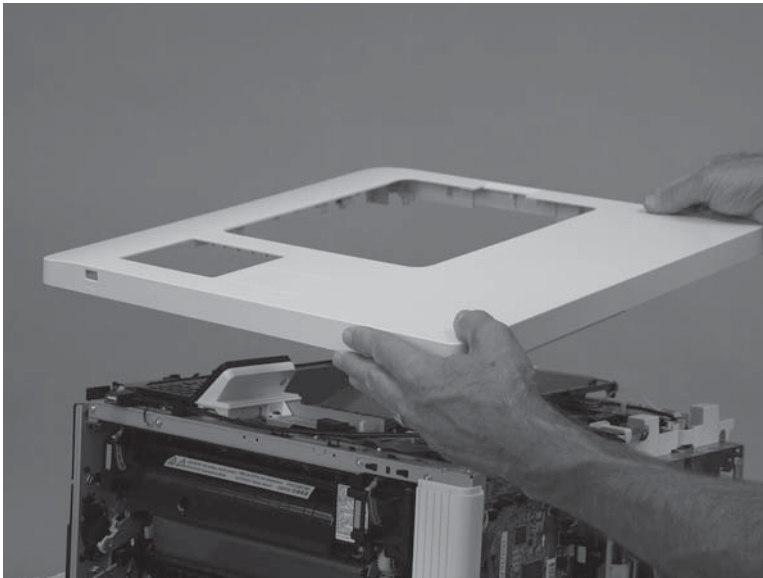

Step 8: Remove the rear upper cover (M577)

 **NOTE:** This step is for the M577 models. For the M552 and M553 models, skip this step and go to [Step 18: Remove the switch \(SW4\) PC board assembly on page 718.](#)

1. Remove two screws (callout 1).

 **Reinstallation tip:** These two screws are self-tapping screws for plastic. When reinstalling them, rotate the screws counterclockwise to align them with the existing thread pattern, and then carefully turn them clockwise to tighten. Do not overtighten. This will prevent stripping the threads inside the screw holes.

Figure 1-1212 Remove two screws



2. Use a small, flat blade screwdriver to release the right edge of the cover.

Figure 1-1213 Release the right edge

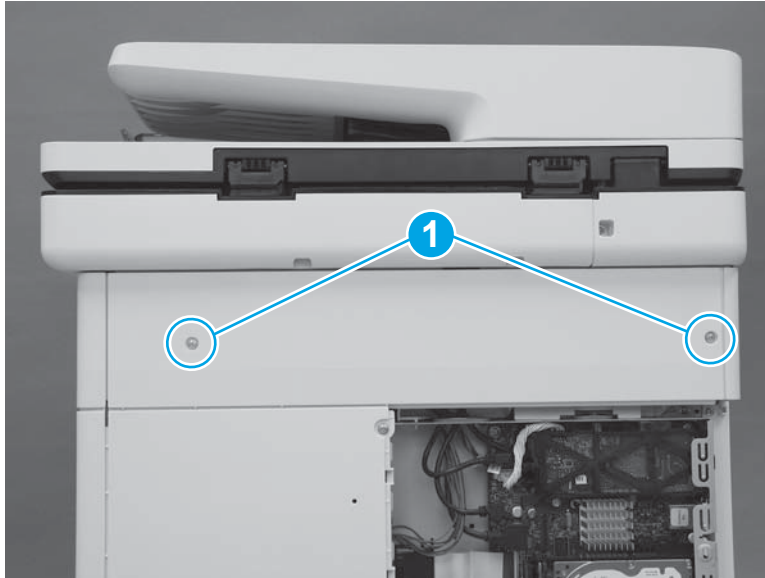
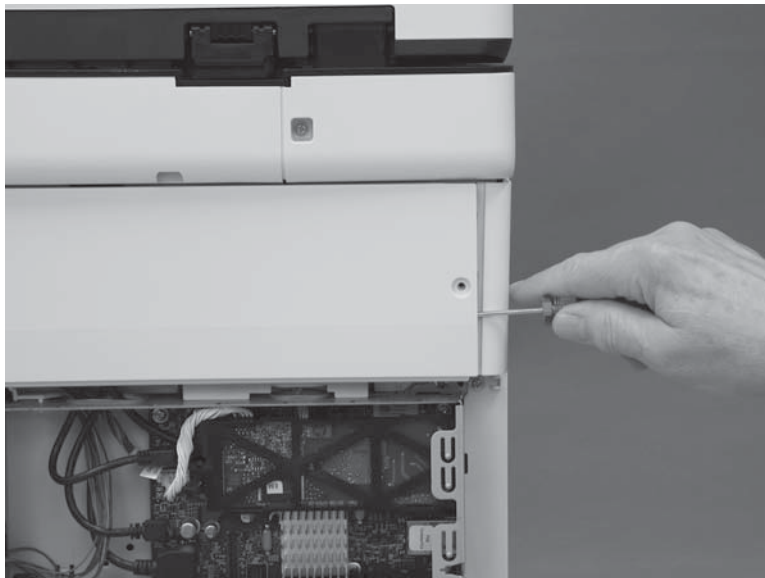

3. Pull the right edge of the cover (callout 1) away from the printer, and then slide the cover to the right (callout 2).

Figure 1-1214 Slide the cover right

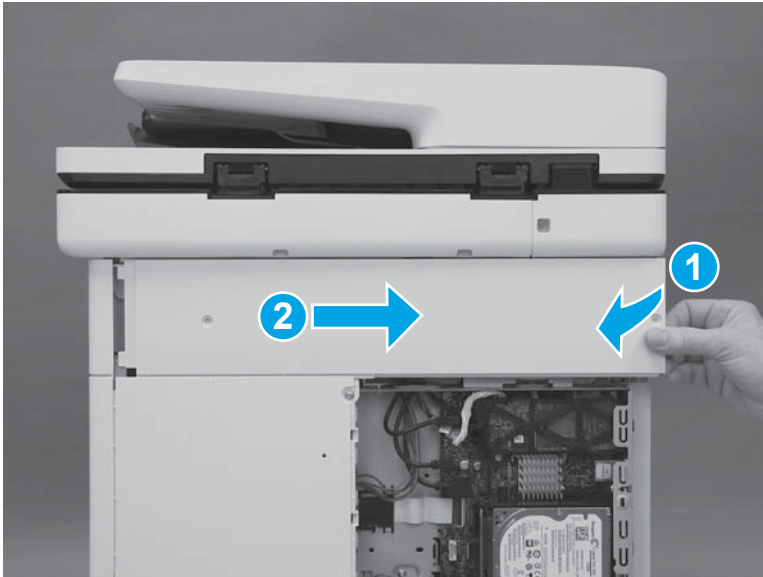

4. Remove the cover.

Figure 1-1215 Remove the cover

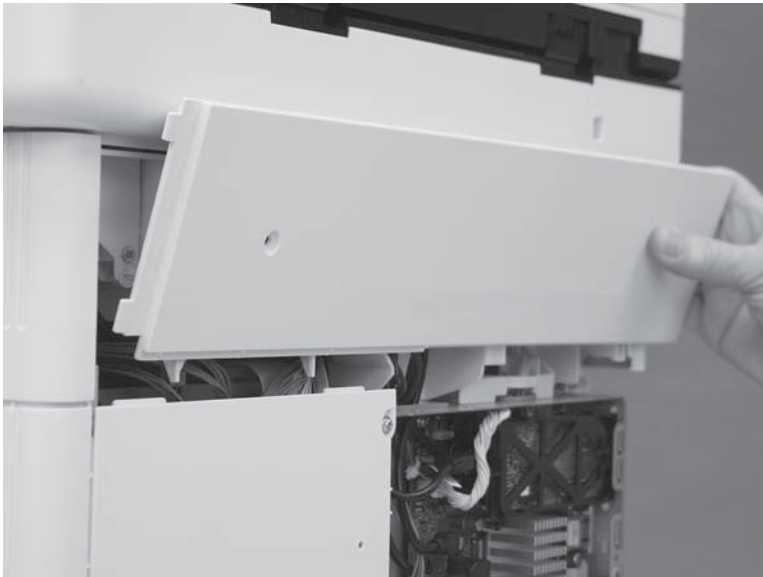

Step 9: Remove the left upper cover (M577)

 **NOTE:** This step is for the M577 models. For the M552 and M553 models, skip this step and go to [Step 18: Remove the switch \(SW4\) PC board assembly on page 718.](#)

1. At the left side of the printer, release one tab (callout 1).

Figure 1-1216 Release one tab

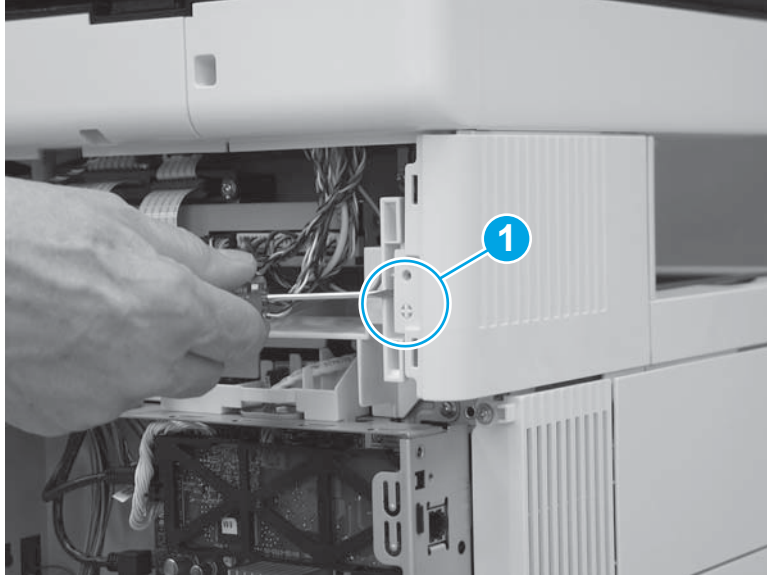

2. Slide the left upper cover toward the back of the printer.

Figure 1-1217 Slide the cover back

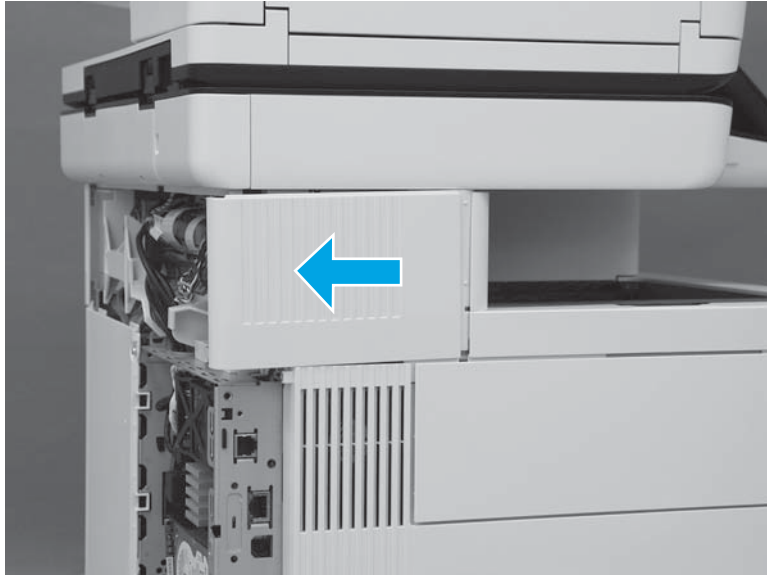

3. Rotate the cover up to remove it.

Figure 1-1218 Remove the left upper cover



Step 10: Remove the right front upper cover (M577dn)



NOTE: This step is for the M577dn model. For the M577c/f/z models, skip this step and to go [Step 11: Remove the stapler cover assembly \(M577c/f/z\) on page 705](#).

For the M552 and M553 models, skip this step and go to [Step 18: Remove the switch \(SW4\) PC board assembly on page 718](#).

1. Remove one screw (callout 1).

Figure 1-1219 Remove one screw

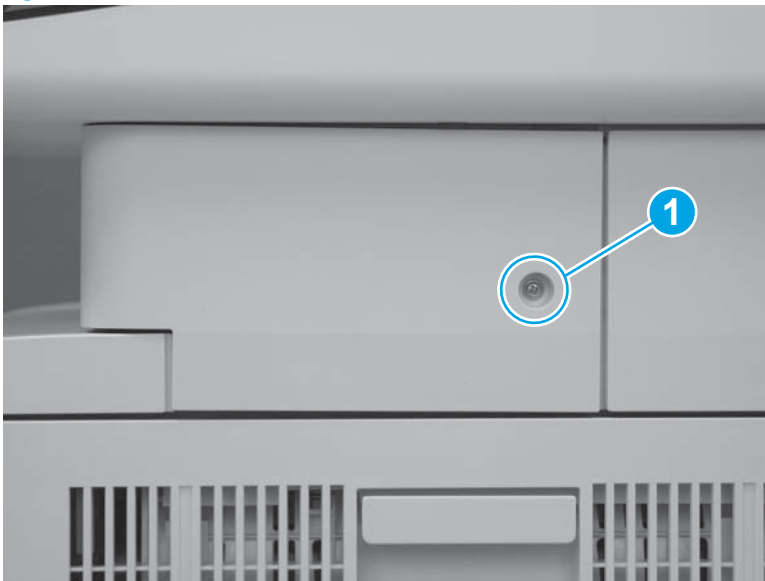

2. Release two tabs at the front edge of the cover (callout 1).

Figure 1-1220 Release two tabs



3. Rotate the front of the cover to the right to remove it.

Figure 1-1221 Rotate the cover



Step 11: Remove the stapler cover assembly (M577c/f/z)

 **NOTE:** This step is for the M577c/f/z models. For the M577dn model, skip this step and go to [Step 12: Remove the integrated scanner assembly \(M577\) on page 707](#).

For the M552 and M553 models, skip this step and go to [Step 18: Remove the switch \(SW4\) PC board assembly on page 718](#).

1. Remove one screw (callout 1).

 **Reinstallation tip:** This is a self-tapping screw for plastic. When reinstalling, rotate the screw counterclockwise to align it with the existing thread pattern, and then carefully turn it clockwise to tighten. Do not overtighten. This will prevent stripping the threads inside the screw hole.

Figure 1-1222 Remove one screw

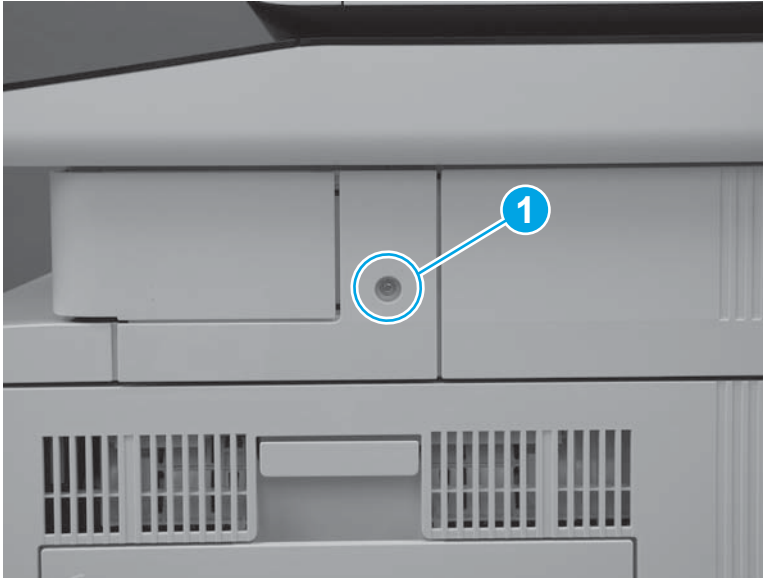

2. Release two tabs at the front edge of the cover (callout 1).

Figure 1-1223 Release two tabs



3. Release the back edge of the cover.

Figure 1-1224 Release the back edge of the cover

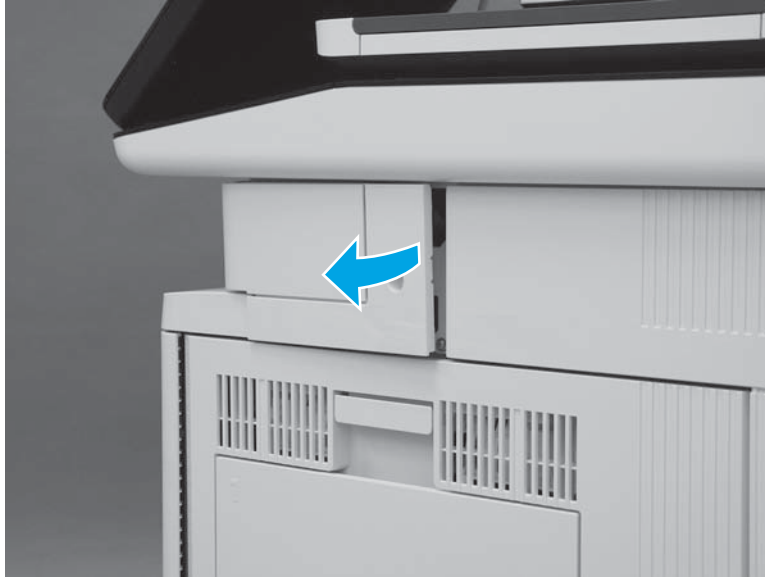



4. Rotate the cover away from the printer to remove it.

Figure 1-1225 Remove the cover



Step 12: Remove the integrated scanner assembly (M577)

 **NOTE:** This step is for the M577 models. For the M552 and M553 models, skip this step and go to [Step 18: Remove the switch \(SW4\) PC board assembly on page 718.](#)

 **NOTE:** The ISA includes the document feeder, image scanner, scanner control board (SCB), control panel, keyboard (M577c/z) and NFC PCA (M577z).

1. At the left side of the printer, remove one screw (callout 1).

Figure 1-1226 Remove one screw

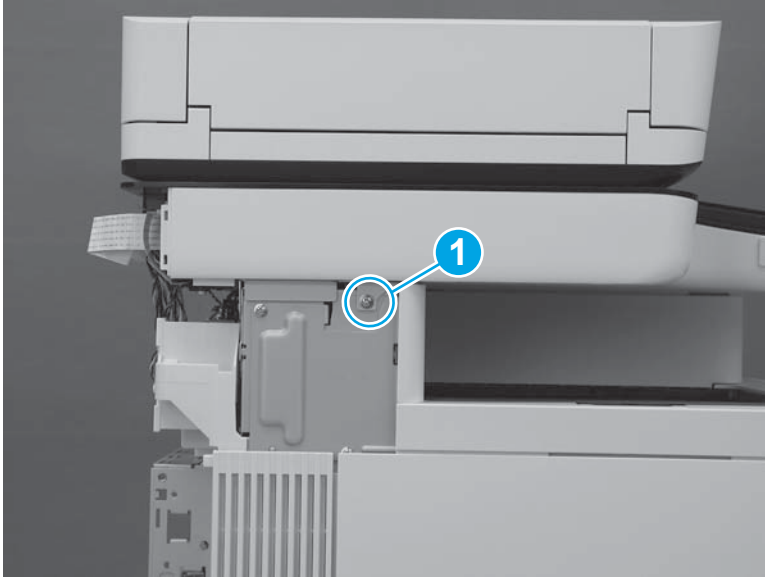

2. At the back side of the printer, remove two screws (callout 1).

Figure 1-1227 Remove two screws

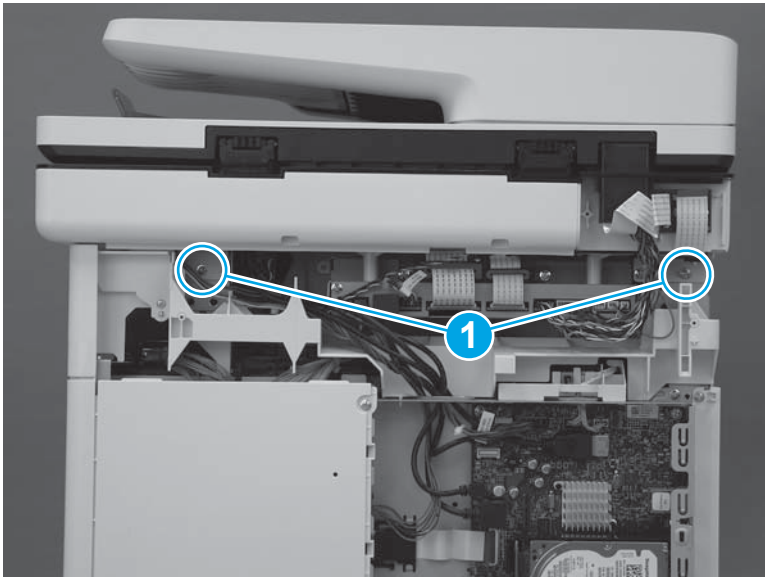

3. At the right side of the printer, remove one screw (callout 1).

Figure 1-1228 Remove one screw

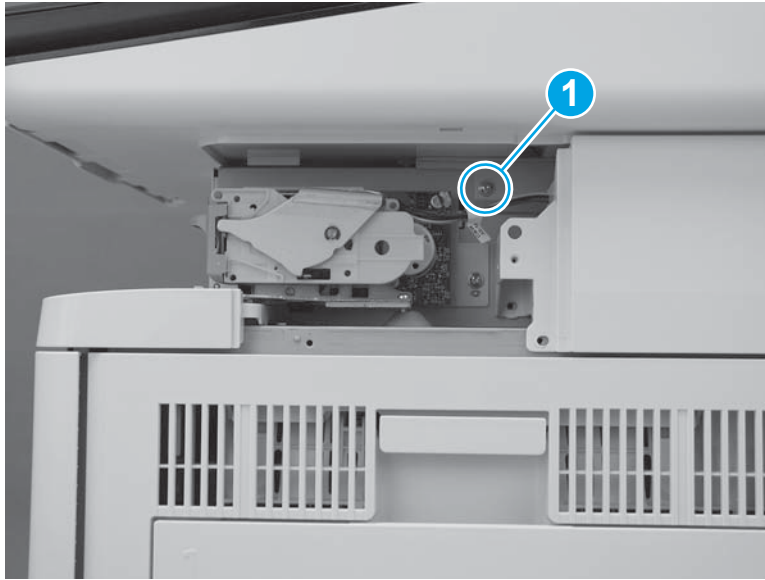

4. Disconnect four connectors on the formatter (callout 1), and then pass the wire harness and cables through the opening in the formatter case (callout 2).

Figure 1-1229 Disconnect four connectors

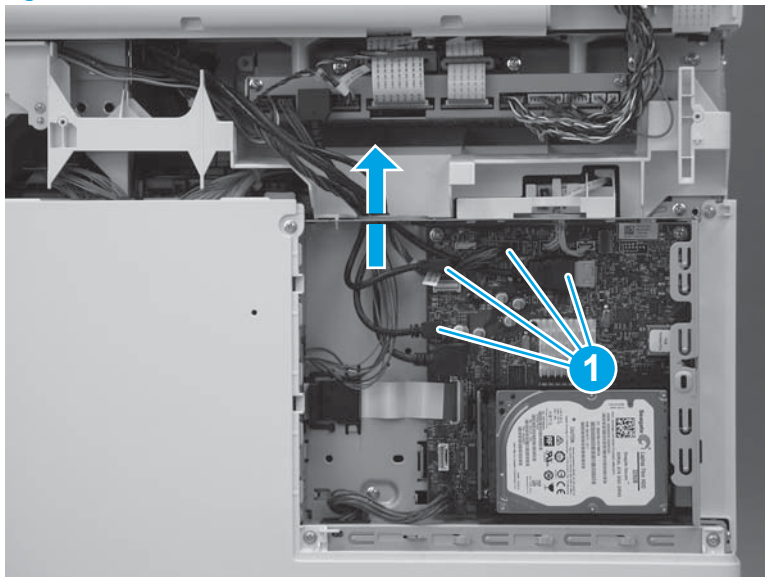

5. Disconnect two connectors on the scanner control board (callout 1).

M577c/f/z only: Disconnect one connector for the stapler on the scanner control board (callout 2).

Figure 1-1230 Disconnect connectors

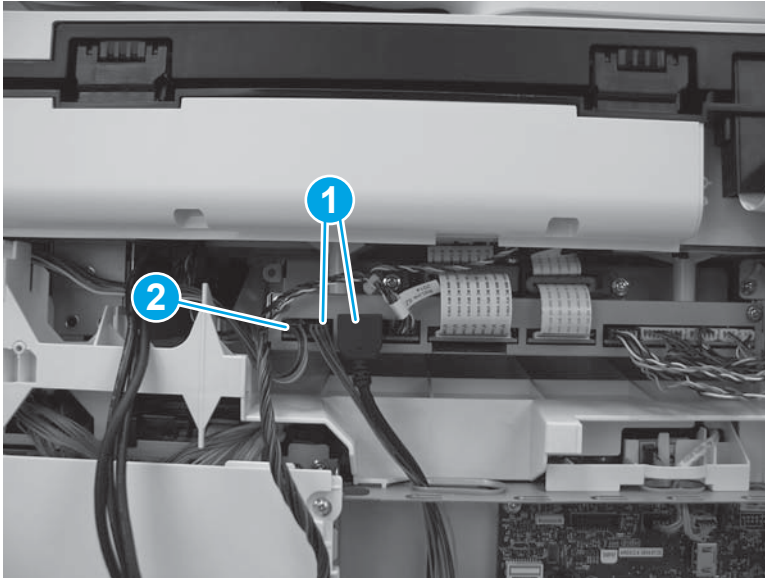

6. Slightly slide the ISA towards the back of the printer to release it.

Figure 1-1231 Slide the ISA towards the back of the printer

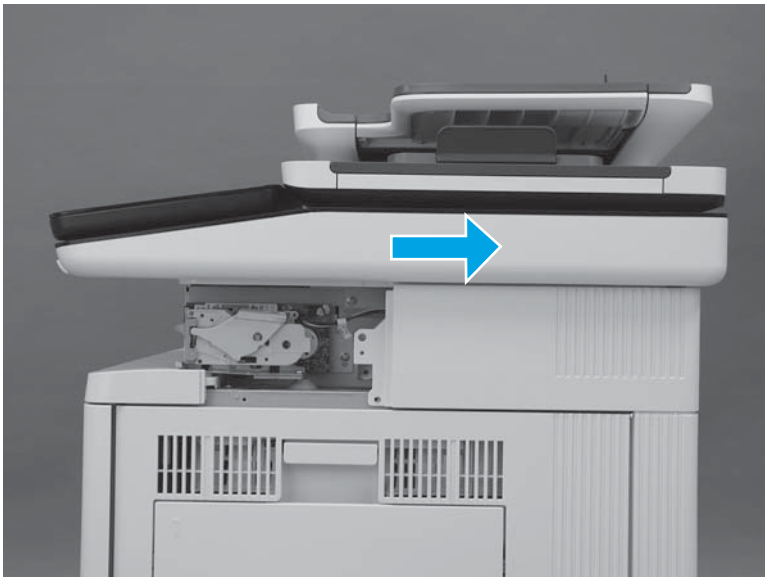

7. Lift the ISA up to remove it.

Figure 1-1232 Remove the ISA

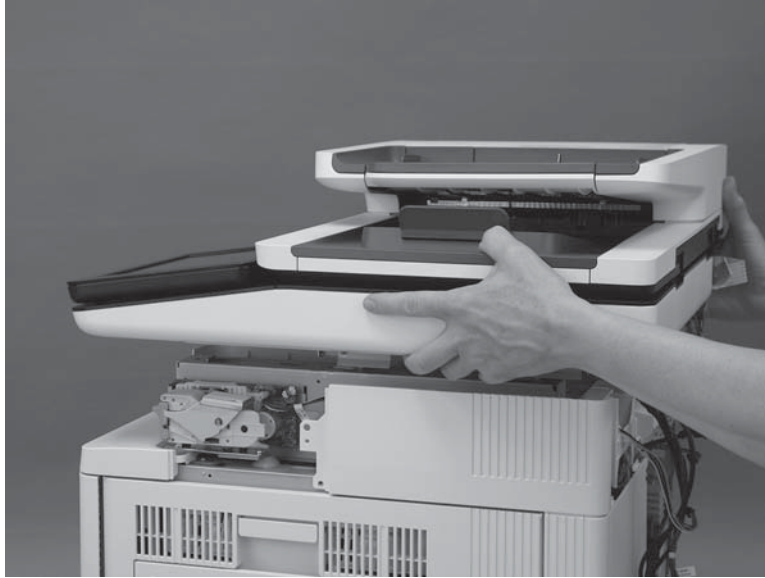

Step 13: Remove the stapler unit (M577f and M577z)

 **NOTE:** This step is for the M577f and M577z models. For the M577dn model, skip this step and to go [Step 14: Remove the right upper cover \(M577\) on page 712.](#)

This step is for the M577 models. For the M552 and M553 models, skip this step and go to [Step 18: Remove the switch \(SW4\) PC board assembly on page 718.](#)

1. Disconnect one connector (callout 1), and then remove two screws (callout 2).

Figure 1-1233 Disconnect connector and remove screws

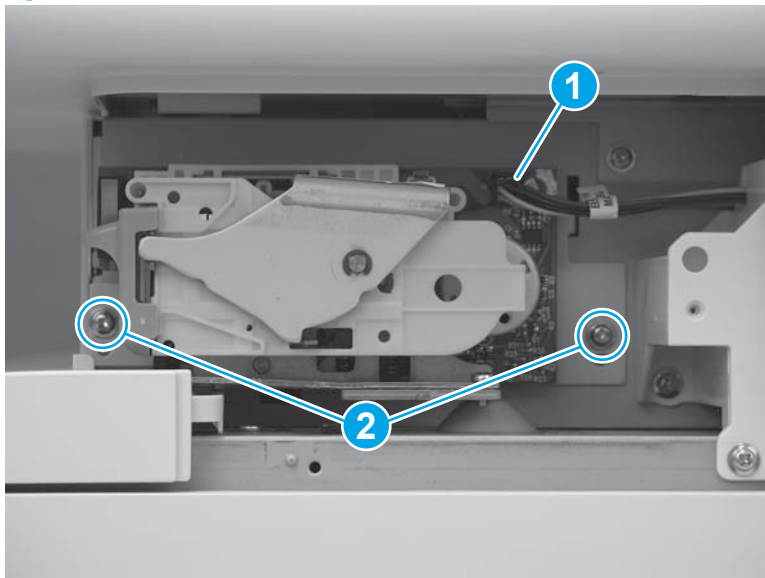

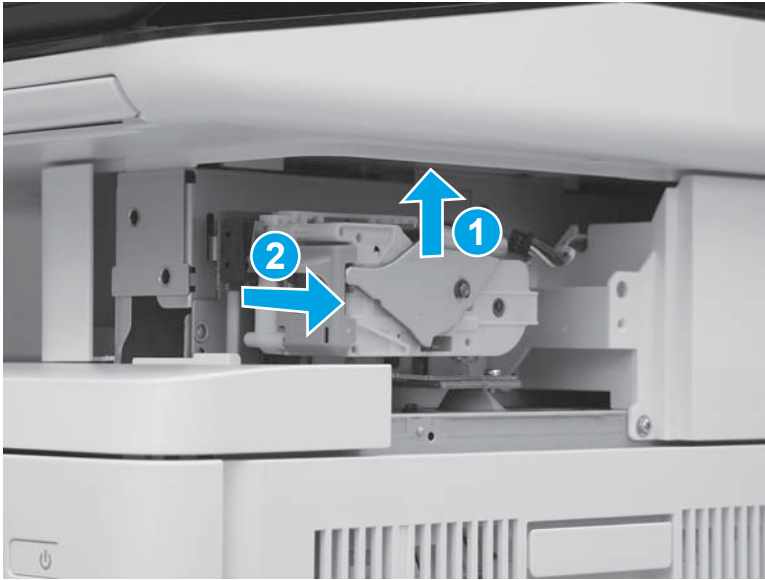

- Slide the stapler unit up (callout 1), and then pull it away from the printer (callout 2) to remove it.

Figure 1-1234 Remove the stapler unit



Step 14: Remove the right upper cover (M577)

 **NOTE:** This step is for the M577 models. For the M552 and M553 models, skip this step and go to [Step 18: Remove the switch \(SW4\) PC board assembly on page 718.](#)

 **NOTE:** The figures below show the image scanner installed. The procedures for removing and installing the right upper cover are the same whether the image scanner is installed or removed."

- At the right side of the printer, remove two screws (callout 1).

M577c/f/z only: Disconnect one connector (callout 2), if it was not already disconnected in a previous step.

Figure 1-1235 Remove two screws and one connector

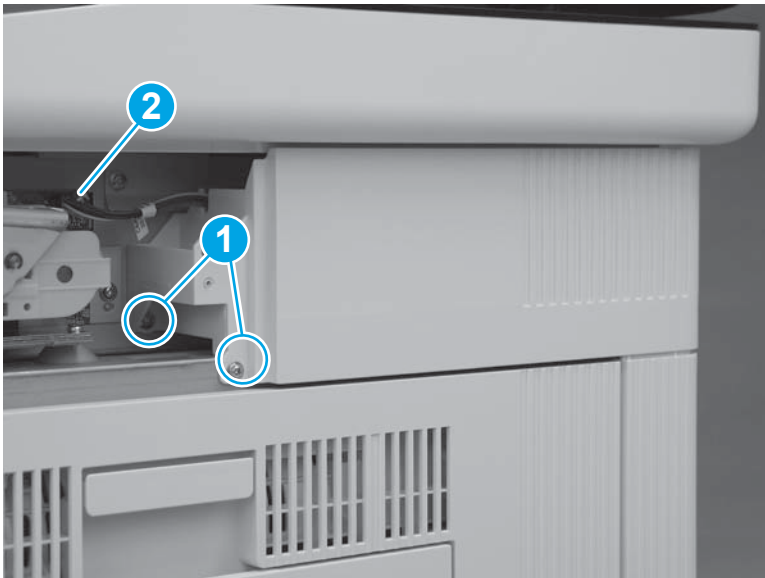

2. At the back of the printer, remove one screw (callout 1).

M577c/f/z only: Disconnect one connector (callout 2), if it was not already disconnected in a previous step.

 **Reinstallation tip:** This screw is smaller than the screws removed in the previous step. When reinstalling the right upper cover, make sure that this screw is installed in the correct position.

Figure 1-1236 Remove one screw and connector



3. Slide the cover toward the back of the printer.

Figure 1-1237 Slide the cover

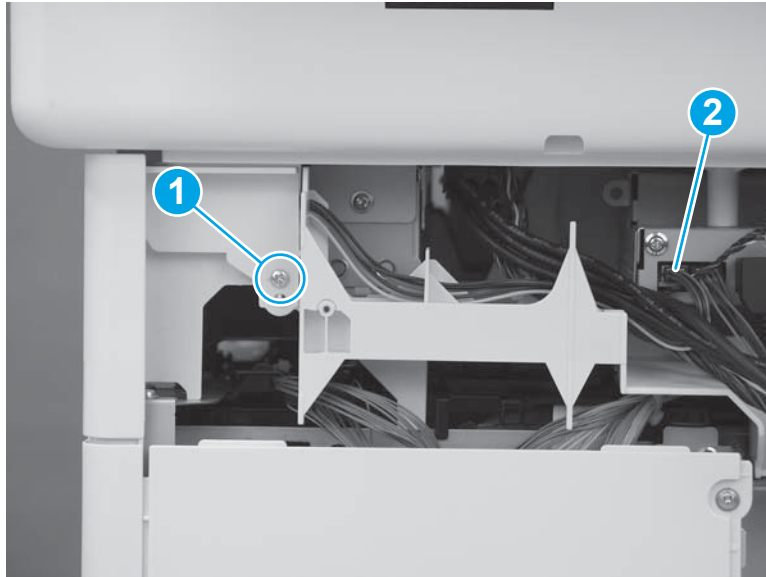
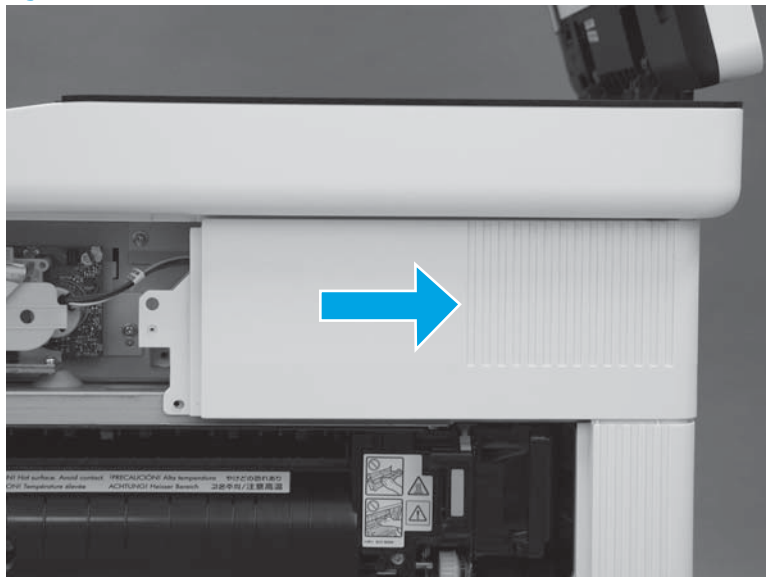

4. Lift the cover away from the printer to remove it.

M577c/f/z only: Release the cables (callout 1) through the slot (callout 2) in the printer.

Figure 1-1238 Remove the cover

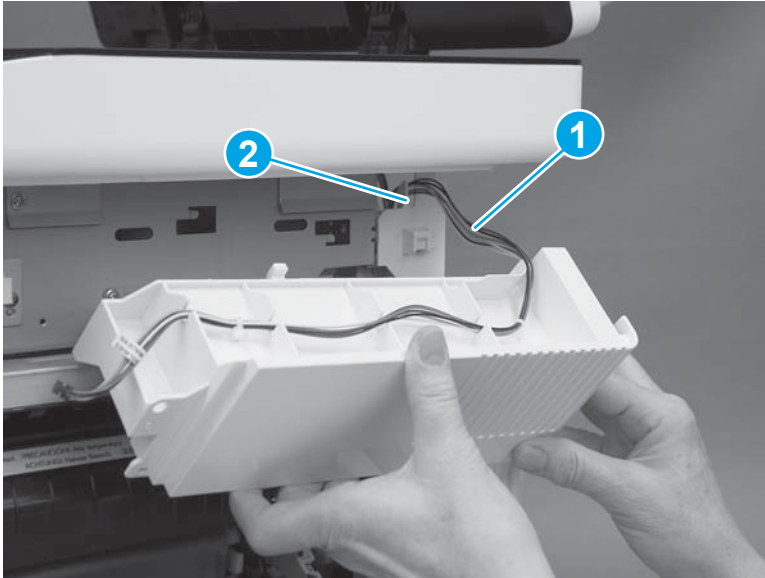

Step 15: Remove the top rear cover (M577)

 **NOTE:** This step is for the M577 models. For the M552 and M553 models, skip this step and go to [Step 18: Remove the switch \(SW4\) PC board assembly on page 718.](#)

1. At the top of the printer, remove five screws (callout 1).

Figure 1-1239 Remove five screws

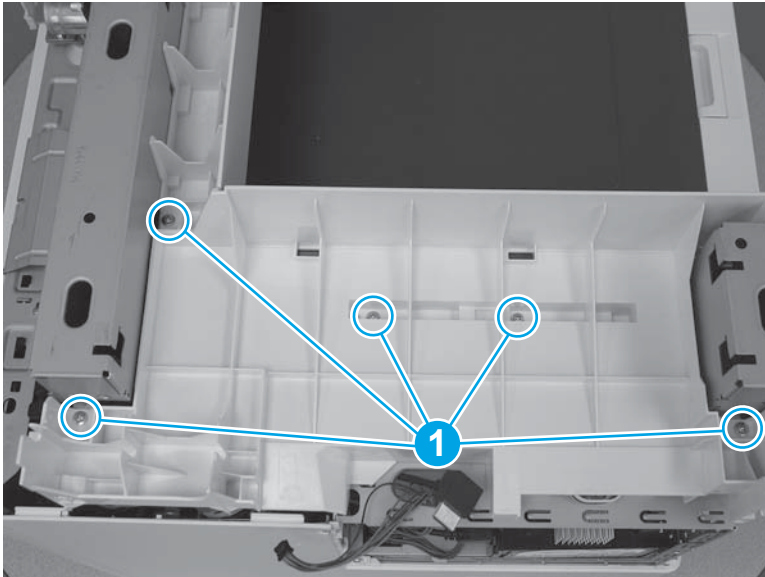

2. Release two tabs (callout 1) on the front edge of the cover.

Figure 1-1240 Release two tabs

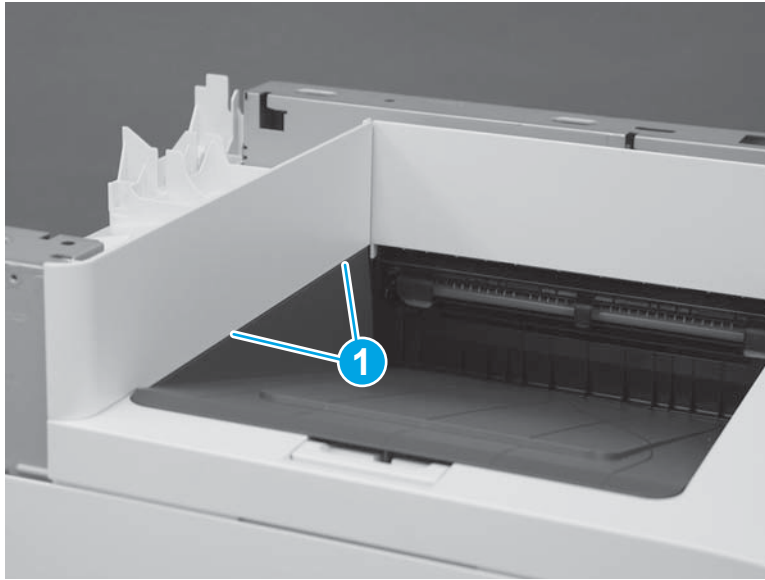

3. Remove the top rear cover.

Figure 1-1241 Remove the top rear cover

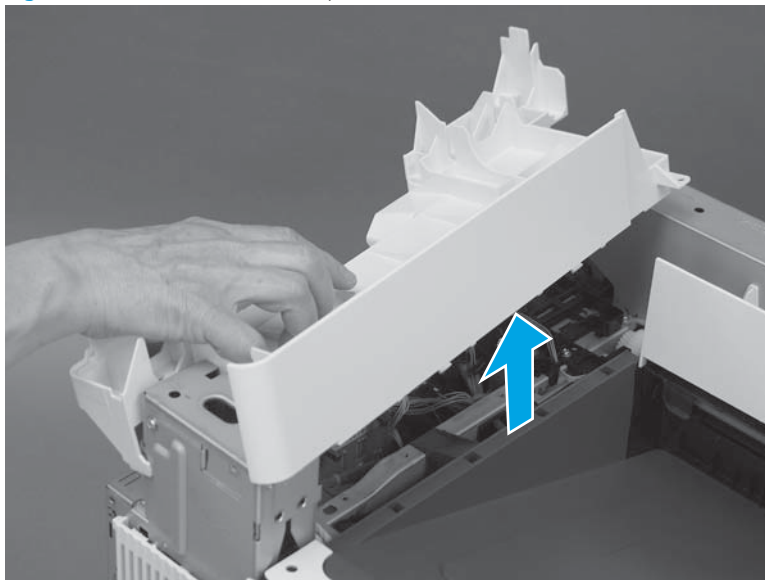

Step 16: Remove the paper feed cover (M577)

 **NOTE:** This step is for the M577 models. For the M552 and M553 models, skip this step and go to [Step 18: Remove the switch \(SW4\) PC board assembly on page 718.](#)

1. Remove one screw (callout 1).

Figure 1-1242 Remove one screw

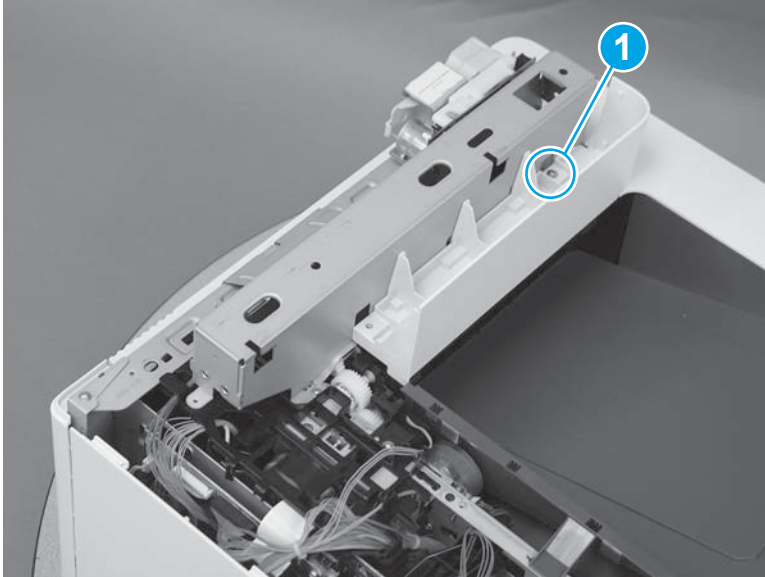

2. Lift the cover up to remove it.

Figure 1-1243 Remove the cover

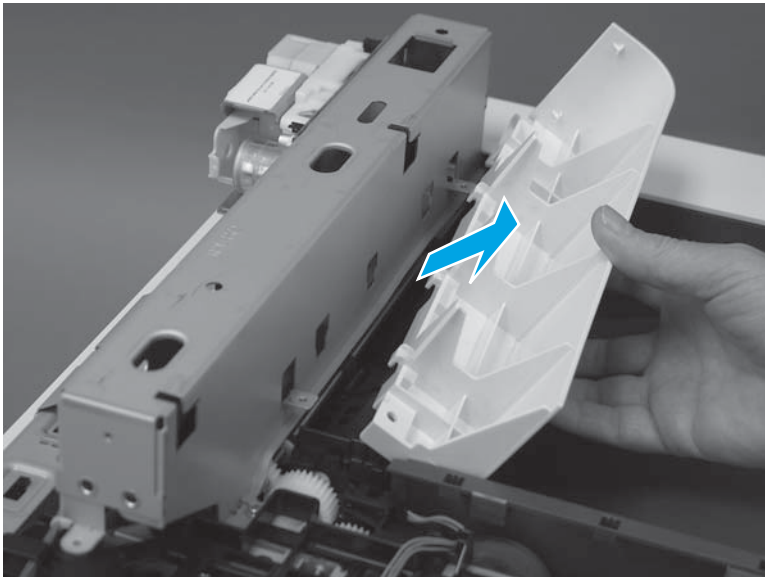

Step 17: Remove the top cover (M577)

 **NOTE:** This step is for the M577 models. For the M552 and M553 models, skip this step and go to [Step 18: Remove the switch \(SW4\) PC board assembly on page 718.](#)

1. At the front of the printer, remove one screw (callout 1).

 **Reinstallation tip:** This screw is longer and a different type of screw than the screw removed in the next step. When reinstalling the top cover, make sure that this screw is installed in the correct position.

Figure 1-1244 Remove one screw



2. At the left side of the printer, remove one screw (callout 1).

Figure 1-1245 Remove one screw

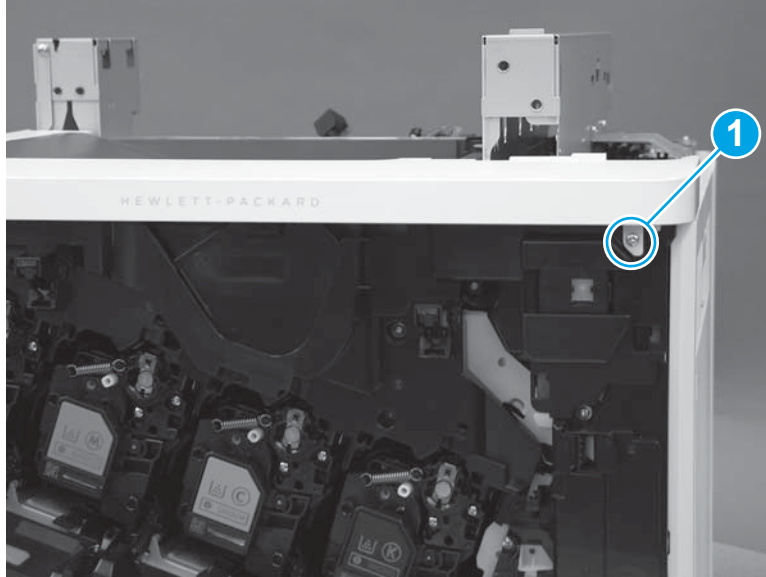
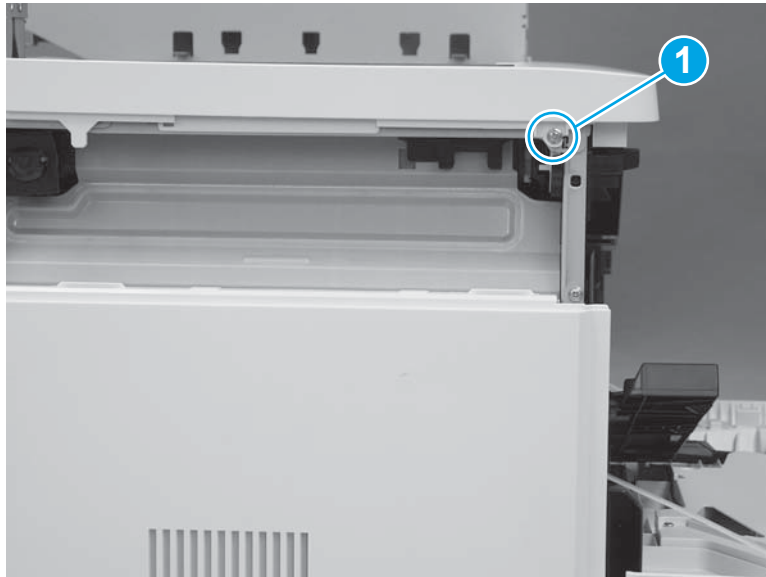

3. At the front of the printer, release one tab (callout 1).

Figure 1-1246 Release one tab

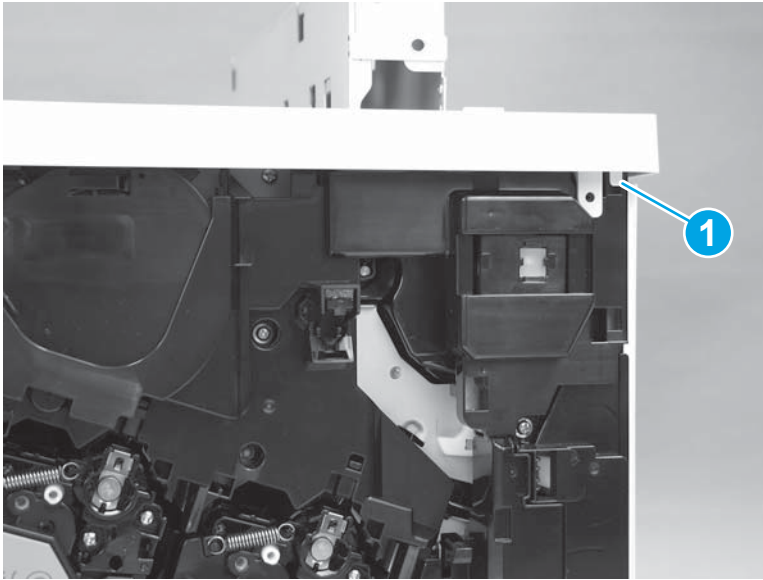

4. At the top of the printer, release two tabs (callout 1) next to the output bin, and then remove the top cover.

Figure 1-1247 Release two tabs

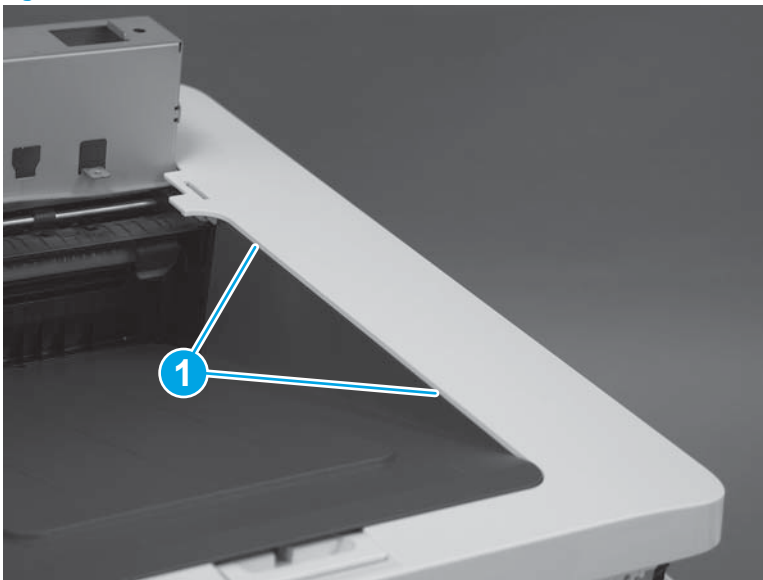

Step 18: Remove the switch (SW4) PC board assembly

1. Do the following:
 - a. If the front and right doors are not already open, open them now.
 - b. Remove one screw (callout 1).

- c. At the upper left corner (callout 2) of the upper cover, carefully pry the cover to the right to release it.
At the lower left edge (callout 3) of the upper cover, carefully pry the cover to the right to remove it

 **NOTE:** Use a small flat blade screwdriver to release and remove the cover.

Figure 1-1248 Remove the upper cover

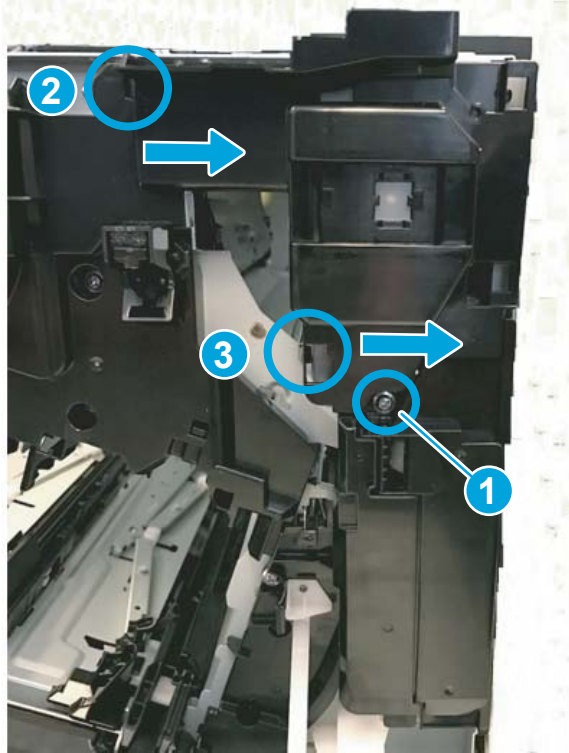

2. Do the following:

 **NOTE:** The switch (SW4) PC board assembly cover consists of a left and right cover.

- a. Release the right-side door strap (callout 1; squeeze two tabs to release the strap from the holder on the door).

- b. Remove one screw (callout 2), and then remove the left side of the cover (callout 3).

Figure 1-1249 Remove the switch left-side cover

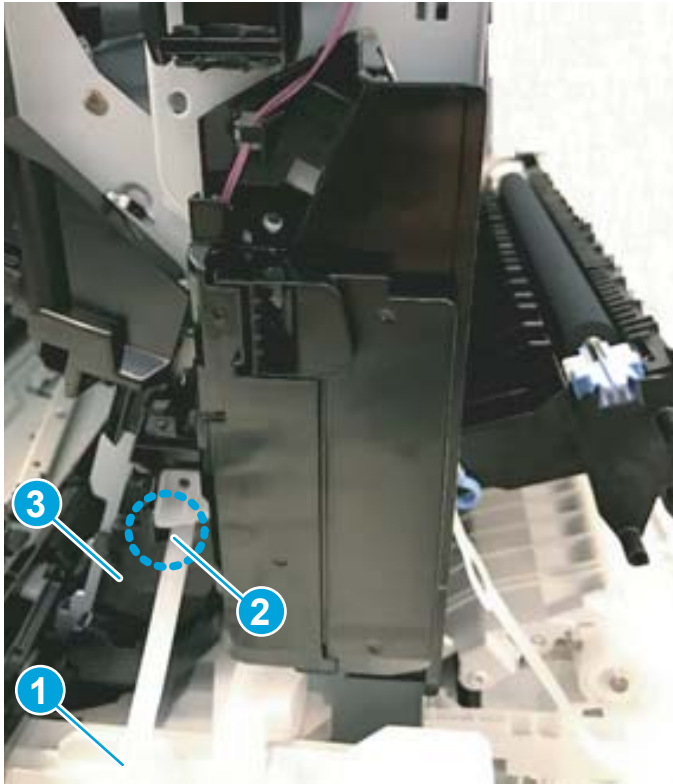

3. Do the following:

CAUTION: The door interlocks behind the switch right-side cover are not captive and can be easily dislodged when handling the cover.

- a. Carefully separate the switch right-side cover from the printer chassis.

NOTE: The cover is still attached to the chassis by a strap. Do not attempt to completely remove the cover.

- b. Release the white strap (callout 1) from the lower door interlock (behind the switch right-side cover).

Figure 1-1250 Release the white strap

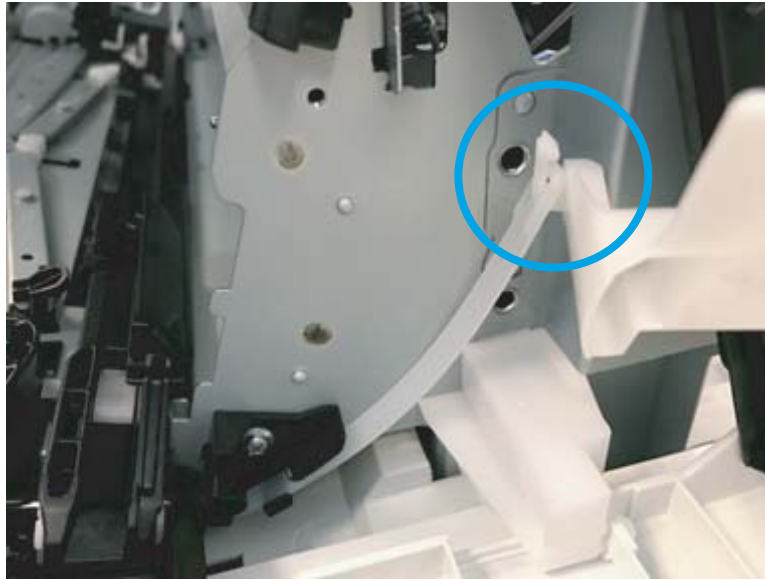

4. Disconnect one connector, and then remove the switch (SW4) PC board assembly switch (callout 1).

Figure 1-1251 Remove the switch

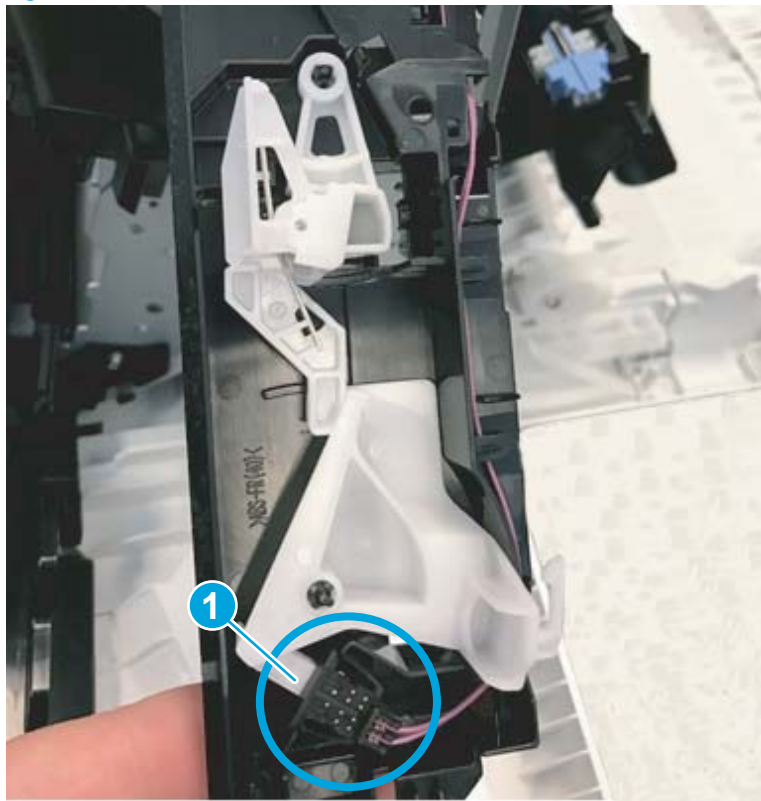

Step 19: Unpack the replacement assembly

Unpack the replacement assembly from the packaging.

For complete information on HP's recycling programs, go to [Product return and recycling](#).

 **CAUTION:**  ESD-sensitive part.

 **NOTE:** HP recommends responsible disposal of the defective assembly.

Figure 1-1252 Recycle and unpack

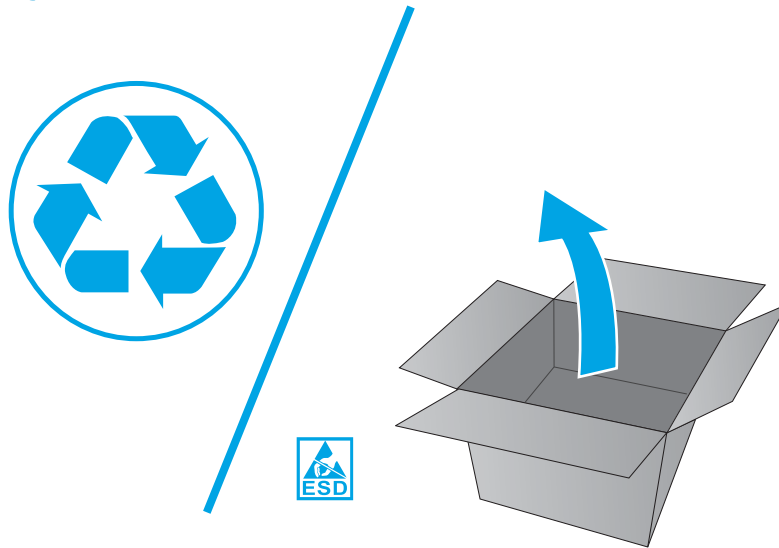

Step 20: Install the switch (SW4) PC board assembly

1. Install the switch (SW4) PC board assembly switch, and then connect one connector (callout 1).

 **NOTE:** If the door interlocks become dislodged, install them as shown below (callout 2).

Figure 1-1253 Install the switch

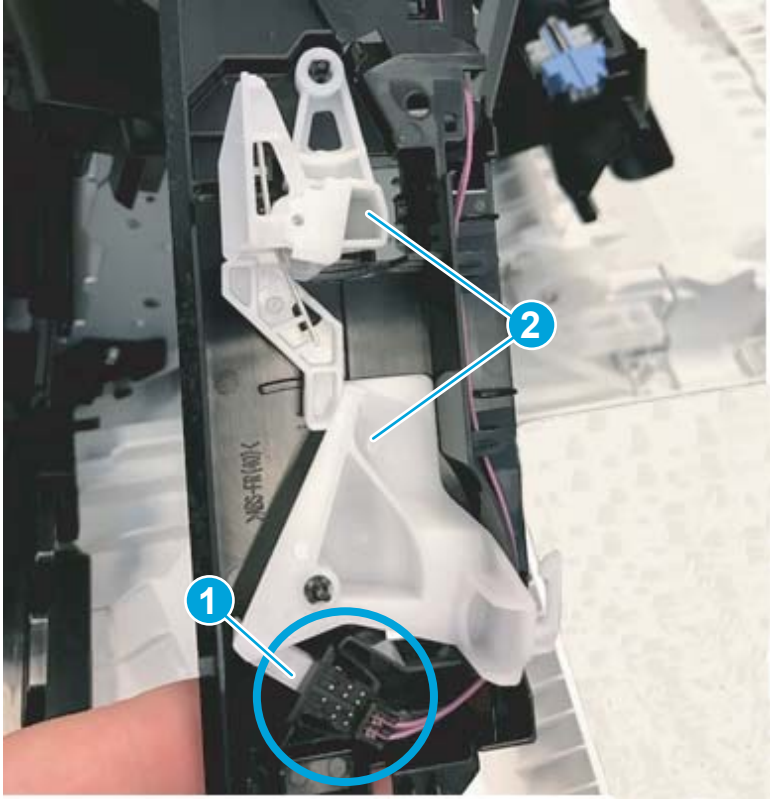

2. Install the switch right-side cover.

 **NOTE:** Make sure that the small tab at the bottom of the cover fits into the slot in the printer chassis.

Figure 1-1254 Install the switch right-side cover



3. When the switch right-side cover is firmly seated, connect the white strap (callout 1) to the lower door interlock.

Figure 1-1255 Connect the white strap

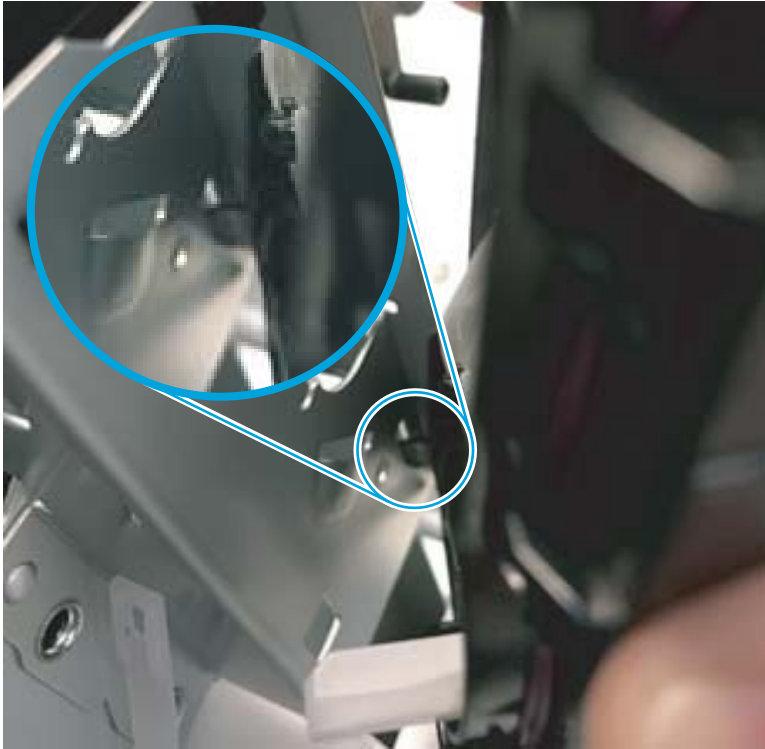
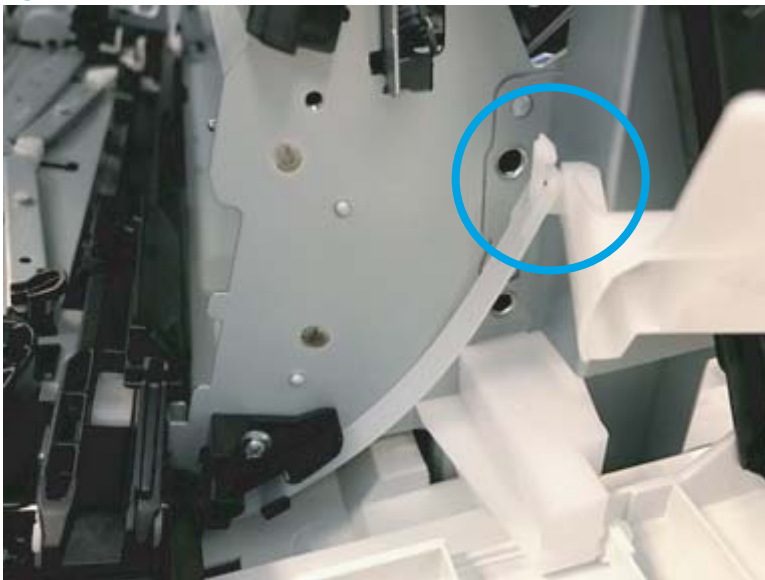

4. Install the switch left-side cover

 **NOTE:** Make sure that the small tab on the lower left corner of the cover (callout 1) is correctly positioned and that the cover is firmly seated, and then install one screw (callout 2).

Figure 1-1256 Install the switch left-side cover



5. Connect the right-side door strap (callout 1).

Figure 1-1257 Connect the door strap

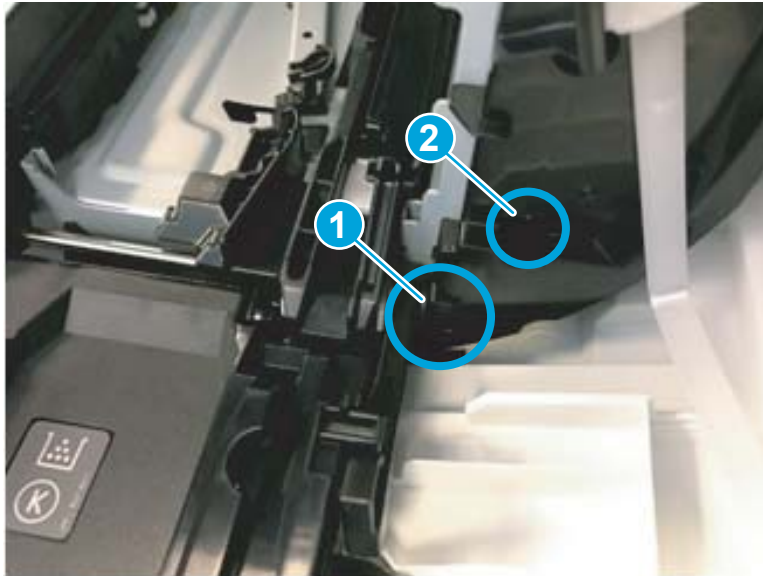
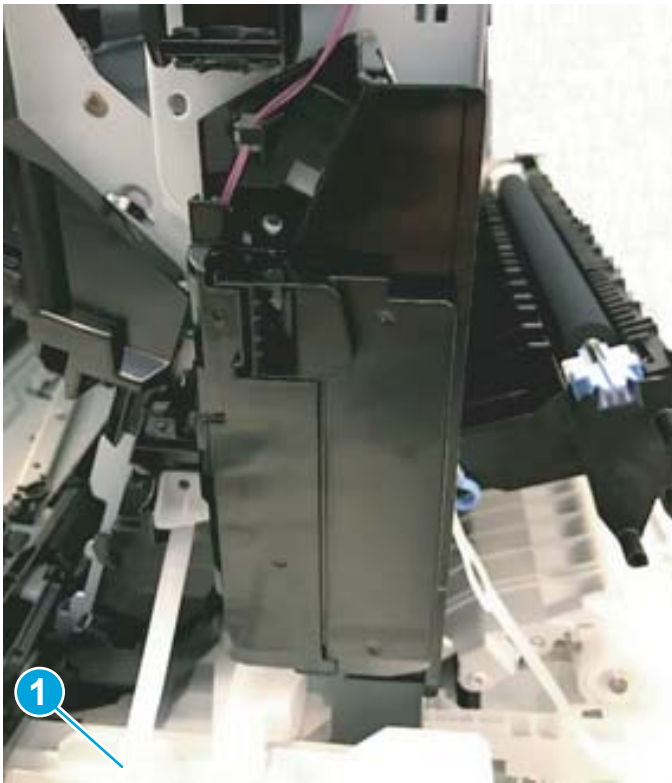

6. Before proceeding, take note of the two tabs along right edge of the upper cover (callout 1). These tabs fit into slots (callout 2) in the printer chassis when the cover is installed.

Figure 1-1258 Tabs on the upper cover

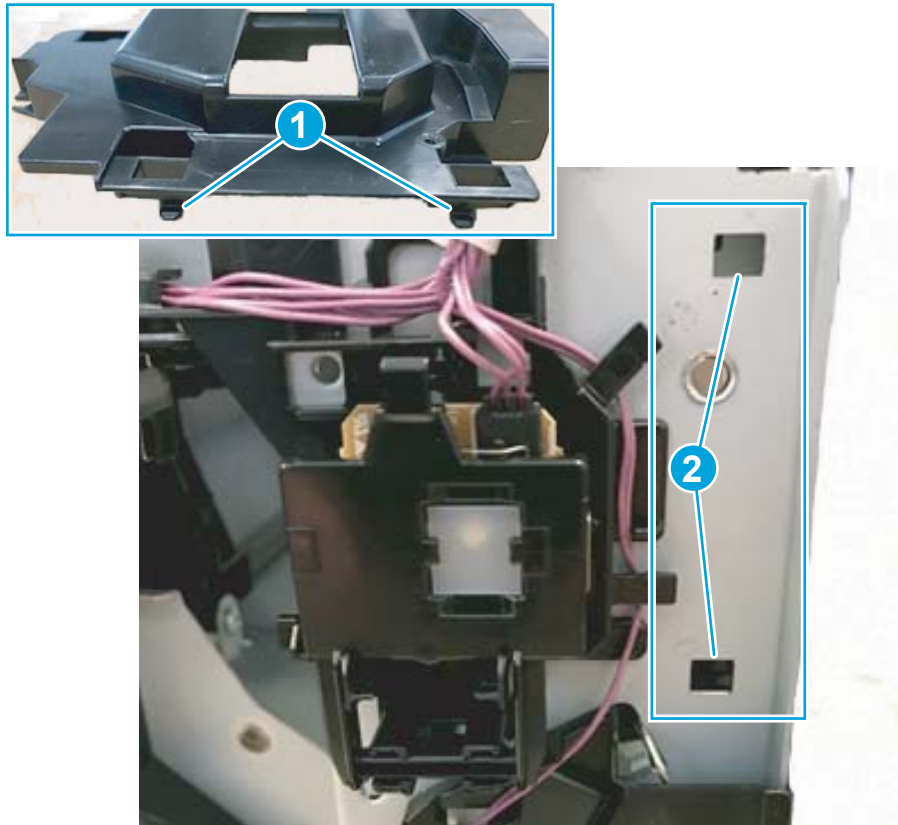

7. Install the upper cover, and then install one screw (callout 1).

Figure 1-1259 Install the upper cover

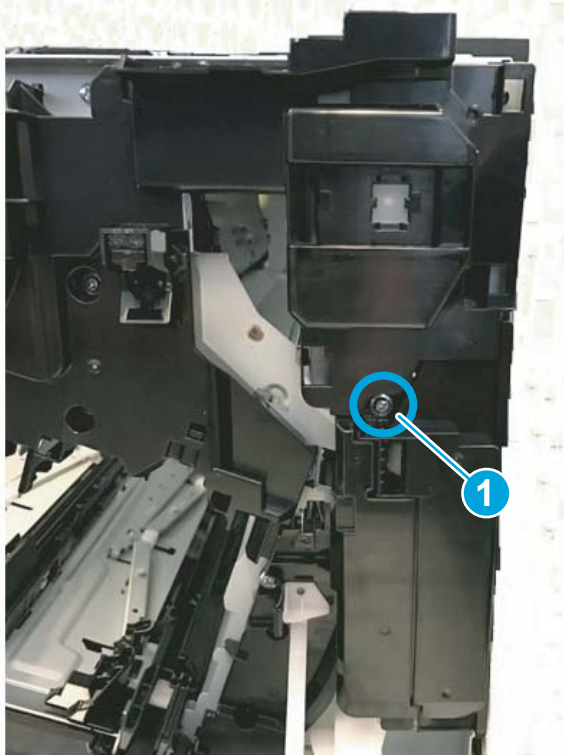

Step 21: Install the top cover (M577)

 **NOTE:** This step is for the M577 models. For the M552 and M553 models, skip this step and go to [Step 31: Install the upper cover \(M553\) on page 745](#).

1. Position the locator pins (callout 1) on the cover in the slots (callout 2) in the printer.

Figure 1-1260 Position the locator pins

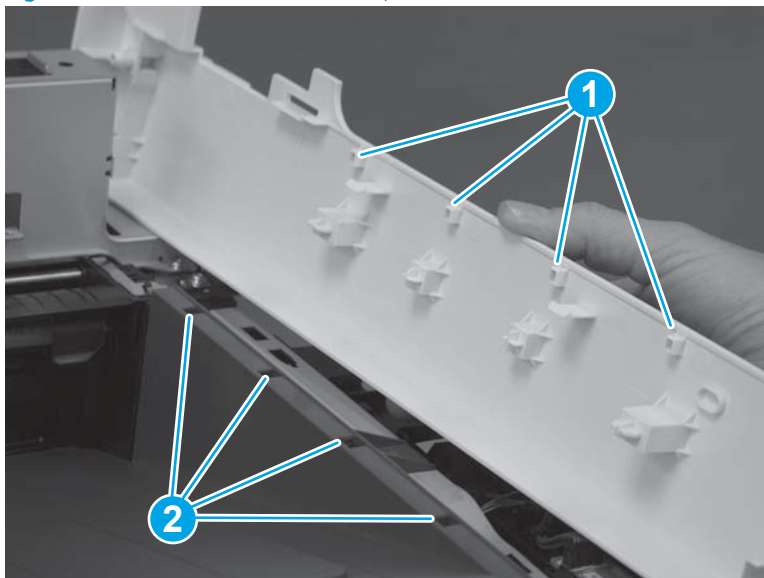

2. Press down on the cover to install it. Make sure that the tabs (callout 1) snap into place.

Figure 1-1261 Press down on the cover

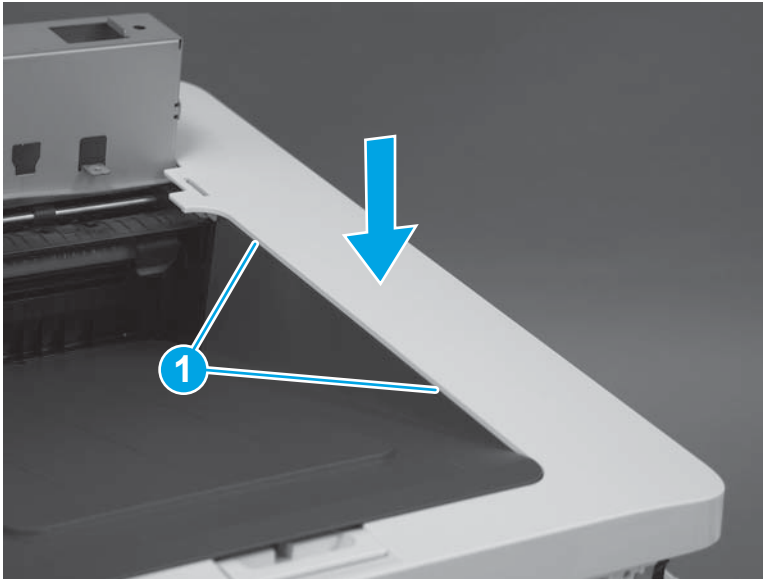

3. At the front of the printer, install one screw (callout 1).

 **Reinstallation tip:** This screw is longer and a different type of screw than the screw installed in the next step. Make sure that this screw is installed in the correct position.

Figure 1-1262 Install one screw



4. At the left side of the printer, install one screw (callout 1).

Figure 1-1263 Install one screw

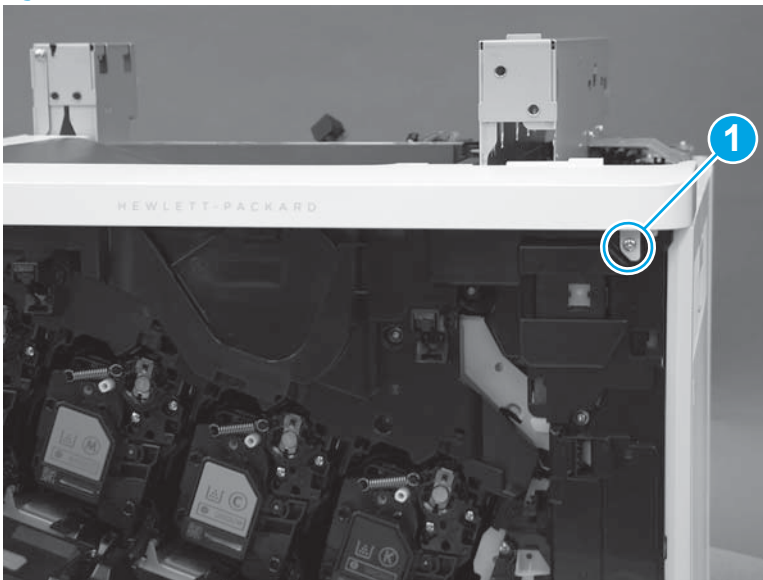
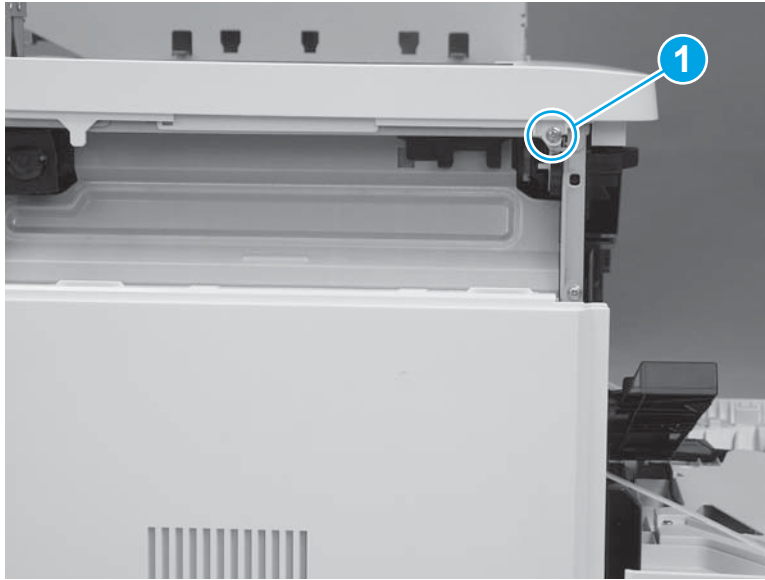

Step 22: Install the paper feed cover (M577)

 **NOTE:** This step is for the M577 models. For the M552 and M553 models, skip this step and go to [Step 31: Install the upper cover \(M553\) on page 745](#).

1. Position the locator tabs (callout 1) on the cover in the slots (callout 2) in the printer. Press down until the cover snaps into place.

Figure 1-1264 Install the cover

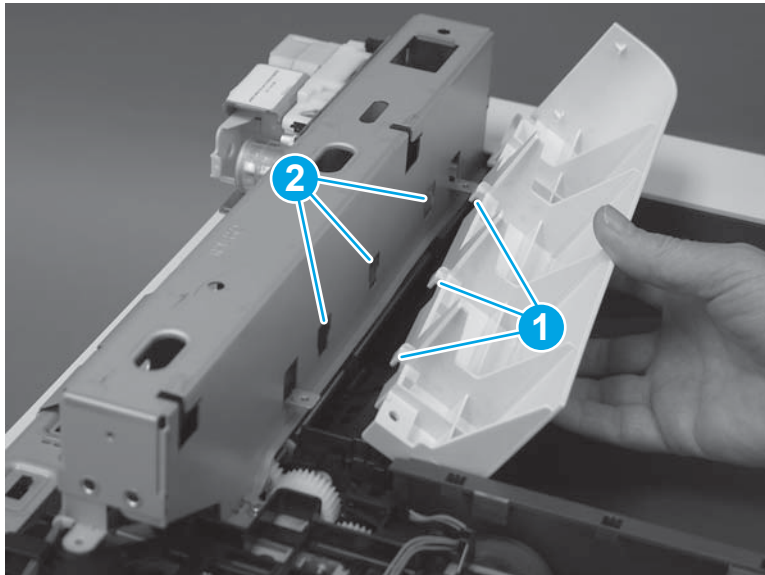

2. Install one screw (callout 1).

Figure 1-1265 Install one screw

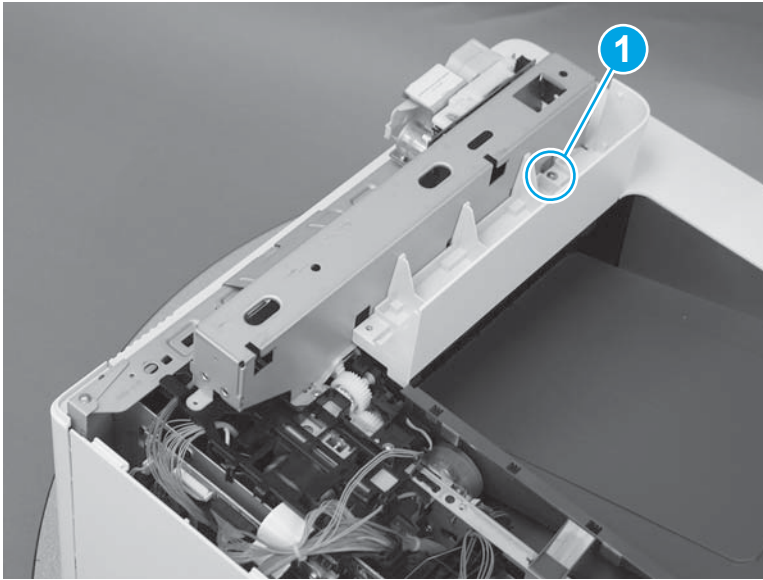

Step 23: Install the top rear cover (M577)

 **NOTE:** This step is for the M577 models. For the M552 and M553 models, skip this step and go to [Step 31: Install the upper cover \(M553\) on page 745](#).

1. Align the locator tabs (callout 1) on the cover with the slots (callout 2) in the printer.

Figure 1-1266 Align the locator tabs

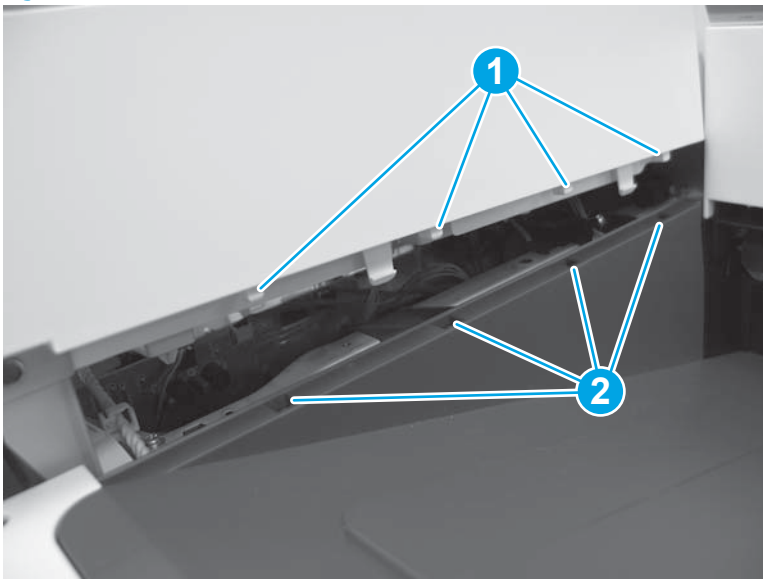

2. Press down to install the cover. Make sure that the tabs snap into place.

Figure 1-1267 Install the cover

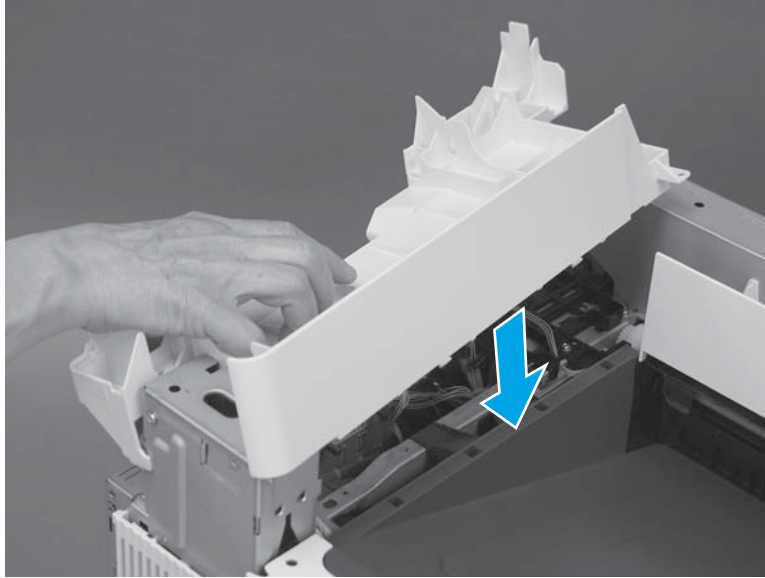

3. At the top of the printer, install five screws (callout 1).

Figure 1-1268 Install five screws

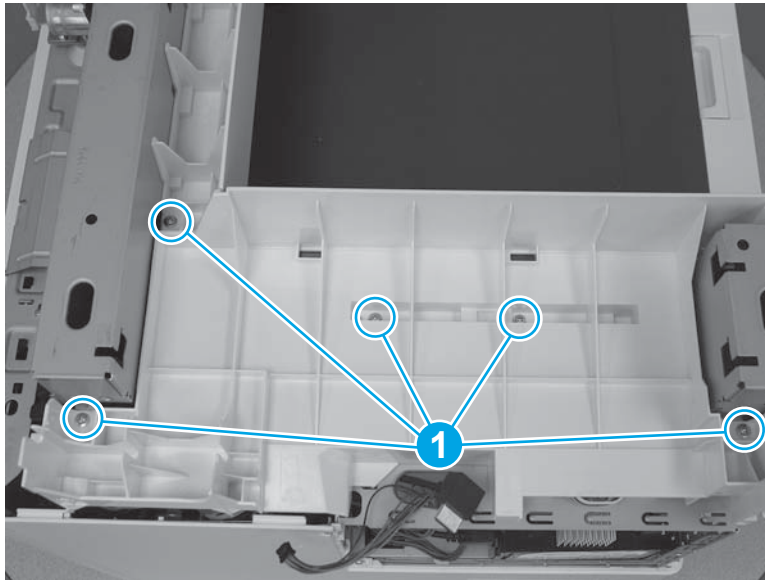

Step 24: Install the right upper cover (M577)

 **NOTE:** This step is for the M577 models. For the M552 and M553 models, skip this step and go to [Step 31: Install the upper cover \(M553\) on page 745](#).

 **NOTE:** The figures below show the image scanner installed. The procedures for removing and installing the right upper cover are the same whether the image scanner is installed or removed."

1. **M577c/f/z only:** Install the cables (callout 1) through the slot (callout 2) in the printer.

Figure 1-1269 Install the cables

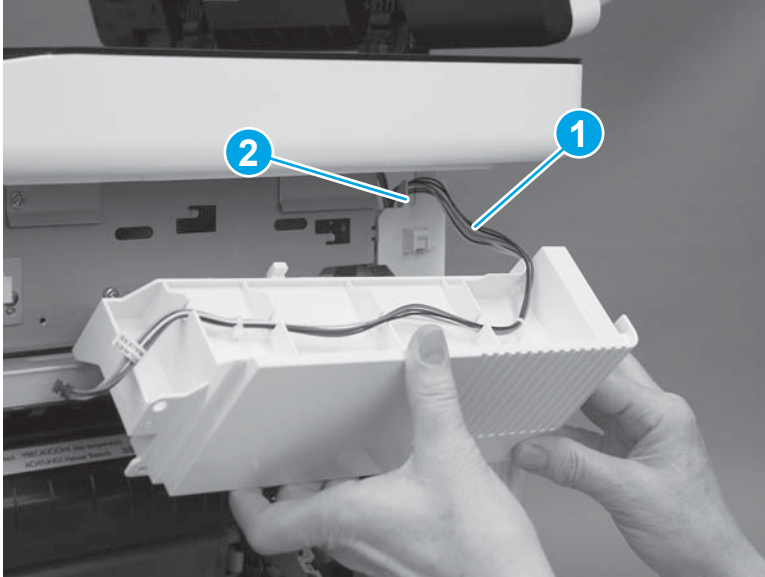

2. Position the hooks (callout 1) on the cover in the slots (callout 2) in the printer.

Figure 1-1270 Position the hooks

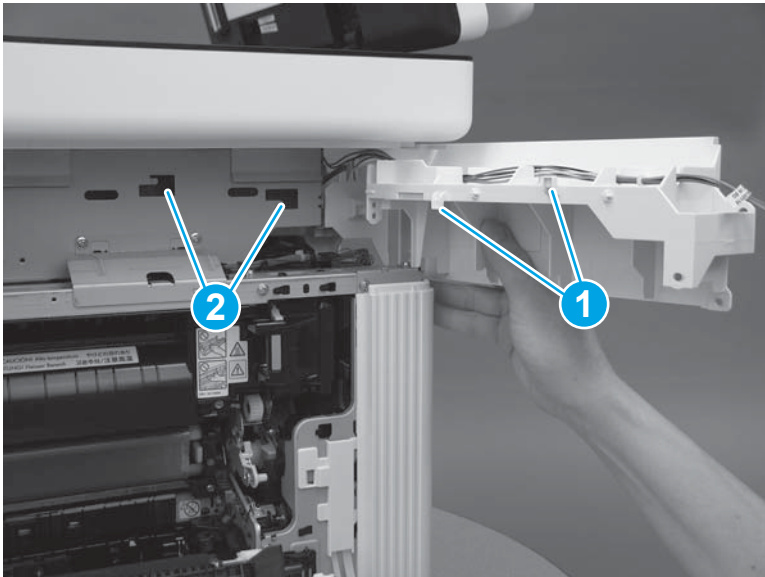

3. Slide the cover toward the front of the printer to install it.

Figure 1-1271 Install the cover

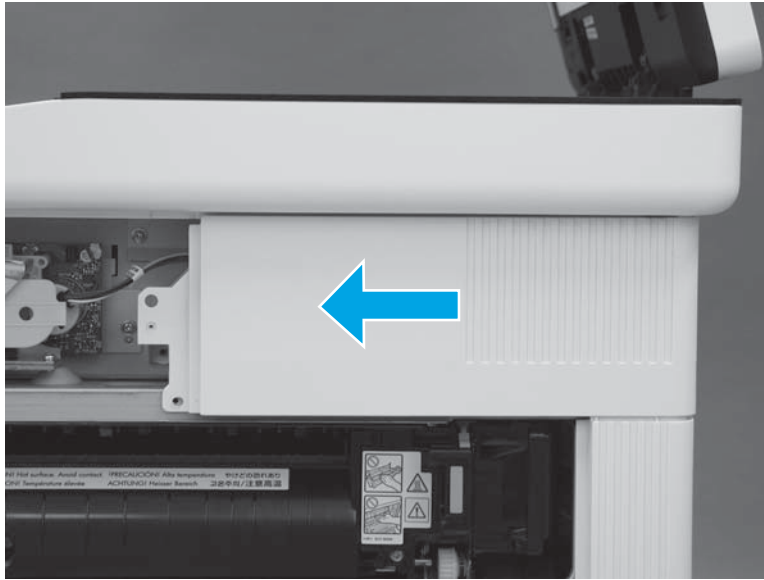

4. At the back of the printer, install one screw (callout 1).

M577c/f/z only: Connect one connector (callout 2), if the integrated scanner assembly is installed.

TIP: This screw is smaller than the screws installed in the next step. Make sure that this screw is installed in the correct position.

Figure 1-1272 Install one screw and connector

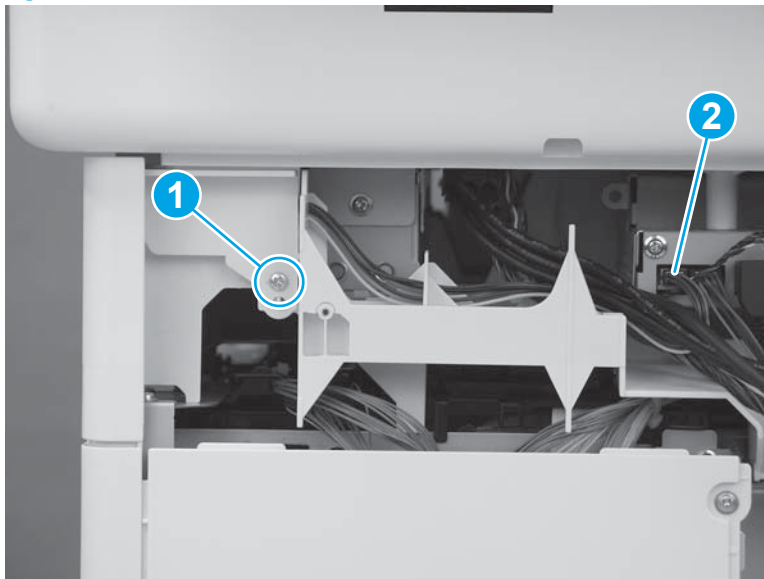

5. At the right side of the printer, install two screws (callout 1).
M577c/f/z only: Connect one connector (callout 2), if the stapler is installed.

Figure 1-1273 Install one screw and connector

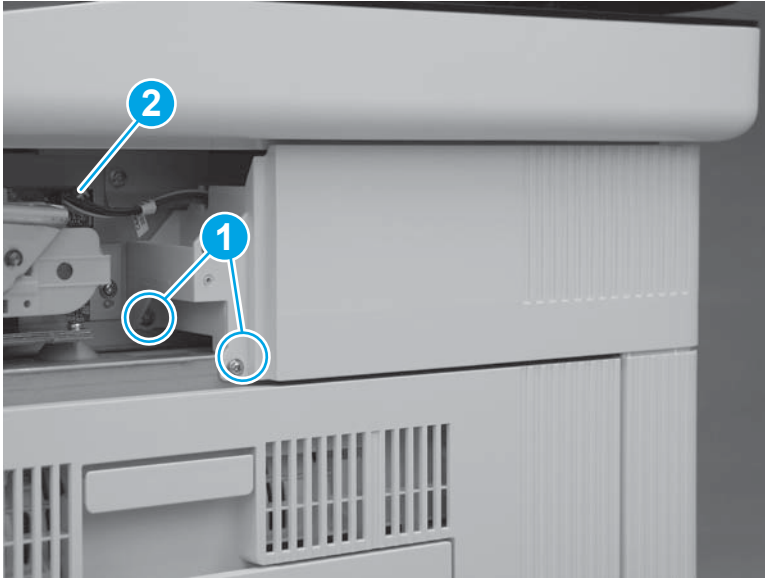

Step 25: Install the stapler unit (M577f and M577z)

 **NOTE:** This step is for the M577f and M577z models only. For the M577dn model, skip this step and go to [Step 26: Install the integrated scanner assembly \(M577\) on page 735](#).

For the M552 and M553 models, skip this step and go to [Step 31: Install the upper cover \(M553\) on page 745](#).

1. Position the hooks (callout 1) on the stapler unit in the slots (callout 2) in the printer.

Figure 1-1274 Position the hooks in the slots

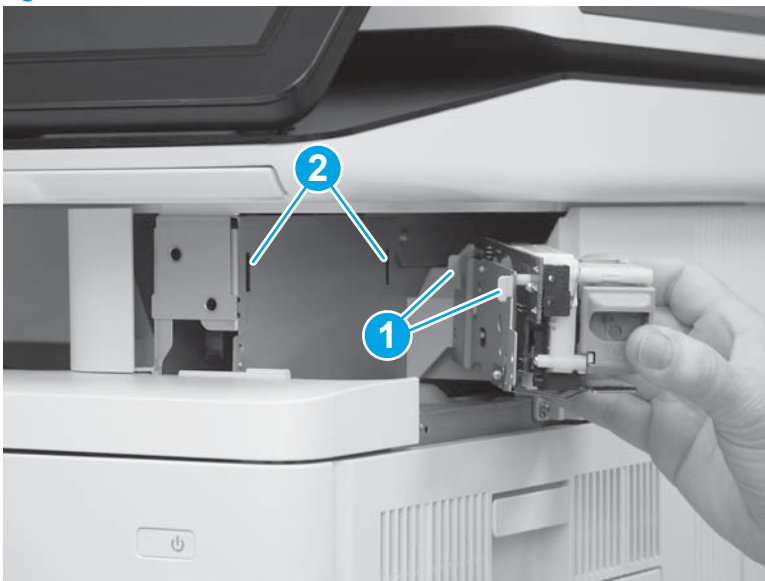

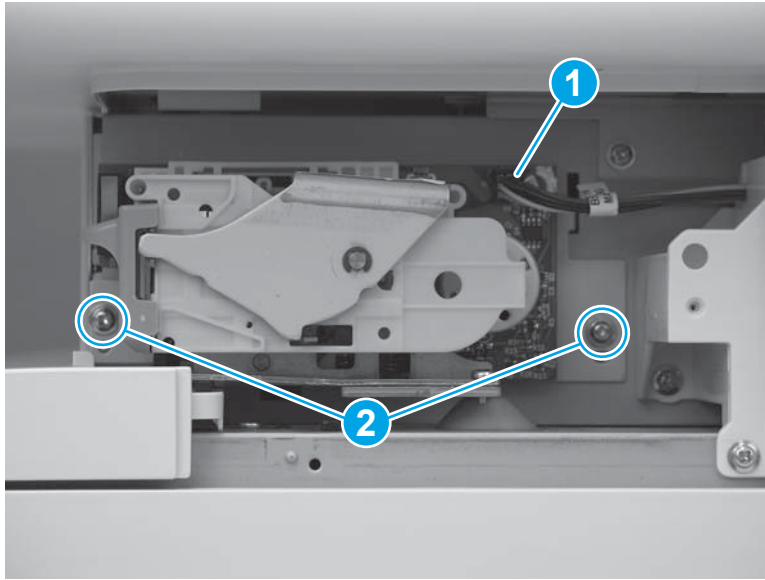

2. Connect one connector (callout 1), and then install two screws (callout 2).

Figure 1-1275 Connect connector and install screws



Step 26: Install the integrated scanner assembly (M577)

 **NOTE:** This step is for the M577 models. For the M552 and M553 models, skip this step and go to [Step 31: Install the upper cover \(M553\) on page 745](#).

 **NOTE:** The ISA includes the document feeder, image scanner, scanner control board (SCB), control panel, keyboard (M577c/z) and NFC PCA (M577z).

1. Before proceeding, locate the mounting pins (callout 1) on the bottom of the ISA and the slots (callout 2) on the printer base.

Figure 1-1276 Locate the ISA mounting pins and slots

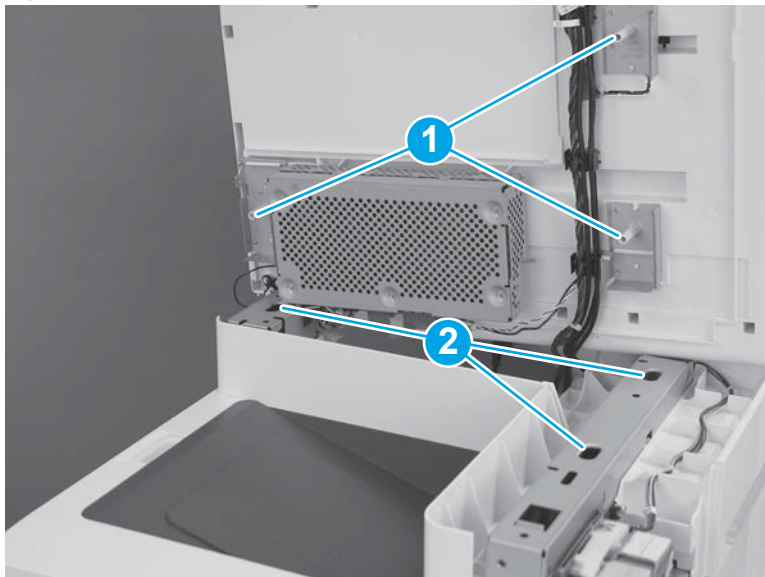

2. Position the ISA on the printer base with the pins in the slots.

 **NOTE:** To locate the pins and slots, see [Figure 1-395 Locate the ISA mounting pins and slots on page 249.](#)

Figure 1-1277 Install the ISA

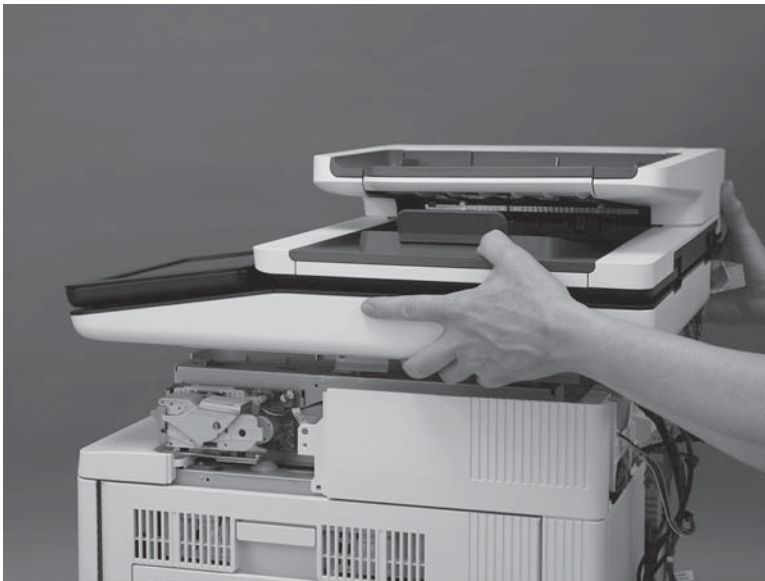

3. Slightly slide the ISA towards the front of the printer to engage it.

Figure 1-1278 Slide the ISA towards the front of the printer

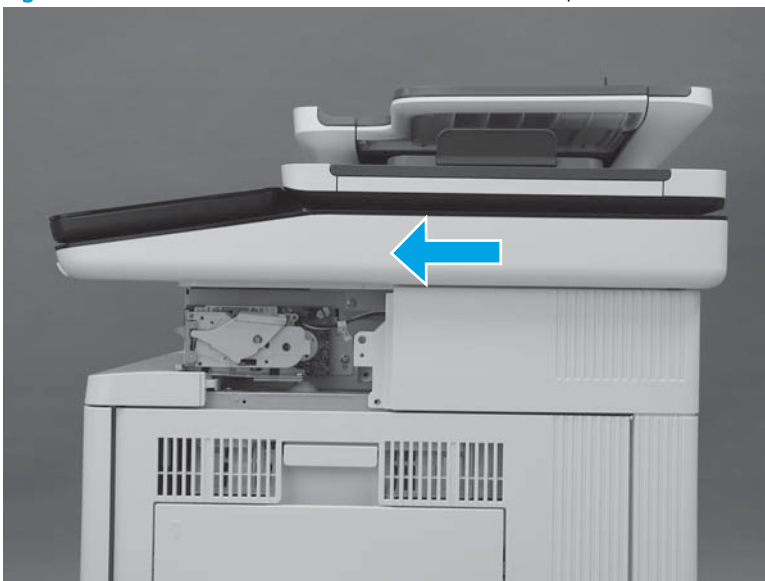

4. At the left side of the printer, install one screw (callout 1).

Figure 1-1279 Install one screw

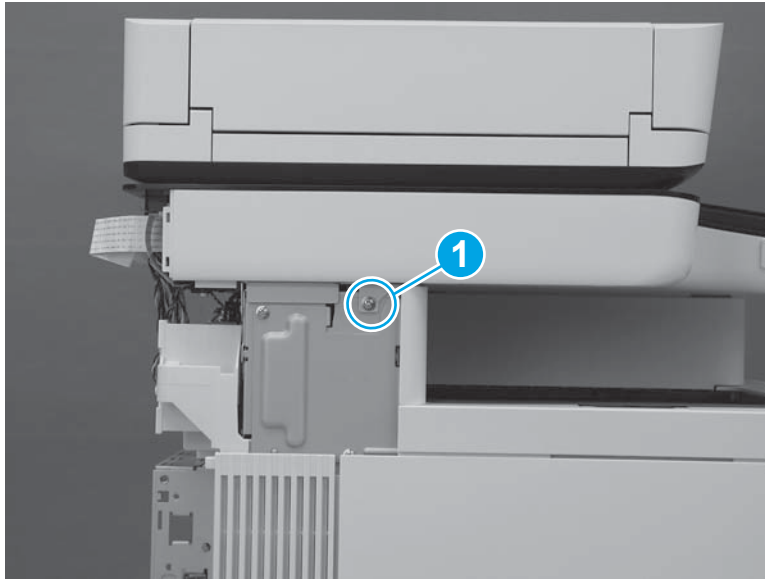

5. At the back of the printer, install two screws (callout 1).

Figure 1-1280 Install two screws

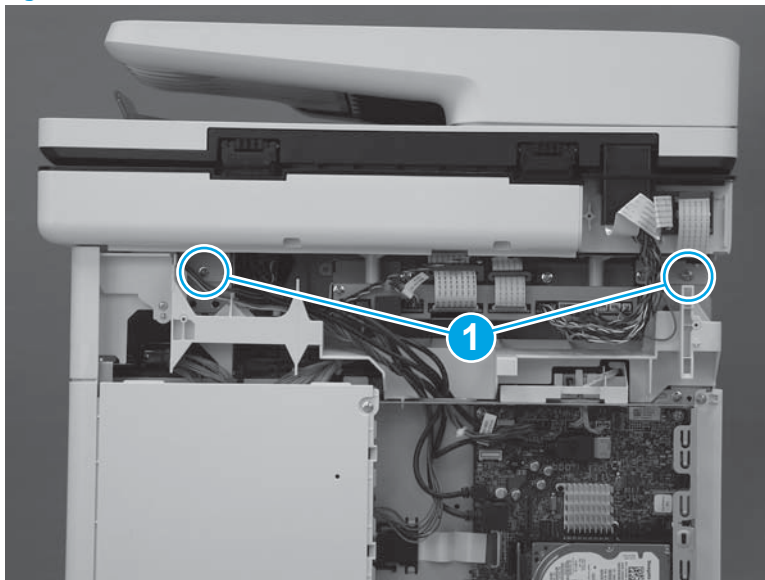

6. At the right side of the printer, install one screw (callout 1).

Figure 1-1281 Install one screw

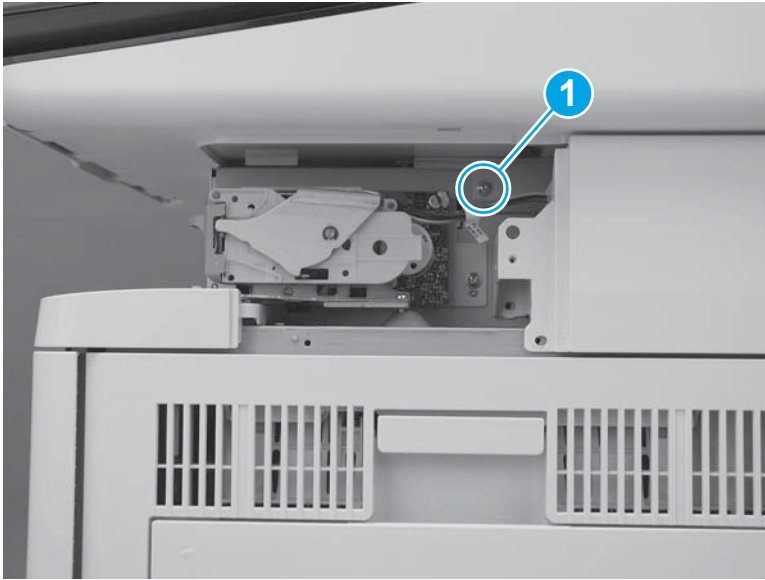

7. Connect two connectors on the scanner control board (callout 1).

M577c/f/z only: Connect one connector for the stapler on the scanner control board (callout 2).

Figure 1-1282 Connect connectors

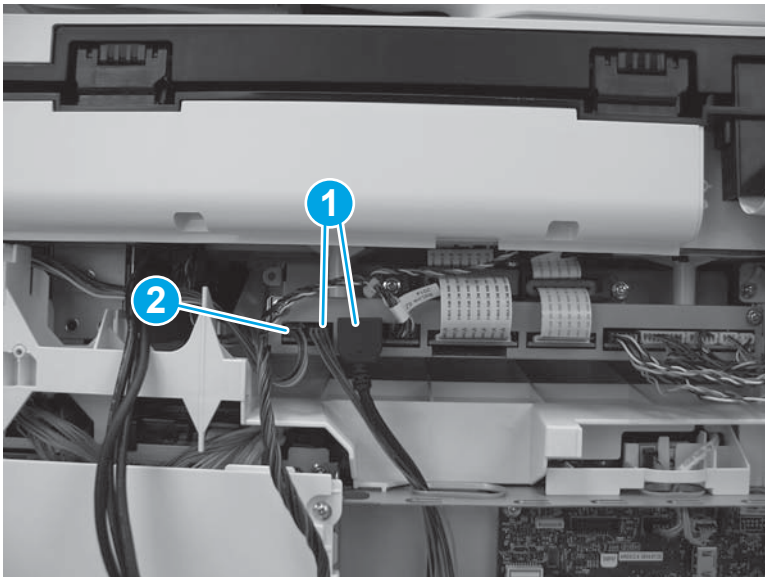

8. Install the wire harness and cables (callout 1) in the retainers (callout 2). Pass them through the opening in the top of the formatter cover (callout 3), and then connect four connectors (callout 4) on the formatter.

Figure 1-1283 Connect four connectors

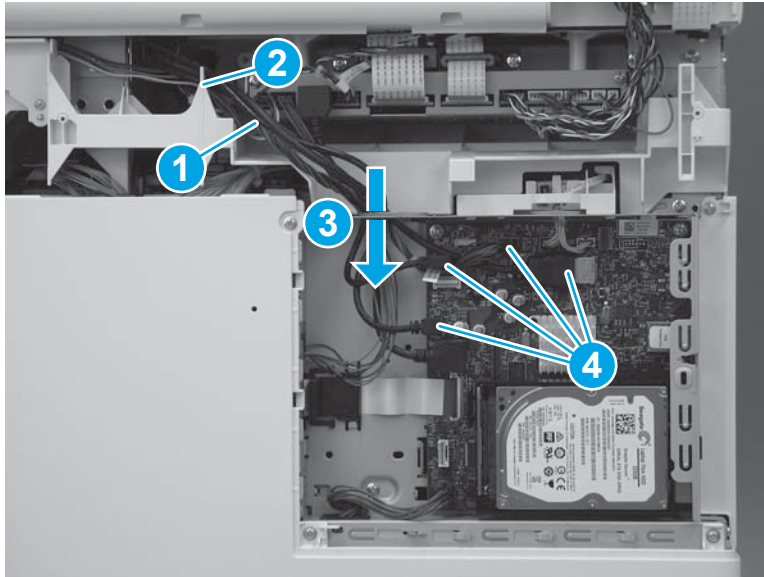

Step 27: Install the stapler cover assembly (M577c/f/z)

 **NOTE:** This step is for the M577c/f/z models only. For the M577dn model, skip this step and go to [Step 28: Install the right front upper cover \(M577dn\) on page 740](#).

For the M552 and M553 models, skip this step and go to [Step 31: Install the upper cover \(M553\) on page 745](#).

1. Install the tabs (callout 1) on the cover in the slots (callout 2) in the printer.

Figure 1-1284 Install two tabs



2. Press the cover toward the left side of the printer until it snaps into place.

Figure 1-1285 Install the cover assembly



3. Install one screw (callout 1).



 **IMPORTANT:** This is a self-tapping screw for plastic. Rotate it counterclockwise to align it with the existing thread pattern, and then carefully turn it clockwise to tighten. Do not overtighten. This will prevent stripping the threads inside the screw hole.

Figure 1-1286 Install one screw

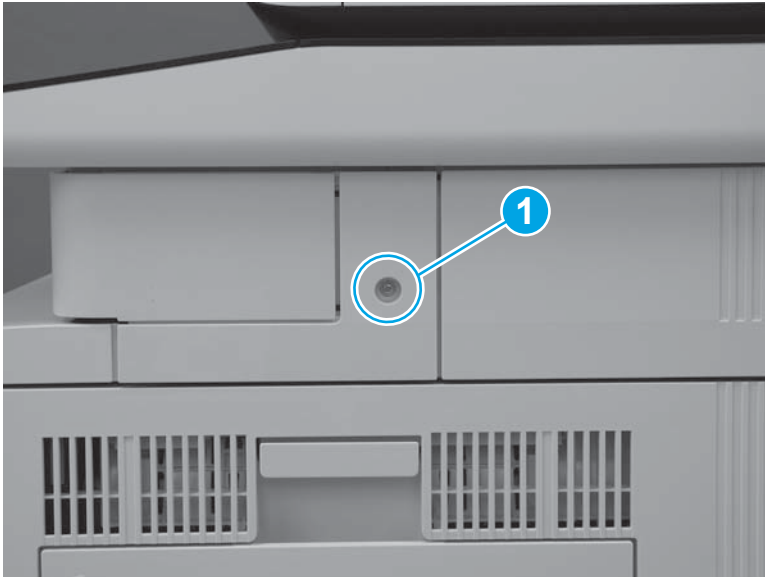

Step 28: Install the right front upper cover (M577dn)

 **NOTE:** This step is for the M577dn model only. For the M577c/f/z models, skip this step and go to [Step 29: Install the left upper cover \(M577\) on page 742](#).

For the M552 and M553 models, skip this step and go to [Step 31: Install the upper cover \(M553\) on page 745](#).

1. Slide the cover toward the left side of the printer to install it. Make sure that the slots (callout 1) in the cover fit over the tabs (callout 2) on the inside of the paper feeder cover.

Figure 1-1287 Install the cover

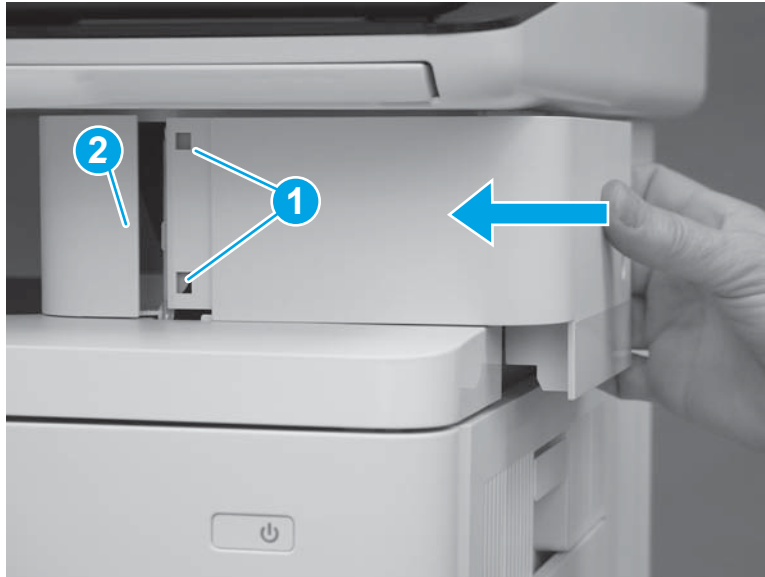

2. Press the right front upper cover (callout 1) and the paper feeder cover (callout 2) together until the tabs on the inside of the covers snap into place.

Figure 1-1288 Press the cover



3. Install one screw (callout 1).

Figure 1-1289 Install one screw

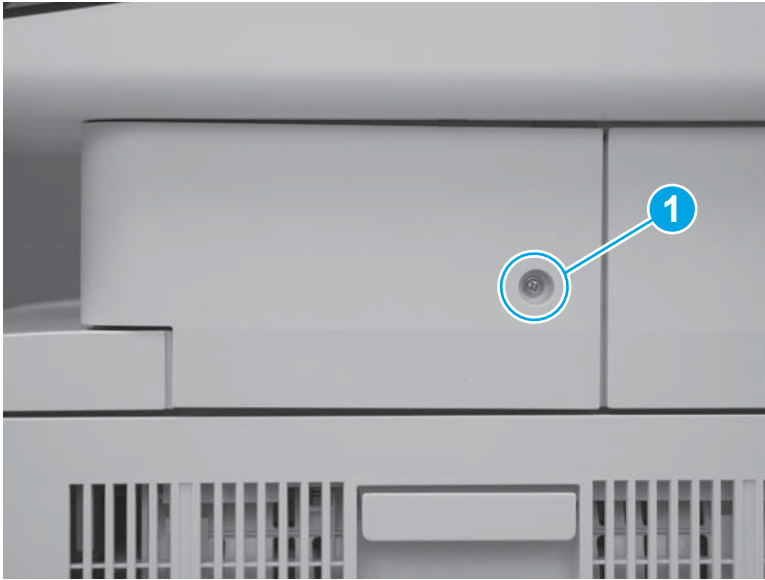

Step 29: Install the left upper cover (M577)

 **NOTE:** This step is for the M577 models. For the M552 and M553 models, skip this step and go to [Step 31: Install the upper cover \(M553\) on page 745](#).

1. Position the tab (callout 1) on the lower edge of the cover behind the left cover (callout 2).

Figure 1-1290 Position the tab

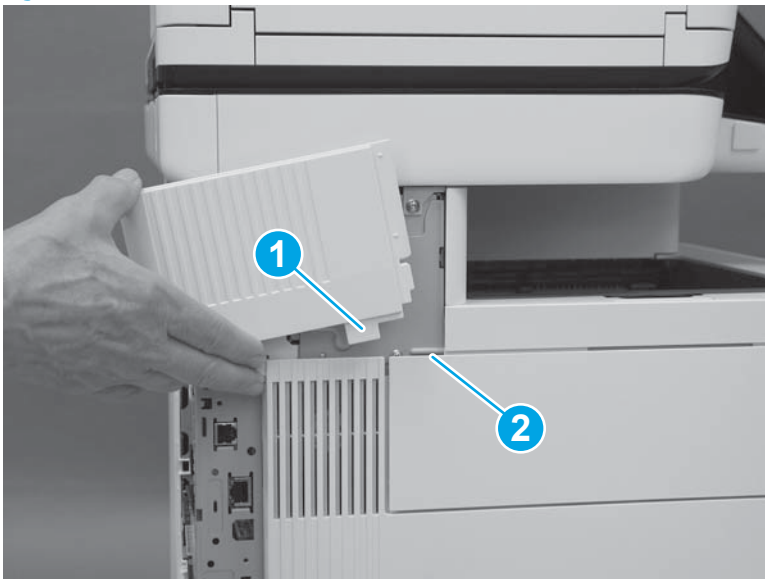

2. Slide the cover toward the front of the printer to install it. Make sure that the edge (callout 1) of the cover fits behind the edge (callout 2) of the top rear cover.

Figure 1-1291 Slide the cover

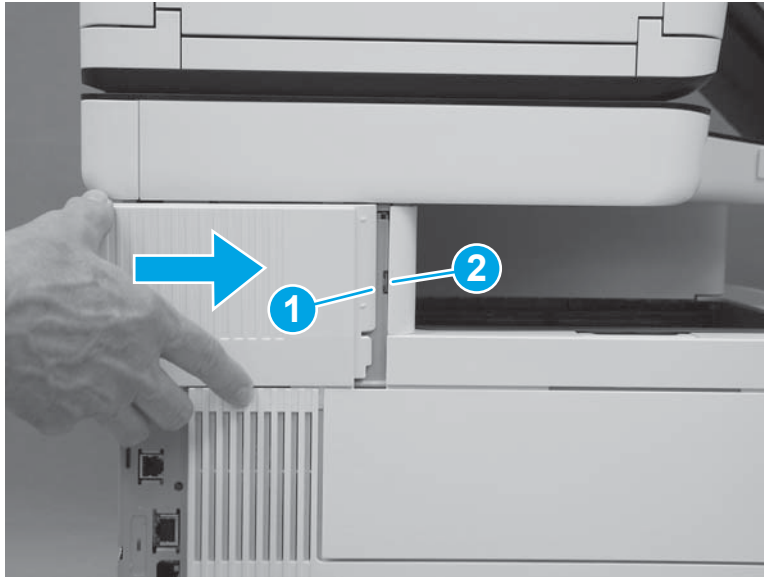

3. Make sure that the tab (callout 1) is fully installed.

Figure 1-1292 Check the tab

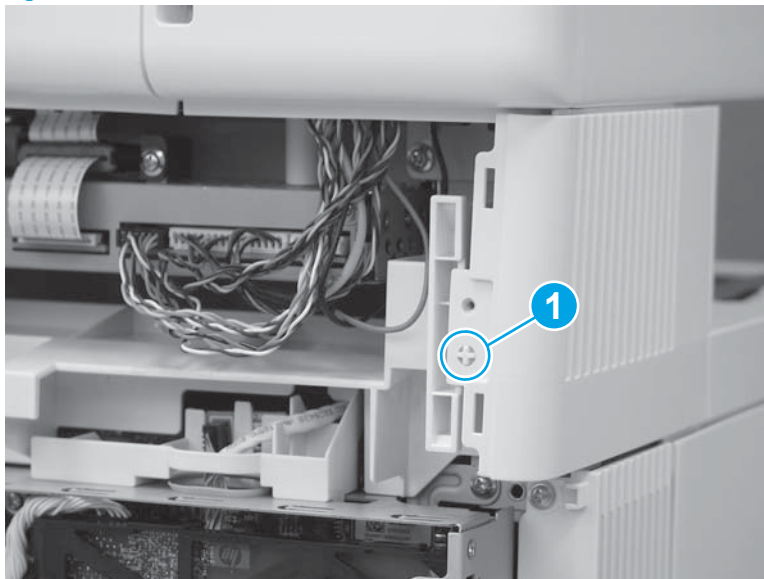

Step 30: Install the rear upper cover (M577)

 **NOTE:** This step is for the M577 models. For the M552 and M553 models, skip this step and go to [Step 31: Install the upper cover \(M553\) on page 745](#).

1. Align the ridge (callout 1) on the lower edge of the rear upper cover in front of the tabs (callout 2) on the top edge of the rear cover.

Figure 1-1293 Align the cover

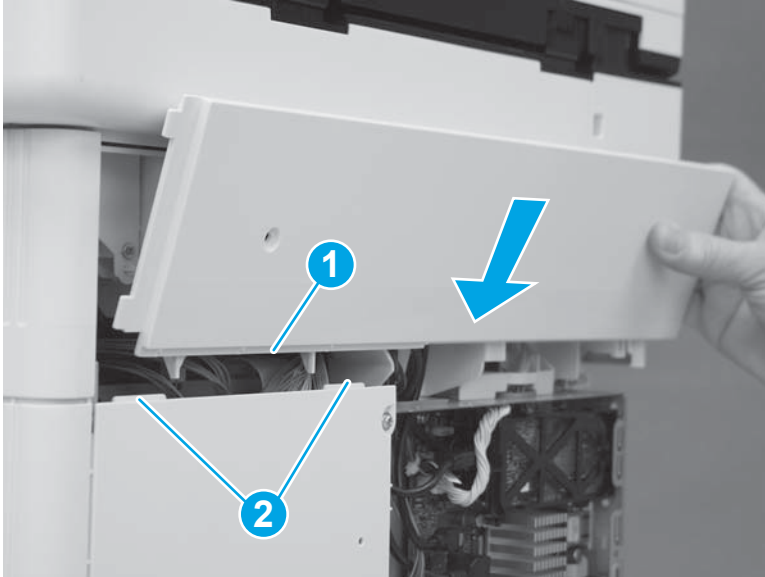

2. Rotate the top of the cover toward the printer.

Figure 1-1294 Rotate the top of the cover

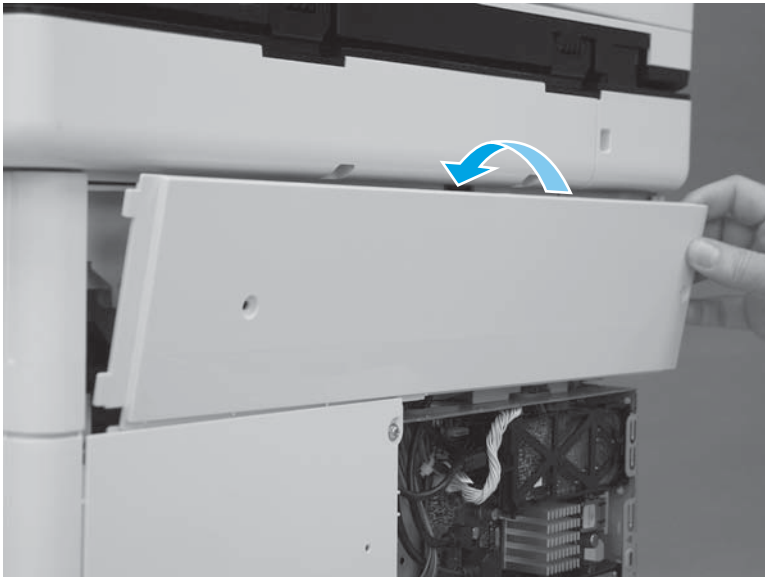

3. Slide the cover to the left (callout 1). Make sure that the tabs (callout 2) on the upper rear cover slide behind the edge (callout 3) of the right upper cover. Make sure that the cover is fully seated.

Figure 1-1295 Slide the cover

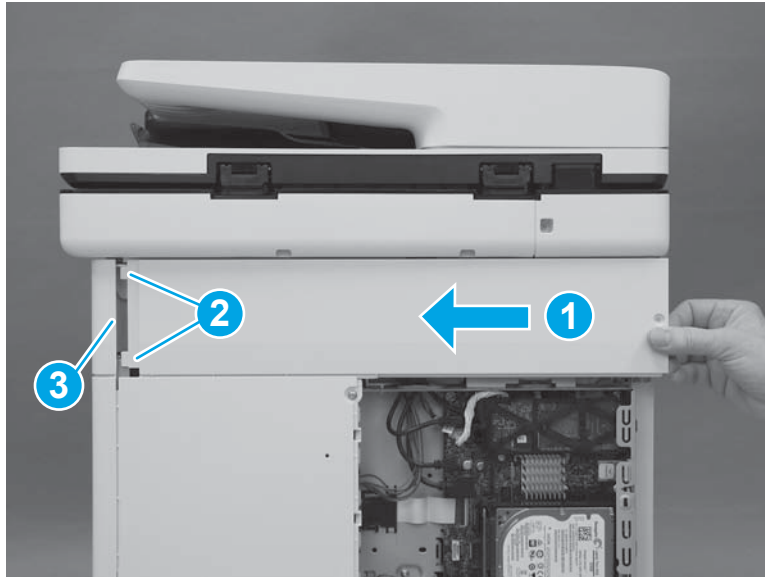

4. Install two screws (callout 1).



 **IMPORTANT:** These two screws are self-tapping screws for plastic. Rotate them counterclockwise to align them with the existing thread pattern, and then carefully turn them clockwise to tighten. Do not overtighten. This will prevent stripping the threads inside the screw holes.

Figure 1-1296 Install two screws

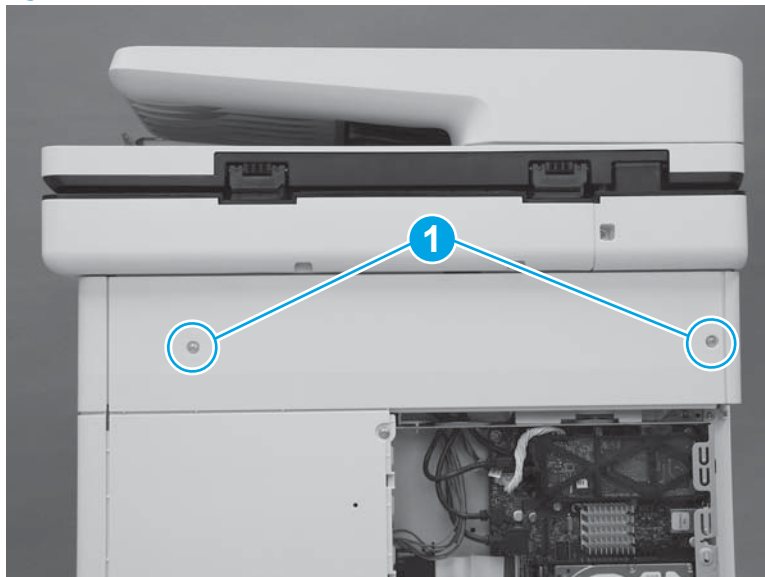

Step 31: Install the upper cover (M553)

 **NOTE:** This step is for the M552 and M553 models. For the M577 models, skip this step and go to [Step 36: Install the TCU on page 754](#).

1. Position the cover on the printer.

 **NOTE:** For the M553x model, do not forget to pass the control-panel wire harness and USB cable through the opening in the cover.

Figure 1-1297 Install the cover



2. Push down on the rear corner of the cover to engage one tab (callout 1).

Figure 1-1298 Engage one tab

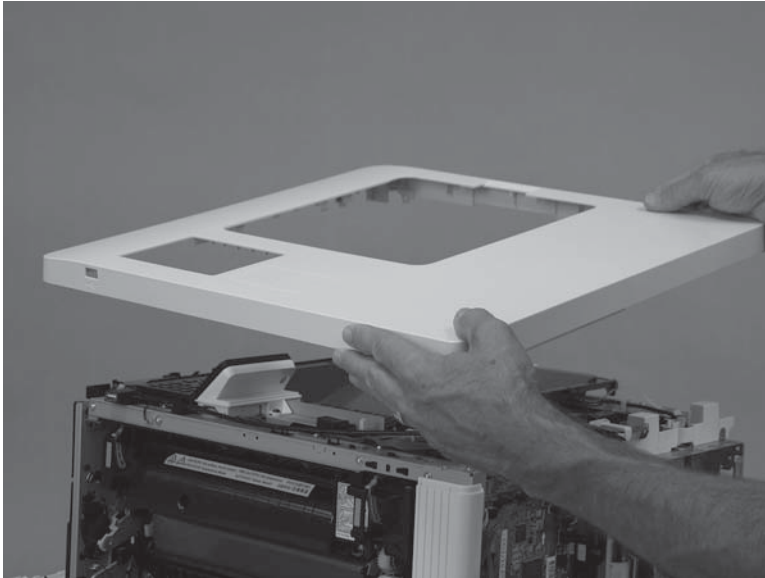
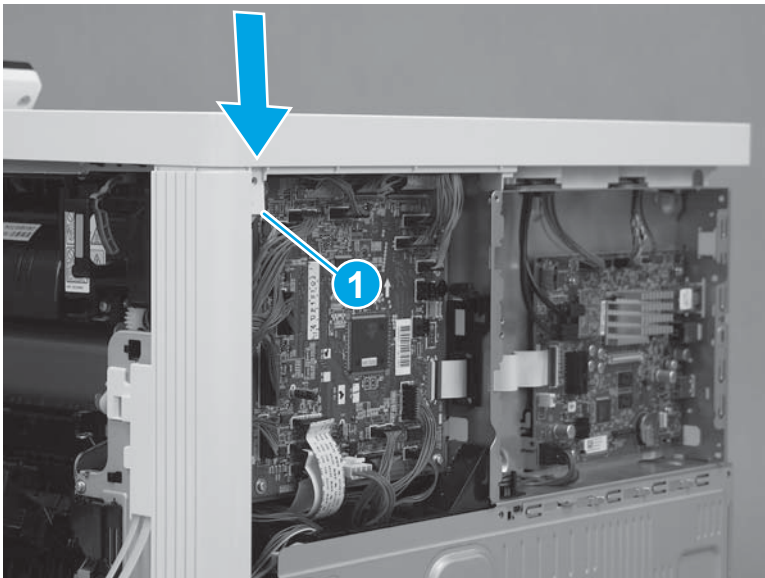

3. Push down on the front corner of the cover to engage one tab (callout 1), and then install one screw (callout 2).

 **NOTE:** This is a self-tapping plastic-thread screw. Make sure that this screw is used in this location when it is reinstalled.

Figure 1-1299 Engage one tab and install one screw



4. Install three screws (callout 1).

Figure 1-1300 Install three screws

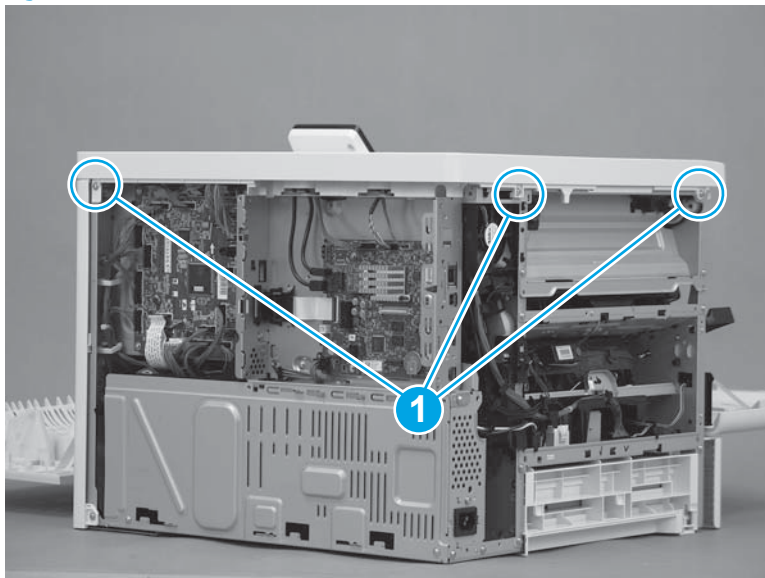

Step 32: Install the left cover (M553)

 **NOTE:** This step is for the M552 and M553 models. For the M577 models, skip this step and go to [Step 36: Install the TCU on page 754](#).

1. Position the cover on the printer.

 **NOTE:** Slightly offset the cover toward the rear of the printer.

Figure 1-1301 Install the cover

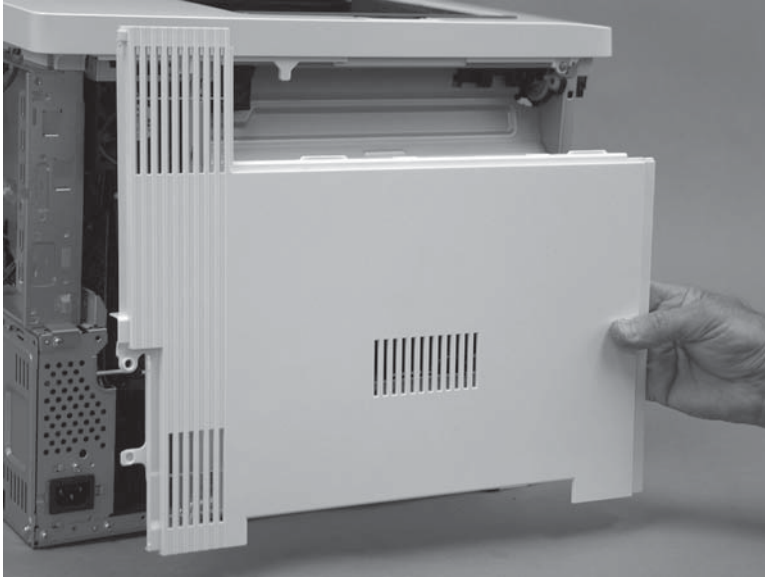

2. Slide the cover (callout 1) toward the front of the printer to engage it. Make sure that the tab (callout 2) snaps into place.

 **NOTE:** Locate the alignment pin (callout 3) on the cover from the front door side of the printer, and then make sure that it is fully engaged in the slot in the chassis.

 **TIP:** While sliding the cover into place, push in on the center of the cover (callout 1) to make sure that the hooks on the back of the cover engage with the slots in the chassis.

Figure 1-1302 Engage the cover



3. At the left side of the printer, install one screw (callout 1).

Figure 1-1303 Install one screw

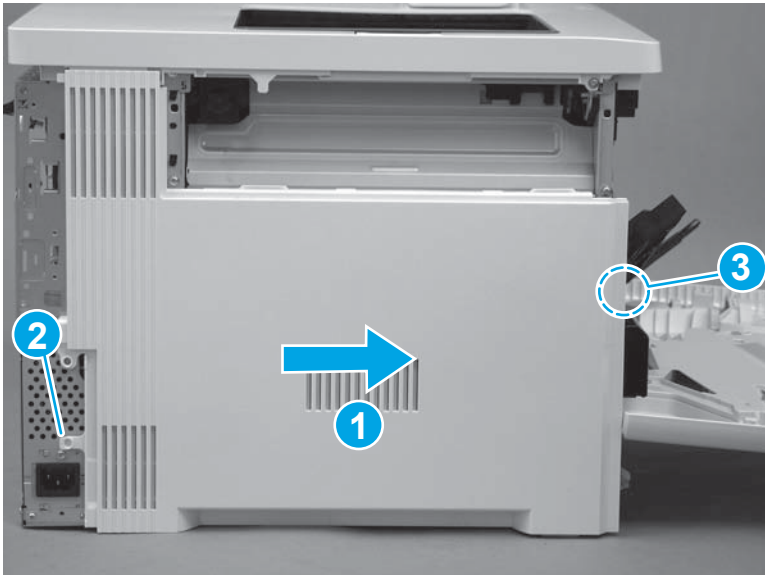
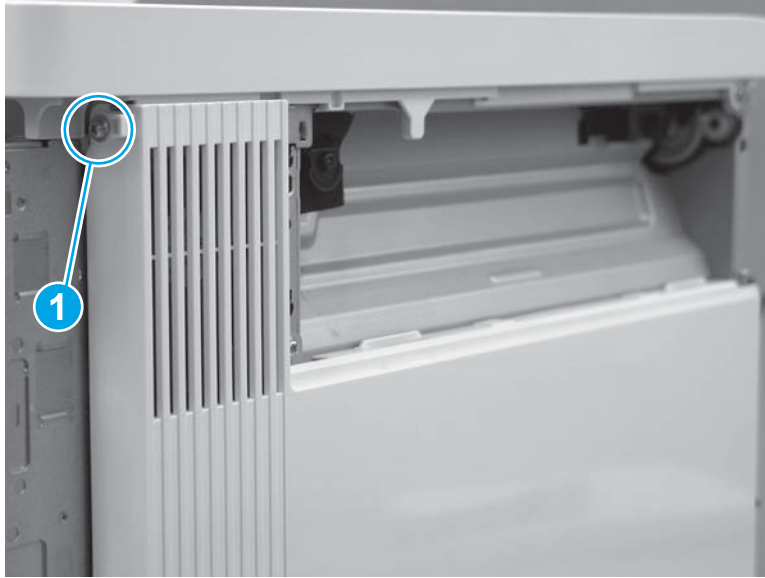

Step 33: Install the rear cover (M553)

 **NOTE:** This step is for the M552 and M553 models. For the M577 models, skip this step and go to [Step 36: Install the TCU on page 754.](#)

1. Position the top of the cover under the upper cover (callout 1), rotate the bottom of the cover onto the chassis (callout 2), and then slide the cover to the left (callout 3) to install it.

Figure 1-1304 Install the cover

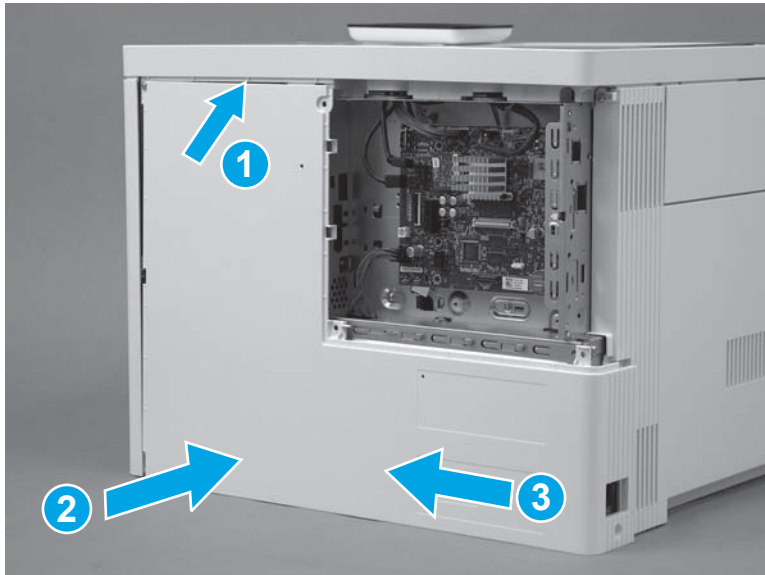

2. Install four screws (callout 1).

Figure 1-1305 Install four screws cover

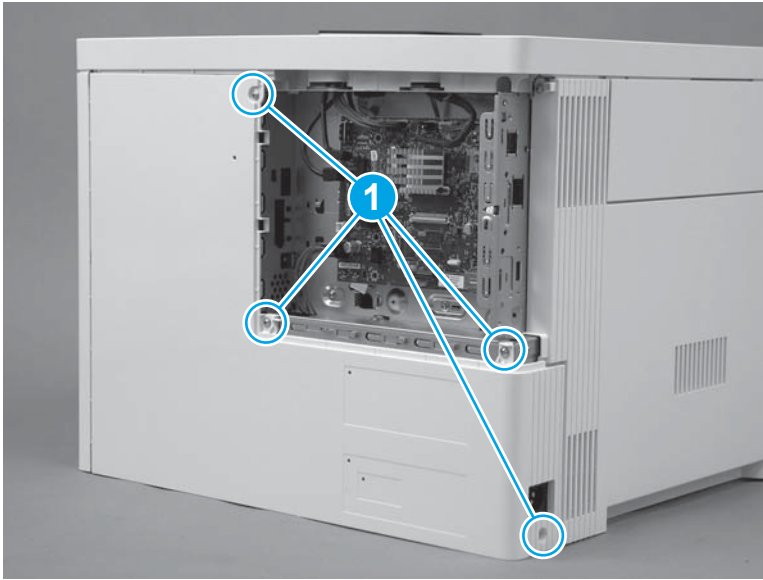

Step 34: Install the control-panel (M553x only)



NOTE: For the M553n/dn and M552dn models, skip this step and go to [Step 35: Install the USB cover \(M553\) on page 753](#).

For the M577 models, skip this step and go to [Step 36: Install the TCU on page 754](#).

1. Place the control panel on the printer as shown.

Figure 1-1306 Place the control panel on the product

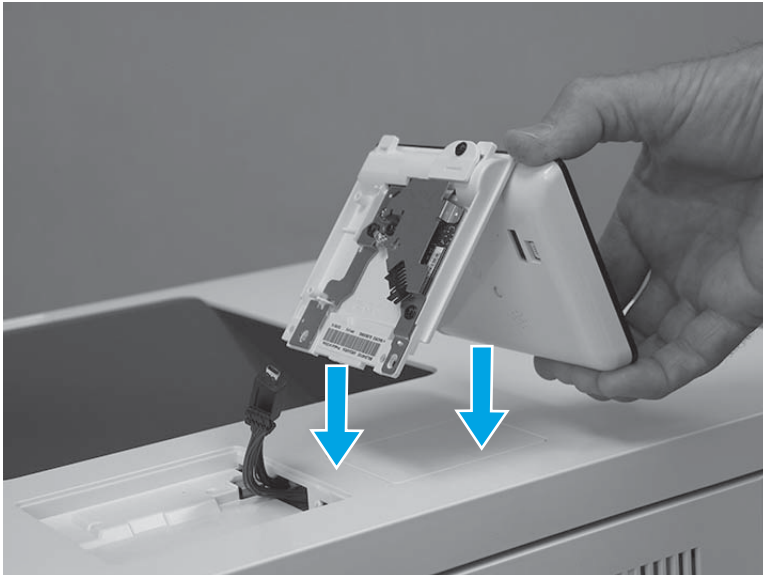

2. Connect one USB cable (callout 1), and one connector (callout 2).

 **IMPORTANT:** Take note of the location of the two mounting tabs (callout 3) on the control-panel assembly.

Figure 1-1307 Connect two connectors



3. Turn the control panel over, and then position the front edge tabs in the slots in the top cover.

Figure 1-1308 Turn the control panel over

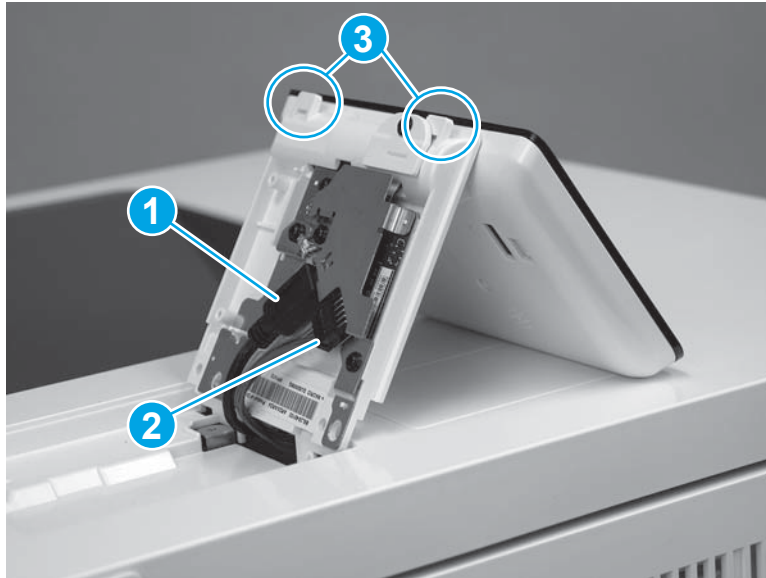
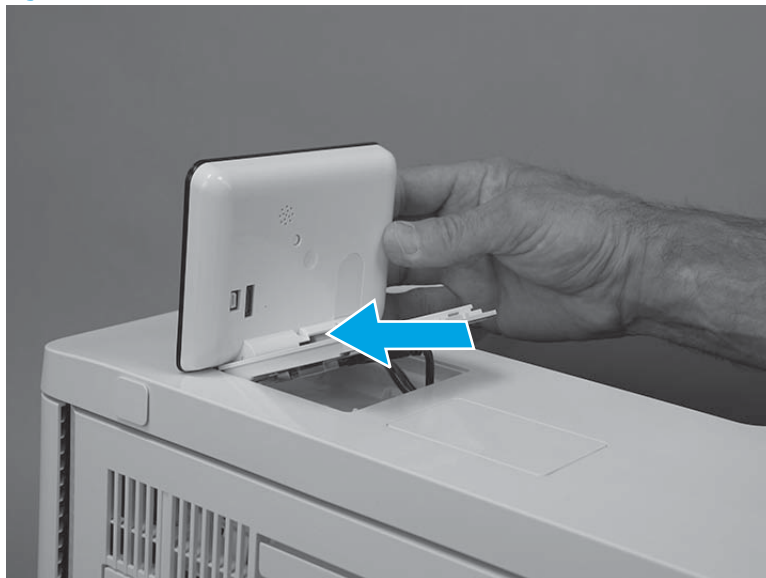

4. Rotate the control-panel base down onto the printer.

Figure 1-1309 Rotate the control-panel base down



5. Use a small Phillips screwdriver to install two screws (callout 1).

Figure 1-1310 Install two screws

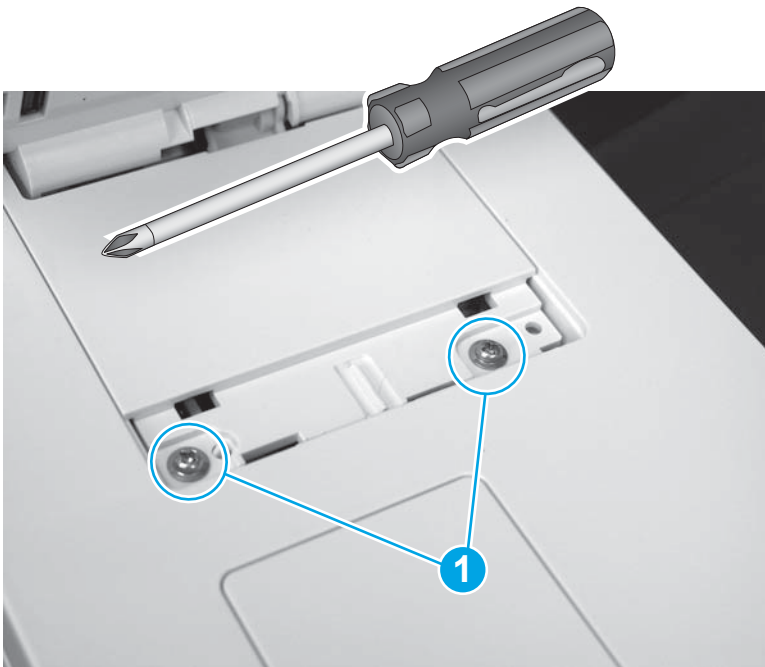

6. Position the screw cover mounting feet into the slots in the top cover (callout 1), and then rotate the cover down (callout 2) to install it.

 **NOTE:** Press down on the cover firmly to make sure that the tabs on the cover (callout 3) snap into place.

Figure 1-1311 Install the cover

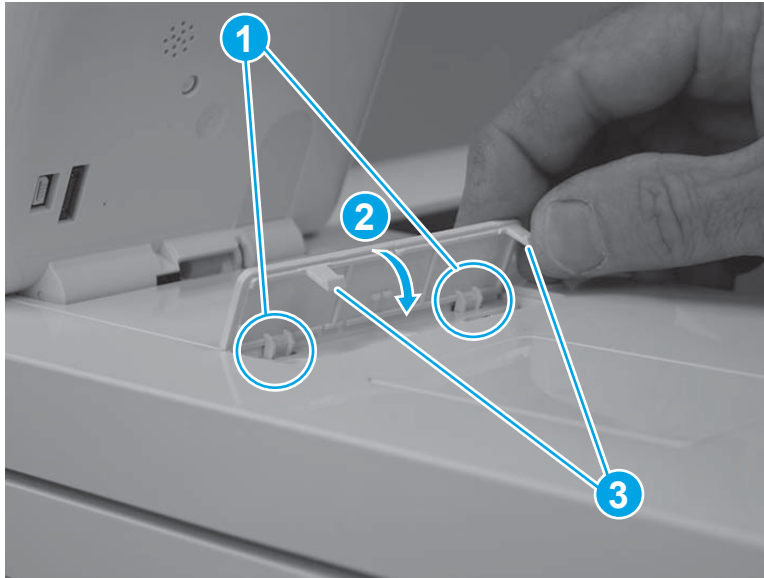

Step 35: Install the USB cover (M553)

 **NOTE:** This step is for the M552 and M553 models. For the M577 models, skip this step and go to [Step 36: Install the TCU on page 754](#).

1. Push the cover into the USB port to install it.

Figure 1-1312 Install the cover



2. Make sure that the USB cover is fully seated after installing it.

Figure 1-1313 Check the installation

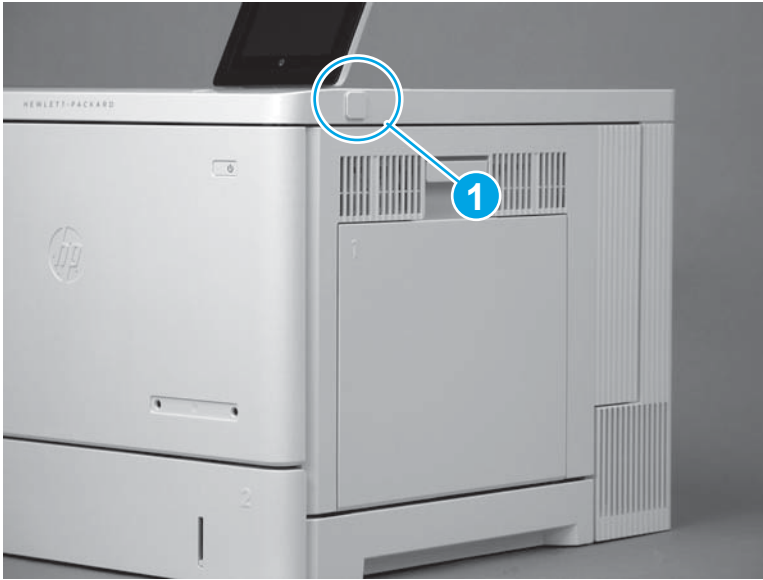

Step 36: Install the TCU

1. Verify that the toner collection hatch cover is in the closed position on the TCU.

Figure 1-1314 Verify that the toner collection hatch cover is closed

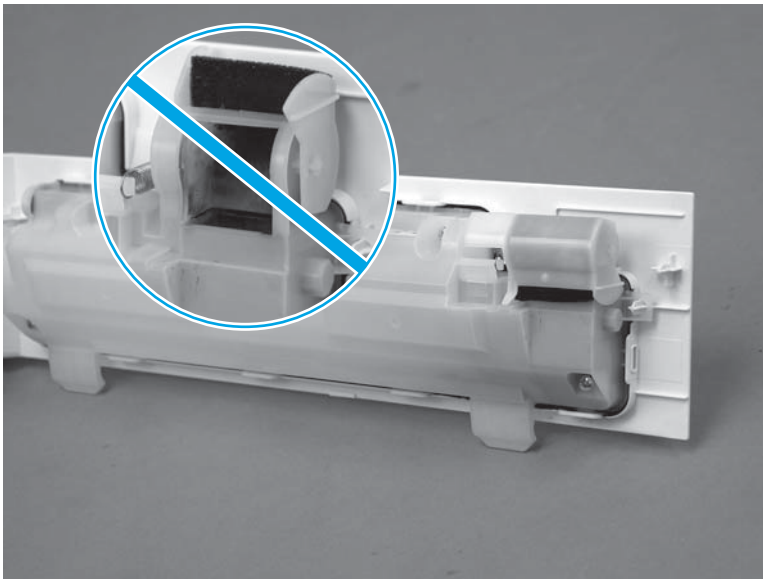

2. Position the TCU with the hinges in the slots provided in the printer (callout 1), and then rotate the TCU up and into the closed position.

 **NOTE:** The toner collection hatch cover automatically opens when the TCU is closed.

Figure 1-1315 Install the TCU



3. Close the front door.

Figure 1-1316 Close the front door

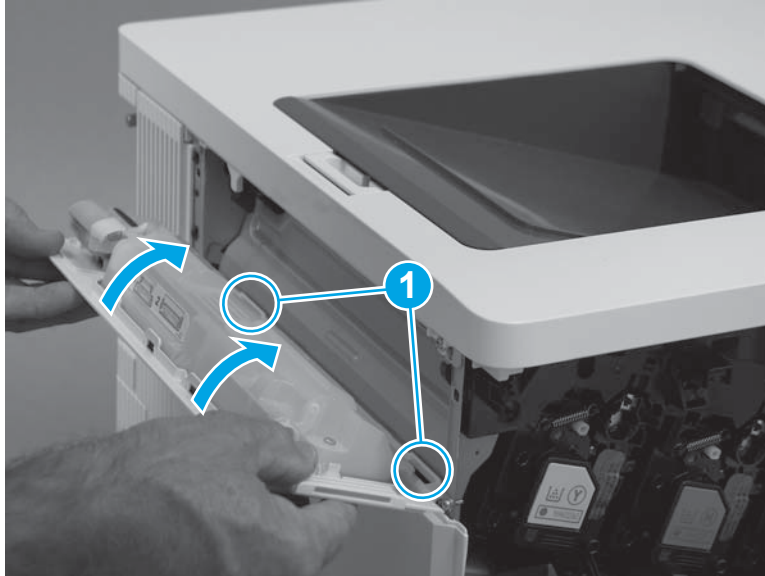

Step 37: Install the formatter cover

- ▲ Slide the cover onto the printer (callout 1) to install it.

 **NOTE:** Make sure that the tabs on the formatter cover align with the slots provided in the printer (callout 2). Tighten the two thumbscrews (callout 3).

 **TIP:** If needed, use the edge of a coin to turn the thumbscrews.

Figure 1-1317 Install the cover

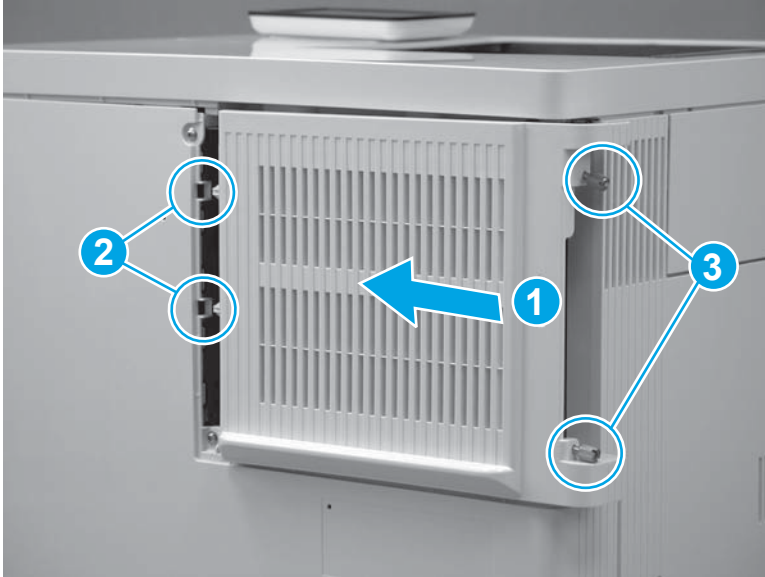

Removal and replacement: Stapler unit (M577c/f/z)

- [Introduction](#)
- [Step 1: Remove the staple cartridge](#)
- [Step 2: Remove the stapler cover assembly](#)
- [Step 3: Remove the stapler unit](#)
- [Step 4: Unpack the replacement assembly](#)
- [Step 5: Install the stapler unit](#)
- [Step 6: Install the stapler cover assembly](#)
- [Step 7: Install the staple cartridge](#)

Introduction

This document provides the procedures to remove and replace the M577 stapler unit.

Before performing service

Turn the printer power off

- Disconnect the power cable.

⚠ WARNING! To avoid damage to the printer, turn the printer off, wait 30 seconds, and then remove the power cord before attempting to service the printer.

Use the table below to identify the correct part number for your printer. To order the part, go to www.hp.com/buy/parts.

Stapler unit part number	
B5L46-60102	Stapler unit

Required tools

- #2 Phillips screwdriver with a magnetic tip

After performing service

Make sure that the rear upper cover is fully seated after replacing it.

Turn the printer power on

- Connect the power cable.
- Use the power switch to turn the power on.

Step 1: Remove the staple cartridge

1. Open the stapler door.

Figure 1-1318 Open the stapler door



2. Pull the staple cartridge straight out of the printer to remove it.

Figure 1-1319 Remove the staple cartridge



3. Close the stapler door.

Figure 1-1320 Close the stapler door



Step 2: Remove the stapler cover assembly

1. Remove one screw (callout 1).

 **Reinstallation tip:** This is a self-tapping screw for plastic. When reinstalling, rotate the screw counterclockwise to align it with the existing thread pattern, and then carefully turn it clockwise to tighten. Do not overtighten. This will prevent stripping the threads inside the screw hole.

Figure 1-1321 Remove one screw



2. Release two tabs at the front edge of the cover (callout 1).

Figure 1-1322 Release two tabs

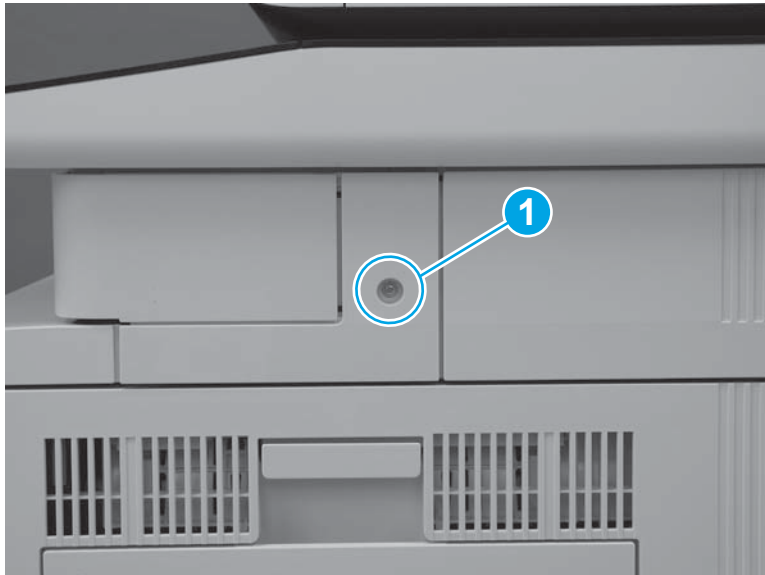

3. Release the back edge of the cover.

Figure 1-1323 Release the back edge of the cover



4. Rotate the cover away from the printer to remove it.

Figure 1-1324 Remove the cover



Step 3: Remove the stapler unit

1. Disconnect one connector (callout 1), and then remove two screws (callout 2).

Figure 1-1325 Disconnect connector and remove screws

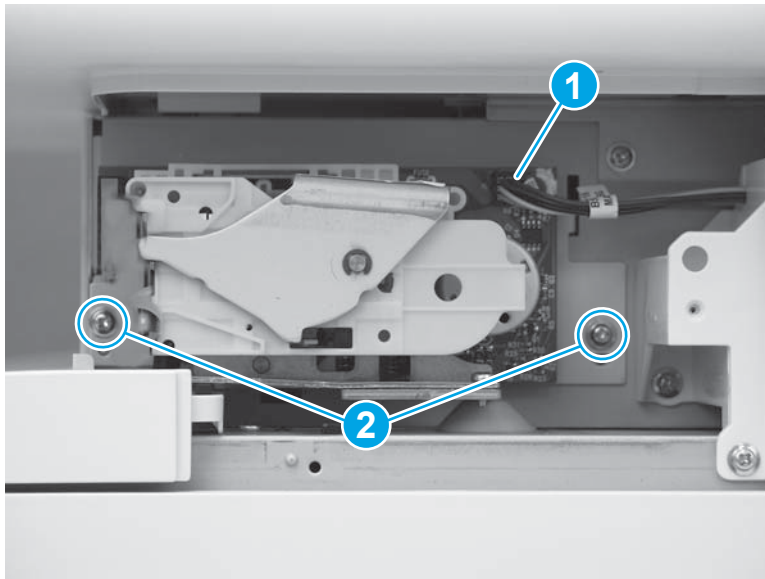

2. Slide the stapler unit up (callout 1), and then pull it away from the printer (callout 2) to remove it.

Figure 1-1326 Remove the stapler unit

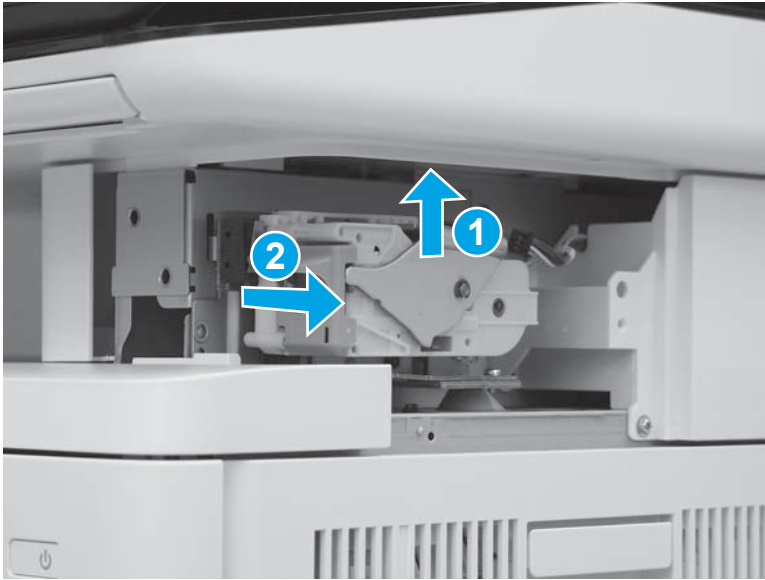

Step 4: Unpack the replacement assembly

Unpack the replacement assembly from the packaging.

For complete information on HP's recycling programs, go to [Product return and recycling](#).

 **NOTE:** HP recommends responsible disposal of the defective part.

Figure 1-1327 Recycle and unpack

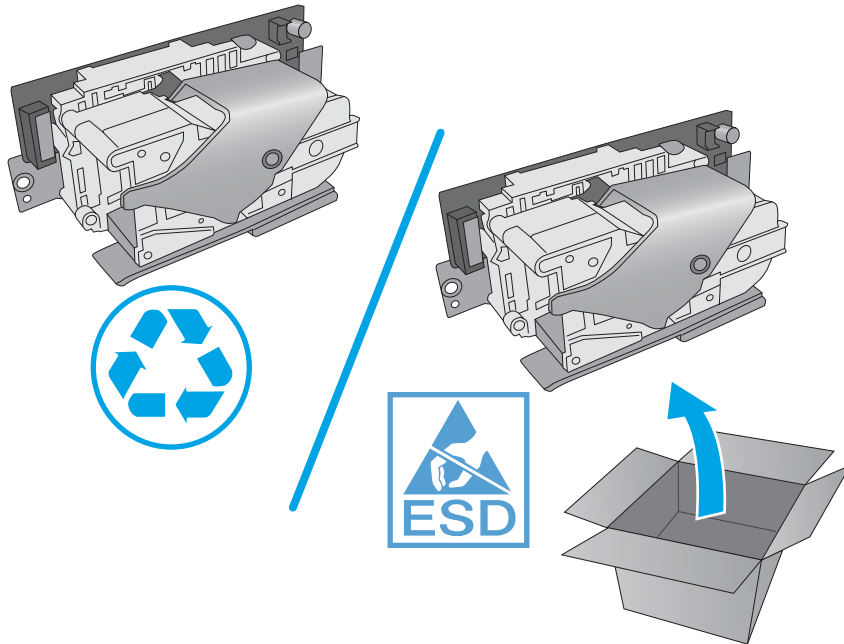

Step 5: Install the stapler unit

1. Position the hooks (callout 1) on the stapler unit in the slots (callout 2) in the printer.

Figure 1-1328 Position the hooks in the slots

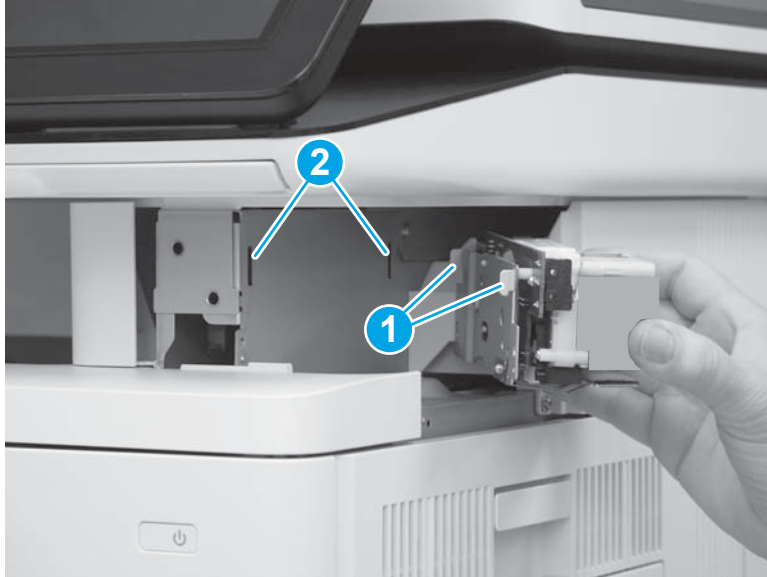

2. Connect one connector (callout 1), and then install two screws (callout 2).

Figure 1-1329 Connect connector and install screws

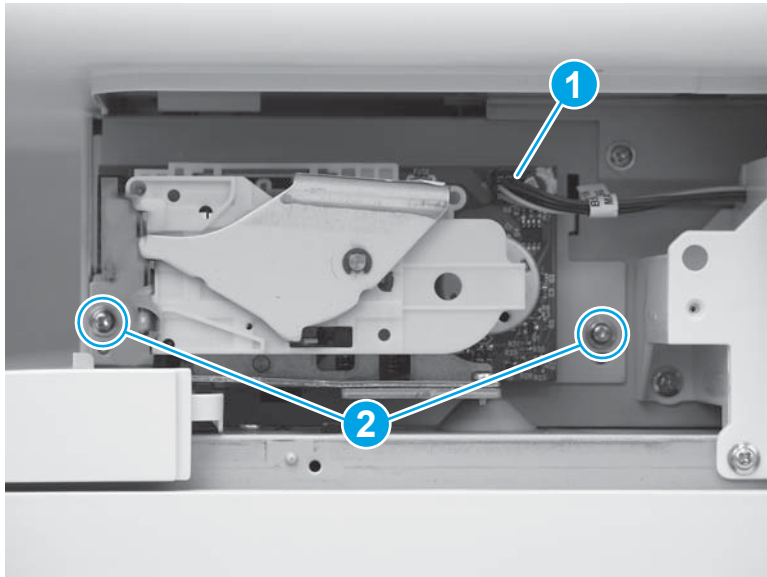

Step 6: Install the stapler cover assembly

1. Install the tabs (callout 1) on the cover in the slots (callout 2) in the printer.

Figure 1-1330 Install two tabs



2. Press the cover toward the left side of the printer until it snaps into place.

Figure 1-1331 Install the cover assembly



3. Install one screw (callout 1).

 **IMPORTANT:** This is a self-tapping screw for plastic. Rotate it counterclockwise to align it with the existing thread pattern, and then carefully turn it clockwise to tighten. Do not overtighten. This will prevent stripping the threads inside the screw hole.

Figure 1-1332 Install one screw



Step 7: Install the staple cartridge

1. Open the stapler door.

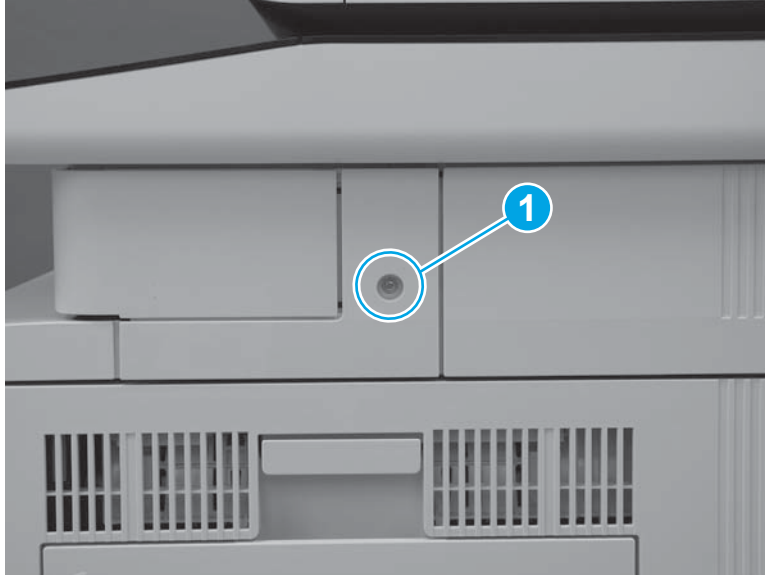
Figure 1-1333 Open the stapler door



2. Push the staple cartridge straight into the printer to install it.

Figure 1-1334 Install the staple cartridge



3. Close the stapler door.

Figure 1-1335 Close the stapler door



Removal and replacement: DC controller

- [Introduction](#)
- [Step 1: Remove the formatter cover](#)
- [Step 2: Remove the rear cover \(M552 and M553\)](#)
- [Step 3: Remove the rear upper cover \(M577\)](#)
- [Step 4: Remove the rear cover \(M577\)](#)
- [Step 5: Remove the DC controller](#)
- [Step 6: Unpack the replacement assembly](#)
- [Step 7: Install the DC controller](#)
- [Step 8: Install the rear cover \(M577\)](#)
- [Step 9: Install the rear upper cover \(M577\)](#)
- [Step 10: Install the rear cover \(M552 and M553\)](#)
- [Step 11: Install the formatter cover](#)

Introduction



This document provides the procedures to remove and replace the DC controller.

Before performing service

Turn the printer power off

- Disconnect the power cable.

 **WARNING!** To avoid damage to the printer, turn the printer off, wait 30 seconds, and then remove the power cord before attempting to service the printer.

 **CAUTION:**  This part contains components that are electrostatic discharge (ESD) sensitive. To reduce the possibility of ESD damage, always touch the sheet-metal chassis to ground yourself before touching an ESD sensitive part.

 **IMPORTANT:** Do not replace the formatter, DC controller, and eMMC PCA or hard-disk drive simultaneously during a single printer servicing. Doing so might cause the printer to become unstable or inoperable.

Use the table below to identify the correct part number for your printer, and then go to <http://h20141.www2.hp.com/hpparts> to order the part.

DC controller part number	
RM2-7186-000CN	DC controller (M552, M553)
RM2-7187-000CN	DC controller (M577)

Required tools

- #2 Phillips screwdriver with a magnetic tip

After performing service

Make sure that all of the connectors on the DC controller are fully seated.

Make sure that the formatter cover is fully seated, and that the thumbscrews are finger tight after replacing it.

Turn the printer power on

- Connect the power cable.
- Use the power switch to turn the power on.

Post service test

Print a configuration page to make sure that the printer is functioning correctly.

Step 1: Remove the formatter cover

1. Locate the formatter cover.

Figure 1-1336 Locate the formatter cover

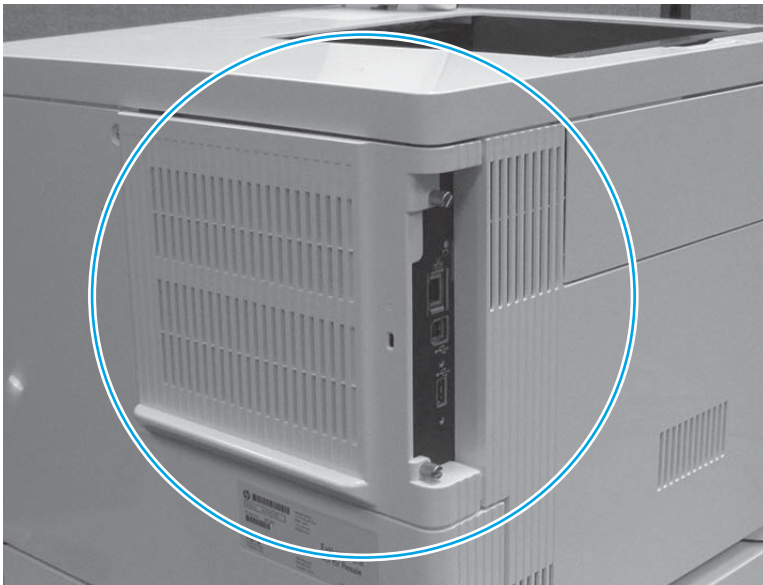

2. Loosen the two thumbscrews (callout 1). Grasp the two thumbscrews, and then slide the cover away from the printer (callout 2) to remove it.

 **TIP:** If needed, use the edge of a coin to turn the thumbscrews.

Figure 1-1337 Loosen the thumbscrews

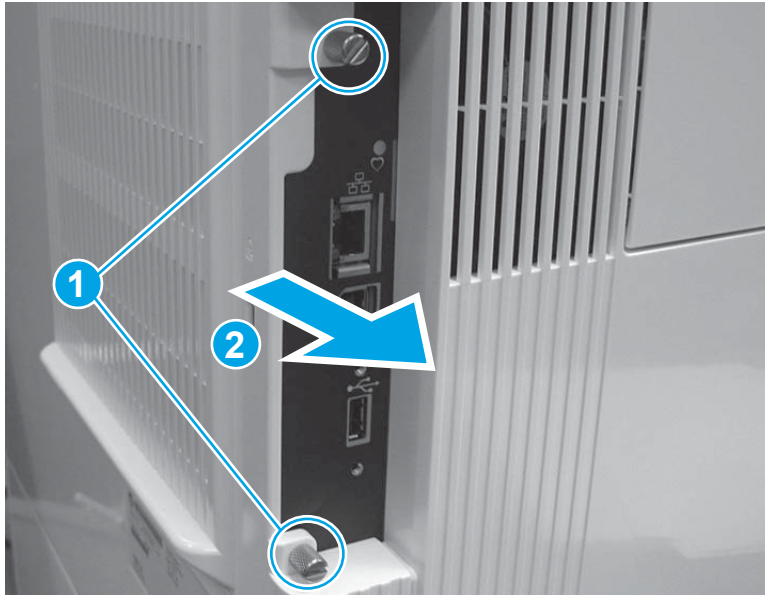

Step 2: Remove the rear cover (M552 and M553)

 **NOTE:** This step is for the M552 and M553 models. For the M577 models, skip this step and go to [Step 3: Remove the rear upper cover \(M577\) on page 770](#).

1. Remove four screws (callout 1).

Figure 1-1338 Remove four screws

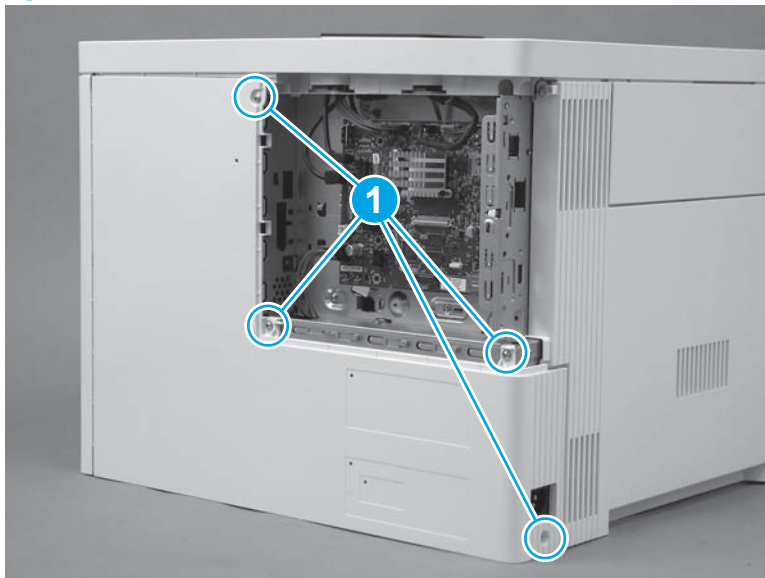

2. Slightly slide the cover to the right (callout 1), rotate the bottom of the cover away from the printer (callout 2), and then pull the top of the cover away from the printer (callout 3) to remove the cover.

Figure 1-1339 Remove the cover

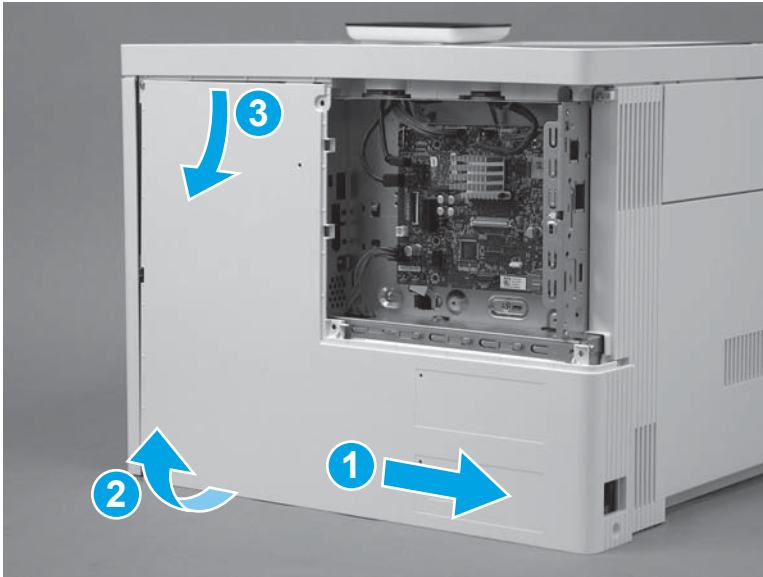

Step 3: Remove the rear upper cover (M577)

 **NOTE:** This step is for the M577 models. For the M552 and M553 models, skip this step and go to [Step 5: Remove the DC controller on page 773](#).

1. Remove two screws (callout 1).

 **Reinstallation tip:** These two screws are self-tapping screws for plastic. When reinstalling them, rotate the screws counterclockwise to align them with the existing thread pattern, and then carefully turn them clockwise to tighten. Do not overtighten. This will prevent stripping the threads inside the screw holes.

Figure 1-1340 Remove two screws



2. Use a small, flat blade screwdriver to release the right edge of the cover.

Figure 1-1341 Release the right edge

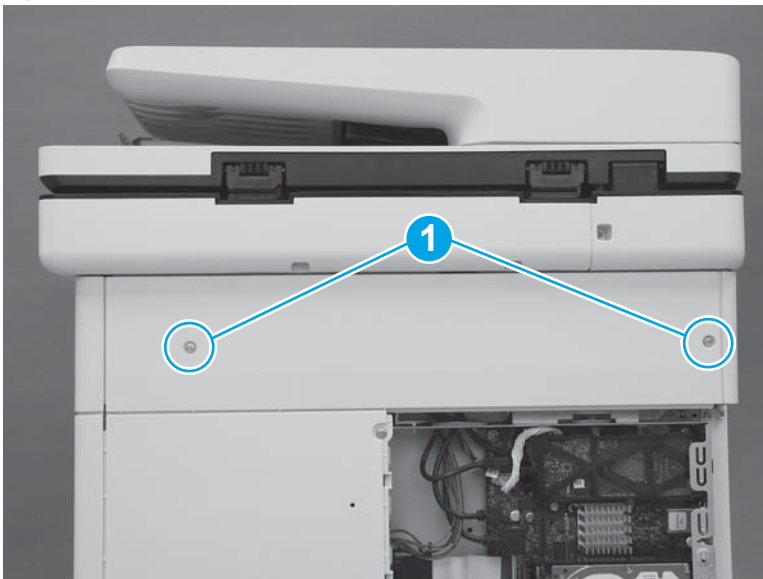
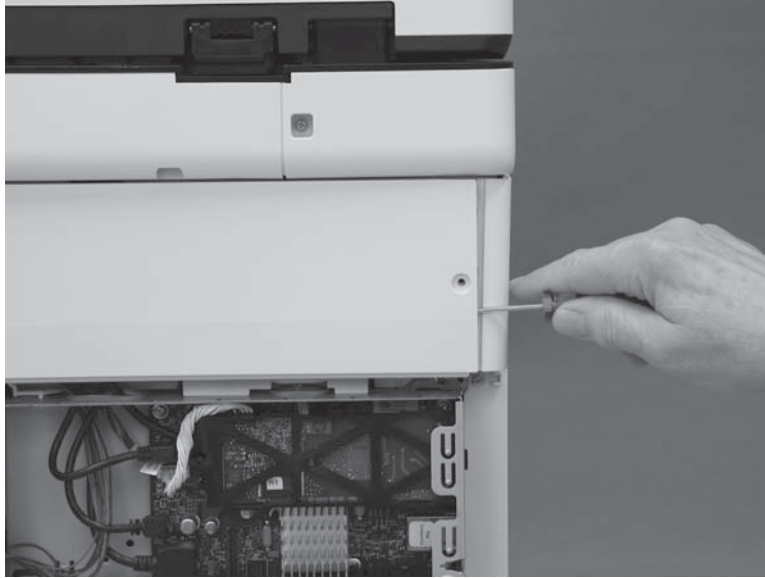

3. Pull the right edge of the cover (callout 1) away from the printer, and then slide the cover to the right (callout 2).

Figure 1-1342 Slide the cover right

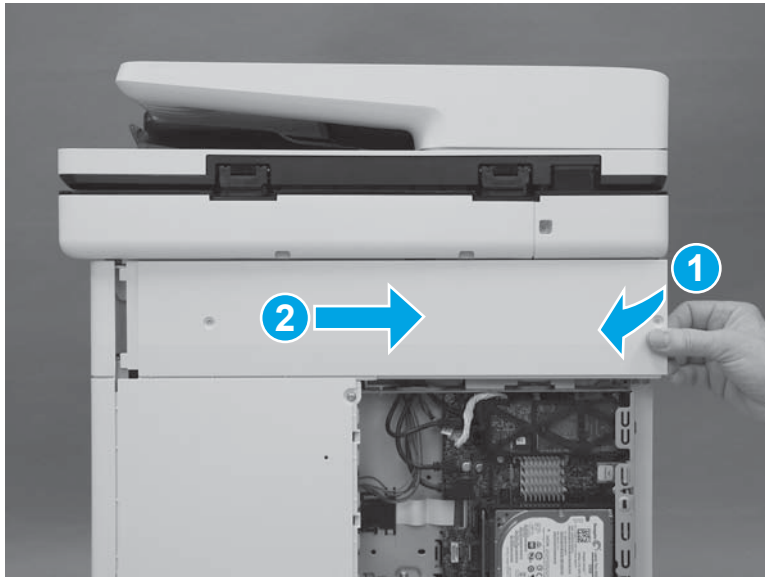

4. Remove the cover.

Figure 1-1343 Remove the cover

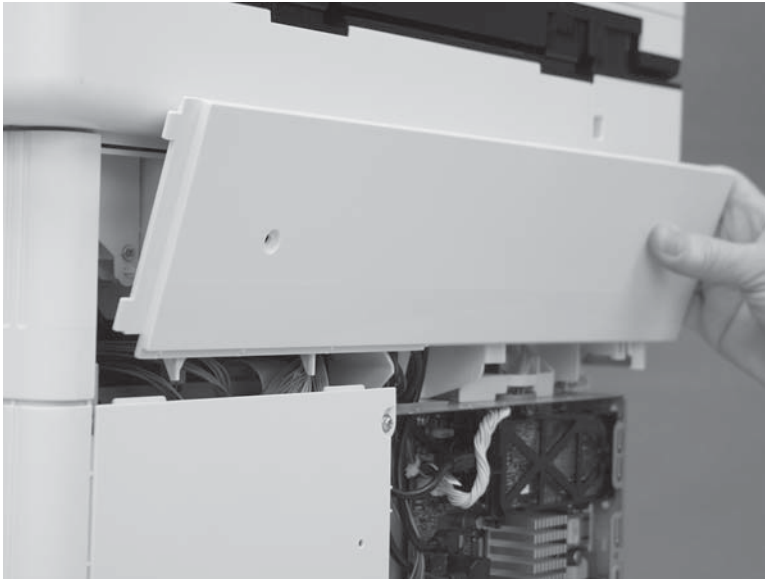

Step 4: Remove the rear cover (M577)

 **NOTE:** This step is for the M577 models. For the M552 and M553 models, skip this step and go to [Step 5: Remove the DC controller on page 773](#).

1. Remove four screws (callout 1).

Figure 1-1344 Remove four screws

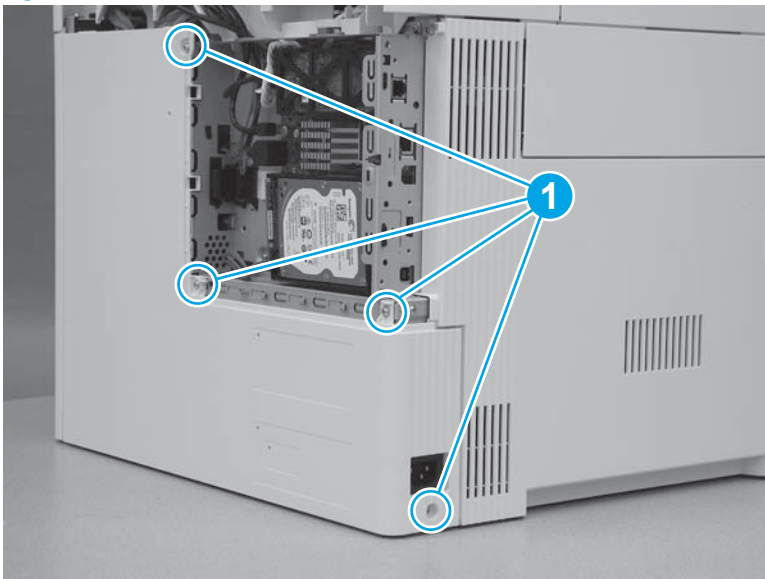

2. Slide the cover to the right to remove it.

Figure 1-1345 Remove the cover

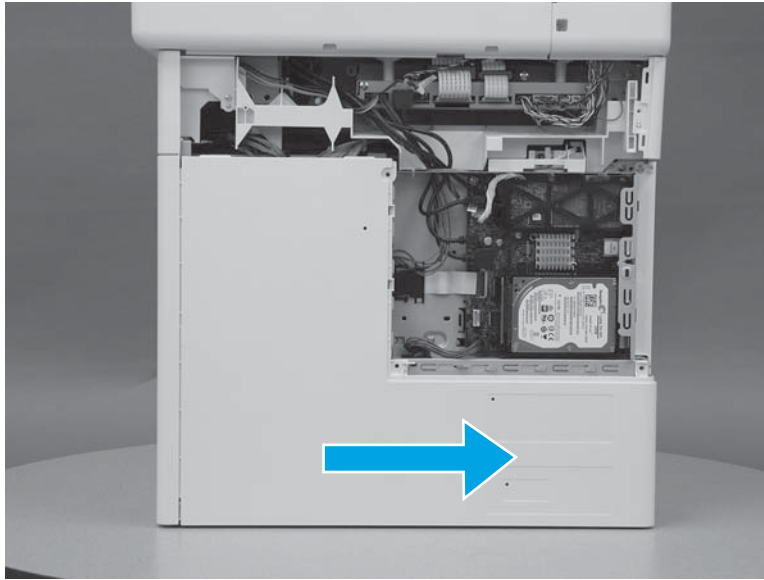

Step 5: Remove the DC controller

 **CAUTION:**  ESD-sensitive part.

1. Disconnect 18 connectors on the DC controller. The flat cables will be disconnected in the next step.
The following connectors are empty:
 - J140, J141, and J143

Figure 1-1346 Disconnect 18 connectors

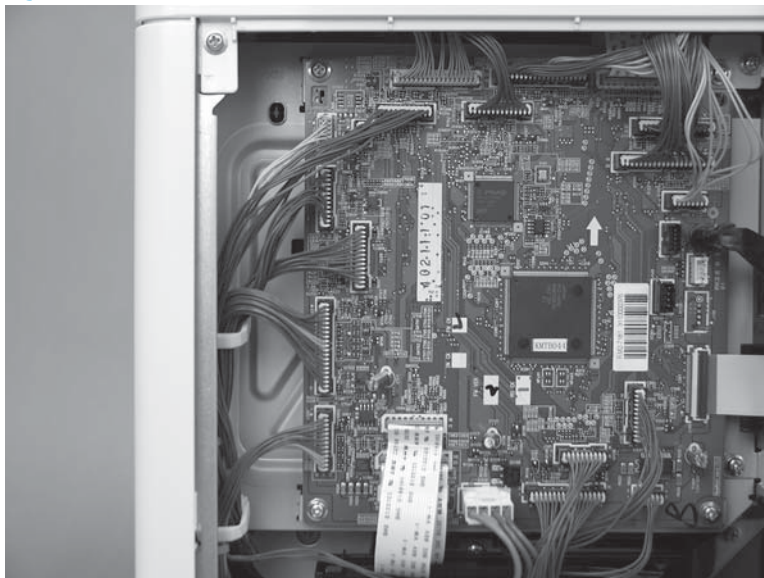

2. Disconnect five flat cables.

 **IMPORTANT:** One of the flat-cable connectors (callout 1) is a Zero Insertion Force (ZIF) connector that uses a hinged retainer to secure the flat cable. The hinged retainer must be opened to release the flat cable.

Figure 1-1347 Disconnect the flat cables



3. Remove four screws (callout 1), and then remove the DC controller (callout 2).

Figure 1-1348 Remove the DC controller

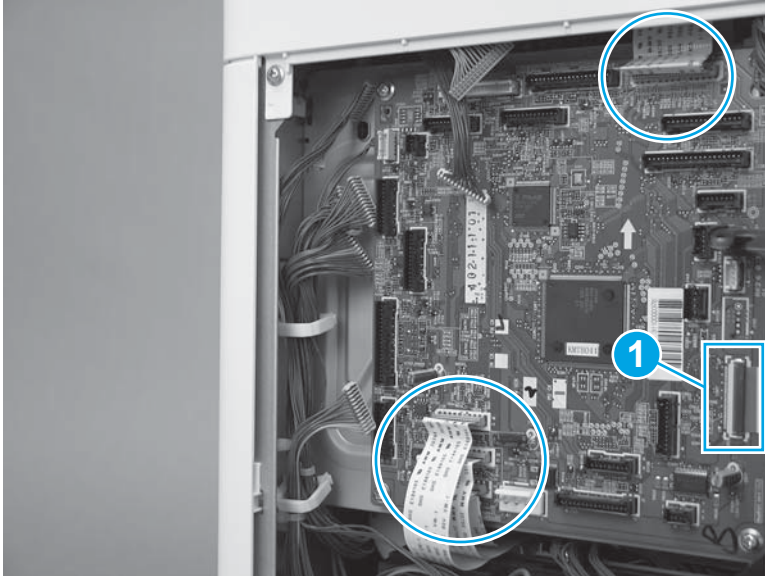
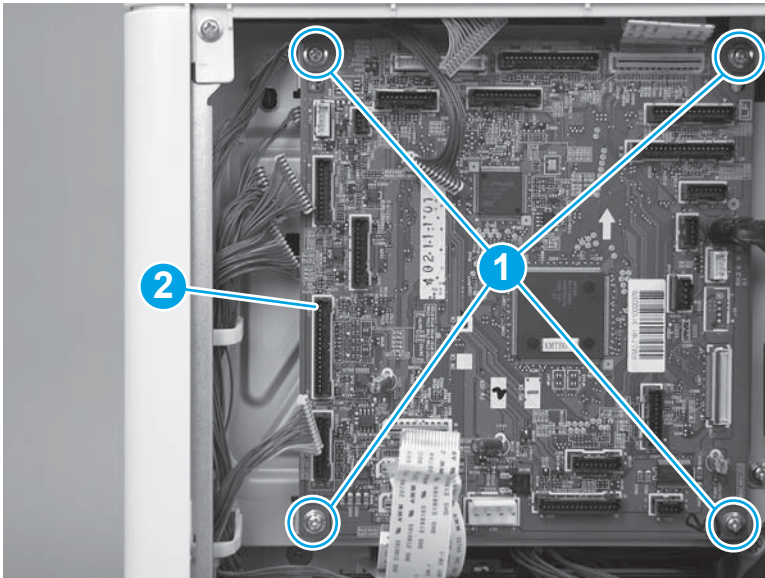

Step 6: Unpack the replacement assembly

Unpack the replacement assembly from the packaging.

 **CAUTION:**  ESD-sensitive part.

For complete information on HP's recycling programs, go to [Product return and recycling](#).

 **NOTE:** HP recommends responsible disposal of the defective assembly.

Figure 1-1349 Recycle and unpack

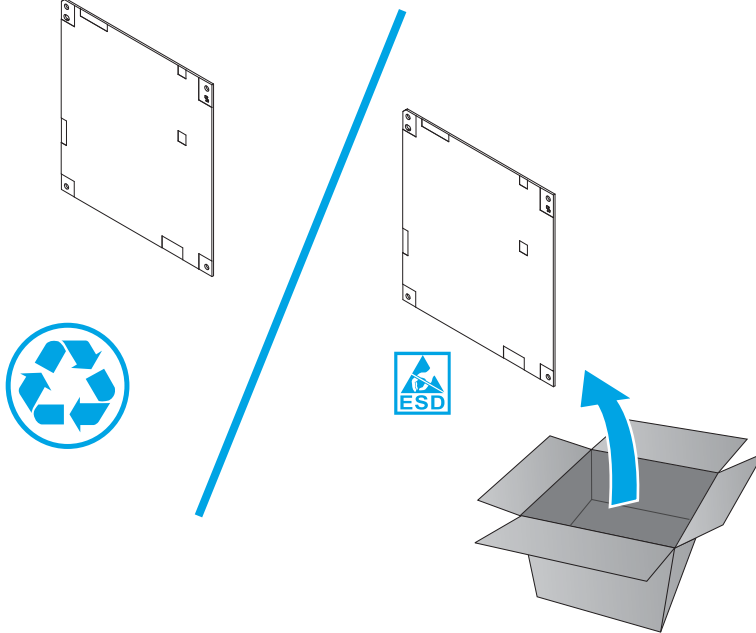

Step 7: Install the DC controller

 **CAUTION:**  ESD-sensitive part.

1. Position the DC controller (callout 1) on the printer, and then install four screws (callout 2).

Figure 1-1350 Install the DC controller

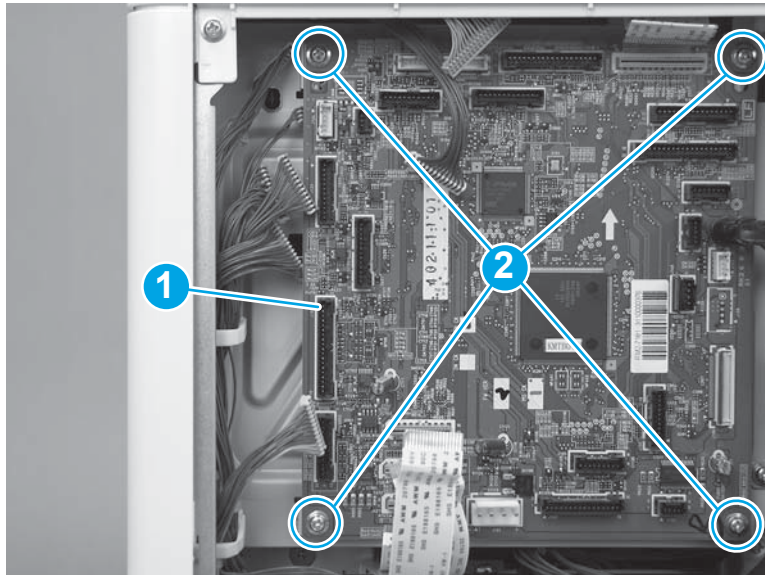

2. Connect five flat cables.

 **IMPORTANT:** One of the flat-cable connectors (callout 1) is a Zero Insertion Force (ZIF) connector that uses a hinged retainer to secure the flat cable. The hinged retainer must be opened to install the flat cable, and then closed to secure the cable.

Figure 1-1351 Connect the flat cables



3. Connect 18 connectors on the DC controller.

When the DC controller is fully reinstalled, the following connectors are empty:

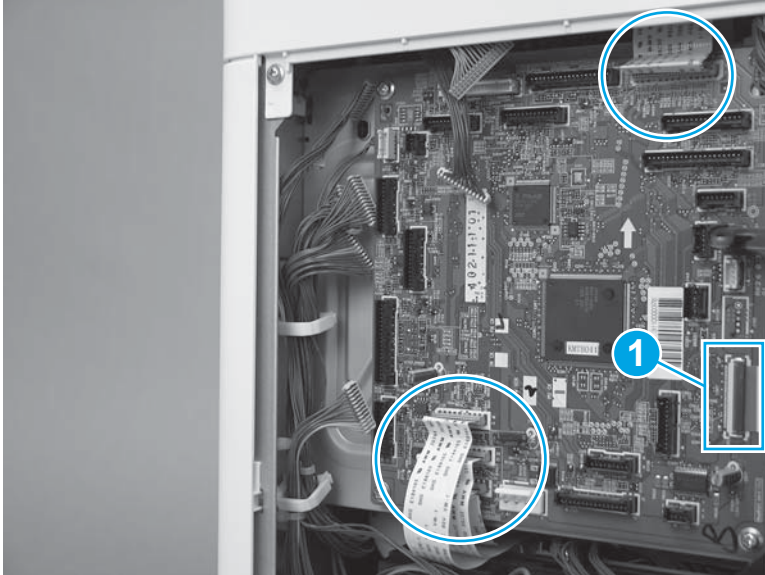
- J140, J141, and J143

Figure 1-1352 Connect all of the connectors

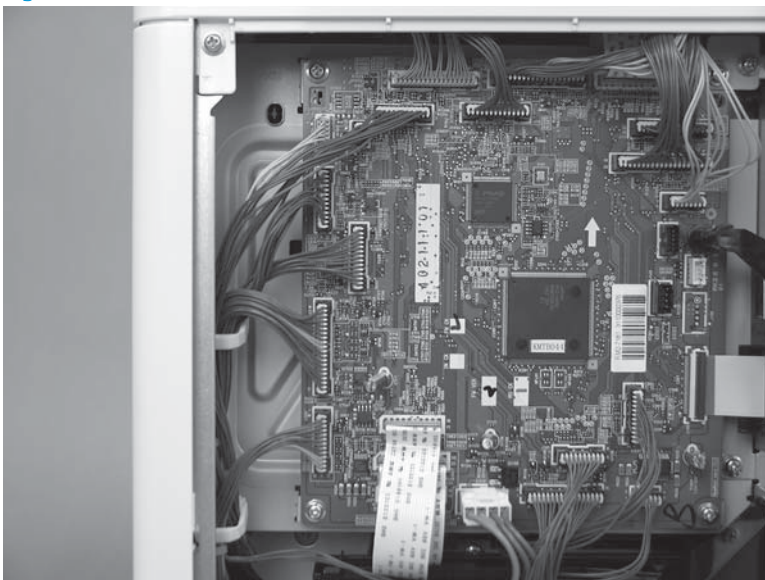

Step 8: Install the rear cover (M577)

 **NOTE:** This step is for the M577 models. For the M552 and M553 models, skip this step and go to [Step 10: Install the rear cover \(M552 and M553\) on page 780](#).

1. Position the hooks (callout 1) on the cover in the slots (callout 2) in the printer.

Figure 1-1353 Position the hooks

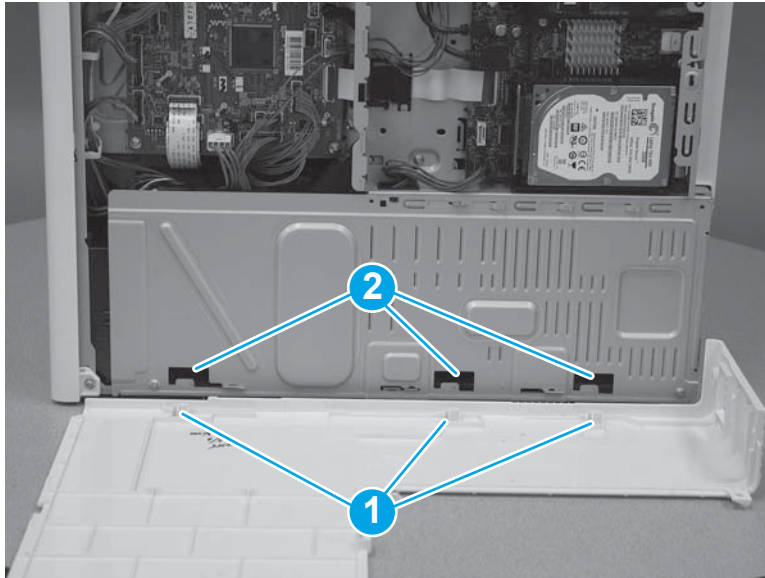

2. Position the back edge (callout 1) of the rear cover behind the edge (callout 2) of the right rear cover. Slide the cover to the left to install it.

Figure 1-1354 Install the cover

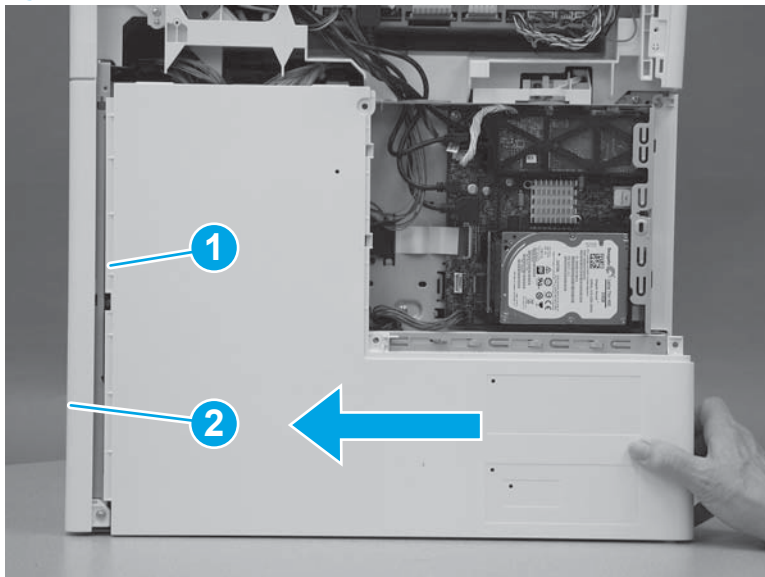

3. Install four screws (callout 1).

Figure 1-1355 Install four screws cover

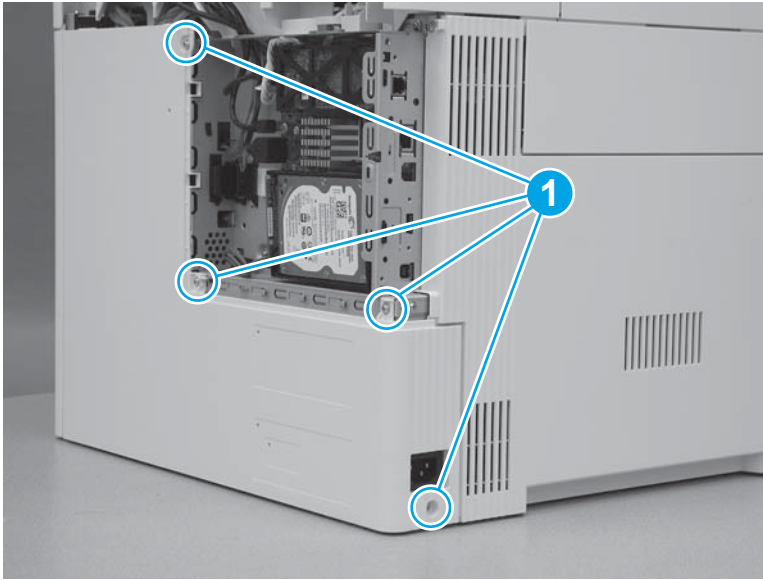

Step 9: Install the rear upper cover (M577)



NOTE: This step is for the M577 models. For the M552 and M553 models, skip this step and go to [Step 10: Install the rear cover \(M552 and M553\) on page 780](#).

1. Align the ridge (callout 1) on the lower edge of the rear upper cover in front of the tabs (callout 2) on the top edge of the rear cover.

Figure 1-1356 Align the cover

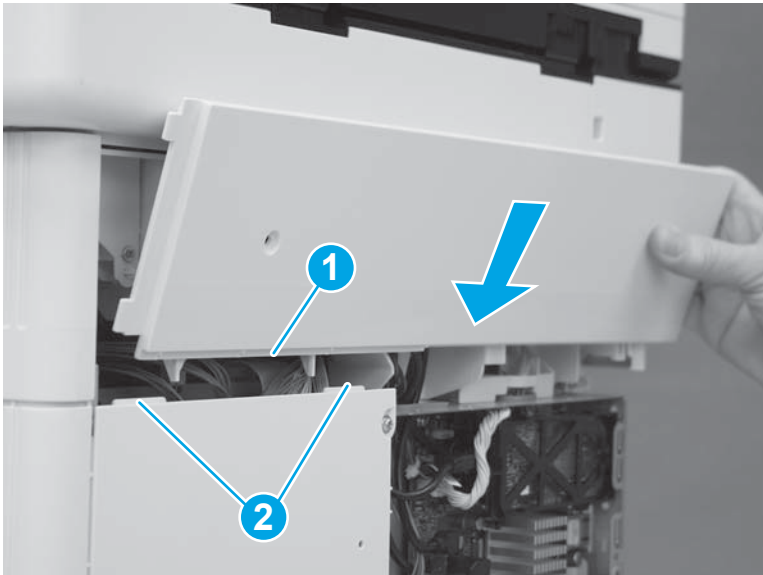

2. Rotate the top of the cover toward the printer.

Figure 1-1357 Rotate the top of the cover

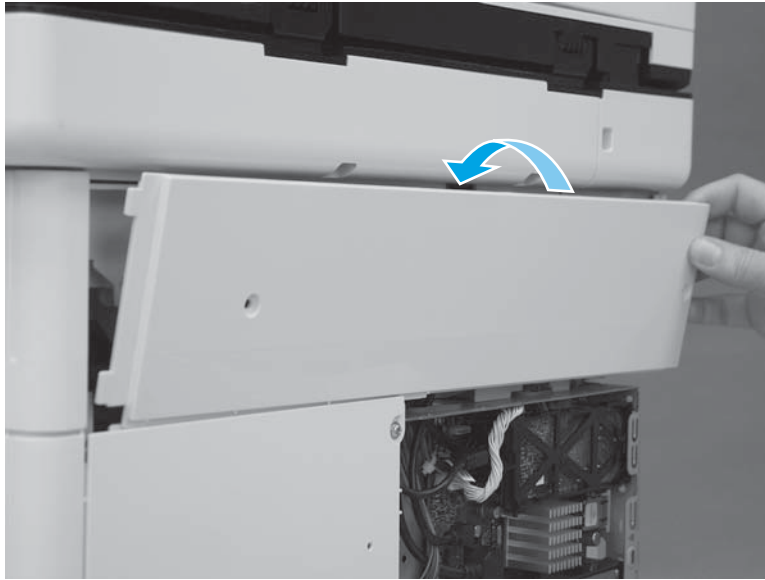

3. Slide the cover to the left (callout 1). Make sure that the tabs (callout 2) on the upper rear cover slide behind the edge (callout 3) of the right upper cover. Make sure that the cover is fully seated.

Figure 1-1358 Slide the cover

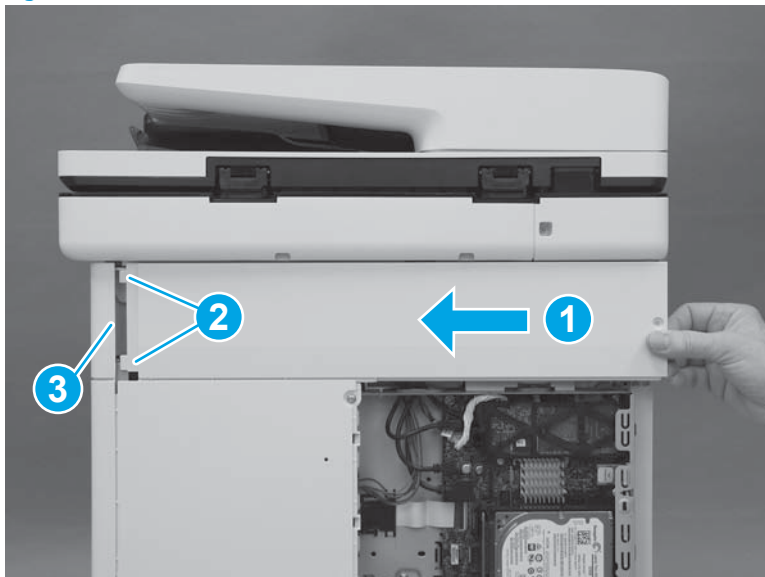

4. Install two screws (callout 1).

IMPORTANT: These two screws are self-tapping screws for plastic. Rotate them counterclockwise to align them with the existing thread pattern, and then carefully turn them clockwise to tighten. Do not overtighten. This will prevent stripping the threads inside the screw holes.

Figure 1-1359 Install two screws

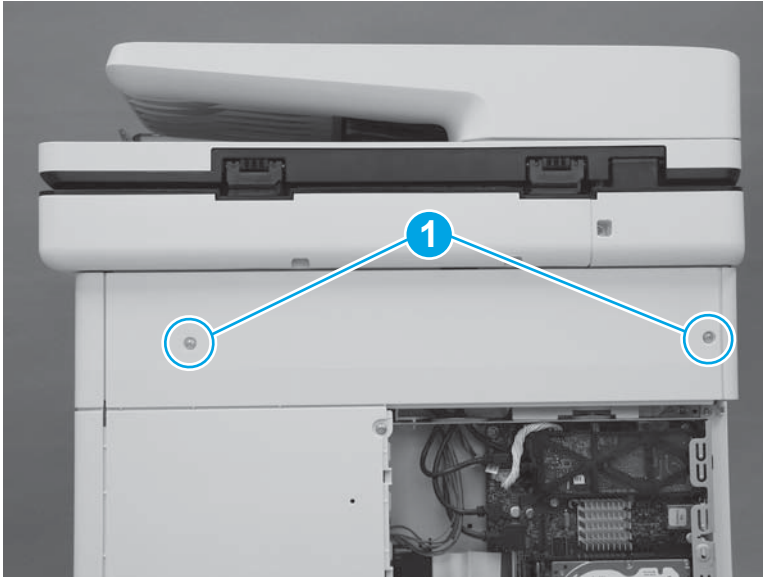

Step 10: Install the rear cover (M552 and M553)

NOTE: This step is for the M552 and M553 models. For the M577 models, skip this step and go to [Step 11: Install the formatter cover on page 781](#).

1. Position the top of the cover under the upper cover (callout 1), rotate the bottom of the cover onto the chassis (callout 2), and then slide the cover to the left (callout 3) to install it.

Figure 1-1360 Install the cover

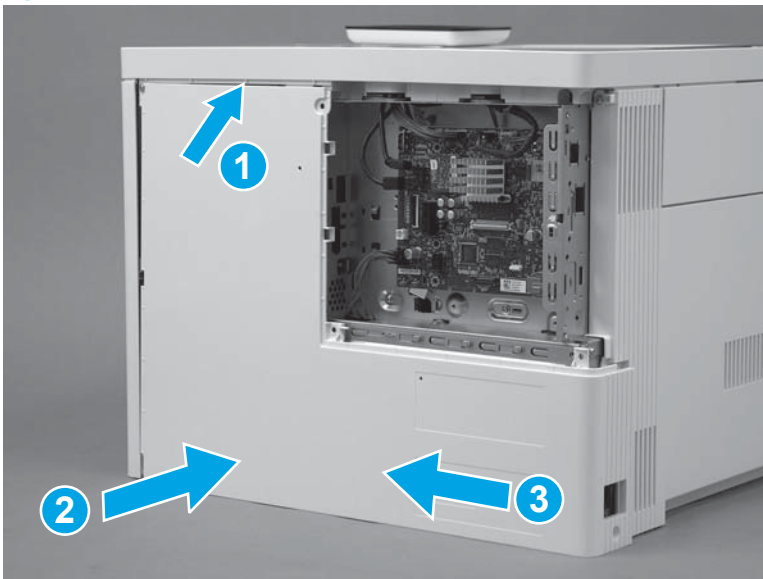

2. Install four screws (callout 1).

Figure 1-1361 Install four screws cover

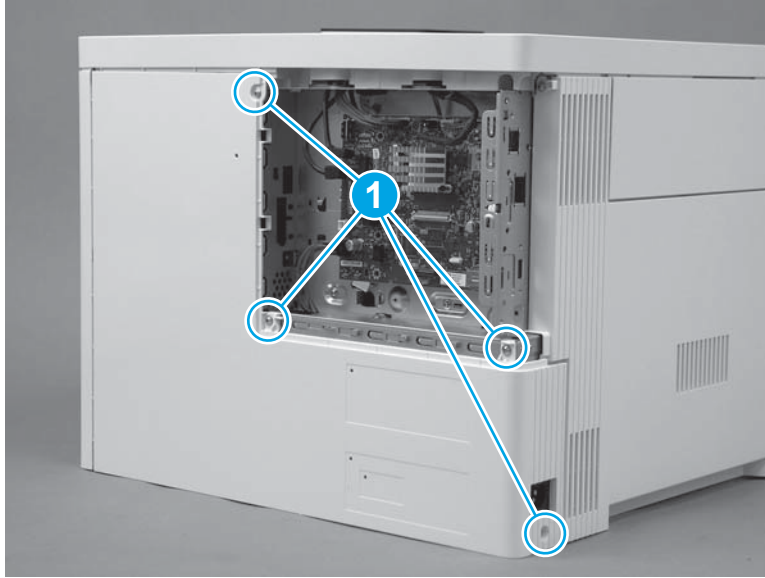

Step 11: Install the formatter cover

- ▲ Slide the cover onto the printer (callout 1) to install it.

 **NOTE:** Make sure that the tabs on the formatter cover align with the slots provided in the printer (callout 2). Tighten the two thumbscrews (callout 3).

 **TIP:** If needed, use the edge of a coin to turn the thumbscrews.

Figure 1-1362 Install the cover



Removal and replacement: Delivery assembly

- [Introduction](#)
- [Step 1: Remove the formatter cover](#)
- [Step 2: Remove the toner collection unit \(TCU\)](#)
- [Step 3: Remove the USB cover \(M552 and M553\)](#)
- [Step 4: Remove the fuser](#)
- [Step 5: Remove the ITB](#)
- [Step 6: Remove the control panel \(M553x only\)](#)
- [Step 7: Remove the rear cover \(M552 and M553\)](#)
- [Step 8: Remove the left cover](#)
- [Step 9: Remove the upper cover \(M552 and M553\)](#)
- [Step 10: Remove the control panel \(M553n/dn and M552dn only\)](#)
- [Step 11: Remove the rear upper cover \(M577\)](#)
- [Step 12: Remove the left upper cover \(M577\)](#)
- [Step 13: Remove the right front upper cover \(M577dn\)](#)
- [Step 14: Remove the stapler cover assembly \(M577c/f/z\)](#)
- [Step 15: Remove the integrated scanner assembly](#)
- [Step 16: Remove the stapler unit \(M577c/f/z\)](#)
- [Step 17: Remove the right upper cover \(M577\)](#)
- [Step 18: Remove the top rear cover \(M577\)](#)
- [Step 19: Remove the paper feed cover \(M577\)](#)
- [Step 20: Remove the top cover \(M577\)](#)
- [Step 21: Remove the top bracket \(M577\)](#)
- [Step 22: Remove the output bin](#)
- [Step 23: Remove the delivery assembly](#)
- [Step 24: Unpack the replacement assembly](#)
- [Step 25: Install the delivery assembly](#)
- [Step 26: Install the output bin](#)
- [Step 27: Install the top bracket \(M577\)](#)
- [Step 28: Install the top cover \(M577\)](#)
- [Step 29: Install the paper feed cover \(M577\)](#)

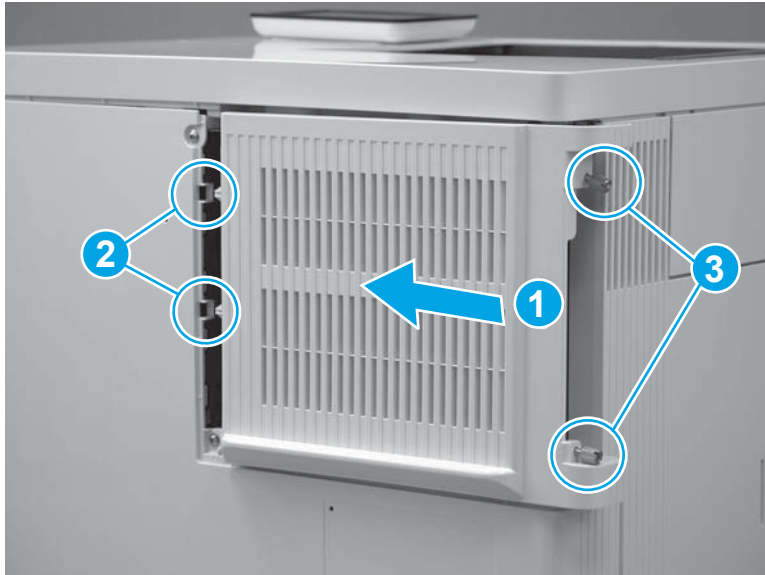
- [Step 30: Install the top rear cover \(M577\)](#)
- [Step 31: Install the right upper cover \(M577\)](#)
- [Step 32: Install the stapler unit \(M577c/f/z\)](#)
- [Step 33: Install the integrated scanner assembly \(M577\)](#)
- [Step 34: Install the stapler cover assembly \(M577c/f/z\)](#)
- [Step 35: Install the right front upper cover \(M577dn\)](#)
- [Step 36: Install the left upper cover \(M577\)](#)
- [Step 37: Install the rear upper cover \(M577\)](#)
- [Step 38: Install the control panel \(M553n/dn and M552dn only\)](#)
- [Step 30: Install the upper cover \(M552 and M553\)](#)
- [Step 40: Install the left cover](#)
- [Step 41: Install the rear cover \(M552 and M553\)](#)
- [Step 42: Install the control-panel assembly \(M553x only\)](#)
- [Step 43: Install the ITB](#)
- [Step 44: Install the fuser](#)
- [Step 45: Install the USB cover \(M552 and M553\)](#)
- [Step 46: Install the TCU](#)
- [Step 47: Install the formatter cover](#)

Introduction

This document provides the procedures to remove and replace the delivery assembly.

Before performing service

-
- ⚡ **TIP:** Some figures might show assemblies removed or installed that have not yet been removed or installed at that specific step. However, the procedures are correct for this printer and the target assembly. Always thoroughly read the instructions that accompany each figure.
-

Turn the printer power off

- Disconnect the power cable.

⚠ WARNING! To avoid damage to the printer, turn the printer off, wait 30 seconds, and then remove the power cord before attempting to service the printer.

- Open the right door.

Use the table below to identify the correct part number for your printer, and then go to <http://h20141.www2.hp.com/hpparts> to order the part.

Delivery assembly part number	
RM2-0092-000CN	Paper delivery assembly (M553n)
RM2-0016-000CN	Paper delivery assembly (M552dn, M553dn, M553x, M577)

Required tools

- #2 Phillips screwdriver with a magnetic tip

After performing service

Make sure that the USB cover is fully seated after replacing it.

Make sure that the TCU is fully closed after replacing it.

Make sure that the formatter cover is fully seated, and that the thumbscrews are finger tight after replacing it.

Make sure that the output bin is flat against the chassis after replacing it.

Turn the printer power on

- Connect the power cable.
- Use the power switch to turn the power on.

Post service test

Print a configuration page to make sure that the printer is functioning correctly.

Step 1: Remove the formatter cover

1. Locate the formatter cover.

Figure 1-1363 Locate the formatter cover

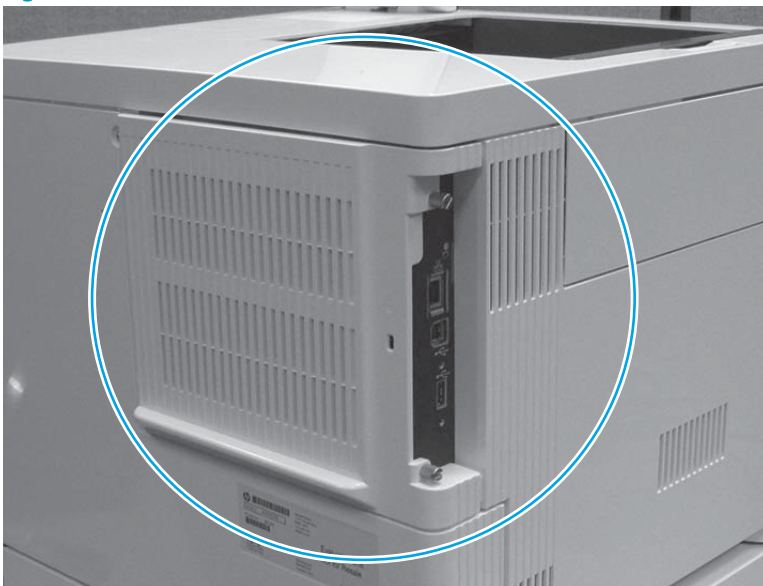

2. Loosen the two thumbscrews (callout 1). Grasp the two thumbscrews, and then slide the cover away from the printer (callout 2) to remove it.

 **TIP:** If needed, use the edge of a coin to turn the thumbscrews.

Figure 1-1364 Loosen the thumbscrews

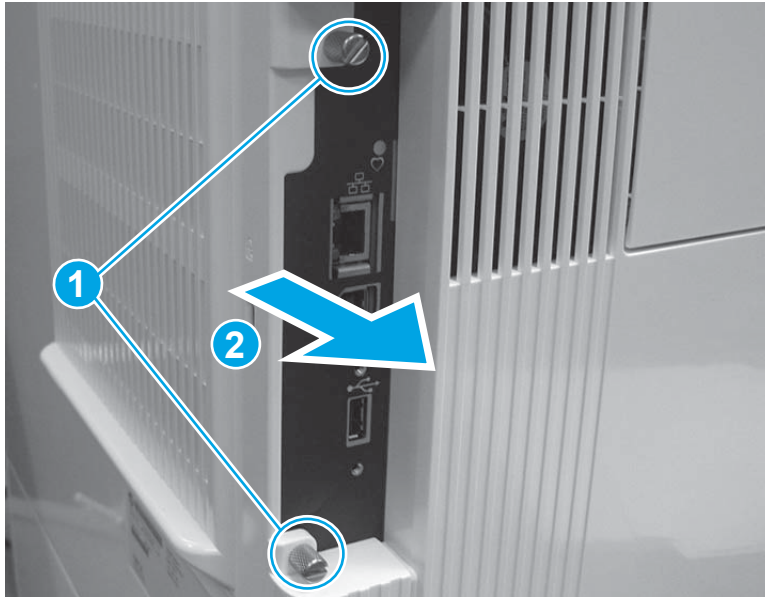

Step 2: Remove the toner collection unit (TCU)

1. Open the front door.

Figure 1-1365 Open the front door



2. Open the TCU.

 **NOTE:** The toner collection hatch cover automatically closes when the TCU is opened.

Figure 1-1366 Open the TCU



3. Pull the TCU away from the printer at an angle to remove it.

⚠ CAUTION: Do not open the toner collection hatch cover when handling the TCU. If toner gets on clothing, wipe it off by using a dry cloth and wash the clothes in cold water. Hot water sets toner into fabric.

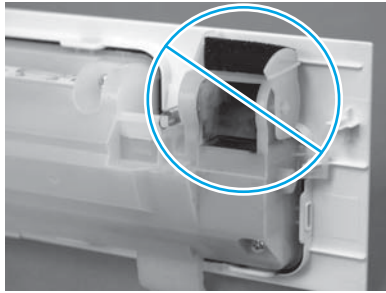
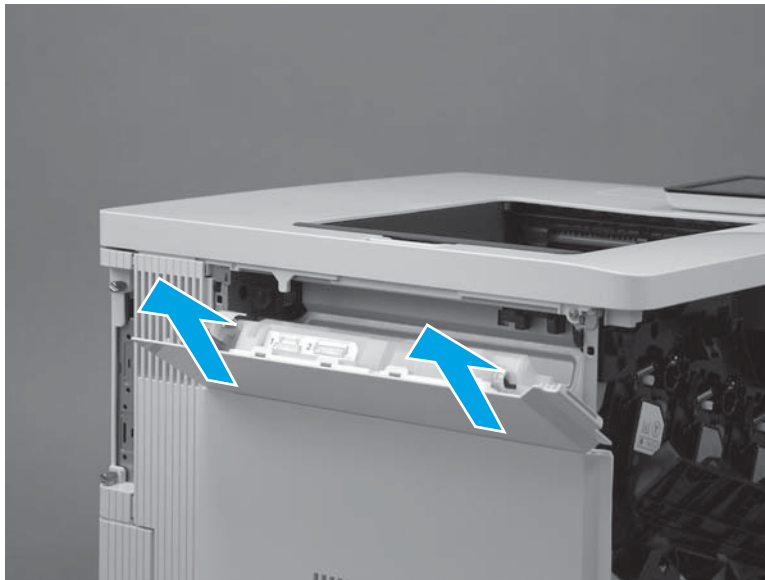

Figure 1-1367 Remove the TCU



Step 3: Remove the USB cover (M552 and M553)

📋 NOTE: This step is for the M552 and M553 models. For the M577 models, skip this step and go to [Step 11: Remove the rear upper cover \(M577\) on page 805](#).

1. Locate the USB cover.

Figure 1-1368 Locate the USB cover



2. Pull the cover off of the printer to remove it.

Figure 1-1369 Remove the cover



Step 4: Remove the fuser

1. Open the right door.

⚠ CAUTION: The fuser is very hot. After turning the printer power off, allow the fuser to cool for at least 30 minutes before removing it.

Figure 1-1370 Open the right door



2. Grasp the two fuser handles, and then squeeze the two blue triggers on the handles to release the fuser.

Figure 1-1371 Release the fuser

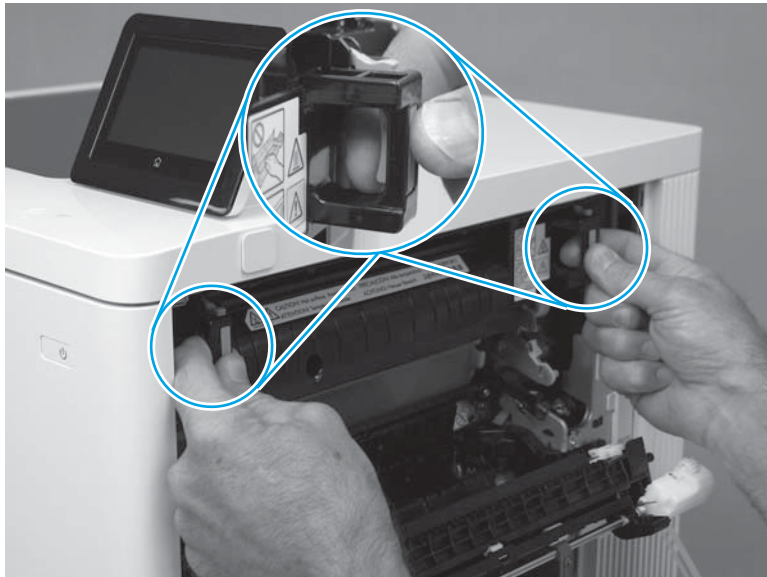

3. Slide the fuser straight out of the printer to remove it.

Figure 1-1372 Remove the fuser



Step 5: Remove the ITB

⚠ CAUTION: Do not touch the grey-plastic belt. Skin oils and fingerprints on the belt can cause print-quality problems.

1. Pull the blue lever to release the ITB drive coupling.

Figure 1-1373 Release the ITB drive coupling

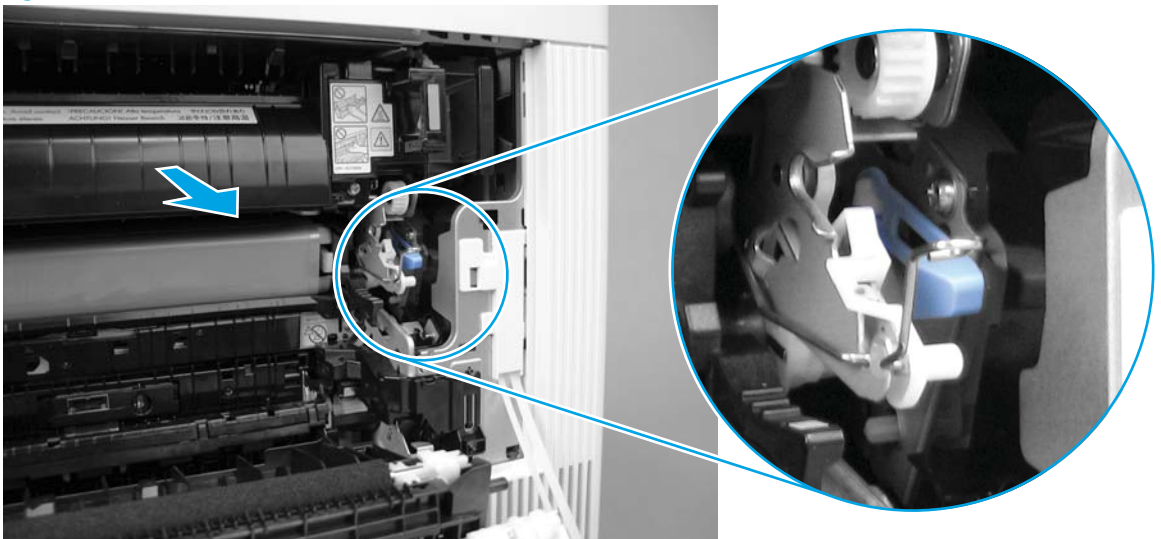

2. Push in on the blue arm to release the secondary transfer roller assembly, and then completely lower the assembly.

 **NOTE:** Press the blue arm on the secondary transfer roller assembly a second time to release the roller assembly when it stops at the halfway open position.

Figure 1-1374 Lower the secondary transfer roller assembly



3. Release the left-side ITB spring (callout 1) from the tab (callout 2).

Figure 1-1375 Release the front-side ITB spring

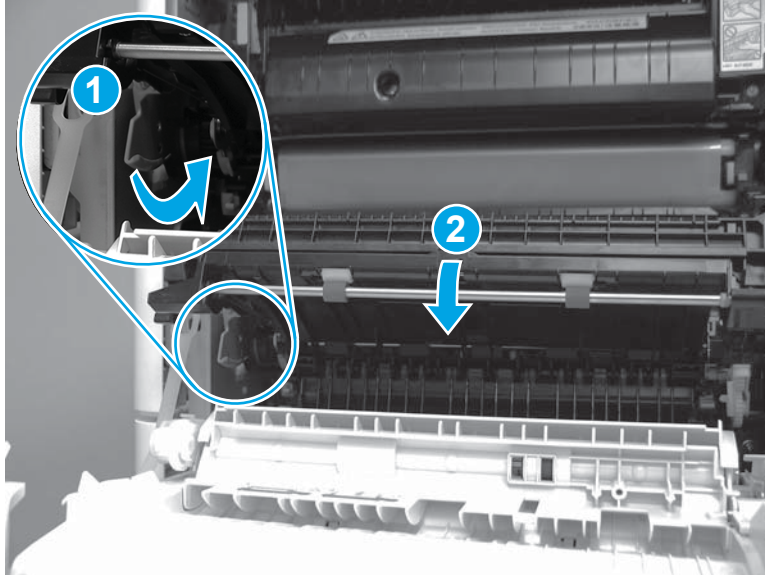
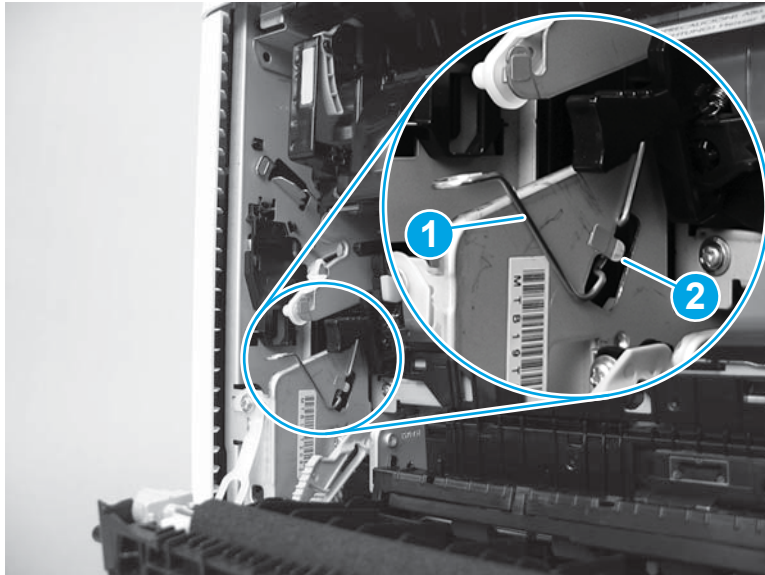

4. Place the left-side ITB spring on the holder to keep it out of the way.

 **TIP:** The holder is colored blue to help locate it.

Figure 1-1376 Place the spring on the holder

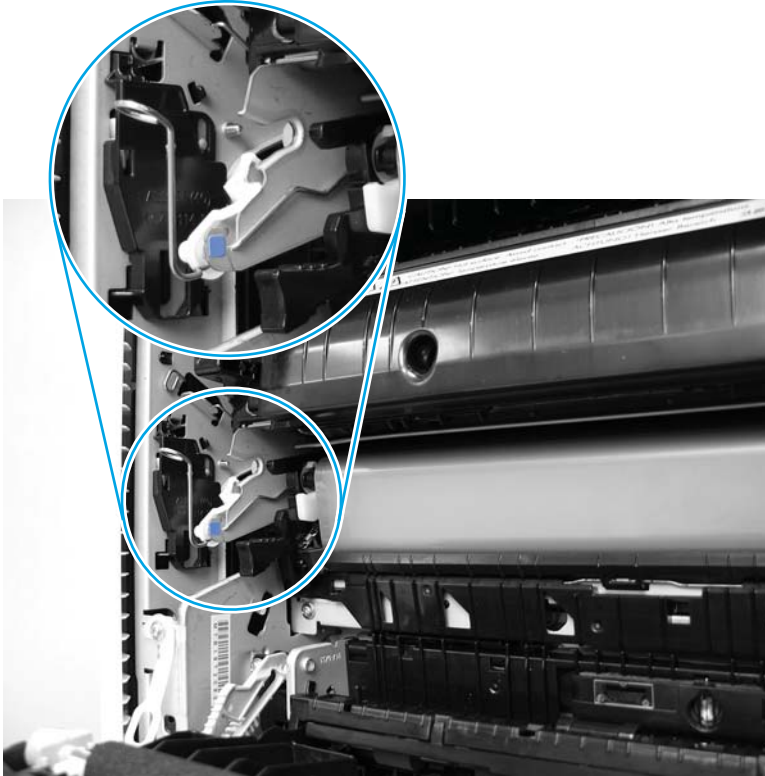

5. Release the right-side ITB spring (callout 1) from the tab (callout 2).

Figure 1-1377 Release the rear-side ITB spring

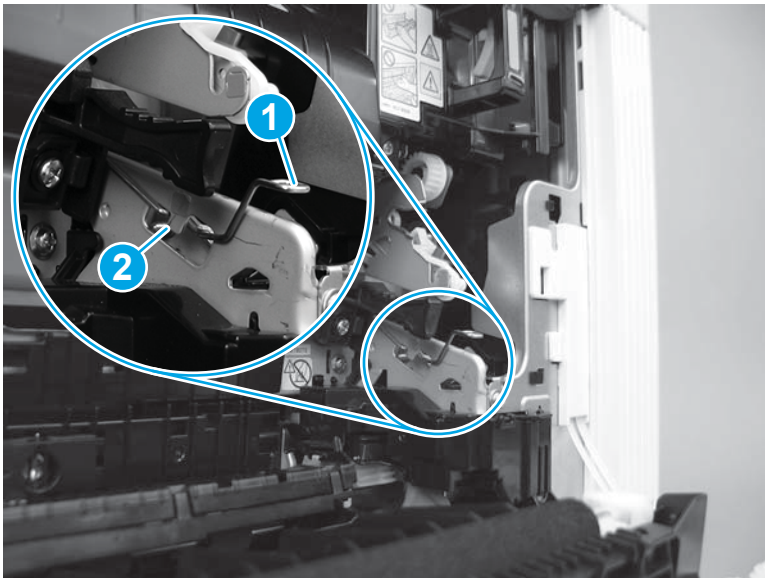

6. Place the right-side ITB spring on the holder to keep it out of the way.

 **TIP:** The holder is colored blue to help locate it.

Figure 1-1378 Place the spring on the holder

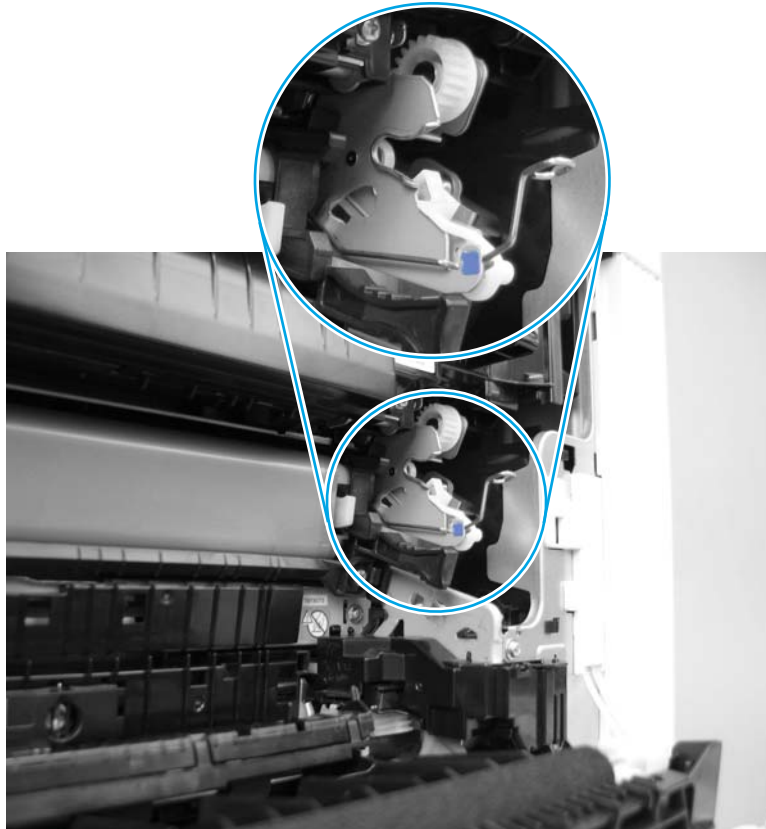

7. Grasp the two blue handles on the ITB.

⚠ CAUTION: If the ITB is removed to access other assemblies in the printer, use care. The ITB is a sensitive assembly. Be careful when handling the ITB so that it is not damaged. Always place the ITB in a safe and protected location.

Figure 1-1379 Grasp the ITB handles

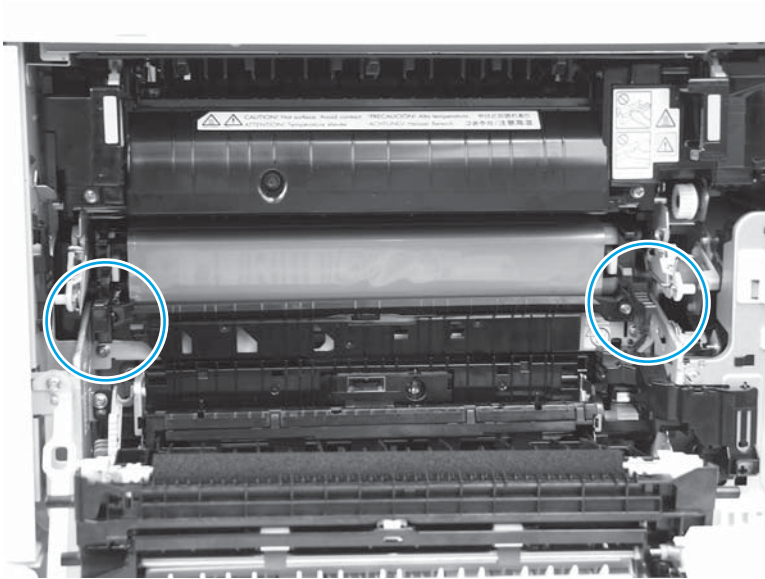

8. Pull the ITB out of the printer to remove it.

⚠ CAUTION: Do not touch the grey-plastic belt. Skin oils and fingerprints on the belt can cause print-quality problems.

Figure 1-1380 Remove the ITB

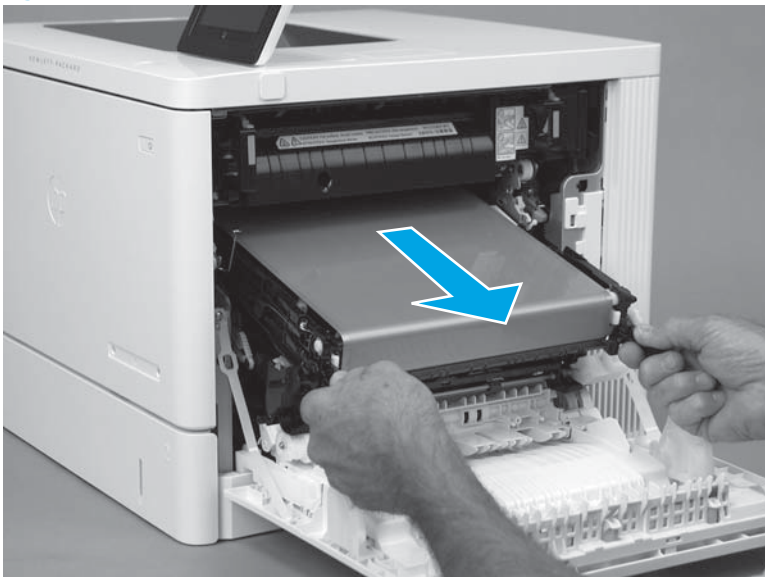

Step 6: Remove the control panel (M553x only)

 **NOTE:** For the M553n/dn and M552dn models, skip this step and go to [Step 7: Remove the rear cover \(M552 and M553\) on page 798](#).

For the M577, skip this step and go to [Step 11: Remove the rear upper cover \(M577\) on page 805](#).

1. Tilt the control panel up.

Figure 1-1381 Tilt the control panel up



2. Use a small flat-blade screwdriver to release the control-panel screws cover tabs.

Figure 1-1382 Release the control-panel screws cover tabs

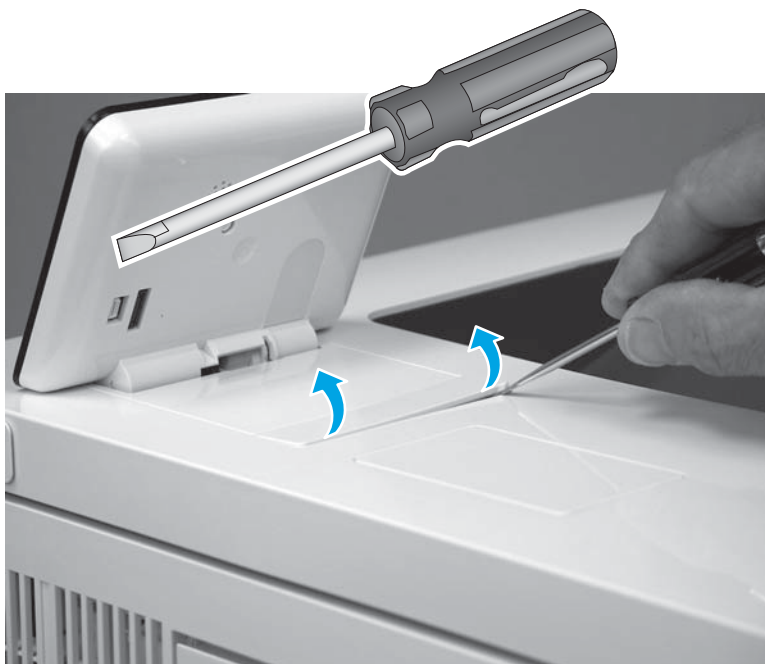

3. Rotate the cover up to remove it.

Figure 1-1383 Remove the cover

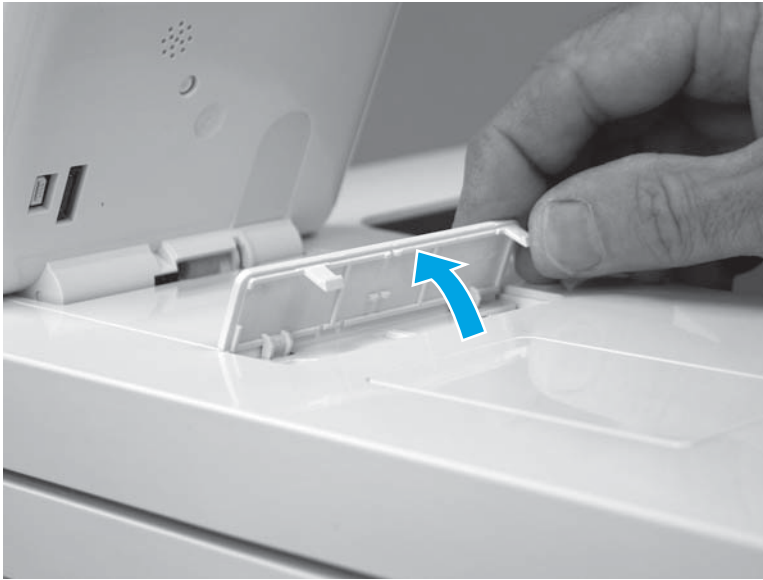

4. Use a small Phillips screwdriver to remove two screws (callout 1).

 **IMPORTANT:** Store the screws in a secure place where they cannot fall down into the printer.

Figure 1-1384 Remove two screws

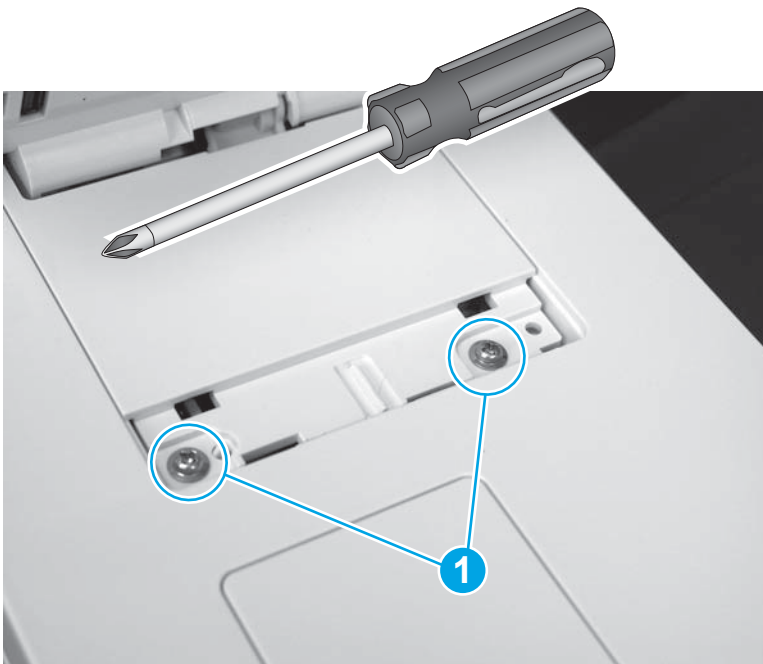

5. Rotate the control-panel base toward the front of the printer.

Figure 1-1385 Rotate the control-panel base up



6. Slightly slide the control-panel base toward the rear of the printer (callout 1) to release it, and then turn the control panel over (callout 2) to access the bottom side.

⚠ CAUTION: The control panel is still attached to the printer. Do not attempt to completely remove the control panel.

Figure 1-1386 Turn the control panel over

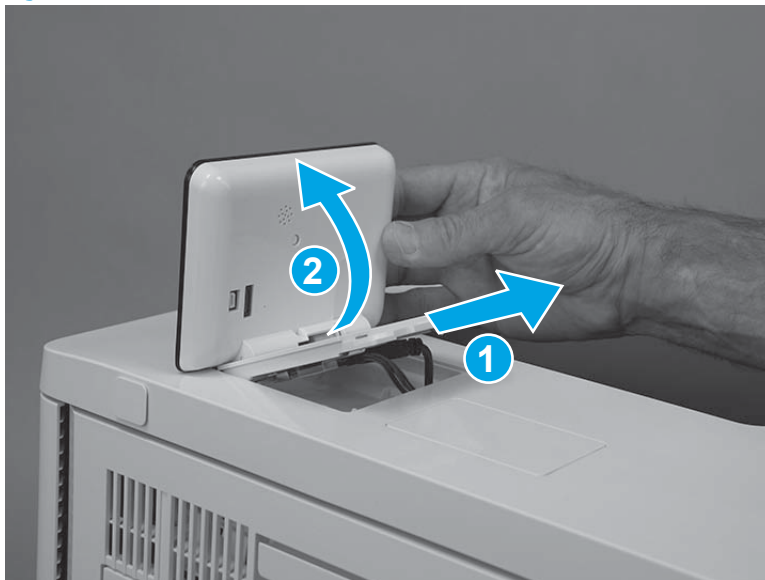

7. Disconnect one USB cable (callout 1), one connector (callout 2), and then remove the control panel.

Figure 1-1387 Disconnect two connectors

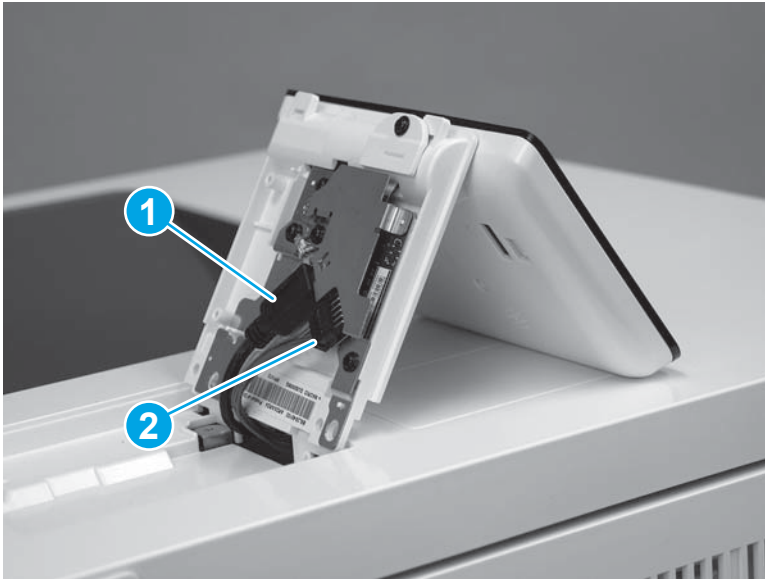

Step 7: Remove the rear cover (M552 and M553)

 **NOTE:** This step is for the M552 and M553 models. For the M577 models, skip this step and go to [Step 11: Remove the rear upper cover \(M577\) on page 805](#).

1. Remove four screws (callout 1).

Figure 1-1388 Remove four screws

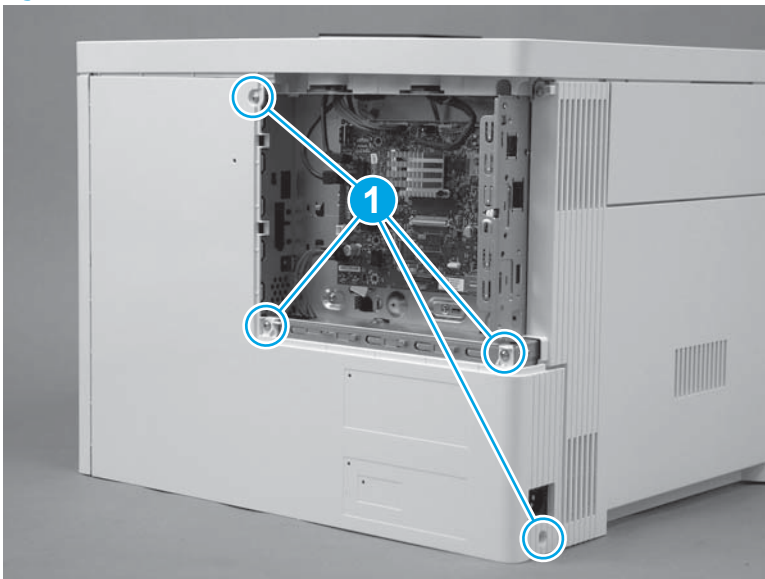

2. Slightly slide the cover to the right (callout 1), rotate the bottom of the cover away from the printer (callout 2), and then pull the top of the cover away from the printer (callout 3) to remove the cover.

Figure 1-1389 Remove the cover

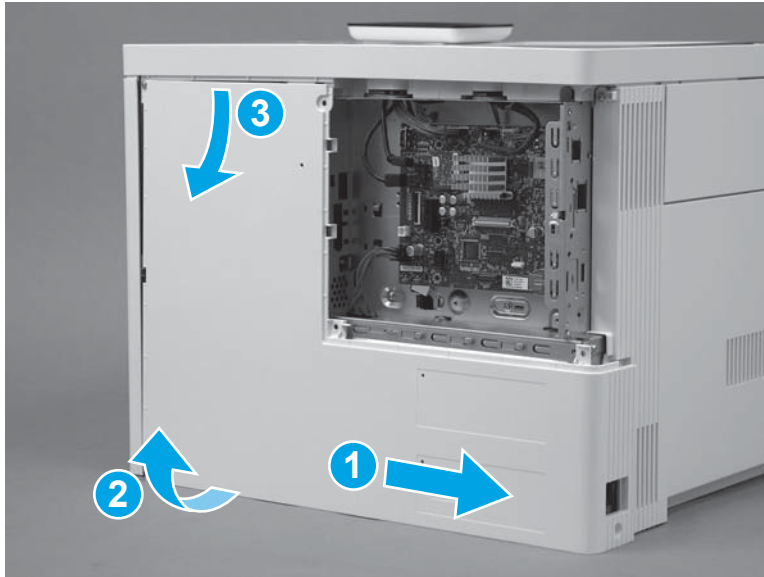

Step 8: Remove the left cover

 **NOTE:** This step is for the M552 and M553 models. For the M577 models, skip this step and go to [Step 11: Remove the rear upper cover \(M577\) on page 805](#).

1. At the left side of the printer, remove one screw (callout 1).

Figure 1-1390 Remove one screw



2. Release one tab (callout 1), rotate the front edge of the cover away from the printer (callout 2), and then slide the cover (callout 3) toward the rear of the printer to release it.

Figure 1-1391 Release the cover

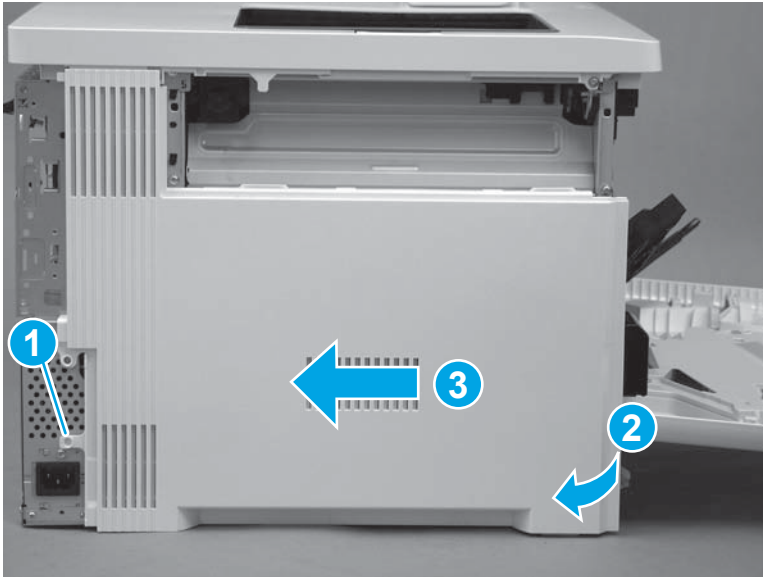

3. Remove the cover.

Figure 1-1392 Remove the cover

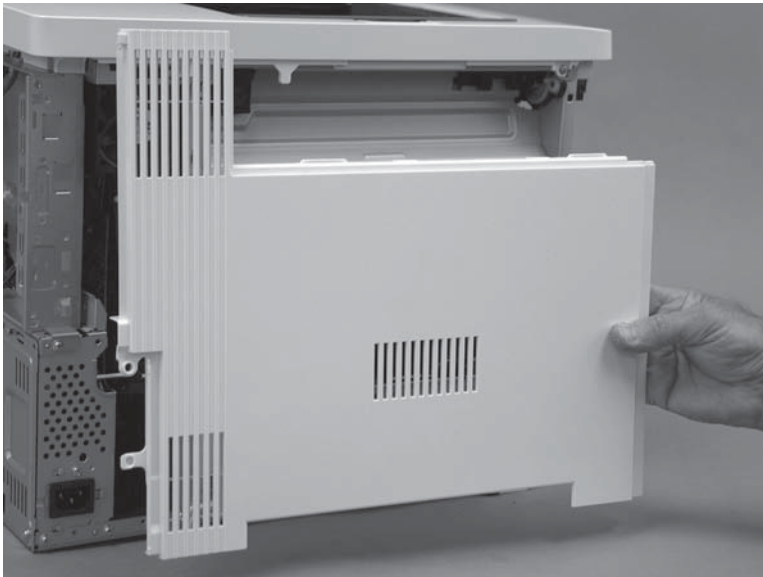

Step 9: Remove the upper cover (M552 and M553)

 **NOTE:** This step is for the M552 and M553 models. For the M577 models, skip this step and go to [Step 11: Remove the rear upper cover \(M577\) on page 805.](#)

1. Remove three screws (callout 1).

Figure 1-1393 Remove three screws

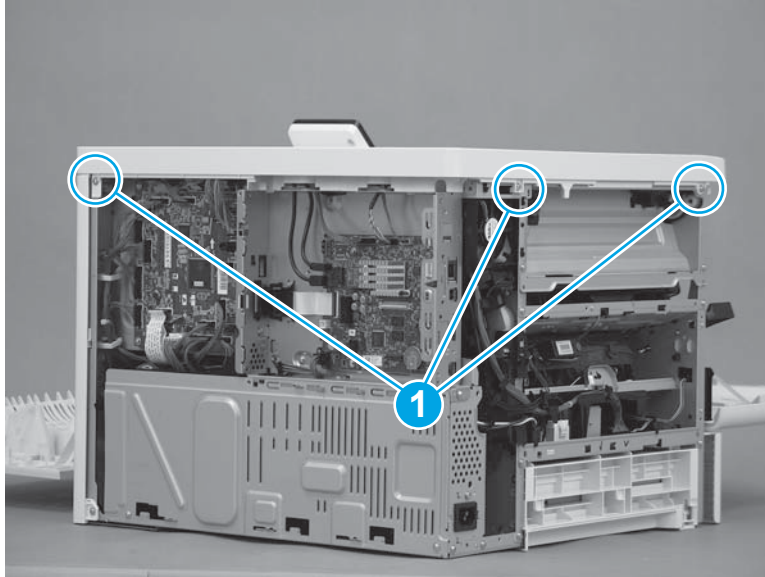

2. Remove one screw (callout 1), release one tab (callout 2), and then slightly separate the corner of the cover from the chassis.

 **NOTE:** This is a self-tapping plastic-thread screw. Make sure that this screw is used in this location when it is reinstalled.

Figure 1-1394 Remove one screw and release one tab



3. Release one tab (callout 1), and then lift up on the cover to release it.

 **NOTE:** If the cover does not release, check for addition tabs by locating the triangles embossed in the cover at tab locations.

Figure 1-1395 Release the cover



4. Remove the cover.

Figure 1-1396 Remove the cover

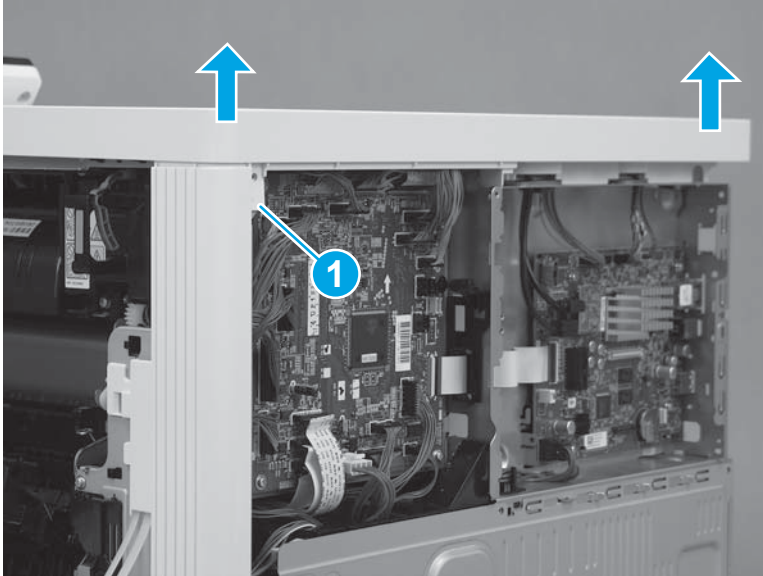
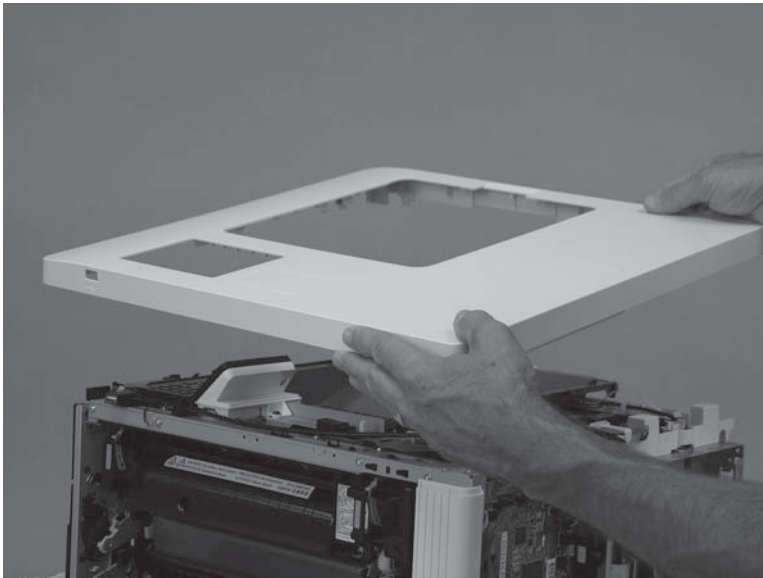

Step 10: Remove the control panel (M553n/dn and M552dn only)

 **NOTE:** For the M553x model, skip this step and go to [Step 22: Remove the output bin on page 824](#).

For the M577 models, skip this step and go to [Step 11: Remove the rear upper cover \(M577\) on page 805](#).

1. Remove one screw (callout 1).

Figure 1-1397 Remove one screw

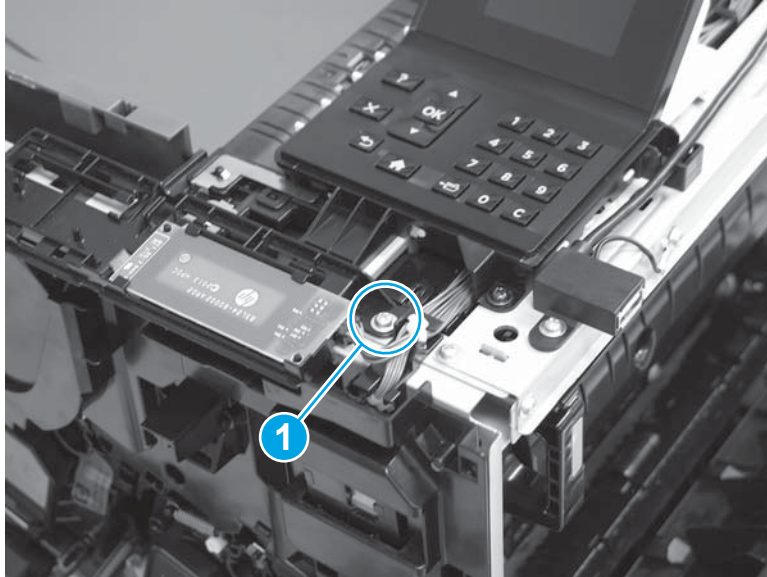

2. Disconnect one connector (callout 1). Rotate the near field communication (NFC) PCA holder up (callout 2), and then slide it to the right (callout 3) to remove it.

Figure 1-1398 Remove the PCA holder

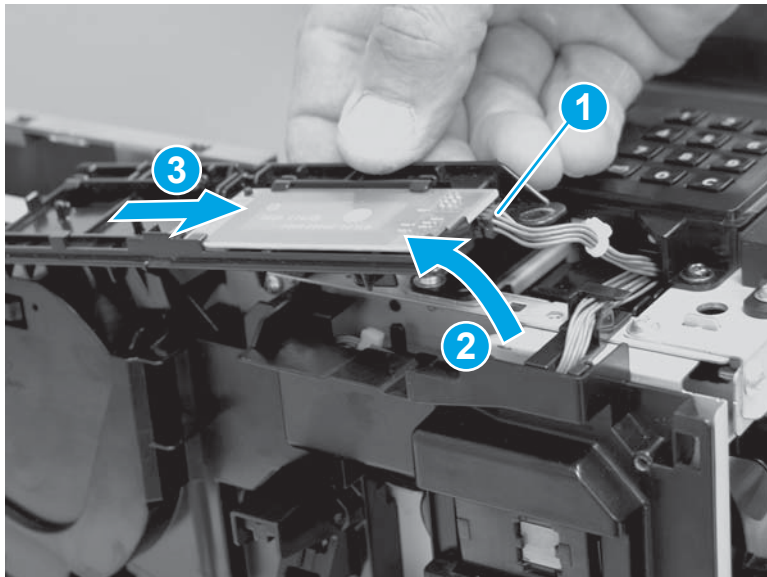

3. Remove one cable from the guide.

Figure 1-1399 Remove one cable



4. Remove four screws (callout 1), and then turn the control panel over (callout 2) to access the bottom side.

⚠ CAUTION: The control panel is still attached to the printer. Do not attempt to completely remove the control panel.

Figure 1-1400 Remove four screws

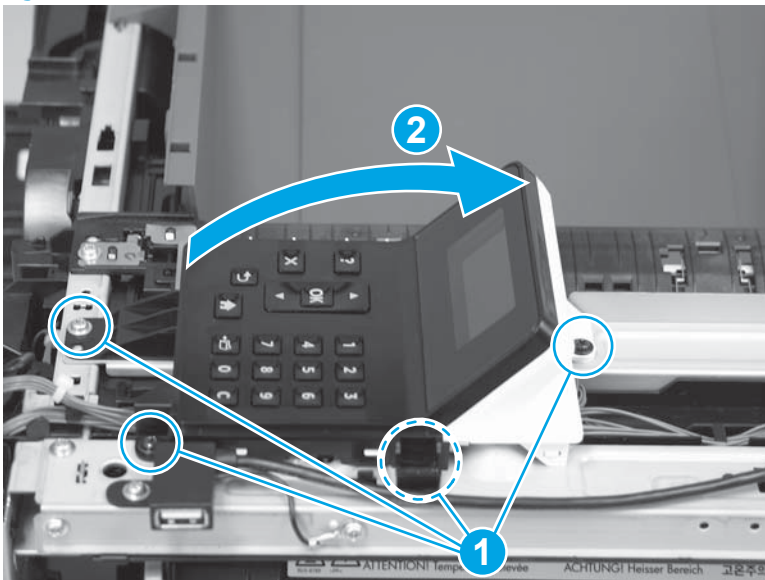

5. Disconnect one connector (callout 1), and then remove the control panel.

Figure 1-1401 Remove the control panel

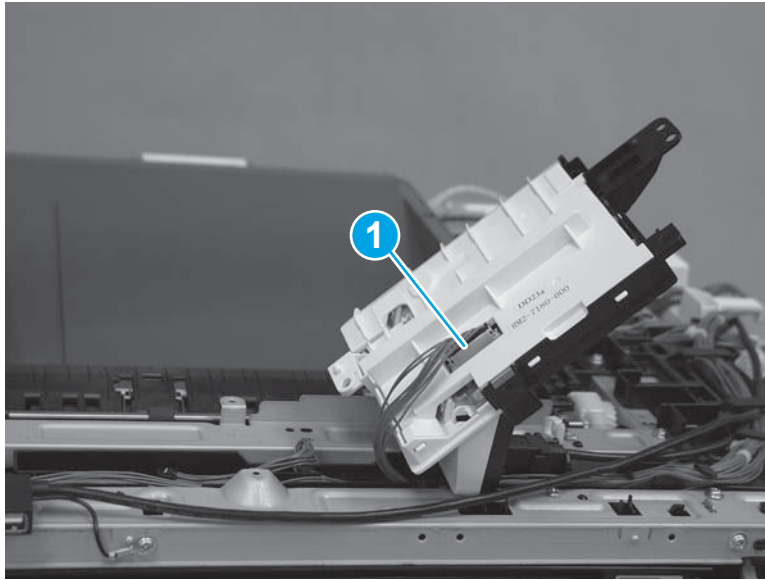

Step 11: Remove the rear upper cover (M577)

 **NOTE:** This step is for the M577 models. For the M552 and M553 models, skip this step and go to [Step 22: Remove the output bin on page 824.](#)

1. Remove two screws (callout 1).

 **Reinstallation tip:** These two screws are self-tapping screws for plastic. When reinstalling them, rotate the screws counterclockwise to align them with the existing thread pattern, and then carefully turn them clockwise to tighten. Do not overtighten. This will prevent stripping the threads inside the screw holes.

Figure 1-1402 Remove two screws



2. Use a small, flat blade screwdriver to release the right edge of the cover.

Figure 1-1403 Release the right edge

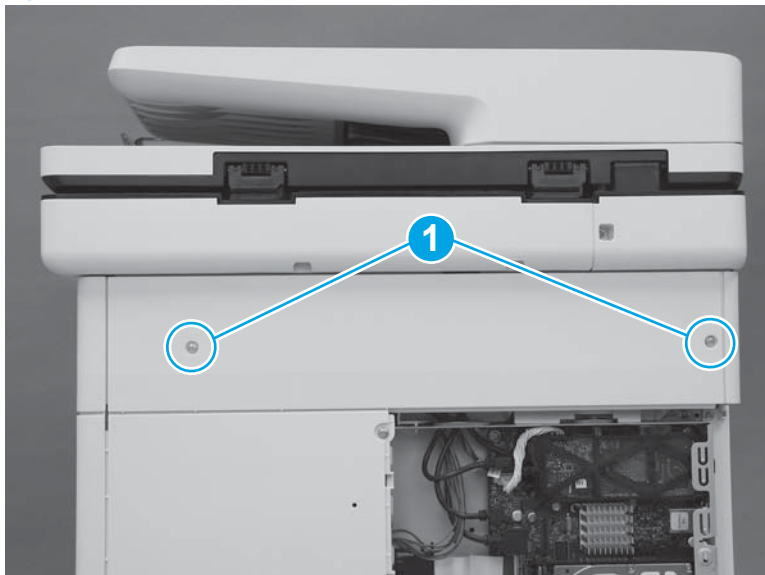
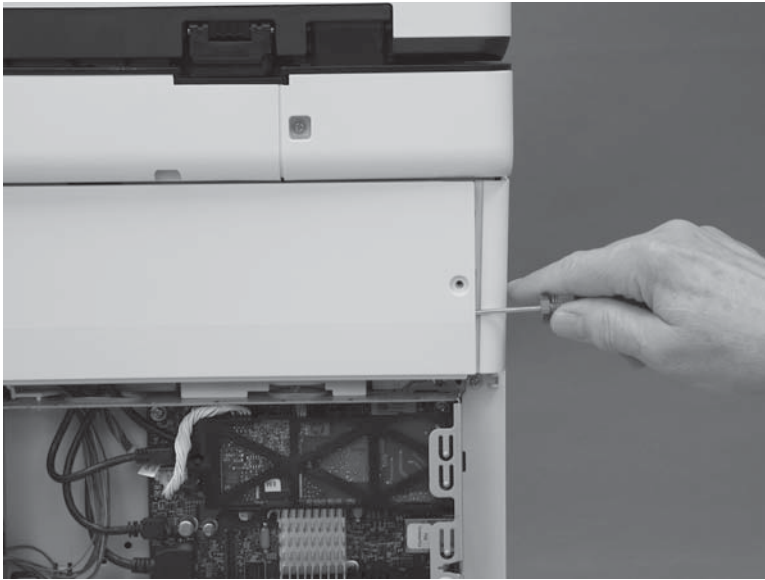

3. Pull the right edge of the cover (callout 1) away from the printer, and then slide the cover to the right (callout 2).

Figure 1-1404 Slide the cover right

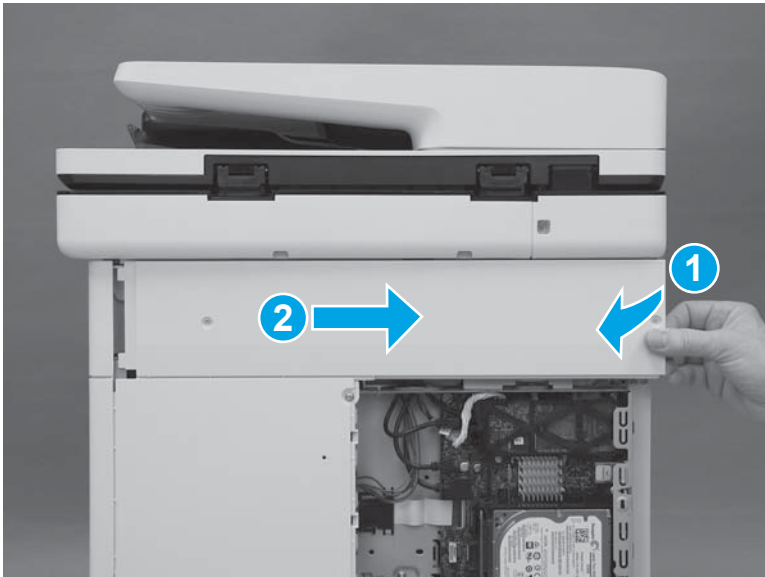

4. Remove the cover.

Figure 1-1405 Remove the cover

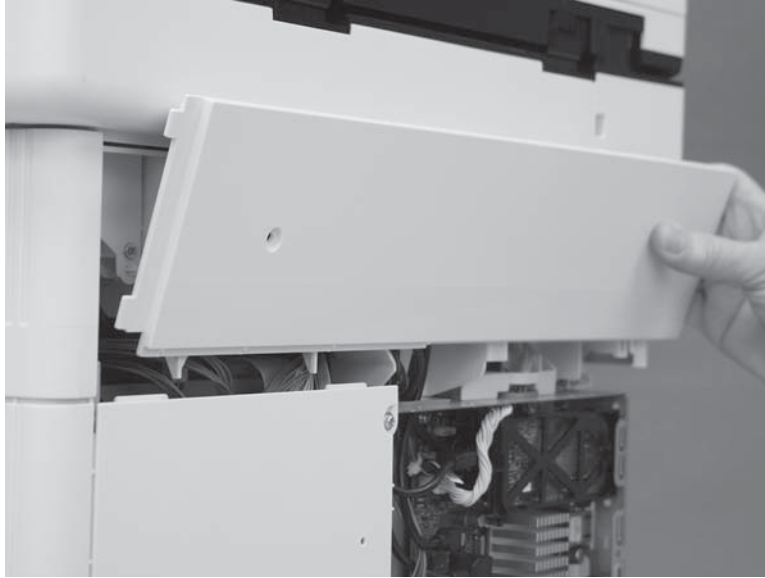

Step 12: Remove the left upper cover (M577)

 **NOTE:** This step is for the M577 models. For the M552 and M553 models, skip this step and go to [Step 22: Remove the output bin on page 824](#).

1. At the left side of the printer, release one tab (callout 1).

Figure 1-1406 Release one tab

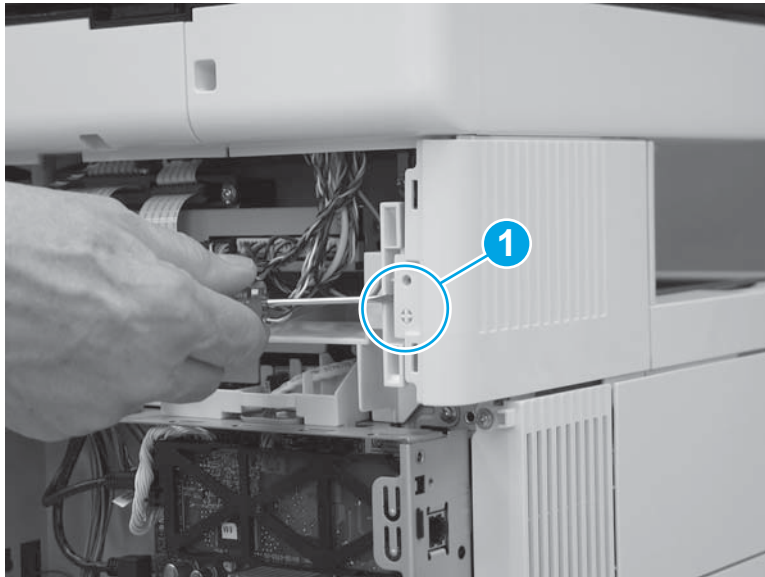

2. Slide the left upper cover toward the back of the printer.

Figure 1-1407 Slide the cover back

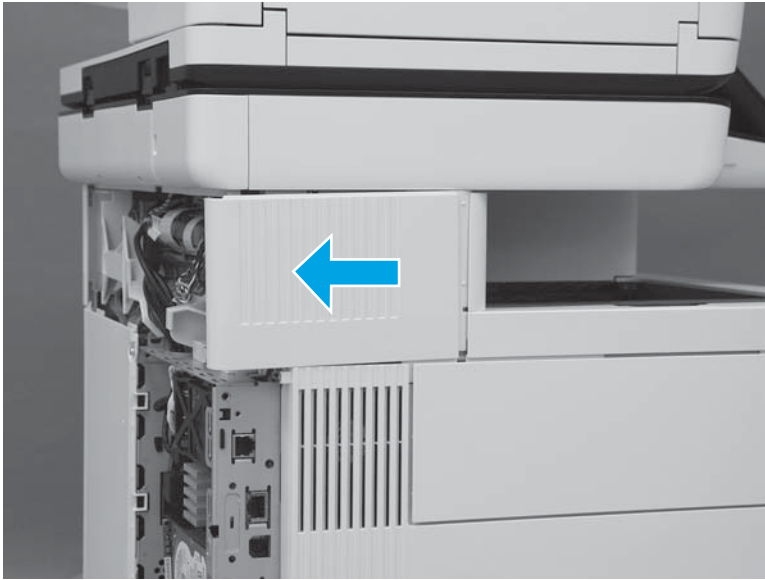

3. Rotate the cover up to remove it.

Figure 1-1408 Remove the left upper cover

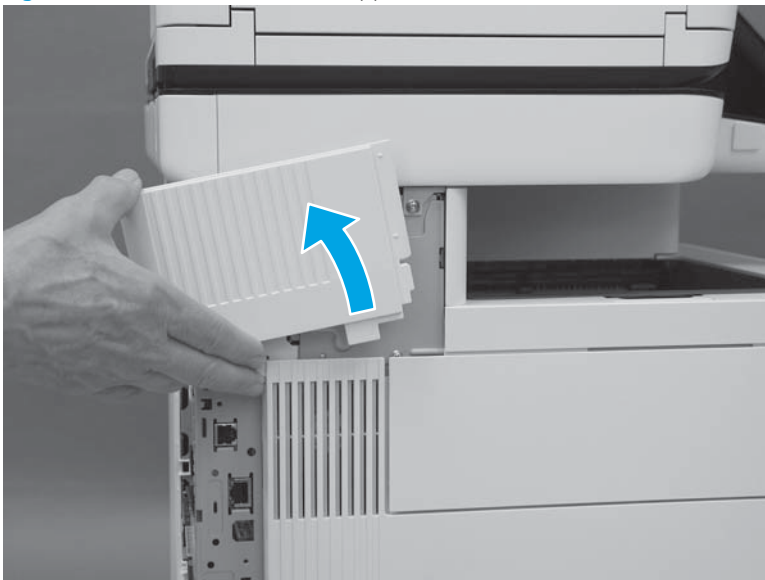

Step 13: Remove the right front upper cover (M577dn)

 **NOTE:** This step is for the M577dn model. For the M577c/f/z models, skip this step and to go [Step 14: Remove the stapler cover assembly \(M577c/f/z\) on page 810.](#)

For the M552 and M553 models, skip this step and go to [Step 22: Remove the output bin on page 824.](#)

1. Remove one screw (callout 1).

Figure 1-1409 Remove one screw

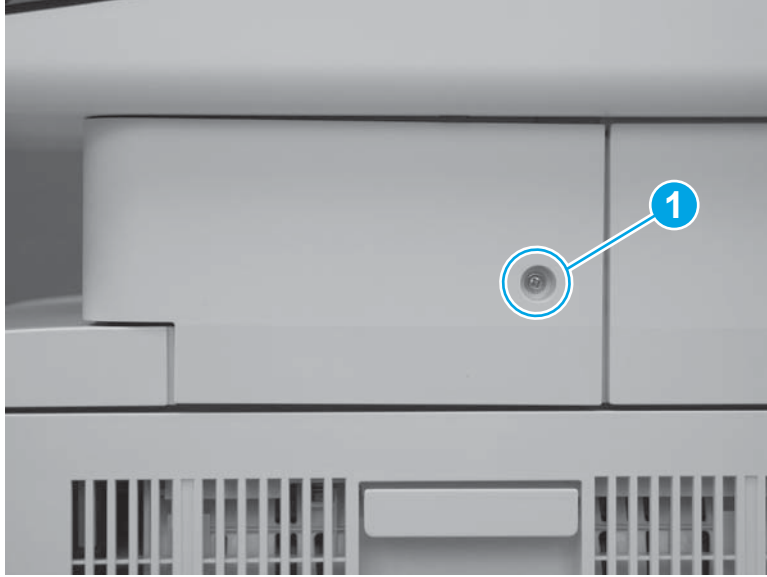

2. Release two tabs at the front edge of the cover (callout 1).

Figure 1-1410 Release two tabs



3. Rotate the front of the cover to the right to remove it.

Figure 1-1411 Rotate the cover



Step 14: Remove the stapler cover assembly (M577c/f/z)

 **NOTE:** This step is for the M577c/f/z models. For the M577dn model, skip this step and to go [Step 15: Remove the integrated scanner assembly on page 812](#).

For the M552 and M553 models, skip this step and go to [Step 22: Remove the output bin on page 824](#).

1. Remove one screw (callout 1).

 **Reinstallation tip:** This is a self-tapping screw for plastic. When reinstalling, rotate the screw counterclockwise to align it with the existing thread pattern, and then carefully turn it clockwise to tighten. Do not overtighten. This will prevent stripping the threads inside the screw hole.

Figure 1-1412 Remove one screw



2. Release two tabs at the front edge of the cover (callout 1).

Figure 1-1413 Release two tabs

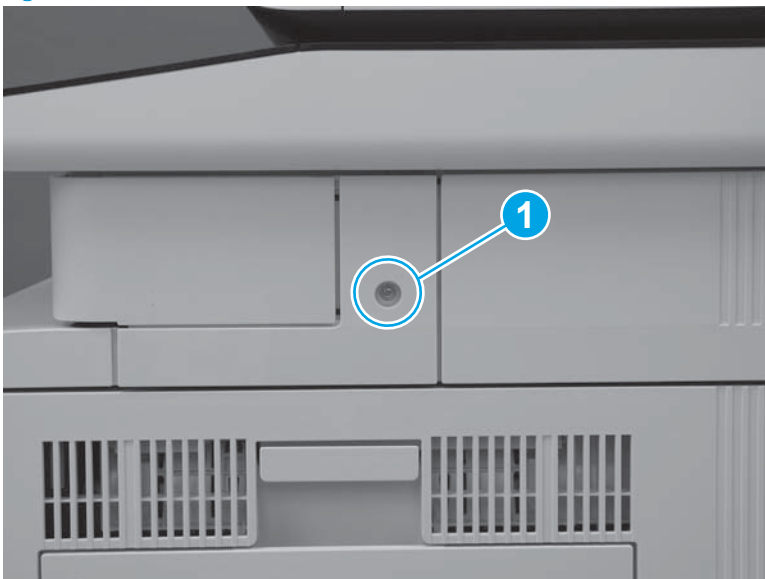

3. Release the back edge of the cover.

Figure 1-1414 Release the back edge of the cover





4. Rotate the cover away from the printer to remove it.

Figure 1-1415 Remove the cover



Step 15: Remove the integrated scanner assembly

 **NOTE:** This step is for the M577 models. For the M552 and M553 models, skip this step and go to [Step 22: Remove the output bin on page 824](#).

 **NOTE:** The ISA includes the document feeder, image scanner, scanner control board (SCB), control panel, keyboard (M577c/z) and NFC PCA (M577z).

1. At the left side of the printer, remove one screw (callout 1).

Figure 1-1416 Remove one screw

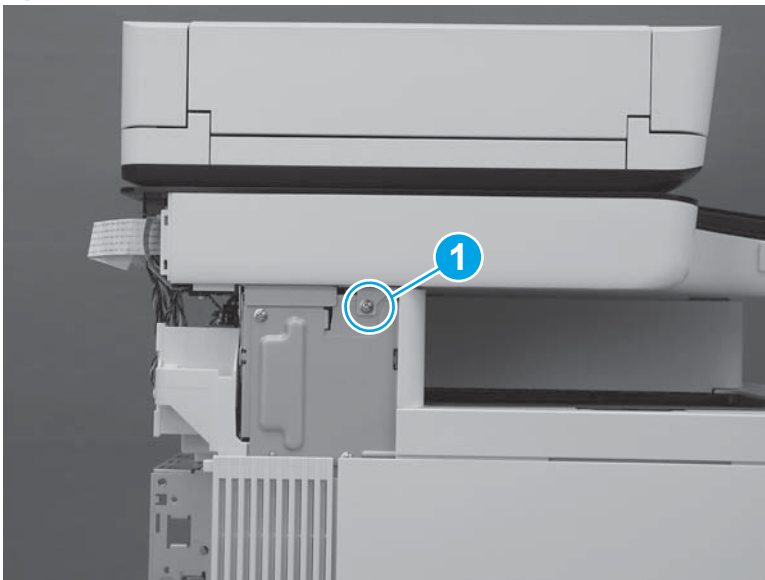

2. At the back side of the printer, remove two screws (callout 1).

Figure 1-1417 Remove two screws

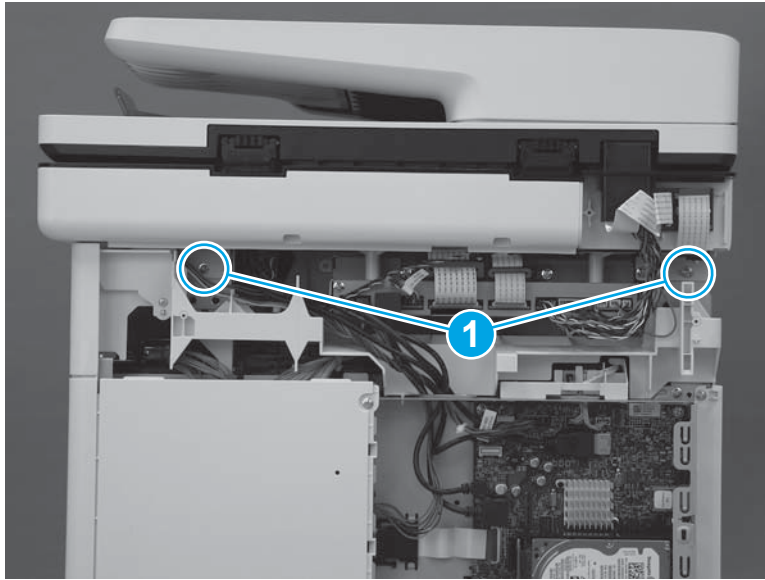

3. At the right side of the printer, remove one screw (callout 1).

Figure 1-1418 Remove one screw

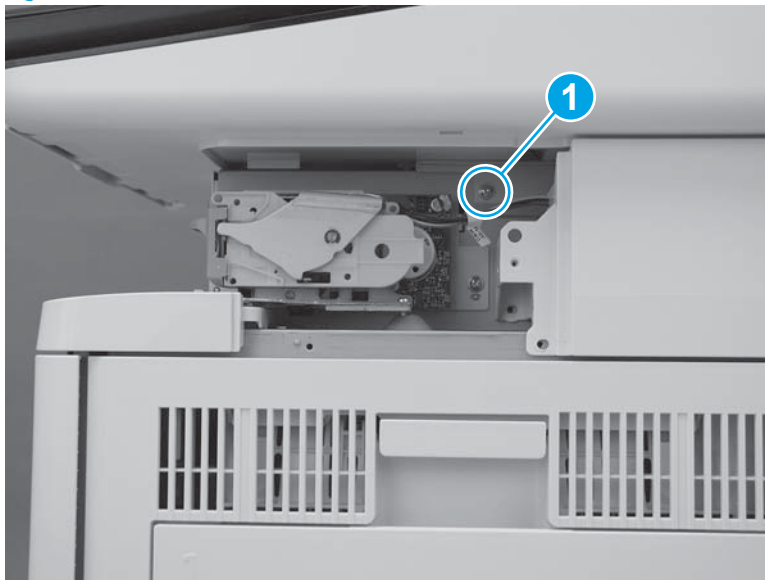

4. Disconnect four connectors on the formatter (callout 1), and then pass the wire harness and cables through the opening in the formatter case (callout 2).

Figure 1-1419 Disconnect four connectors

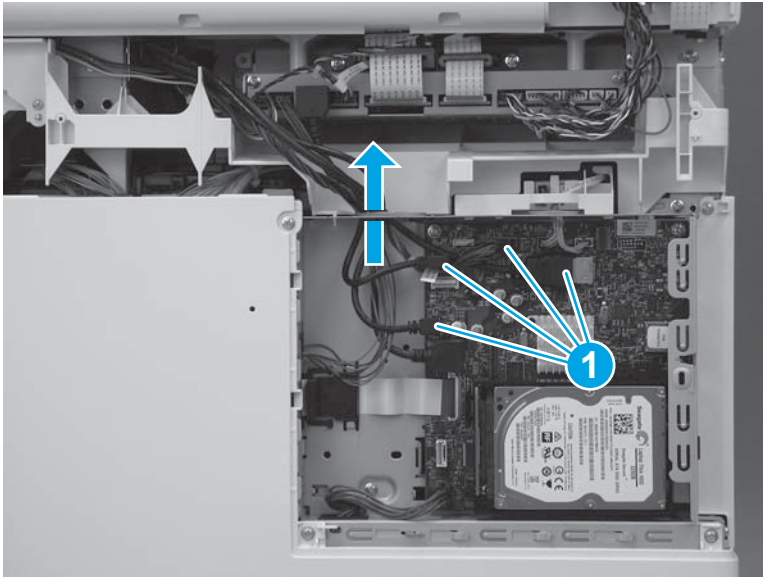

5. Disconnect two connectors on the scanner control board (callout 1).

M577c/f/z only: Disconnect one connector for the stapler on the scanner control board (callout 2).

Figure 1-1420 Disconnect connectors

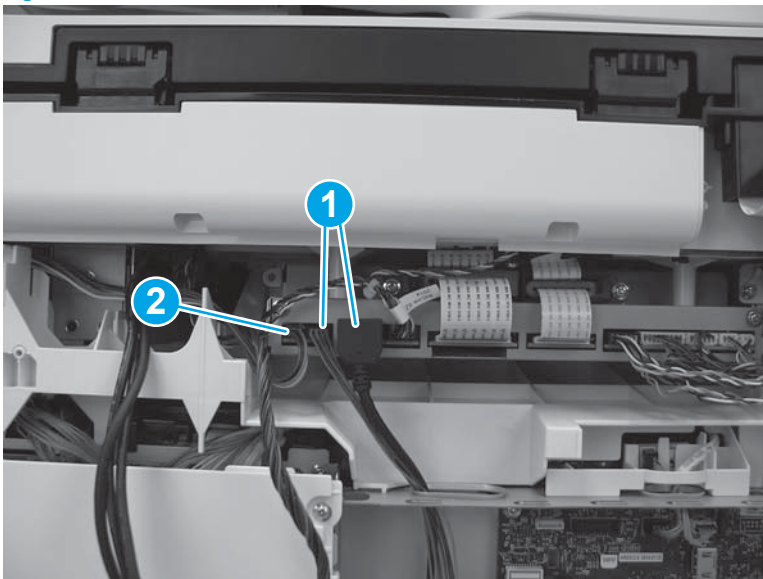

6. Slightly slide the ISA towards the back of the printer to release it.

Figure 1-1421 Slide the ISA towards the back of the printer

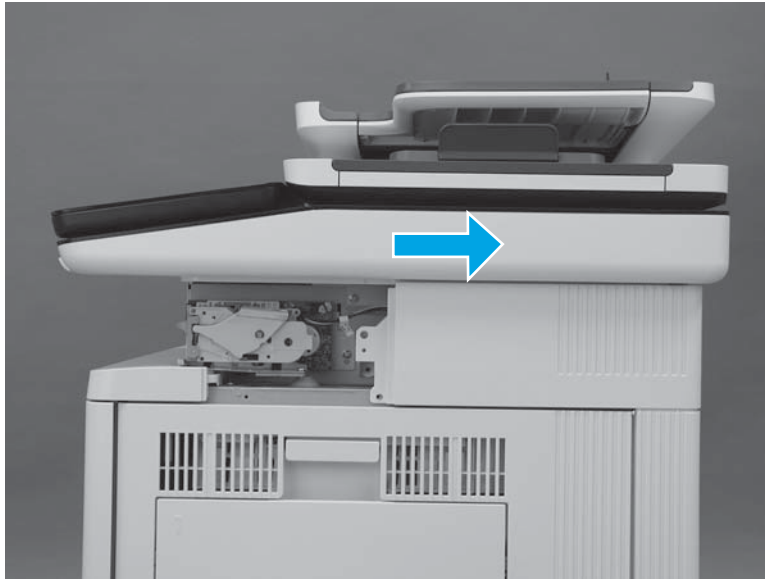

7. Lift the ISA up to remove it.

Figure 1-1422 Remove the ISA



Step 16: Remove the stapler unit (M577c/f/z)

 **NOTE:** This step is for the M577c/f/z models. For the M577dn model, skip this step and to go [Step 17: Remove the right upper cover \(M577\) on page 816](#).

For the M552 and M553 models, skip this step and go to [Step 22: Remove the output bin on page 824](#).

1. Disconnect one connector (callout 1), and then remove two screws (callout 2).

Figure 1-1423 Disconnect connector and remove screws

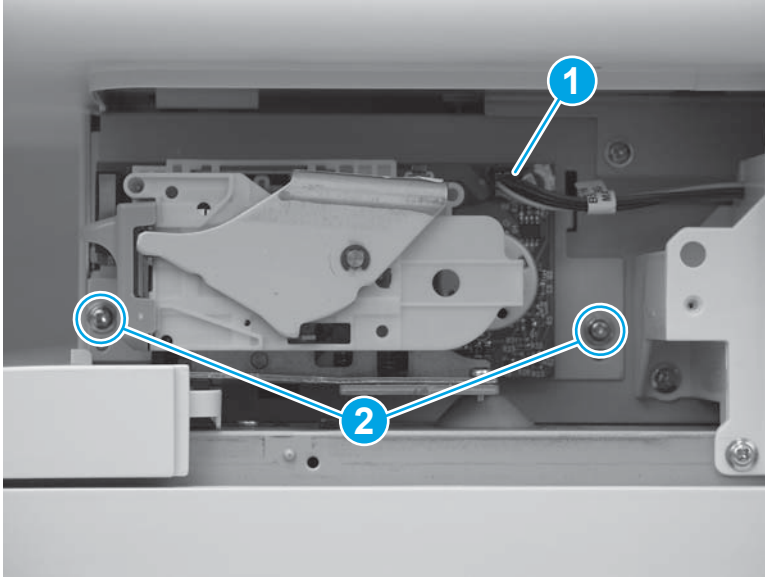

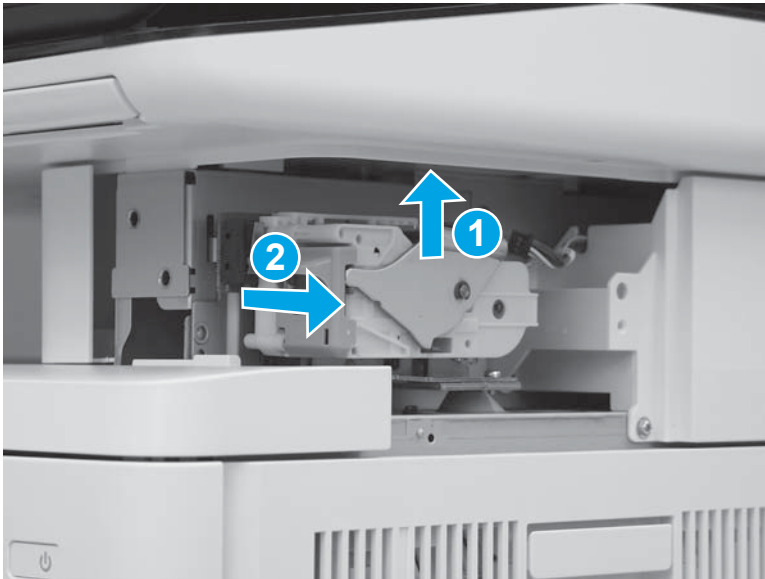

2. Slide the stapler unit up (callout 1), and then pull it away from the printer (callout 2) to remove it.

Figure 1-1424 Remove the stapler unit



Step 17: Remove the right upper cover (M577)

 **NOTE:** This step is for the M577 models. For the M552 and M553 models, skip this step and go to [Step 22: Remove the output bin on page 824](#).

 **NOTE:** The figures below show the image scanner installed. The procedures for removing and installing the right upper cover are the same whether the image scanner is installed or removed."

1. At the right side of the printer, remove two screws (callout 1).

M577c/f/z only: Disconnect one connector (callout 2), if it was not already disconnected in a previous step.

Figure 1-1425 Remove two screws and one connector

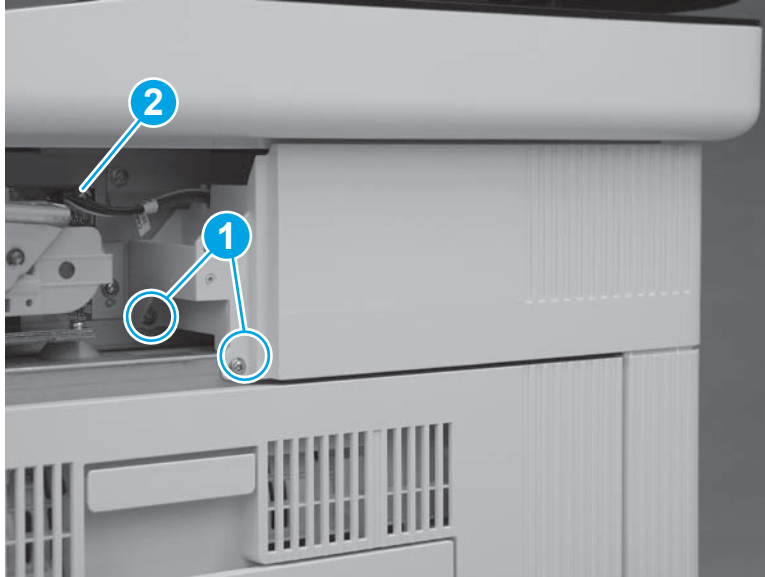

2. At the back of the printer, remove one screw (callout 1).

M577c/f/z only: Disconnect one connector (callout 2), if it was not already disconnected in a previous step.

 **Reinstallation tip:** This screw is smaller than the screws removed in the previous step. When reinstalling the right upper cover, make sure that this screw is installed in the correct position.

Figure 1-1426 Remove one screw and connector



3. Slide the cover toward the back of the printer.

Figure 1-1427 Slide the cover

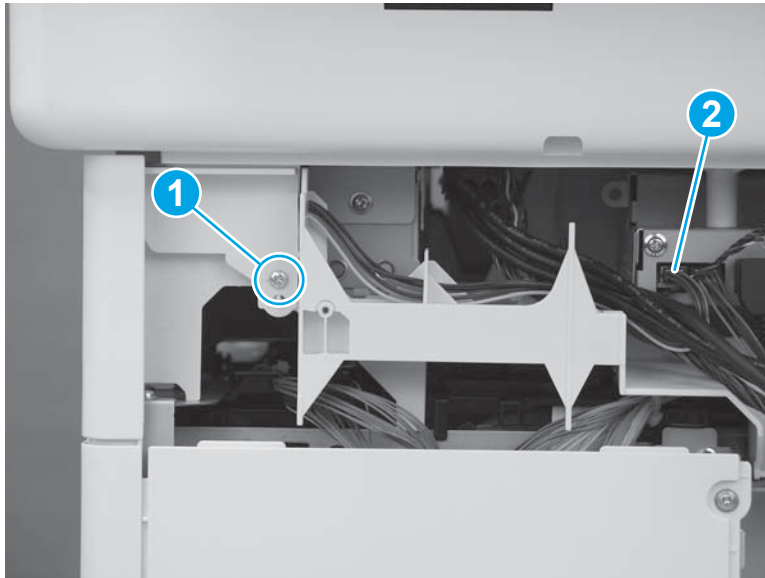
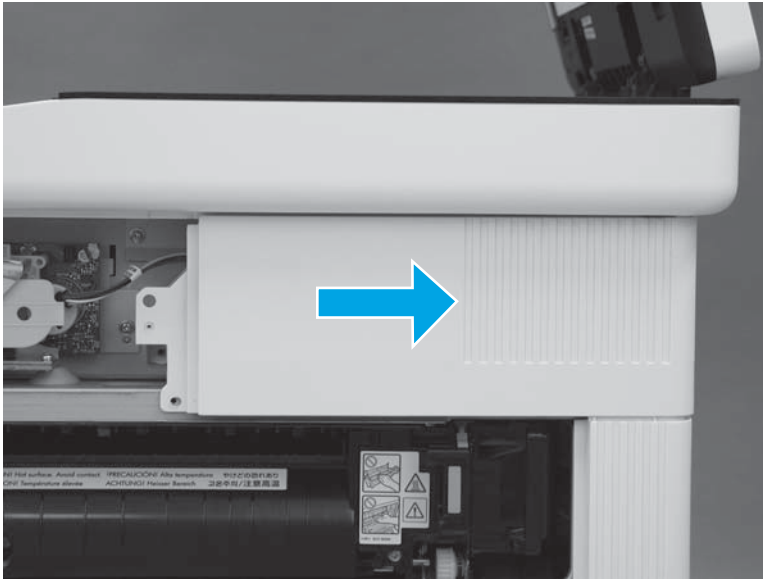

4. Lift the cover away from the printer to remove it.

M577c/f/z only: Release the cables (callout 1) through the slot (callout 2) in the printer.

Figure 1-1428 Remove the cover

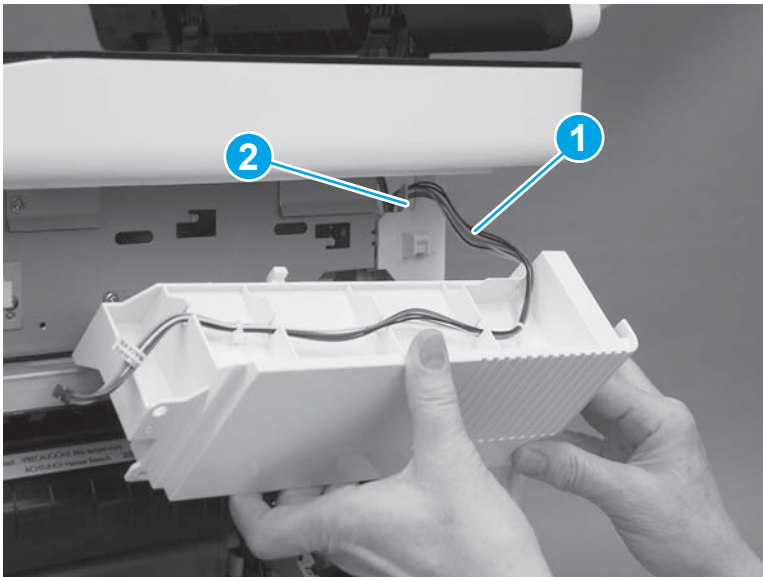

Step 18: Remove the top rear cover (M577)

 **NOTE:** This step is for the M577 models. For the M552 and M553 models, skip this step and go to [Step 22: Remove the output bin on page 824](#).

1. At the top of the printer, remove five screws (callout 1).

Figure 1-1429 Remove five screws

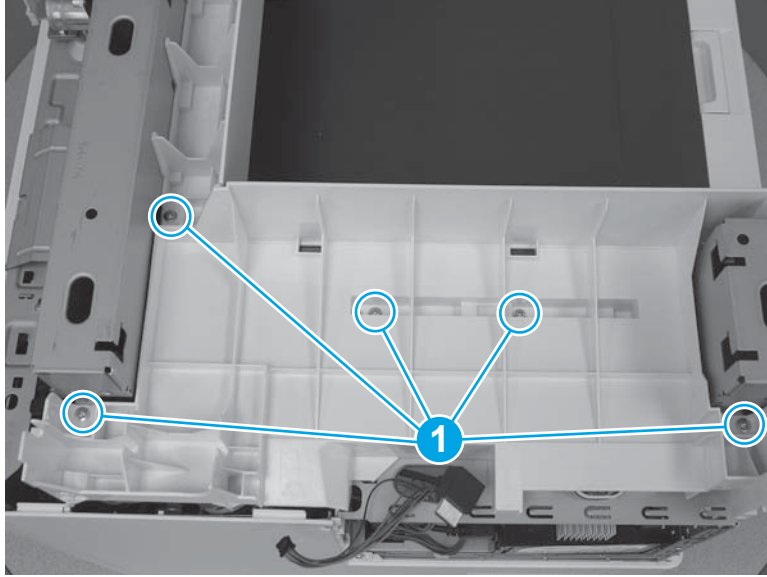

2. Release two tabs (callout 1) on the front edge of the cover.

Figure 1-1430 Release two tabs

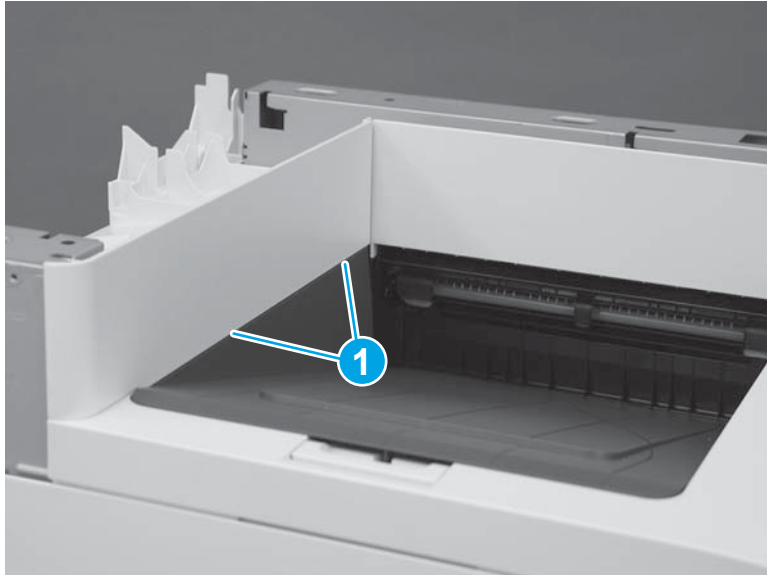

3. Remove the top rear cover.

Figure 1-1431 Remove the top rear cover

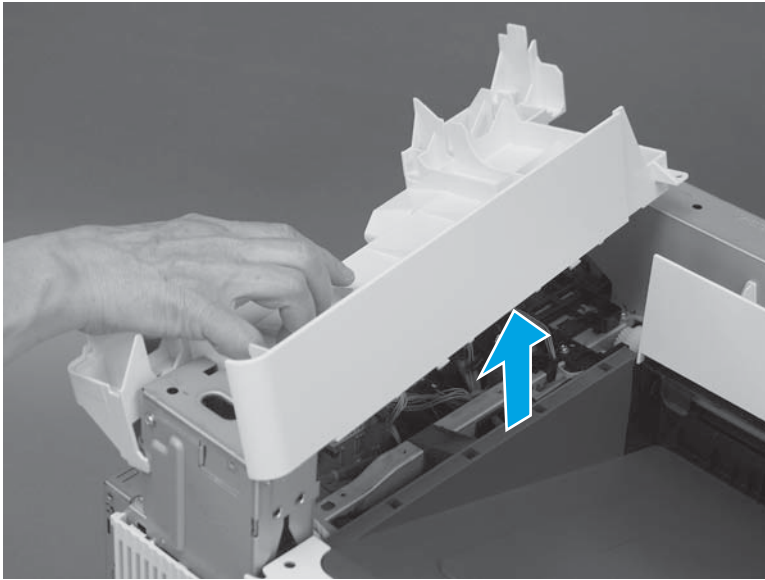

Step 19: Remove the paper feed cover (M577)



NOTE: This step is for the M577 models. For the M552 and M553 models, skip this step and go to [Step 22: Remove the output bin on page 824](#).

1. Remove one screw (callout 1).

Figure 1-1432 Remove one screw

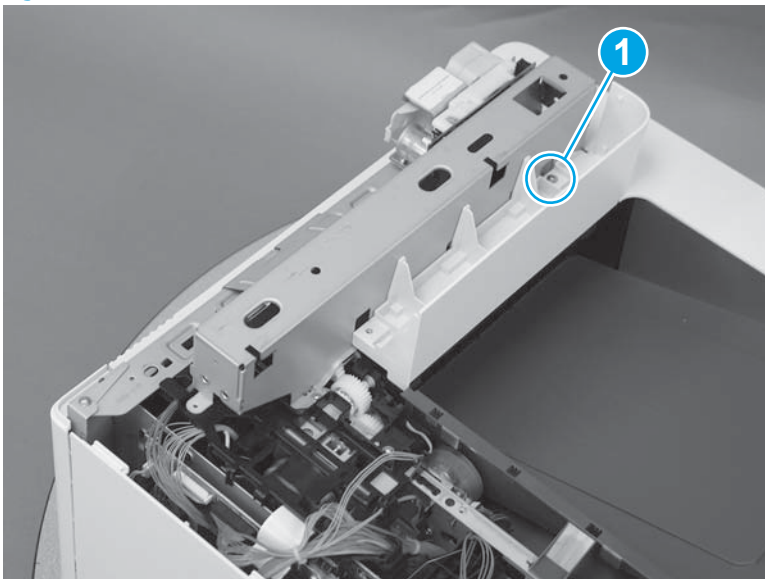

2. Lift the cover up to remove it.

Figure 1-1433 Remove the cover

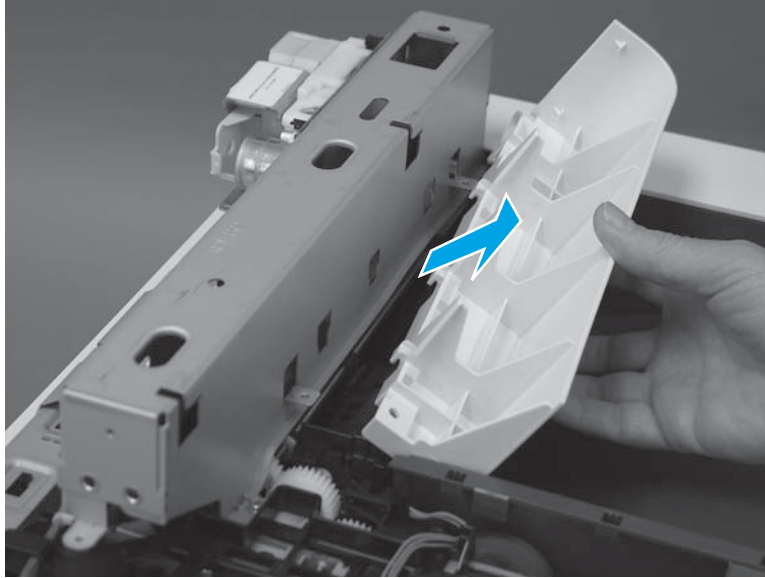

Step 20: Remove the top cover (M577)

 **NOTE:** This step is for the M577 models. For the M552 and M553 models, skip this step and go to [Step 22: Remove the output bin on page 824](#).

1. At the front of the printer, remove one screw (callout 1).

 **Reinstallation tip:** This screw is longer and a different type of screw than the screw removed in the next step. When reinstalling the top cover, make sure that this screw is installed in the correct position.

Figure 1-1434 Remove one screw



2. At the left side of the printer, remove one screw (callout 1).

Figure 1-1435 Remove one screw

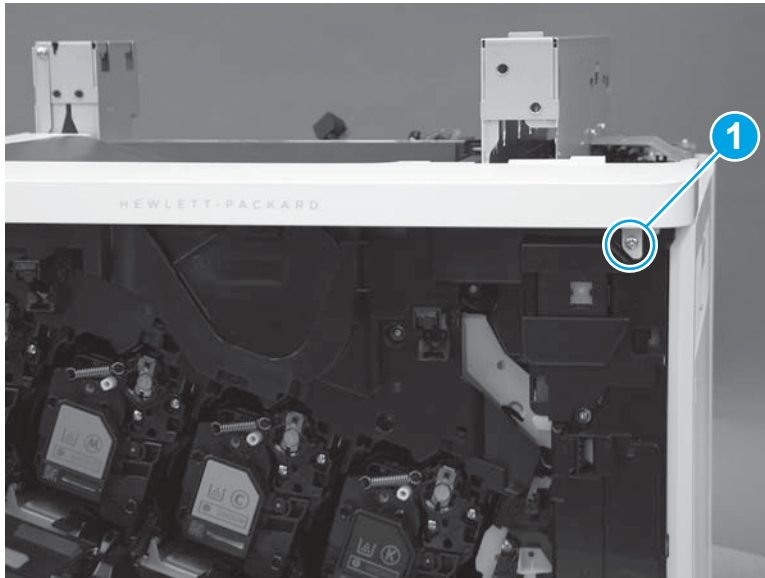
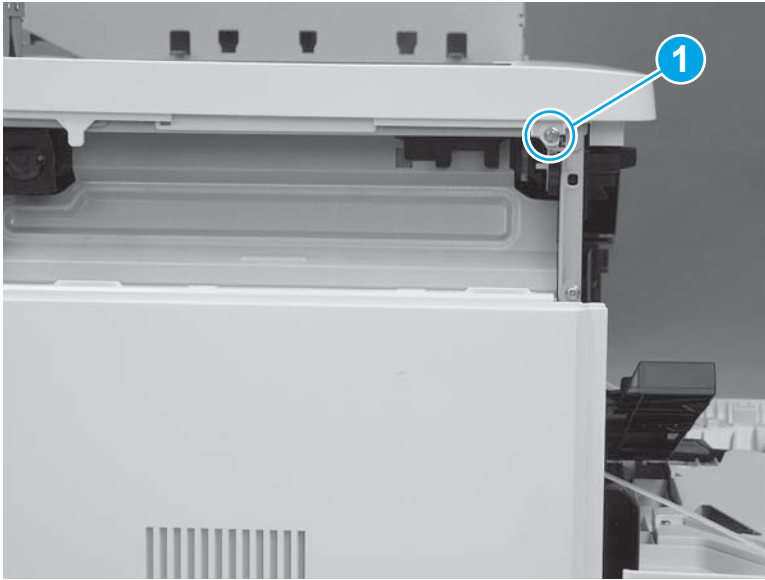

3. At the front of the printer, release one tab (callout 1).

Figure 1-1436 Release one tab

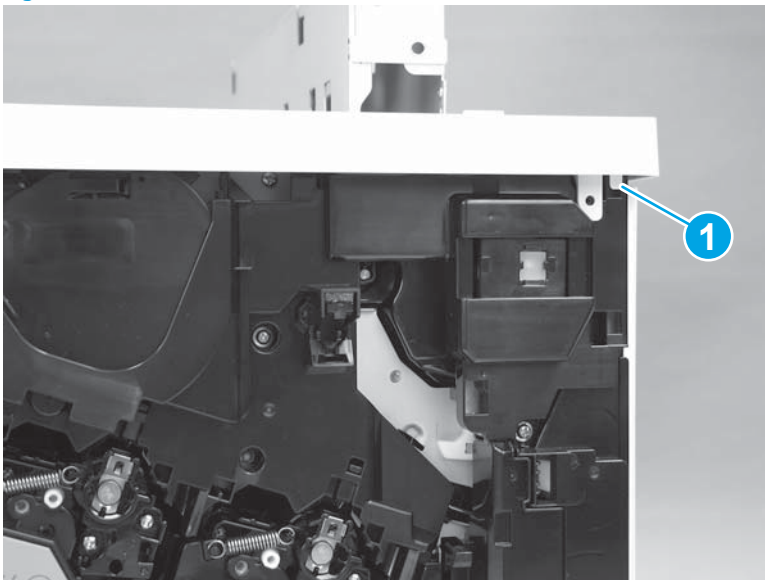

4. At the top of the printer, release two tabs (callout 1) next to the output bin, and then remove the top cover.

Figure 1-1437 Release two tabs

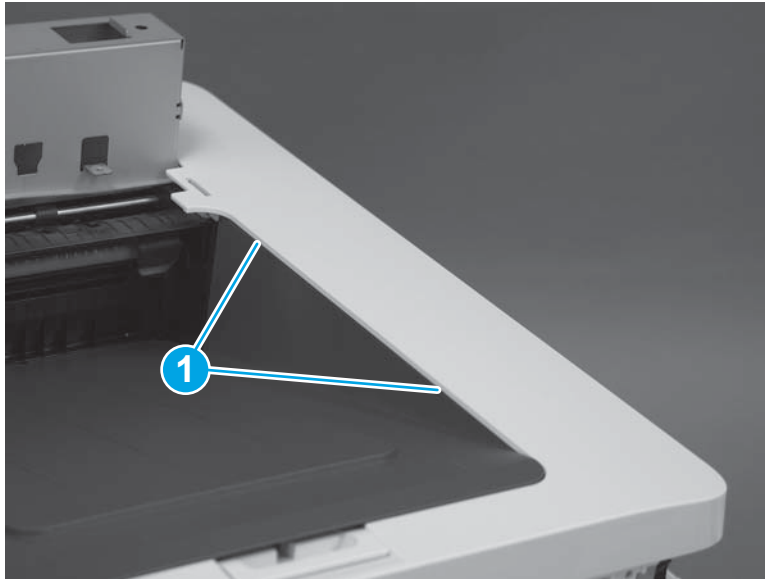

Step 21: Remove the top bracket (M577)

 **NOTE:** This step is for the M577 models. For the M552 and M553 models, skip this step and go to [Step 22: Remove the output bin on page 824](#).

1. At the top of the printer, remove three screws (callout 1).

Figure 1-1438 Remove three screws

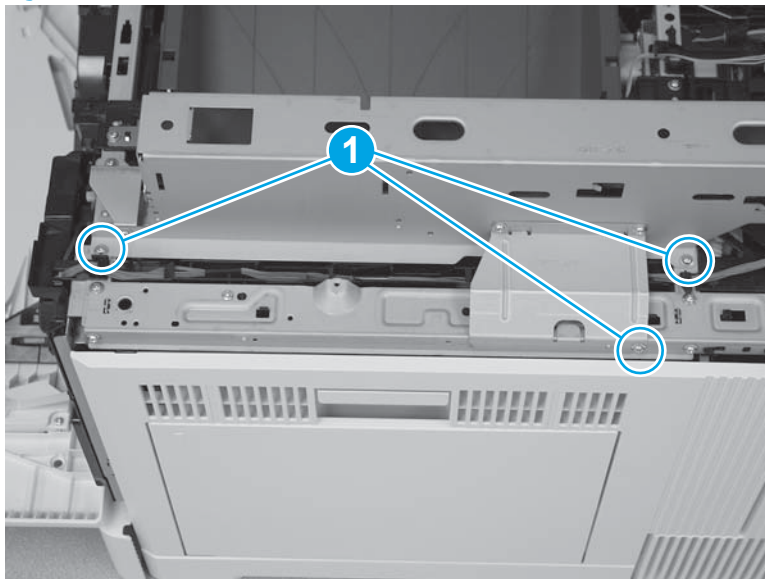

2. At the top of the printer, remove two screws (callout 1).

Figure 1-1439 Remove two screws

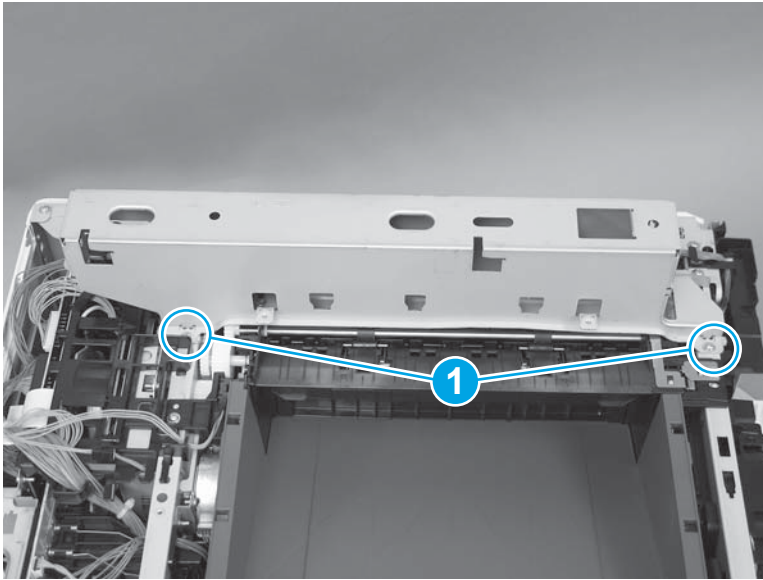

3. Lift the top bracket up to remove it.

Figure 1-1440 Remove the bracket

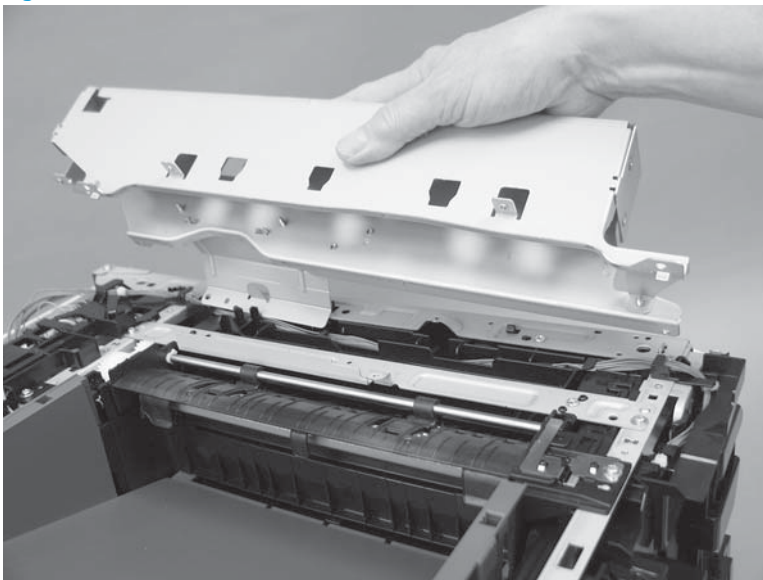

Step 22: Remove the output bin

1. Slightly slide and lift the cover to release it.

Figure 1-1441 Release the cover

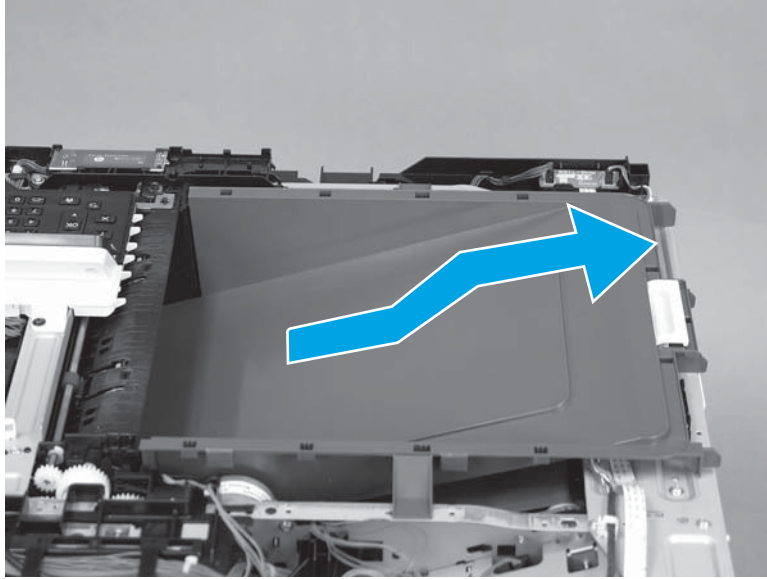

2. Remove the cover.

Figure 1-1442 Remove the cover

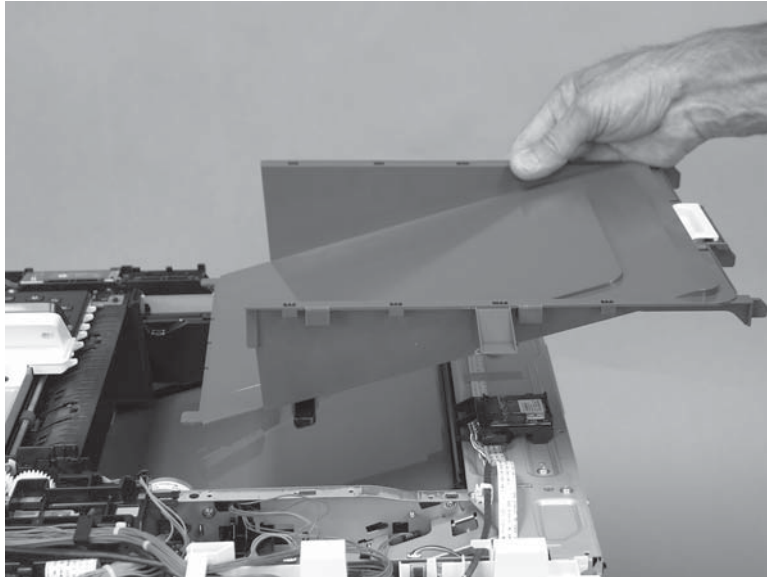

Step 23: Remove the delivery assembly

1. At the right side of the printer, remove two screws (callout 1).

 **NOTE:** These two screws are the self-tapping type.

Figure 1-1443 Remove two screws

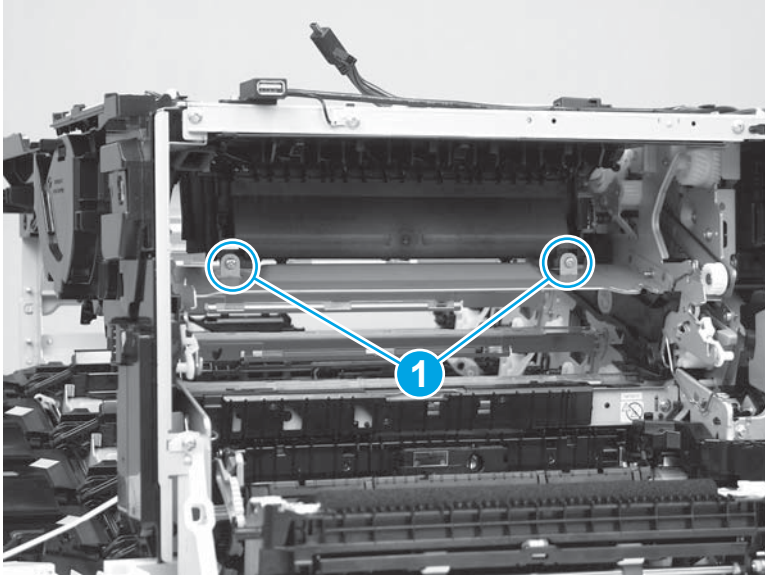

2. **M553x only:** At the top-front-right corner of the printer, disconnect one connector (callout 1), remove one screw (callout 2), and then remove the near field communication (NFC) PCA and holder by sliding them to the right (callout 3).

Figure 1-1444 Remove the PCA

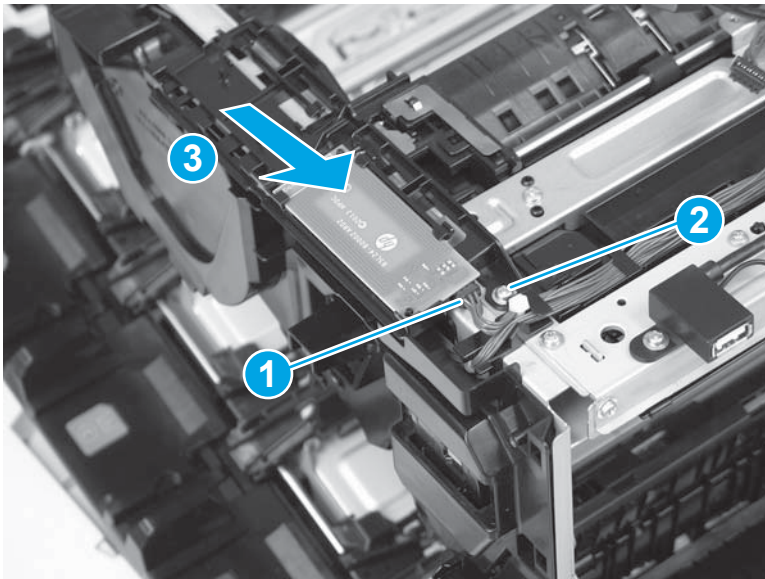

3. Release two retainers (callout 1), remove the USB cable (callout 2) from the retainers, and then disconnect one connector (callout 3).

Figure 1-1445 Release two retainers and disconnect one connector

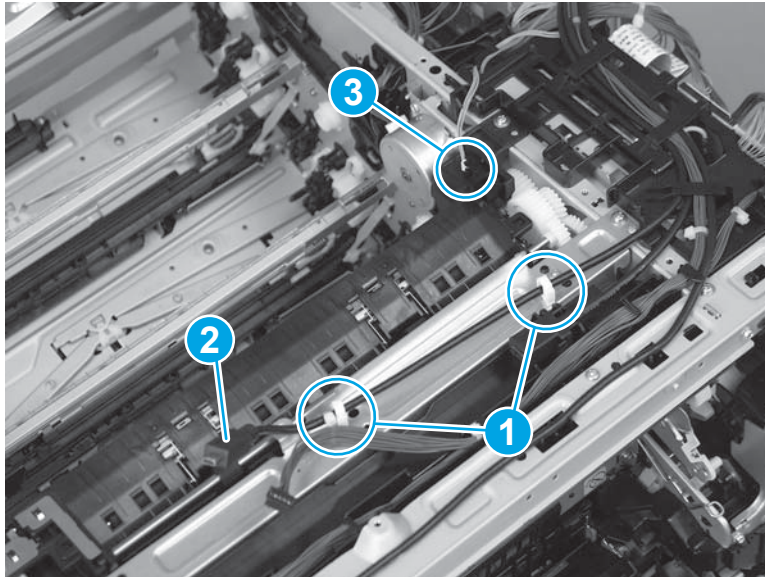

4. Remove four screws (callout 1).

Figure 1-1446 Remove four screws

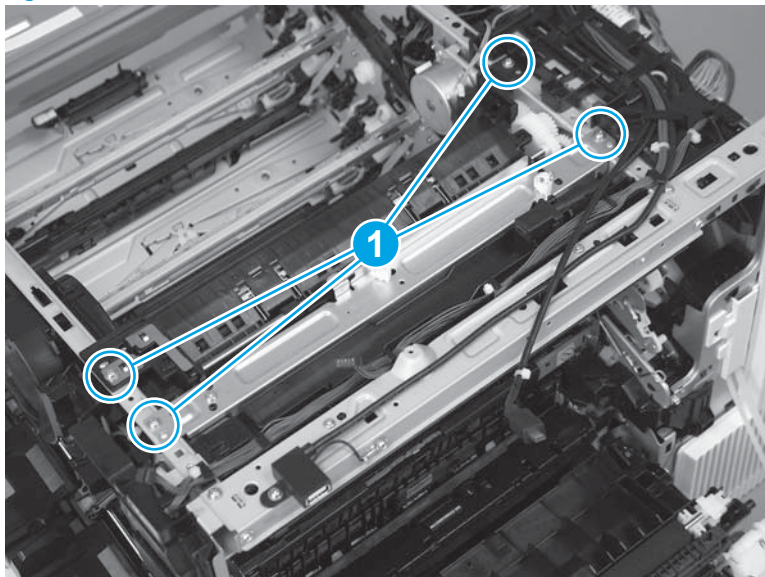

5. Remove the delivery assembly.

 **NOTE:** The solenoid plunger and arm (callout 1) located on the right side of the assembly are not captive. Do not lose the plunger and arm when handling the assembly.

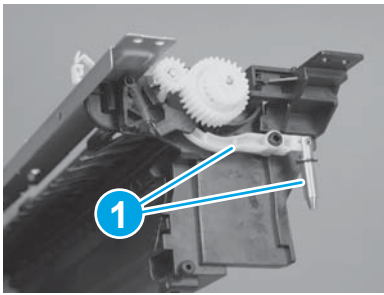
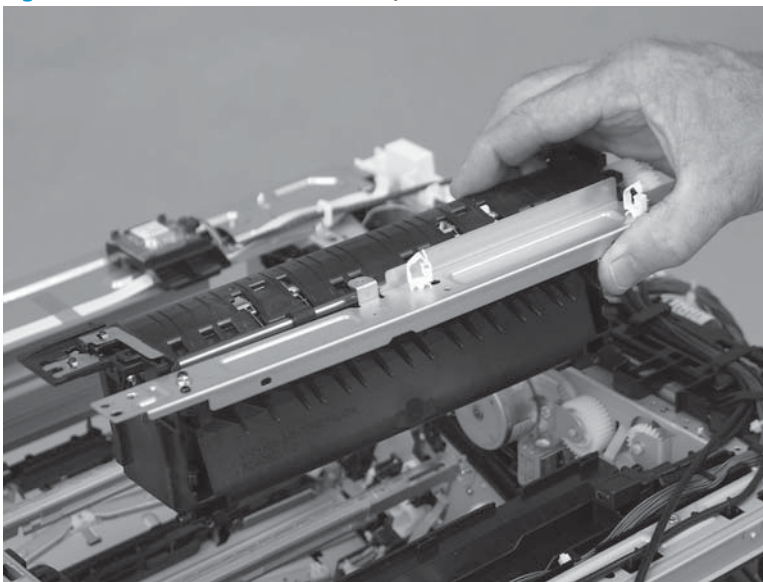

Figure 1-1447 Remove the assembly



Step 24: Unpack the replacement assembly

Unpack the replacement assembly from the packaging.

For complete information on HP's recycling programs, go to [Product return and recycling](#).

 **NOTE:** HP recommends responsible disposal of the defective assembly.

Figure 1-1448 Recycle and unpack

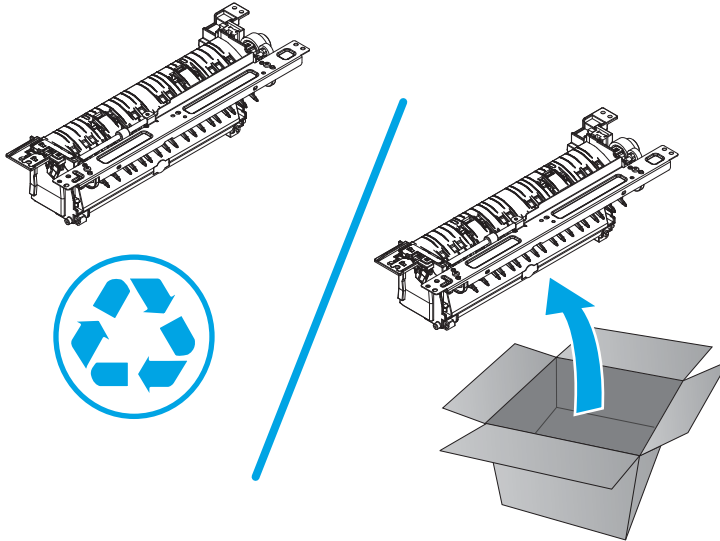

Step 25: Install the delivery assembly

1. Locate the solenoid plunger and arm (callout 1) on the right side of the removed delivery assembly.

Figure 1-1449 Locate the solenoid plunger

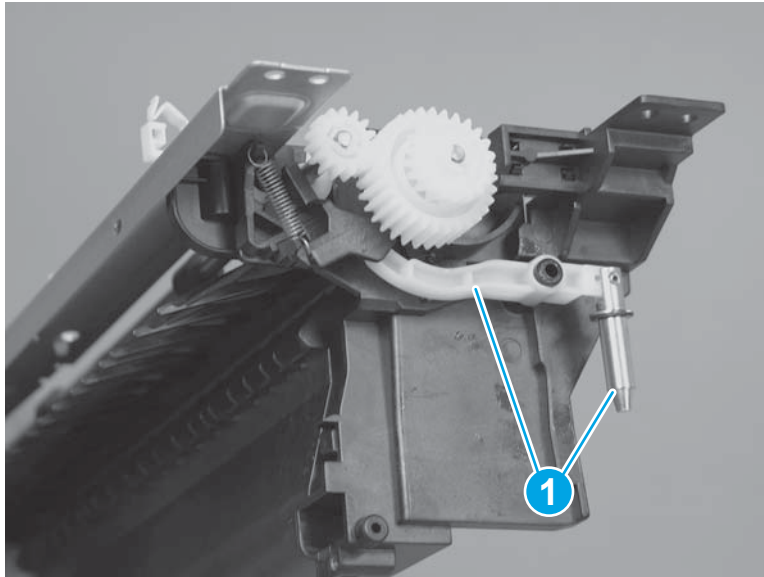

2. Remove the arm from the assembly.

Figure 1-1450 Remove the arm

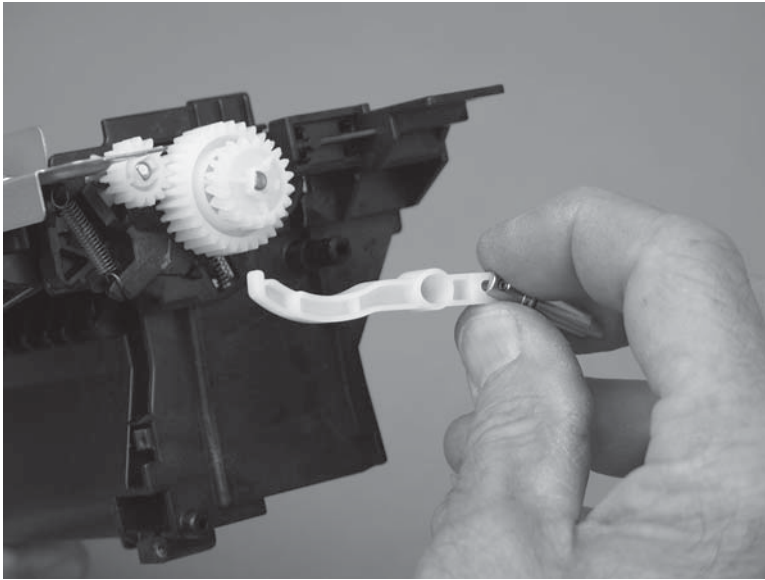

3. Pull the solenoid plunger off of the arm to separate them.

Figure 1-1451 Separate the solenoid plunger from the arm

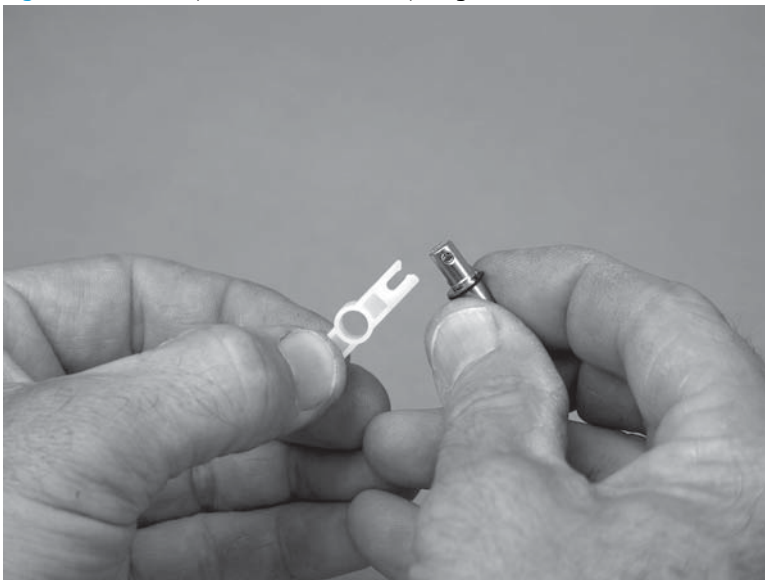

4. Install the solenoid plunger on the arm of the replacement delivery assembly.

Figure 1-1452 Install the solenoid plunger

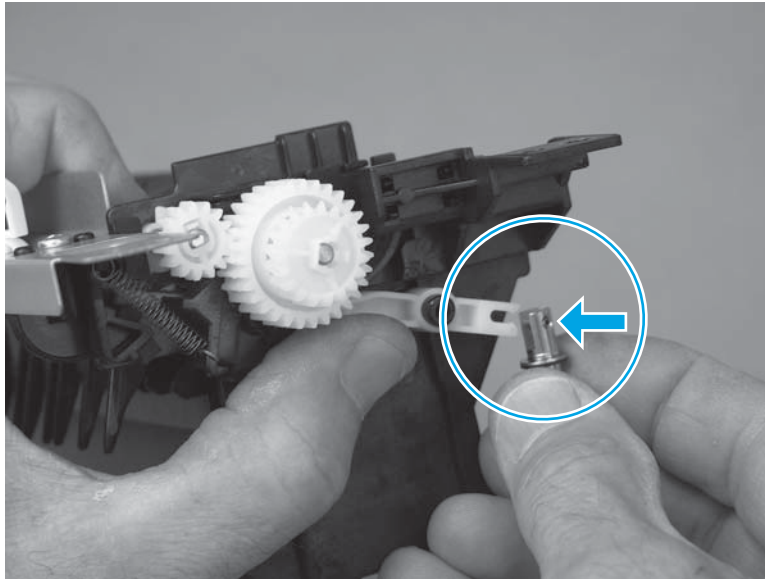

5. Position the delivery assembly on the printer—make sure that the solenoid plunger is placed into the solenoid when the assembly is installed.

Figure 1-1453 Install the assembly

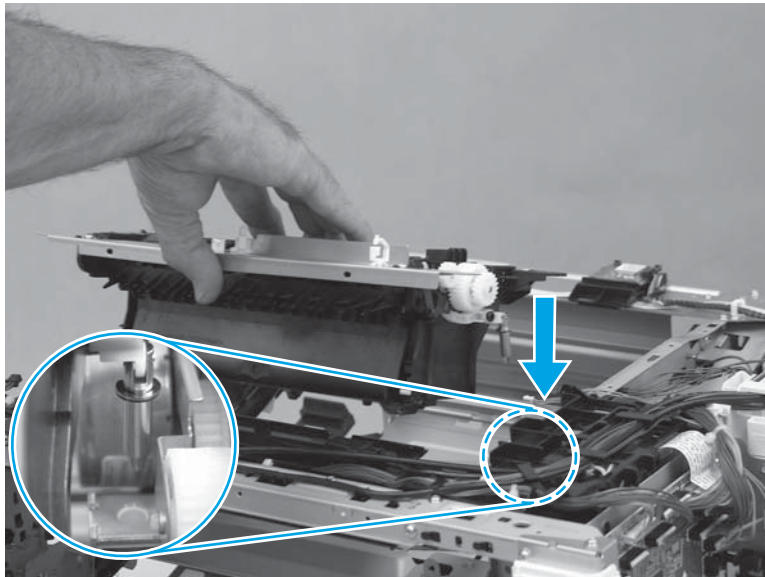

6. Install four screws (callout 1).

Figure 1-1454 Install four screws

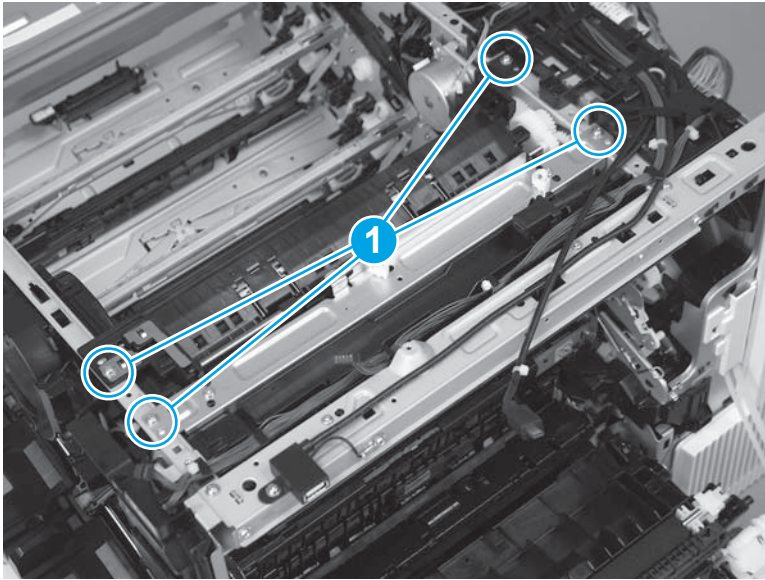

7. Connect one connector (callout 1), and then place the USB cable (callout 2) in the retainers (callout 3).

Figure 1-1455 Connect one connector

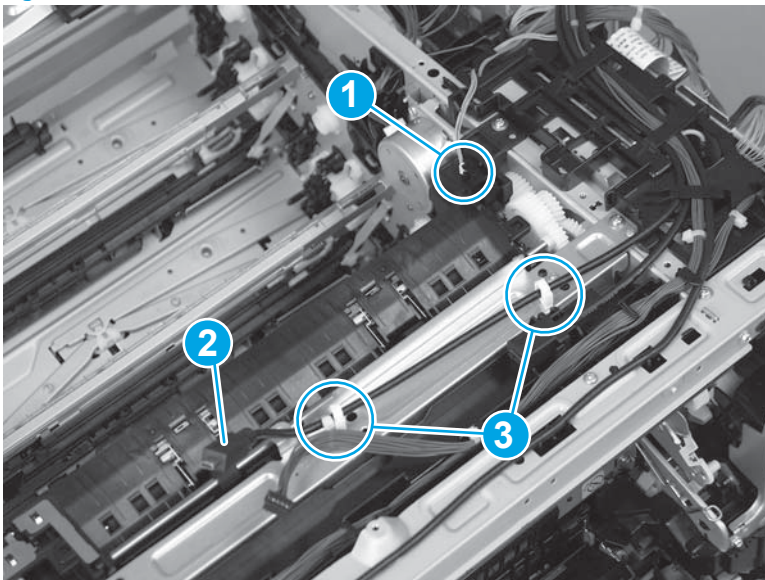

8. **M553x only:** At the top-front-right corner of the printer, install the tab on the NFC PCA holder (callout 1) in the slot (callout 2) in the chassis.

Figure 1-1456 Install the PCA holder

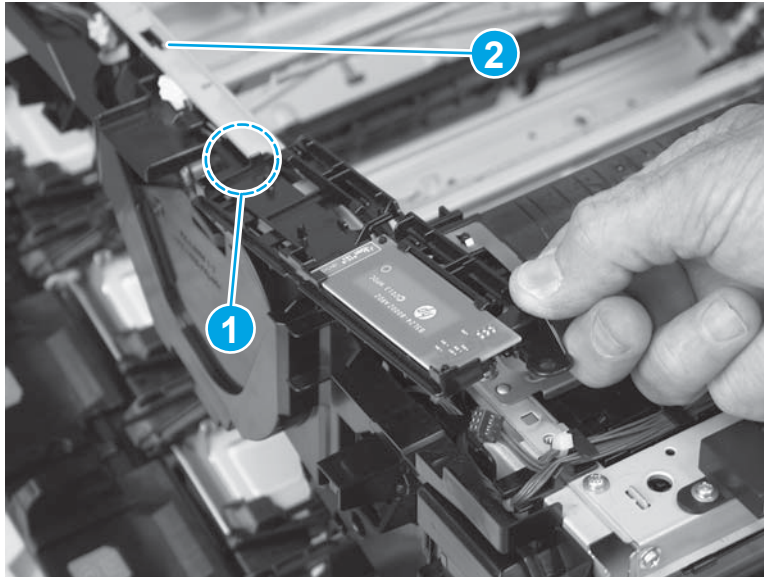

9. **M553x only:** Rotate the NFC PCA holder down (callout 1) to install it, and then install one screw (callout 2).

Figure 1-1457 Install one screw

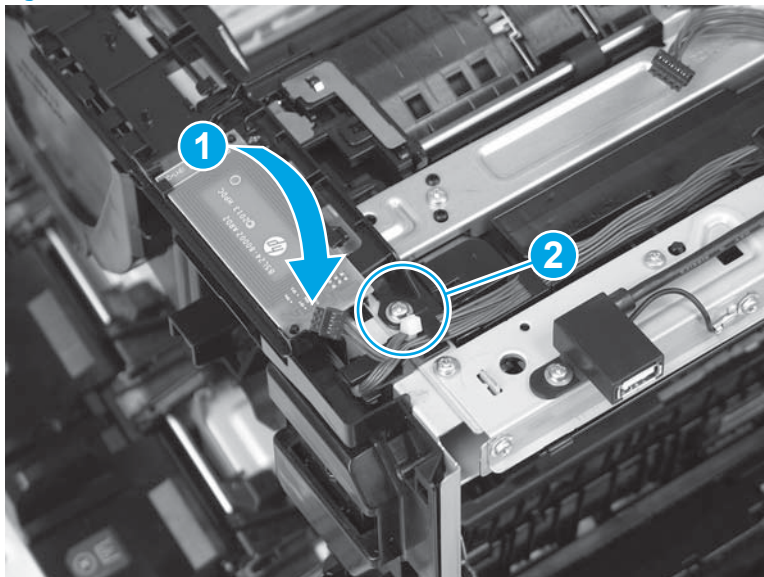

10. **M553x only:** Connect one connector (callout 1) on the NFC PCA.

Figure 1-1458 Connect one connector

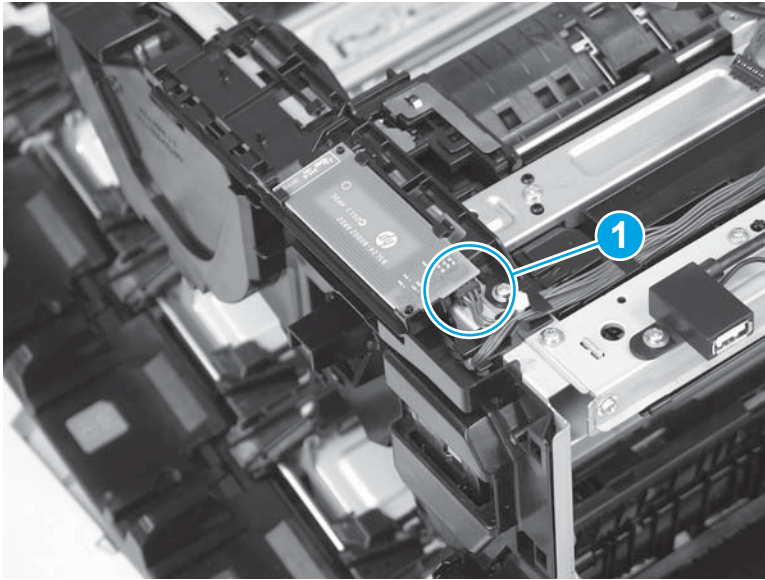

11. At the right side of the printer, install two screws (callout 1).

 **NOTE:** These two screws are the self-tapping type.

Figure 1-1459 Install two screws

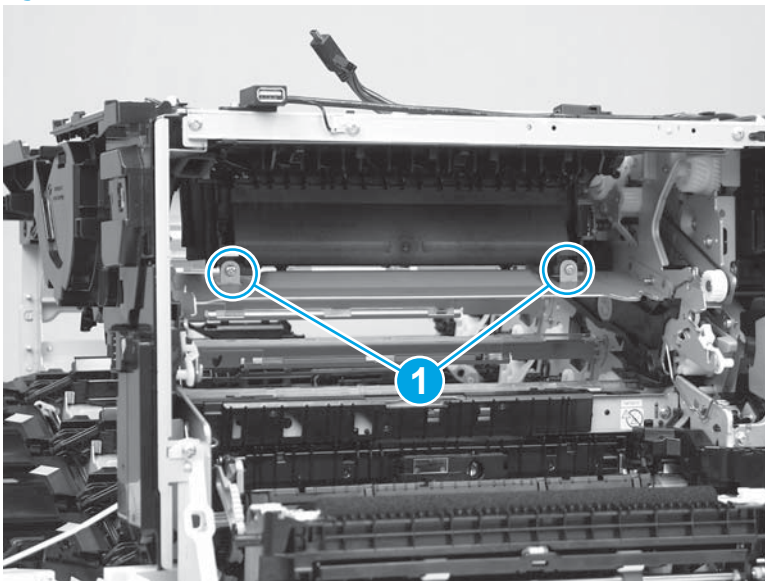

Step 26: Install the output bin

1. Position the cover near the printer.

Figure 1-1460 Install the cover

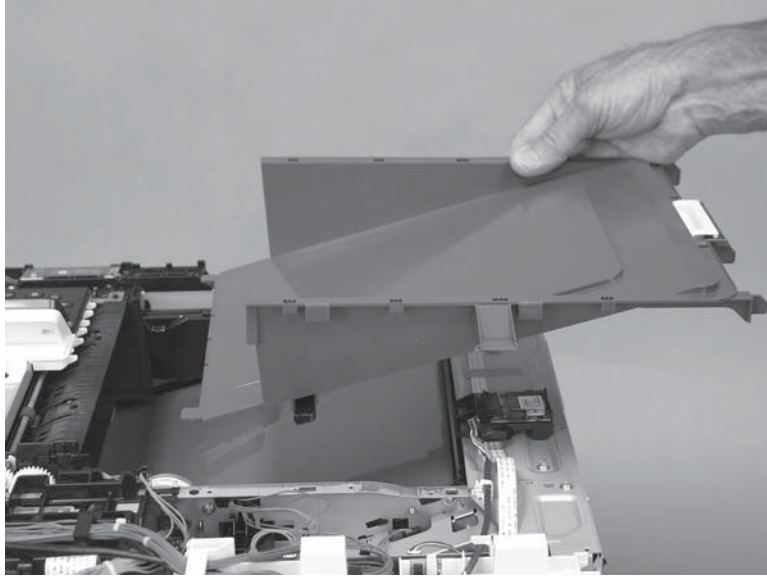

2. Align the tabs on the cover with the slots in the printer.

Figure 1-1461 Align the tabs

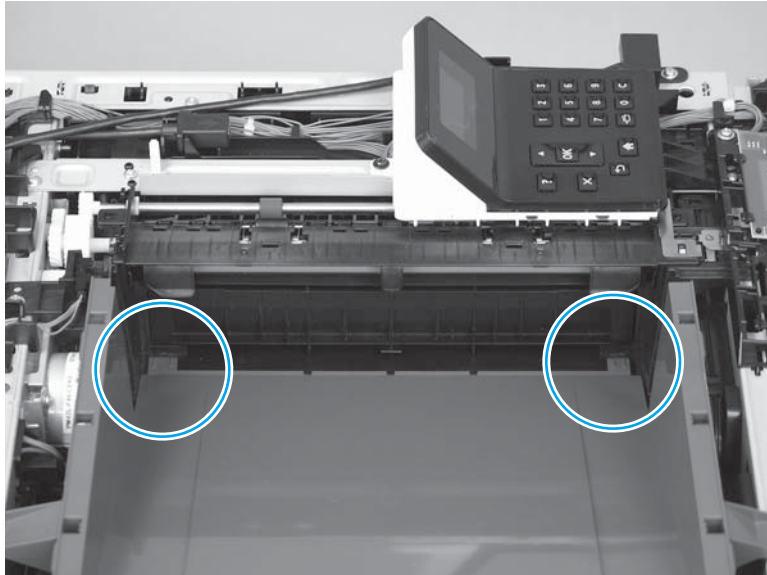

3. Slide and lower the cover onto the printer to install it.

Figure 1-1462 Release the cover

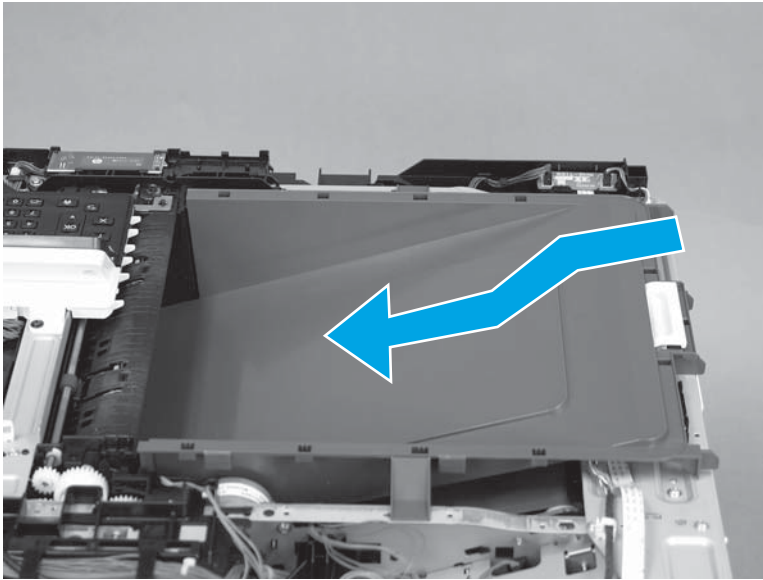

4. Verify that the tabs on the front- and rear-side of the cover are correctly installed in the slots in the chassis.

Figure 1-1463 Verify the installation

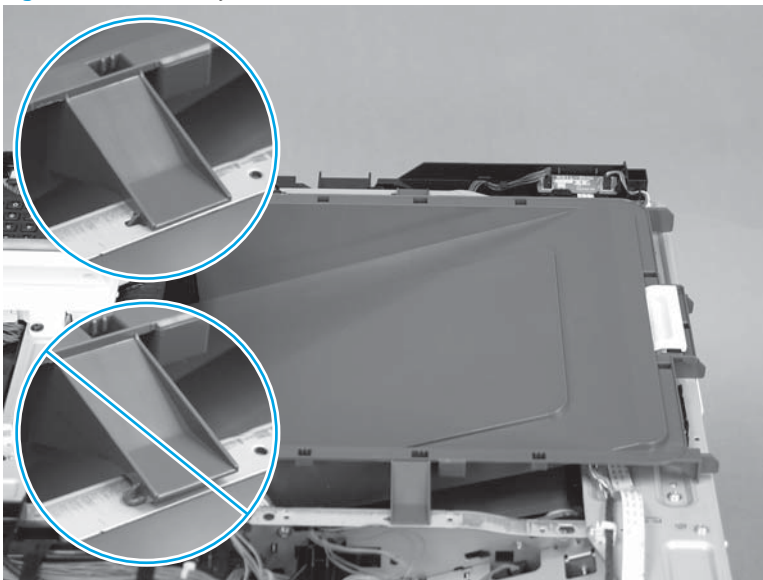

Step 27: Install the top bracket (M577)

 **NOTE:** This step is for the M577 models. For the M552 and M553 models, skip this step and go to [Step 38: Install the control panel \(M553n/dn and M552dn only\) on page 856.](#)

1. Position the tabs (callout 1) on the bracket in the slots (callout 2) in the printer.

Figure 1-1464 Position the tabs in the slots

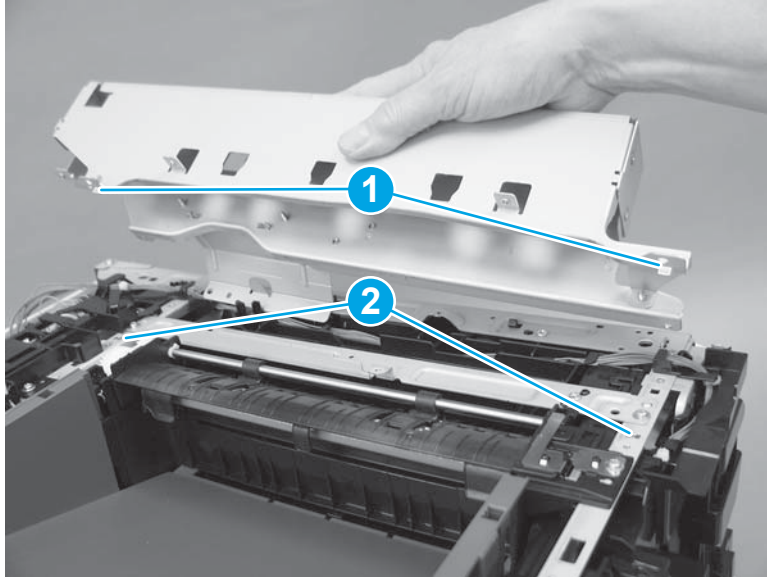

2. At the top of the printer, install two screws (callout 1).

Figure 1-1465 Install two screws

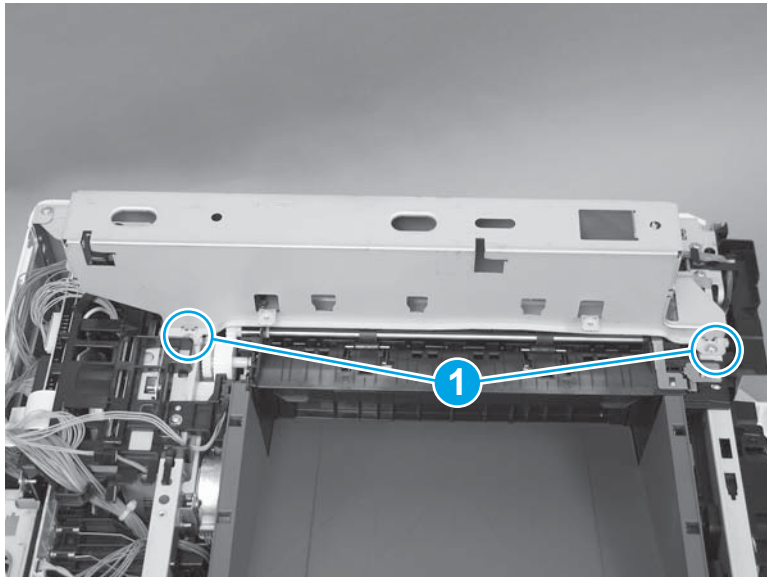

3. At the top of the printer, install three screws (callout 1).

Figure 1-1466 Install three screws

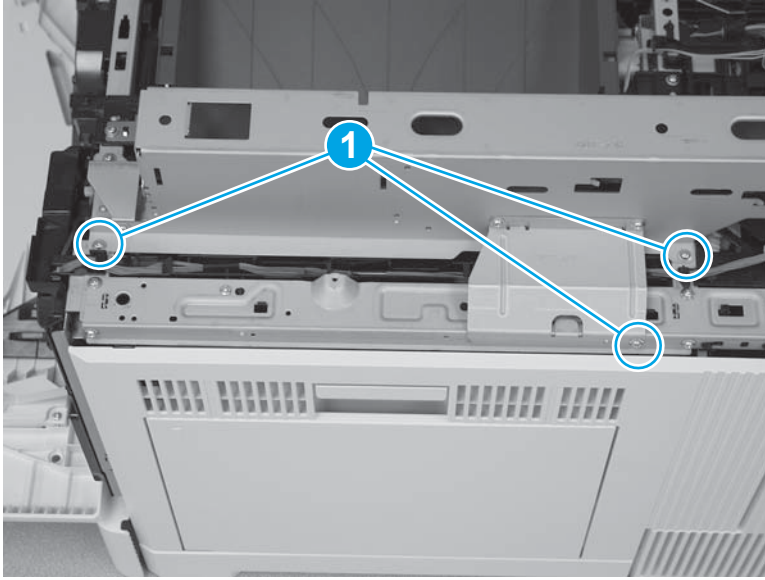

Step 28: Install the top cover (M577)

 **NOTE:** This step is for the M577 models. For the M552 and M553 models, skip this step and go to [Step 38: Install the control panel \(M553n/dn and M552dn only\) on page 856.](#)

1. Position the locator pins (callout 1) on the cover in the slots (callout 2) in the printer.

Figure 1-1467 Position the locator pins

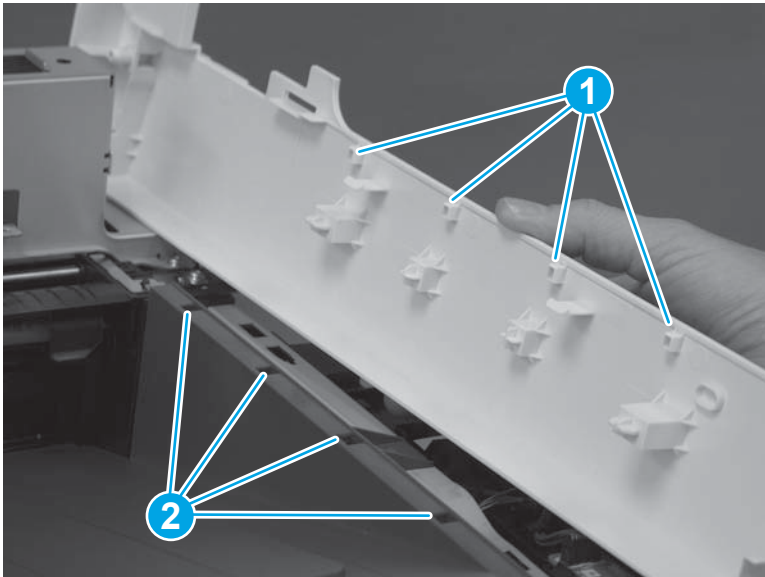

2. Press down on the cover to install it. Make sure that the tabs (callout 1) snap into place.

Figure 1-1468 Press down on the cover

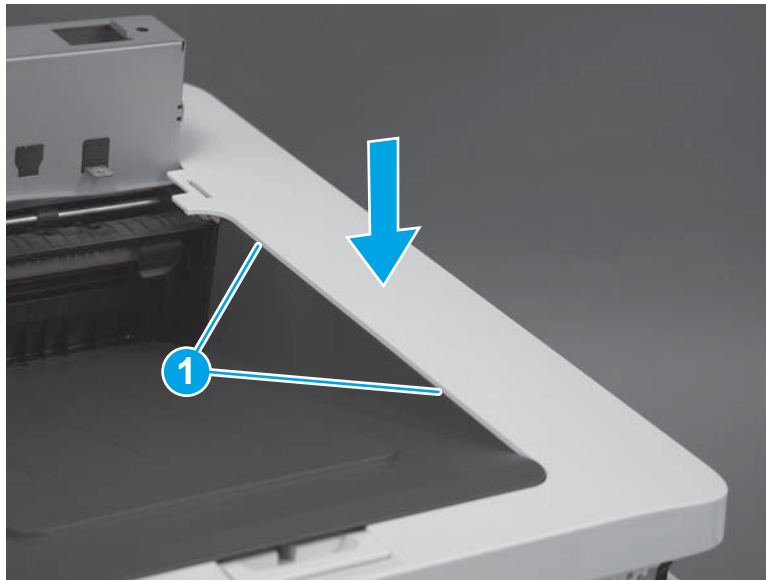

3. At the front of the printer, install one screw (callout 1).

 **Reinstallation tip:** This screw is longer and a different type of screw than the screw installed in the next step. Make sure that this screw is installed in the correct position.

Figure 1-1469 Install one screw



4. At the left side of the printer, install one screw (callout 1).

Figure 1-1470 Install one screw

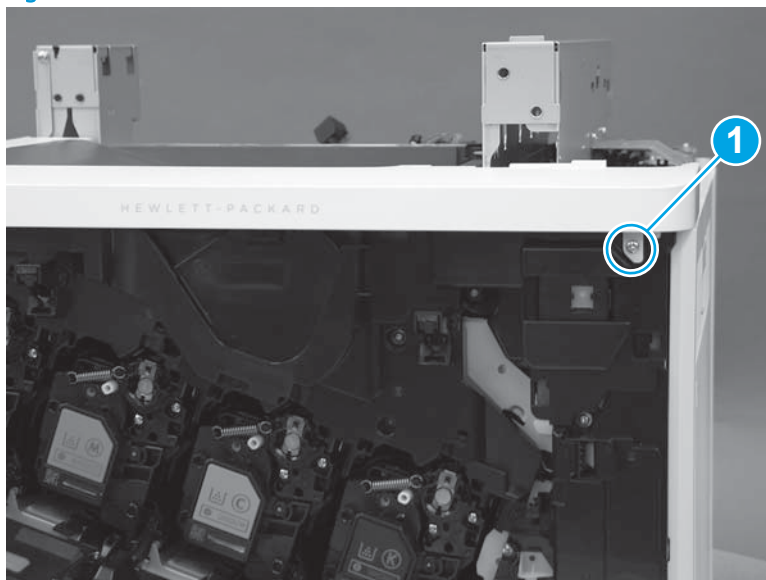
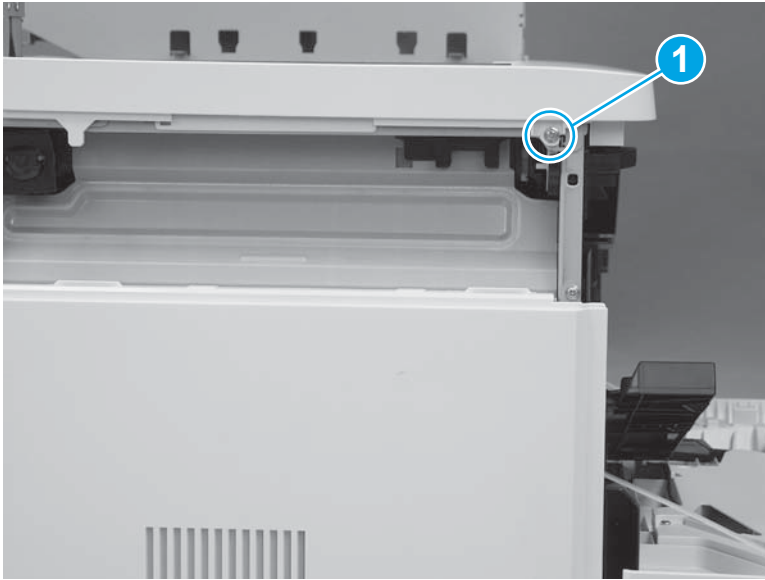

Step 29: Install the paper feed cover (M577)



NOTE: This step is for the M577 models. For the M552 and M553 models, skip this step and go to [Step 38: Install the control panel \(M553n/dn and M552dn only\) on page 856.](#)

1. Position the locator tabs (callout 1) on the cover in the slots (callout 2) in the printer. Press down until the cover snaps into place.

Figure 1-1471 Install the cover

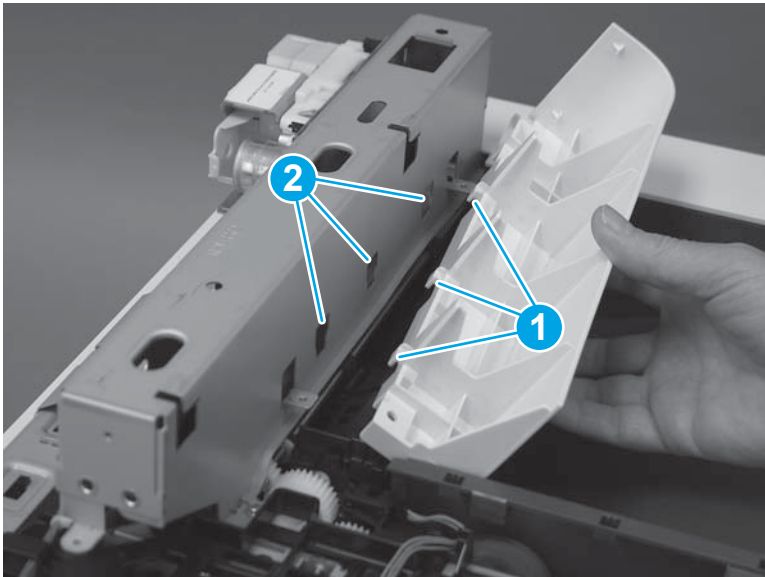

2. Install one screw (callout 1).

Figure 1-1472 Install one screw

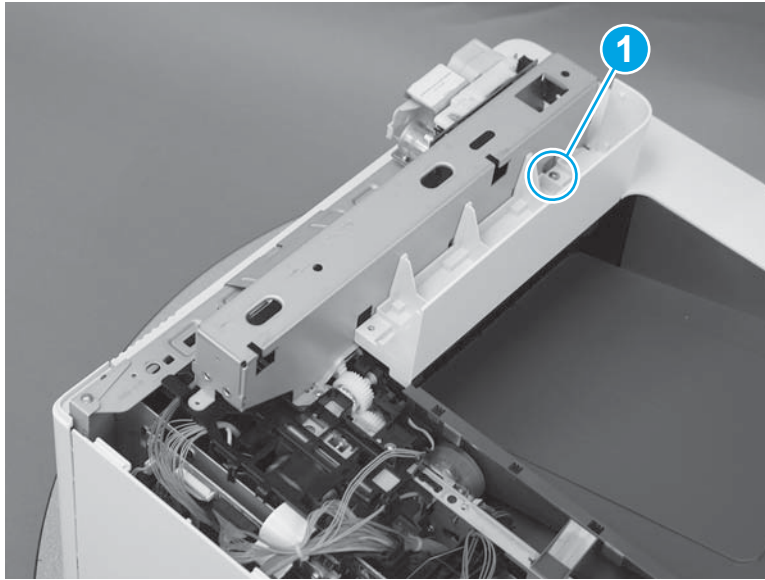

Step 30: Install the top rear cover (M577)

 **NOTE:** This step is for the M577 models. For the M552 and M553 models, skip this step and go to [Step 38: Install the control panel \(M553n/dn and M552dn only\) on page 856.](#)

1. Align the locator tabs (callout 1) on the cover with the slots (callout 2) in the printer.

Figure 1-1473 Align the locator tabs

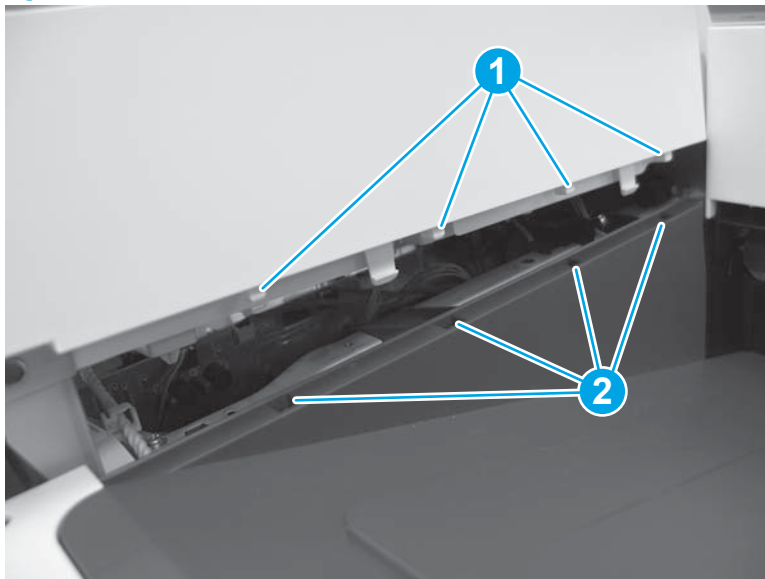

2. Press down to install the cover. Make sure that the tabs snap into place.

Figure 1-1474 Install the cover

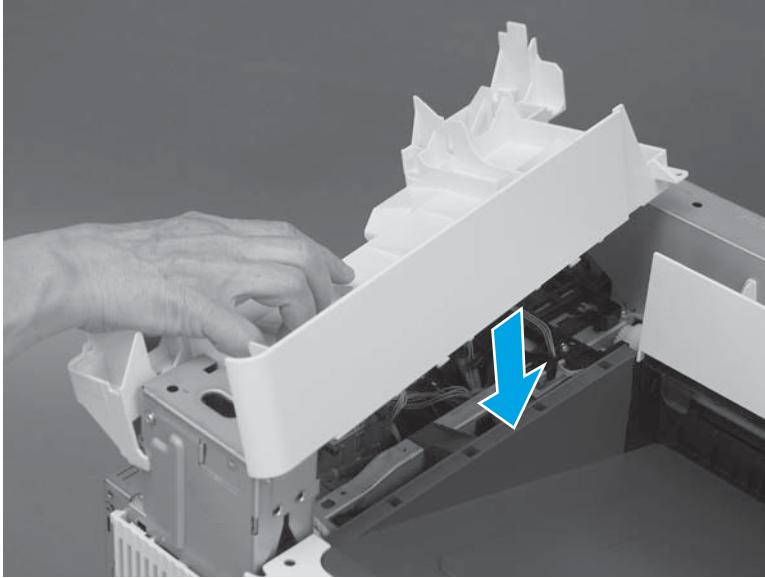

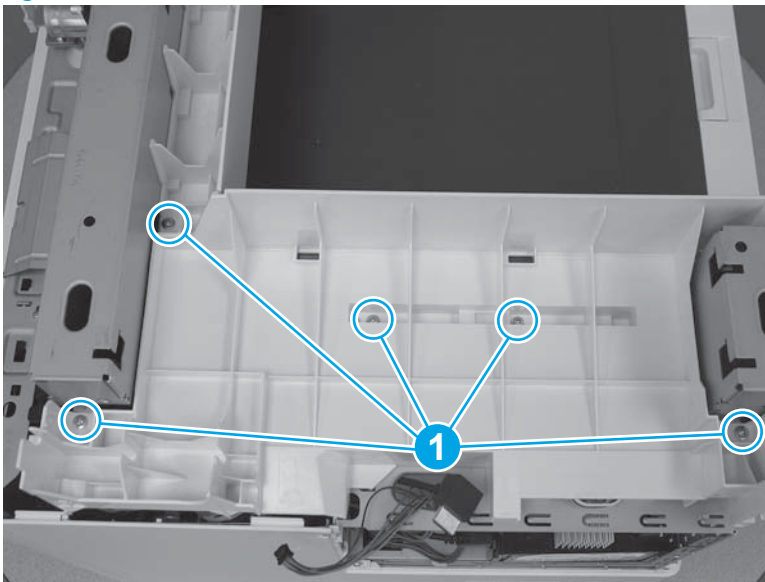

3. At the top of the printer, install five screws (callout 1).

Figure 1-1475 Install five screws



Step 31: Install the right upper cover (M577)

 **NOTE:** This step is for the M577 models. For the M552 and M553 models, skip this step and go to [Step 38: Install the control panel \(M553n/dn and M552dn only\) on page 856.](#)

 **NOTE:** The figures below show the image scanner installed. The procedures for removing and installing the right upper cover are the same whether the image scanner is installed or removed."

1. **M577c/f/z only:** Install the cables (callout 1) through the slot (callout 2) in the printer.

Figure 1-1476 Install the cables

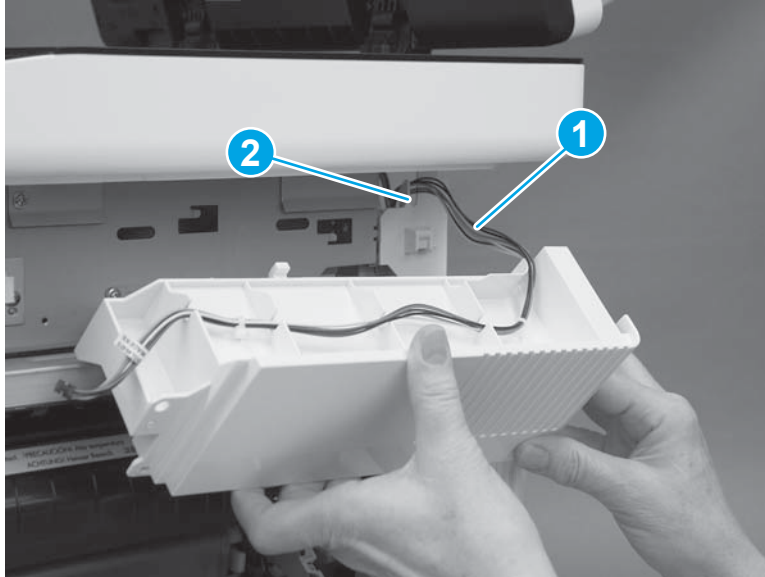

2. Position the hooks (callout 1) on the cover in the slots (callout 2) in the printer.

Figure 1-1477 Position the hooks

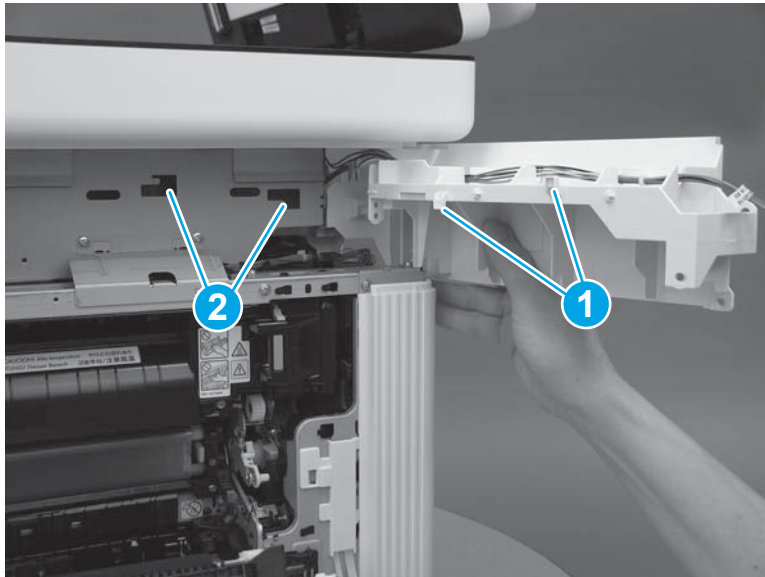

3. Slide the cover toward the front of the printer to install it.

Figure 1-1478 Install the cover

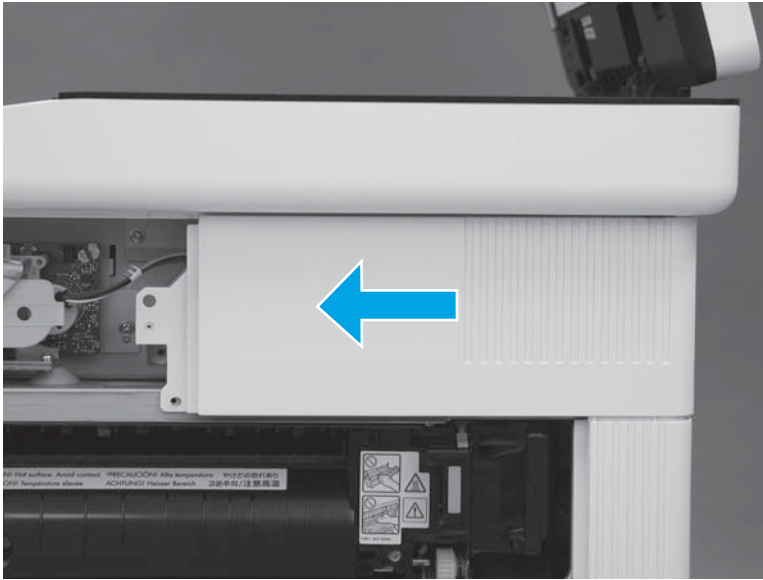

4. At the back of the printer, install one screw (callout 1).

M577c/f/z only: Connect one connector (callout 2), if the integrated scanner assembly is installed.

TIP: This screw is smaller than the screws installed in the next step. Make sure that this screw is installed in the correct position.

Figure 1-1479 Install one screw and connector

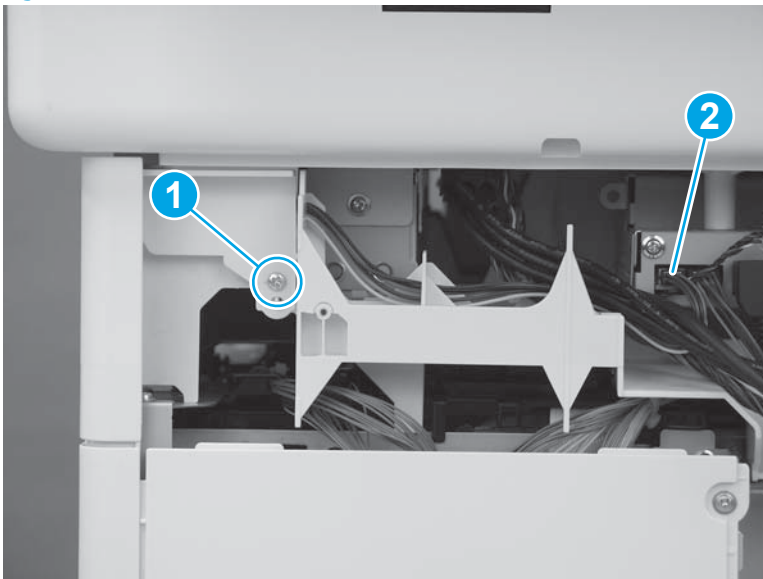

5. At the right side of the printer, install two screws (callout 1).

M577c/f/z only: Connect one connector (callout 2), if the stapler is installed.

Figure 1-1480 Install one screw and connector

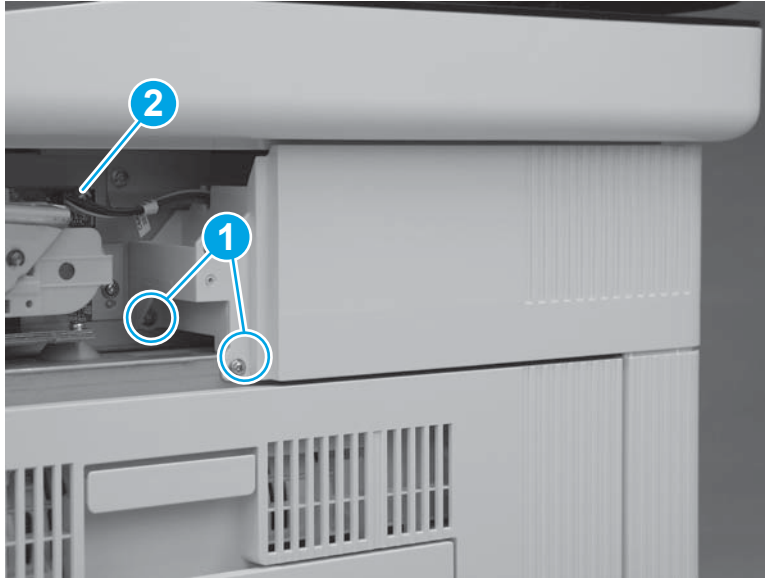

Step 32: Install the stapler unit (M577c/f/z)

 **NOTE:** This step is for the M577c/f/z models only. For the M577dn model, skip this step and go to [Step 33: Install the integrated scanner assembly \(M577\) on page 846](#).

For the M552 and M553 models, skip this step and go to [Step 38: Install the control panel \(M553n/dn and M552dn only\) on page 856](#).

1. Position the hooks (callout 1) on the stapler unit in the slots (callout 2) in the printer.

Figure 1-1481 Position the hooks in the slots

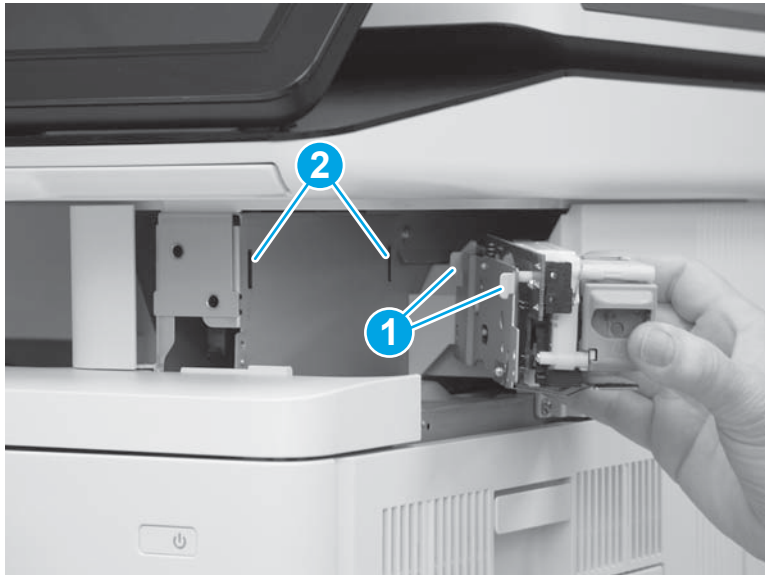

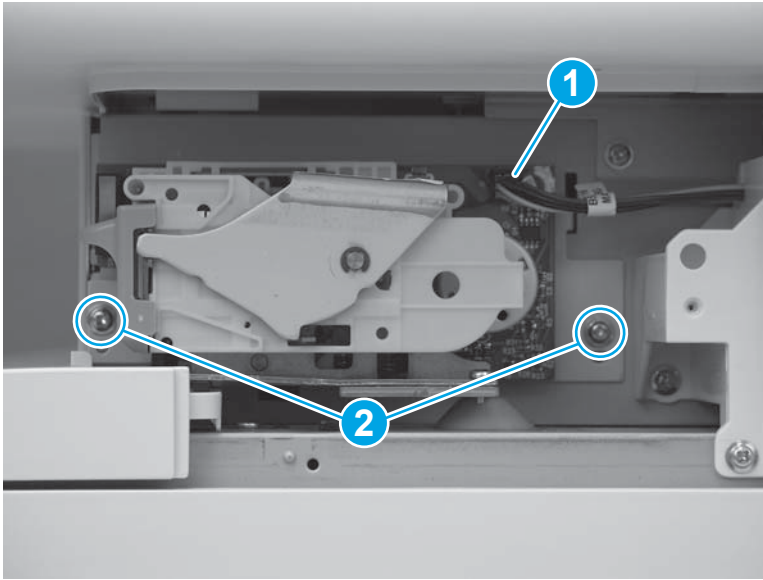

2. Connect one connector (callout 1), and then install two screws (callout 2).

Figure 1-1482 Connect connector and install screws



Step 33: Install the integrated scanner assembly (M577)

 **NOTE:** This step is for the M577 models. For the M552 and M553 models, skip this step and go to [Step 38: Install the control panel \(M553n/dn and M552dn only\) on page 856.](#)

 **NOTE:** The ISA includes the document feeder, image scanner, scanner control board (SCB), control panel, keyboard (M577c/z) and NFC PCA (M577z).

1. Before proceeding, locate the mounting pins (callout 1) on the bottom of the ISA and the slots (callout 2) on the printer base.

Figure 1-1483 Locate the ISA mounting pins and slots

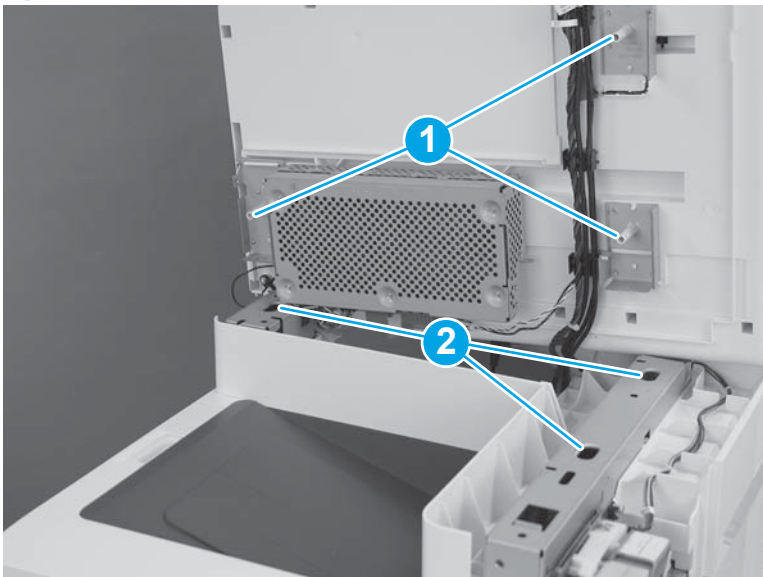

2. Position the ISA on the printer base with the pins in the slots.

 **NOTE:** To locate the pins and slots, see [Figure 1-395 Locate the ISA mounting pins and slots on page 249](#).

Figure 1-1484 Install the ISA



3. Slightly slide the ISA towards the front of the printer to engage it.

Figure 1-1485 Slide the ISA towards the front of the printer

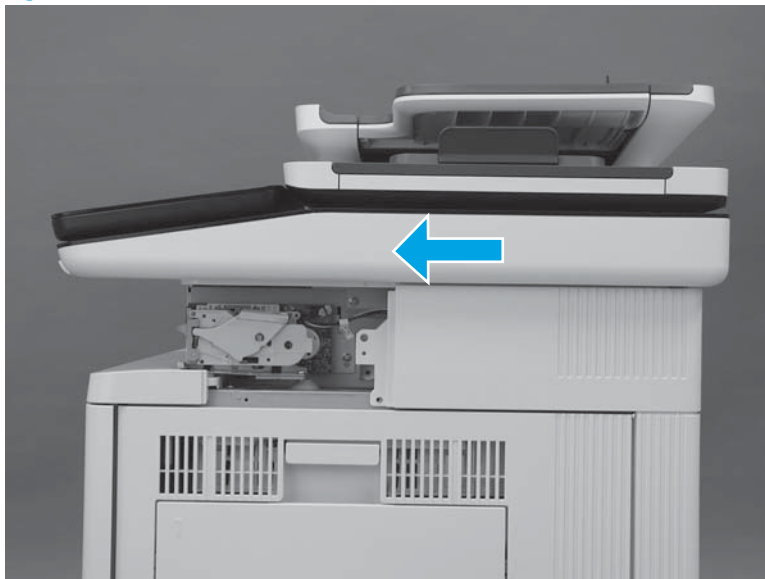

4. At the left side of the printer, install one screw (callout 1).

Figure 1-1486 Install one screw

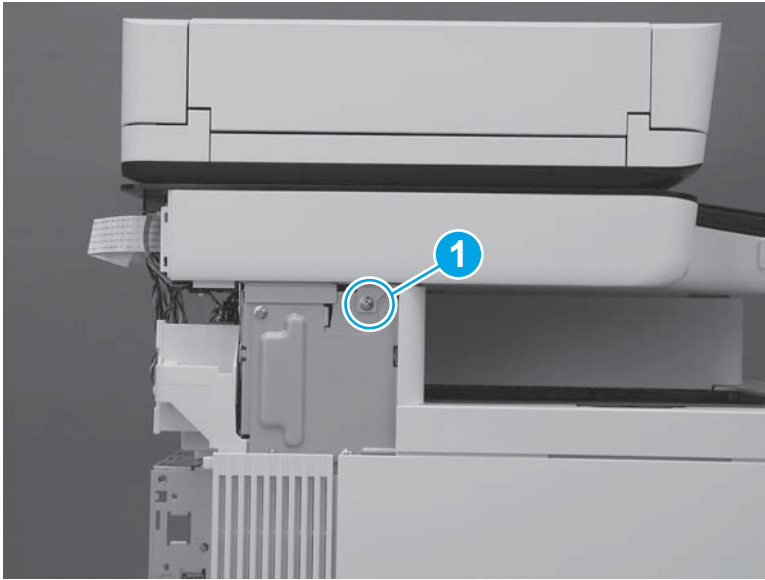

5. At the back of the printer, install two screws (callout 1).

Figure 1-1487 Install two screws

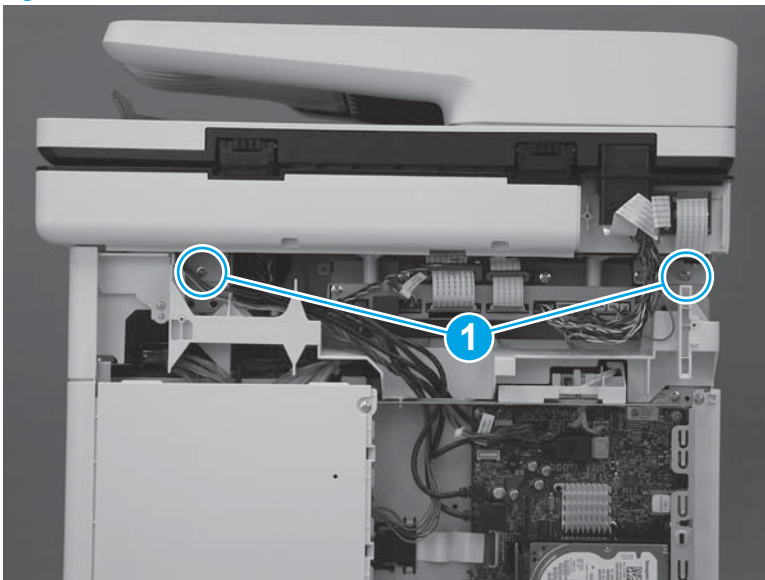

6. At the right side of the printer, install one screw (callout 1).

Figure 1-1488 Install one screw

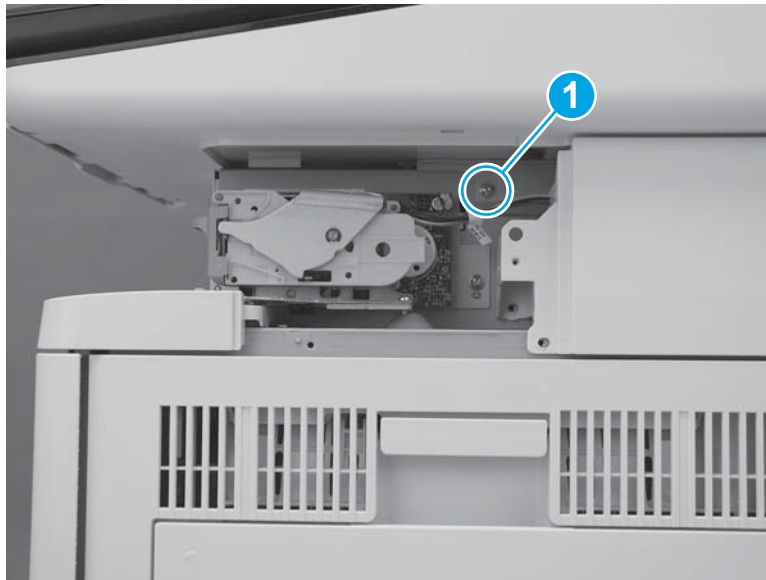

7. Connect two connectors on the scanner control board (callout 1).

M577c/f/z only: Connect one connector for the stapler on the scanner control board (callout 2).

Figure 1-1489 Connect connectors

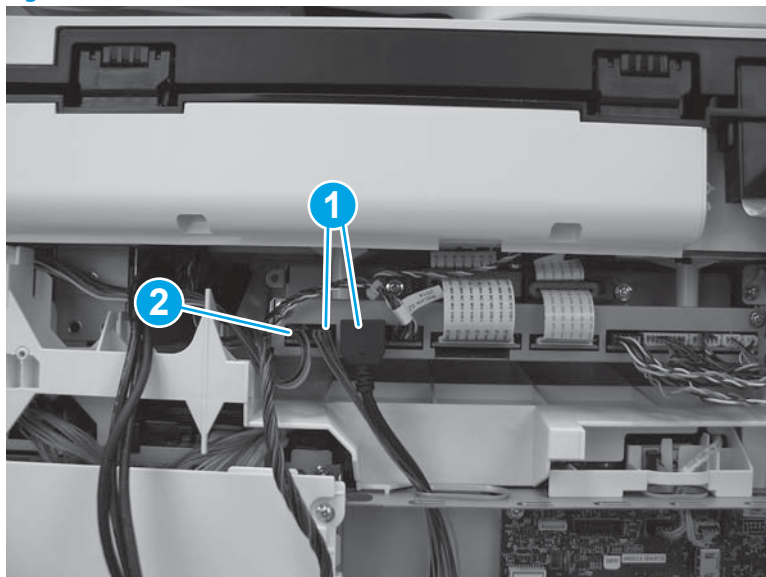

8. Install the wire harness and cables (callout 1) in the retainers (callout 2). Pass them through the opening in the top of the formatter cover (callout 3), and then connect four connectors (callout 4) on the formatter.

Figure 1-1490 Connect four connectors

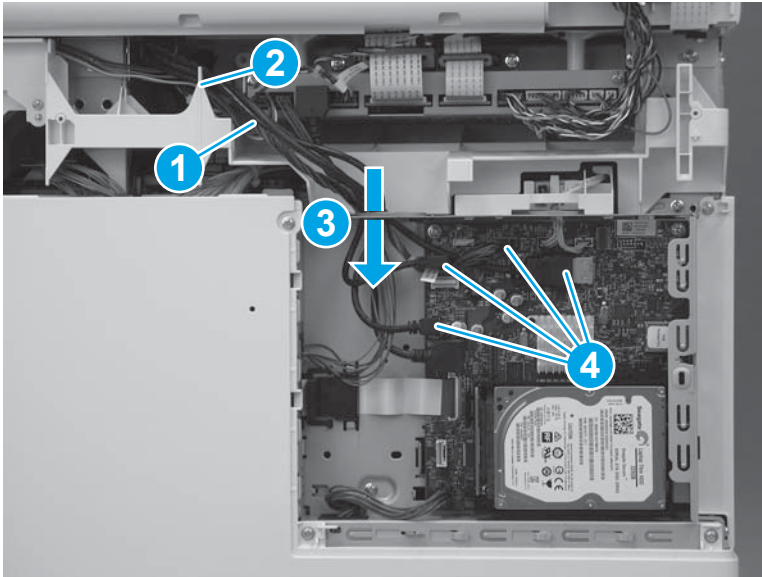

Step 34: Install the stapler cover assembly (M577c/f/z)

 **NOTE:** This step is for the M577c/f/z models only. For the M577dn model, skip this step and go to [Step 35: Install the right front upper cover \(M577dn\) on page 851](#).

For the M552 and M553 models, skip this step and go to [Step 38: Install the control panel \(M553n/dn and M552dn only\) on page 856](#).

1. Install the tabs (callout 1) on the cover in the slots (callout 2) in the printer.

Figure 1-1491 Install two tabs



2. Press the cover toward the left side of the printer until it snaps into place.

Figure 1-1492 Install the cover assembly



3. Install one screw (callout 1).



 **IMPORTANT:** This is a self-tapping screw for plastic. Rotate it counterclockwise to align it with the existing thread pattern, and then carefully turn it clockwise to tighten. Do not overtighten. This will prevent stripping the threads inside the screw hole.

Figure 1-1493 Install one screw

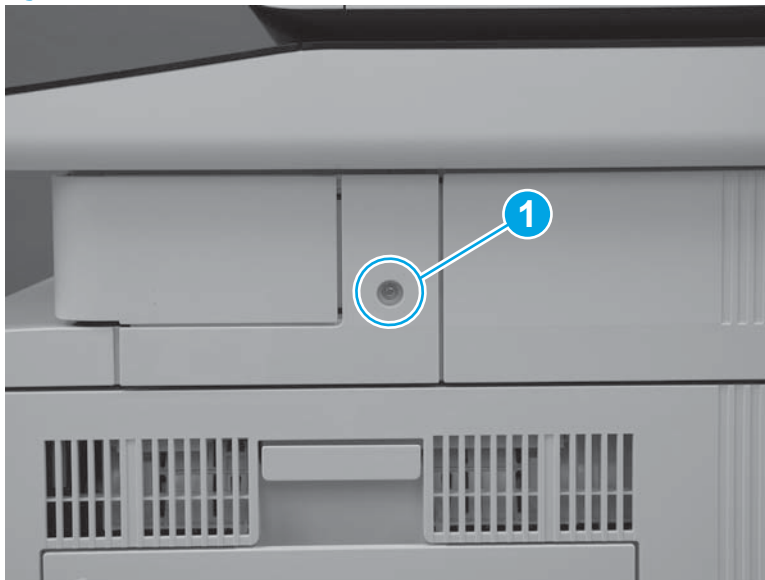

Step 35: Install the right front upper cover (M577dn)

 **NOTE:** This step is for the M577dn model only. For the M577c/f/z models, skip this step and go to [Step 36: Install the left upper cover \(M577\) on page 853](#).

For the M552 and M553 models, skip this step and go to [Step 38: Install the control panel \(M553n/dn and M552dn only\) on page 856](#).

1. Slide the cover toward the left side of the printer to install it. Make sure that the slots (callout 1) in the cover fit over the tabs (callout 2) on the inside of the paper feeder cover.

Figure 1-1494 Install the cover

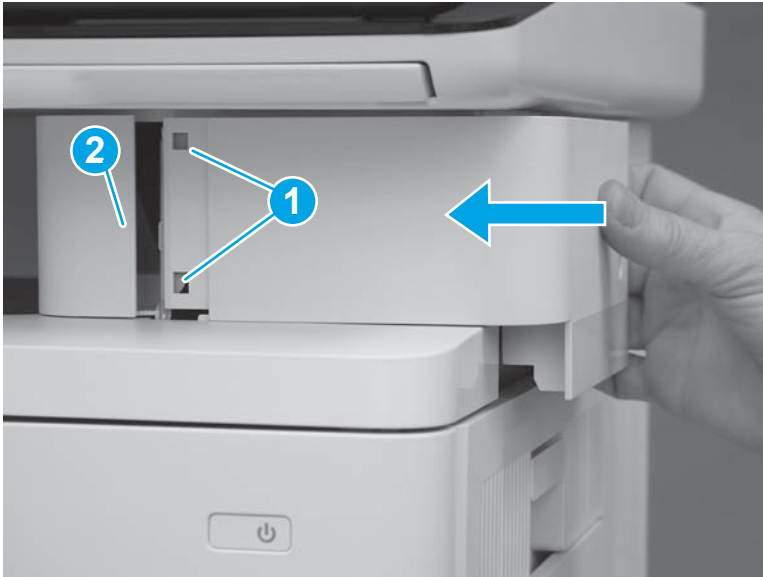

2. Press the right front upper cover (callout 1) and the paper feeder cover (callout 2) together until the tabs on the inside of the covers snap into place.

Figure 1-1495 Press the cover



3. Install one screw (callout 1).

Figure 1-1496 Install one screw

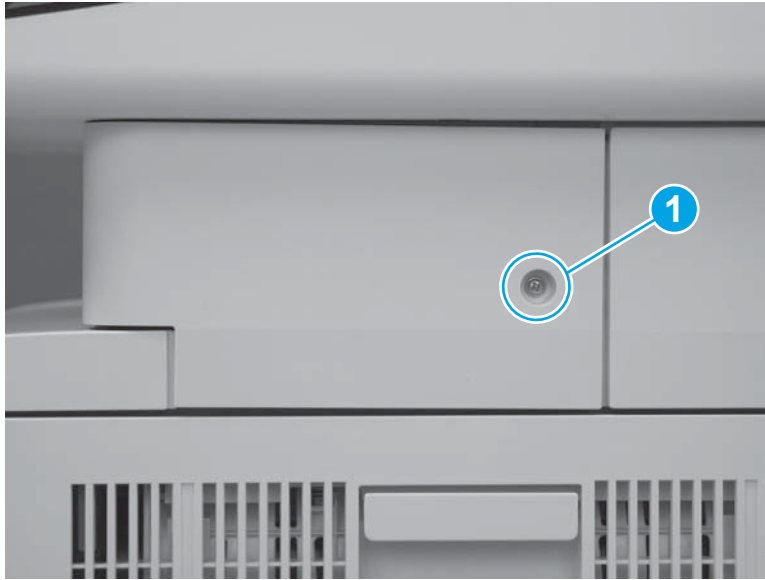

Step 36: Install the left upper cover (M577)

 **NOTE:** This step is for the M577 models. For the M552 and M553 models, skip this step and go to [Step 38: Install the control panel \(M553n/dn and M552dn only\) on page 856.](#)

1. Position the tab (callout 1) on the lower edge of the cover behind the left cover (callout 2).

Figure 1-1497 Position the tab

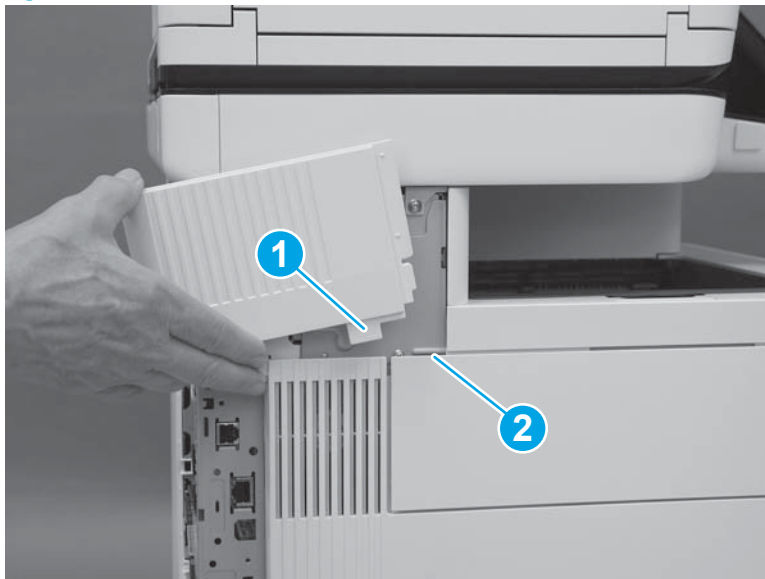

2. Slide the cover toward the front of the printer to install it. Make sure that the edge (callout 1) of the cover fits behind the edge (callout 2) of the top rear cover.

Figure 1-1498 Slide the cover

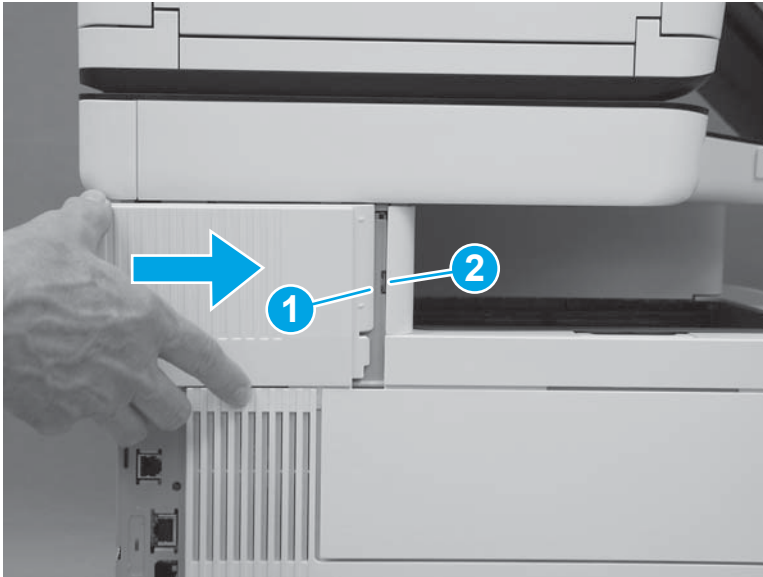

3. Make sure that the tab (callout 1) is fully installed.

Figure 1-1499 Check the tab

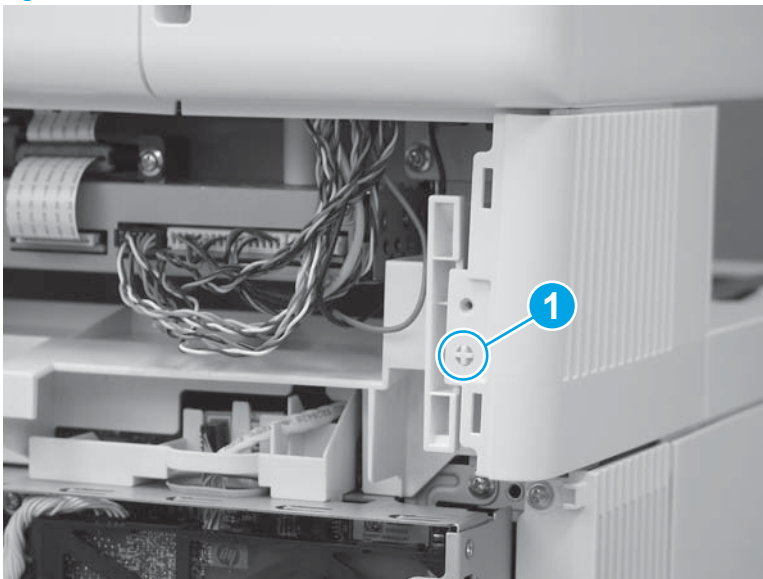

Step 37: Install the rear upper cover (M577)

 **NOTE:** This step is for the M577 models. For the M552 and M553 models, skip this step and go to [Step 38: Install the control panel \(M553n/dn and M552dn only\) on page 856.](#)

1. Align the ridge (callout 1) on the lower edge of the rear upper cover in front of the tabs (callout 2) on the top edge of the rear cover.

Figure 1-1500 Align the cover

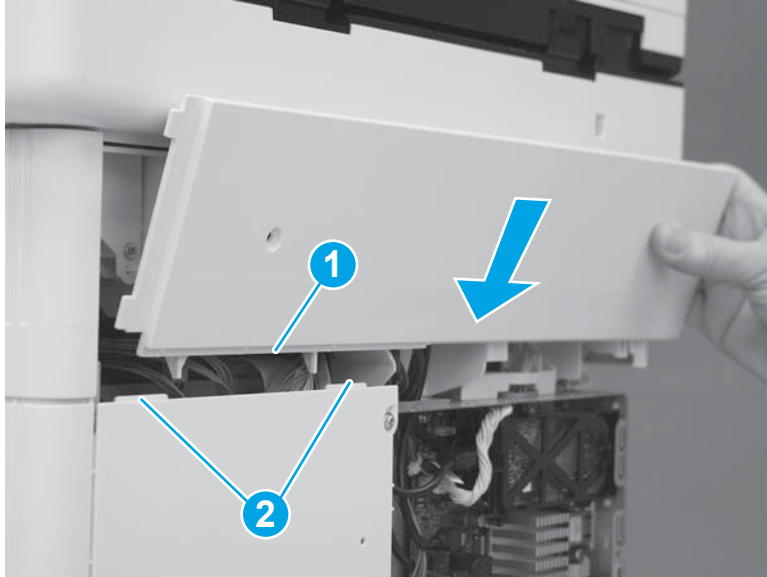

2. Rotate the top of the cover toward the printer.

Figure 1-1501 Rotate the top of the cover



3. Slide the cover to the left (callout 1). Make sure that the tabs (callout 2) on the upper rear cover slide behind the edge (callout 3) of the right upper cover. Make sure that the cover is fully seated.

Figure 1-1502 Slide the cover

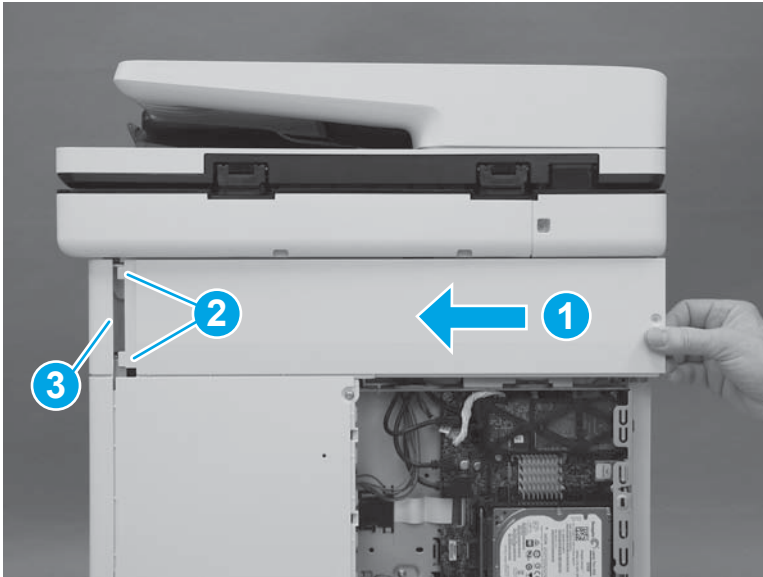

4. Install two screws (callout 1).



 **IMPORTANT:** These two screws are self-tapping screws for plastic. Rotate them counterclockwise to align them with the existing thread pattern, and then carefully turn them clockwise to tighten. Do not overtighten. This will prevent stripping the threads inside the screw holes.

Figure 1-1503 Install two screws

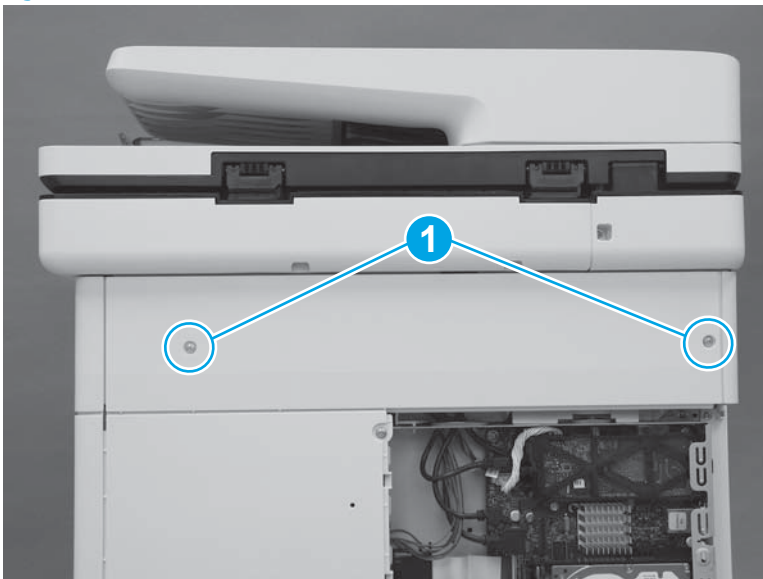

Step 38: Install the control panel (M553n/dn and M552dn only)

 **NOTE:** This step is for the M553n/dn and M552dn models. For the M553x model, skip this step and go to [Step 30: Install the upper cover \(M552 and M553\) on page 859](#).

1. Position the control panel on the printer, and then connect one connector (callout 1).

Figure 1-1504 Connect one connector

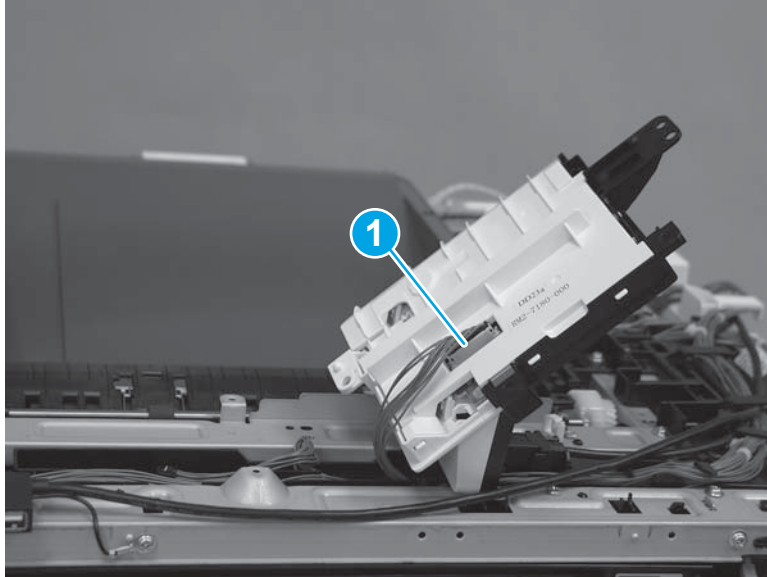

2. Turn the control panel over (callout 1), and then install four screws (callout 2).

Figure 1-1505 Install four screws

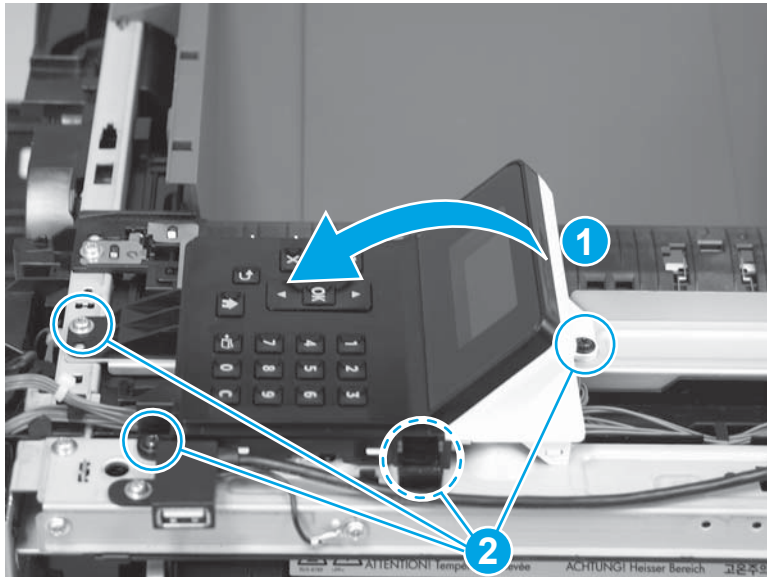

3. Place one cable in the guide.

Figure 1-1506 Place one cable in the guide



4. Install the tab on the NFC PCA holder (callout 1) in the slot (callout 2) in the chassis.

Figure 1-1507 Install the tab

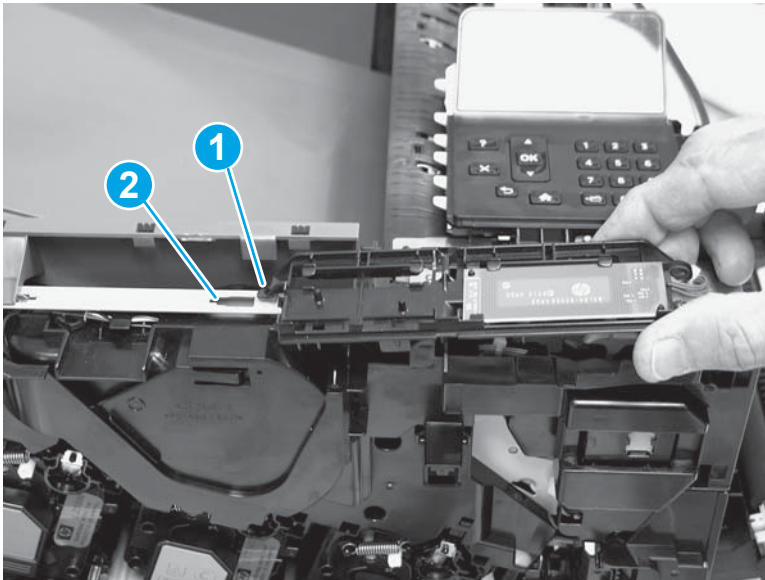

5. Rotate the NFC PCA holder down (callout 1) to install it, connect one connector (callout 2), and then install one screw (callout 3).

Figure 1-1508 Install one screw

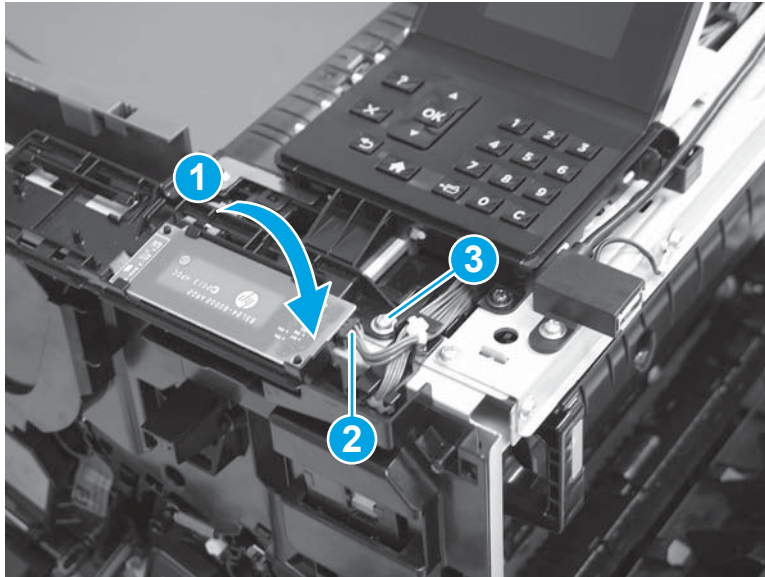

Step 30: Install the upper cover (M552 and M553)

 **NOTE:** This step is for the M552 and M553 models. For the M577 models, skip this step and go to [Step 46: Install the TCU on page 873](#).

1. Position the cover on the printer.

 **NOTE:** For the M553x model, do not forget to pass the control-panel wire harness and USB cable through the opening in the cover.

Figure 1-1509 Install the cover



2. Push down on the rear corner of the cover to engage one tab (callout 1).

Figure 1-1510 Engage one tab

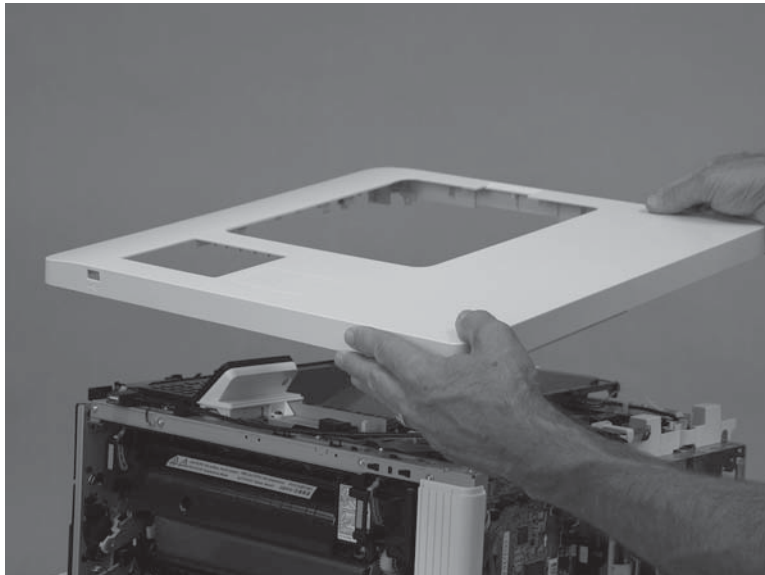
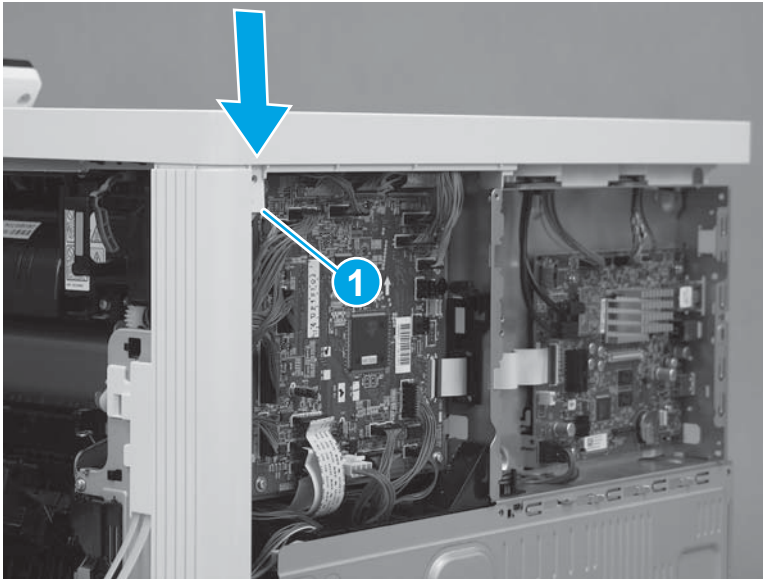

3. Push down on the front corner of the cover to engage one tab (callout 1), and then install one screw (callout 2).

 **NOTE:** This is a self-tapping plastic-thread screw. Make sure that this screw is used in this location when it is reinstalled.

Figure 1-1511 Engage one tab and install one screw



4. Install three screws (callout 1).

Figure 1-1512 Install three screws

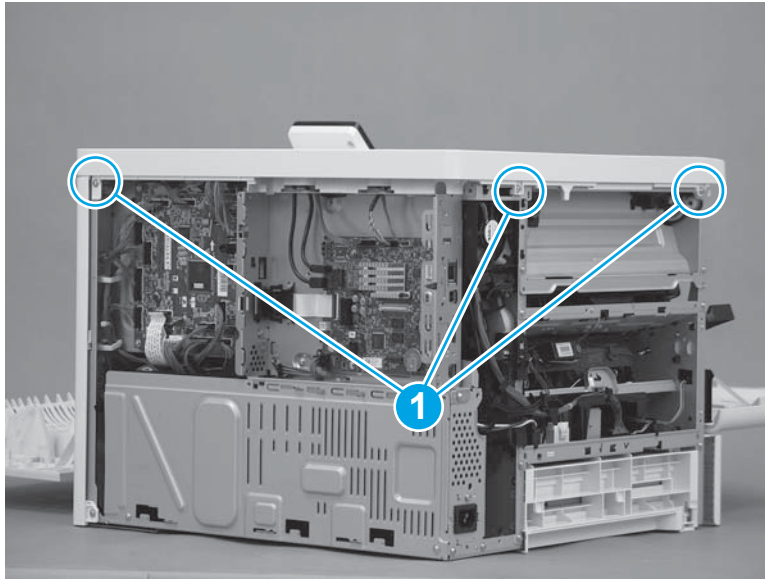

Step 40: Install the left cover

 **NOTE:** This step is for the M552 and M553 models. For the M577 models, skip this step and go to [Step 46: Install the TCU on page 873](#).

1. Position the cover on the printer.

 **NOTE:** Slightly offset the cover toward the rear of the printer.

Figure 1-1513 Install the cover

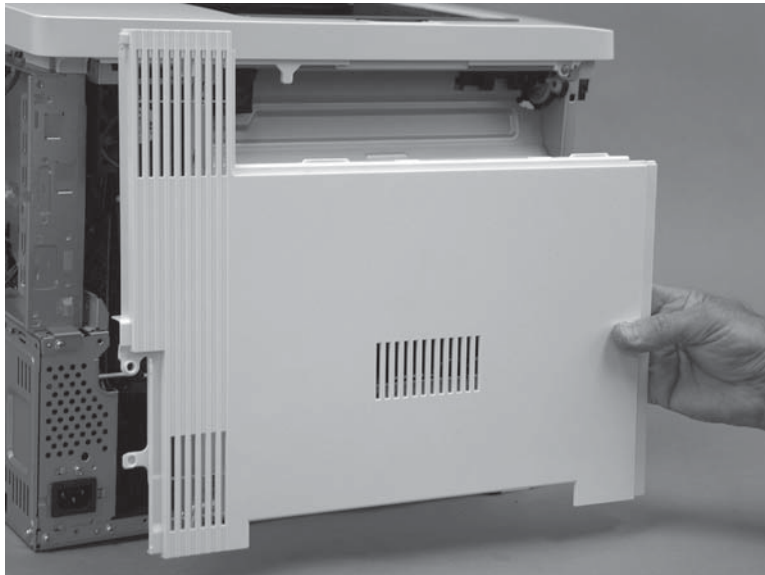

- Slide the cover (callout 1) toward the front of the printer to engage it. Make sure that the tab (callout 2) snaps into place.

 **NOTE:** Locate the alignment pin (callout 3) on the cover from the front door side of the printer, and then make sure that it is fully engaged in the slot in the chassis.

 **TIP:** While sliding the cover into place, push in on the center of the cover (callout 1) to make sure that the hooks on the back of the cover engage with the slots in the chassis.

Figure 1-1514 Engage the cover



- At the left side of the printer, install one screw (callout 1).

Figure 1-1515 Install one screw

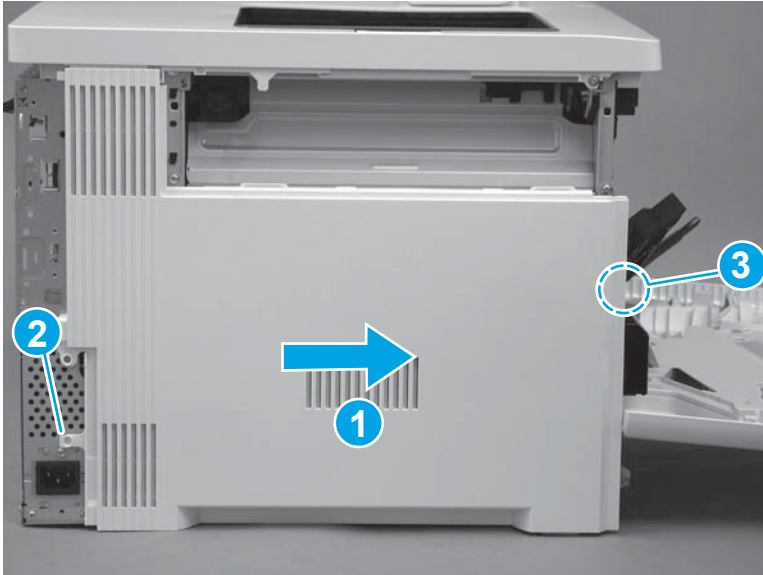
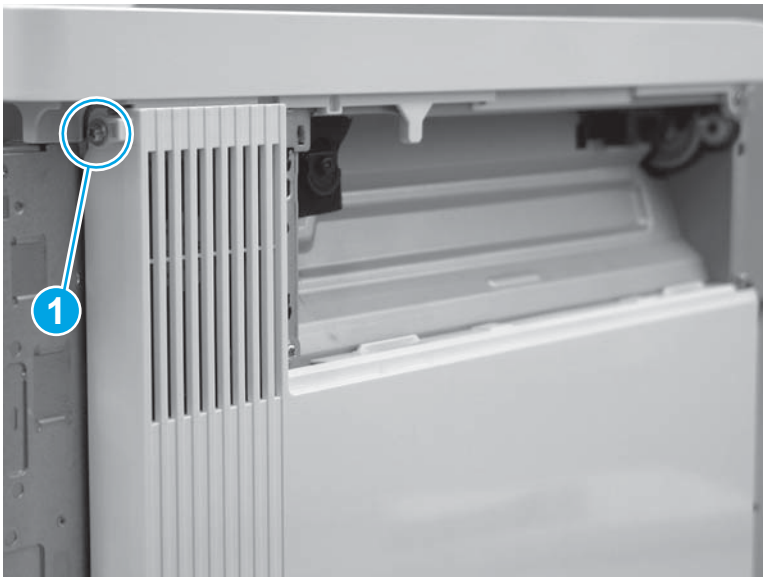

Step 41: Install the rear cover (M552 and M553)

 **NOTE:** This step is for the M552 and M553 models. For the M577 models, skip this step and go to [Step 46: Install the TCU on page 873](#).

1. Position the top of the cover under the upper cover (callout 1), rotate the bottom of the cover onto the chassis (callout 2), and then slide the cover to the left (callout 3) to install it.

Figure 1-1516 Install the cover

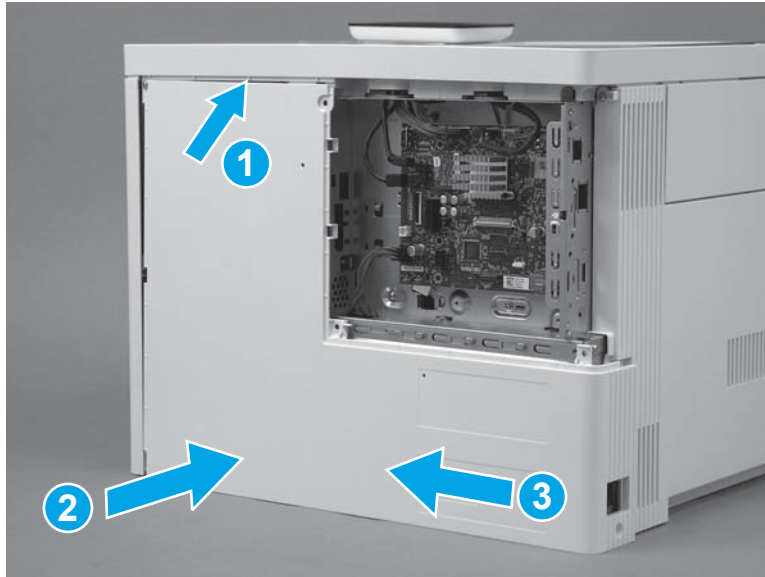

2. Install four screws (callout 1).

Figure 1-1517 Install four screws cover

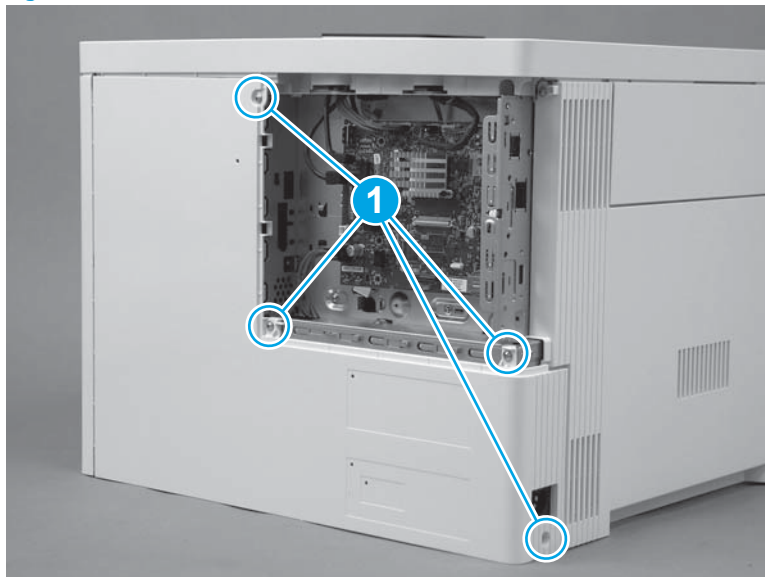

Step 42: Install the control-panel assembly (M553x only)

 **NOTE:** For the M553n/dn and M552dn models, skip this step and go to [Step 37: Install the USB cover \(M553\) on page 682](#).

For the M577 models, skip this step and go to [Step 46: Install the TCU on page 873](#).

1. Place the control panel on the printer as shown.

Figure 1-1518 Place the control panel on the product

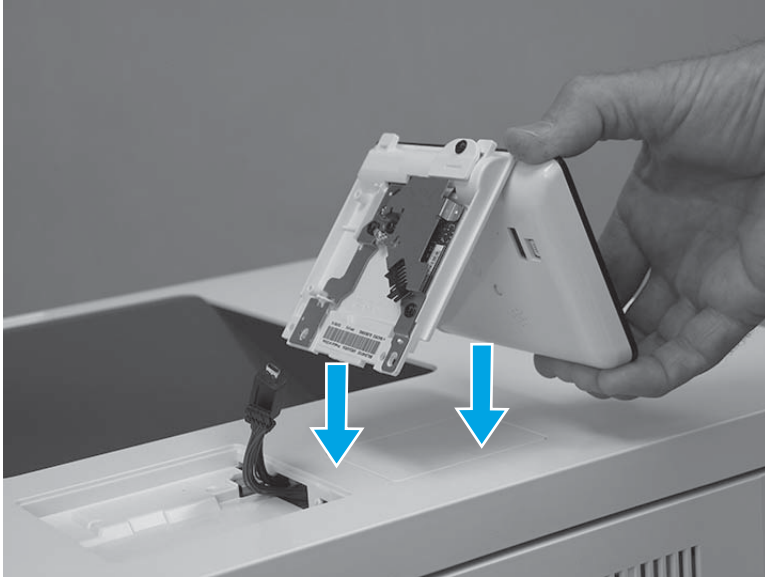

2. Connect one USB cable (callout 1), and one connector (callout 2).

 **IMPORTANT:** Take note of the location of the two mounting tabs (callout 3) on the control-panel assembly.

Figure 1-1519 Connect two connectors



3. Turn the control panel over, and then position the front edge tabs in the slots in the top cover.

Figure 1-1520 Turn the control panel over

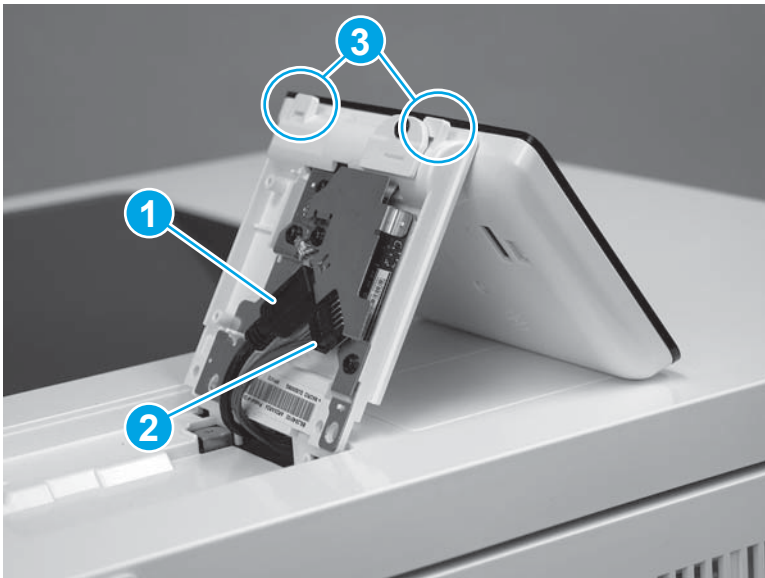
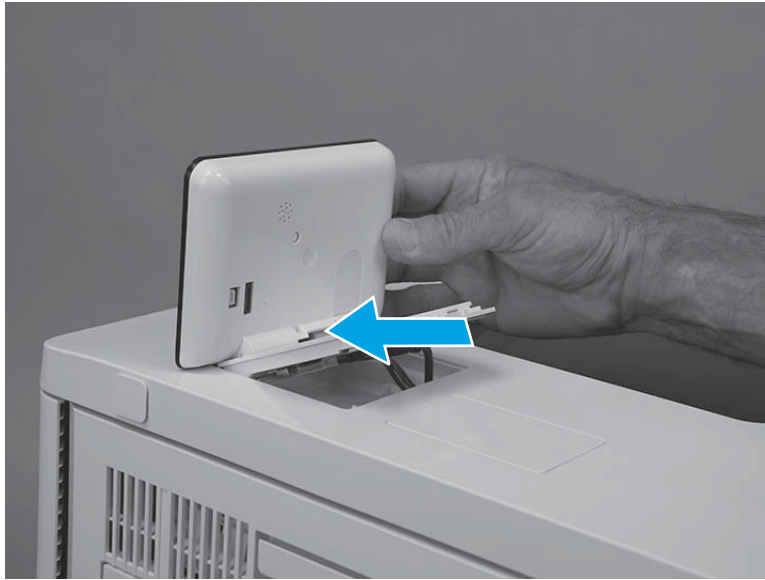

4. Rotate the control-panel base down onto the printer.

Figure 1-1521 Rotate the control-panel base down



5. Use a small Phillips screwdriver to install two screws (callout 1).

Figure 1-1522 Install two screws

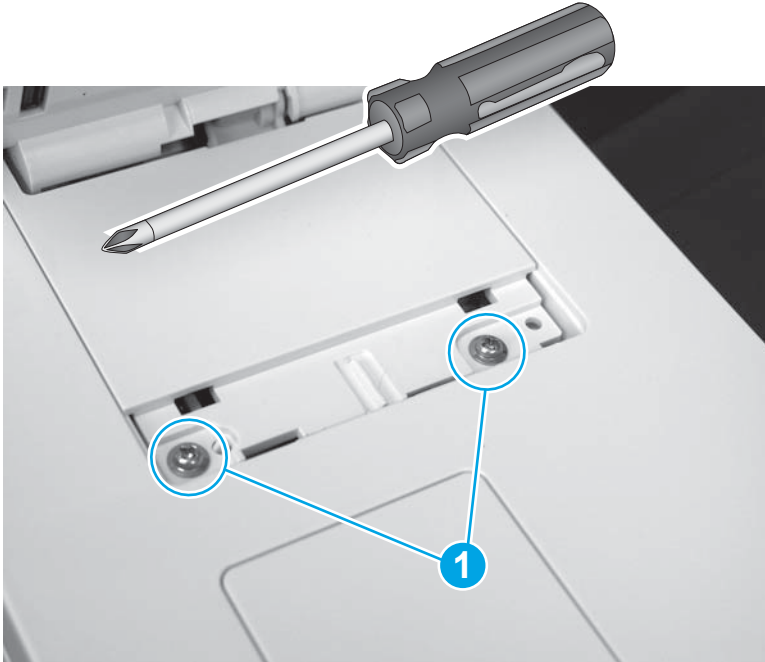

6. Position the screw cover mounting feet into the slots in the top cover (callout 1), and then rotate the cover down (callout 2) to install it.

 **NOTE:** Press down on the cover firmly to make sure that the tabs on the cover (callout 3) snap into place.

Figure 1-1523 Install the cover

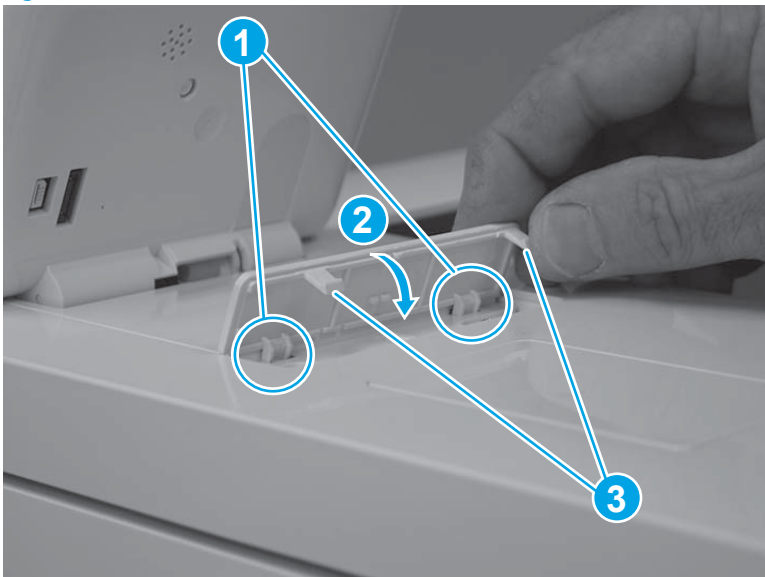

Step 43: Install the ITB

CAUTION: Do not touch the grey-plastic belt. Skin oils and fingerprints on the belt can cause print-quality problems.

1. Handle the replacement ITB by the edges. Do not touch the grey-plastic belt. Skin oils and fingerprints on the belt can cause print-quality problems.

Figure 1-1524 Handle the ITB by the edges

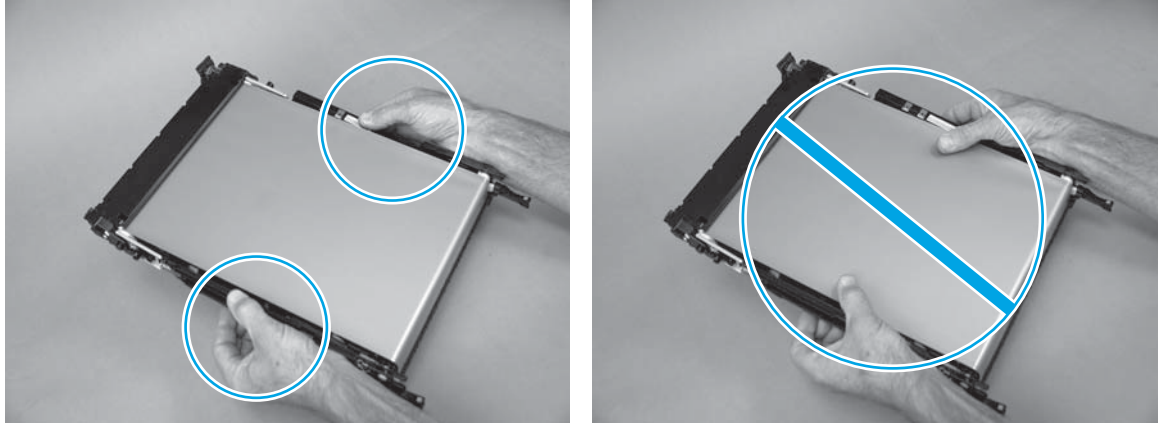

2. Align the ITB with the slots in the printer, and then carefully push it into the printer.

NOTE: Be careful. Do not dislodge the ITB retainer springs from the holders on the chassis. The springs can interfere with installing the ITB.

Figure 1-1525 Align the ITB with the slots in the product

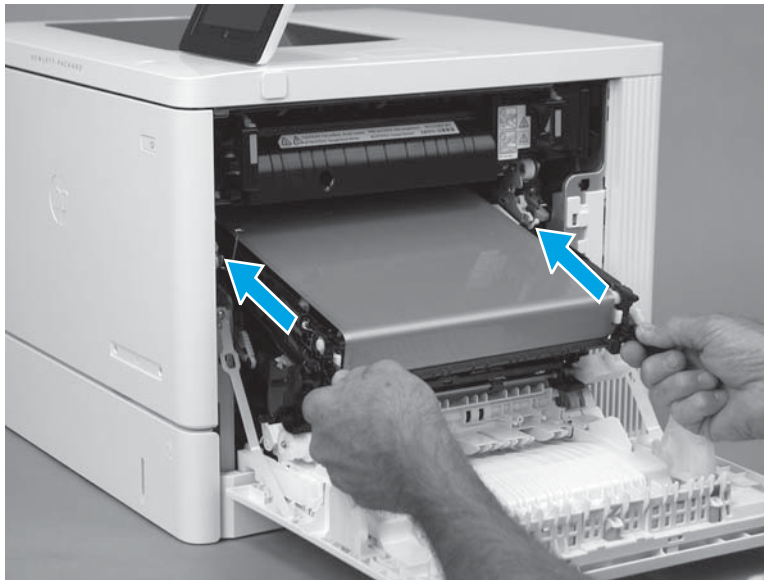

3. Continue to carefully push the ITB into the printer until it is fully installed.

Figure 1-1526 Install the ITB

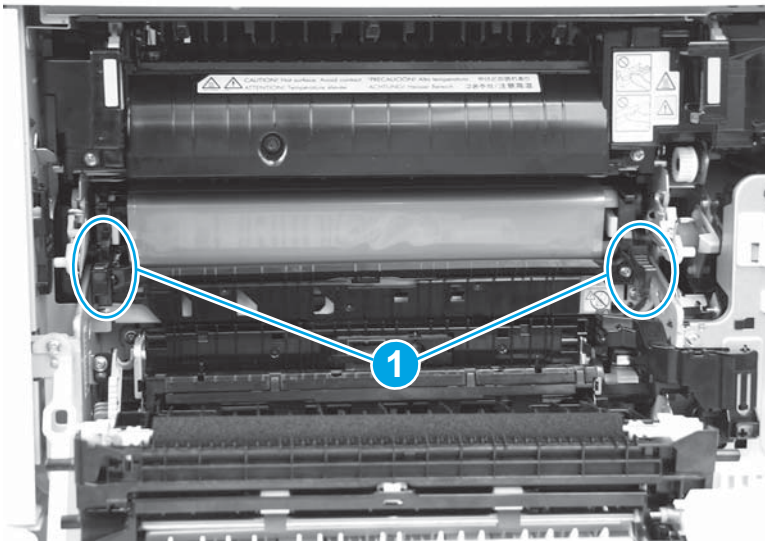

4. Remove the right-side ITB spring from the holder.

Figure 1-1527 Remove the spring from the holder



5. Fasten the right-side ITB spring (callout 1) under the tab (callout 2).

Figure 1-1528 Fasten the rear-side ITB spring

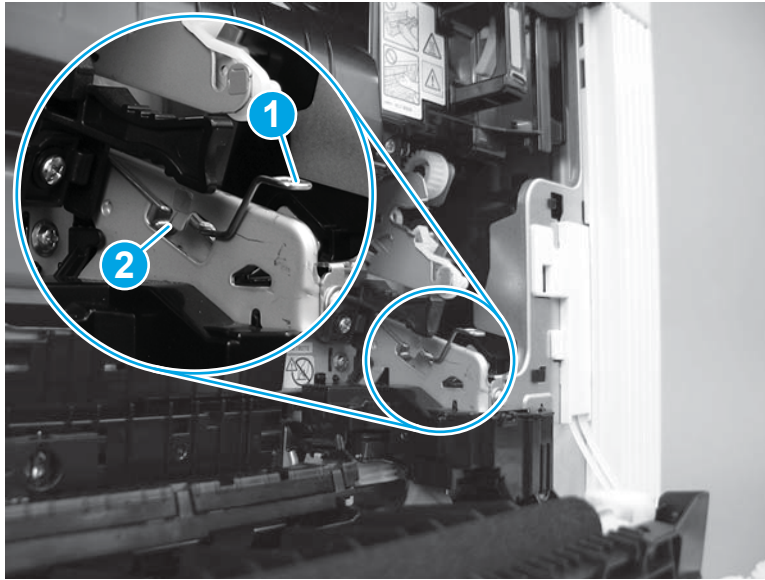

6. Remove the left-side ITB spring from the holder.

Figure 1-1529 Remove the spring from the holder

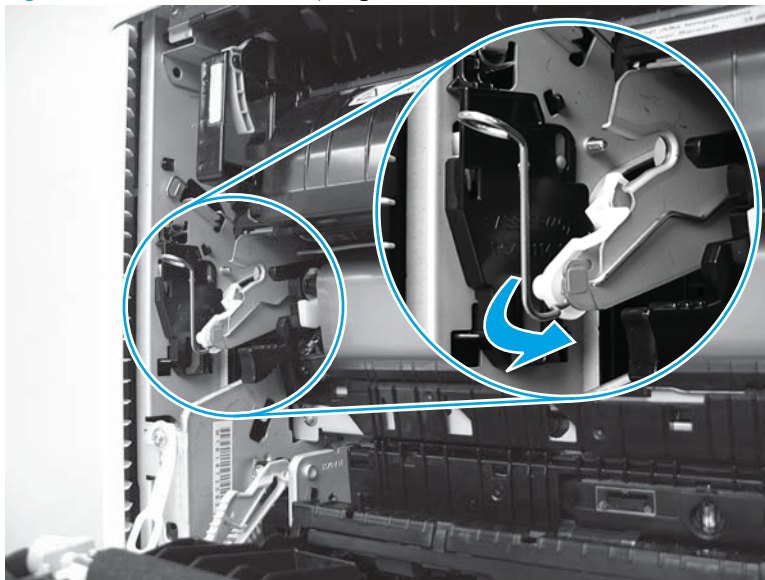

7. Fasten the left-side ITB spring (callout 1) under the tab (callout 2).

Figure 1-1530 Fasten the front-side ITB spring

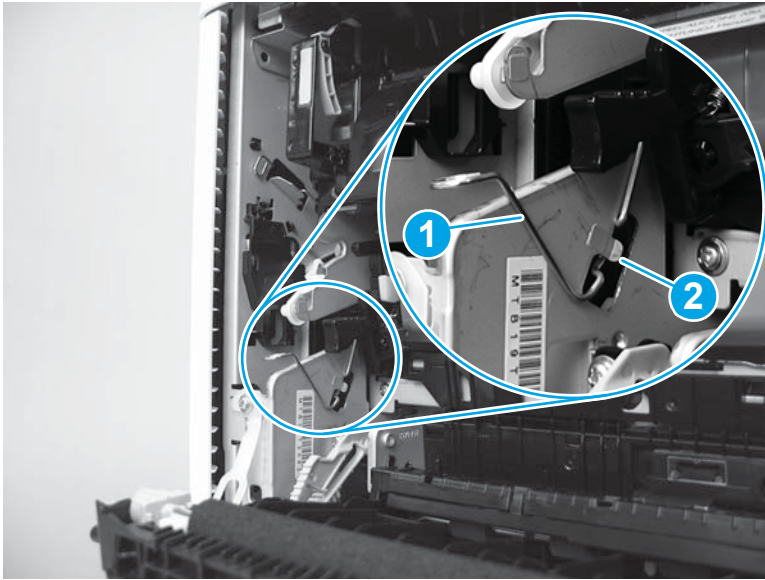

8. Push in the blue lever to engage the ITB drive coupling.

Figure 1-1531 Engage the ITB drive coupling

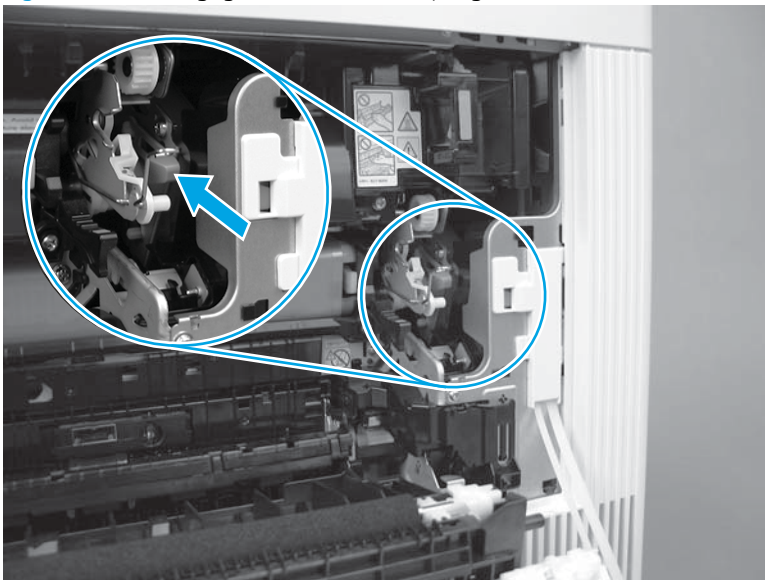

Step 44: Install the fuser

1. Align the fuser with the opening in the printer.

Figure 1-1532 Align the fuser with the opening

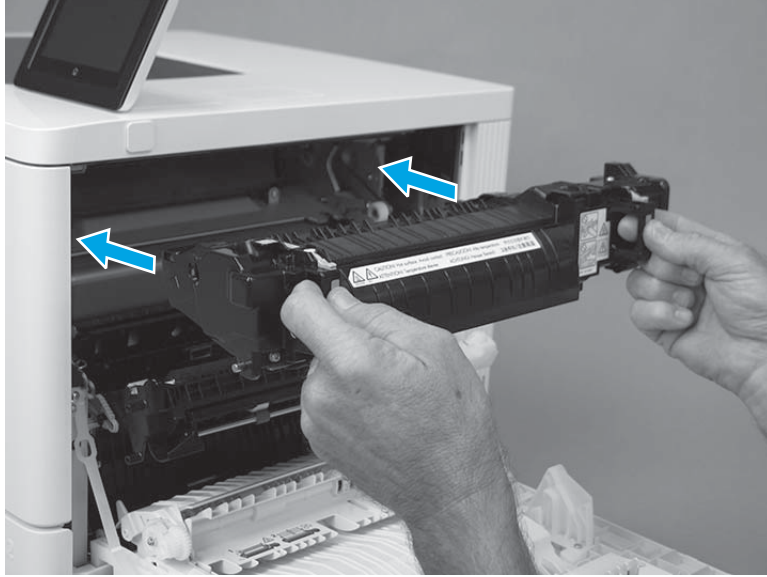

2. Slide the fuser into the printer, push in to install it, and then make sure that it is fully seated.

 **TIP:** When the fuser is fully seated, the two blue triggers on the handles make an audible click.

Figure 1-1533 Install the fuser

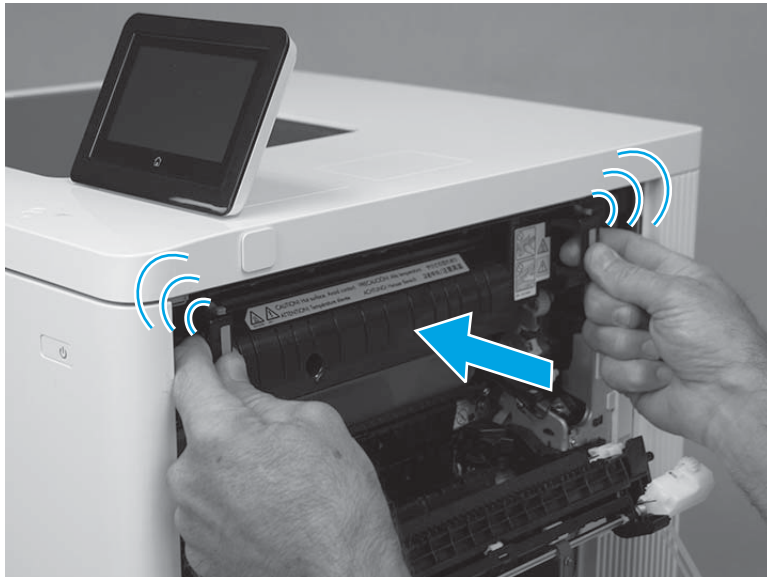

3. Close the right door.

Figure 1-1534 Close the right door



Step 45: Install the USB cover (M552 and M553)



NOTE: This step is for the M552 and M553 models. For the M577 models, skip this step and go to [Step 46: Install the TCU on page 873](#).

1. Push the cover into the USB port to install it.

Figure 1-1535 Install the cover



2. Make sure that the USB cover is fully seated after installing it.

Figure 1-1536 Check the installation

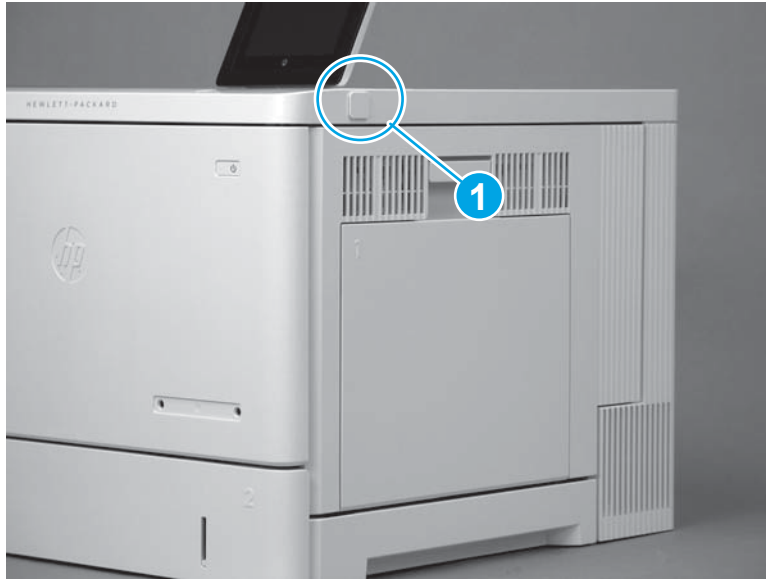

Step 46: Install the TCU

1. Verify that the toner collection hatch cover is in the closed position on the TCU.

Figure 1-1537 Verify that the toner collection hatch cover is closed

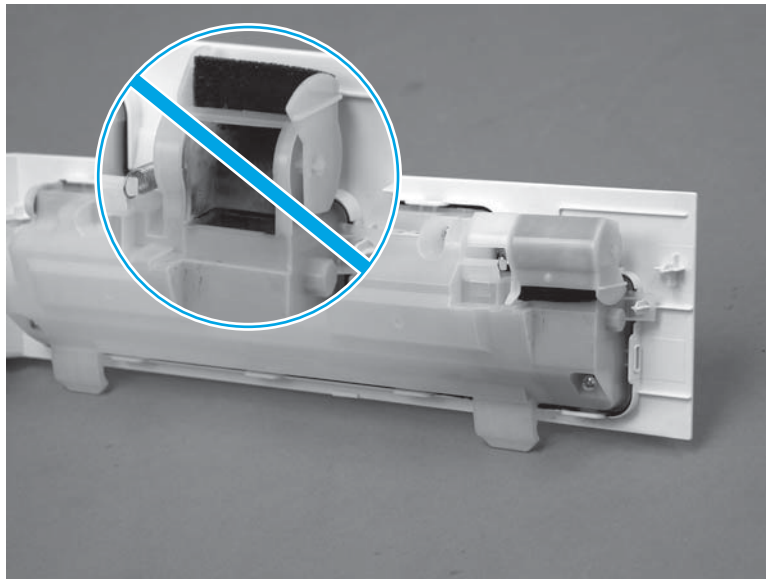

2. Position the TCU with the hinges in the slots provided in the printer (callout 1), and then rotate the TCU up and into the closed position.

 **NOTE:** The toner collection hatch cover automatically opens when the TCU is closed.

Figure 1-1538 Install the TCU



3. Close the front door.

Figure 1-1539 Close the front door

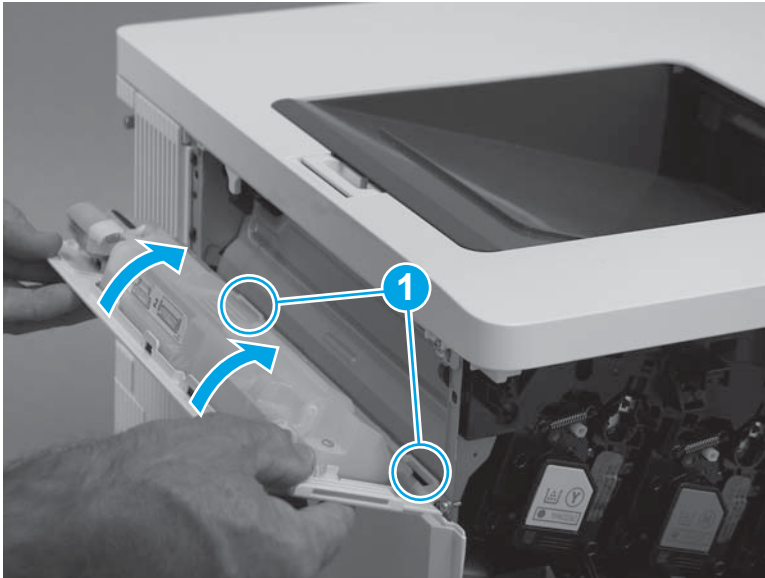

Step 47: Install the formatter cover

- ▲ Slide the cover onto the printer (callout 1) to install it.

 **NOTE:** Make sure that the tabs on the formatter cover align with the slots provided in the printer (callout 2). Tighten the two thumbscrews (callout 3).

 **TIP:** If needed, use the edge of a coin to turn the thumbscrews.

Figure 1-1540 Install the cover

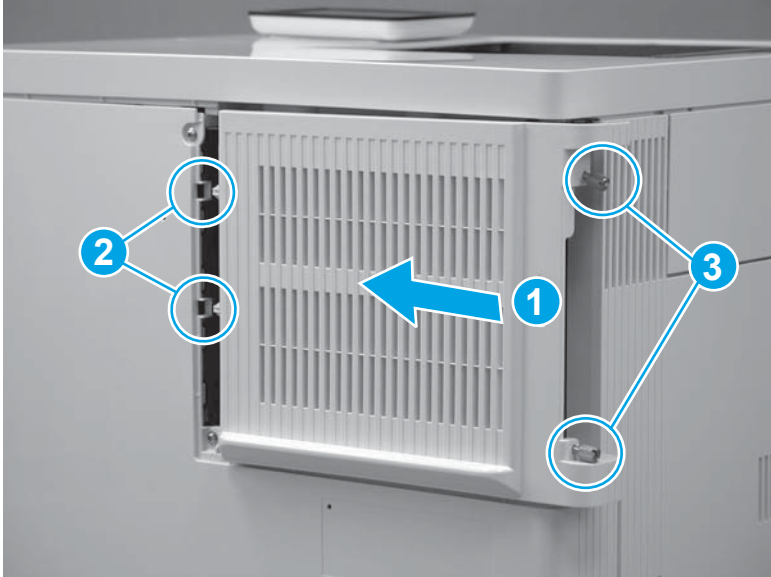

Removal and replacement: Formatter (M552 and M553)

- [Introduction](#)
- [Step 1: Remove the formatter cover](#)
- [Step 2: Remove the hard-disk drive \(HDD\)](#)
- [Step 3: Remove the embedded MultiMedia Card \(eMMC\)](#)
- [Step 4: Remove the dual inline memory module \(DIMM\)](#)
- [Step 5: Remove the trusted platform module \(TPM\)](#)
- [Step 6: Remove the formatter](#)
- [Step 7: Unpack the replacement assembly](#)
- [Step 8: Install the formatter](#)
- [Step 9: Install the DIMM](#)
- [Step 10: Install the eMMC](#)
- [Step 11: Install the TPM](#)
- [Step 12: Install the HDD](#)
- [Step 13: Install the formatter cover](#)

Introduction



This document provides the procedures to remove and replace the formatter.

Before performing service

Turn the printer power off

- Disconnect the power cable.

 **WARNING!** To avoid damage to the printer, turn the printer off, wait 30 seconds, and then remove the power cord before attempting to service the printer.

 **CAUTION:**  This part contains components that are electrostatic discharge (ESD) sensitive. To reduce the possibility of ESD damage, always touch the sheet-metal chassis to ground yourself before touching an ESD sensitive part.

 **IMPORTANT:** Do not replace the formatter, DC controller, and eMMC PCA or hard-disk drive simultaneously during a single printer servicing. Doing so might cause the printer to become unstable or inoperable.

Use the table below to identify the correct part number for your printer, and then go to <http://h20141.www2.hp.com/hpparts> to order the part.

Formatter kit number	
B5L23-67903	Formatter (M552)
B5L23-67904	Formatter (M552; India and China only)
B5L24-67909	Formatter (M553n, M553dn, M553dh)
B5L24-67908	Formatter (M553n, M553dn, M553dh; India and China only)
B5L26-67901	Formatter (M553x)
B5L26-67902	Formatter (M553x; India and China only)

Required tools

- #2 Phillips screwdriver with a magnetic tip

After performing service

Make sure that all of the connectors on the formatter are fully seated.

Make sure that the formatter cover is fully seated, and that the thumbscrews are finger tight after replacing it.

Turn the printer power on

- Connect the power cable.
- Use the power switch to turn the power on.

Post service test

Print a configuration page to make sure that the printer is functioning correctly.

Step 1: Remove the formatter cover

1. Locate the formatter cover.

Figure 1-1541 Locate the formatter cover

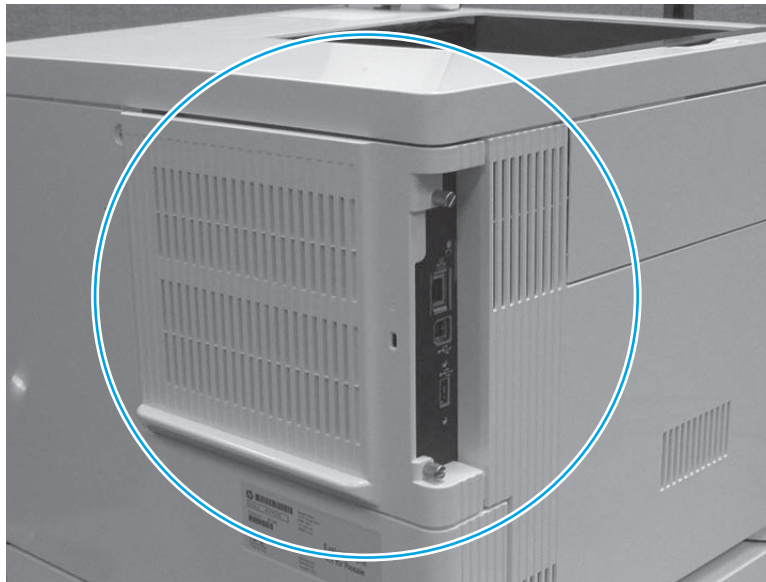

2. Loosen the two thumbscrews (callout 1). Grasp the two thumbscrews, and then slide the cover away from the printer (callout 2) to remove it.

 **TIP:** If needed, use the edge of a coin to turn the thumbscrews.

Figure 1-1542 Loosen the thumbscrews

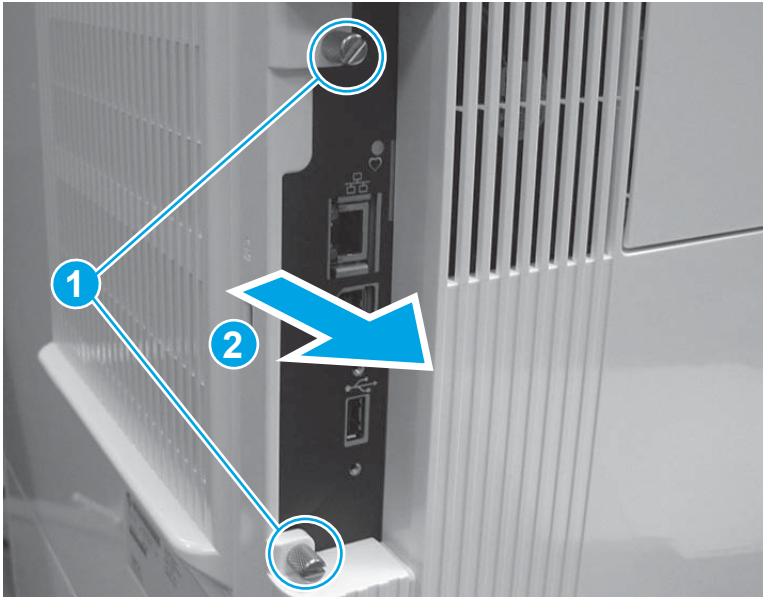

Step 2: Remove the hard-disk drive (HDD)

 **NOTE:** If the optional HDD is not installed, skip this step and go to [Step 3: Remove the embedded MultiMedia Card \(eMMC\) on page 879](#).

 **CAUTION:**  ESD-sensitive part.

1. Release one tab (callout 1), grasp the HDD mounting bracket, and then rotate the connector end of the bracket up (callout 2) and away from the formatter to release it.

Figure 1-1543 Release the HDD

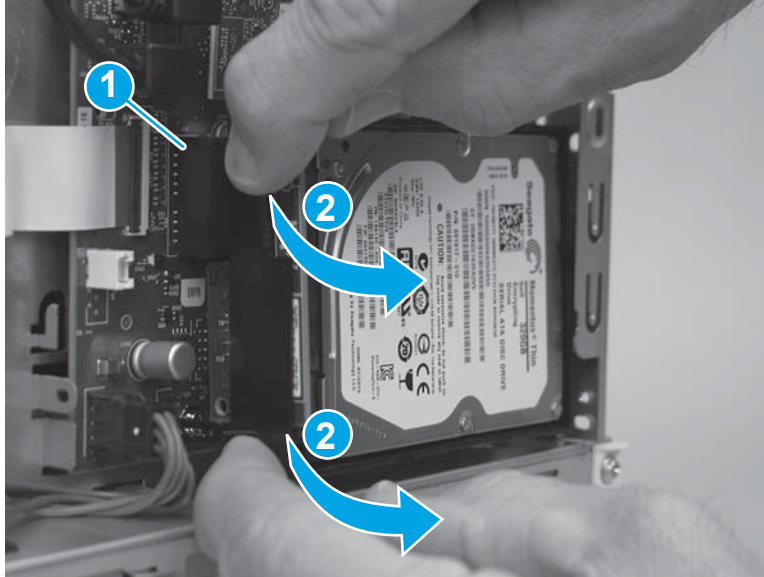

2. Slide the HDD away from the printer to remove it.

Figure 1-1544 Remove the HDD

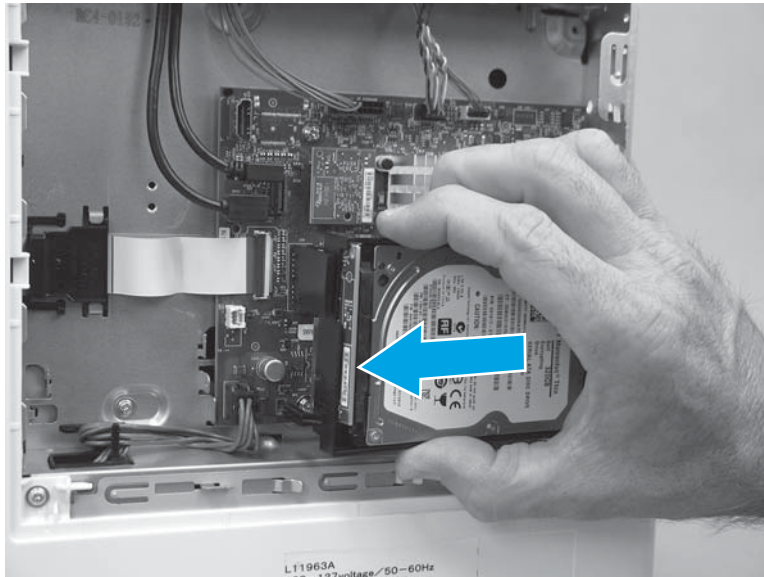

Step 3: Remove the embedded MultiMedia Card (eMMC)

 **NOTE:** If the formatter is being removed to gain access to other assemblies, skip this step and go to [Step 6: Remove the formatter on page 882](#).

 **CAUTION:**  ESD-sensitive part.

- ▲ Locate the eMMC component on the formatter, and then pull it straight off of the formatter to remove it.

Figure 1-1545 Remove the eMMC

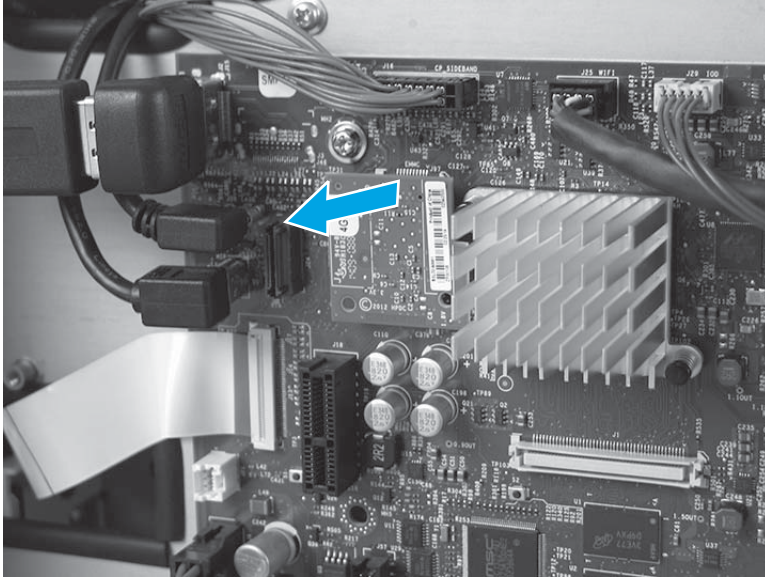

Step 4: Remove the dual inline memory module (DIMM)

 **NOTE:** If the formatter is being removed to gain access to other assemblies (or the optional DIMM is not installed), skip this step and go to [Step 6: Remove the formatter on page 882](#).

 **CAUTION:**  ESD-sensitive part.

1. Locate the DIMM component on the formatter.

Figure 1-1546 Locate the DIMM

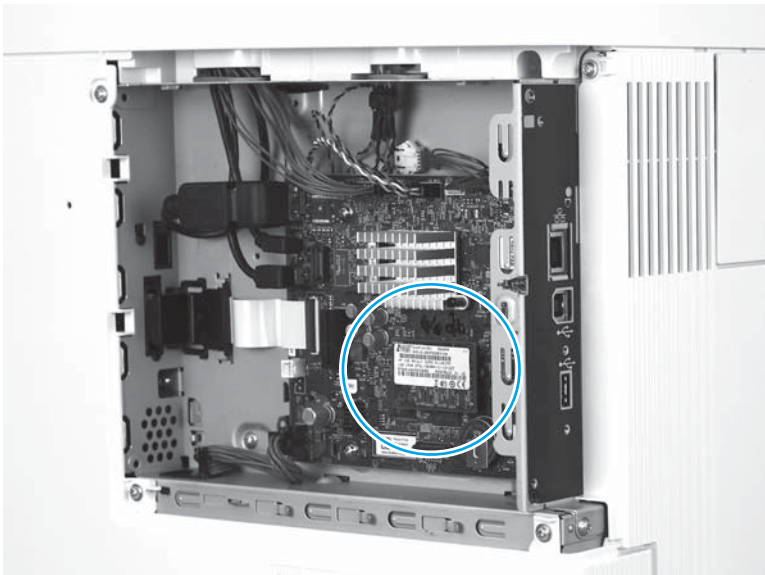

2. Pull the DIMM straight off of the formatter to remove it.

Figure 1-1547 Remove the DIMM

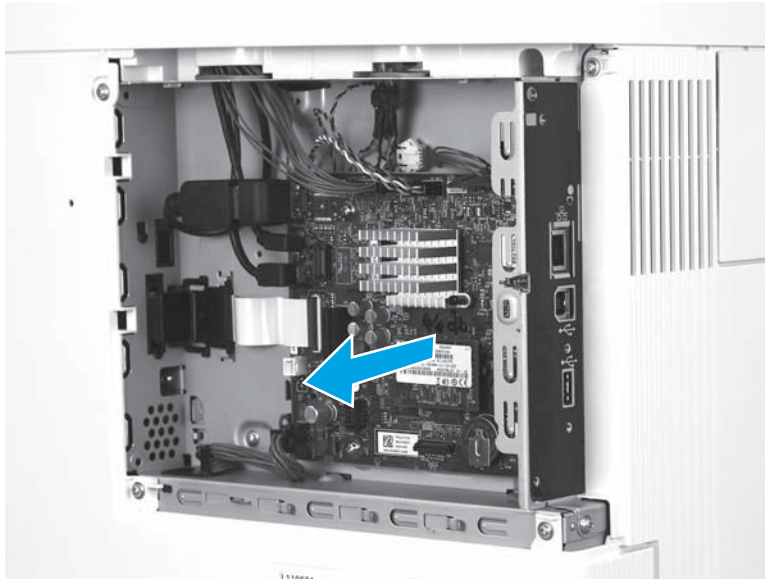

Step 5: Remove the trusted platform module (TPM)

 **NOTE:** If the formatter is being removed to gain access to other assemblies (or the optional TPM is not installed), skip this step and go to [Step 6: Remove the formatter on page 882](#).

 **CAUTION:**  ESD-sensitive part.

1. Locate the TPM component on the formatter.

Figure 1-1548 Locate the TPM

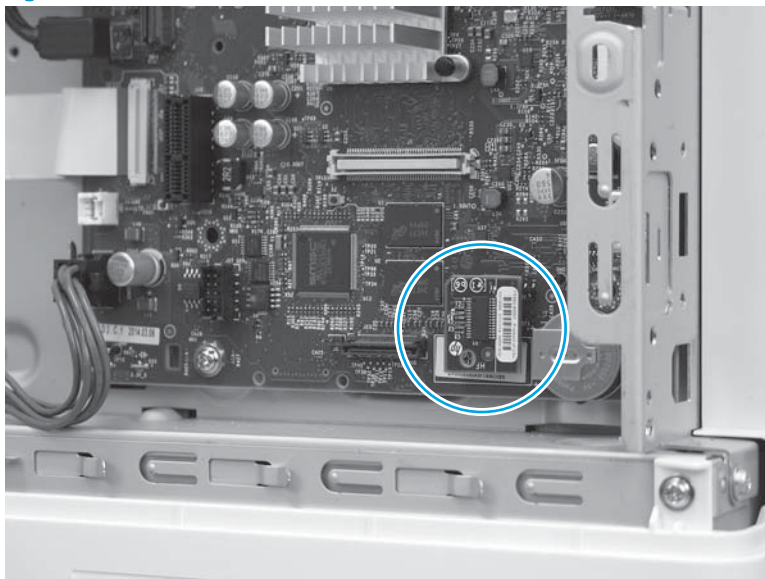

2. Pull the TPM straight off of the formatter to remove it.

Figure 1-1549 Remove the TPM

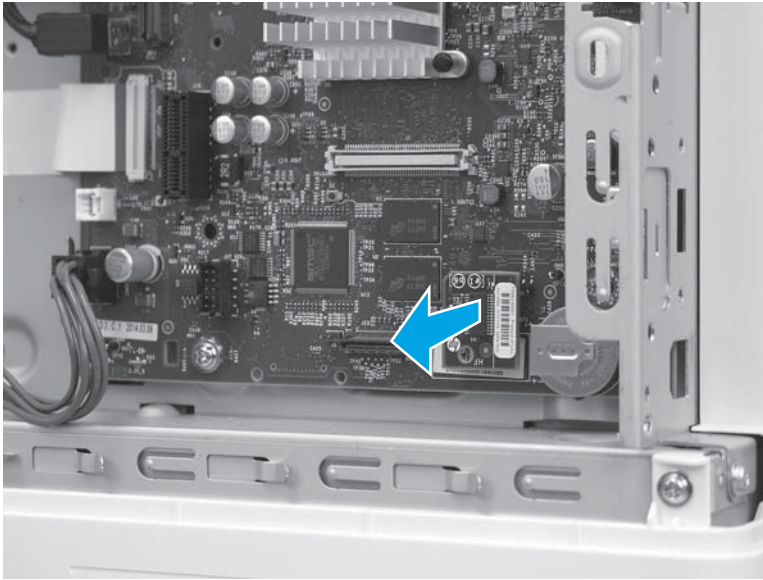

Step 6: Remove the formatter

 **CAUTION:**  ESD-sensitive part.

1. Disconnect all of the connectors on the formatter.

The following connectors are empty:

- All models: J1 (this connector is empty unless the optional DIMM is installed)
- M553n/dn and M552dn: J2 (callout 1; this is the touchscreen connector for the M553x model)
- All models: J9 (this connector is empty unless the optional internal USB ports component is installed)
- All models: J18 (this connector is empty unless the optional hard-disk-drive (HDD) is installed)
- All models: J23
- All models: J24
- M553n/dn and M552dn: J25 (this is the wireless connector for the M553x model)
- All models: J57
- All models: J98 (this connector is empty unless the optional trusted platform module (TPM) is installed)

 **IMPORTANT:** The flat-cable connector (callout 2) is a Zero Insertion Force (ZIF) connector that uses a hinged retainer to secure the flat cable. The hinged retainer must be opened to release the flat cable.

Figure 1-1550 Disconnect all connectors



2. Remove four screws (callout 1), and then remove the formatter.

Figure 1-1551 Remove the formatter

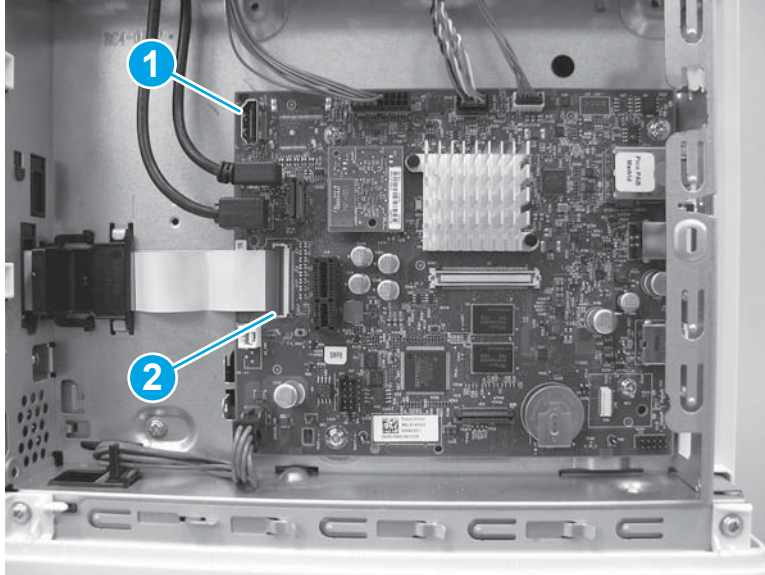
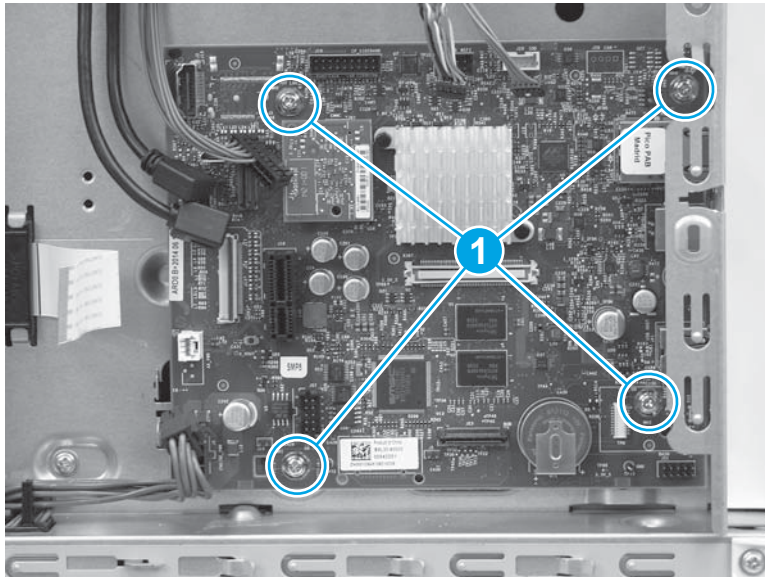

Step 7: Unpack the replacement assembly

Unpack the replacement assembly from the packaging.

 **CAUTION:**  ESD-sensitive part.

For complete information on HP's recycling programs, go to [Product return and recycling](#).

 **NOTE:** HP recommends responsible disposal of the defective assembly.

Figure 1-1552 Recycle and unpack

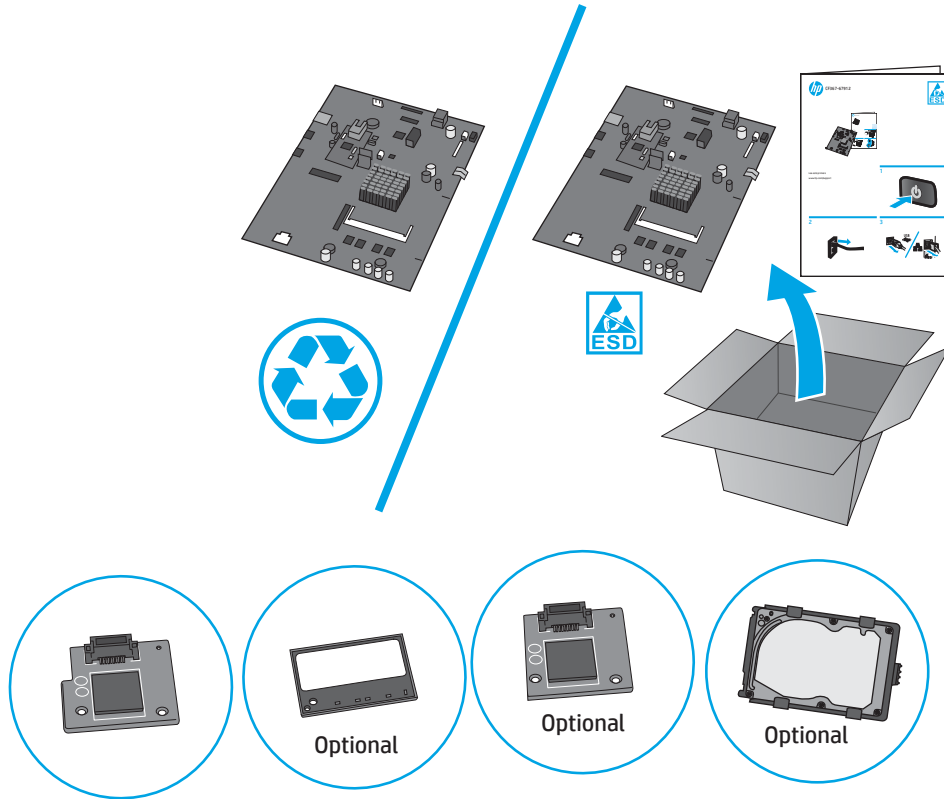

Step 8: Install the formatter

 **CAUTION:**  ESD-sensitive part.

1. Position the formatter in the printer, and then install four screws (callout 1).

Figure 1-1553 Install the formatter

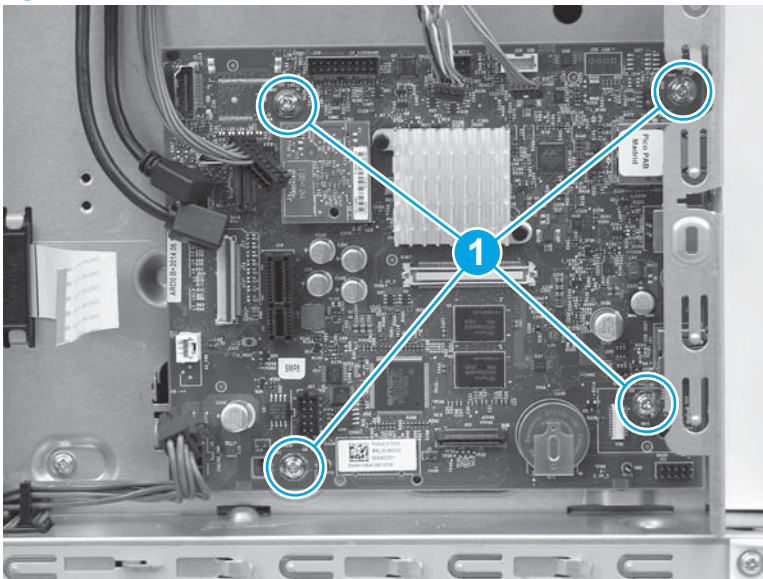

2. Connect all of the connectors on the formatter.

The following connectors are empty:

- All models: J1 (this connector is empty unless the optional DIMM is installed)
- M553n/dn and M552dn: J2 (callout 1; this is the touchscreen connector for the M553x model)
- All models: J9 (this connector is empty unless the optional internal USB ports component is installed)
- All models: J18 (this connector is empty unless the optional hard-disk-drive (HDD) is installed)
- All models: J23
- All models: J24
- M553n/dn and M552dn: J25 (this is the wireless connector for the M553x model)
- All models: J57
- All models: J98 (this connector is empty unless the optional trusted platform module (TPM) is installed)

 **IMPORTANT:** The flat-cable connector (callout 2) is a Zero Insertion Force (ZIF) connector that uses a hinged retainer to secure the flat cable. The hinged retainer must be opened to install the flat cable.

Figure 1-1554 Connect all connectors



Step 9: Install the DIMM

 **NOTE:** If the formatter was removed to gain access to other assemblies (or the optional DIMM is not installed), skip this step and go to [Step 10: Install the eMMC on page 887](#).

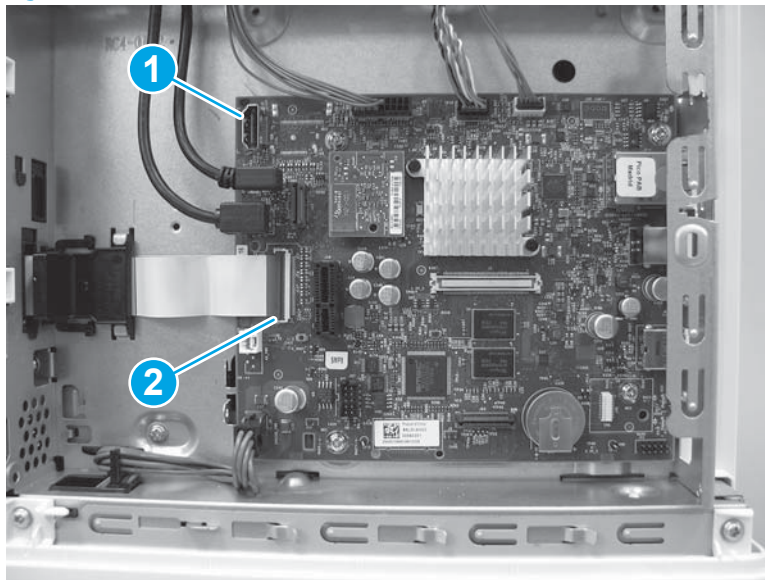
 **CAUTION:**  ESD-sensitive part.

1. The DIMM connector (callout 1) is keyed, and can only be installed in one direction in the formatter connector (callout 2).

Figure 1-1555 The DIMM connector

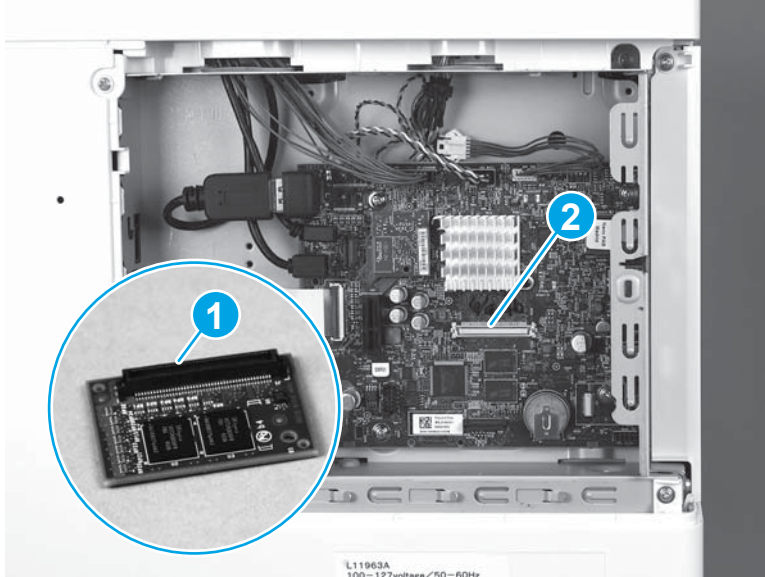

2. Align the connector on the DIMM with the connector on the formatter, and then push the DIMM onto the formatter to install it.

Figure 1-1556 Install the DIMM

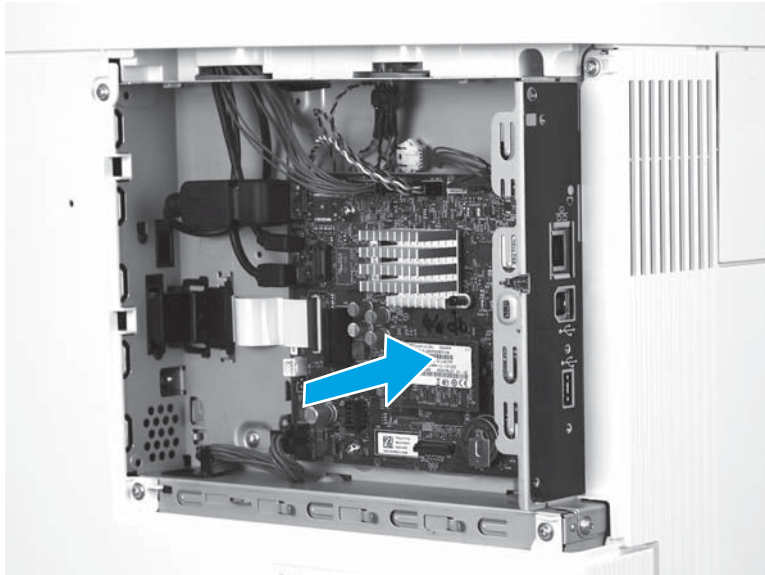

3. Verify that the DIMM is fully seated in the connector.

Figure 1-1557 Verify the installation

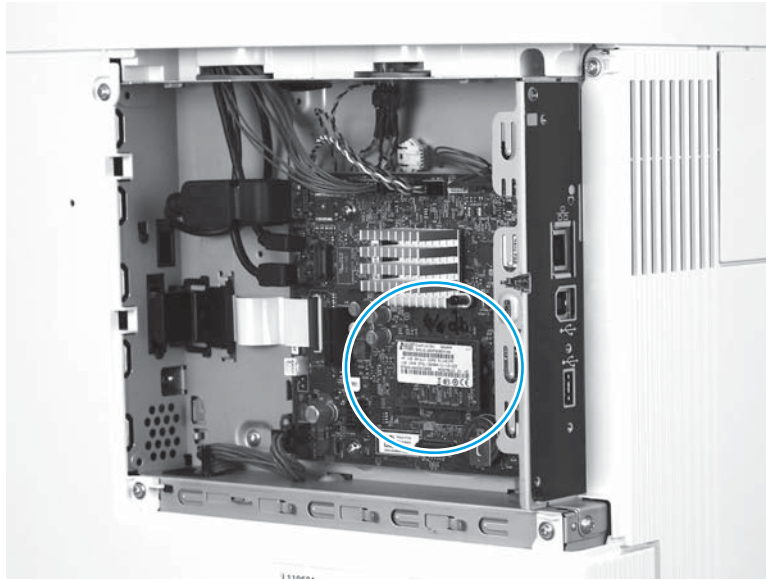

Step 10: Install the eMMC

 **NOTE:** If the formatter was removed to gain access to other assemblies, skip this step and go to [Step 12: Install the HDD on page 889](#).

 **CAUTION:**  ESD-sensitive part.

1. Align the connector on the replacement eMMC (callout 1) with the connector on the formatter (callout 2), and then push the eMMC onto the formatter to install it.

 **NOTE:** The eMMC can only be installed in one direction on the formatter.

Figure 1-1558 Install the eMMC

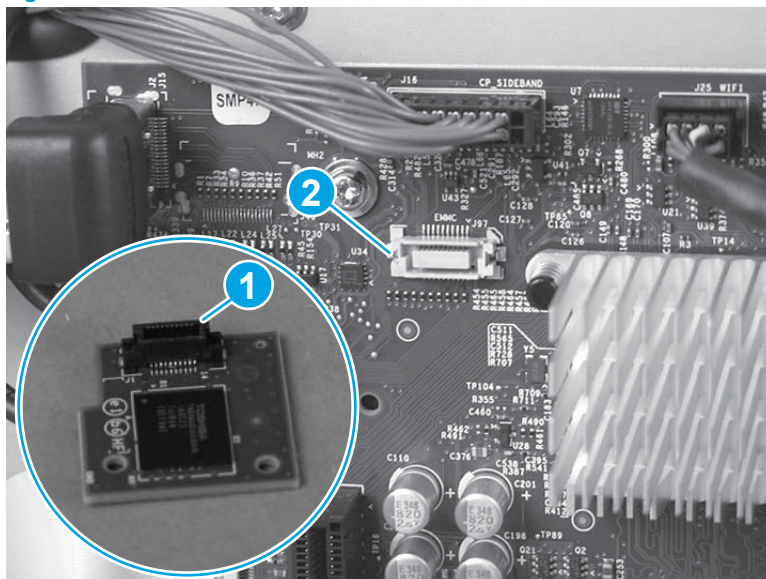

2. Push down on the eMMC to make sure that it is fully seated in the connector.

Figure 1-1559 Verify the installation

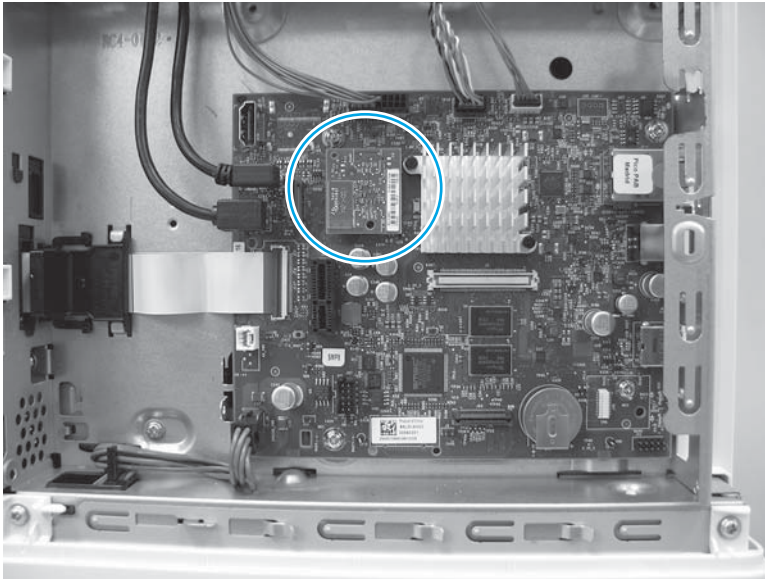

Step 11: Install the TPM

 **NOTE:** If the formatter was removed to gain access to other assemblies (or the optional TPM is not installed), skip this step and go to [Step 12: Install the HDD on page 889](#).

 **CAUTION:**  ESD-sensitive part.

1. Align the connector on the TPM (callout 1) with the connector on the formatter (callout 2), and then push the TPM onto the formatter to install it.

 **NOTE:** The TPM can only be install in one direction on the formatter.

Figure 1-1560 Install the TPM

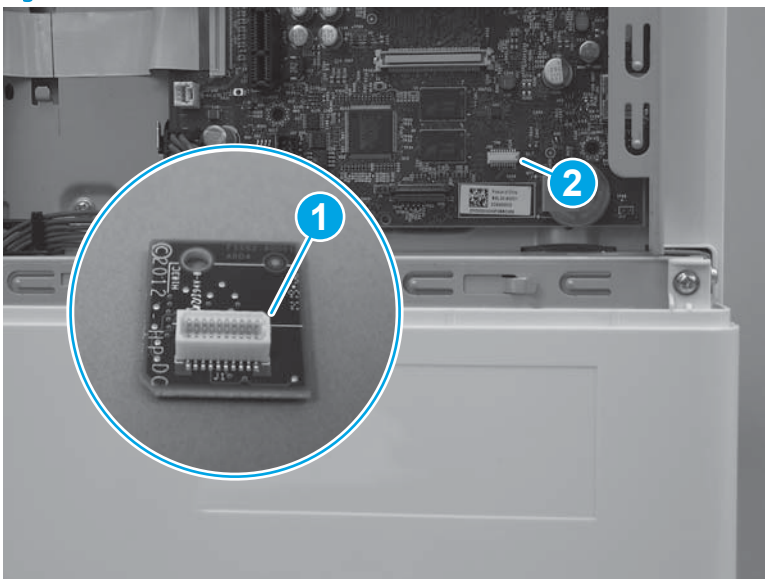

2. Verify that the TPM is fully seated in the connector.

Figure 1-1561 Verify that the TPM is fully seated

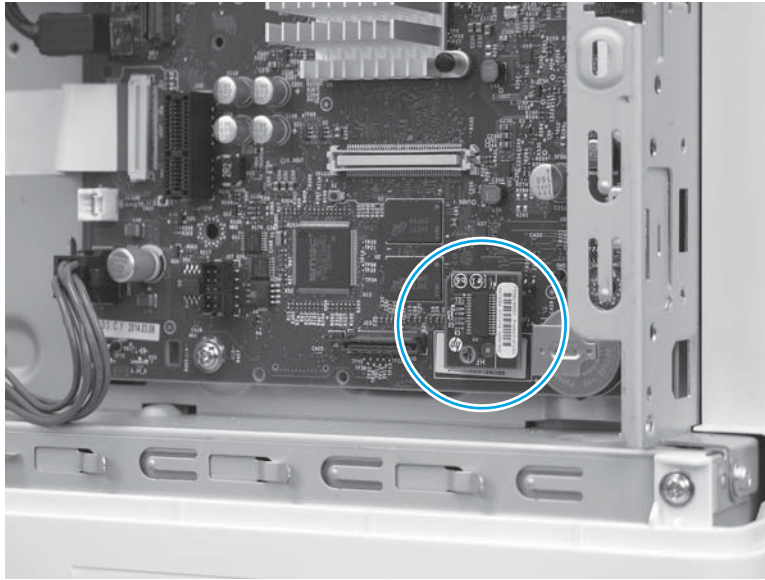

Step 12: Install the HDD

 **NOTE:** If the optional HDD is not installed, skip this step and go to [Step 13: Install the formatter cover on page 890](#).

 **CAUTION:**  ESD-sensitive part.

1. Align the end of the holder (callout 1) with the slot in the chassis (callout 2), and then slide the HDD into the printer (callout 3) to engage the holder with the chassis.

Figure 1-1562 Install the holder

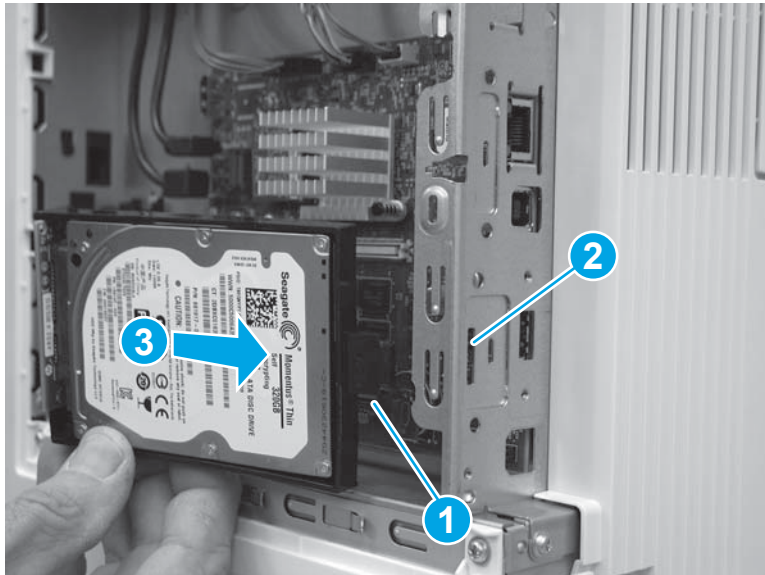

2. Rotate the HDD connector (callout 1) down and into the connector on the formatter to install it.

 **NOTE:** Make sure that the tabs (callout 2) snap into place, and that the HDD is securely installed.

Figure 1-1563 Release the HDD



Step 13: Install the formatter cover

- ▲ Slide the cover onto the printer (callout 1) to install it.

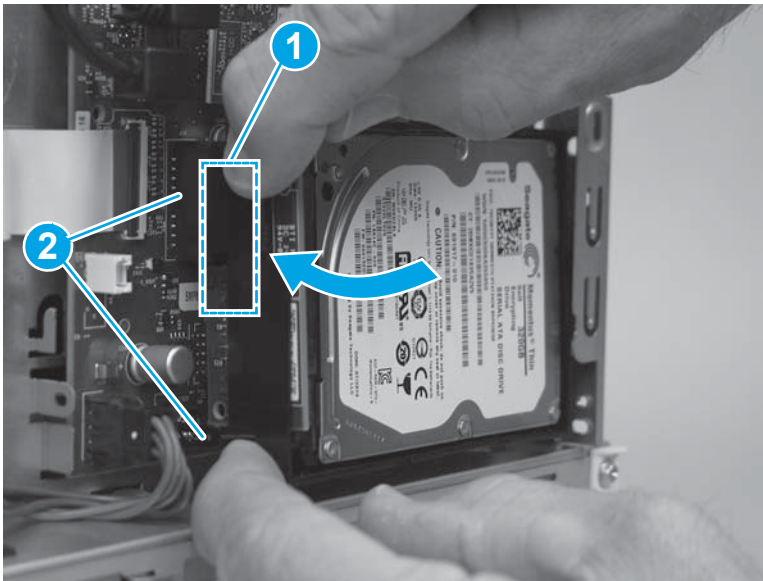
 **NOTE:** Make sure that the tabs on the formatter cover align with the slots provided in the printer (callout 2). Tighten the two thumbscrews (callout 3).

 **TIP:** If needed, use the edge of a coin to turn the thumbscrews.

Figure 1-1564 Install the cover

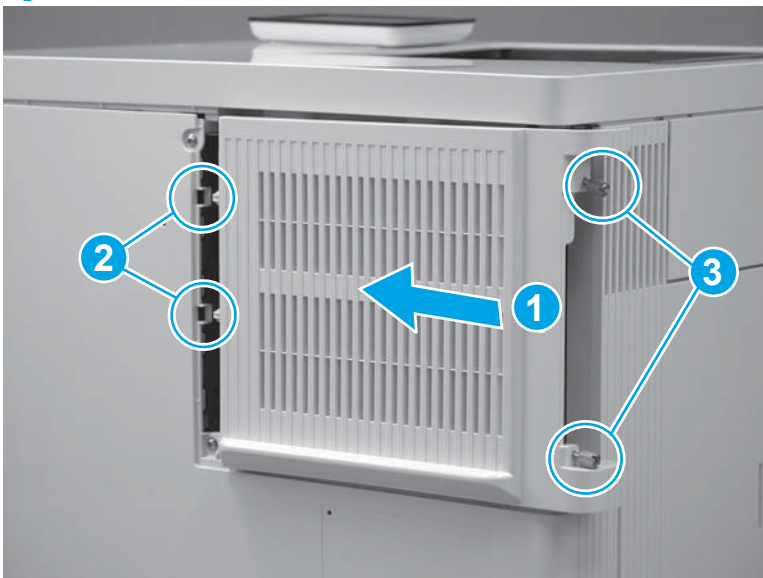

Removal and replacement: Formatter (M577)

- [Introduction](#)
- [Step 1: Remove the formatter cover](#)
- [Step 2: Remove the hard-disk drive \(HDD\) \(M577\)](#)
- [Step 3: Remove the fax PCA \(M577c/f/z\)](#)
- [Step 4: Remove the dual inline memory module \(DIMM\) \(M577\)](#)
- [Step 5: Remove the formatter](#)
- [Step 6: Unpack the replacement assembly](#)
- [Step 7: Install the formatter](#)
- [Step 8: Install the DIMM \(M577\)](#)
- [Step 9: Install the fax PCA \(M577c/f/z\)](#)
- [Step 10: Install the HDD \(M577\)](#)
- [Step 11: Install the formatter cover](#)

Introduction



This document provides the procedures to remove and replace the M577 formatter.

Before performing service

Turn the printer power off

- Disconnect the power cable.

 **WARNING!** To avoid damage to the printer, turn the printer off, wait 30 seconds, and then remove the power cord before attempting to service the printer.

 **CAUTION:**  This part contains components that are electrostatic discharge (ESD) sensitive. To reduce the possibility of ESD damage, always touch the sheet-metal chassis to ground yourself before touching an ESD sensitive part.

 **IMPORTANT:** Do not replace the formatter, DC controller, and hard-disk drive simultaneously during a single printer servicing. Doing so might cause the printer to become unstable or inoperable.

Use the table below to identify the correct part number for your printer, and then go to <http://h20141.www2.hp.com/hpparts> to order the part.

Formatter (M577) kit number	
B5L46-67909	Formatter (M577)
B5L46-67911	Formatter (M577; India and China only)

Required tools

- #2 Phillips screwdriver with a magnetic tip

After performing service

Make sure that all of the connectors on the formatter are fully seated.

Make sure that the formatter cover is fully seated, and that the thumbscrews are finger tight after replacing it.

Turn the printer power on

- Connect the power cable.
- Use the power switch to turn the power on.

Post service test

Print a configuration page to make sure that the printer is functioning correctly.

Step 1: Remove the formatter cover

1. Locate the formatter cover.

Figure 1-1565 Locate the formatter cover

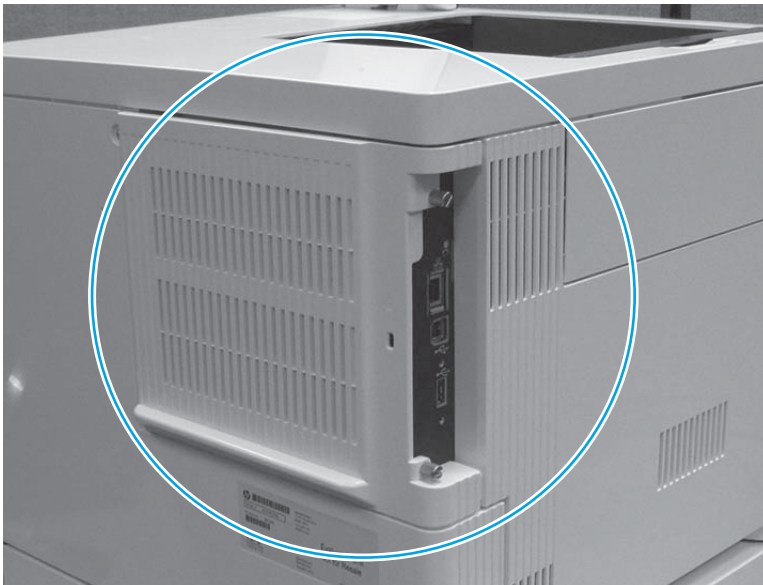

2. Loosen the two thumbscrews (callout 1). Grasp the two thumbscrews, and then slide the cover away from the printer (callout 2) to remove it.

 **TIP:** If needed, use the edge of a coin to turn the thumbscrews.

Figure 1-1566 Loosen the thumbscrews

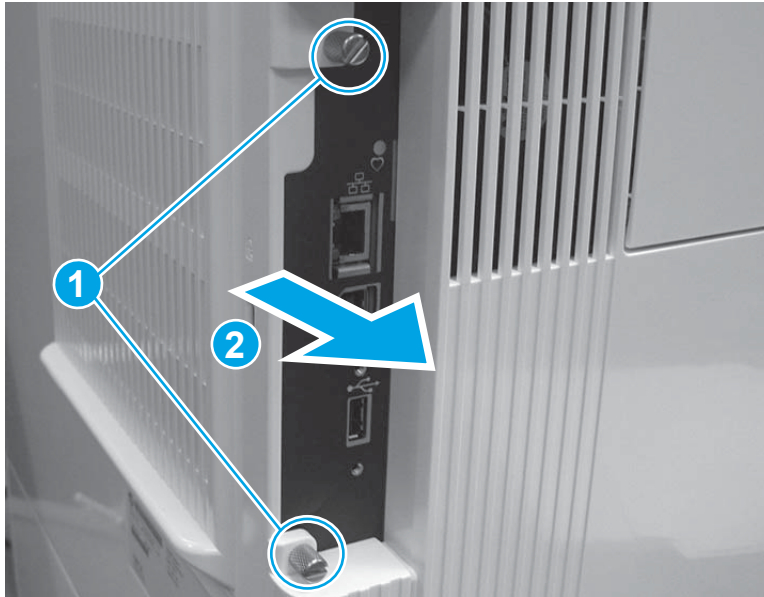

Step 2: Remove the hard-disk drive (HDD) (M577)

 **CAUTION:**  ESD-sensitive part.

1. Release two tabs (callout 1). Hold the tabs in the released position, and then rotate the hard disk drive (HDD) up (callout 2) to release the connector from the formatter.

Figure 1-1567 Release the HDD

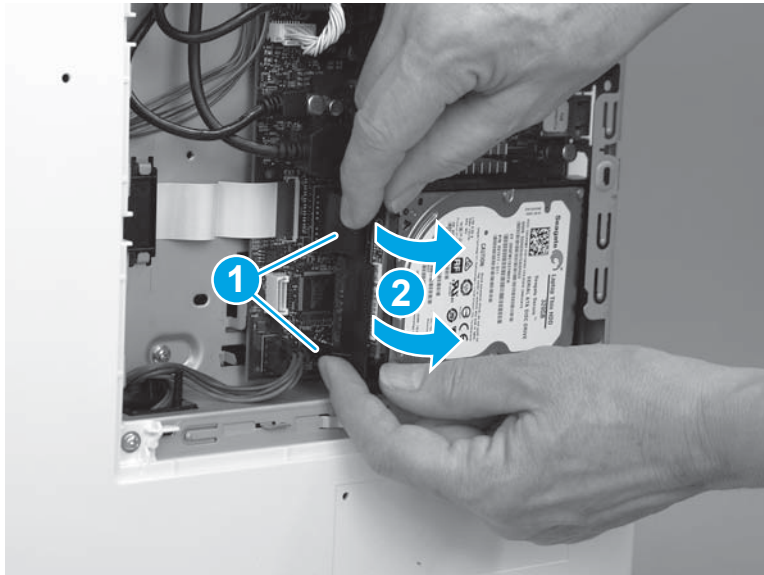

2. Slide the HDD away from the printer to remove it.

Figure 1-1568 Remove the HDD



Step 3: Remove the fax PCA (M577c/f/z)

 **NOTE:** If the fax PCA is not installed, skip this step and go to [Step 4: Remove the dual inline memory module \(DIMM\) \(M577\)](#) on page 896.

 **CAUTION:**  ESD-sensitive part.

1. Locate the fax PCA component on the formatter.

Figure 1-1569 Locate the fax PCA

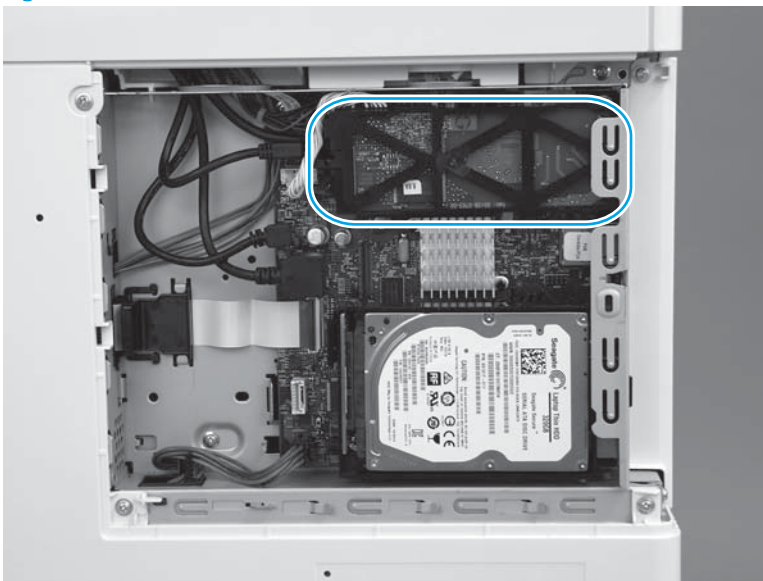

2. Release the connector latch (callout 1), and then pull the connector away from the formatter (callout 2) to disconnect it.

Figure 1-1570 Disconnect one connector

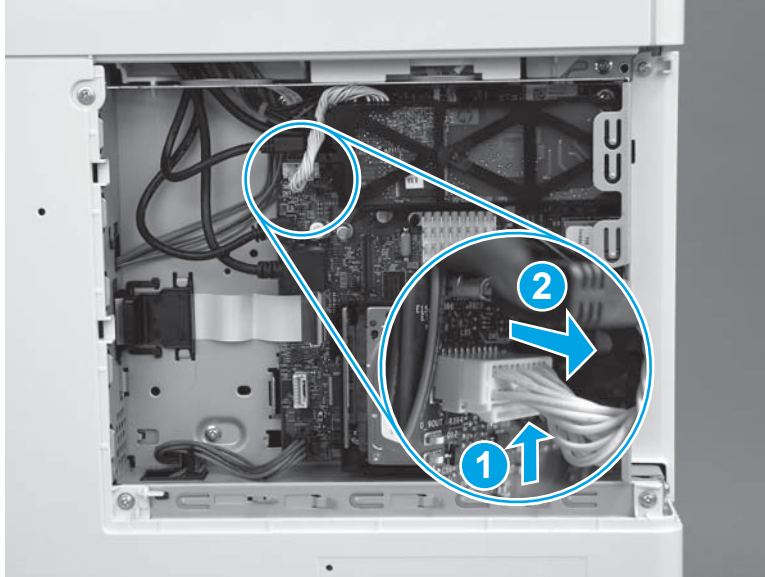

3. Release one retainer (callout 1) by pressing the bracket arms together.

Figure 1-1571 Release one latch

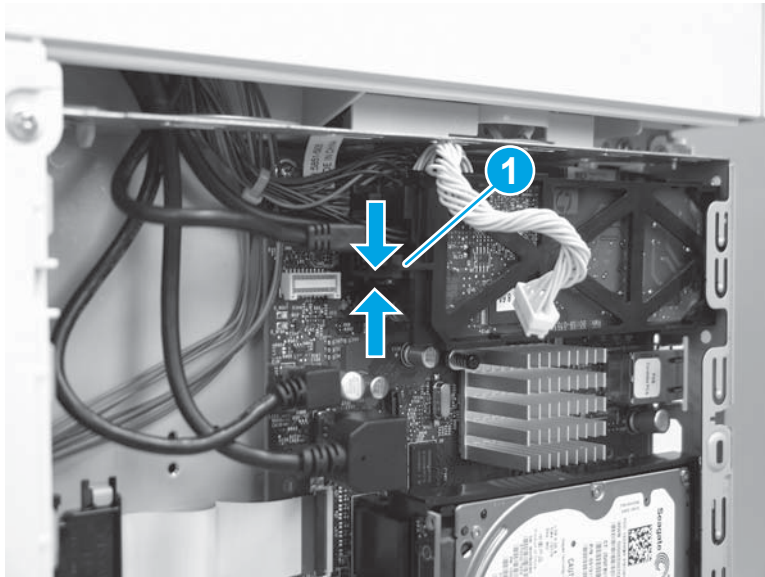

4. Rotate the end of the fax PCA (callout 1) away from the formatter, and then slide the PCA left (callout 2) to remove it.

Figure 1-1572 Remove the fax PCA

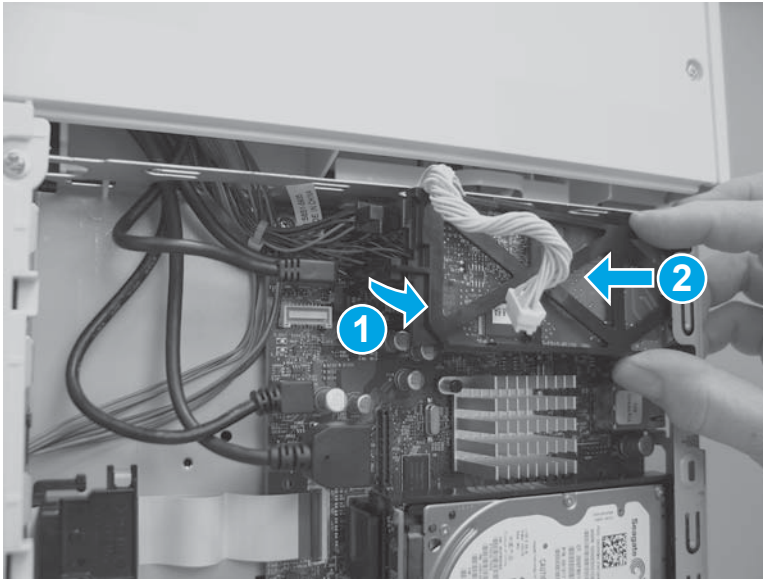

Step 4: Remove the dual inline memory module (DIMM) (M577)

 **NOTE:** If the DIMM is not installed, skip this step and go to [Step 5: Remove the formatter on page 897](#).

 **CAUTION:**  ESD-sensitive part.

1. Locate the DIMM component on the formatter.

Figure 1-1573 Locate the DIMM

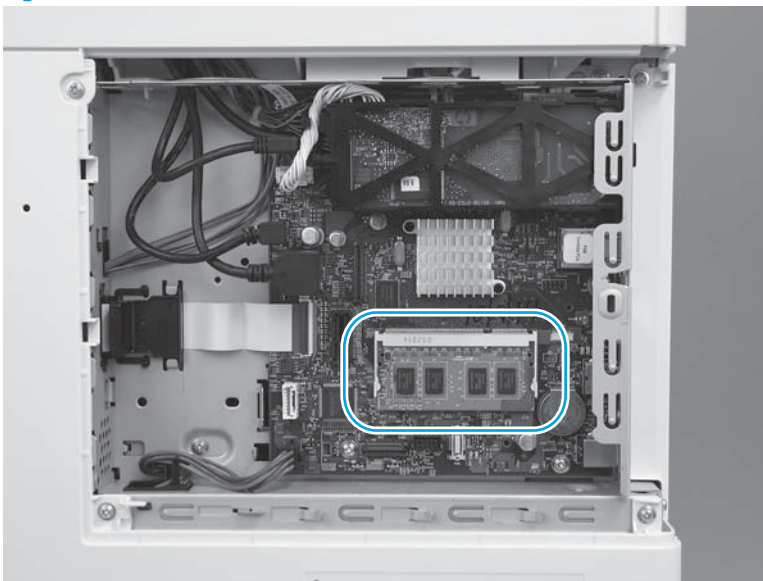

2. Do the following:
 - a. Release two locking arms (callout 1).

Figure 1-1574 Release the DIMM

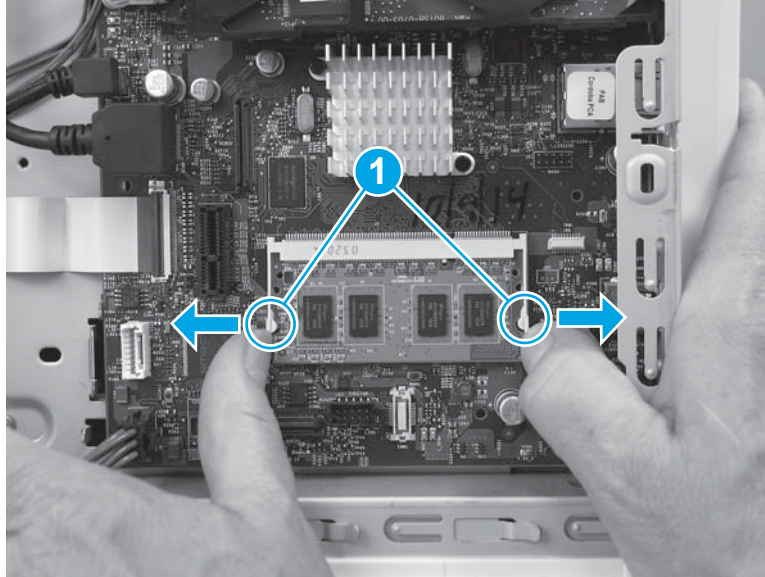

- b. Pull the DIMM down and away from the holder to remove it.

Figure 1-1575 Remove the DIMM (M527)

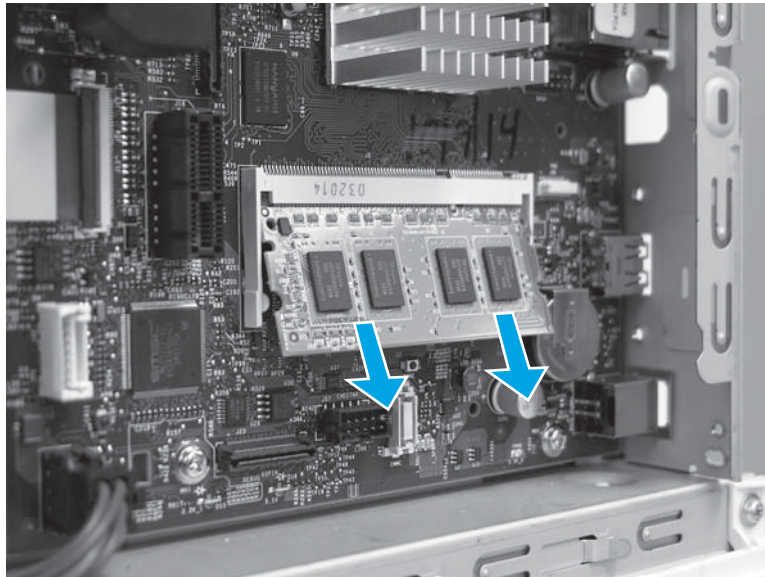

Step 5: Remove the formatter

 **CAUTION:**  ESD-sensitive part.

1. Disconnect all of the connectors on the formatter.

The following connectors are empty:

- All models: J1 (this connector is empty unless the optional DIMM is installed)
- All models: J3
- M577dn: J15 (this is the fax connector for the M577f/z/c models)

- All models: J21 (this connector is empty unless the optional internal USB ports component is installed)
- All models: J23
- All models: J24
- All models: J51
- All models: J57
- All models: J97
- All models: J98 (this connector is empty unless the optional trusted platform module (TPM) is installed)

 **IMPORTANT:** The flat-cable connector (callout 1) is a Zero Insertion Force (ZIF) connector that uses a hinged retainer to secure the flat cable. The hinged retainer must be opened to release the flat cable.

Figure 1-1576 Disconnect all connectors



2. Remove four screws (callout 1).

Figure 1-1577 Remove four screws

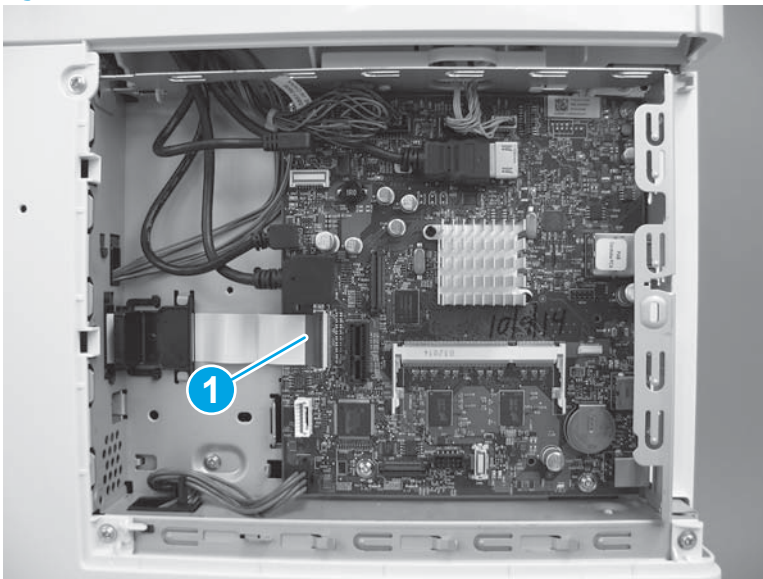
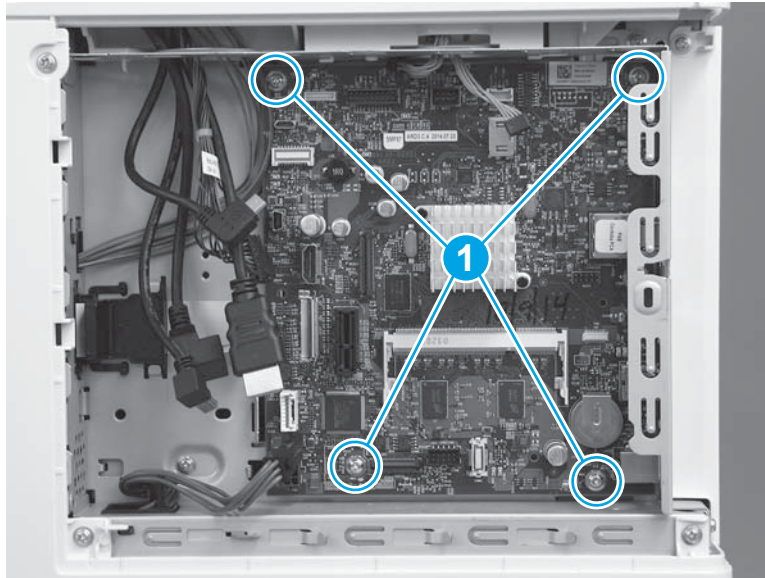

3. Remove the formatter.

Figure 1-1578 Remove the formatter

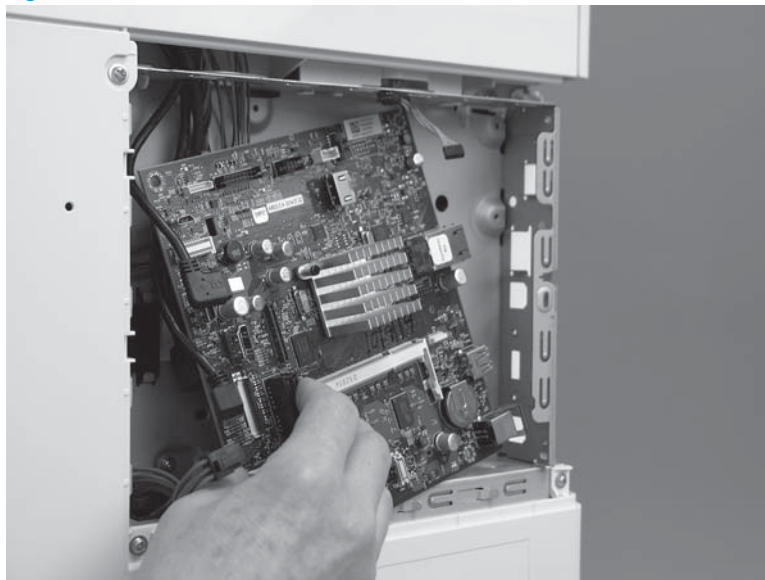

Step 6: Unpack the replacement assembly

Unpack the replacement assembly from the packaging.

 **CAUTION:**  ESD-sensitive part.

For complete information on HP's recycling programs, go to [Product return and recycling](#).

 **NOTE:** HP recommends responsible disposal of the defective assembly.

Figure 1-1579 Recycle and unpack

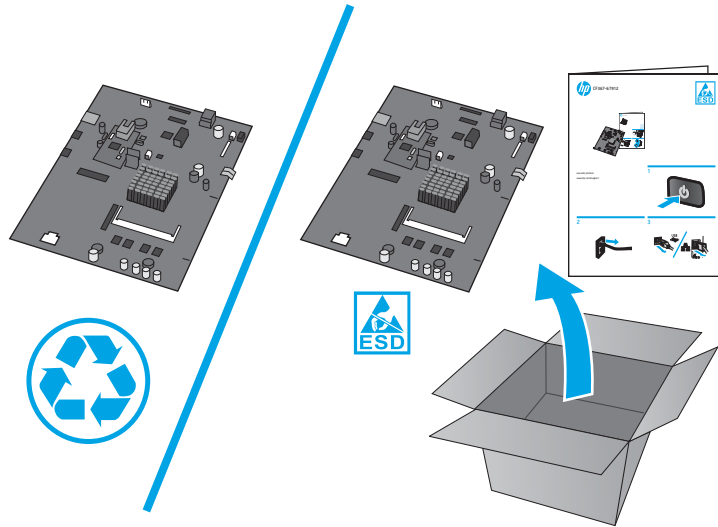

Step 7: Install the formatter

 **CAUTION:**  ESD-sensitive part.

1. Position the formatter in the printer. Make sure that the network port (callout 1) fits through the opening (callout 2) in the formatter case.

Figure 1-1580 Install the formatter

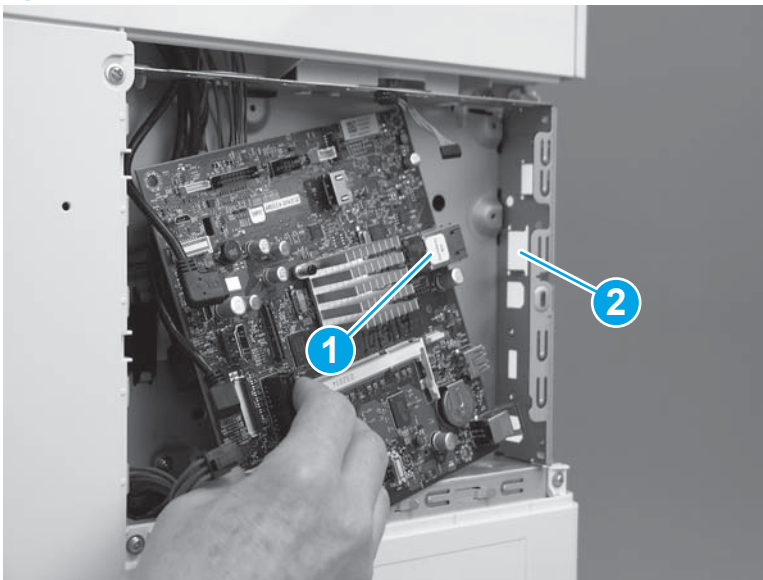

2. Install four screws (callout 1).

Figure 1-1581 Install four screws

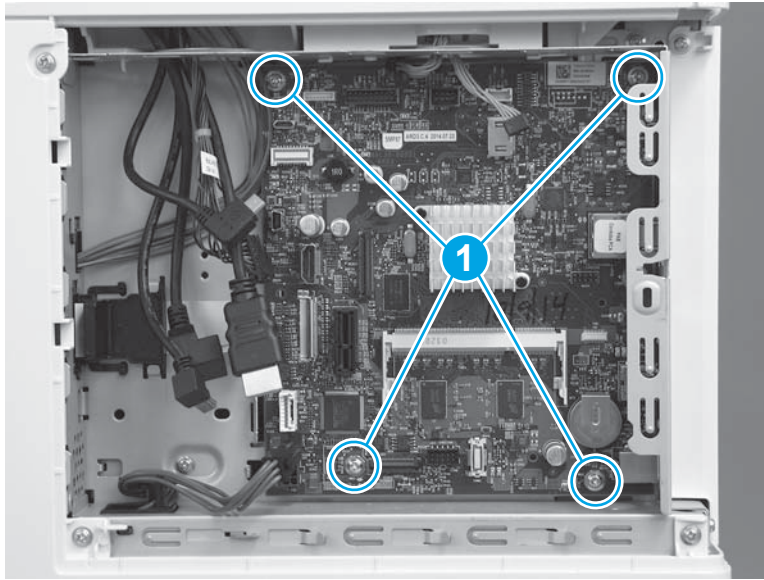

3. Connect all of the connectors on the formatter.

The following connectors are empty:

- All models: J1 (this connector is empty unless the optional DIMM is installed)
- All models: J3
- M577dn: J15 (this is the fax connector for the M577f/z/c models)
- All models: J21 (this connector is empty unless the optional internal USB ports component is installed)
- All models: J23
- All models: J24
- All models: J51
- All models: J57
- All models: J97
- All models: J98 (this connector is empty unless the optional trusted platform module (TPM) is installed)

 **IMPORTANT:** The flat-cable connector (callout 1) is a Zero Insertion Force (ZIF) connector that uses a hinged retainer to secure the flat cable. The hinged retainer must be opened to install the flat cable, and then closed after the cable is installed.

Figure 1-1582 Connect all connectors



Step 8: Install the DIMM (M577)

 **NOTE:** If the DIMM is not installed, skip this step and go to [Step 9: Install the fax PCA \(M577c/f/z\)](#) on page 903.

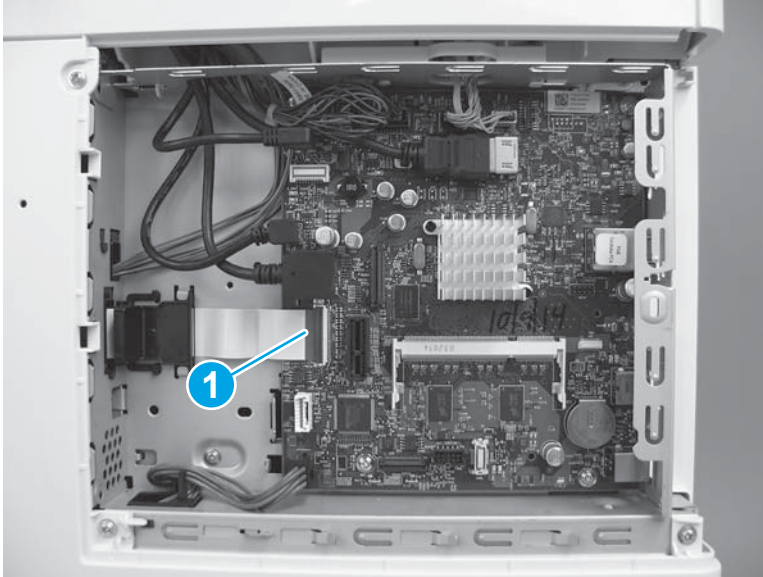
 **CAUTION:**  ESD-sensitive part.

1. Insert the top edge of the DIMM (callout 1) in the holder (callout 2).

 **Reinstallation tip:** The DIMM is keyed and can only be inserted in the holder one way.

Figure 1-1583 Insert the DIMM



2. Make sure that the DIMM is fully installed in the holder (callout 1), and then rotate the bottom edge of the DIMM toward the holder (callout 2).

Figure 1-1584 Install the DIMM

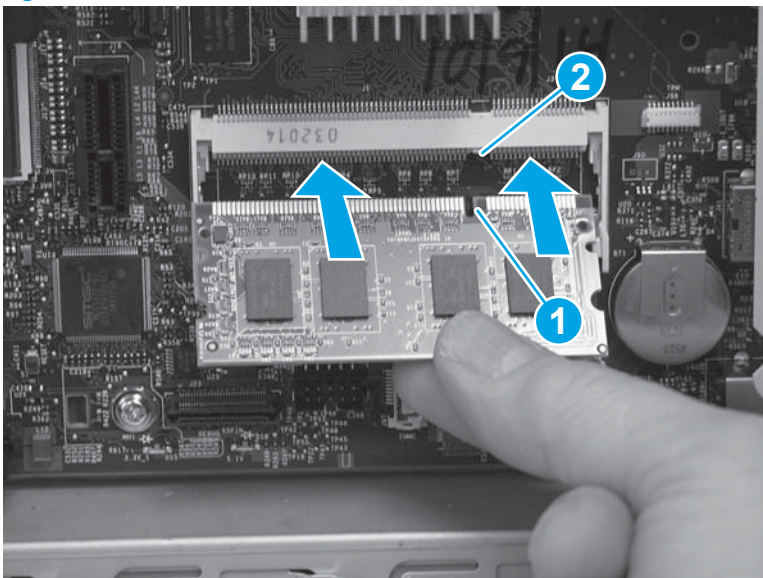
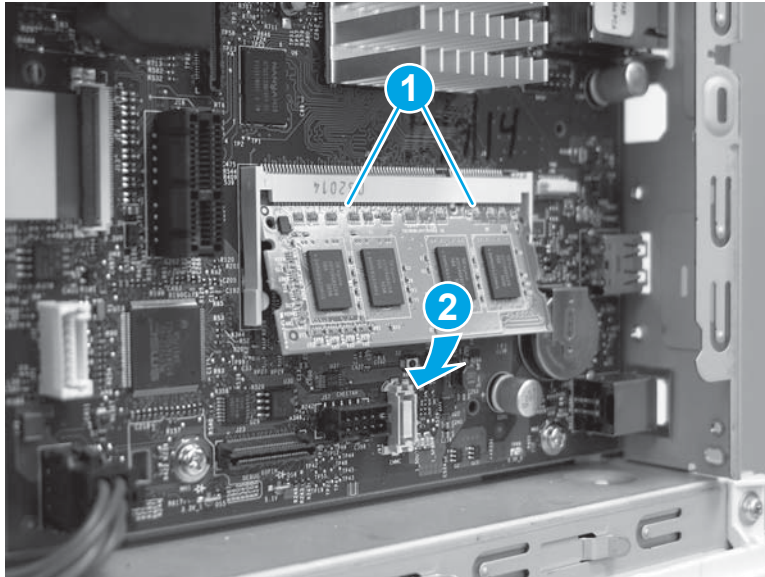

3. Make sure that the DIMM snaps into the locking arms (callout 1).

Figure 1-1585 Snap the DIMM into place

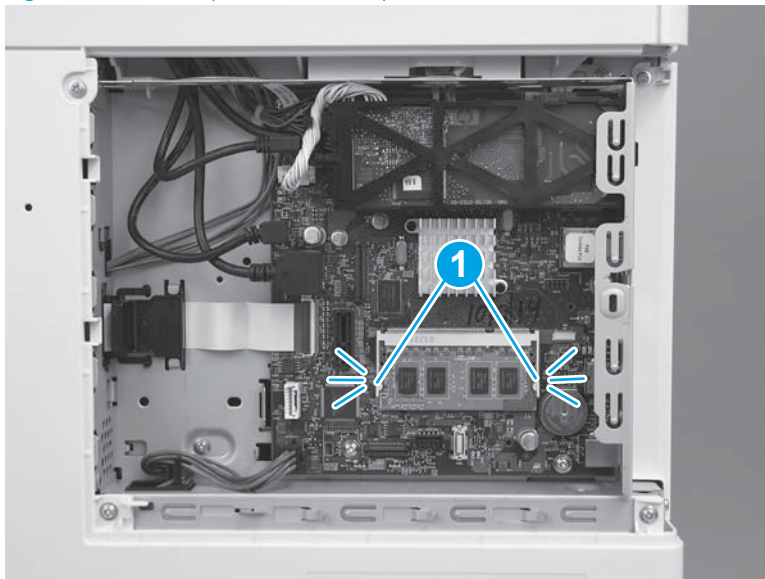

Step 9: Install the fax PCA (M577c/f/z)

 **NOTE:** If the fax PCA is not installed, skip this step and go to [Step 10: Install the HDD \(M577\) on page 905](#).

 **CAUTION:**  ESD-sensitive part.

1. Position the tab and telephone port (callout 1) on the fax PCA in the slots (callout 2) in the formatter case.

Figure 1-1586 Position the fax PCA

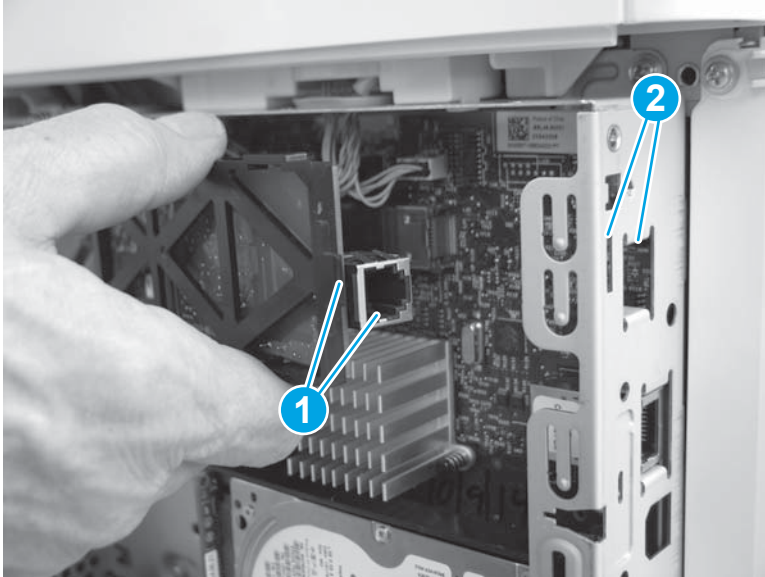

2. Slide the fax PCA to the right (callout 1) until the tab and telephone port described in the previous step and seated in the formatter case. Position the retainer (callout 2) in the slot (callout 3) in the formatter. Rotate the end of the fax PCA toward the formatter (callout 4) until the retainer snaps into place.

Figure 1-1587 Install the fax PCA

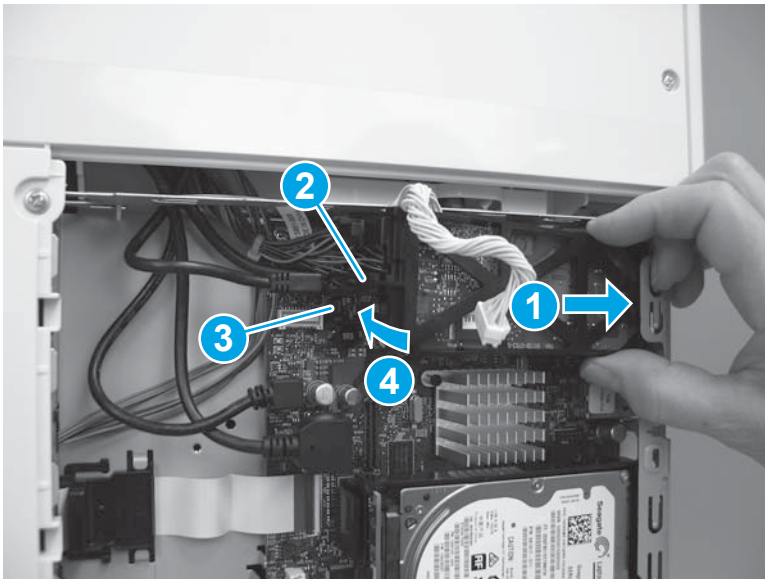

3. Position the cable (callout 1) in the guide (callout 2), and then connect one connector (callout 3).

Figure 1-1588 Connect the connector

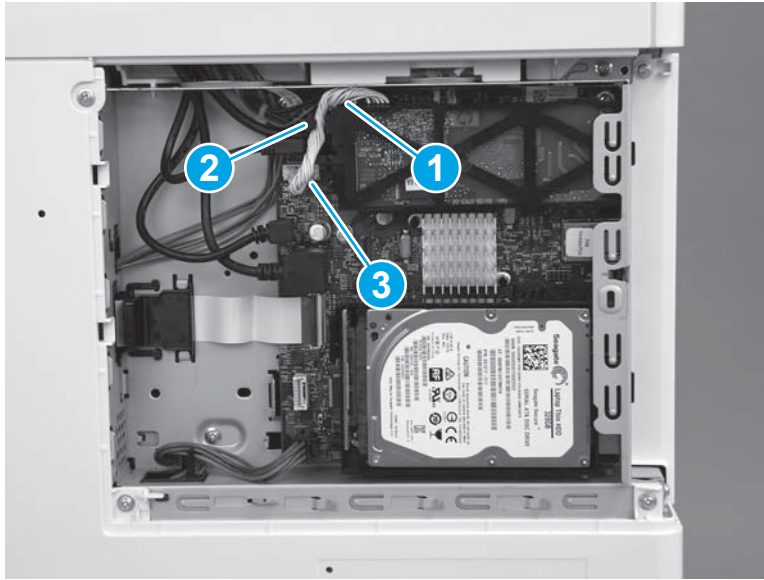

Step 10: Install the HDD (M577)

 **CAUTION:**  ESD-sensitive part.

1. Align the end of the bracket (callout 1) with the slot in the chassis (callout 2), and then slide the HDD into the printer (callout 3) to engage the bracket with the chassis.

Figure 1-1589 Install the holder

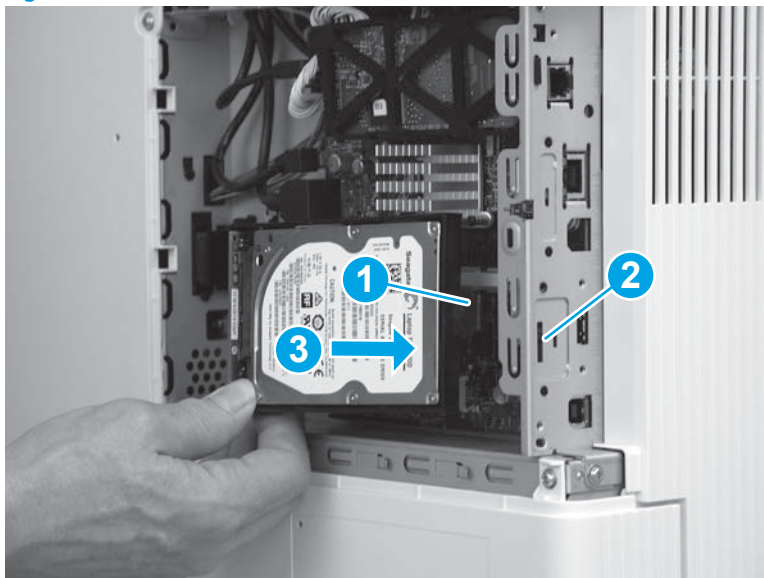

2. Hold the HDD connector latch (callout 1) in the released position, and then rotate the HDD down and into the connector on the formatter to install it.

 **NOTE:** Make sure that the tab (callout 2) snaps into place, and that the HDD is securely installed.

Figure 1-1590 Release the HDD



Step 11: Install the formatter cover

- ▲ Slide the cover onto the printer (callout 1) to install it.

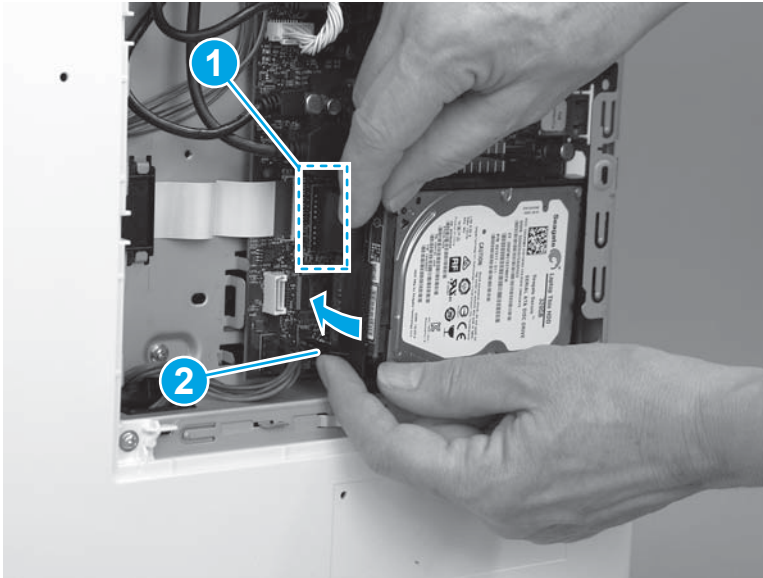
 **NOTE:** Make sure that the tabs on the formatter cover align with the slots provided in the printer (callout 2). Tighten the two thumbscrews (callout 3).

 **TIP:** If needed, use the edge of a coin to turn the thumbscrews.

Figure 1-1591 Install the cover

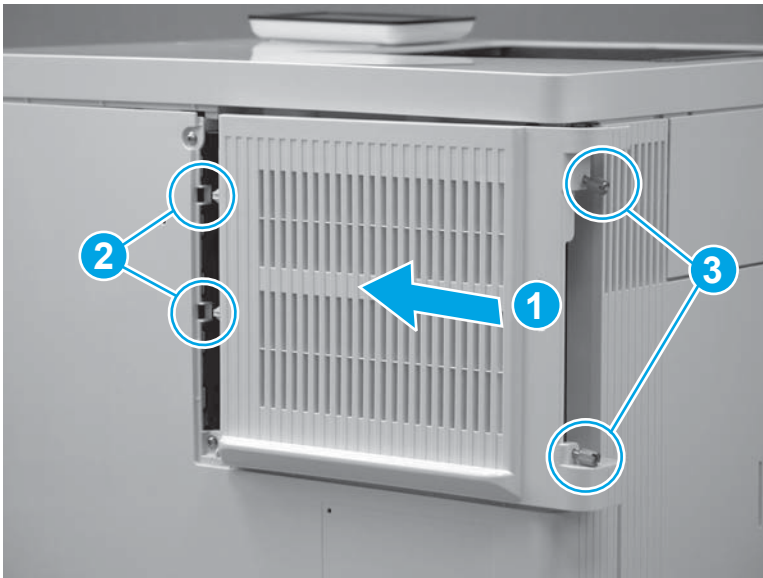

Removal and replacement: Formatter case assembly

- [Introduction](#)
- [Step 1: Remove the toner collection unit \(TCU\)](#)
- [Step 2: Remove the formatter cover](#)
- [Step 3: Remove the formatter \(M552 and M553\)](#)
- [Step 4: Remove the hard-disk drive \(HDD\) \(M577\)](#)
- [Step 5: Remove the fax PCA \(M577c/f/z\)](#)
- [Step 6: Remove the formatter \(M577\)](#)
- [Step 7: Remove the rear cover \(M552 and M553\)](#)
- [Step 8: Remove the rear upper cover \(M577\)](#)
- [Step 9: Remove the rear cover \(M577\)](#)
- [Step 10: Remove the left cover](#)
- [Step 11: Remove the formatter case](#)
- [Step 12: Unpack the replacement assembly](#)
- [Step 13: Install the formatter case](#)
- [Step 14: Install the left cover](#)
- [Step 15: Install the rear cover \(M577\)](#)
- [Step 16: Install the rear upper cover \(M577\)](#)
- [Step 17: Install the rear cover \(M552 and M553\)](#)
- [Step 18: Install the formatter \(M577\)](#)
- [Step 19: Install the fax PCA \(M577c/f/z\)](#)
- [Step 20: Install the HDD \(M577\)](#)
- [Step 21: Install the formatter \(M552 and M553\)](#)
- [Step 22: Install the formatter cover](#)
- [Step 23: Install the TCU](#)

Introduction

This document provides the procedures to remove and replace the formatter case assembly.

Before performing service

Turn the printer power off

- Disconnect the power cable.

 **WARNING!** To avoid damage to the printer, turn the printer off, wait 30 seconds, and then remove the power cord before attempting to service the printer.

- Open the right door.

Use the table below to identify the correct part number for your printer, and then go to <http://h20141.www2.hp.com/hpparts> to order the part.

Formatter case assembly part number	
Not orderable	Formatter case assembly

Required tools

- #2 Phillips screwdriver with a magnetic tip

After performing service

Make sure that all of the connectors on the formatter are fully seated.

Make sure that the TCU is fully closed after replacing it.

Make sure that the formatter cover is fully seated, and that the thumbscrews are finger tight after replacing it.

Turn the printer power on

- Connect the power cable.
- Use the power switch to turn the power on.

Post service test

Print a configuration page to make sure that the printer is functioning correctly.

Step 1: Remove the toner collection unit (TCU)

 **NOTE:** The M553 model is shown in some of the figures below. The procedure is also correct for the M577 models.

1. Open the front door.

Figure 1-1592 Open the front door



2. Open the TCU.

 **NOTE:** The toner collection hatch cover automatically closes when the TCU is opened.

Figure 1-1593 Open the TCU



3. Pull the TCU away from the printer at an angle to remove it.

⚠ CAUTION: Do not open the toner collection hatch cover when handling the TCU. If toner gets on clothing, wipe it off by using a dry cloth and wash the clothes in cold water. Hot water sets toner into fabric.

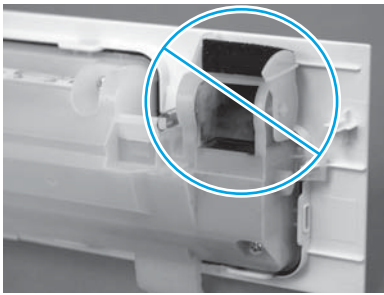
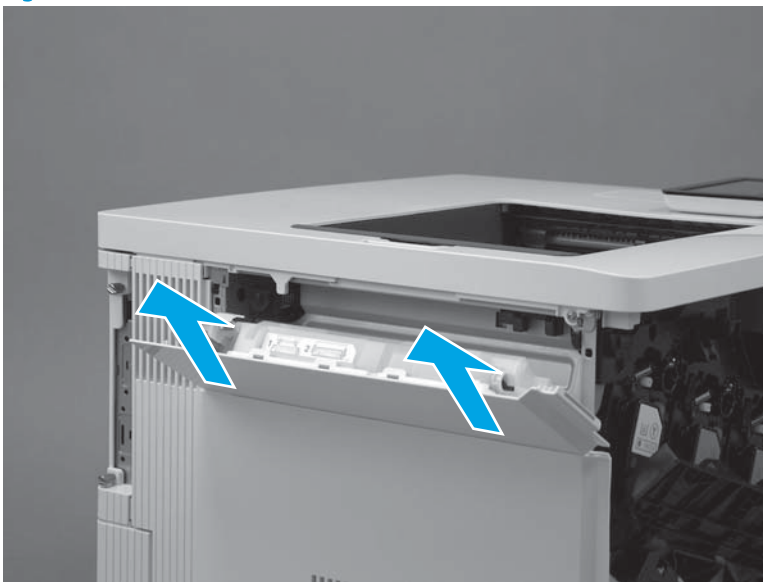

Figure 1-1594 Remove the TCU



Step 2: Remove the formatter cover

1. Locate the formatter cover.

Figure 1-1595 Locate the formatter cover

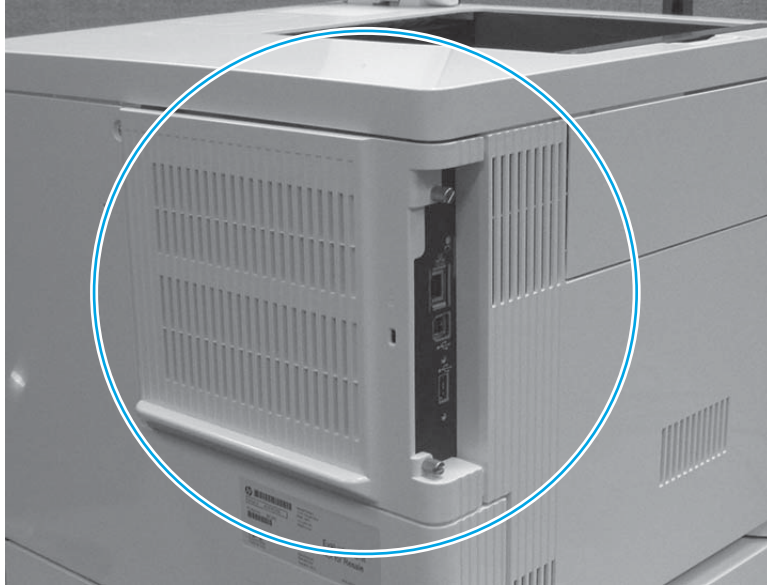

2. Loosen the two thumbscrews (callout 1). Grasp the two thumbscrews, and then slide the cover away from the printer (callout 2) to remove it.

 **TIP:** If needed, use the edge of a coin to turn the thumbscrews.

Figure 1-1596 Loosen the thumbscrews

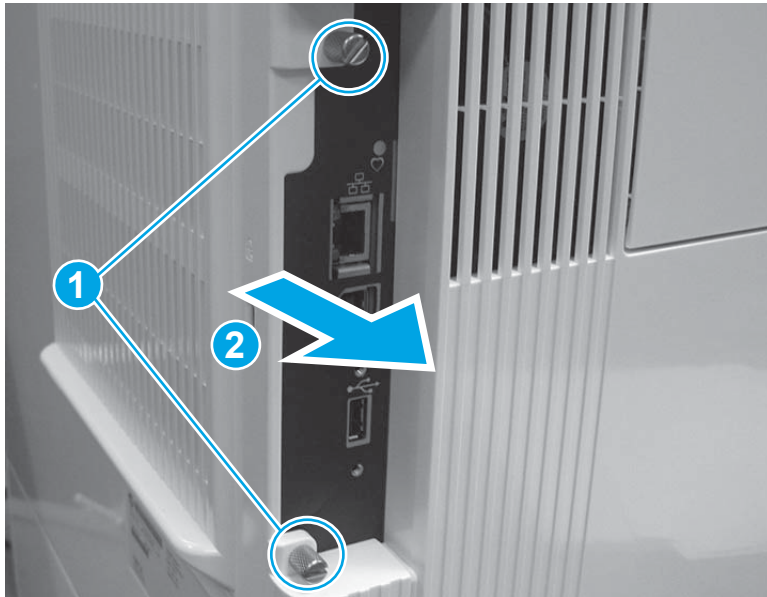

Step 3: Remove the formatter (M552 and M553)

 **NOTE:** This step is for the M552 and M553 models. For the M577 models, skip this step and go to [Step 4: Remove the hard-disk drive \(HDD\) \(M577\) on page 913](#).

If the optional hard-disk drive (HDD) is installed, it must be removed to gain access to the formatter mounting screws.

Release two tabs along the left edge of the HDD, rotate the left edge away from the product, and then slide the HDD to the left to remove it.

 **CAUTION:**  ESD-sensitive part.

1. Disconnect all of the connectors on the formatter.

The following connectors are empty:

- All models: J1 (this connector is empty unless the optional DIMM is installed)
- M553n/dn and M552dn: J2 (callout 1; this is the touchscreen connector for the M553x model)
- All models: J9 (this connector is empty unless the optional internal USB ports component is installed)
- All models: J18 (this connector is empty unless the optional hard-disk-drive (HDD) is installed)
- All models: J23
- All models: J24
- M553n/dn and M552dn: J25 (this is the wireless connector for the M553x model)
- All models: J57
- All models: J98 (this connector is empty unless the optional trusted platform module (TPM) is installed)

 **IMPORTANT:** The flat-cable connector (callout 2) is a Zero Insertion Force (ZIF) connector that uses a hinged retainer to secure the flat cable. The hinged retainer must be opened to release the flat cable.

Figure 1-1597 Disconnect all connectors



2. Remove four screws (callout 1), and then remove the formatter.

Figure 1-1598 Remove the formatter

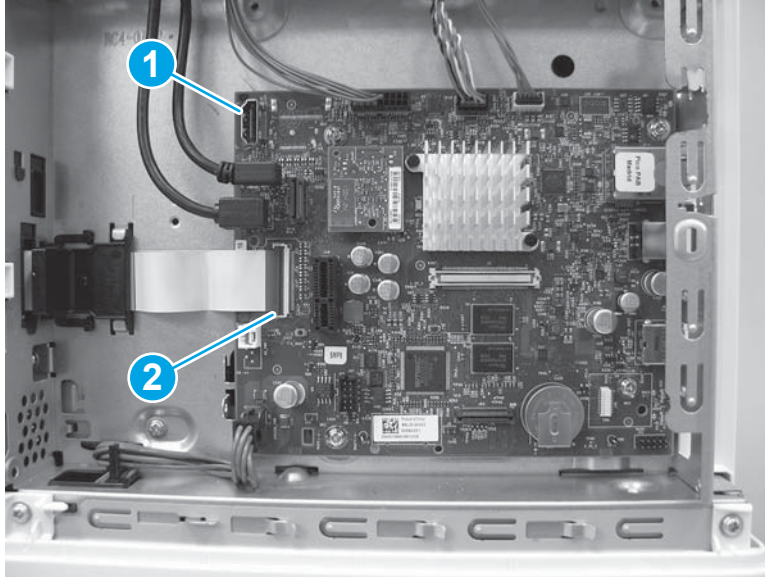
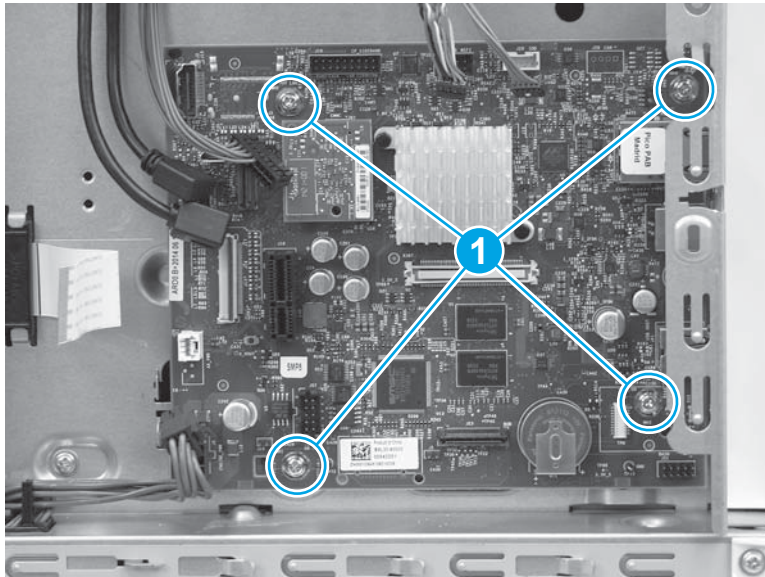

Step 4: Remove the hard-disk drive (HDD) (M577)

 **NOTE:** This step is for the M577 models. For the M552 and M553 models, skip this step and go to [Step 7: Remove the rear cover \(M552 and M553\) on page 918.](#)

 **CAUTION:**  ESD-sensitive part.

1. Release two tabs (callout 1). Hold the tabs in the released position, and then rotate the hard disk drive (HDD) up (callout 2) to release the connector from the formatter.

Figure 1-1599 Release the HDD

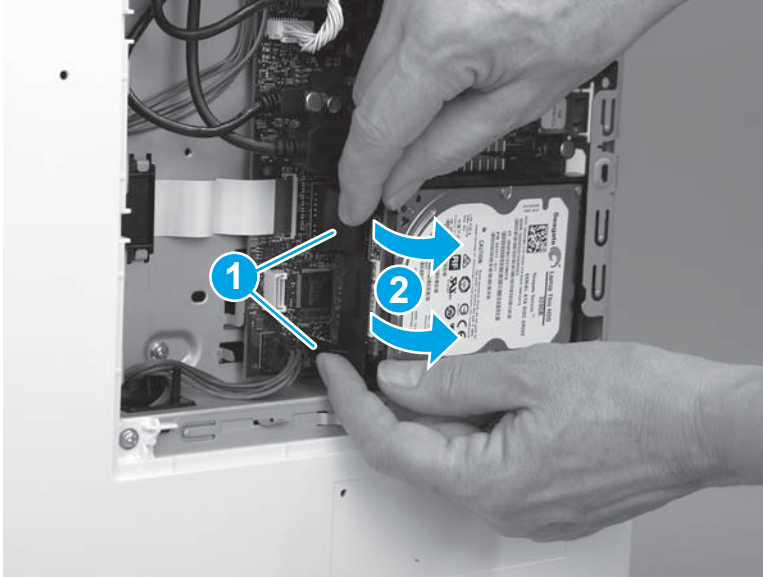

2. Slide the HDD away from the printer to remove it.

Figure 1-1600 Remove the HDD



Step 5: Remove the fax PCA (M577c/f/z)

 **NOTE:** This step is for the M577c/f/z models. For the M577n model, skip this step and go to [Step 6: Remove the formatter \(M577\) on page 916](#).

For the M552 and M553 models, skip this step and go to [Step 7: Remove the rear cover \(M552 and M553\) on page 918](#).

 **CAUTION:**  ESD-sensitive part.

1. Locate the fax PCA component on the formatter.

Figure 1-1601 Locate the fax PCA

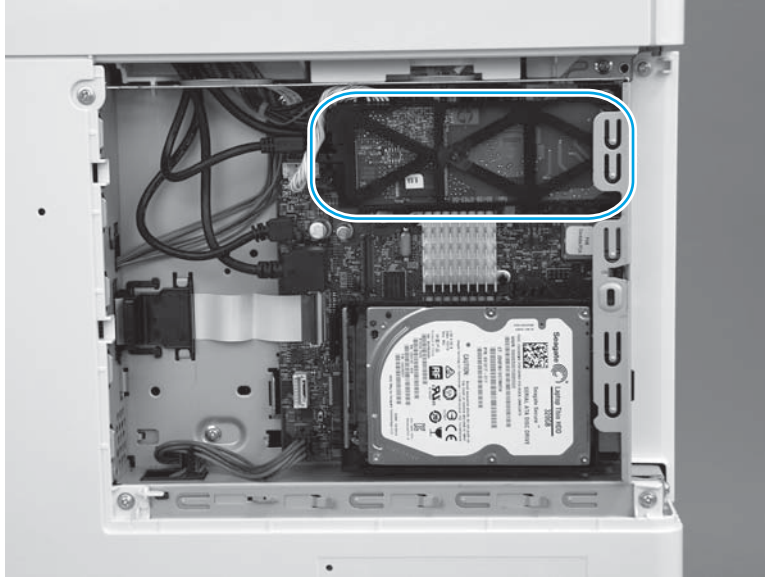

2. Release the connector latch (callout 1), and then pull the connector away from the formatter (callout 2) to disconnect it.

Figure 1-1602 Disconnect one connector

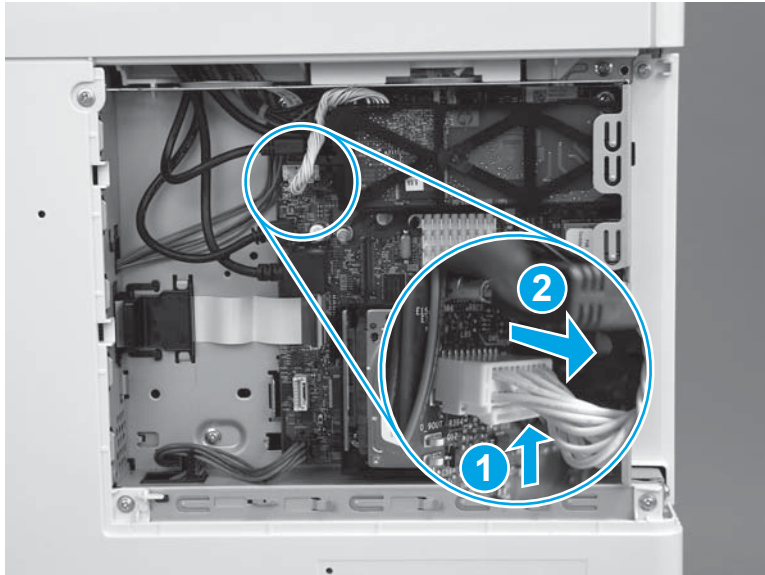

3. Release one retainer (callout 1) by pressing the bracket arms together.

Figure 1-1603 Release one latch

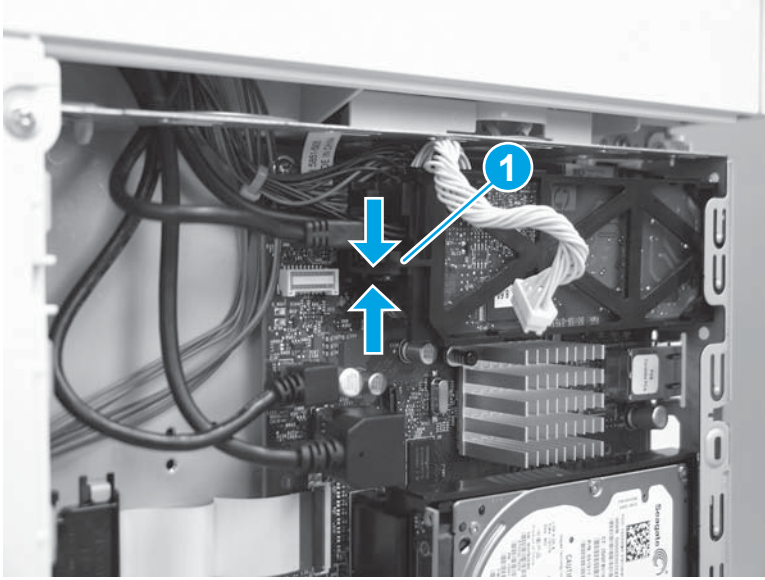

4. Rotate the end of the fax PCA (callout 1) away from the formatter, and then slide the PCA left (callout 2) to remove it.

Figure 1-1604 Remove the fax PCA

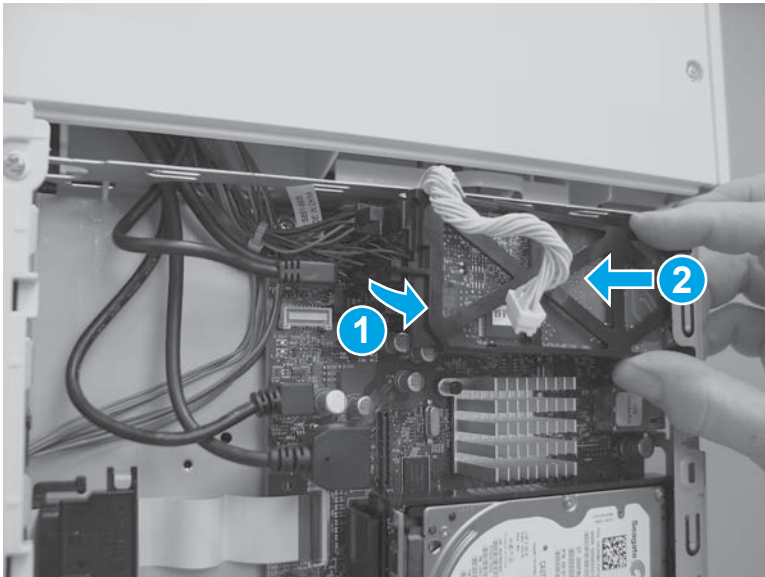

Step 6: Remove the formatter (M577)

 **NOTE:** This step is for the M577 models. For the M552 and M553 models, skip this step and go to [Step 7: Remove the rear cover \(M552 and M553\) on page 918.](#)

 **CAUTION:**  ESD-sensitive part.

1. Disconnect all of the connectors on the formatter.

The following connectors are empty:

- All models: J1 (this connector is empty unless the optional DIMM is installed)
- All models: J3
- M577dn: J15 (this is the fax connector for the M577f/z/c models)
- All models: J21 (this connector is empty unless the optional internal USB ports component is installed)
- All models: J23
- All models: J24
- All models: J51
- All models: J57
- All models: J97
- All models: J98 (this connector is empty unless the optional trusted platform module (TPM) is installed)

 **IMPORTANT:** The flat-cable connector (callout 1) is a Zero Insertion Force (ZIF) connector that uses a hinged retainer to secure the flat cable. The hinged retainer must be opened to release the flat cable.

Figure 1-1605 Disconnect all connectors



2. Remove four screws (callout 1).

Figure 1-1606 Remove four screws

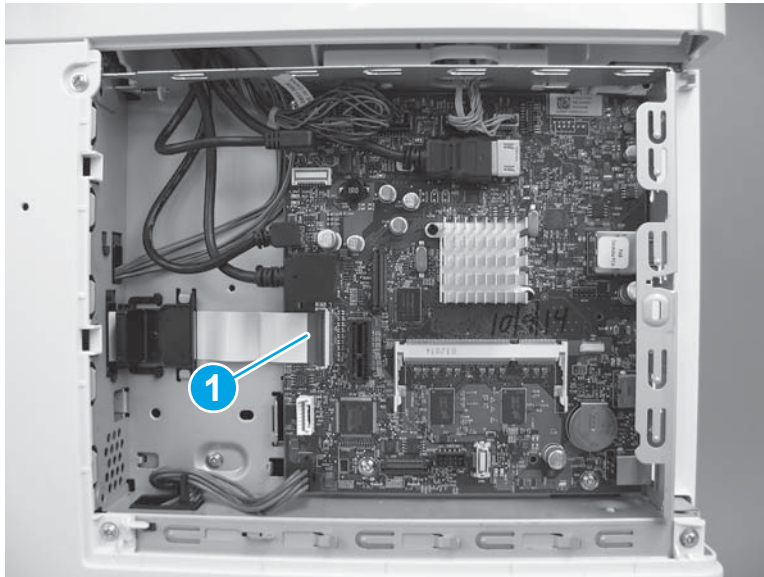
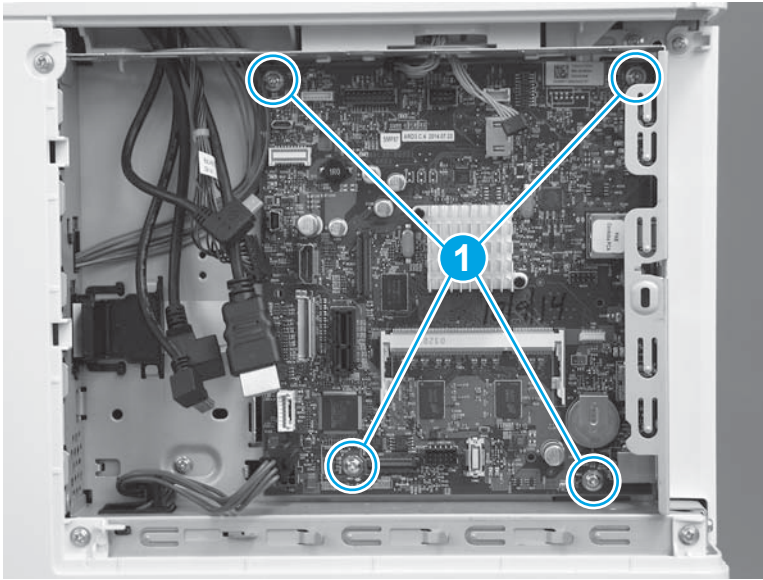

3. Remove the formatter.

Figure 1-1607 Remove the formatter

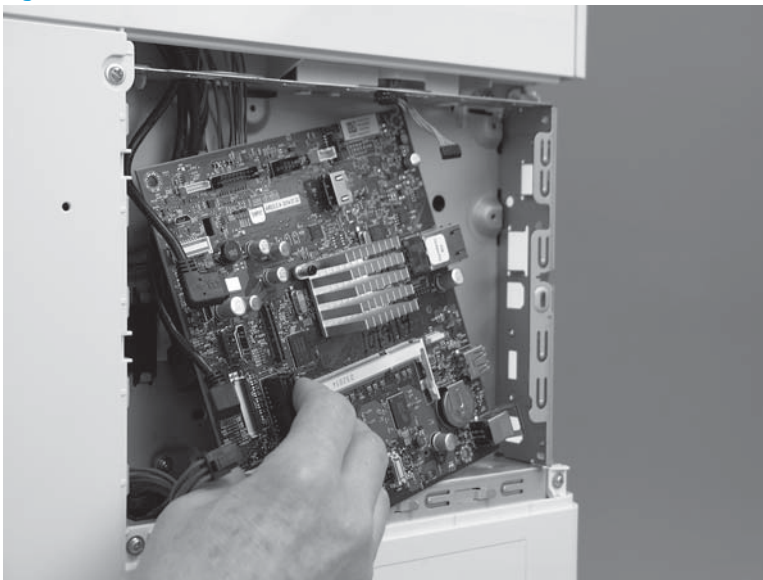

Step 7: Remove the rear cover (M552 and M553)

 **NOTE:** This step is for the M552 and M553 models. For the M577 models, skip this step and go to [Step 8: Remove the rear upper cover \(M577\) on page 919.](#)

1. Remove four screws (callout 1).

Figure 1-1608 Remove four screws

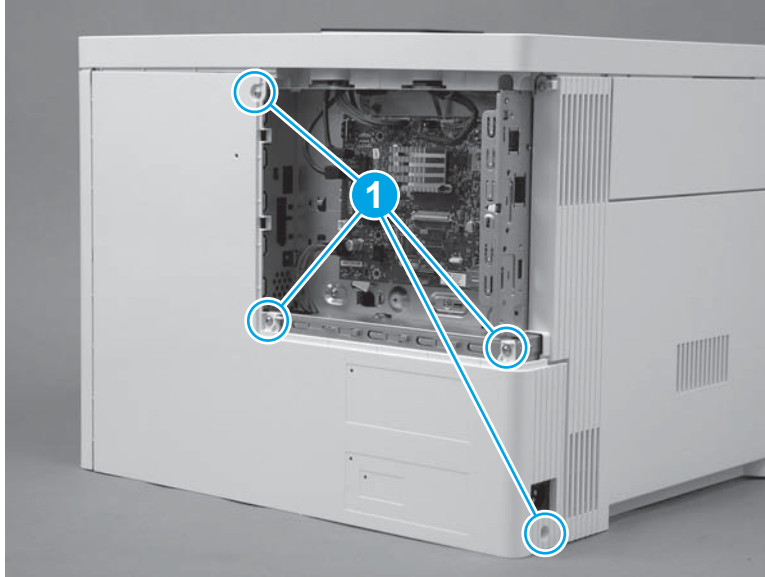

2. Slightly slide the cover to the right (callout 1), rotate the bottom of the cover away from the printer (callout 2), and then pull the top of the cover away from the printer (callout 3) to remove the cover.

Figure 1-1609 Remove the cover

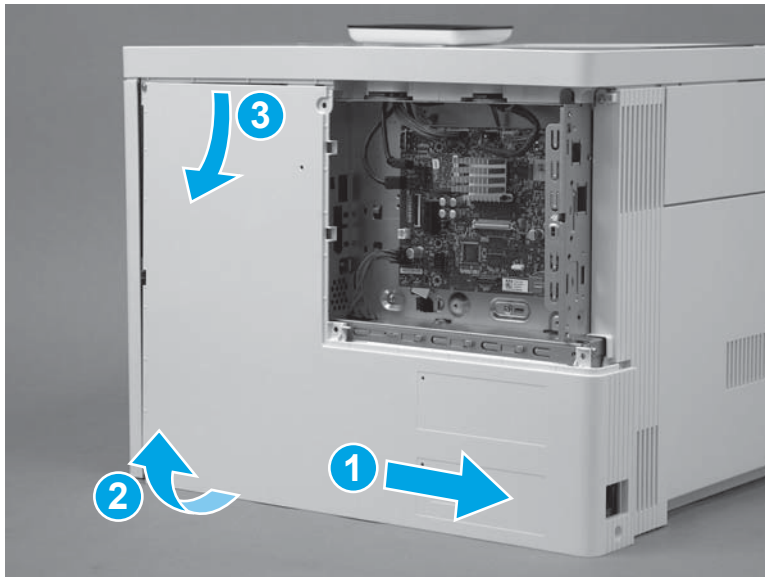

Step 8: Remove the rear upper cover (M577)

 **NOTE:** This step is for the M577 models. For the M552 and M553 models, skip this step and go to [Step 10: Remove the left cover on page 922](#).

1. Remove two screws (callout 1).

 **Reinstallation tip:** These two screws are self-tapping screws for plastic. When reinstalling them, rotate the screws counterclockwise to align them with the existing thread pattern, and then carefully turn them clockwise to tighten. Do not overtighten. This will prevent stripping the threads inside the screw holes.

Figure 1-1610 Remove two screws



2. Use a small, flat blade screwdriver to release the right edge of the cover.

Figure 1-1611 Release the right edge

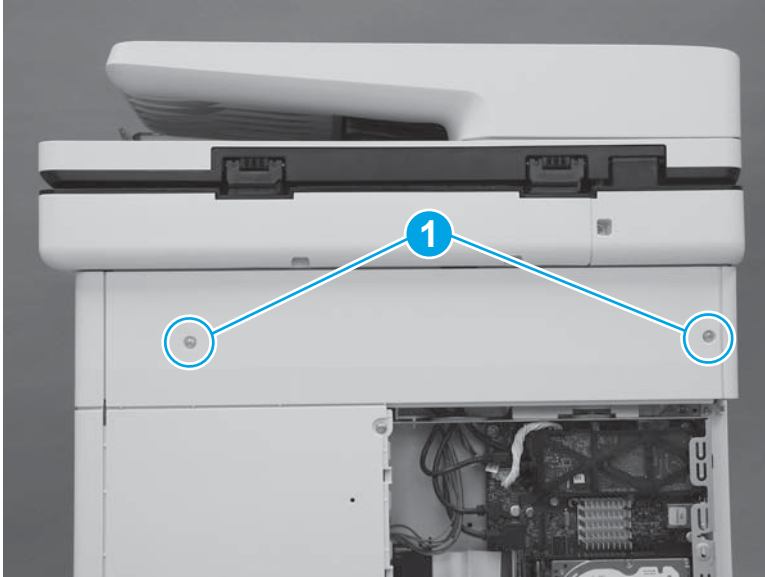
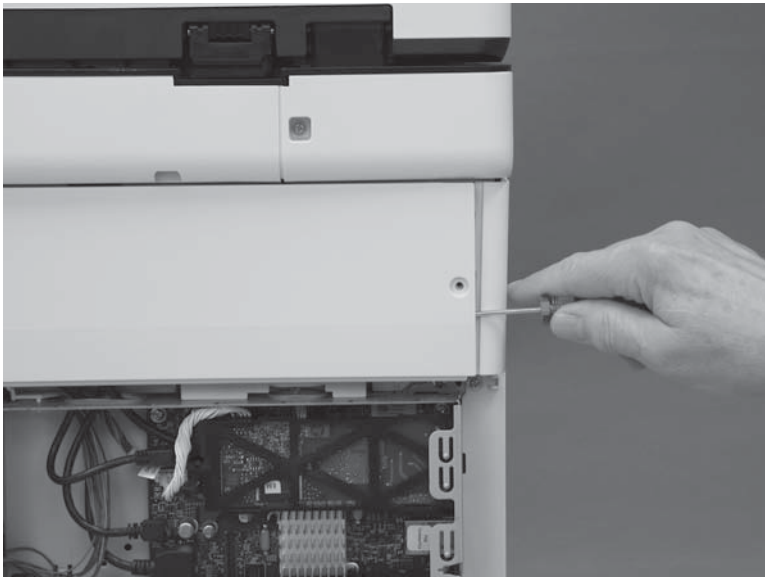

3. Pull the right edge of the cover (callout 1) away from the printer, and then slide the cover to the right (callout 2).

Figure 1-1612 Slide the cover right

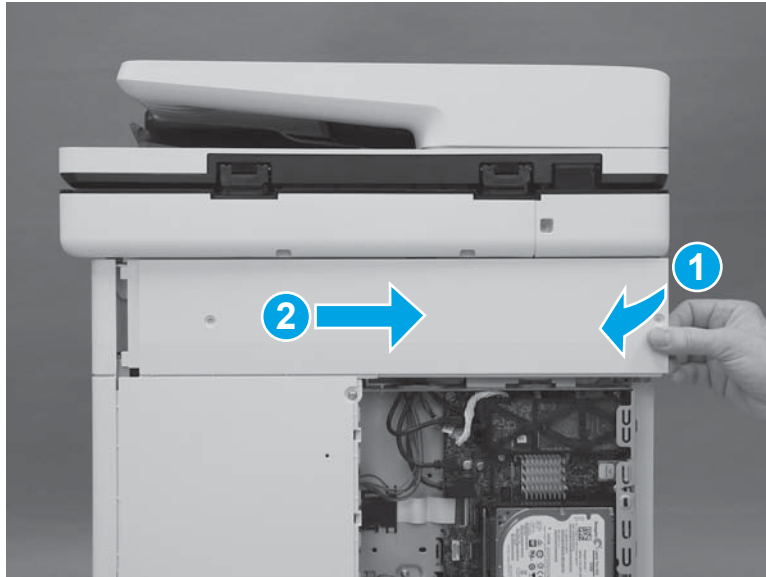

4. Remove the cover.

Figure 1-1613 Remove the cover

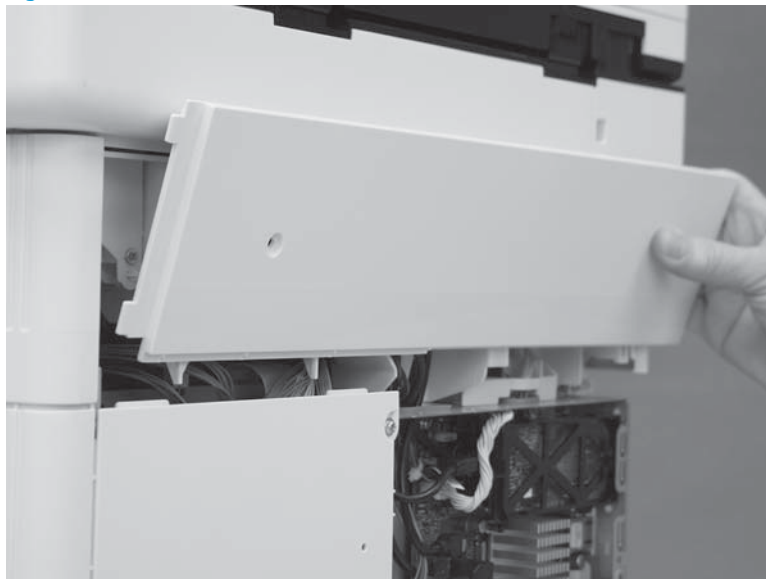

Step 9: Remove the rear cover (M577)

 **NOTE:** This step is for the M577 models. For the M552 and M553 models, skip this step and go to [Step 10: Remove the left cover on page 922](#).

1. Remove four screws (callout 1).

Figure 1-1614 Remove four screws

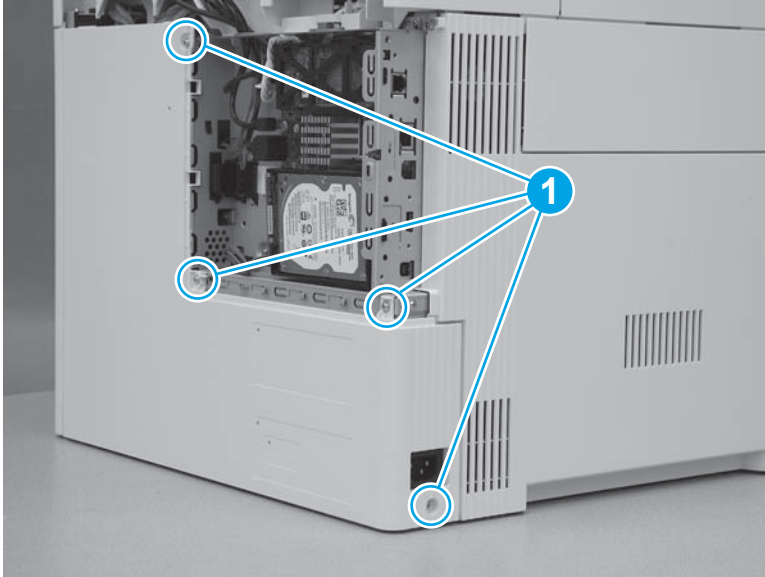

2. Slide the cover to the right to remove it.

Figure 1-1615 Remove the cover

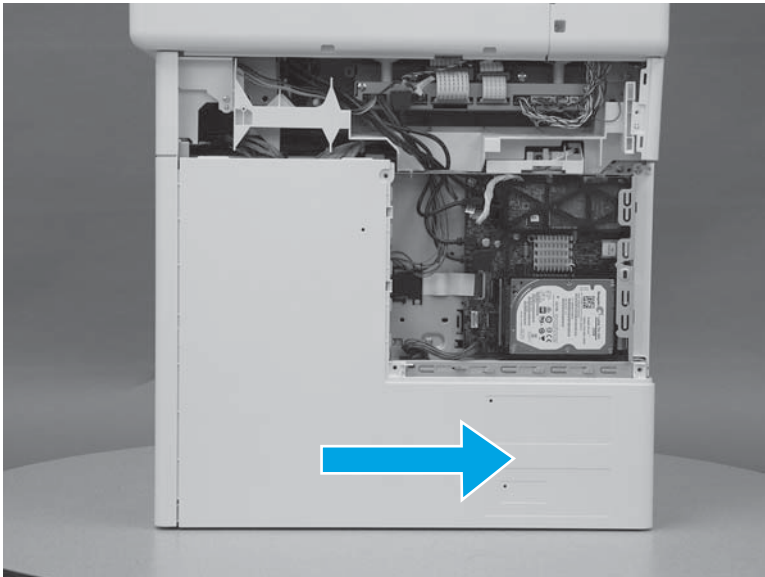

Step 10: Remove the left cover

1. At the left side of the printer, remove one screw (callout 1).

Figure 1-1616 Remove one screw



2. Release one tab (callout 1), rotate the front edge of the cover away from the printer (callout 2), and then slide the cover (callout 3) toward the rear of the printer to release it.

Figure 1-1617 Release the cover

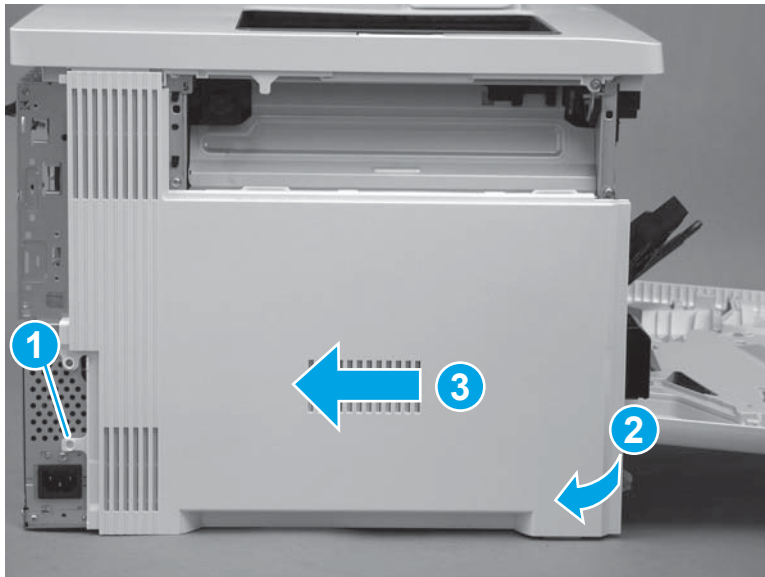

3. Remove the cover.

Figure 1-1618 Remove the cover

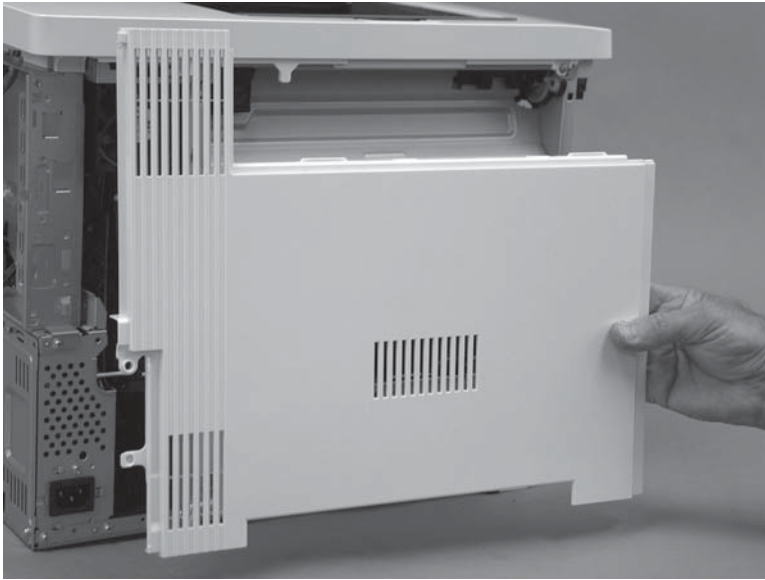

Step 11: Remove the formatter case

1. **M577 only:** Disconnect one connector (callout 1), and then pass the wire harness (callout 2) through two openings in the formatter case (callout 3).

Figure 1-1619 Disconnect one connector

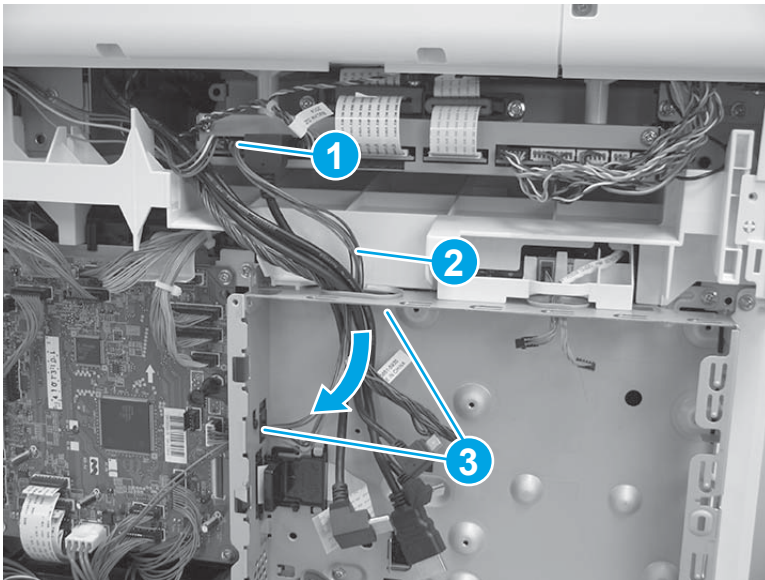

2. Release two tabs (callout 1) on the black plastic bracket. Hold the tabs in the released position, and then slide the bracket (callout 2) to the right to remove it from the formatter case.

Figure 1-1620 Remove the bracket

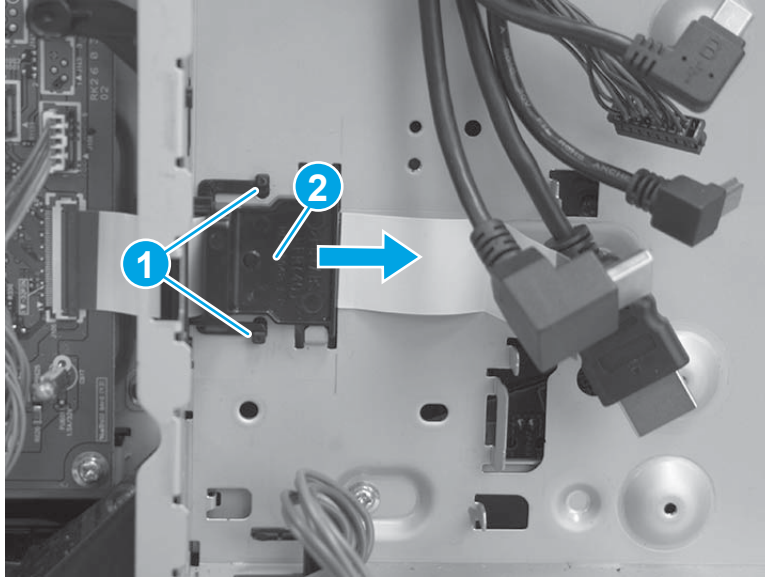

3. Remove two screws (callout 1), and then slide the low-voltage power supply (LVPS) cover to the right to remove it.

Figure 1-1621 Remove the LVPS cover

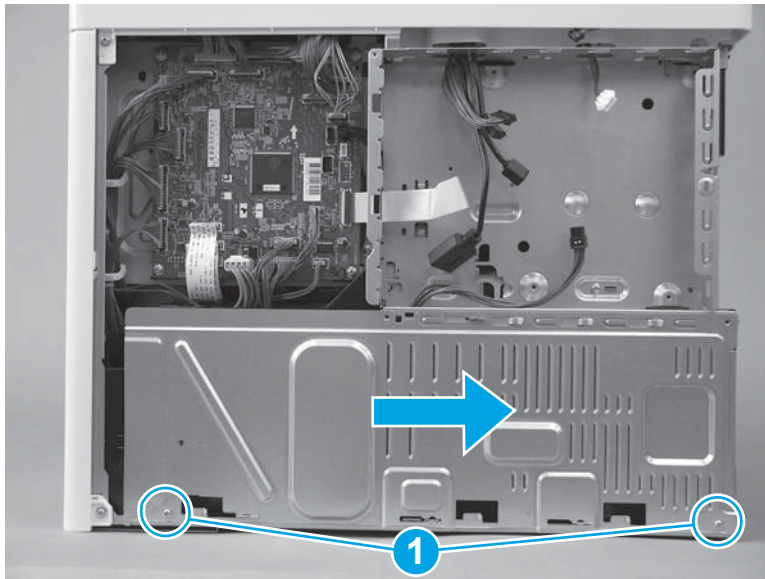

4. Pass two wire harnesses and one flat cable (callout 1) through the opening in the formatter case, and then release one wire harness from the retainer (callout 2).

⚠ CAUTION: The flat cable might be attached to the formatter case with double-sided tape. Make sure that this tape is released, so that the flat cable is not damaged when the formatter case is removed.

Figure 1-1622 Release wire harnesses and flat cable

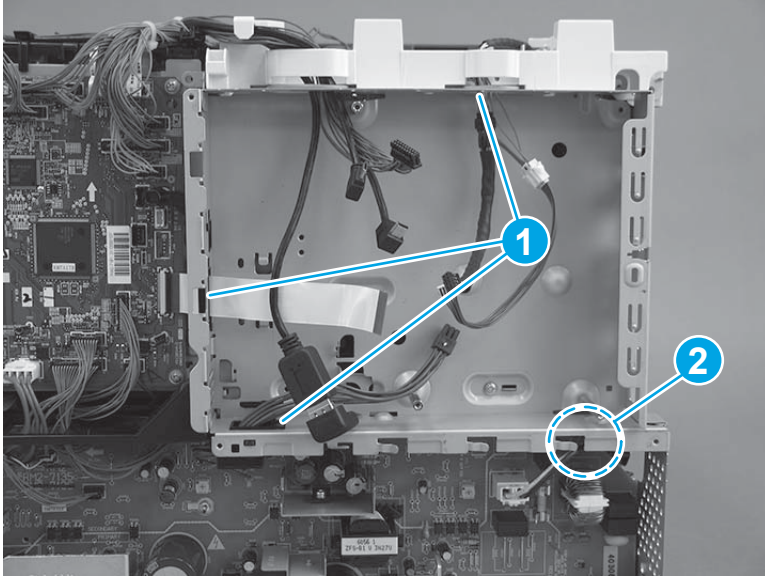

5. Remove six screws (callout 1).

Figure 1-1623 Remove six screws

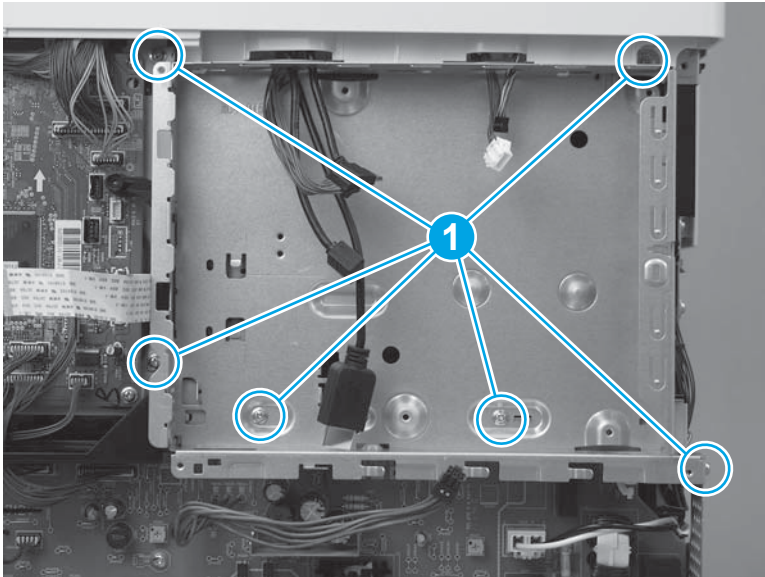

6. Rotate the bottom of the formatter case away from the printer (callout 1), and then pull it down (callout 2) to release it.

Figure 1-1624 Release the formatter case

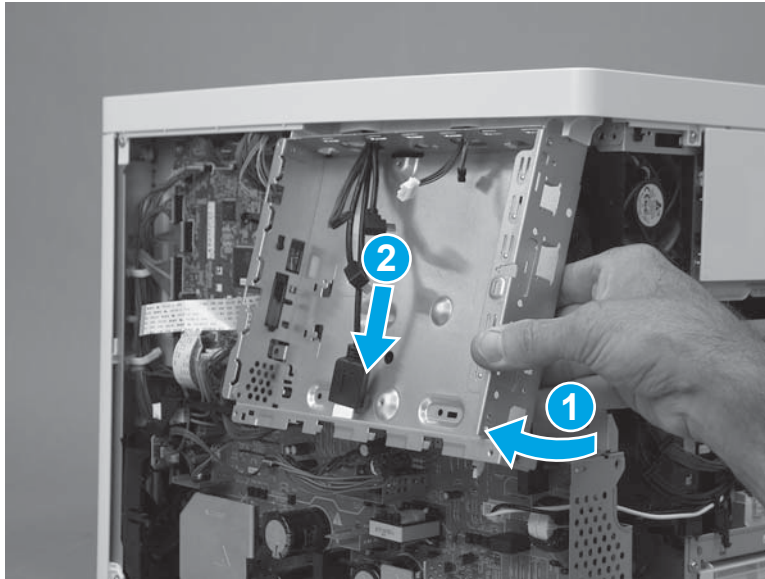

7. Pass the wire harnesses through the opening in the formatter case to remove it.

 **IMPORTANT:** If the formatter case is removed so that it can be replaced, make sure to transfer the memory PCA (island of data) and plastic bracket (callout 1) to the replacement case.

Figure 1-1625 Remove the formatter case



Step 12: Unpack the replacement assembly

Unpack the replacement assembly from the packaging.

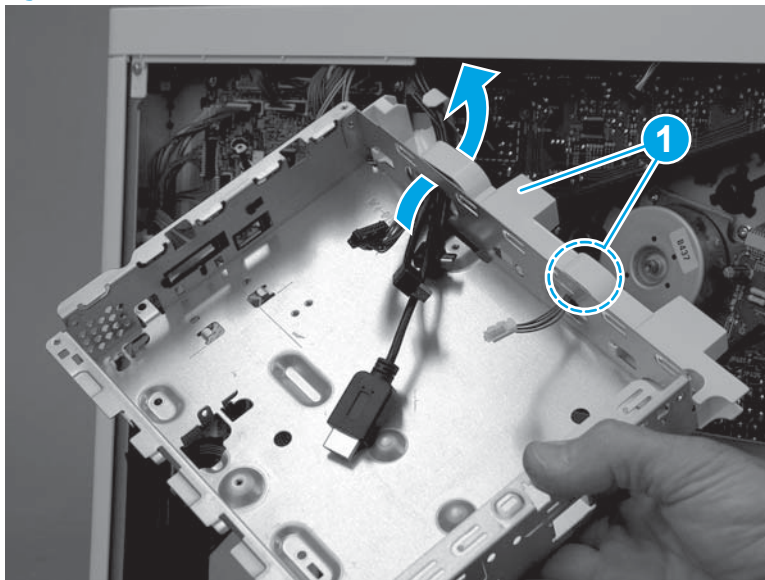
For complete information on HP's recycling programs, go to [Product return and recycling](#).

 **NOTE:** HP recommends responsible disposal of the defective part.

Figure 1-1626 Recycle and unpack

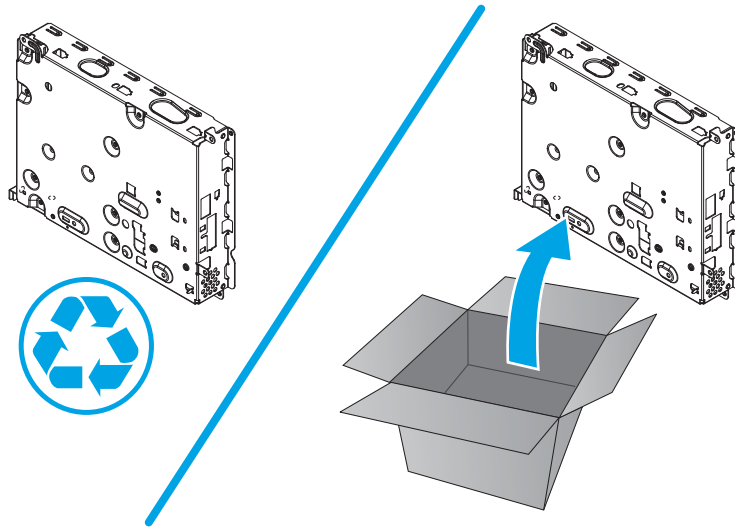

Step 13: Install the formatter case

1. Pass the wire harnesses through the opening in the formatter case.

Figure 1-1627 Pass the wire harnesses through the opening

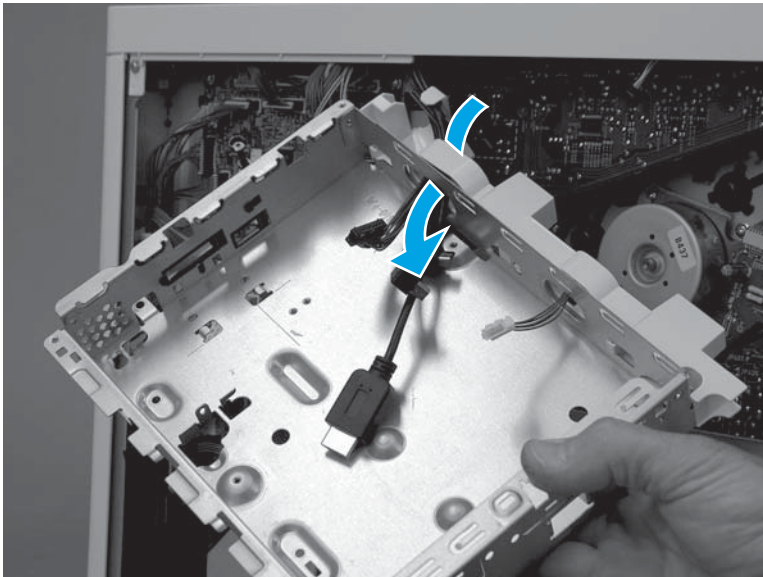

2. Position the top of the formatter case on the printer (callout 1), and then rotate the bottom of the case (callout 2) into the printer.

Figure 1-1628 Install the formatter case

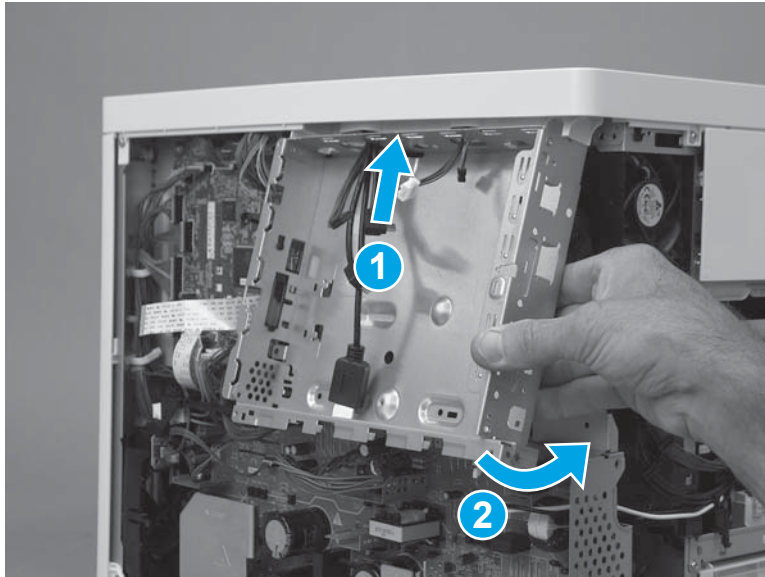

3. Install six screws (callout 1).

Figure 1-1629 Install six screws

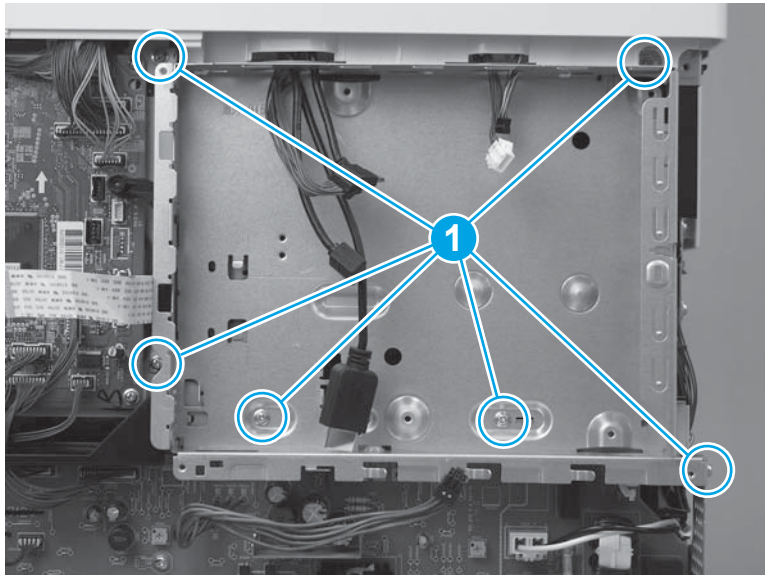

4. Pass two wire harnesses and one flat cable (callout 1) through the opening in the formatter case, and then install one wire harness in the retainer (callout 2).

 **IMPORTANT:** Make sure that the flat cable is securely fastened to the DC controller, and was not dislodged when the formatter case was removed.

Figure 1-1630 Install wire harnesses and flat cable

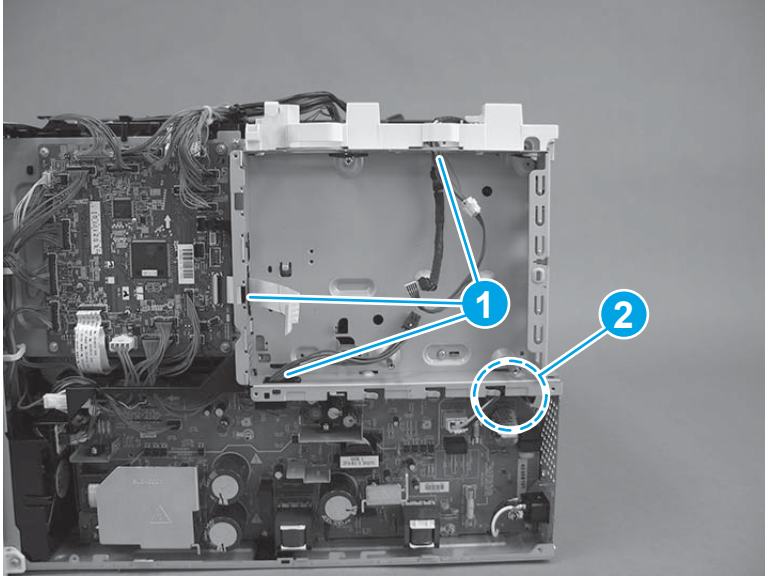

5. Position the LVPS cover on the printer, slide the cover to the left to install it, and then install two screws (callout 1).

Figure 1-1631 Install the LVPS cover

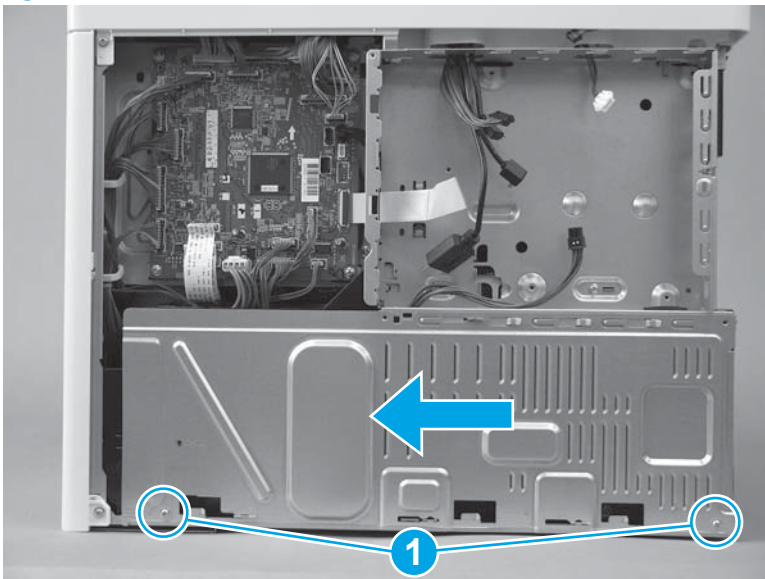

6. If no tape is affixed to the back of the flat cable, skip this step. If double-sided tape is affixed to the back of the flat cable, align the line (callout 1) on the cable with the edge (callout 2) of the opening in the sheet metal. Press to attach the flat cable to the formatter case.

Figure 1-1632 Attach the flat cable

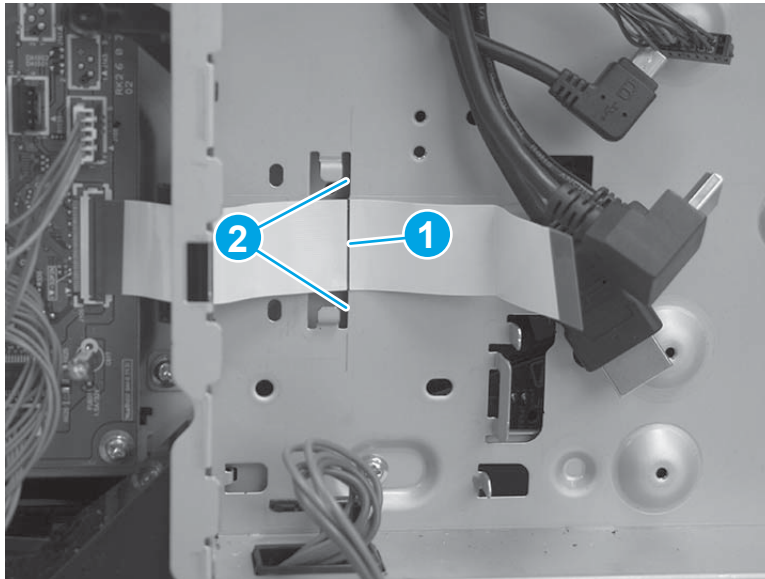

7. Position the bracket over the flat cable, and then slide the bracket to the left to install it. Make sure that the edges of the bracket fit under the sheet metal tabs (callout 1) on the formatter case and that the tabs (callout 2) snap into place.

Figure 1-1633 Position the bracket

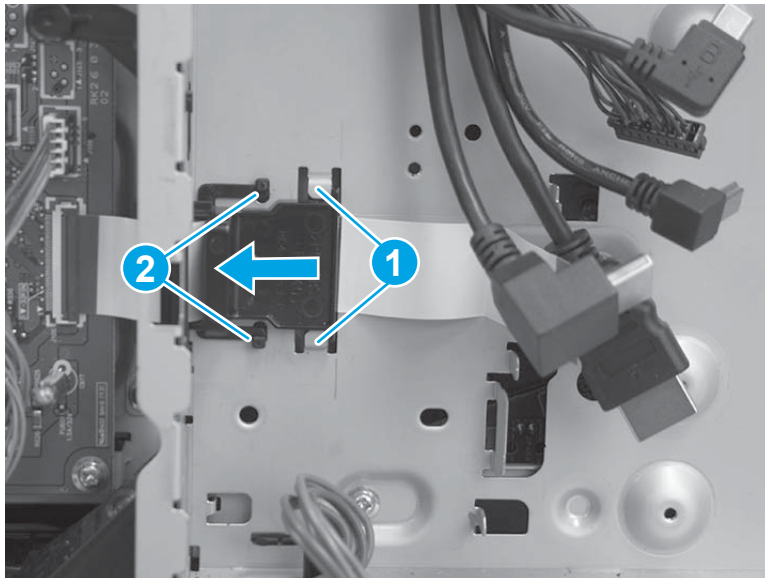

8. **M577 only:** Pass the wire harness (callout 1) through the openings in the formatter case (callout 2), and then connect one connector (callout 3).

Figure 1-1634 Connect one connector

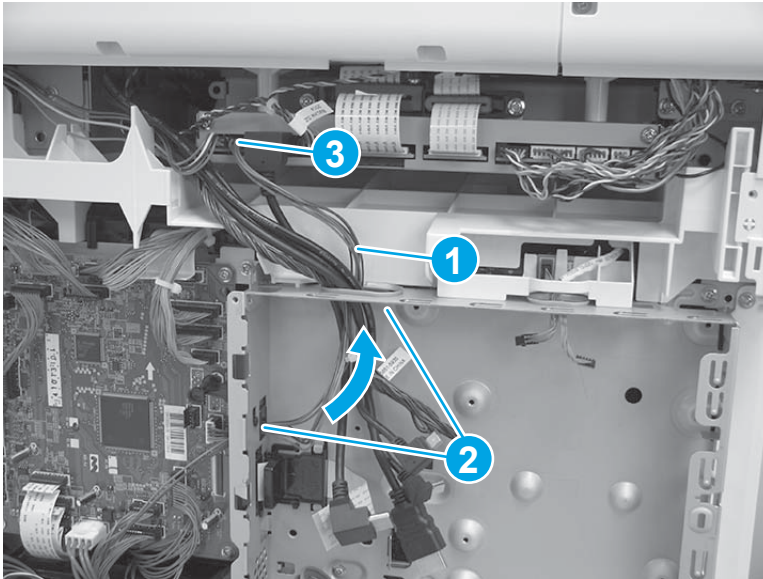

Step 14: Install the left cover

1. Position the cover on the printer.

 **NOTE:** Slightly offset the cover toward the rear of the printer.

Figure 1-1635 Install the cover

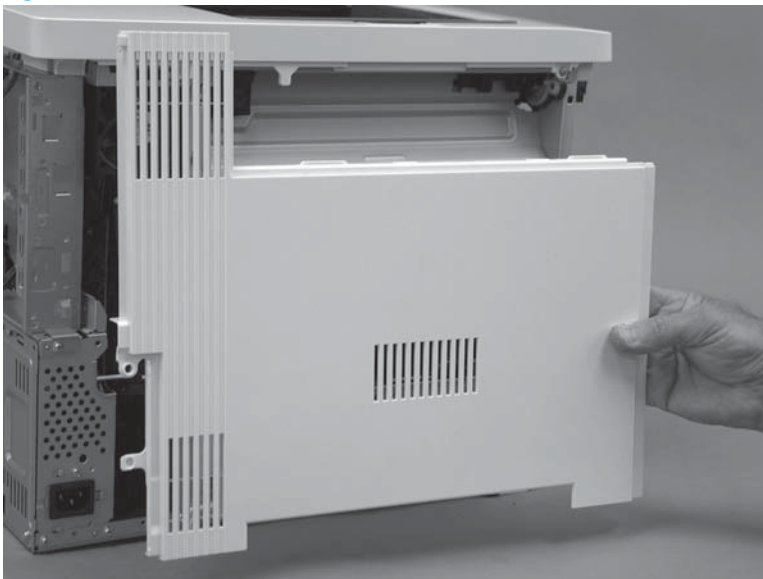

2. Slide the cover (callout 1) toward the front of the printer to engage it. Make sure that the tab (callout 2) snaps into place.

 **NOTE:** Locate the alignment pin (callout 3) on the cover from the front door side of the printer, and then make sure that it is fully engaged in the slot in the chassis.

 **TIP:** While sliding the cover into place, push in on the center of the cover (callout 1) to make sure that the hooks on the back of the cover engage with the slots in the chassis.

Figure 1-1636 Engage the cover

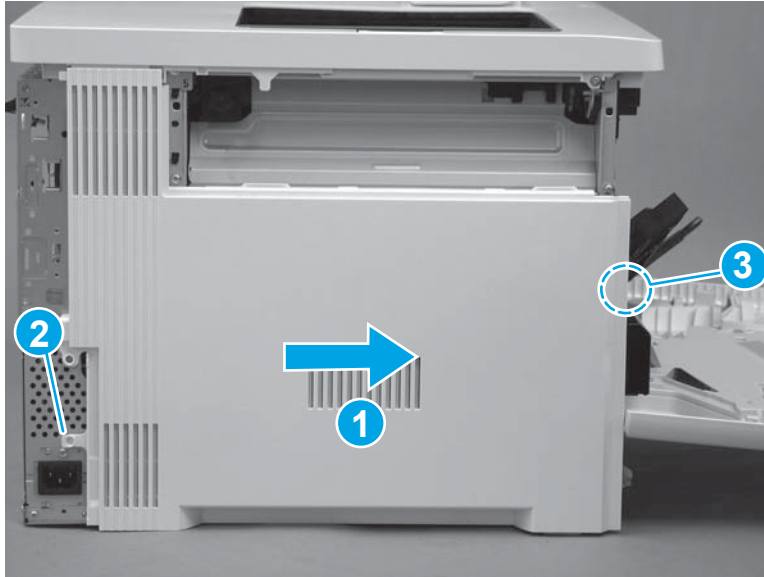

3. At the left side of the printer, install one screw (callout 1).

Figure 1-1637 Install one screw

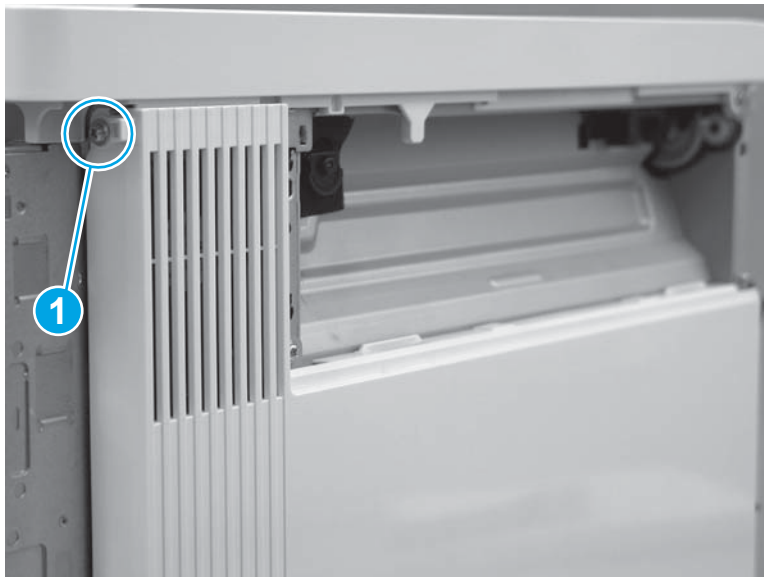

Step 15: Install the rear cover (M577)

 **NOTE:** This step is for the M577 models. For the M552 and M553 models, skip this step and go to [Step 17: Install the rear cover \(M552 and M553\) on page 937](#).

1. Position the hooks (callout 1) on the cover in the slots (callout 2) in the printer.

Figure 1-1638 Position the hooks

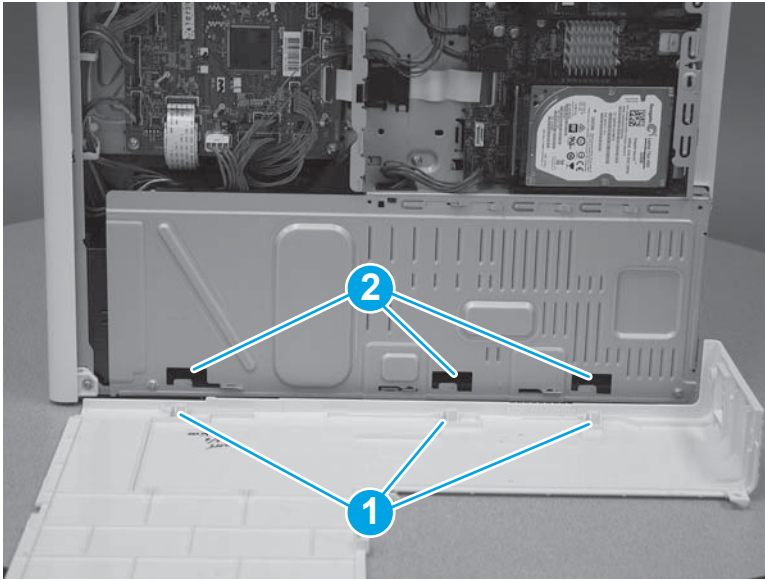

2. Position the back edge (callout 1) of the rear cover behind the edge (callout 2) of the right rear cover. Slide the cover to the left to install it.

Figure 1-1639 Install the cover

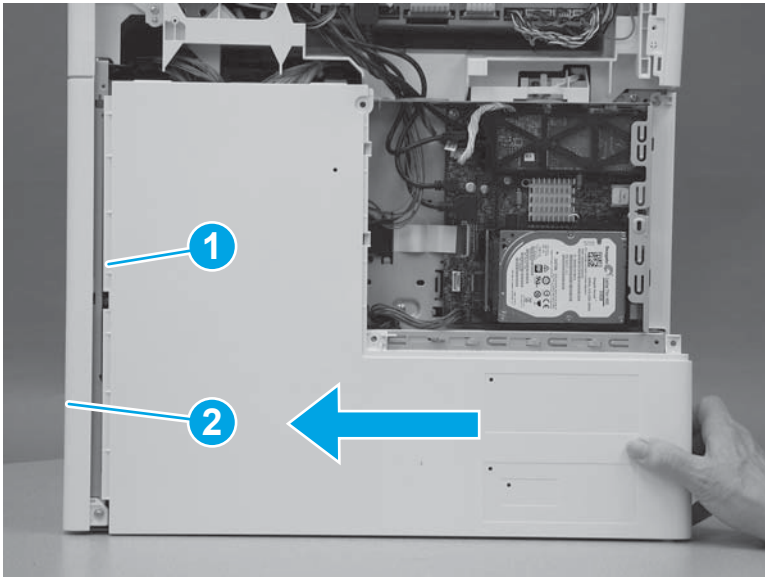

3. Install four screws (callout 1).

Figure 1-1640 Install four screws cover

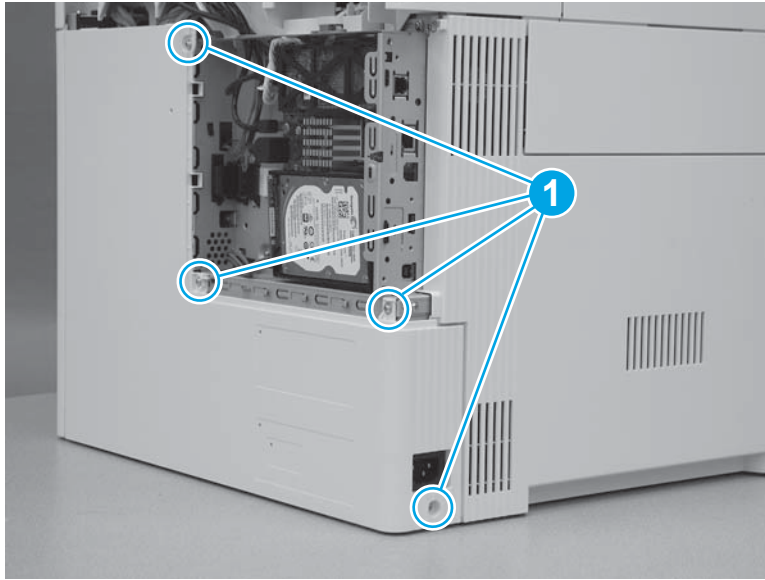

Step 16: Install the rear upper cover (M577)

 **NOTE:** This step is for the M577 models. For the M552 and M553 models, skip this step and go to [Step 17: Install the rear cover \(M552 and M553\) on page 937](#).

1. Align the ridge (callout 1) on the lower edge of the rear upper cover in front of the tabs (callout 2) on the top edge of the rear cover.

Figure 1-1641 Align the cover

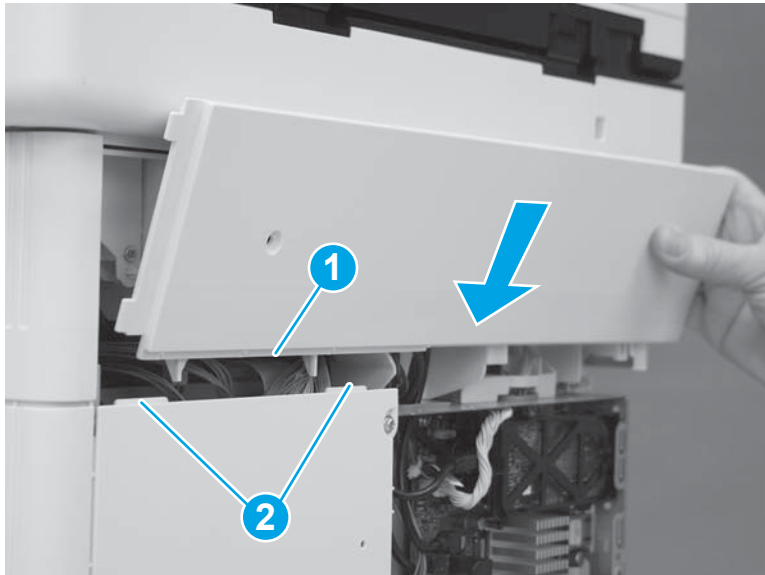

2. Rotate the top of the cover toward the printer.

Figure 1-1642 Rotate the top of the cover

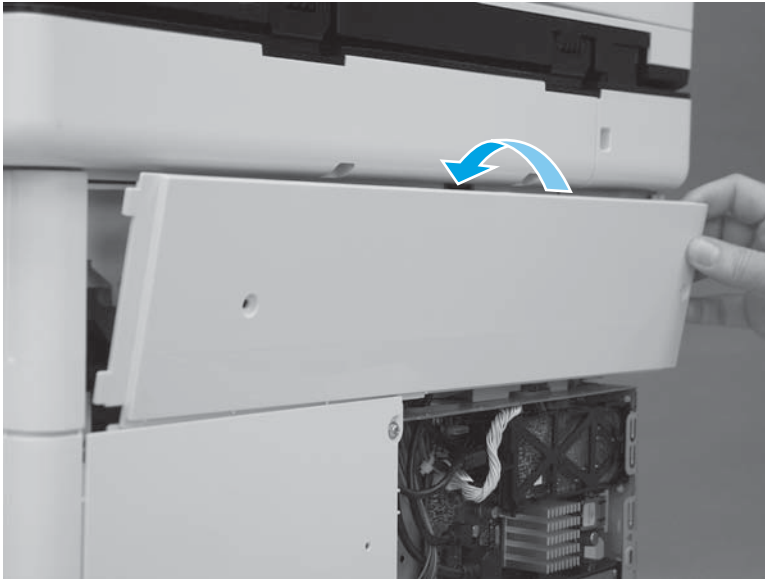

3. Slide the cover to the left (callout 1). Make sure that the tabs (callout 2) on the upper rear cover slide behind the edge (callout 3) of the right upper cover. Make sure that the cover is fully seated.

Figure 1-1643 Slide the cover

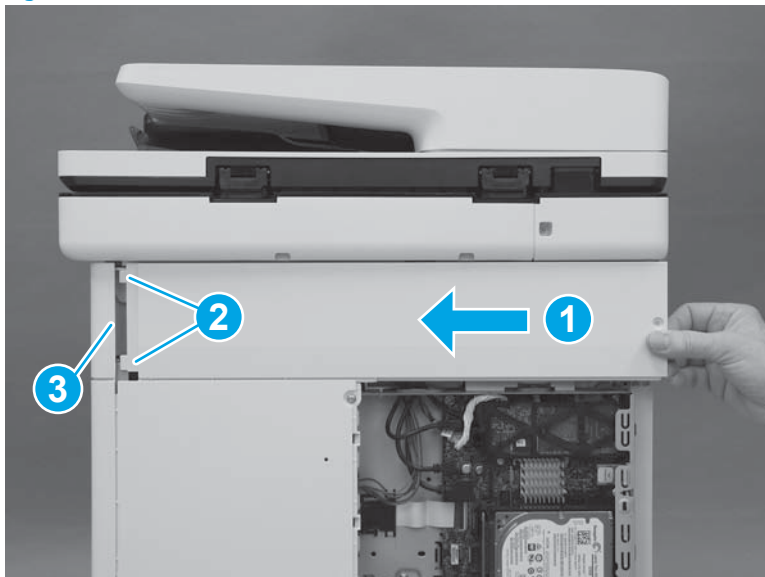

4. Install two screws (callout 1).

 **IMPORTANT:** These two screws are self-tapping screws for plastic. Rotate them counterclockwise to align them with the existing thread pattern, and then carefully turn them clockwise to tighten. Do not overtighten. This will prevent stripping the threads inside the screw holes.

Figure 1-1644 Install two screws



Step 17: Install the rear cover (M552 and M553)

 **NOTE:** This step is for the M552 and M553 models. For the M577 models, skip this step and go to [Step 18: Install the formatter \(M577\) on page 938](#).

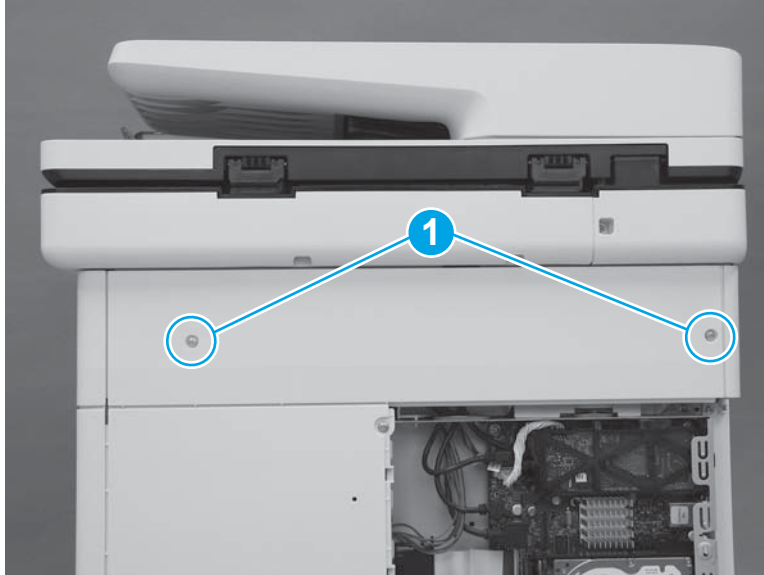
1. Position the top of the cover under the upper cover (callout 1), rotate the bottom of the cover onto the chassis (callout 2), and then slide the cover to the left (callout 3) to install it.

Figure 1-1645 Install the cover

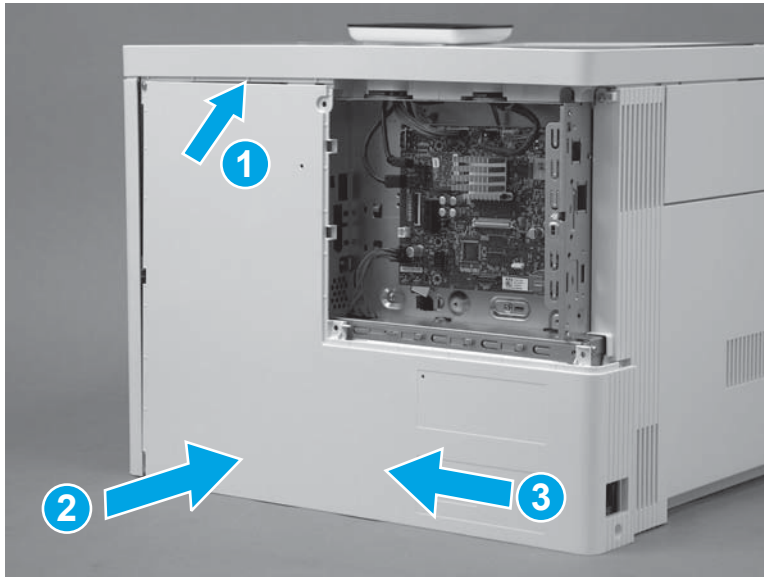

2. Install four screws (callout 1).

Figure 1-1646 Install four screws cover

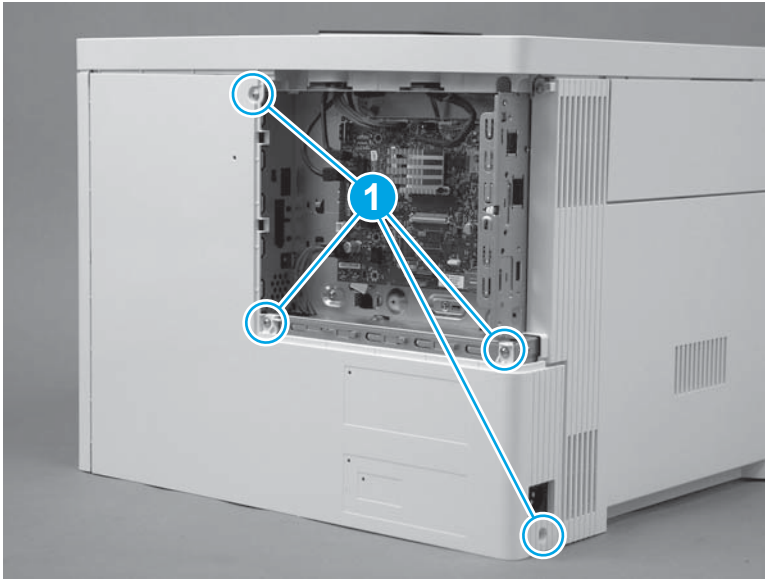

Step 18: Install the formatter (M577)

 **NOTE:** This step is for the M577 models. For the M552 and M553 models, skip this step and to go [Step 21: Install the formatter \(M552 and M553\) on page 943](#).

 **CAUTION:**  ESD-sensitive part.

1. Position the formatter in the printer. Make sure that the network port (callout 1) fits through the opening (callout 2) in the formatter case.

Figure 1-1647 Install the formatter

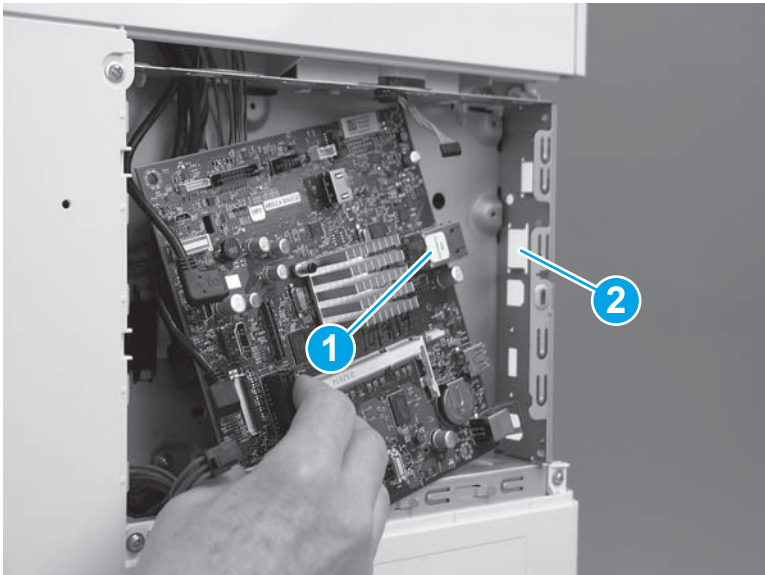

2. Install four screws (callout 1).

Figure 1-1648 Install four screws

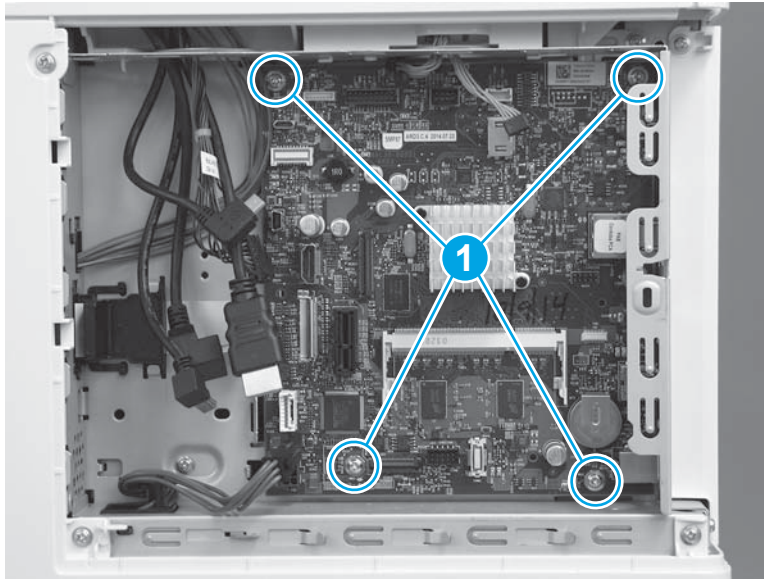

3. Connect all of the connectors on the formatter.

The following connectors are empty:

- All models: J1 (this connector is empty unless the optional DIMM is installed)
- All models: J3
- M577dn: J15 (this is the fax connector for the M577f/z/c models)
- All models: J21 (this connector is empty unless the optional internal USB ports component is installed)
- All models: J23
- All models: J24
- All models: J51
- All models: J57
- All models: J97
- All models: J98 (this connector is empty unless the optional trusted platform module (TPM) is installed)

 **IMPORTANT:** The flat-cable connector (callout 1) is a Zero Insertion Force (ZIF) connector that uses a hinged retainer to secure the flat cable. The hinged retainer must be opened to install the flat cable, and then closed after the cable is installed.

Figure 1-1649 Connect all connectors



Step 19: Install the fax PCA (M577c/f/z)

 **NOTE:** This step is for the M577c/f/z models. For the M577n model, skip this step and go to [Step 20: Install the HDD \(M577\) on page 941](#).

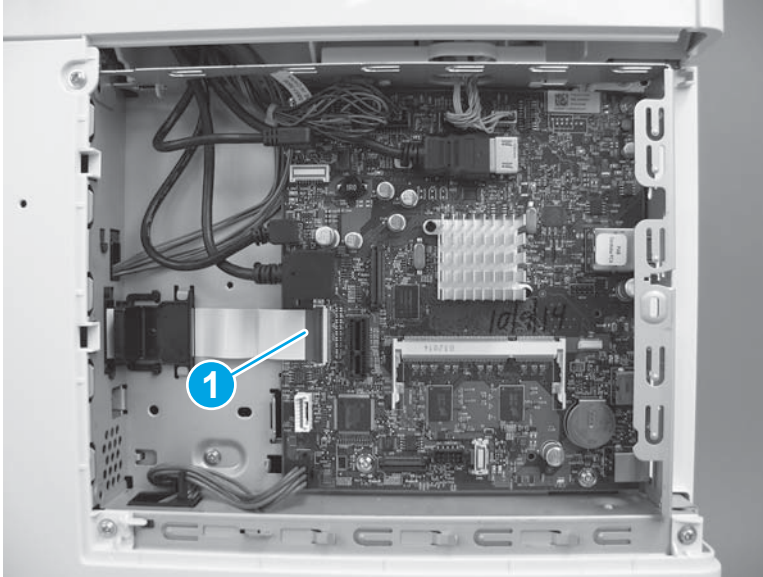
For the M552 and M553 models, skip this step and go to [Step 21: Install the formatter \(M552 and M553\) on page 943](#).

 **CAUTION:**  ESD-sensitive part.

1. Position the tab and telephone port (callout 1) on the fax PCA in the slots (callout 2) in the formatter case.

Figure 1-1650 Position the fax PCA

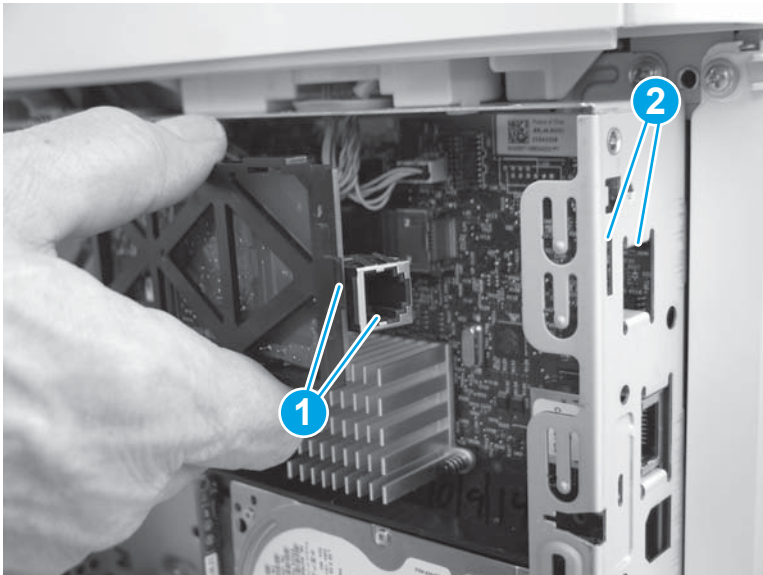

- Slide the fax PCA to the right (callout 1) until the tab and telephone port described in the previous step and seated in the formatter case. Position the retainer (callout 2) in the slot (callout 3) in the formatter. Rotate the end of the fax PCA toward the formatter (callout 4) until the retainer snaps into place.

Figure 1-1651 Install the fax PCA

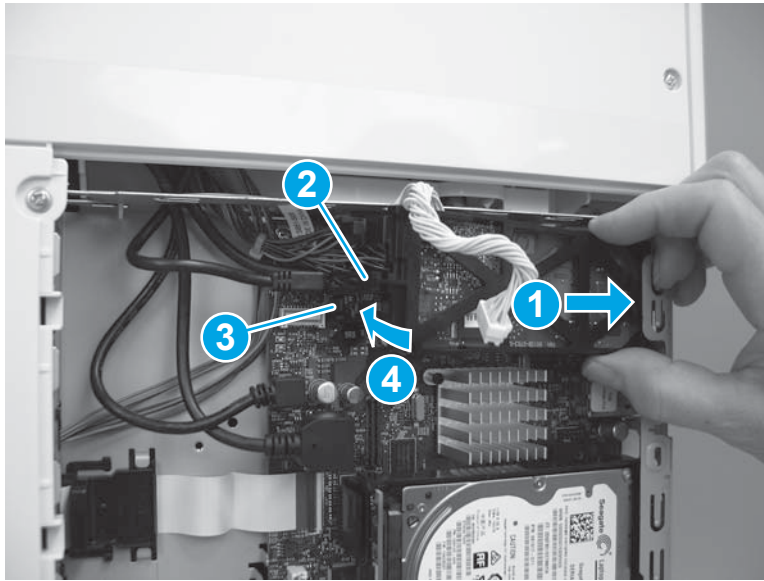

- Position the cable (callout 1) in the guide (callout 2), and then connect one connector (callout 3).

Figure 1-1652 Connect the connector

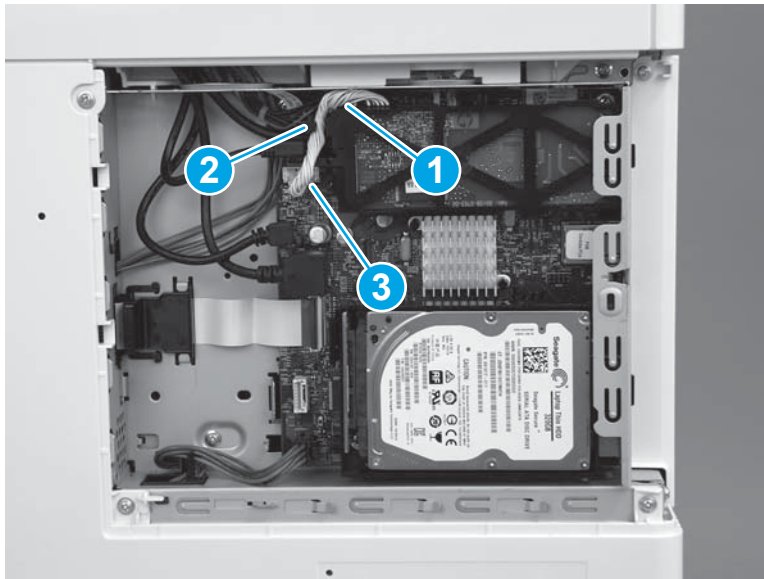

Step 20: Install the HDD (M577)

 **NOTE:** This step is for the M577 models. For the M552 and M553 models, skip this step and go to [Step 21: Install the formatter \(M552 and M553\) on page 943](#).

 **CAUTION:**  ESD-sensitive part.

1. Align the end of the bracket (callout 1) with the slot in the chassis (callout 2), and then slide the HDD into the printer (callout 3) to engage the bracket with the chassis.

Figure 1-1653 Install the holder

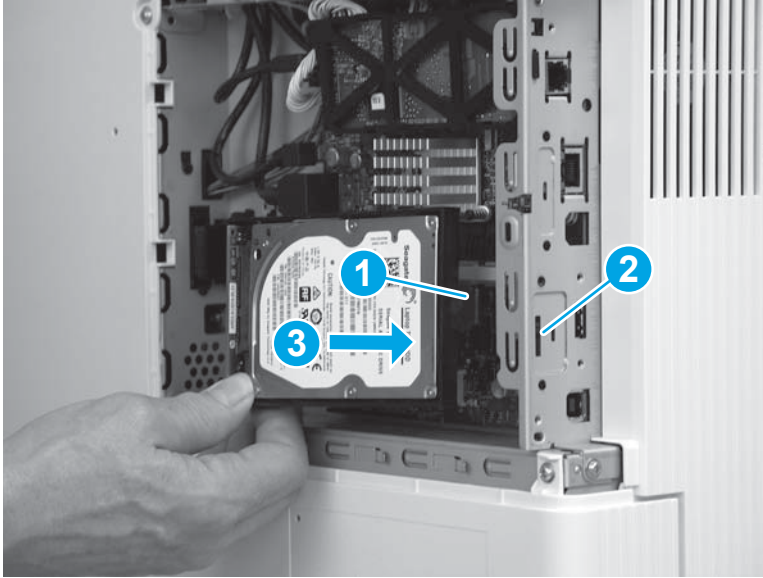

2. Hold the HDD connector latch (callout 1) in the released position, and then rotate the HDD down and into the connector on the formatter to install it.



 **NOTE:** Make sure that the tab (callout 2) snaps into place, and that the HDD is securely installed.

Figure 1-1654 Release the HDD

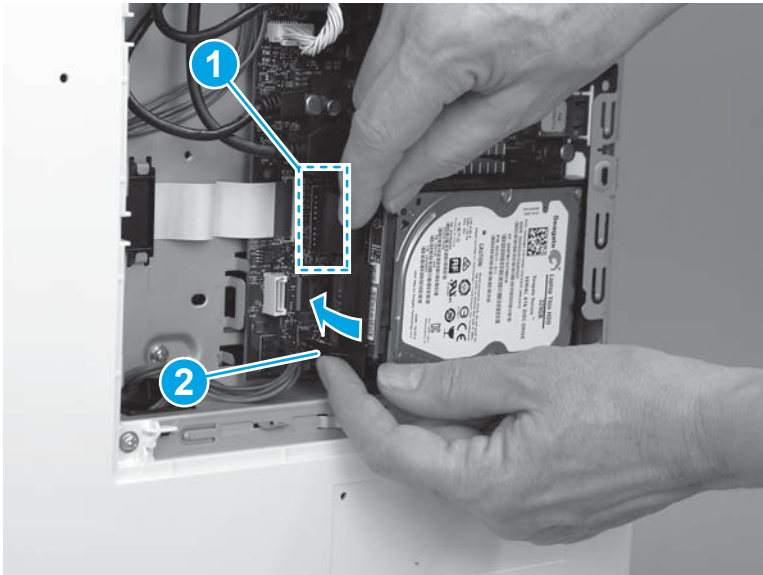

Step 21: Install the formatter (M552 and M553)

 **NOTE:** This step is for the M552 and M553 models. For the M577 models, skip this step and go to [Step 22: Install the formatter cover on page 944](#).

If the optional hard-disk drive (HDD) was removed, do not forget to reinstall it after the formatter is reinstalled.

Engage the HDD holder with the chassis, rotate the HDD connector down and into the connector on the formatter. Make sure that the tabs snap into place.

 **CAUTION:**  ESD-sensitive part.

1. Position the formatter in the printer, and then install four screws (callout 1).

Figure 1-1655 Install the formatter

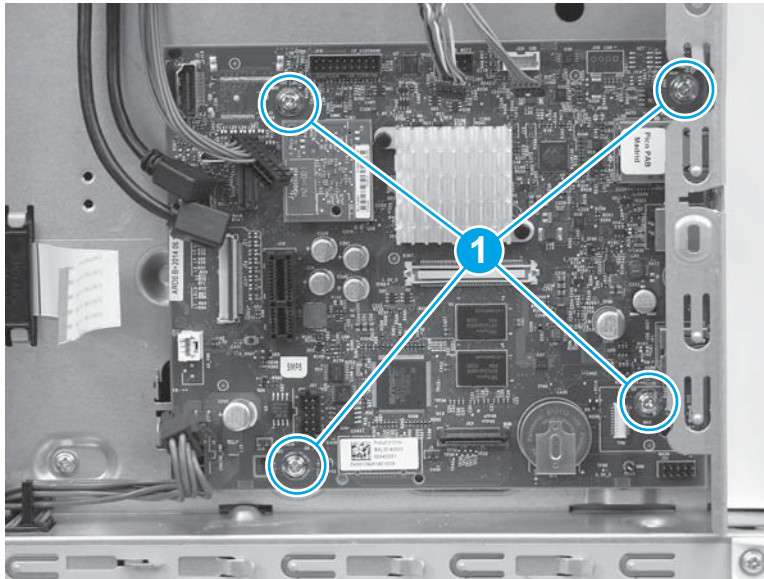

2. Connect all of the connectors on the formatter.

The following connectors are empty:

- All models: J1 (this connector is empty unless the optional DIMM is installed)
- M553n/dn and M552dn: J2 (callout 1; this is the touchscreen connector for the M553x model)
- All models: J9 (this connector is empty unless the optional internal USB ports component is installed)
- All models: J18 (this connector is empty unless the optional hard-disk-drive (HDD) is installed)
- All models: J23
- All models: J24
- M553n/dn and M552dn: J25 (this is the wireless connector for the M553x model)
- All models: J57
- All models: J98 (this connector is empty unless the optional trusted platform module (TPM) is installed)

IMPORTANT: The flat-cable connector (callout 2) is a Zero Insertion Force (ZIF) connector that uses a hinged retainer to secure the flat cable. The hinged retainer must be opened to install the flat cable.

Figure 1-1656 Connect all connectors

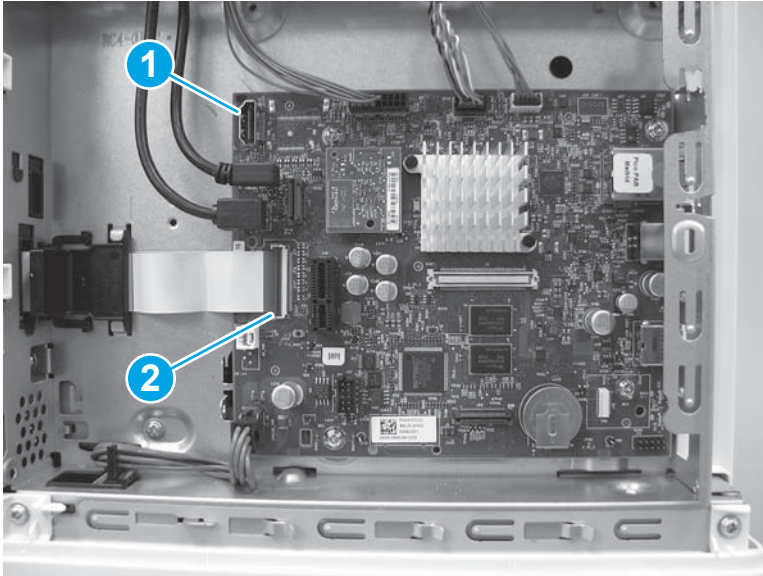

Step 22: Install the formatter cover

- ▲ Slide the cover onto the printer (callout 1) to install it.

NOTE: Make sure that the tabs on the formatter cover align with the slots provided in the printer (callout 2). Tighten the two thumbscrews (callout 3).

TIP: If needed, use the edge of a coin to turn the thumbscrews.

Figure 1-1657 Install the cover

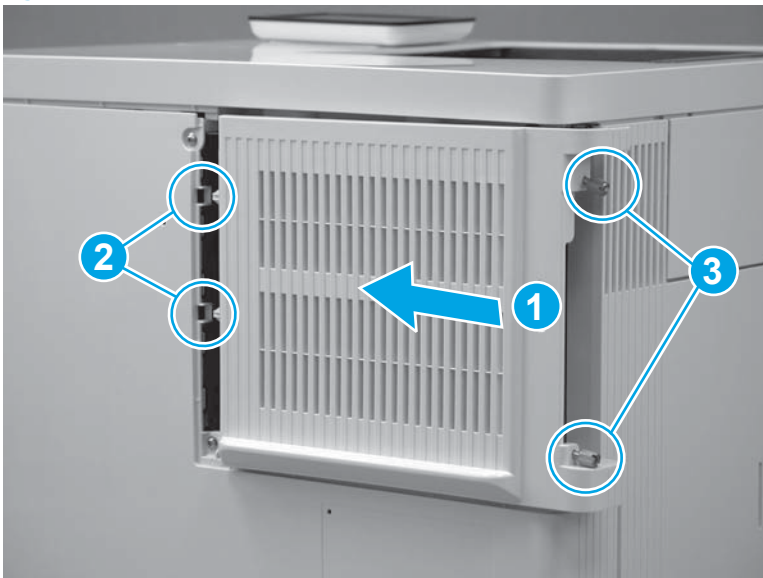

Step 23: Install the TCU

1. Verify that the toner collection hatch cover is in the closed position on the TCU.

Figure 1-1658 Verify that the toner collection hatch cover is closed

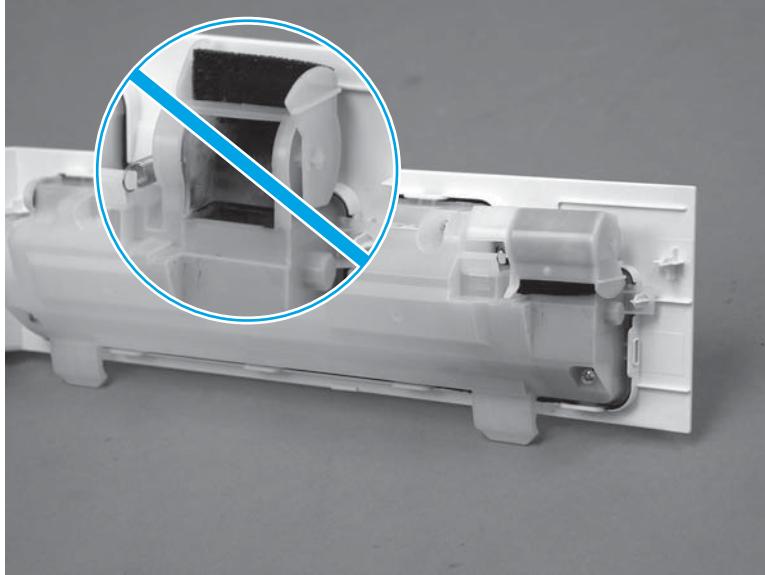

2. Position the TCU with the hinges in the slots provided in the printer (callout 1), and then rotate the TCU up and into the closed position.

 **NOTE:** The toner collection hatch cover automatically opens when the TCU is closed.

Figure 1-1659 Install the TCU

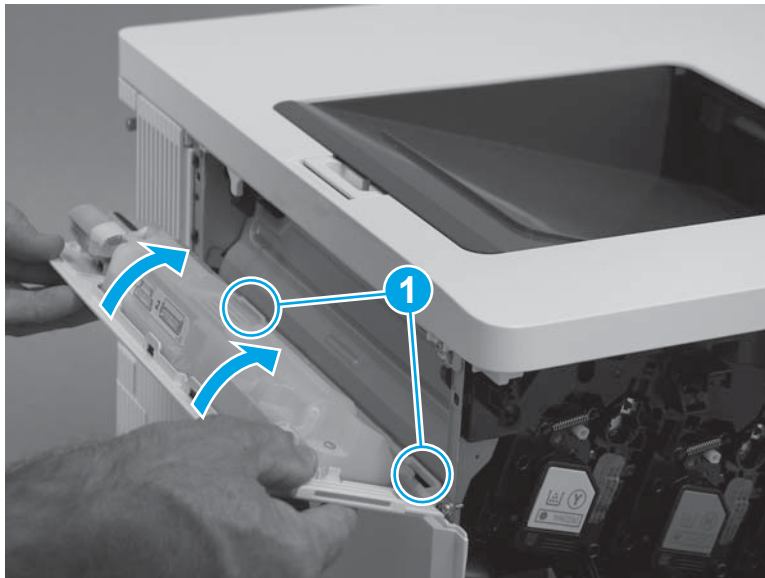

3. Close the front door.

Figure 1-1660 Close the front door



Removal and replacement: Fuser power supply

- [Introduction](#)
- [Step 1: Remove the toner collection unit \(TCU\)](#)
- [Step 2: Remove the formatter cover](#)
- [Step 3: Remove the rear cover \(M552 and M553\)](#)
- [Step 4: Remove the rear upper cover \(M577\)](#)
- [Step 5: Remove the rear cover \(M577\)](#)
- [Step 6: Remove the left cover](#)
- [Step 7: Remove the fuser power supply](#)
- [Step 8: Unpack the replacement assembly](#)
- [Step 9: Install the fuser power supply](#)
- [Step 10: Install the left cover](#)
- [Step 11: Install the rear cover \(M577\)](#)
- [Step 12: Install the rear upper cover \(M577\)](#)
- [Step 13: Install the rear cover \(M552 and M553\)](#)
- [Step 14: Install the formatter cover](#)
- [Step 15: Install the TCU](#)

Introduction

This document provides the procedures to remove and replace the fuser power supply.



Before performing service

Turn the printer power off

- Disconnect the power cable.

 **WARNING!** To avoid damage to the printer, turn the printer off, wait 30 seconds, and then remove the power cord before attempting to service the printer.

- Open the right door.

 **CAUTION:**  This part contains components that are electrostatic discharge (ESD) sensitive. To reduce the possibility of ESD damage, always touch the sheet-metal chassis to ground yourself before touching an ESD sensitive part.

Use the table below to identify the correct part number for your printer, and then go to <http://h20141.www2.hp.com/hpparts> to order the part.

Fuser power supply part number

RM2-7125-000CN

Fuser power supply

Required tools

- #2 Phillips screwdriver with a magnetic tip

After performing service

Make sure that the TCU is fully closed after replacing it.

Make sure that the formatter cover is fully seated, and that the thumbscrews are finger tight after replacing it.

Turn the printer power on

- Connect the power cable.
- Use the power switch to turn the power on.

Post service test

Print a configuration page to make sure that the printer is functioning correctly.

Step 1: Remove the toner collection unit (TCU)

1. Open the front door.

Figure 1-1661 Open the front door



2. Open the TCU.

 **NOTE:** The toner collection hatch cover automatically closes when the TCU is opened.

Figure 1-1662 Open the TCU



3. Pull the TCU away from the printer at an angle to remove it.

⚠ CAUTION: Do not open the toner collection hatch cover when handling the TCU. If toner gets on clothing, wipe it off by using a dry cloth and wash the clothes in cold water. Hot water sets toner into fabric.

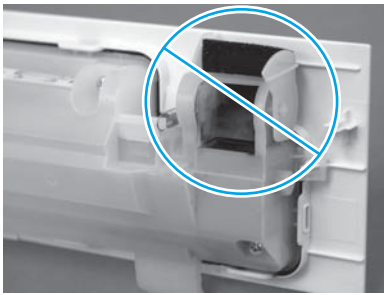
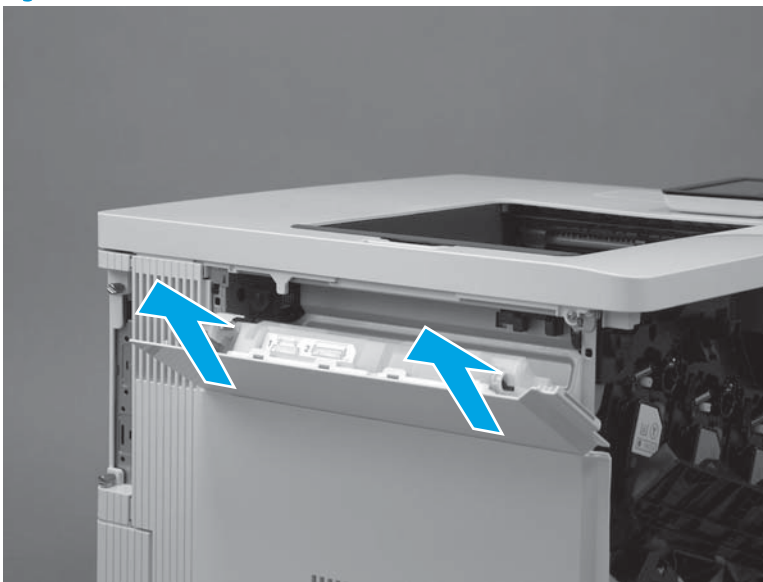

Figure 1-1663 Remove the TCU



Step 2: Remove the formatter cover

1. Locate the formatter cover.

Figure 1-1664 Locate the formatter cover

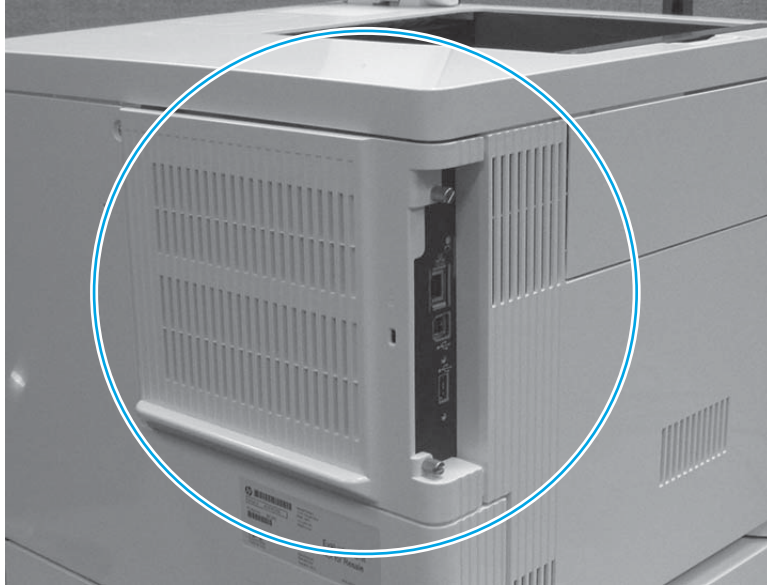

2. Loosen the two thumbscrews (callout 1). Grasp the two thumbscrews, and then slide the cover away from the printer (callout 2) to remove it.

 **TIP:** If needed, use the edge of a coin to turn the thumbscrews.

Figure 1-1665 Loosen the thumbscrews

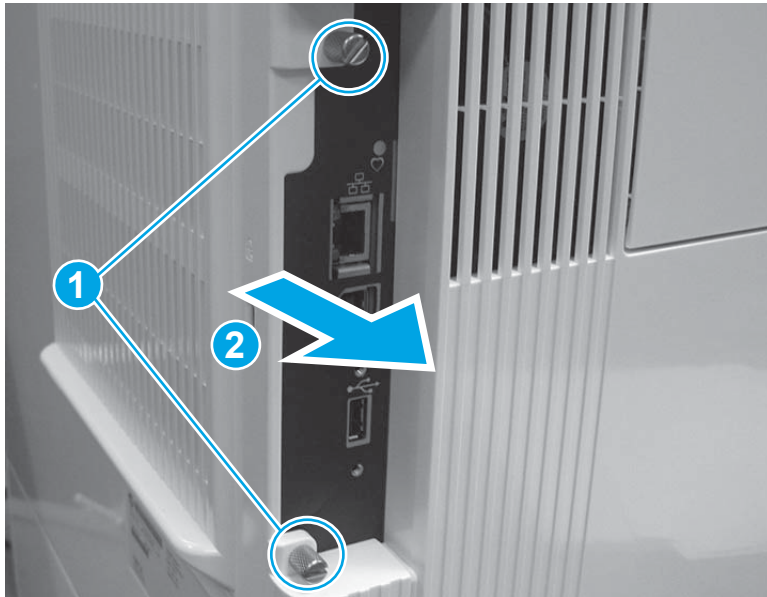

Step 3: Remove the rear cover (M552 and M553)

 **NOTE:** This step is for the M552 and M553 models. For the M577 models, skip this step and go to [Step 4: Remove the rear upper cover \(M577\) on page 952.](#)

1. Remove four screws (callout 1).

Figure 1-1666 Remove four screws

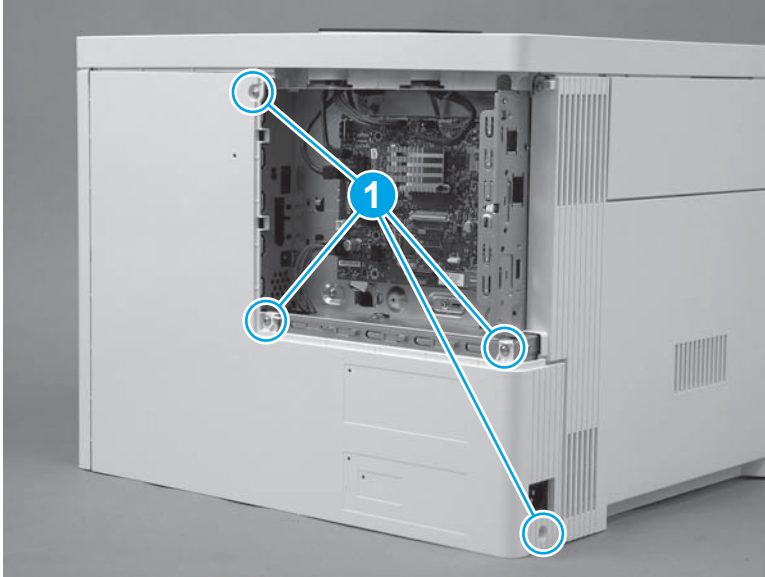

2. Slightly slide the cover to the right (callout 1), rotate the bottom of the cover away from the printer (callout 2), and then pull the top of the cover away from the printer (callout 3) to remove the cover.

Figure 1-1667 Remove the cover

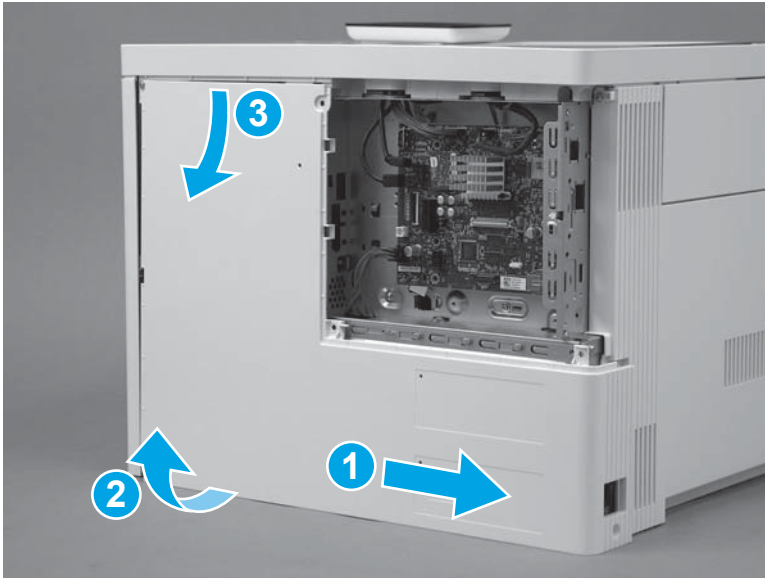

Step 4: Remove the rear upper cover (M577)

 **NOTE:** This step is for the M577 models. For the M552 and M553 models, skip this step and go to [Step 6: Remove the left cover on page 955](#).

1. Remove two screws (callout 1).

 **Reinstallation tip:** These two screws are self-tapping screws for plastic. When reinstalling them, rotate the screws counterclockwise to align them with the existing thread pattern, and then carefully turn them clockwise to tighten. Do not overtighten. This will prevent stripping the threads inside the screw holes.

Figure 1-1668 Remove two screws



2. Use a small, flat blade screwdriver to release the right edge of the cover.

Figure 1-1669 Release the right edge

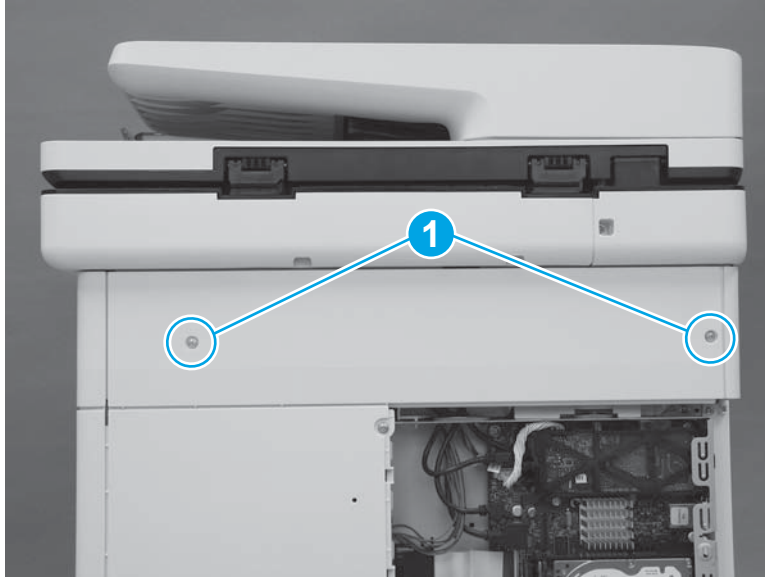
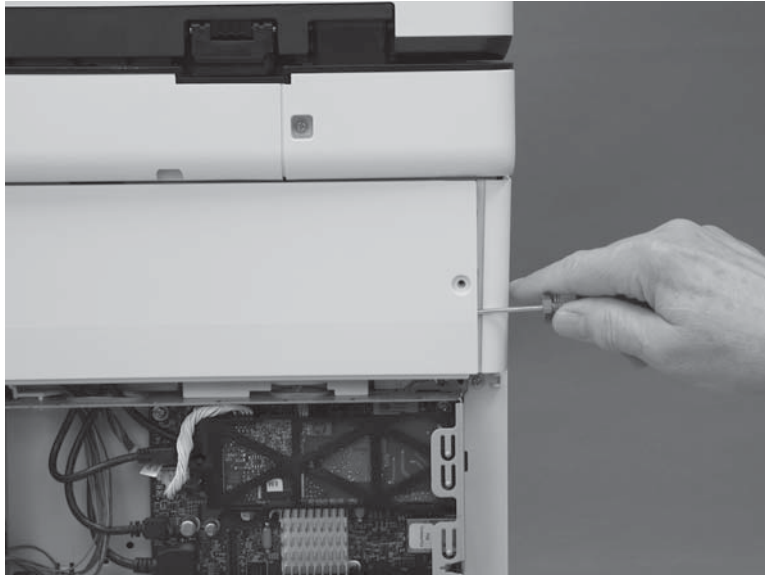

3. Pull the right edge of the cover (callout 1) away from the printer, and then slide the cover to the right (callout 2).

Figure 1-1670 Slide the cover right

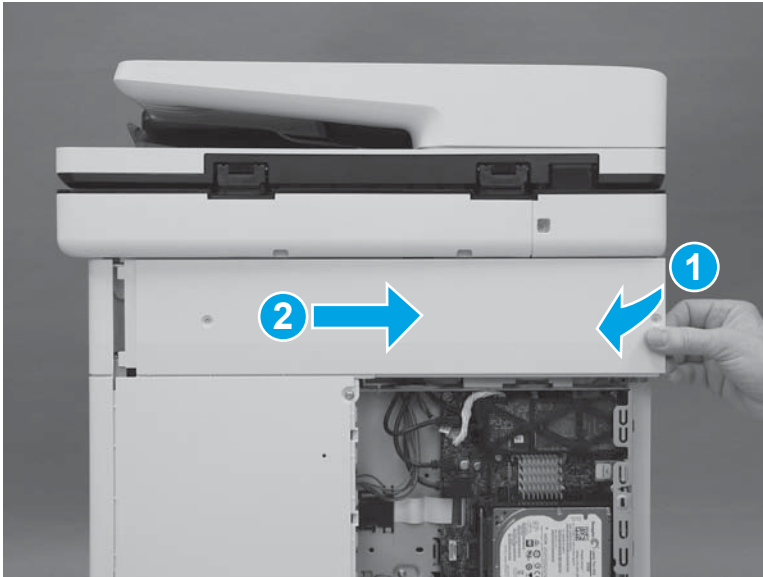

4. Remove the cover.

Figure 1-1671 Remove the cover

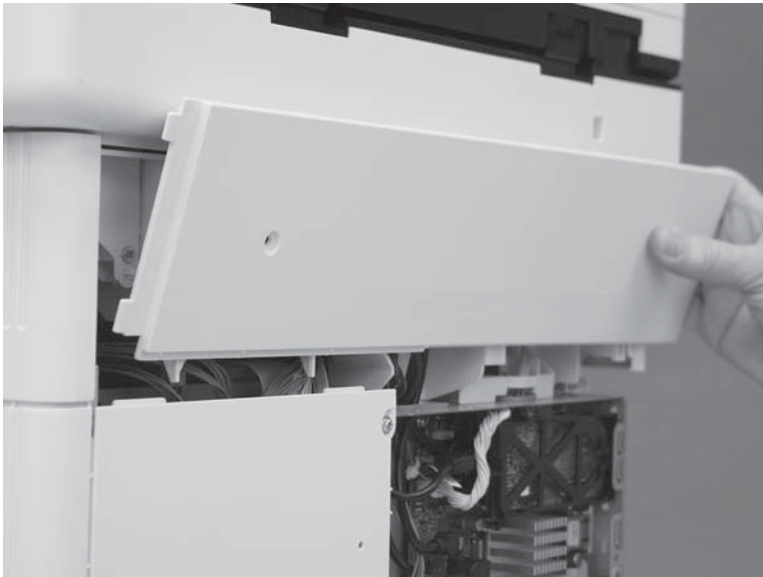

Step 5: Remove the rear cover (M577)

 **NOTE:** This step is for the M577 models. For the M552 and M553 models, skip this step and go to [Step 6: Remove the left cover on page 955](#).

1. Remove four screws (callout 1).

Figure 1-1672 Remove four screws

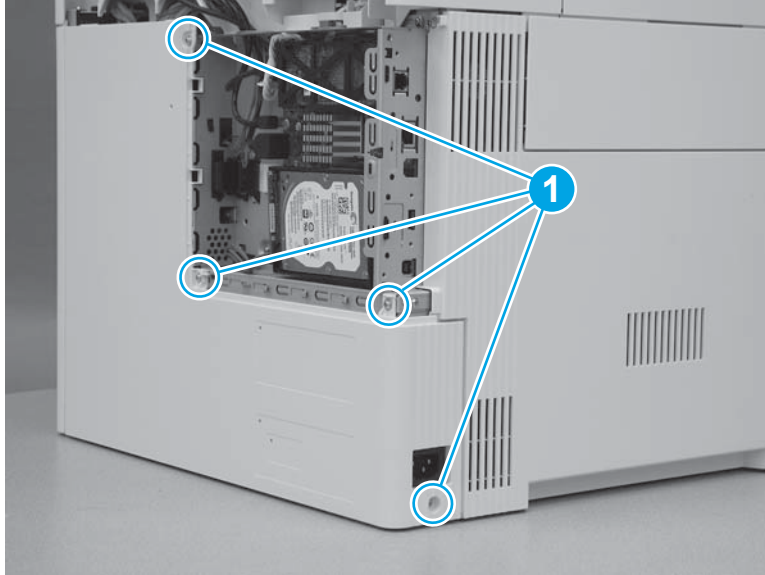

2. Slide the cover to the right to remove it.

Figure 1-1673 Remove the cover

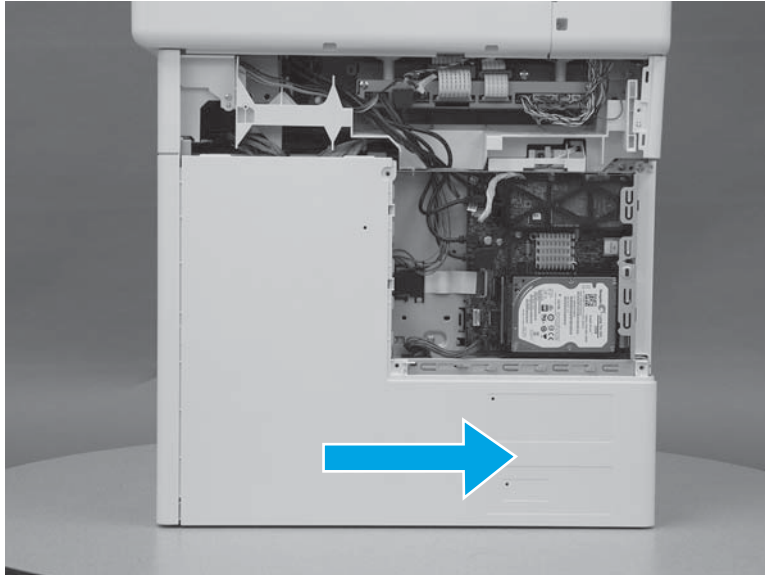

Step 6: Remove the left cover

1. At the left side of the printer, remove one screw (callout 1).

Figure 1-1674 Remove one screw



2. Release one tab (callout 1), rotate the front edge of the cover away from the printer (callout 2), and then slide the cover (callout 3) toward the rear of the printer to release it.

Figure 1-1675 Release the cover

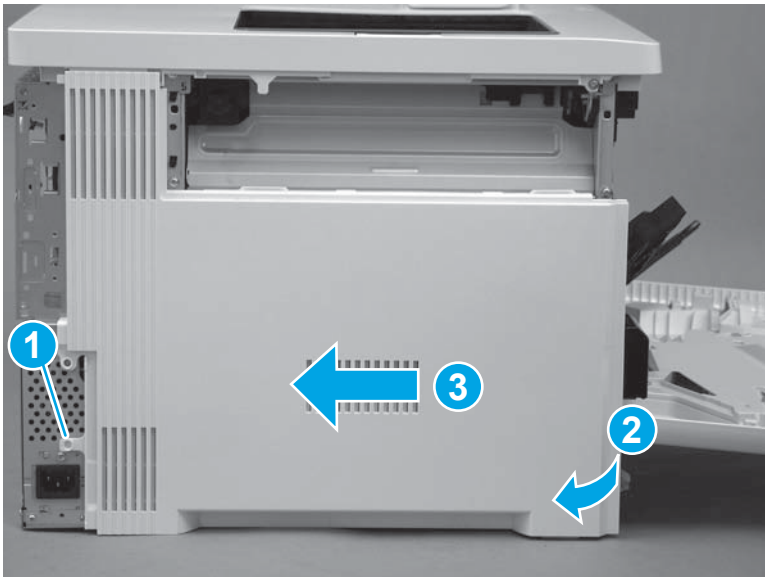

3. Remove the cover.

Figure 1-1676 Remove the cover

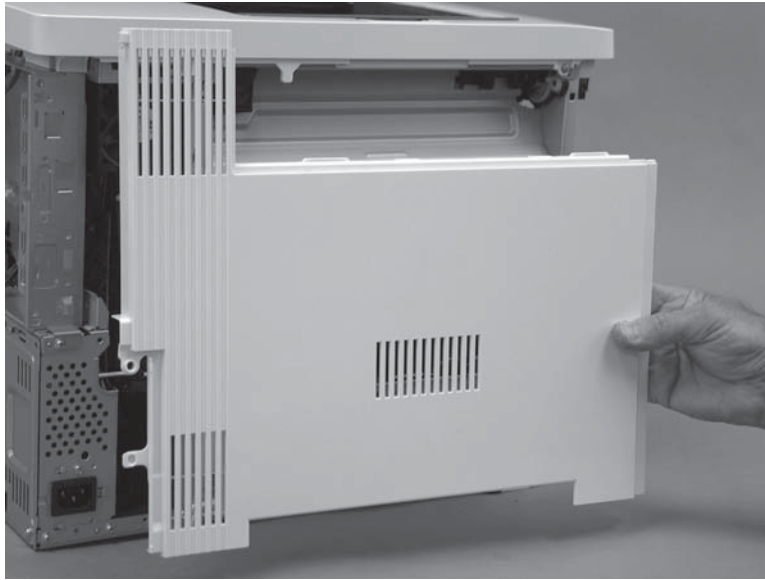

Step 7: Remove the fuser power supply

1. Remove two screws (callout 1), and then slide the low-voltage power supply (LVPS) cover to the right to remove it.

Figure 1-1677 Remove the LVPS cover

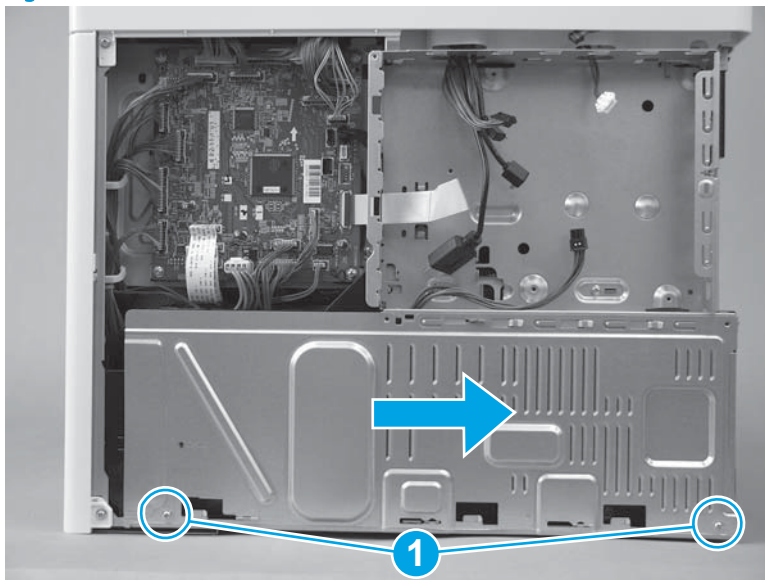

2. Disconnect one connector (callout 1).

Figure 1-1678 Disconnect one connector

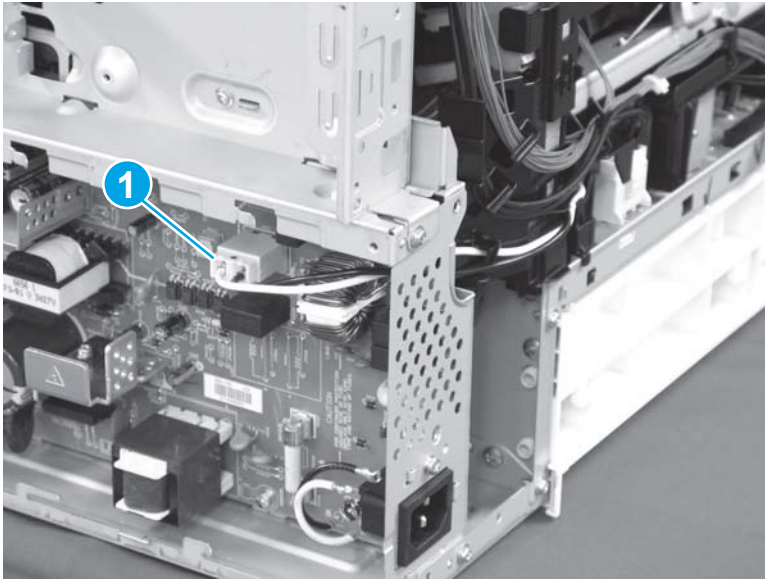

3. Pass the wire harness through the opening in the chassis.

Figure 1-1679 Pass the wire harness through the opening

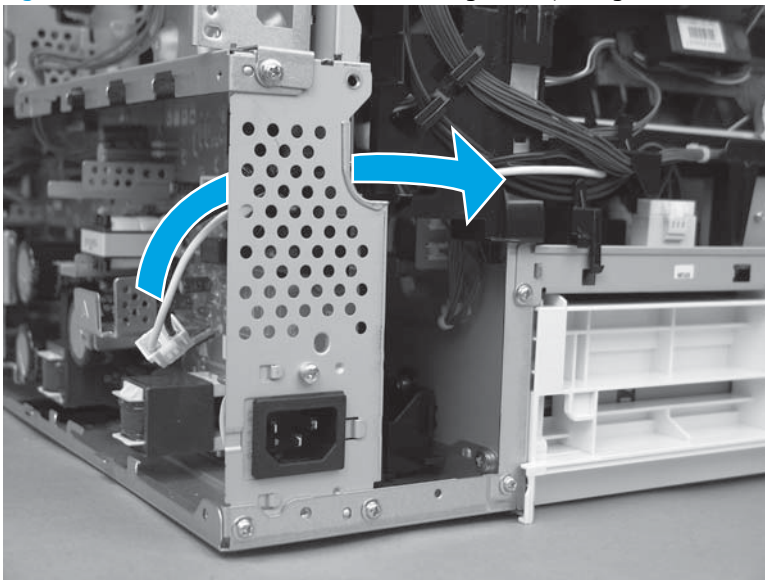

4. Disconnect three connectors (callout 1).

Figure 1-1680 Disconnect three connectors

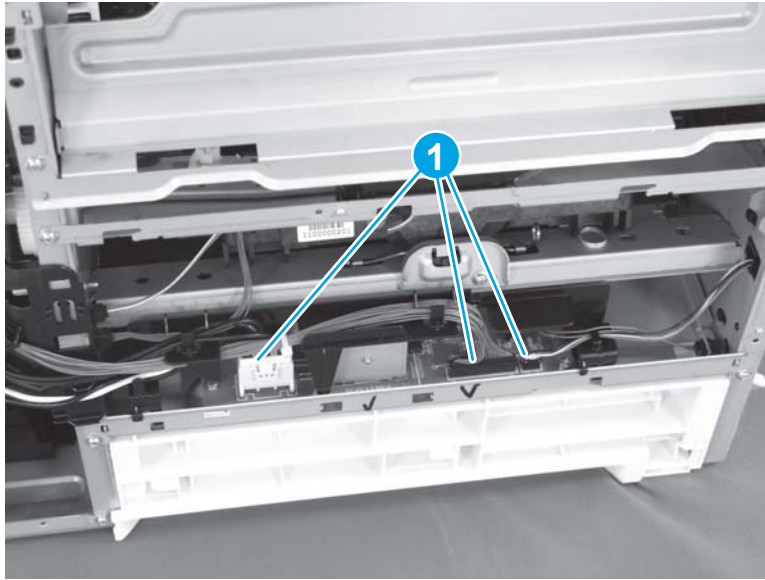

5. Remove two screws (callout 1), and then remove the fuser power supply (callout 2).

Figure 1-1681 Remove the fuser power supply

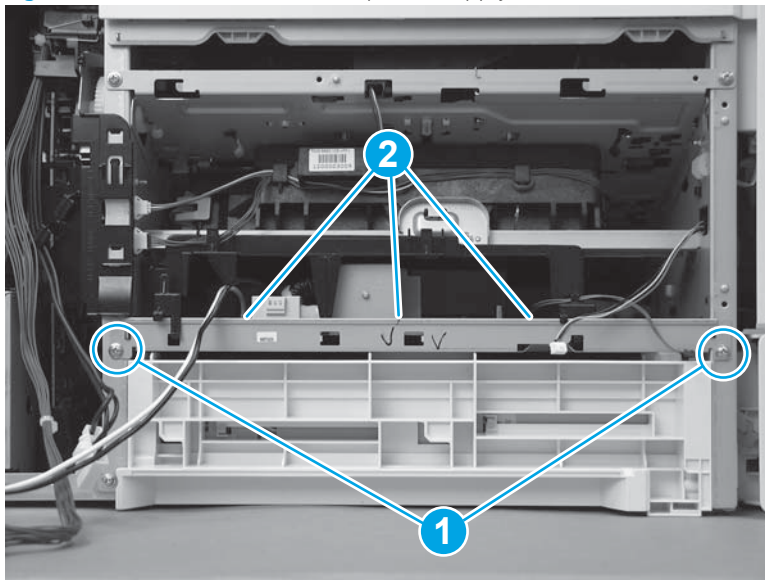

Step 8: Unpack the replacement assembly

Unpack the replacement assembly from the packaging.

 **CAUTION:**  ESD-sensitive part.

For complete information on HP's recycling programs, go to [Product return and recycling](#).

 **NOTE:** HP recommends responsible disposal of the defective assembly.

Figure 1-1682 Recycle and unpack

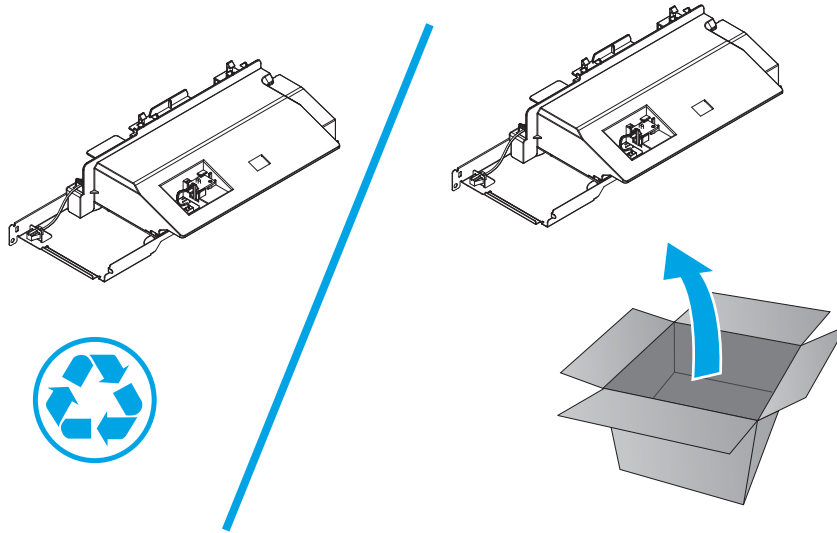

Step 9: Install the fuser power supply

1. Position the fuser power supply (callout 1) in the printer, and then install two screws (callout 2).

Figure 1-1683 Remove the fuser power supply

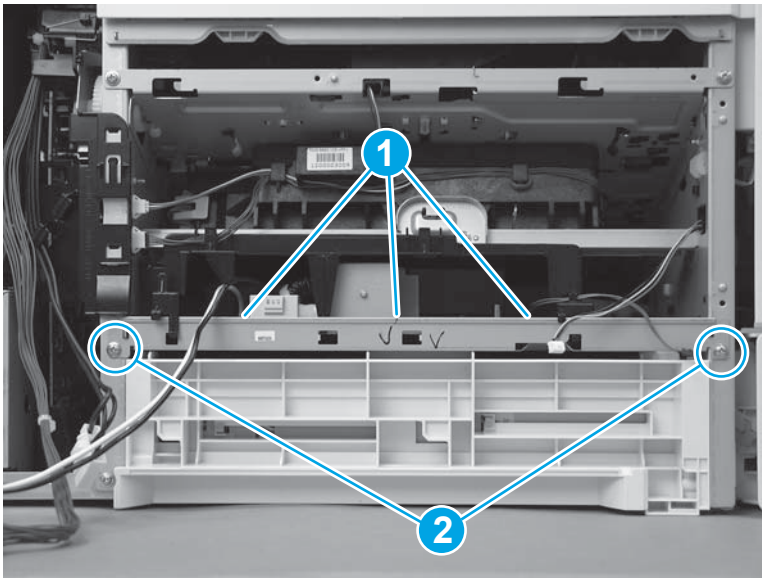

2. Connect three connectors (callout 1).

Figure 1-1684 Connect three connectors

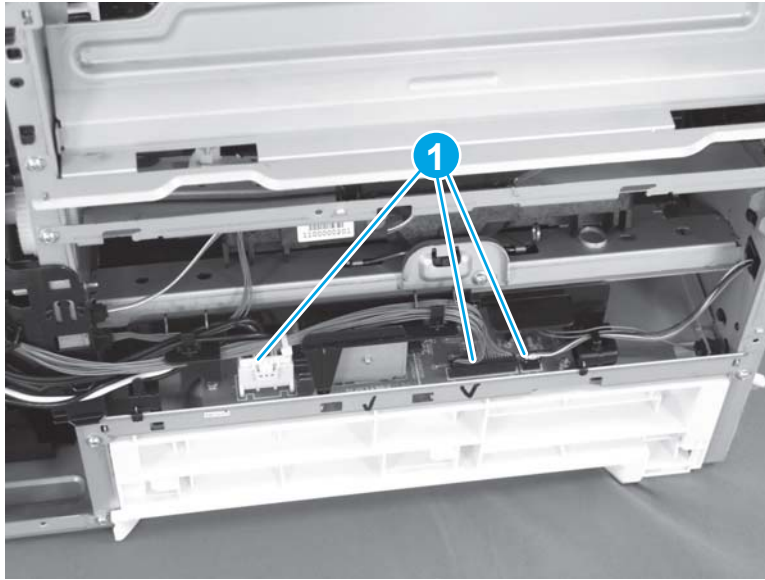

3. Pass the wire harness through the opening in the chassis.

Figure 1-1685 Pass the wire harness through the opening

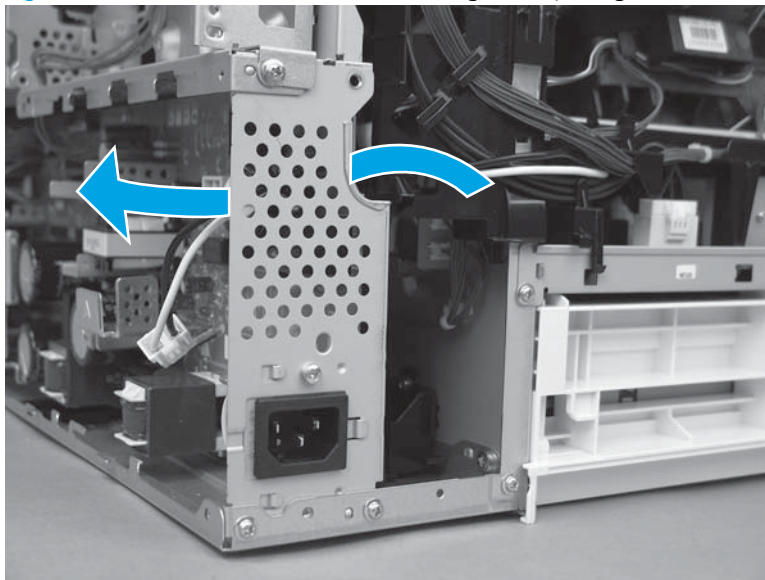

4. Connect one connector (callout 1).

Figure 1-1686 Connect one connector

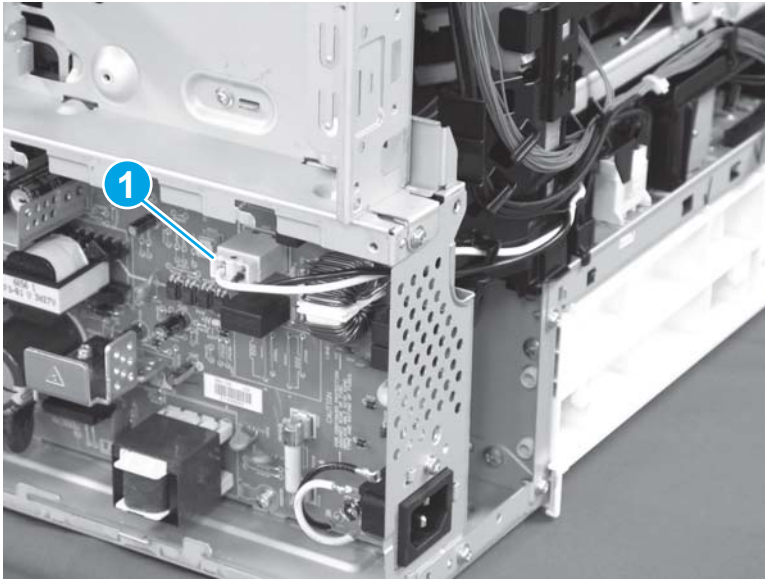

5. Position the LVPS cover on the printer, slide the cover to the left to install it, and then install two screws (callout 1).

Figure 1-1687 Install the LVPS cover

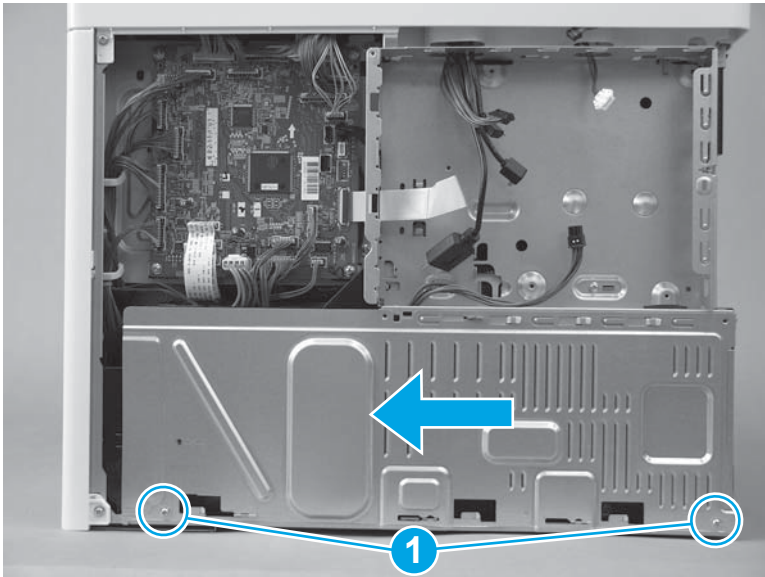

Step 10: Install the left cover

1. Position the cover on the printer.

 **NOTE:** Slightly offset the cover toward the rear of the printer.

Figure 1-1688 Install the cover

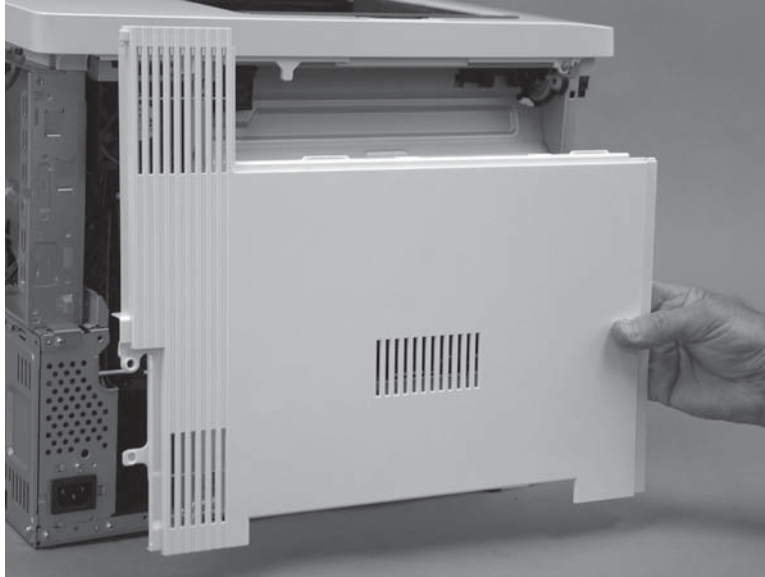

2. Slide the cover (callout 1) toward the front of the printer to engage it. Make sure that the tab (callout 2) snaps into place.

 **NOTE:** Locate the alignment pin (callout 3) on the cover from the front door side of the printer, and then make sure that it is fully engaged in the slot in the chassis.

 **TIP:** While sliding the cover into place, push in on the center of the cover (callout 1) to make sure that the hooks on the back of the cover engage with the slots in the chassis.

Figure 1-1689 Engage the cover



3. At the left side of the printer, install one screw (callout 1).

Figure 1-1690 Install one screw

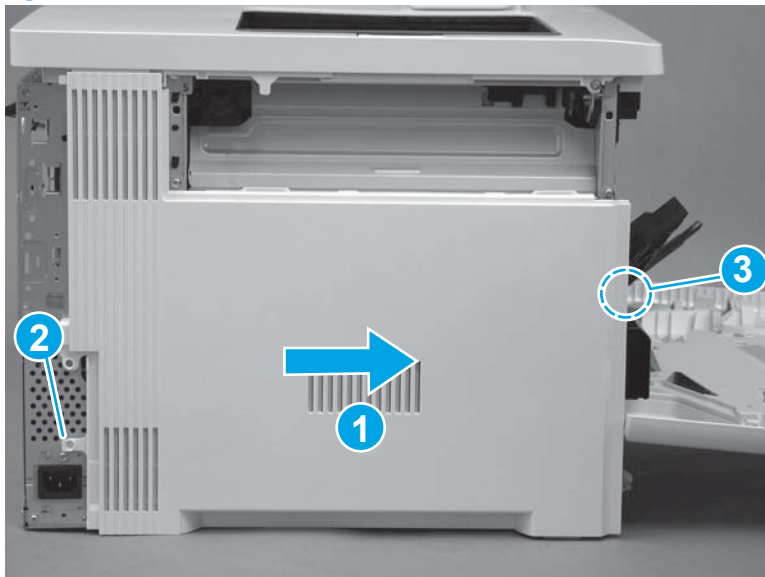

Step 11: Install the rear cover (M577)

 **NOTE:** This step is for the M577 models. For the M552 and M553 models, skip this step and go to [Step 13: Install the rear cover \(M552 and M553\) on page 967](#).

1. Position the hooks (callout 1) on the cover in the slots (callout 2) in the printer.

Figure 1-1691 Position the hooks

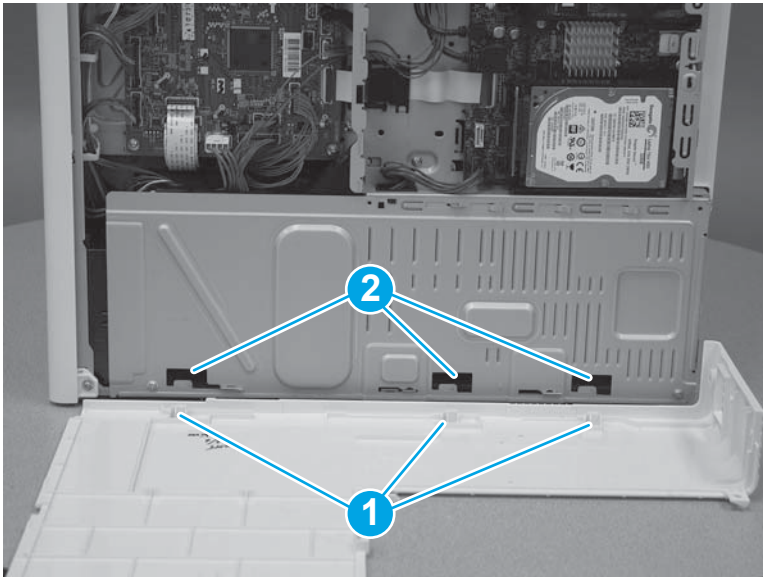

2. Position the back edge (callout 1) of the rear cover behind the edge (callout 2) of the right rear cover. Slide the cover to the left to install it.

Figure 1-1692 Install the cover

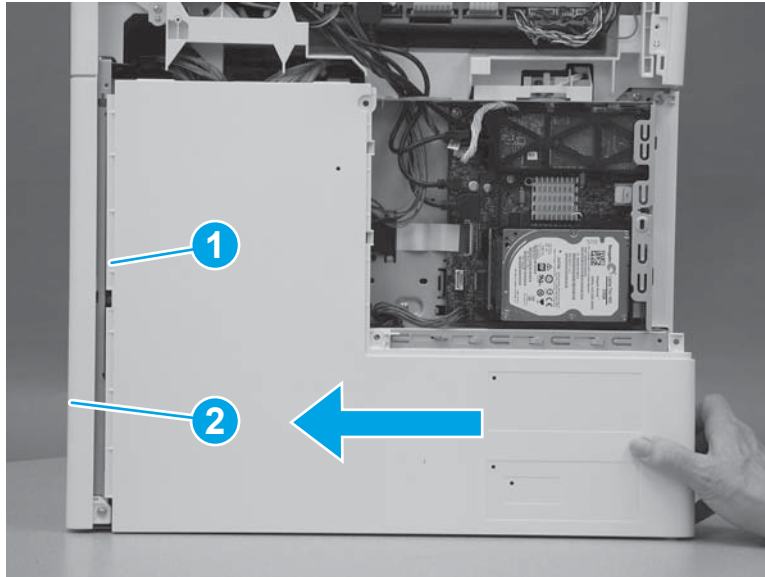

3. Install four screws (callout 1).

Figure 1-1693 Install four screws cover

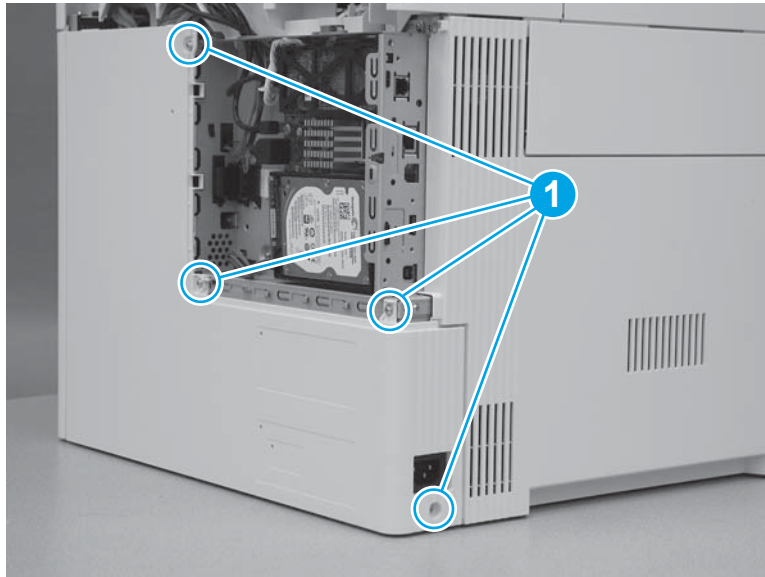

Step 12: Install the rear upper cover (M577)

 **NOTE:** This step is for the M577 models. For the M552 and M553 models, skip this step and go to [Step 13: Install the rear cover \(M552 and M553\) on page 967](#).

1. Align the ridge (callout 1) on the lower edge of the rear upper cover in front of the tabs (callout 2) on the top edge of the rear cover.

Figure 1-1694 Align the cover

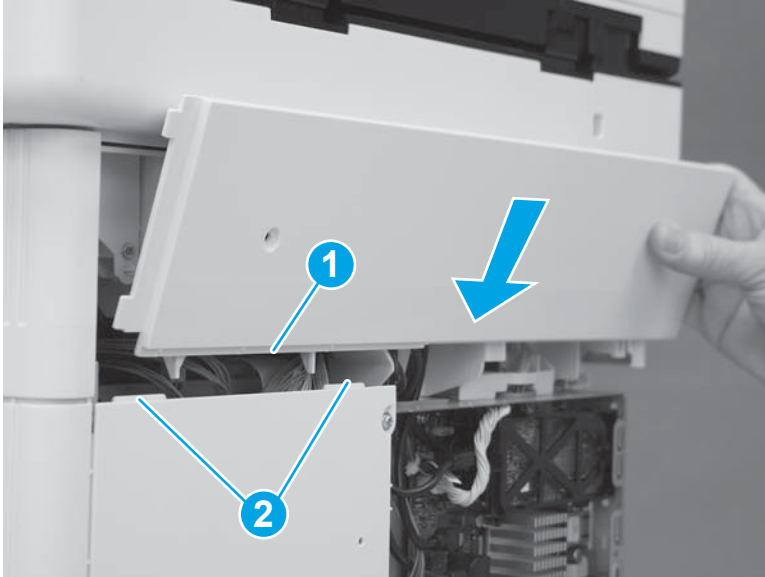

2. Rotate the top of the cover toward the printer.

Figure 1-1695 Rotate the top of the cover

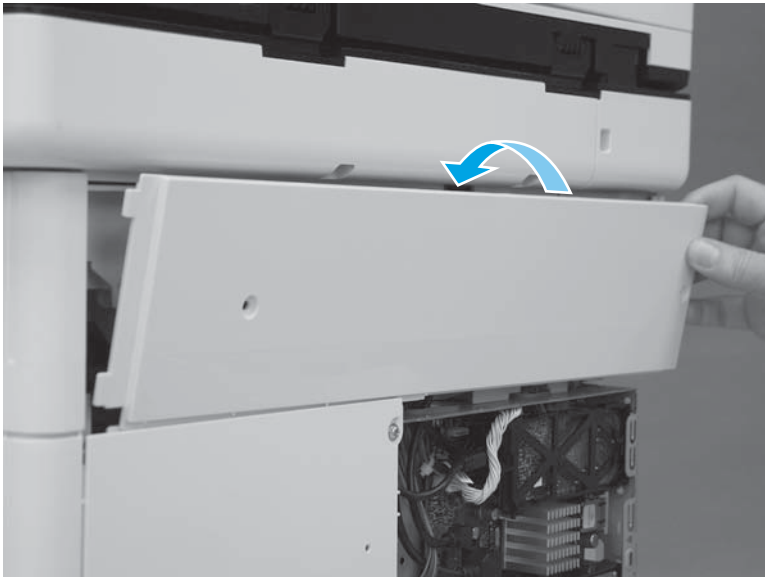

3. Slide the cover to the left (callout 1). Make sure that the tabs (callout 2) on the upper rear cover slide behind the edge (callout 3) of the right upper cover. Make sure that the cover is fully seated.

Figure 1-1696 Slide the cover

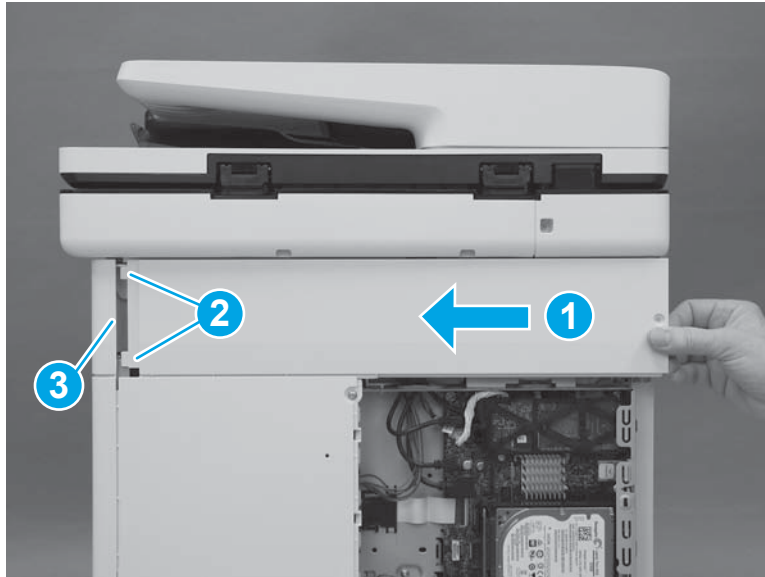

4. Install two screws (callout 1).



 **IMPORTANT:** These two screws are self-tapping screws for plastic. Rotate them counterclockwise to align them with the existing thread pattern, and then carefully turn them clockwise to tighten. Do not overtighten. This will prevent stripping the threads inside the screw holes.

Figure 1-1697 Install two screws

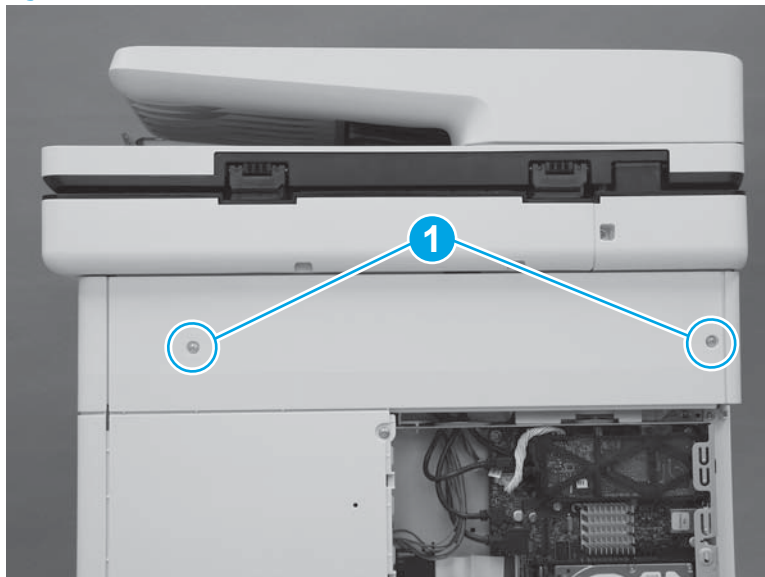

Step 13: Install the rear cover (M552 and M553)

 **NOTE:** This step is for the M552 and M553 models. For the M577 models, skip this step and go to [Step 14: Install the formatter cover on page 968](#).

1. Position the top of the cover under the upper cover (callout 1), rotate the bottom of the cover onto the chassis (callout 2), and then slide the cover to the left (callout 3) to install it.

Figure 1-1698 Install the cover

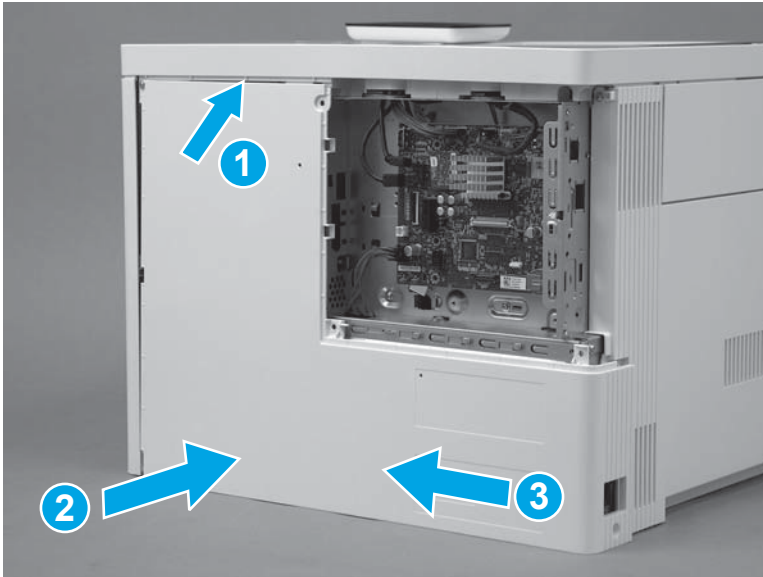

2. Install four screws (callout 1).

Figure 1-1699 Install four screws cover

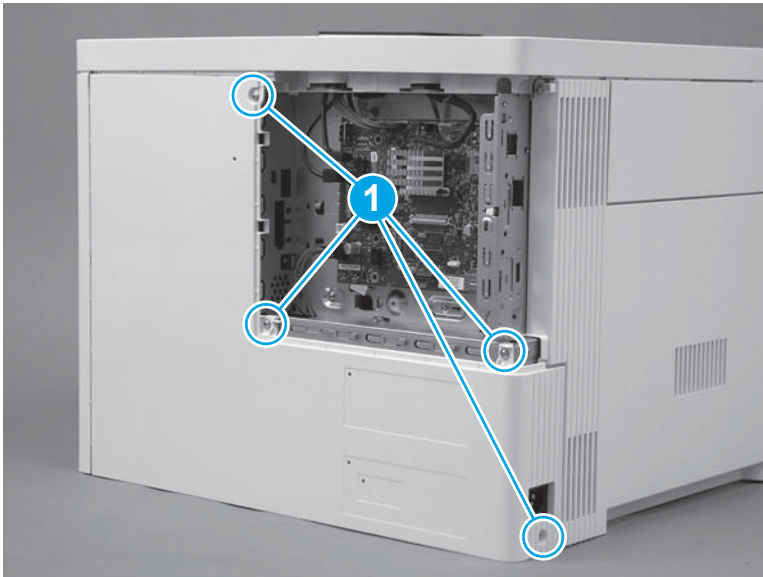

Step 14: Install the formatter cover

- ▲ Slide the cover onto the printer (callout 1) to install it.

 **NOTE:** Make sure that the tabs on the formatter cover align with the slots provided in the printer (callout 2). Tighten the two thumbscrews (callout 3).

 **TIP:** If needed, use the edge of a coin to turn the thumbscrews.

Figure 1-1700 Install the cover

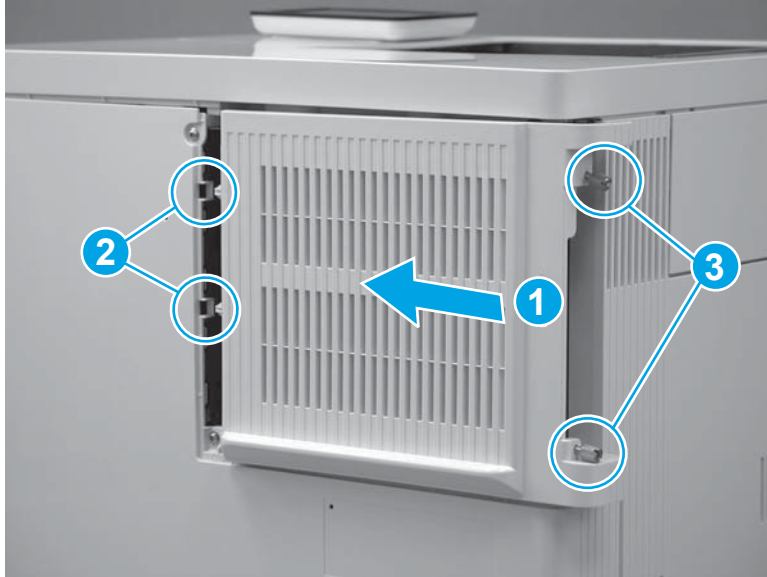

Step 15: Install the TCU

1. Verify that the toner collection hatch cover is in the closed position on the TCU.

Figure 1-1701 Verify that the toner collection hatch cover is closed

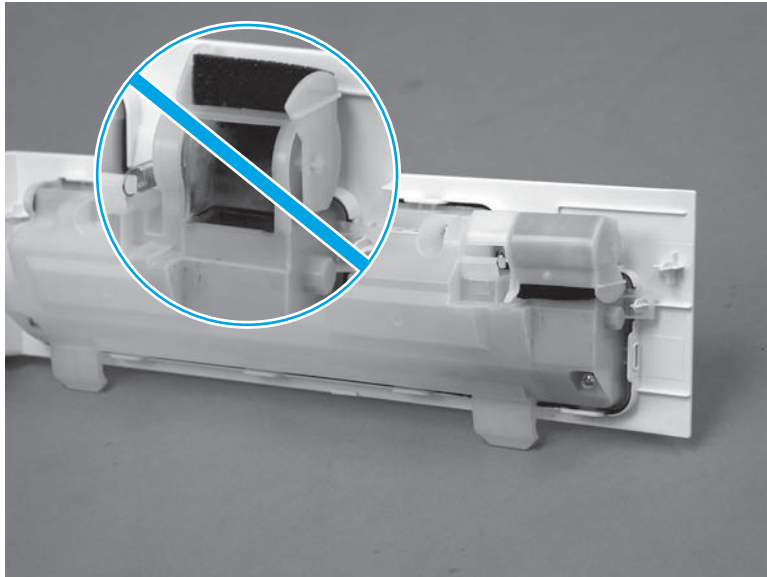

2. Position the TCU with the hinges in the slots provided in the printer (callout 1), and then rotate the TCU up and into the closed position.

 **NOTE:** The toner collection hatch cover automatically opens when the TCU is closed.

Figure 1-1702 Install the TCU



3. Close the front door.

Figure 1-1703 Close the front door

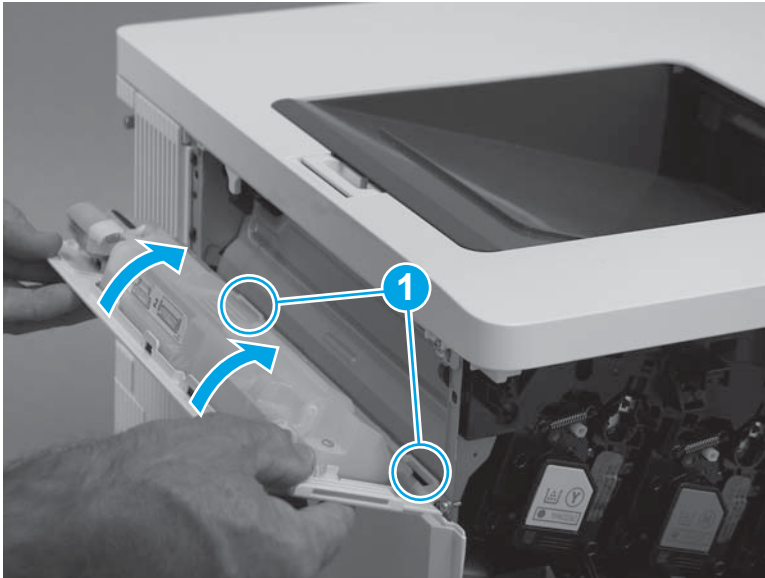

Removal and replacement: Low-voltage power supply (LVPS)

- [Introduction](#)
- [Step 1: Remove the toner collection unit \(TCU\)](#)
- [Step 2: Remove the formatter cover](#)
- [Step 3: Remove the formatter \(M552 and M553\)](#)
- [Step 4: Remove the hard-disk drive \(HDD\) \(M577\)](#)
- [Step 5: Remove the fax PCA \(M577c/f/z\)](#)
- [Step 6: Remove the formatter \(M577\)](#)
- [Step 7: Remove the rear cover \(M552 and M553\)](#)
- [Step 8: Remove the rear upper cover \(M577\)](#)
- [Step 9: Remove the rear cover \(M577\)](#)
- [Step 10: Remove the left cover](#)
- [Step 11: Remove the formatter case](#)
- [Step 12: Remove the low-voltage power supply \(LVPS\)](#)
- [Step 13: Unpack the replacement assembly](#)
- [Step 14: Install the LVPS](#)
- [Step 15: Install the formatter case](#)
- [Step 16: Install the left cover](#)
- [Step 17: Install the rear cover \(M577\)](#)
- [Step 18: Install the rear upper cover \(M577\)](#)
- [Step 19: Install the rear cover \(M552 and M553\)](#)
- [Step 20: Install the formatter \(M577\)](#)
- [Step 21: Install the fax PCA \(M577c/f/z\)](#)
- [Step 22: Install the HDD \(M577\)](#)
- [Step 23: Install the formatter \(M552 and M553\)](#)
- [Step 24: Install the formatter cover](#)
- [Step 25: Install the TCU](#)

Introduction



This document provides the procedures to remove and replace the low-voltage power supply (LVPS).

Before performing service

Turn the printer power off

- Disconnect the power cable.

 **WARNING!** To avoid damage to the printer, turn the printer off, wait 30 seconds, and then remove the power cord before attempting to service the printer.

 **CAUTION:**  This part contains components that are electrostatic discharge (ESD) sensitive. To reduce the possibility of ESD damage, always touch the sheet-metal chassis to ground yourself before touching an ESD sensitive part.

Use the table below to identify the correct part number for your printer, and then go to <http://h20141.www2.hp.com/hpparts> to order the part.

Low-voltage power supply (LVPS) part number	
---	--

RM2-7164-000CN

Low-voltage power supply (LVPS)

Required tools

- #2 Phillips screwdriver with a magnetic tip

After performing service

Make sure that all of the connectors on the LVPS are fully seated.

Make sure that all of the connectors on the formatter are fully seated.

Make sure that the formatter cover is fully seated, and that the thumbscrews are finger tight after replacing it.

Turn the printer power on

- Connect the power cable.
- Use the power switch to turn the power on.

Post service test

Print a configuration page to make sure that the printer is functioning correctly.

Step 1: Remove the toner collection unit (TCU)

1. Open the front door.

Figure 1-1704 Open the front door



2. Open the TCU.

 **NOTE:** The toner collection hatch cover automatically closes when the TCU is opened.

Figure 1-1705 Open the TCU



3. Pull the TCU away from the printer at an angle to remove it.

⚠ CAUTION: Do not open the toner collection hatch cover when handling the TCU. If toner gets on clothing, wipe it off by using a dry cloth and wash the clothes in cold water. Hot water sets toner into fabric.

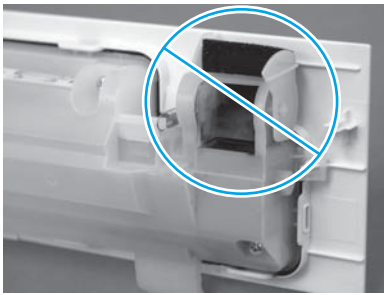
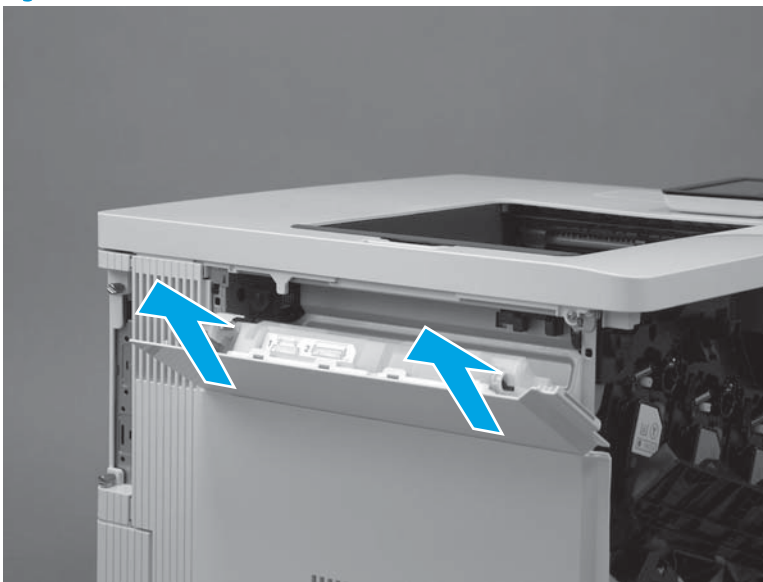

Figure 1-1706 Remove the TCU



Step 2: Remove the formatter cover

1. Locate the formatter cover.

Figure 1-1707 Locate the formatter cover

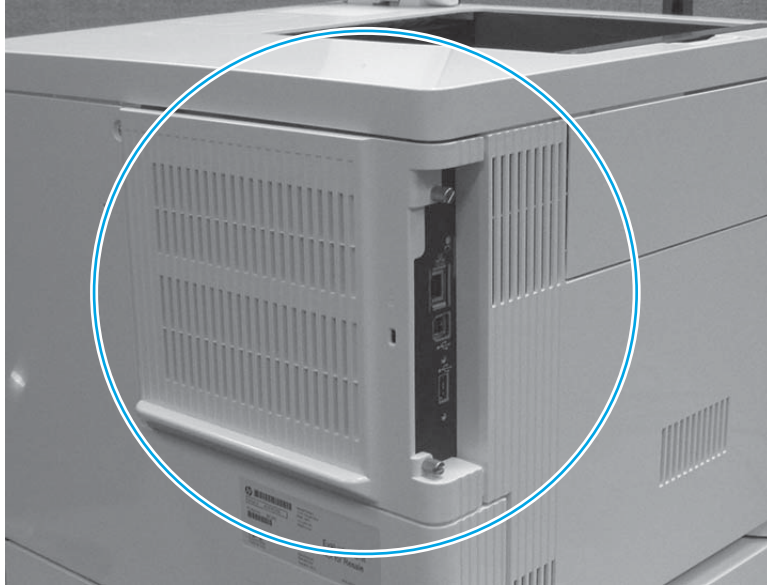

2. Loosen the two thumbscrews (callout 1). Grasp the two thumbscrews, and then slide the cover away from the printer (callout 2) to remove it.

 **TIP:** If needed, use the edge of a coin to turn the thumbscrews.

Figure 1-1708 Loosen the thumbscrews

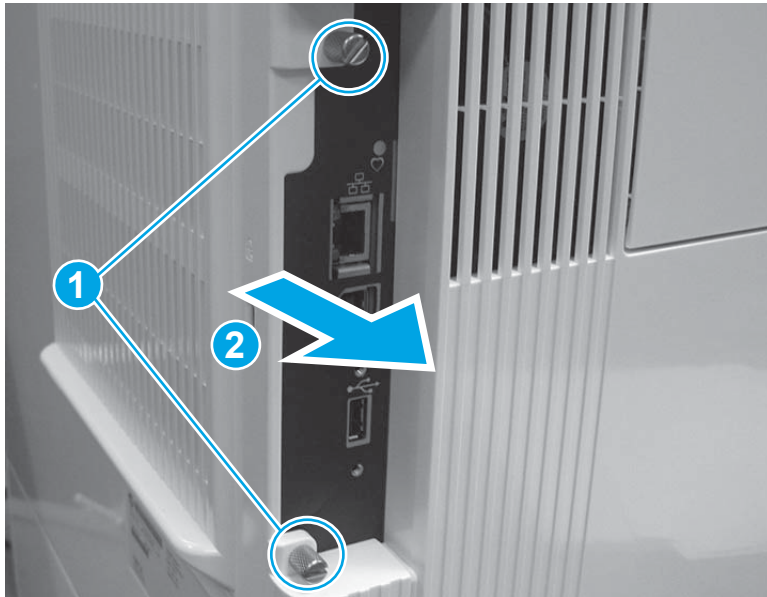

Step 3: Remove the formatter (M552 and M553)

 **NOTE:** This step is for the M552 and M553 models. For the M577 models, skip this step and go to [Step 4: Remove the hard-disk drive \(HDD\) \(M577\) on page 977](#).

If the optional hard-disk drive (HDD) is installed, it must be removed to gain access to the formatter mounting screws.

Release two tabs along the left edge of the HDD, rotate the left edge away from the product, and then slide the HDD to the left to remove it.

 **CAUTION:**  ESD-sensitive part.

1. Disconnect all of the connectors on the formatter.

The following connectors are empty:

- All models: J1 (this connector is empty unless the optional DIMM is installed)
- M553n/dn and M552dn: J2 (callout 1; this is the touchscreen connector for the M553x model)
- All models: J9 (this connector is empty unless the optional internal USB ports component is installed)
- All models: J18 (this connector is empty unless the optional hard-disk-drive (HDD) is installed)
- All models: J23
- All models: J24
- M553n/dn and M552dn: J25 (this is the wireless connector for the M553x model)
- All models: J57
- All models: J98 (this connector is empty unless the optional trusted platform module (TPM) is installed)

 **IMPORTANT:** The flat-cable connector (callout 2) is a Zero Insertion Force (ZIF) connector that uses a hinged retainer to secure the flat cable. The hinged retainer must be opened to release the flat cable.

Figure 1-1709 Disconnect all connectors



2. Remove four screws (callout 1), and then remove the formatter.

Figure 1-1710 Remove the formatter

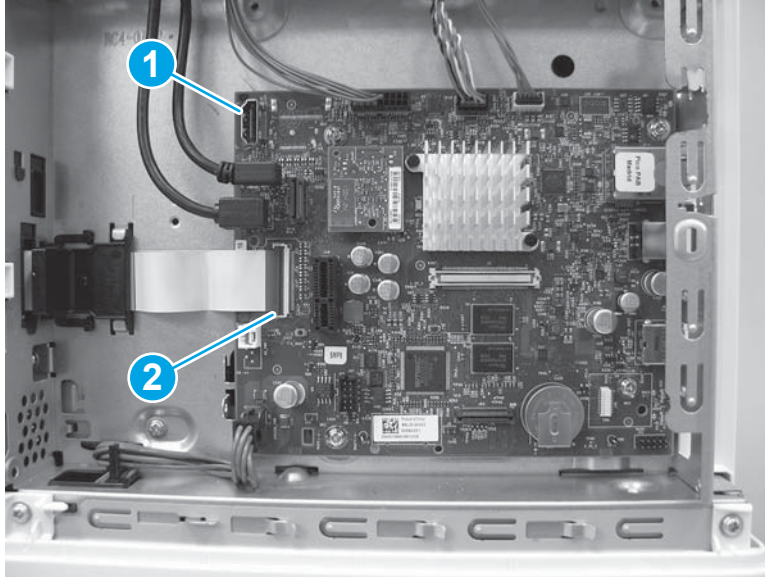
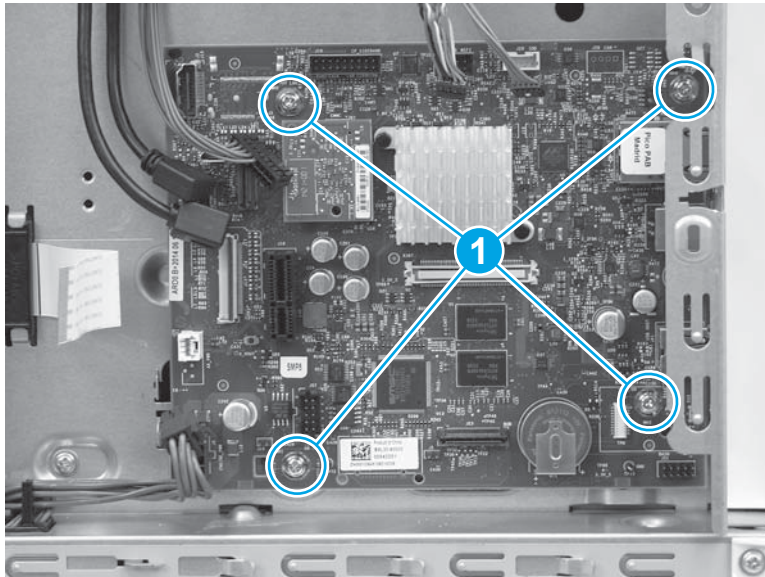

Step 4: Remove the hard-disk drive (HDD) (M577)

 **NOTE:** This step is for the M577 models. For the M552 and M553 models, skip this step and go to [Step 7: Remove the rear cover \(M552 and M553\) on page 982.](#)

 **CAUTION:**  ESD-sensitive part.

1. Release two tabs (callout 1). Hold the tabs in the released position, and then rotate the hard disk drive (HDD) up (callout 2) to release the connector from the formatter.

Figure 1-1711 Release the HDD

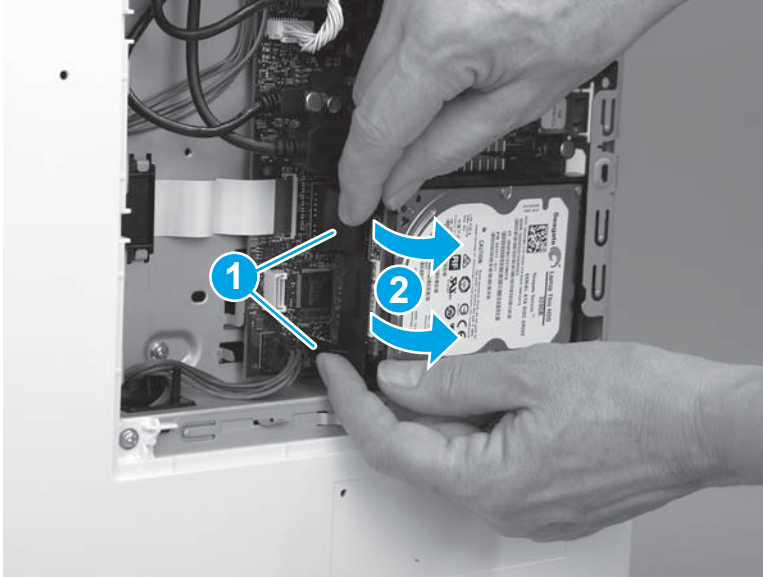

2. Slide the HDD away from the printer to remove it.

Figure 1-1712 Remove the HDD



Step 5: Remove the fax PCA (M577c/f/z)

 **NOTE:** This step is for the M577c/f/z models. For the M577n model, skip this step and go to [Step 6: Remove the formatter \(M577\) on page 980](#).

For the M552 and M553 models, skip this step and go to [Step 7: Remove the rear cover \(M552 and M553\) on page 982](#).

 **CAUTION:**  ESD-sensitive part.

1. Locate the fax PCA component on the formatter.

Figure 1-1713 Locate the fax PCA

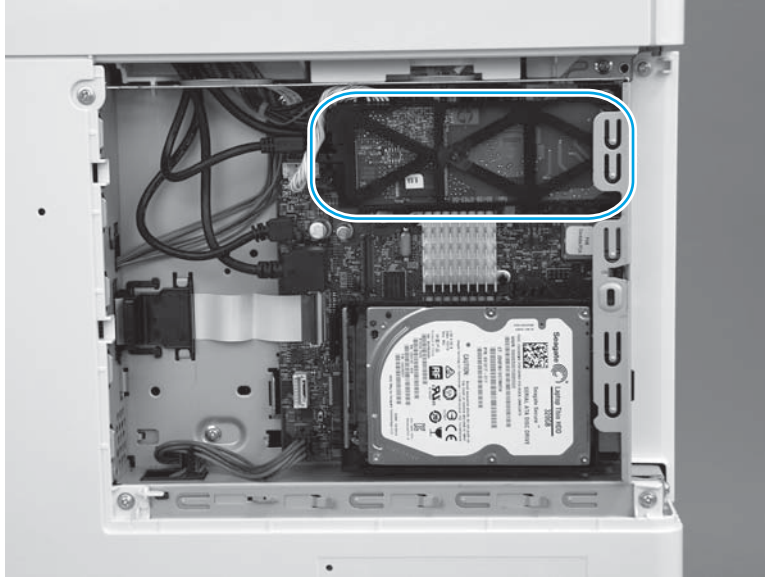

2. Release the connector latch (callout 1), and then pull the connector away from the formatter (callout 2) to disconnect it.

Figure 1-1714 Disconnect one connector

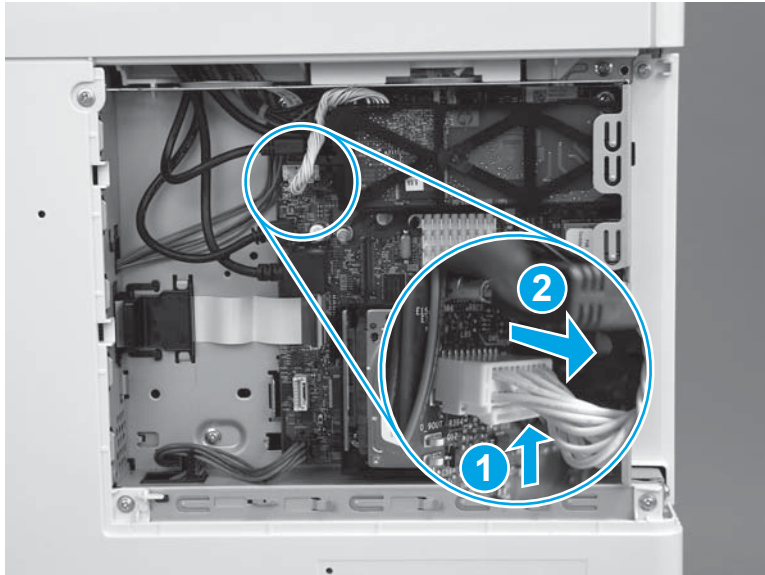

3. Release one retainer (callout 1) by pressing the bracket arms together.

Figure 1-1715 Release one latch

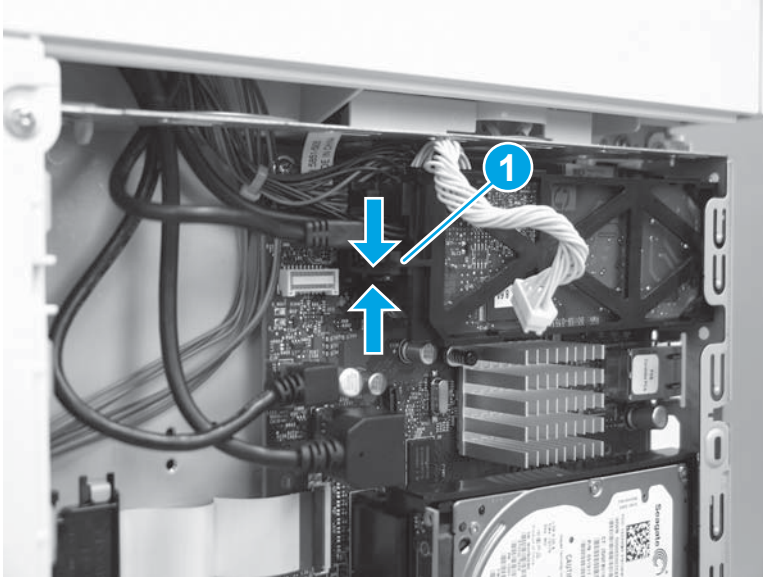

4. Rotate the end of the fax PCA (callout 1) away from the formatter, and then slide the PCA left (callout 2) to remove it.

Figure 1-1716 Remove the fax PCA

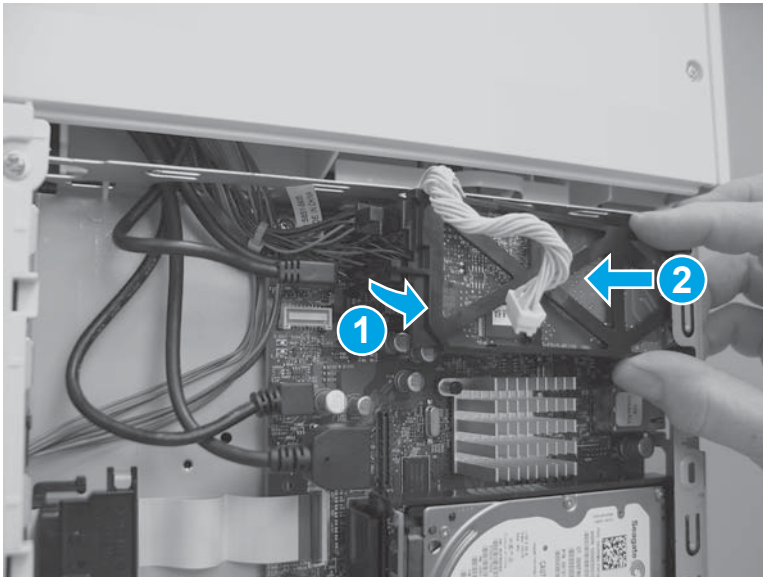

Step 6: Remove the formatter (M577)

 **NOTE:** This step is for the M577 models. For the M552 and M553 models, skip this step and go to [Step 7: Remove the rear cover \(M552 and M553\) on page 982.](#)

 **CAUTION:**  ESD-sensitive part.

1. Disconnect all of the connectors on the formatter.

The following connectors are empty:

- All models: J1 (this connector is empty unless the optional DIMM is installed)
- All models: J3
- M577dn: J15 (this is the fax connector for the M577f/z/c models)
- All models: J21 (this connector is empty unless the optional internal USB ports component is installed)
- All models: J23
- All models: J24
- All models: J51
- All models: J57
- All models: J97
- All models: J98 (this connector is empty unless the optional trusted platform module (TPM) is installed)

 **IMPORTANT:** The flat-cable connector (callout 1) is a Zero Insertion Force (ZIF) connector that uses a hinged retainer to secure the flat cable. The hinged retainer must be opened to release the flat cable.

Figure 1-1717 Disconnect all connectors



2. Remove four screws (callout 1).

Figure 1-1718 Remove four screws

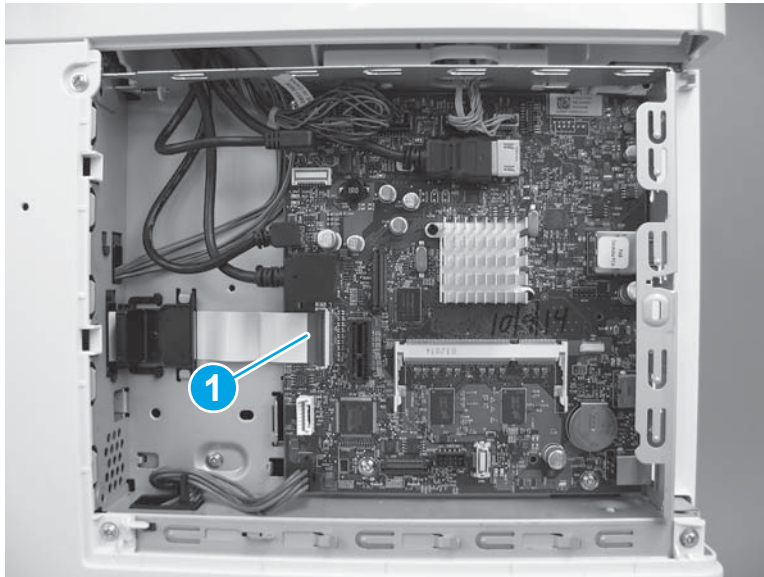
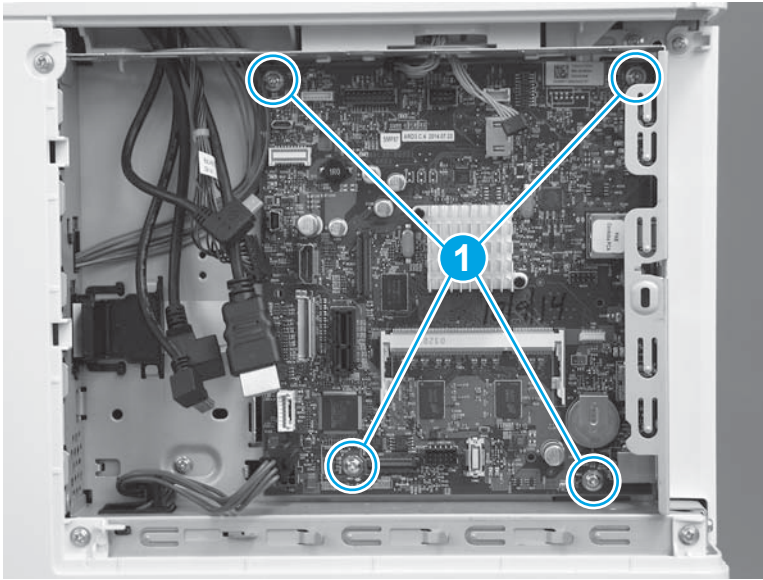

3. Remove the formatter.

Figure 1-1719 Remove the formatter

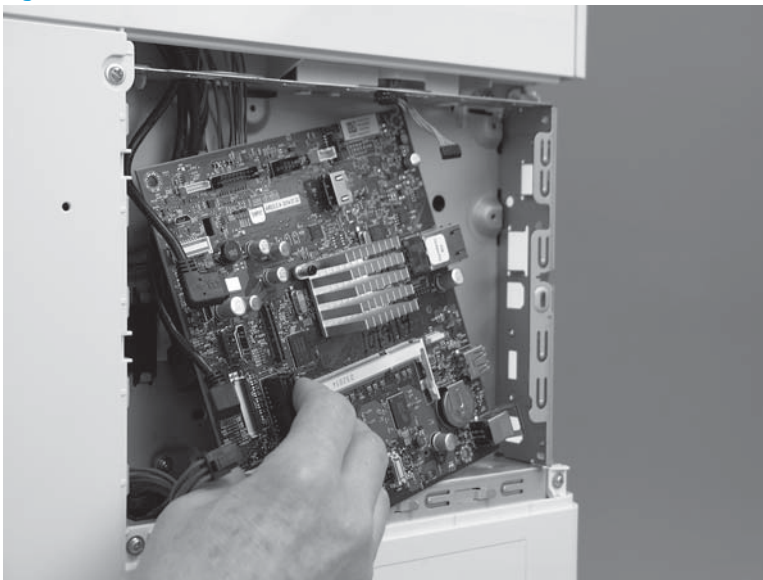

Step 7: Remove the rear cover (M552 and M553)

 **NOTE:** This step is for the M552 and M553 models. For the M577 models, skip this step and go to [Step 8: Remove the rear upper cover \(M577\) on page 983](#).

1. Remove four screws (callout 1).

Figure 1-1720 Remove four screws

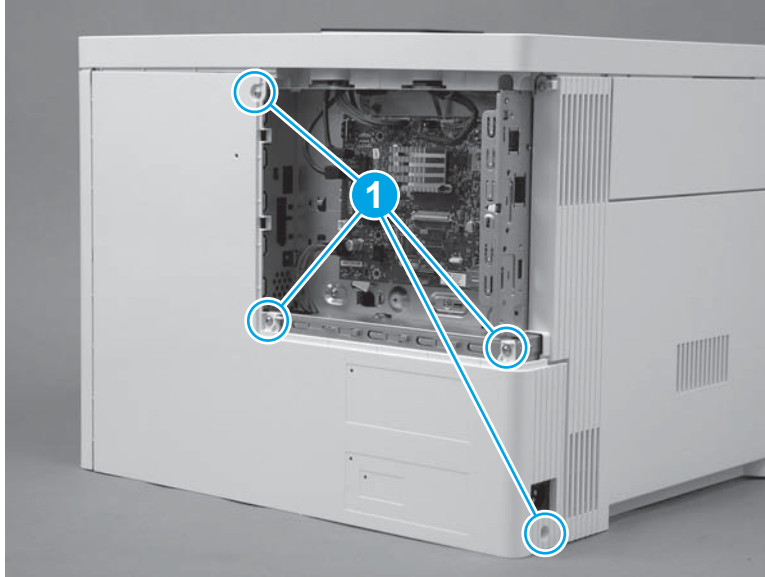

2. Slightly slide the cover to the right (callout 1), rotate the bottom of the cover away from the printer (callout 2), and then pull the top of the cover away from the printer (callout 3) to remove the cover.

Figure 1-1721 Remove the cover

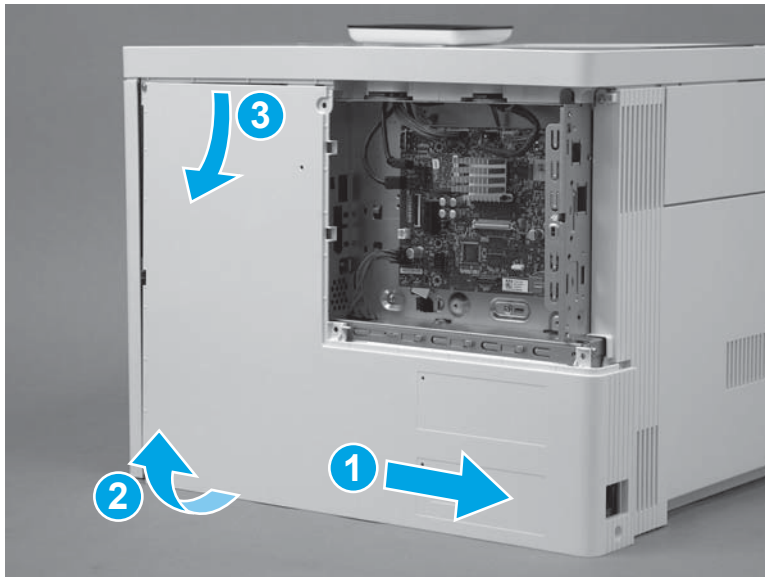

Step 8: Remove the rear upper cover (M577)

 **NOTE:** This step is for the M577 models. For the M552 and M553 models, skip this step and go to [Step 10: Remove the left cover on page 986](#).

1. Remove two screws (callout 1).

 **Reinstallation tip:** These two screws are self-tapping screws for plastic. When reinstalling them, rotate the screws counterclockwise to align them with the existing thread pattern, and then carefully turn them clockwise to tighten. Do not overtighten. This will prevent stripping the threads inside the screw holes.

Figure 1-1722 Remove two screws



2. Use a small, flat blade screwdriver to release the right edge of the cover.

Figure 1-1723 Release the right edge

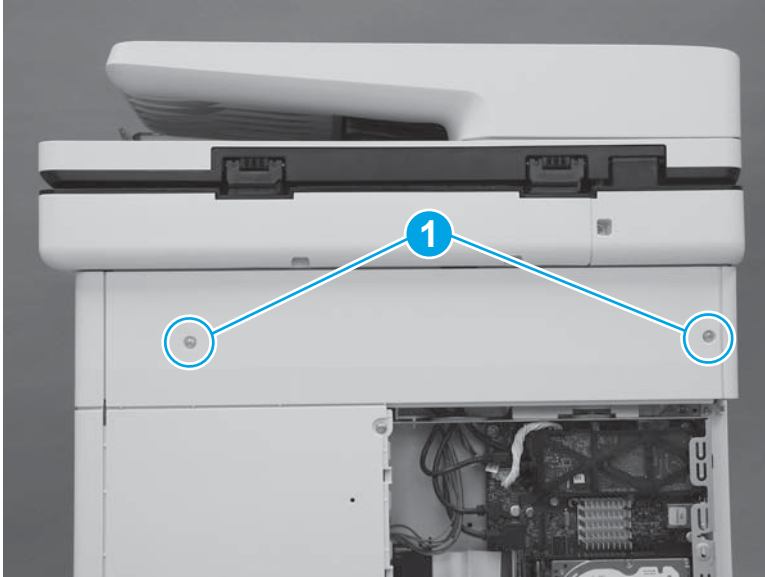
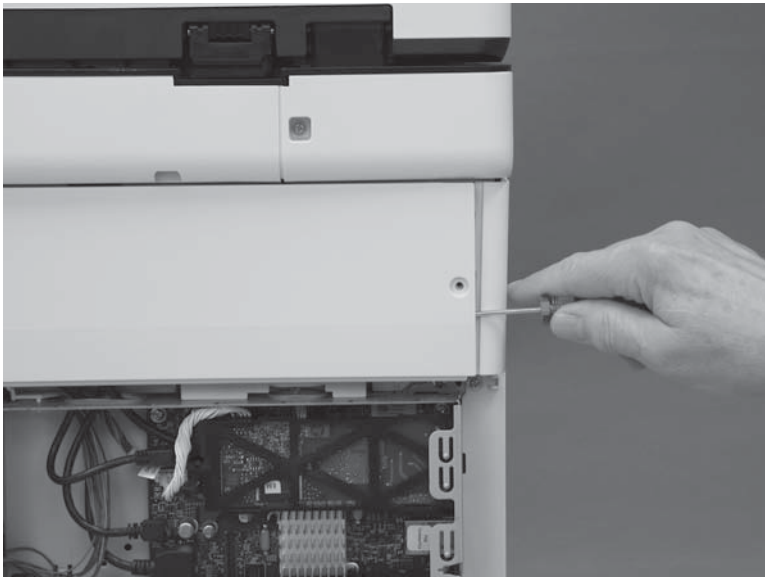

3. Pull the right edge of the cover (callout 1) away from the printer, and then slide the cover to the right (callout 2).

Figure 1-1724 Slide the cover right

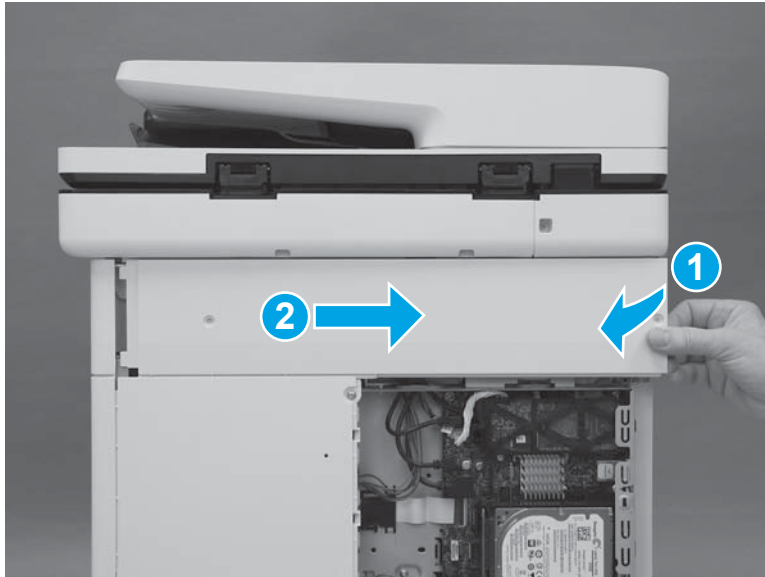

4. Remove the cover.

Figure 1-1725 Remove the cover

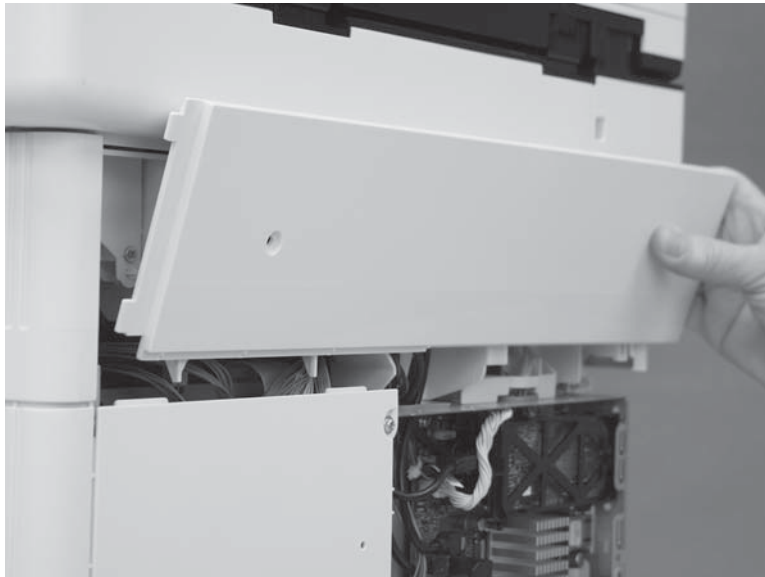

Step 9: Remove the rear cover (M577)

 **NOTE:** This step is for the M577 models. For the M552 and M553 models, skip this step and go to [Step 10: Remove the left cover on page 986.](#)

1. Remove four screws (callout 1).

Figure 1-1726 Remove four screws

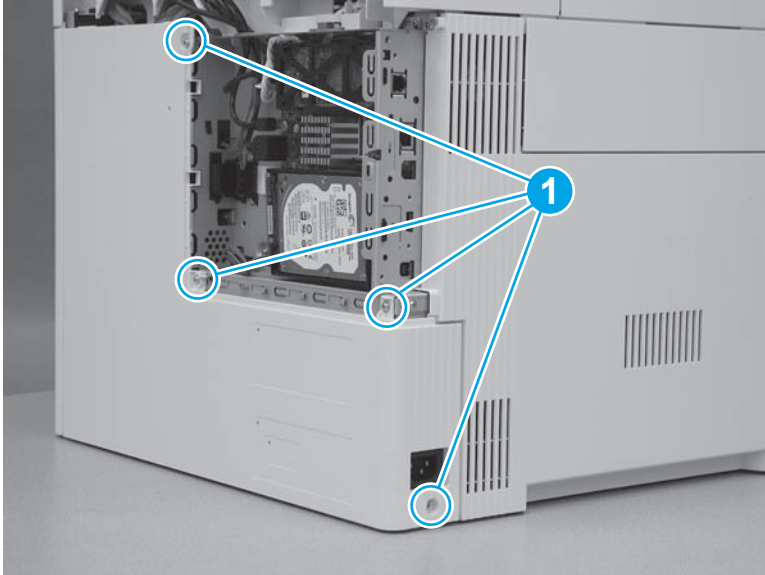

2. Slide the cover to the right to remove it.

Figure 1-1727 Remove the cover

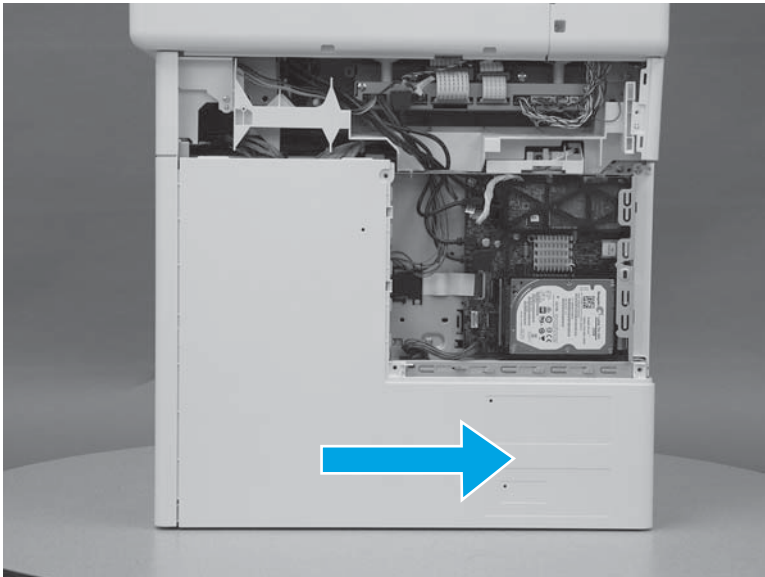

Step 10: Remove the left cover

1. At the left side of the printer, remove one screw (callout 1).

Figure 1-1728 Remove one screw



2. Release one tab (callout 1), rotate the front edge of the cover away from the printer (callout 2), and then slide the cover (callout 3) toward the rear of the printer to release it.

Figure 1-1729 Release the cover

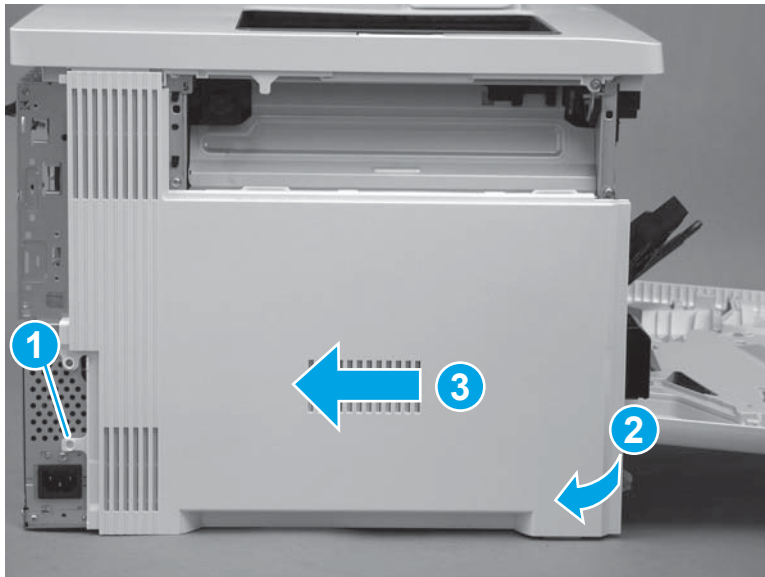

3. Remove the cover.

Figure 1-1730 Remove the cover

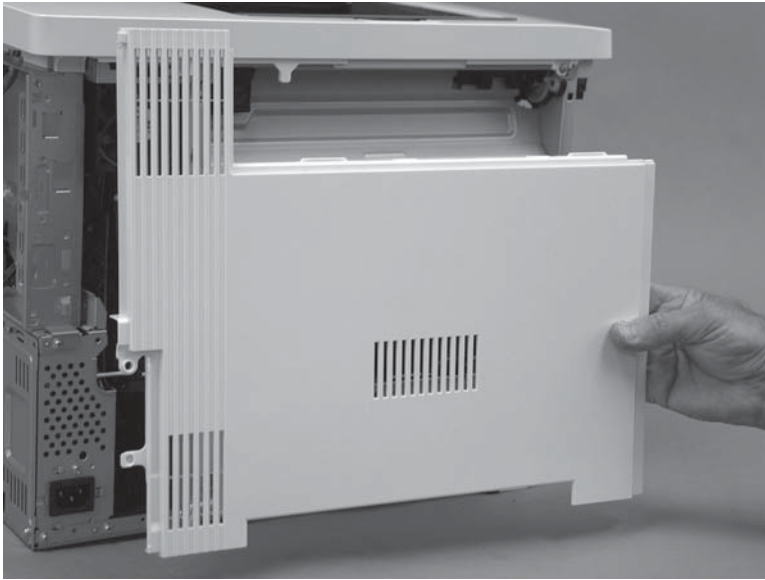

Step 11: Remove the formatter case

1. **M577 only:** Disconnect one connector (callout 1), and then pass the wire harness (callout 2) through two openings in the formatter case (callout 3).

Figure 1-1731 Disconnect one connector

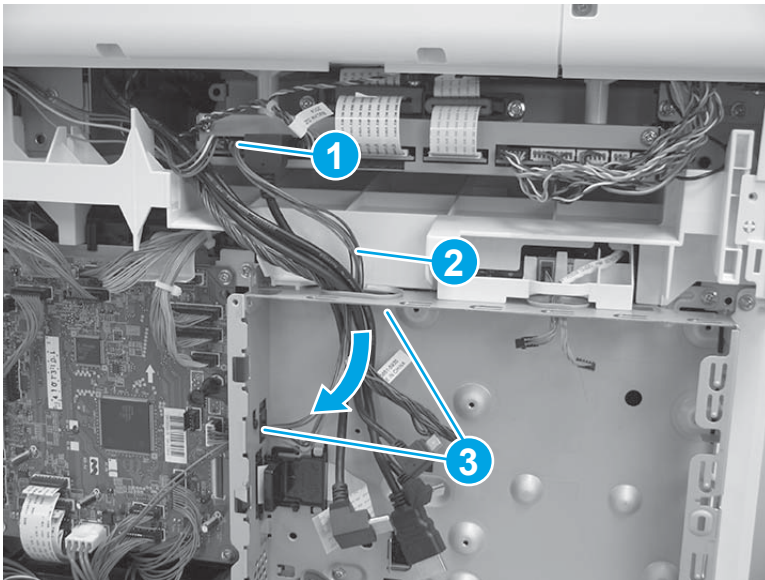

2. Release two tabs (callout 1) on the black plastic bracket. Hold the tabs in the released position, and then slide the bracket (callout 2) to the right to remove it from the formatter case.

Figure 1-1732 Remove the bracket

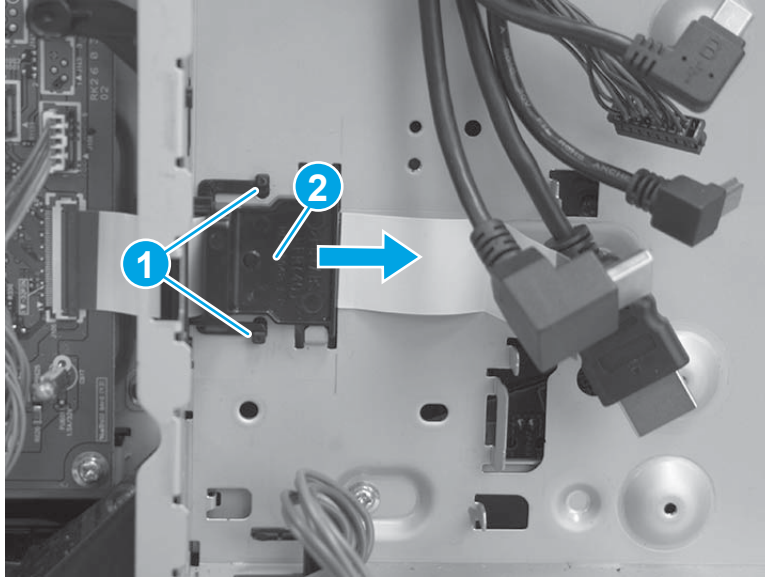

3. Remove two screws (callout 1), and then slide the low-voltage power supply (LVPS) cover to the right to remove it.

Figure 1-1733 Remove the LVPS cover

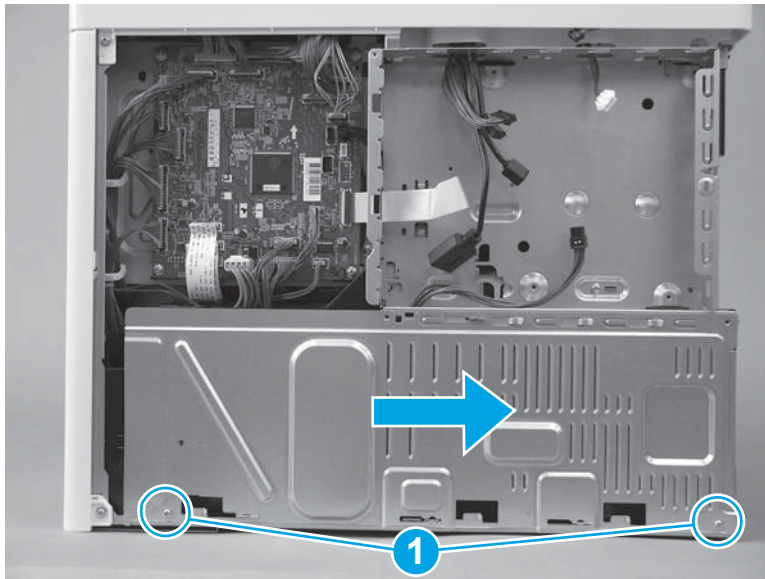

4. Pass two wire harnesses and one flat cable (callout 1) through the opening in the formatter case, and then release one wire harness from the retainer (callout 2).

⚠ CAUTION: The flat cable might be attached to the formatter case with double-sided tape. Make sure that this tape is released, so that the flat cable is not damaged when the formatter case is removed.

Figure 1-1734 Release wire harnesses and flat cable

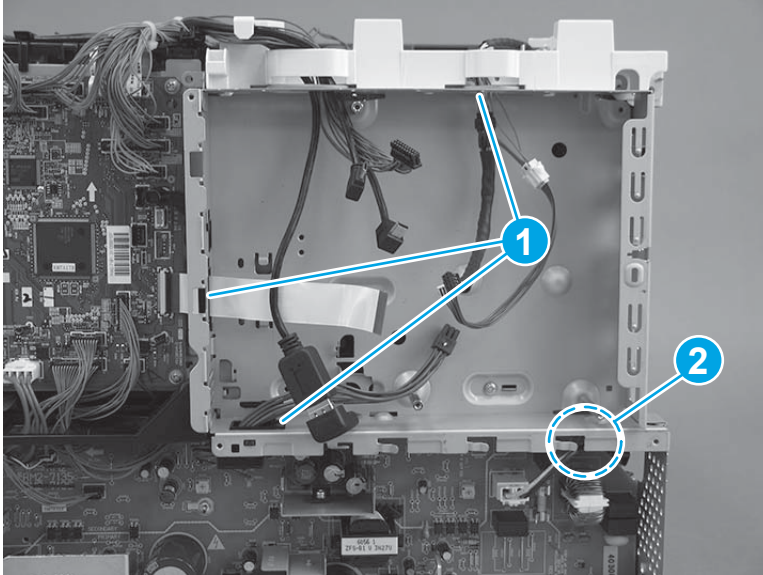

5. Remove six screws (callout 1).

Figure 1-1735 Remove six screws

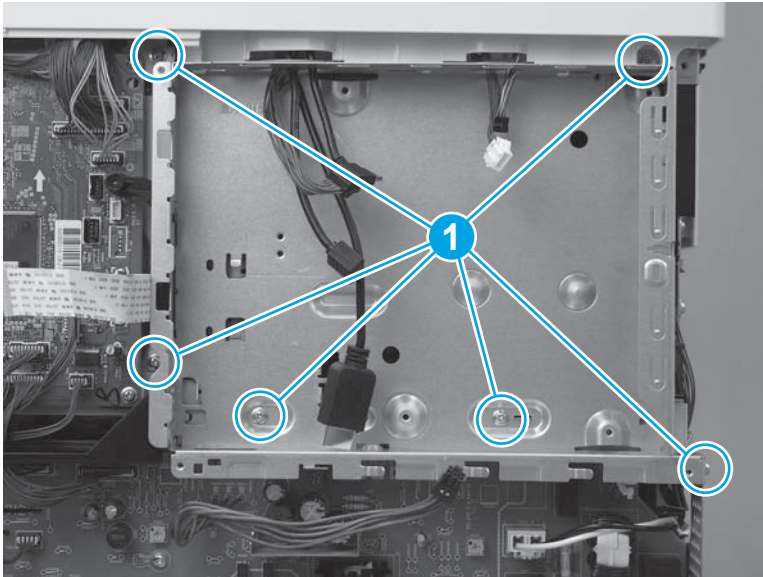

6. Rotate the bottom of the formatter case away from the printer (callout 1), and then pull it down (callout 2) to release it.

Figure 1-1736 Release the formatter case

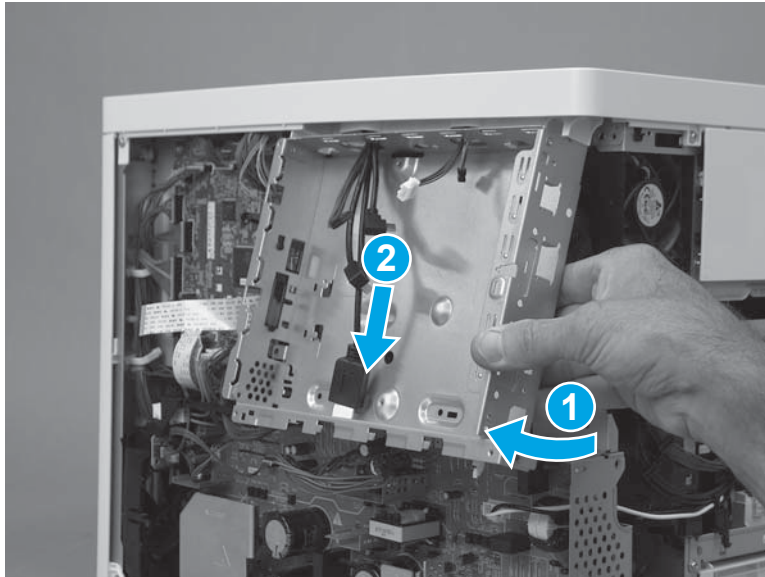

7. Pass the wire harnesses through the opening in the formatter case to remove it.

 **IMPORTANT:** If the formatter case is removed so that it can be replaced, make sure to transfer the memory PCA (island of data) and plastic bracket (callout 1) to the replacement case.

Figure 1-1737 Remove the formatter case



Step 12: Remove the low-voltage power supply (LVPS)

 **CAUTION:**  ESD-sensitive part.

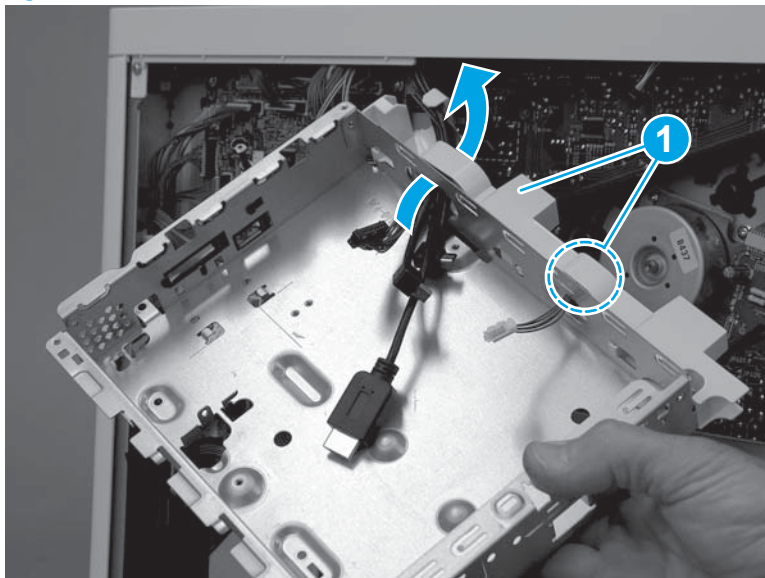
1. Disconnect one wire harness (callout 1), and then pass the wire harness through the opening (callout 2) in the chassis.

Figure 1-1738 Disconnect one wire harness

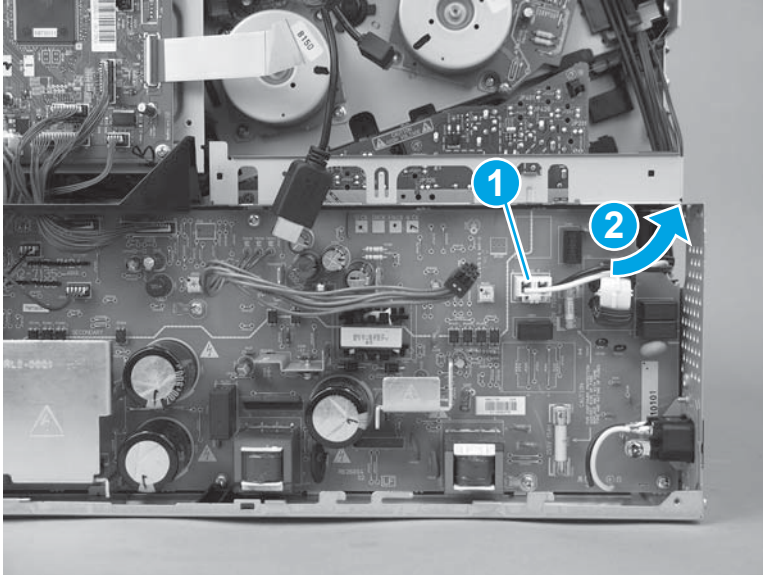

2. Disconnect three connectors on the DC controller (callout 1), and then disconnect four connectors (callout 2) on the LVPS.

Figure 1-1739 Disconnect seven connectors

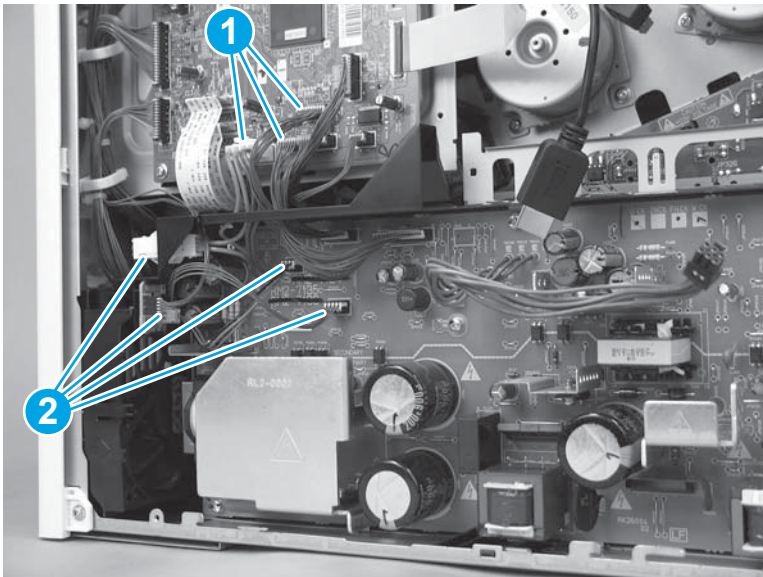

3. Pass the wire harnesses from the DC controller to the LVPS through the opening in the chassis (callout 1), and then release the wire harnesses from the retainer (callout 2).

Figure 1-1740 Pass the wire harnesses through the opening

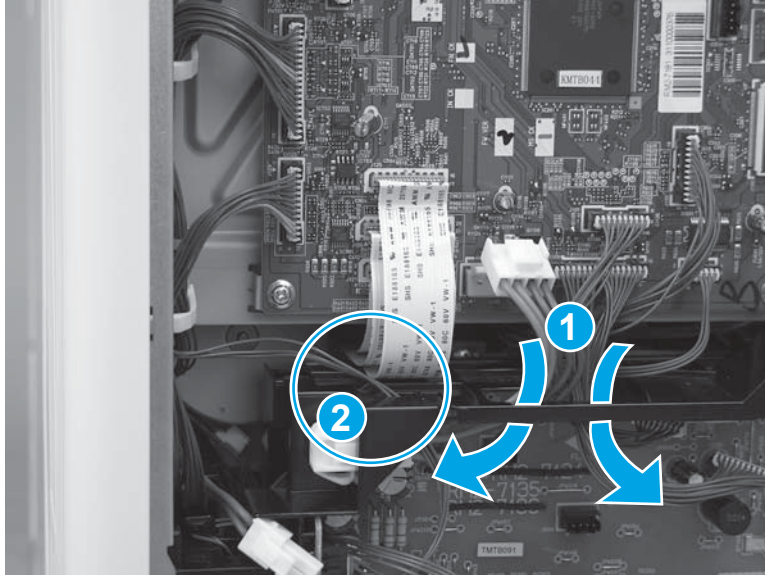

4. Remove three screws (callout 1).

Figure 1-1741 Remove three screws

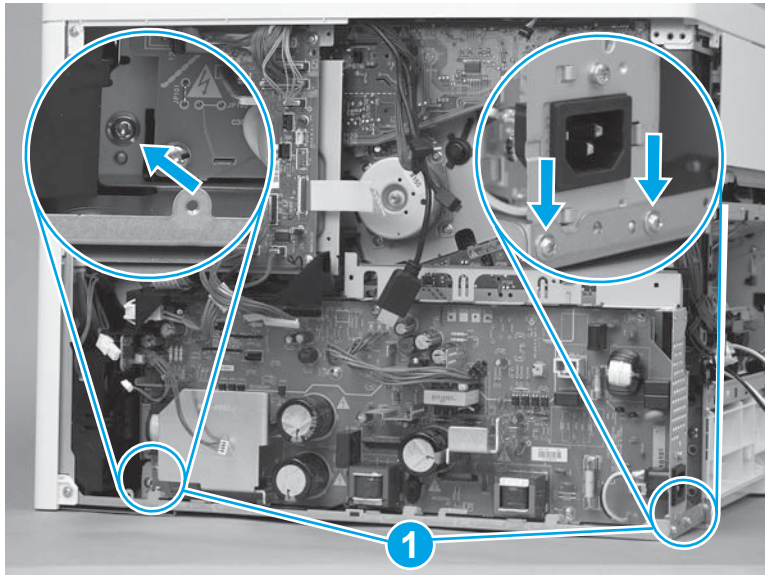

5. Rotate the top of the LVPS away from the printer (callout 1), and then slide it up and out (callout 2) of the printer to remove it.

Figure 1-1742 Remove the LVPS

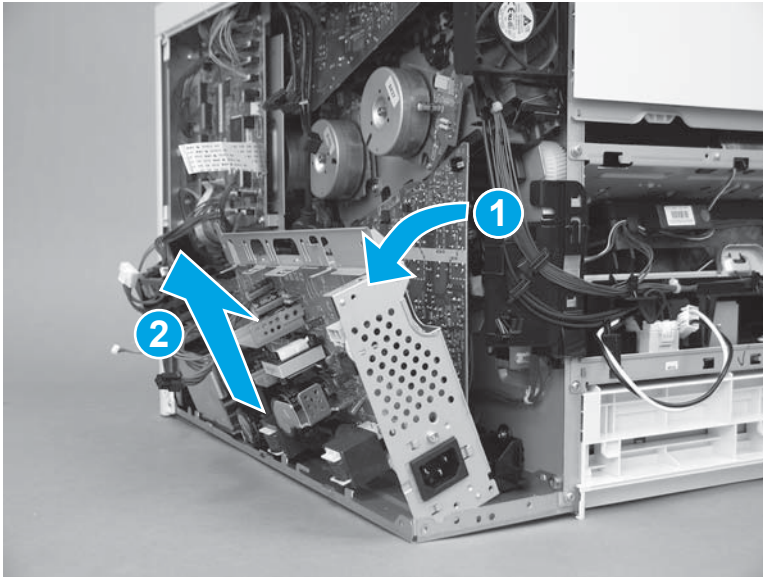

Step 13: Unpack the replacement assembly

Unpack the replacement assembly from the packaging.

 **CAUTION:**  ESD-sensitive part.

For complete information on HP's recycling programs, go to [Product return and recycling](#).

 **NOTE:** HP recommends responsible disposal of the defective assembly.

Figure 1-1743 Recycle and unpack

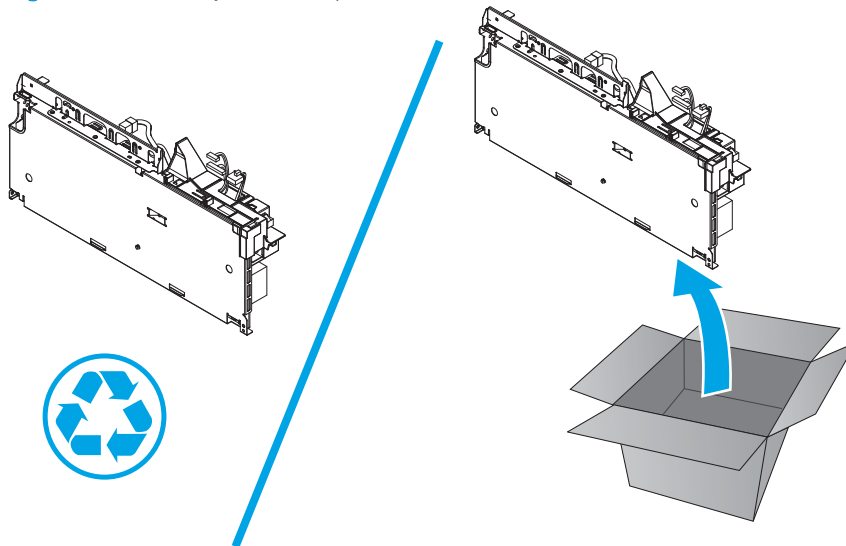

Step 14: Install the LVPS

 **CAUTION:**  ESD-sensitive part.

1. Position the bottom of the LVPS in the printer (callout 1) at a slight angle, and then rotate the top of it into the printer (callout 2) to install it.

Figure 1-1744 Install the LVPS

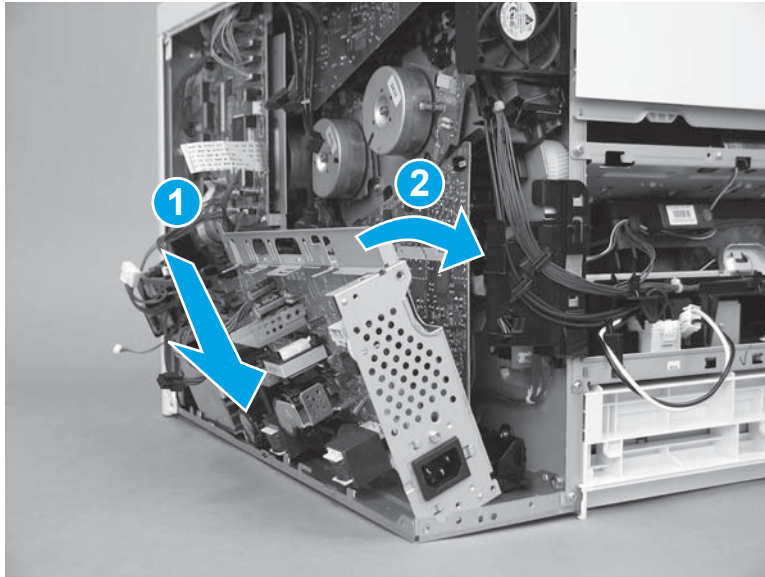

2. Install three screws (callout 1).

Figure 1-1745 Install three screws

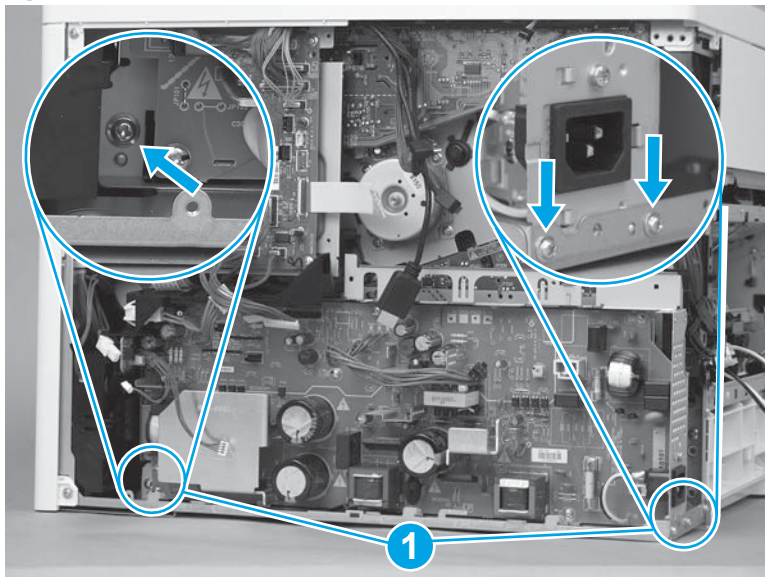

3. Pass the wire harnesses from the DC controller to the LVPS through the opening in the chassis (callout 1), and then install the wire harnesses in the retainer (callout 2).

Figure 1-1746 Pass the wire harnesses through the opening

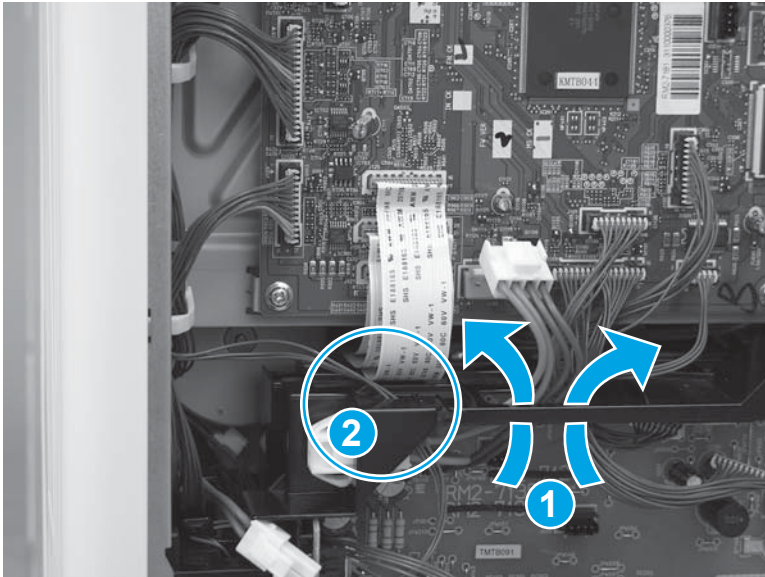

4. Connect three connectors on the DC controller (callout 1), and then connect four connectors (callout 2) on the LVPS.

Figure 1-1747 Connect seven connectors

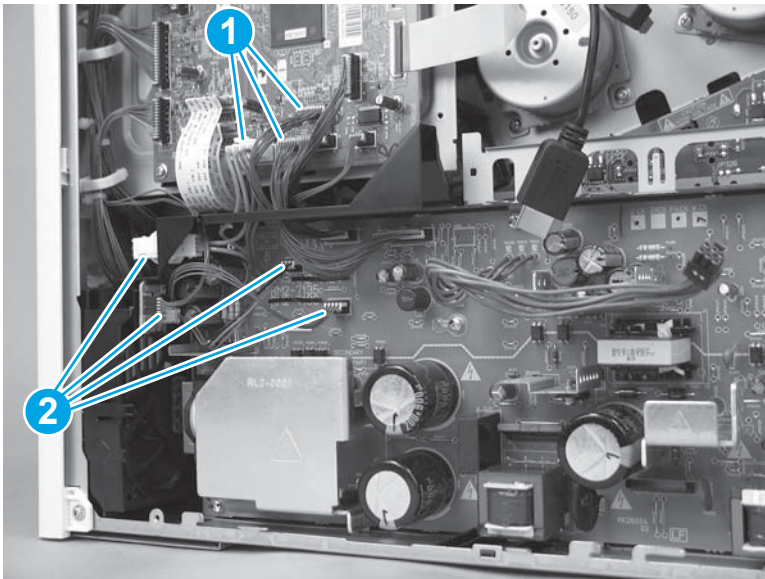

5. Pass the wire harness through the opening (callout 1) in the chassis, and then connect one wire harness (callout 2).

Figure 1-1748 Connect one wire harness

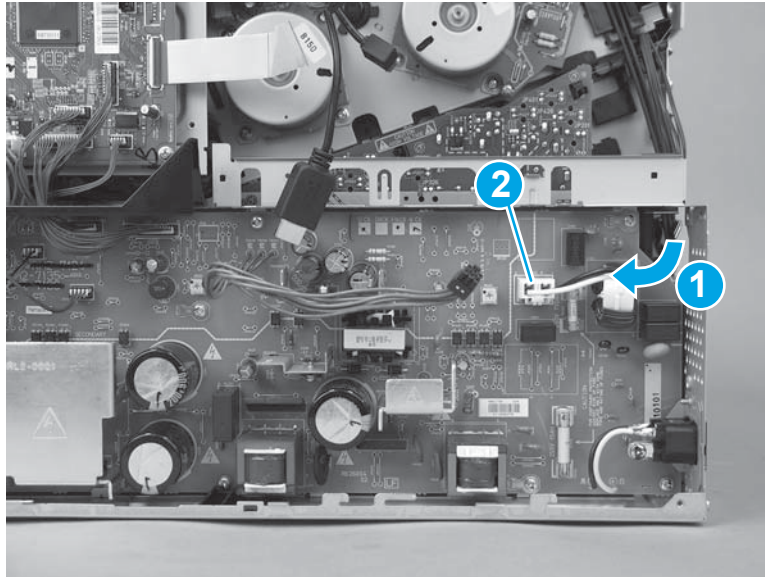

Step 15: Install the formatter case

1. Pass the wire harnesses through the opening in the formatter case.

Figure 1-1749 Pass the wire harnesses through the opening

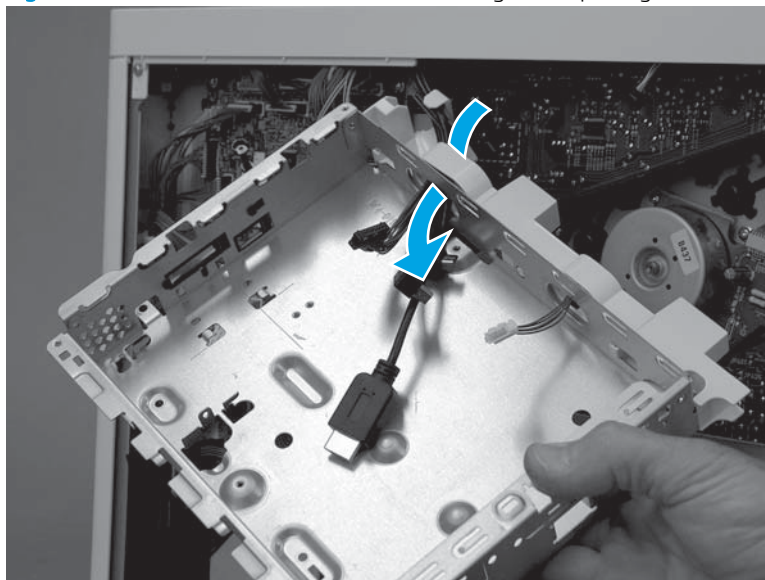

2. Position the top of the formatter case on the printer (callout 1), and then rotate the bottom of the case (callout 2) into the printer.

Figure 1-1750 Install the formatter case

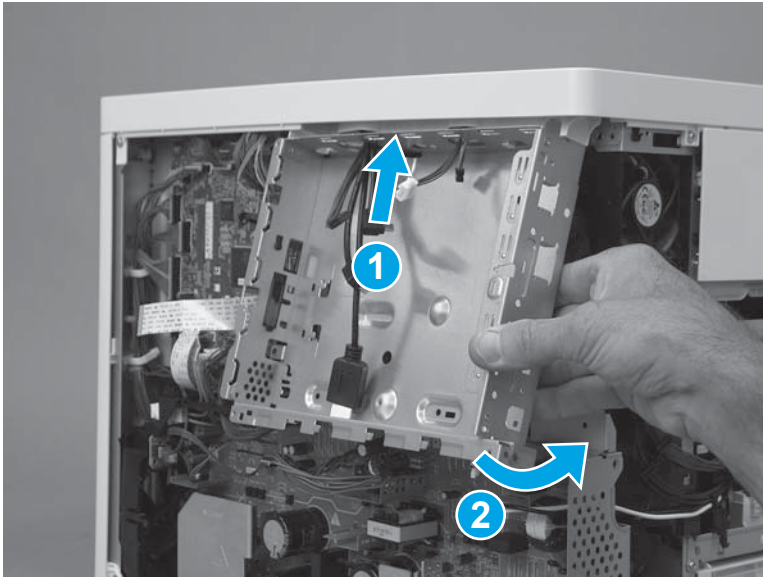

3. Install six screws (callout 1).

Figure 1-1751 Install six screws

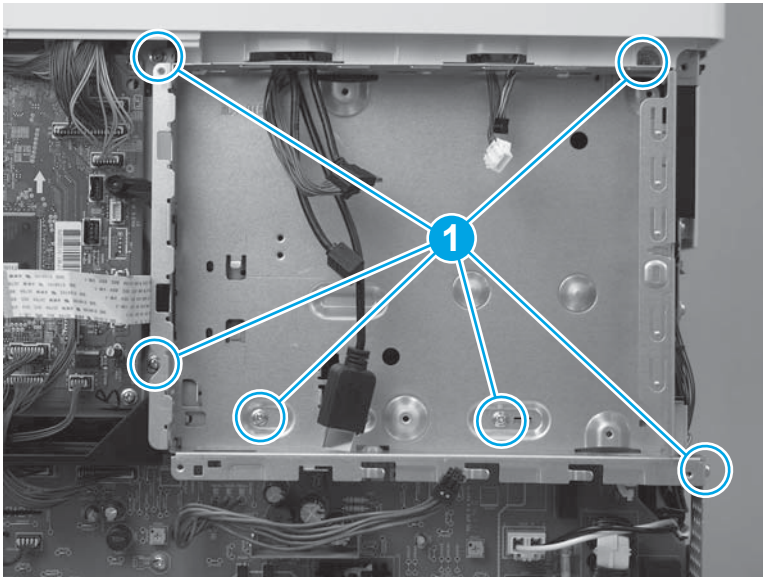

4. Pass two wire harnesses and one flat cable (callout 1) through the opening in the formatter case, and then install one wire harness in the retainer (callout 2).

 **IMPORTANT:** Make sure that the flat cable is securely fastened to the DC controller, and was not dislodged when the formatter case was removed.

Figure 1-1752 Install wire harnesses and flat cable



5. Position the LVPS cover on the printer, slide the cover to the left to install it, and then install two screws (callout 1).

Figure 1-1753 Install the LVPS cover

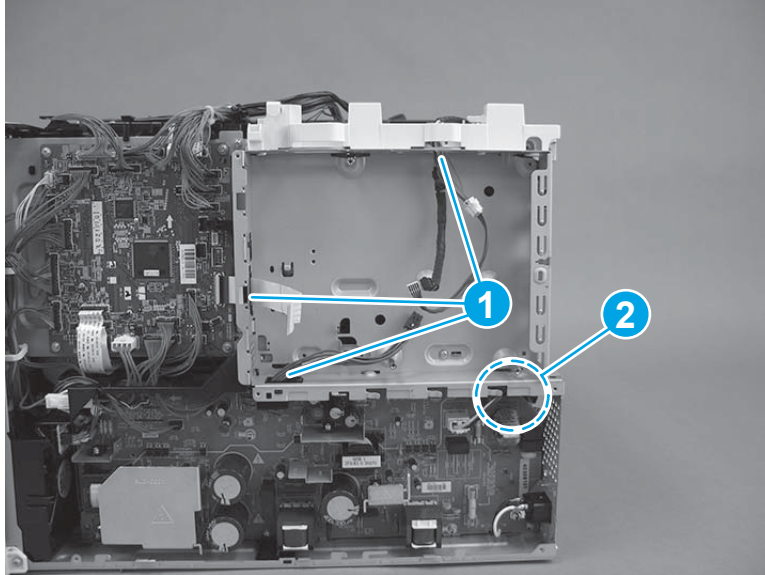
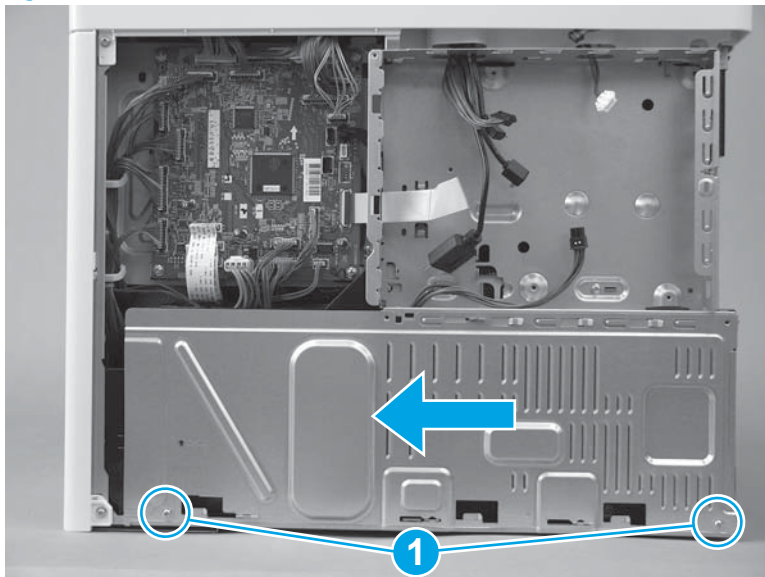

6. If no tape is affixed to the back of the flat cable, skip this step. If double-sided tape is affixed to the back of the flat cable, align the line (callout 1) on the cable with the edge (callout 2) of the opening in the sheet metal. Press to attach the flat cable to the formatter case.

Figure 1-1754 Attach the flat cable

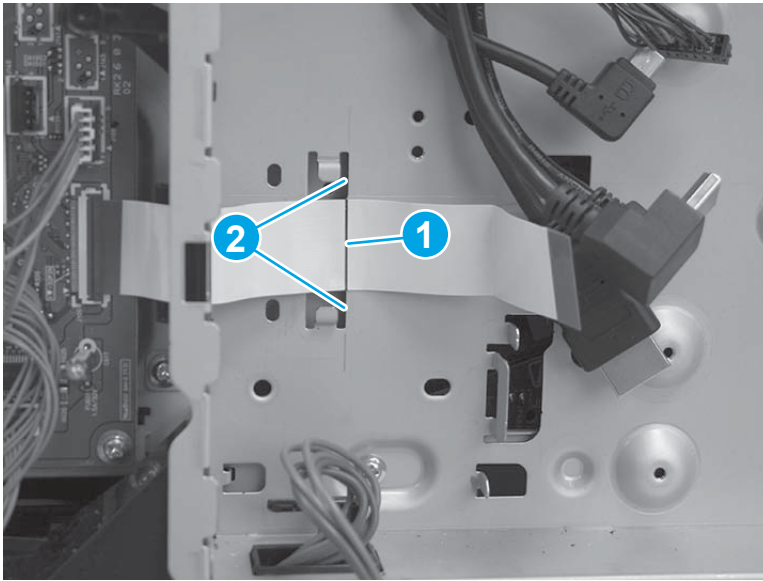

7. Position the bracket over the flat cable, and then slide the bracket to the left to install it. Make sure that the edges of the bracket fit under the sheet metal tabs (callout 1) on the formatter case and that the tabs (callout 2) snap into place.

Figure 1-1755 Position the bracket

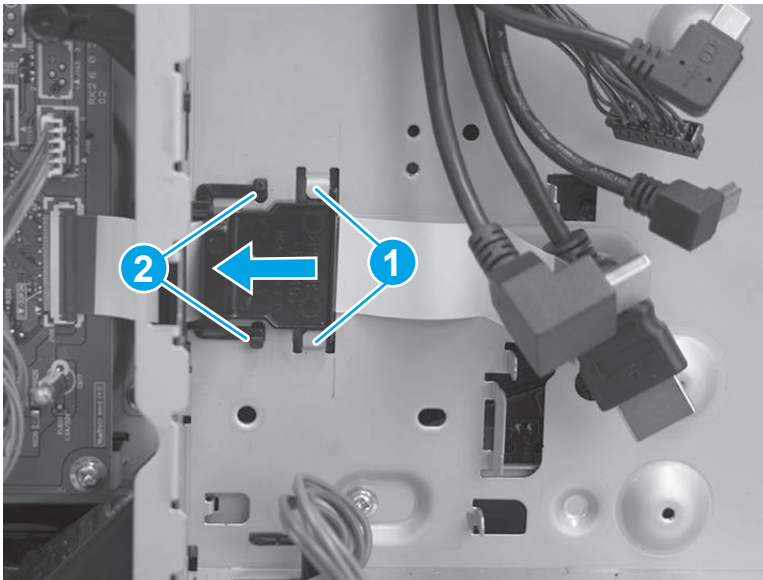

8. **M577 only:** Pass the wire harness (callout 1) through the openings in the formatter case (callout 2), and then connect one connector (callout 3).

Figure 1-1756 Connect one connector

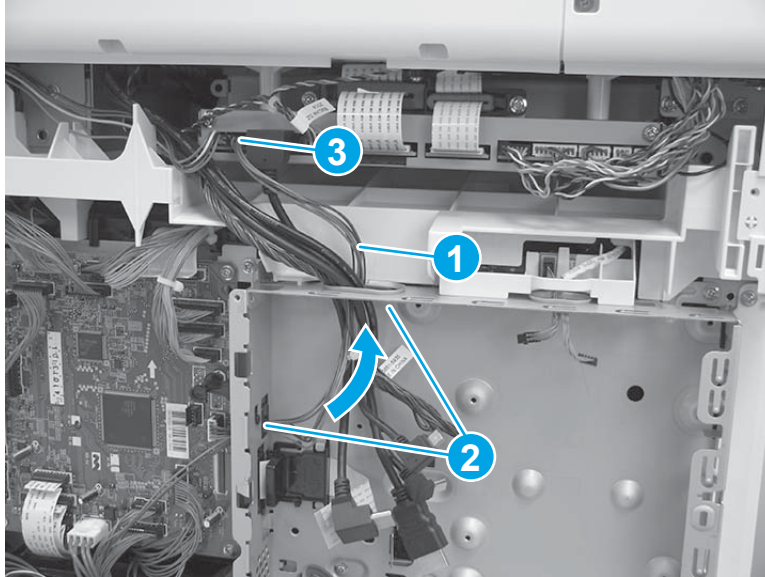

Step 16: Install the left cover

1. Position the cover on the printer.

 **NOTE:** Slightly offset the cover toward the rear of the printer.

Figure 1-1757 Install the cover

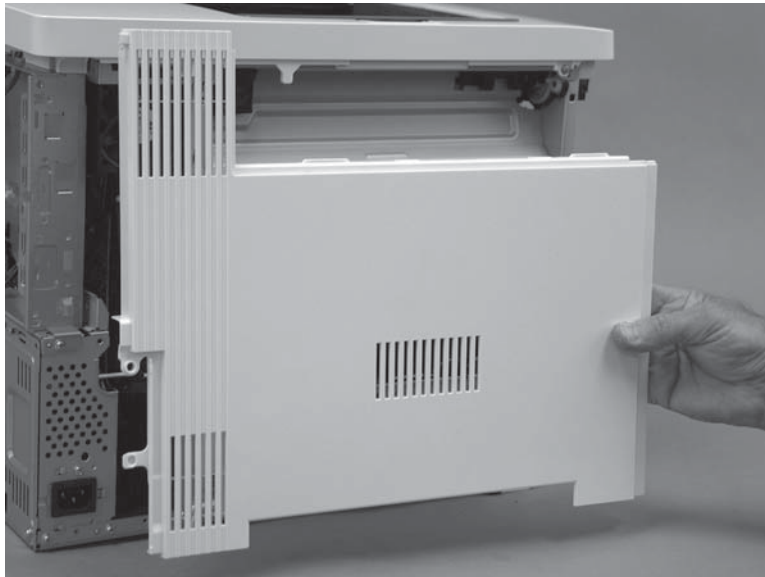

- Slide the cover (callout 1) toward the front of the printer to engage it. Make sure that the tab (callout 2) snaps into place.

 **NOTE:** Locate the alignment pin (callout 3) on the cover from the front door side of the printer, and then make sure that it is fully engaged in the slot in the chassis.

 **TIP:** While sliding the cover into place, push in on the center of the cover (callout 1) to make sure that the hooks on the back of the cover engage with the slots in the chassis.

Figure 1-1758 Engage the cover



- At the left side of the printer, install one screw (callout 1).

Figure 1-1759 Install one screw

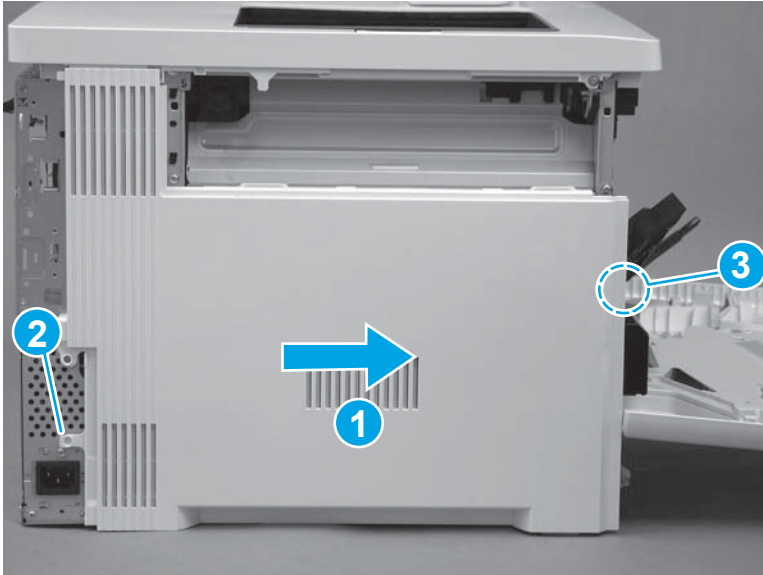

Step 17: Install the rear cover (M577)

 **NOTE:** This step is for the M577 models. For the M552 and M553 models, skip this step and go to [Step 19: Install the rear cover \(M552 and M553\) on page 1006](#).

1. Position the hooks (callout 1) on the cover in the slots (callout 2) in the printer.

Figure 1-1760 Position the hooks

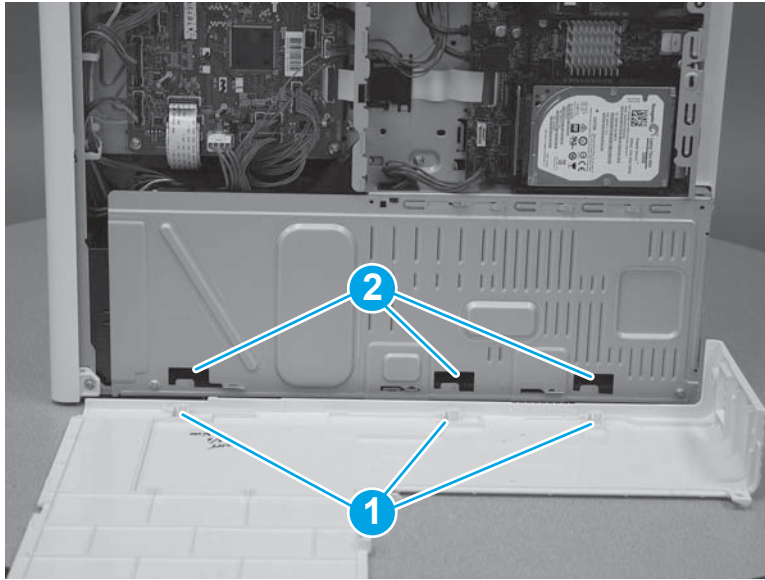

2. Position the back edge (callout 1) of the rear cover behind the edge (callout 2) of the right rear cover. Slide the cover to the left to install it.

Figure 1-1761 Install the cover

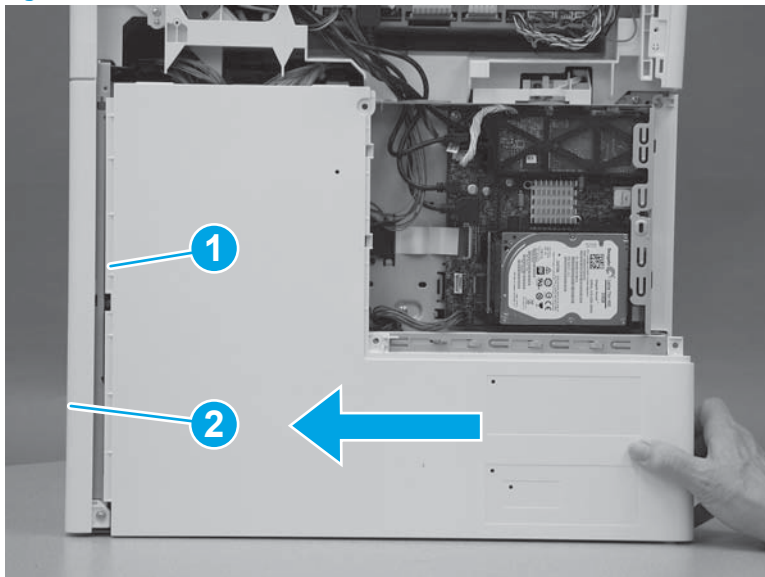

3. Install four screws (callout 1).

Figure 1-1762 Install four screws cover

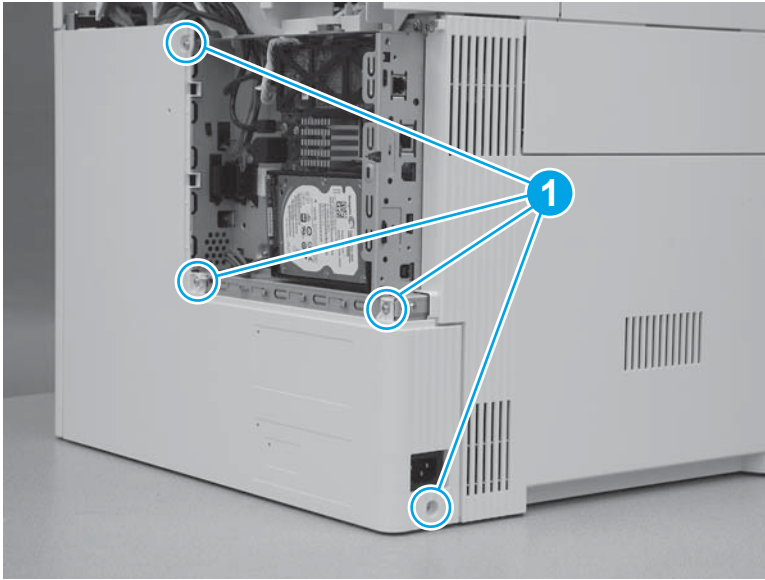

Step 18: Install the rear upper cover (M577)



NOTE: This step is for the M577 models. For the M552 and M553 models, skip this step and go to [Step 19: Install the rear cover \(M552 and M553\) on page 1006](#).

1. Align the ridge (callout 1) on the lower edge of the rear upper cover in front of the tabs (callout 2) on the top edge of the rear cover.

Figure 1-1763 Align the cover

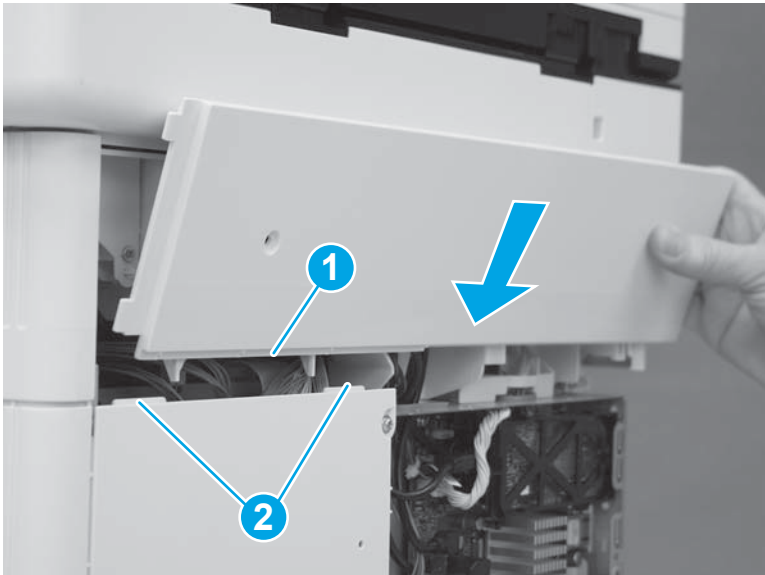

2. Rotate the top of the cover toward the printer.

Figure 1-1764 Rotate the top of the cover

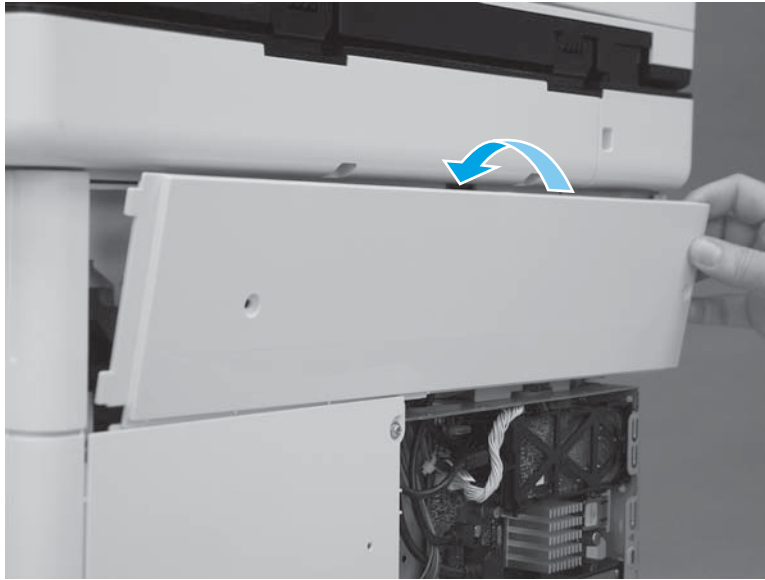

3. Slide the cover to the left (callout 1). Make sure that the tabs (callout 2) on the upper rear cover slide behind the edge (callout 3) of the right upper cover. Make sure that the cover is fully seated.

Figure 1-1765 Slide the cover

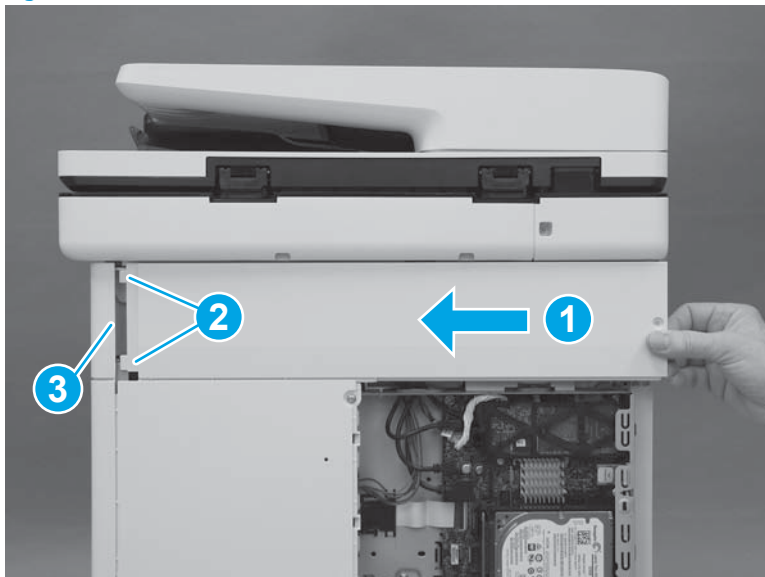

4. Install two screws (callout 1).

 **IMPORTANT:** These two screws are self-tapping screws for plastic. Rotate them counterclockwise to align them with the existing thread pattern, and then carefully turn them clockwise to tighten. Do not overtighten. This will prevent stripping the threads inside the screw holes.

Figure 1-1766 Install two screws



Step 19: Install the rear cover (M552 and M553)

 **NOTE:** This step is for the M552 and M553 models. For the M577 models, skip this step and go to [Step 20: Install the formatter \(M577\) on page 1007](#).

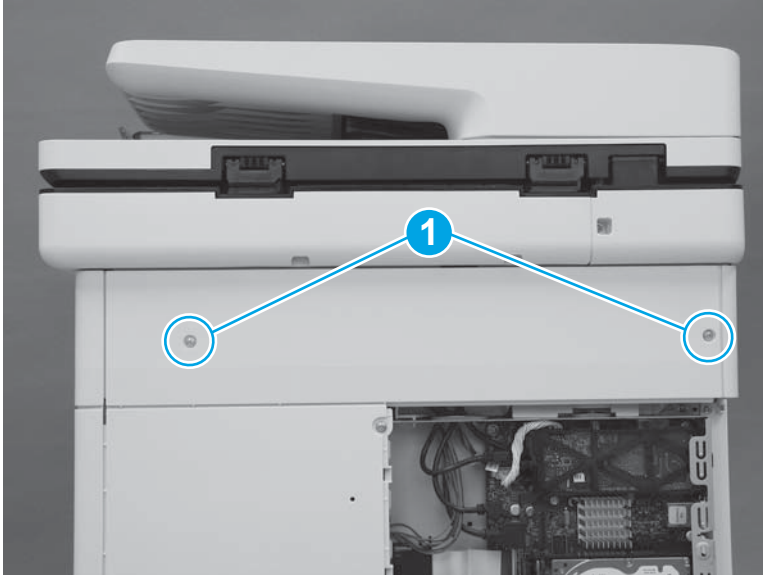
1. Position the top of the cover under the upper cover (callout 1), rotate the bottom of the cover onto the chassis (callout 2), and then slide the cover to the left (callout 3) to install it.

Figure 1-1767 Install the cover

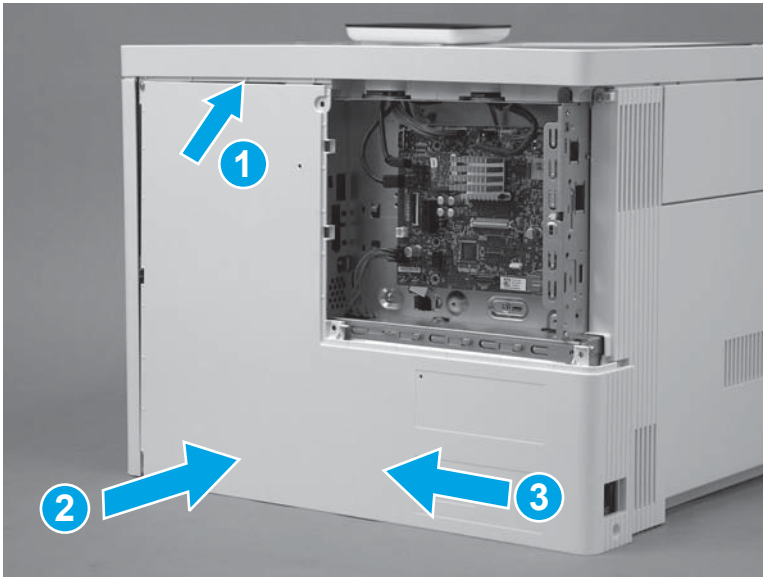

2. Install four screws (callout 1).

Figure 1-1768 Install four screws cover

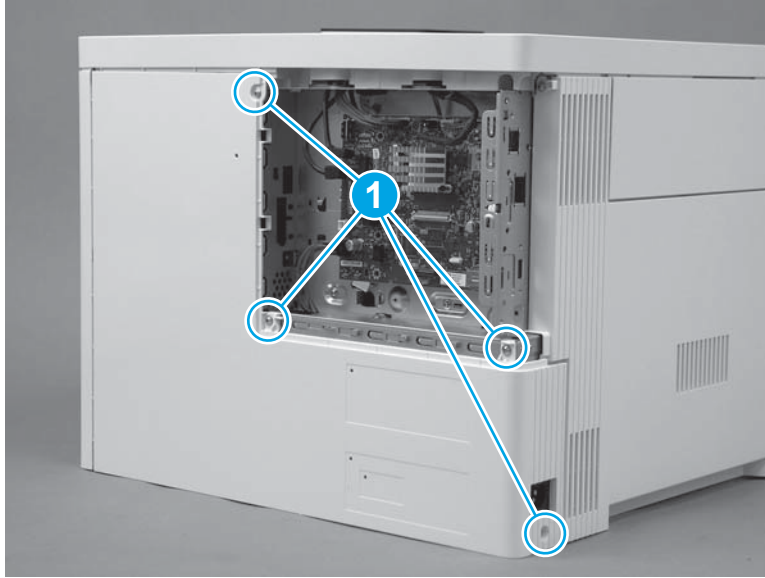

Step 20: Install the formatter (M577)

 **NOTE:** This step is for the M577 models. For the M552 and M553 models, skip this step and to go [Step 23: Install the formatter \(M552 and M553\) on page 1012](#).

 **CAUTION:**  ESD-sensitive part.

1. Position the formatter in the printer. Make sure that the network port (callout 1) fits through the opening (callout 2) in the formatter case.

Figure 1-1769 Install the formatter

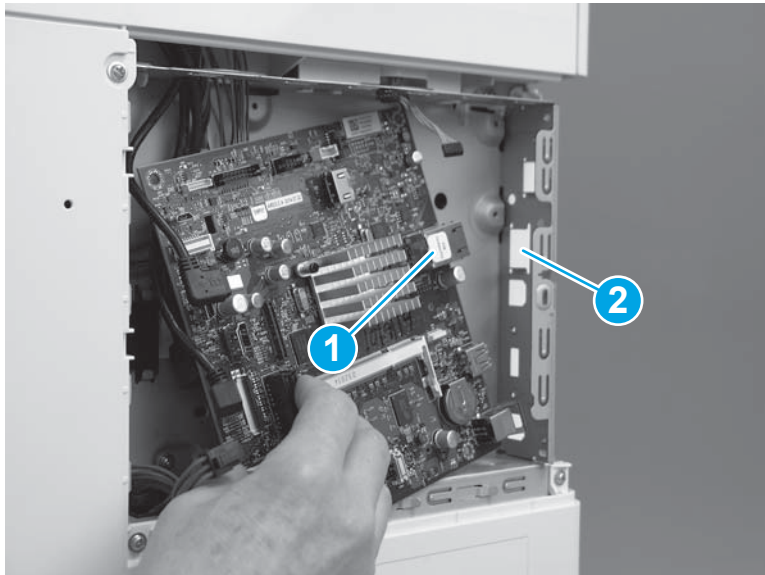

2. Install four screws (callout 1).

Figure 1-1770 Install four screws

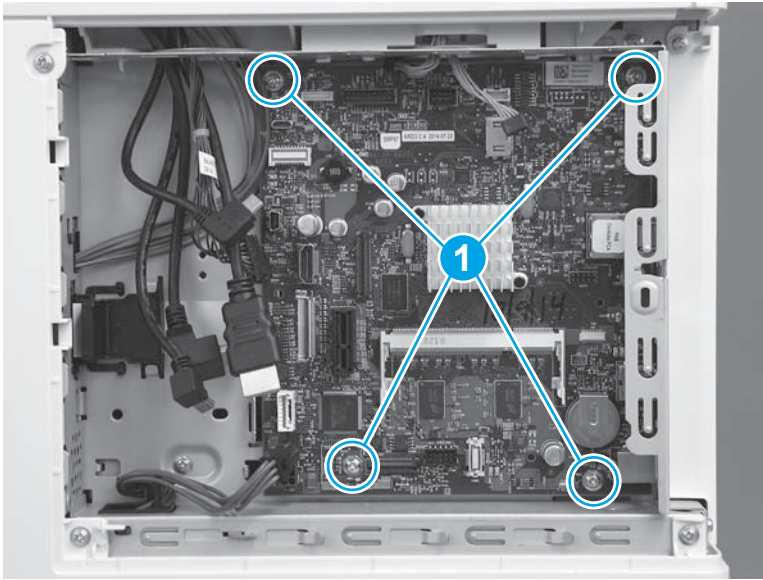

3. Connect all of the connectors on the formatter.

The following connectors are empty:

- All models: J1 (this connector is empty unless the optional DIMM is installed)
- All models: J3
- M577dn: J15 (this is the fax connector for the M577f/z/c models)
- All models: J21 (this connector is empty unless the optional internal USB ports component is installed)
- All models: J23
- All models: J24
- All models: J51
- All models: J57
- All models: J97
- All models: J98 (this connector is empty unless the optional trusted platform module (TPM) is installed)



 **IMPORTANT:** The flat-cable connector (callout 1) is a Zero Insertion Force (ZIF) connector that uses a hinged retainer to secure the flat cable. The hinged retainer must be opened to install the flat cable, and then closed after the cable is installed.

Figure 1-1771 Connect all connectors

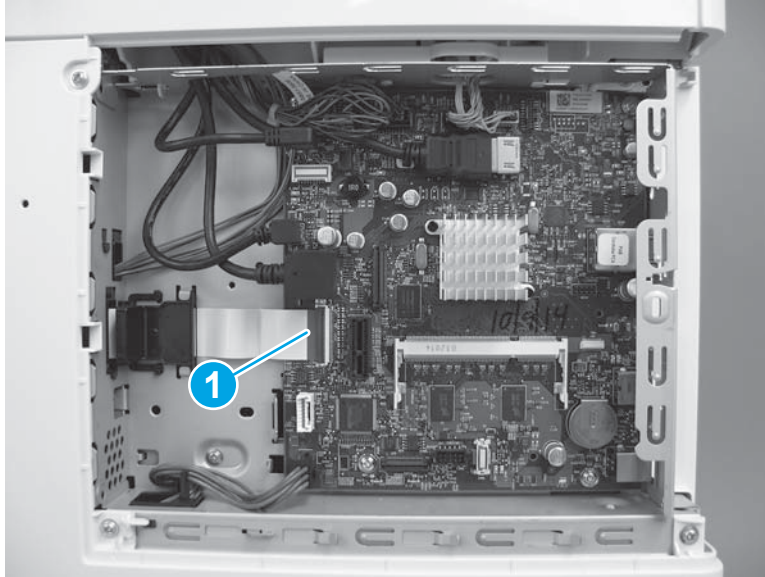

Step 21: Install the fax PCA (M577c/f/z)

 **NOTE:** This step is for the M577c/f/z models. For the M577n model, skip this step and go to [Step 22: Install the HDD \(M577\) on page 1010](#).

For the M552 and M553 models, skip this step and go to [Step 23: Install the formatter \(M552 and M553\) on page 1012](#).

 **CAUTION:**  ESD-sensitive part.

1. Position the tab and telephone port (callout 1) on the fax PCA in the slots (callout 2) in the formatter case.

Figure 1-1772 Position the fax PCA

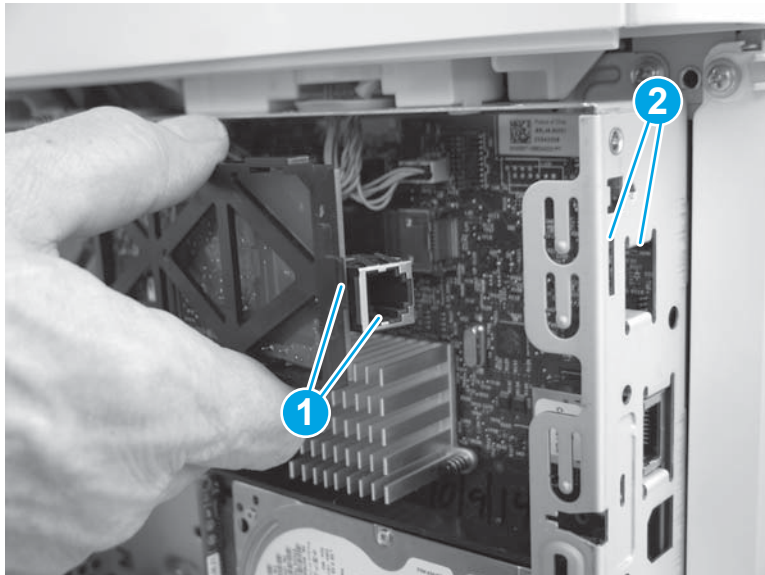

- Slide the fax PCA to the right (callout 1) until the tab and telephone port described in the previous step and seated in the formatter case. Position the retainer (callout 2) in the slot (callout 3) in the formatter. Rotate the end of the fax PCA toward the formatter (callout 4) until the retainer snaps into place.

Figure 1-1773 Install the fax PCA

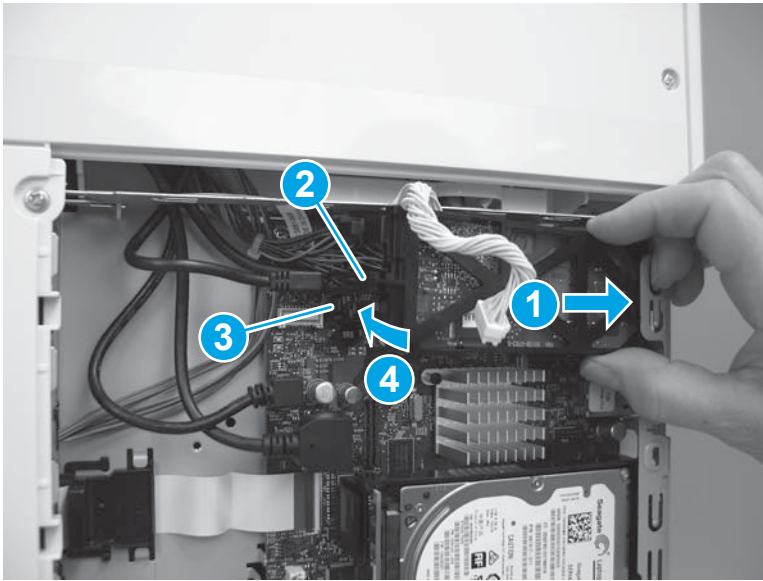

- Position the cable (callout 1) in the guide (callout 2), and then connect one connector (callout 3).

Figure 1-1774 Connect the connector

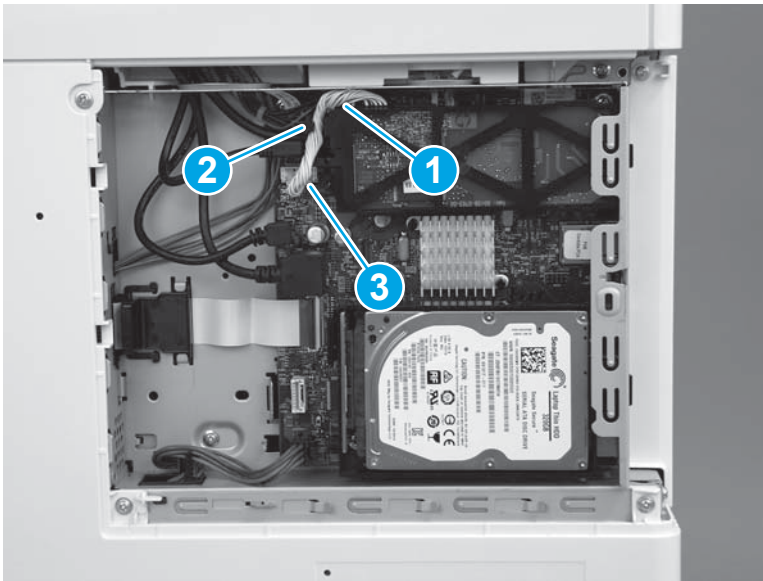

Step 22: Install the HDD (M577)



NOTE: This step is for the M577 models. For the M552 and M553 models, skip this step and go to [Step 23: Install the formatter \(M552 and M553\) on page 1012](#).

 **CAUTION:**  ESD-sensitive part.

1. Align the end of the bracket (callout 1) with the slot in the chassis (callout 2), and then slide the HDD into the printer (callout 3) to engage the bracket with the chassis.

Figure 1-1775 Install the holder

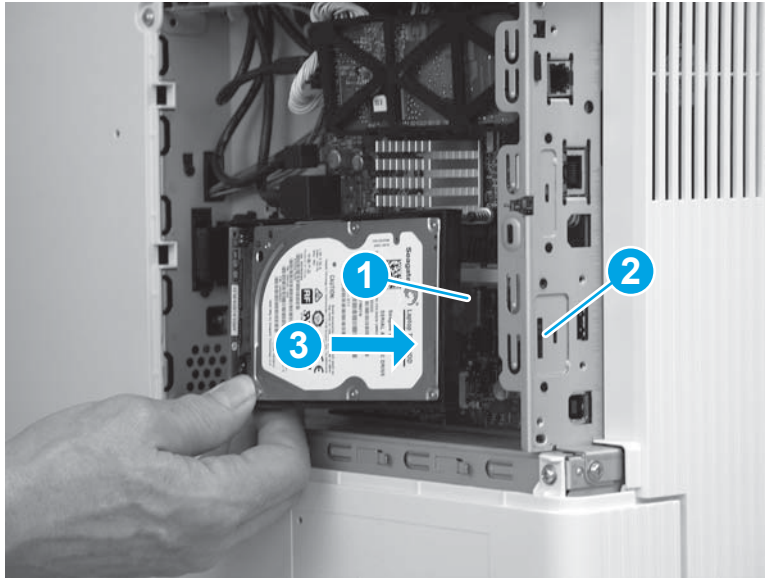

2. Hold the HDD connector latch (callout 1) in the released position, and then rotate the HDD down and into the connector on the formatter to install it.

 **NOTE:** Make sure that the tab (callout 2) snaps into place, and that the HDD is securely installed.

Figure 1-1776 Release the HDD

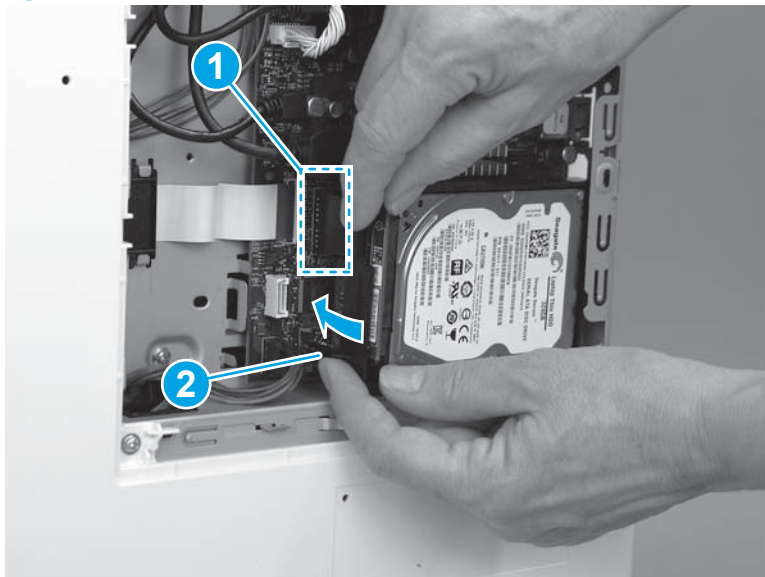

Step 23: Install the formatter (M552 and M553)

 **NOTE:** This step is for the M552 and M553 models. For the M577 models, skip this step and go to [Step 24: Install the formatter cover on page 1013](#).

If the optional hard-disk drive (HDD) was removed, do not forget to reinstall it after the formatter is reinstalled.

Engage the HDD holder with the chassis, rotate the HDD connector down and into the connector on the formatter. Make sure that the tabs snap into place.

 **CAUTION:**  ESD-sensitive part.

1. Position the formatter in the printer, and then install four screws (callout 1).

Figure 1-1777 Install the formatter

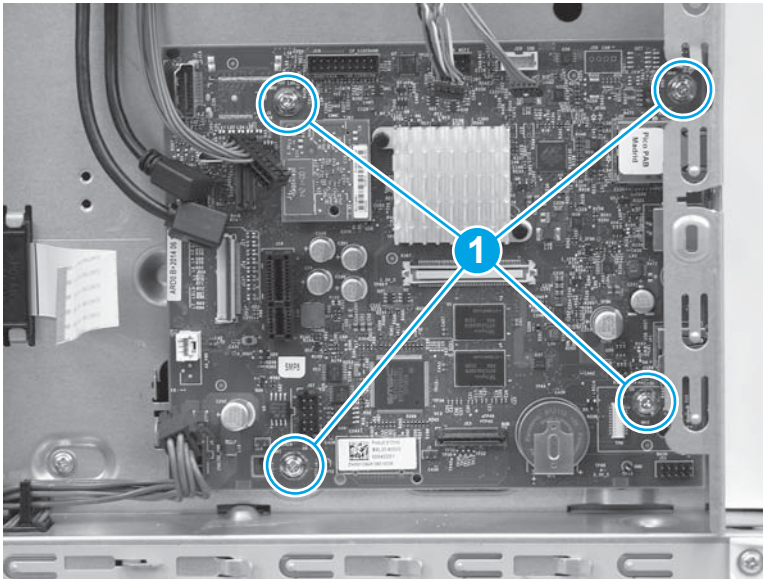

2. Connect all of the connectors on the formatter.

The following connectors are empty:

- All models: J1 (this connector is empty unless the optional DIMM is installed)
- M553n/dn and M552dn: J2 (callout 1; this is the touchscreen connector for the M553x model)
- All models: J9 (this connector is empty unless the optional internal USB ports component is installed)
- All models: J18 (this connector is empty unless the optional hard-disk-drive (HDD) is installed)
- All models: J23
- All models: J24
- M553n/dn and M552dn: J25 (this is the wireless connector for the M553x model)
- All models: J57
- All models: J98 (this connector is empty unless the optional trusted platform module (TPM) is installed)



 **IMPORTANT:** The flat-cable connector (callout 2) is a Zero Insertion Force (ZIF) connector that uses a hinged retainer to secure the flat cable. The hinged retainer must be opened to install the flat cable.

Figure 1-1778 Connect all connectors

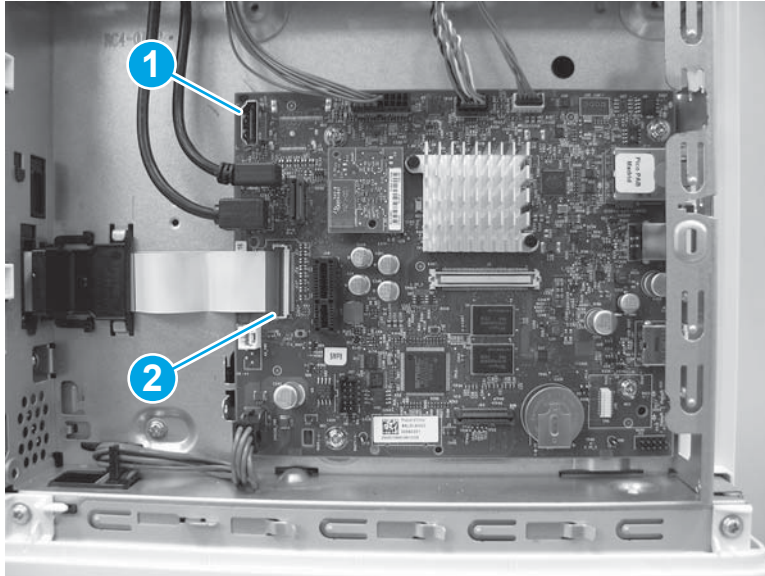

Step 24: Install the formatter cover

- ▲ Slide the cover onto the printer (callout 1) to install it.

 **NOTE:** Make sure that the tabs on the formatter cover align with the slots provided in the printer (callout 2). Tighten the two thumbscrews (callout 3).

 **TIP:** If needed, use the edge of a coin to turn the thumbscrews.

Figure 1-1779 Install the cover



Step 25: Install the TCU

1. Verify that the toner collection hatch cover is in the closed position on the TCU.

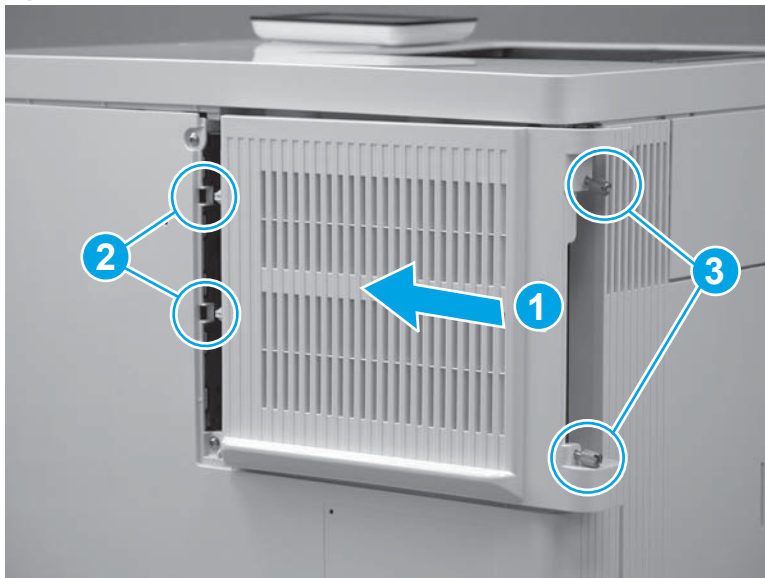
Figure 1-1780 Verify that the toner collection hatch cover is closed

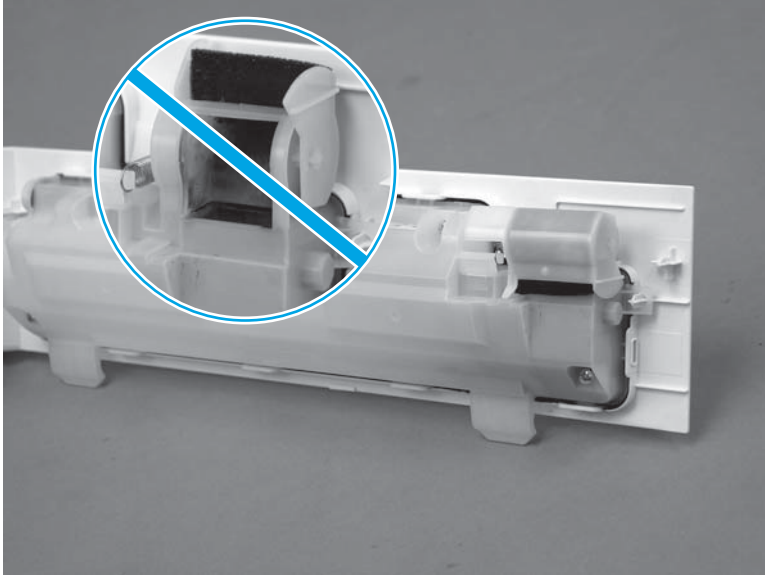

2. Position the TCU with the hinges in the slots provided in the printer (callout 1), and then rotate the TCU up and into the closed position.

 **NOTE:** The toner collection hatch cover automatically opens when the TCU is closed.

Figure 1-1781 Install the TCU



3. Close the front door.

Figure 1-1782 Close the front door

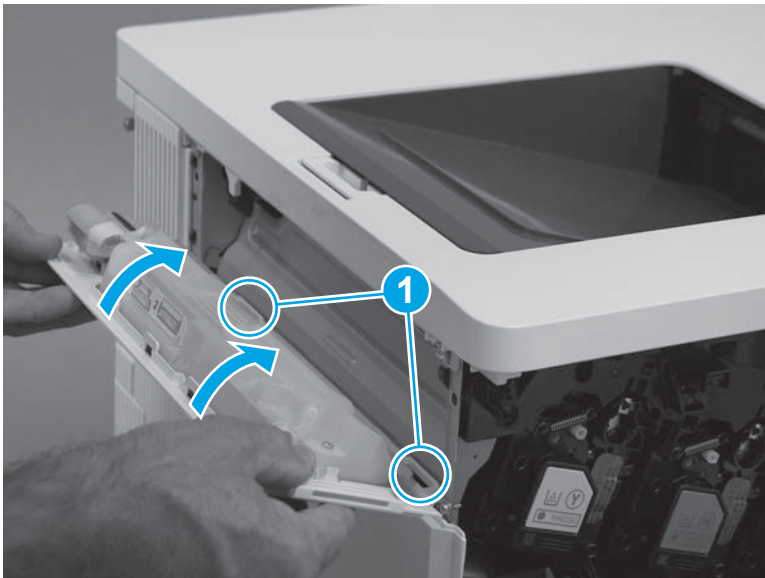

Removal and replacement: High-voltage power supply D (HVPSD)

- [Introduction](#)
- [Step 1: Remove the toner collection unit \(TCU\)](#)
- [Step 2: Remove the formatter cover](#)
- [Step 3: Remove the formatter \(M552 and M553\)](#)
- [Step 4: Remove the hard-disk drive \(HDD\) \(M577\)](#)
- [Step 5: Remove the fax PCA \(M577c/f/z\)](#)
- [Step 6: Remove the formatter \(M577\)](#)
- [Step 7: Remove the rear cover \(M552 and M553\)](#)
- [Step 8: Remove the rear upper cover \(M577\)](#)
- [Step 9: Remove the rear cover \(M577\)](#)
- [Step 10: Remove the left cover](#)
- [Step 11: Remove the formatter case](#)
- [Step 12: Remove the low-voltage power supply \(LVPS\)](#)
- [Step 13: Remove the high-voltage power supply D \(HVPSD\)](#)
- [Step 14: Unpack the replacement assembly](#)
- [Step 15: Install the HVPSD](#)
- [Step 16: Install the LVPS](#)
- [Step 17: Install the formatter case](#)
- [Step 18: Install the left cover](#)
- [Step 19: Install the rear cover \(M577\)](#)
- [Step 20: Install the rear upper cover \(M577\)](#)
- [Step 21: Install the rear cover \(M552 and M553\)](#)
- [Step 22: Install the formatter \(M577\)](#)
- [Step 23: Install the fax PCA \(M577c/f/z\)](#)
- [Step 24: Install the HDD \(M577\)](#)
- [Step 25: Install the formatter \(M552 and M553\)](#)
- [Step 26: Install the formatter cover](#)
- [Step 27: Install the TCU](#)

Introduction



This document provides the procedures to remove and replace the high-voltage power supply D (HVPSD).

Before performing service

Turn the printer power off

- Disconnect the power cable.

 **WARNING!** To avoid damage to the printer, turn the printer off, wait 30 seconds, and then remove the power cord before attempting to service the printer.

 **CAUTION:**  This part contains components that are electrostatic discharge (ESD) sensitive. To reduce the possibility of ESD damage, always touch the sheet-metal chassis to ground yourself before touching an ESD sensitive part.

Use the table below to identify the correct part number for your printer, and then go to <http://h20141.www2.hp.com/hpparts> to order the part.

High-voltage power supply D (HVPSD) part number	
RM2-7122-000CN	High-voltage power supply D (HVPSD)

Required tools

- #2 Phillips screwdriver with a magnetic tip

After performing service

Make sure that all of the connectors on the HVPSD are fully seated.

Make sure that all of the connectors on the LVPS are fully seated.

Make sure that all of the connectors on the formatter are fully seated.

Make sure that the formatter cover is fully seated, and that the thumbscrews are finger tight after replacing it.

Turn the printer power on

- Connect the power cable.
- Use the power switch to turn the power on.

Post service test

Print a configuration page to make sure that the printer is functioning correctly.

Step 1: Remove the toner collection unit (TCU)

1. Open the front door.

Figure 1-1783 Open the front door



2. Open the TCU.

 **NOTE:** The toner collection hatch cover automatically closes when the TCU is opened.

Figure 1-1784 Open the TCU



3. Pull the TCU away from the printer at an angle to remove it.

⚠ CAUTION: Do not open the toner collection hatch cover when handling the TCU. If toner gets on clothing, wipe it off by using a dry cloth and wash the clothes in cold water. Hot water sets toner into fabric.

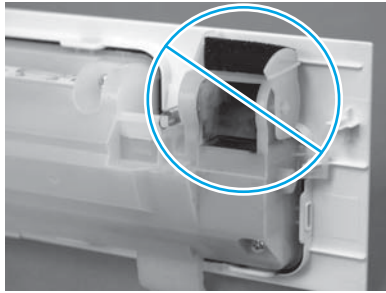
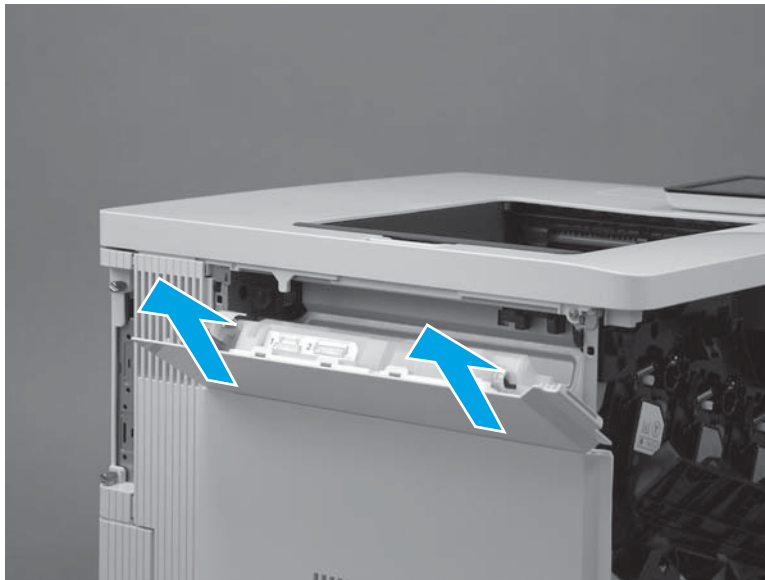

Figure 1-1785 Remove the TCU



Step 2: Remove the formatter cover

1. Locate the formatter cover.

Figure 1-1786 Locate the formatter cover

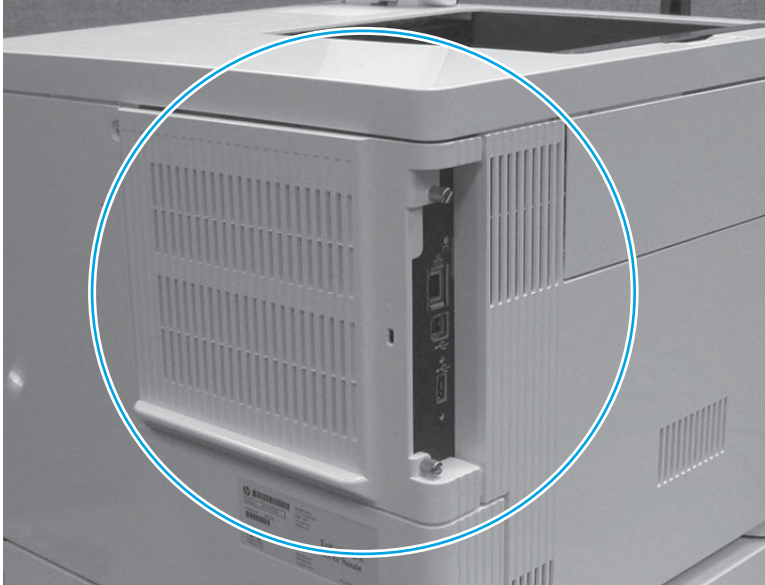

2. Loosen the two thumbscrews (callout 1). Grasp the two thumbscrews, and then slide the cover away from the printer (callout 2) to remove it.

 **TIP:** If needed, use the edge of a coin to turn the thumbscrews.

Figure 1-1787 Loosen the thumbscrews

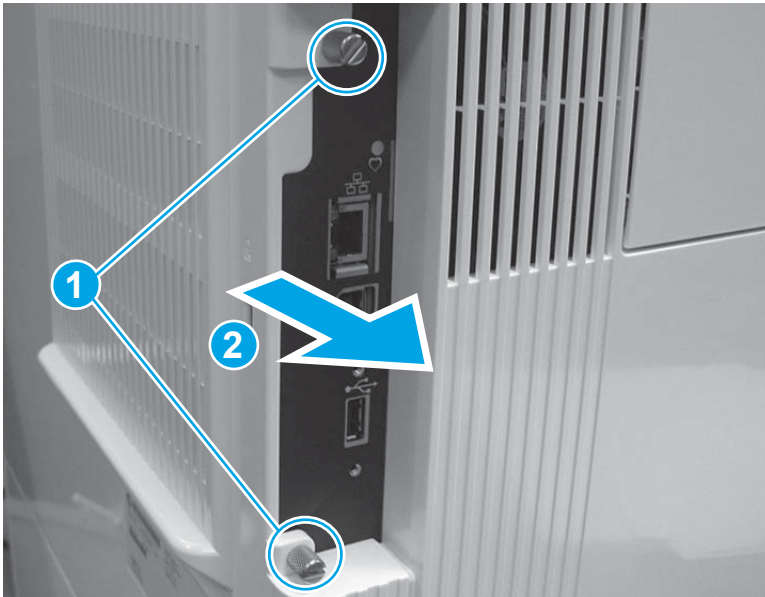

Step 3: Remove the formatter (M552 and M553)

 **NOTE:** This step is for the M552 and M553 models. For the M577 models, skip this step and go to [Step 4: Remove the hard-disk drive \(HDD\) \(M577\) on page 1022](#).

If the optional hard-disk drive (HDD) is installed, it must be removed to gain access to the formatter mounting screws.

Release two tabs along the left edge of the HDD, rotate the left edge away from the product, and then slide the HDD to the left to remove it.

 **CAUTION:**  ESD-sensitive part.

1. Disconnect all of the connectors on the formatter.

The following connectors are empty:

- All models: J1 (this connector is empty unless the optional DIMM is installed)
- M553n/dn and M552dn: J2 (callout 1; this is the touchscreen connector for the M553x model)
- All models: J9 (this connector is empty unless the optional internal USB ports component is installed)
- All models: J18 (this connector is empty unless the optional hard-disk-drive (HDD) is installed)
- All models: J23
- All models: J24
- M553n/dn and M552dn: J25 (this is the wireless connector for the M553x model)
- All models: J57
- All models: J98 (this connector is empty unless the optional trusted platform module (TPM) is installed)

 **IMPORTANT:** The flat-cable connector (callout 2) is a Zero Insertion Force (ZIF) connector that uses a hinged retainer to secure the flat cable. The hinged retainer must be opened to release the flat cable.

Figure 1-1788 Disconnect all connectors



2. Remove four screws (callout 1), and then remove the formatter.

Figure 1-1789 Remove the formatter

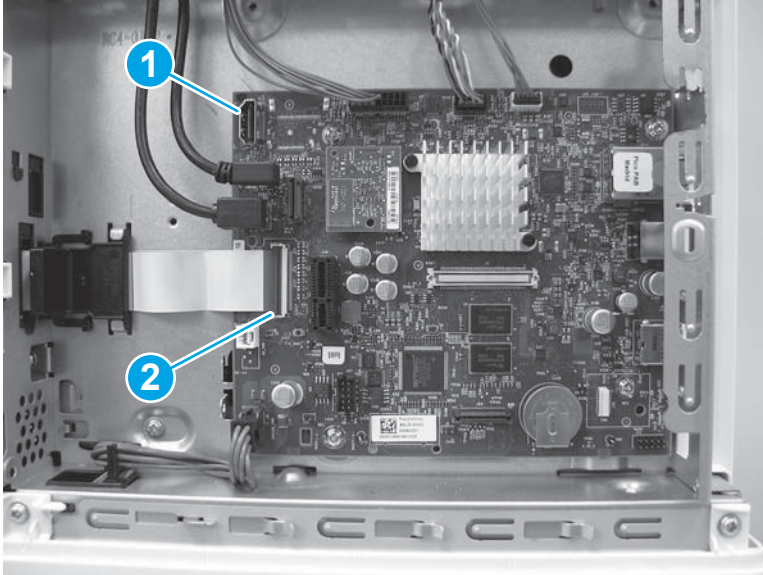
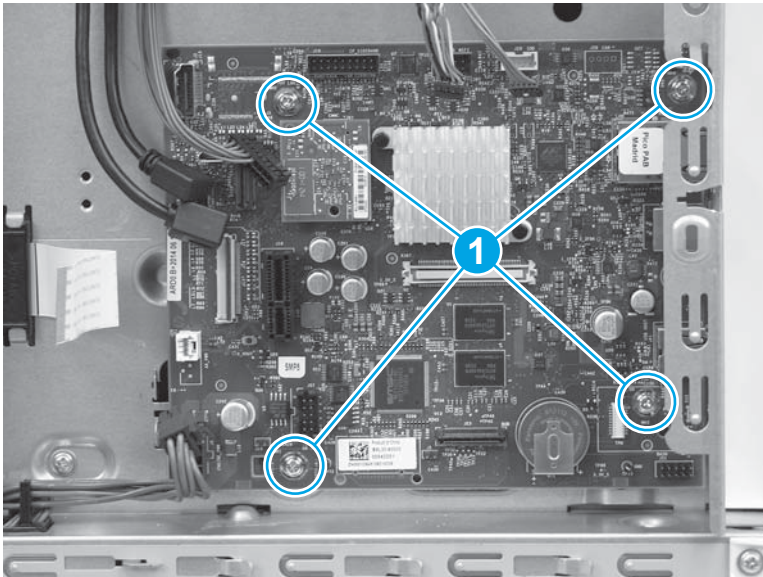

Step 4: Remove the hard-disk drive (HDD) (M577)

 **NOTE:** This step is for the M577 models. For the M552 and M553 models, skip this step and go to [Step 7: Remove the rear cover \(M552 and M553\) on page 1027](#).

 **CAUTION:**  ESD-sensitive part.

1. Release two tabs (callout 1). Hold the tabs in the released position, and then rotate the hard disk drive (HDD) up (callout 2) to release the connector from the formatter.

Figure 1-1790 Release the HDD

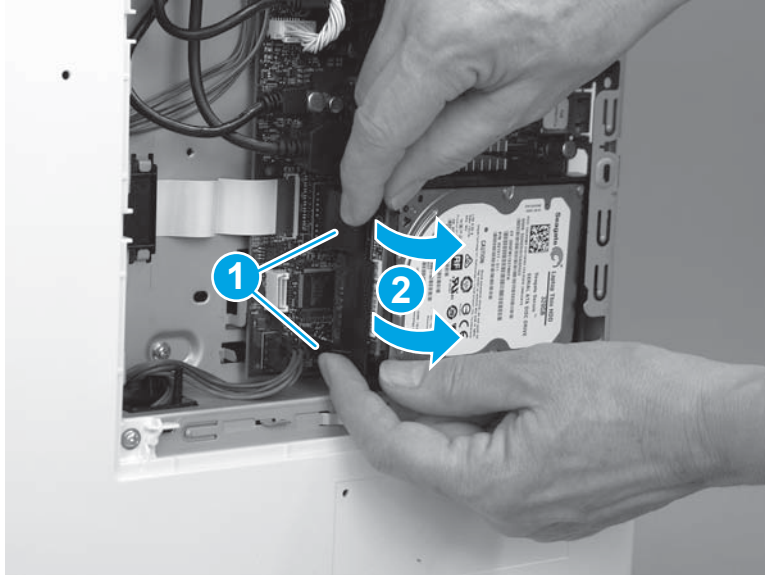

2. Slide the HDD away from the printer to remove it.

Figure 1-1791 Remove the HDD

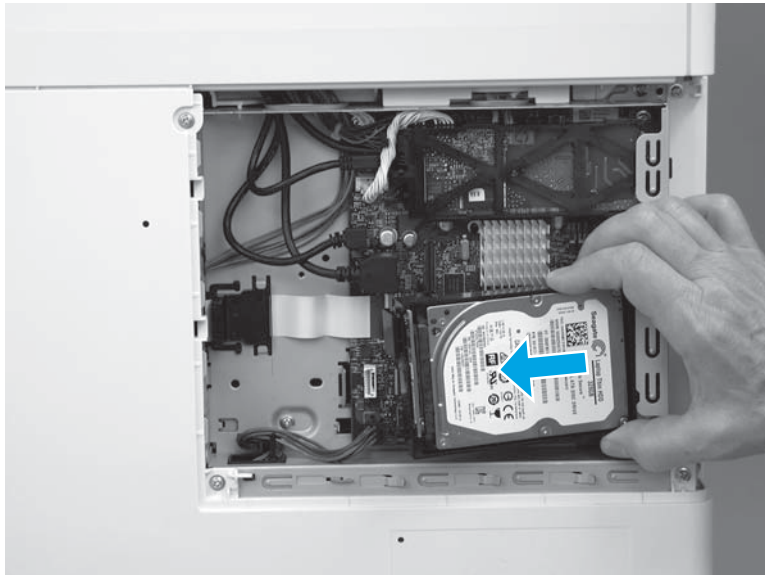

Step 5: Remove the fax PCA (M577c/f/z)

 **NOTE:** This step is for the M577c/f/z models. For the M577n model, skip this step and go to [Step 6: Remove the formatter \(M577\) on page 1025](#).

For the M552 and M553 models, skip this step and go to [Step 7: Remove the rear cover \(M552 and M553\) on page 1027](#).

 **CAUTION:**  ESD-sensitive part.

1. Locate the fax PCA component on the formatter.

Figure 1-1792 Locate the fax PCA

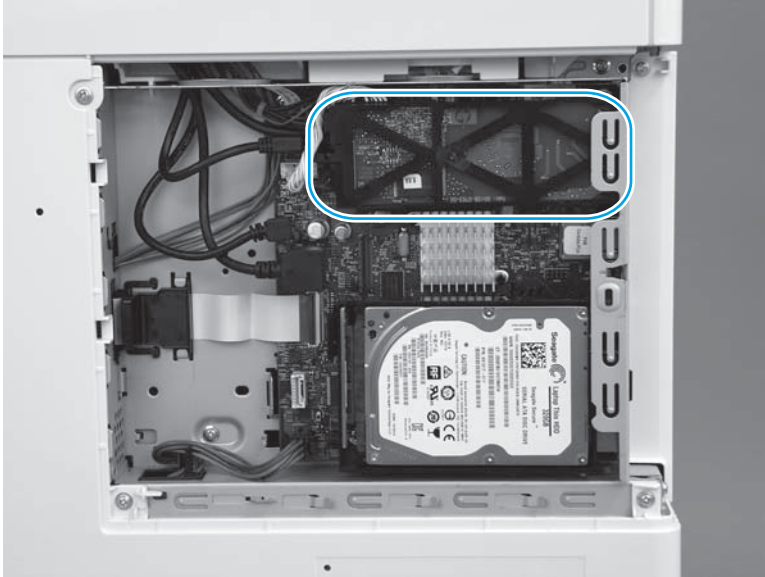

2. Release the connector latch (callout 1), and then pull the connector away from the formatter (callout 2) to disconnect it.

Figure 1-1793 Disconnect one connector

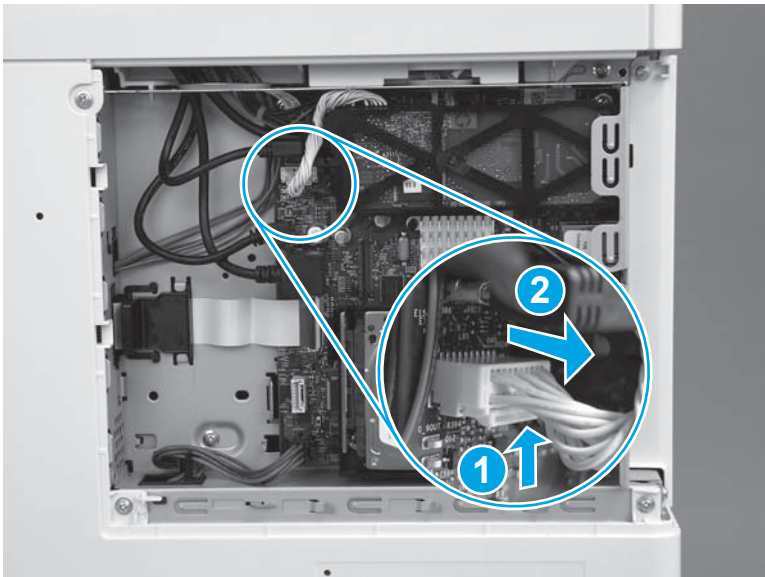

3. Release one retainer (callout 1) by pressing the bracket arms together.

Figure 1-1794 Release one latch

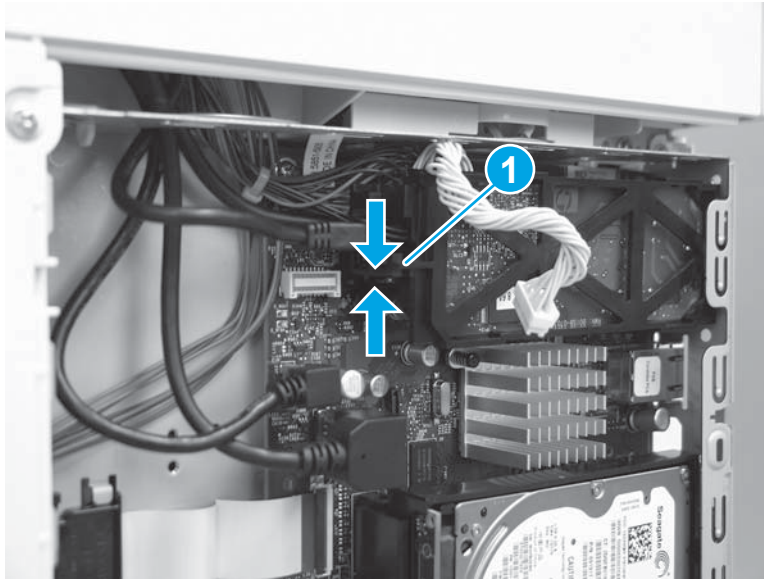

4. Rotate the end of the fax PCA (callout 1) away from the formatter, and then slide the PCA left (callout 2) to remove it.

Figure 1-1795 Remove the fax PCA

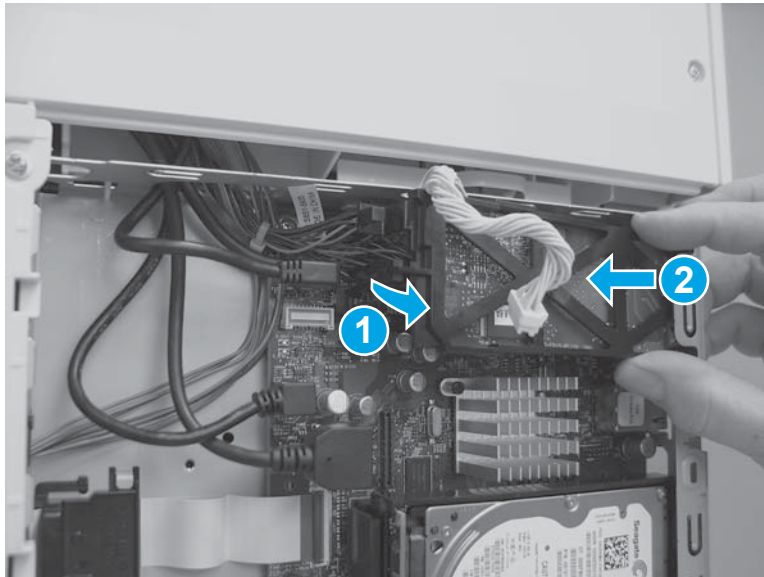

Step 6: Remove the formatter (M577)

 **NOTE:** This step is for the M577 models. For the M552 and M553 models, skip this step and go to [Step 7: Remove the rear cover \(M552 and M553\) on page 1027.](#)

 **CAUTION:**  ESD-sensitive part.

1. Disconnect all of the connectors on the formatter.

The following connectors are empty:

- All models: J1 (this connector is empty unless the optional DIMM is installed)
- All models: J3
- M577dn: J15 (this is the fax connector for the M577f/z/c models)
- All models: J21 (this connector is empty unless the optional internal USB ports component is installed)
- All models: J23
- All models: J24
- All models: J51
- All models: J57
- All models: J97
- All models: J98 (this connector is empty unless the optional trusted platform module (TPM) is installed)

 **IMPORTANT:** The flat-cable connector (callout 1) is a Zero Insertion Force (ZIF) connector that uses a hinged retainer to secure the flat cable. The hinged retainer must be opened to release the flat cable.

Figure 1-1796 Disconnect all connectors



2. Remove four screws (callout 1).

Figure 1-1797 Remove four screws

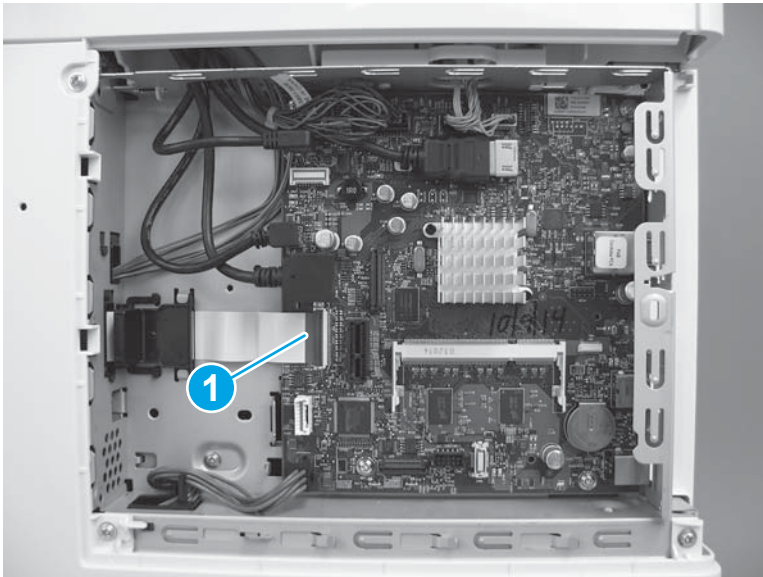
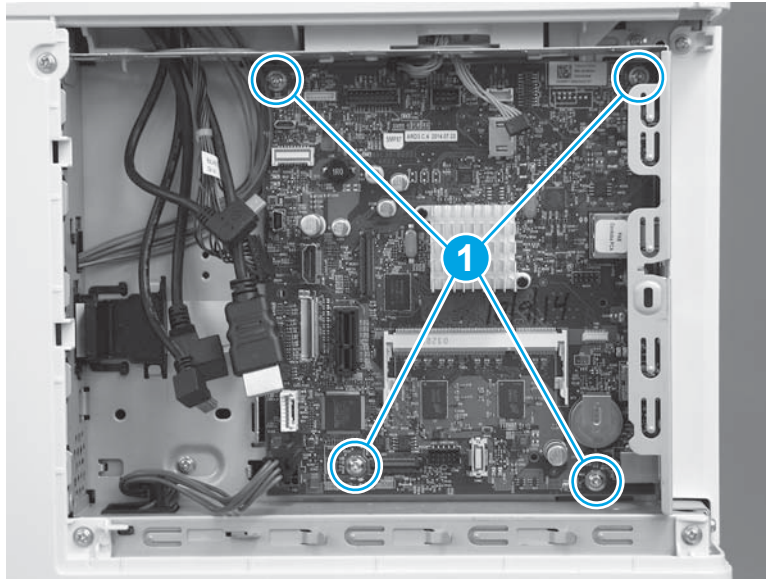

3. Remove the formatter.

Figure 1-1798 Remove the formatter

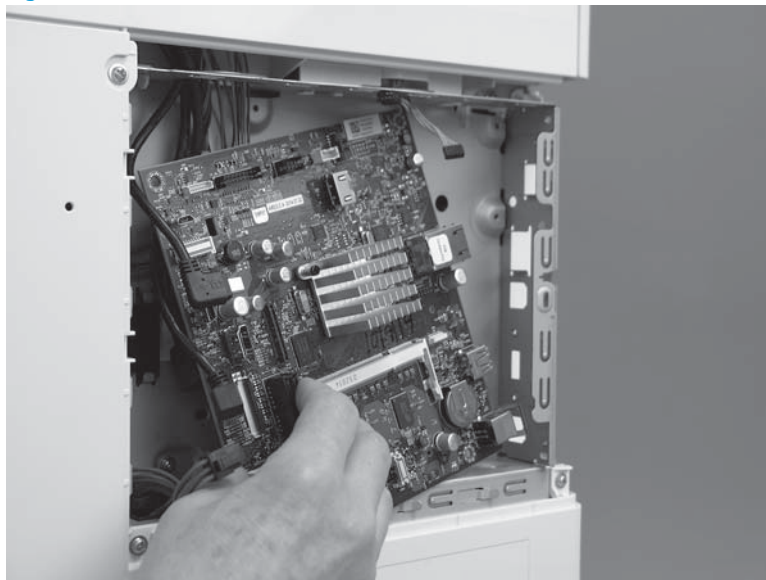

Step 7: Remove the rear cover (M552 and M553)

 **NOTE:** This step is for the M552 and M553 models. For the M577 models, skip this step and go to [Step 8: Remove the rear upper cover \(M577\) on page 1028.](#)

1. Remove four screws (callout 1).

Figure 1-1799 Remove four screws

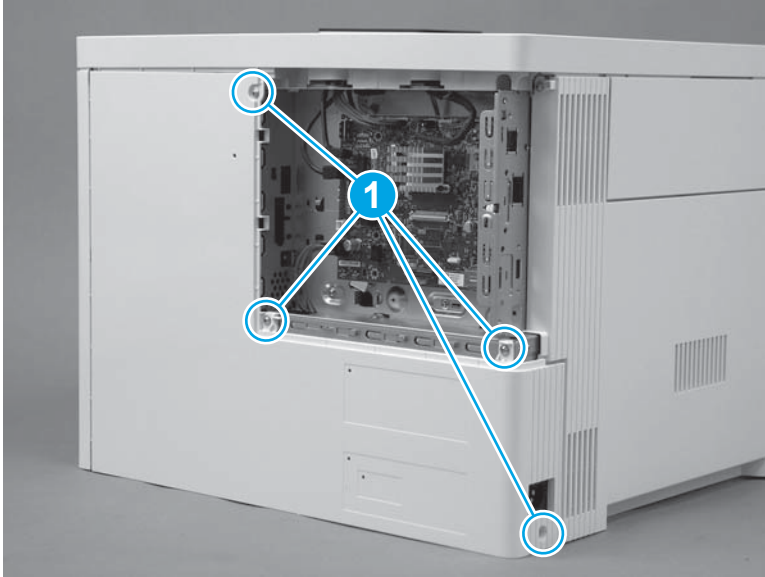

2. Slightly slide the cover to the right (callout 1), rotate the bottom of the cover away from the printer (callout 2), and then pull the top of the cover away from the printer (callout 3) to remove the cover.

Figure 1-1800 Remove the cover

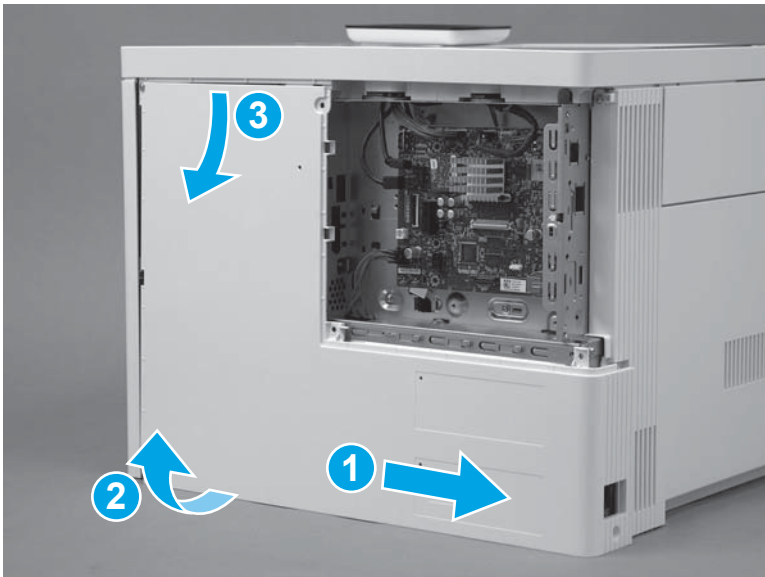

Step 8: Remove the rear upper cover (M577)

 **NOTE:** This step is for the M577 models. For the M552 and M553 models, skip this step and go to [Step 10: Remove the left cover on page 1031](#).

1. Remove two screws (callout 1).

 **Reinstallation tip:** These two screws are self-tapping screws for plastic. When reinstalling them, rotate the screws counterclockwise to align them with the existing thread pattern, and then carefully turn them clockwise to tighten. Do not overtighten. This will prevent stripping the threads inside the screw holes.

Figure 1-1801 Remove two screws



2. Use a small, flat blade screwdriver to release the right edge of the cover.

Figure 1-1802 Release the right edge

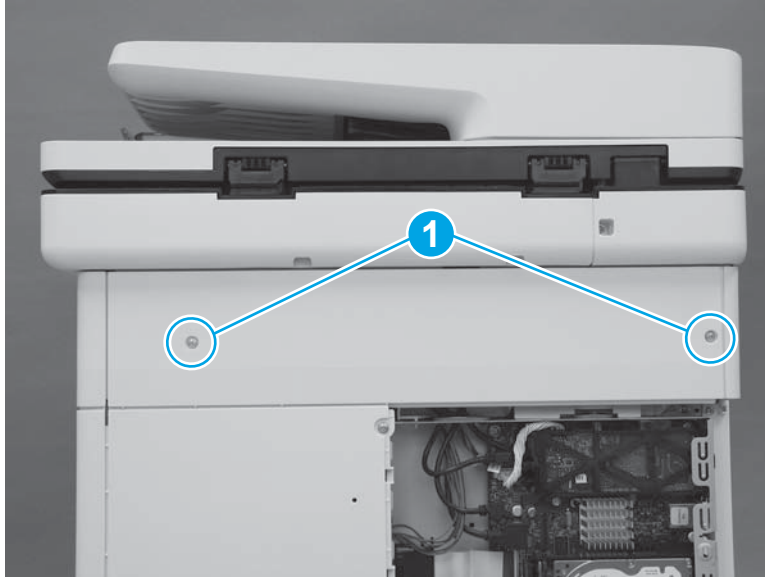
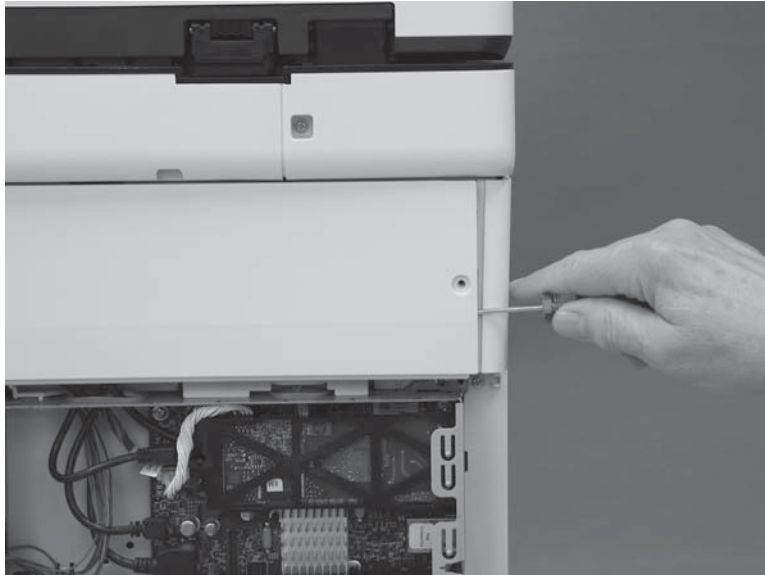

3. Pull the right edge of the cover (callout 1) away from the printer, and then slide the cover to the right (callout 2).

Figure 1-1803 Slide the cover right

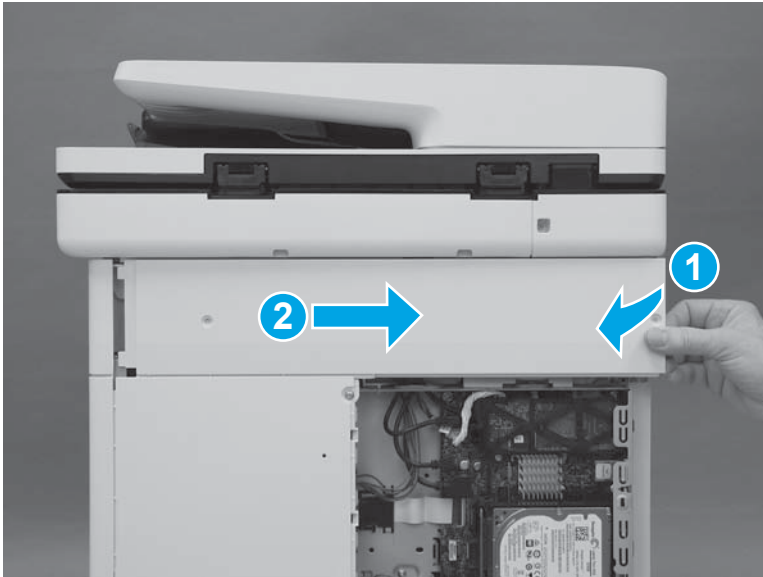

4. Remove the cover.

Figure 1-1804 Remove the cover

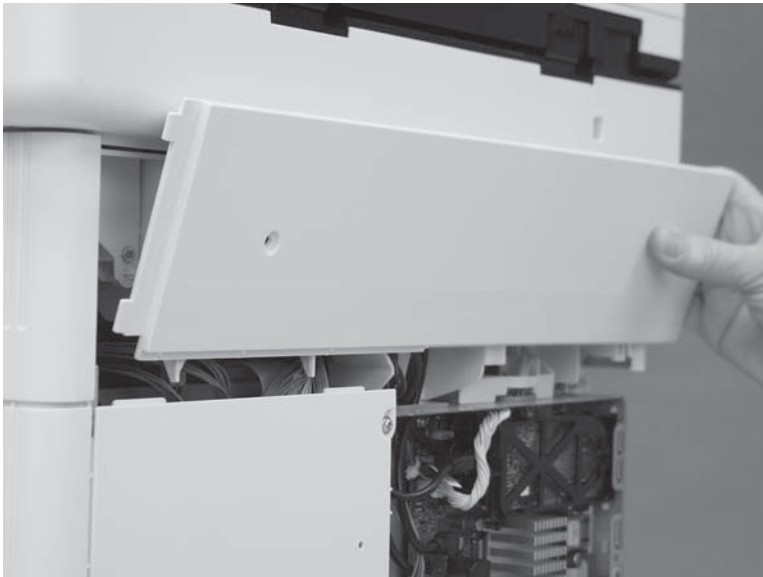

Step 9: Remove the rear cover (M577)

 **NOTE:** This step is for the M577 models. For the M552 and M553 models, skip this step and go to [Step 10: Remove the left cover on page 1031](#).

1. Remove four screws (callout 1).

Figure 1-1805 Remove four screws

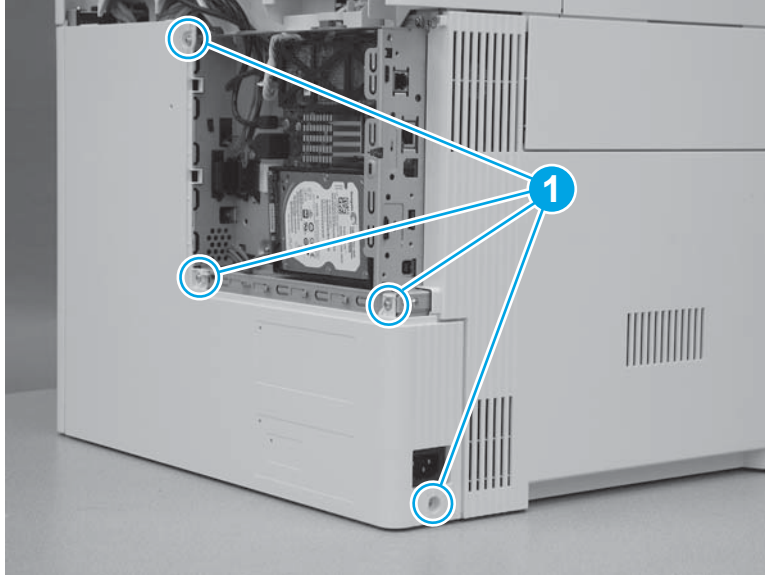

2. Slide the cover to the right to remove it.

Figure 1-1806 Remove the cover

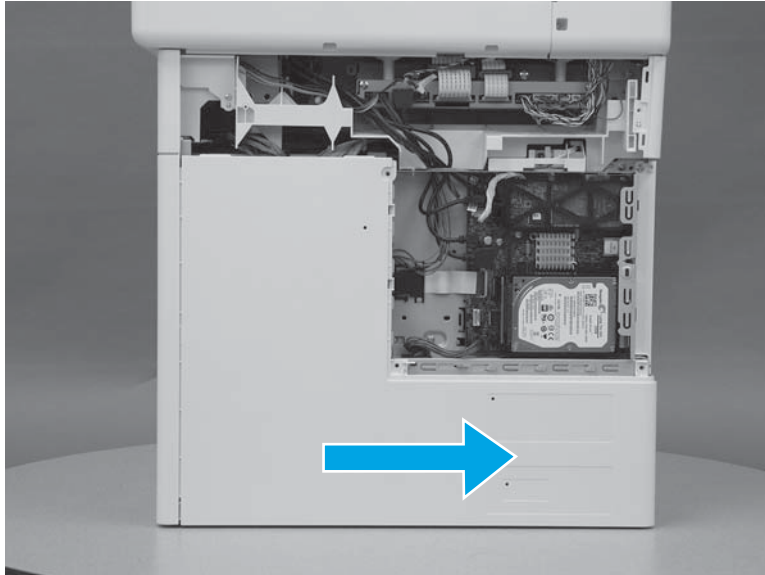

Step 10: Remove the left cover

1. At the left side of the printer, remove one screw (callout 1).

Figure 1-1807 Remove one screw



2. Release one tab (callout 1), rotate the front edge of the cover away from the printer (callout 2), and then slide the cover (callout 3) toward the rear of the printer to release it.

Figure 1-1808 Release the cover

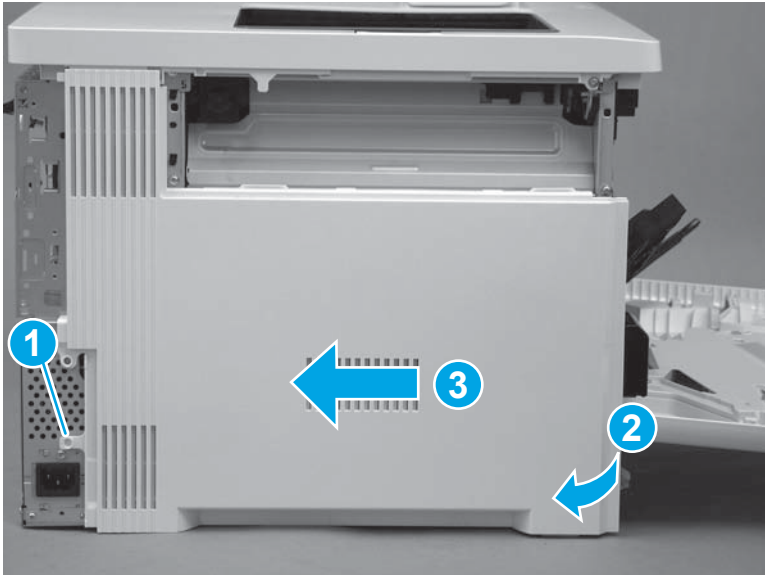

3. Remove the cover.

Figure 1-1809 Remove the cover

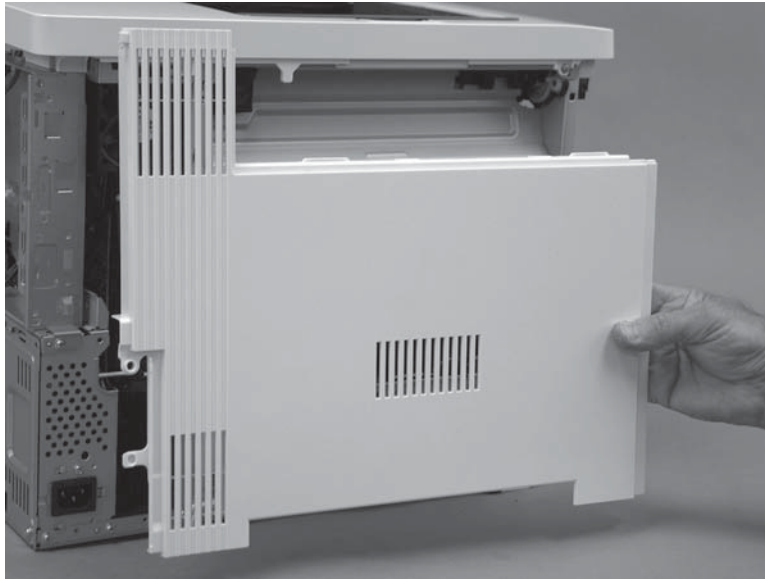

Step 11: Remove the formatter case

1. **M577 only:** Disconnect one connector (callout 1), and then pass the wire harness (callout 2) through two openings in the formatter case (callout 3).

Figure 1-1810 Disconnect one connector

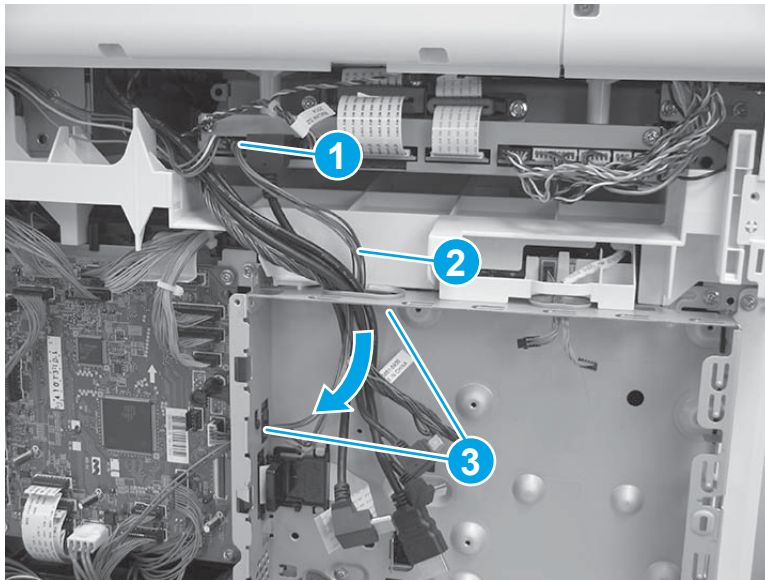

2. Release two tabs (callout 1) on the black plastic bracket. Hold the tabs in the released position, and then slide the bracket (callout 2) to the right to remove it from the formatter case.

Figure 1-1811 Remove the bracket

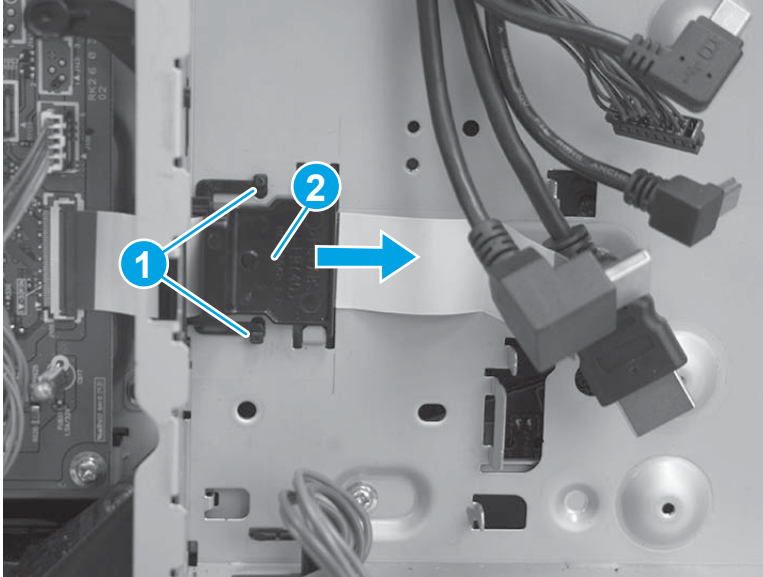

3. Remove two screws (callout 1), and then slide the low-voltage power supply (LVPS) cover to the right to remove it.

Figure 1-1812 Remove the LVPS cover

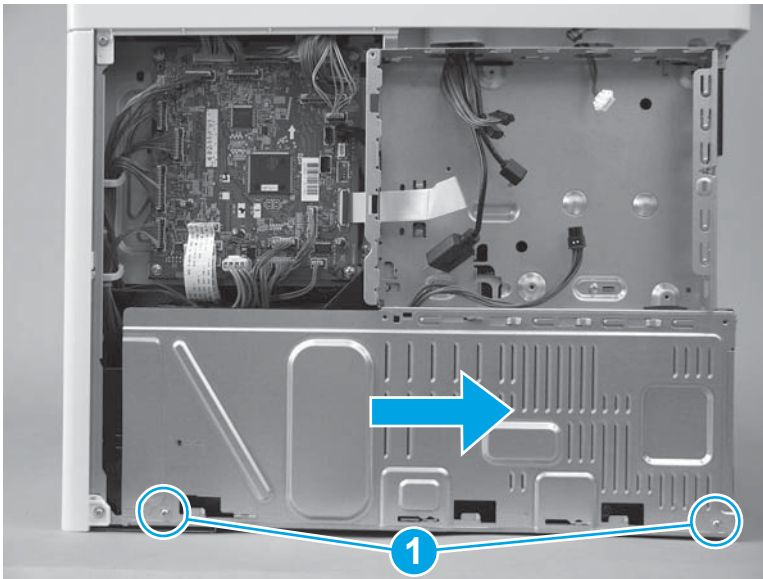

4. Pass two wire harnesses and one flat cable (callout 1) through the opening in the formatter case, and then release one wire harness from the retainer (callout 2).

⚠ CAUTION: The flat cable might be attached to the formatter case with double-sided tape. Make sure that this tape is released, so that the flat cable is not damaged when the formatter case is removed.

Figure 1-1813 Release wire harnesses and flat cable

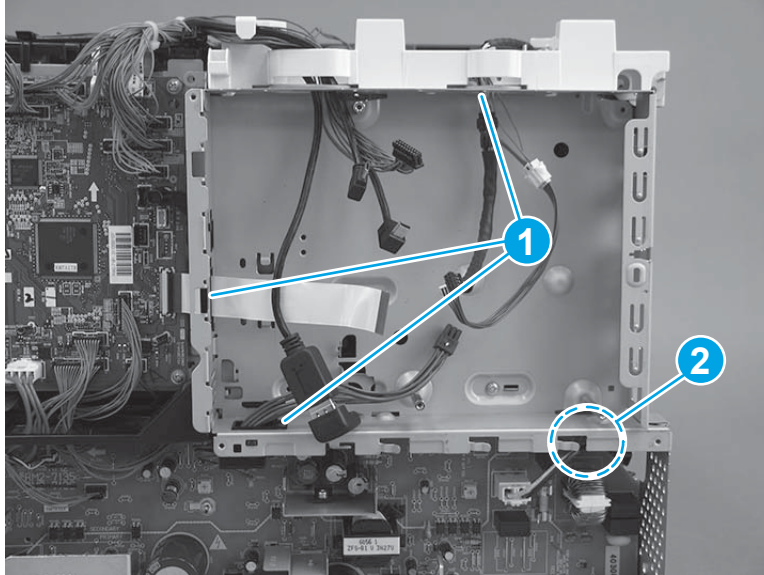

5. Remove six screws (callout 1).

Figure 1-1814 Remove six screws

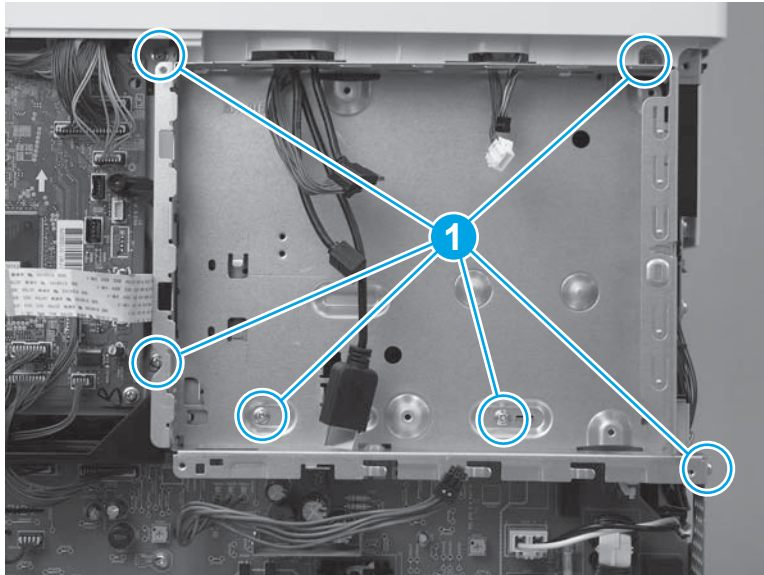

6. Rotate the bottom of the formatter case away from the printer (callout 1), and then pull it down (callout 2) to release it.

Figure 1-1815 Release the formatter case

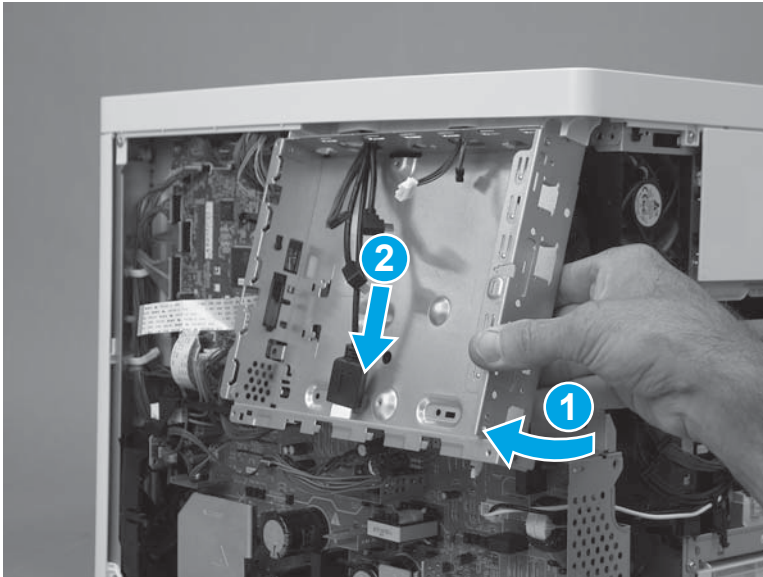

7. Pass the wire harnesses through the opening in the formatter case to remove it.

 **IMPORTANT:** If the formatter case is removed so that it can be replaced, make sure to transfer the memory PCA (island of data) and plastic bracket (callout 1) to the replacement case.

Figure 1-1816 Remove the formatter case

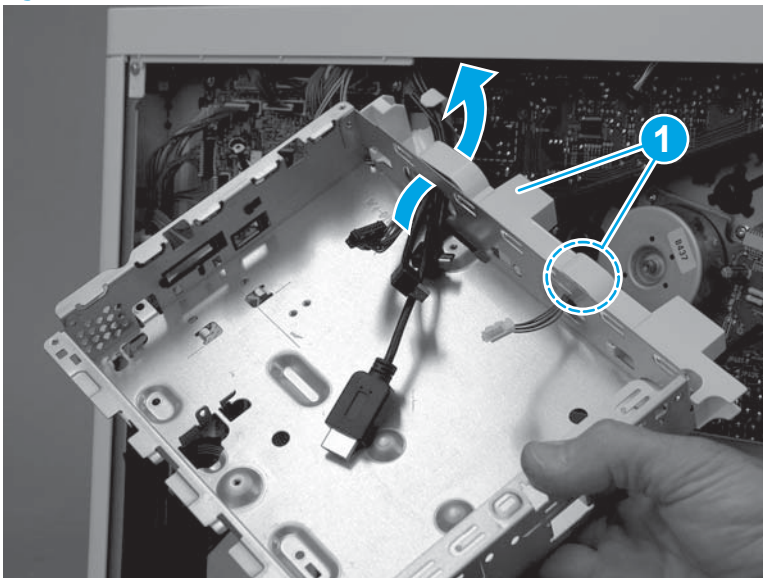

Step 12: Remove the low-voltage power supply (LVPS)

 **CAUTION:**  ESD-sensitive part.

1. Disconnect one wire harness (callout 1), and then pass the wire harness through the opening (callout 2) in the chassis.

Figure 1-1817 Disconnect one wire harness

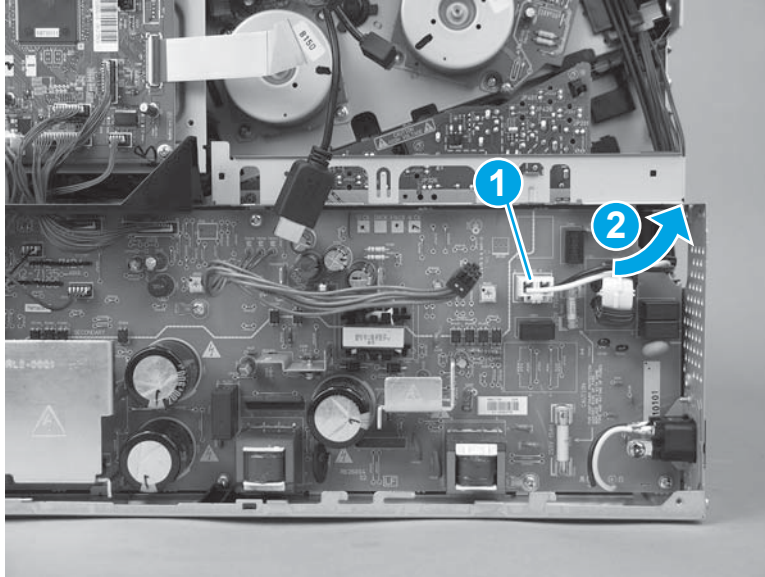

2. Disconnect three connectors on the DC controller (callout 1), and then disconnect four connectors (callout 2) on the LVPS.

Figure 1-1818 Disconnect seven connectors

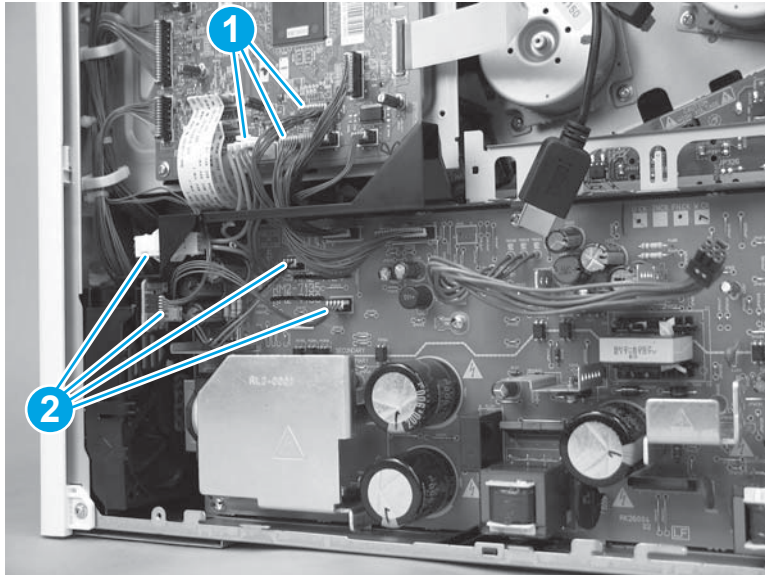

3. Pass the wire harnesses from the DC controller to the LVPS through the opening in the chassis (callout 1), and then release the wire harnesses from the retainer (callout 2).

Figure 1-1819 Pass the wire harnesses through the opening

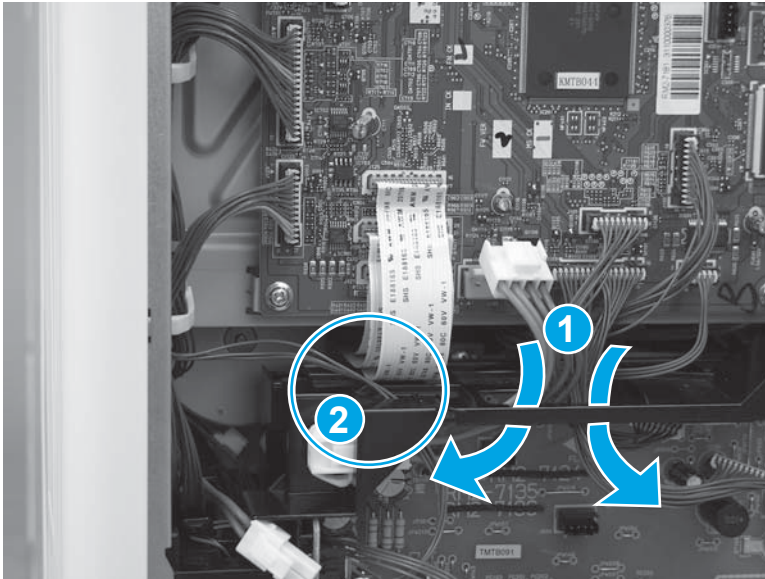

4. Remove three screws (callout 1).

Figure 1-1820 Remove three screws

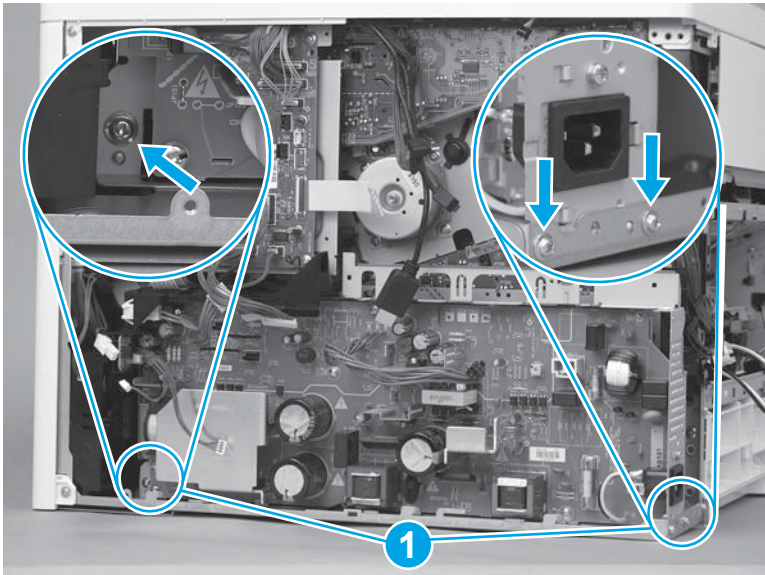

5. Rotate the top of the LVPS away from the printer (callout 1), and then slide it up and out (callout 2) of the printer to remove it.

Figure 1-1821 Remove the LVPS

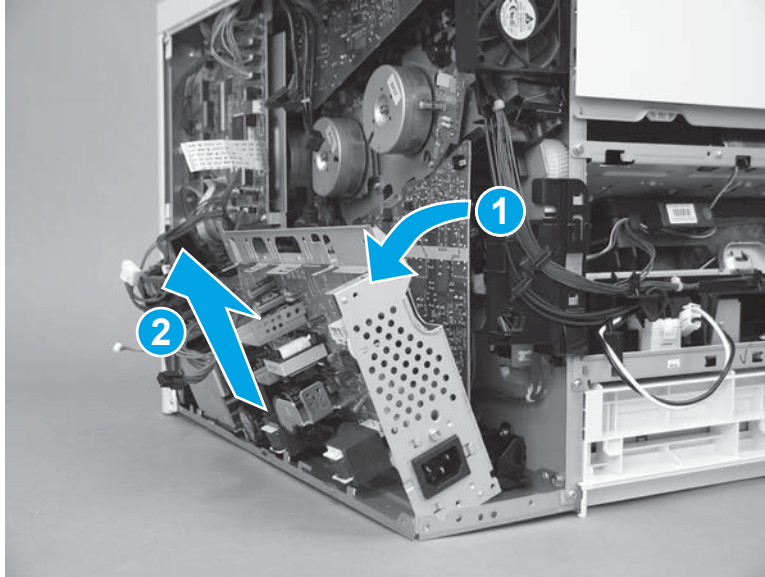

Step 13: Remove the high-voltage power supply D (HVPSD)

 **CAUTION:**  ESD-sensitive part.

1. Disconnect one flat cable (callout 1) on the DC controller.

Figure 1-1822 Disconnect one flat cable

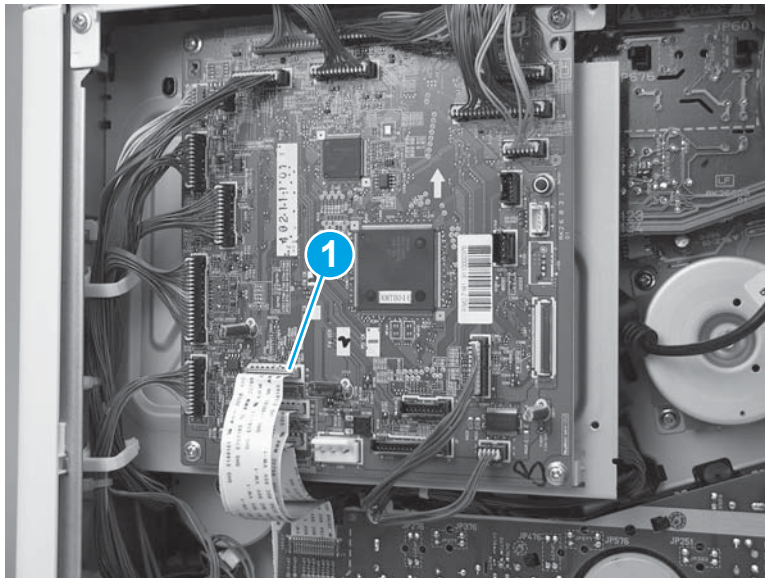

2. Remove two screws (callout 1), and then remove one self tapping screw (callout 2) on the HVPSD.

Figure 1-1823 Remove three screws

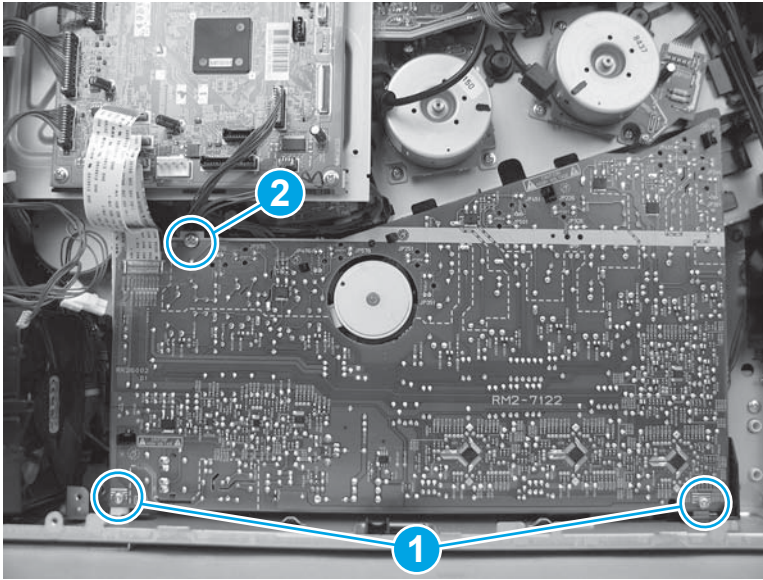

3. Release five tabs (callout 1), and then remove the HVPSD (callout 2).

Figure 1-1824 Remove the HVPSD

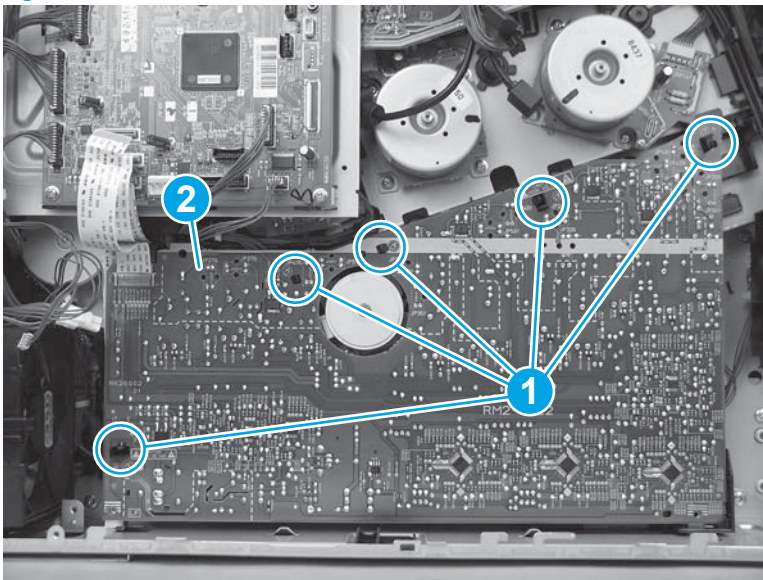

Step 14: Unpack the replacement assembly

Unpack the replacement assembly from the packaging.

 **CAUTION:**  ESD-sensitive part.

For complete information on HP's recycling programs, go to [Product return and recycling](#).

 **NOTE:** HP recommends responsible disposal of the defective assembly.

Figure 1-1825 Recycle and unpack

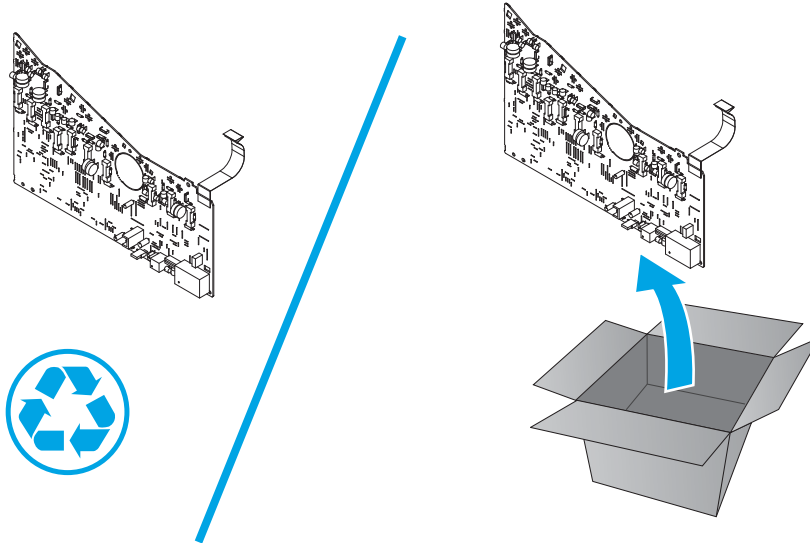

Step 15: Install the HVPSD

 **CAUTION:**  ESD-sensitive part.

1. Position the bottom right corner of the HVPSD (callout 1) behind the black tab, and then rotate it up and onto the printer (callout 2).

Figure 1-1826 Install the HVPSD

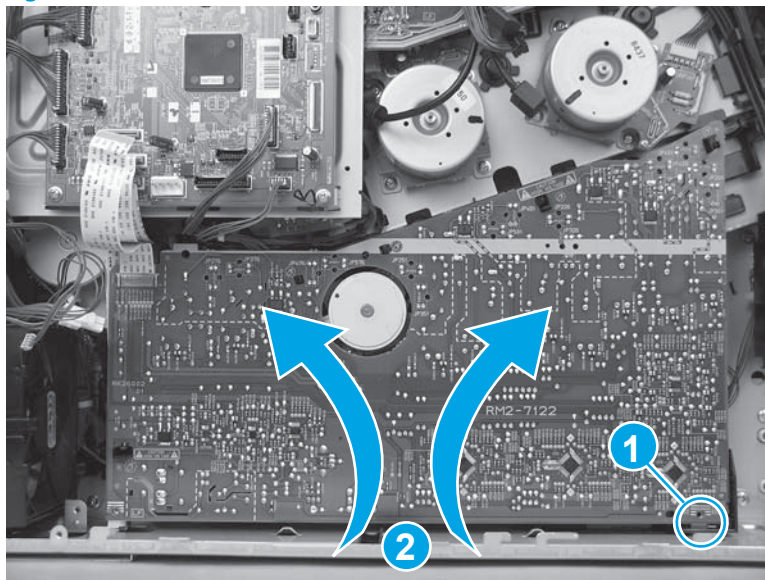

2. Press it onto five tabs (callout 2).

 **IMPORTANT:** Make sure that all five tabs snap into place.

Figure 1-1827 Press the tabs



3. Install two screws (callout 1), and then install one self tapping screw (callout 2) on the HVPSD.

Figure 1-1828 Install three screws

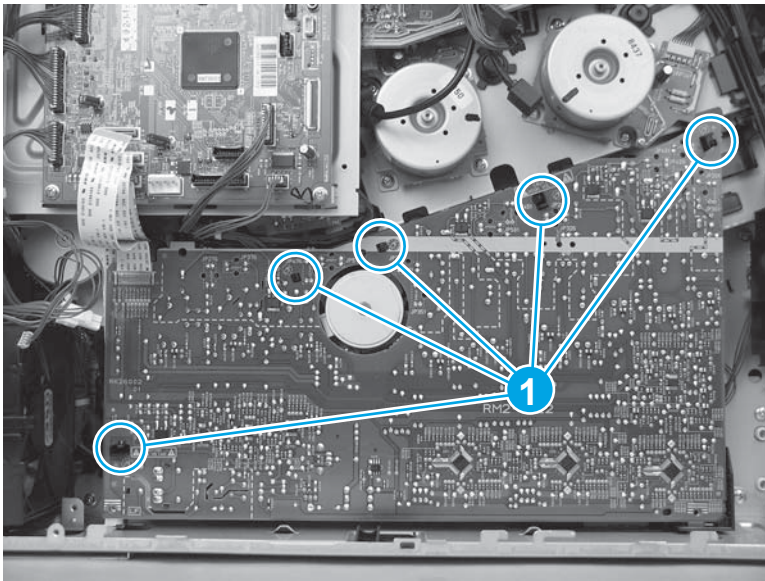
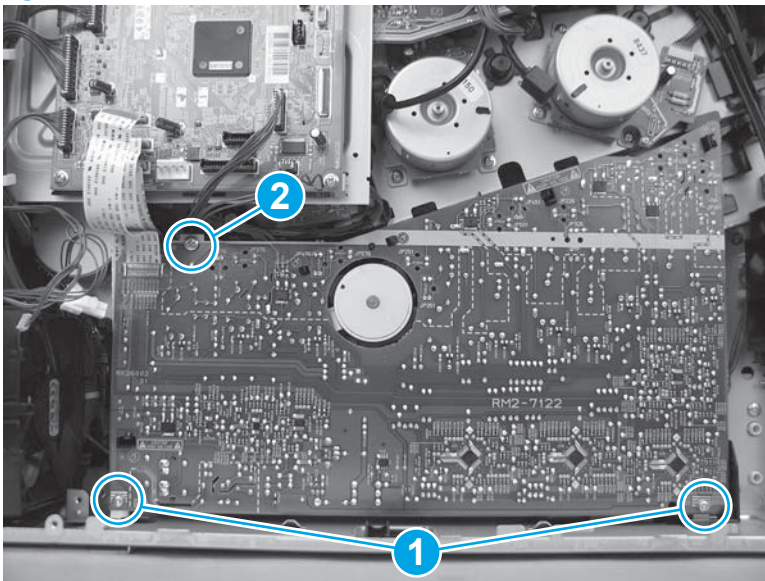

4. Connect one flat cable (callout 1) on the DC controller.

Figure 1-1829 Connect one flat cable

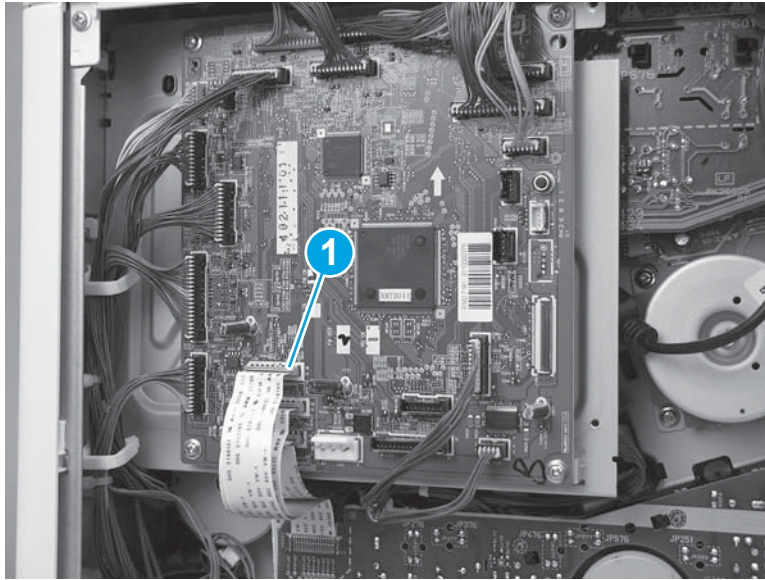

Step 16: Install the LVPS

 **CAUTION:**  ESD-sensitive part.

1. Position the bottom of the LVPS in the printer (callout 1) at a slight angle, and then rotate the top of it into the printer (callout 2) to install it.

Figure 1-1830 Install the LVPS

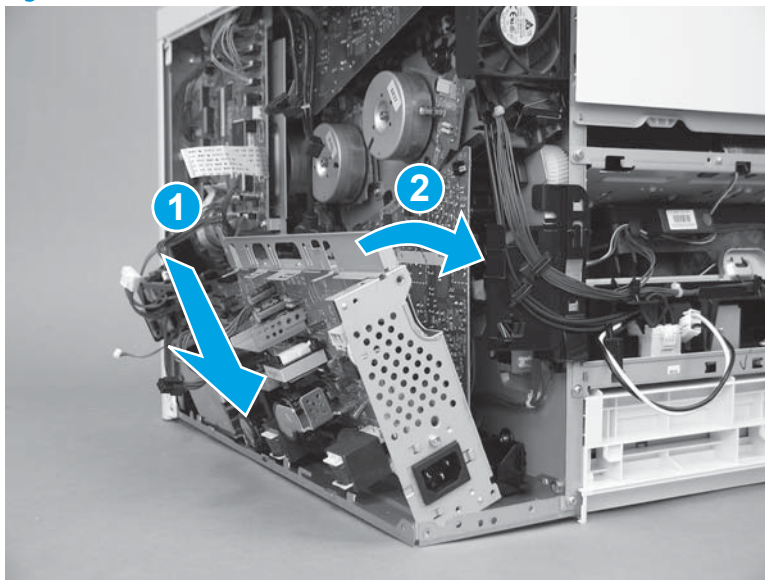

2. Install three screws (callout 1).

Figure 1-1831 Install three screws

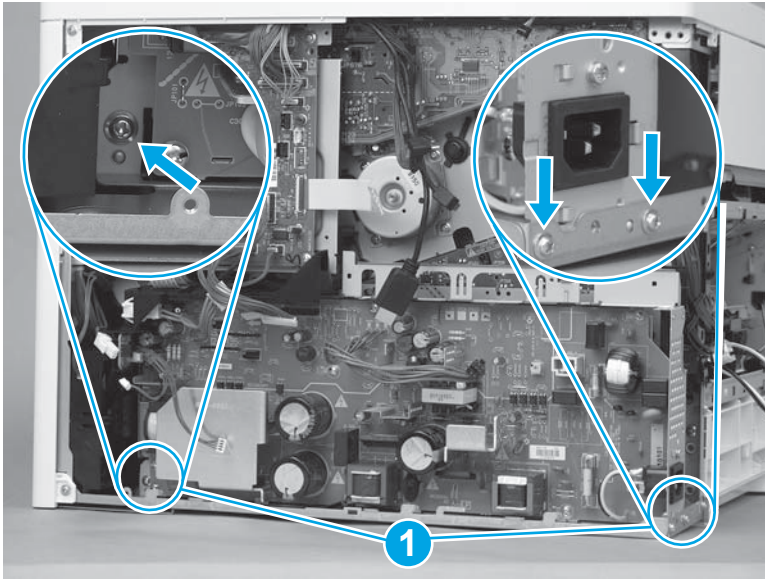

3. Pass the wire harnesses from the DC controller to the LVPS through the opening in the chassis (callout 1), and then install the wire harnesses in the retainer (callout 2).

Figure 1-1832 Pass the wire harnesses through the opening

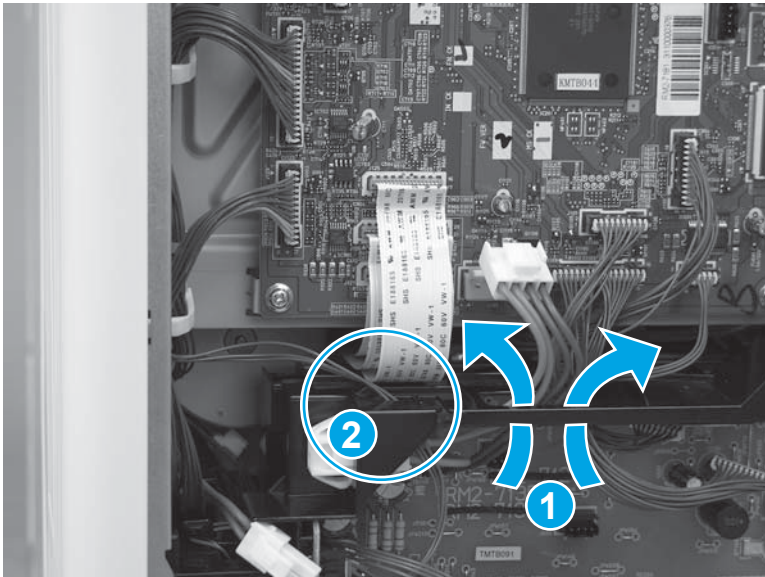

4. Connect three connectors on the DC controller (callout 1), and then connect four connectors (callout 2) on the LVPS.

Figure 1-1833 Connect seven connectors

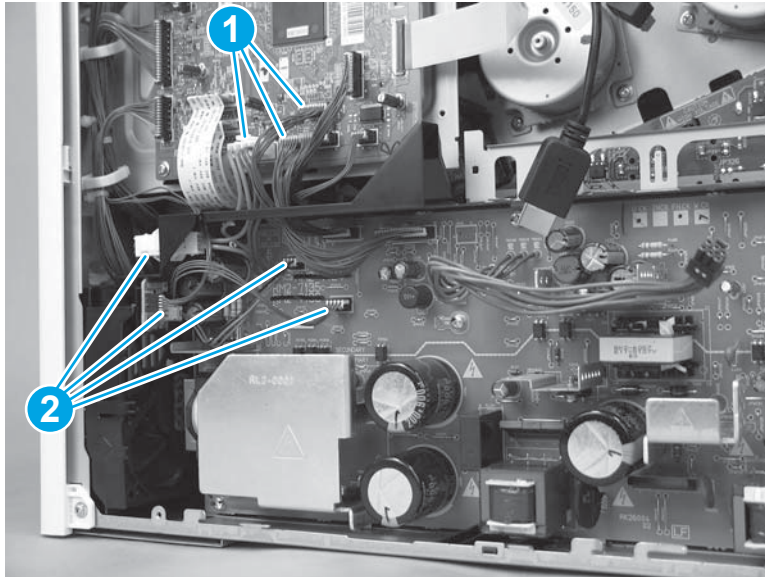

5. Pass the wire harness through the opening (callout 1) in the chassis, and then connect one wire harness (callout 2).

Figure 1-1834 Connect one wire harness

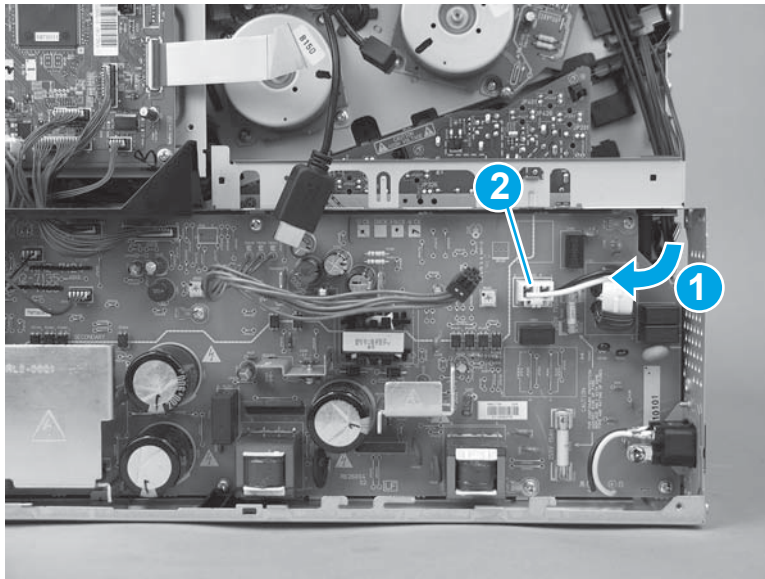

Step 17: Install the formatter case

1. Pass the wire harnesses through the opening in the formatter case.

Figure 1-1835 Pass the wire harnesses through the opening

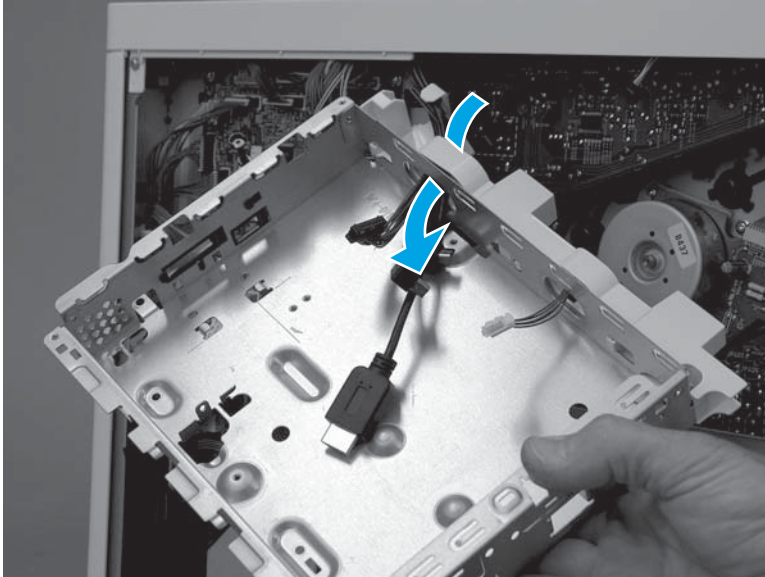

2. Position the top of the formatter case on the printer (callout 1), and then rotate the bottom of the case (callout 2) into the printer.

Figure 1-1836 Install the formatter case

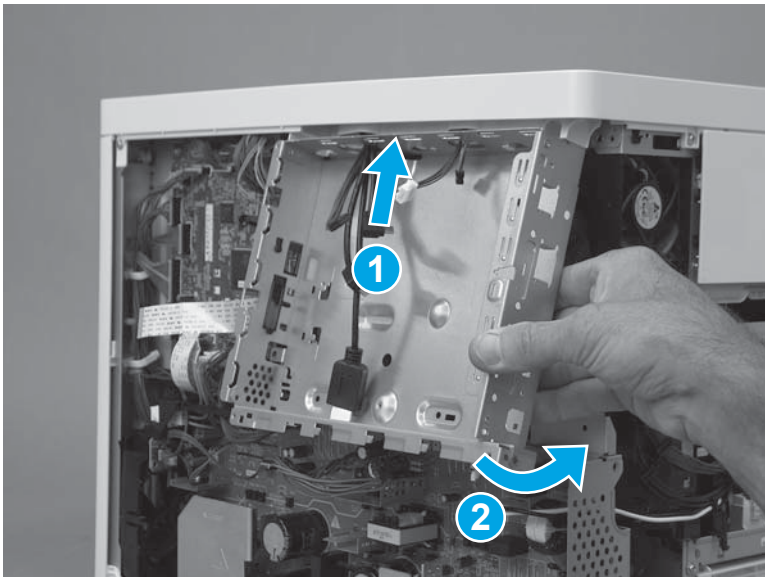

3. Install six screws (callout 1).

Figure 1-1837 Install six screws

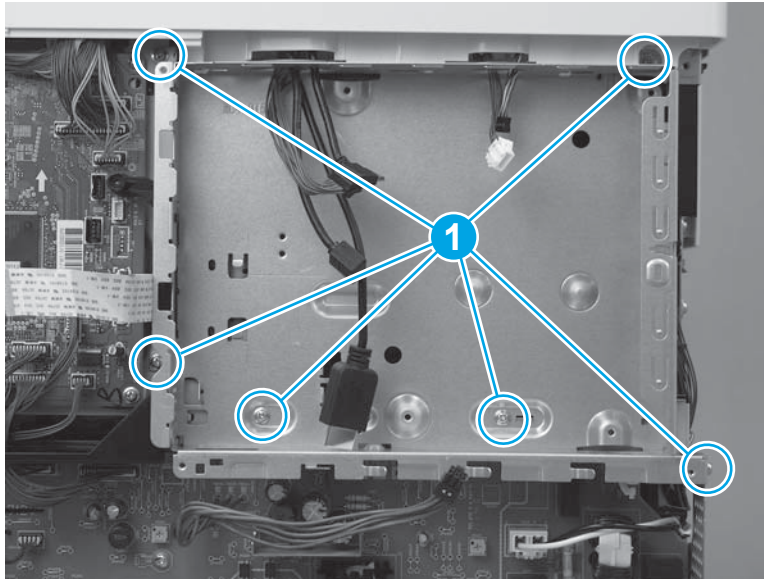

4. Pass two wire harnesses and one flat cable (callout 1) through the opening in the formatter case, and then install one wire harness in the retainer (callout 2).

 **IMPORTANT:** Make sure that the flat cable is securely fastened to the DC controller, and was not dislodged when the formatter case was removed.

Figure 1-1838 Install wire harnesses and flat cable

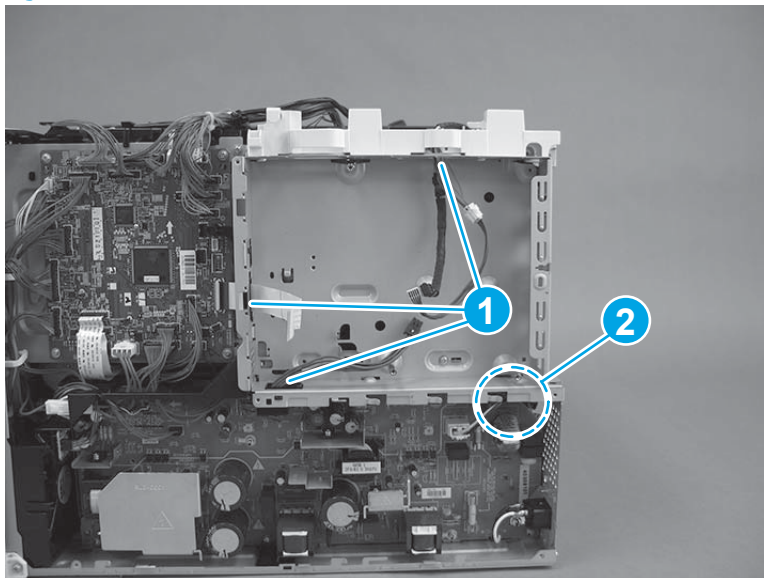

5. Position the LVPS cover on the printer, slide the cover to the left to install it, and then install two screws (callout 1).

Figure 1-1839 Install the LVPS cover

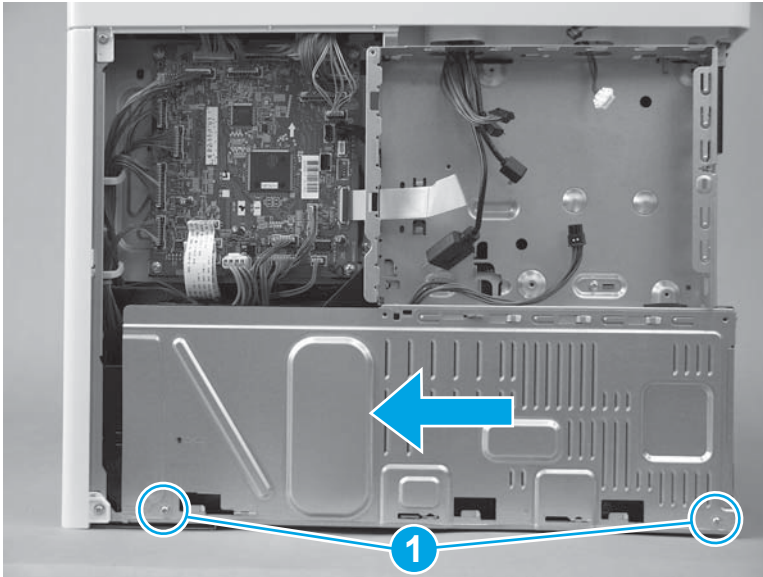

6. If no tape is affixed to the back of the flat cable, skip this step. If double-sided tape is affixed to the back of the flat cable, align the line (callout 1) on the cable with the edge (callout 2) of the opening in the sheet metal. Press to attach the flat cable to the formatter case.

Figure 1-1840 Attach the flat cable

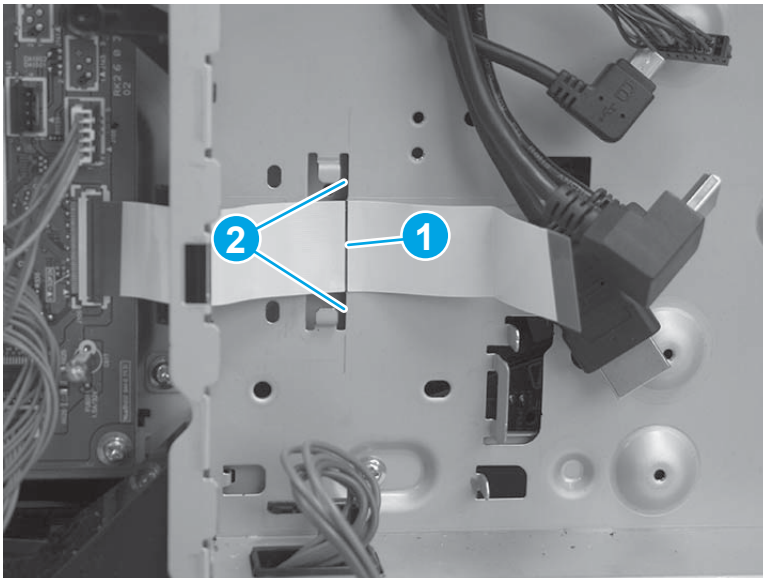

7. Position the bracket over the flat cable, and then slide the bracket to the left to install it. Make sure that the edges of the bracket fit under the sheet metal tabs (callout 1) on the formatter case and that the tabs (callout 2) snap into place.

Figure 1-1841 Position the bracket

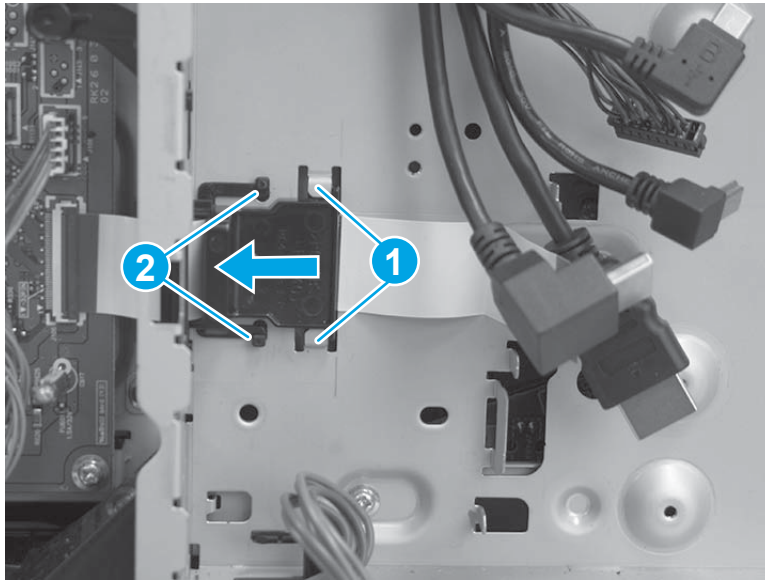

8. **M577 only:** Pass the wire harness (callout 1) through the openings in the formatter case (callout 2), and then connect one connector (callout 3).

Figure 1-1842 Connect one connector

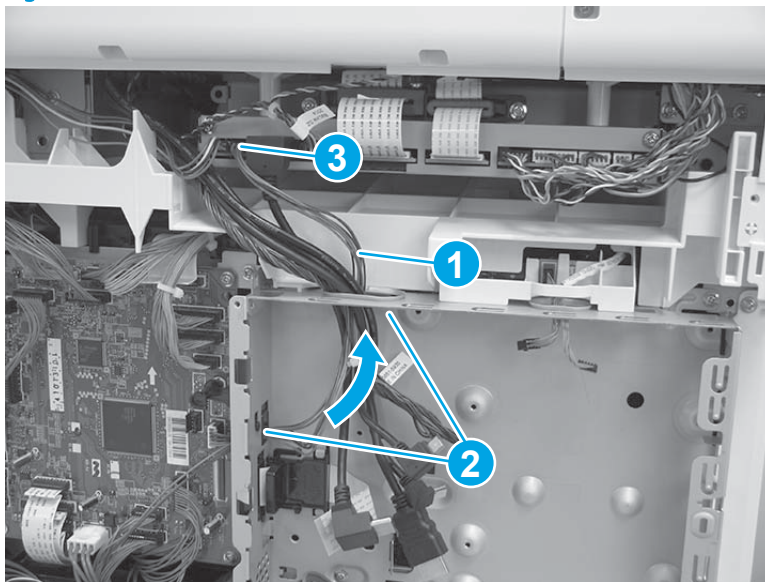

Step 18: Install the left cover

1. Position the cover on the printer.

 **NOTE:** Slightly offset the cover toward the rear of the printer.

Figure 1-1843 Install the cover

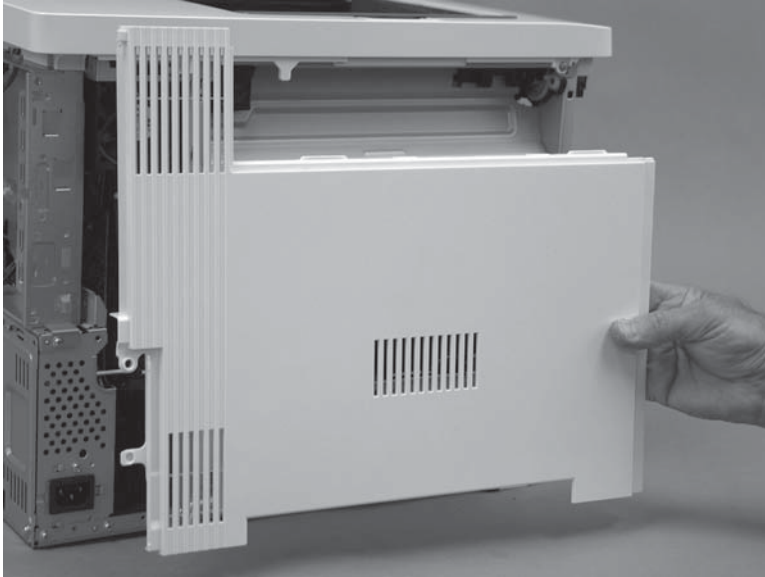

2. Slide the cover (callout 1) toward the front of the printer to engage it. Make sure that the tab (callout 2) snaps into place.

 **NOTE:** Locate the alignment pin (callout 3) on the cover from the front door side of the printer, and then make sure that it is fully engaged in the slot in the chassis.

 **TIP:** While sliding the cover into place, push in on the center of the cover (callout 1) to make sure that the hooks on the back of the cover engage with the slots in the chassis.

Figure 1-1844 Engage the cover



3. At the left side of the printer, install one screw (callout 1).

Figure 1-1845 Install one screw

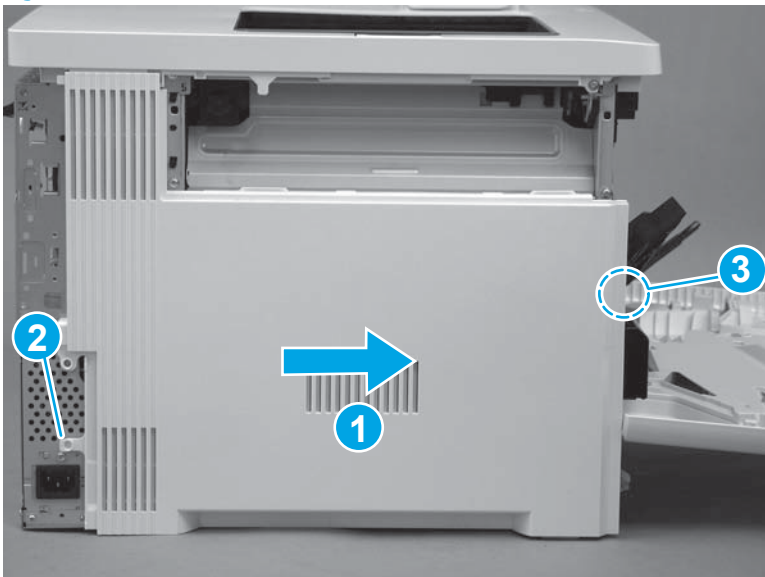

Step 19: Install the rear cover (M577)

 **NOTE:** This step is for the M577 models. For the M552 and M553 models, skip this step and go to [Step 21: Install the rear cover \(M552 and M553\) on page 1054](#).

1. Position the hooks (callout 1) on the cover in the slots (callout 2) in the printer.

Figure 1-1846 Position the hooks

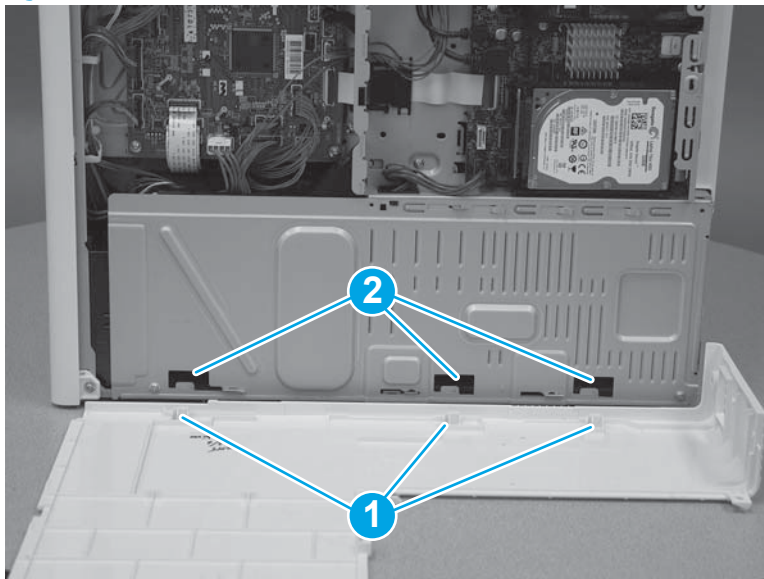

2. Position the back edge (callout 1) of the rear cover behind the edge (callout 2) of the right rear cover. Slide the cover to the left to install it.

Figure 1-1847 Install the cover

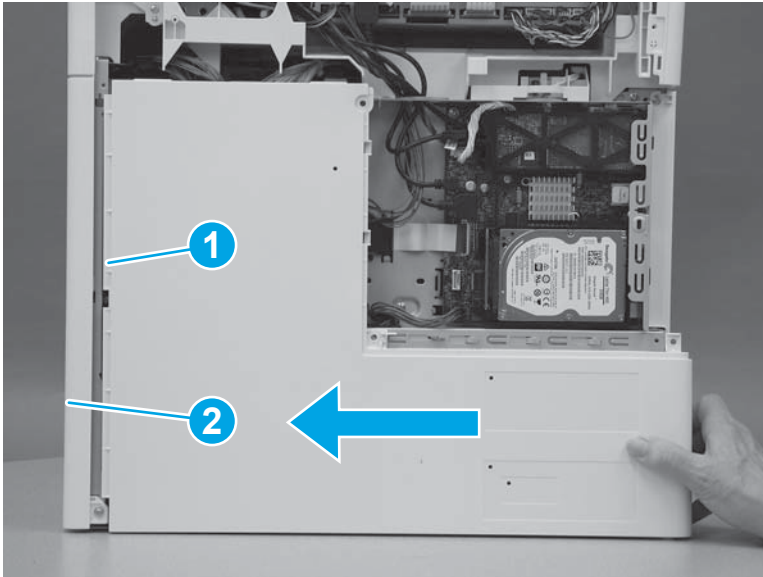

3. Install four screws (callout 1).

Figure 1-1848 Install four screws cover

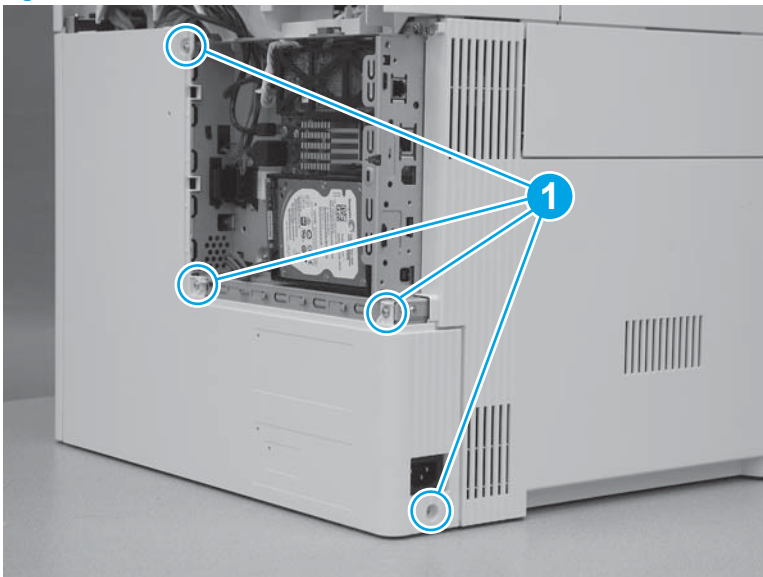

Step 20: Install the rear upper cover (M577)

 **NOTE:** This step is for the M577 models. For the M552 and M553 models, skip this step and go to [Step 21: Install the rear cover \(M552 and M553\) on page 1054](#).

1. Align the ridge (callout 1) on the lower edge of the rear upper cover in front of the tabs (callout 2) on the top edge of the rear cover.

Figure 1-1849 Align the cover

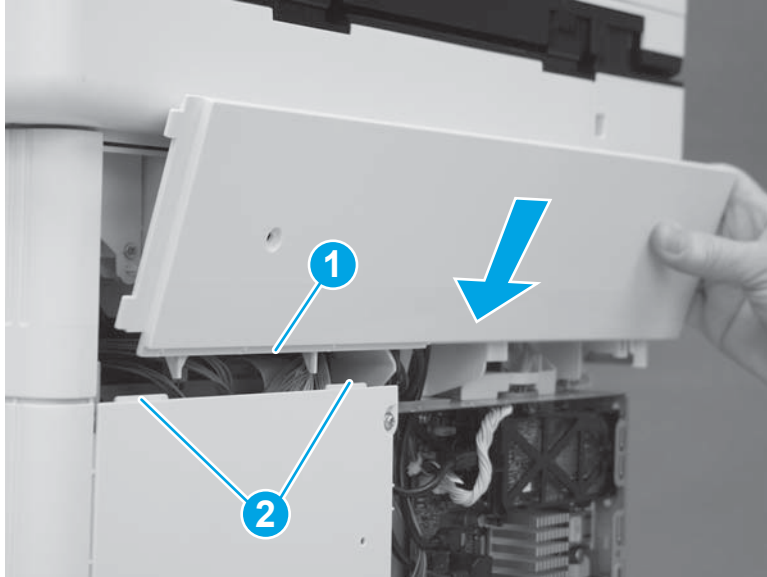

2. Rotate the top of the cover toward the printer.

Figure 1-1850 Rotate the top of the cover



3. Slide the cover to the left (callout 1). Make sure that the tabs (callout 2) on the upper rear cover slide behind the edge (callout 3) of the right upper cover. Make sure that the cover is fully seated.

Figure 1-1851 Slide the cover

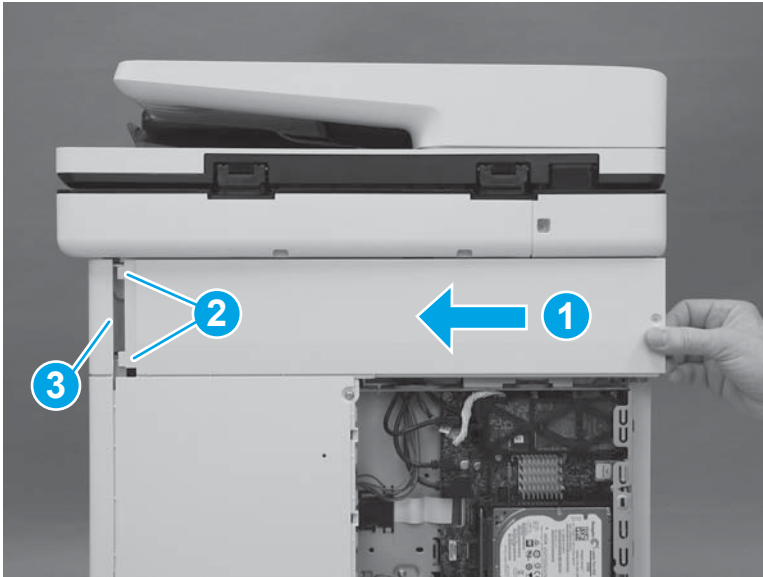

4. Install two screws (callout 1).

 **IMPORTANT:** These two screws are self-tapping screws for plastic. Rotate them counterclockwise to align them with the existing thread pattern, and then carefully turn them clockwise to tighten. Do not overtighten. This will prevent stripping the threads inside the screw holes.

Figure 1-1852 Install two screws



Step 21: Install the rear cover (M552 and M553)

 **NOTE:** This step is for the M552 and M553 models. For the M577 models, skip this step and go to [Step 22: Install the formatter \(M577\) on page 1055](#).

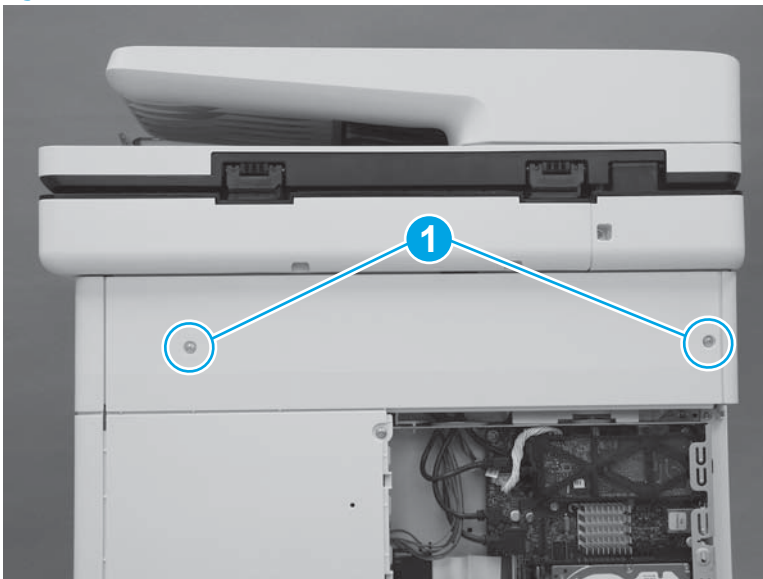
1. Position the top of the cover under the upper cover (callout 1), rotate the bottom of the cover onto the chassis (callout 2), and then slide the cover to the left (callout 3) to install it.

Figure 1-1853 Install the cover

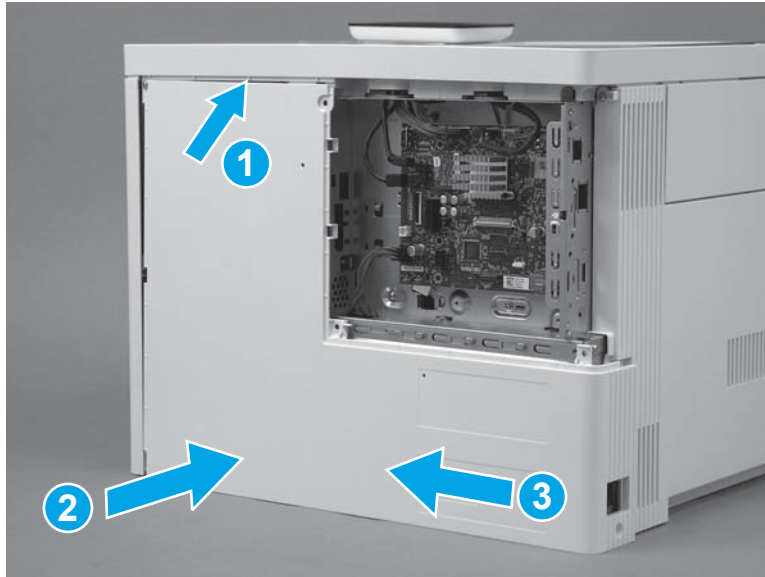

2. Install four screws (callout 1).

Figure 1-1854 Install four screws cover

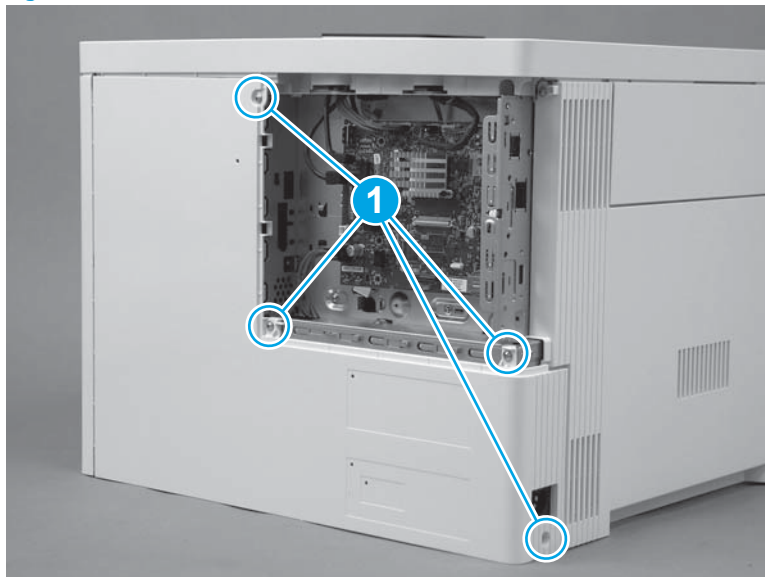

Step 22: Install the formatter (M577)

 **NOTE:** This step is for the M577 models. For the M552 and M553 models, skip this step and to go [Step 25: Install the formatter \(M552 and M553\) on page 1060](#).

 **CAUTION:**  ESD-sensitive part.

1. Position the formatter in the printer. Make sure that the network port (callout 1) fits through the opening (callout 2) in the formatter case.

Figure 1-1855 Install the formatter

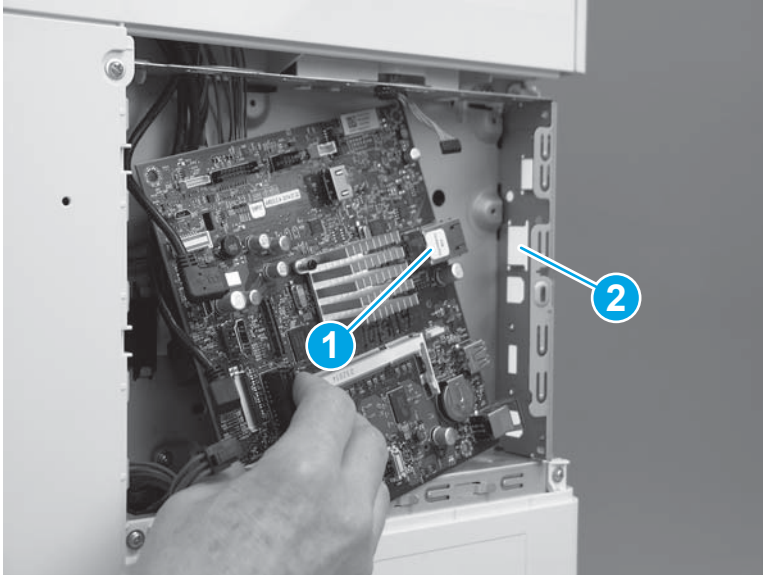

2. Install four screws (callout 1).

Figure 1-1856 Install four screws

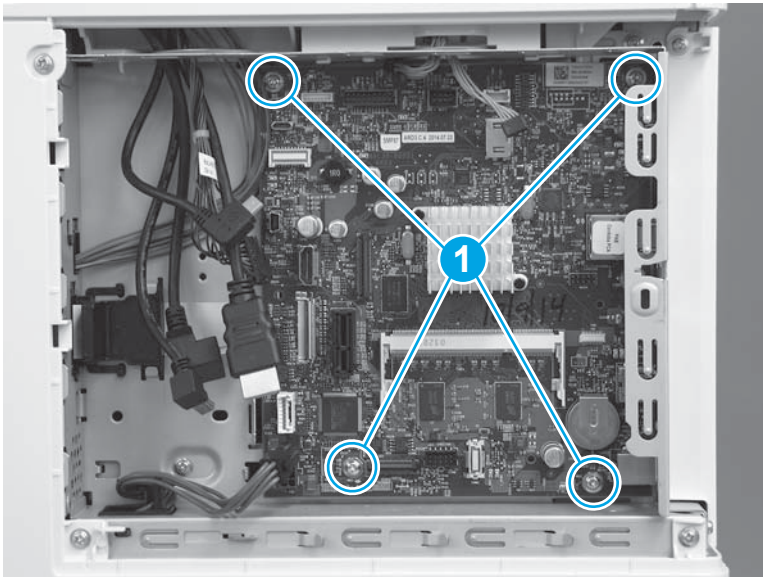

3. Connect all of the connectors on the formatter.

The following connectors are empty:

- All models: J1 (this connector is empty unless the optional DIMM is installed)
- All models: J3
- M577dn: J15 (this is the fax connector for the M577f/z/c models)
- All models: J21 (this connector is empty unless the optional internal USB ports component is installed)
- All models: J23

- All models: J24
- All models: J51
- All models: J57
- All models: J97
- All models: J98 (this connector is empty unless the optional trusted platform module (TPM) is installed)

 **IMPORTANT:** The flat-cable connector (callout 1) is a Zero Insertion Force (ZIF) connector that uses a hinged retainer to secure the flat cable. The hinged retainer must be opened to install the flat cable, and then closed after the cable is installed.

Figure 1-1857 Connect all connectors



Step 23: Install the fax PCA (M577c/f/z)

 **NOTE:** This step is for the M577c/f/z models. For the M577n model, skip this step and go to [Step 24: Install the HDD \(M577\) on page 1059](#).

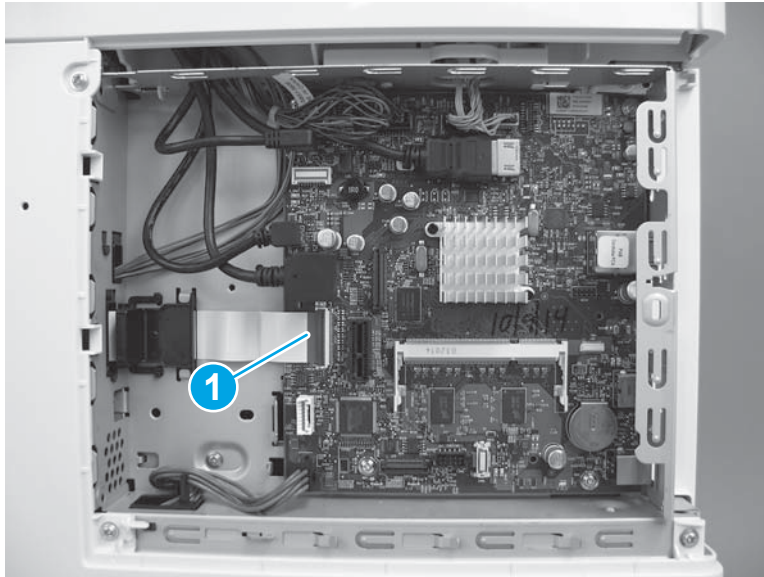
For the M552 and M553 models, skip this step and go to [Step 25: Install the formatter \(M552 and M553\) on page 1060](#).

 **CAUTION:**  ESD-sensitive part.

1. Position the tab and telephone port (callout 1) on the fax PCA in the slots (callout 2) in the formatter case.

Figure 1-1858 Position the fax PCA

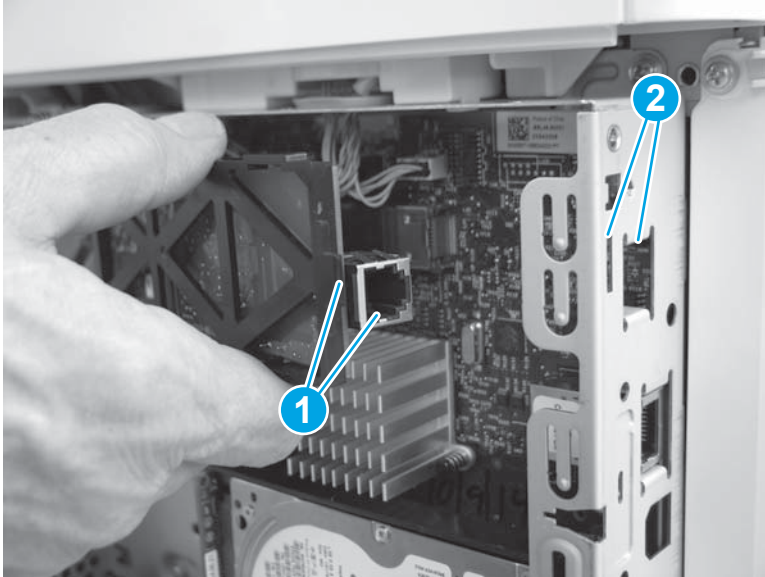

2. Slide the fax PCA to the right (callout 1) until the tab and telephone port described in the previous step and seated in the formatter case. Position the retainer (callout 2) in the slot (callout 3) in the formatter. Rotate the end of the fax PCA toward the formatter (callout 4) until the retainer snaps into place.

Figure 1-1859 Install the fax PCA

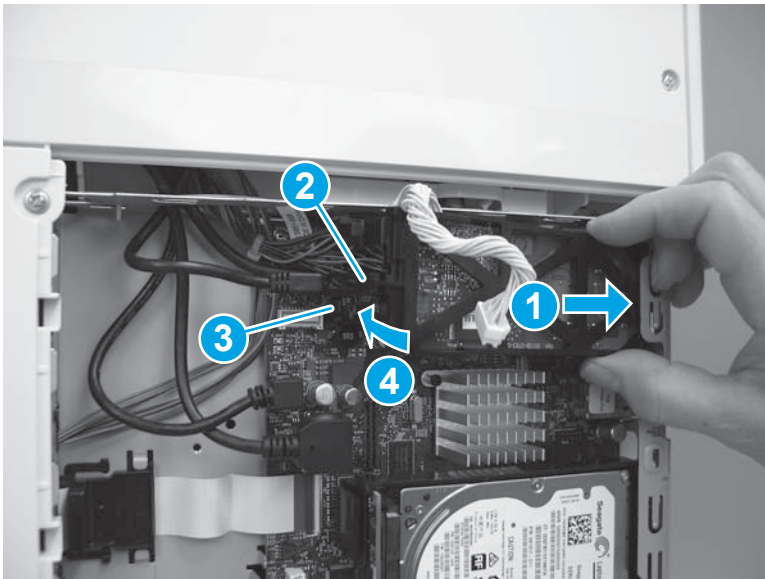

3. Position the cable (callout 1) in the guide (callout 2), and then connect one connector (callout 3).

Figure 1-1860 Connect the connector

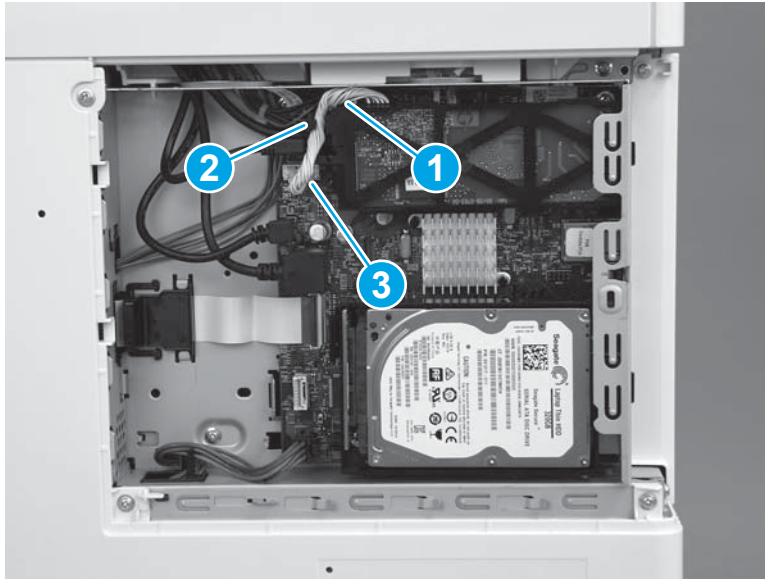

Step 24: Install the HDD (M577)

 **NOTE:** This step is for the M577 models. For the M552 and M553 models, skip this step and go to [Step 25: Install the formatter \(M552 and M553\) on page 1060](#).

 **CAUTION:**  ESD-sensitive part.

1. Align the end of the bracket (callout 1) with the slot in the chassis (callout 2), and then slide the HDD into the printer (callout 3) to engage the bracket with the chassis.

Figure 1-1861 Install the holder

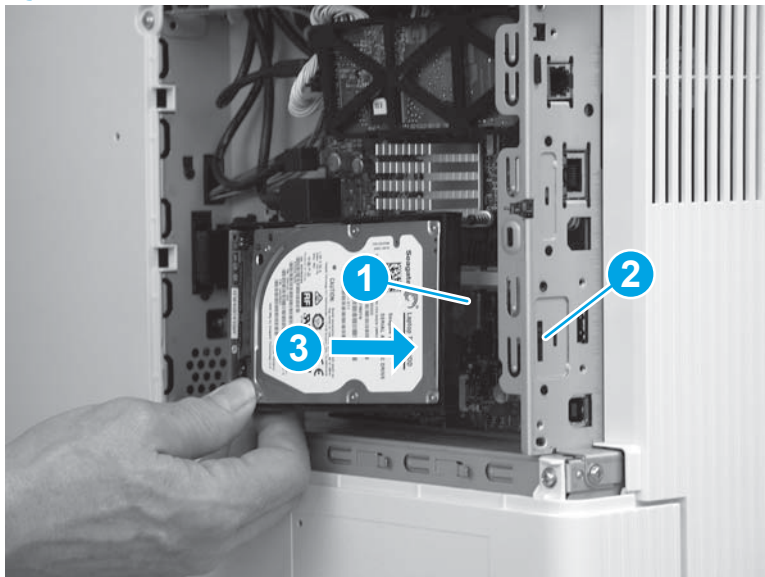

2. Hold the HDD connector latch (callout 1) in the released position, and then rotate the HDD down and into the connector on the formatter to install it.

 **NOTE:** Make sure that the tab (callout 2) snaps into place, and that the HDD is securely installed.

Figure 1-1862 Release the HDD



Step 25: Install the formatter (M552 and M553)

 **NOTE:** This step is for the M552 and M553 models. For the M577 models, skip this step and go to [Step 26: Install the formatter cover on page 1062](#).

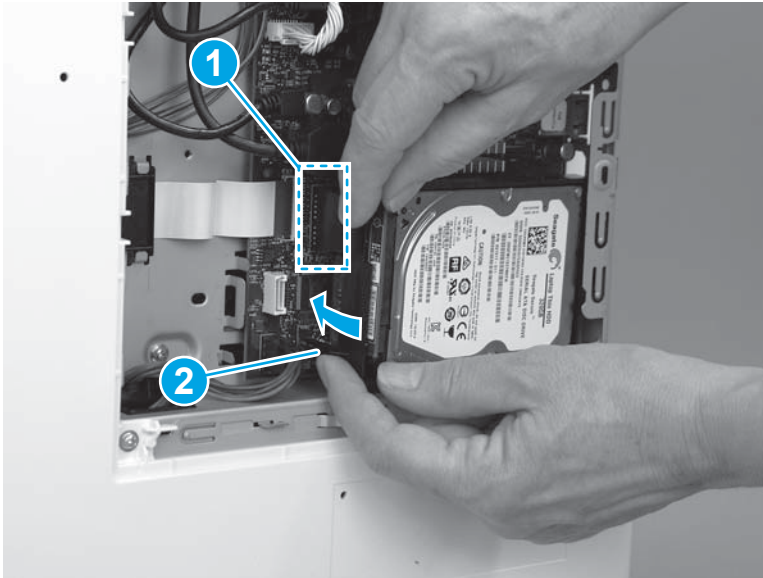
If the optional hard-disk drive (HDD) was removed, do not forget to reinstall it after the formatter is reinstalled.

Engage the HDD holder with the chassis, rotate the HDD connector down and into the connector on the formatter. Make sure that the tabs snap into place.

 **CAUTION:**  ESD-sensitive part.

1. Position the formatter in the printer, and then install four screws (callout 1).

Figure 1-1863 Install the formatter

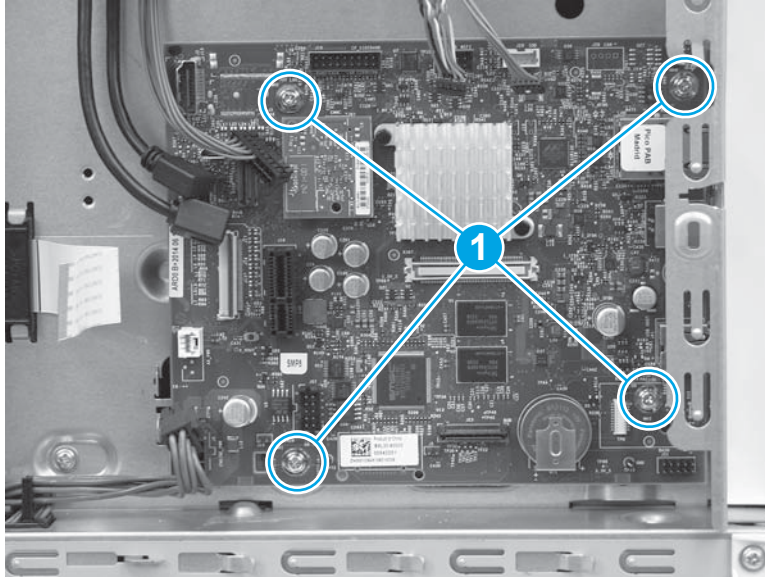

2. Connect all of the connectors on the formatter.

The following connectors are empty:

- All models: J1 (this connector is empty unless the optional DIMM is installed)
- M553n/dn and M552dn: J2 (callout 1; this is the touchscreen connector for the M553x model)
- All models: J9 (this connector is empty unless the optional internal USB ports component is installed)
- All models: J18 (this connector is empty unless the optional hard-disk-drive (HDD) is installed)
- All models: J23
- All models: J24
- M553n/dn and M552dn: J25 (this is the wireless connector for the M553x model)
- All models: J57
- All models: J98 (this connector is empty unless the optional trusted platform module (TPM) is installed)

 **IMPORTANT:** The flat-cable connector (callout 2) is a Zero Insertion Force (ZIF) connector that uses a hinged retainer to secure the flat cable. The hinged retainer must be opened to install the flat cable.

Figure 1-1864 Connect all connectors



Step 26: Install the formatter cover

- ▲ Slide the cover onto the printer (callout 1) to install it.

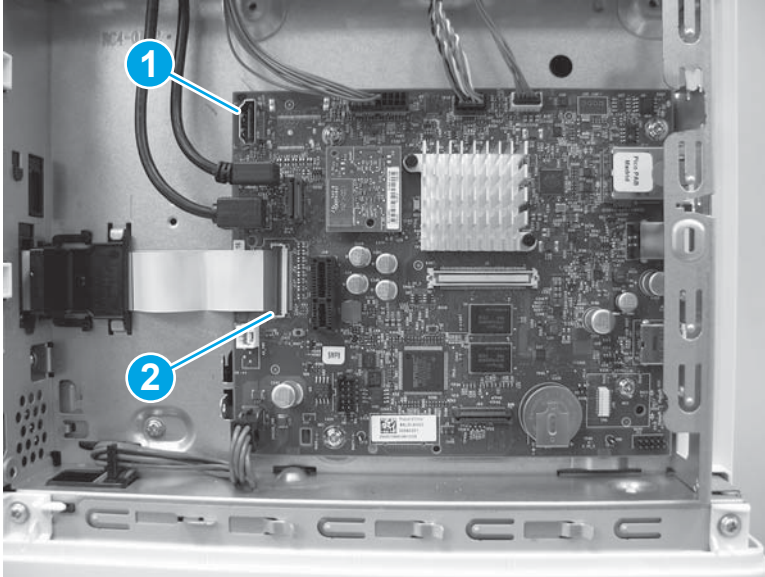
 **NOTE:** Make sure that the tabs on the formatter cover align with the slots provided in the printer (callout 2). Tighten the two thumbscrews (callout 3).

 **TIP:** If needed, use the edge of a coin to turn the thumbscrews.

Figure 1-1865 Install the cover

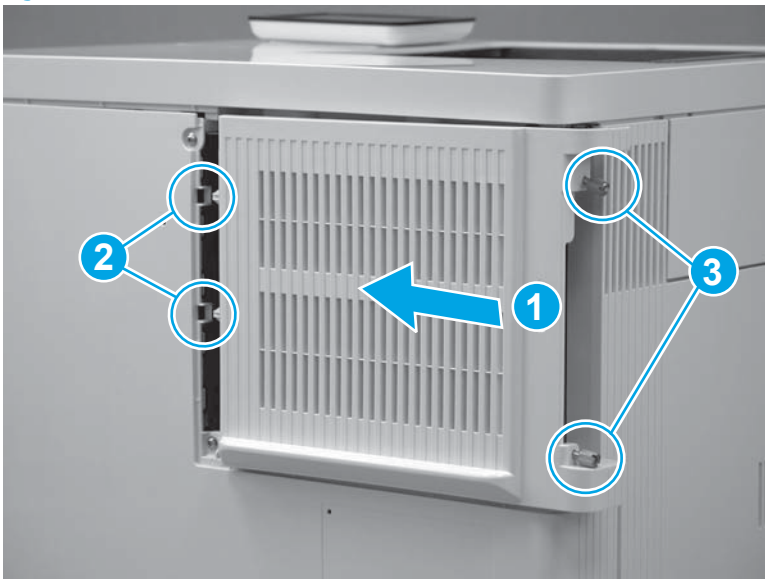

Step 27: Install the TCU

1. Verify that the toner collection hatch cover is in the closed position on the TCU.

Figure 1-1866 Verify that the toner collection hatch cover is closed

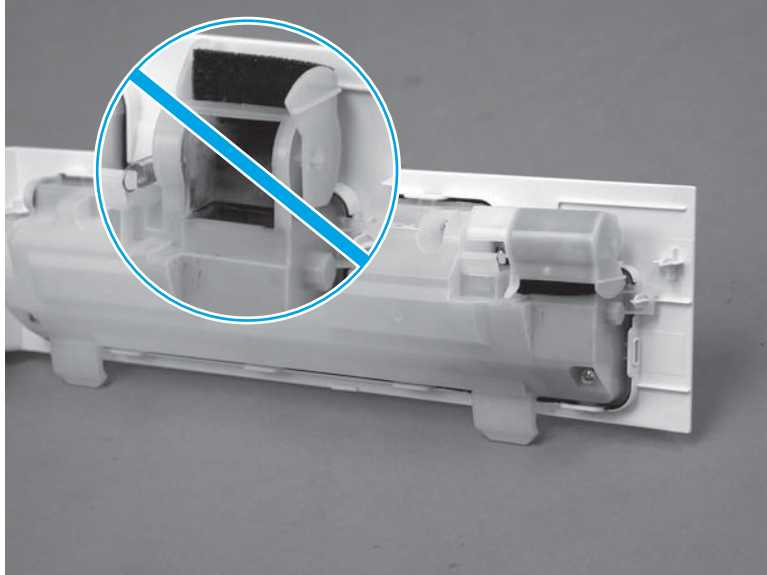

2. Position the TCU with the hinges in the slots provided in the printer (callout 1), and then rotate the TCU up and into the closed position.

 **NOTE:** The toner collection hatch cover automatically opens when the TCU is closed.

Figure 1-1867 Install the TCU

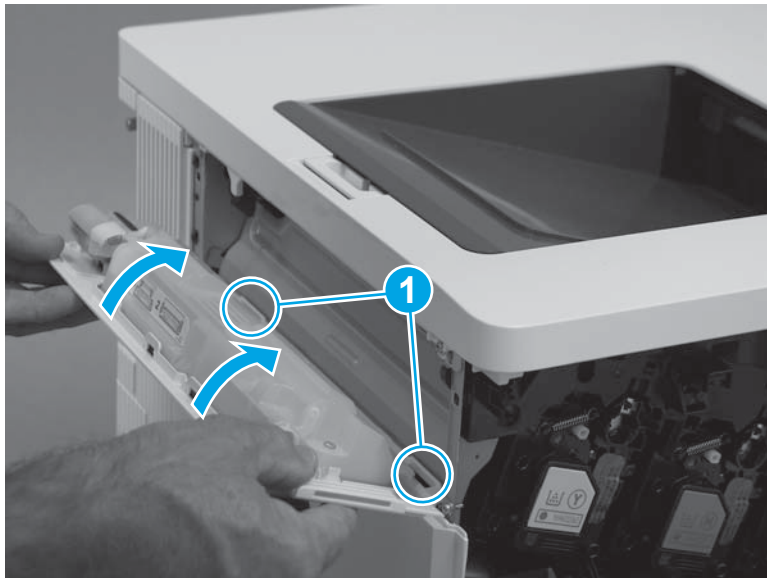

3. Close the front door.

Figure 1-1868 Close the front door



Removal and replacement: Drum motor 1 (M1)

- [Introduction](#)
- [Step 1: Remove the toner collection unit \(TCU\)](#)
- [Step 2: Remove the formatter cover](#)
- [Step 3: Remove the formatter \(M552 and M553\)](#)
- [Step 4: Remove the hard-disk drive \(HDD\) \(M577\)](#)
- [Step 5: Remove the fax PCA \(M577c/f/z\)](#)
- [Step 6: Remove the formatter \(M577\)](#)
- [Step 7: Remove the rear cover \(M552 and M553\)](#)
- [Step 8: Remove the rear upper cover \(M577\)](#)
- [Step 9: Remove the rear cover \(M577\)](#)
- [Step 10: Remove the left cover](#)
- [Step 11: Remove the formatter case](#)
- [Step 12: Remove drum motor 1 \(M1\)](#)
- [Step 13: Unpack the replacement assembly](#)
- [Step 14: Install drum motor 1 \(M1\)](#)
- [Step 15: Install the formatter case](#)
- [Step 16: Install the left cover](#)
- [Step 17: Install the rear cover \(M577\)](#)
- [Step 18: Install the rear upper cover \(M577\)](#)
- [Step 19: Install the rear cover \(M552 and M553\)](#)
- [Step 20: Install the formatter \(M577\)](#)
- [Step 21: Install the fax PCA \(M577c/f/z\)](#)
- [Step 22: Install the HDD \(M577\)](#)
- [Step 23: Install the formatter \(M552 and M553\)](#)
- [Step 24: Install the formatter cover](#)
- [Step 25: Install the TCU](#)

Introduction

This document provides the procedures to remove and replace the drum motor 1 (M1).

Before performing service

Turn the printer power off

- Disconnect the power cable.

 **WARNING!** To avoid damage to the printer, turn the printer off, wait 30 seconds, and then remove the power cord before attempting to service the printer.

Use the table below to identify the correct part number for your printer, and then go to <http://h20141.www2.hp.com/hpparts> to order the part.

Drum motor 1 (M1) part number	
RM2-0078-000CN	Drum motor 1 (M1)

Required tools

- #2 Phillips screwdriver with a magnetic tip

After performing service

Make sure that all of the connectors on the LVPS are fully seated.

Make sure that all of the connectors on the formatter are fully seated.

Make sure that the formatter cover is fully seated, and that the thumbscrews are finger tight after replacing it.

Turn the printer power on

- Connect the power cable.
- Use the power switch to turn the power on.

Post service test

Use the components test to test the motor. For more information, see the printer troubleshooting manual.

Step 1: Remove the toner collection unit (TCU)

1. Open the front door.

Figure 1-1869 Open the front door



2. Open the TCU.

 **NOTE:** The toner collection hatch cover automatically closes when the TCU is opened.

Figure 1-1870 Open the TCU



3. Pull the TCU away from the printer at an angle to remove it.

⚠ CAUTION: Do not open the toner collection hatch cover when handling the TCU. If toner gets on clothing, wipe it off by using a dry cloth and wash the clothes in cold water. Hot water sets toner into fabric.

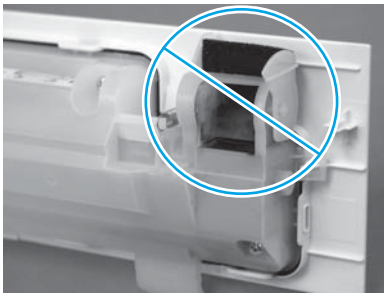
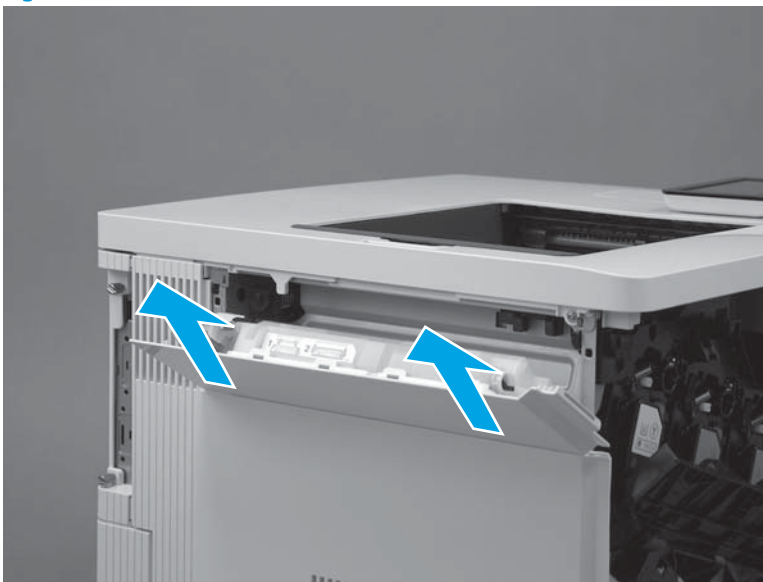

Figure 1-1871 Remove the TCU



Step 2: Remove the formatter cover

1. Locate the formatter cover.

Figure 1-1872 Locate the formatter cover

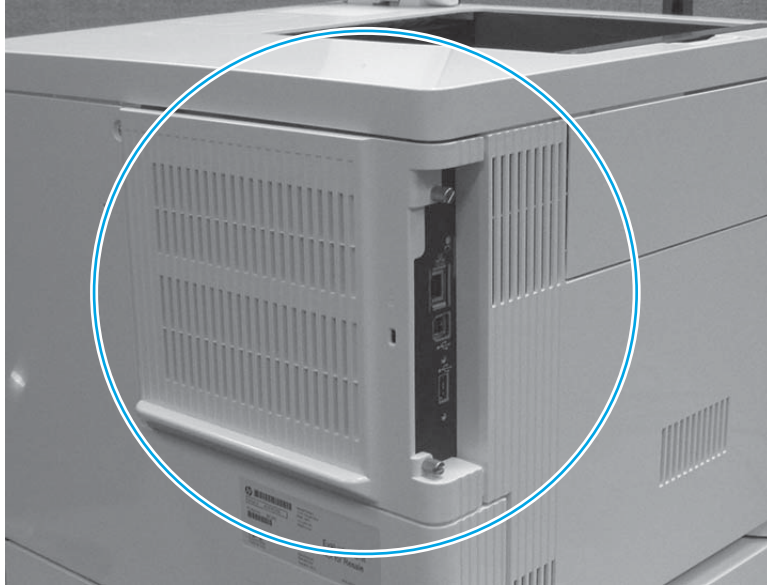

2. Loosen the two thumbscrews (callout 1). Grasp the two thumbscrews, and then slide the cover away from the printer (callout 2) to remove it.

 **TIP:** If needed, use the edge of a coin to turn the thumbscrews.

Figure 1-1873 Loosen the thumbscrews

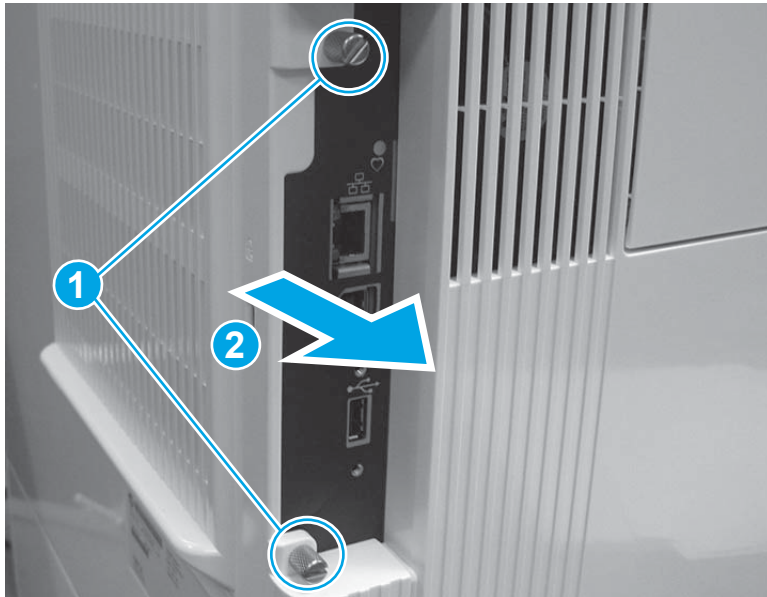

Step 3: Remove the formatter (M552 and M553)

 **NOTE:** This step is for the M552 and M553 models. For the M577 models, skip this step and go to [Step 4: Remove the hard-disk drive \(HDD\) \(M577\) on page 1071](#).

If the optional hard-disk drive (HDD) is installed, it must be removed to gain access to the formatter mounting screws.

Release two tabs along the left edge of the HDD, rotate the left edge away from the product, and then slide the HDD to the left to remove it.

 **CAUTION:**  ESD-sensitive part.

1. Disconnect all of the connectors on the formatter.

The following connectors are empty:

- All models: J1 (this connector is empty unless the optional DIMM is installed)
- M553n/dn and M552dn: J2 (callout 1; this is the touchscreen connector for the M553x model)
- All models: J9 (this connector is empty unless the optional internal USB ports component is installed)
- All models: J18 (this connector is empty unless the optional hard-disk-drive (HDD) is installed)
- All models: J23
- All models: J24
- M553n/dn and M552dn: J25 (this is the wireless connector for the M553x model)
- All models: J57
- All models: J98 (this connector is empty unless the optional trusted platform module (TPM) is installed)

 **IMPORTANT:** The flat-cable connector (callout 2) is a Zero Insertion Force (ZIF) connector that uses a hinged retainer to secure the flat cable. The hinged retainer must be opened to release the flat cable.

Figure 1-1874 Disconnect all connectors



2. Remove four screws (callout 1), and then remove the formatter.

Figure 1-1875 Remove the formatter

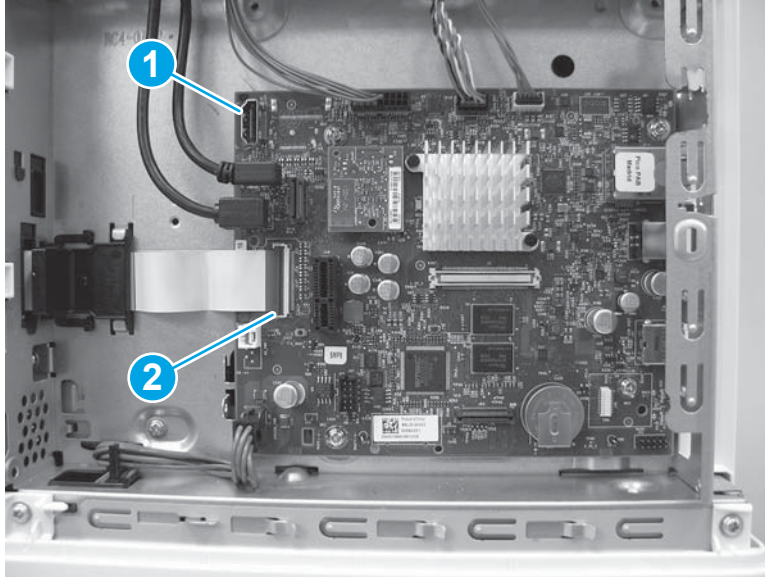
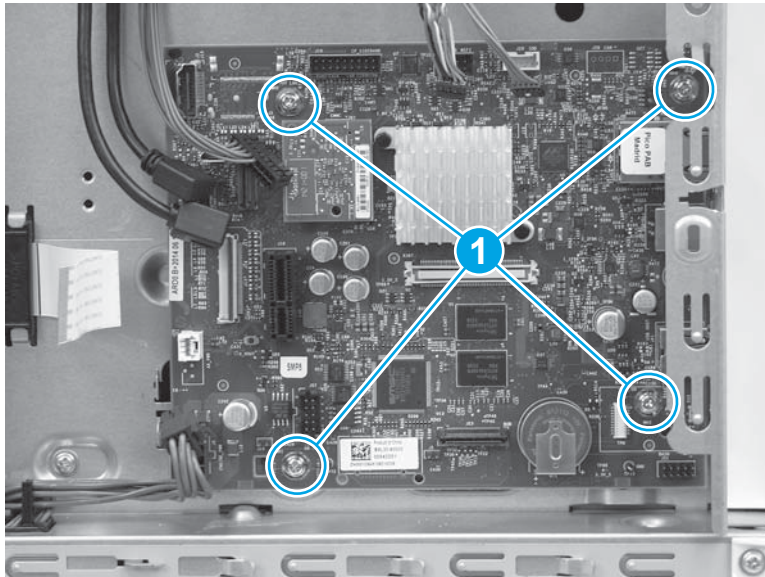

Step 4: Remove the hard-disk drive (HDD) (M577)

 **NOTE:** This step is for the M577 models. For the M552 and M553 models, skip this step and go to [Step 7: Remove the rear cover \(M552 and M553\) on page 1076](#).

 **CAUTION:**  ESD-sensitive part.

1. Release two tabs (callout 1). Hold the tabs in the released position, and then rotate the hard disk drive (HDD) up (callout 2) to release the connector from the formatter.

Figure 1-1876 Release the HDD

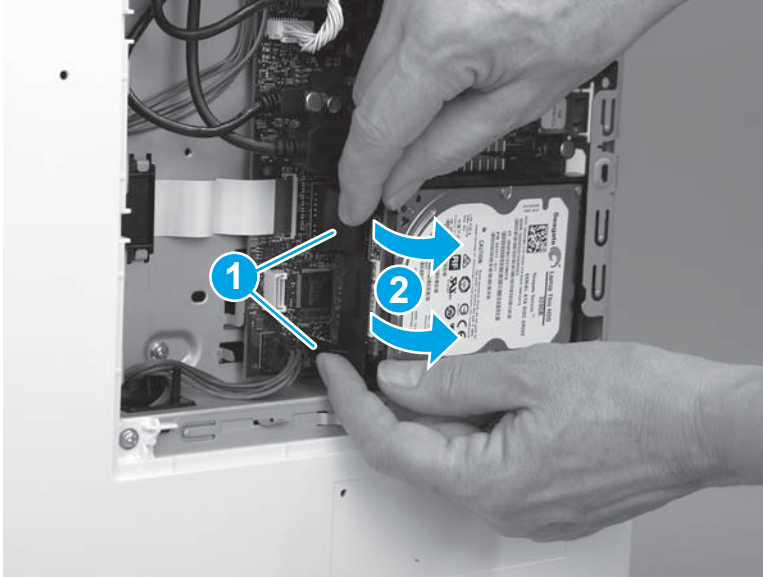

2. Slide the HDD away from the printer to remove it.

Figure 1-1877 Remove the HDD



Step 5: Remove the fax PCA (M577c/f/z)

 **NOTE:** This step is for the M577c/f/z models. For the M577n model, skip this step and go to [Step 6: Remove the formatter \(M577\) on page 1074](#).

For the M552 and M553 models, skip this step and go to [Step 7: Remove the rear cover \(M552 and M553\) on page 1076](#).

 **CAUTION:**  ESD-sensitive part.

1. Locate the fax PCA component on the formatter.

Figure 1-1878 Locate the fax PCA

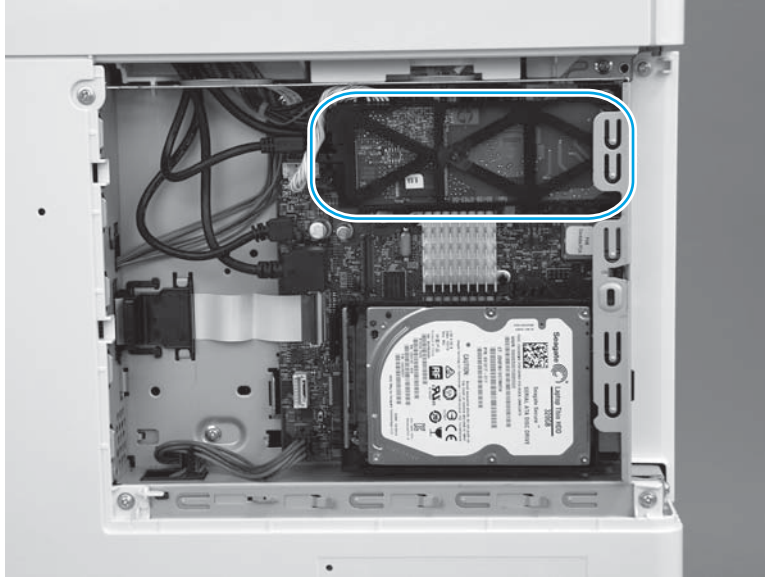

2. Release the connector latch (callout 1), and then pull the connector away from the formatter (callout 2) to disconnect it.

Figure 1-1879 Disconnect one connector

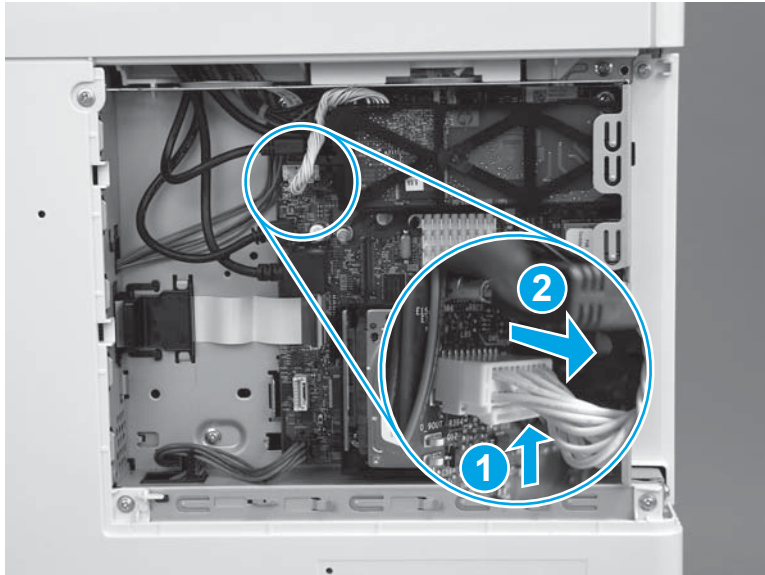

3. Release one retainer (callout 1) by pressing the bracket arms together.

Figure 1-1880 Release one latch

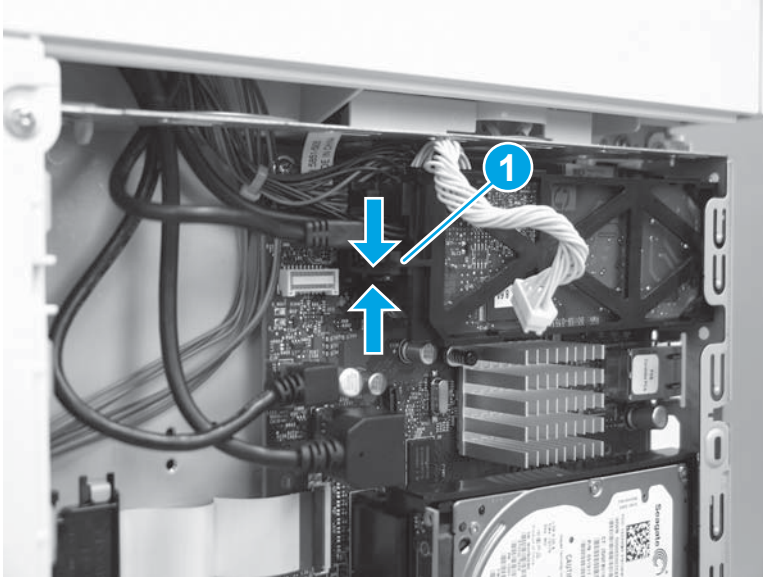

4. Rotate the end of the fax PCA (callout 1) away from the formatter, and then slide the PCA left (callout 2) to remove it.

Figure 1-1881 Remove the fax PCA

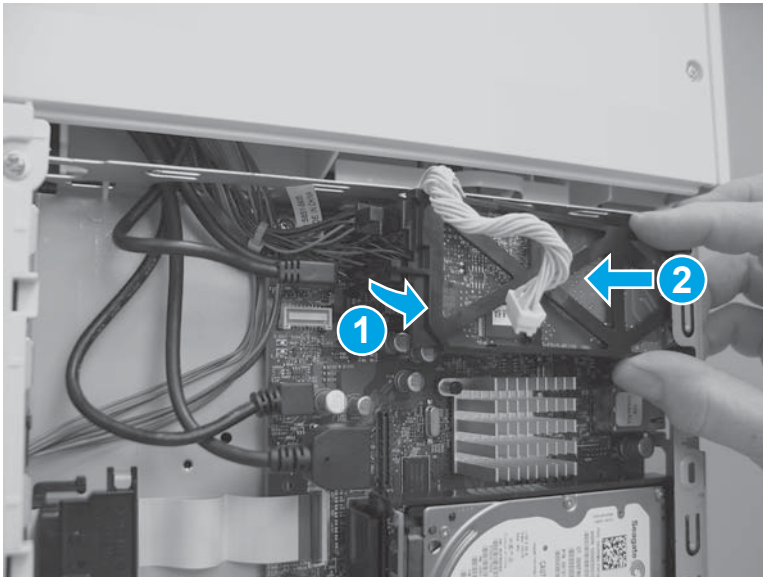

Step 6: Remove the formatter (M577)

 **NOTE:** This step is for the M577 models. For the M552 and M553 models, skip this step and go to [Step 7: Remove the rear cover \(M552 and M553\) on page 1076.](#)

 **CAUTION:**  ESD-sensitive part.

1. Disconnect all of the connectors on the formatter.

The following connectors are empty:

- All models: J1 (this connector is empty unless the optional DIMM is installed)
- All models: J3
- M577dn: J15 (this is the fax connector for the M577f/z/c models)
- All models: J21 (this connector is empty unless the optional internal USB ports component is installed)
- All models: J23
- All models: J24
- All models: J51
- All models: J57
- All models: J97
- All models: J98 (this connector is empty unless the optional trusted platform module (TPM) is installed)

 **IMPORTANT:** The flat-cable connector (callout 1) is a Zero Insertion Force (ZIF) connector that uses a hinged retainer to secure the flat cable. The hinged retainer must be opened to release the flat cable.

Figure 1-1882 Disconnect all connectors



2. Remove four screws (callout 1).

Figure 1-1883 Remove four screws

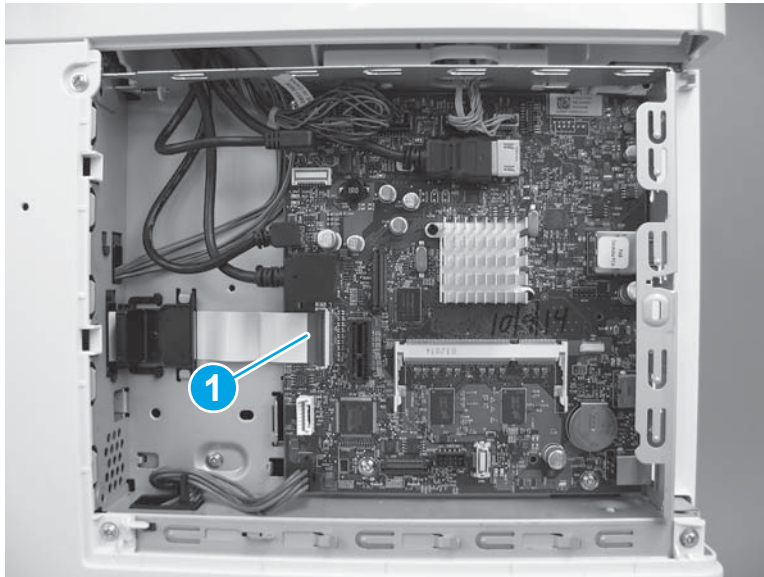
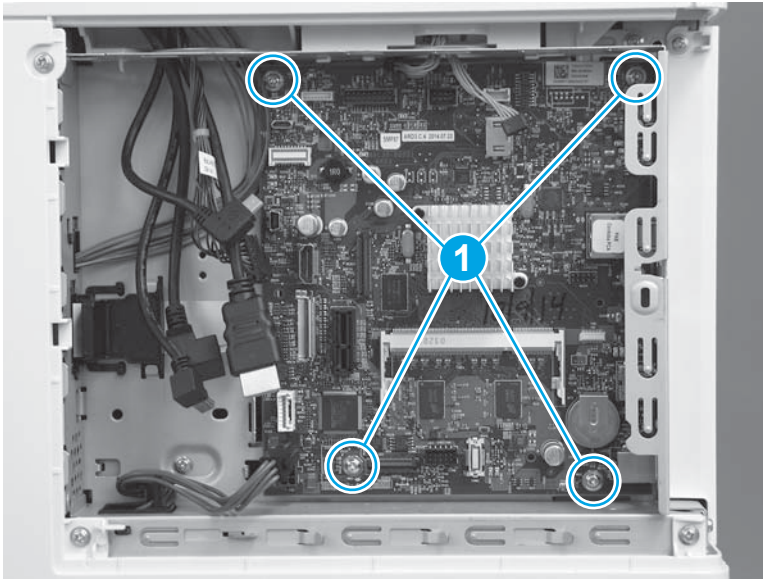

3. Remove the formatter.

Figure 1-1884 Remove the formatter

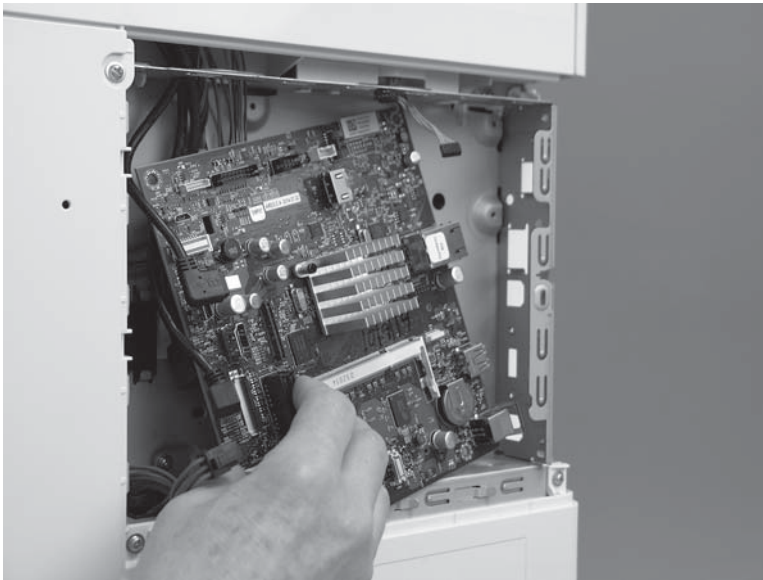

Step 7: Remove the rear cover (M552 and M553)

 **NOTE:** This step is for the M552 and M553 models. For the M577 models, skip this step and go to [Step 8: Remove the rear upper cover \(M577\) on page 1077.](#)

1. Remove four screws (callout 1).

Figure 1-1885 Remove four screws

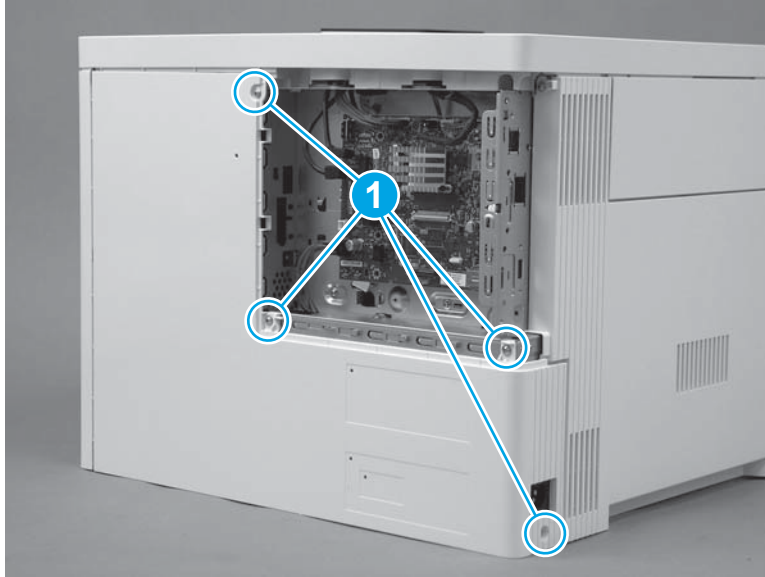

2. Slightly slide the cover to the right (callout 1), rotate the bottom of the cover away from the printer (callout 2), and then pull the top of the cover away from the printer (callout 3) to remove the cover.

Figure 1-1886 Remove the cover

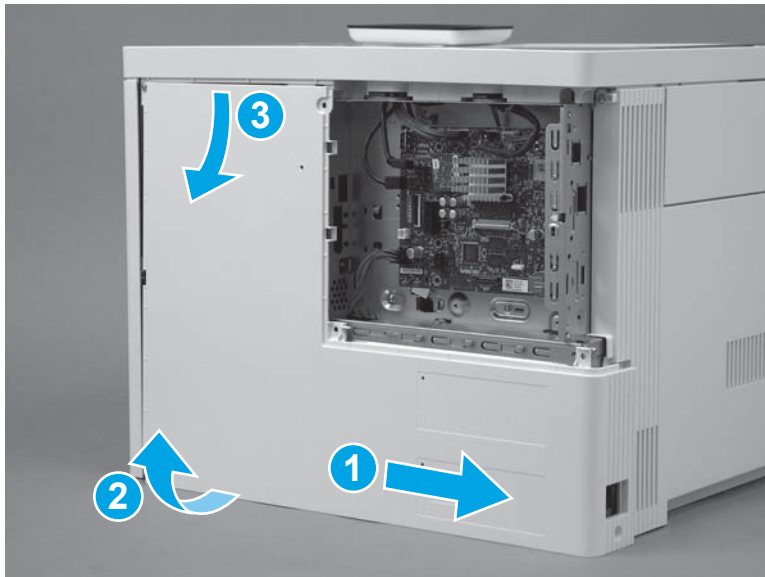

Step 8: Remove the rear upper cover (M577)

 **NOTE:** This step is for the M577 models. For the M552 and M553 models, skip this step and go to [Step 10: Remove the left cover on page 1080](#).

1. Remove two screws (callout 1).

 **Reinstallation tip:** These two screws are self-tapping screws for plastic. When reinstalling them, rotate the screws counterclockwise to align them with the existing thread pattern, and then carefully turn them clockwise to tighten. Do not overtighten. This will prevent stripping the threads inside the screw holes.

Figure 1-1887 Remove two screws



2. Use a small, flat blade screwdriver to release the right edge of the cover.

Figure 1-1888 Release the right edge

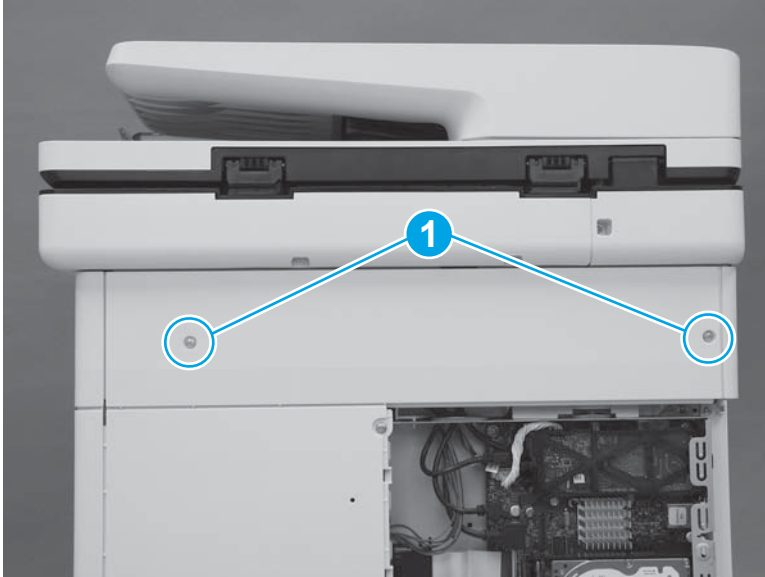
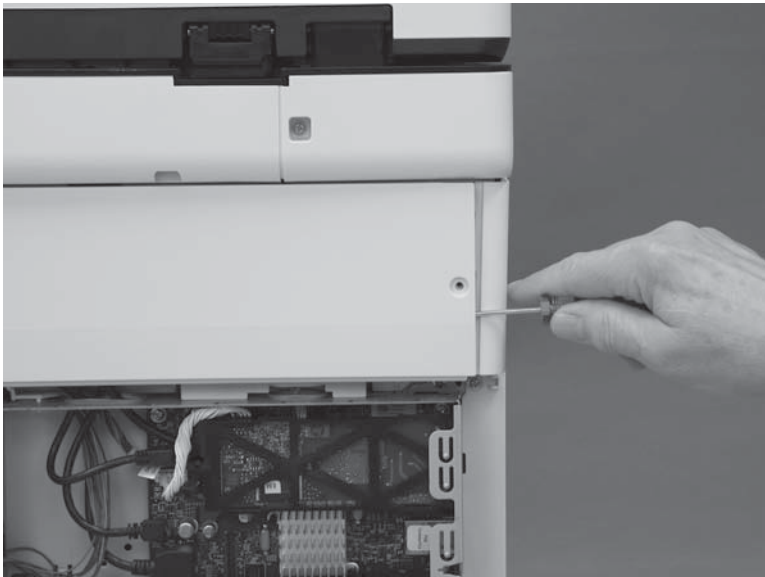

3. Pull the right edge of the cover (callout 1) away from the printer, and then slide the cover to the right (callout 2).

Figure 1-1889 Slide the cover right

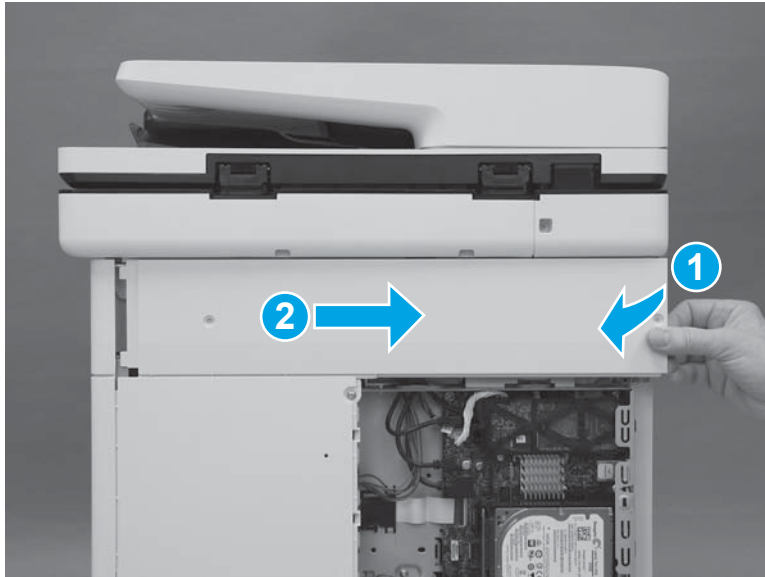

4. Remove the cover.

Figure 1-1890 Remove the cover

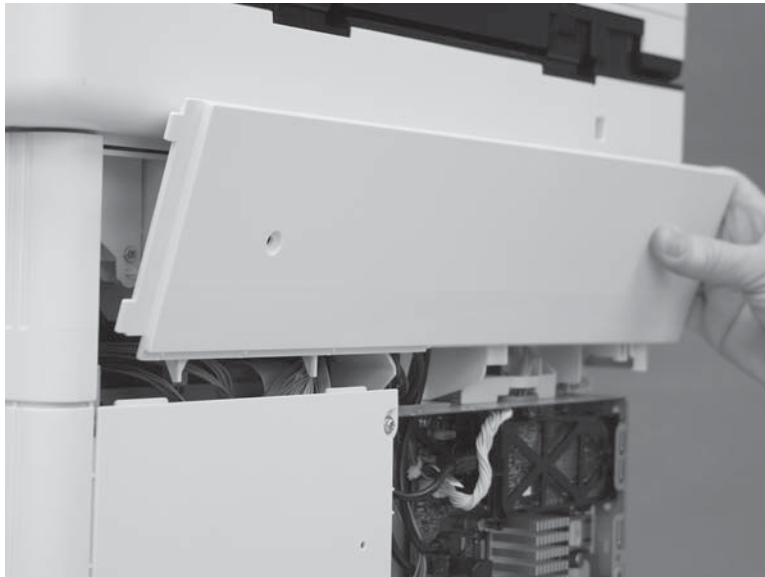

Step 9: Remove the rear cover (M577)

 **NOTE:** This step is for the M577 models. For the M552 and M553 models, skip this step and go to [Step 10: Remove the left cover on page 1080](#).

1. Remove four screws (callout 1).

Figure 1-1891 Remove four screws

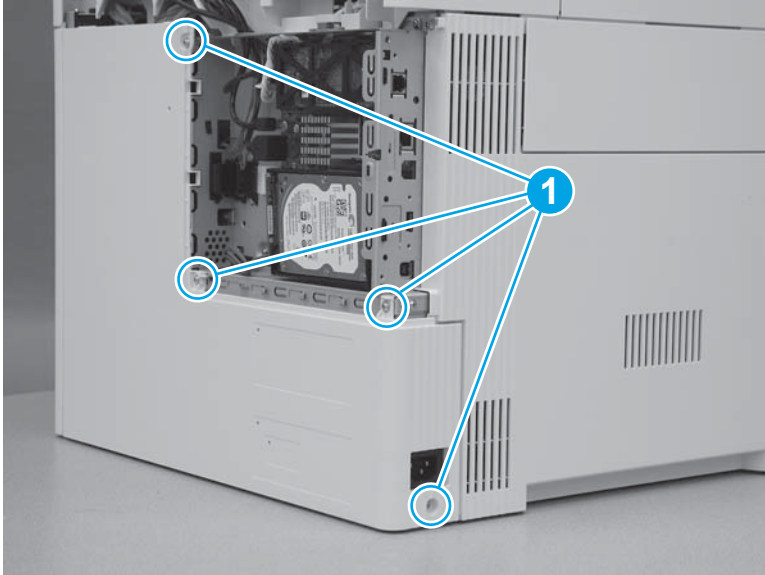

2. Slide the cover to the right to remove it.

Figure 1-1892 Remove the cover

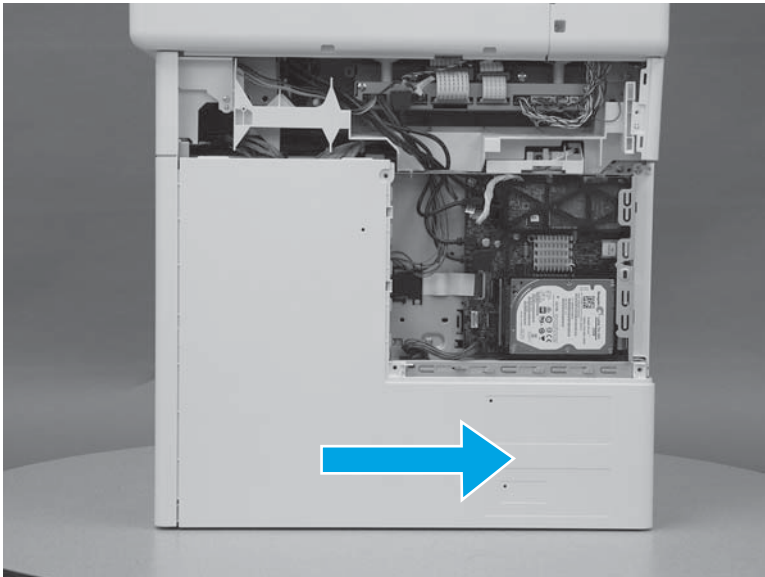

Step 10: Remove the left cover

1. At the left side of the printer, remove one screw (callout 1).

Figure 1-1893 Remove one screw



2. Release one tab (callout 1), rotate the front edge of the cover away from the printer (callout 2), and then slide the cover (callout 3) toward the rear of the printer to release it.

Figure 1-1894 Release the cover

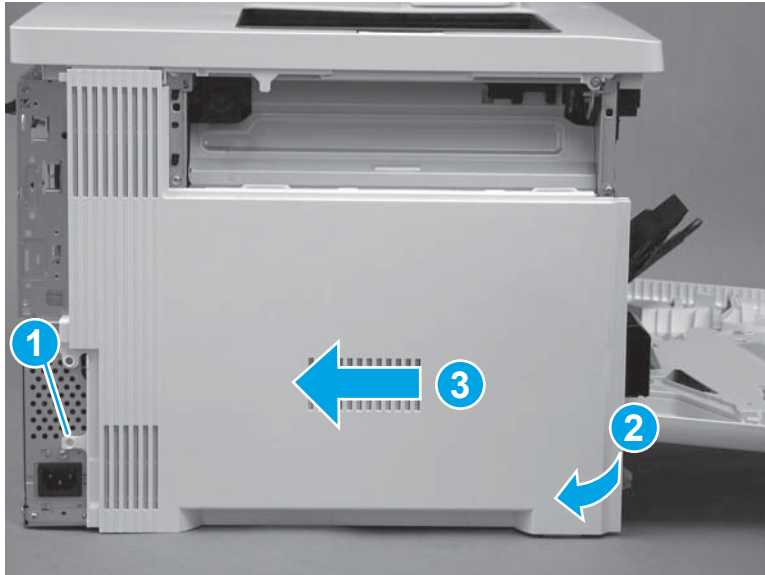

3. Remove the cover.

Figure 1-1895 Remove the cover

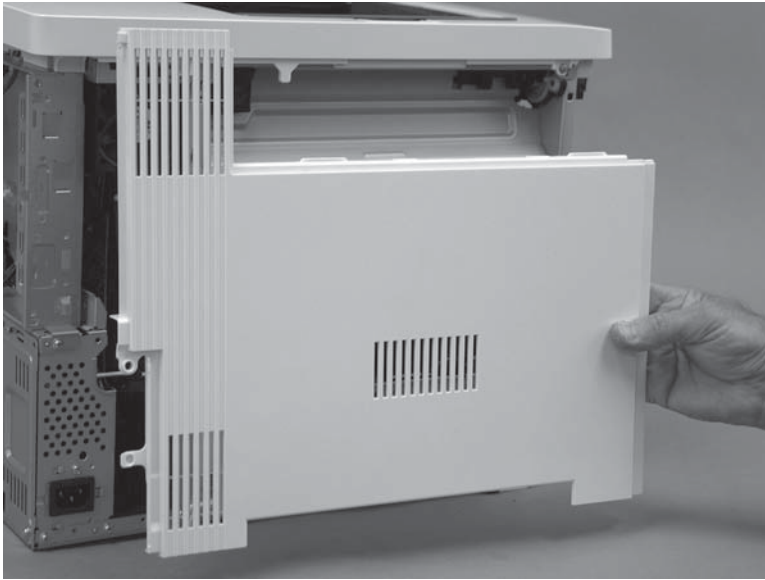

Step 11: Remove the formatter case

1. **M577 only:** Disconnect one connector (callout 1), and then pass the wire harness (callout 2) through two openings in the formatter case (callout 3).

Figure 1-1896 Disconnect one connector

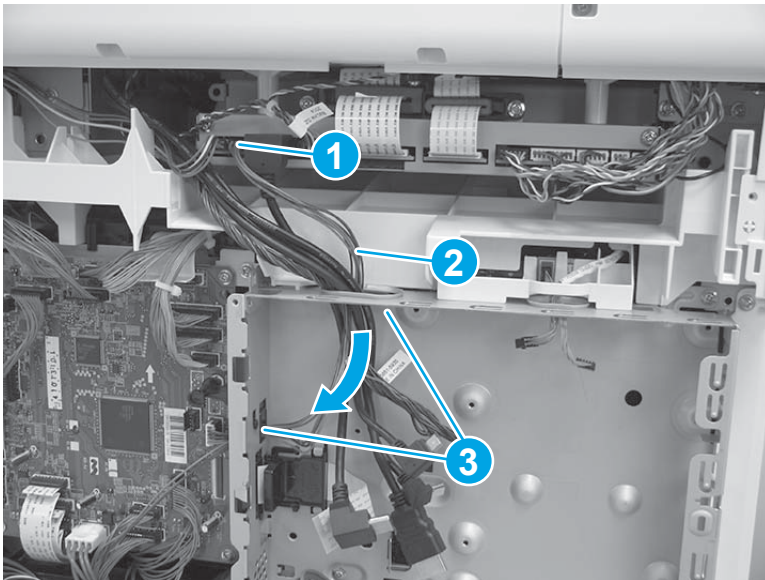

2. Release two tabs (callout 1) on the black plastic bracket. Hold the tabs in the released position, and then slide the bracket (callout 2) to the right to remove it from the formatter case.

Figure 1-1897 Remove the bracket

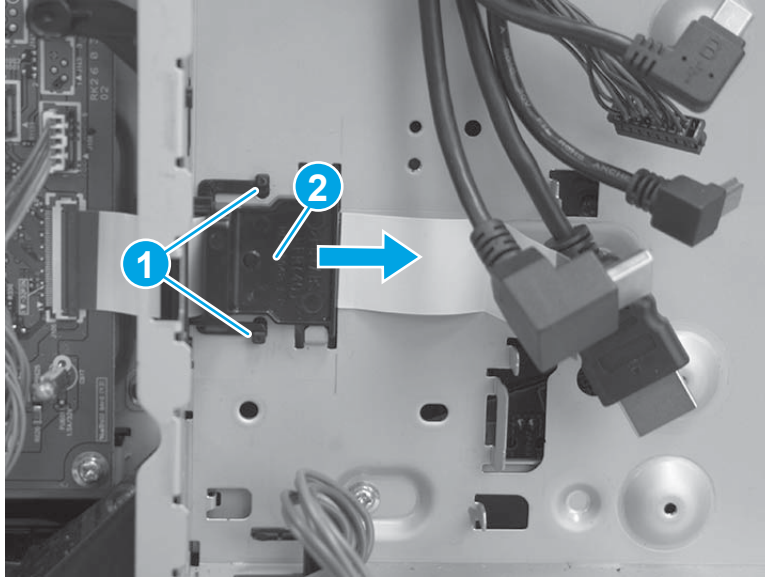

3. Remove two screws (callout 1), and then slide the low-voltage power supply (LVPS) cover to the right to remove it.

Figure 1-1898 Remove the LVPS cover

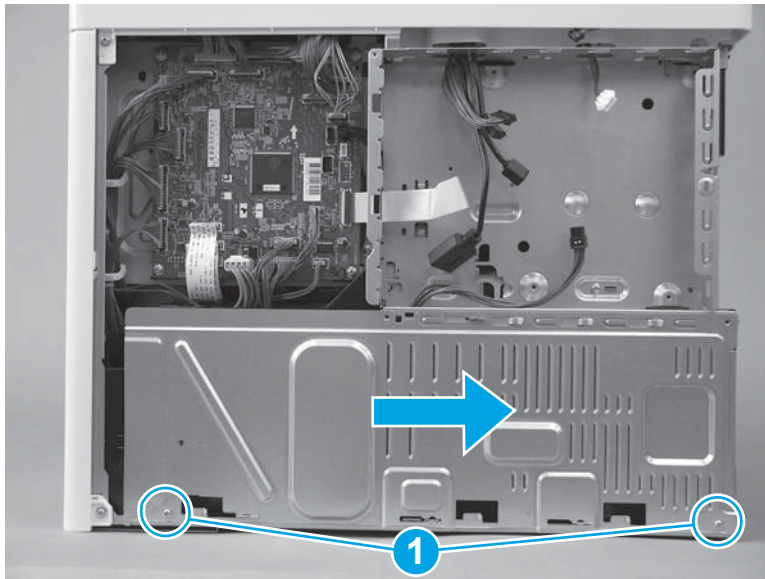

4. Pass two wire harnesses and one flat cable (callout 1) through the opening in the formatter case, and then release one wire harness from the retainer (callout 2).

⚠ CAUTION: The flat cable might be attached to the formatter case with double-sided tape. Make sure that this tape is released, so that the flat cable is not damaged when the formatter case is removed.

Figure 1-1899 Release wire harnesses and flat cable

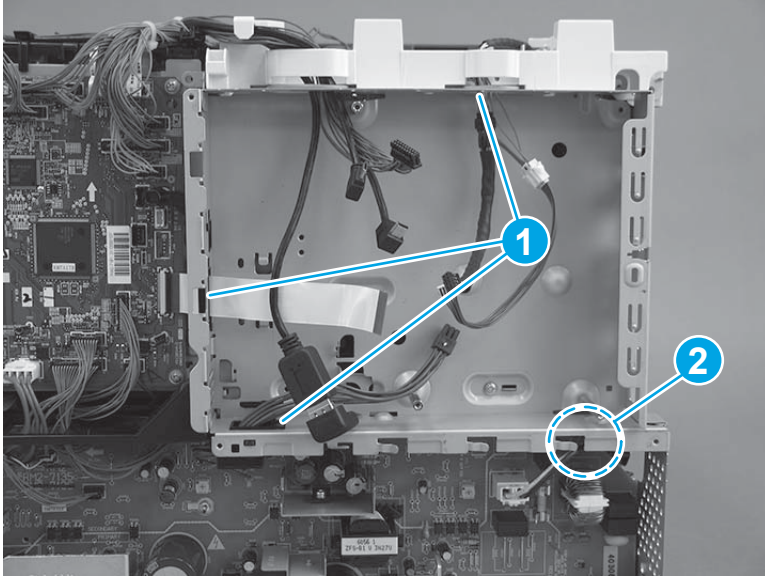

5. Remove six screws (callout 1).

Figure 1-1900 Remove six screws

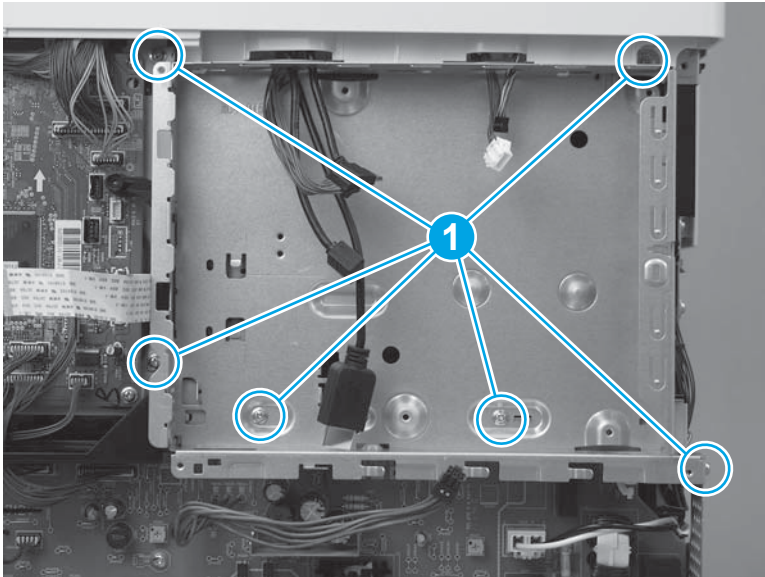

6. Rotate the bottom of the formatter case away from the printer (callout 1), and then pull it down (callout 2) to release it.

Figure 1-1901 Release the formatter case

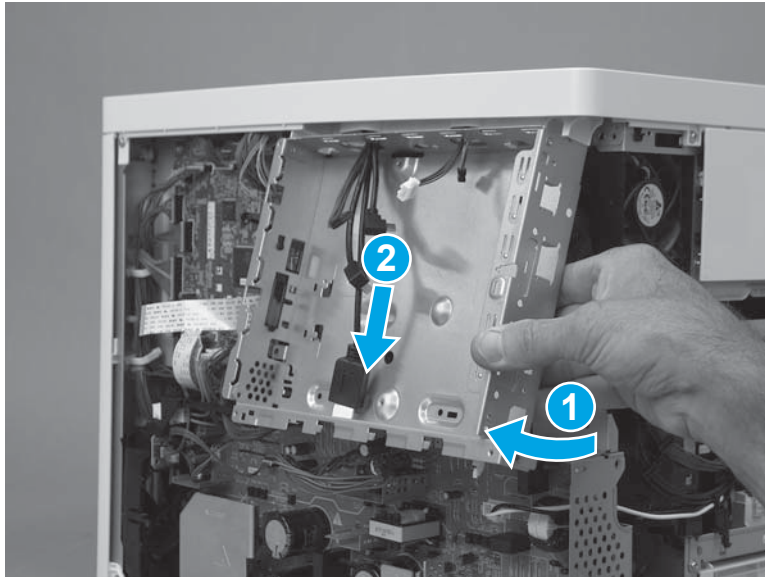

7. Pass the wire harnesses through the opening in the formatter case to remove it.

 **IMPORTANT:** If the formatter case is removed so that it can be replaced, make sure to transfer the memory PCA (island of data) and plastic bracket (callout 1) to the replacement case.

Figure 1-1902 Remove the formatter case

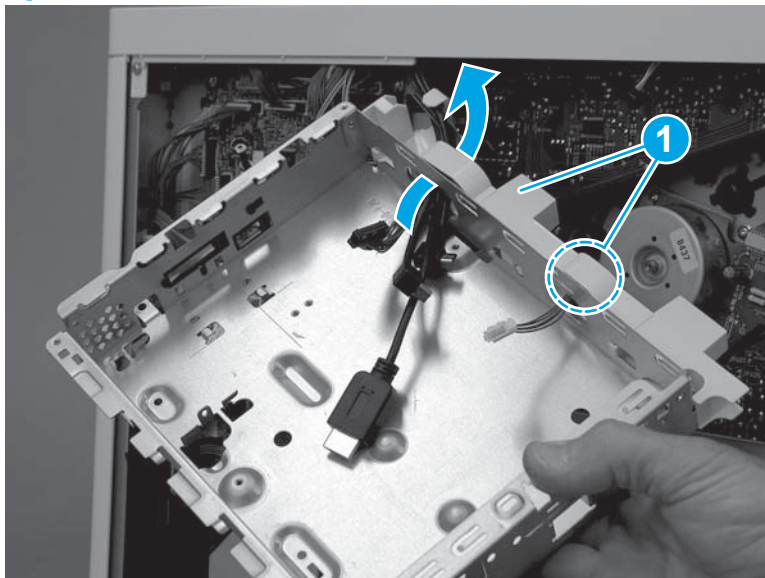

Step 12: Remove drum motor 1 (M1)

- ▲ Disconnect one connector (callout 1), remove four screws (callout 2), and then remove the motor.

Figure 1-1903 Remove the motor

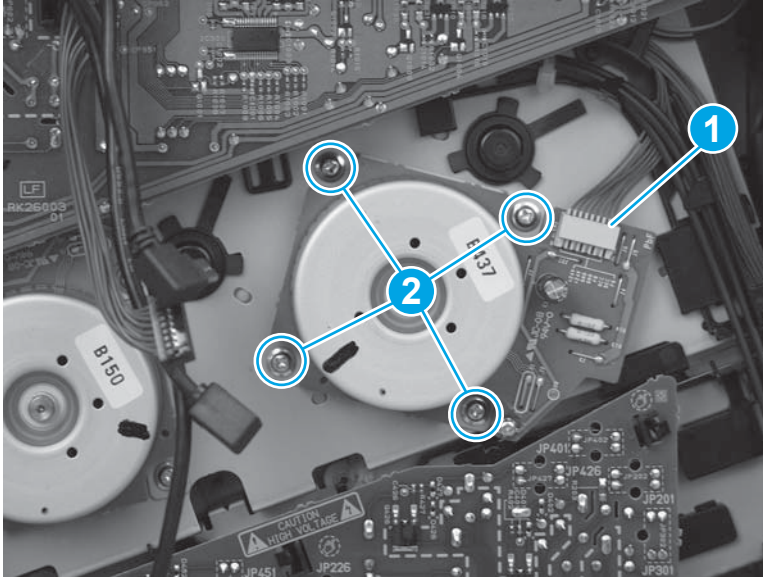

Step 13: Unpack the replacement assembly

Unpack the replacement assembly from the packaging.

For complete information on HP's recycling programs, go to [Product return and recycling](#).

 **NOTE:** HP recommends responsible disposal of the defective assembly.

Figure 1-1904 Recycle and unpack

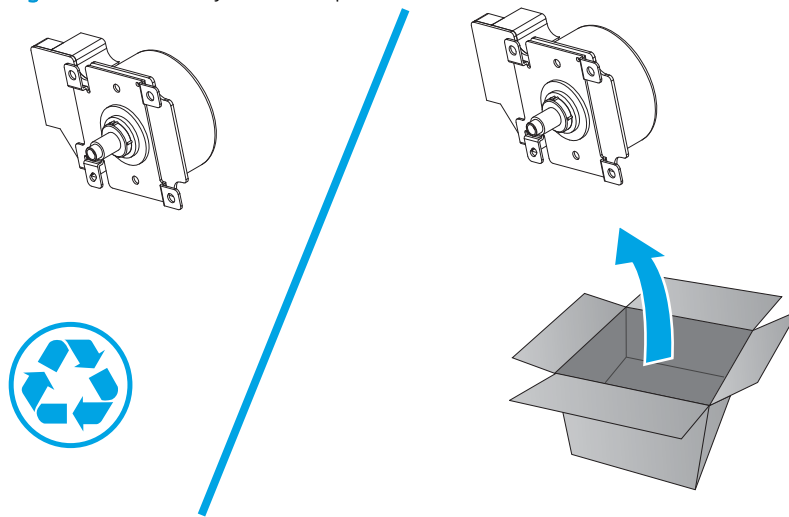

Step 14: Install drum motor 1 (M1)

- ▲ Position the motor on the printer, install four screws (callout 1), and then connect one connector (callout 2).

Figure 1-1905 Install the motor

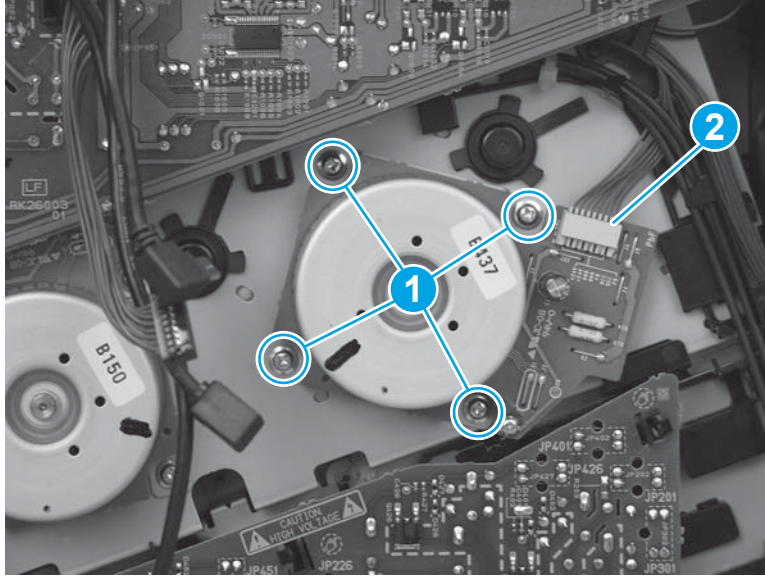

Step 15: Install the formatter case

1. Pass the wire harnesses through the opening in the formatter case.

Figure 1-1906 Pass the wire harnesses through the opening

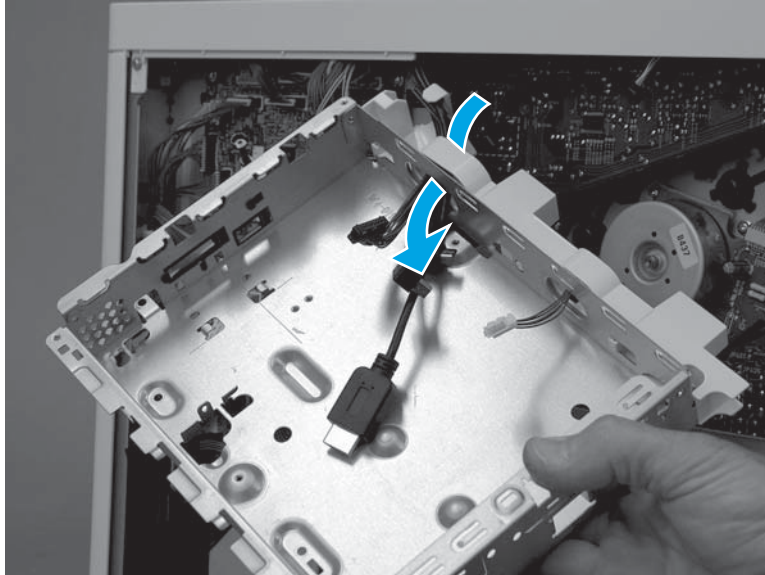

2. Position the top of the formatter case on the printer (callout 1), and then rotate the bottom of the case (callout 2) into the printer.

Figure 1-1907 Install the formatter case

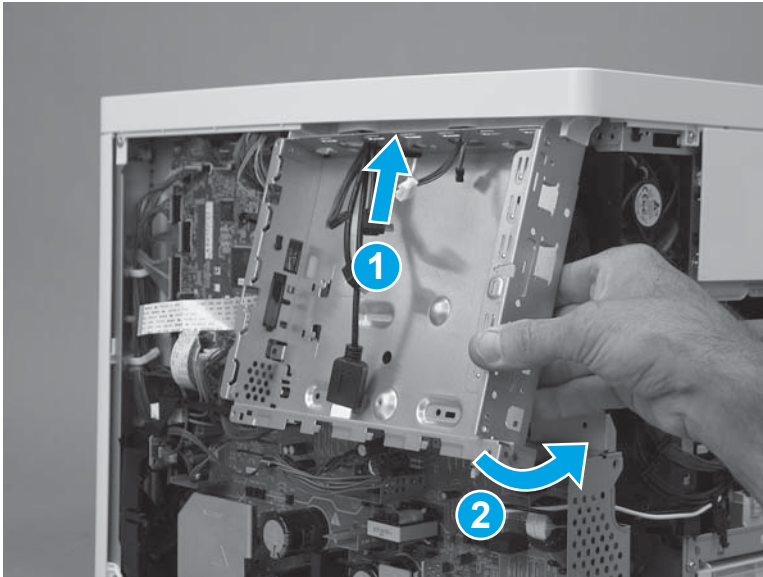

3. Install six screws (callout 1).

Figure 1-1908 Install six screws

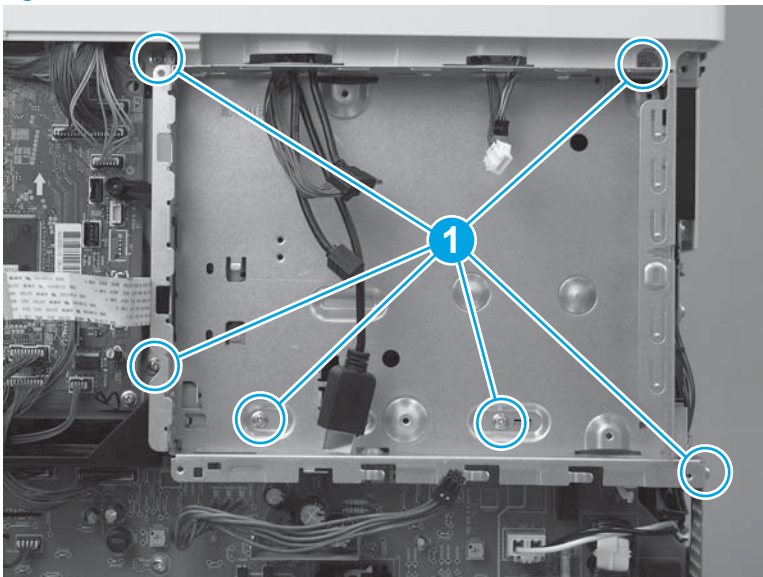

4. Pass two wire harnesses and one flat cable (callout 1) through the opening in the formatter case, and then install one wire harness in the retainer (callout 2).

 **IMPORTANT:** Make sure that the flat cable is securely fastened to the DC controller, and was not dislodged when the formatter case was removed.

Figure 1-1909 Install wire harnesses and flat cable



5. Position the LVPS cover on the printer, slide the cover to the left to install it, and then install two screws (callout 1).

Figure 1-1910 Install the LVPS cover

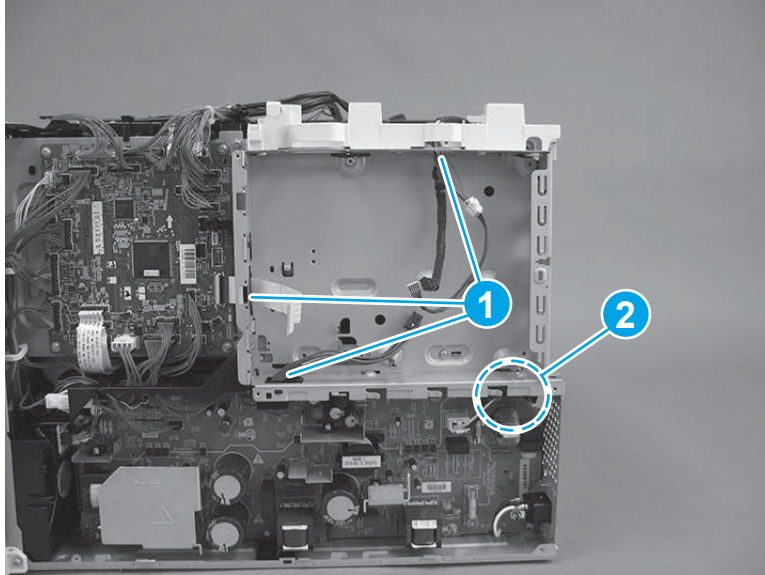
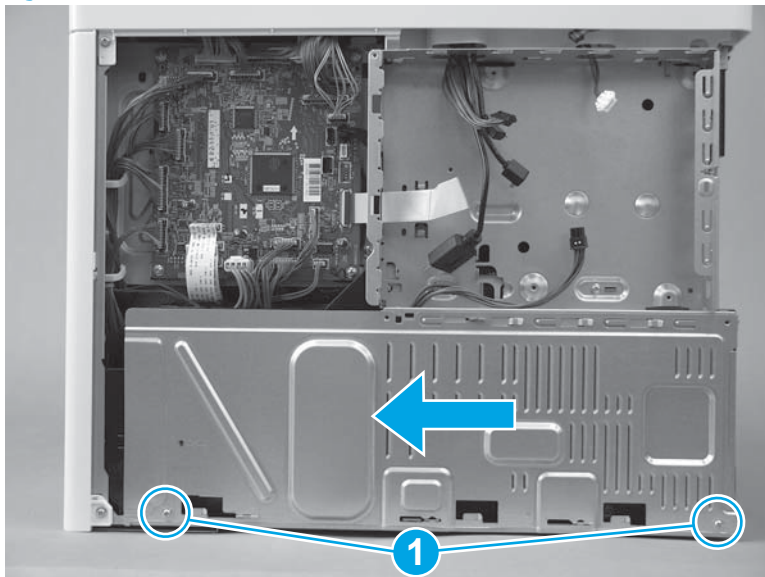

6. If no tape is affixed to the back of the flat cable, skip this step. If double-sided tape is affixed to the back of the flat cable, align the line (callout 1) on the cable with the edge (callout 2) of the opening in the sheet metal. Press to attach the flat cable to the formatter case.

Figure 1-1911 Attach the flat cable

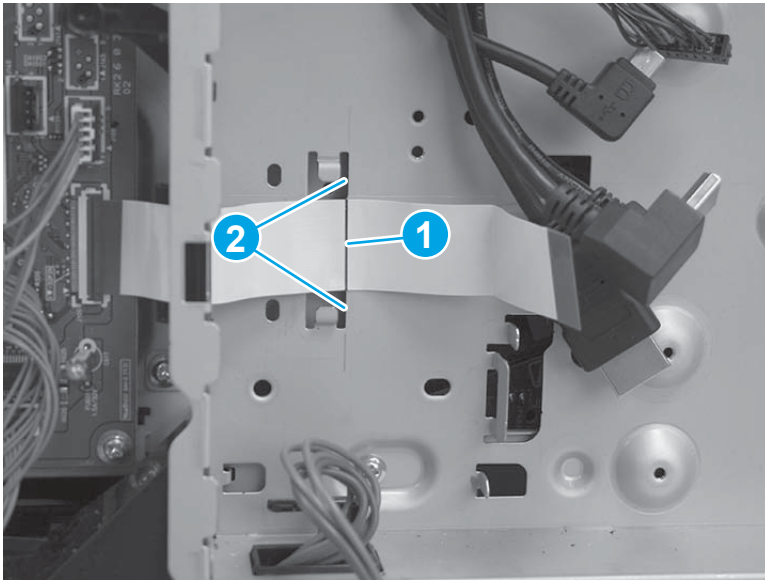

7. Position the bracket over the flat cable, and then slide the bracket to the left to install it. Make sure that the edges of the bracket fit under the sheet metal tabs (callout 1) on the formatter case and that the tabs (callout 2) snap into place.

Figure 1-1912 Position the bracket

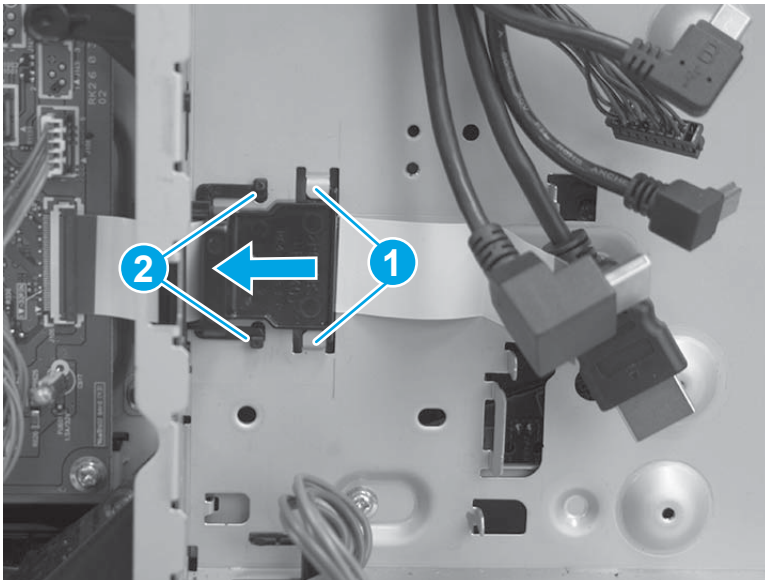

8. **M577 only:** Pass the wire harness (callout 1) through the openings in the formatter case (callout 2), and then connect one connector (callout 3).

Figure 1-1913 Connect one connector

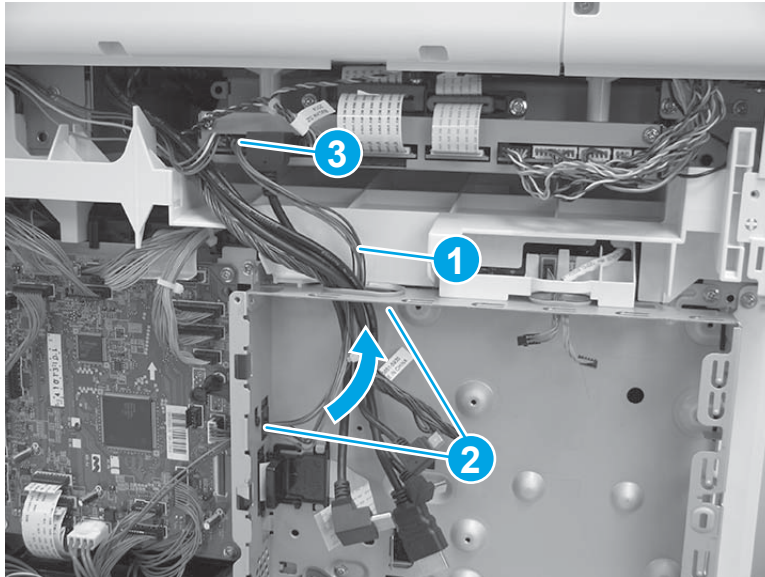

Step 16: Install the left cover

1. Position the cover on the printer.

 **NOTE:** Slightly offset the cover toward the rear of the printer.

Figure 1-1914 Install the cover

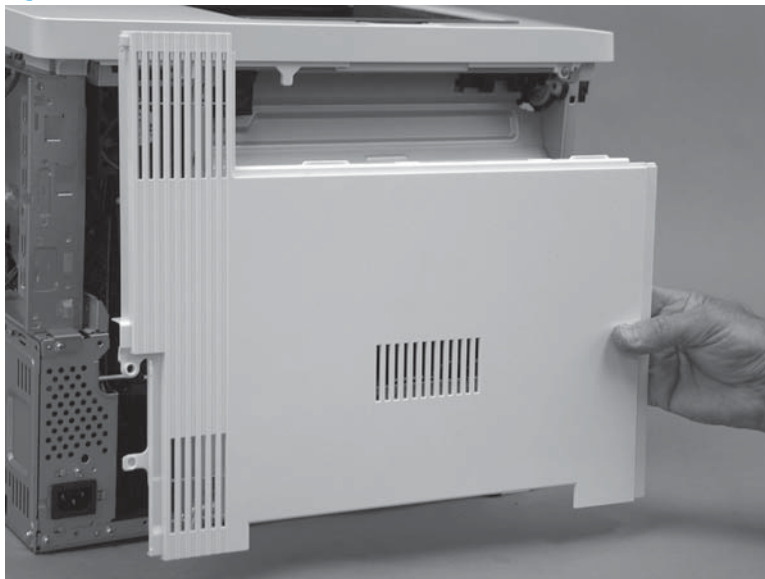

- Slide the cover (callout 1) toward the front of the printer to engage it. Make sure that the tab (callout 2) snaps into place.

 **NOTE:** Locate the alignment pin (callout 3) on the cover from the front door side of the printer, and then make sure that it is fully engaged in the slot in the chassis.

 **TIP:** While sliding the cover into place, push in on the center of the cover (callout 1) to make sure that the hooks on the back of the cover engage with the slots in the chassis.

Figure 1-1915 Engage the cover



- At the left side of the printer, install one screw (callout 1).

Figure 1-1916 Install one screw

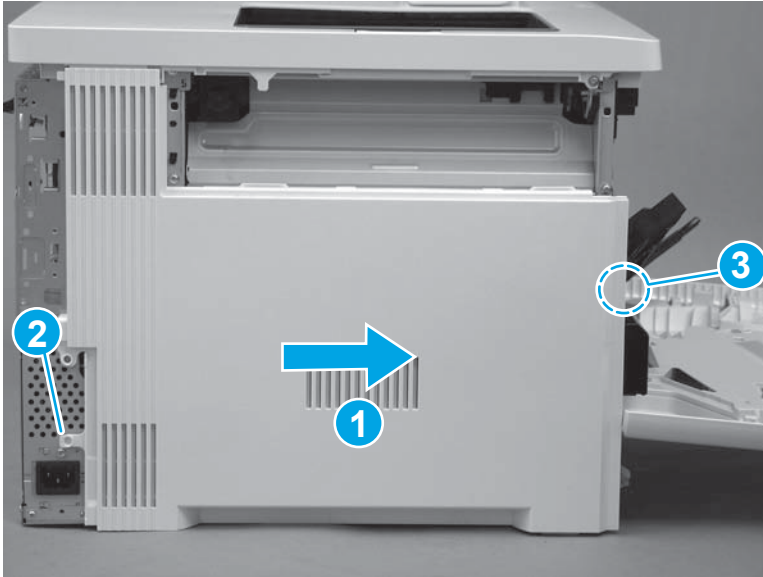
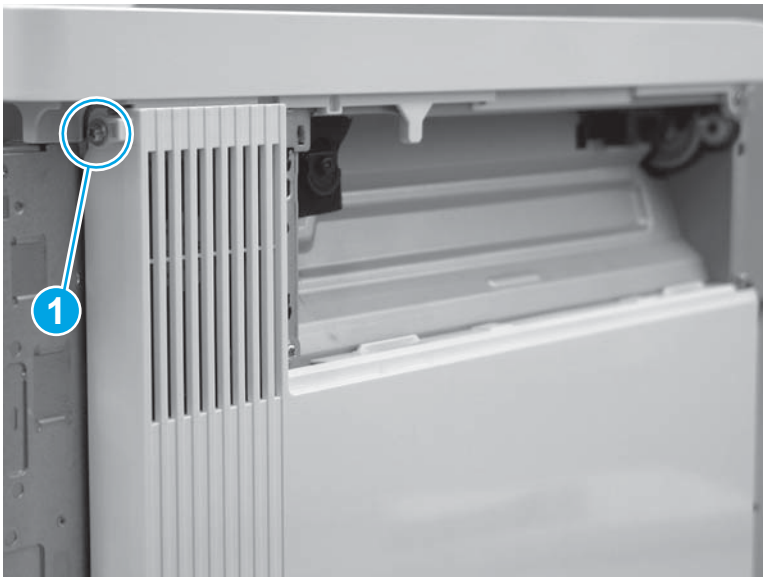

Step 17: Install the rear cover (M577)

 **NOTE:** This step is for the M577 models. For the M552 and M553 models, skip this step and go to [Step 19: Install the rear cover \(M552 and M553\) on page 1096](#).

1. Position the hooks (callout 1) on the cover in the slots (callout 2) in the printer.

Figure 1-1917 Position the hooks

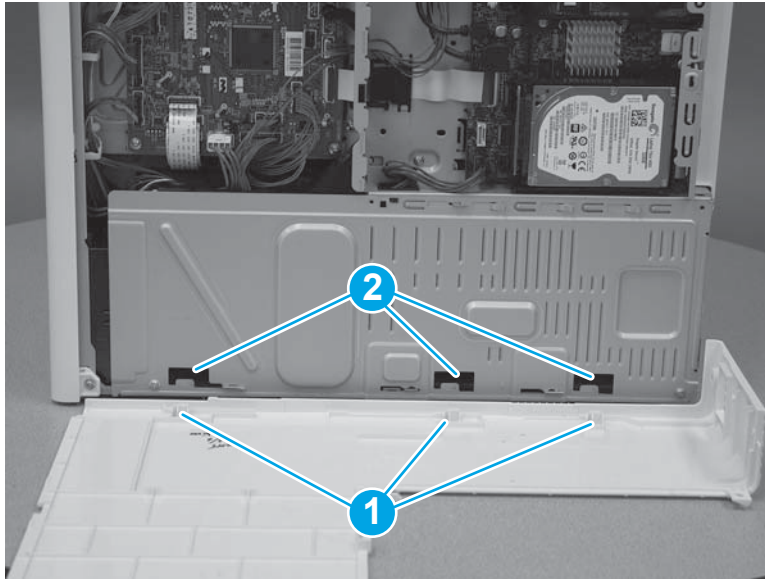

2. Position the back edge (callout 1) of the rear cover behind the edge (callout 2) of the right rear cover. Slide the cover to the left to install it.

Figure 1-1918 Install the cover

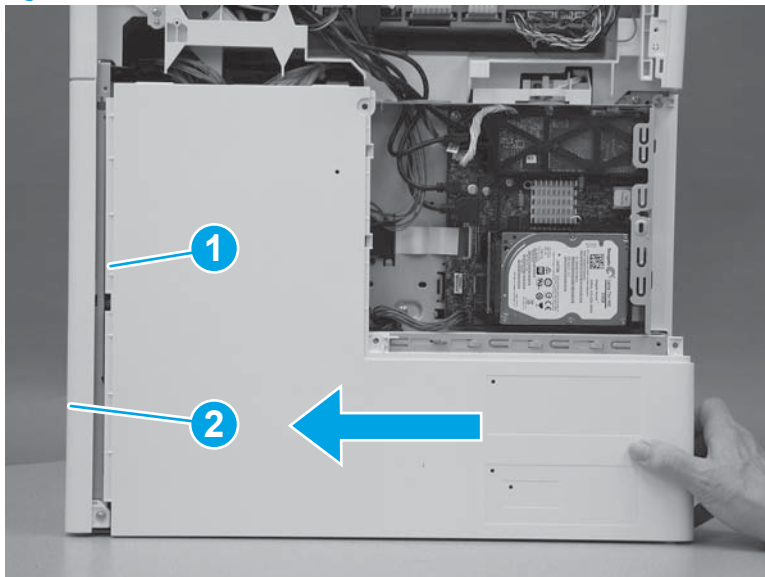

3. Install four screws (callout 1).

Figure 1-1919 Install four screws cover

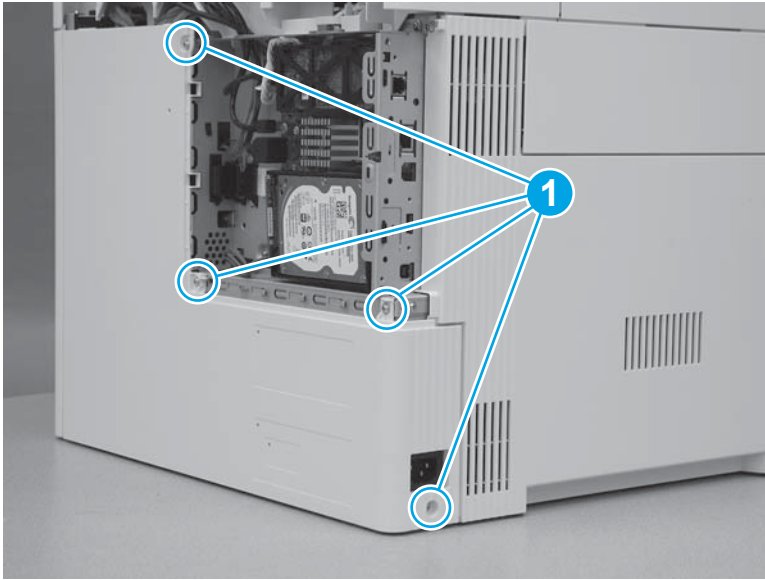

Step 18: Install the rear upper cover (M577)

 **NOTE:** This step is for the M577 models. For the M552 and M553 models, skip this step and go to [Step 19: Install the rear cover \(M552 and M553\) on page 1096](#).

1. Align the ridge (callout 1) on the lower edge of the rear upper cover in front of the tabs (callout 2) on the top edge of the rear cover.

Figure 1-1920 Align the cover

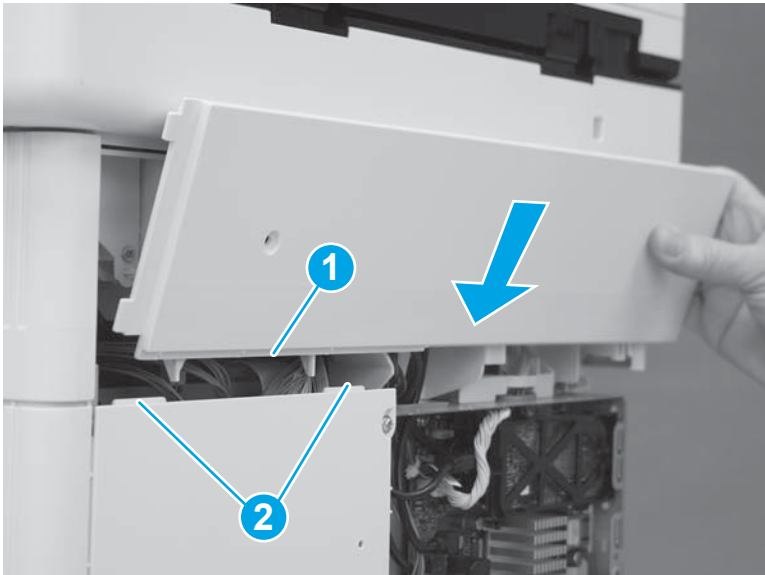

2. Rotate the top of the cover toward the printer.

Figure 1-1921 Rotate the top of the cover

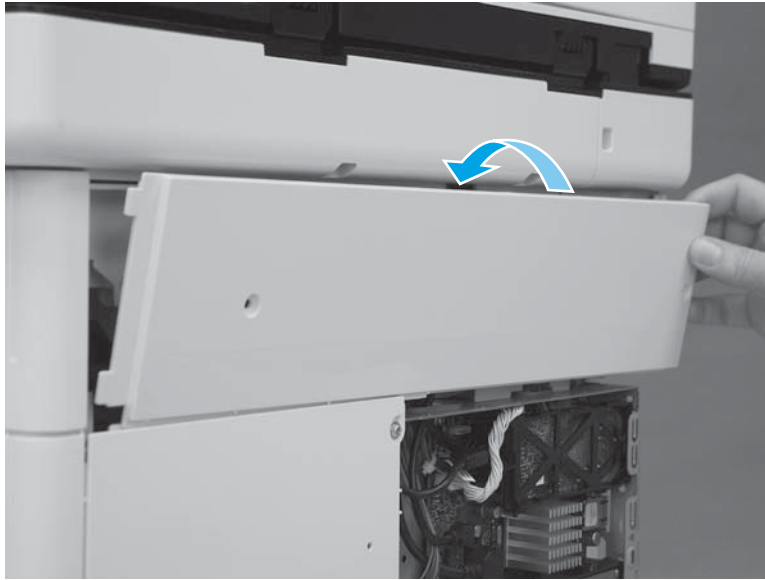

3. Slide the cover to the left (callout 1). Make sure that the tabs (callout 2) on the upper rear cover slide behind the edge (callout 3) of the right upper cover. Make sure that the cover is fully seated.

Figure 1-1922 Slide the cover

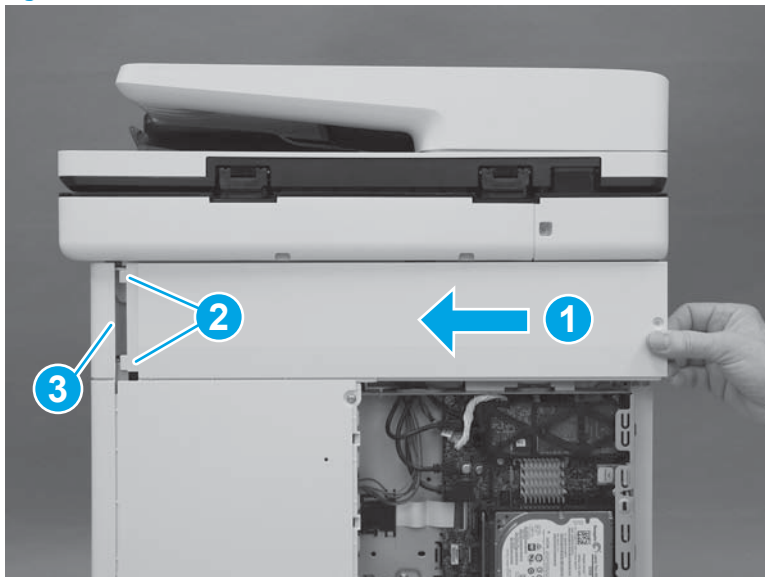

4. Install two screws (callout 1).



 **IMPORTANT:** These two screws are self-tapping screws for plastic. Rotate them counterclockwise to align them with the existing thread pattern, and then carefully turn them clockwise to tighten. Do not overtighten. This will prevent stripping the threads inside the screw holes.

Figure 1-1923 Install two screws

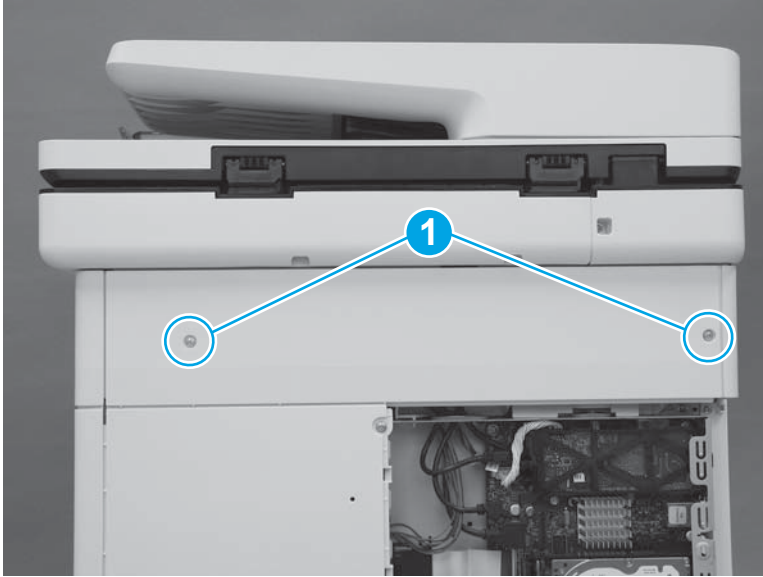

Step 19: Install the rear cover (M552 and M553)

 **NOTE:** This step is for the M552 and M553 models. For the M577 models, skip this step and go to [Step 20: Install the formatter \(M577\) on page 1097](#).

1. Position the top of the cover under the upper cover (callout 1), rotate the bottom of the cover onto the chassis (callout 2), and then slide the cover to the left (callout 3) to install it.

Figure 1-1924 Install the cover

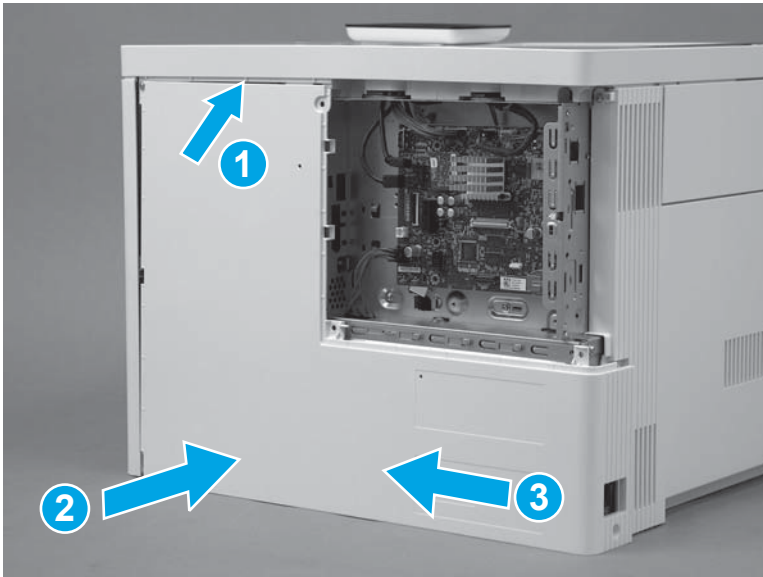

2. Install four screws (callout 1).

Figure 1-1925 Install four screws cover

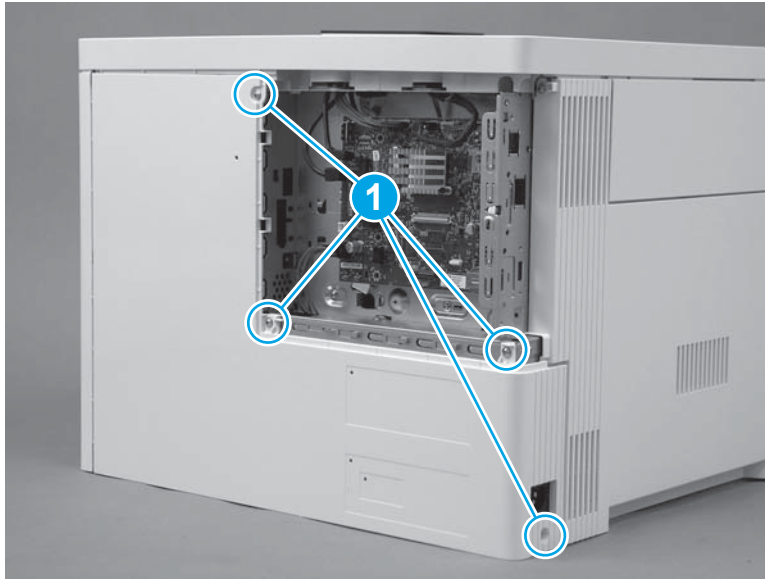

Step 20: Install the formatter (M577)

 **NOTE:** This step is for the M577 models. For the M552 and M553 models, skip this step and to go [Step 23: Install the formatter \(M552 and M553\) on page 1102](#).

 **CAUTION:**  ESD-sensitive part.

1. Position the formatter in the printer. Make sure that the network port (callout 1) fits through the opening (callout 2) in the formatter case.

Figure 1-1926 Install the formatter

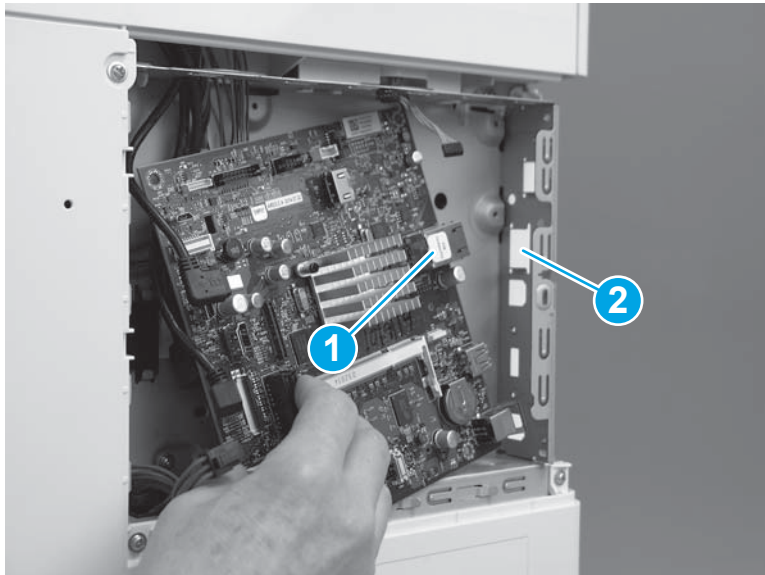

2. Install four screws (callout 1).

Figure 1-1927 Install four screws

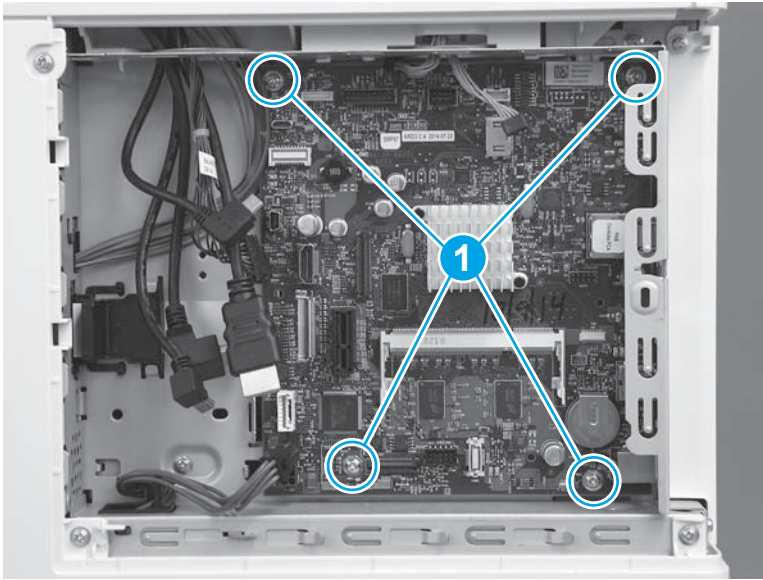

3. Connect all of the connectors on the formatter.

The following connectors are empty:

- All models: J1 (this connector is empty unless the optional DIMM is installed)
- All models: J3
- M577dn: J15 (this is the fax connector for the M577f/z/c models)
- All models: J21 (this connector is empty unless the optional internal USB ports component is installed)
- All models: J23
- All models: J24
- All models: J51
- All models: J57
- All models: J97
- All models: J98 (this connector is empty unless the optional trusted platform module (TPM) is installed)



 **IMPORTANT:** The flat-cable connector (callout 1) is a Zero Insertion Force (ZIF) connector that uses a hinged retainer to secure the flat cable. The hinged retainer must be opened to install the flat cable, and then closed after the cable is installed.

Figure 1-1928 Connect all connectors

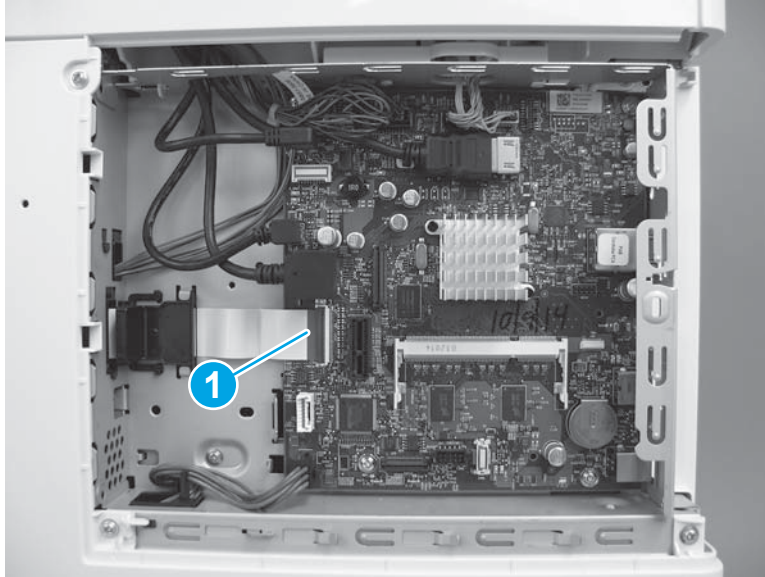

Step 21: Install the fax PCA (M577c/f/z)

 **NOTE:** This step is for the M577c/f/z models. For the M577n model, skip this step and go to [Step 22: Install the HDD \(M577\) on page 1100](#).

For the M552 and M553 models, skip this step and go to [Step 23: Install the formatter \(M552 and M553\) on page 1102](#).

 **CAUTION:**  ESD-sensitive part.

1. Position the tab and telephone port (callout 1) on the fax PCA in the slots (callout 2) in the formatter case.

Figure 1-1929 Position the fax PCA

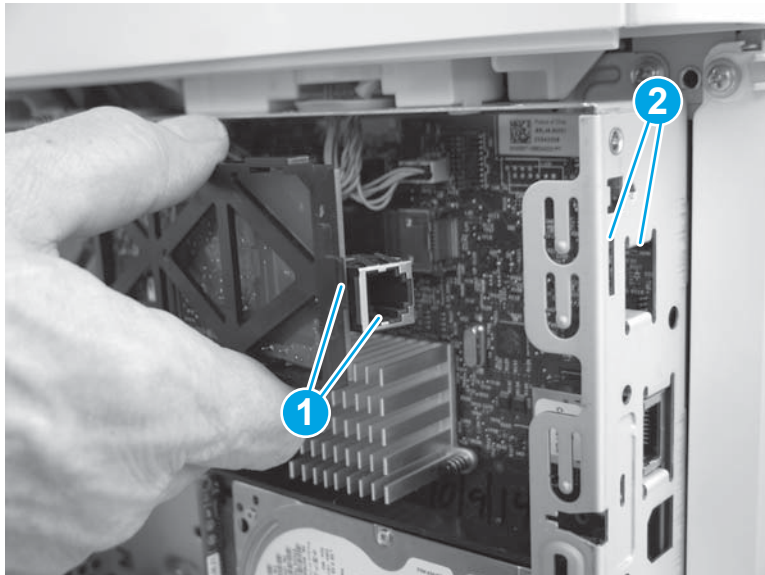

- Slide the fax PCA to the right (callout 1) until the tab and telephone port described in the previous step and seated in the formatter case. Position the retainer (callout 2) in the slot (callout 3) in the formatter. Rotate the end of the fax PCA toward the formatter (callout 4) until the retainer snaps into place.

Figure 1-1930 Install the fax PCA

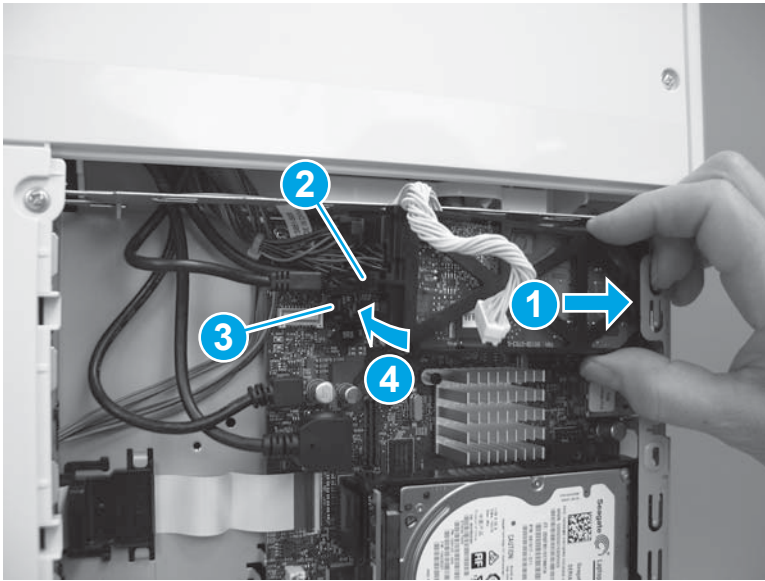

- Position the cable (callout 1) in the guide (callout 2), and then connect one connector (callout 3).

Figure 1-1931 Connect the connector

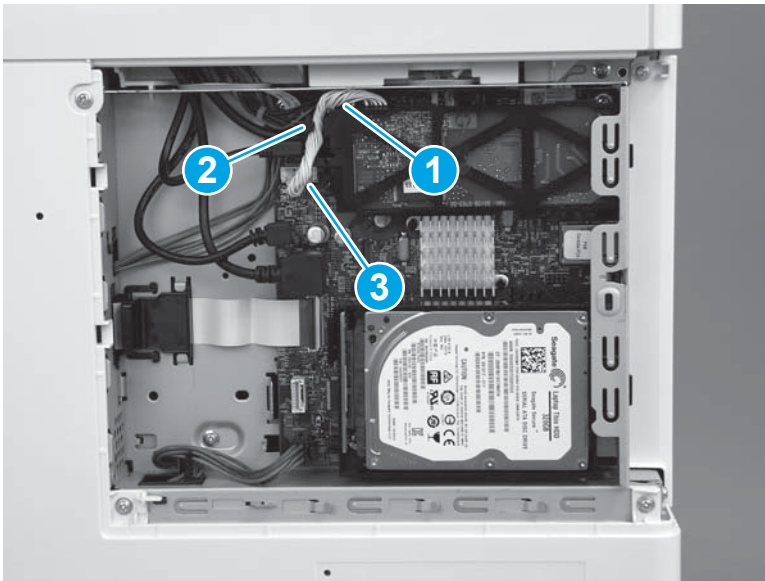

Step 22: Install the HDD (M577)



NOTE: This step is for the M577 models. For the M552 and M553 models, skip this step and go to [Step 23: Install the formatter \(M552 and M553\) on page 1102](#).

 **CAUTION:**  ESD-sensitive part.

1. Align the end of the bracket (callout 1) with the slot in the chassis (callout 2), and then slide the HDD into the printer (callout 3) to engage the bracket with the chassis.

Figure 1-1932 Install the holder

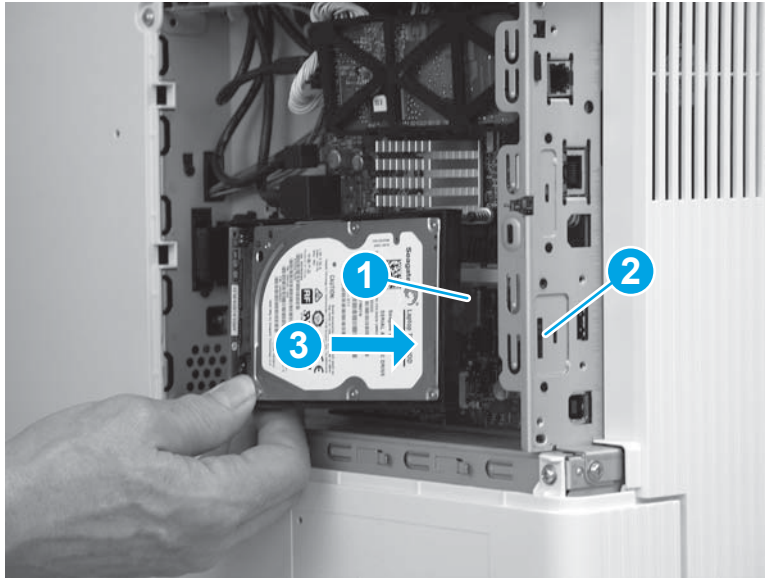

2. Hold the HDD connector latch (callout 1) in the released position, and then rotate the HDD down and into the connector on the formatter to install it.

 **NOTE:** Make sure that the tab (callout 2) snaps into place, and that the HDD is securely installed.

Figure 1-1933 Release the HDD

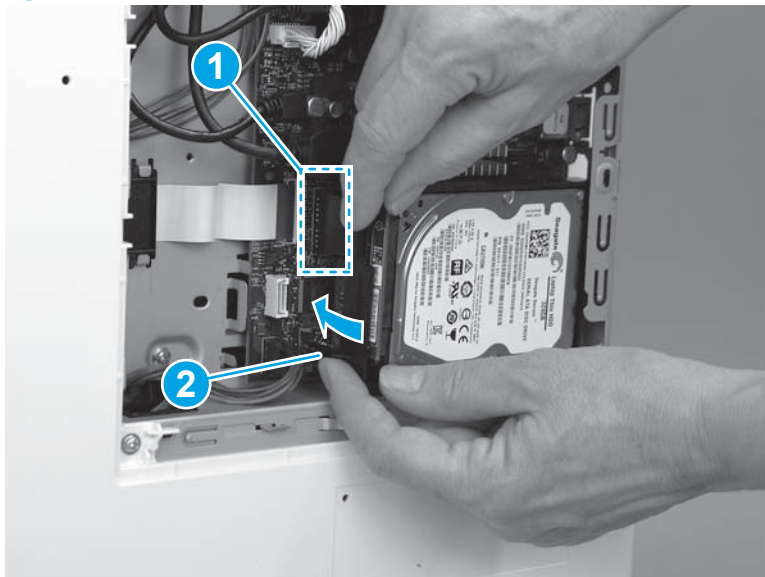

Step 23: Install the formatter (M552 and M553)

 **NOTE:** This step is for the M552 and M553 models. For the M577 models, skip this step and go to [Step 24: Install the formatter cover on page 1103](#).

If the optional hard-disk drive (HDD) was removed, do not forget to reinstall it after the formatter is reinstalled.

Engage the HDD holder with the chassis, rotate the HDD connector down and into the connector on the formatter. Make sure that the tabs snap into place.

 **CAUTION:**  ESD-sensitive part.

1. Position the formatter in the printer, and then install four screws (callout 1).

Figure 1-1934 Install the formatter

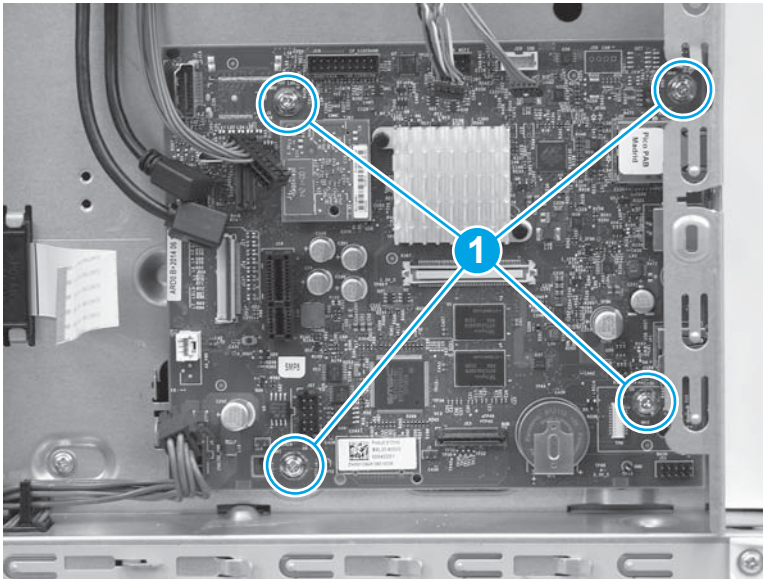

2. Connect all of the connectors on the formatter.

The following connectors are empty:

- All models: J1 (this connector is empty unless the optional DIMM is installed)
- M553n/dn and M552dn: J2 (callout 1; this is the touchscreen connector for the M553x model)
- All models: J9 (this connector is empty unless the optional internal USB ports component is installed)
- All models: J18 (this connector is empty unless the optional hard-disk-drive (HDD) is installed)
- All models: J23
- All models: J24
- M553n/dn and M552dn: J25 (this is the wireless connector for the M553x model)
- All models: J57
- All models: J98 (this connector is empty unless the optional trusted platform module (TPM) is installed)



 **IMPORTANT:** The flat-cable connector (callout 2) is a Zero Insertion Force (ZIF) connector that uses a hinged retainer to secure the flat cable. The hinged retainer must be opened to install the flat cable.

Figure 1-1935 Connect all connectors

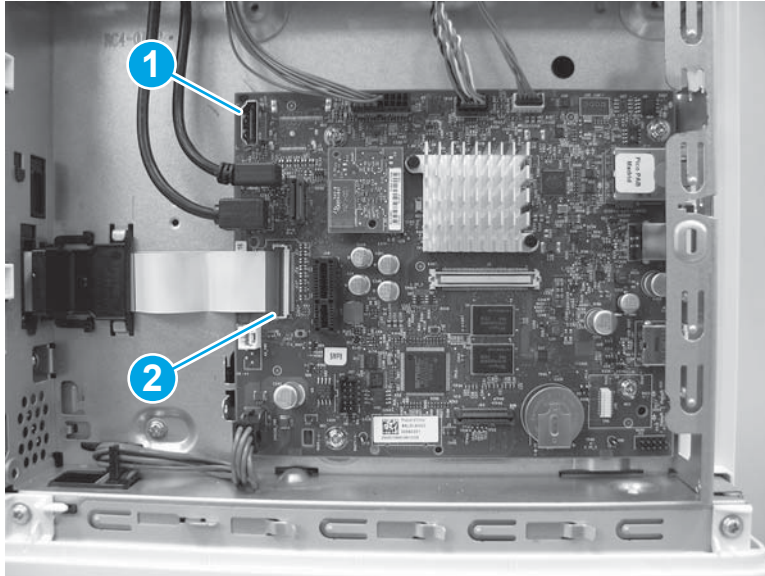

Step 24: Install the formatter cover

- ▲ Slide the cover onto the printer (callout 1) to install it.

 **NOTE:** Make sure that the tabs on the formatter cover align with the slots provided in the printer (callout 2). Tighten the two thumbscrews (callout 3).

 **TIP:** If needed, use the edge of a coin to turn the thumbscrews.

Figure 1-1936 Install the cover



Step 25: Install the TCU

1. Verify that the toner collection hatch cover is in the closed position on the TCU.

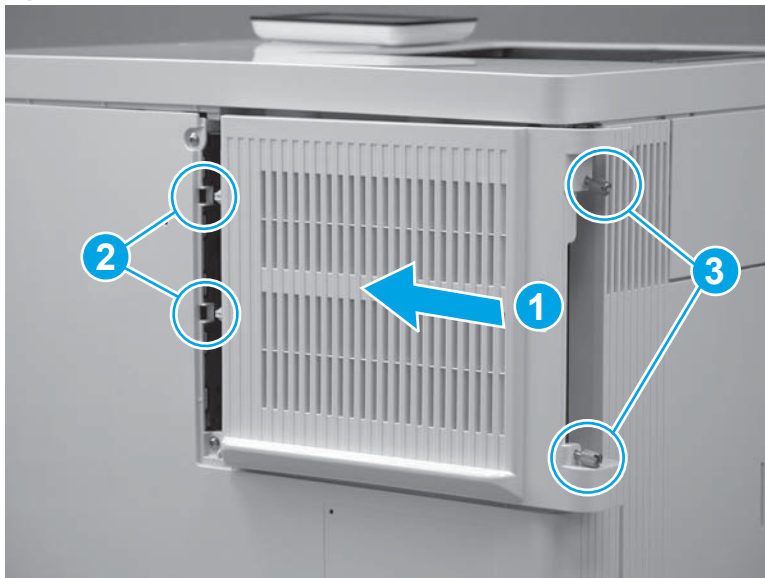
Figure 1-1937 Verify that the toner collection hatch cover is closed

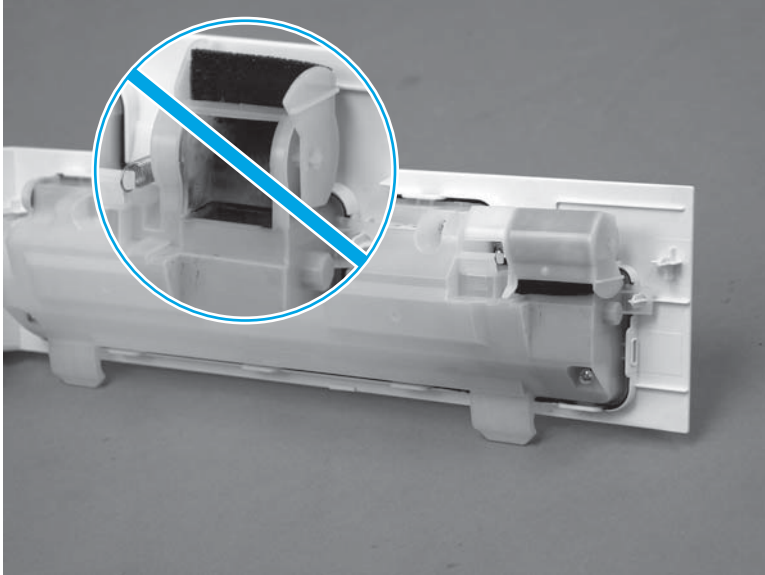

2. Position the TCU with the hinges in the slots provided in the printer (callout 1), and then rotate the TCU up and into the closed position.

 **NOTE:** The toner collection hatch cover automatically opens when the TCU is closed.

Figure 1-1938 Install the TCU



3. Close the front door.

Figure 1-1939 Close the front door

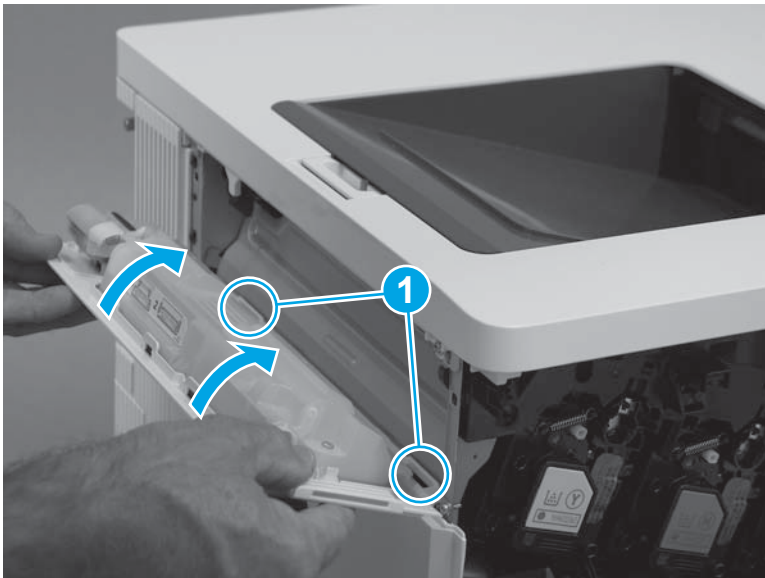

Removal and replacement: Power-supply fan (FM1)

- [Introduction](#)
- [Step 1: Remove the USB cover](#)
- [Step 2: Remove the control panel \(M553x only\)](#)
- [Step 3: Remove the toner collection unit \(TCU\)](#)
- [Step 4: Remove the formatter cover](#)
- [Step 5: Remove the rear cover \(M552 and M553\)](#)
- [Step 6: Remove the rear upper cover \(M577\)](#)
- [Step 7: Remove the rear cover \(M577\)](#)
- [Step 8: Remove the left cover](#)
- [Step 9: Remove the upper cover \(M552 and M553\)](#)
- [Step 10: Remove the right front upper cover \(M577dn\)](#)
- [Step 11: Remove the stapler cover assembly \(M577f and M577z\)](#)
- [Step 12: Remove the right upper cover \(M577\)](#)
- [Step 13: Remove the right rear cover](#)
- [Step 14: Remove the formatter \(M552 and M553\)](#)
- [Step 15: Remove the hard-disk drive \(HDD\) \(M577\)](#)
- [Step 16: Remove the fax PCA \(M577c/f/z\)](#)
- [Step 17: Remove the formatter \(M577\)](#)
- [Step 18: Remove the formatter case](#)
- [Step 19: Remove the low-voltage power supply \(LVPS\)](#)
- [Step 20: Remove the power supply fan \(FM1\)](#)
- [Step 21: Unpack the replacement assembly](#)
- [Step 22: Install the power-supply fan \(FM1\)](#)
- [Step 23: Install the LVPS](#)
- [Step 24: Install the formatter case](#)
- [Step 25: Install the formatter \(M577\)](#)
- [Step 26: Install the fax PCA \(M577c/f/z\)](#)
- [Step 27: Install the HDD \(M577\)](#)
- [Step 28: Install the formatter \(M552 and M553\)](#)
- [Step 29: Install the right rear cover](#)

- [Step 30: Install the right upper cover \(M577\)](#)
- [Step 31: Install the stapler cover assembly \(M577f and M577z\)](#)
- [Step 32: Install the right front upper cover \(M577dn\)](#)
- [Step 33: Install the upper cover \(M552 and M553\)](#)
- [Step 34: Install the left cover](#)
- [Step 35: Install the rear cover \(M577\)](#)
- [Step 36: Install the rear upper cover \(M577\)](#)
- [Step 37: Install the rear cover \(M552 and M553\)](#)
- [Step 38: Install the formatter cover](#)
- [Step 39: Install the TCU](#)
- [Step 40: Install the control-panel assembly \(M553x only\)](#)
- [Step 41: Install the USB cover](#)

Introduction

This document provides the procedures to remove and replace the power-supply fan (FM1).

Before performing service

Turn the printer power off

- Disconnect the power cable.

⚠ WARNING! To avoid damage to the printer, turn the printer off, wait 30 seconds, and then remove the power cord before attempting to service the printer.

Use the table below to identify the correct part number for your printer, and then go to <http://h20141.www2.hp.com/hpparts> to order the part.

Power supply fan (FM1) part number	
RK2-2416-000CN	Power supply fan (FM1)

Required tools

- #2 Phillips screwdriver with a magnetic tip

After performing service

Make sure that all of the connectors on the LVPS are fully seated.

Make sure that all of the connectors on the formatter are fully seated.

Make sure that the formatter cover is fully seated, and that the thumbscrews are finger tight after replacing it.

Turn the printer power on

- Connect the power cable.
- Use the power switch to turn the power on.

Step 1: Remove the USB cover

 **NOTE:** This step is for the M552 and M553 models. For the M577 models, skip this step and to go [Step 4: Remove the formatter cover on page 1114](#).

1. Locate the USB cover.

Figure 1-1940 Locate the USB cover

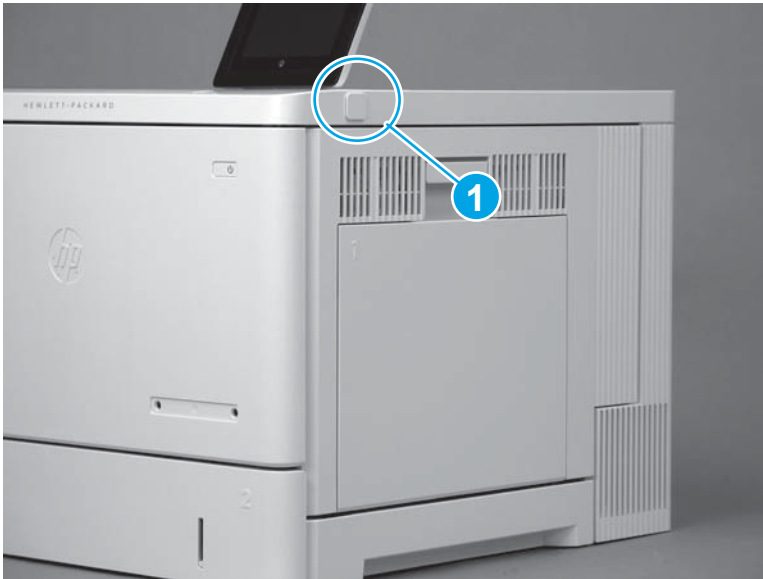

2. Pull the cover off of the printer to remove it.

Figure 1-1941 Remove the cover



Step 2: Remove the control panel (M553x only)

 **NOTE:** This step is for the M553x model. For the M553n/dn and M552dn models, skip this step and go to [Step 3: Remove the toner collection unit \(TCU\) on page 1112](#).

For the M577 models, skip this step and go to [Step 4: Remove the formatter cover on page 1114](#).

1. Tilt the control panel up.

Figure 1-1942 Tilt the control panel up



2. Use a small flat-blade screwdriver to release the control-panel screws cover tabs.

Figure 1-1943 Release the control-panel screws cover tabs



3. Rotate the cover up to remove it.

Figure 1-1944 Remove the cover

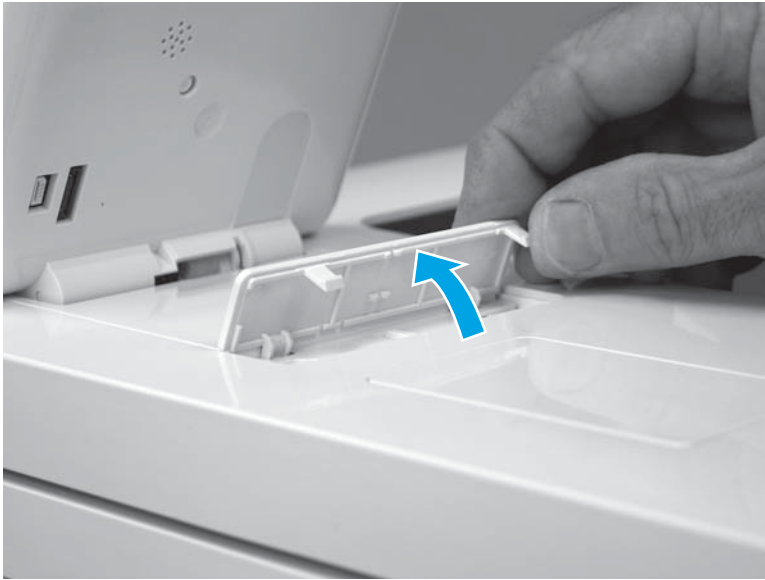

4. Use a small Phillips screwdriver to remove two screws (callout 1).

 **IMPORTANT:** Store the screws in a secure place where they cannot fall down into the printer.

Figure 1-1945 Remove two screws

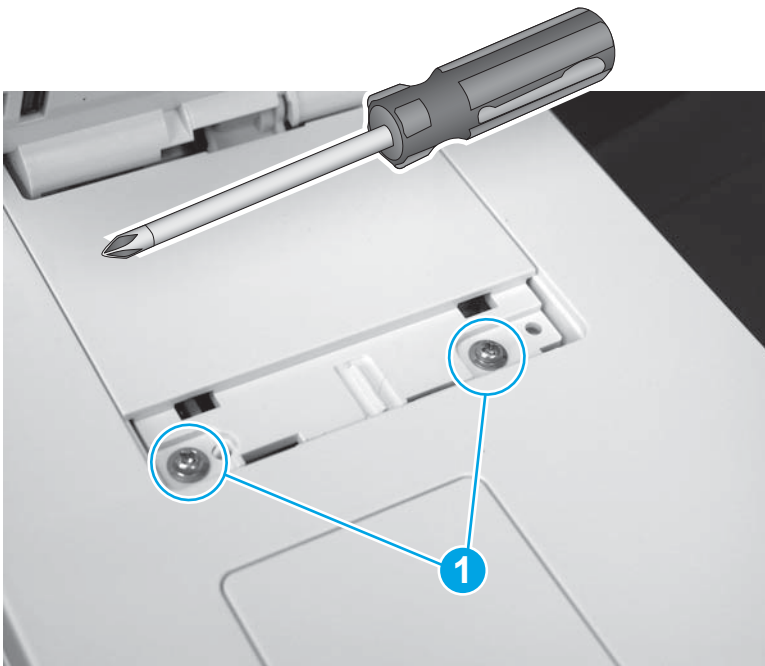

5. Rotate the control-panel base toward the front of the printer.

Figure 1-1946 Rotate the control-panel base up



6. Slightly slide the control-panel base toward the rear of the printer (callout 1) to release it, and then turn the control panel over (callout 2) to access the bottom side.

⚠ CAUTION: The control panel is still attached to the printer. Do not attempt to completely remove the control panel.

Figure 1-1947 Turn the control panel over

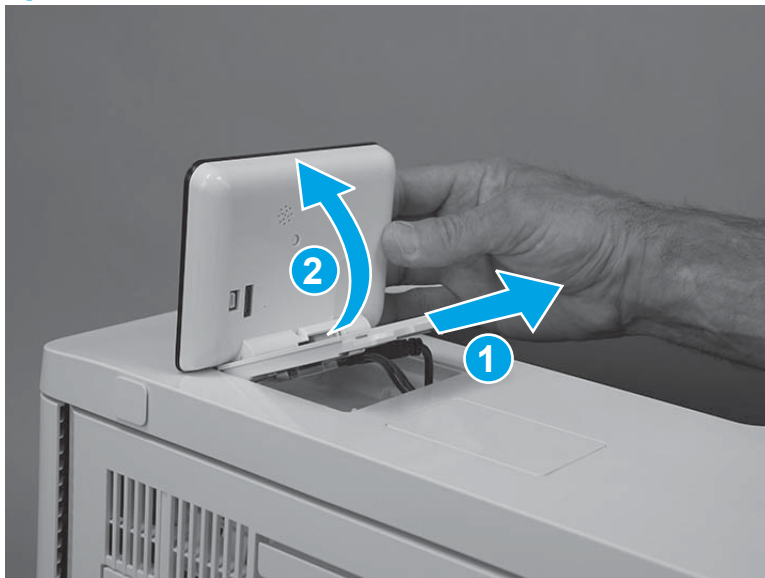

7. Disconnect one USB cable (callout 1), one connector (callout 2), and then remove the control panel.

Figure 1-1948 Disconnect two connectors

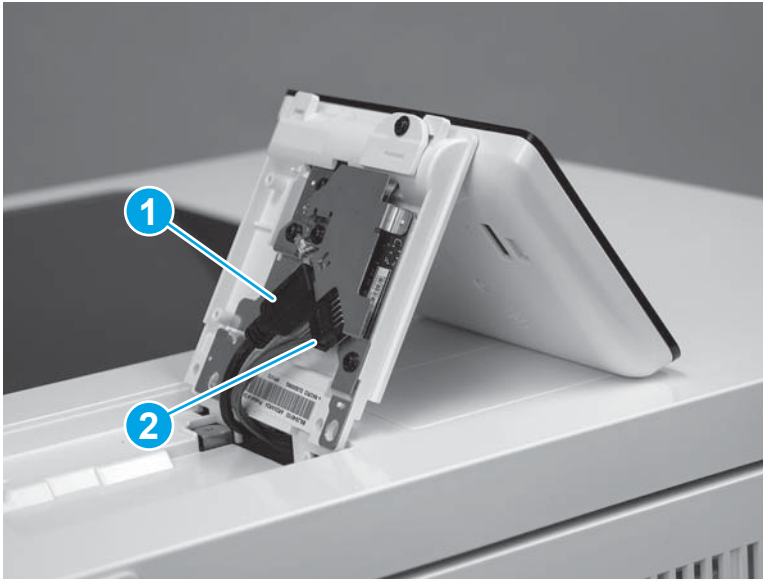

Step 3: Remove the toner collection unit (TCU)

 **NOTE:** This step is for the M552 and M553 models. For the M577 models, skip this step and to go [Step 4: Remove the formatter cover on page 1114.](#)

1. Open the front door.

Figure 1-1949 Open the front door



2. Open the TCU.

 **NOTE:** The toner collection hatch cover automatically closes when the TCU is opened.

Figure 1-1950 Open the TCU



3. Pull the TCU away from the printer at an angle to remove it.

⚠ CAUTION: Do not open the toner collection hatch cover when handling the TCU. If toner gets on clothing, wipe it off by using a dry cloth and wash the clothes in cold water. Hot water sets toner into fabric.

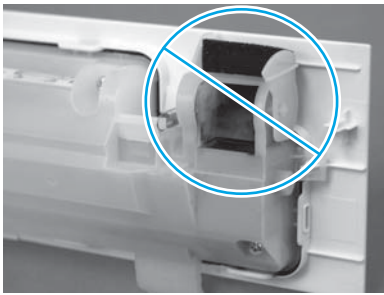
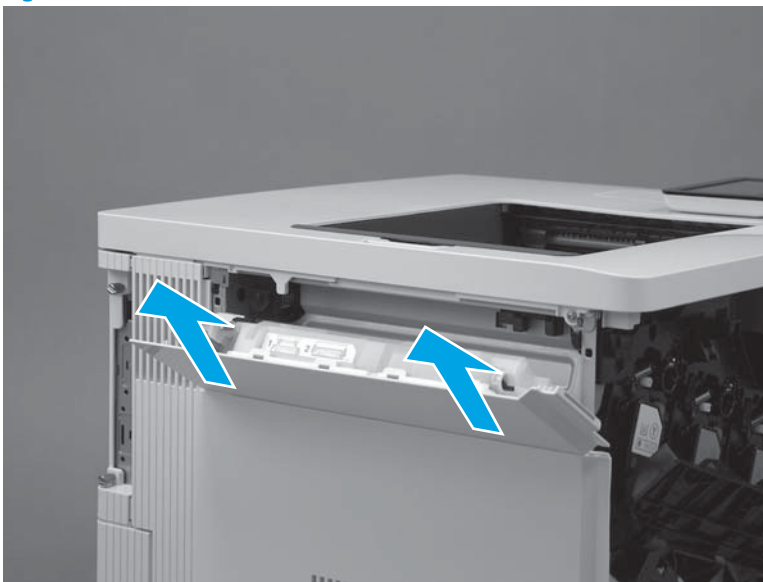

Figure 1-1951 Remove the TCU



Step 4: Remove the formatter cover

1. Locate the formatter cover.

Figure 1-1952 Locate the formatter cover

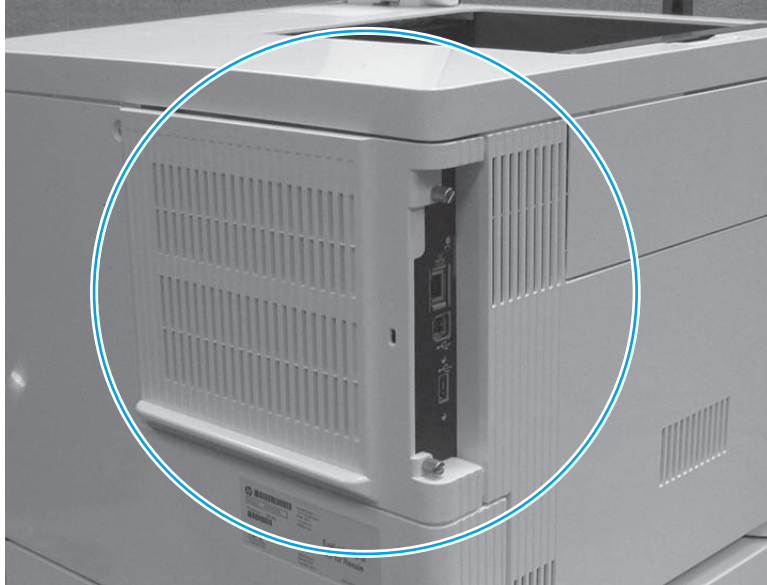

2. Loosen the two thumbscrews (callout 1). Grasp the two thumbscrews, and then slide the cover away from the printer (callout 2) to remove it.

 **TIP:** If needed, use the edge of a coin to turn the thumbscrews.

Figure 1-1953 Loosen the thumbscrews

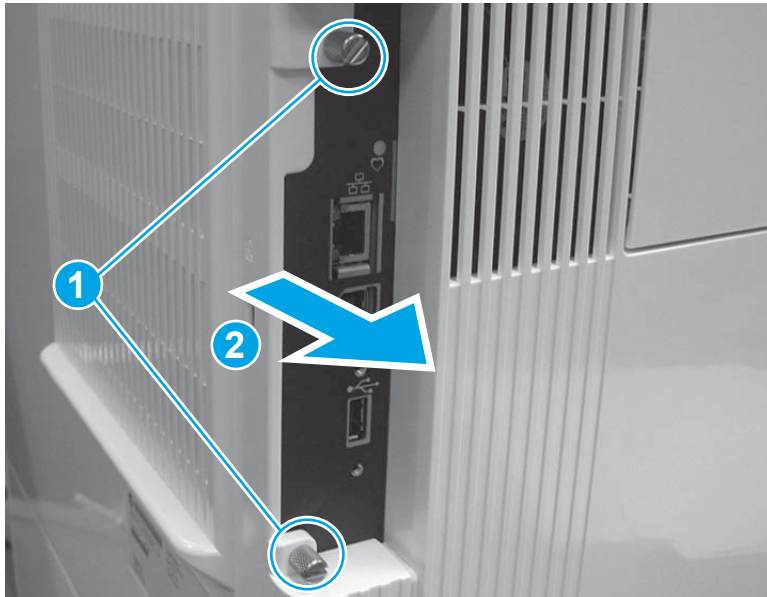

Step 5: Remove the rear cover (M552 and M553)

 **NOTE:** This step is for the M552 and M553 models. For the M577 models, skip this step and to go [Step 6: Remove the rear upper cover \(M577\) on page 1116.](#)

1. Remove four screws (callout 1).

Figure 1-1954 Remove four screws

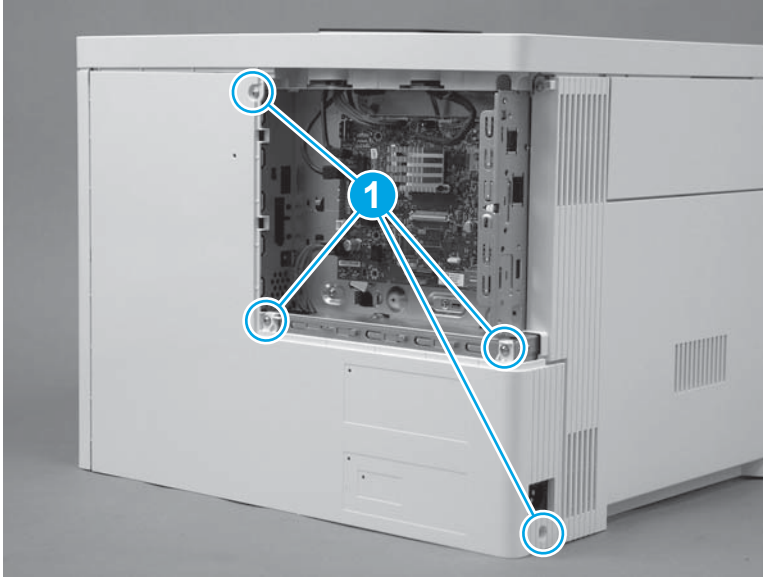

2. Slightly slide the cover to the right (callout 1), rotate the bottom of the cover away from the printer (callout 2), and then pull the top of the cover away from the printer (callout 3) to remove the cover.

Figure 1-1955 Remove the cover

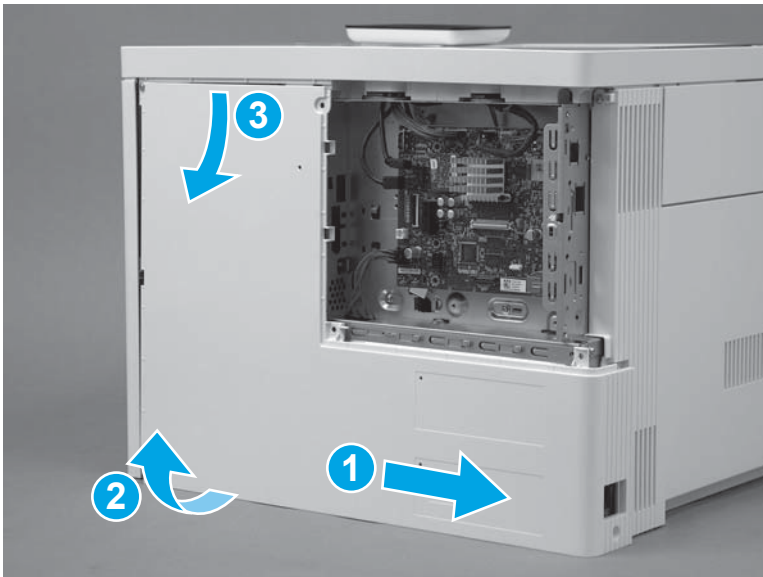

Step 6: Remove the rear upper cover (M577)

 **NOTE:** This step is for the M577 models. For the M552 and M553 models, skip this step and go to [Step 8: Remove the left cover on page 1119](#).

1. Remove two screws (callout 1).

 **Reinstallation tip:** These two screws are self-tapping screws for plastic. When reinstalling them, rotate the screws counterclockwise to align them with the existing thread pattern, and then carefully turn them clockwise to tighten. Do not overtighten. This will prevent stripping the threads inside the screw holes.

Figure 1-1956 Remove two screws



2. Use a small, flat blade screwdriver to release the right edge of the cover.

Figure 1-1957 Release the right edge

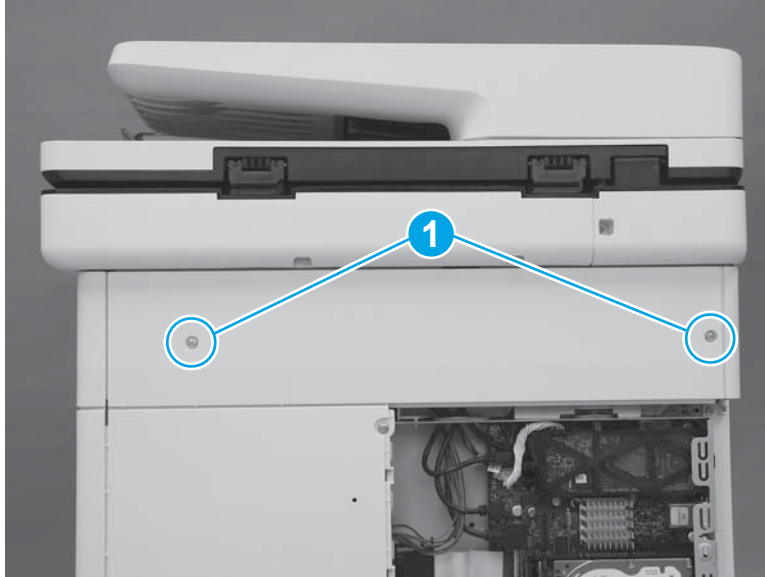
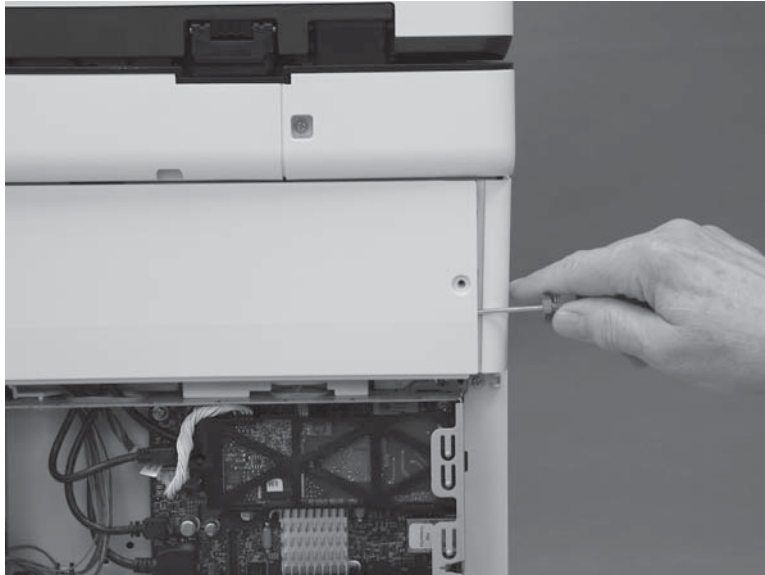

3. Pull the right edge of the cover (callout 1) away from the printer, and then slide the cover to the right (callout 2).

Figure 1-1958 Slide the cover right

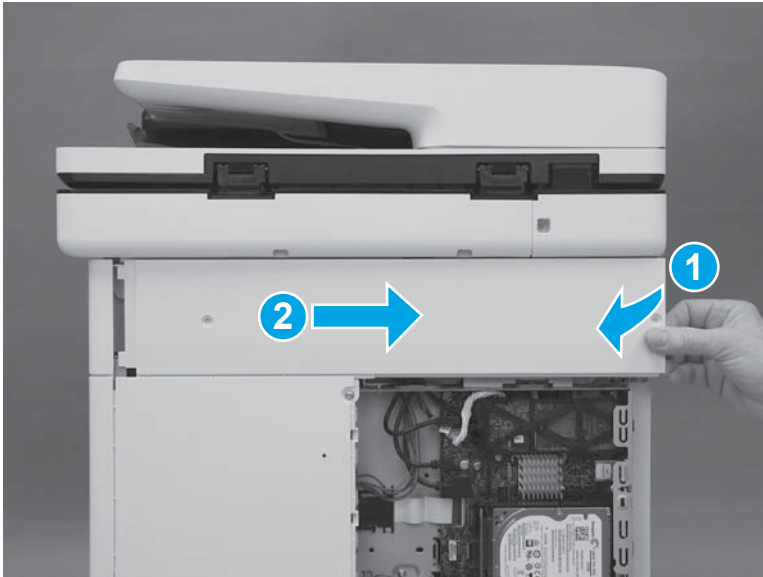

4. Remove the cover.

Figure 1-1959 Remove the cover

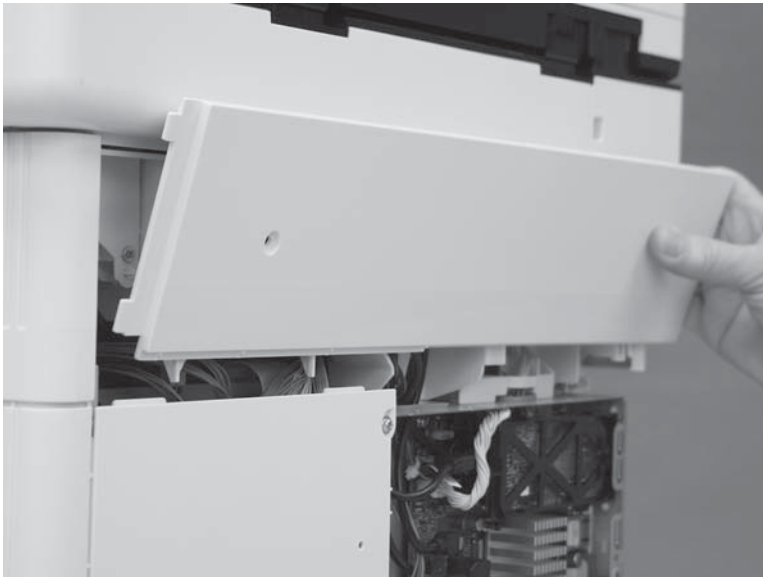

Step 7: Remove the rear cover (M577)

 **NOTE:** This step is for the M577 models. For the M552 and M553 models, skip this step and go to [Step 8: Remove the left cover on page 1119](#).

1. Remove four screws (callout 1).

Figure 1-1960 Remove four screws

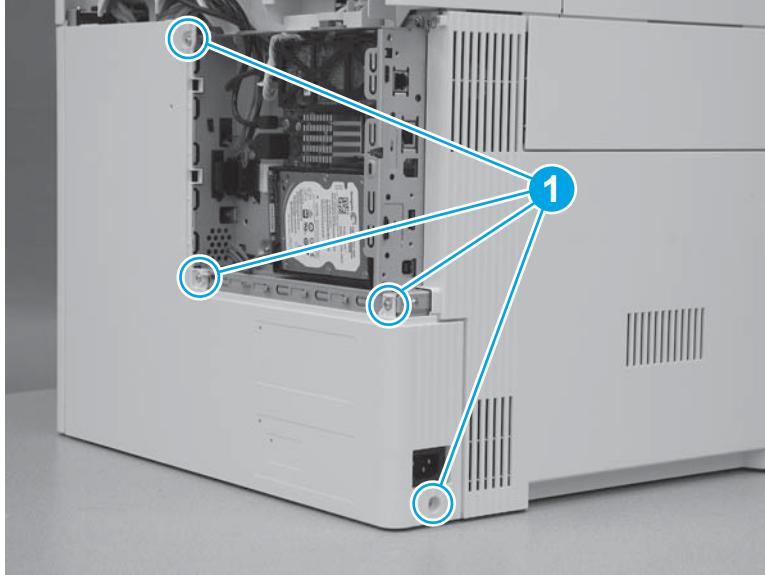

2. Slide the cover to the right to remove it.

Figure 1-1961 Remove the cover

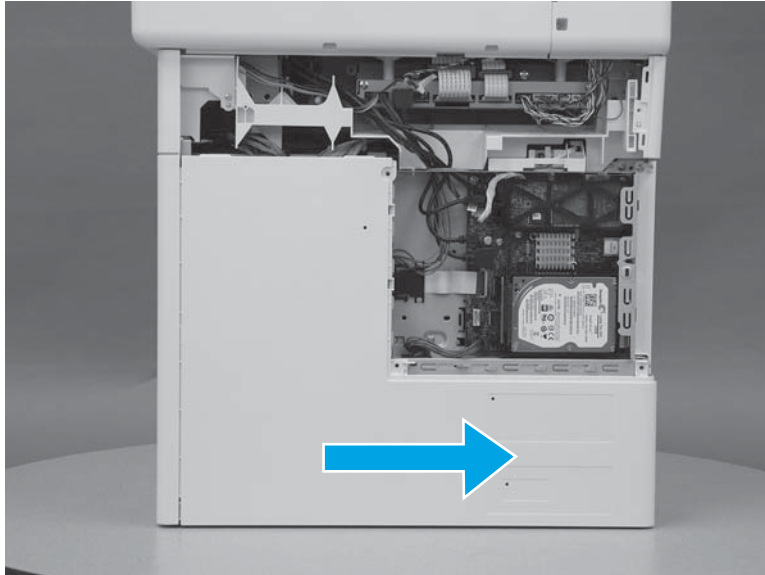

Step 8: Remove the left cover

1. At the left side of the printer, remove one screw (callout 1).

Figure 1-1962 Remove one screw



2. Release one tab (callout 1), rotate the front edge of the cover away from the printer (callout 2), and then slide the cover (callout 3) toward the rear of the printer to release it.

Figure 1-1963 Release the cover

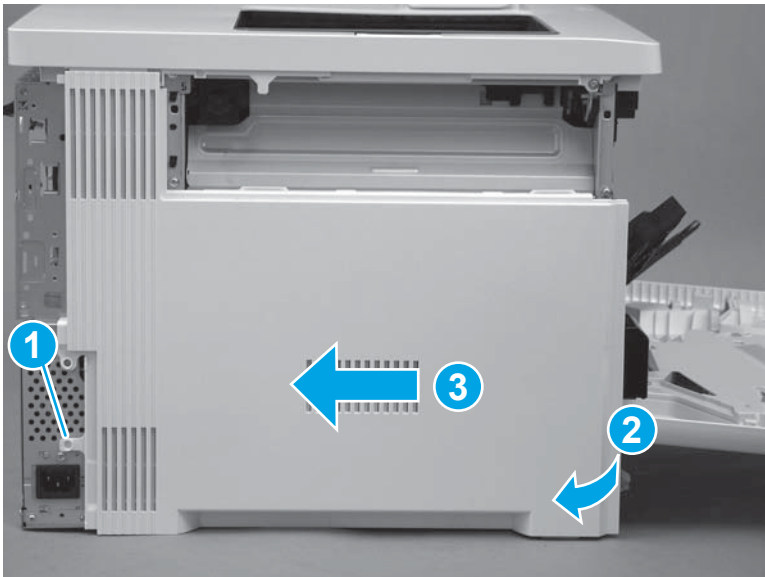

3. Remove the cover.

Figure 1-1964 Remove the cover

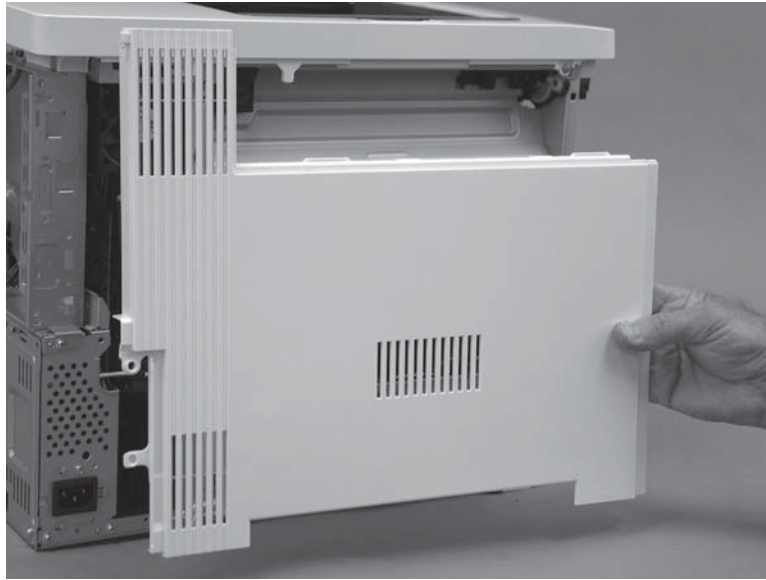

Step 9: Remove the upper cover (M552 and M553)

 **NOTE:** This step is for the M552 and M553 models. For the M577 models, skip this step and go to [Step 10: Remove the right front upper cover \(M577dn\) on page 1123](#)

1. Remove three screws (callout 1).

Figure 1-1965 Remove three screws

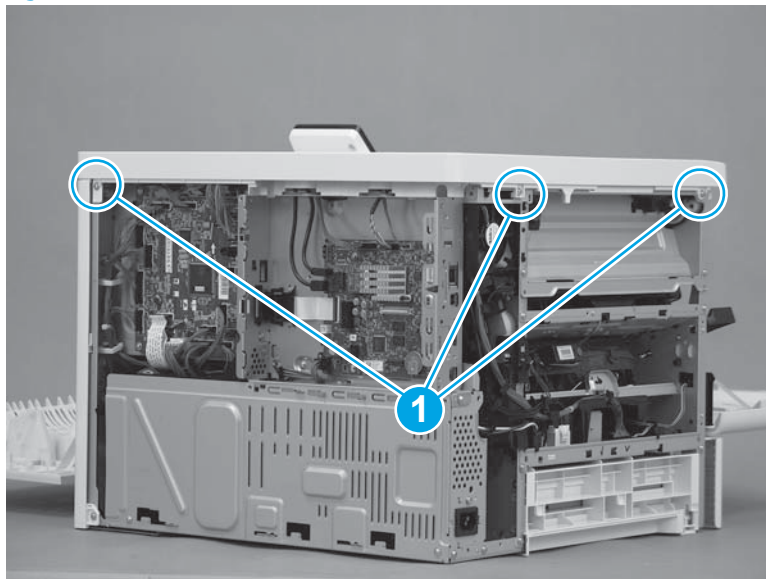

2. Remove one screw (callout 1), release one tab (callout 2), and then slightly separate the corner of the cover from the chassis.

 **NOTE:** This is a self-tapping plastic-thread screw. Make sure that this screw is used in this location when it is reinstalled.

Figure 1-1966 Remove one screw and release one tab



3. Release one tab (callout 1), and then lift up on the cover to release it.

 **NOTE:** If the cover does not release, check for addition tabs by locating the triangles embossed in the cover at tab locations.

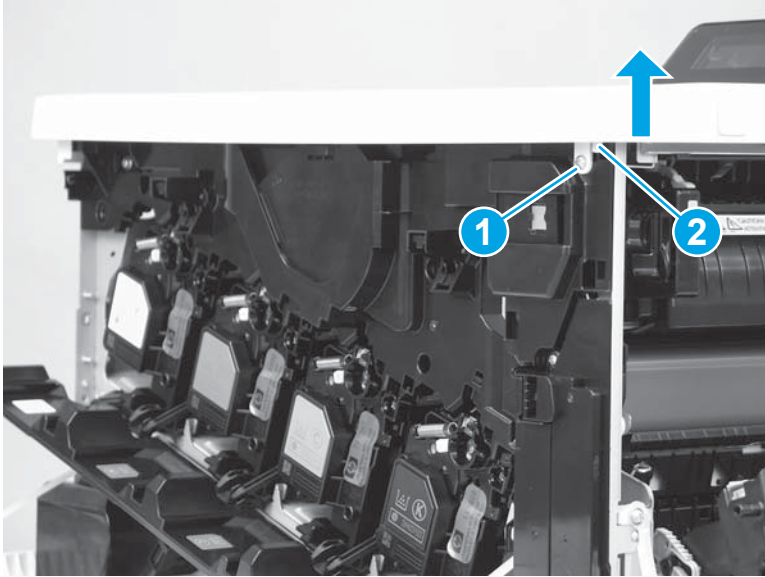
Figure 1-1967 Release the cover



4. Remove the cover.

Figure 1-1968 Remove the cover

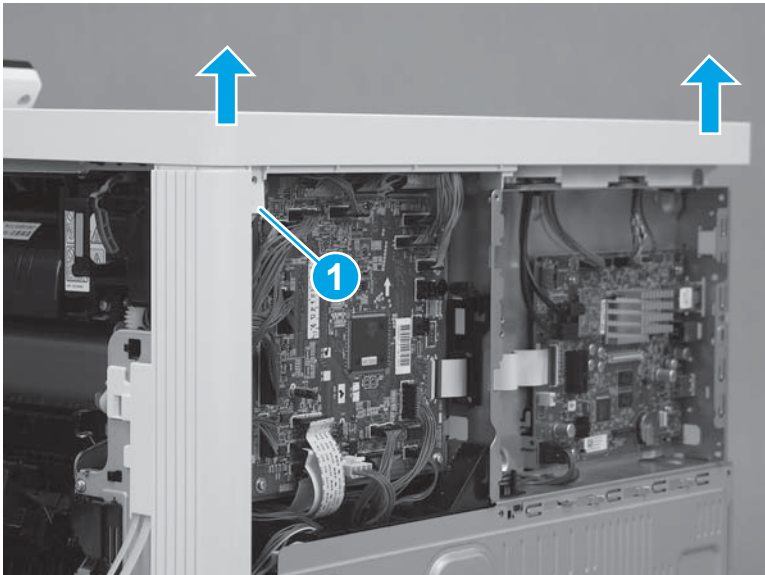
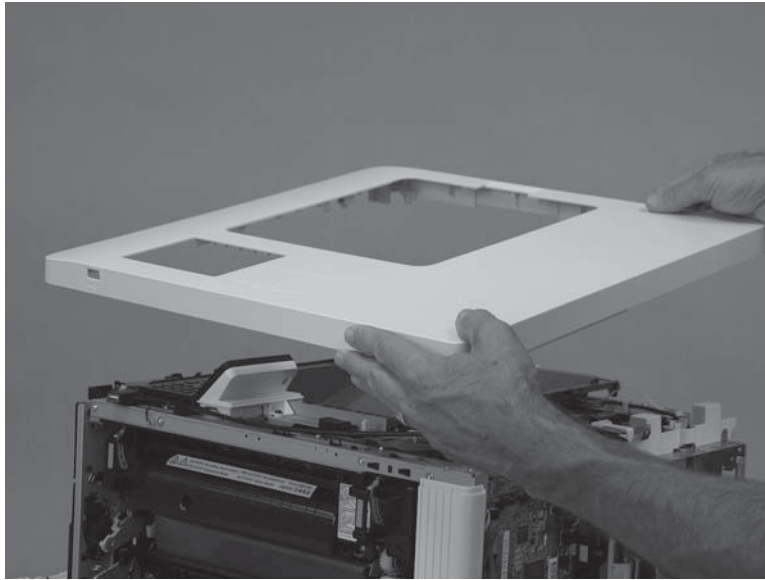

Step 10: Remove the right front upper cover (M577dn)

 **NOTE:** This step is for the M577dn model. For the M577f and M577z models, skip this step and to go [Step 11: Remove the stapler cover assembly \(M577f and M577z\) on page 1124.](#)

For the M552 and M553 models, skip this step and go to [Step 13: Remove the right rear cover on page 1128.](#)

1. Remove one screw (callout 1).

Figure 1-1969 Remove one screw

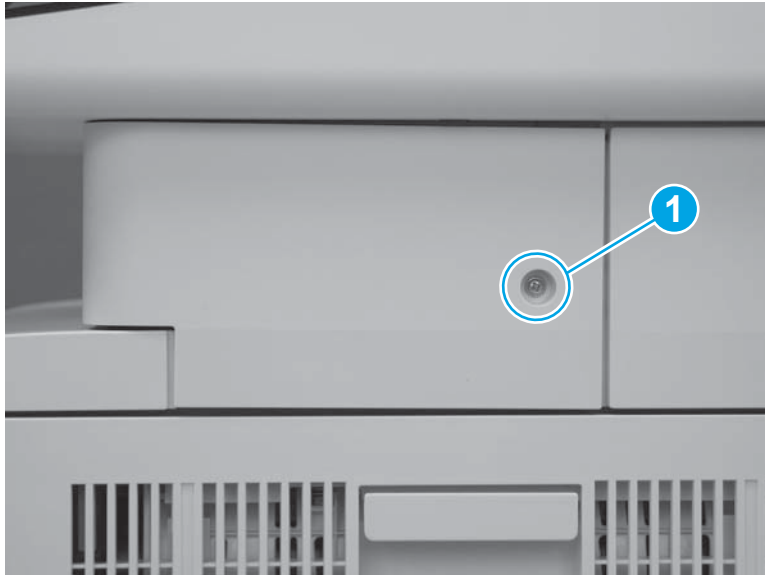

2. Release two tabs at the front edge of the cover (callout 1).

Figure 1-1970 Release two tabs



3. Rotate the front of the cover to the right to remove it.

Figure 1-1971 Rotate the cover



Step 11: Remove the stapler cover assembly (M577f and M577z)

 **NOTE:** This step is for the M577f and M577z models. For the M577dn model, skip this step and to go [Step 12: Remove the right upper cover \(M577\) on page 1126.](#)

For the M552 and M553 models, skip this step and go to [Step 13: Remove the right rear cover on page 1128.](#)

1. Remove one screw (callout 1).

 **Reinstallation tip:** This is a self-tapping screw for plastic. When reinstalling, rotate the screw counterclockwise to align it with the existing thread pattern, and then carefully turn it clockwise to tighten. Do not overtighten. This will prevent stripping the threads inside the screw hole.

Figure 1-1972 Remove one screw

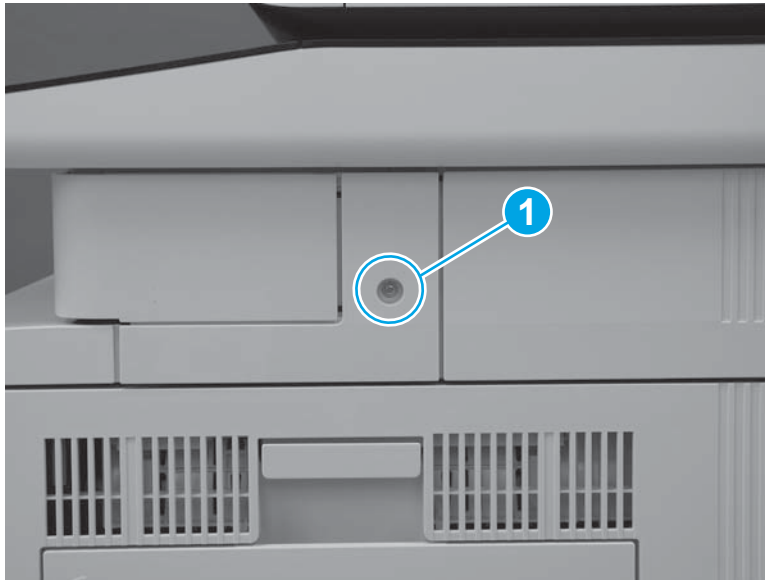

2. Release two tabs at the front edge of the cover (callout 1).

Figure 1-1973 Release two tabs



3. Release the back edge of the cover.

Figure 1-1974 Release the back edge of the cover

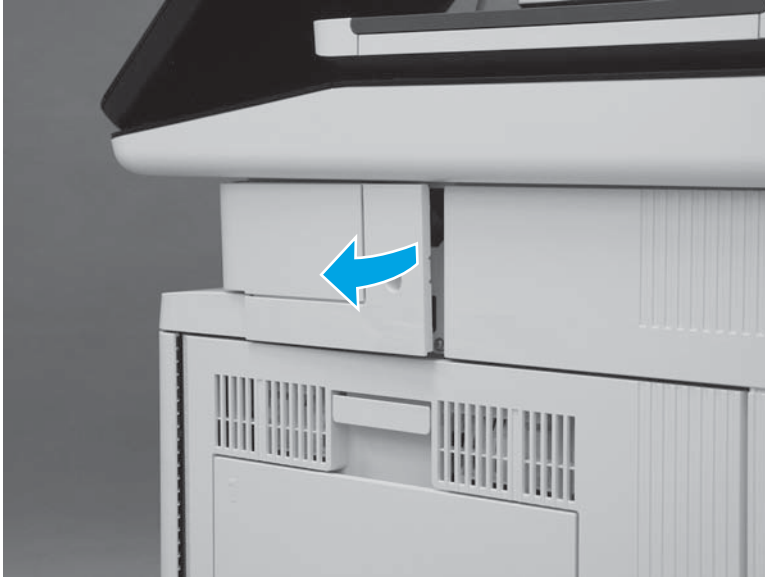



4. Rotate the cover away from the printer to remove it.

Figure 1-1975 Remove the cover



Step 12: Remove the right upper cover (M577)

 **NOTE:** This step is for the M577 models. For the M552 and M553 models, skip this step and go to [Step 13: Remove the right rear cover on page 1128.](#)

 **NOTE:** The figures below show the image scanner installed. The procedures for removing and installing the right upper cover are the same whether the image scanner is installed or removed."

1. At the right side of the printer, remove two screws (callout 1).

M577c/f/z only: Disconnect one connector (callout 2), if it was not already disconnected in a previous step.

Figure 1-1976 Remove two screws and one connector

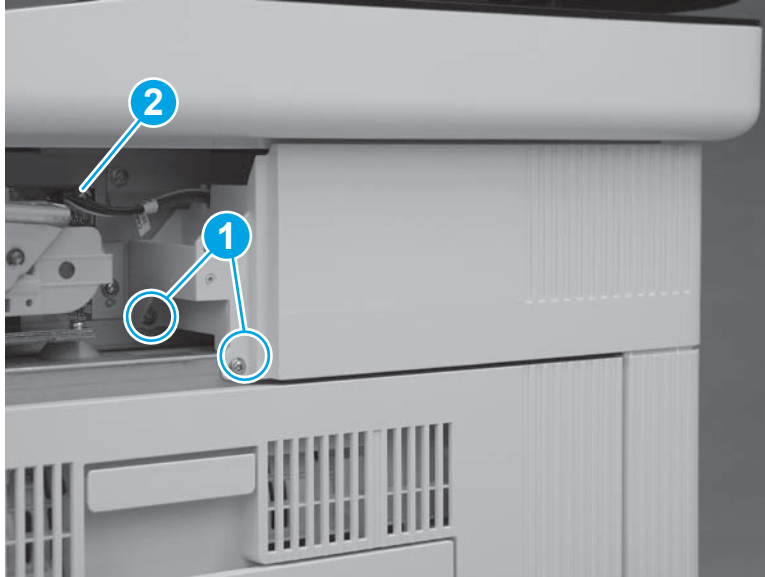

2. At the back of the printer, remove one screw (callout 1).

M577c/f/z only: Disconnect one connector (callout 2), if it was not already disconnected in a previous step.

 **Reinstallation tip:** This screw is smaller than the screws removed in the previous step. When reinstalling the right upper cover, make sure that this screw is installed in the correct position.

Figure 1-1977 Remove one screw and connector



3. Slide the cover toward the back of the printer.

Figure 1-1978 Slide the cover

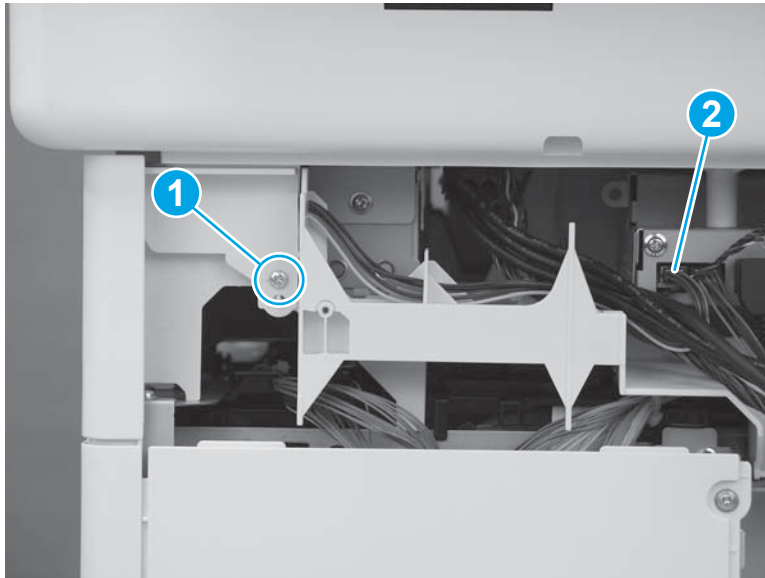
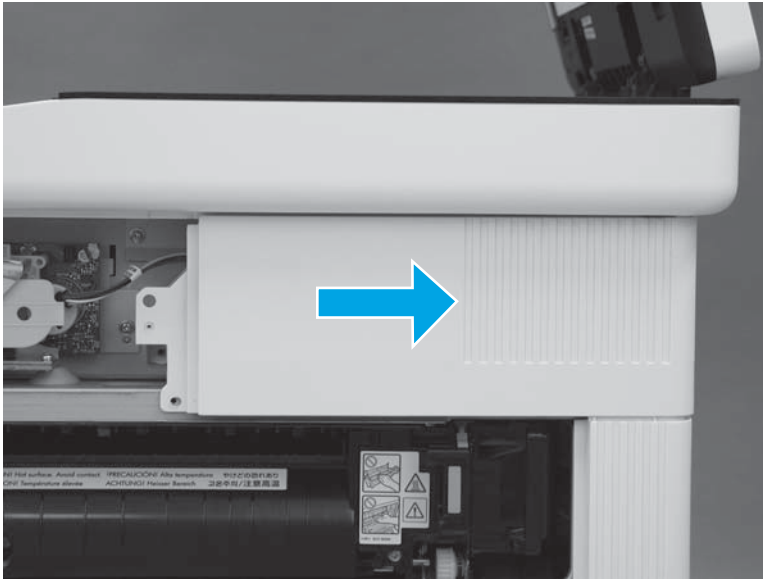

4. Lift the cover away from the printer to remove it.

M577c/f/z only: Release the cables (callout 1) through the slot (callout 2) in the printer.

Figure 1-1979 Remove the cover

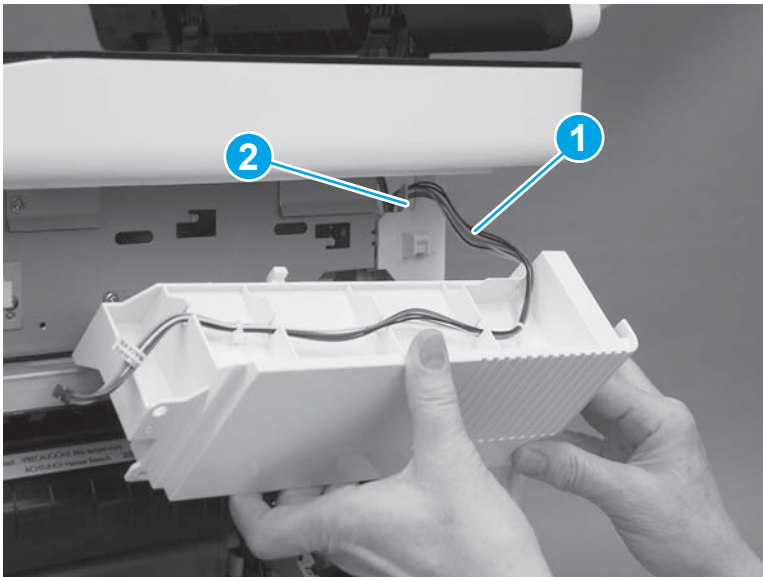

Step 13: Remove the right rear cover

1. Remove one screw (callout 1), and then slide the cover toward the rear of the printer (callout 2) to release it.

 **TIP:** If the right door is closed, open it now.

Figure 1-1980 Release the cover

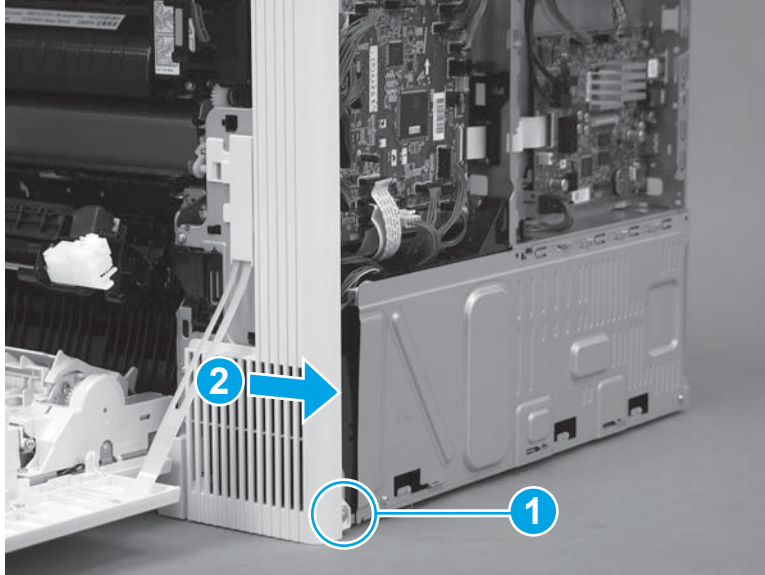

2. Remove the cover.

Figure 1-1981 Remove the cover

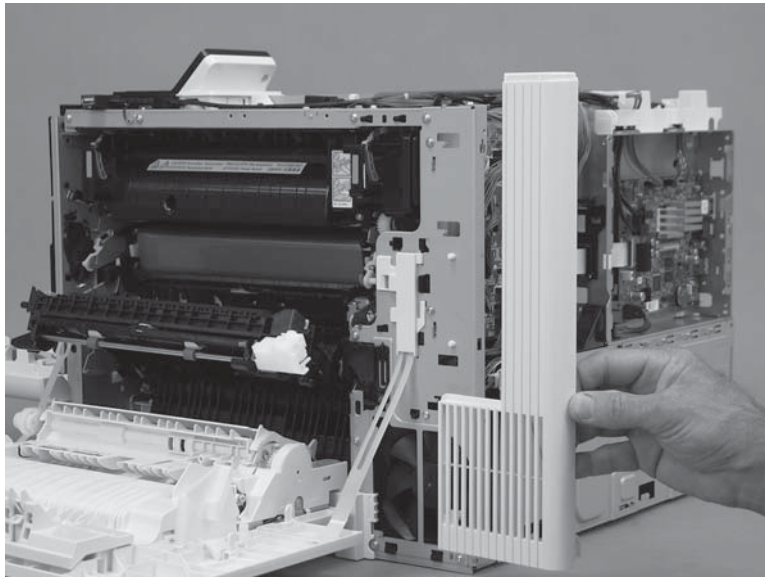

Step 14: Remove the formatter (M552 and M553)

 **NOTE:** This step is for the M552 and M553 models. For the M577 models, skip this step and go to [Step 17: Remove the formatter \(M577\) on page 1134](#)

If the optional hard-disk drive (HDD) is installed, it must be removed to gain access to the formatter mounting screws.

Release two tabs along the left edge of the HDD, rotate the left edge away from the product, and then slide the HDD to the left to remove it.

CAUTION:  ESD-sensitive part.

1. Disconnect all of the connectors on the formatter.

The following connectors are empty:

- All models: J1 (this connector is empty unless the optional DIMM is installed)
- M553n/dn and M552dn: J2 (callout 1; this is the touchscreen connector for the M553x model)
- All models: J9 (this connector is empty unless the optional internal USB ports component is installed)
- All models: J18 (this connector is empty unless the optional hard-disk-drive (HDD) is installed)
- All models: J23
- All models: J24
- M553n/dn and M552dn: J25 (this is the wireless connector for the M553x model)
- All models: J57
- All models: J98 (this connector is empty unless the optional trusted platform module (TPM) is installed)

 **IMPORTANT:** The flat-cable connector (callout 2) is a Zero Insertion Force (ZIF) connector that uses a hinged retainer to secure the flat cable. The hinged retainer must be opened to release the flat cable.

Figure 1-1982 Disconnect all connectors



2. Remove four screws (callout 1), and then remove the formatter.

Figure 1-1983 Remove the formatter

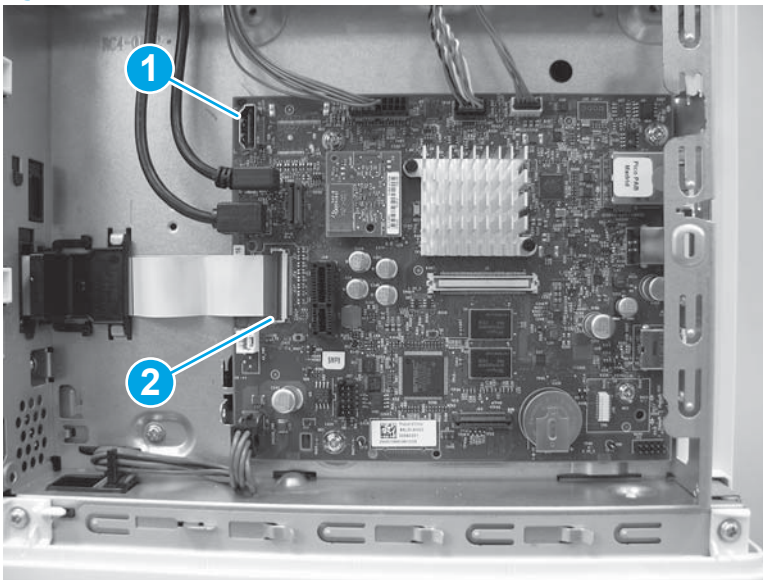
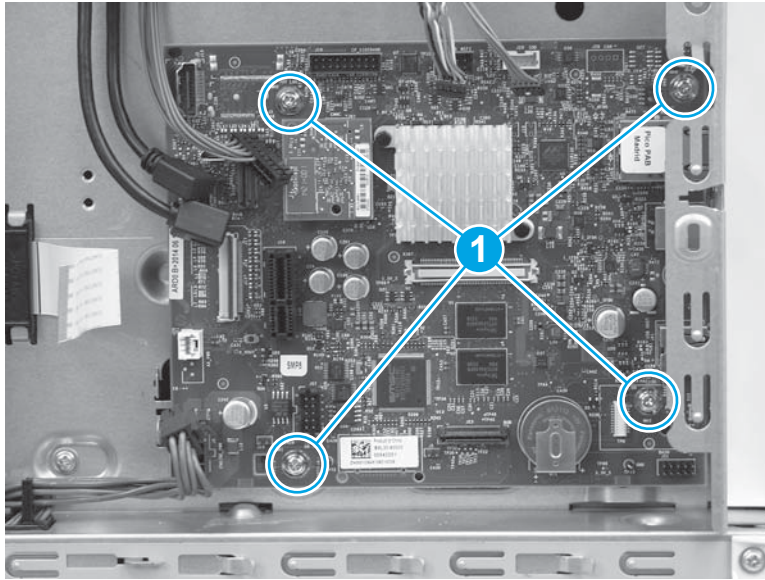

Step 15: Remove the hard-disk drive (HDD) (M577)

 **NOTE:** This step is for the M577 models. For the M552 and M553 models, skip this step and go to [Step 18: Remove the formatter case on page 1136](#).

 **CAUTION:**  ESD-sensitive part.

1. Release two tabs (callout 1). Hold the tabs in the released position, and then rotate the hard disk drive (HDD) up (callout 2) to release the connector from the formatter.

Figure 1-1984 Release the HDD

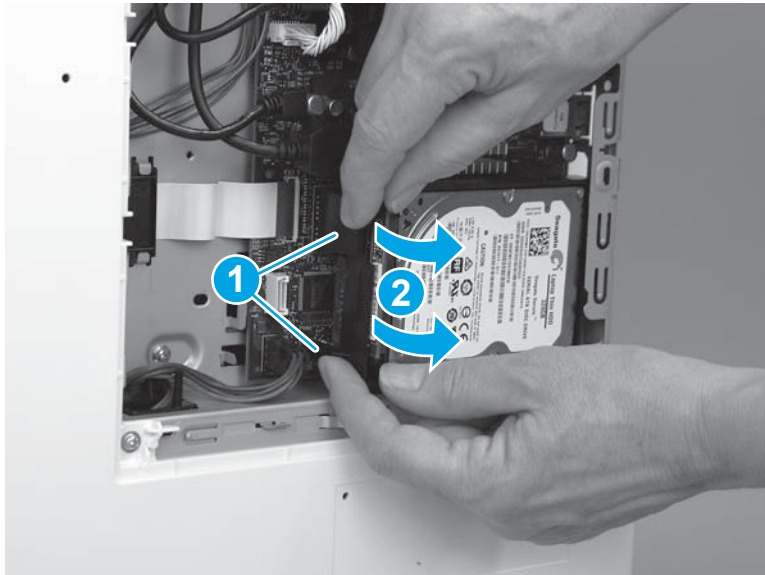

2. Slide the HDD away from the printer to remove it.

Figure 1-1985 Remove the HDD

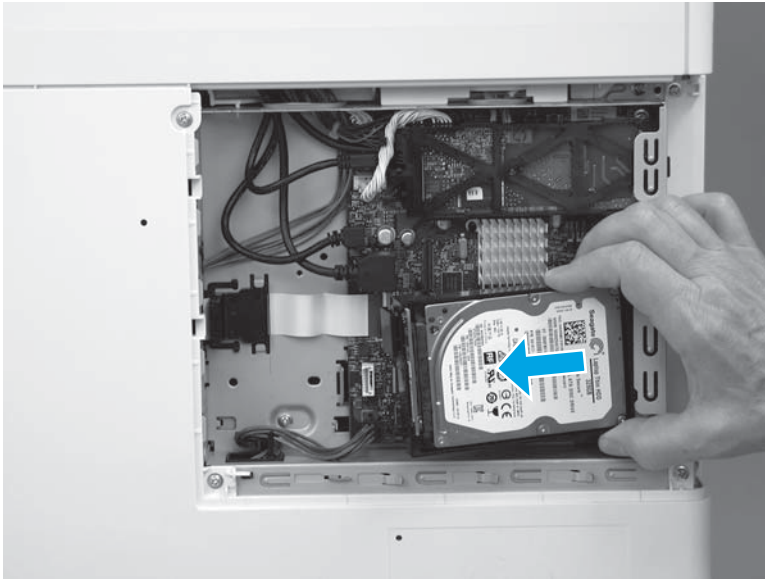

Step 16: Remove the fax PCA (M577c/f/z)

 **NOTE:** This step is for the M577c/f/z models. For the M577n model, skip this step and go to [Step 17: Remove the formatter \(M577\) on page 1134](#).

For the M552 and M553 models, skip this step and go to [Step 18: Remove the formatter case on page 1136](#).

 **CAUTION:**  ESD-sensitive part.

1. Locate the fax PCA component on the formatter.

Figure 1-1986 Locate the fax PCA

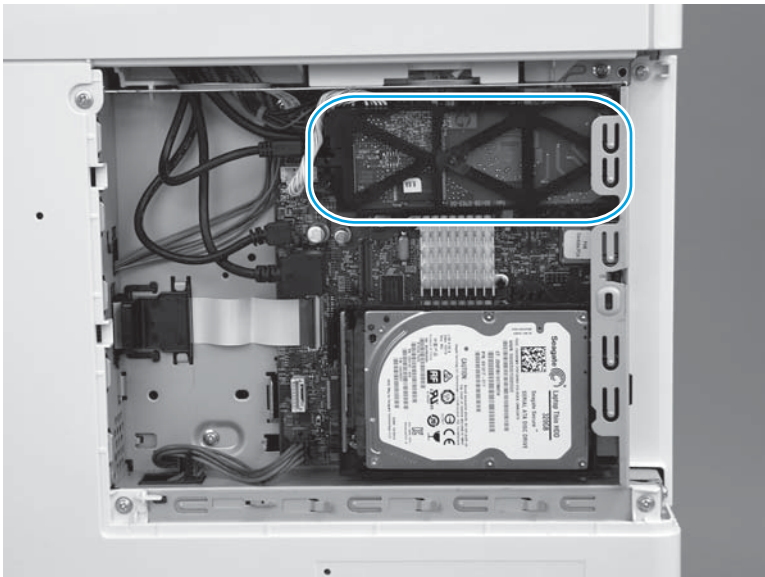

2. Release the connector latch (callout 1), and then pull the connector away from the formatter (callout 2) to disconnect it.

Figure 1-1987 Disconnect one connector

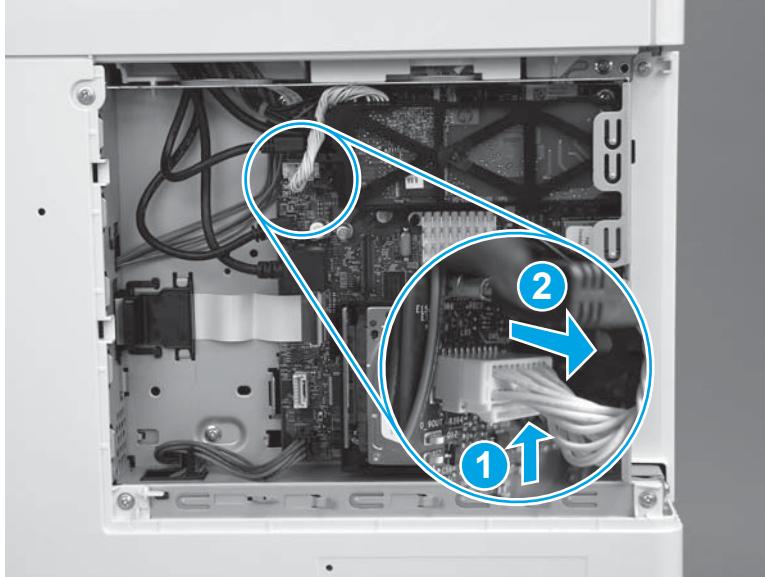

3. Release one retainer (callout 1) by pressing the bracket arms together.

Figure 1-1988 Release one latch

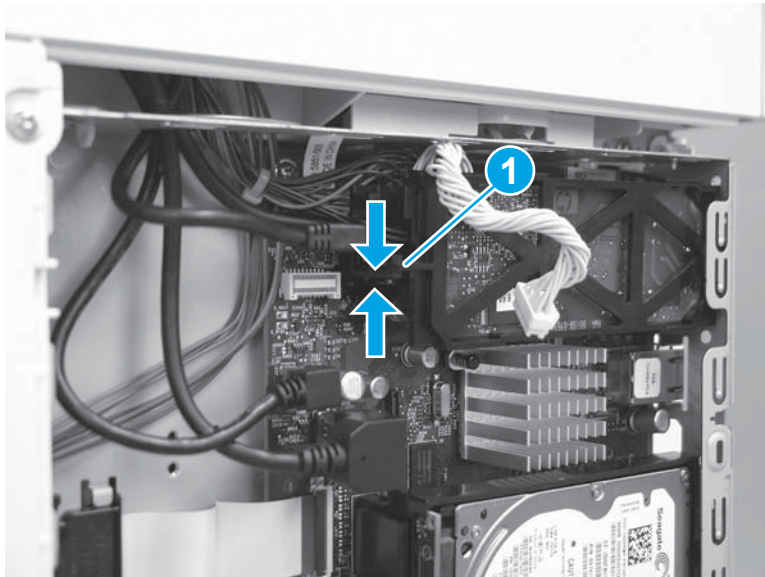

4. Rotate the end of the fax PCA (callout 1) away from the formatter, and then slide the PCA left (callout 2) to remove it.

Figure 1-1989 Remove the fax PCA

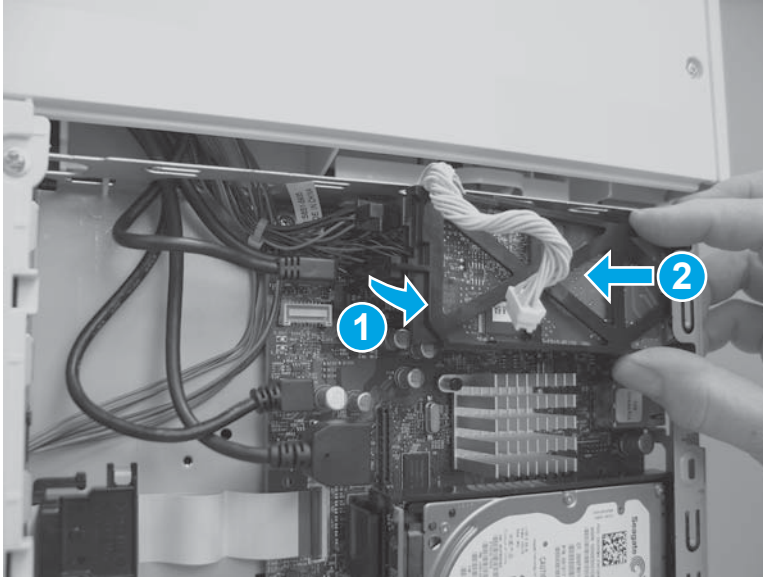

Step 17: Remove the formatter (M577)



NOTE: This step is for the M577 models. For the M552 and M553 models, skip this step and go to [Step 18: Remove the formatter case on page 1136](#).



CAUTION:  ESD-sensitive part.

1. Disconnect all of the connectors on the formatter.

The following connectors are empty:

- All models: J1 (this connector is empty unless the optional DIMM is installed)
- All models: J3
- M577dn: J15 (this is the fax connector for the M577f/z/c models)
- All models: J21 (this connector is empty unless the optional internal USB ports component is installed)
- All models: J23
- All models: J24
- All models: J51
- All models: J57
- All models: J97
- All models: J98 (this connector is empty unless the optional trusted platform module (TPM) is installed)

 **IMPORTANT:** The flat-cable connector (callout 1) is a Zero Insertion Force (ZIF) connector that uses a hinged retainer to secure the flat cable. The hinged retainer must be opened to release the flat cable.

Figure 1-1990 Disconnect all connectors



2. Remove four screws (callout 1).

Figure 1-1991 Remove four screws

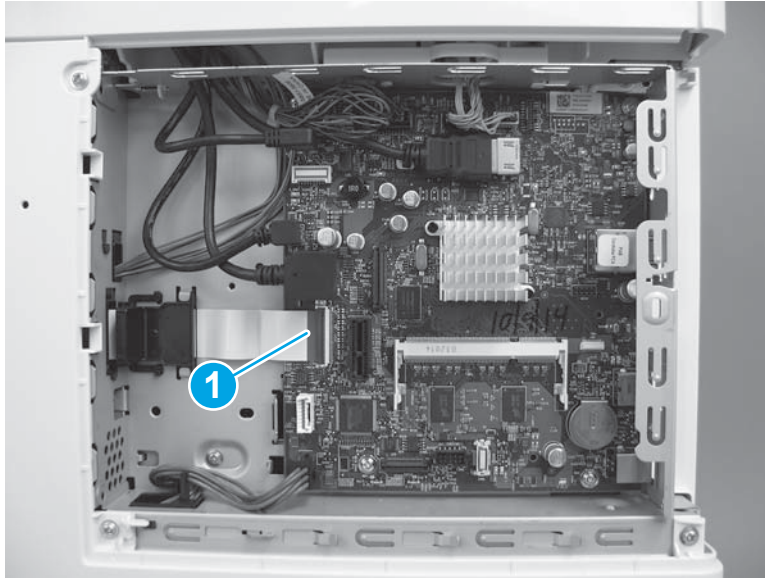
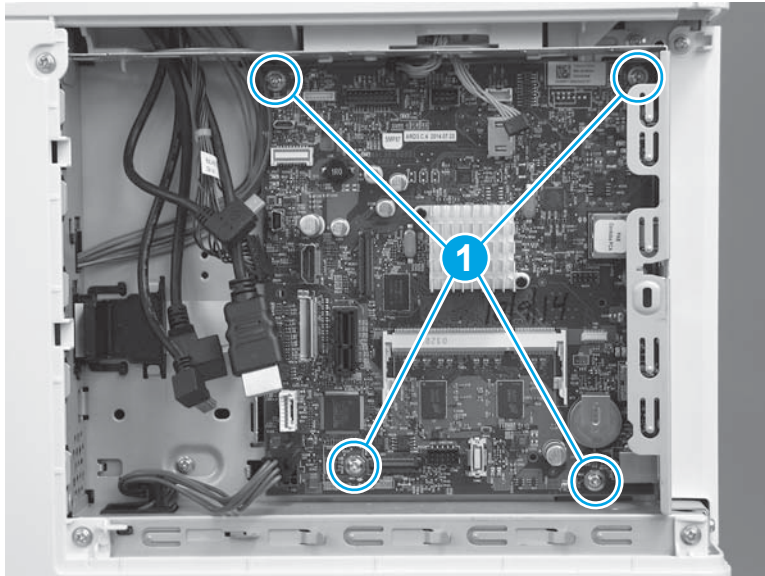

3. Remove the formatter.

Figure 1-1992 Remove the formatter

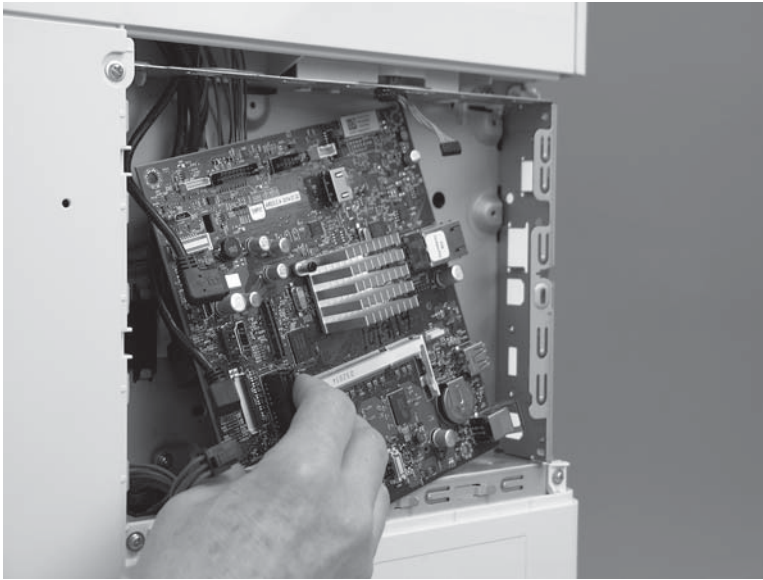

Step 18: Remove the formatter case

1. **M577 only:** Disconnect one connector (callout 1), and then pass the wire harness (callout 2) through two openings in the formatter case (callout 3).

Figure 1-1993 Disconnect one connector

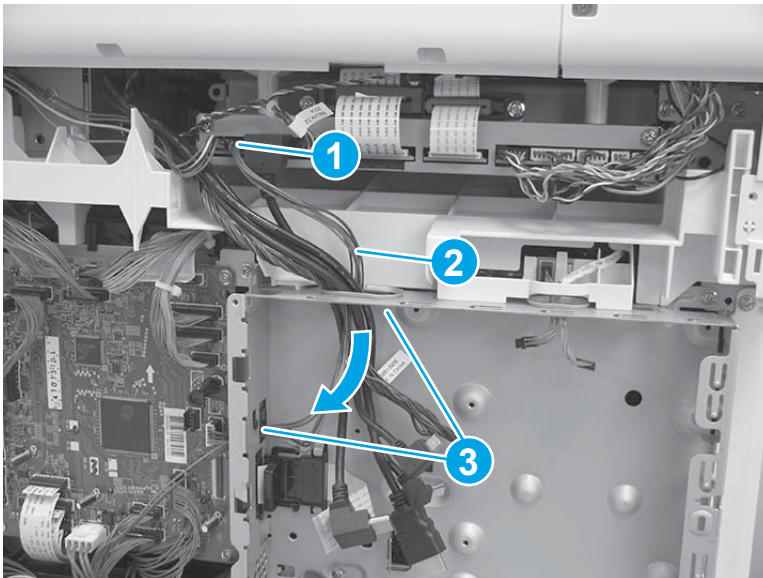

2. Release two tabs (callout 1) on the black plastic bracket. Hold the tabs in the released position, and then slide the bracket (callout 2) to the right to remove it from the formatter case.

Figure 1-1994 Remove the bracket

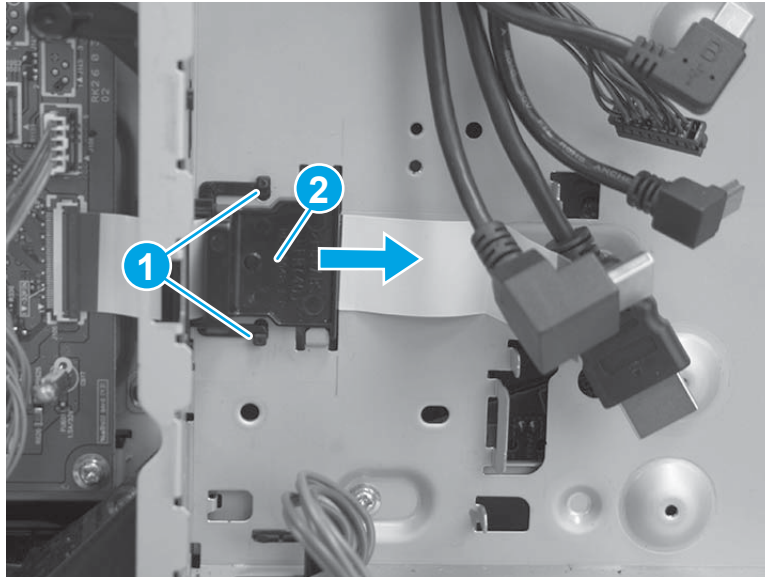

3. Remove two screws (callout 1), and then slide the low-voltage power supply (LVPS) cover to the right to remove it.

Figure 1-1995 Remove the LVPS cover

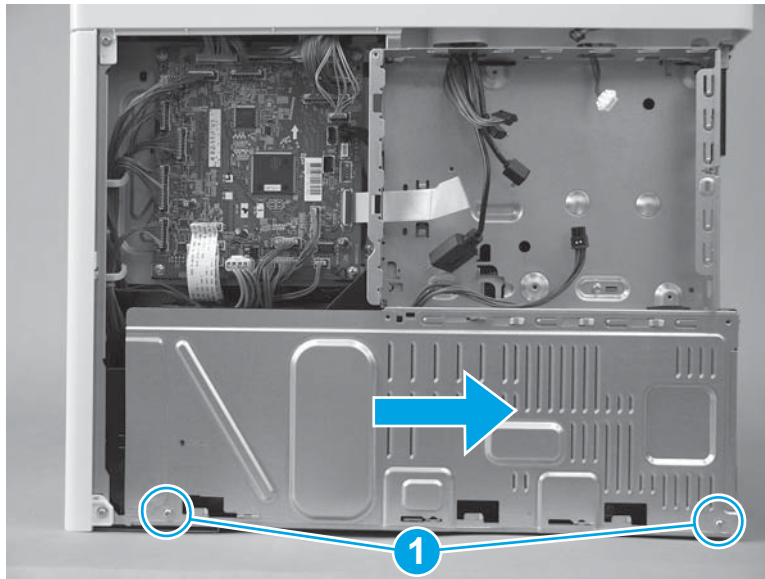

4. Pass two wire harnesses and one flat cable (callout 1) through the opening in the formatter case, and then release one wire harness from the retainer (callout 2).

⚠ CAUTION: The flat cable might be attached to the formatter case with double-sided tape. Make sure that this tape is released, so that the flat cable is not damaged when the formatter case is removed.

Figure 1-1996 Release wire harnesses and flat cable

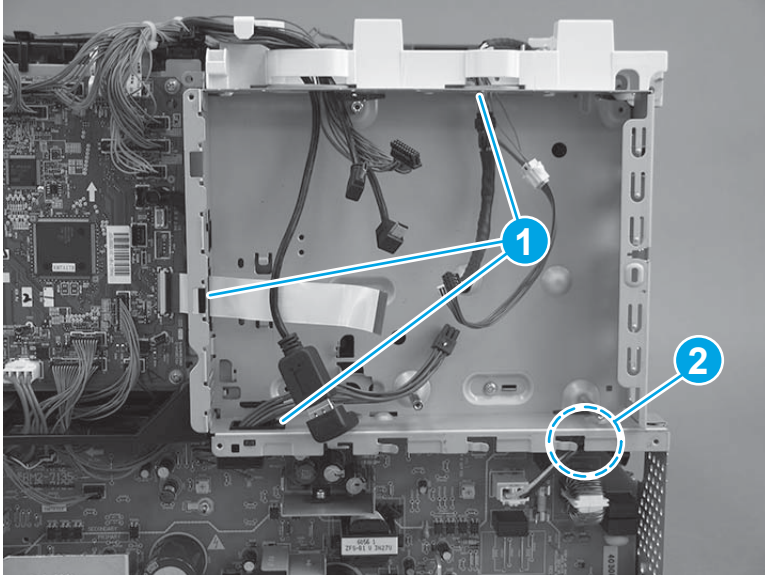

5. Remove six screws (callout 1).

Figure 1-1997 Remove six screws

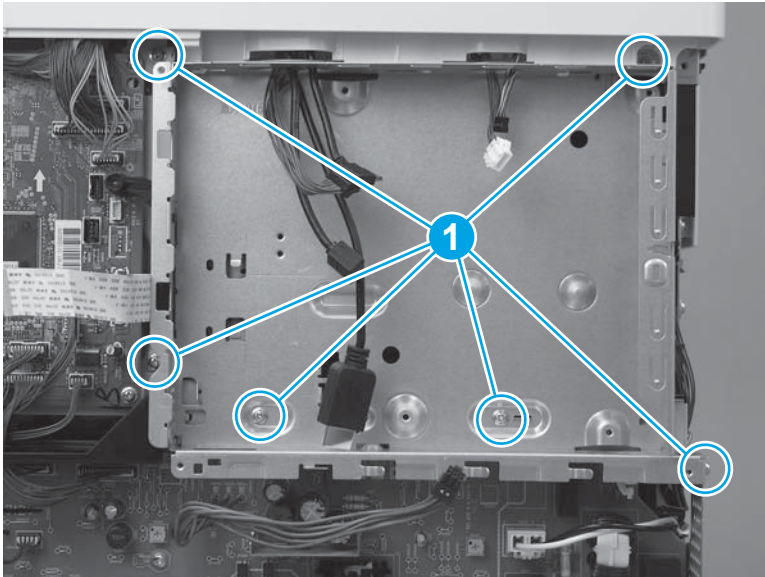

6. Rotate the bottom of the formatter case away from the printer (callout 1), and then pull it down (callout 2) to release it.

Figure 1-1998 Release the formatter case

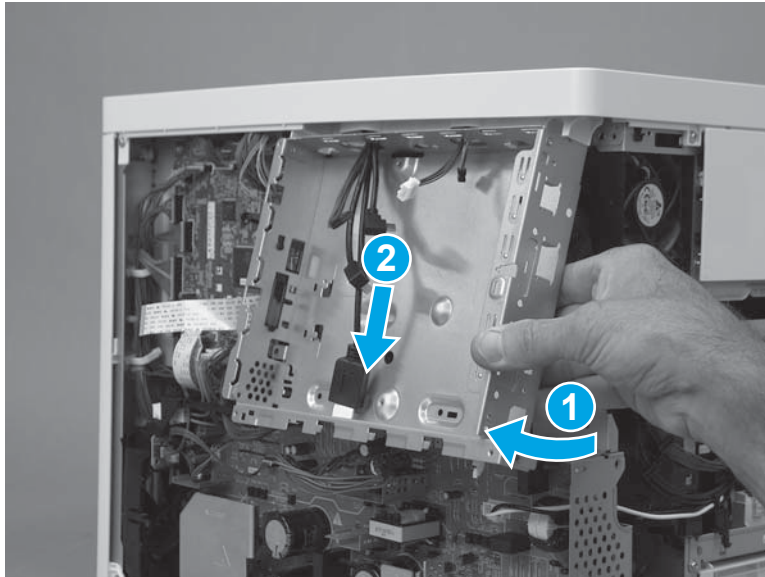

7. Pass the wire harnesses through the opening in the formatter case to remove it.

 **IMPORTANT:** If the formatter case is removed so that it can be replaced, make sure to transfer the memory PCA (island of data) and plastic bracket (callout 1) to the replacement case.

Figure 1-1999 Remove the formatter case



Step 19: Remove the low-voltage power supply (LVPS)

 **CAUTION:**  ESD-sensitive part.

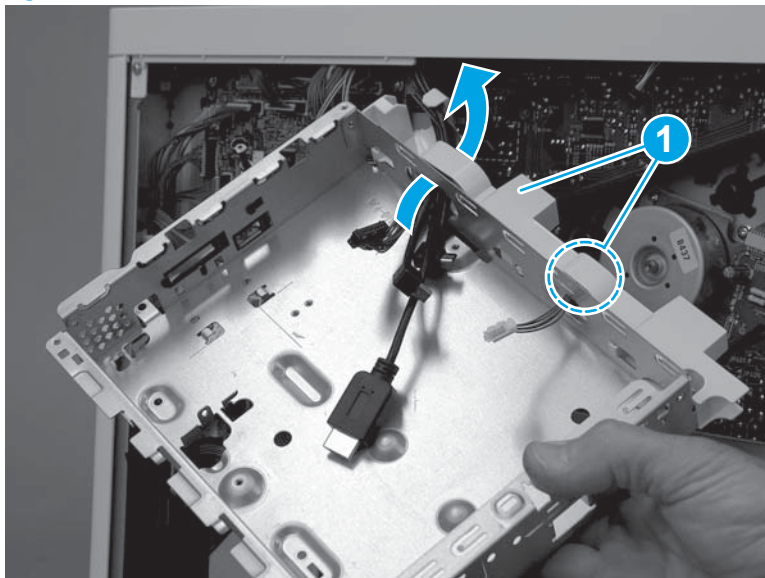
1. Disconnect one wire harness (callout 1), and then pass the wire harness through the opening (callout 2) in the chassis.

Figure 1-2000 Disconnect one wire harness

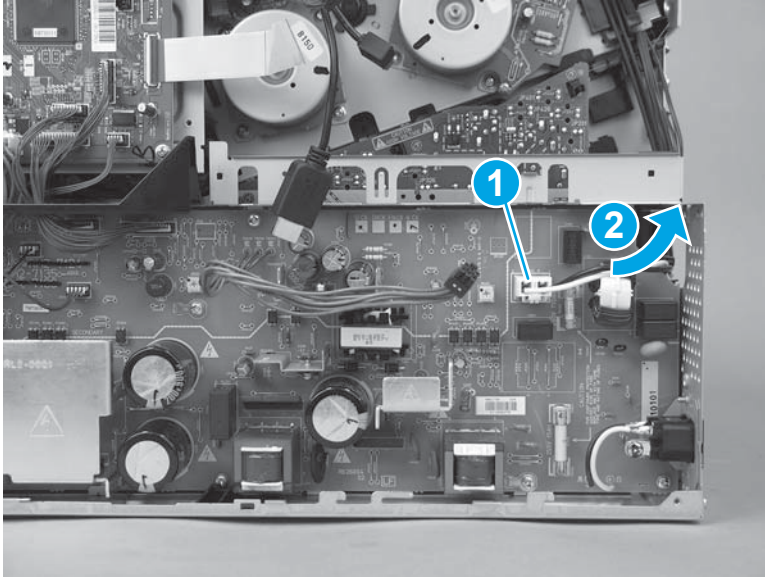

2. Disconnect three connectors on the DC controller (callout 1), and then disconnect four connectors (callout 2) on the LVPS.

Figure 1-2001 Disconnect seven connectors

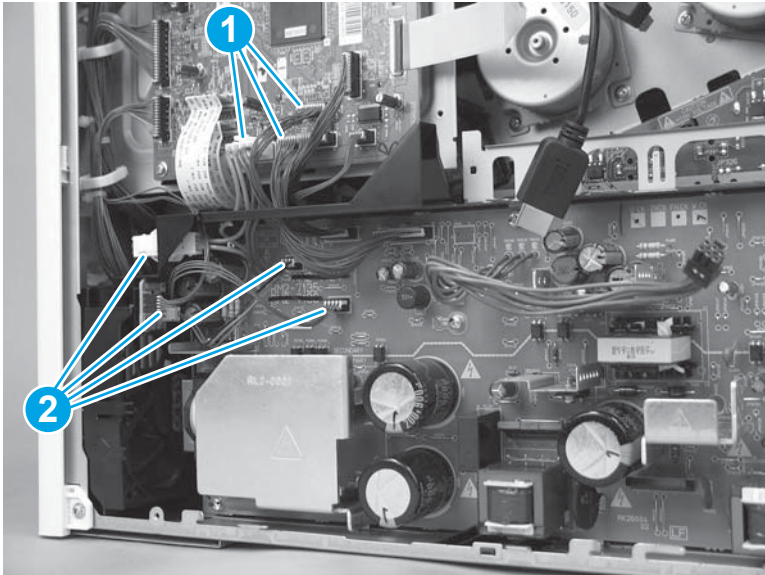

3. Pass the wire harnesses from the DC controller to the LVPS through the opening in the chassis (callout 1), and then release the wire harnesses from the retainer (callout 2).

Figure 1-2002 Pass the wire harnesses through the opening

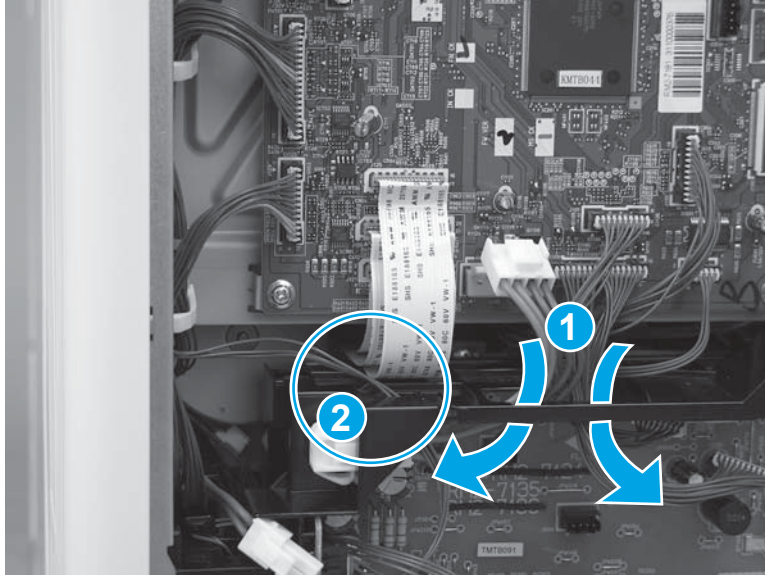

4. Remove three screws (callout 1).

Figure 1-2003 Remove three screws

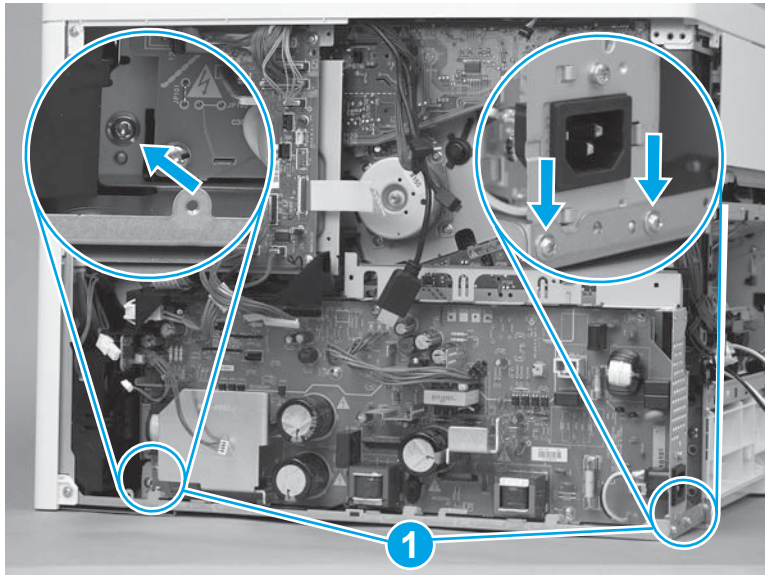

5. Rotate the top of the LVPS away from the printer (callout 1), and then slide it up and out (callout 2) of the printer to remove it.

Figure 1-2004 Remove the LVPS

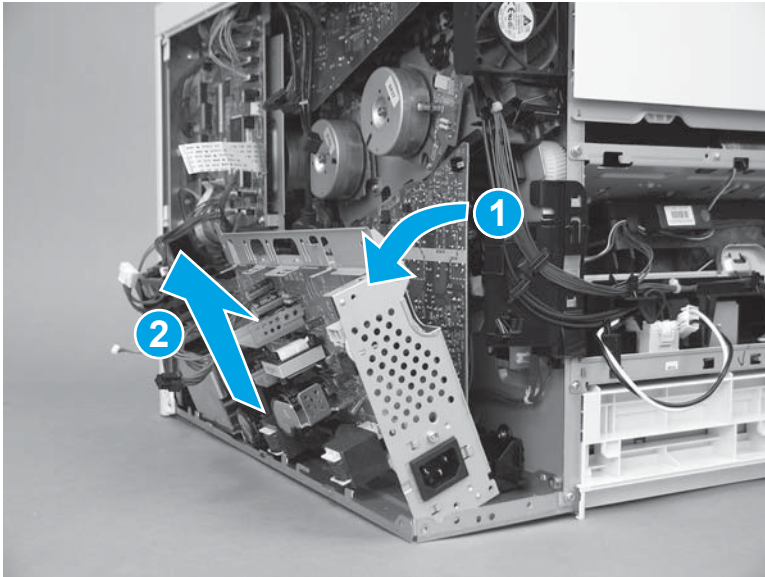

Step 20: Remove the power supply fan (FM1)

1. Remove one screw (callout 1).

Figure 1-2005 Remove one screw

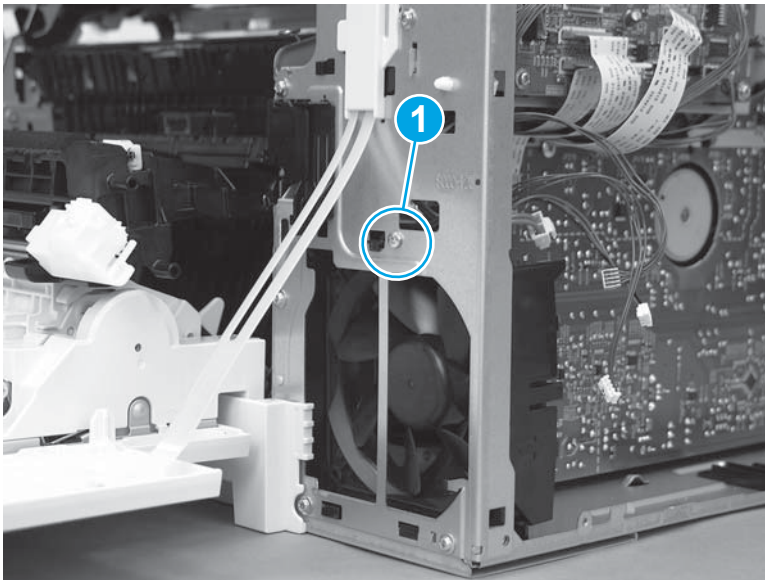

2. Release the wire harnesses from the retainer on the top of the fan bracket.

Figure 1-2006 Release the wire harnesses

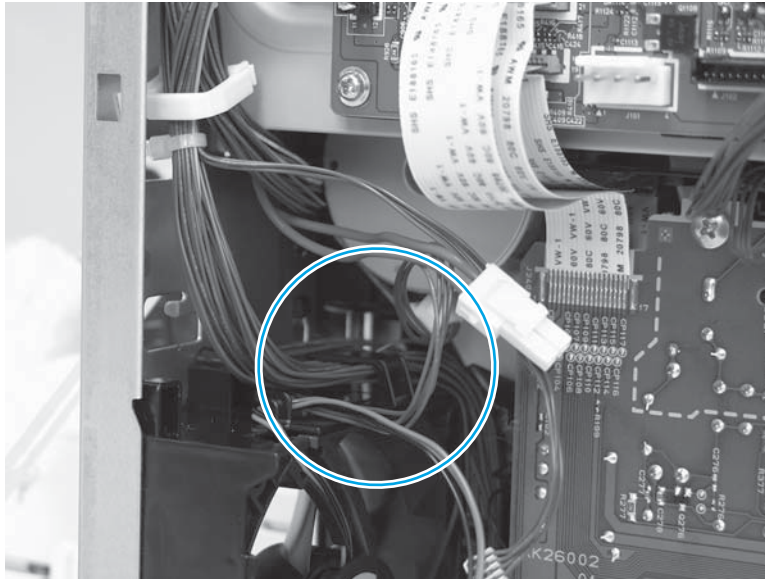

3. Lift the fan up (callout 1), and then slide it out of the printer (callout 2) to remove it.

Figure 1-2007 Remove the fan

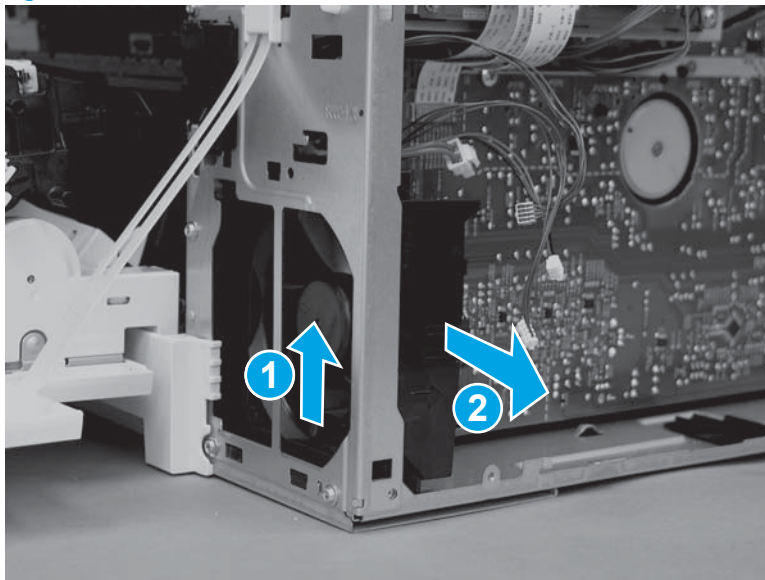

Step 21: Unpack the replacement assembly

Unpack the replacement assembly from the packaging.

For complete information on HP's recycling programs, go to [Product return and recycling](#).

 **NOTE:** HP recommends responsible disposal of the defective assembly.

Figure 1-2008 Recycle and unpack

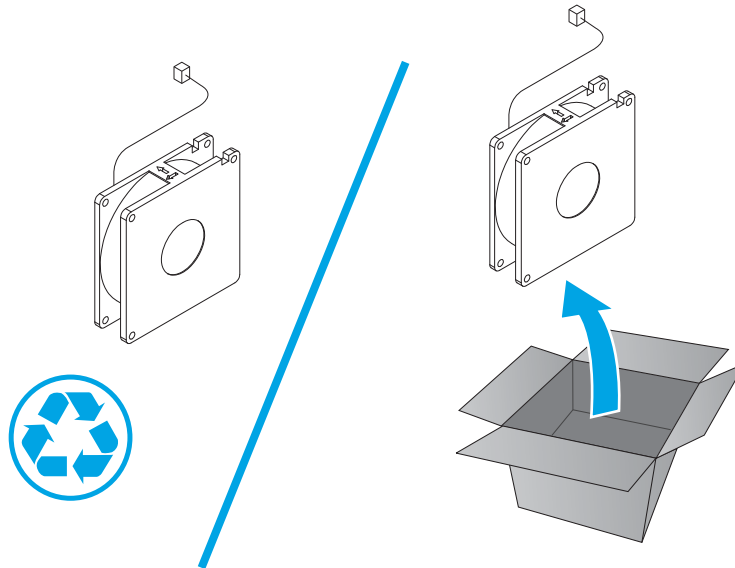

Step 22: Install the power-supply fan (FM1)

1. Slide the fan in (callout 1) and then down (callout 2) into the printer to install it.

 **NOTE:** Make sure that the arrow (callout 3) embossed on the fan holder faces into the printer.

Figure 1-2009 Install the fan



2. Place the wire harnesses in the retainer on the top of the fan bracket.

Figure 1-2010 Place the wire harnesses in the retainer

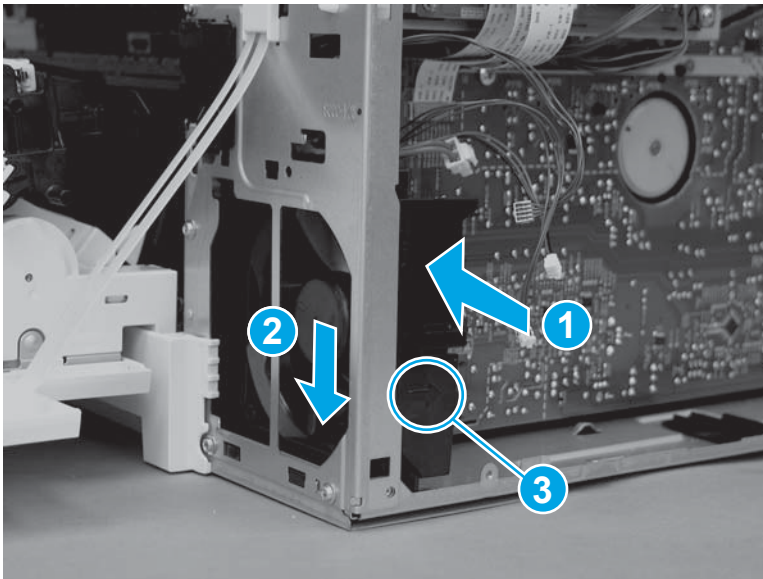
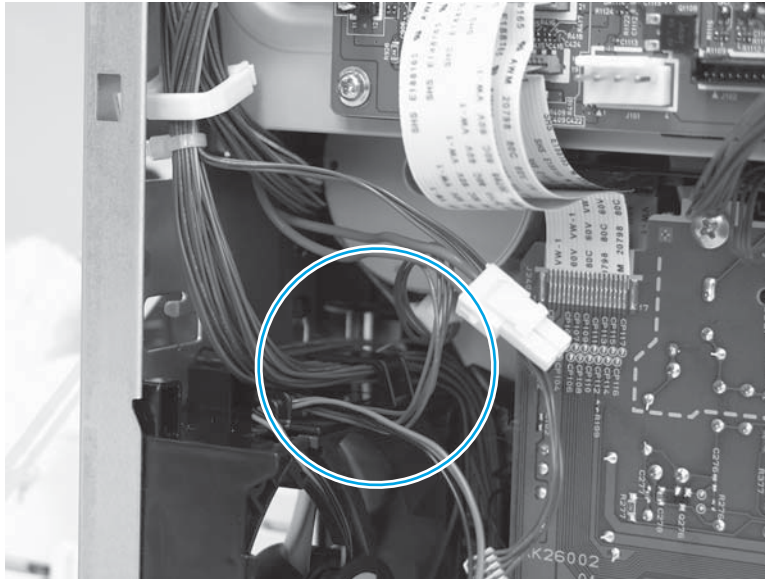

3. Install one screw (callout 1).

Figure 1-2011 Install one screw

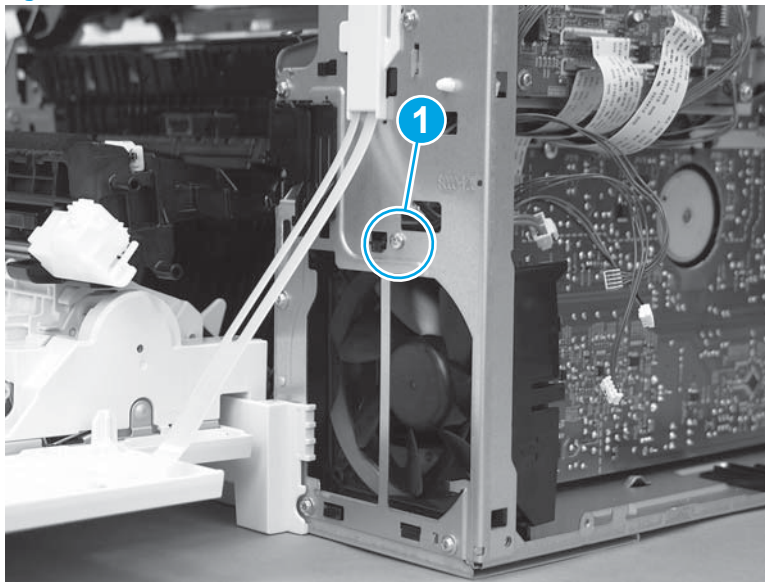

Step 23: Install the LVPS

 **CAUTION:**  ESD-sensitive part.

1. Position the bottom of the LVPS in the printer (callout 1) at a slight angle, and then rotate the top of it into the printer (callout 2) to install it.

Figure 1-2012 Install the LVPS

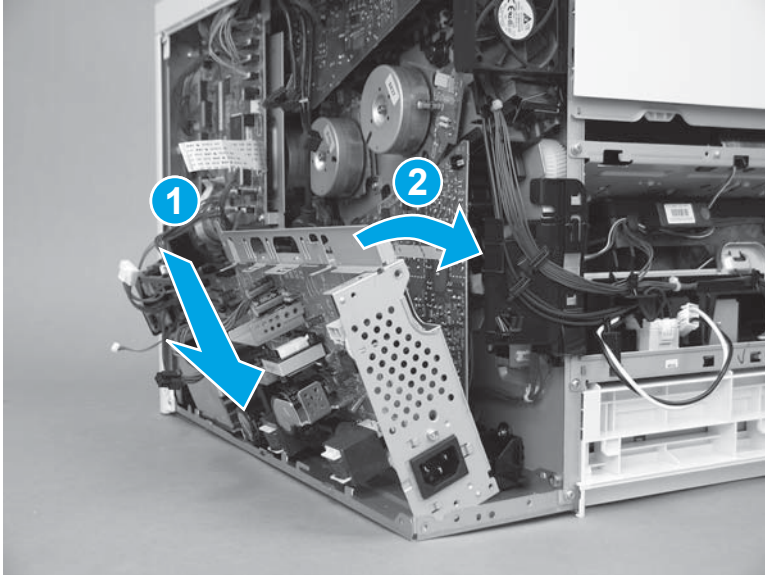

2. Install three screws (callout 1).

Figure 1-2013 Install three screws

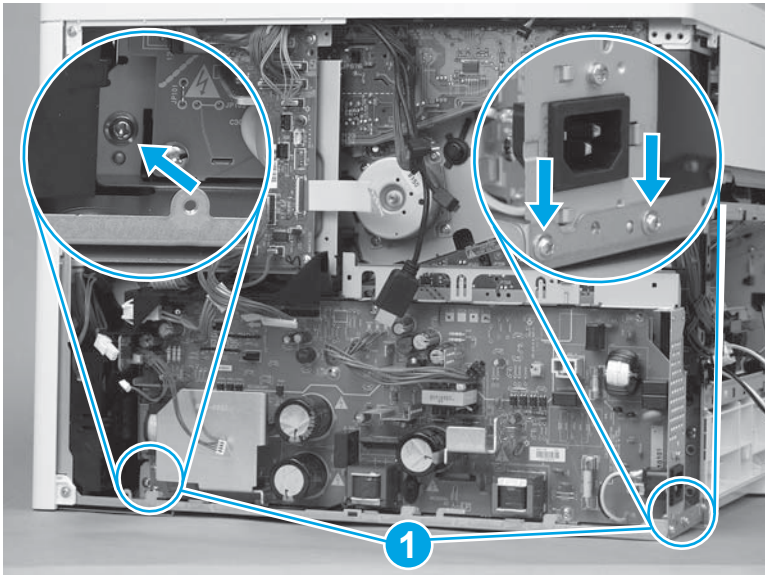

3. Pass the wire harnesses from the DC controller to the LVPS through the opening in the chassis (callout 1), and then install the wire harnesses in the retainer (callout 2).

Figure 1-2014 Pass the wire harnesses through the opening

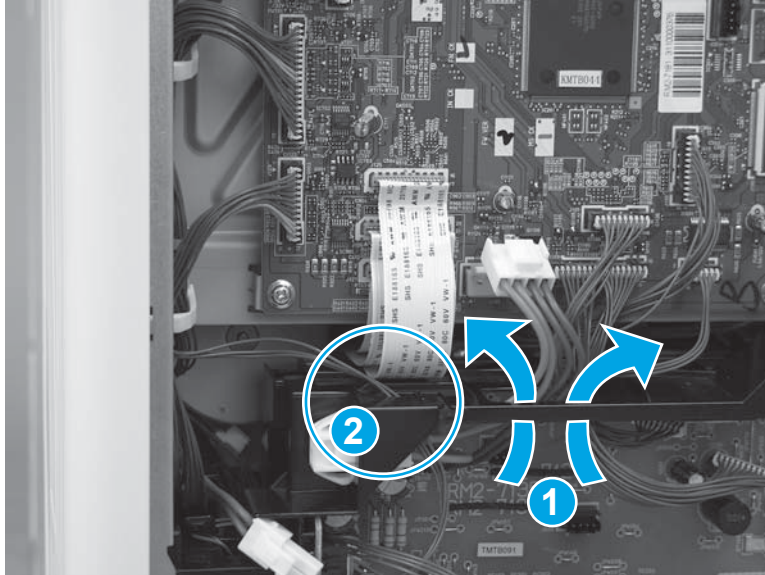

4. Connect three connectors on the DC controller (callout 1), and then connect four connectors (callout 2) on the LVPS.

Figure 1-2015 Connect seven connectors

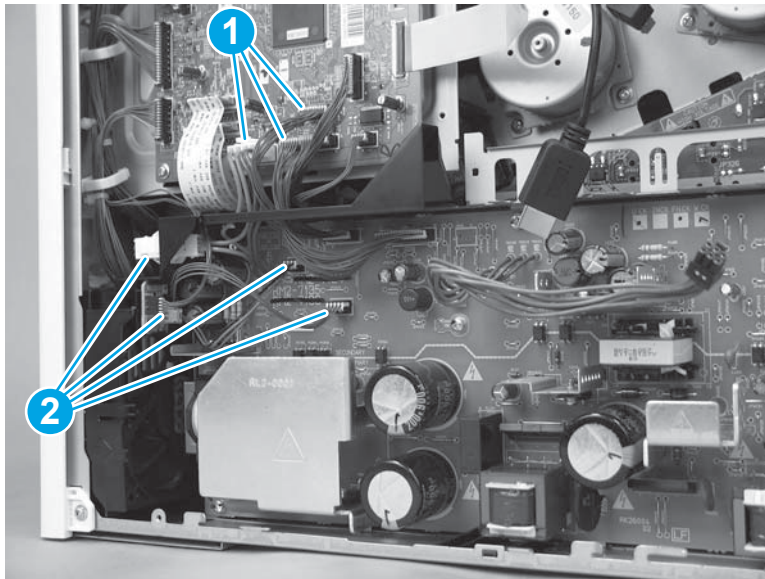

5. Pass the wire harness through the opening (callout 1) in the chassis, and then connect one wire harness (callout 2).

Figure 1-2016 Connect one wire harness

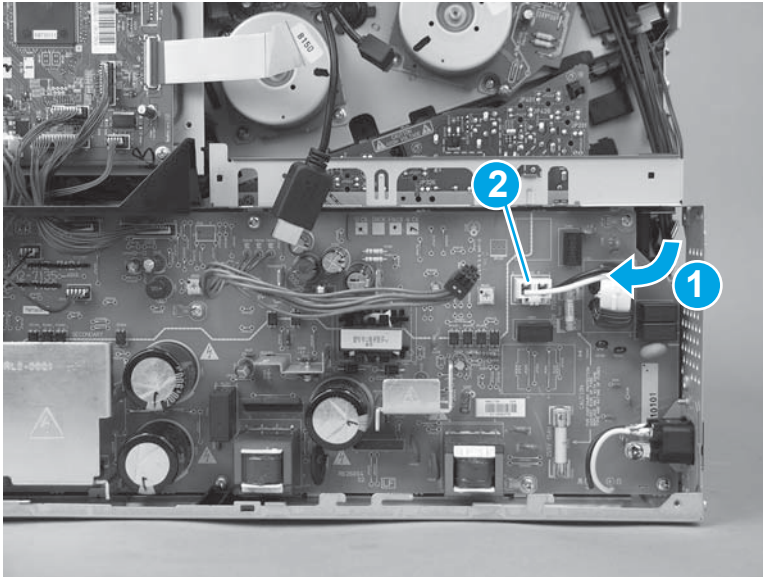

Step 24: Install the formatter case

1. Pass the wire harnesses through the opening in the formatter case.

Figure 1-2017 Pass the wire harnesses through the opening

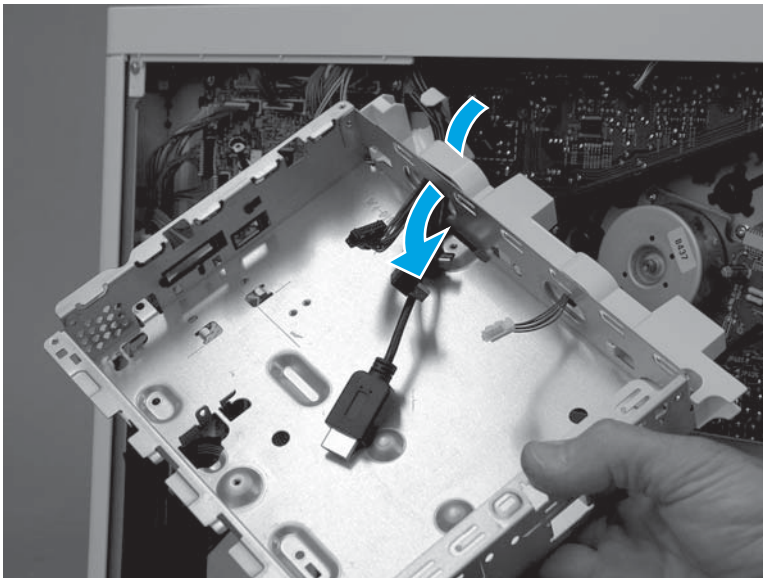

2. Position the top of the formatter case on the printer (callout 1), and then rotate the bottom of the case (callout 2) into the printer.

Figure 1-2018 Install the formatter case

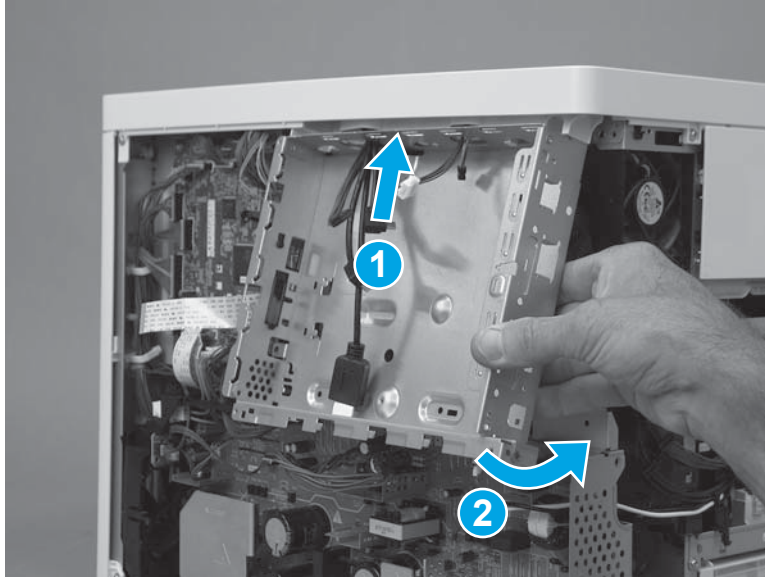

3. Install six screws (callout 1).

Figure 1-2019 Install six screws

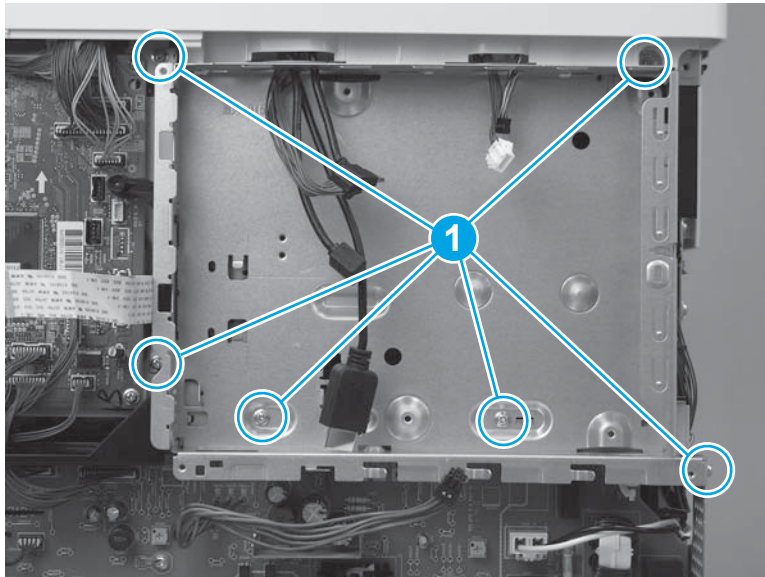

4. Pass two wire harnesses and one flat cable (callout 1) through the opening in the formatter case, and then install one wire harness in the retainer (callout 2).

 **IMPORTANT:** Make sure that the flat cable is securely fastened to the DC controller, and was not dislodged when the formatter case was removed.

Figure 1-2020 Install wire harnesses and flat cable

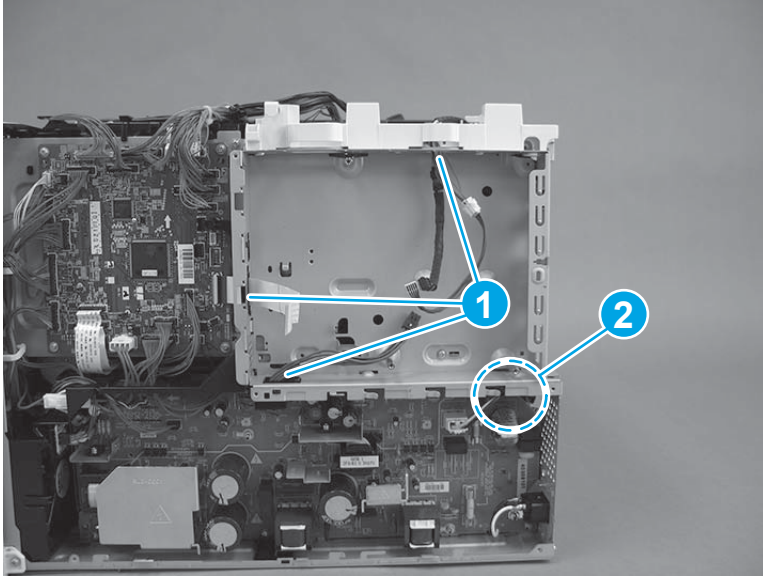

5. Position the LVPS cover on the printer, slide the cover to the left to install it, and then install two screws (callout 1).

Figure 1-2021 Install the LVPS cover

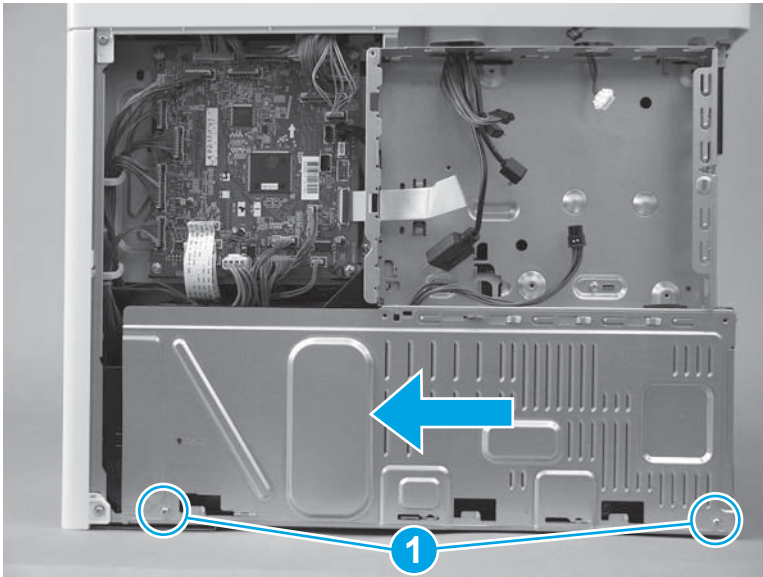

6. If no tape is affixed to the back of the flat cable, skip this step. If double-sided tape is affixed to the back of the flat cable, align the line (callout 1) on the cable with the edge (callout 2) of the opening in the sheet metal. Press to attach the flat cable to the formatter case.

Figure 1-2022 Attach the flat cable

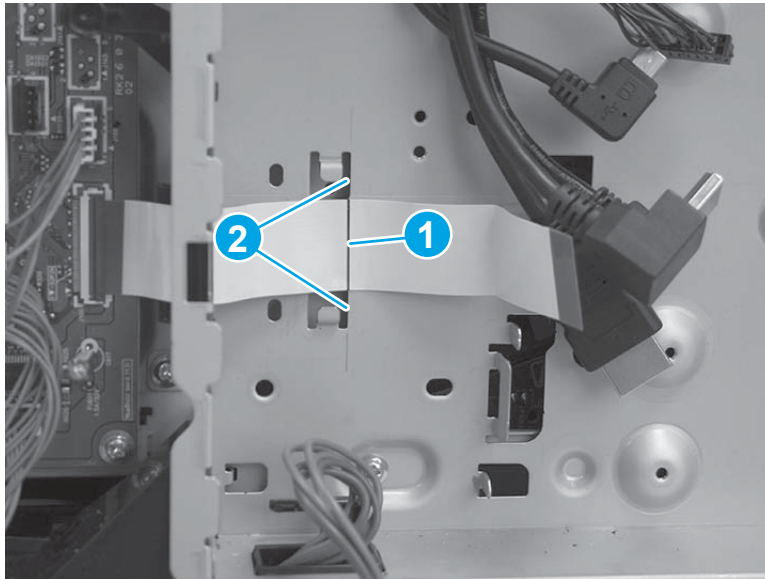

7. Position the bracket over the flat cable, and then slide the bracket to the left to install it. Make sure that the edges of the bracket fit under the sheet metal tabs (callout 1) on the formatter case and that the tabs (callout 2) snap into place.

Figure 1-2023 Position the bracket

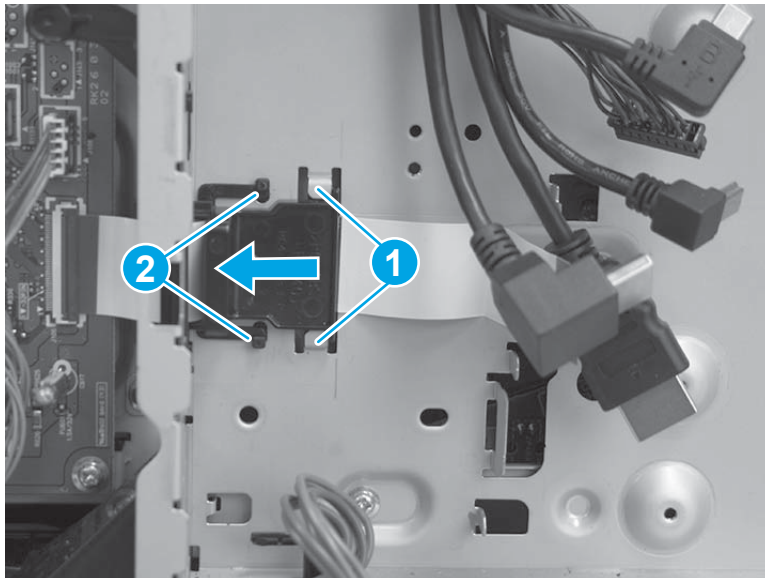

8. **M577 only:** Pass the wire harness (callout 1) through the openings in the formatter case (callout 2), and then connect one connector (callout 3).

Figure 1-2024 Connect one connector

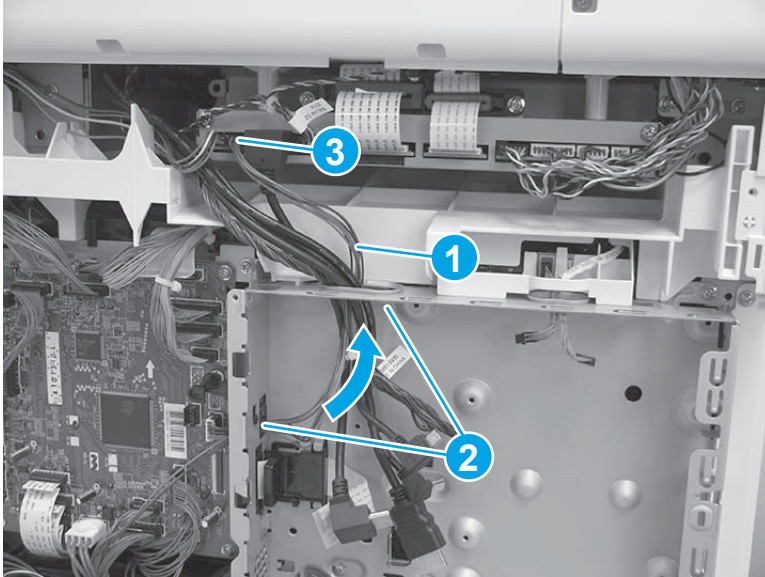

Step 25: Install the formatter (M577)

 **NOTE:** This step is for the M577 models. For the M552 and M553 models, skip this step and go to [Step 28: Install the formatter \(M552 and M553\) on page 1157](#).

 **CAUTION:**  ESD-sensitive part.

1. Position the formatter in the printer. Make sure that the network port (callout 1) fits through the opening (callout 2) in the formatter case.

Figure 1-2025 Install the formatter

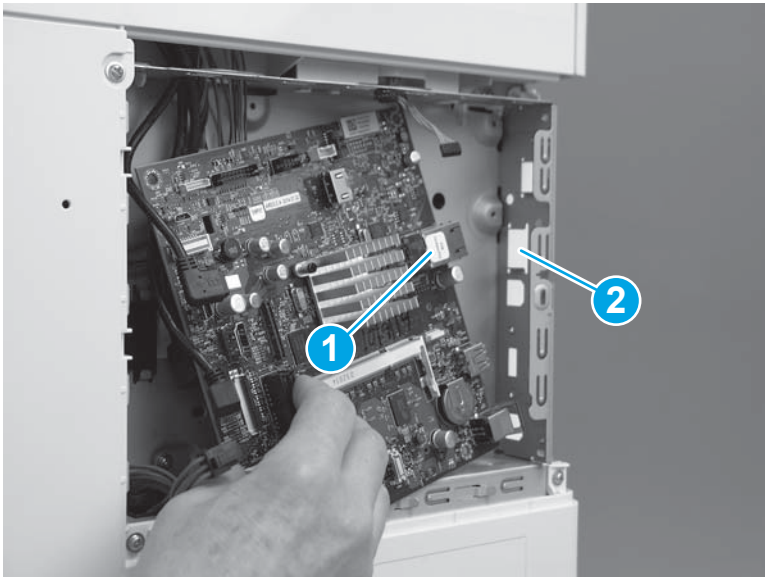

2. Install four screws (callout 1).

Figure 1-2026 Install four screws

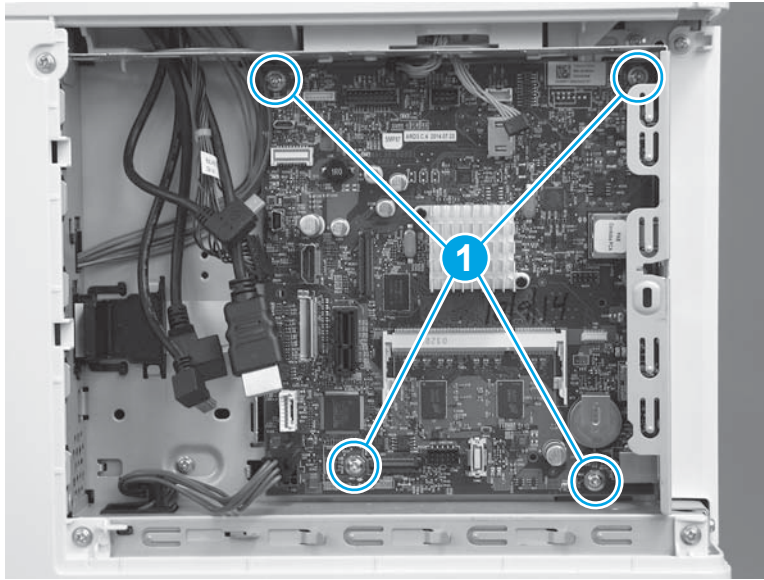

3. Connect all of the connectors on the formatter.

The following connectors are empty:

- All models: J1 (this connector is empty unless the optional DIMM is installed)
- All models: J3
- M577dn: J15 (this is the fax connector for the M577f/z/c models)
- All models: J21 (this connector is empty unless the optional internal USB ports component is installed)
- All models: J23
- All models: J24
- All models: J51
- All models: J57
- All models: J97
- All models: J98 (this connector is empty unless the optional trusted platform module (TPM) is installed)

 **IMPORTANT:** The flat-cable connector (callout 1) is a Zero Insertion Force (ZIF) connector that uses a hinged retainer to secure the flat cable. The hinged retainer must be opened to install the flat cable, and then closed after the cable is installed.

Figure 1-2027 Connect all connectors



Step 26: Install the fax PCA (M577c/f/z)

 **NOTE:** This step is for the M577c/f/z models. For the M577n model, skip this step and go to [Step 27: Install the HDD \(M577\) on page 1155](#).

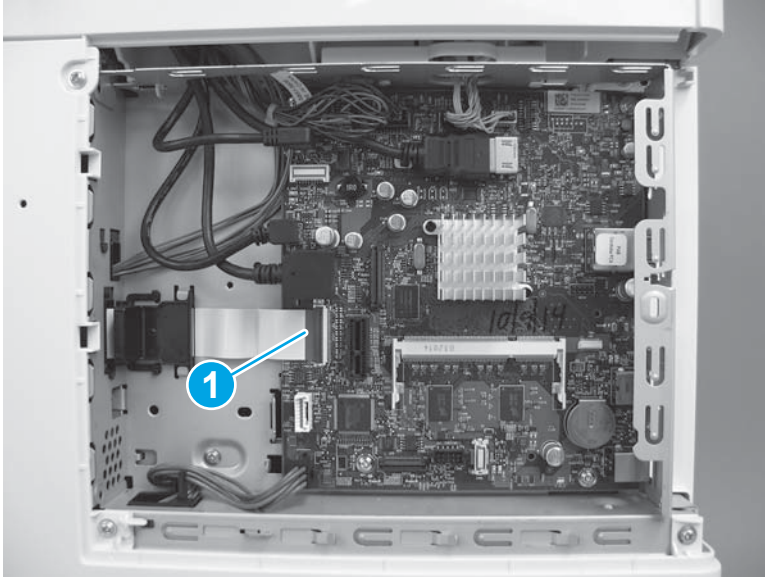
For the M552 and M553 models, skip this step and go to [Step 28: Install the formatter \(M552 and M553\) on page 1157](#).

 **CAUTION:**  ESD-sensitive part.

1. Position the tab and telephone port (callout 1) on the fax PCA in the slots (callout 2) in the formatter case.

Figure 1-2028 Position the fax PCA

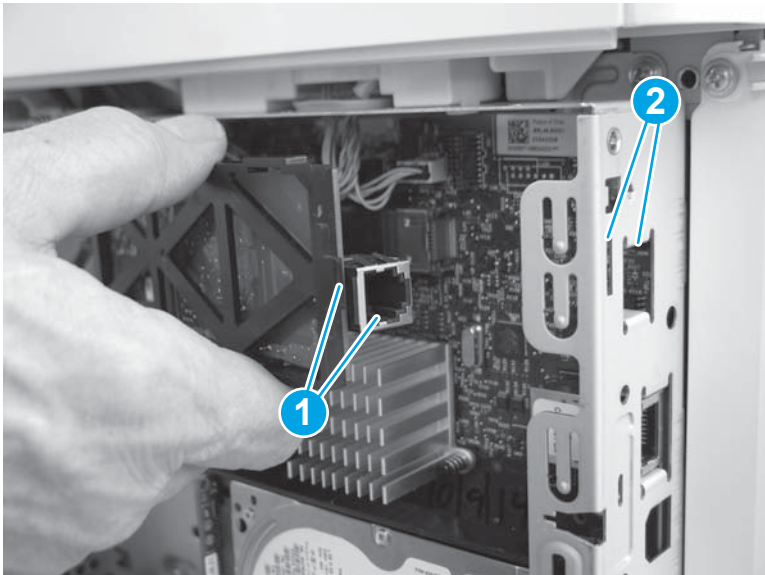

- Slide the fax PCA to the right (callout 1) until the tab and telephone port described in the previous step and seated in the formatter case. Position the retainer (callout 2) in the slot (callout 3) in the formatter. Rotate the end of the fax PCA toward the formatter (callout 4) until the retainer snaps into place.

Figure 1-2029 Install the fax PCA

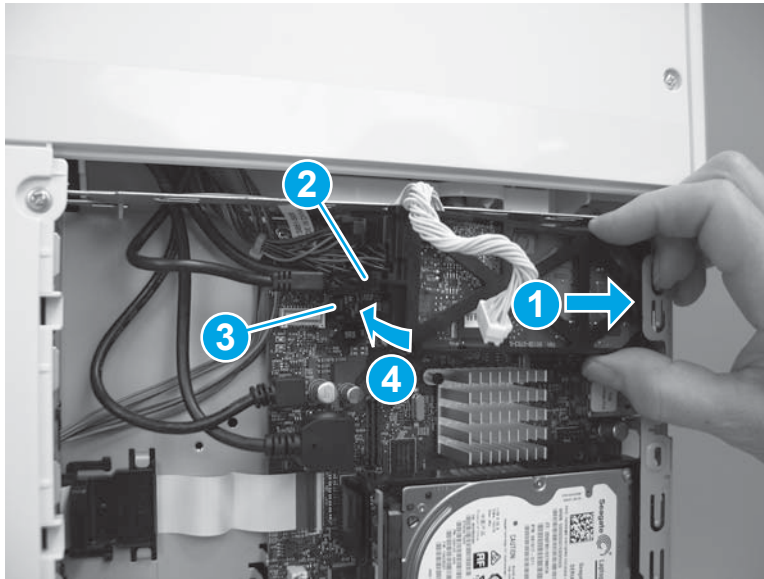

- Position the cable (callout 1) in the guide (callout 2), and then connect one connector (callout 3).

Figure 1-2030 Connect the connector

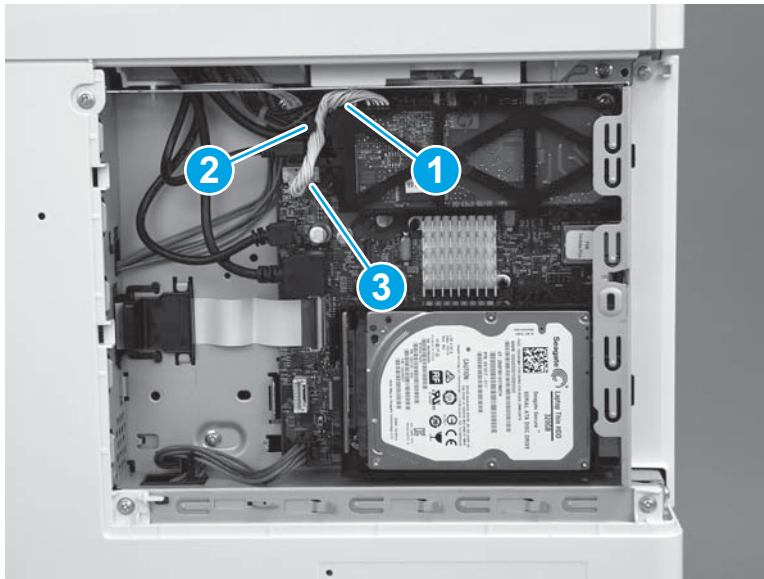

Step 27: Install the HDD (M577)

 **NOTE:** This step is for the M577 models. For the M552 and M553 models, skip this step and go to [Step 28: Install the formatter \(M552 and M553\) on page 1157.](#)

 **CAUTION:**  ESD-sensitive part.

1. Align the end of the bracket (callout 1) with the slot in the chassis (callout 2), and then slide the HDD into the printer (callout 3) to engage the bracket with the chassis.

Figure 1-2031 Install the holder

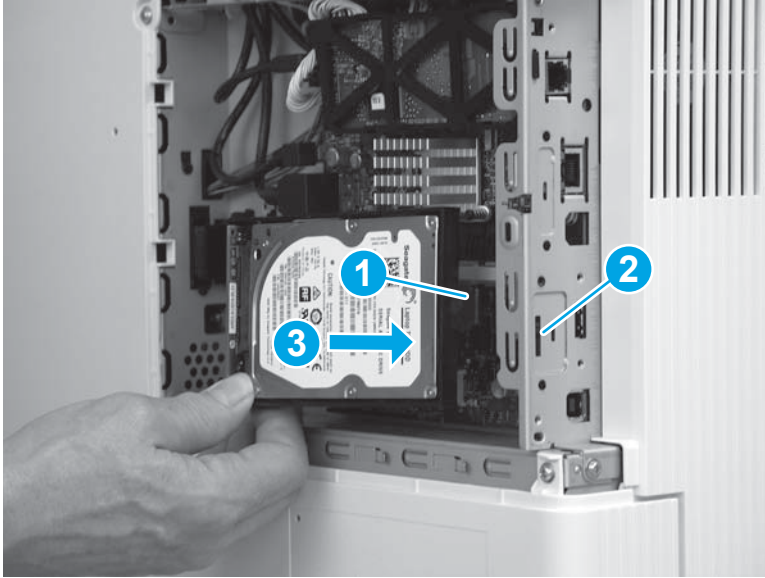

2. Hold the HDD connector latch (callout 1) in the released position, and then rotate the HDD down and into the connector on the formatter to install it.



 **NOTE:** Make sure that the tab (callout 2) snaps into place, and that the HDD is securely installed.

Figure 1-2032 Release the HDD

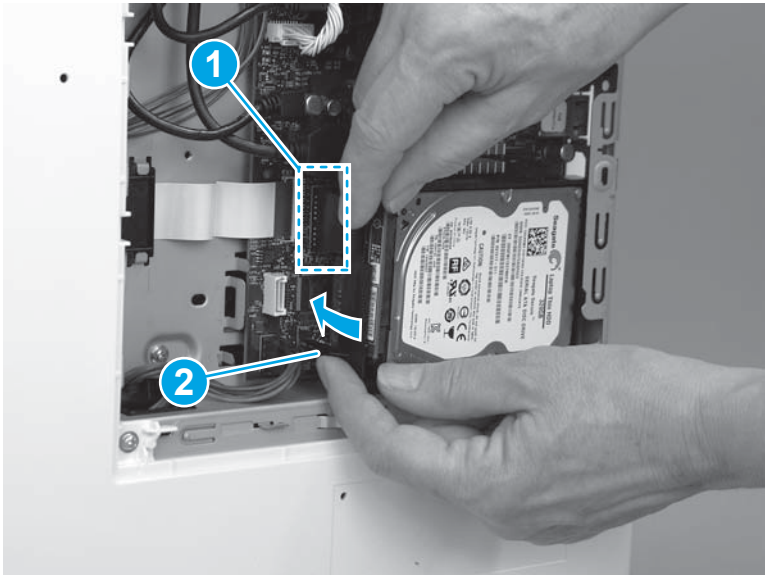

Step 28: Install the formatter (M552 and M553)

 **NOTE:** This step is for the M552 and M553 models. For the M577 models, skip this step and to go [Step 29: Install the right rear cover on page 1158](#)

If the optional hard-disk drive (HDD) was removed, do not forget to reinstall it after the formatter is reinstalled.

Engage the HDD holder with the chassis, rotate the HDD connector down and into the connector on the formatter. Make sure that the tabs snap into place.

 **CAUTION:**  ESD-sensitive part.

1. Position the formatter in the printer, and then install four screws (callout 1).

Figure 1-2033 Install the formatter

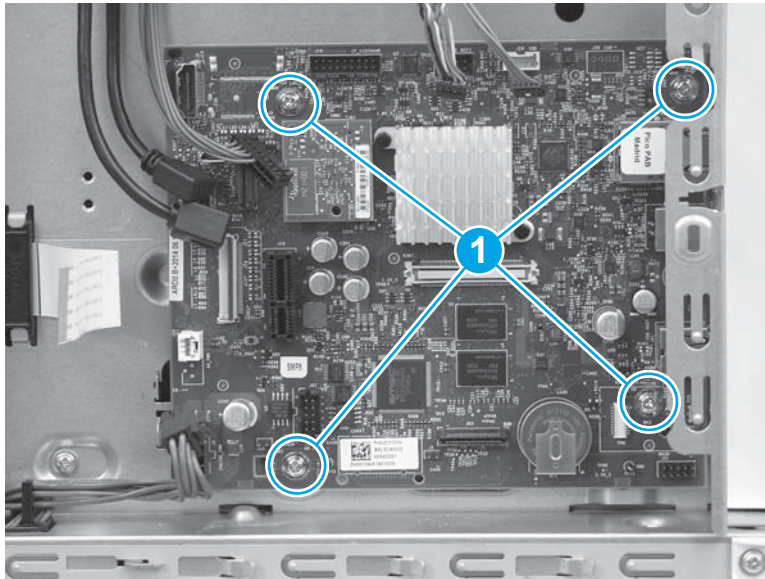

2. Connect all of the connectors on the formatter.

The following connectors are empty:

- All models: J1 (this connector is empty unless the optional DIMM is installed)
- M553n/dn and M552dn: J2 (callout 1; this is the touchscreen connector for the M553x model)
- All models: J9 (this connector is empty unless the optional internal USB ports component is installed)
- All models: J18 (this connector is empty unless the optional hard-disk-drive (HDD) is installed)
- All models: J23
- All models: J24
- M553n/dn and M552dn: J25 (this is the wireless connector for the M553x model)
- All models: J57
- All models: J98 (this connector is empty unless the optional trusted platform module (TPM) is installed)

 **IMPORTANT:** The flat-cable connector (callout 2) is a Zero Insertion Force (ZIF) connector that uses a hinged retainer to secure the flat cable. The hinged retainer must be opened to install the flat cable.

Figure 1-2034 Connect all connectors



Step 29: Install the right rear cover

1. Position the cover on the printer.

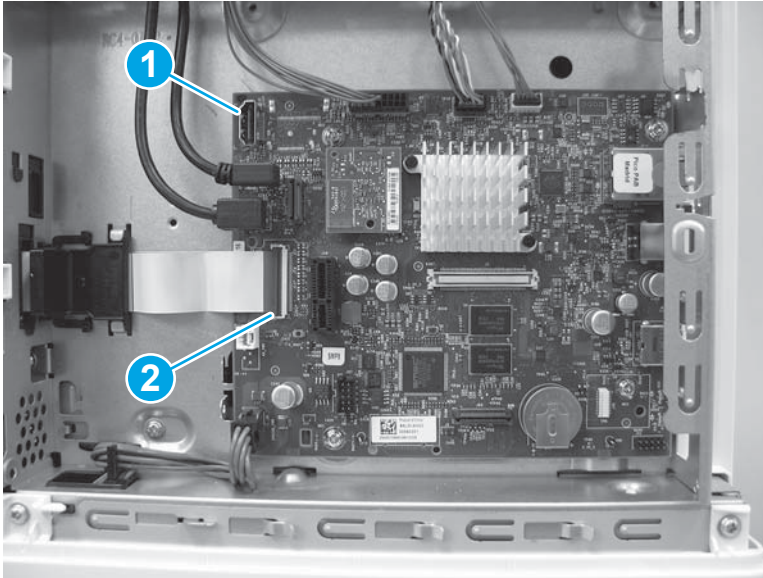
Figure 1-2035 Install the cover

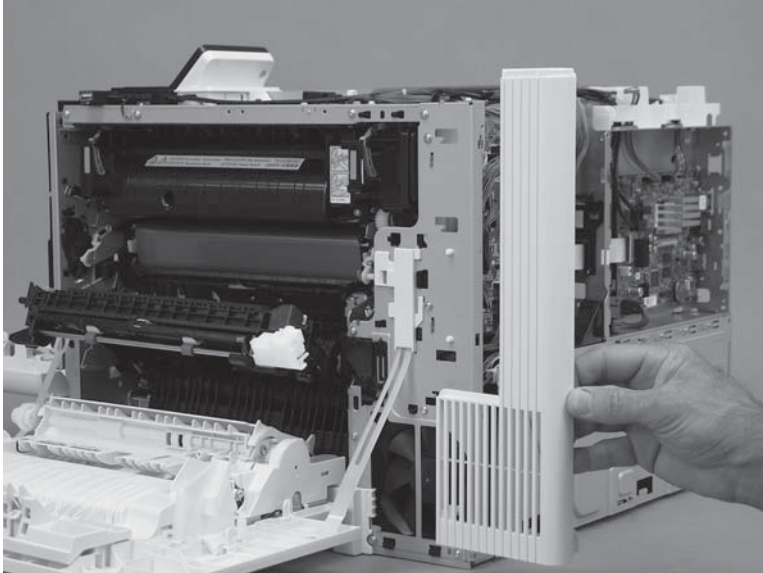

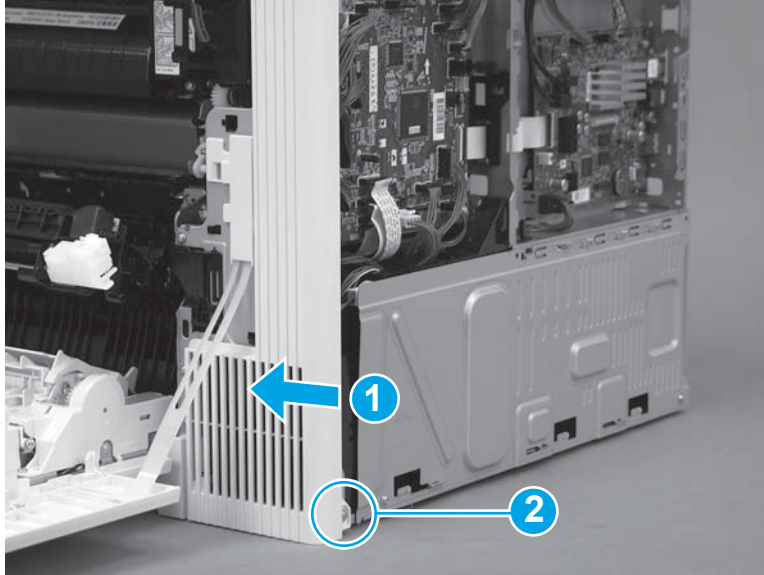

2. Slide the cover toward the right door (callout 1) to engage it with the printer, and then install one screw (callout 2).

Figure 1-2036 Install one screw



Step 30: Install the right upper cover (M577)

 **NOTE:** This step is for the M577 models. For the M552 and M553 models, skip this step and go to [Step 33: Install the upper cover \(M552 and M553\) on page 1165](#).

 **NOTE:** The figures below show the image scanner installed. The procedures for removing and installing the right upper cover are the same whether the image scanner is installed or removed."

1. **M577c/f/z only:** Install the cables (callout 1) through the slot (callout 2) in the printer.

Figure 1-2037 Install the cables

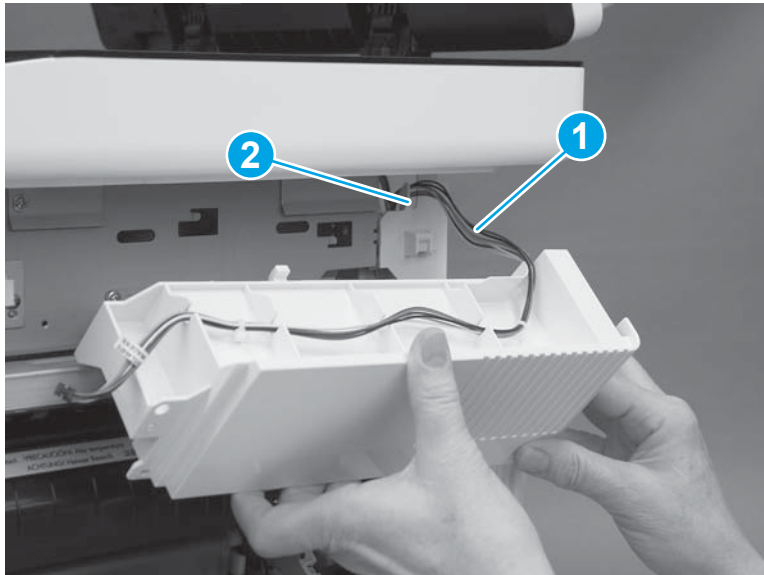

2. Position the hooks (callout 1) on the cover in the slots (callout 2) in the printer.

Figure 1-2038 Position the hooks

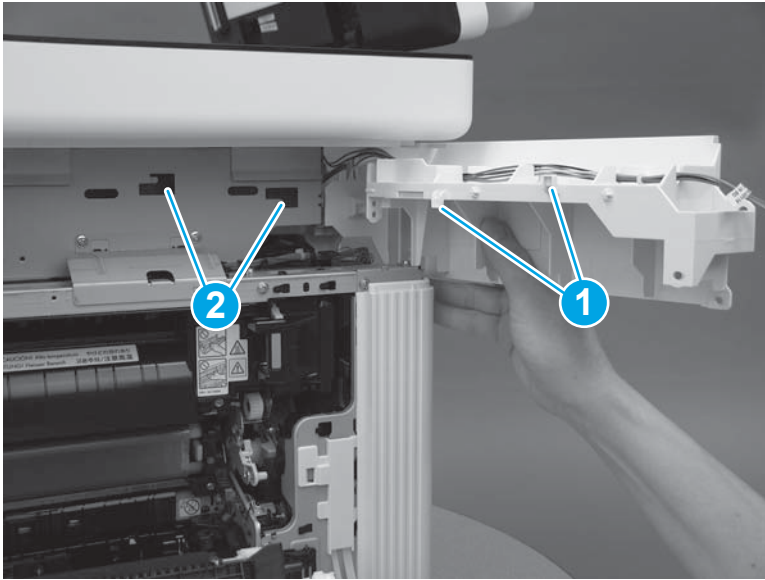

3. Slide the cover toward the front of the printer to install it.

Figure 1-2039 Install the cover

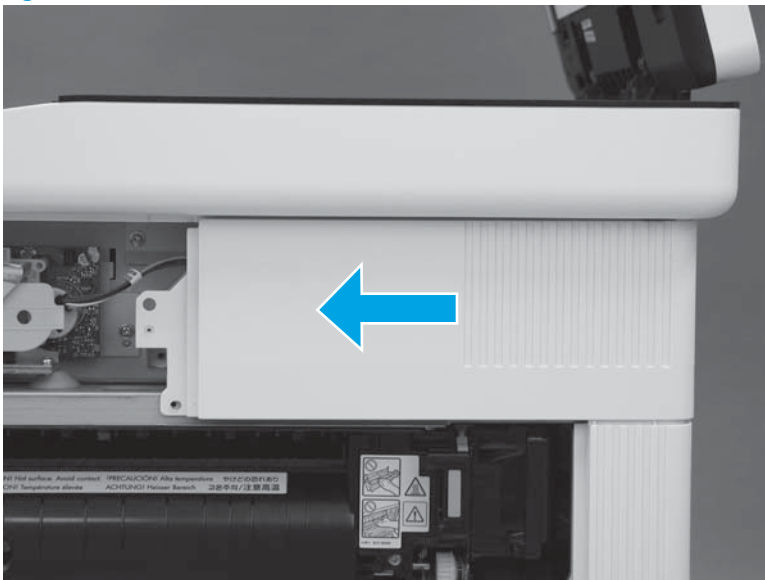

4. At the back of the printer, install one screw (callout 1).

M577c/f/z only: Connect one connector (callout 2), if the integrated scanner assembly is installed.

TIP: This screw is smaller than the screws installed in the next step. Make sure that this screw is installed in the correct position.

Figure 1-2040 Install one screw and connector

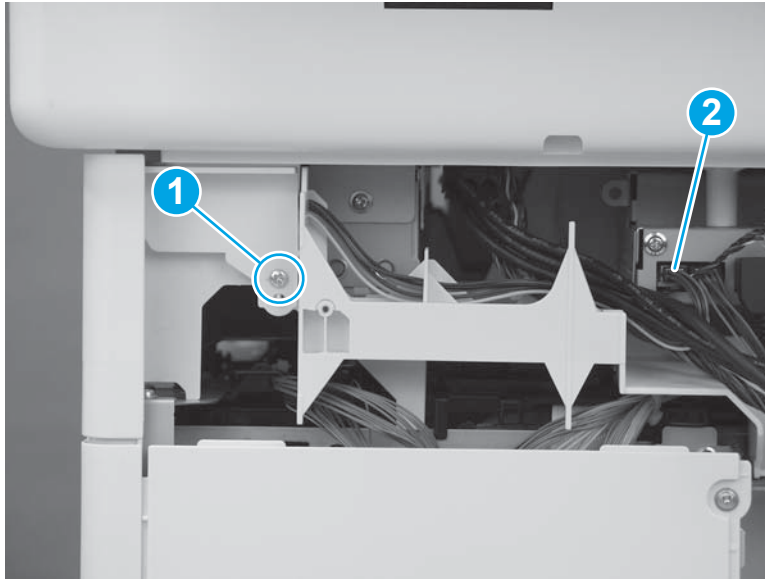

5. At the right side of the printer, install two screws (callout 1).

M577c/f/z only: Connect one connector (callout 2), if the stapler is installed.

Figure 1-2041 Install one screw and connector

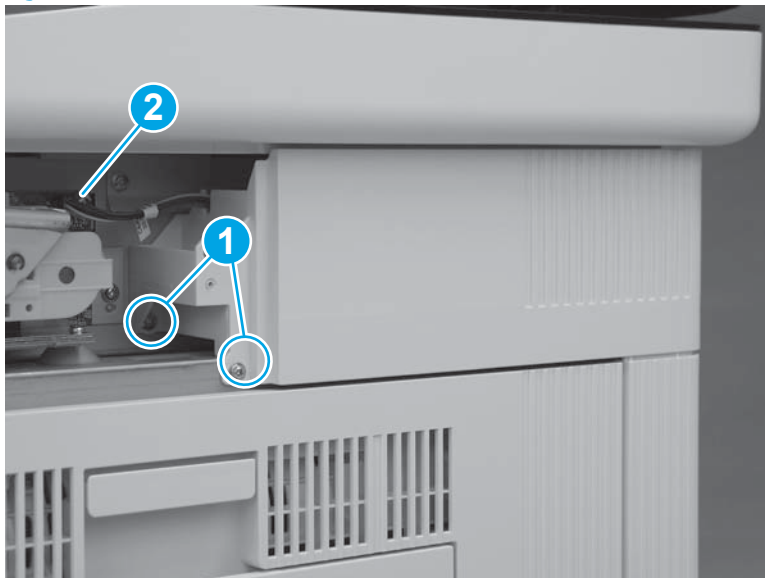

Step 31: Install the stapler cover assembly (M577f and M577z)

 **NOTE:** This step is for the M577c/f/z models. For the M577dn model, skip this step and go to [Step 32: Install the right front upper cover \(M577dn\) on page 1163](#).

For the M552 and M553 models, skip this step and go to [Step 33: Install the upper cover \(M552 and M553\) on page 1165](#).

1. Install the tabs (callout 1) on the cover in the slots (callout 2) in the printer.

Figure 1-2042 Install two tabs



2. Press the cover toward the left side of the printer until it snaps into place.

Figure 1-2043 Install the cover assembly



3. Install one screw (callout 1).



 **IMPORTANT:** This is a self-tapping screw for plastic. Rotate it counterclockwise to align it with the existing thread pattern, and then carefully turn it clockwise to tighten. Do not overtighten. This will prevent stripping the threads inside the screw hole.

Figure 1-2044 Install one screw

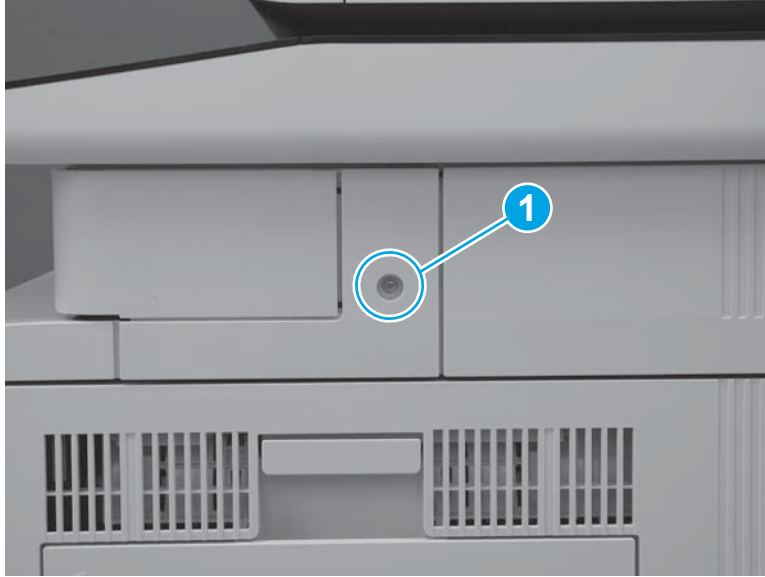

Step 32: Install the right front upper cover (M577dn)

 **NOTE:** This step is for the M577dn model. For the M577c/f/z models, skip this step and to go [Step 34: Install the left cover on page 1167](#).

For the M552 and M553 models, skip this step and go to [Step 33: Install the upper cover \(M552 and M553\) on page 1165](#).

1. Slide the cover toward the left side of the printer to install it. Make sure that the slots (callout 1) in the cover fit over the tabs (callout 2) on the inside of the paper feeder cover.

Figure 1-2045 Install the cover



2. Press the right front upper cover (callout 1) and the paper feeder cover (callout 2) together until the tabs on the inside of the covers snap into place.

Figure 1-2046 Press the cover



3. Install one screw (callout 1).

Figure 1-2047 Install one screw

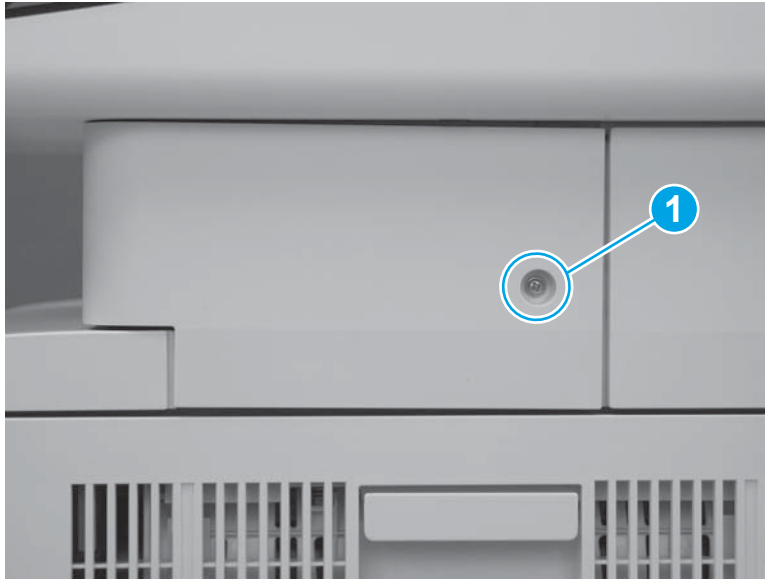

Step 33: Install the upper cover (M552 and M553)

 **NOTE:** This step is for the M552 and M553 models. For the M577 models, skip this step and to go [Step 34: Install the left cover on page 1167](#).

1. Position the cover on the printer.

 **NOTE:** For the M553x model, do not forget to pass the control-panel wire harness and USB cable through the opening in the cover.

Figure 1-2048 Install the cover



2. Push down on the rear corner of the cover to engage one tab (callout 1).

Figure 1-2049 Engage one tab

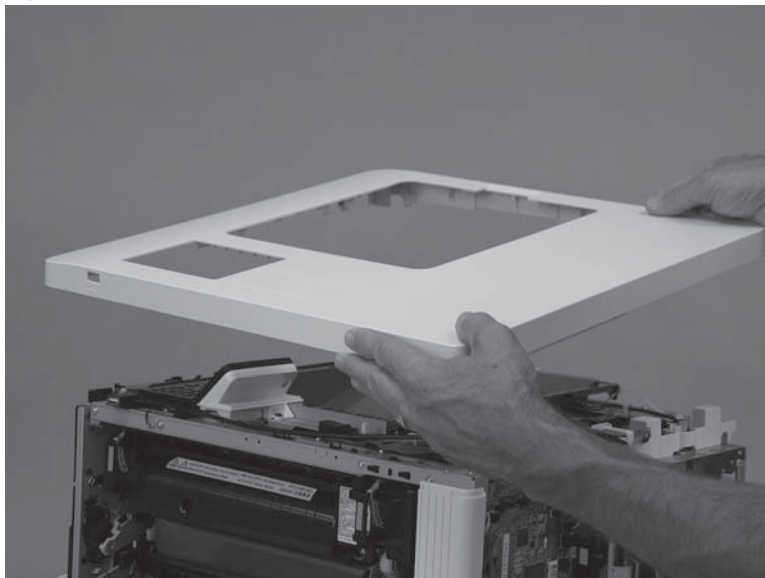
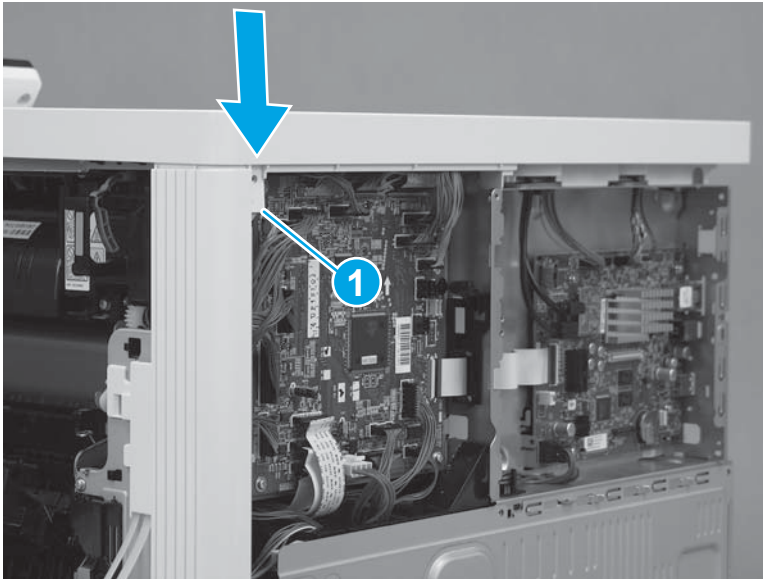

3. Push down on the front corner of the cover to engage one tab (callout 1), and then install one screw (callout 2).

 **NOTE:** This is a self-tapping plastic-thread screw. Make sure that this screw is used in this location when it is reinstalled.

Figure 1-2050 Engage one tab and install one screw



4. Install three screws (callout 1).

Figure 1-2051 Install three screws

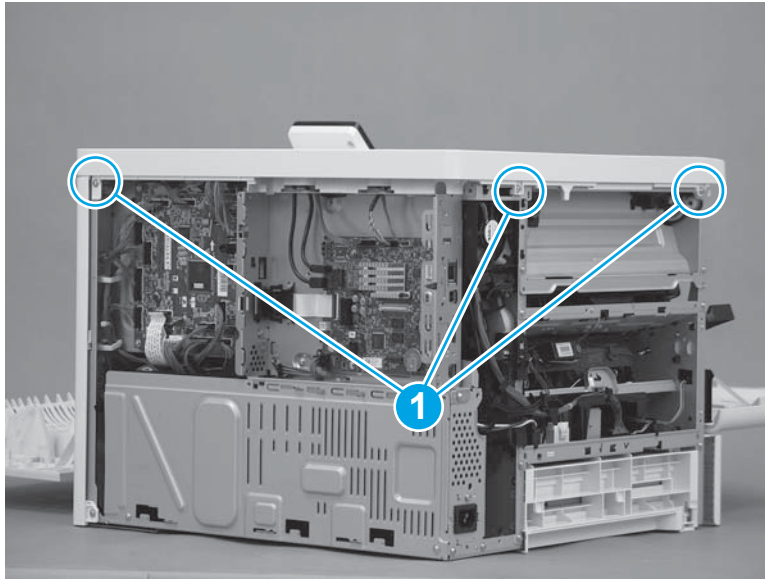

Step 34: Install the left cover

1. Position the cover on the printer.

 **NOTE:** Slightly offset the cover toward the rear of the printer.

Figure 1-2052 Install the cover

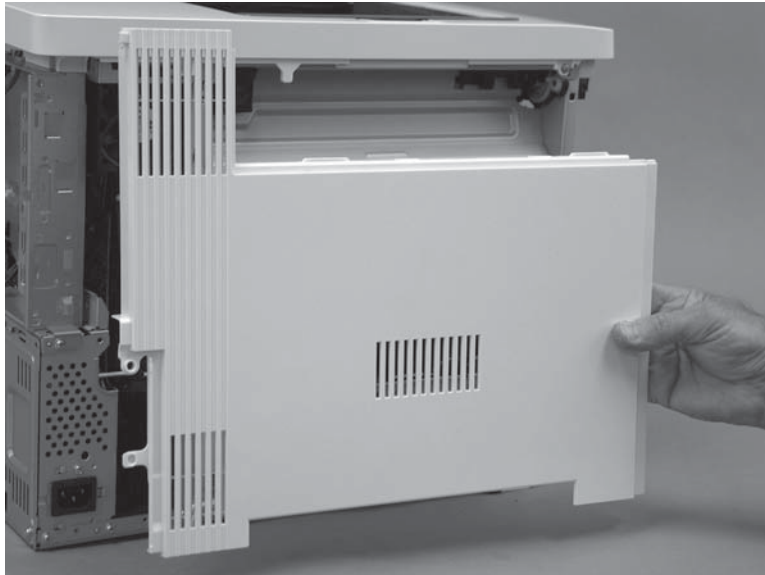

- Slide the cover (callout 1) toward the front of the printer to engage it. Make sure that the tab (callout 2) snaps into place.

 **NOTE:** Locate the alignment pin (callout 3) on the cover from the front door side of the printer, and then make sure that it is fully engaged in the slot in the chassis.

 **TIP:** While sliding the cover into place, push in on the center of the cover (callout 1) to make sure that the hooks on the back of the cover engage with the slots in the chassis.

Figure 1-2053 Engage the cover



- At the left side of the printer, install one screw (callout 1).

Figure 1-2054 Install one screw

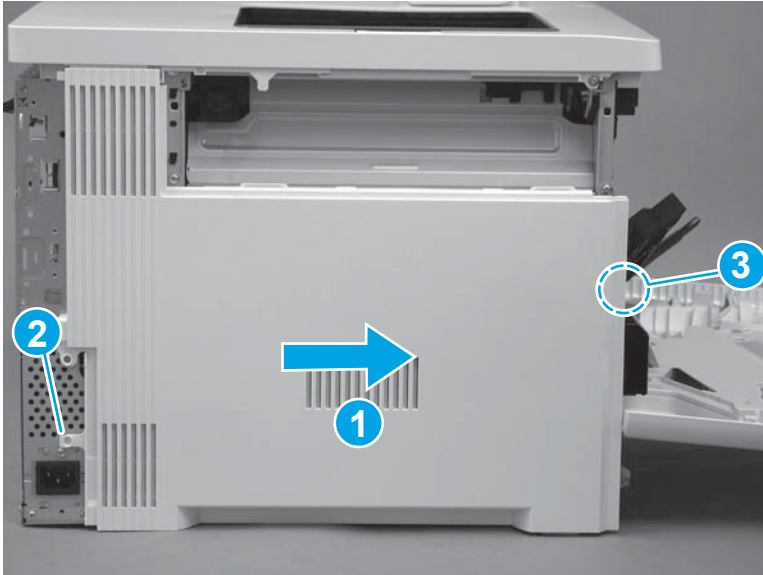

Step 35: Install the rear cover (M577)

 **NOTE:** This step is for the M577 models. For the M552 and M553 models, skip this step and go to [Step 37: Install the rear cover \(M552 and M553\) on page 1172](#).

1. Position the hooks (callout 1) on the cover in the slots (callout 2) in the printer.

Figure 1-2055 Position the hooks

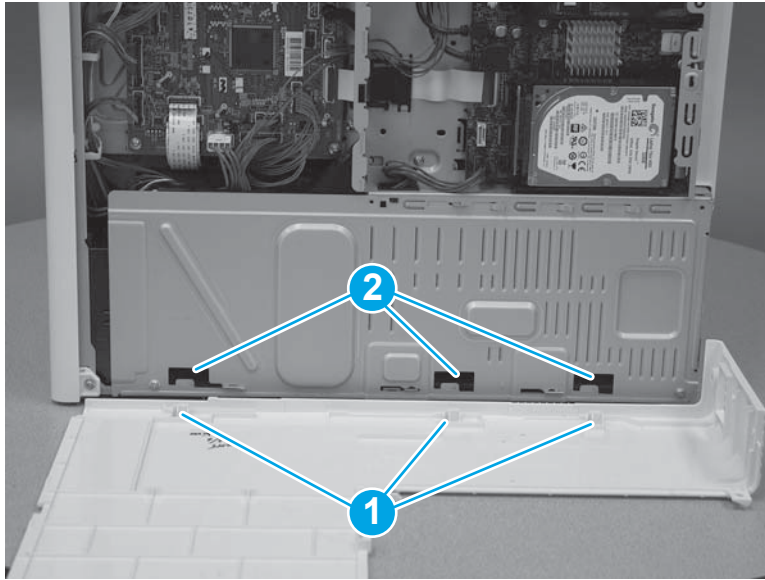

2. Position the back edge (callout 1) of the rear cover behind the edge (callout 2) of the right rear cover. Slide the cover to the left to install it.

Figure 1-2056 Install the cover

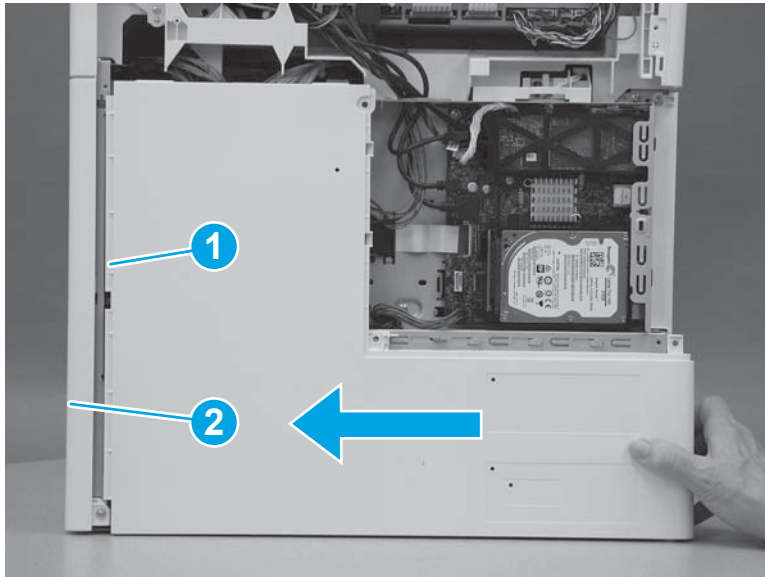

3. Install four screws (callout 1).

Figure 1-2057 Install four screws cover

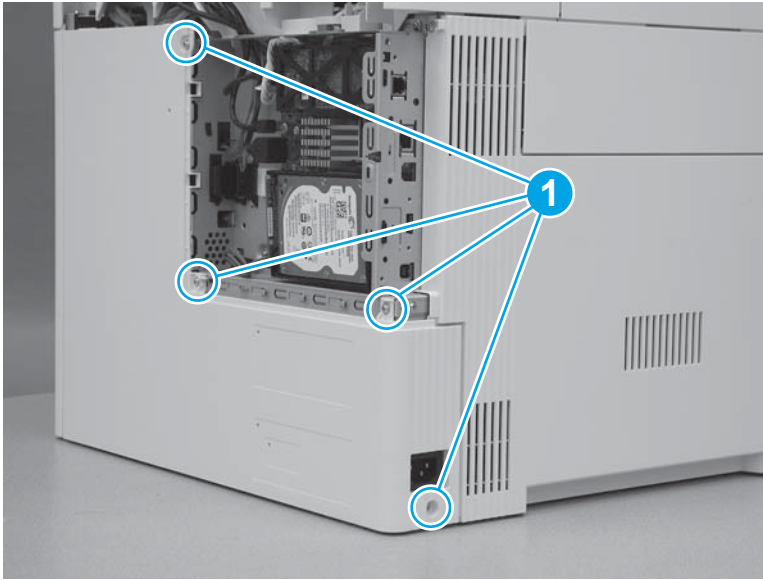

Step 36: Install the rear upper cover (M577)



NOTE: This step is for the M577 models. For the M552 and M553 models, skip this step and go to [Step 37: Install the rear cover \(M552 and M553\) on page 1172](#).

1. Align the ridge (callout 1) on the lower edge of the rear upper cover in front of the tabs (callout 2) on the top edge of the rear cover.

Figure 1-2058 Align the cover

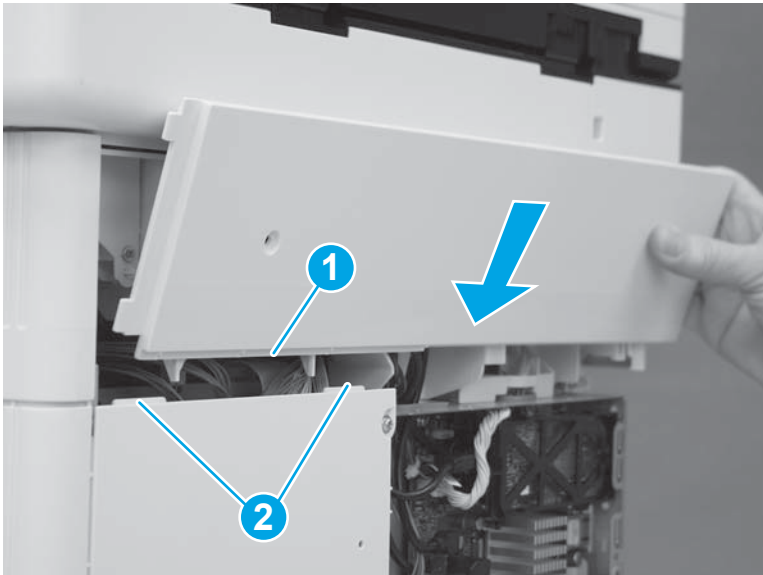

2. Rotate the top of the cover toward the printer.

Figure 1-2059 Rotate the top of the cover

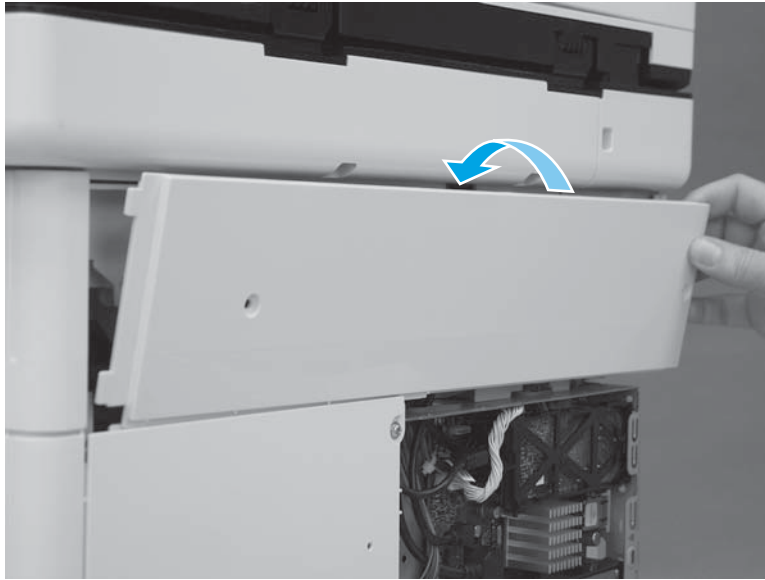

3. Slide the cover to the left (callout 1). Make sure that the tabs (callout 2) on the upper rear cover slide behind the edge (callout 3) of the right upper cover. Make sure that the cover is fully seated.

Figure 1-2060 Slide the cover

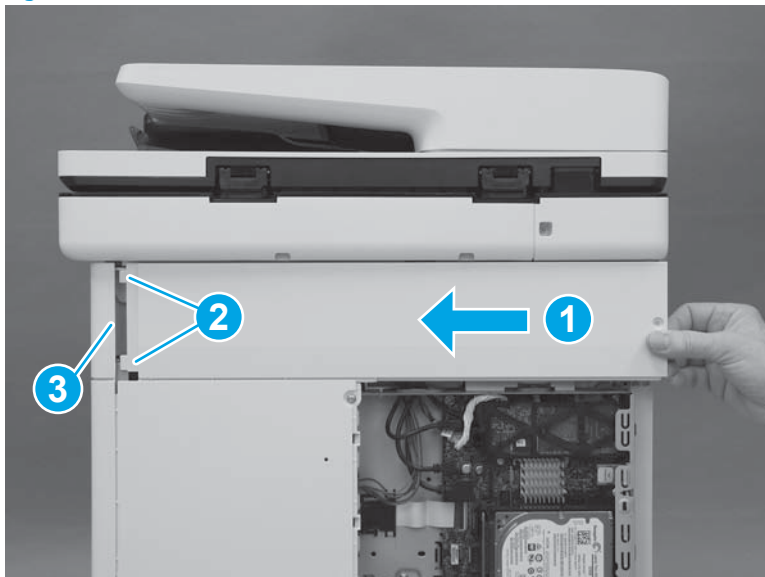

4. Install two screws (callout 1).

 **IMPORTANT:** These two screws are self-tapping screws for plastic. Rotate them counterclockwise to align them with the existing thread pattern, and then carefully turn them clockwise to tighten. Do not overtighten. This will prevent stripping the threads inside the screw holes.

Figure 1-2061 Install two screws



Step 37: Install the rear cover (M552 and M553)

 **NOTE:** This step is for the M552 and M553 models. For the M577 models, skip this step and go to [Step 38: Install the formatter cover on page 1173](#)

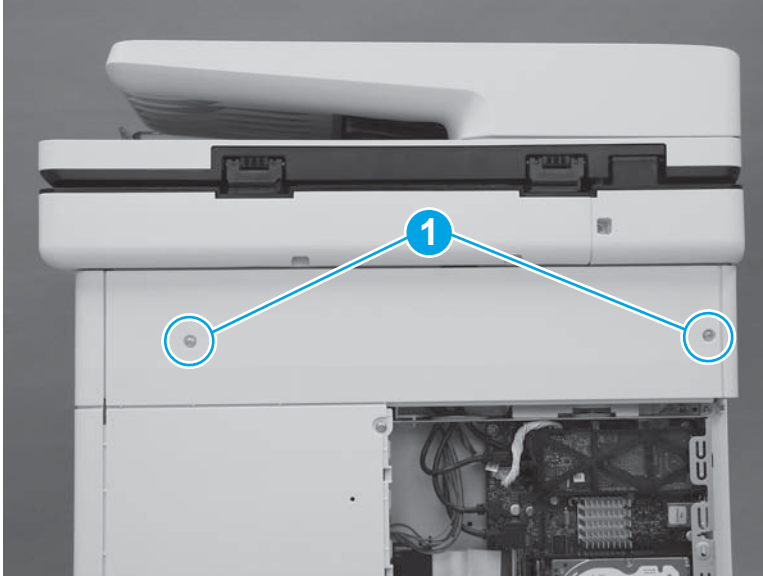
1. Position the top of the cover under the upper cover (callout 1), rotate the bottom of the cover onto the chassis (callout 2), and then slide the cover to the left (callout 3) to install it.

Figure 1-2062 Install the cover

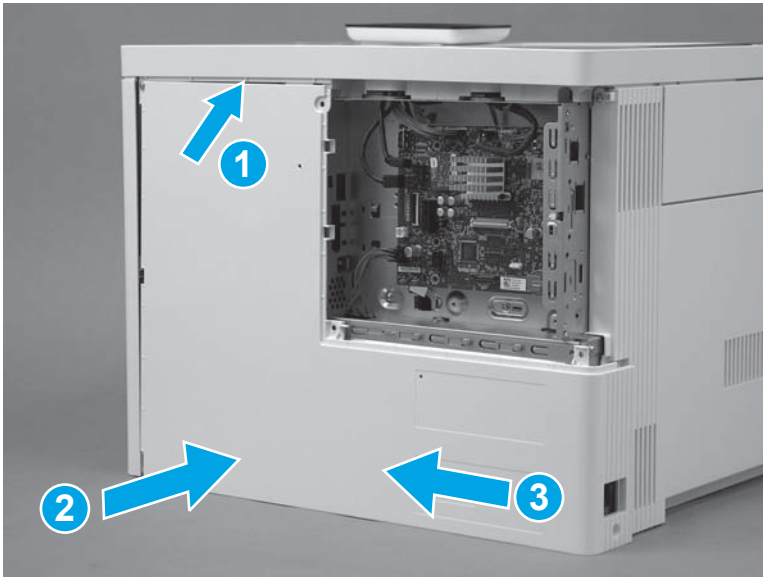

2. Install four screws (callout 1).

Figure 1-2063 Install four screws cover

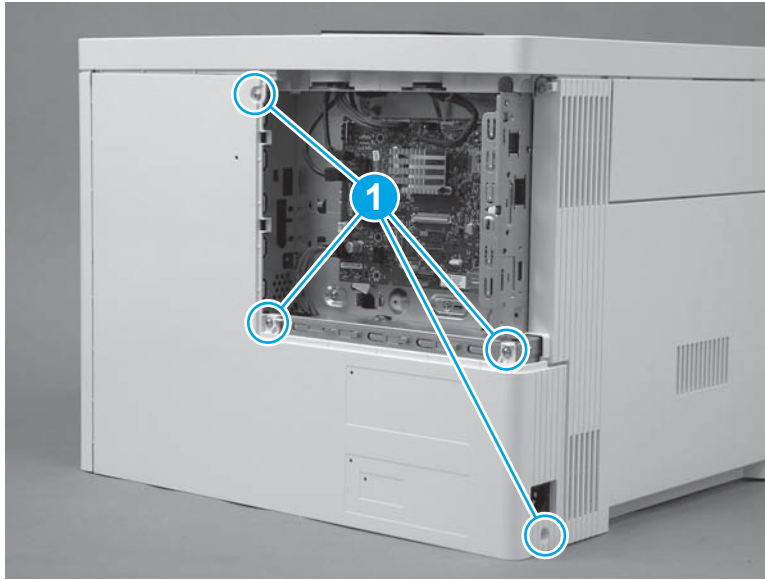

Step 38: Install the formatter cover

- ▲ Slide the cover onto the printer (callout 1) to install it.

 **NOTE:** Make sure that the tabs on the formatter cover align with the slots provided in the printer (callout 2). Tighten the two thumbscrews (callout 3).

 **TIP:** If needed, use the edge of a coin to turn the thumbscrews.

Figure 1-2064 Install the cover



Step 39: Install the TCU

 **NOTE:** This step is for the M552 and M553 models. For the M577 models, skip this step.

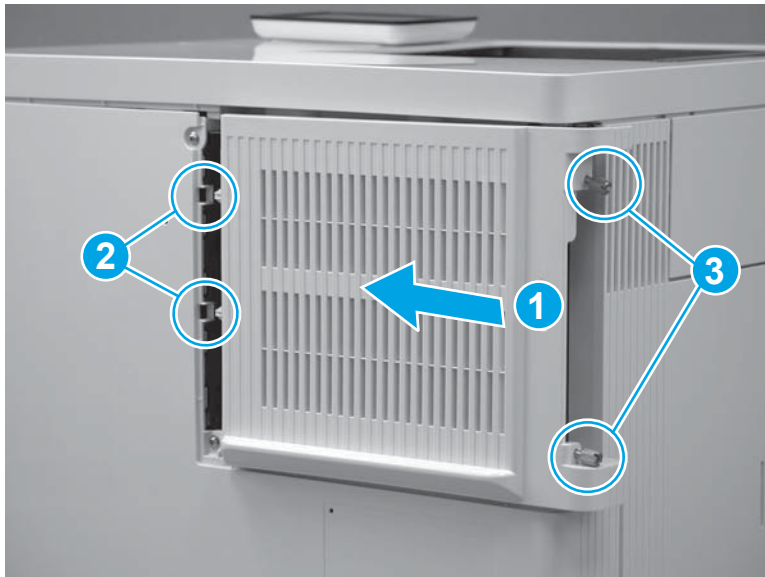
1. Verify that the toner collection hatch cover is in the closed position on the TCU.

Figure 1-2065 Verify that the toner collection hatch cover is closed

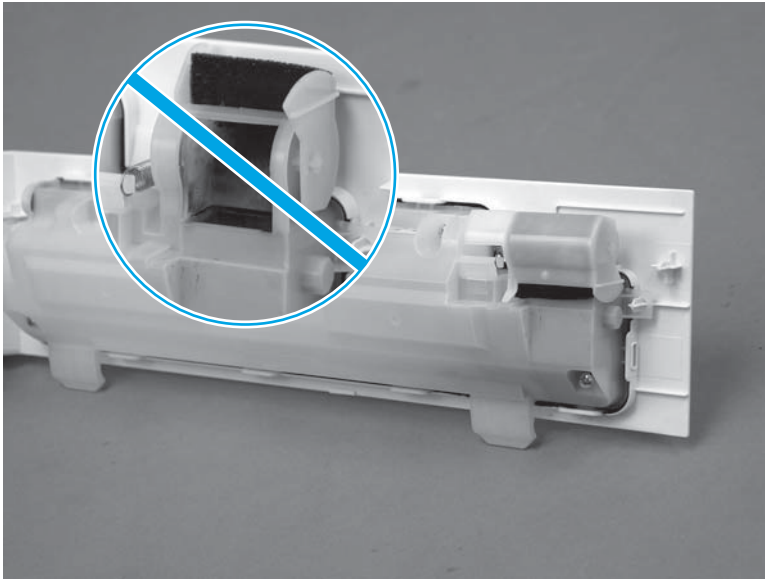

2. Position the TCU with the hinges in the slots provided in the printer (callout 1), and then rotate the TCU up and into the closed position.

 **NOTE:** The toner collection hatch cover automatically opens when the TCU is closed.

Figure 1-2066 Install the TCU



3. Close the front door.

Figure 1-2067 Close the front door

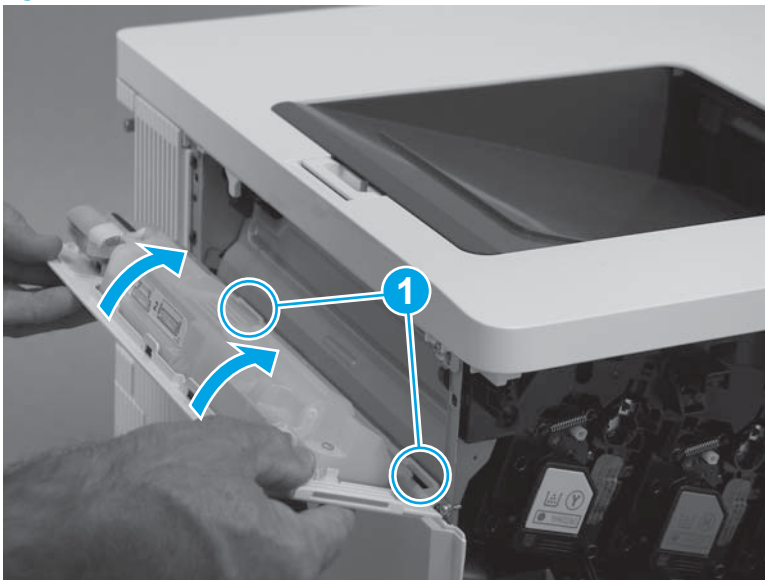

Step 40: Install the control-panel assembly (M553x only)

 **NOTE:** This step is for the M553x model. For the M553n/dn and M552dn models, skip this step and go to [Step 17: Install the USB cover on page 515](#).

For the M577 models, skip this step.

1. Place the control panel on the printer as shown.

Figure 1-2068 Place the control panel on the product

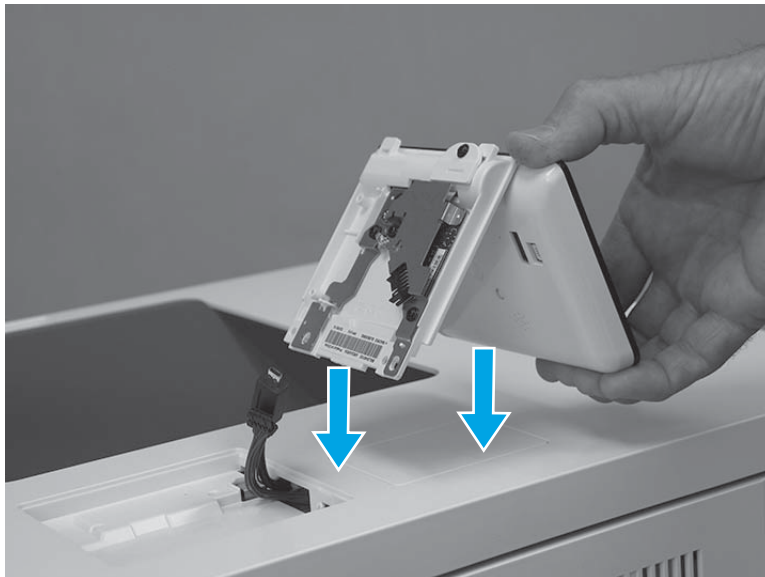

2. Connect one USB cable (callout 1), and one connector (callout 2).

 **IMPORTANT:** Take note of the location of the two mounting tabs (callout 3) on the control-panel assembly.

Figure 1-2069 Connect two connectors



3. Turn the control panel over, and then position the front edge tabs in the slots in the top cover.

Figure 1-2070 Turn the control panel over

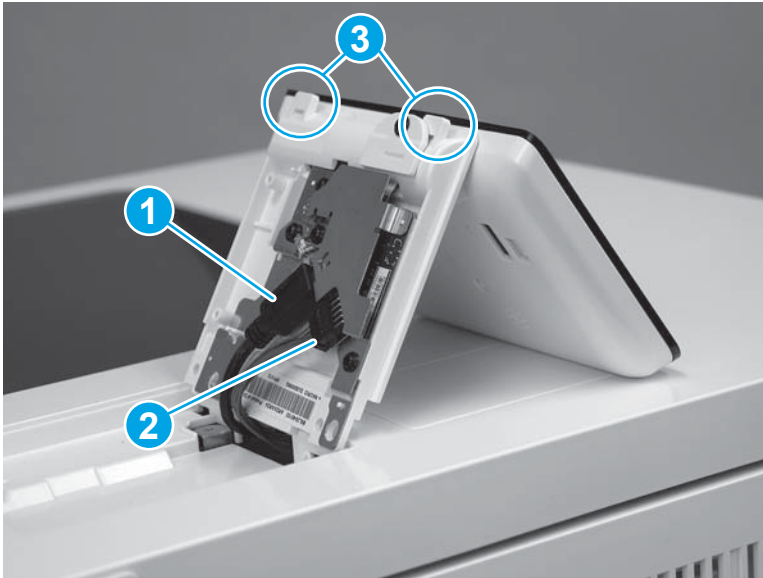
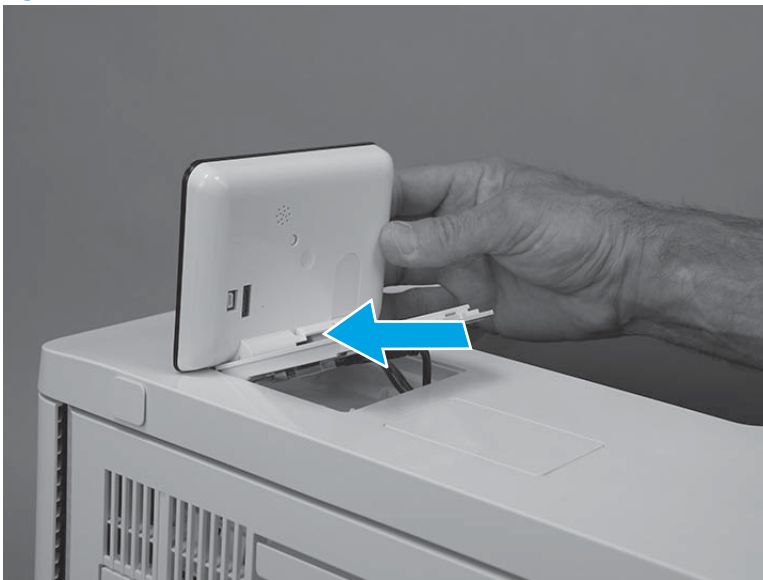

4. Rotate the control-panel base down onto the printer.

Figure 1-2071 Rotate the control-panel base down



5. Use a small Phillips screwdriver to install two screws (callout 1).

Figure 1-2072 Install two screws

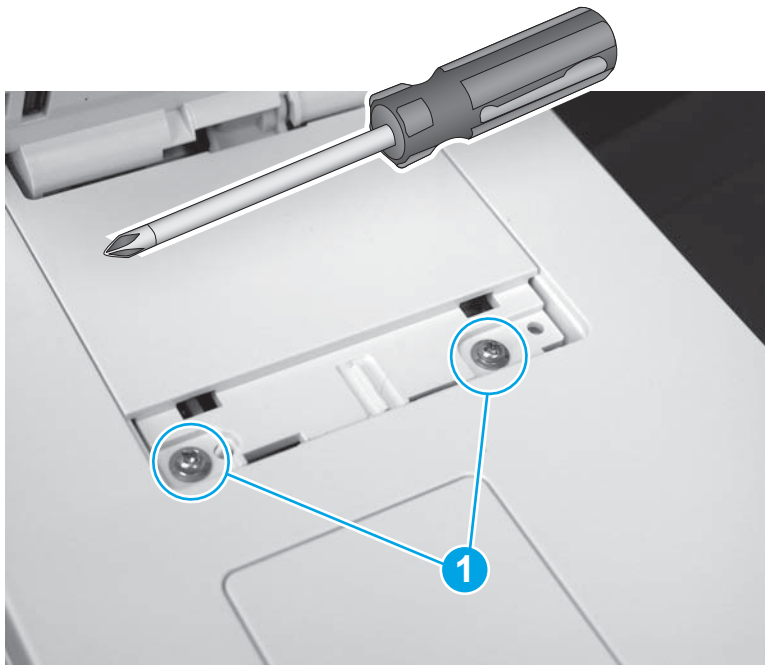

6. Position the screw cover mounting feet into the slots in the top cover (callout 1), and then rotate the cover down (callout 2) to install it.



 **NOTE:** Press down on the cover firmly to make sure that the tabs on the cover (callout 3) snap into place.

Figure 1-2073 Install the cover

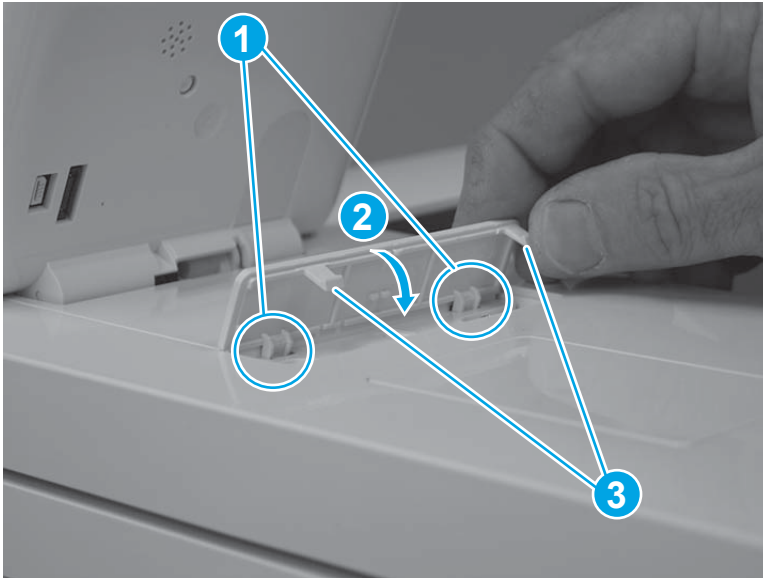

Step 41: Install the USB cover

 **NOTE:** This step is for the M552 and M553 models. For the M577 models, skip this step.

1. Push the cover into the USB port to install it.

Figure 1-2074 Install the cover



2. Make sure that the USB cover is fully seated after installing it.

Figure 1-2075 Check the installation

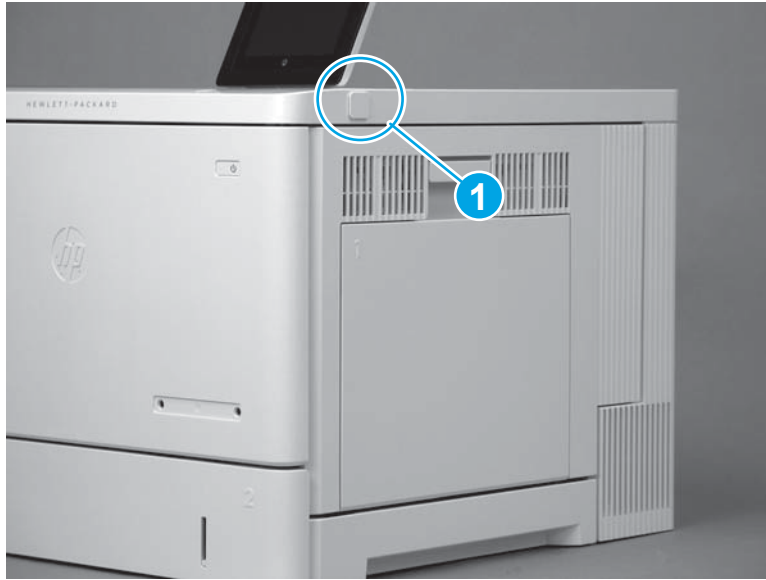

Removal and replacement: Developing disengagement motor (M6)

- [Introduction](#)
- [Step 1: Remove the toner collection unit \(TCU\)](#)
- [Step 2: Remove the formatter cover](#)
- [Step 3: Remove the formatter \(M552 and M553\)](#)
- [Step 4: Remove the hard-disk drive \(HDD\) \(M577\)](#)
- [Step 5: Remove the fax PCA \(M577c/f/z\)](#)
- [Step 6: Remove the formatter \(M577\)](#)
- [Step 7: Remove the rear cover \(M552 and M553\)](#)
- [Step 8: Remove the rear upper cover \(M577\)](#)
- [Step 9: Remove the rear cover \(M577\)](#)
- [Step 10: Remove the left cover](#)
- [Step 11: Remove the formatter case](#)
- [Step 12: Remove the low-voltage power supply \(LVPS\)](#)
- [Step 13: Remove the high-voltage power supply D \(HVPSD\)](#)
- [Step 14: Remove the developing disengagement motor \(M6\)](#)
- [Step 15: Unpack the replacement assembly](#)
- [Step 16: Install the developing disengagement motor \(M6\)](#)
- [Step 17: Install the HVPSD](#)
- [Step 18: Install the LVPS](#)
- [Step 19: Install the formatter case](#)
- [Step 20: Install the left cover](#)
- [Step 21: Install the rear cover \(M577\)](#)
- [Step 22: Install the rear upper cover \(M577\)](#)
- [Step 23: Install the rear cover \(M552 and M553\)](#)
- [Step 24: Install the formatter \(M577\)](#)
- [Step 25: Install the fax PCA \(M577c/f/z\)](#)
- [Step 26: Install the HDD \(M577\)](#)
- [Step 27: Install the formatter \(M552 and M553\)](#)
- [Step 28: Install the formatter cover](#)
- [Step 29: Install the TCU](#)

Introduction

This document provides the procedures to remove and replace the developing disengagement motor (M6).

Before performing service

Turn the printer power off

- Disconnect the power cable.

⚠ WARNING! To avoid damage to the printer, turn the printer off, wait 30 seconds, and then remove the power cord before attempting to service the printer.

Use the table below to identify the correct part number for your printer, and then go to <http://h20141.www2.hp.com/hpparts> to order the part.

Developing disengagement motor (M6) part number	
RK2-6027-000CN	Developing disengagement motor (M6)

Required tools

- #2 Phillips screwdriver with a magnetic tip

After performing service

Make sure that all of the connectors on the HVPSD are fully seated.

Make sure that all of the connectors on the LVPS are fully seated.

Make sure that all of the connectors on the formatter are fully seated.

Make sure that the formatter cover is fully seated, and that the thumbscrews are finger tight after replacing it.

Turn the printer power on

- Connect the power cable.
- Use the power switch to turn the power on.

Post service test

Use the components test to test the motor. For more information, see the printer troubleshooting manual.

Step 1: Remove the toner collection unit (TCU)

1. Open the front door.

Figure 1-2076 Open the front door



2. Open the TCU.



NOTE: The toner collection hatch cover automatically closes when the TCU is opened.

Figure 1-2077 Open the TCU



3. Pull the TCU away from the printer at an angle to remove it.

⚠ CAUTION: Do not open the toner collection hatch cover when handling the TCU. If toner gets on clothing, wipe it off by using a dry cloth and wash the clothes in cold water. Hot water sets toner into fabric.

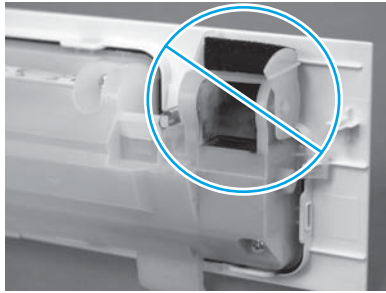
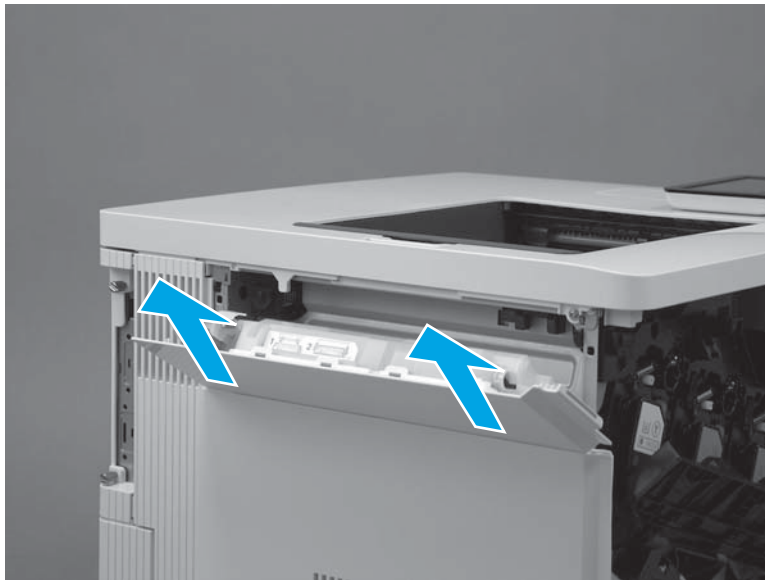

Figure 1-2078 Remove the TCU



Step 2: Remove the formatter cover

1. Locate the formatter cover.

Figure 1-2079 Locate the formatter cover

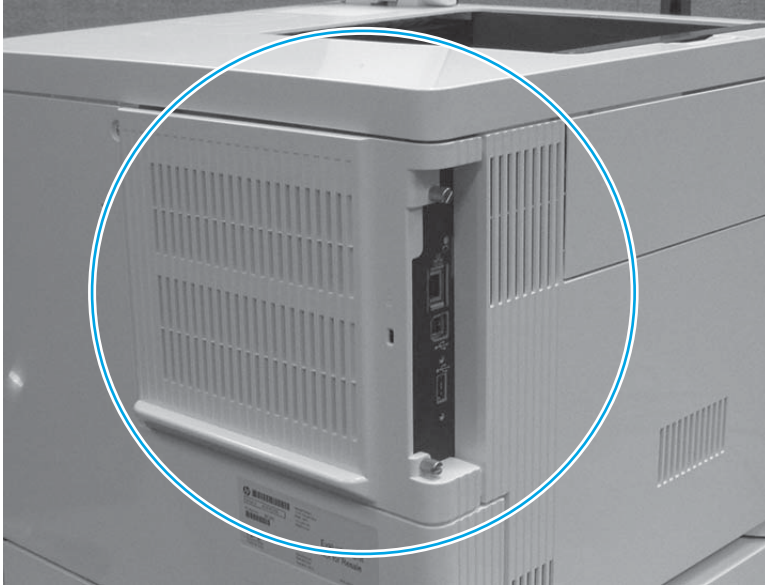

2. Loosen the two thumbscrews (callout 1). Grasp the two thumbscrews, and then slide the cover away from the printer (callout 2) to remove it.

 **TIP:** If needed, use the edge of a coin to turn the thumbscrews.

Figure 1-2080 Loosen the thumbscrews

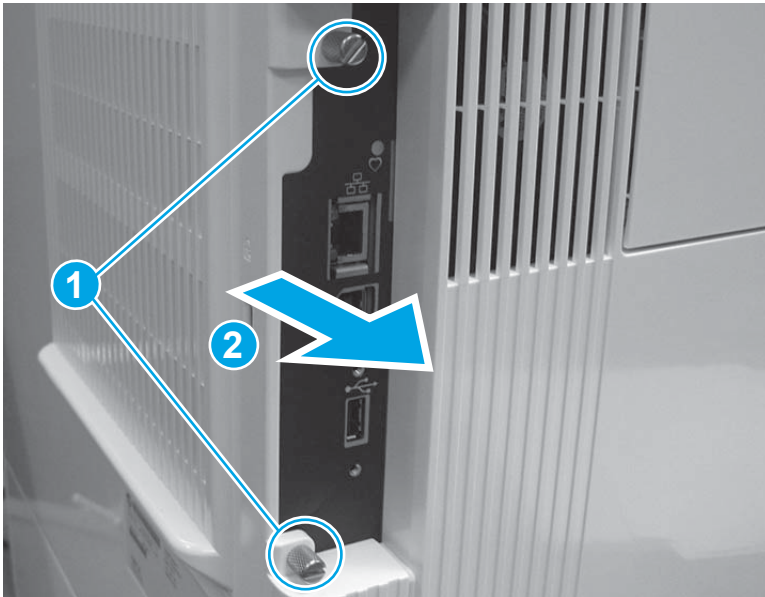

Step 3: Remove the formatter (M552 and M553)

 **NOTE:** This step is for the M552 and M553 models. For the M577 models, skip this step and go to [Step 4: Remove the hard-disk drive \(HDD\) \(M577\) on page 1186](#).

If the optional hard-disk drive (HDD) is installed, it must be removed to gain access to the formatter mounting screws.

Release two tabs along the left edge of the HDD, rotate the left edge away from the product, and then slide the HDD to the left to remove it.

 **CAUTION:**  ESD-sensitive part.

1. Disconnect all of the connectors on the formatter.

The following connectors are empty:

- All models: J1 (this connector is empty unless the optional DIMM is installed)
- M553n/dn and M552dn: J2 (callout 1; this is the touchscreen connector for the M553x model)
- All models: J9 (this connector is empty unless the optional internal USB ports component is installed)
- All models: J18 (this connector is empty unless the optional hard-disk-drive (HDD) is installed)
- All models: J23
- All models: J24
- M553n/dn and M552dn: J25 (this is the wireless connector for the M553x model)
- All models: J57
- All models: J98 (this connector is empty unless the optional trusted platform module (TPM) is installed)

 **IMPORTANT:** The flat-cable connector (callout 2) is a Zero Insertion Force (ZIF) connector that uses a hinged retainer to secure the flat cable. The hinged retainer must be opened to release the flat cable.

Figure 1-2081 Disconnect all connectors



2. Remove four screws (callout 1), and then remove the formatter.

Figure 1-2082 Remove the formatter

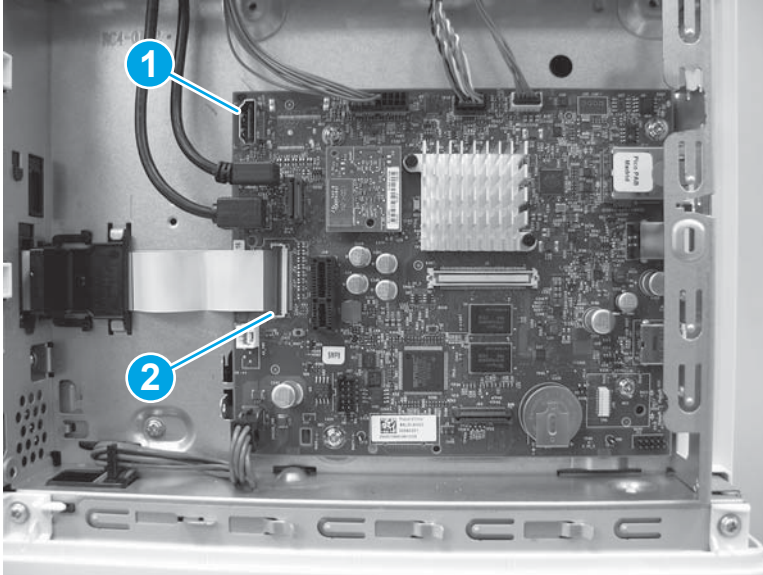
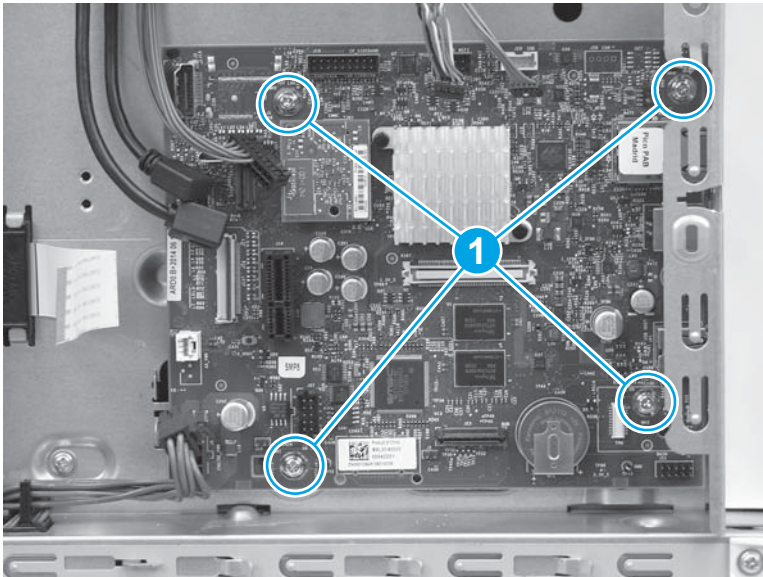

Step 4: Remove the hard-disk drive (HDD) (M577)

 **NOTE:** This step is for the M577 models. For the M552 and M553 models, skip this step and go to [Step 7: Remove the rear cover \(M552 and M553\) on page 1191](#).

 **CAUTION:**  ESD-sensitive part.

1. Release two tabs (callout 1). Hold the tabs in the released position, and then rotate the hard disk drive (HDD) up (callout 2) to release the connector from the formatter.

Figure 1-2083 Release the HDD

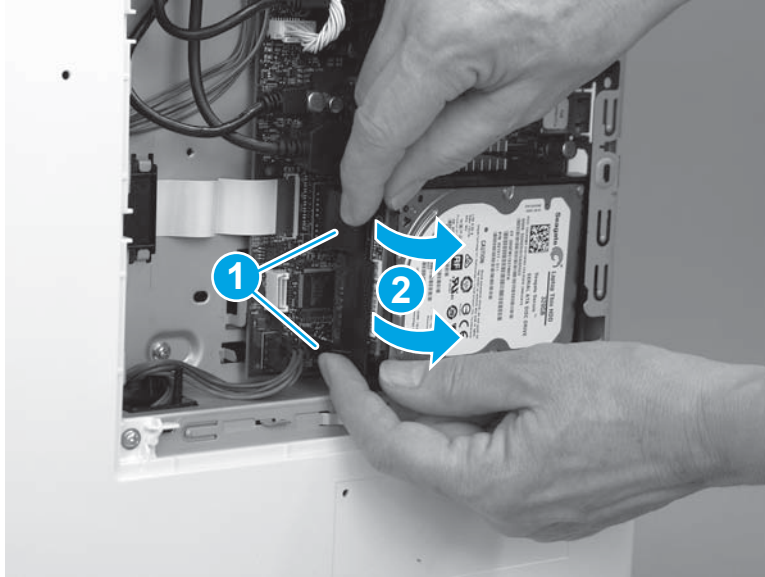

2. Slide the HDD away from the printer to remove it.

Figure 1-2084 Remove the HDD

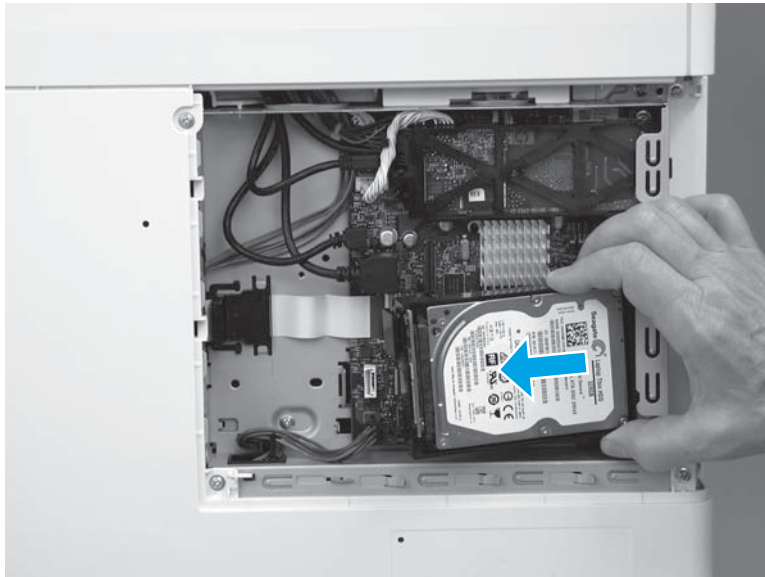

Step 5: Remove the fax PCA (M577c/f/z)

 **NOTE:** This step is for the M577c/f/z models. For the M577n model, skip this step and go to [Step 6: Remove the formatter \(M577\) on page 1189](#).

For the M552 and M553 models, skip this step and go to [Step 7: Remove the rear cover \(M552 and M553\) on page 1191](#).

 **CAUTION:**  ESD-sensitive part.

1. Locate the fax PCA component on the formatter.

Figure 1-2085 Locate the fax PCA

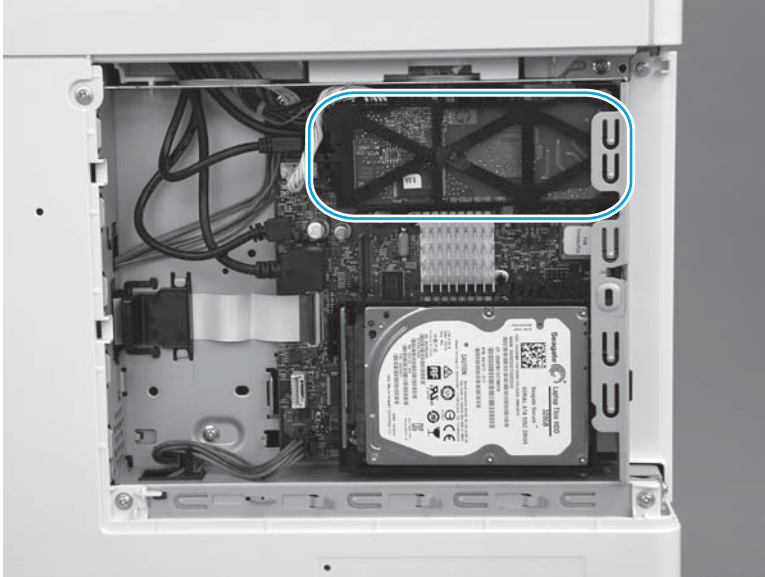

2. Release the connector latch (callout 1), and then pull the connector away from the formatter (callout 2) to disconnect it.

Figure 1-2086 Disconnect one connector

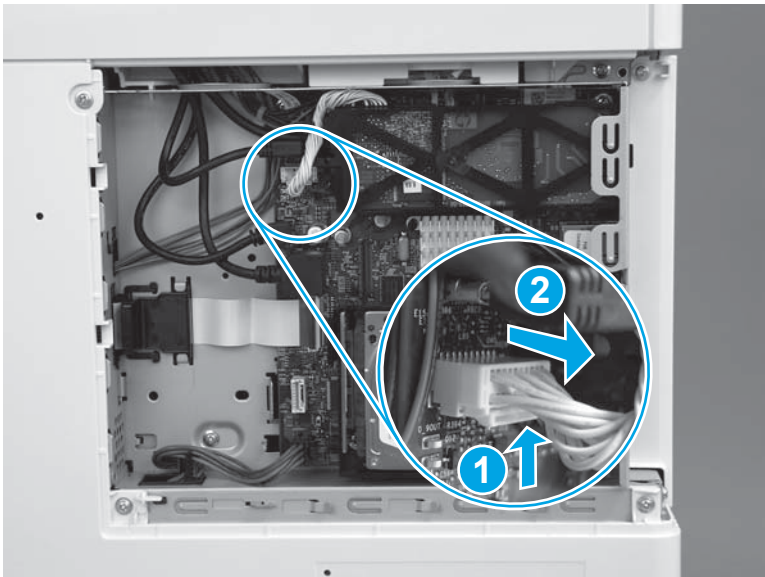

3. Release one retainer (callout 1) by pressing the bracket arms together.

Figure 1-2087 Release one latch

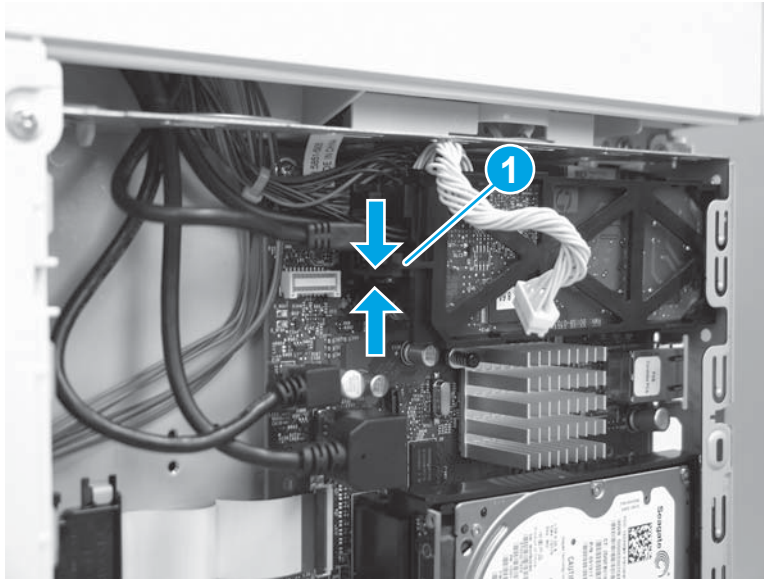

4. Rotate the end of the fax PCA (callout 1) away from the formatter, and then slide the PCA left (callout 2) to remove it.

Figure 1-2088 Remove the fax PCA

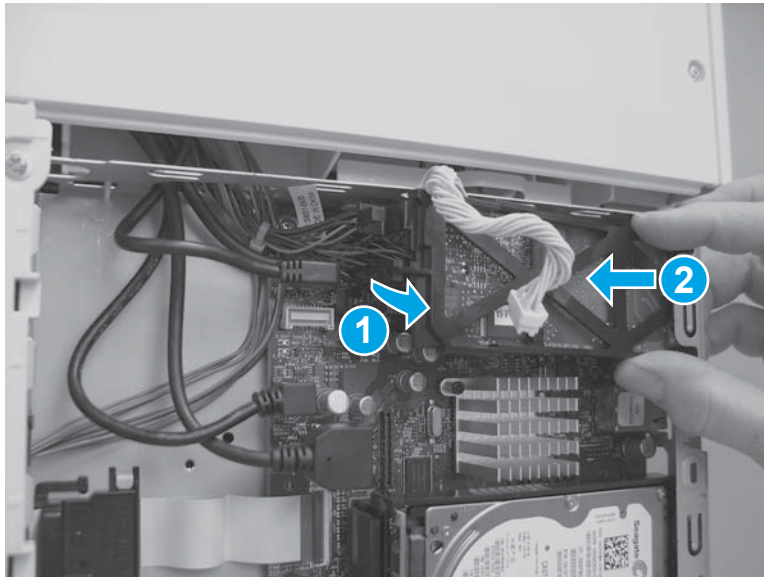

Step 6: Remove the formatter (M577)

 **NOTE:** This step is for the M577 models. For the M552 and M553 models, skip this step and go to [Step 7: Remove the rear cover \(M552 and M553\) on page 1191.](#)

 **CAUTION:**  ESD-sensitive part.

1. Disconnect all of the connectors on the formatter.

The following connectors are empty:

- All models: J1 (this connector is empty unless the optional DIMM is installed)
- All models: J3
- M577dn: J15 (this is the fax connector for the M577f/z/c models)
- All models: J21 (this connector is empty unless the optional internal USB ports component is installed)
- All models: J23
- All models: J24
- All models: J51
- All models: J57
- All models: J97
- All models: J98 (this connector is empty unless the optional trusted platform module (TPM) is installed)

 **IMPORTANT:** The flat-cable connector (callout 1) is a Zero Insertion Force (ZIF) connector that uses a hinged retainer to secure the flat cable. The hinged retainer must be opened to release the flat cable.

Figure 1-2089 Disconnect all connectors



2. Remove four screws (callout 1).

Figure 1-2090 Remove four screws

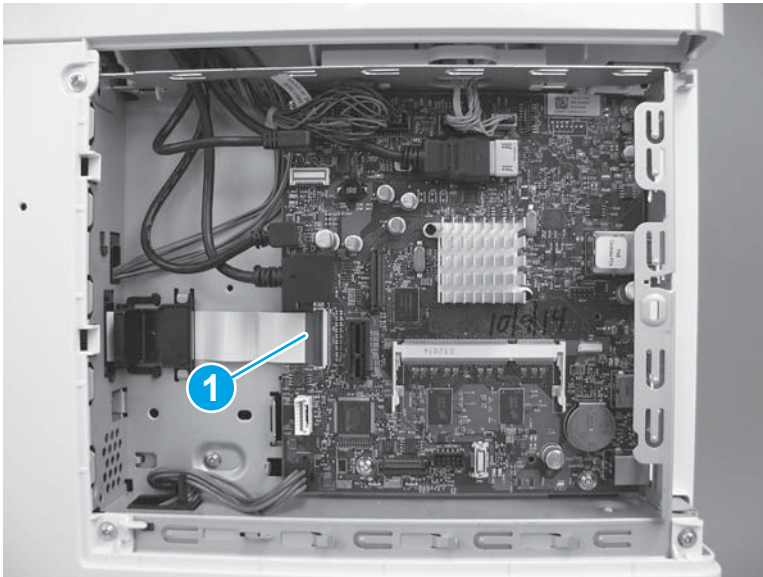
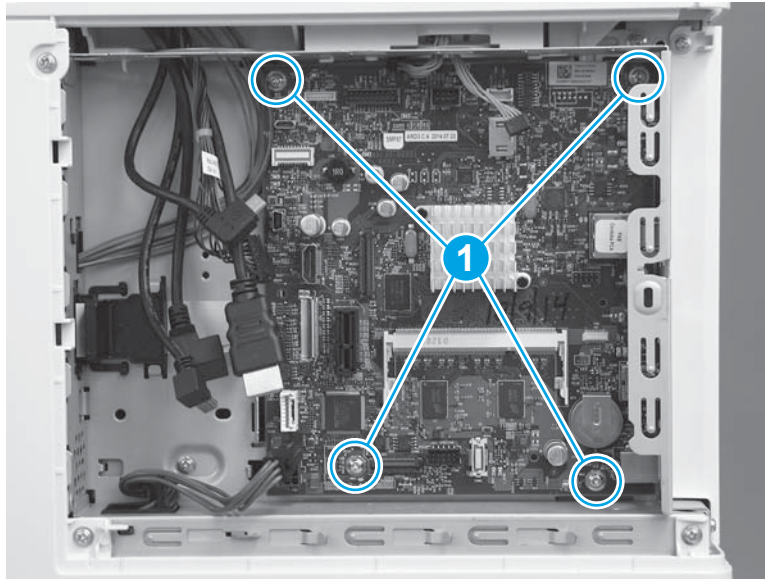

3. Remove the formatter.

Figure 1-2091 Remove the formatter

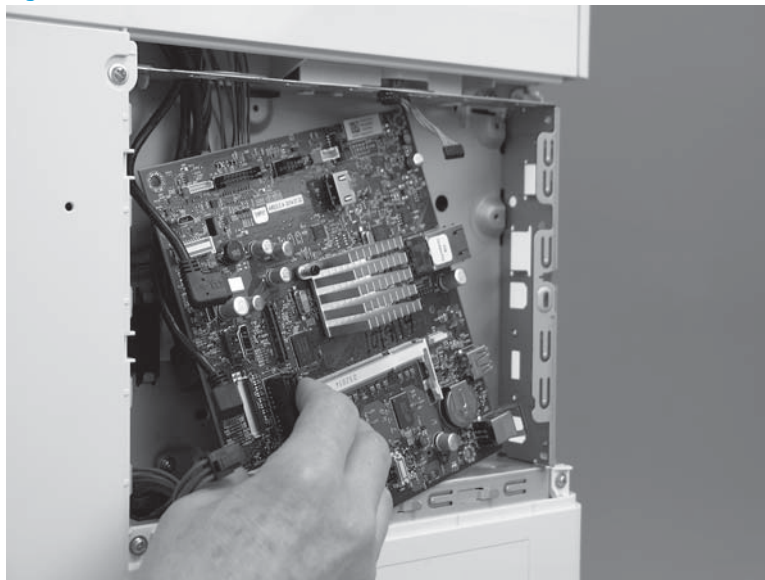

Step 7: Remove the rear cover (M552 and M553)

 **NOTE:** This step is for the M552 and M553 models. For the M577 models, skip this step and go to [Step 8: Remove the rear upper cover \(M577\) on page 1192.](#)

1. Remove four screws (callout 1).

Figure 1-2092 Remove four screws

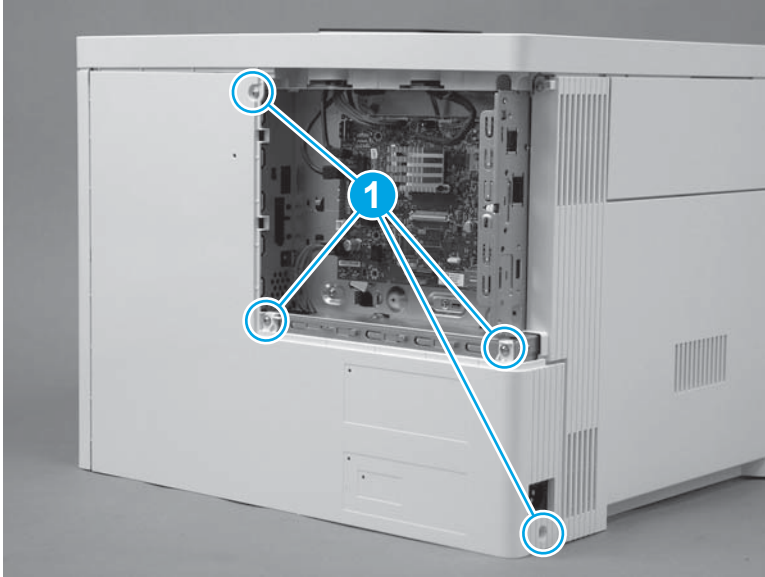

2. Slightly slide the cover to the right (callout 1), rotate the bottom of the cover away from the printer (callout 2), and then pull the top of the cover away from the printer (callout 3) to remove the cover.

Figure 1-2093 Remove the cover

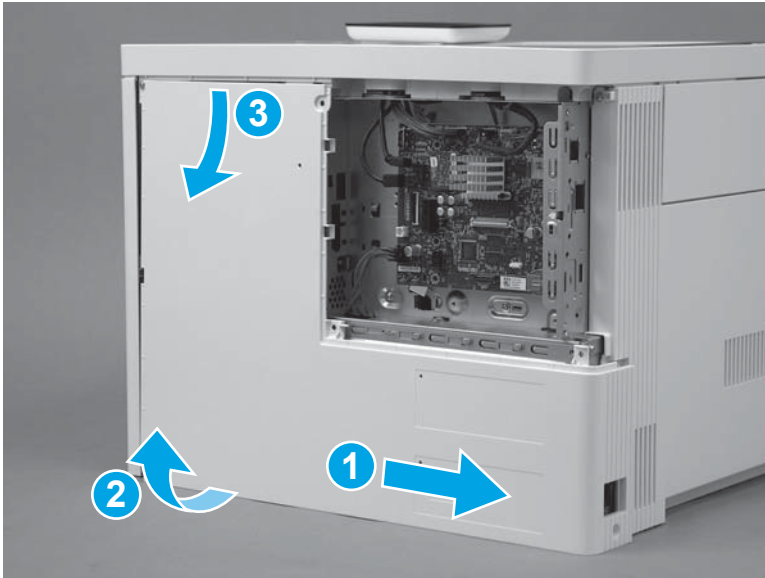

Step 8: Remove the rear upper cover (M577)

 **NOTE:** This step is for the M577 models. For the M552 and M553 models, skip this step and go to [Step 10: Remove the left cover on page 1195](#).

1. Remove two screws (callout 1).

 **Reinstallation tip:** These two screws are self-tapping screws for plastic. When reinstalling them, rotate the screws counterclockwise to align them with the existing thread pattern, and then carefully turn them clockwise to tighten. Do not overtighten. This will prevent stripping the threads inside the screw holes.

Figure 1-2094 Remove two screws



2. Use a small, flat blade screwdriver to release the right edge of the cover.

Figure 1-2095 Release the right edge

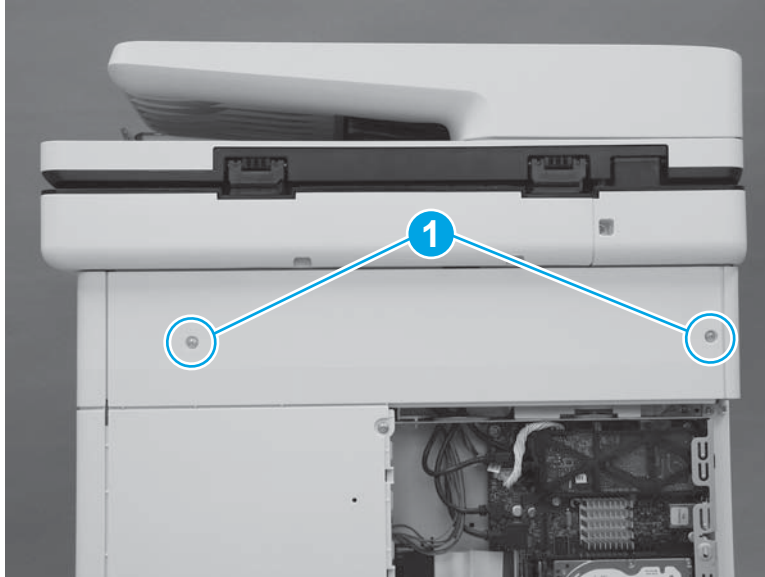
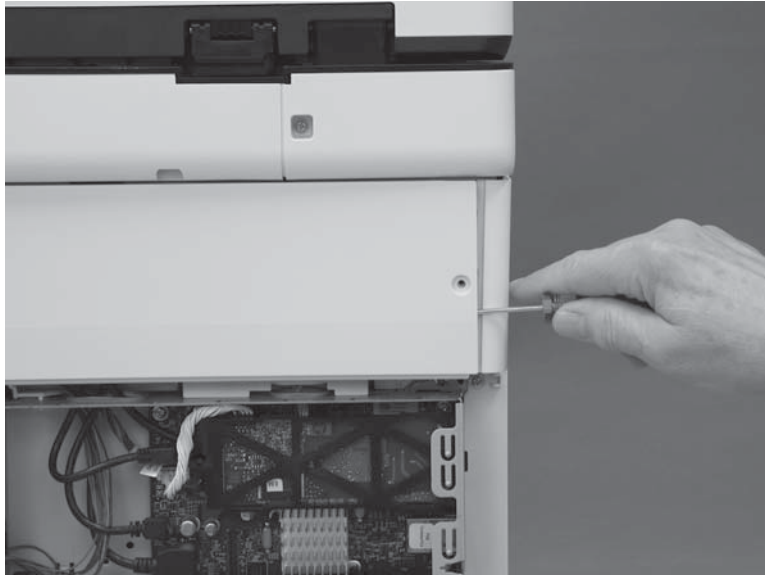

3. Pull the right edge of the cover (callout 1) away from the printer, and then slide the cover to the right (callout 2).

Figure 1-2096 Slide the cover right

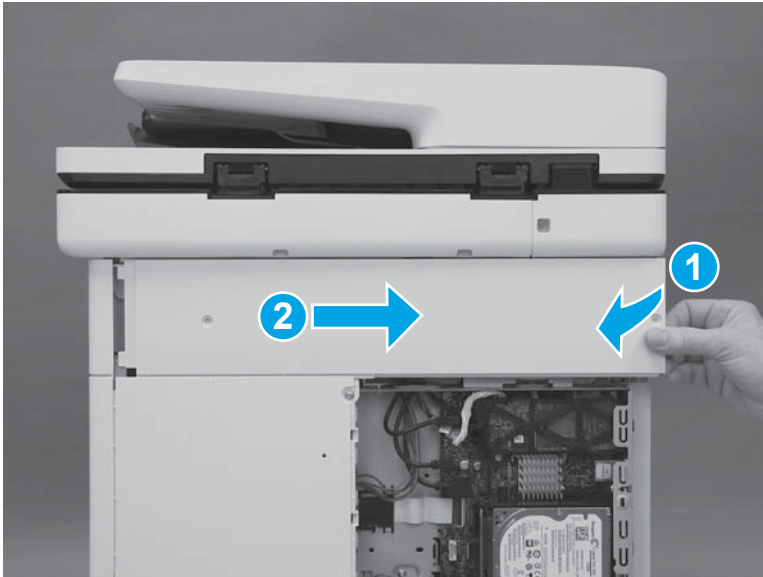

4. Remove the cover.

Figure 1-2097 Remove the cover

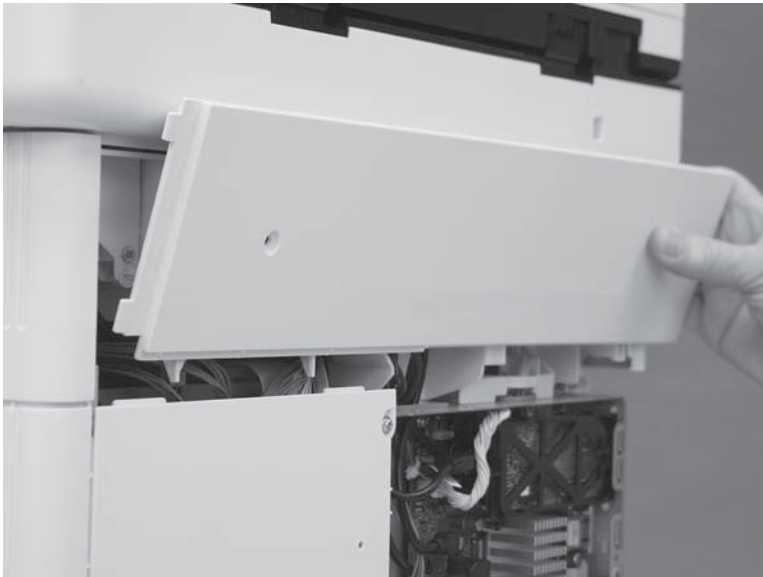

Step 9: Remove the rear cover (M577)

 **NOTE:** This step is for the M577 models. For the M552 and M553 models, skip this step and go to [Step 10: Remove the left cover on page 1195](#).

1. Remove four screws (callout 1).

Figure 1-2098 Remove four screws

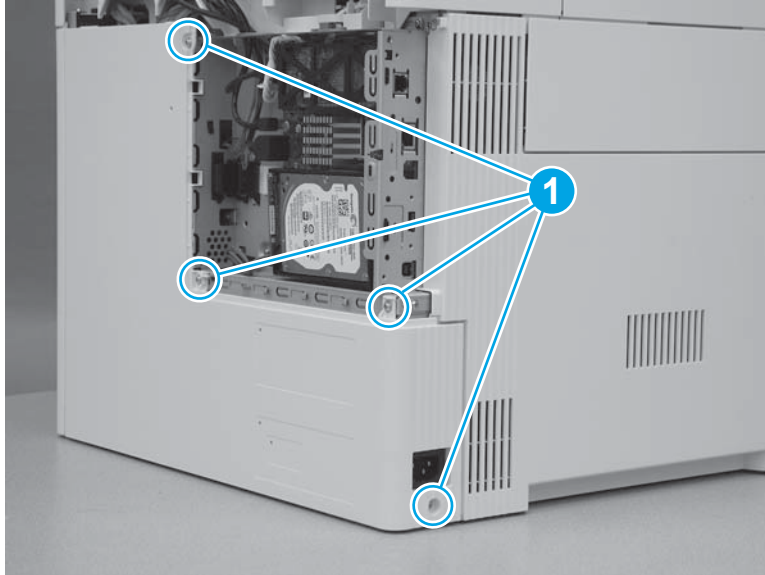

2. Slide the cover to the right to remove it.

Figure 1-2099 Remove the cover

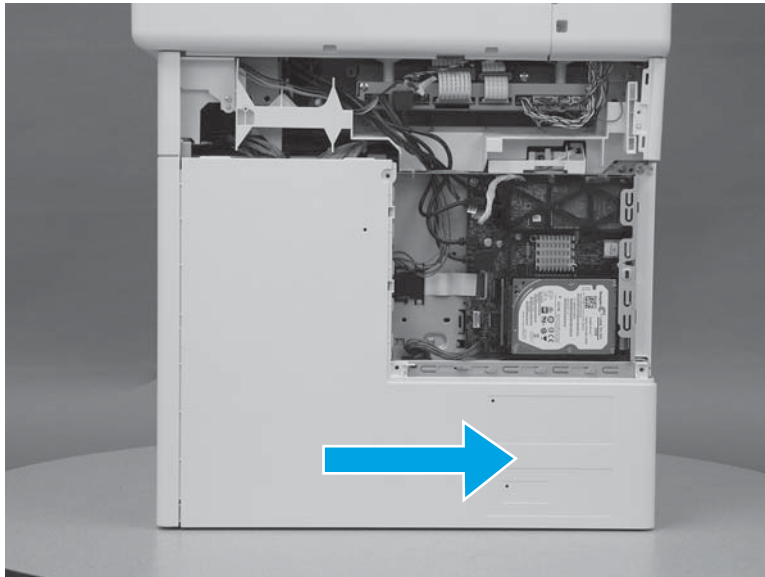

Step 10: Remove the left cover

1. At the left side of the printer, remove one screw (callout 1).

Figure 1-2100 Remove one screw



2. Release one tab (callout 1), rotate the front edge of the cover away from the printer (callout 2), and then slide the cover (callout 3) toward the rear of the printer to release it.

Figure 1-2101 Release the cover

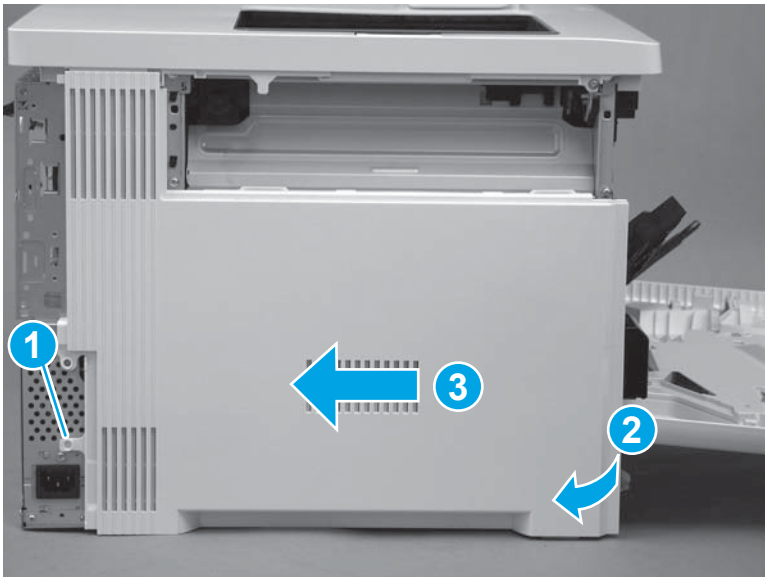

3. Remove the cover.

Figure 1-2102 Remove the cover

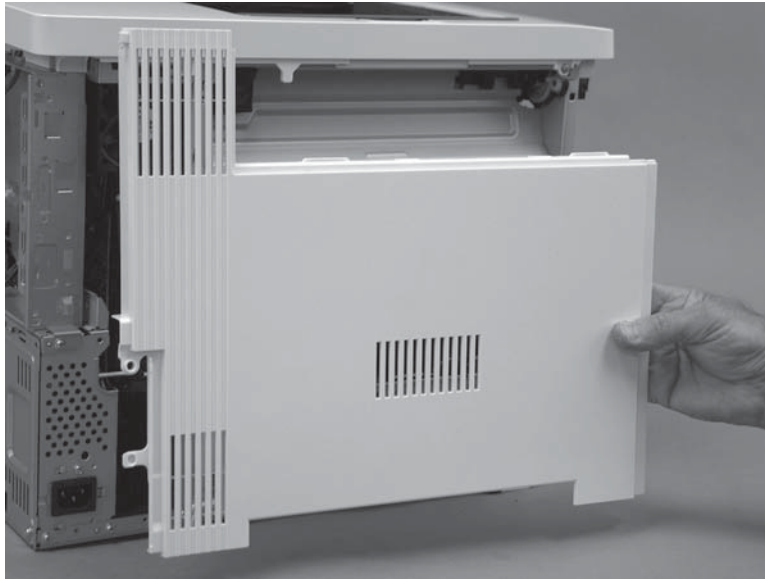

Step 11: Remove the formatter case

1. **M577 only:** Disconnect one connector (callout 1), and then pass the wire harness (callout 2) through two openings in the formatter case (callout 3).

Figure 1-2103 Disconnect one connector

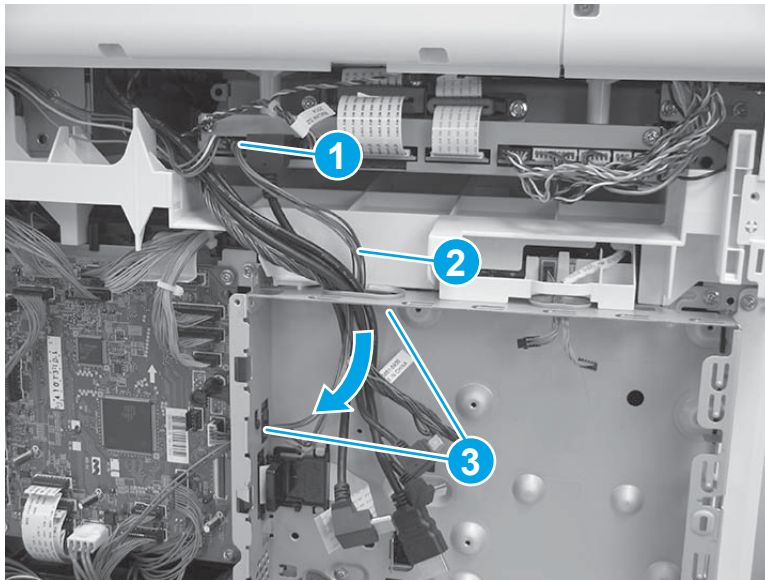

2. Release two tabs (callout 1) on the black plastic bracket. Hold the tabs in the released position, and then slide the bracket (callout 2) to the right to remove it from the formatter case.

Figure 1-2104 Remove the bracket

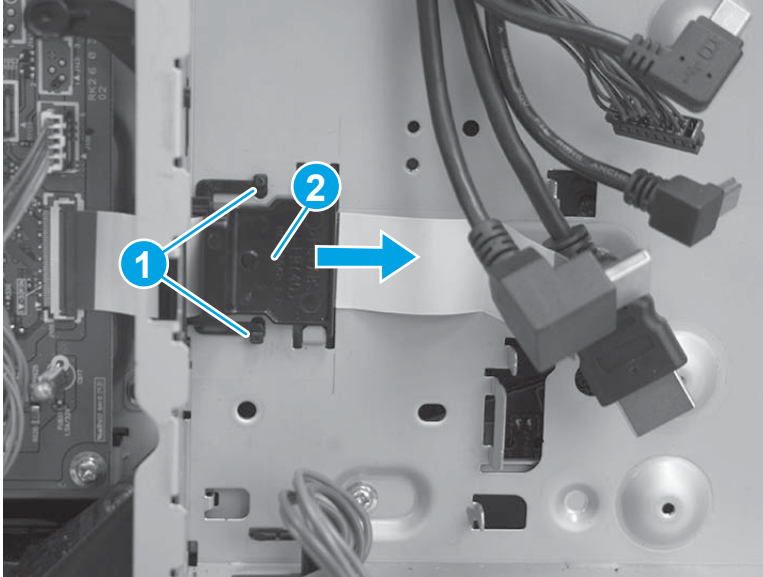

3. Remove two screws (callout 1), and then slide the low-voltage power supply (LVPS) cover to the right to remove it.

Figure 1-2105 Remove the LVPS cover

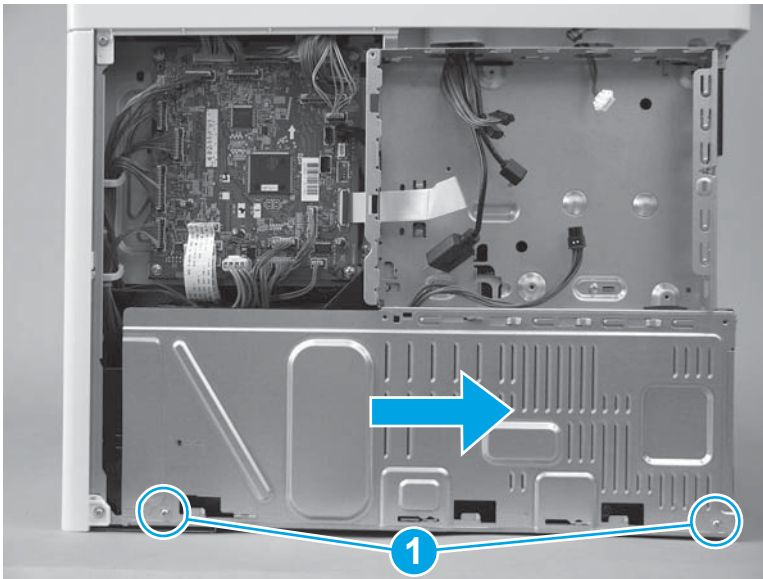

4. Pass two wire harnesses and one flat cable (callout 1) through the opening in the formatter case, and then release one wire harness from the retainer (callout 2).

⚠ CAUTION: The flat cable might be attached to the formatter case with double-sided tape. Make sure that this tape is released, so that the flat cable is not damaged when the formatter case is removed.

Figure 1-2106 Release wire harnesses and flat cable

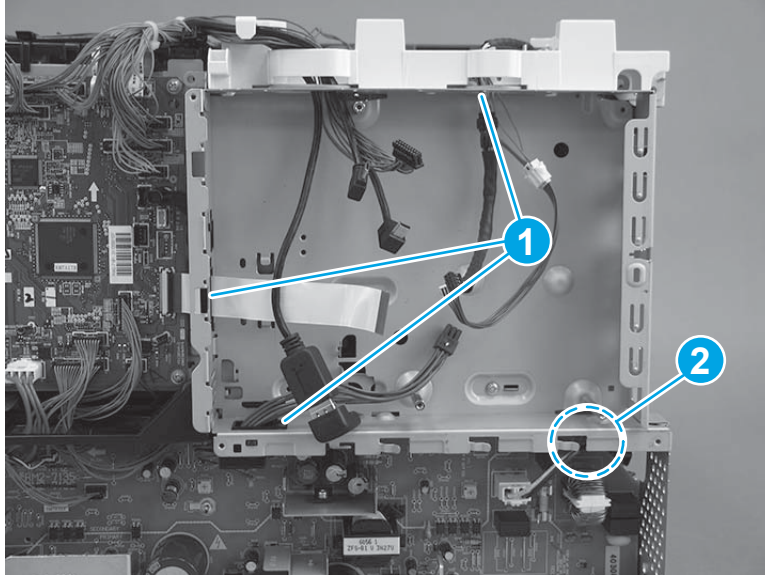

5. Remove six screws (callout 1).

Figure 1-2107 Remove six screws

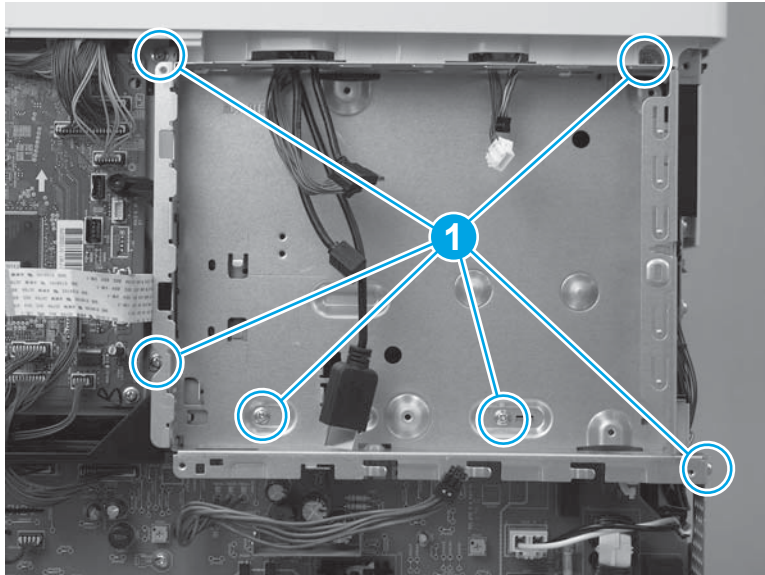

6. Rotate the bottom of the formatter case away from the printer (callout 1), and then pull it down (callout 2) to release it.

Figure 1-2108 Release the formatter case

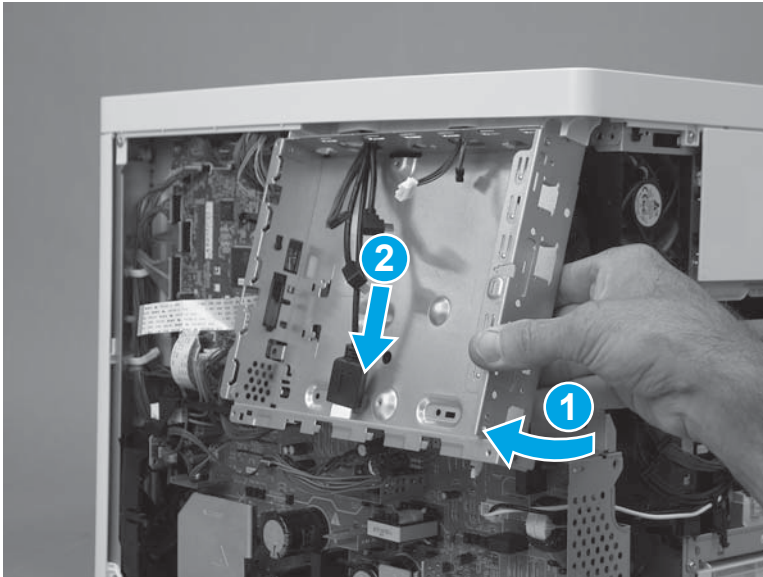

7. Pass the wire harnesses through the opening in the formatter case to remove it.

 **IMPORTANT:** If the formatter case is removed so that it can be replaced, make sure to transfer the memory PCA (island of data) and plastic bracket (callout 1) to the replacement case.

Figure 1-2109 Remove the formatter case

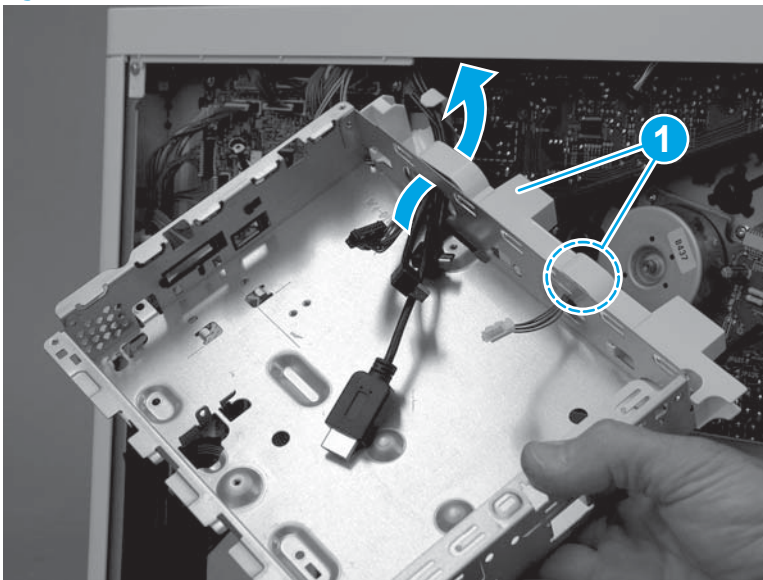

Step 12: Remove the low-voltage power supply (LVPS)

 **CAUTION:**  ESD-sensitive part.

1. Disconnect one wire harness (callout 1), and then pass the wire harness through the opening (callout 2) in the chassis.

Figure 1-2110 Disconnect one wire harness

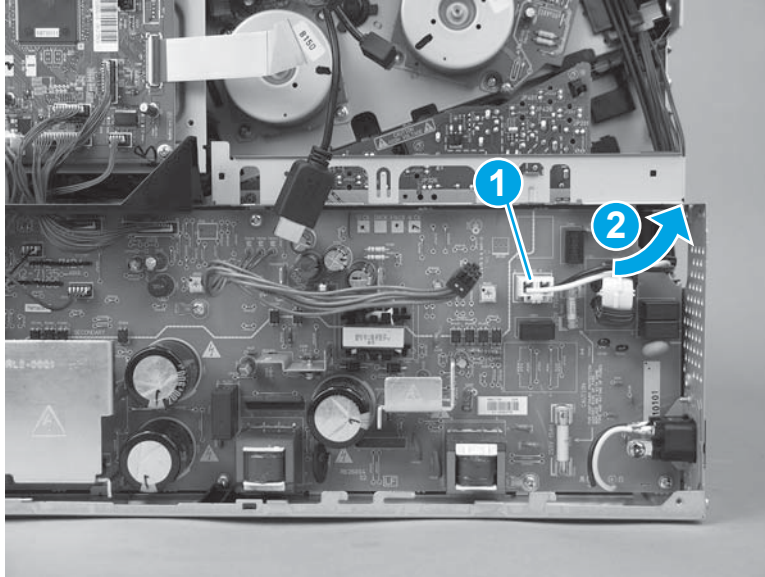

2. Disconnect three connectors on the DC controller (callout 1), and then disconnect four connectors (callout 2) on the LVPS.

Figure 1-2111 Disconnect seven connectors

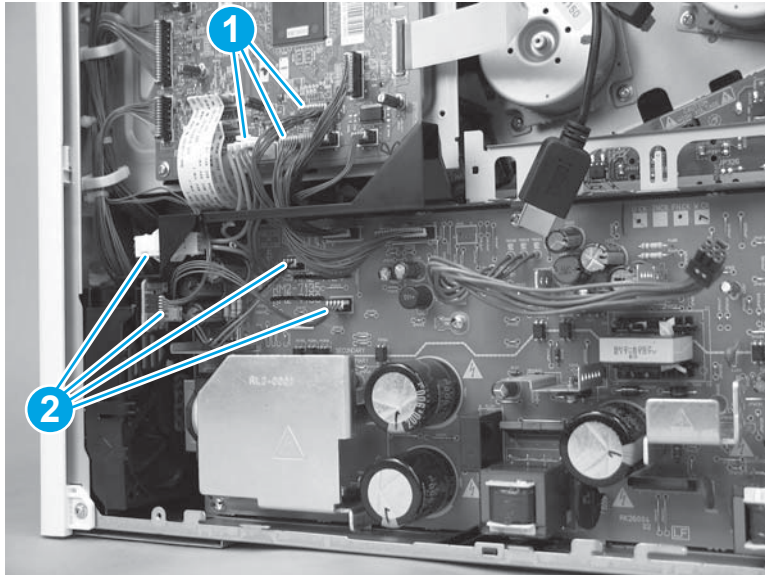

3. Pass the wire harnesses from the DC controller to the LVPS through the opening in the chassis (callout 1), and then release the wire harnesses from the retainer (callout 2).

Figure 1-2112 Pass the wire harnesses through the opening

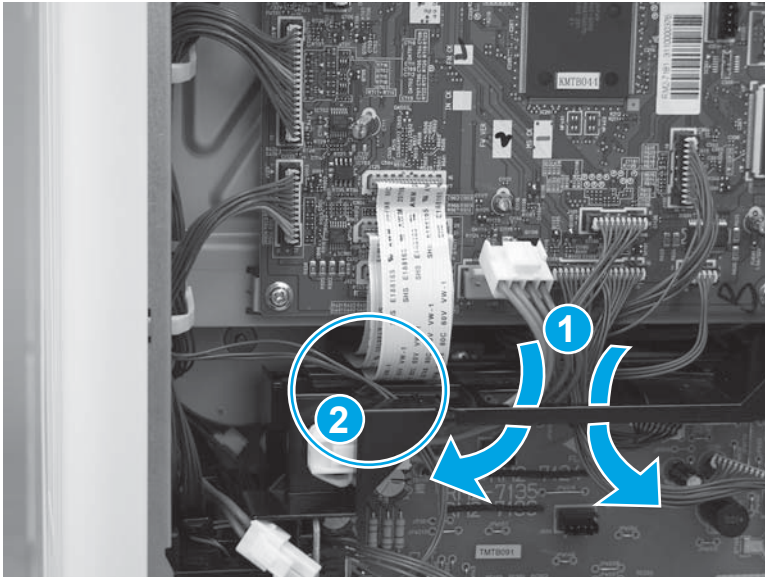

4. Remove three screws (callout 1).

Figure 1-2113 Remove three screws

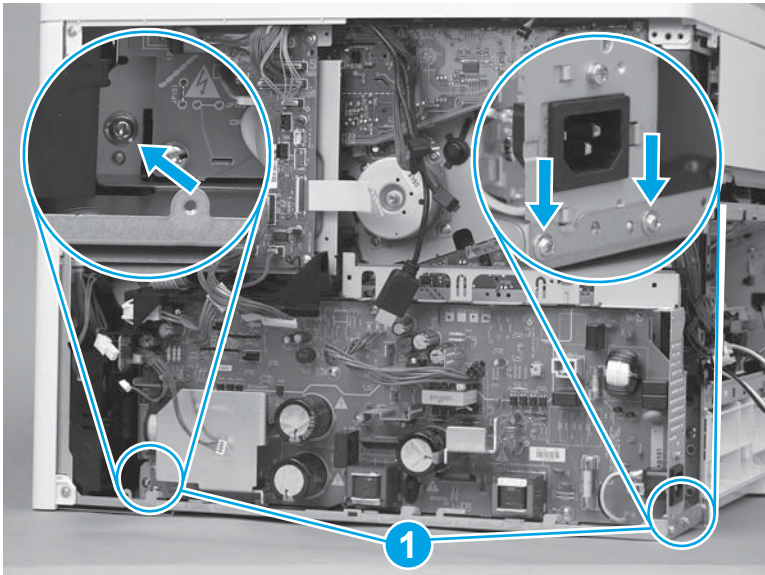

5. Rotate the top of the LVPS away from the printer (callout 1), and then slide it up and out (callout 2) of the printer to remove it.

Figure 1-2114 Remove the LVPS

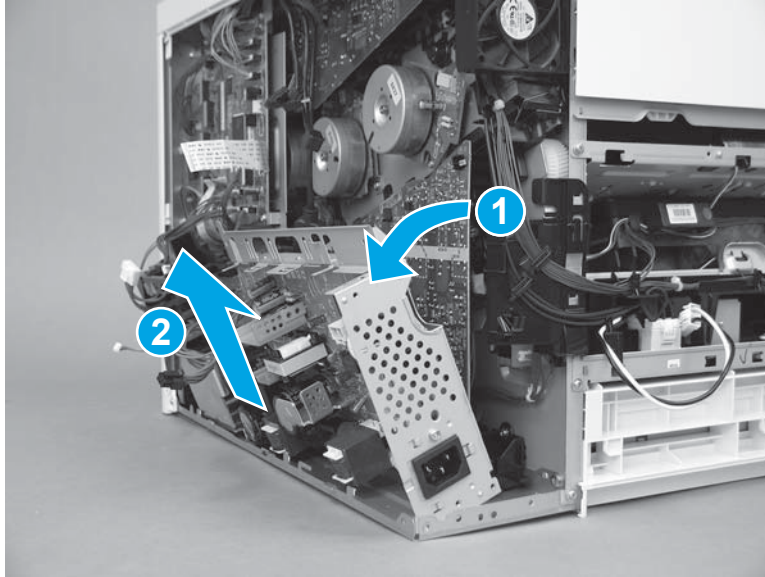

Step 13: Remove the high-voltage power supply D (HVPSD)

 **CAUTION:**  ESD-sensitive part.

1. Disconnect one flat cable (callout 1) on the DC controller.

Figure 1-2115 Disconnect one flat cable

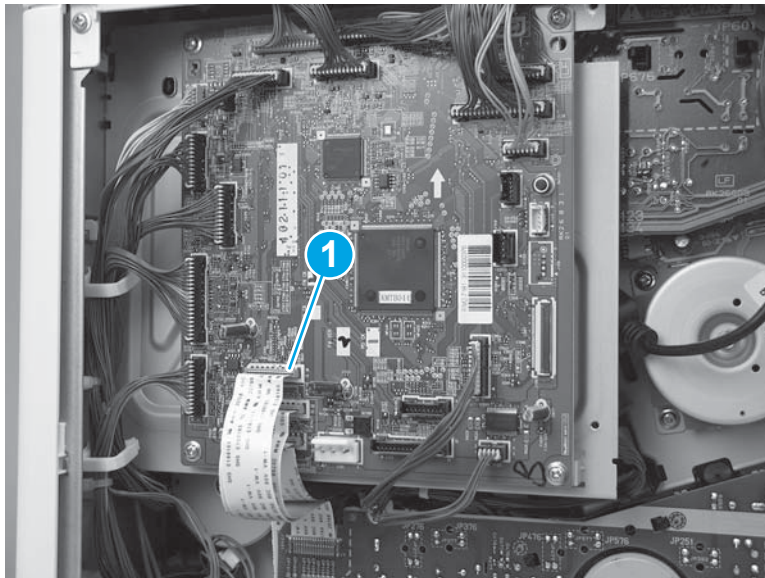

2. Remove two screws (callout 1), and then remove one self tapping screw (callout 2) on the HVPSD.

Figure 1-2116 Remove three screws

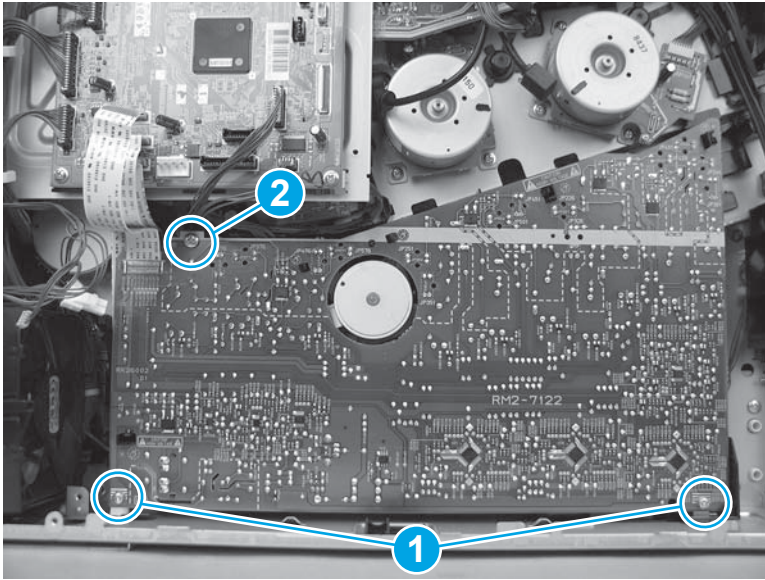

3. Release five tabs (callout 1), and then remove the HVPSD (callout 2).

Figure 1-2117 Remove the HVPSD

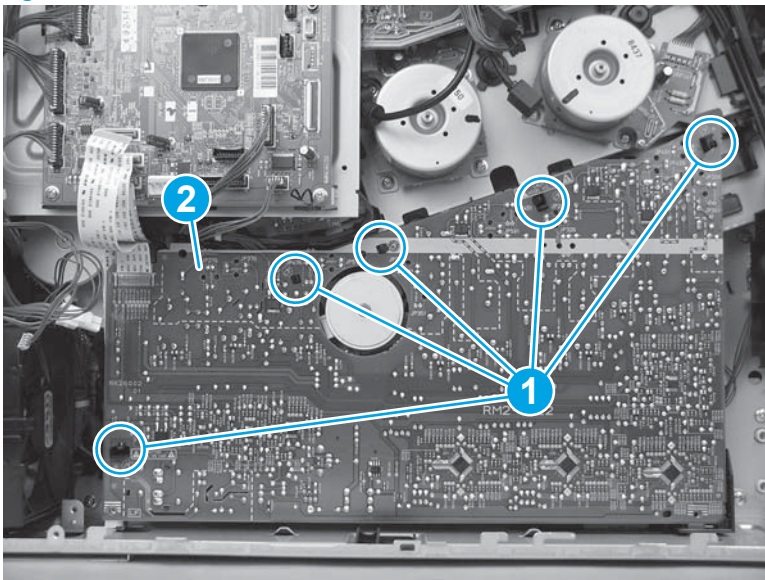

Step 14: Remove the developing disengagement motor (M6)

- ▲ Disconnect one connector (callout 1), remove two screws (callout 2), and then remove the motor.

Figure 1-2118 Remove the motor

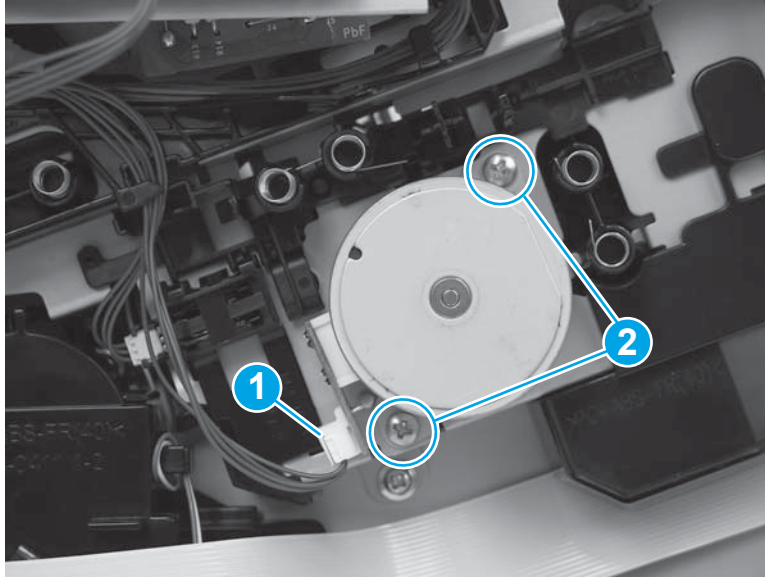

Step 15: Unpack the replacement assembly

Unpack the replacement assembly from the packaging.

For complete information on HP's recycling programs, go to [Product return and recycling](#).

 **NOTE:** HP recommends responsible disposal of the defective assembly.

Figure 1-2119 Recycle and unpack

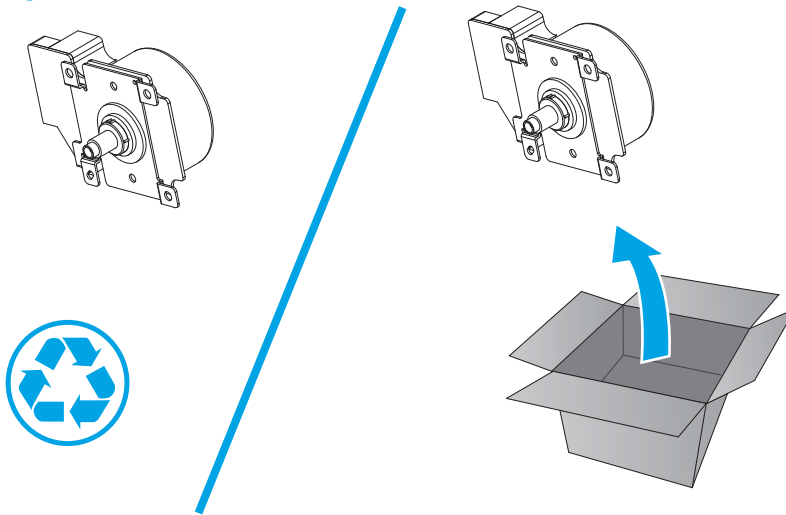

Step 16: Install the developing disengagement motor (M6)

- ▲ Position the motor on the printer, install two screws (callout 1), and then connect one connector (callout 2).

Figure 1-2120 Install the motor

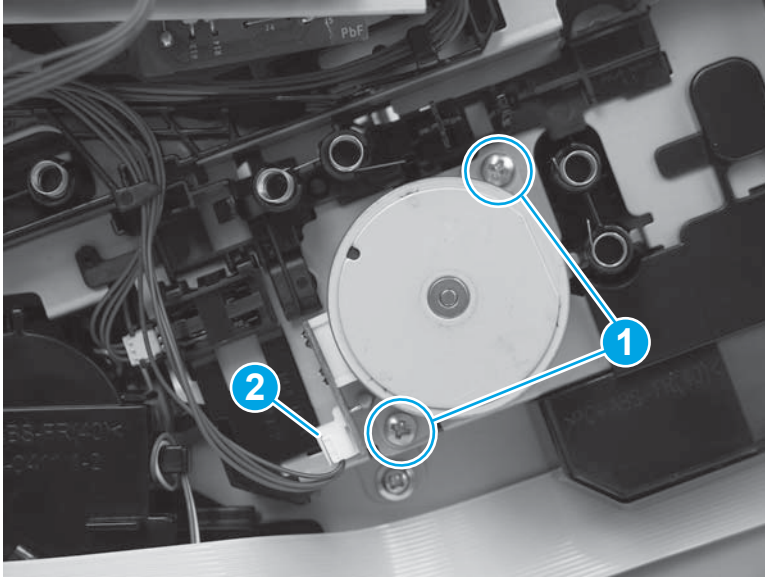

Step 17: Install the HVPSD

 **CAUTION:**  ESD-sensitive part.

1. Position the bottom right corner of the HVPSD (callout 1) behind the black tab, and then rotate it up and onto the printer (callout 2).

Figure 1-2121 Install the HVPSD

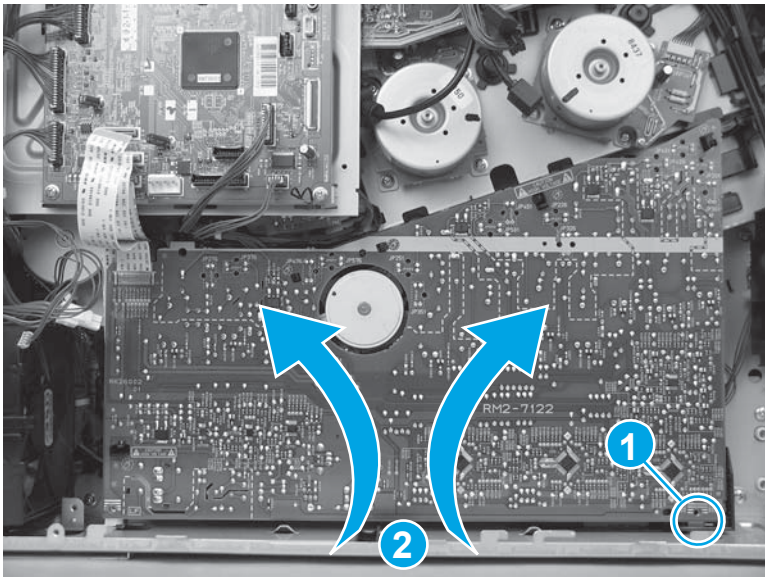

2. Press it onto five tabs (callout 2).

 **IMPORTANT:** Make sure that all five tabs snap into place.

Figure 1-2122 Press the tabs



3. Install two screws (callout 1), and then install one self tapping screw (callout 2) on the HVPSD.

Figure 1-2123 Install three screws

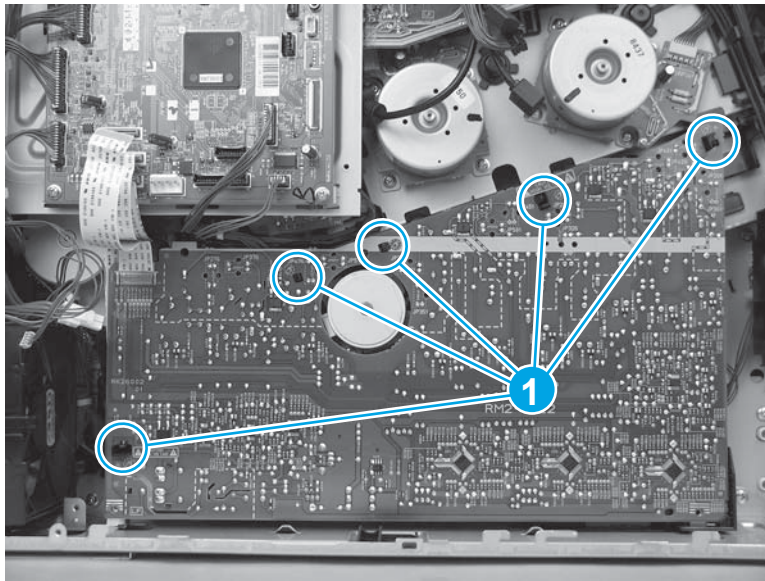
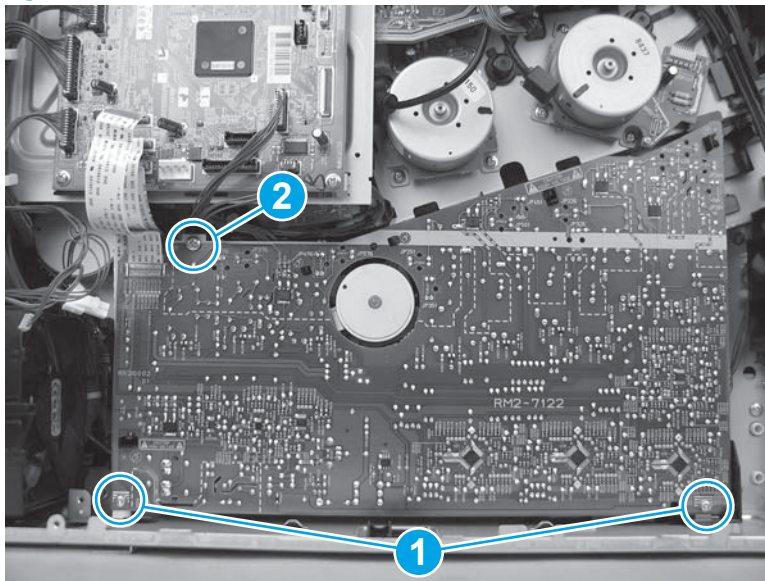

4. Connect one flat cable (callout 1) on the DC controller.

Figure 1-2124 Connect one flat cable

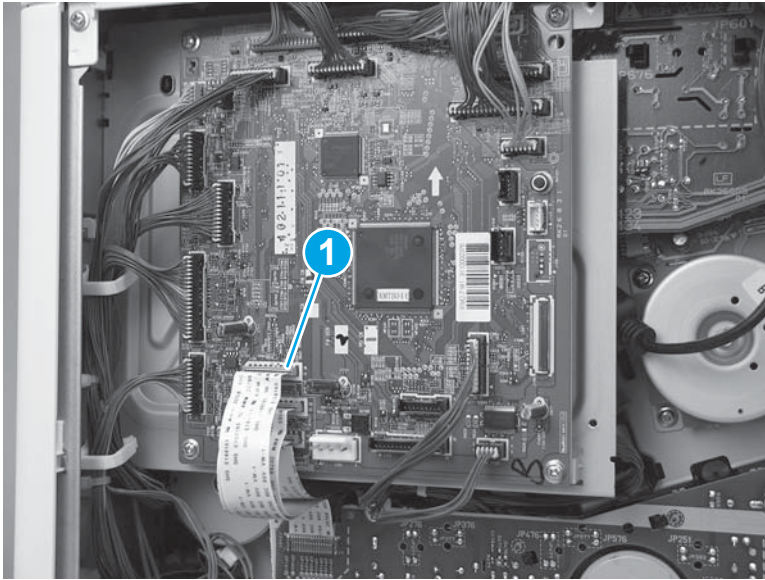

Step 18: Install the LVPS

 **CAUTION:**  ESD-sensitive part.

1. Position the bottom of the LVPS in the printer (callout 1) at a slight angle, and then rotate the top of it into the printer (callout 2) to install it.

Figure 1-2125 Install the LVPS

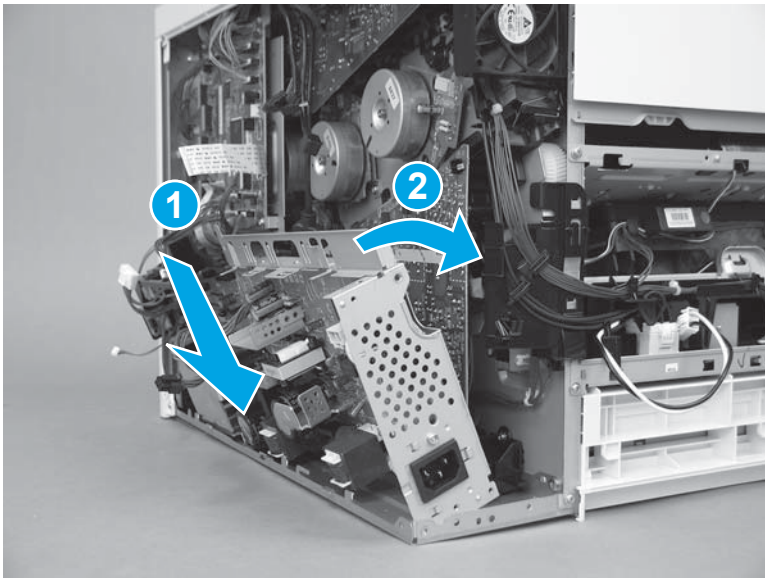

2. Install three screws (callout 1).

Figure 1-2126 Install three screws

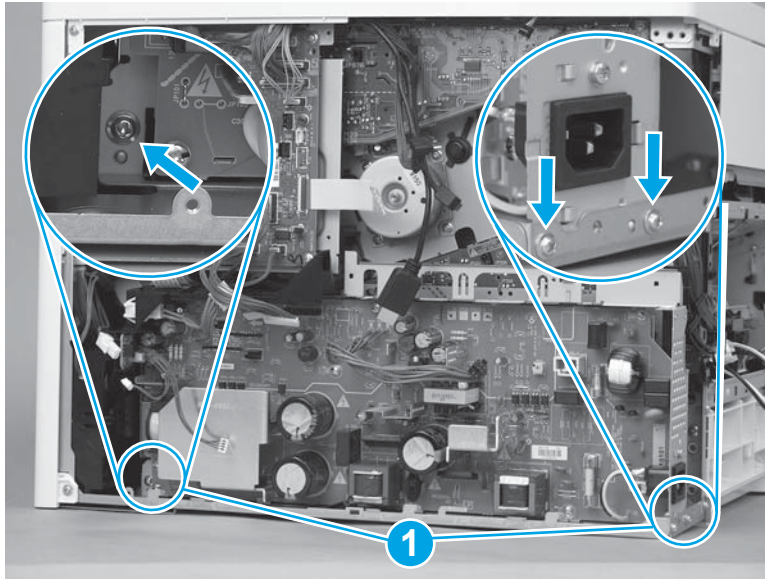

3. Pass the wire harnesses from the DC controller to the LVPS through the opening in the chassis (callout 1), and then install the wire harnesses in the retainer (callout 2).

Figure 1-2127 Pass the wire harnesses through the opening

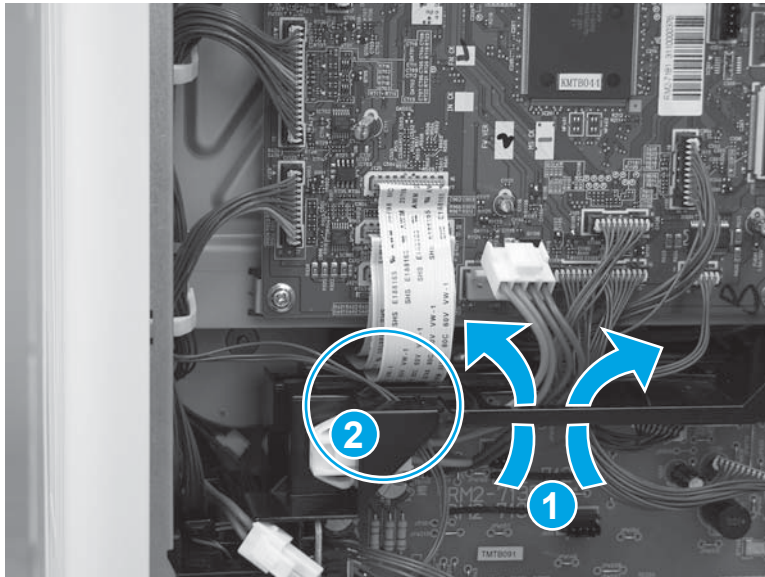

4. Connect three connectors on the DC controller (callout 1), and then connect four connectors (callout 2) on the LVPS.

Figure 1-2128 Connect seven connectors

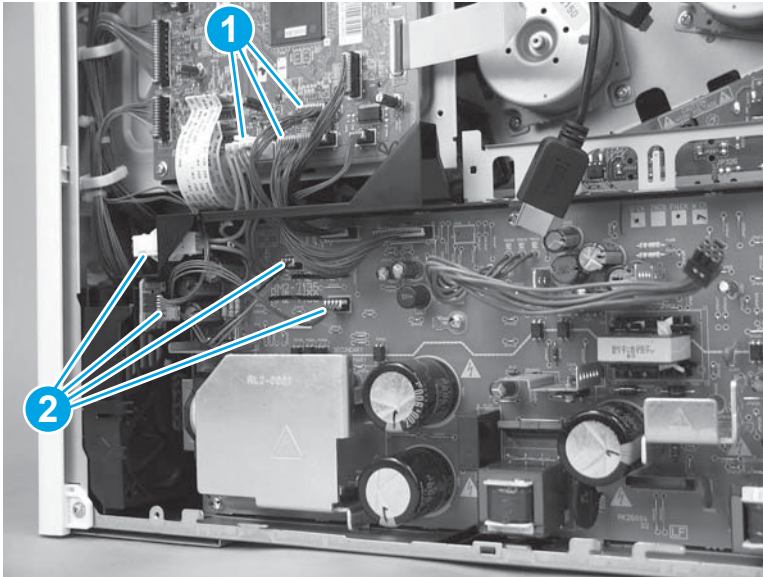

5. Pass the wire harness through the opening (callout 1) in the chassis, and then connect one wire harness (callout 2).

Figure 1-2129 Connect one wire harness

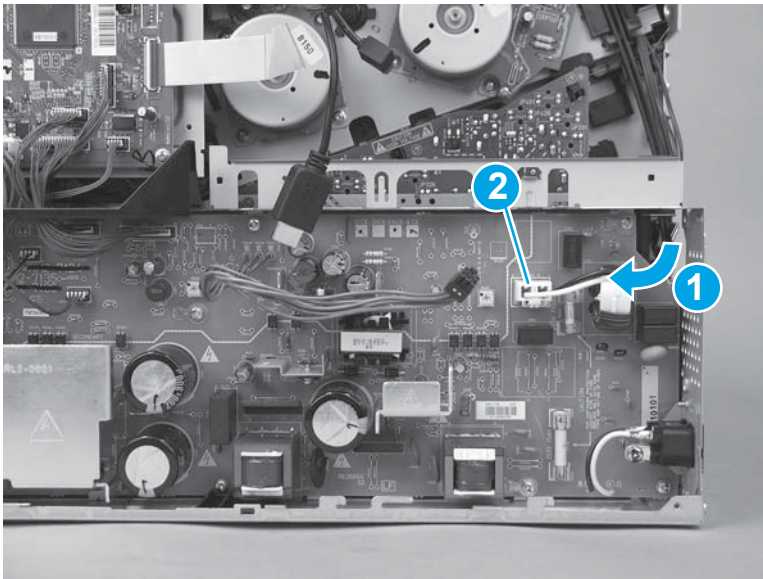

Step 19: Install the formatter case

1. Pass the wire harnesses through the opening in the formatter case.

Figure 1-2130 Pass the wire harnesses through the opening

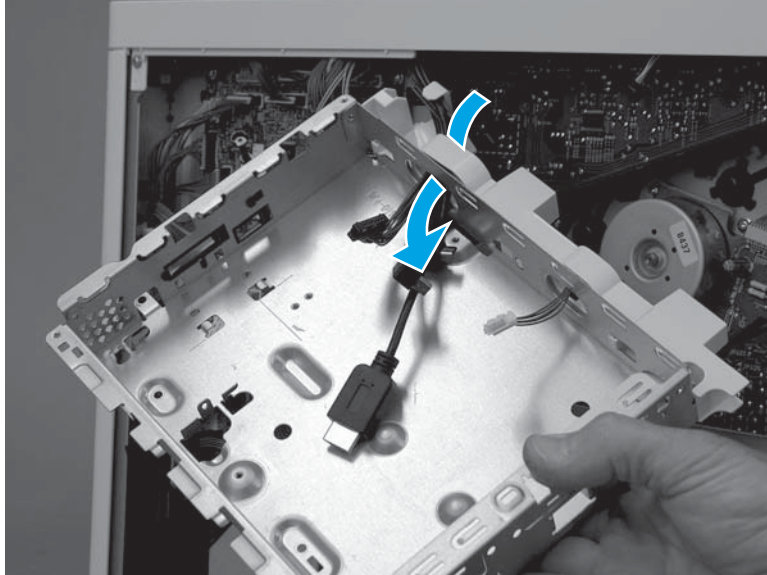

2. Position the top of the formatter case on the printer (callout 1), and then rotate the bottom of the case (callout 2) into the printer.

Figure 1-2131 Install the formatter case

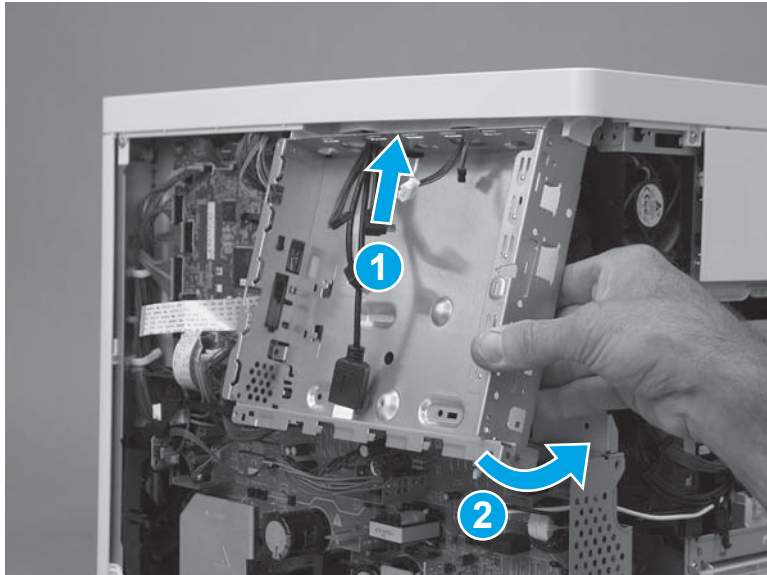

3. Install six screws (callout 1).

Figure 1-2132 Install six screws

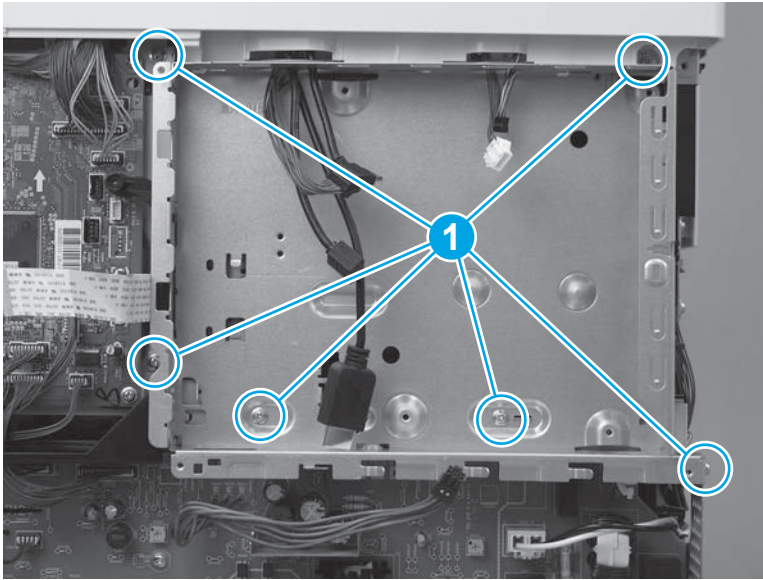

4. Pass two wire harnesses and one flat cable (callout 1) through the opening in the formatter case, and then install one wire harness in the retainer (callout 2).

 **IMPORTANT:** Make sure that the flat cable is securely fastened to the DC controller, and was not dislodged when the formatter case was removed.

Figure 1-2133 Install wire harnesses and flat cable

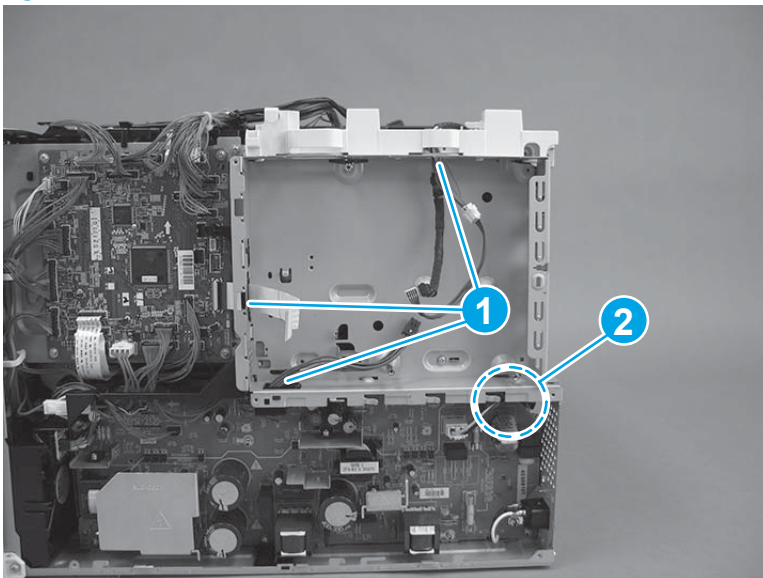

5. Position the LVPS cover on the printer, slide the cover to the left to install it, and then install two screws (callout 1).

Figure 1-2134 Install the LVPS cover

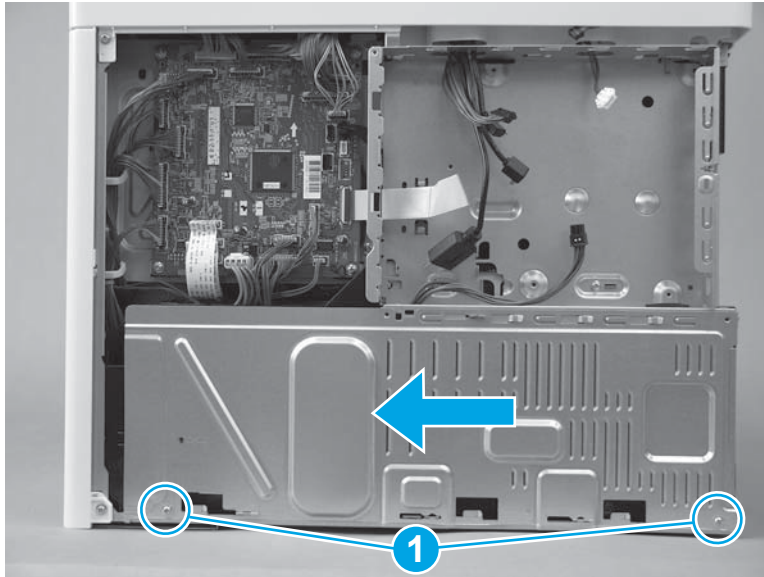

6. If no tape is affixed to the back of the flat cable, skip this step. If double-sided tape is affixed to the back of the flat cable, align the line (callout 1) on the cable with the edge (callout 2) of the opening in the sheet metal. Press to attach the flat cable to the formatter case.

Figure 1-2135 Attach the flat cable

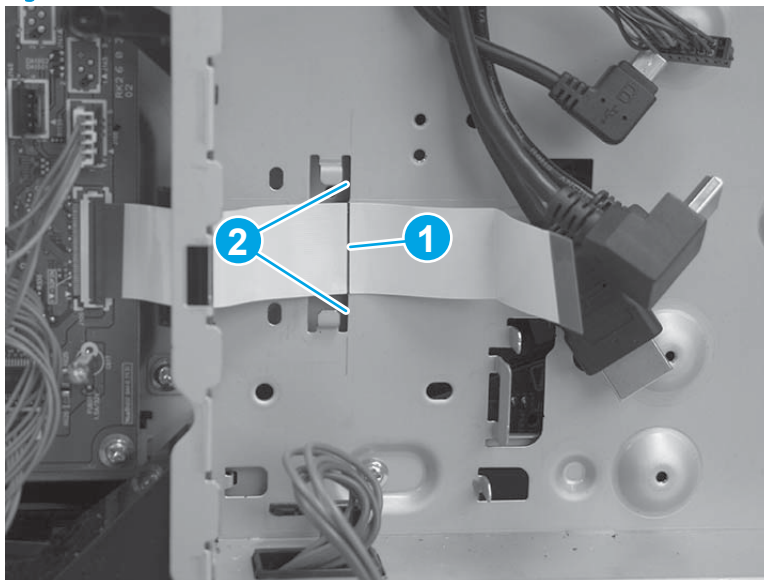

7. Position the bracket over the flat cable, and then slide the bracket to the left to install it. Make sure that the edges of the bracket fit under the sheet metal tabs (callout 1) on the formatter case and that the tabs (callout 2) snap into place.

Figure 1-2136 Position the bracket

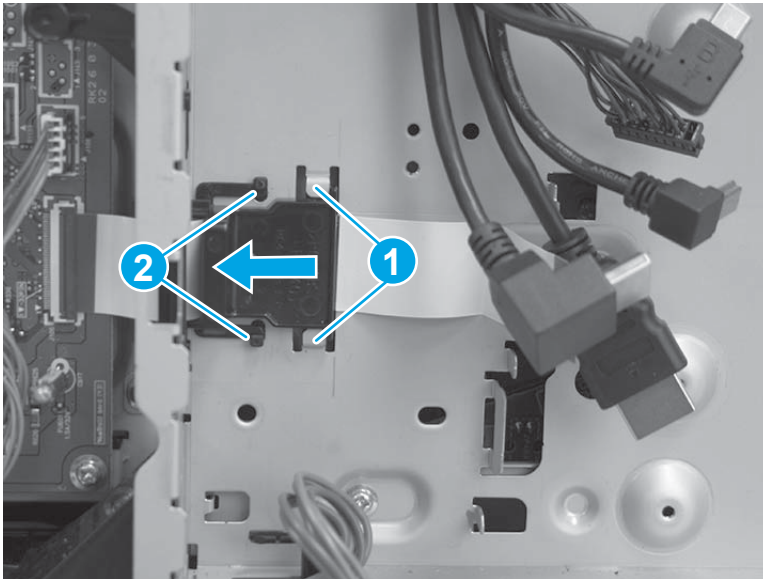

8. **M577 only:** Pass the wire harness (callout 1) through the openings in the formatter case (callout 2), and then connect one connector (callout 3).

Figure 1-2137 Connect one connector

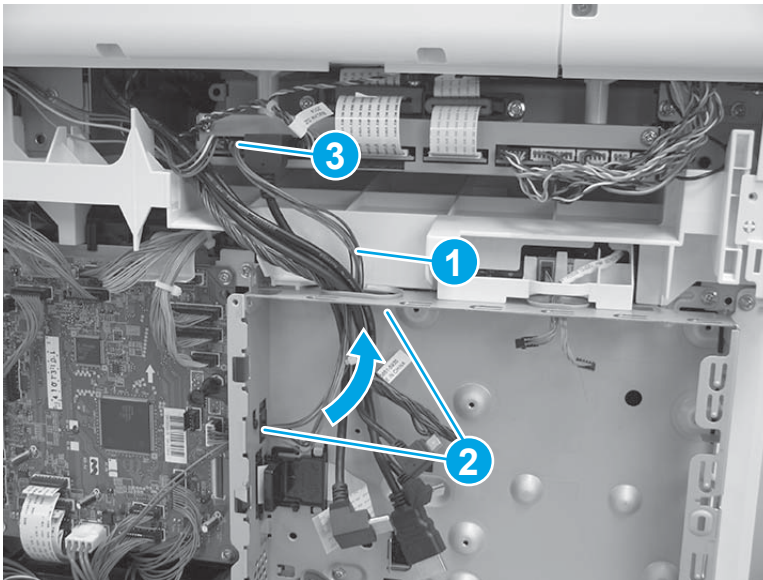

Step 20: Install the left cover

1. Position the cover on the printer.

 **NOTE:** Slightly offset the cover toward the rear of the printer.

Figure 1-2138 Install the cover

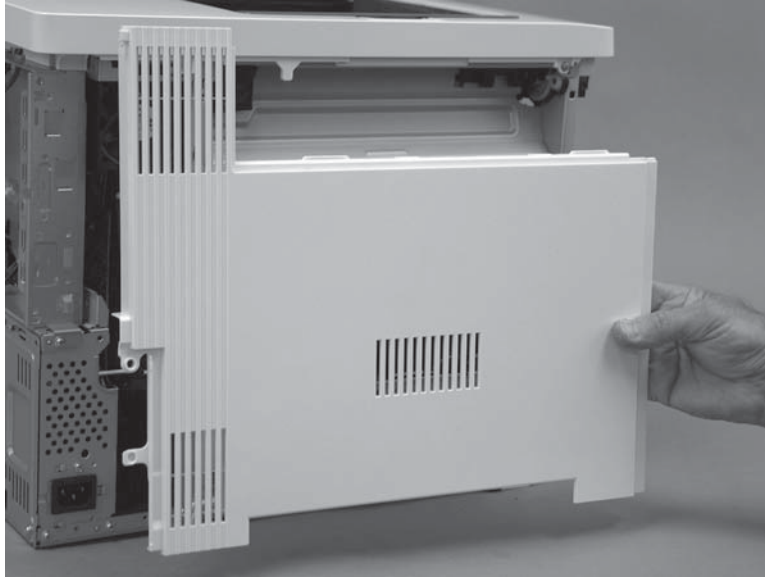

2. Slide the cover (callout 1) toward the front of the printer to engage it. Make sure that the tab (callout 2) snaps into place.

 **NOTE:** Locate the alignment pin (callout 3) on the cover from the front door side of the printer, and then make sure that it is fully engaged in the slot in the chassis.

 **TIP:** While sliding the cover into place, push in on the center of the cover (callout 1) to make sure that the hooks on the back of the cover engage with the slots in the chassis.

Figure 1-2139 Engage the cover



3. At the left side of the printer, install one screw (callout 1).

Figure 1-2140 Install one screw

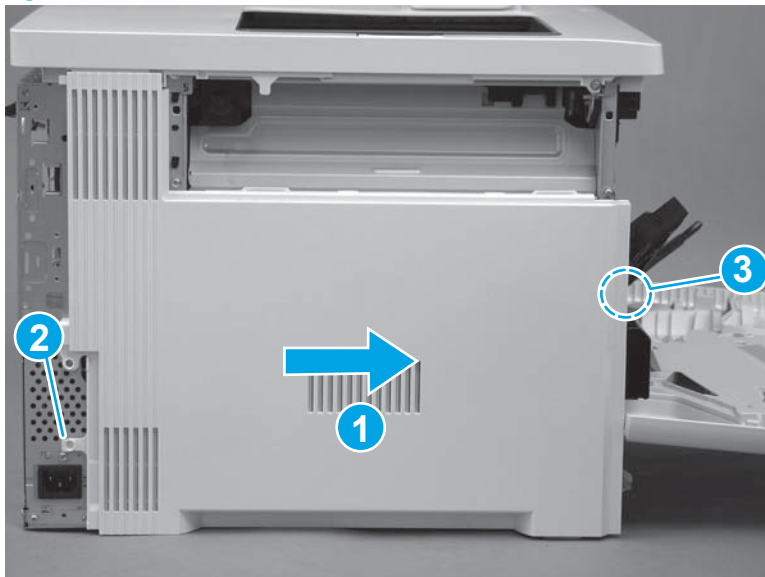

Step 21: Install the rear cover (M577)

 **NOTE:** This step is for the M577 models. For the M552 and M553 models, skip this step and go to [Step 23: Install the rear cover \(M552 and M553\) on page 1219](#).

1. Position the hooks (callout 1) on the cover in the slots (callout 2) in the printer.

Figure 1-2141 Position the hooks

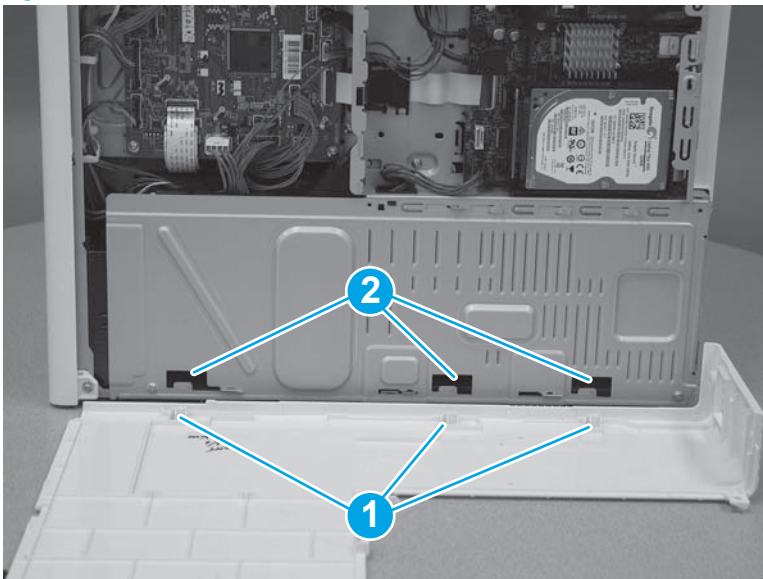

2. Position the back edge (callout 1) of the rear cover behind the edge (callout 2) of the right rear cover. Slide the cover to the left to install it.

Figure 1-2142 Install the cover

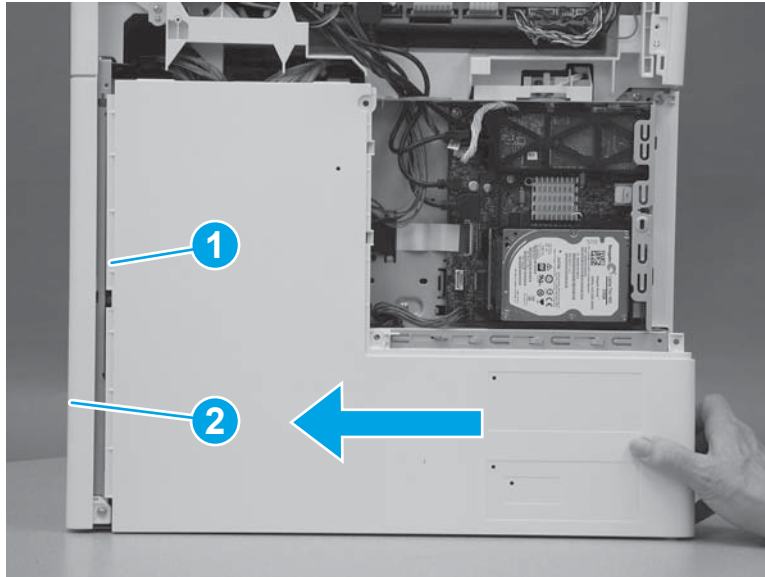

3. Install four screws (callout 1).

Figure 1-2143 Install four screws cover

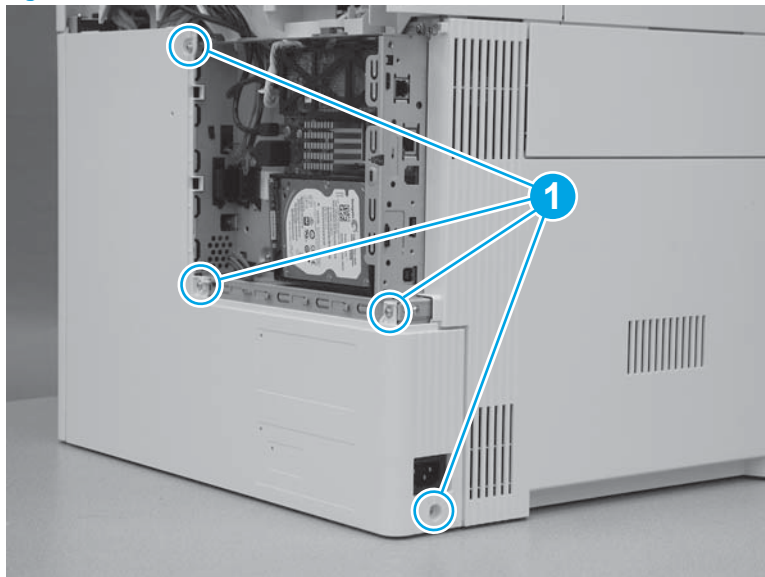

Step 22: Install the rear upper cover (M577)

 **NOTE:** This step is for the M577 models. For the M552 and M553 models, skip this step and go to [Step 23: Install the rear cover \(M552 and M553\) on page 1219.](#)

1. Align the ridge (callout 1) on the lower edge of the rear upper cover in front of the tabs (callout 2) on the top edge of the rear cover.

Figure 1-2144 Align the cover

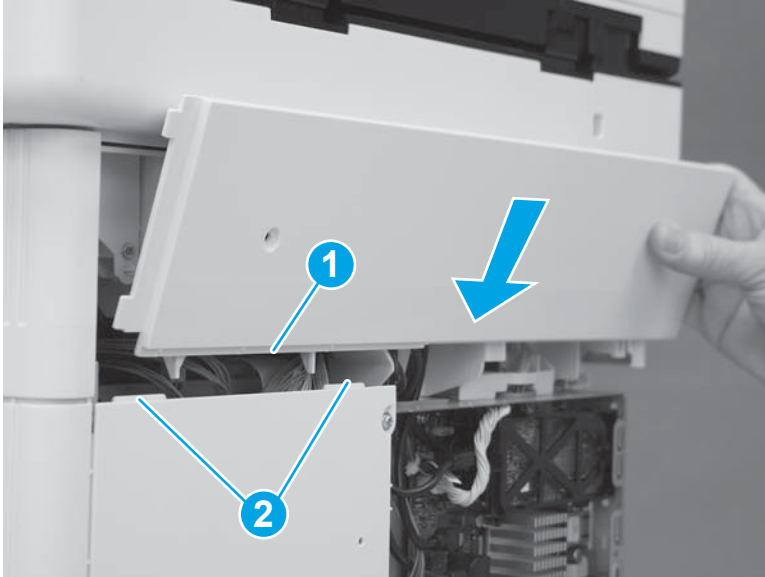

2. Rotate the top of the cover toward the printer.

Figure 1-2145 Rotate the top of the cover

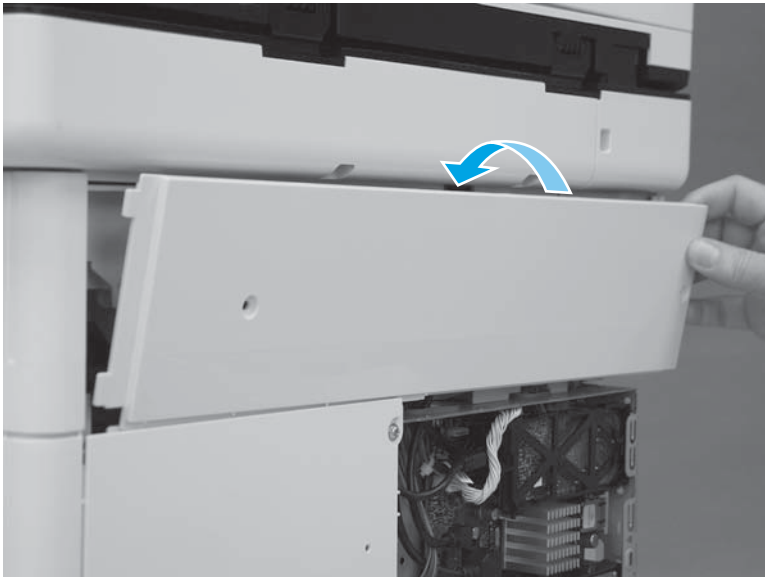

- Slide the cover to the left (callout 1). Make sure that the tabs (callout 2) on the upper rear cover slide behind the edge (callout 3) of the right upper cover. Make sure that the cover is fully seated.

Figure 1-2146 Slide the cover

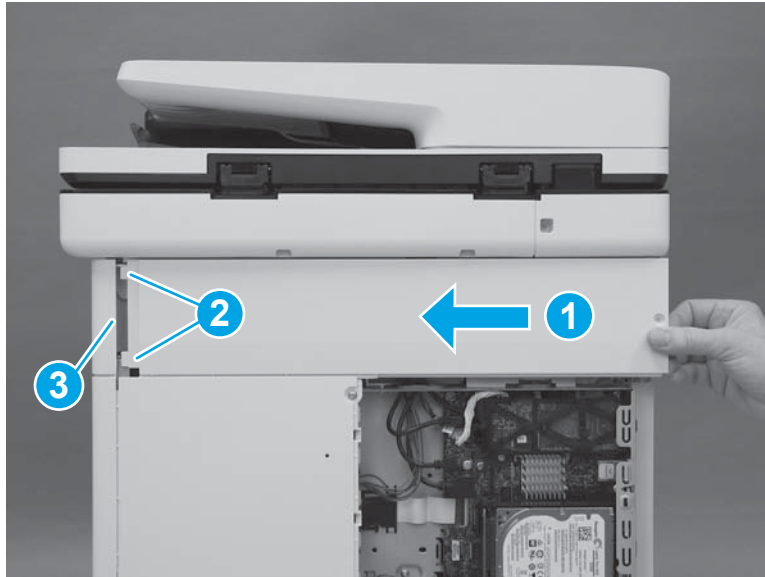

- Install two screws (callout 1).



 **IMPORTANT:** These two screws are self-tapping screws for plastic. Rotate them counterclockwise to align them with the existing thread pattern, and then carefully turn them clockwise to tighten. Do not overtighten. This will prevent stripping the threads inside the screw holes.

Figure 1-2147 Install two screws

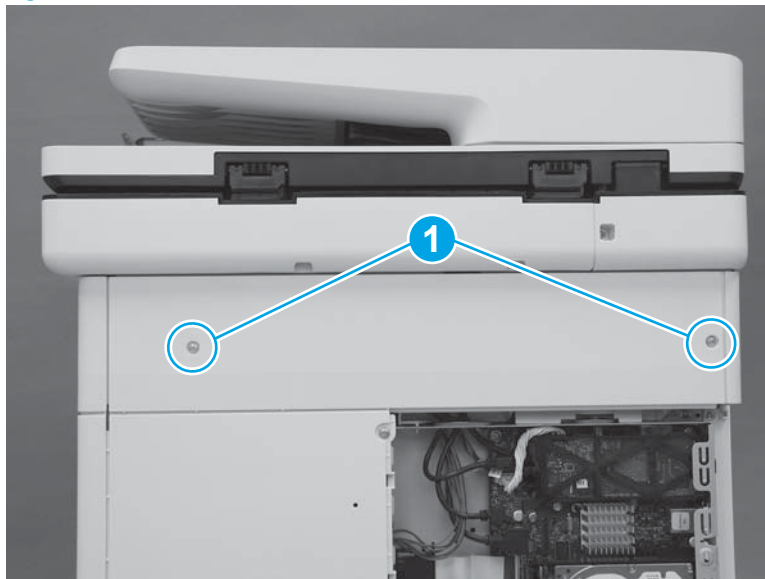

Step 23: Install the rear cover (M552 and M553)

 **NOTE:** This step is for the M552 and M553 models. For the M577 models, skip this step and go to [Step 24: Install the formatter \(M577\) on page 1220](#).

1. Position the top of the cover under the upper cover (callout 1), rotate the bottom of the cover onto the chassis (callout 2), and then slide the cover to the left (callout 3) to install it.

Figure 1-2148 Install the cover

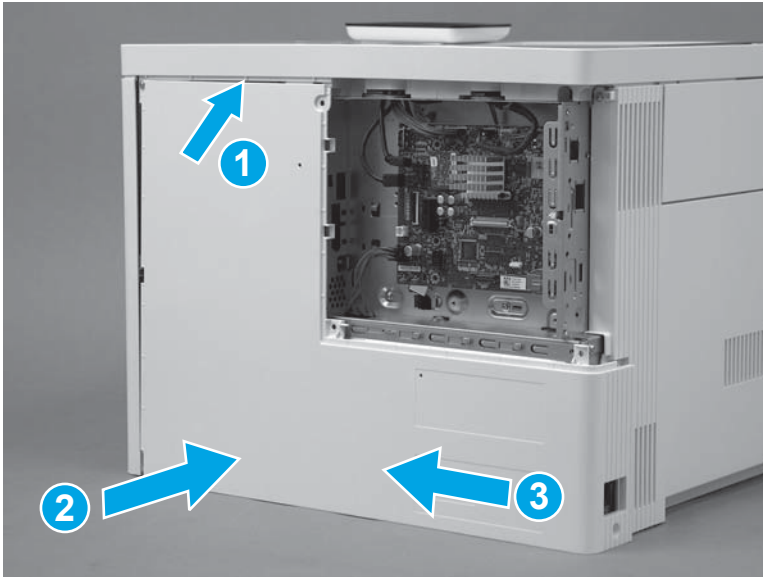

2. Install four screws (callout 1).

Figure 1-2149 Install four screws cover

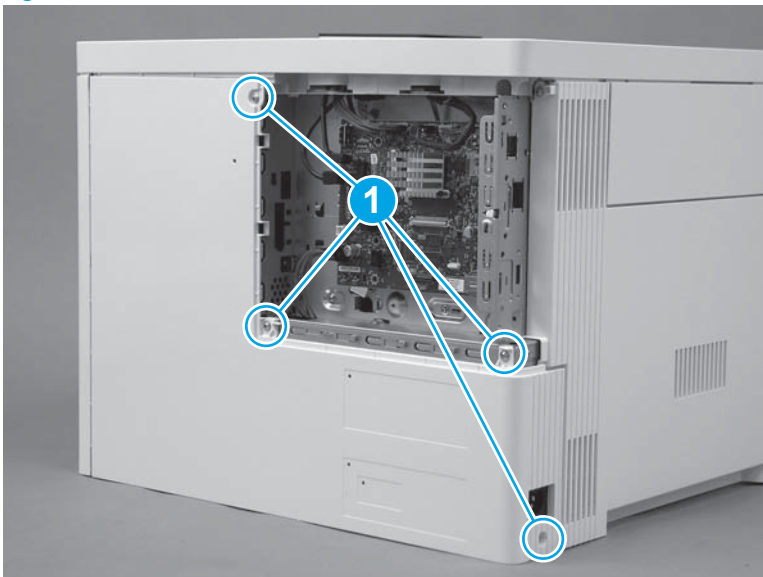

Step 24: Install the formatter (M577)

 **NOTE:** This step is for the M577 models. For the M552 and M553 models, skip this step and to go [Step 27: Install the formatter \(M552 and M553\) on page 1225](#).

 **CAUTION:**  ESD-sensitive part.

1. Position the formatter in the printer. Make sure that the network port (callout 1) fits through the opening (callout 2) in the formatter case.

Figure 1-2150 Install the formatter

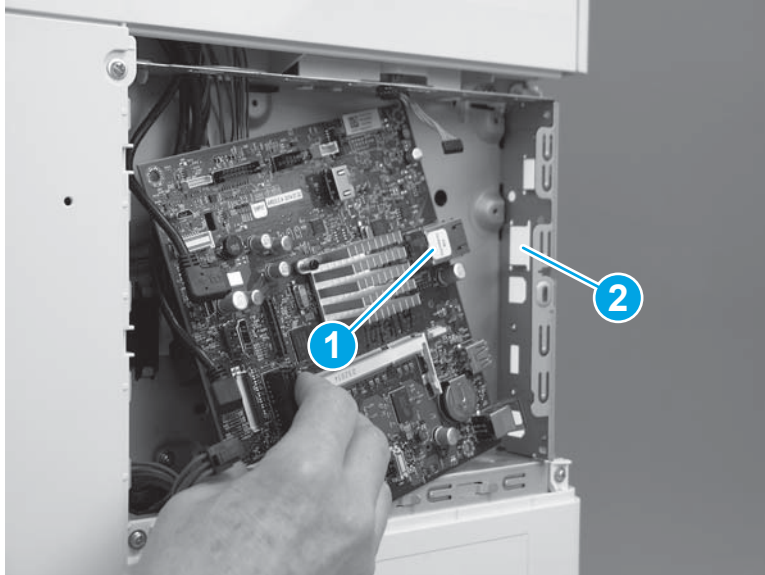

2. Install four screws (callout 1).

Figure 1-2151 Install four screws

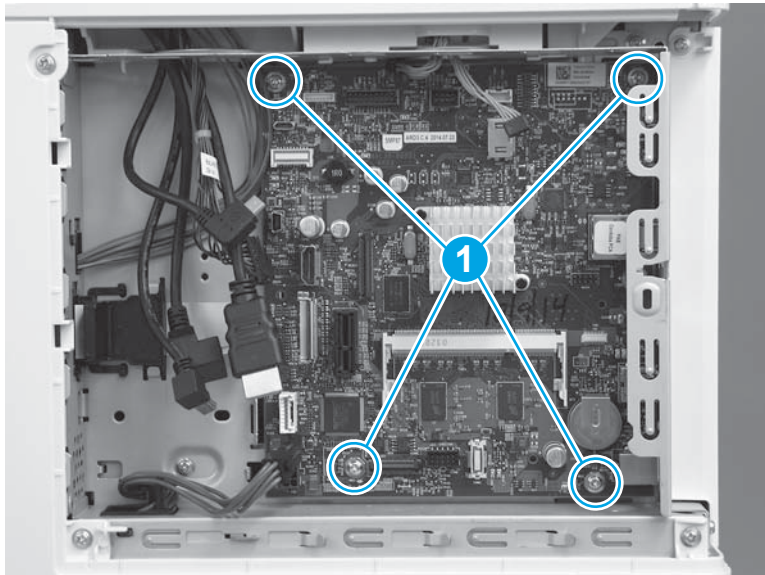

3. Connect all of the connectors on the formatter.

The following connectors are empty:

- All models: J1 (this connector is empty unless the optional DIMM is installed)
- All models: J3
- M577dn: J15 (this is the fax connector for the M577f/z/c models)
- All models: J21 (this connector is empty unless the optional internal USB ports component is installed)
- All models: J23

- All models: J24
- All models: J51
- All models: J57
- All models: J97
- All models: J98 (this connector is empty unless the optional trusted platform module (TPM) is installed)

 **IMPORTANT:** The flat-cable connector (callout 1) is a Zero Insertion Force (ZIF) connector that uses a hinged retainer to secure the flat cable. The hinged retainer must be opened to install the flat cable, and then closed after the cable is installed.

Figure 1-2152 Connect all connectors



Step 25: Install the fax PCA (M577c/f/z)

 **NOTE:** This step is for the M577c/f/z models. For the M577n model, skip this step and go to [Step 26: Install the HDD \(M577\) on page 1224](#).

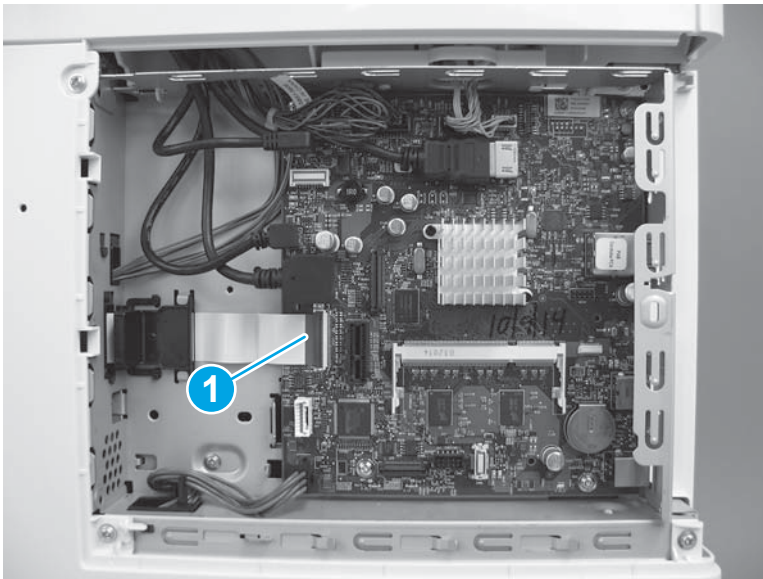
For the M552 and M553 models, skip this step and go to [Step 27: Install the formatter \(M552 and M553\) on page 1225](#).

 **CAUTION:**  ESD-sensitive part.

1. Position the tab and telephone port (callout 1) on the fax PCA in the slots (callout 2) in the formatter case.

Figure 1-2153 Position the fax PCA

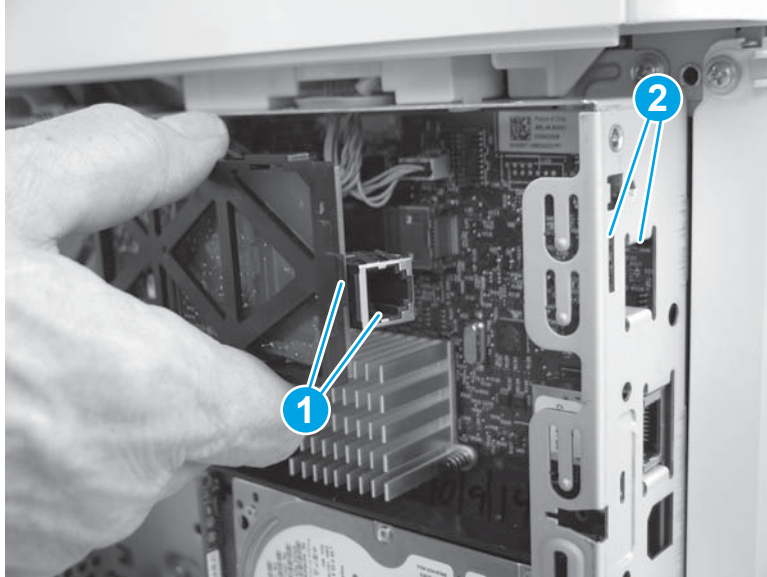

2. Slide the fax PCA to the right (callout 1) until the tab and telephone port described in the previous step and seated in the formatter case. Position the retainer (callout 2) in the slot (callout 3) in the formatter. Rotate the end of the fax PCA toward the formatter (callout 4) until the retainer snaps into place.

Figure 1-2154 Install the fax PCA

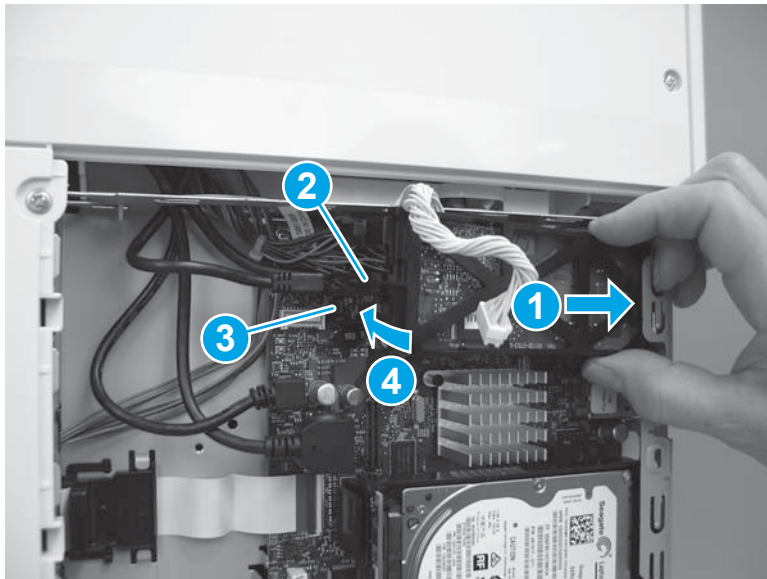

3. Position the cable (callout 1) in the guide (callout 2), and then connect one connector (callout 3).

Figure 1-2155 Connect the connector

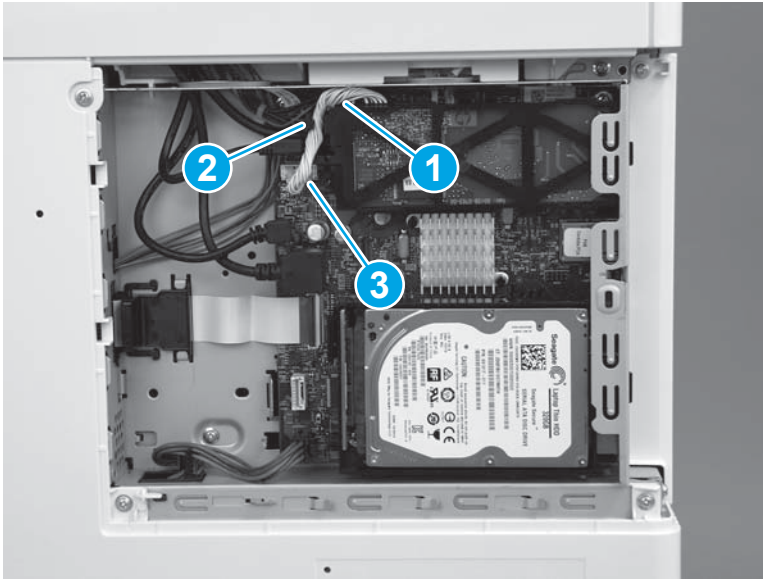

Step 26: Install the HDD (M577)

 **NOTE:** This step is for the M577 models. For the M552 and M553 models, skip this step and go to [Step 27: Install the formatter \(M552 and M553\) on page 1225](#).

 **CAUTION:**  ESD-sensitive part.

1. Align the end of the bracket (callout 1) with the slot in the chassis (callout 2), and then slide the HDD into the printer (callout 3) to engage the bracket with the chassis.

Figure 1-2156 Install the holder

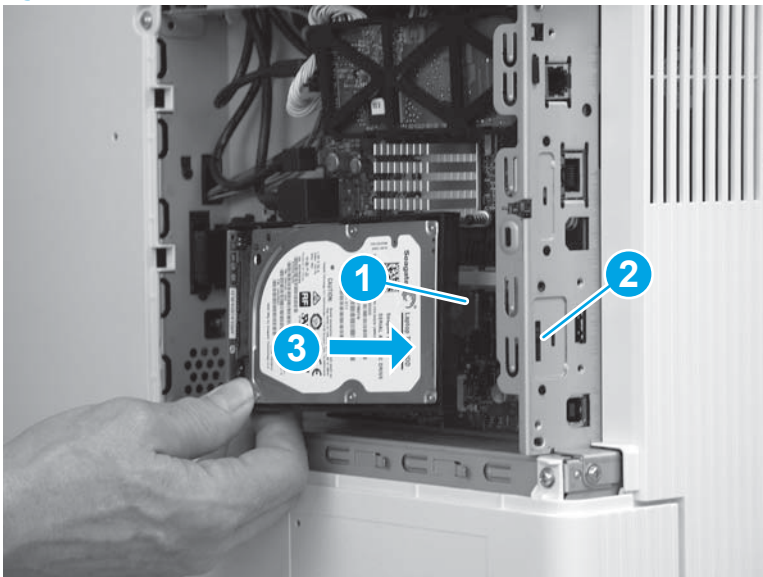

2. Hold the HDD connector latch (callout 1) in the released position, and then rotate the HDD down and into the connector on the formatter to install it.

 **NOTE:** Make sure that the tab (callout 2) snaps into place, and that the HDD is securely installed.

Figure 1-2157 Release the HDD



Step 27: Install the formatter (M552 and M553)

 **NOTE:** This step is for the M552 and M553 models. For the M577 models, skip this step and go to [Step 28: Install the formatter cover on page 1227](#).

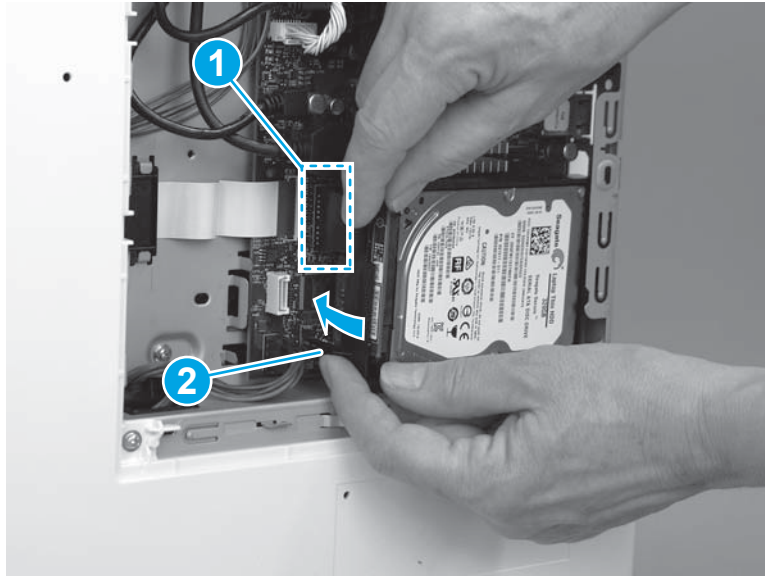
If the optional hard-disk drive (HDD) was removed, do not forget to reinstall it after the formatter is reinstalled.

Engage the HDD holder with the chassis, rotate the HDD connector down and into the connector on the formatter. Make sure that the tabs snap into place.

 **CAUTION:**  ESD-sensitive part.

1. Position the formatter in the printer, and then install four screws (callout 1).

Figure 1-2158 Install the formatter

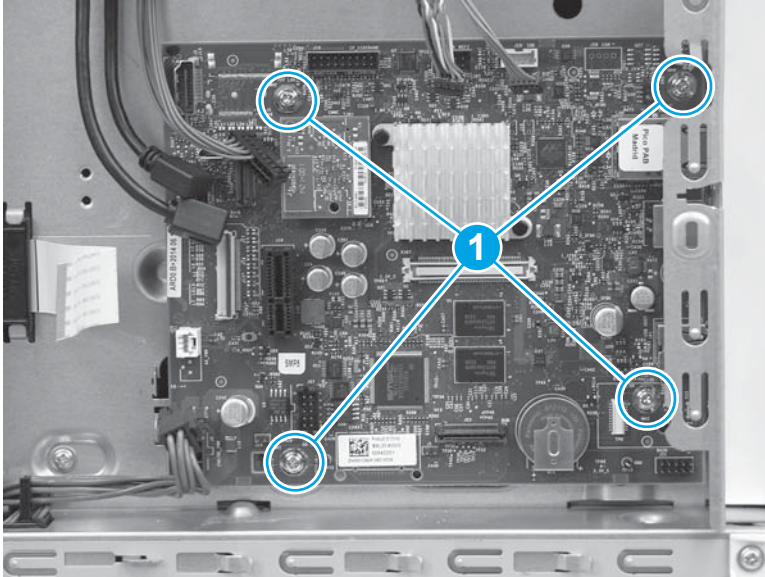

2. Connect all of the connectors on the formatter.

The following connectors are empty:

- All models: J1 (this connector is empty unless the optional DIMM is installed)
- M553n/dn and M552dn: J2 (callout 1; this is the touchscreen connector for the M553x model)
- All models: J9 (this connector is empty unless the optional internal USB ports component is installed)
- All models: J18 (this connector is empty unless the optional hard-disk-drive (HDD) is installed)
- All models: J23
- All models: J24
- M553n/dn and M552dn: J25 (this is the wireless connector for the M553x model)
- All models: J57
- All models: J98 (this connector is empty unless the optional trusted platform module (TPM) is installed)



 **IMPORTANT:** The flat-cable connector (callout 2) is a Zero Insertion Force (ZIF) connector that uses a hinged retainer to secure the flat cable. The hinged retainer must be opened to install the flat cable.

Figure 1-2159 Connect all connectors

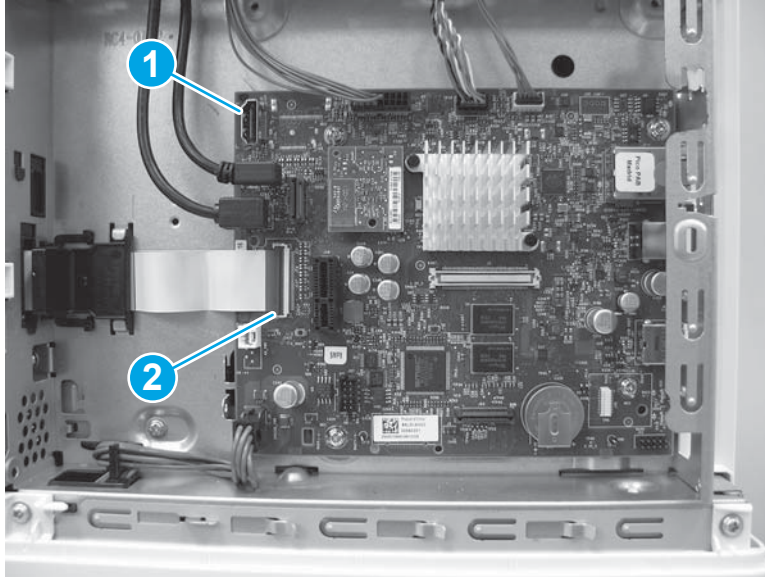

Step 28: Install the formatter cover

- ▲ Slide the cover onto the printer (callout 1) to install it.

 **NOTE:** Make sure that the tabs on the formatter cover align with the slots provided in the printer (callout 2). Tighten the two thumbscrews (callout 3).

 **TIP:** If needed, use the edge of a coin to turn the thumbscrews.

Figure 1-2160 Install the cover

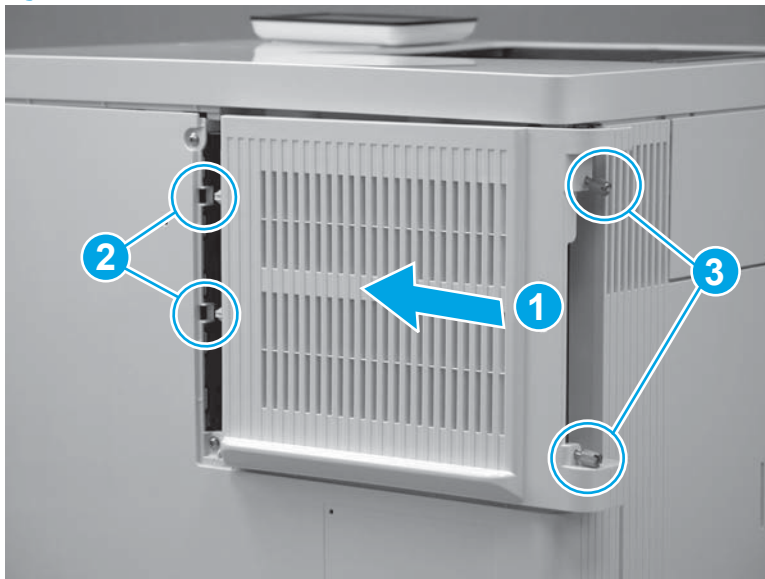

Step 29: Install the TCU

1. Verify that the toner collection hatch cover is in the closed position on the TCU.

Figure 1-2161 Verify that the toner collection hatch cover is closed

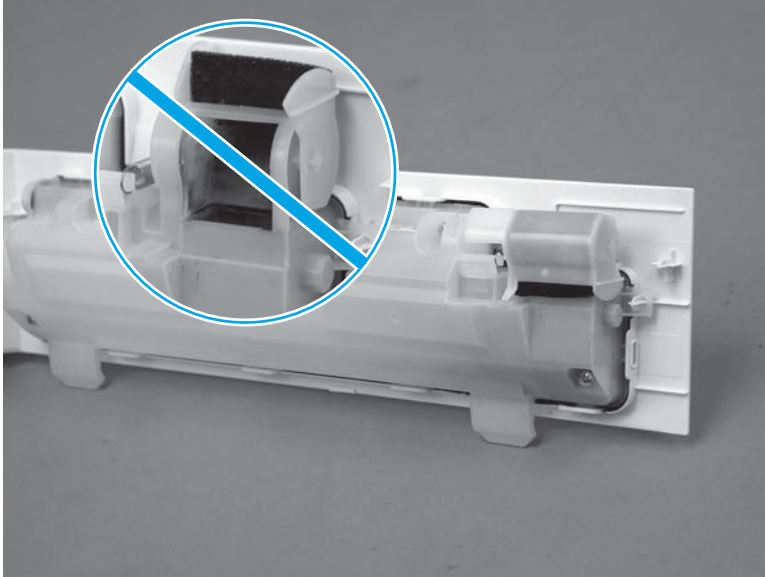

2. Position the TCU with the hinges in the slots provided in the printer (callout 1), and then rotate the TCU up and into the closed position.

 **NOTE:** The toner collection hatch cover automatically opens when the TCU is closed.

Figure 1-2162 Install the TCU

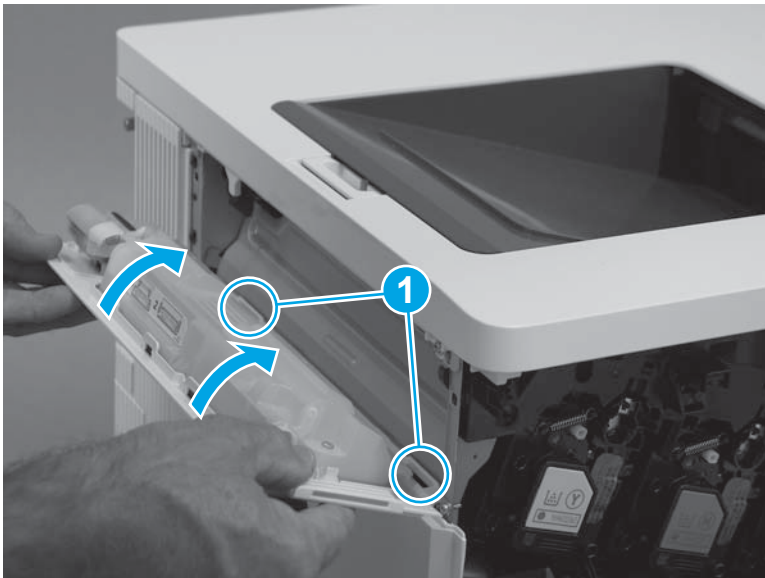

3. Close the front door.

Figure 1-2163 Close the front door



Removal and replacement: Auto close assembly

- [Introduction](#)
- [Step 1: Remove the toner collection unit \(TCU\)](#)
- [Step 2: Remove the formatter cover](#)
- [Step 3: Remove the formatter \(M552 and M553\)](#)
- [Step 4: Remove the hard-disk drive \(HDD\) \(M577\)](#)
- [Step 5: Remove the fax PCA \(M577c/f/z\)](#)
- [Step 6: Remove the formatter \(M577\)](#)
- [Step 7: Remove the rear cover \(M552 and M553\)](#)
- [Step 8: Remove the rear upper cover \(M577\)](#)
- [Step 9: Remove the rear cover \(M577\)](#)
- [Step 10: Remove the left cover](#)
- [Step 11: Remove the formatter case](#)
- [Step 12: Remove the low-voltage power supply \(LVPS\)](#)
- [Step 13: Remove the high-voltage power supply D \(HVPSD\)](#)
- [Step 14: Remove the auto close assembly](#)
- [Step 15: Unpack the replacement assembly](#)
- [Step 16: Install the auto close assembly](#)
- [Step 17: Install the HVPSD](#)
- [Step 18: Install the LVPS](#)
- [Step 19: Install the formatter case](#)
- [Step 20: Install the left cover](#)
- [Step 21: Install the rear cover \(M577\)](#)
- [Step 22: Install the rear upper cover \(M577\)](#)
- [Step 23: Install the rear cover \(M552 and M553\)](#)
- [Step 24: Install the formatter \(M577\)](#)
- [Step 25: Install the fax PCA \(M577c/f/z\)](#)
- [Step 26: Install the HDD \(M577\)](#)
- [Step 27: Install the formatter \(M552 and M553\)](#)
- [Step 28: Install the formatter cover](#)
- [Step 29: Install the TCU](#)

Introduction

This document provides the procedures to remove and replace the auto close assembly.

Before performing service

Turn the printer power off

- Disconnect the power cable.

⚠ WARNING! To avoid damage to the printer, turn the printer off, wait 30 seconds, and then remove the power cord before attempting to service the printer.

Use the table below to identify the correct part number for your printer, and then go to <http://h20141.www2.hp.com/hpparts> to order the part.

Auto close assembly part number	
RM2-5147-000CN	Auto close assembly

Required tools

- #2 Phillips screwdriver with a magnetic tip

After performing service

Make sure that all of the connectors on the HVPSD are fully seated.

Make sure that all of the connectors on the LVPS are fully seated.

Make sure that all of the connectors on the formatter are fully seated.

Make sure that the formatter cover is fully seated, and that the thumbscrews are finger tight after replacing it.

Turn the printer power on

- Connect the power cable.
- Use the power switch to turn the power on.

Step 1: Remove the toner collection unit (TCU)

1. Open the front door.

Figure 1-2164 Open the front door



2. Open the TCU.

 **NOTE:** The toner collection hatch cover automatically closes when the TCU is opened.

Figure 1-2165 Open the TCU



3. Pull the TCU away from the printer at an angle to remove it.

⚠ CAUTION: Do not open the toner collection hatch cover when handling the TCU. If toner gets on clothing, wipe it off by using a dry cloth and wash the clothes in cold water. Hot water sets toner into fabric.

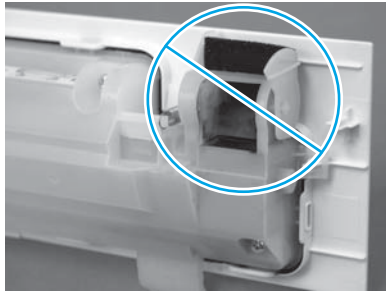
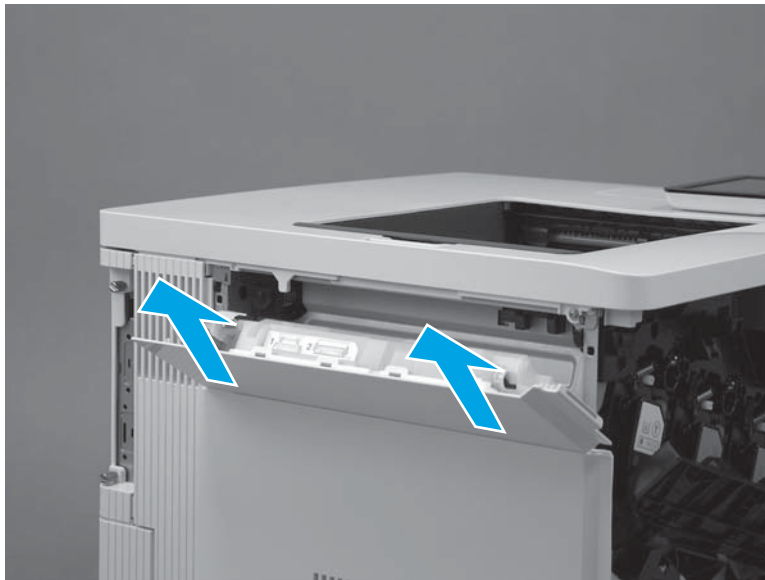

Figure 1-2166 Remove the TCU



Step 2: Remove the formatter cover

1. Locate the formatter cover.

Figure 1-2167 Locate the formatter cover

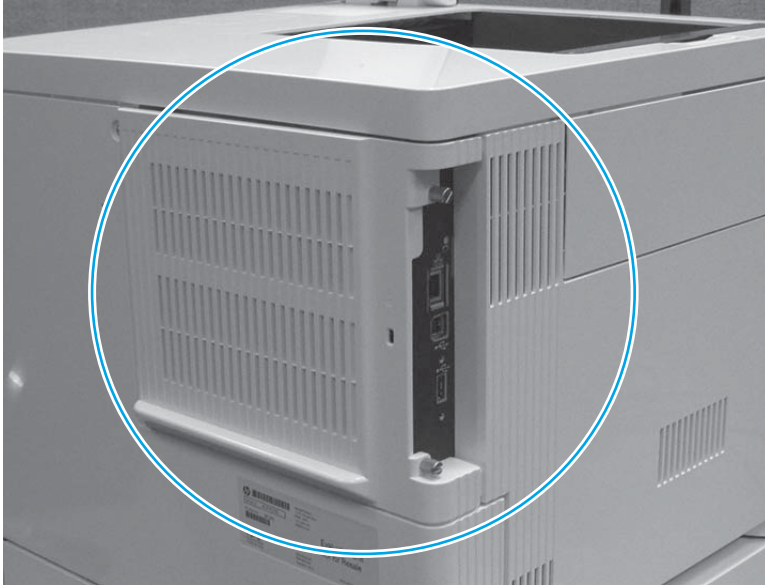

2. Loosen the two thumbscrews (callout 1). Grasp the two thumbscrews, and then slide the cover away from the printer (callout 2) to remove it.

 **TIP:** If needed, use the edge of a coin to turn the thumbscrews.

Figure 1-2168 Loosen the thumbscrews

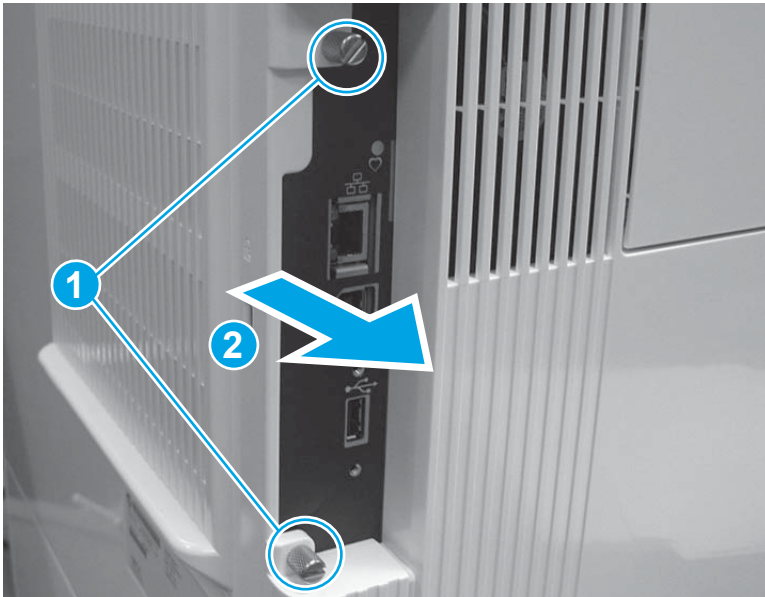

Step 3: Remove the formatter (M552 and M553)

 **NOTE:** This step is for the M552 and M553 models. For the M577 models, skip this step and go to [Step 4: Remove the hard-disk drive \(HDD\) \(M577\) on page 1022](#).

If the optional hard-disk drive (HDD) is installed, it must be removed to gain access to the formatter mounting screws.

Release two tabs along the left edge of the HDD, rotate the left edge away from the product, and then slide the HDD to the left to remove it.

 **CAUTION:**  ESD-sensitive part.

1. Disconnect all of the connectors on the formatter.

The following connectors are empty:

- All models: J1 (this connector is empty unless the optional DIMM is installed)
- M553n/dn and M552dn: J2 (callout 1; this is the touchscreen connector for the M553x model)
- All models: J9 (this connector is empty unless the optional internal USB ports component is installed)
- All models: J18 (this connector is empty unless the optional hard-disk-drive (HDD) is installed)
- All models: J23
- All models: J24
- M553n/dn and M552dn: J25 (this is the wireless connector for the M553x model)
- All models: J57
- All models: J98 (this connector is empty unless the optional trusted platform module (TPM) is installed)

 **IMPORTANT:** The flat-cable connector (callout 2) is a Zero Insertion Force (ZIF) connector that uses a hinged retainer to secure the flat cable. The hinged retainer must be opened to release the flat cable.

Figure 1-2169 Disconnect all connectors



2. Remove four screws (callout 1), and then remove the formatter.

Figure 1-2170 Remove the formatter

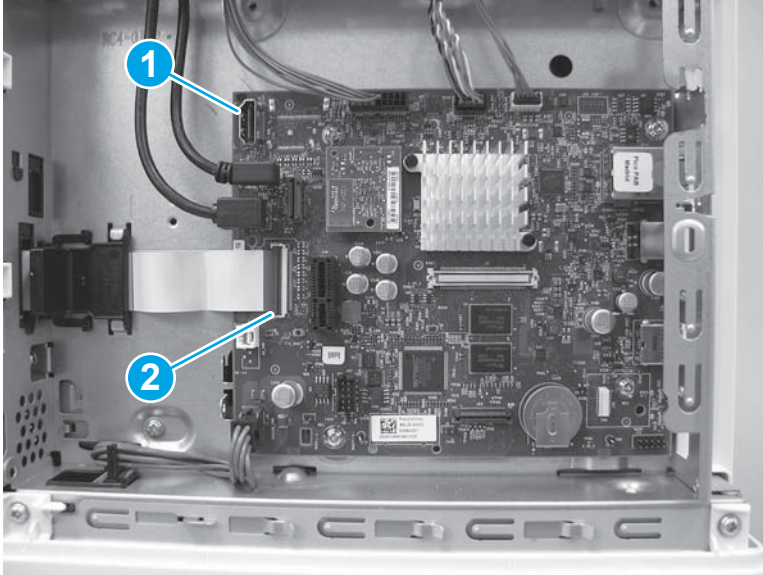
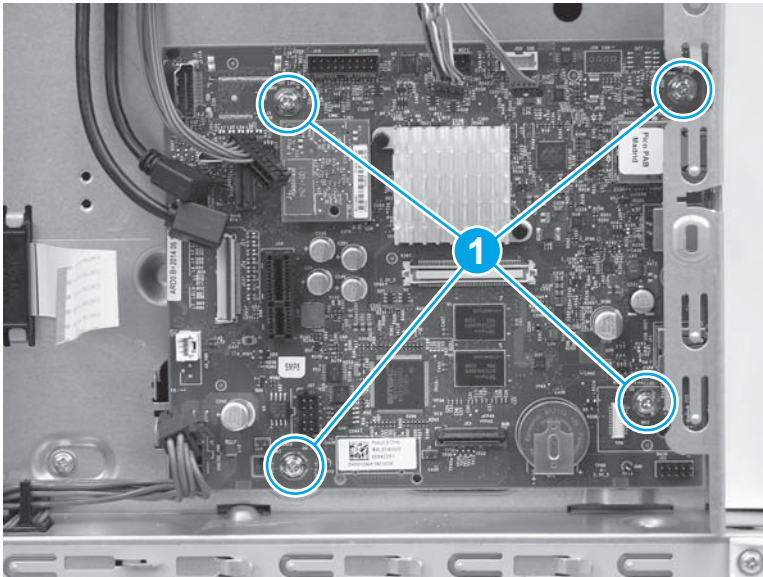

Step 4: Remove the hard-disk drive (HDD) (M577)

 **NOTE:** This step is for the M577 models. For the M552 and M553 models, skip this step and go to [Step 7: Remove the rear cover \(M552 and M553\) on page 1241](#).

 **CAUTION:**  ESD-sensitive part.

1. Release two tabs (callout 1). Hold the tabs in the released position, and then rotate the hard disk drive (HDD) up (callout 2) to release the connector from the formatter.

Figure 1-2171 Release the HDD

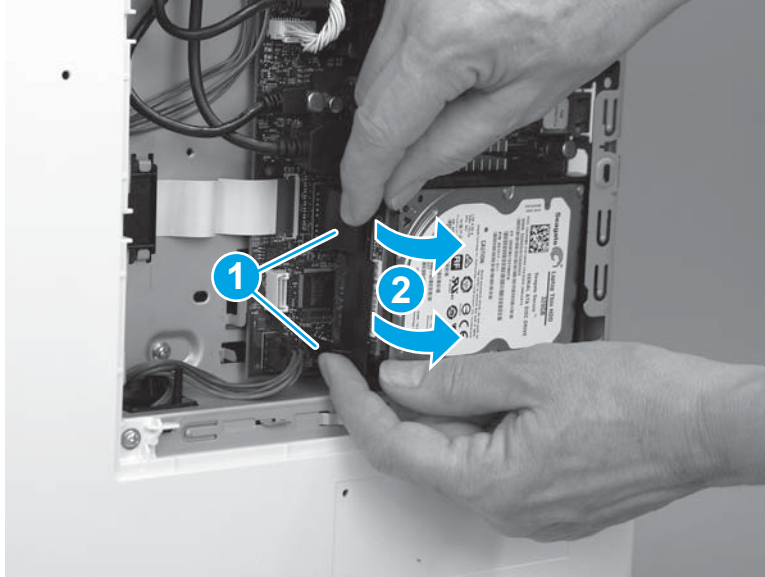

2. Slide the HDD away from the printer to remove it.

Figure 1-2172 Remove the HDD

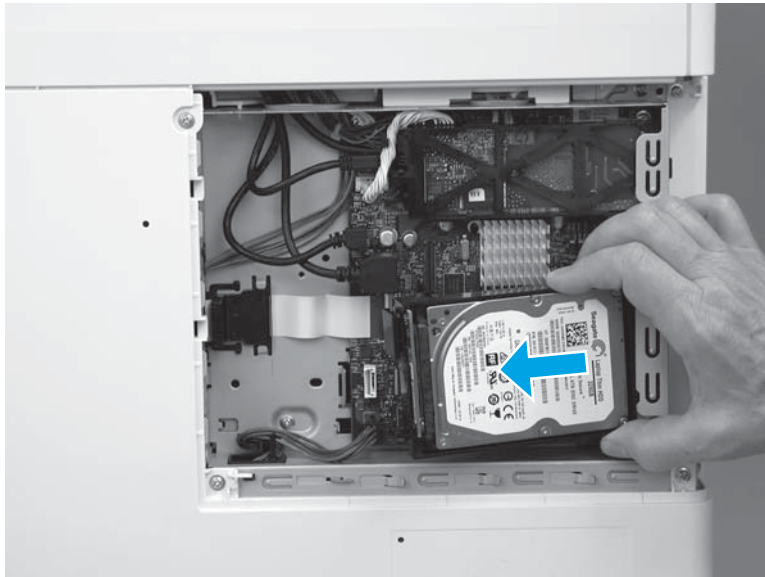

Step 5: Remove the fax PCA (M577c/f/z)

 **NOTE:** This step is for the M577c/f/z models. For the M577n model, skip this step and go to [Step 6: Remove the formatter \(M577\) on page 1239](#).

For the M552 and M553 models, skip this step and go to [Step 7: Remove the rear cover \(M552 and M553\) on page 1241](#).

 **CAUTION:**  ESD-sensitive part.

1. Locate the fax PCA component on the formatter.

Figure 1-2173 Locate the fax PCA

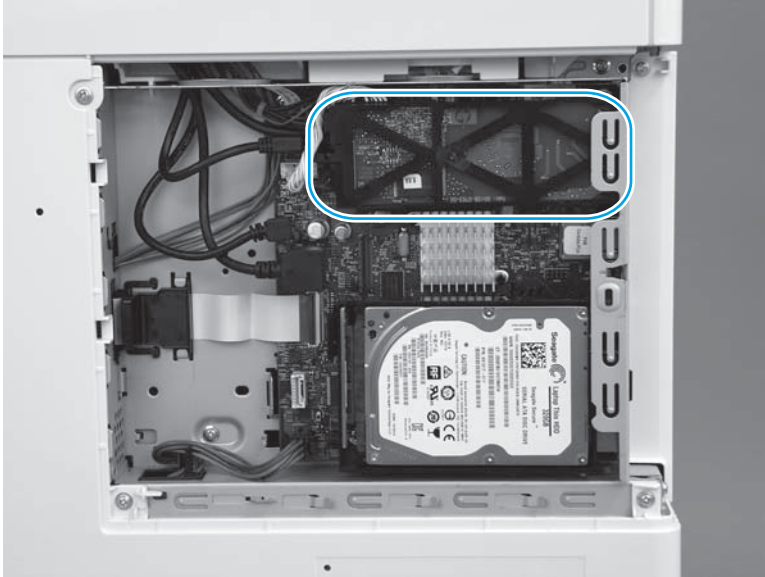

2. Release the connector latch (callout 1), and then pull the connector away from the formatter (callout 2) to disconnect it.

Figure 1-2174 Disconnect one connector

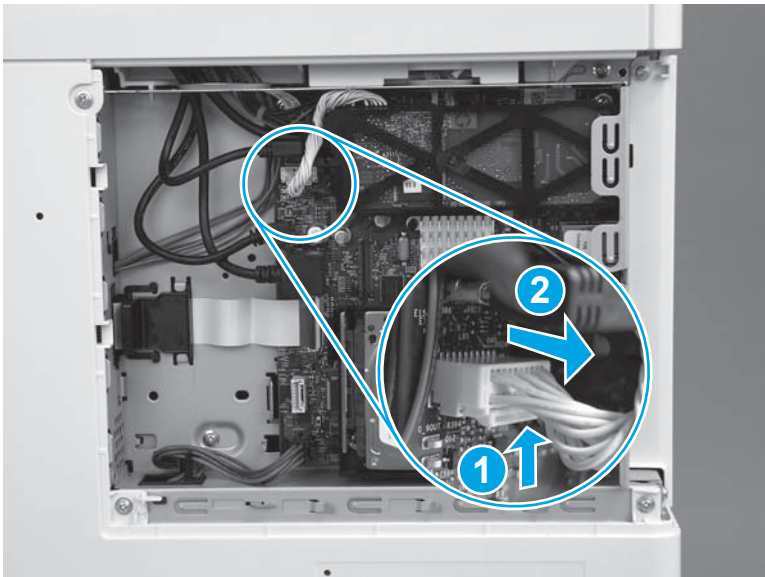

3. Release one retainer (callout 1) by pressing the bracket arms together.

Figure 1-2175 Release one latch

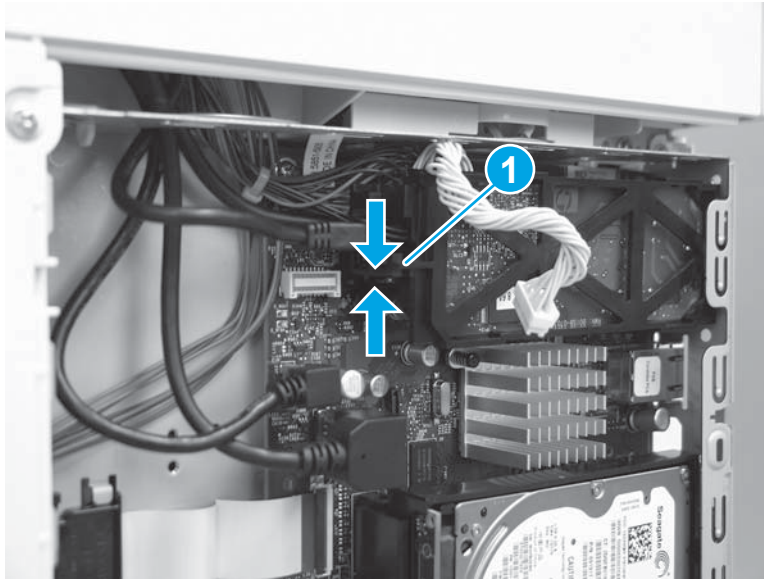

4. Rotate the end of the fax PCA (callout 1) away from the formatter, and then slide the PCA left (callout 2) to remove it.

Figure 1-2176 Remove the fax PCA

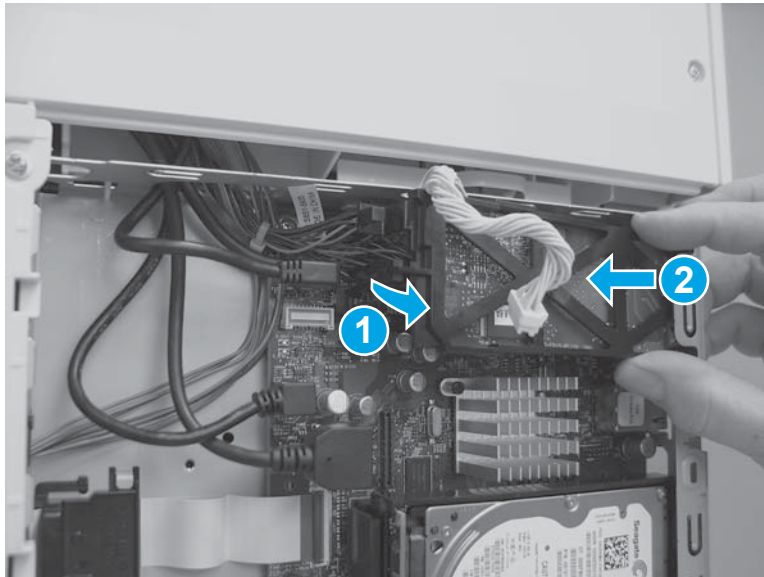

Step 6: Remove the formatter (M577)

 **NOTE:** This step is for the M577 models. For the M552 and M553 models, skip this step and go to [Step 7: Remove the rear cover \(M552 and M553\) on page 1241.](#)

 **CAUTION:**  ESD-sensitive part.

1. Disconnect all of the connectors on the formatter.

The following connectors are empty:

- All models: J1 (this connector is empty unless the optional DIMM is installed)
- All models: J3
- M577dn: J15 (this is the fax connector for the M577f/z/c models)
- All models: J21 (this connector is empty unless the optional internal USB ports component is installed)
- All models: J23
- All models: J24
- All models: J51
- All models: J57
- All models: J97
- All models: J98 (this connector is empty unless the optional trusted platform module (TPM) is installed)

 **IMPORTANT:** The flat-cable connector (callout 1) is a Zero Insertion Force (ZIF) connector that uses a hinged retainer to secure the flat cable. The hinged retainer must be opened to release the flat cable.

Figure 1-2177 Disconnect all connectors



2. Remove four screws (callout 1).

Figure 1-2178 Remove four screws

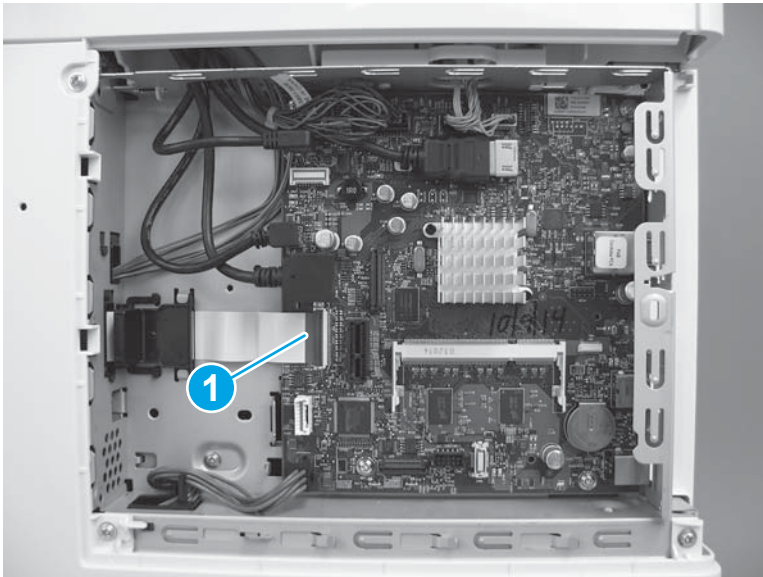
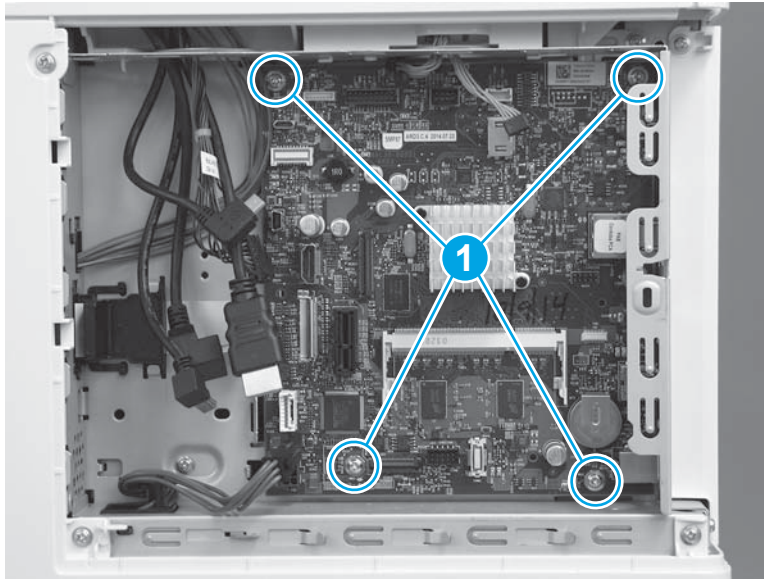

3. Remove the formatter.

Figure 1-2179 Remove the formatter

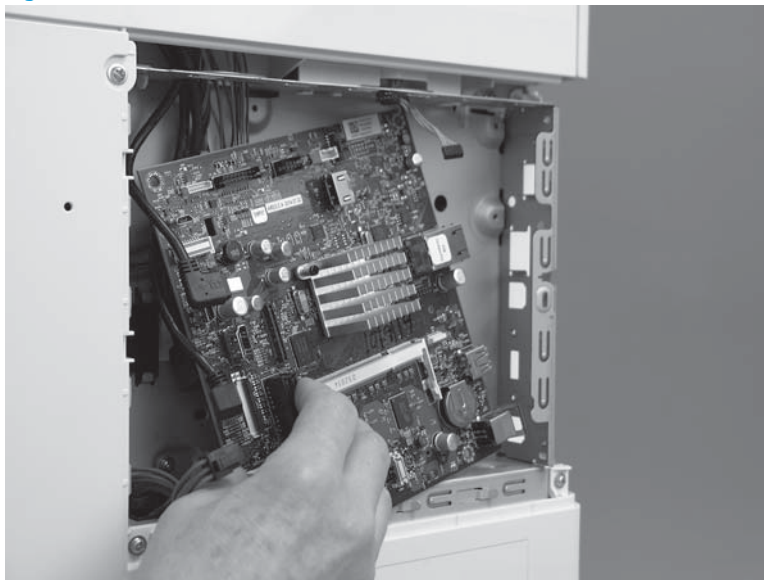

Step 7: Remove the rear cover (M552 and M553)

 **NOTE:** This step is for the M552 and M553 models. For the M577 models, skip this step and go to [Step 8: Remove the rear upper cover \(M577\) on page 1242.](#)

1. Remove four screws (callout 1).

Figure 1-2180 Remove four screws

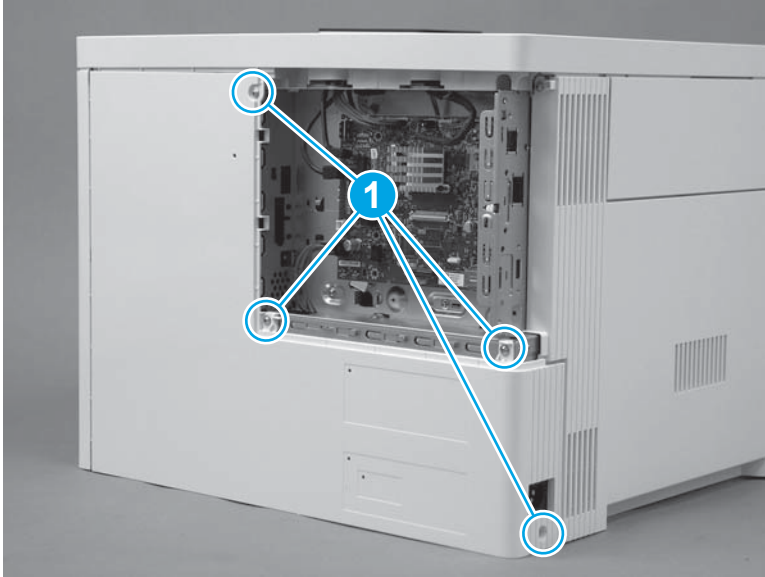

2. Slightly slide the cover to the right (callout 1), rotate the bottom of the cover away from the printer (callout 2), and then pull the top of the cover away from the printer (callout 3) to remove the cover.

Figure 1-2181 Remove the cover

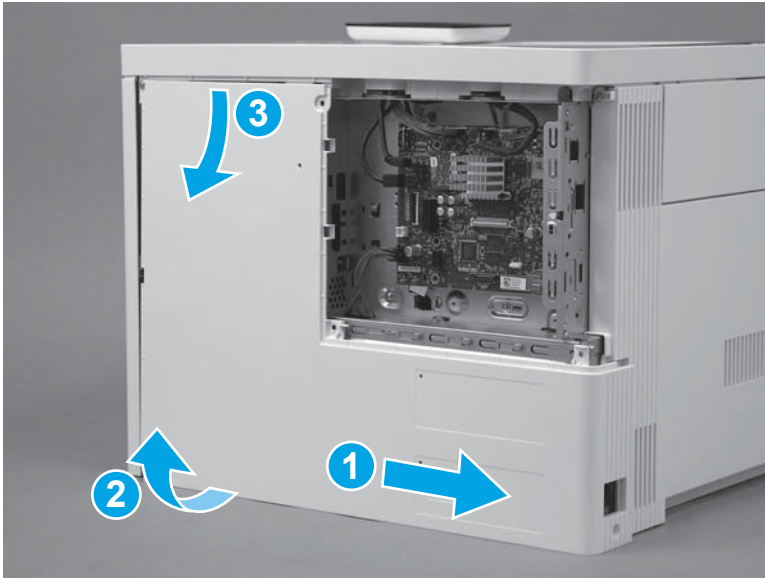

Step 8: Remove the rear upper cover (M577)

 **NOTE:** This step is for the M577 models. For the M552 and M553 models, skip this step and go to [Step 10: Remove the left cover on page 1245](#).

1. Remove two screws (callout 1).

 **Reinstallation tip:** These two screws are self-tapping screws for plastic. When reinstalling them, rotate the screws counterclockwise to align them with the existing thread pattern, and then carefully turn them clockwise to tighten. Do not overtighten. This will prevent stripping the threads inside the screw holes.

Figure 1-2182 Remove two screws



2. Use a small, flat blade screwdriver to release the right edge of the cover.

Figure 1-2183 Release the right edge

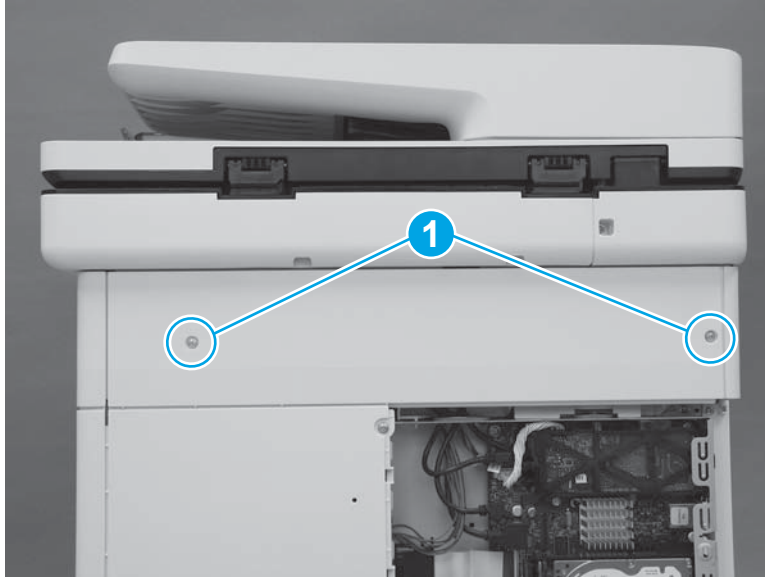
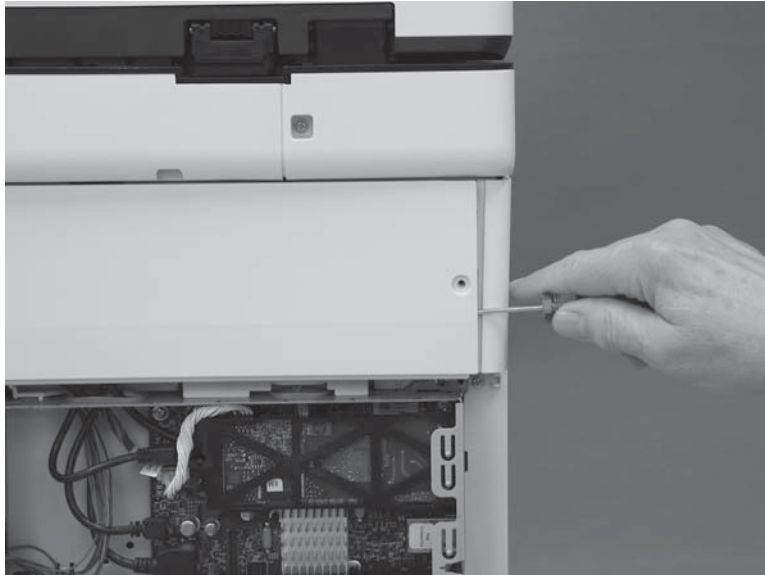

3. Pull the right edge of the cover (callout 1) away from the printer, and then slide the cover to the right (callout 2).

Figure 1-2184 Slide the cover right

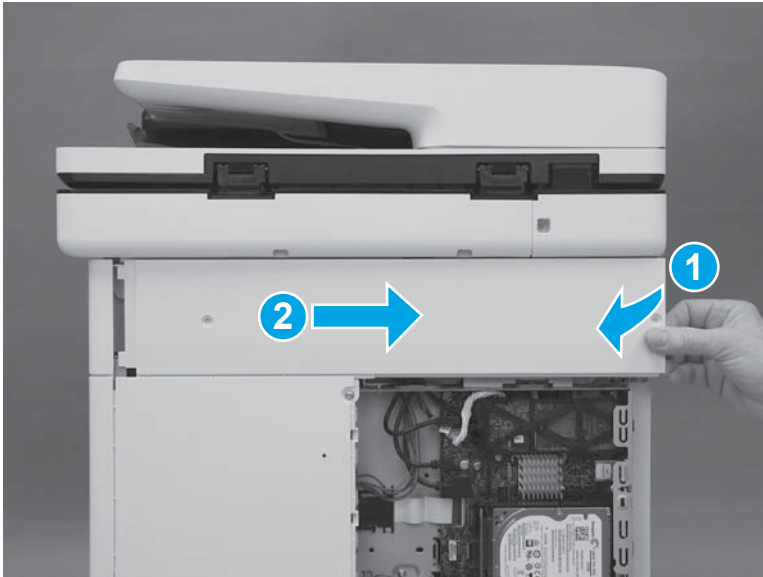

4. Remove the cover.

Figure 1-2185 Remove the cover

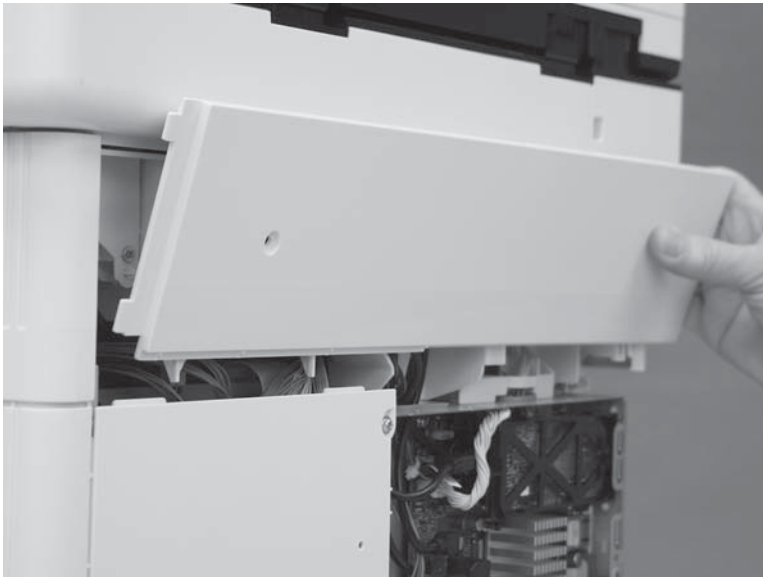

Step 9: Remove the rear cover (M577)

 **NOTE:** This step is for the M577 models. For the M552 and M553 models, skip this step and go to [Step 10: Remove the left cover on page 1245](#).

1. Remove four screws (callout 1).

Figure 1-2186 Remove four screws

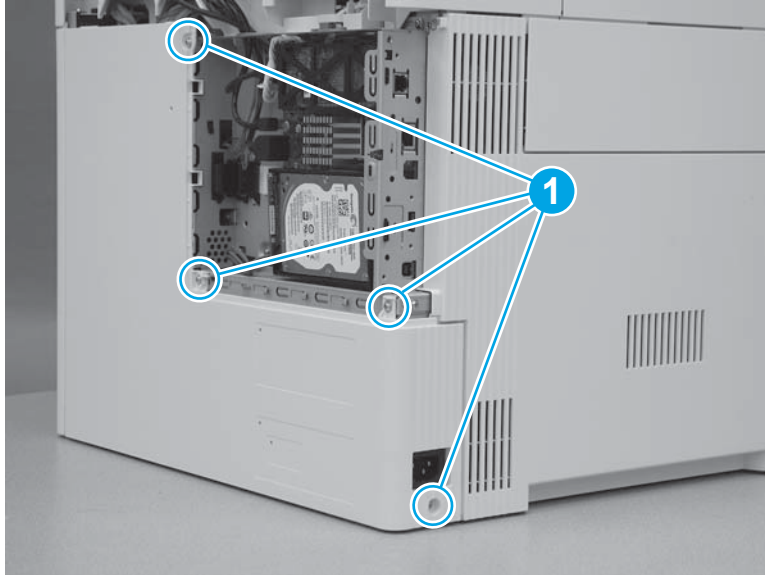

2. Slide the cover to the right to remove it.

Figure 1-2187 Remove the cover

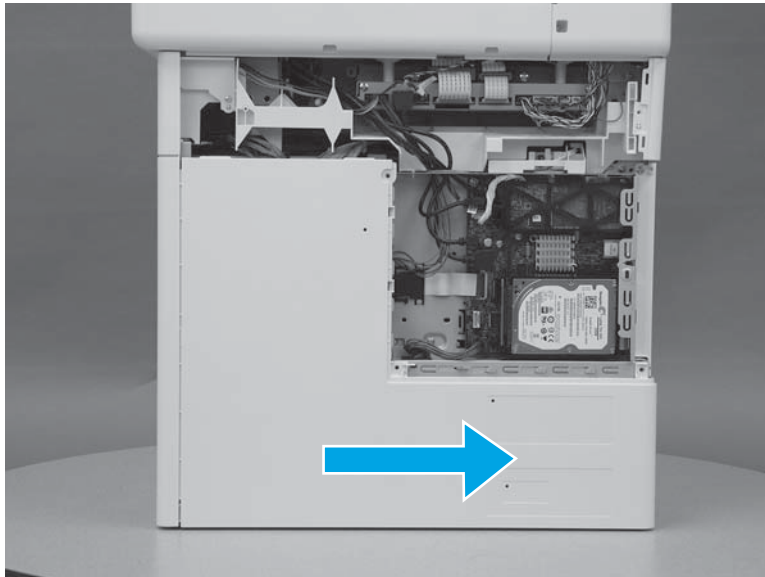

Step 10: Remove the left cover

1. At the left side of the printer, remove one screw (callout 1).

Figure 1-2188 Remove one screw



2. Release one tab (callout 1), rotate the front edge of the cover away from the printer (callout 2), and then slide the cover (callout 3) toward the rear of the printer to release it.

Figure 1-2189 Release the cover

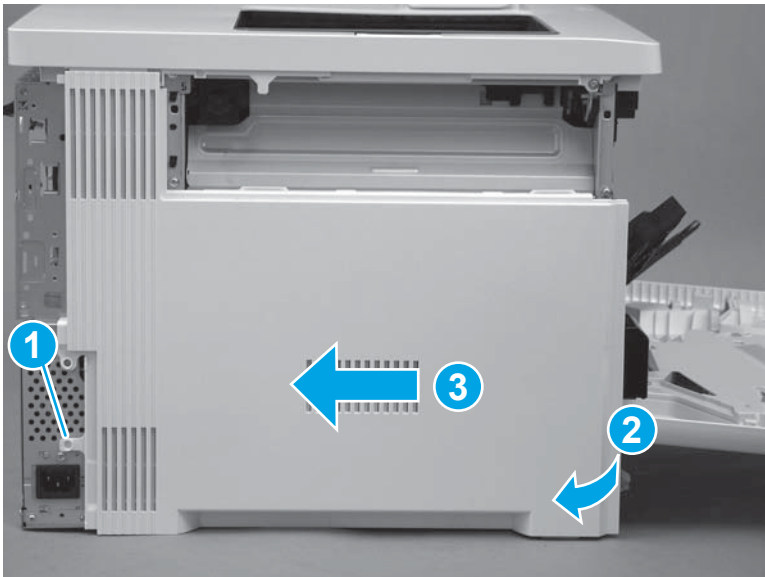

3. Remove the cover.

Figure 1-2190 Remove the cover

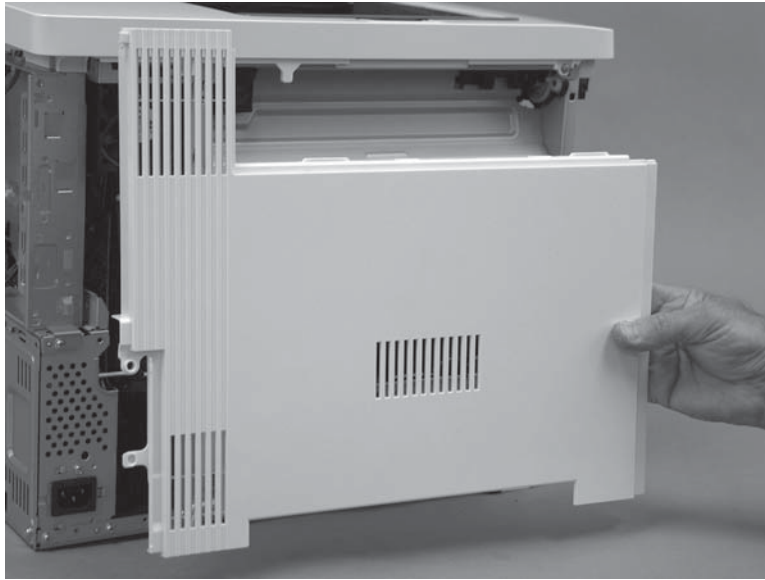

Step 11: Remove the formatter case

1. **M577 only:** Disconnect one connector (callout 1), and then pass the wire harness (callout 2) through two openings in the formatter case (callout 3).

Figure 1-2191 Disconnect one connector

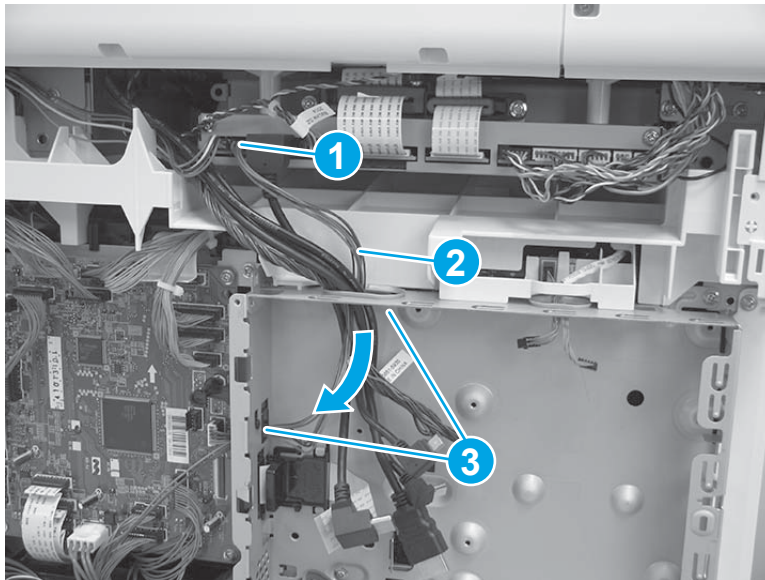

2. Release two tabs (callout 1) on the black plastic bracket. Hold the tabs in the released position, and then slide the bracket (callout 2) to the right to remove it from the formatter case.

Figure 1-2192 Remove the bracket

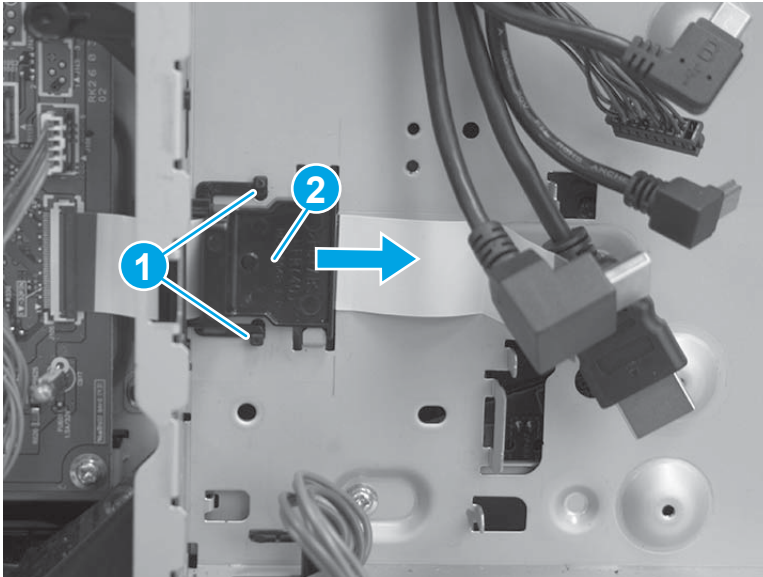

3. Remove two screws (callout 1), and then slide the low-voltage power supply (LVPS) cover to the right to remove it.

Figure 1-2193 Remove the LVPS cover

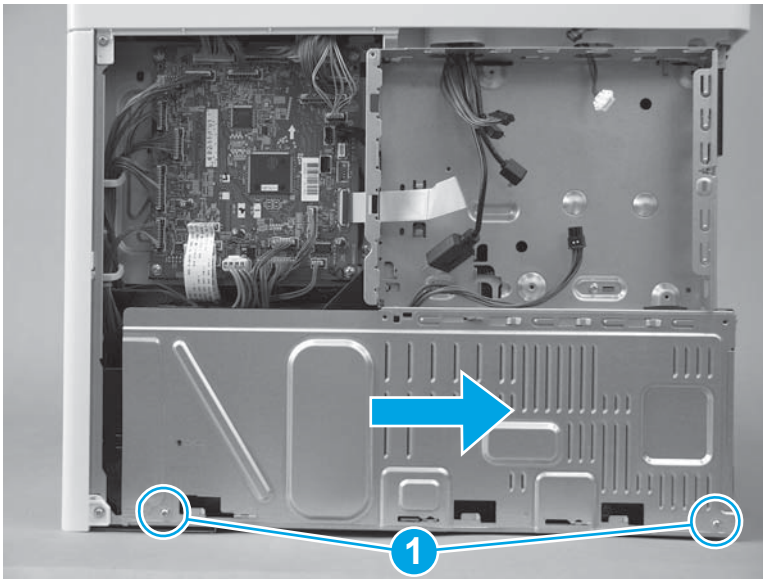

4. Pass two wire harnesses and one flat cable (callout 1) through the opening in the formatter case, and then release one wire harness from the retainer (callout 2).

⚠ CAUTION: The flat cable might be attached to the formatter case with double-sided tape. Make sure that this tape is released, so that the flat cable is not damaged when the formatter case is removed.

Figure 1-2194 Release wire harnesses and flat cable

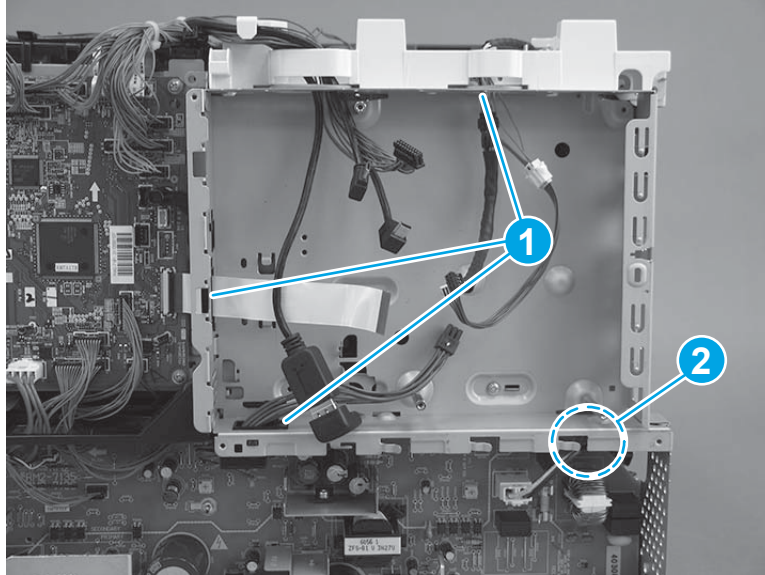

5. Remove six screws (callout 1).

Figure 1-2195 Remove six screws

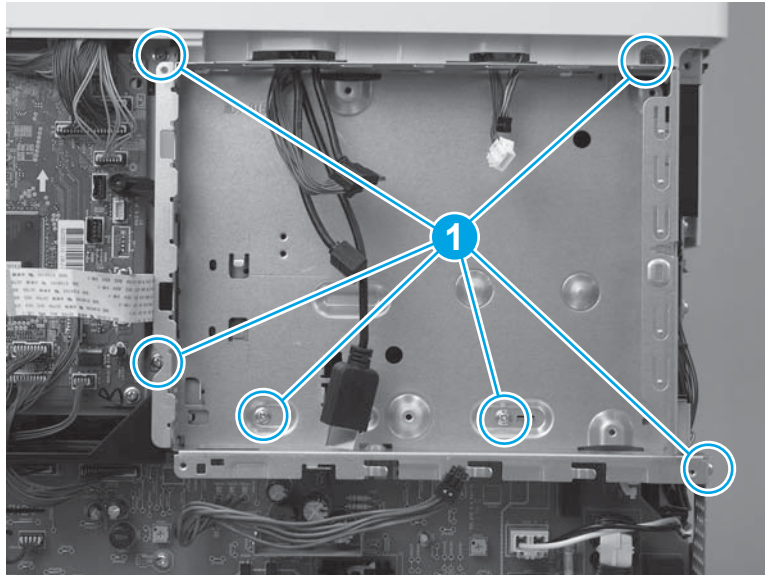

6. Rotate the bottom of the formatter case away from the printer (callout 1), and then pull it down (callout 2) to release it.

Figure 1-2196 Release the formatter case

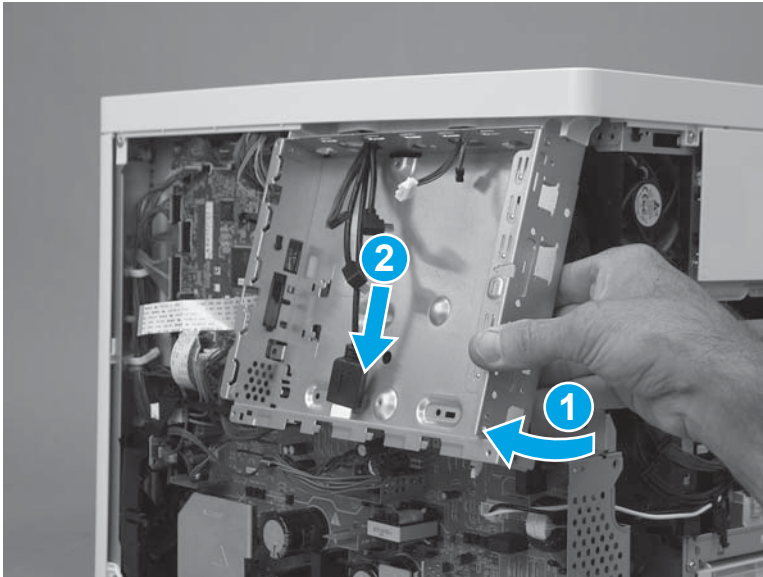

7. Pass the wire harnesses through the opening in the formatter case to remove it.

 **IMPORTANT:** If the formatter case is removed so that it can be replaced, make sure to transfer the memory PCA (island of data) and plastic bracket (callout 1) to the replacement case.

Figure 1-2197 Remove the formatter case



Step 12: Remove the low-voltage power supply (LVPS)

 **CAUTION:**  ESD-sensitive part.

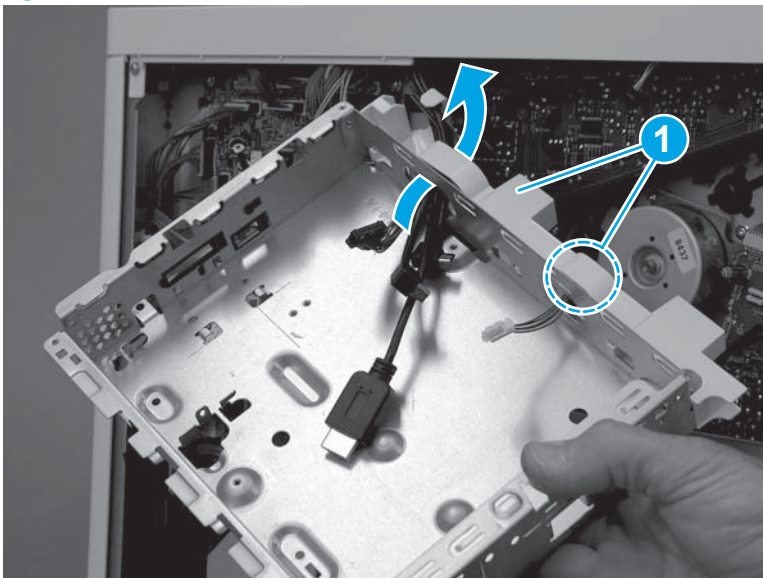
1. Disconnect one wire harness (callout 1), and then pass the wire harness through the opening (callout 2) in the chassis.

Figure 1-2198 Disconnect one wire harness

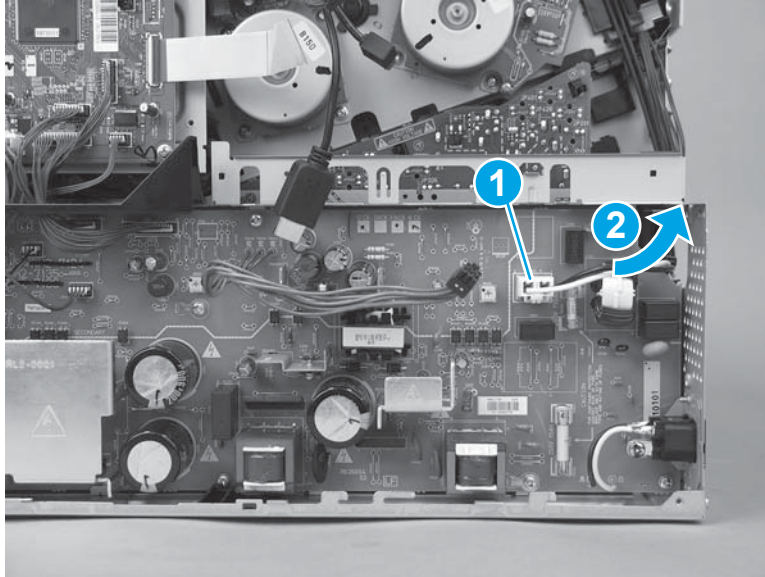

2. Disconnect three connectors on the DC controller (callout 1), and then disconnect four connectors (callout 2) on the LVPS.

Figure 1-2199 Disconnect seven connectors

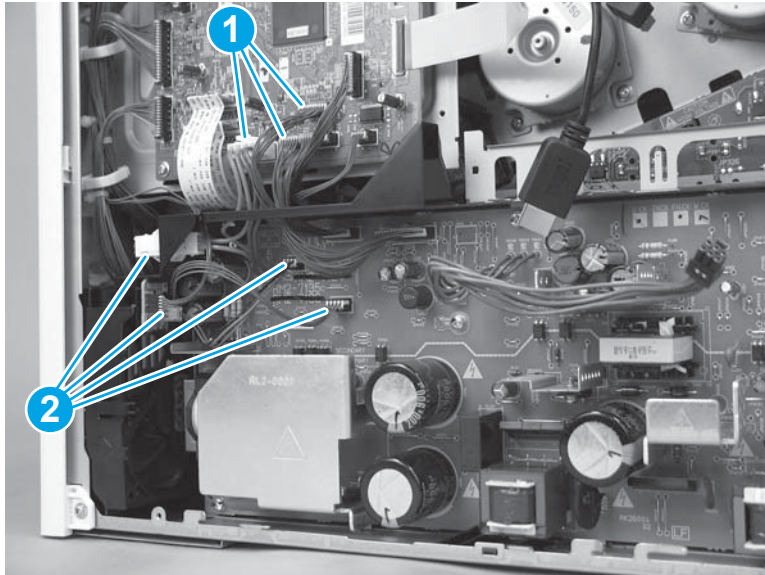

3. Pass the wire harnesses from the DC controller to the LVPS through the opening in the chassis (callout 1), and then release the wire harnesses from the retainer (callout 2).

Figure 1-2200 Pass the wire harnesses through the opening

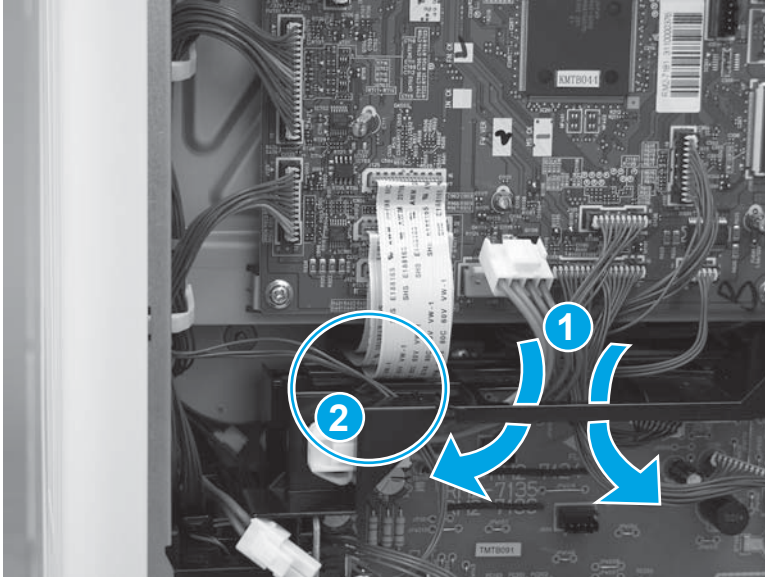

4. Remove three screws (callout 1).

Figure 1-2201 Remove three screws

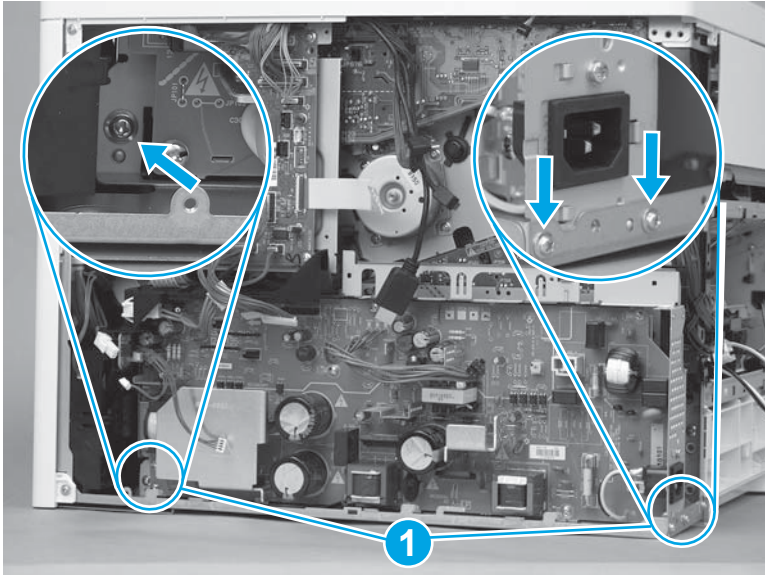

5. Rotate the top of the LVPS away from the printer (callout 1), and then slide it up and out (callout 2) of the printer to remove it.

Figure 1-2202 Remove the LVPS

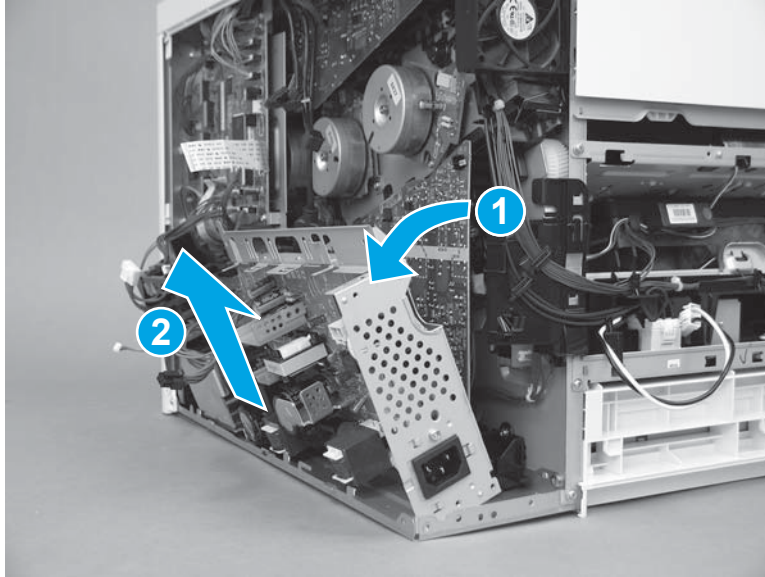

Step 13: Remove the high-voltage power supply D (HVPSD)

 **CAUTION:**  ESD-sensitive part.

1. Disconnect one flat cable (callout 1) on the DC controller.

Figure 1-2203 Disconnect one flat cable

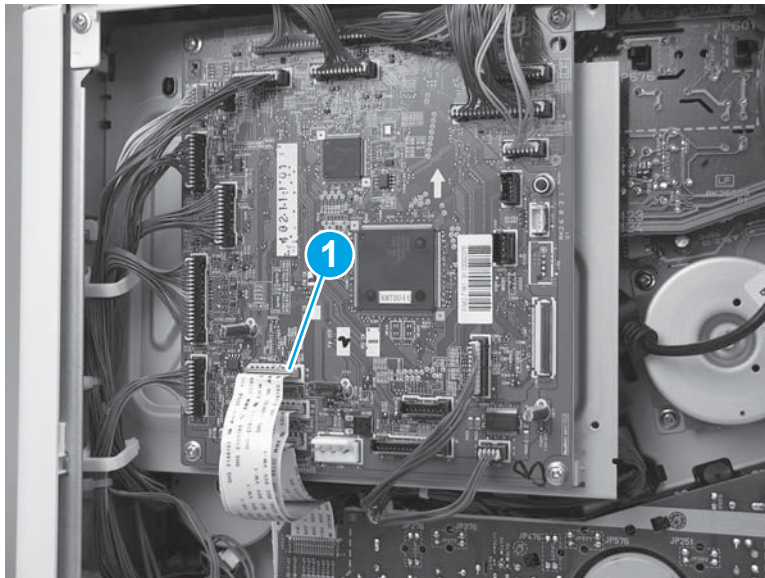

2. Remove two screws (callout 1), and then remove one self tapping screw (callout 2) on the HVPSD.

Figure 1-2204 Remove three screws

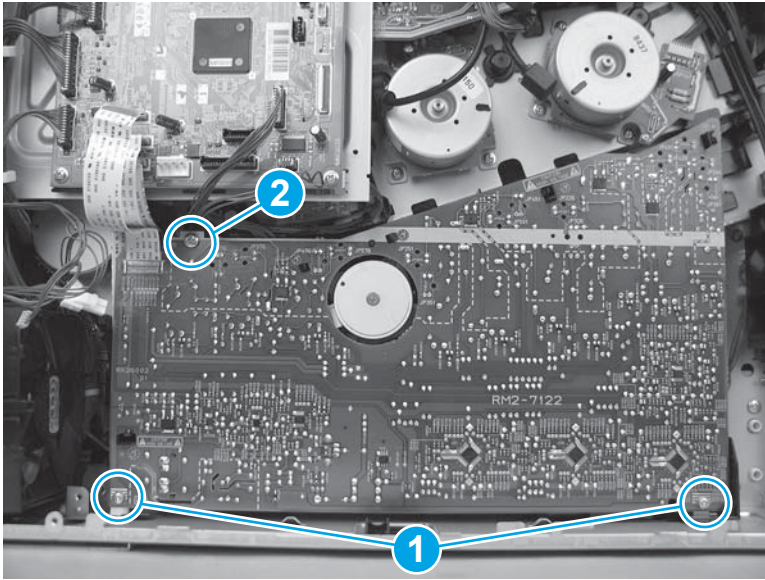

3. Release five tabs (callout 1), and then remove the HVPSD (callout 2).

Figure 1-2205 Remove the HVPSD

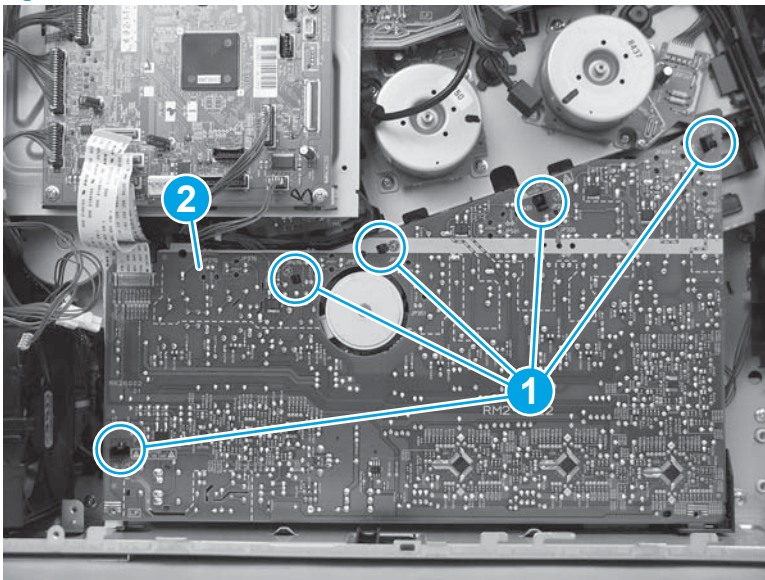

Step 14: Remove the auto close assembly

- ▲ Disconnect four connectors (callout 1/2), remove two screws (callout 3), and then remove the auto close assembly (callout 4).

Figure 1-2206 Remove the assembly

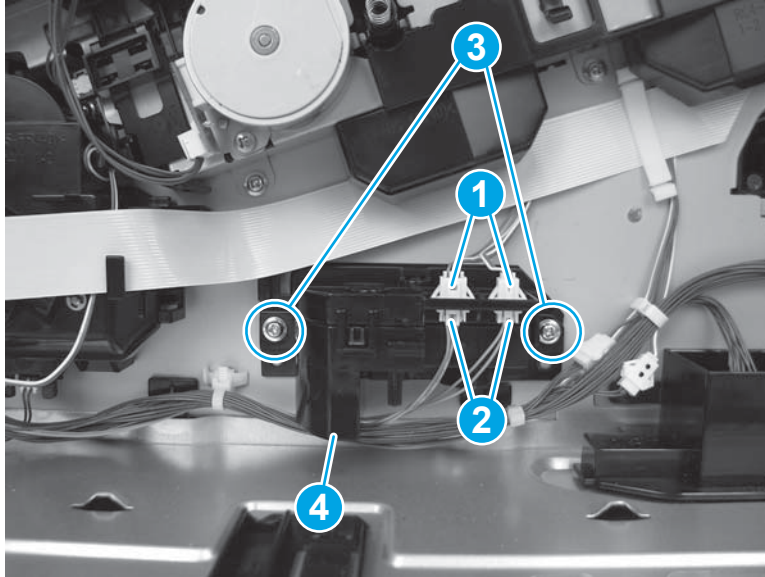

Step 15: Unpack the replacement assembly

Unpack the replacement assembly from the packaging.

For complete information on HP's recycling programs, go to [Product return and recycling](#).

 **NOTE:** HP recommends responsible disposal of the defective assembly.

Figure 1-2207 Recycle and unpack

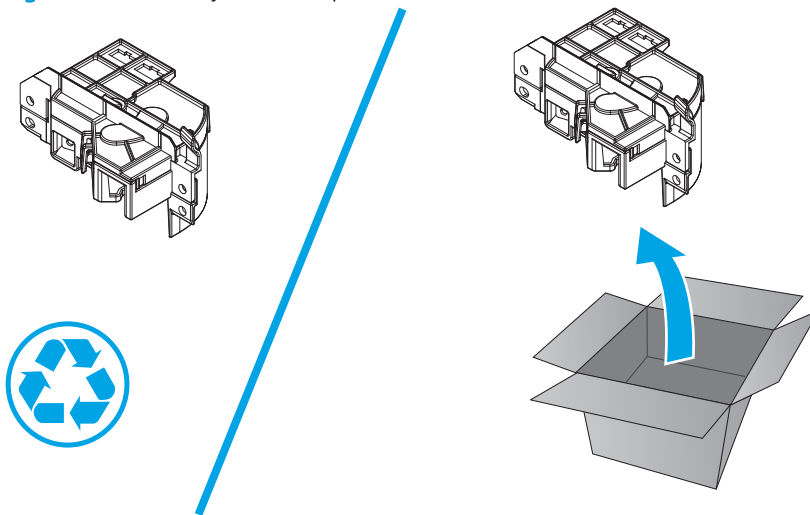

Step 16: Install the auto close assembly

- ▲ Position the auto close assembly on the printer, install two screws (callout 1), and then connect four connectors (callout 2/3).

Figure 1-2208 Install the assembly

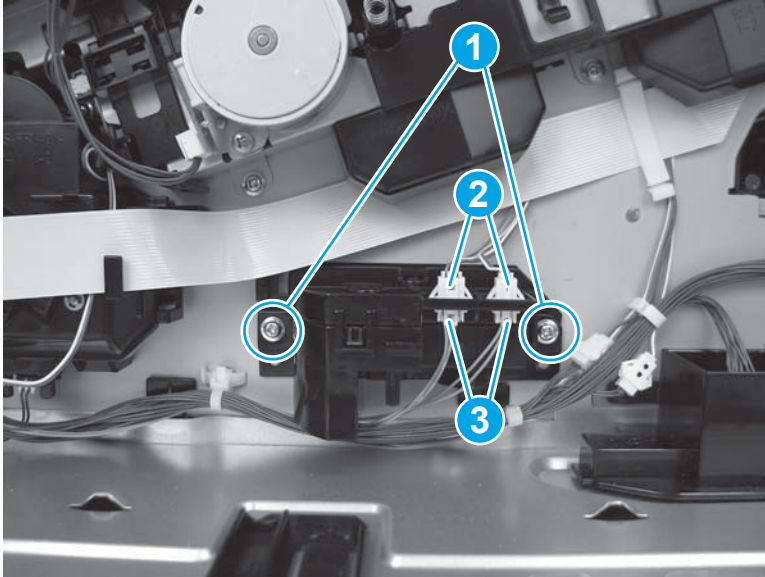

Step 17: Install the HVPSD

 **CAUTION:**  ESD-sensitive part.

1. Position the bottom right corner of the HVPSD (callout 1) behind the black tab, and then rotate it up and onto the printer (callout 2).

Figure 1-2209 Install the HVPSD

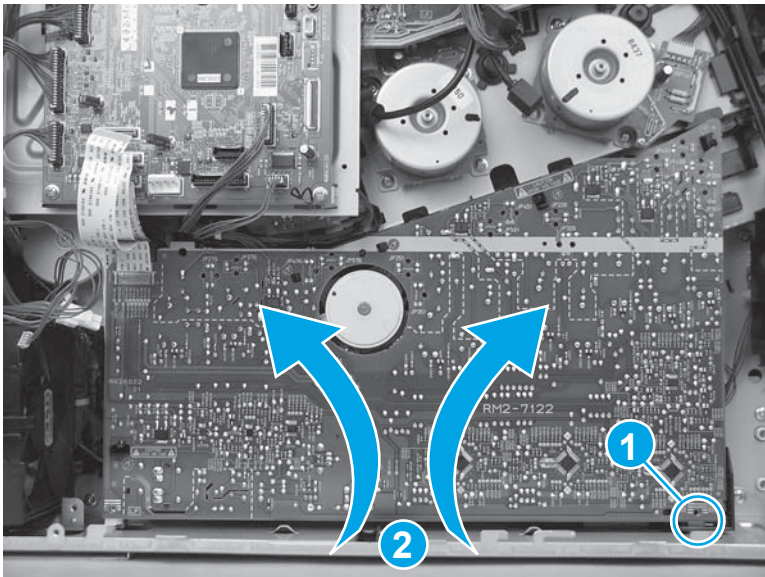

2. Press it onto five tabs (callout 2).

 **IMPORTANT:** Make sure that all five tabs snap into place.

Figure 1-2210 Press the tabs



3. Install two screws (callout 1), and then install one self tapping screw (callout 2) on the HVPSD.

Figure 1-2211 Install three screws

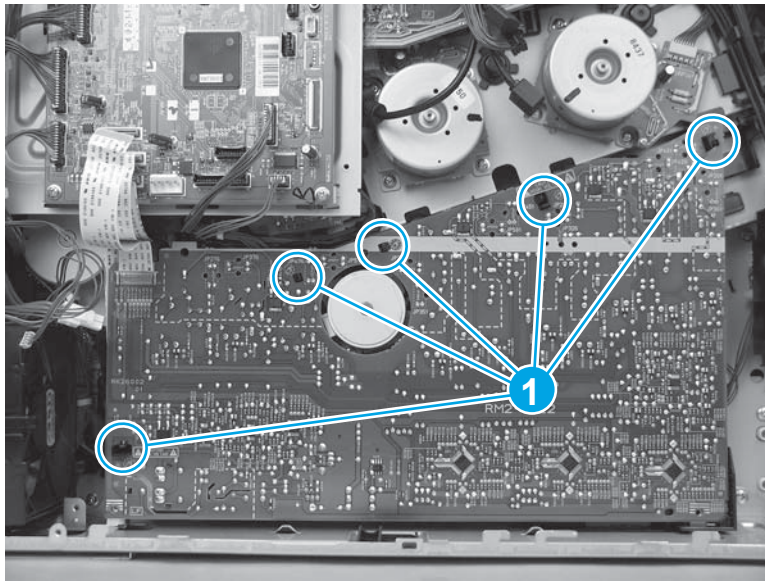
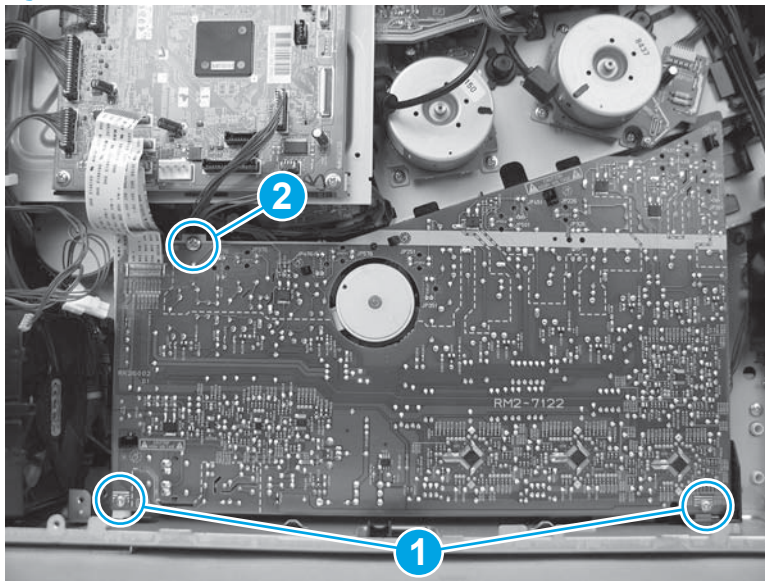

4. Connect one flat cable (callout 1) on the DC controller.

Figure 1-2212 Connect one flat cable

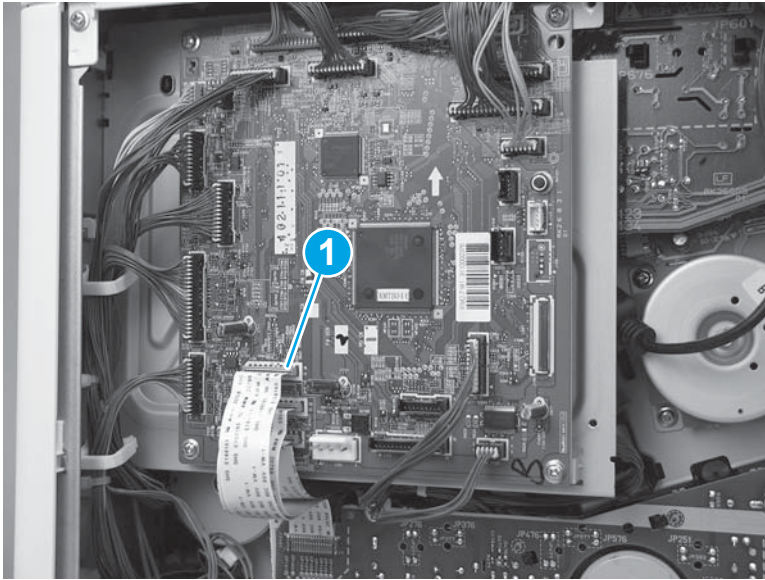

Step 18: Install the LVPS

 **CAUTION:**  ESD-sensitive part.

1. Position the bottom of the LVPS in the printer (callout 1) at a slight angle, and then rotate the top of it into the printer (callout 2) to install it.

Figure 1-2213 Install the LVPS

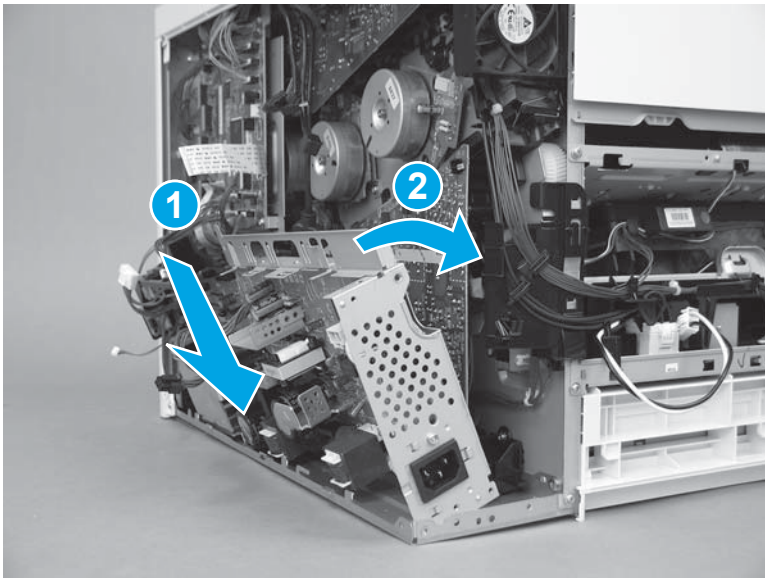

2. Install three screws (callout 1).

Figure 1-2214 Install three screws

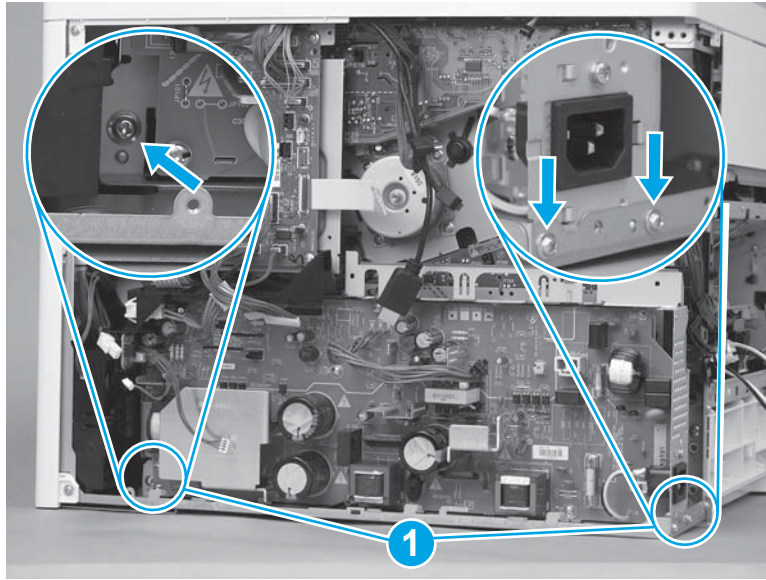

3. Pass the wire harnesses from the DC controller to the LVPS through the opening in the chassis (callout 1), and then install the wire harnesses in the retainer (callout 2).

Figure 1-2215 Pass the wire harnesses through the opening

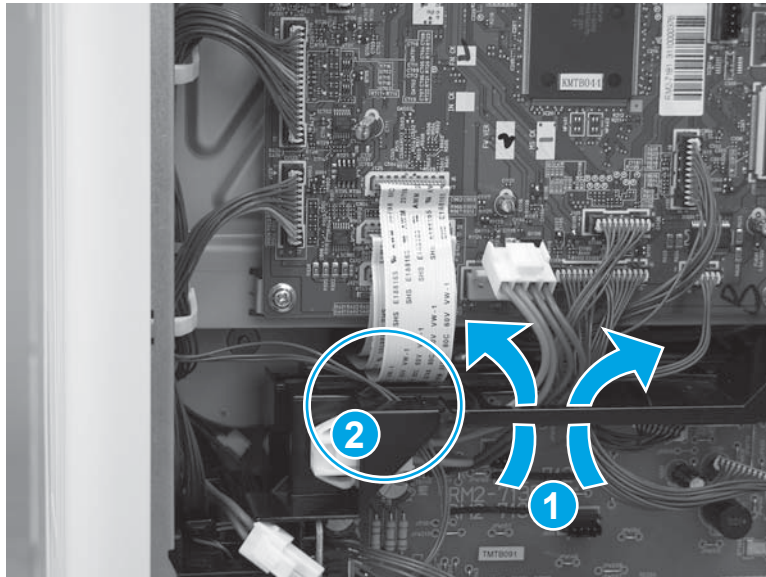

4. Connect three connectors on the DC controller (callout 1), and then connect four connectors (callout 2) on the LVPS.

Figure 1-2216 Connect seven connectors

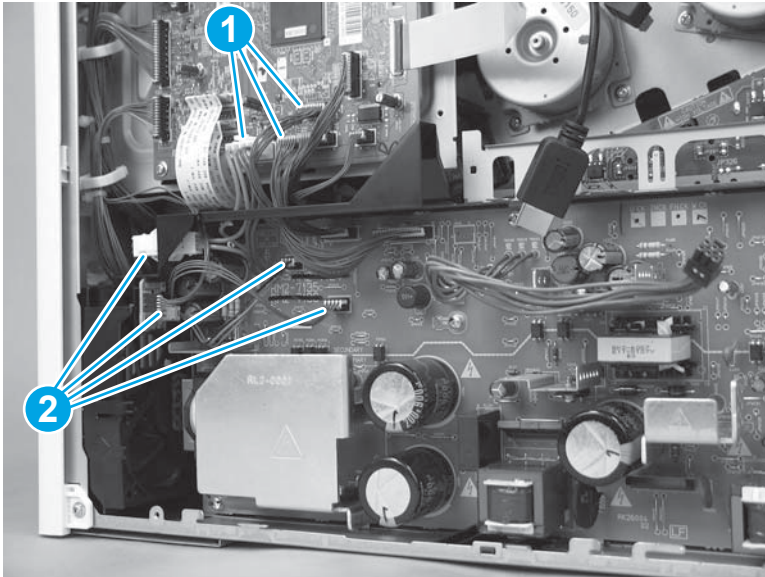

5. Pass the wire harness through the opening (callout 1) in the chassis, and then connect one wire harness (callout 2).

Figure 1-2217 Connect one wire harness

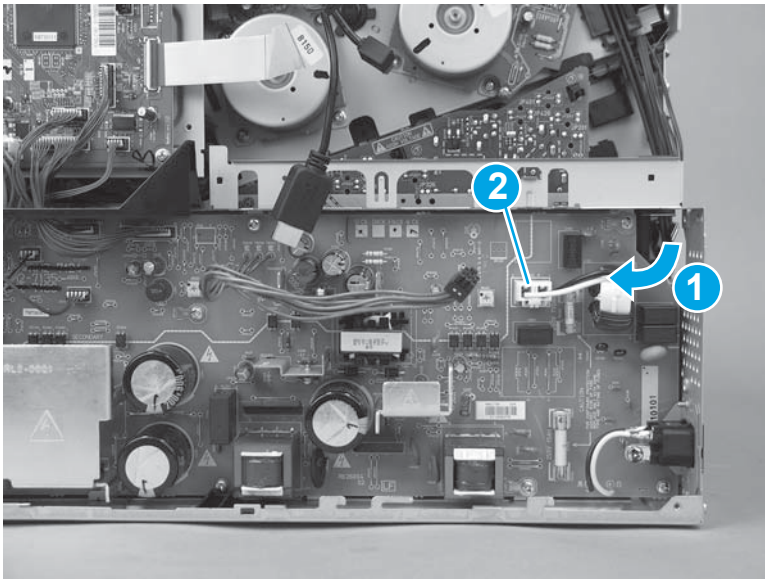

Step 19: Install the formatter case

1. Pass the wire harnesses through the opening in the formatter case.

Figure 1-2218 Pass the wire harnesses through the opening

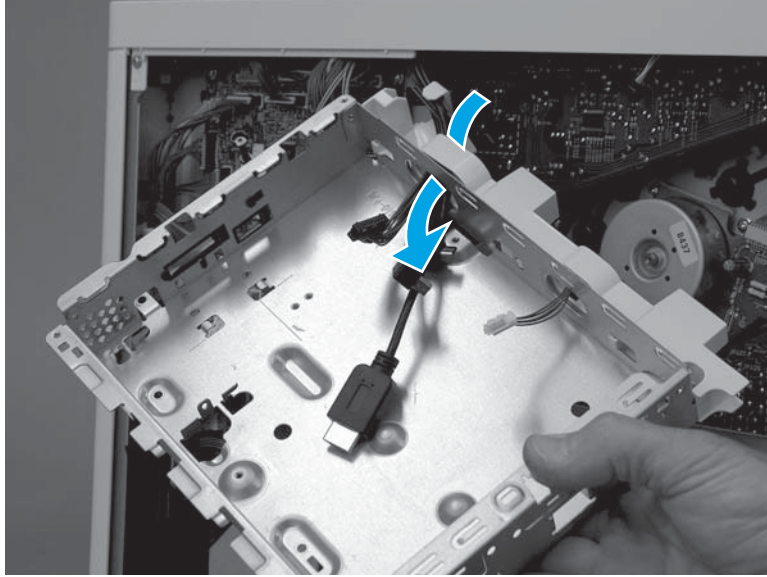

2. Position the top of the formatter case on the printer (callout 1), and then rotate the bottom of the case (callout 2) into the printer.

Figure 1-2219 Install the formatter case

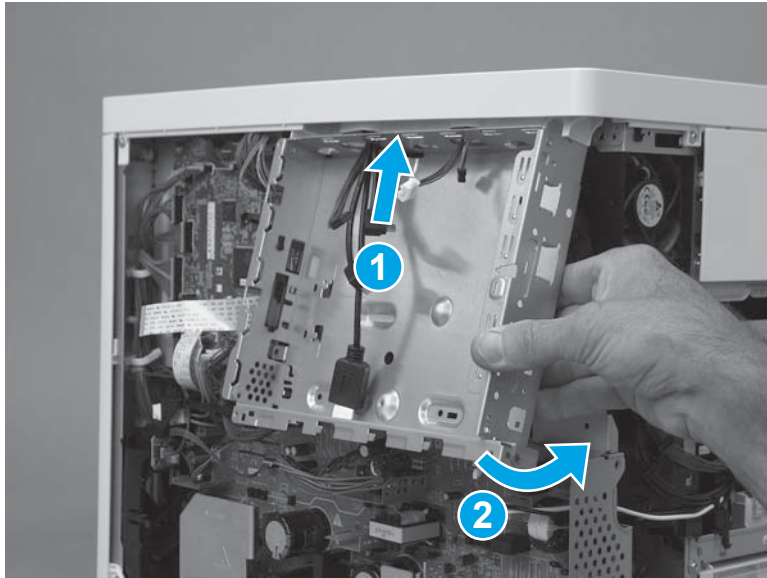

3. Install six screws (callout 1).

Figure 1-2220 Install six screws

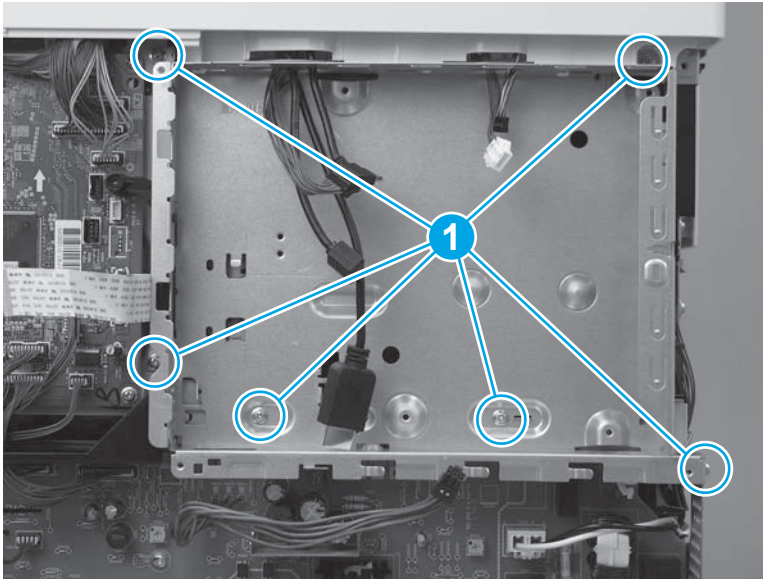

4. Pass two wire harnesses and one flat cable (callout 1) through the opening in the formatter case, and then install one wire harness in the retainer (callout 2).

 **IMPORTANT:** Make sure that the flat cable is securely fastened to the DC controller, and was not dislodged when the formatter case was removed.

Figure 1-2221 Install wire harnesses and flat cable

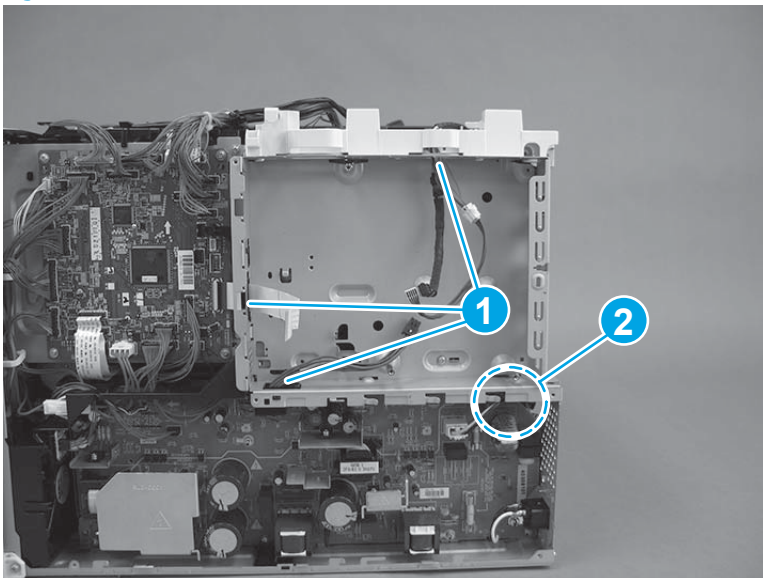

5. Position the LVPS cover on the printer, slide the cover to the left to install it, and then install two screws (callout 1).

Figure 1-2222 Install the LVPS cover

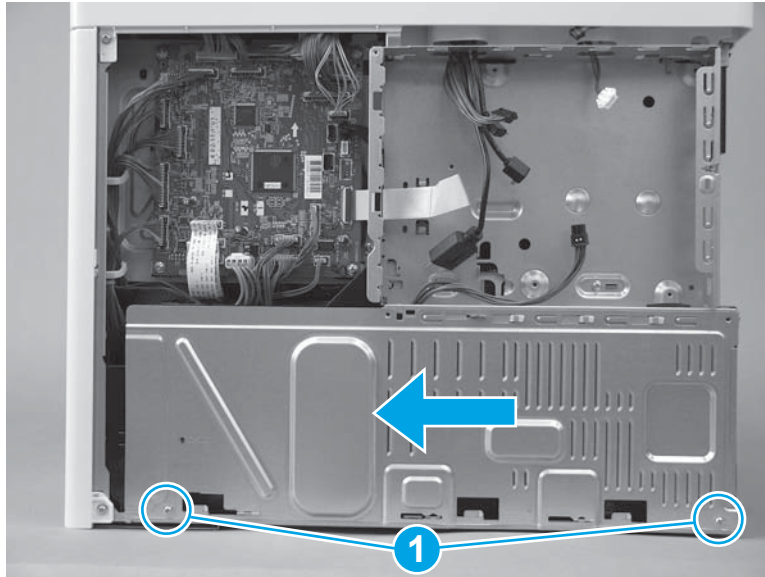

6. If no tape is affixed to the back of the flat cable, skip this step. If double-sided tape is affixed to the back of the flat cable, align the line (callout 1) on the cable with the edge (callout 2) of the opening in the sheet metal. Press to attach the flat cable to the formatter case.

Figure 1-2223 Attach the flat cable

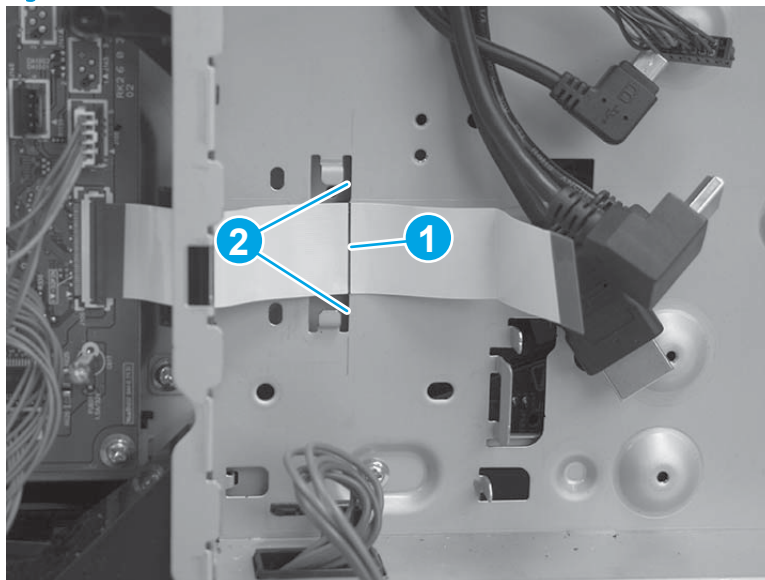

7. Position the bracket over the flat cable, and then slide the bracket to the left to install it. Make sure that the edges of the bracket fit under the sheet metal tabs (callout 1) on the formatter case and that the tabs (callout 2) snap into place.

Figure 1-2224 Position the bracket

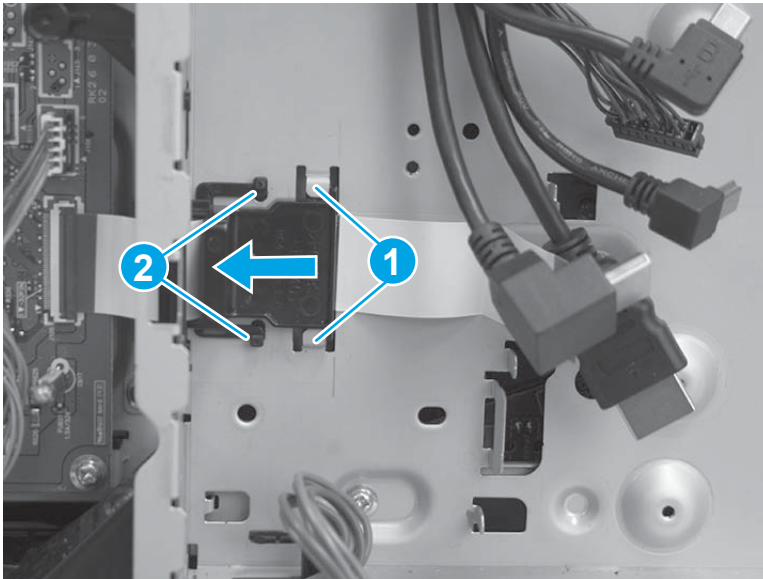

8. **M577 only:** Pass the wire harness (callout 1) through the openings in the formatter case (callout 2), and then connect one connector (callout 3).

Figure 1-2225 Connect one connector

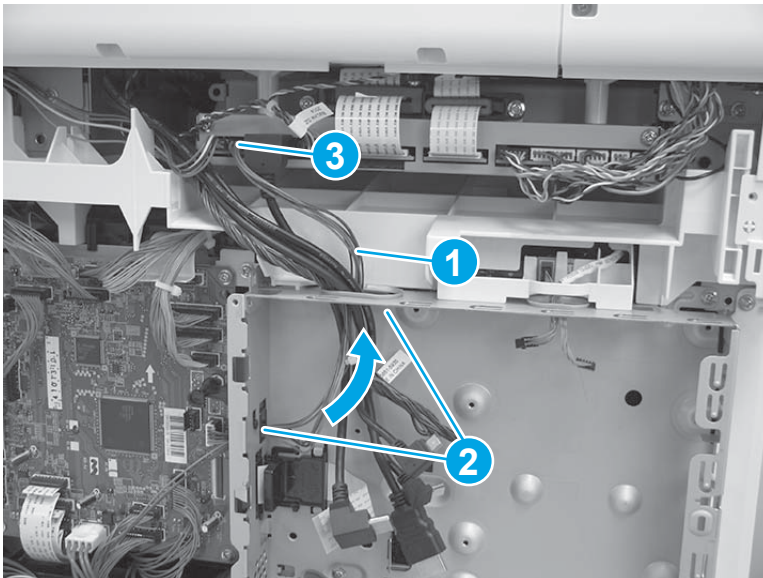

Step 20: Install the left cover

1. Position the cover on the printer.

 **NOTE:** Slightly offset the cover toward the rear of the printer.

Figure 1-2226 Install the cover

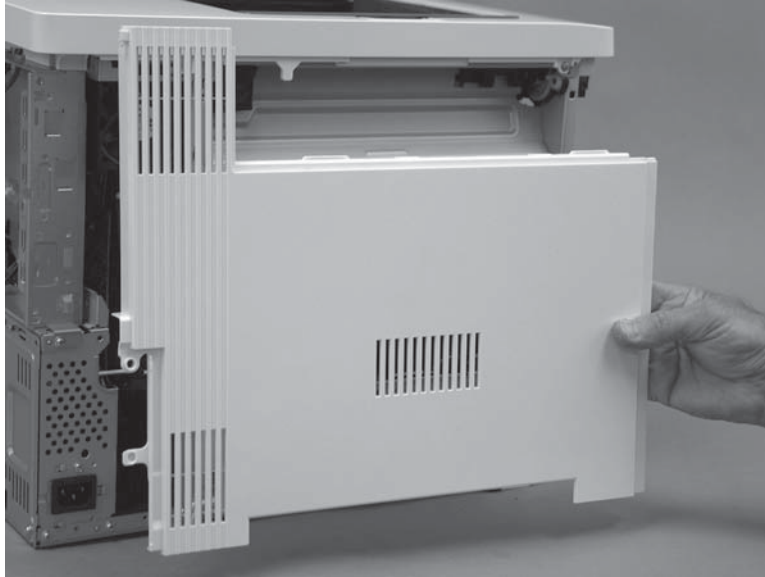

2. Slide the cover (callout 1) toward the front of the printer to engage it. Make sure that the tab (callout 2) snaps into place.

 **NOTE:** Locate the alignment pin (callout 3) on the cover from the front door side of the printer, and then make sure that it is fully engaged in the slot in the chassis.

 **TIP:** While sliding the cover into place, push in on the center of the cover (callout 1) to make sure that the hooks on the back of the cover engage with the slots in the chassis.

Figure 1-2227 Engage the cover



3. At the left side of the printer, install one screw (callout 1).

Figure 1-2228 Install one screw

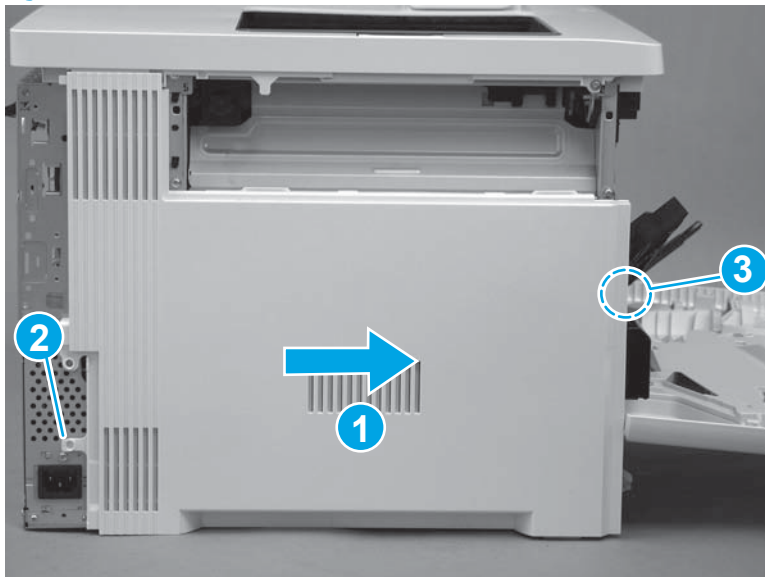

Step 21: Install the rear cover (M577)

 **NOTE:** This step is for the M577 models. For the M552 and M553 models, skip this step and go to [Step 23: Install the rear cover \(M552 and M553\)](#) on page 1269.

1. Position the hooks (callout 1) on the cover in the slots (callout 2) in the printer.

Figure 1-2229 Position the hooks

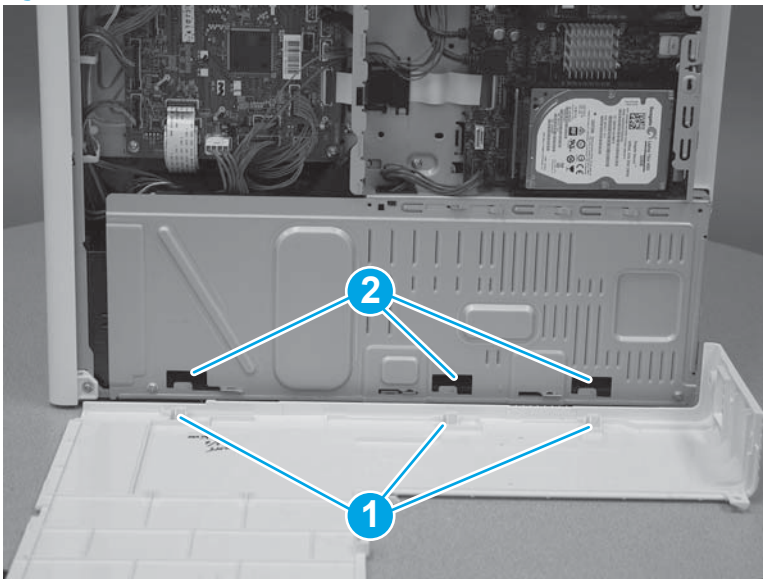

2. Position the back edge (callout 1) of the rear cover behind the edge (callout 2) of the right rear cover. Slide the cover to the left to install it.

Figure 1-2230 Install the cover

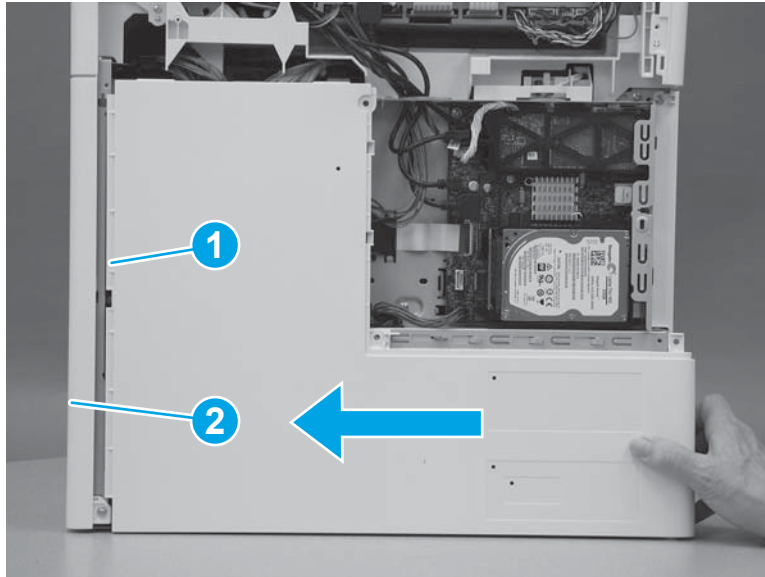

3. Install four screws (callout 1).

Figure 1-2231 Install four screws cover

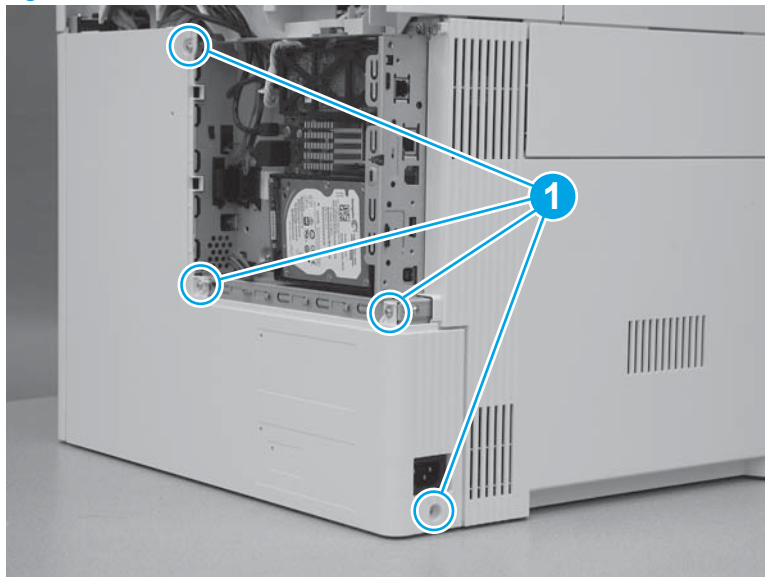

Step 22: Install the rear upper cover (M577)

 **NOTE:** This step is for the M577 models. For the M552 and M553 models, skip this step and go to [Step 23: Install the rear cover \(M552 and M553\) on page 1269.](#)

1. Align the ridge (callout 1) on the lower edge of the rear upper cover in front of the tabs (callout 2) on the top edge of the rear cover.

Figure 1-2232 Align the cover

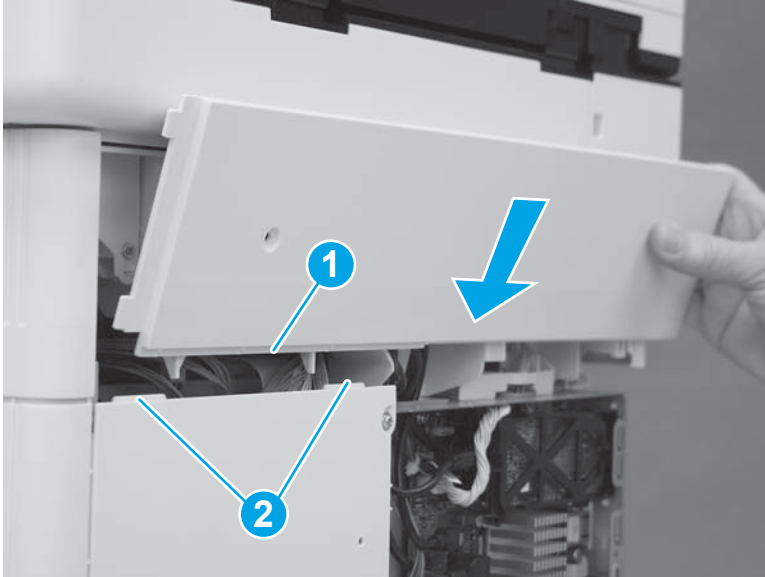

2. Rotate the top of the cover toward the printer.

Figure 1-2233 Rotate the top of the cover

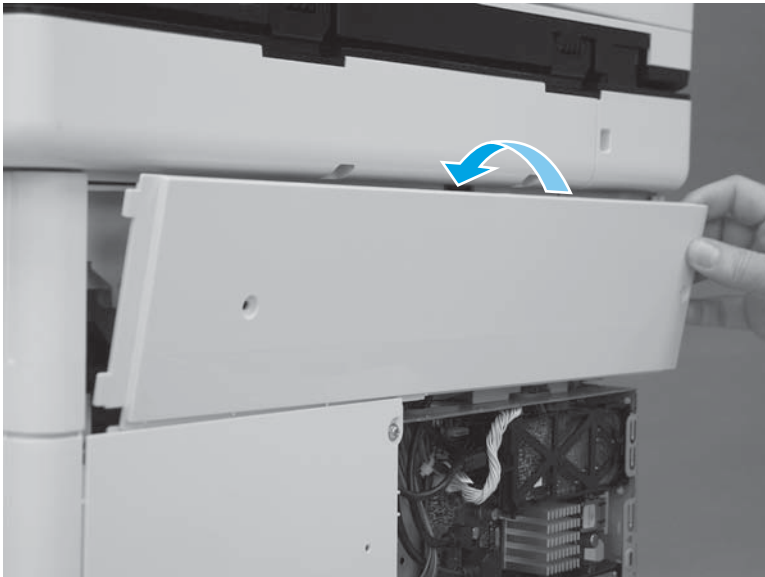

3. Slide the cover to the left (callout 1). Make sure that the tabs (callout 2) on the upper rear cover slide behind the edge (callout 3) of the right upper cover. Make sure that the cover is fully seated.

Figure 1-2234 Slide the cover

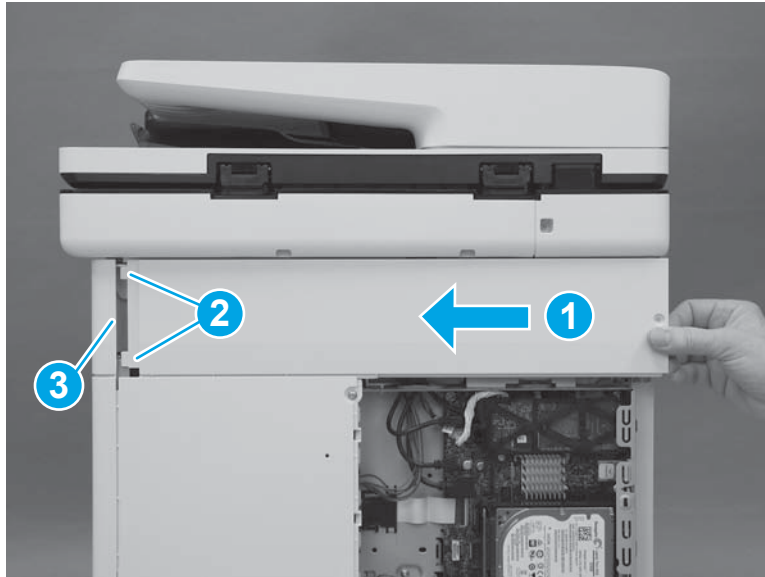

4. Install two screws (callout 1).



 **IMPORTANT:** These two screws are self-tapping screws for plastic. Rotate them counterclockwise to align them with the existing thread pattern, and then carefully turn them clockwise to tighten. Do not overtighten. This will prevent stripping the threads inside the screw holes.

Figure 1-2235 Install two screws

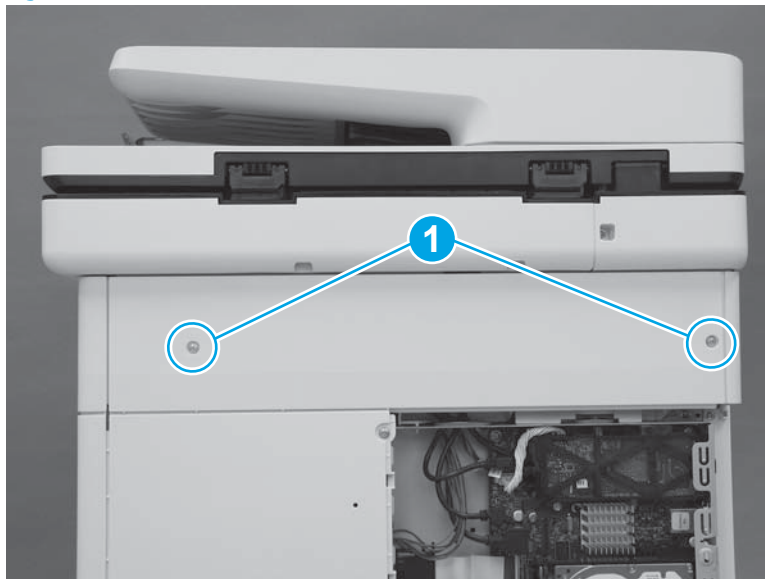

Step 23: Install the rear cover (M552 and M553)

 **NOTE:** This step is for the M552 and M553 models. For the M577 models, skip this step and go to [Step 24: Install the formatter \(M577\) on page 1270](#).

1. Position the top of the cover under the upper cover (callout 1), rotate the bottom of the cover onto the chassis (callout 2), and then slide the cover to the left (callout 3) to install it.

Figure 1-2236 Install the cover

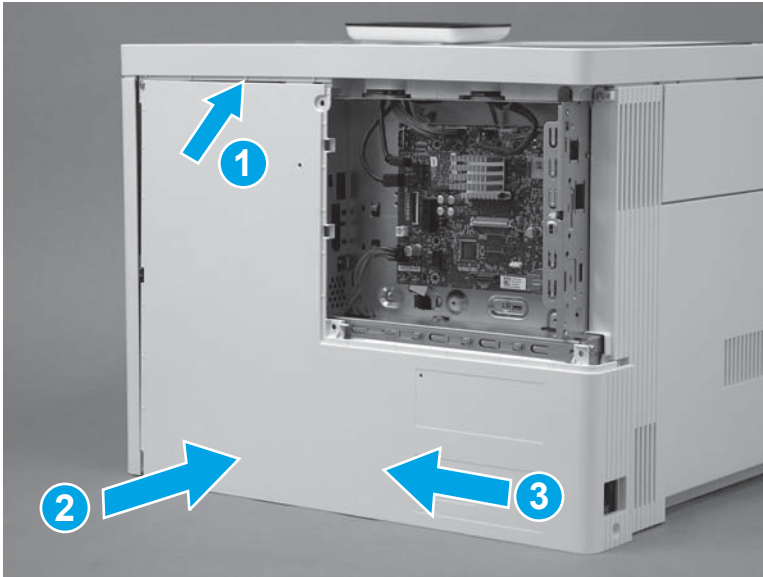

2. Install four screws (callout 1).

Figure 1-2237 Install four screws cover

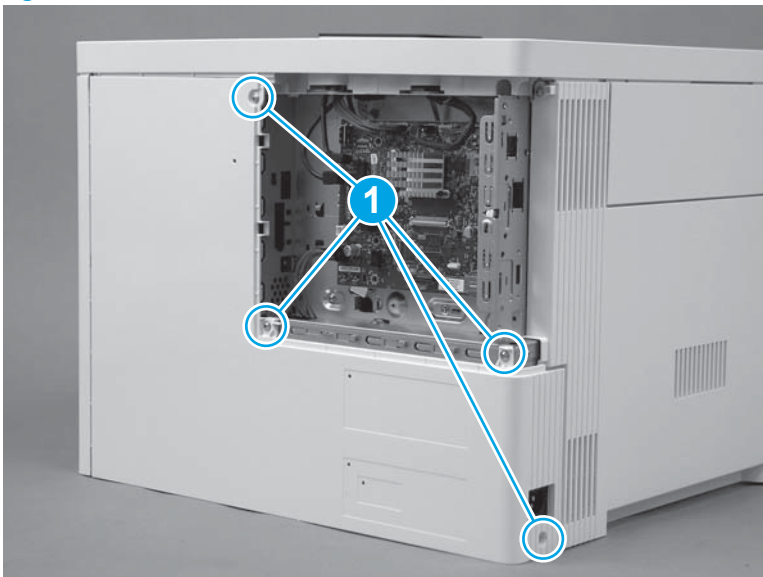

Step 24: Install the formatter (M577)

 **NOTE:** This step is for the M577 models. For the M552 and M553 models, skip this step and to go [Step 27: Install the formatter \(M552 and M553\) on page 1275](#).

 **CAUTION:**  ESD-sensitive part.

1. Position the formatter in the printer. Make sure that the network port (callout 1) fits through the opening (callout 2) in the formatter case.

Figure 1-2238 Install the formatter

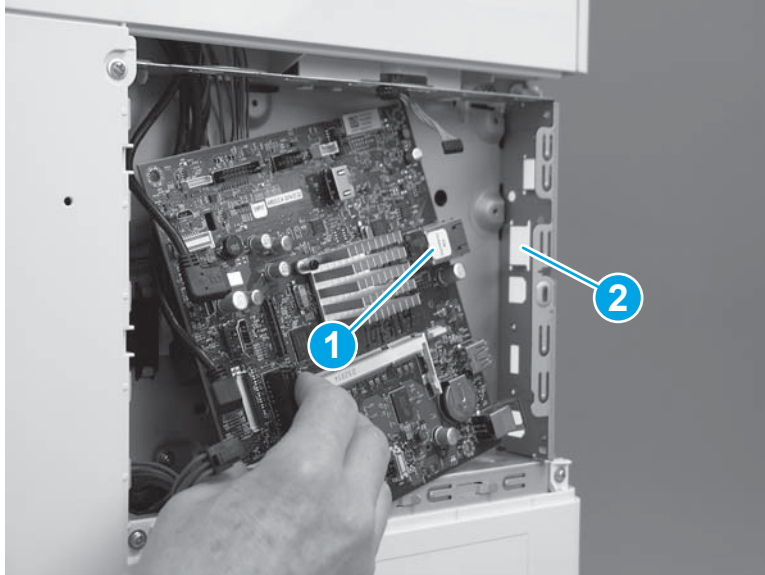

2. Install four screws (callout 1).

Figure 1-2239 Install four screws

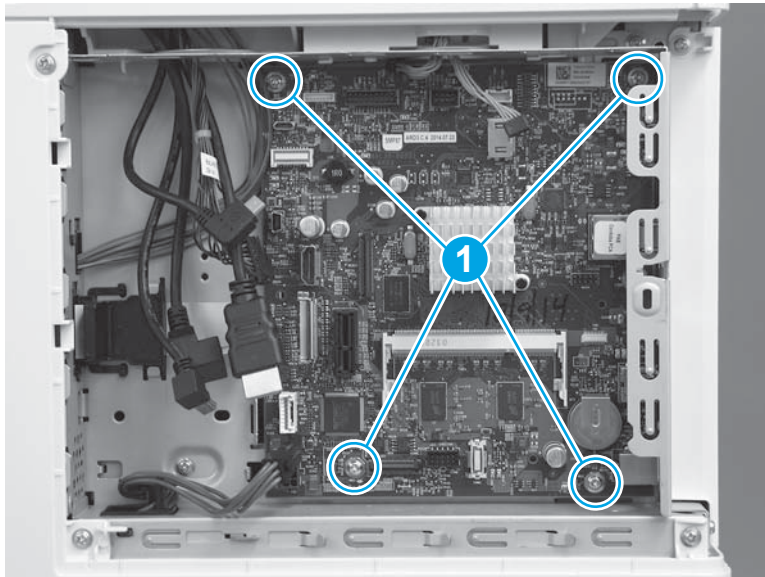

3. Connect all of the connectors on the formatter.

The following connectors are empty:

- All models: J1 (this connector is empty unless the optional DIMM is installed)
- All models: J3
- M577dn: J15 (this is the fax connector for the M577f/z/c models)
- All models: J21 (this connector is empty unless the optional internal USB ports component is installed)
- All models: J23

- All models: J24
- All models: J51
- All models: J57
- All models: J97
- All models: J98 (this connector is empty unless the optional trusted platform module (TPM) is installed)

 **IMPORTANT:** The flat-cable connector (callout 1) is a Zero Insertion Force (ZIF) connector that uses a hinged retainer to secure the flat cable. The hinged retainer must be opened to install the flat cable, and then closed after the cable is installed.

Figure 1-2240 Connect all connectors



Step 25: Install the fax PCA (M577c/f/z)

 **NOTE:** This step is for the M577c/f/z models. For the M577n model, skip this step and go to [Step 26: Install the HDD \(M577\) on page 1274](#).

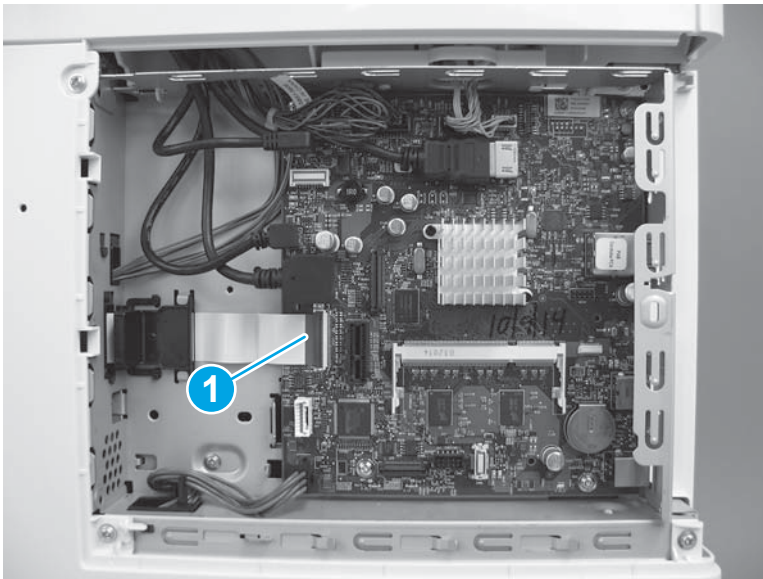
For the M552 and M553 models, skip this step and go to [Step 27: Install the formatter \(M552 and M553\) on page 1275](#).

 **CAUTION:**  ESD-sensitive part.

1. Position the tab and telephone port (callout 1) on the fax PCA in the slots (callout 2) in the formatter case.

Figure 1-2241 Position the fax PCA

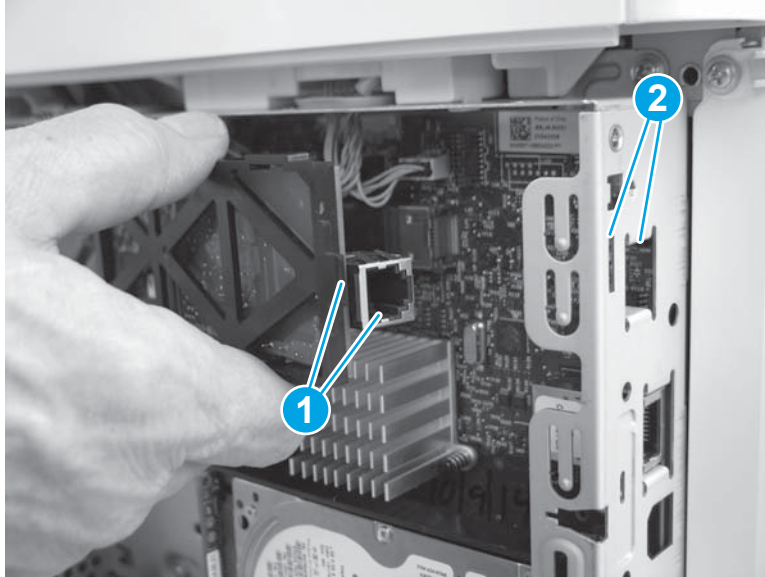

2. Slide the fax PCA to the right (callout 1) until the tab and telephone port described in the previous step and seated in the formatter case. Position the retainer (callout 2) in the slot (callout 3) in the formatter. Rotate the end of the fax PCA toward the formatter (callout 4) until the retainer snaps into place.

Figure 1-2242 Install the fax PCA

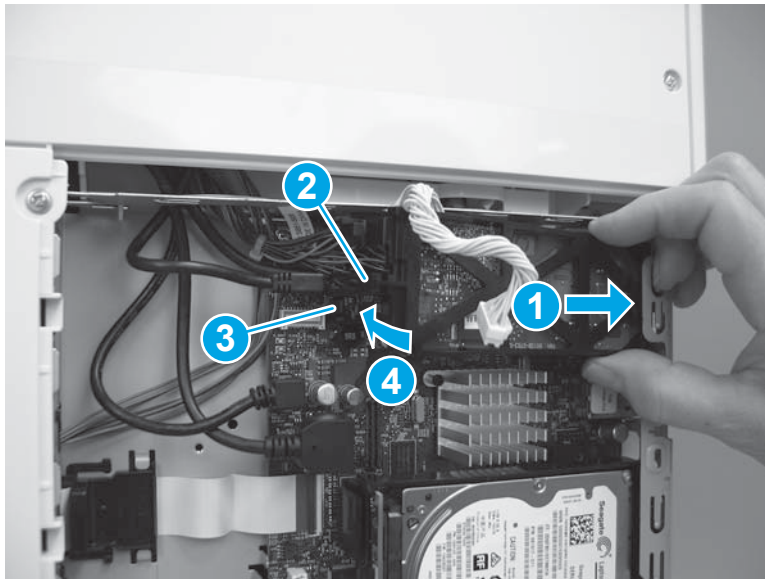

3. Position the cable (callout 1) in the guide (callout 2), and then connect one connector (callout 3).

Figure 1-2243 Connect the connector

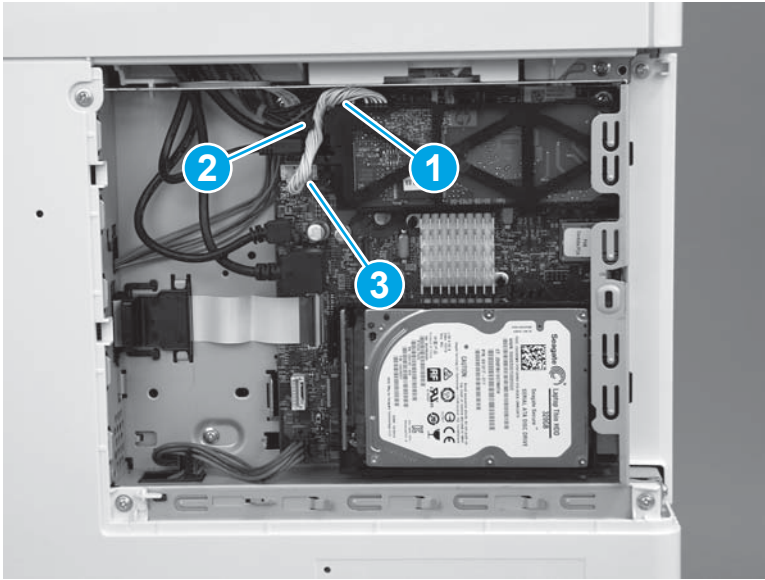

Step 26: Install the HDD (M577)

 **NOTE:** This step is for the M577 models. For the M552 and M553 models, skip this step and go to [Step 27: Install the formatter \(M552 and M553\) on page 1275](#).

 **CAUTION:**  ESD-sensitive part.

1. Align the end of the bracket (callout 1) with the slot in the chassis (callout 2), and then slide the HDD into the printer (callout 3) to engage the bracket with the chassis.

Figure 1-2244 Install the holder

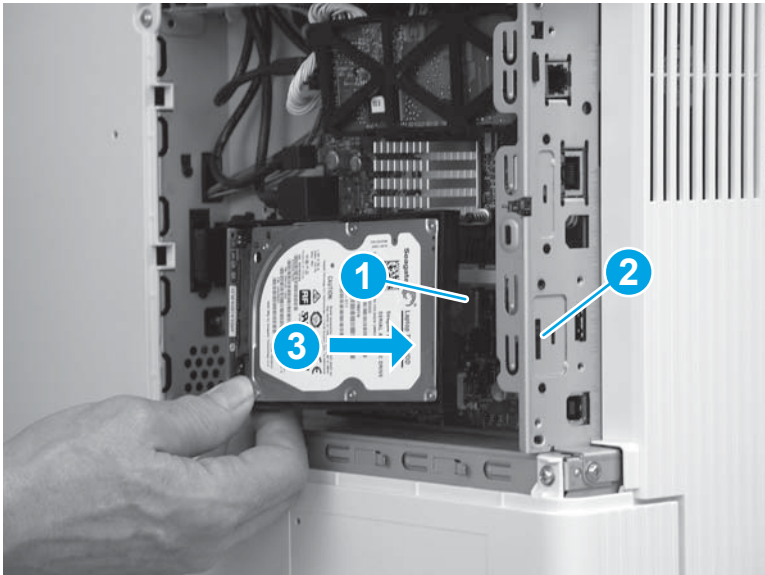

2. Hold the HDD connector latch (callout 1) in the released position, and then rotate the HDD down and into the connector on the formatter to install it.

 **NOTE:** Make sure that the tab (callout 2) snaps into place, and that the HDD is securely installed.

Figure 1-2245 Release the HDD

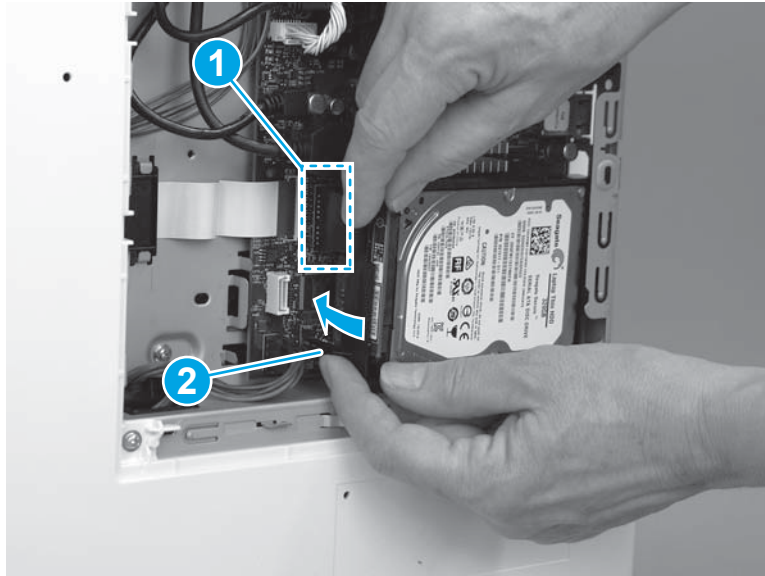

Step 27: Install the formatter (M552 and M553)

 **NOTE:** This step is for the M552 and M553 models. For the M577 models, skip this step and go to [Step 28: Install the formatter cover on page 1277](#).

If the optional hard-disk drive (HDD) was removed, do not forget to reinstall it after the formatter is reinstalled.

Engage the HDD holder with the chassis, rotate the HDD connector down and into the connector on the formatter. Make sure that the tabs snap into place.

 **CAUTION:**  ESD-sensitive part.

1. Position the formatter in the printer, and then install four screws (callout 1).

Figure 1-2246 Install the formatter

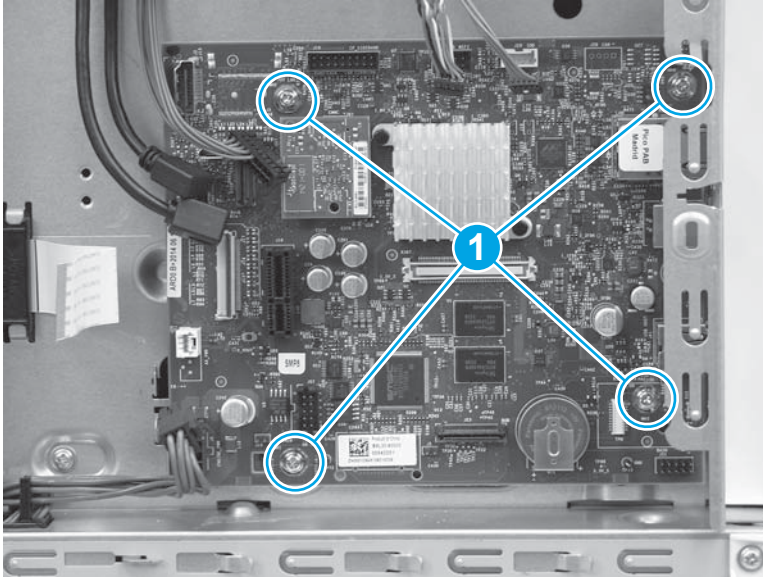

2. Connect all of the connectors on the formatter.

The following connectors are empty:

- All models: J1 (this connector is empty unless the optional DIMM is installed)
- M553n/dn and M552dn: J2 (callout 1; this is the touchscreen connector for the M553x model)
- All models: J9 (this connector is empty unless the optional internal USB ports component is installed)
- All models: J18 (this connector is empty unless the optional hard-disk-drive (HDD) is installed)
- All models: J23
- All models: J24
- M553n/dn and M552dn: J25 (this is the wireless connector for the M553x model)
- All models: J57
- All models: J98 (this connector is empty unless the optional trusted platform module (TPM) is installed)



 **IMPORTANT:** The flat-cable connector (callout 2) is a Zero Insertion Force (ZIF) connector that uses a hinged retainer to secure the flat cable. The hinged retainer must be opened to install the flat cable.

Figure 1-2247 Connect all connectors

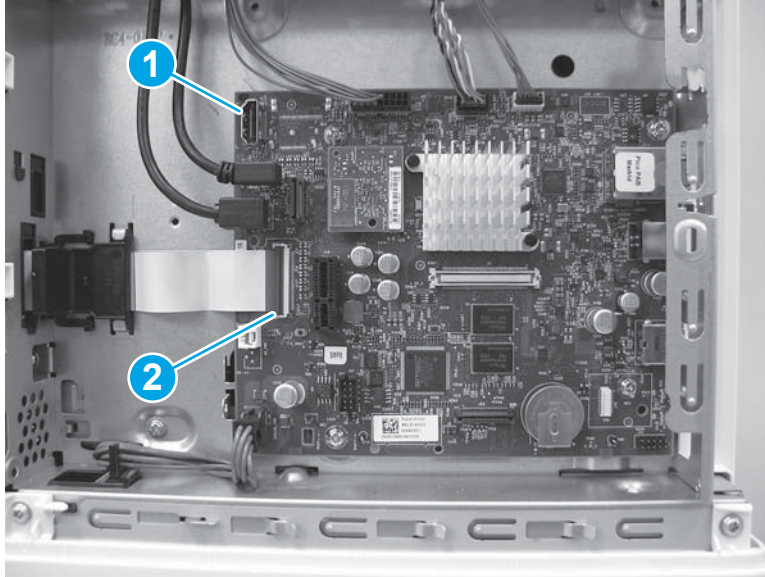

Step 28: Install the formatter cover

- ▲ Slide the cover onto the printer (callout 1) to install it.

 **NOTE:** Make sure that the tabs on the formatter cover align with the slots provided in the printer (callout 2). Tighten the two thumbscrews (callout 3).

 **TIP:** If needed, use the edge of a coin to turn the thumbscrews.

Figure 1-2248 Install the cover

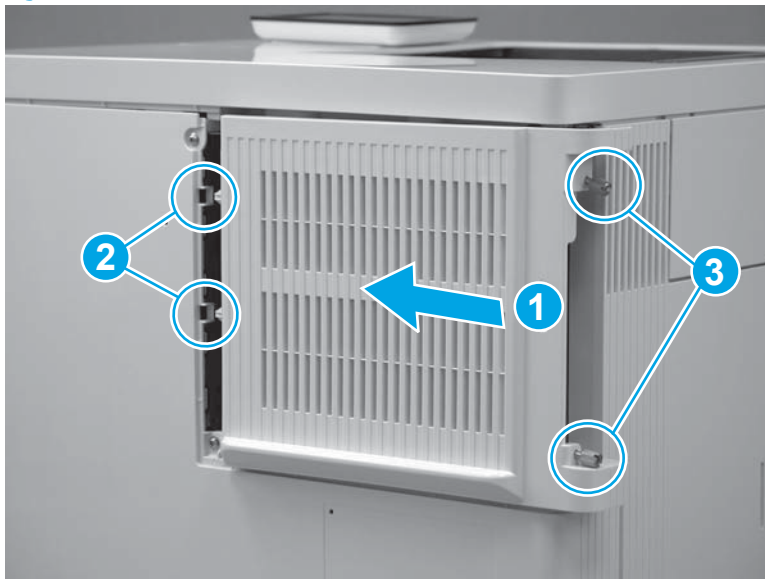

Step 29: Install the TCU

1. Verify that the toner collection hatch cover is in the closed position on the TCU.

Figure 1-2249 Verify that the toner collection hatch cover is closed

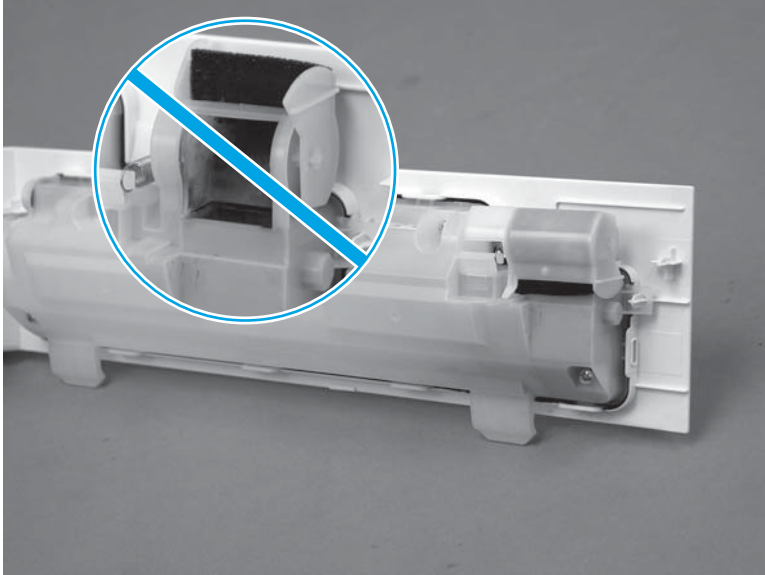

2. Position the TCU with the hinges in the slots provided in the printer (callout 1), and then rotate the TCU up and into the closed position.

 **NOTE:** The toner collection hatch cover automatically opens when the TCU is closed.

Figure 1-2250 Install the TCU



3. Close the front door.

Figure 1-2251 Close the front door

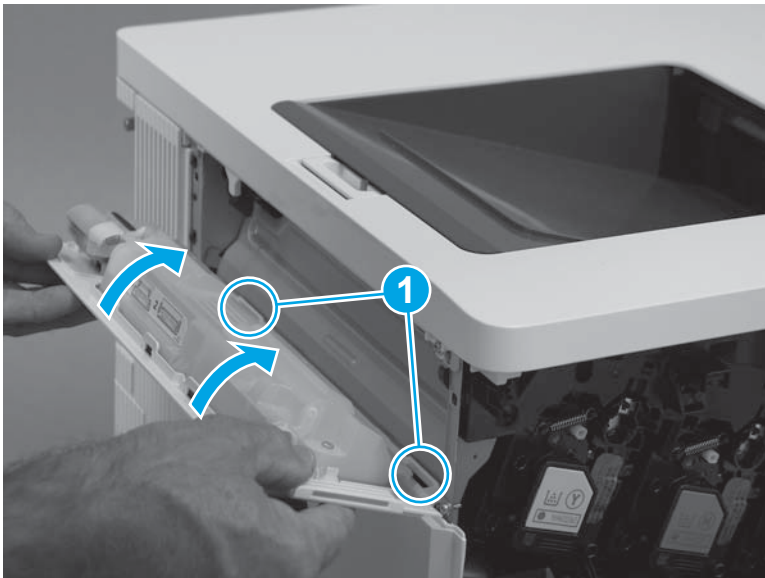

Removal and replacement: Lifter drive assembly

- [Introduction](#)
- [Step 1: Remove the toner collection unit \(TCU\)](#)
- [Step 2: Remove the formatter cover](#)
- [Step 3: Remove the formatter \(M552 and M553\)](#)
- [Step 4: Remove the hard-disk drive \(HDD\) \(M577\)](#)
- [Step 5: Remove the fax PCA \(M577c/f/z\)](#)
- [Step 6: Remove the formatter \(M577\)](#)
- [Step 7: Remove the rear cover \(M552 and M553\)](#)
- [Step 8: Remove the rear upper cover \(M577\)](#)
- [Step 9: Remove the rear cover \(M577\)](#)
- [Step 10: Remove the left cover](#)
- [Step 11: Remove the formatter case](#)
- [Step 12: Remove the low-voltage power supply \(LVPS\)](#)
- [Step 13: Remove the high-voltage power supply D \(HVPSD\)](#)
- [Step 14: Remove the lifter drive assembly](#)
- [Step 15: Unpack the replacement assembly](#)
- [Step 16: Install the lifter drive assembly](#)
- [Step 17: Install the HVPSD](#)
- [Step 18: Install the LVPS](#)
- [Step 19: Install the formatter case](#)
- [Step 20: Install the left cover](#)
- [Step 21: Install the rear cover \(M577\)](#)
- [Step 22: Install the rear upper cover \(M577\)](#)
- [Step 23: Install the rear cover \(M552 and M553\)](#)
- [Step 24: Install the formatter \(M577\)](#)
- [Step 25: Install the fax PCA \(M577c/f/z\)](#)
- [Step 26: Install the HDD \(M577\)](#)
- [Step 27: Install the formatter \(M552 and M553\)](#)
- [Step 28: Install the formatter cover](#)
- [Step 29: Install the TCU](#)

Introduction

This document provides the procedures to remove and replace the lifter drive assembly.

Before performing service

Turn the printer power off

- Disconnect the power cable.

⚠ WARNING! To avoid damage to the printer, turn the printer off, wait 30 seconds, and then remove the power cord before attempting to service the printer.

Use the table below to identify the correct part number for your printer, and then go to <http://h20141.www2.hp.com/hpparts> to order the part.

Lifter drive assembly part number	
RM2-0010-000CN	Lifter drive assembly

Required tools

- #2 Phillips screwdriver with a magnetic tip

After performing service

Make sure that all of the connectors on the HVPSD are fully seated.

Make sure that all of the connectors on the LVPS are fully seated.

Make sure that all of the connectors on the formatter are fully seated.

Make sure that the formatter cover is fully seated, and that the thumbscrews are finger tight after replacing it.

Turn the printer power on

- Connect the power cable.
- Use the power switch to turn the power on.

Post service test

Print a configuration page to make sure that the printer is functioning correctly.

Step 1: Remove the toner collection unit (TCU)

1. Open the front door.

Figure 1-2252 Open the front door



2. Open the TCU.

 **NOTE:** The toner collection hatch cover automatically closes when the TCU is opened.

Figure 1-2253 Open the TCU



3. Pull the TCU away from the printer at an angle to remove it.

⚠ CAUTION: Do not open the toner collection hatch cover when handling the TCU. If toner gets on clothing, wipe it off by using a dry cloth and wash the clothes in cold water. Hot water sets toner into fabric.

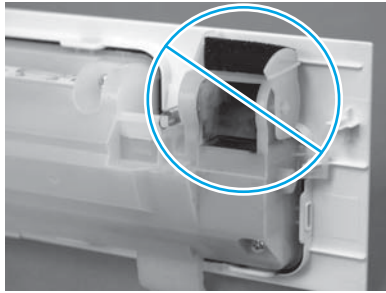
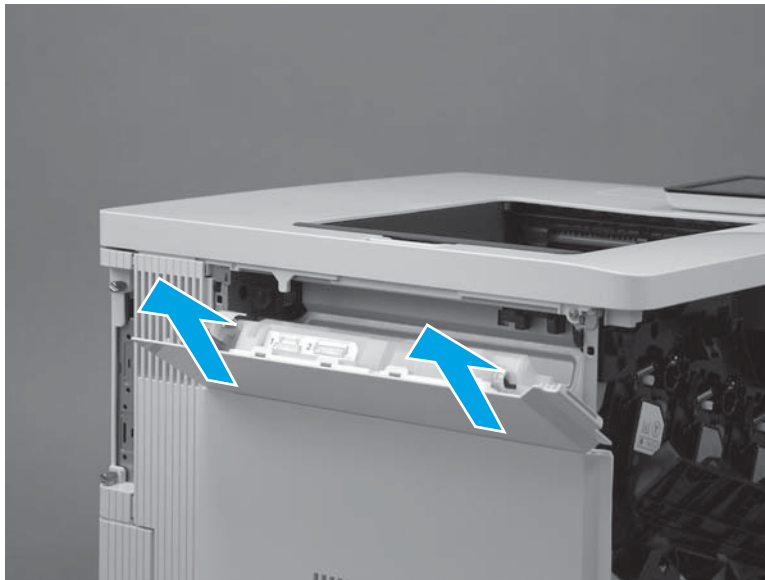

Figure 1-2254 Remove the TCU



Step 2: Remove the formatter cover

1. Locate the formatter cover.

Figure 1-2255 Locate the formatter cover

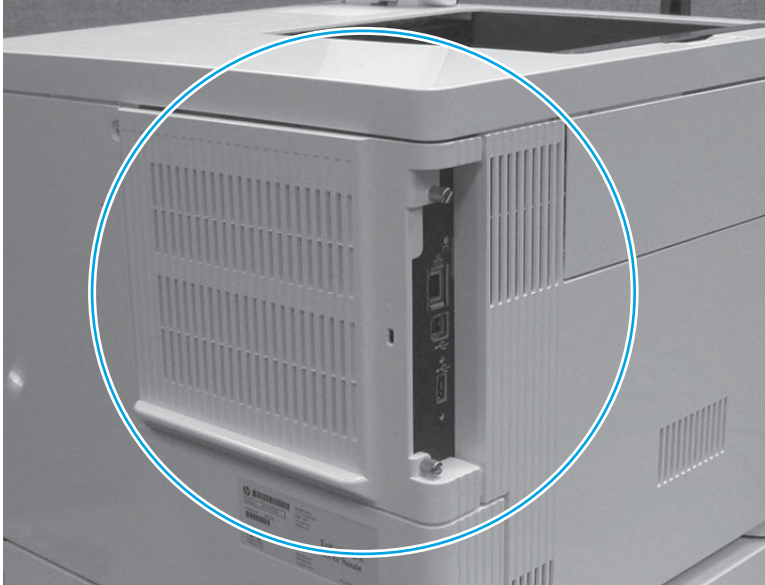

2. Loosen the two thumbscrews (callout 1). Grasp the two thumbscrews, and then slide the cover away from the printer (callout 2) to remove it.

 **TIP:** If needed, use the edge of a coin to turn the thumbscrews.

Figure 1-2256 Loosen the thumbscrews

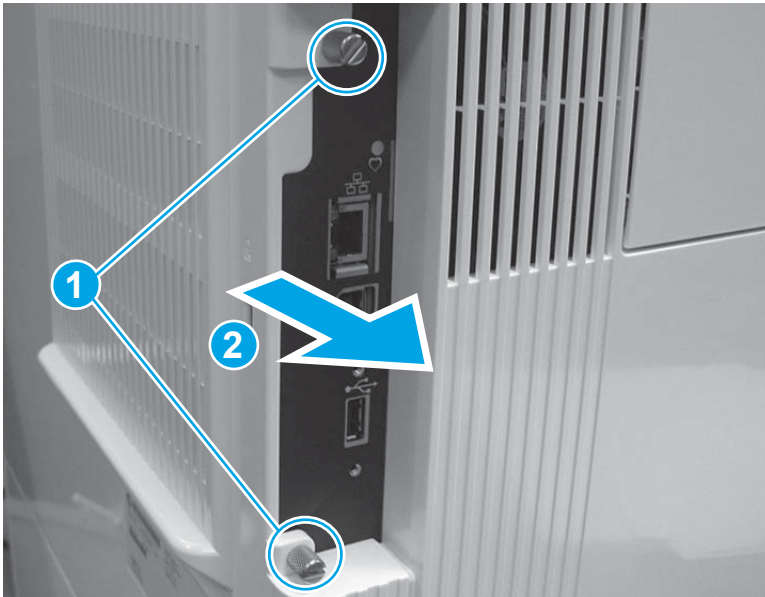

Step 3: Remove the formatter (M552 and M553)

 **NOTE:** This step is for the M552 and M553 models. For the M577 models, skip this step and go to [Step 4: Remove the hard-disk drive \(HDD\) \(M577\) on page 1286](#).

If the optional hard-disk drive (HDD) is installed, it must be removed to gain access to the formatter mounting screws.

Release two tabs along the left edge of the HDD, rotate the left edge away from the product, and then slide the HDD to the left to remove it.

 **CAUTION:**  ESD-sensitive part.

1. Disconnect all of the connectors on the formatter.

The following connectors are empty:

- All models: J1 (this connector is empty unless the optional DIMM is installed)
- M553n/dn and M552dn: J2 (callout 1; this is the touchscreen connector for the M553x model)
- All models: J9 (this connector is empty unless the optional internal USB ports component is installed)
- All models: J18 (this connector is empty unless the optional hard-disk-drive (HDD) is installed)
- All models: J23
- All models: J24
- M553n/dn and M552dn: J25 (this is the wireless connector for the M553x model)
- All models: J57
- All models: J98 (this connector is empty unless the optional trusted platform module (TPM) is installed)

 **IMPORTANT:** The flat-cable connector (callout 2) is a Zero Insertion Force (ZIF) connector that uses a hinged retainer to secure the flat cable. The hinged retainer must be opened to release the flat cable.

Figure 1-2257 Disconnect all connectors



2. Remove four screws (callout 1), and then remove the formatter.

Figure 1-2258 Remove the formatter

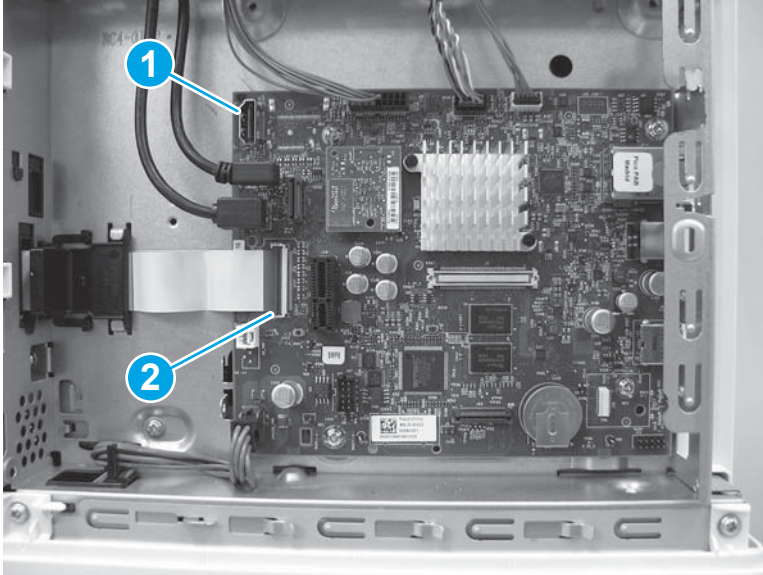
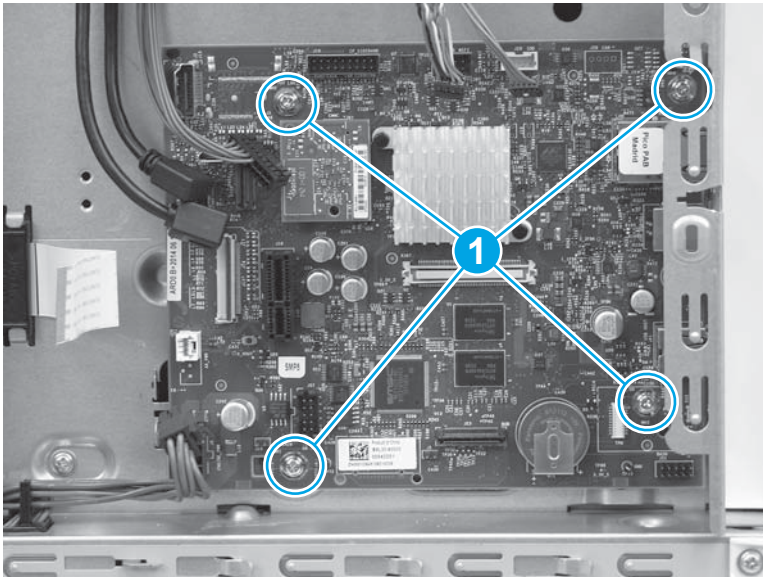

Step 4: Remove the hard-disk drive (HDD) (M577)

 **NOTE:** This step is for the M577 models. For the M552 and M553 models, skip this step and go to [Step 7: Remove the rear cover \(M552 and M553\) on page 1291](#).

 **CAUTION:**  ESD-sensitive part.

1. Release two tabs (callout 1). Hold the tabs in the released position, and then rotate the hard disk drive (HDD) up (callout 2) to release the connector from the formatter.

Figure 1-2259 Release the HDD

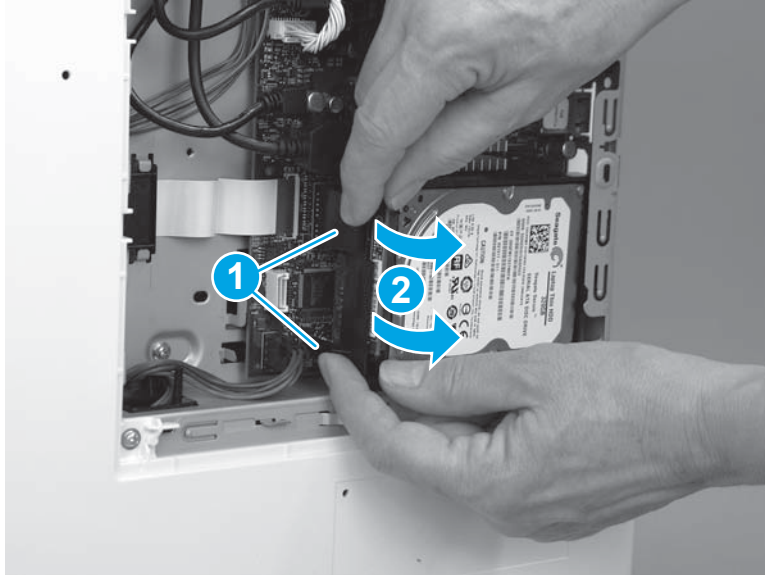

2. Slide the HDD away from the printer to remove it.

Figure 1-2260 Remove the HDD



Step 5: Remove the fax PCA (M577c/f/z)

 **NOTE:** This step is for the M577c/f/z models. For the M577n model, skip this step and go to [Step 6: Remove the formatter \(M577\) on page 1289](#).

For the M552 and M553 models, skip this step and go to [Step 7: Remove the rear cover \(M552 and M553\) on page 1291](#).

 **CAUTION:**  ESD-sensitive part.

1. Locate the fax PCA component on the formatter.

Figure 1-2261 Locate the fax PCA

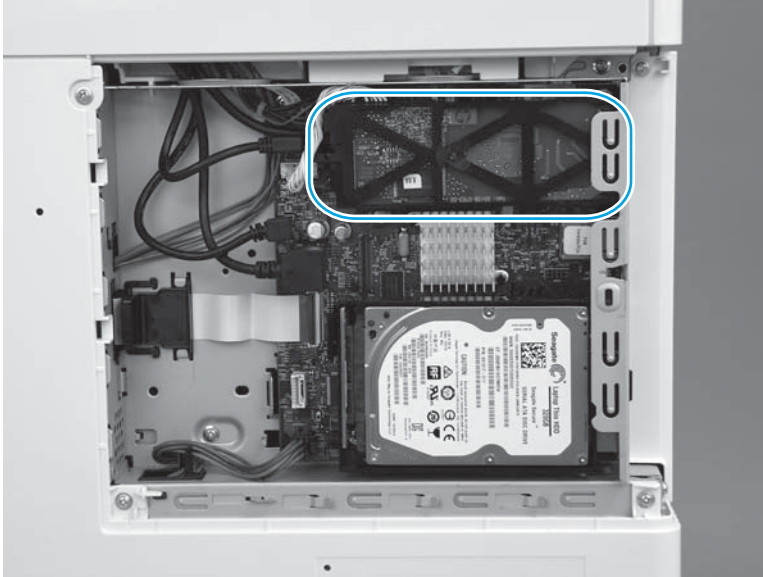

2. Release the connector latch (callout 1), and then pull the connector away from the formatter (callout 2) to disconnect it.

Figure 1-2262 Disconnect one connector

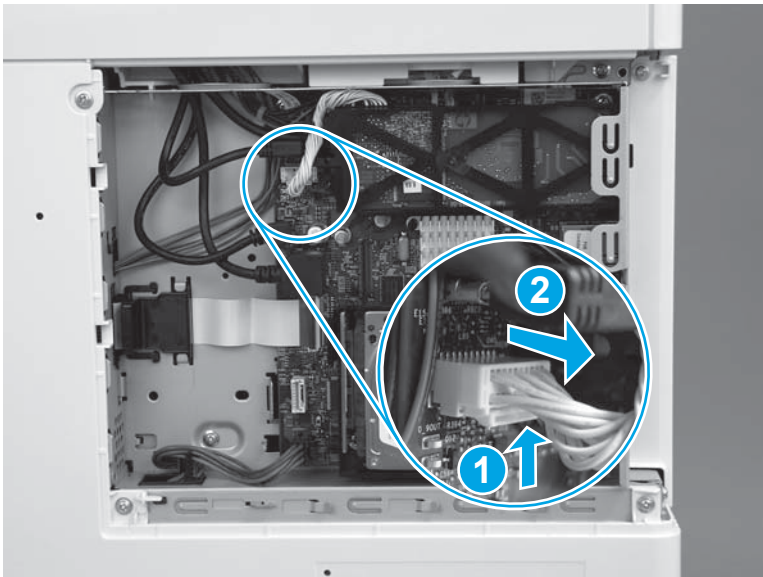

3. Release one retainer (callout 1) by pressing the bracket arms together.

Figure 1-2263 Release one latch

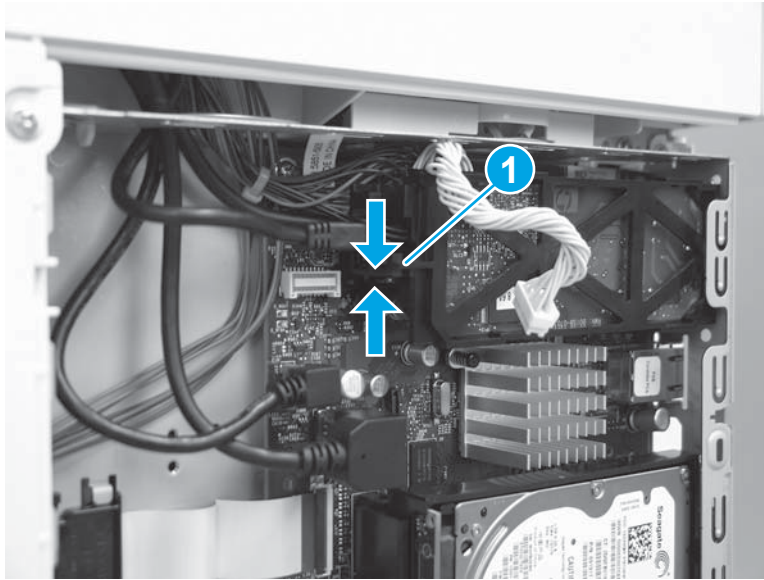

4. Rotate the end of the fax PCA (callout 1) away from the formatter, and then slide the PCA left (callout 2) to remove it.

Figure 1-2264 Remove the fax PCA

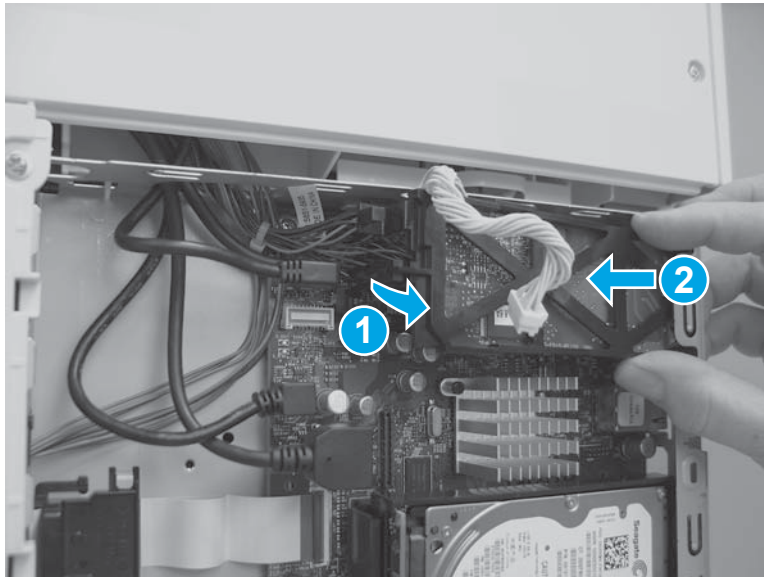

Step 6: Remove the formatter (M577)

 **NOTE:** This step is for the M577 models. For the M552 and M553 models, skip this step and go to [Step 7: Remove the rear cover \(M552 and M553\) on page 1291.](#)

 **CAUTION:**  ESD-sensitive part.

1. Disconnect all of the connectors on the formatter.

The following connectors are empty:

- All models: J1 (this connector is empty unless the optional DIMM is installed)
- All models: J3
- M577dn: J15 (this is the fax connector for the M577f/z/c models)
- All models: J21 (this connector is empty unless the optional internal USB ports component is installed)
- All models: J23
- All models: J24
- All models: J51
- All models: J57
- All models: J97
- All models: J98 (this connector is empty unless the optional trusted platform module (TPM) is installed)

 **IMPORTANT:** The flat-cable connector (callout 1) is a Zero Insertion Force (ZIF) connector that uses a hinged retainer to secure the flat cable. The hinged retainer must be opened to release the flat cable.

Figure 1-2265 Disconnect all connectors



2. Remove four screws (callout 1).

Figure 1-2266 Remove four screws

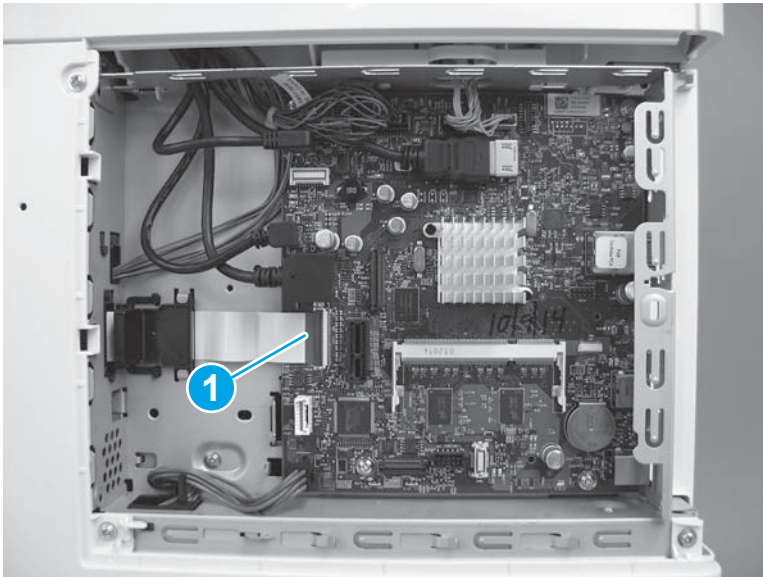
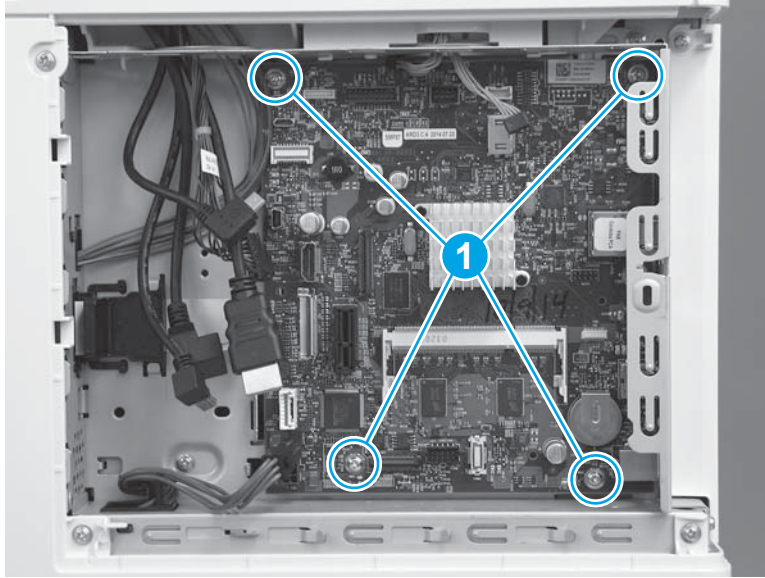

3. Remove the formatter.

Figure 1-2267 Remove the formatter

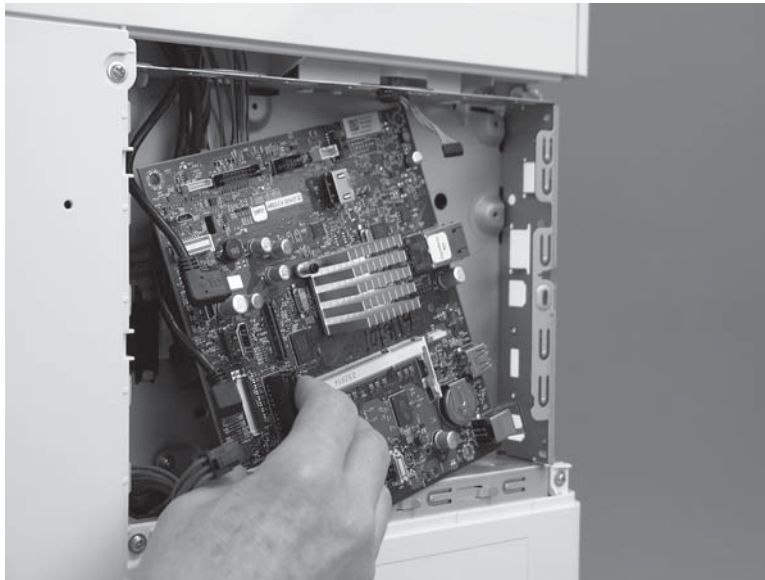

Step 7: Remove the rear cover (M552 and M553)

 **NOTE:** This step is for the M552 and M553 models. For the M577 models, skip this step and go to [Step 6: Remove the rear upper cover \(M577\) on page 432.](#)

1. Remove four screws (callout 1).

Figure 1-2268 Remove four screws

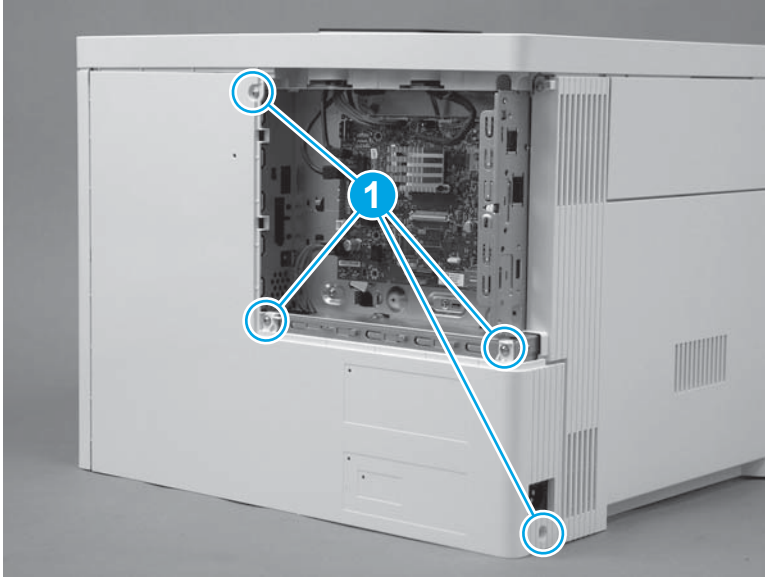

2. Slightly slide the cover to the right (callout 1), rotate the bottom of the cover away from the printer (callout 2), and then pull the top of the cover away from the printer (callout 3) to remove the cover.

Figure 1-2269 Remove the cover

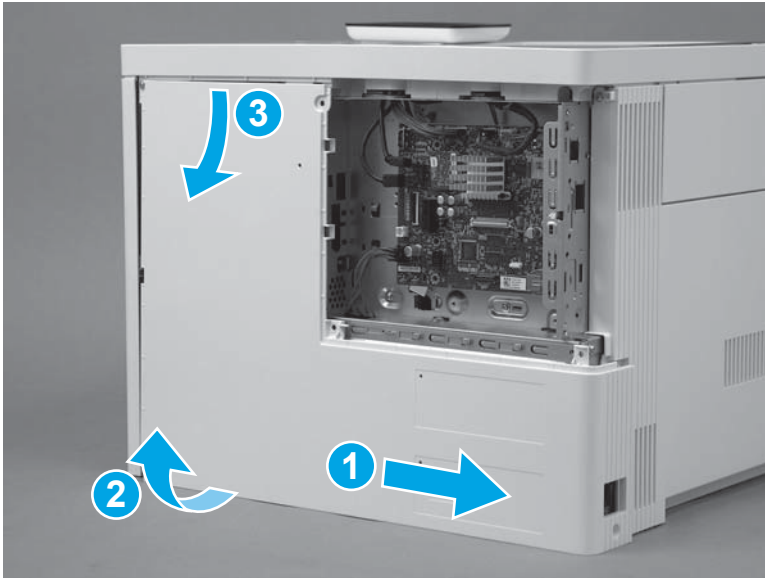

Step 8: Remove the rear upper cover (M577)

 **NOTE:** This step is for the M577 models. For the M552 and M553 models, skip this step and go to [Step 10: Remove the left cover on page 1295](#).

1. Remove two screws (callout 1).

 **Reinstallation tip:** These two screws are self-tapping screws for plastic. When reinstalling them, rotate the screws counterclockwise to align them with the existing thread pattern, and then carefully turn them clockwise to tighten. Do not overtighten. This will prevent stripping the threads inside the screw holes.

Figure 1-2270 Remove two screws



2. Use a small, flat blade screwdriver to release the right edge of the cover.

Figure 1-2271 Release the right edge

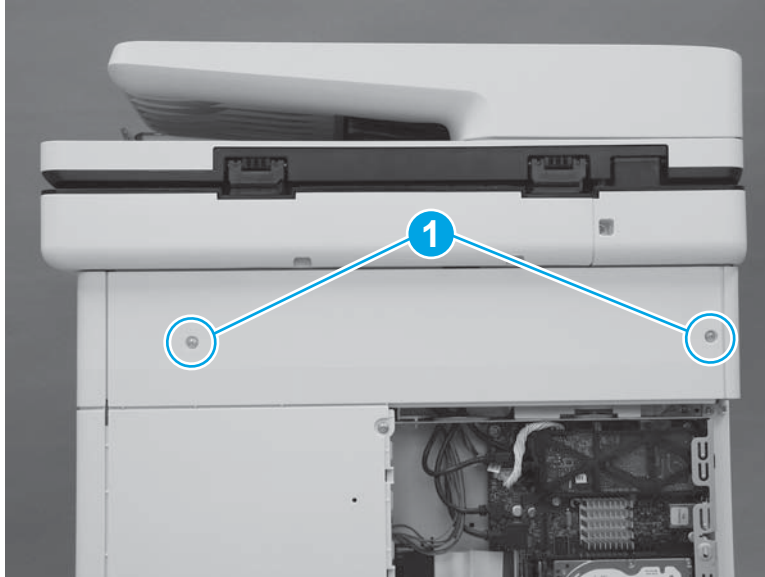
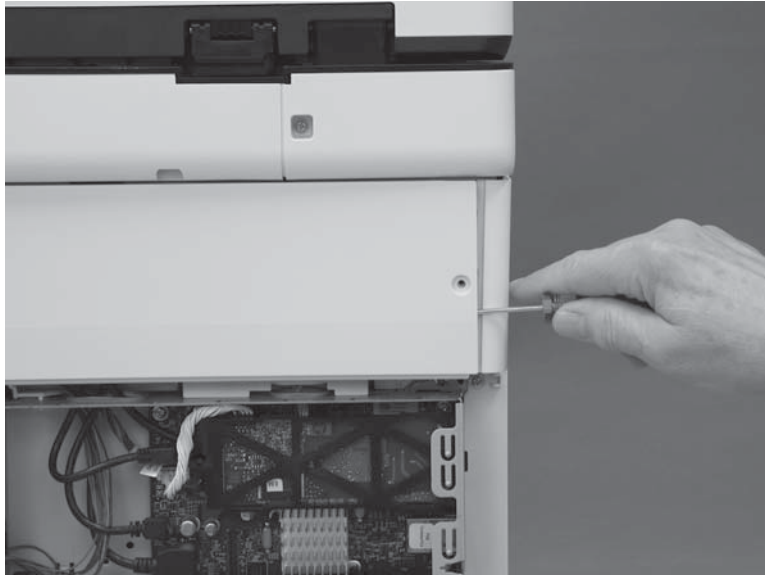

3. Pull the right edge of the cover (callout 1) away from the printer, and then slide the cover to the right (callout 2).

Figure 1-2272 Slide the cover right

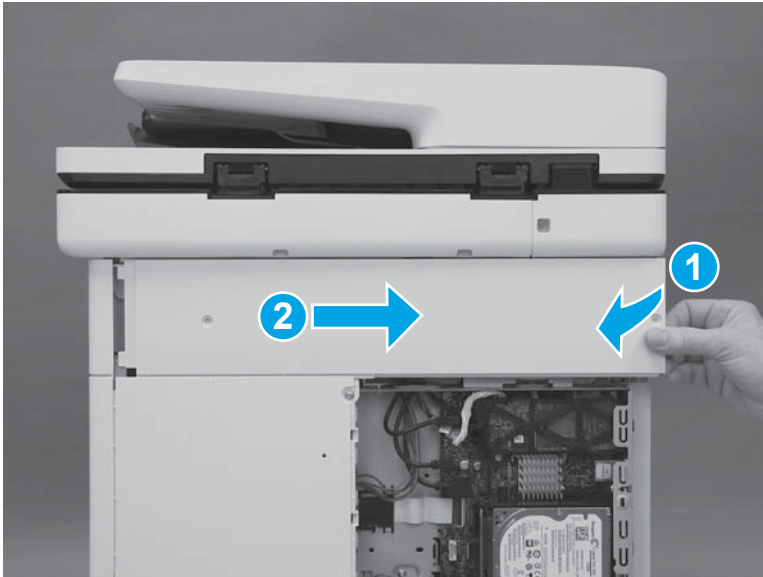

4. Remove the cover.

Figure 1-2273 Remove the cover

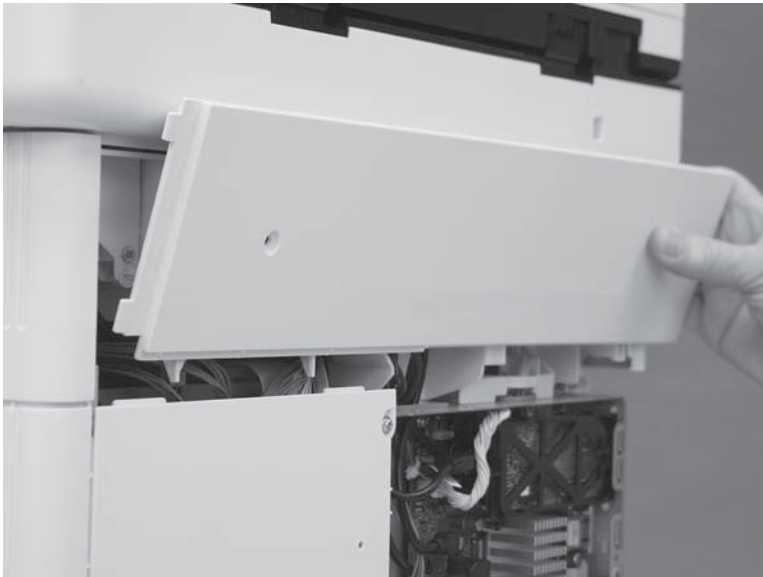

Step 9: Remove the rear cover (M577)

 **NOTE:** This step is for the M577 models. For the M552 and M553 models, skip this step and go to [Step 10: Remove the left cover on page 1295](#).

1. Remove four screws (callout 1).

Figure 1-2274 Remove four screws

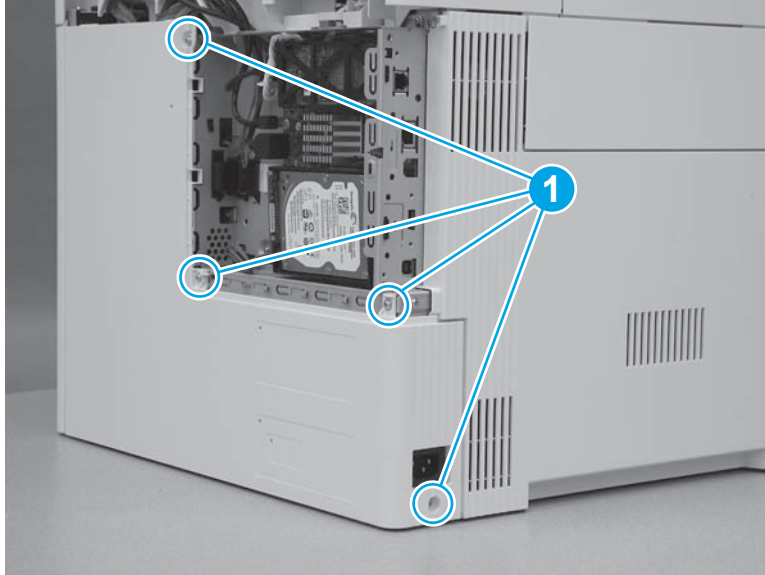

2. Slide the cover to the right to remove it.

Figure 1-2275 Remove the cover

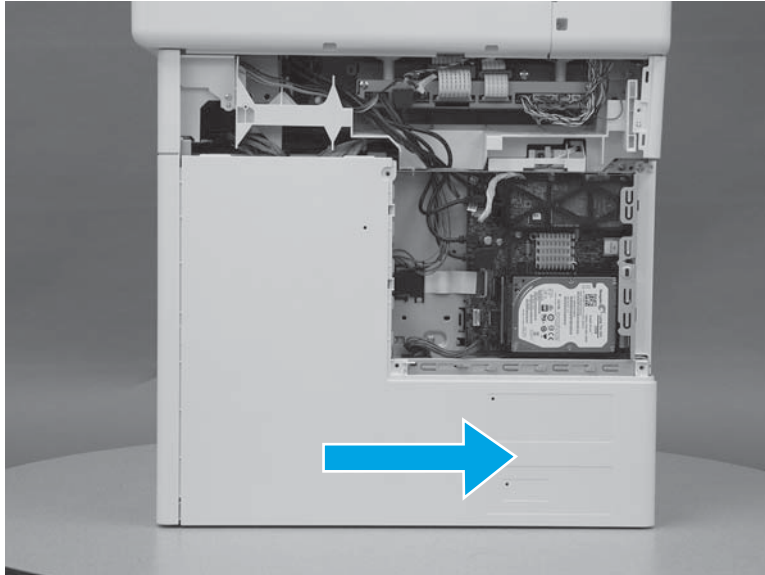

Step 10: Remove the left cover

1. At the left side of the printer, remove one screw (callout 1).

Figure 1-2276 Remove one screw



2. Release one tab (callout 1), rotate the front edge of the cover away from the printer (callout 2), and then slide the cover (callout 3) toward the rear of the printer to release it.

Figure 1-2277 Release the cover

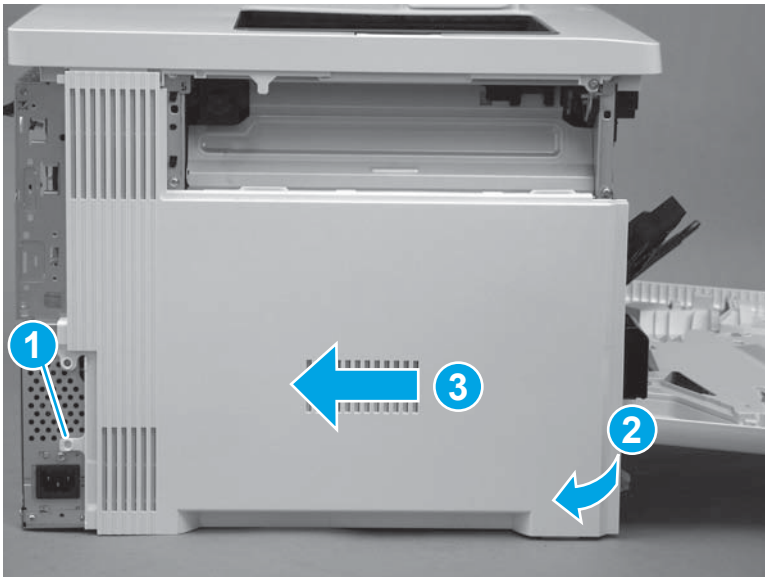

3. Remove the cover.

Figure 1-2278 Remove the cover

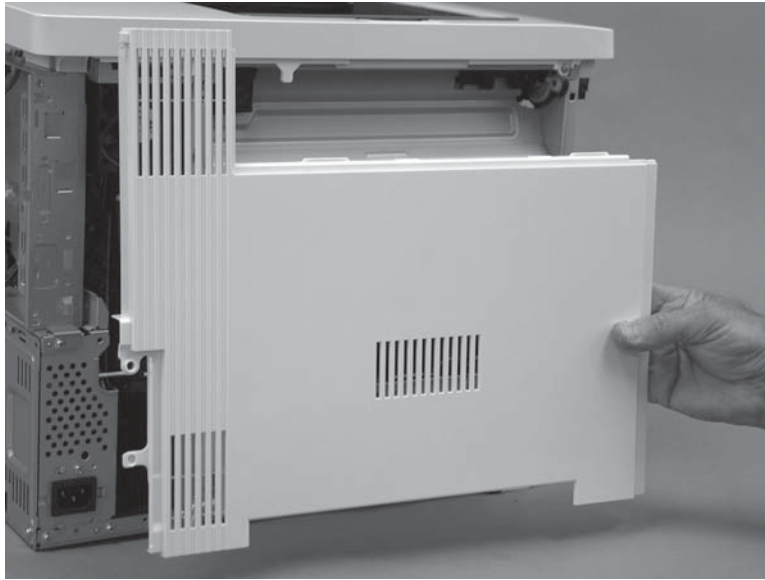

Step 11: Remove the formatter case

1. **M577 only:** Disconnect one connector (callout 1), and then pass the wire harness (callout 2) through two openings in the formatter case (callout 3).

Figure 1-2279 Disconnect one connector

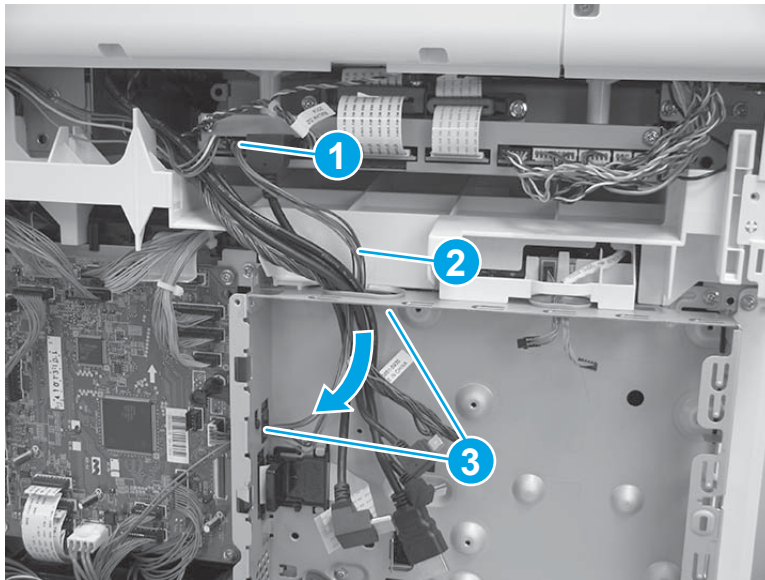

2. Release two tabs (callout 1) on the black plastic bracket. Hold the tabs in the released position, and then slide the bracket (callout 2) to the right to remove it from the formatter case.

Figure 1-2280 Remove the bracket

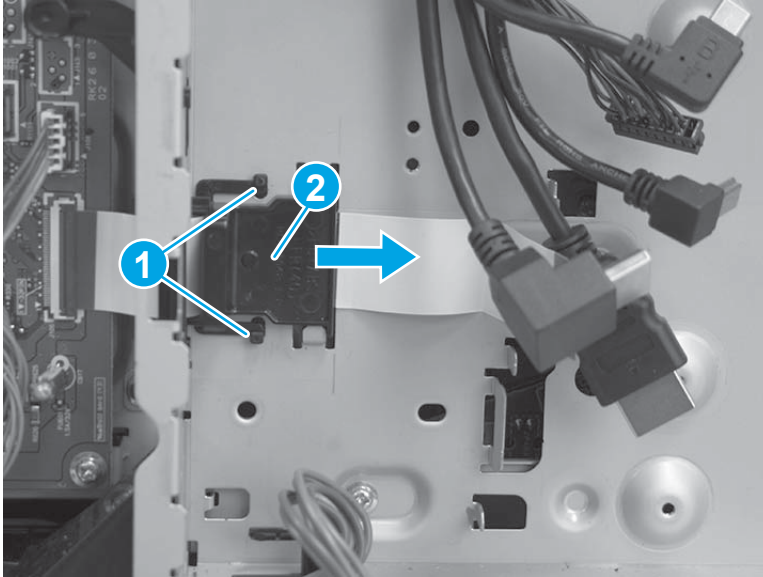

3. Remove two screws (callout 1), and then slide the low-voltage power supply (LVPS) cover to the right to remove it.

Figure 1-2281 Remove the LVPS cover

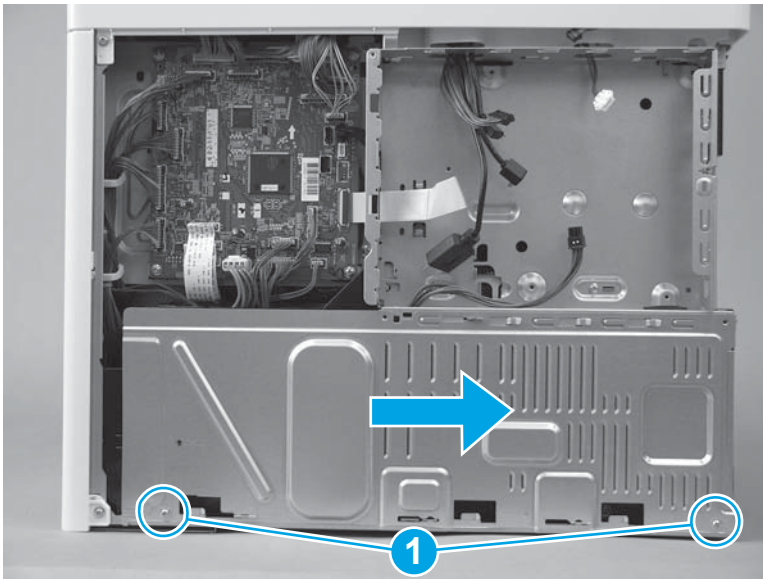

4. Pass two wire harnesses and one flat cable (callout 1) through the opening in the formatter case, and then release one wire harness from the retainer (callout 2).

⚠ CAUTION: The flat cable might be attached to the formatter case with double-sided tape. Make sure that this tape is released, so that the flat cable is not damaged when the formatter case is removed.

Figure 1-2282 Release wire harnesses and flat cable

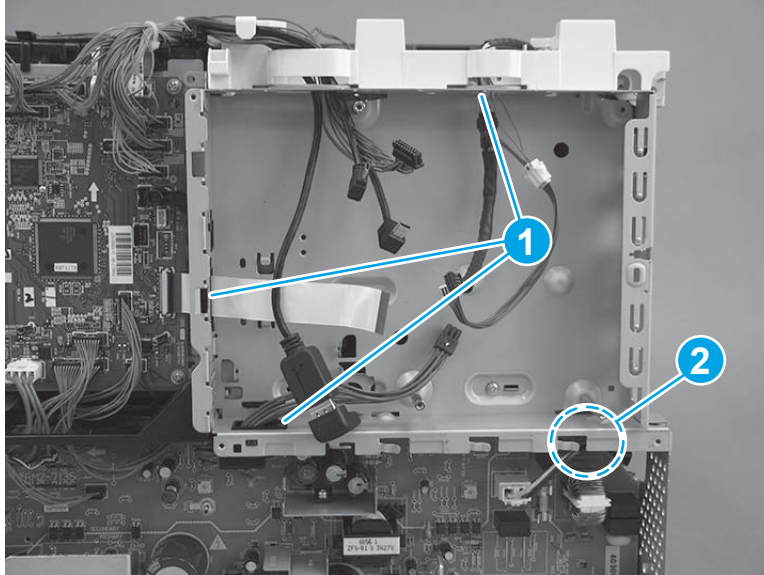

5. Remove six screws (callout 1).

Figure 1-2283 Remove six screws

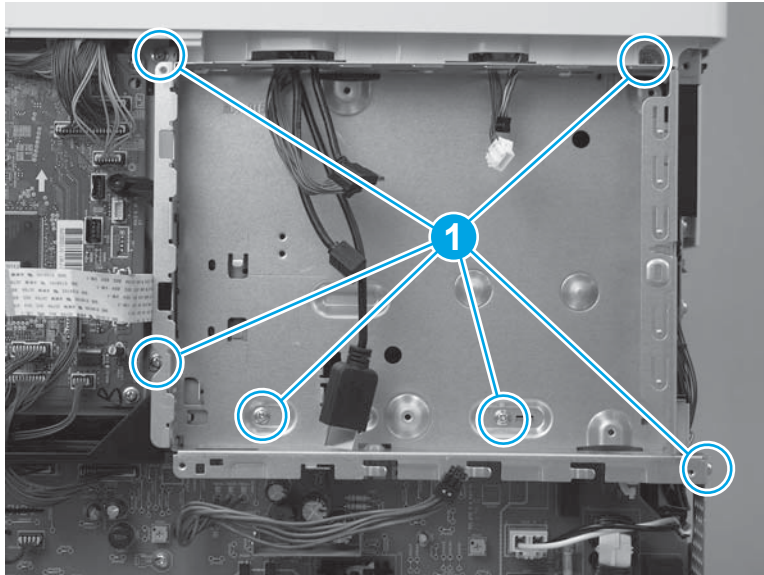

6. Rotate the bottom of the formatter case away from the printer (callout 1), and then pull it down (callout 2) to release it.

Figure 1-2284 Release the formatter case

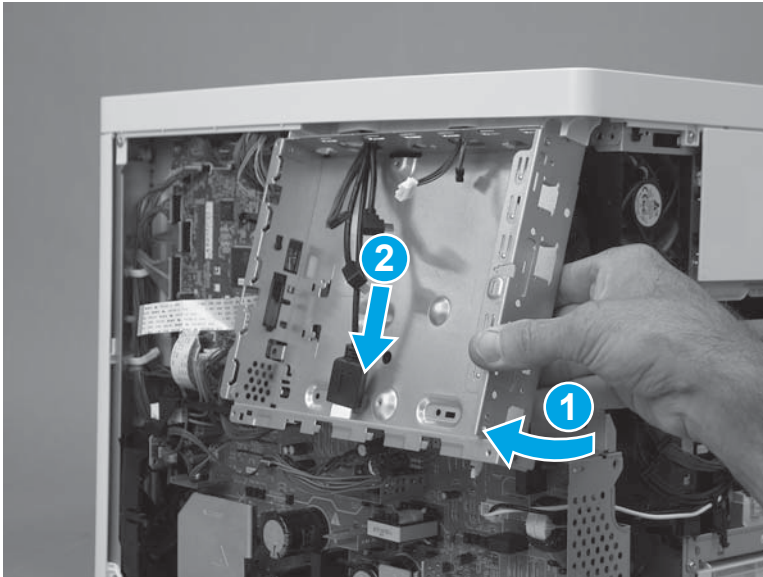

7. Pass the wire harnesses through the opening in the formatter case to remove it.

 **IMPORTANT:** If the formatter case is removed so that it can be replaced, make sure to transfer the memory PCA (island of data) and plastic bracket (callout 1) to the replacement case.

Figure 1-2285 Remove the formatter case



Step 12: Remove the low-voltage power supply (LVPS)

 **CAUTION:**  ESD-sensitive part.

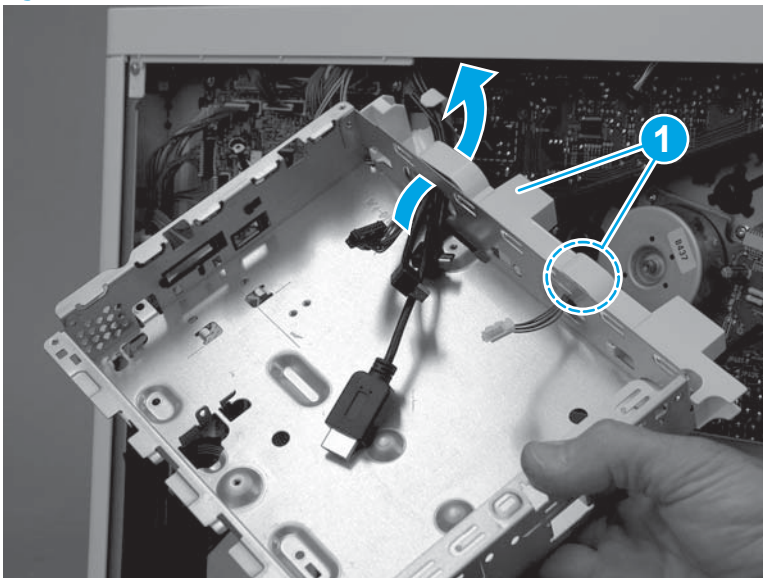
1. Disconnect one wire harness (callout 1), and then pass the wire harness through the opening (callout 2) in the chassis.

Figure 1-2286 Disconnect one wire harness

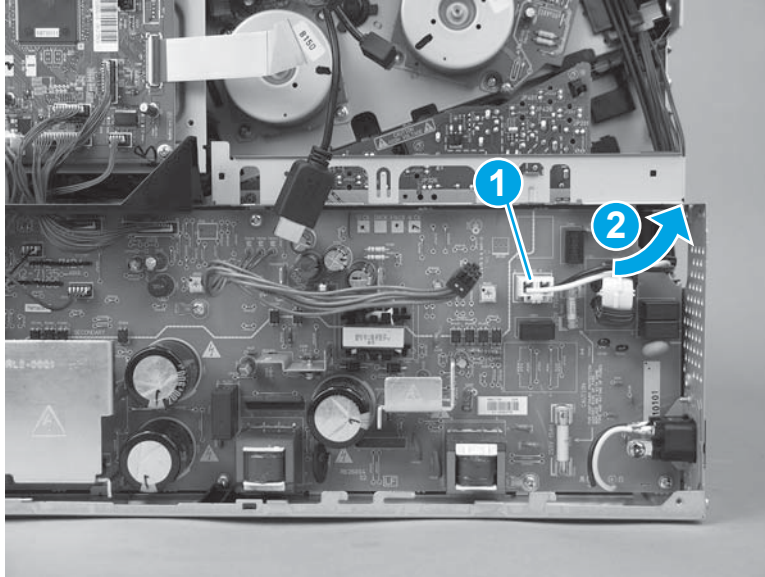

2. Disconnect three connectors on the DC controller (callout 1), and then disconnect four connectors (callout 2) on the LVPS.

Figure 1-2287 Disconnect seven connectors

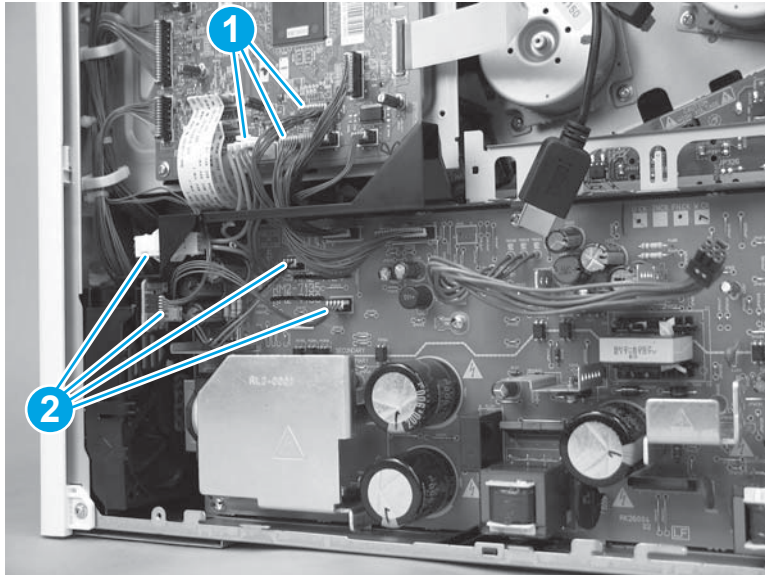

3. Pass the wire harnesses from the DC controller to the LVPS through the opening in the chassis (callout 1), and then release the wire harnesses from the retainer (callout 2).

Figure 1-2288 Pass the wire harnesses through the opening

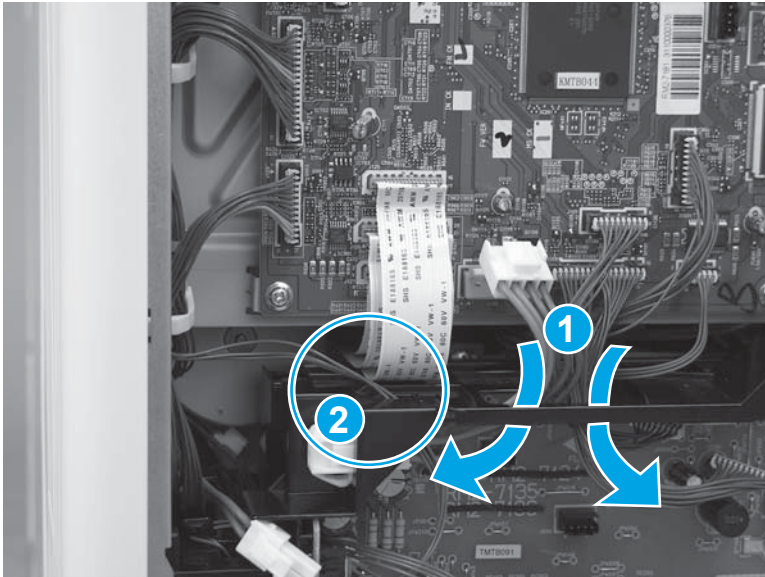

4. Remove three screws (callout 1).

Figure 1-2289 Remove three screws

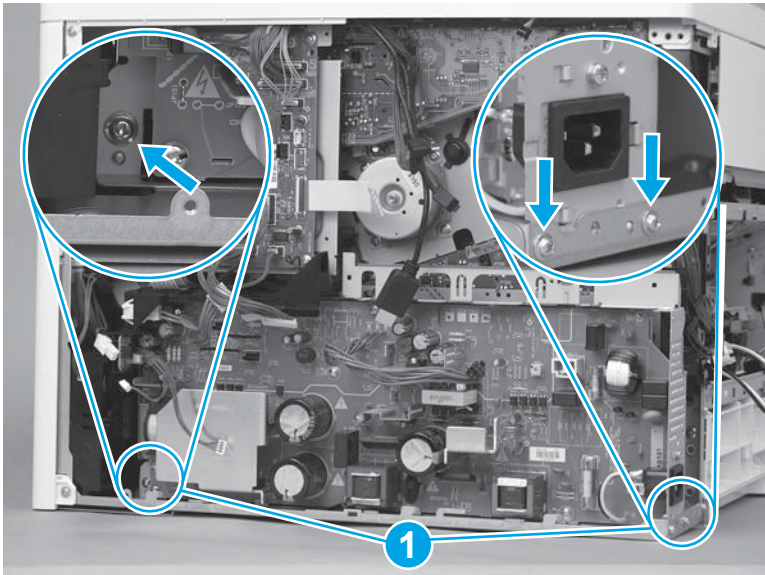

5. Rotate the top of the LVPS away from the printer (callout 1), and then slide it up and out (callout 2) of the printer to remove it.

Figure 1-2290 Remove the LVPS

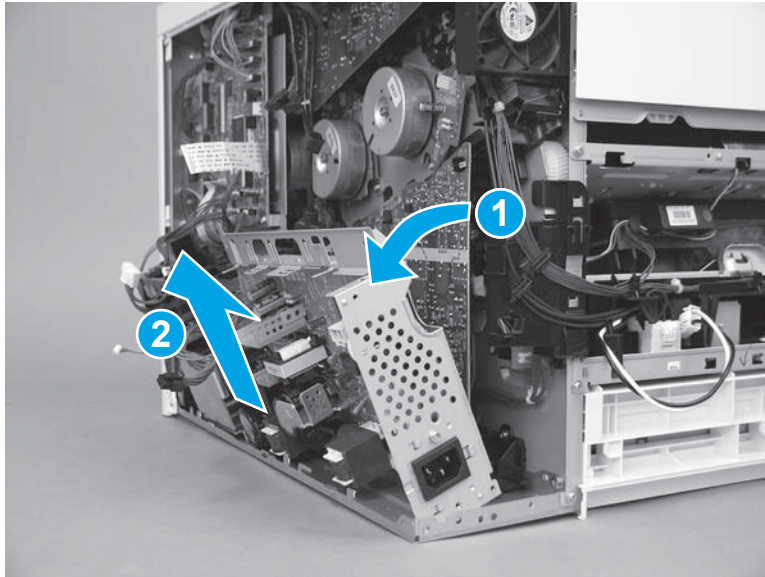

Step 13: Remove the high-voltage power supply D (HVPSD)

 **CAUTION:**  ESD-sensitive part.

1. Disconnect one flat cable (callout 1) on the DC controller.

Figure 1-2291 Disconnect one flat cable

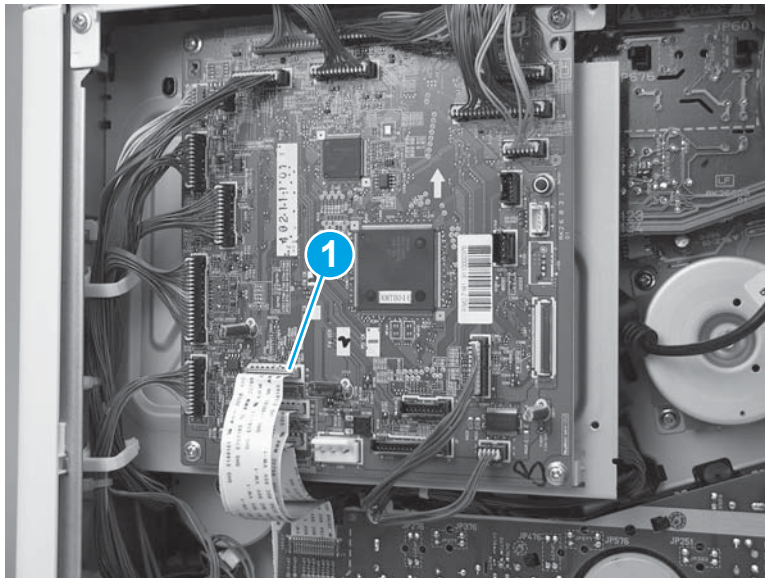

2. Remove two screws (callout 1), and then remove one self tapping screw (callout 2) on the HVPSD.

Figure 1-2292 Remove three screws

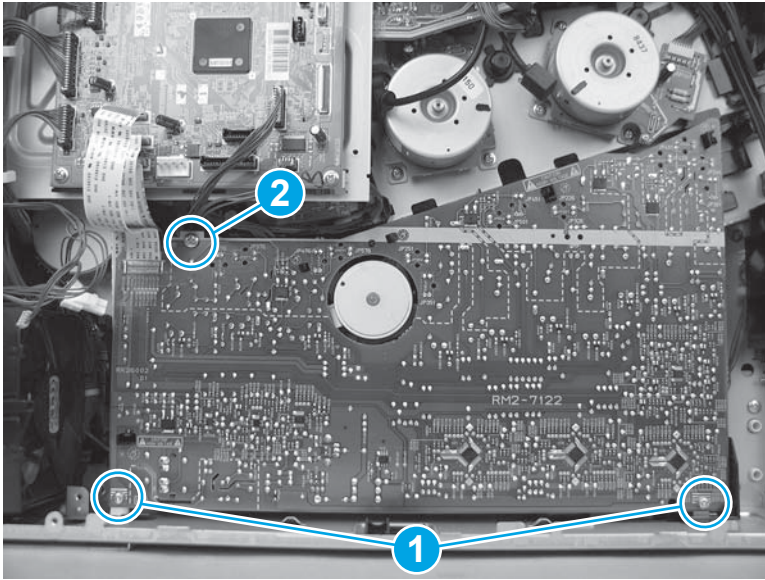

3. Release five tabs (callout 1), and then remove the HVPSD (callout 2).

Figure 1-2293 Remove the HVPSD

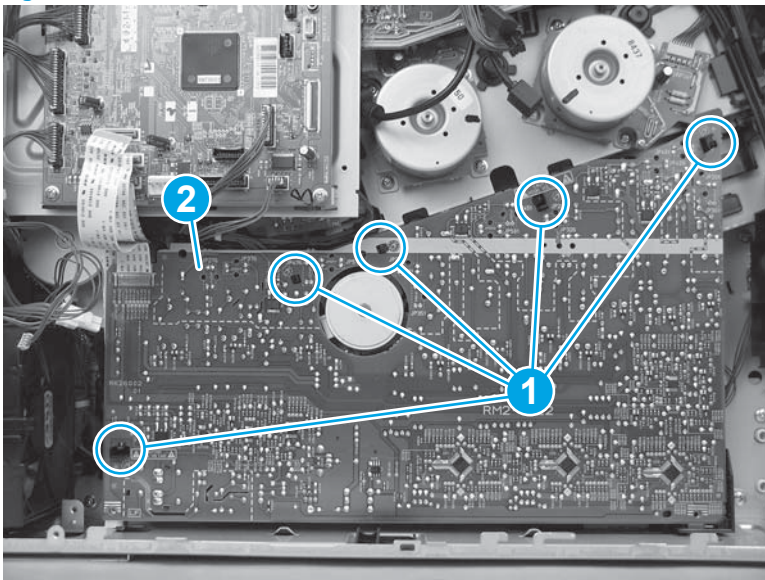

Step 14: Remove the lifter drive assembly

1. Disconnect two connectors (callout 1).

Figure 1-2294 Disconnect two connectors

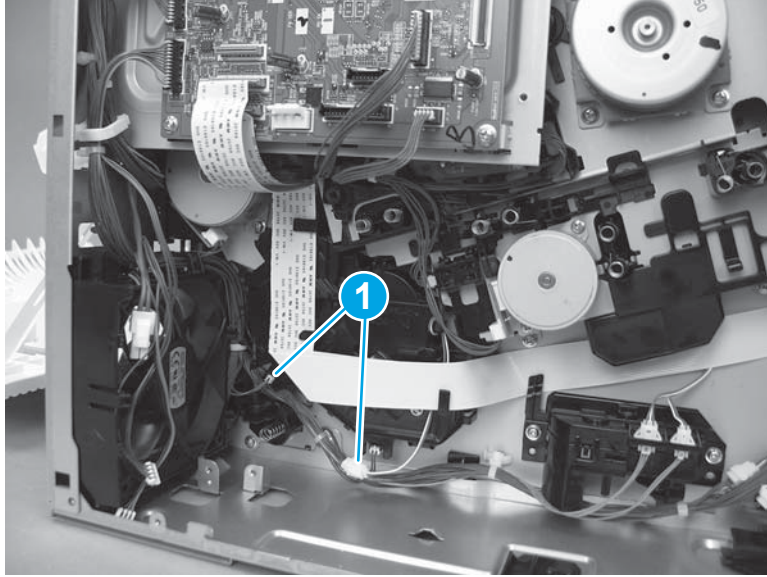

2. Disconnect two flat cables (callout 1), and then release them from the retainers (callout 2).

Figure 1-2295 Disconnect two flat cables

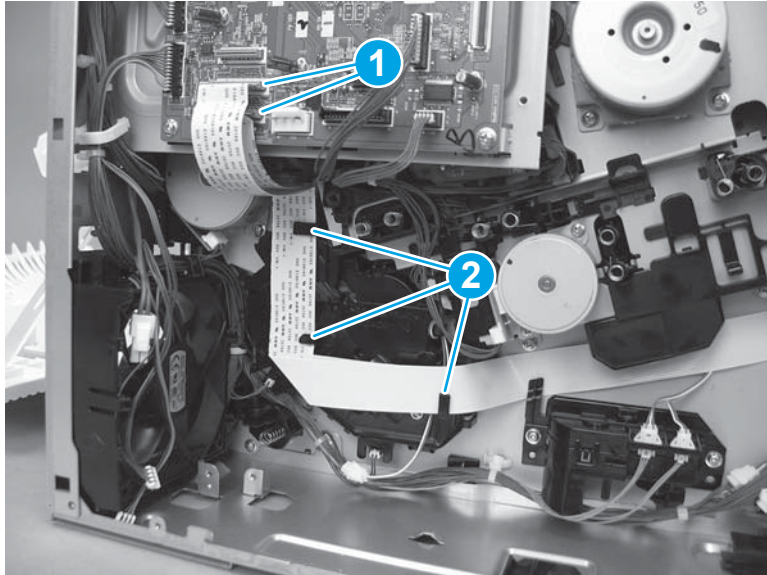

3. Remove two screws (callout 1), release one tab (callout 2), and then remove the lifter drive assembly (callout 3).

 **NOTE:** Release one wire harness from the retainer (callout 4) as the assembly is removed.

Figure 1-2296 Remove the assembly



Step 15: Unpack the replacement assembly

Unpack the replacement assembly from the packaging.

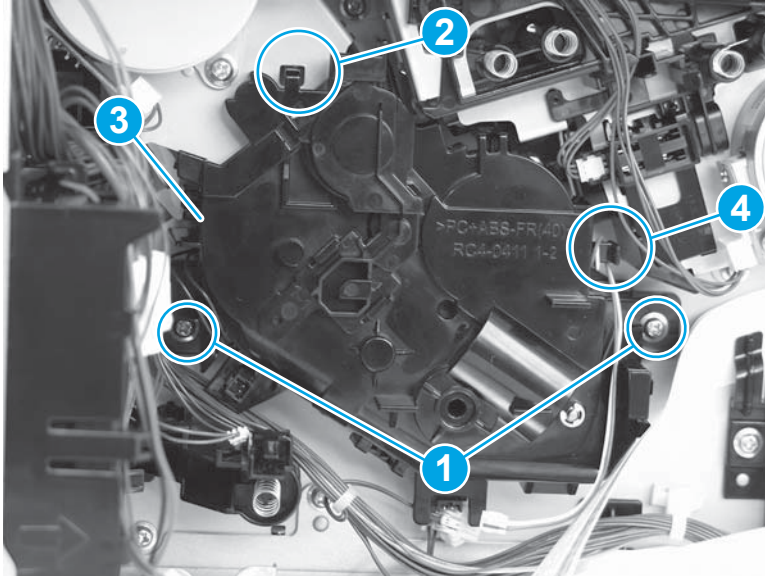
For complete information on HP's recycling programs, go to [Product return and recycling](#).

 **NOTE:** HP recommends responsible disposal of the defective assembly.

Figure 1-2297 Recycle and unpack

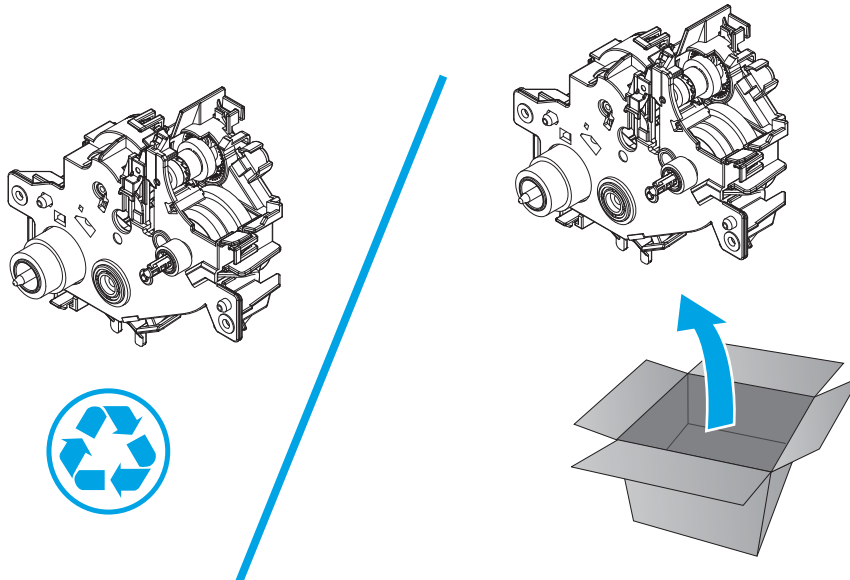

Step 16: Install the lifter drive assembly

1. Install one wire harness on the retainer (callout 1), position the lifter drive assembly in the printer (make sure that one tab (callout 2) snaps into place), and then install two screws (callout 3).

 **TIP:** It might be easier to install the assembly if the bottom of the assembly is installed first, and then the top of the assembly is rotated into place.

Figure 1-2298 Install the lifter drive

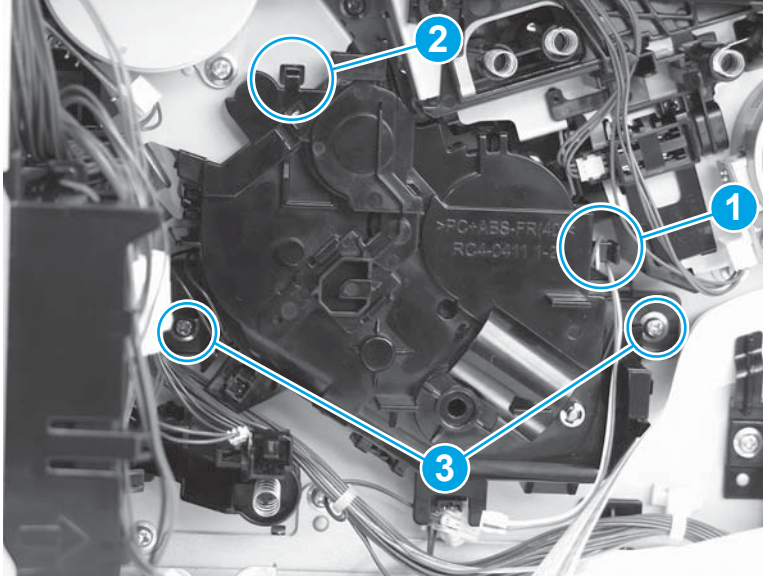

2. Connect two flat cables (callout 1), and then place them in the retainers (callout 2).

Figure 1-2299 Connect two flat cables

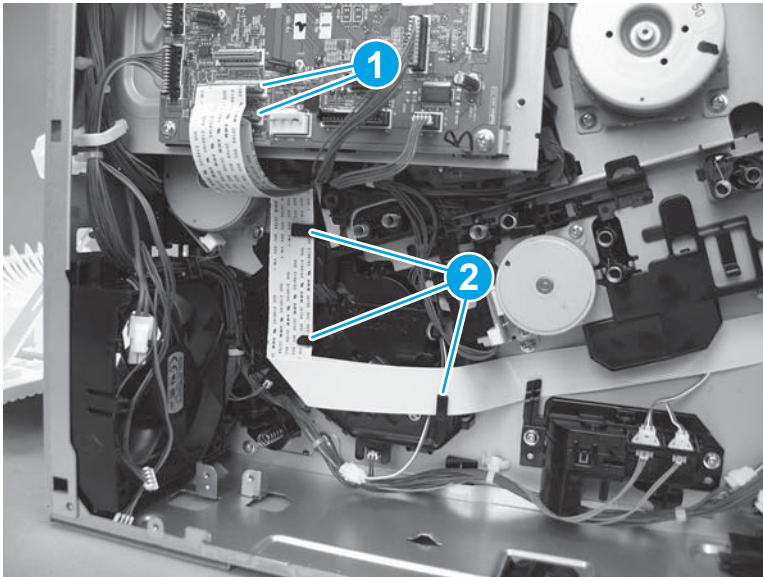

3. Connect two connectors (callout 1).

Figure 1-2300 Connect two connectors

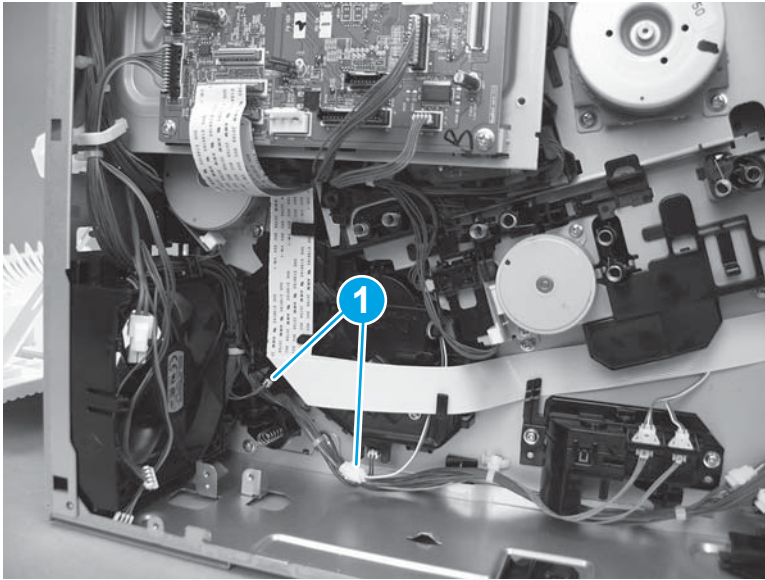

Step 17: Install the HVPSD

 **CAUTION:**  ESD-sensitive part.

1. Position the bottom right corner of the HVPSD (callout 1) behind the black tab, and then rotate it up and onto the printer (callout 2).

Figure 1-2301 Install the HVPSD

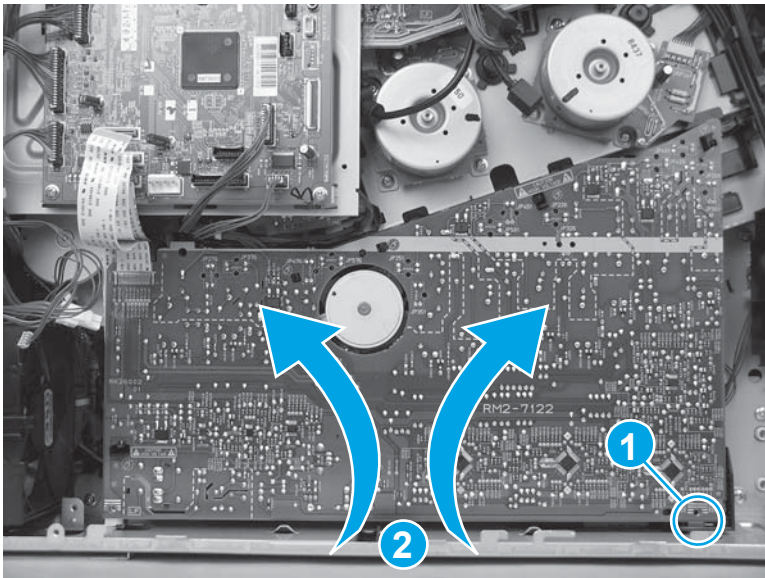

2. Press it onto five tabs (callout 2).

 **IMPORTANT:** Make sure that all five tabs snap into place.

Figure 1-2302 Press the tabs



3. Install two screws (callout 1), and then install one self tapping screw (callout 2) on the HVPSD.

Figure 1-2303 Install three screws

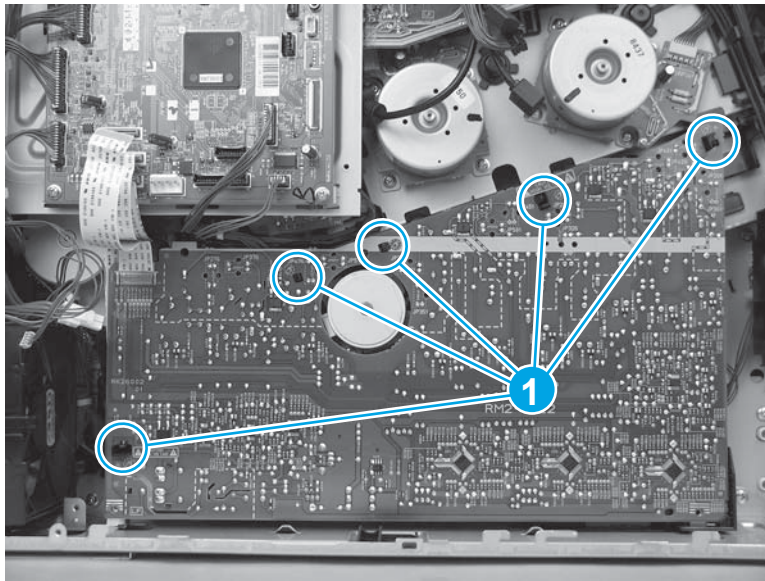
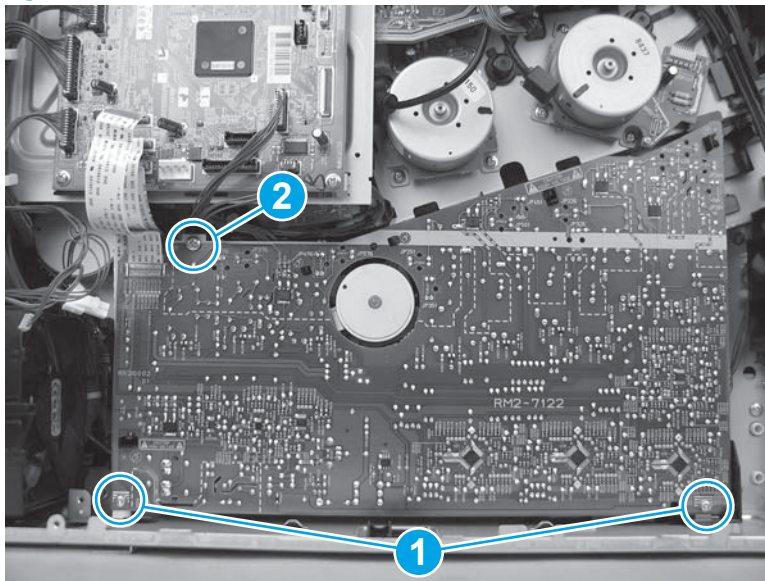

4. Connect one flat cable (callout 1) on the DC controller.

Figure 1-2304 Connect one flat cable

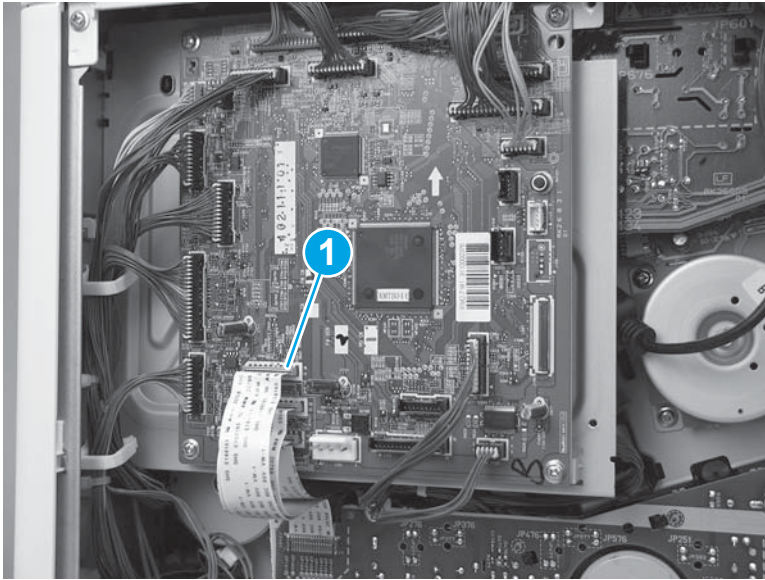

Step 18: Install the LVPS

 **CAUTION:**  ESD-sensitive part.

1. Position the bottom of the LVPS in the printer (callout 1) at a slight angle, and then rotate the top of it into the printer (callout 2) to install it.

Figure 1-2305 Install the LVPS

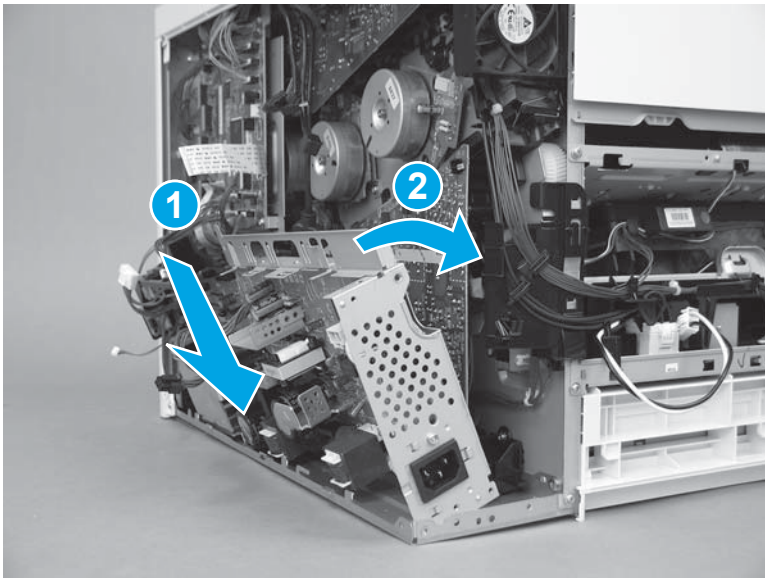

2. Install three screws (callout 1).

Figure 1-2306 Install three screws

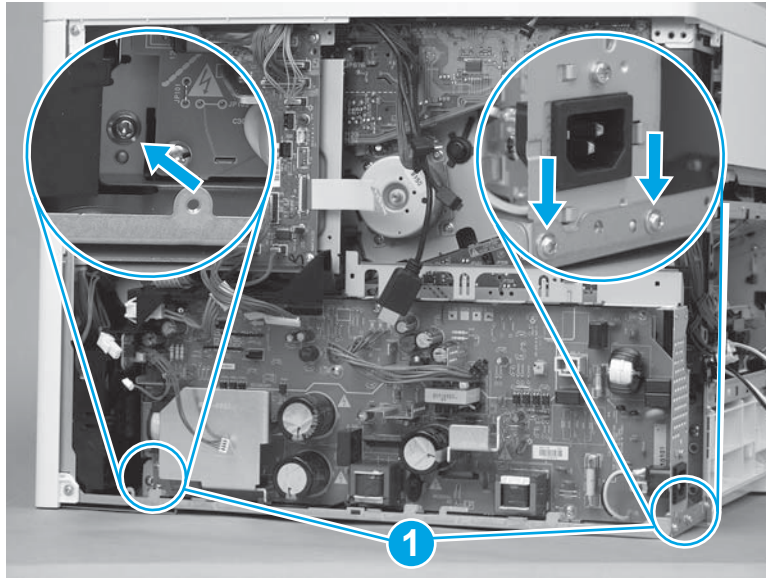

3. Pass the wire harnesses from the DC controller to the LVPS through the opening in the chassis (callout 1), and then install the wire harnesses in the retainer (callout 2).

Figure 1-2307 Pass the wire harnesses through the opening

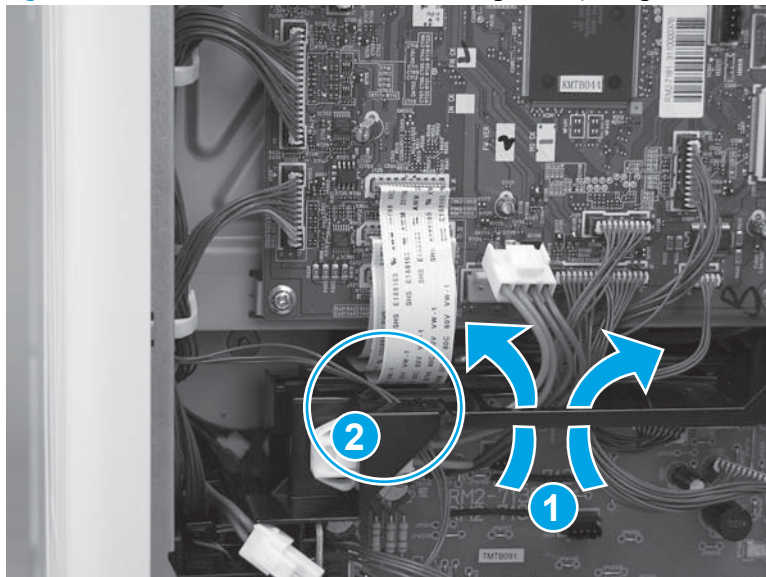

4. Connect three connectors on the DC controller (callout 1), and then connect four connectors (callout 2) on the LVPS.

Figure 1-2308 Connect seven connectors

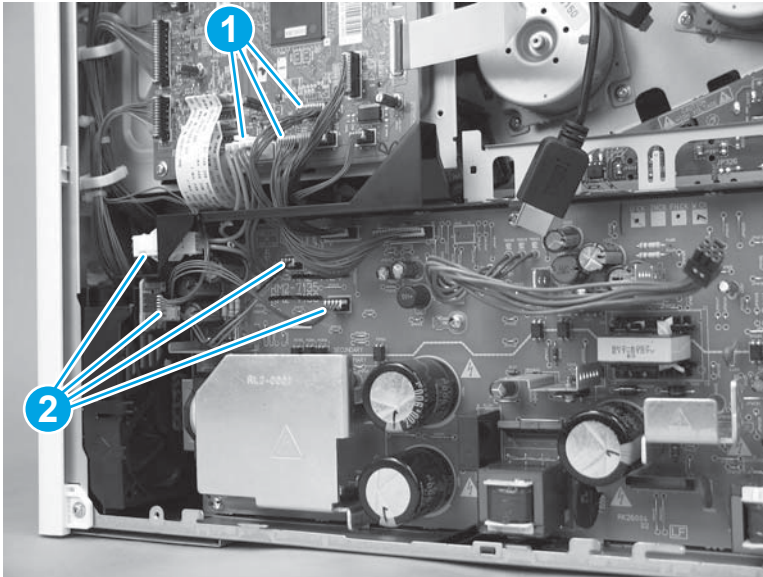

5. Pass the wire harness through the opening (callout 1) in the chassis, and then connect one wire harness (callout 2).

Figure 1-2309 Connect one wire harness

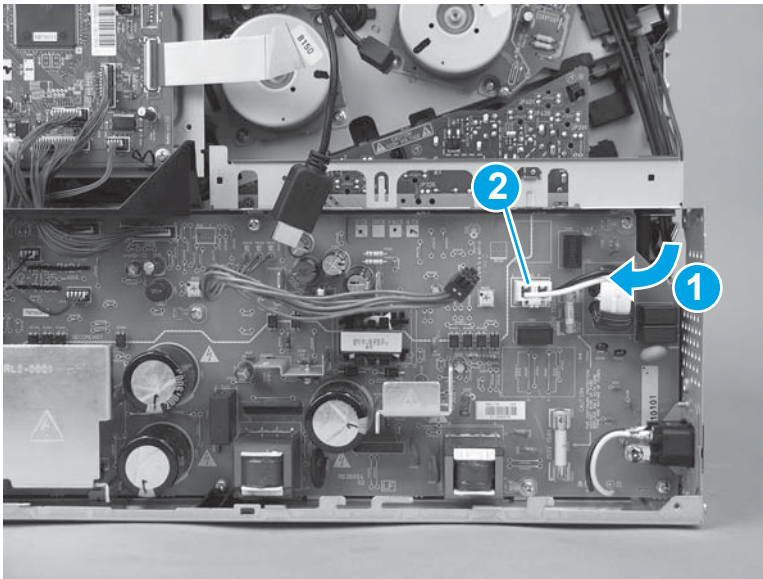

Step 19: Install the formatter case

1. Pass the wire harnesses through the opening in the formatter case.

Figure 1-2310 Pass the wire harnesses through the opening

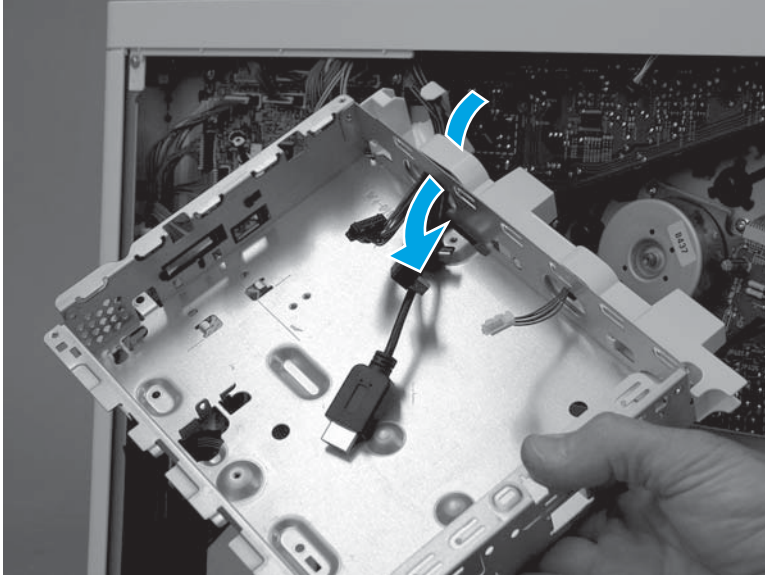

2. Position the top of the formatter case on the printer (callout 1), and then rotate the bottom of the case (callout 2) into the printer.

Figure 1-2311 Install the formatter case

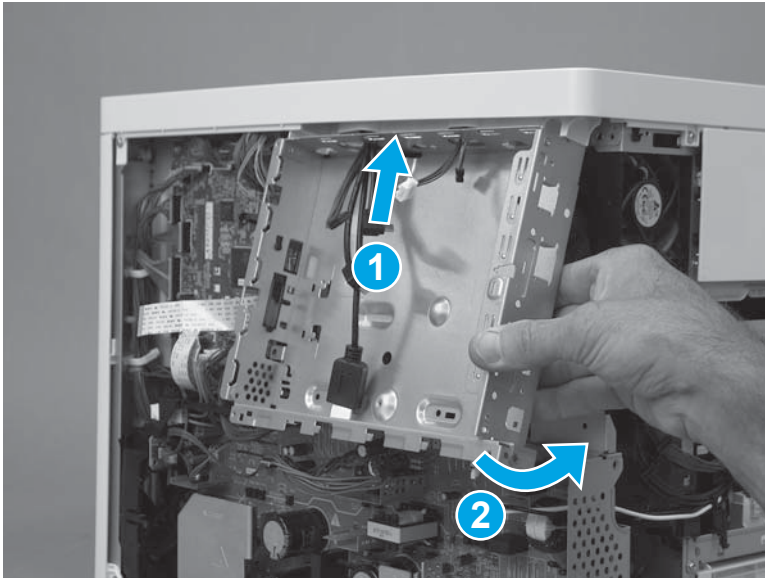

3. Install six screws (callout 1).

Figure 1-2312 Install six screws

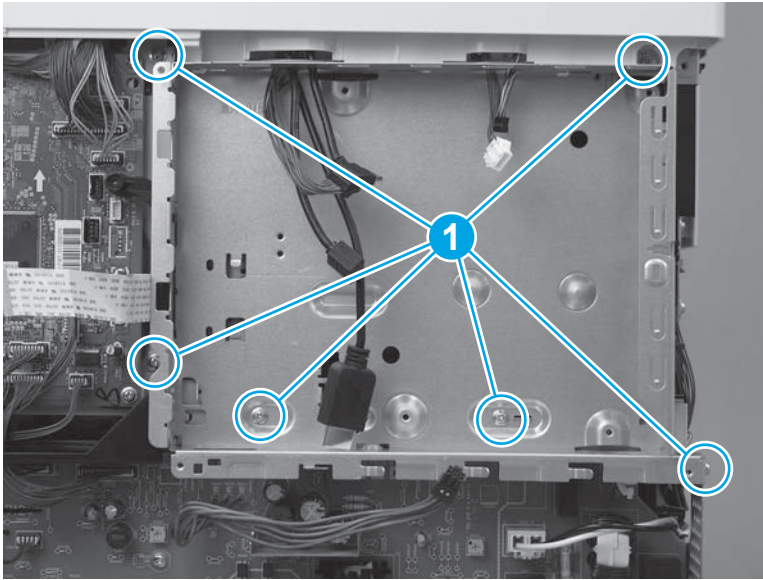

4. Pass two wire harnesses and one flat cable (callout 1) through the opening in the formatter case, and then install one wire harness in the retainer (callout 2).

 **IMPORTANT:** Make sure that the flat cable is securely fastened to the DC controller, and was not dislodged when the formatter case was removed.

Figure 1-2313 Install wire harnesses and flat cable

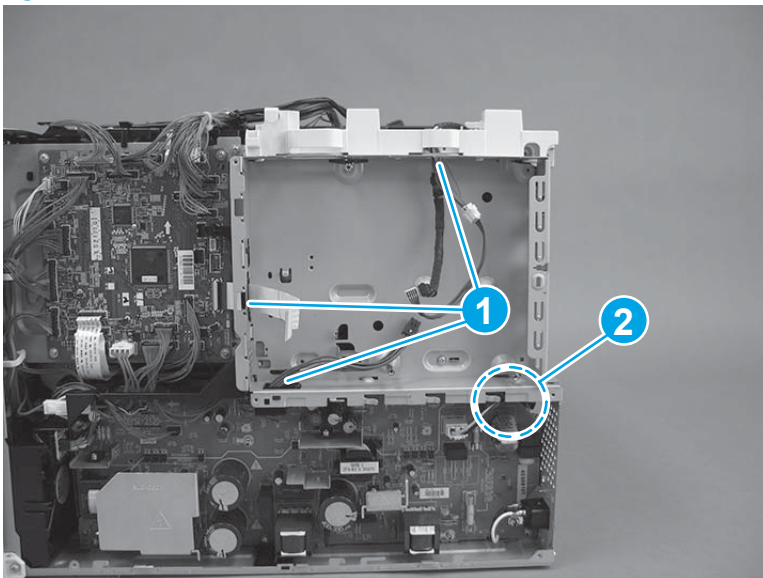

5. Position the LVPS cover on the printer, slide the cover to the left to install it, and then install two screws (callout 1).

Figure 1-2314 Install the LVPS cover

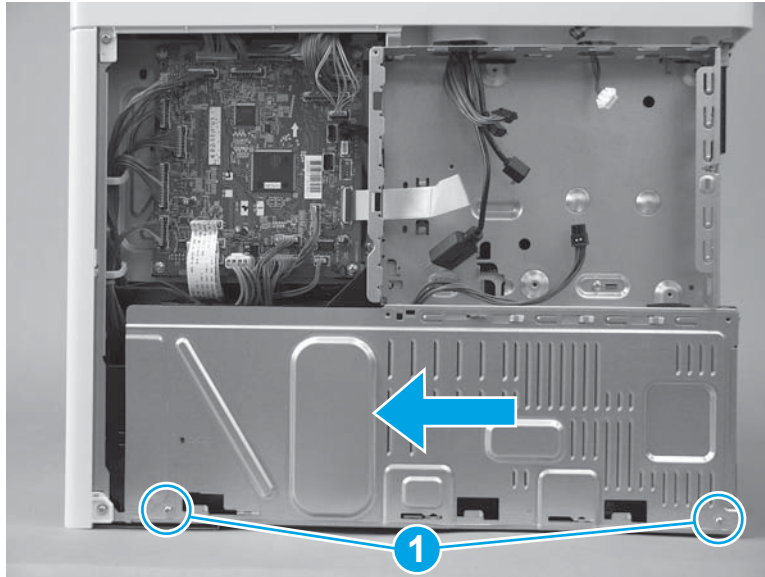

6. If no tape is affixed to the back of the flat cable, skip this step. If double-sided tape is affixed to the back of the flat cable, align the line (callout 1) on the cable with the edge (callout 2) of the opening in the sheet metal. Press to attach the flat cable to the formatter case.

Figure 1-2315 Attach the flat cable

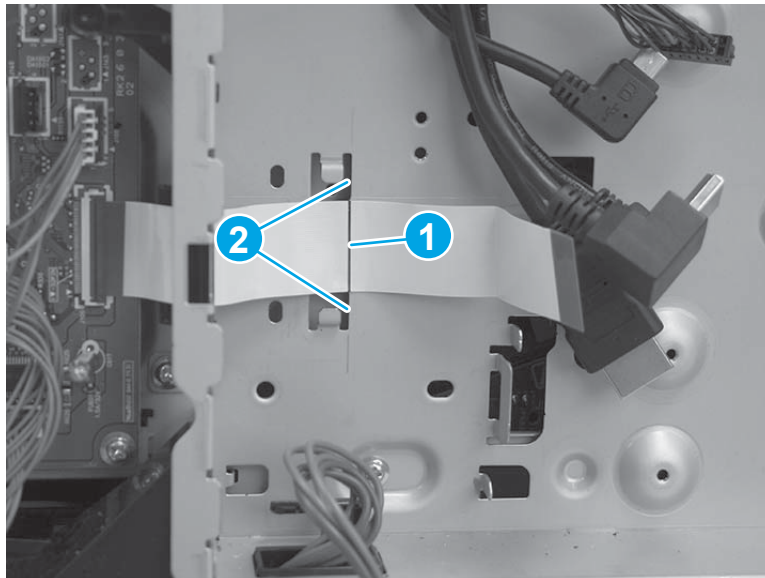

7. Position the bracket over the flat cable, and then slide the bracket to the left to install it. Make sure that the edges of the bracket fit under the sheet metal tabs (callout 1) on the formatter case and that the tabs (callout 2) snap into place.

Figure 1-2316 Position the bracket

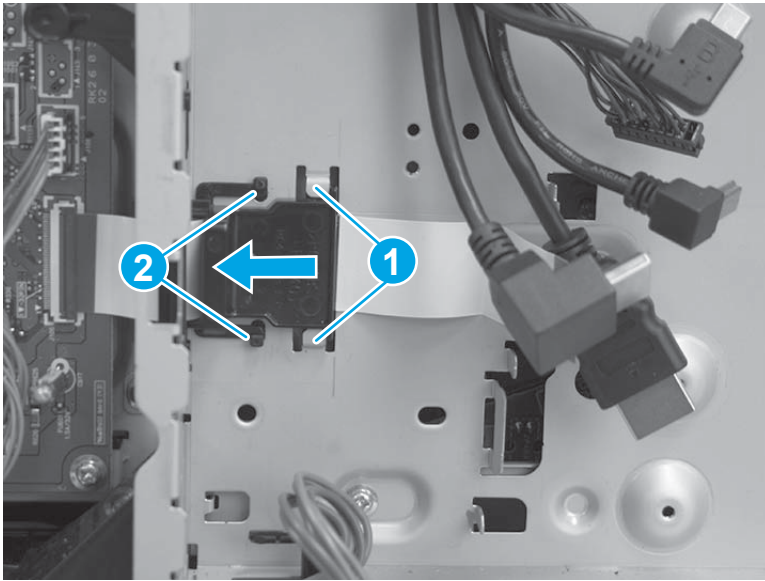

8. **M577 only:** Pass the wire harness (callout 1) through the openings in the formatter case (callout 2), and then connect one connector (callout 3).

Figure 1-2317 Connect one connector

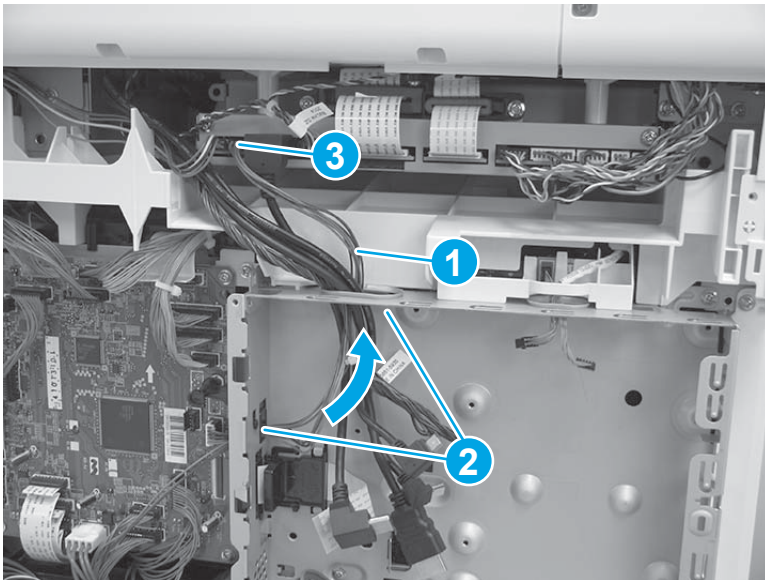

Step 20: Install the left cover

1. Position the cover on the printer.

 **NOTE:** Slightly offset the cover toward the rear of the printer.

Figure 1-2318 Install the cover

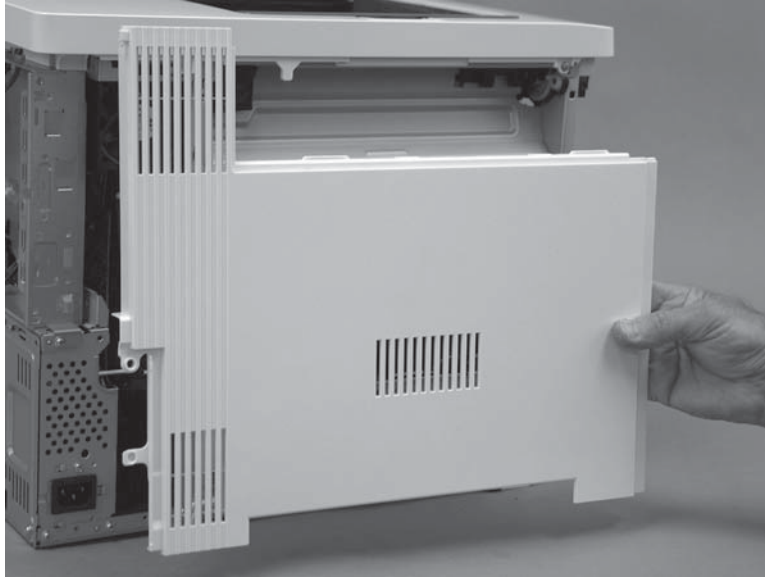

2. Slide the cover (callout 1) toward the front of the printer to engage it. Make sure that the tab (callout 2) snaps into place.

 **NOTE:** Locate the alignment pin (callout 3) on the cover from the front door side of the printer, and then make sure that it is fully engaged in the slot in the chassis.

 **TIP:** While sliding the cover into place, push in on the center of the cover (callout 1) to make sure that the hooks on the back of the cover engage with the slots in the chassis.

Figure 1-2319 Engage the cover



3. At the left side of the printer, install one screw (callout 1).

Figure 1-2320 Install one screw

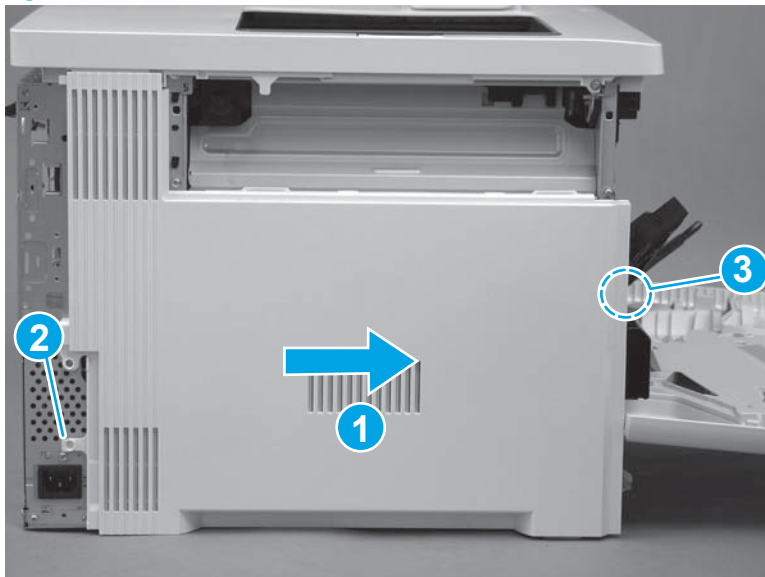

Step 21: Install the rear cover (M577)

 **NOTE:** This step is for the M577 models. For the M552 and M553 models, skip this step and go to [Step 23: Install the rear cover \(M552 and M553\) on page 1321](#).

1. Position the hooks (callout 1) on the cover in the slots (callout 2) in the printer.

Figure 1-2321 Position the hooks

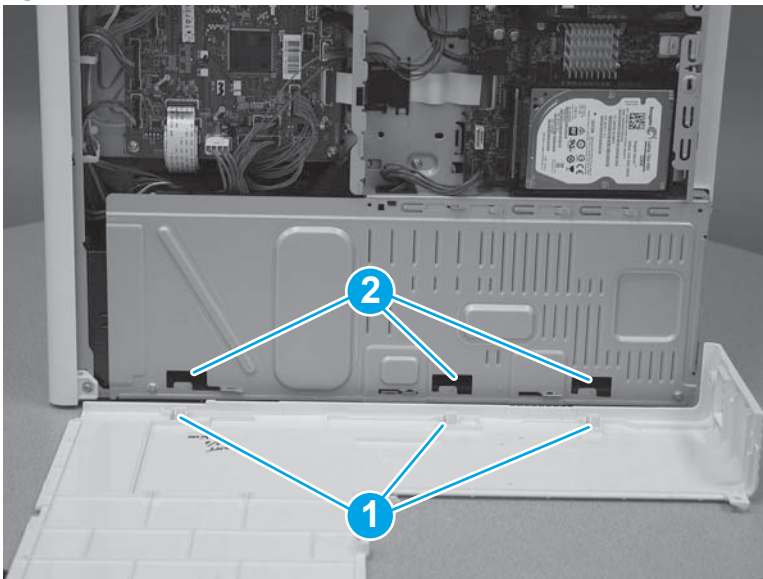

2. Position the back edge (callout 1) of the rear cover behind the edge (callout 2) of the right rear cover. Slide the cover to the left to install it.

Figure 1-2322 Install the cover

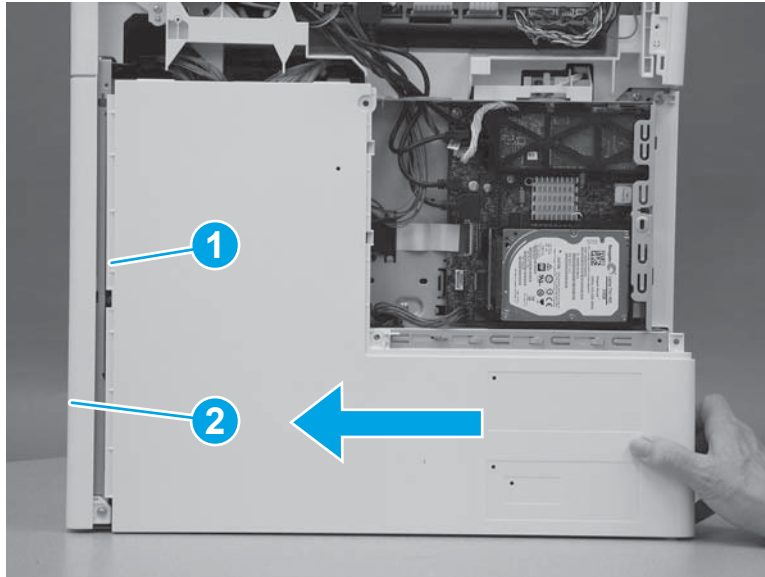

3. Install four screws (callout 1).

Figure 1-2323 Install four screws cover

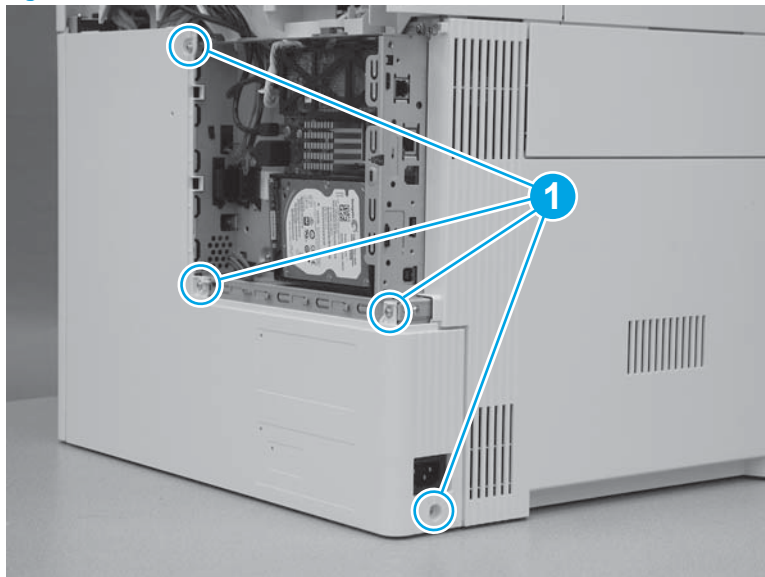

Step 22: Install the rear upper cover (M577)

 **NOTE:** This step is for the M577 models. For the M552 and M553 models, skip this step and go to [Step 23: Install the rear cover \(M552 and M553\) on page 1321](#).

1. Align the ridge (callout 1) on the lower edge of the rear upper cover in front of the tabs (callout 2) on the top edge of the rear cover.

Figure 1-2324 Align the cover

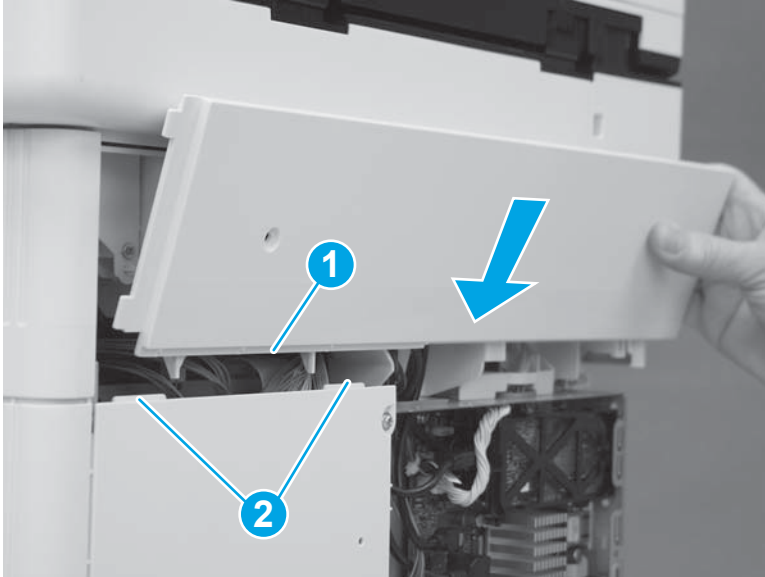

2. Rotate the top of the cover toward the printer.

Figure 1-2325 Rotate the top of the cover

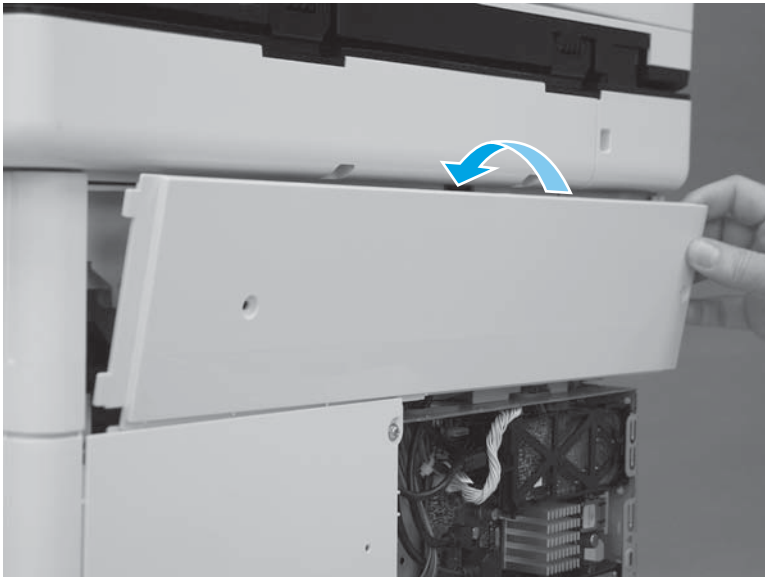

3. Slide the cover to the left (callout 1). Make sure that the tabs (callout 2) on the upper rear cover slide behind the edge (callout 3) of the right upper cover. Make sure that the cover is fully seated.

Figure 1-2326 Slide the cover

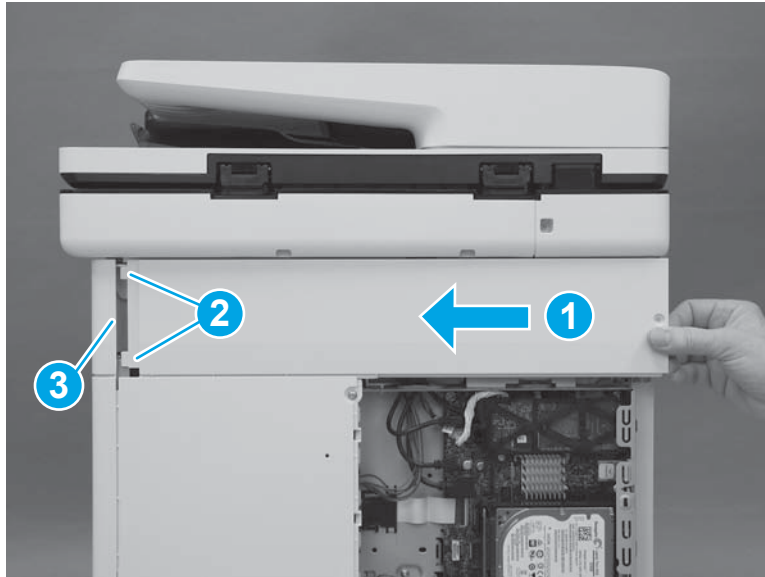

4. Install two screws (callout 1).



 **IMPORTANT:** These two screws are self-tapping screws for plastic. Rotate them counterclockwise to align them with the existing thread pattern, and then carefully turn them clockwise to tighten. Do not overtighten. This will prevent stripping the threads inside the screw holes.

Figure 1-2327 Install two screws

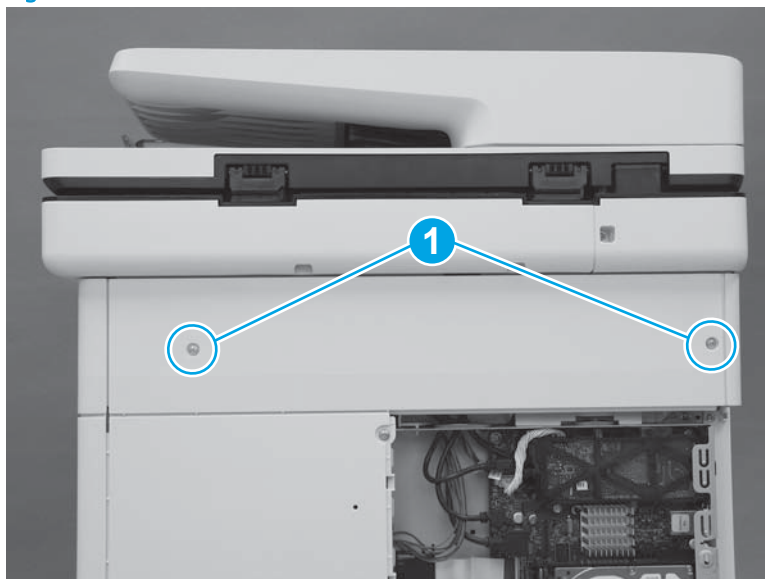

Step 23: Install the rear cover (M552 and M553)

 **NOTE:** This step is for the M552 and M553 models. For the M577 models, skip this step and go to [Step 24: Install the formatter \(M577\) on page 1322](#).

1. Position the top of the cover under the upper cover (callout 1), rotate the bottom of the cover onto the chassis (callout 2), and then slide the cover to the left (callout 3) to install it.

Figure 1-2328 Install the cover

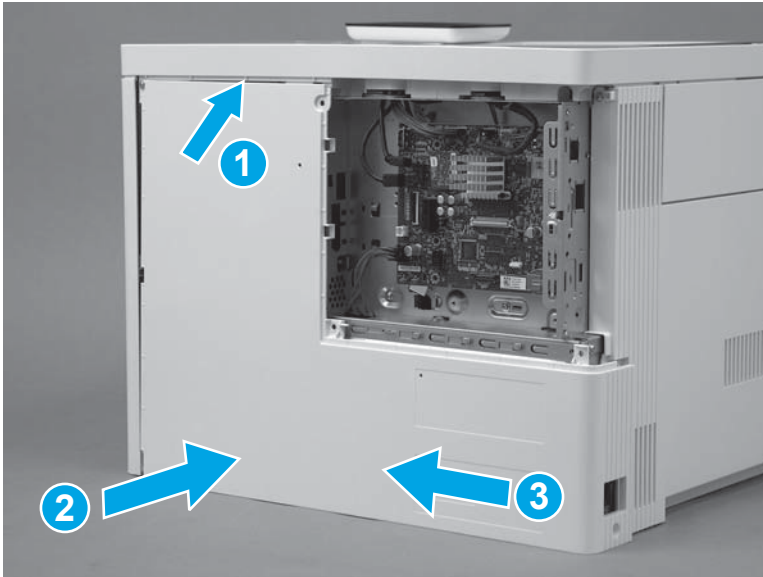

2. Install four screws (callout 1).

Figure 1-2329 Install four screws cover

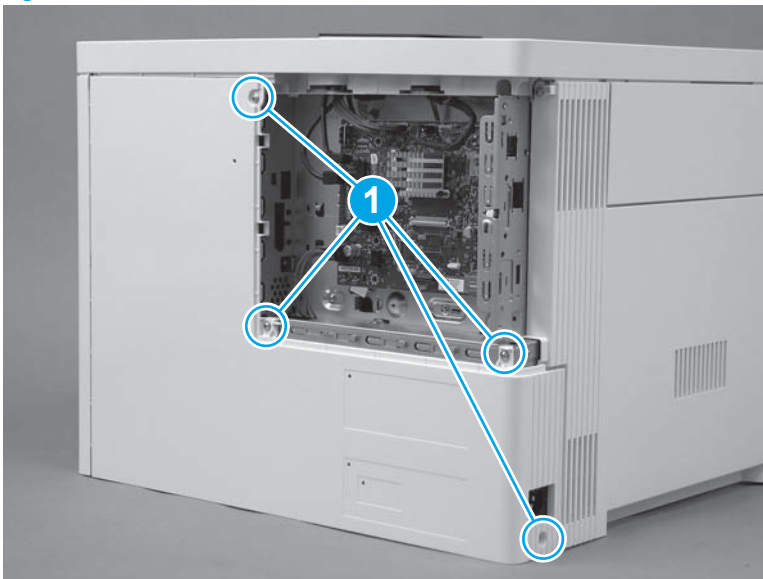

Step 24: Install the formatter (M577)

 **NOTE:** This step is for the M577 models. For the M552 and M553 models, skip this step and to go [Step 27: Install the formatter \(M552 and M553\) on page 1327](#).

 **CAUTION:**  ESD-sensitive part.

1. Position the formatter in the printer. Make sure that the network port (callout 1) fits through the opening (callout 2) in the formatter case.

Figure 1-2330 Install the formatter

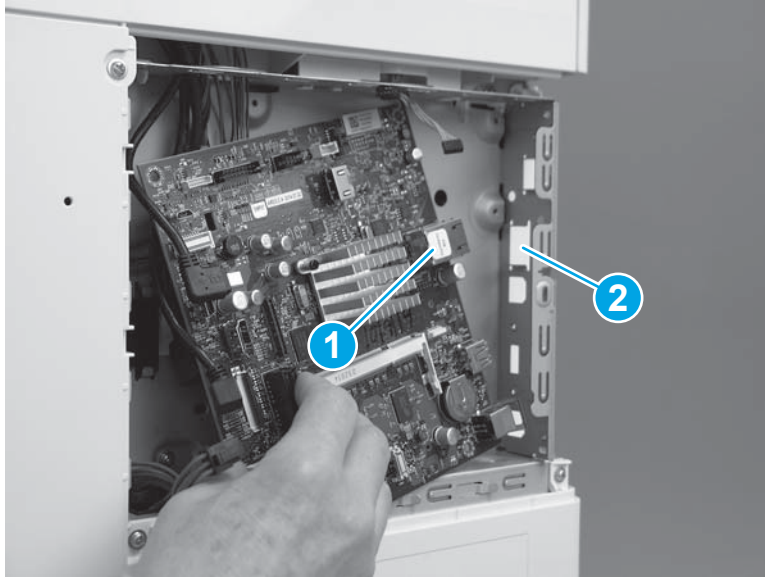

2. Install four screws (callout 1).

Figure 1-2331 Install four screws

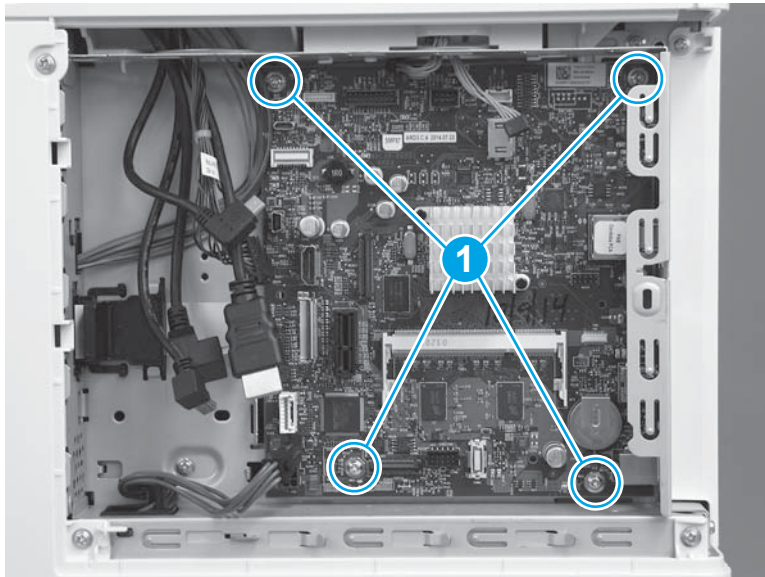

3. Connect all of the connectors on the formatter.

The following connectors are empty:

- All models: J1 (this connector is empty unless the optional DIMM is installed)
- All models: J3
- M577dn: J15 (this is the fax connector for the M577f/z/c models)
- All models: J21 (this connector is empty unless the optional internal USB ports component is installed)
- All models: J23

- All models: J24
- All models: J51
- All models: J57
- All models: J97
- All models: J98 (this connector is empty unless the optional trusted platform module (TPM) is installed)

 **IMPORTANT:** The flat-cable connector (callout 1) is a Zero Insertion Force (ZIF) connector that uses a hinged retainer to secure the flat cable. The hinged retainer must be opened to install the flat cable, and then closed after the cable is installed.

Figure 1-2332 Connect all connectors



Step 25: Install the fax PCA (M577c/f/z)

 **NOTE:** This step is for the M577c/f/z models. For the M577n model, skip this step and go to [Step 26: Install the HDD \(M577\) on page 1326](#).

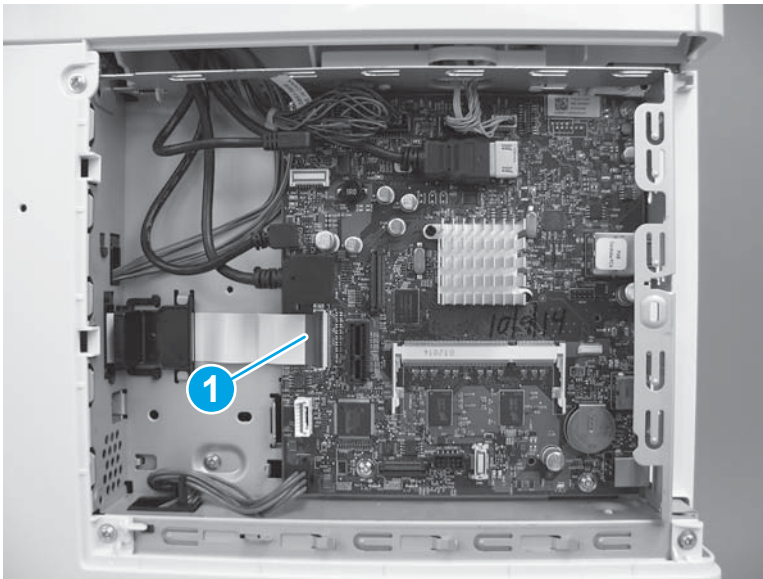
For the M552 and M553 models, skip this step and go to [Step 27: Install the formatter \(M552 and M553\) on page 1327](#).

 **CAUTION:**  ESD-sensitive part.

1. Position the tab and telephone port (callout 1) on the fax PCA in the slots (callout 2) in the formatter case.

Figure 1-2333 Position the fax PCA

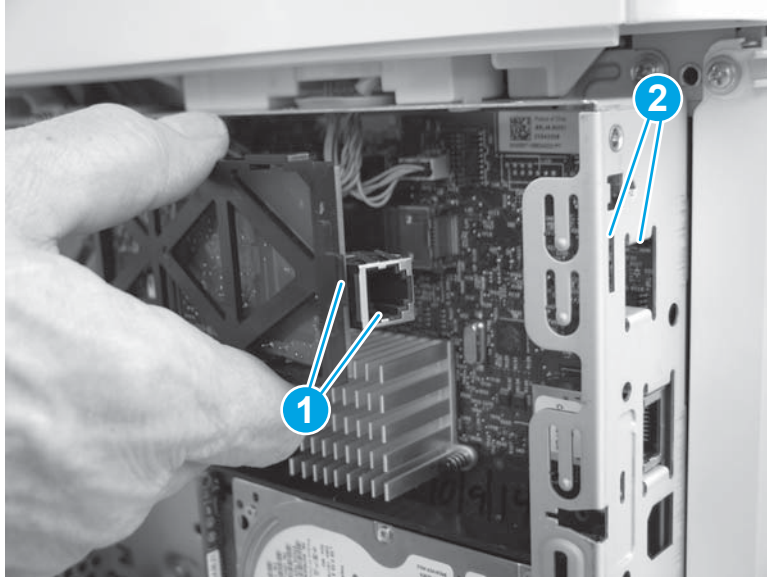

2. Slide the fax PCA to the right (callout 1) until the tab and telephone port described in the previous step and seated in the formatter case. Position the retainer (callout 2) in the slot (callout 3) in the formatter. Rotate the end of the fax PCA toward the formatter (callout 4) until the retainer snaps into place.

Figure 1-2334 Install the fax PCA

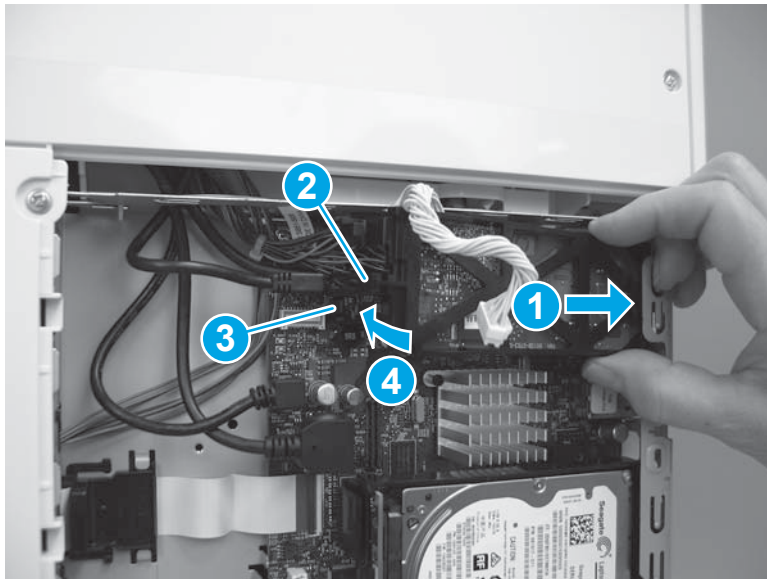

3. Position the cable (callout 1) in the guide (callout 2), and then connect one connector (callout 3).

Figure 1-2335 Connect the connector

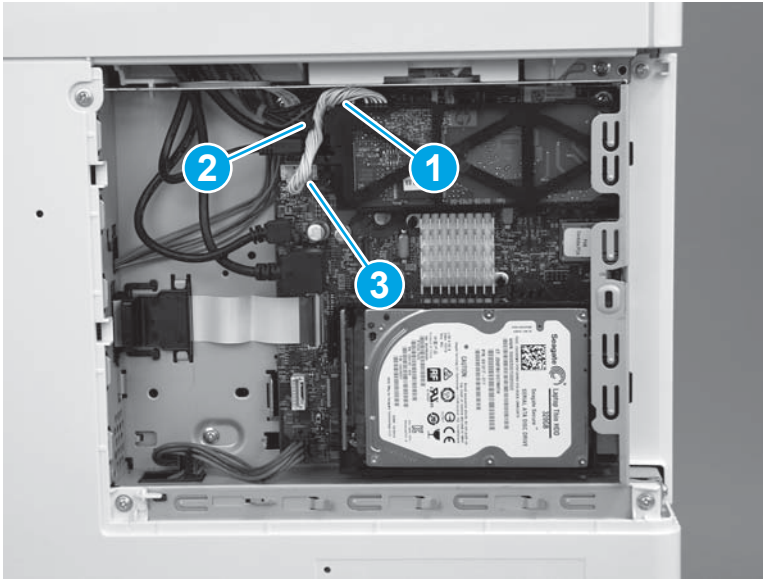

Step 26: Install the HDD (M577)

 **NOTE:** This step is for the M577 models. For the M552 and M553 models, skip this step and go to [Step 27: Install the formatter \(M552 and M553\) on page 1327](#).

 **CAUTION:**  ESD-sensitive part.

1. Align the end of the bracket (callout 1) with the slot in the chassis (callout 2), and then slide the HDD into the printer (callout 3) to engage the bracket with the chassis.

Figure 1-2336 Install the holder

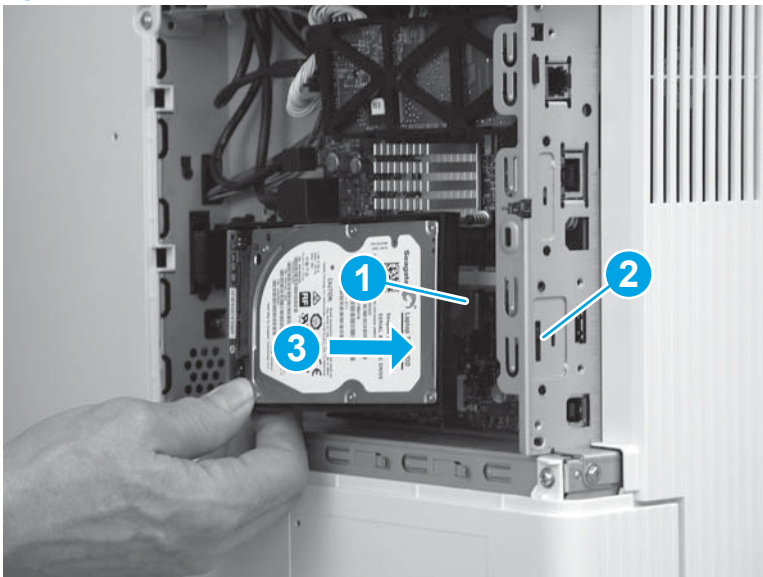

2. Hold the HDD connector latch (callout 1) in the released position, and then rotate the HDD down and into the connector on the formatter to install it.

 **NOTE:** Make sure that the tab (callout 2) snaps into place, and that the HDD is securely installed.

Figure 1-2337 Release the HDD



Step 27: Install the formatter (M552 and M553)

 **NOTE:** This step is for the M552 and M553 models. For the M577 models, skip this step and go to [Step 28: Install the formatter cover on page 1329](#).

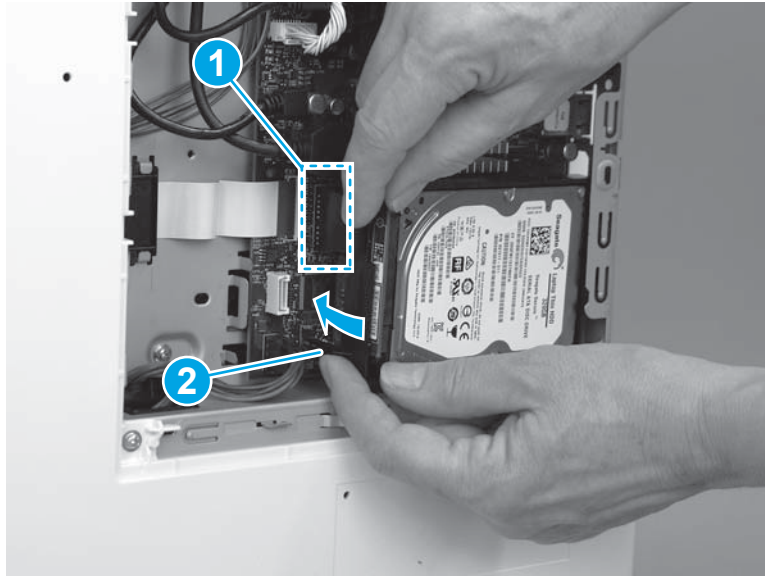
If the optional hard-disk drive (HDD) was removed, do not forget to reinstall it after the formatter is reinstalled.

Engage the HDD holder with the chassis, rotate the HDD connector down and into the connector on the formatter. Make sure that the tabs snap into place.

 **CAUTION:**  ESD-sensitive part.

1. Position the formatter in the printer, and then install four screws (callout 1).

Figure 1-2338 Install the formatter

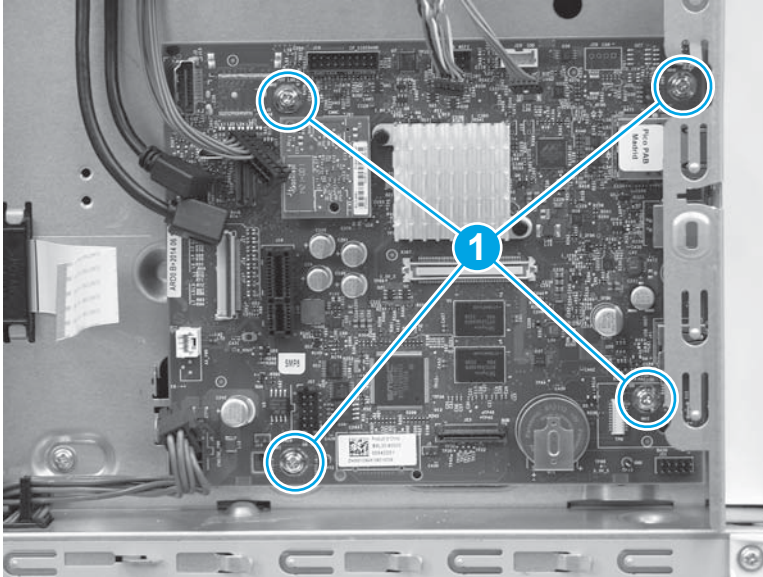

2. Connect all of the connectors on the formatter.

The following connectors are empty:

- All models: J1 (this connector is empty unless the optional DIMM is installed)
- M553n/dn and M552dn: J2 (callout 1; this is the touchscreen connector for the M553x model)
- All models: J9 (this connector is empty unless the optional internal USB ports component is installed)
- All models: J18 (this connector is empty unless the optional hard-disk-drive (HDD) is installed)
- All models: J23
- All models: J24
- M553n/dn and M552dn: J25 (this is the wireless connector for the M553x model)
- All models: J57
- All models: J98 (this connector is empty unless the optional trusted platform module (TPM) is installed)



 **IMPORTANT:** The flat-cable connector (callout 2) is a Zero Insertion Force (ZIF) connector that uses a hinged retainer to secure the flat cable. The hinged retainer must be opened to install the flat cable.

Figure 1-2339 Connect all connectors

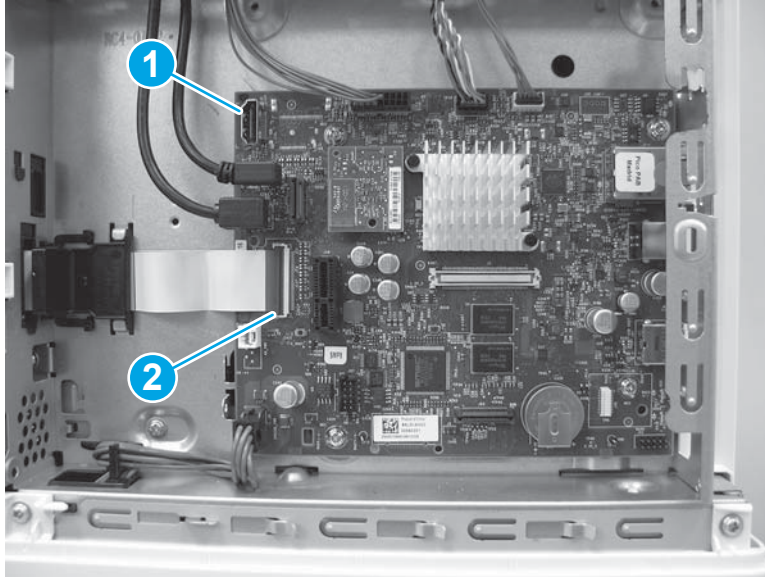

Step 28: Install the formatter cover

- ▲ Slide the cover onto the printer (callout 1) to install it.

 **NOTE:** Make sure that the tabs on the formatter cover align with the slots provided in the printer (callout 2). Tighten the two thumbscrews (callout 3).

 **TIP:** If needed, use the edge of a coin to turn the thumbscrews.

Figure 1-2340 Install the cover

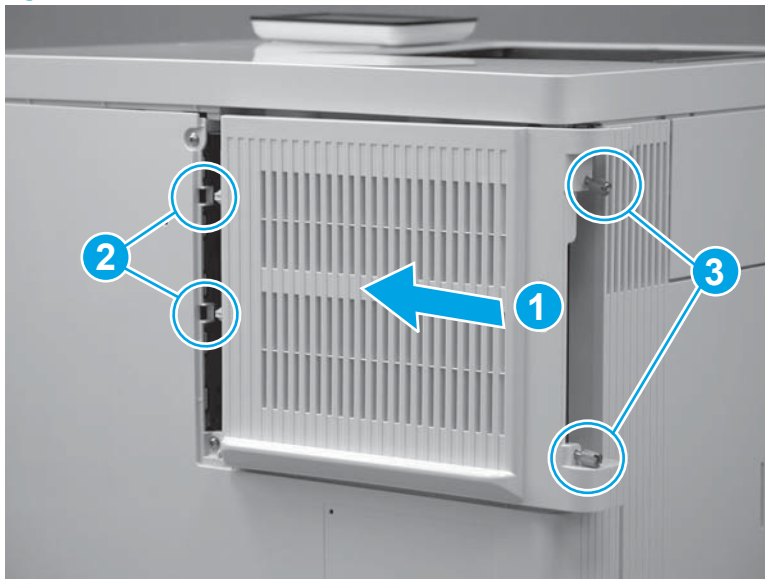

Step 29: Install the TCU

1. Verify that the toner collection hatch cover is in the closed position on the TCU.

Figure 1-2341 Verify that the toner collection hatch cover is closed

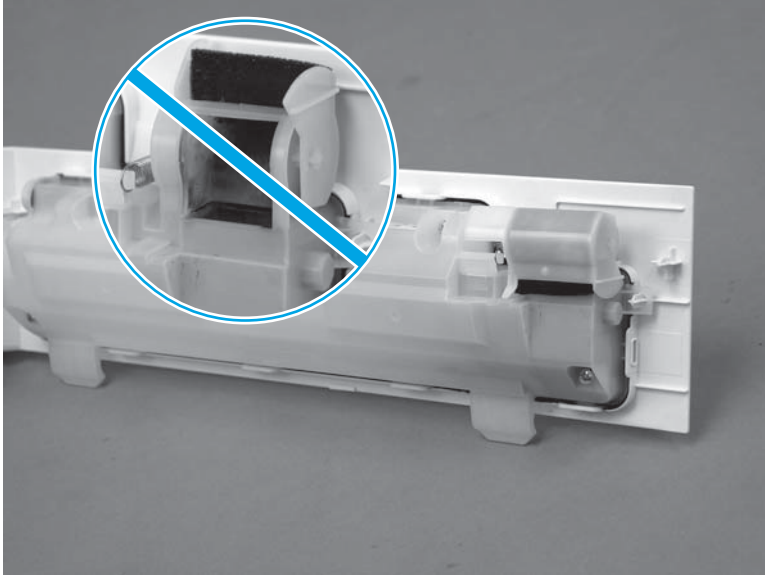

2. Position the TCU with the hinges in the slots provided in the printer (callout 1), and then rotate the TCU up and into the closed position.

 **NOTE:** The toner collection hatch cover automatically opens when the TCU is closed.

Figure 1-2342 Install the TCU



3. Close the front door.

Figure 1-2343 Close the front door

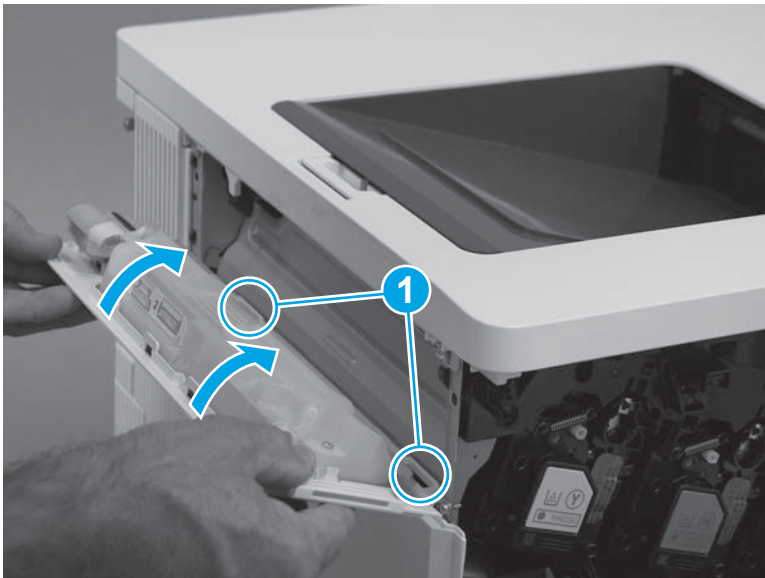

Removal and replacement: Laser/scanner assembly

- [Introduction](#)
- [Step 1: Remove the toner collection unit \(TCU\)](#)
- [Step 2: Remove the toner cartridges](#)
- [Step 3: Remove the formatter cover](#)
- [Step 4: Remove the formatter \(M552 and M553\)](#)
- [Step 5: Remove the hard-disk drive \(HDD\) \(M577\)](#)
- [Step 6: Remove the fax PCA \(M577c/f/z\)](#)
- [Step 7: Remove the formatter \(M577\)](#)
- [Step 8: Remove the rear cover \(M552 and M553\)](#)
- [Step 9: Remove the rear upper cover \(M577\)](#)
- [Step 10: Remove the rear cover \(M577\)](#)
- [Step 11: Remove the left cover](#)
- [Step 12: Remove the formatter case](#)
- [Step 13: Remove the low-voltage power supply \(LVPS\)](#)
- [Step 14: Remove the high-voltage power supply D \(HVPSD\)](#)
- [Step 15: Remove the laser/scanner assembly](#)
- [Step 16: Unpack the replacement assembly](#)
- [Step 17: Install the laser/scanner assembly](#)
- [Step 18: Install the HVPSD](#)
- [Step 19: Install the LVPS](#)
- [Step 20: Install the formatter case](#)
- [Step 21: Install the left cover](#)
- [Step 22: Install the rear cover \(M577\)](#)
- [Step 23: Install the rear upper cover \(M577\)](#)
- [Step 24: Install the rear cover \(M552 and M553\)](#)
- [Step 25: Install the formatter \(M577\)](#)
- [Step 26: Install the fax PCA \(M577c/f/z\)](#)
- [Step 27: Install the HDD \(M577\)](#)
- [Step 28: Install the formatter \(M552 and M553\)](#)
- [Step 29: Install the formatter cover](#)

- [Step 30: Install the toner cartridges](#)
- [Step 31: Install the TCU](#)

Introduction



This document provides the procedures to remove and replace the laser/scanner assembly.

Before performing service

Turn the printer power off

- Disconnect the power cable.

 **WARNING!** To avoid damage to the printer, turn the printer off, wait 30 seconds, and then remove the power cord before attempting to service the printer.

 **CAUTION:**  This part contains components that are electrostatic discharge (ESD) sensitive. To reduce the possibility of ESD damage, always touch the sheet-metal chassis to ground yourself before touching an ESD sensitive part.

Use the table below to identify the correct part number for your printer, and then go to <http://h20141.www2.hp.com/hpparts> to order the part.

Laser/scanner assembly part number	
RM2-6545-000CN	Laser/scanner assembly

Required tools

- #2 Phillips screwdriver with a magnetic tip

After performing service

Make sure that all of the connectors on the HVPSD are fully seated.

Make sure that all of the connectors on the LVPS are fully seated.

Make sure that all of the connectors on the formatter are fully seated.

Make sure that the formatter cover is fully seated, and that the thumbscrews are finger tight after replacing it.

Turn the printer power on

- Connect the power cable.
- Use the power switch to turn the power on.

Post service test

Print a configuration page to make sure that the printer is functioning correctly.

Step 1: Remove the toner collection unit (TCU)

1. Open the front door.

Figure 1-2344 Open the front door



2. Open the TCU.

 **NOTE:** The toner collection hatch cover automatically closes when the TCU is opened.

Figure 1-2345 Open the TCU



3. Pull the TCU away from the printer at an angle to remove it.

⚠ CAUTION: Do not open the toner collection hatch cover when handling the TCU. If toner gets on clothing, wipe it off by using a dry cloth and wash the clothes in cold water. Hot water sets toner into fabric.

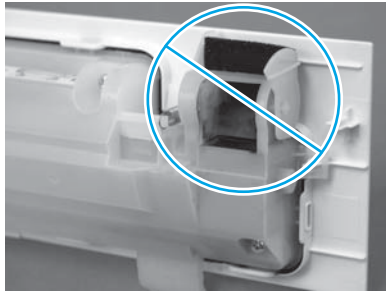
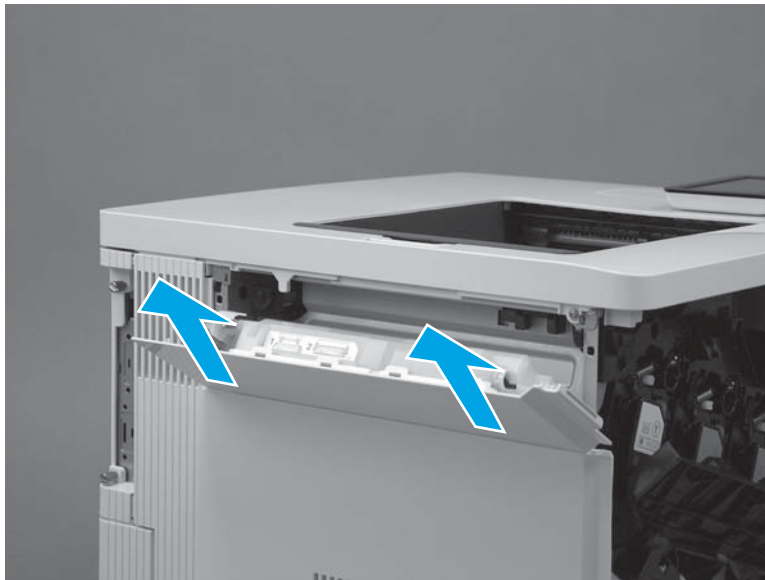

Figure 1-2346 Remove the TCU



Step 2: Remove the toner cartridges

- ▲ Grasp the handle of the toner cartridge and pull out to remove it. Repeat this step for the remaining toner cartridges.

Figure 1-2347 Remove the toner cartridge

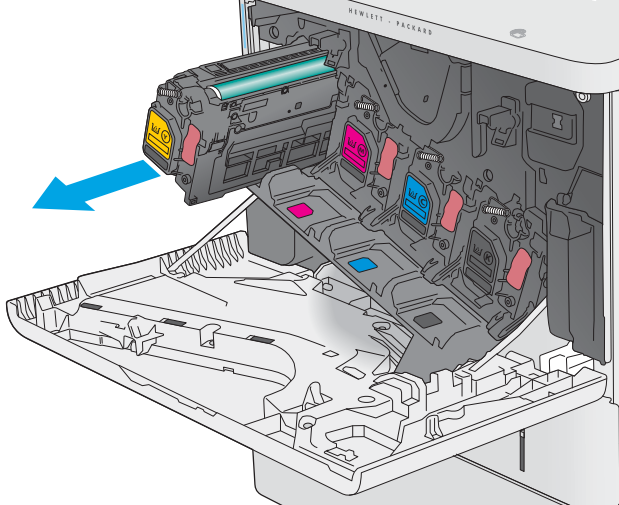

Step 3: Remove the formatter cover

1. Locate the formatter cover.

Figure 1-2348 Locate the formatter cover

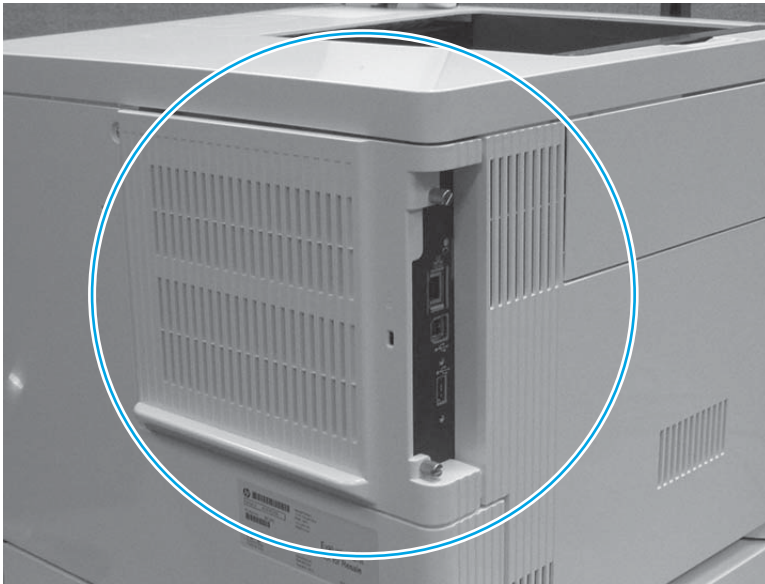

2. Loosen the two thumbscrews (callout 1). Grasp the two thumbscrews, and then slide the cover away from the printer (callout 2) to remove it.

 **TIP:** If needed, use the edge of a coin to turn the thumbscrews.

Figure 1-2349 Loosen the thumbscrews

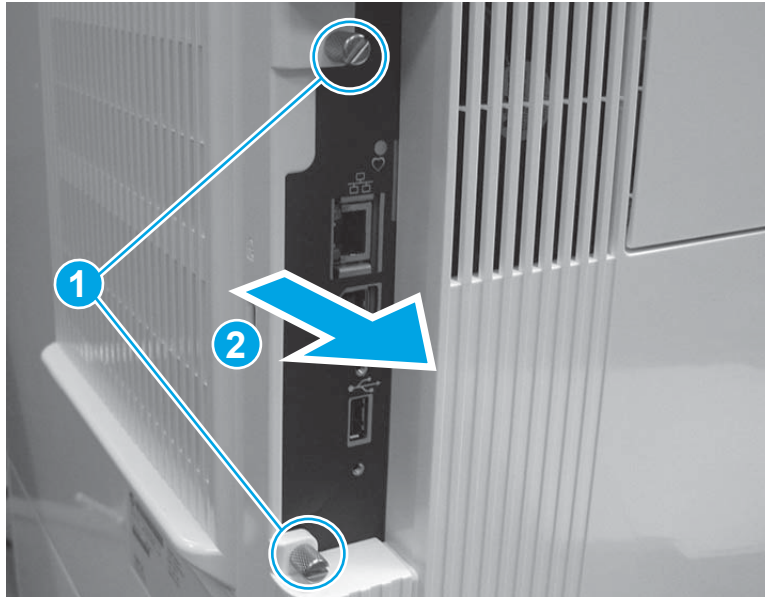

Step 4: Remove the formatter (M552 and M553)

 **NOTE:** This step is for the M552 and M553 models. For the M577 models, skip this step and go to [Step 5: Remove the hard-disk drive \(HDD\) \(M577\) on page 1338](#).

If the optional hard-disk drive (HDD) is installed, it must be removed to gain access to the formatter mounting screws.

Release two tabs along the left edge of the HDD, rotate the left edge away from the product, and then slide the HDD to the left to remove it.

 **CAUTION:**  ESD-sensitive part.

1. Disconnect all of the connectors on the formatter.

The following connectors are empty:

- All models: J1 (this connector is empty unless the optional DIMM is installed)
- M553n/dn and M552dn: J2 (callout 1; this is the touchscreen connector for the M553x model)
- All models: J9 (this connector is empty unless the optional internal USB ports component is installed)
- All models: J18 (this connector is empty unless the optional hard-disk-drive (HDD) is installed)
- All models: J23
- All models: J24
- M553n/dn and M552dn: J25 (this is the wireless connector for the M553x model)

- All models: J57
- All models: J98 (this connector is empty unless the optional trusted platform module (TPM) is installed)

 **IMPORTANT:** The flat-cable connector (callout 2) is a Zero Insertion Force (ZIF) connector that uses a hinged retainer to secure the flat cable. The hinged retainer must be opened to release the flat cable.

Figure 1-2350 Disconnect all connectors

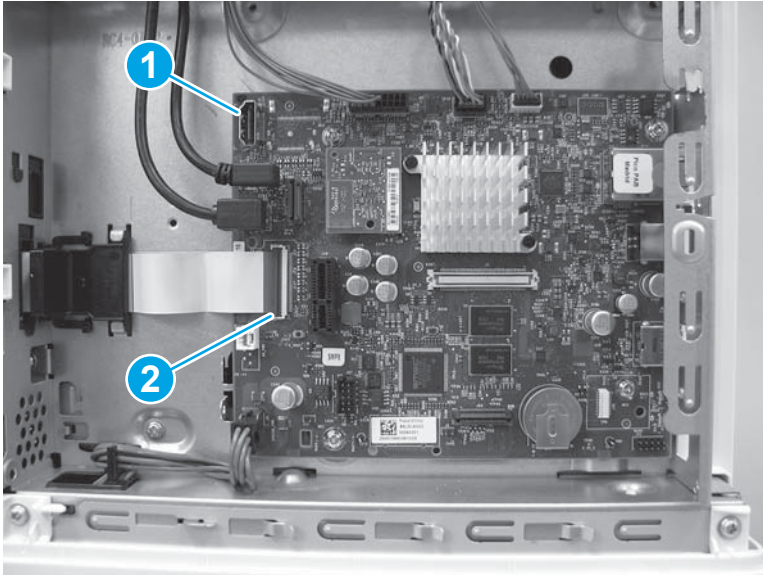

2. Remove four screws (callout 1), and then remove the formatter.

Figure 1-2351 Remove the formatter

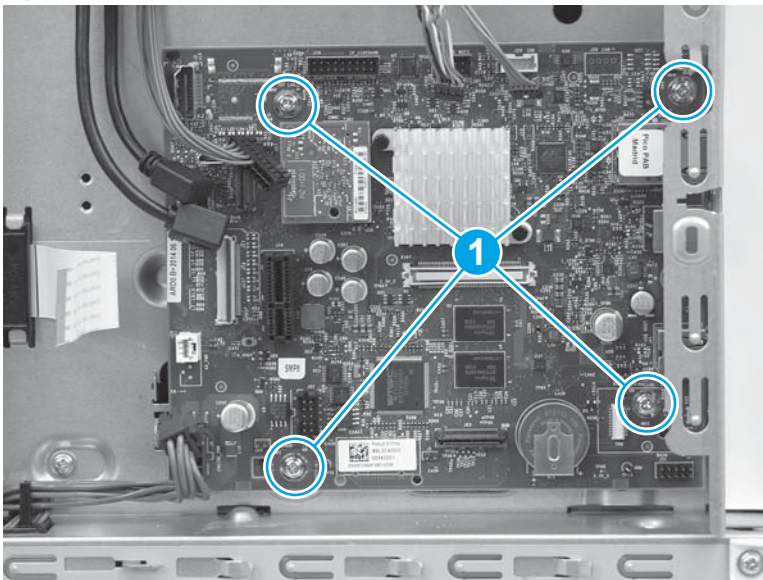

Step 5: Remove the hard-disk drive (HDD) (M577)

 **NOTE:** This step is for the M577 models. For the M552 and M553 models, skip this step and go to [Step 8: Remove the rear cover \(M552 and M553\) on page 1343](#).

 **CAUTION:**  ESD-sensitive part.

1. Release two tabs (callout 1). Hold the tabs in the released position, and then rotate the hard disk drive (HDD) up (callout 2) to release the connector from the formatter.

Figure 1-2352 Release the HDD

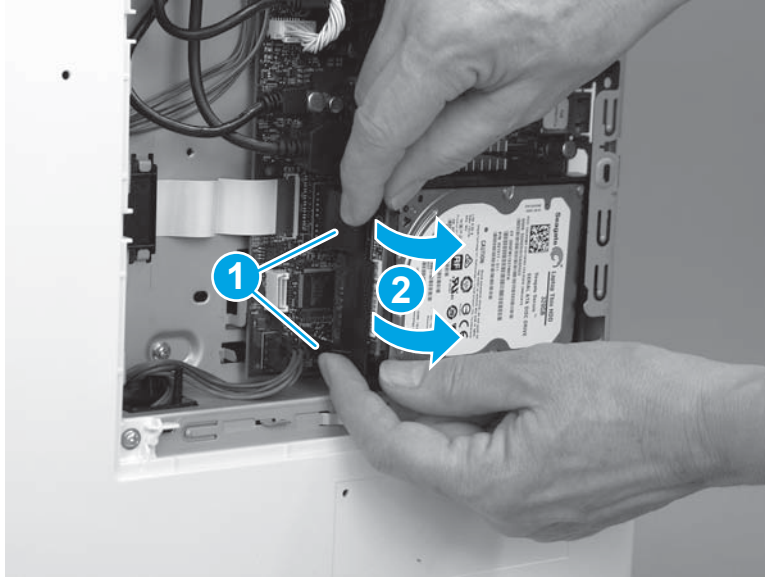

2. Slide the HDD away from the printer to remove it.

Figure 1-2353 Remove the HDD



Step 6: Remove the fax PCA (M577c/f/z)

 **NOTE:** This step is for the M577c/f/z models. For the M577n model, skip this step and go to [Step 7: Remove the formatter \(M577\) on page 1341](#).

For the M552 and M553 models, skip this step and go to [Step 8: Remove the rear cover \(M552 and M553\) on page 1343](#).

 **CAUTION:**  ESD-sensitive part.

1. Locate the fax PCA component on the formatter.

Figure 1-2354 Locate the fax PCA

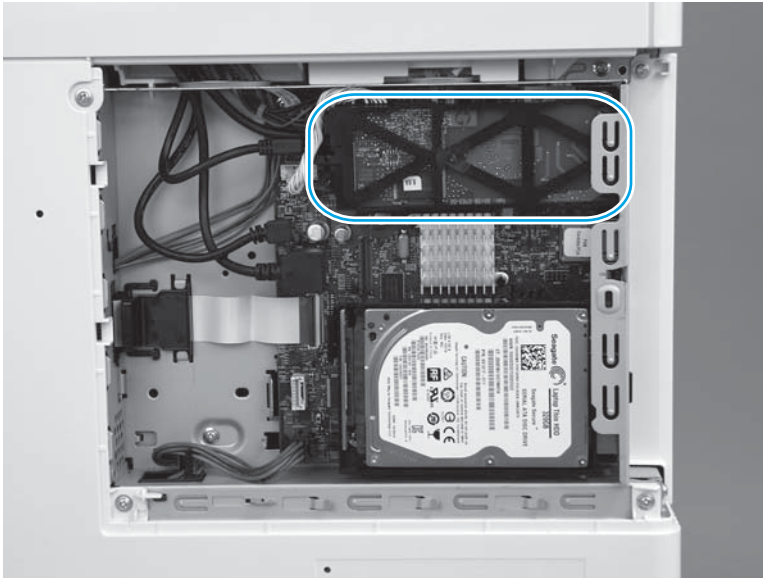

2. Release the connector latch (callout 1), and then pull the connector away from the formatter (callout 2) to disconnect it.

Figure 1-2355 Disconnect one connector

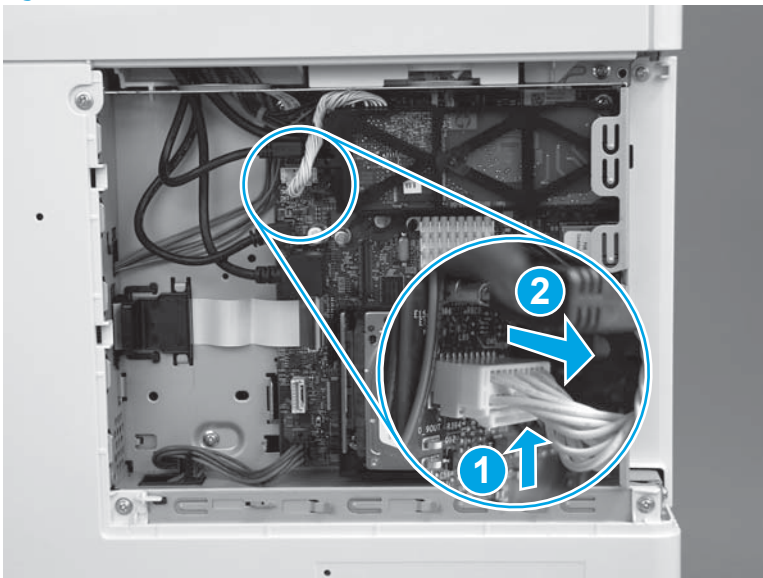

3. Release one retainer (callout 1) by pressing the bracket arms together.

Figure 1-2356 Release one latch

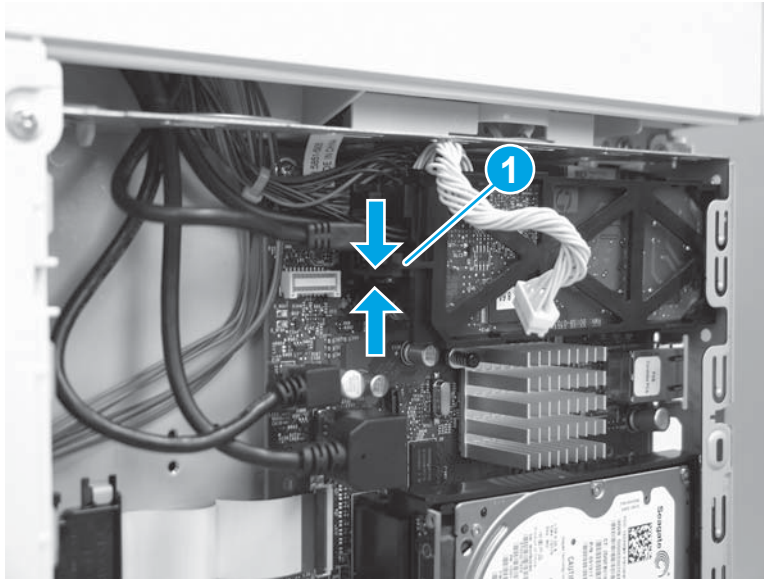

4. Rotate the end of the fax PCA (callout 1) away from the formatter, and then slide the PCA left (callout 2) to remove it.

Figure 1-2357 Remove the fax PCA

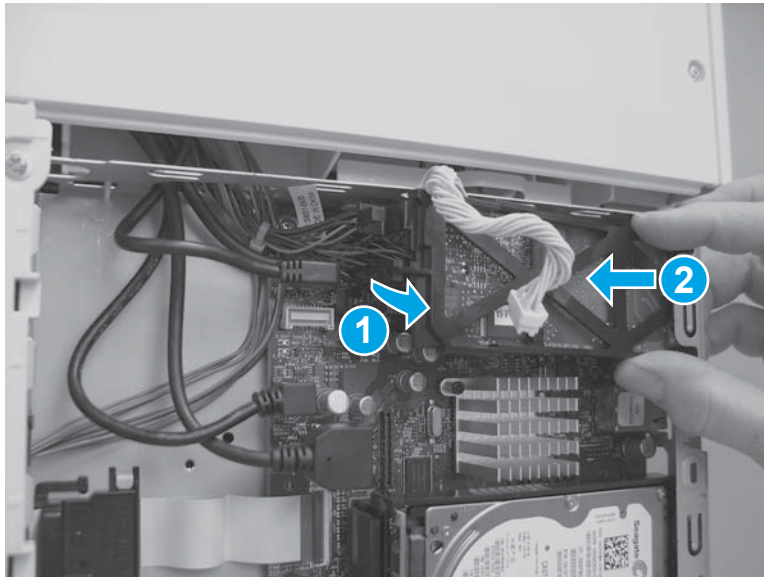

Step 7: Remove the formatter (M577)

 **NOTE:** This step is for the M577 models. For the M552 and M553 models, skip this step and go to [Step 8: Remove the rear cover \(M552 and M553\) on page 1343.](#)

 **CAUTION:**  ESD-sensitive part.

1. Disconnect all of the connectors on the formatter.

The following connectors are empty:

- All models: J1 (this connector is empty unless the optional DIMM is installed)
- All models: J3
- M577dn: J15 (this is the fax connector for the M577f/z/c models)
- All models: J21 (this connector is empty unless the optional internal USB ports component is installed)
- All models: J23
- All models: J24
- All models: J51
- All models: J57
- All models: J97
- All models: J98 (this connector is empty unless the optional trusted platform module (TPM) is installed)

 **IMPORTANT:** The flat-cable connector (callout 1) is a Zero Insertion Force (ZIF) connector that uses a hinged retainer to secure the flat cable. The hinged retainer must be opened to release the flat cable.

Figure 1-2358 Disconnect all connectors



2. Remove four screws (callout 1).

Figure 1-2359 Remove four screws

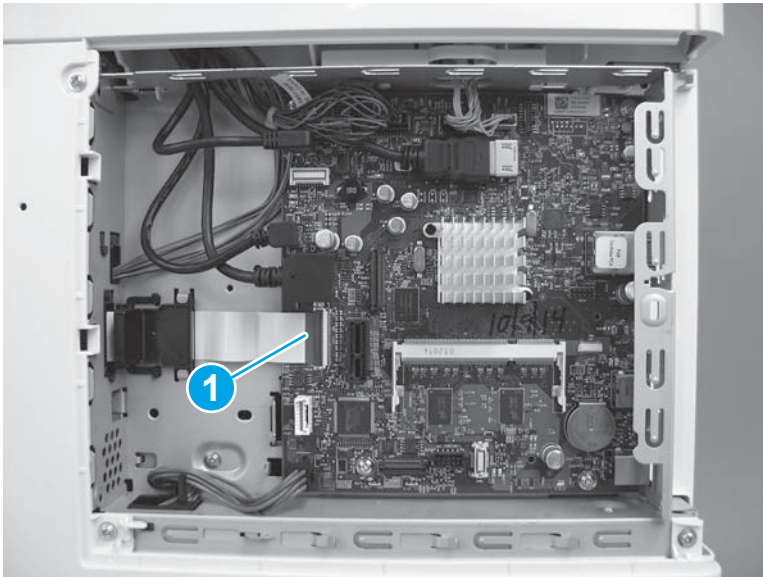
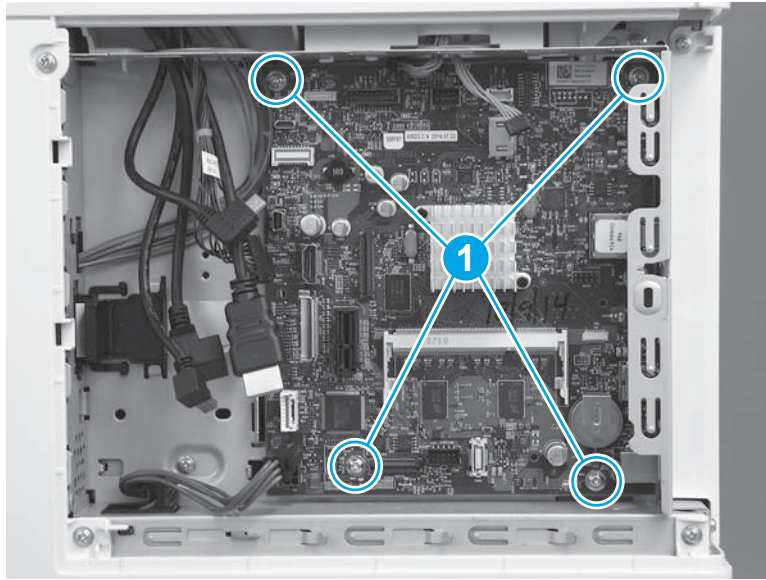

3. Remove the formatter.

Figure 1-2360 Remove the formatter

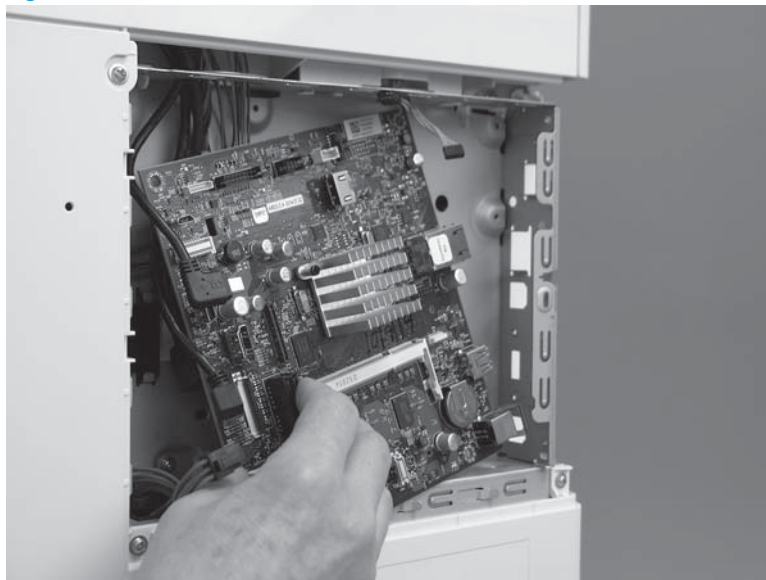

Step 8: Remove the rear cover (M552 and M553)

 **NOTE:** This step is for the M552 and M553 models. For the M577 models, skip this step and go to [Step 9: Remove the rear upper cover \(M577\) on page 1344.](#)

1. Remove four screws (callout 1).

Figure 1-2361 Remove four screws

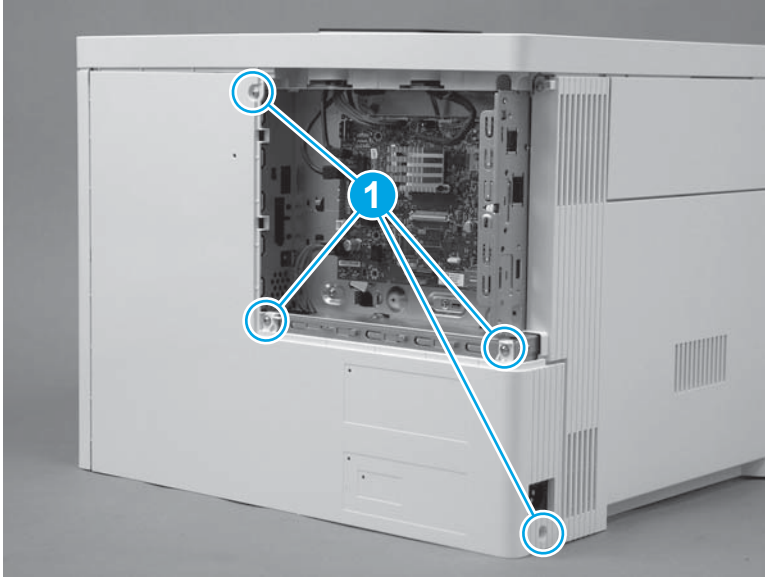

2. Slightly slide the cover to the right (callout 1), rotate the bottom of the cover away from the printer (callout 2), and then pull the top of the cover away from the printer (callout 3) to remove the cover.

Figure 1-2362 Remove the cover

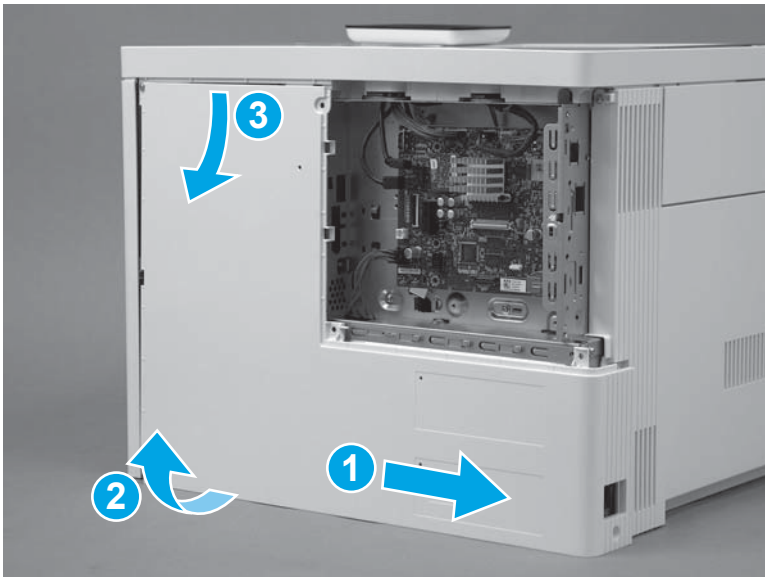

Step 9: Remove the rear upper cover (M577)

 **NOTE:** This step is for the M577 models. For the M552 and M553 models, skip this step and go to [Step 11: Remove the left cover on page 1347](#).

1. Remove two screws (callout 1).

 **Reinstallation tip:** These two screws are self-tapping screws for plastic. When reinstalling them, rotate the screws counterclockwise to align them with the existing thread pattern, and then carefully turn them clockwise to tighten. Do not overtighten. This will prevent stripping the threads inside the screw holes.

Figure 1-2363 Remove two screws



2. Use a small, flat blade screwdriver to release the right edge of the cover.

Figure 1-2364 Release the right edge

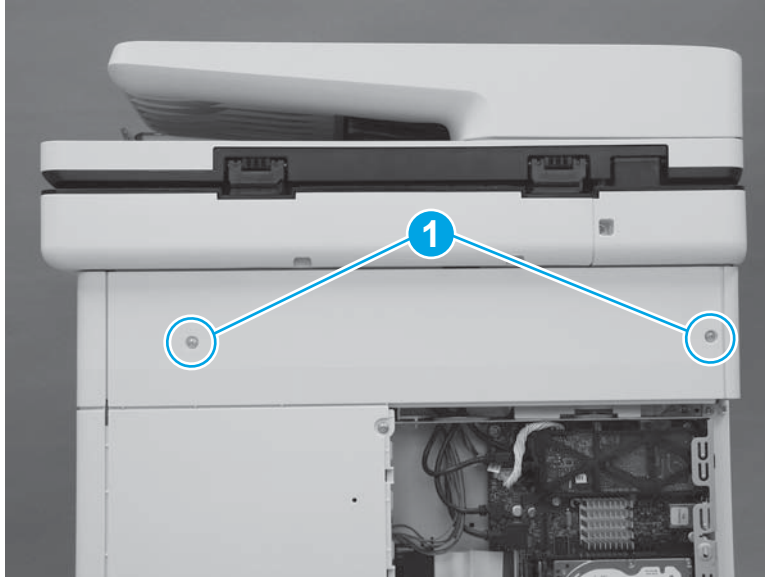
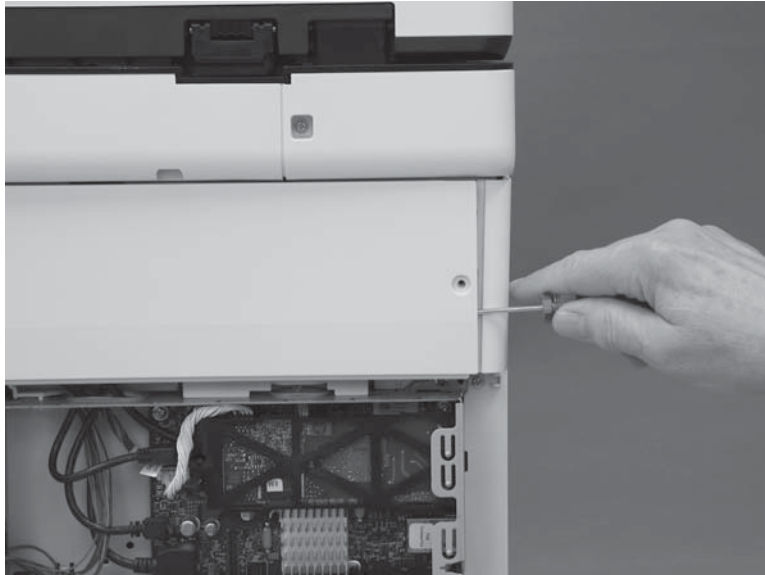

3. Pull the right edge of the cover (callout 1) away from the printer, and then slide the cover to the right (callout 2).

Figure 1-2365 Slide the cover right

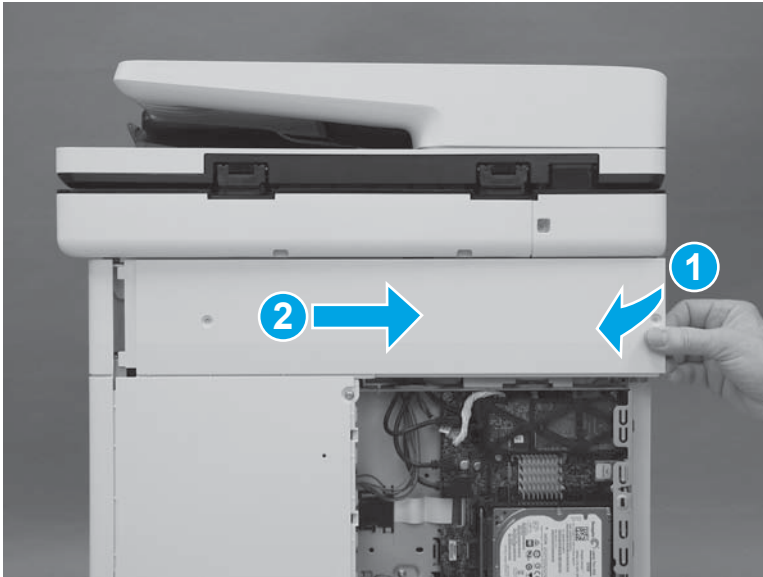

4. Remove the cover.

Figure 1-2366 Remove the cover

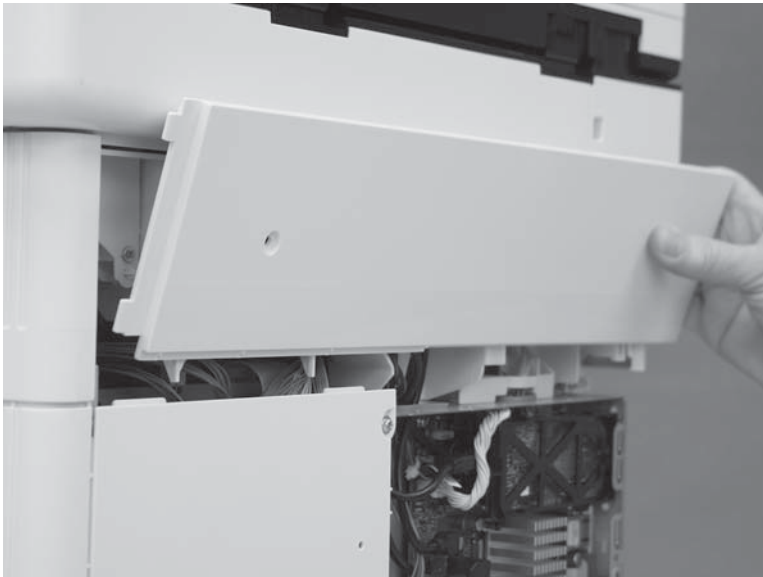

Step 10: Remove the rear cover (M577)

 **NOTE:** This step is for the M577 models. For the M552 and M553 models, skip this step and go to [Step 11: Remove the left cover on page 1347](#).

1. Remove four screws (callout 1).

Figure 1-2367 Remove four screws

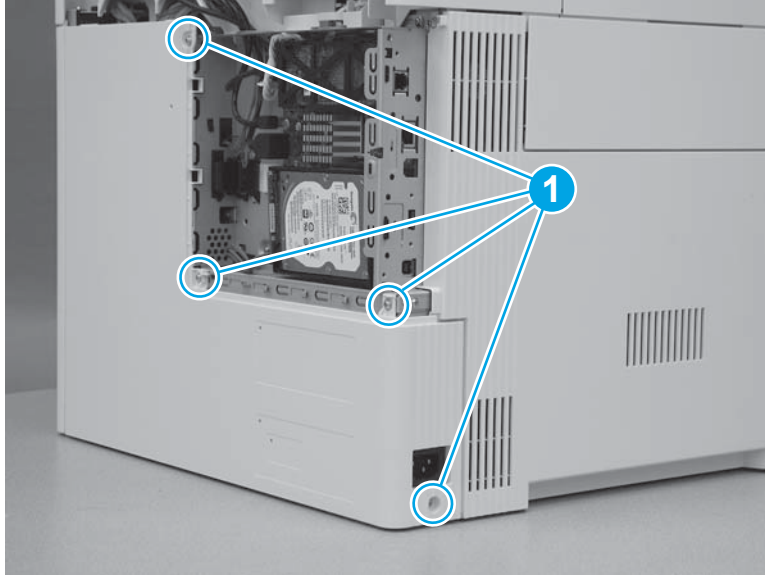

2. Slide the cover to the right to remove it.

Figure 1-2368 Remove the cover

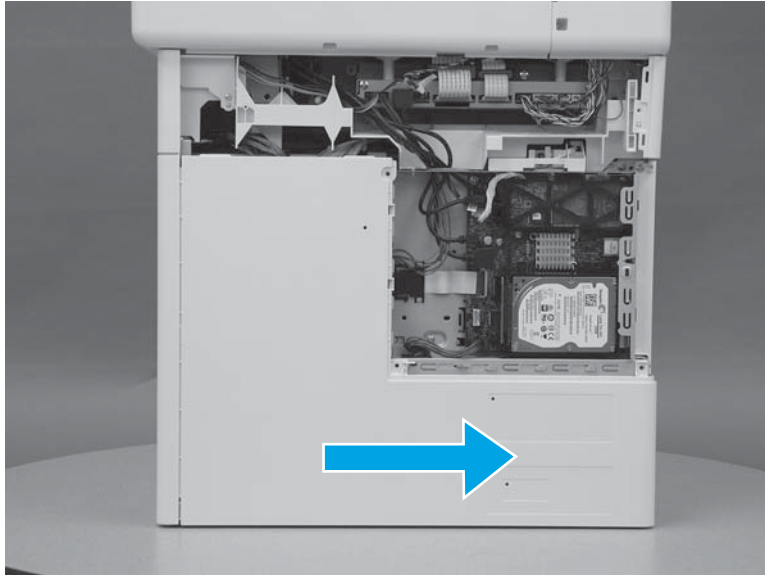

Step 11: Remove the left cover

1. At the left side of the printer, remove one screw (callout 1).

Figure 1-2369 Remove one screw



2. Release one tab (callout 1), rotate the front edge of the cover away from the printer (callout 2), and then slide the cover (callout 3) toward the rear of the printer to release it.

Figure 1-2370 Release the cover

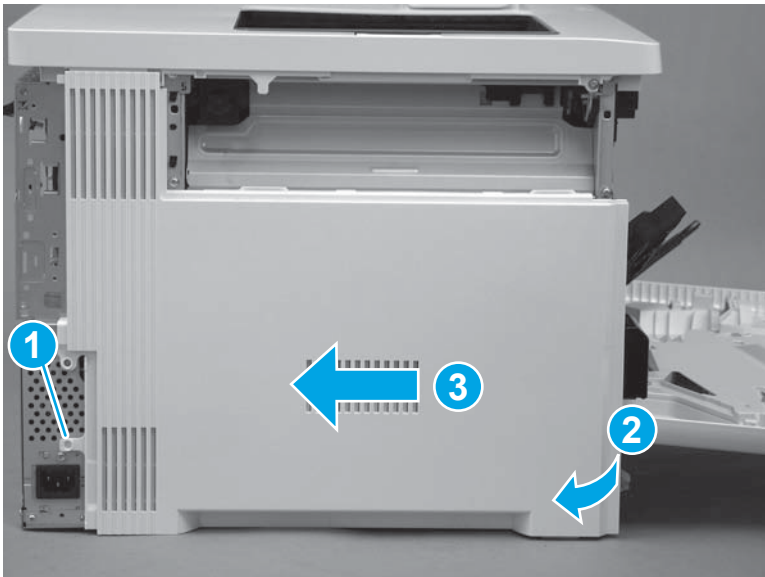

3. Remove the cover.

Figure 1-2371 Remove the cover

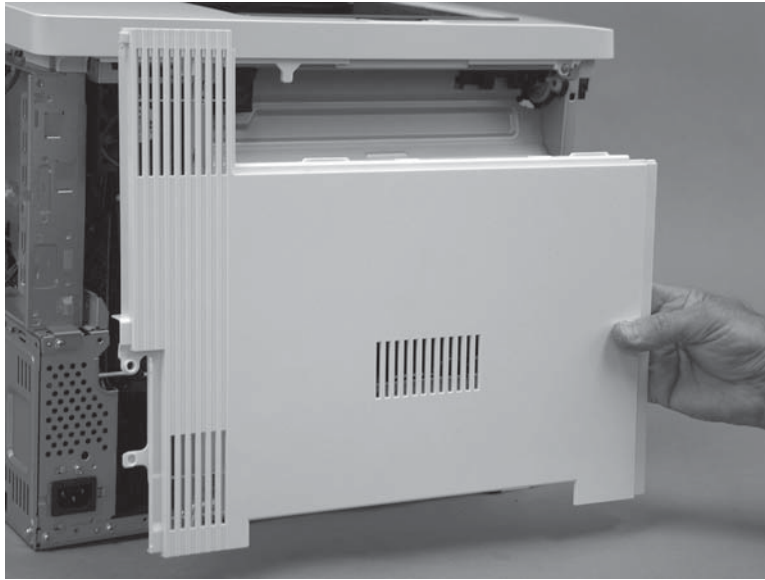

Step 12: Remove the formatter case

1. **M577 only:** Disconnect one connector (callout 1), and then pass the wire harness (callout 2) through two openings in the formatter case (callout 3).

Figure 1-2372 Disconnect one connector

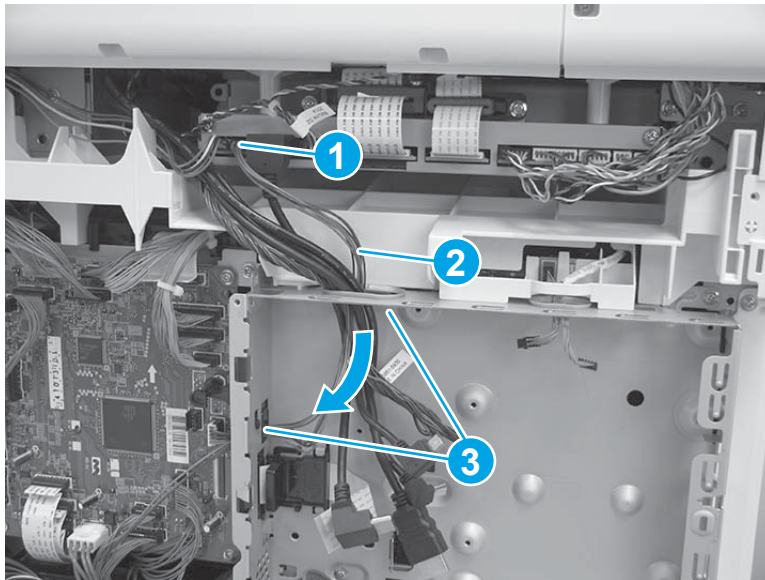

2. Release two tabs (callout 1) on the black plastic bracket. Hold the tabs in the released position, and then slide the bracket (callout 2) to the right to remove it from the formatter case.

Figure 1-2373 Remove the bracket

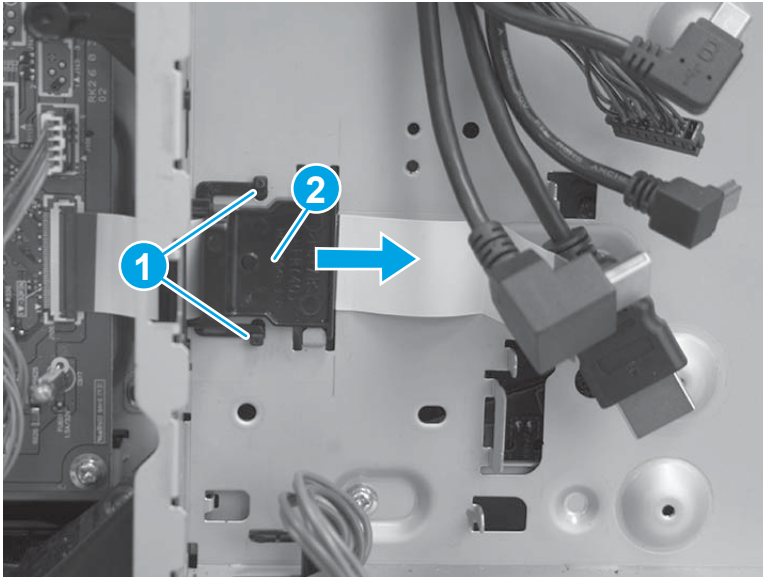

3. Remove two screws (callout 1), and then slide the low-voltage power supply (LVPS) cover to the right to remove it.

Figure 1-2374 Remove the LVPS cover

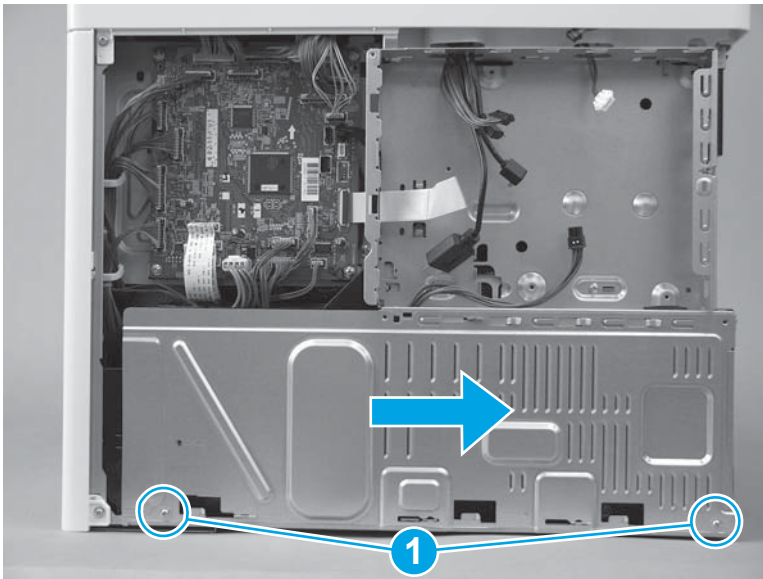

4. Pass two wire harnesses and one flat cable (callout 1) through the opening in the formatter case, and then release one wire harness from the retainer (callout 2).

⚠ CAUTION: The flat cable might be attached to the formatter case with double-sided tape. Make sure that this tape is released, so that the flat cable is not damaged when the formatter case is removed.

Figure 1-2375 Release wire harnesses and flat cable

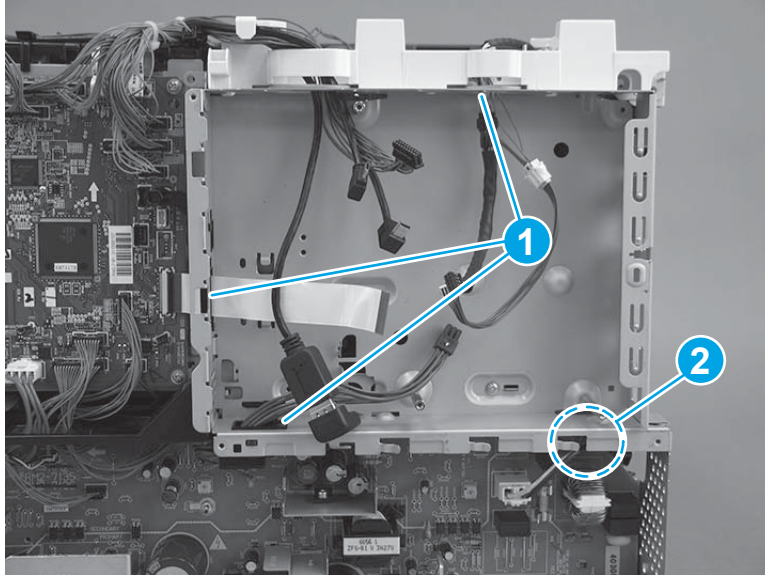

5. Remove six screws (callout 1).

Figure 1-2376 Remove six screws

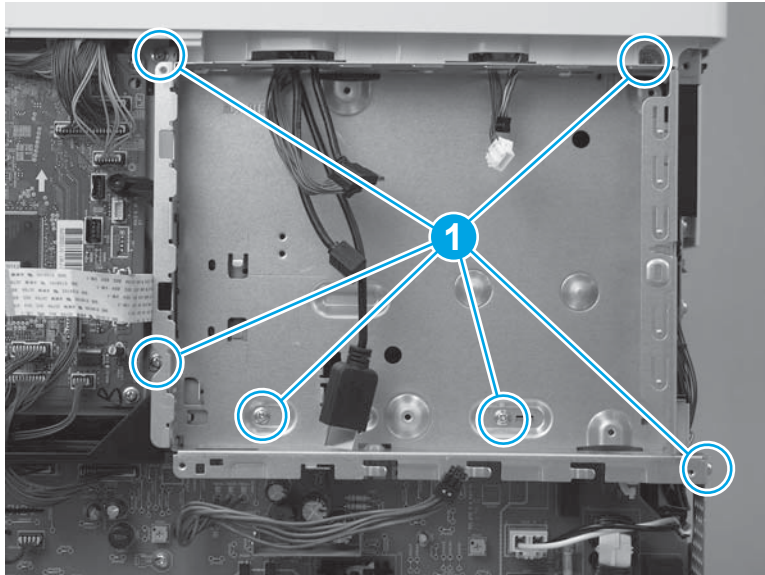

6. Rotate the bottom of the formatter case away from the printer (callout 1), and then pull it down (callout 2) to release it.

Figure 1-2377 Release the formatter case

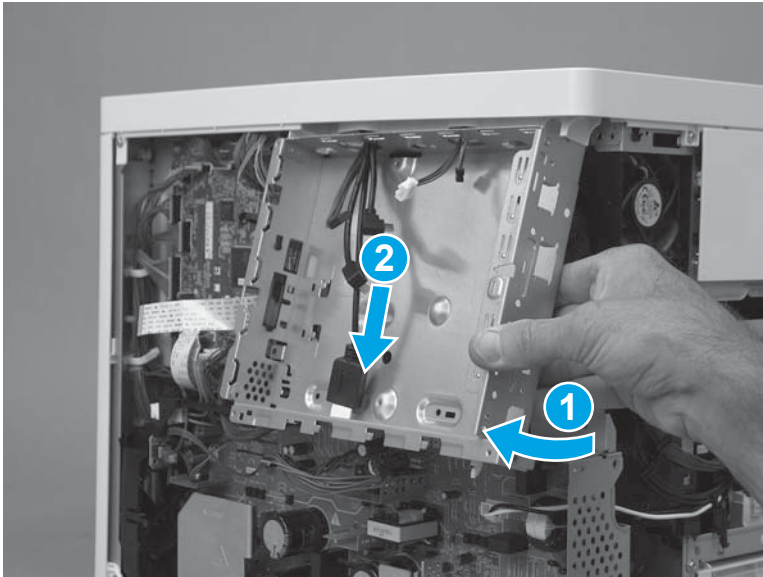

7. Pass the wire harnesses through the opening in the formatter case to remove it.

 **IMPORTANT:** If the formatter case is removed so that it can be replaced, make sure to transfer the memory PCA (island of data) and plastic bracket (callout 1) to the replacement case.

Figure 1-2378 Remove the formatter case

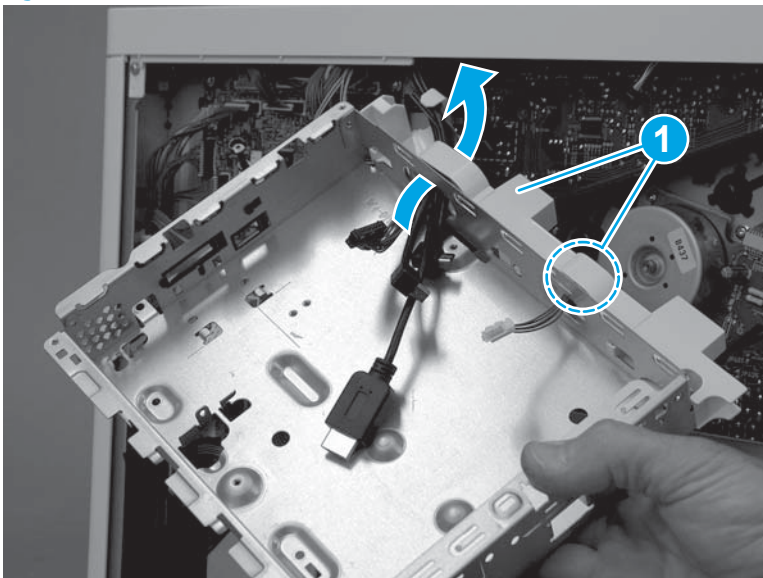

Step 13: Remove the low-voltage power supply (LVPS)

 **CAUTION:**  ESD-sensitive part.

1. Disconnect one wire harness (callout 1), and then pass the wire harness through the opening (callout 2) in the chassis.

Figure 1-2379 Disconnect one wire harness

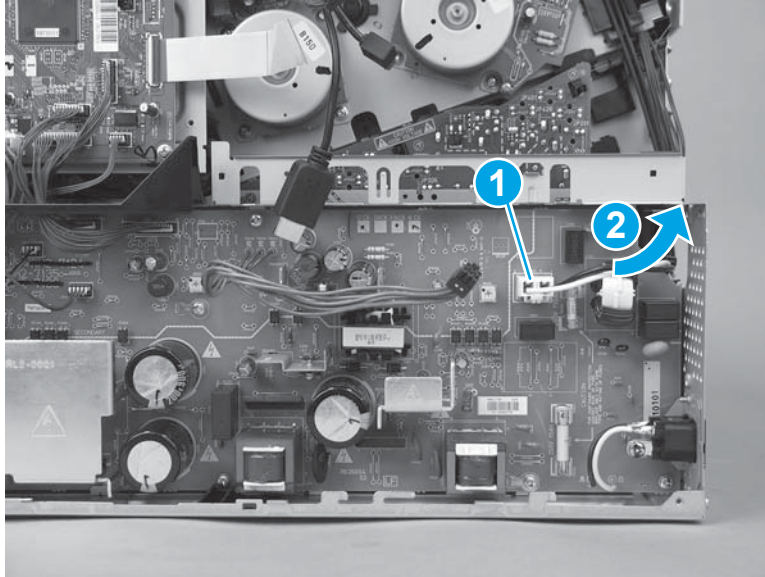

2. Disconnect three connectors on the DC controller (callout 1), and then disconnect four connectors (callout 2) on the LVPS.

Figure 1-2380 Disconnect seven connectors

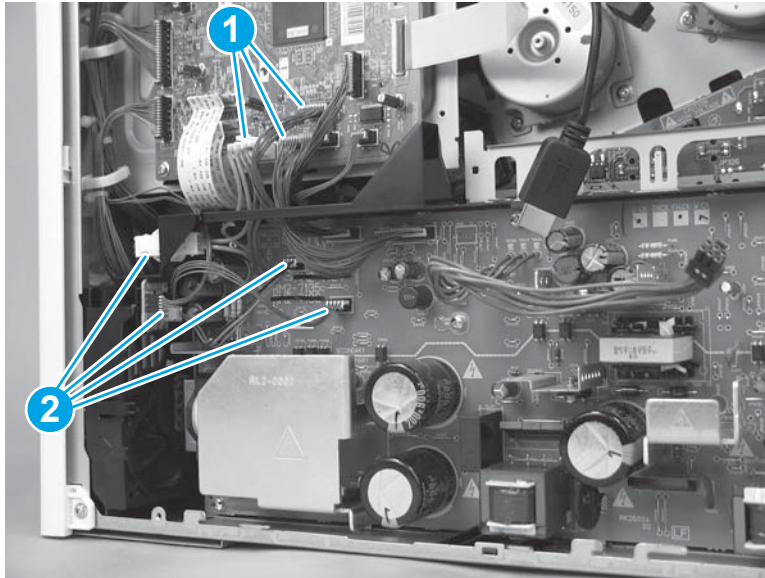

3. Pass the wire harnesses from the DC controller to the LVPS through the opening in the chassis (callout 1), and then release the wire harnesses from the retainer (callout 2).

Figure 1-2381 Pass the wire harnesses through the opening

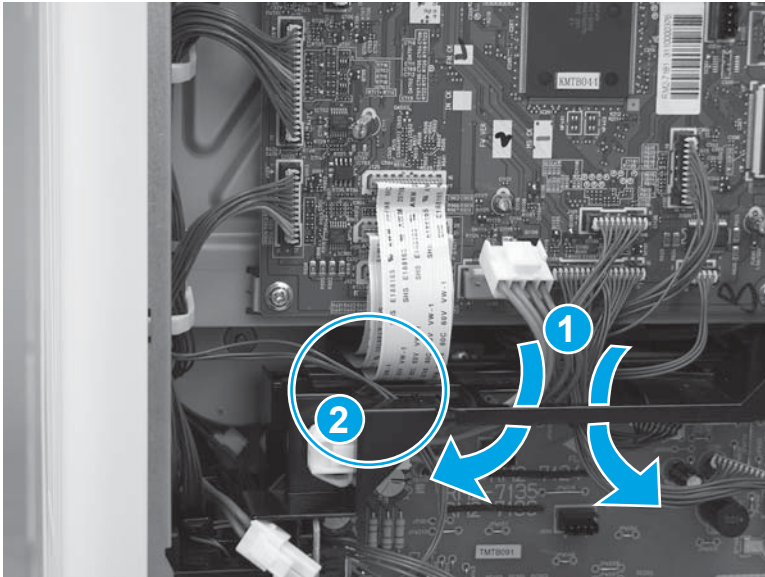

4. Remove three screws (callout 1).

Figure 1-2382 Remove three screws

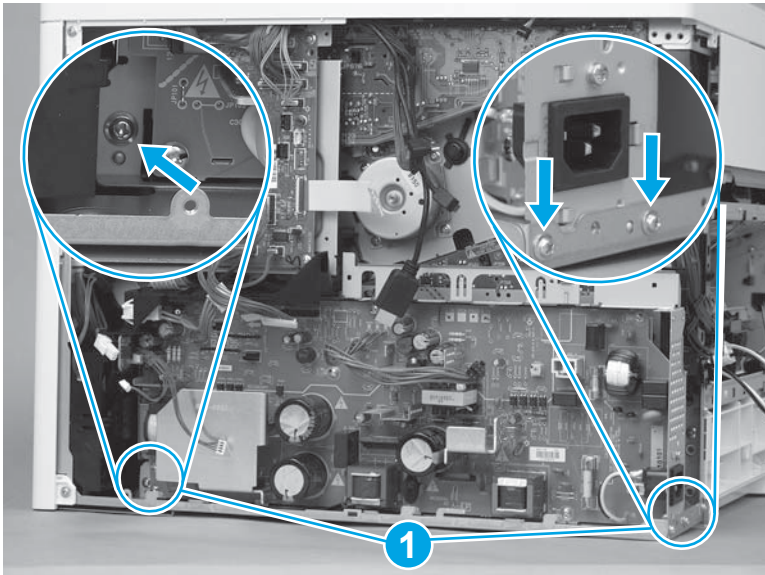

5. Rotate the top of the LVPS away from the printer (callout 1), and then slide it up and out (callout 2) of the printer to remove it.

Figure 1-2383 Remove the LVPS

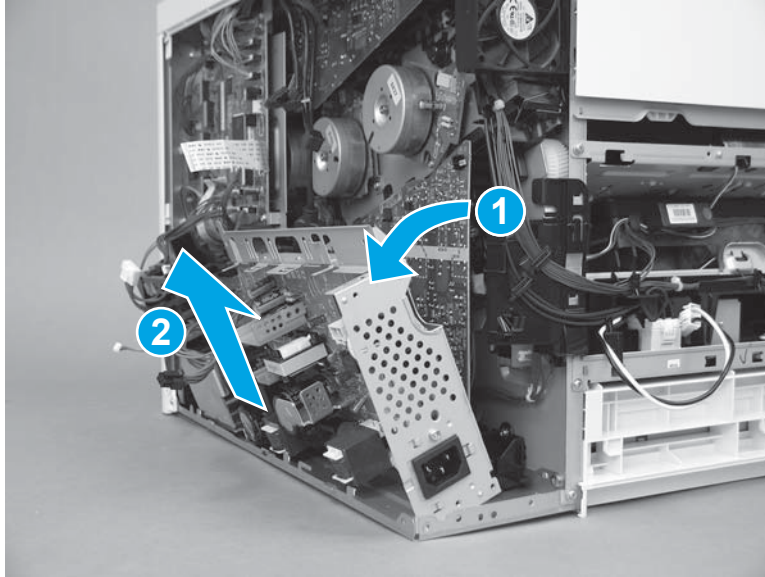

Step 14: Remove the high-voltage power supply D (HVPSD)

 **CAUTION:**  ESD-sensitive part.

1. Disconnect one flat cable (callout 1) on the DC controller.

Figure 1-2384 Disconnect one flat cable

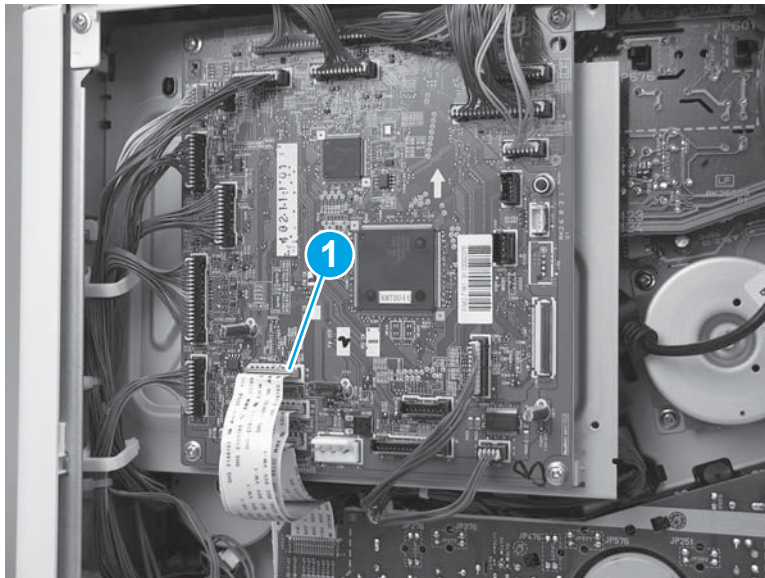

2. Remove two screws (callout 1), and then remove one self tapping screw (callout 2) on the HVPSD.

Figure 1-2385 Remove three screws

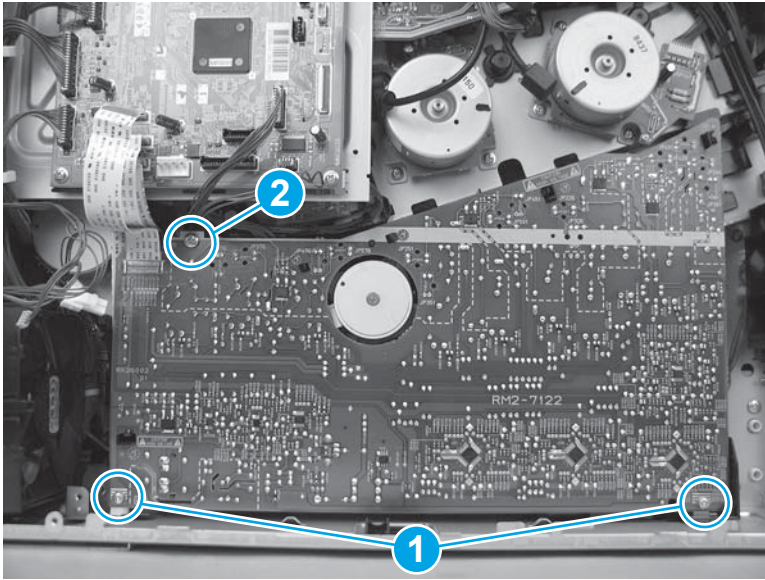

3. Release five tabs (callout 1), and then remove the HVPSD (callout 2).

Figure 1-2386 Remove the HVPSD

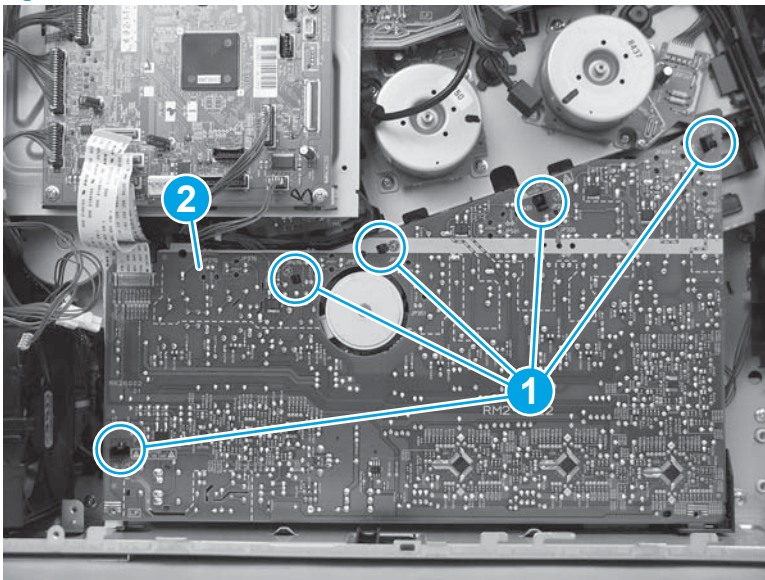

Step 15: Remove the laser/scanner assembly

1. Release one wire harness from the retainer (callout 1).

Figure 1-2387 Release one wire harness

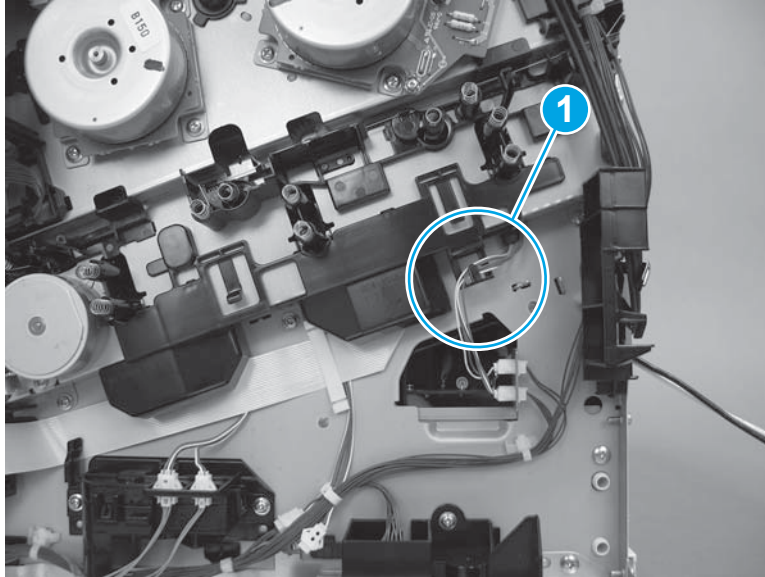

2. Release two tabs (callout 1), and then pull down on the guide (callout 2) to release it.

Figure 1-2388 Release two tabs

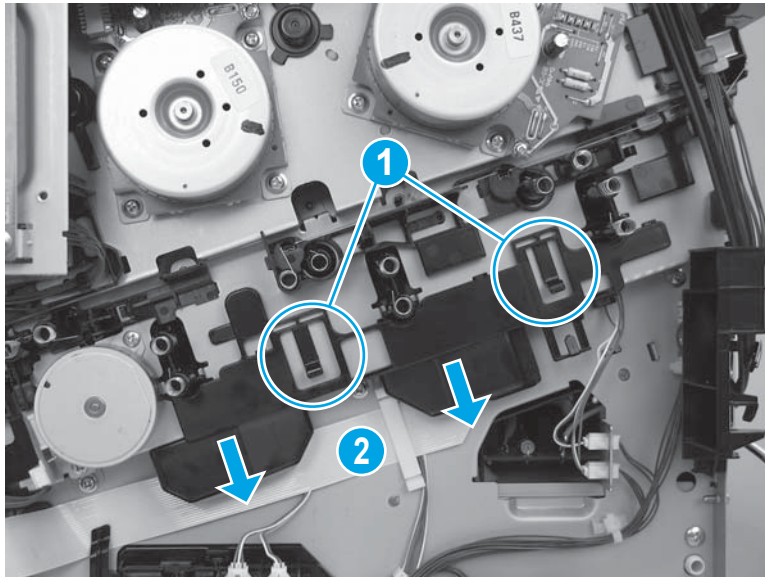

3. Remove the guide.

Figure 1-2389 Remove the guide

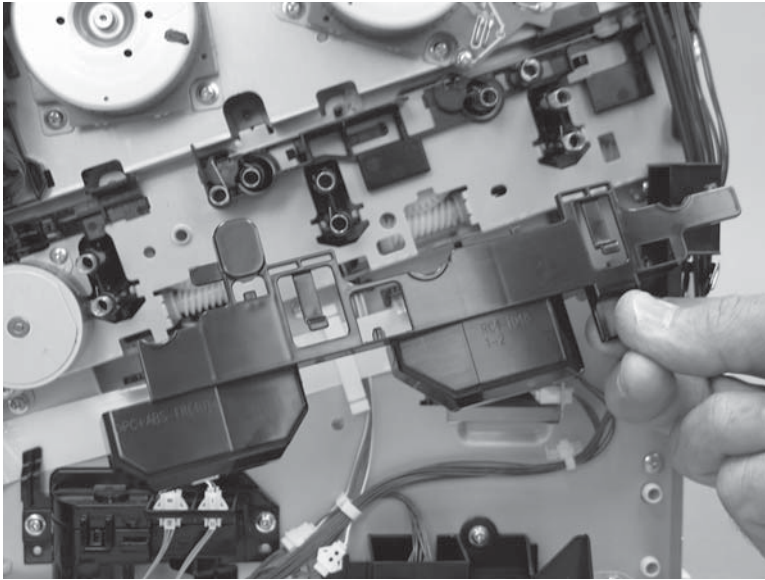

4. Disconnect two flat cables (callout 1).

Figure 1-2390 Disconnect two flat cables

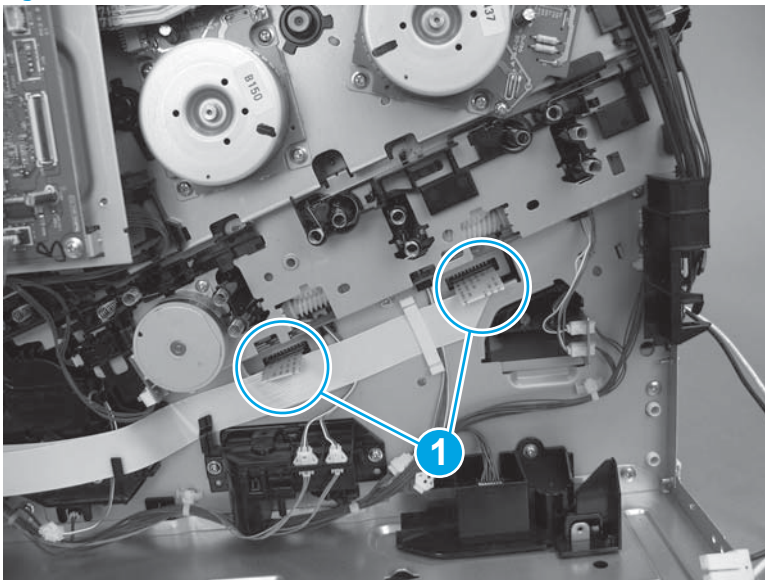

5. At the rear of the printer, disconnect two connectors (callout 1).

Figure 1-2391 Disconnect two connectors

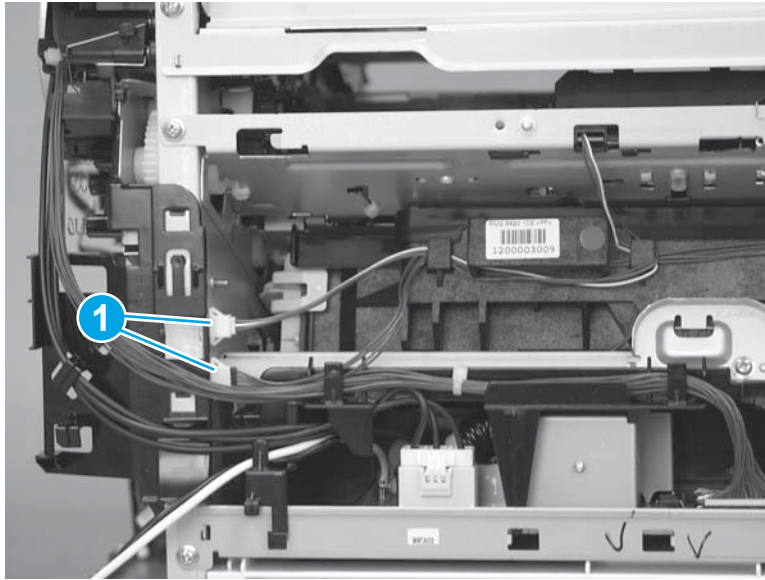

6. At the rear of the printer, remove one screw (callout 1), and then remove the sheet-metal plate (callout 2).

Figure 1-2392 Remove one screw and the plate

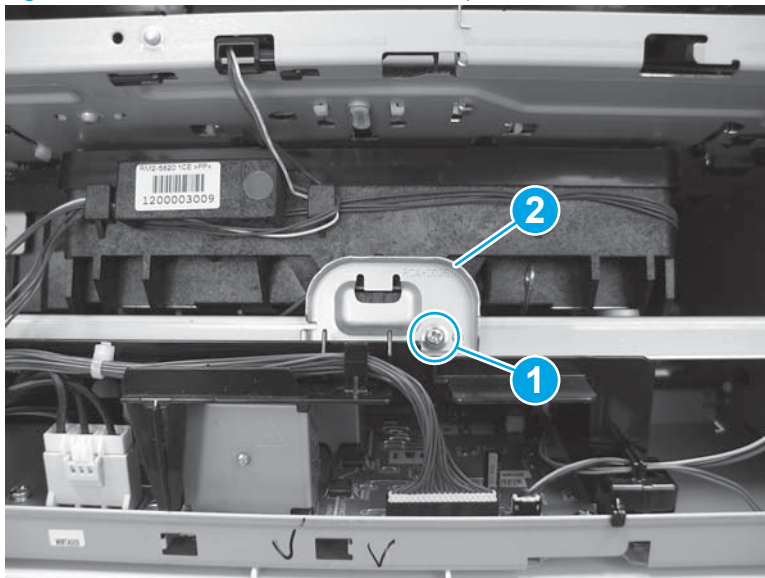

7. At the rear of the printer, push down on the spring (callout 1), and then lift it up (callout 2) to release it from the tab on the chassis.

Figure 1-2393 Release the spring

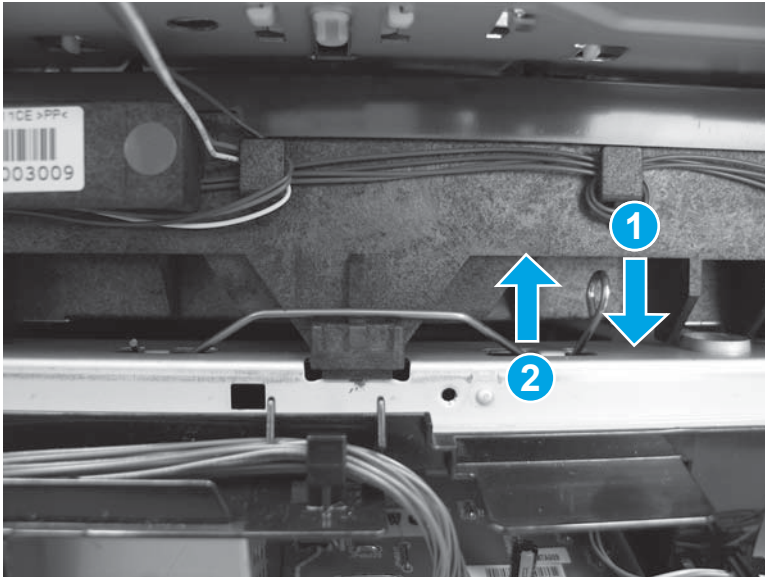

8. Remove the spring.

Figure 1-2394 Remove the spring

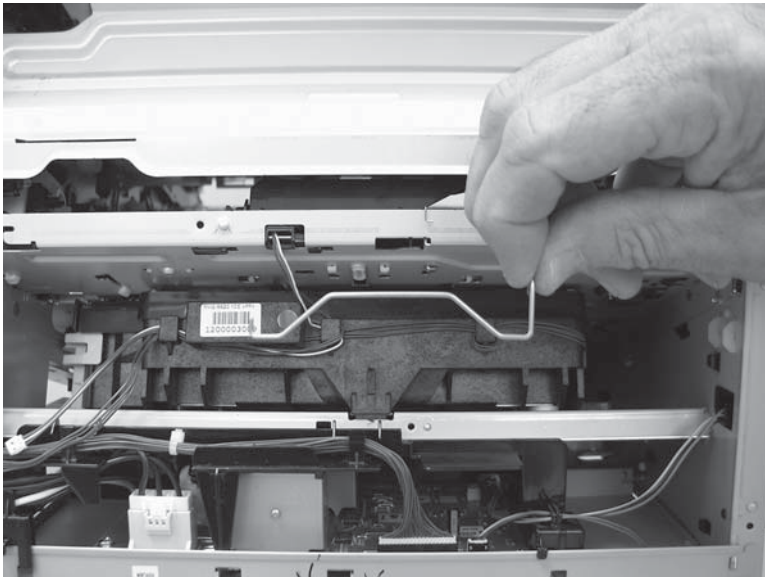

9. At the rear of the printer, release the wire harness from the retainers (callout 1).

Figure 1-2395 Release the wire harness

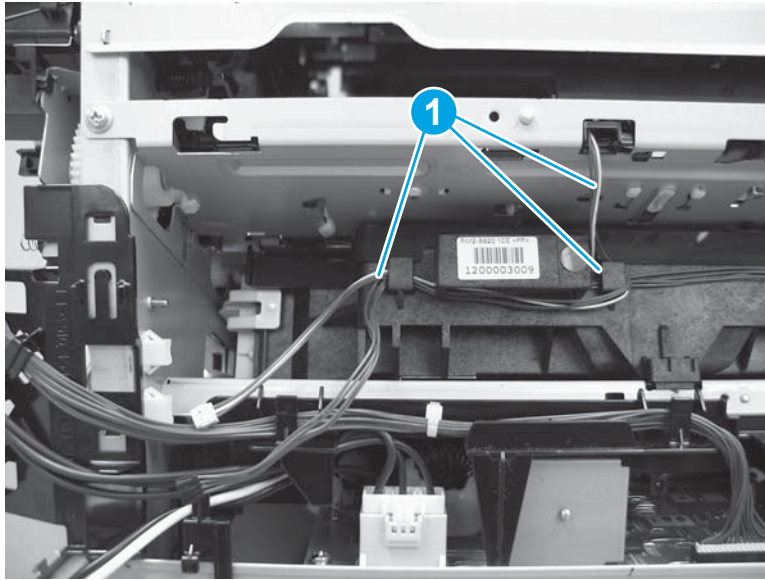

10. Pull the laser/scanner assembly straight out of the printer to remove it.

⚠ CAUTION: To avoid damaging the glass cleaners, make sure that the front door is open before removing the laser/scanner assembly.

Figure 1-2396 Remove the laser/scanner assembly

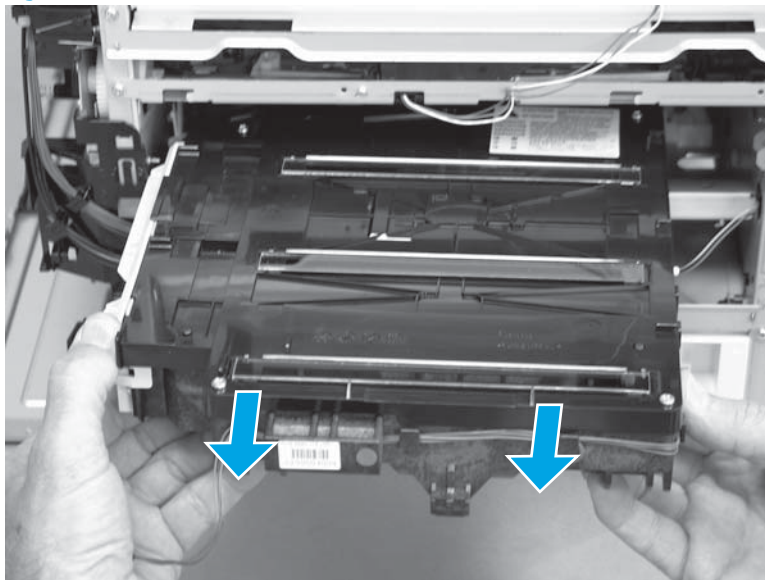

Step 16: Unpack the replacement assembly

Unpack the replacement assembly from the packaging.

For complete information on HP's recycling programs, go to [Product return and recycling](#).

📝 NOTE: HP recommends responsible disposal of the defective assembly.

Figure 1-2397 Recycle and unpack

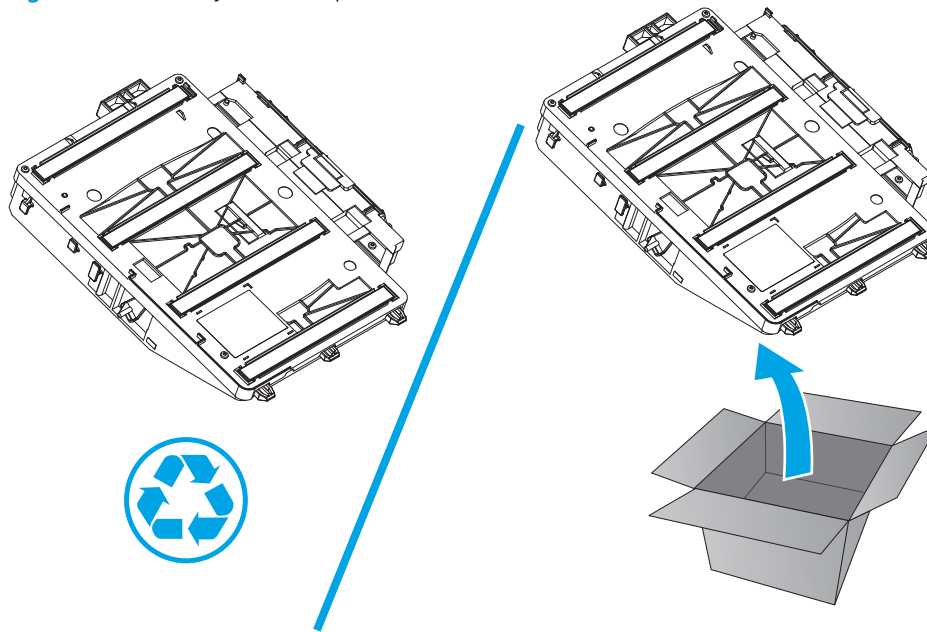

Step 17: Install the laser/scanner assembly

1. Handle the replacement laser/scanner assembly by the edges. Do not touch the two glass windows. Skin oils on the windows can cause image quality problems.

Figure 1-2398 Handle the laser/scanner assembly carefully

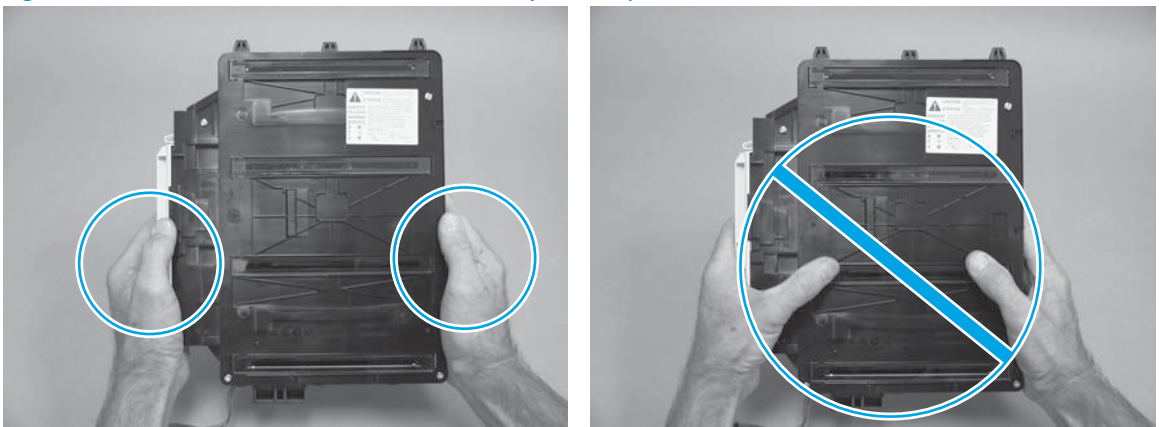

- Slide the laser/scanner assembly straight into the printer to install it.

CAUTION: To avoid damaging the glass cleaners, make sure that the front door is open before installing the laser/scanner assembly.

Figure 1-2399 Install the laser/scanner assembly

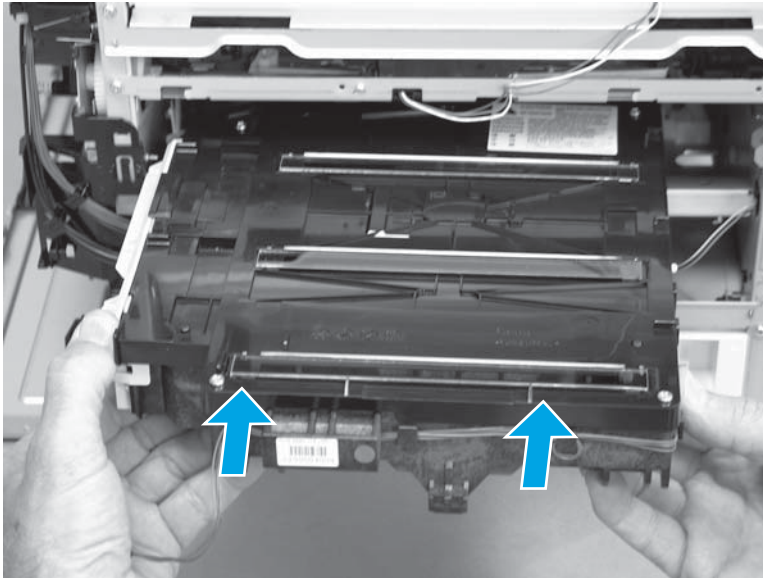

- Hook the spring under the tab on the chassis (callout 1), and then push it down and under the second tab (callout 2) to install it.

Figure 1-2400 Release the spring

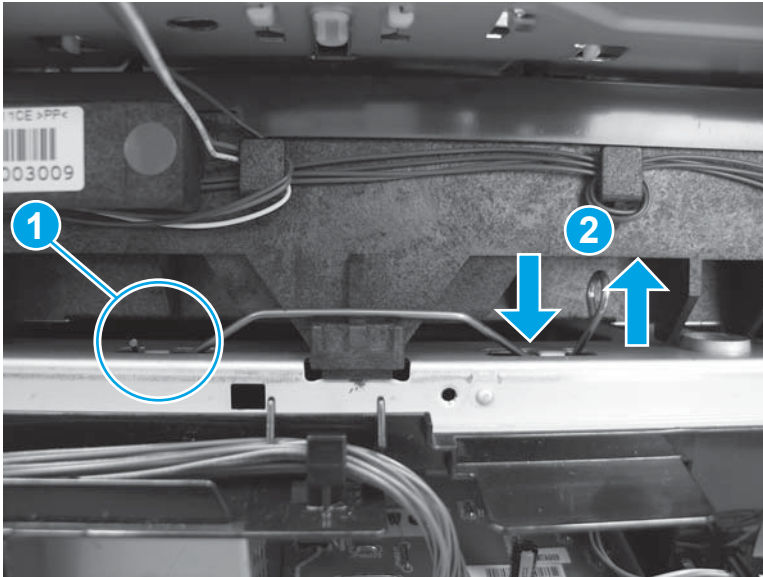

4. Position the sheet-metal plate (callout 1) on the printer, and then install one screw (callout 2).

Figure 1-2401 Install the plate and one screw

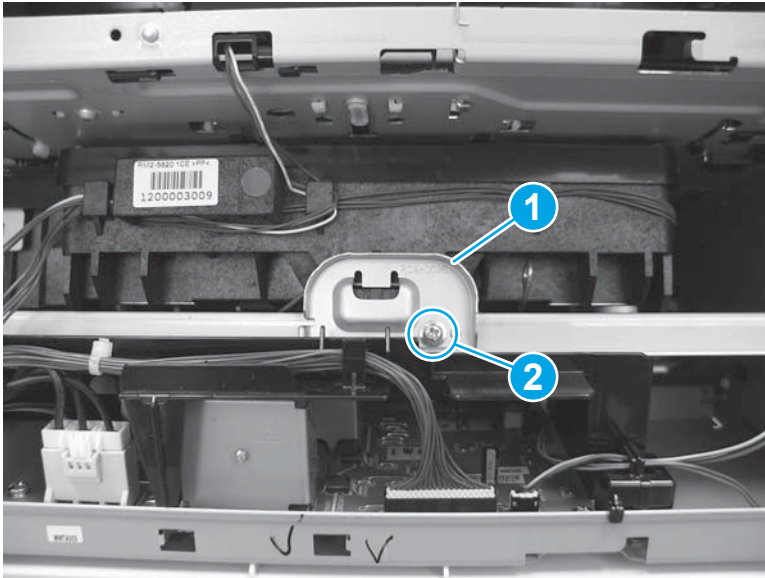

5. Place the wire harness in the retainers (callout 1).

Figure 1-2402 Place the wire harness in the retainers

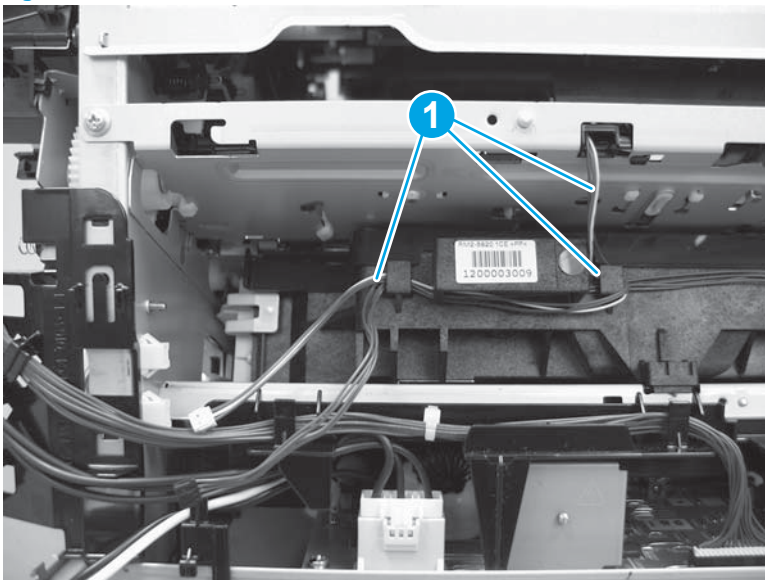

6. Connect two connectors (callout 1).

Figure 1-2403 Connect two connectors

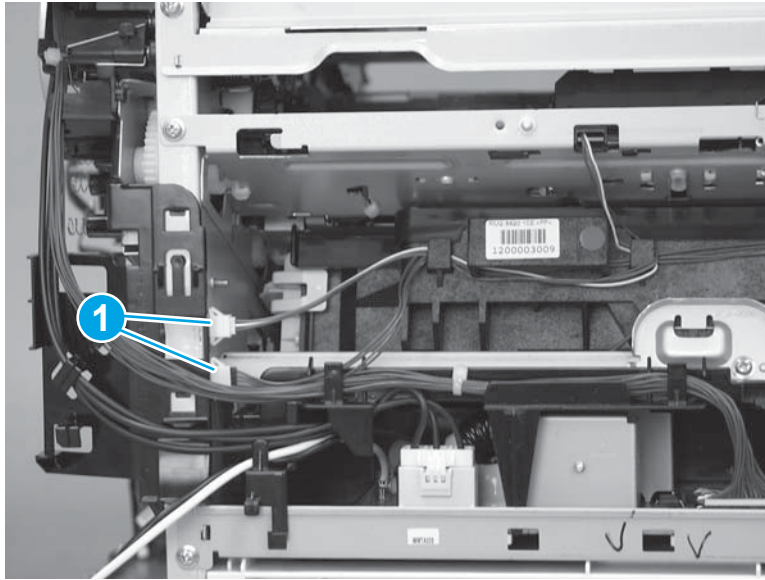

7. Connect two flat cables (callout 1).

Figure 1-2404 Connect two flat cables

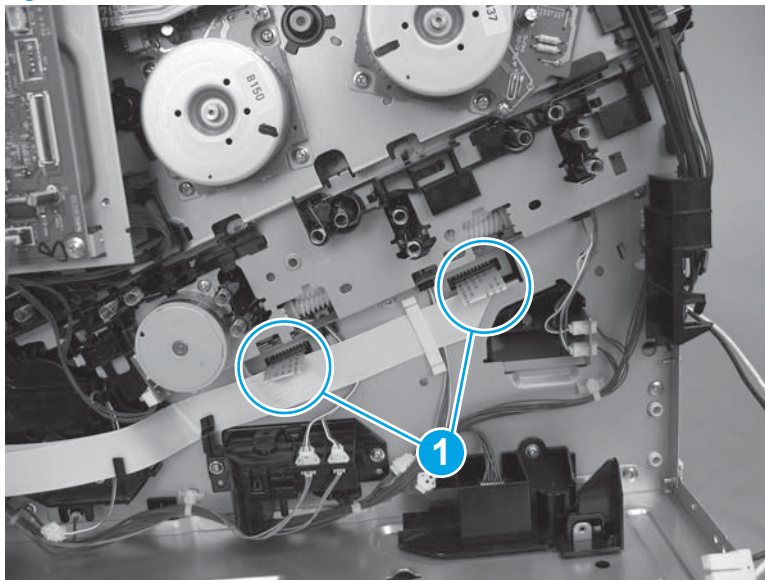

8. Position the guide on the printer, and then slide it up to engage the two tabs (callout 1) and install it.

Figure 1-2405 Install the guide

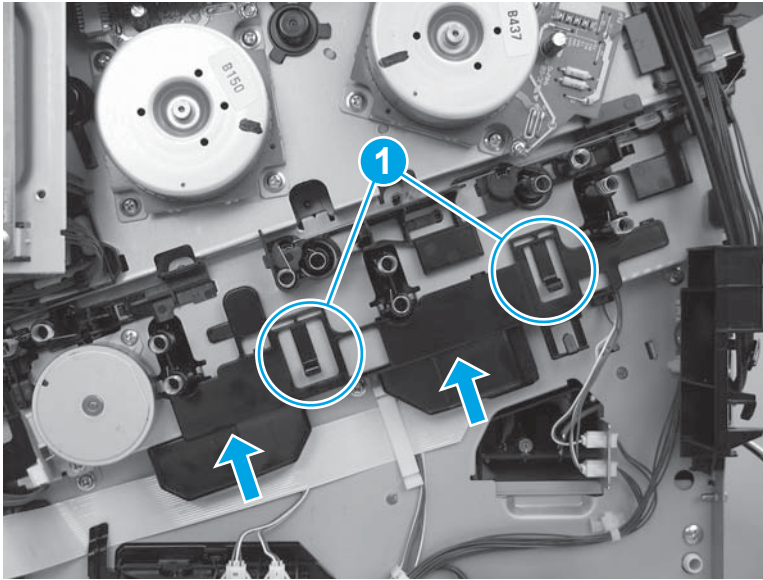

9. Place one wire harness in the retainer (callout 1).

Figure 1-2406 Place one wire harness in the retainer

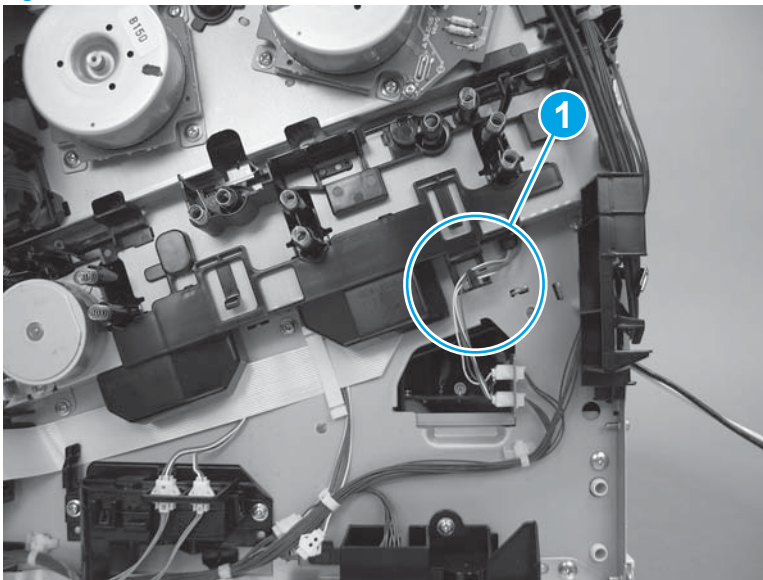

Step 18: Install the HVPDS

 **CAUTION:**  ESD-sensitive part.

1. Position the bottom right corner of the HVPDS (callout 1) behind the black tab, and then rotate it up and onto the printer (callout 2).

Figure 1-2407 Install the HVPSD

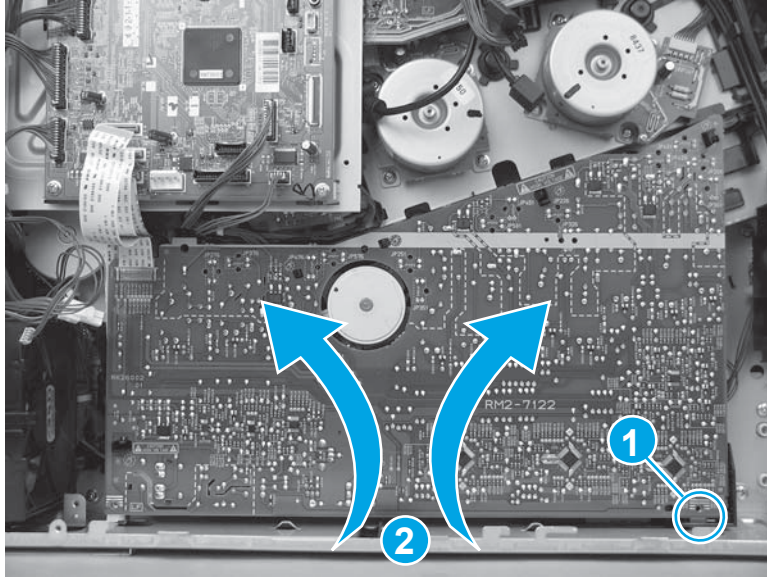

2. Press it onto five tabs (callout 2).

 **IMPORTANT:** Make sure that all five tabs snap into place.

Figure 1-2408 Press the tabs



3. Install two screws (callout 1), and then install one self tapping screw (callout 2) on the HVPSD.

Figure 1-2409 Install three screws

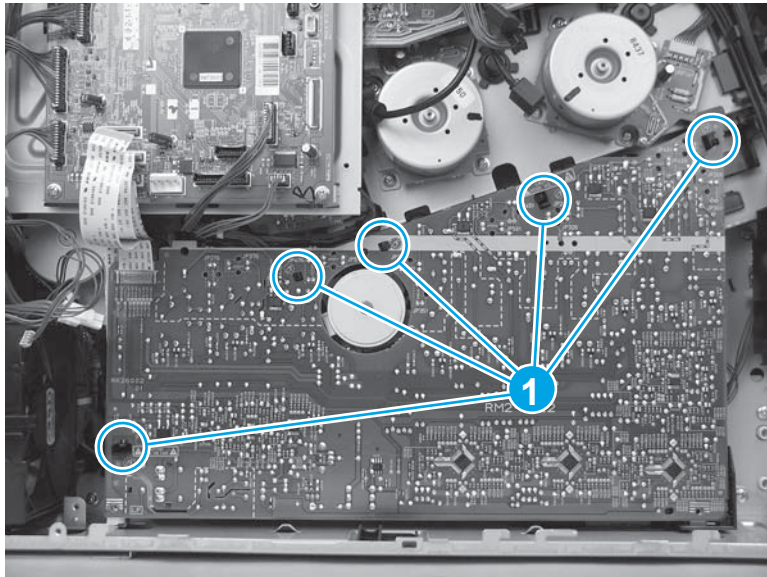
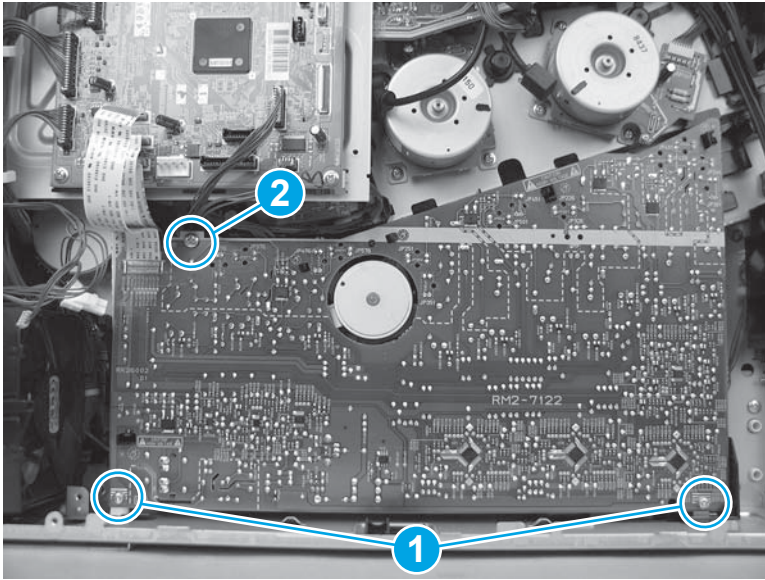

4. Connect one flat cable (callout 1) on the DC controller.

Figure 1-2410 Connect one flat cable

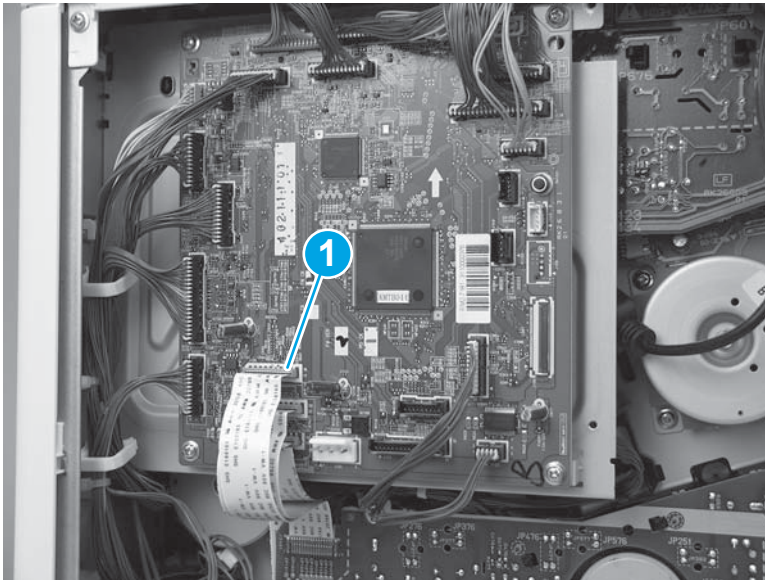

Step 19: Install the LVPS

 **CAUTION:**  ESD-sensitive part.

1. Position the bottom of the LVPS in the printer (callout 1) at a slight angle, and then rotate the top of it into the printer (callout 2) to install it.

Figure 1-2411 Install the LVPS

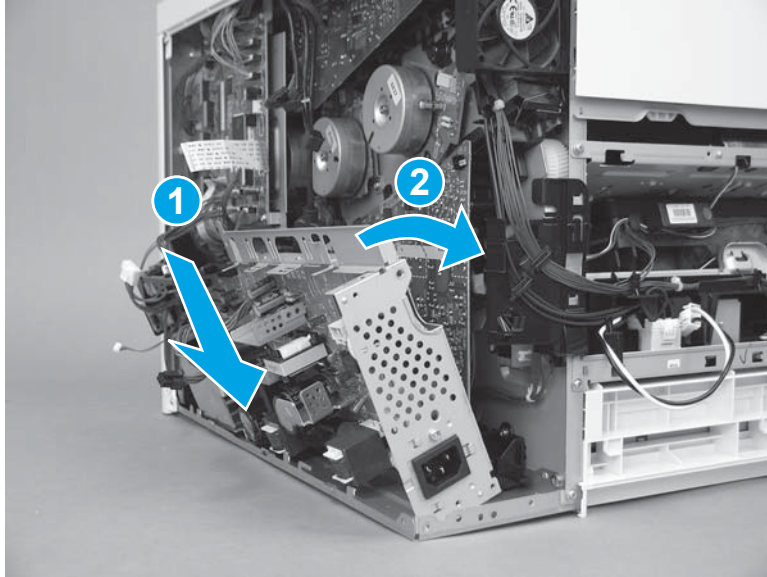

2. Install three screws (callout 1).

Figure 1-2412 Install three screws

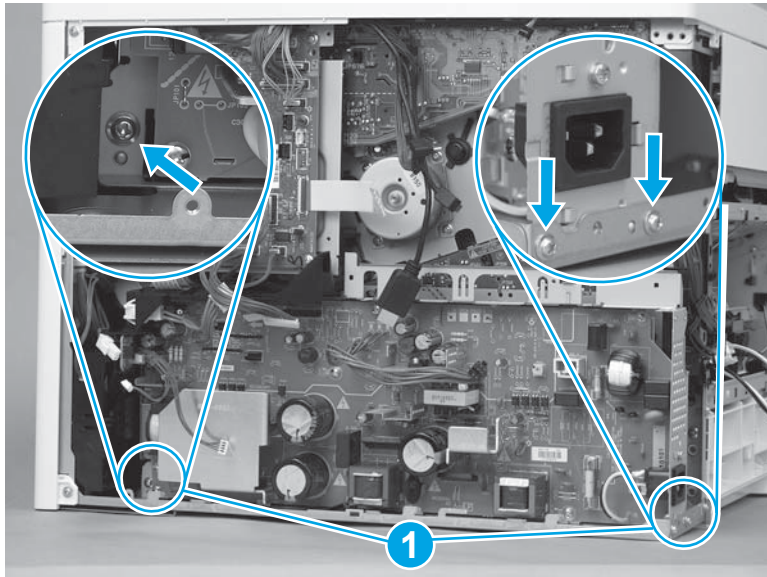

3. Pass the wire harnesses from the DC controller to the LVPS through the opening in the chassis (callout 1), and then install the wire harnesses in the retainer (callout 2).

Figure 1-2413 Pass the wire harnesses through the opening

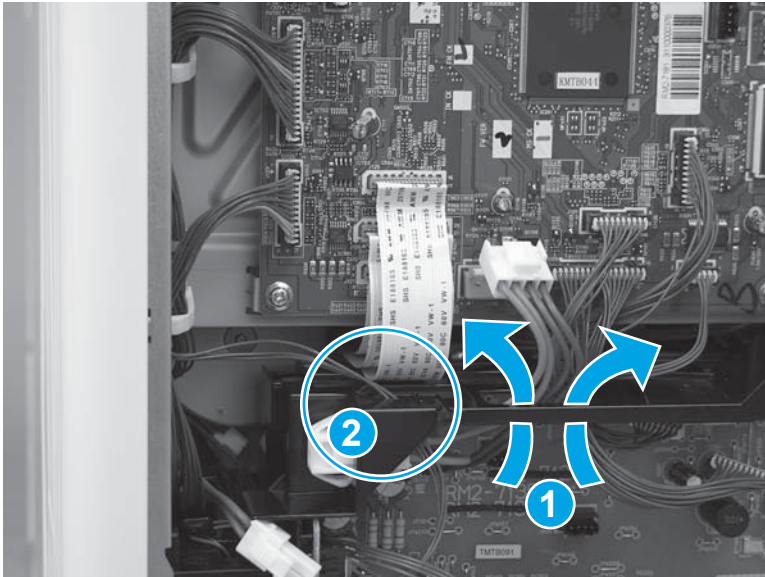

4. Connect three connectors on the DC controller (callout 1), and then connect four connectors (callout 2) on the LVPS.

Figure 1-2414 Connect seven connectors

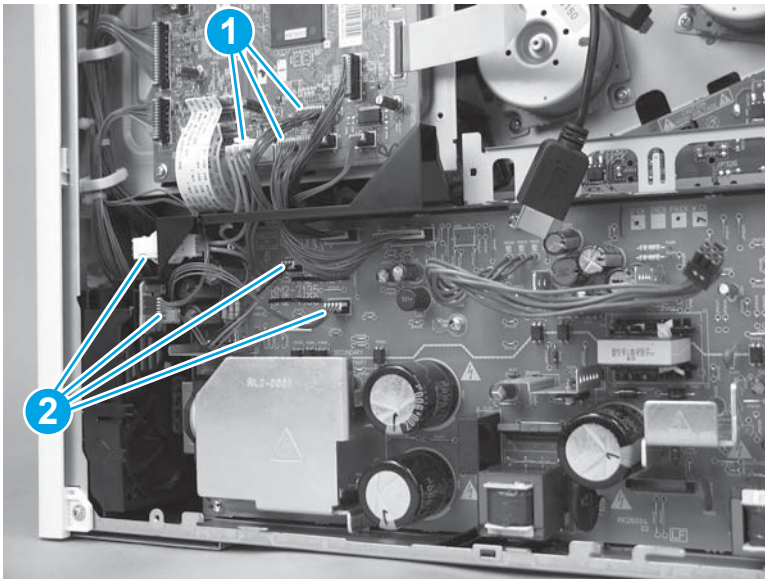

5. Pass the wire harness through the opening (callout 1) in the chassis, and then connect one wire harness (callout 2).

Figure 1-2415 Connect one wire harness

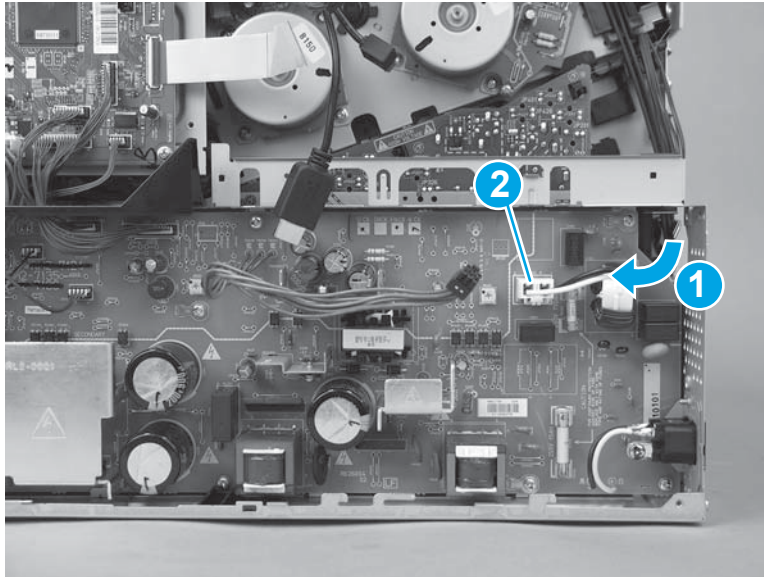

Step 20: Install the formatter case

1. Pass the wire harnesses through the opening in the formatter case.

Figure 1-2416 Pass the wire harnesses through the opening

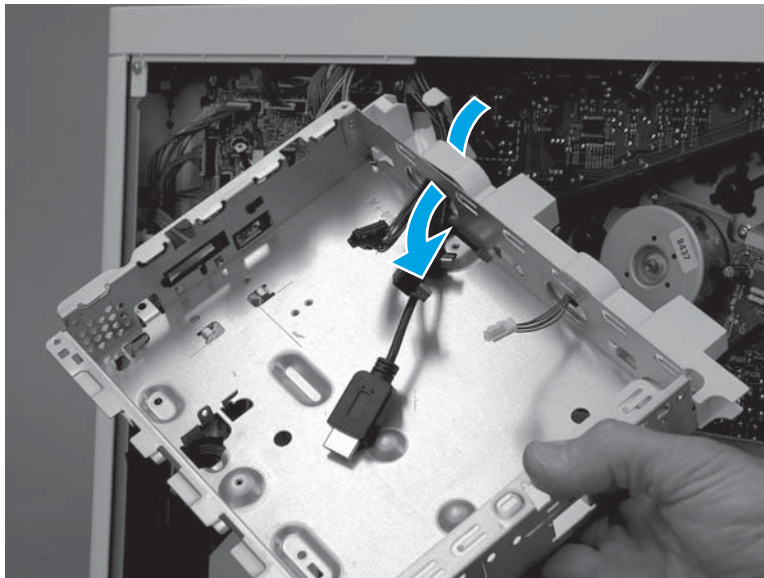

2. Position the top of the formatter case on the printer (callout 1), and then rotate the bottom of the case (callout 2) into the printer.

Figure 1-2417 Install the formatter case

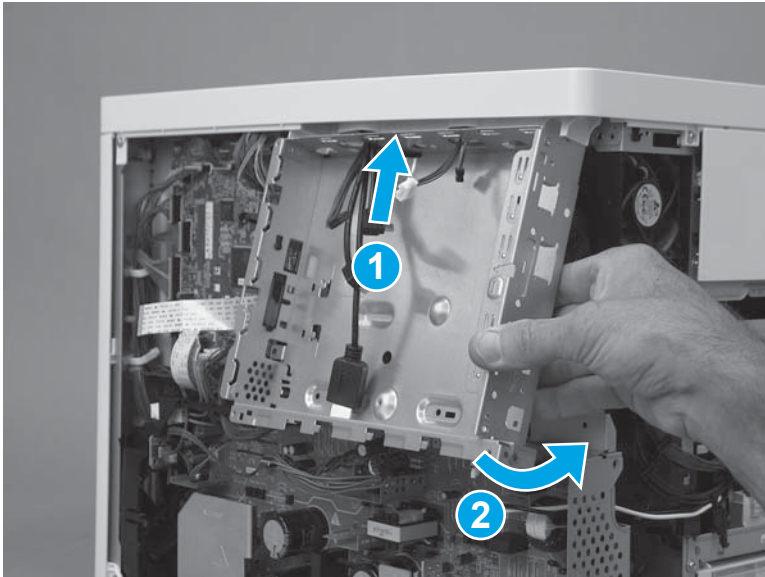

3. Install six screws (callout 1).

Figure 1-2418 Install six screws

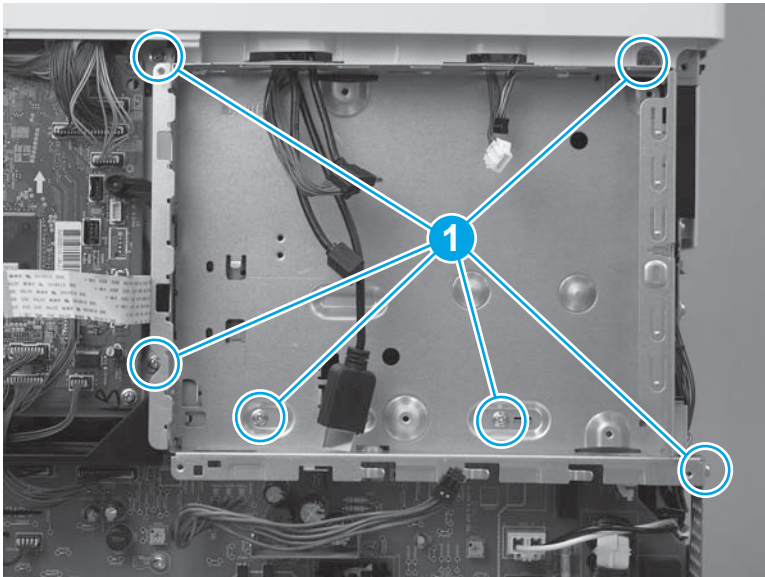

4. Pass two wire harnesses and one flat cable (callout 1) through the opening in the formatter case, and then install one wire harness in the retainer (callout 2).

 **IMPORTANT:** Make sure that the flat cable is securely fastened to the DC controller, and was not dislodged when the formatter case was removed.

Figure 1-2419 Install wire harnesses and flat cable

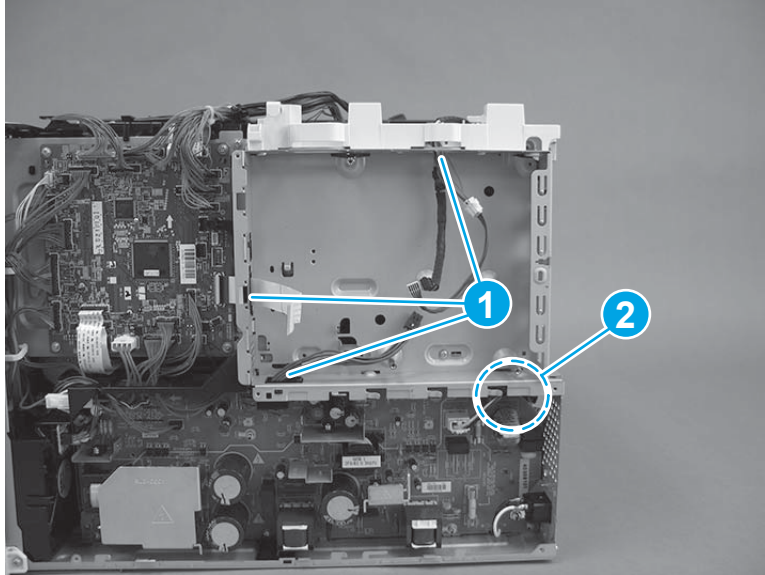

5. Position the LVPS cover on the printer, slide the cover to the left to install it, and then install two screws (callout 1).

Figure 1-2420 Install the LVPS cover

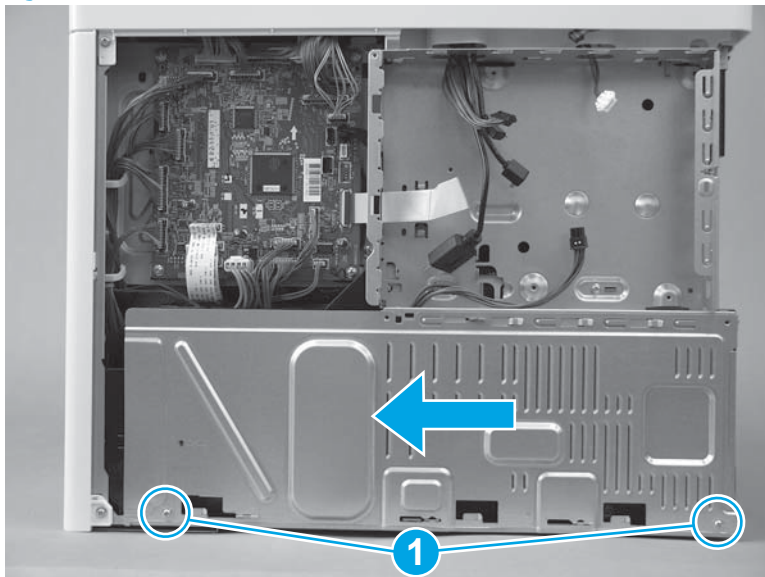

6. If no tape is affixed to the back of the flat cable, skip this step. If double-sided tape is affixed to the back of the flat cable, align the line (callout 1) on the cable with the edge (callout 2) of the opening in the sheet metal. Press to attach the flat cable to the formatter case.

Figure 1-2421 Attach the flat cable

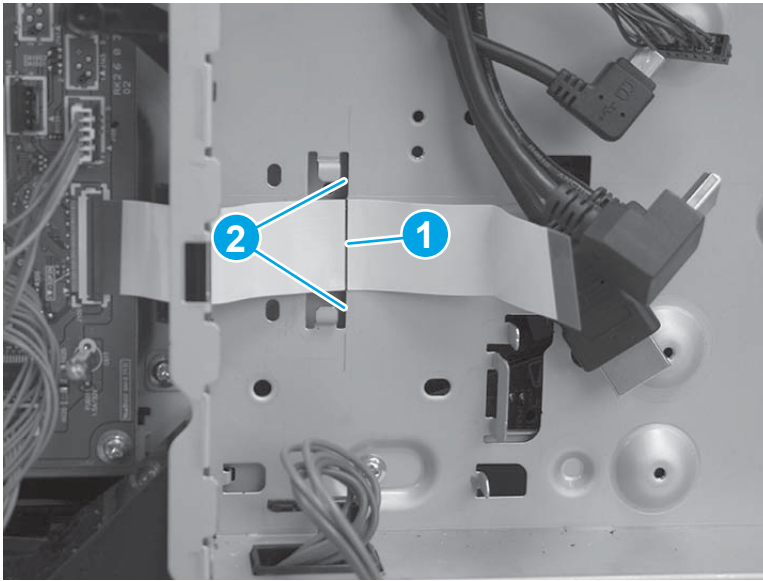

7. Position the bracket over the flat cable, and then slide the bracket to the left to install it. Make sure that the edges of the bracket fit under the sheet metal tabs (callout 1) on the formatter case and that the tabs (callout 2) snap into place.

Figure 1-2422 Position the bracket

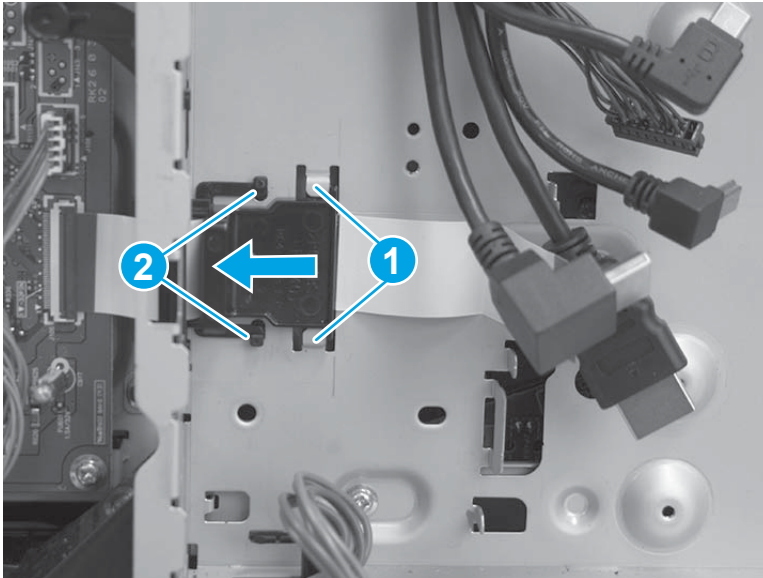

8. **M577 only:** Pass the wire harness (callout 1) through the openings in the formatter case (callout 2), and then connect one connector (callout 3).

Figure 1-2423 Connect one connector

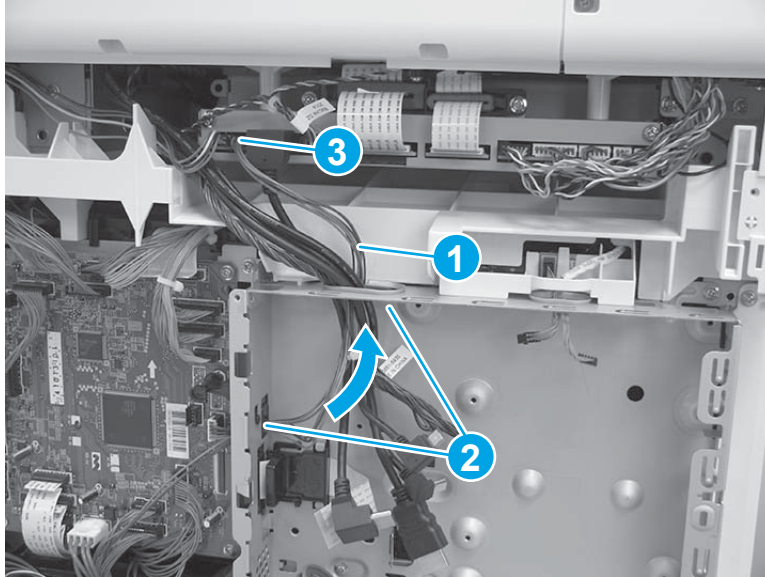

Step 21: Install the left cover

1. Position the cover on the printer.

 **NOTE:** Slightly offset the cover toward the rear of the printer.

Figure 1-2424 Install the cover

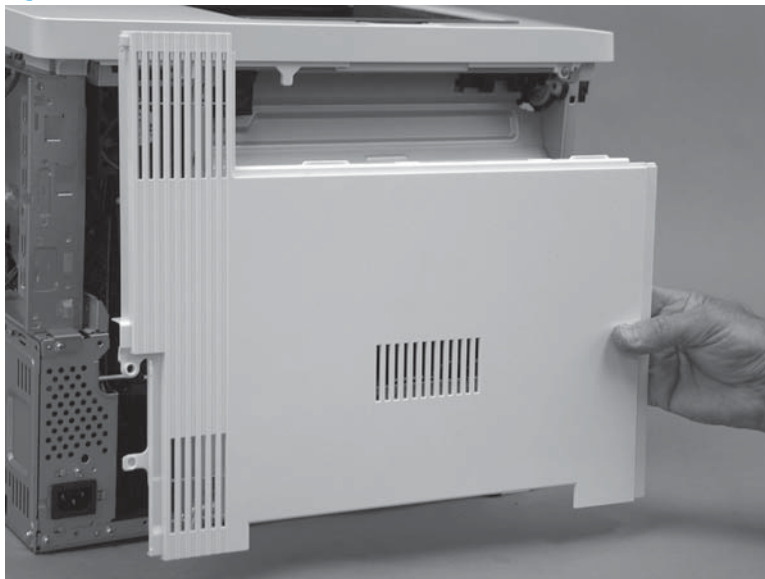

- Slide the cover (callout 1) toward the front of the printer to engage it. Make sure that the tab (callout 2) snaps into place.

 **NOTE:** Locate the alignment pin (callout 3) on the cover from the front door side of the printer, and then make sure that it is fully engaged in the slot in the chassis.

 **TIP:** While sliding the cover into place, push in on the center of the cover (callout 1) to make sure that the hooks on the back of the cover engage with the slots in the chassis.

Figure 1-2425 Engage the cover



- At the left side of the printer, install one screw (callout 1).

Figure 1-2426 Install one screw

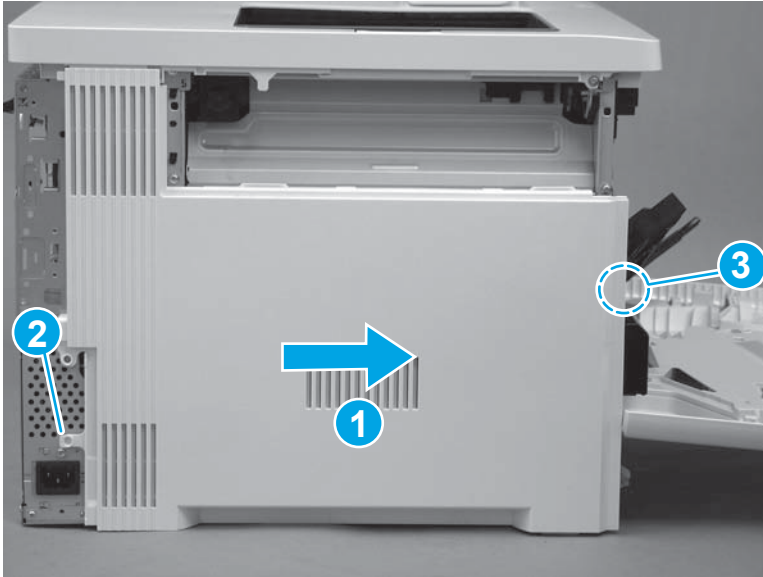

Step 22: Install the rear cover (M577)

 **NOTE:** This step is for the M577 models. For the M552 and M553 models, skip this step and go to [Step 24: Install the rear cover \(M552 and M553\) on page 1380](#).

1. Position the hooks (callout 1) on the cover in the slots (callout 2) in the printer.

Figure 1-2427 Position the hooks

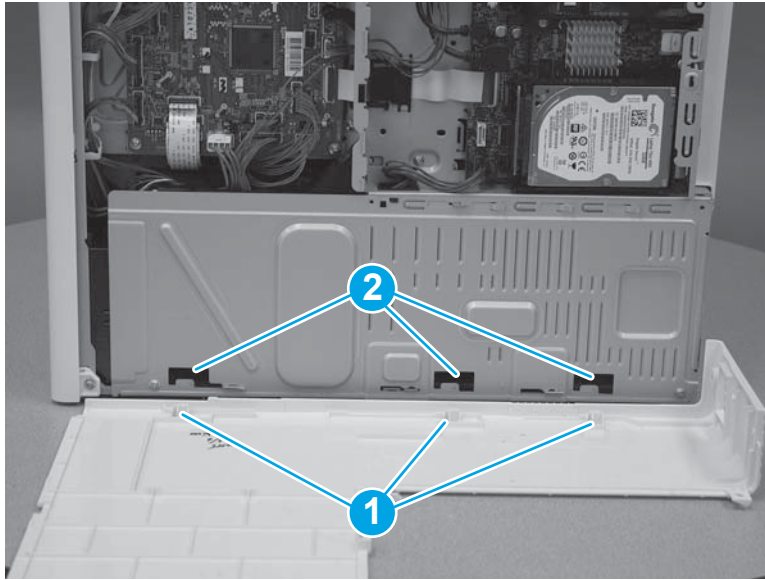

2. Position the back edge (callout 1) of the rear cover behind the edge (callout 2) of the right rear cover. Slide the cover to the left to install it.

Figure 1-2428 Install the cover

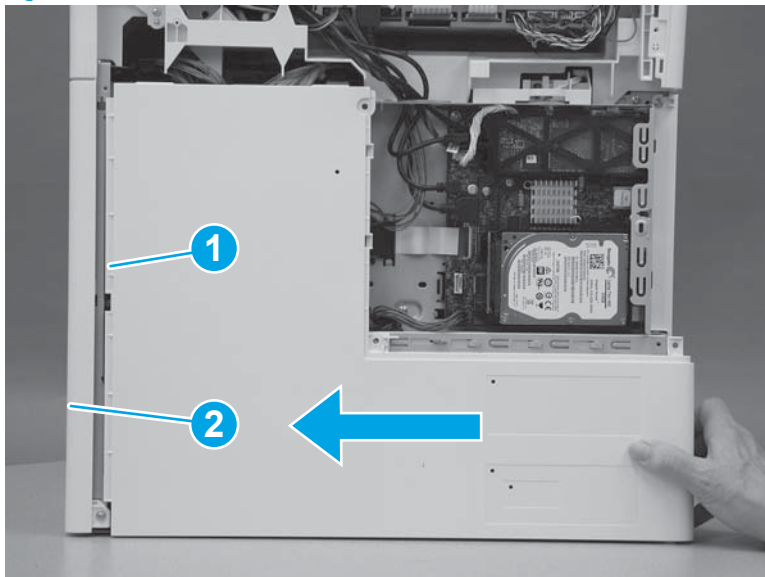

3. Install four screws (callout 1).

Figure 1-2429 Install four screws cover

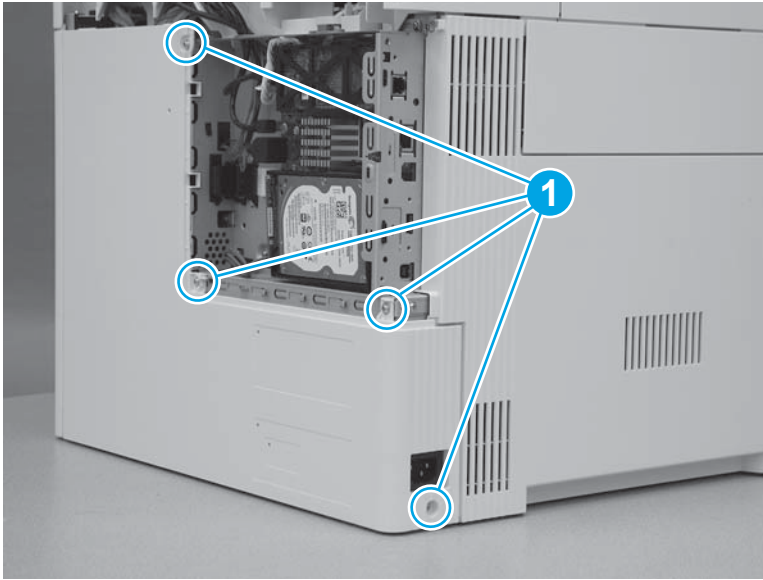

Step 23: Install the rear upper cover (M577)

 **NOTE:** This step is for the M577 models. For the M552 and M553 models, skip this step and go to [Step 24: Install the rear cover \(M552 and M553\) on page 1380](#).

1. Align the ridge (callout 1) on the lower edge of the rear upper cover in front of the tabs (callout 2) on the top edge of the rear cover.

Figure 1-2430 Align the cover

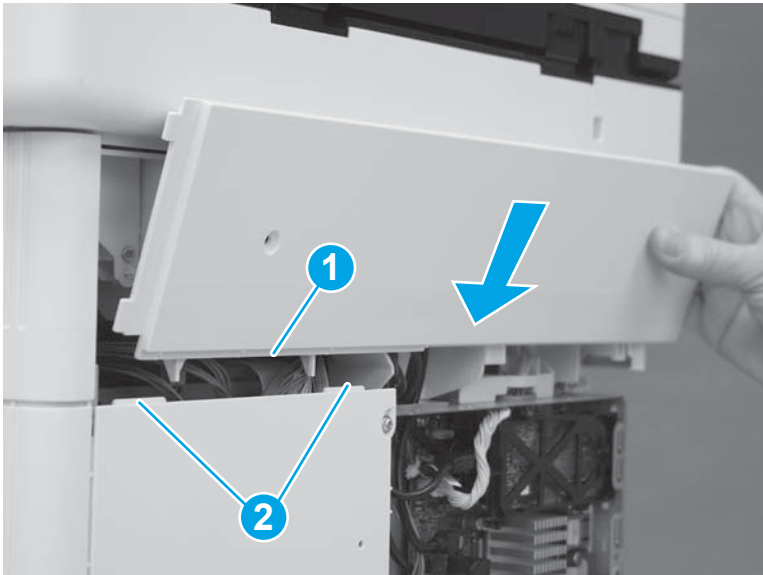

2. Rotate the top of the cover toward the printer.

Figure 1-2431 Rotate the top of the cover

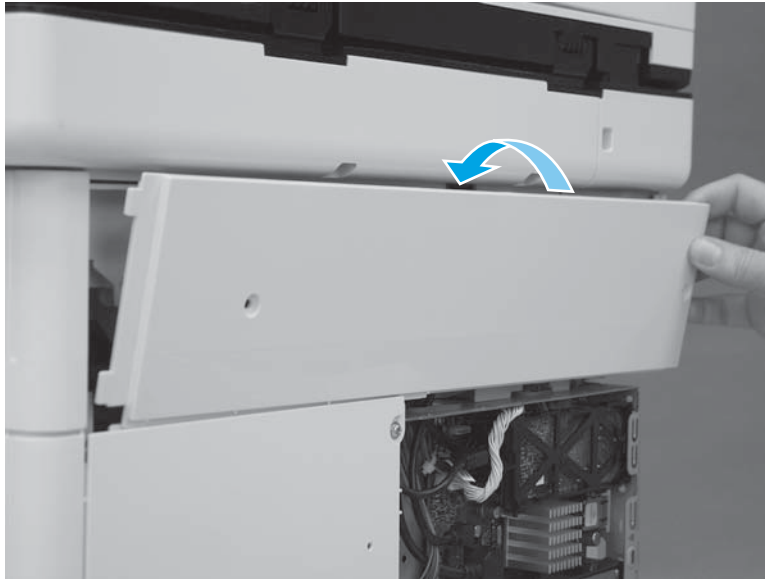

3. Slide the cover to the left (callout 1). Make sure that the tabs (callout 2) on the upper rear cover slide behind the edge (callout 3) of the right upper cover. Make sure that the cover is fully seated.

Figure 1-2432 Slide the cover

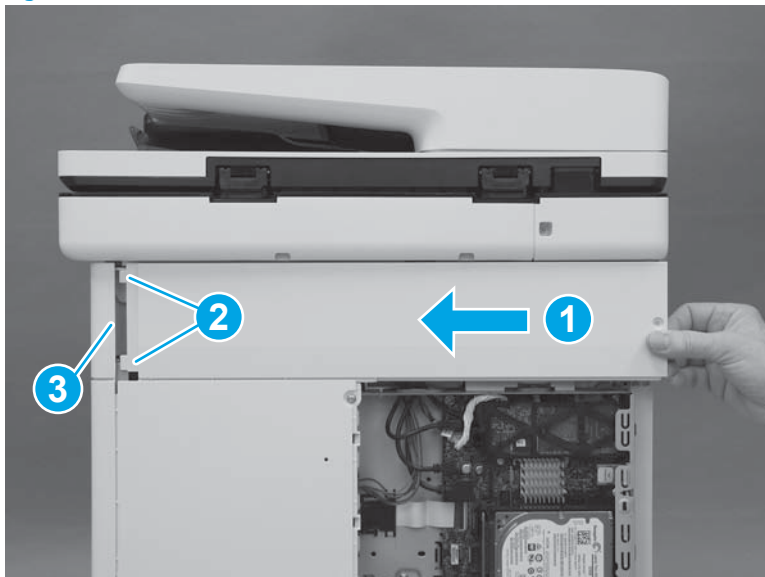

4. Install two screws (callout 1).



 **IMPORTANT:** These two screws are self-tapping screws for plastic. Rotate them counterclockwise to align them with the existing thread pattern, and then carefully turn them clockwise to tighten. Do not overtighten. This will prevent stripping the threads inside the screw holes.

Figure 1-2433 Install two screws

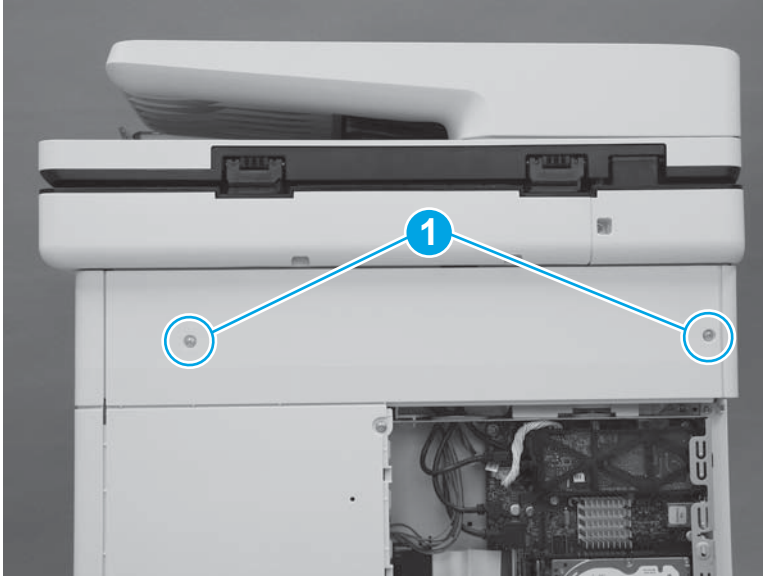

Step 24: Install the rear cover (M552 and M553)

 **NOTE:** This step is for the M552 and M553 models. For the M577 models, skip this step and go to [Step 25: Install the formatter \(M577\) on page 1381](#).

1. Position the top of the cover under the upper cover (callout 1), rotate the bottom of the cover onto the chassis (callout 2), and then slide the cover to the left (callout 3) to install it.

Figure 1-2434 Install the cover

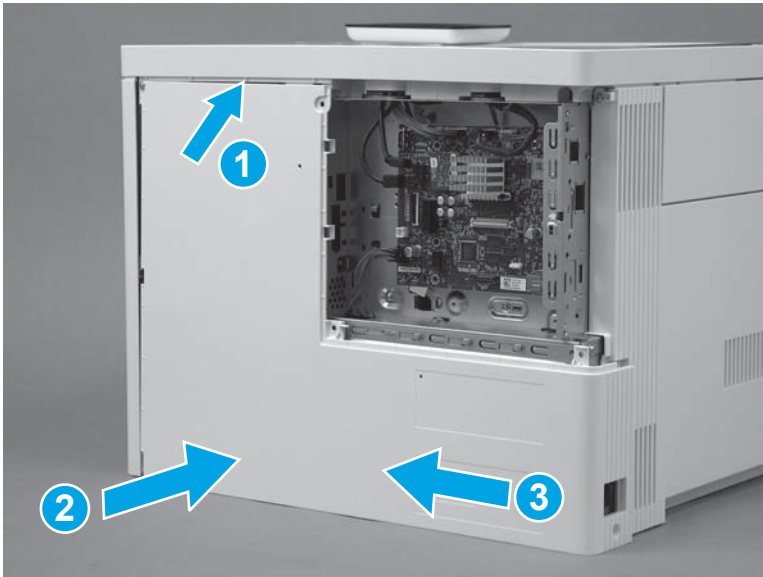

2. Install four screws (callout 1).

Figure 1-2435 Install four screws cover

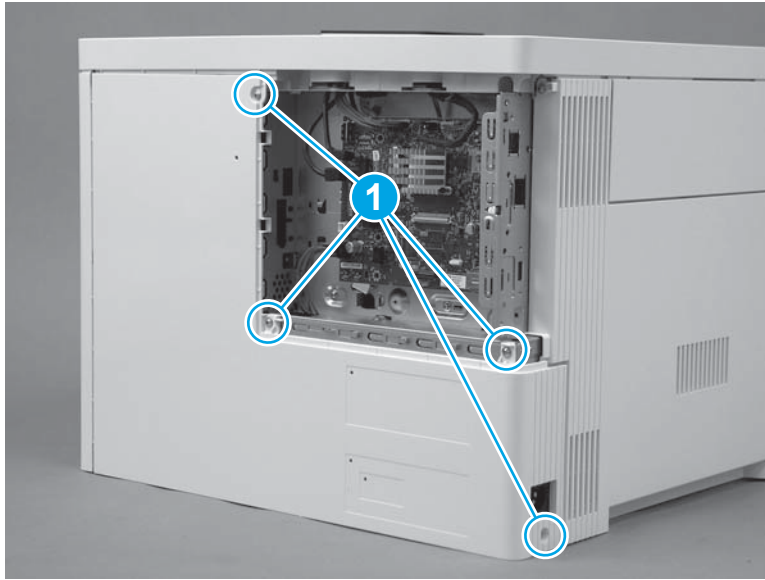

Step 25: Install the formatter (M577)

 **NOTE:** This step is for the M577 models. For the M552 and M553 models, skip this step and to go [Step 28: Install the formatter \(M552 and M553\) on page 1386](#).

 **CAUTION:**  ESD-sensitive part.

1. Position the formatter in the printer. Make sure that the network port (callout 1) fits through the opening (callout 2) in the formatter case.

Figure 1-2436 Install the formatter

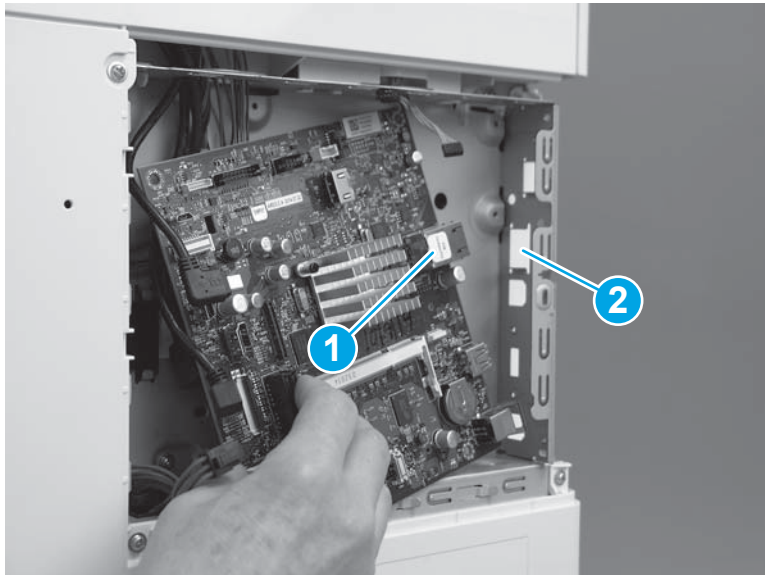

2. Install four screws (callout 1).

Figure 1-2437 Install four screws

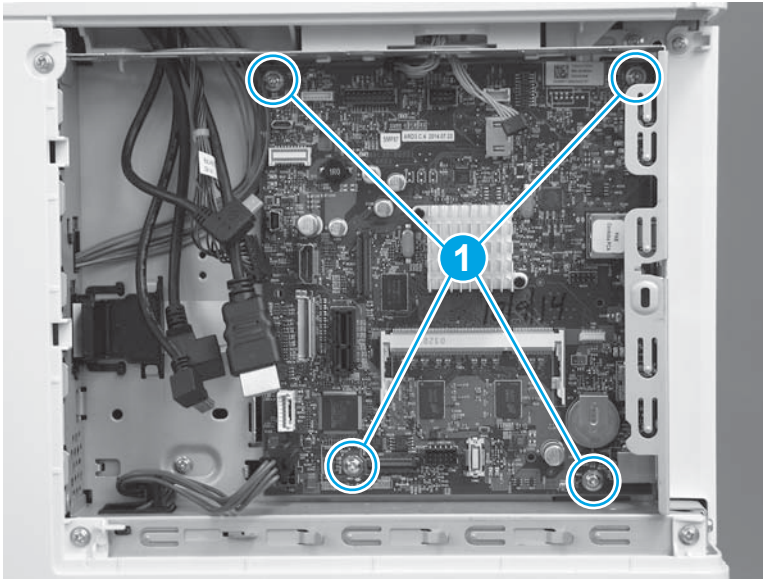

3. Connect all of the connectors on the formatter.

The following connectors are empty:

- All models: J1 (this connector is empty unless the optional DIMM is installed)
- All models: J3
- M577dn: J15 (this is the fax connector for the M577f/z/c models)
- All models: J21 (this connector is empty unless the optional internal USB ports component is installed)
- All models: J23
- All models: J24
- All models: J51
- All models: J57
- All models: J97
- All models: J98 (this connector is empty unless the optional trusted platform module (TPM) is installed)

 **IMPORTANT:** The flat-cable connector (callout 1) is a Zero Insertion Force (ZIF) connector that uses a hinged retainer to secure the flat cable. The hinged retainer must be opened to install the flat cable, and then closed after the cable is installed.

Figure 1-2438 Connect all connectors



Step 26: Install the fax PCA (M577c/f/z)

 **NOTE:** This step is for the M577c/f/z models. For the M577n model, skip this step and go to [Step 27: Install the HDD \(M577\) on page 1384](#).

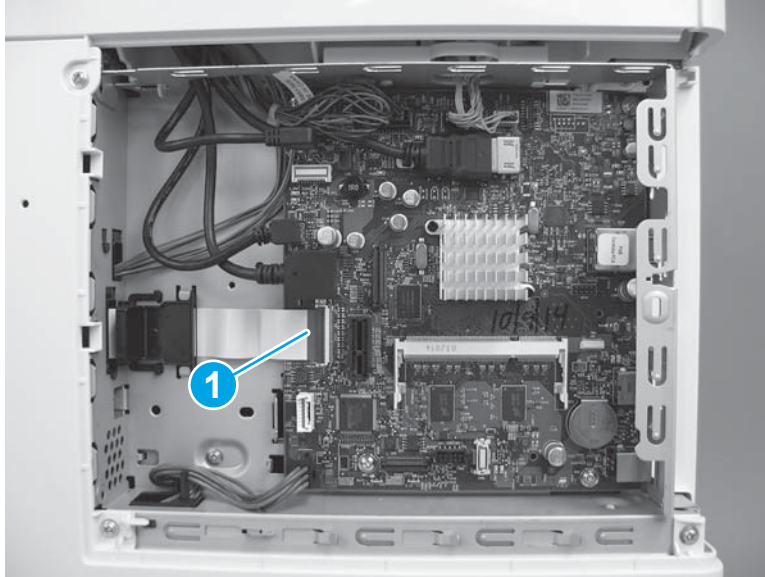
For the M552 and M553 models, skip this step and go to [Step 28: Install the formatter \(M552 and M553\) on page 1386](#).

 **CAUTION:**  ESD-sensitive part.

1. Position the tab and telephone port (callout 1) on the fax PCA in the slots (callout 2) in the formatter case.

Figure 1-2439 Position the fax PCA

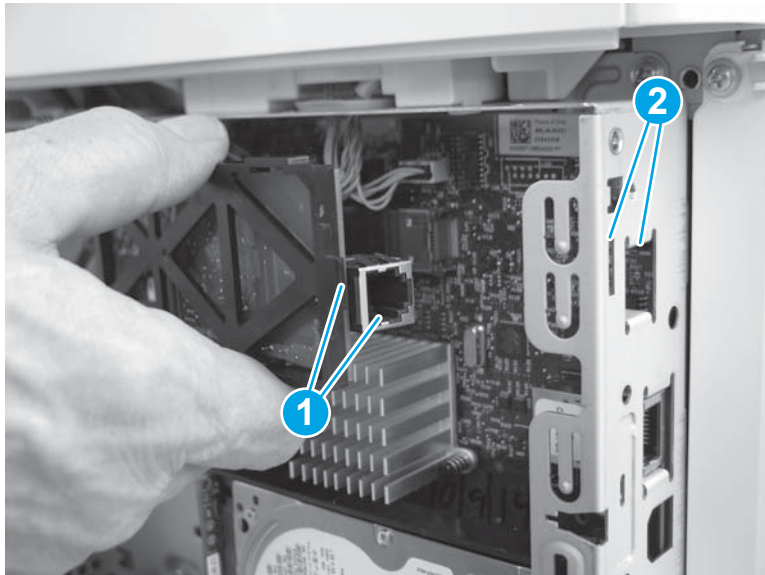

- Slide the fax PCA to the right (callout 1) until the tab and telephone port described in the previous step and seated in the formatter case. Position the retainer (callout 2) in the slot (callout 3) in the formatter. Rotate the end of the fax PCA toward the formatter (callout 4) until the retainer snaps into place.

Figure 1-2440 Install the fax PCA

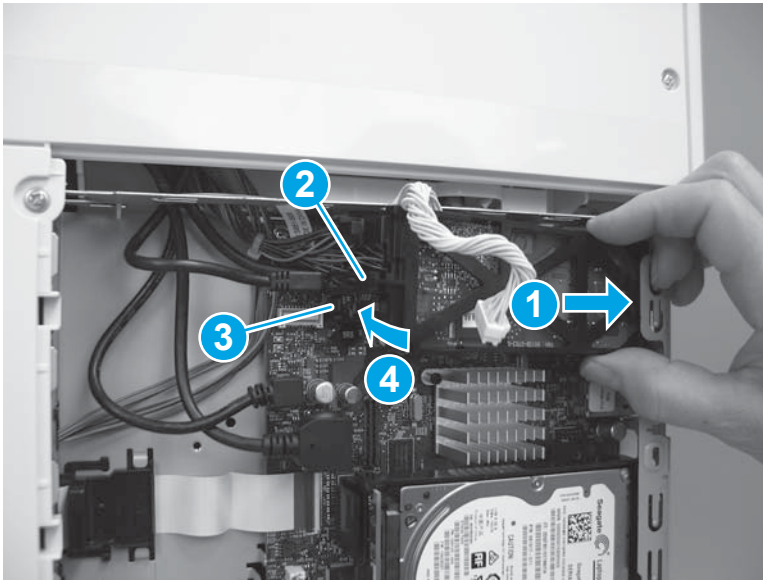

- Position the cable (callout 1) in the guide (callout 2), and then connect one connector (callout 3).

Figure 1-2441 Connect the connector

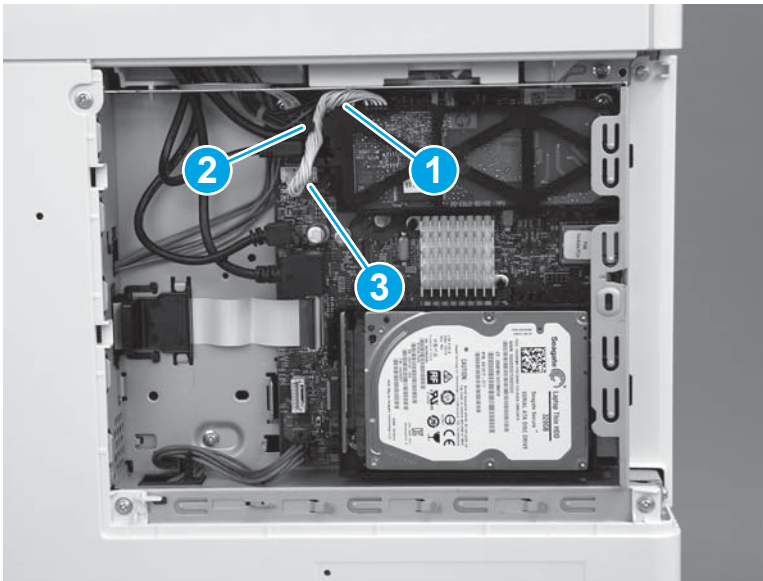

Step 27: Install the HDD (M577)

 **NOTE:** This step is for the M577 models. For the M552 and M553 models, skip this step and go to [Step 28: Install the formatter \(M552 and M553\) on page 1386](#).

 **CAUTION:**  ESD-sensitive part.

1. Align the end of the bracket (callout 1) with the slot in the chassis (callout 2), and then slide the HDD into the printer (callout 3) to engage the bracket with the chassis.

Figure 1-2442 Install the holder

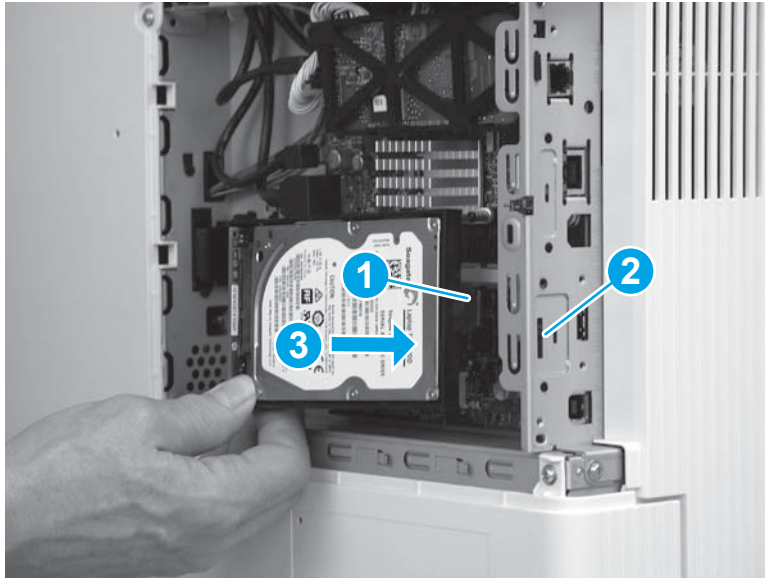

2. Hold the HDD connector latch (callout 1) in the released position, and then rotate the HDD down and into the connector on the formatter to install it.



 **NOTE:** Make sure that the tab (callout 2) snaps into place, and that the HDD is securely installed.

Figure 1-2443 Release the HDD

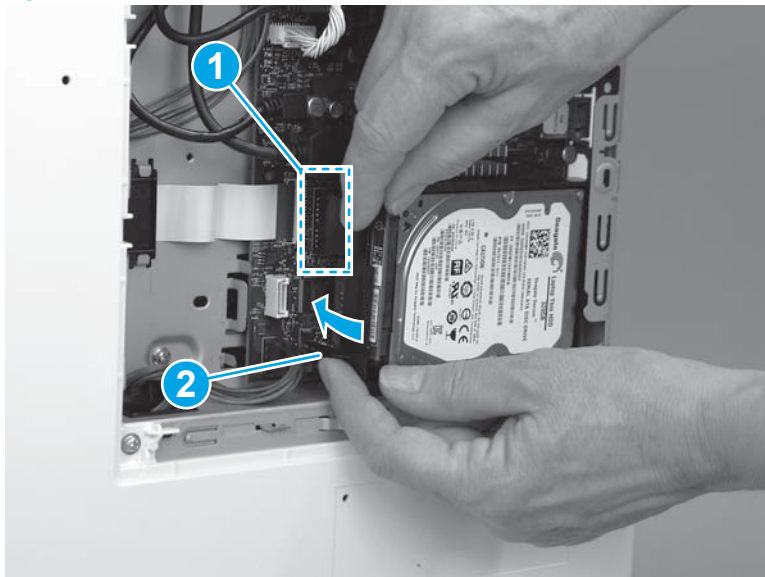

Step 28: Install the formatter (M552 and M553)

 **NOTE:** This step is for the M552 and M553 models. For the M577 models, skip this step and go to [Step 29: Install the formatter cover on page 1387](#).

If the optional hard-disk drive (HDD) was removed, do not forget to reinstall it after the formatter is reinstalled.

Engage the HDD holder with the chassis, rotate the HDD connector down and into the connector on the formatter. Make sure that the tabs snap into place.

 **CAUTION:**  ESD-sensitive part.

1. Position the formatter in the printer, and then install four screws (callout 1).

Figure 1-2444 Install the formatter

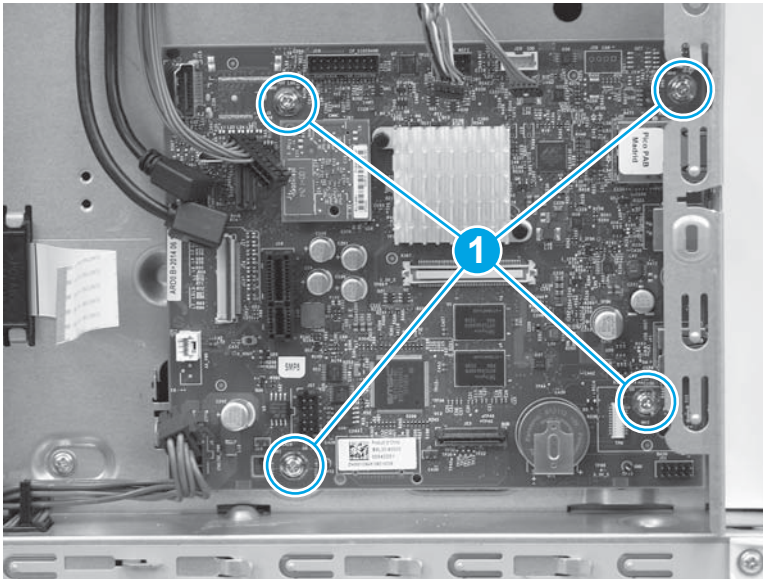

2. Connect all of the connectors on the formatter.

The following connectors are empty:

- All models: J1 (this connector is empty unless the optional DIMM is installed)
- M553n/dn and M552dn: J2 (callout 1; this is the touchscreen connector for the M553x model)
- All models: J9 (this connector is empty unless the optional internal USB ports component is installed)
- All models: J18 (this connector is empty unless the optional hard-disk-drive (HDD) is installed)
- All models: J23
- All models: J24
- M553n/dn and M552dn: J25 (this is the wireless connector for the M553x model)
- All models: J57
- All models: J98 (this connector is empty unless the optional trusted platform module (TPM) is installed)



 **IMPORTANT:** The flat-cable connector (callout 2) is a Zero Insertion Force (ZIF) connector that uses a hinged retainer to secure the flat cable. The hinged retainer must be opened to install the flat cable.

Figure 1-2445 Connect all connectors

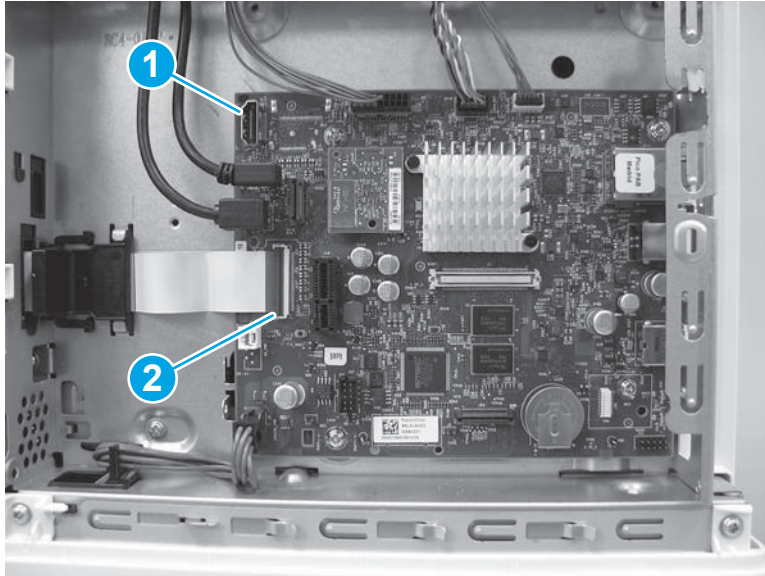

Step 29: Install the formatter cover

- ▲ Slide the cover onto the printer (callout 1) to install it.

 **NOTE:** Make sure that the tabs on the formatter cover align with the slots provided in the printer (callout 2). Tighten the two thumbscrews (callout 3).

 **TIP:** If needed, use the edge of a coin to turn the thumbscrews.

Figure 1-2446 Install the cover

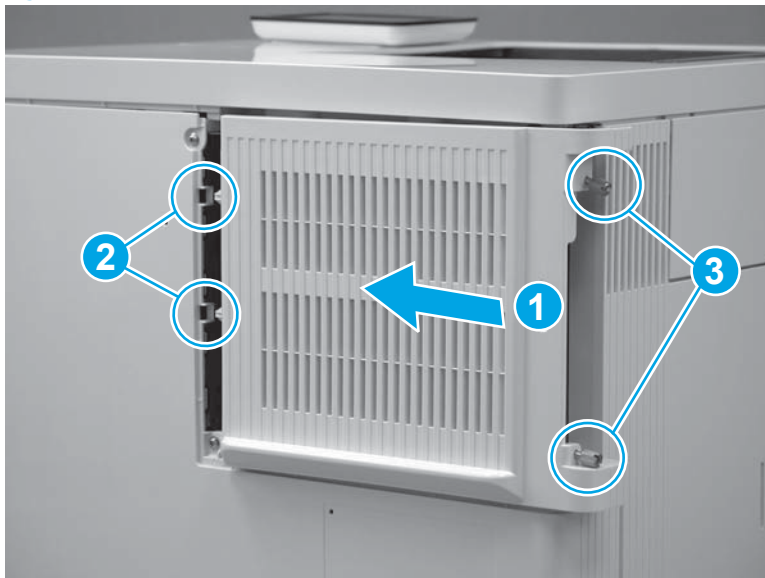

Step 30: Install the toner cartridges

- ▲ Support the toner cartridge underneath with one hand while holding the cartridge handle with the other. Align the toner cartridge with its slot on the shelf, and then insert the toner cartridge into the printer. Repeat this step for the remaining toner cartridges.

 **NOTE:** Avoid touching the green imaging drum. Fingerprints on the imaging drum can cause print defects.

 **TIP:** Leave the front door open until the TCU is reinstalled.

Figure 1-2447 Install a toner cartridge



Step 31: Install the TCU

1. Verify that the toner collection hatch cover is in the closed position on the TCU.

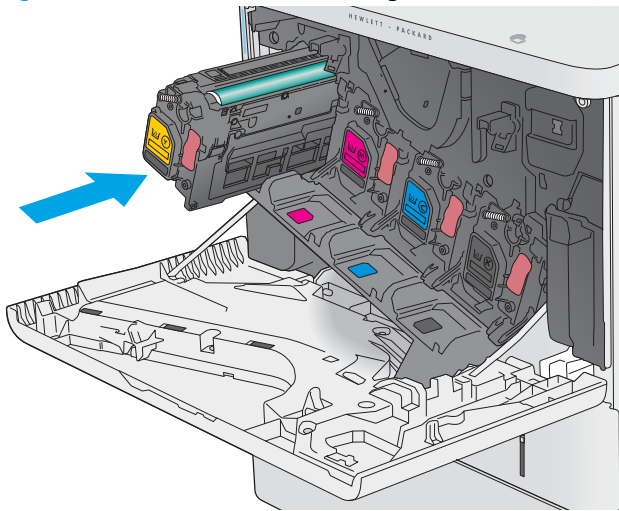
Figure 1-2448 Verify that the toner collection hatch cover is closed

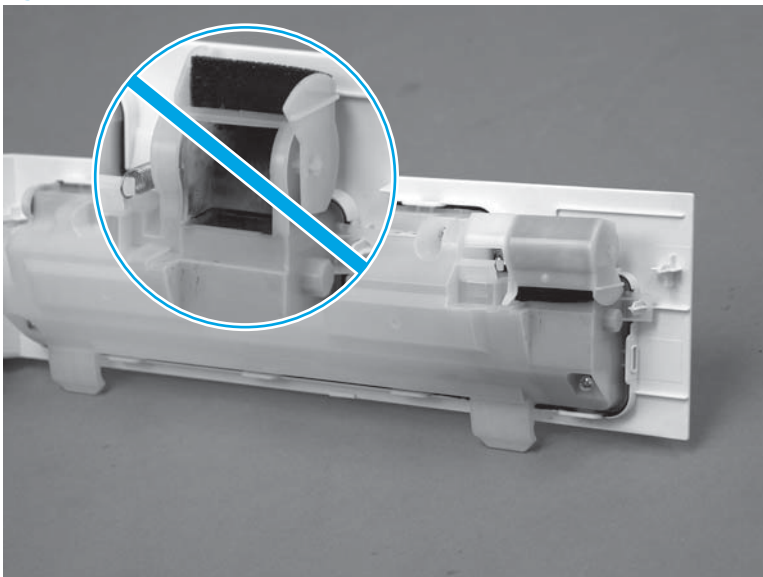

2. Position the TCU with the hinges in the slots provided in the printer (callout 1), and then rotate the TCU up and into the closed position.

 **NOTE:** The toner collection hatch cover automatically opens when the TCU is closed.

Figure 1-2449 Install the TCU



3. Close the front door.

Figure 1-2450 Close the front door

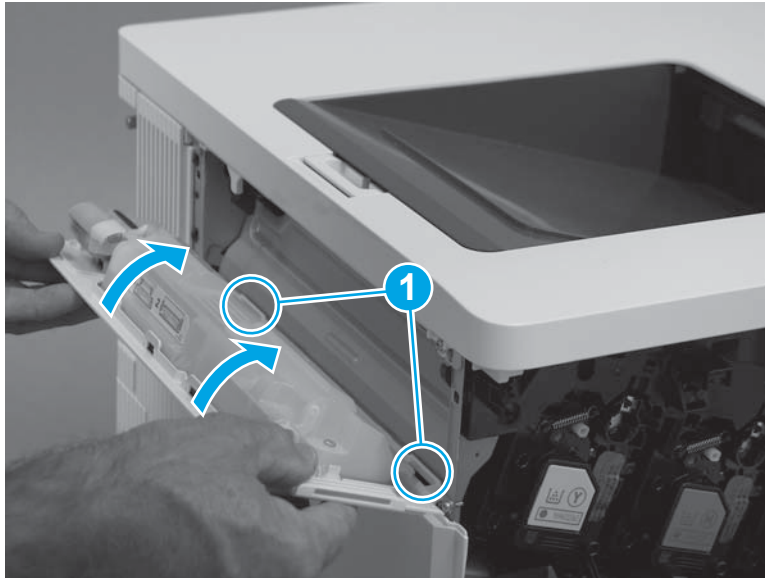

Removal and replacement: Delivery fan (FM3)

- [Introduction](#)
- [Step 1: Remove the USB cover \(M552 and M553\)](#)
- [Step 2: Remove the control panel \(M553x only\)](#)
- [Step 3: Remove the tray](#)
- [Step 4: Remove the toner collection unit \(TCU\)](#)
- [Step 5: Remove the formatter cover](#)
- [Step 6: Remove the formatter \(M552 and M553\)](#)
- [Step 7: Remove the hard-disk drive \(HDD\) \(M577\)](#)
- [Step 8: Remove the fax PCA \(M577c/f/z\)](#)
- [Step 9: Remove the formatter \(M577\)](#)
- [Step 10: Remove the rear cover \(M552 and M553\)](#)
- [Step 11: Remove the rear upper cover \(M577\)](#)
- [Step 12: Remove the rear cover \(M577\)](#)
- [Step 13: Remove the left upper cover \(M577\)](#)
- [Step 14: Remove the right front upper cover \(M577dn\)](#)
- [Step 15: Remove the stapler cover assembly \(M577c/f/z\)](#)
- [Step 16: Remove the integrated scanner assembly \(ISA\) \(M577\)](#)
- [Step 17: Remove the right upper cover \(M577\)](#)
- [Step 18: Remove the top rear cover \(M577\)](#)
- [Step 19: Remove the left cover](#)
- [Step 20: Remove the upper cover \(M552 and M553\)](#)
- [Step 21: Remove the formatter case](#)
- [Step 22: Remove the delivery fan \(FM3\)](#)
- [Step 23: Unpack the replacement assembly](#)
- [Step 24: Install the delivery fan \(FM3\)](#)
- [Step 25: Install the formatter case](#)
- [Step 26: Install the upper cover \(M552 and M553\)](#)
- [Step 27: Install the left cover](#)
- [Step 28: Install the top rear cover \(M577\)](#)
- [Step 29: Install the right upper cover \(M577\)](#)

- [Step 30: Install the integrated scanner assembly \(ISA\) \(M577\)](#)
- [Step 31: Install the stapler cover assembly \(M577c/f/z\)](#)
- [Step 32: Install the right front upper cover \(M577dn\)](#)
- [Step 33: Install the left upper cover \(M577\)](#)
- [Step 34: Install the rear cover \(M577\)](#)
- [Step 35: Install the rear upper cover \(M577\)](#)
- [Step 36: Install the rear cover \(M552 and M553\)](#)
- [Step 37: Install the formatter \(M577\)](#)
- [Step 38: Install the fax PCA \(M577c/f/z\)](#)
- [Step 39: Install the HDD \(M577\)](#)
- [Step 40: Install the formatter \(M552 and M553\)](#)
- [Step 41: Install the formatter cover](#)
- [Step 42: Install the TCU](#)
- [Step 43: Install the tray](#)
- [Step 44: Install the control-panel assembly \(M553x only\)](#)
- [Step 45: Install the USB cover \(M552 and M553\)](#)

Introduction

This document provides the procedures to remove and replace the delivery fan (FM3).

Before performing service

Turn the printer power off

- Disconnect the power cable.

⚠ WARNING! To avoid damage to the printer, turn the printer off, wait 30 seconds, and then remove the power cord before attempting to service the printer.

Use the table below to identify the correct part number for your printer, and then go to <http://h20141.www2.hp.com/hpparts> to order the part.

Delivery fan (FM3) part number	
RK2-2728-000CN	Delivery fan (FM3)

Required tools

- #2 Phillips screwdriver with a magnetic tip

After performing service

Make sure that all of the connectors on the formatter are fully seated.

Make sure that the formatter cover is fully seated, and that the thumbscrews are finger tight after replacing it.

Turn the printer power on

- Connect the power cable.
- Use the power switch to turn the power on.

Step 1: Remove the USB cover (M552 and M553)

 **NOTE:** This step is for the M552 and M553 models. For the M577 models, skip this step and go to [Step 3: Remove the tray on page 1397](#).

1. Locate the USB cover.

Figure 1-2451 Locate the USB cover

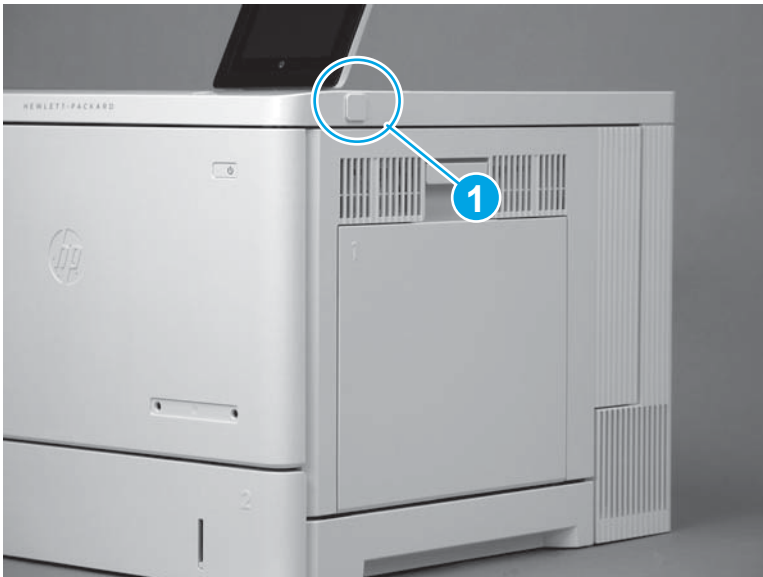

2. Pull the cover off of the printer to remove it.

Figure 1-2452 Remove the cover



Step 2: Remove the control panel (M553x only)

 **NOTE:** This step is for the M553x model. For the M553n/dn, M552dn, and M577 models, skip this step and go to [Step 3: Remove the tray on page 1397](#).

1. Tilt the control panel up.

Figure 1-2453 Tilt the control panel up



2. Use a small flat-blade screwdriver to release the control-panel screws cover tabs.

Figure 1-2454 Release the control-panel screws cover tabs



3. Rotate the cover up to remove it.

Figure 1-2455 Remove the cover



4. Use a small Phillips screwdriver to remove two screws (callout 1).

 **IMPORTANT:** Store the screws in a secure place where they cannot fall down into the printer.

Figure 1-2456 Remove two screws

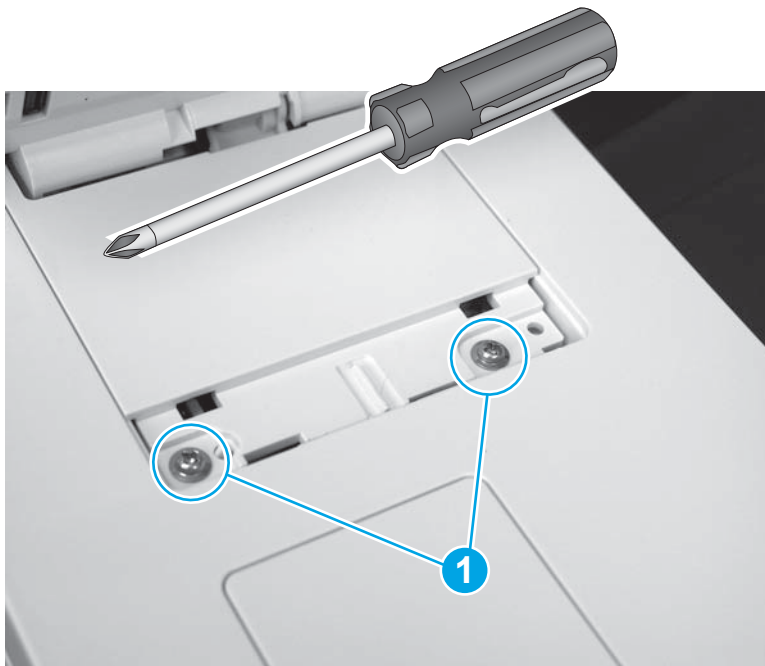

5. Rotate the control-panel base toward the front of the printer.

Figure 1-2457 Rotate the control-panel base up



6. Slightly slide the control-panel base toward the rear of the printer (callout 1) to release it, and then turn the control panel over (callout 2) to access the bottom side.

⚠ CAUTION: The control panel is still attached to the printer. Do not attempt to completely remove the control panel.

Figure 1-2458 Turn the control panel over

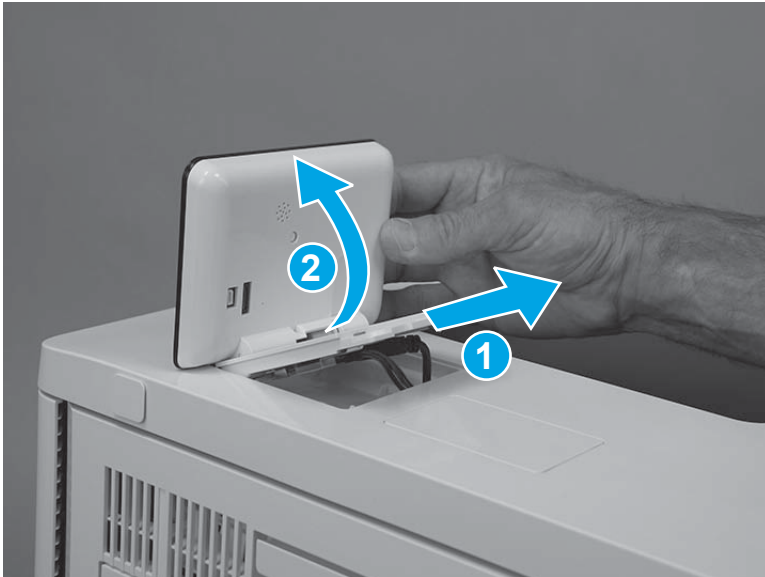

7. Disconnect one USB cable (callout 1), one connector (callout 2), and then remove the control panel.

Figure 1-2459 Disconnect two connectors

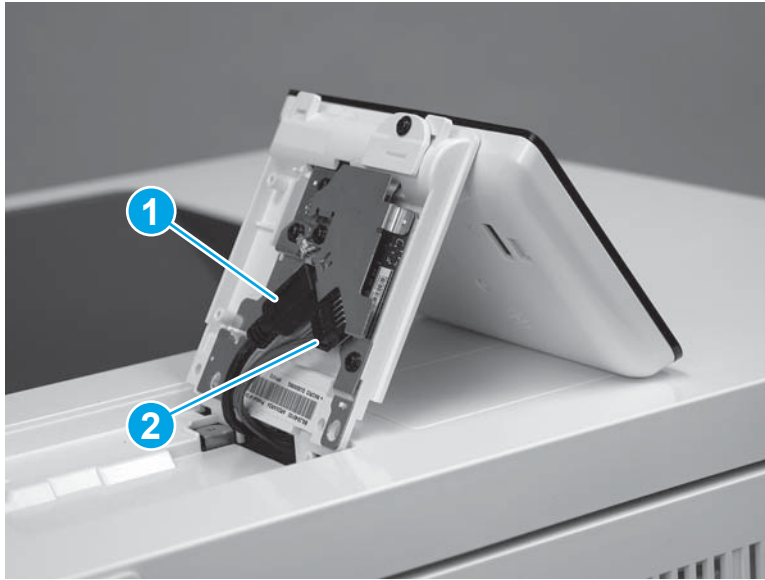

Step 3: Remove the tray

1. Pull the tray out until it stops.

Figure 1-2460 Pull the tray out



2. Lift the front of the tray, and then pull it out of the printer to remove it.

Figure 1-2461 Remove the tray

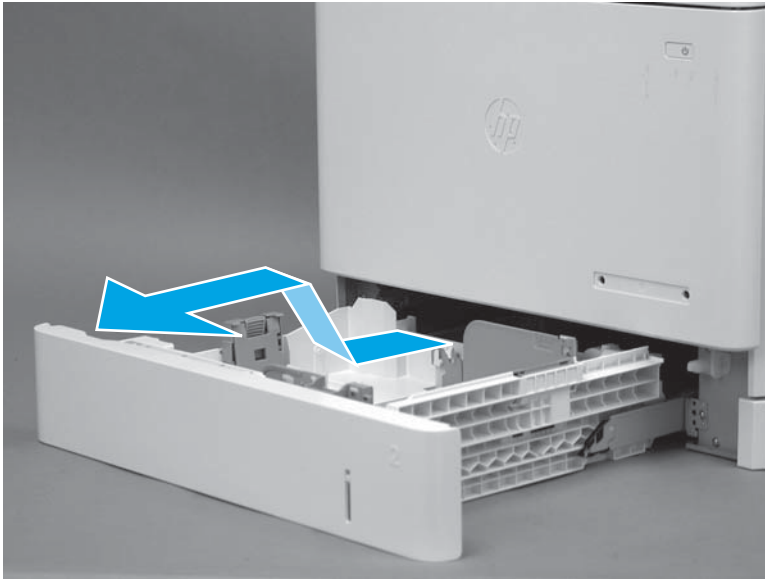

Step 4: Remove the toner collection unit (TCU)

1. Open the front door.

Figure 1-2462 Open the front door



2. Open the TCU.

 **NOTE:** The toner collection hatch cover automatically closes when the TCU is opened.

Figure 1-2463 Open the TCU



3. Pull the TCU away from the printer at an angle to remove it.

⚠ CAUTION: Do not open the toner collection hatch cover when handling the TCU. If toner gets on clothing, wipe it off by using a dry cloth and wash the clothes in cold water. Hot water sets toner into fabric.

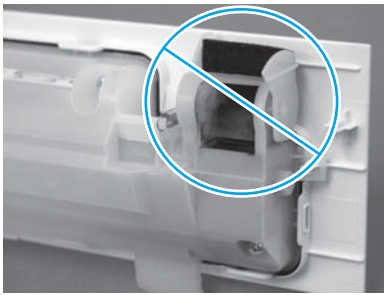
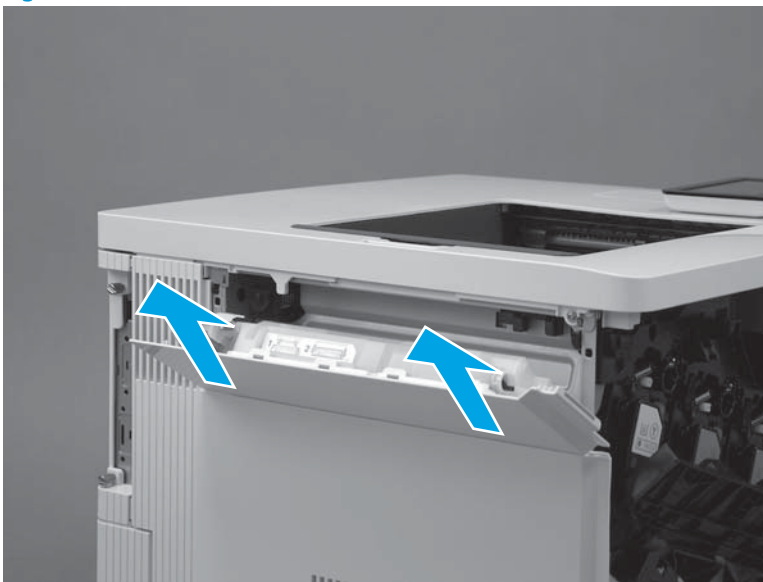

Figure 1-2464 Remove the TCU



Step 5: Remove the formatter cover

1. Locate the formatter cover.

Figure 1-2465 Locate the formatter cover

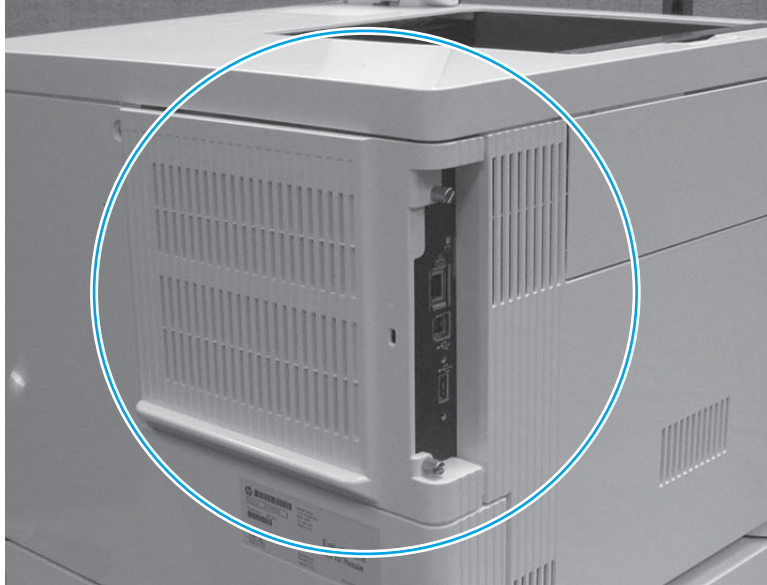

2. Loosen the two thumbscrews (callout 1). Grasp the two thumbscrews, and then slide the cover away from the printer (callout 2) to remove it.

 **TIP:** If needed, use the edge of a coin to turn the thumbscrews.

Figure 1-2466 Loosen the thumbscrews

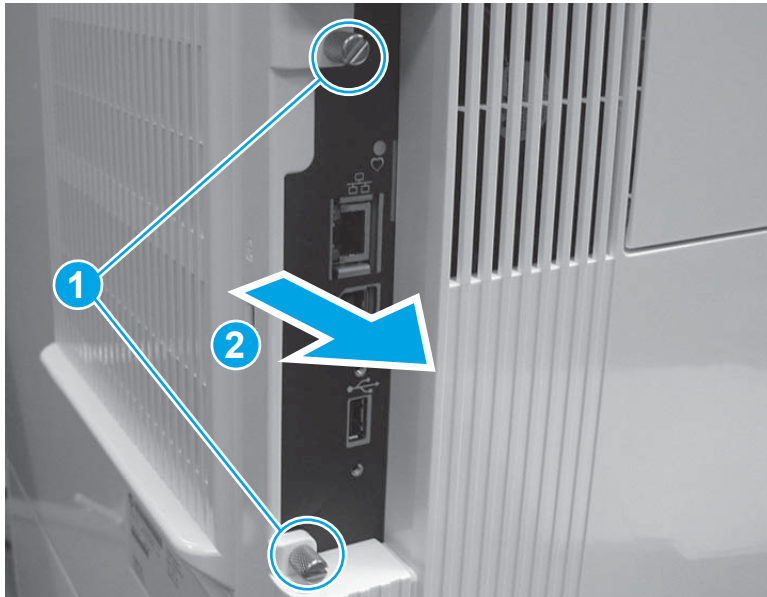

Step 6: Remove the formatter (M552 and M553)

 **NOTE:** This step is for the M552 and M553 models. For the M577 models, skip this step and go to [Step 7: Remove the hard-disk drive \(HDD\) \(M577\) on page 1403](#).

If the optional hard-disk drive (HDD) is installed, it must be removed to gain access to the formatter mounting screws.

Release two tabs along the left edge of the HDD, rotate the left edge away from the product, and then slide the HDD to the left to remove it.

 **CAUTION:**  ESD-sensitive part.

1. Disconnect all of the connectors on the formatter.

The following connectors are empty:

- All models: J1 (this connector is empty unless the optional DIMM is installed)
- M553n/dn and M552dn: J2 (callout 1; this is the touchscreen connector for the M553x model)
- All models: J9 (this connector is empty unless the optional internal USB ports component is installed)
- All models: J18 (this connector is empty unless the optional hard-disk-drive (HDD) is installed)
- All models: J23
- All models: J24
- M553n/dn and M552dn: J25 (this is the wireless connector for the M553x model)
- All models: J57
- All models: J98 (this connector is empty unless the optional trusted platform module (TPM) is installed)

 **IMPORTANT:** The flat-cable connector (callout 2) is a Zero Insertion Force (ZIF) connector that uses a hinged retainer to secure the flat cable. The hinged retainer must be opened to release the flat cable.

Figure 1-2467 Disconnect all connectors



2. Remove four screws (callout 1), and then remove the formatter.

Figure 1-2468 Remove the formatter

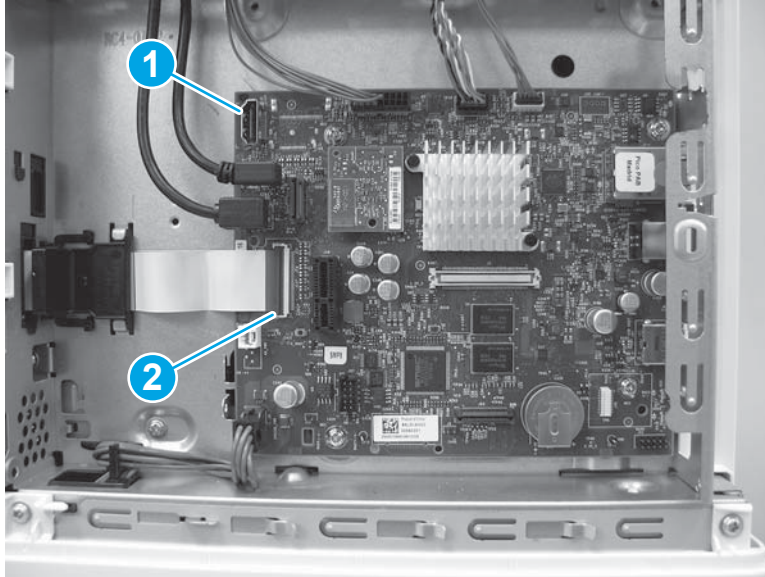
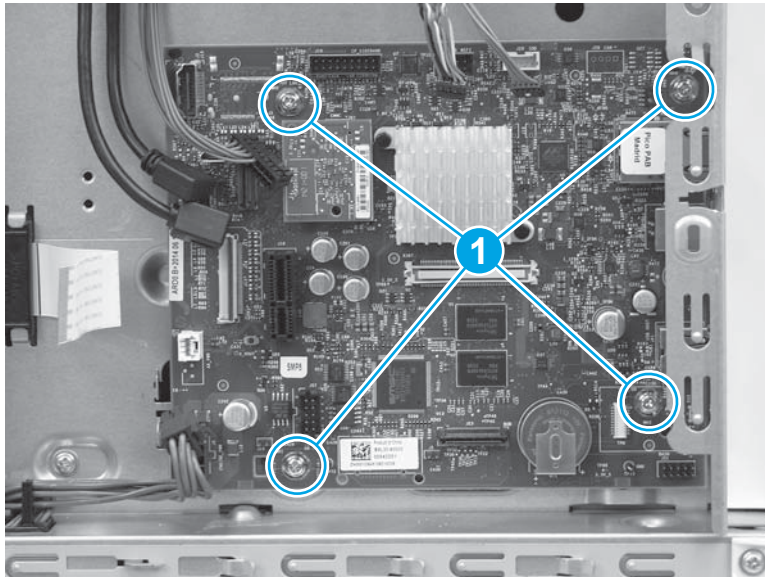

Step 7: Remove the hard-disk drive (HDD) (M577)

 **NOTE:** This step is for the M577 models. For the M552 and M553 models, skip this step and go to [Step 10: Remove the rear cover \(M552 and M553\) on page 1408.](#)

 **CAUTION:**  ESD-sensitive part.

1. Release two tabs (callout 1). Hold the tabs in the released position, and then rotate the hard disk drive (HDD) up (callout 2) to release the connector from the formatter.

Figure 1-2469 Release the HDD

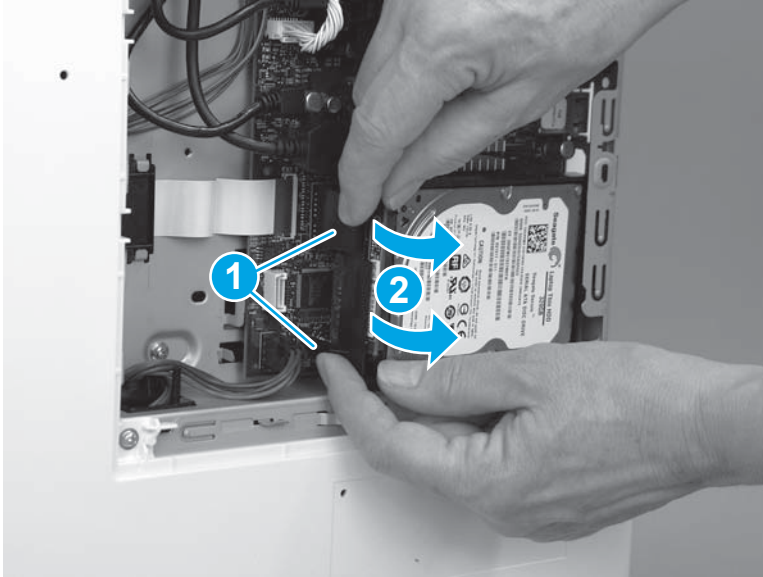

2. Slide the HDD away from the printer to remove it.

Figure 1-2470 Remove the HDD



Step 8: Remove the fax PCA (M577c/f/z)

 **NOTE:** This step is for the M577c/f/z models. For the M577n model, skip this step and go to [Step 9: Remove the formatter \(M577\) on page 1406](#).

For the M552 and M553 models, skip this step and go to [Step 10: Remove the rear cover \(M552 and M553\) on page 1408](#).

 **CAUTION:**  ESD-sensitive part.

1. Locate the fax PCA component on the formatter.

Figure 1-2471 Locate the fax PCA

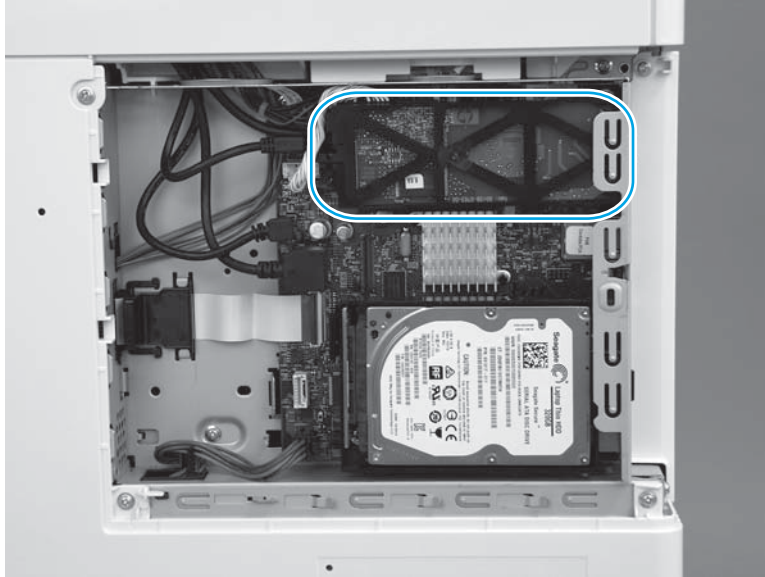

2. Release the connector latch (callout 1), and then pull the connector away from the formatter (callout 2) to disconnect it.

Figure 1-2472 Disconnect one connector

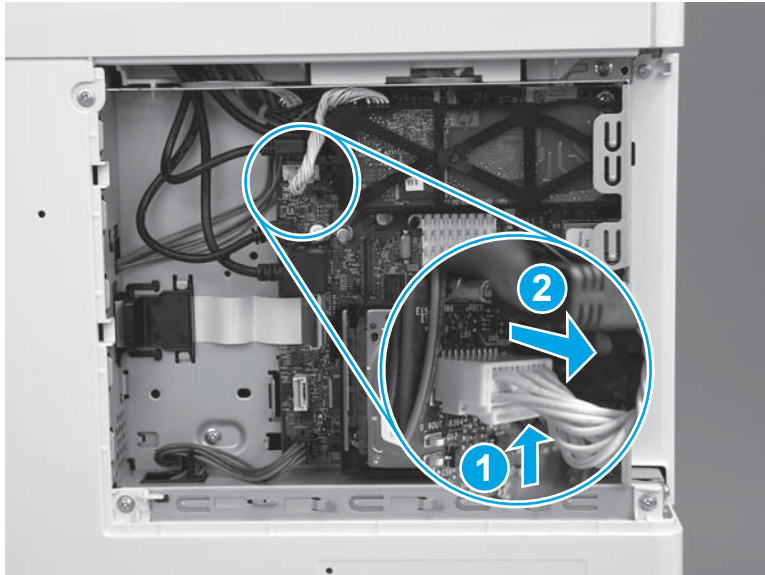

3. Release one retainer (callout 1) by pressing the bracket arms together.

Figure 1-2473 Release one latch

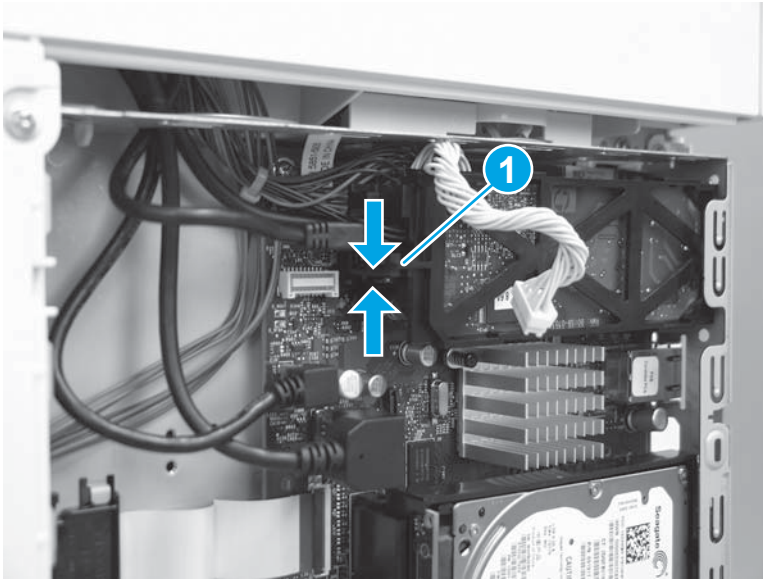

4. Rotate the end of the fax PCA (callout 1) away from the formatter, and then slide the PCA left (callout 2) to remove it.

Figure 1-2474 Remove the fax PCA

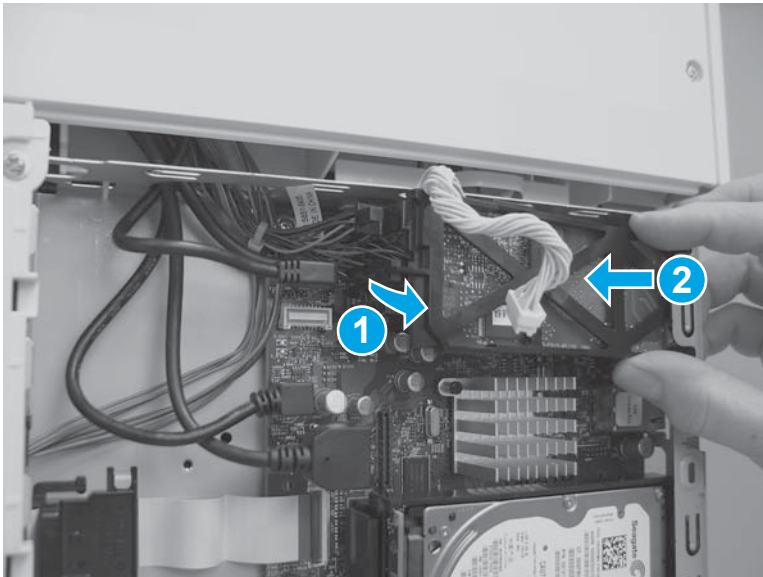

Step 9: Remove the formatter (M577)

 **NOTE:** This step is for the M577 models. For the M552 and M553 models, skip this step and go to [Step 10: Remove the rear cover \(M552 and M553\) on page 1408.](#)

 **CAUTION:**  ESD-sensitive part.

1. Disconnect all of the connectors on the formatter.

The following connectors are empty:

- All models: J1 (this connector is empty unless the optional DIMM is installed)
- All models: J3
- M577dn: J15 (this is the fax connector for the M577f/z/c models)
- All models: J21 (this connector is empty unless the optional internal USB ports component is installed)
- All models: J23
- All models: J24
- All models: J51
- All models: J57
- All models: J97
- All models: J98 (this connector is empty unless the optional trusted platform module (TPM) is installed)

 **IMPORTANT:** The flat-cable connector (callout 1) is a Zero Insertion Force (ZIF) connector that uses a hinged retainer to secure the flat cable. The hinged retainer must be opened to release the flat cable.

Figure 1-2475 Disconnect all connectors



2. Remove four screws (callout 1).

Figure 1-2476 Remove four screws

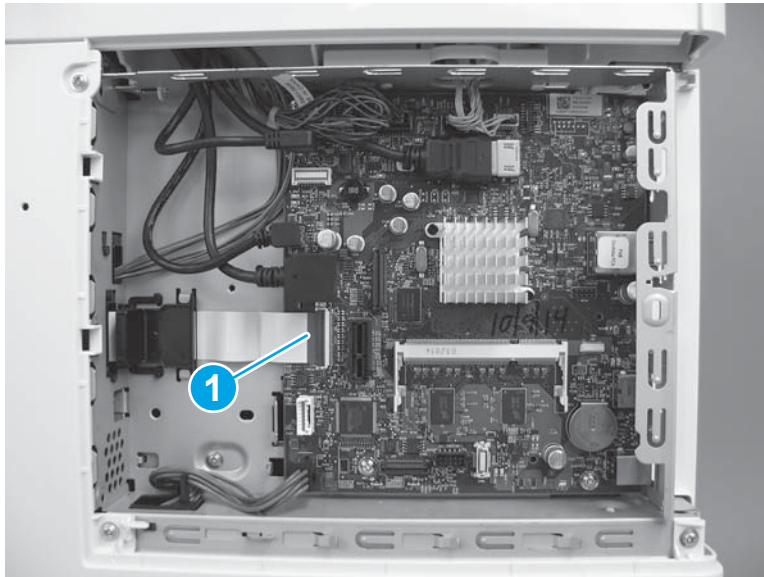
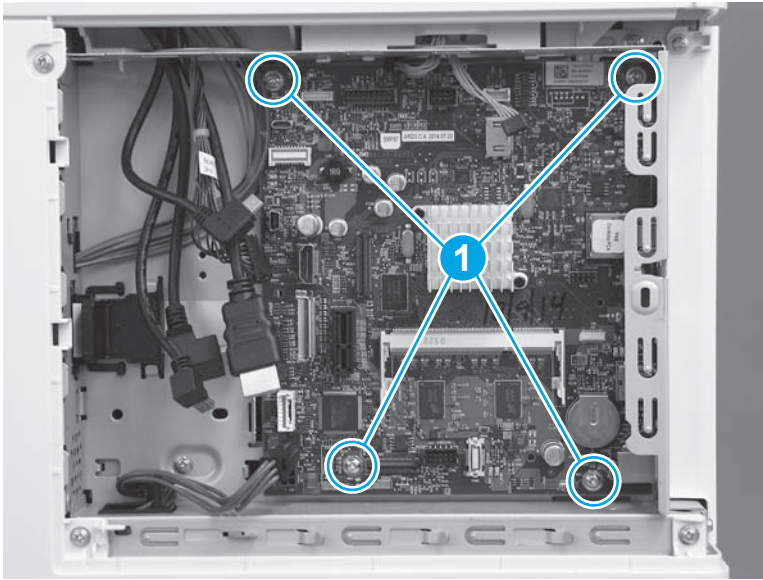

3. Remove the formatter.

Figure 1-2477 Remove the formatter

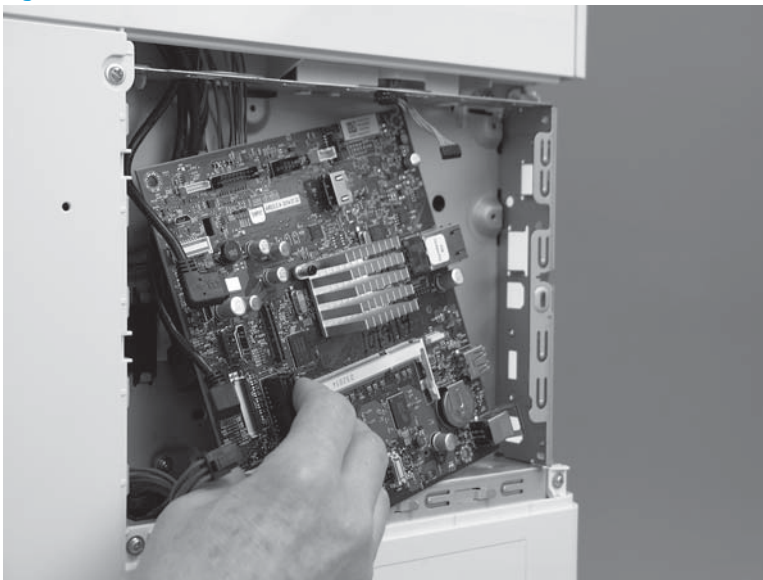

Step 10: Remove the rear cover (M552 and M553)

 **NOTE:** This step is for the M552 and M553 models. For the M577 models, skip this step and go to [Step 11: Remove the rear upper cover \(M577\) on page 1409.](#)

1. Remove four screws (callout 1).

Figure 1-2478 Remove four screws

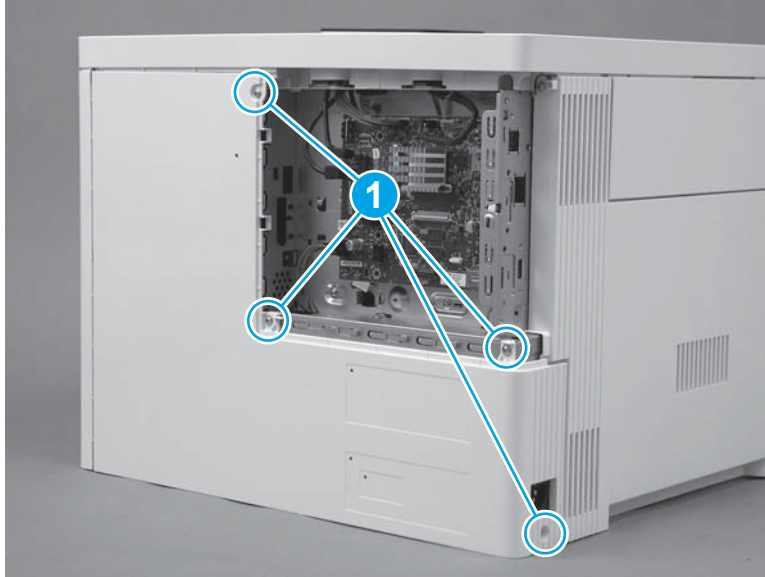

2. Slightly slide the cover to the right (callout 1), rotate the bottom of the cover away from the printer (callout 2), and then pull the top of the cover away from the printer (callout 3) to remove the cover.

Figure 1-2479 Remove the cover

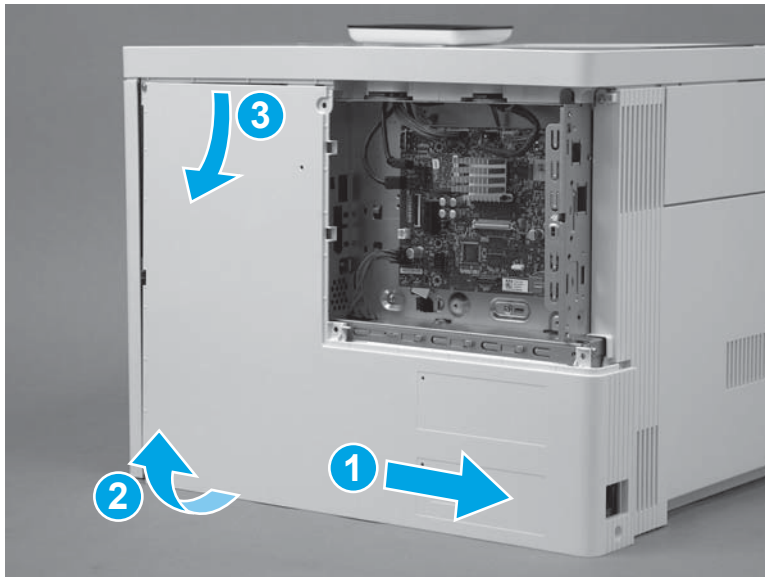

Step 11: Remove the rear upper cover (M577)

 **NOTE:** This step is for the M577 models. For the M552 and M553 models, skip this step and go to [Step 19: Remove the left cover on page 1424](#).

1. Remove two screws (callout 1).

 **Reinstallation tip:** These two screws are self-tapping screws for plastic. When reinstalling them, rotate the screws counterclockwise to align them with the existing thread pattern, and then carefully turn them clockwise to tighten. Do not overtighten. This will prevent stripping the threads inside the screw holes.

Figure 1-2480 Remove two screws



2. Use a small, flat blade screwdriver to release the right edge of the cover.

Figure 1-2481 Release the right edge

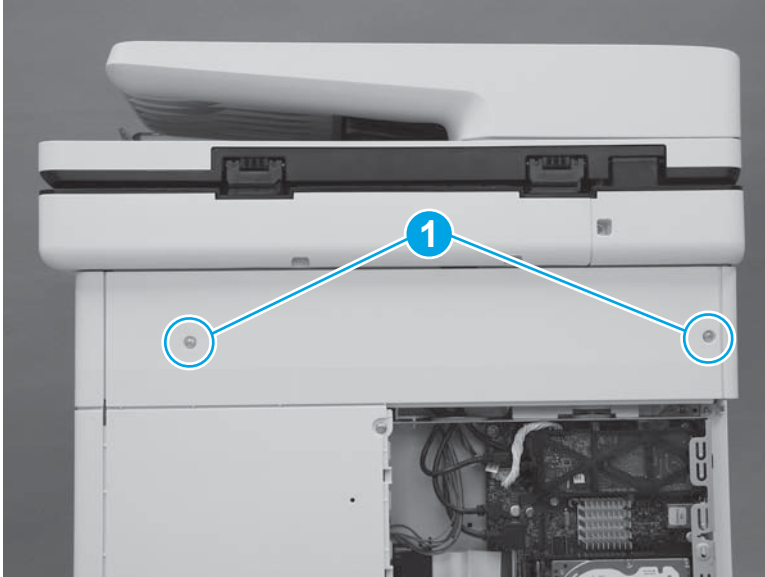
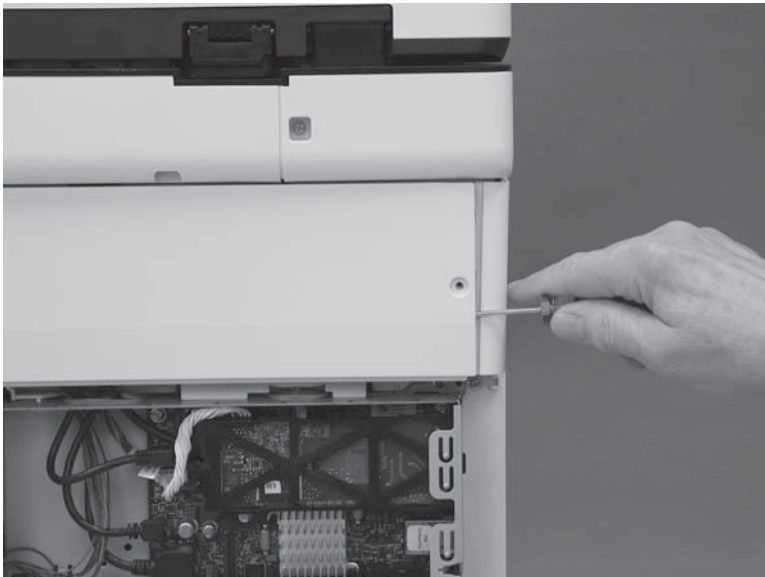

3. Pull the right edge of the cover (callout 1) away from the printer, and then slide the cover to the right (callout 2).

Figure 1-2482 Slide the cover right

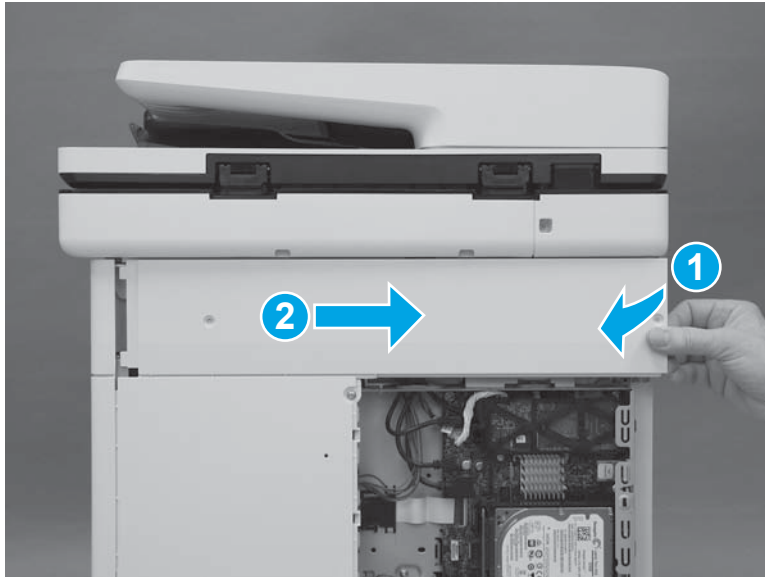

4. Remove the cover.

Figure 1-2483 Remove the cover

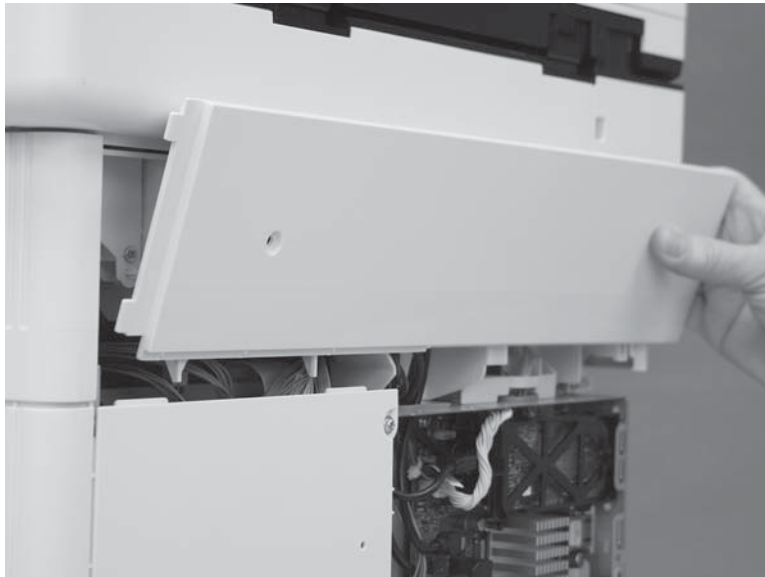

Step 12: Remove the rear cover (M577)

 **NOTE:** This step is for the M577 models. For the M552 and M553 models, skip this step and go to [Step 19: Remove the left cover on page 1424](#).

1. Remove four screws (callout 1).

Figure 1-2484 Remove four screws

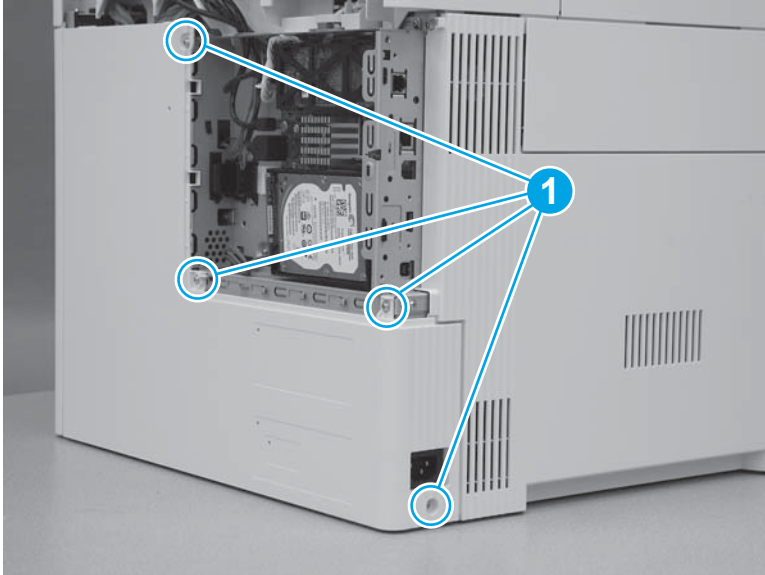

2. Slide the cover to the right to remove it.

Figure 1-2485 Remove the cover

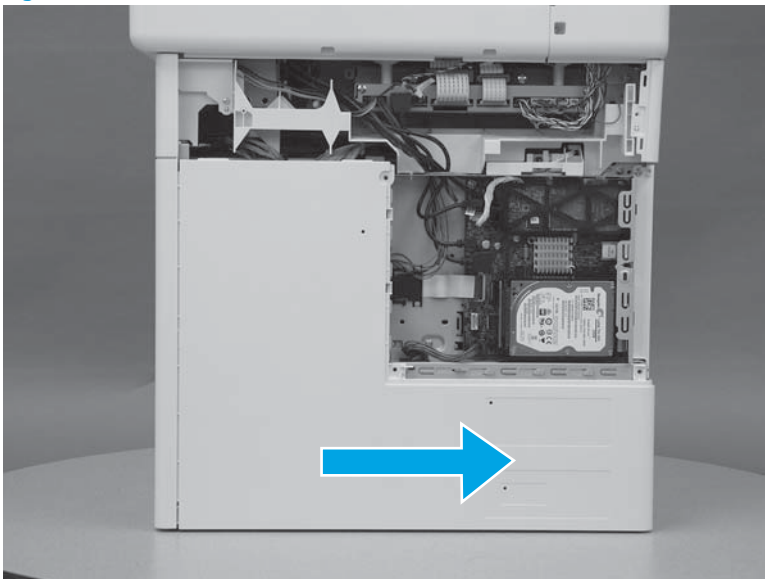

Step 13: Remove the left upper cover (M577)

 **NOTE:** This step is for the M577 models. For the M552 and M553 models, skip this step and go to [Step 19: Remove the left cover on page 1424](#).

1. At the left side of the printer, release one tab (callout 1).

Figure 1-2486 Release one tab

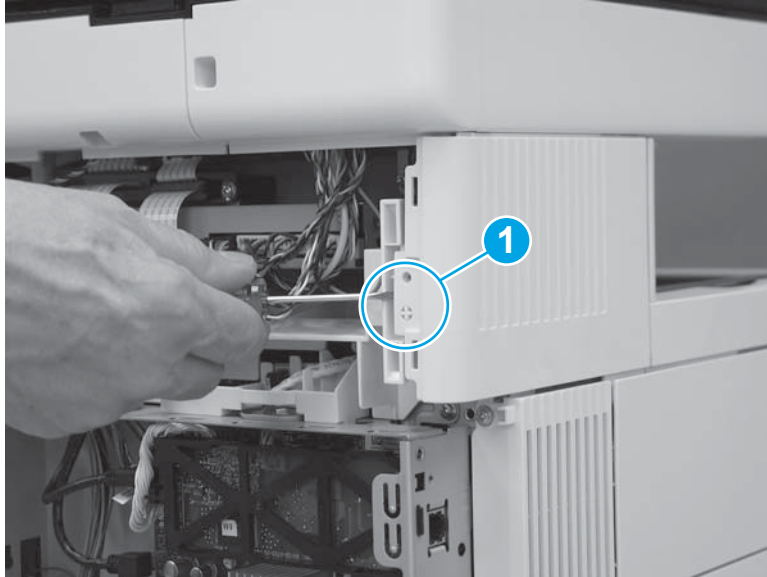

2. Slide the left upper cover toward the back of the printer.

Figure 1-2487 Slide the cover back

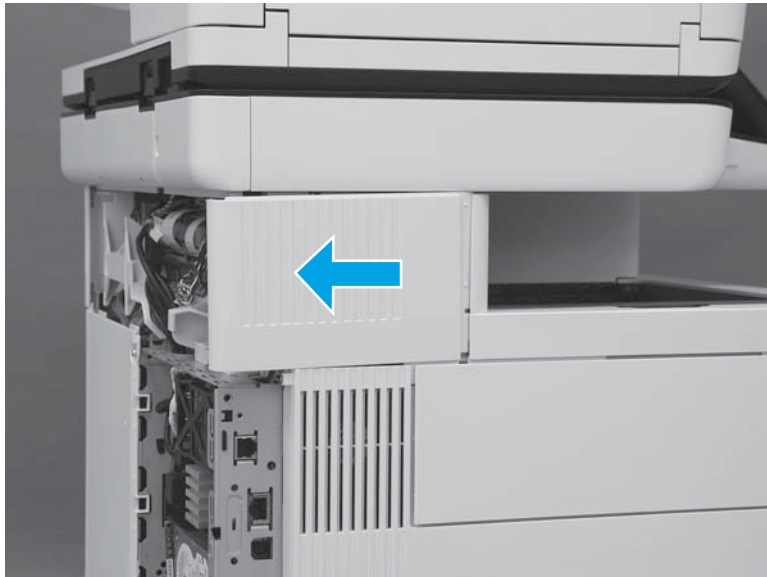

3. Rotate the cover up to remove it.

Figure 1-2488 Remove the left upper cover



Step 14: Remove the right front upper cover (M577dn)



NOTE: This step is for the M577dn model. For the M577c/f/z models, skip this step and go to [Step 15: Remove the stapler cover assembly \(M577c/f/z\) on page 1415](#).

For the M552 and M553 models, skip this step and go to [Step 19: Remove the left cover on page 1424](#).

1. Remove one screw (callout 1).

Figure 1-2489 Remove one screw

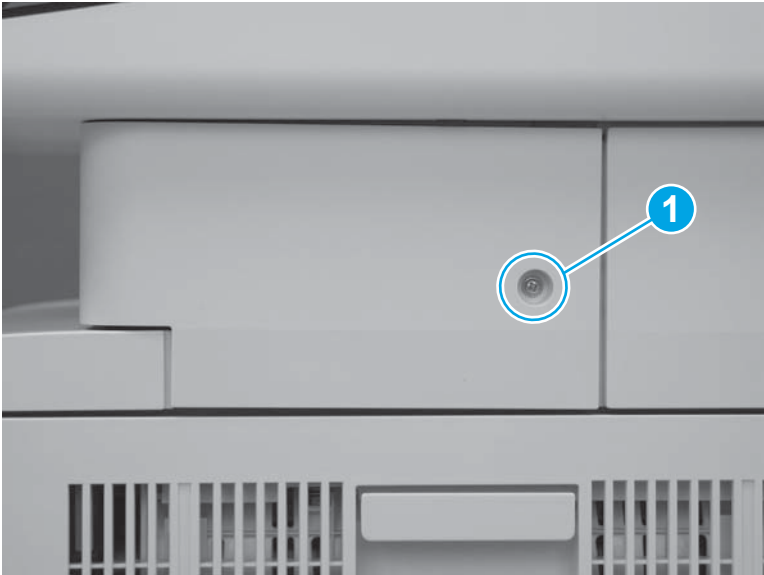

2. Release two tabs at the front edge of the cover (callout 1).

Figure 1-2490 Release two tabs



3. Rotate the front of the cover to the right to remove it.

Figure 1-2491 Rotate the cover



Step 15: Remove the stapler cover assembly (M577c/f/z)

 **NOTE:** This step is for the M577c/f/z models. For the M577dn model, skip this step and to go [Step 17: Remove the right upper cover \(M577\) on page 1420.](#)

For the M552 and M553 models, skip this step and go to [Step 19: Remove the left cover on page 1424.](#)

1. Remove one screw (callout 1).

 **Reinstallation tip:** This is a self-tapping screw for plastic. When reinstalling, rotate the screw counterclockwise to align it with the existing thread pattern, and then carefully turn it clockwise to tighten. Do not overtighten. This will prevent stripping the threads inside the screw hole.

Figure 1-2492 Remove one screw

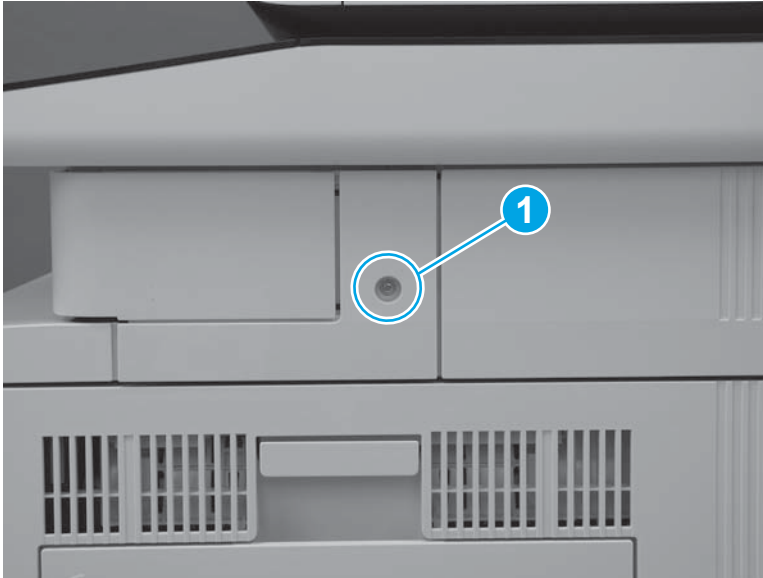

2. Release two tabs at the front edge of the cover (callout 1).

Figure 1-2493 Release two tabs



3. Release the back edge of the cover.

Figure 1-2494 Release the back edge of the cover

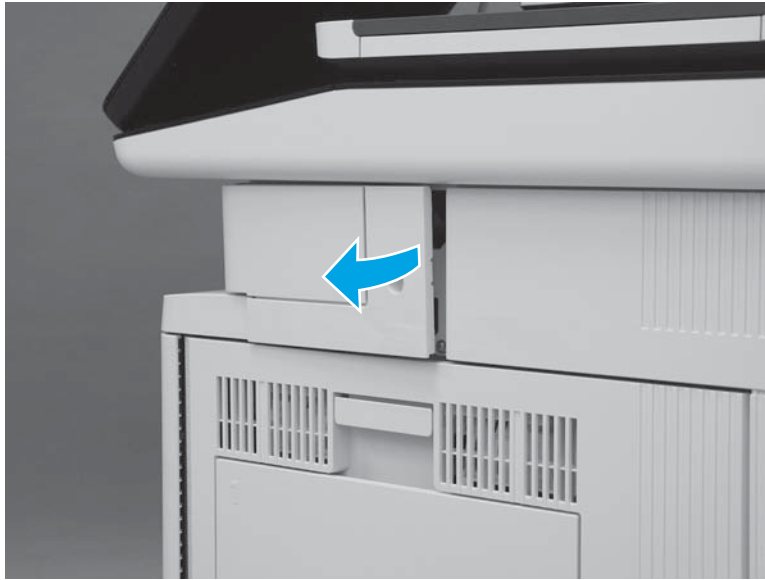



4. Rotate the cover away from the printer to remove it.

Figure 1-2495 Remove the cover



Step 16: Remove the integrated scanner assembly (ISA) (M577)

 **NOTE:** This step is for the M577 models. For the M552 and M553 models, skip this step and go to [Step 19: Remove the left cover on page 1424](#).

 **NOTE:** The ISA includes the document feeder, image scanner, scanner control board (SCB), control panel, keyboard (M577c/z) and NFC PCA (M577z).

1. At the left side of the printer, remove one screw (callout 1).

Figure 1-2496 Remove one screw

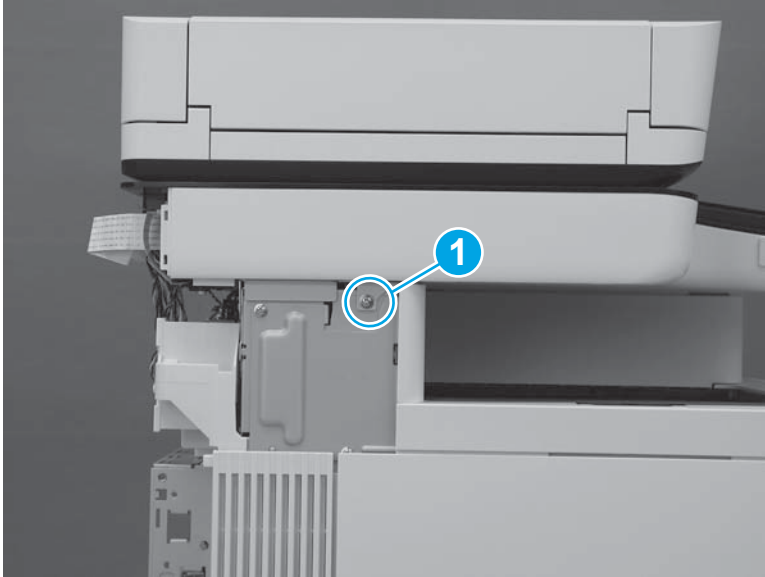

2. At the back side of the printer, remove two screws (callout 1).

Figure 1-2497 Remove two screws

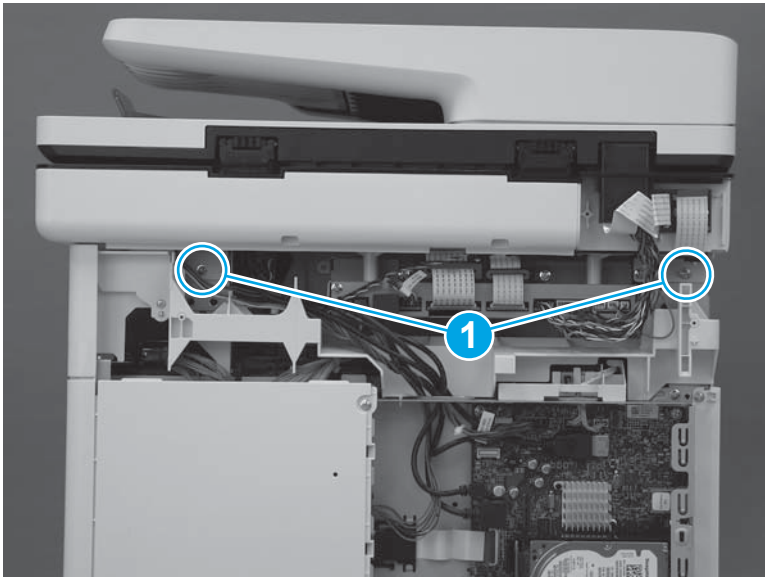

3. At the right side of the printer, remove one screw (callout 1).

Figure 1-2498 Remove one screw

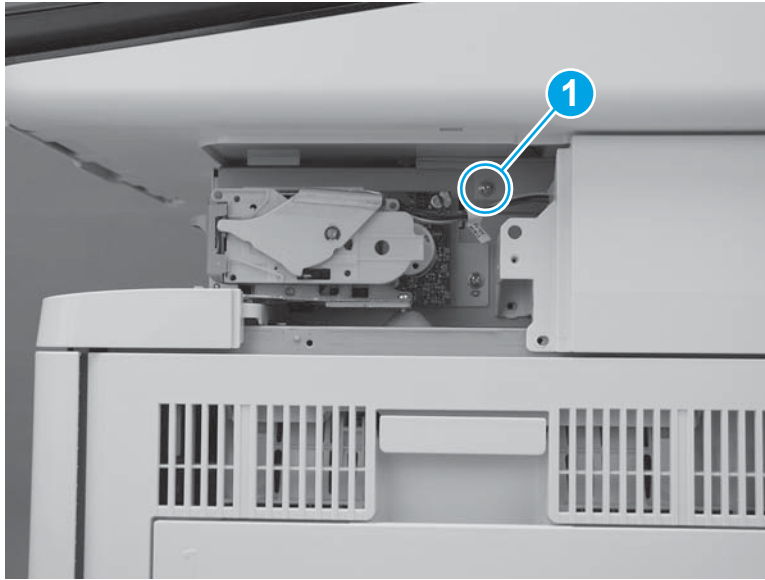

4. Disconnect two connectors on the scanner control board (callout 1).

M577c/f/z only: Disconnect one connector for the stapler on the scanner control board (callout 2).

Figure 1-2499 Disconnect connectors

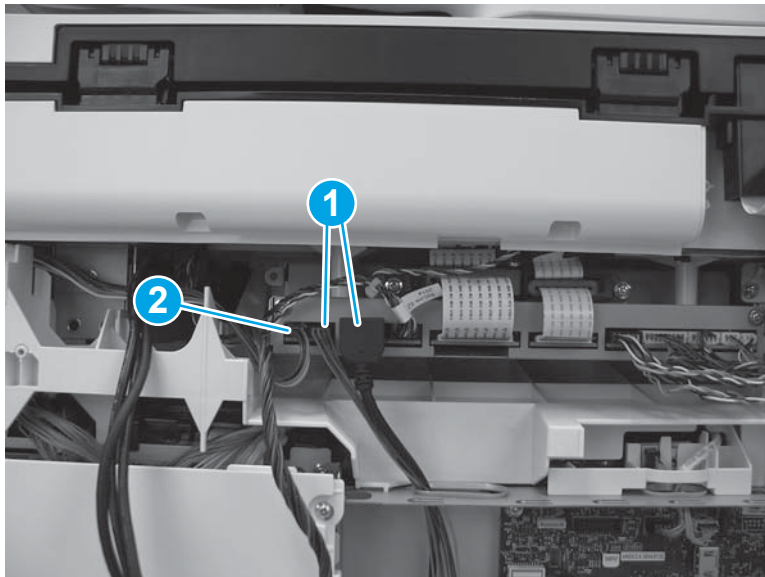

5. Slightly slide the ISA towards the back of the printer to release it.

Figure 1-2500 Slide the ISA towards the back of the printer

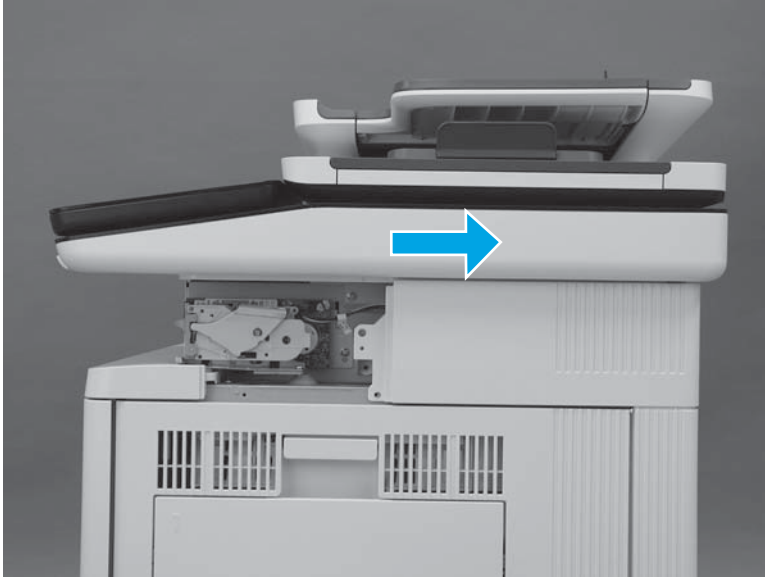

6. Lift the ISA up to remove it.

 **NOTE:** When lifting the ISA, carefully pass the cables through the opening in the top of the formatter case.

Figure 1-2501 Remove the ISA

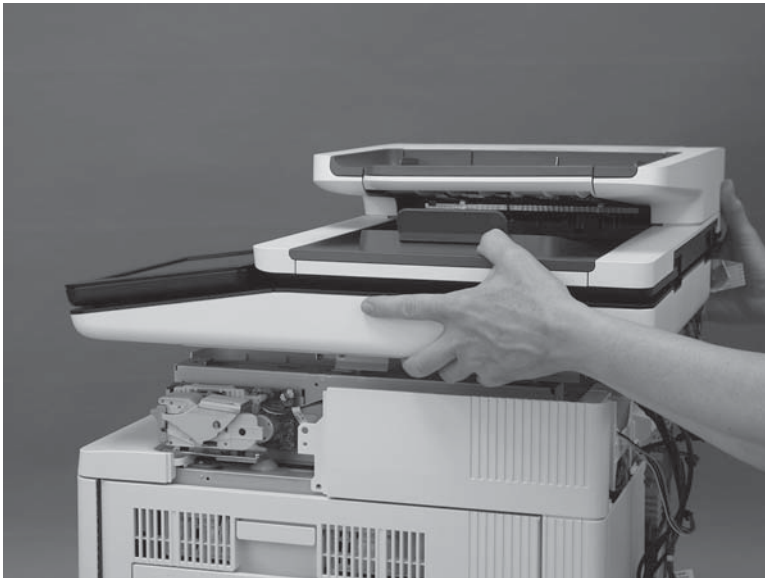

Step 17: Remove the right upper cover (M577)

 **NOTE:** This step is for the M577 models. For the M552 and M553 models, skip this step and go to [Step 19: Remove the left cover on page 1424](#).

 **NOTE:** The figures below show the image scanner installed. The procedures for removing and installing the right upper cover are the same whether the image scanner is installed or removed."

1. At the right side of the printer, remove two screws (callout 1).

M577c/f/z only: Disconnect one connector (callout 2), if it was not already disconnected in a previous step.

Figure 1-2502 Remove two screws and one connector

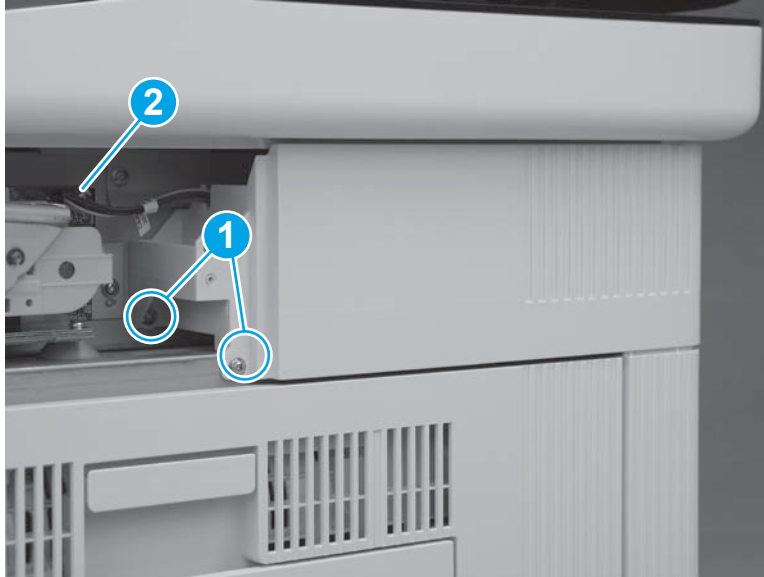

2. At the back of the printer, remove one screw (callout 1).

M577c/f/z only: Disconnect one connector (callout 2), if it was not already disconnected in a previous step.

 **Reinstallation tip:** This screw is smaller than the screws removed in the previous step. When reinstalling the right upper cover, make sure that this screw is installed in the correct position.

Figure 1-2503 Remove one screw and connector



3. Slide the cover toward the back of the printer.

Figure 1-2504 Slide the cover

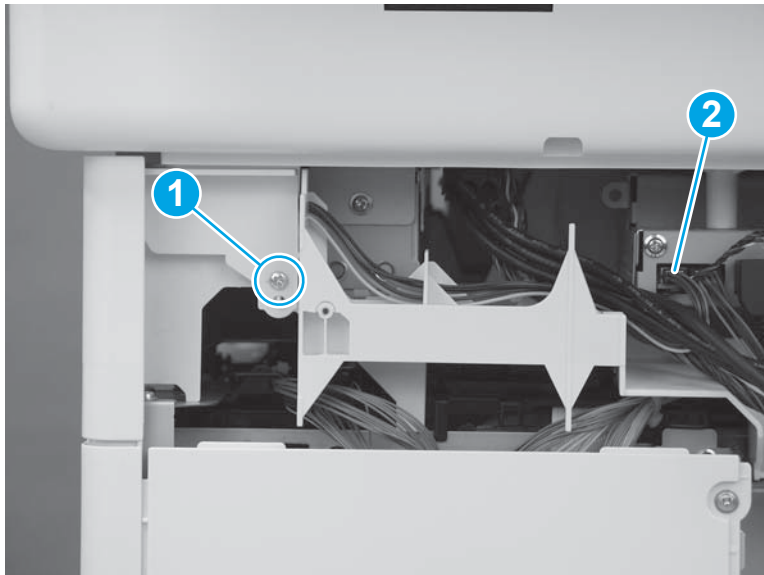
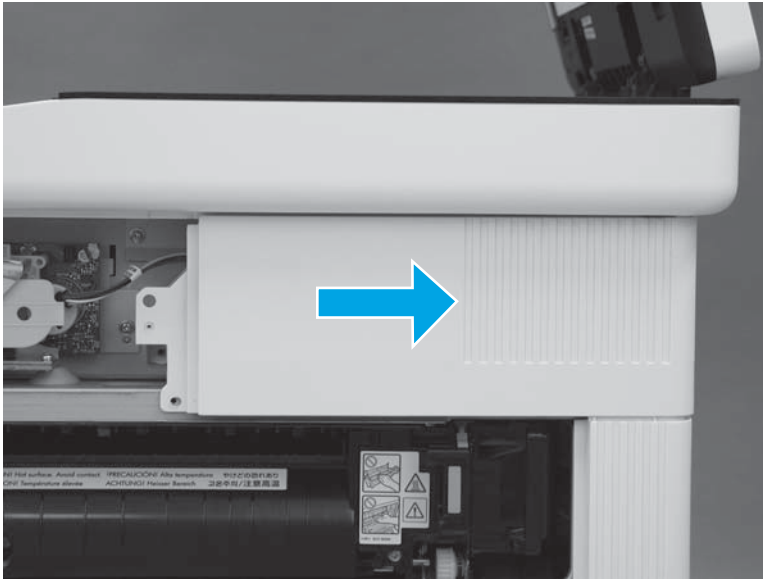

4. Lift the cover away from the printer to remove it.

M577c/f/z only: Release the cables (callout 1) through the slot (callout 2) in the printer.

Figure 1-2505 Remove the cover

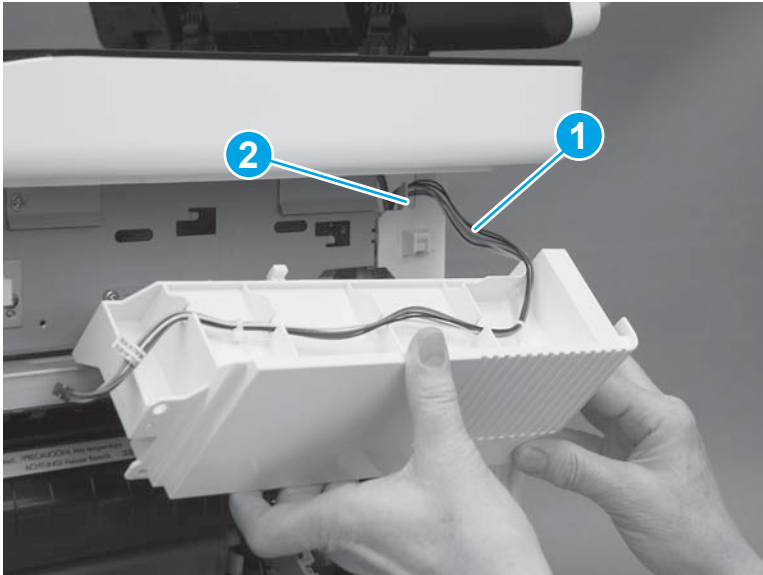

Step 18: Remove the top rear cover (M577)

 **NOTE:** This step is for the M577 models. For the M552 and M553 models, skip this step and go to [Step 19: Remove the left cover on page 1424.](#)

1. At the front of the printer, remove one screw (callout 1).

 **Reinstallation tip:** This screw is longer and a different type of screw than the screw removed in the next step. When reinstalling the top cover, make sure that this screw is installed in the correct position.

Figure 1-2506 Remove one screw



2. At the left side of the printer, remove one screw (callout 1).

Figure 1-2507 Remove one screw

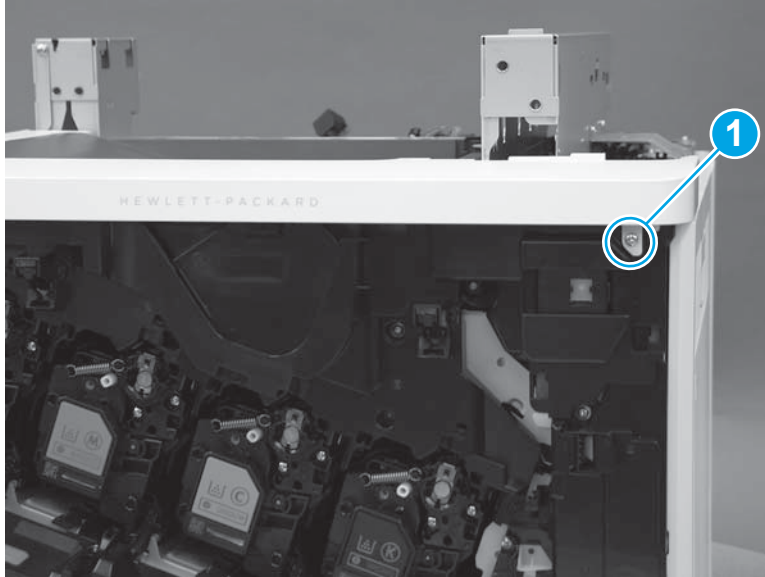
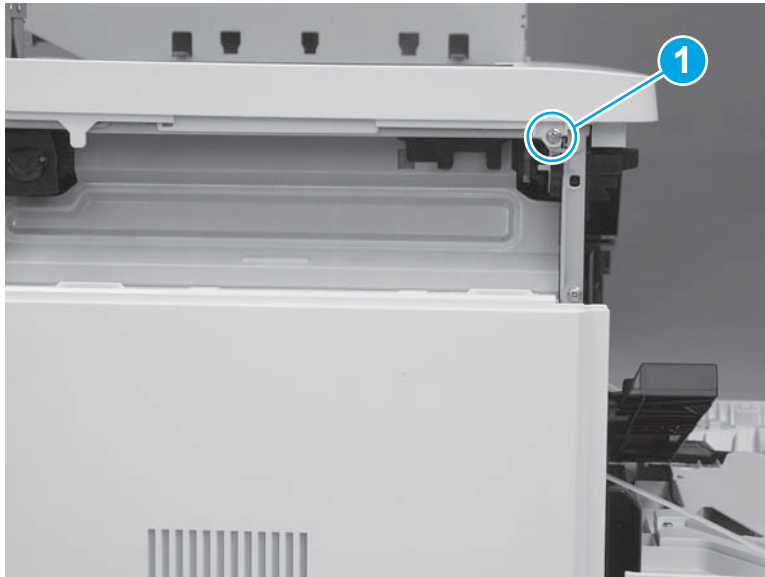

3. At the front of the printer, release one tab (callout 1).

Figure 1-2508 Release one tab

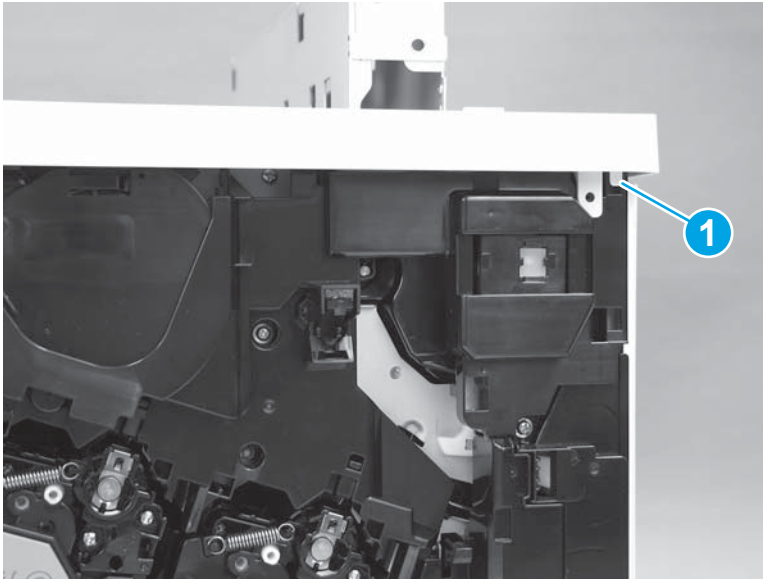

4. At the top of the printer, release two tabs (callout 1) next to the output bin, and then remove the top cover.

Figure 1-2509 Release two tabs

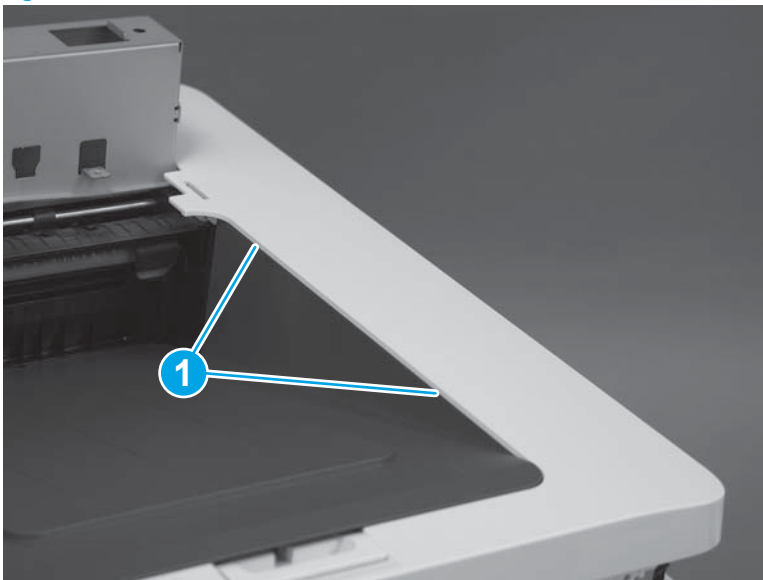

Step 19: Remove the left cover

1. At the left side of the printer, remove one screw (callout 1).

Figure 1-2510 Remove one screw



2. Release one tab (callout 1), rotate the front edge of the cover away from the printer (callout 2), and then slide the cover (callout 3) toward the rear of the printer to release it.

Figure 1-2511 Release the cover

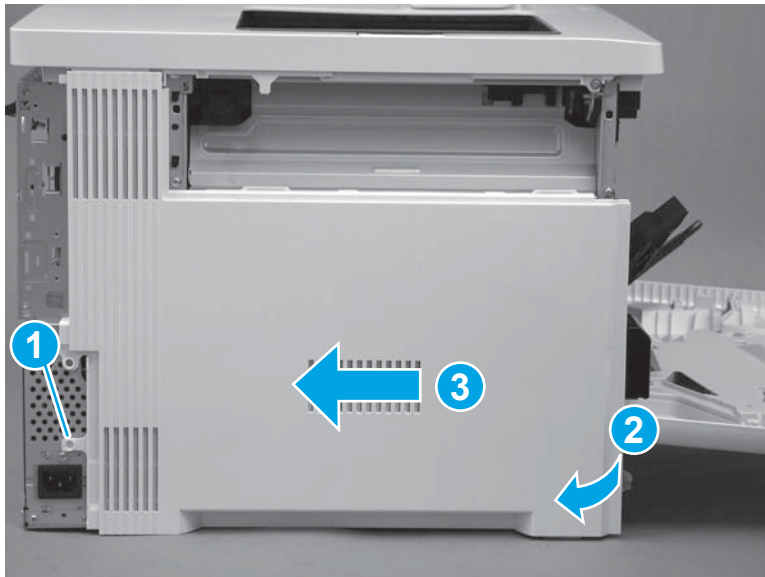

3. Remove the cover.

Figure 1-2512 Remove the cover

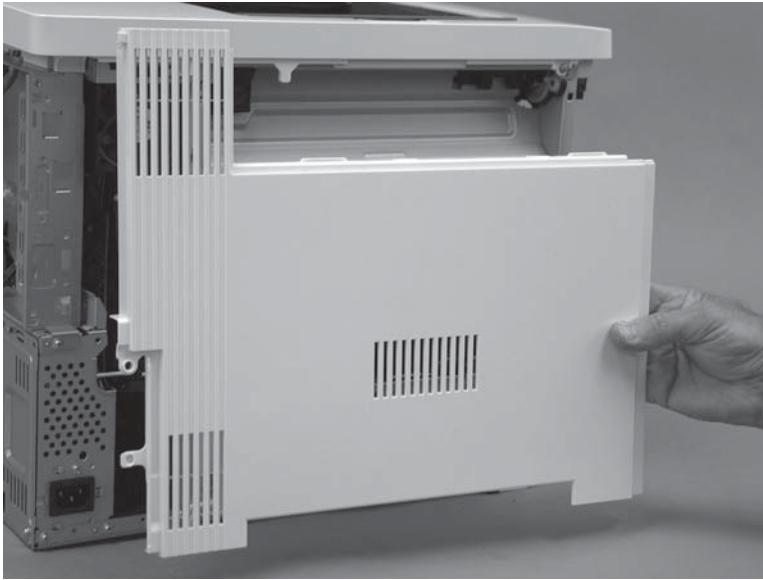

Step 20: Remove the upper cover (M552 and M553)

 **NOTE:** This step is for the M552 and M553 models. For the M577 models, skip this step and go to [Step 21: Remove the formatter case on page 1428](#).

1. Remove three screws (callout 1).

Figure 1-2513 Remove three screws

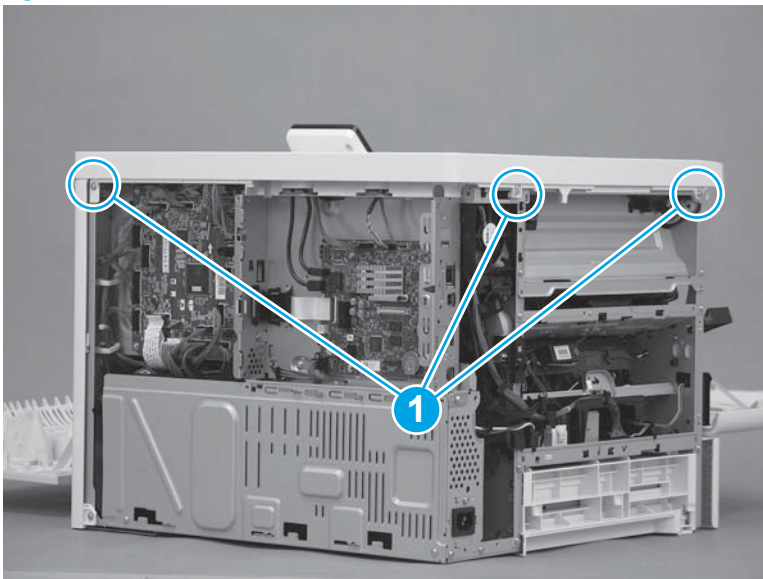

2. Remove one screw (callout 1), release one tab (callout 2), and then slightly separate the corner of the cover from the chassis.

 **NOTE:** This is a self-tapping plastic-thread screw. Make sure that this screw is used in this location when it is reinstalled.

Figure 1-2514 Remove one screw and release one tab



3. Release one tab (callout 1), and then lift up on the cover to release it.

 **NOTE:** If the cover does not release, check for additional tabs by locating the triangles embossed in the cover at tab locations.

Figure 1-2515 Release the cover



4. Remove the cover.

Figure 1-2516 Remove the cover

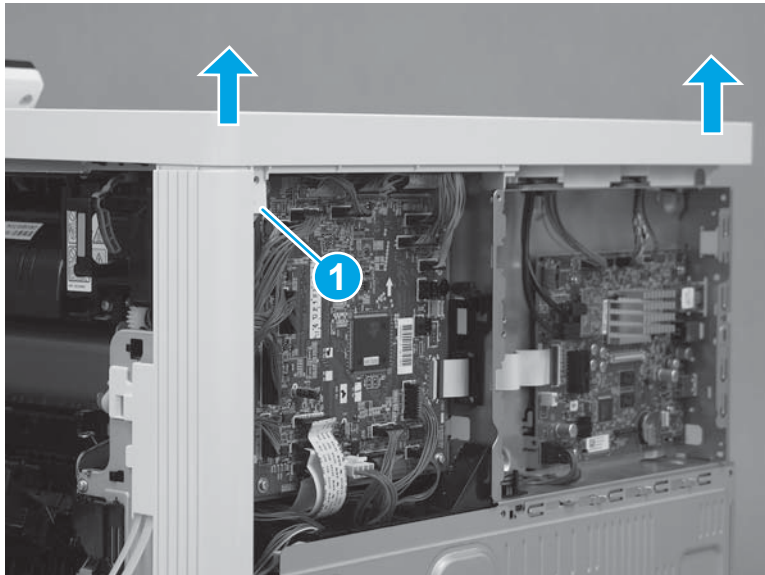
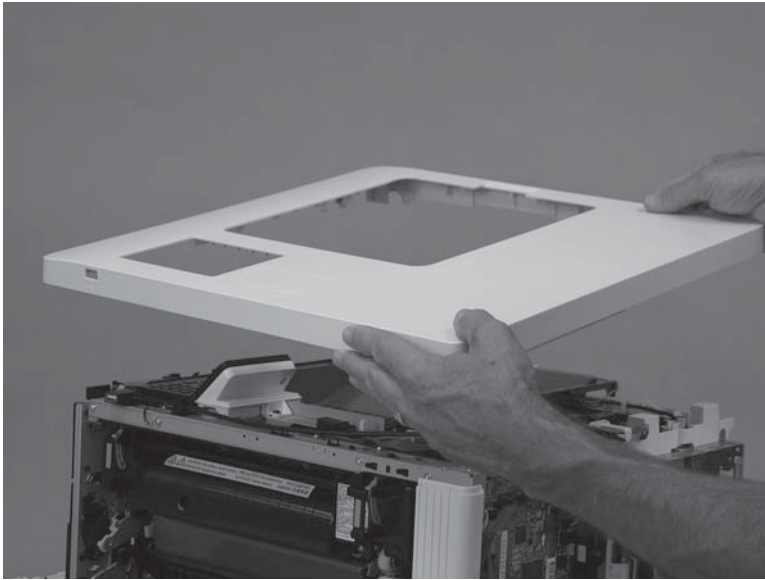

Step 21: Remove the formatter case

1. **M577 only:** Disconnect one connector (callout 1), and then pass the wire harness (callout 2) through two openings in the formatter case (callout 3).

Figure 1-2517 Disconnect one connector

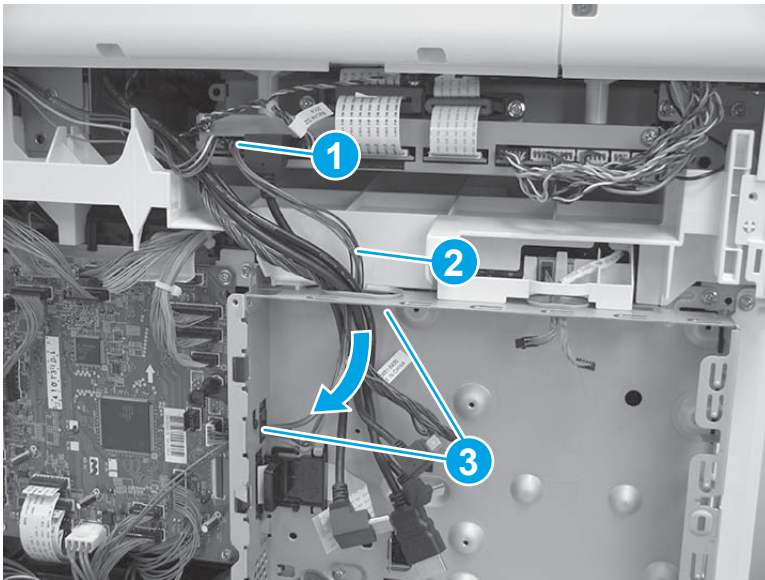

2. Release two tabs (callout 1) on the black plastic bracket. Hold the tabs in the released position, and then slide the bracket (callout 2) to the right to remove it from the formatter case.

Figure 1-2518 Remove the bracket

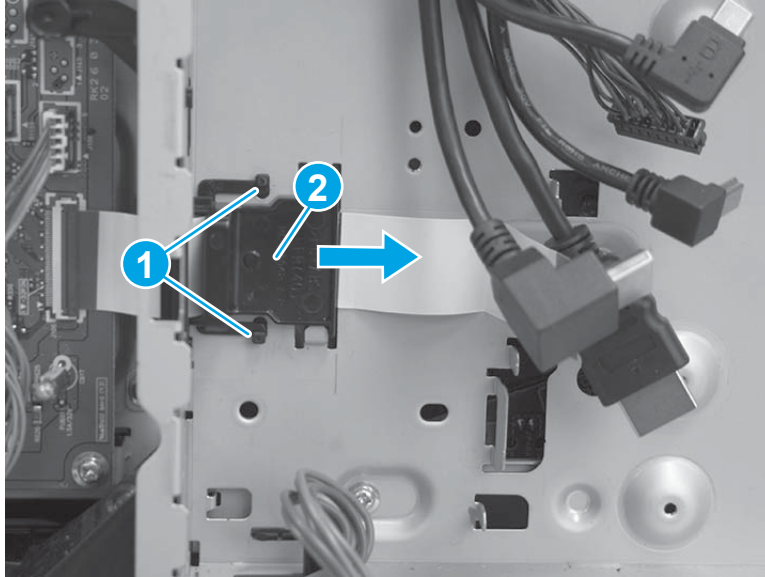

3. Remove two screws (callout 1), and then slide the low-voltage power supply (LVPS) cover to the right to remove it.

Figure 1-2519 Remove the LVPS cover

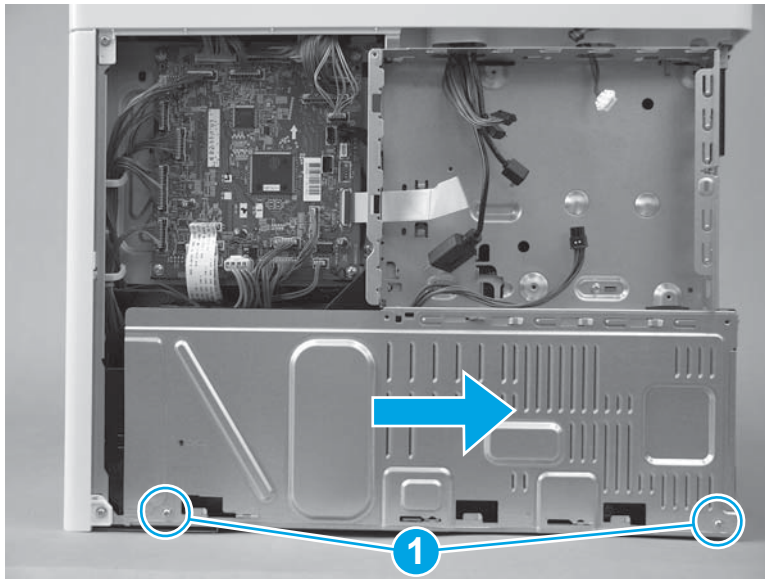

4. Pass two wire harnesses and one flat cable (callout 1) through the opening in the formatter case, and then release one wire harness from the retainer (callout 2).

⚠ CAUTION: The flat cable might be attached to the formatter case with double-sided tape. Make sure that this tape is released, so that the flat cable is not damaged when the formatter case is removed.

Figure 1-2520 Release wire harnesses and flat cable

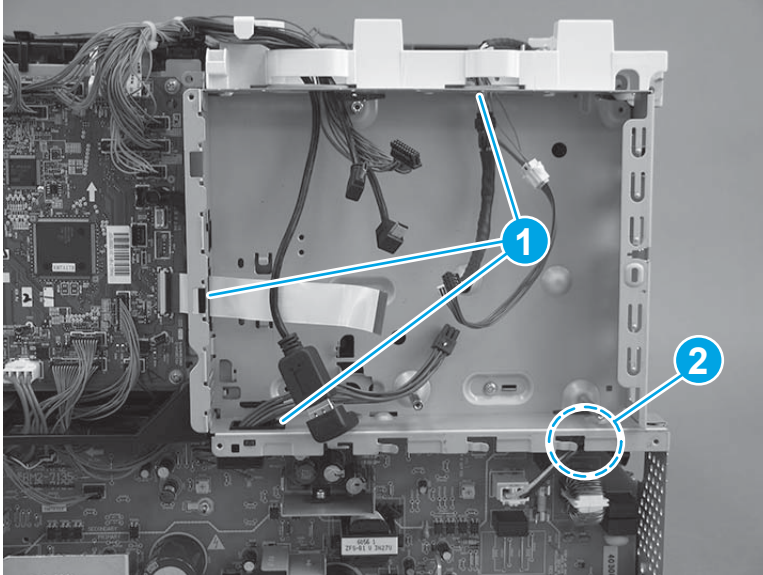

5. Remove six screws (callout 1).

Figure 1-2521 Remove six screws

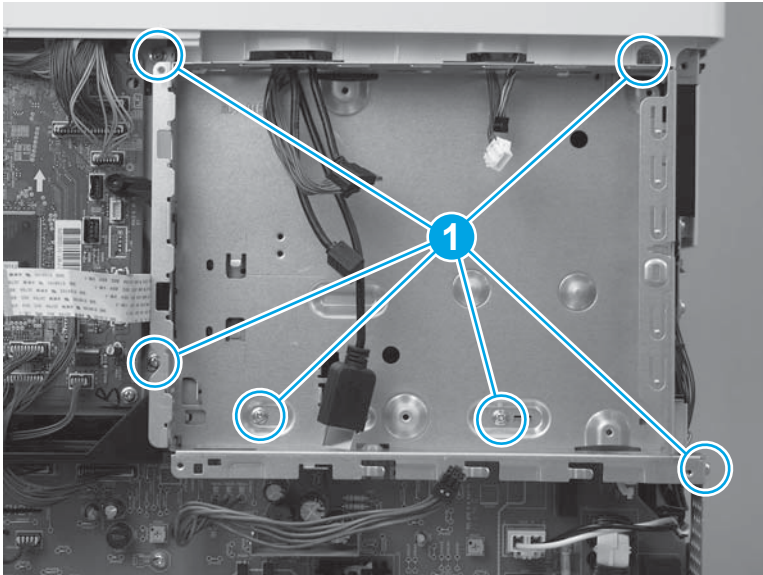

6. Rotate the bottom of the formatter case away from the printer (callout 1), and then pull it down (callout 2) to release it.

Figure 1-2522 Release the formatter case

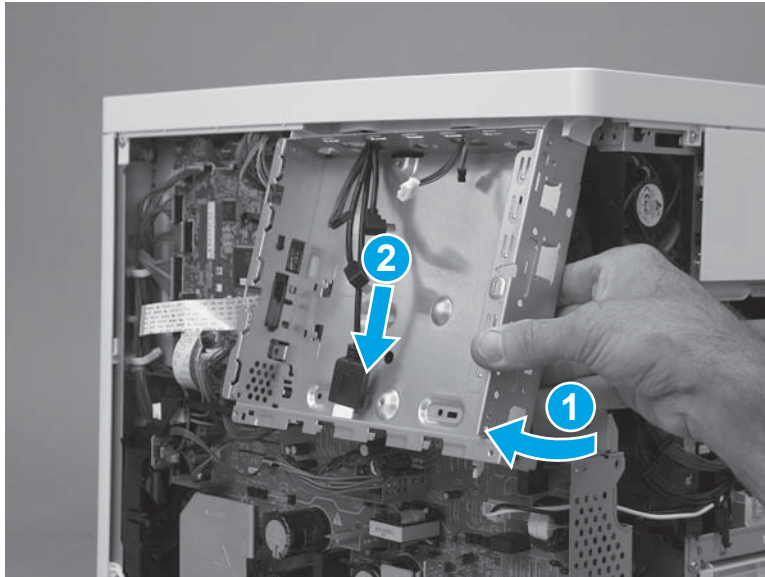

7. Pass the wire harnesses through the opening in the formatter case to remove it.

 **IMPORTANT:** If the formatter case is removed so that it can be replaced, make sure to transfer the memory PCA (island of data) and plastic bracket (callout 1) to the replacement case.

Figure 1-2523 Remove the formatter case



Step 22: Remove the delivery fan (FM3)

1. Disconnect one connector (callout 1).

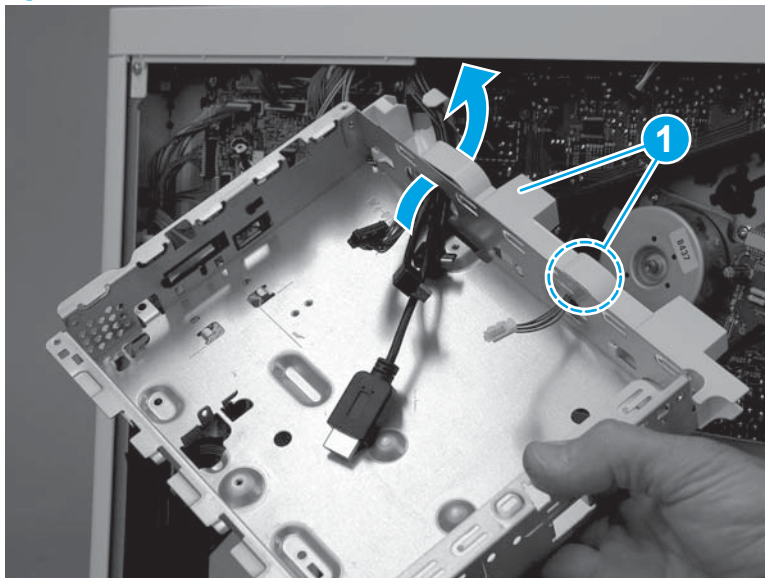
Figure 1-2524 Disconnect one connector

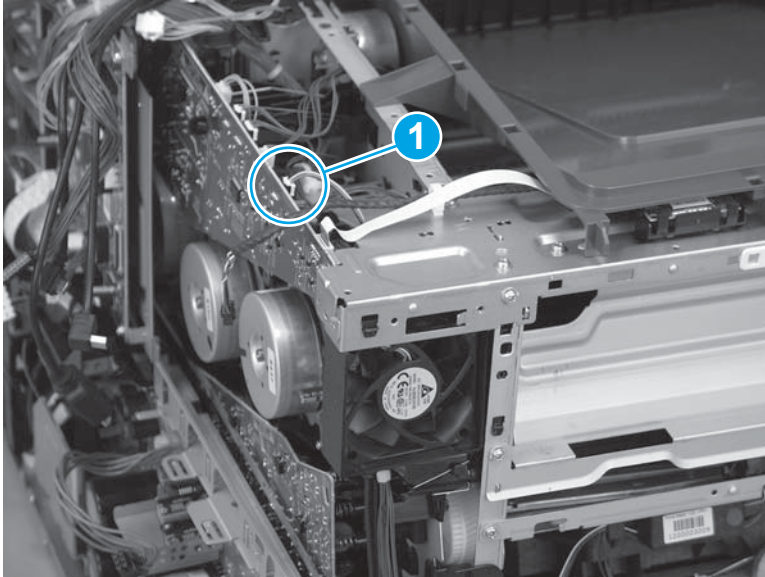

2. Remove one screw (callout 1).

 **NOTE:** This screw does not secure the fan to the chassis. However it is necessary to remove it so that the corner of the high-voltage power supply T (HVPST) can be moved out of the way to remove the fan.

Figure 1-2525 Remove one screw



3. Slide the fan up to release it.

Figure 1-2526 Release the fan

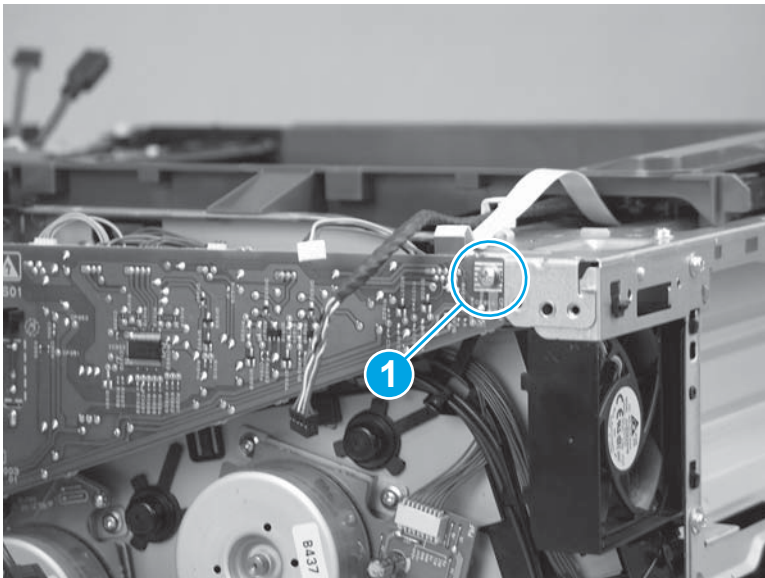
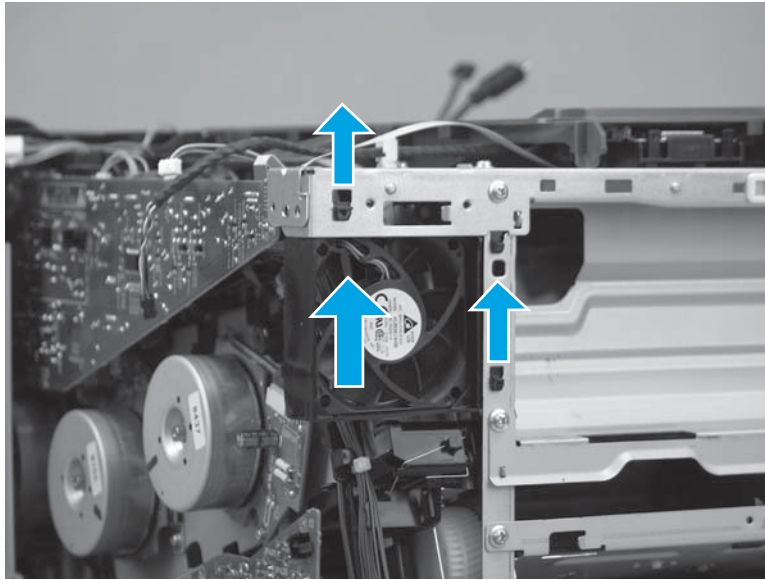

4. Slightly flex the corner of the HVPST out of the way (callout 1), and then remove the fan.

⚠ CAUTION: Do not over flex the HVPST and damage it.

📝 NOTE: Look at the arrows embossed on the fan or the holder. When a replacement fan is installed, make sure that the embossed arrows face the correct direction.

Figure 1-2527 Remove the fan

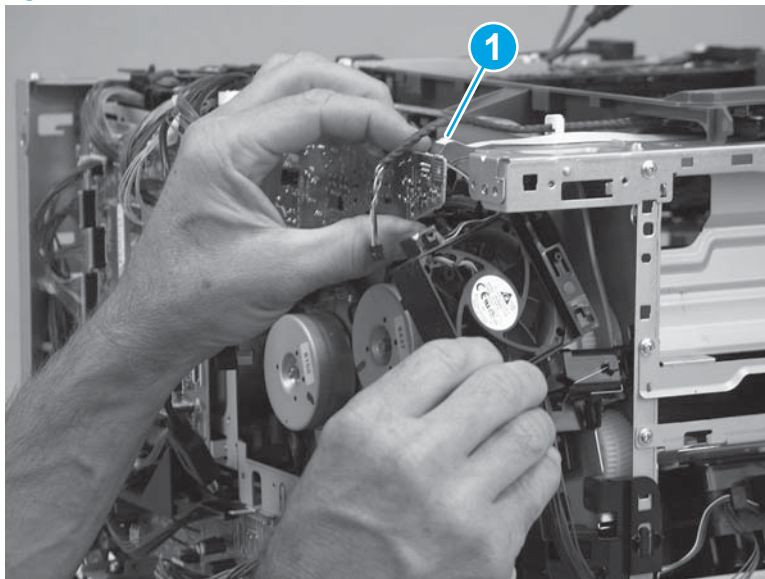

Step 23: Unpack the replacement assembly

Unpack the replacement assembly from the packaging.

For complete information on HP's recycling programs, go to [Product return and recycling](#).

 **NOTE:** HP recommends responsible disposal of the defective assembly.

Figure 1-2528 Recycle and unpack

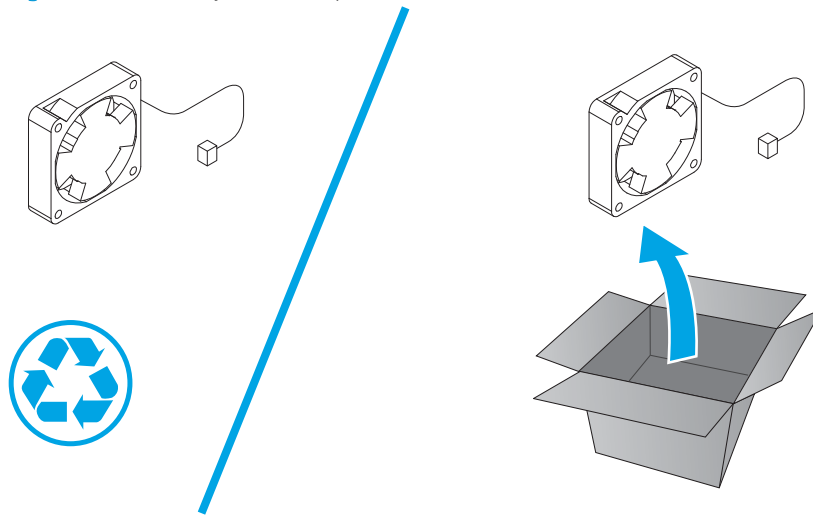

Step 24: Install the delivery fan (FM3)

1. Slightly flex the corner of the HVPST out of the way (callout 1), and then install the fan.

 **CAUTION:** Do not over flex the HVPST and damage it.

 **NOTE:** Make sure that the arrows embossed on the fan face the correct direction.

Figure 1-2529 Install the fan



2. Slide the fan down to engage it with the chassis.

Figure 1-2530 Engage the fan with the chassis

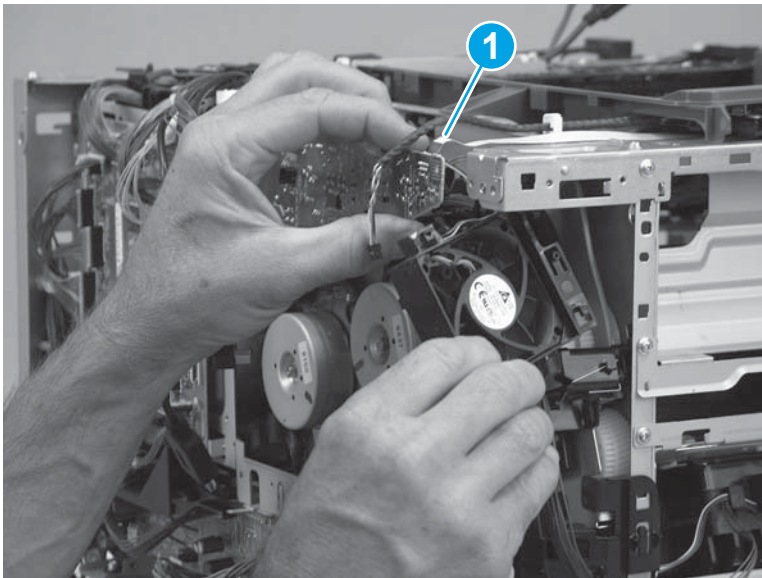
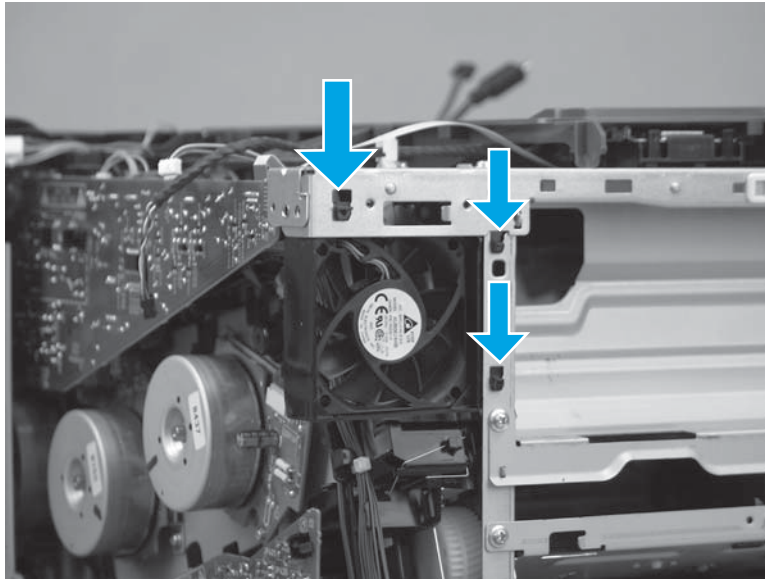

3. Install one screw (callout 1).

Figure 1-2531 Install one screw

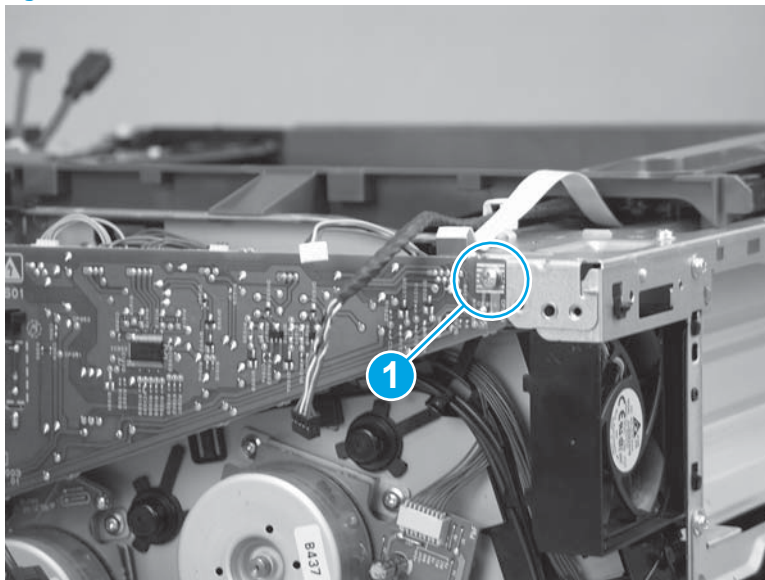

4. Connect one connector (callout 1).

Figure 1-2532 Connect one connector

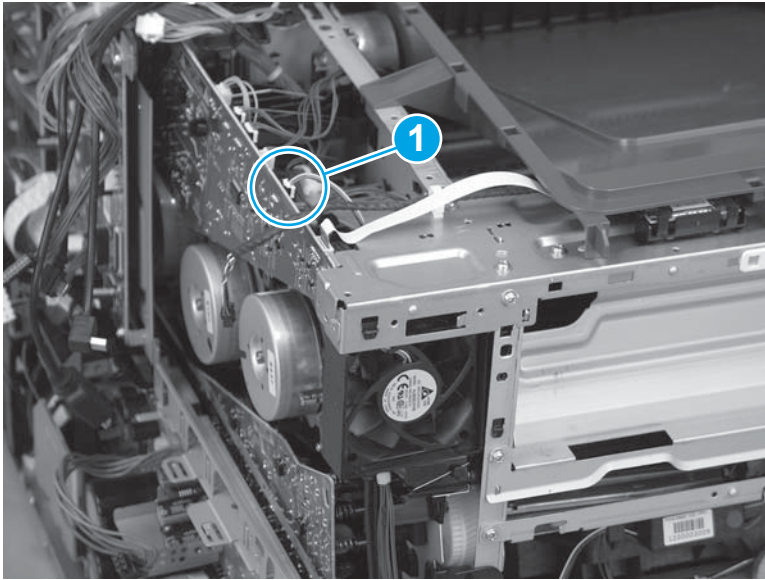

Step 25: Install the formatter case

1. Pass the wire harnesses through the opening in the formatter case.

Figure 1-2533 Pass the wire harnesses through the opening

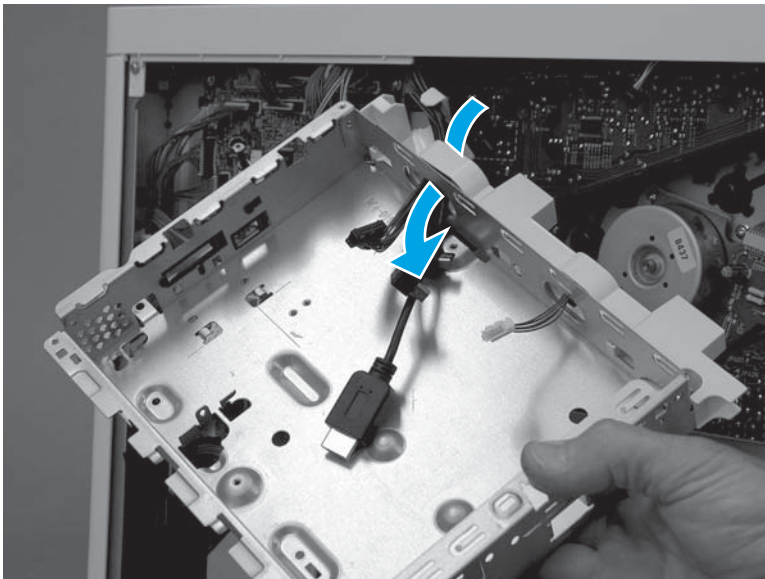

2. Position the top of the formatter case on the printer (callout 1), and then rotate the bottom of the case (callout 2) into the printer.

Figure 1-2534 Install the formatter case

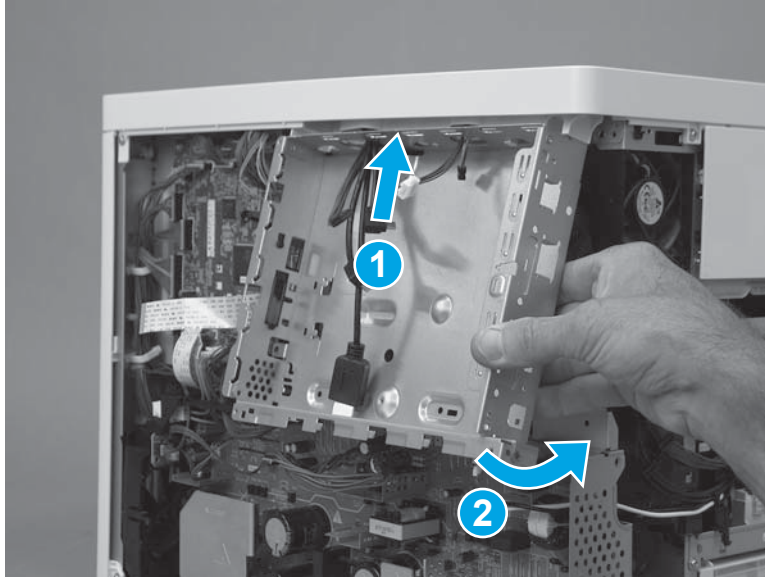

3. Install six screws (callout 1).

Figure 1-2535 Install six screws

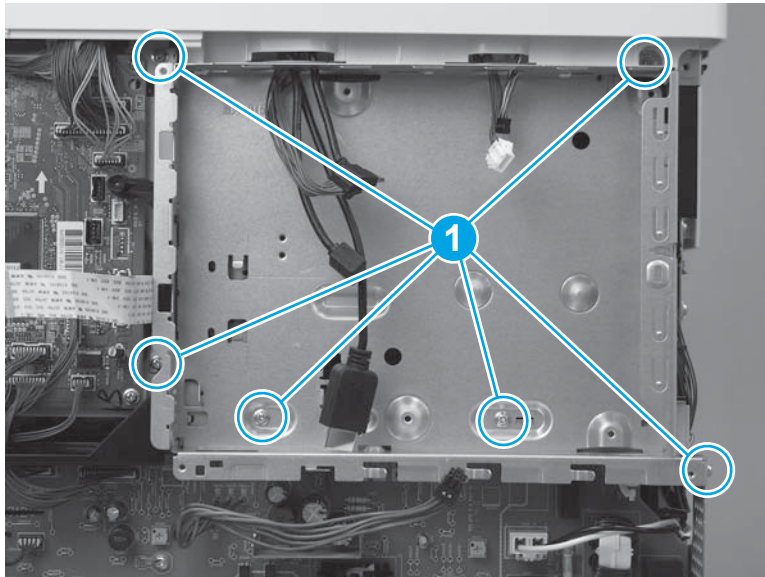

4. Pass two wire harnesses and one flat cable (callout 1) through the opening in the formatter case, and then install one wire harness in the retainer (callout 2).

 **IMPORTANT:** Make sure that the flat cable is securely fastened to the DC controller, and was not dislodged when the formatter case was removed.

Figure 1-2536 Install wire harnesses and flat cable

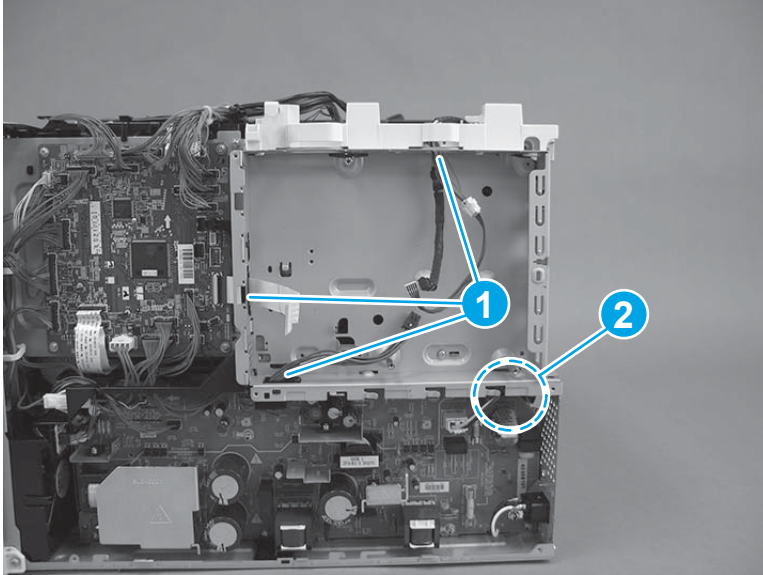

5. Position the LVPS cover on the printer, slide the cover to the left to install it, and then install two screws (callout 1).

Figure 1-2537 Install the LVPS cover

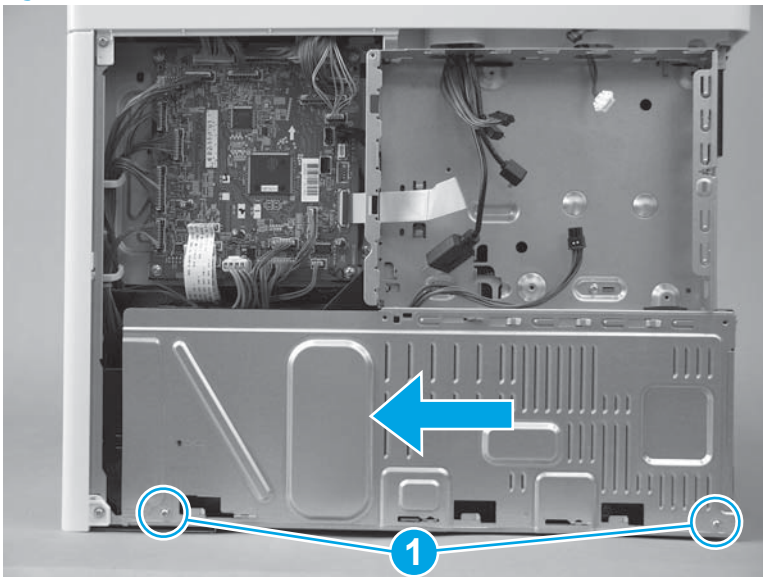

6. If no tape is affixed to the back of the flat cable, skip this step. If double-sided tape is affixed to the back of the flat cable, align the line (callout 1) on the cable with the edge (callout 2) of the opening in the sheet metal. Press to attach the flat cable to the formatter case.

Figure 1-2538 Attach the flat cable

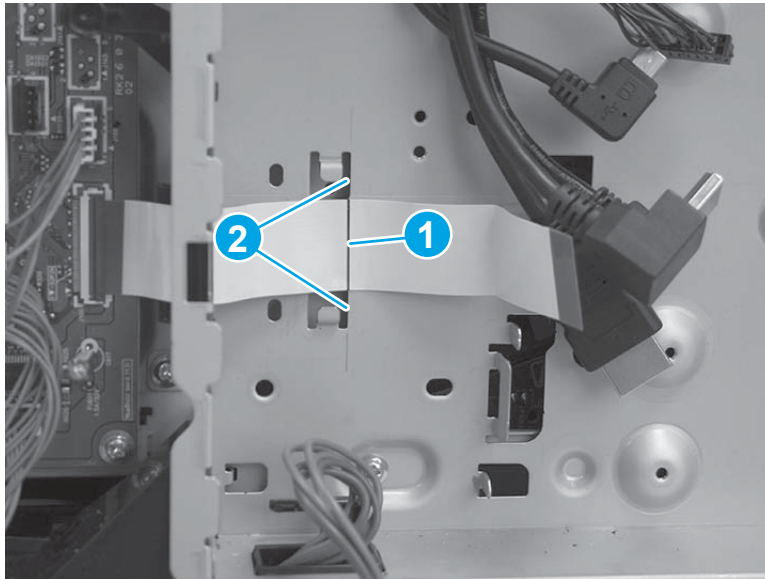

7. Position the bracket over the flat cable, and then slide the bracket to the left to install it. Make sure that the edges of the bracket fit under the sheet metal tabs (callout 1) on the formatter case and that the tabs (callout 2) snap into place.

Figure 1-2539 Position the bracket

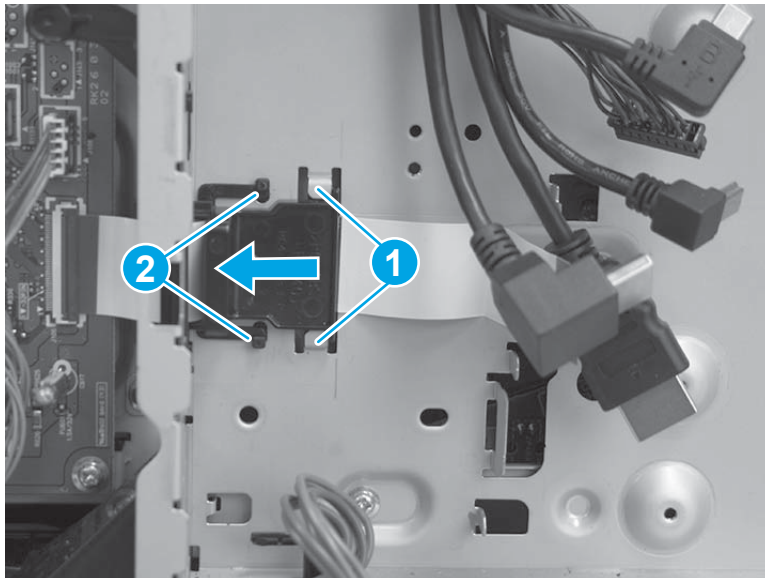

8. **M577 only:** Pass the wire harness (callout 1) through the openings in the formatter case (callout 2), and then connect one connector (callout 3).

Figure 1-2540 Connect one connector

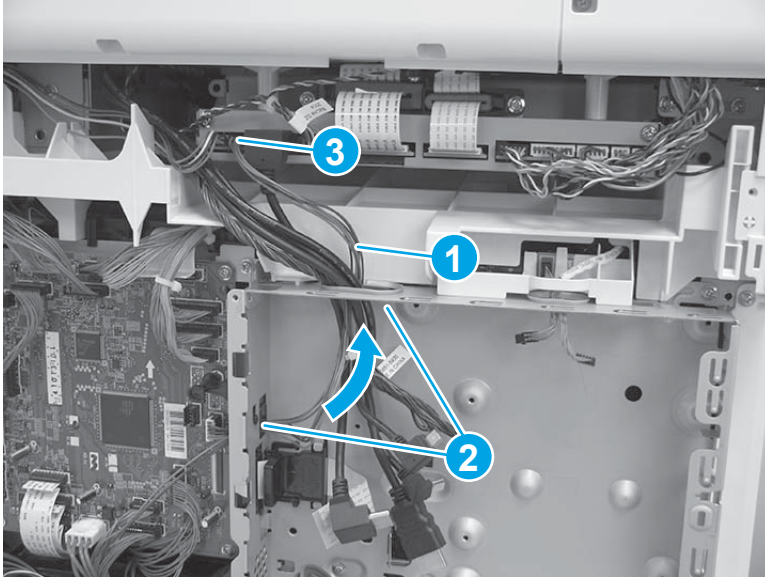

Step 26: Install the upper cover (M552 and M553)

 **NOTE:** This step is for the M552 and M553 models. For the M577 models, skip this step and go to [Step 27: Install the left cover on page 1442](#).

1. Position the cover on the printer.

 **NOTE:** For the M553x model, do not forget to pass the control-panel wire harness and USB cable through the opening in the cover.

Figure 1-2541 Install the cover



2. Push down on the rear corner of the cover to engage one tab (callout 1).

Figure 1-2542 Engage one tab

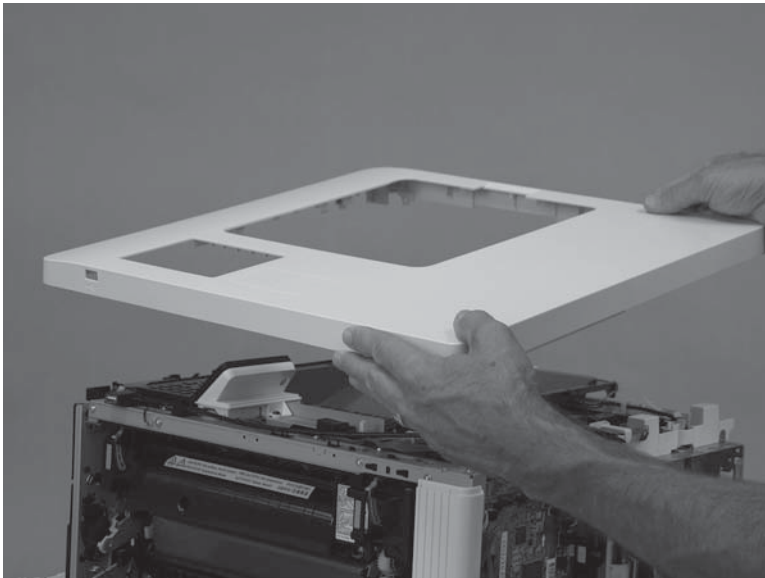
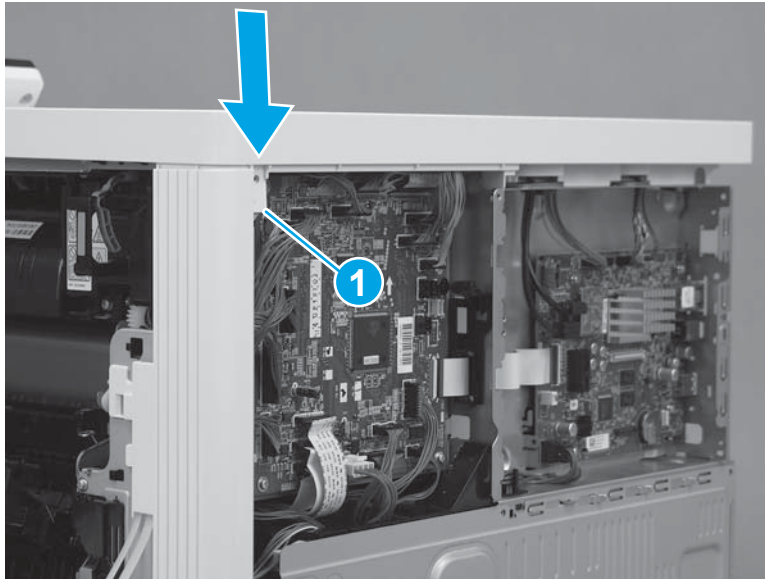

3. Push down on the front corner of the cover to engage one tab (callout 1), and then install one screw (callout 2).

 **NOTE:** This is a self-tapping plastic-thread screw. Make sure that this screw is used in this location when it is reinstalled.

Figure 1-2543 Engage one tab and install one screw



4. Install three screws (callout 1).

Figure 1-2544 Install three screws

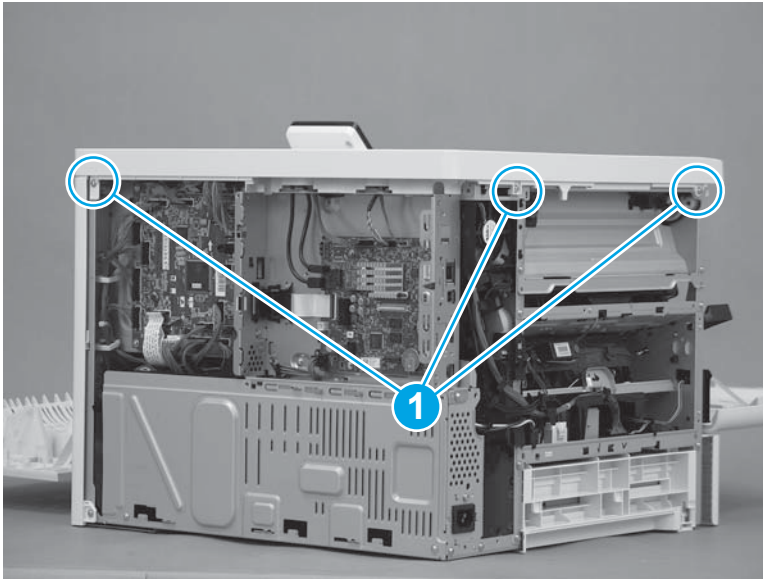

Step 27: Install the left cover

1. Position the cover on the printer.

 **NOTE:** Slightly offset the cover toward the rear of the printer.

Figure 1-2545 Install the cover

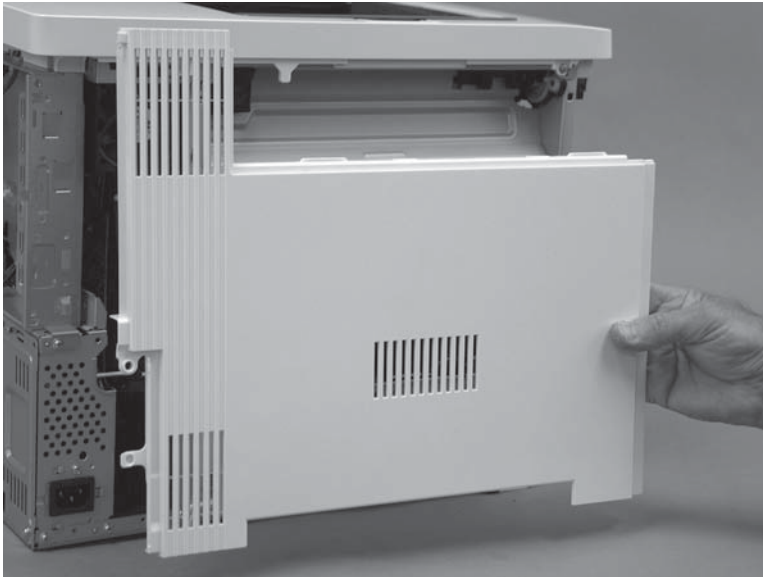

2. Slide the cover (callout 1) toward the front of the printer to engage it. Make sure that the tab (callout 2) snaps into place.

 **NOTE:** Locate the alignment pin (callout 3) on the cover from the front door side of the printer, and then make sure that it is fully engaged in the slot in the chassis.

 **TIP:** While sliding the cover into place, push in on the center of the cover (callout 1) to make sure that the hooks on the back of the cover engage with the slots in the chassis.

Figure 1-2546 Engage the cover



3. At the left side of the printer, install one screw (callout 1).

Figure 1-2547 Install one screw

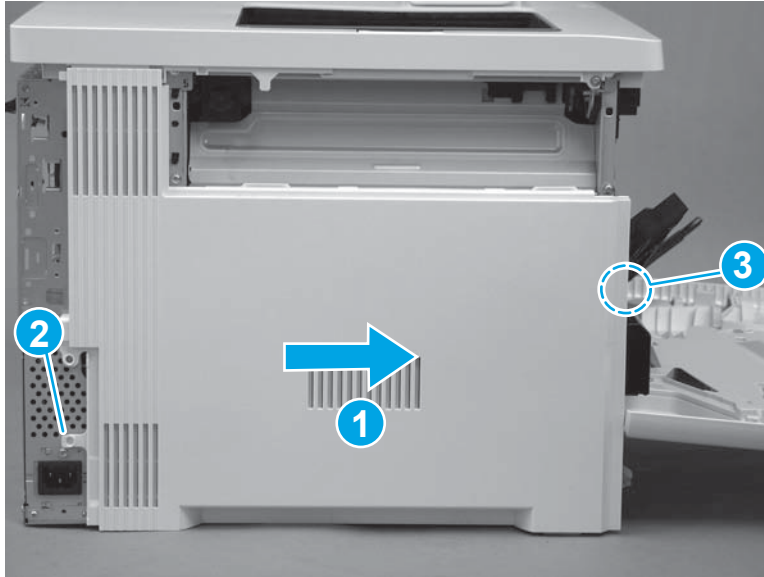
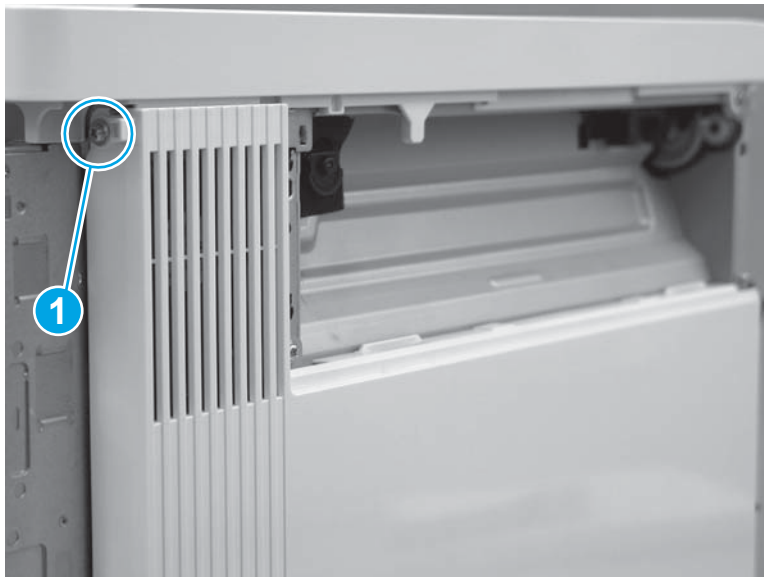

Step 28: Install the top rear cover (M577)

 **NOTE:** This step is for the M577 models. For the M552 and M553 models, skip this step and go to [Step 36: Install the rear cover \(M552 and M553\) on page 1460](#).

1. Position the locator pins (callout 1) on the cover in the slots (callout 2) in the printer.

Figure 1-2548 Position the locator pins

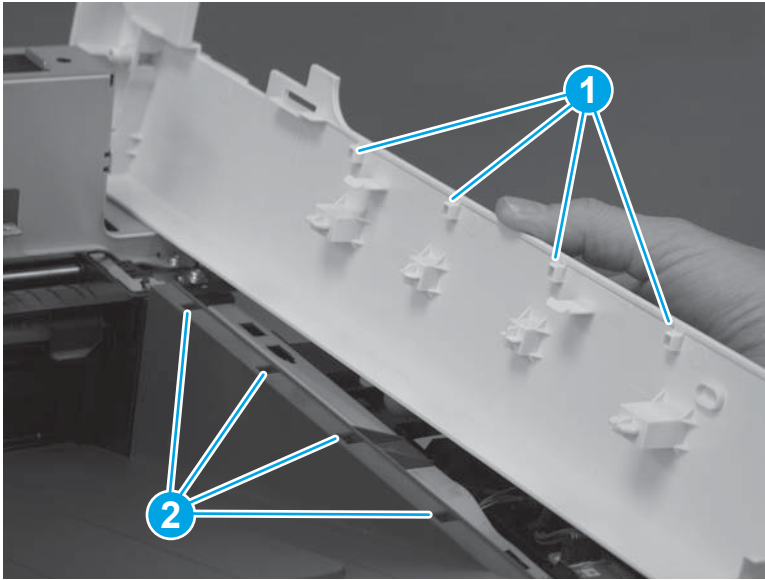

2. Press down on the cover to install it. Make sure that the tabs (callout 1) snap into place.

Figure 1-2549 Press down on the cover

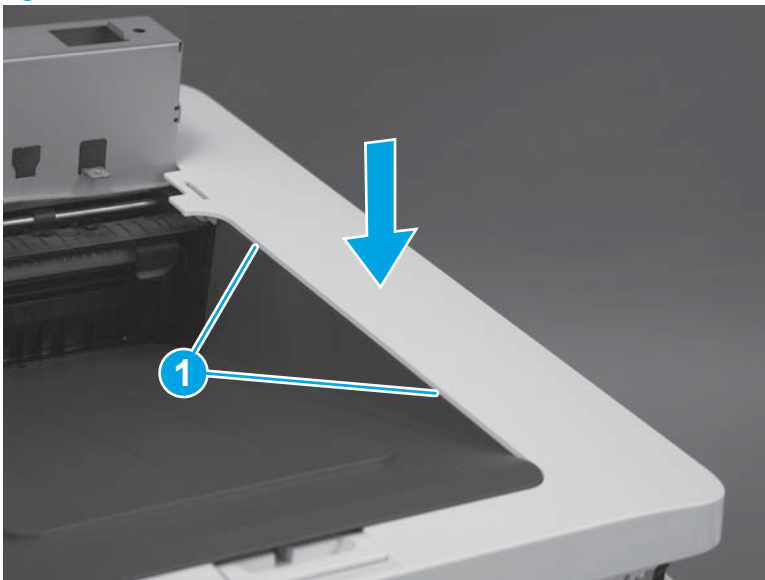

3. At the front of the printer, install one screw (callout 1).

 **Reinstallation tip:** This screw is longer and a different type of screw than the screw installed in the next step. Make sure that this screw is installed in the correct position.

Figure 1-2550 Install one screw



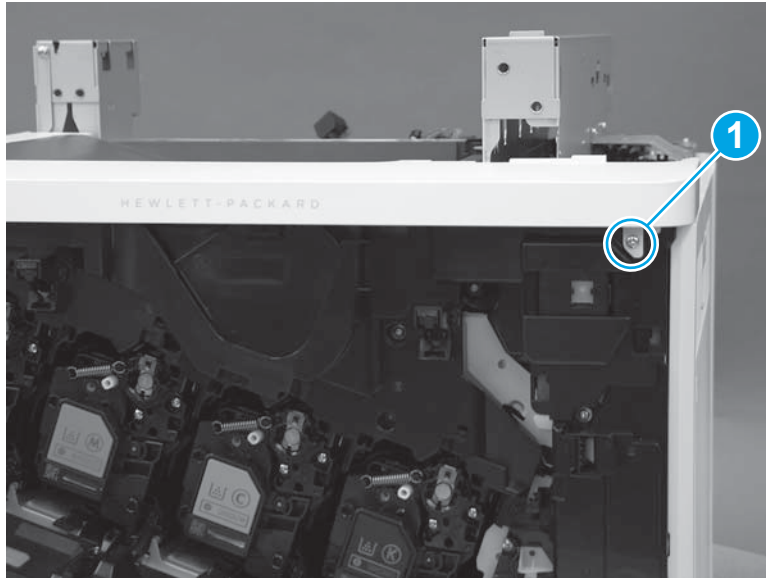
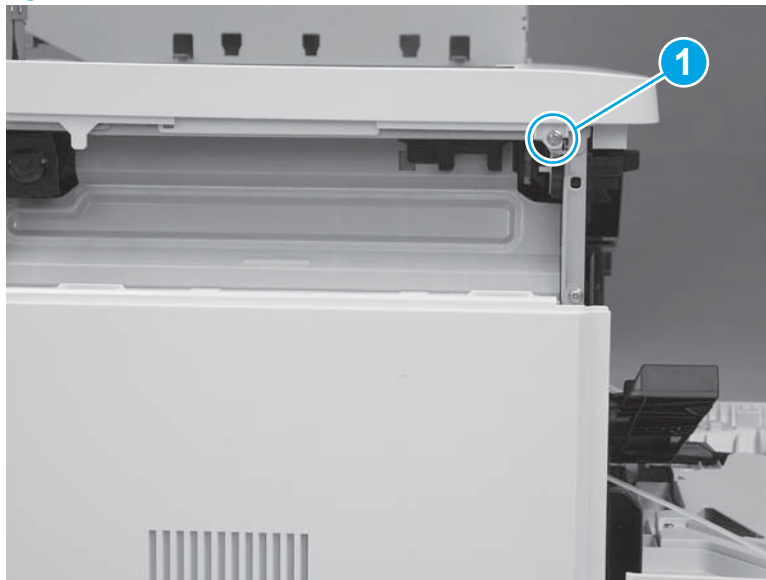

4. At the left side of the printer, install one screw (callout 1).

Figure 1-2551 Install one screw



Step 29: Install the right upper cover (M577)

 **NOTE:** This step is for the M577 models. For the M552 and M553 models, skip this step and go to [Step 36: Install the rear cover \(M552 and M553\) on page 1460.](#)

 **NOTE:** The figures below show the image scanner installed. The procedures for removing and installing the right upper cover are the same whether the image scanner is installed or removed."

1. **M577c/f/z only:** Install the cables (callout 1) through the slot (callout 2) in the printer.

Figure 1-2552 Install the cables

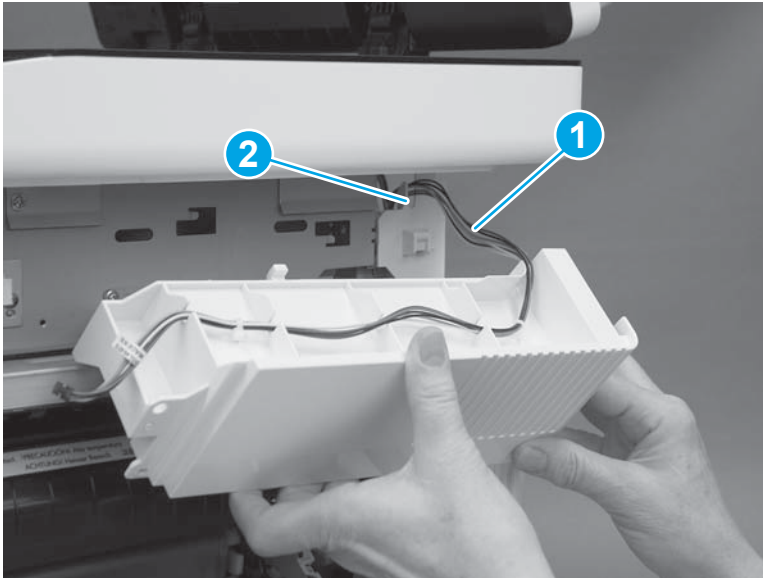

2. Position the hooks (callout 1) on the cover in the slots (callout 2) in the printer.

Figure 1-2553 Position the hooks

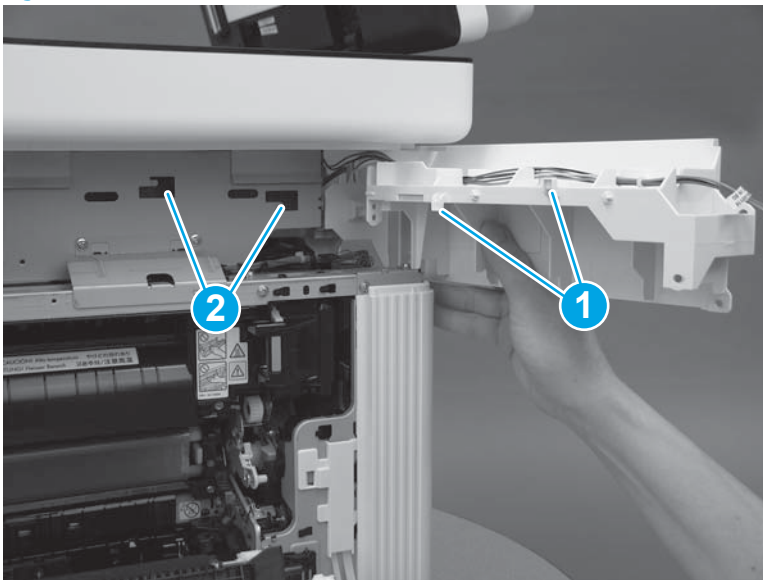

3. Slide the cover toward the front of the printer to install it.

Figure 1-2554 Install the cover

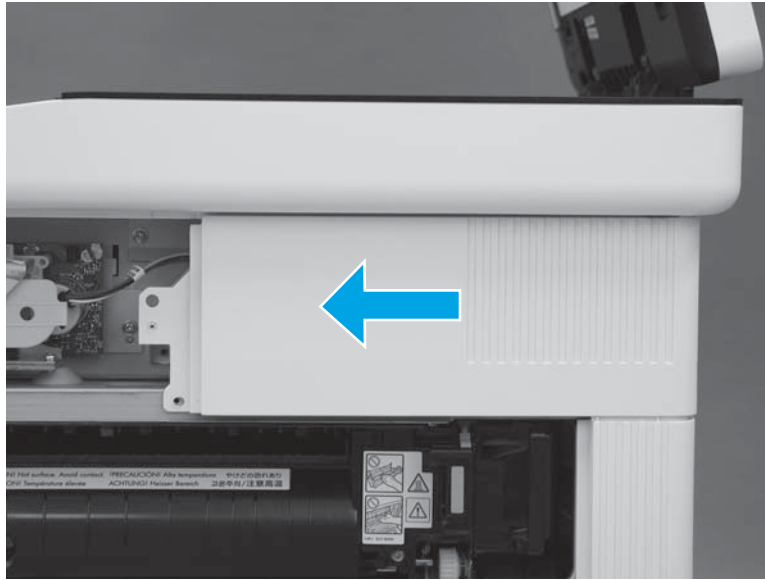

4. At the back of the printer, install one screw (callout 1).

M577c/f/z only: Connect one connector (callout 2), if the integrated scanner assembly is installed.

TIP: This screw is smaller than the screws installed in the next step. Make sure that this screw is installed in the correct position.

Figure 1-2555 Install one screw and connector

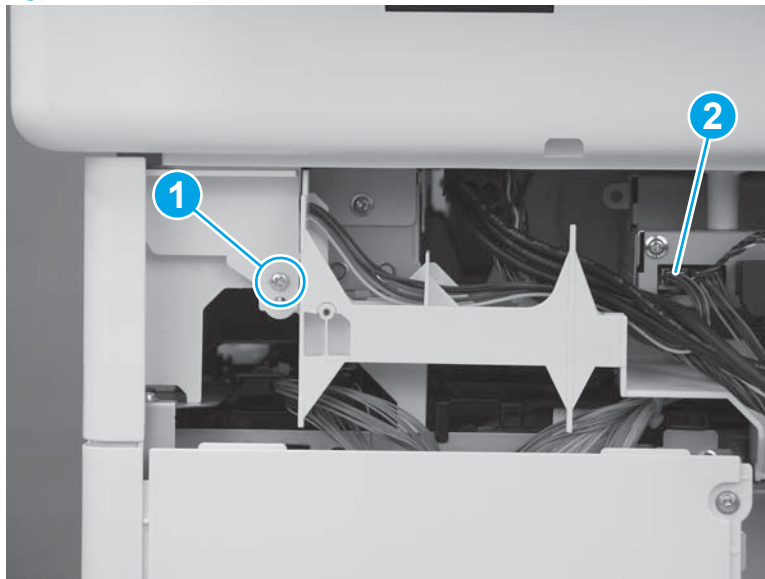

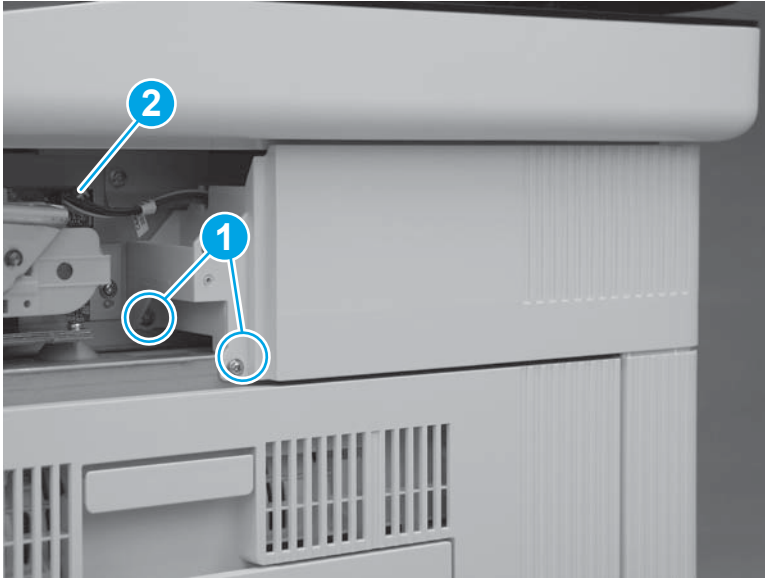

- At the right side of the printer, install two screws (callout 1).
M577c/f/z only: Connect one connector (callout 2), if the stapler is installed.

Figure 1-2556 Install one screw and connector



Step 30: Install the integrated scanner assembly (ISA) (M577)

-
-  **NOTE:** This step is for the M577 models. For the M552 and M553 models, skip this step and go to [Step 36: Install the rear cover \(M552 and M553\) on page 1460](#).
-
-  **NOTE:** The ISA includes the document feeder, image scanner, scanner control board (SCB), control panel, keyboard (M577c/z) and NFC PCA (M577z).
-

- Before proceeding, locate the mounting pins (callout 1) on the bottom of the ISA and the slots (callout 2) on the printer base.

Figure 1-2557 Locate the ISA mounting pins and slots

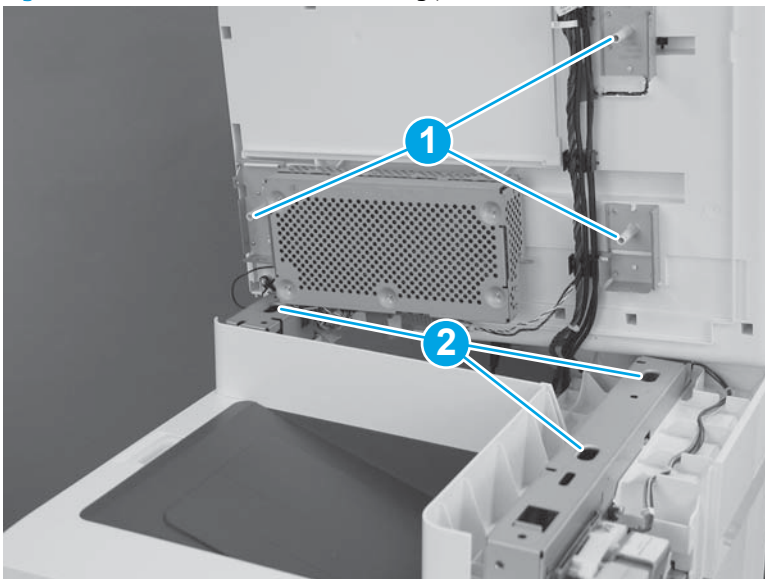

2. Position the ISA on the printer base with the pins in the slots.

 **NOTE:** To locate the pins and slots, see [Figure 1-395 Locate the ISA mounting pins and slots on page 249](#).

When installing the ISA, carefully pass the cables through the opening in the top of the formatter case.

Figure 1-2558 Install the ISA



3. Slightly slide the ISA towards the front of the printer to engage it.

Figure 1-2559 Slide the ISA towards the front of the printer

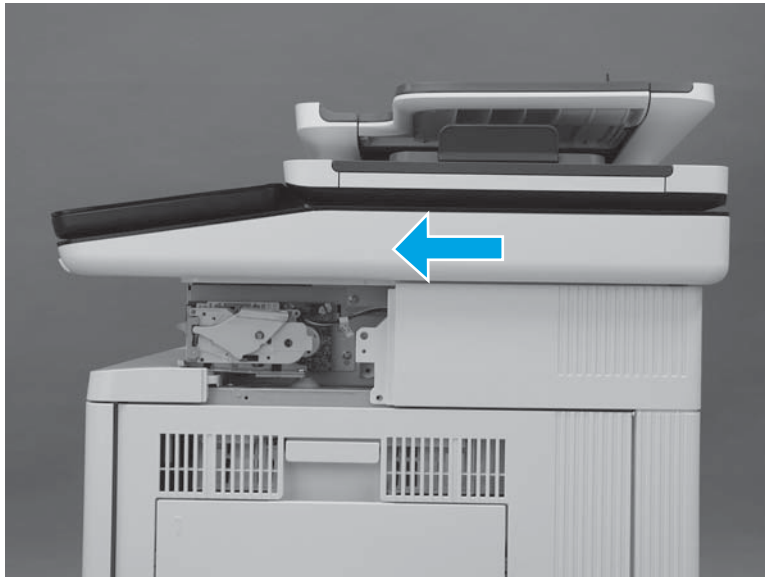

4. At the left side of the printer, install one screw (callout 1).

Figure 1-2560 Install one screw

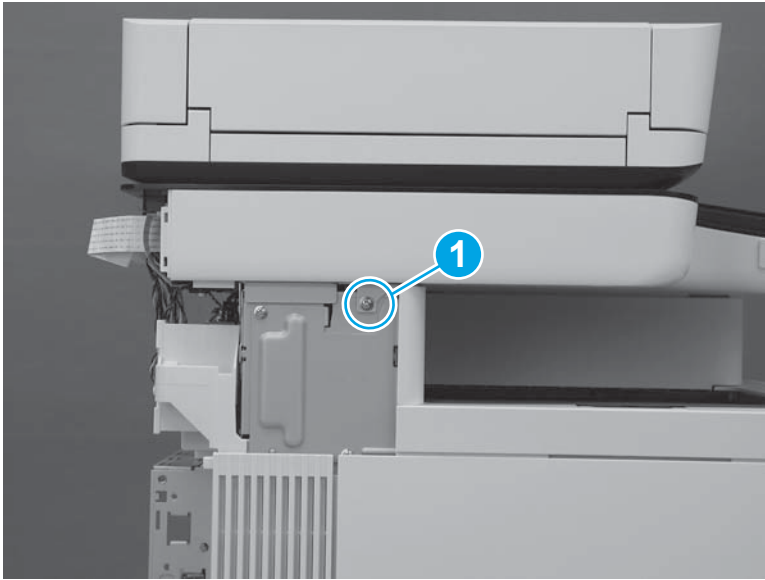

5. At the back of the printer, install two screws (callout 1).

Figure 1-2561 Install two screws

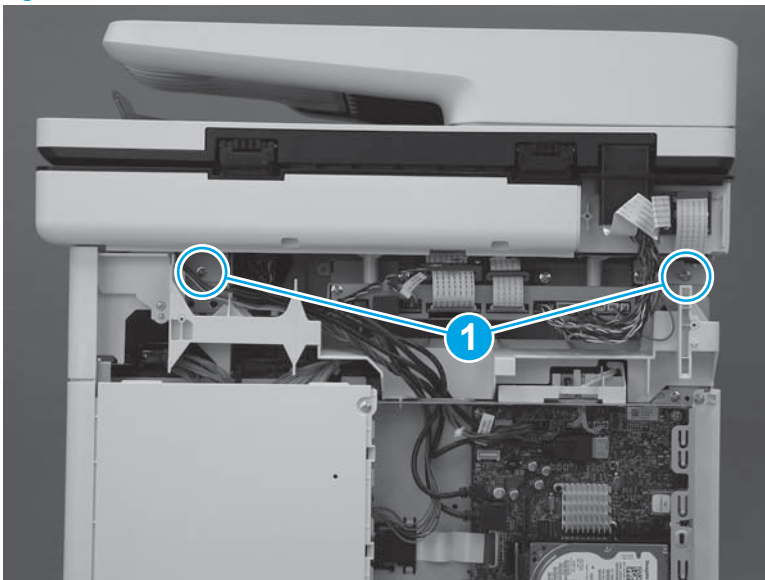

6. At the right side of the printer, install one screw (callout 1).

Figure 1-2562 Install one screw

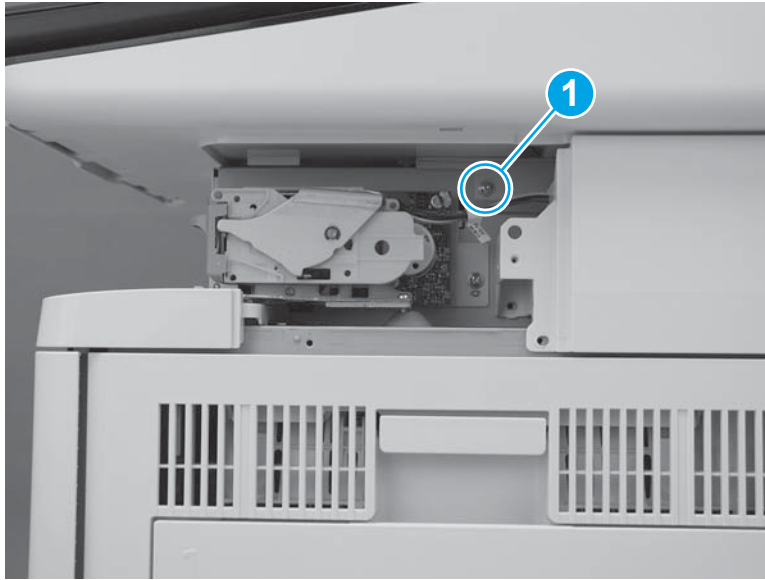

7. Connect two connectors on the scanner control board (callout 1).

M577c/f/z only: Connect one connector for the stapler on the scanner control board (callout 2).

Figure 1-2563 Connect connectors

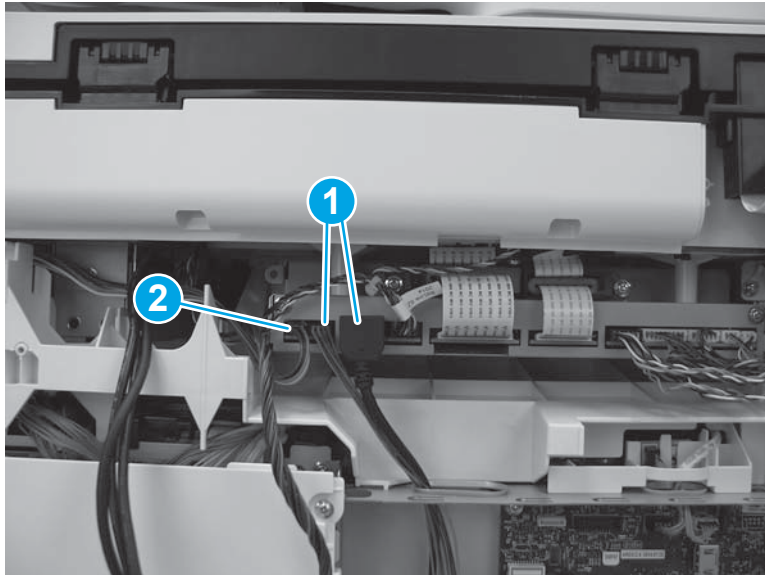

Step 31: Install the stapler cover assembly (M577c/f/z)

 **NOTE:** This step is for the M577c/f/z models only. For the M577dn model, skip this step and go to [Step 32: Install the right front upper cover \(M577dn\) on page 1453](#).

For the M552 and M553 models, skip this step and go to [Step 36: Install the rear cover \(M552 and M553\) on page 1460](#).

1. Install the tabs (callout 1) on the cover in the slots (callout 2) in the printer.

Figure 1-2564 Install two tabs



2. Press the cover toward the left side of the printer until it snaps into place.

Figure 1-2565 Install the cover assembly



3. Install one screw (callout 1).



 **IMPORTANT:** This is a self-tapping screw for plastic. Rotate it counterclockwise to align it with the existing thread pattern, and then carefully turn it clockwise to tighten. Do not overtighten. This will prevent stripping the threads inside the screw hole.

Figure 1-2566 Install one screw

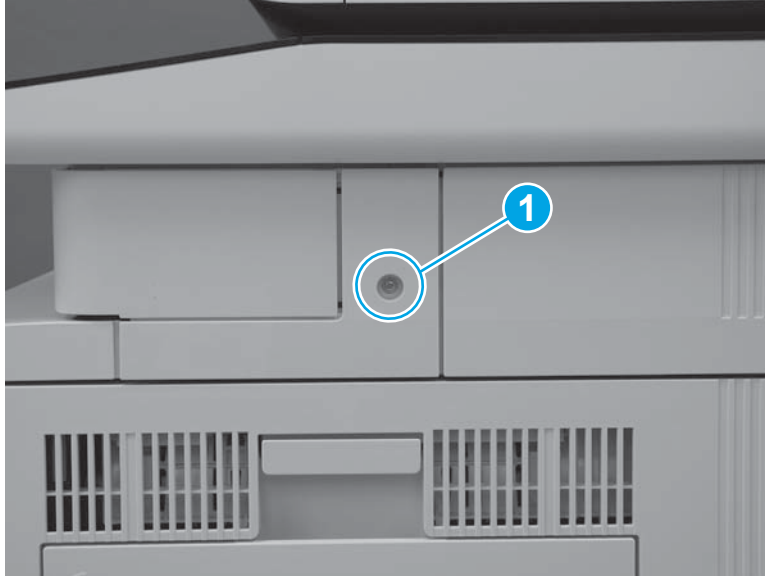

Step 32: Install the right front upper cover (M577dn)

 **NOTE:** This step is for the M577dn model only. For the M577c/f/z models, skip this step and go to [Step 33: Install the left upper cover \(M577\) on page 1455](#).

For the M552 and M553 models, skip this step and go to [Step 36: Install the rear cover \(M552 and M553\) on page 1460](#).

1. Slide the cover toward the left side of the printer to install it. Make sure that the slots (callout 1) in the cover fit over the tabs (callout 2) on the inside of the paper feeder cover.

Figure 1-2567 Install the cover



2. Press the right front upper cover (callout 1) and the paper feeder cover (callout 2) together until the tabs on the inside of the covers snap into place.

Figure 1-2568 Press the cover



3. Install one screw (callout 1).

Figure 1-2569 Install one screw

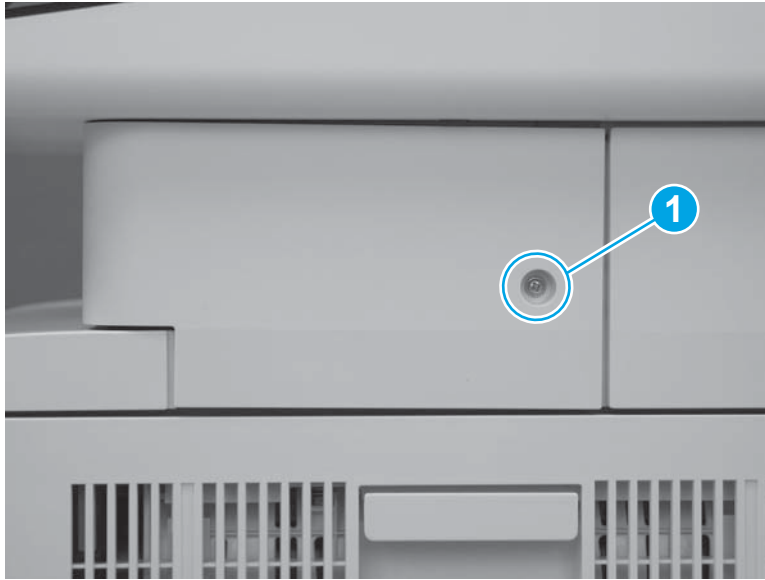

Step 33: Install the left upper cover (M577)

 **NOTE:** This step is for the M577 models. For the M552 and M553 models, skip this step and go to [Step 36: Install the rear cover \(M552 and M553\) on page 1460](#).

1. Position the tab (callout 1) on the lower edge of the cover behind the left cover (callout 2).

Figure 1-2570 Position the tab

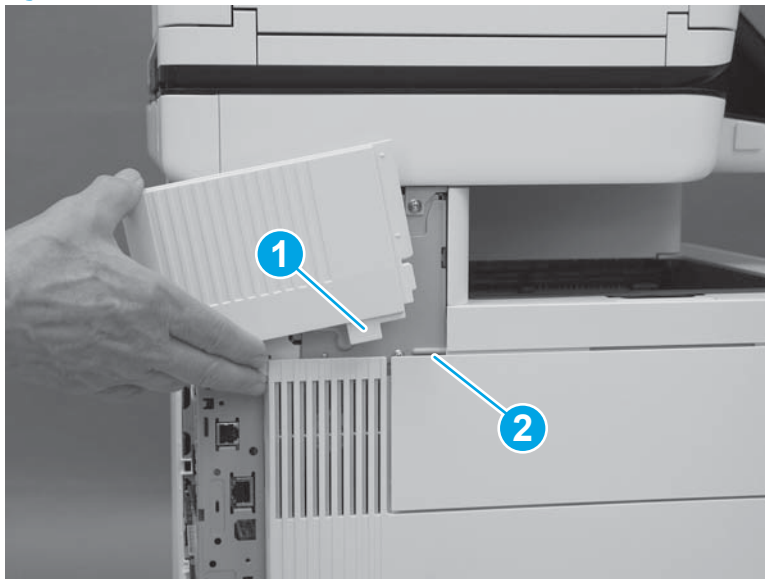

2. Slide the cover toward the front of the printer to install it. Make sure that the edge (callout 1) of the cover fits behind the edge (callout 2) of the top rear cover.

Figure 1-2571 Slide the cover

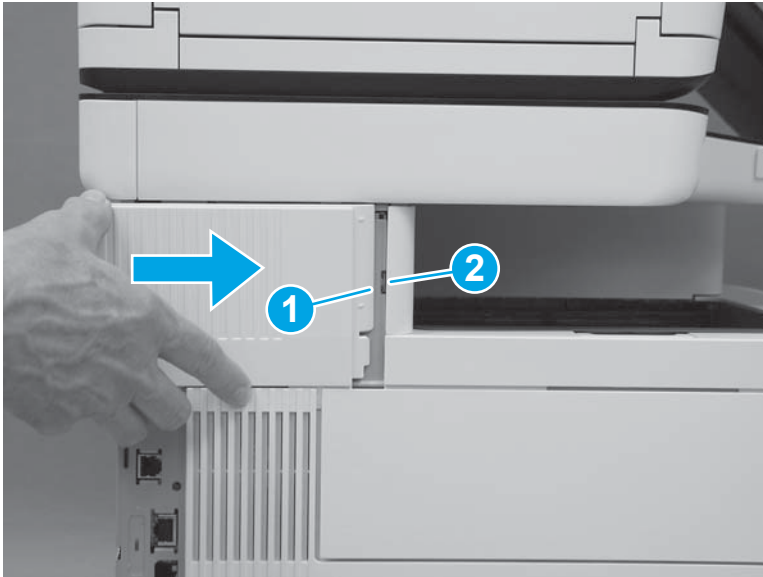

3. Make sure that the tab (callout 1) is fully installed.

Figure 1-2572 Check the tab

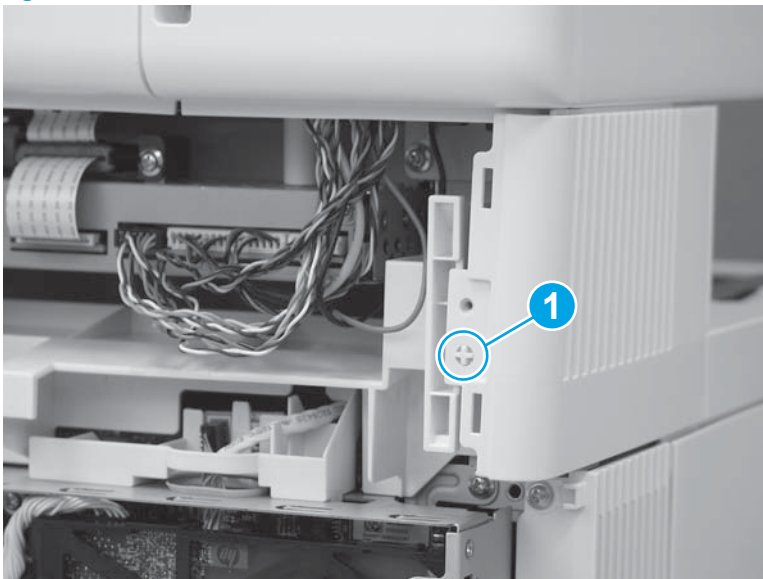

Step 34: Install the rear cover (M577)

 **NOTE:** This step is for the M577 models. For the M552 and M553 models, skip this step and go to [Step 36: Install the rear cover \(M552 and M553\) on page 1460](#).

1. Position the hooks (callout 1) on the cover in the slots (callout 2) in the printer.

Figure 1-2573 Position the hooks

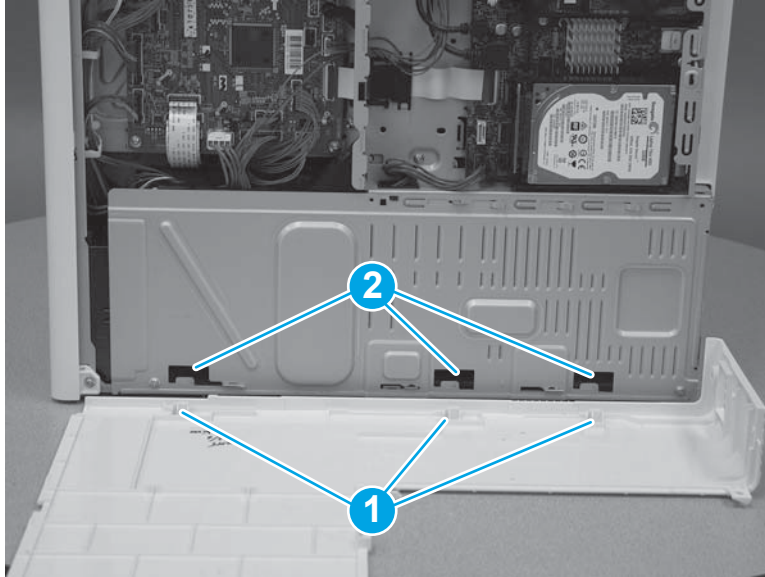

2. Position the back edge (callout 1) of the rear cover behind the edge (callout 2) of the right rear cover. Slide the cover to the left to install it.

Figure 1-2574 Install the cover

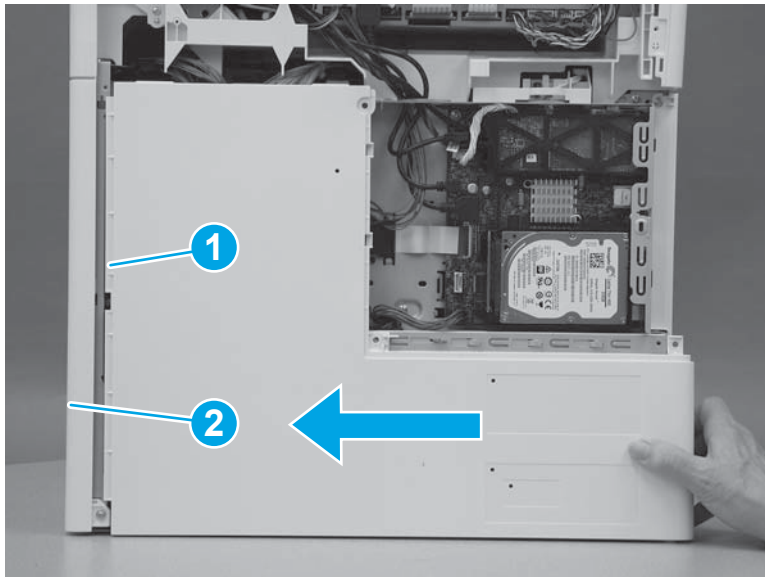

3. Install four screws (callout 1).

Figure 1-2575 Install four screws cover

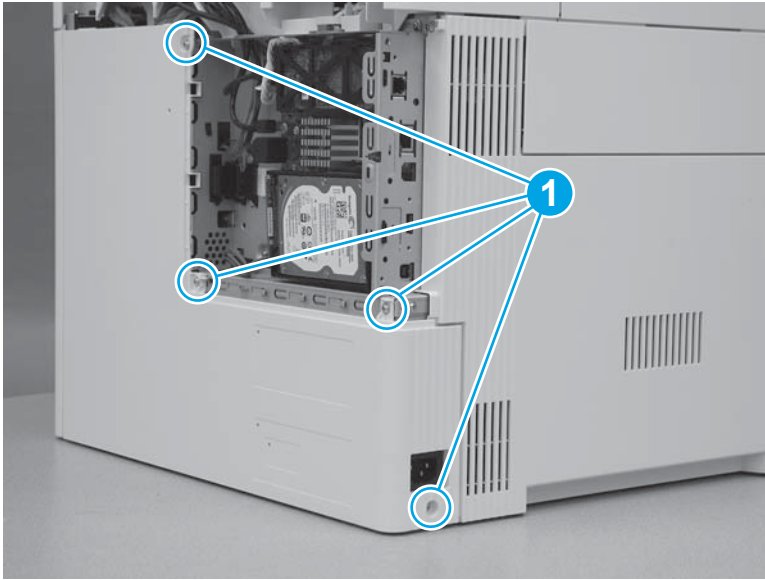

Step 35: Install the rear upper cover (M577)



NOTE: This step is for the M577 models. For the M552 and M553 models, skip this step and go to [Step 36: Install the rear cover \(M552 and M553\) on page 1460](#).

1. Align the ridge (callout 1) on the lower edge of the rear upper cover in front of the tabs (callout 2) on the top edge of the rear cover.

Figure 1-2576 Align the cover

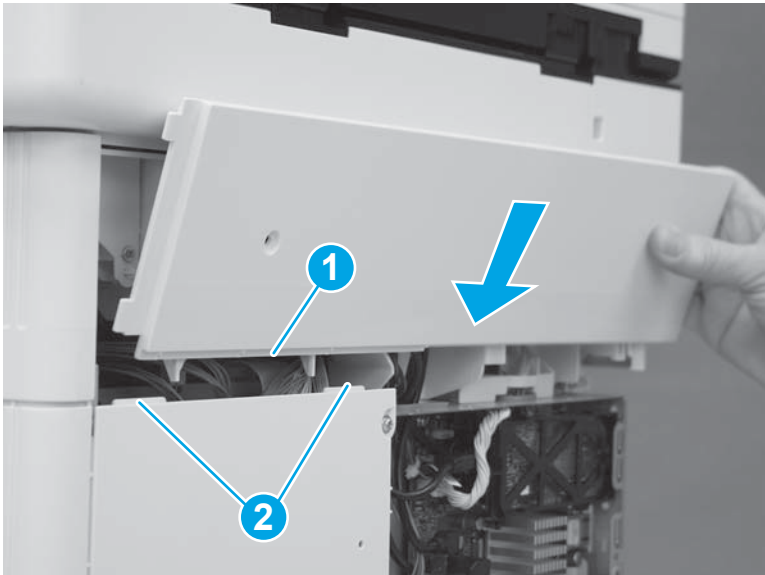

2. Rotate the top of the cover toward the printer.

Figure 1-2577 Rotate the top of the cover

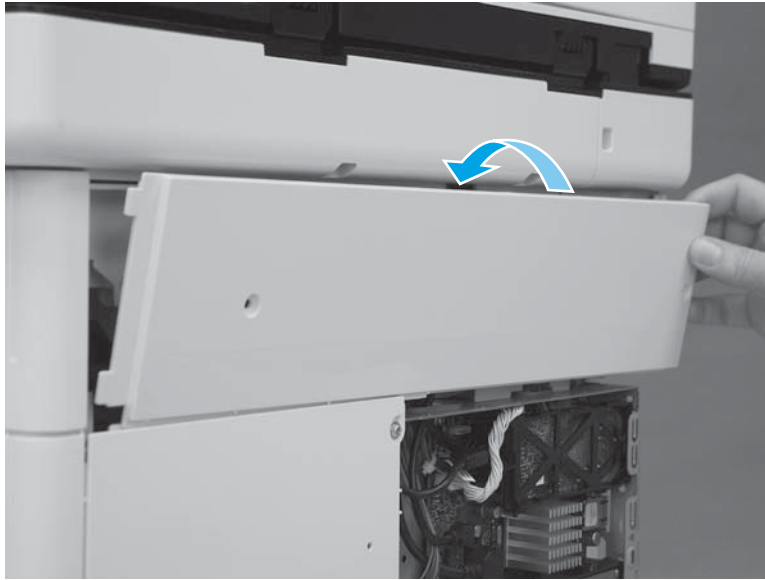

3. Slide the cover to the left (callout 1). Make sure that the tabs (callout 2) on the upper rear cover slide behind the edge (callout 3) of the right upper cover. Make sure that the cover is fully seated.

Figure 1-2578 Slide the cover

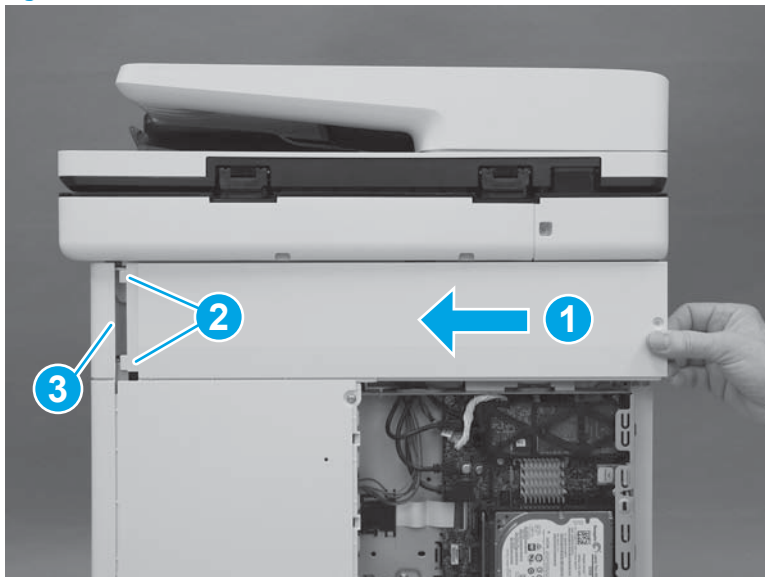

4. Install two screws (callout 1).



 **IMPORTANT:** These two screws are self-tapping screws for plastic. Rotate them counterclockwise to align them with the existing thread pattern, and then carefully turn them clockwise to tighten. Do not overtighten. This will prevent stripping the threads inside the screw holes.

Figure 1-2579 Install two screws

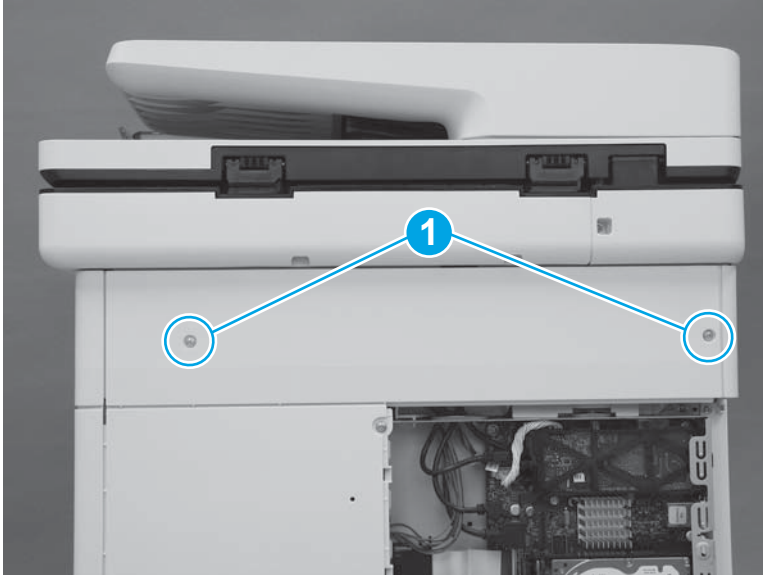

Step 36: Install the rear cover (M552 and M553)

 **NOTE:** This step is for the M552 and M553 models. For the M577 models, skip this step and go to [Step 37: Install the formatter \(M577\) on page 1461](#).

1. Position the top of the cover under the upper cover (callout 1), rotate the bottom of the cover onto the chassis (callout 2), and then slide the cover to the left (callout 3) to install it.

Figure 1-2580 Install the cover

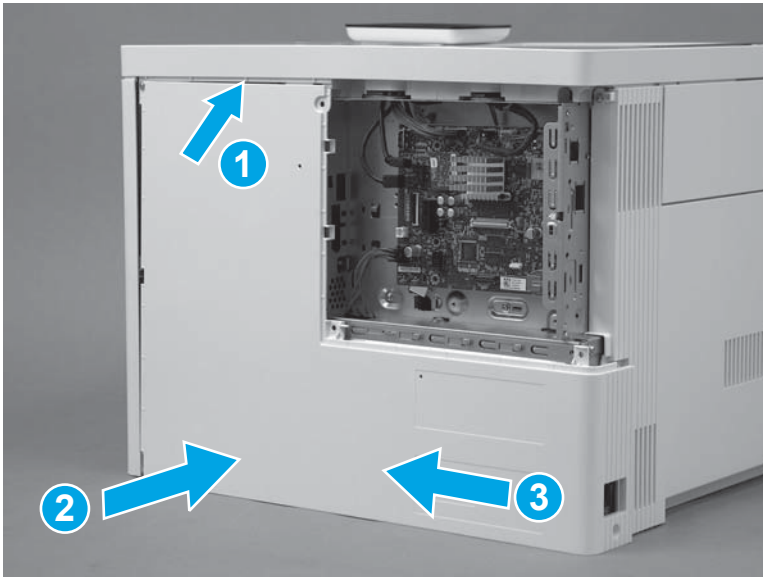

2. Install four screws (callout 1).

Figure 1-2581 Install four screws cover

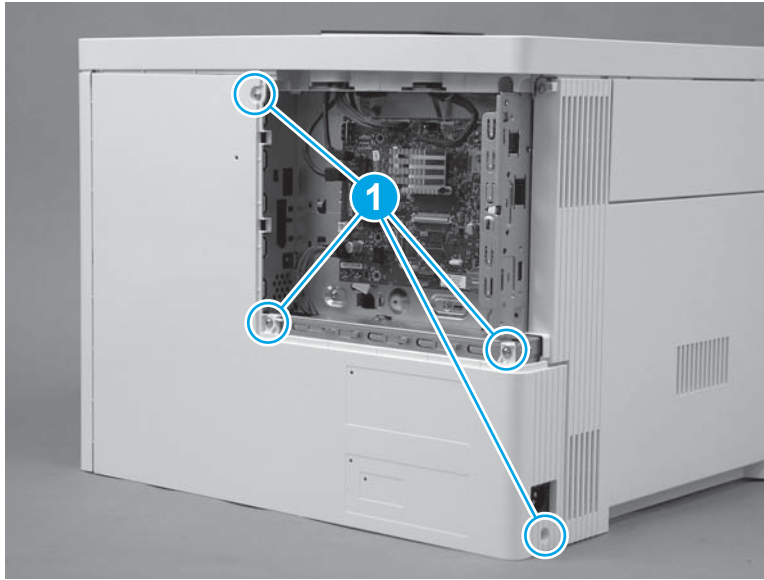

Step 37: Install the formatter (M577)

 **NOTE:** This step is for the M577 models. For the M552 and M553 models, skip this step and to go [Step 40: Install the formatter \(M552 and M553\) on page 1466](#).

 **CAUTION:**  ESD-sensitive part.

1. Position the formatter in the printer. Make sure that the network port (callout 1) fits through the opening (callout 2) in the formatter case.

Figure 1-2582 Install the formatter

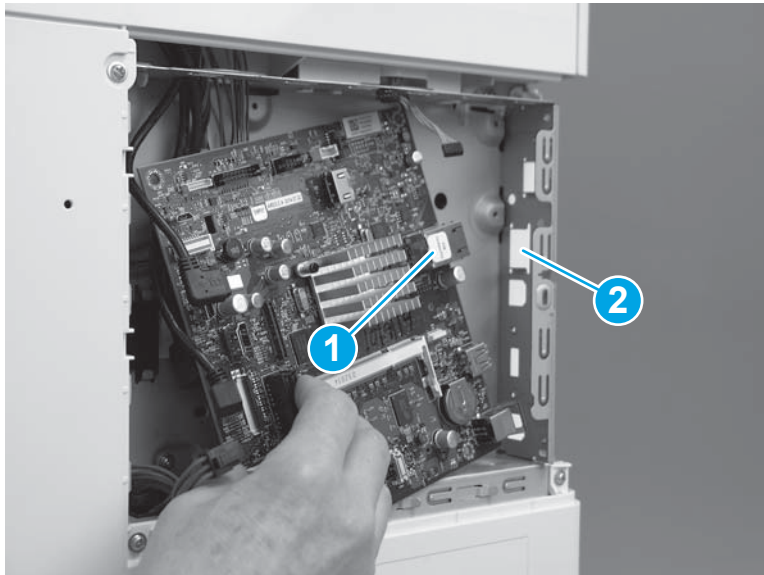

2. Install four screws (callout 1).

Figure 1-2583 Install four screws

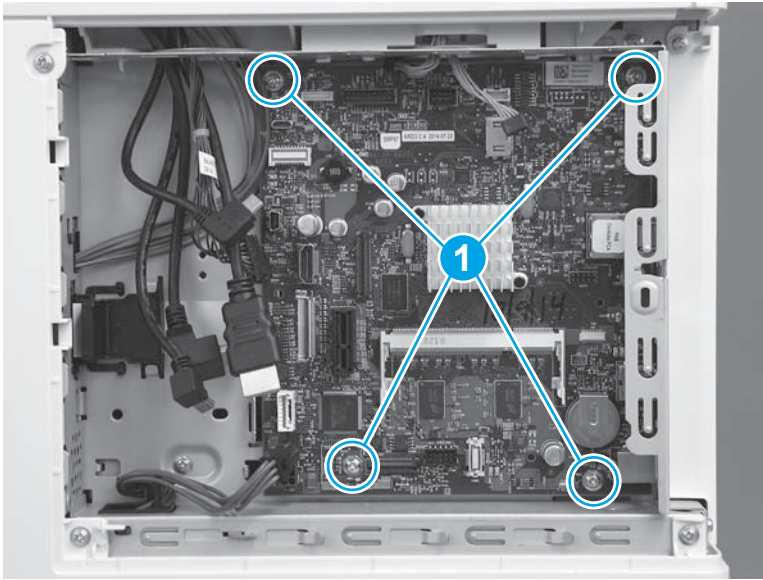

3. Connect all of the connectors on the formatter.

The following connectors are empty:

- All models: J1 (this connector is empty unless the optional DIMM is installed)
- All models: J3
- M577dn: J15 (this is the fax connector for the M577f/z/c models)
- All models: J21 (this connector is empty unless the optional internal USB ports component is installed)
- All models: J23
- All models: J24
- All models: J51
- All models: J57
- All models: J97
- All models: J98 (this connector is empty unless the optional trusted platform module (TPM) is installed)

 **IMPORTANT:** The flat-cable connector (callout 1) is a Zero Insertion Force (ZIF) connector that uses a hinged retainer to secure the flat cable. The hinged retainer must be opened to install the flat cable, and then closed after the cable is installed.

Figure 1-2584 Connect all connectors



Step 38: Install the fax PCA (M577c/f/z)

 **NOTE:** This step is for the M577c/f/z models. For the M577n model, skip this step and go to [Step 39: Install the HDD \(M577\) on page 1464](#).

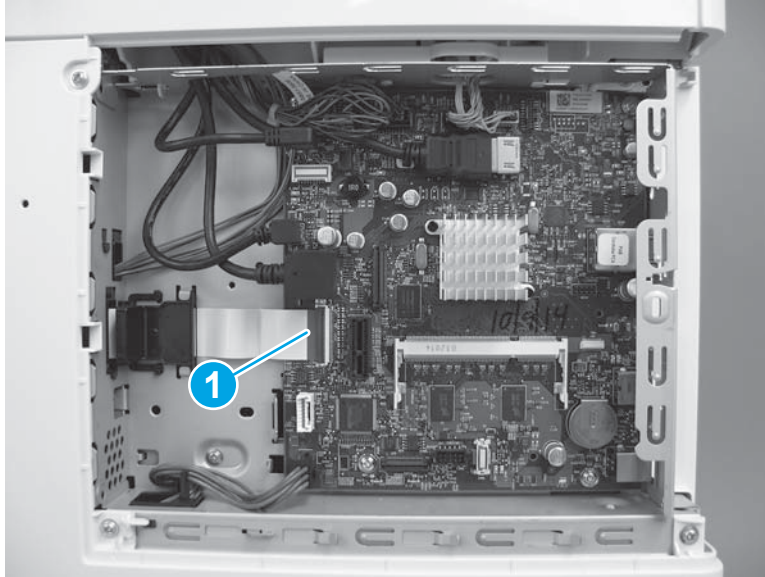
For the M552 and M553 models, skip this step and go to [Step 40: Install the formatter \(M552 and M553\) on page 1466](#).

 **CAUTION:**  ESD-sensitive part.

1. Position the tab and telephone port (callout 1) on the fax PCA in the slots (callout 2) in the formatter case.

Figure 1-2585 Position the fax PCA

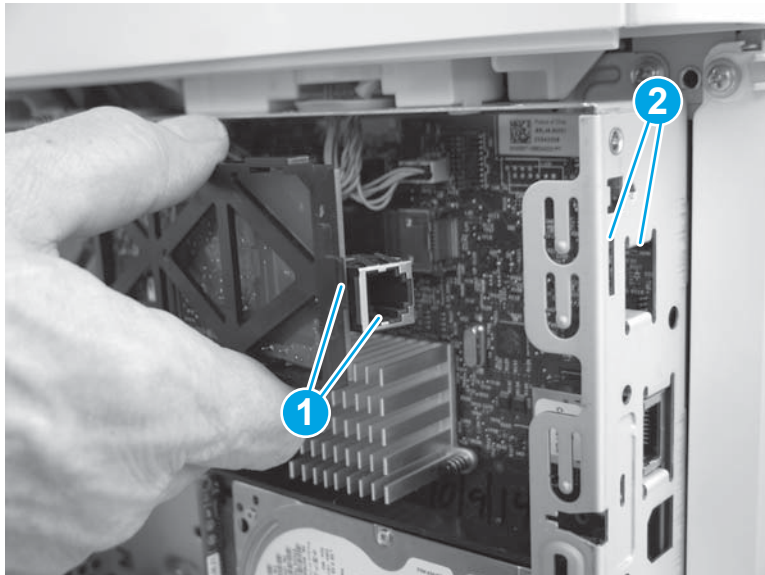

- Slide the fax PCA to the right (callout 1) until the tab and telephone port described in the previous step and seated in the formatter case. Position the retainer (callout 2) in the slot (callout 3) in the formatter. Rotate the end of the fax PCA toward the formatter (callout 4) until the retainer snaps into place.

Figure 1-2586 Install the fax PCA

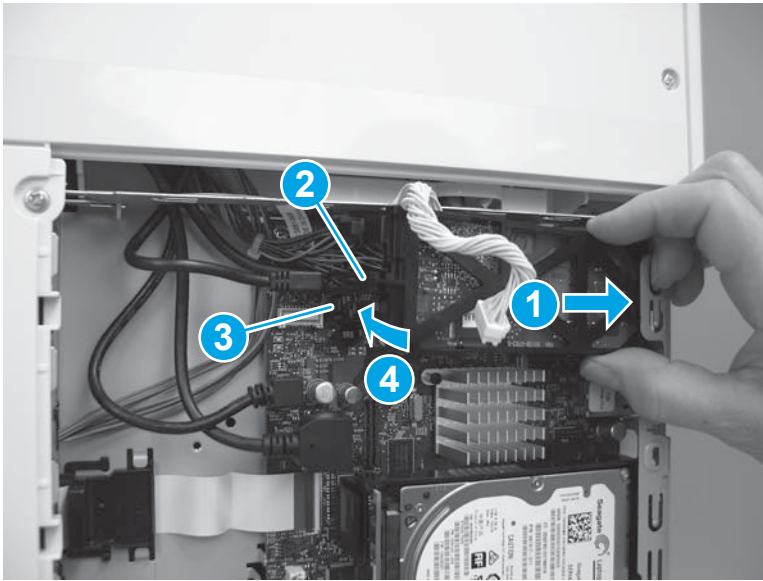

- Position the cable (callout 1) in the guide (callout 2), and then connect one connector (callout 3).

Figure 1-2587 Connect the connector

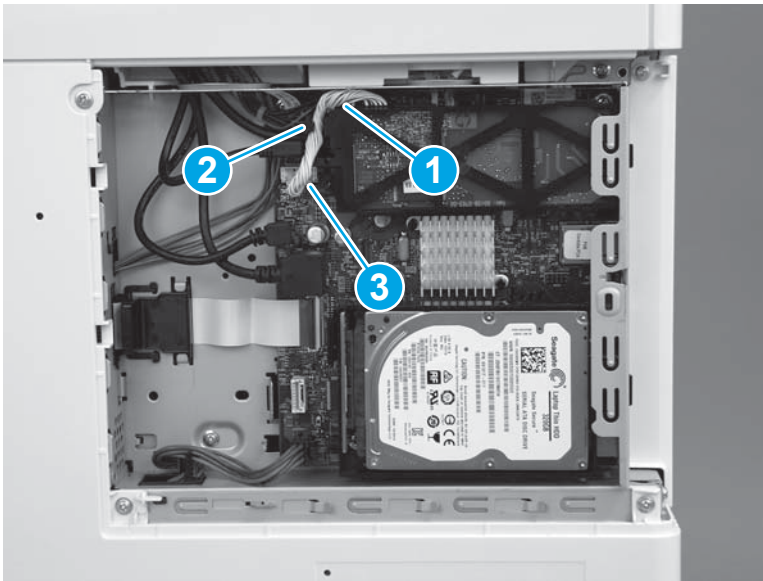

Step 39: Install the HDD (M577)

 **NOTE:** This step is for the M577 models. For the M552 and M553 models, skip this step and go to [Step 40: Install the formatter \(M552 and M553\) on page 1466](#).

 **CAUTION:**  ESD-sensitive part.

1. Align the end of the bracket (callout 1) with the slot in the chassis (callout 2), and then slide the HDD into the printer (callout 3) to engage the bracket with the chassis.

Figure 1-2588 Install the holder

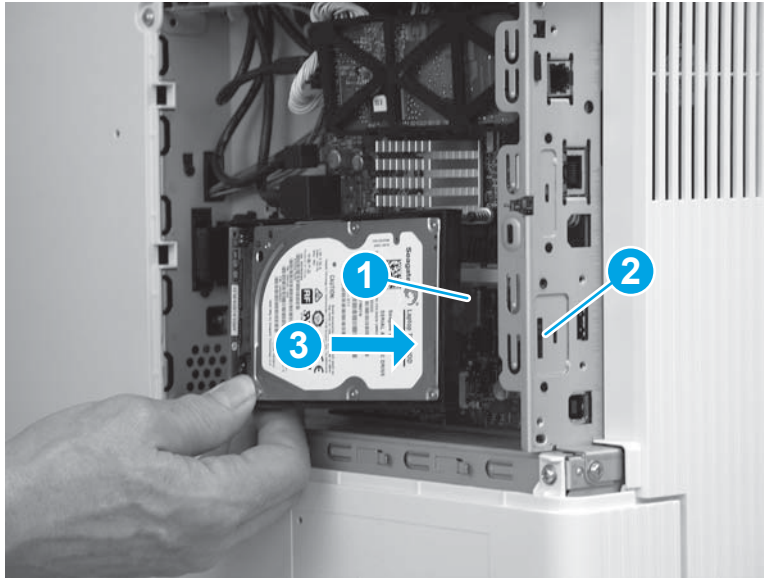

2. Hold the HDD connector latch (callout 1) in the released position, and then rotate the HDD down and into the connector on the formatter to install it.

 **NOTE:** Make sure that the tab (callout 2) snaps into place, and that the HDD is securely installed.

Figure 1-2589 Release the HDD

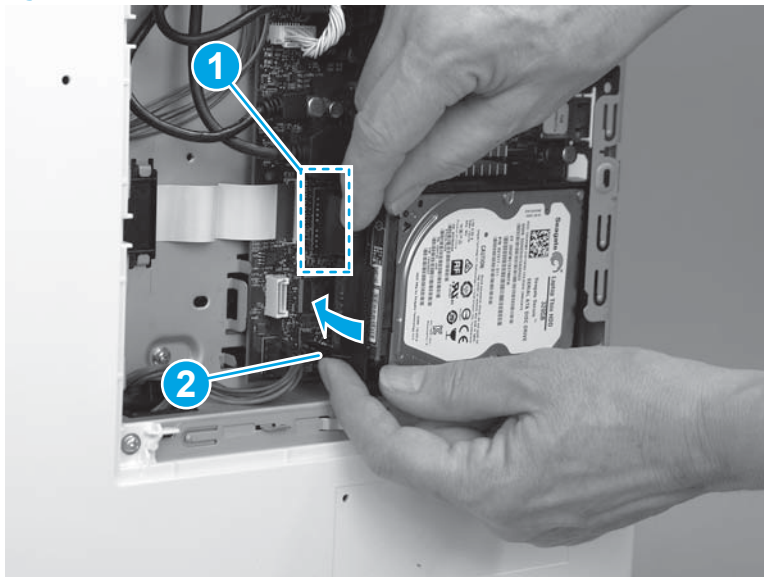

Step 40: Install the formatter (M552 and M553)

 **NOTE:** This step is for the M552 and M553 models. For the M577 models, skip this step and go to [Step 41: Install the formatter cover on page 1467](#).

If the optional hard-disk drive (HDD) was removed, do not forget to reinstall it after the formatter is reinstalled.

Engage the HDD holder with the chassis, rotate the HDD connector down and into the connector on the formatter. Make sure that the tabs snap into place.

 **CAUTION:**  ESD-sensitive part.

1. Position the formatter in the printer, and then install four screws (callout 1).

Figure 1-2590 Install the formatter

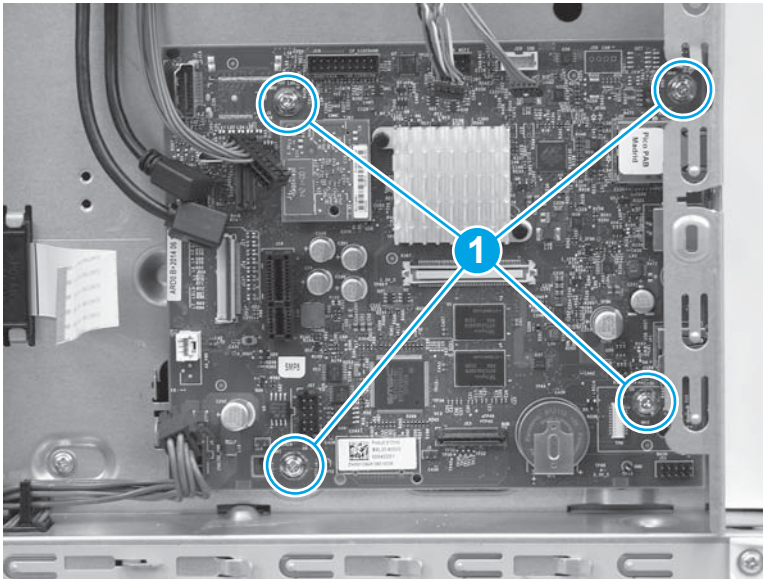

2. Connect all of the connectors on the formatter.

The following connectors are empty:

- All models: J1 (this connector is empty unless the optional DIMM is installed)
- M553n/dn and M552dn: J2 (callout 1; this is the touchscreen connector for the M553x model)
- All models: J9 (this connector is empty unless the optional internal USB ports component is installed)
- All models: J18 (this connector is empty unless the optional hard-disk-drive (HDD) is installed)
- All models: J23
- All models: J24
- M553n/dn and M552dn: J25 (this is the wireless connector for the M553x model)
- All models: J57
- All models: J98 (this connector is empty unless the optional trusted platform module (TPM) is installed)



 **IMPORTANT:** The flat-cable connector (callout 2) is a Zero Insertion Force (ZIF) connector that uses a hinged retainer to secure the flat cable. The hinged retainer must be opened to install the flat cable.

Figure 1-2591 Connect all connectors

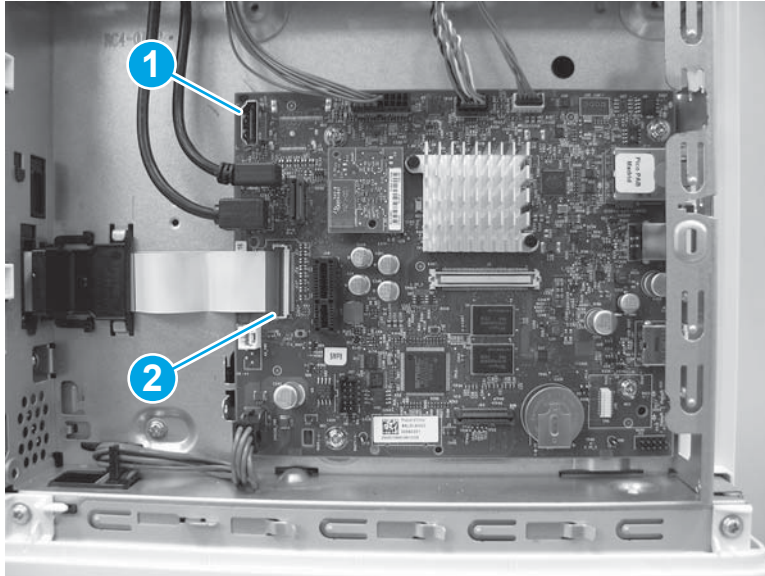

Step 41: Install the formatter cover

- ▲ Slide the cover onto the printer (callout 1) to install it.

 **NOTE:** Make sure that the tabs on the formatter cover align with the slots provided in the printer (callout 2). Tighten the two thumbscrews (callout 3).

 **TIP:** If needed, use the edge of a coin to turn the thumbscrews.

Figure 1-2592 Install the cover

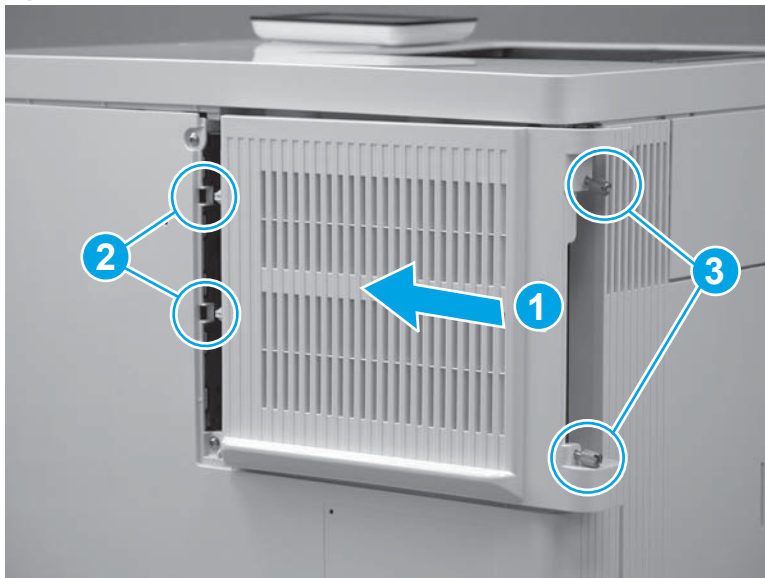

Step 42: Install the TCU

1. Verify that the toner collection hatch cover is in the closed position on the TCU.

Figure 1-2593 Verify that the toner collection hatch cover is closed

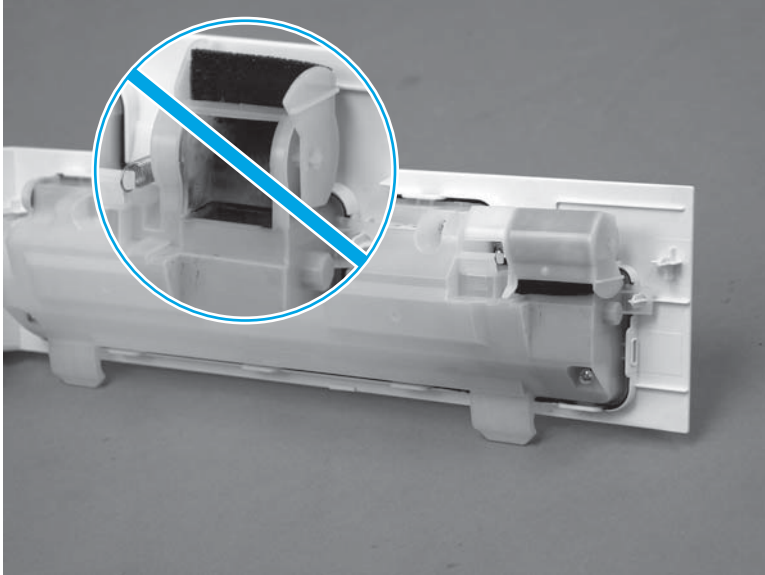

2. Position the TCU with the hinges in the slots provided in the printer (callout 1), and then rotate the TCU up and into the closed position.

 **NOTE:** The toner collection hatch cover automatically opens when the TCU is closed.

Figure 1-2594 Install the TCU



3. Close the front door.

Figure 1-2595 Close the front door

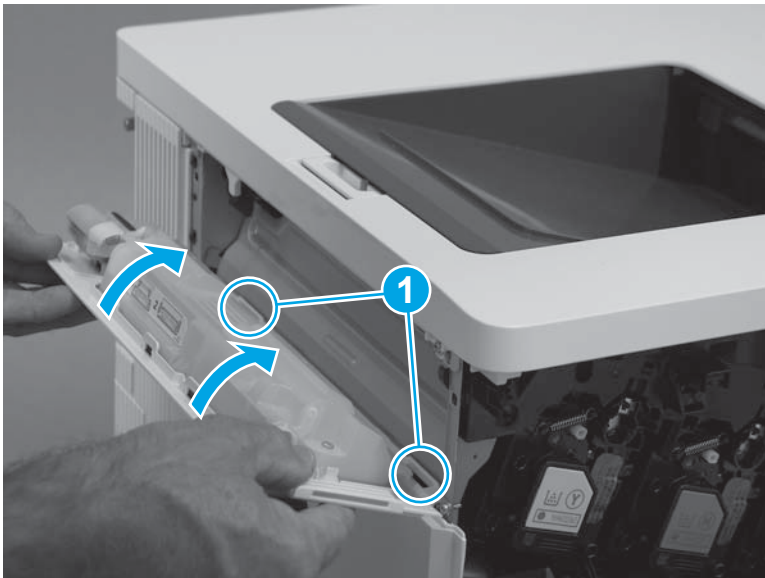

Step 43: Install the tray

1. With the front of the tray slightly lifted, align the sides of the tray with the rails in the printer, and then carefully slide the tray into the printer.

 **TIP:** As the tray slides into the printer, lower the front of it.

Figure 1-2596 Install the tray



2. Close the tray.

Figure 1-2597 Close the tray



Step 44: Install the control-panel assembly (M553x only)

 **NOTE:** For the M553n/dn and M552dn models, skip this step and go to [Step 45: Install the USB cover \(M552 and M553\) on page 1473](#).

For the M577 models, skip this step.

1. Place the control panel on the printer as shown.

Figure 1-2598 Place the control panel on the product

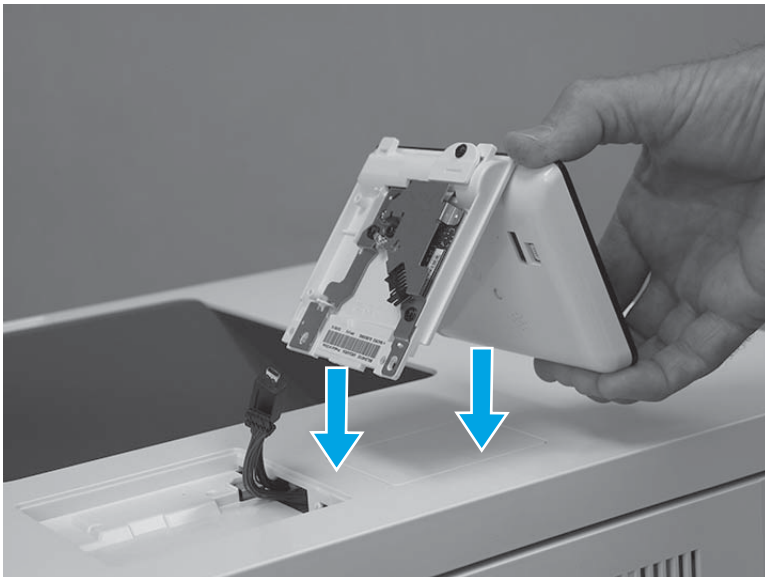

2. Connect one USB cable (callout 1), and one connector (callout 2).

 **IMPORTANT:** Take note of the location of the two mounting tabs (callout 3) on the control-panel assembly.

Figure 1-2599 Connect two connectors



3. Turn the control panel over, and then position the front edge tabs in the slots in the top cover.

Figure 1-2600 Turn the control panel over

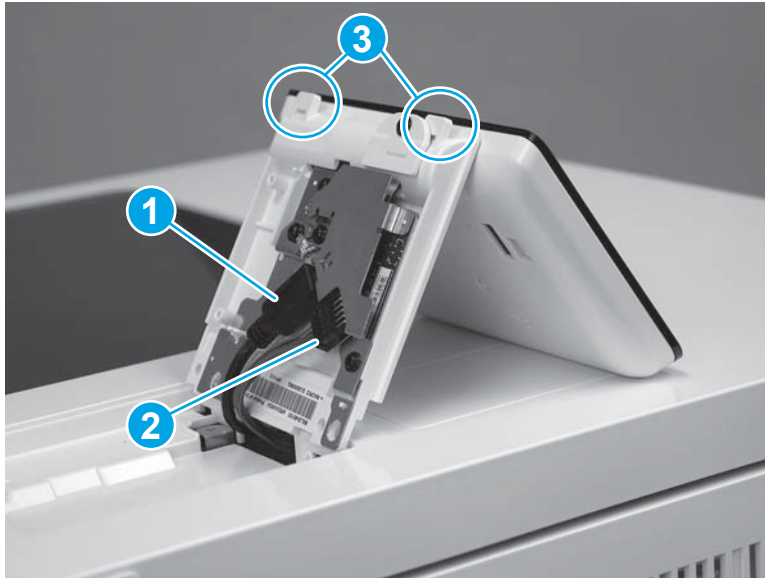
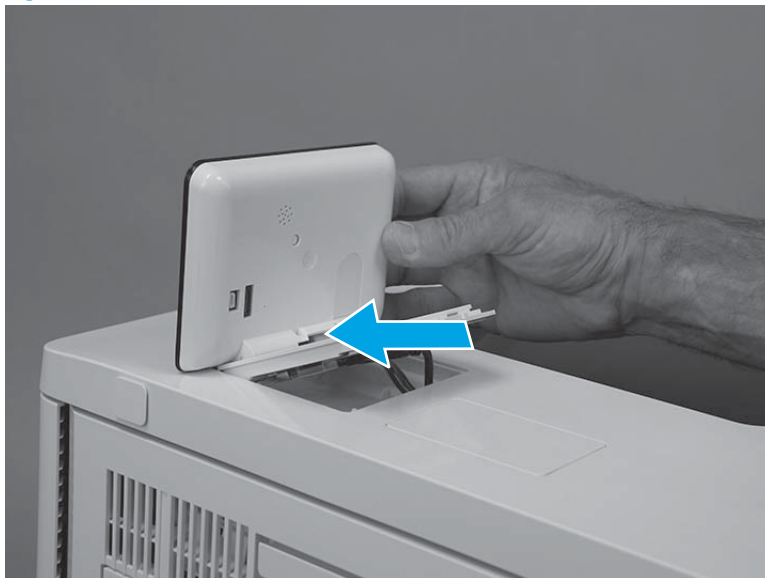

4. Rotate the control-panel base down onto the printer.

Figure 1-2601 Rotate the control-panel base down



5. Use a small Phillips screwdriver to install two screws (callout 1).

Figure 1-2602 Install two screws

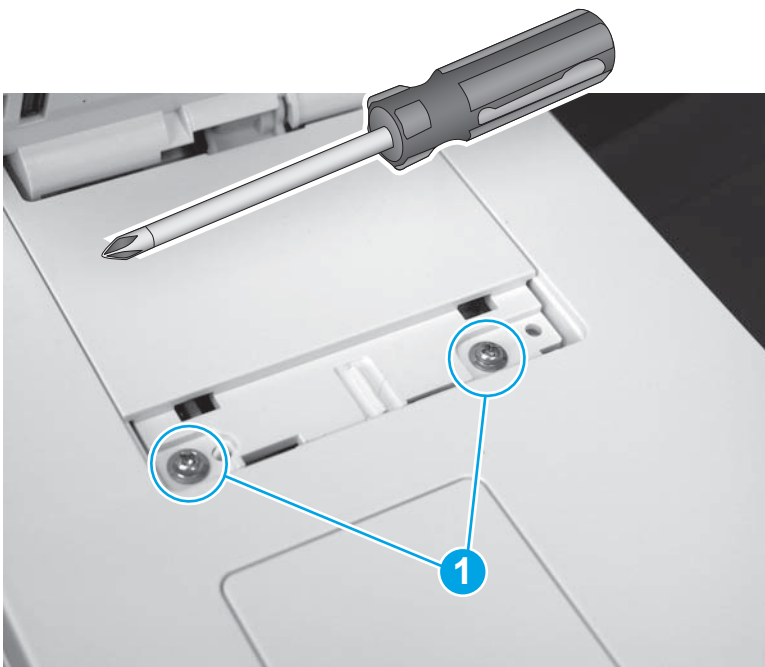

6. Position the screw cover mounting feet into the slots in the top cover (callout 1), and then rotate the cover down (callout 2) to install it.

 **NOTE:** Press down on the cover firmly to make sure that the tabs on the cover (callout 3) snap into place.

Figure 1-2603 Install the cover

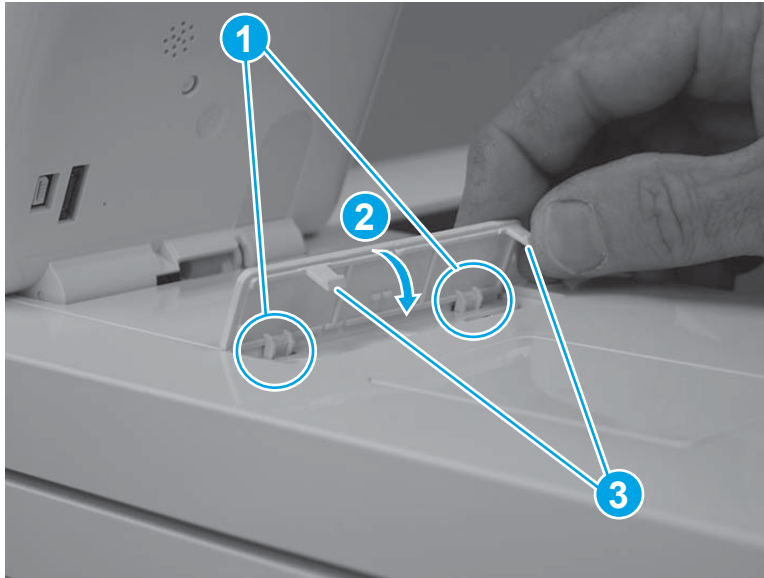

Step 45: Install the USB cover (M552 and M553)

 **NOTE:** This step is for the M552 and M553 models. For the M577 models, skip this step.

1. Push the cover into the USB port to install it.

Figure 1-2604 Install the cover



2. Make sure that the USB cover is fully seated after installing it.

Figure 1-2605 Check the installation

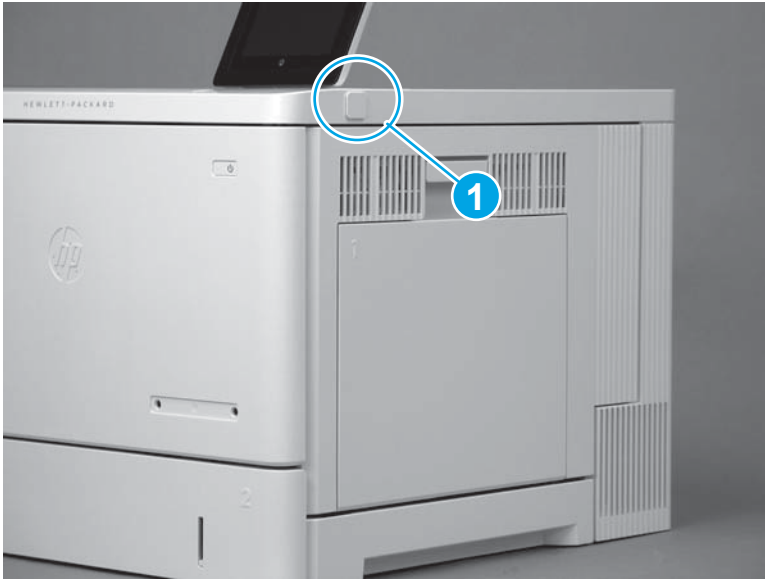

Removal and replacement: High-voltage power supply T (HVPST)

- [Introduction](#)
- [Step 1: Remove the USB cover \(M552 and M553\)](#)
- [Step 2: Remove the control panel \(M553x only\)](#)
- [Step 3: Remove the tray](#)
- [Step 4: Remove the toner collection unit \(TCU\)](#)
- [Step 5: Remove the formatter cover](#)
- [Step 6: Remove the formatter \(M552 and M553\)](#)
- [Step 7: Remove the hard-disk drive \(HDD\) \(M577\)](#)
- [Step 8: Remove the fax PCA \(M577c/f/z\)](#)
- [Step 9: Remove the formatter \(M577\)](#)
- [Step 10: Remove the rear cover \(M552 and M553\)](#)
- [Step 11: Remove the rear upper cover \(M577\)](#)
- [Step 12: Remove the rear cover \(M577\)](#)
- [Step 13: Remove the left upper cover \(M577\)](#)
- [Step 14: Remove the right front upper cover \(M577dn\)](#)
- [Step 15: Remove the stapler cover assembly \(M577c/f/z\)](#)
- [Step 16: Remove the integrated scanner assembly \(ISA\) \(M577\)](#)
- [Step 17: Remove the right upper cover \(M577\)](#)
- [Step 18: Remove the top rear cover \(M577\)](#)
- [Step 19: Remove the left cover](#)
- [Step 20: Remove the upper cover \(M552 and M553\)](#)
- [Step 21: Remove the formatter case](#)
- [Step 22: Remove the right rear cover](#)
- [Step 23: Remove the DC controller and sheet-metal bracket](#)
- [Step 24: Remove the high-voltage power supply T \(HVPST\)](#)
- [Step 25: Unpack the replacement assembly](#)
- [Step 26: Install the HVPST](#)
- [Step 27: Install the DC controller and sheet-metal bracket](#)
- [Step 28: Install the right rear cover](#)
- [Step 29: Install the formatter case](#)

- [Step 30: Install the upper cover \(M552 and M553\)](#)
- [Step 31: Install the left cover](#)
- [Step 32: Install the top rear cover \(M577\)](#)
- [Step 33: Install the right upper cover \(M577\)](#)
- [Step 34: Install the integrated scanner assembly \(ISA\) \(M577\)](#)
- [Step 35: Install the stapler cover assembly \(M577c/f/z\)](#)
- [Step 36: Install the right front upper cover \(M577dn\)](#)
- [Step 37: Install the left upper cover \(M577\)](#)
- [Step 38: Install the rear cover \(M577\)](#)
- [Step 39: Install the rear upper cover \(M577\)](#)
- [Step 40: Install the rear cover \(M552 and M553\)](#)
- [Step 41: Install the formatter \(M577\)](#)
- [Step 42: Install the fax PCA \(M577c/f/z\)](#)
- [Step 43: Install the HDD \(M577\)](#)
- [Step 44: Install the formatter \(M552 and M553\)](#)
- [Step 45: Install the formatter cover](#)
- [Step 46: Install the TCU](#)
- [Step 47: Install the tray](#)
- [Step 48: Install the control-panel assembly \(M553x only\)](#)
- [Step 49: Install the USB cover \(M552 and M553\)](#)

Introduction



This document provides the procedures to remove and replace the high-voltage power supply T (HVPST).

Before performing service

Turn the printer power off

- Disconnect the power cable.

 **WARNING!** To avoid damage to the printer, turn the printer off, wait 30 seconds, and then remove the power cord before attempting to service the printer.

 **CAUTION:**  This part contains components that are electrostatic discharge (ESD) sensitive. To reduce the possibility of ESD damage, always touch the sheet-metal chassis to ground yourself before touching an ESD sensitive part.

Use the table below to identify the correct part number for your printer, and then go to <http://h20141.www2.hp.com/hpparts> to order the part.

High-voltage power supply T (HVPST) part number	
RM2-7123-000CN	High-voltage power supply T (HVPST) M552dn, M553dn, M553x, M577)
RM2-7134-000CN	High-voltage power supply T (HVPST) (M553n)

Required tools

- #2 Phillips screwdriver with a magnetic tip

After performing service

Make sure that all of the connectors on the HVPST are fully seated.

Make sure that all of the connectors on the DC controller are fully seated.

Make sure that all of the connectors on the formatter are fully seated.

Make sure that the formatter cover is fully seated, and that the thumbscrews are finger tight after replacing it.

Turn the printer power on

- Connect the power cable.
- Use the power switch to turn the power on.

Post service test

Print a configuration page to make sure that the printer is functioning correctly.

Step 1: Remove the USB cover (M552 and M553)

 **NOTE:** This step is for the M552 and M553 models. For the M577 models, skip this step and go to [Step 3: Remove the tray on page 1482](#).

1. Locate the USB cover.

Figure 1-2606 Locate the USB cover



2. Pull the cover off of the printer to remove it.

Figure 1-2607 Remove the cover



Step 2: Remove the control panel (M553x only)

 **NOTE:** This step is for the M553x model. For the M553n/dn, M552dn, and M577 models, skip this step and go to [Step 3: Remove the tray on page 1482](#).

1. Tilt the control panel up.

Figure 1-2608 Tilt the control panel up



2. Use a small flat-blade screwdriver to release the control-panel screws cover tabs.

Figure 1-2609 Release the control-panel screws cover tabs

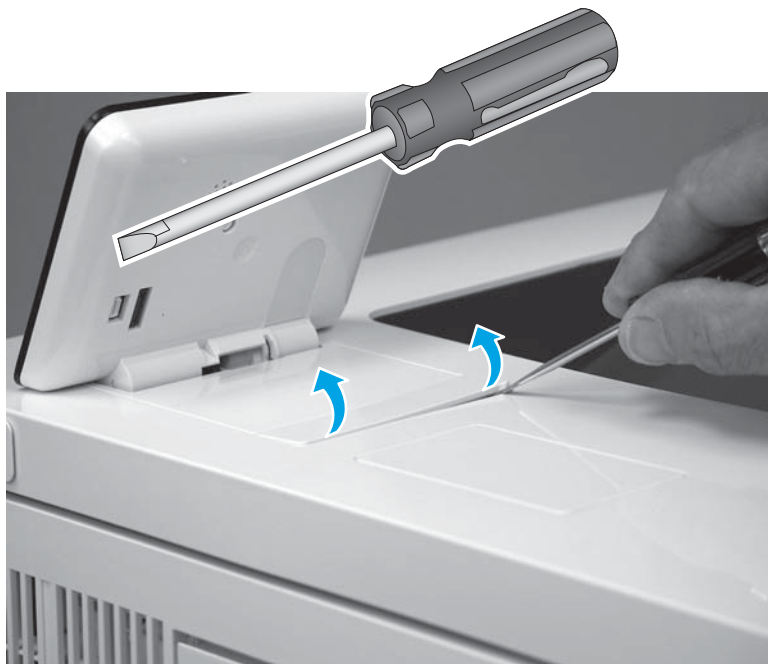

3. Rotate the cover up to remove it.

Figure 1-2610 Remove the cover

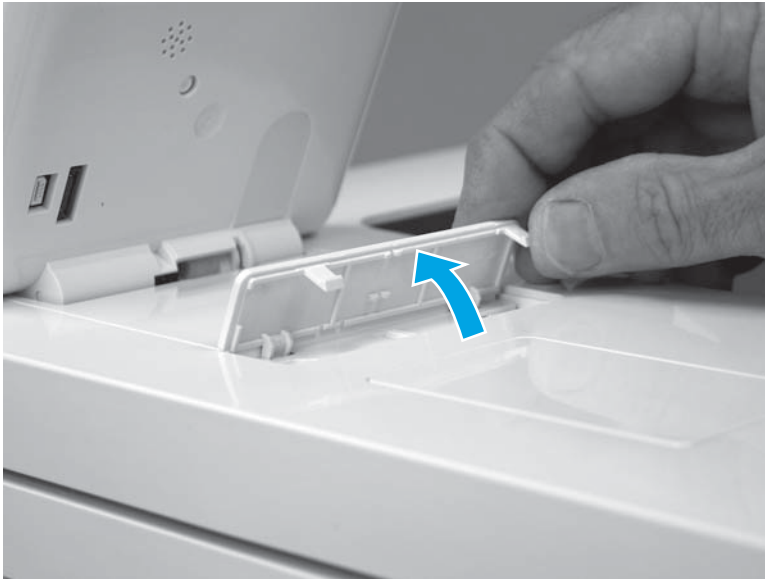

4. Use a small Phillips screwdriver to remove two screws (callout 1).

 **IMPORTANT:** Store the screws in a secure place where they cannot fall down into the printer.

Figure 1-2611 Remove two screws

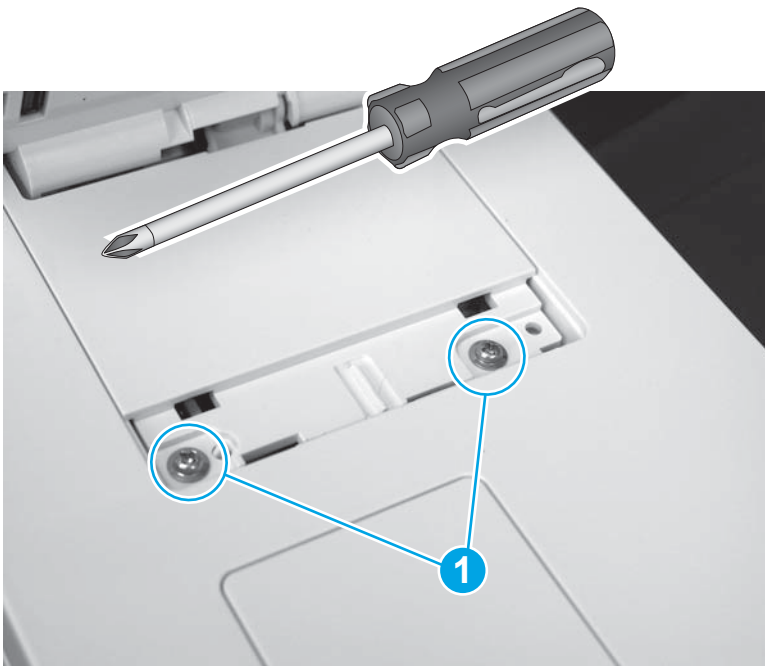

5. Rotate the control-panel base toward the front of the printer.

Figure 1-2612 Rotate the control-panel base up



6. Slightly slide the control-panel base toward the rear of the printer (callout 1) to release it, and then turn the control panel over (callout 2) to access the bottom side.

⚠ CAUTION: The control panel is still attached to the printer. Do not attempt to completely remove the control panel.

Figure 1-2613 Turn the control panel over

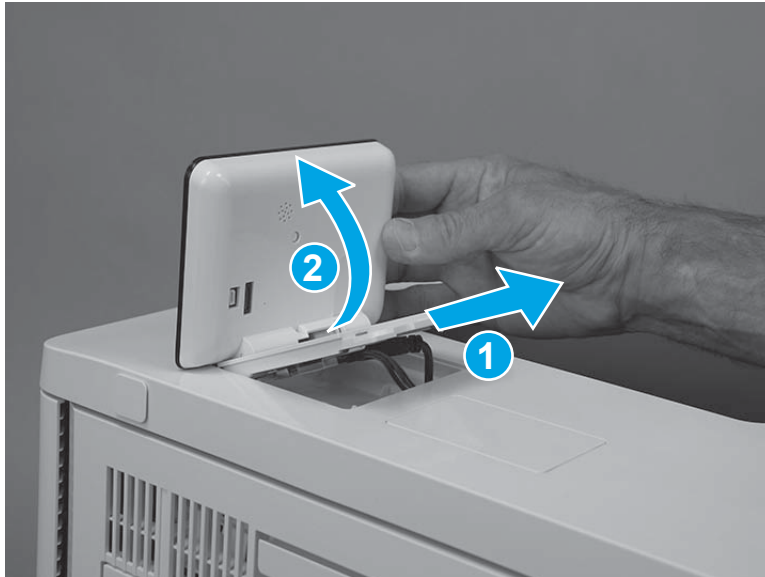

7. Disconnect one USB cable (callout 1), one connector (callout 2), and then remove the control panel.

Figure 1-2614 Disconnect two connectors

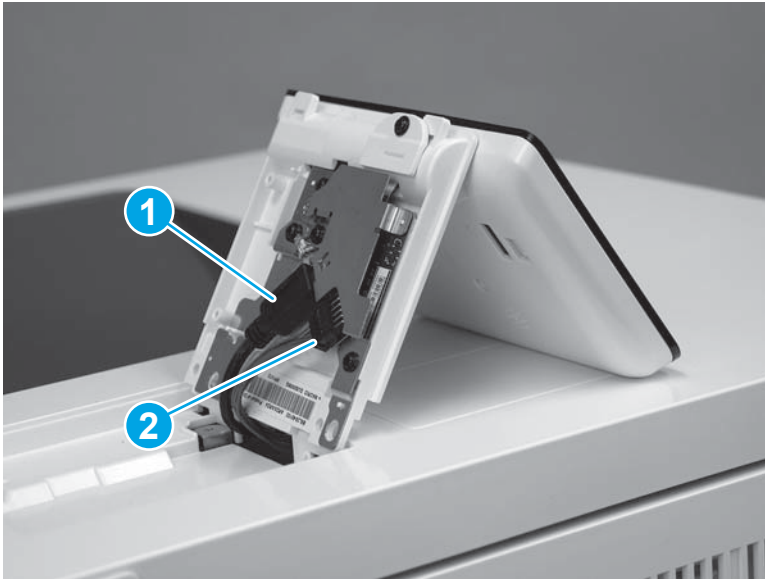

Step 3: Remove the tray

1. Pull the tray out until it stops.

Figure 1-2615 Pull the tray out



2. Lift the front of the tray, and then pull it out of the printer to remove it.

Figure 1-2616 Remove the tray

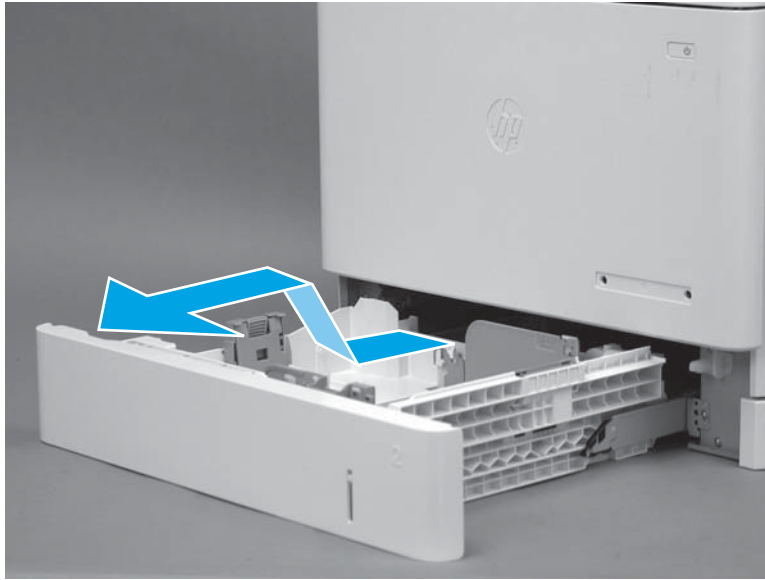

Step 4: Remove the toner collection unit (TCU)

1. Open the front door.

Figure 1-2617 Open the front door



2. Open the TCU.

 **NOTE:** The toner collection hatch cover automatically closes when the TCU is opened.

Figure 1-2618 Open the TCU



3. Pull the TCU away from the printer at an angle to remove it.

⚠ CAUTION: Do not open the toner collection hatch cover when handling the TCU. If toner gets on clothing, wipe it off by using a dry cloth and wash the clothes in cold water. Hot water sets toner into fabric.

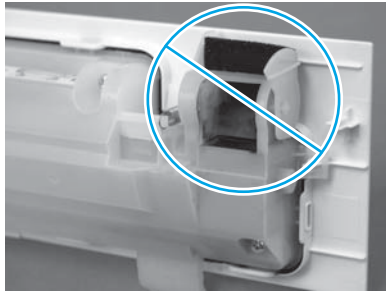
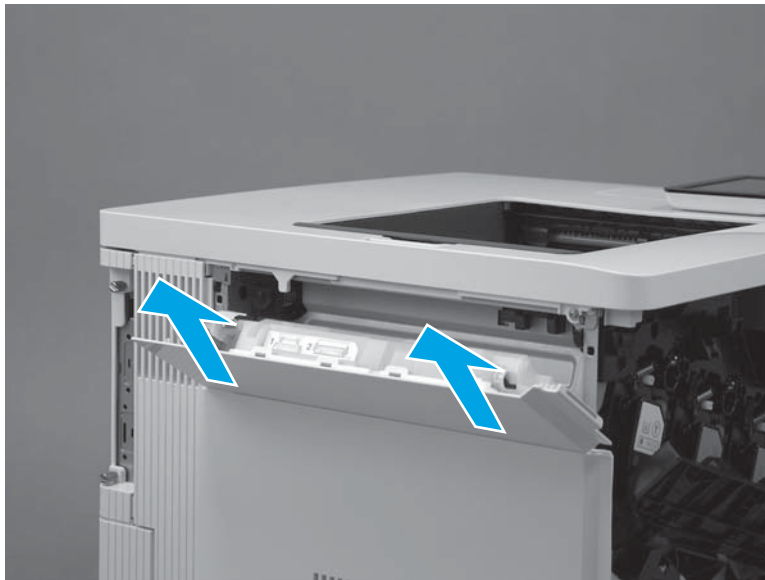

Figure 1-2619 Remove the TCU



Step 5: Remove the formatter cover

1. Locate the formatter cover.

Figure 1-2620 Locate the formatter cover

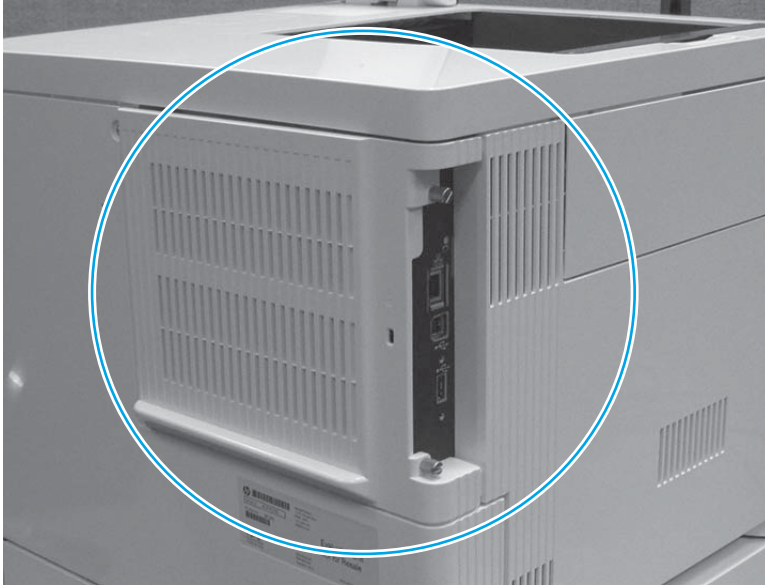

2. Loosen the two thumbscrews (callout 1). Grasp the two thumbscrews, and then slide the cover away from the printer (callout 2) to remove it.

 **TIP:** If needed, use the edge of a coin to turn the thumbscrews.

Figure 1-2621 Loosen the thumbscrews

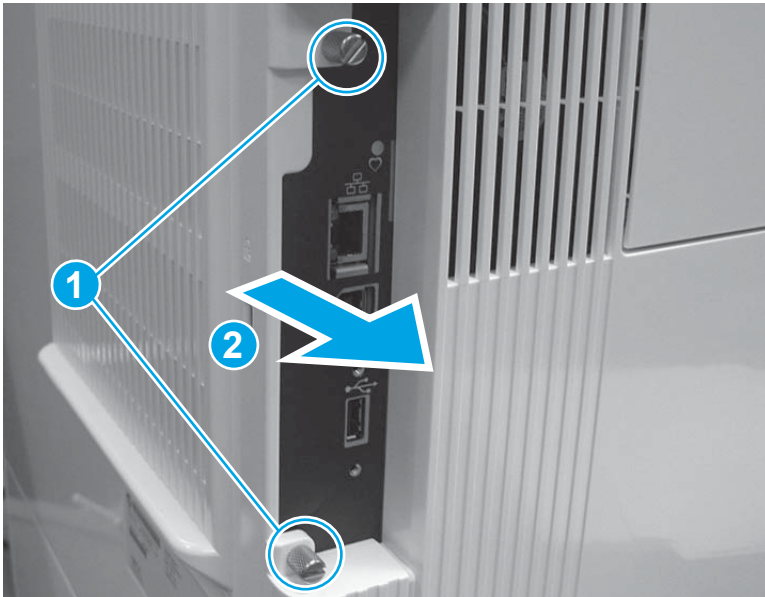

Step 6: Remove the formatter (M552 and M553)

 **NOTE:** This step is for the M552 and M553 models. For the M577 models, skip this step and go to [Step 7: Remove the hard-disk drive \(HDD\) \(M577\) on page 1488](#).

If the optional hard-disk drive (HDD) is installed, it must be removed to gain access to the formatter mounting screws.

Release two tabs along the left edge of the HDD, rotate the left edge away from the product, and then slide the HDD to the left to remove it.

 **CAUTION:**  ESD-sensitive part.

1. Disconnect all of the connectors on the formatter.

The following connectors are empty:

- All models: J1 (this connector is empty unless the optional DIMM is installed)
- M553n/dn and M552dn: J2 (callout 1; this is the touchscreen connector for the M553x model)
- All models: J9 (this connector is empty unless the optional internal USB ports component is installed)
- All models: J18 (this connector is empty unless the optional hard-disk-drive (HDD) is installed)
- All models: J23
- All models: J24
- M553n/dn and M552dn: J25 (this is the wireless connector for the M553x model)
- All models: J57
- All models: J98 (this connector is empty unless the optional trusted platform module (TPM) is installed)

 **IMPORTANT:** The flat-cable connector (callout 2) is a Zero Insertion Force (ZIF) connector that uses a hinged retainer to secure the flat cable. The hinged retainer must be opened to release the flat cable.

Figure 1-2622 Disconnect all connectors



2. Remove four screws (callout 1), and then remove the formatter.

Figure 1-2623 Remove the formatter

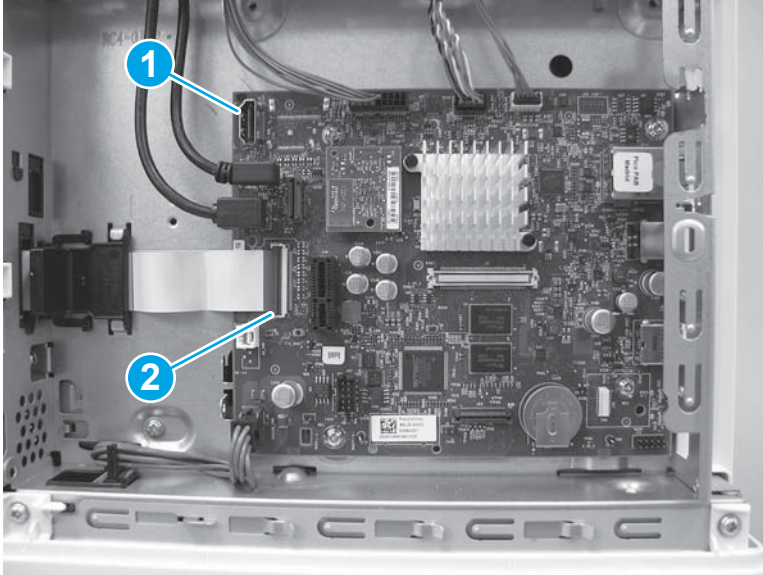
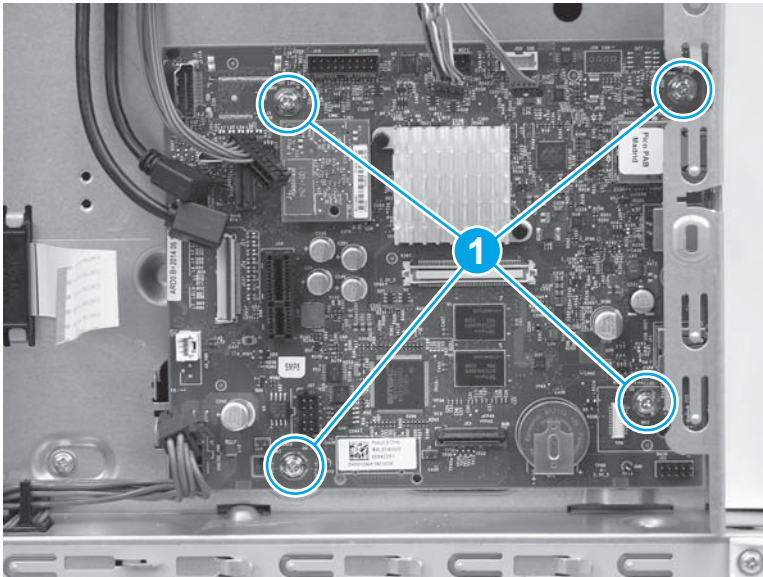

Step 7: Remove the hard-disk drive (HDD) (M577)

 **NOTE:** This step is for the M577 models. For the M552 and M553 models, skip this step and go to [Step 10: Remove the rear cover \(M552 and M553\) on page 1493](#).

 **CAUTION:**  ESD-sensitive part.

1. Release two tabs (callout 1). Hold the tabs in the released position, and then rotate the hard disk drive (HDD) up (callout 2) to release the connector from the formatter.

Figure 1-2624 Release the HDD

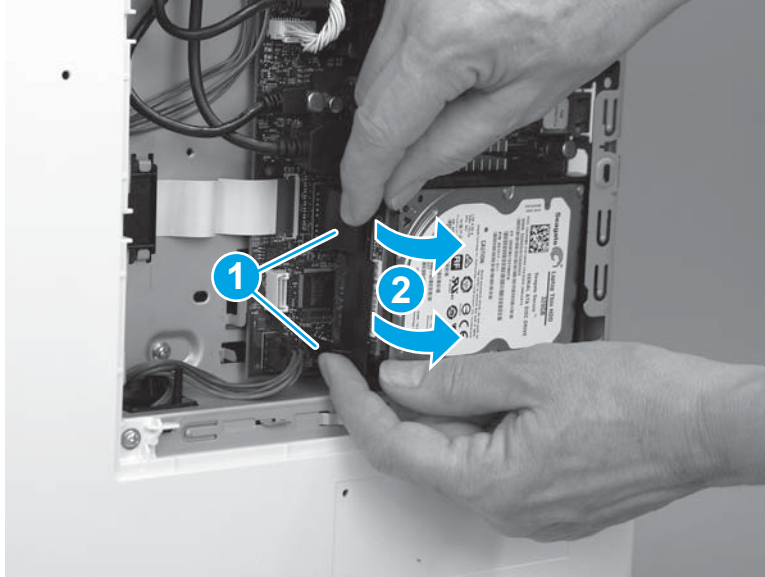

2. Slide the HDD away from the printer to remove it.

Figure 1-2625 Remove the HDD

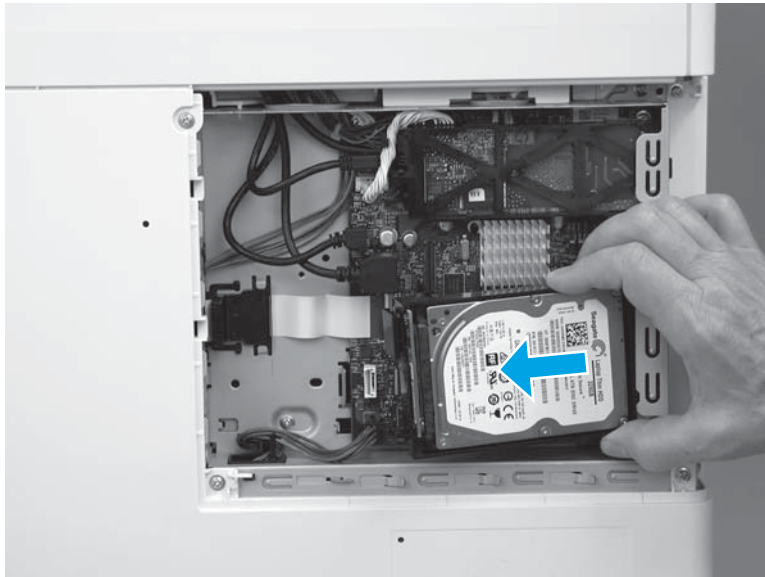

Step 8: Remove the fax PCA (M577c/f/z)

 **NOTE:** This step is for the M577c/f/z models. For the M577n model, skip this step and go to [Step 9: Remove the formatter \(M577\) on page 1491](#).

For the M552 and M553 models, skip this step and go to [Step 10: Remove the rear cover \(M552 and M553\) on page 1493](#).

 **CAUTION:**  ESD-sensitive part.

1. Locate the fax PCA component on the formatter.

Figure 1-2626 Locate the fax PCA

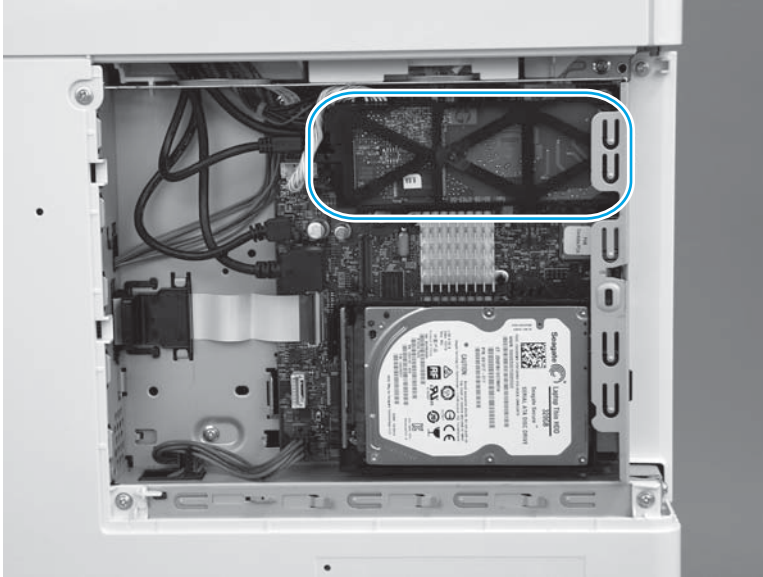

2. Release the connector latch (callout 1), and then pull the connector away from the formatter (callout 2) to disconnect it.

Figure 1-2627 Disconnect one connector

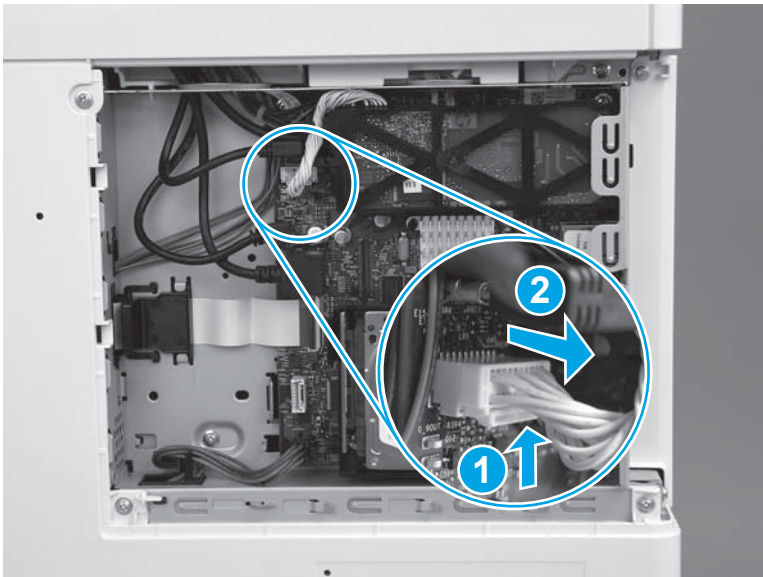

3. Release one retainer (callout 1) by pressing the bracket arms together.

Figure 1-2628 Release one latch

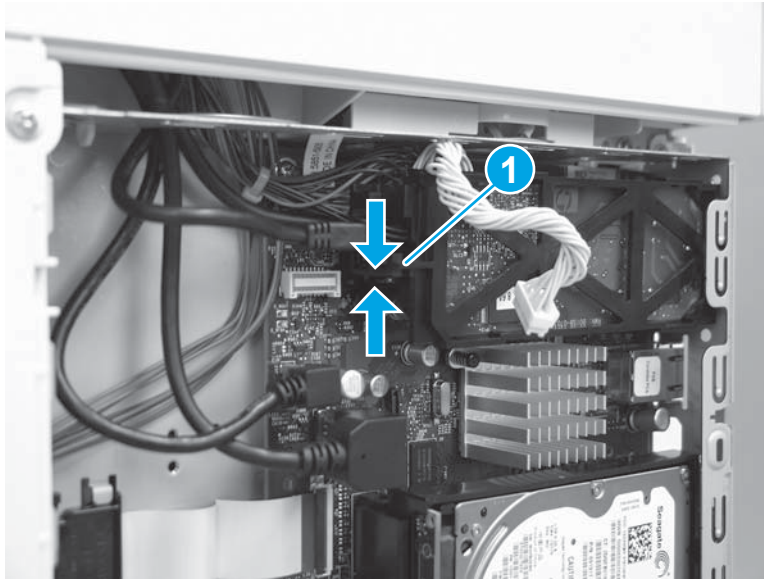

4. Rotate the end of the fax PCA (callout 1) away from the formatter, and then slide the PCA left (callout 2) to remove it.

Figure 1-2629 Remove the fax PCA

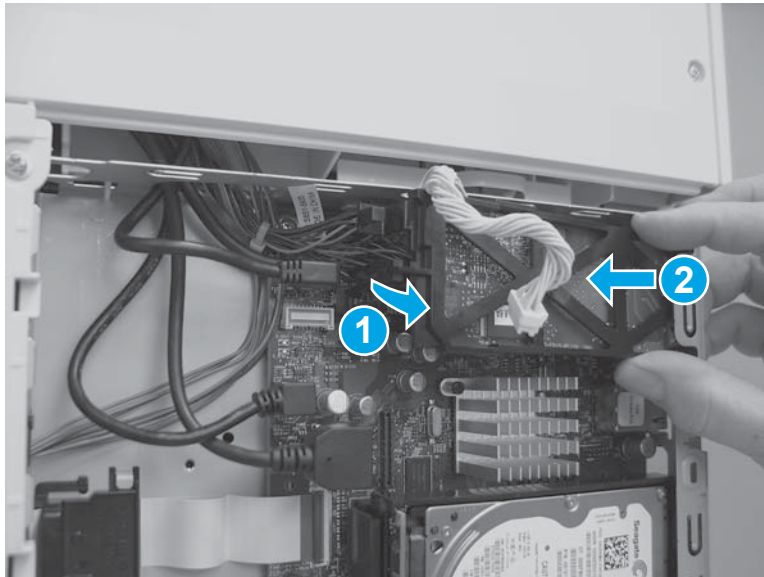

Step 9: Remove the formatter (M577)

 **NOTE:** This step is for the M577 models. For the M552 and M553 models, skip this step and go to [Step 10: Remove the rear cover \(M552 and M553\) on page 1493.](#)

 **CAUTION:**  ESD-sensitive part.

1. Disconnect all of the connectors on the formatter.

The following connectors are empty:

- All models: J1 (this connector is empty unless the optional DIMM is installed)
- All models: J3
- M577dn: J15 (this is the fax connector for the M577f/z/c models)
- All models: J21 (this connector is empty unless the optional internal USB ports component is installed)
- All models: J23
- All models: J24
- All models: J51
- All models: J57
- All models: J97
- All models: J98 (this connector is empty unless the optional trusted platform module (TPM) is installed)

 **IMPORTANT:** The flat-cable connector (callout 1) is a Zero Insertion Force (ZIF) connector that uses a hinged retainer to secure the flat cable. The hinged retainer must be opened to release the flat cable.

Figure 1-2630 Disconnect all connectors



2. Remove four screws (callout 1).

Figure 1-2631 Remove four screws

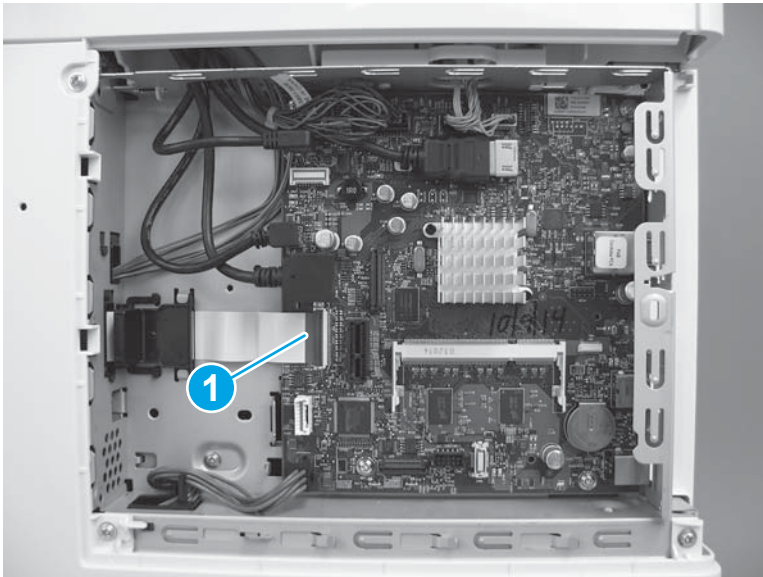
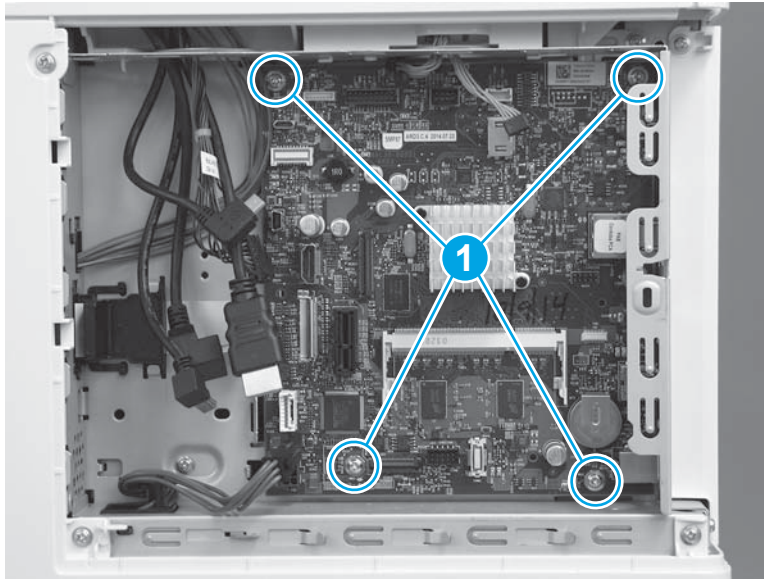

3. Remove the formatter.

Figure 1-2632 Remove the formatter

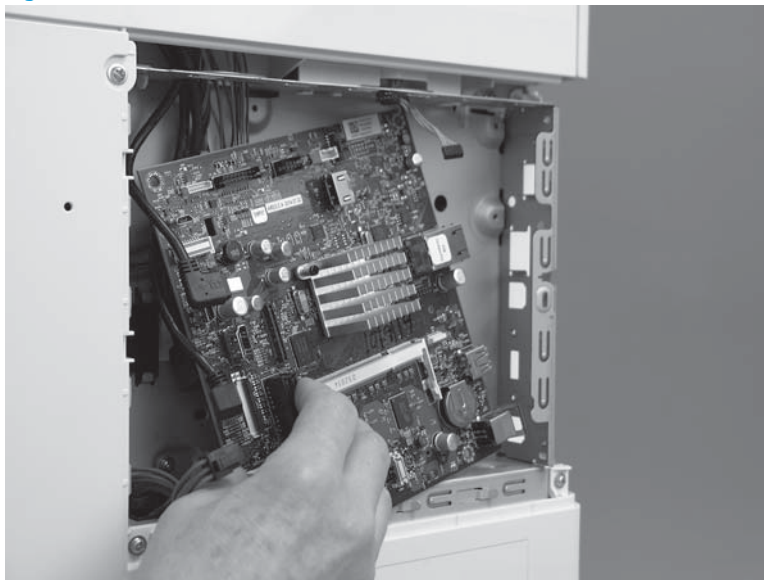

Step 10: Remove the rear cover (M552 and M553)

 **NOTE:** This step is for the M552 and M553 models. For the M577 models, skip this step and go to [Step 11: Remove the rear upper cover \(M577\) on page 1494.](#)

1. Remove four screws (callout 1).

Figure 1-2633 Remove four screws

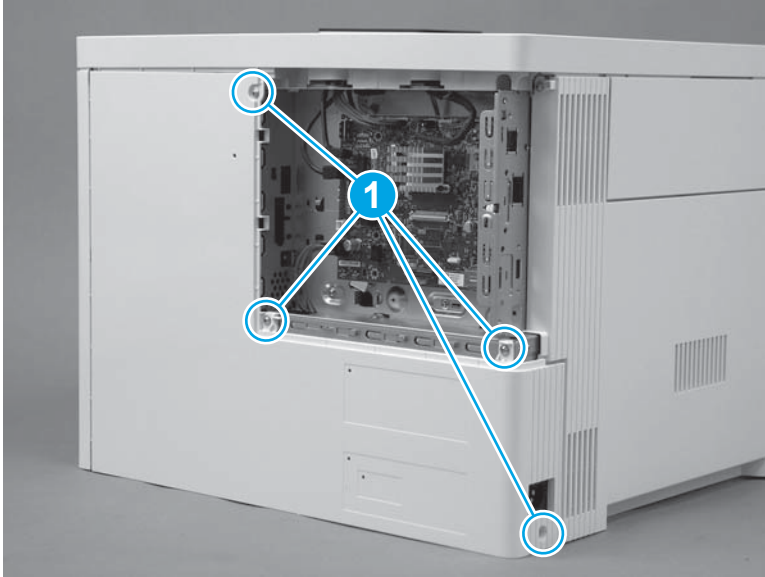

2. Slightly slide the cover to the right (callout 1), rotate the bottom of the cover away from the printer (callout 2), and then pull the top of the cover away from the printer (callout 3) to remove the cover.

Figure 1-2634 Remove the cover

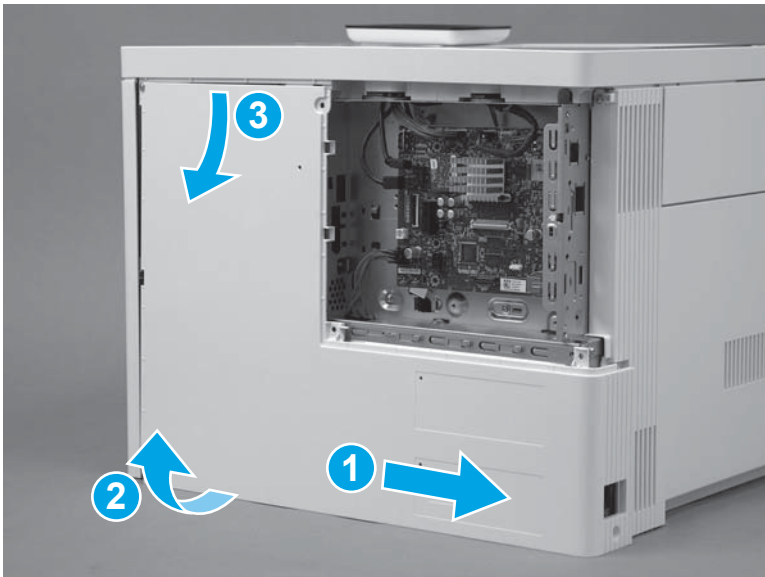

Step 11: Remove the rear upper cover (M577)

 **NOTE:** This step is for the M577 models. For the M552 and M553 models, skip this step and go to [Step 19: Remove the left cover on page 1509](#).

1. Remove two screws (callout 1).

 **Reinstallation tip:** These two screws are self-tapping screws for plastic. When reinstalling them, rotate the screws counterclockwise to align them with the existing thread pattern, and then carefully turn them clockwise to tighten. Do not overtighten. This will prevent stripping the threads inside the screw holes.

Figure 1-2635 Remove two screws



2. Use a small, flat blade screwdriver to release the right edge of the cover.

Figure 1-2636 Release the right edge

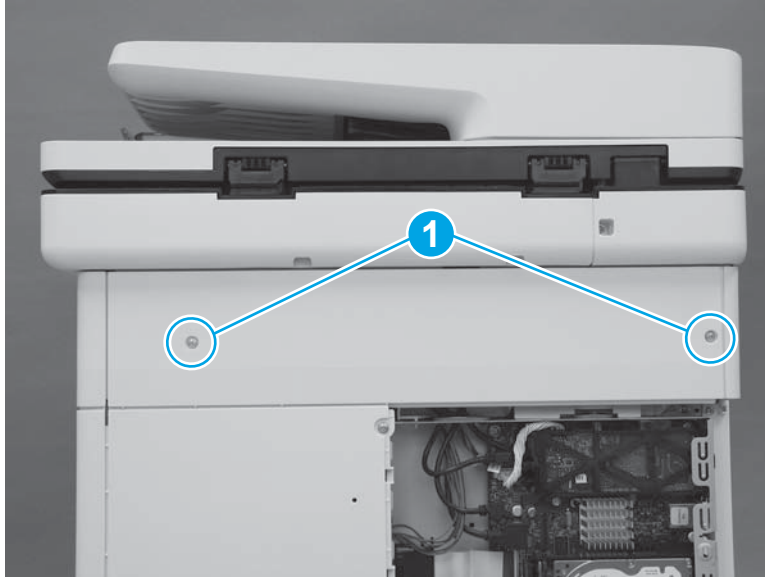
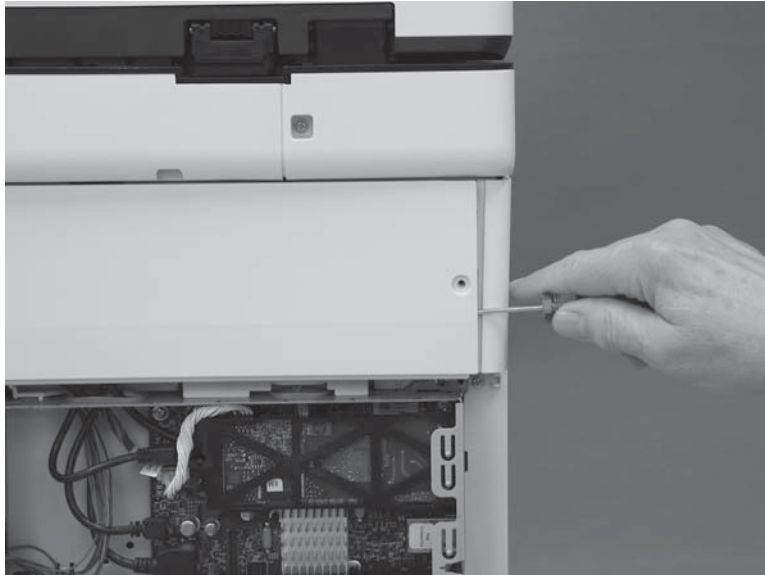

3. Pull the right edge of the cover (callout 1) away from the printer, and then slide the cover to the right (callout 2).

Figure 1-2637 Slide the cover right

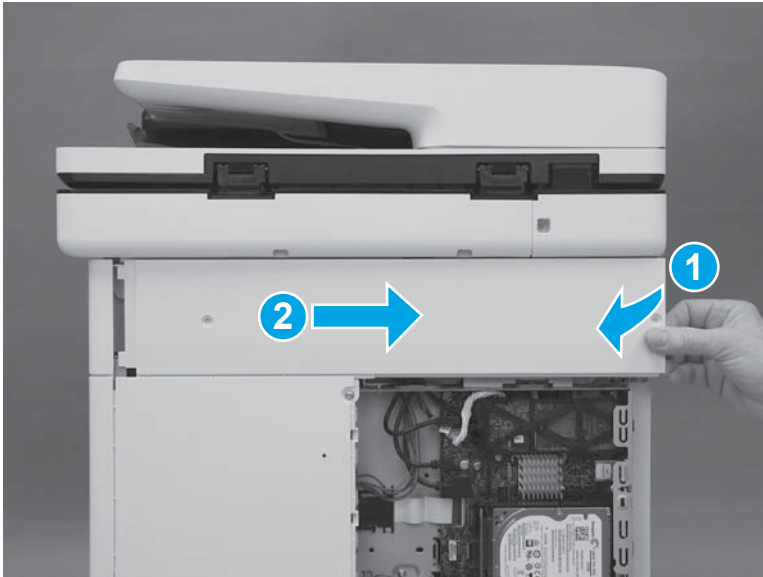

4. Remove the cover.

Figure 1-2638 Remove the cover

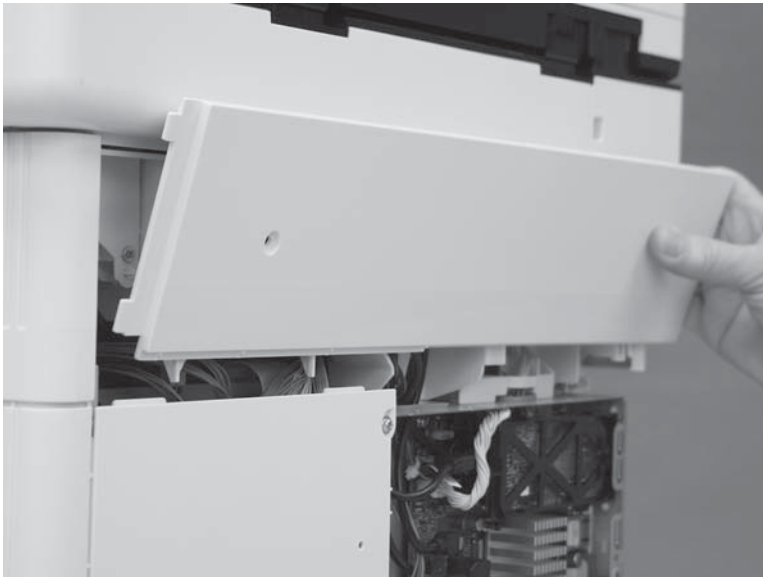

Step 12: Remove the rear cover (M577)

 **NOTE:** This step is for the M577 models. For the M552 and M553 models, skip this step and go to [Step 19: Remove the left cover on page 1509](#).

1. Remove four screws (callout 1).

Figure 1-2639 Remove four screws

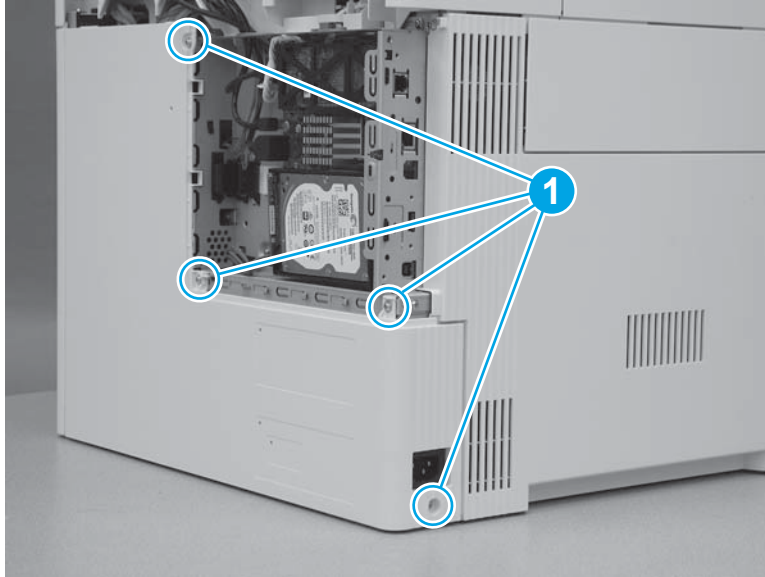

2. Slide the cover to the right to remove it.

Figure 1-2640 Remove the cover

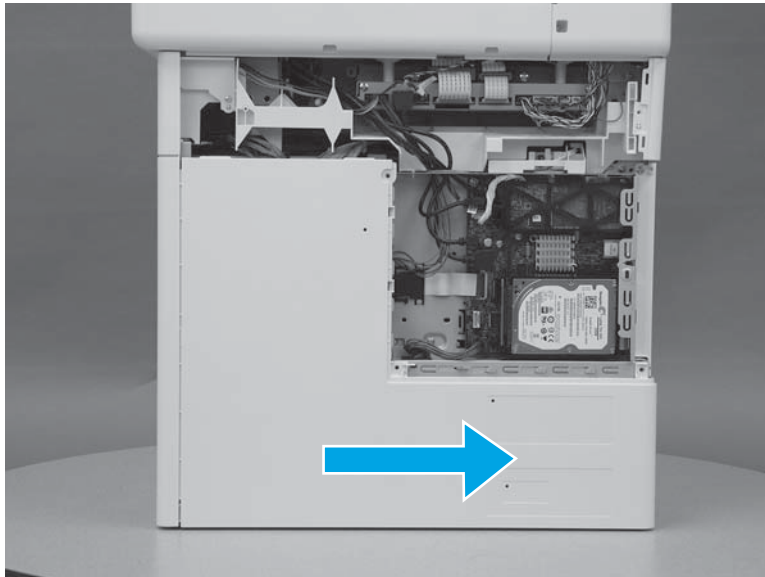

Step 13: Remove the left upper cover (M577)

 **NOTE:** This step is for the M577 models. For the M552 and M553 models, skip this step and go to [Step 19: Remove the left cover on page 1509](#).

1. At the left side of the printer, release one tab (callout 1).

Figure 1-2641 Release one tab

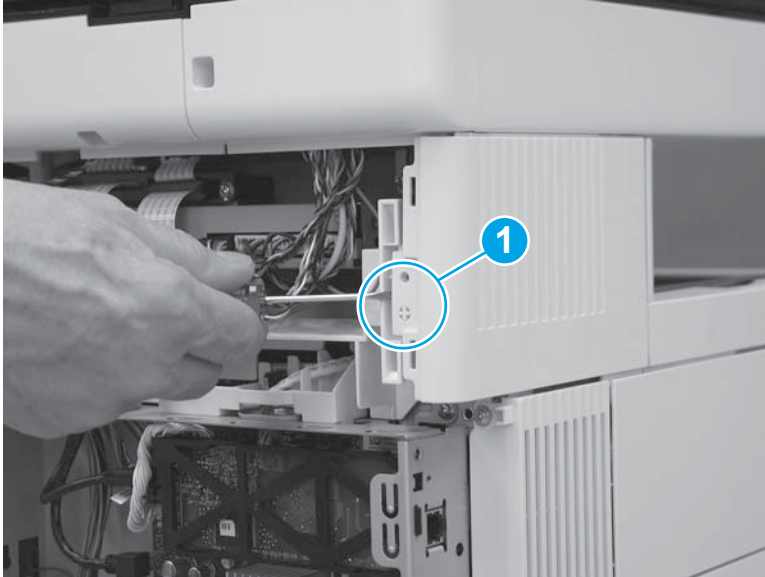

2. Slide the left upper cover toward the back of the printer.

Figure 1-2642 Slide the cover back

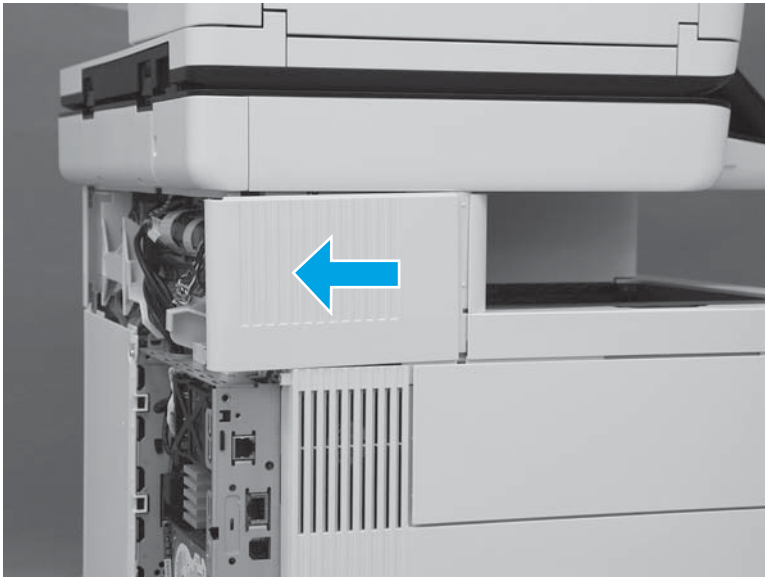

3. Rotate the cover up to remove it.

Figure 1-2643 Remove the left upper cover



Step 14: Remove the right front upper cover (M577dn)

 **NOTE:** This step is for the M577dn model. For the M577c/f/z models, skip this step and to go [Step 15: Remove the stapler cover assembly \(M577c/f/z\) on page 1500](#).

For the M552 and M553 models, skip this step and go to [Step 19: Remove the left cover on page 1509](#).

1. Remove one screw (callout 1).

Figure 1-2644 Remove one screw

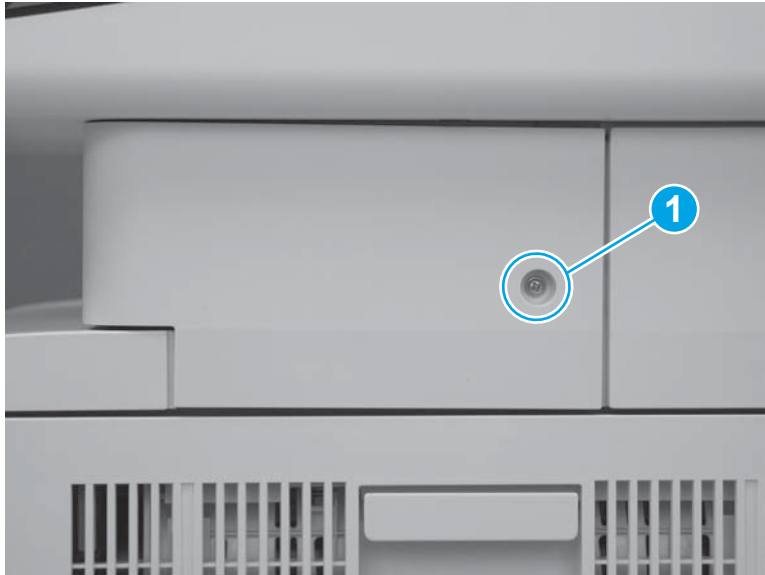

2. Release two tabs at the front edge of the cover (callout 1).

Figure 1-2645 Release two tabs



3. Rotate the front of the cover to the right to remove it.

Figure 1-2646 Rotate the cover



Step 15: Remove the stapler cover assembly (M577c/f/z)

 **NOTE:** This step is for the M577c/f/z models. For the M577dn model, skip this step and go to [Step 17: Remove the right upper cover \(M577\) on page 1505](#).

For the M552 and M553 models, skip this step and go to [Step 19: Remove the left cover on page 1509](#).

1. Remove one screw (callout 1).

 **Reinstallation tip:** This is a self-tapping screw for plastic. When reinstalling, rotate the screw counterclockwise to align it with the existing thread pattern, and then carefully turn it clockwise to tighten. Do not overtighten. This will prevent stripping the threads inside the screw hole.

Figure 1-2647 Remove one screw



2. Release two tabs at the front edge of the cover (callout 1).

Figure 1-2648 Release two tabs

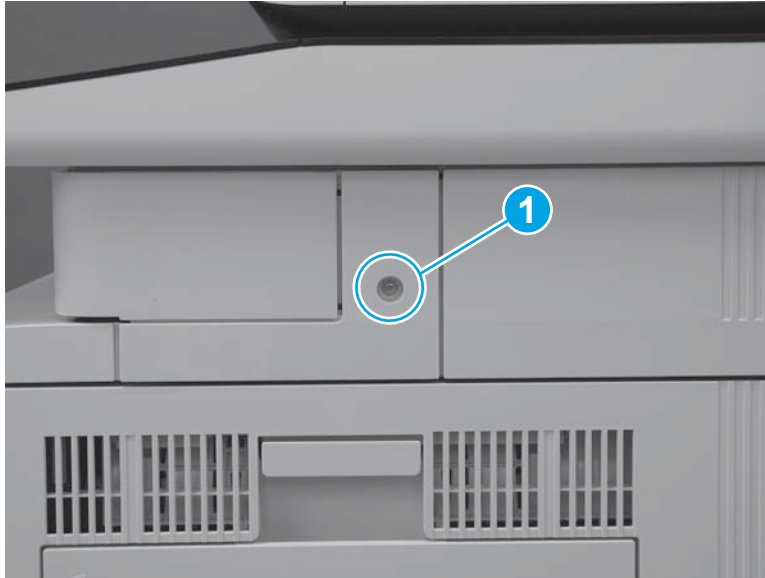

3. Release the back edge of the cover.

Figure 1-2649 Release the back edge of the cover

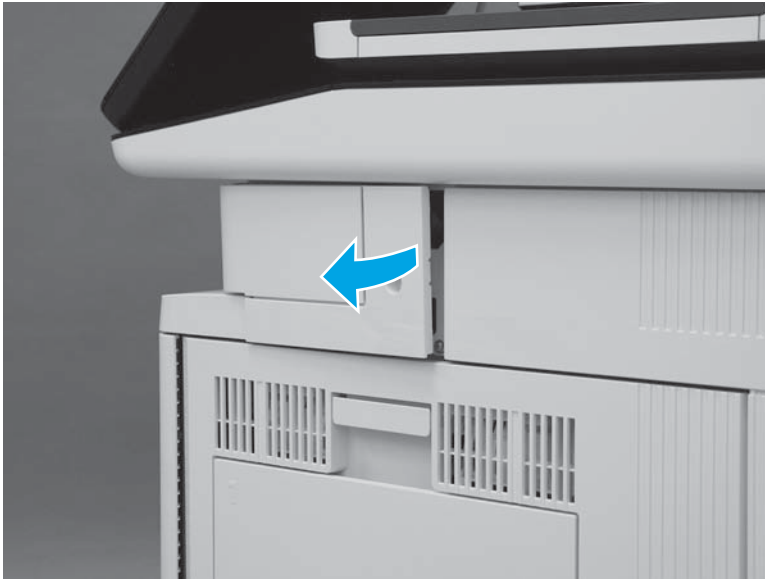



4. Rotate the cover away from the printer to remove it.

Figure 1-2650 Remove the cover



Step 16: Remove the integrated scanner assembly (ISA) (M577)

 **NOTE:** This step is for the M577 models. For the M552 and M553 models, skip this step and go to [Step 19: Remove the left cover on page 1509](#).

 **NOTE:** The ISA includes the document feeder, image scanner, scanner control board (SCB), control panel, keyboard (M577c/z) and NFC PCA (M577z).

1. At the left side of the printer, remove one screw (callout 1).

Figure 1-2651 Remove one screw

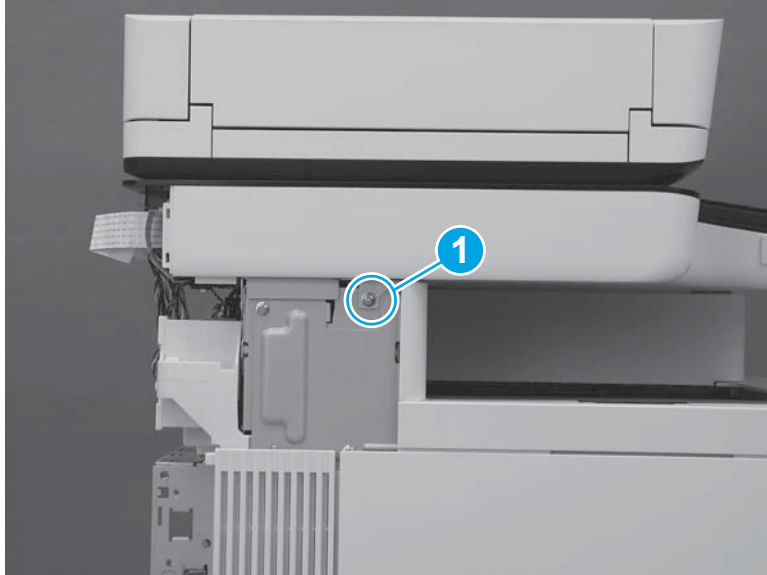

2. At the back side of the printer, remove two screws (callout 1).

Figure 1-2652 Remove two screws

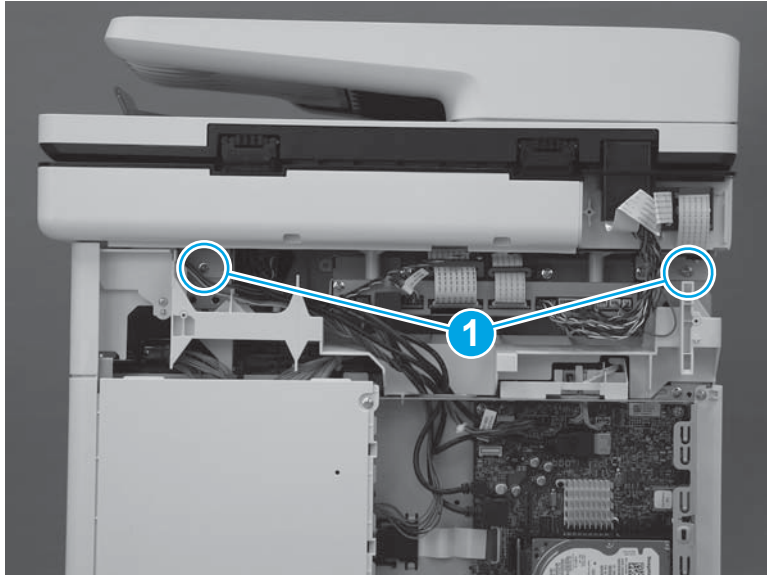

3. At the right side of the printer, remove one screw (callout 1).

Figure 1-2653 Remove one screw

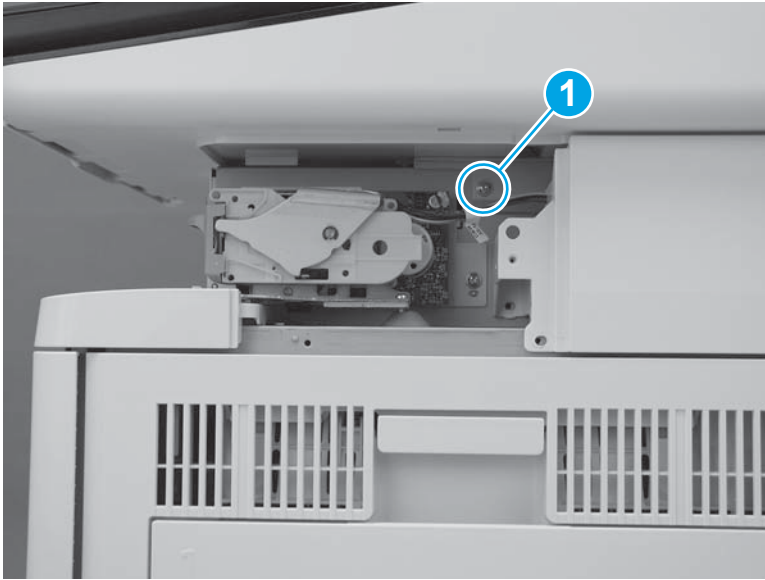

4. Disconnect two connectors on the scanner control board (callout 1).

M577c/f/z only: Disconnect one connector for the stapler on the scanner control board (callout 2).

Figure 1-2654 Disconnect connectors

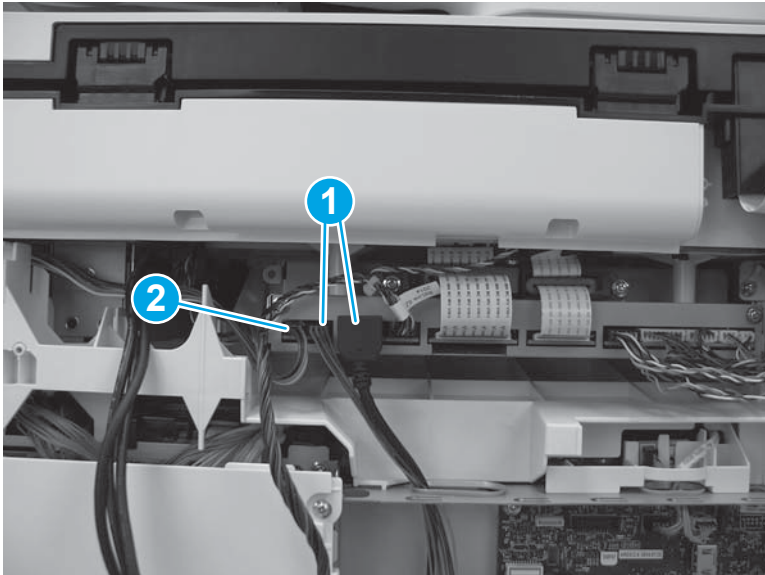

5. Slightly slide the ISA towards the back of the printer to release it.

Figure 1-2655 Slide the ISA towards the back of the printer

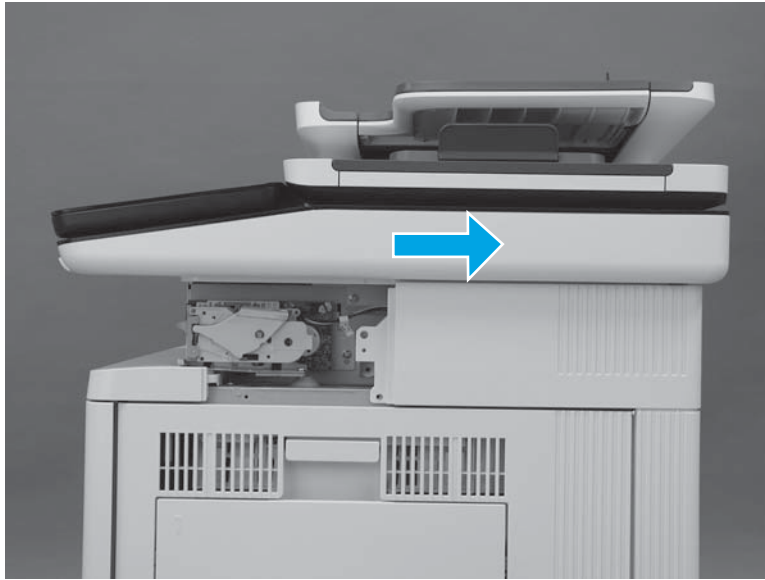

6. Lift the ISA up to remove it.

 **NOTE:** When lifting the ISA, carefully pass the cables through the opening in the top of the formatter case.

Figure 1-2656 Remove the ISA

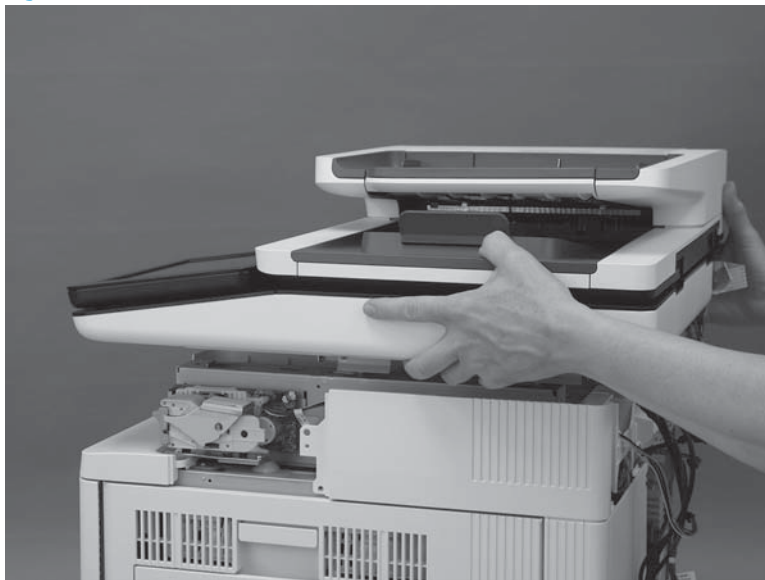

Step 17: Remove the right upper cover (M577)

 **NOTE:** This step is for the M577 models. For the M552 and M553 models, skip this step and go to [Step 19: Remove the left cover on page 1509](#).

 **NOTE:** The figures below show the image scanner installed. The procedures for removing and installing the right upper cover are the same whether the image scanner is installed or removed."

1. At the right side of the printer, remove two screws (callout 1).

M577c/f/z only: Disconnect one connector (callout 2), if it was not already disconnected in a previous step.

Figure 1-2657 Remove two screws and one connector

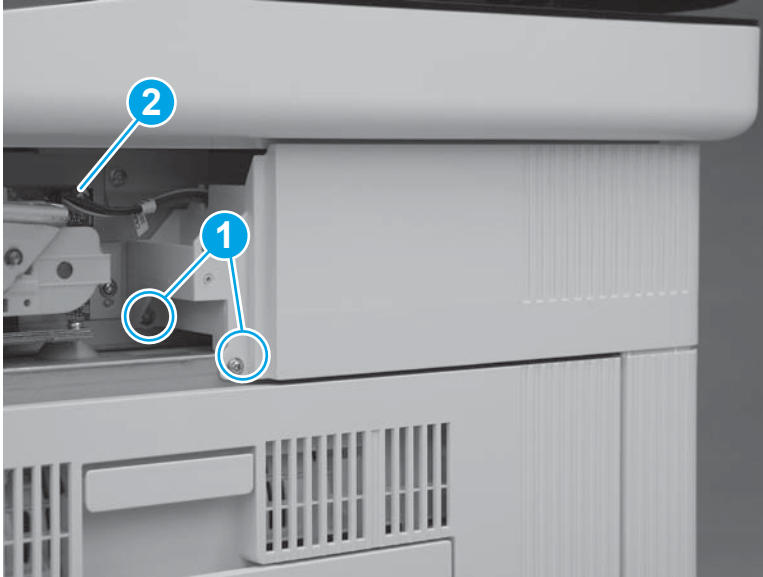

2. At the back of the printer, remove one screw (callout 1).

M577c/f/z only: Disconnect one connector (callout 2), if it was not already disconnected in a previous step.

 **Reinstallation tip:** This screw is smaller than the screws removed in the previous step. When reinstalling the right upper cover, make sure that this screw is installed in the correct position.

Figure 1-2658 Remove one screw and connector

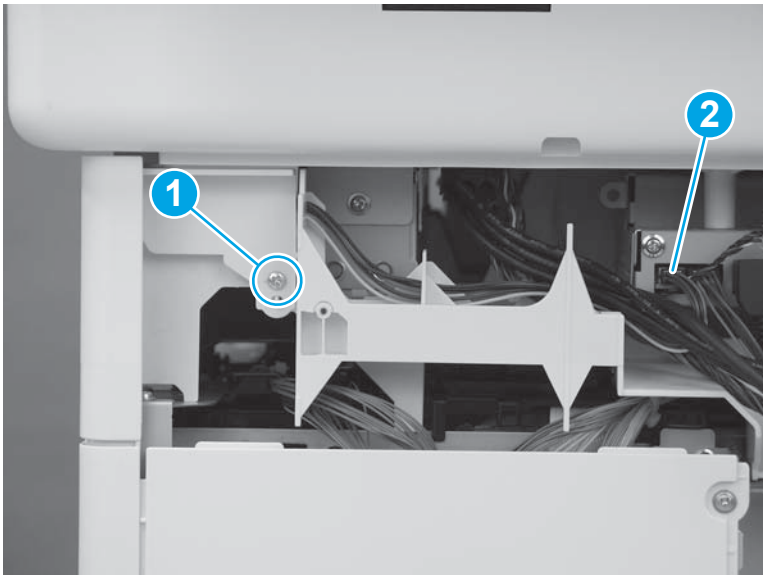

3. Slide the cover toward the back of the printer.

Figure 1-2659 Slide the cover

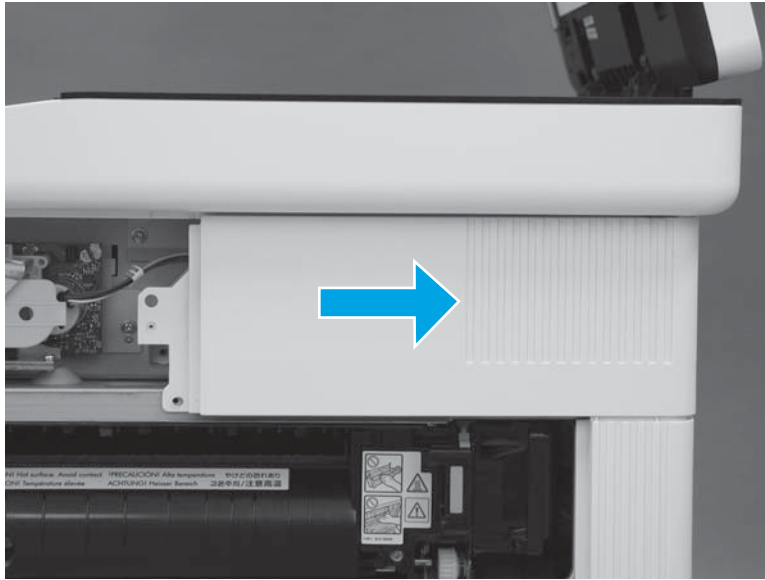

4. Lift the cover away from the printer to remove it.

M577c/f/z only: Release the cables (callout 1) through the slot (callout 2) in the printer.

Figure 1-2660 Remove the cover

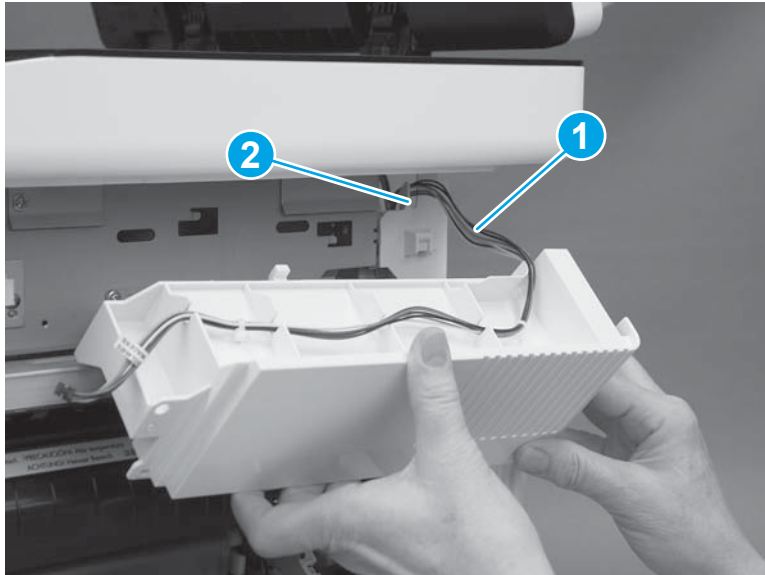

Step 18: Remove the top rear cover (M577)

 **NOTE:** This step is for the M577 models. For the M552 and M553 models, skip this step and go to [Step 19: Remove the left cover on page 1509](#).

1. At the top of the printer, remove five screws (callout 1).

Figure 1-2661 Remove five screws

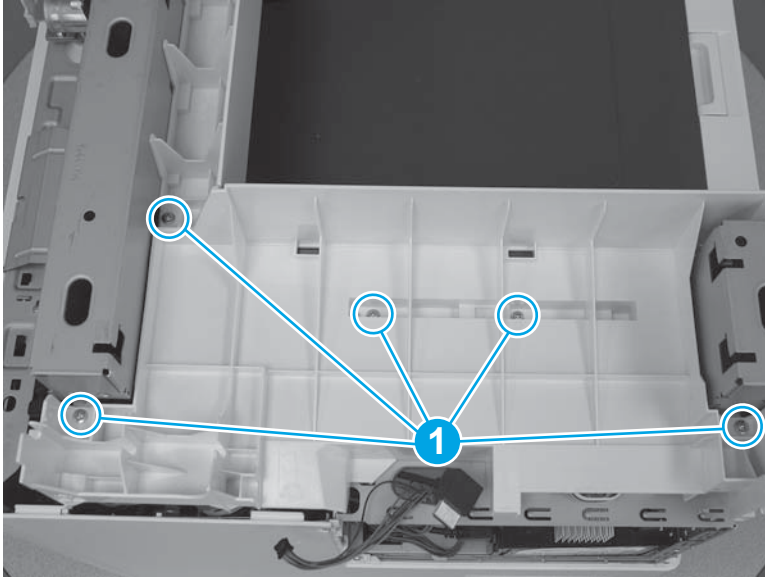

2. Release two tabs (callout 1) on the front edge of the cover.

Figure 1-2662 Release two tabs

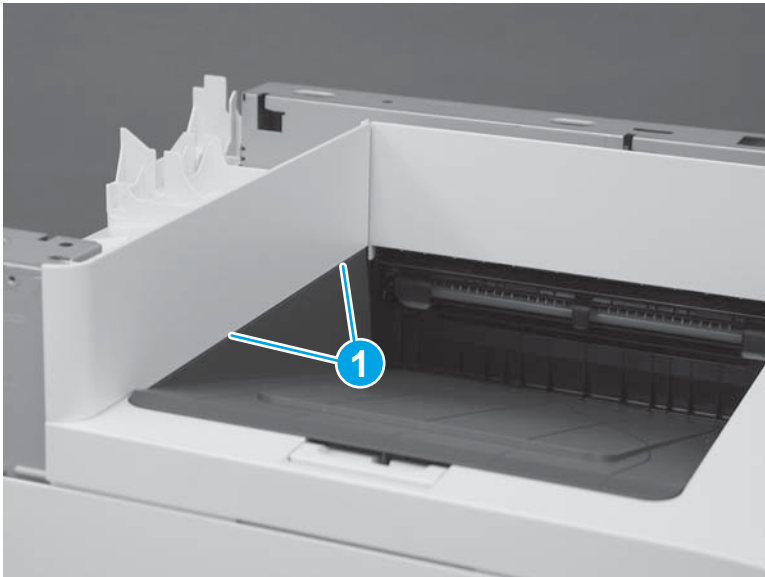

3. Remove the top rear cover.

Figure 1-2663 Remove the top rear cover

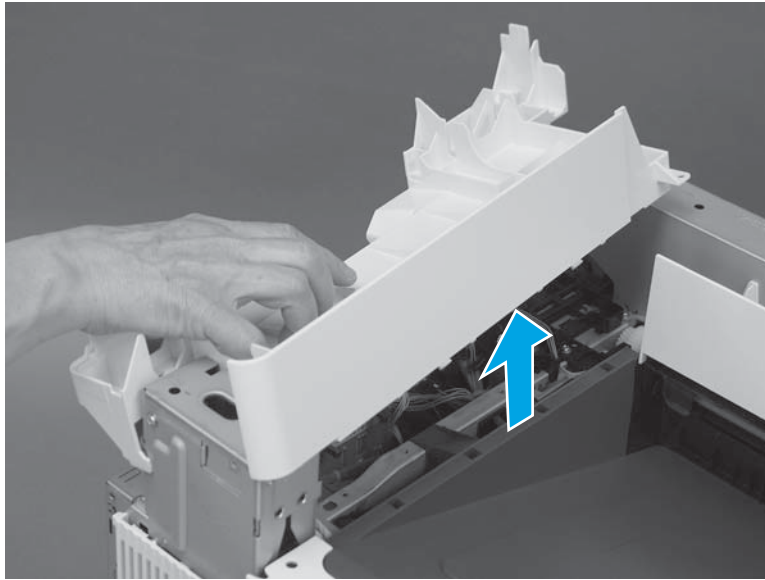

Step 19: Remove the left cover

1. At the left side of the printer, remove one screw (callout 1).

Figure 1-2664 Remove one screw



2. Release one tab (callout 1), rotate the front edge of the cover away from the printer (callout 2), and then slide the cover (callout 3) toward the rear of the printer to release it.

Figure 1-2665 Release the cover

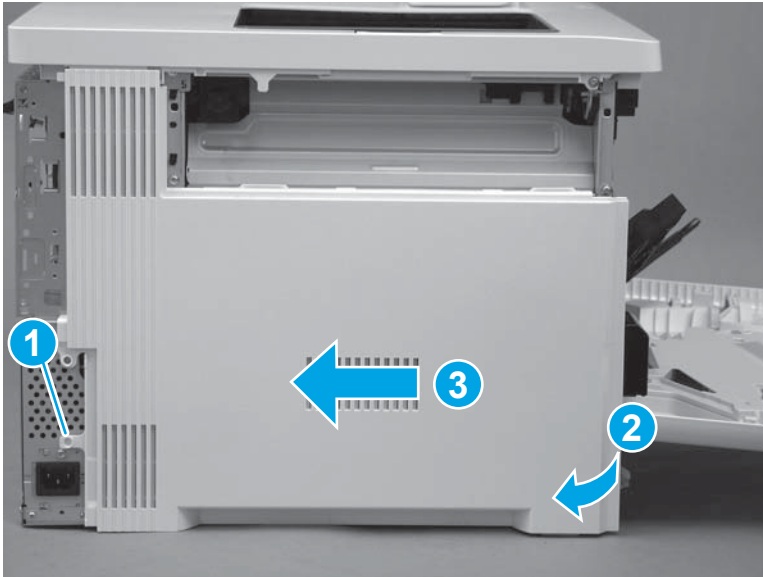

3. Remove the cover.

Figure 1-2666 Remove the cover

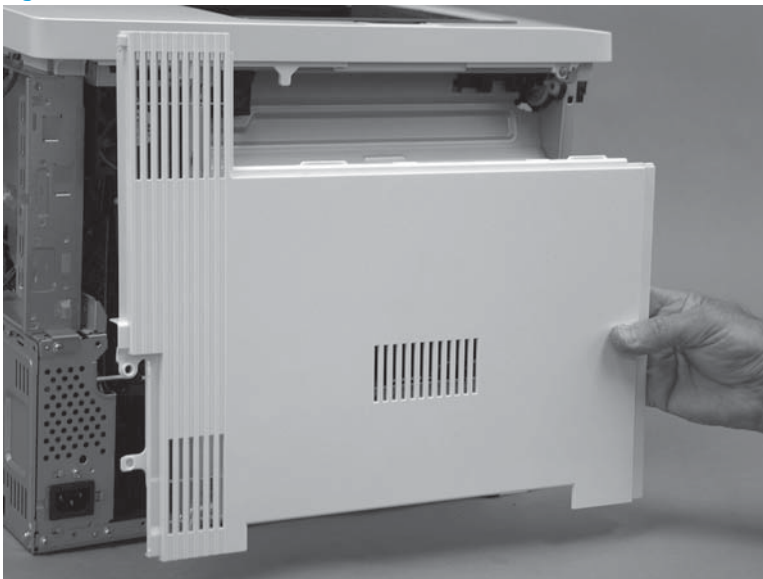

Step 20: Remove the upper cover (M552 and M553)

 **NOTE:** This step is for the M552 and M553 models. For the M577 models, skip this step and go to [Step 21: Remove the formatter case on page 1512.](#)

1. Remove three screws (callout 1).

Figure 1-2667 Remove three screws

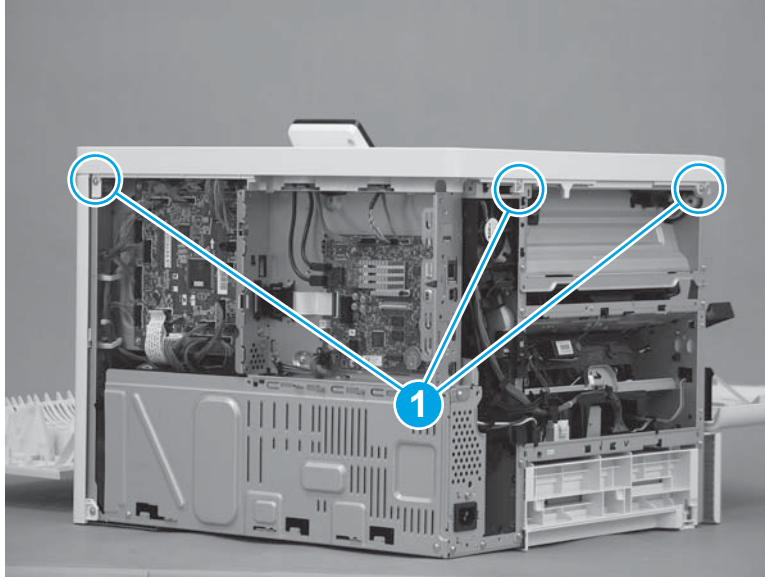

2. Remove one screw (callout 1), release one tab (callout 2), and then slightly separate the corner of the cover from the chassis.

 **NOTE:** This is a self-tapping plastic-thread screw. Make sure that this screw is used in this location when it is reinstalled.

Figure 1-2668 Remove one screw and release one tab



3. Release one tab (callout 1), and then lift up on the cover to release it.

 **NOTE:** If the cover does not release, check for addition tabs by locating the triangles embossed in the cover at tab locations.

Figure 1-2669 Release the cover



4. Remove the cover.

Figure 1-2670 Remove the cover

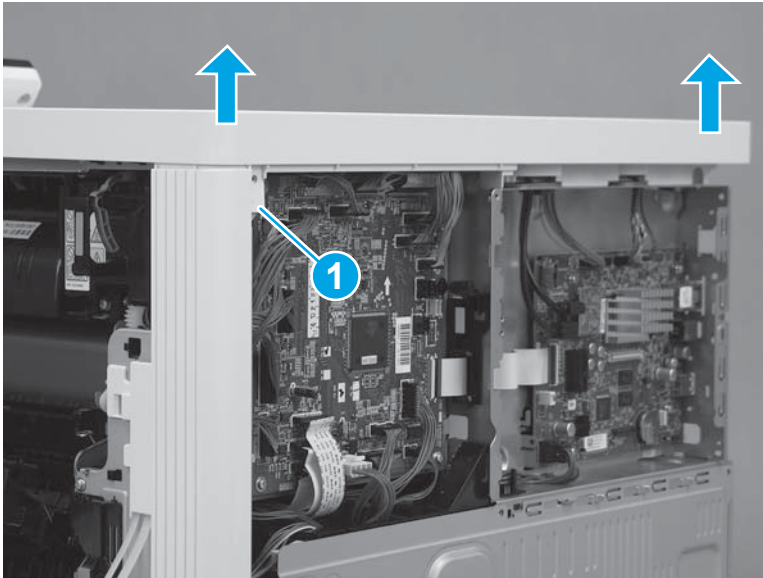
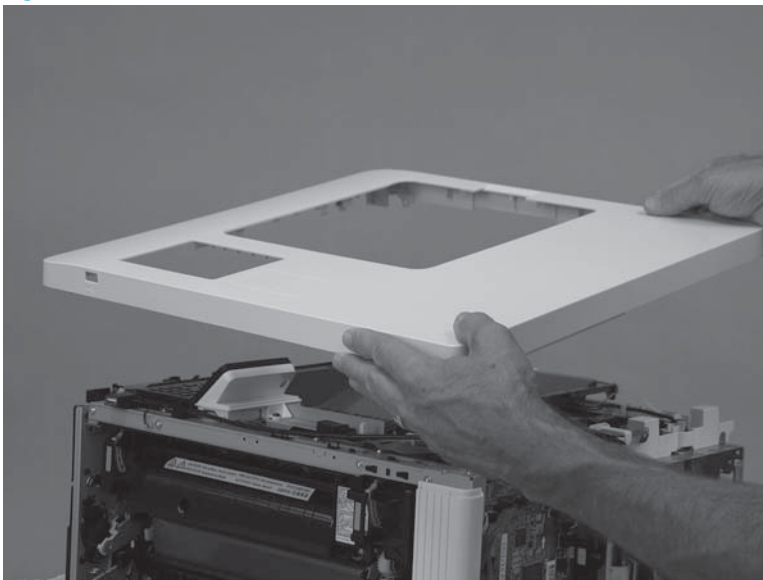

Step 21: Remove the formatter case

1. **M577 only:** Disconnect one connector (callout 1), and then pass the wire harness (callout 2) through two openings in the formatter case (callout 3).

Figure 1-2671 Disconnect one connector

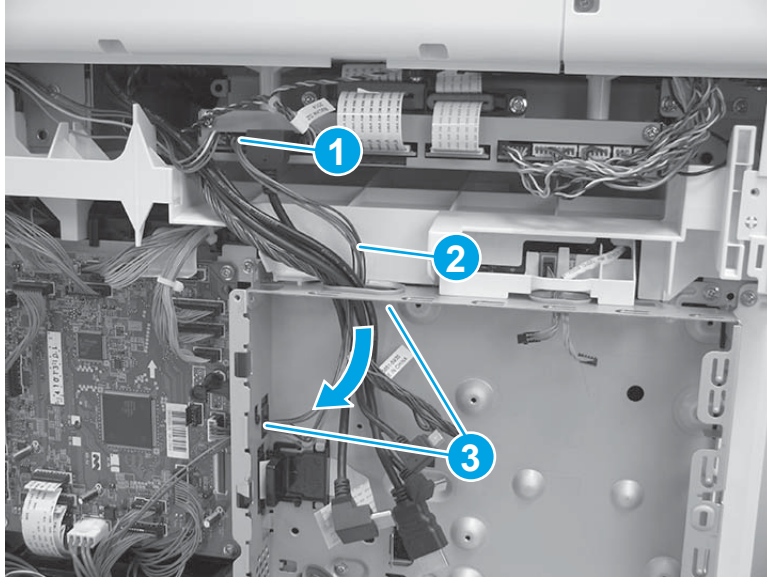

2. Release two tabs (callout 1) on the black plastic bracket. Hold the tabs in the released position, and then slide the bracket (callout 2) to the right to remove it from the formatter case.

Figure 1-2672 Remove the bracket

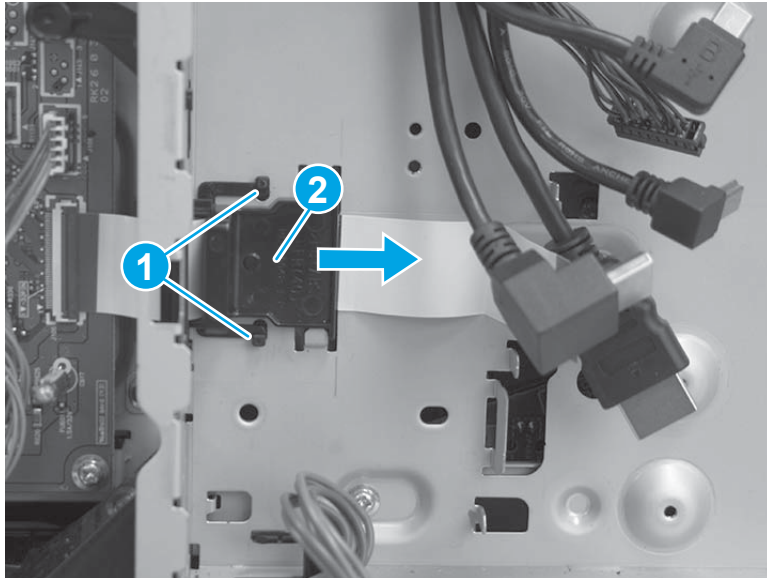

3. Remove two screws (callout 1), and then slide the low-voltage power supply (LVPS) cover to the right to remove it.

Figure 1-2673 Remove the LVPS cover

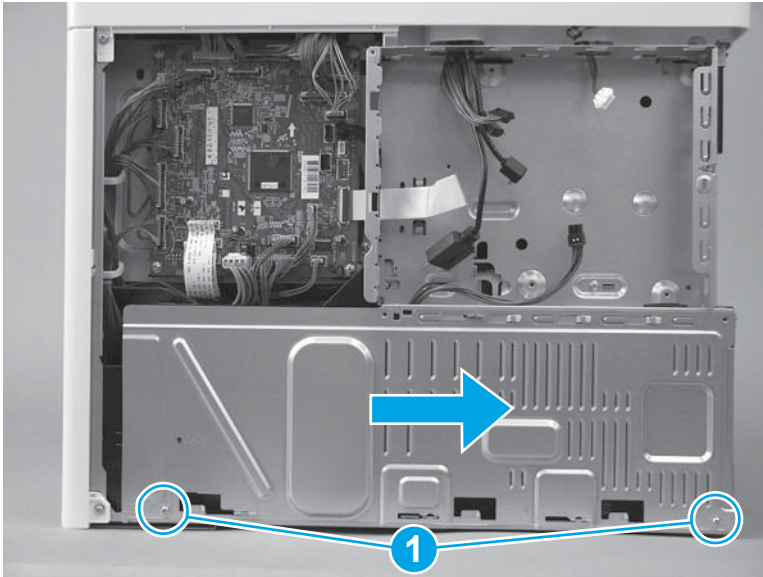

4. Pass two wire harnesses and one flat cable (callout 1) through the opening in the formatter case, and then release one wire harness from the retainer (callout 2).

CAUTION: The flat cable might be attached to the formatter case with double-sided tape. Make sure that this tape is released, so that the flat cable is not damaged when the formatter case is removed.

Figure 1-2674 Release wire harnesses and flat cable

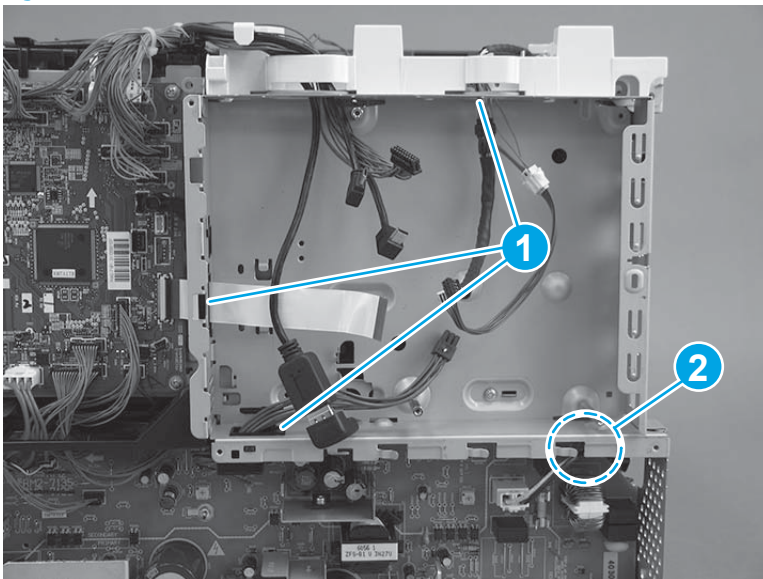

5. Remove six screws (callout 1).

Figure 1-2675 Remove six screws

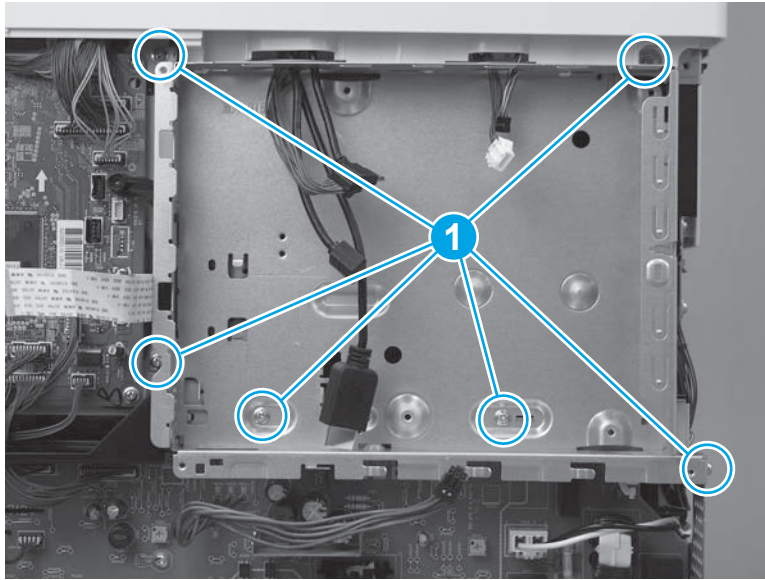

6. Rotate the bottom of the formatter case away from the printer (callout 1), and then pull it down (callout 2) to release it.

Figure 1-2676 Release the formatter case

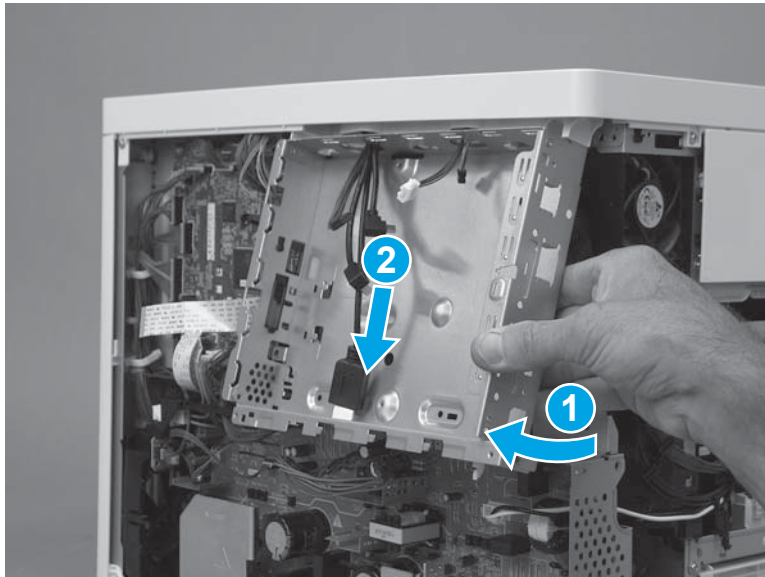

7. Pass the wire harnesses through the opening in the formatter case to remove it.

 **IMPORTANT:** If the formatter case is removed so that it can be replaced, make sure to transfer the memory PCA (island of data) and plastic bracket (callout 1) to the replacement case.

Figure 1-2677 Remove the formatter case



Step 22: Remove the right rear cover

1. Remove one screw (callout 1), and then slide the cover toward the rear of the printer (callout 2) to release it.

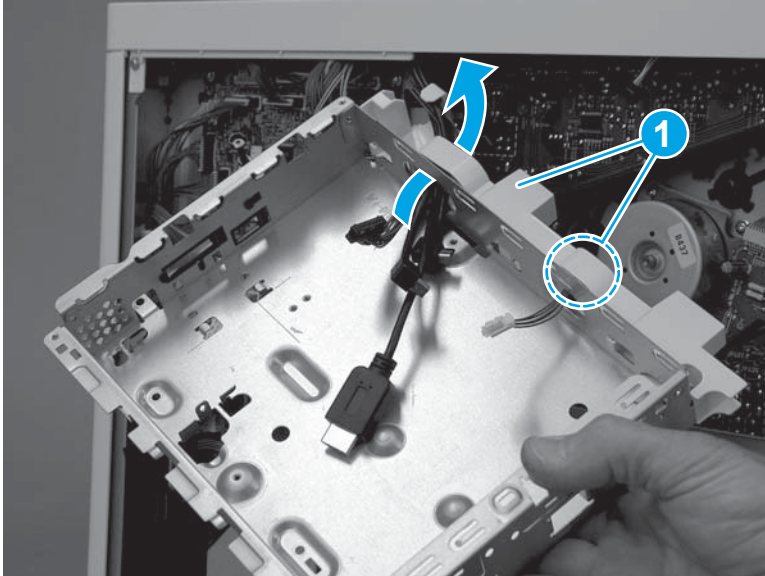
 **TIP:** If the right door is closed, open it now.

Figure 1-2678 Release the cover



2. Remove the cover.

Figure 1-2679 Remove the cover

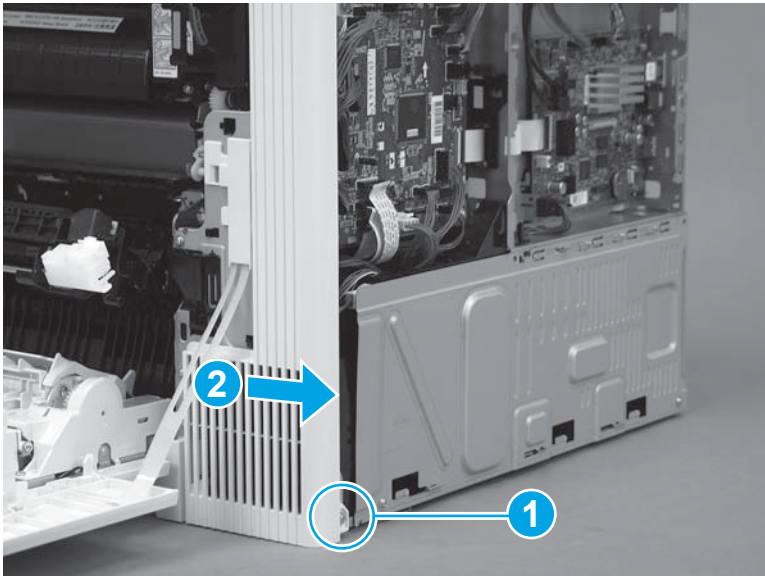
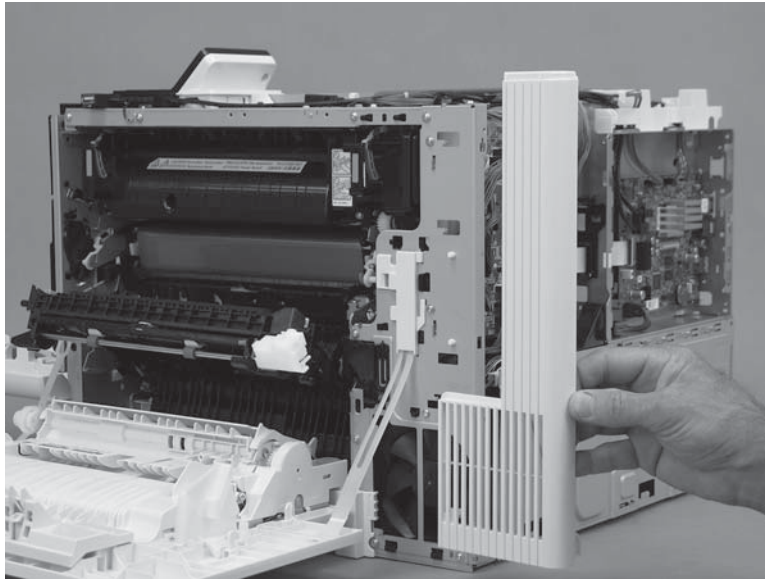

Step 23: Remove the DC controller and sheet-metal bracket

 **CAUTION:**  ESD sensitive part.

1. Disconnect all of the connectors, and then remove two screws (callout 1).

The following connectors are empty:

- J140, J141, and J143

Figure 1-2680 Remove two screws

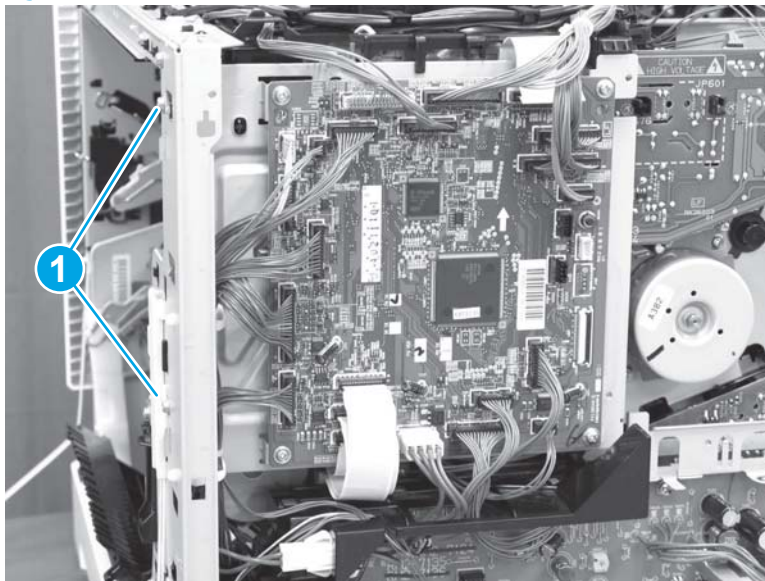

2. Lift up on the DC controller and sheet-metal plate to remove it.

Figure 1-2681 Remove the plate

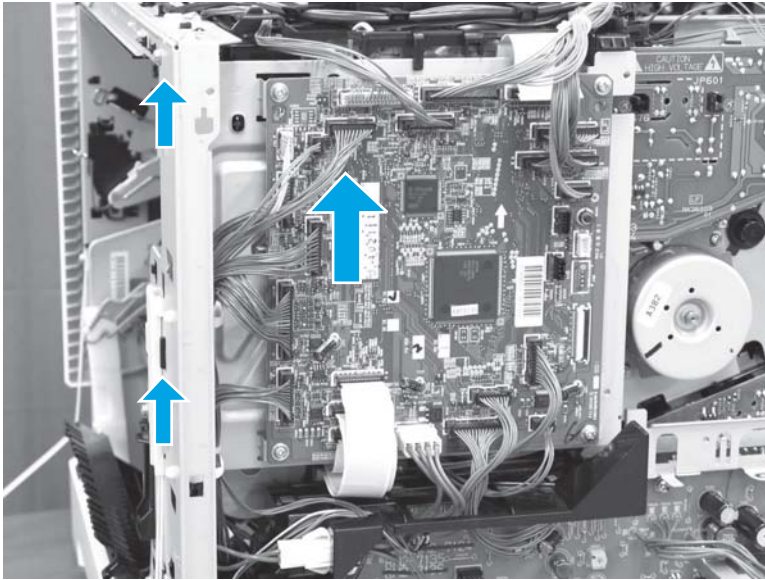

Step 24: Remove the high-voltage power supply T (HVPST)

 **CAUTION:**  ESD-sensitive part.

1. Disconnect five connectors (callout 1), and then disconnect one flat cable (callout 2).

Figure 1-2682 Disconnect five connectors and one flat cable

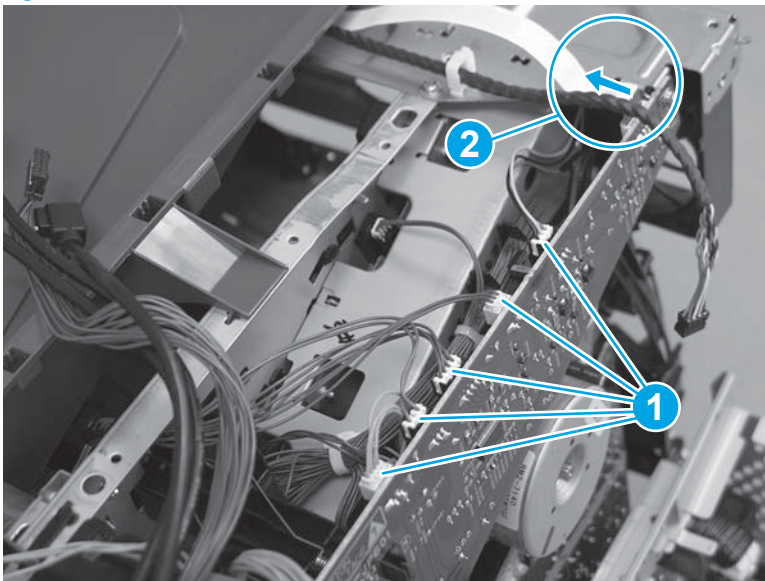

2. Remove one screw (callout 1).

Figure 1-2683 Remove one screw

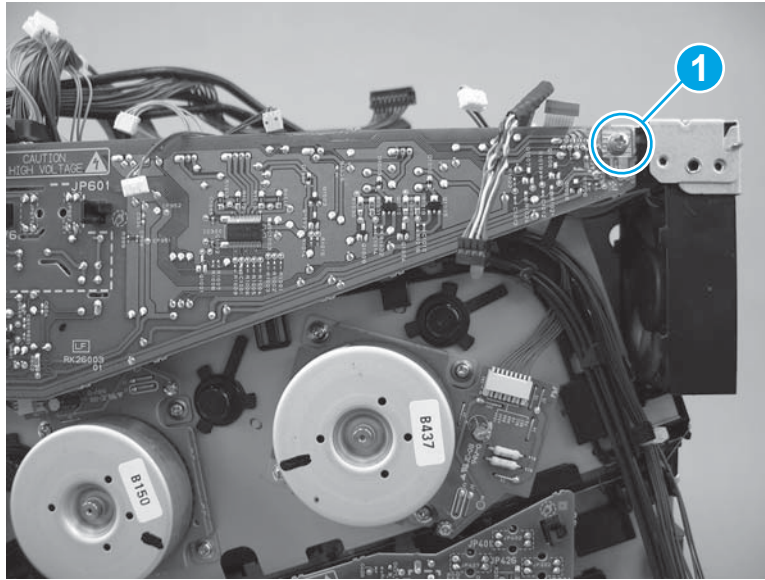

3. Release two tabs (callout 1), and then separate the HVPST from the printer.

⚠ CAUTION: Do not attempt to completely remove the HVPST. It is still connected to the printer by ground wire harness.

Figure 1-2684 Release the HVPST

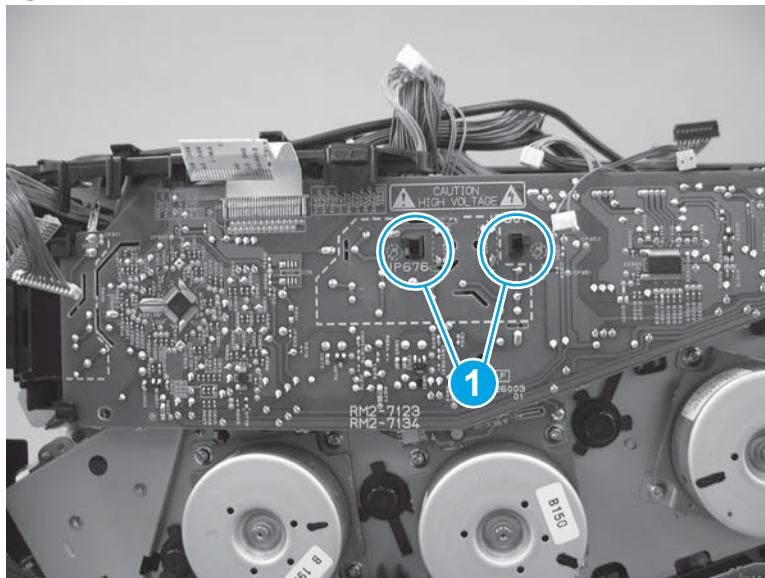

4. Release one ground wire connector (callout 1), and then remove the HVPST.

Figure 1-2685 Remove the HVPST

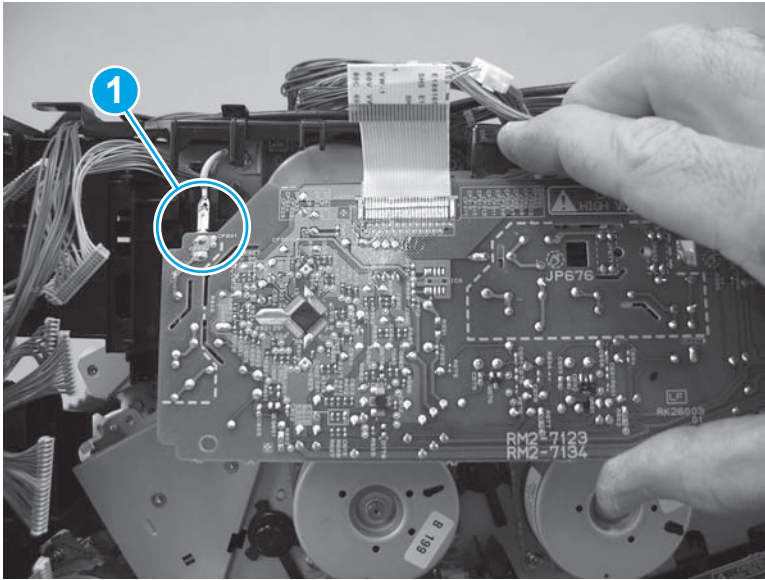

Step 25: Unpack the replacement assembly

Unpack the replacement assembly from the packaging.

CAUTION:  ESD-sensitive part.

For complete information on HP's recycling programs, go to [Product return and recycling](#).

NOTE:  HP recommends responsible disposal of the defective assembly.

Figure 1-2686 Recycle and unpack

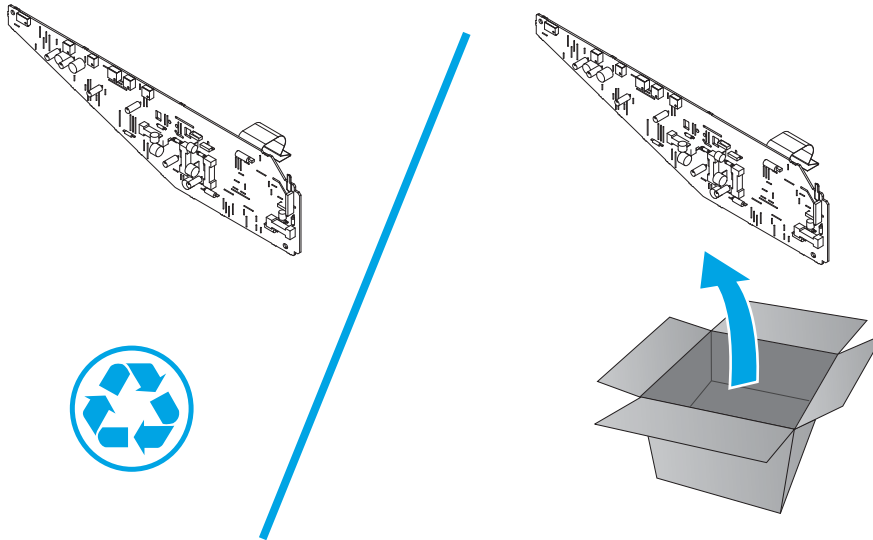

Step 26: Install the HVPST

 **CAUTION:**  ESD-sensitive part.

1. Connect one ground wire connector (callout 1).

Figure 1-2687 Connect one ground wire

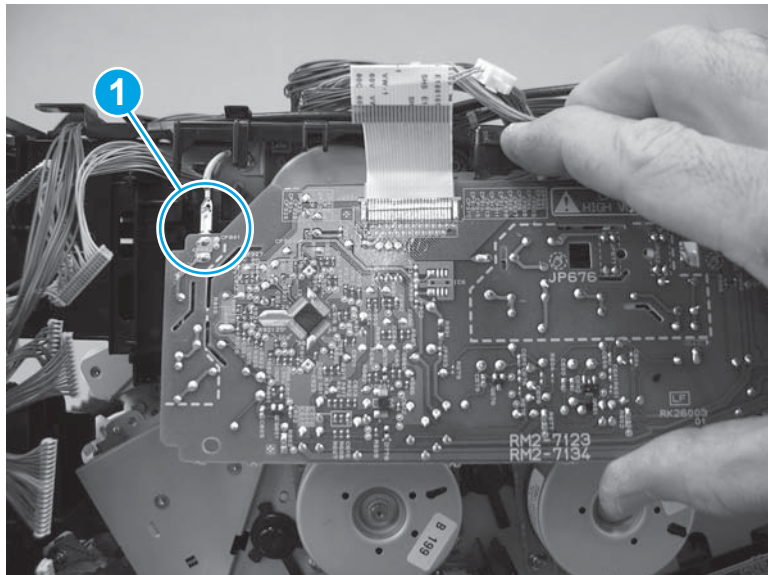

2. Position the HVPST on the printer, and then push in to engage two tabs (callout 1).

 **NOTE:** Make sure that the tabs snap into place.

Figure 1-2688 Install the HVPST



3. Install one screw (callout 1).

Figure 1-2689 Install one screw

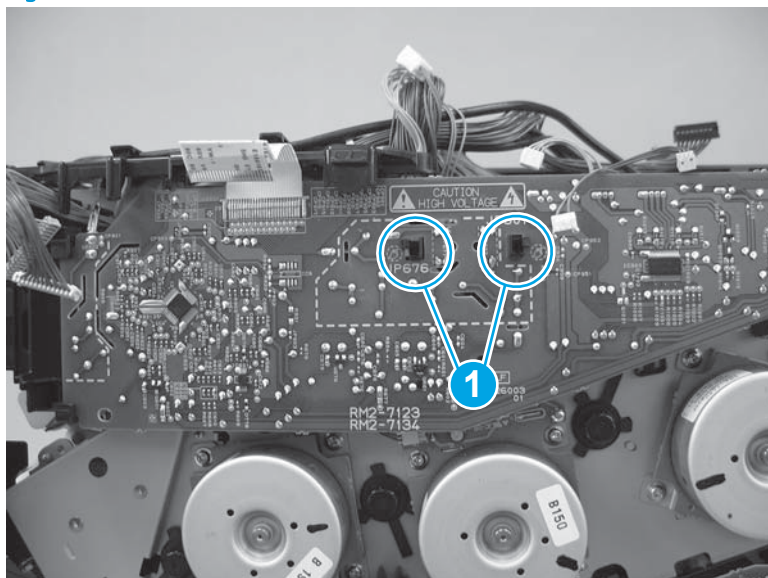
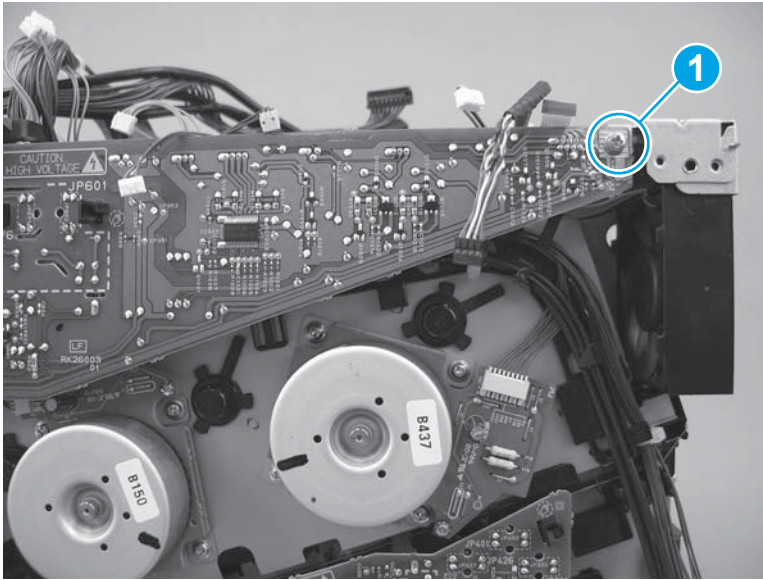

4. Connect five connectors (callout 1), and then connect one flat cable (callout 2).

Figure 1-2690 Connect five connectors and one flat cable

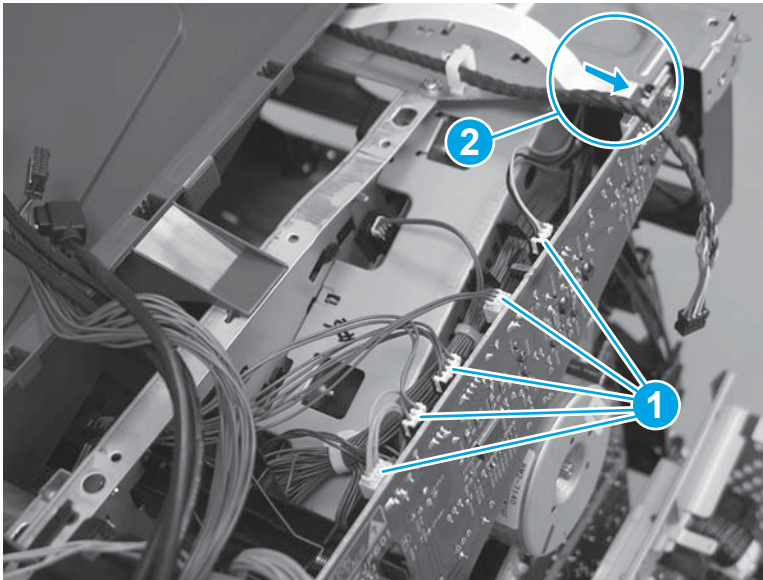

Step 27: Install the DC controller and sheet-metal bracket

 **CAUTION:**  ESD-sensitive part.

1. Position the DC controller and sheet-metal plate on the printer, and then push down to engage the plate with the chassis.

Figure 1-2691 Install the plate

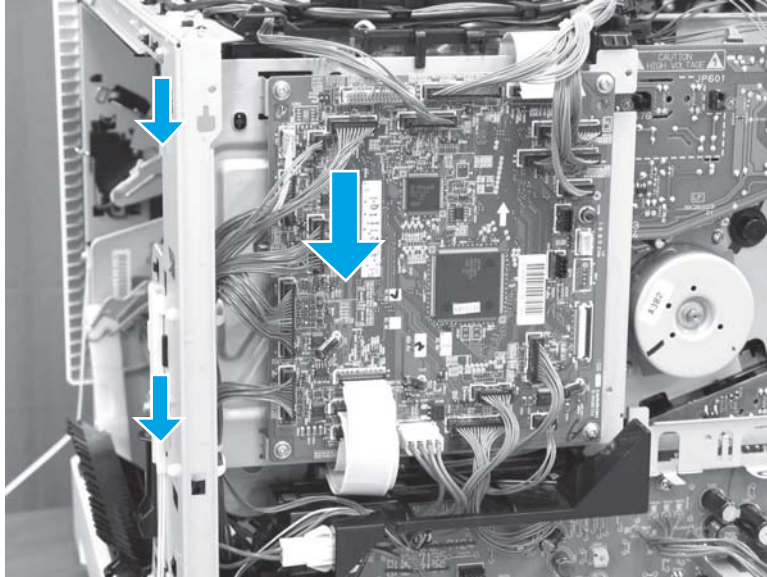

2. Install two screws (callout 1), and then connect all of the connectors.

The following connectors are empty:

- J140, J141, and J143

Figure 1-2692 Install two screws

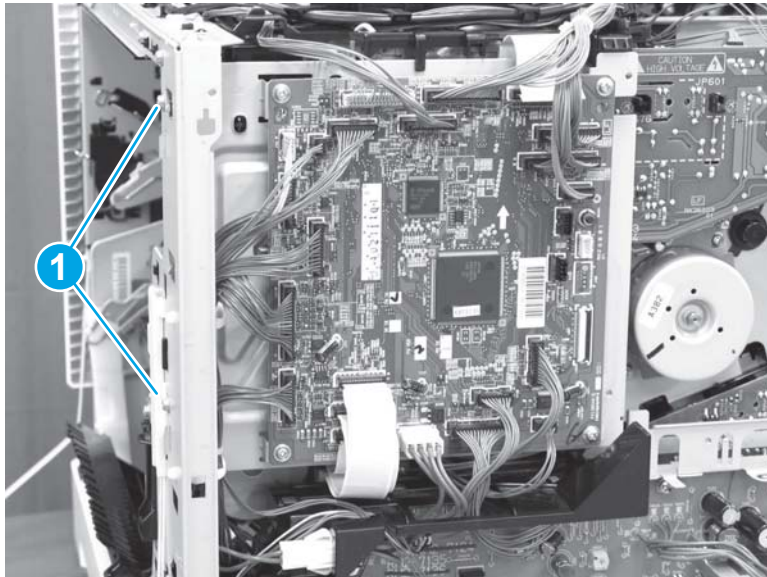

Step 28: Install the right rear cover

1. Position the cover on the printer.

Figure 1-2693 Install the cover

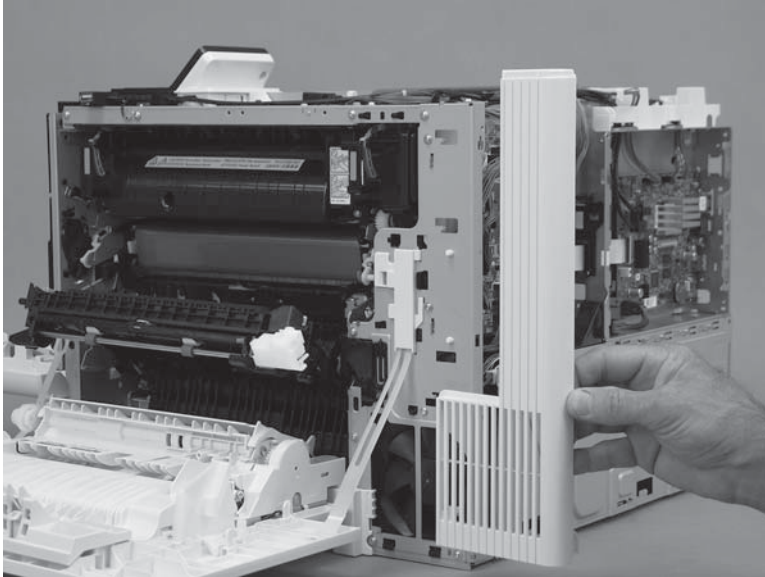

2. Slide the cover toward the right door (callout 1) to engage it with the printer, and then install one screw (callout 2).

Figure 1-2694 Install one screw

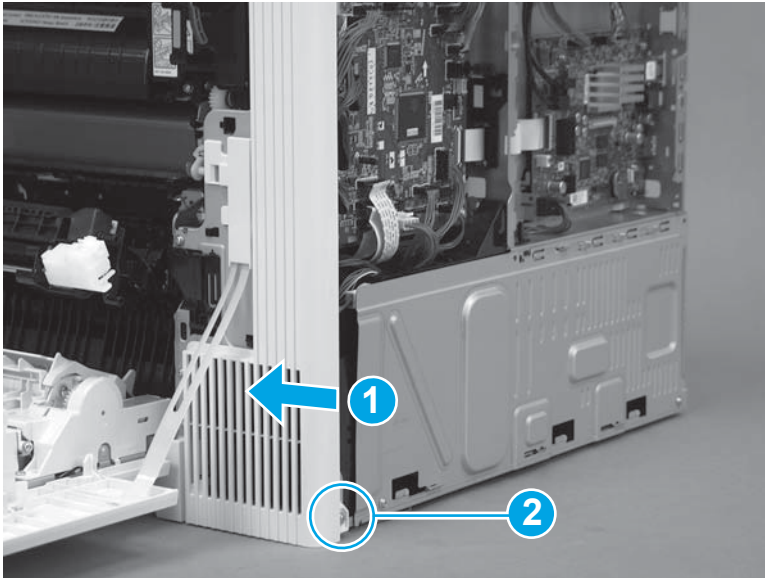

Step 29: Install the formatter case

1. Pass the wire harnesses through the opening in the formatter case.

Figure 1-2695 Pass the wire harnesses through the opening

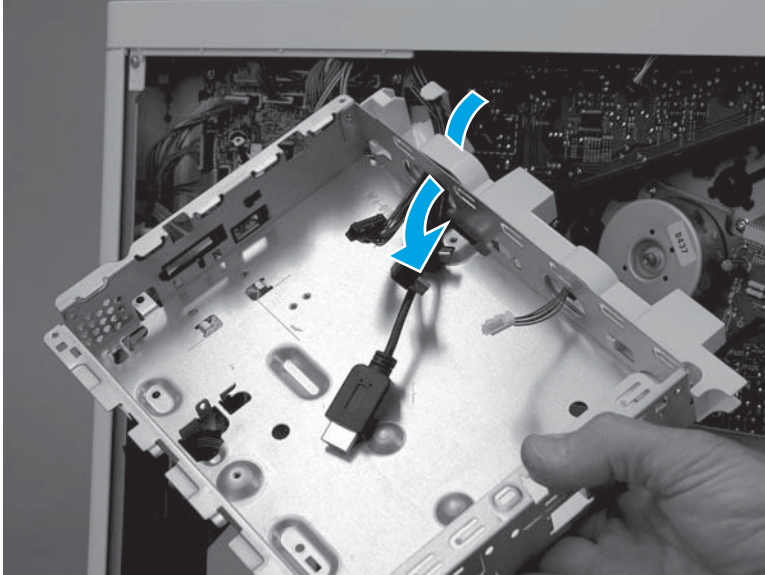

2. Position the top of the formatter case on the printer (callout 1), and then rotate the bottom of the case (callout 2) into the printer.

Figure 1-2696 Install the formatter case

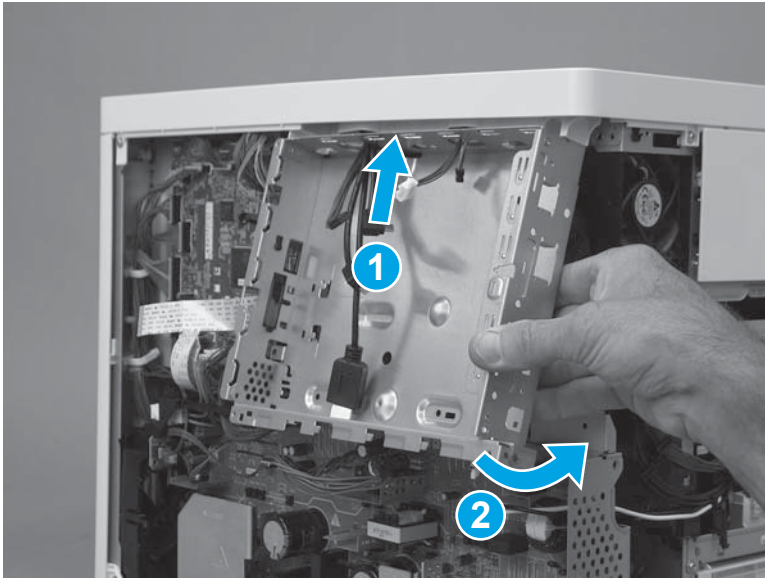

3. Install six screws (callout 1).

Figure 1-2697 Install six screws

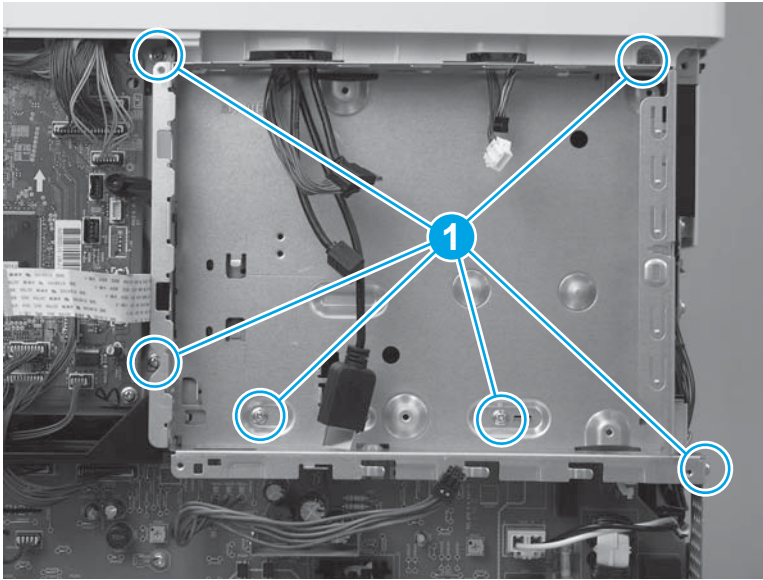

4. Pass two wire harnesses and one flat cable (callout 1) through the opening in the formatter case, and then install one wire harness in the retainer (callout 2).

 **IMPORTANT:** Make sure that the flat cable is securely fastened to the DC controller, and was not dislodged when the formatter case was removed.

Figure 1-2698 Install wire harnesses and flat cable

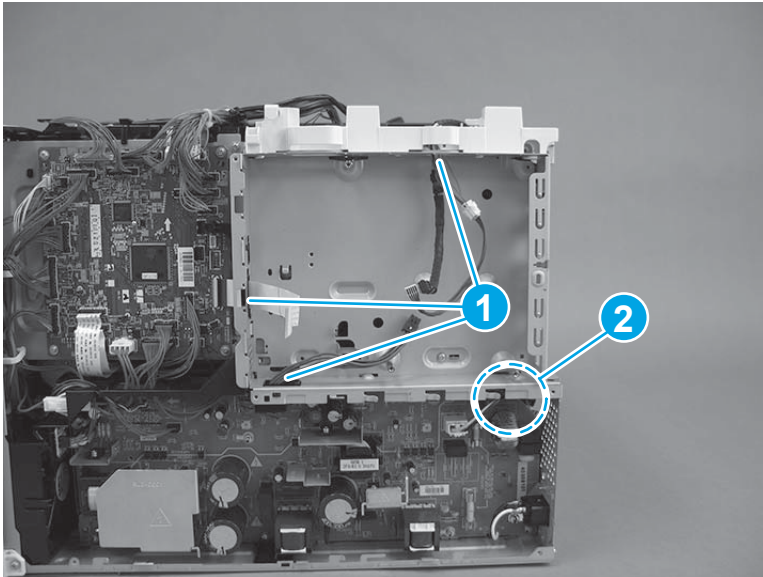

5. Position the LVPS cover on the printer, slide the cover to the left to install it, and then install two screws (callout 1).

Figure 1-2699 Install the LVPS cover

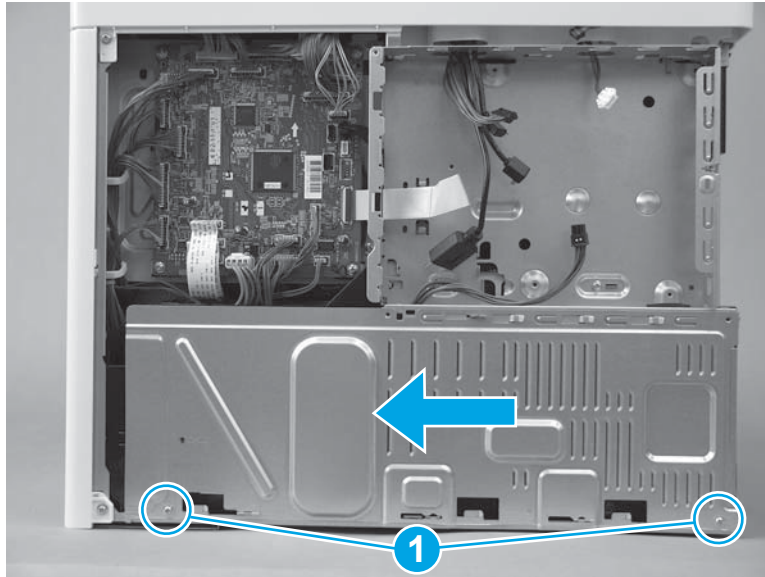

6. If no tape is affixed to the back of the flat cable, skip this step. If double-sided tape is affixed to the back of the flat cable, align the line (callout 1) on the cable with the edge (callout 2) of the opening in the sheet metal. Press to attach the flat cable to the formatter case.

Figure 1-2700 Attach the flat cable

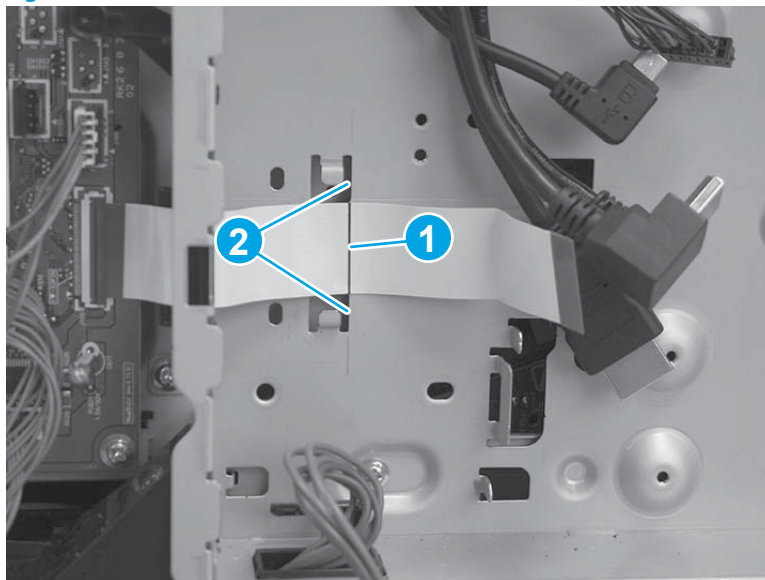

7. Position the bracket over the flat cable, and then slide the bracket to the left to install it. Make sure that the edges of the bracket fit under the sheet metal tabs (callout 1) on the formatter case and that the tabs (callout 2) snap into place.

Figure 1-2701 Position the bracket

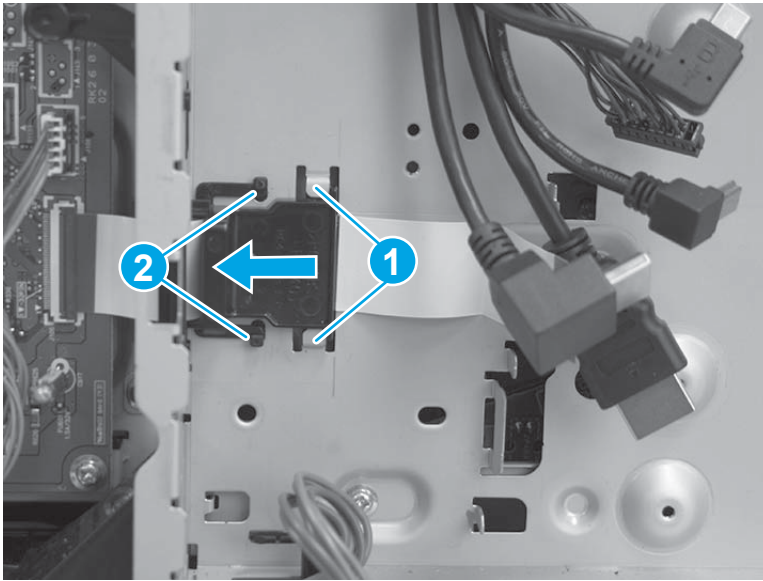

8. **M577 only:** Pass the wire harness (callout 1) through the openings in the formatter case (callout 2), and then connect one connector (callout 3).

Figure 1-2702 Connect one connector

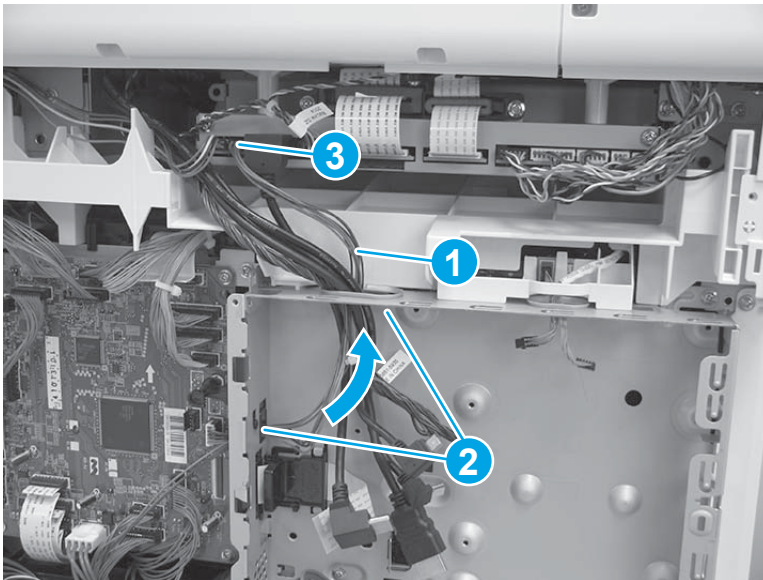

Step 30: Install the upper cover (M552 and M553)

 **NOTE:** This step is for the M552 and M553 models. For the M577 models, skip this step and go to [Step 31: Install the left cover on page 1530.](#)

1. Position the cover on the printer.

 **NOTE:** For the M553x model, do not forget to pass the control-panel wire harness and USB cable through the opening in the cover.

Figure 1-2703 Install the cover



2. Push down on the rear corner of the cover to engage one tab (callout 1).

Figure 1-2704 Engage one tab

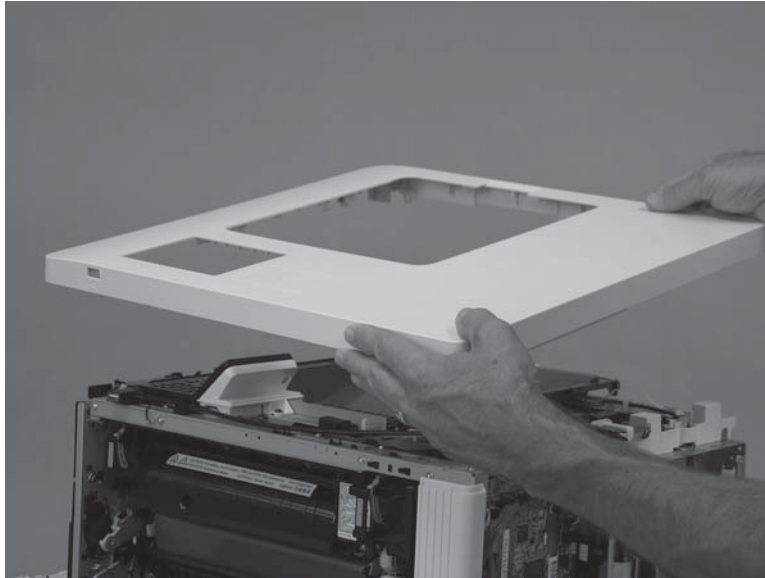
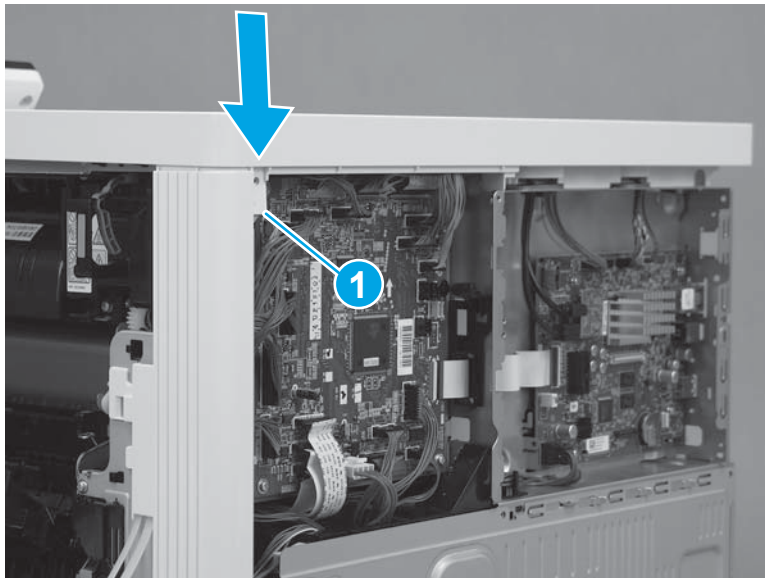

3. Push down on the front corner of the cover to engage one tab (callout 1), and then install one screw (callout 2).

 **NOTE:** This is a self-tapping plastic-thread screw. Make sure that this screw is used in this location when it is reinstalled.

Figure 1-2705 Engage one tab and install one screw



4. Install three screws (callout 1).

Figure 1-2706 Install three screws

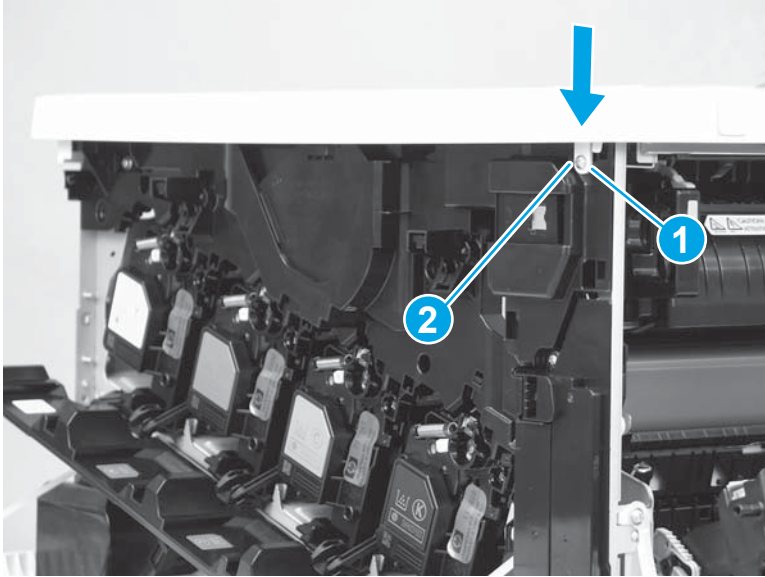
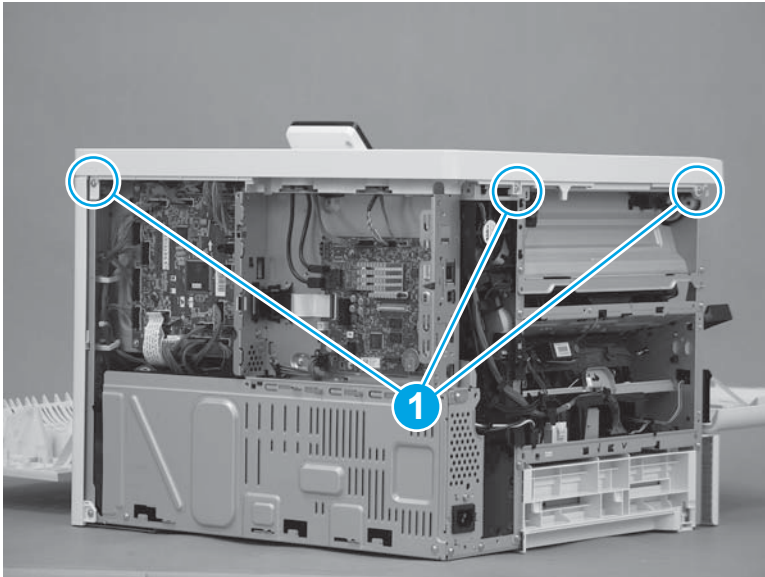

Step 31: Install the left cover

1. Position the cover on the printer.

 **NOTE:** Slightly offset the cover toward the rear of the printer.

Figure 1-2707 Install the cover

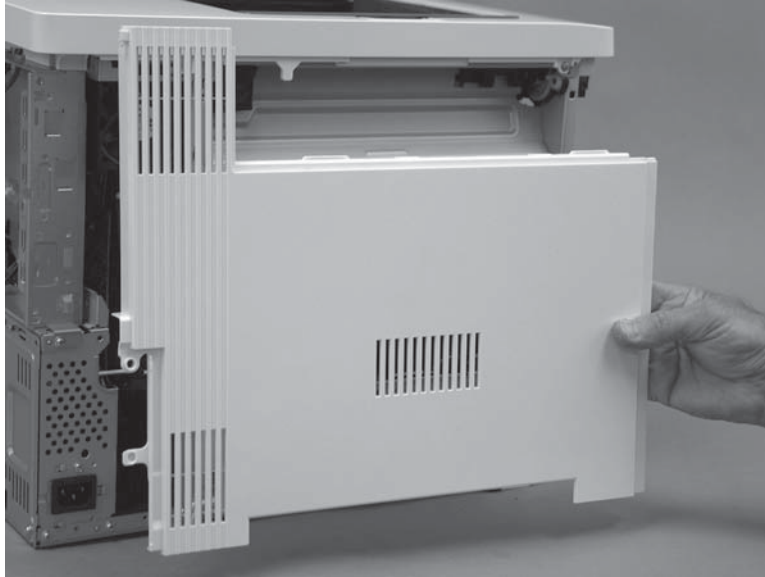

2. Slide the cover (callout 1) toward the front of the printer to engage it. Make sure that the tab (callout 2) snaps into place.

 **NOTE:** Locate the alignment pin (callout 3) on the cover from the front door side of the printer, and then make sure that it is fully engaged in the slot in the chassis.

 **TIP:** While sliding the cover into place, push in on the center of the cover (callout 1) to make sure that the hooks on the back of the cover engage with the slots in the chassis.

Figure 1-2708 Engage the cover



3. At the left side of the printer, install one screw (callout 1).

Figure 1-2709 Install one screw

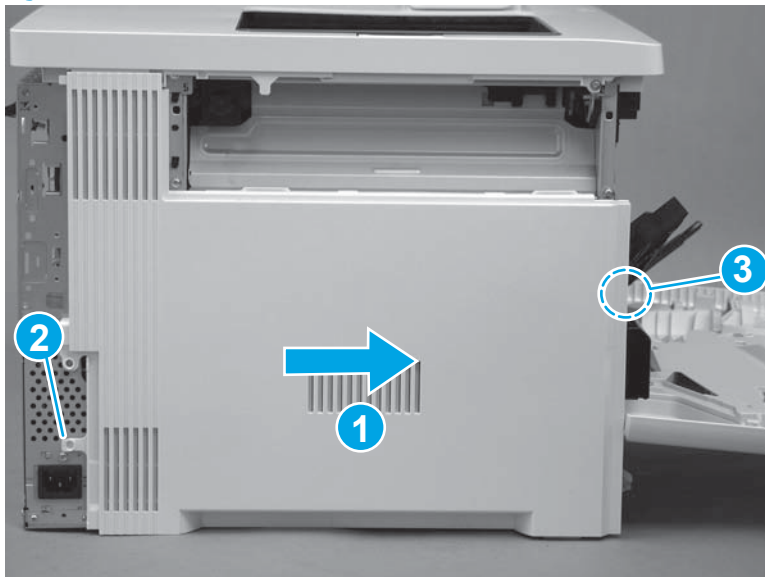

Step 32: Install the top rear cover (M577)

 **NOTE:** This step is for the M577 models. For the M552 and M553 models, skip this step and go to [Step 40: Install the rear cover \(M552 and M553\) on page 1548](#).

1. Align the locator tabs (callout 1) on the cover with the slots (callout 2) in the printer.

Figure 1-2710 Align the locator tabs

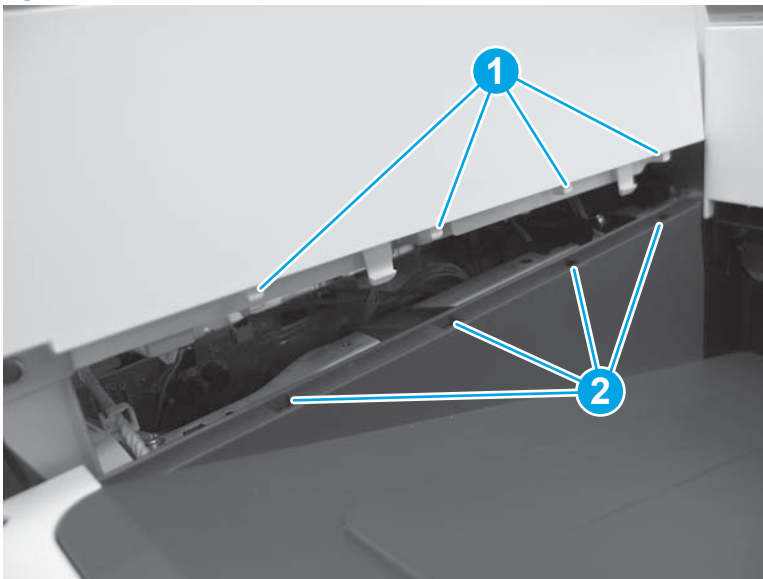

2. Press down to install the cover. Make sure that the tabs snap into place.

Figure 1-2711 Install the cover

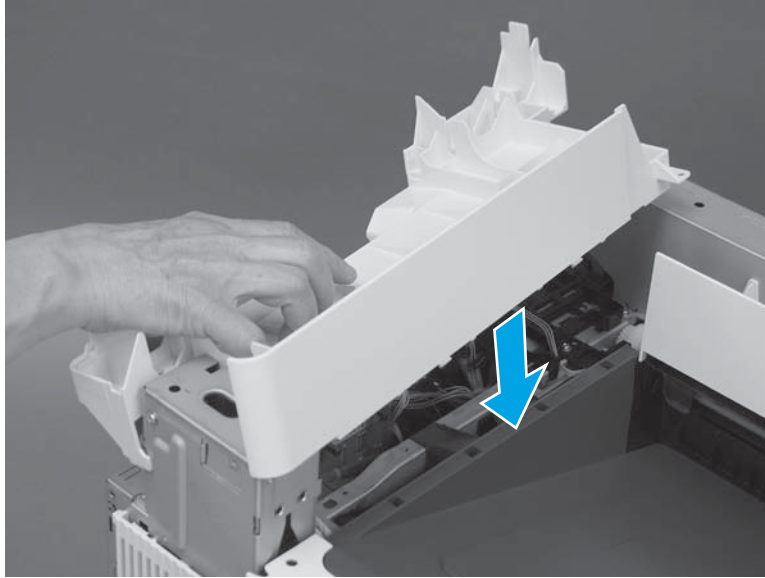

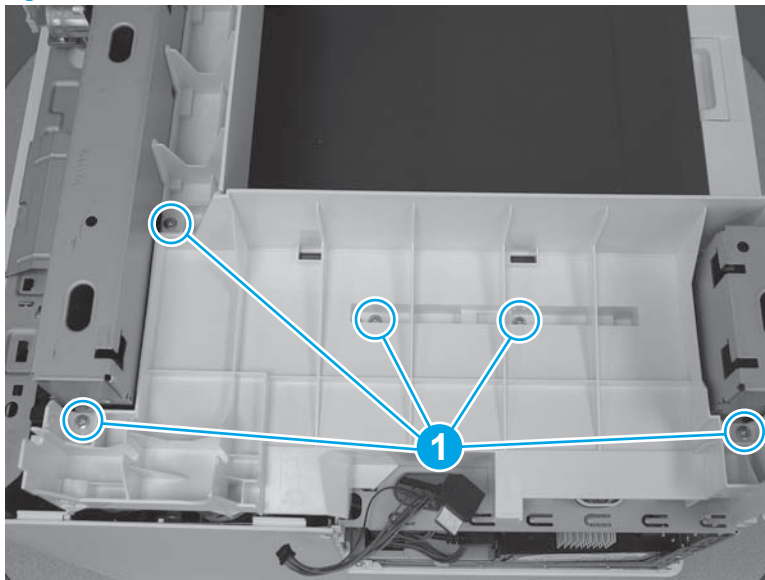

3. At the top of the printer, install five screws (callout 1).

Figure 1-2712 Install five screws



Step 33: Install the right upper cover (M577)

 **NOTE:** This step is for the M577 models. For the M552 and M553 models, skip this step and go to [Step 40: Install the rear cover \(M552 and M553\) on page 1548.](#)

 **NOTE:** The figures below show the image scanner installed. The procedures for removing and installing the right upper cover are the same whether the image scanner is installed or removed."

1. **M577c/f/z only:** Install the cables (callout 1) through the slot (callout 2) in the printer.

Figure 1-2713 Install the cables

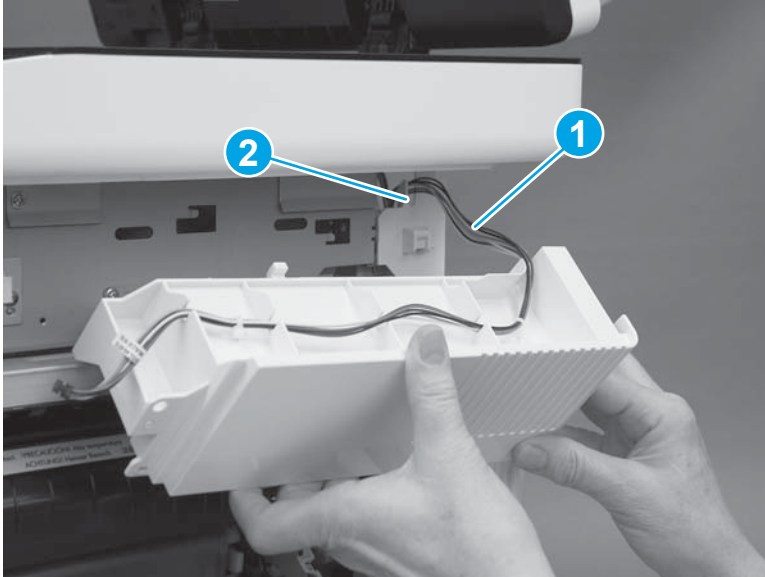

2. Position the hooks (callout 1) on the cover in the slots (callout 2) in the printer.

Figure 1-2714 Position the hooks

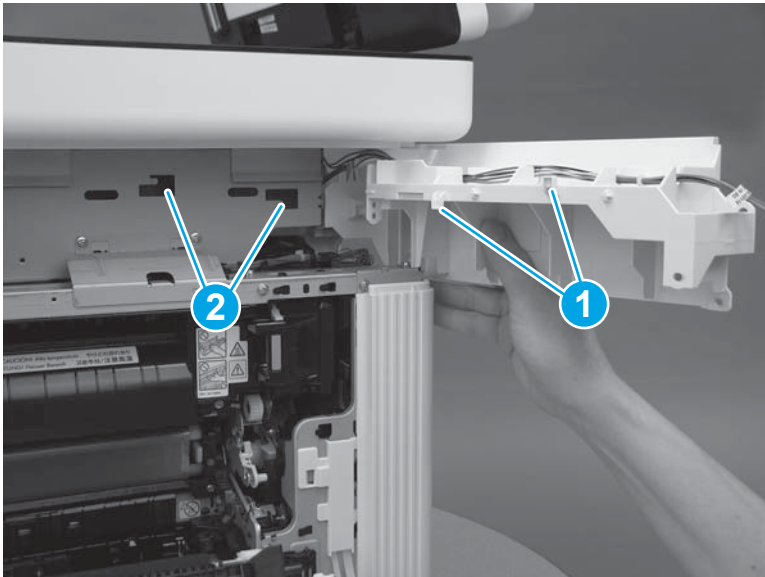

3. Slide the cover toward the front of the printer to install it.

Figure 1-2715 Install the cover

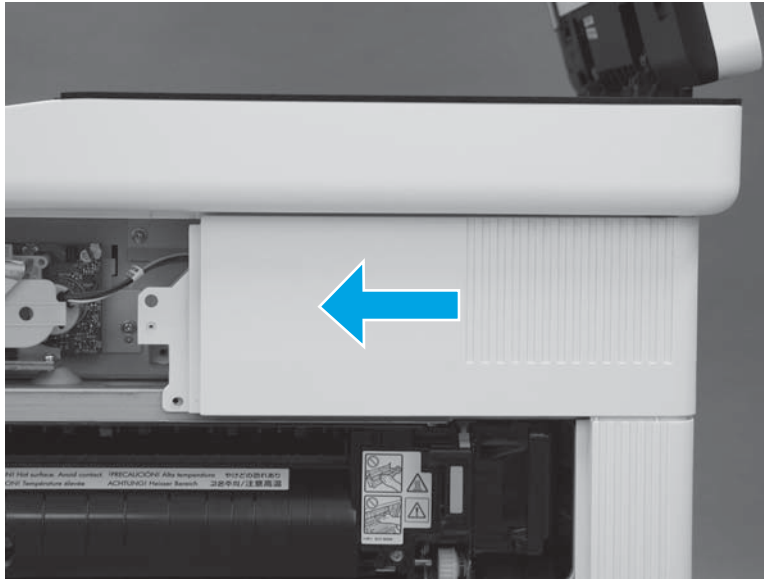

4. At the back of the printer, install one screw (callout 1).

M577c/f/z only: Connect one connector (callout 2), if the integrated scanner assembly is installed.

TIP: This screw is smaller than the screws installed in the next step. Make sure that this screw is installed in the correct position.

Figure 1-2716 Install one screw and connector

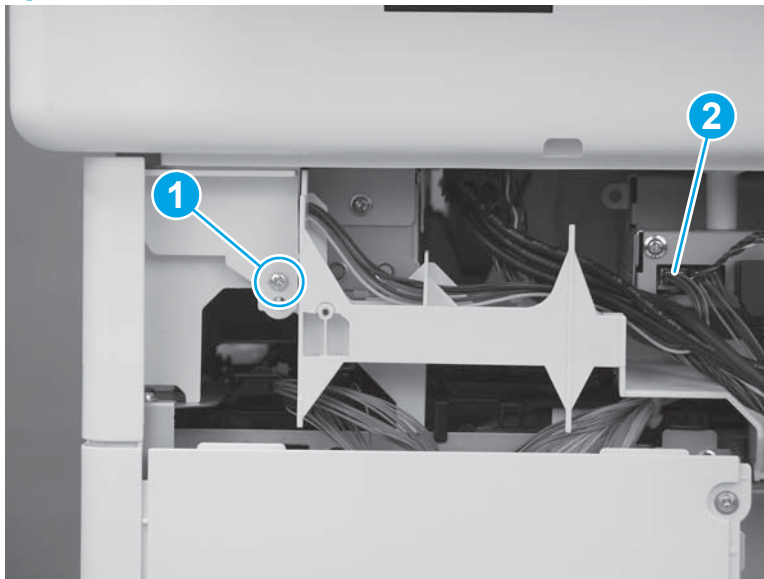

5. At the right side of the printer, install two screws (callout 1).

M577c/f/z only: Connect one connector (callout 2), if the stapler is installed.

Figure 1-2717 Install one screw and connector

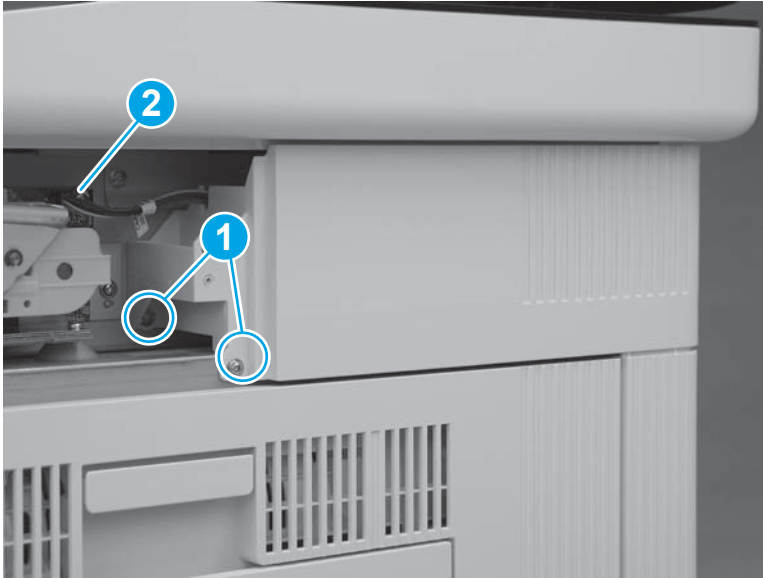

Step 34: Install the integrated scanner assembly (ISA) (M577)

 **NOTE:** This step is for the M577 models. For the M552 and M553 models, skip this step and go to [Step 40: Install the rear cover \(M552 and M553\) on page 1548](#).

 **NOTE:** The ISA includes the document feeder, image scanner, scanner control board (SCB), control panel, keyboard (M577c/z) and NFC PCA (M577z).

1. Before proceeding, locate the mounting pins (callout 1) on the bottom of the ISA and the slots (callout 2) on the printer base.

Figure 1-2718 Locate the ISA mounting pins and slots

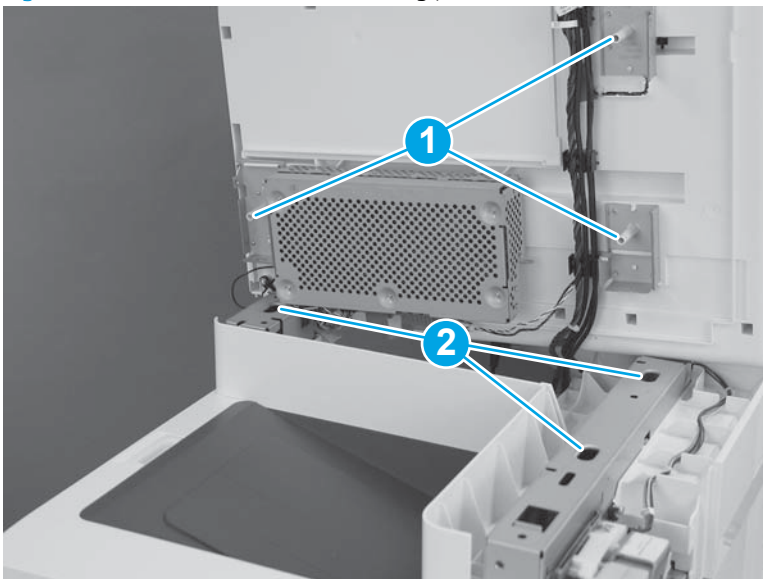

2. Position the ISA on the printer base with the pins in the slots.

 **NOTE:** To locate the pins and slots, see [Figure 1-395 Locate the ISA mounting pins and slots on page 249](#).

When installing the ISA, carefully pass the cables through the opening in the top of the formatter case.

Figure 1-2719 Install the ISA



3. Slightly slide the ISA towards the front of the printer to engage it.

Figure 1-2720 Slide the ISA towards the front of the printer

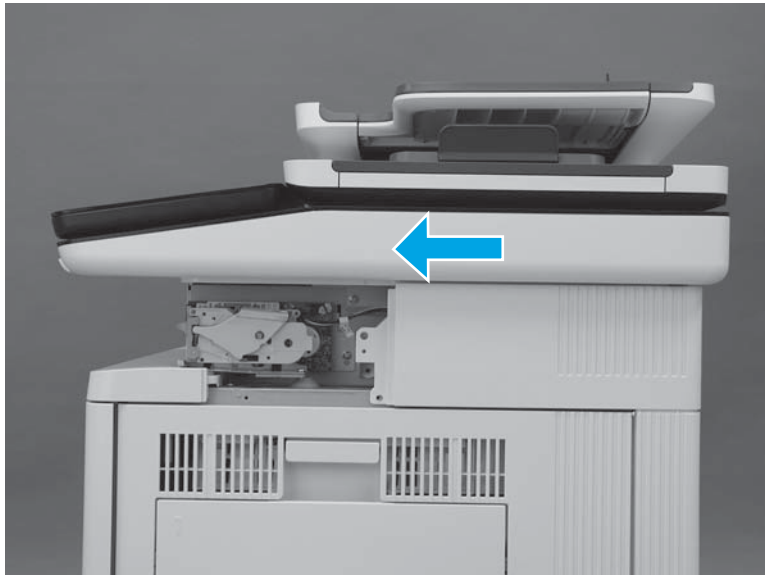

4. At the left side of the printer, install one screw (callout 1).

Figure 1-2721 Install one screw

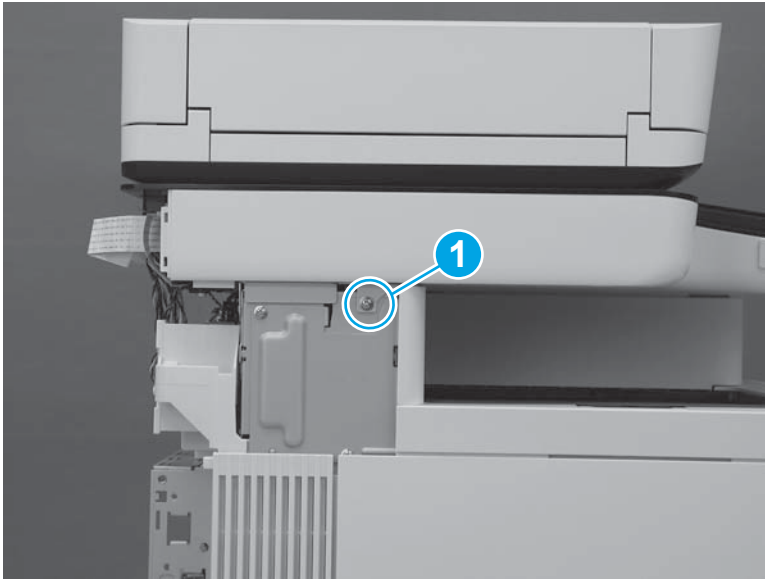

5. At the back of the printer, install two screws (callout 1).

Figure 1-2722 Install two screws

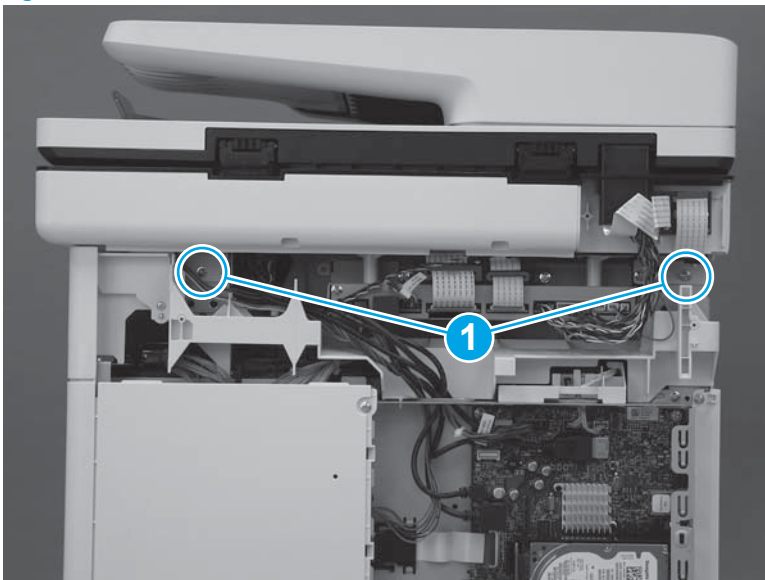

6. At the right side of the printer, install one screw (callout 1).

Figure 1-2723 Install one screw

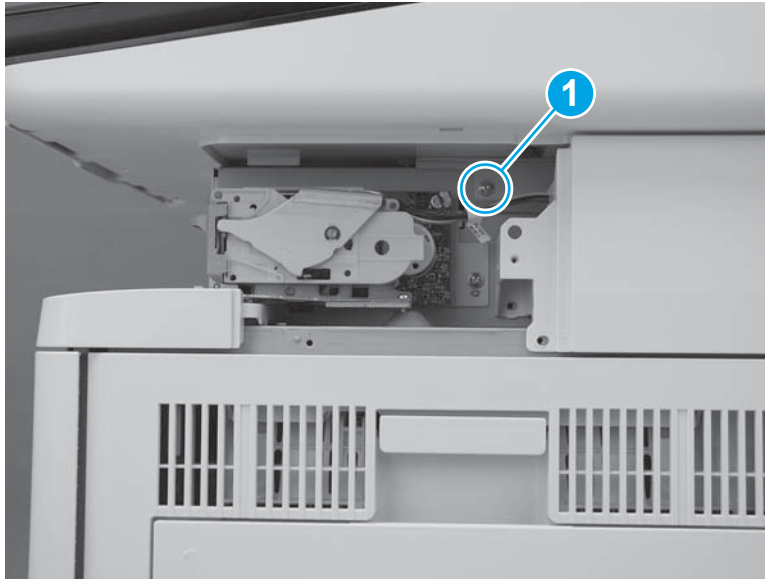

7. Connect two connectors on the scanner control board (callout 1).

M577c/f/z only: Connect one connector for the stapler on the scanner control board (callout 2).

Figure 1-2724 Connect connectors

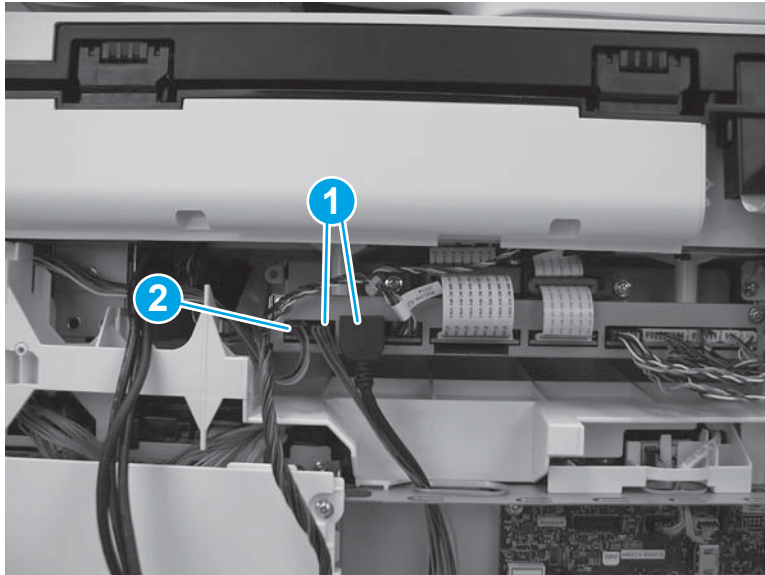

Step 35: Install the stapler cover assembly (M577c/f/z)

 **NOTE:** This step is for the M577c/f/z models only. For the M577dn model, skip this step and go to [Step 36: Install the right front upper cover \(M577dn\) on page 1541](#).

For the M552 and M553 models, skip this step and go to [Step 40: Install the rear cover \(M552 and M553\) on page 1548](#).

1. Install the tabs (callout 1) on the cover in the slots (callout 2) in the printer.

Figure 1-2725 Install two tabs



2. Press the cover toward the left side of the printer until it snaps into place.

Figure 1-2726 Install the cover assembly



3. Install one screw (callout 1).



 **IMPORTANT:** This is a self-tapping screw for plastic. Rotate it counterclockwise to align it with the existing thread pattern, and then carefully turn it clockwise to tighten. Do not overtighten. This will prevent stripping the threads inside the screw hole.

Figure 1-2727 Install one screw

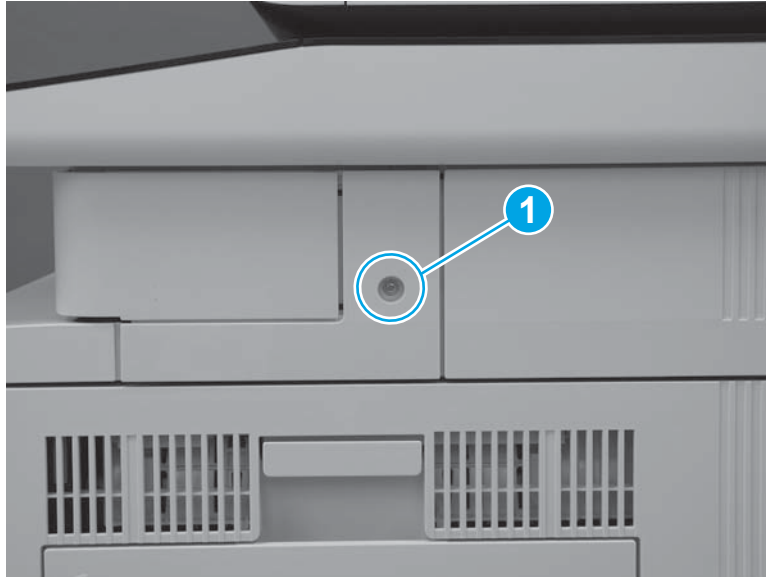

Step 36: Install the right front upper cover (M577dn)

 **NOTE:** This step is for the M577dn model only. For the M577c/f/z models, skip this step and go to [Step 37: Install the left upper cover \(M577\) on page 1543](#).

For the M552 and M553 models, skip this step and go to [Step 40: Install the rear cover \(M552 and M553\) on page 1548](#).

1. Slide the cover toward the left side of the printer to install it. Make sure that the slots (callout 1) in the cover fit over the tabs (callout 2) on the inside of the paper feeder cover.

Figure 1-2728 Install the cover



2. Press the right front upper cover (callout 1) and the paper feeder cover (callout 2) together until the tabs on the inside of the covers snap into place.

Figure 1-2729 Press the cover



3. Install one screw (callout 1).

Figure 1-2730 Install one screw

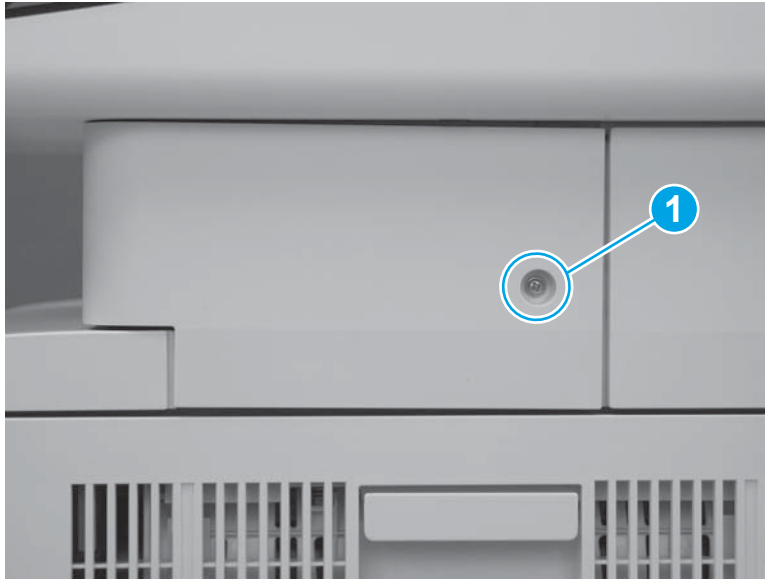

Step 37: Install the left upper cover (M577)

 **NOTE:** This step is for the M577 models. For the M552 and M553 models, skip this step and go to [Step 40: Install the rear cover \(M552 and M553\) on page 1548](#).

1. Position the tab (callout 1) on the lower edge of the cover behind the left cover (callout 2).

Figure 1-2731 Position the tab

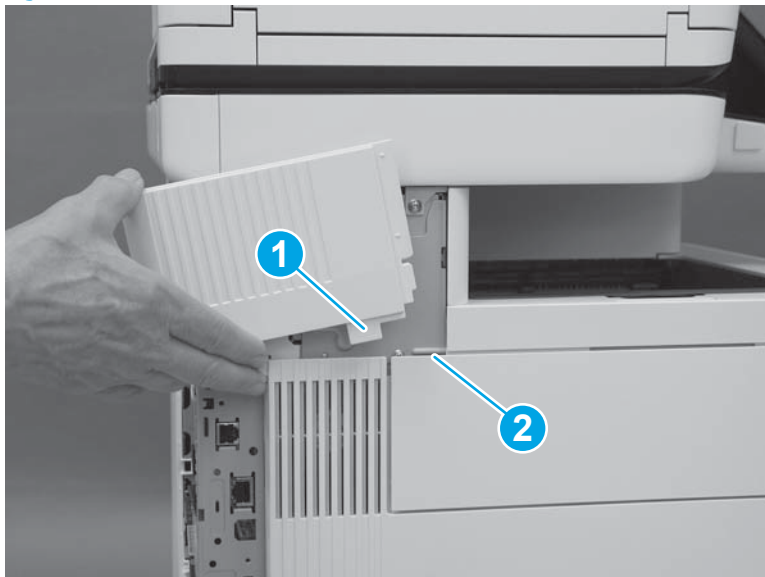

2. Slide the cover toward the front of the printer to install it. Make sure that the edge (callout 1) of the cover fits behind the edge (callout 2) of the top rear cover.

Figure 1-2732 Slide the cover

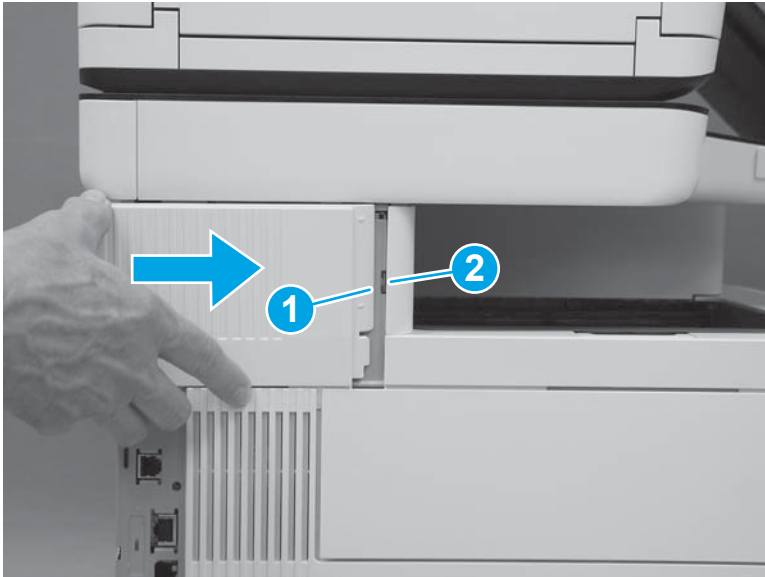

3. Make sure that the tab (callout 1) is fully installed.

Figure 1-2733 Check the tab

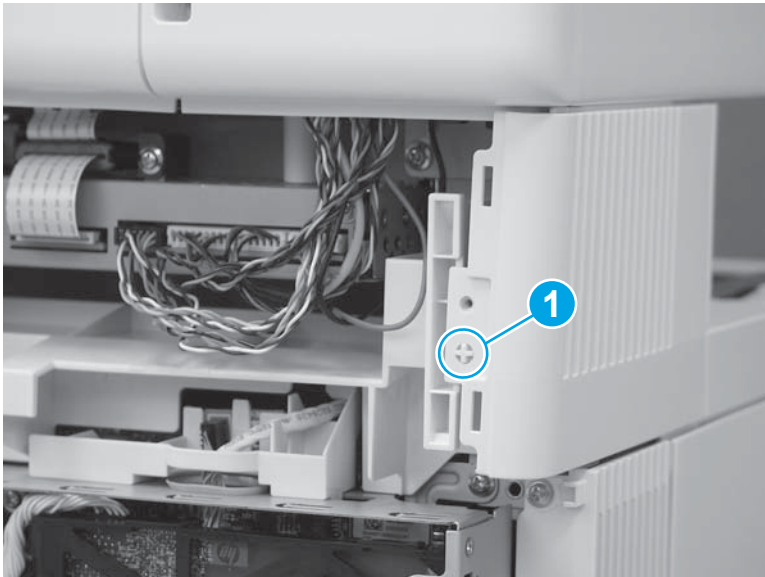

Step 38: Install the rear cover (M577)

 **NOTE:** This step is for the M577 models. For the M552 and M553 models, skip this step and go to [Step 40: Install the rear cover \(M552 and M553\) on page 1548](#).

1. Position the hooks (callout 1) on the cover in the slots (callout 2) in the printer.

Figure 1-2734 Position the hooks

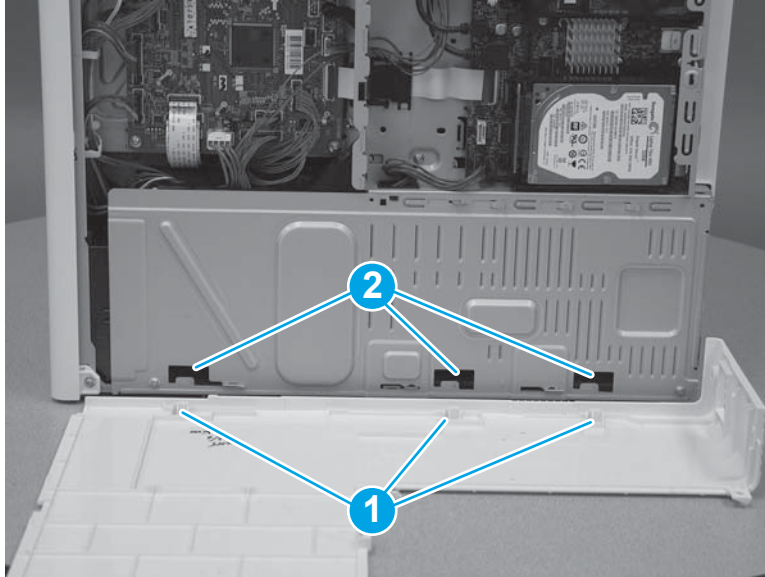

2. Position the back edge (callout 1) of the rear cover behind the edge (callout 2) of the right rear cover. Slide the cover to the left to install it.

Figure 1-2735 Install the cover

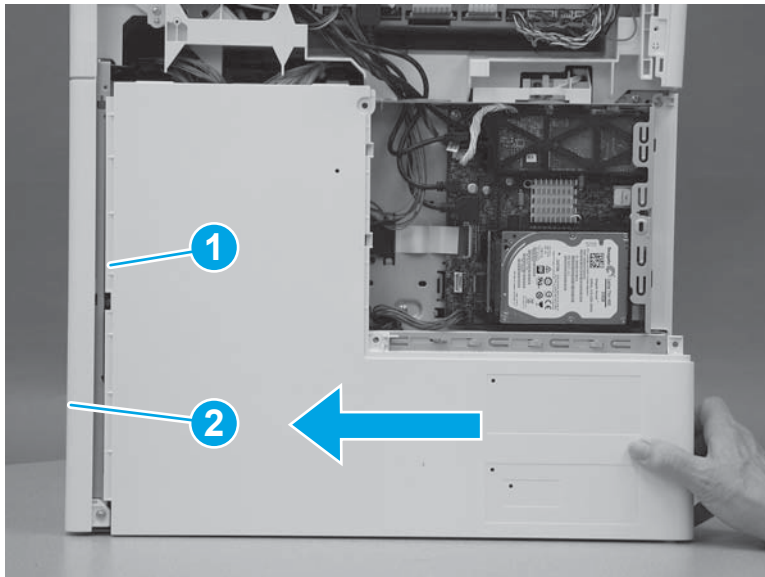

3. Install four screws (callout 1).

Figure 1-2736 Install four screws cover

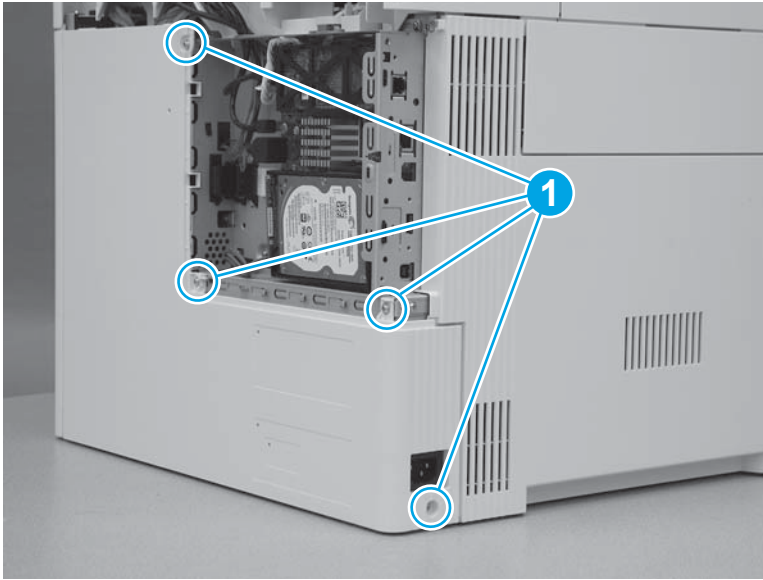

Step 39: Install the rear upper cover (M577)



NOTE: This step is for the M577 models. For the M552 and M553 models, skip this step and go to [Step 40: Install the rear cover \(M552 and M553\) on page 1548](#).

1. Align the ridge (callout 1) on the lower edge of the rear upper cover in front of the tabs (callout 2) on the top edge of the rear cover.

Figure 1-2737 Align the cover

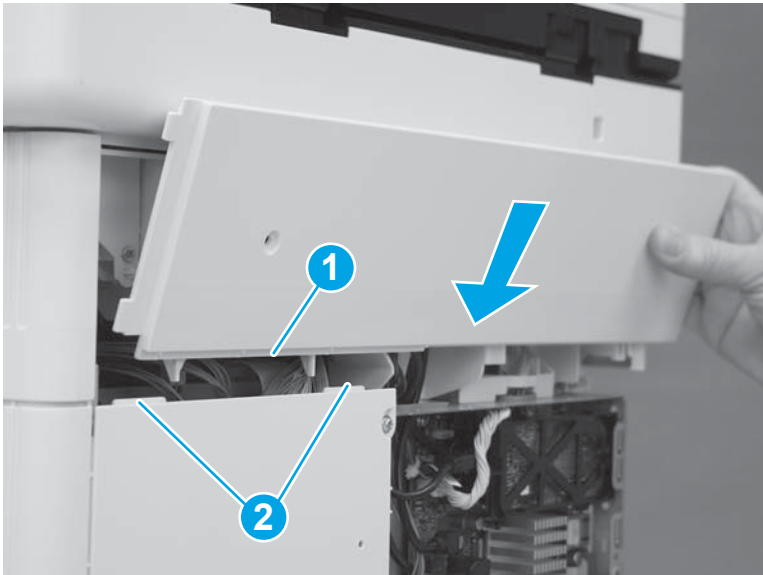

2. Rotate the top of the cover toward the printer.

Figure 1-2738 Rotate the top of the cover

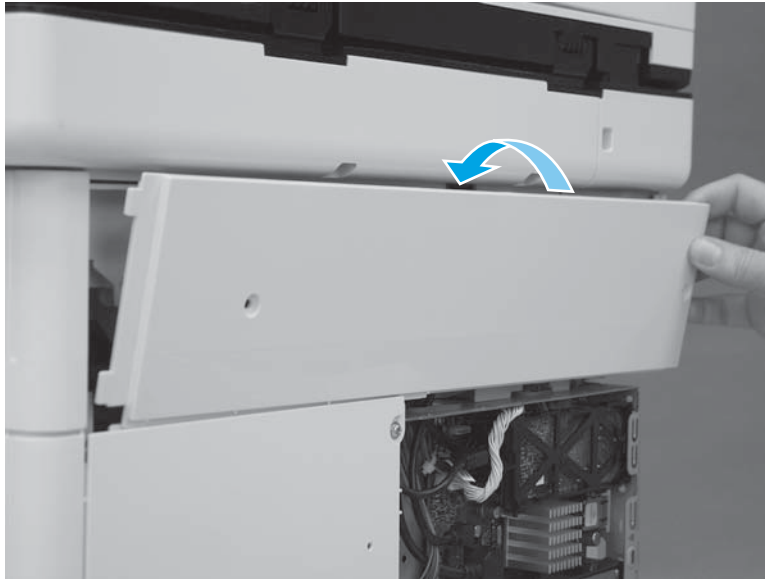

3. Slide the cover to the left (callout 1). Make sure that the tabs (callout 2) on the upper rear cover slide behind the edge (callout 3) of the right upper cover. Make sure that the cover is fully seated.

Figure 1-2739 Slide the cover

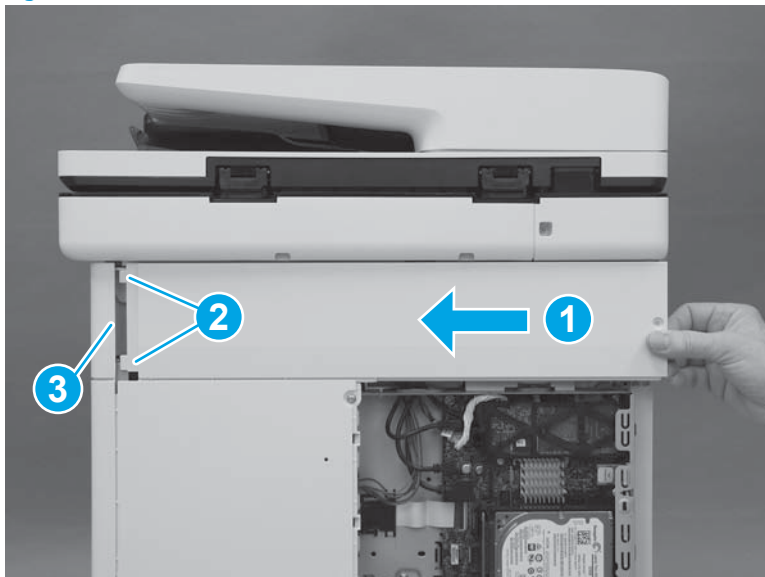

4. Install two screws (callout 1).



 **IMPORTANT:** These two screws are self-tapping screws for plastic. Rotate them counterclockwise to align them with the existing thread pattern, and then carefully turn them clockwise to tighten. Do not overtighten. This will prevent stripping the threads inside the screw holes.

Figure 1-2740 Install two screws

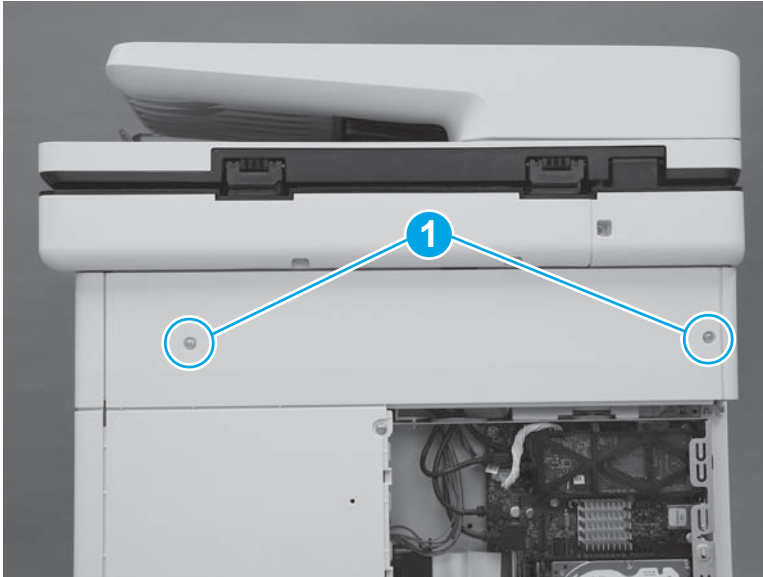

Step 40: Install the rear cover (M552 and M553)

 **NOTE:** This step is for the M552 and M553 models. For the M577 models, skip this step and go to [Step 41: Install the formatter \(M577\) on page 1549](#).

1. Position the top of the cover under the upper cover (callout 1), rotate the bottom of the cover onto the chassis (callout 2), and then slide the cover to the left (callout 3) to install it.

Figure 1-2741 Install the cover

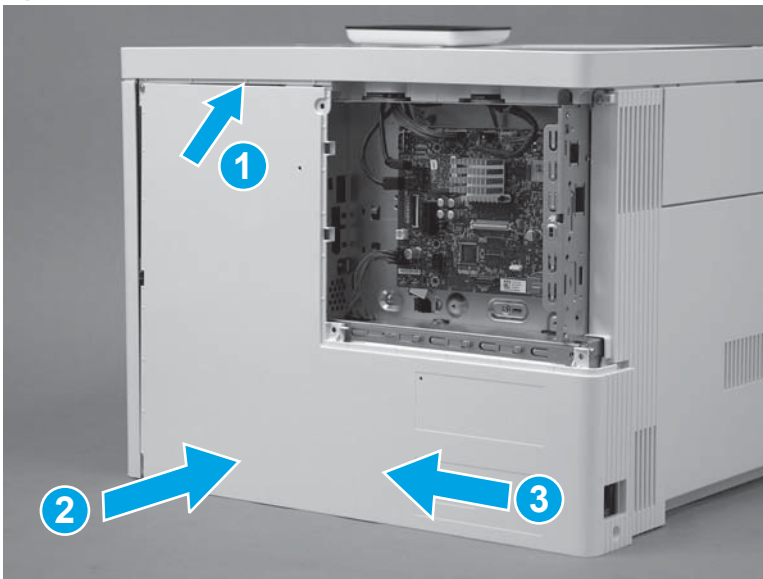

2. Install four screws (callout 1).

Figure 1-2742 Install four screws cover

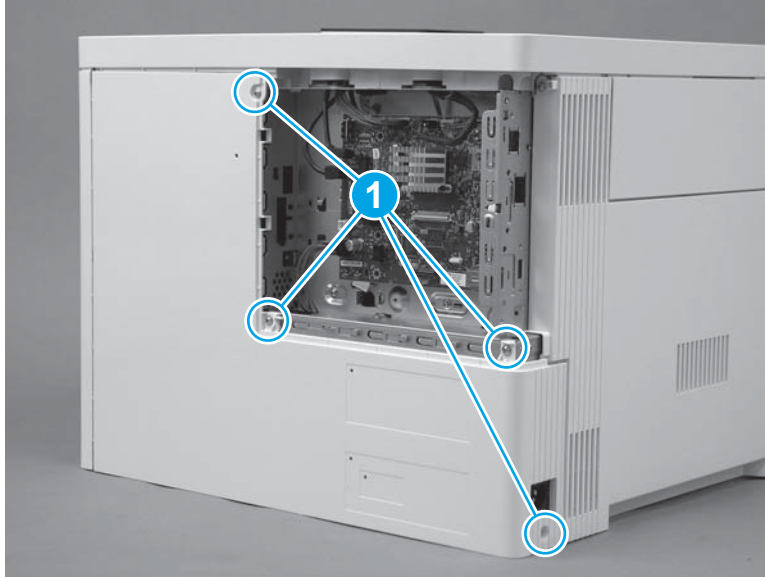

Step 41: Install the formatter (M577)

 **NOTE:** This step is for the M577 models. For the M552 and M553 models, skip this step and to go [Step 44: Install the formatter \(M552 and M553\) on page 1554](#).

 **CAUTION:**  ESD-sensitive part.

1. Position the formatter in the printer. Make sure that the network port (callout 1) fits through the opening (callout 2) in the formatter case.

Figure 1-2743 Install the formatter

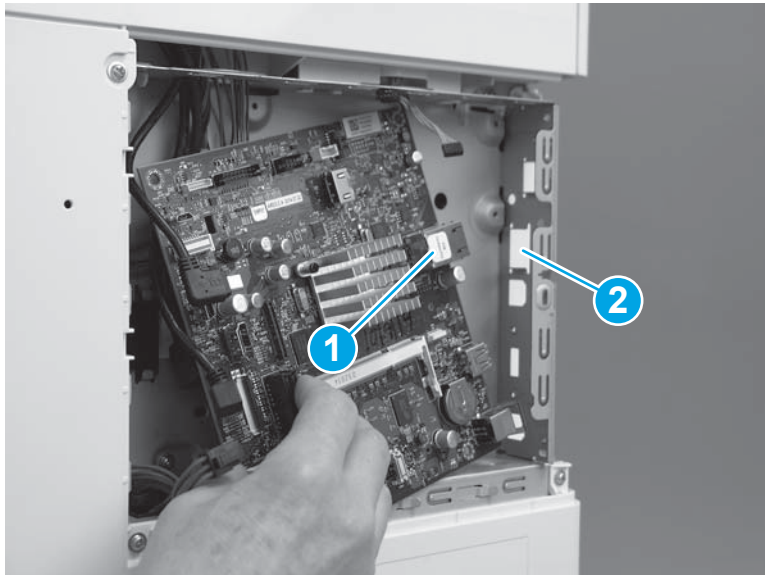

2. Install four screws (callout 1).

Figure 1-2744 Install four screws

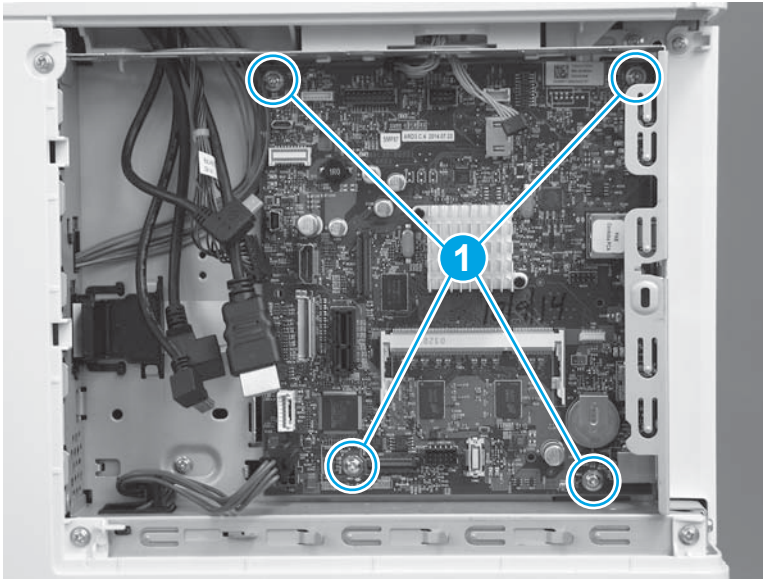

3. Connect all of the connectors on the formatter.

The following connectors are empty:

- All models: J1 (this connector is empty unless the optional DIMM is installed)
- All models: J3
- M577dn: J15 (this is the fax connector for the M577f/z/c models)
- All models: J21 (this connector is empty unless the optional internal USB ports component is installed)
- All models: J23
- All models: J24
- All models: J51
- All models: J57
- All models: J97
- All models: J98 (this connector is empty unless the optional trusted platform module (TPM) is installed)

 **IMPORTANT:** The flat-cable connector (callout 1) is a Zero Insertion Force (ZIF) connector that uses a hinged retainer to secure the flat cable. The hinged retainer must be opened to install the flat cable, and then closed after the cable is installed.

Figure 1-2745 Connect all connectors



Step 42: Install the fax PCA (M577c/f/z)

 **NOTE:** This step is for the M577c/f/z models. For the M577n model, skip this step and go to [Step 43: Install the HDD \(M577\) on page 1552](#).

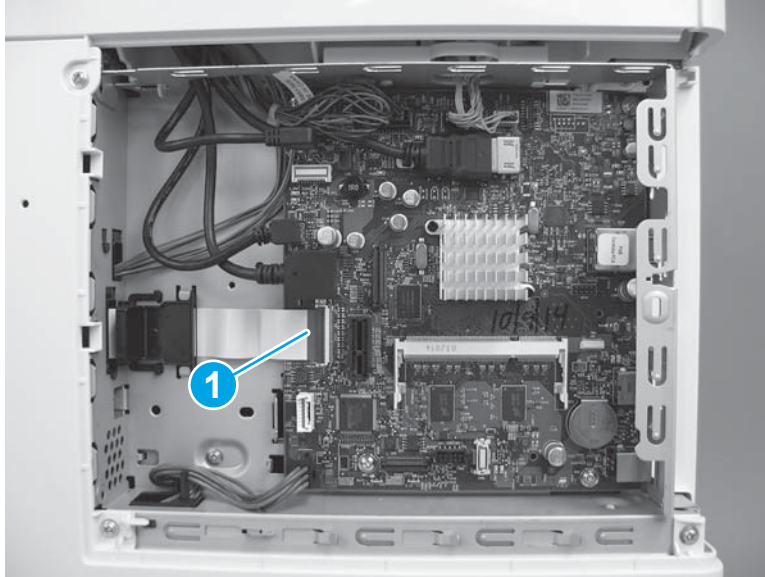
For the M552 and M553 models, skip this step and go to [Step 44: Install the formatter \(M552 and M553\) on page 1554](#).

 **CAUTION:**  ESD-sensitive part.

1. Position the tab and telephone port (callout 1) on the fax PCA in the slots (callout 2) in the formatter case.

Figure 1-2746 Position the fax PCA

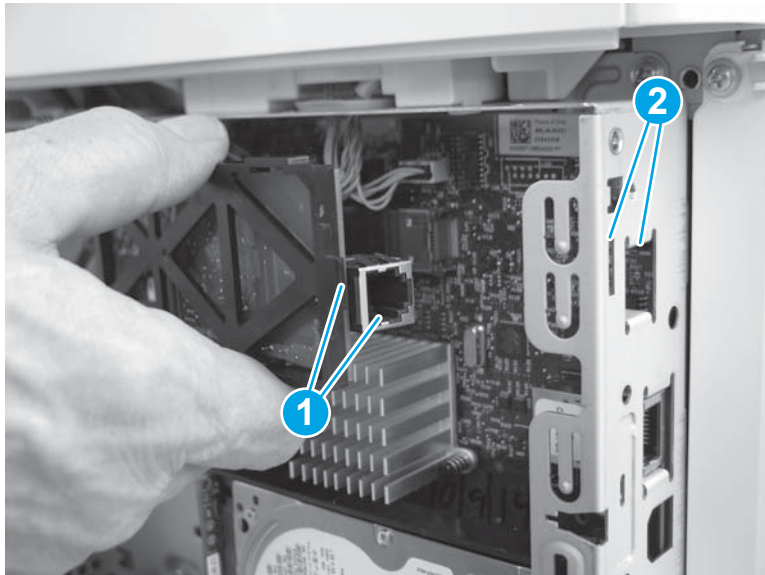

- Slide the fax PCA to the right (callout 1) until the tab and telephone port described in the previous step and seated in the formatter case. Position the retainer (callout 2) in the slot (callout 3) in the formatter. Rotate the end of the fax PCA toward the formatter (callout 4) until the retainer snaps into place.

Figure 1-2747 Install the fax PCA

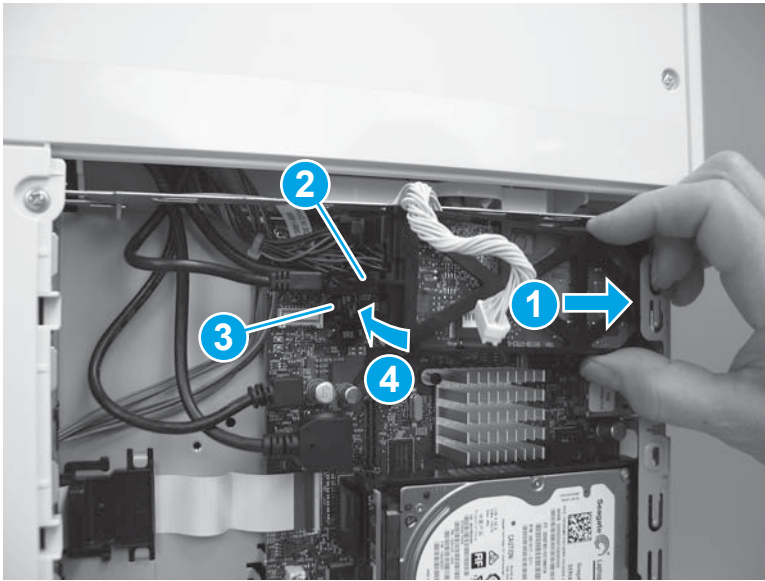

- Position the cable (callout 1) in the guide (callout 2), and then connect one connector (callout 3).

Figure 1-2748 Connect the connector

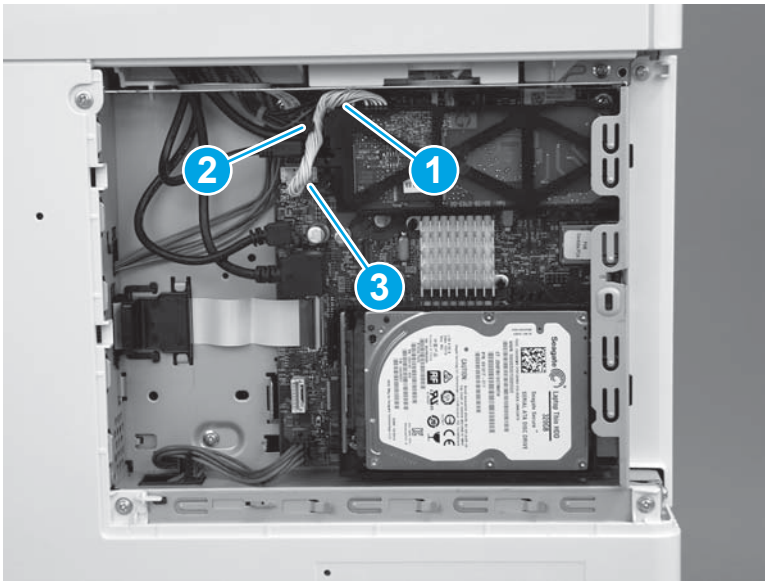

Step 43: Install the HDD (M577)

 **NOTE:** This step is for the M577 models. For the M552 and M553 models, skip this step and go to [Step 44: Install the formatter \(M552 and M553\) on page 1554](#).

 **CAUTION:**  ESD-sensitive part.

1. Align the end of the bracket (callout 1) with the slot in the chassis (callout 2), and then slide the HDD into the printer (callout 3) to engage the bracket with the chassis.

Figure 1-2749 Install the holder

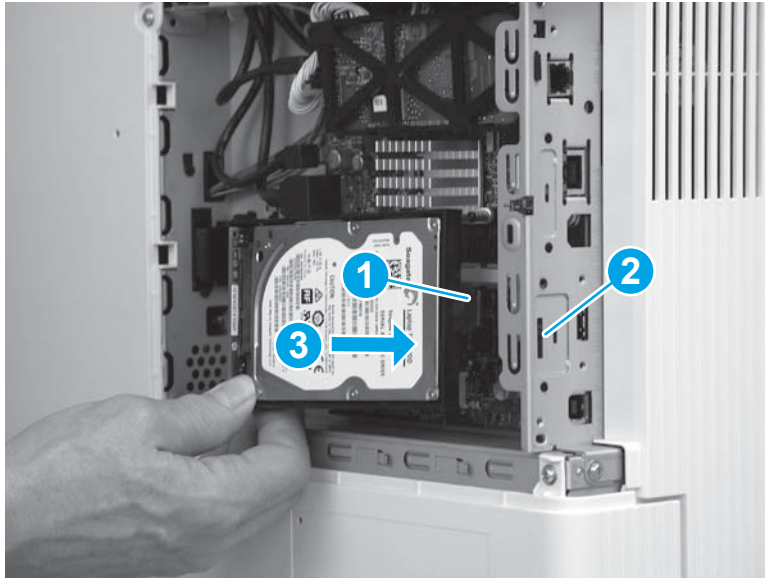

2. Hold the HDD connector latch (callout 1) in the released position, and then rotate the HDD down and into the connector on the formatter to install it.

 **NOTE:** Make sure that the tab (callout 2) snaps into place, and that the HDD is securely installed.

Figure 1-2750 Release the HDD

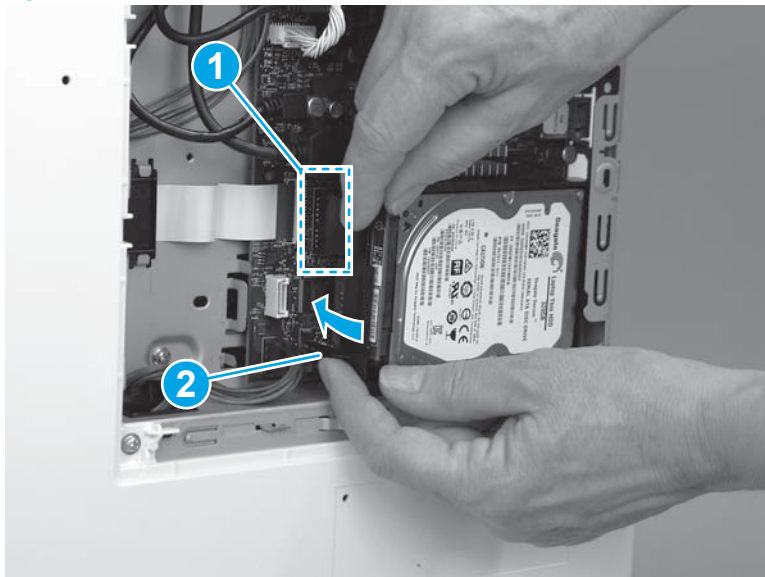

Step 44: Install the formatter (M552 and M553)

 **NOTE:** This step is for the M552 and M553 models. For the M577 models, skip this step and go to [Step 45: Install the formatter cover on page 1555](#).

If the optional hard-disk drive (HDD) was removed, do not forget to reinstall it after the formatter is reinstalled.

Engage the HDD holder with the chassis, rotate the HDD connector down and into the connector on the formatter. Make sure that the tabs snap into place.

 **CAUTION:**  ESD-sensitive part.

1. Position the formatter in the printer, and then install four screws (callout 1).

Figure 1-2751 Install the formatter

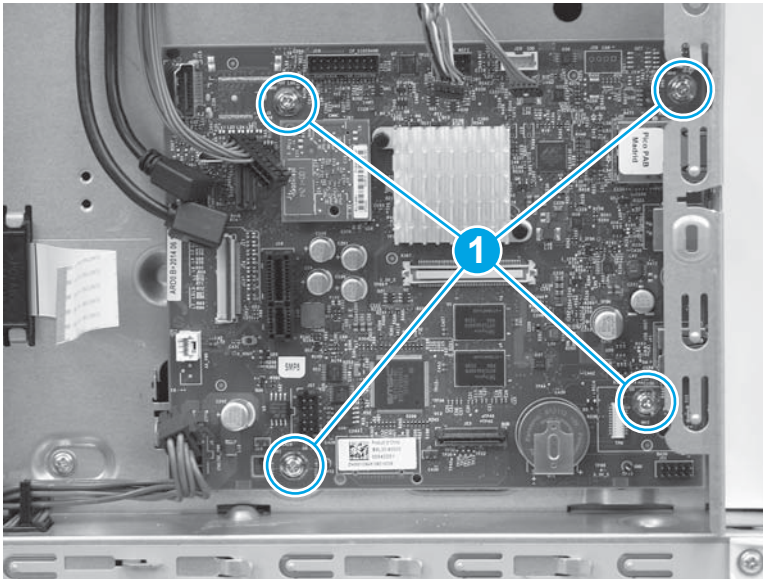

2. Connect all of the connectors on the formatter.

The following connectors are empty:

- All models: J1 (this connector is empty unless the optional DIMM is installed)
- M553n/dn and M552dn: J2 (callout 1; this is the touchscreen connector for the M553x model)
- All models: J9 (this connector is empty unless the optional internal USB ports component is installed)
- All models: J18 (this connector is empty unless the optional hard-disk-drive (HDD) is installed)
- All models: J23
- All models: J24
- M553n/dn and M552dn: J25 (this is the wireless connector for the M553x model)
- All models: J57
- All models: J98 (this connector is empty unless the optional trusted platform module (TPM) is installed)

 **IMPORTANT:** The flat-cable connector (callout 2) is a Zero Insertion Force (ZIF) connector that uses a hinged retainer to secure the flat cable. The hinged retainer must be opened to install the flat cable.

Figure 1-2752 Connect all connectors



Step 45: Install the formatter cover

- ▲ Slide the cover onto the printer (callout 1) to install it.

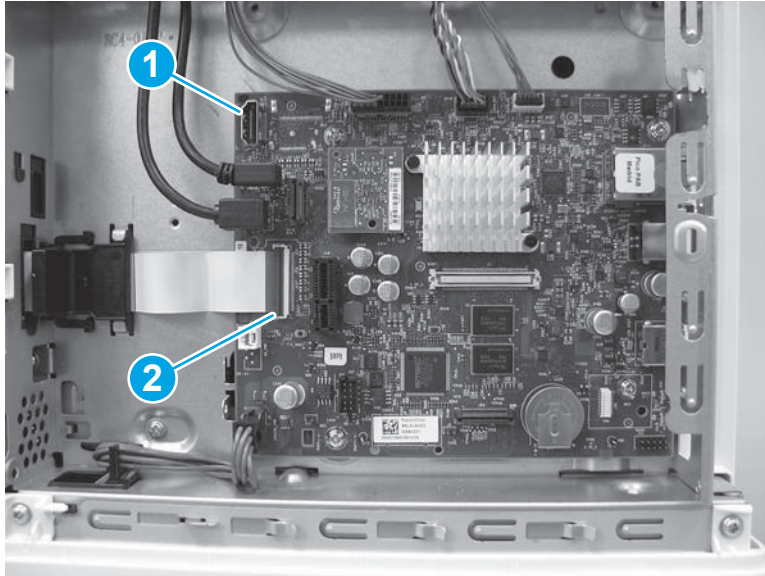
 **NOTE:** Make sure that the tabs on the formatter cover align with the slots provided in the printer (callout 2). Tighten the two thumbscrews (callout 3).

 **TIP:** If needed, use the edge of a coin to turn the thumbscrews.

Figure 1-2753 Install the cover

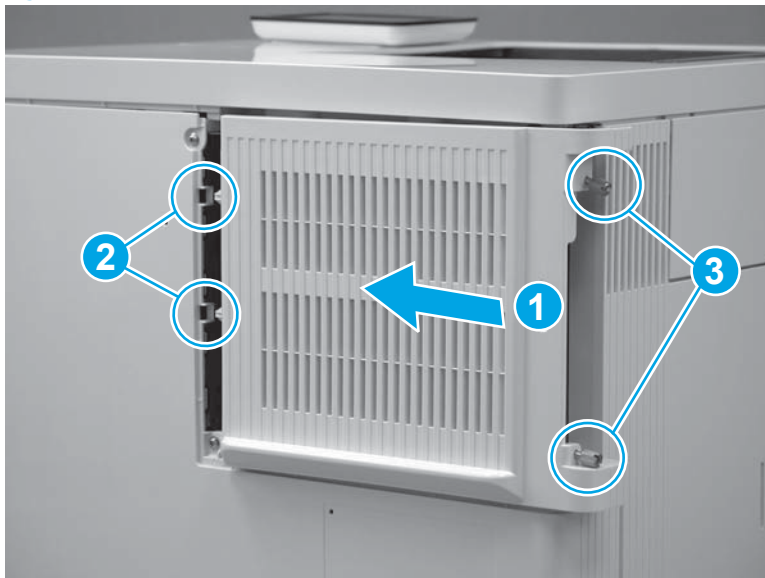

Step 46: Install the TCU

1. Verify that the toner collection hatch cover is in the closed position on the TCU.

Figure 1-2754 Verify that the toner collection hatch cover is closed

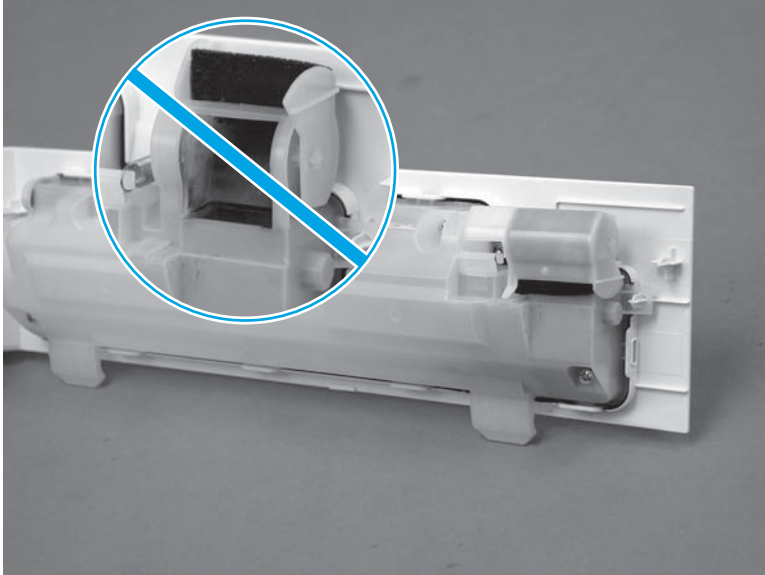

2. Position the TCU with the hinges in the slots provided in the printer (callout 1), and then rotate the TCU up and into the closed position.

 **NOTE:** The toner collection hatch cover automatically opens when the TCU is closed.

Figure 1-2755 Install the TCU



3. Close the front door.

Figure 1-2756 Close the front door

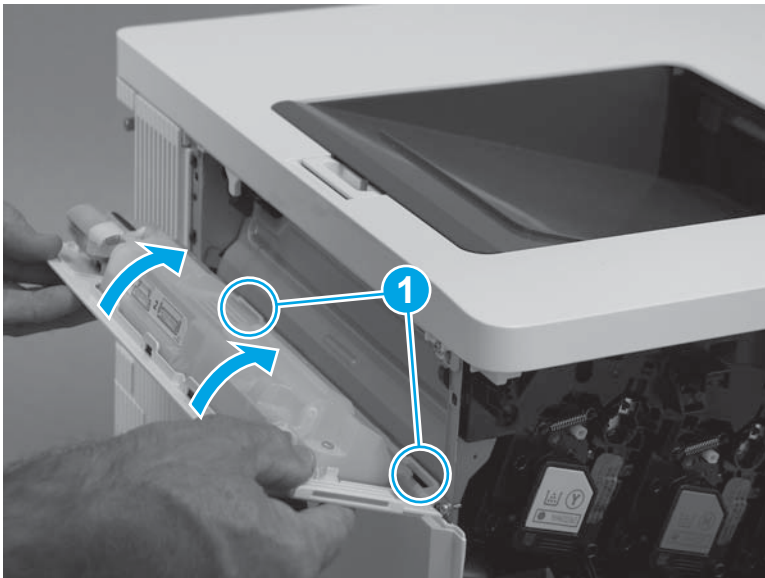

Step 47: Install the tray

1. With the front of the tray slightly lifted, align the sides of the tray with the rails in the printer, and then carefully slide the tray into the printer.

 **TIP:** As the tray slides into the printer, lower the front of it.

Figure 1-2757 Install the tray



2. Close the tray.

Figure 1-2758 Close the tray



Step 48: Install the control-panel assembly (M553x only)

 **NOTE:** For the M553n/dn and M552dn models, skip this step and go to [Step 49: Install the USB cover \(M552 and M553\)](#) on page 1561.

For the M577 models, skip this step.

1. Place the control panel on the printer as shown.

Figure 1-2759 Place the control panel on the product

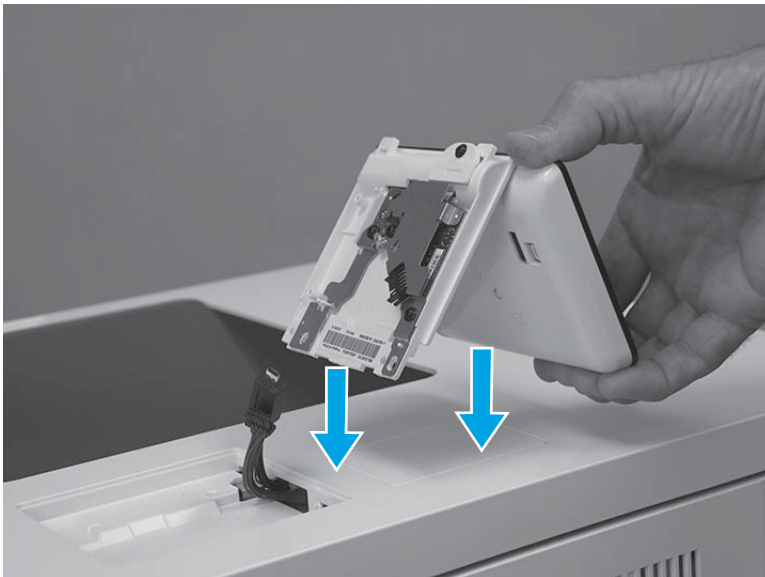

2. Connect one USB cable (callout 1), and one connector (callout 2).

 **IMPORTANT:** Take note of the location of the two mounting tabs (callout 3) on the control-panel assembly.

Figure 1-2760 Connect two connectors



3. Turn the control panel over, and then position the front edge tabs in the slots in the top cover.

Figure 1-2761 Turn the control panel over

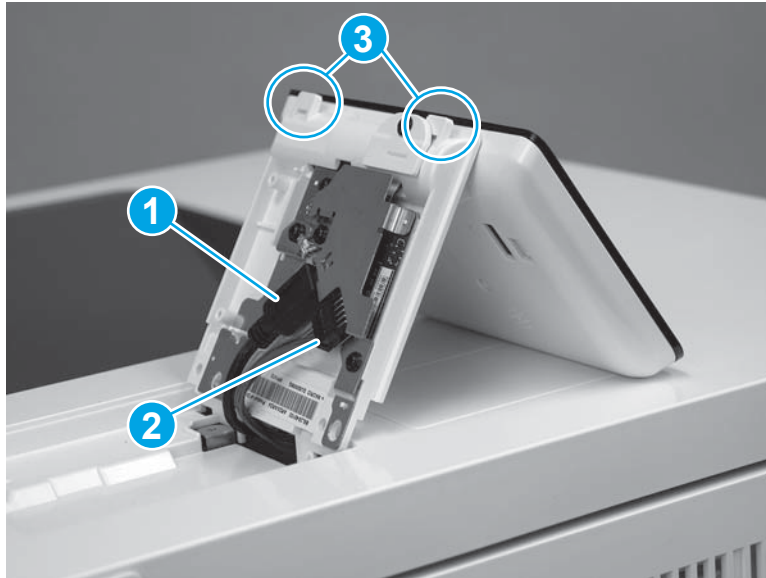
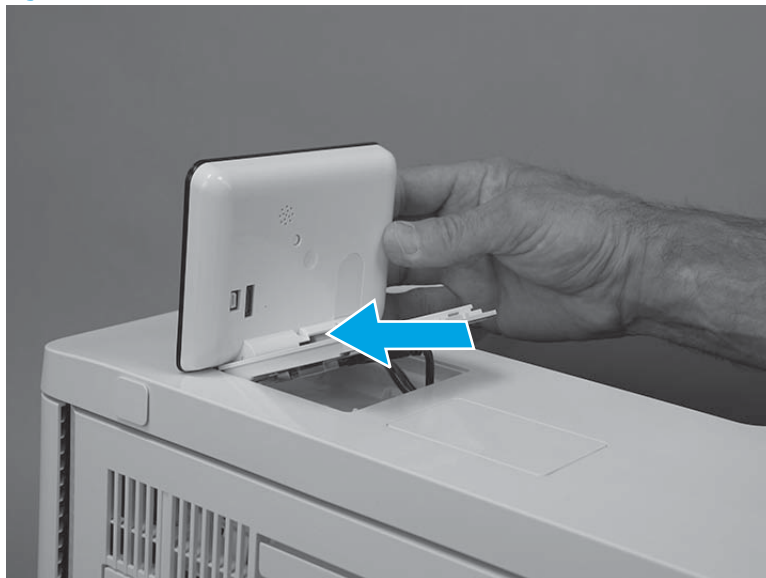

4. Rotate the control-panel base down onto the printer.

Figure 1-2762 Rotate the control-panel base down



5. Use a small Phillips screwdriver to install two screws (callout 1).

Figure 1-2763 Install two screws

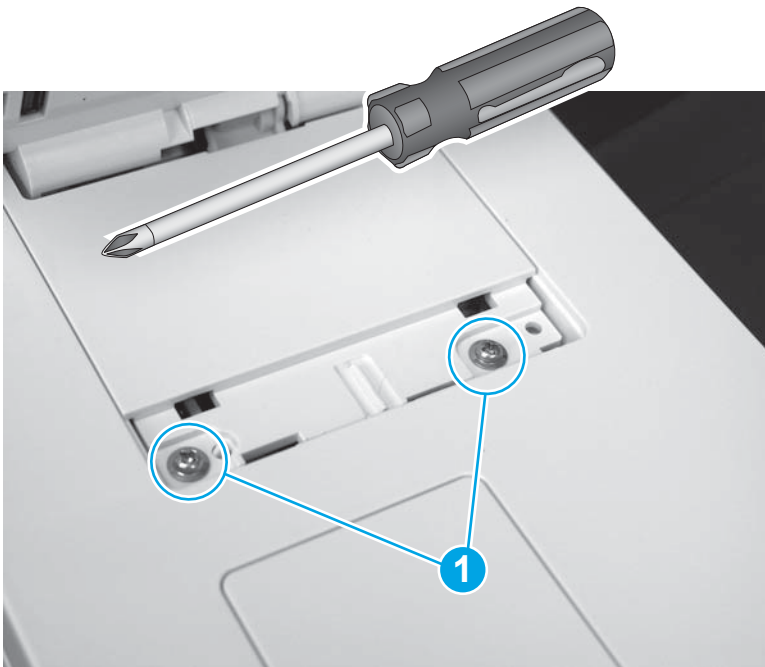

6. Position the screw cover mounting feet into the slots in the top cover (callout 1), and then rotate the cover down (callout 2) to install it.

 **NOTE:** Press down on the cover firmly to make sure that the tabs on the cover (callout 3) snap into place.

Figure 1-2764 Install the cover

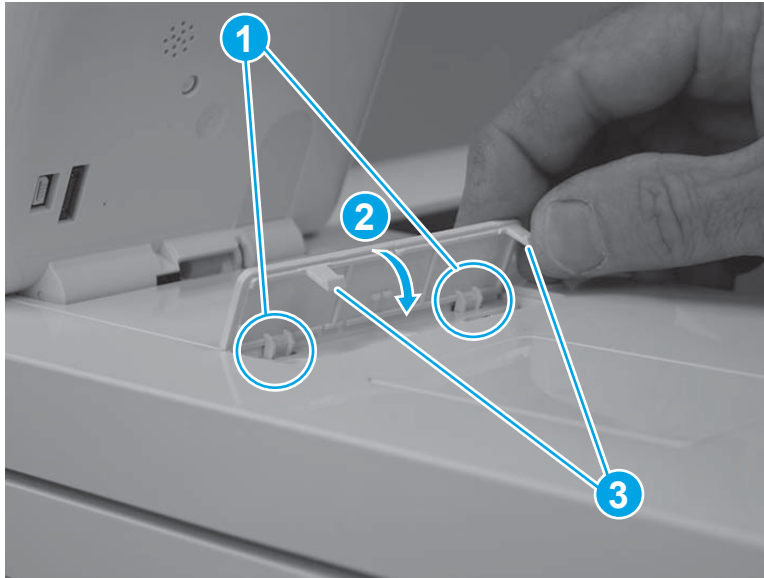

Step 49: Install the USB cover (M552 and M553)

 **NOTE:** This step is for the M552 and M553 models. For the M577 models, skip this step.

1. Push the cover into the USB port to install it.

Figure 1-2765 Install the cover



2. Make sure that the USB cover is fully seated after installing it.

Figure 1-2766 Check the installation



Removal and replacement: Drum motor 2 (M2)

- [Introduction](#)
- [Step 1: Remove the USB cover \(M552 and M553\)](#)
- [Step 2: Remove the control panel \(M553x only\)](#)
- [Step 3: Remove the tray](#)
- [Step 4: Remove the toner collection unit \(TCU\)](#)
- [Step 5: Remove the formatter cover](#)
- [Step 6: Remove the formatter \(M552 and M553\)](#)
- [Step 7: Remove the hard-disk drive \(HDD\) \(M577\)](#)
- [Step 8: Remove the fax PCA \(M577c/f/z\)](#)
- [Step 9: Remove the formatter \(M577\)](#)
- [Step 10: Remove the rear cover \(M552 and M553\)](#)
- [Step 11: Remove the rear upper cover \(M577\)](#)
- [Step 12: Remove the rear cover \(M577\)](#)
- [Step 13: Remove the left upper cover \(M577\)](#)
- [Step 14: Remove the right front upper cover \(M577dn\)](#)
- [Step 15: Remove the stapler cover assembly \(M577c/f/z\)](#)
- [Step 16: Remove the integrated scanner assembly \(ISA\) \(M577\)](#)
- [Step 17: Remove the right upper cover \(M577\)](#)
- [Step 18: Remove the top rear cover \(M577\)](#)
- [Step 19: Remove the left cover](#)
- [Step 20: Remove the upper cover \(M552 and M553\)](#)
- [Step 21: Remove the formatter case](#)
- [Step 22: Remove the right rear cover](#)
- [Step 23: Remove the DC controller and sheet-metal bracket](#)
- [Step 24: Remove the high-voltage power supply T \(HVPST\)](#)
- [Step 25: Remove drum motor 2 \(M2\)](#)
- [Step 26: Unpack the replacement assembly](#)
- [Step 27: Install drum motor 2 \(M2\)](#)
- [Step 28: Install the HVPST](#)
- [Step 29: Install the DC controller and sheet-metal bracket](#)

- [Step 30: Install the right rear cover](#)
- [Step 31: Install the formatter case](#)
- [Step 32: Install the upper cover \(M552 and M553\)](#)
- [Step 33: Install the left cover](#)
- [Step 34: Install the top rear cover \(M577\)](#)
- [Step 35: Install the right upper cover \(M577\)](#)
- [Step 36: Install the integrated scanner assembly \(ISA\) \(M577\)](#)
- [Step 37: Install the stapler cover assembly \(M577c/f/z\)](#)
- [Step 38: Install the right front upper cover \(M577dn\)](#)
- [Step 39: Install the left upper cover \(M577\)](#)
- [Step 40: Install the rear cover \(M577\)](#)
- [Step 41: Install the rear upper cover \(M577\)](#)
- [Step 42: Install the rear cover \(M552 and M553\)](#)
- [Step 43: Install the formatter \(M577\)](#)
- [Step 44: Install the fax PCA \(M577c/f/z\)](#)
- [Step 45: Install the HDD \(M577\)](#)
- [Step 46: Install the formatter \(M552 and M553\)](#)
- [Step 47: Install the formatter cover](#)
- [Step 48: Install the TCU](#)
- [Step 49: Install the tray](#)
- [Step 50: Install the control-panel assembly \(M553x only\)](#)
- [Step 51: Install the USB cover \(M552 and M553\)](#)

Introduction

This document provides the procedures to remove and replace the drum motor 2 (M2).

Before performing service

Turn the printer power off

- Disconnect the power cable.

 **WARNING!** To avoid damage to the printer, turn the printer off, wait 30 seconds, and then remove the power cord before attempting to service the printer.

Use the table below to identify the correct part number for your printer, and then go to <http://h20141.www2.hp.com/hpparts> to order the part.

Drum motor 2 (M2) part number

RM2-0078-000CN

Drum motor 2 (M2)

Required tools

- #2 Phillips screwdriver with a magnetic tip

After performing service

Make sure that all of the connectors on the HVPST are fully seated.

Make sure that all of the connectors on the DC controller are fully seated.

Make sure that all of the connectors on the formatter are fully seated.

Make sure that the formatter cover is fully seated, and that the thumbscrews are finger tight after replacing it.

Turn the printer power on

- Connect the power cable.
- Use the power switch to turn the power on.

Post service test

Use the components test to test the motor. For more information, see the printer troubleshooting manual.

Step 1: Remove the USB cover (M552 and M553)

 **NOTE:** This step is for the M552 and M553 models. For the M577 models, skip this step and go to [Step 3: Remove the tray on page 1570](#).

1. Locate the USB cover.

Figure 1-2767 Locate the USB cover



2. Pull the cover off of the printer to remove it.

Figure 1-2768 Remove the cover



Step 2: Remove the control panel (M553x only)

 **NOTE:** This step is for the M553x model. For the M553n/dn, M552dn, and M577 models, skip this step and go to [Step 3: Remove the tray on page 1570](#).

1. Tilt the control panel up.

Figure 1-2769 Tilt the control panel up



2. Use a small flat-blade screwdriver to release the control-panel screws cover tabs.

Figure 1-2770 Release the control-panel screws cover tabs

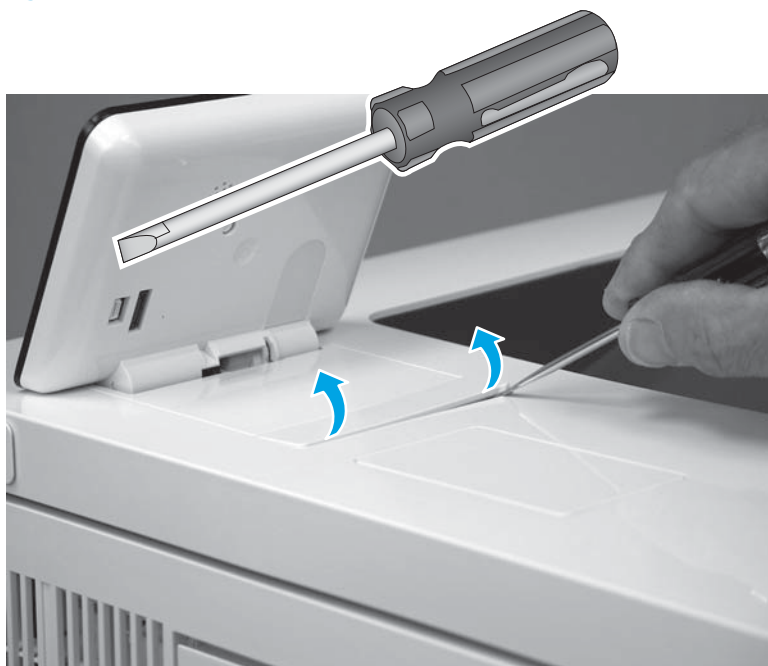

3. Rotate the cover up to remove it.

Figure 1-2771 Remove the cover

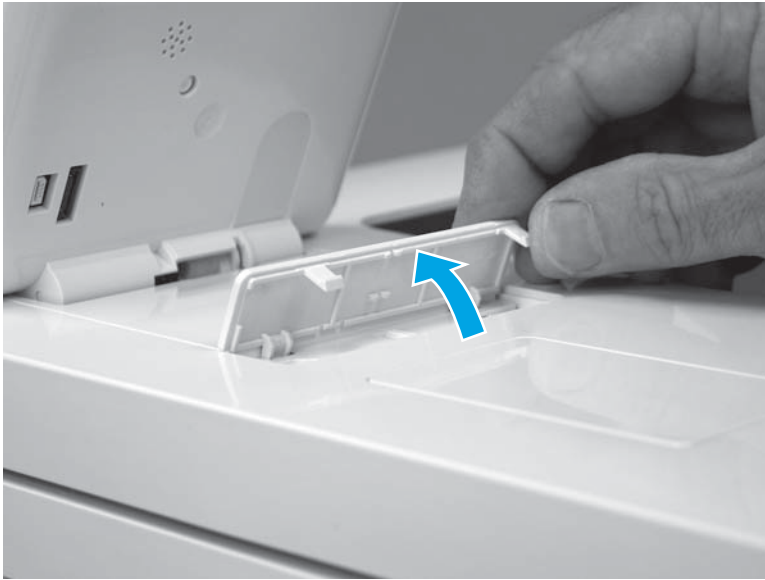

4. Use a small Phillips screwdriver to remove two screws (callout 1).

 **IMPORTANT:** Store the screws in a secure place where they cannot fall down into the printer.

Figure 1-2772 Remove two screws

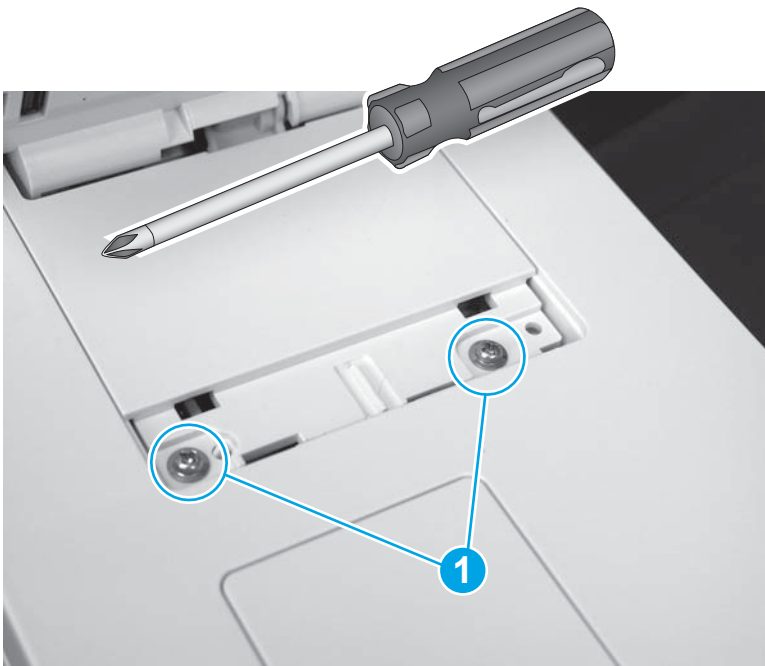

5. Rotate the control-panel base toward the front of the printer.

Figure 1-2773 Rotate the control-panel base up



6. Slightly slide the control-panel base toward the rear of the printer (callout 1) to release it, and then turn the control panel over (callout 2) to access the bottom side.

⚠ CAUTION: The control panel is still attached to the printer. Do not attempt to completely remove the control panel.

Figure 1-2774 Turn the control panel over

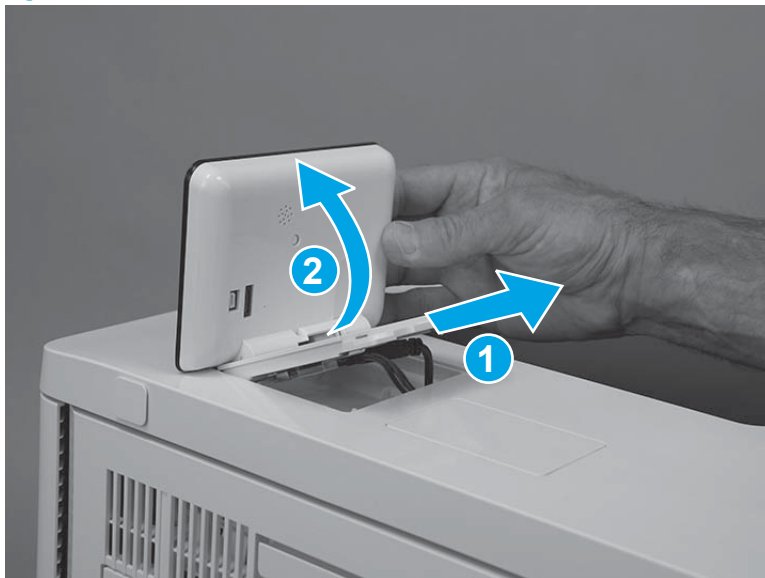

7. Disconnect one USB cable (callout 1), one connector (callout 2), and then remove the control panel.

Figure 1-2775 Disconnect two connectors

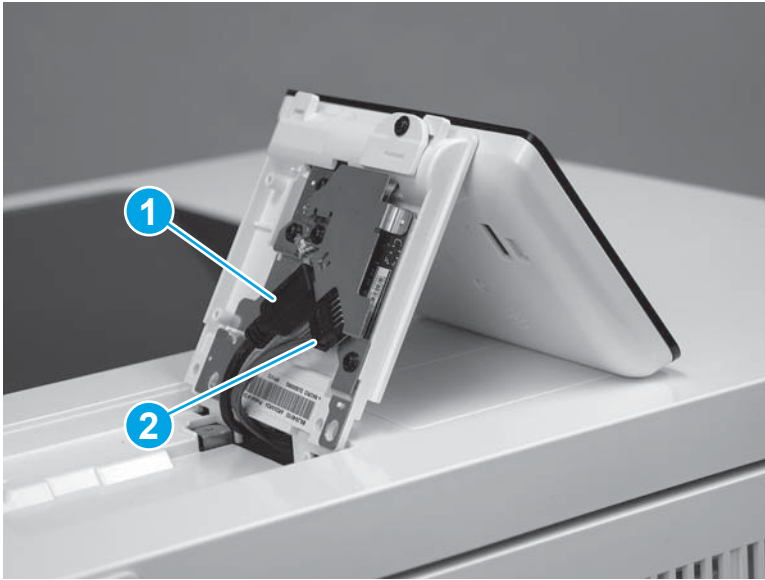

Step 3: Remove the tray

1. Pull the tray out until it stops.

Figure 1-2776 Pull the tray out



2. Lift the front of the tray, and then pull it out of the printer to remove it.

Figure 1-2777 Remove the tray

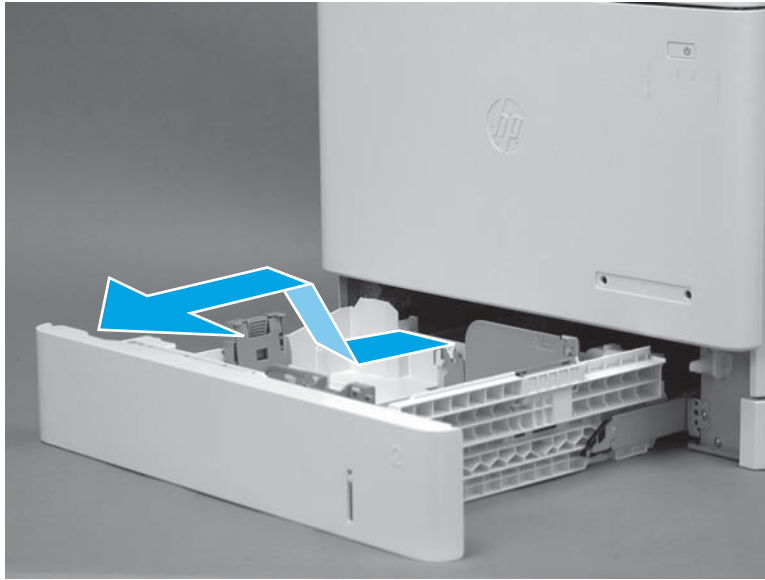

Step 4: Remove the toner collection unit (TCU)

1. Open the front door.

Figure 1-2778 Open the front door



2. Open the TCU.

 **NOTE:** The toner collection hatch cover automatically closes when the TCU is opened.

Figure 1-2779 Open the TCU



3. Pull the TCU away from the printer at an angle to remove it.

⚠ CAUTION: Do not open the toner collection hatch cover when handling the TCU. If toner gets on clothing, wipe it off by using a dry cloth and wash the clothes in cold water. Hot water sets toner into fabric.

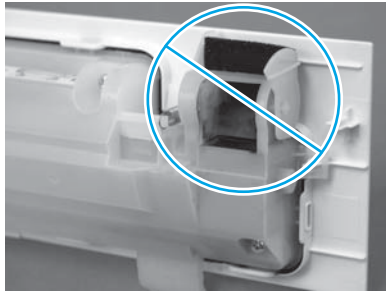
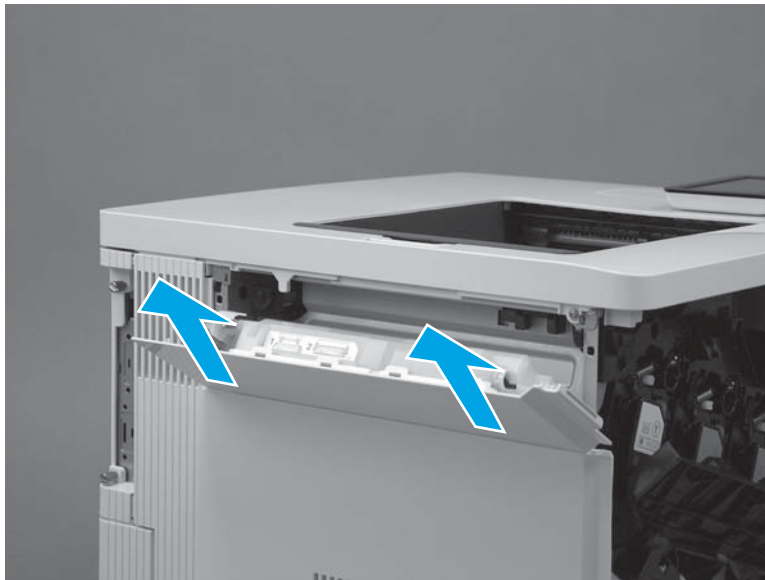

Figure 1-2780 Remove the TCU



Step 5: Remove the formatter cover

1. Locate the formatter cover.

Figure 1-2781 Locate the formatter cover

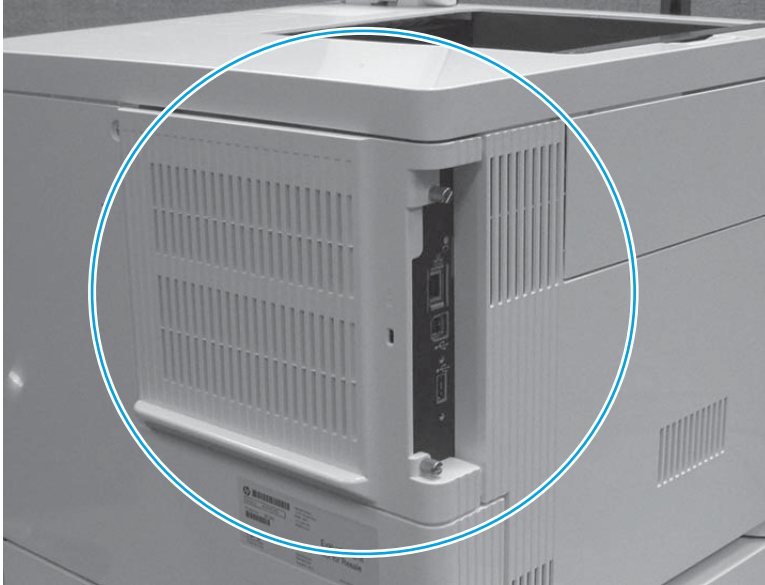

2. Loosen the two thumbscrews (callout 1). Grasp the two thumbscrews, and then slide the cover away from the printer (callout 2) to remove it.

 **TIP:** If needed, use the edge of a coin to turn the thumbscrews.

Figure 1-2782 Loosen the thumbscrews

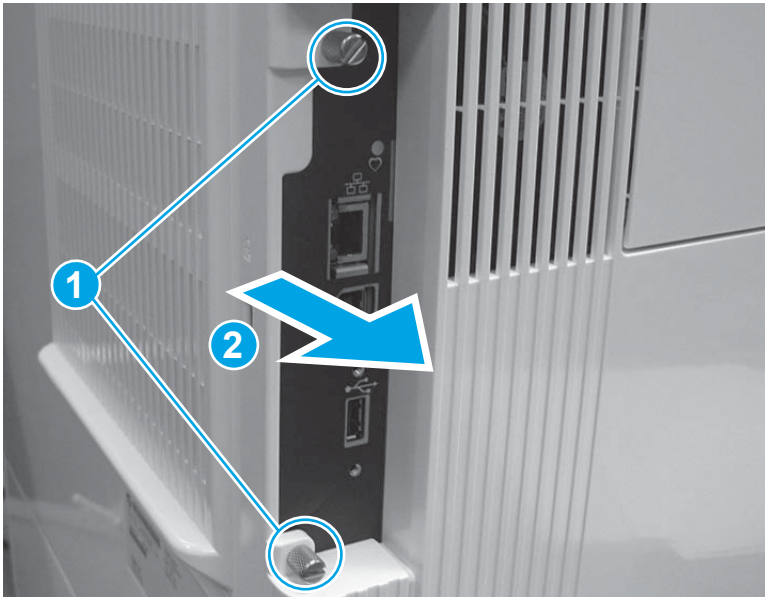

Step 6: Remove the formatter (M552 and M553)

 **NOTE:** This step is for the M552 and M553 models. For the M577 models, skip this step and go to [Step 7: Remove the hard-disk drive \(HDD\) \(M577\) on page 1576](#).

If the optional hard-disk drive (HDD) is installed, it must be removed to gain access to the formatter mounting screws.

Release two tabs along the left edge of the HDD, rotate the left edge away from the product, and then slide the HDD to the left to remove it.

 **CAUTION:**  ESD-sensitive part.

1. Disconnect all of the connectors on the formatter.

The following connectors are empty:

- All models: J1 (this connector is empty unless the optional DIMM is installed)
- M553n/dn and M552dn: J2 (callout 1; this is the touchscreen connector for the M553x model)
- All models: J9 (this connector is empty unless the optional internal USB ports component is installed)
- All models: J18 (this connector is empty unless the optional hard-disk-drive (HDD) is installed)
- All models: J23
- All models: J24
- M553n/dn and M552dn: J25 (this is the wireless connector for the M553x model)
- All models: J57
- All models: J98 (this connector is empty unless the optional trusted platform module (TPM) is installed)

 **IMPORTANT:** The flat-cable connector (callout 2) is a Zero Insertion Force (ZIF) connector that uses a hinged retainer to secure the flat cable. The hinged retainer must be opened to release the flat cable.

Figure 1-2783 Disconnect all connectors



2. Remove four screws (callout 1), and then remove the formatter.

Figure 1-2784 Remove the formatter

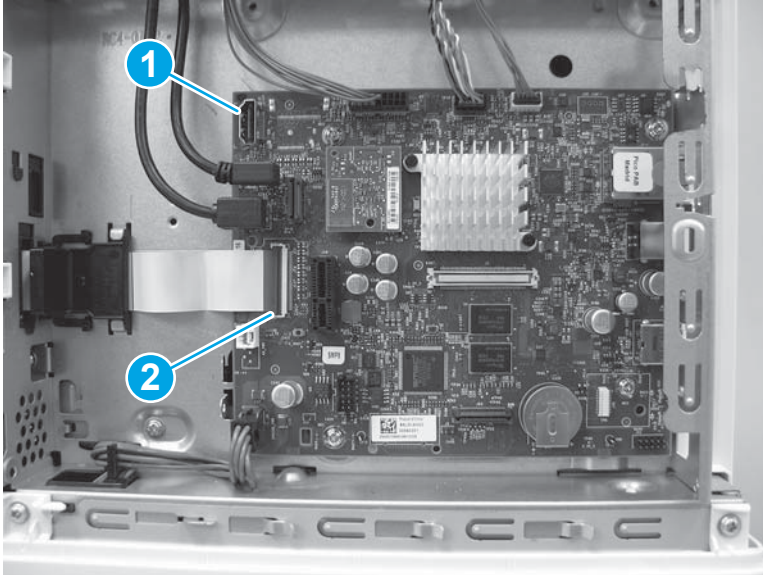
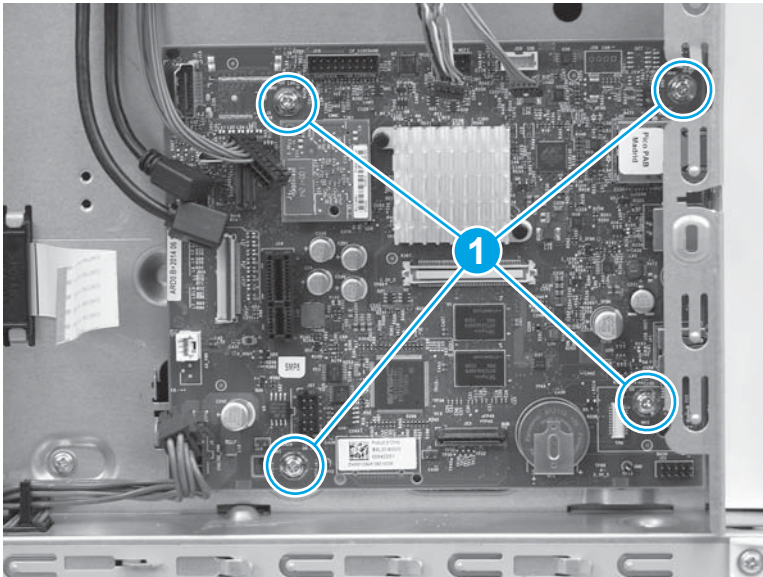

Step 7: Remove the hard-disk drive (HDD) (M577)

 **NOTE:** This step is for the M577 models. For the M552 and M553 models, skip this step and go to [Step 10: Remove the rear cover \(M552 and M553\) on page 1581](#).

 **CAUTION:**  ESD-sensitive part.

1. Release two tabs (callout 1). Hold the tabs in the released position, and then rotate the hard disk drive (HDD) up (callout 2) to release the connector from the formatter.

Figure 1-2785 Release the HDD

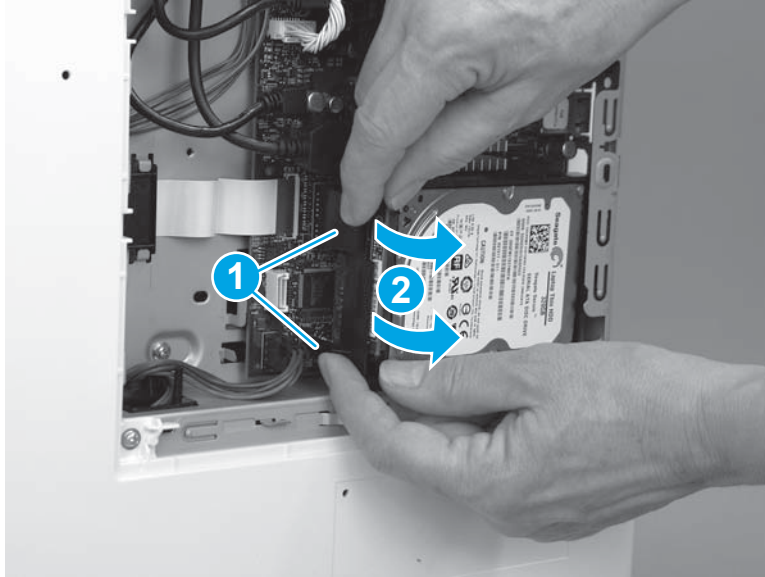

2. Slide the HDD away from the printer to remove it.

Figure 1-2786 Remove the HDD

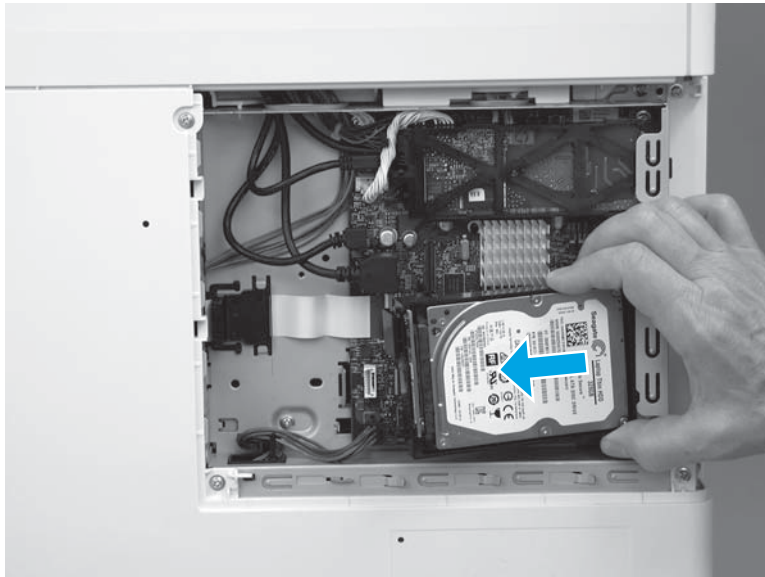

Step 8: Remove the fax PCA (M577c/f/z)

 **NOTE:** This step is for the M577c/f/z models. For the M577n model, skip this step and go to [Step 9: Remove the formatter \(M577\) on page 1579](#).

For the M552 and M553 models, skip this step and go to [Step 10: Remove the rear cover \(M552 and M553\) on page 1581](#).

 **CAUTION:**  ESD-sensitive part.

1. Locate the fax PCA component on the formatter.

Figure 1-2787 Locate the fax PCA

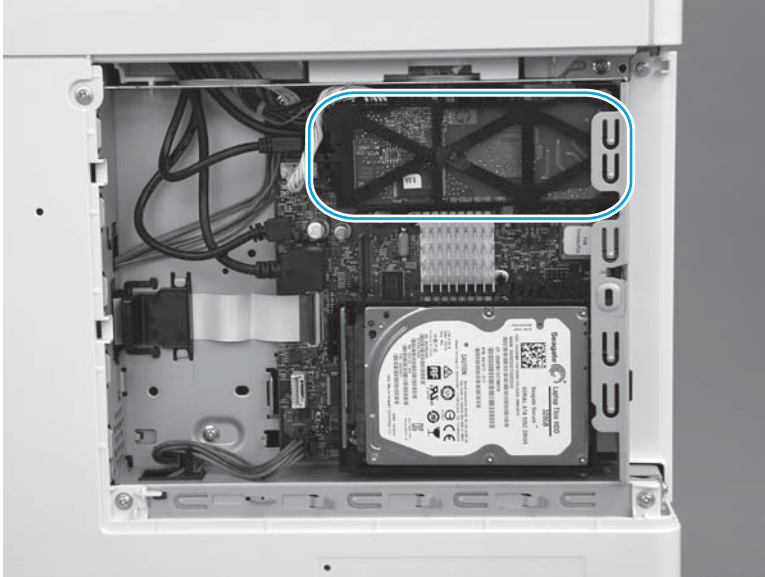

2. Release the connector latch (callout 1), and then pull the connector away from the formatter (callout 2) to disconnect it.

Figure 1-2788 Disconnect one connector

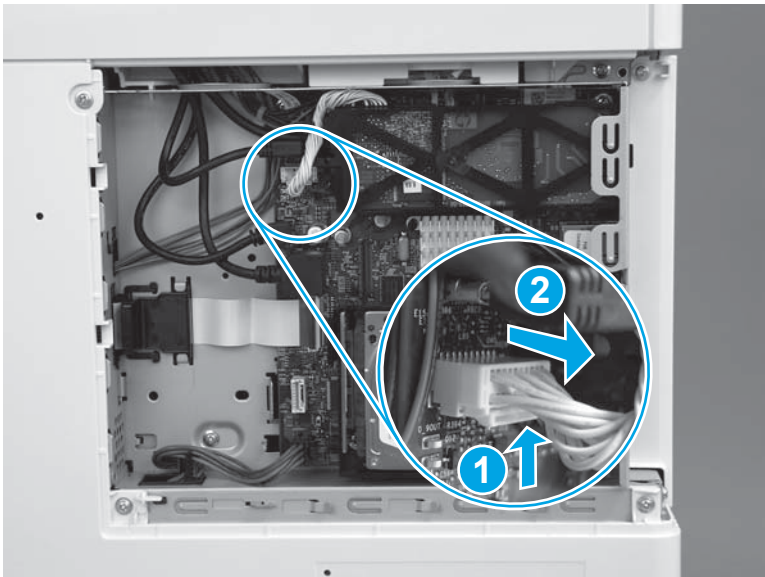

3. Release one retainer (callout 1) by pressing the bracket arms together.

Figure 1-2789 Release one latch

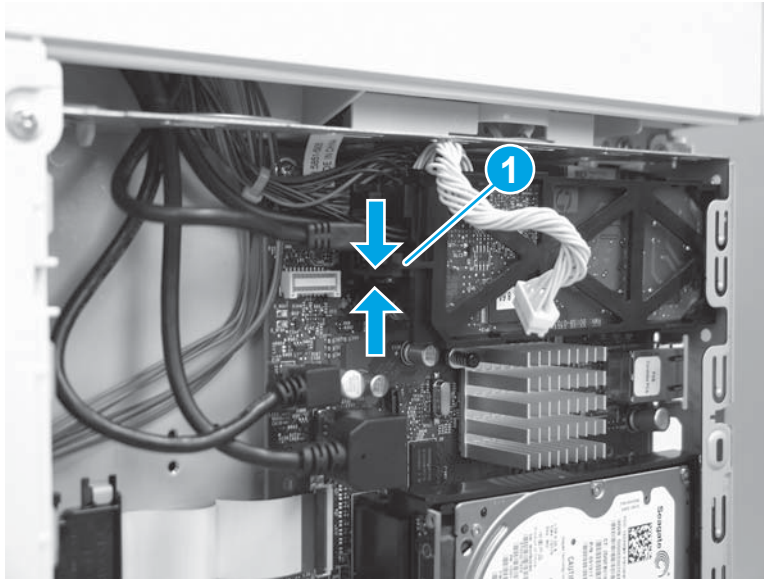

4. Rotate the end of the fax PCA (callout 1) away from the formatter, and then slide the PCA left (callout 2) to remove it.

Figure 1-2790 Remove the fax PCA

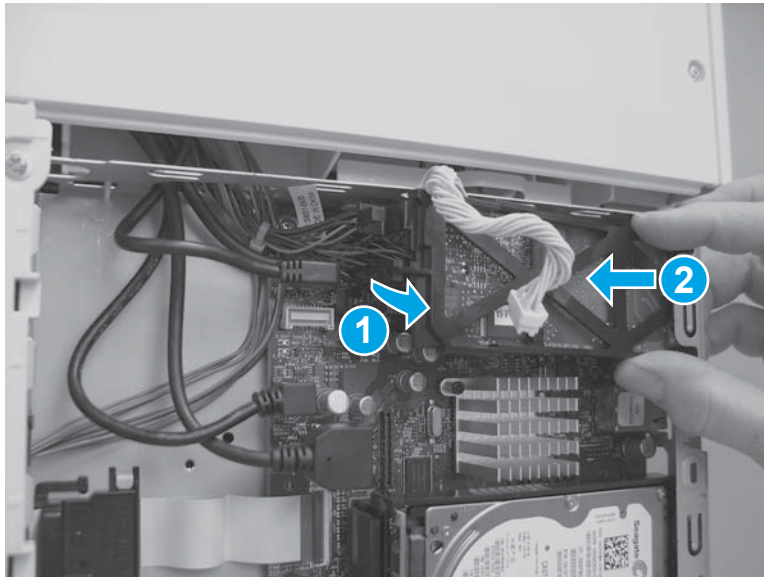

Step 9: Remove the formatter (M577)

 **NOTE:** This step is for the M577 models. For the M552 and M553 models, skip this step and go to [Step 10: Remove the rear cover \(M552 and M553\) on page 1581.](#)

 **CAUTION:**  ESD-sensitive part.

1. Disconnect all of the connectors on the formatter.

The following connectors are empty:

- All models: J1 (this connector is empty unless the optional DIMM is installed)
- All models: J3
- M577dn: J15 (this is the fax connector for the M577f/z/c models)
- All models: J21 (this connector is empty unless the optional internal USB ports component is installed)
- All models: J23
- All models: J24
- All models: J51
- All models: J57
- All models: J97
- All models: J98 (this connector is empty unless the optional trusted platform module (TPM) is installed)

 **IMPORTANT:** The flat-cable connector (callout 1) is a Zero Insertion Force (ZIF) connector that uses a hinged retainer to secure the flat cable. The hinged retainer must be opened to release the flat cable.

Figure 1-2791 Disconnect all connectors



2. Remove four screws (callout 1).

Figure 1-2792 Remove four screws

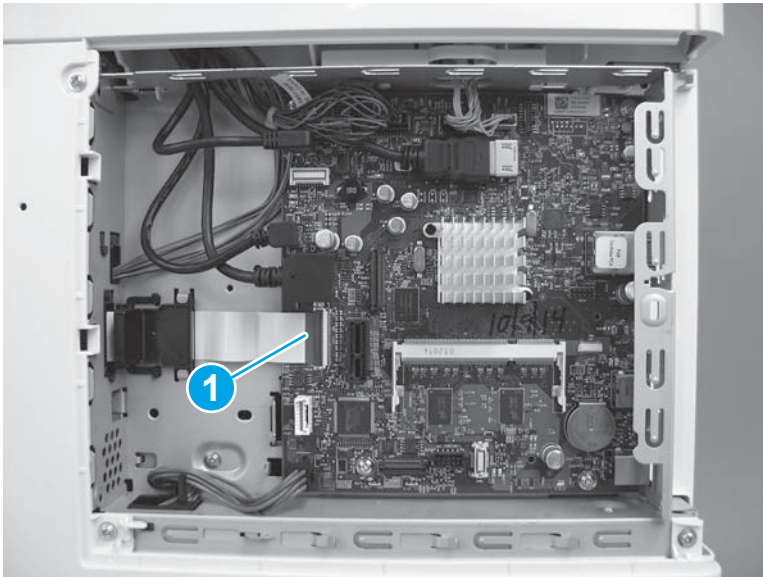
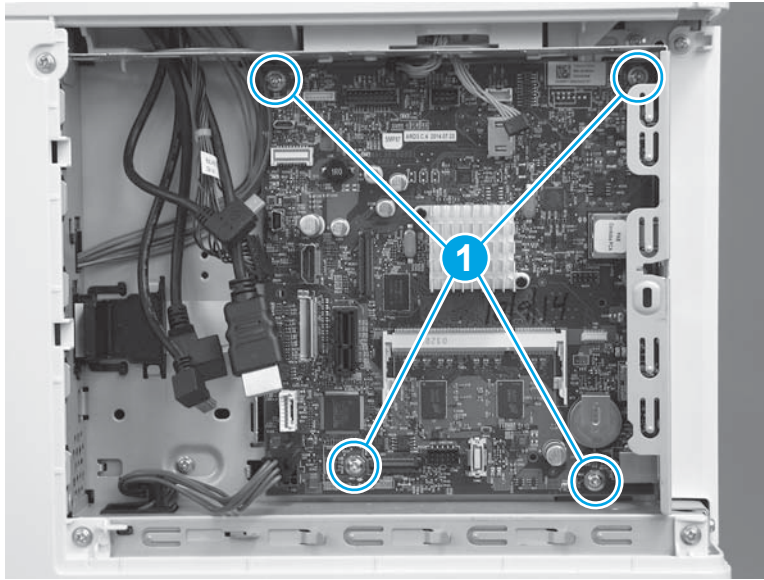

3. Remove the formatter.

Figure 1-2793 Remove the formatter

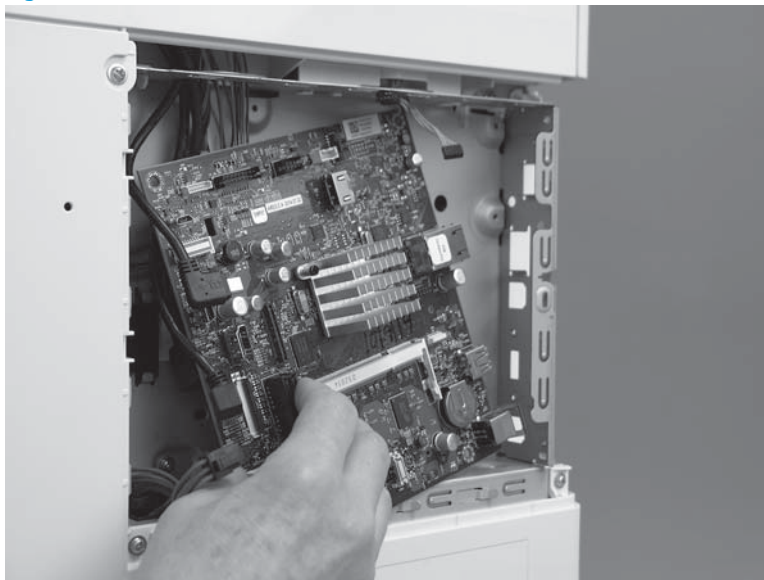

Step 10: Remove the rear cover (M552 and M553)

 **NOTE:** This step is for the M552 and M553 models. For the M577 models, skip this step and go to [Step 11: Remove the rear upper cover \(M577\) on page 1582.](#)

1. Remove four screws (callout 1).

Figure 1-2794 Remove four screws

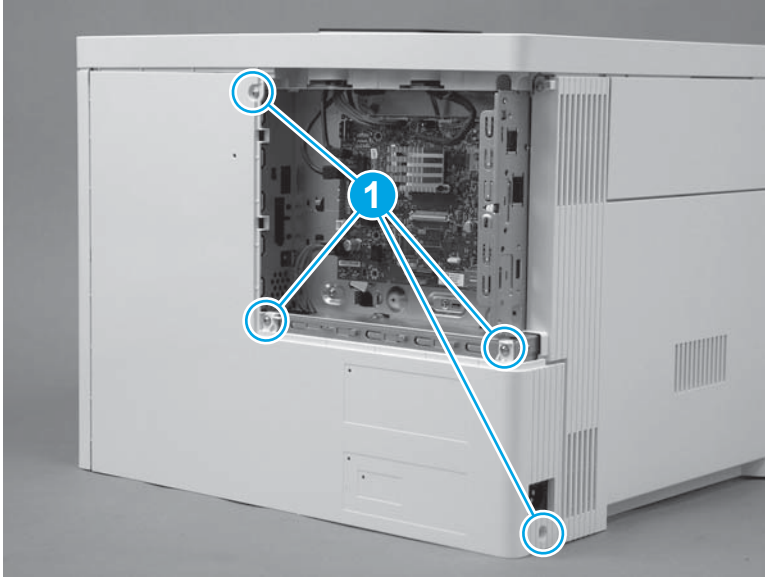

2. Slightly slide the cover to the right (callout 1), rotate the bottom of the cover away from the printer (callout 2), and then pull the top of the cover away from the printer (callout 3) to remove the cover.

Figure 1-2795 Remove the cover

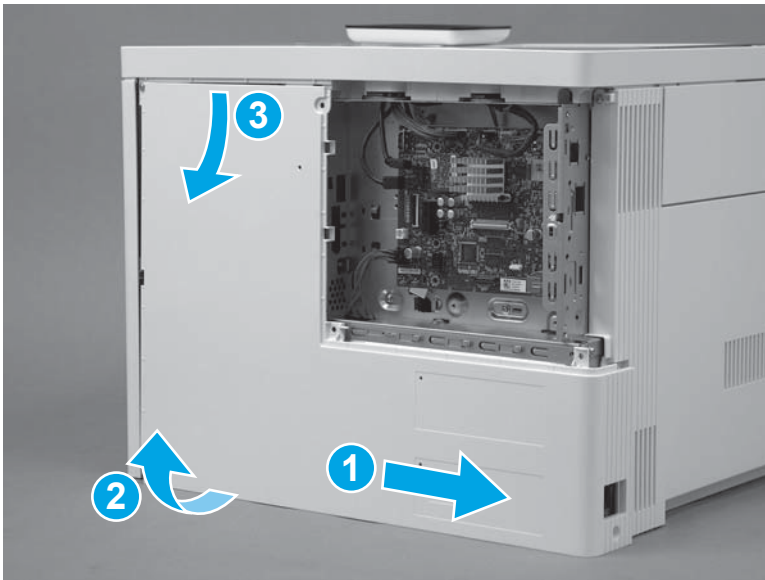

Step 11: Remove the rear upper cover (M577)

 **NOTE:** This step is for the M577 models. For the M552 and M553 models, skip this step and go to [Step 19: Remove the left cover on page 1597](#).

1. Remove two screws (callout 1).

 **Reinstallation tip:** These two screws are self-tapping screws for plastic. When reinstalling them, rotate the screws counterclockwise to align them with the existing thread pattern, and then carefully turn them clockwise to tighten. Do not overtighten. This will prevent stripping the threads inside the screw holes.

Figure 1-2796 Remove two screws



2. Use a small, flat blade screwdriver to release the right edge of the cover.

Figure 1-2797 Release the right edge

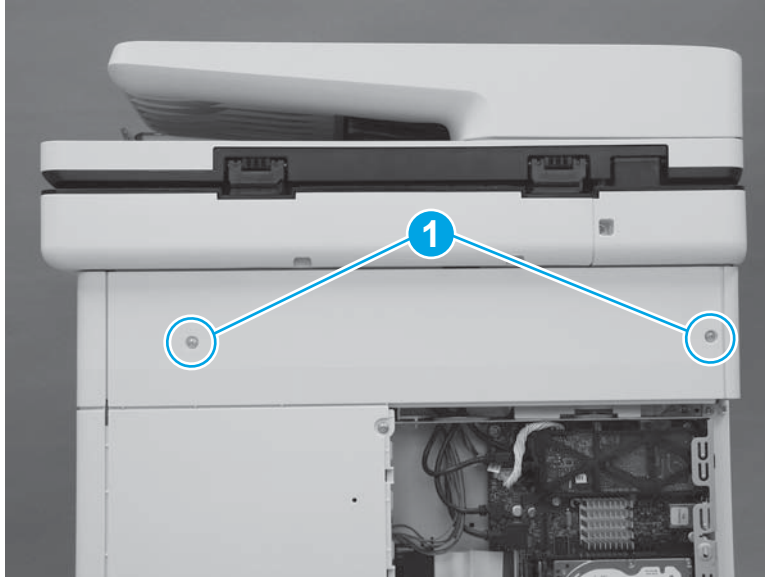
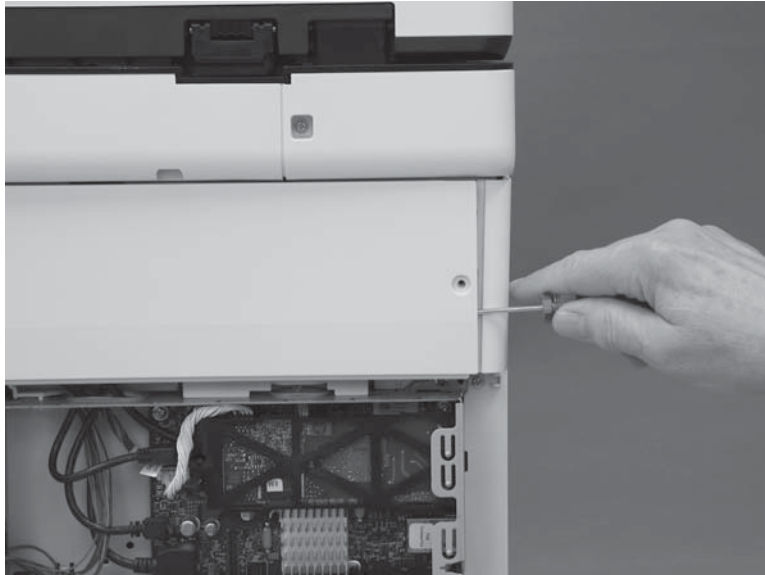

3. Pull the right edge of the cover (callout 1) away from the printer, and then slide the cover to the right (callout 2).

Figure 1-2798 Slide the cover right

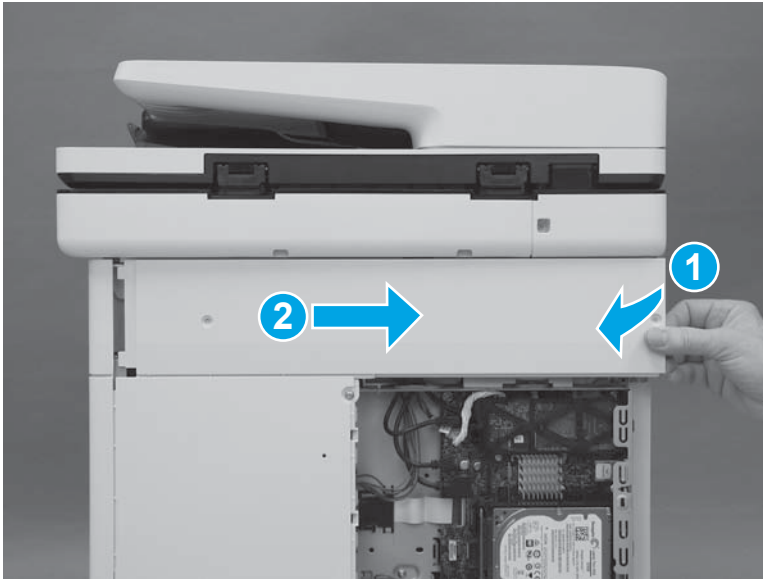

4. Remove the cover.

Figure 1-2799 Remove the cover

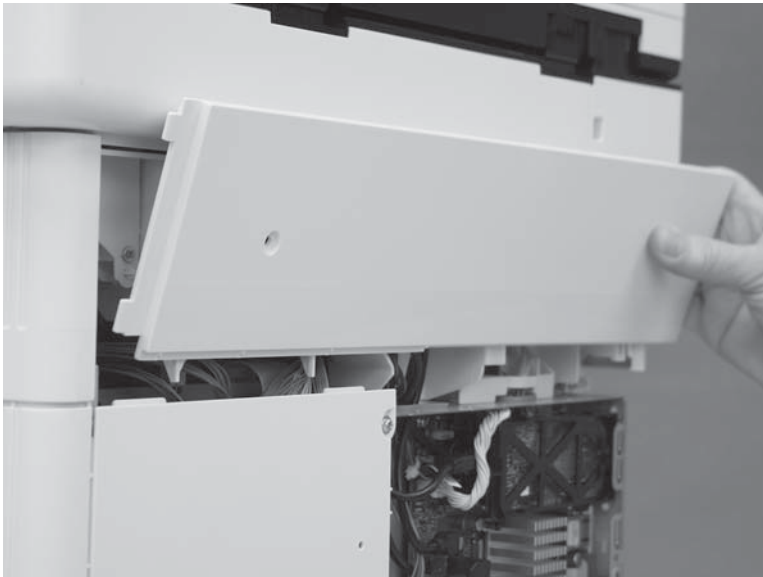

Step 12: Remove the rear cover (M577)

 **NOTE:** This step is for the M577 models. For the M552 and M553 models, skip this step and go to [Step 19: Remove the left cover on page 1597](#).

1. Remove four screws (callout 1).

Figure 1-2800 Remove four screws

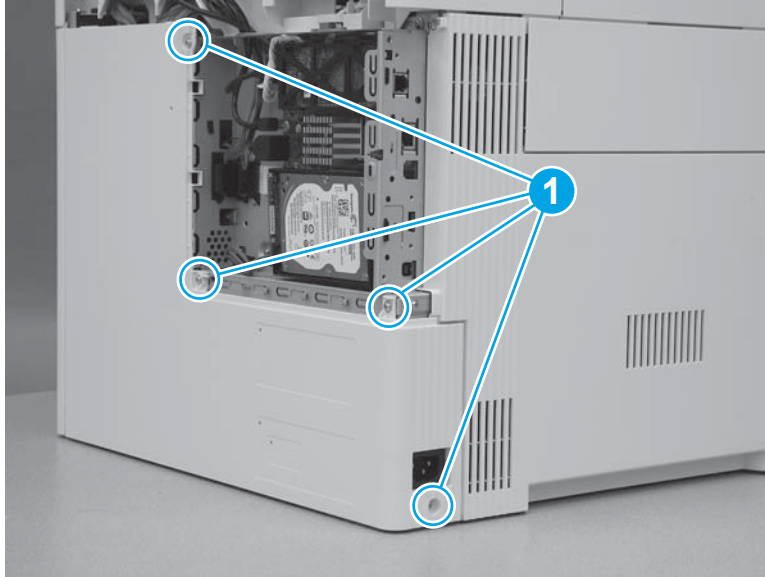

2. Slide the cover to the right to remove it.

Figure 1-2801 Remove the cover

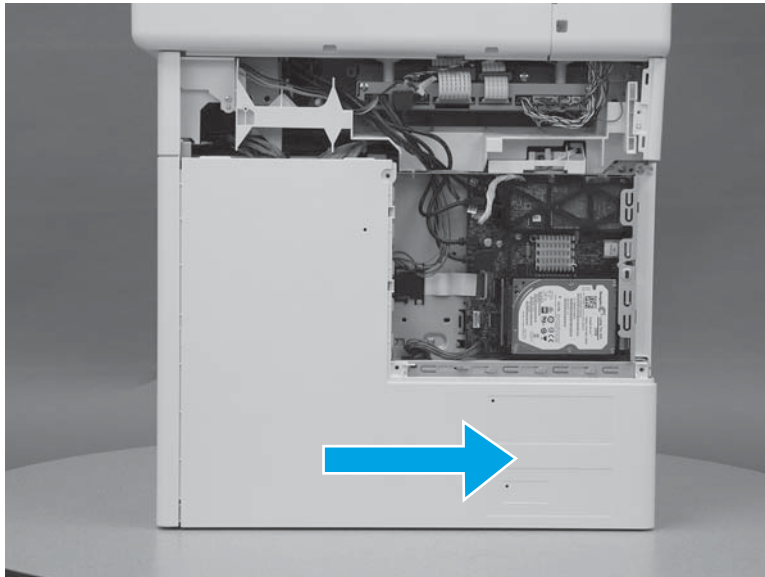

Step 13: Remove the left upper cover (M577)

 **NOTE:** This step is for the M577 models. For the M552 and M553 models, skip this step and go to [Step 19: Remove the left cover on page 1597](#).

1. At the left side of the printer, release one tab (callout 1).

Figure 1-2802 Release one tab

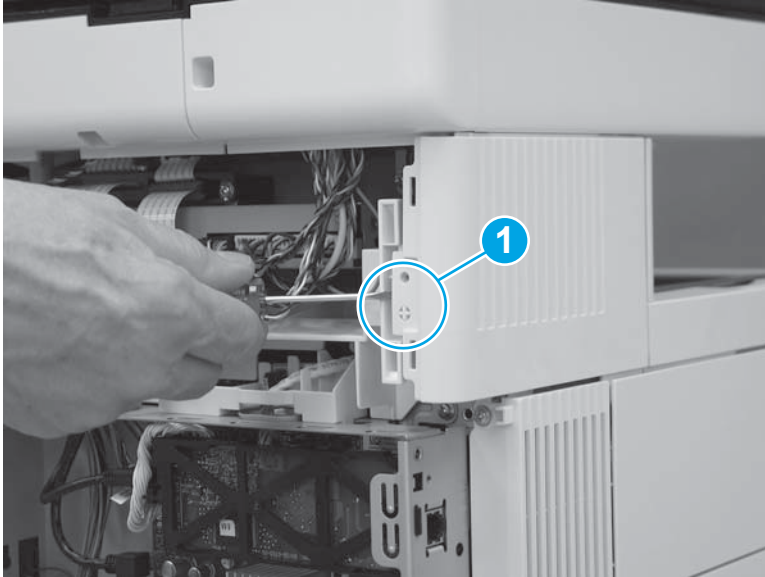

2. Slide the left upper cover toward the back of the printer.

Figure 1-2803 Slide the cover back

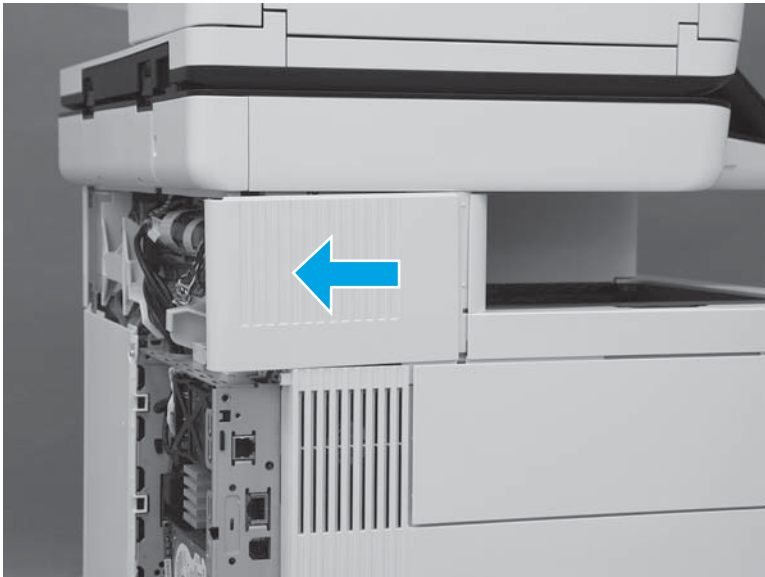

3. Rotate the cover up to remove it.

Figure 1-2804 Remove the left upper cover



Step 14: Remove the right front upper cover (M577dn)

 **NOTE:** This step is for the M577dn model. For the M577c/f/z models, skip this step and to go [Step 15: Remove the stapler cover assembly \(M577c/f/z\) on page 1588](#).

For the M552 and M553 models, skip this step and go to [Step 19: Remove the left cover on page 1597](#).

1. Remove one screw (callout 1).

Figure 1-2805 Remove one screw

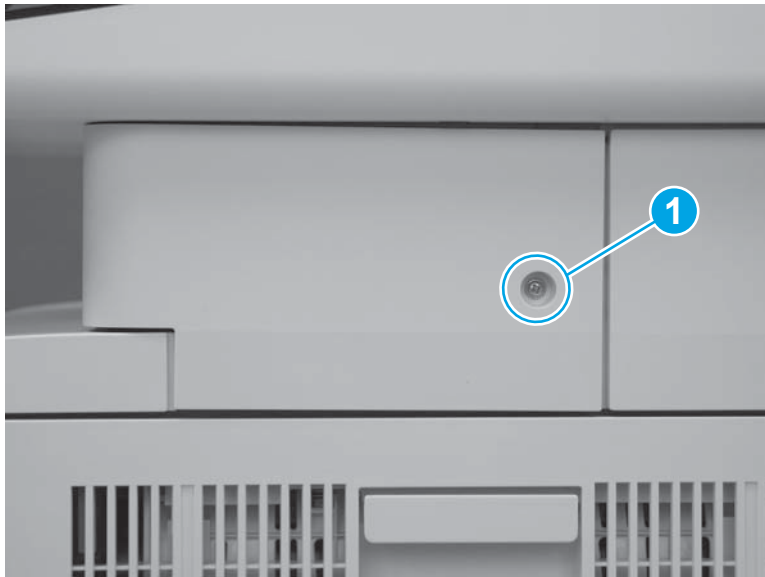

2. Release two tabs at the front edge of the cover (callout 1).

Figure 1-2806 Release two tabs



3. Rotate the front of the cover to the right to remove it.

Figure 1-2807 Rotate the cover



Step 15: Remove the stapler cover assembly (M577c/f/z)

 **NOTE:** This step is for the M577c/f/z models. For the M577dn model, skip this step and go to [Step 17: Remove the right upper cover \(M577\) on page 1593](#).

For the M552 and M553 models, skip this step and go to [Step 19: Remove the left cover on page 1597](#).

1. Remove one screw (callout 1).

 **Reinstallation tip:** This is a self-tapping screw for plastic. When reinstalling, rotate the screw counterclockwise to align it with the existing thread pattern, and then carefully turn it clockwise to tighten. Do not overtighten. This will prevent stripping the threads inside the screw hole.

Figure 1-2808 Remove one screw



2. Release two tabs at the front edge of the cover (callout 1).

Figure 1-2809 Release two tabs

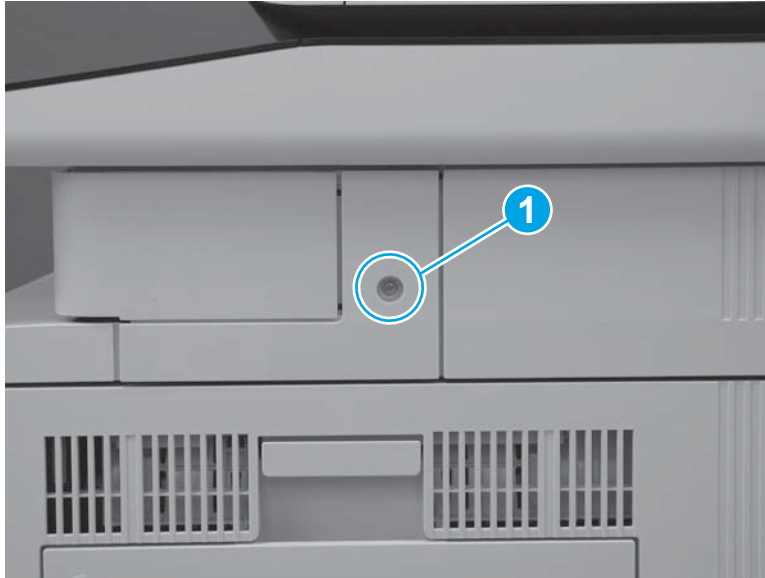

3. Release the back edge of the cover.

Figure 1-2810 Release the back edge of the cover

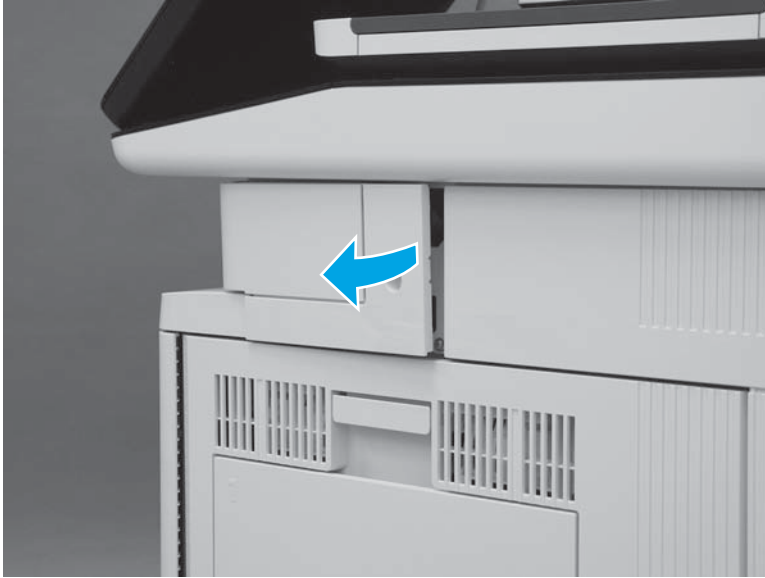



4. Rotate the cover away from the printer to remove it.

Figure 1-2811 Remove the cover



Step 16: Remove the integrated scanner assembly (ISA) (M577)

 **NOTE:** This step is for the M577 models. For the M552 and M553 models, skip this step and go to [Step 19: Remove the left cover on page 1597](#).

 **NOTE:** The ISA includes the document feeder, image scanner, scanner control board (SCB), control panel, keyboard (M577c/z) and NFC PCA (M577z).

1. At the left side of the printer, remove one screw (callout 1).

Figure 1-2812 Remove one screw

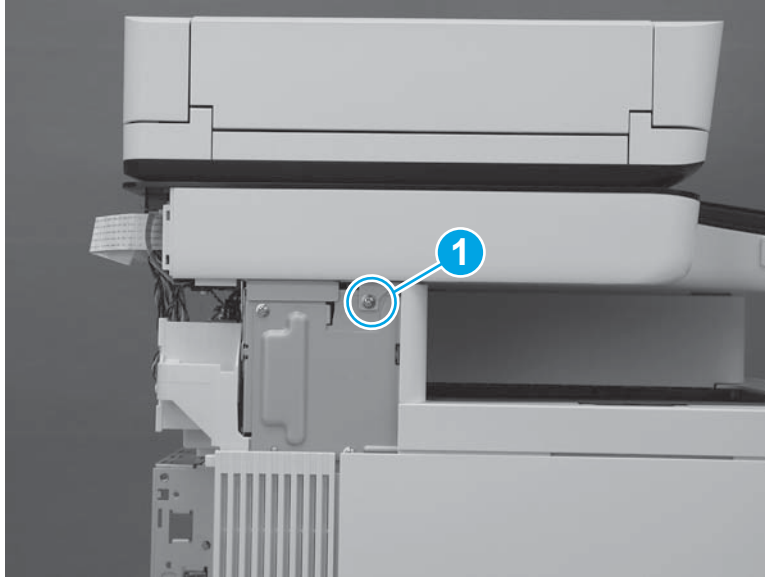

2. At the back side of the printer, remove two screws (callout 1).

Figure 1-2813 Remove two screws

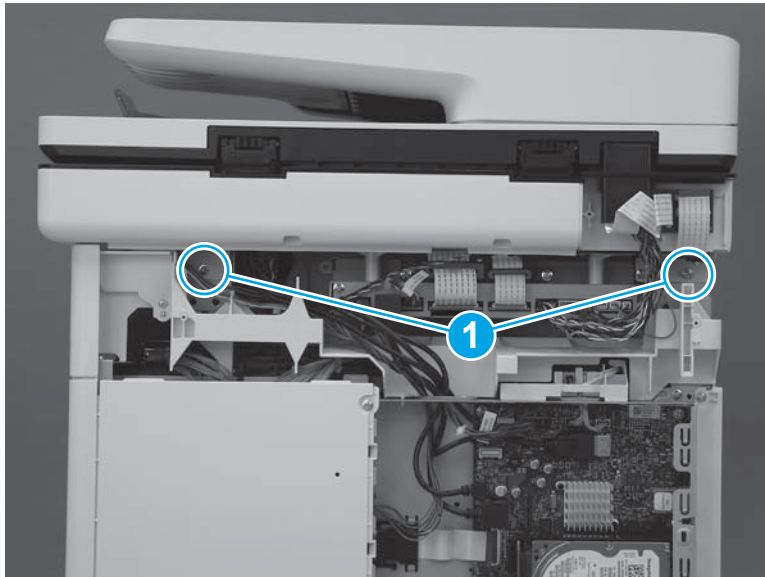

3. At the right side of the printer, remove one screw (callout 1).

Figure 1-2814 Remove one screw

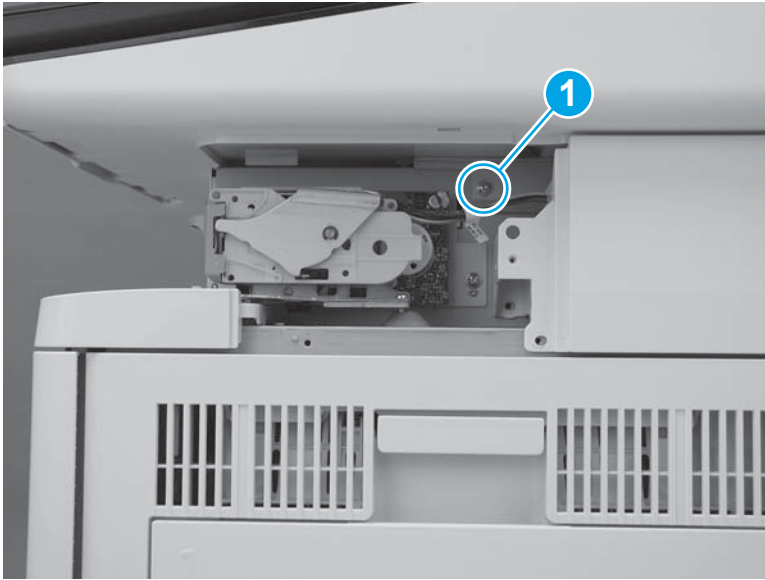

4. Disconnect two connectors on the scanner control board (callout 1).

M577c/f/z only: Disconnect one connector for the stapler on the scanner control board (callout 2).

Figure 1-2815 Disconnect connectors

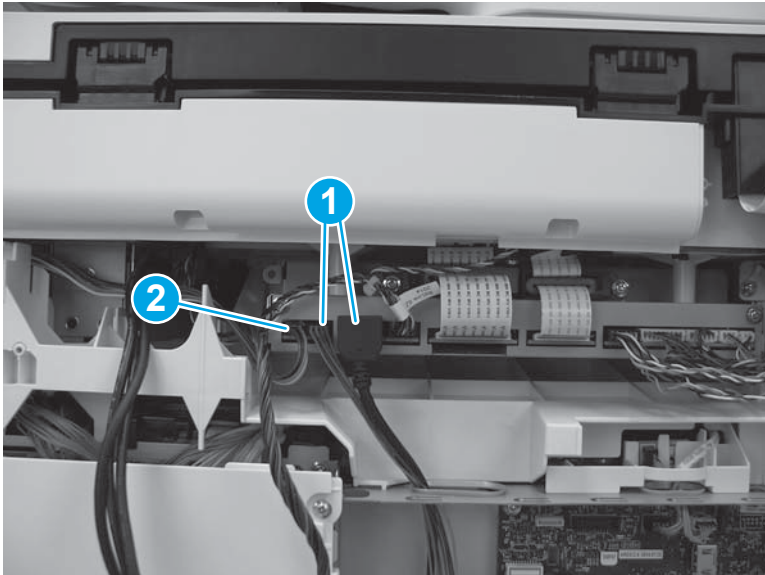

5. Slightly slide the ISA towards the back of the printer to release it.

Figure 1-2816 Slide the ISA towards the back of the printer

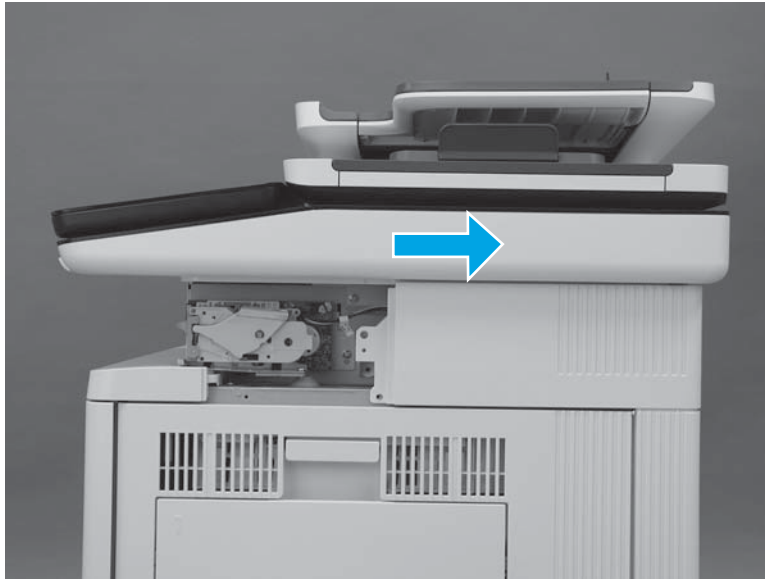

6. Lift the ISA up to remove it.

 **NOTE:** When lifting the ISA, carefully pass the cables through the opening in the top of the formatter case.

Figure 1-2817 Remove the ISA

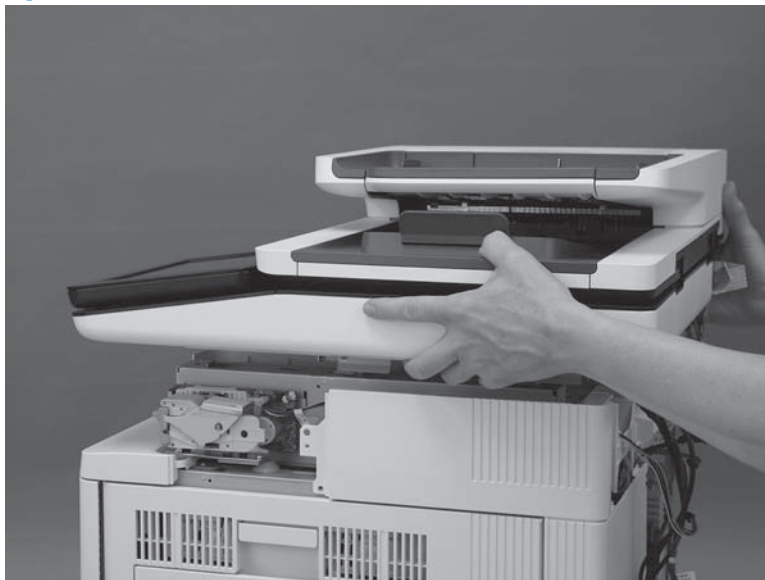

Step 17: Remove the right upper cover (M577)

 **NOTE:** This step is for the M577 models. For the M552 and M553 models, skip this step and go to [Step 19: Remove the left cover on page 1597](#).

 **NOTE:** The figures below show the image scanner installed. The procedures for removing and installing the right upper cover are the same whether the image scanner is installed or removed."

1. At the right side of the printer, remove two screws (callout 1).

M577c/f/z only: Disconnect one connector (callout 2), if it was not already disconnected in a previous step.

Figure 1-2818 Remove two screws and one connector

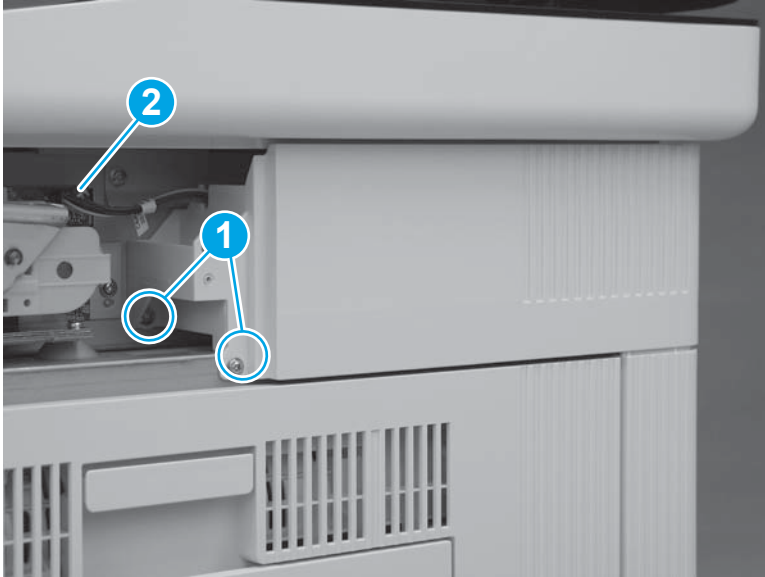

2. At the back of the printer, remove one screw (callout 1).

M577c/f/z only: Disconnect one connector (callout 2), if it was not already disconnected in a previous step.

 **Reinstallation tip:** This screw is smaller than the screws removed in the previous step. When reinstalling the right upper cover, make sure that this screw is installed in the correct position.

Figure 1-2819 Remove one screw and connector



3. Slide the cover toward the back of the printer.

Figure 1-2820 Slide the cover

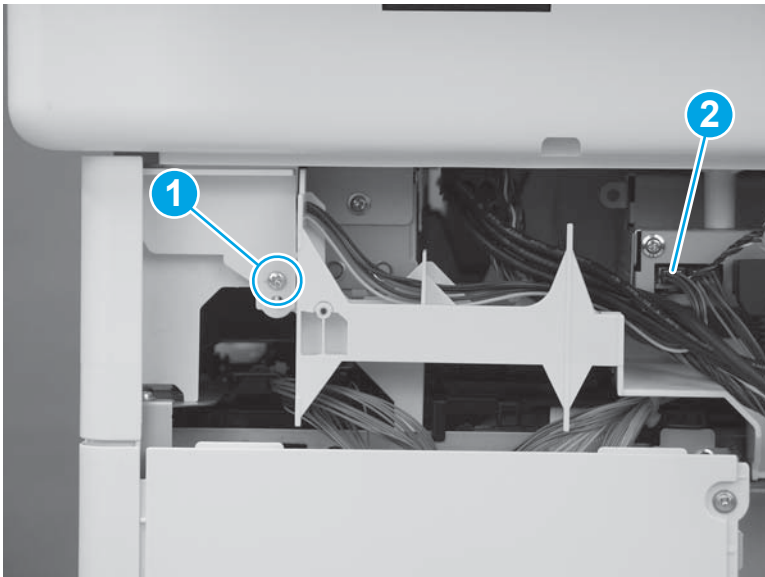
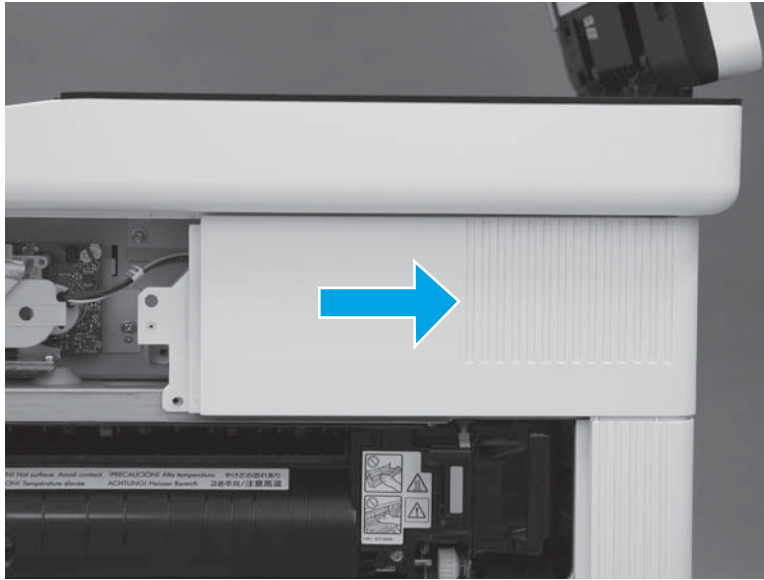

4. Lift the cover away from the printer to remove it.

M577c/f/z only: Release the cables (callout 1) through the slot (callout 2) in the printer.

Figure 1-2821 Remove the cover

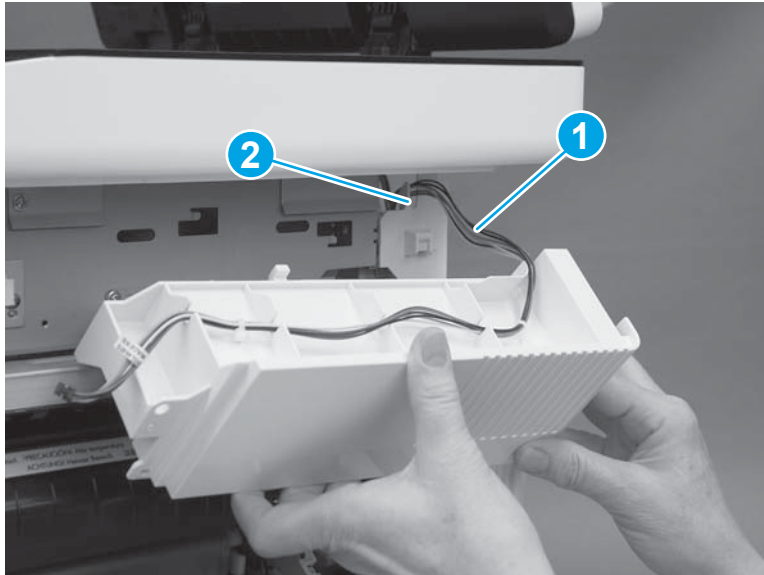

Step 18: Remove the top rear cover (M577)

 **NOTE:** This step is for the M577 models. For the M552 and M553 models, skip this step and go to [Step 19: Remove the left cover on page 1597](#).

1. At the top of the printer, remove five screws (callout 1).

Figure 1-2822 Remove five screws

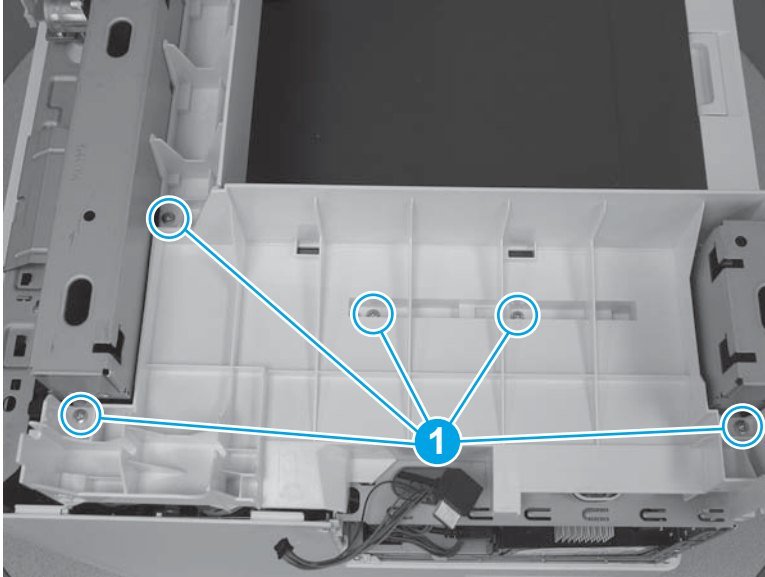

2. Release two tabs (callout 1) on the front edge of the cover.

Figure 1-2823 Release two tabs

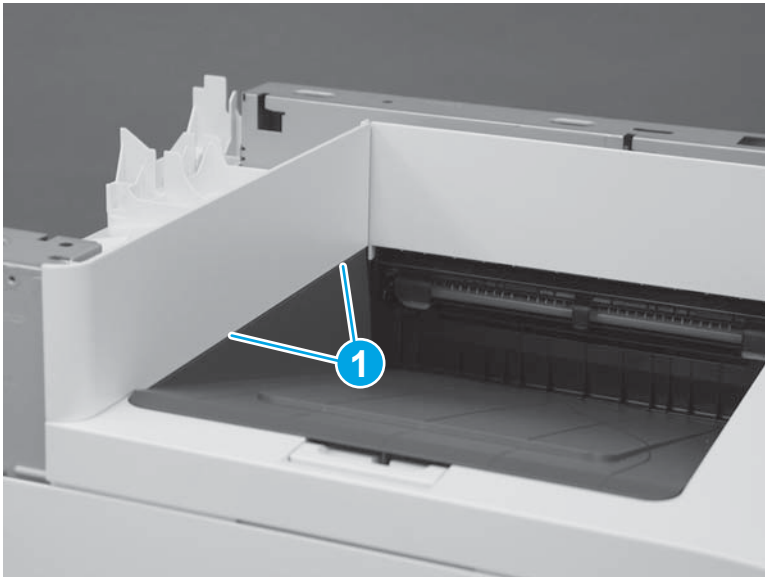

3. Remove the top rear cover.

Figure 1-2824 Remove the top rear cover

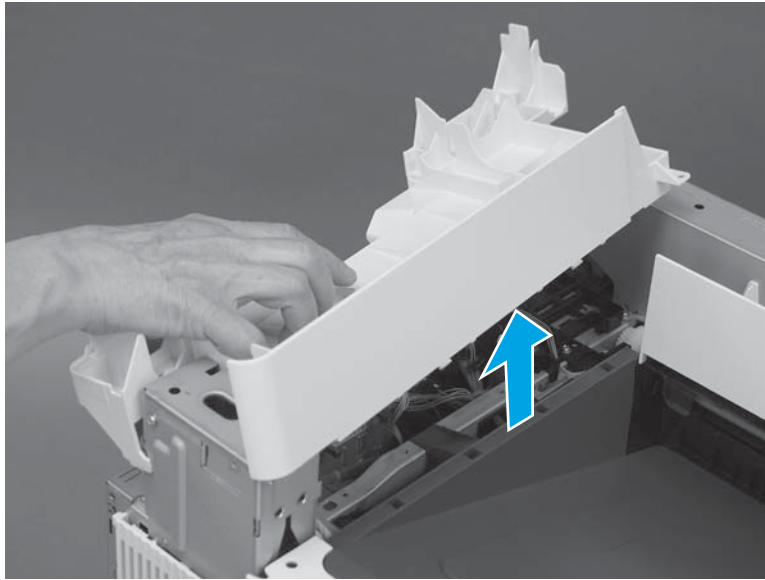

Step 19: Remove the left cover

1. At the left side of the printer, remove one screw (callout 1).

Figure 1-2825 Remove one screw



2. Release one tab (callout 1), rotate the front edge of the cover away from the printer (callout 2), and then slide the cover (callout 3) toward the rear of the printer to release it.

Figure 1-2826 Release the cover

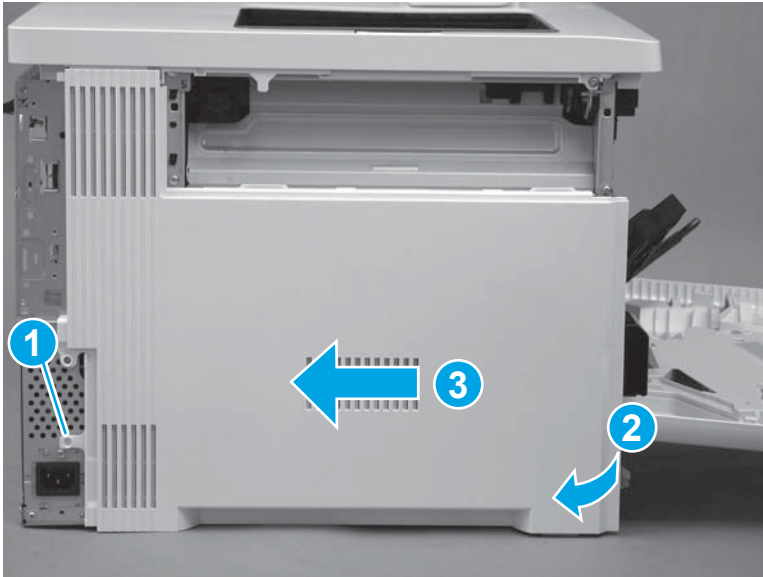

3. Remove the cover.

Figure 1-2827 Remove the cover

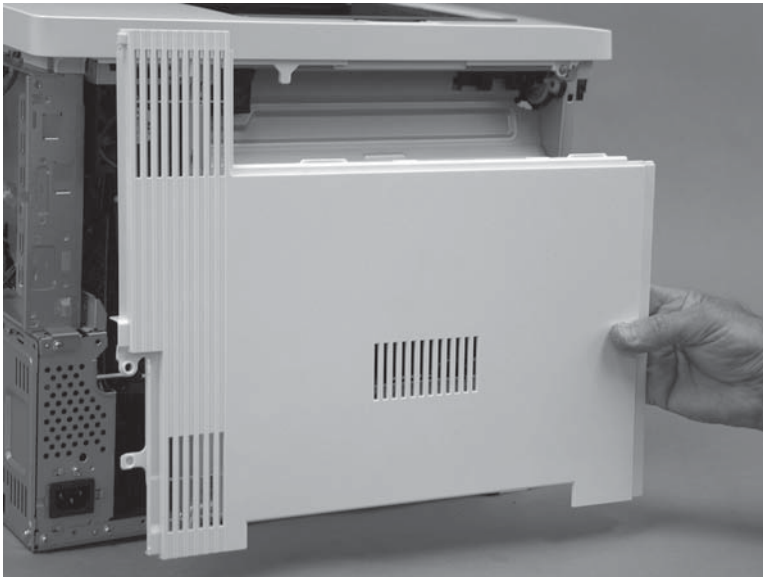

Step 20: Remove the upper cover (M552 and M553)

 **NOTE:** This step is for the M552 and M553 models. For the M577 models, skip this step and go to [Step 21: Remove the formatter case on page 1600.](#)

1. Remove three screws (callout 1).

Figure 1-2828 Remove three screws

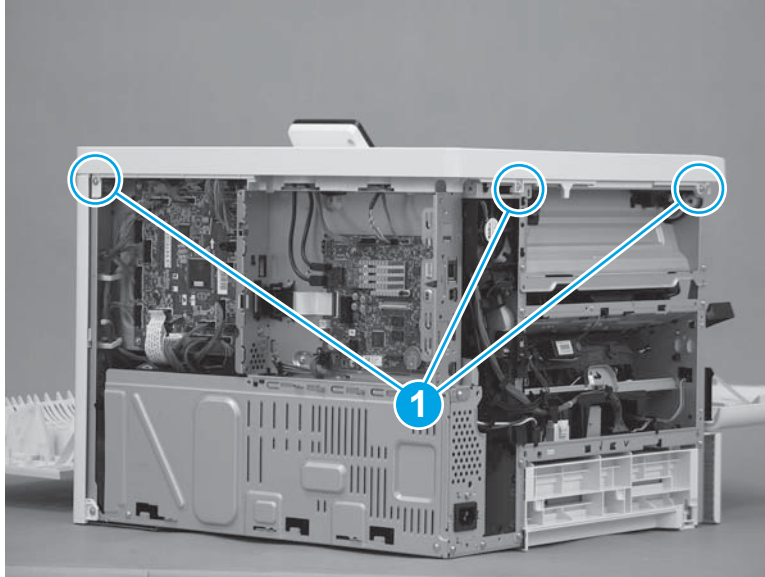

2. Remove one screw (callout 1), release one tab (callout 2), and then slightly separate the corner of the cover from the chassis.

 **NOTE:** This is a self-tapping plastic-thread screw. Make sure that this screw is used in this location when it is reinstalled.

Figure 1-2829 Remove one screw and release one tab



3. Release one tab (callout 1), and then lift up on the cover to release it.

 **NOTE:** If the cover does not release, check for addition tabs by locating the triangles embossed in the cover at tab locations.

Figure 1-2830 Release the cover



4. Remove the cover.

Figure 1-2831 Remove the cover

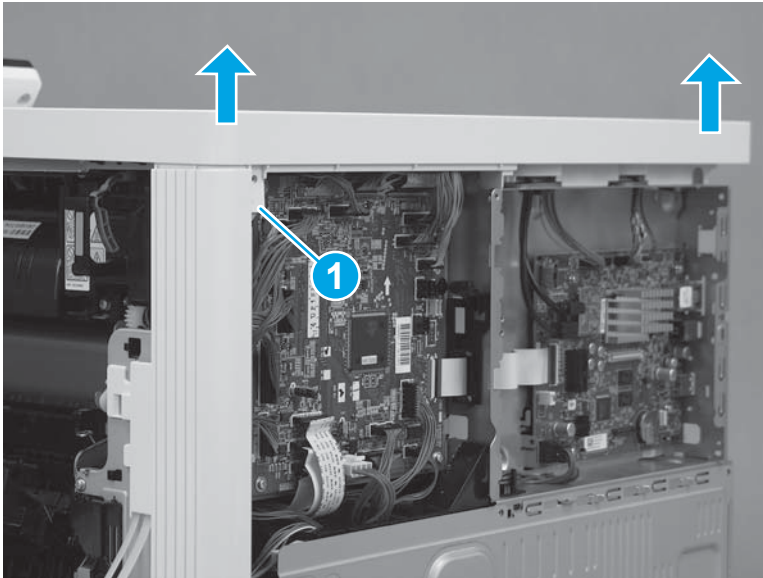
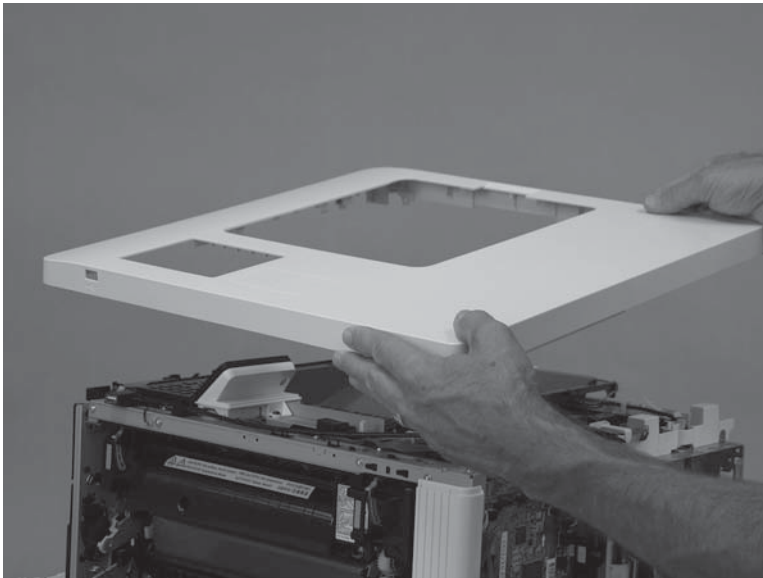

Step 21: Remove the formatter case

1. **M577 only:** Disconnect one connector (callout 1), and then pass the wire harness (callout 2) through two openings in the formatter case (callout 3).

Figure 1-2832 Disconnect one connector

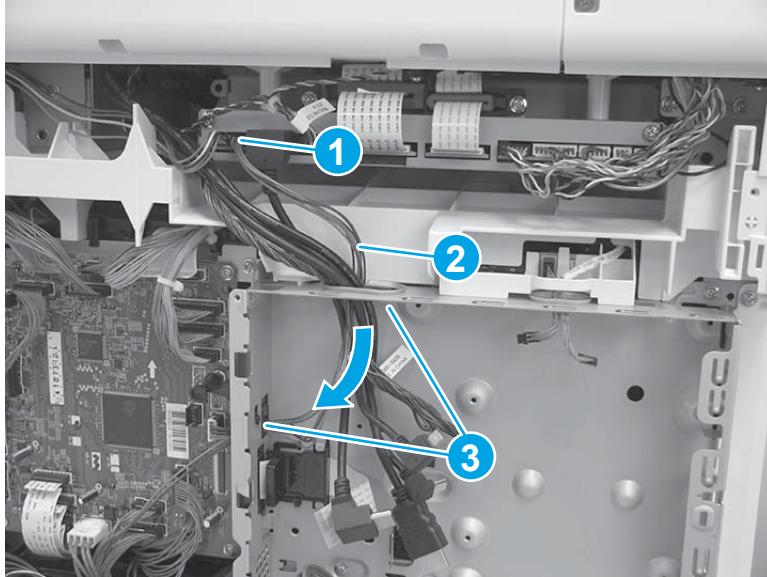

2. Release two tabs (callout 1) on the black plastic bracket. Hold the tabs in the released position, and then slide the bracket (callout 2) to the right to remove it from the formatter case.

Figure 1-2833 Remove the bracket

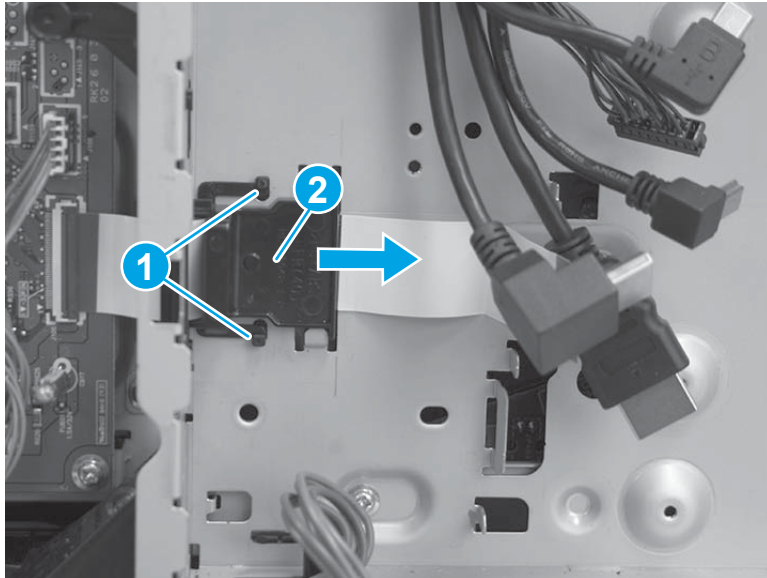

3. Remove two screws (callout 1), and then slide the low-voltage power supply (LVPS) cover to the right to remove it.

Figure 1-2834 Remove the LVPS cover

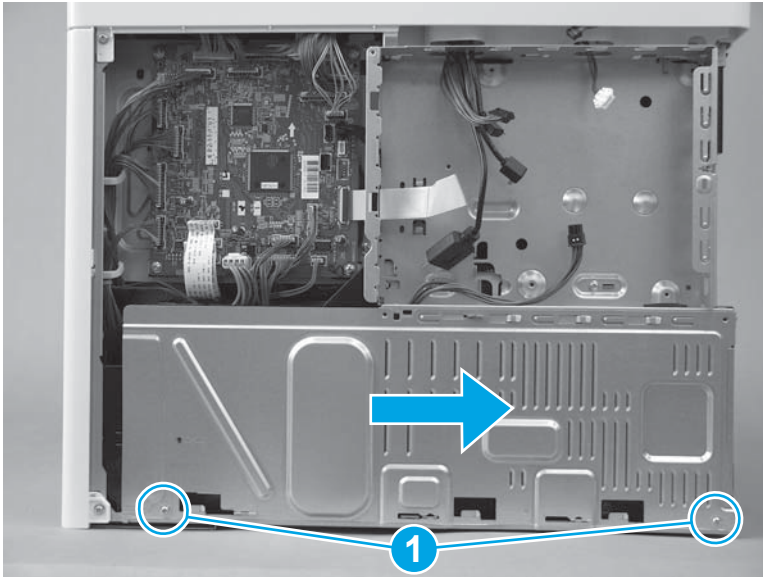

4. Pass two wire harnesses and one flat cable (callout 1) through the opening in the formatter case, and then release one wire harness from the retainer (callout 2).

CAUTION: The flat cable might be attached to the formatter case with double-sided tape. Make sure that this tape is released, so that the flat cable is not damaged when the formatter case is removed.

Figure 1-2835 Release wire harnesses and flat cable

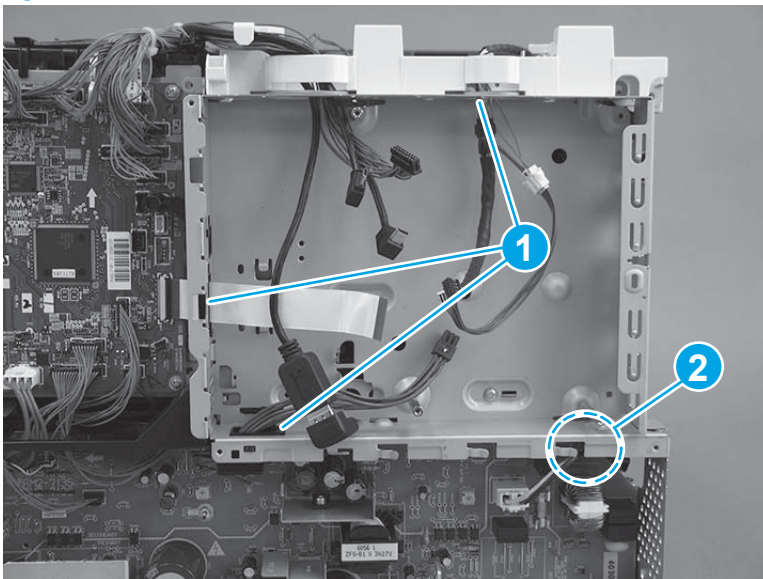

5. Remove six screws (callout 1).

Figure 1-2836 Remove six screws

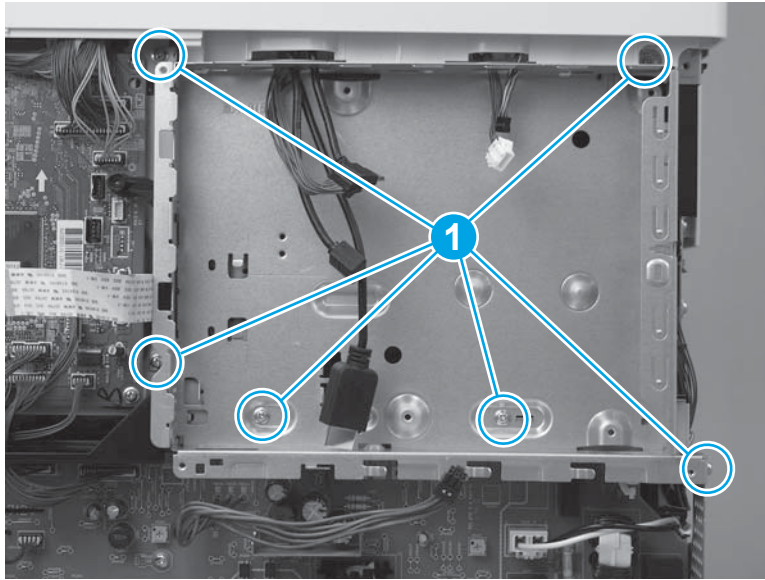

6. Rotate the bottom of the formatter case away from the printer (callout 1), and then pull it down (callout 2) to release it.

Figure 1-2837 Release the formatter case

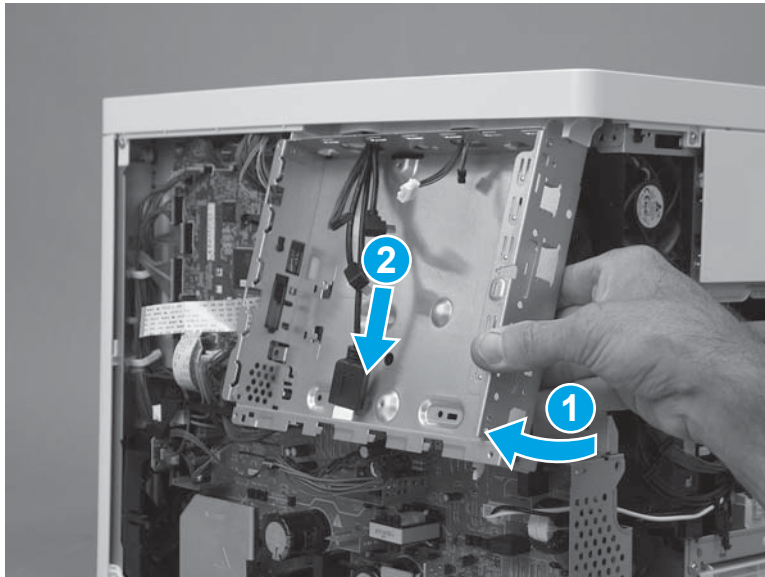

7. Pass the wire harnesses through the opening in the formatter case to remove it.

 **IMPORTANT:** If the formatter case is removed so that it can be replaced, make sure to transfer the memory PCA (island of data) and plastic bracket (callout 1) to the replacement case.

Figure 1-2838 Remove the formatter case



Step 22: Remove the right rear cover

1. Remove one screw (callout 1), and then slide the cover toward the rear of the printer (callout 2) to release it.

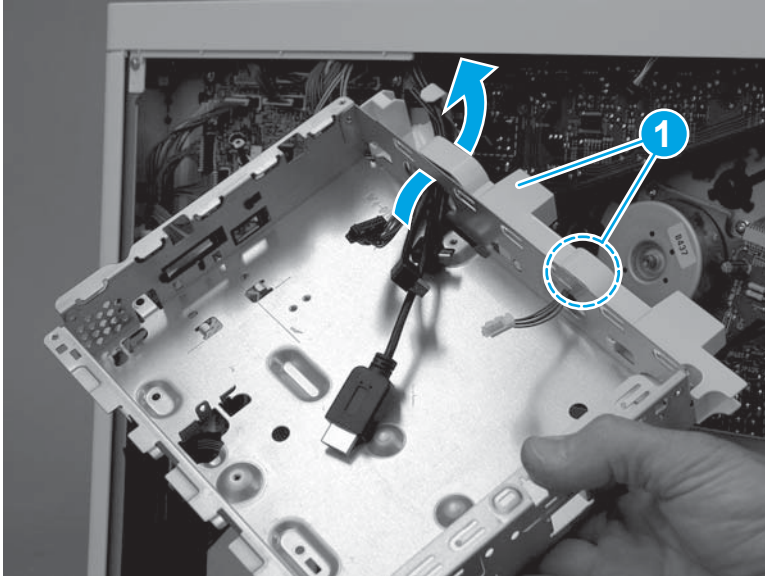
 **TIP:** If the right door is closed, open it now.

Figure 1-2839 Release the cover



2. Remove the cover.

Figure 1-2840 Remove the cover

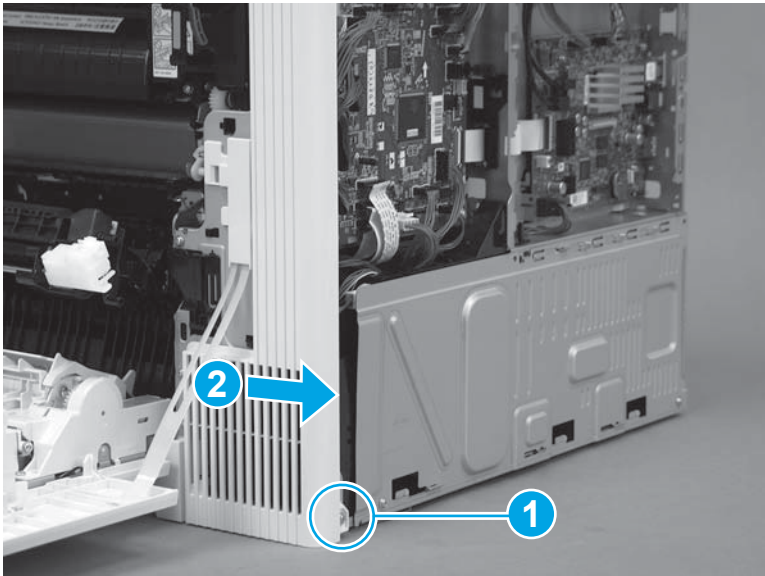
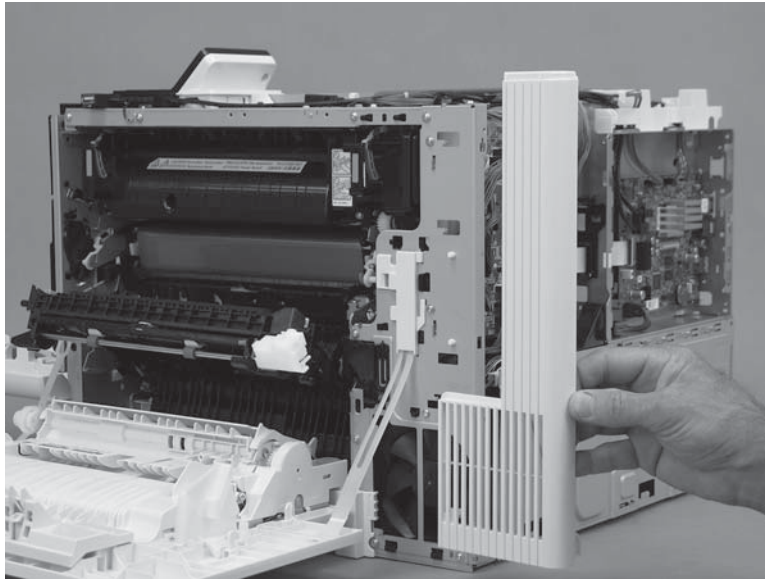

Step 23: Remove the DC controller and sheet-metal bracket

 **CAUTION:**  ESD sensitive part.

1. Disconnect all of the connectors, and then remove two screws (callout 1).

The following connectors are empty:

- J140, J141, and J143

Figure 1-2841 Remove two screws

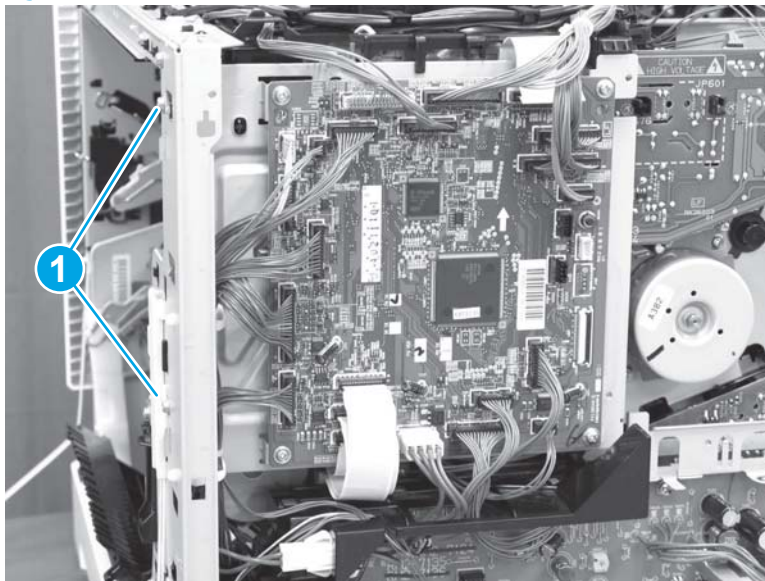

2. Lift up on the DC controller and sheet-metal plate to remove it.

Figure 1-2842 Remove the plate

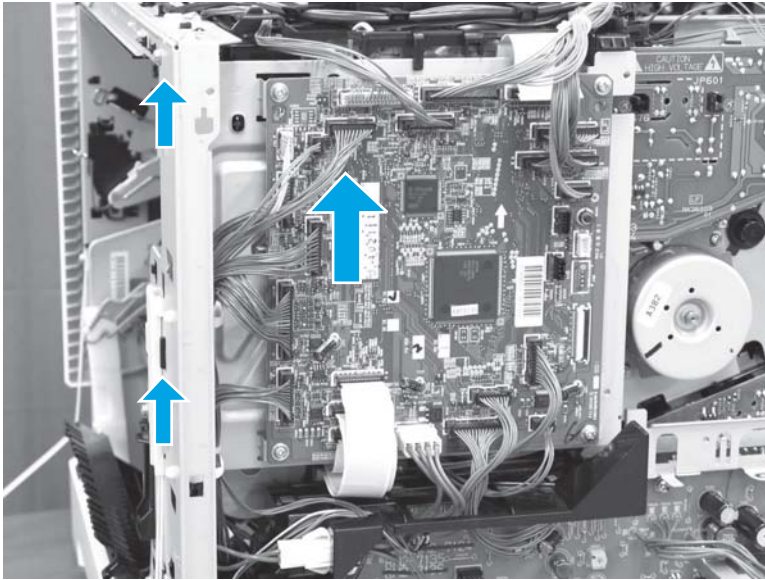

Step 24: Remove the high-voltage power supply T (HVPST)

 **CAUTION:**  ESD-sensitive part.

1. Disconnect five connectors (callout 1), and then disconnect one flat cable (callout 2).

Figure 1-2843 Disconnect five connectors and one flat cable

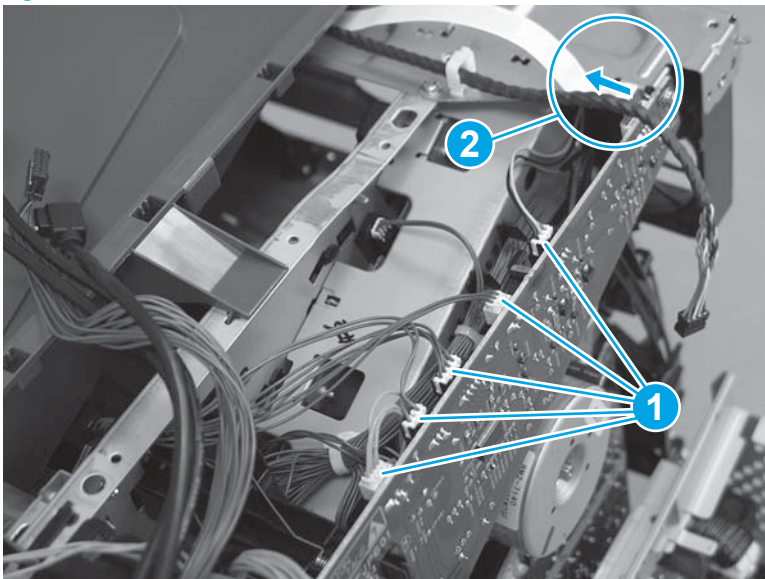

2. Remove one screw (callout 1).

Figure 1-2844 Remove one screw

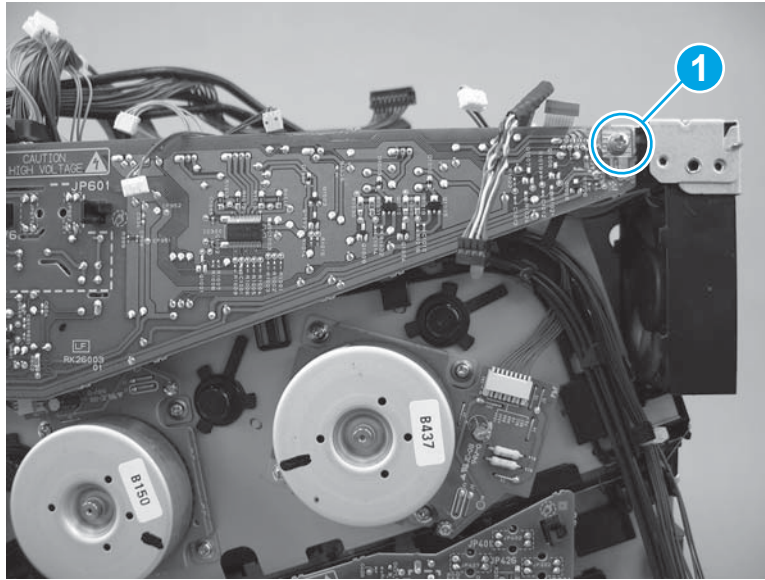

3. Release two tabs (callout 1), and then separate the HVPST from the printer.

⚠ CAUTION: Do not attempt to completely remove the HVPST. It is still connected to the printer by ground wire harness.

Figure 1-2845 Release the HVPST

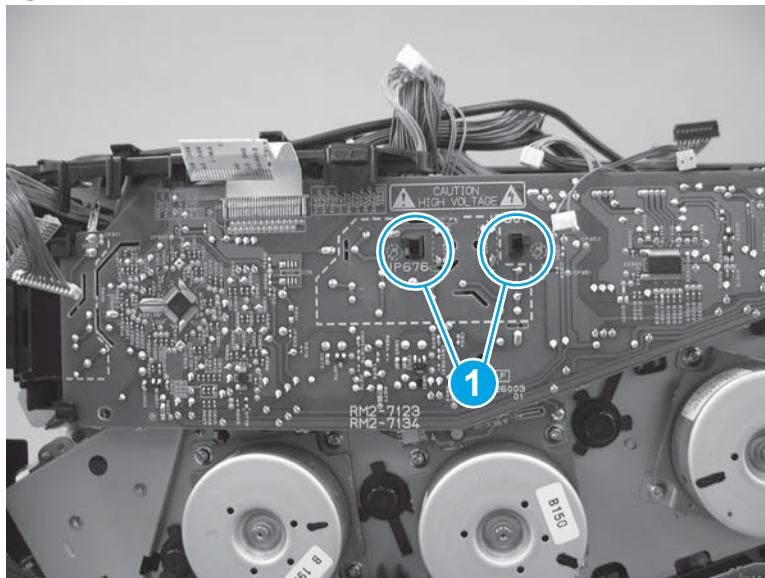

4. Release one ground wire connector (callout 1), and then remove the HVPST.

Figure 1-2846 Remove the HVPST

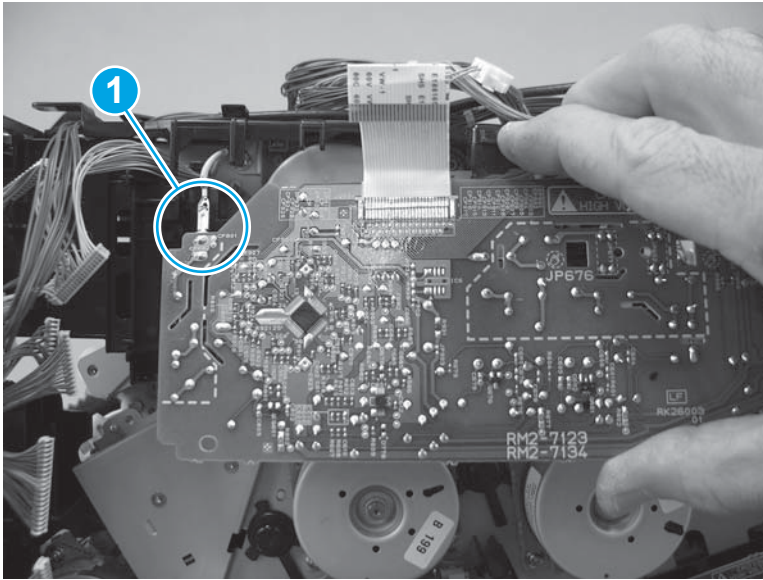

Step 25: Remove drum motor 2 (M2)

- ▲ Disconnect one connector (callout 1), remove four screws (callout 2), and then remove the motor.

Figure 1-2847 Remove the motor

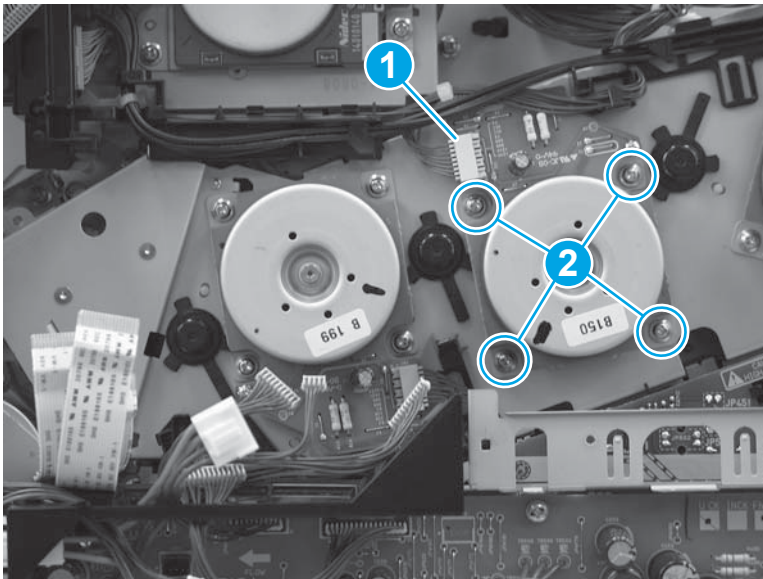

Step 26: Unpack the replacement assembly

Unpack the replacement assembly from the packaging.

For complete information on HP's recycling programs, go to [Product return and recycling](#).

 **NOTE:** HP recommends responsible disposal of the defective assembly.

Figure 1-2848 Recycle and unpack

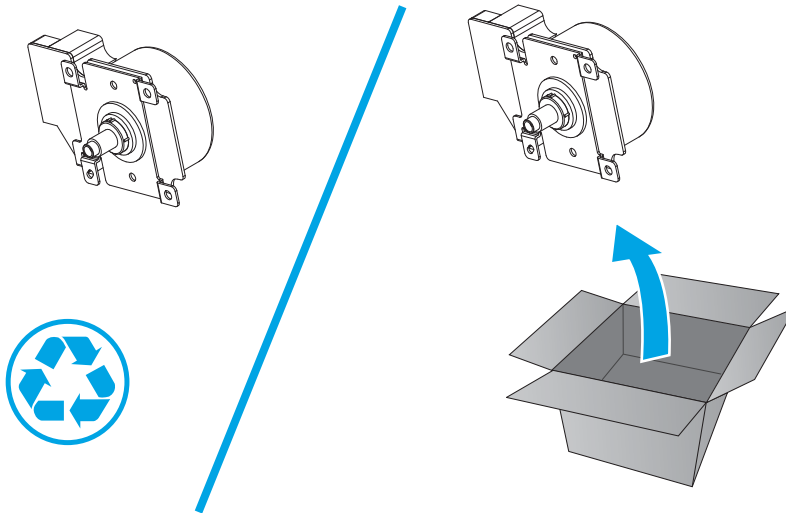

Step 27: Install drum motor 2 (M2)

- ▲ Position the motor on the printer, install four screws (callout 1), and then connect one connector (callout 2).

Figure 1-2849 Install the motor

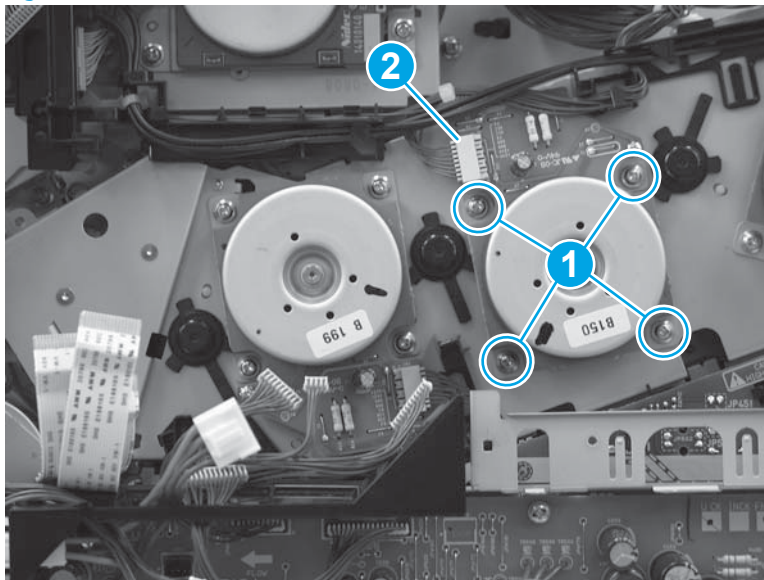

Step 28: Install the HVPST

⚠ **CAUTION:**  ESD-sensitive part.

1. Connect one ground wire connector (callout 1).

Figure 1-2850 Connect one ground wire

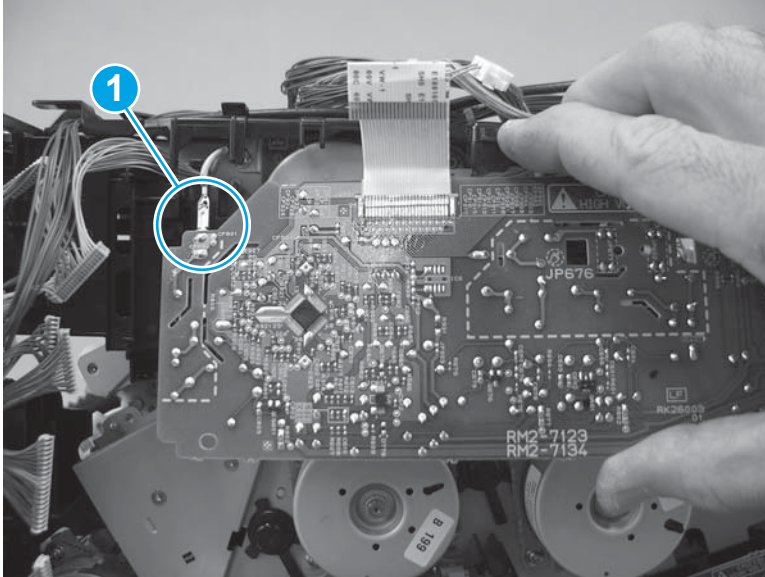

2. Position the HVPST on the printer, and then push in to engage two tabs (callout 1).

 **NOTE:** Make sure that the tabs snap into place.

Figure 1-2851 Install the HVPST

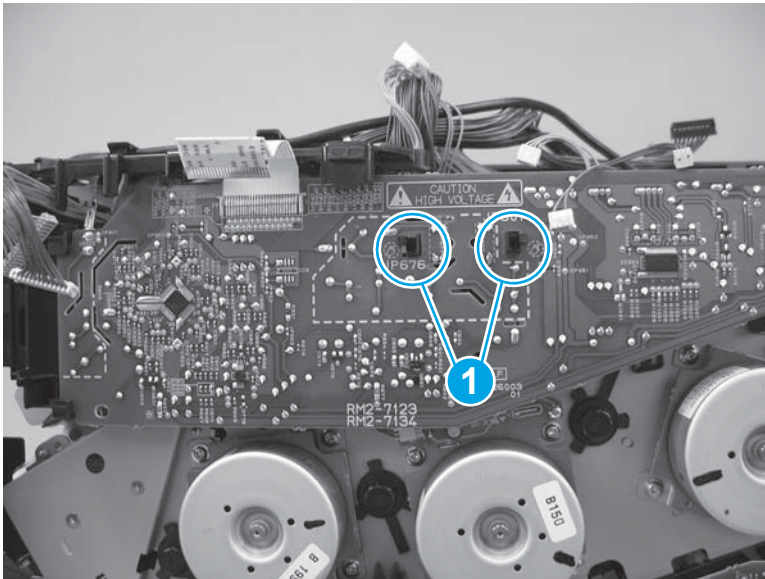

3. Install one screw (callout 1).

Figure 1-2852 Install one screw

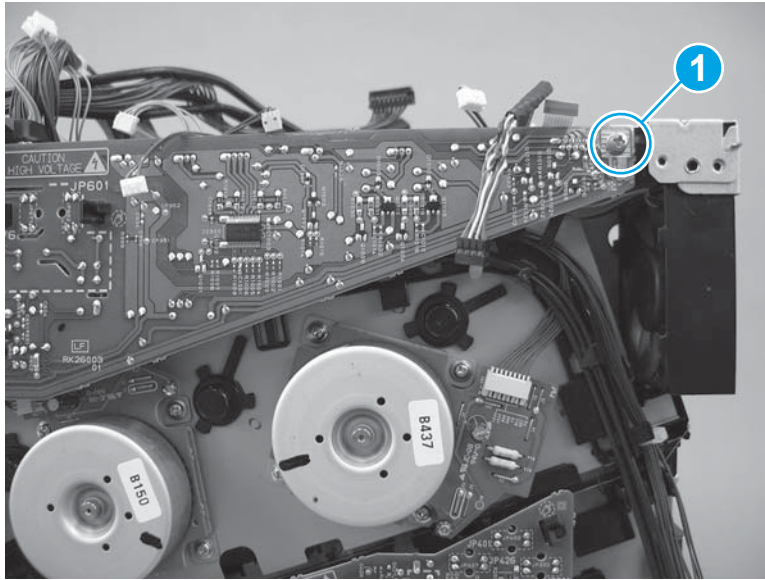

4. Connect five connectors (callout 1), and then connect one flat cable (callout 2).

Figure 1-2853 Connect five connectors and one flat cable

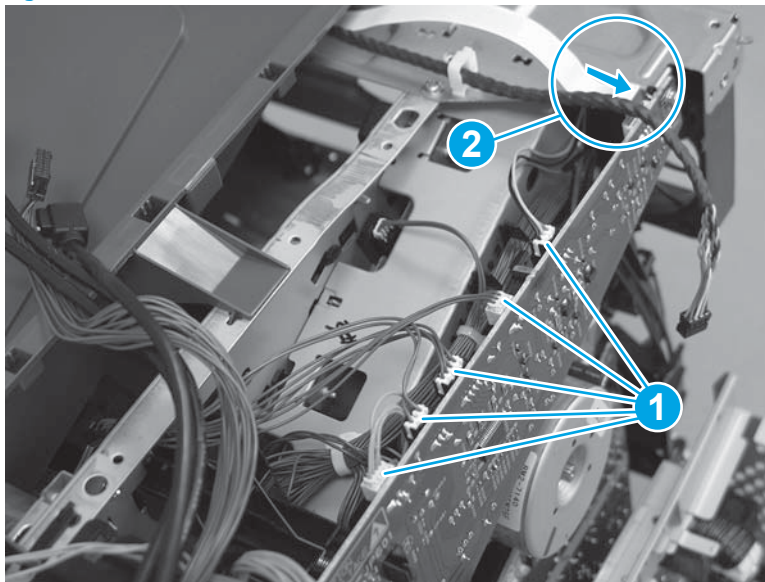

Step 29: Install the DC controller and sheet-metal bracket

 **CAUTION:**  ESD-sensitive part.

1. Position the DC controller and sheet-metal plate on the printer, and then push down to engage the plate with the chassis.

Figure 1-2854 Install the plate

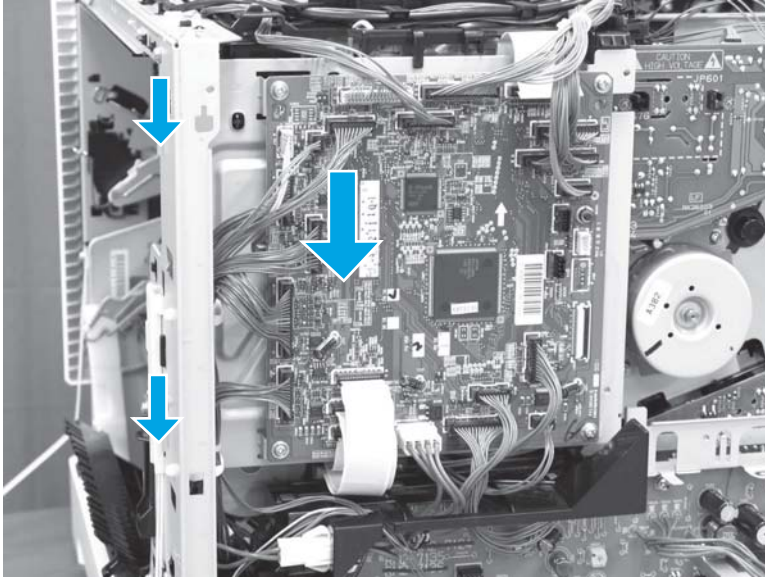

2. Install two screws (callout 1), and then connect all of the connectors.

The following connectors are empty:

- J140, J141, and J143

Figure 1-2855 Install two screws

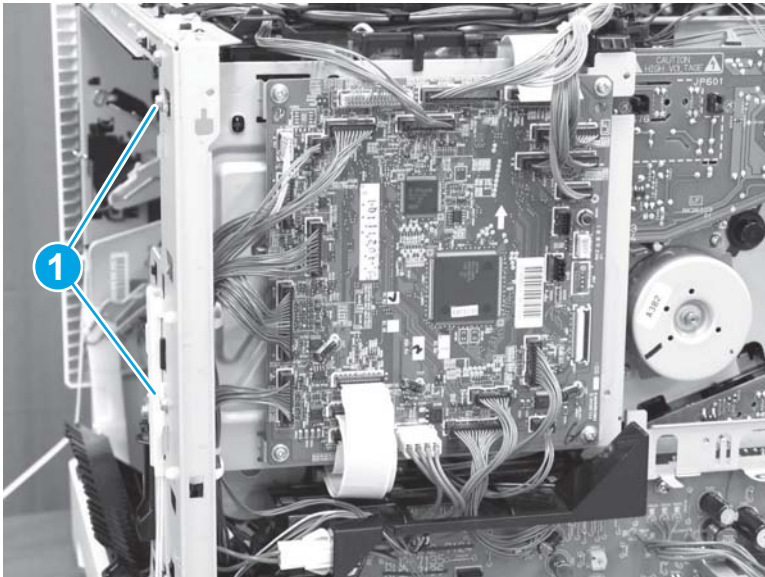

Step 30: Install the right rear cover

1. Position the cover on the printer.

Figure 1-2856 Install the cover

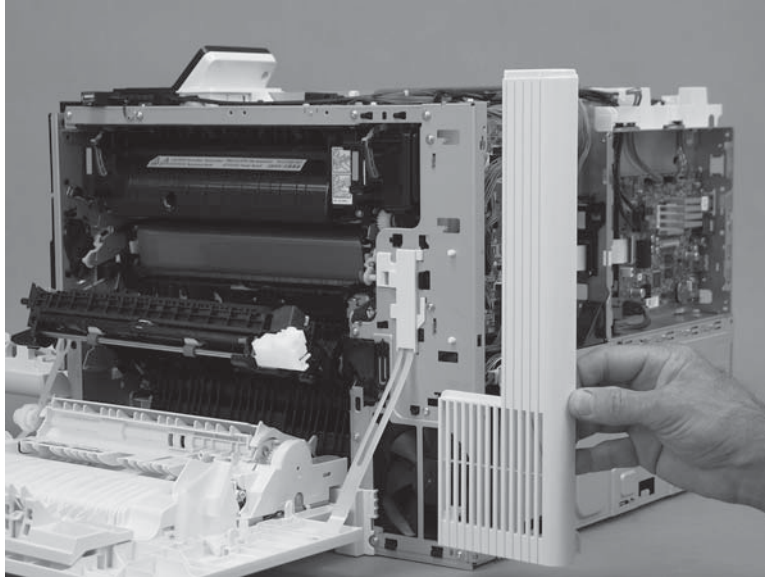

2. Slide the cover toward the right door (callout 1) to engage it with the printer, and then install one screw (callout 2).

Figure 1-2857 Install one screw

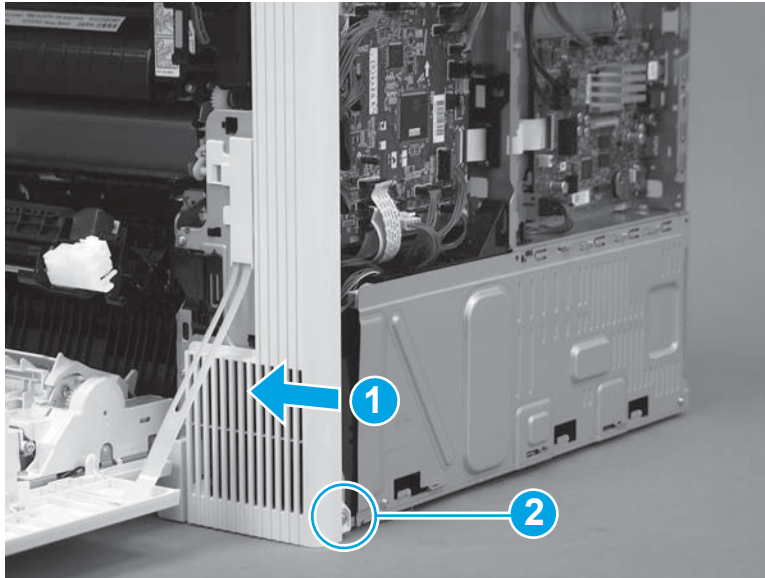

Step 31: Install the formatter case

1. Pass the wire harnesses through the opening in the formatter case.

Figure 1-2858 Pass the wire harnesses through the opening

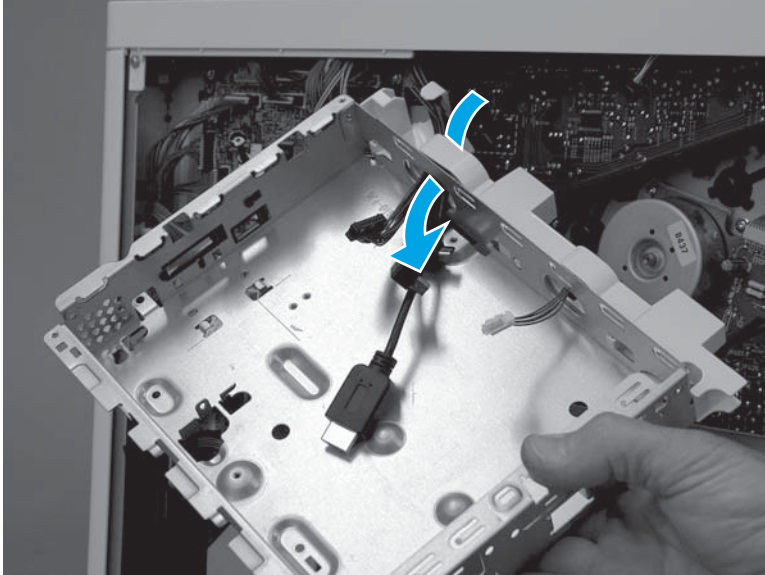

2. Position the top of the formatter case on the printer (callout 1), and then rotate the bottom of the case (callout 2) into the printer.

Figure 1-2859 Install the formatter case

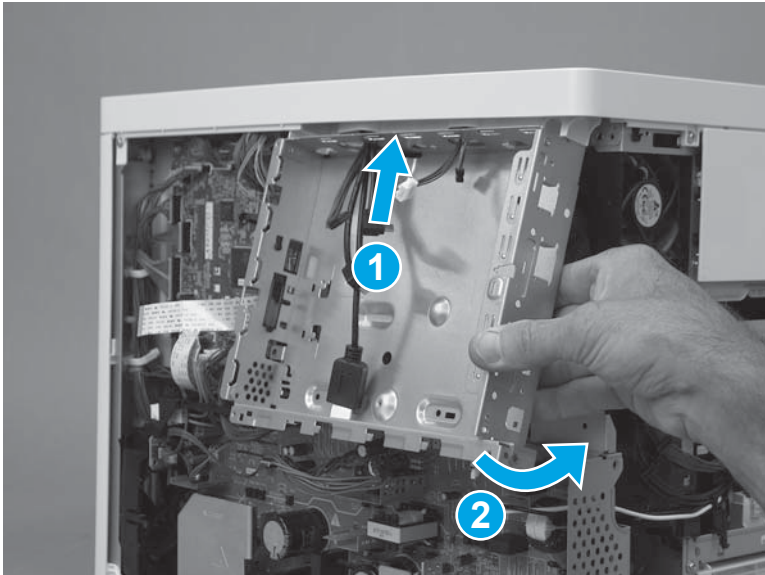

3. Install six screws (callout 1).

Figure 1-2860 Install six screws

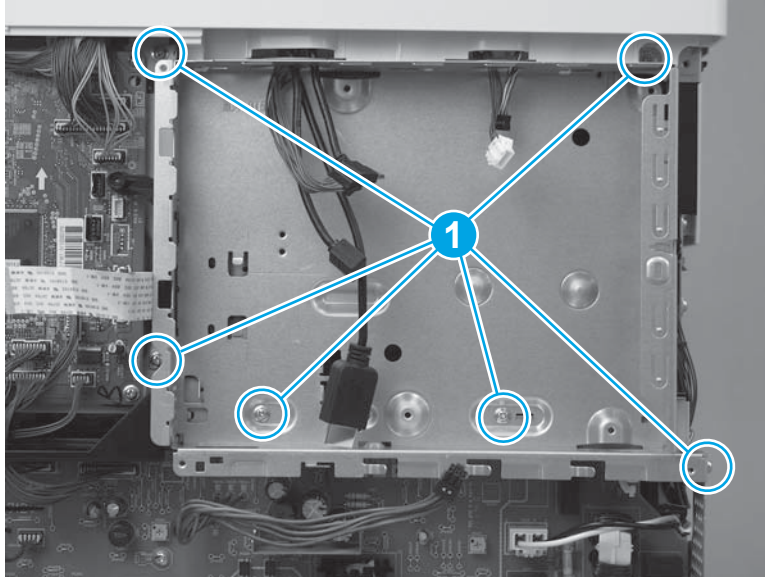

4. Pass two wire harnesses and one flat cable (callout 1) through the opening in the formatter case, and then install one wire harness in the retainer (callout 2).

 **IMPORTANT:** Make sure that the flat cable is securely fastened to the DC controller, and was not dislodged when the formatter case was removed.

Figure 1-2861 Install wire harnesses and flat cable

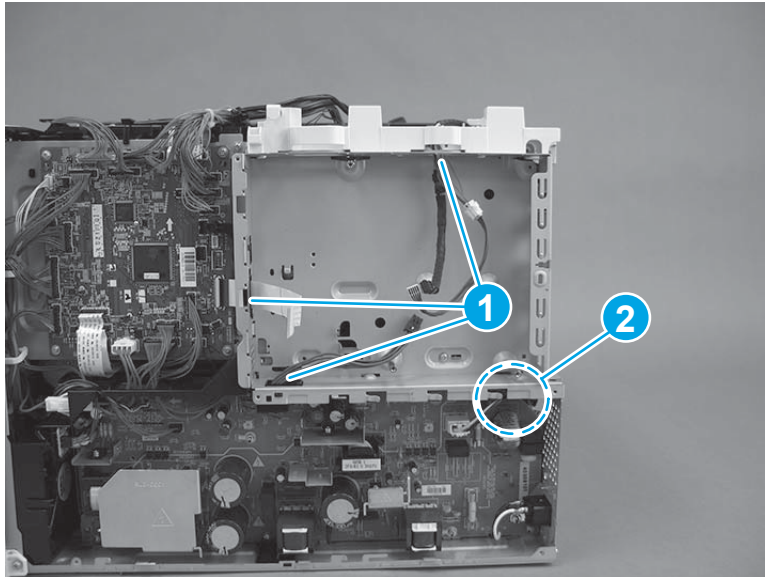

5. Position the LVPS cover on the printer, slide the cover to the left to install it, and then install two screws (callout 1).

Figure 1-2862 Install the LVPS cover

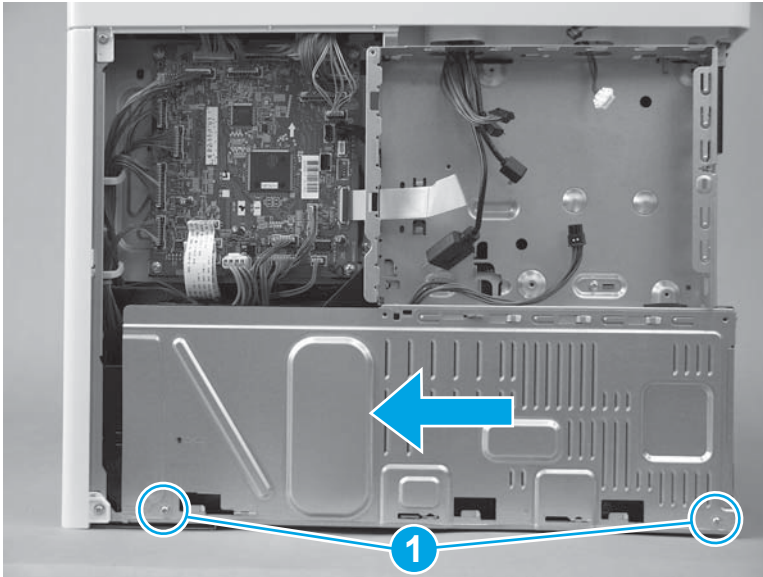

6. If no tape is affixed to the back of the flat cable, skip this step. If double-sided tape is affixed to the back of the flat cable, align the line (callout 1) on the cable with the edge (callout 2) of the opening in the sheet metal. Press to attach the flat cable to the formatter case.

Figure 1-2863 Attach the flat cable

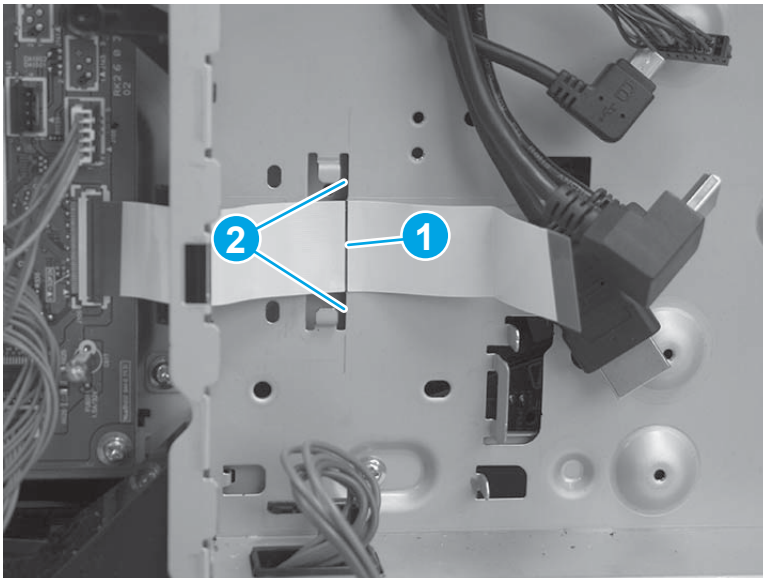

7. Position the bracket over the flat cable, and then slide the bracket to the left to install it. Make sure that the edges of the bracket fit under the sheet metal tabs (callout 1) on the formatter case and that the tabs (callout 2) snap into place.

Figure 1-2864 Position the bracket

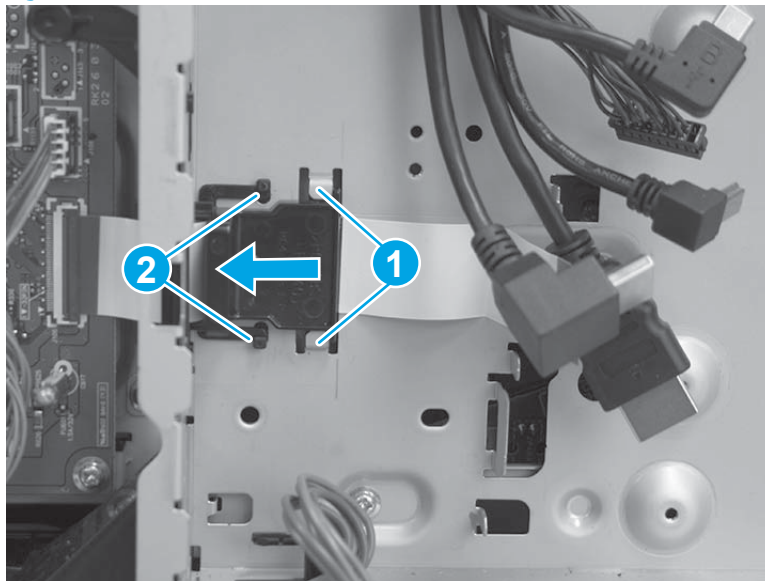

8. **M577 only:** Pass the wire harness (callout 1) through the openings in the formatter case (callout 2), and then connect one connector (callout 3).

Figure 1-2865 Connect one connector

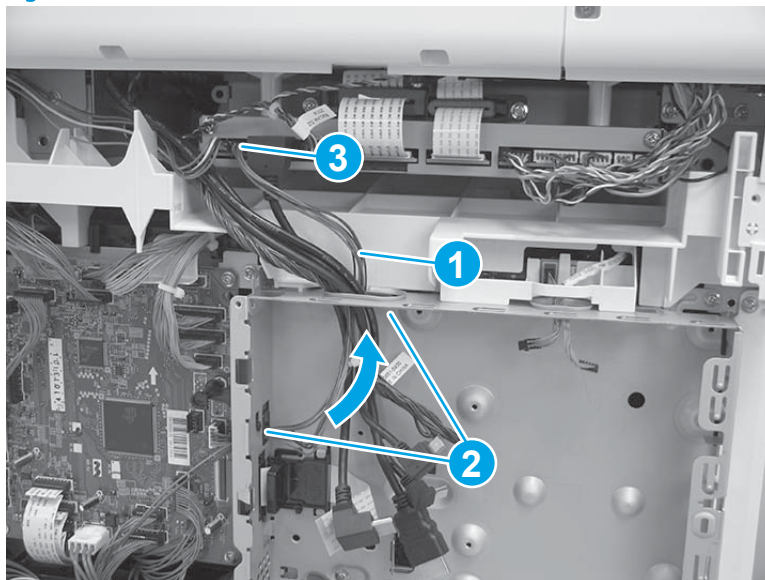

Step 32: Install the upper cover (M552 and M553)

 **NOTE:** This step is for the M552 and M553 models. For the M577 models, skip this step and go to [Step 33: Install the left cover on page 1619](#).

1. Position the cover on the printer.

 **NOTE:** For the M553x model, do not forget to pass the control-panel wire harness and USB cable through the opening in the cover.

Figure 1-2866 Install the cover



2. Push down on the rear corner of the cover to engage one tab (callout 1).

Figure 1-2867 Engage one tab

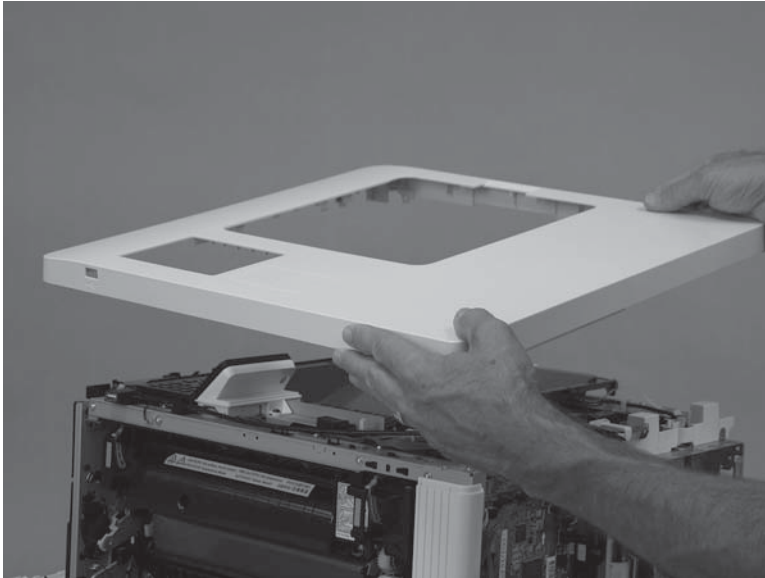
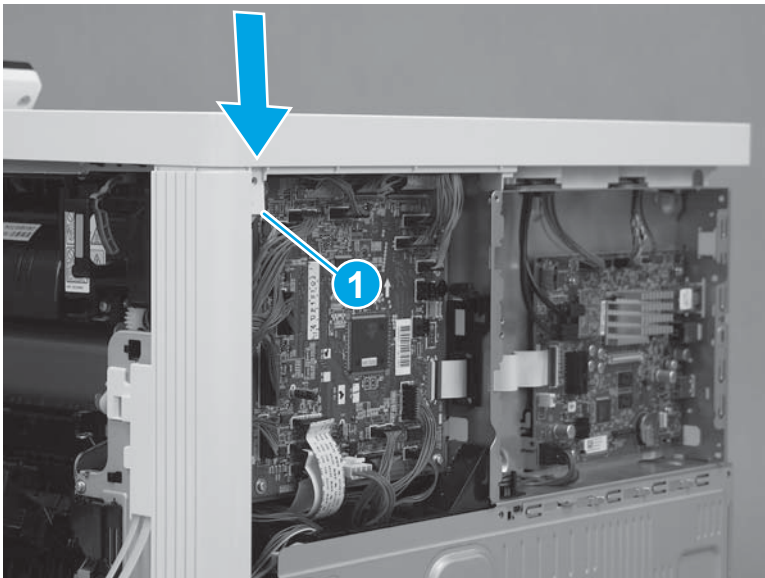

3. Push down on the front corner of the cover to engage one tab (callout 1), and then install one screw (callout 2).

 **NOTE:** This is a self-tapping plastic-thread screw. Make sure that this screw is used in this location when it is reinstalled.

Figure 1-2868 Engage one tab and install one screw



4. Install three screws (callout 1).

Figure 1-2869 Install three screws

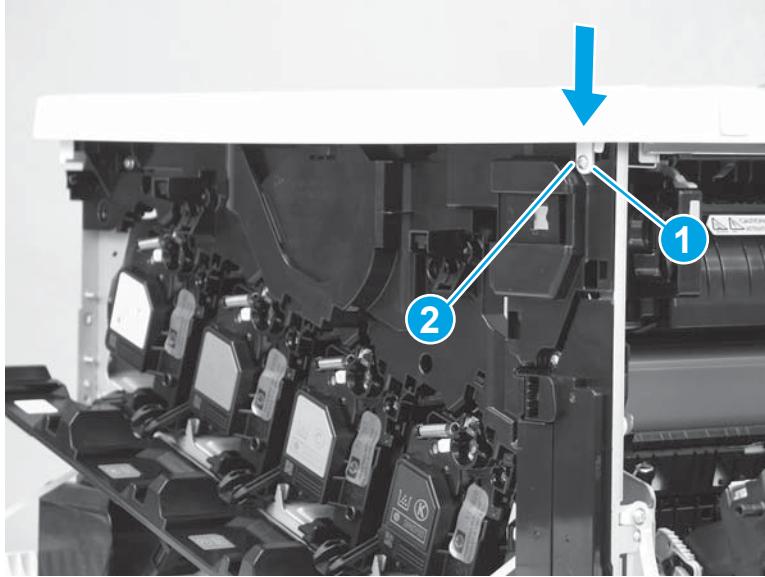
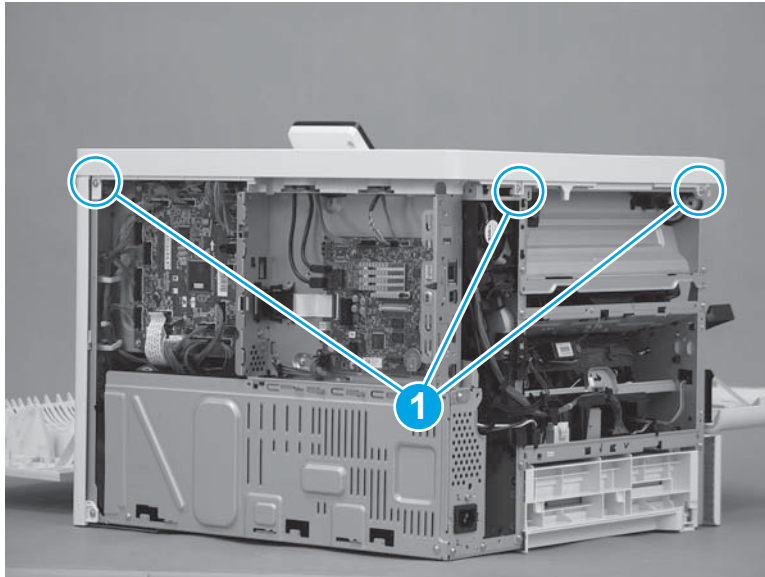

Step 33: Install the left cover

1. Position the cover on the printer.

 **NOTE:** Slightly offset the cover toward the rear of the printer.

Figure 1-2870 Install the cover

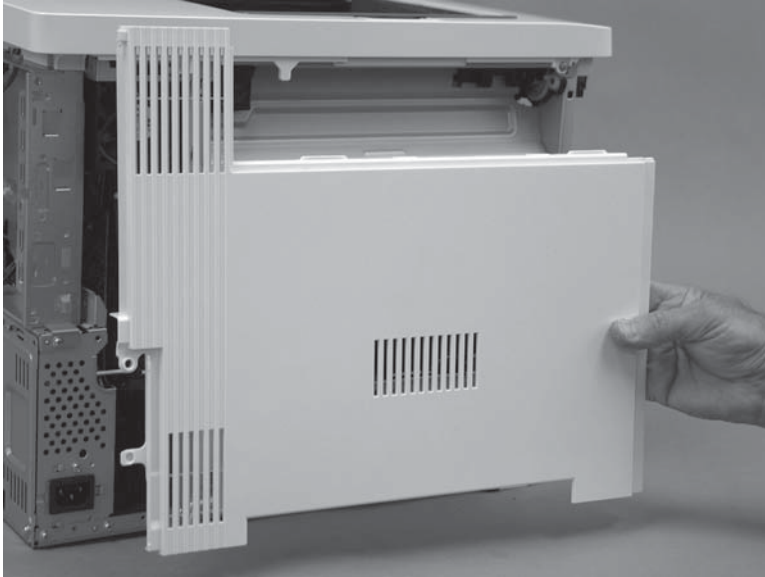

2. Slide the cover (callout 1) toward the front of the printer to engage it. Make sure that the tab (callout 2) snaps into place.

 **NOTE:** Locate the alignment pin (callout 3) on the cover from the front door side of the printer, and then make sure that it is fully engaged in the slot in the chassis.

 **TIP:** While sliding the cover into place, push in on the center of the cover (callout 1) to make sure that the hooks on the back of the cover engage with the slots in the chassis.

Figure 1-2871 Engage the cover



3. At the left side of the printer, install one screw (callout 1).

Figure 1-2872 Install one screw

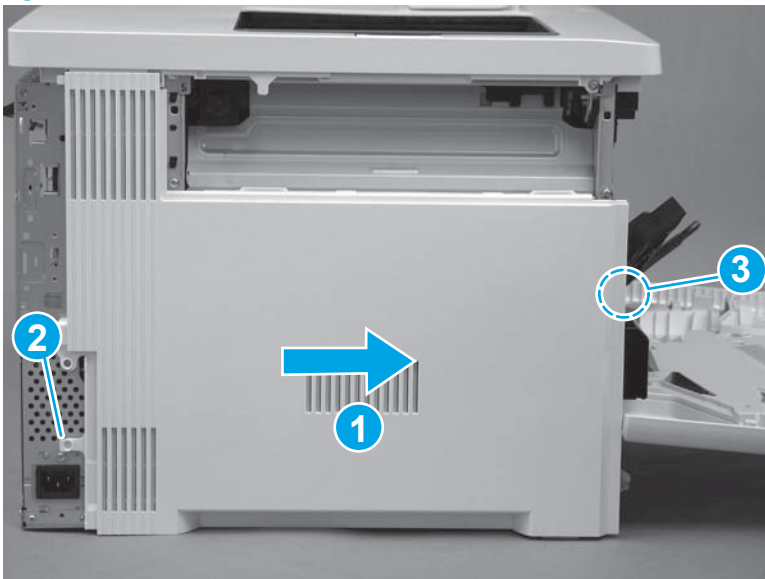

Step 34: Install the top rear cover (M577)

 **NOTE:** This step is for the M577 models. For the M552 and M553 models, skip this step and go to [Step 42: Install the rear cover \(M552 and M553\) on page 1637](#).

1. Align the locator tabs (callout 1) on the cover with the slots (callout 2) in the printer.

Figure 1-2873 Align the locator tabs

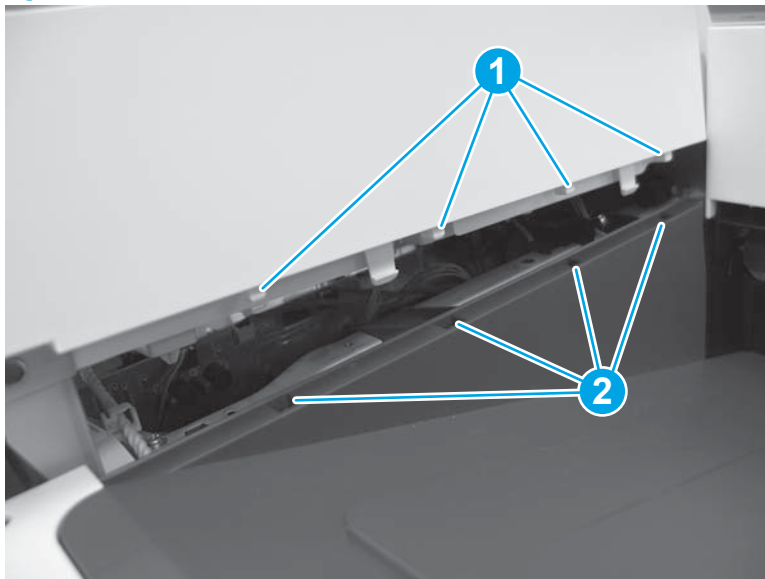

2. Press down to install the cover. Make sure that the tabs snap into place.

Figure 1-2874 Install the cover

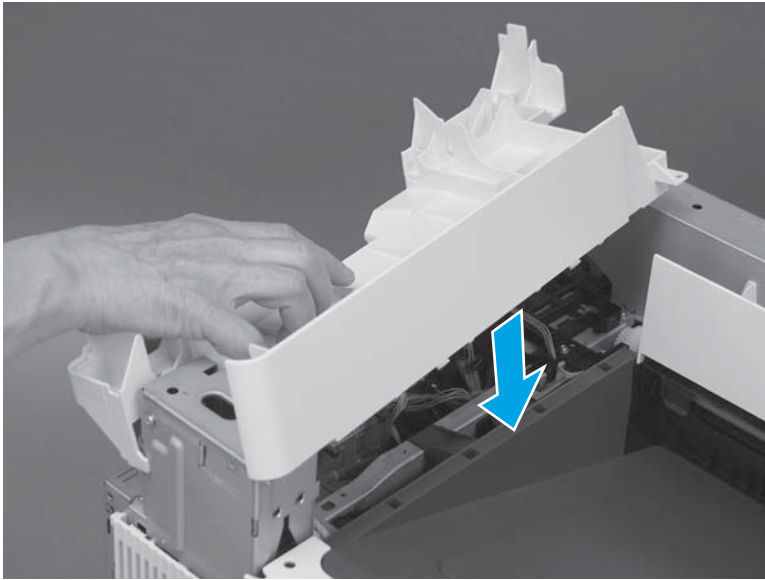

3. At the top of the printer, install five screws (callout 1).

Figure 1-2875 Install five screws

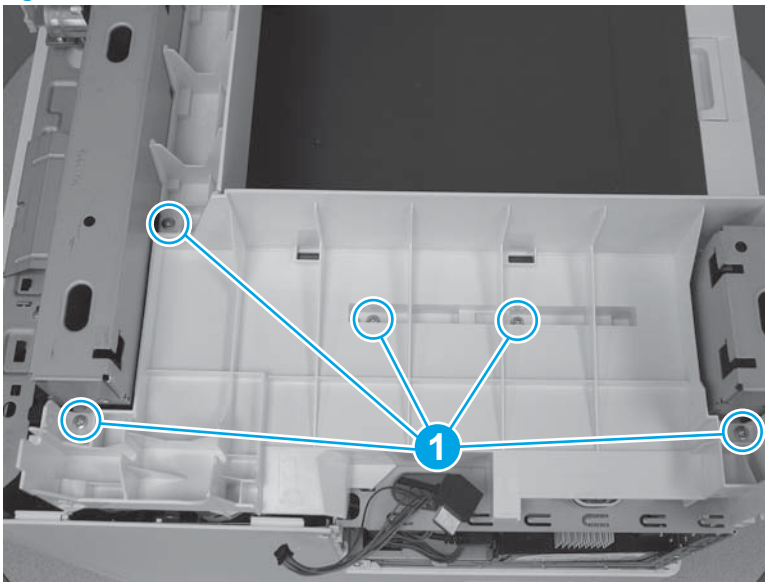

Step 35: Install the right upper cover (M577)

 **NOTE:** This step is for the M577 models. For the M552 and M553 models, skip this step and go to [Step 42: Install the rear cover \(M552 and M553\) on page 1637](#).

 **NOTE:** The figures below show the image scanner installed. The procedures for removing and installing the right upper cover are the same whether the image scanner is installed or removed."

1. **M577c/f/z only:** Install the cables (callout 1) through the slot (callout 2) in the printer.

Figure 1-2876 Install the cables

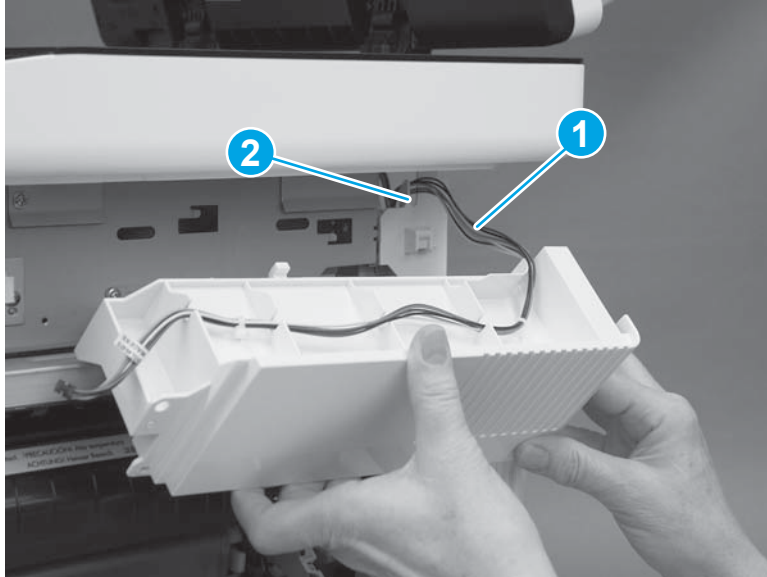

2. Position the hooks (callout 1) on the cover in the slots (callout 2) in the printer.

Figure 1-2877 Position the hooks

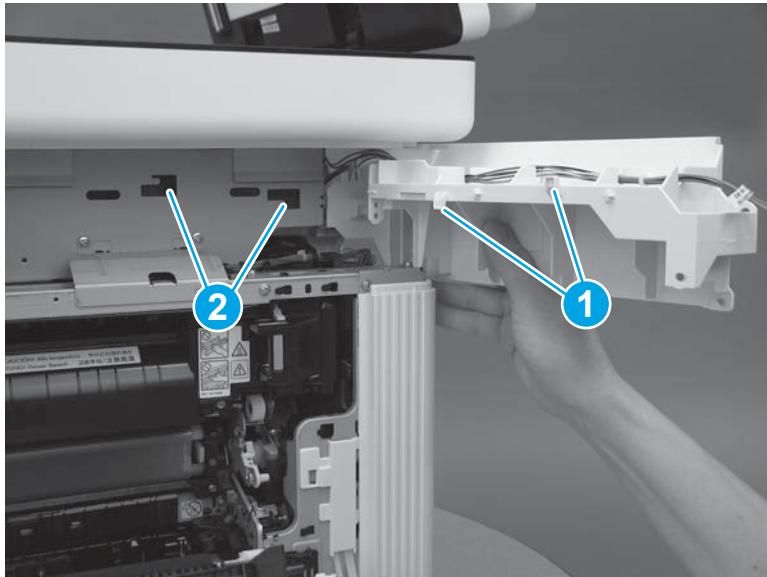

3. Slide the cover toward the front of the printer to install it.

Figure 1-2878 Install the cover

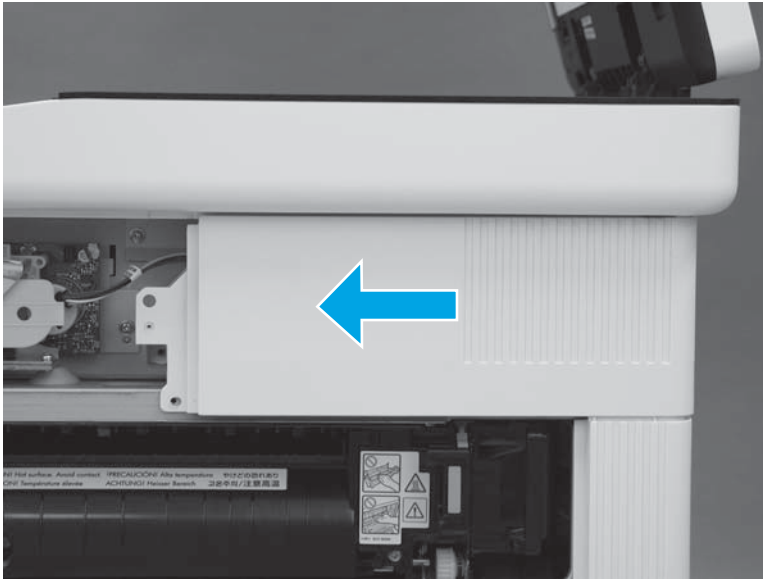

4. At the back of the printer, install one screw (callout 1).

M577c/f/z only: Connect one connector (callout 2), if the integrated scanner assembly is installed.

TIP: This screw is smaller than the screws installed in the next step. Make sure that this screw is installed in the correct position.

Figure 1-2879 Install one screw and connector

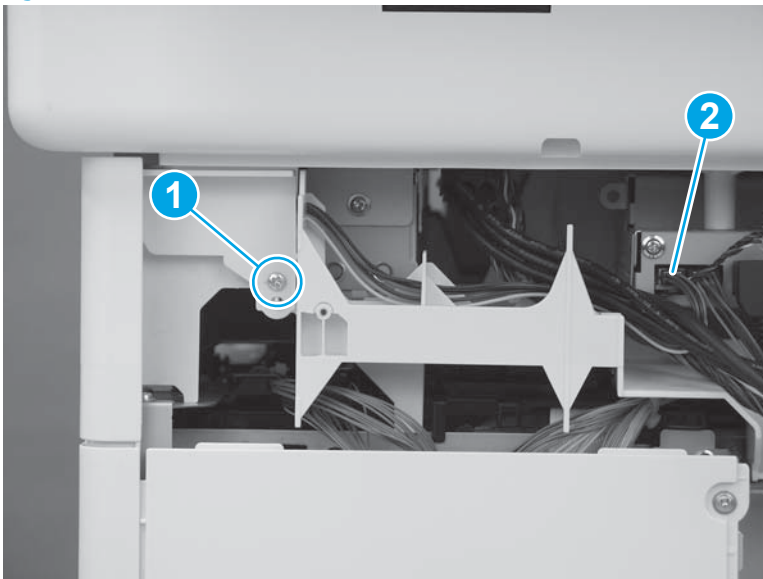

5. At the right side of the printer, install two screws (callout 1).

M577c/f/z only: Connect one connector (callout 2), if the stapler is installed.

Figure 1-2880 Install one screw and connector

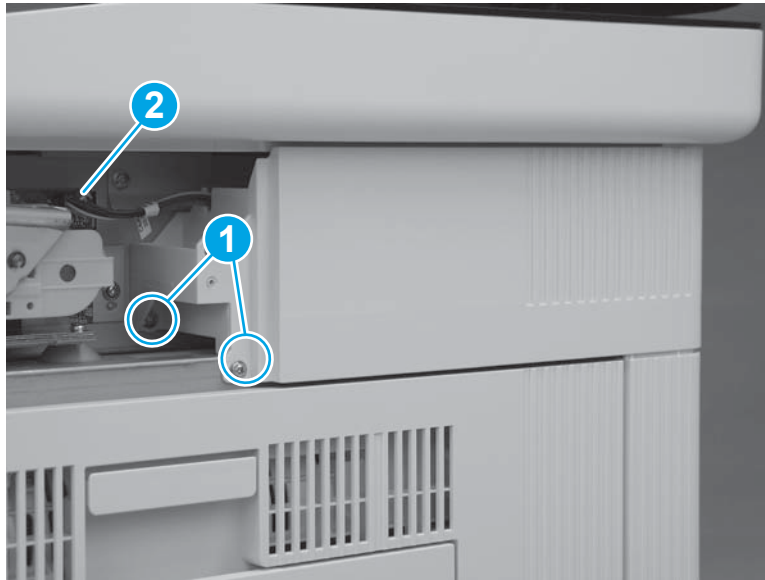

Step 36: Install the integrated scanner assembly (ISA) (M577)

 **NOTE:** This step is for the M577 models. For the M552 and M553 models, skip this step and go to [Step 42: Install the rear cover \(M552 and M553\) on page 1637](#).

 **NOTE:** The ISA includes the document feeder, image scanner, scanner control board (SCB), control panel, keyboard (M577c/z) and NFC PCA (M577z).

1. Before proceeding, locate the mounting pins (callout 1) on the bottom of the ISA and the slots (callout 2) on the printer base.

Figure 1-2881 Locate the ISA mounting pins and slots

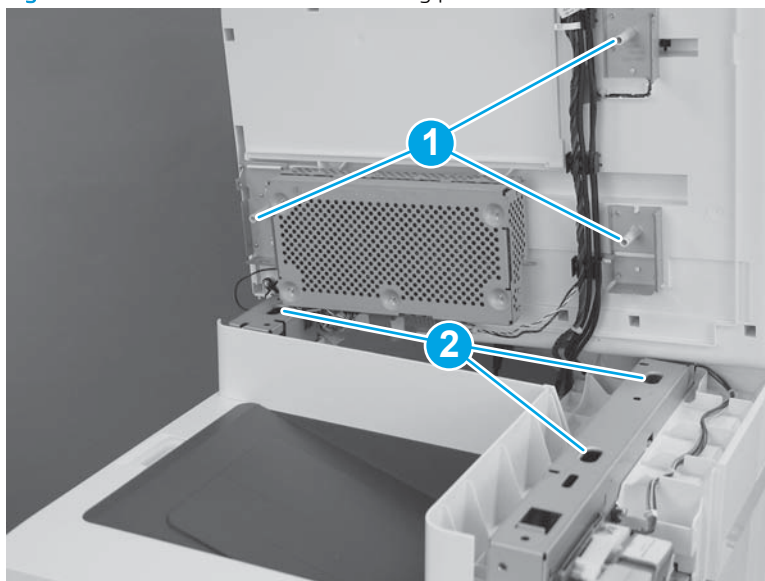

2. Position the ISA on the printer base with the pins in the slots.

 **NOTE:** To locate the pins and slots, see [Figure 1-395 Locate the ISA mounting pins and slots on page 249](#).

When installing the ISA, carefully pass the cables through the opening in the top of the formatter case.

Figure 1-2882 Install the ISA

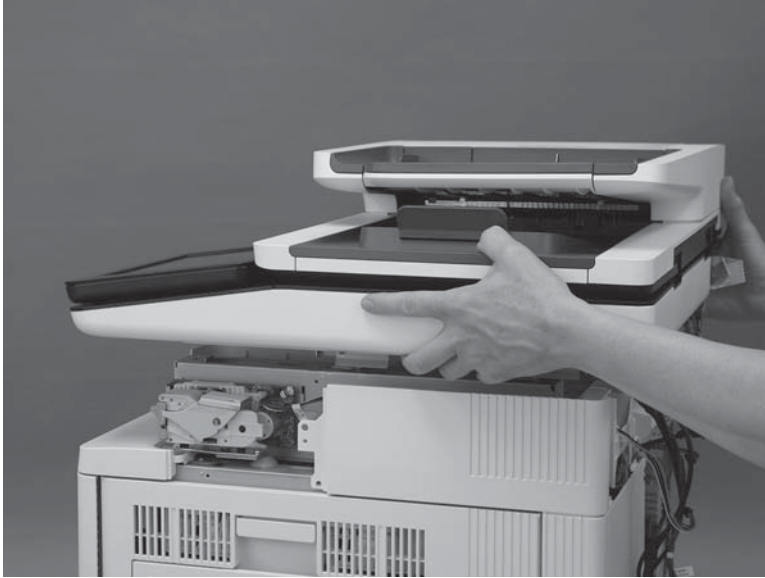

3. Slightly slide the ISA towards the front of the printer to engage it.

Figure 1-2883 Slide the ISA towards the front of the printer

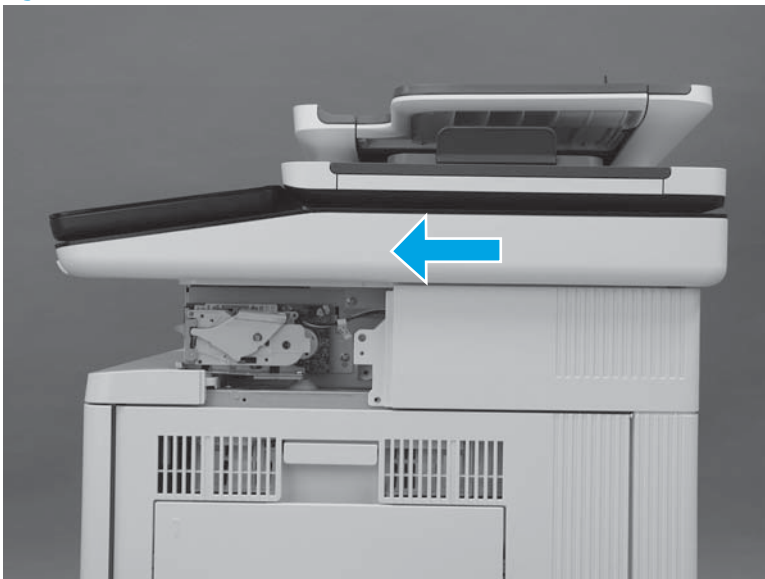

4. At the left side of the printer, install one screw (callout 1).

Figure 1-2884 Install one screw

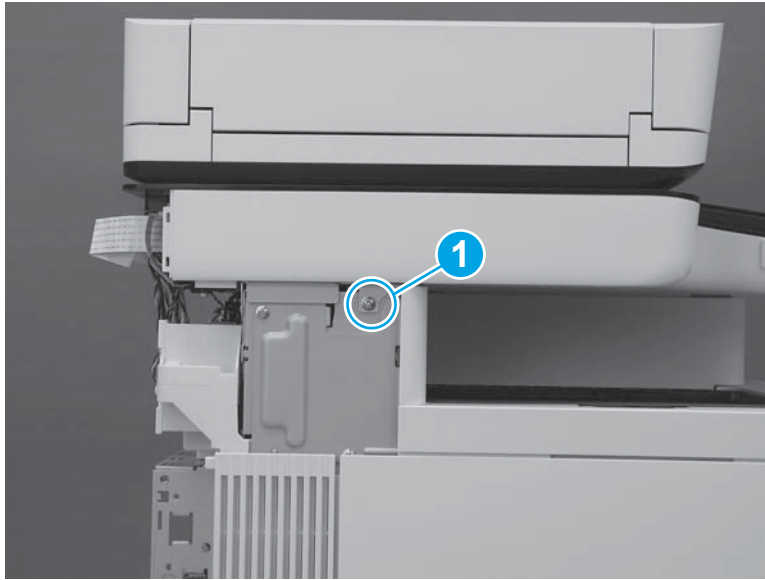

5. At the back of the printer, install two screws (callout 1).

Figure 1-2885 Install two screws

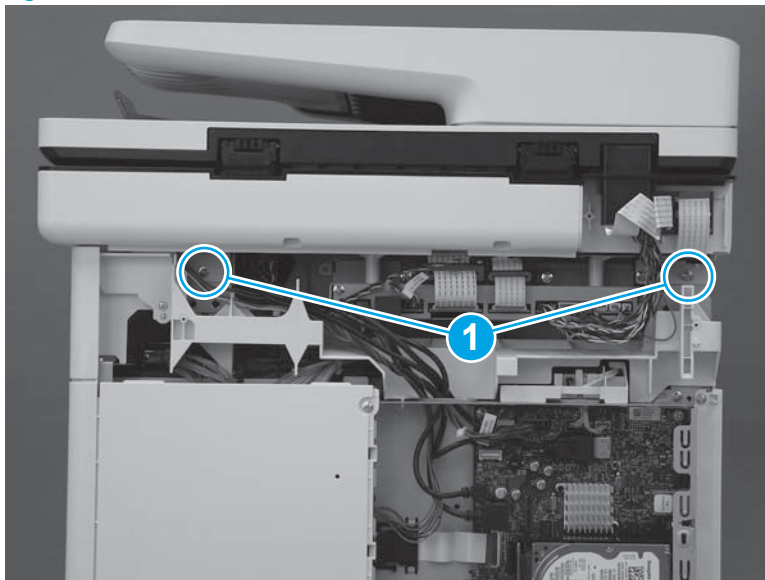

6. At the right side of the printer, install one screw (callout 1).

Figure 1-2886 Install one screw

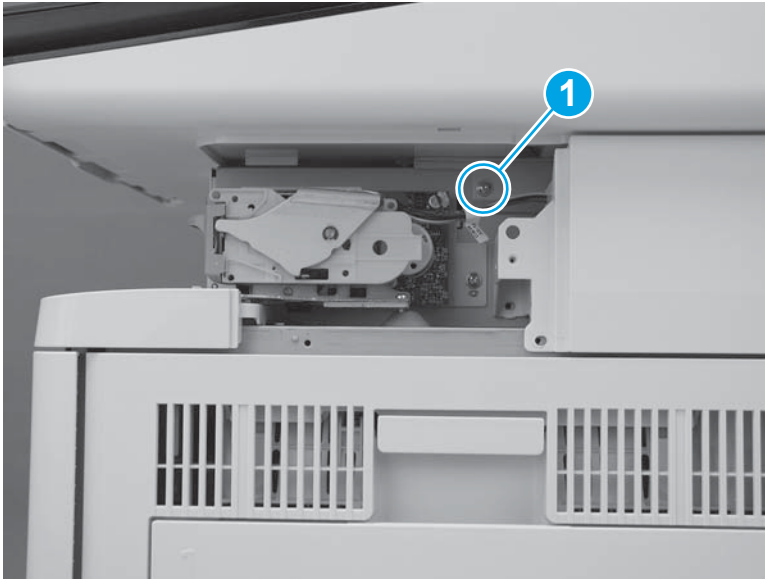

7. Connect two connectors on the scanner control board (callout 1).

M577c/f/z only: Connect one connector for the stapler on the scanner control board (callout 2).

Figure 1-2887 Connect connectors

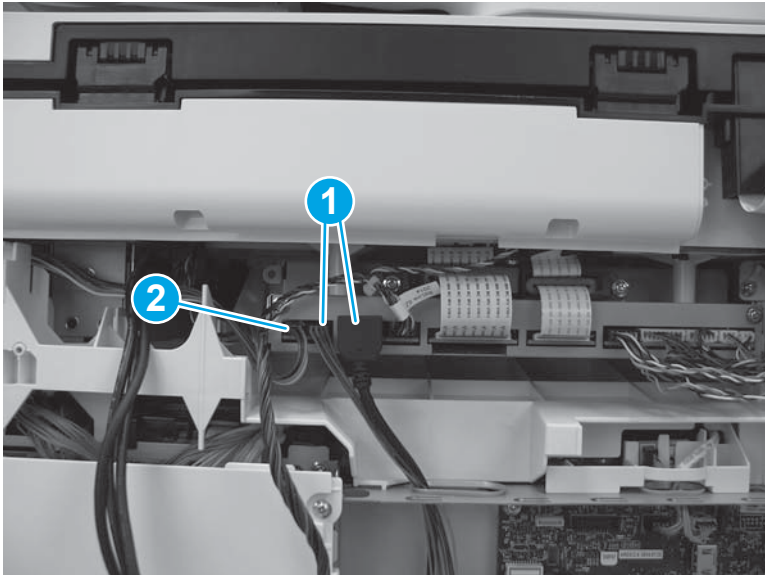

Step 37: Install the stapler cover assembly (M577c/f/z)

 **NOTE:** This step is for the M577c/f/z models only. For the M577dn model, skip this step and go to [Step 38: Install the right front upper cover \(M577dn\) on page 1630](#).

For the M552 and M553 models, skip this step and go to [Step 42: Install the rear cover \(M552 and M553\) on page 1637](#).

1. Install the tabs (callout 1) on the cover in the slots (callout 2) in the printer.

Figure 1-2888 Install two tabs



2. Press the cover toward the left side of the printer until it snaps into place.

Figure 1-2889 Install the cover assembly



3. Install one screw (callout 1).



 **IMPORTANT:** This is a self-tapping screw for plastic. Rotate it counterclockwise to align it with the existing thread pattern, and then carefully turn it clockwise to tighten. Do not overtighten. This will prevent stripping the threads inside the screw hole.

Figure 1-2890 Install one screw

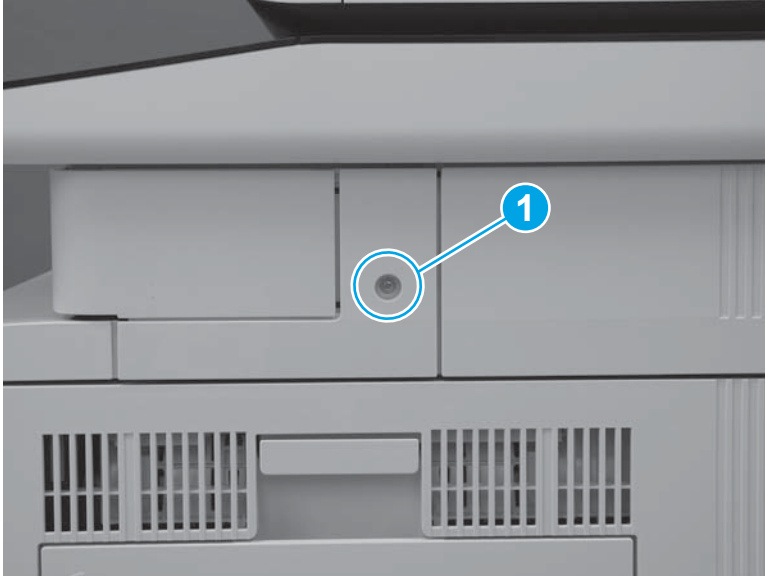

Step 38: Install the right front upper cover (M577dn)

 **NOTE:** This step is for the M577dn model only. For the M577c/f/z models, skip this step and go to [Step 39: Install the left upper cover \(M577\) on page 1632](#).

For the M552 and M553 models, skip this step and go to [Step 42: Install the rear cover \(M552 and M553\) on page 1637](#).

1. Slide the cover toward the left side of the printer to install it. Make sure that the slots (callout 1) in the cover fit over the tabs (callout 2) on the inside of the paper feeder cover.

Figure 1-2891 Install the cover



2. Press the right front upper cover (callout 1) and the paper feeder cover (callout 2) together until the tabs on the inside of the covers snap into place.

Figure 1-2892 Press the cover



3. Install one screw (callout 1).

Figure 1-2893 Install one screw

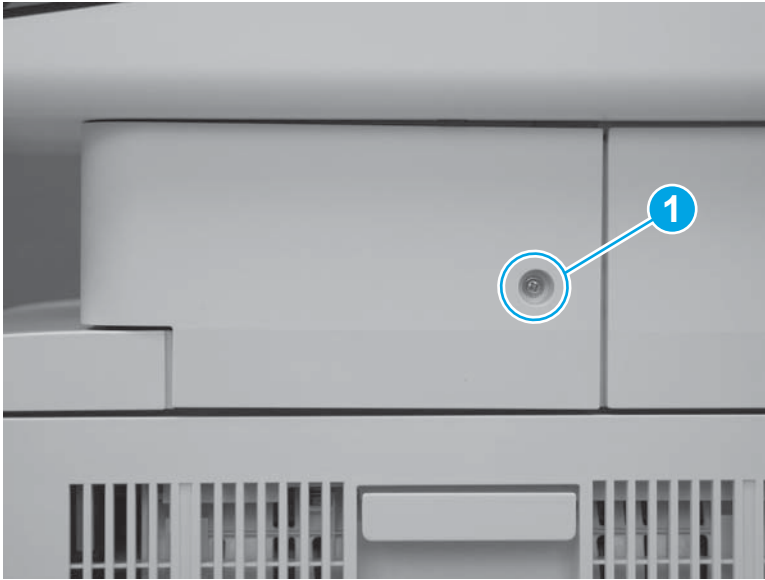

Step 39: Install the left upper cover (M577)

 **NOTE:** This step is for the M577 models. For the M552 and M553 models, skip this step and go to [Step 42: Install the rear cover \(M552 and M553\) on page 1637](#).

1. Position the tab (callout 1) on the lower edge of the cover behind the left cover (callout 2).

Figure 1-2894 Position the tab

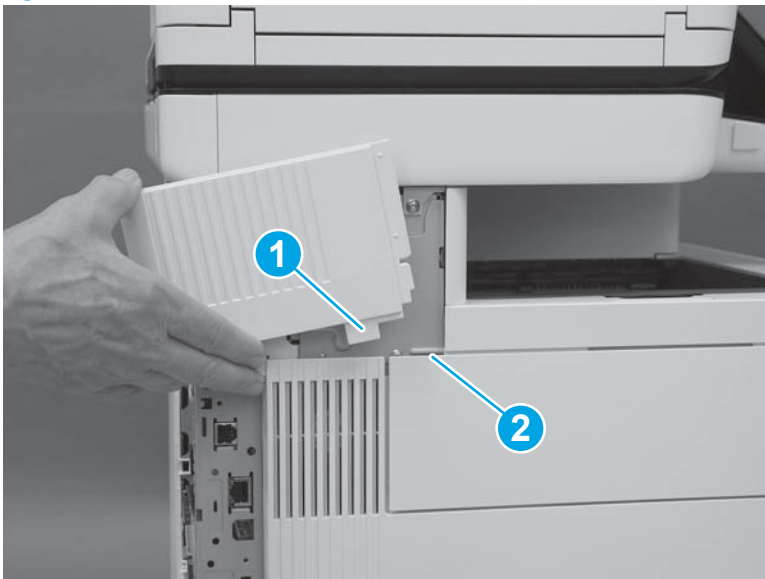

2. Slide the cover toward the front of the printer to install it. Make sure that the edge (callout 1) of the cover fits behind the edge (callout 2) of the top rear cover.

Figure 1-2895 Slide the cover

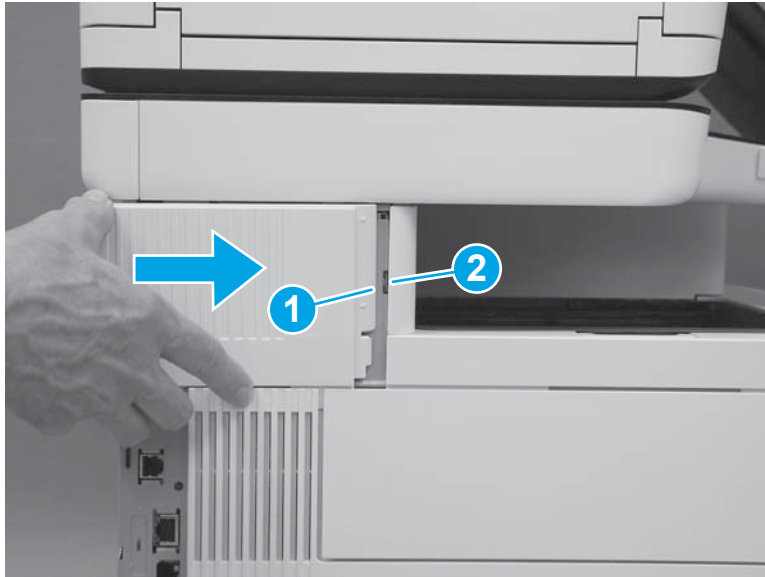

3. Make sure that the tab (callout 1) is fully installed.

Figure 1-2896 Check the tab

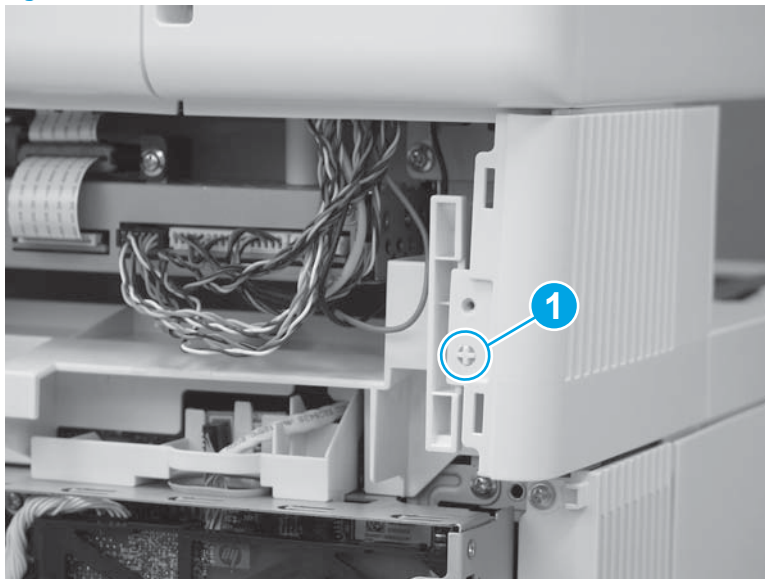

Step 40: Install the rear cover (M577)

 **NOTE:** This step is for the M577 models. For the M552 and M553 models, skip this step and go to [Step 42: Install the rear cover \(M552 and M553\) on page 1637](#).

1. Position the hooks (callout 1) on the cover in the slots (callout 2) in the printer.

Figure 1-2897 Position the hooks

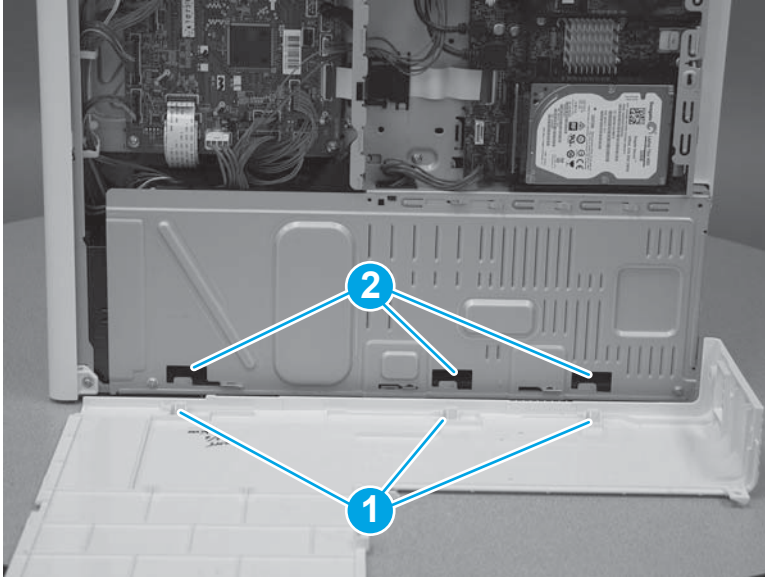

2. Position the back edge (callout 1) of the rear cover behind the edge (callout 2) of the right rear cover. Slide the cover to the left to install it.

Figure 1-2898 Install the cover

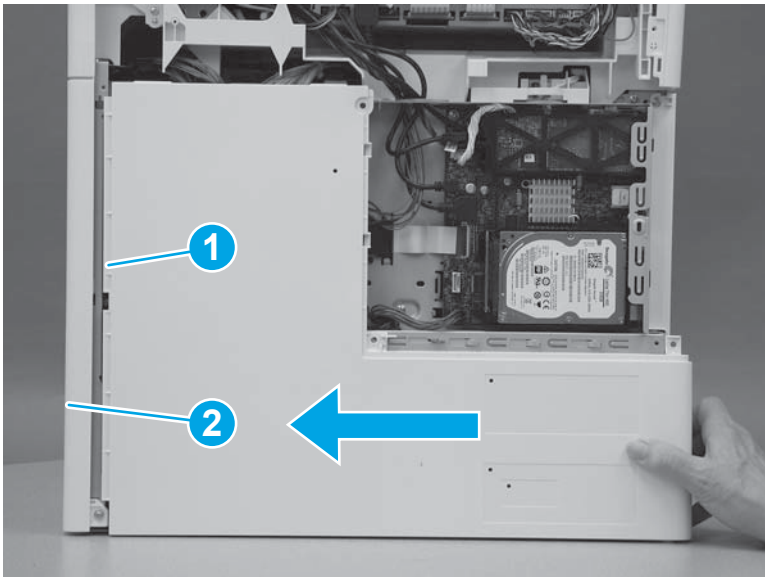

3. Install four screws (callout 1).

Figure 1-2899 Install four screws cover

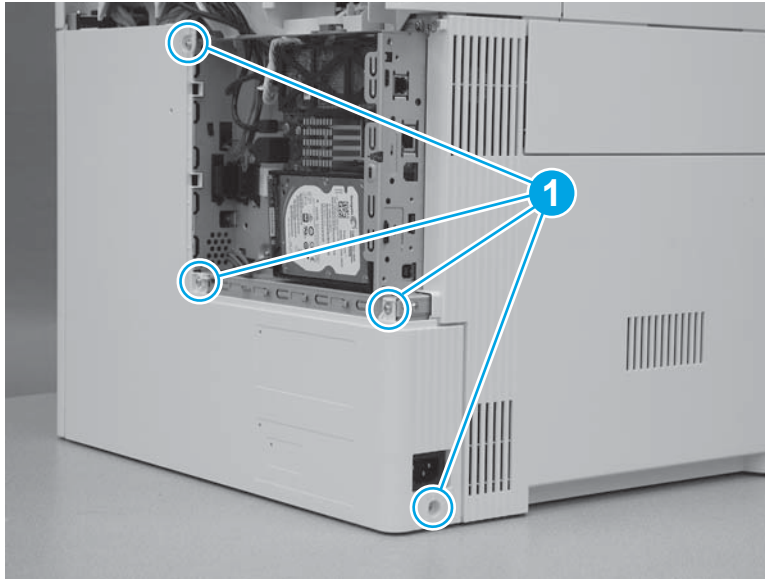

Step 41: Install the rear upper cover (M577)

 **NOTE:** This step is for the M577 models. For the M552 and M553 models, skip this step and go to [Step 42: Install the rear cover \(M552 and M553\) on page 1637](#).

1. Align the ridge (callout 1) on the lower edge of the rear upper cover in front of the tabs (callout 2) on the top edge of the rear cover.

Figure 1-2900 Align the cover

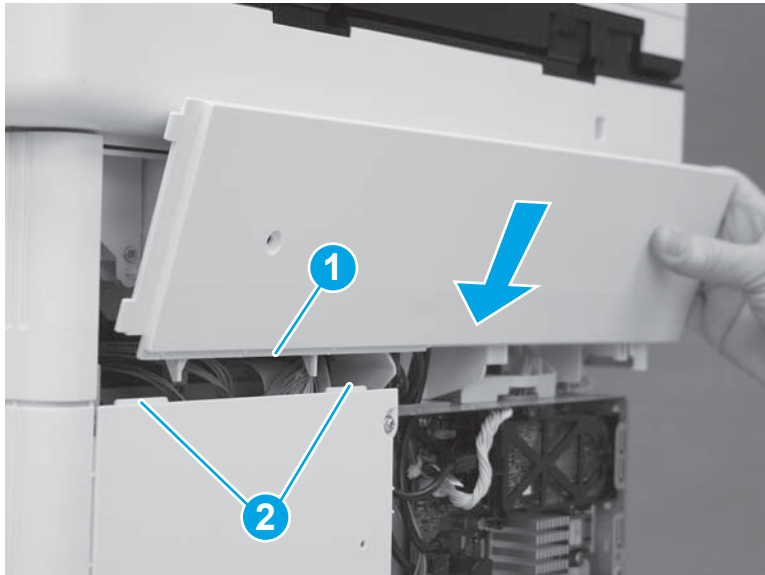

2. Rotate the top of the cover toward the printer.

Figure 1-2901 Rotate the top of the cover

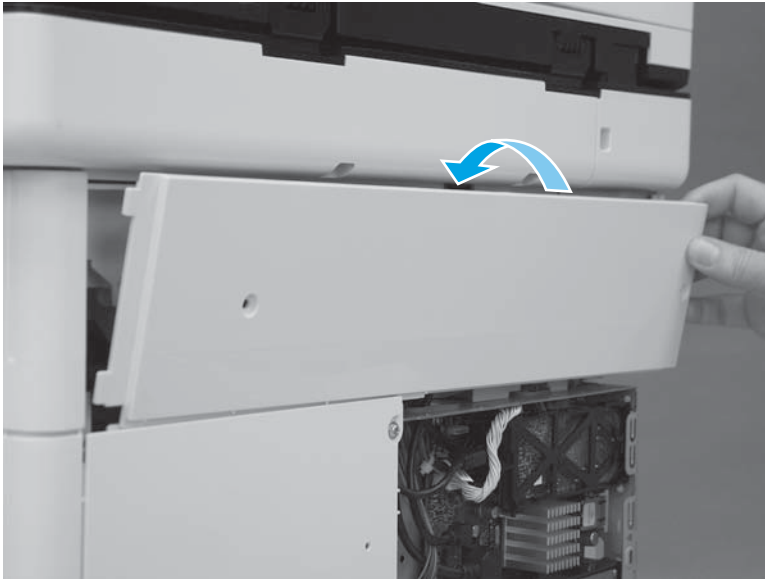

3. Slide the cover to the left (callout 1). Make sure that the tabs (callout 2) on the upper rear cover slide behind the edge (callout 3) of the right upper cover. Make sure that the cover is fully seated.

Figure 1-2902 Slide the cover

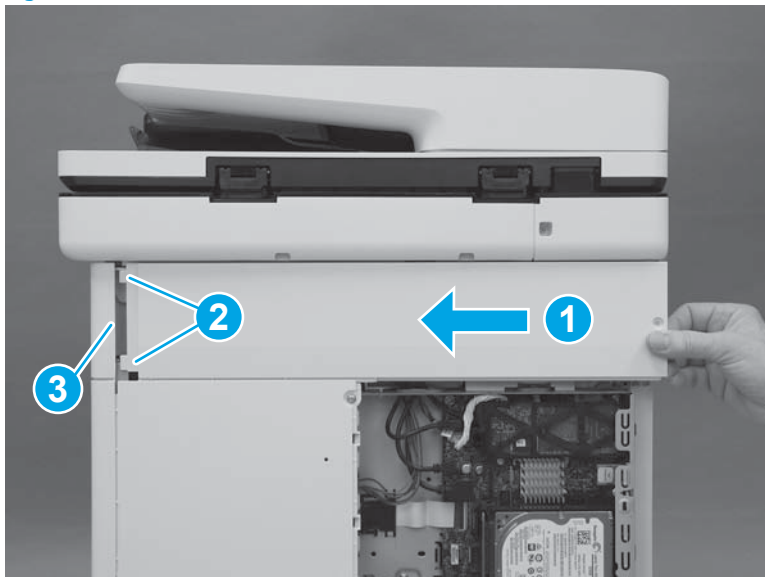

4. Install two screws (callout 1).

 **IMPORTANT:** These two screws are self-tapping screws for plastic. Rotate them counterclockwise to align them with the existing thread pattern, and then carefully turn them clockwise to tighten. Do not overtighten. This will prevent stripping the threads inside the screw holes.

Figure 1-2903 Install two screws



Step 42: Install the rear cover (M552 and M553)

 **NOTE:** This step is for the M552 and M553 models. For the M577 models, skip this step and go to [Step 43: Install the formatter \(M577\) on page 1638](#).

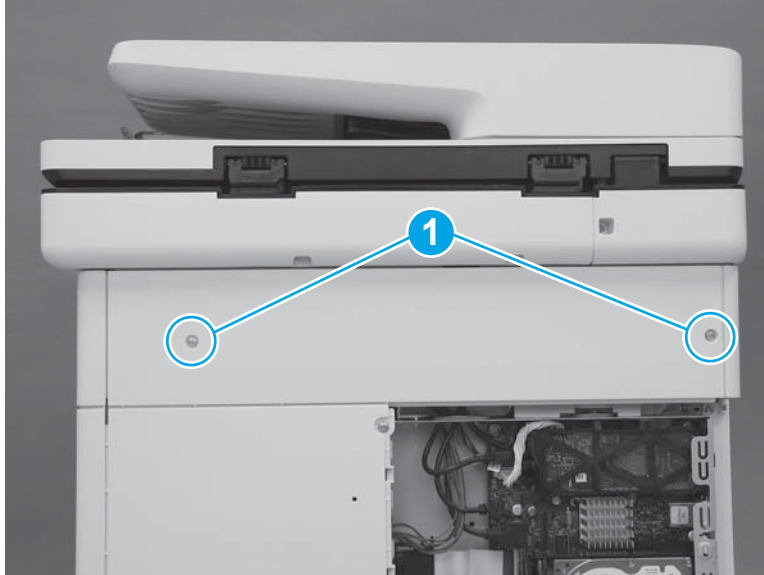
1. Position the top of the cover under the upper cover (callout 1), rotate the bottom of the cover onto the chassis (callout 2), and then slide the cover to the left (callout 3) to install it.

Figure 1-2904 Install the cover

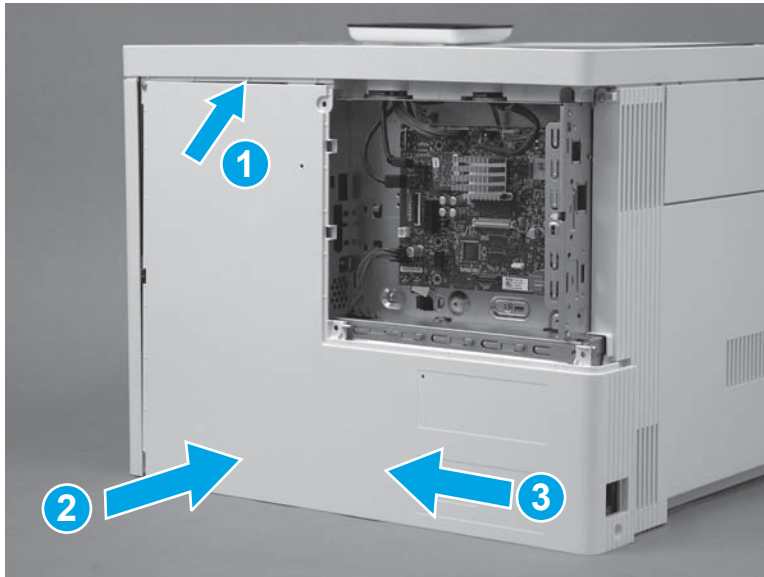

2. Install four screws (callout 1).

Figure 1-2905 Install four screws cover

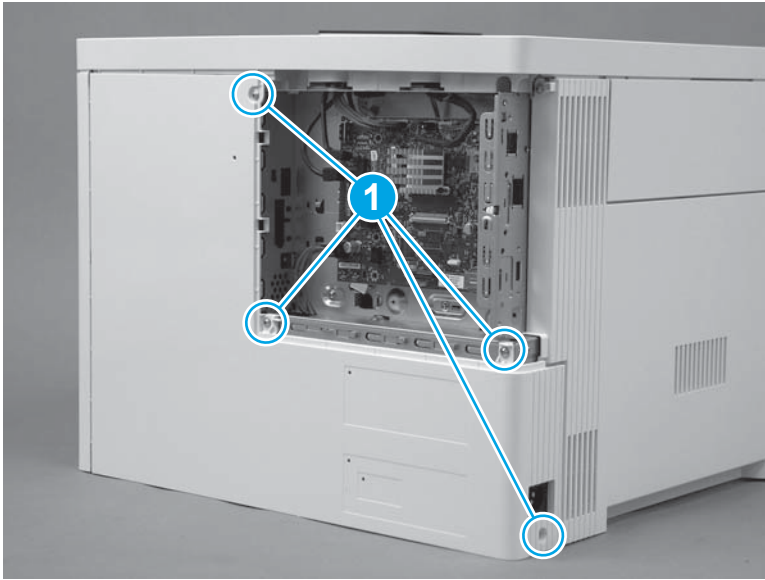

Step 43: Install the formatter (M577)

 **NOTE:** This step is for the M577 models. For the M552 and M553 models, skip this step and to go [Step 46: Install the formatter \(M552 and M553\) on page 1643](#).

 **CAUTION:**  ESD-sensitive part.

1. Position the formatter in the printer. Make sure that the network port (callout 1) fits through the opening (callout 2) in the formatter case.

Figure 1-2906 Install the formatter

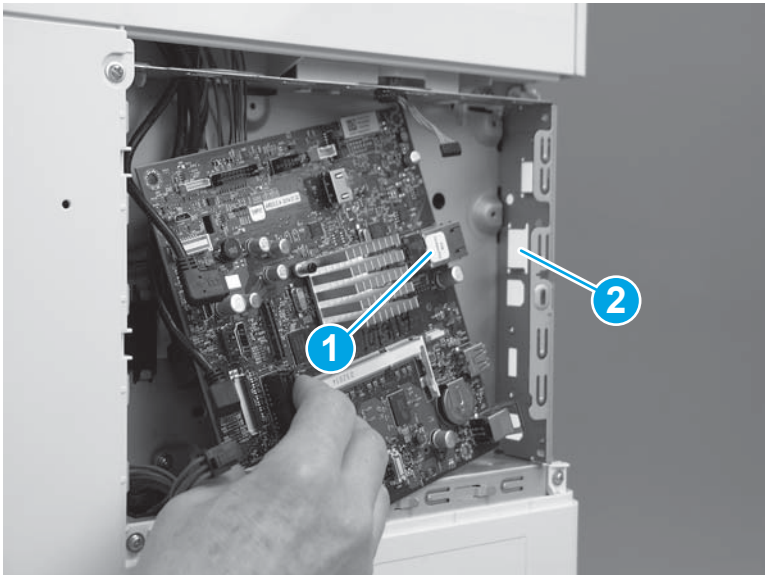

2. Install four screws (callout 1).

Figure 1-2907 Install four screws

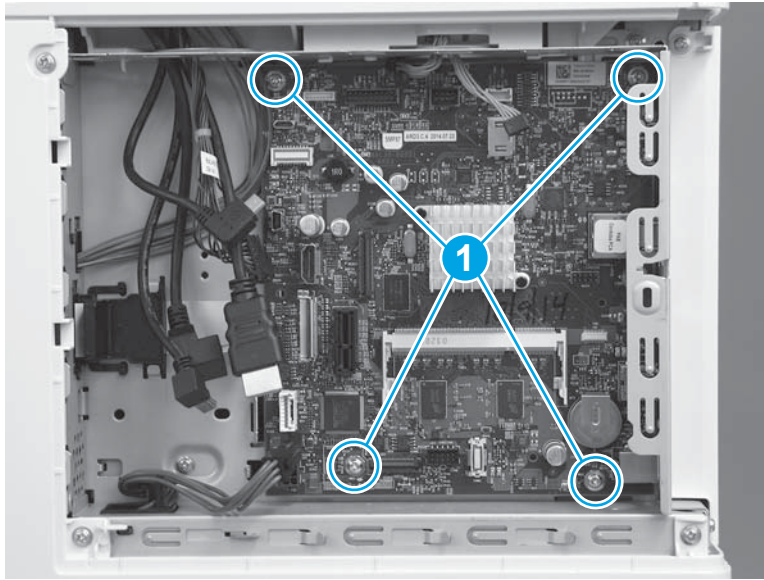

3. Connect all of the connectors on the formatter.

The following connectors are empty:

- All models: J1 (this connector is empty unless the optional DIMM is installed)
- All models: J3
- M577dn: J15 (this is the fax connector for the M577f/z/c models)
- All models: J21 (this connector is empty unless the optional internal USB ports component is installed)
- All models: J23
- All models: J24
- All models: J51
- All models: J57
- All models: J97
- All models: J98 (this connector is empty unless the optional trusted platform module (TPM) is installed)

 **IMPORTANT:** The flat-cable connector (callout 1) is a Zero Insertion Force (ZIF) connector that uses a hinged retainer to secure the flat cable. The hinged retainer must be opened to install the flat cable, and then closed after the cable is installed.

Figure 1-2908 Connect all connectors



Step 44: Install the fax PCA (M577c/f/z)

 **NOTE:** This step is for the M577c/f/z models. For the M577n model, skip this step and go to [Step 45: Install the HDD \(M577\) on page 1641](#).

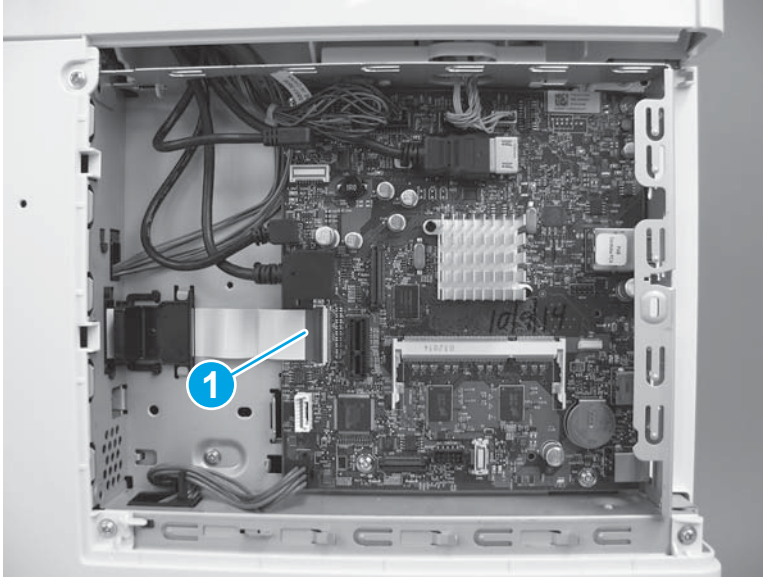
For the M552 and M553 models, skip this step and go to [Step 46: Install the formatter \(M552 and M553\) on page 1643](#).

 **CAUTION:**  ESD-sensitive part.

1. Position the tab and telephone port (callout 1) on the fax PCA in the slots (callout 2) in the formatter case.

Figure 1-2909 Position the fax PCA

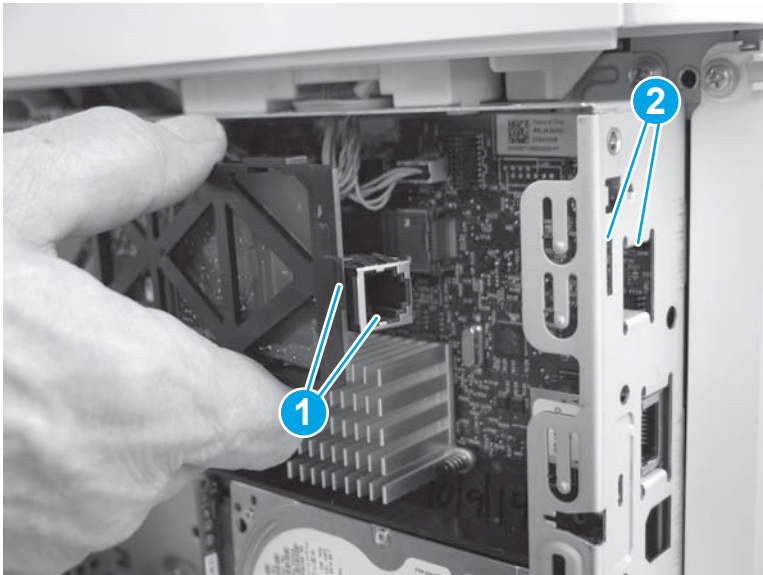

- Slide the fax PCA to the right (callout 1) until the tab and telephone port described in the previous step and seated in the formatter case. Position the retainer (callout 2) in the slot (callout 3) in the formatter. Rotate the end of the fax PCA toward the formatter (callout 4) until the retainer snaps into place.

Figure 1-2910 Install the fax PCA

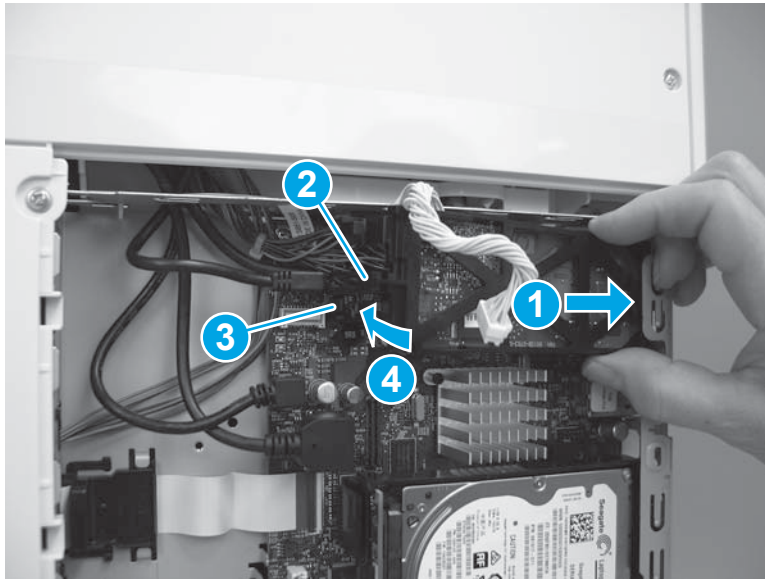

- Position the cable (callout 1) in the guide (callout 2), and then connect one connector (callout 3).

Figure 1-2911 Connect the connector

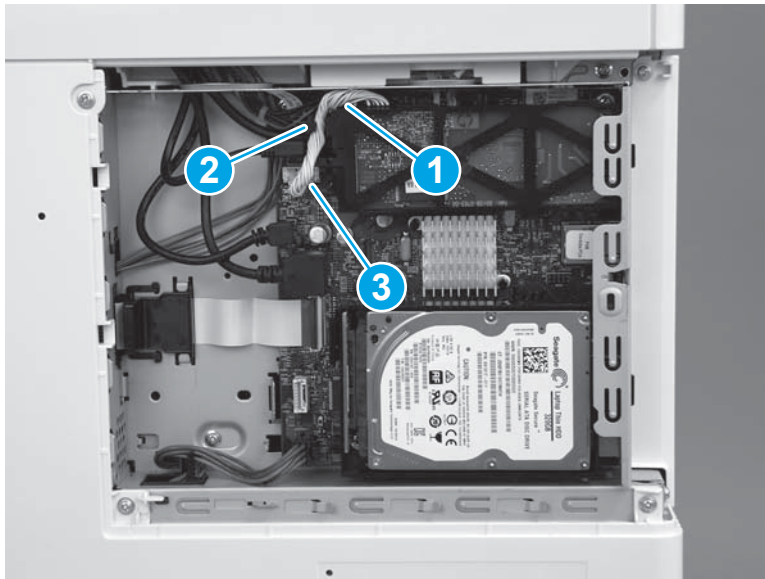

Step 45: Install the HDD (M577)

 **NOTE:** This step is for the M577 models. For the M552 and M553 models, skip this step and go to [Step 46: Install the formatter \(M552 and M553\) on page 1643](#).

 **CAUTION:**  ESD-sensitive part.

1. Align the end of the bracket (callout 1) with the slot in the chassis (callout 2), and then slide the HDD into the printer (callout 3) to engage the bracket with the chassis.

Figure 1-2912 Install the holder

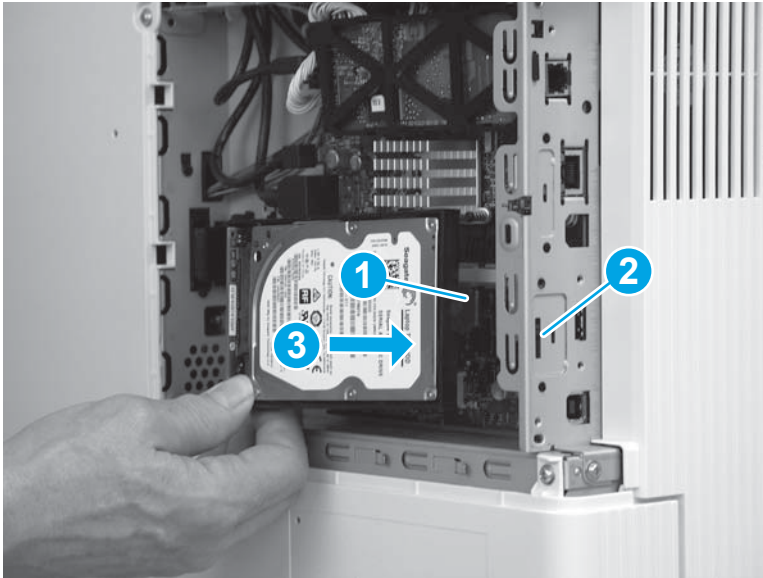

2. Hold the HDD connector latch (callout 1) in the released position, and then rotate the HDD down and into the connector on the formatter to install it.

 **NOTE:** Make sure that the tab (callout 2) snaps into place, and that the HDD is securely installed.

Figure 1-2913 Release the HDD

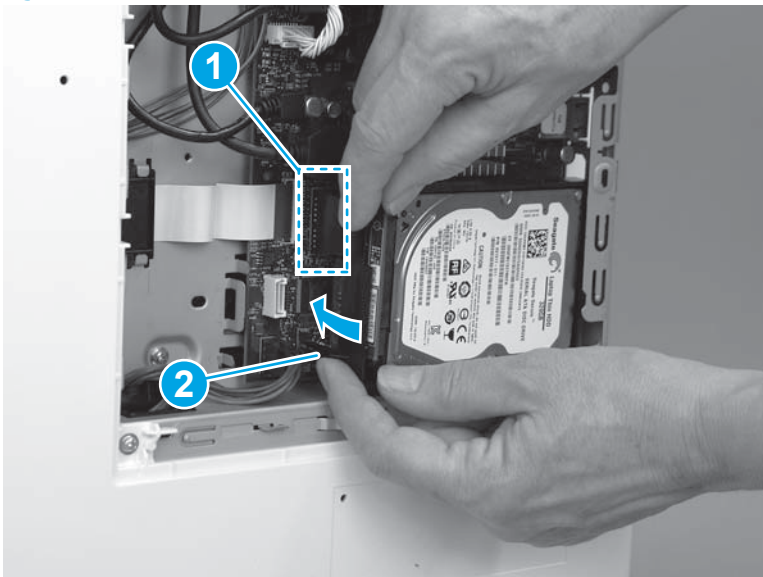

Step 46: Install the formatter (M552 and M553)

 **NOTE:** This step is for the M552 and M553 models. For the M577 models, skip this step and go to [Step 47: Install the formatter cover on page 1644](#).

If the optional hard-disk drive (HDD) was removed, do not forget to reinstall it after the formatter is reinstalled.

Engage the HDD holder with the chassis, rotate the HDD connector down and into the connector on the formatter. Make sure that the tabs snap into place.

 **CAUTION:**  ESD-sensitive part.

1. Position the formatter in the printer, and then install four screws (callout 1).

Figure 1-2914 Install the formatter

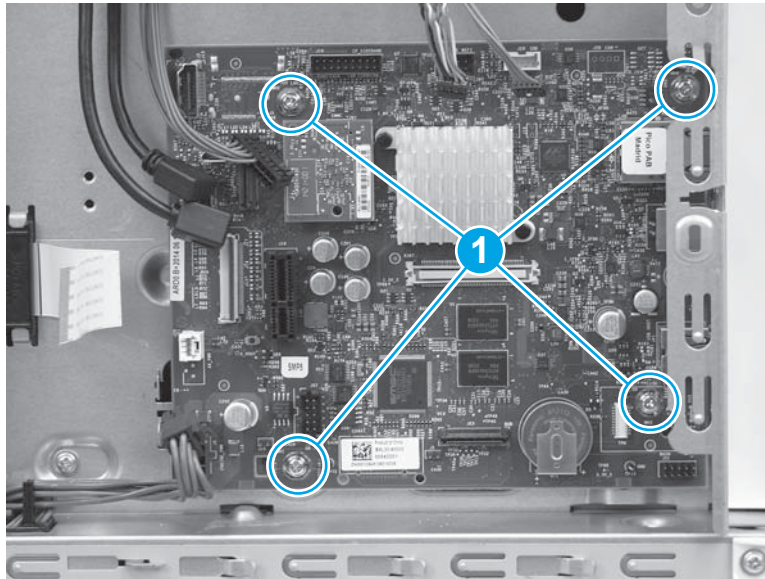

2. Connect all of the connectors on the formatter.

The following connectors are empty:

- All models: J1 (this connector is empty unless the optional DIMM is installed)
- M553n/dn and M552dn: J2 (callout 1; this is the touchscreen connector for the M553x model)
- All models: J9 (this connector is empty unless the optional internal USB ports component is installed)
- All models: J18 (this connector is empty unless the optional hard-disk-drive (HDD) is installed)
- All models: J23
- All models: J24
- M553n/dn and M552dn: J25 (this is the wireless connector for the M553x model)
- All models: J57
- All models: J98 (this connector is empty unless the optional trusted platform module (TPM) is installed)

IMPORTANT: The flat-cable connector (callout 2) is a Zero Insertion Force (ZIF) connector that uses a hinged retainer to secure the flat cable. The hinged retainer must be opened to install the flat cable.

Figure 1-2915 Connect all connectors

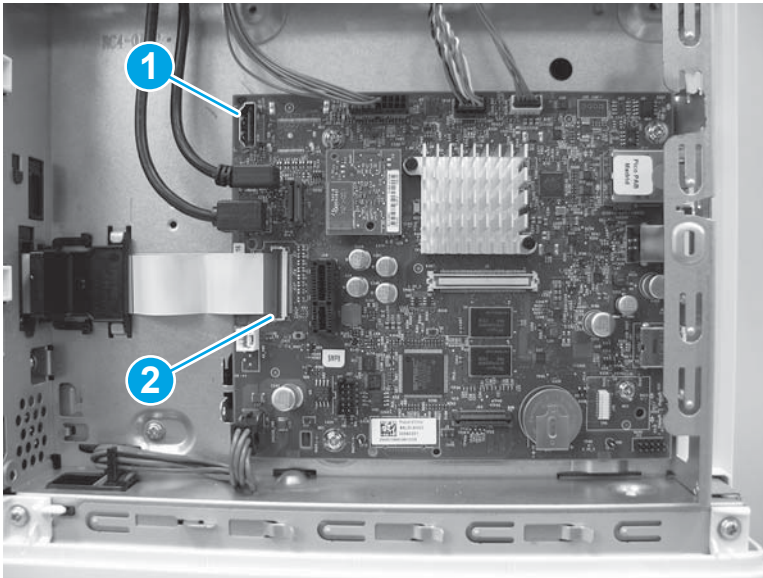

Step 47: Install the formatter cover

- ▲ Slide the cover onto the printer (callout 1) to install it.

NOTE: Make sure that the tabs on the formatter cover align with the slots provided in the printer (callout 2). Tighten the two thumbscrews (callout 3).

TIP: If needed, use the edge of a coin to turn the thumbscrews.

Figure 1-2916 Install the cover

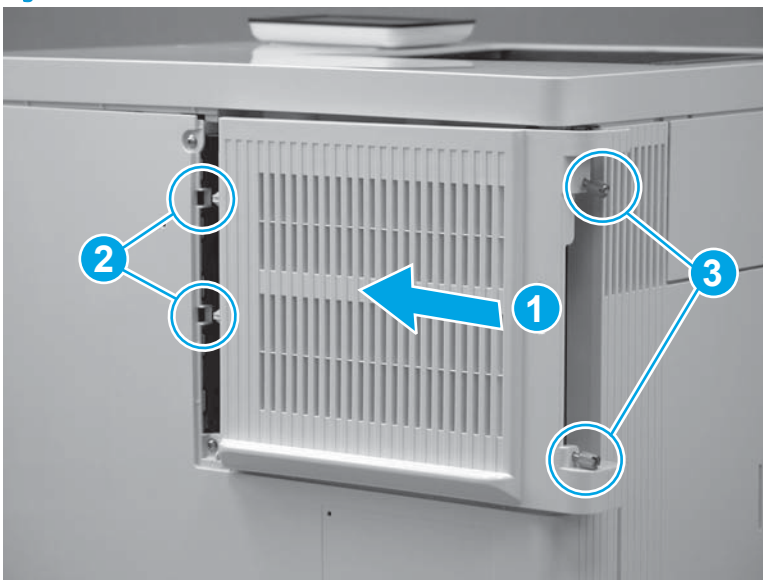

Step 48: Install the TCU

1. Verify that the toner collection hatch cover is in the closed position on the TCU.

Figure 1-2917 Verify that the toner collection hatch cover is closed

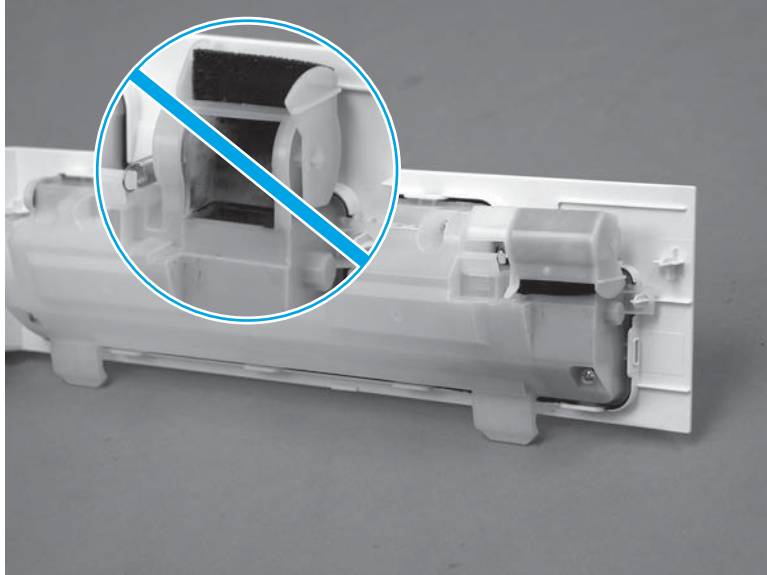

2. Position the TCU with the hinges in the slots provided in the printer (callout 1), and then rotate the TCU up and into the closed position.

 **NOTE:** The toner collection hatch cover automatically opens when the TCU is closed.

Figure 1-2918 Install the TCU



3. Close the front door.

Figure 1-2919 Close the front door

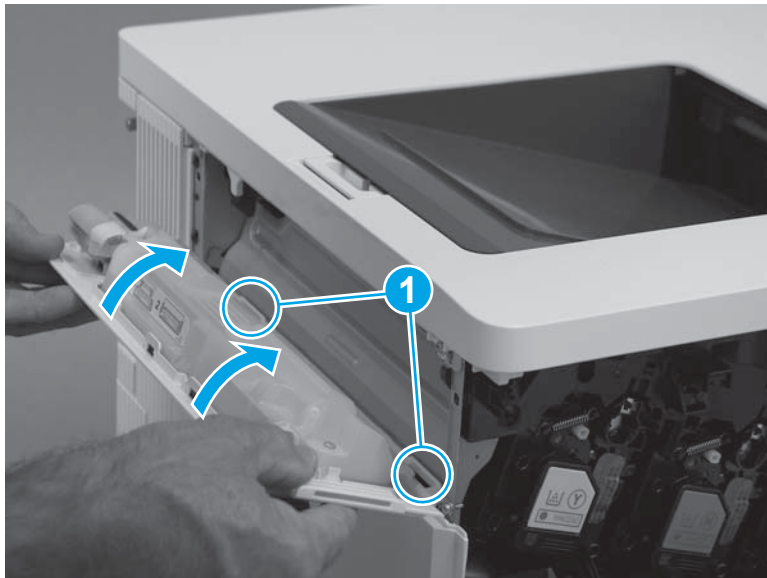

Step 49: Install the tray

1. With the front of the tray slightly lifted, align the sides of the tray with the rails in the printer, and then carefully slide the tray into the printer.

 **TIP:** As the tray slides into the printer, lower the front of it.

Figure 1-2920 Install the tray



2. Close the tray.

Figure 1-2921 Close the tray



Step 50: Install the control-panel assembly (M553x only)

 **NOTE:** For the M553n/dn and M552dn models, skip this step and go to [Step 51: Install the USB cover \(M552 and M553\) on page 1650](#).

For the M577 models, skip this step.

1. Place the control panel on the printer as shown.

Figure 1-2922 Place the control panel on the product

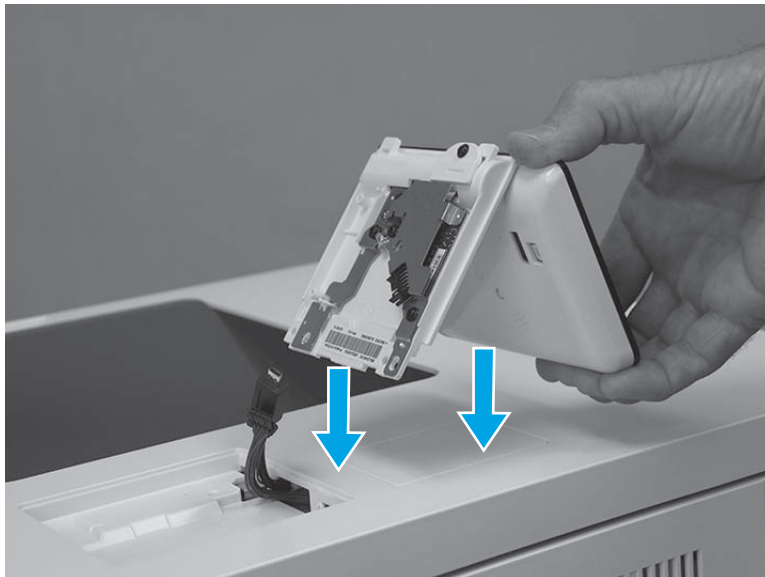

2. Connect one USB cable (callout 1), and one connector (callout 2).

 **IMPORTANT:** Take note of the location of the two mounting tabs (callout 3) on the control-panel assembly.

Figure 1-2923 Connect two connectors



3. Turn the control panel over, and then position the front edge tabs in the slots in the top cover.

Figure 1-2924 Turn the control panel over

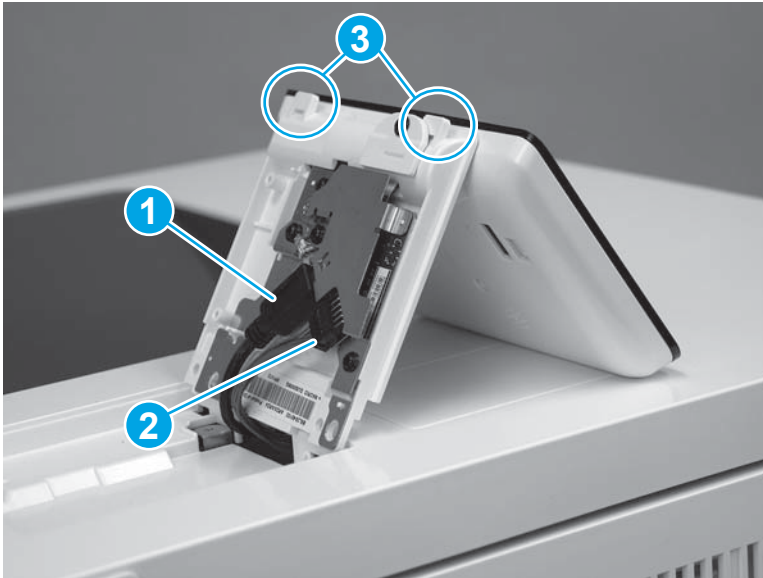
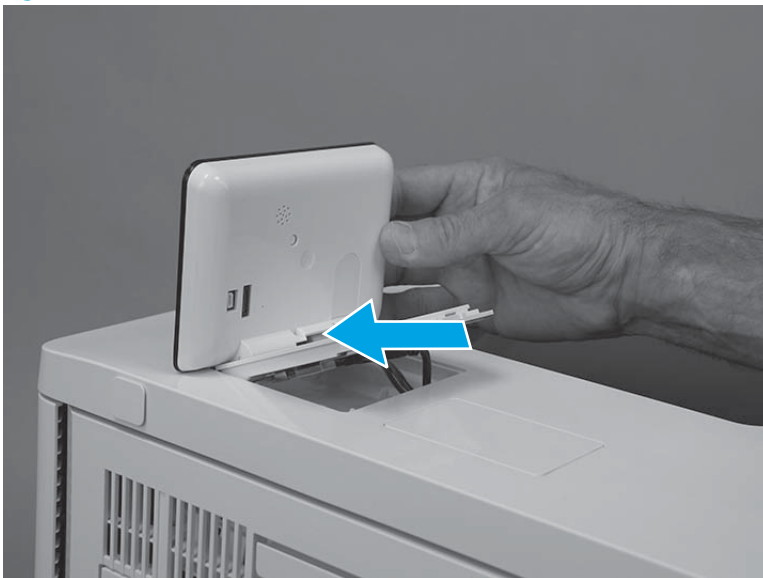

4. Rotate the control-panel base down onto the printer.

Figure 1-2925 Rotate the control-panel base down



5. Use a small Phillips screwdriver to install two screws (callout 1).

Figure 1-2926 Install two screws

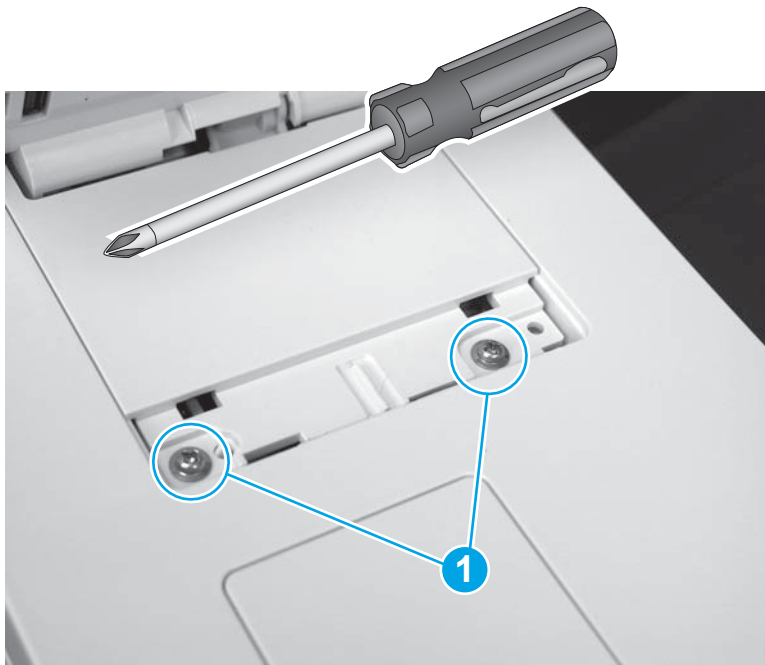

6. Position the screw cover mounting feet into the slots in the top cover (callout 1), and then rotate the cover down (callout 2) to install it.

 **NOTE:** Press down on the cover firmly to make sure that the tabs on the cover (callout 3) snap into place.

Figure 1-2927 Install the cover

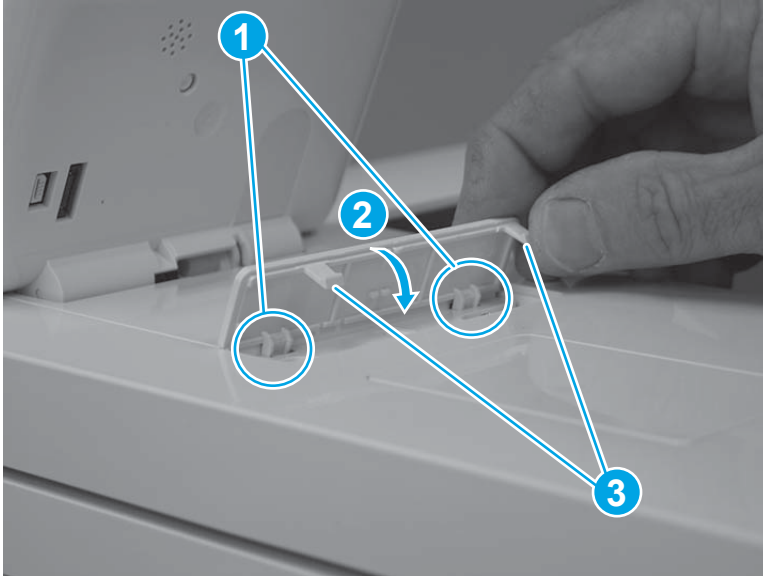

Step 51: Install the USB cover (M552 and M553)

 **NOTE:** This step is for the M552 and M553 models. For the M577 models, skip this step.

1. Push the cover into the USB port to install it.

Figure 1-2928 Install the cover



2. Make sure that the USB cover is fully seated after installing it.

Figure 1-2929 Check the installation

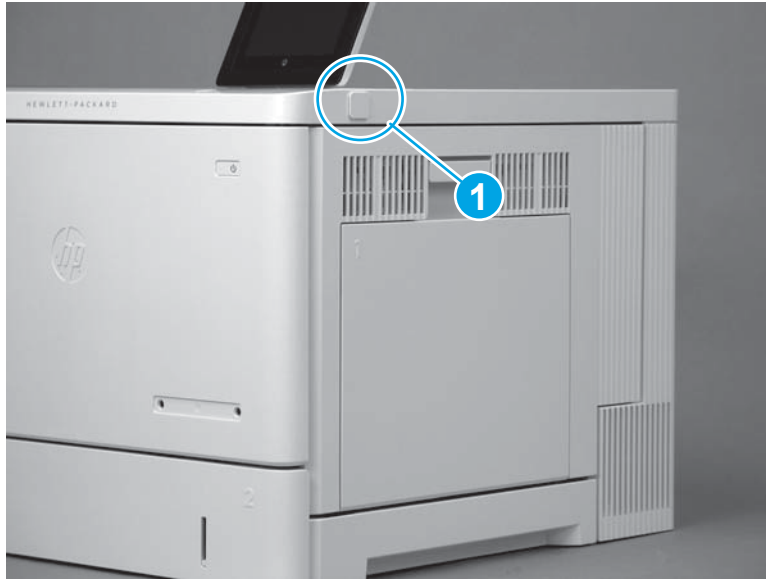

Removal and replacement: Drum motor 3 (M3)

- [Introduction](#)
- [Step 1: Remove the USB cover \(M552 and M553\)](#)
- [Step 2: Remove the control panel \(M553x only\)](#)
- [Step 3: Remove the tray](#)
- [Step 4: Remove the toner collection unit \(TCU\)](#)
- [Step 5: Remove the formatter cover](#)
- [Step 6: Remove the formatter \(M552 and M553\)](#)
- [Step 7: Remove the hard-disk drive \(HDD\) \(M577\)](#)
- [Step 8: Remove the fax PCA \(M577c/f/z\)](#)
- [Step 9: Remove the formatter \(M577\)](#)
- [Step 10: Remove the rear cover \(M552 and M553\)](#)
- [Step 11: Remove the rear upper cover \(M577\)](#)
- [Step 12: Remove the rear cover \(M577\)](#)
- [Step 13: Remove the left upper cover \(M577\)](#)
- [Step 14: Remove the right front upper cover \(M577dn\)](#)
- [Step 15: Remove the stapler cover assembly \(M577c/f/z\)](#)
- [Step 16: Remove the integrated scanner assembly \(ISA\) \(M577\)](#)
- [Step 17: Remove the right upper cover \(M577\)](#)
- [Step 18: Remove the top rear cover \(M577\)](#)
- [Step 19: Remove the left cover](#)
- [Step 20: Remove the upper cover \(M552 and M553\)](#)
- [Step 21: Remove the formatter case](#)
- [Step 22: Remove the right rear cover](#)
- [Step 23: Remove the DC controller and sheet-metal bracket](#)
- [Step 24: Remove the high-voltage power supply T \(HVPST\)](#)
- [Step 25: Remove drum motor 3 \(M3\)](#)
- [Step 26: Unpack the replacement assembly](#)
- [Step 27: Install drum motor 3 \(M3\)](#)
- [Step 28: Install the HVPST](#)
- [Step 29: Install the DC controller and sheet-metal bracket](#)

- [Step 30: Install the right rear cover](#)
- [Step 31: Install the formatter case](#)
- [Step 32: Install the upper cover \(M552 and M553\)](#)
- [Step 33: Install the left cover](#)
- [Step 34: Install the top rear cover \(M577\)](#)
- [Step 35: Install the right upper cover \(M577\)](#)
- [Step 36: Install the integrated scanner assembly \(ISA\) \(M577\)](#)
- [Step 37: Install the stapler cover assembly \(M577c/f/z\)](#)
- [Step 38: Install the right front upper cover \(M577dn\)](#)
- [Step 39: Install the left upper cover \(M577\)](#)
- [Step 40: Install the rear cover \(M577\)](#)
- [Step 41: Install the rear upper cover \(M577\)](#)
- [Step 42: Install the rear cover \(M552 and M553\)](#)
- [Step 43: Install the formatter \(M577\)](#)
- [Step 44: Install the fax PCA \(M577c/f/z\)](#)
- [Step 45: Install the HDD \(M577\)](#)
- [Step 46: Install the formatter \(M552 and M553\)](#)
- [Step 47: Install the formatter cover](#)
- [Step 48: Install the TCU](#)
- [Step 49: Install the tray](#)
- [Step 50: Install the control-panel assembly \(M553x only\)](#)
- [Step 51: Install the USB cover \(M552 and M553\)](#)

Introduction

This document provides the procedures to remove and replace the drum motor 3 (M3).

Before performing service

Turn the printer power off

- Disconnect the power cable.

⚠ WARNING! To avoid damage to the printer, turn the printer off, wait 30 seconds, and then remove the power cord before attempting to service the printer.

Use the table below to identify the correct part number for your printer, and then go to <http://h20141.www2.hp.com/hpparts> to order the part.

Drum motor 3 (M3) part number

RM2-0078-000CN

Drum motor 3 (M3)

Required tools

- #2 Phillips screwdriver with a magnetic tip

After performing service

Make sure that all of the connectors on the HVPST are fully seated.

Make sure that all of the connectors on the DC controller are fully seated.

Make sure that all of the connectors on the formatter are fully seated.

Make sure that the formatter cover is fully seated, and that the thumbscrews are finger tight after replacing it.

Turn the printer power on

- Connect the power cable.
- Use the power switch to turn the power on.

Post service test

Use the components test to test the motor. For more information, see the printer troubleshooting manual.

Step 1: Remove the USB cover (M552 and M553)

 **NOTE:** This step is for the M552 and M553 models. For the M577 models, skip this step and go to [Step 3: Remove the tray on page 1659](#).

1. Locate the USB cover.

Figure 1-2930 Locate the USB cover



2. Pull the cover off of the printer to remove it.

Figure 1-2931 Remove the cover



Step 2: Remove the control panel (M553x only)

 **NOTE:** This step is for the M553x model. For the M553n/dn, M552dn, and M577 models, skip this step and go to [Step 3: Remove the tray on page 1659](#).

1. Tilt the control panel up.

Figure 1-2932 Tilt the control panel up



2. Use a small flat-blade screwdriver to release the control-panel screws cover tabs.

Figure 1-2933 Release the control-panel screws cover tabs



3. Rotate the cover up to remove it.

Figure 1-2934 Remove the cover



4. Use a small Phillips screwdriver to remove two screws (callout 1).

 **IMPORTANT:** Store the screws in a secure place where they cannot fall down into the printer.

Figure 1-2935 Remove two screws

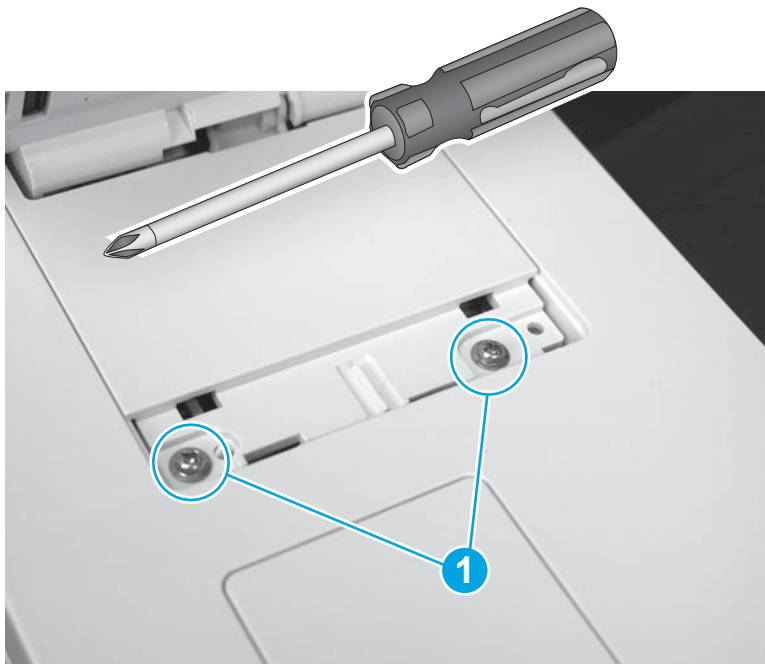

5. Rotate the control-panel base toward the front of the printer.

Figure 1-2936 Rotate the control-panel base up



6. Slightly slide the control-panel base toward the rear of the printer (callout 1) to release it, and then turn the control panel over (callout 2) to access the bottom side.

CAUTION: The control panel is still attached to the printer. Do not attempt to completely remove the control panel.

Figure 1-2937 Turn the control panel over

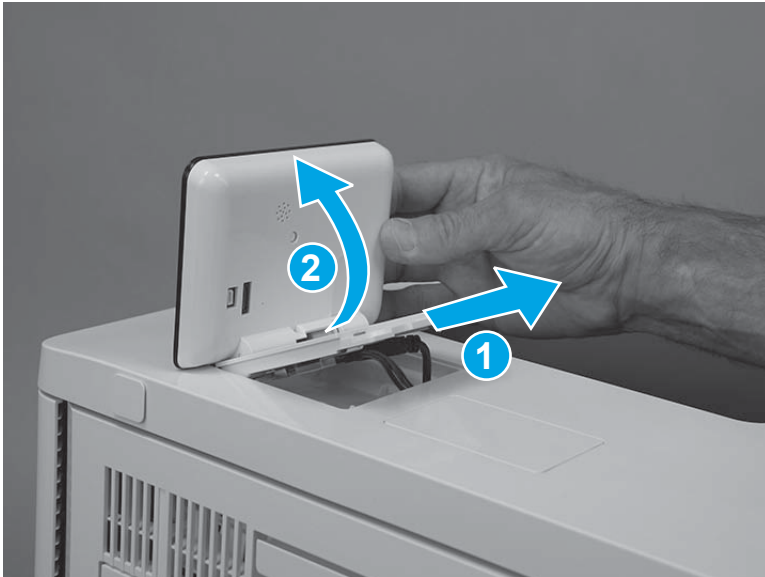

7. Disconnect one USB cable (callout 1), one connector (callout 2), and then remove the control panel.

Figure 1-2938 Disconnect two connectors

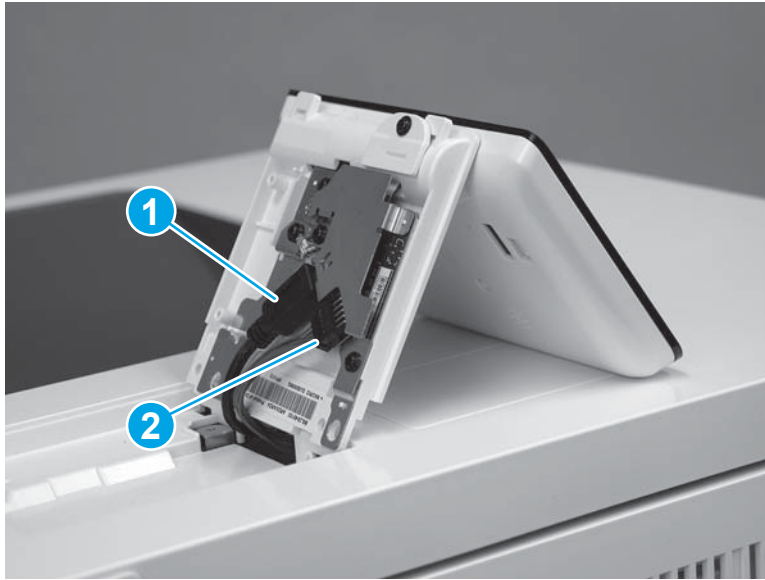

Step 3: Remove the tray

1. Pull the tray out until it stops.

Figure 1-2939 Pull the tray out



2. Lift the front of the tray, and then pull it out of the printer to remove it.

Figure 1-2940 Remove the tray

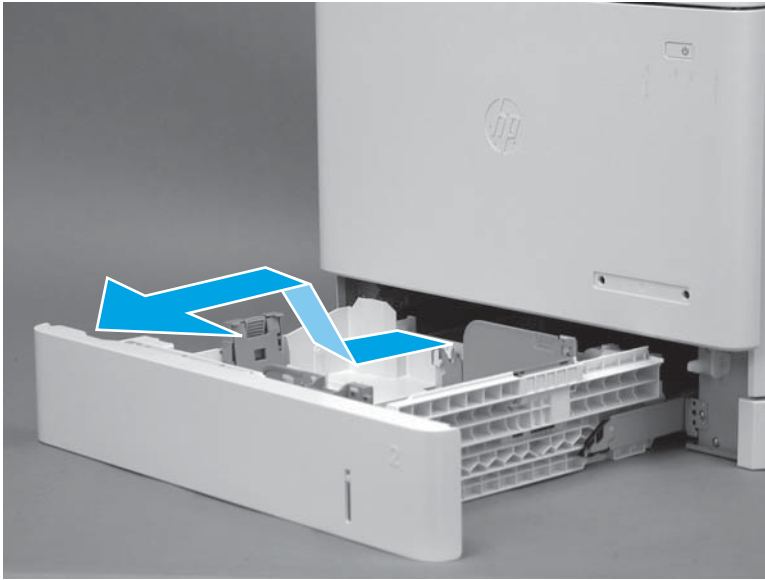

Step 4: Remove the toner collection unit (TCU)

1. Open the front door.

Figure 1-2941 Open the front door



2. Open the TCU.

 **NOTE:** The toner collection hatch cover automatically closes when the TCU is opened.

Figure 1-2942 Open the TCU



3. Pull the TCU away from the printer at an angle to remove it.

⚠ CAUTION: Do not open the toner collection hatch cover when handling the TCU. If toner gets on clothing, wipe it off by using a dry cloth and wash the clothes in cold water. Hot water sets toner into fabric.

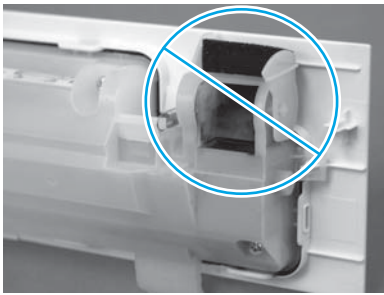
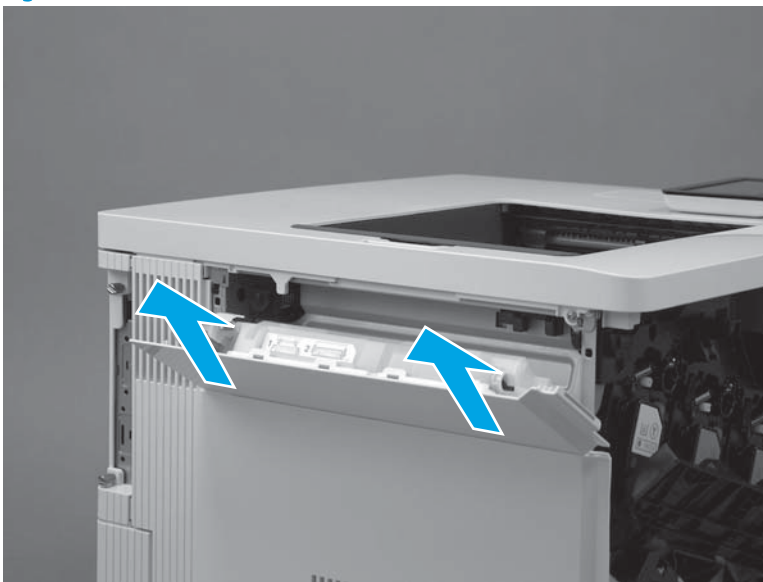

Figure 1-2943 Remove the TCU



Step 5: Remove the formatter cover

1. Locate the formatter cover.

Figure 1-2944 Locate the formatter cover

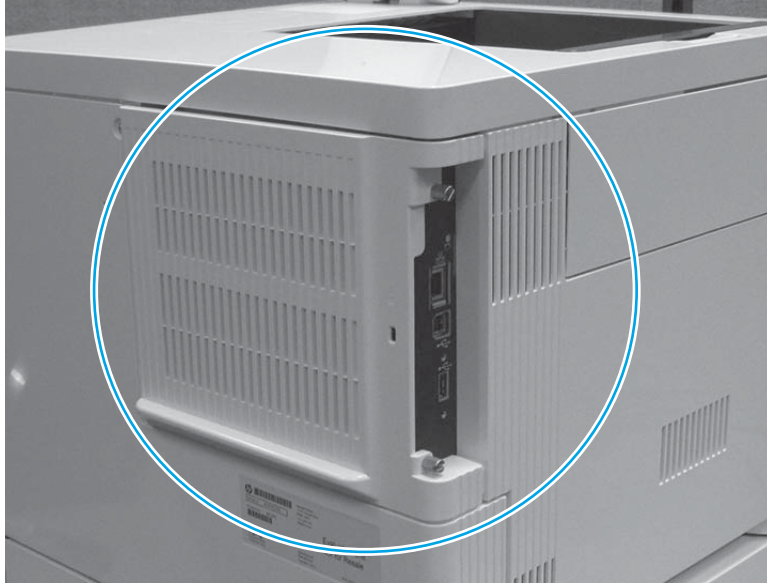

2. Loosen the two thumbscrews (callout 1). Grasp the two thumbscrews, and then slide the cover away from the printer (callout 2) to remove it.

 **TIP:** If needed, use the edge of a coin to turn the thumbscrews.

Figure 1-2945 Loosen the thumbscrews

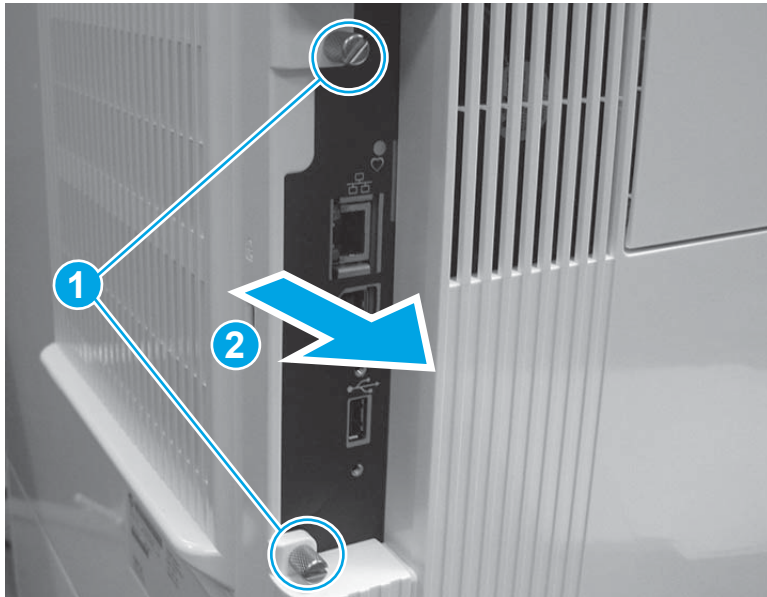

Step 6: Remove the formatter (M552 and M553)

 **NOTE:** This step is for the M552 and M553 models. For the M577 models, skip this step and go to [Step 7: Remove the hard-disk drive \(HDD\) \(M577\) on page 1665](#).

If the optional hard-disk drive (HDD) is installed, it must be removed to gain access to the formatter mounting screws.

Release two tabs along the left edge of the HDD, rotate the left edge away from the product, and then slide the HDD to the left to remove it.

 **CAUTION:**  ESD-sensitive part.

1. Disconnect all of the connectors on the formatter.

The following connectors are empty:

- All models: J1 (this connector is empty unless the optional DIMM is installed)
- M553n/dn and M552dn: J2 (callout 1; this is the touchscreen connector for the M553x model)
- All models: J9 (this connector is empty unless the optional internal USB ports component is installed)
- All models: J18 (this connector is empty unless the optional hard-disk-drive (HDD) is installed)
- All models: J23
- All models: J24
- M553n/dn and M552dn: J25 (this is the wireless connector for the M553x model)
- All models: J57
- All models: J98 (this connector is empty unless the optional trusted platform module (TPM) is installed)

 **IMPORTANT:** The flat-cable connector (callout 2) is a Zero Insertion Force (ZIF) connector that uses a hinged retainer to secure the flat cable. The hinged retainer must be opened to release the flat cable.

Figure 1-2946 Disconnect all connectors



2. Remove four screws (callout 1), and then remove the formatter.

Figure 1-2947 Remove the formatter

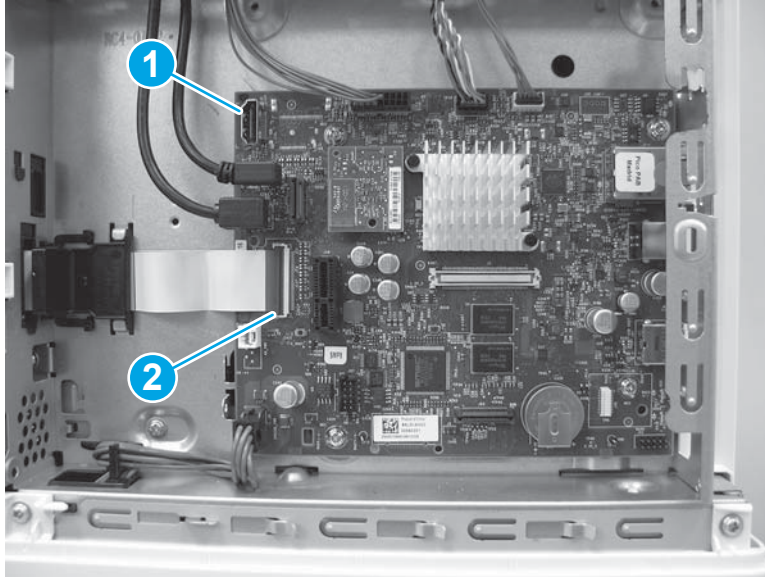
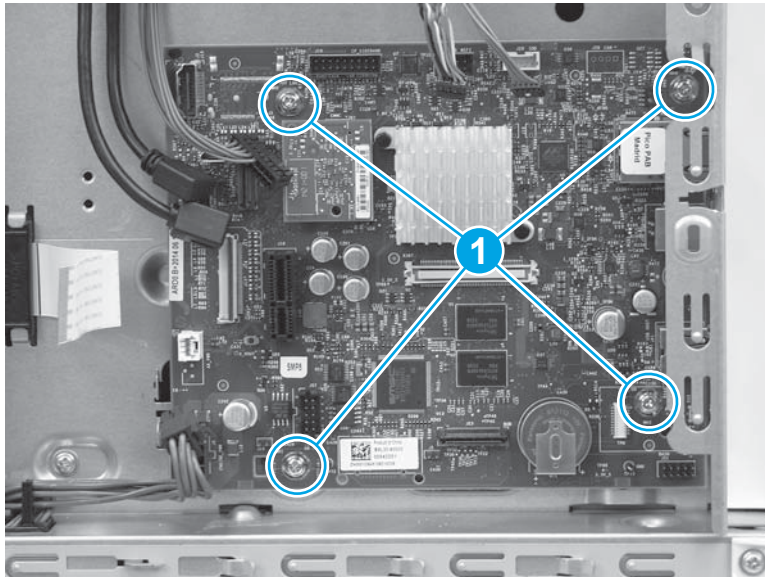

Step 7: Remove the hard-disk drive (HDD) (M577)

 **NOTE:** This step is for the M577 models. For the M552 and M553 models, skip this step and go to [Step 10: Remove the rear cover \(M552 and M553\) on page 1670.](#)

 **CAUTION:**  ESD-sensitive part.

1. Release two tabs (callout 1). Hold the tabs in the released position, and then rotate the hard disk drive (HDD) up (callout 2) to release the connector from the formatter.

Figure 1-2948 Release the HDD

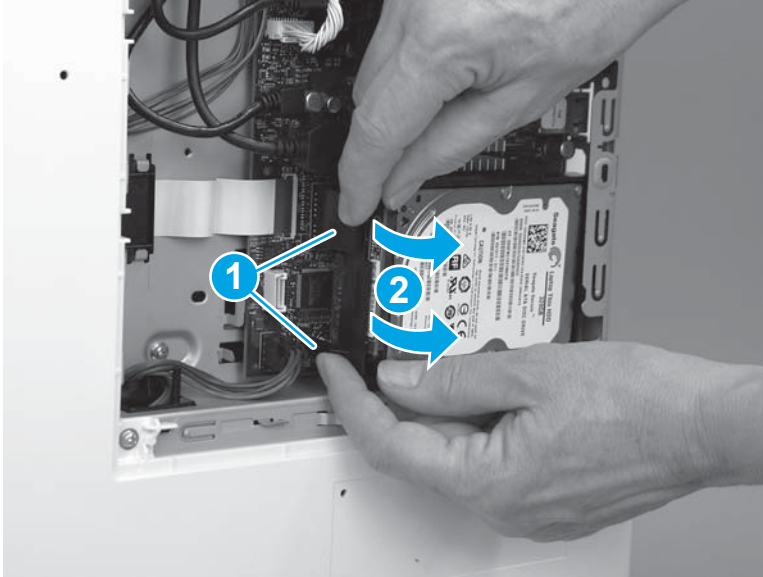

2. Slide the HDD away from the printer to remove it.

Figure 1-2949 Remove the HDD



Step 8: Remove the fax PCA (M577c/f/z)

 **NOTE:** This step is for the M577c/f/z models. For the M577n model, skip this step and go to [Step 9: Remove the formatter \(M577\) on page 1668](#).

For the M552 and M553 models, skip this step and go to [Step 10: Remove the rear cover \(M552 and M553\) on page 1670](#).

 **CAUTION:**  ESD-sensitive part.

1. Locate the fax PCA component on the formatter.

Figure 1-2950 Locate the fax PCA

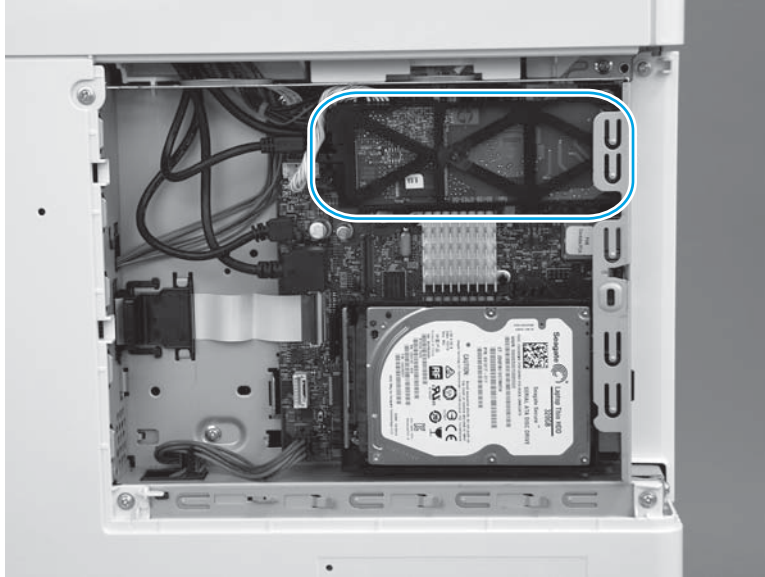

2. Release the connector latch (callout 1), and then pull the connector away from the formatter (callout 2) to disconnect it.

Figure 1-2951 Disconnect one connector

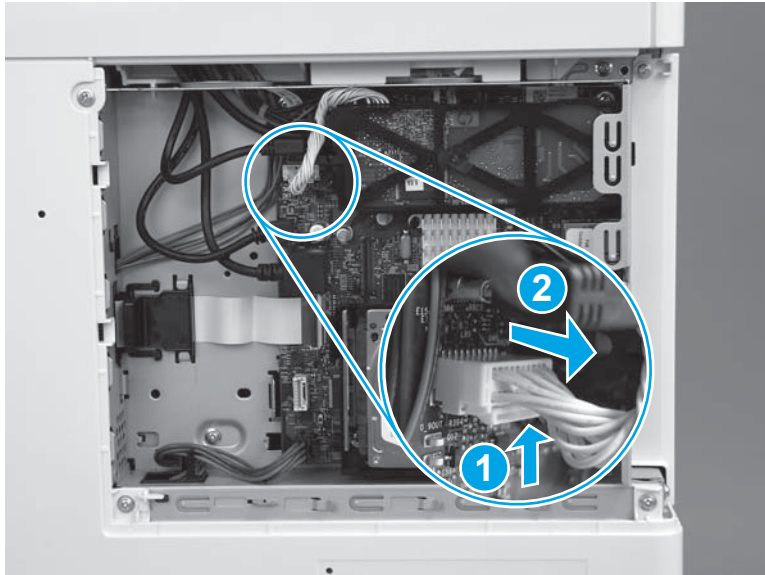

3. Release one retainer (callout 1) by pressing the bracket arms together.

Figure 1-2952 Release one latch

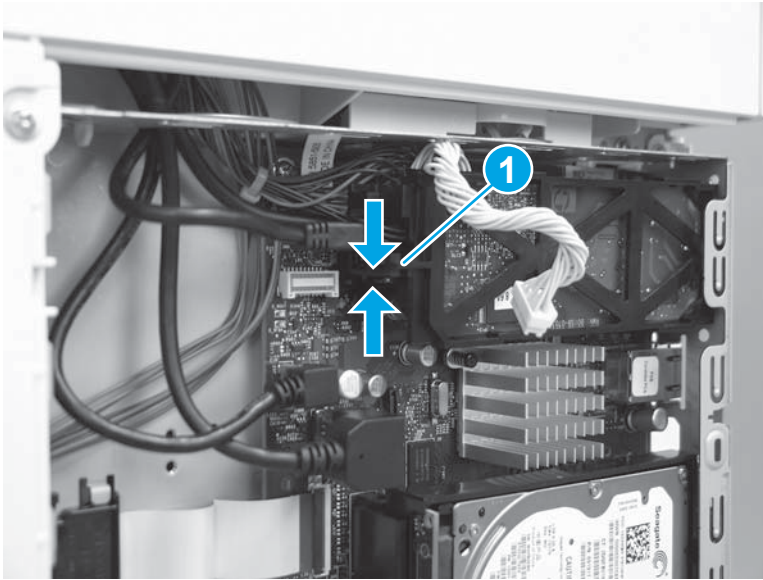

4. Rotate the end of the fax PCA (callout 1) away from the formatter, and then slide the PCA left (callout 2) to remove it.

Figure 1-2953 Remove the fax PCA

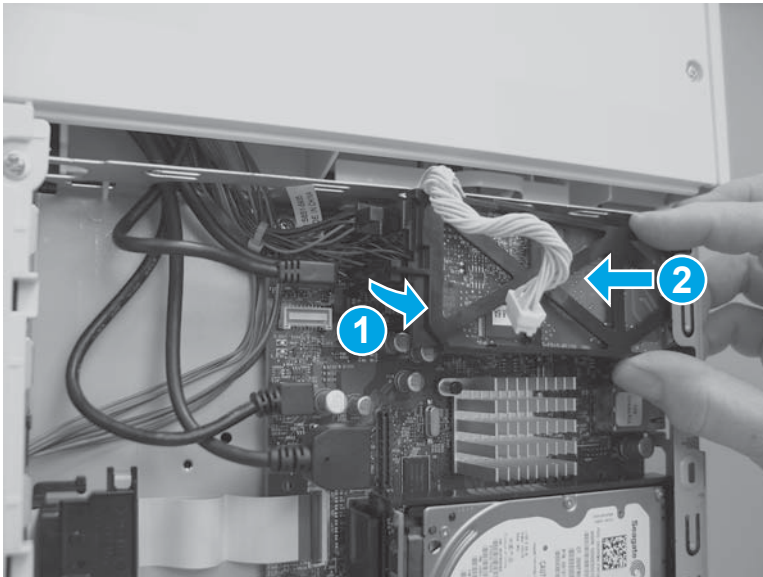

Step 9: Remove the formatter (M577)

 **NOTE:** This step is for the M577 models. For the M552 and M553 models, skip this step and go to [Step 10: Remove the rear cover \(M552 and M553\) on page 1670.](#)

 **CAUTION:**  ESD-sensitive part.

1. Disconnect all of the connectors on the formatter.

The following connectors are empty:

- All models: J1 (this connector is empty unless the optional DIMM is installed)
- All models: J3
- M577dn: J15 (this is the fax connector for the M577f/z/c models)
- All models: J21 (this connector is empty unless the optional internal USB ports component is installed)
- All models: J23
- All models: J24
- All models: J51
- All models: J57
- All models: J97
- All models: J98 (this connector is empty unless the optional trusted platform module (TPM) is installed)

 **IMPORTANT:** The flat-cable connector (callout 1) is a Zero Insertion Force (ZIF) connector that uses a hinged retainer to secure the flat cable. The hinged retainer must be opened to release the flat cable.

Figure 1-2954 Disconnect all connectors



2. Remove four screws (callout 1).

Figure 1-2955 Remove four screws

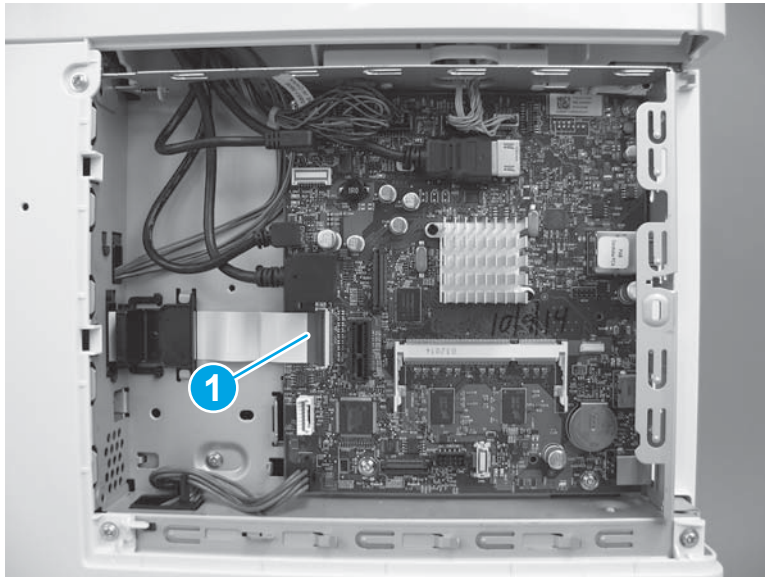
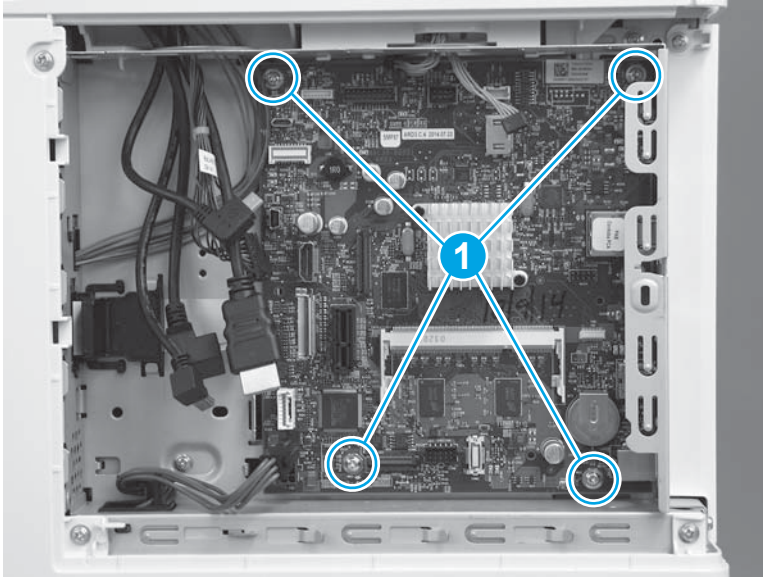

3. Remove the formatter.

Figure 1-2956 Remove the formatter

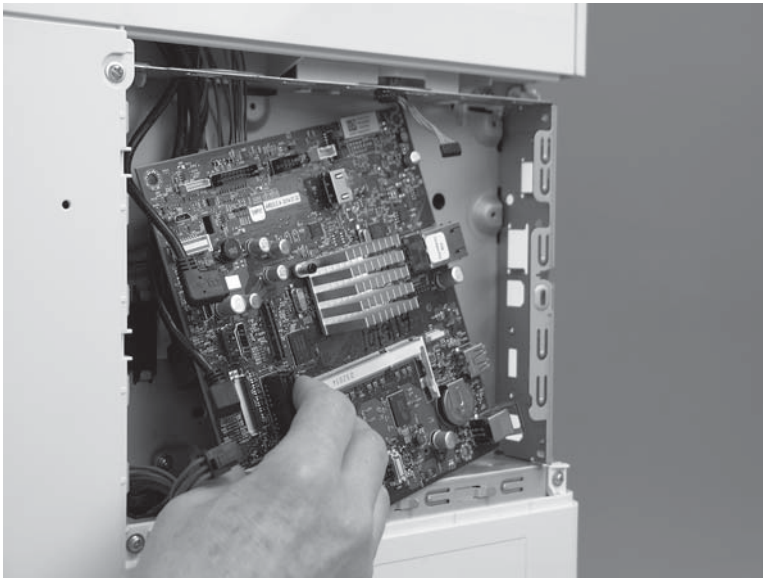

Step 10: Remove the rear cover (M552 and M553)

 **NOTE:** This step is for the M552 and M553 models. For the M577 models, skip this step and go to [Step 11: Remove the rear upper cover \(M577\) on page 1671.](#)

1. Remove four screws (callout 1).

Figure 1-2957 Remove four screws

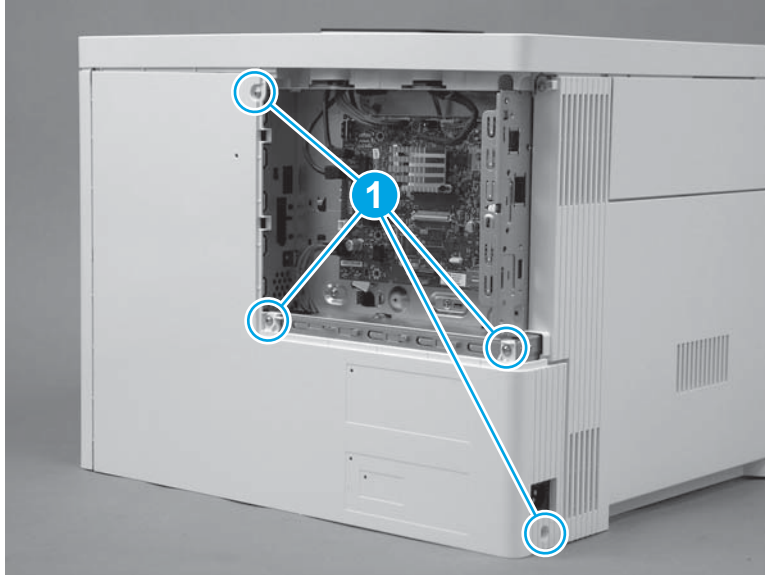

2. Slightly slide the cover to the right (callout 1), rotate the bottom of the cover away from the printer (callout 2), and then pull the top of the cover away from the printer (callout 3) to remove the cover.

Figure 1-2958 Remove the cover

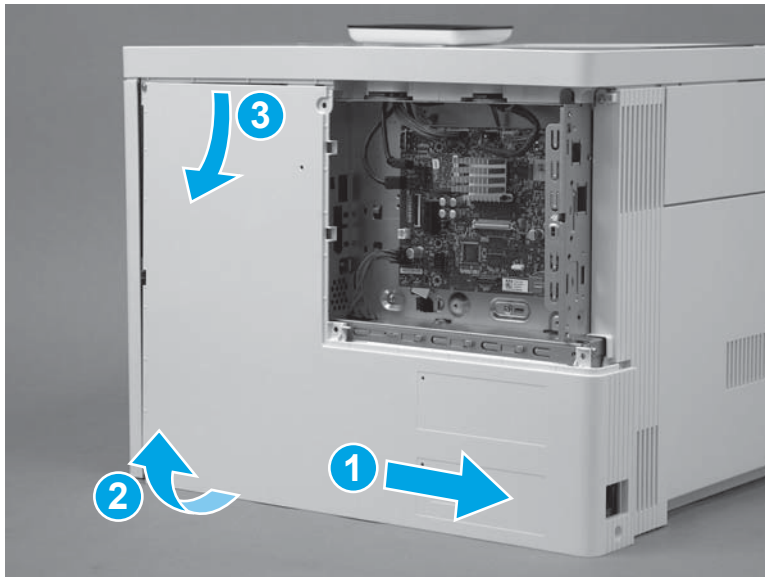

Step 11: Remove the rear upper cover (M577)

 **NOTE:** This step is for the M577 models. For the M552 and M553 models, skip this step and go to [Step 19: Remove the left cover on page 1686](#).

1. Remove two screws (callout 1).

 **Reinstallation tip:** These two screws are self-tapping screws for plastic. When reinstalling them, rotate the screws counterclockwise to align them with the existing thread pattern, and then carefully turn them clockwise to tighten. Do not overtighten. This will prevent stripping the threads inside the screw holes.

Figure 1-2959 Remove two screws



2. Use a small, flat blade screwdriver to release the right edge of the cover.

Figure 1-2960 Release the right edge

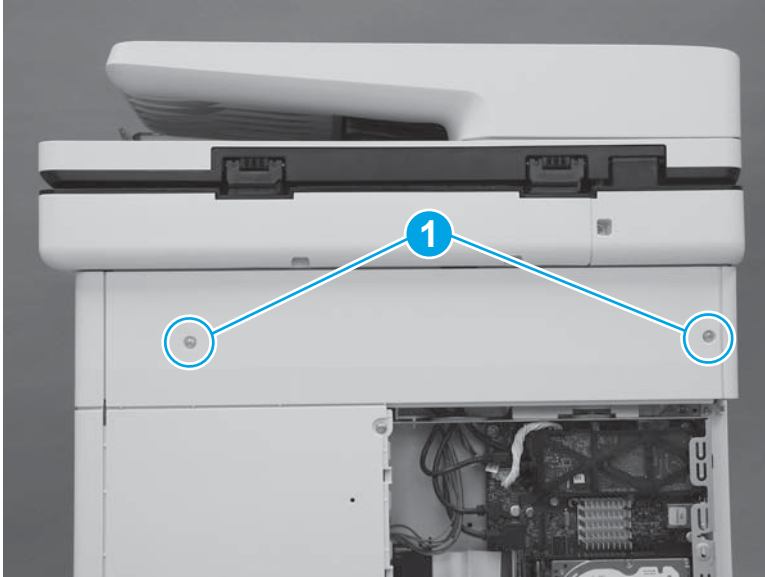
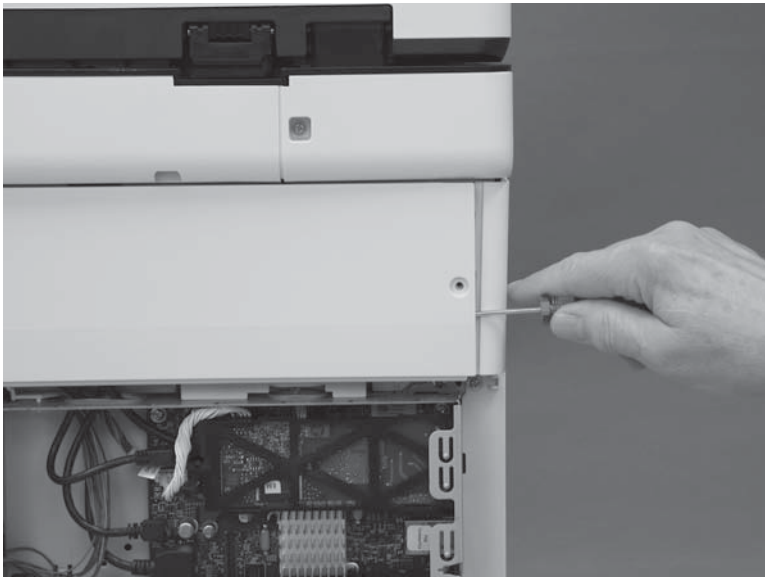

3. Pull the right edge of the cover (callout 1) away from the printer, and then slide the cover to the right (callout 2).

Figure 1-2961 Slide the cover right

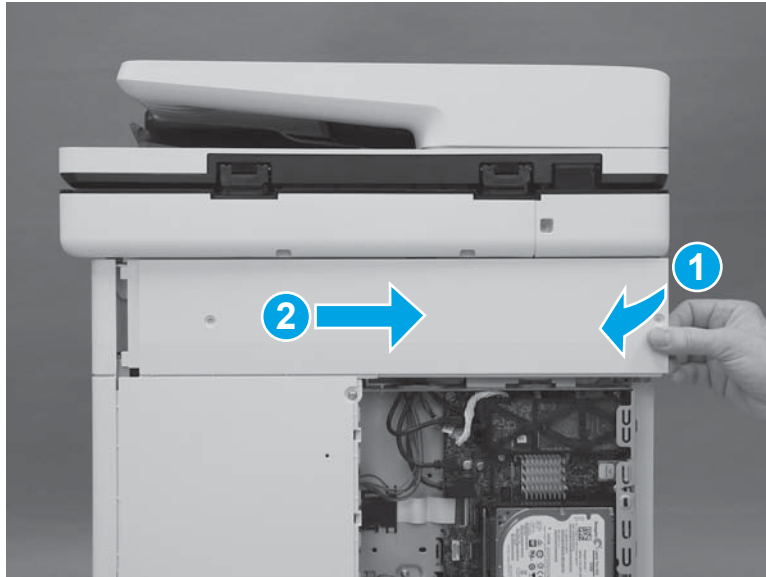

4. Remove the cover.

Figure 1-2962 Remove the cover

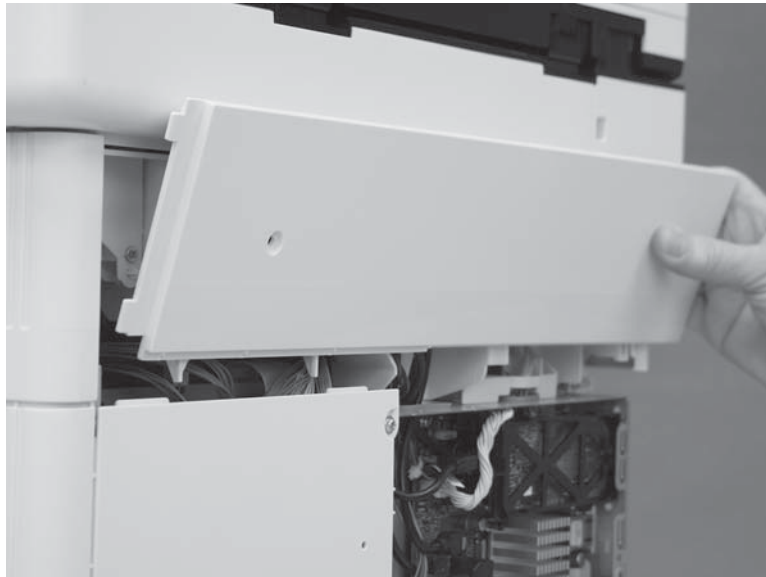

Step 12: Remove the rear cover (M577)

 **NOTE:** This step is for the M577 models. For the M552 and M553 models, skip this step and go to [Step 19: Remove the left cover on page 1686](#).

1. Remove four screws (callout 1).

Figure 1-2963 Remove four screws

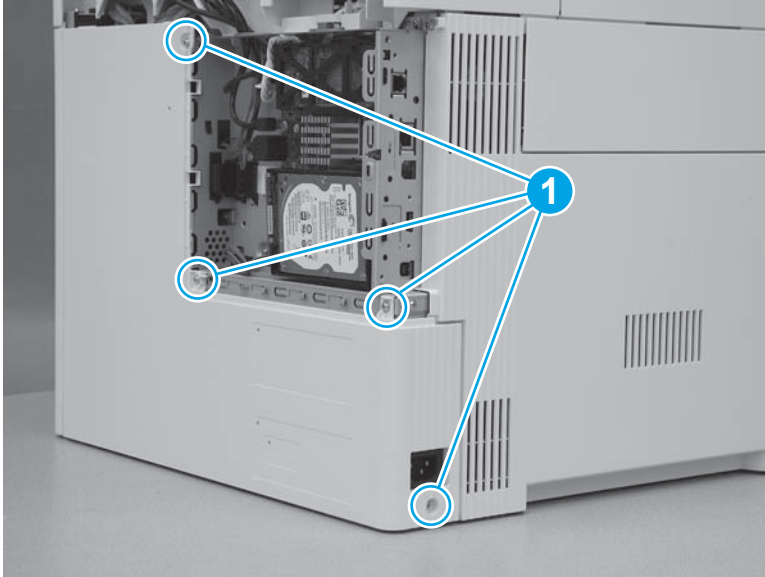

2. Slide the cover to the right to remove it.

Figure 1-2964 Remove the cover

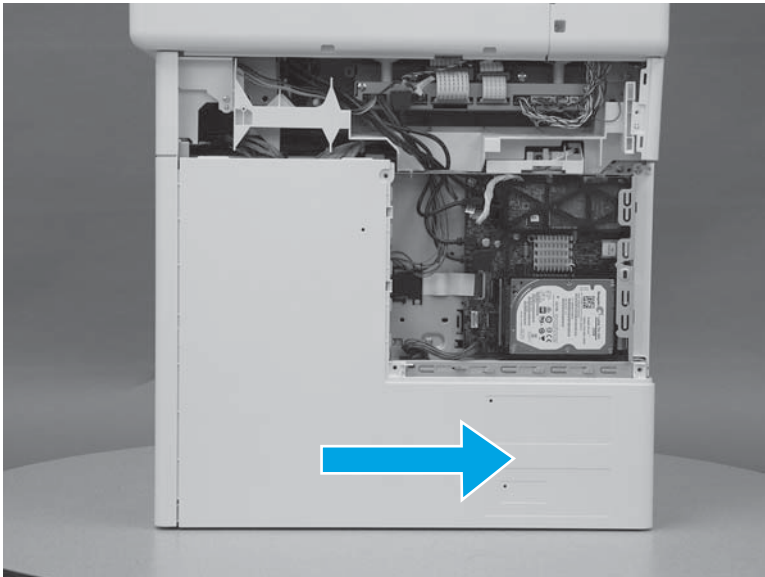

Step 13: Remove the left upper cover (M577)

 **NOTE:** This step is for the M577 models. For the M552 and M553 models, skip this step and go to [Step 19: Remove the left cover on page 1686](#).

1. At the left side of the printer, release one tab (callout 1).

Figure 1-2965 Release one tab

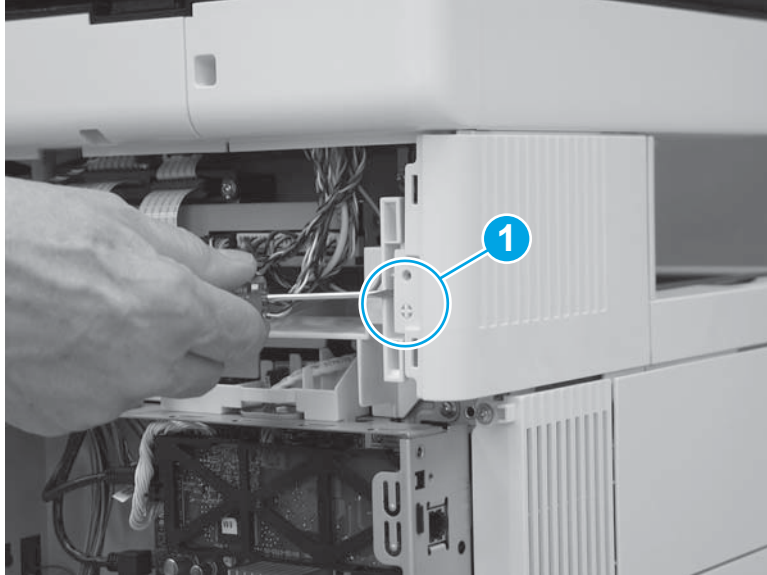

2. Slide the left upper cover toward the back of the printer.

Figure 1-2966 Slide the cover back

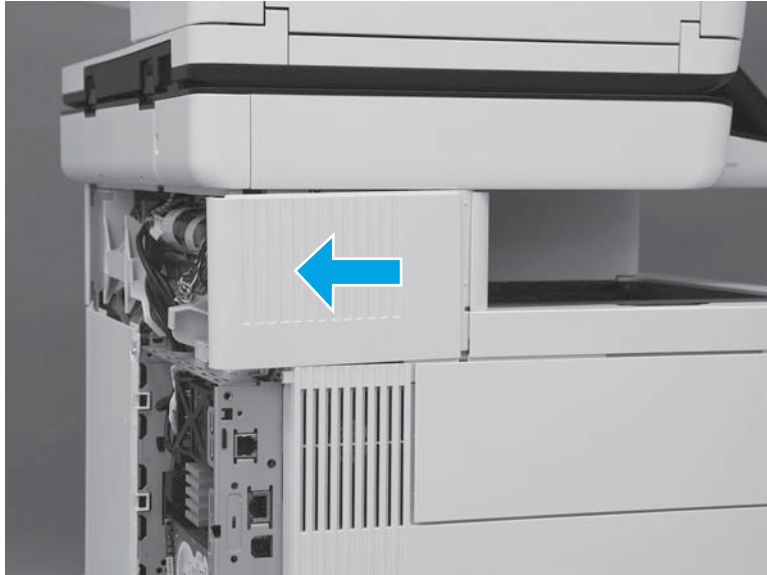

3. Rotate the cover up to remove it.

Figure 1-2967 Remove the left upper cover



Step 14: Remove the right front upper cover (M577dn)

 **NOTE:** This step is for the M577dn model. For the M577c/f/z models, skip this step and to go [Step 15: Remove the stapler cover assembly \(M577c/f/z\) on page 1677](#).

For the M552 and M553 models, skip this step and go to [Step 19: Remove the left cover on page 1686](#).

1. Remove one screw (callout 1).

Figure 1-2968 Remove one screw

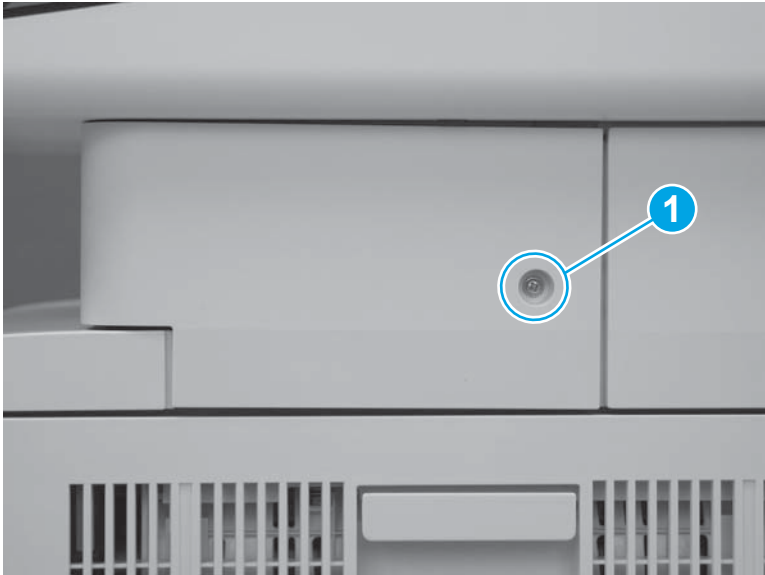

2. Release two tabs at the front edge of the cover (callout 1).

Figure 1-2969 Release two tabs



3. Rotate the front of the cover to the right to remove it.

Figure 1-2970 Rotate the cover



Step 15: Remove the stapler cover assembly (M577c/f/z)

 **NOTE:** This step is for the M577c/f/z models. For the M577dn model, skip this step and go to [Step 17: Remove the right upper cover \(M577\) on page 1682](#).

For the M552 and M553 models, skip this step and go to [Step 19: Remove the left cover on page 1686](#).

1. Remove one screw (callout 1).

 **Reinstallation tip:** This is a self-tapping screw for plastic. When reinstalling, rotate the screw counterclockwise to align it with the existing thread pattern, and then carefully turn it clockwise to tighten. Do not overtighten. This will prevent stripping the threads inside the screw hole.

Figure 1-2971 Remove one screw

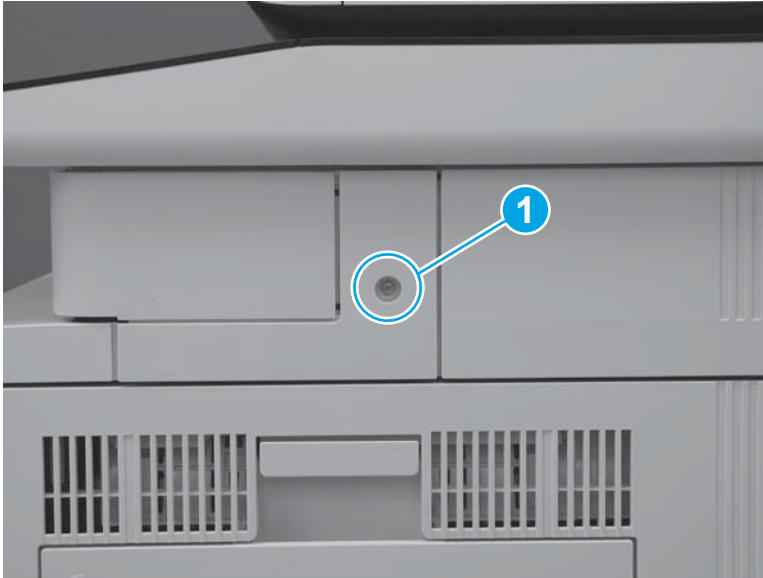

2. Release two tabs at the front edge of the cover (callout 1).

Figure 1-2972 Release two tabs



3. Release the back edge of the cover.

Figure 1-2973 Release the back edge of the cover





4. Rotate the cover away from the printer to remove it.

Figure 1-2974 Remove the cover



Step 16: Remove the integrated scanner assembly (ISA) (M577)

 **NOTE:** This step is for the M577 models. For the M552 and M553 models, skip this step and go to [Step 19: Remove the left cover on page 1686](#).

 **NOTE:** The ISA includes the document feeder, image scanner, scanner control board (SCB), control panel, keyboard (M577c/z) and NFC PCA (M577z).

1. At the left side of the printer, remove one screw (callout 1).

Figure 1-2975 Remove one screw

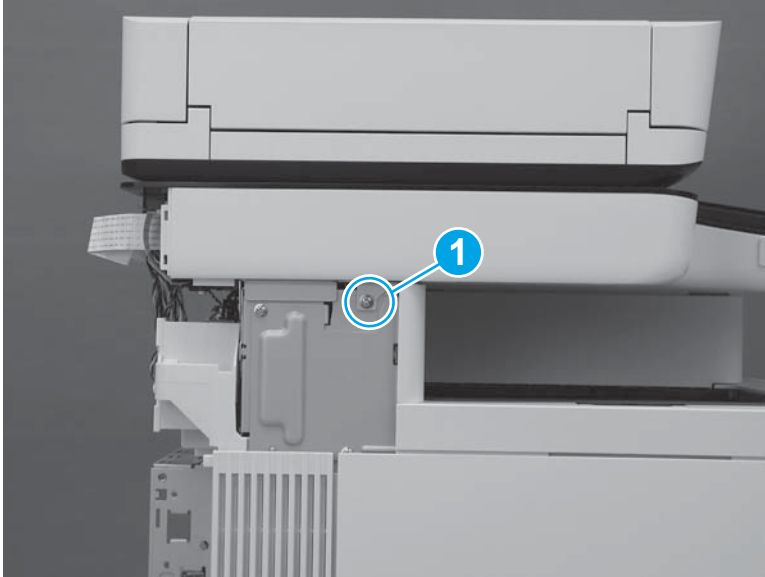

2. At the back side of the printer, remove two screws (callout 1).

Figure 1-2976 Remove two screws

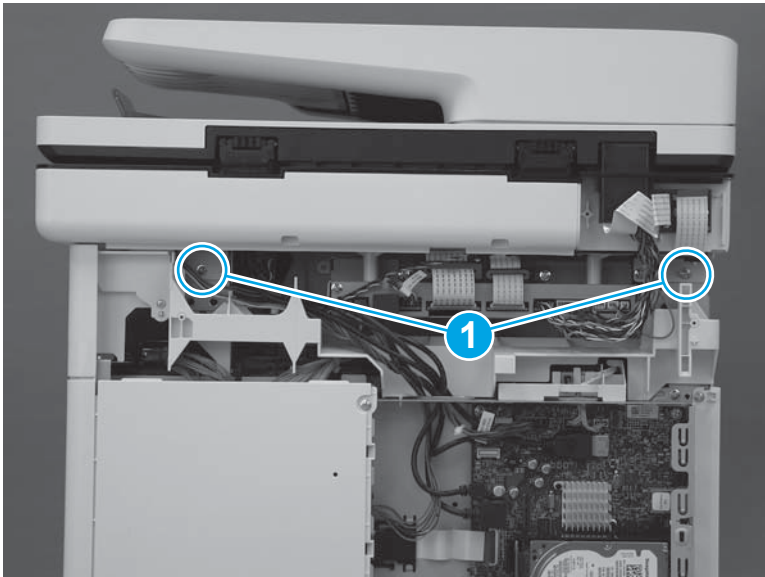

3. At the right side of the printer, remove one screw (callout 1).

Figure 1-2977 Remove one screw

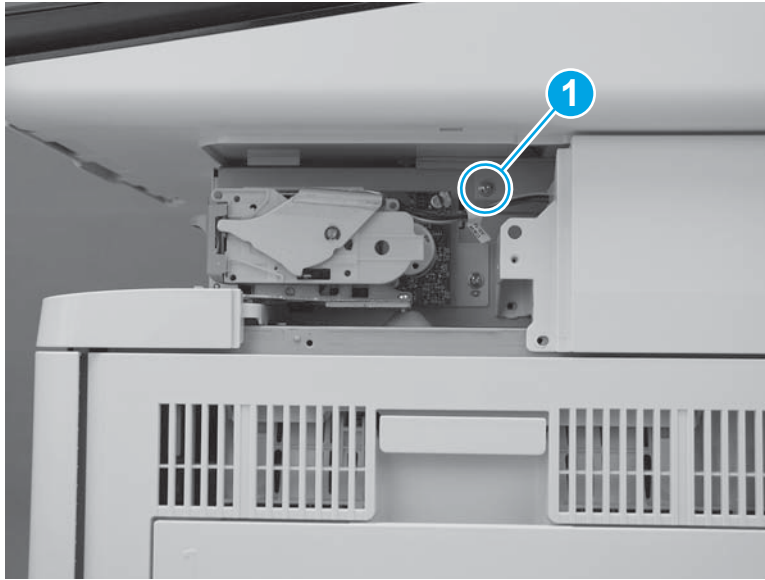

4. Disconnect two connectors on the scanner control board (callout 1).

M577c/f/z only: Disconnect one connector for the stapler on the scanner control board (callout 2).

Figure 1-2978 Disconnect connectors

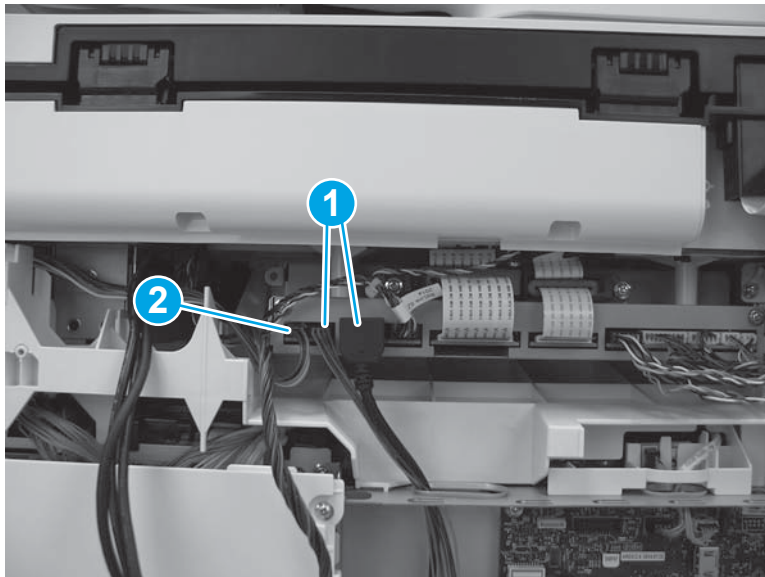

5. Slightly slide the ISA towards the back of the printer to release it.

Figure 1-2979 Slide the ISA towards the back of the printer

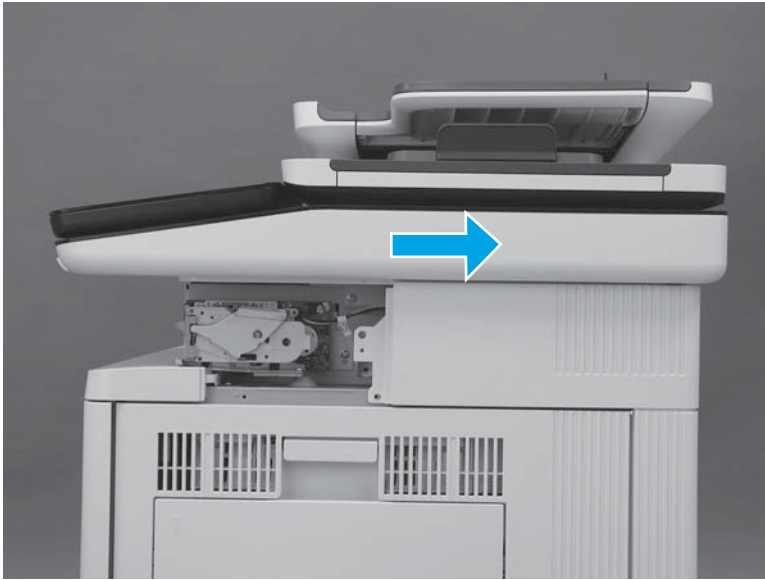

6. Lift the ISA up to remove it.

 **NOTE:** When lifting the ISA, carefully pass the cables through the opening in the top of the formatter case.

Figure 1-2980 Remove the ISA

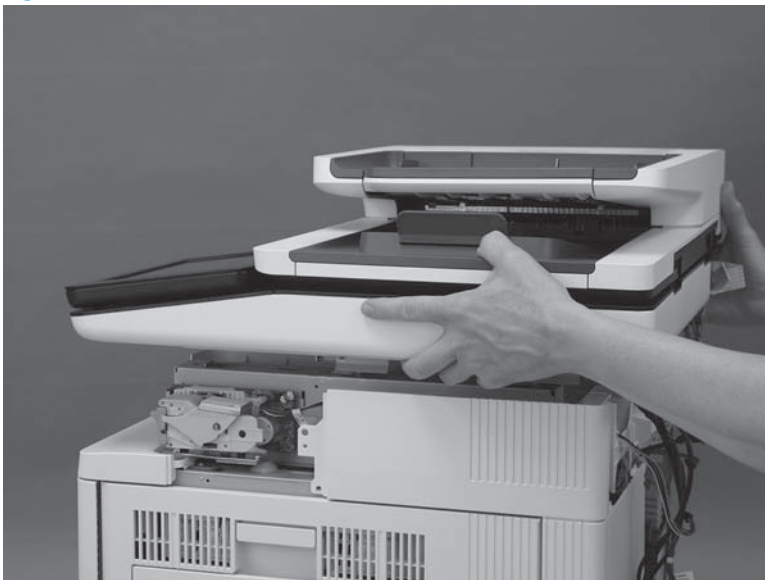

Step 17: Remove the right upper cover (M577)

 **NOTE:** This step is for the M577 models. For the M552 and M553 models, skip this step and go to [Step 19: Remove the left cover on page 1686](#).

 **NOTE:** The figures below show the image scanner installed. The procedures for removing and installing the right upper cover are the same whether the image scanner is installed or removed."

1. At the right side of the printer, remove two screws (callout 1).

M577c/f/z only: Disconnect one connector (callout 2), if it was not already disconnected in a previous step.

Figure 1-2981 Remove two screws and one connector

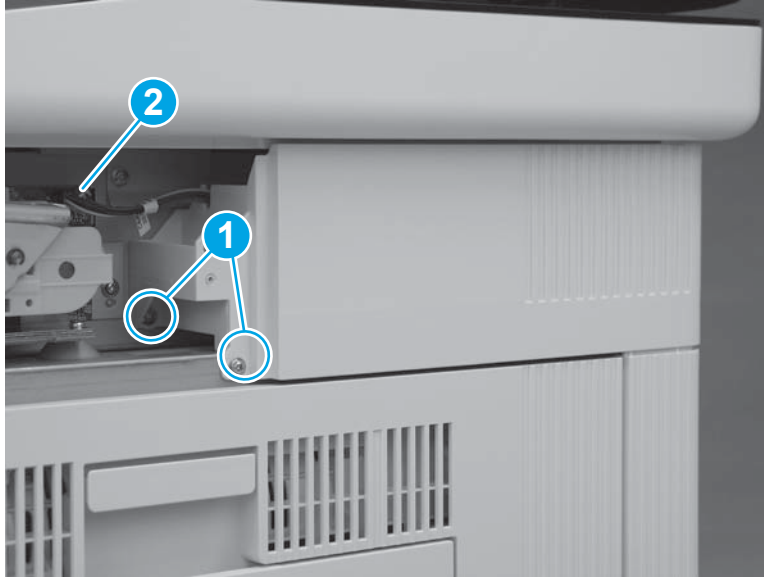

2. At the back of the printer, remove one screw (callout 1).

M577c/f/z only: Disconnect one connector (callout 2), if it was not already disconnected in a previous step.

 **Reinstallation tip:** This screw is smaller than the screws removed in the previous step. When reinstalling the right upper cover, make sure that this screw is installed in the correct position.

Figure 1-2982 Remove one screw and connector



3. Slide the cover toward the back of the printer.

Figure 1-2983 Slide the cover

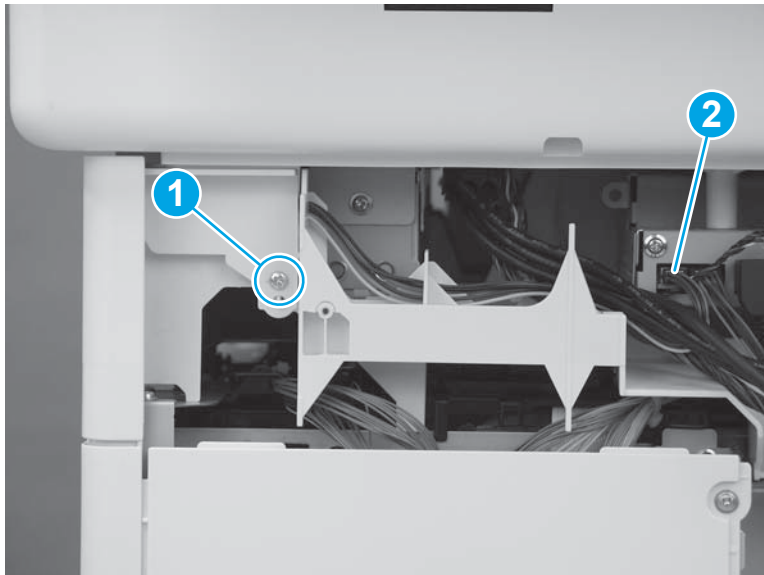
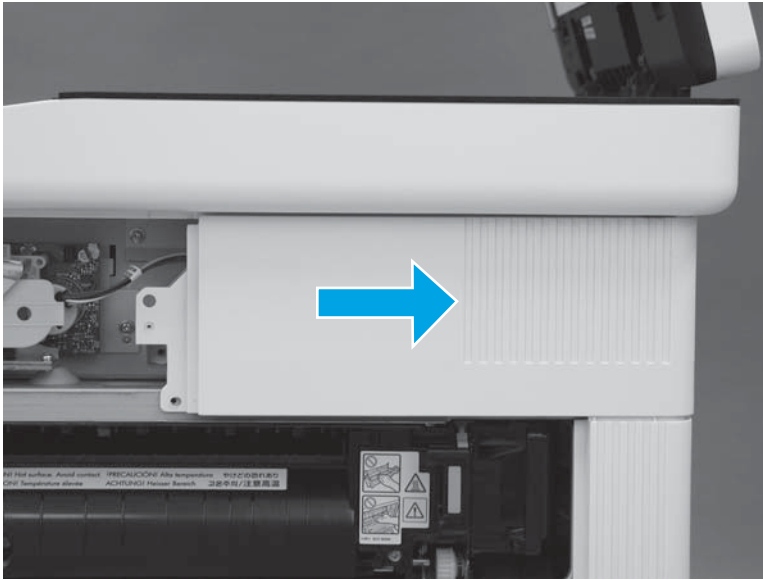

4. Lift the cover away from the printer to remove it.

M577c/f/z only: Release the cables (callout 1) through the slot (callout 2) in the printer.

Figure 1-2984 Remove the cover

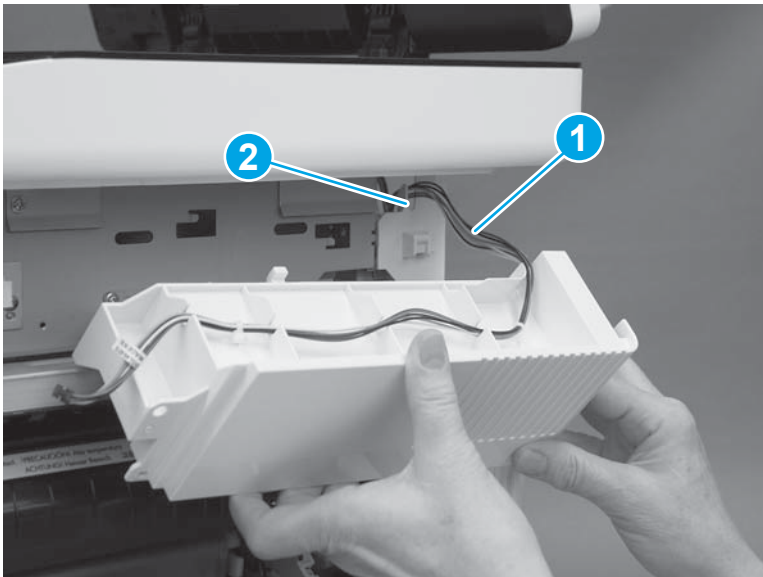

Step 18: Remove the top rear cover (M577)

 **NOTE:** This step is for the M577 models. For the M552 and M553 models, skip this step and go to [Step 19: Remove the left cover on page 1686](#).

1. At the top of the printer, remove five screws (callout 1).

Figure 1-2985 Remove five screws

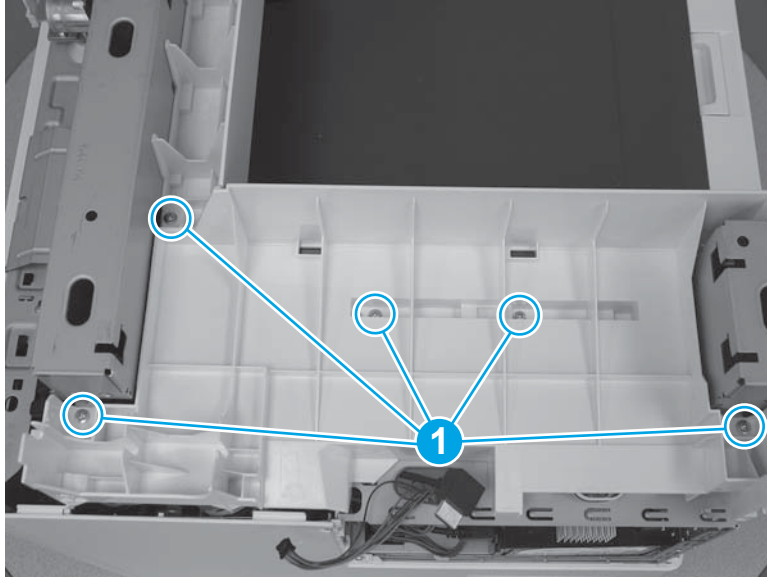

2. Release two tabs (callout 1) on the front edge of the cover.

Figure 1-2986 Release two tabs

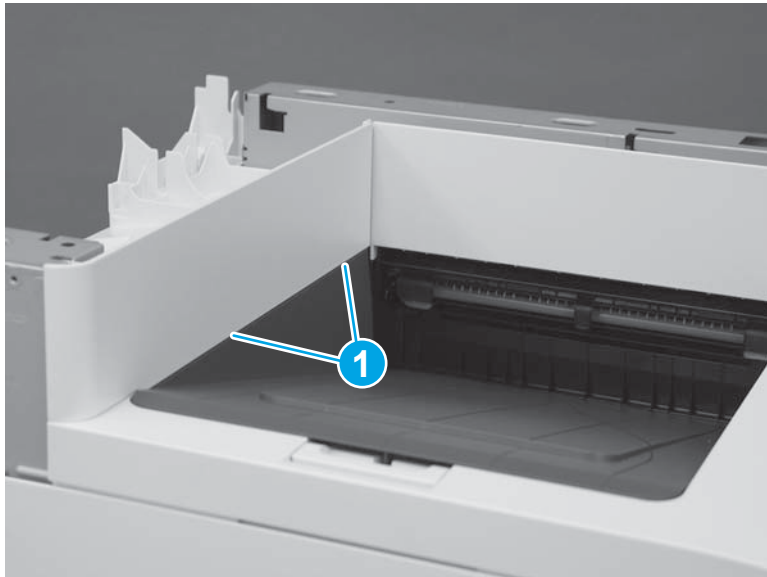

3. Remove the top rear cover.

Figure 1-2987 Remove the top rear cover

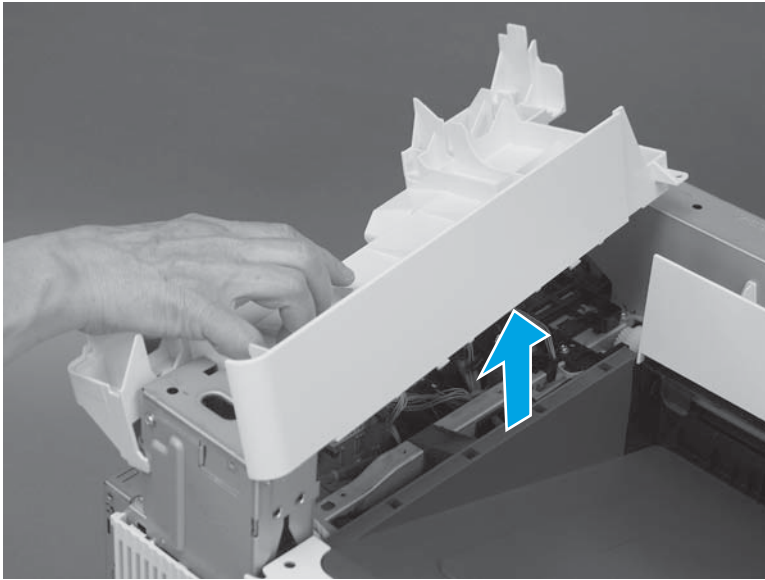

Step 19: Remove the left cover

1. At the left side of the printer, remove one screw (callout 1).

Figure 1-2988 Remove one screw



2. Release one tab (callout 1), rotate the front edge of the cover away from the printer (callout 2), and then slide the cover (callout 3) toward the rear of the printer to release it.

Figure 1-2989 Release the cover

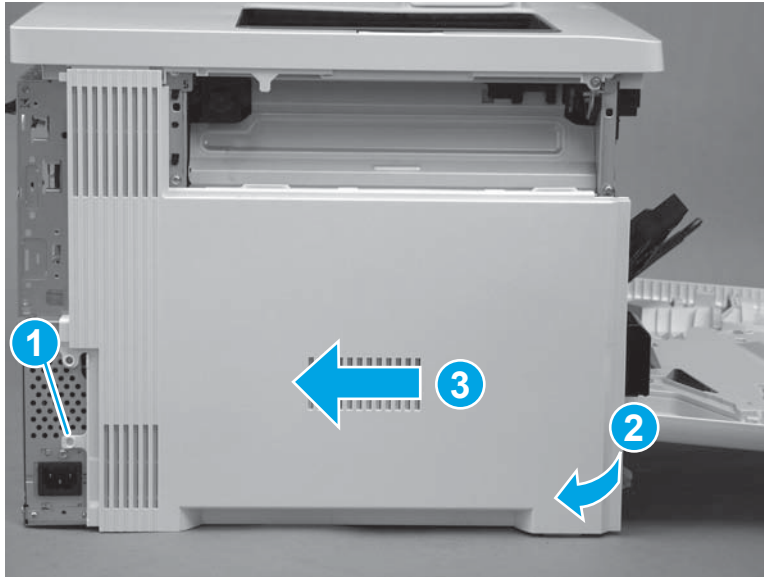

3. Remove the cover.

Figure 1-2990 Remove the cover

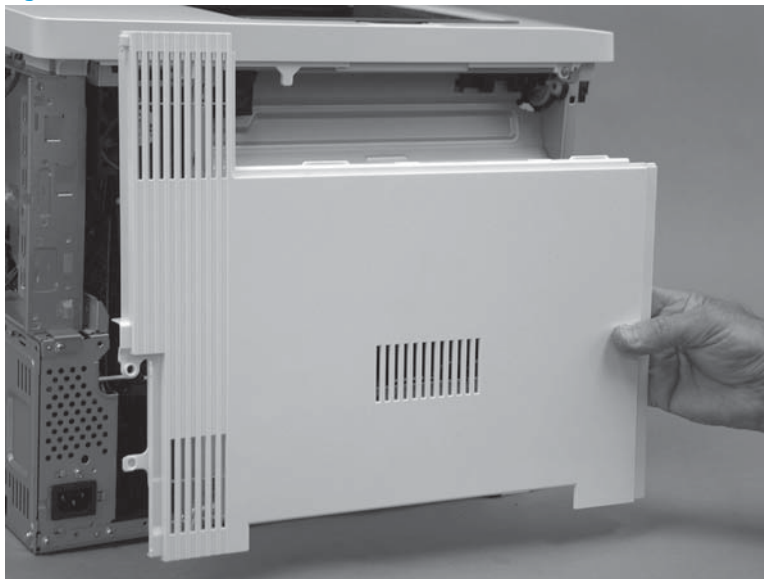

Step 20: Remove the upper cover (M552 and M553)

 **NOTE:** This step is for the M552 and M553 models. For the M577 models, skip this step and go to [Step 21: Remove the formatter case on page 1689.](#)

1. Remove three screws (callout 1).

Figure 1-2991 Remove three screws

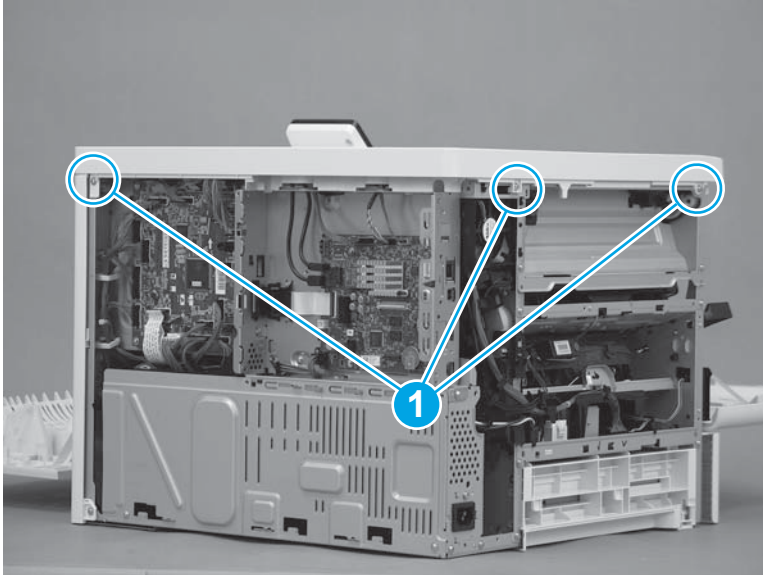

2. Remove one screw (callout 1), release one tab (callout 2), and then slightly separate the corner of the cover from the chassis.

 **NOTE:** This is a self-tapping plastic-thread screw. Make sure that this screw is used in this location when it is reinstalled.

Figure 1-2992 Remove one screw and release one tab



3. Release one tab (callout 1), and then lift up on the cover to release it.

 **NOTE:** If the cover does not release, check for additional tabs by locating the triangles embossed in the cover at tab locations.

Figure 1-2993 Release the cover



4. Remove the cover.

Figure 1-2994 Remove the cover

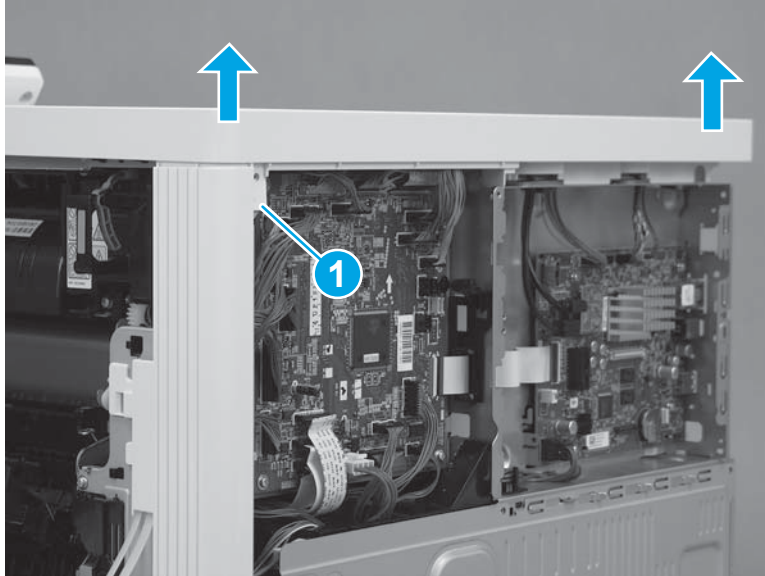
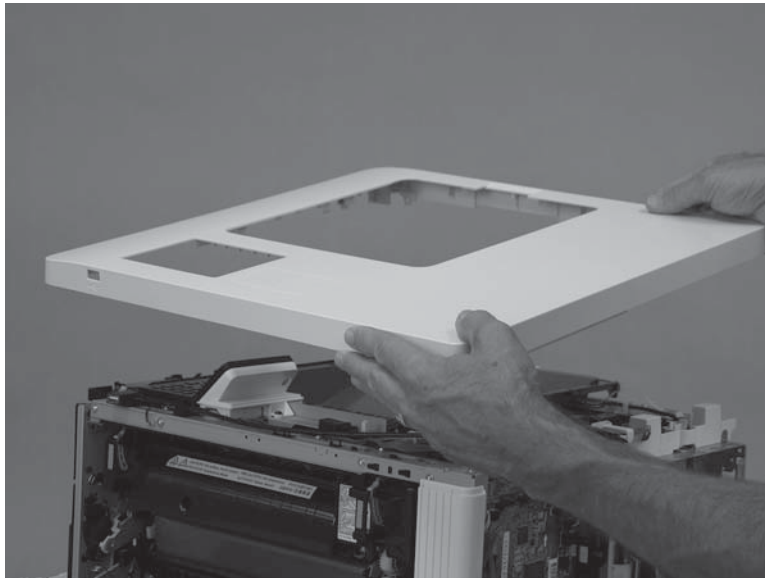

Step 21: Remove the formatter case

1. **M577 only:** Disconnect one connector (callout 1), and then pass the wire harness (callout 2) through two openings in the formatter case (callout 3).

Figure 1-2995 Disconnect one connector

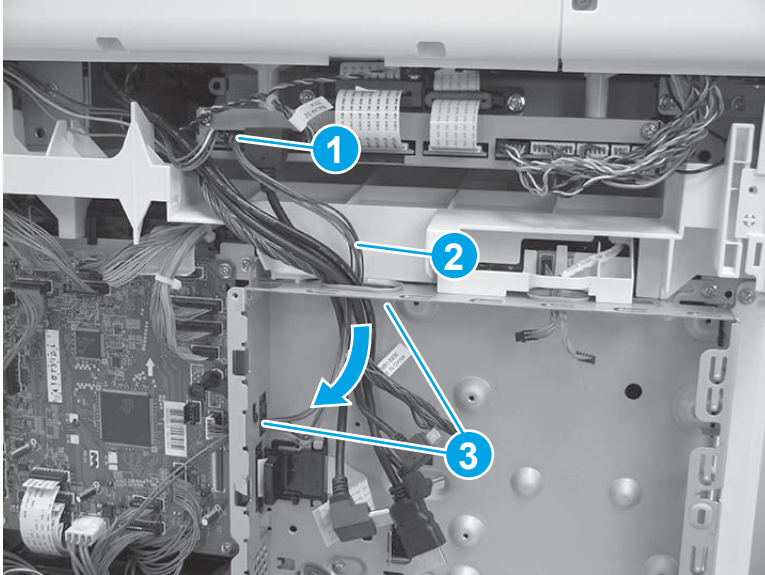

2. Release two tabs (callout 1) on the black plastic bracket. Hold the tabs in the released position, and then slide the bracket (callout 2) to the right to remove it from the formatter case.

Figure 1-2996 Remove the bracket

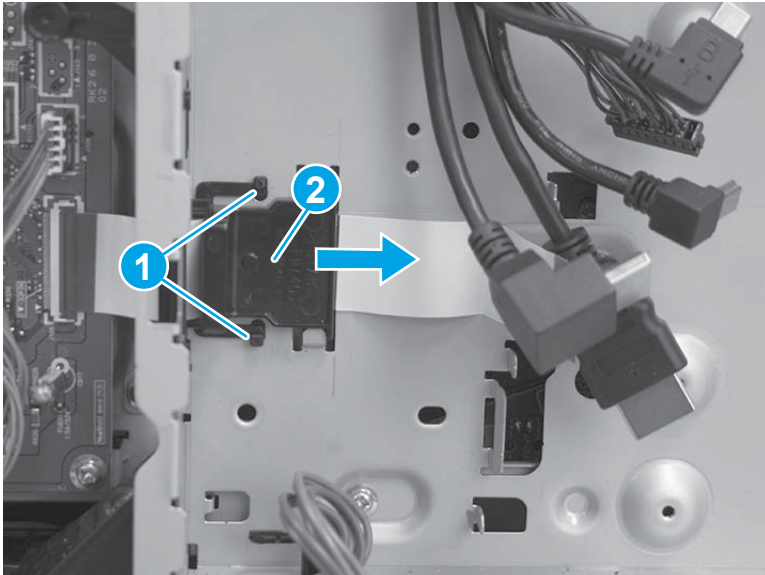

3. Remove two screws (callout 1), and then slide the low-voltage power supply (LVPS) cover to the right to remove it.

Figure 1-2997 Remove the LVPS cover

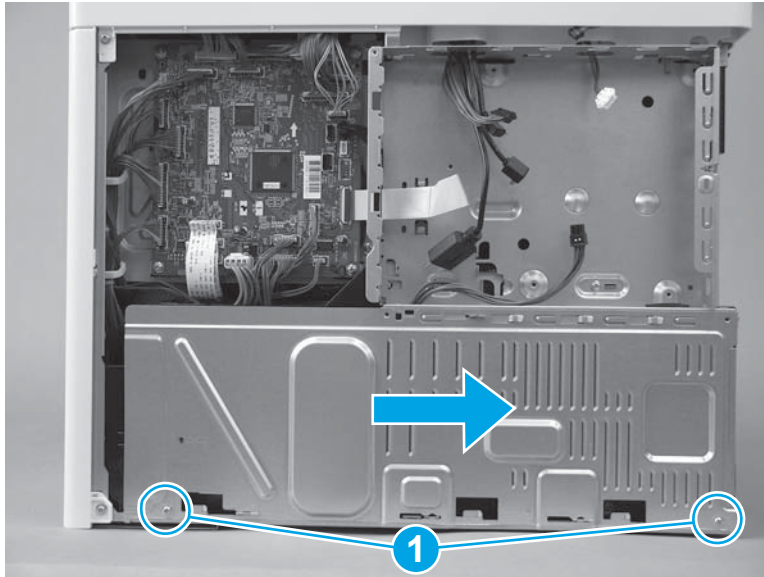

4. Pass two wire harnesses and one flat cable (callout 1) through the opening in the formatter case, and then release one wire harness from the retainer (callout 2).

⚠ CAUTION: The flat cable might be attached to the formatter case with double-sided tape. Make sure that this tape is released, so that the flat cable is not damaged when the formatter case is removed.

Figure 1-2998 Release wire harnesses and flat cable

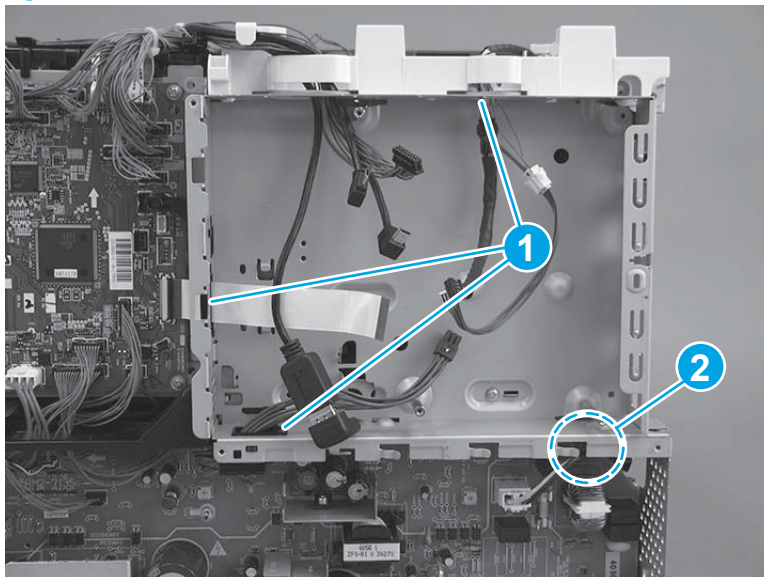

5. Remove six screws (callout 1).

Figure 1-2999 Remove six screws

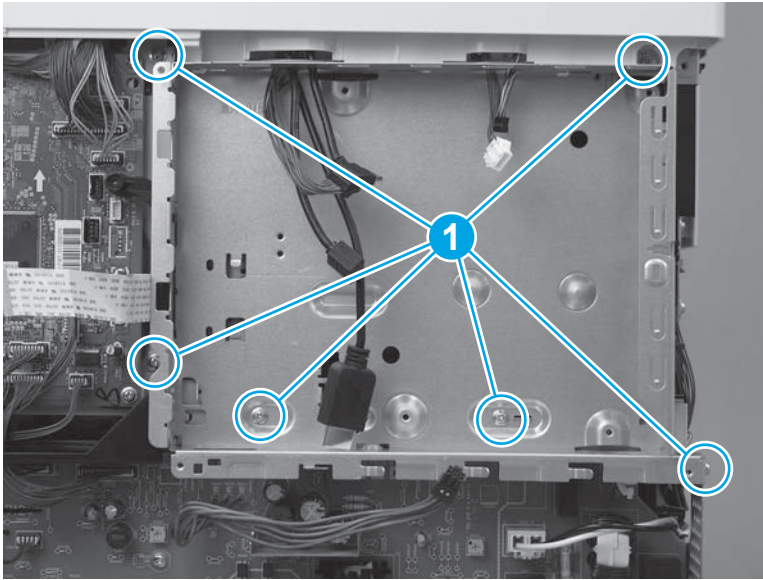

6. Rotate the bottom of the formatter case away from the printer (callout 1), and then pull it down (callout 2) to release it.

Figure 1-3000 Release the formatter case

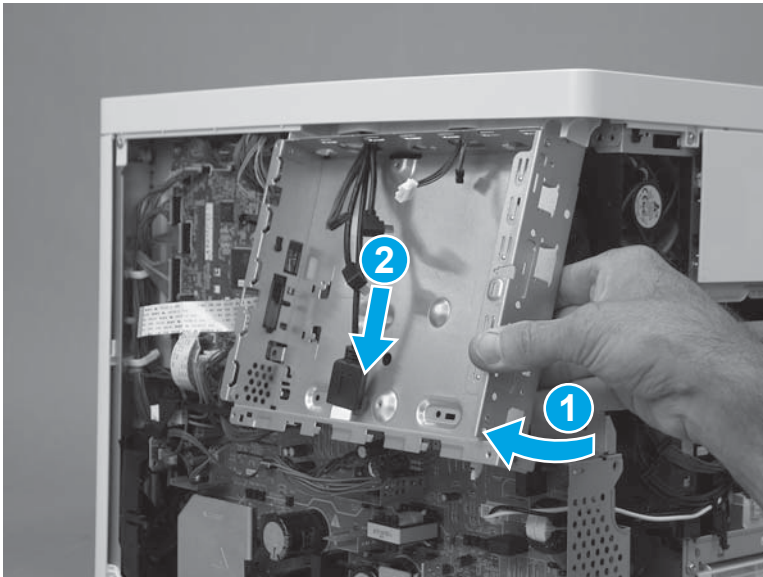

7. Pass the wire harnesses through the opening in the formatter case to remove it.

 **IMPORTANT:** If the formatter case is removed so that it can be replaced, make sure to transfer the memory PCA (island of data) and plastic bracket (callout 1) to the replacement case.

Figure 1-3001 Remove the formatter case



Step 22: Remove the right rear cover

1. Remove one screw (callout 1), and then slide the cover toward the rear of the printer (callout 2) to release it.

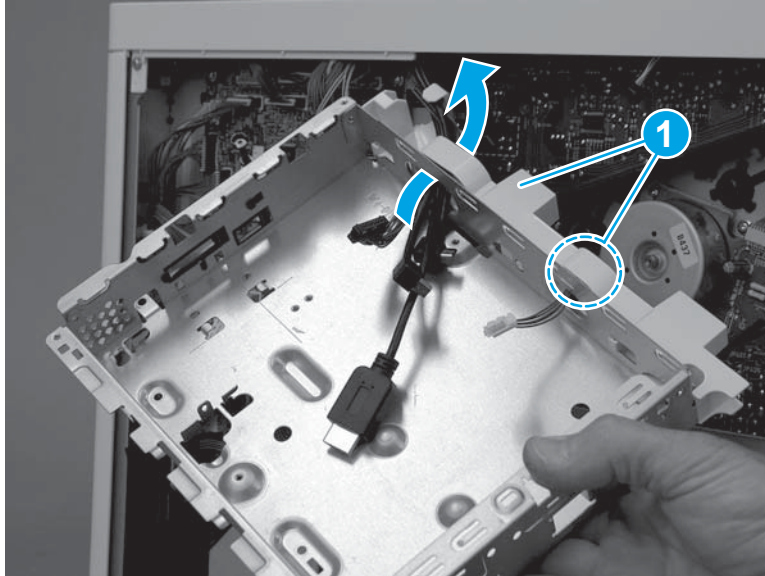
 **TIP:** If the right door is closed, open it now.

Figure 1-3002 Release the cover



2. Remove the cover.

Figure 1-3003 Remove the cover

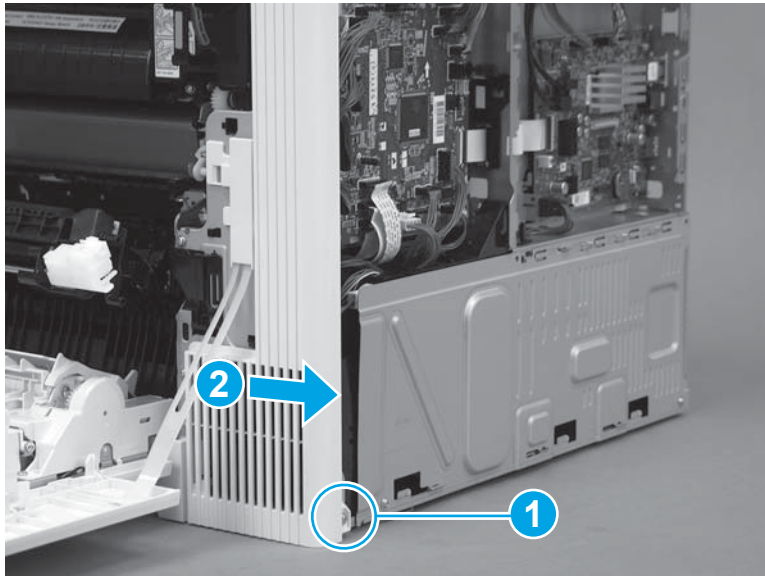
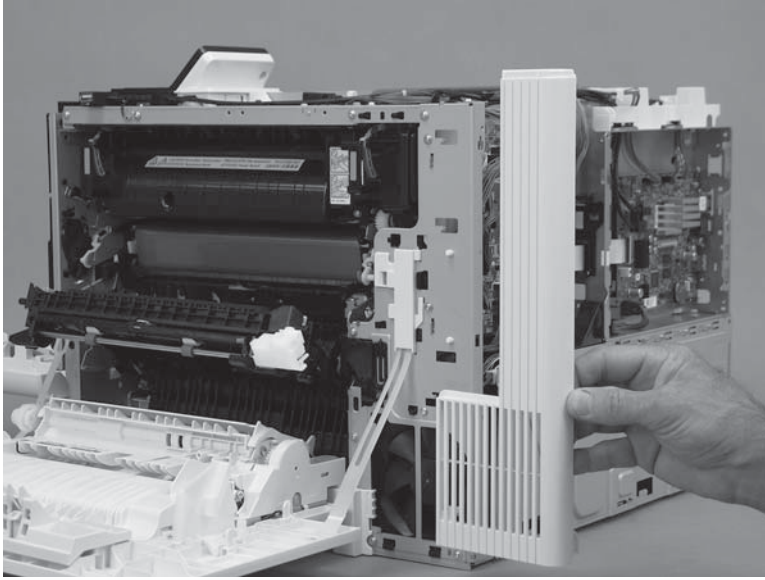

Step 23: Remove the DC controller and sheet-metal bracket

 **CAUTION:**  ESD sensitive part.

1. Disconnect all of the connectors, and then remove two screws (callout 1).

The following connectors are empty:

- J140, J141, and J143

Figure 1-3004 Remove two screws

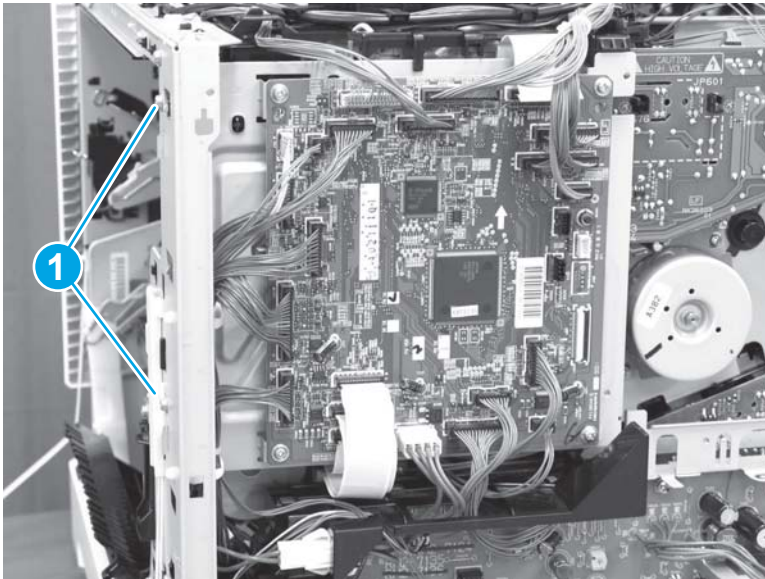

2. Lift up on the DC controller and sheet-metal plate to remove it.

Figure 1-3005 Remove the plate

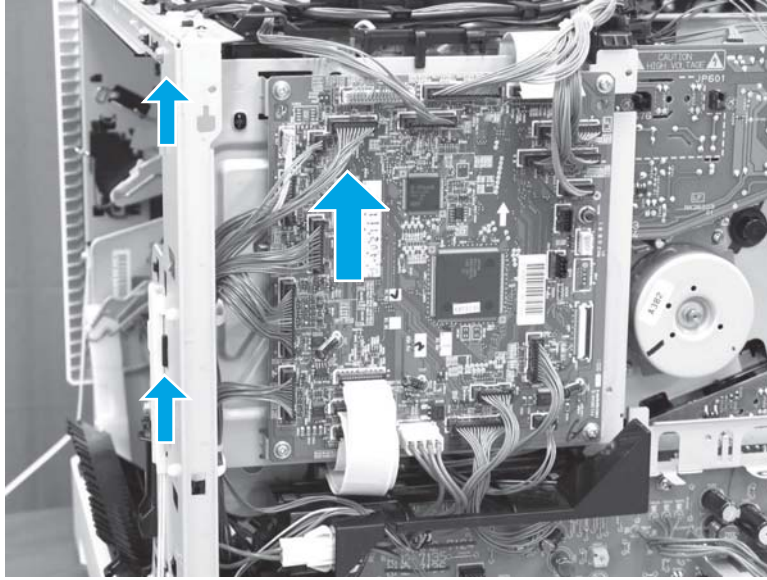

Step 24: Remove the high-voltage power supply T (HVPST)

 **CAUTION:**  ESD-sensitive part.

1. Disconnect five connectors (callout 1), and then disconnect one flat cable (callout 2).

Figure 1-3006 Disconnect five connectors and one flat cable

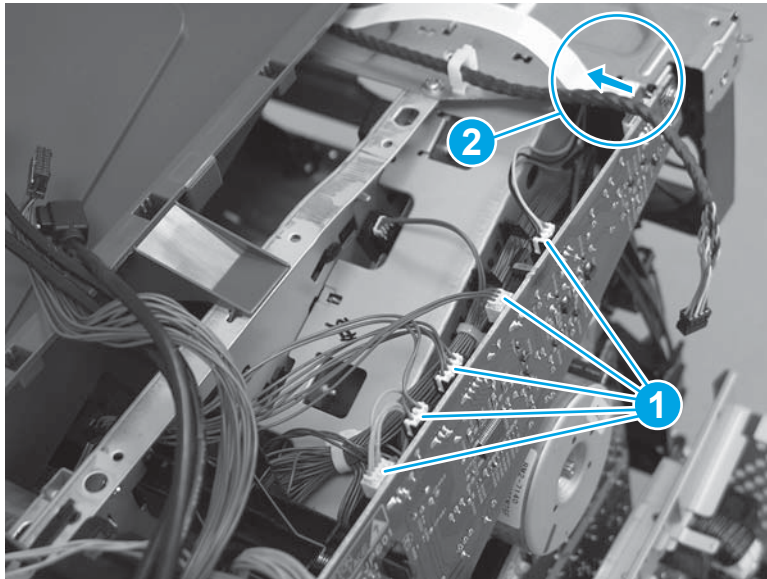

2. Remove one screw (callout 1).

Figure 1-3007 Remove one screw

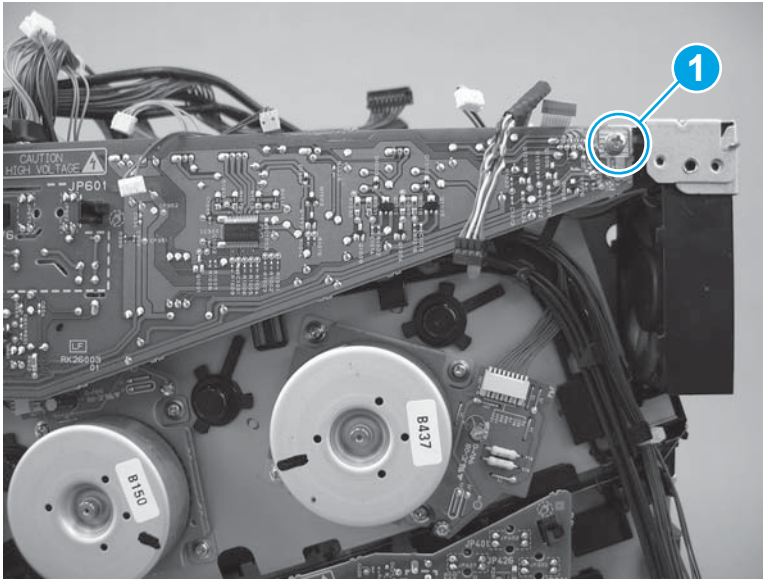

3. Release two tabs (callout 1), and then separate the HVPST from the printer.

⚠ CAUTION: Do not attempt to completely remove the HVPST. It is still connected to the printer by ground wire harness.

Figure 1-3008 Release the HVPST

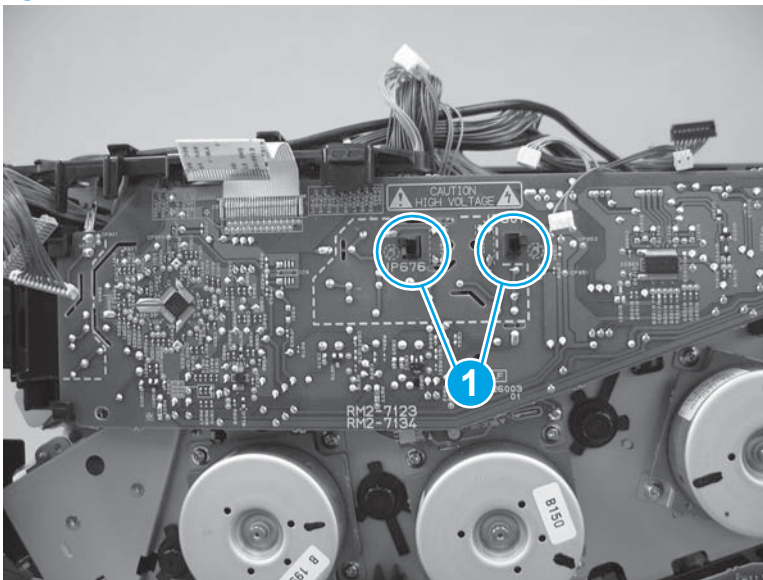

4. Release one ground wire connector (callout 1), and then remove the HVPST.

Figure 1-3009 Remove the HVPST

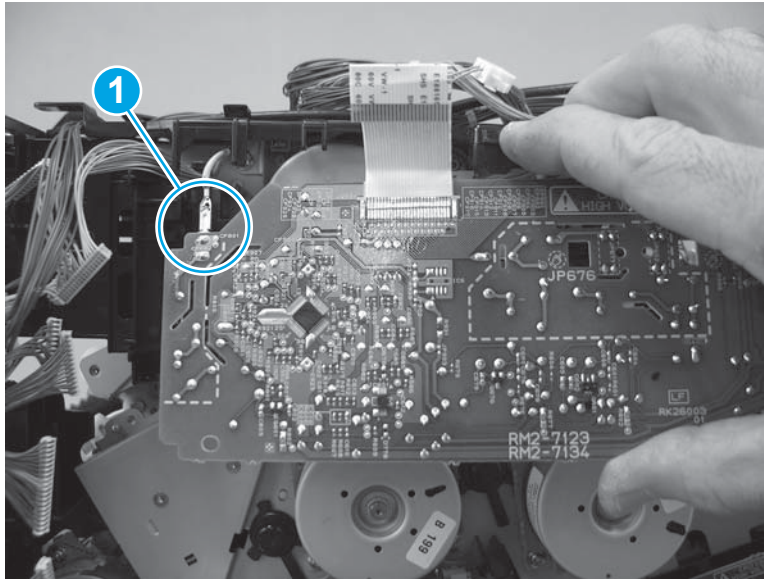

Step 25: Remove drum motor 3 (M3)

- ▲ Disconnect one connector (callout 1), remove four screws (callout 2), and then remove the motor.

Figure 1-3010 Remove the motor

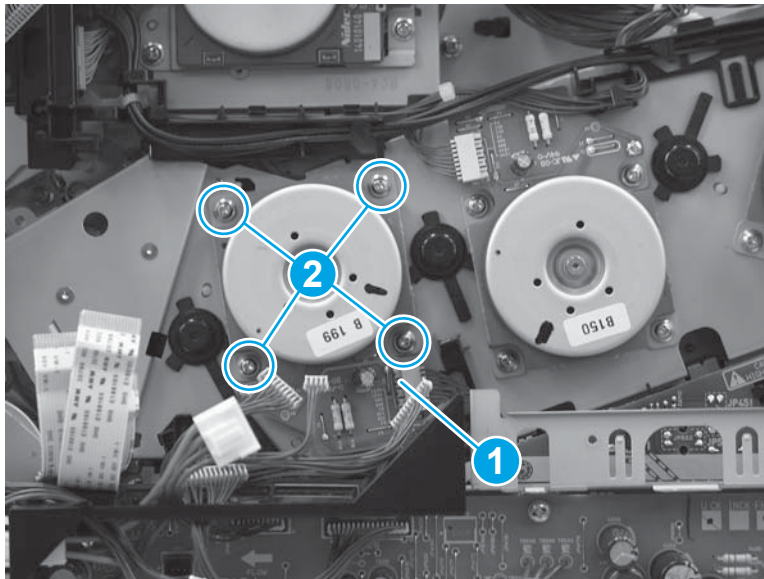

Step 26: Unpack the replacement assembly

Unpack the replacement assembly from the packaging.

For complete information on HP's recycling programs, go to [Product return and recycling](#).

 **NOTE:** HP recommends responsible disposal of the defective assembly.

Figure 1-3011 Recycle and unpack

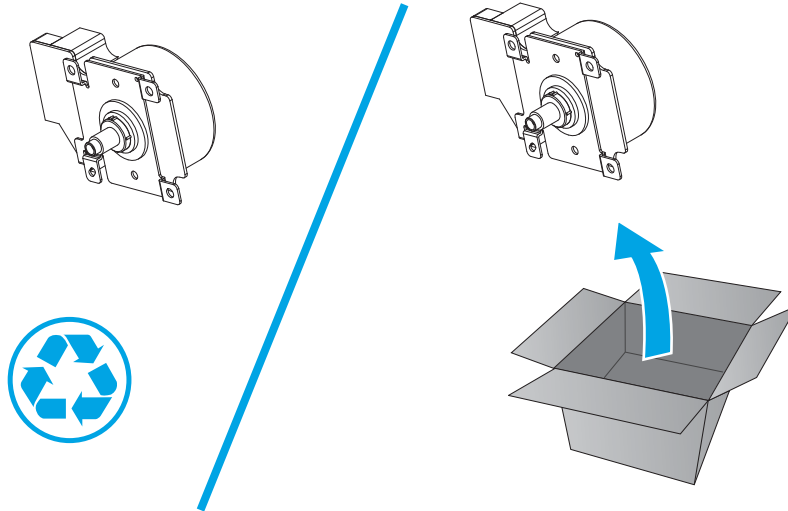

Step 27: Install drum motor 3 (M3)

- ▲ Position the motor on the printer, install four screws (callout 1), and then connect one connector (callout 2).

Figure 1-3012 Install the motor

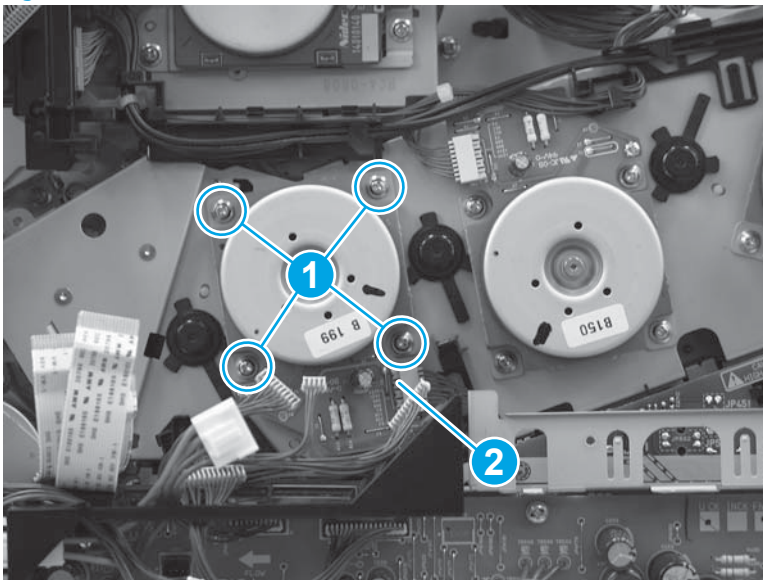

Step 28: Install the HVPST

⚠ **CAUTION:**  ESD-sensitive part.

1. Connect one ground wire connector (callout 1).

Figure 1-3013 Connect one ground wire

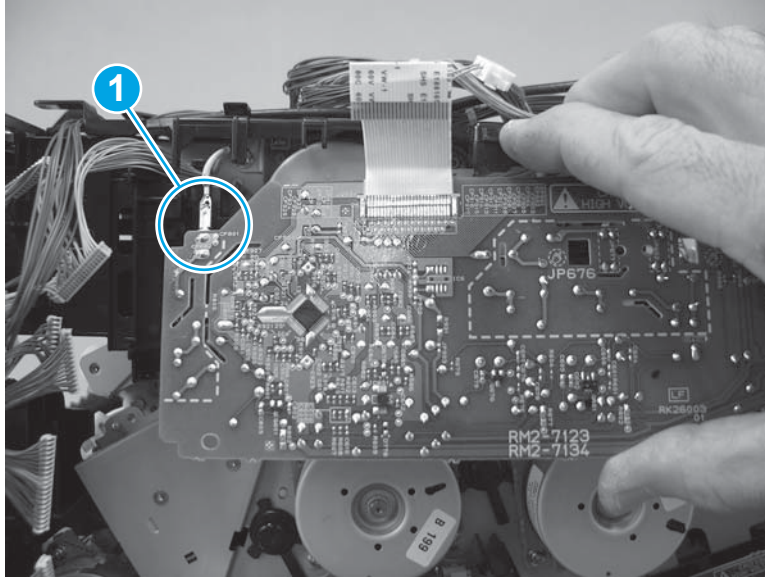

2. Position the HVPST on the printer, and then push in to engage two tabs (callout 1).

 **NOTE:** Make sure that the tabs snap into place.

Figure 1-3014 Install the HVPST

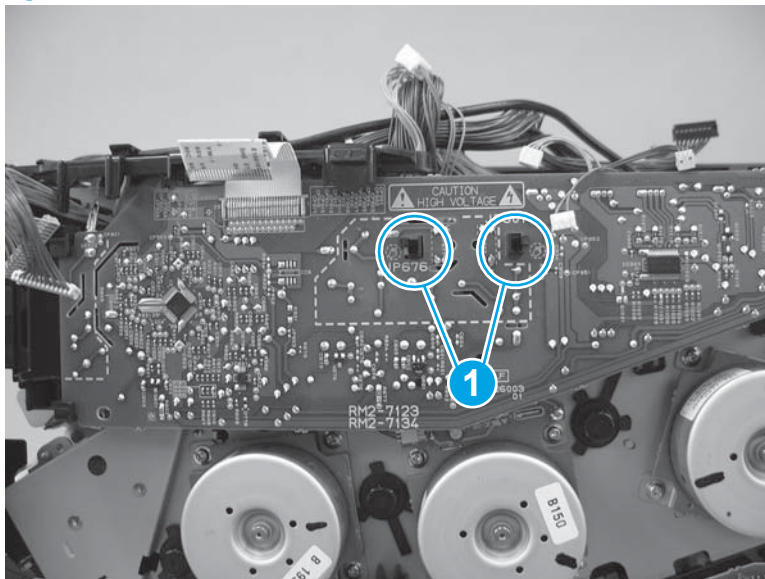

3. Install one screw (callout 1).

Figure 1-3015 Install one screw

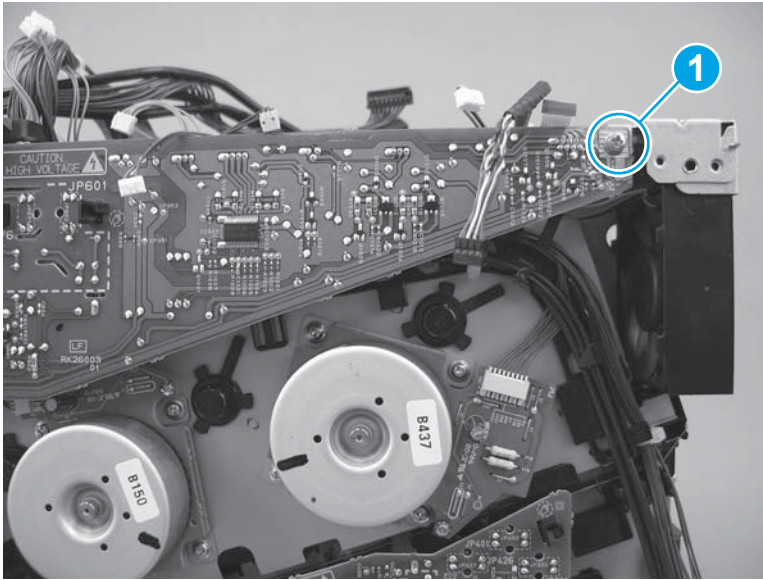

4. Connect five connectors (callout 1), and then connect one flat cable (callout 2).

Figure 1-3016 Connect five connectors and one flat cable

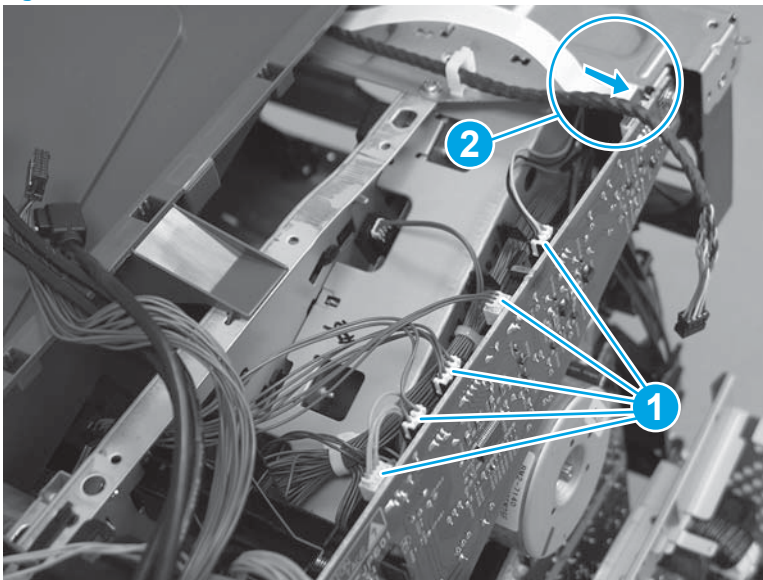

Step 29: Install the DC controller and sheet-metal bracket

 **CAUTION:**  ESD-sensitive part.

1. Position the DC controller and sheet-metal plate on the printer, and then push down to engage the plate with the chassis.

Figure 1-3017 Install the plate

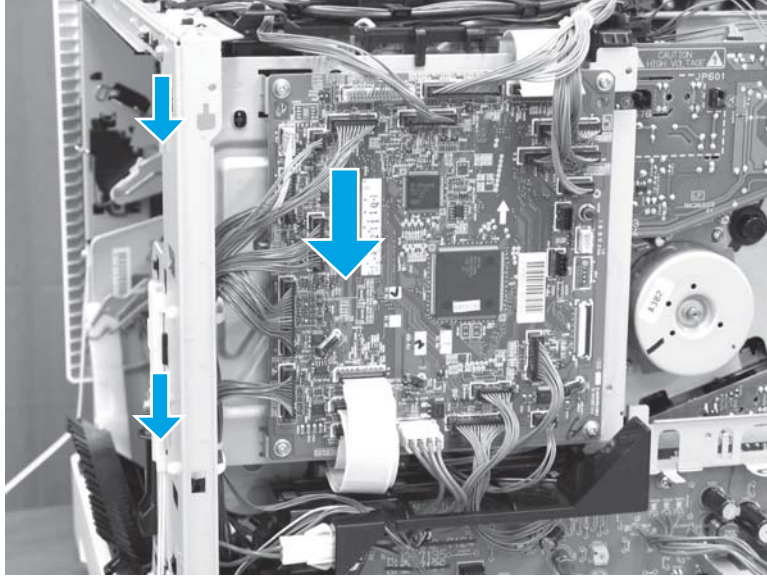

2. Install two screws (callout 1), and then connect all of the connectors.

The following connectors are empty:

- J140, J141, and J143

Figure 1-3018 Install two screws

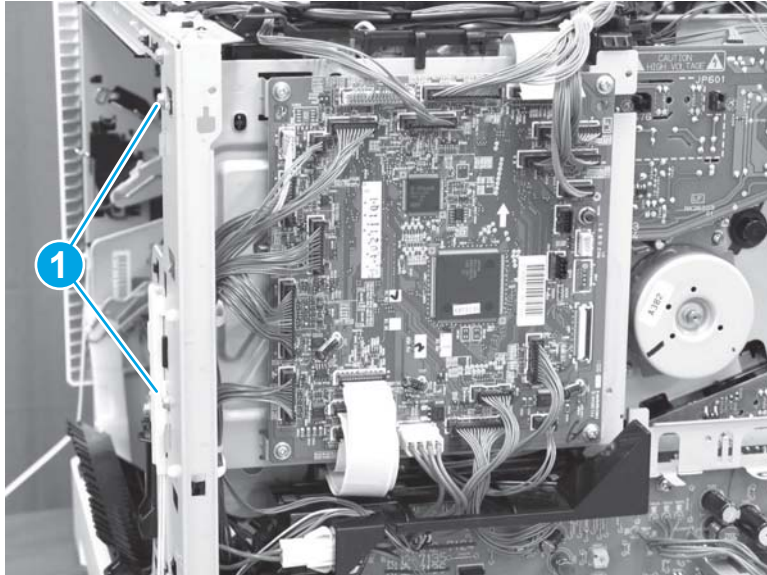

Step 30: Install the right rear cover

1. Position the cover on the printer.

Figure 1-3019 Install the cover

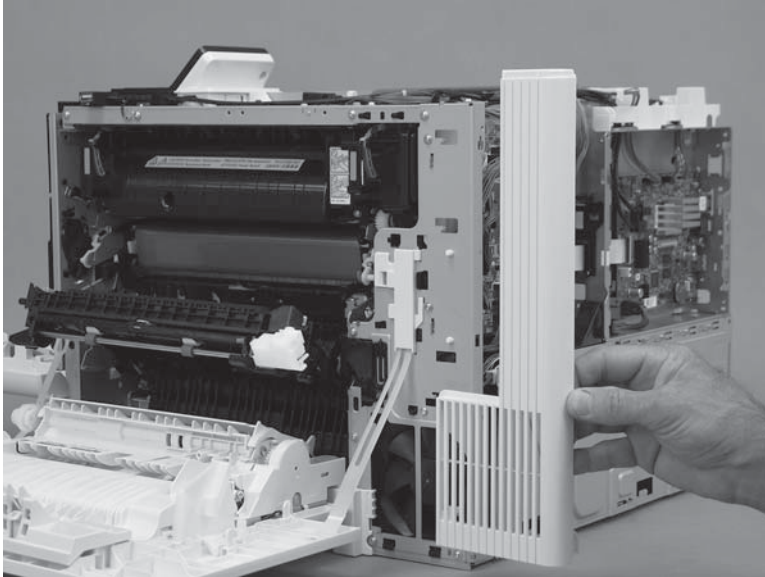

2. Slide the cover toward the right door (callout 1) to engage it with the printer, and then install one screw (callout 2).

Figure 1-3020 Install one screw

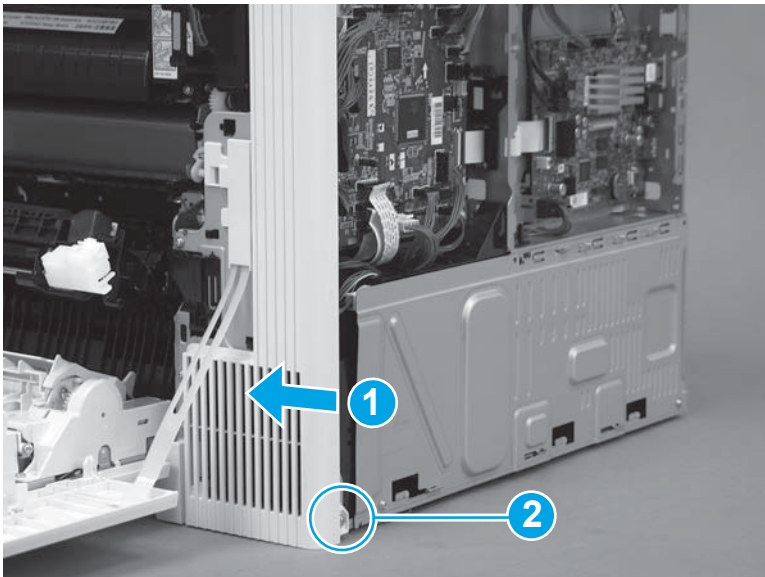

Step 31: Install the formatter case

1. Pass the wire harnesses through the opening in the formatter case.

Figure 1-3021 Pass the wire harnesses through the opening

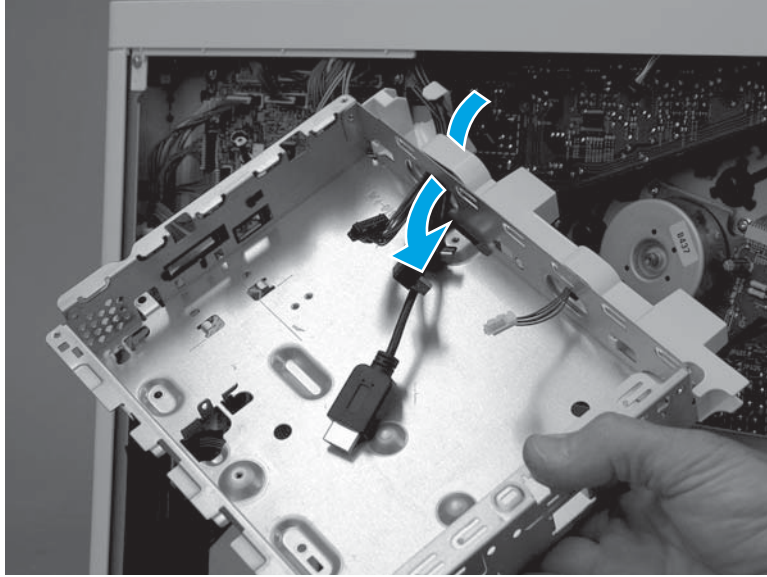

2. Position the top of the formatter case on the printer (callout 1), and then rotate the bottom of the case (callout 2) into the printer.

Figure 1-3022 Install the formatter case

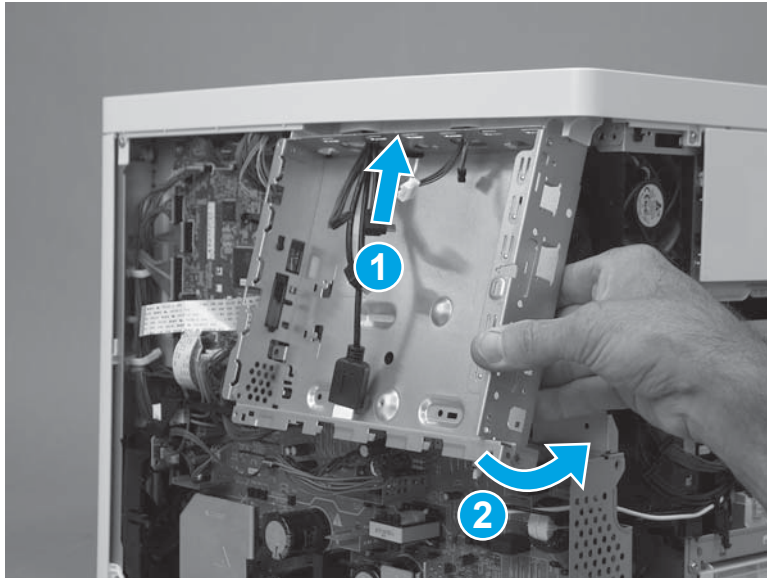

3. Install six screws (callout 1).

Figure 1-3023 Install six screws

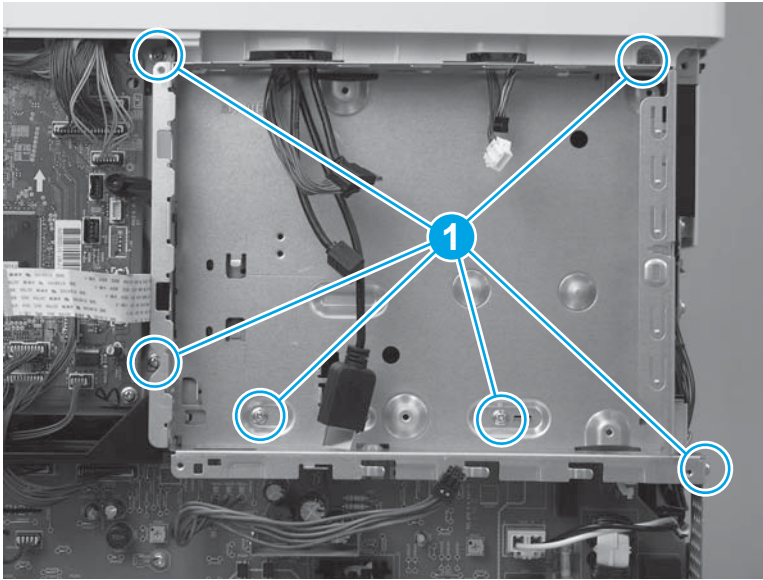

4. Pass two wire harnesses and one flat cable (callout 1) through the opening in the formatter case, and then install one wire harness in the retainer (callout 2).

 **IMPORTANT:** Make sure that the flat cable is securely fastened to the DC controller, and was not dislodged when the formatter case was removed.

Figure 1-3024 Install wire harnesses and flat cable

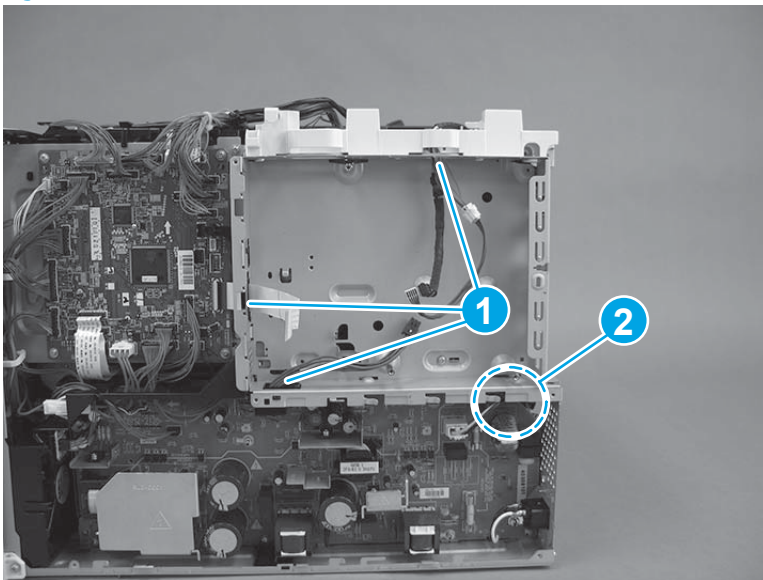

5. Position the LVPS cover on the printer, slide the cover to the left to install it, and then install two screws (callout 1).

Figure 1-3025 Install the LVPS cover

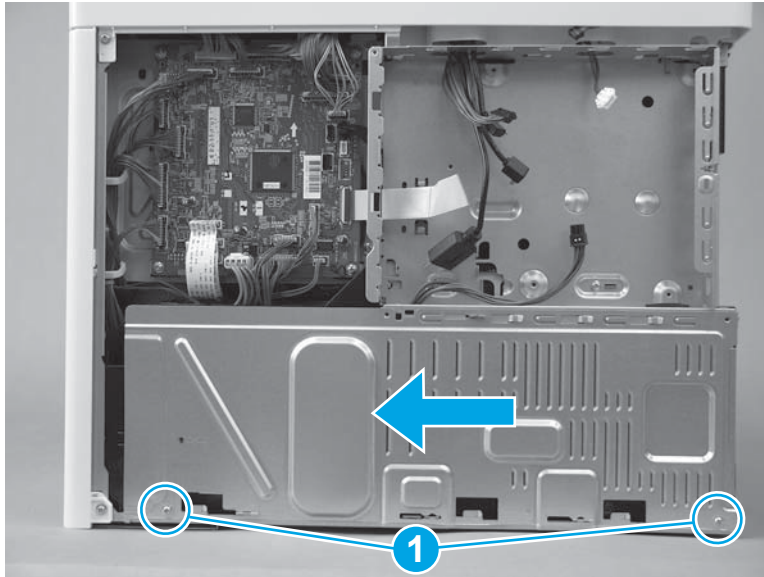

6. If no tape is affixed to the back of the flat cable, skip this step. If double-sided tape is affixed to the back of the flat cable, align the line (callout 1) on the cable with the edge (callout 2) of the opening in the sheet metal. Press to attach the flat cable to the formatter case.

Figure 1-3026 Attach the flat cable

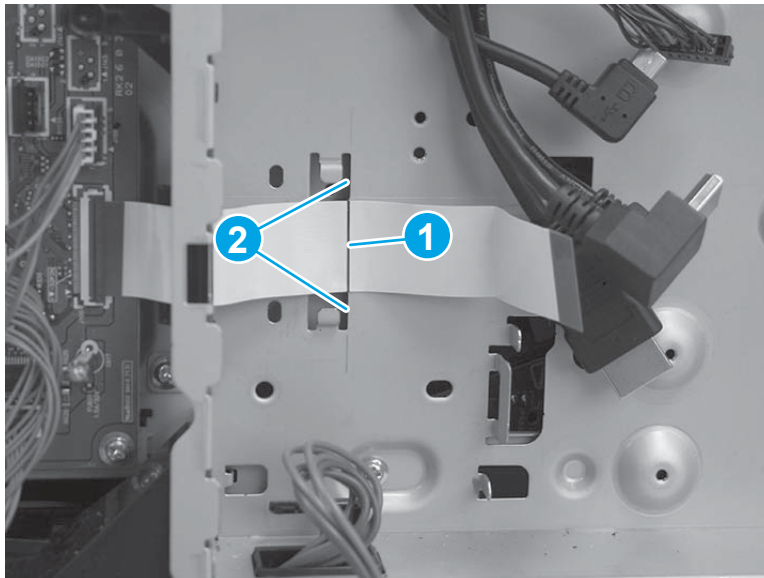

7. Position the bracket over the flat cable, and then slide the bracket to the left to install it. Make sure that the edges of the bracket fit under the sheet metal tabs (callout 1) on the formatter case and that the tabs (callout 2) snap into place.

Figure 1-3027 Position the bracket

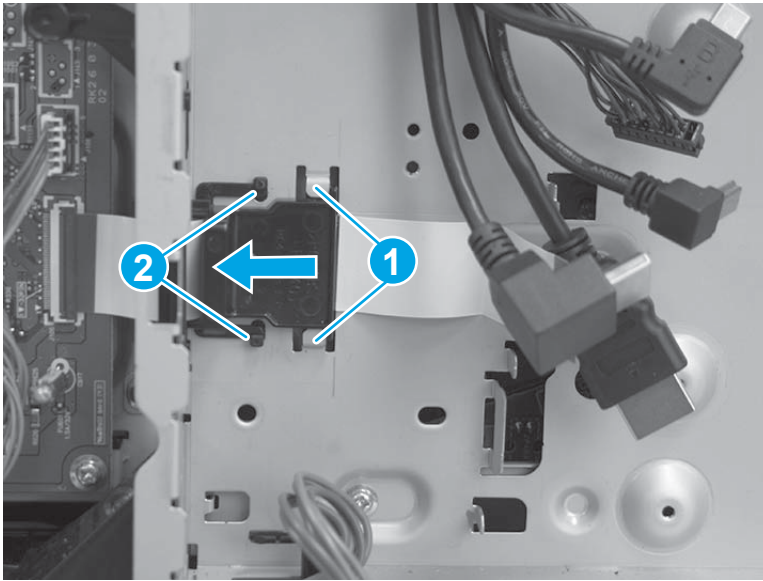

8. **M577 only:** Pass the wire harness (callout 1) through the openings in the formatter case (callout 2), and then connect one connector (callout 3).

Figure 1-3028 Connect one connector

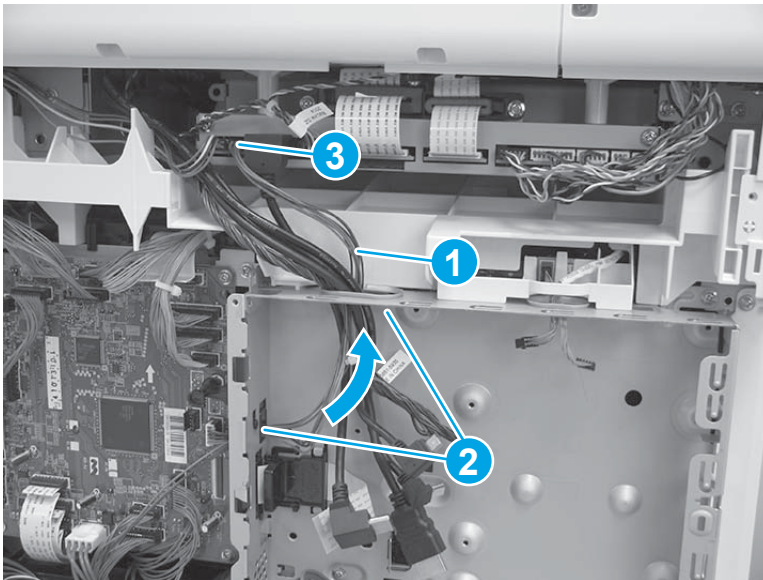

Step 32: Install the upper cover (M552 and M553)

 **NOTE:** This step is for the M552 and M553 models. For the M577 models, skip this step and go to [Step 33: Install the left cover on page 1708](#).

1. Position the cover on the printer.

 **NOTE:** For the M553x model, do not forget to pass the control-panel wire harness and USB cable through the opening in the cover.

Figure 1-3029 Install the cover



2. Push down on the rear corner of the cover to engage one tab (callout 1).

Figure 1-3030 Engage one tab

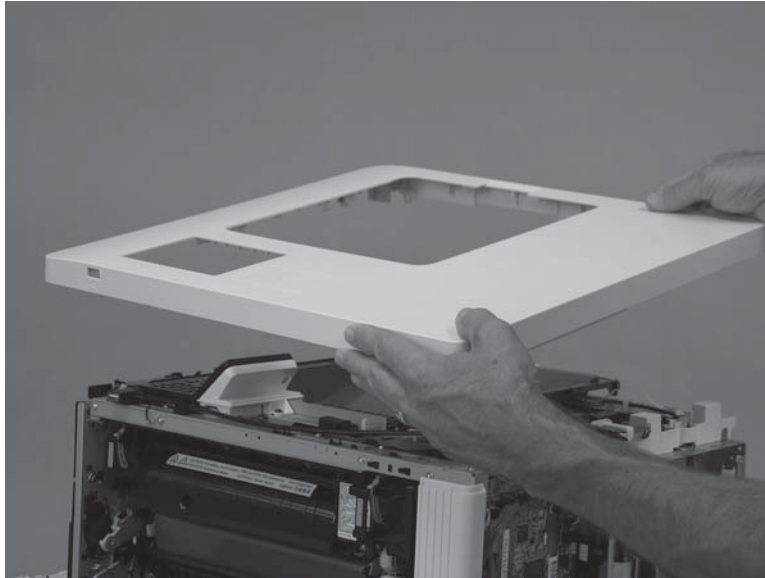
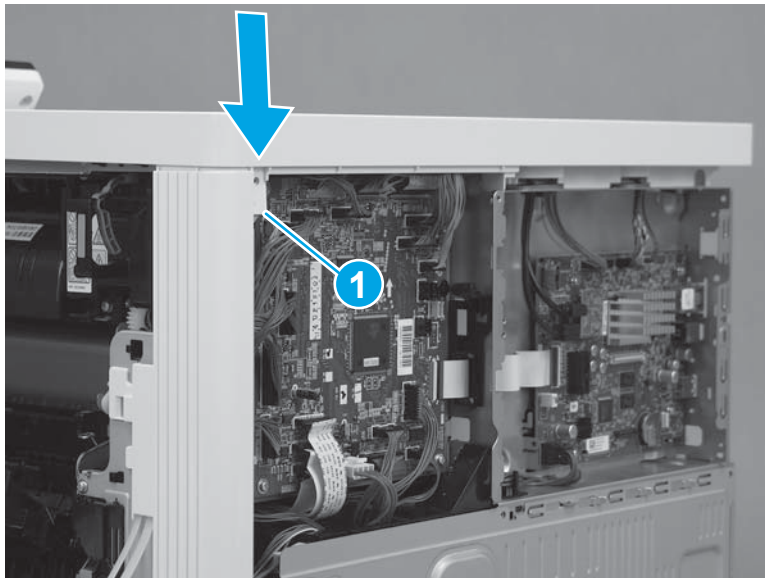

3. Push down on the front corner of the cover to engage one tab (callout 1), and then install one screw (callout 2).

 **NOTE:** This is a self-tapping plastic-thread screw. Make sure that this screw is used in this location when it is reinstalled.

Figure 1-3031 Engage one tab and install one screw



4. Install three screws (callout 1).

Figure 1-3032 Install three screws

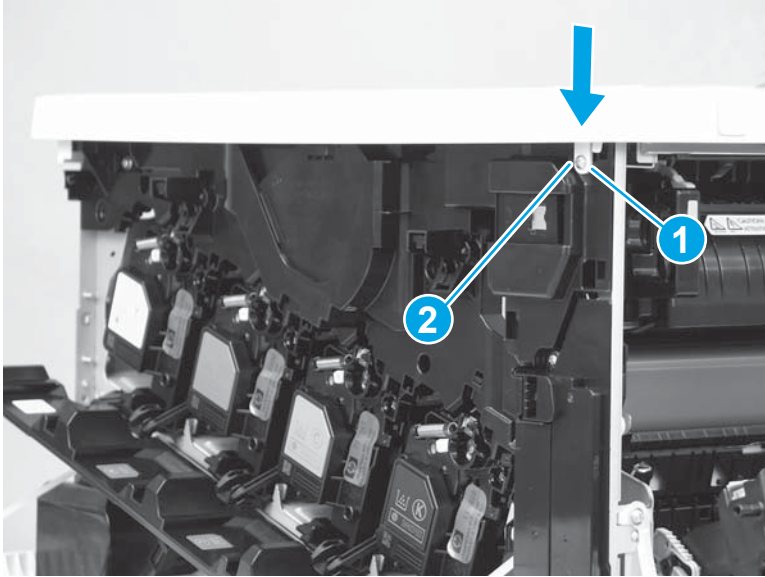
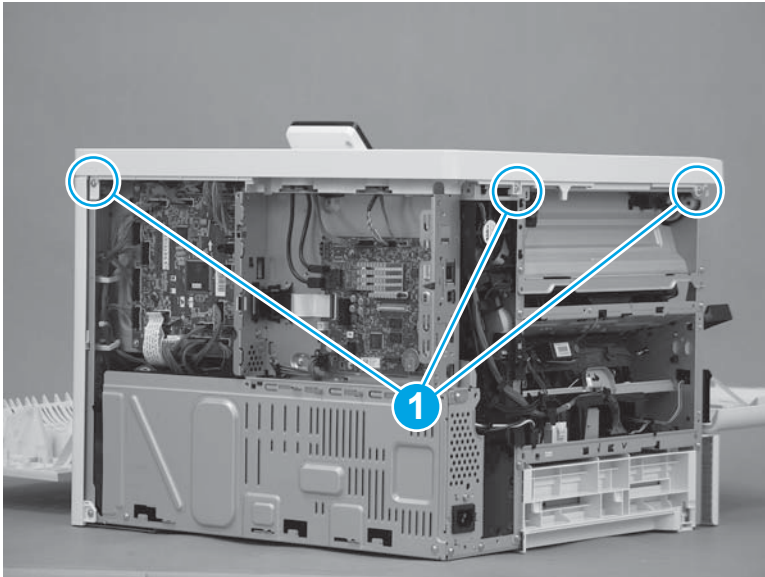

Step 33: Install the left cover

1. Position the cover on the printer.

 **NOTE:** Slightly offset the cover toward the rear of the printer.

Figure 1-3033 Install the cover

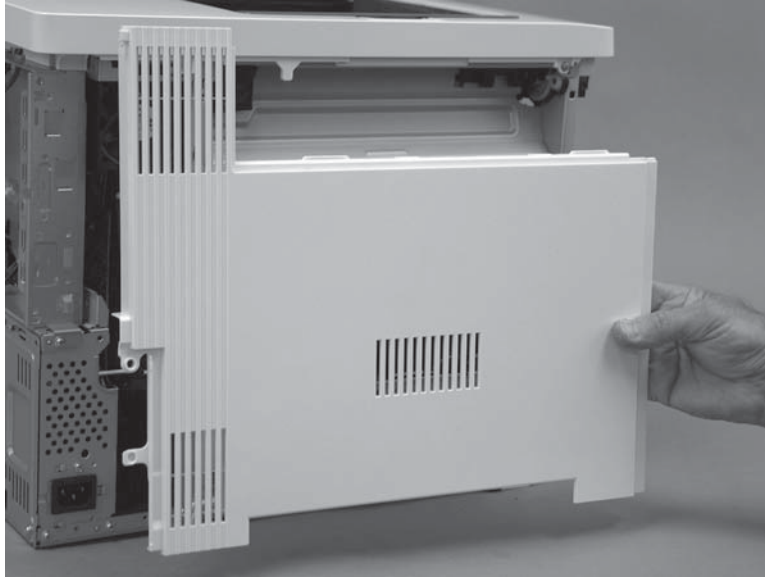

2. Slide the cover (callout 1) toward the front of the printer to engage it. Make sure that the tab (callout 2) snaps into place.

 **NOTE:** Locate the alignment pin (callout 3) on the cover from the front door side of the printer, and then make sure that it is fully engaged in the slot in the chassis.

 **TIP:** While sliding the cover into place, push in on the center of the cover (callout 1) to make sure that the hooks on the back of the cover engage with the slots in the chassis.

Figure 1-3034 Engage the cover



3. At the left side of the printer, install one screw (callout 1).

Figure 1-3035 Install one screw

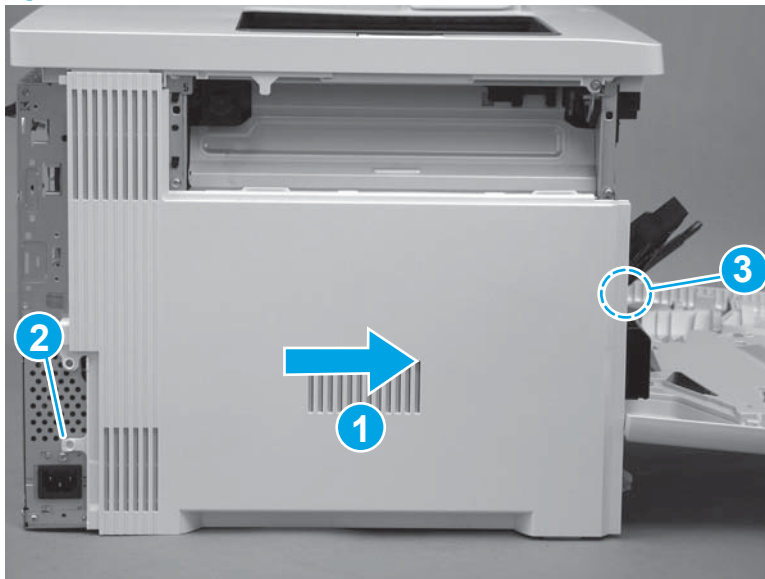

Step 34: Install the top rear cover (M577)

 **NOTE:** This step is for the M577 models. For the M552 and M553 models, skip this step and go to [Step 42: Install the rear cover \(M552 and M553\) on page 1726](#).

1. Align the locator tabs (callout 1) on the cover with the slots (callout 2) in the printer.

Figure 1-3036 Align the locator tabs

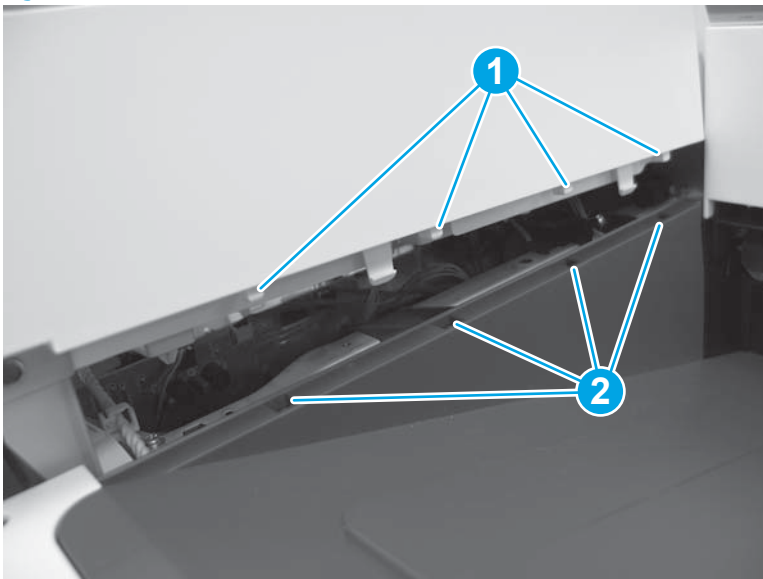

2. Press down to install the cover. Make sure that the tabs snap into place.

Figure 1-3037 Install the cover

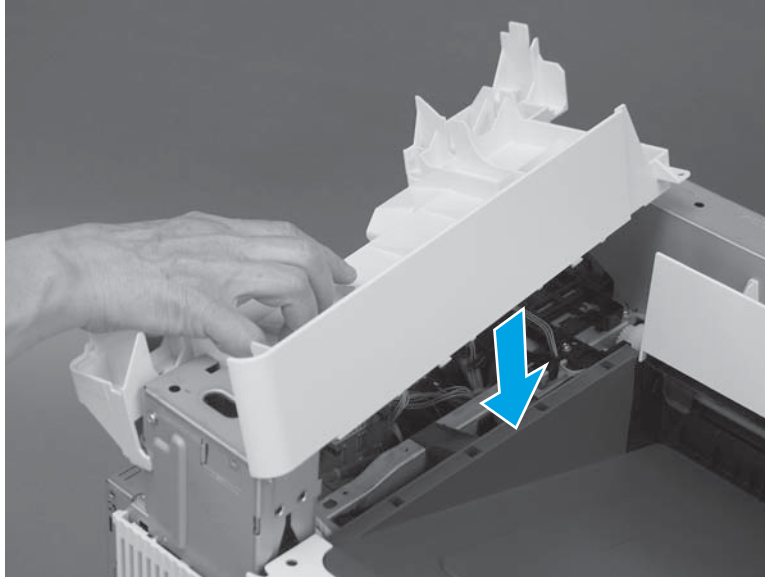

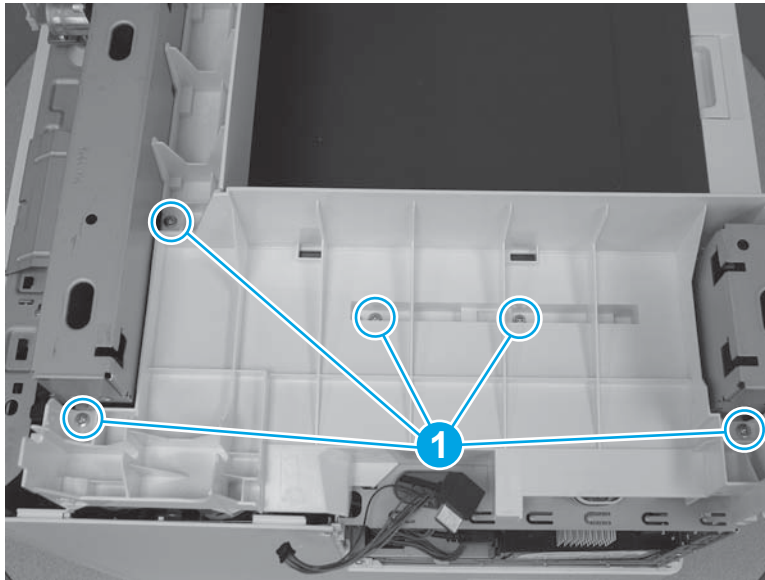

3. At the top of the printer, install five screws (callout 1).

Figure 1-3038 Install five screws



Step 35: Install the right upper cover (M577)

 **NOTE:** This step is for the M577 models. For the M552 and M553 models, skip this step and go to [Step 42: Install the rear cover \(M552 and M553\) on page 1726.](#)

 **NOTE:** The figures below show the image scanner installed. The procedures for removing and installing the right upper cover are the same whether the image scanner is installed or removed."

1. **M577c/f/z only:** Install the cables (callout 1) through the slot (callout 2) in the printer.

Figure 1-3039 Install the cables

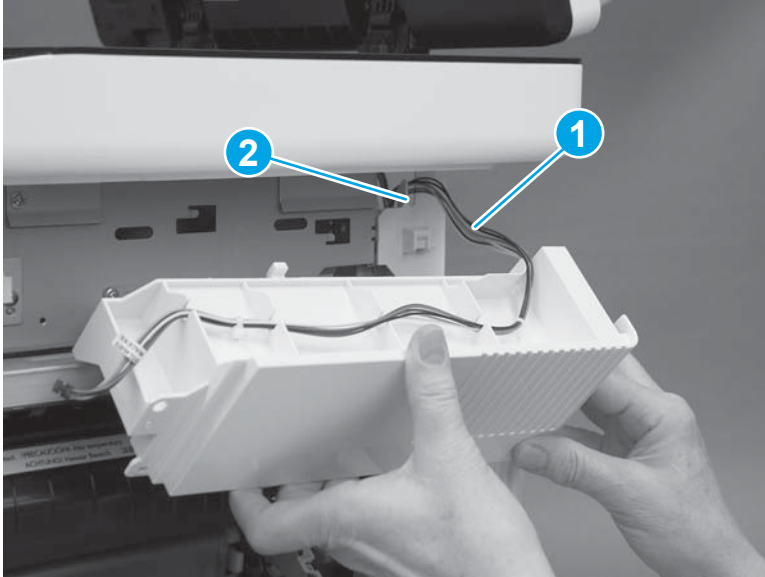

2. Position the hooks (callout 1) on the cover in the slots (callout 2) in the printer.

Figure 1-3040 Position the hooks

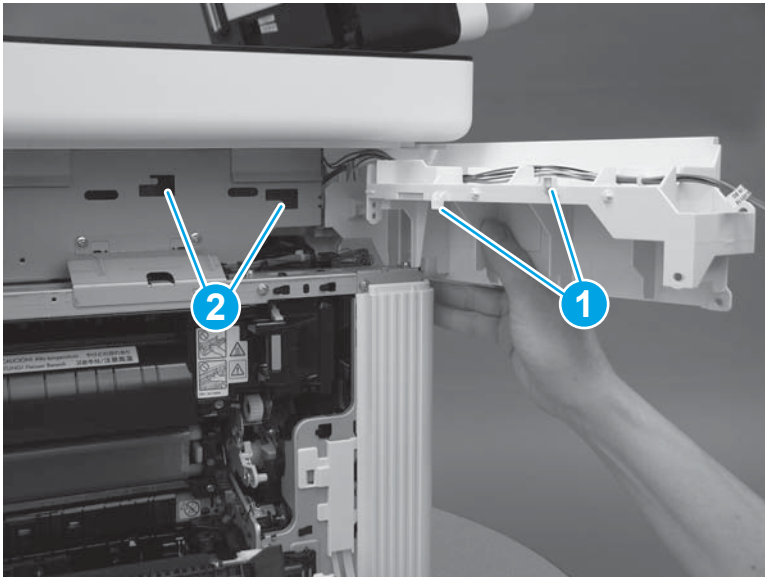

3. Slide the cover toward the front of the printer to install it.

Figure 1-3041 Install the cover

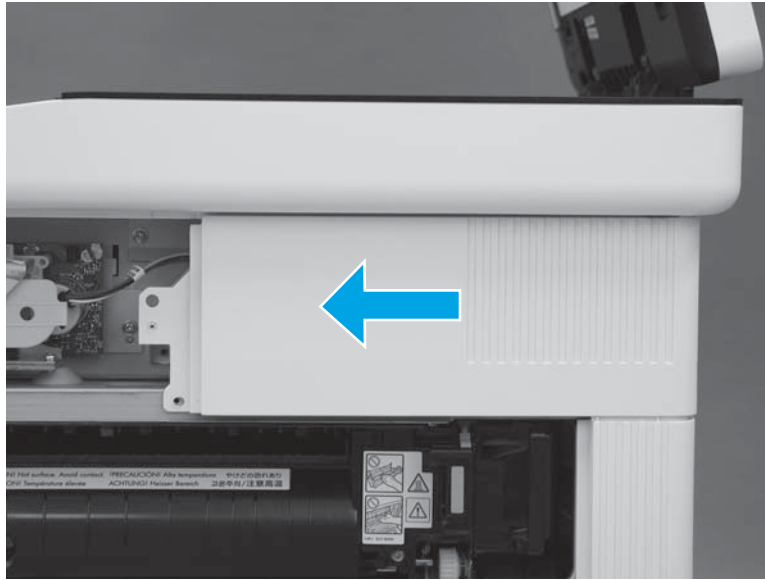

4. At the back of the printer, install one screw (callout 1).

M577c/f/z only: Connect one connector (callout 2), if the integrated scanner assembly is installed.

TIP: This screw is smaller than the screws installed in the next step. Make sure that this screw is installed in the correct position.

Figure 1-3042 Install one screw and connector

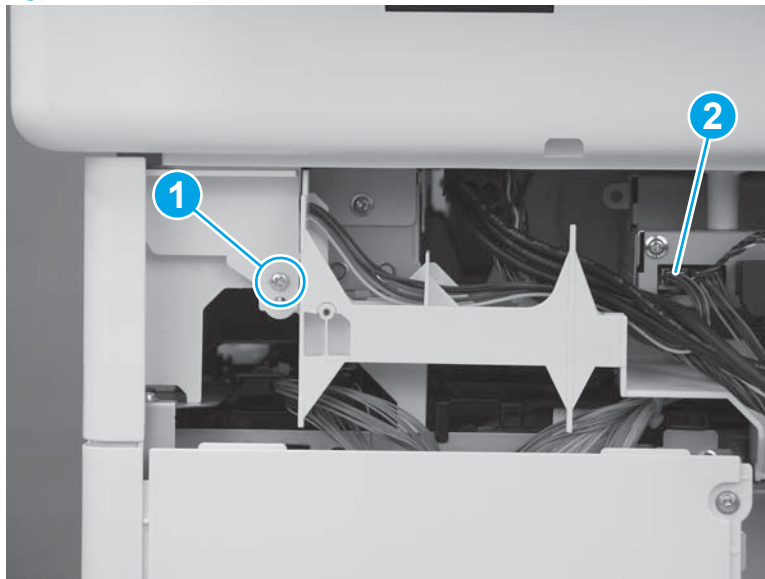

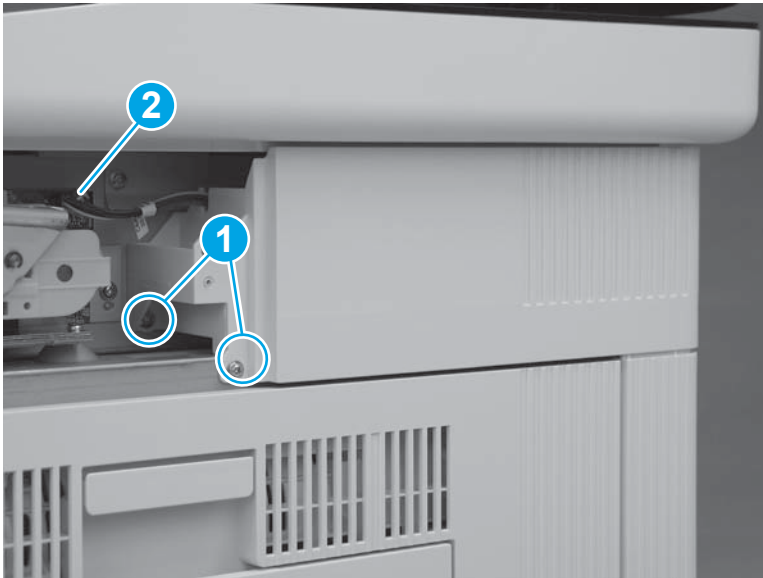

- At the right side of the printer, install two screws (callout 1).
M577c/f/z only: Connect one connector (callout 2), if the stapler is installed.

Figure 1-3043 Install one screw and connector



Step 36: Install the integrated scanner assembly (ISA) (M577)

-
-  **NOTE:** This step is for the M577 models. For the M552 and M553 models, skip this step and go to [Step 42: Install the rear cover \(M552 and M553\) on page 1726](#).
-
-  **NOTE:** The ISA includes the document feeder, image scanner, scanner control board (SCB), control panel, keyboard (M577c/z) and NFC PCA (M577z).
-

- Before proceeding, locate the mounting pins (callout 1) on the bottom of the ISA and the slots (callout 2) on the printer base.

Figure 1-3044 Locate the ISA mounting pins and slots

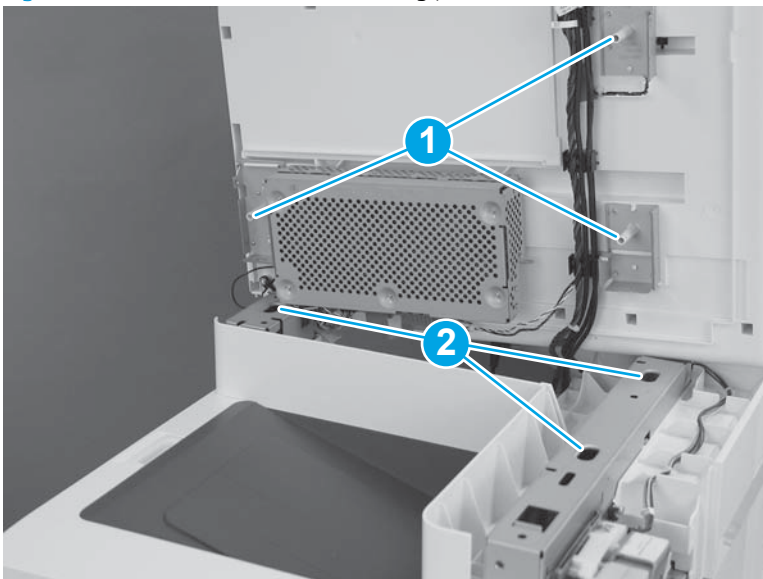

2. Position the ISA on the printer base with the pins in the slots.

 **NOTE:** To locate the pins and slots, see [Figure 1-395 Locate the ISA mounting pins and slots on page 249](#).

When installing the ISA, carefully pass the cables through the opening in the top of the formatter case.

Figure 1-3045 Install the ISA



3. Slightly slide the ISA towards the front of the printer to engage it.

Figure 1-3046 Slide the ISA towards the front of the printer

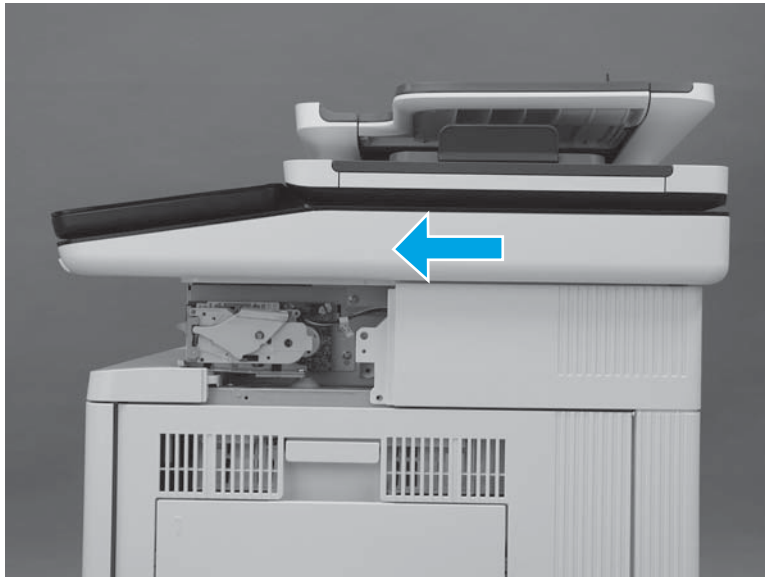

4. At the left side of the printer, install one screw (callout 1).

Figure 1-3047 Install one screw

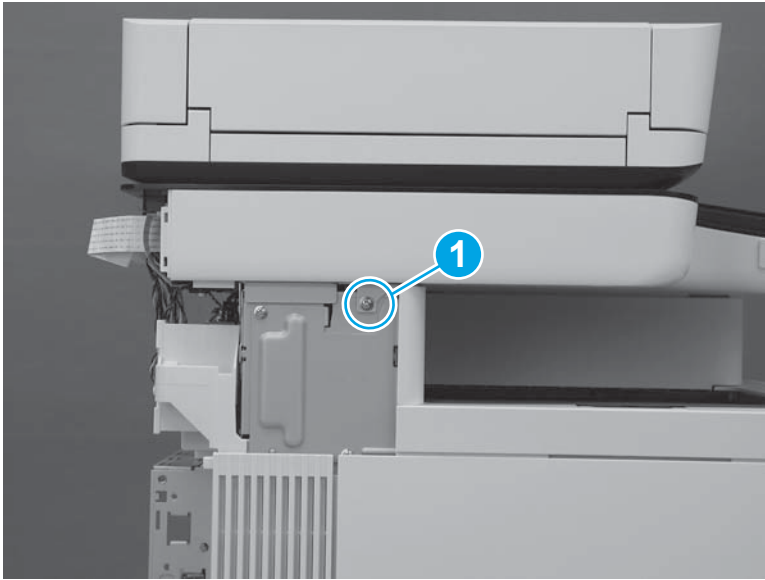

5. At the back of the printer, install two screws (callout 1).

Figure 1-3048 Install two screws

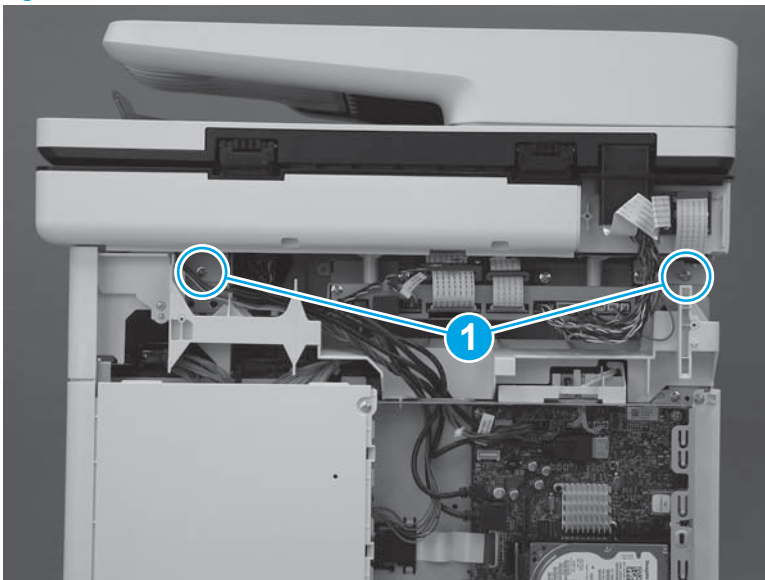

6. At the right side of the printer, install one screw (callout 1).

Figure 1-3049 Install one screw

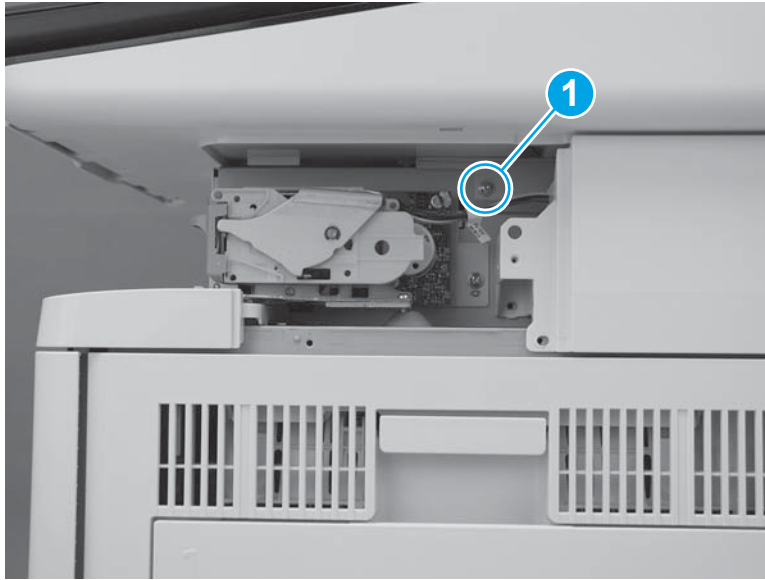

7. Connect two connectors on the scanner control board (callout 1).

M577c/f/z only: Connect one connector for the stapler on the scanner control board (callout 2).

Figure 1-3050 Connect connectors

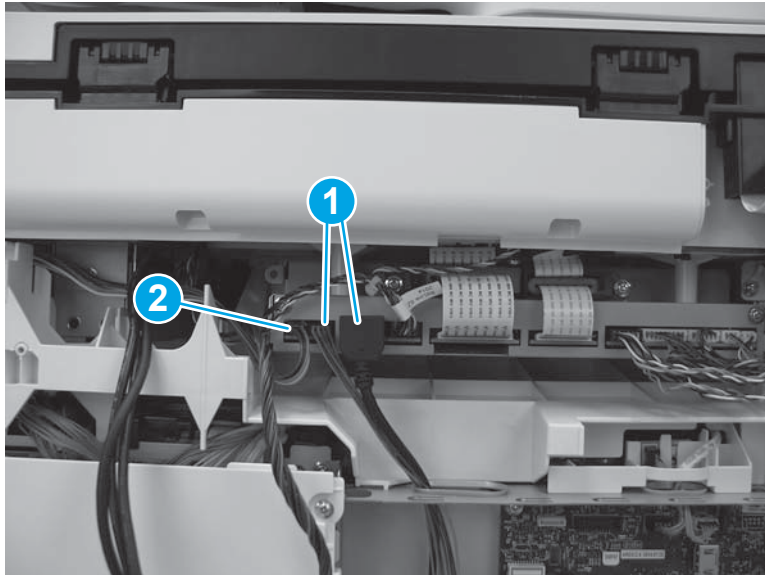

Step 37: Install the stapler cover assembly (M577c/f/z)

 **NOTE:** This step is for the M577c/f/z models only. For the M577dn model, skip this step and go to [Step 38: Install the right front upper cover \(M577dn\) on page 1719](#).

For the M552 and M553 models, skip this step and go to [Step 42: Install the rear cover \(M552 and M553\) on page 1726](#).

1. Install the tabs (callout 1) on the cover in the slots (callout 2) in the printer.

Figure 1-3051 Install two tabs



2. Press the cover toward the left side of the printer until it snaps into place.

Figure 1-3052 Install the cover assembly



3. Install one screw (callout 1).



 **IMPORTANT:** This is a self-tapping screw for plastic. Rotate it counterclockwise to align it with the existing thread pattern, and then carefully turn it clockwise to tighten. Do not overtighten. This will prevent stripping the threads inside the screw hole.

Figure 1-3053 Install one screw

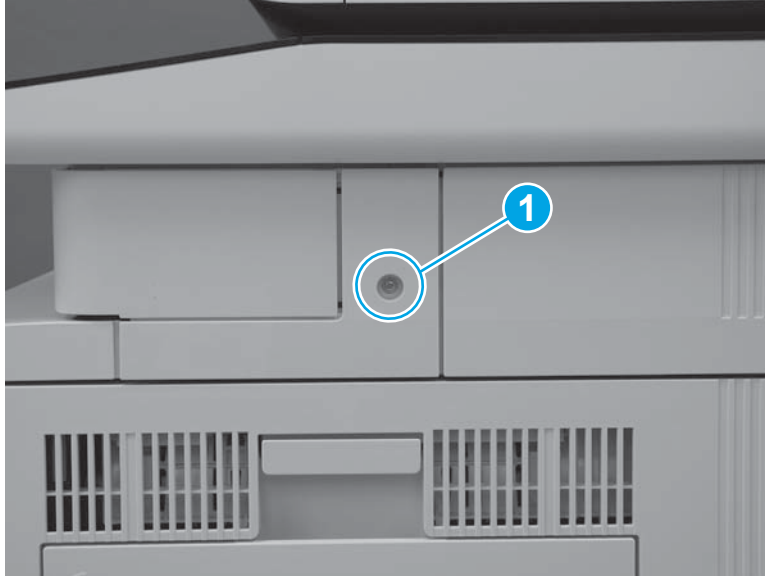

Step 38: Install the right front upper cover (M577dn)

 **NOTE:** This step is for the M577dn model only. For the M577c/f/z models, skip this step and go to [Step 39: Install the left upper cover \(M577\) on page 1721](#).

For the M552 and M553 models, skip this step and go to [Step 42: Install the rear cover \(M552 and M553\) on page 1726](#).

1. Slide the cover toward the left side of the printer to install it. Make sure that the slots (callout 1) in the cover fit over the tabs (callout 2) on the inside of the paper feeder cover.

Figure 1-3054 Install the cover



2. Press the right front upper cover (callout 1) and the paper feeder cover (callout 2) together until the tabs on the inside of the covers snap into place.

Figure 1-3055 Press the cover



3. Install one screw (callout 1).

Figure 1-3056 Install one screw

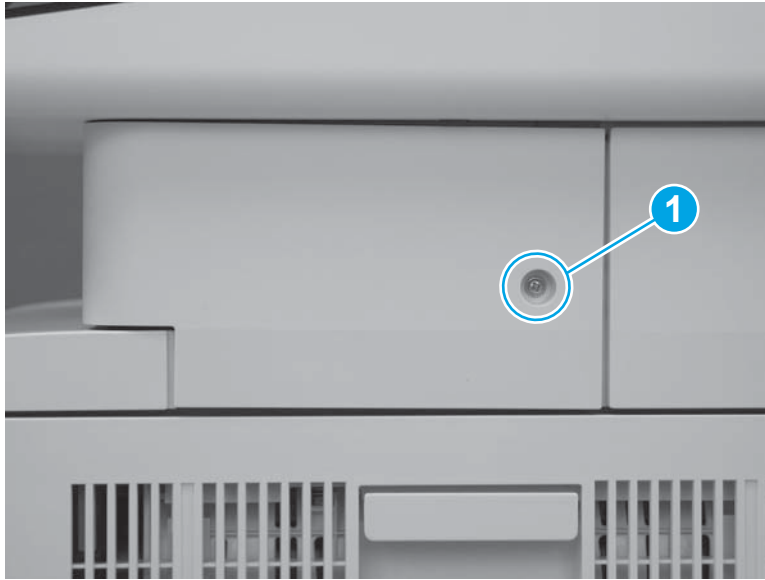

Step 39: Install the left upper cover (M577)

 **NOTE:** This step is for the M577 models. For the M552 and M553 models, skip this step and go to [Step 42: Install the rear cover \(M552 and M553\) on page 1726](#).

1. Position the tab (callout 1) on the lower edge of the cover behind the left cover (callout 2).

Figure 1-3057 Position the tab

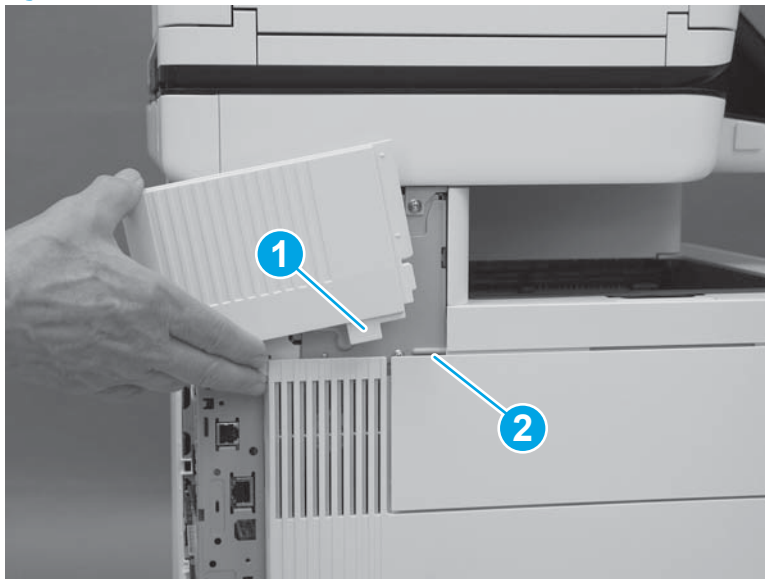

2. Slide the cover toward the front of the printer to install it. Make sure that the edge (callout 1) of the cover fits behind the edge (callout 2) of the top rear cover.

Figure 1-3058 Slide the cover

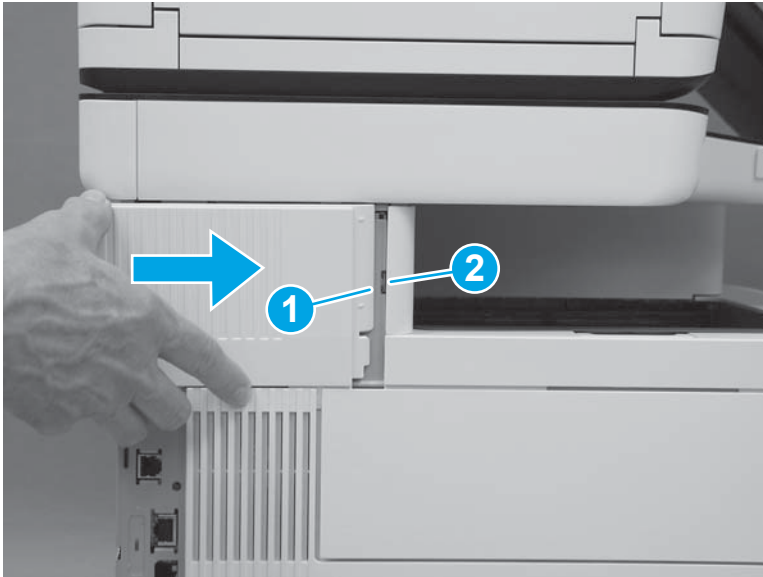

3. Make sure that the tab (callout 1) is fully installed.

Figure 1-3059 Check the tab

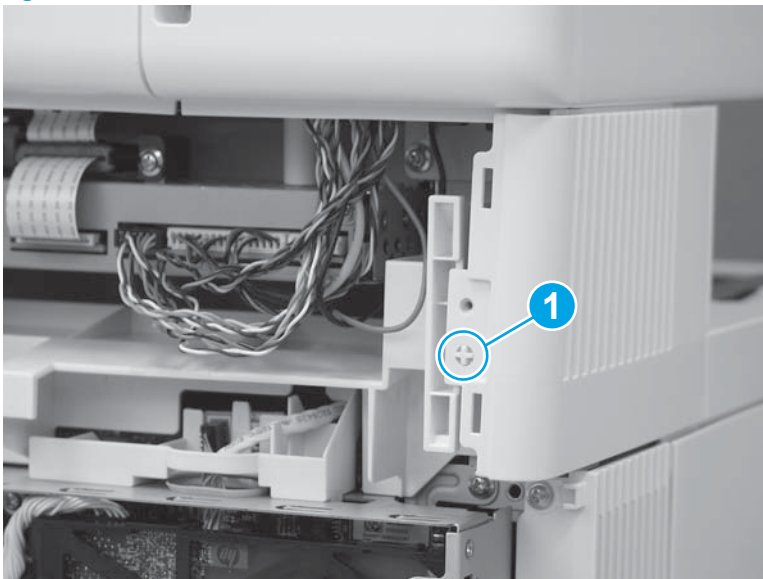

Step 40: Install the rear cover (M577)

 **NOTE:** This step is for the M577 models. For the M552 and M553 models, skip this step and go to [Step 42: Install the rear cover \(M552 and M553\) on page 1726](#).

1. Position the hooks (callout 1) on the cover in the slots (callout 2) in the printer.

Figure 1-3060 Position the hooks

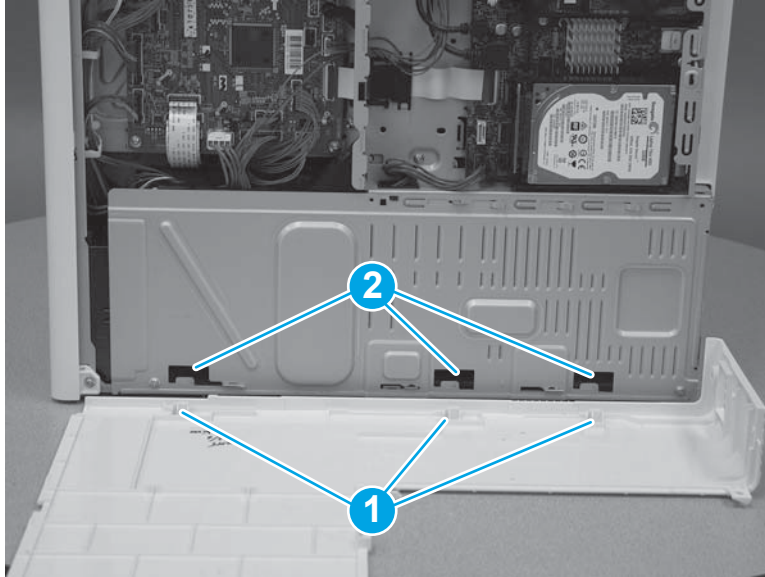

2. Position the back edge (callout 1) of the rear cover behind the edge (callout 2) of the right rear cover. Slide the cover to the left to install it.

Figure 1-3061 Install the cover

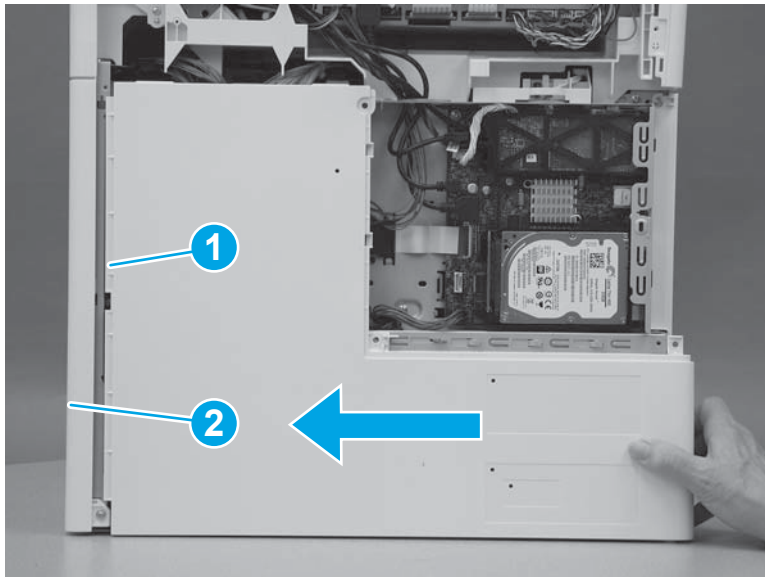

3. Install four screws (callout 1).

Figure 1-3062 Install four screws cover

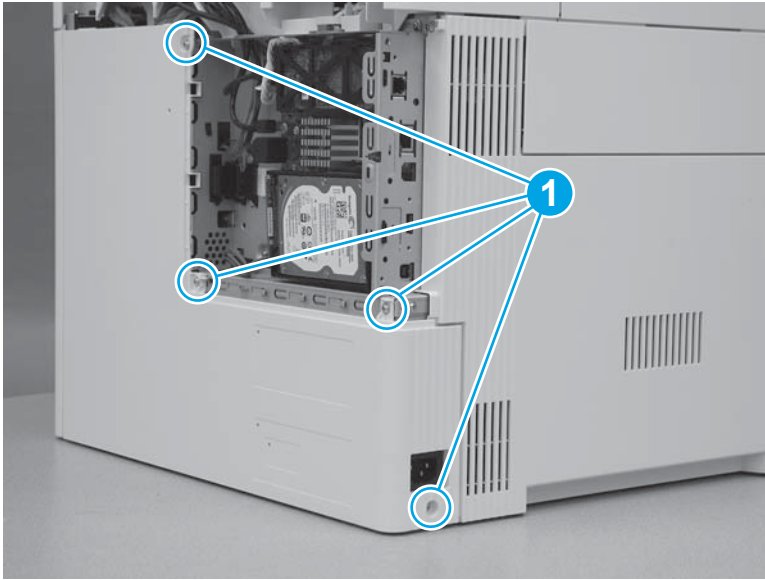

Step 41: Install the rear upper cover (M577)



NOTE: This step is for the M577 models. For the M552 and M553 models, skip this step and go to [Step 42: Install the rear cover \(M552 and M553\) on page 1726](#).

1. Align the ridge (callout 1) on the lower edge of the rear upper cover in front of the tabs (callout 2) on the top edge of the rear cover.

Figure 1-3063 Align the cover

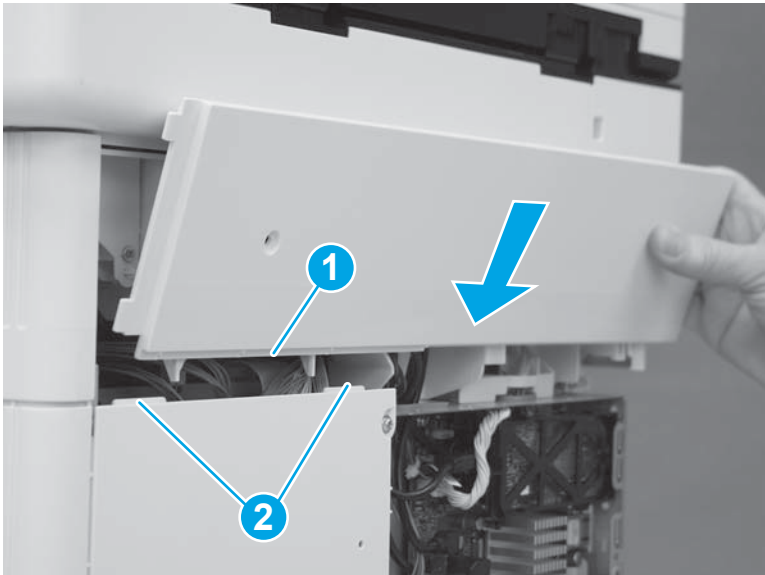

2. Rotate the top of the cover toward the printer.

Figure 1-3064 Rotate the top of the cover

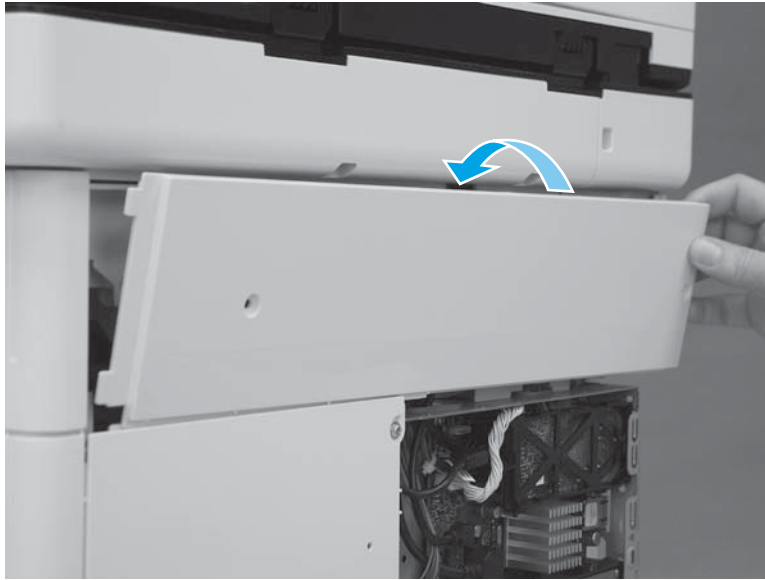

3. Slide the cover to the left (callout 1). Make sure that the tabs (callout 2) on the upper rear cover slide behind the edge (callout 3) of the right upper cover. Make sure that the cover is fully seated.

Figure 1-3065 Slide the cover

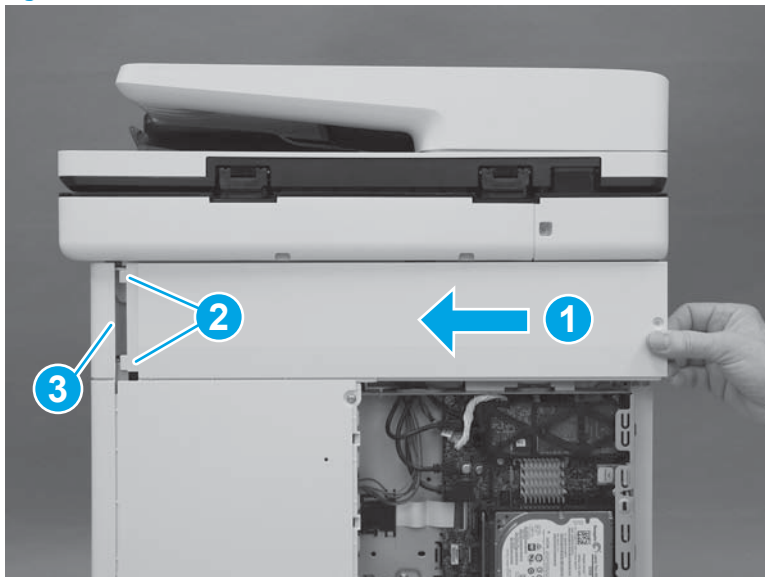

4. Install two screws (callout 1).



 **IMPORTANT:** These two screws are self-tapping screws for plastic. Rotate them counterclockwise to align them with the existing thread pattern, and then carefully turn them clockwise to tighten. Do not overtighten. This will prevent stripping the threads inside the screw holes.

Figure 1-3066 Install two screws

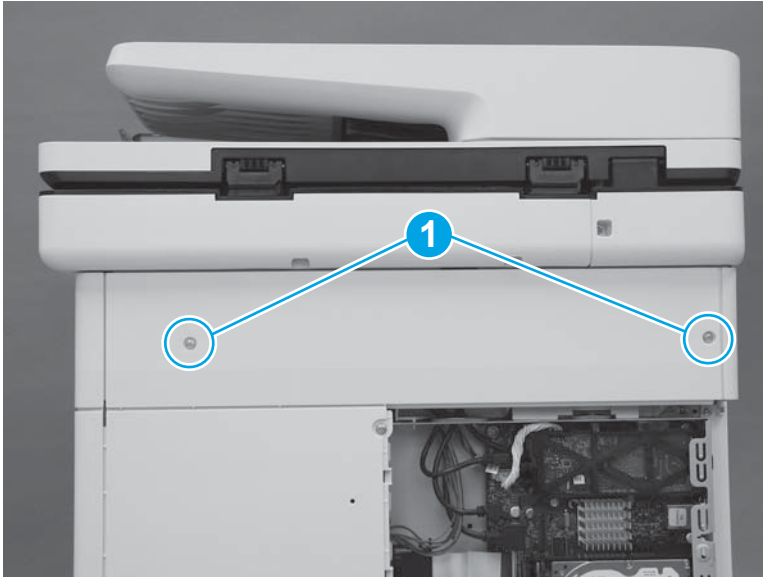

Step 42: Install the rear cover (M552 and M553)

 **NOTE:** This step is for the M552 and M553 models. For the M577 models, skip this step and go to [Step 43: Install the formatter \(M577\) on page 1727](#).

1. Position the top of the cover under the upper cover (callout 1), rotate the bottom of the cover onto the chassis (callout 2), and then slide the cover to the left (callout 3) to install it.

Figure 1-3067 Install the cover

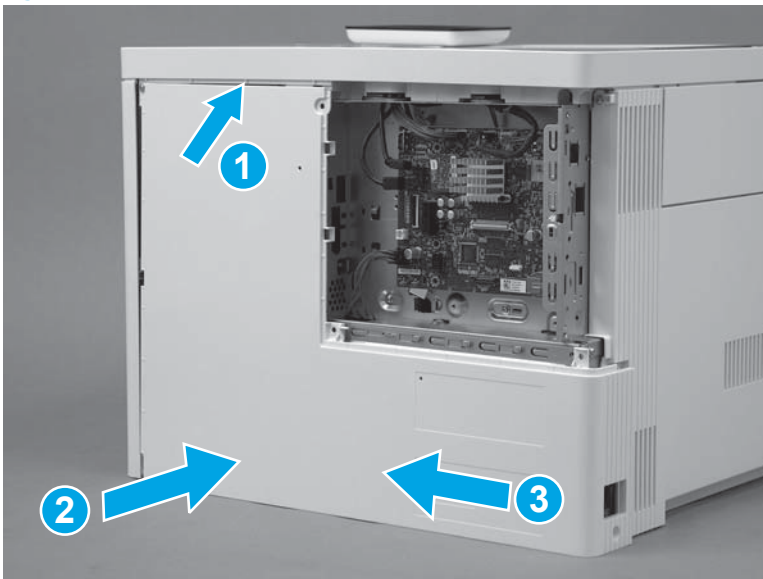

2. Install four screws (callout 1).

Figure 1-3068 Install four screws cover

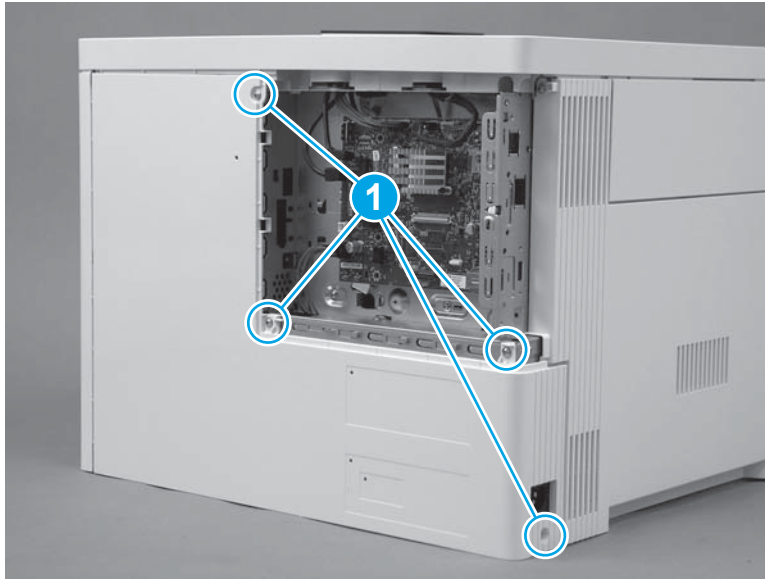

Step 43: Install the formatter (M577)

 **NOTE:** This step is for the M577 models. For the M552 and M553 models, skip this step and to go [Step 46: Install the formatter \(M552 and M553\) on page 1732](#).

 **CAUTION:**  ESD-sensitive part.

1. Position the formatter in the printer. Make sure that the network port (callout 1) fits through the opening (callout 2) in the formatter case.

Figure 1-3069 Install the formatter

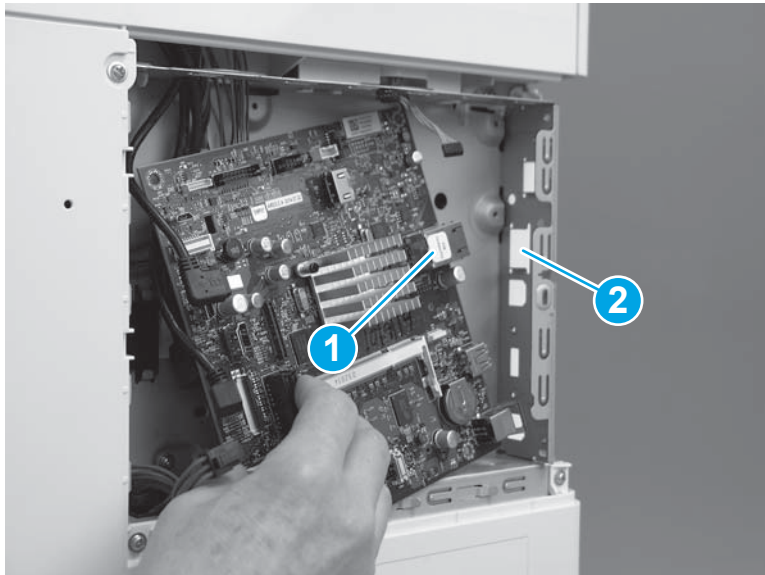

2. Install four screws (callout 1).

Figure 1-3070 Install four screws

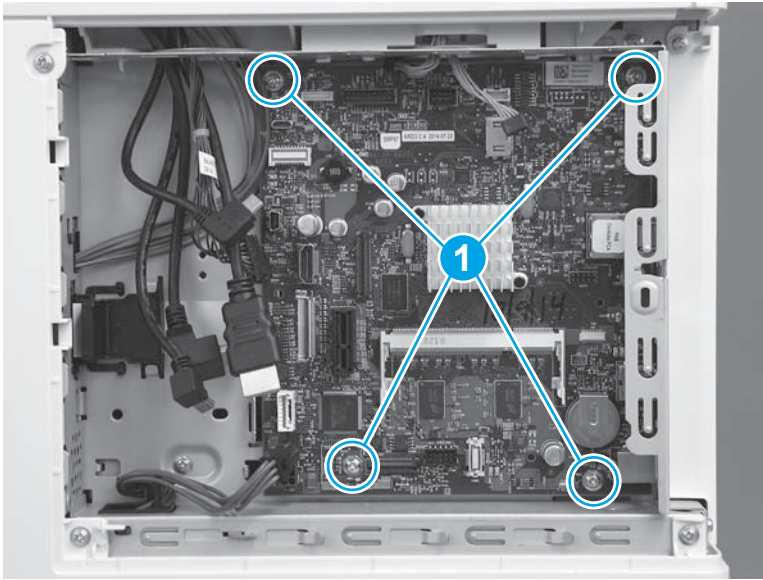

3. Connect all of the connectors on the formatter.

The following connectors are empty:

- All models: J1 (this connector is empty unless the optional DIMM is installed)
- All models: J3
- M577dn: J15 (this is the fax connector for the M577f/z/c models)
- All models: J21 (this connector is empty unless the optional internal USB ports component is installed)
- All models: J23
- All models: J24
- All models: J51
- All models: J57
- All models: J97
- All models: J98 (this connector is empty unless the optional trusted platform module (TPM) is installed)

 **IMPORTANT:** The flat-cable connector (callout 1) is a Zero Insertion Force (ZIF) connector that uses a hinged retainer to secure the flat cable. The hinged retainer must be opened to install the flat cable, and then closed after the cable is installed.

Figure 1-3071 Connect all connectors



Step 44: Install the fax PCA (M577c/f/z)

 **NOTE:** This step is for the M577c/f/z models. For the M577n model, skip this step and go to [Step 45: Install the HDD \(M577\) on page 1730](#).

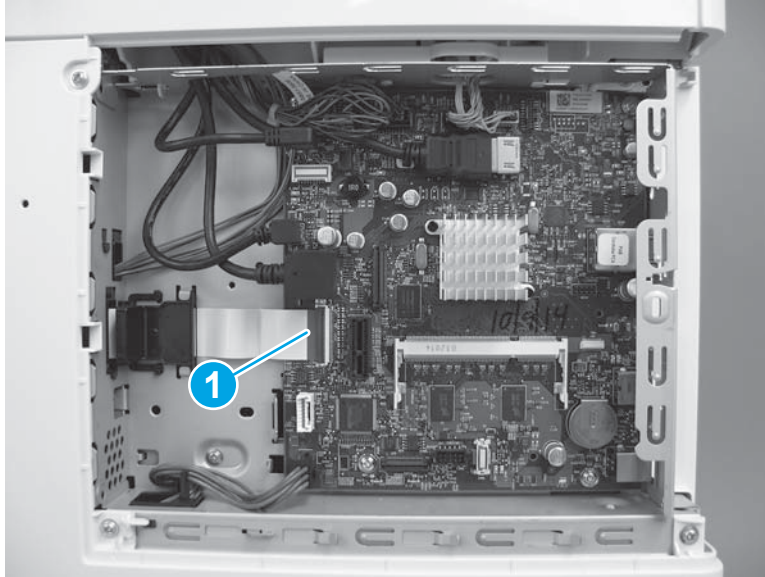
For the M552 and M553 models, skip this step and go to [Step 46: Install the formatter \(M552 and M553\) on page 1732](#).

 **CAUTION:**  ESD-sensitive part.

1. Position the tab and telephone port (callout 1) on the fax PCA in the slots (callout 2) in the formatter case.

Figure 1-3072 Position the fax PCA

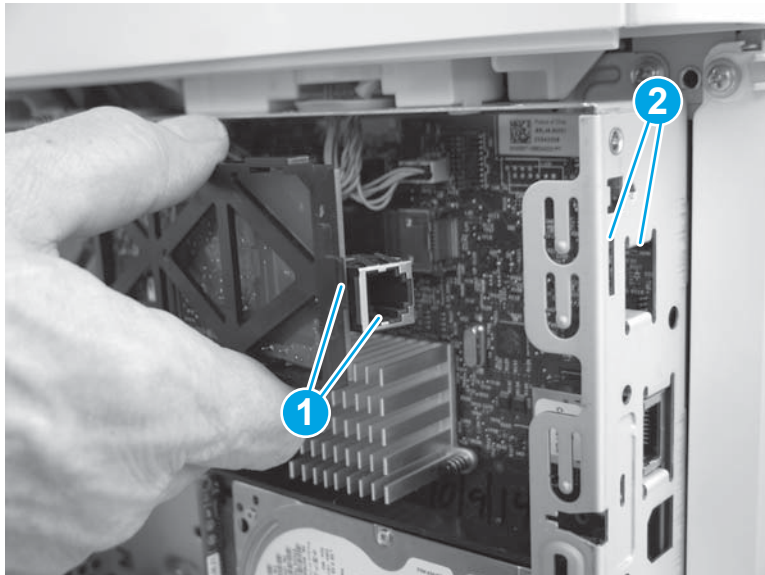

- Slide the fax PCA to the right (callout 1) until the tab and telephone port described in the previous step and seated in the formatter case. Position the retainer (callout 2) in the slot (callout 3) in the formatter. Rotate the end of the fax PCA toward the formatter (callout 4) until the retainer snaps into place.

Figure 1-3073 Install the fax PCA

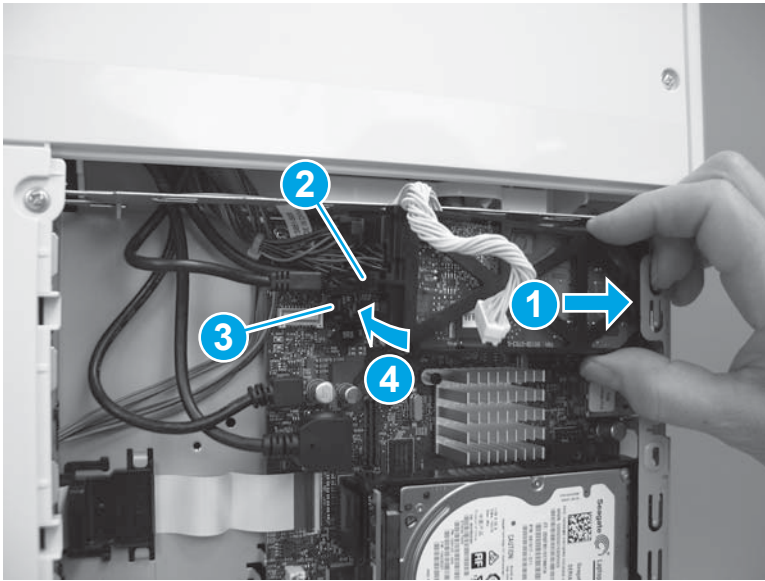

- Position the cable (callout 1) in the guide (callout 2), and then connect one connector (callout 3).

Figure 1-3074 Connect the connector

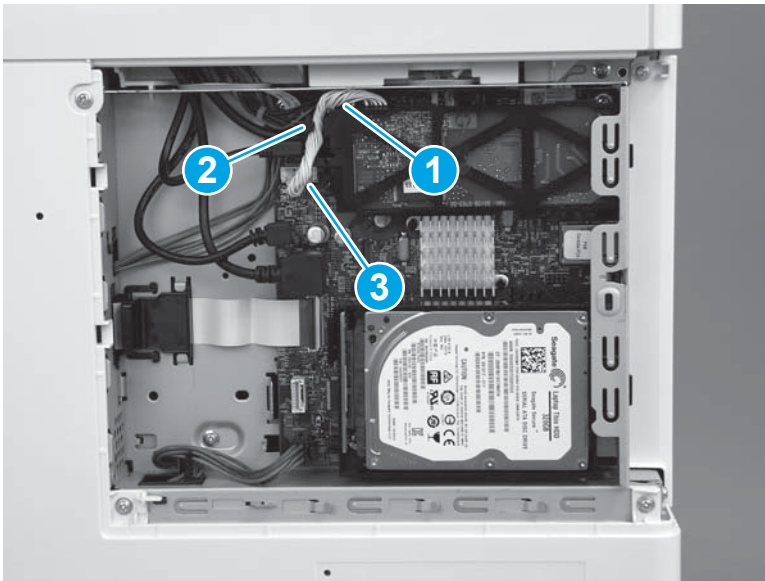

Step 45: Install the HDD (M577)



NOTE: This step is for the M577 models. For the M552 and M553 models, skip this step and go to [Step 46: Install the formatter \(M552 and M553\) on page 1732](#).

 **CAUTION:**  ESD-sensitive part.

1. Align the end of the bracket (callout 1) with the slot in the chassis (callout 2), and then slide the HDD into the printer (callout 3) to engage the bracket with the chassis.

Figure 1-3075 Install the holder

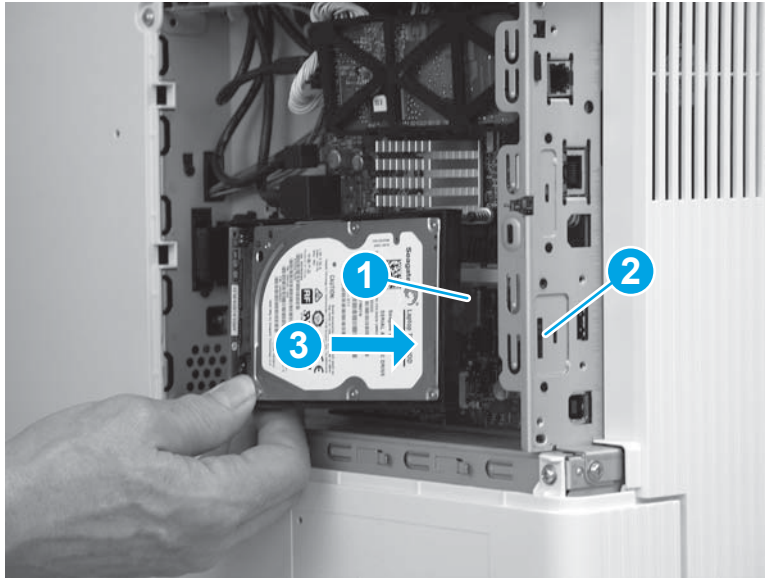

2. Hold the HDD connector latch (callout 1) in the released position, and then rotate the HDD down and into the connector on the formatter to install it.

 **NOTE:** Make sure that the tab (callout 2) snaps into place, and that the HDD is securely installed.

Figure 1-3076 Release the HDD

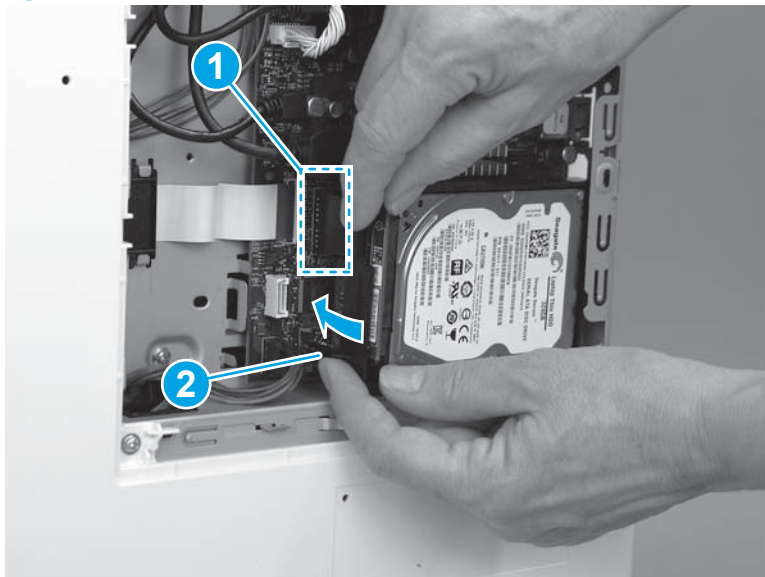

Step 46: Install the formatter (M552 and M553)

 **NOTE:** This step is for the M552 and M553 models. For the M577 models, skip this step and go to [Step 47: Install the formatter cover on page 1733](#).

If the optional hard-disk drive (HDD) was removed, do not forget to reinstall it after the formatter is reinstalled.

Engage the HDD holder with the chassis, rotate the HDD connector down and into the connector on the formatter. Make sure that the tabs snap into place.

 **CAUTION:**  ESD-sensitive part.

1. Position the formatter in the printer, and then install four screws (callout 1).

Figure 1-3077 Install the formatter

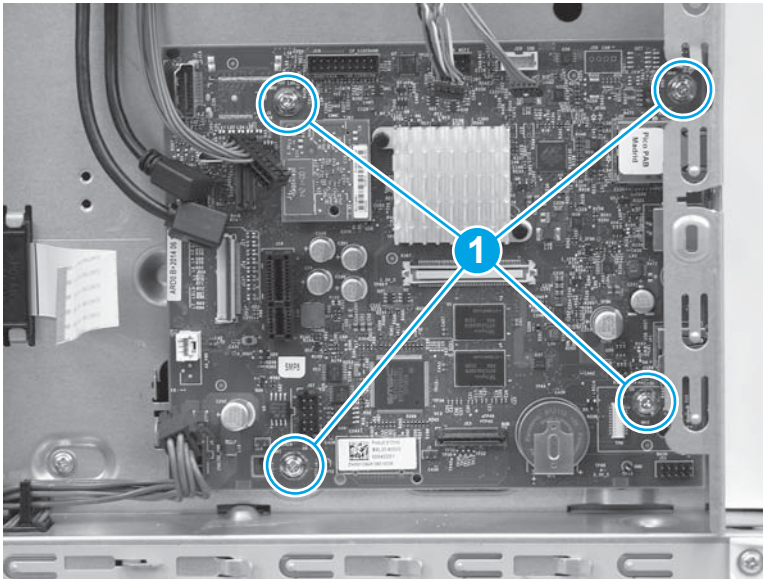

2. Connect all of the connectors on the formatter.

The following connectors are empty:

- All models: J1 (this connector is empty unless the optional DIMM is installed)
- M553n/dn and M552dn: J2 (callout 1; this is the touchscreen connector for the M553x model)
- All models: J9 (this connector is empty unless the optional internal USB ports component is installed)
- All models: J18 (this connector is empty unless the optional hard-disk-drive (HDD) is installed)
- All models: J23
- All models: J24
- M553n/dn and M552dn: J25 (this is the wireless connector for the M553x model)
- All models: J57
- All models: J98 (this connector is empty unless the optional trusted platform module (TPM) is installed)



 **IMPORTANT:** The flat-cable connector (callout 2) is a Zero Insertion Force (ZIF) connector that uses a hinged retainer to secure the flat cable. The hinged retainer must be opened to install the flat cable.

Figure 1-3078 Connect all connectors

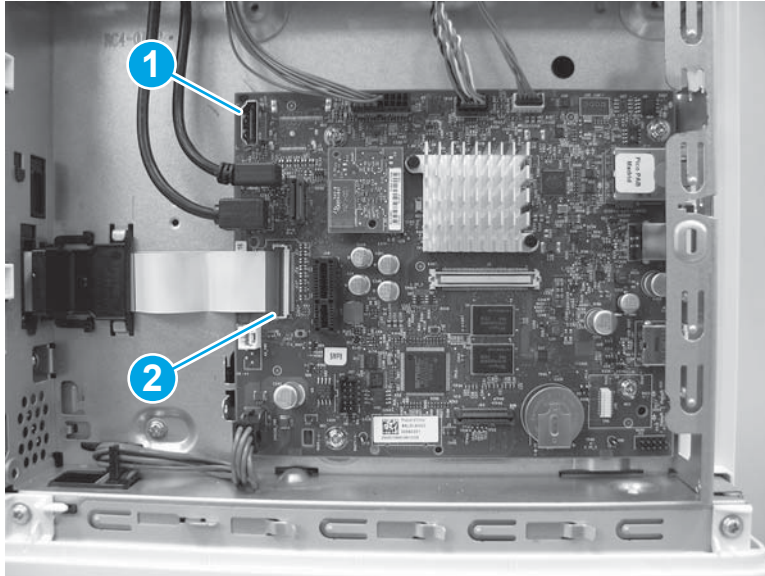

Step 47: Install the formatter cover

- ▲ Slide the cover onto the printer (callout 1) to install it.

 **NOTE:** Make sure that the tabs on the formatter cover align with the slots provided in the printer (callout 2). Tighten the two thumbscrews (callout 3).

 **TIP:** If needed, use the edge of a coin to turn the thumbscrews.

Figure 1-3079 Install the cover



Step 48: Install the TCU

1. Verify that the toner collection hatch cover is in the closed position on the TCU.

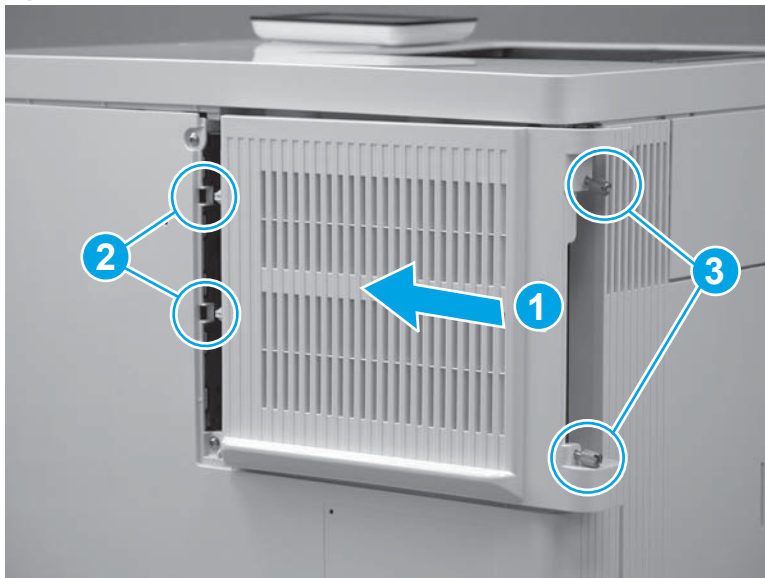
Figure 1-3080 Verify that the toner collection hatch cover is closed

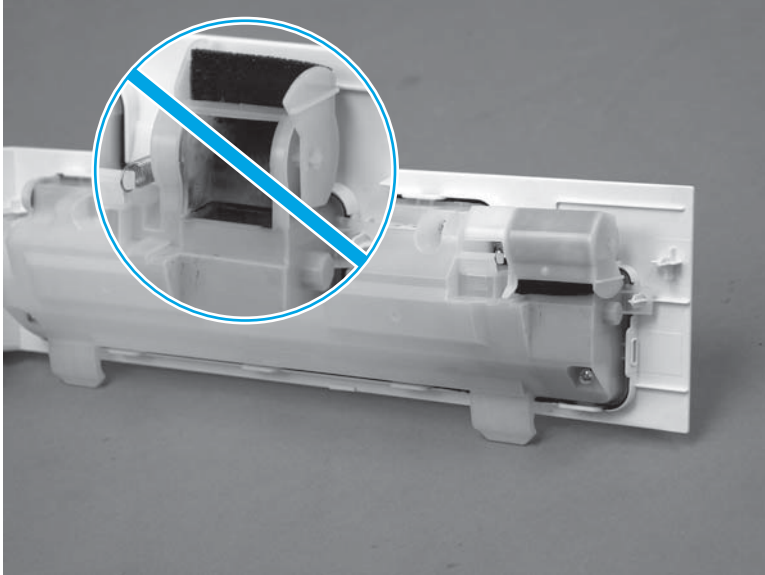

2. Position the TCU with the hinges in the slots provided in the printer (callout 1), and then rotate the TCU up and into the closed position.

 **NOTE:** The toner collection hatch cover automatically opens when the TCU is closed.

Figure 1-3081 Install the TCU



3. Close the front door.

Figure 1-3082 Close the front door

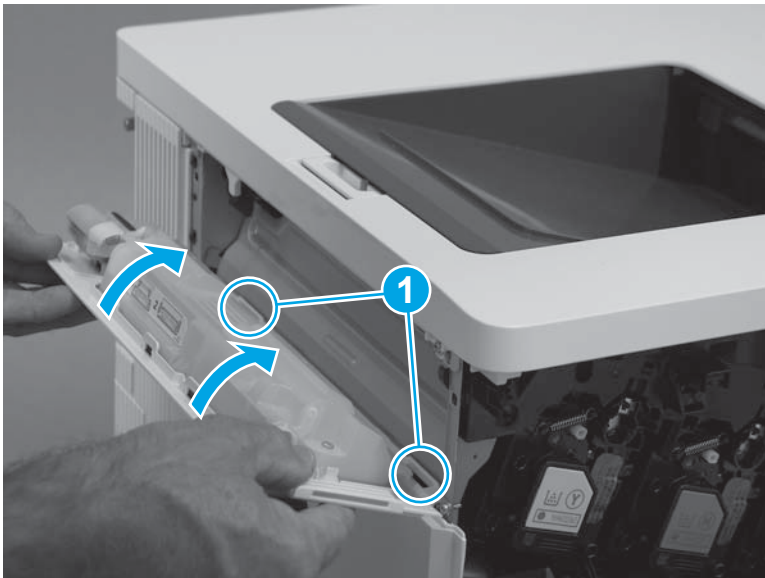

Step 49: Install the tray

1. With the front of the tray slightly lifted, align the sides of the tray with the rails in the printer, and then carefully slide the tray into the printer.

 **TIP:** As the tray slides into the printer, lower the front of it.

Figure 1-3083 Install the tray



2. Close the tray.

Figure 1-3084 Close the tray



Step 50: Install the control-panel assembly (M553x only)

 **NOTE:** For the M553n/dn and M552dn models, skip this step and go to [Step 51: Install the USB cover \(M552 and M553\) on page 1739](#).

For the M577 models, skip this step.

1. Place the control panel on the printer as shown.

Figure 1-3085 Place the control panel on the product

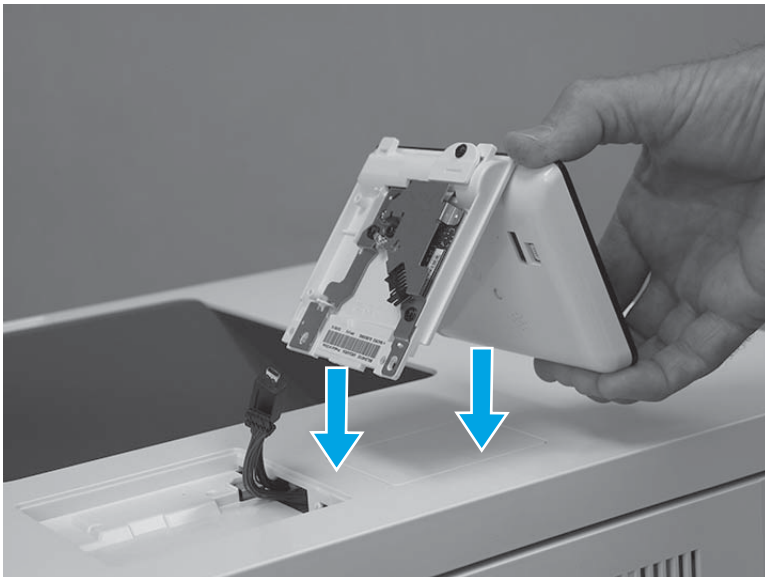

2. Connect one USB cable (callout 1), and one connector (callout 2).

 **IMPORTANT:** Take note of the location of the two mounting tabs (callout 3) on the control-panel assembly.

Figure 1-3086 Connect two connectors



3. Turn the control panel over, and then position the front edge tabs in the slots in the top cover.

Figure 1-3087 Turn the control panel over

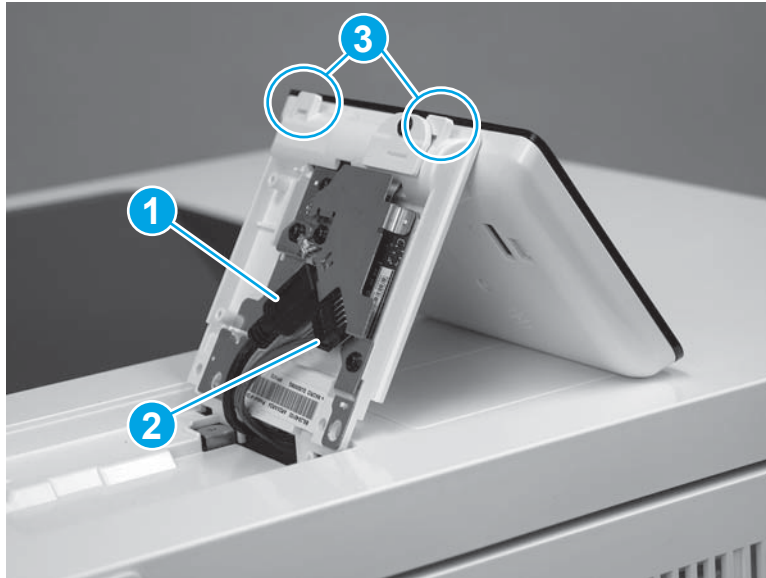
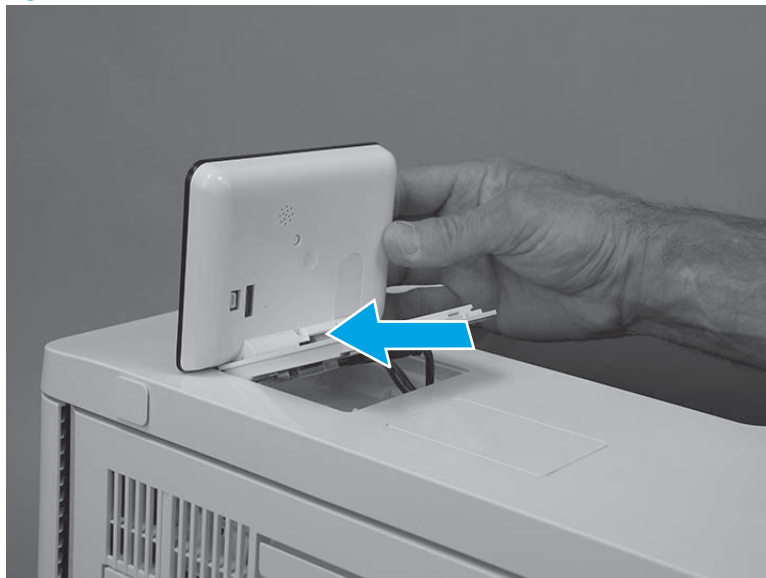

4. Rotate the control-panel base down onto the printer.

Figure 1-3088 Rotate the control-panel base down



5. Use a small Phillips screwdriver to install two screws (callout 1).

Figure 1-3089 Install two screws

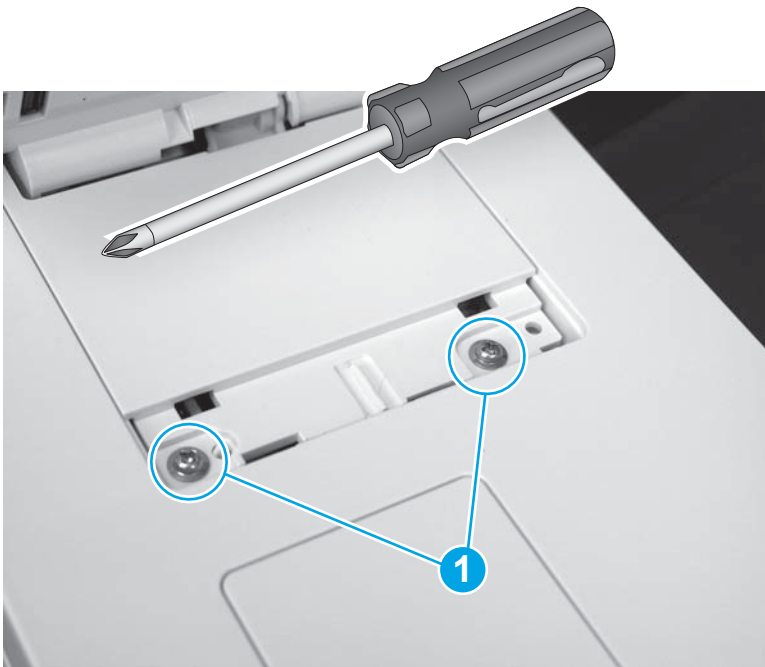

6. Position the screw cover mounting feet into the slots in the top cover (callout 1), and then rotate the cover down (callout 2) to install it.

 **NOTE:** Press down on the cover firmly to make sure that the tabs on the cover (callout 3) snap into place.

Figure 1-3090 Install the cover

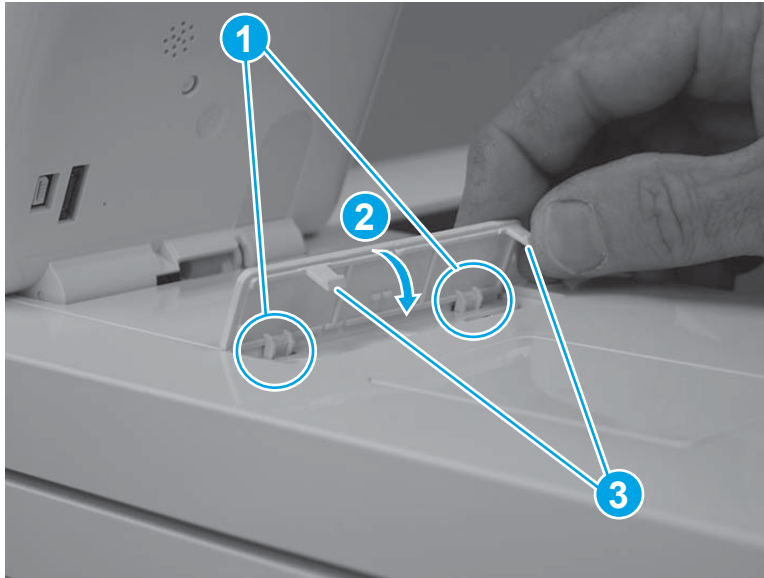

Step 51: Install the USB cover (M552 and M553)

 **NOTE:** This step is for the M552 and M553 models. For the M577 models, skip this step.

1. Push the cover into the USB port to install it.

Figure 1-3091 Install the cover



2. Make sure that the USB cover is fully seated after installing it.

Figure 1-3092 Check the installation

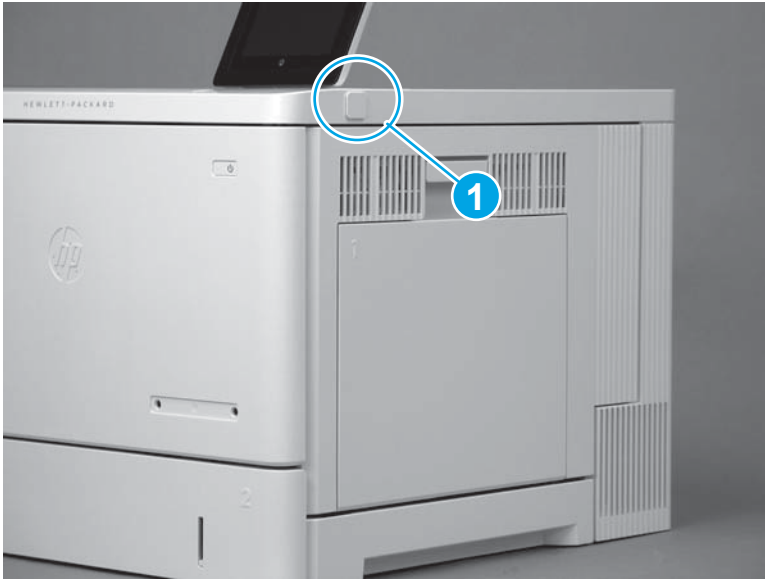

Removal and replacement: Fuser motor (M4)

- [Introduction](#)
- [Step 1: Remove the USB cover \(M552 and M553\)](#)
- [Step 2: Remove the control panel \(M553x only\)](#)
- [Step 3: Remove the tray](#)
- [Step 4: Remove the toner collection unit \(TCU\)](#)
- [Step 5: Remove the formatter cover](#)
- [Step 6: Remove the formatter \(M552 and M553\)](#)
- [Step 7: Remove the hard-disk drive \(HDD\) \(M577\)](#)
- [Step 8: Remove the fax PCA \(M577c/f/z\)](#)
- [Step 9: Remove the formatter \(M577\)](#)
- [Step 10: Remove the rear cover \(M552 and M553\)](#)
- [Step 11: Remove the rear upper cover \(M577\)](#)
- [Step 12: Remove the rear cover \(M577\)](#)
- [Step 13: Remove the left upper cover \(M577\)](#)
- [Step 14: Remove the right front upper cover \(M577dn\)](#)
- [Step 15: Remove the stapler cover assembly \(M577c/f/z\)](#)
- [Step 16: Remove the integrated scanner assembly \(ISA\) \(M577\)](#)
- [Step 17: Remove the right upper cover \(M577\)](#)
- [Step 18: Remove the top rear cover \(M577\)](#)
- [Step 19: Remove the left cover](#)
- [Step 20: Remove the upper cover \(M552 and M553\)](#)
- [Step 21: Remove the formatter case](#)
- [Step 22: Remove the right rear cover](#)
- [Step 23: Remove the DC controller and sheet-metal bracket](#)
- [Step 24: Remove the high-voltage power supply T \(HVPST\)](#)
- [Step 25: Remove the fuser motor \(M4\)](#)
- [Step 26: Unpack the replacement assembly](#)
- [Step 27: Install the fuser motor \(M4\)](#)
- [Step 28: Install the HVPST](#)
- [Step 29: Install the DC controller and sheet-metal bracket](#)

- [Step 30: Install the right rear cover](#)
- [Step 31: Install the formatter case](#)
- [Step 32: Install the upper cover \(M552 and M553\)](#)
- [Step 33: Install the left cover](#)
- [Step 34: Install the top rear cover \(M577\)](#)
- [Step 35: Install the right upper cover \(M577\)](#)
- [Step 36: Install the integrated scanner assembly \(ISA\) \(M577\)](#)
- [Step 37: Install the stapler cover assembly \(M577c/f/z\)](#)
- [Step 38: Install the right front upper cover \(M577dn\)](#)
- [Step 39: Install the left upper cover \(M577\)](#)
- [Step 40: Install the rear cover \(M577\)](#)
- [Step 41: Install the rear upper cover \(M577\)](#)
- [Step 42: Install the rear cover \(M552 and M553\)](#)
- [Step 43: Install the formatter \(M577\)](#)
- [Step 44: Install the fax PCA \(M577c/f/z\)](#)
- [Step 45: Install the HDD \(M577\)](#)
- [Step 46: Install the formatter \(M552 and M553\)](#)
- [Step 47: Install the formatter cover](#)
- [Step 48: Install the TCU](#)
- [Step 49: Install the tray](#)
- [Step 50: Install the control-panel assembly \(M553x only\)](#)
- [Step 51: Install the USB cover \(M552 and M553\)](#)

Introduction

This document provides the procedures to remove and replace the fuser motor (M4).

Before performing service

Turn the printer power off

- Disconnect the power cable.

 **WARNING!** To avoid damage to the printer, turn the printer off, wait 30 seconds, and then remove the power cord before attempting to service the printer.

Use the table below to identify the correct part number for your printer, and then go to <http://h20141.www2.hp.com/hpparts> to order the part.

Fuser motor (M4) part number

RM2-0077-000CN

Fuser motor (M4)

Required tools

- #2 Phillips screwdriver with a magnetic tip

After performing service

Make sure that all of the connectors on the HVPST are fully seated.

Make sure that all of the connectors on the DC controller are fully seated.

Make sure that all of the connectors on the formatter are fully seated.

Make sure that the formatter cover is fully seated, and that the thumbscrews are finger tight after replacing it.

Turn the printer power on

- Connect the power cable.
- Use the power switch to turn the power on.

Post service test

Use the components test to test the motor. For more information, see the printer troubleshooting manual.

Step 1: Remove the USB cover (M552 and M553)

 **NOTE:** This step is for the M552 and M553 models. For the M577 models, skip this step and go to [Step 3: Remove the tray on page 1748](#).

1. Locate the USB cover.

Figure 1-3093 Locate the USB cover



2. Pull the cover off of the printer to remove it.

Figure 1-3094 Remove the cover



Step 2: Remove the control panel (M553x only)

 **NOTE:** This step is for the M553x model. For the M553n/dn, M552dn, and M577 models, skip this step and go to [Step 3: Remove the tray on page 1748](#).

1. Tilt the control panel up.

Figure 1-3095 Tilt the control panel up



2. Use a small flat-blade screwdriver to release the control-panel screws cover tabs.

Figure 1-3096 Release the control-panel screws cover tabs



3. Rotate the cover up to remove it.

Figure 1-3097 Remove the cover



4. Use a small Phillips screwdriver to remove two screws (callout 1).

 **IMPORTANT:** Store the screws in a secure place where they cannot fall down into the printer.

Figure 1-3098 Remove two screws

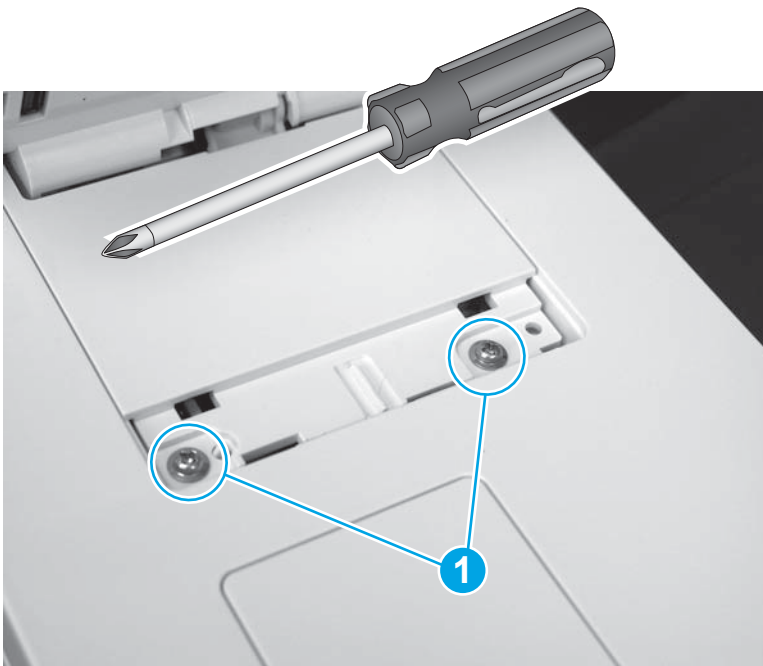

5. Rotate the control-panel base toward the front of the printer.

Figure 1-3099 Rotate the control-panel base up



6. Slightly slide the control-panel base toward the rear of the printer (callout 1) to release it, and then turn the control panel over (callout 2) to access the bottom side.

⚠ CAUTION: The control panel is still attached to the printer. Do not attempt to completely remove the control panel.

Figure 1-3100 Turn the control panel over

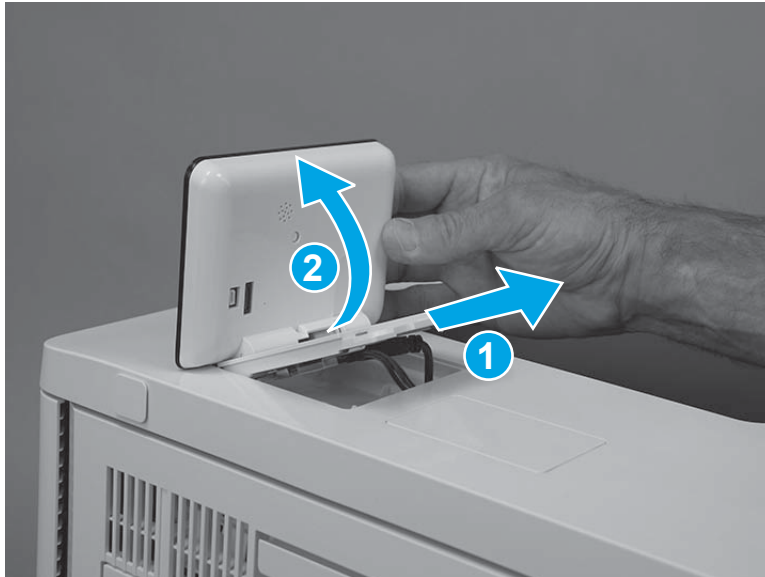

7. Disconnect one USB cable (callout 1), one connector (callout 2), and then remove the control panel.

Figure 1-3101 Disconnect two connectors

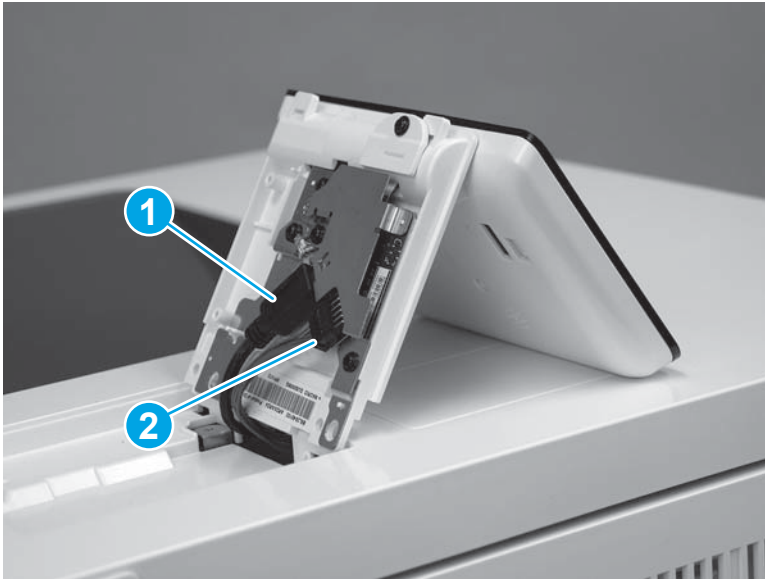

Step 3: Remove the tray

1. Pull the tray out until it stops.

Figure 1-3102 Pull the tray out



2. Lift the front of the tray, and then pull it out of the printer to remove it.

Figure 1-3103 Remove the tray

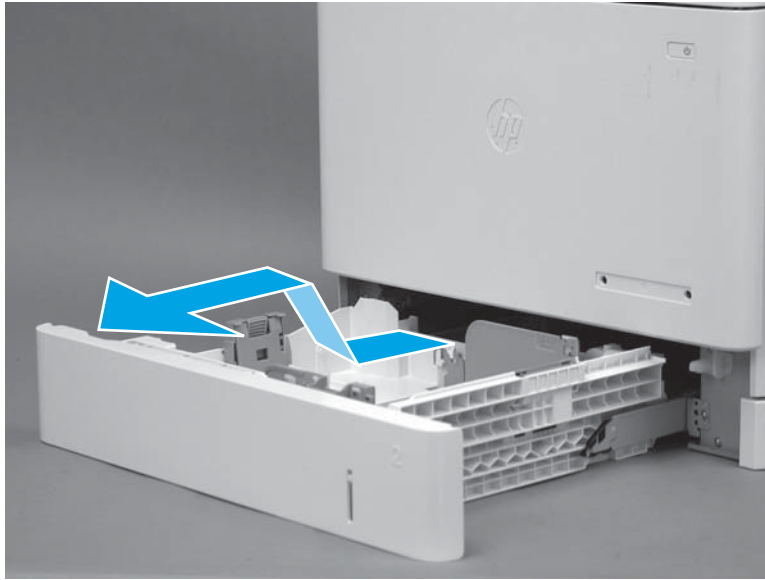

Step 4: Remove the toner collection unit (TCU)

1. Open the front door.

Figure 1-3104 Open the front door



2. Open the TCU.

 **NOTE:** The toner collection hatch cover automatically closes when the TCU is opened.

Figure 1-3105 Open the TCU



3. Pull the TCU away from the printer at an angle to remove it.

⚠ CAUTION: Do not open the toner collection hatch cover when handling the TCU. If toner gets on clothing, wipe it off by using a dry cloth and wash the clothes in cold water. Hot water sets toner into fabric.

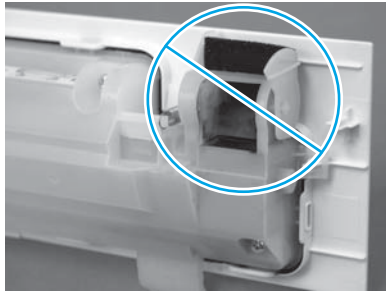
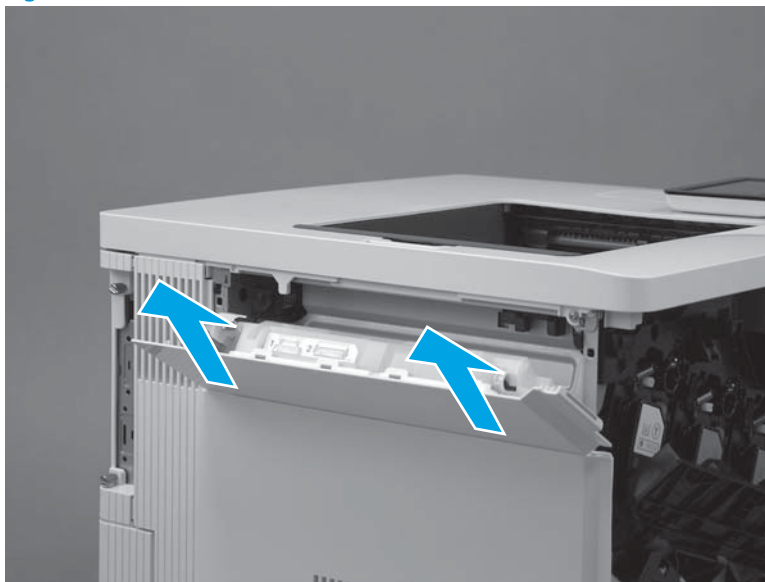

Figure 1-3106 Remove the TCU



Step 5: Remove the formatter cover

1. Locate the formatter cover.

Figure 1-3107 Locate the formatter cover

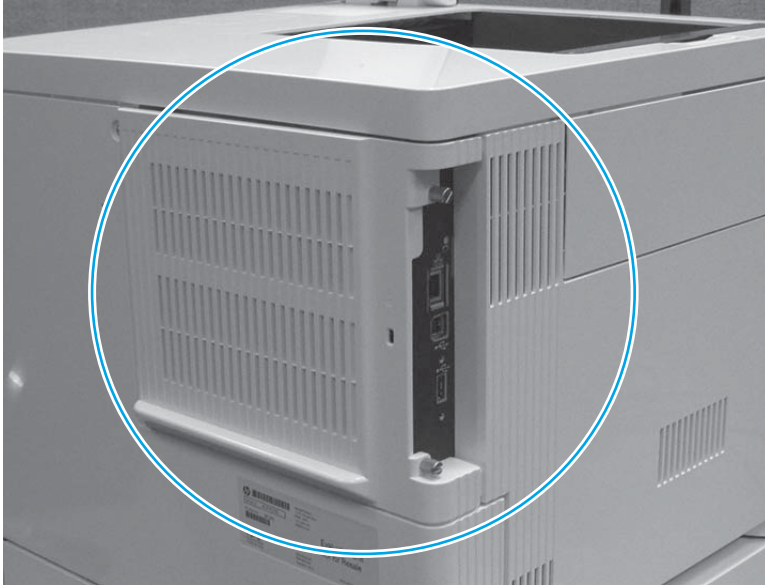

2. Loosen the two thumbscrews (callout 1). Grasp the two thumbscrews, and then slide the cover away from the printer (callout 2) to remove it.

 **TIP:** If needed, use the edge of a coin to turn the thumbscrews.

Figure 1-3108 Loosen the thumbscrews

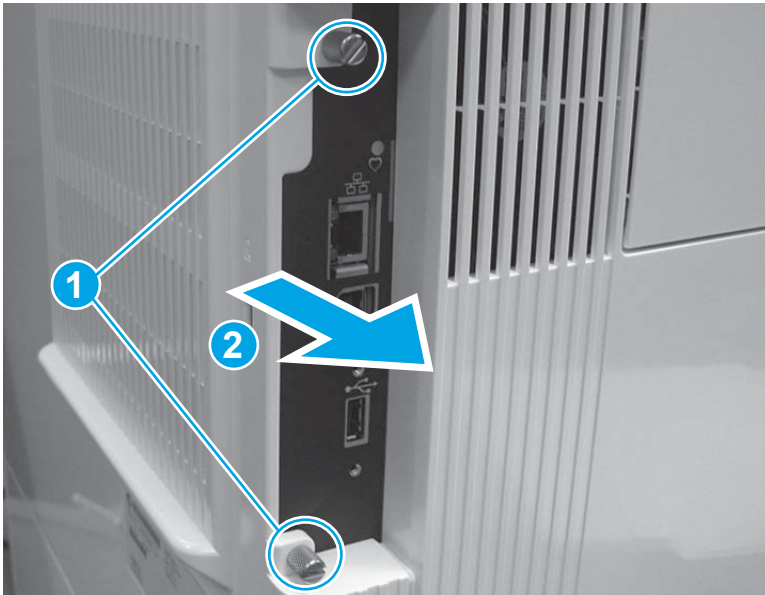

Step 6: Remove the formatter (M552 and M553)

 **NOTE:** This step is for the M552 and M553 models. For the M577 models, skip this step and go to [Step 7: Remove the hard-disk drive \(HDD\) \(M577\) on page 1754](#).

If the optional hard-disk drive (HDD) is installed, it must be removed to gain access to the formatter mounting screws.

Release two tabs along the left edge of the HDD, rotate the left edge away from the product, and then slide the HDD to the left to remove it.

 **CAUTION:**  ESD-sensitive part.

1. Disconnect all of the connectors on the formatter.

The following connectors are empty:

- All models: J1 (this connector is empty unless the optional DIMM is installed)
- M553n/dn and M552dn: J2 (callout 1; this is the touchscreen connector for the M553x model)
- All models: J9 (this connector is empty unless the optional internal USB ports component is installed)
- All models: J18 (this connector is empty unless the optional hard-disk-drive (HDD) is installed)
- All models: J23
- All models: J24
- M553n/dn and M552dn: J25 (this is the wireless connector for the M553x model)
- All models: J57
- All models: J98 (this connector is empty unless the optional trusted platform module (TPM) is installed)

 **IMPORTANT:** The flat-cable connector (callout 2) is a Zero Insertion Force (ZIF) connector that uses a hinged retainer to secure the flat cable. The hinged retainer must be opened to release the flat cable.

Figure 1-3109 Disconnect all connectors



2. Remove four screws (callout 1), and then remove the formatter.

Figure 1-3110 Remove the formatter

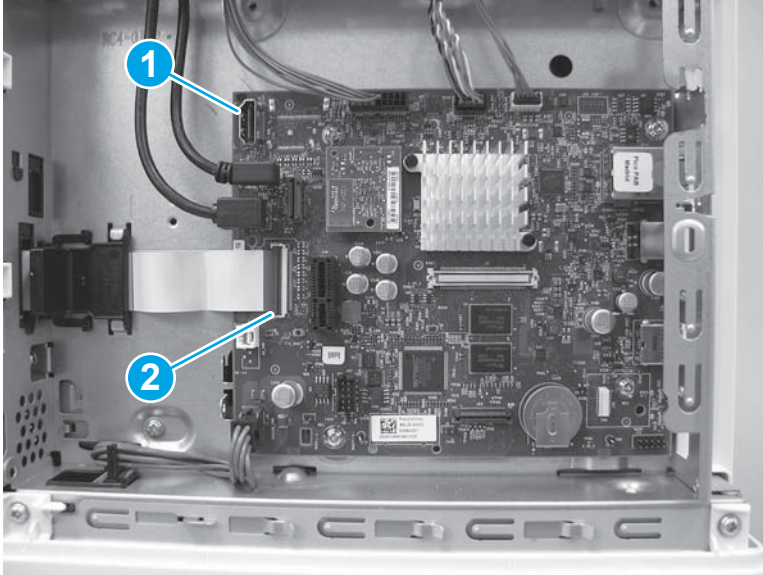
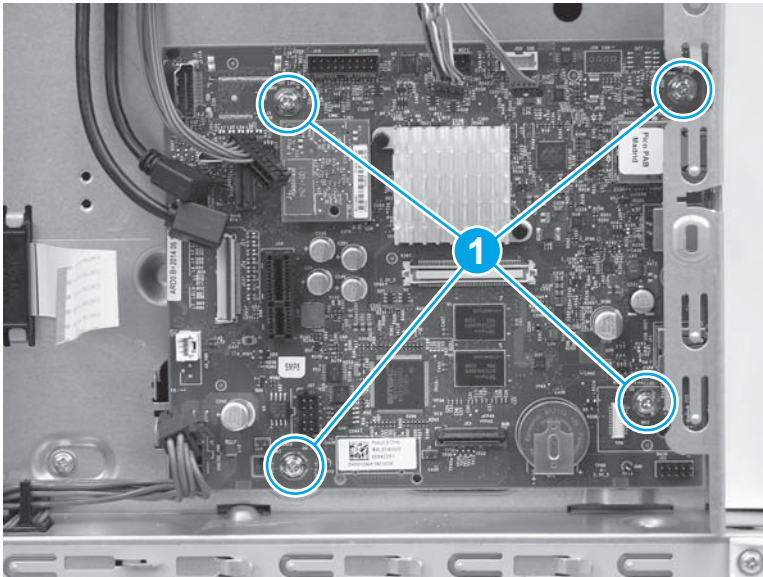

Step 7: Remove the hard-disk drive (HDD) (M577)

 **NOTE:** This step is for the M577 models. For the M552 and M553 models, skip this step and go to [Step 10: Remove the rear cover \(M552 and M553\) on page 1759](#).

 **CAUTION:**  ESD-sensitive part.

1. Release two tabs (callout 1). Hold the tabs in the released position, and then rotate the hard disk drive (HDD) up (callout 2) to release the connector from the formatter.

Figure 1-3111 Release the HDD

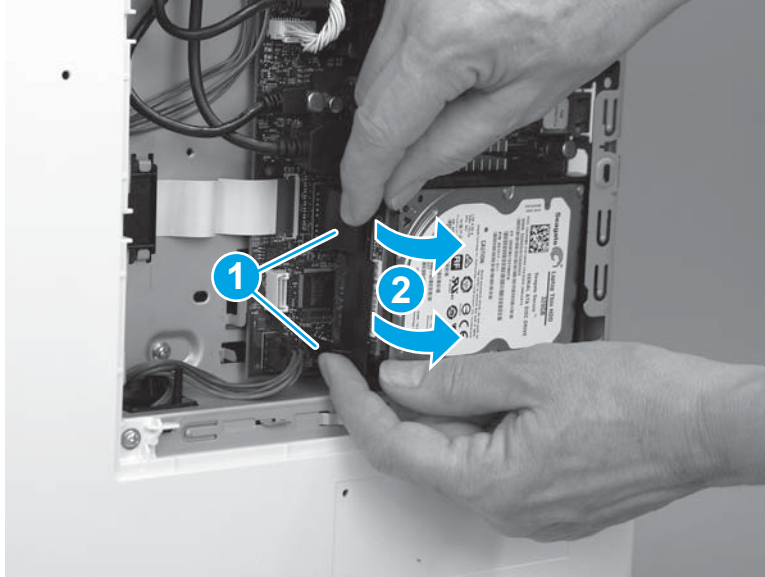

2. Slide the HDD away from the printer to remove it.

Figure 1-3112 Remove the HDD

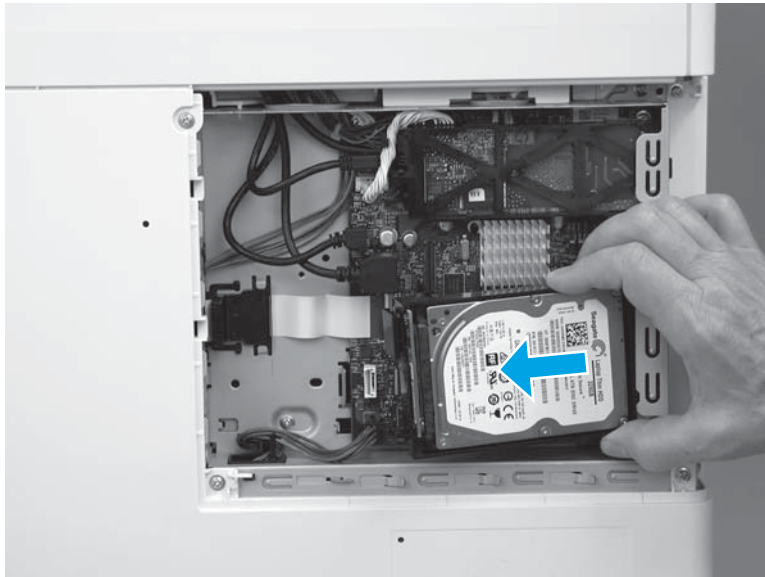

Step 8: Remove the fax PCA (M577c/f/z)

 **NOTE:** This step is for the M577c/f/z models. For the M577n model, skip this step and go to [Step 9: Remove the formatter \(M577\) on page 1757](#).

For the M552 and M553 models, skip this step and go to [Step 10: Remove the rear cover \(M552 and M553\) on page 1759](#).

 **CAUTION:**  ESD-sensitive part.

1. Locate the fax PCA component on the formatter.

Figure 1-3113 Locate the fax PCA

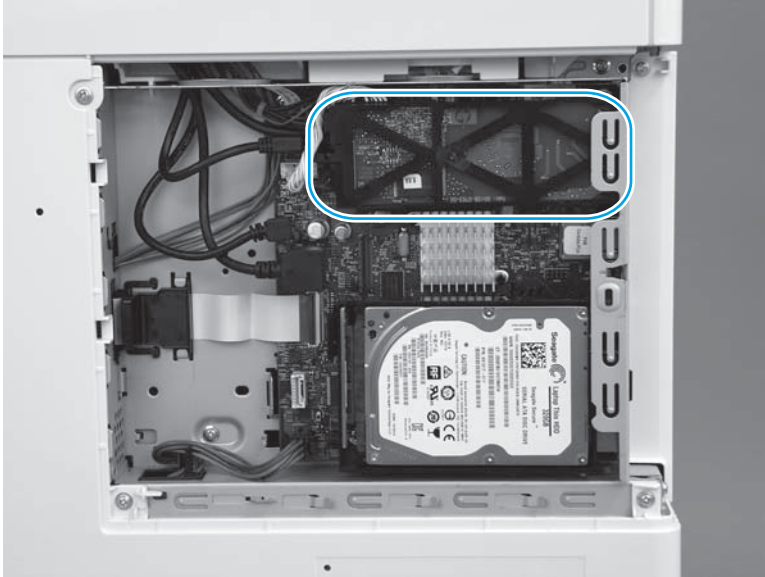

2. Release the connector latch (callout 1), and then pull the connector away from the formatter (callout 2) to disconnect it.

Figure 1-3114 Disconnect one connector

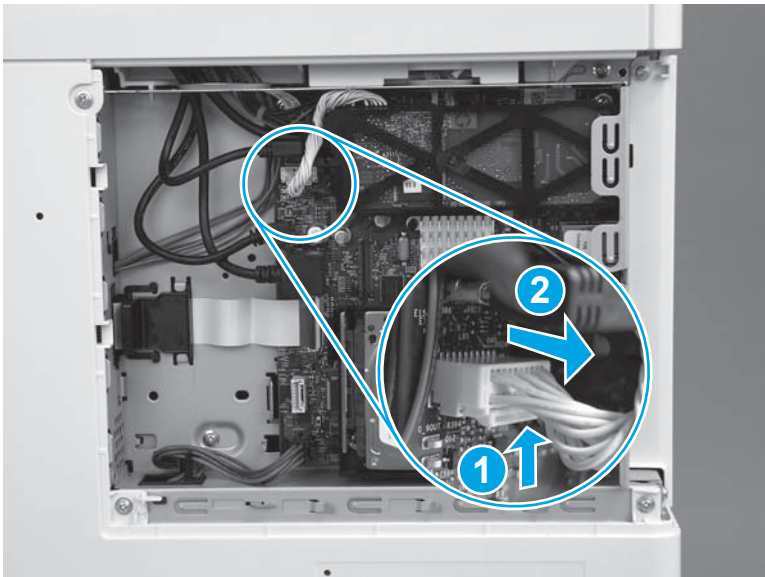

3. Release one retainer (callout 1) by pressing the bracket arms together.

Figure 1-3115 Release one latch

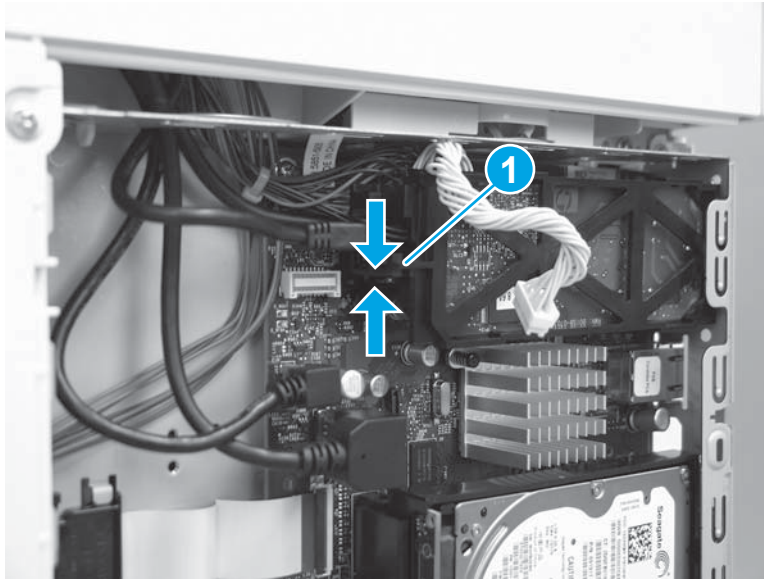

4. Rotate the end of the fax PCA (callout 1) away from the formatter, and then slide the PCA left (callout 2) to remove it.

Figure 1-3116 Remove the fax PCA

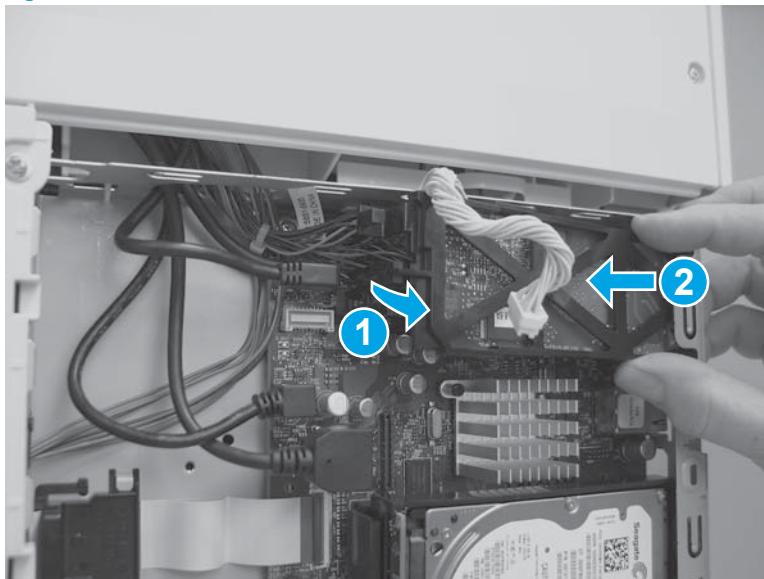

Step 9: Remove the formatter (M577)

 **NOTE:** This step is for the M577 models. For the M552 and M553 models, skip this step and go to [Step 10: Remove the rear cover \(M552 and M553\) on page 1759.](#)

 **CAUTION:**  ESD-sensitive part.

1. Disconnect all of the connectors on the formatter.

The following connectors are empty:

- All models: J1 (this connector is empty unless the optional DIMM is installed)
- All models: J3
- M577dn: J15 (this is the fax connector for the M577f/z/c models)
- All models: J21 (this connector is empty unless the optional internal USB ports component is installed)
- All models: J23
- All models: J24
- All models: J51
- All models: J57
- All models: J97
- All models: J98 (this connector is empty unless the optional trusted platform module (TPM) is installed)

 **IMPORTANT:** The flat-cable connector (callout 1) is a Zero Insertion Force (ZIF) connector that uses a hinged retainer to secure the flat cable. The hinged retainer must be opened to release the flat cable.

Figure 1-3117 Disconnect all connectors



2. Remove four screws (callout 1).

Figure 1-3118 Remove four screws

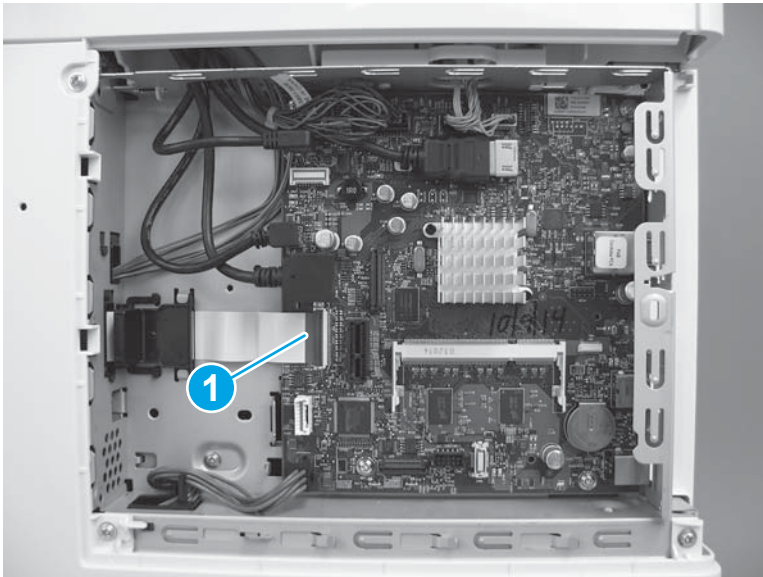
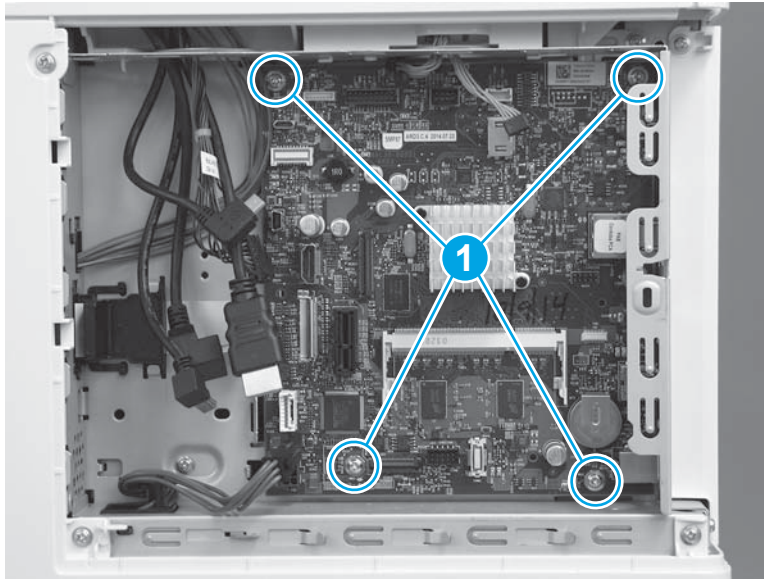

3. Remove the formatter.

Figure 1-3119 Remove the formatter

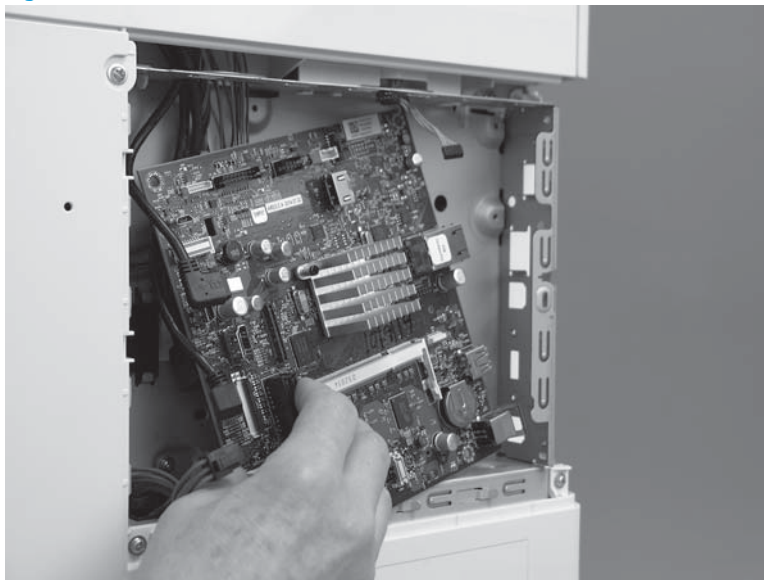

Step 10: Remove the rear cover (M552 and M553)

 **NOTE:** This step is for the M552 and M553 models. For the M577 models, skip this step and go to [Step 11: Remove the rear upper cover \(M577\) on page 1760.](#)

1. Remove four screws (callout 1).

Figure 1-3120 Remove four screws

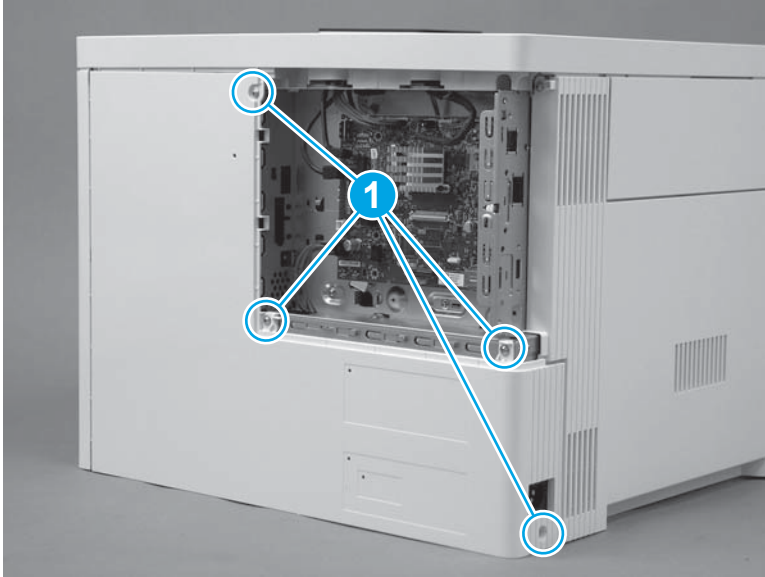

2. Slightly slide the cover to the right (callout 1), rotate the bottom of the cover away from the printer (callout 2), and then pull the top of the cover away from the printer (callout 3) to remove the cover.

Figure 1-3121 Remove the cover

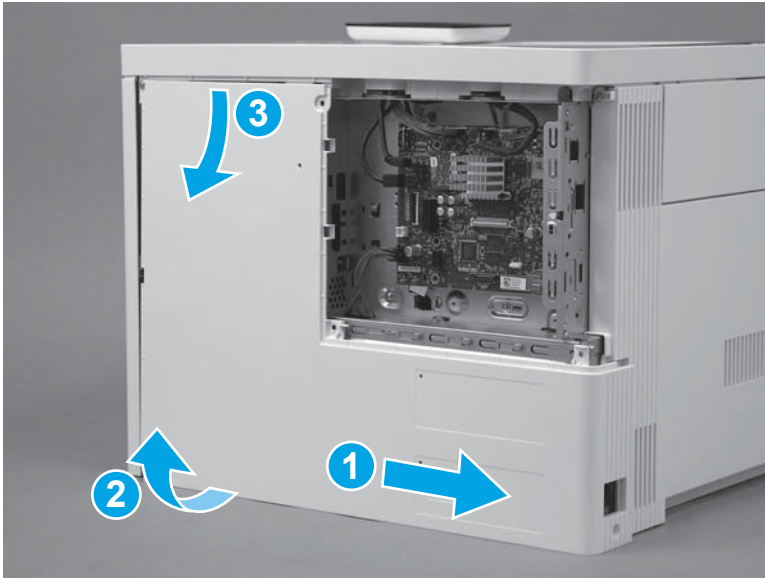

Step 11: Remove the rear upper cover (M577)

 **NOTE:** This step is for the M577 models. For the M552 and M553 models, skip this step and go to [Step 19: Remove the left cover on page 1775](#).

1. Remove two screws (callout 1).

 **Reinstallation tip:** These two screws are self-tapping screws for plastic. When reinstalling them, rotate the screws counterclockwise to align them with the existing thread pattern, and then carefully turn them clockwise to tighten. Do not overtighten. This will prevent stripping the threads inside the screw holes.

Figure 1-3122 Remove two screws



2. Use a small, flat blade screwdriver to release the right edge of the cover.

Figure 1-3123 Release the right edge

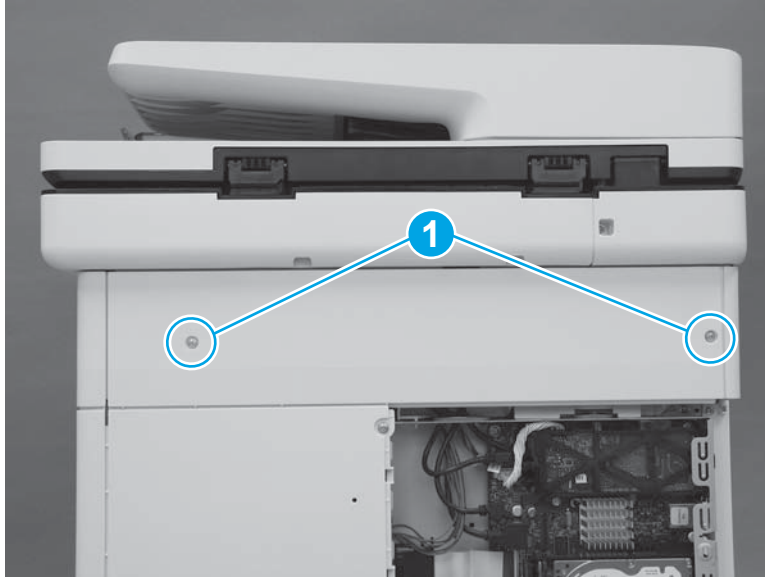
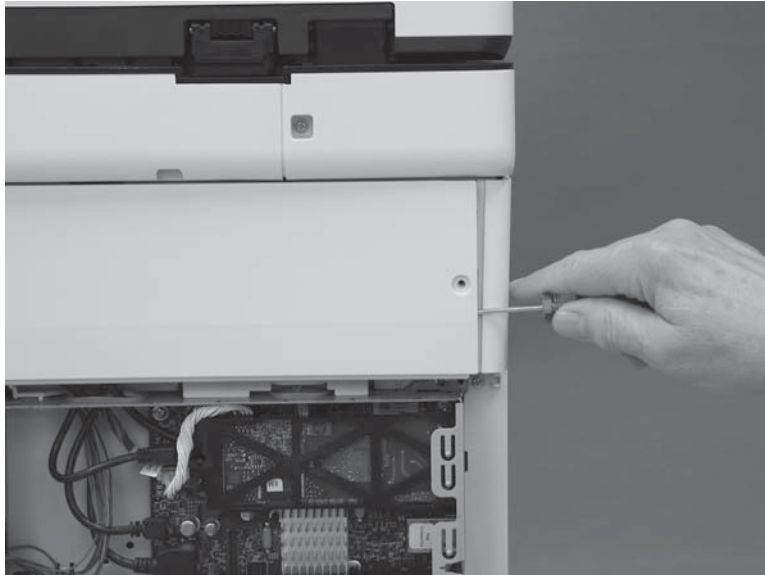

3. Pull the right edge of the cover (callout 1) away from the printer, and then slide the cover to the right (callout 2).

Figure 1-3124 Slide the cover right

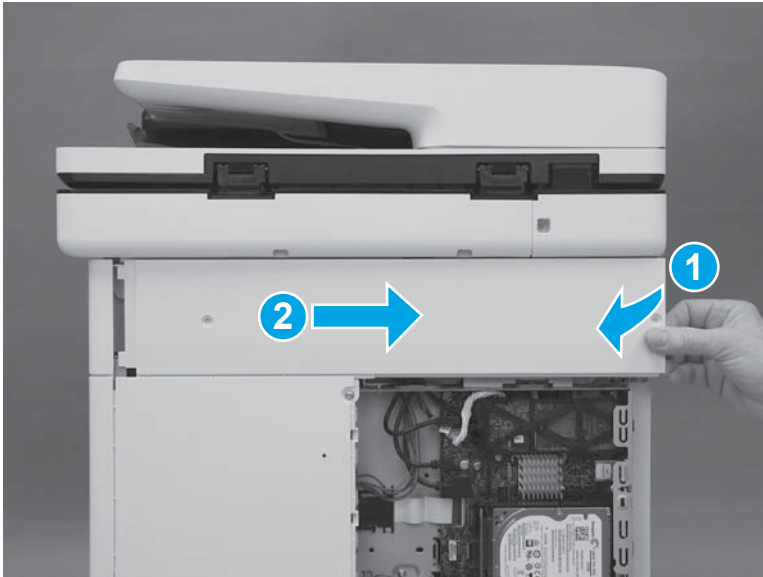

4. Remove the cover.

Figure 1-3125 Remove the cover

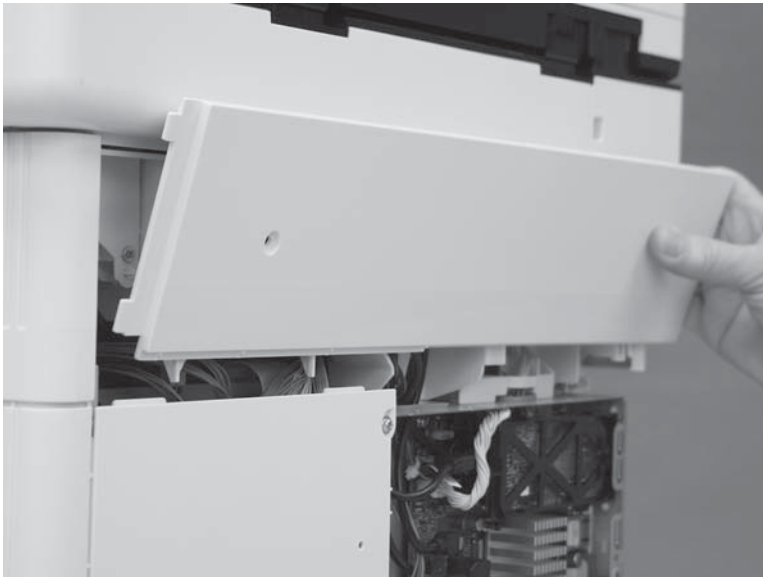

Step 12: Remove the rear cover (M577)

 **NOTE:** This step is for the M577 models. For the M552 and M553 models, skip this step and go to [Step 19: Remove the left cover on page 1775](#).

1. Remove four screws (callout 1).

Figure 1-3126 Remove four screws

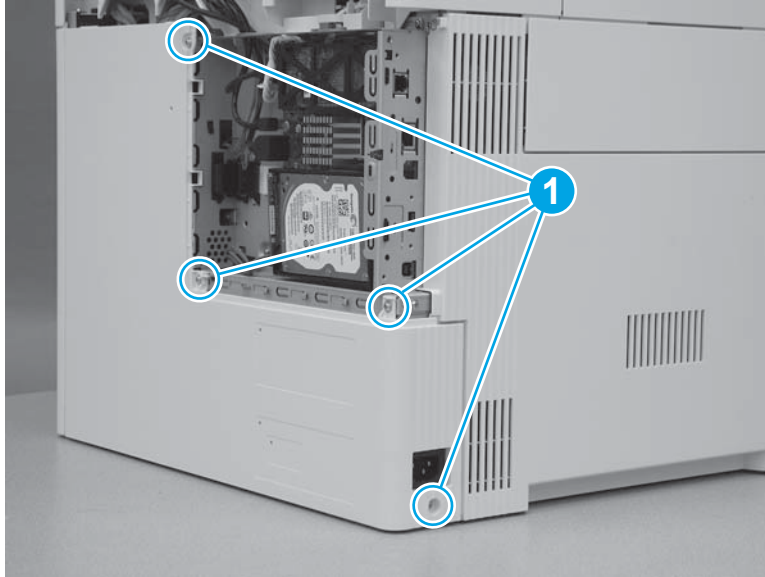

2. Slide the cover to the right to remove it.

Figure 1-3127 Remove the cover

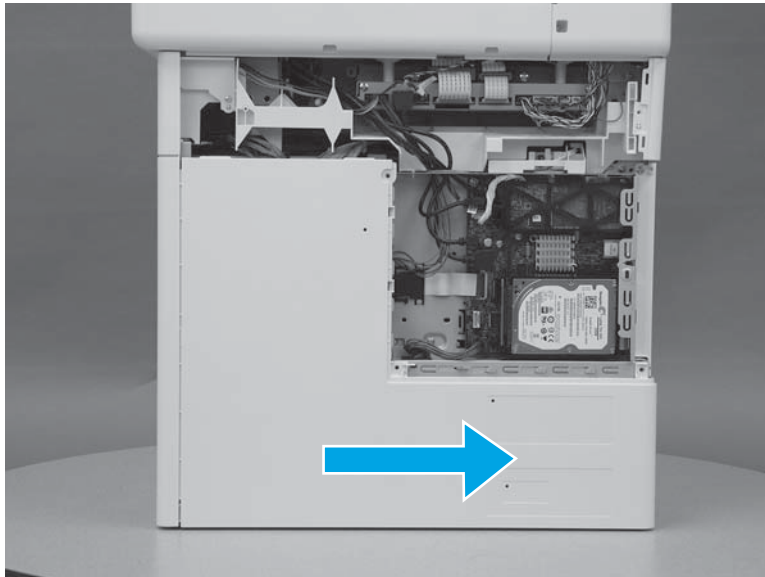

Step 13: Remove the left upper cover (M577)

 **NOTE:** This step is for the M577 models. For the M552 and M553 models, skip this step and go to [Step 19: Remove the left cover on page 1775](#).

1. At the left side of the printer, release one tab (callout 1).

Figure 1-3128 Release one tab

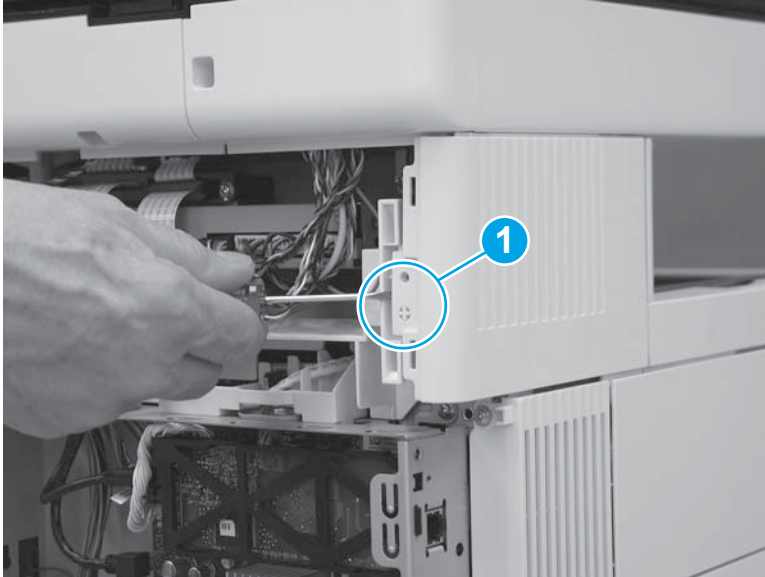

2. Slide the left upper cover toward the back of the printer.

Figure 1-3129 Slide the cover back

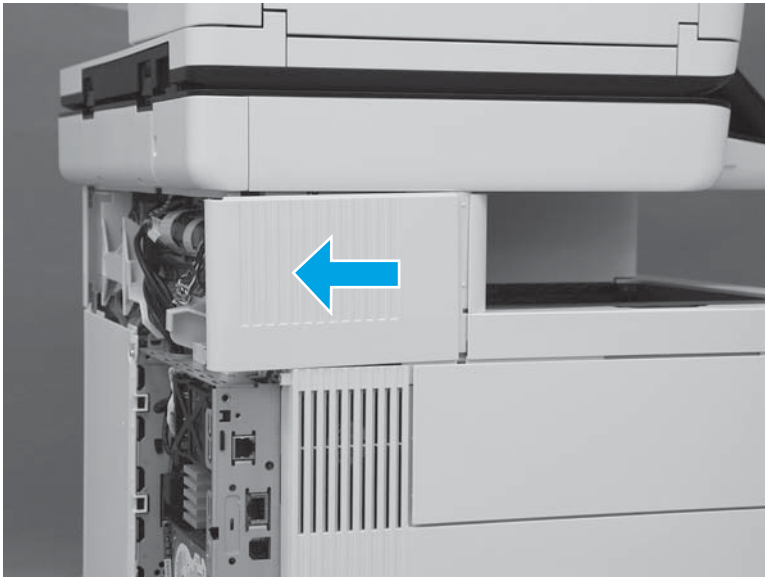

3. Rotate the cover up to remove it.

Figure 1-3130 Remove the left upper cover



Step 14: Remove the right front upper cover (M577dn)

 **NOTE:** This step is for the M577dn model. For the M577c/f/z models, skip this step and to go [Step 15: Remove the stapler cover assembly \(M577c/f/z\) on page 1766](#).

For the M552 and M553 models, skip this step and go to [Step 19: Remove the left cover on page 1775](#).

1. Remove one screw (callout 1).

Figure 1-3131 Remove one screw

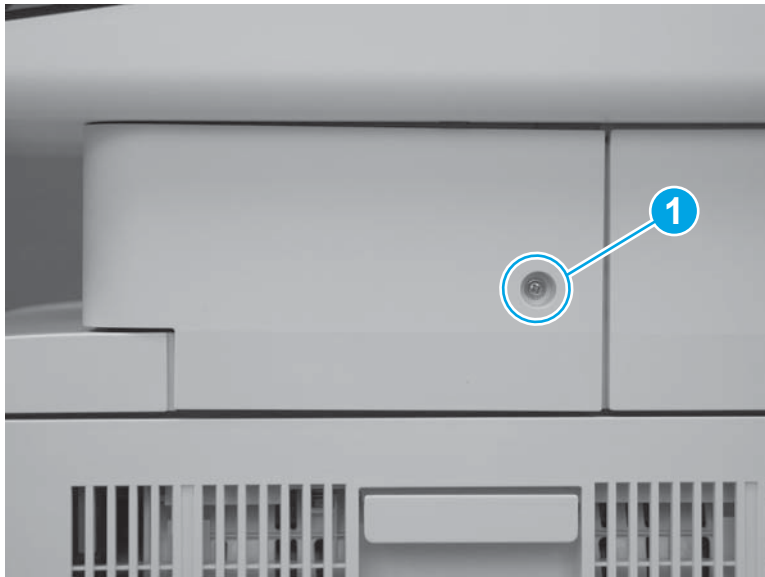

2. Release two tabs at the front edge of the cover (callout 1).

Figure 1-3132 Release two tabs



3. Rotate the front of the cover to the right to remove it.

Figure 1-3133 Rotate the cover



Step 15: Remove the stapler cover assembly (M577c/f/z)

 **NOTE:** This step is for the M577c/f/z models. For the M577dn model, skip this step and to go [Step 17: Remove the right upper cover \(M577\) on page 1771](#).

For the M552 and M553 models, skip this step and go to [Step 19: Remove the left cover on page 1775](#).

1. Remove one screw (callout 1).

 **Reinstallation tip:** This is a self-tapping screw for plastic. When reinstalling, rotate the screw counterclockwise to align it with the existing thread pattern, and then carefully turn it clockwise to tighten. Do not overtighten. This will prevent stripping the threads inside the screw hole.

Figure 1-3134 Remove one screw



2. Release two tabs at the front edge of the cover (callout 1).

Figure 1-3135 Release two tabs

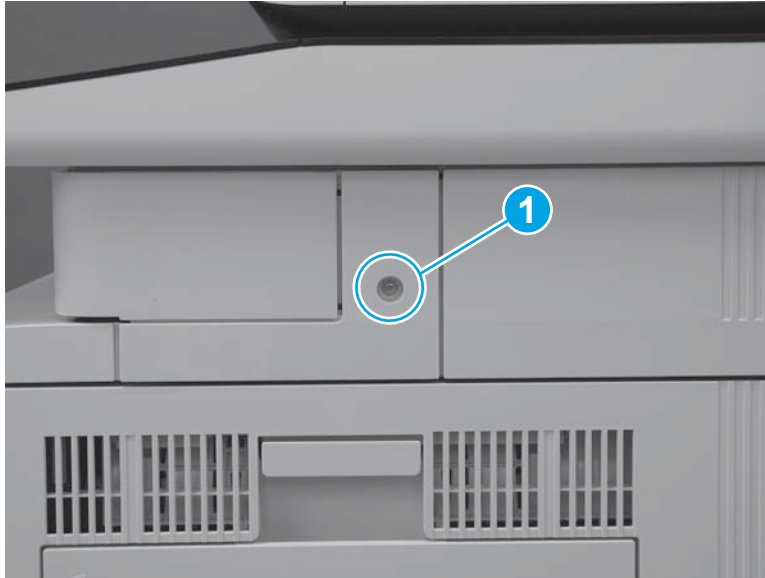

3. Release the back edge of the cover.

Figure 1-3136 Release the back edge of the cover

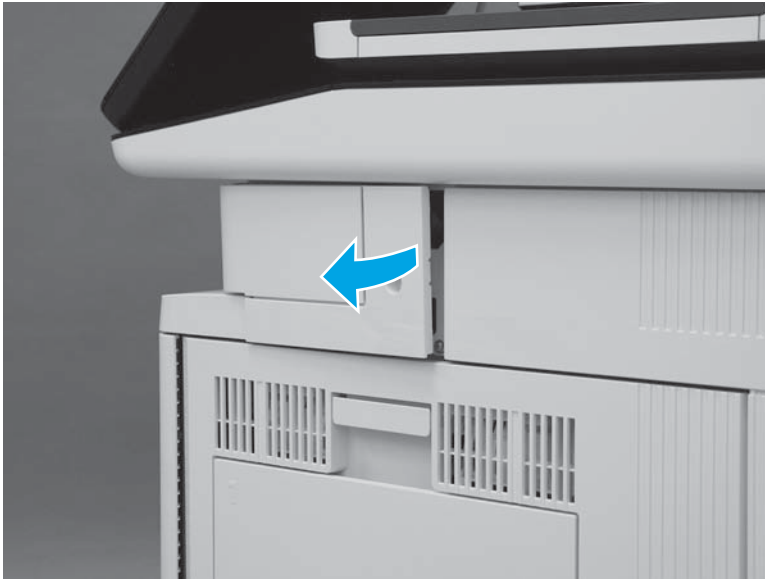



4. Rotate the cover away from the printer to remove it.

Figure 1-3137 Remove the cover



Step 16: Remove the integrated scanner assembly (ISA) (M577)

 **NOTE:** This step is for the M577 models. For the M552 and M553 models, skip this step and go to [Step 19: Remove the left cover on page 1775](#).

 **NOTE:** The ISA includes the document feeder, image scanner, scanner control board (SCB), control panel, keyboard (M577c/z) and NFC PCA (M577z).

1. At the left side of the printer, remove one screw (callout 1).

Figure 1-3138 Remove one screw

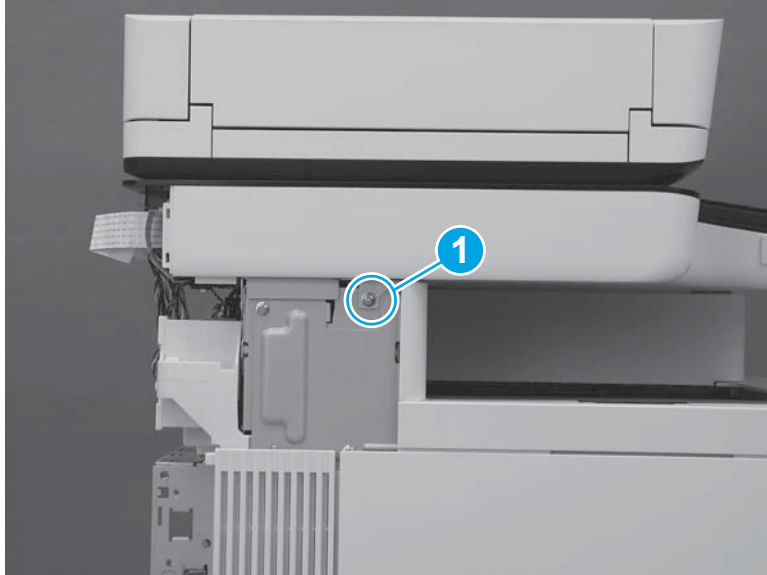

2. At the back side of the printer, remove two screws (callout 1).

Figure 1-3139 Remove two screws

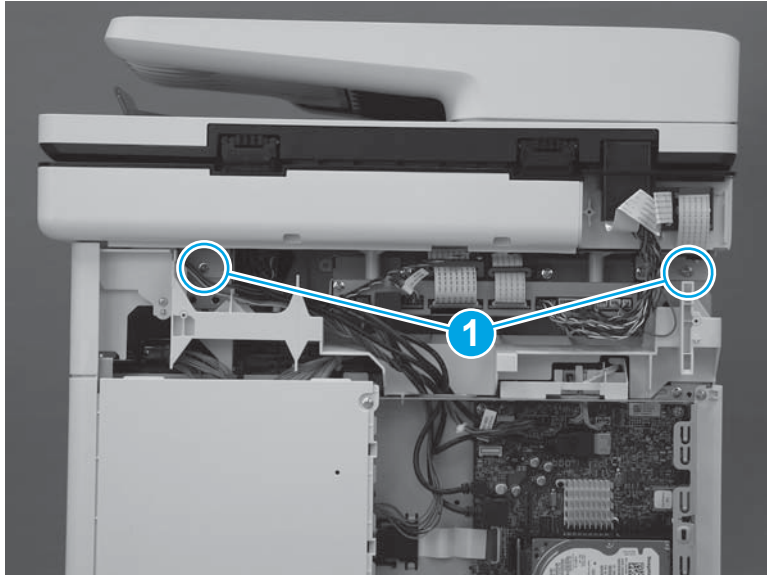

3. At the right side of the printer, remove one screw (callout 1).

Figure 1-3140 Remove one screw

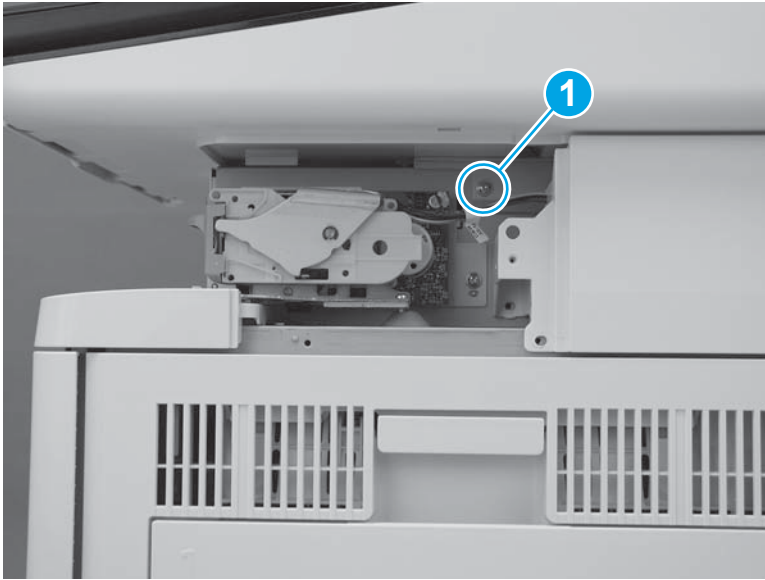

4. Disconnect two connectors on the scanner control board (callout 1).

M577c/f/z only: Disconnect one connector for the stapler on the scanner control board (callout 2).

Figure 1-3141 Disconnect connectors

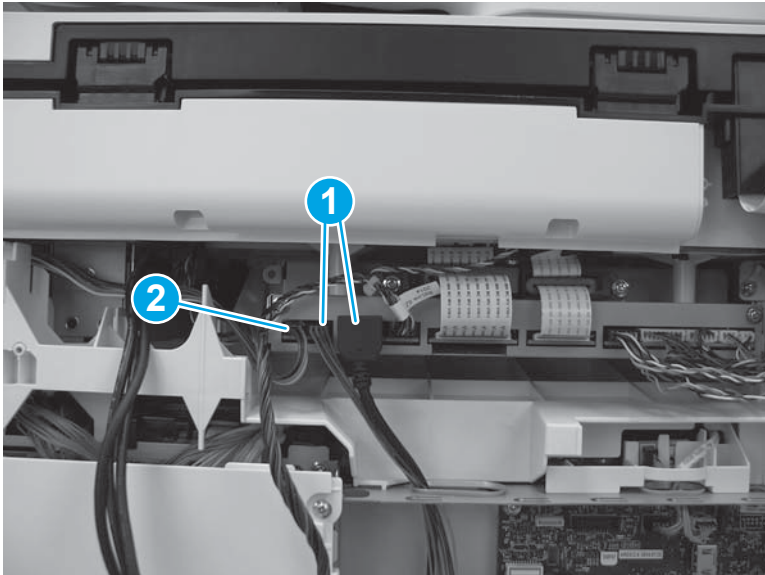

5. Slightly slide the ISA towards the back of the printer to release it.

Figure 1-3142 Slide the ISA towards the back of the printer

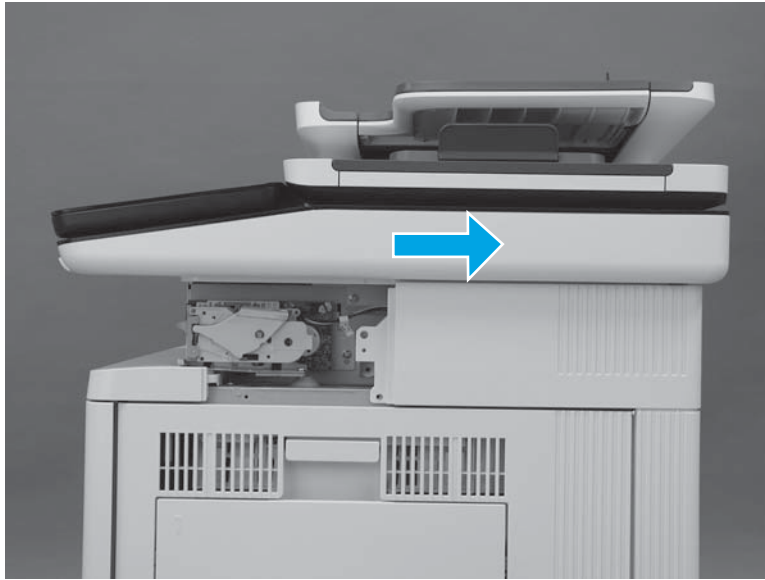

6. Lift the ISA up to remove it.

 **NOTE:** When lifting the ISA, carefully pass the cables through the opening in the top of the formatter case.

Figure 1-3143 Remove the ISA

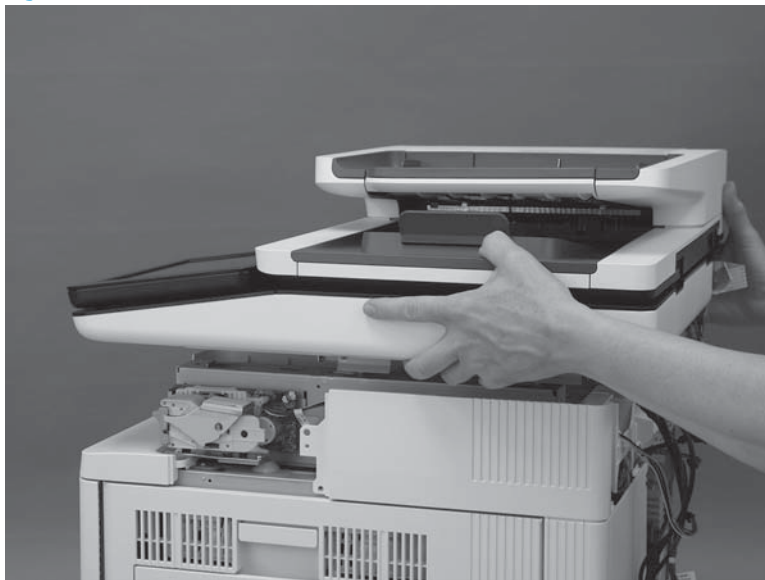

Step 17: Remove the right upper cover (M577)

 **NOTE:** This step is for the M577 models. For the M552 and M553 models, skip this step and go to [Step 19: Remove the left cover on page 1775](#).

 **NOTE:** The figures below show the image scanner installed. The procedures for removing and installing the right upper cover are the same whether the image scanner is installed or removed."

1. At the right side of the printer, remove two screws (callout 1).

M577c/f/z only: Disconnect one connector (callout 2), if it was not already disconnected in a previous step.

Figure 1-3144 Remove two screws and one connector

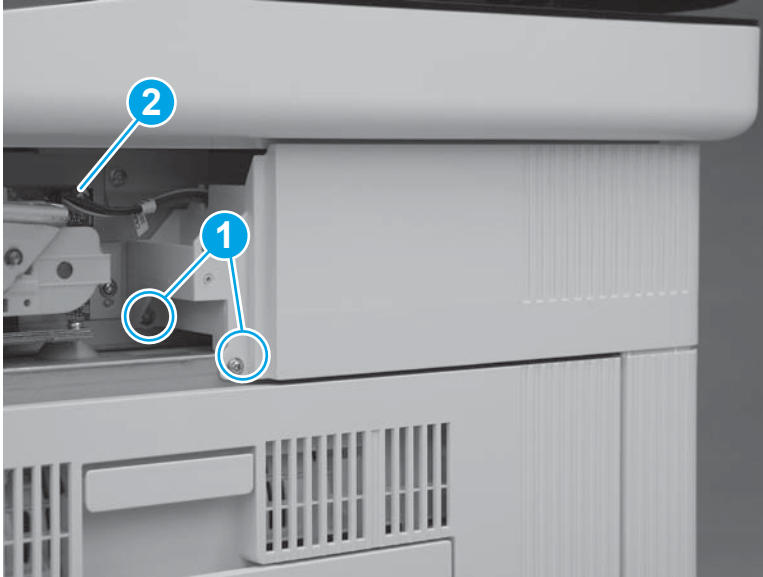

2. At the back of the printer, remove one screw (callout 1).

M577c/f/z only: Disconnect one connector (callout 2), if it was not already disconnected in a previous step.

 **Reinstallation tip:** This screw is smaller than the screws removed in the previous step. When reinstalling the right upper cover, make sure that this screw is installed in the correct position.

Figure 1-3145 Remove one screw and connector



3. Slide the cover toward the back of the printer.

Figure 1-3146 Slide the cover

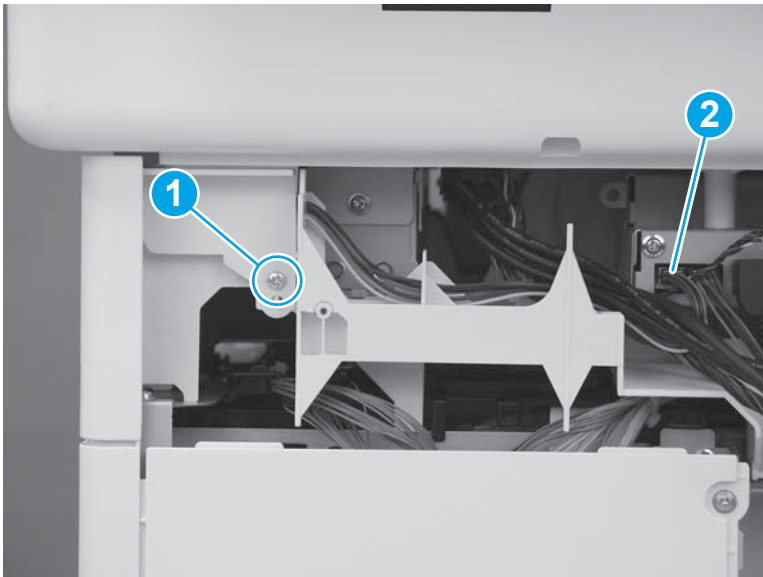
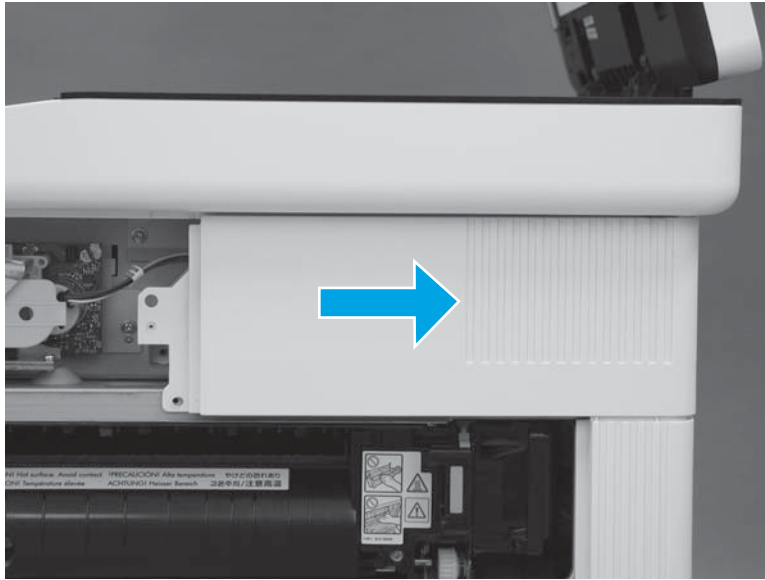

4. Lift the cover away from the printer to remove it.

M577c/f/z only: Release the cables (callout 1) through the slot (callout 2) in the printer.

Figure 1-3147 Remove the cover

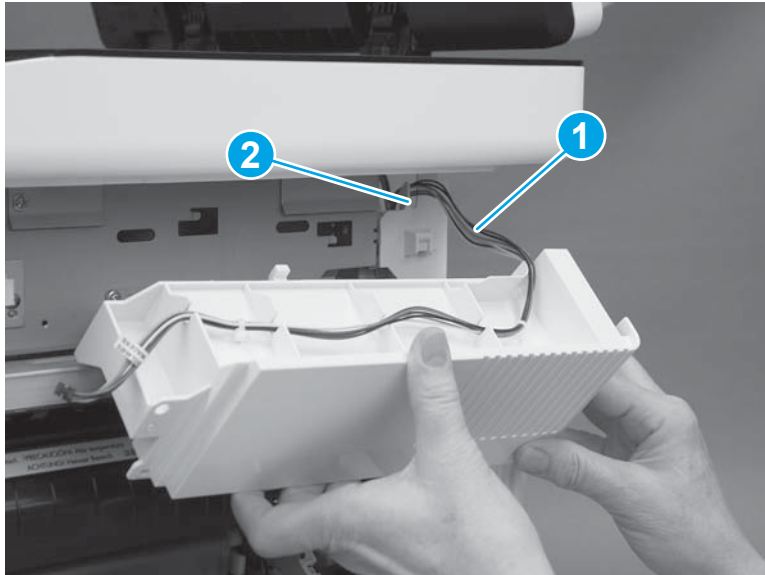

Step 18: Remove the top rear cover (M577)

 **NOTE:** This step is for the M577 models. For the M552 and M553 models, skip this step and go to [Step 19: Remove the left cover on page 1775](#).

1. At the top of the printer, remove five screws (callout 1).

Figure 1-3148 Remove five screws

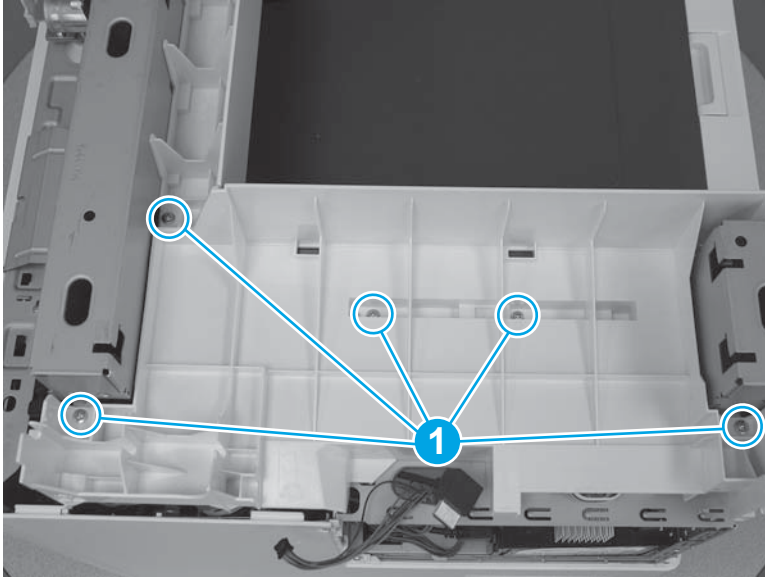

2. Release two tabs (callout 1) on the front edge of the cover.

Figure 1-3149 Release two tabs

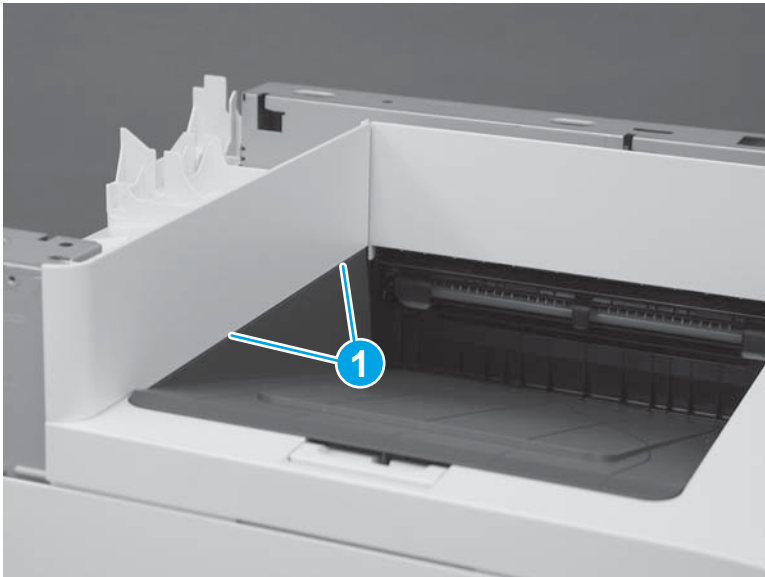

3. Remove the top rear cover.

Figure 1-3150 Remove the top rear cover

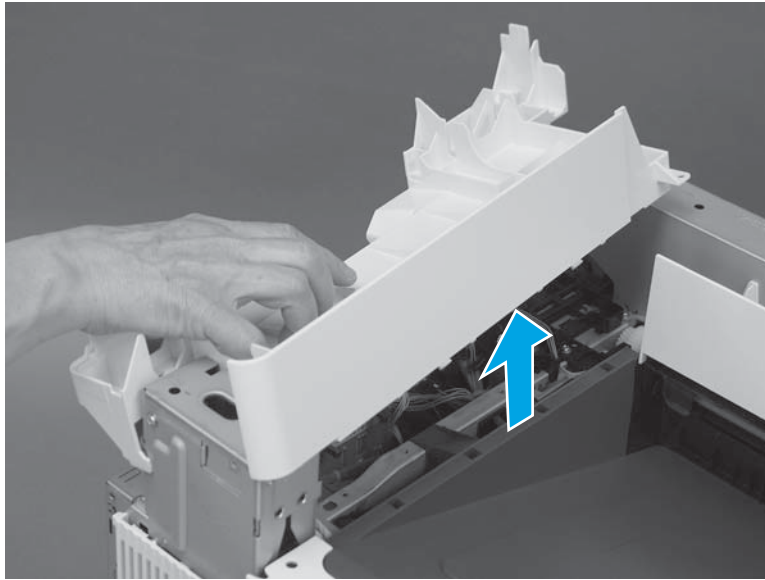

Step 19: Remove the left cover

1. At the left side of the printer, remove one screw (callout 1).

Figure 1-3151 Remove one screw



2. Release one tab (callout 1), rotate the front edge of the cover away from the printer (callout 2), and then slide the cover (callout 3) toward the rear of the printer to release it.

Figure 1-3152 Release the cover

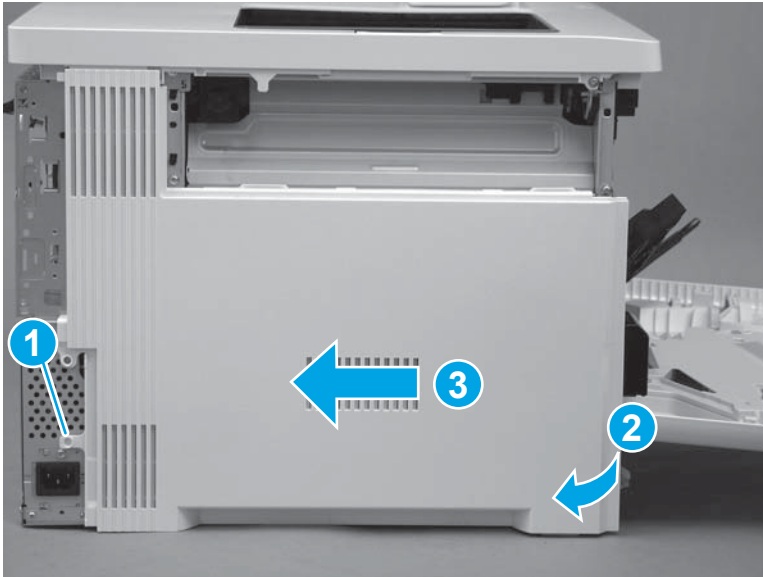

3. Remove the cover.

Figure 1-3153 Remove the cover

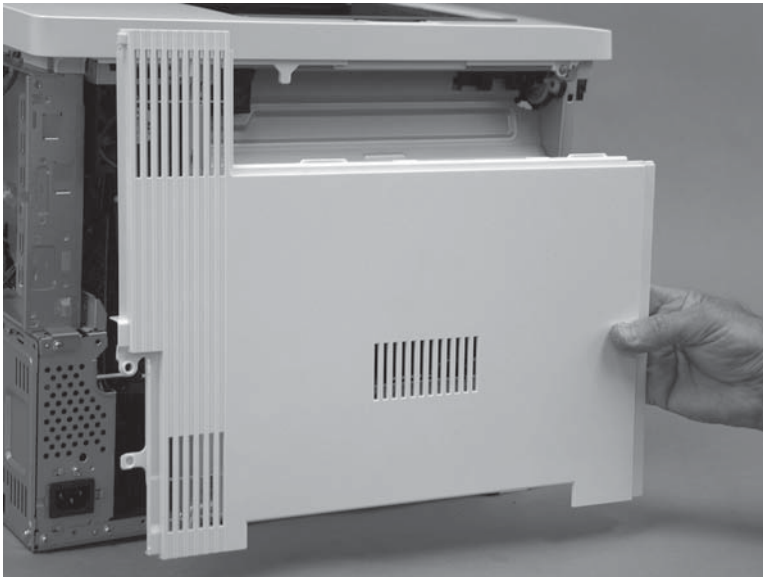

Step 20: Remove the upper cover (M552 and M553)

 **NOTE:** This step is for the M552 and M553 models. For the M577 models, skip this step and go to [Step 21: Remove the formatter case on page 1778.](#)

1. Remove three screws (callout 1).

Figure 1-3154 Remove three screws

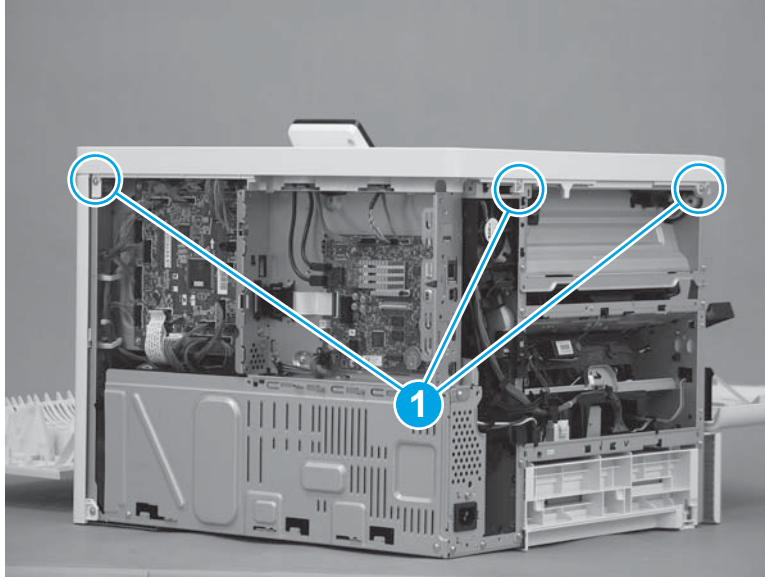

2. Remove one screw (callout 1), release one tab (callout 2), and then slightly separate the corner of the cover from the chassis.

 **NOTE:** This is a self-tapping plastic-thread screw. Make sure that this screw is used in this location when it is reinstalled.

Figure 1-3155 Remove one screw and release one tab



3. Release one tab (callout 1), and then lift up on the cover to release it.

 **NOTE:** If the cover does not release, check for addition tabs by locating the triangles embossed in the cover at tab locations.

Figure 1-3156 Release the cover



4. Remove the cover.

Figure 1-3157 Remove the cover

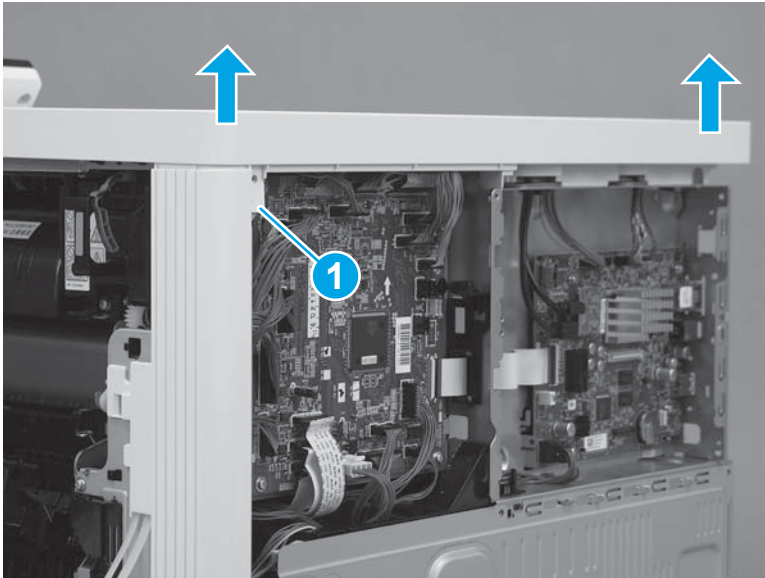
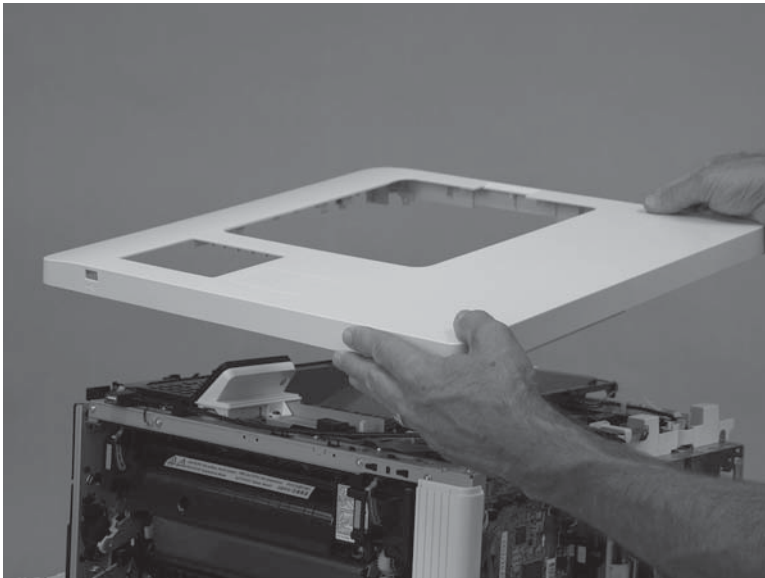

Step 21: Remove the formatter case

1. **M577 only:** Disconnect one connector (callout 1), and then pass the wire harness (callout 2) through two openings in the formatter case (callout 3).

Figure 1-3158 Disconnect one connector

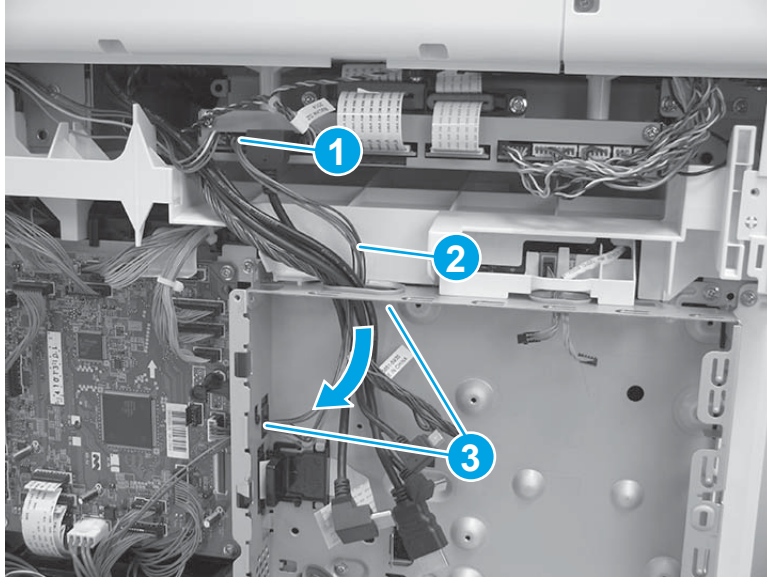

2. Release two tabs (callout 1) on the black plastic bracket. Hold the tabs in the released position, and then slide the bracket (callout 2) to the right to remove it from the formatter case.

Figure 1-3159 Remove the bracket

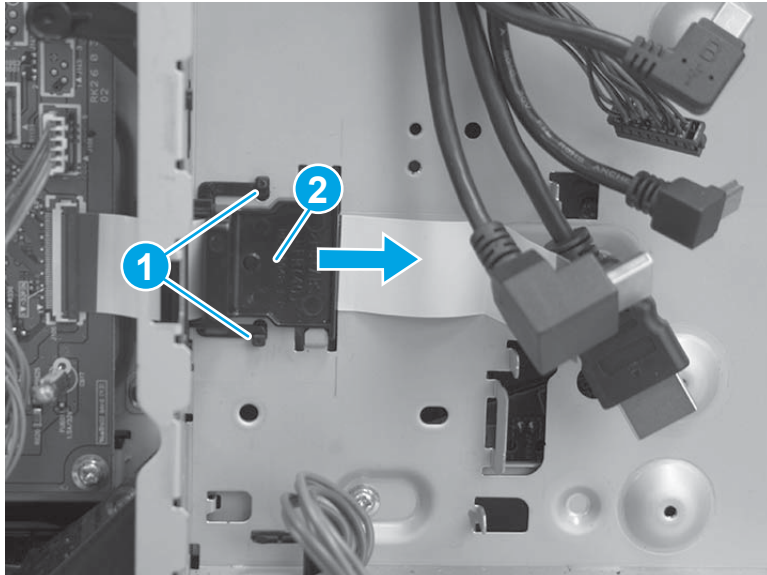

3. Remove two screws (callout 1), and then slide the low-voltage power supply (LVPS) cover to the right to remove it.

Figure 1-3160 Remove the LVPS cover

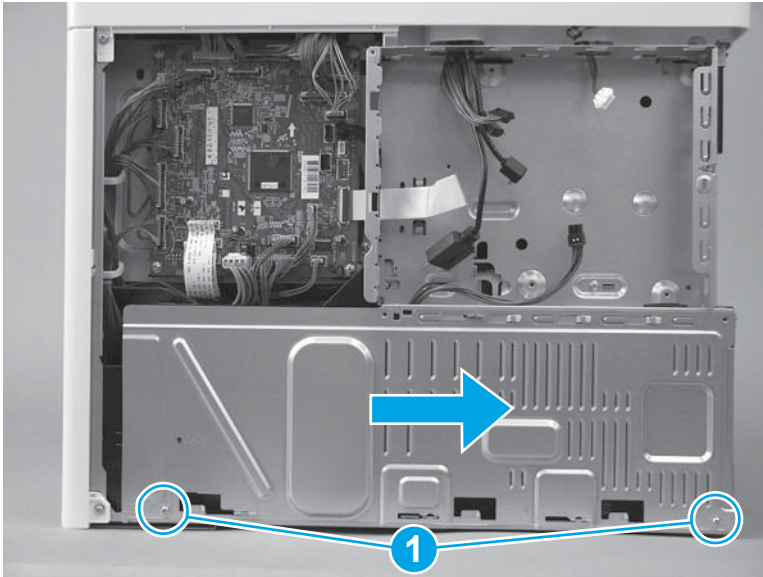

4. Pass two wire harnesses and one flat cable (callout 1) through the opening in the formatter case, and then release one wire harness from the retainer (callout 2).

CAUTION: The flat cable might be attached to the formatter case with double-sided tape. Make sure that this tape is released, so that the flat cable is not damaged when the formatter case is removed.

Figure 1-3161 Release wire harnesses and flat cable

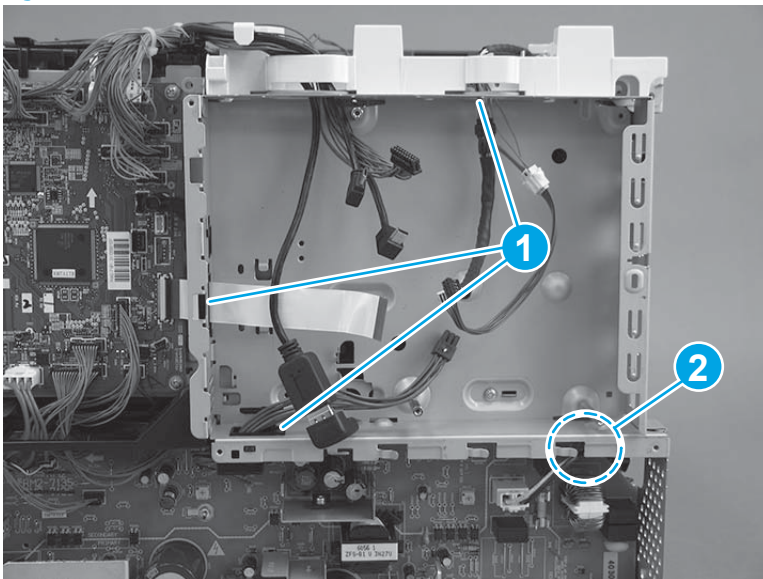

5. Remove six screws (callout 1).

Figure 1-3162 Remove six screws

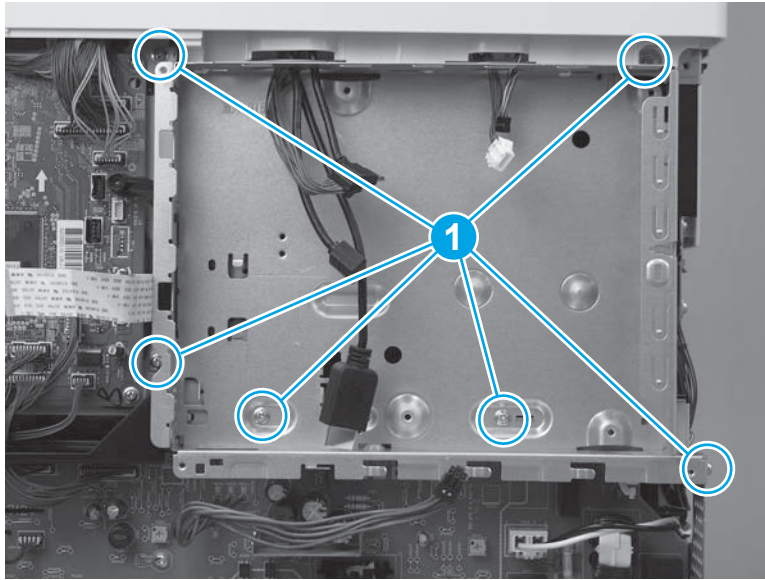

6. Rotate the bottom of the formatter case away from the printer (callout 1), and then pull it down (callout 2) to release it.

Figure 1-3163 Release the formatter case

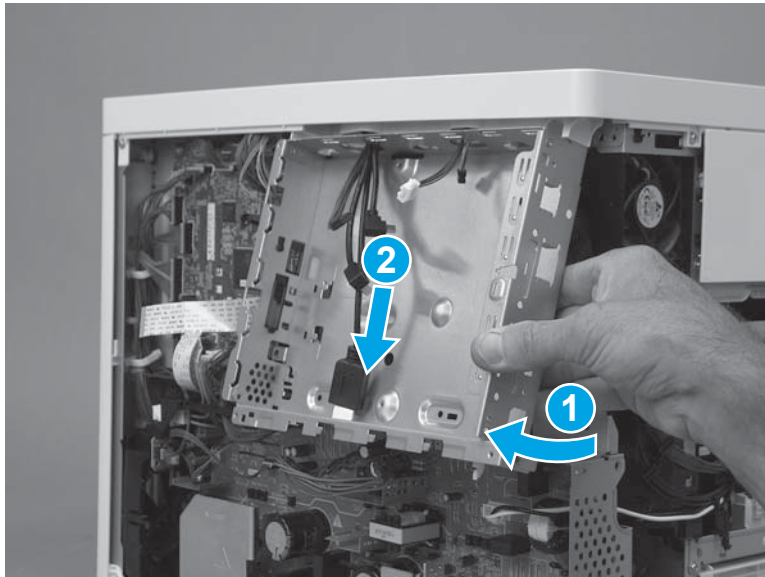

7. Pass the wire harnesses through the opening in the formatter case to remove it.

 **IMPORTANT:** If the formatter case is removed so that it can be replaced, make sure to transfer the memory PCA (island of data) and plastic bracket (callout 1) to the replacement case.

Figure 1-3164 Remove the formatter case



Step 22: Remove the right rear cover

1. Remove one screw (callout 1), and then slide the cover toward the rear of the printer (callout 2) to release it.

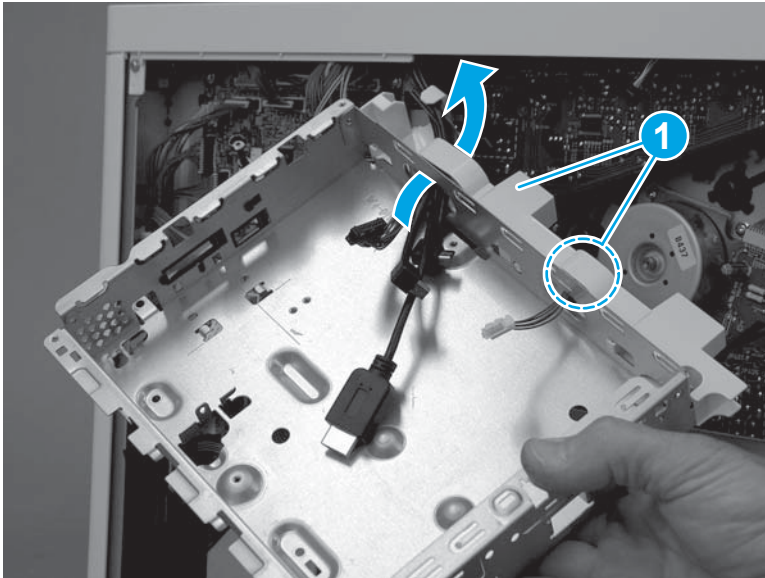
 **TIP:** If the right door is closed, open it now.

Figure 1-3165 Release the cover



2. Remove the cover.

Figure 1-3166 Remove the cover

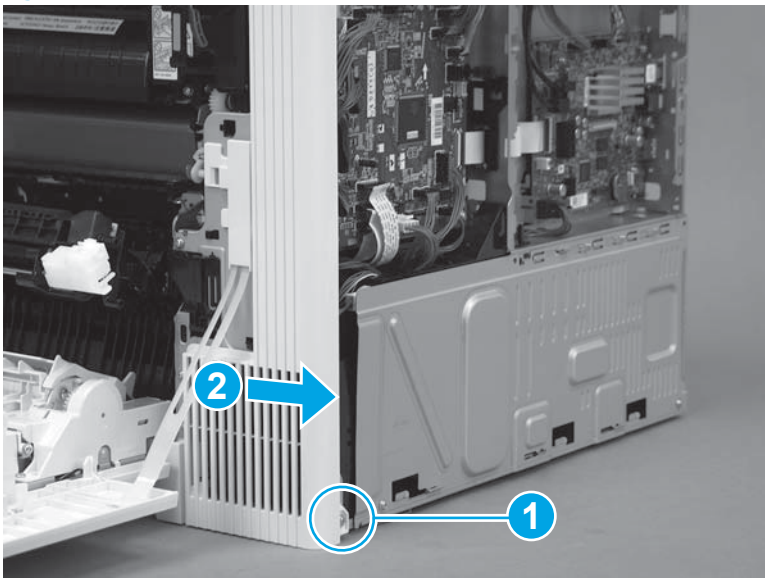
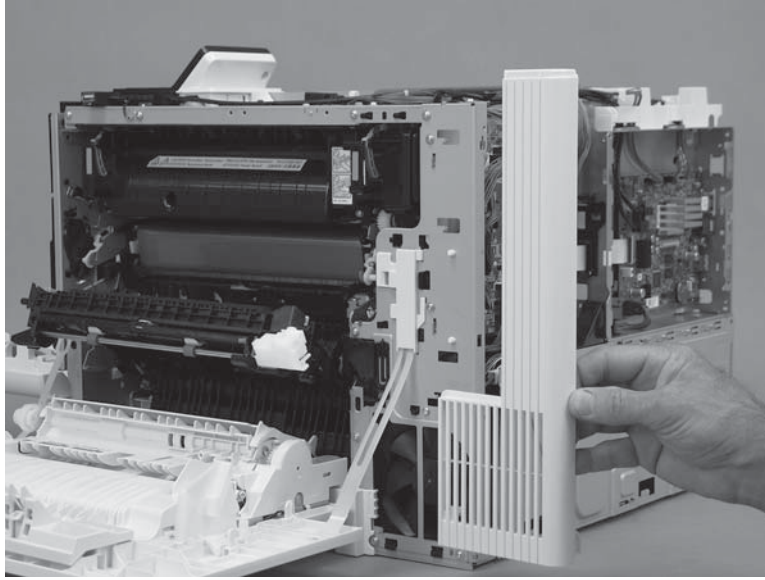

Step 23: Remove the DC controller and sheet-metal bracket

 **CAUTION:**  ESD sensitive part.

1. Disconnect all of the connectors, and then remove two screws (callout 1).

The following connectors are empty:

- J140, J141, and J143

Figure 1-3167 Remove two screws

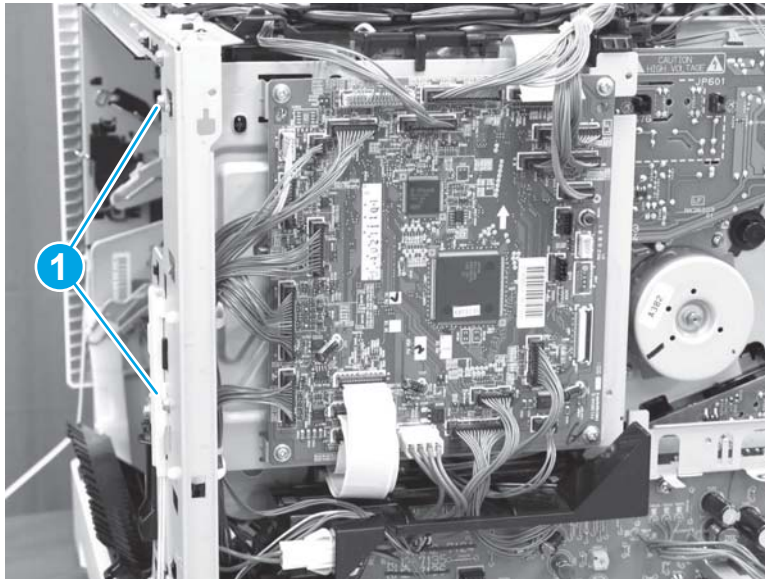

2. Lift up on the DC controller and sheet-metal plate to remove it.

Figure 1-3168 Remove the plate

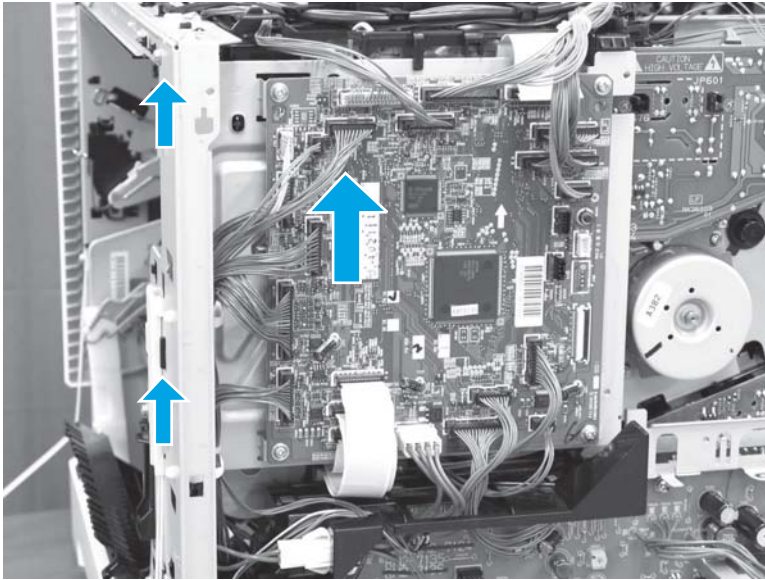

Step 24: Remove the high-voltage power supply T (HVPST)

 **CAUTION:**  ESD-sensitive part.

1. Disconnect five connectors (callout 1), and then disconnect one flat cable (callout 2).

Figure 1-3169 Disconnect five connectors and one flat cable

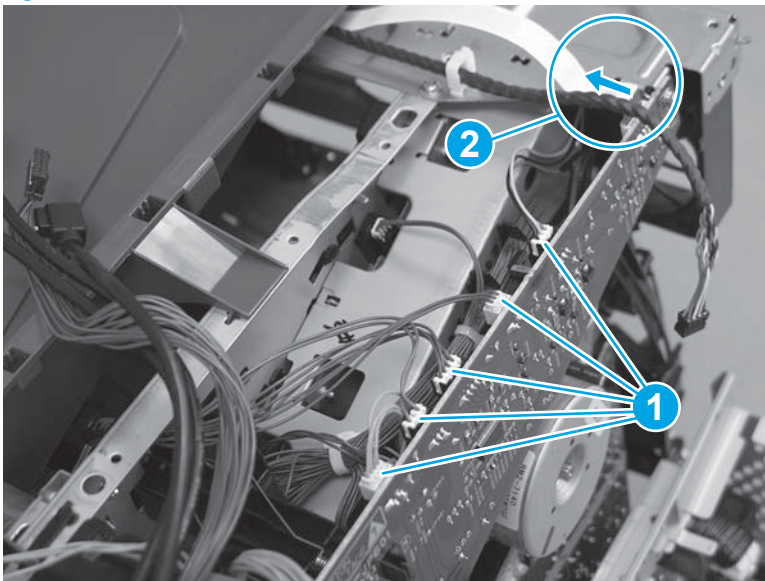

2. Remove one screw (callout 1).

Figure 1-3170 Remove one screw

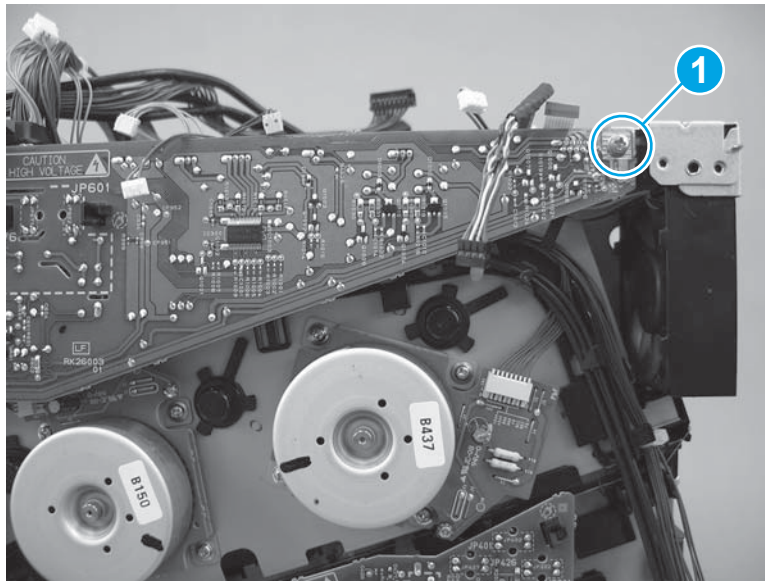

3. Release two tabs (callout 1), and then separate the HVPST from the printer.

⚠ CAUTION: Do not attempt to completely remove the HVPST. It is still connected to the printer by ground wire harness.

Figure 1-3171 Release the HVPST

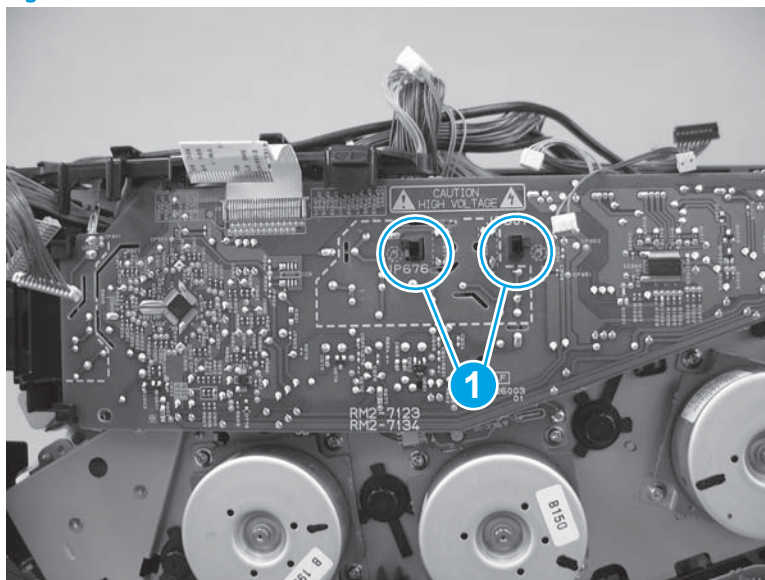

4. Release one ground wire connector (callout 1), and then remove the HVPST.

Figure 1-3172 Remove the HVPST

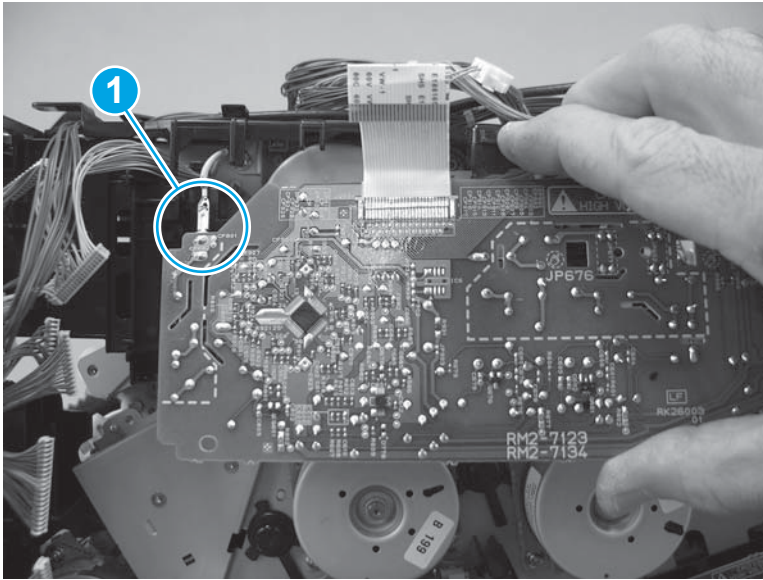

Step 25: Remove the fuser motor (M4)

- ▲ Disconnect one connector (callout 1), remove three screws (callout 2), and then remove the motor.

Figure 1-3173 Remove the motor

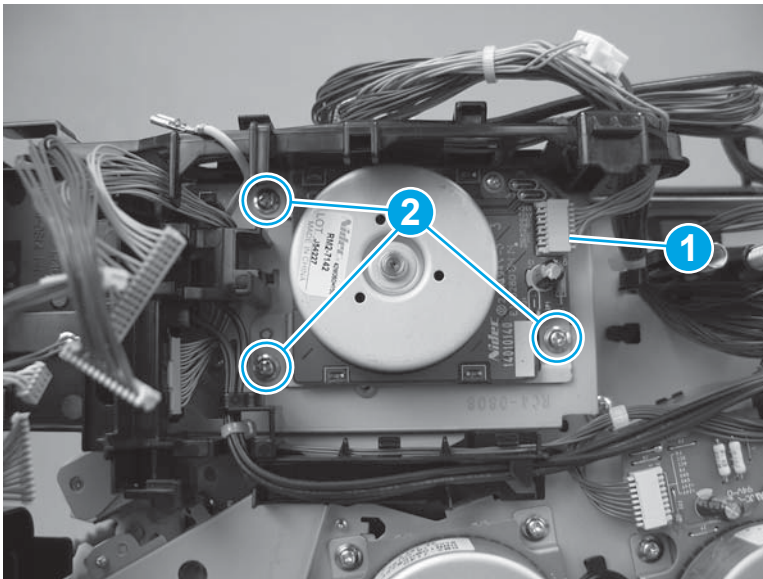

Step 26: Unpack the replacement assembly

Unpack the replacement assembly from the packaging.

For complete information on HP's recycling programs, go to [Product return and recycling](#).

 **NOTE:** HP recommends responsible disposal of the defective assembly.

Figure 1-3174 Recycle and unpack

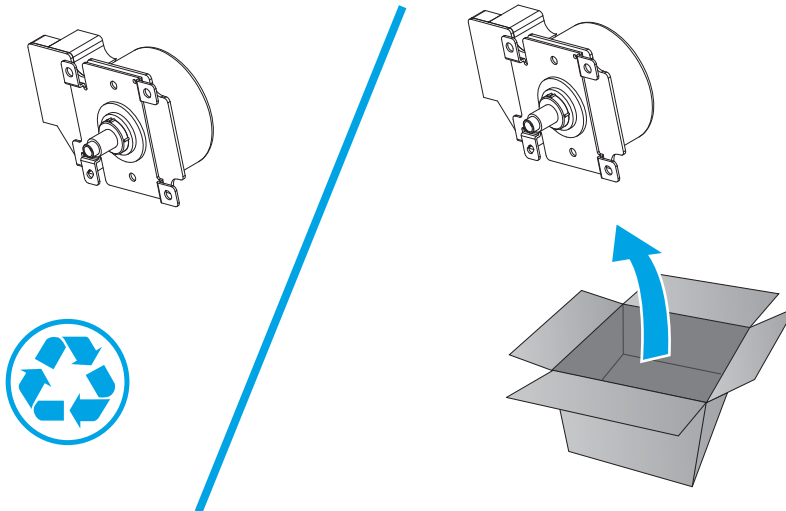

Step 27: Install the fuser motor (M4)

- ▲ Position the motor on the printer, install three screws (callout 1), and then connect one connector (callout 2).

Figure 1-3175 Install the motor

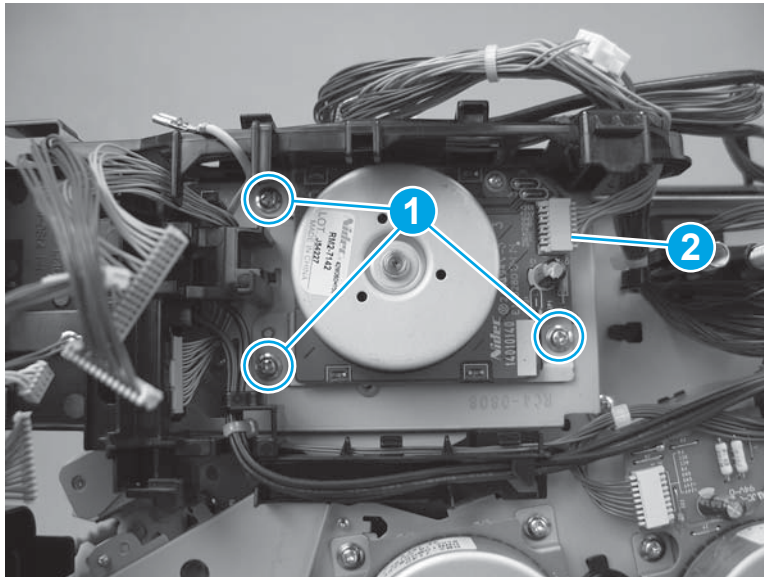

Step 28: Install the HVPST

⚠ **CAUTION:**  ESD-sensitive part.

1. Connect one ground wire connector (callout 1).

Figure 1-3176 Connect one ground wire

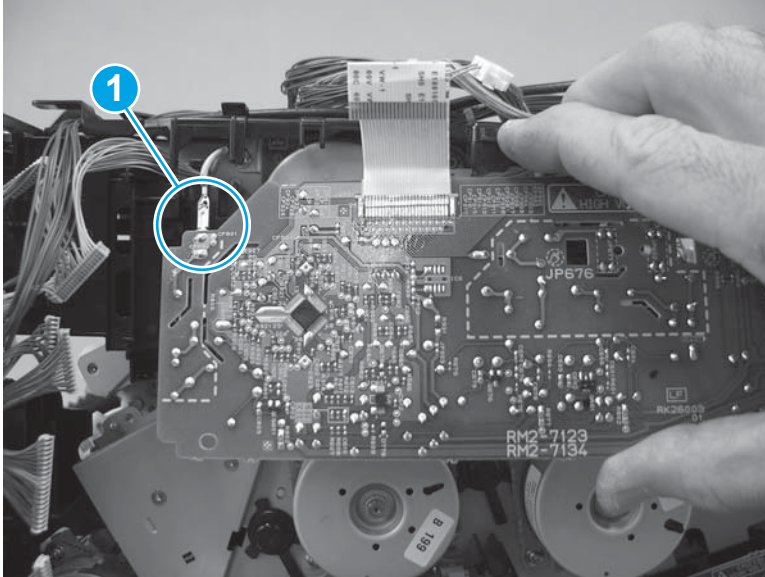

2. Position the HVPST on the printer, and then push in to engage two tabs (callout 1).

 **NOTE:** Make sure that the tabs snap into place.

Figure 1-3177 Install the HVPST

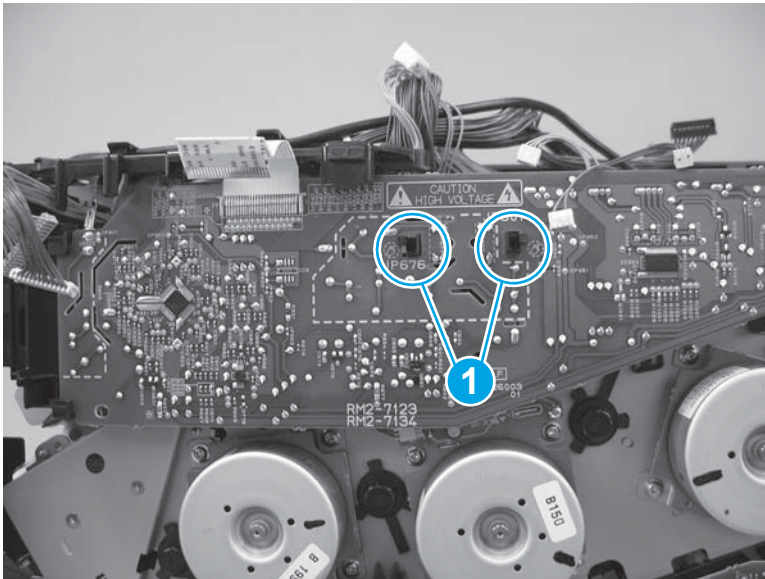

3. Install one screw (callout 1).

Figure 1-3178 Install one screw

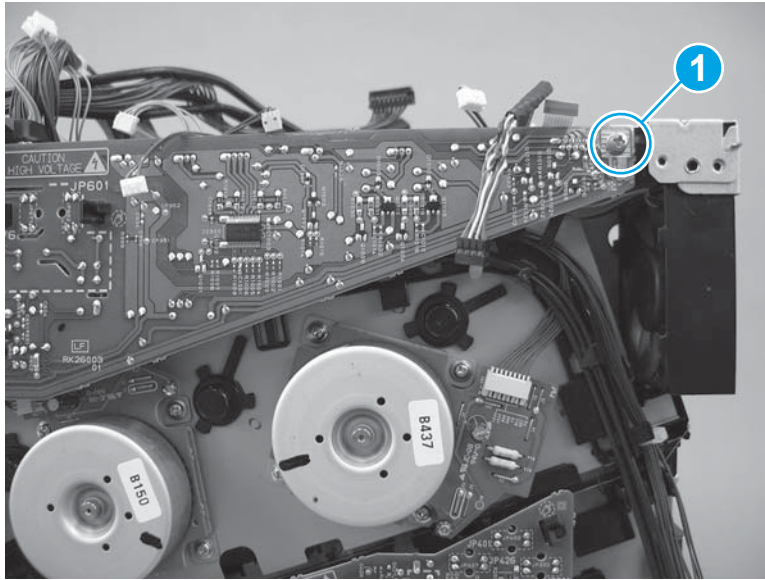

4. Connect five connectors (callout 1), and then connect one flat cable (callout 2).

Figure 1-3179 Connect five connectors and one flat cable

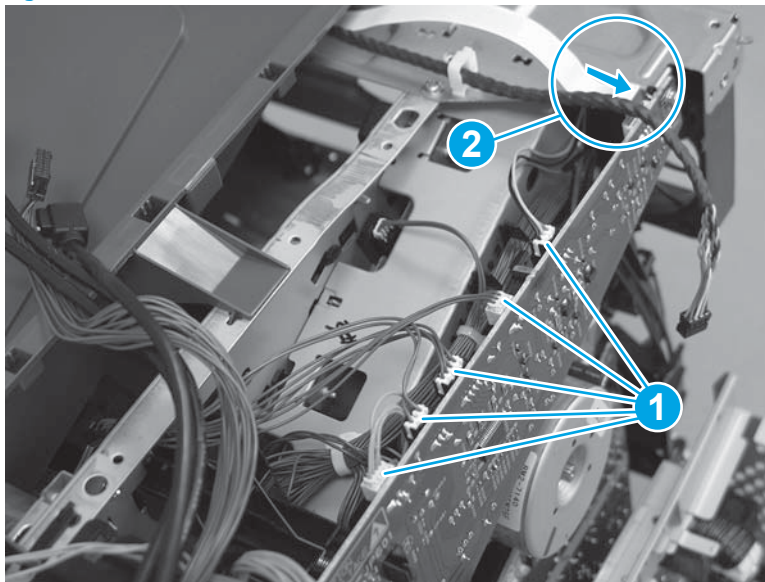

Step 29: Install the DC controller and sheet-metal bracket

 **CAUTION:**  ESD-sensitive part.

1. Position the DC controller and sheet-metal plate on the printer, and then push down to engage the plate with the chassis.

Figure 1-3180 Install the plate

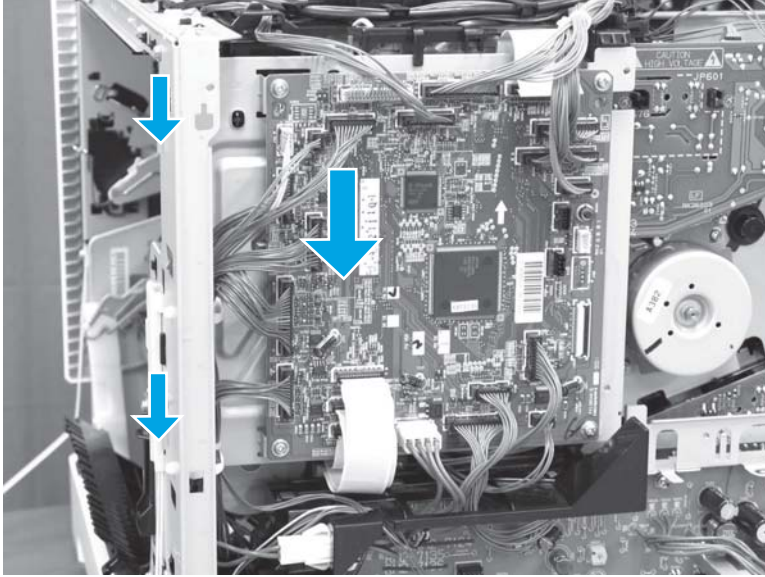

2. Install two screws (callout 1), and then connect all of the connectors.

The following connectors are empty:

- J140, J141, and J143

Figure 1-3181 Install two screws

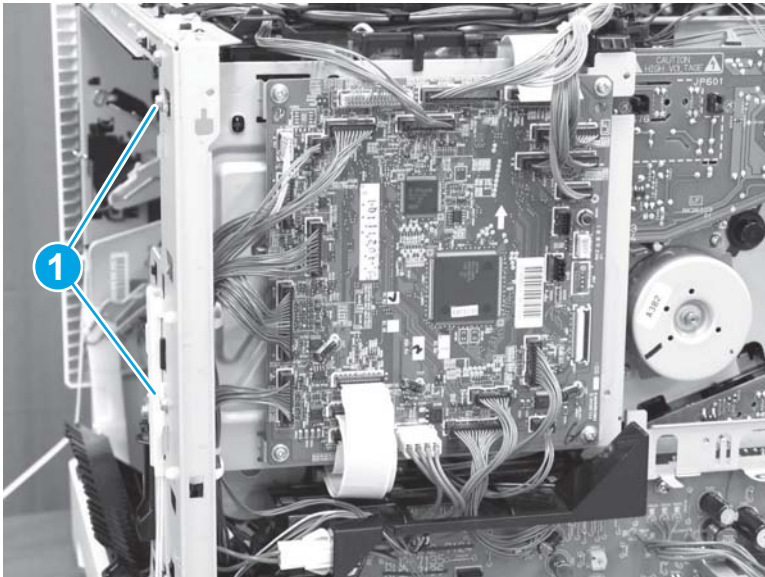

Step 30: Install the right rear cover

1. Position the cover on the printer.

Figure 1-3182 Install the cover

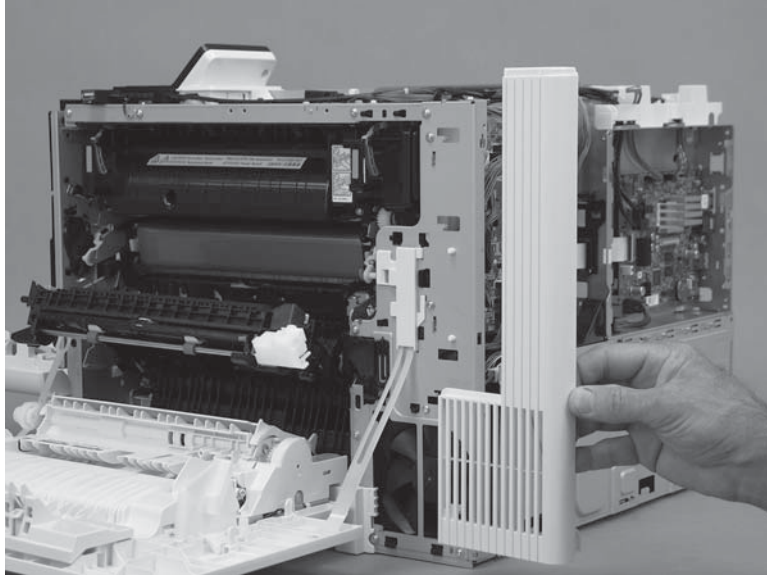

2. Slide the cover toward the right door (callout 1) to engage it with the printer, and then install one screw (callout 2).

Figure 1-3183 Install one screw

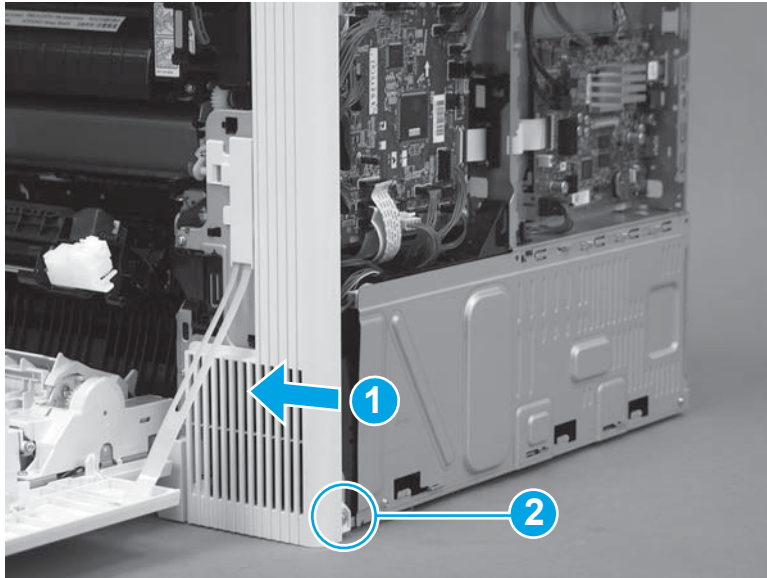

Step 31: Install the formatter case

1. Pass the wire harnesses through the opening in the formatter case.

Figure 1-3184 Pass the wire harnesses through the opening

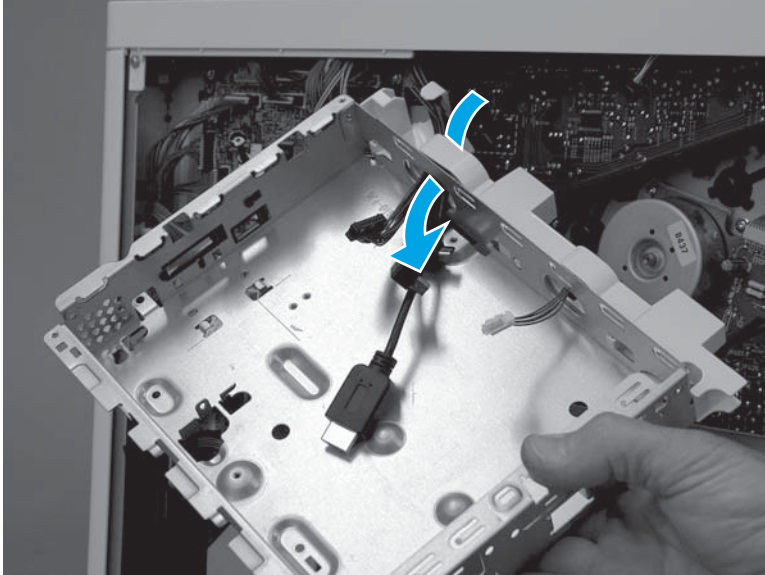

2. Position the top of the formatter case on the printer (callout 1), and then rotate the bottom of the case (callout 2) into the printer.

Figure 1-3185 Install the formatter case

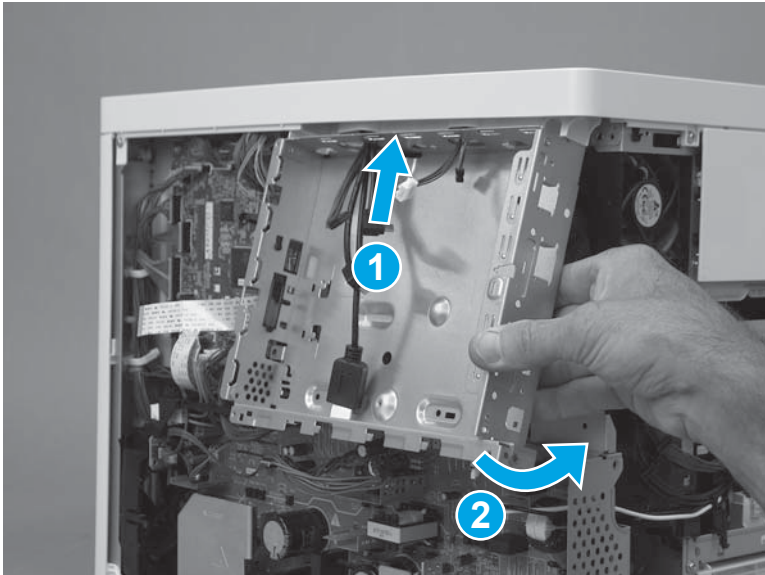

3. Install six screws (callout 1).

Figure 1-3186 Install six screws

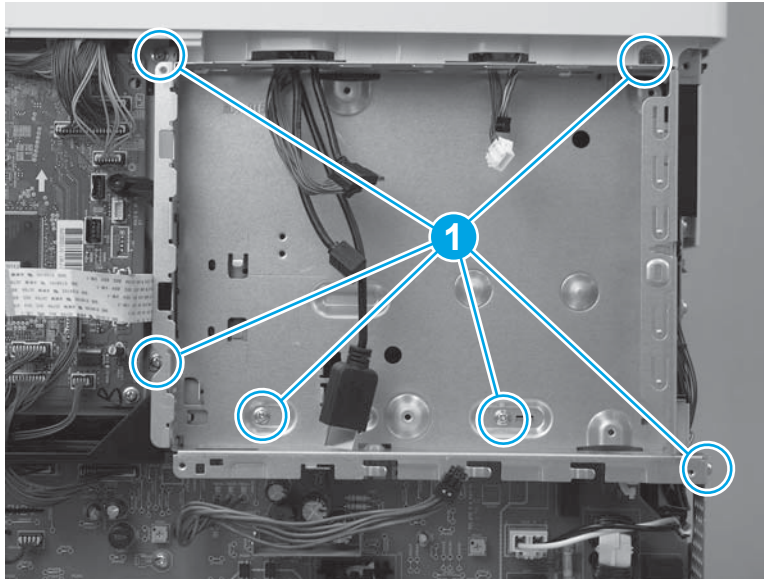

4. Pass two wire harnesses and one flat cable (callout 1) through the opening in the formatter case, and then install one wire harness in the retainer (callout 2).

 **IMPORTANT:** Make sure that the flat cable is securely fastened to the DC controller, and was not dislodged when the formatter case was removed.

Figure 1-3187 Install wire harnesses and flat cable

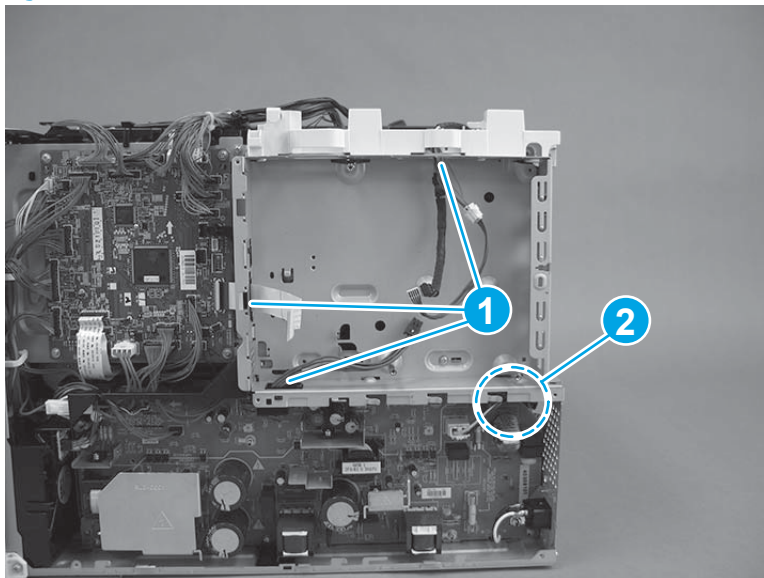

5. Position the LVPS cover on the printer, slide the cover to the left to install it, and then install two screws (callout 1).

Figure 1-3188 Install the LVPS cover

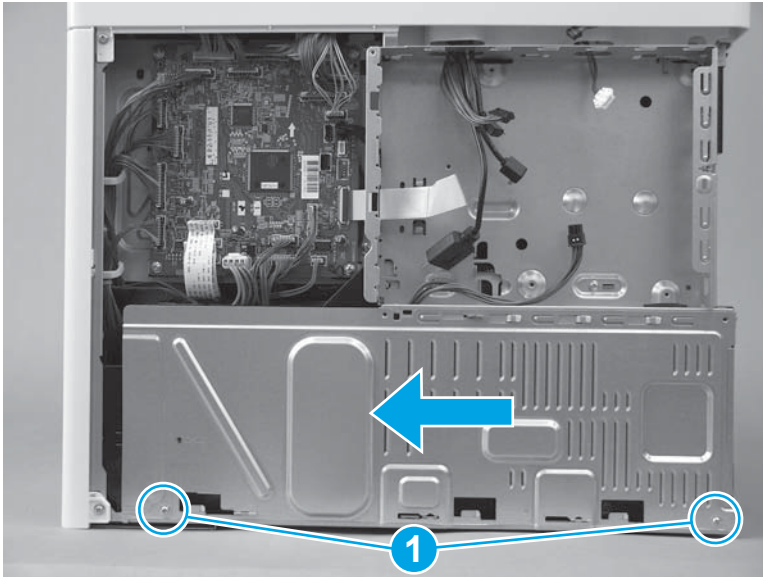

6. If no tape is affixed to the back of the flat cable, skip this step. If double-sided tape is affixed to the back of the flat cable, align the line (callout 1) on the cable with the edge (callout 2) of the opening in the sheet metal. Press to attach the flat cable to the formatter case.

Figure 1-3189 Attach the flat cable

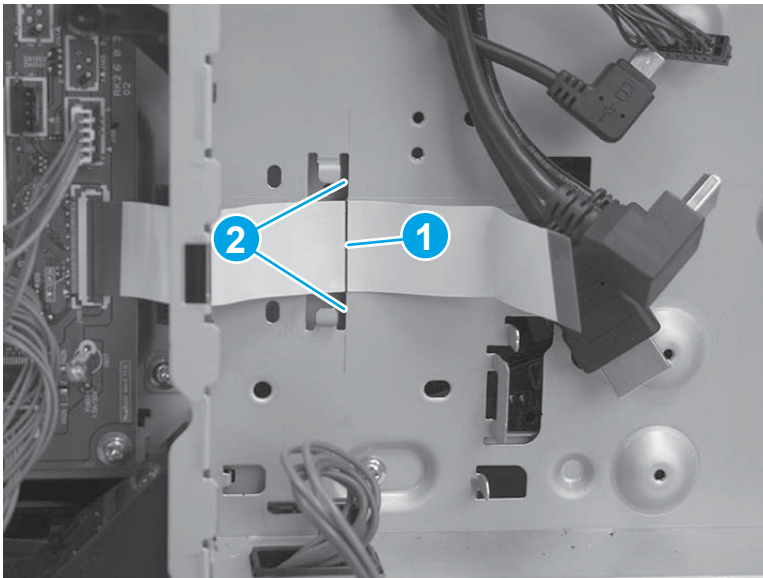

7. Position the bracket over the flat cable, and then slide the bracket to the left to install it. Make sure that the edges of the bracket fit under the sheet metal tabs (callout 1) on the formatter case and that the tabs (callout 2) snap into place.

Figure 1-3190 Position the bracket

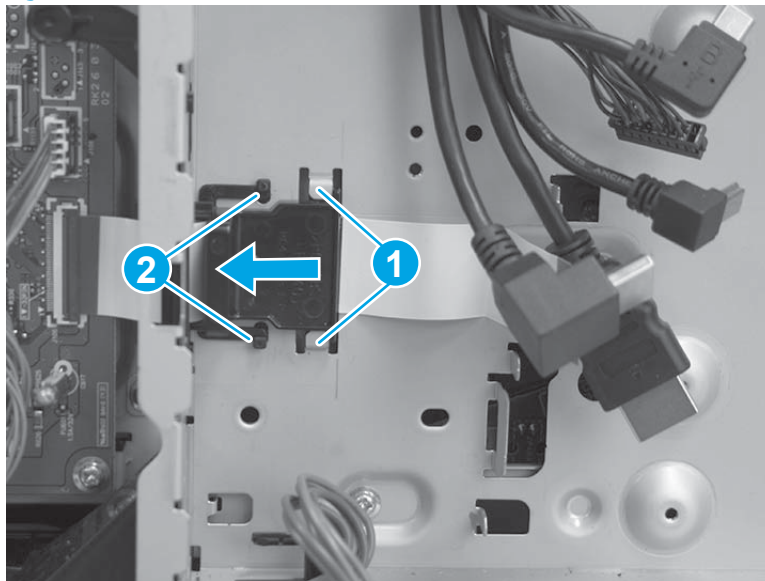

8. **M577 only:** Pass the wire harness (callout 1) through the openings in the formatter case (callout 2), and then connect one connector (callout 3).

Figure 1-3191 Connect one connector

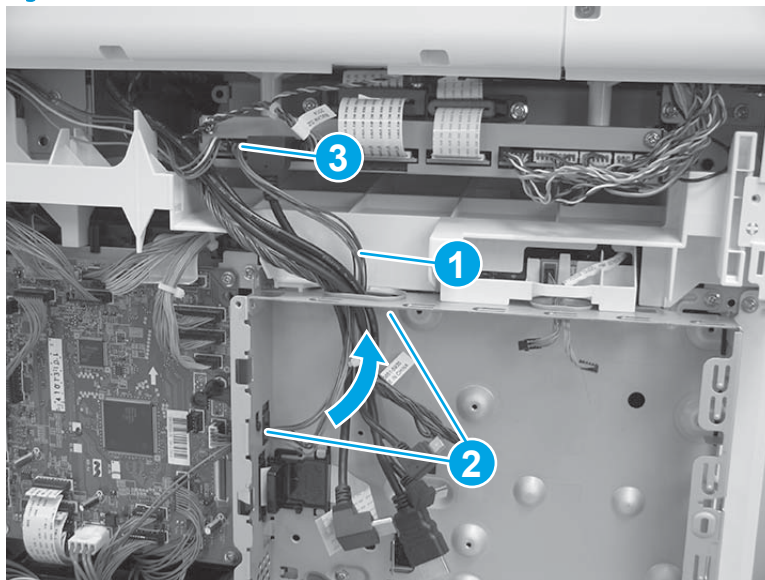

Step 32: Install the upper cover (M552 and M553)

 **NOTE:** This step is for the M552 and M553 models. For the M577 models, skip this step and go to [Step 33: Install the left cover on page 1797.](#)

1. Position the cover on the printer.

 **NOTE:** For the M553x model, do not forget to pass the control-panel wire harness and USB cable through the opening in the cover.

Figure 1-3192 Install the cover



2. Push down on the rear corner of the cover to engage one tab (callout 1).

Figure 1-3193 Engage one tab

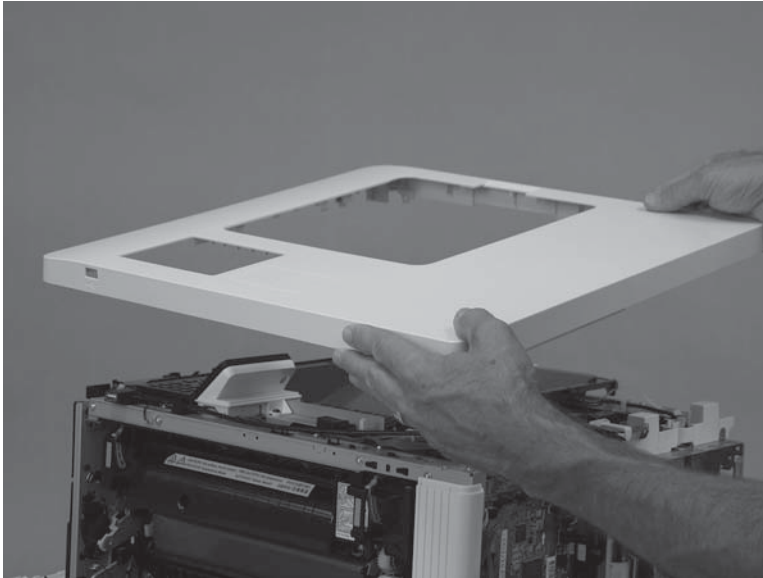
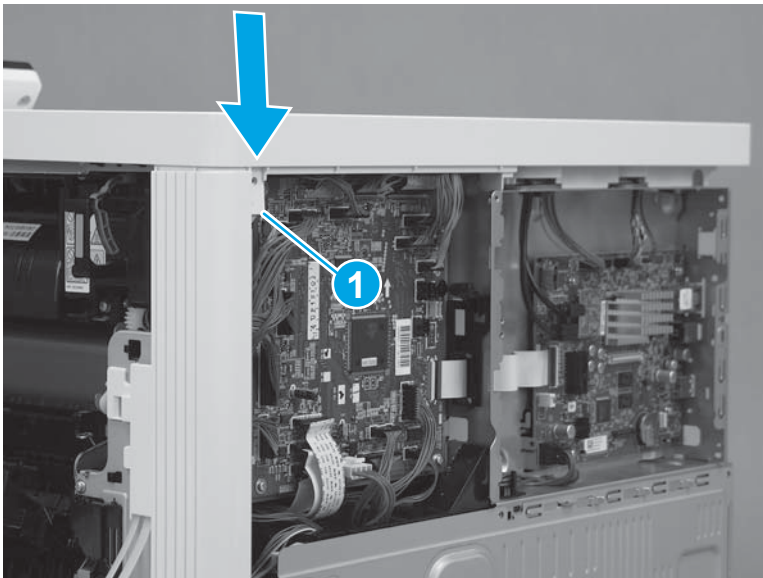

3. Push down on the front corner of the cover to engage one tab (callout 1), and then install one screw (callout 2).

 **NOTE:** This is a self-tapping plastic-thread screw. Make sure that this screw is used in this location when it is reinstalled.

Figure 1-3194 Engage one tab and install one screw



4. Install three screws (callout 1).

Figure 1-3195 Install three screws

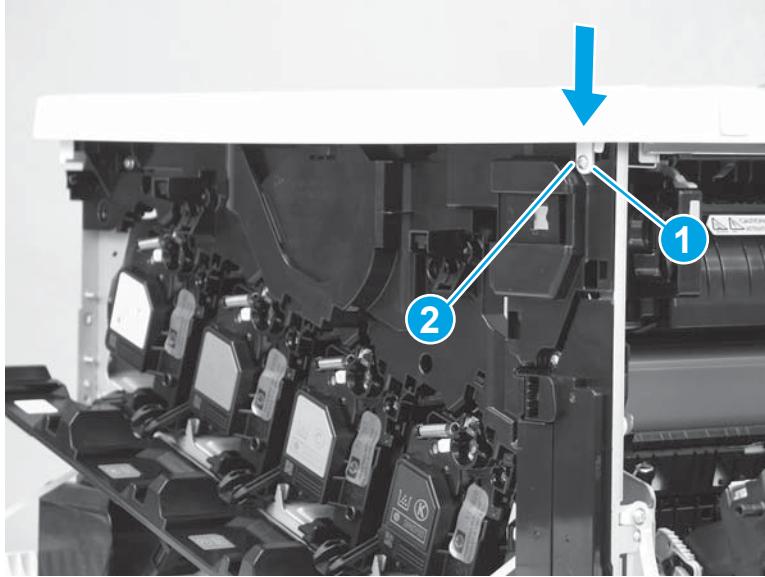
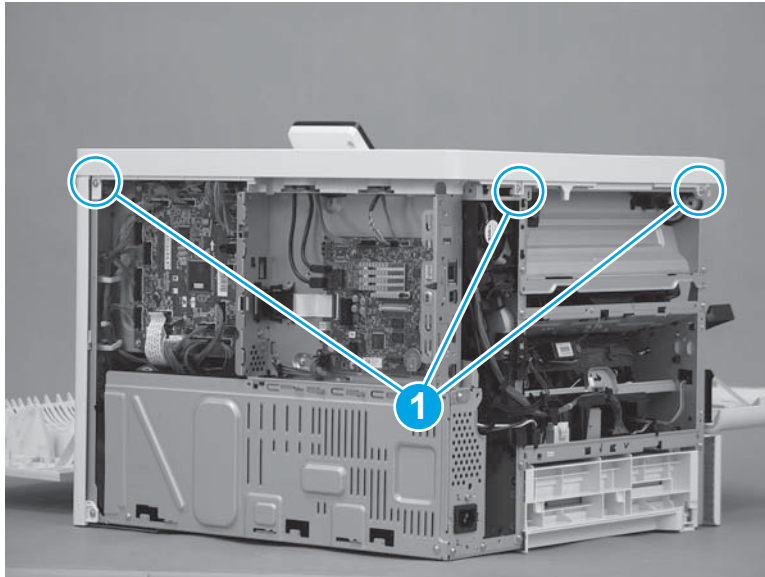

Step 33: Install the left cover

1. Position the cover on the printer.

 **NOTE:** Slightly offset the cover toward the rear of the printer.

Figure 1-3196 Install the cover

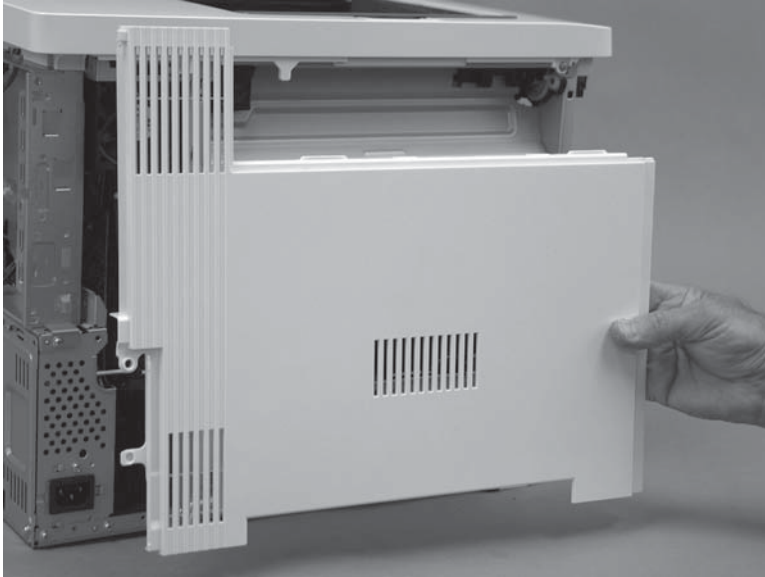

2. Slide the cover (callout 1) toward the front of the printer to engage it. Make sure that the tab (callout 2) snaps into place.

 **NOTE:** Locate the alignment pin (callout 3) on the cover from the front door side of the printer, and then make sure that it is fully engaged in the slot in the chassis.

 **TIP:** While sliding the cover into place, push in on the center of the cover (callout 1) to make sure that the hooks on the back of the cover engage with the slots in the chassis.

Figure 1-3197 Engage the cover



3. At the left side of the printer, install one screw (callout 1).

Figure 1-3198 Install one screw

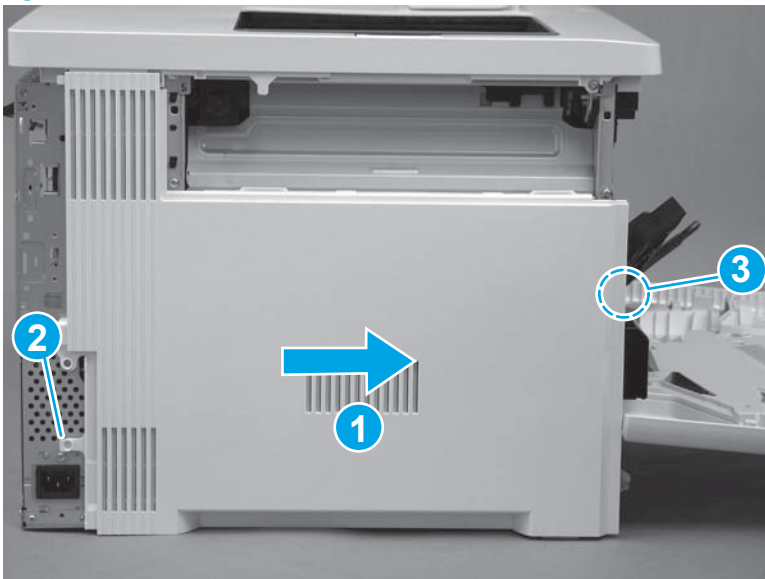

Step 34: Install the top rear cover (M577)

 **NOTE:** This step is for the M577 models. For the M552 and M553 models, skip this step and go to [Step 42: Install the rear cover \(M552 and M553\) on page 1815](#).

1. Align the locator tabs (callout 1) on the cover with the slots (callout 2) in the printer.

Figure 1-3199 Align the locator tabs

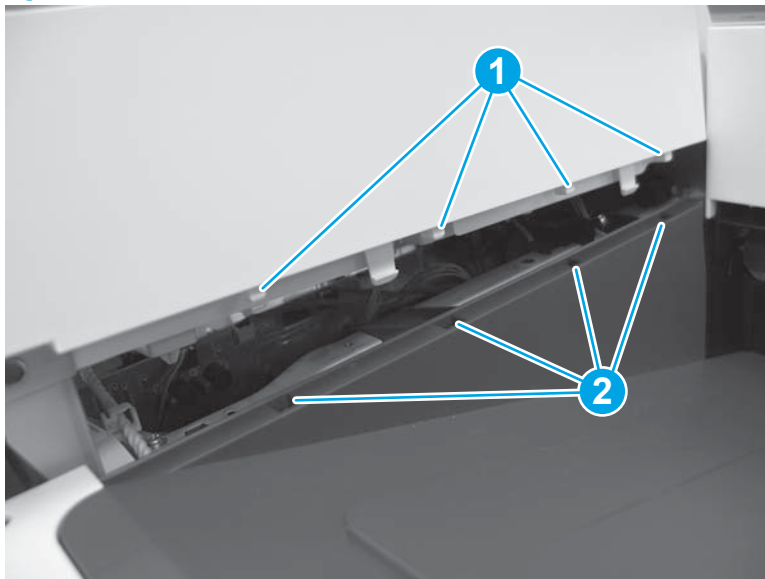

2. Press down to install the cover. Make sure that the tabs snap into place.

Figure 1-3200 Install the cover

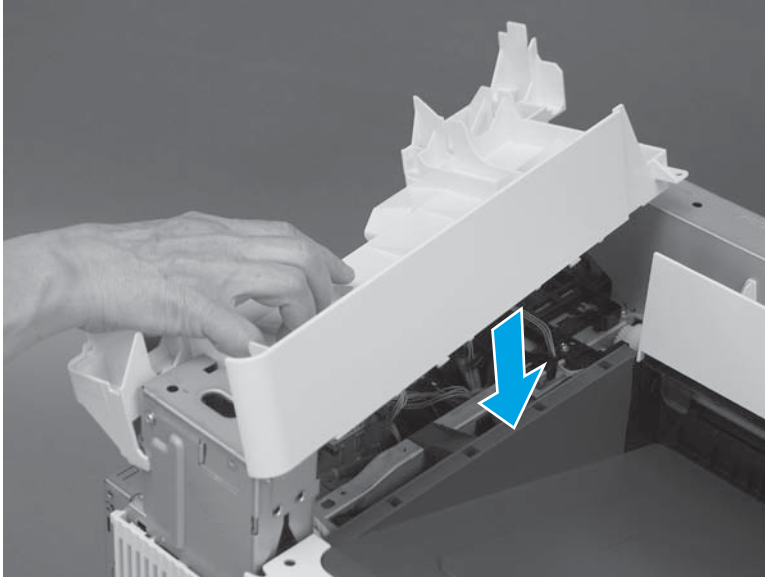

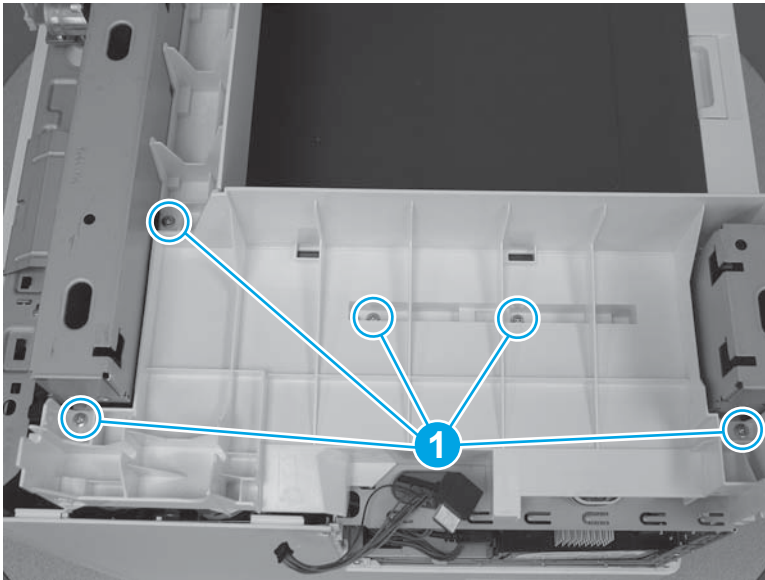

3. At the top of the printer, install five screws (callout 1).

Figure 1-3201 Install five screws



Step 35: Install the right upper cover (M577)

 **NOTE:** This step is for the M577 models. For the M552 and M553 models, skip this step and go to [Step 42: Install the rear cover \(M552 and M553\) on page 1815](#).

 **NOTE:** The figures below show the image scanner installed. The procedures for removing and installing the right upper cover are the same whether the image scanner is installed or removed."

1. **M577c/f/z only:** Install the cables (callout 1) through the slot (callout 2) in the printer.

Figure 1-3202 Install the cables

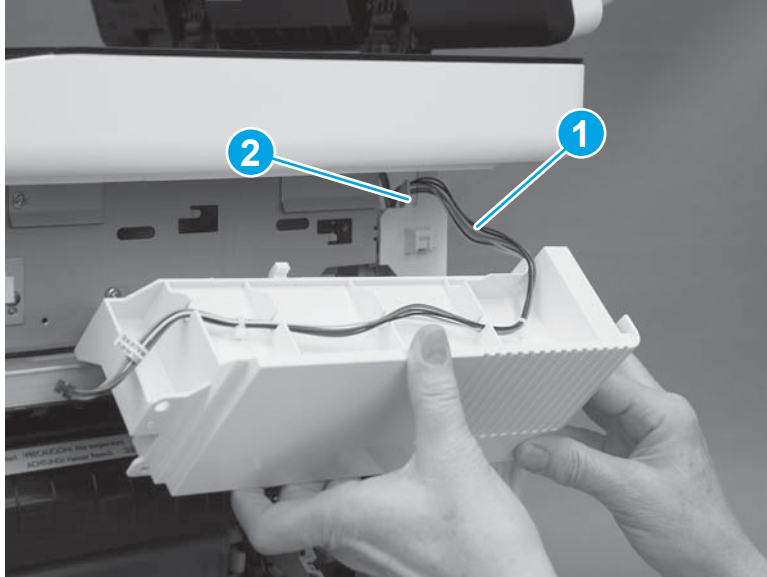

2. Position the hooks (callout 1) on the cover in the slots (callout 2) in the printer.

Figure 1-3203 Position the hooks

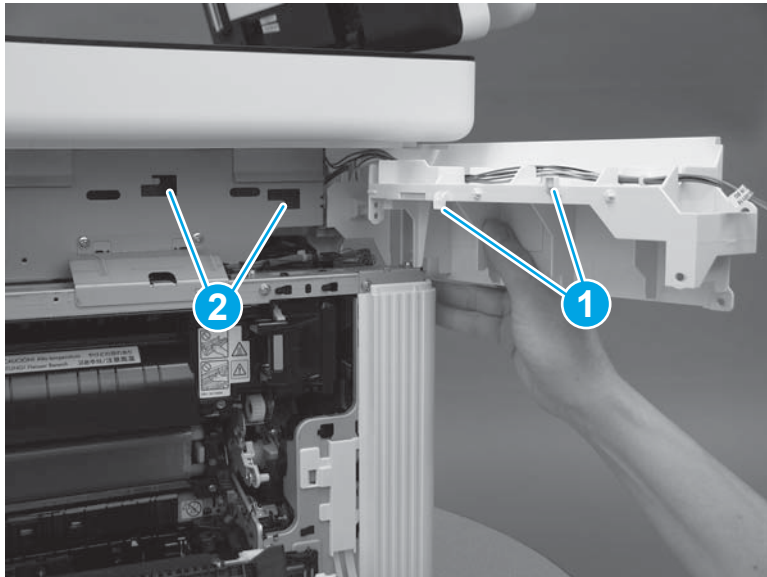

3. Slide the cover toward the front of the printer to install it.

Figure 1-3204 Install the cover

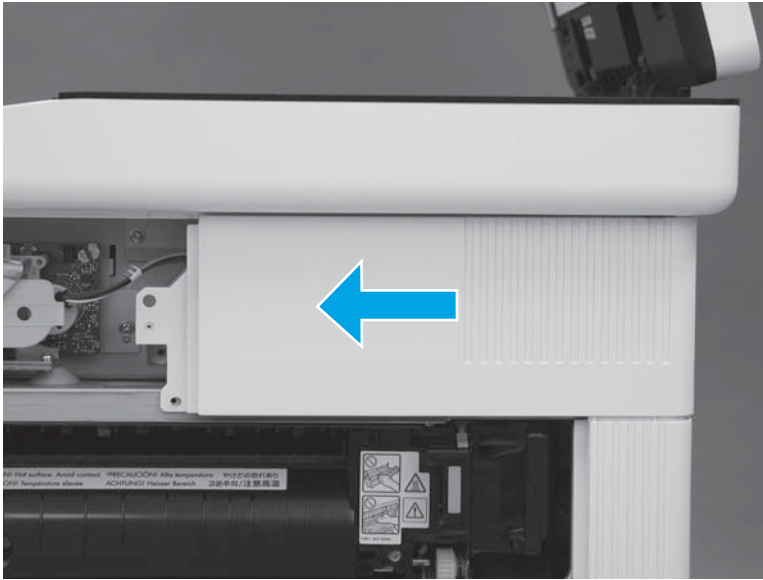

4. At the back of the printer, install one screw (callout 1).

M577c/f/z only: Connect one connector (callout 2), if the integrated scanner assembly is installed.

TIP: This screw is smaller than the screws installed in the next step. Make sure that this screw is installed in the correct position.

Figure 1-3205 Install one screw and connector

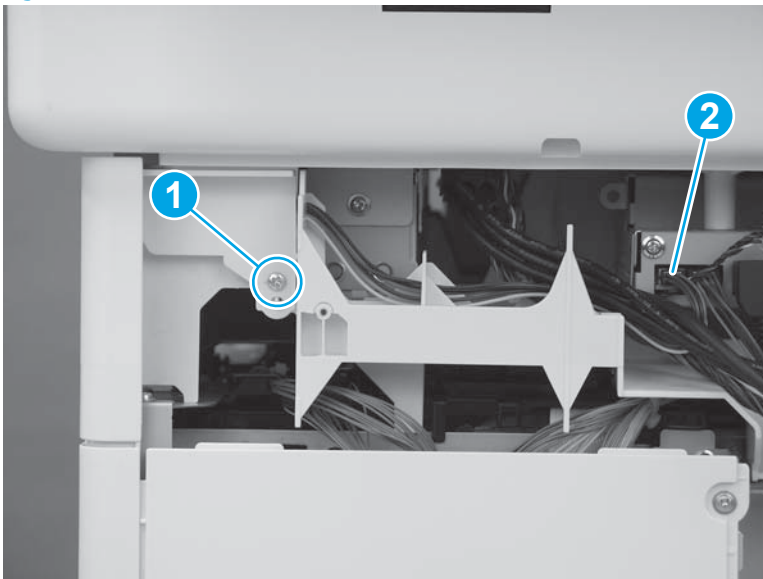

5. At the right side of the printer, install two screws (callout 1).

M577c/f/z only: Connect one connector (callout 2), if the stapler is installed.

Figure 1-3206 Install one screw and connector

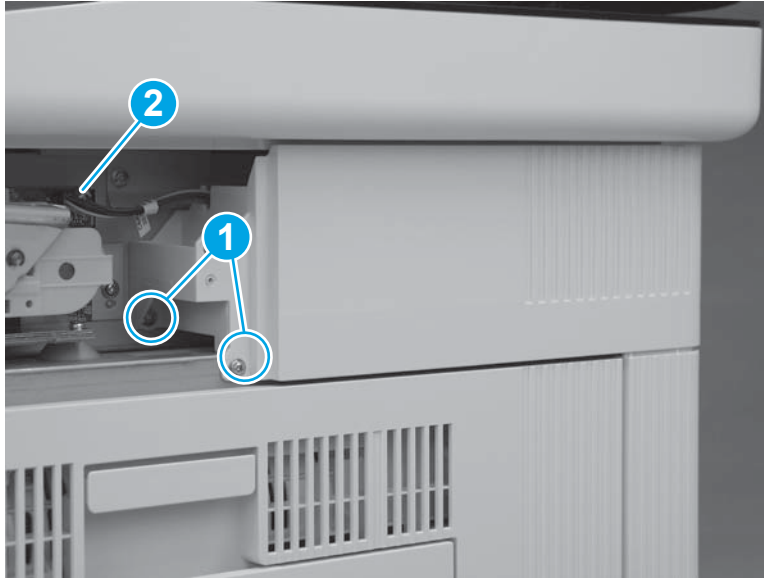

Step 36: Install the integrated scanner assembly (ISA) (M577)

 **NOTE:** This step is for the M577 models. For the M552 and M553 models, skip this step and go to [Step 42: Install the rear cover \(M552 and M553\) on page 1815](#).

 **NOTE:** The ISA includes the document feeder, image scanner, scanner control board (SCB), control panel, keyboard (M577c/z) and NFC PCA (M577z).

1. Before proceeding, locate the mounting pins (callout 1) on the bottom of the ISA and the slots (callout 2) on the printer base.

Figure 1-3207 Locate the ISA mounting pins and slots

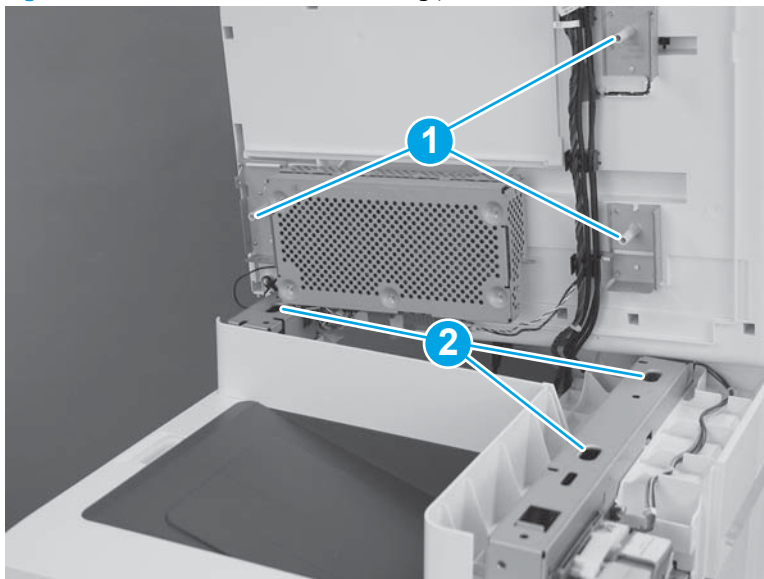

2. Position the ISA on the printer base with the pins in the slots.

 **NOTE:** To locate the pins and slots, see [Figure 1-395 Locate the ISA mounting pins and slots on page 249](#).

When installing the ISA, carefully pass the cables through the opening in the top of the formatter case.

Figure 1-3208 Install the ISA

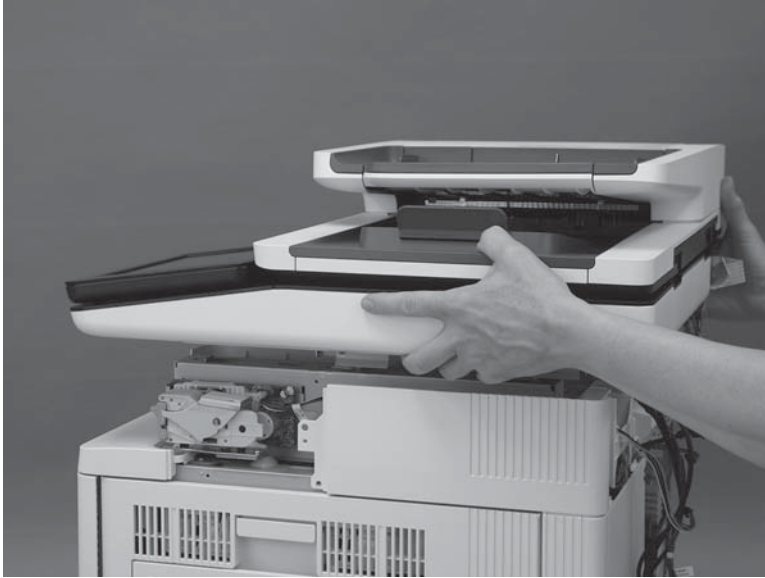

3. Slightly slide the ISA towards the front of the printer to engage it.

Figure 1-3209 Slide the ISA towards the front of the printer

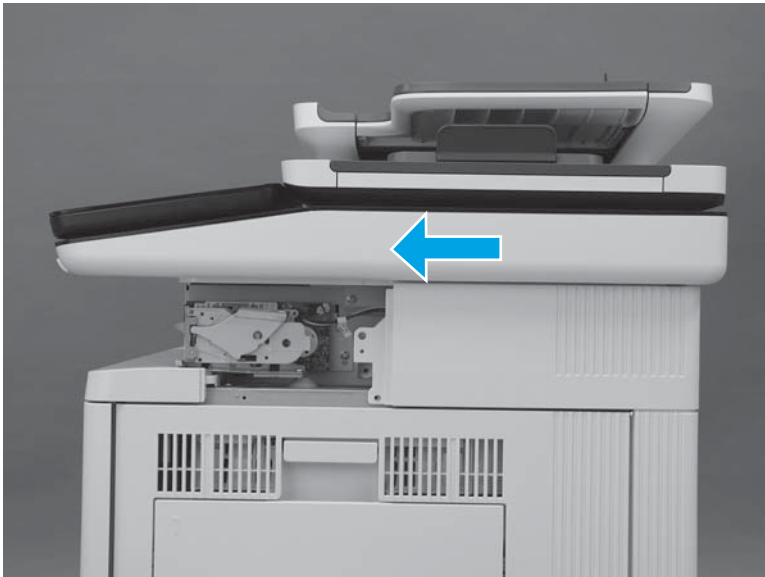

4. At the left side of the printer, install one screw (callout 1).

Figure 1-3210 Install one screw

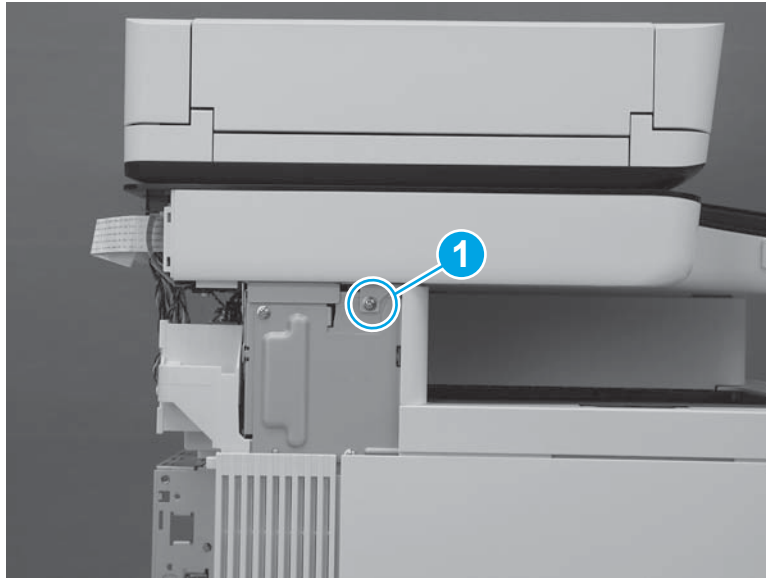

5. At the back of the printer, install two screws (callout 1).

Figure 1-3211 Install two screws

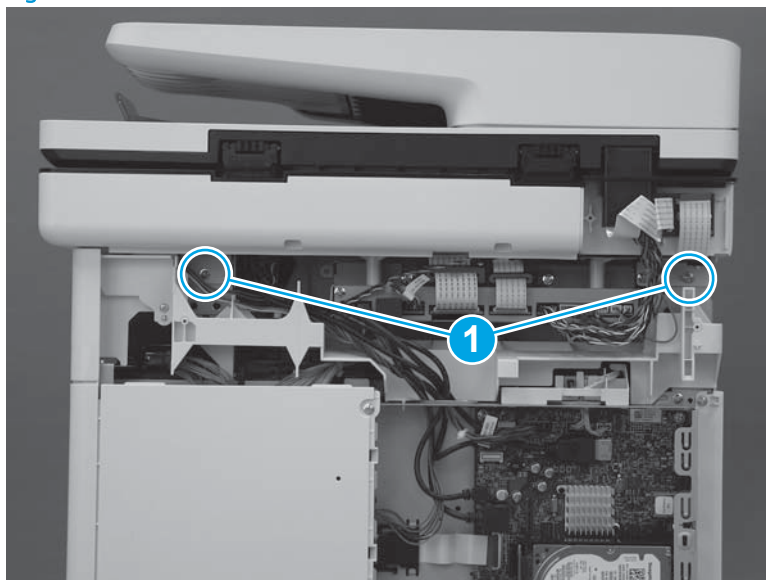

6. At the right side of the printer, install one screw (callout 1).

Figure 1-3212 Install one screw

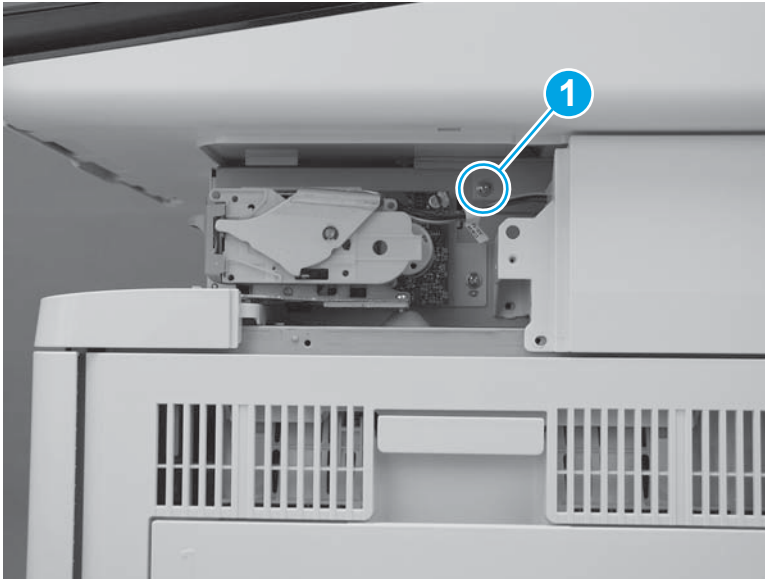

7. Connect two connectors on the scanner control board (callout 1).

M577c/f/z only: Connect one connector for the stapler on the scanner control board (callout 2).

Figure 1-3213 Connect connectors

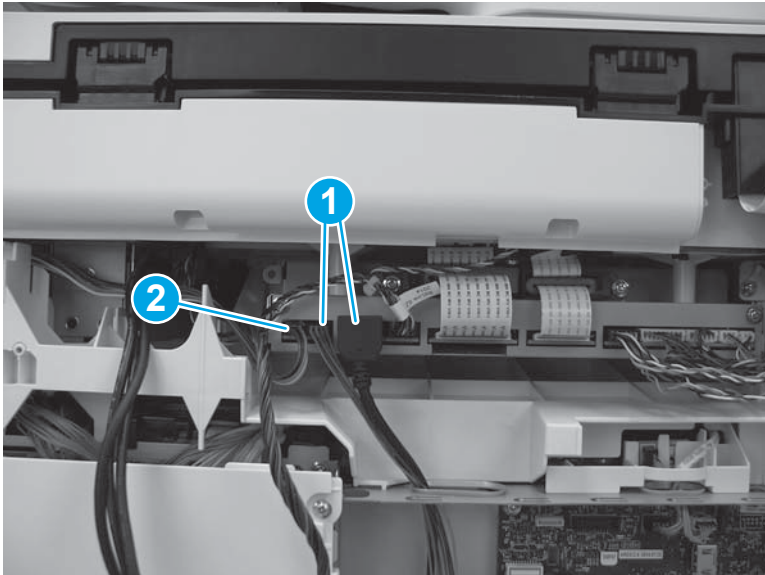

Step 37: Install the stapler cover assembly (M577c/f/z)

 **NOTE:** This step is for the M577c/f/z models only. For the M577dn model, skip this step and go to [Step 38: Install the right front upper cover \(M577dn\) on page 1808](#).

For the M552 and M553 models, skip this step and go to [Step 42: Install the rear cover \(M552 and M553\) on page 1815](#).

1. Install the tabs (callout 1) on the cover in the slots (callout 2) in the printer.

Figure 1-3214 Install two tabs



2. Press the cover toward the left side of the printer until it snaps into place.

Figure 1-3215 Install the cover assembly



3. Install one screw (callout 1).



 **IMPORTANT:** This is a self-tapping screw for plastic. Rotate it counterclockwise to align it with the existing thread pattern, and then carefully turn it clockwise to tighten. Do not overtighten. This will prevent stripping the threads inside the screw hole.

Figure 1-3216 Install one screw

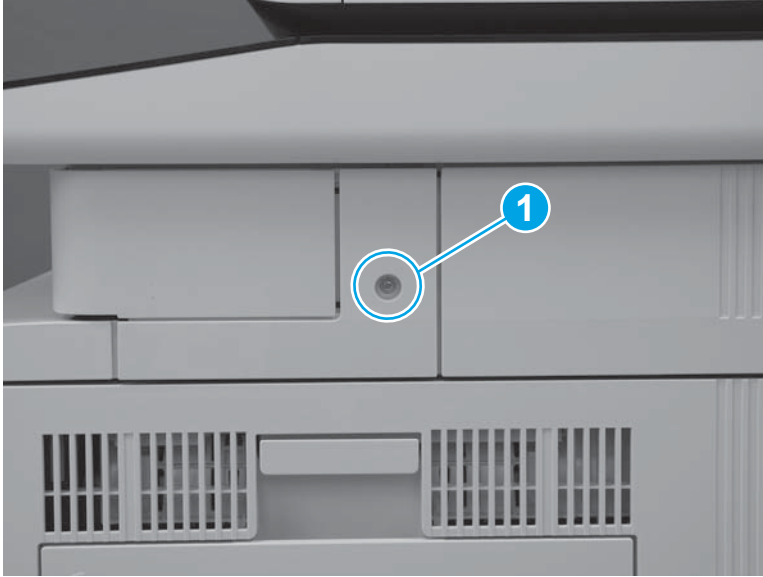

Step 38: Install the right front upper cover (M577dn)

 **NOTE:** This step is for the M577dn model only. For the M577c/f/z models, skip this step and go to [Step 39: Install the left upper cover \(M577\) on page 1810](#).

For the M552 and M553 models, skip this step and go to [Step 42: Install the rear cover \(M552 and M553\) on page 1815](#).

1. Slide the cover toward the left side of the printer to install it. Make sure that the slots (callout 1) in the cover fit over the tabs (callout 2) on the inside of the paper feeder cover.

Figure 1-3217 Install the cover



2. Press the right front upper cover (callout 1) and the paper feeder cover (callout 2) together until the tabs on the inside of the covers snap into place.

Figure 1-3218 Press the cover



3. Install one screw (callout 1).

Figure 1-3219 Install one screw

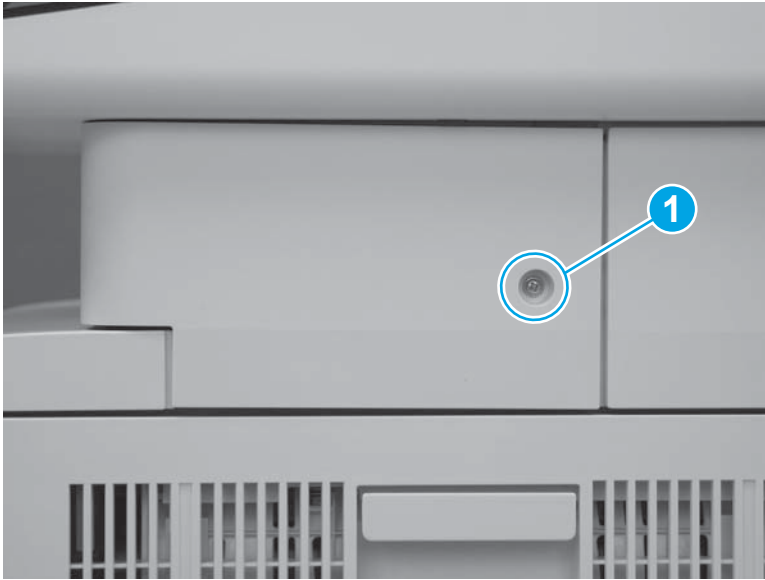

Step 39: Install the left upper cover (M577)

 **NOTE:** This step is for the M577 models. For the M552 and M553 models, skip this step and go to [Step 42: Install the rear cover \(M552 and M553\) on page 1815](#).

1. Position the tab (callout 1) on the lower edge of the cover behind the left cover (callout 2).

Figure 1-3220 Position the tab

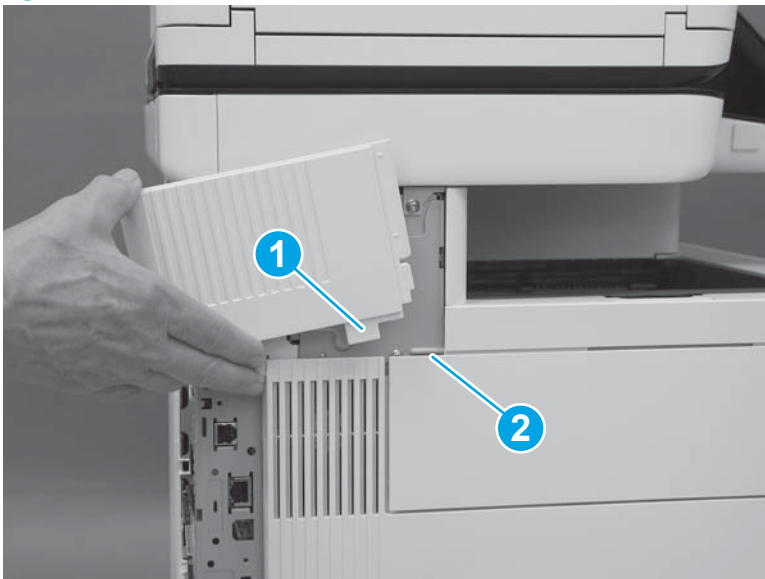

2. Slide the cover toward the front of the printer to install it. Make sure that the edge (callout 1) of the cover fits behind the edge (callout 2) of the top rear cover.

Figure 1-3221 Slide the cover

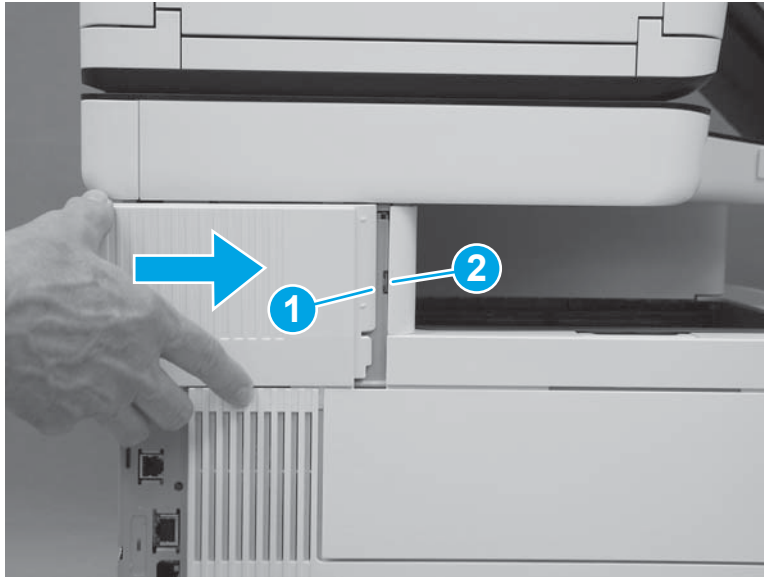

3. Make sure that the tab (callout 1) is fully installed.

Figure 1-3222 Check the tab

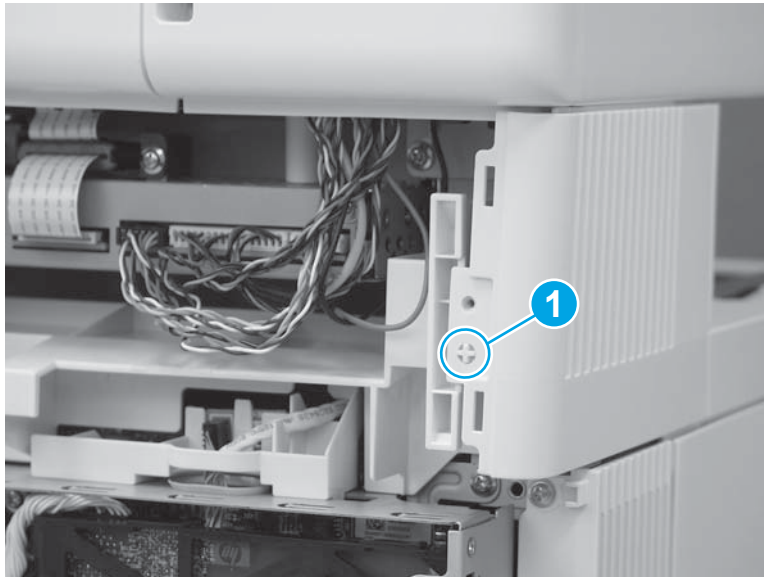

Step 40: Install the rear cover (M577)

 **NOTE:** This step is for the M577 models. For the M552 and M553 models, skip this step and go to [Step 42: Install the rear cover \(M552 and M553\) on page 1815](#).

1. Position the hooks (callout 1) on the cover in the slots (callout 2) in the printer.

Figure 1-3223 Position the hooks

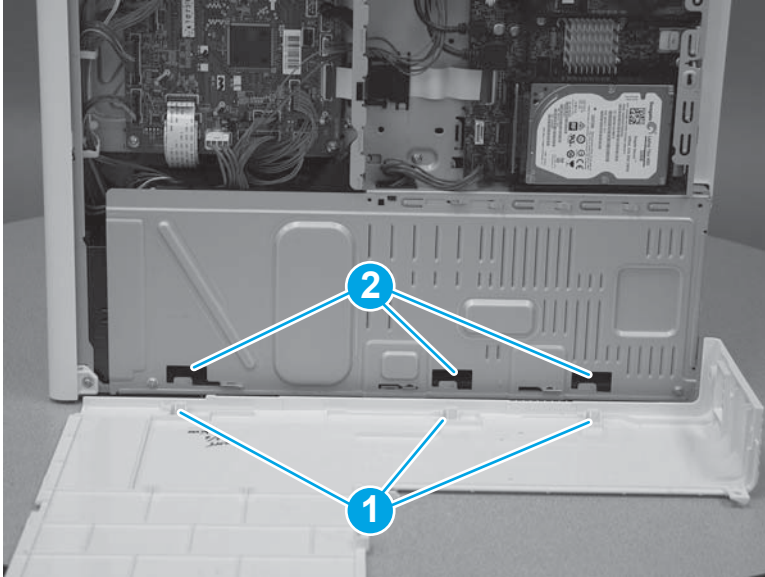

2. Position the back edge (callout 1) of the rear cover behind the edge (callout 2) of the right rear cover. Slide the cover to the left to install it.

Figure 1-3224 Install the cover

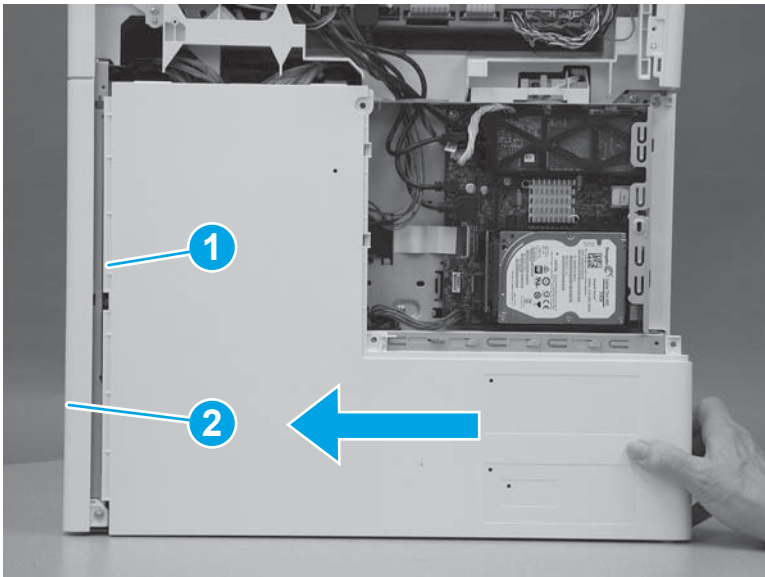

3. Install four screws (callout 1).

Figure 1-3225 Install four screws cover

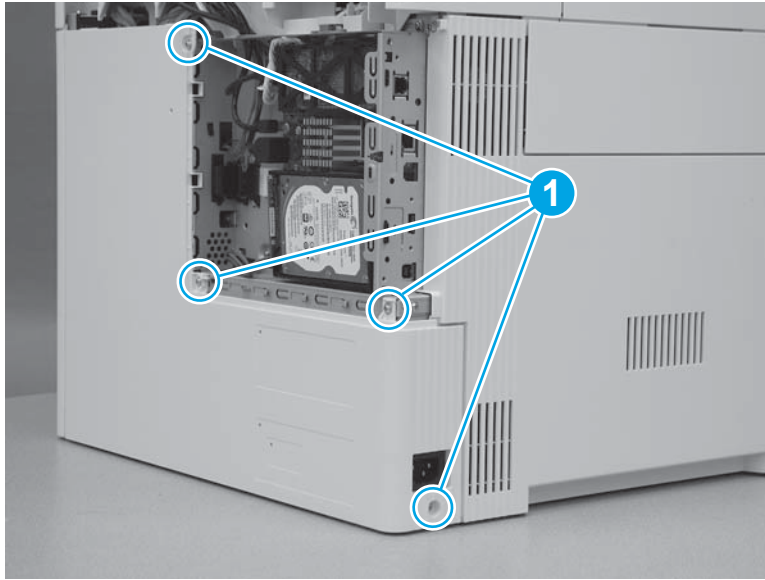

Step 41: Install the rear upper cover (M577)

 **NOTE:** This step is for the M577 models. For the M552 and M553 models, skip this step and go to [Step 42: Install the rear cover \(M552 and M553\) on page 1815](#).

1. Align the ridge (callout 1) on the lower edge of the rear upper cover in front of the tabs (callout 2) on the top edge of the rear cover.

Figure 1-3226 Align the cover

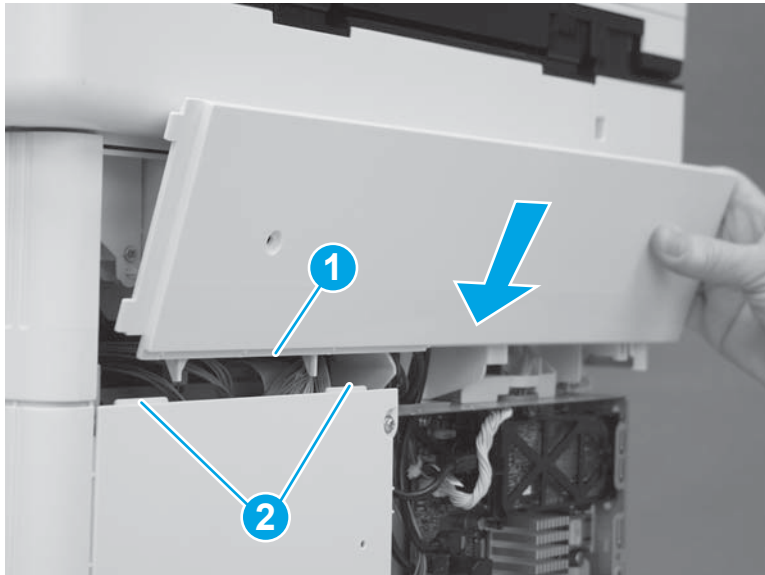

2. Rotate the top of the cover toward the printer.

Figure 1-3227 Rotate the top of the cover

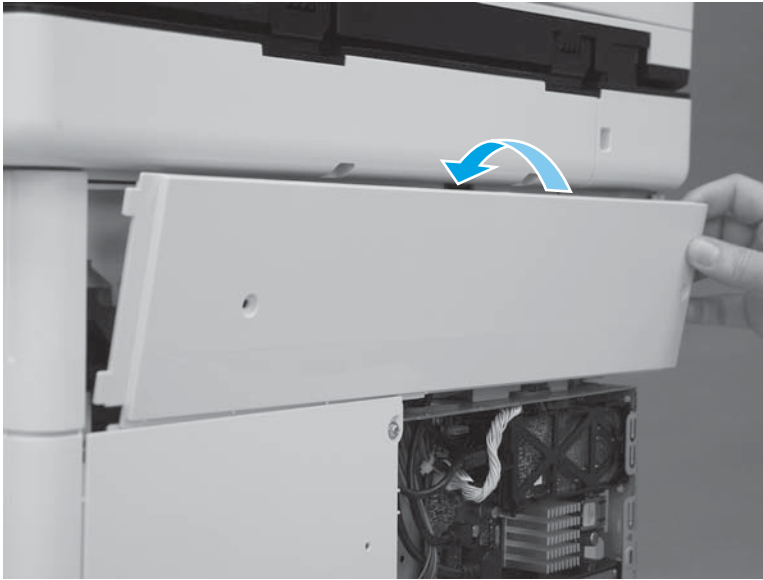

3. Slide the cover to the left (callout 1). Make sure that the tabs (callout 2) on the upper rear cover slide behind the edge (callout 3) of the right upper cover. Make sure that the cover is fully seated.

Figure 1-3228 Slide the cover

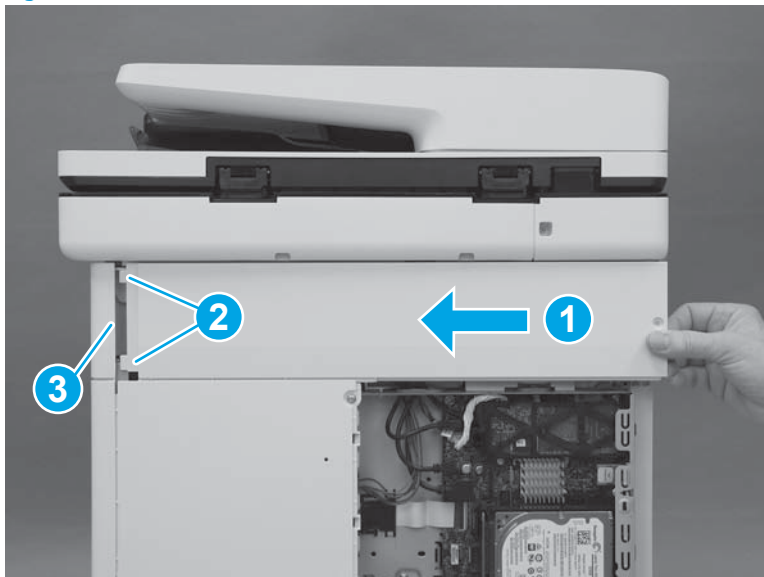

4. Install two screws (callout 1).

 **IMPORTANT:** These two screws are self-tapping screws for plastic. Rotate them counterclockwise to align them with the existing thread pattern, and then carefully turn them clockwise to tighten. Do not overtighten. This will prevent stripping the threads inside the screw holes.

Figure 1-3229 Install two screws



Step 42: Install the rear cover (M552 and M553)

 **NOTE:** This step is for the M552 and M553 models. For the M577 models, skip this step and go to [Step 43: Install the formatter \(M577\) on page 1816](#).

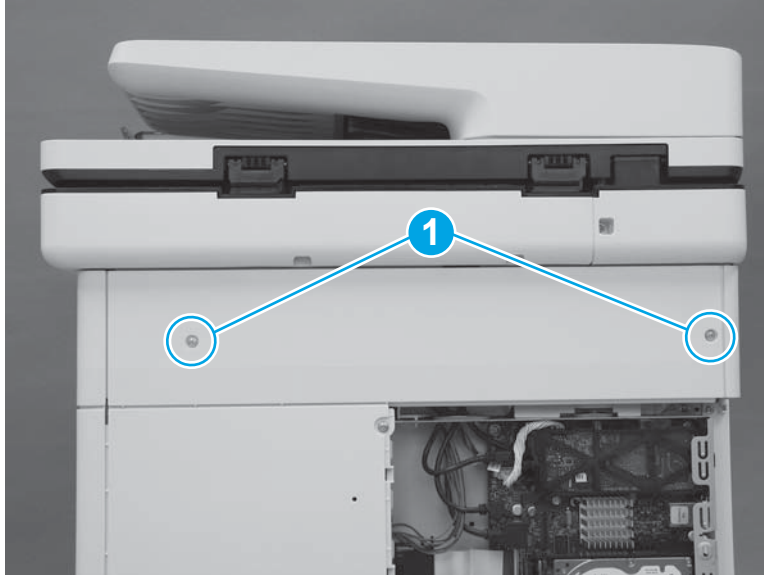
1. Position the top of the cover under the upper cover (callout 1), rotate the bottom of the cover onto the chassis (callout 2), and then slide the cover to the left (callout 3) to install it.

Figure 1-3230 Install the cover

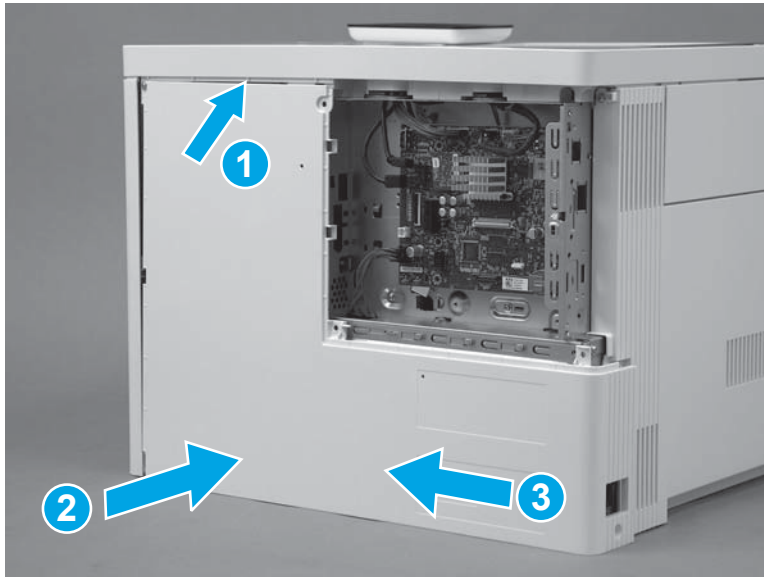

2. Install four screws (callout 1).

Figure 1-3231 Install four screws cover

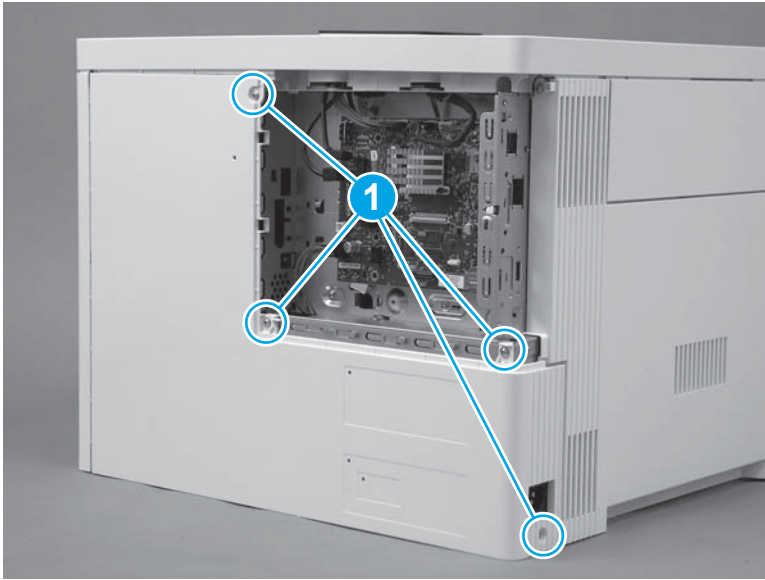

Step 43: Install the formatter (M577)

 **NOTE:** This step is for the M577 models. For the M552 and M553 models, skip this step and to go [Step 46: Install the formatter \(M552 and M553\) on page 1821](#).

 **CAUTION:**  ESD-sensitive part.

1. Position the formatter in the printer. Make sure that the network port (callout 1) fits through the opening (callout 2) in the formatter case.

Figure 1-3232 Install the formatter

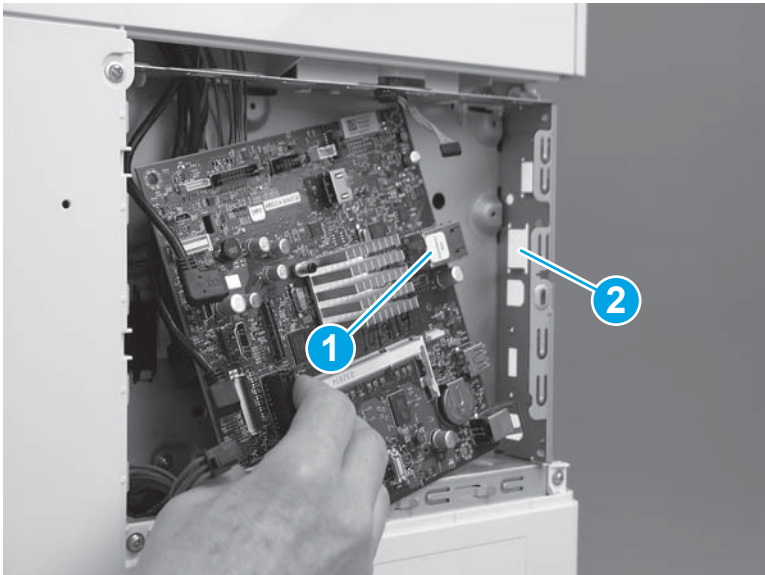

2. Install four screws (callout 1).

Figure 1-3233 Install four screws

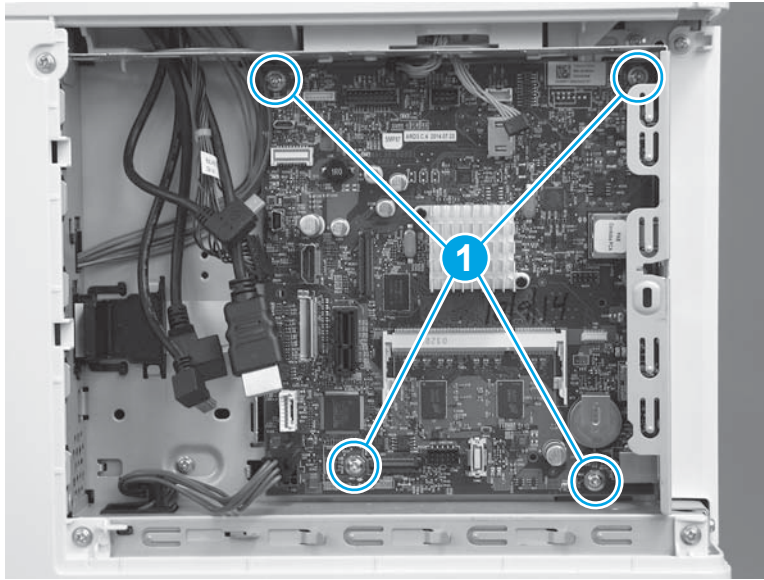

3. Connect all of the connectors on the formatter.

The following connectors are empty:

- All models: J1 (this connector is empty unless the optional DIMM is installed)
- All models: J3
- M577dn: J15 (this is the fax connector for the M577f/z/c models)
- All models: J21 (this connector is empty unless the optional internal USB ports component is installed)
- All models: J23
- All models: J24
- All models: J51
- All models: J57
- All models: J97
- All models: J98 (this connector is empty unless the optional trusted platform module (TPM) is installed)

 **IMPORTANT:** The flat-cable connector (callout 1) is a Zero Insertion Force (ZIF) connector that uses a hinged retainer to secure the flat cable. The hinged retainer must be opened to install the flat cable, and then closed after the cable is installed.

Figure 1-3234 Connect all connectors



Step 44: Install the fax PCA (M577c/f/z)

 **NOTE:** This step is for the M577c/f/z models. For the M577n model, skip this step and go to [Step 45: Install the HDD \(M577\) on page 1819](#).

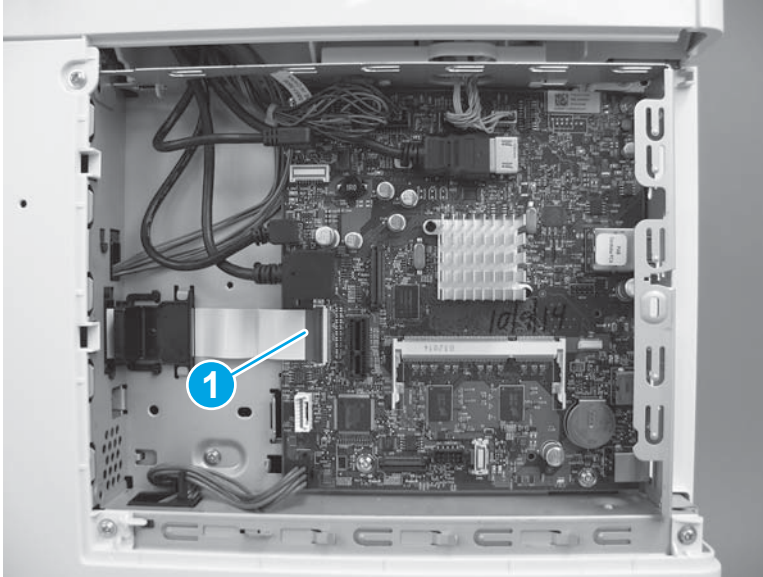
For the M552 and M553 models, skip this step and go to [Step 46: Install the formatter \(M552 and M553\) on page 1821](#).

 **CAUTION:**  ESD-sensitive part.

1. Position the tab and telephone port (callout 1) on the fax PCA in the slots (callout 2) in the formatter case.

Figure 1-3235 Position the fax PCA

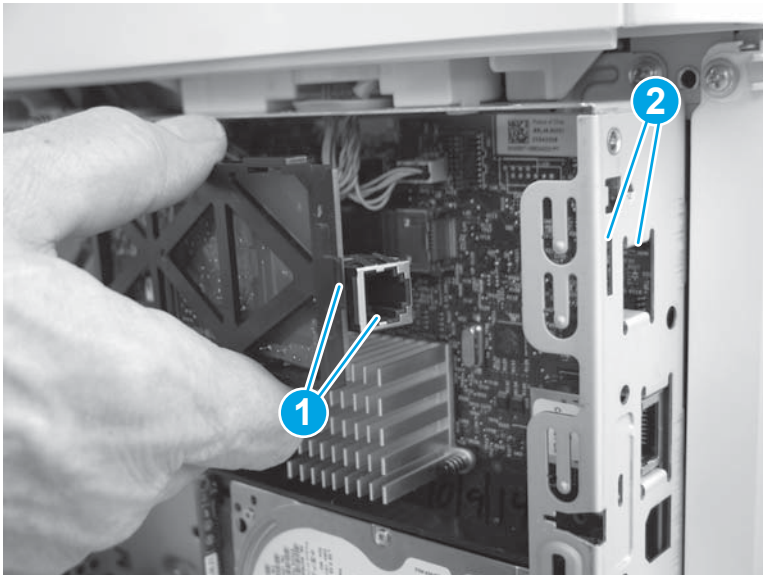

- Slide the fax PCA to the right (callout 1) until the tab and telephone port described in the previous step and seated in the formatter case. Position the retainer (callout 2) in the slot (callout 3) in the formatter. Rotate the end of the fax PCA toward the formatter (callout 4) until the retainer snaps into place.

Figure 1-3236 Install the fax PCA

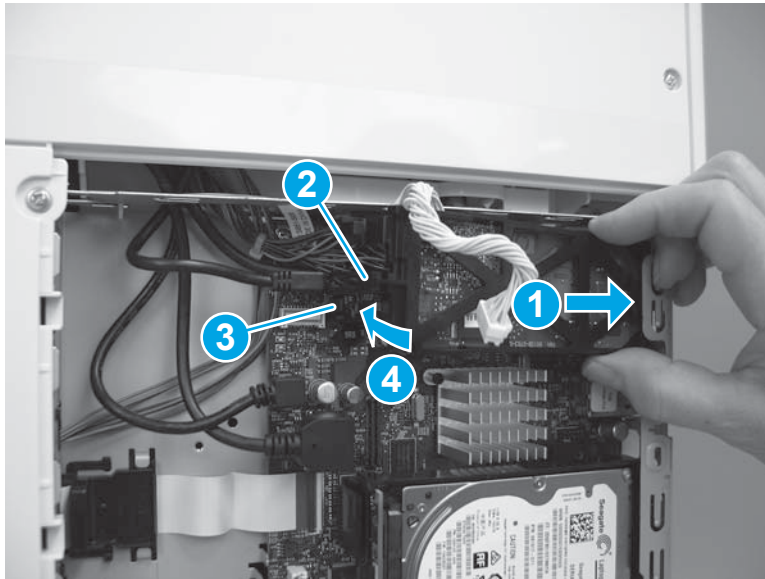

- Position the cable (callout 1) in the guide (callout 2), and then connect one connector (callout 3).

Figure 1-3237 Connect the connector

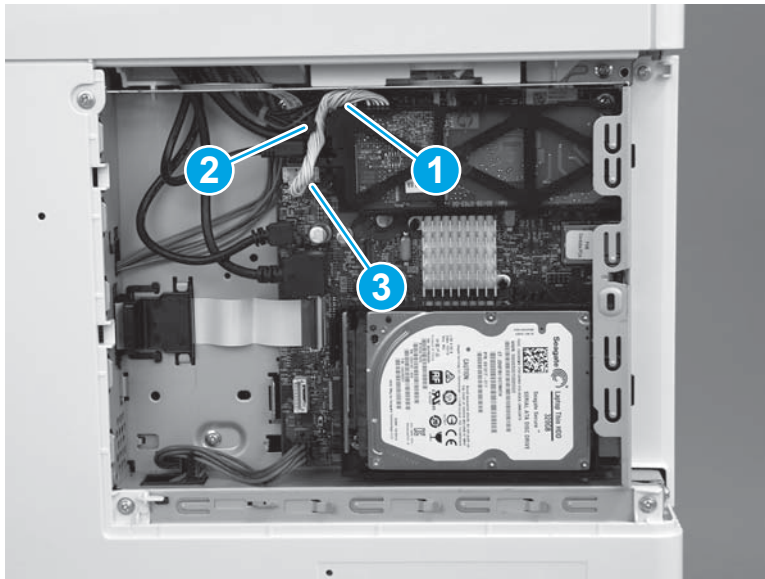

Step 45: Install the HDD (M577)

 **NOTE:** This step is for the M577 models. For the M552 and M553 models, skip this step and go to [Step 46: Install the formatter \(M552 and M553\) on page 1821](#).

 **CAUTION:**  ESD-sensitive part.

1. Align the end of the bracket (callout 1) with the slot in the chassis (callout 2), and then slide the HDD into the printer (callout 3) to engage the bracket with the chassis.

Figure 1-3238 Install the holder

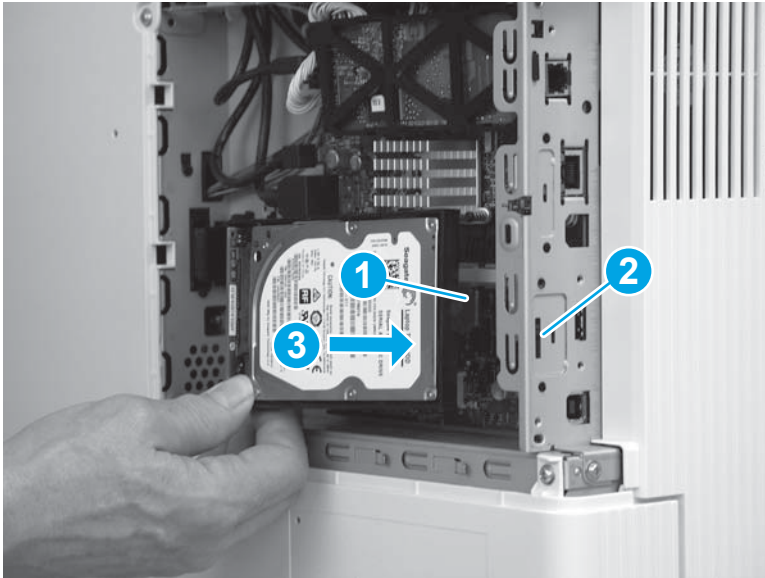

2. Hold the HDD connector latch (callout 1) in the released position, and then rotate the HDD down and into the connector on the formatter to install it.

 **NOTE:** Make sure that the tab (callout 2) snaps into place, and that the HDD is securely installed.

Figure 1-3239 Release the HDD



Step 46: Install the formatter (M552 and M553)

 **NOTE:** This step is for the M552 and M553 models. For the M577 models, skip this step and go to [Step 47: Install the formatter cover on page 1822](#).

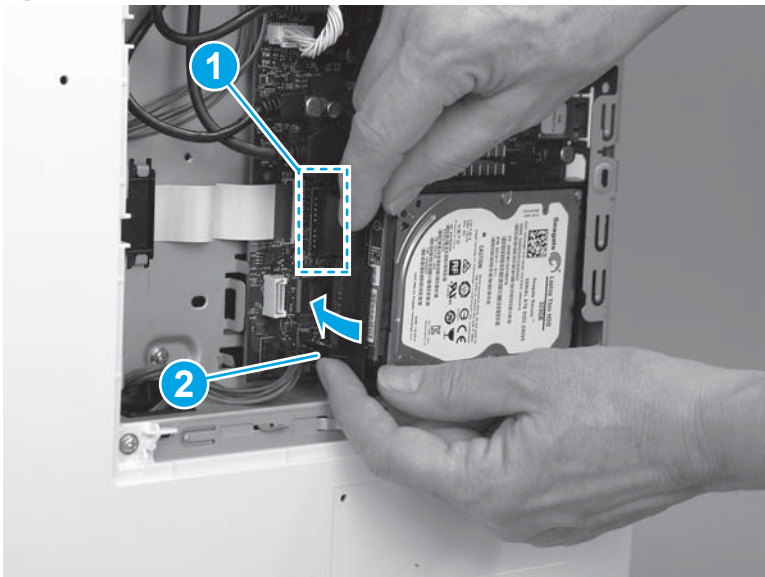
If the optional hard-disk drive (HDD) was removed, do not forget to reinstall it after the formatter is reinstalled.

Engage the HDD holder with the chassis, rotate the HDD connector down and into the connector on the formatter. Make sure that the tabs snap into place.

 **CAUTION:**  ESD-sensitive part.

1. Position the formatter in the printer, and then install four screws (callout 1).

Figure 1-3240 Install the formatter

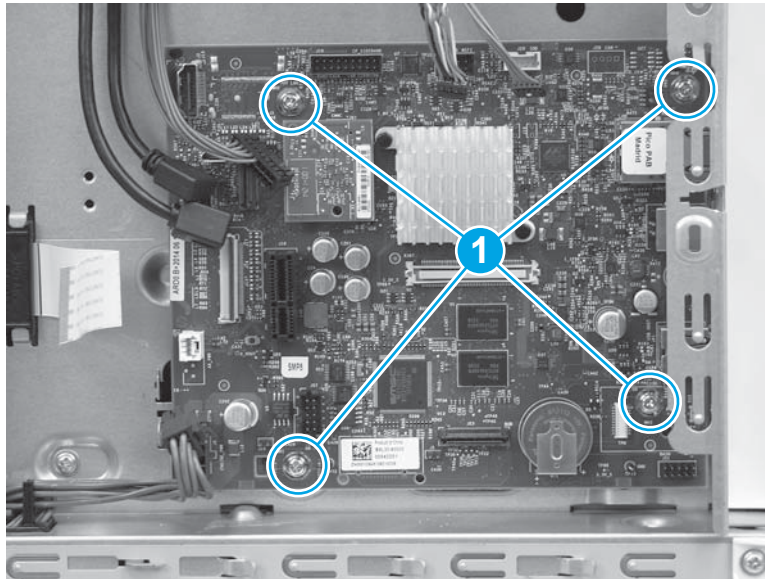

2. Connect all of the connectors on the formatter.

The following connectors are empty:

- All models: J1 (this connector is empty unless the optional DIMM is installed)
- M553n/dn and M552dn: J2 (callout 1; this is the touchscreen connector for the M553x model)
- All models: J9 (this connector is empty unless the optional internal USB ports component is installed)
- All models: J18 (this connector is empty unless the optional hard-disk-drive (HDD) is installed)
- All models: J23
- All models: J24
- M553n/dn and M552dn: J25 (this is the wireless connector for the M553x model)
- All models: J57
- All models: J98 (this connector is empty unless the optional trusted platform module (TPM) is installed)

 **IMPORTANT:** The flat-cable connector (callout 2) is a Zero Insertion Force (ZIF) connector that uses a hinged retainer to secure the flat cable. The hinged retainer must be opened to install the flat cable.

Figure 1-3241 Connect all connectors

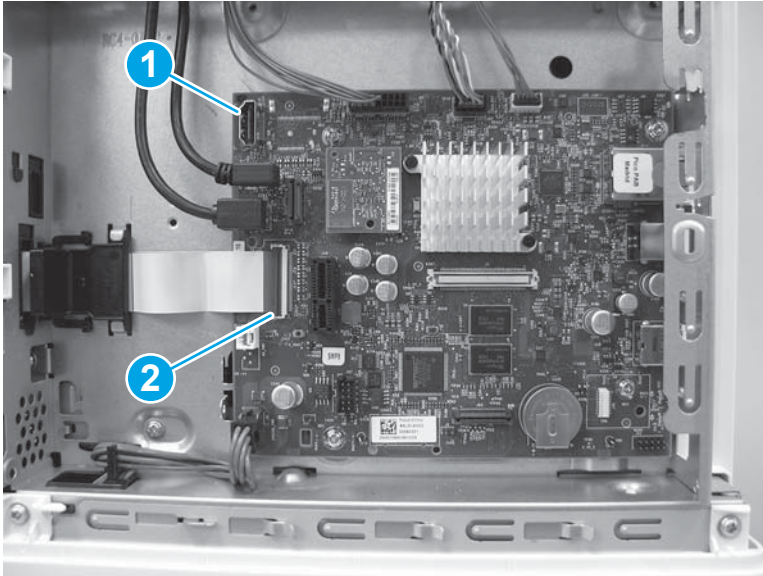

Step 47: Install the formatter cover

- ▲ Slide the cover onto the printer (callout 1) to install it.

 **NOTE:** Make sure that the tabs on the formatter cover align with the slots provided in the printer (callout 2). Tighten the two thumbscrews (callout 3).

 **TIP:** If needed, use the edge of a coin to turn the thumbscrews.

Figure 1-3242 Install the cover

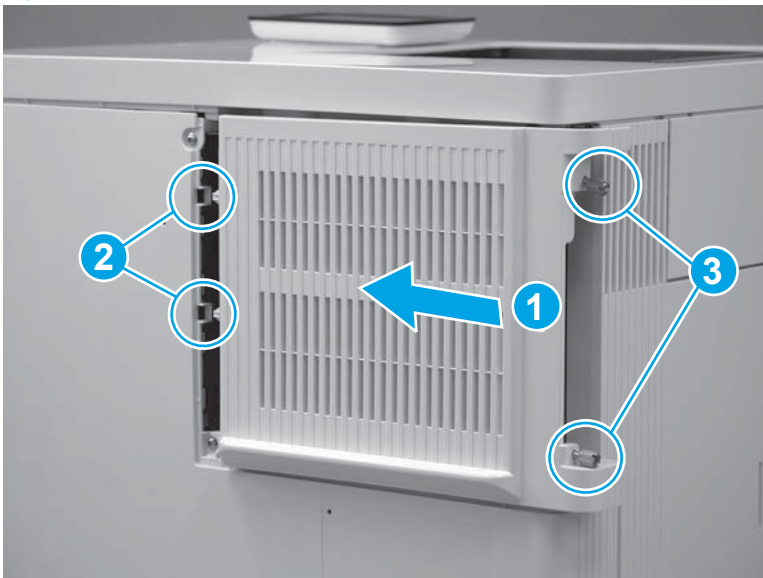

Step 48: Install the TCU

1. Verify that the toner collection hatch cover is in the closed position on the TCU.

Figure 1-3243 Verify that the toner collection hatch cover is closed

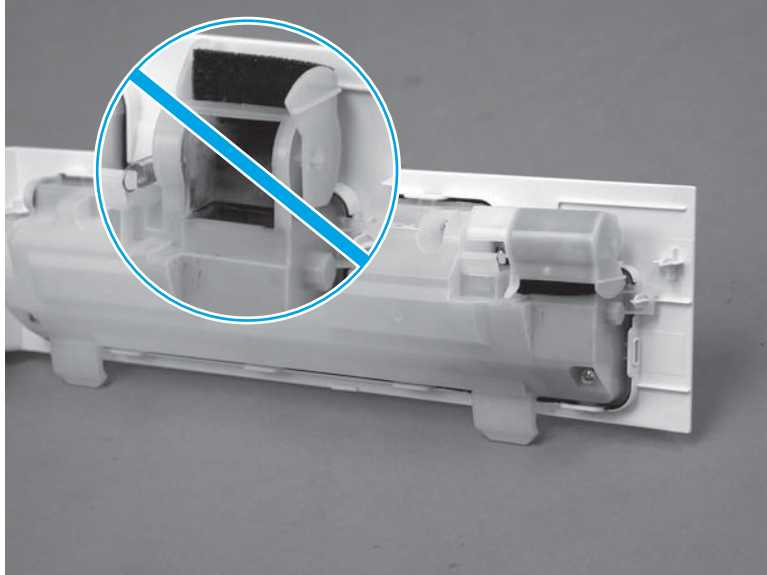

2. Position the TCU with the hinges in the slots provided in the printer (callout 1), and then rotate the TCU up and into the closed position.

 **NOTE:** The toner collection hatch cover automatically opens when the TCU is closed.

Figure 1-3244 Install the TCU

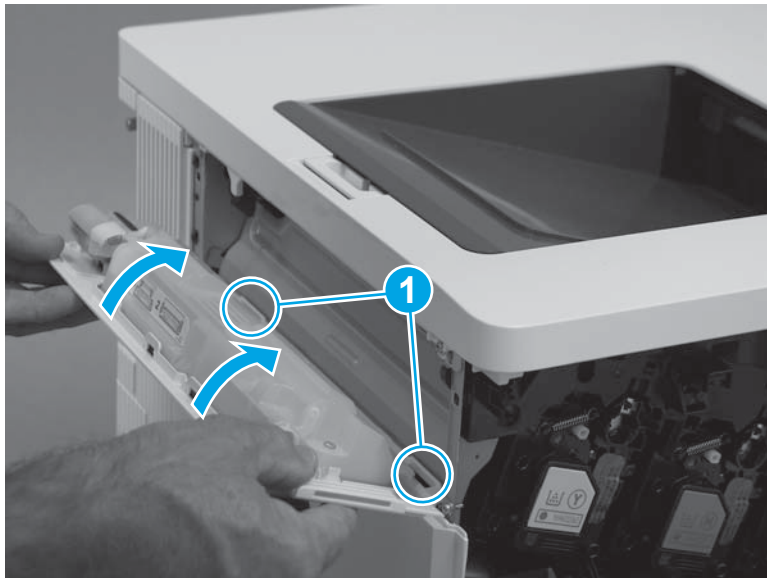

3. Close the front door.

Figure 1-3245 Close the front door



Step 49: Install the tray

1. With the front of the tray slightly lifted, align the sides of the tray with the rails in the printer, and then carefully slide the tray into the printer.

 **TIP:** As the tray slides into the printer, lower the front of it.

Figure 1-3246 Install the tray



2. Close the tray.

Figure 1-3247 Close the tray



Step 50: Install the control-panel assembly (M553x only)

 **NOTE:** For the M553n/dn and M552dn models, skip this step and go to [Step 51: Install the USB cover \(M552 and M553\) on page 1828](#).

For the M577 models, skip this step.

1. Place the control panel on the printer as shown.

Figure 1-3248 Place the control panel on the product

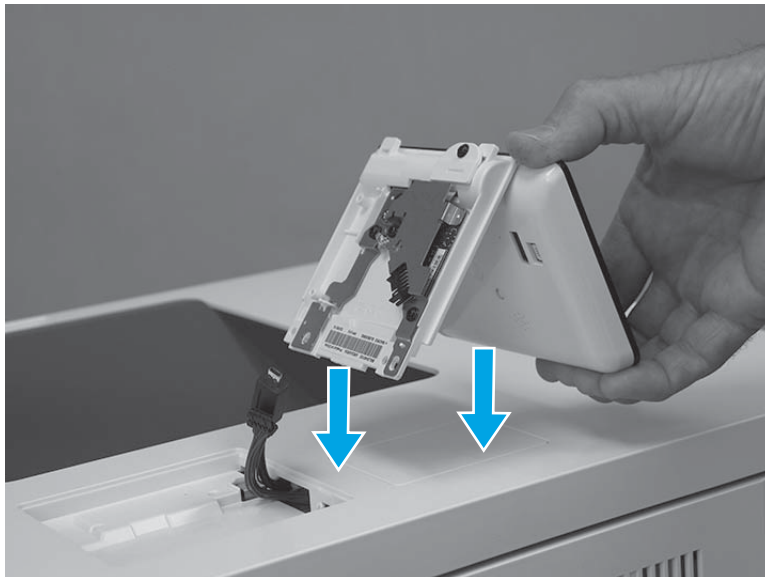

2. Connect one USB cable (callout 1), and one connector (callout 2).

 **IMPORTANT:** Take note of the location of the two mounting tabs (callout 3) on the control-panel assembly.

Figure 1-3249 Connect two connectors



3. Turn the control panel over, and then position the front edge tabs in the slots in the top cover.

Figure 1-3250 Turn the control panel over

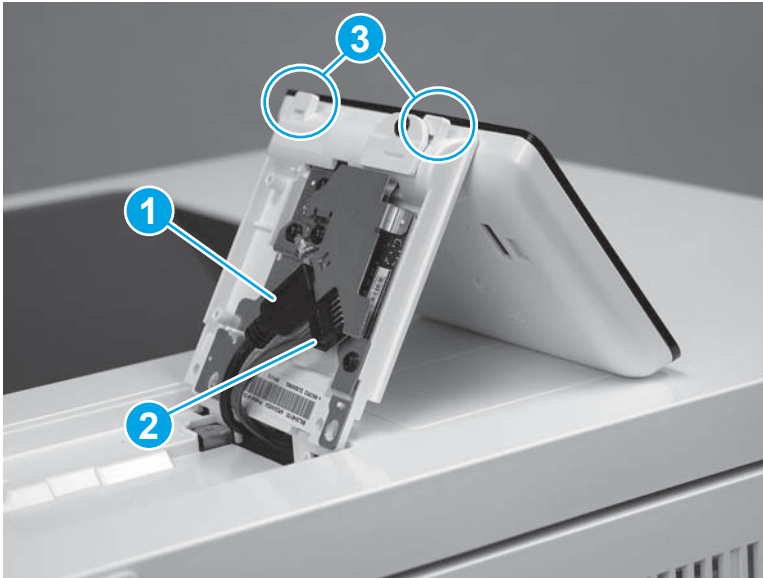
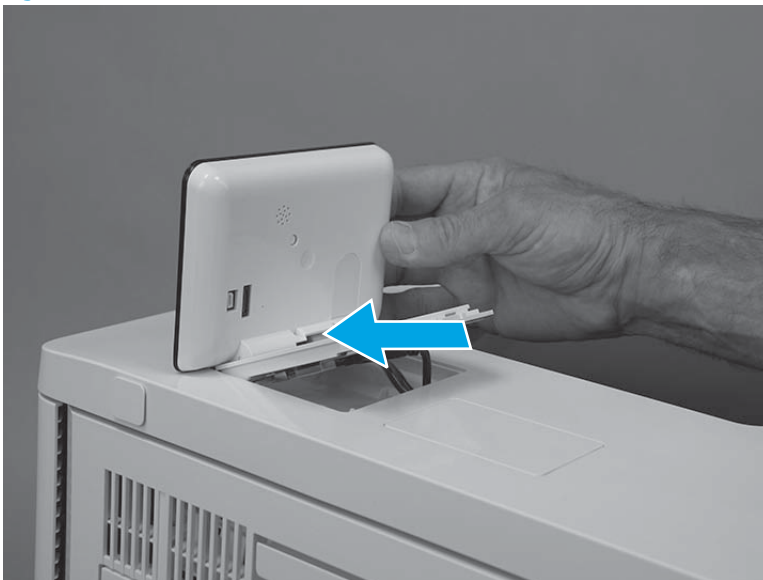

4. Rotate the control-panel base down onto the printer.

Figure 1-3251 Rotate the control-panel base down



5. Use a small Phillips screwdriver to install two screws (callout 1).

Figure 1-3252 Install two screws

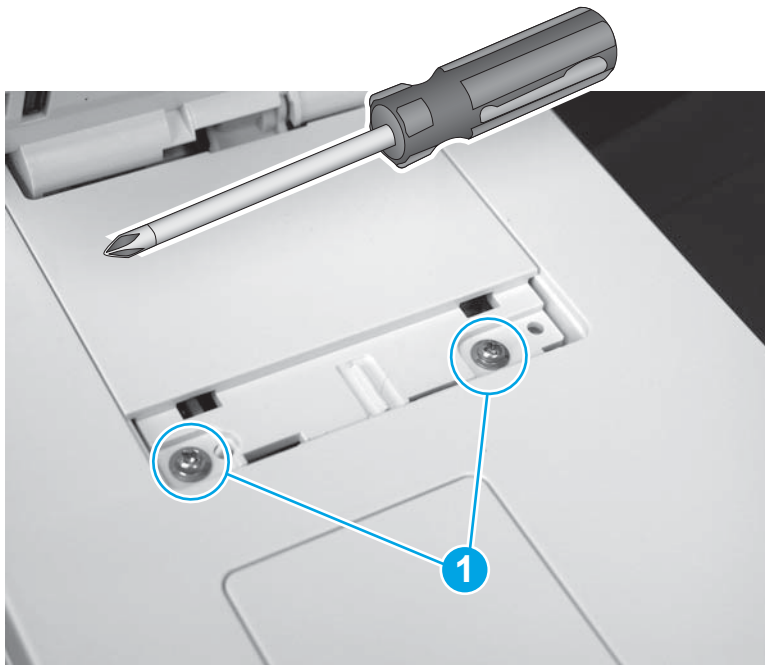

6. Position the screw cover mounting feet into the slots in the top cover (callout 1), and then rotate the cover down (callout 2) to install it.



 **NOTE:** Press down on the cover firmly to make sure that the tabs on the cover (callout 3) snap into place.

Figure 1-3253 Install the cover

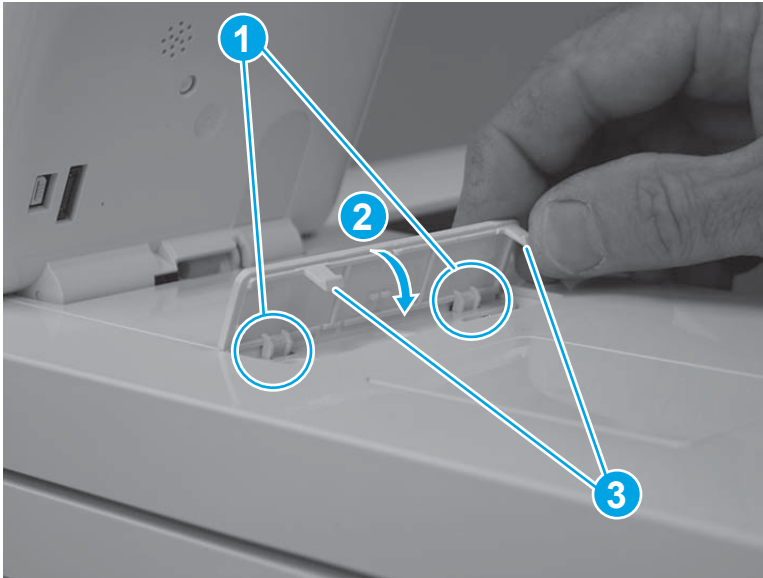

Step 51: Install the USB cover (M552 and M553)

 **NOTE:** This step is for the M552 and M553 models. For the M577 models, skip this step.

1. Push the cover into the USB port to install it.

Figure 1-3254 Install the cover



2. Make sure that the USB cover is fully seated after installing it.

Figure 1-3255 Check the installation



Removal and replacement: Environmental sensor printed circuit assembly (PCA)

- [Introduction](#)
- [Step 1: Remove the formatter cover](#)
- [Step 2: Remove the rear cover \(M552 and M553\)](#)
- [Step 3: Remove the rear upper cover \(M577\)](#)
- [Step 4: Remove the rear cover \(M577\)](#)
- [Step 5: Remove the environmental sensor PCA](#)
- [Step 6: Unpack the replacement assembly](#)
- [Step 7: Install the environmental sensor PCA](#)
- [Step 8: Install the rear cover \(M577\)](#)
- [Step 9: Install the rear upper cover \(M577\)](#)
- [Step 10: Install the rear cover \(M552 and M553\)](#)
- [Step 11: Install the formatter cover](#)

Introduction



This document provides the procedures to remove and replace the environmental sensor printed circuit assembly (PCA).

Before performing service

Turn the printer power off

- Disconnect the power cable.

 **WARNING!** To avoid damage to the printer, turn the printer off, wait 30 seconds, and then remove the power cord before attempting to service the printer.

 **CAUTION:**  This part contains components that are electrostatic discharge (ESD) sensitive. To reduce the possibility of ESD damage, always touch the sheet-metal chassis to ground yourself before touching an ESD sensitive part.

Use the table below to identify the correct part number for your printer, and then go to <http://h20141.www2.hp.com/hpparts> to order the part.

Environmental sensor printed circuit assembly (PCA) part number	
---	--

RM2-7154-000CN

Environmental sensor printed circuit assembly (PCA)

Required tools

- #2 Phillips screwdriver with a magnetic tip

After performing service

Turn the printer power on

- Connect the power cable.
- Use the power switch to turn the power on.

Post service test

Print a configuration page to make sure that the printer is functioning correctly.

Step 1: Remove the formatter cover

1. Locate the formatter cover.

Figure 1-3256 Locate the formatter cover

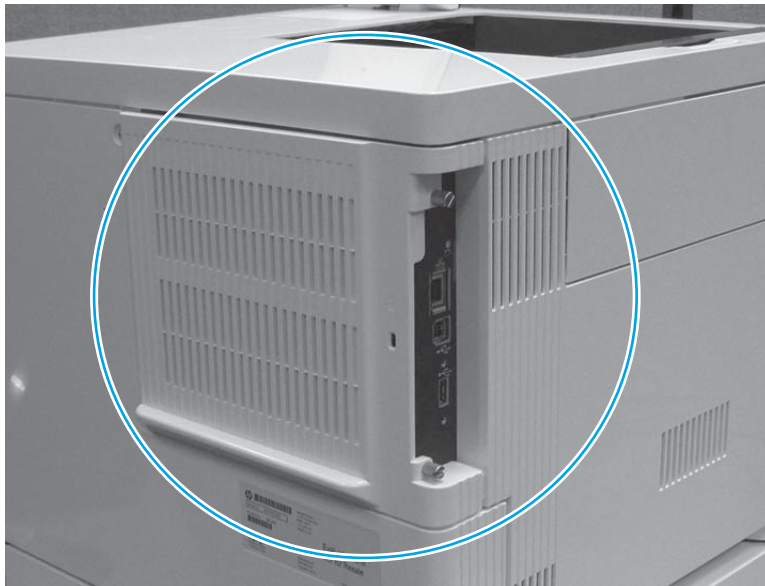

2. Loosen the two thumbscrews (callout 1). Grasp the two thumbscrews, and then slide the cover away from the printer (callout 2) to remove it.

 **TIP:** If needed, use the edge of a coin to turn the thumbscrews.

Figure 1-3257 Loosen the thumbscrews

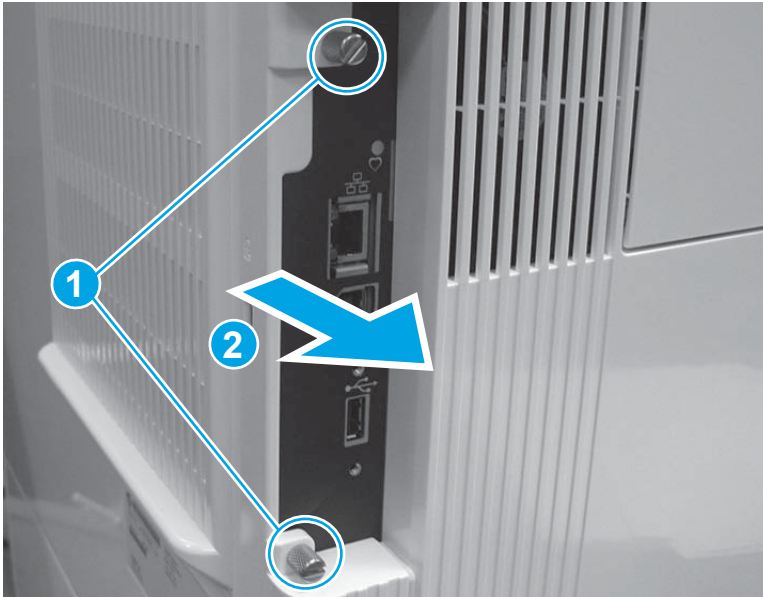

Step 2: Remove the rear cover (M552 and M553)

 **NOTE:** This step is for the M552 and M553 models. For the M577 models, skip this step and go to [Step 3: Remove the rear upper cover \(M577\) on page 1833](#).

1. Remove four screws (callout 1).

Figure 1-3258 Remove four screws

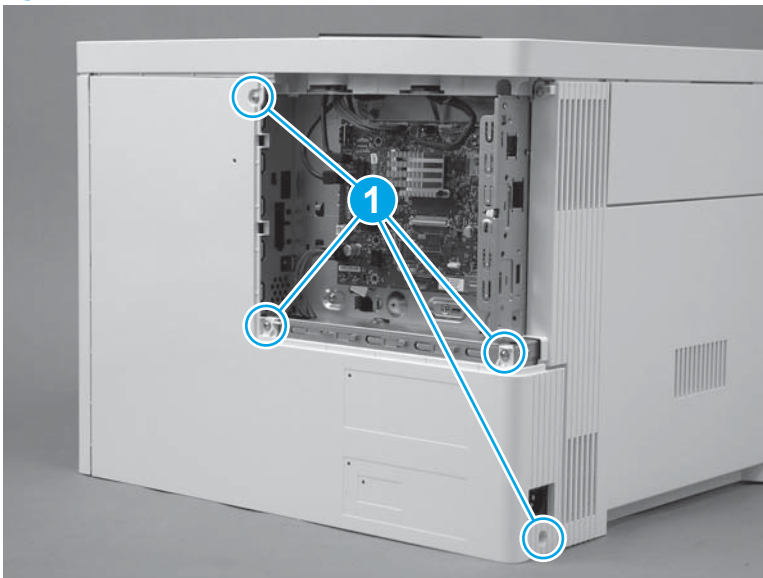

2. Slightly slide the cover to the right (callout 1), rotate the bottom of the cover away from the printer (callout 2), and then pull the top of the cover away from the printer (callout 3) to remove the cover.

Figure 1-3259 Remove the cover

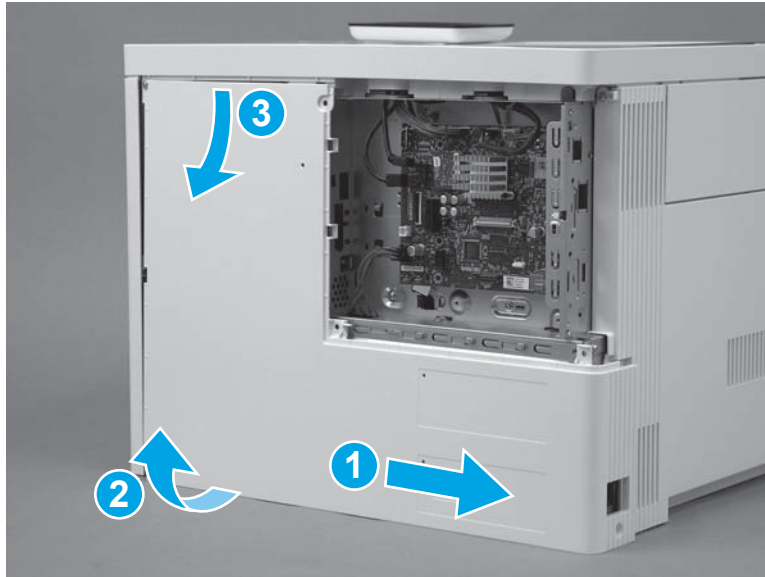

Step 3: Remove the rear upper cover (M577)

 **NOTE:** This step is for the M577 models. For the M552 and M553 models, skip this step and go to [Step 5: Remove the environmental sensor PCA on page 1836](#).

1. Remove two screws (callout 1).

 **Reinstallation tip:** These two screws are self-tapping screws for plastic. When reinstalling them, rotate the screws counterclockwise to align them with the existing thread pattern, and then carefully turn them clockwise to tighten. Do not overtighten. This will prevent stripping the threads inside the screw holes.

Figure 1-3260 Remove two screws



2. Use a small, flat blade screwdriver to release the right edge of the cover.

Figure 1-3261 Release the right edge

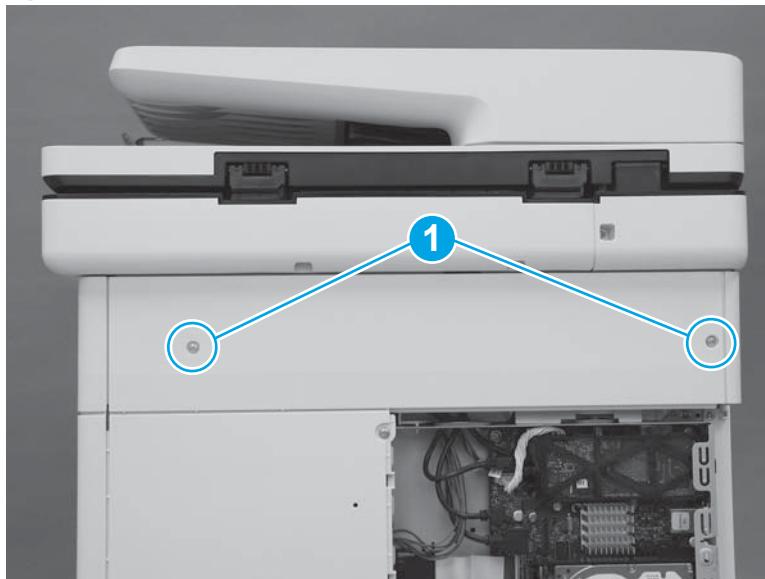
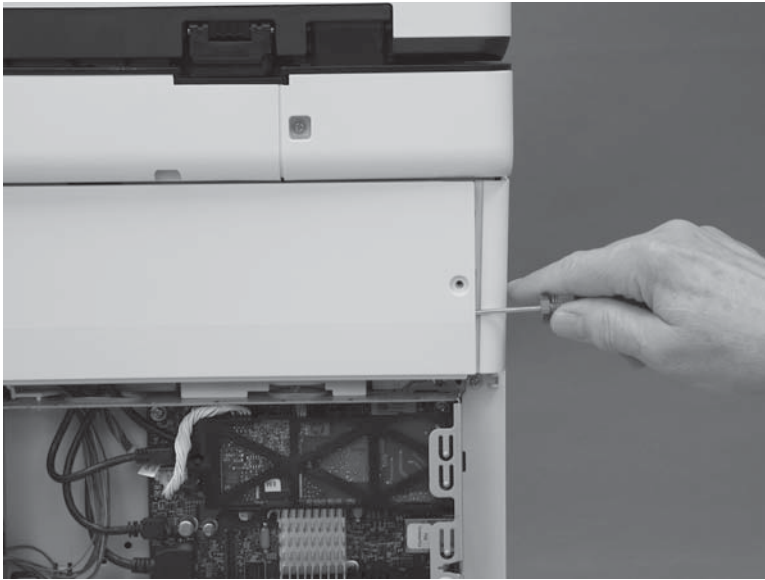

3. Pull the right edge of the cover (callout 1) away from the printer, and then slide the cover to the right (callout 2).

Figure 1-3262 Slide the cover right

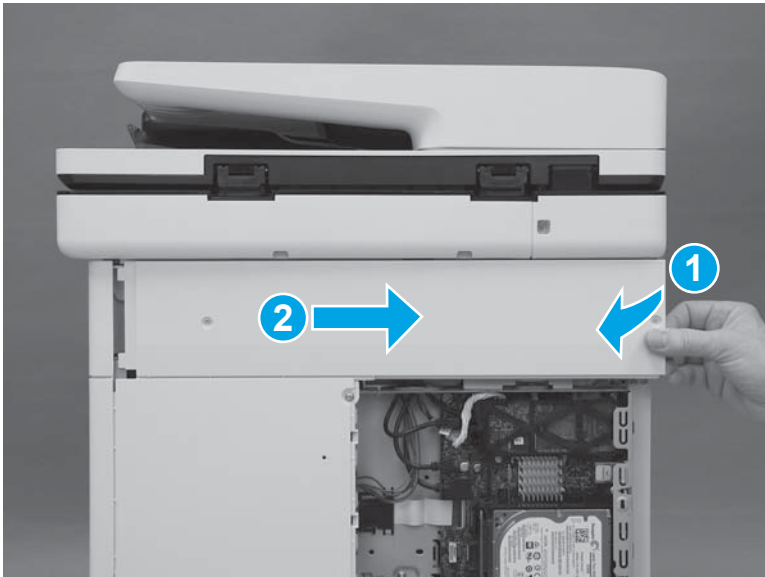

4. Remove the cover.

Figure 1-3263 Remove the cover

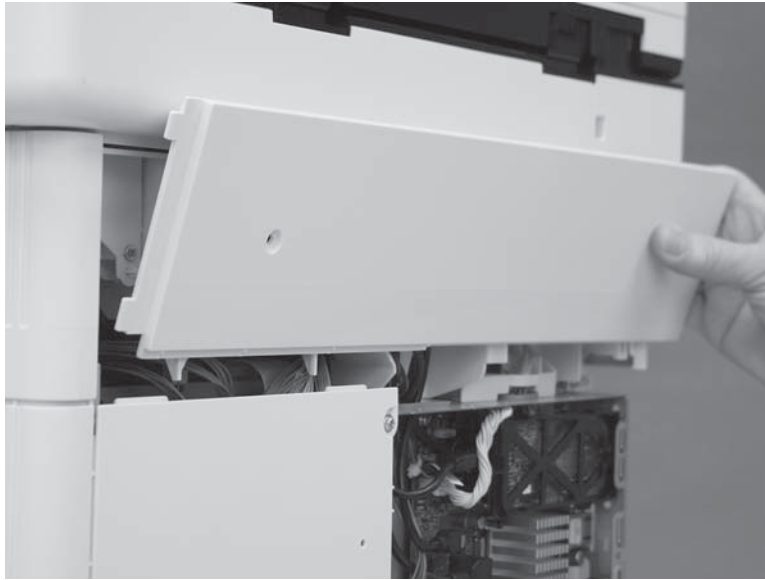

Step 4: Remove the rear cover (M577)

 **NOTE:** This step is for the M577 models. For the M552 and M553 models, skip this step and go to [Step 5: Remove the environmental sensor PCA on page 1836](#).

1. Remove four screws (callout 1).

Figure 1-3264 Remove four screws

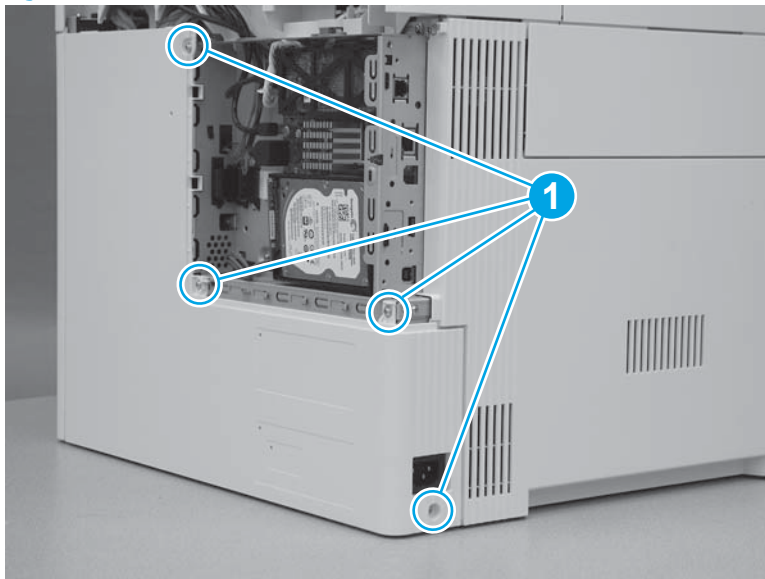

2. Slide the cover to the right to remove it.

Figure 1-3265 Remove the cover

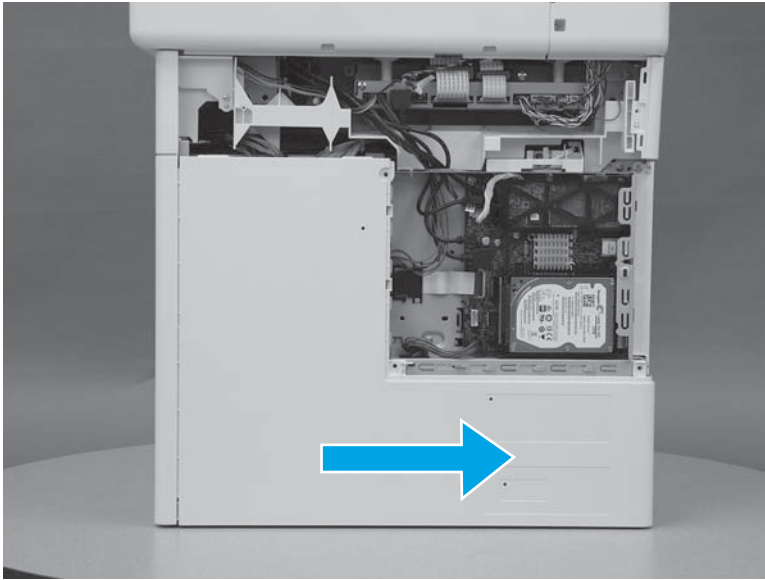

Step 5: Remove the environmental sensor PCA

 **CAUTION:**  ESD-sensitive part.

1. Remove two screws (callout 1), and then slide the low-voltage power supply (LVPS) cover to the right to remove it.

Figure 1-3266 Remove the LVPS cover

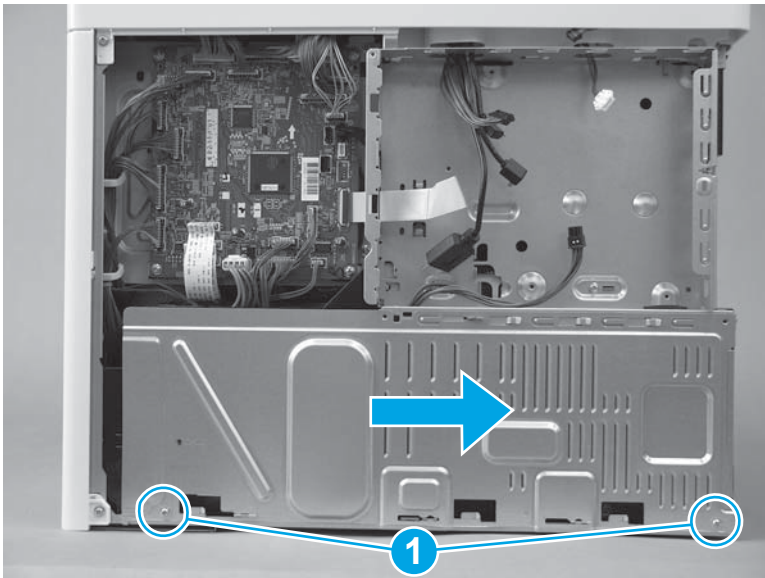

2. Disconnect one connector (callout 1).

Figure 1-3267 Disconnect one connector

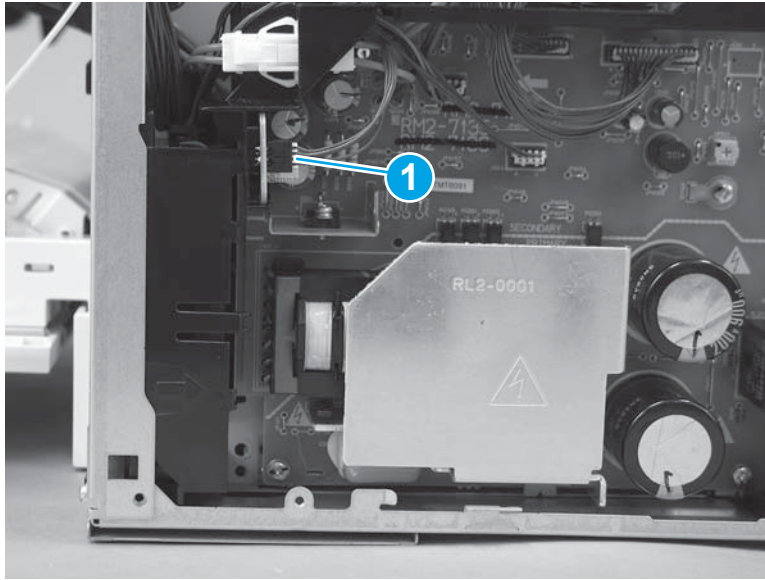

3. Slide the environmental sensor PCA out of the holder to remove it.

Figure 1-3268 Remove the sensor

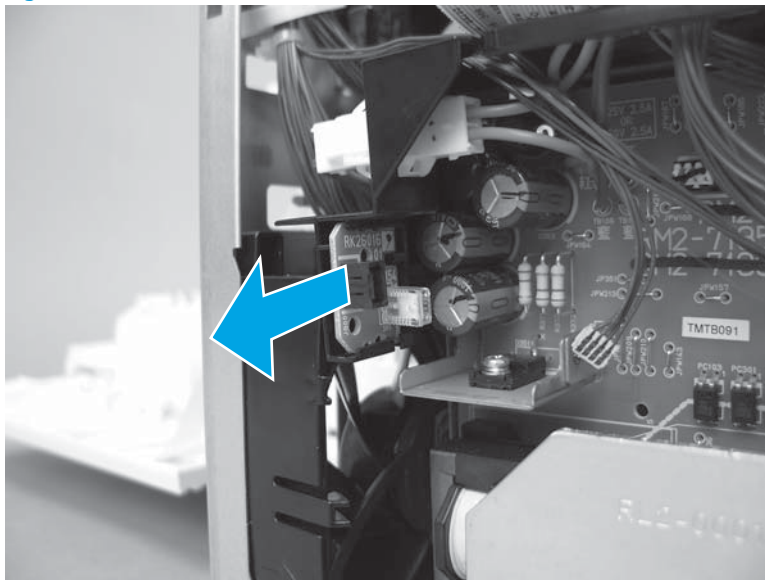

Step 6: Unpack the replacement assembly

Unpack the replacement assembly from the packaging.

 **CAUTION:**  ESD-sensitive part.

For complete information on HP's recycling programs, go to [Product return and recycling](#).

 **NOTE:** HP recommends responsible disposal of the defective assembly.

Figure 1-3269 Recycle and unpack

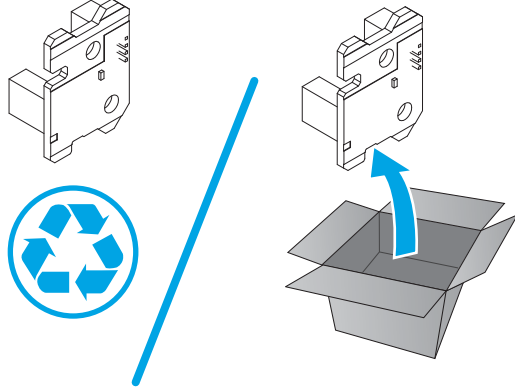

Step 7: Install the environmental sensor PCA

 **CAUTION:**  ESD-sensitive part.

1. Slide the environmental sensor PCA into the holder to install it.

Figure 1-3270 Install the sensor

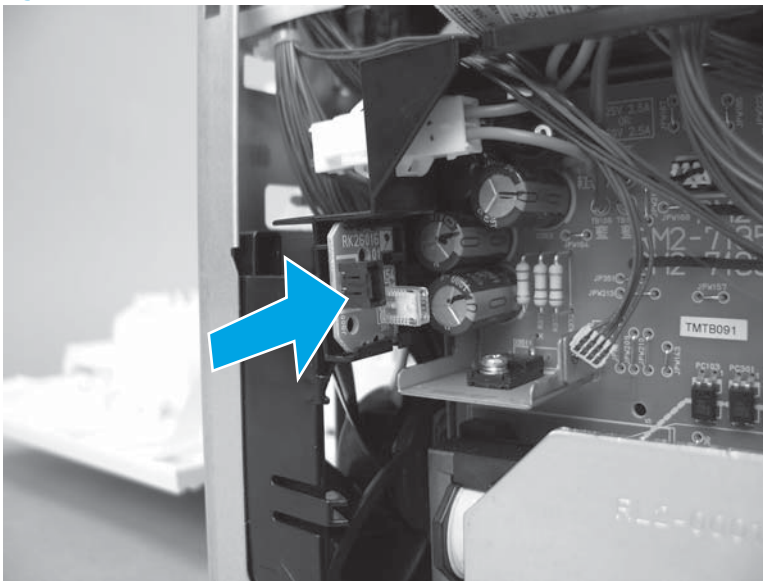

2. Connect one connector (callout 1).

Figure 1-3271 Connect one connector

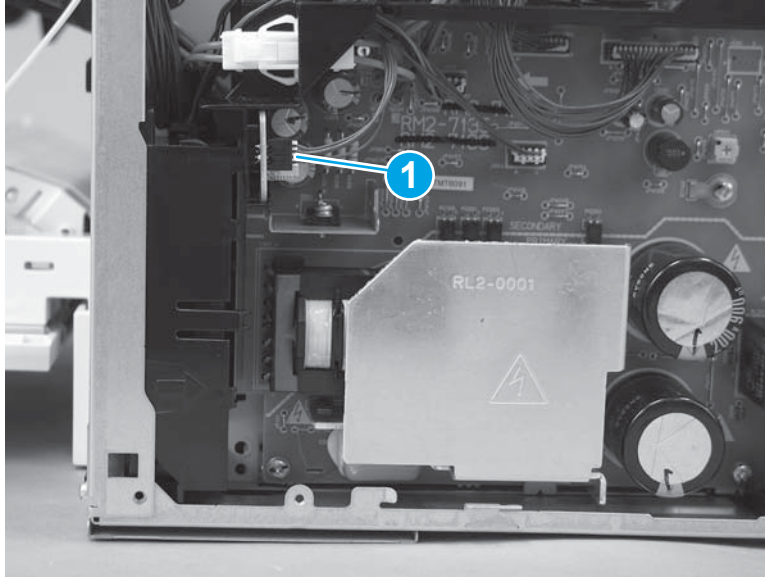

3. Position the LVPS cover on the chassis, slide the cover to the left to install it, and then install two screws (callout 1).

Figure 1-3272 Install the LVPS cover

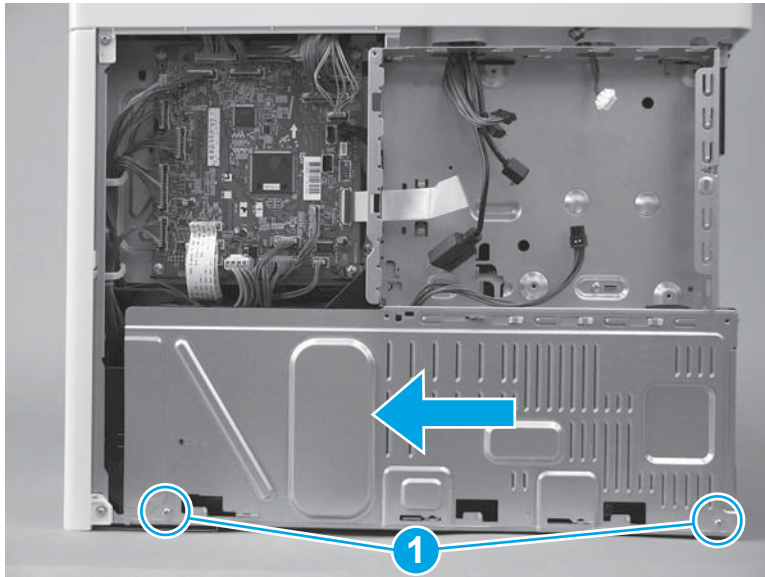

Step 8: Install the rear cover (M577)

 **NOTE:** This step is for the M577 models. For the M552 and M553 models, skip this step and go to [Step 10: Install the rear cover \(M552 and M553\) on page 1843](#).

1. Position the hooks (callout 1) on the cover in the slots (callout 2) in the printer.

Figure 1-3273 Position the hooks

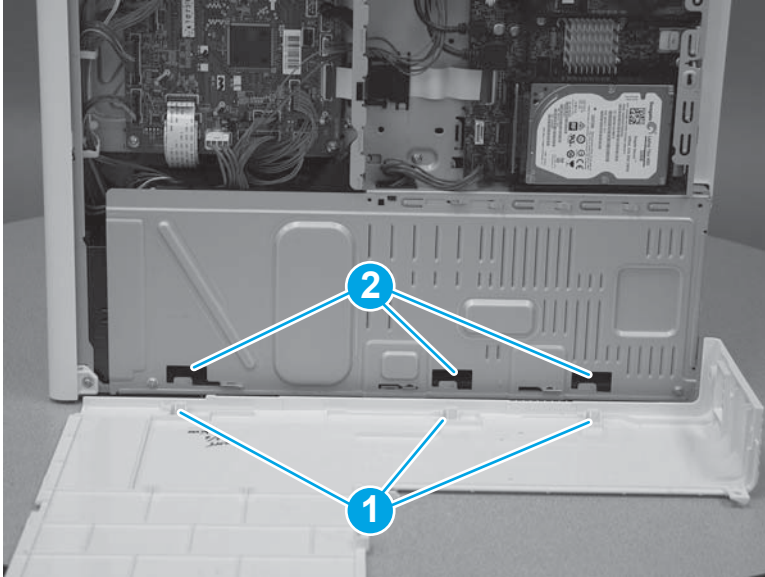

2. Position the back edge (callout 1) of the rear cover behind the edge (callout 2) of the right rear cover. Slide the cover to the left to install it.

Figure 1-3274 Install the cover

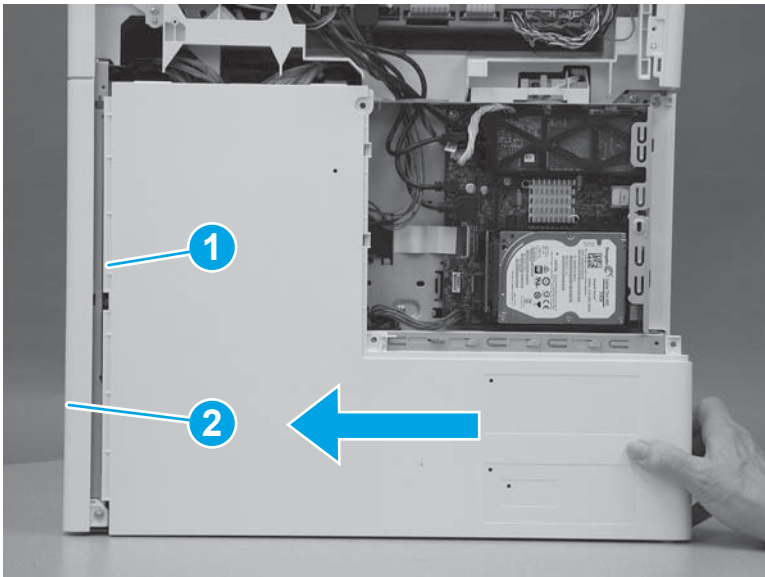

3. Install four screws (callout 1).

Figure 1-3275 Install four screws cover

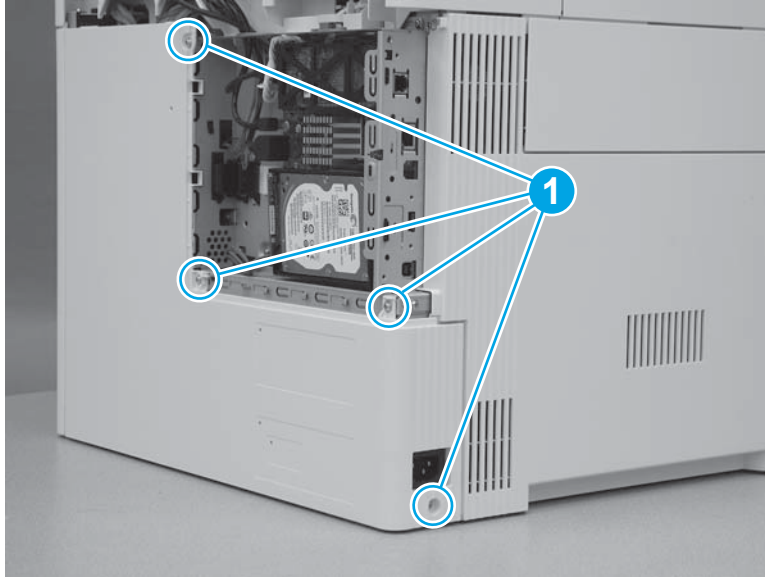

Step 9 Install the rear upper cover (M577)

 **NOTE:** This step is for the M577 models. For the M552 and M553 models, skip this step and go to [Step 10: Install the rear cover \(M552 and M553\) on page 1843](#).

1. Align the ridge (callout 1) on the lower edge of the rear upper cover in front of the tabs (callout 2) on the top edge of the rear cover.

Figure 1-3276 Align the cover

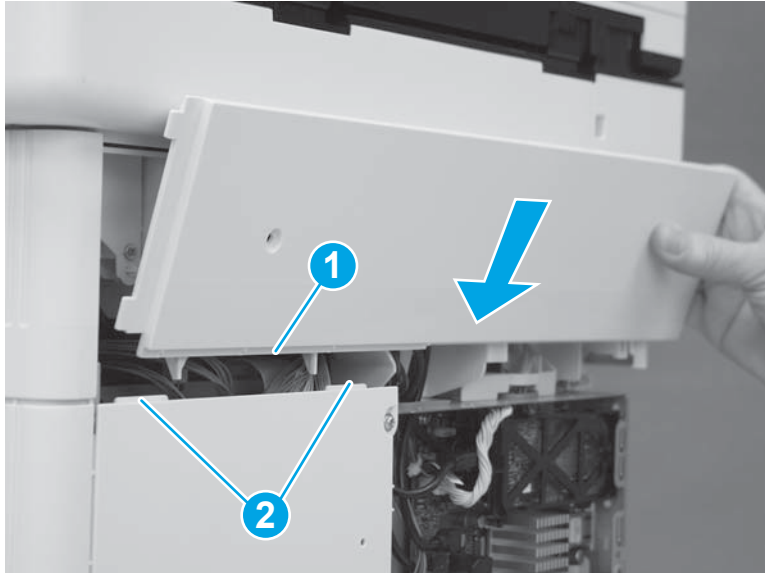

2. Rotate the top of the cover toward the printer.

Figure 1-3277 Rotate the top of the cover

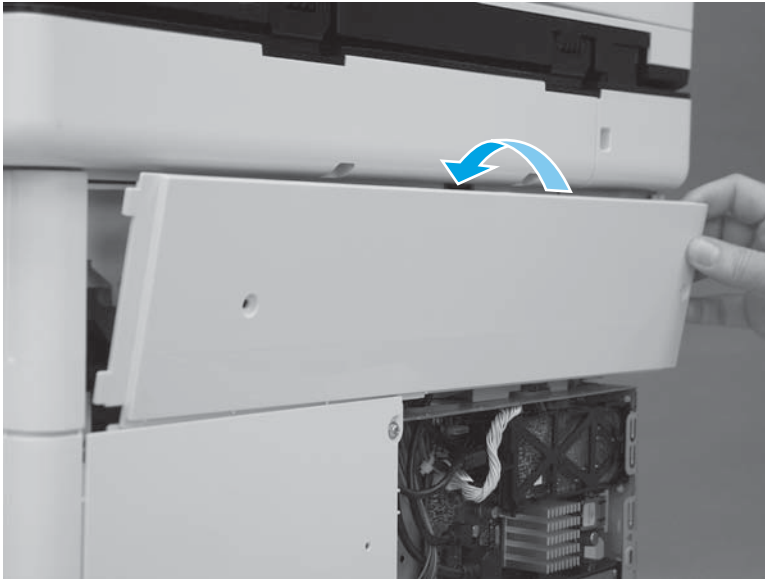

3. Slide the cover to the left (callout 1). Make sure that the tabs (callout 2) on the upper rear cover slide behind the edge (callout 3) of the right upper cover. Make sure that the cover is fully seated.

Figure 1-3278 Slide the cover

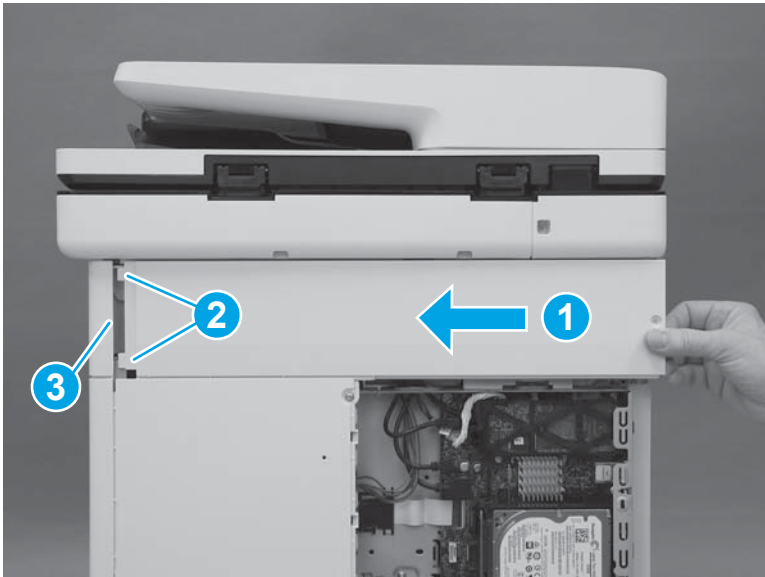

4. Install two screws (callout 1).

 **IMPORTANT:** These two screws are self-tapping screws for plastic. Rotate them counterclockwise to align them with the existing thread pattern, and then carefully turn them clockwise to tighten. Do not overtighten. This will prevent stripping the threads inside the screw holes.

Figure 1-3279 Install two screws



Step 10: Install the rear cover (M552 and M553)

 **NOTE:** This step is for the M552 and M553 models. For the M577 models, skip this step and go to [Step 11: Install the formatter cover on page 1844](#).

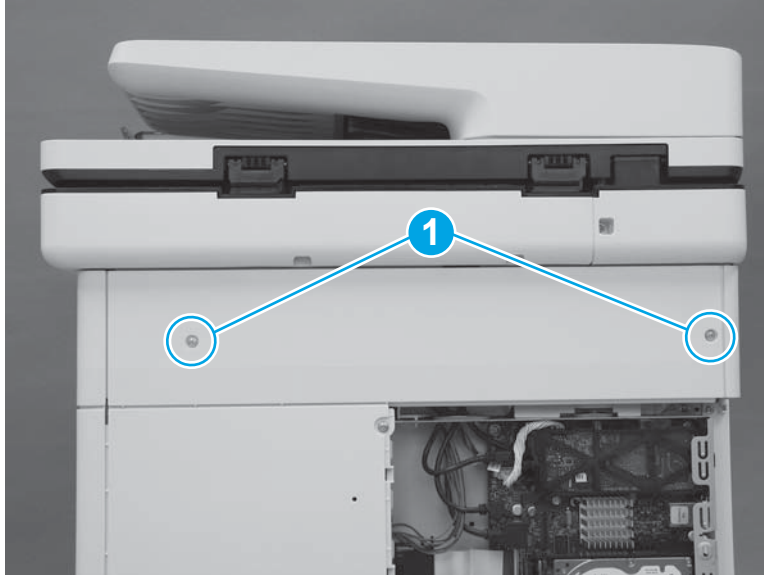
1. Position the top of the cover under the upper cover (callout 1), rotate the bottom of the cover onto the chassis (callout 2), and then slide the cover to the left (callout 3) to install it.

Figure 1-3280 Install the cover

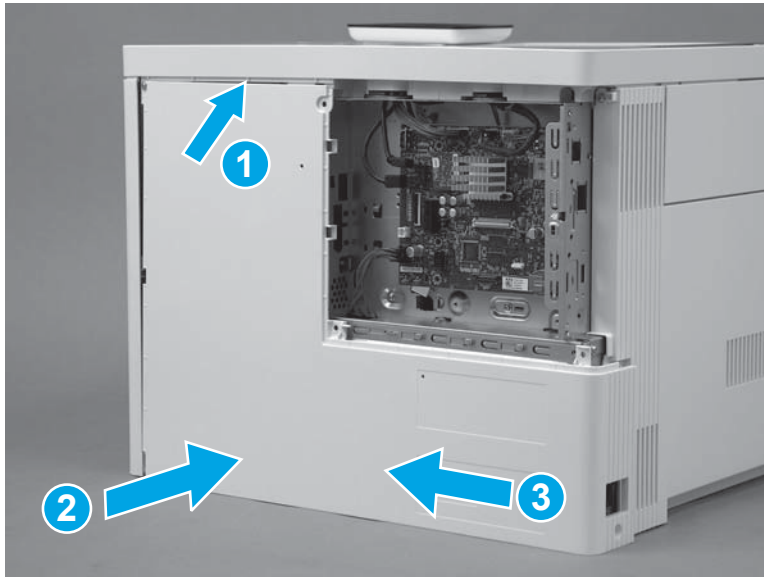

2. Install four screws (callout 1).

Figure 1-3281 Install four screws cover

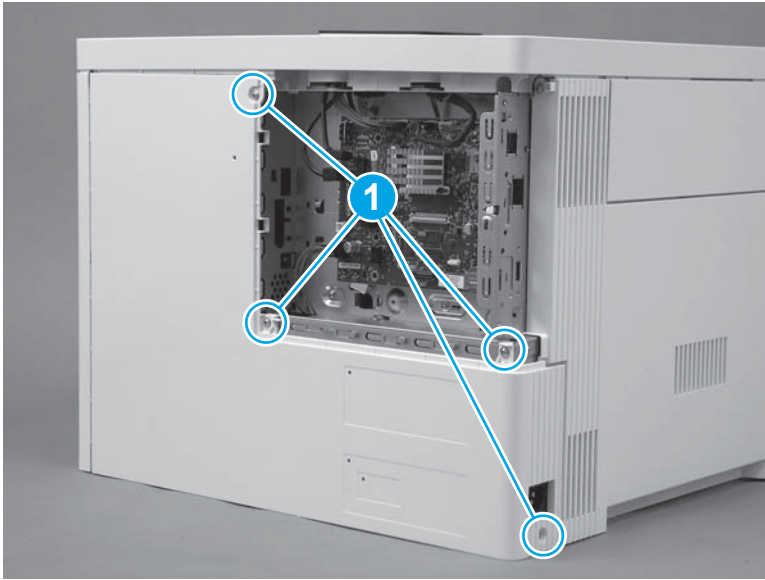

Step 11: Install the formatter cover

- ▲ Slide the cover onto the printer (callout 1) to install it.

 **NOTE:** Make sure that the tabs on the formatter cover align with the slots provided in the printer (callout 2). Tighten the two thumbscrews (callout 3).

 **TIP:** If needed, use the edge of a coin to turn the thumbscrews.

Figure 1-3282 Install the cover

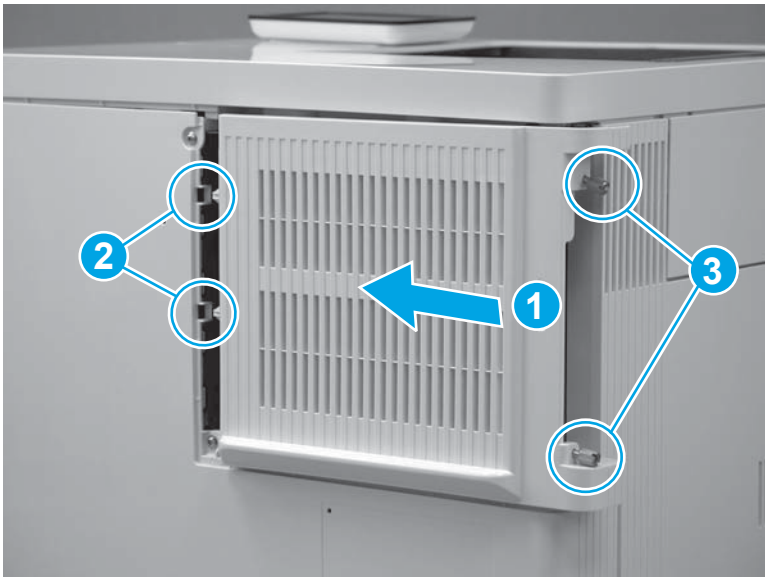

Removal and replacement: Fuser drive assembly

- [Introduction](#)
- [Step 1: Remove the USB cover \(M552 and M553\)](#)
- [Step 2: Remove the fuser](#)
- [Step 3: Remove the control panel \(M553x only\)](#)
- [Step 4: Remove the tray](#)
- [Step 5: Remove the toner collection unit \(TCU\)](#)
- [Step 6: Remove the formatter cover](#)
- [Step 7: Remove the formatter \(M552 and M553\)](#)
- [Step 8: Remove the hard-disk drive \(HDD\) \(M577\)](#)
- [Step 9: Remove the fax PCA \(M577c/f/z\)](#)
- [Step 10: Remove the formatter \(M577\)](#)
- [Step 11: Remove the rear cover \(M552 and M553\)](#)
- [Step 12: Remove the rear upper cover \(M577\)](#)
- [Step 13: Remove the rear cover \(M577\)](#)
- [Step 14: Remove the left upper cover \(M577\)](#)
- [Step 15: Remove the right front upper cover \(M577dn\)](#)
- [Step 16: Remove the stapler cover assembly \(M577c/f/z\)](#)
- [Step 17: Remove the integrated scanner assembly \(ISA\) \(M577\)](#)
- [Step 18: Remove the stapler unit \(M577c/f/z\)](#)
- [Step 19: Remove the right upper cover \(M577\)](#)
- [Step 20: Remove the top rear cover \(M577\)](#)
- [Step 21: Remove the paper feed cover \(M577\)](#)
- [Step 22: Remove the top cover \(M577\)](#)
- [Step 23: Remove the top bracket \(M577\)](#)
- [Step 24: Remove the left cover](#)
- [Step 25: Remove the upper cover \(M552 and M553\)](#)
- [Step 26: Remove the formatter case](#)
- [Step 27: Remove the right rear cover](#)
- [Step 28: Remove the DC controller and sheet-metal bracket](#)
- [Step 29: Remove the high-voltage power supply T \(HVPST\)](#)

- [Step 30: Remove the fuser drive assembly](#)
- [Step 31: Unpack the replacement assembly](#)
- [Step 32: Install the fuser drive assembly](#)
- [Step 33: Install the HVPST](#)
- [Step 34: Install the DC controller and sheet-metal bracket](#)
- [Step 35: Install the right rear cover](#)
- [Step 36: Install the formatter case](#)
- [Step 37: Install the upper cover \(M552 and M553\)](#)
- [Step 38: Install the left cover](#)
- [Step 39: Install the top bracket \(M577\)](#)
- [Step 40: Install the top cover \(M577\)](#)
- [Step 41: Install the paper feed cover \(M577\)](#)
- [Step 42: Install the top rear cover \(M577\)](#)
- [Step 43: Install the right upper cover \(M577\)](#)
- [Step 44: Install the stapler unit \(M577c/f/z\)](#)
- [Step 45: Install the integrated scanner assembly \(ISA\) \(M577\)](#)
- [Step 46: Install the stapler cover assembly \(M577c/f/z\)](#)
- [Step 47: Install the right front upper cover \(M577dn\)](#)
- [Step 48: Install the left upper cover \(M577\)](#)
- [Step 49: Install the rear cover \(M577\)](#)
- [Step 50: Install the rear upper cover \(M577\)](#)
- [Step 51: Install the rear cover \(M552 and M553\)](#)
- [Step 52: Install the formatter \(M577\)](#)
- [Step 53: Install the fax PCA \(M577c/f/z\)](#)
- [Step 54: Install the HDD \(M577\)](#)
- [Step 55: Install the formatter \(M552 and M553\)](#)
- [Step 56: Install the formatter cover](#)
- [Step 57: Install the TCU](#)
- [Step 58: Install the tray](#)
- [Step 59: Install the control-panel assembly \(M553x only\)](#)
- [Step 60: Install the fuser](#)

- [Step 61: Install the USB cover \(M552 and M553\)](#)

Introduction

This document provides the procedures to remove and replace the fuser drive assembly.

 **NOTE:** The fuser drive assembly includes the fuser motor (M4).

Before performing service

 **TIP:** Some figures might show assemblies removed or installed that have not yet been removed or installed at that specific step. However, the procedures are correct for this printer and the target assembly. Always thoroughly read the instructions that accompany each figure.

Turn the printer power off

- Disconnect the power cable.

 **WARNING!** To avoid damage to the printer, turn the printer off, wait 30 seconds, and then remove the power cord before attempting to service the printer.

Use the table below to identify the correct part number for your printer, and then go to <http://h20141.www2.hp.com/hpparts> to order the part.

Fuser drive assembly part number	
RM2-0091-000CN	Fuser drive assembly (M553n)
RM2-0009-000CN	Fuser drive assembly (M552dn, M553dn, M553x, M577)

Required tools

- #2 Phillips screwdriver with a magnetic tip

After performing service

Make sure that all of the connectors on the HVPST are fully seated.

Make sure that all of the connectors on the DC controller are fully seated.

Make sure that all of the connectors on the formatter are fully seated.

Make sure that the formatter cover is fully seated, and that the thumbscrews are finger tight after replacing it.

Turn the printer power on

- Connect the power cable.
- Use the power switch to turn the power on.

Post service test

Use the components test to test the (fuser) motor. For more information, see the printer troubleshooting manual.

Step 1: Remove the USB cover (M552 and M553)

 **NOTE:** This step is for the M552 and M553 models. For the M577 models, skip this step and go to [Step 4: Remove the tray on page 1854](#).

1. Locate the USB cover.

Figure 1-3283 Locate the USB cover



2. Pull the cover off of the printer to remove it.

Figure 1-3284 Remove the cover



Step 2: Remove the fuser

1. Open the right door.

 **CAUTION:** The fuser is very hot. After turning the printer power off, allow the fuser to cool for at least 30 minutes before removing it.

Figure 1-3285 Open the right door



2. Grasp the two fuser handles, and then squeeze the two blue triggers on the handles to release the fuser.

Figure 1-3286 Release the fuser

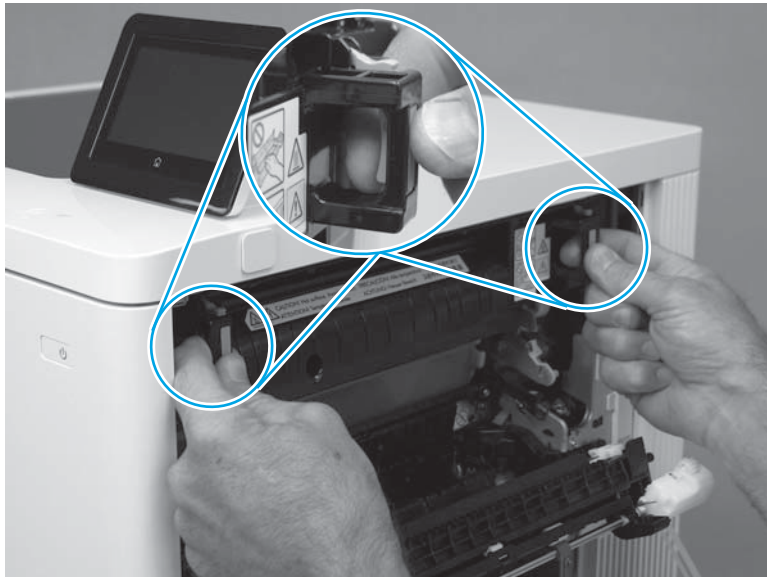

3. Slide the fuser straight out of the printer to remove it.

Figure 1-3287 Remove the fuser

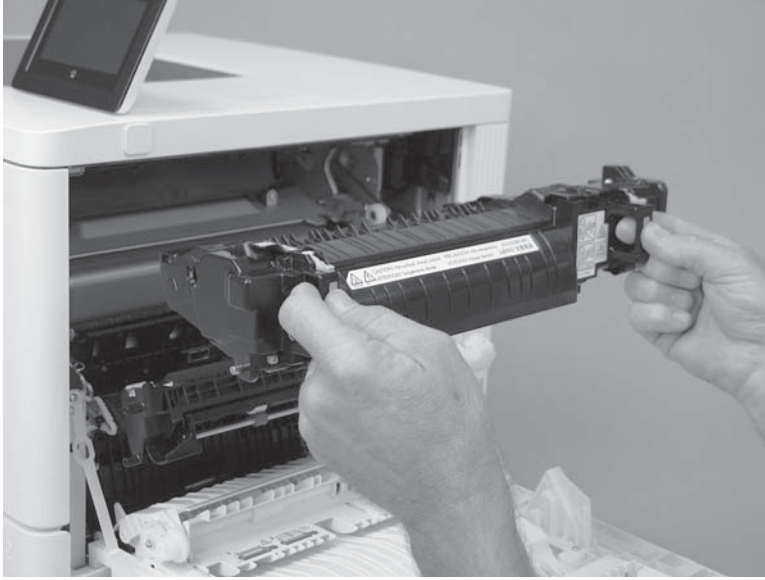

Step 3: Remove the control panel (M553x only)

 **NOTE:** This step is for the M553x model. For the M553n/dn, M552dn, and M577 models, skip this step and go to [Step 4: Remove the tray on page 1854](#).

1. Tilt the control panel up.

Figure 1-3288 Tilt the control panel up



2. Use a small flat-blade screwdriver to release the control-panel screws cover tabs.

Figure 1-3289 Release the control-panel screws cover tabs



3. Rotate the cover up to remove it.

Figure 1-3290 Remove the cover

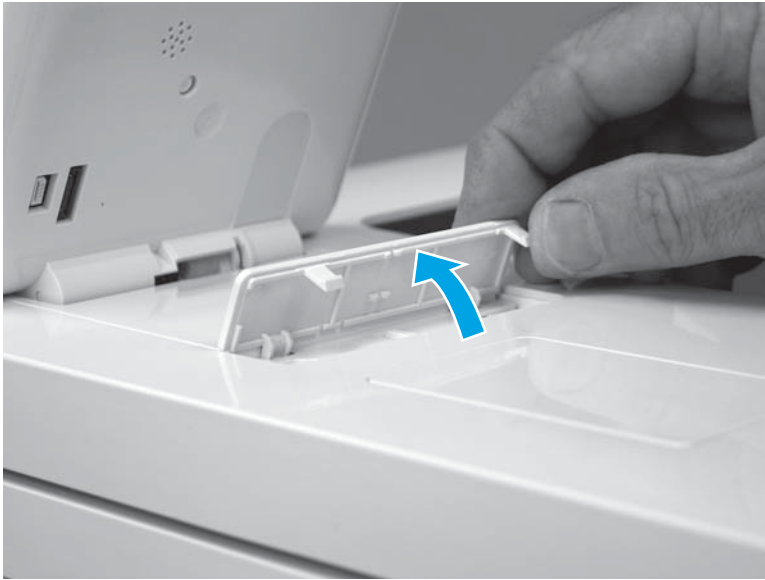

4. Use a small Phillips screwdriver to remove two screws (callout 1).

 **IMPORTANT:** Store the screws in a secure place where they cannot fall down into the printer.

Figure 1-3291 Remove two screws

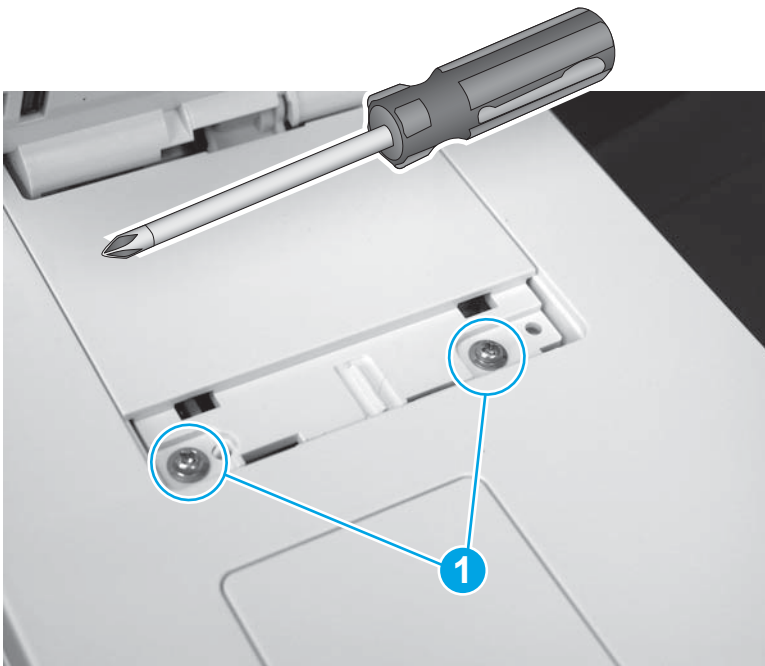

5. Rotate the control-panel base toward the front of the printer.

Figure 1-3292 Rotate the control-panel base up



6. Slightly slide the control-panel base toward the rear of the printer (callout 1) to release it, and then turn the control panel over (callout 2) to access the bottom side.

⚠ CAUTION: The control panel is still attached to the printer. Do not attempt to completely remove the control panel.

Figure 1-3293 Turn the control panel over

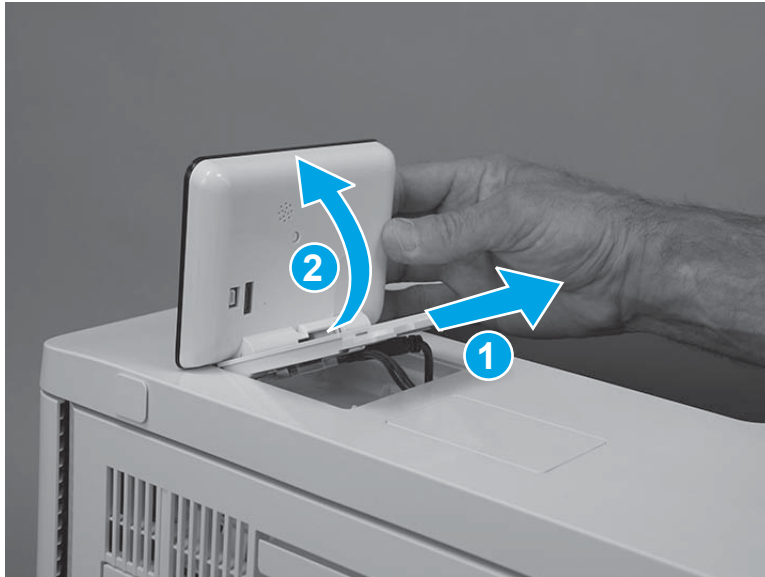

7. Disconnect one USB cable (callout 1), one connector (callout 2), and then remove the control panel.

Figure 1-3294 Disconnect two connectors

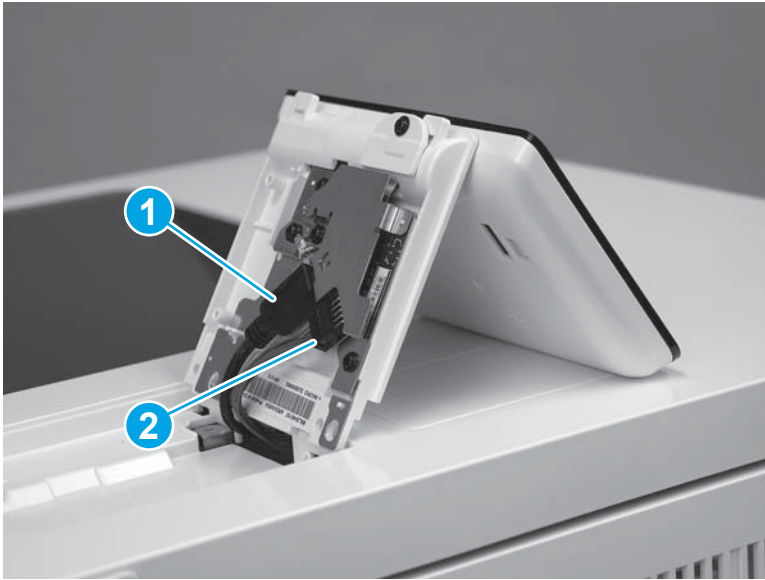

Step 4: Remove the tray

1. Pull the tray out until it stops.

Figure 1-3295 Pull the tray out



2. Lift the front of the tray, and then pull it out of the printer to remove it.

Figure 1-3296 Remove the tray

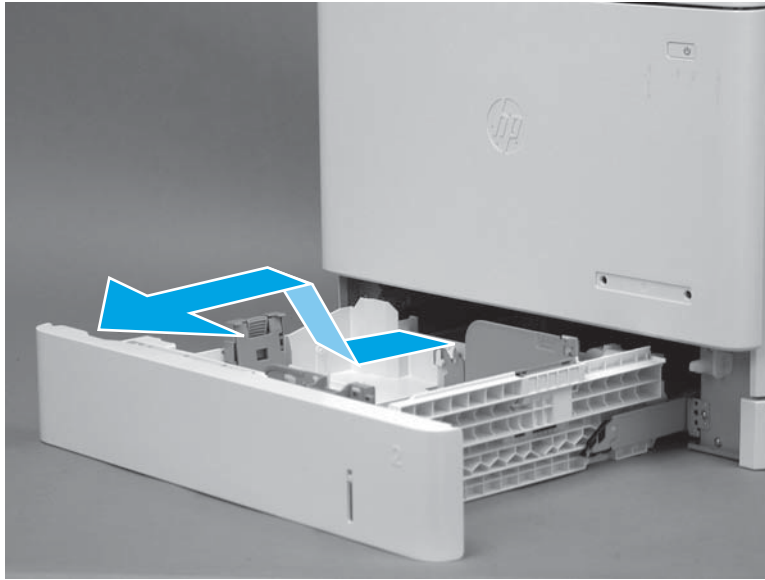

Step 5: Remove the toner collection unit (TCU)

1. Open the front door.

Figure 1-3297 Open the front door



2. Open the TCU.

 **NOTE:** The toner collection hatch cover automatically closes when the TCU is opened.

Figure 1-3298 Open the TCU



3. Pull the TCU away from the printer at an angle to remove it.

⚠ CAUTION: Do not open the toner collection hatch cover when handling the TCU. If toner gets on clothing, wipe it off by using a dry cloth and wash the clothes in cold water. Hot water sets toner into fabric.

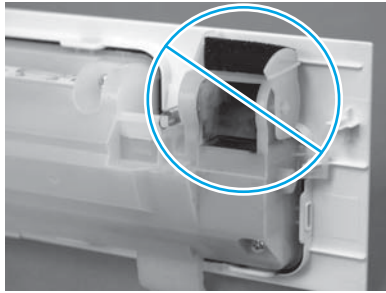
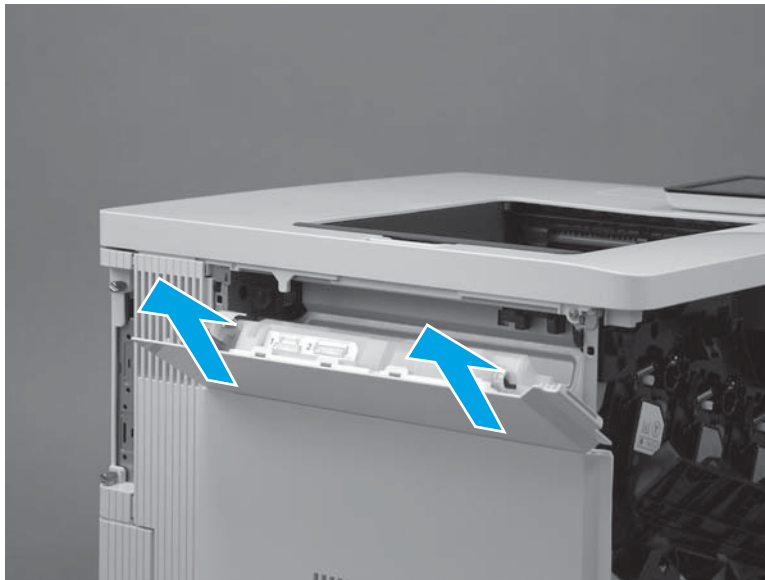

Figure 1-3299 Remove the TCU



Step 6: Remove the formatter cover

1. Locate the formatter cover.

Figure 1-3300 Locate the formatter cover

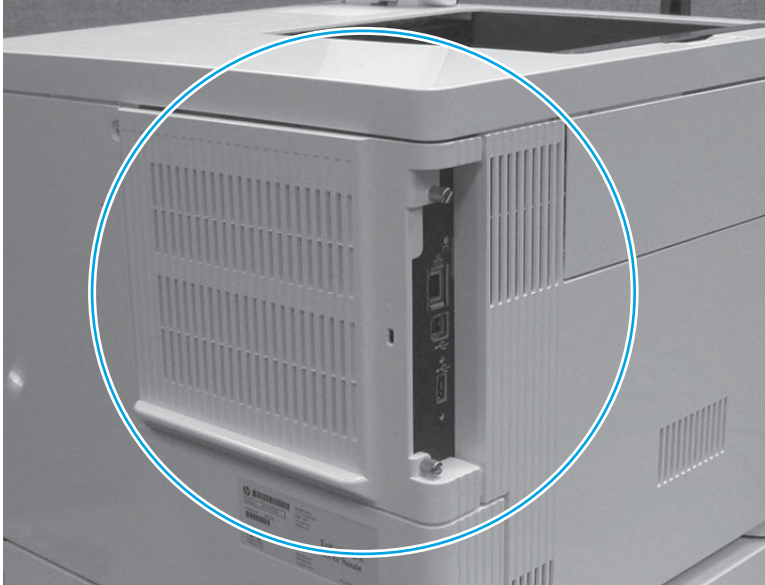

2. Loosen the two thumbscrews (callout 1). Grasp the two thumbscrews, and then slide the cover away from the printer (callout 2) to remove it.

 **TIP:** If needed, use the edge of a coin to turn the thumbscrews.

Figure 1-3301 Loosen the thumbscrews

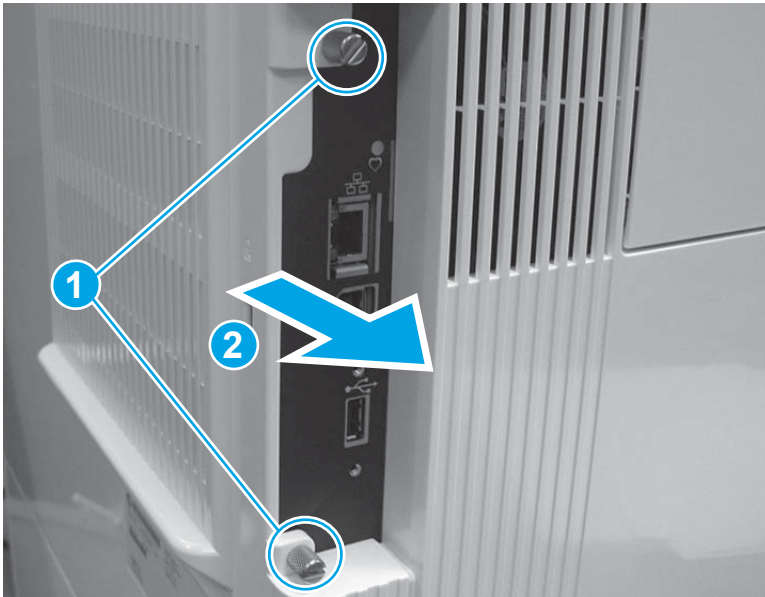

Step 7: Remove the formatter (M552 and M553)

 **NOTE:** This step is for the M552 and M553 models. For the M577 models, skip this step and go to [Step 8: Remove the hard-disk drive \(HDD\) \(M577\) on page 1860](#).

If the optional hard-disk drive (HDD) is installed, it must be removed to gain access to the formatter mounting screws.

Release two tabs along the left edge of the HDD, rotate the left edge away from the product, and then slide the HDD to the left to remove it.

 **CAUTION:**  ESD-sensitive part.

1. Disconnect all of the connectors on the formatter.

The following connectors are empty:

- All models: J1 (this connector is empty unless the optional DIMM is installed)
- M553n/dn and M552dn: J2 (callout 1; this is the touchscreen connector for the M553x model)
- All models: J9 (this connector is empty unless the optional internal USB ports component is installed)
- All models: J18 (this connector is empty unless the optional hard-disk-drive (HDD) is installed)
- All models: J23
- All models: J24
- M553n/dn and M552dn: J25 (this is the wireless connector for the M553x model)
- All models: J57
- All models: J98 (this connector is empty unless the optional trusted platform module (TPM) is installed)

 **IMPORTANT:** The flat-cable connector (callout 2) is a Zero Insertion Force (ZIF) connector that uses a hinged retainer to secure the flat cable. The hinged retainer must be opened to release the flat cable.

Figure 1-3302 Disconnect all connectors



2. Remove four screws (callout 1), and then remove the formatter.

Figure 1-3303 Remove the formatter

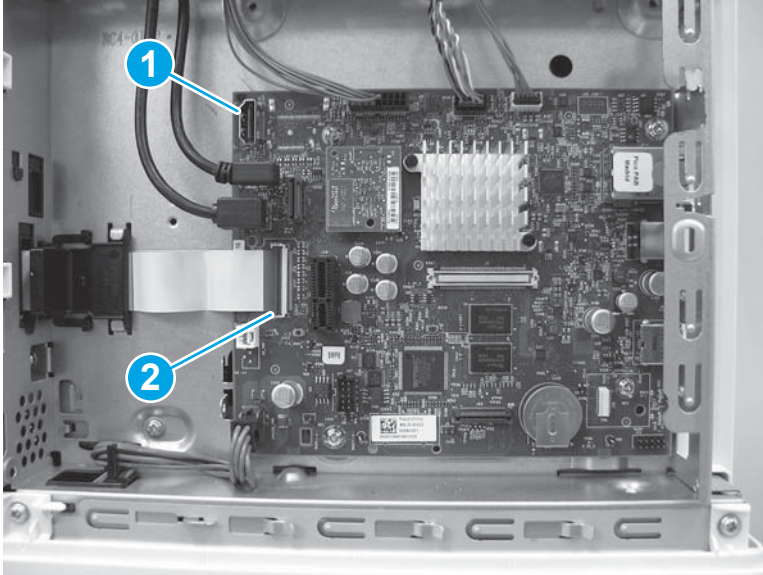
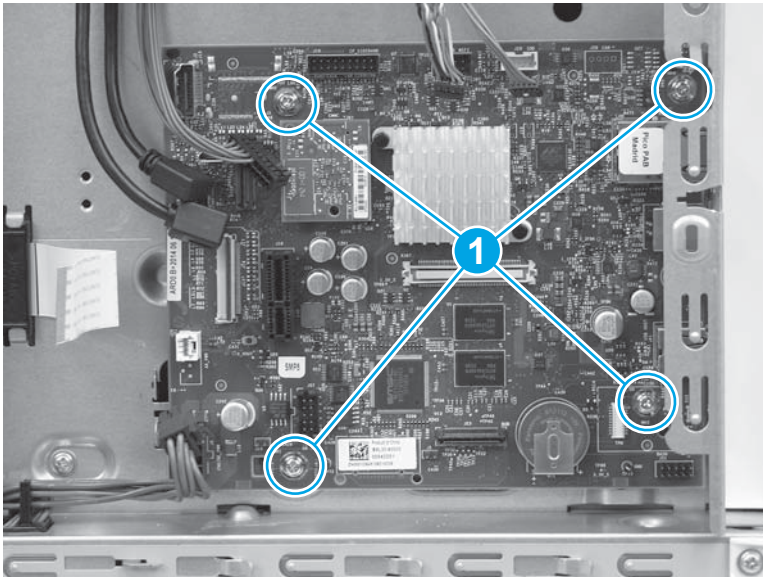

Step 8: Remove the hard-disk drive (HDD) (M577)

 **NOTE:** This step is for the M577 models. For the M552 and M553 models, skip this step and go to [Step 11: Remove the rear cover \(M552 and M553\) on page 1865](#).

 **CAUTION:**  ESD-sensitive part.

1. Release two tabs (callout 1). Hold the tabs in the released position, and then rotate the hard disk drive (HDD) up (callout 2) to release the connector from the formatter.

Figure 1-3304 Release the HDD

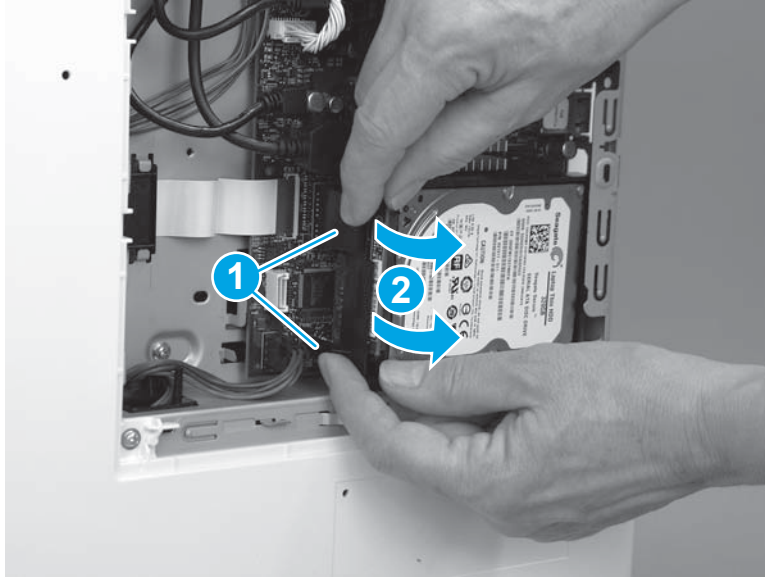

2. Slide the HDD away from the printer to remove it.

Figure 1-3305 Remove the HDD



Step 9: Remove the fax PCA (M577c/f/z)

 **NOTE:** This step is for the M577c/f/z models. For the M577n model, skip this step and go to [Step 10: Remove the formatter \(M577\) on page 1863](#).

For the M552 and M553 models, skip this step and go to [Step 11: Remove the rear cover \(M552 and M553\) on page 1865](#).

 **CAUTION:**  ESD-sensitive part.

1. Locate the fax PCA component on the formatter.

Figure 1-3306 Locate the fax PCA

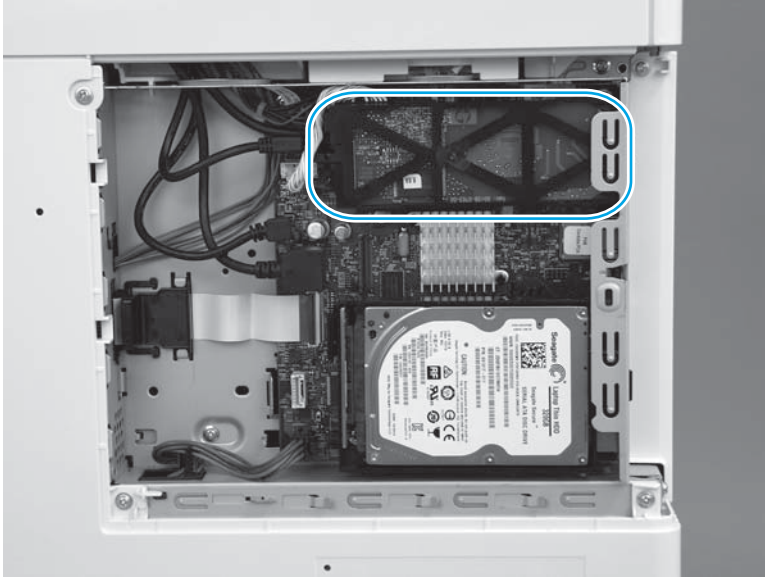

2. Release the connector latch (callout 1), and then pull the connector away from the formatter (callout 2) to disconnect it.

Figure 1-3307 Disconnect one connector

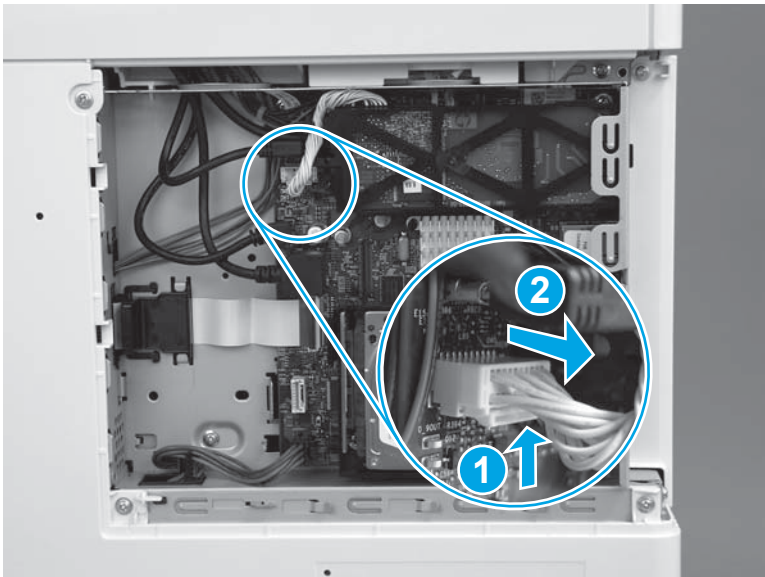

3. Release one retainer (callout 1) by pressing the bracket arms together.

Figure 1-3308 Release one latch

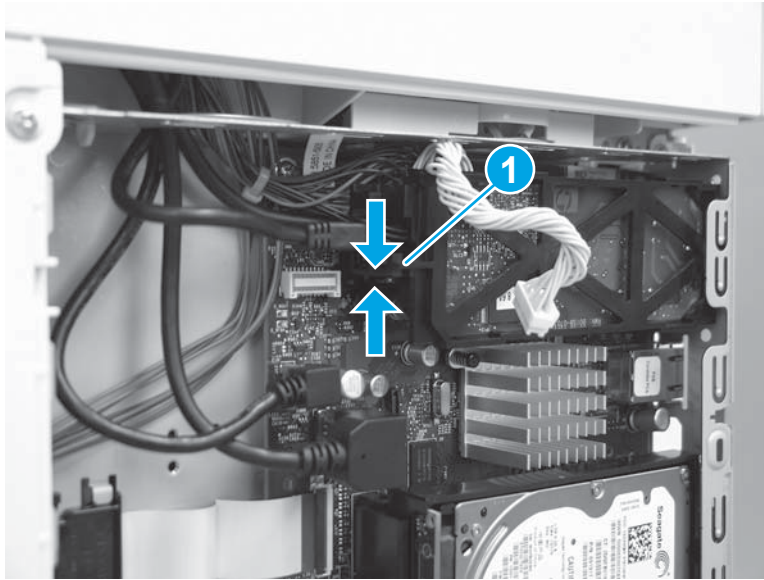

4. Rotate the end of the fax PCA (callout 1) away from the formatter, and then slide the PCA left (callout 2) to remove it.

Figure 1-3309 Remove the fax PCA

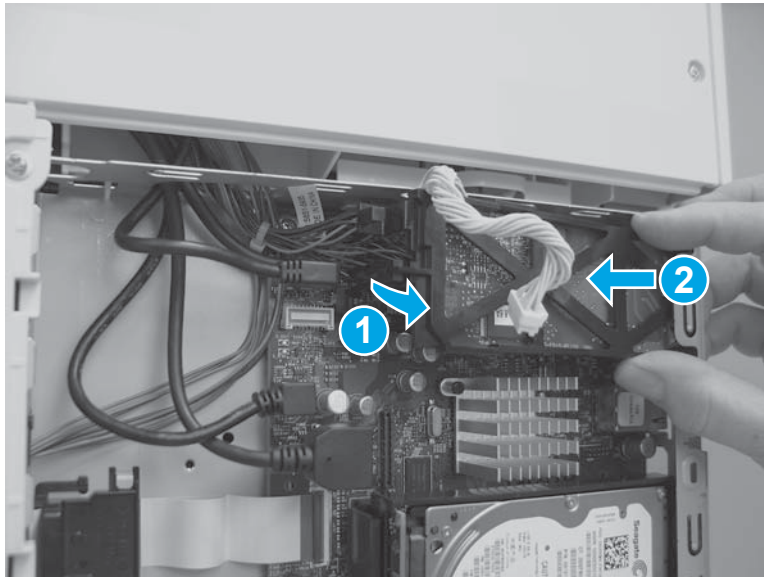

Step 10: Remove the formatter (M577)

 **NOTE:** This step is for the M577 models. For the M552 and M553 models, skip this step and go to [Step 11: Remove the rear cover \(M552 and M553\) on page 1865.](#)

 **CAUTION:**  ESD-sensitive part.

1. Disconnect all of the connectors on the formatter.

The following connectors are empty:

- All models: J1 (this connector is empty unless the optional DIMM is installed)
- All models: J3
- M577dn: J15 (this is the fax connector for the M577f/z/c models)
- All models: J21 (this connector is empty unless the optional internal USB ports component is installed)
- All models: J23
- All models: J24
- All models: J51
- All models: J57
- All models: J97
- All models: J98 (this connector is empty unless the optional trusted platform module (TPM) is installed)

 **IMPORTANT:** The flat-cable connector (callout 1) is a Zero Insertion Force (ZIF) connector that uses a hinged retainer to secure the flat cable. The hinged retainer must be opened to release the flat cable.

Figure 1-3310 Disconnect all connectors



2. Remove four screws (callout 1).

Figure 1-3311 Remove four screws

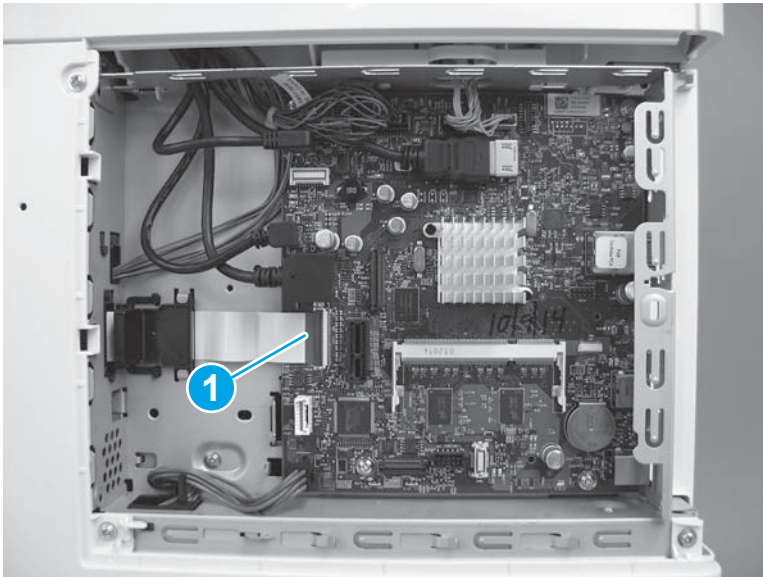
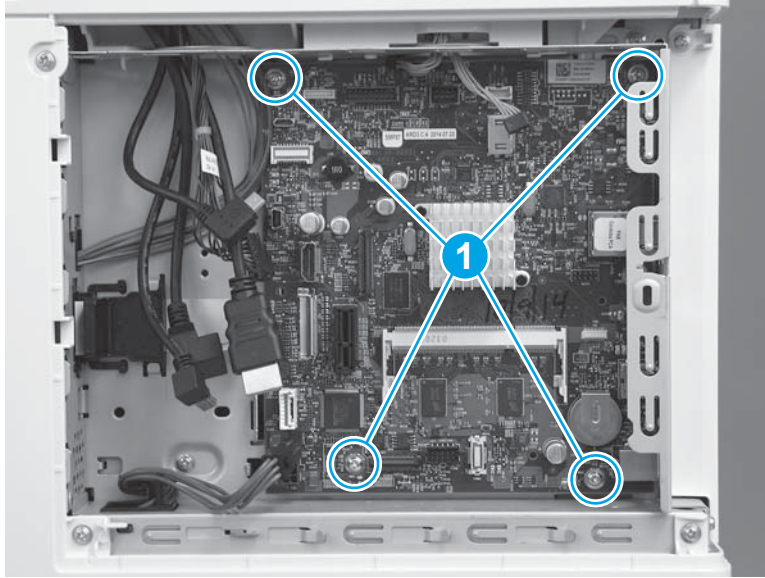

3. Remove the formatter.

Figure 1-3312 Remove the formatter

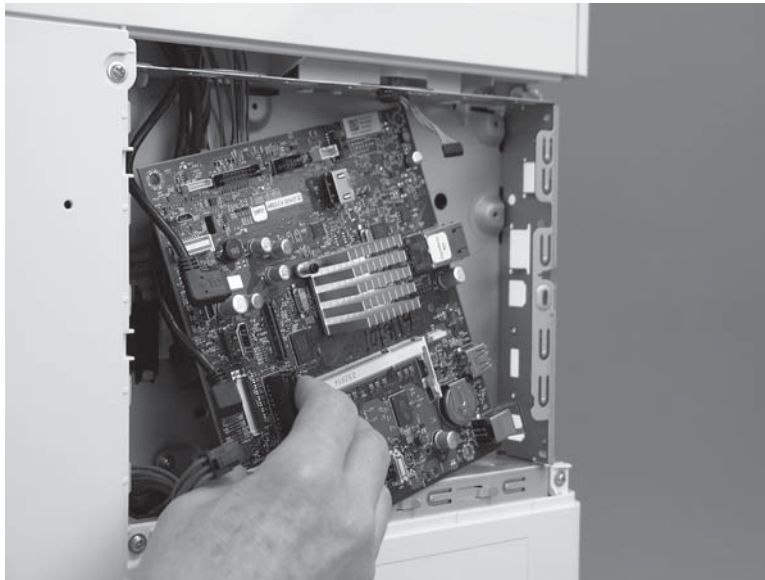

Step 11: Remove the rear cover (M552 and M553)

 **NOTE:** This step is for the M552 and M553 models. For the M577 models, skip this step and go to [Step 12: Remove the rear upper cover \(M577\) on page 1866.](#)

1. Remove four screws (callout 1).

Figure 1-3313 Remove four screws

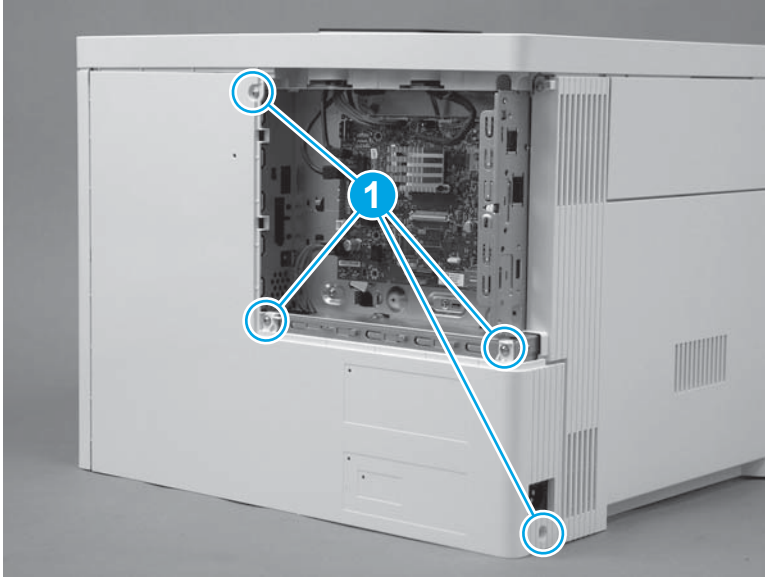

2. Slightly slide the cover to the right (callout 1), rotate the bottom of the cover away from the printer (callout 2), and then pull the top of the cover away from the printer (callout 3) to remove the cover.

Figure 1-3314 Remove the cover

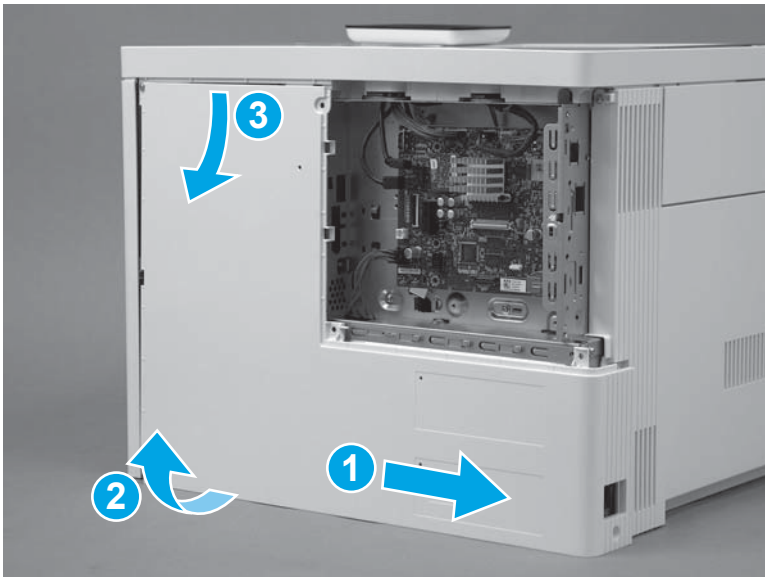

Step 12: Remove the rear upper cover (M577)

 **NOTE:** This step is for the M577 models. For the M552 and M553 models, skip this step and go to [Step 24: Remove the left cover on page 1886](#).

1. Remove two screws (callout 1).

 **Reinstallation tip:** These two screws are self-tapping screws for plastic. When reinstalling them, rotate the screws counterclockwise to align them with the existing thread pattern, and then carefully turn them clockwise to tighten. Do not overtighten. This will prevent stripping the threads inside the screw holes.

Figure 1-3315 Remove two screws



2. Use a small, flat blade screwdriver to release the right edge of the cover.

Figure 1-3316 Release the right edge

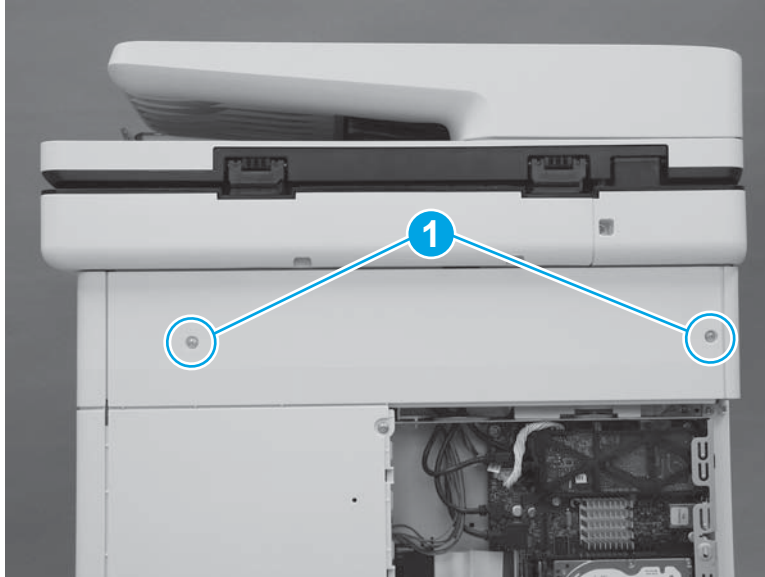
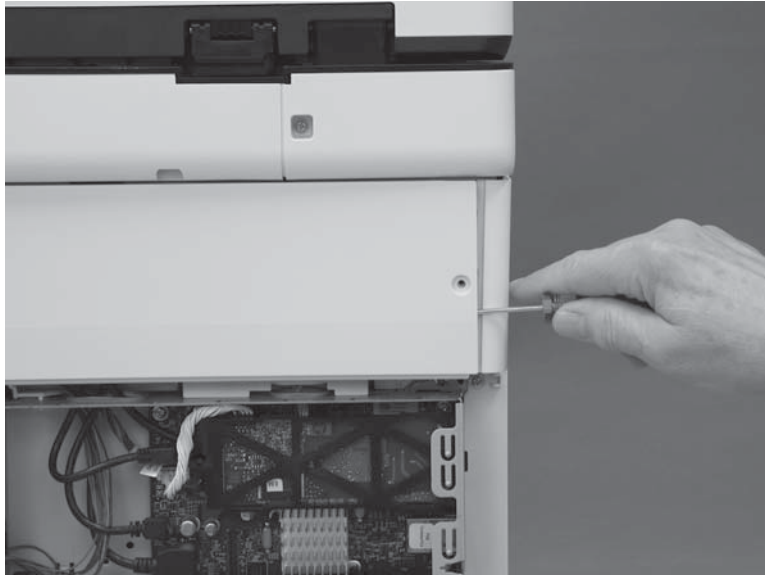

3. Pull the right edge of the cover (callout 1) away from the printer, and then slide the cover to the right (callout 2).

Figure 1-3317 Slide the cover right

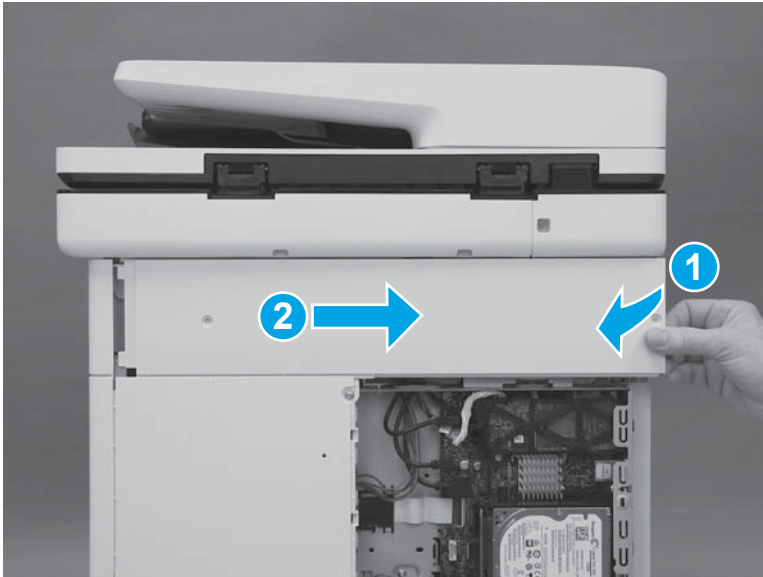

4. Remove the cover.

Figure 1-3318 Remove the cover

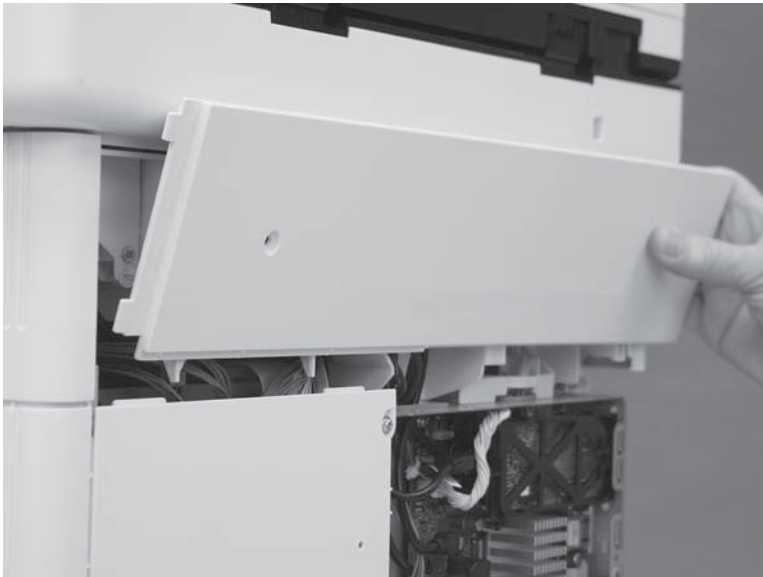

Step 13: Remove the rear cover (M577)

 **NOTE:** This step is for the M577 models. For the M552 and M553 models, skip this step and go to [Step 24: Remove the left cover on page 1886](#).

1. Remove four screws (callout 1).

Figure 1-3319 Remove four screws

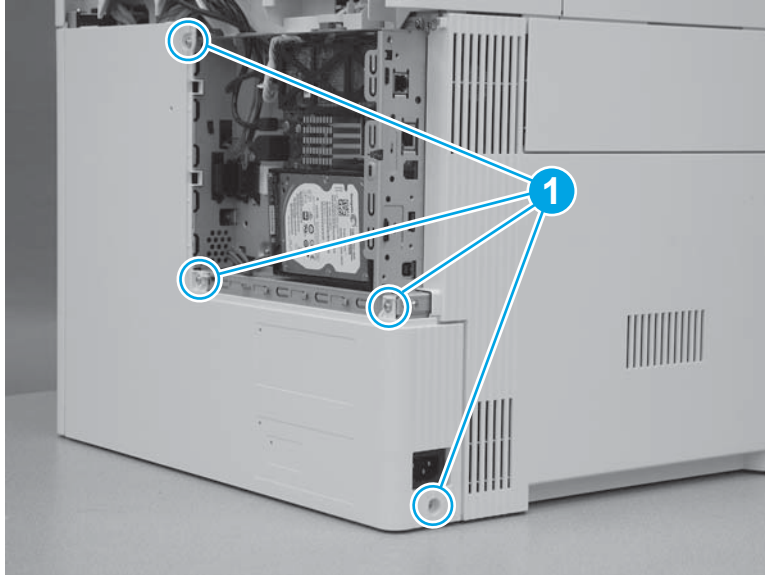

2. Slide the cover to the right to remove it.

Figure 1-3320 Remove the cover

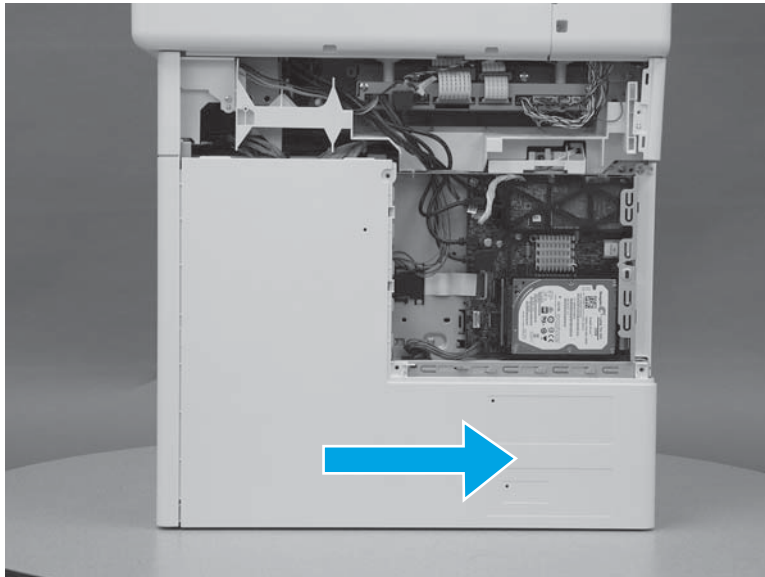

Step 14: Remove the left upper cover (M577)

 **NOTE:** This step is for the M577 models. For the M552 and M553 models, skip this step and go to [Step 24: Remove the left cover on page 1886](#).

1. At the left side of the printer, release one tab (callout 1).

Figure 1-3321 Release one tab

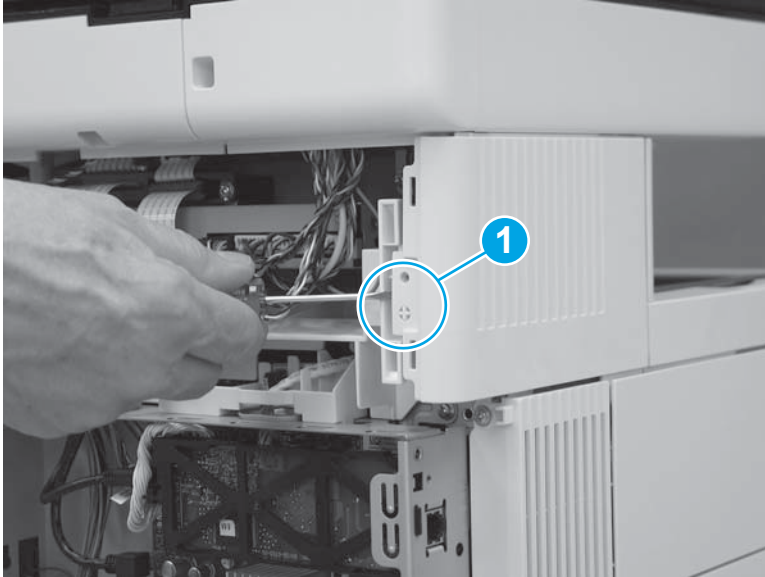

2. Slide the left upper cover toward the back of the printer.

Figure 1-3322 Slide the cover back

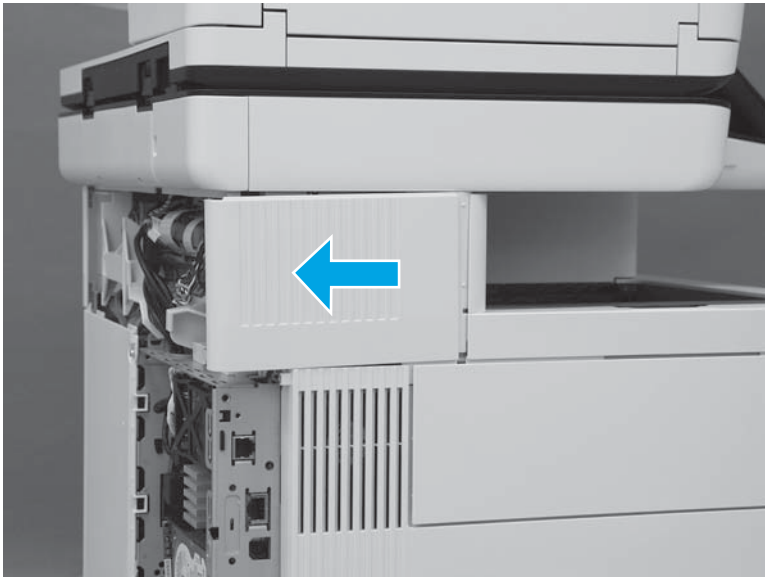

3. Rotate the cover up to remove it.

Figure 1-3323 Remove the left upper cover

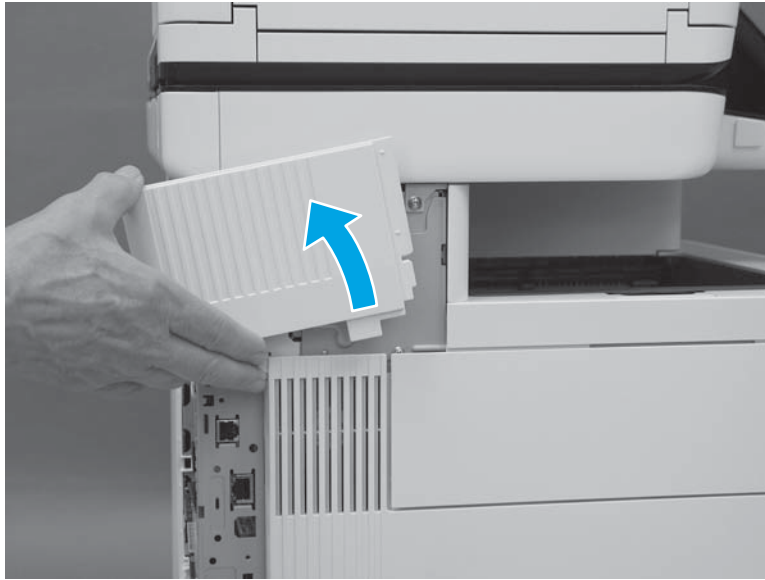

Step 15: Remove the right front upper cover (M577dn)

 **NOTE:** This step is for the M577dn model. For the M577c/f/z models, skip this step and to go [Step 16: Remove the stapler cover assembly \(M577c/f/z\) on page 1872](#).

For the M552 and M553 models, skip this step and go to [Step 24: Remove the left cover on page 1886](#).

1. Remove one screw (callout 1).

Figure 1-3324 Remove one screw

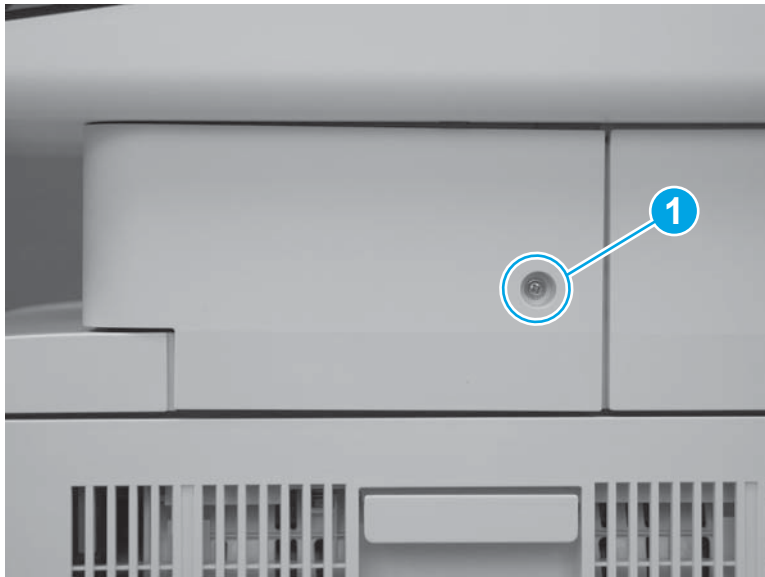

2. Release two tabs at the front edge of the cover (callout 1).

Figure 1-3325 Release two tabs



3. Rotate the front of the cover to the right to remove it.

Figure 1-3326 Rotate the cover



Step 16: Remove the stapler cover assembly (M577c/f/z)

 **NOTE:** This step is for the M577c/f/z models. For the M577dn model, skip this step and go to [Step 19: Remove the right upper cover \(M577\) on page 1878](#).

For the M552 and M553 models, skip this step and go to [Step 24: Remove the left cover on page 1886](#).

1. Remove one screw (callout 1).

 **Reinstallation tip:** This is a self-tapping screw for plastic. When reinstalling, rotate the screw counterclockwise to align it with the existing thread pattern, and then carefully turn it clockwise to tighten. Do not overtighten. This will prevent stripping the threads inside the screw hole.

Figure 1-3327 Remove one screw



2. Release two tabs at the front edge of the cover (callout 1).

Figure 1-3328 Release two tabs

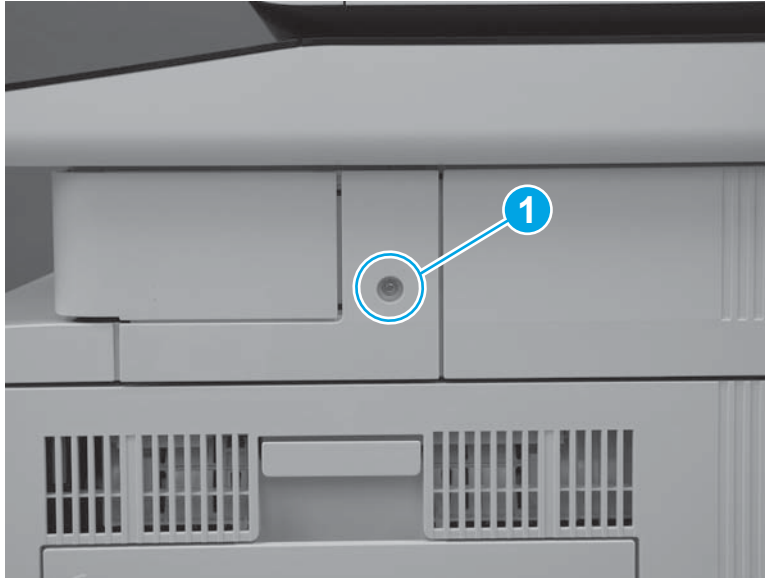

3. Release the back edge of the cover.

Figure 1-3329 Release the back edge of the cover

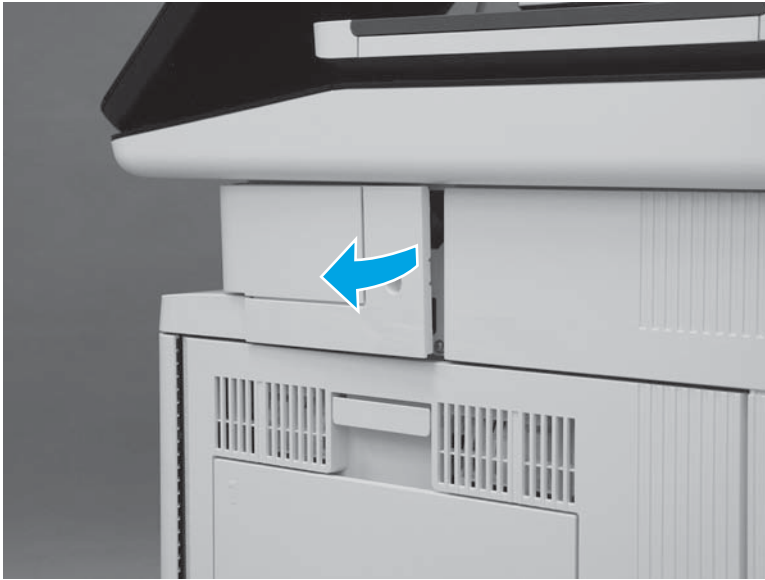



4. Rotate the cover away from the printer to remove it.

Figure 1-3330 Remove the cover



Step 17: Remove the integrated scanner assembly (ISA) (M577)

 **NOTE:** This step is for the M577 models. For the M552 and M553 models, skip this step and go to [Step 24: Remove the left cover on page 1886](#).

 **NOTE:** The ISA includes the document feeder, image scanner, scanner control board (SCB), control panel, keyboard (M577c/z) and NFC PCA (M577z).

1. At the left side of the printer, remove one screw (callout 1).

Figure 1-3331 Remove one screw

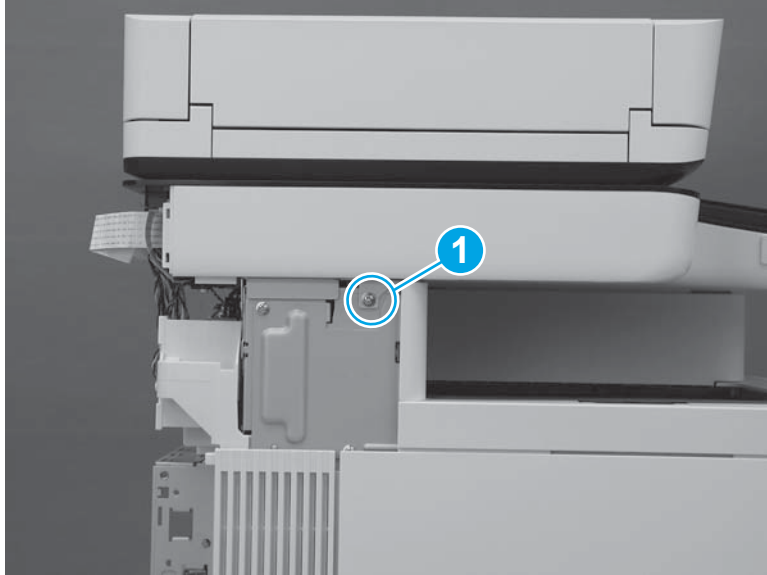

2. At the back side of the printer, remove two screws (callout 1).

Figure 1-3332 Remove two screws

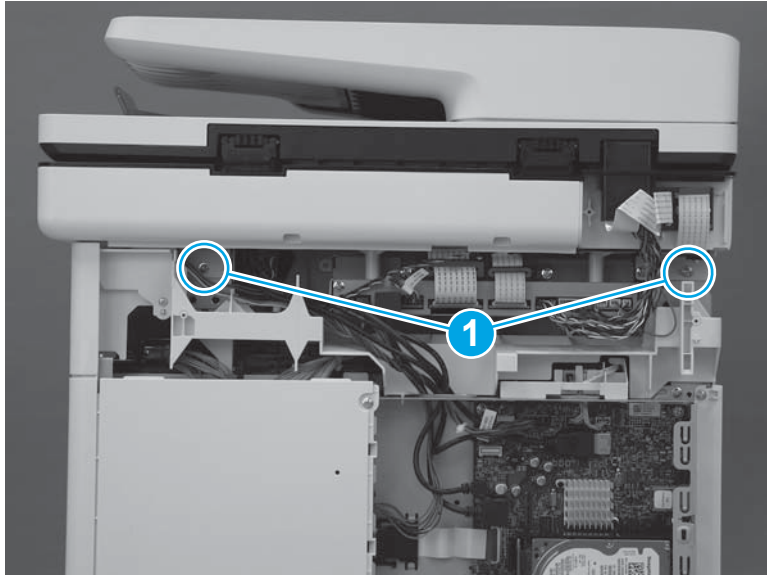

3. At the right side of the printer, remove one screw (callout 1).

Figure 1-3333 Remove one screw

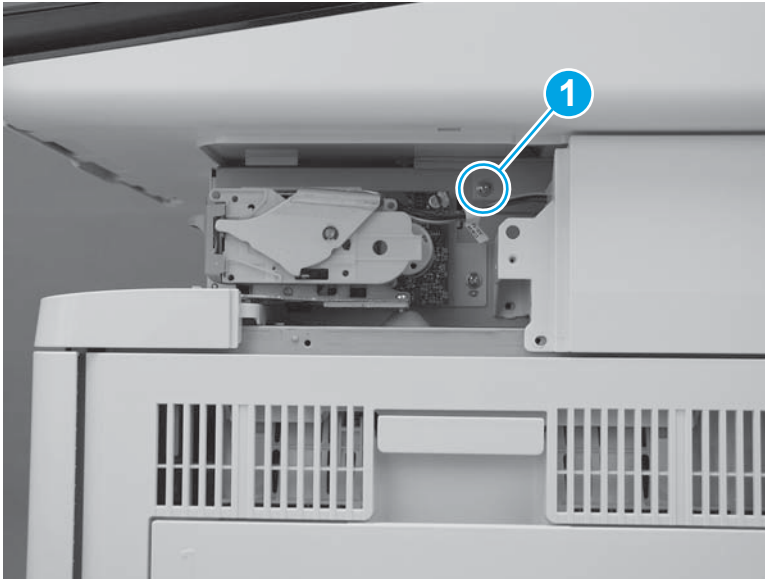

4. Disconnect two connectors on the scanner control board (callout 1).

M577c/f/z only: Disconnect one connector for the stapler on the scanner control board (callout 2).

Figure 1-3334 Disconnect connectors

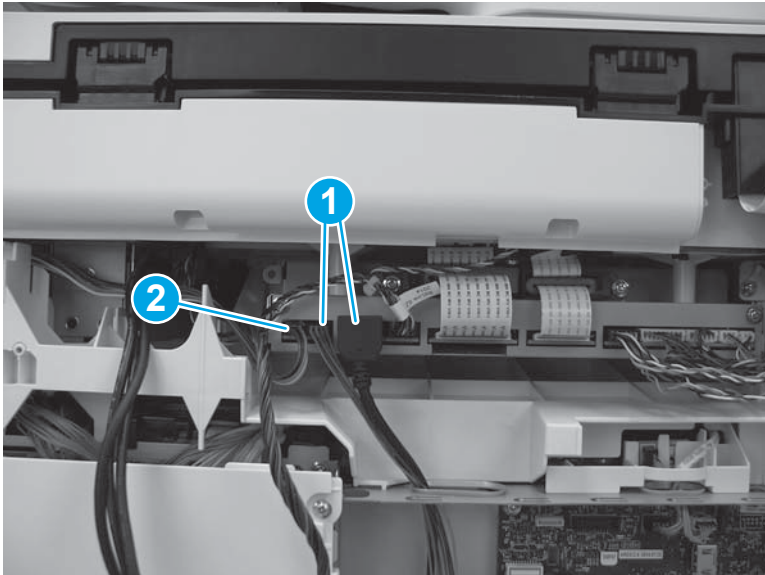

5. Slightly slide the ISA towards the back of the printer to release it.

Figure 1-3335 Slide the ISA towards the back of the printer

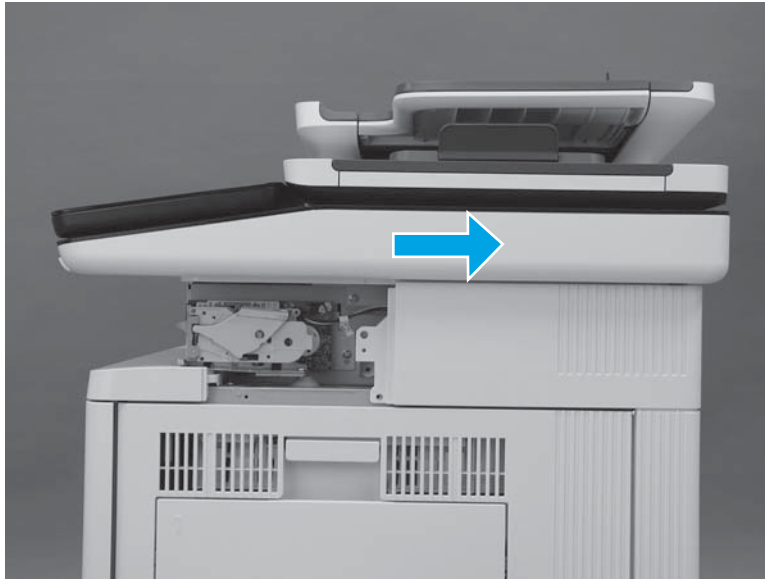

6. Lift the ISA up to remove it.

 **NOTE:** When lifting the ISA, carefully pass the cables through the opening in the top of the formatter case.

Figure 1-3336 Remove the ISA

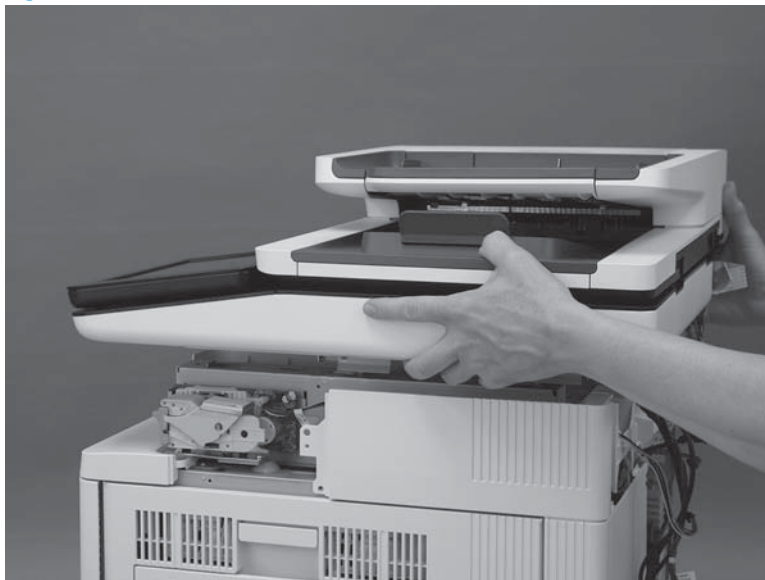

Step 18: Remove the stapler unit (M577c/f/z)

 **NOTE:** This step is for the M577c/f/z models. For the M577dn model, skip this step and to go [Step 20: Remove the top rear cover \(M577\) on page 1880](#).

For the M552 and M553 models, skip this step and go to [Step 24: Remove the left cover on page 1886](#).

1. Disconnect one connector (callout 1), and then remove two screws (callout 2).

Figure 1-3337 Disconnect connector and remove screws

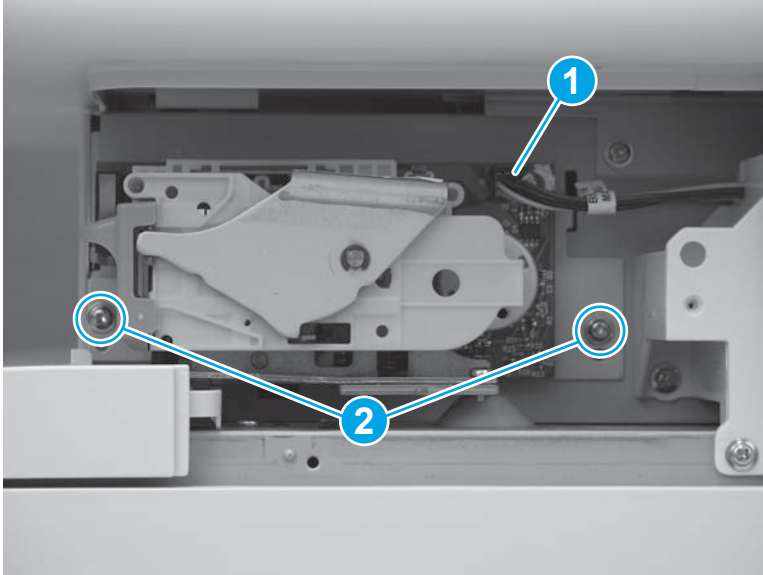

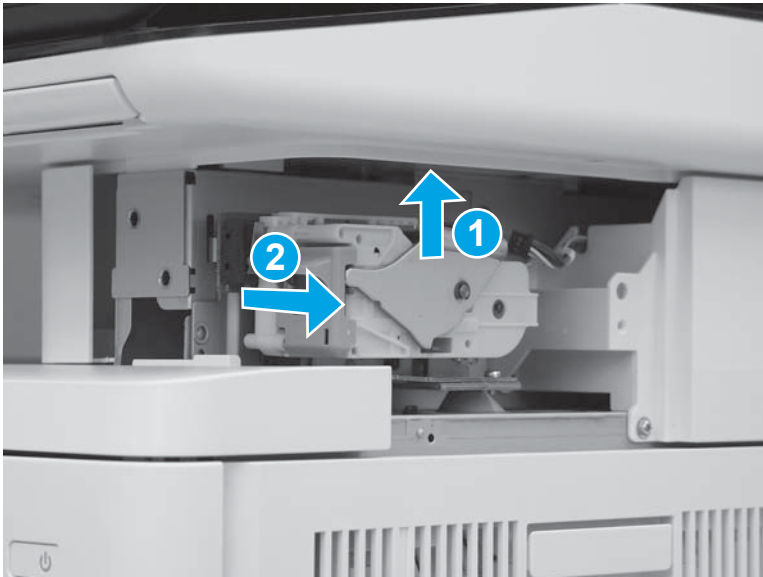

2. Slide the stapler unit up (callout 1), and then pull it away from the printer (callout 2) to remove it.

Figure 1-3338 Remove the stapler unit



Step 19: Remove the right upper cover (M577)

 **NOTE:** This step is for the M577 models. For the M552 and M553 models, skip this step and go to [Step 24: Remove the left cover on page 1886](#).

 **NOTE:** The figures below show the image scanner installed. The procedures for removing and installing the right upper cover are the same whether the image scanner is installed or removed."

1. At the right side of the printer, remove two screws (callout 1).

M577c/f/z only: Disconnect one connector (callout 2), if it was not already disconnected in a previous step.

Figure 1-3339 Remove two screws and one connector

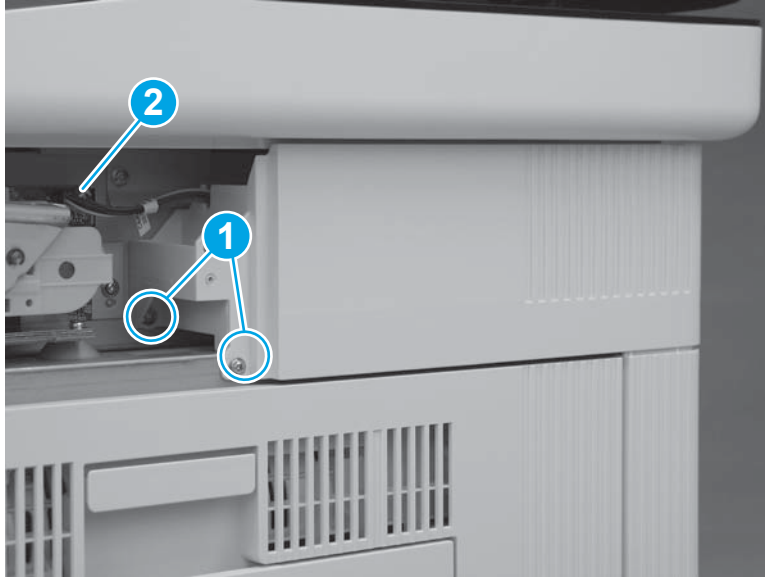

2. At the back of the printer, remove one screw (callout 1).

M577c/f/z only: Disconnect one connector (callout 2), if it was not already disconnected in a previous step.

 **Reinstallation tip:** This screw is smaller than the screws removed in the previous step. When reinstalling the right upper cover, make sure that this screw is installed in the correct position.

Figure 1-3340 Remove one screw and connector



3. Slide the cover toward the back of the printer.

Figure 1-3341 Slide the cover

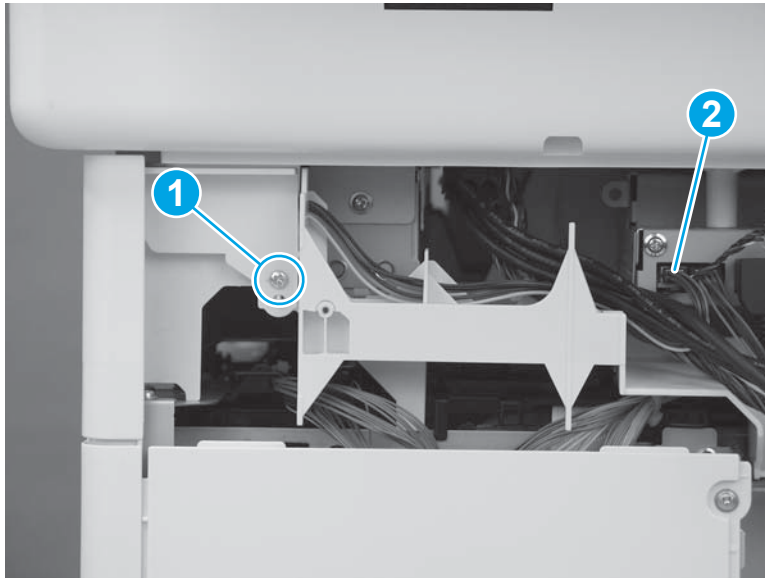
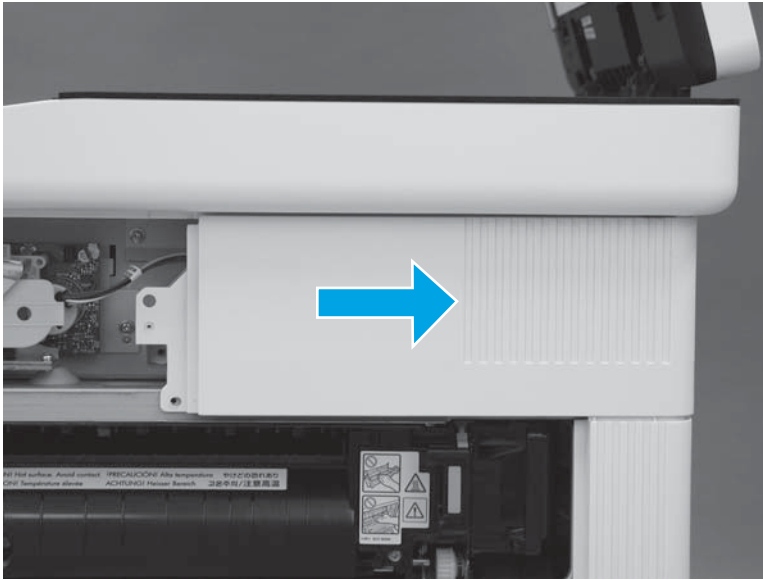

4. Lift the cover away from the printer to remove it.

M577c/f/z only: Release the cables (callout 1) through the slot (callout 2) in the printer.

Figure 1-3342 Remove the cover

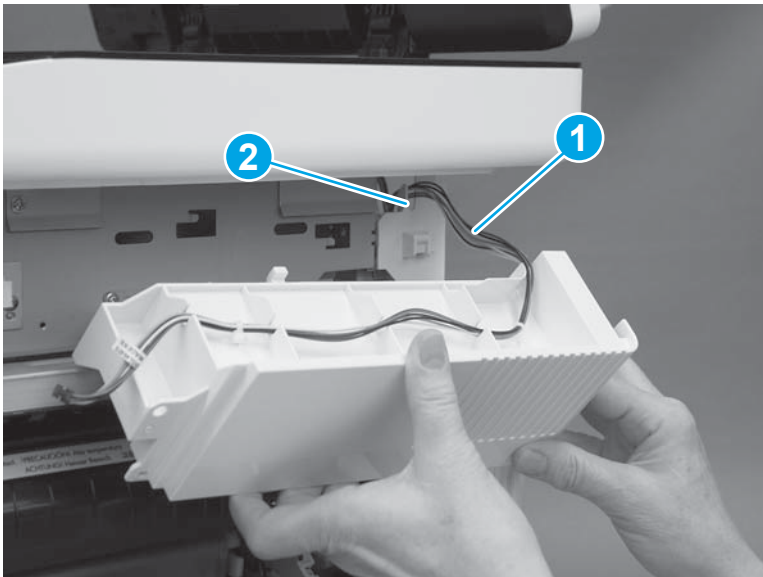

Step 20: Remove the top rear cover (M577)

 **NOTE:** This step is for the M577 models. For the M552 and M553 models, skip this step and go to [Step 24: Remove the left cover on page 1886](#).

1. At the top of the printer, remove five screws (callout 1).

Figure 1-3343 Remove five screws

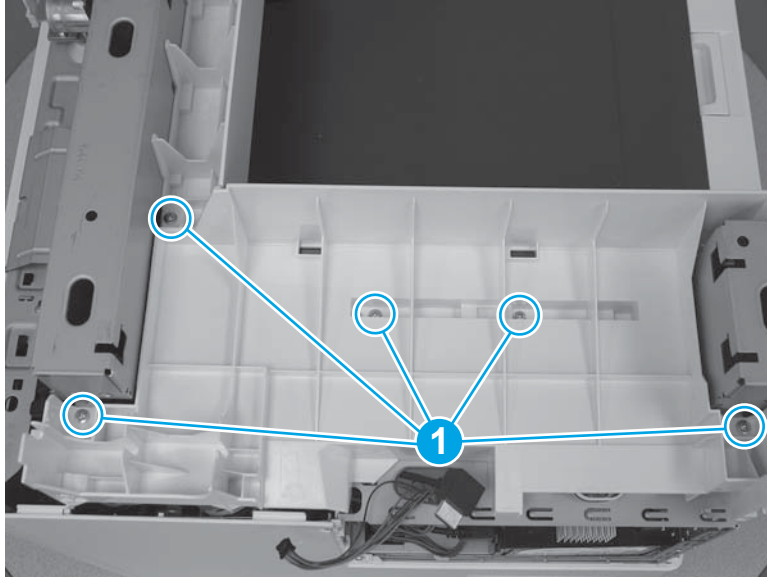

2. Release two tabs (callout 1) on the front edge of the cover.

Figure 1-3344 Release two tabs

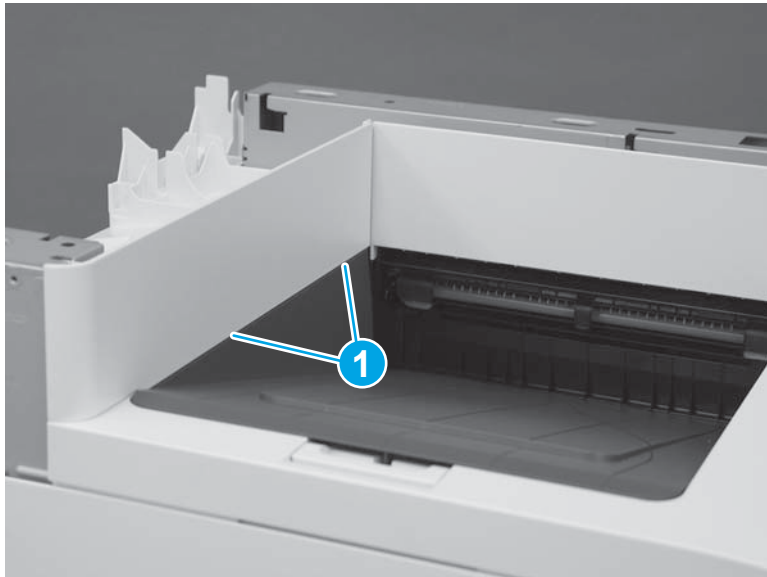

3. Remove the top rear cover.

Figure 1-3345 Remove the top rear cover

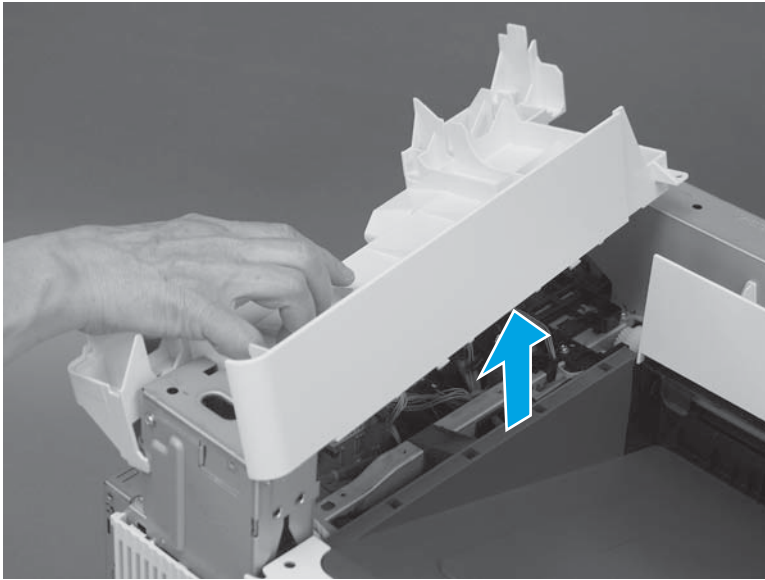

Step 21: Remove the paper feed cover (M577)

 **NOTE:** This step is for the M577 models. For the M552 and M553 models, skip this step and go to [Step 24: Remove the left cover on page 1886](#).

1. Remove one screw (callout 1).

Figure 1-3346 Remove one screw

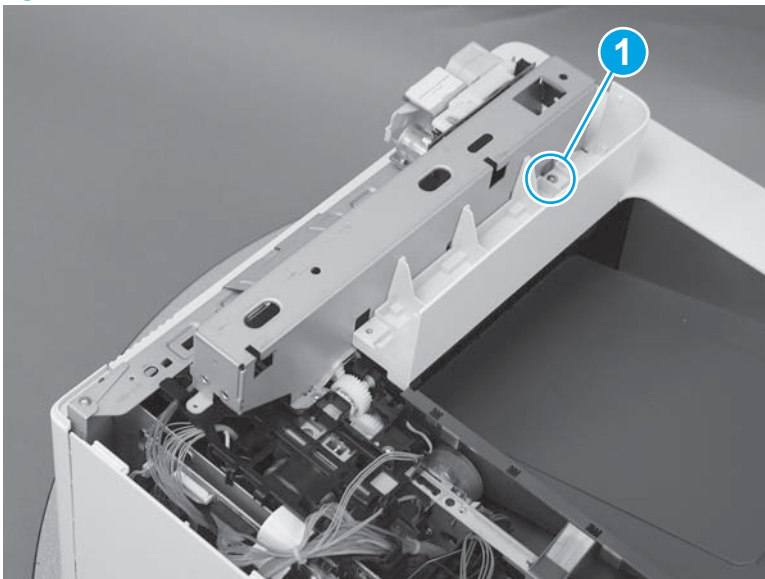

2. Lift the cover up to remove it.

Figure 1-3347 Remove the cover

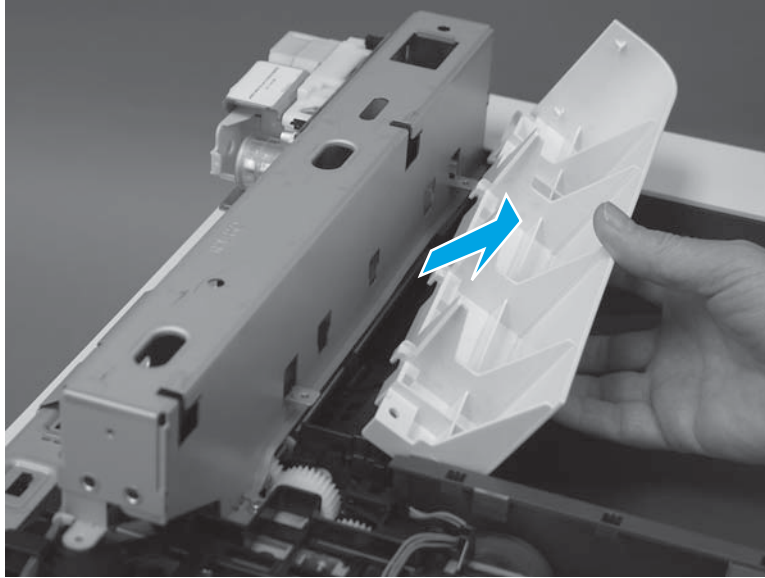

Step 22: Remove the top cover (M577)

 **NOTE:** This step is for the M577 models. For the M552 and M553 models, skip this step and go to [Step 24: Remove the left cover on page 1886](#).

1. At the front of the printer, remove one screw (callout 1).

 **Reinstallation tip:** This screw is longer and a different type of screw than the screw removed in the next step. When reinstalling the top cover, make sure that this screw is installed in the correct position.

Figure 1-3348 Remove one screw



2. At the left side of the printer, remove one screw (callout 1).

Figure 1-3349 Remove one screw

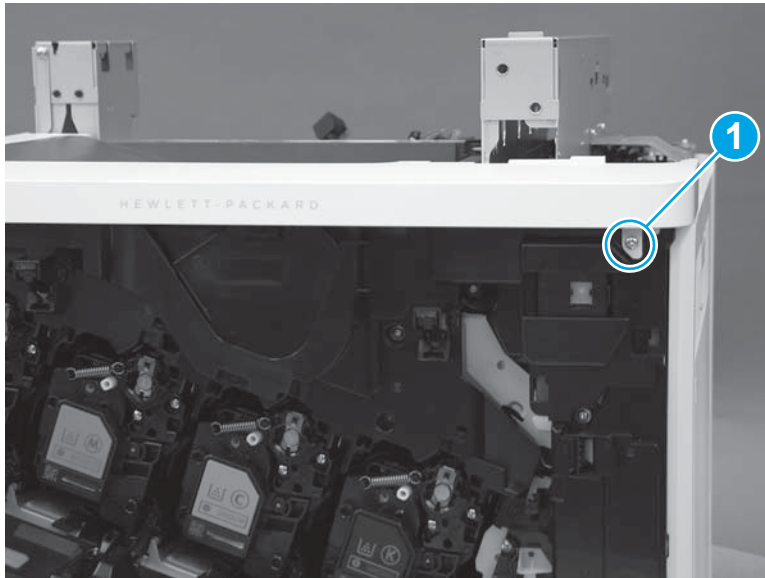
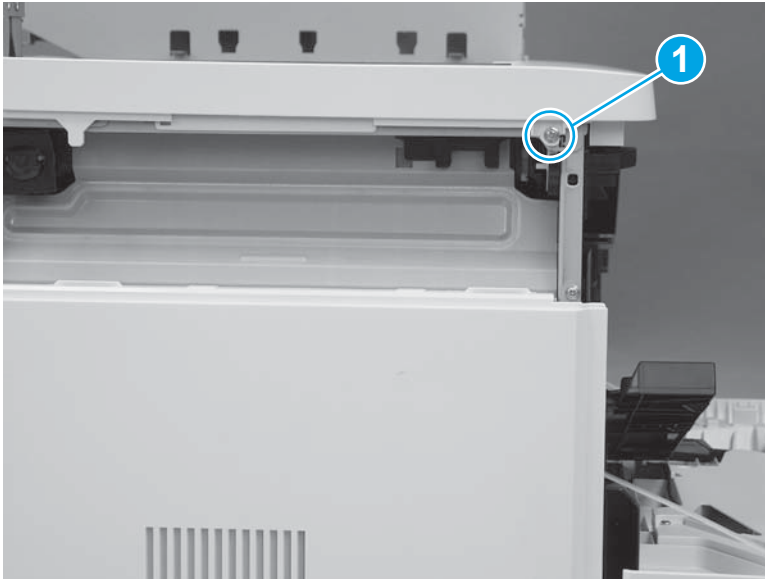

3. At the front of the printer, release one tab (callout 1).

Figure 1-3350 Release one tab

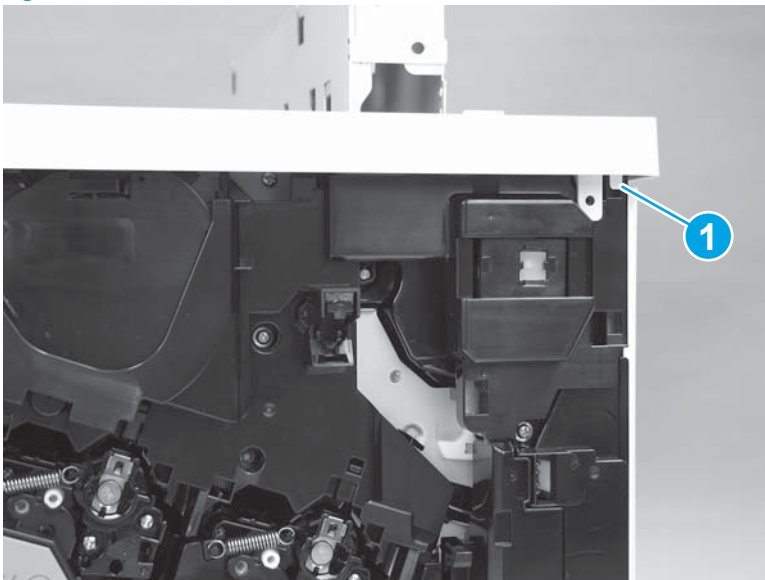

4. At the top of the printer, release two tabs (callout 1) next to the output bin, and then remove the top cover.

Figure 1-3351 Release two tabs

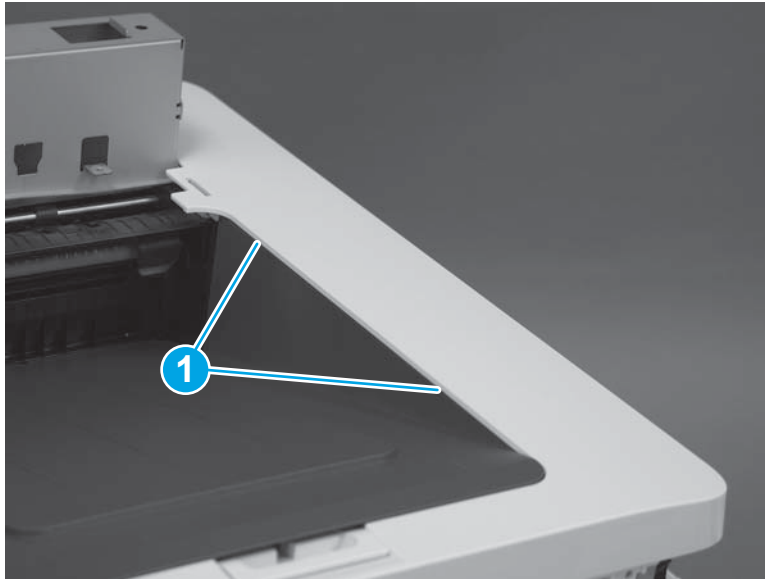

Step 23: Remove the top bracket (M577)

 **NOTE:** This step is for the M577 models. For the M552 and M553 models, skip this step and go to [Step 24: Remove the left cover on page 1886](#).

1. At the top of the printer, remove three screws (callout 1).

Figure 1-3352 Remove three screws

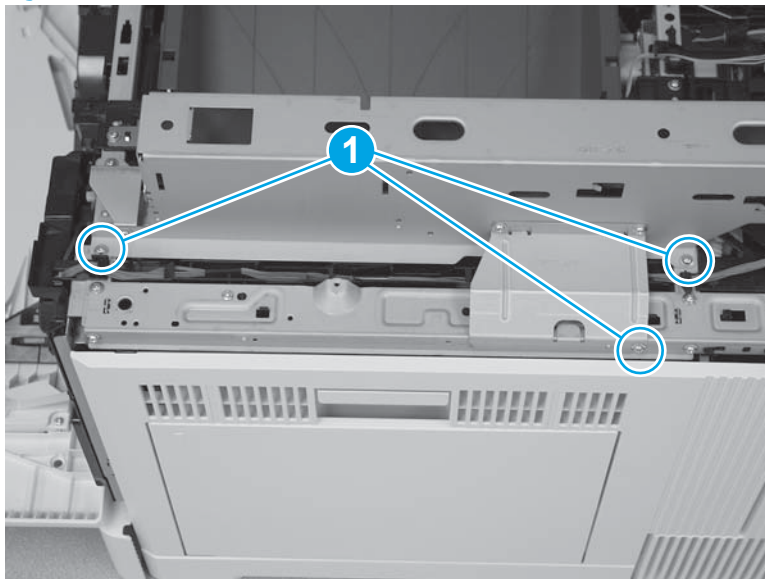

2. At the top of the printer, remove two screws (callout 1).

Figure 1-3353 Remove two screws

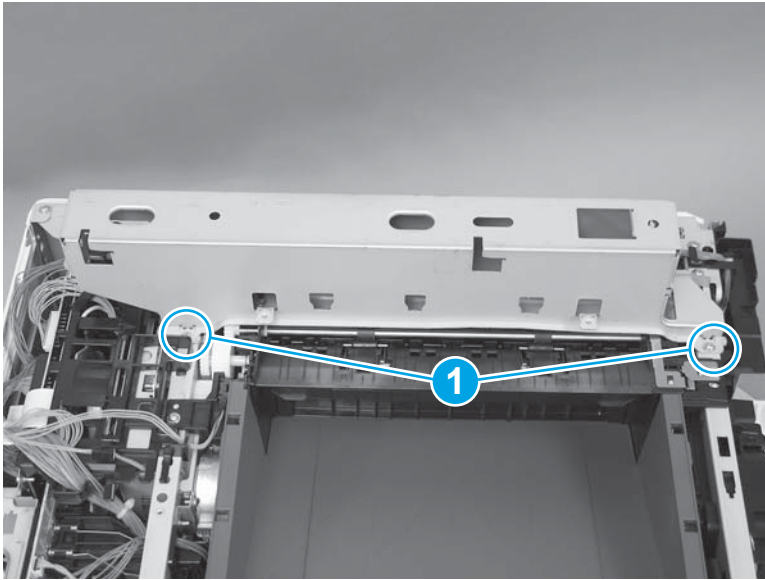

3. Lift the top bracket up to remove it.

Figure 1-3354 Remove the bracket

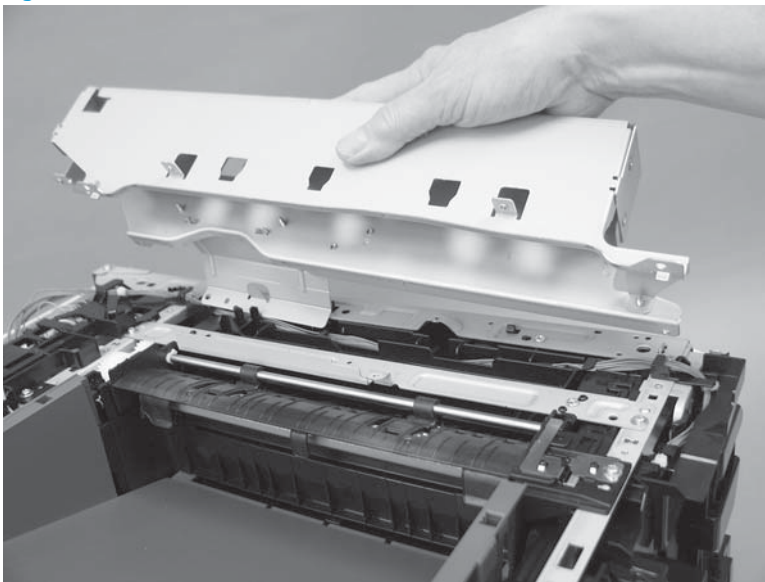

Step 24: Remove the left cover

1. At the left side of the printer, remove one screw (callout 1).

Figure 1-3355 Remove one screw



2. Release one tab (callout 1), rotate the front edge of the cover away from the printer (callout 2), and then slide the cover (callout 3) toward the rear of the printer to release it.

Figure 1-3356 Release the cover

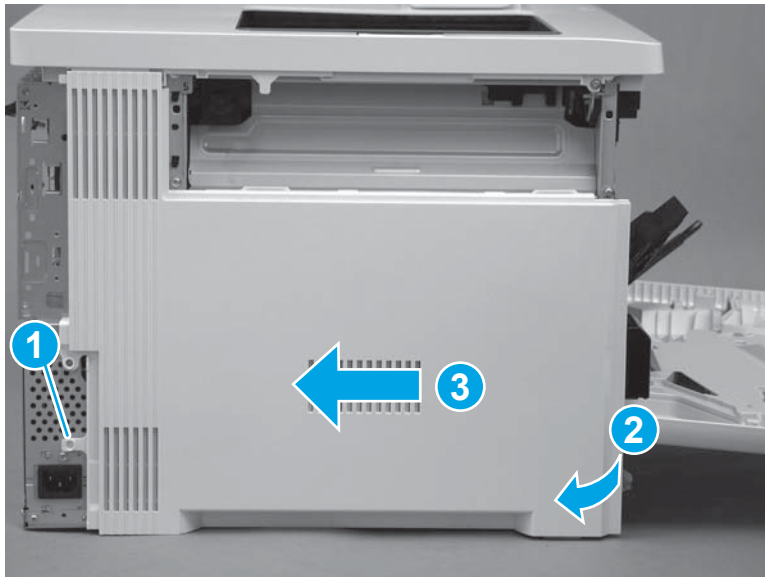

3. Remove the cover.

Figure 1-3357 Remove the cover

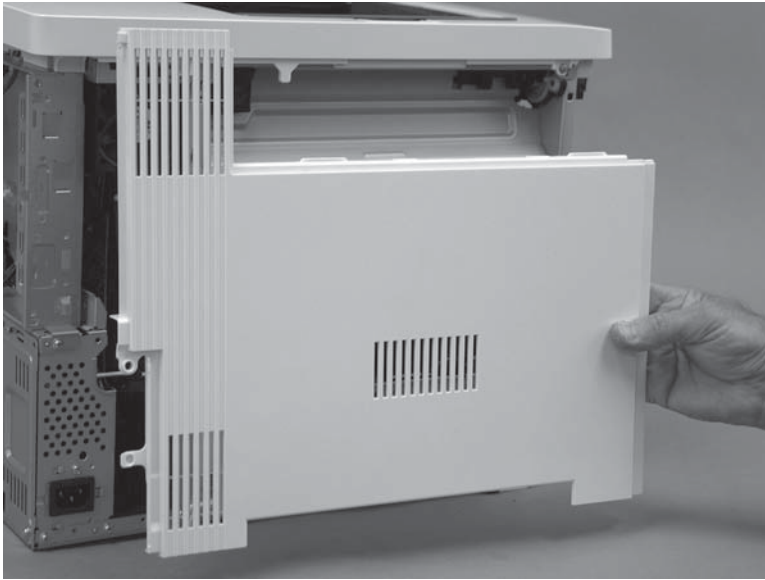

Step 25: Remove the upper cover (M552 and M553)

 **NOTE:** This step is for the M552 and M553 models. For the M577 models, skip this step and go to [Step 26: Remove the formatter case on page 1890.](#)

1. Remove three screws (callout 1).

Figure 1-3358 Remove three screws

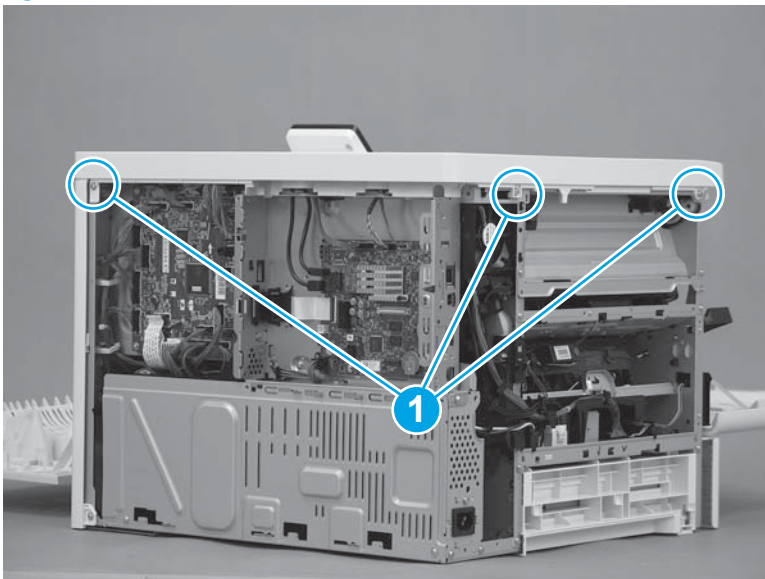

2. Remove one screw (callout 1), release one tab (callout 2), and then slightly separate the corner of the cover from the chassis.

 **NOTE:** This is a self-tapping plastic-thread screw. Make sure that this screw is used in this location when it is reinstalled.

Figure 1-3359 Remove one screw and release one tab



3. Release one tab (callout 1), and then lift up on the cover to release it.

 **NOTE:** If the cover does not release, check for additional tabs by locating the triangles embossed in the cover at tab locations.

Figure 1-3360 Release the cover



4. Remove the cover.

Figure 1-3361 Remove the cover

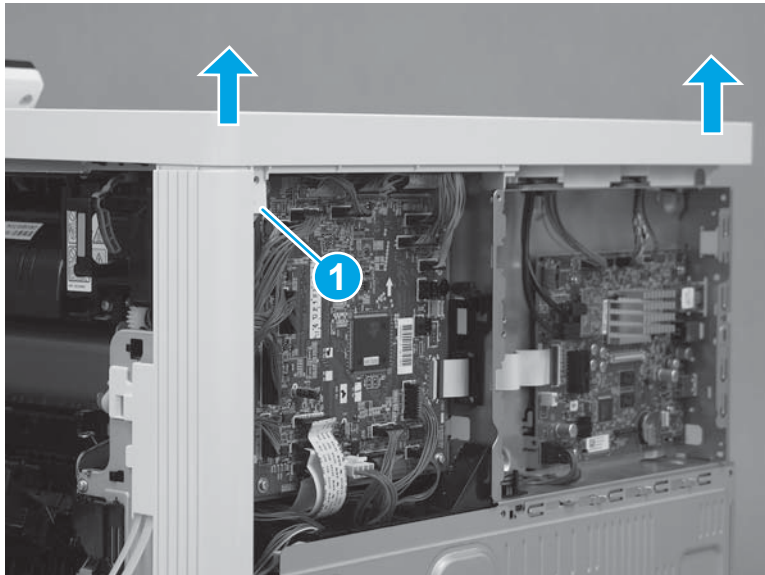
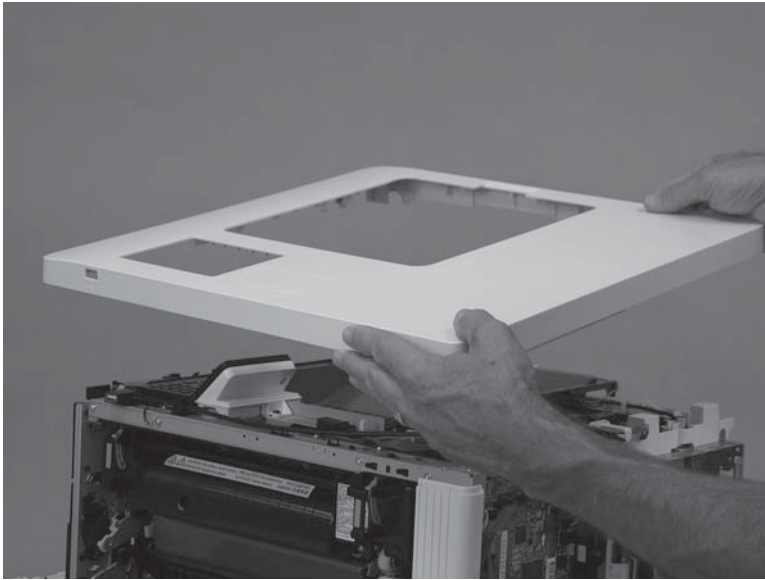

Step 26: Remove the formatter case

1. **M577 only:** Disconnect one connector (callout 1), and then pass the wire harness (callout 2) through two openings in the formatter case (callout 3).

Figure 1-3362 Disconnect one connector

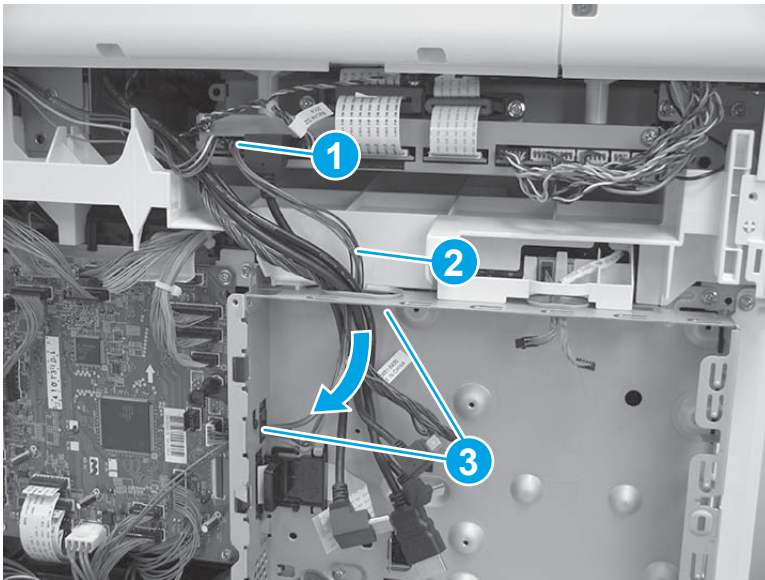

2. Release two tabs (callout 1) on the black plastic bracket. Hold the tabs in the released position, and then slide the bracket (callout 2) to the right to remove it from the formatter case.

Figure 1-3363 Remove the bracket

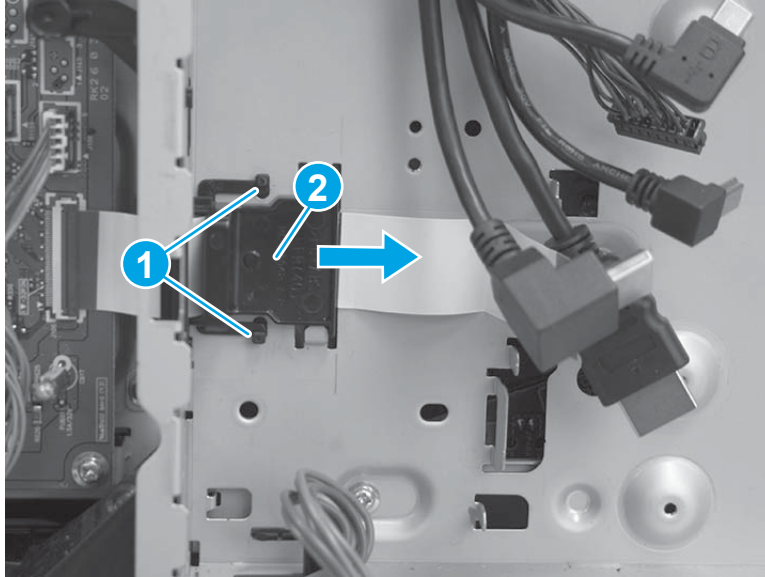

3. Remove two screws (callout 1), and then slide the low-voltage power supply (LVPS) cover to the right to remove it.

Figure 1-3364 Remove the LVPS cover

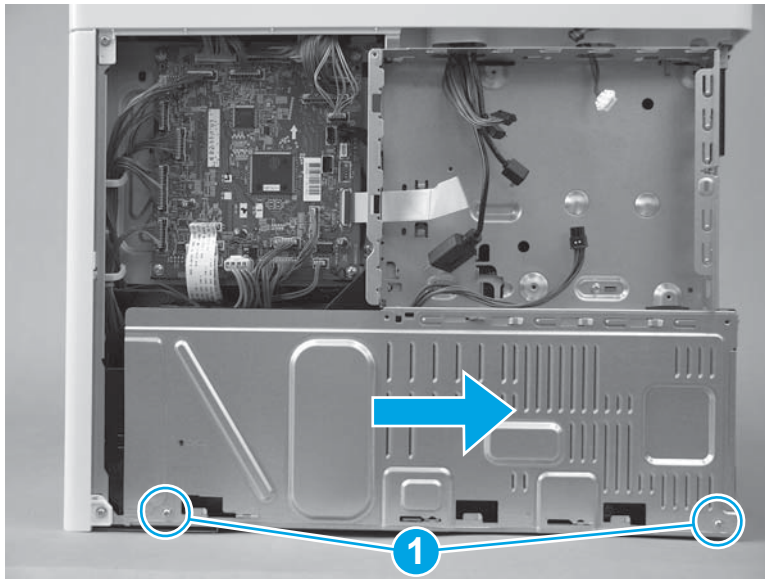

4. Pass two wire harnesses and one flat cable (callout 1) through the opening in the formatter case, and then release one wire harness from the retainer (callout 2).

⚠ CAUTION: The flat cable might be attached to the formatter case with double-sided tape. Make sure that this tape is released, so that the flat cable is not damaged when the formatter case is removed.

Figure 1-3365 Release wire harnesses and flat cable

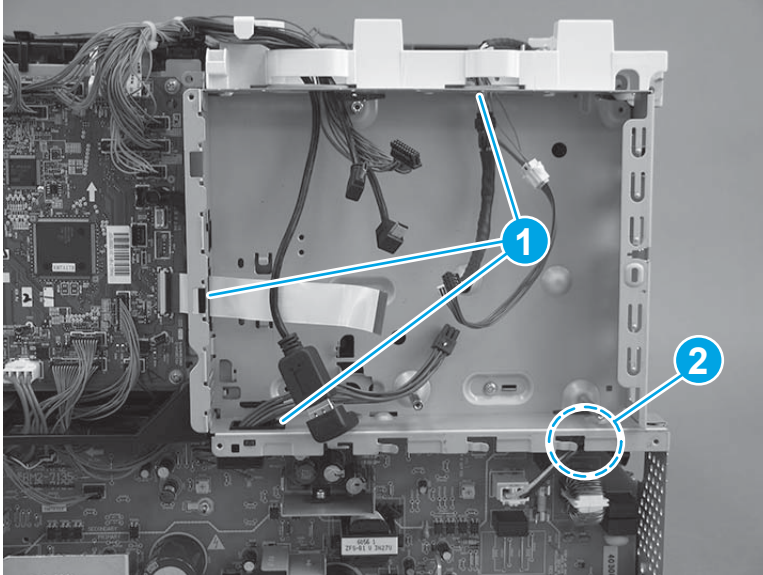

5. Remove six screws (callout 1).

Figure 1-3366 Remove six screws

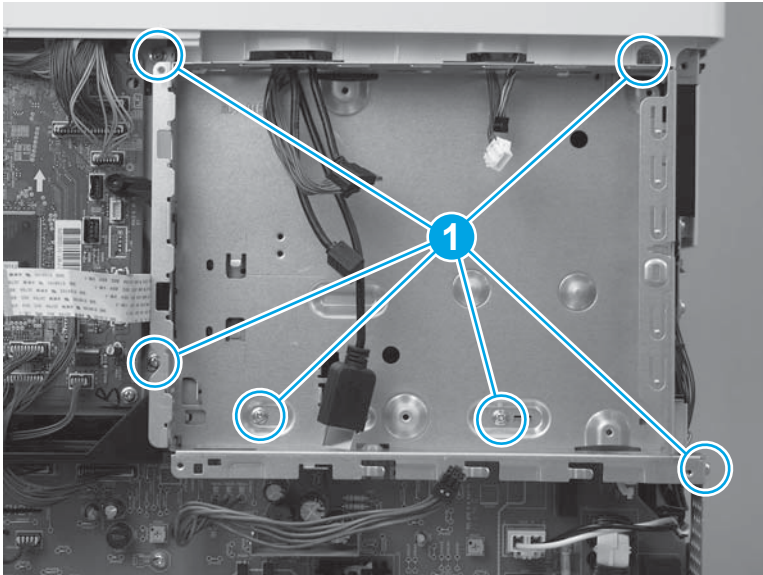

6. Rotate the bottom of the formatter case away from the printer (callout 1), and then pull it down (callout 2) to release it.

Figure 1-3367 Release the formatter case

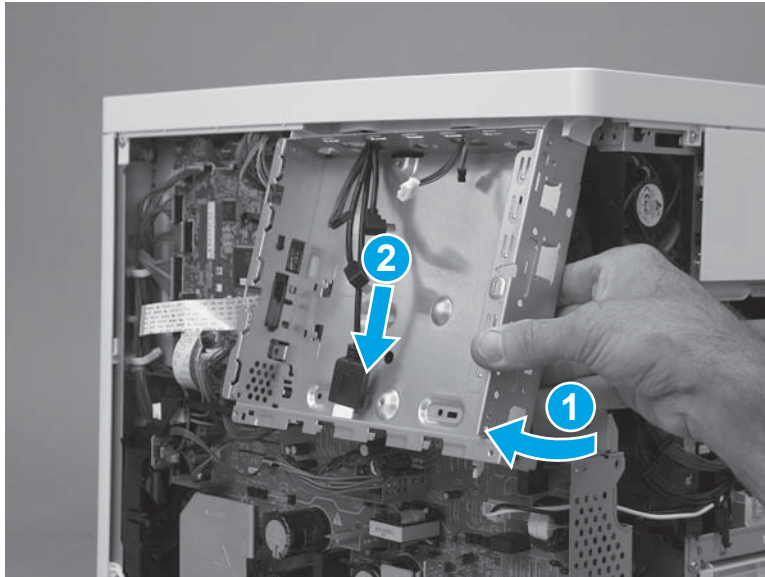

7. Pass the wire harnesses through the opening in the formatter case to remove it.

 **IMPORTANT:** If the formatter case is removed so that it can be replaced, make sure to transfer the memory PCA (island of data) and plastic bracket (callout 1) to the replacement case.

Figure 1-3368 Remove the formatter case



Step 27: Remove the right rear cover

1. Remove one screw (callout 1), and then slide the cover toward the rear of the printer (callout 2) to release it.

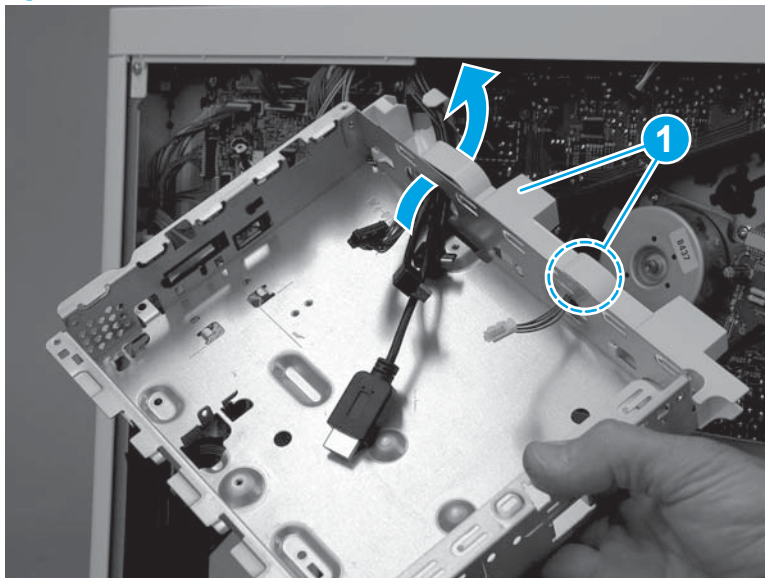
 **TIP:** If the right door is closed, open it now.

Figure 1-3369 Release the cover

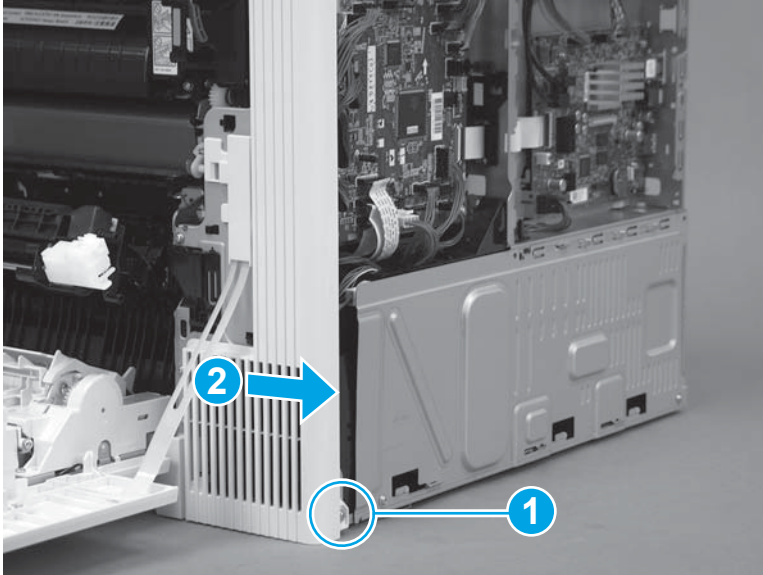

2. Remove the cover.

Figure 1-3370 Remove the cover

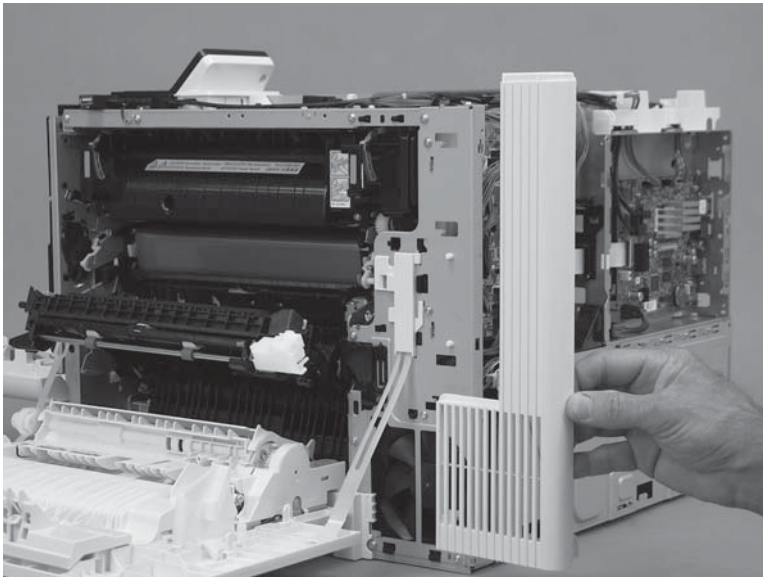

Step 28: Remove the DC controller and sheet-metal bracket

 **CAUTION:**  ESD sensitive part.

1. Disconnect all of the connectors, and then remove two screws (callout 1).
The following connectors are empty:
 - J140, J141, and J143

Figure 1-3371 Remove two screws

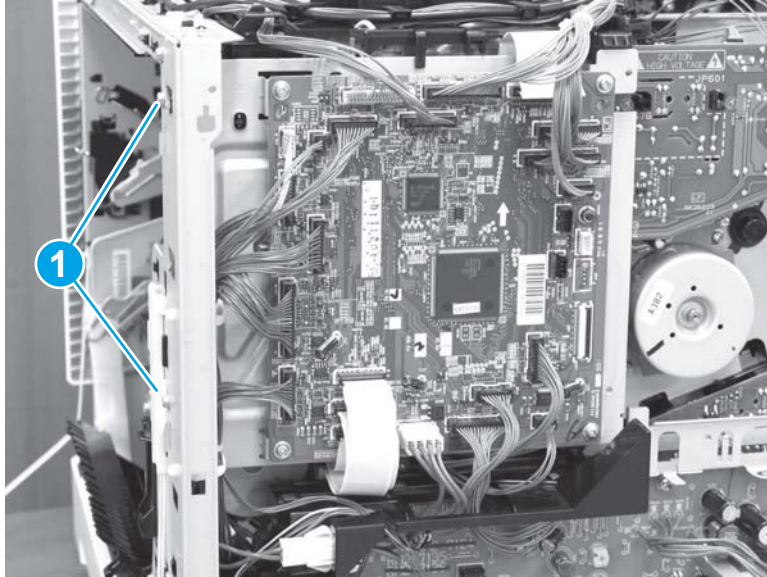

2. Lift up on the DC controller and sheet-metal plate to remove it.

Figure 1-3372 Remove the plate

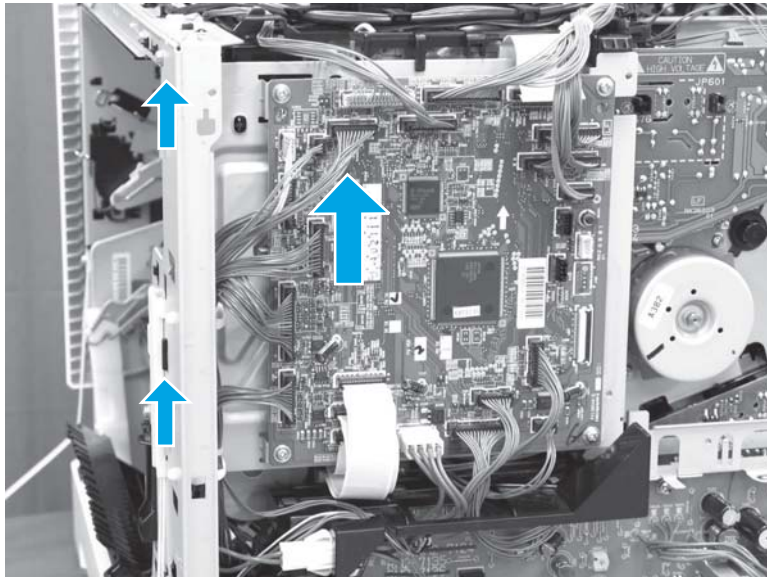

Step 29: Remove the high-voltage power supply T (HVPST)

 **CAUTION:**  ESD-sensitive part.

1. Disconnect five connectors (callout 1), and then disconnect one flat cable (callout 2).

Figure 1-3373 Disconnect five connectors and one flat cable

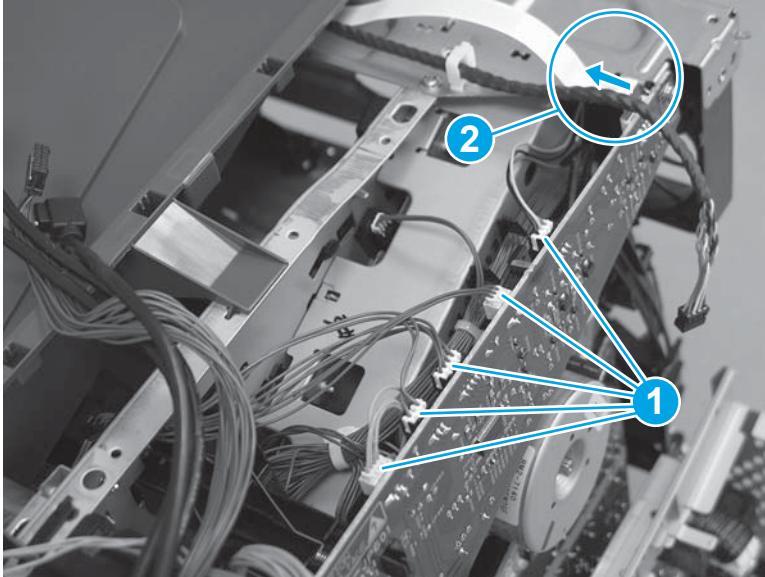

2. Remove one screw (callout 1).

Figure 1-3374 Remove one screw

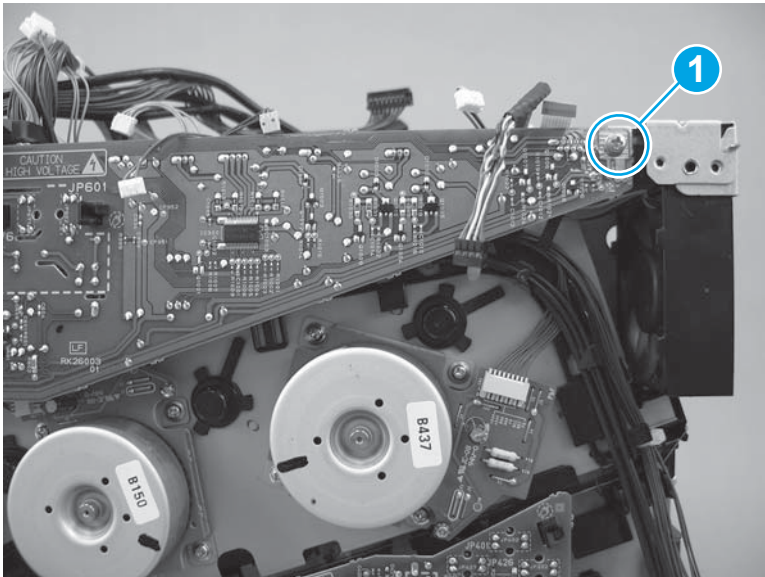

3. Release two tabs (callout 1), and then separate the HVPST from the printer.

CAUTION: Do not attempt to completely remove the HVPST. It is still connected to the printer by ground wire harness.

Figure 1-3375 Release the HVPST

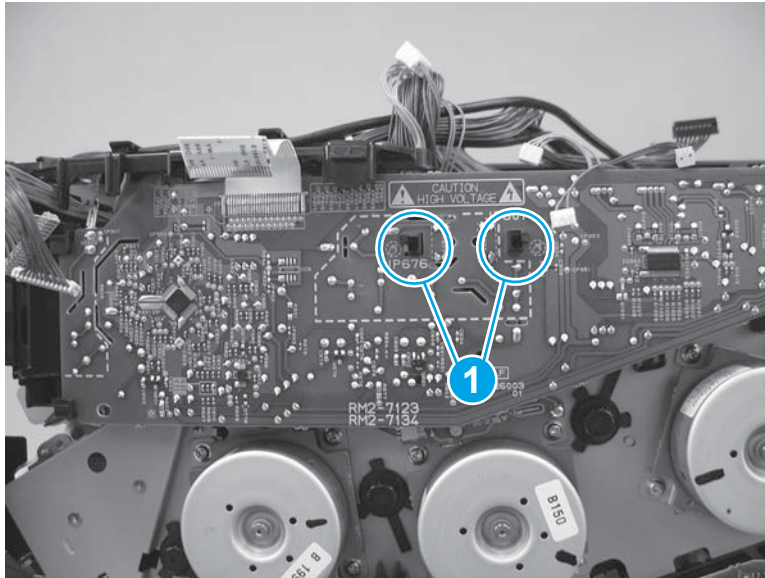

4. Release one ground wire connector (callout 1), and then remove the HVPST.

Figure 1-3376 Remove the HVPST

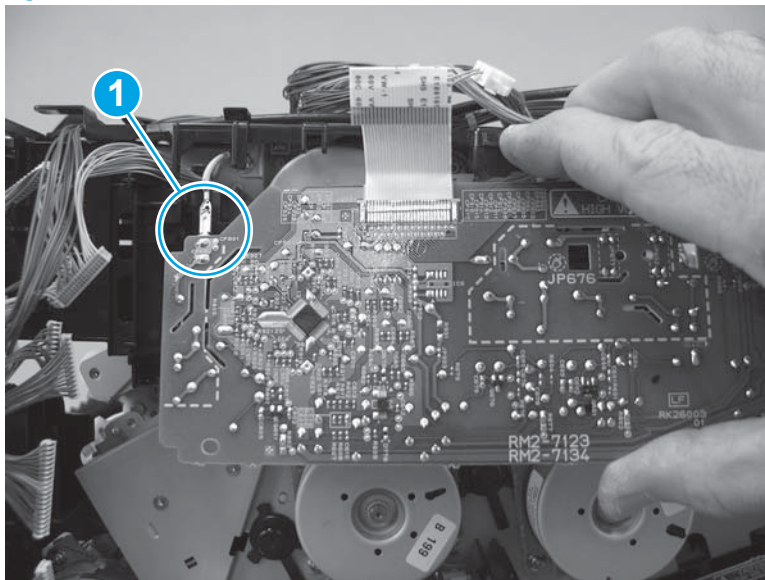

Step 30: Remove the fuser drive assembly

1. Release one tab (callout 1), slide the guide to release it (callout 2), and then rotate the guide up and away from the chassis to move it out of the way (callout 3).

CAUTION: One wire harnesses in the guide is still attached to the fuser motor. Do not attempt to completely remove the guide.

Figure 1-3377 Move the guide out of the way

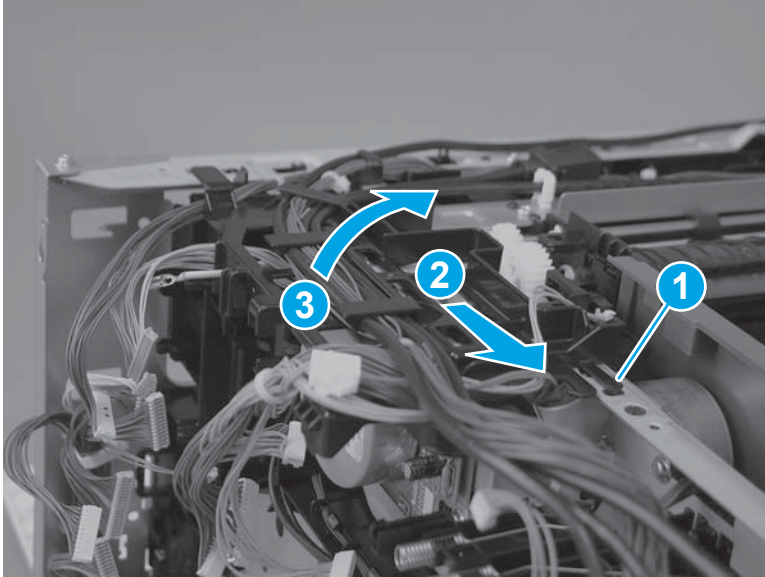

2. Disconnect one connector (callout 1).

Figure 1-3378 Disconnect one connector

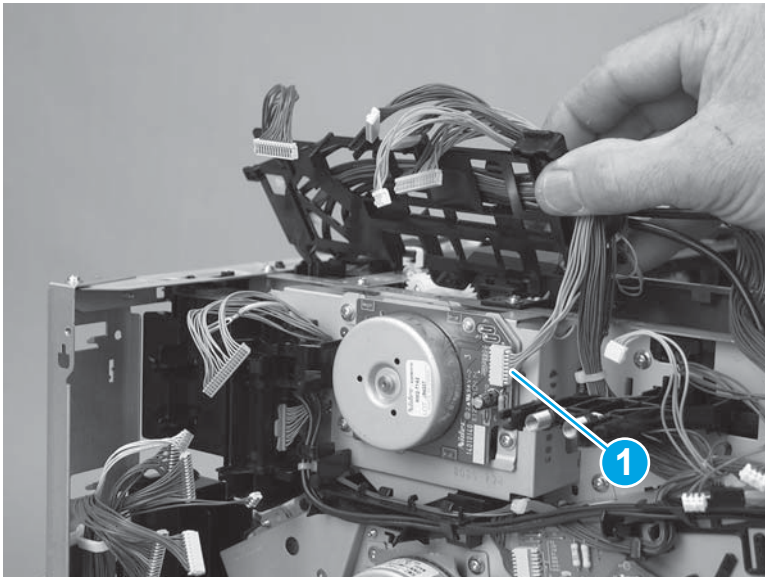

3. Remove one screw (callout 1).

Figure 1-3379 Remove one screw

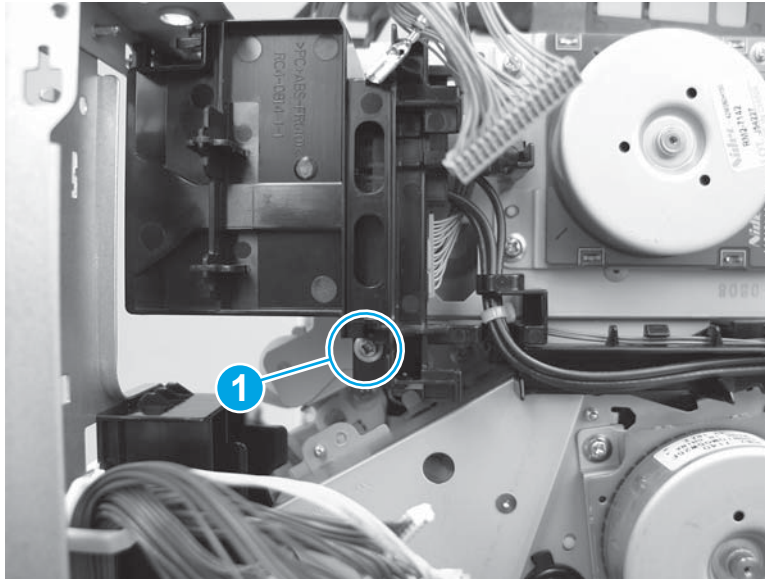

4. Release one tab (callout 1), slide the guide down to release it (callout 2), and then rotate the guide away from the chassis to remove it (callout 3).

Figure 1-3380 Remove the guide

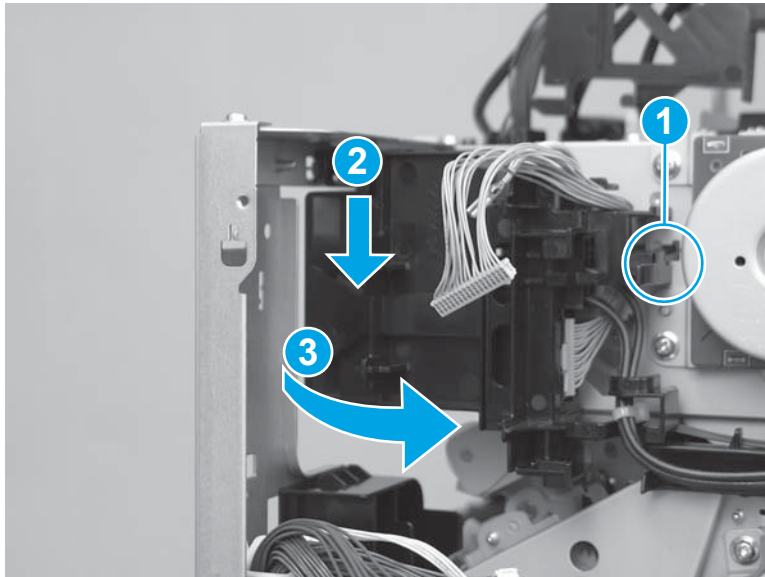

5. Remove three screws (callout 1).

Figure 1-3381 Remove three screws

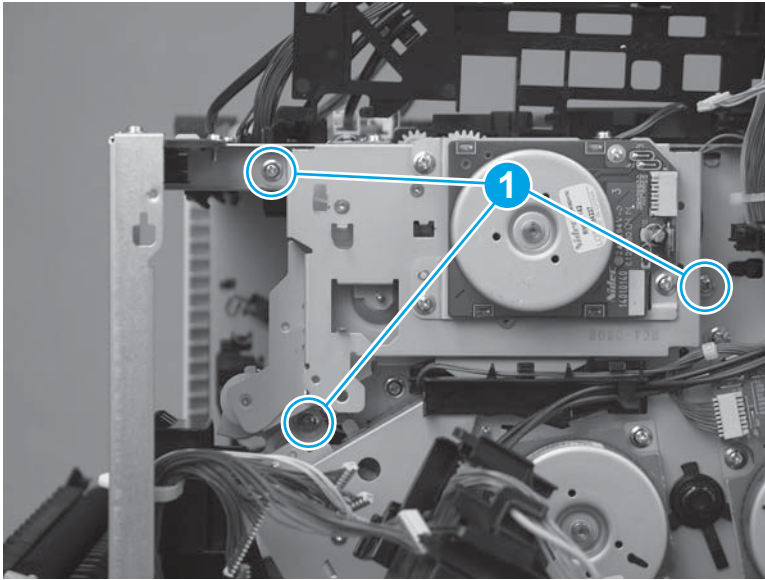

6. Remove the assembly.

CAUTION: Two gears on the back side of the assembly are not captive. Handle the assembly carefully.

Figure 1-3382 Remove the assembly

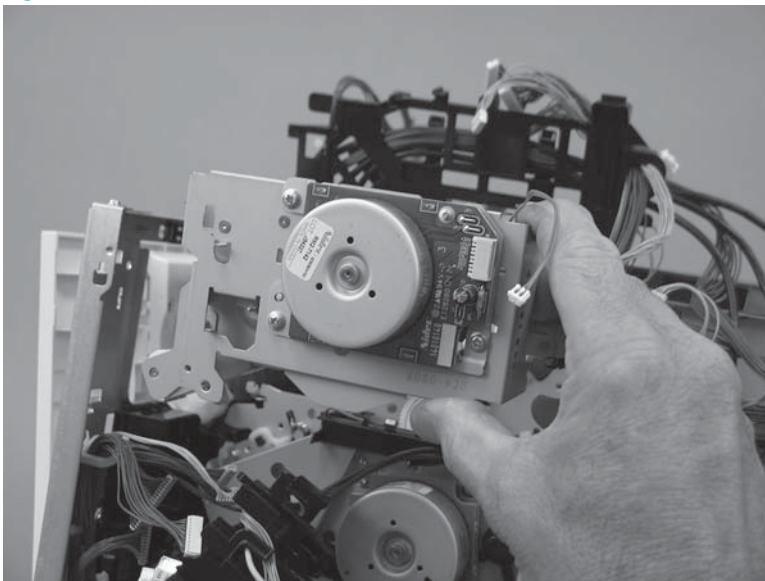

Step 31: Unpack the replacement assembly

Unpack the replacement assembly from the packaging.

For complete information on HP's recycling programs, go to [Product return and recycling](#).

⚠ CAUTION: Two gears (callout 1) on the back side of the assembly are not captive. Handle the assembly carefully.

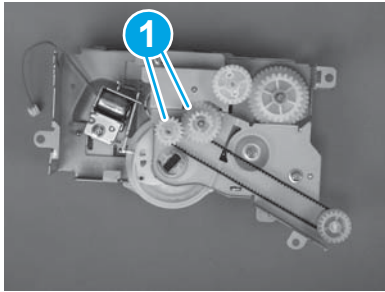

📄 NOTE: HP recommends responsible disposal of the defective assembly.

Figure 1-3383 Recycle and unpack

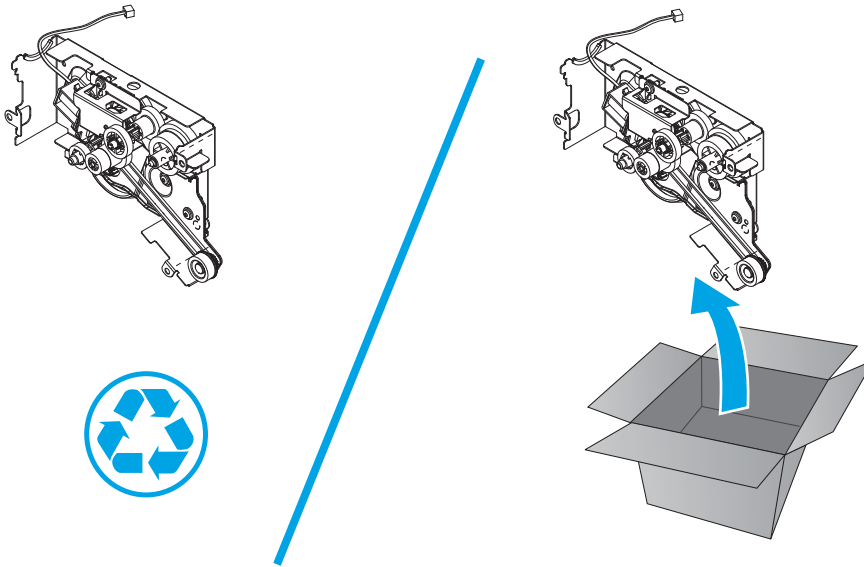

Step 32: Install the fuser drive assembly

1. Two gears (callout 1) on the back side of the assembly are not captive. If the gears are dislodged, install them as shown.

⚠ CAUTION: Handle the assembly carefully.

Figure 1-3384 Check the gears on the assembly

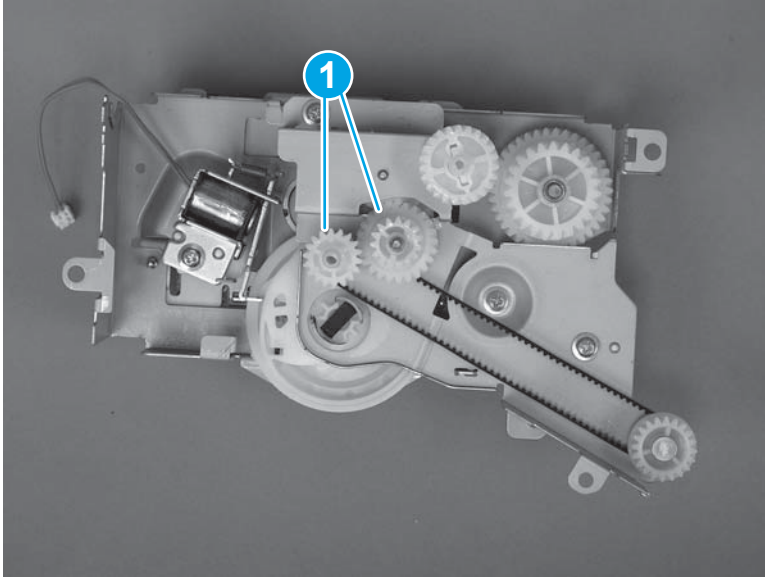

2. Position the assembly on the chassis, and then install three screws (callout 1).

Figure 1-3385 Install three screws

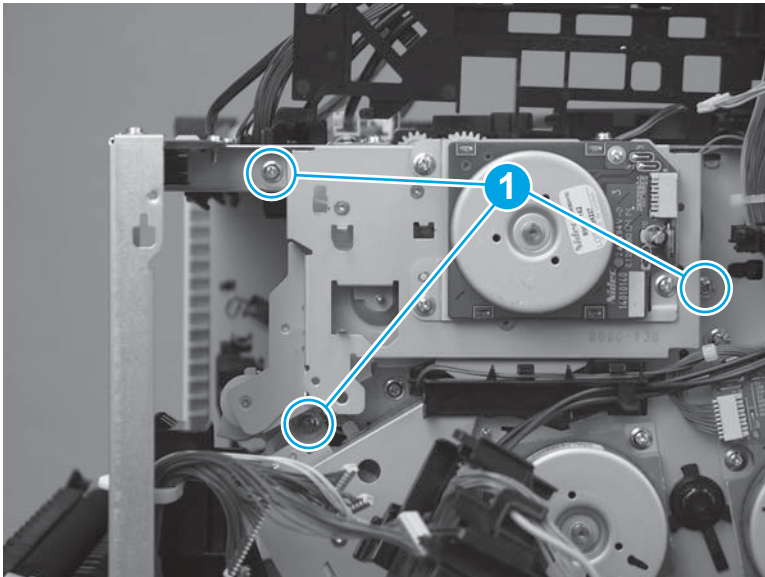

3. Position the guide on the chassis (callout 1), slide the guide up to engage it (callout 2), and then verify that the tab (callout 3) snaps into place.

Figure 1-3386 Install the guide

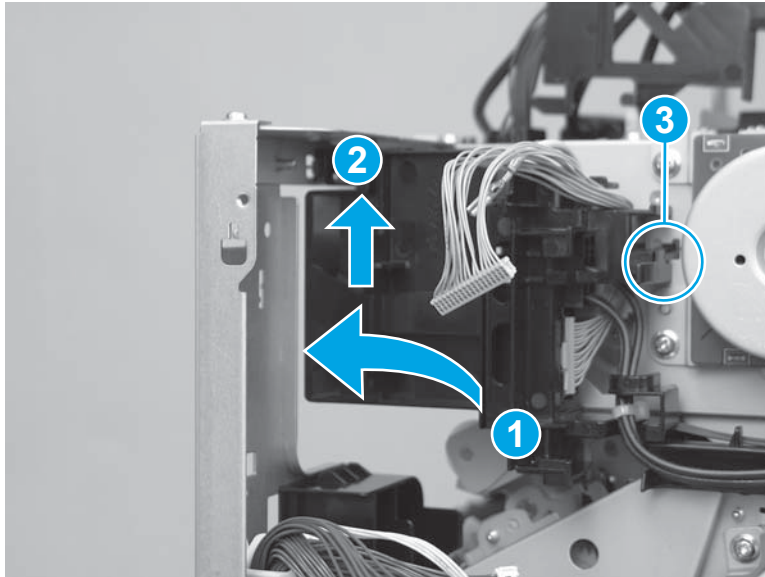

4. Install one screw (callout 1).

Figure 1-3387 Install one screw

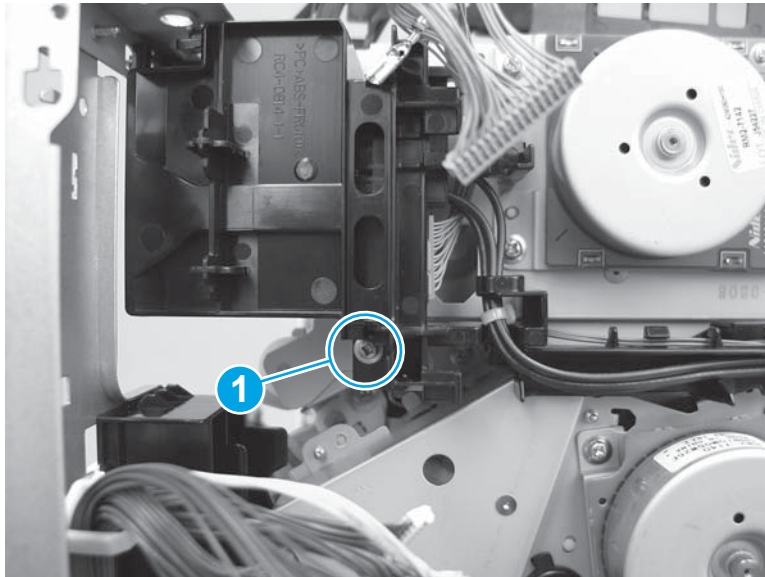

5. Connect one connector (callout 1).

Figure 1-3388 Connect one connector

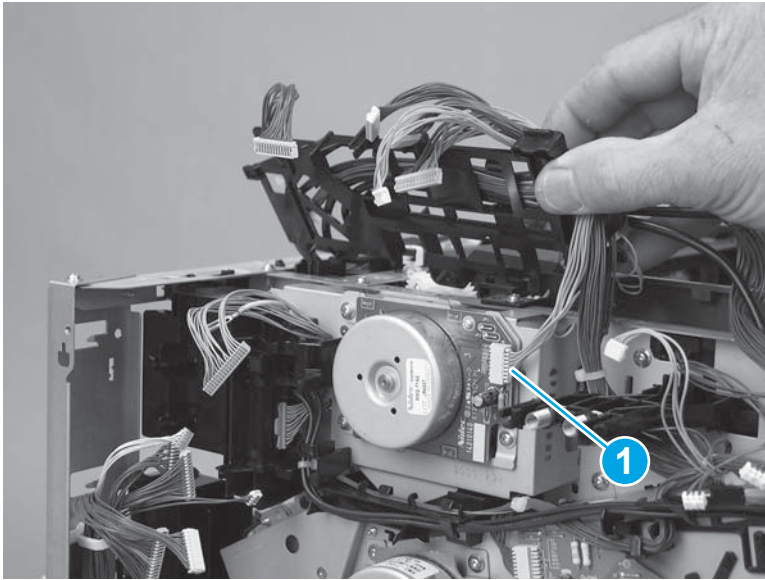

6. Rotate the guide down and onto the chassis (callout 1), slide the guide to engage it (callout 2), and then make sure that the tab (callout 3) snaps into place.

CAUTION: Do not dislodge the fuser motor connector when installing the guide.

Figure 1-3389 Install the guide

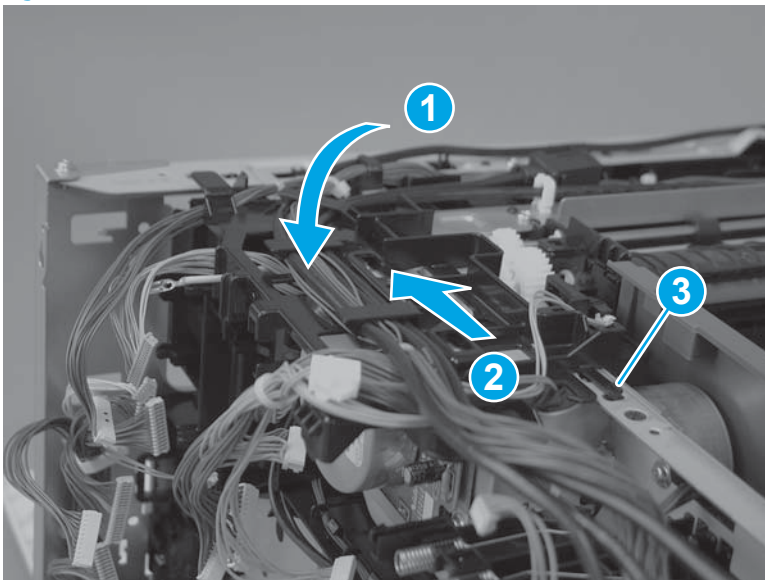

Step 33: Install the HVPST

CAUTION:  ESD-sensitive part.

1. Connect one ground wire connector (callout 1).

Figure 1-3390 Connect one ground wire

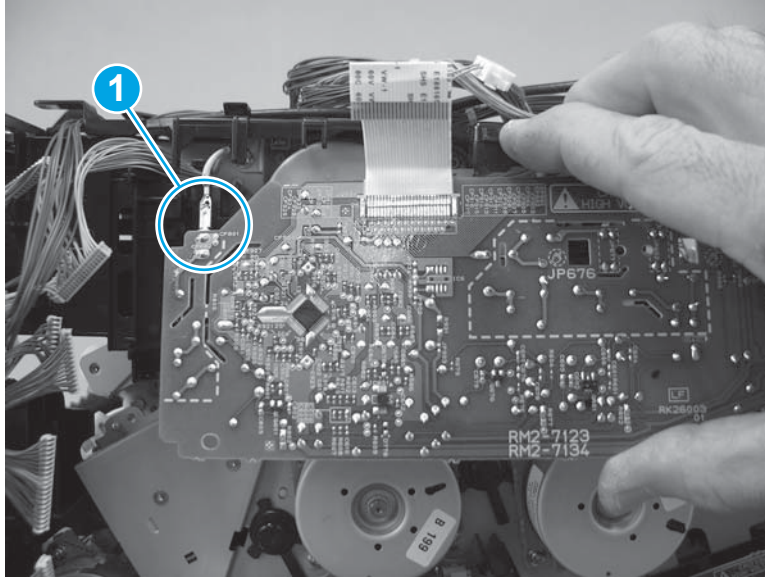

2. Position the HVPST on the printer, and then push in to engage two tabs (callout 1).

 **NOTE:** Make sure that the tabs snap into place.

Figure 1-3391 Install the HVPST



3. Install one screw (callout 1).

Figure 1-3392 Install one screw

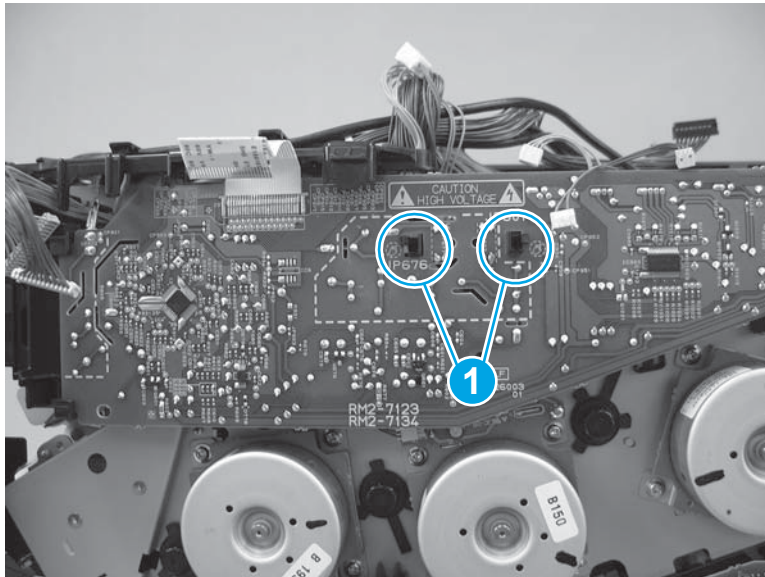
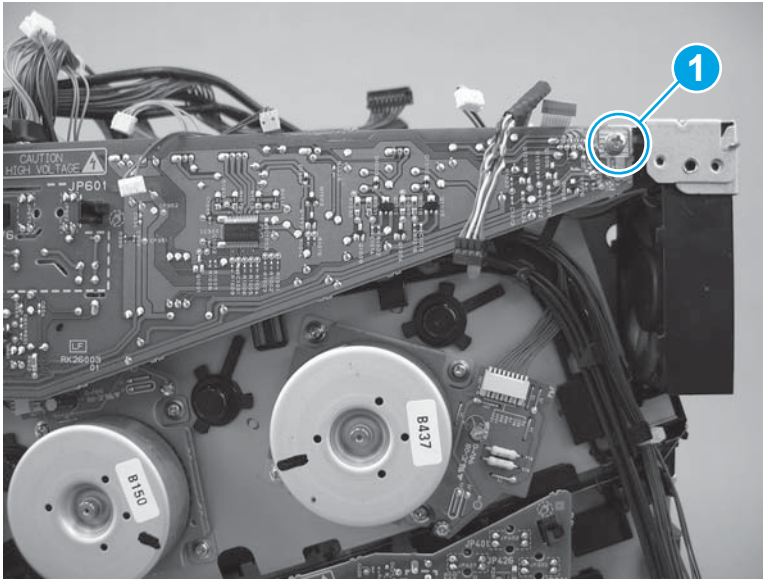

4. Connect five connectors (callout 1), and then connect one flat cable (callout 2).

Figure 1-3393 Connect five connectors and one flat cable

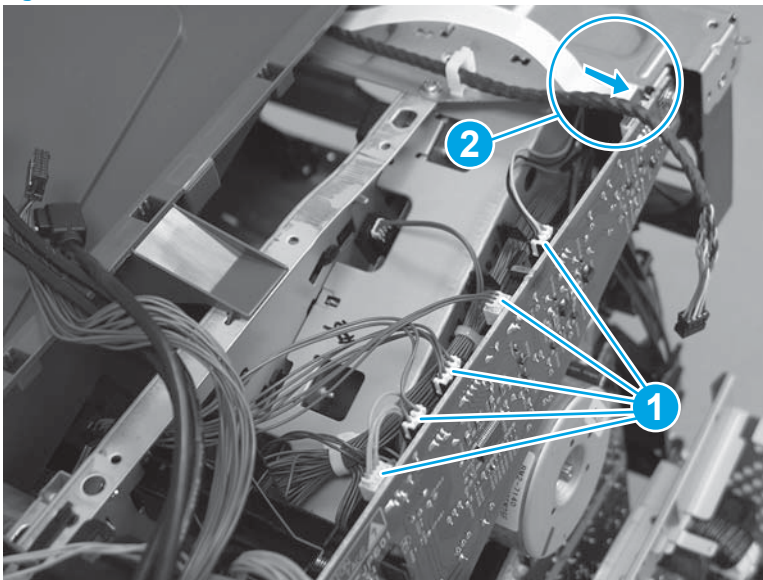

Step 34: Install the DC controller and sheet-metal bracket

 **CAUTION:**  ESD-sensitive part.

1. Position the DC controller and sheet-metal plate on the printer, and then push down to engage the plate with the chassis.

Figure 1-3394 Install the plate

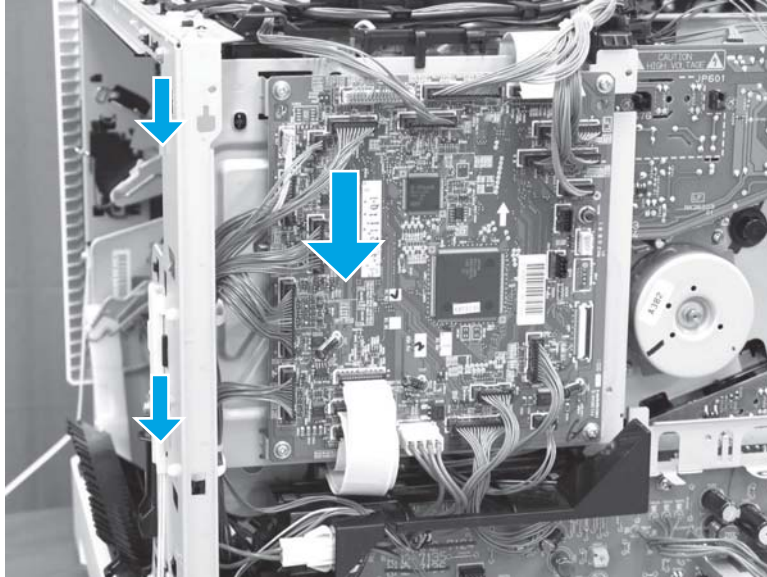

2. Install two screws (callout 1), and then connect all of the connectors.

The following connectors are empty:

- J140, J141, and J143

Figure 1-3395 Install two screws

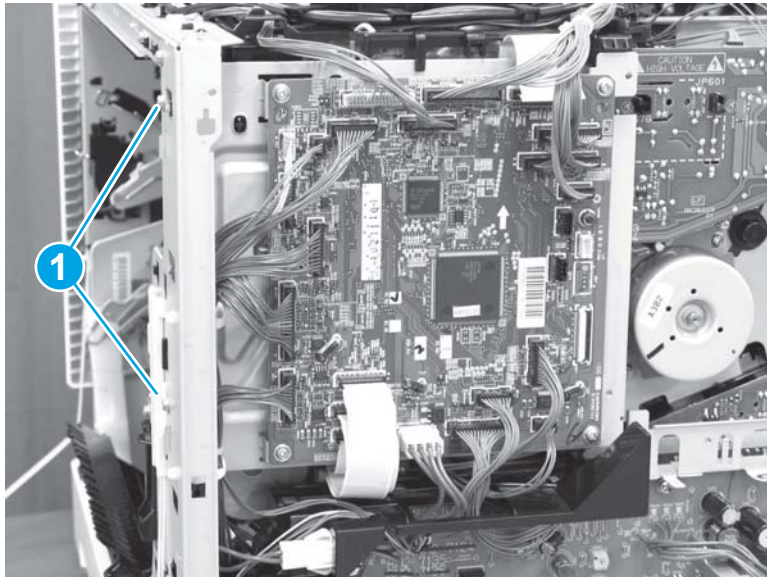

Step 35: Install the right rear cover

1. Position the cover on the printer.

Figure 1-3396 Install the cover

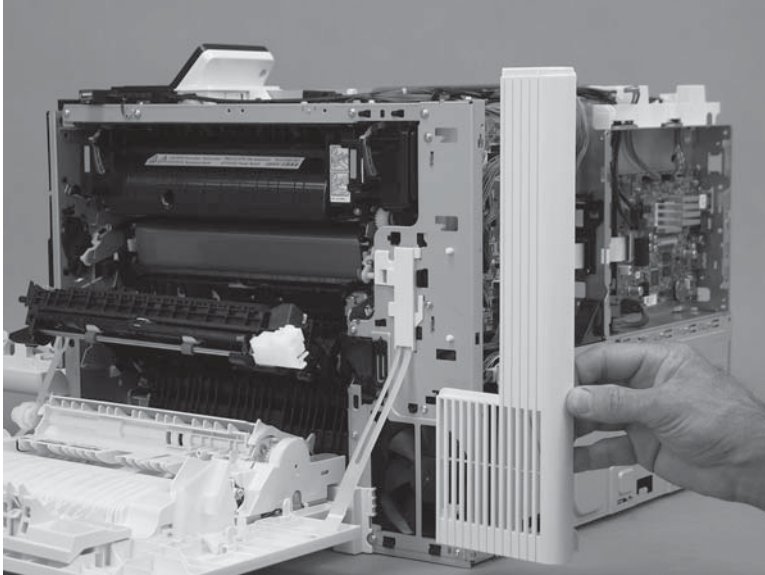

2. Slide the cover toward the right door (callout 1) to engage it with the printer, and then install one screw (callout 2).

Figure 1-3397 Install one screw

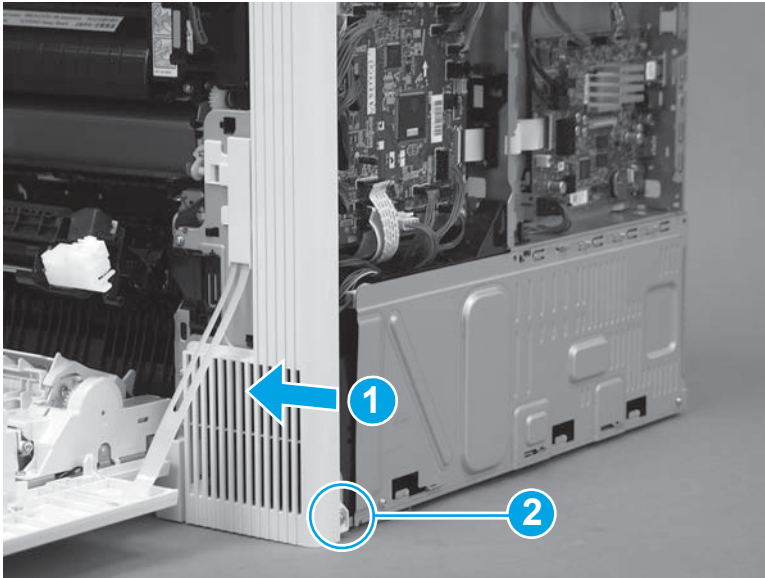

Step 36: Install the formatter case

1. Pass the wire harnesses through the opening in the formatter case.

Figure 1-3398 Pass the wire harnesses through the opening

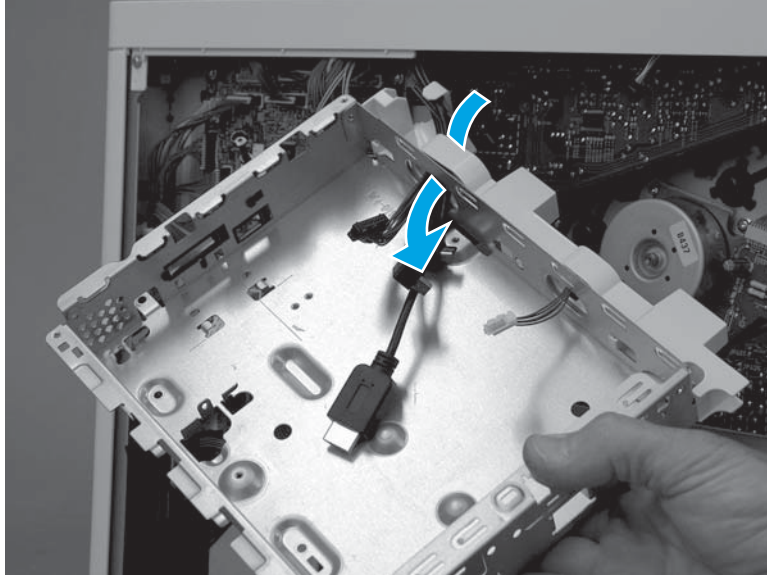

2. Position the top of the formatter case on the printer (callout 1), and then rotate the bottom of the case (callout 2) into the printer.

Figure 1-3399 Install the formatter case

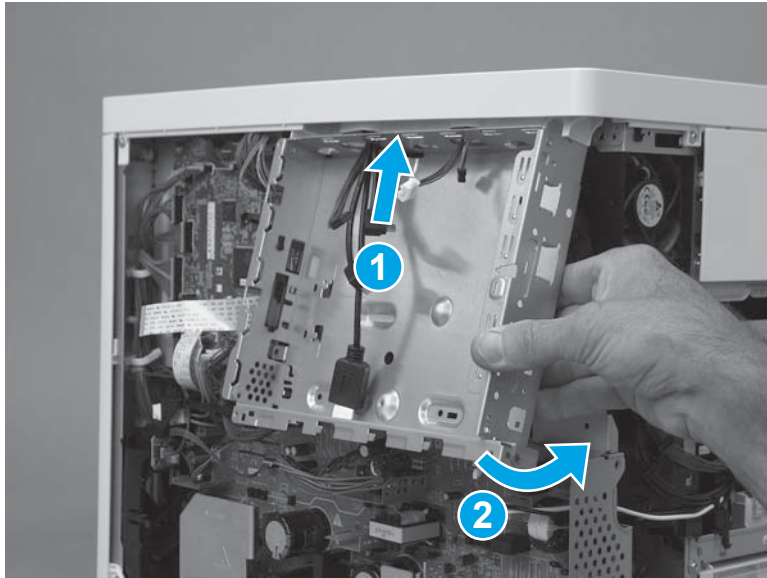

3. Install six screws (callout 1).

Figure 1-3400 Install six screws

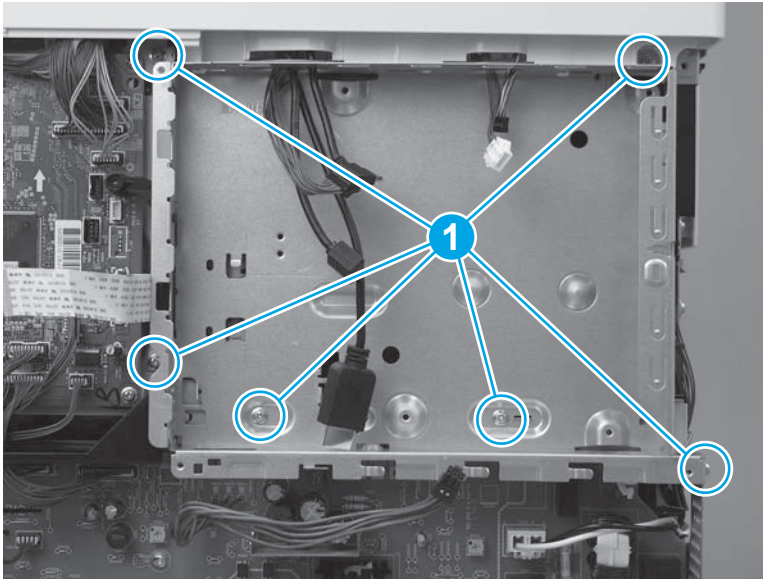

4. Pass two wire harnesses and one flat cable (callout 1) through the opening in the formatter case, and then install one wire harness in the retainer (callout 2).

 **IMPORTANT:** Make sure that the flat cable is securely fastened to the DC controller, and was not dislodged when the formatter case was removed.

Figure 1-3401 Install wire harnesses and flat cable

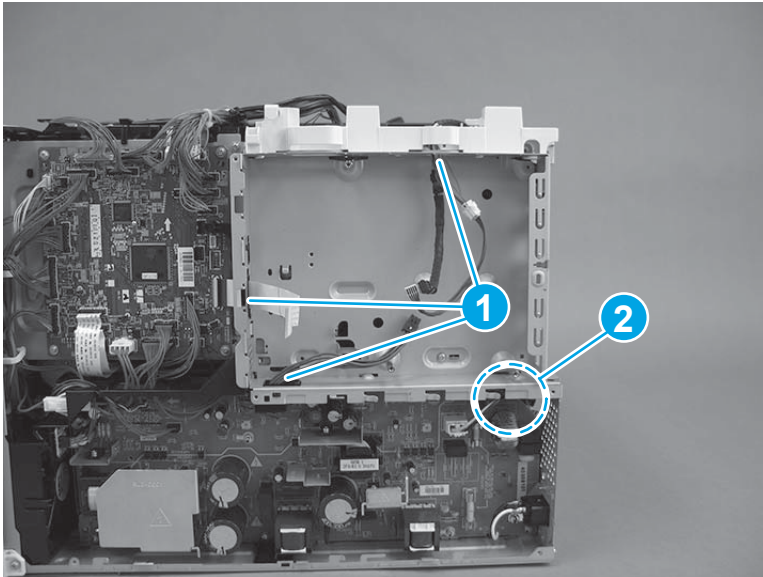

5. Position the LVPS cover on the printer, slide the cover to the left to install it, and then install two screws (callout 1).

Figure 1-3402 Install the LVPS cover

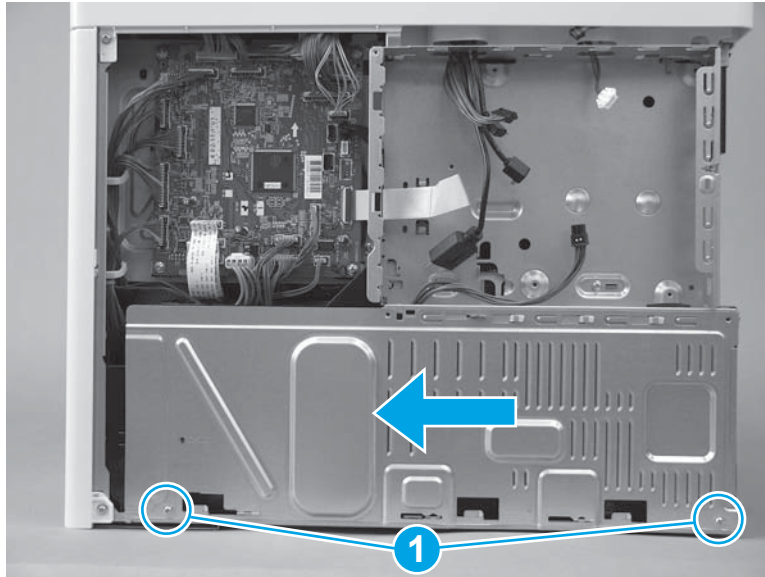

6. If no tape is affixed to the back of the flat cable, skip this step. If double-sided tape is affixed to the back of the flat cable, align the line (callout 1) on the cable with the edge (callout 2) of the opening in the sheet metal. Press to attach the flat cable to the formatter case.

Figure 1-3403 Attach the flat cable

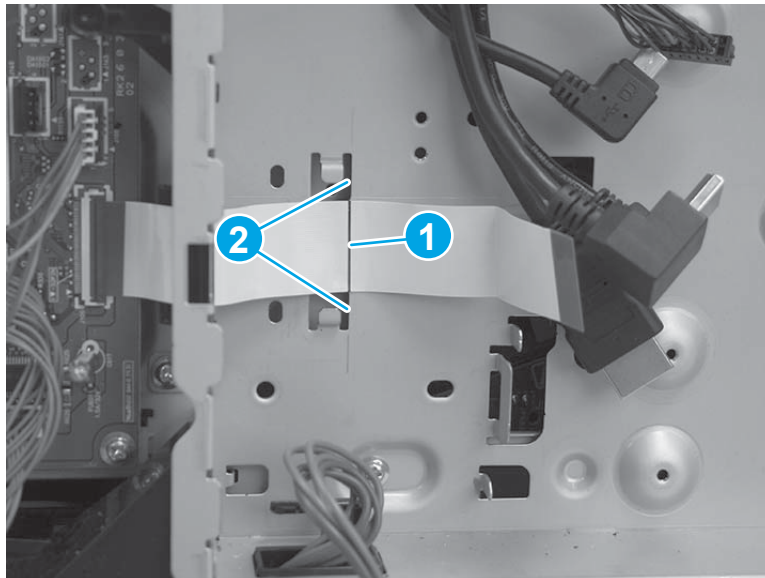

7. Position the bracket over the flat cable, and then slide the bracket to the left to install it. Make sure that the edges of the bracket fit under the sheet metal tabs (callout 1) on the formatter case and that the tabs (callout 2) snap into place.

Figure 1-3404 Position the bracket

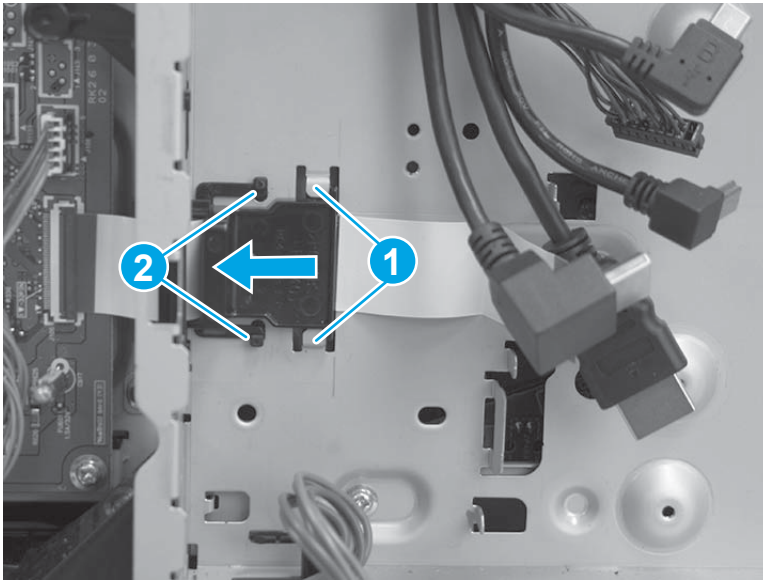

8. **M577 only:** Pass the wire harness (callout 1) through the openings in the formatter case (callout 2), and then connect one connector (callout 3).

Figure 1-3405 Connect one connector

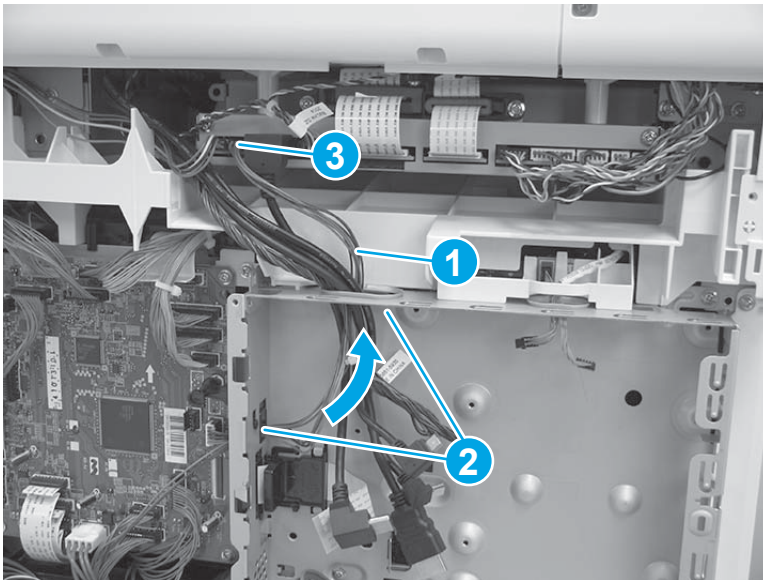

Step 37: Install the upper cover (M552 and M553)

 **NOTE:** This step is for the M552 and M553 models. For the M577 models, skip this step and go to [Step 38: Install the left cover on page 1914.](#)

1. Position the cover on the printer.

 **NOTE:** For the M553x model, do not forget to pass the control-panel wire harness and USB cable through the opening in the cover.

Figure 1-3406 Install the cover



2. Push down on the rear corner of the cover to engage one tab (callout 1).

Figure 1-3407 Engage one tab

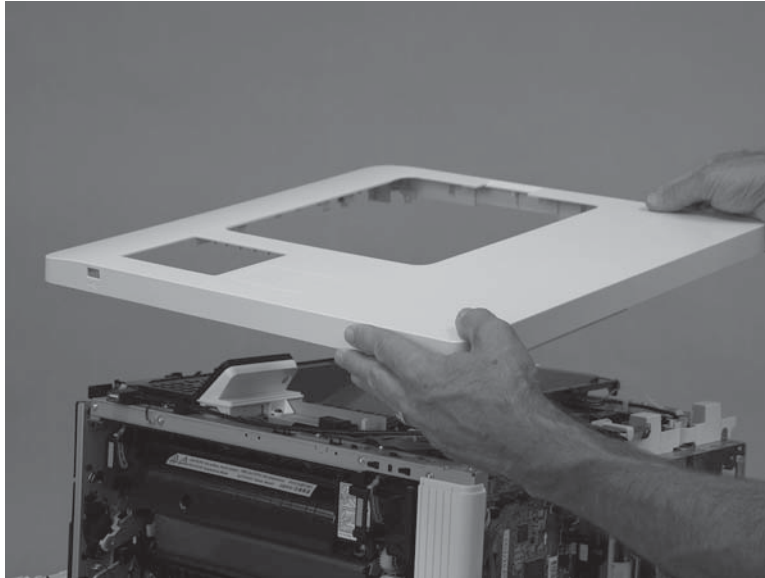
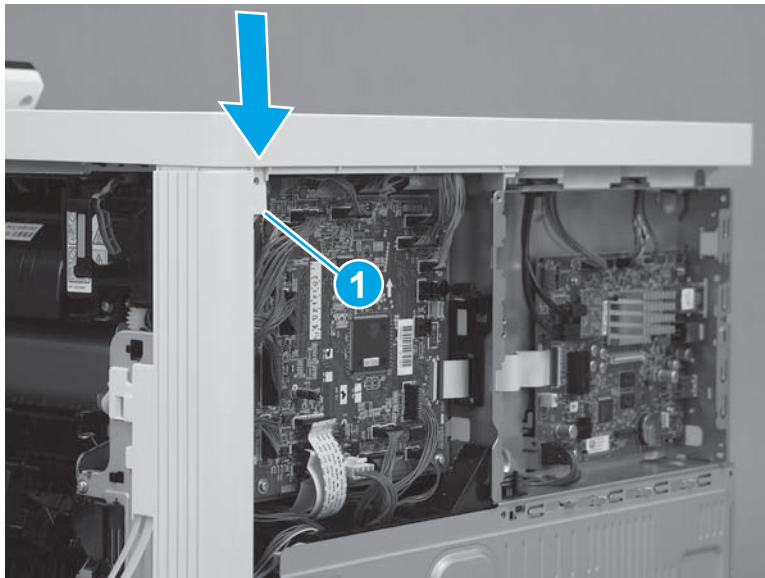

3. Push down on the front corner of the cover to engage one tab (callout 1), and then install one screw (callout 2).

 **NOTE:** This is a self-tapping plastic-thread screw. Make sure that this screw is used in this location when it is reinstalled.

Figure 1-3408 Engage one tab and install one screw



4. Install three screws (callout 1).

Figure 1-3409 Install three screws

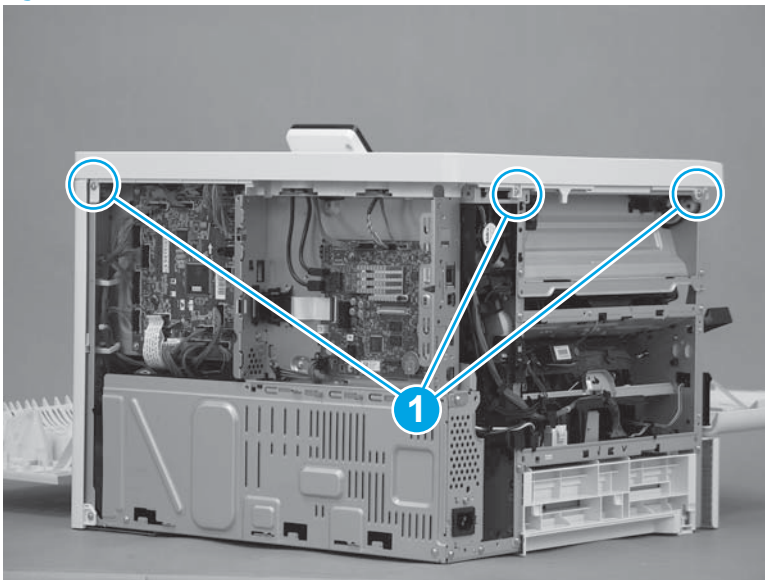

Step 38: Install the left cover

1. Position the cover on the printer.

 **NOTE:** Slightly offset the cover toward the rear of the printer.

Figure 1-3410 Install the cover

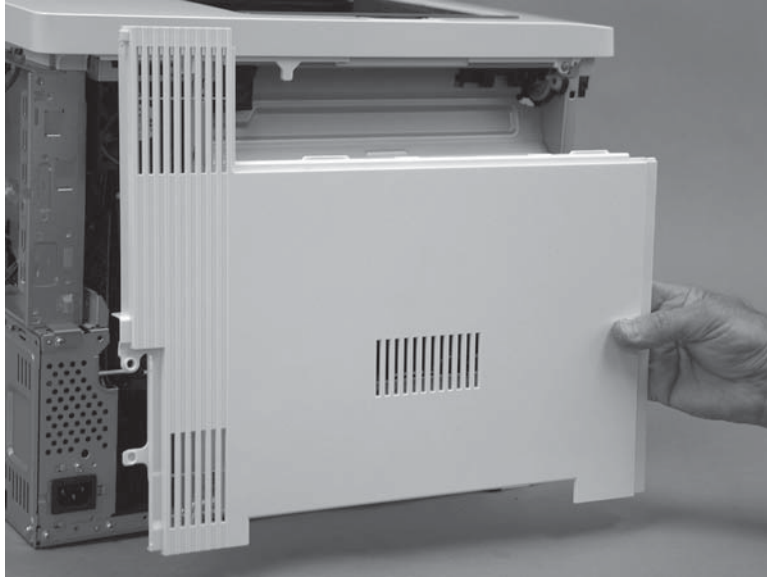

2. Slide the cover (callout 1) toward the front of the printer to engage it. Make sure that the tab (callout 2) snaps into place.

 **NOTE:** Locate the alignment pin (callout 3) on the cover from the front door side of the printer, and then make sure that it is fully engaged in the slot in the chassis.

 **TIP:** While sliding the cover into place, push in on the center of the cover (callout 1) to make sure that the hooks on the back of the cover engage with the slots in the chassis.

Figure 1-3411 Engage the cover



3. At the left side of the printer, install one screw (callout 1).

Figure 1-3412 Install one screw

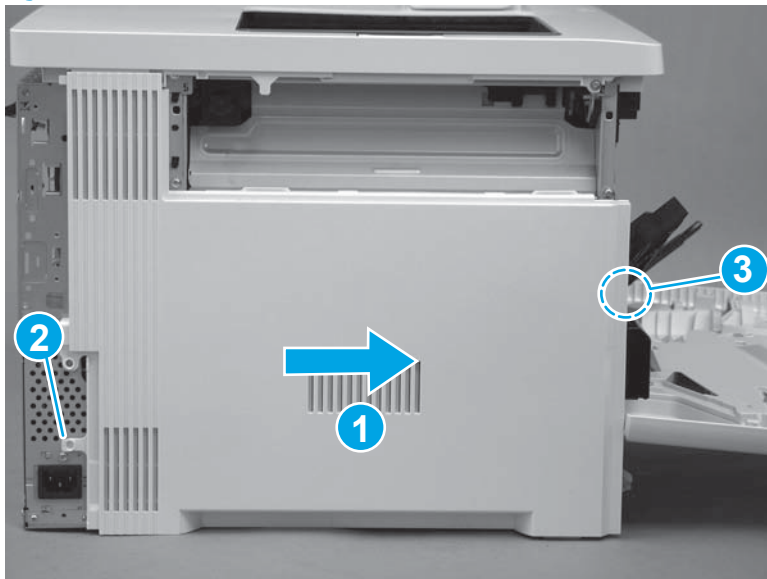

Step 39: Install the top bracket (M577)

 **NOTE:** This step is for the M577 models. For the M552 and M553 models, skip this step and go to [Step 51: Install the rear cover \(M552 and M553\) on page 1938](#).

1. Position the tabs (callout 1) on the bracket in the slots (callout 2) in the printer.

Figure 1-3413 Position the tabs in the slots

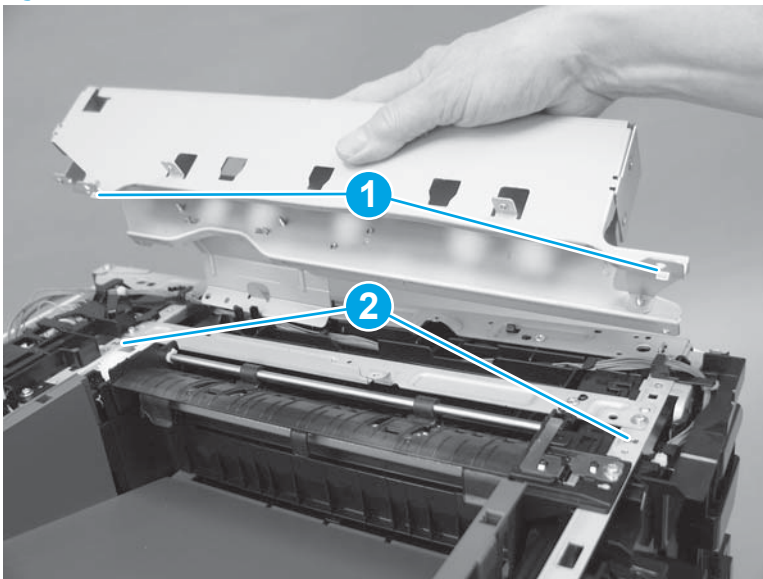

2. At the top of the printer, install two screws (callout 1).

Figure 1-3414 Install two screws

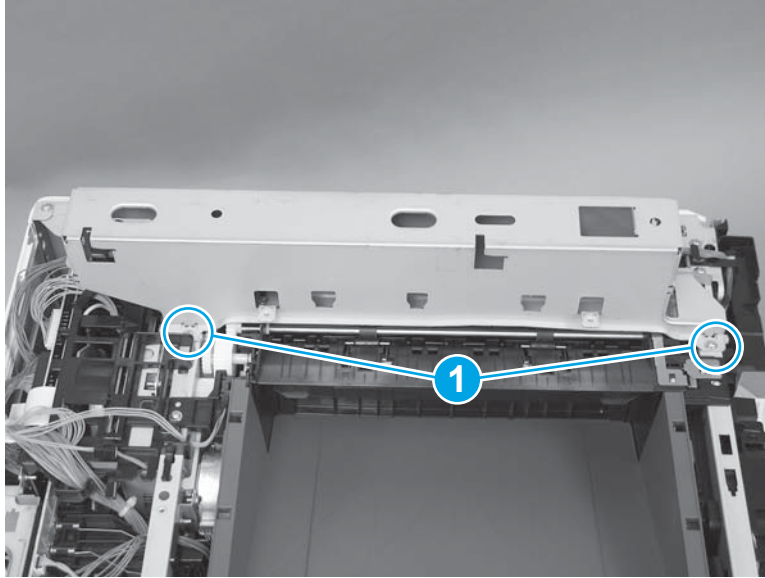

3. At the top of the printer, install three screws (callout 1).

Figure 1-3415 Install three screws

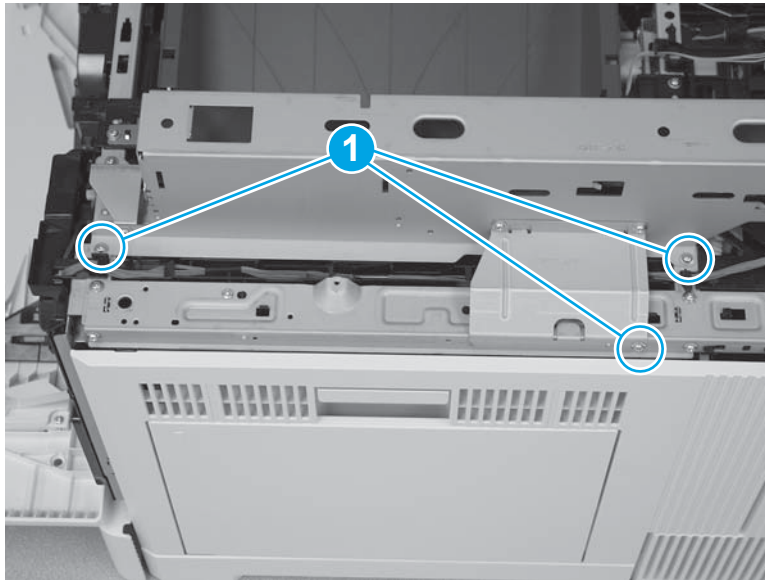

Step 40: Install the top cover (M577)

 **NOTE:** This step is for the M577 models. For the M552 and M553 models, skip this step and go to [Step 51: Install the rear cover \(M552 and M553\) on page 1938](#).

1. Position the locator pins (callout 1) on the cover in the slots (callout 2) in the printer.

Figure 1-3416 Position the locator pins

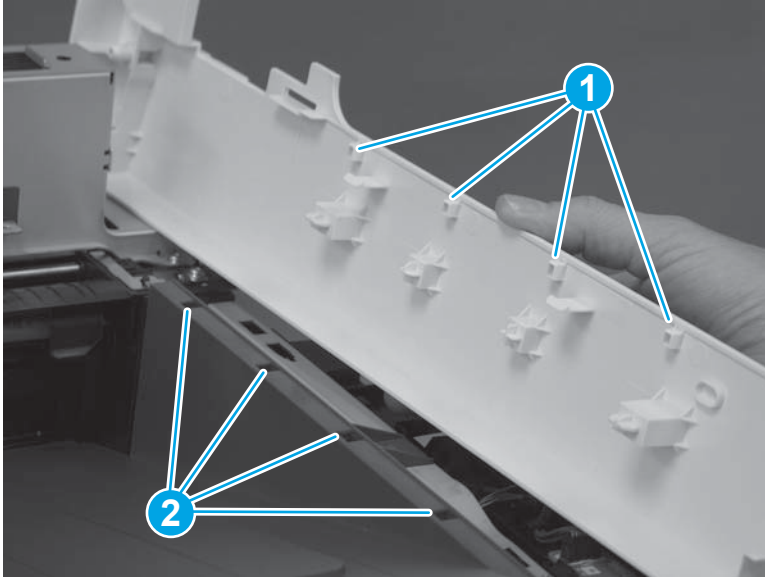

2. Press down on the cover to install it. Make sure that the tabs (callout 1) snap into place.

Figure 1-3417 Press down on the cover

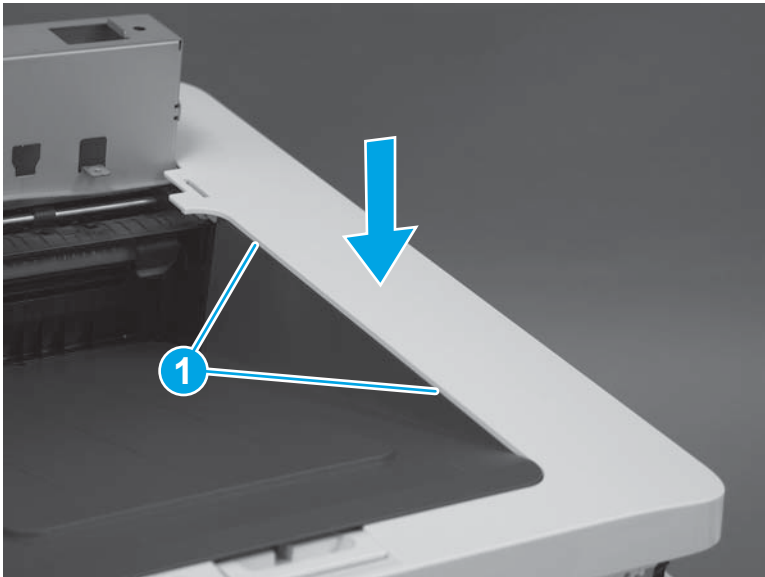

3. At the front of the printer, install one screw (callout 1).

 **Reinstallation tip:** This screw is longer and a different type of screw than the screw installed in the next step. Make sure that this screw is installed in the correct position.

Figure 1-3418 Install one screw



4. At the left side of the printer, install one screw (callout 1).

Figure 1-3419 Install one screw

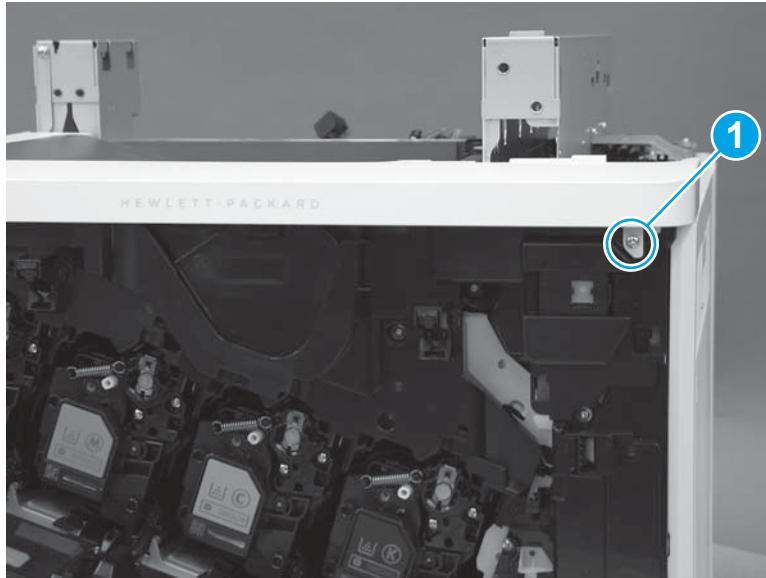
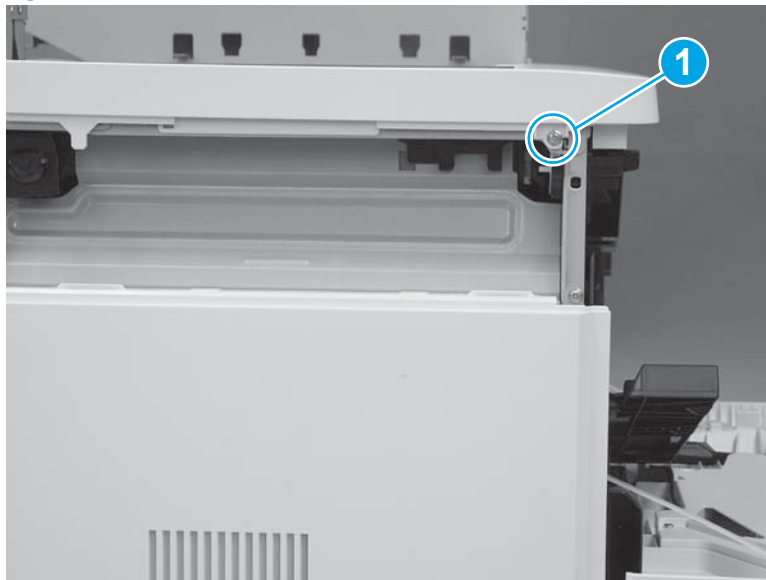

Step 41: Install the paper feed cover (M577)

 **NOTE:** This step is for the M577 models. For the M552 and M553 models, skip this step and go to [Step 51: Install the rear cover \(M552 and M553\) on page 1938](#).

1. Position the locator tabs (callout 1) on the cover in the slots (callout 2) in the printer. Press down until the cover snaps into place.

Figure 1-3420 Install the cover

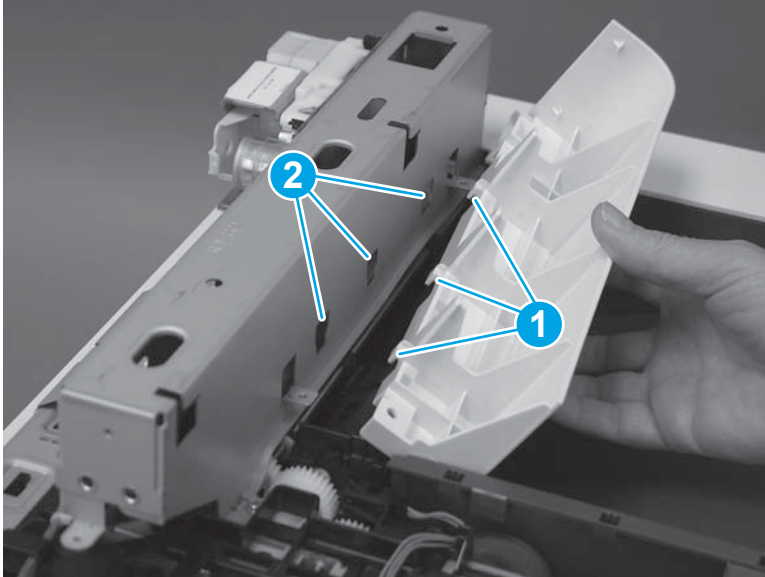

2. Install one screw (callout 1).

Figure 1-3421 Install one screw

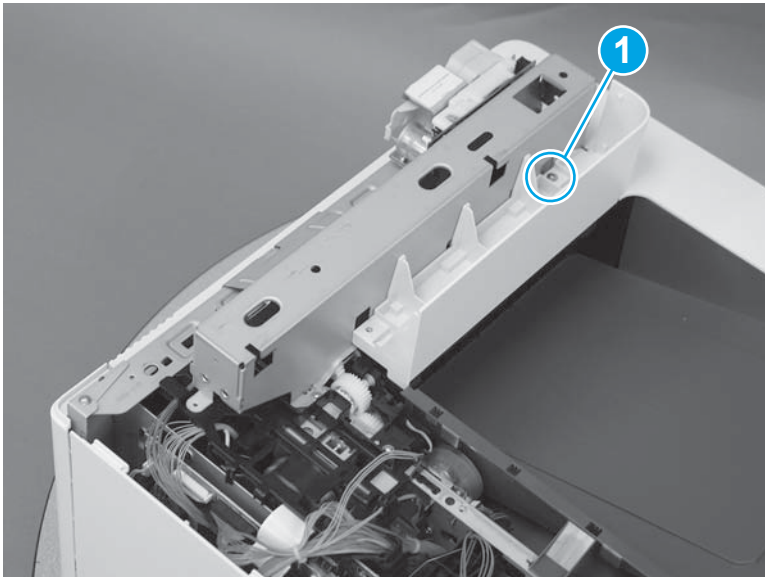

Step 42: Install the top rear cover (M577)

 **NOTE:** This step is for the M577 models. For the M552 and M553 models, skip this step and go to [Step 51: Install the rear cover \(M552 and M553\) on page 1938](#).

1. Align the locator tabs (callout 1) on the cover with the slots (callout 2) in the printer.

Figure 1-3422 Align the locator tabs

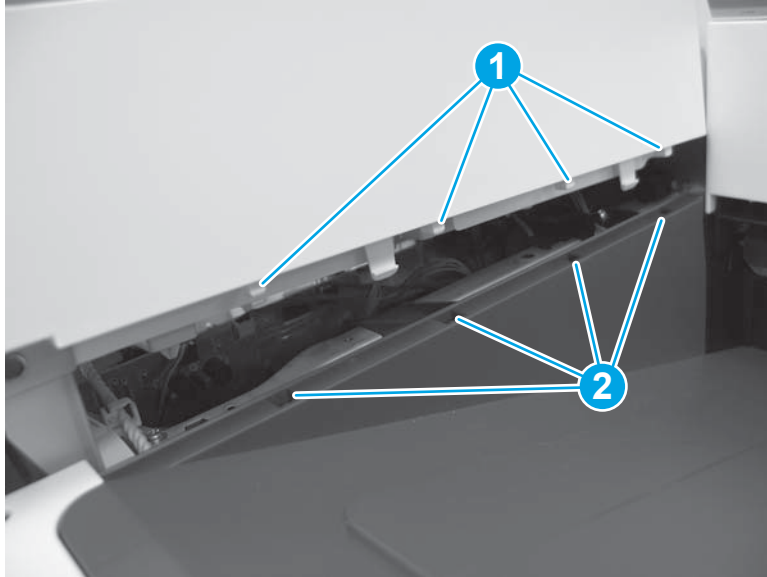

2. Press down to install the cover. Make sure that the tabs snap into place.

Figure 1-3423 Install the cover

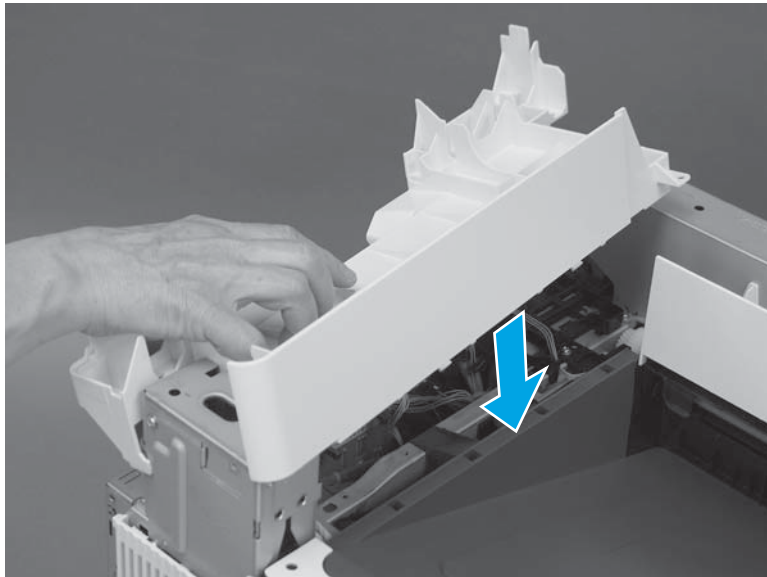

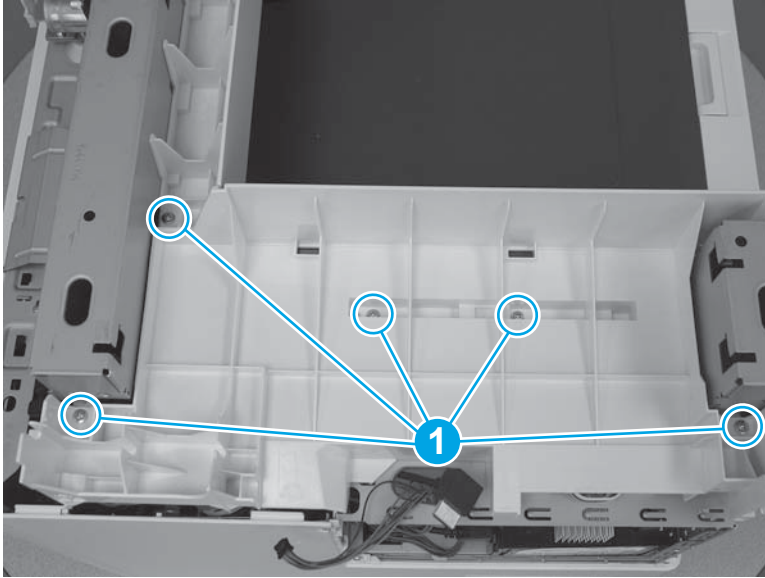

3. At the top of the printer, install five screws (callout 1).

Figure 1-3424 Install five screws



Step 43: Install the right upper cover (M577)

 **NOTE:** This step is for the M577 models. For the M552 and M553 models, skip this step and go to [Step 51: Install the rear cover \(M552 and M553\) on page 1938](#).

 **NOTE:** The figures below show the image scanner installed. The procedures for removing and installing the right upper cover are the same whether the image scanner is installed or removed."

1. **M577c/f/z only:** Install the cables (callout 1) through the slot (callout 2) in the printer.

Figure 1-3425 Install the cables

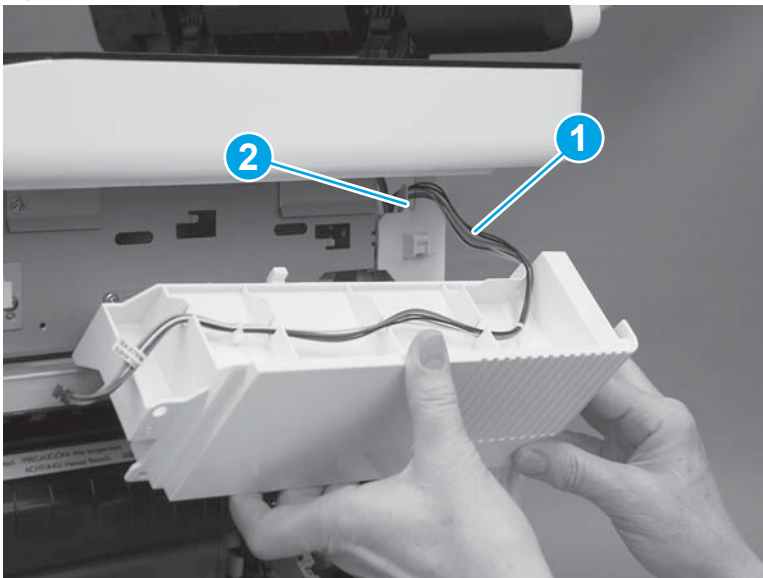

2. Position the hooks (callout 1) on the cover in the slots (callout 2) in the printer.

Figure 1-3426 Position the hooks

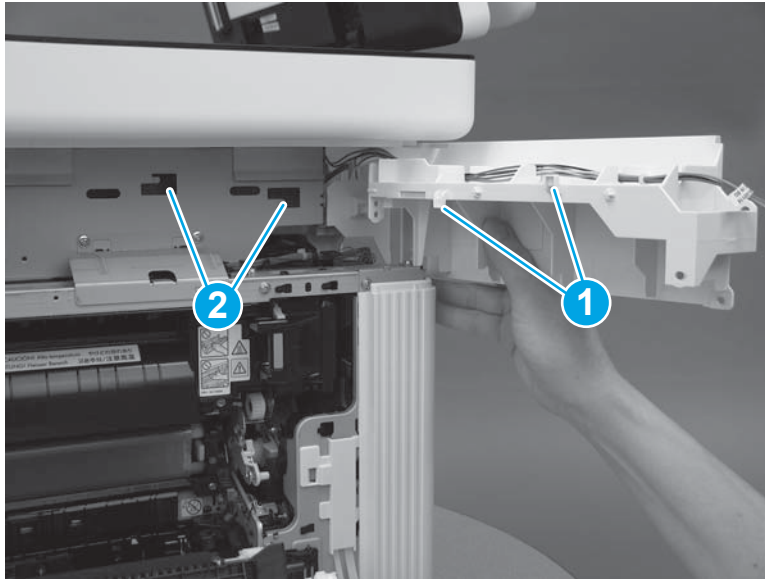

3. Slide the cover toward the front of the printer to install it.

Figure 1-3427 Install the cover

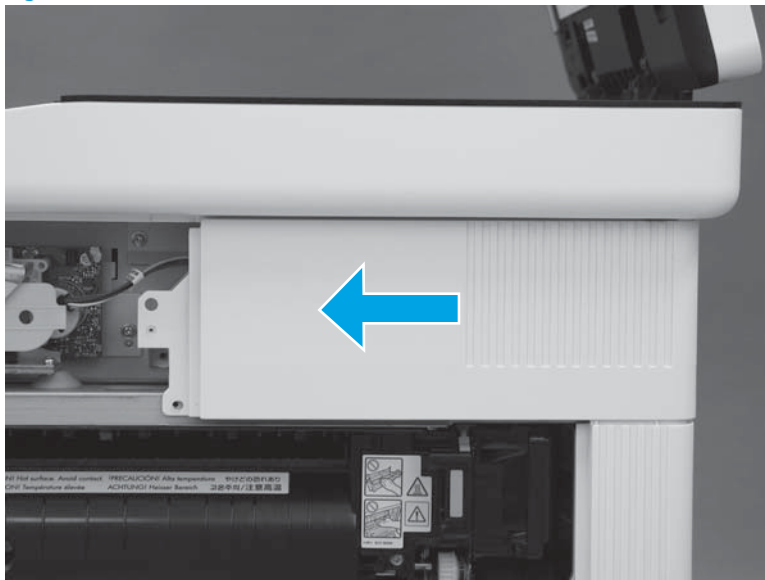

4. At the back of the printer, install one screw (callout 1).

M577c/f/z only: Connect one connector (callout 2), if the integrated scanner assembly is installed.

TIP: This screw is smaller than the screws installed in the next step. Make sure that this screw is installed in the correct position.

Figure 1-3428 Install one screw and connector



5. At the right side of the printer, install two screws (callout 1).

M577c/f/z only: Connect one connector (callout 2), if the stapler is installed.

Figure 1-3429 Install one screw and connector

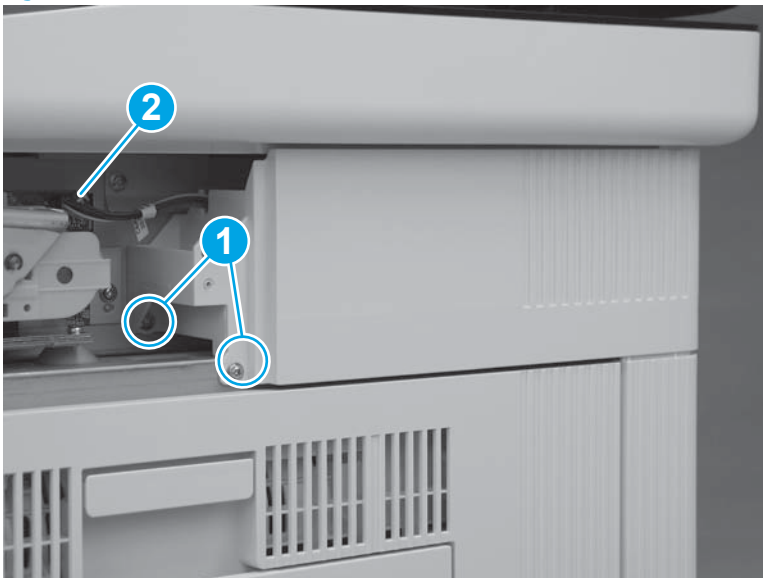

Step 44: Install the stapler unit (M577c/f/z)

 **NOTE:** This step is for the M577c/f/z models. For the M577dn model, skip this step and go to [Step 45: Install the integrated scanner assembly \(ISA\) \(M577\) on page 1926](#).

For the M552 and M553 models, skip this step and go to [Step 51: Install the rear cover \(M552 and M553\) on page 1938](#).

1. Position the hooks (callout 1) on the stapler unit in the slots (callout 2) in the printer.

Figure 1-3430 Position the hooks in the slots

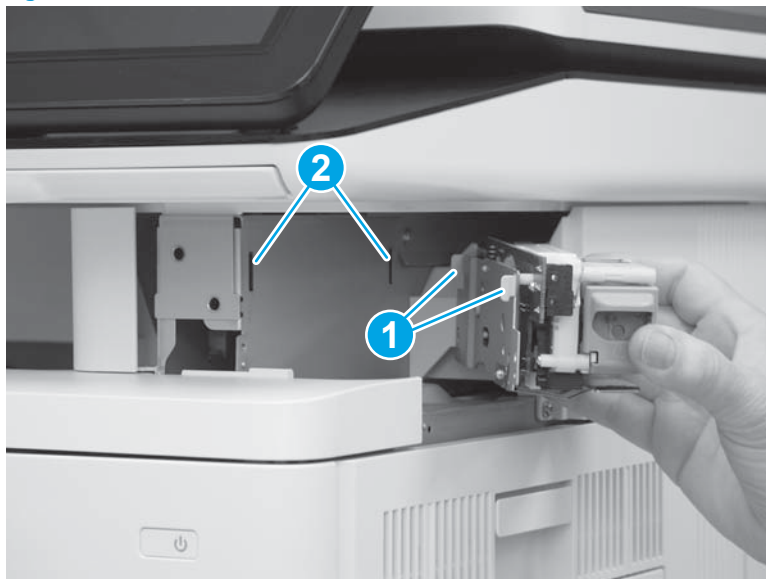

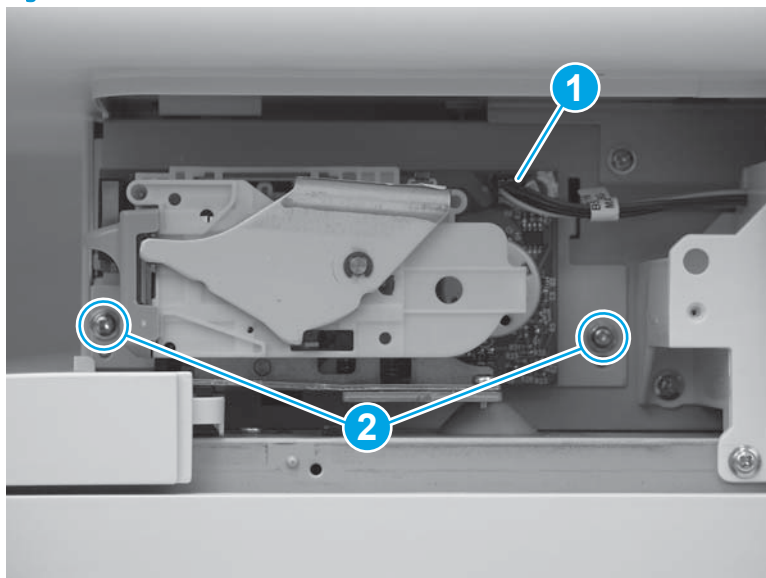

2. Connect one connector (callout 1), and then install two screws (callout 2).

Figure 1-3431 Connect connector and install screws



Step 45: Install the integrated scanner assembly (ISA) (M577)

 **NOTE:** This step is for the M577 models. For the M552 and M553 models, skip this step and go to [Step 51: Install the rear cover \(M552 and M553\) on page 1938](#).

 **NOTE:** The ISA includes the document feeder, image scanner, scanner control board (SCB), control panel, keyboard (M577c/z) and NFC PCA (M577z).

1. Before proceeding, locate the mounting pins (callout 1) on the bottom of the ISA and the slots (callout 2) on the printer base.

Figure 1-3432 Locate the ISA mounting pins and slots

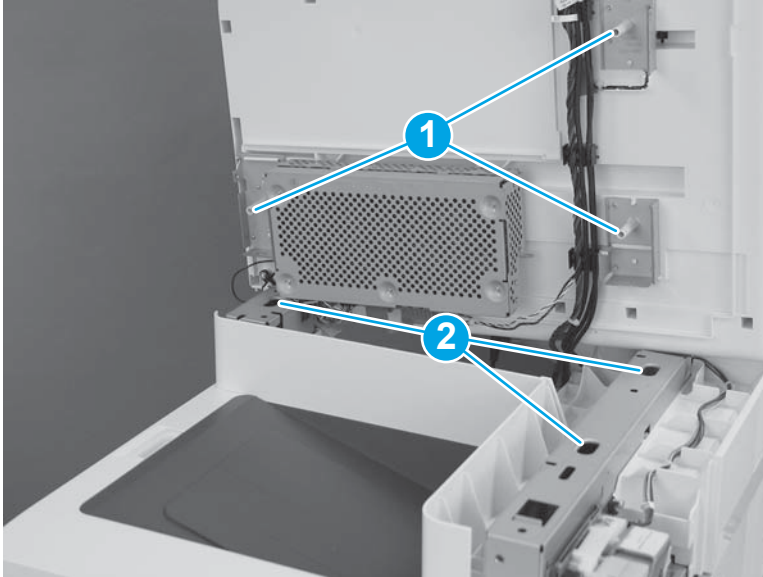

2. Position the ISA on the printer base with the pins in the slots.

 **NOTE:** To locate the pins and slots, see [Figure 1-395 Locate the ISA mounting pins and slots on page 249](#).

When installing the ISA, carefully pass the cables through the opening in the top of the formatter case.

Figure 1-3433 Install the ISA



3. Slightly slide the ISA towards the front of the printer to engage it.

Figure 1-3434 Slide the ISA towards the front of the printer

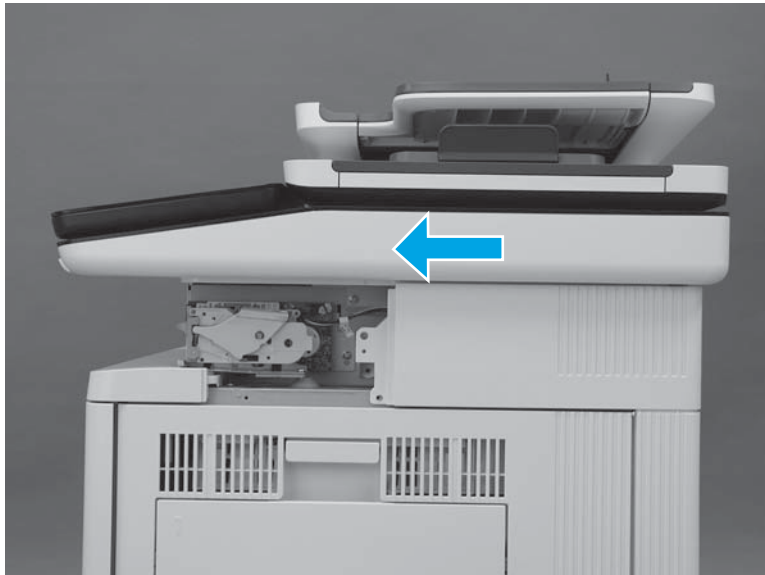

4. At the left side of the printer, install one screw (callout 1).

Figure 1-3435 Install one screw

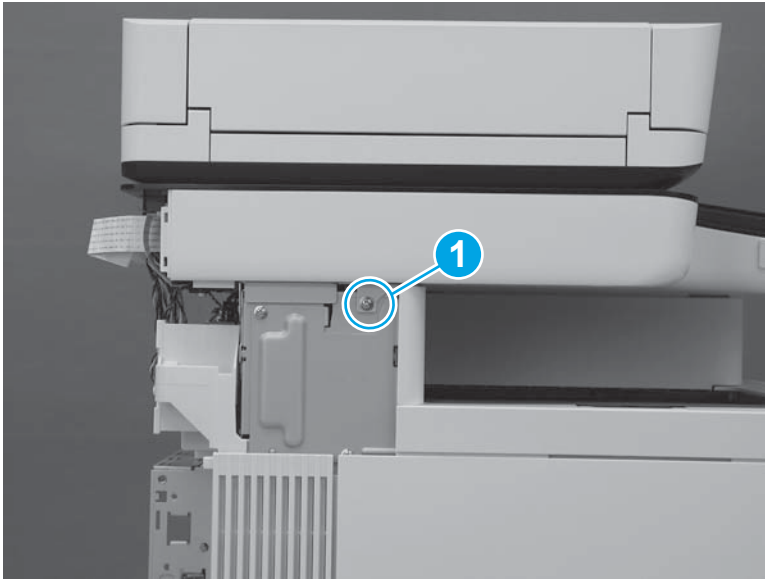

5. At the back of the printer, install two screws (callout 1).

Figure 1-3436 Install two screws

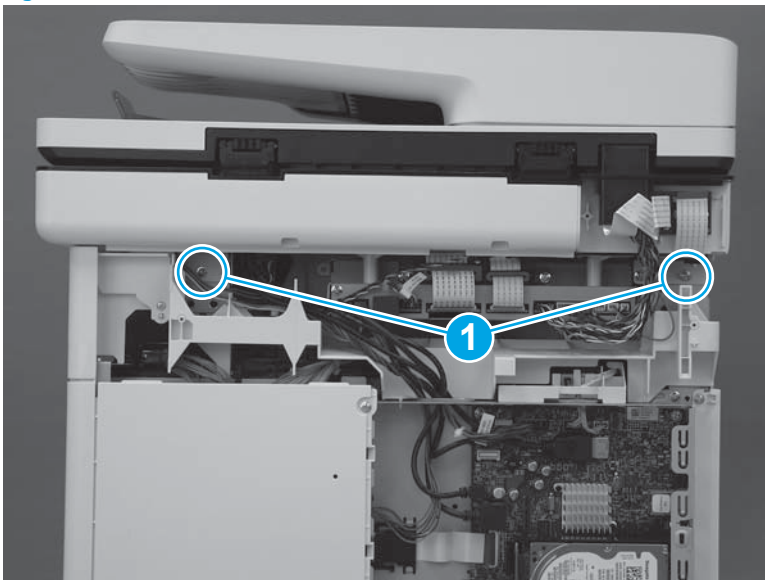

6. At the right side of the printer, install one screw (callout 1).

Figure 1-3437 Install one screw

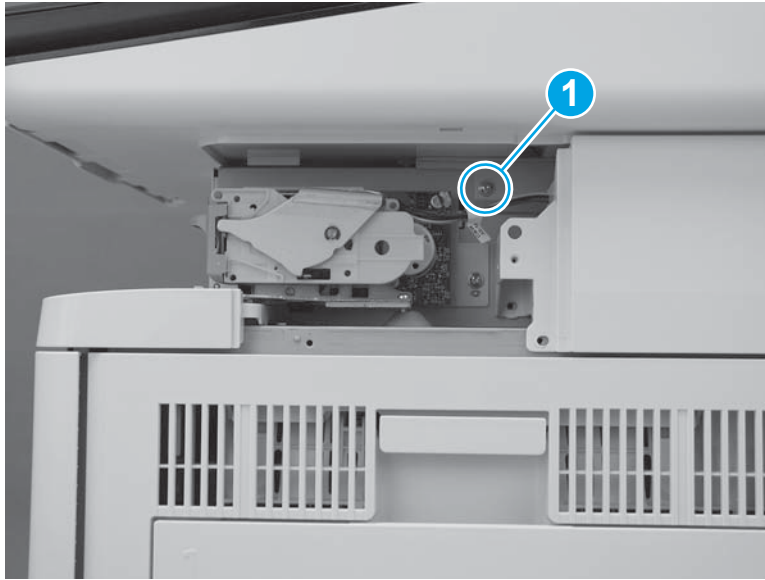

7. Connect two connectors on the scanner control board (callout 1).

M577c/f/z only: Connect one connector for the stapler on the scanner control board (callout 2).

Figure 1-3438 Connect connectors

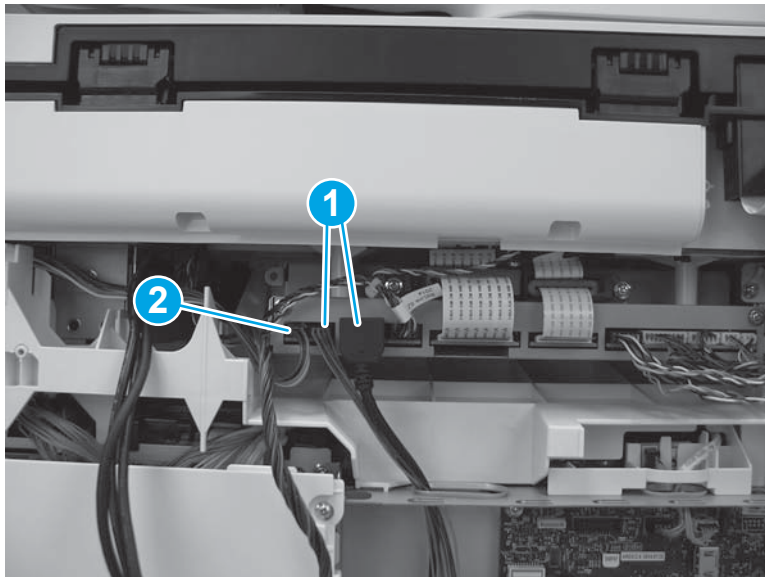

Step 46: Install the stapler cover assembly (M577c/f/z)

 **NOTE:** This step is for the M577c/f/z models only. For the M577dn model, skip this step and go to [Step 47: Install the right front upper cover \(M577dn\) on page 1931](#).

For the M552 and M553 models, skip this step and go to [Step 51: Install the rear cover \(M552 and M553\) on page 1938](#).

1. Install the tabs (callout 1) on the cover in the slots (callout 2) in the printer.

Figure 1-3439 Install two tabs



2. Press the cover toward the left side of the printer until it snaps into place.

Figure 1-3440 Install the cover assembly



3. Install one screw (callout 1).



 **IMPORTANT:** This is a self-tapping screw for plastic. Rotate it counterclockwise to align it with the existing thread pattern, and then carefully turn it clockwise to tighten. Do not overtighten. This will prevent stripping the threads inside the screw hole.

Figure 1-3441 Install one screw

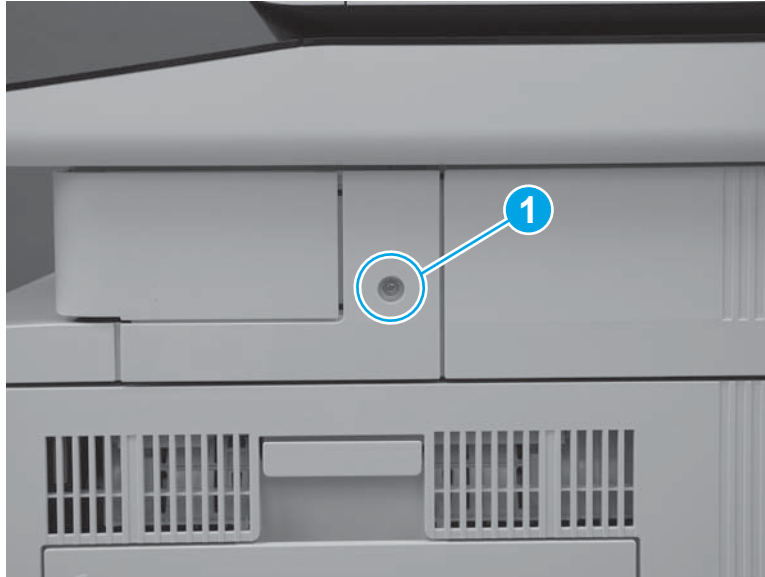

Step 47: Install the right front upper cover (M577dn)

 **NOTE:** This step is for the M577dn model only. For the M577c/f/z models, skip this step and go to [Step 48: Install the left upper cover \(M577\) on page 1933](#).

For the M552 and M553 models, skip this step and go to [Step 51: Install the rear cover \(M552 and M553\) on page 1938](#).

1. Slide the cover toward the left side of the printer to install it. Make sure that the slots (callout 1) in the cover fit over the tabs (callout 2) on the inside of the paper feeder cover.

Figure 1-3442 Install the cover



2. Press the right front upper cover (callout 1) and the paper feeder cover (callout 2) together until the tabs on the inside of the covers snap into place.

Figure 1-3443 Press the cover



3. Install one screw (callout 1).

Figure 1-3444 Install one screw

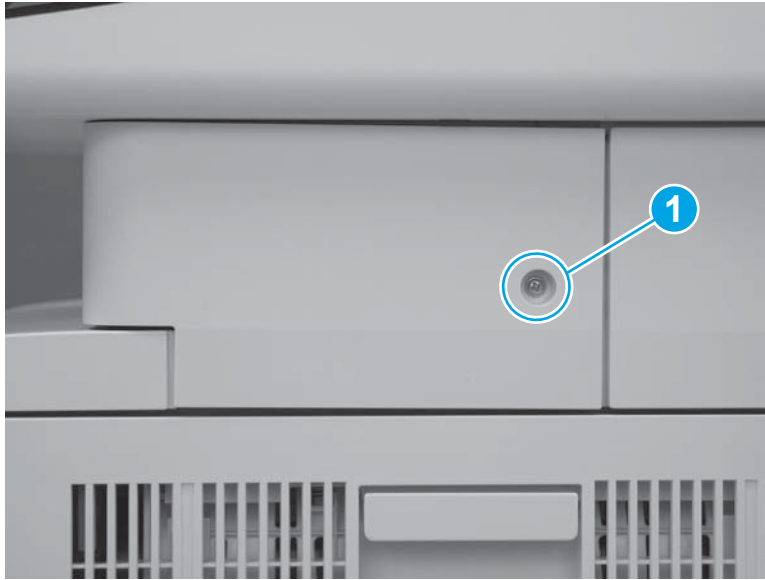

Step 48: Install the left upper cover (M577)

 **NOTE:** This step is for the M577 models. For the M552 and M553 models, skip this step and go to [Step 51: Install the rear cover \(M552 and M553\) on page 1938](#).

1. Position the tab (callout 1) on the lower edge of the cover behind the left cover (callout 2).

Figure 1-3445 Position the tab

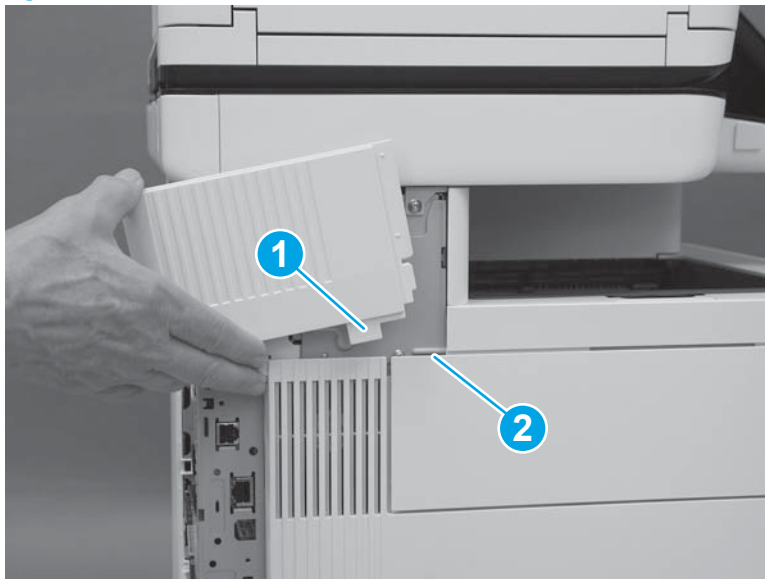

2. Slide the cover toward the front of the printer to install it. Make sure that the edge (callout 1) of the cover fits behind the edge (callout 2) of the top rear cover.

Figure 1-3446 Slide the cover

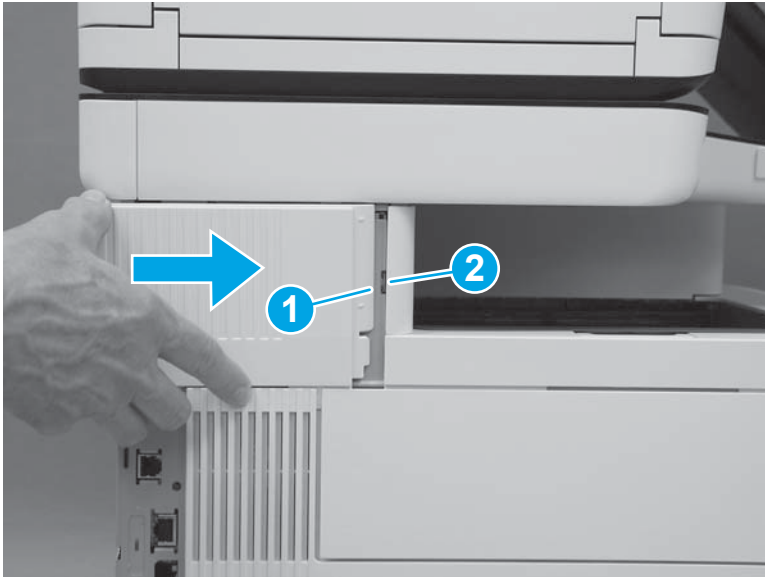

3. Make sure that the tab (callout 1) is fully installed.

Figure 1-3447 Check the tab

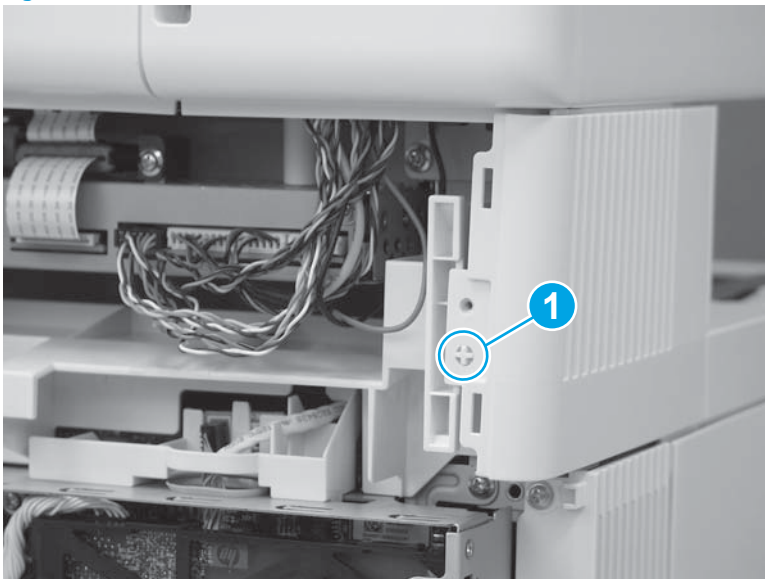

Step 49: Install the rear cover (M577)

 **NOTE:** This step is for the M577 models. For the M552 and M553 models, skip this step and go to [Step 51: Install the rear cover \(M552 and M553\) on page 1938](#).

1. Position the hooks (callout 1) on the cover in the slots (callout 2) in the printer.

Figure 1-3448 Position the hooks

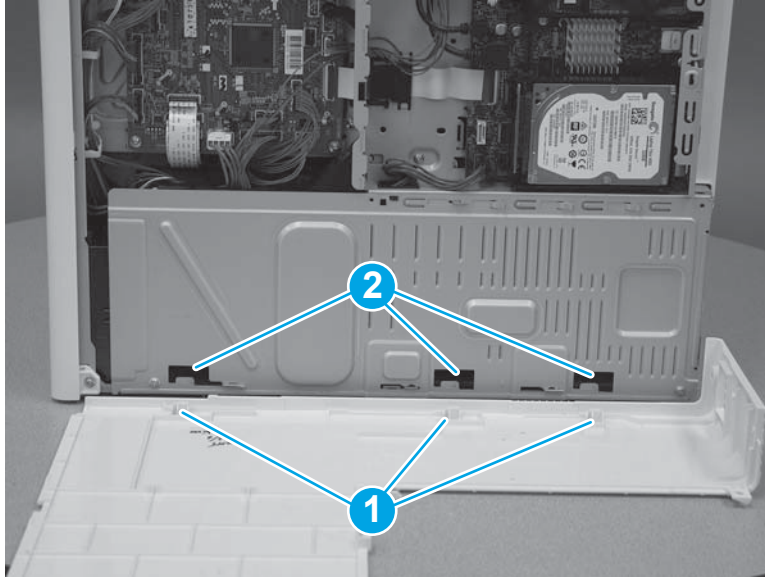

2. Position the back edge (callout 1) of the rear cover behind the edge (callout 2) of the right rear cover. Slide the cover to the left to install it.

Figure 1-3449 Install the cover

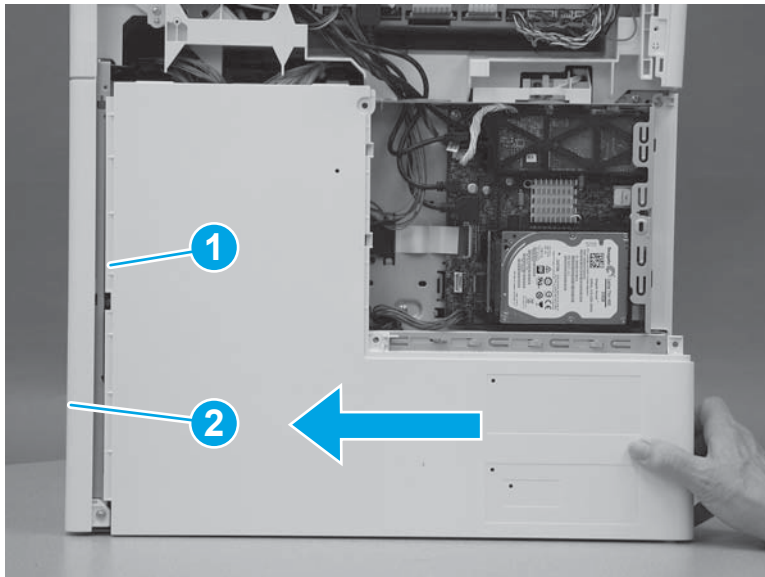

3. Install four screws (callout 1).

Figure 1-3450 Install four screws cover

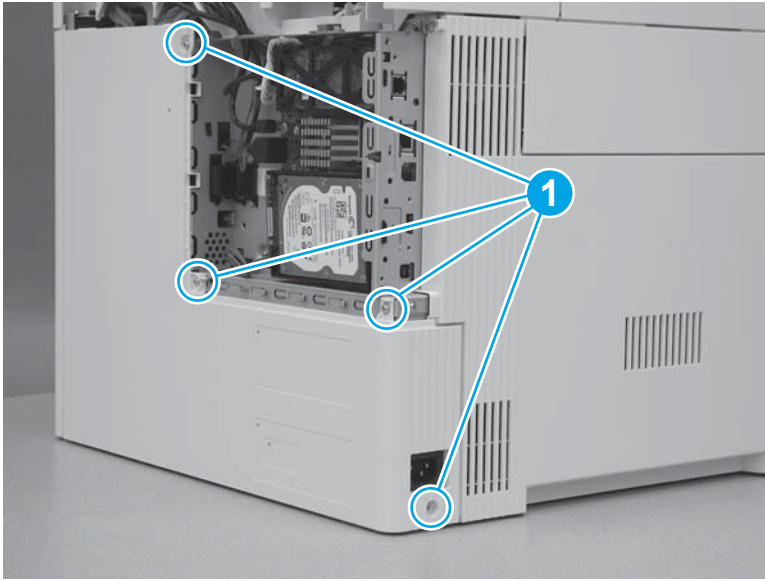

Step 50: Install the rear upper cover (M577)



NOTE: This step is for the M577 models. For the M552 and M553 models, skip this step and go to [Step 51: Install the rear cover \(M552 and M553\) on page 1938](#).

1. Align the ridge (callout 1) on the lower edge of the rear upper cover in front of the tabs (callout 2) on the top edge of the rear cover.

Figure 1-3451 Align the cover

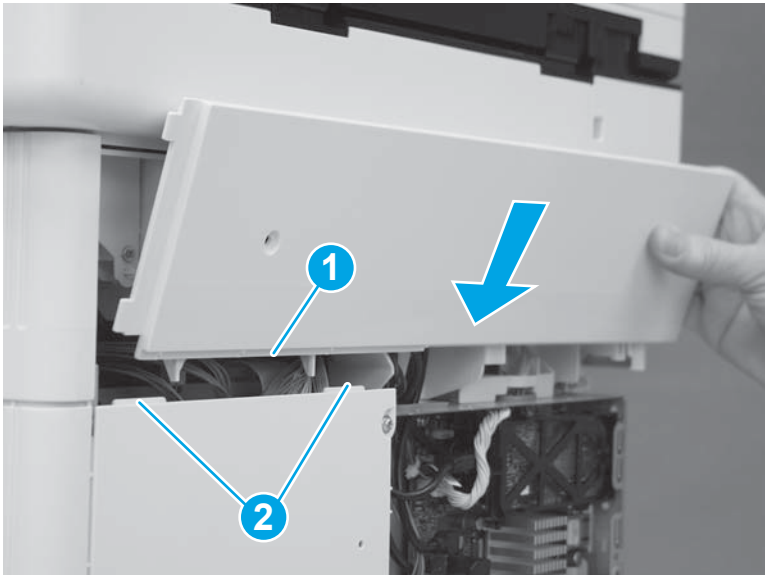

2. Rotate the top of the cover toward the printer.

Figure 1-3452 Rotate the top of the cover

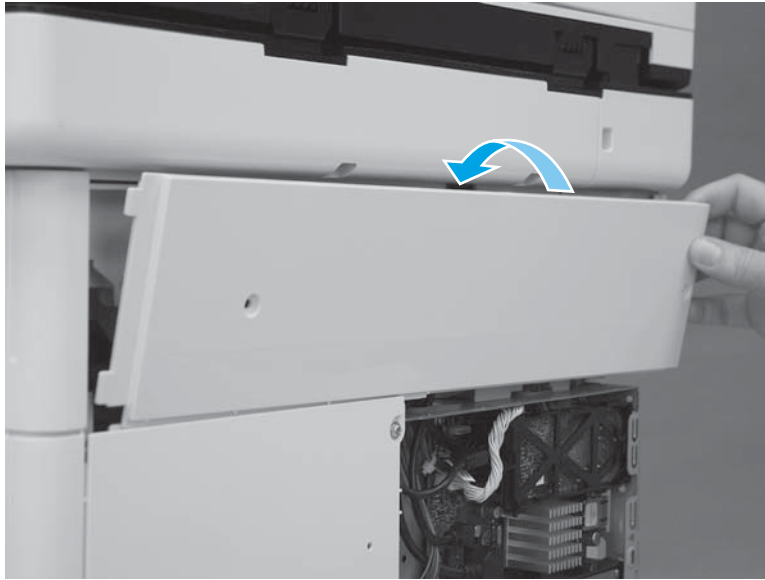

3. Slide the cover to the left (callout 1). Make sure that the tabs (callout 2) on the upper rear cover slide behind the edge (callout 3) of the right upper cover. Make sure that the cover is fully seated.

Figure 1-3453 Slide the cover

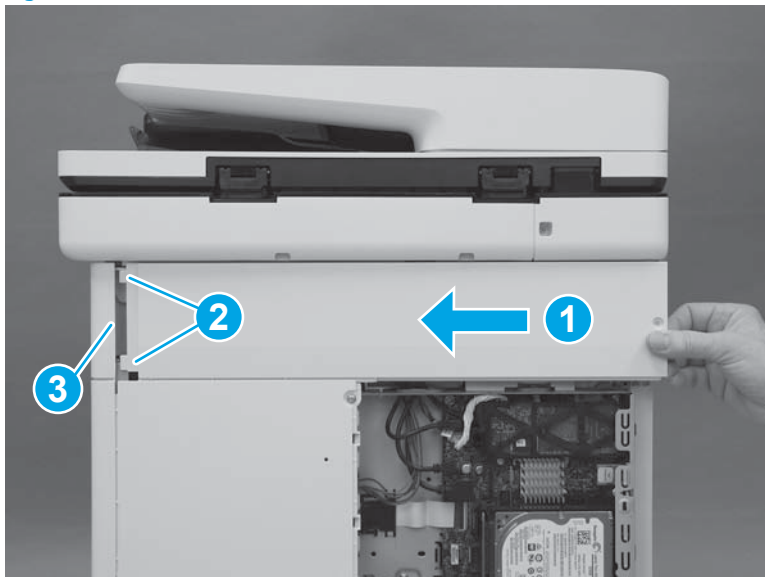

4. Install two screws (callout 1).



 **IMPORTANT:** These two screws are self-tapping screws for plastic. Rotate them counterclockwise to align them with the existing thread pattern, and then carefully turn them clockwise to tighten. Do not overtighten. This will prevent stripping the threads inside the screw holes.

Figure 1-3454 Install two screws

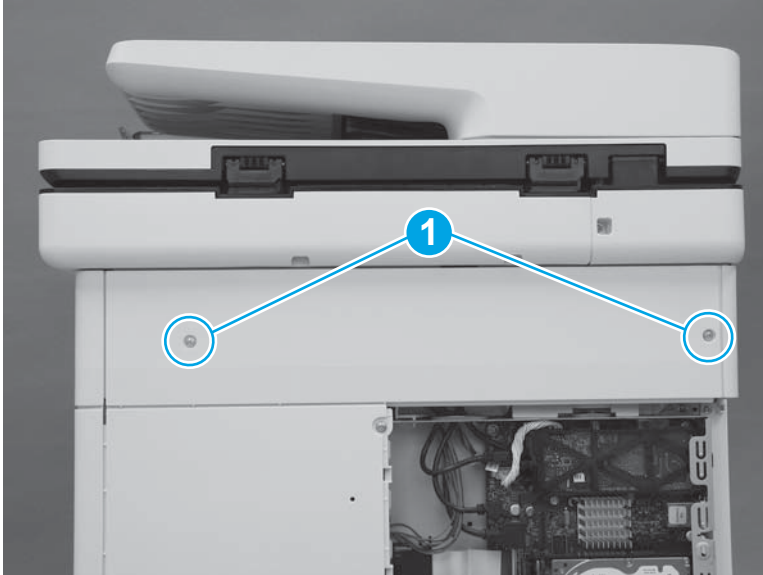

Step 51: Install the rear cover (M552 and M553)

 **NOTE:** This step is for the M552 and M553 models. For the M577 models, skip this step and go to [Step 52: Install the formatter \(M577\) on page 1939](#).

1. Position the top of the cover under the upper cover (callout 1), rotate the bottom of the cover onto the chassis (callout 2), and then slide the cover to the left (callout 3) to install it.

Figure 1-3455 Install the cover

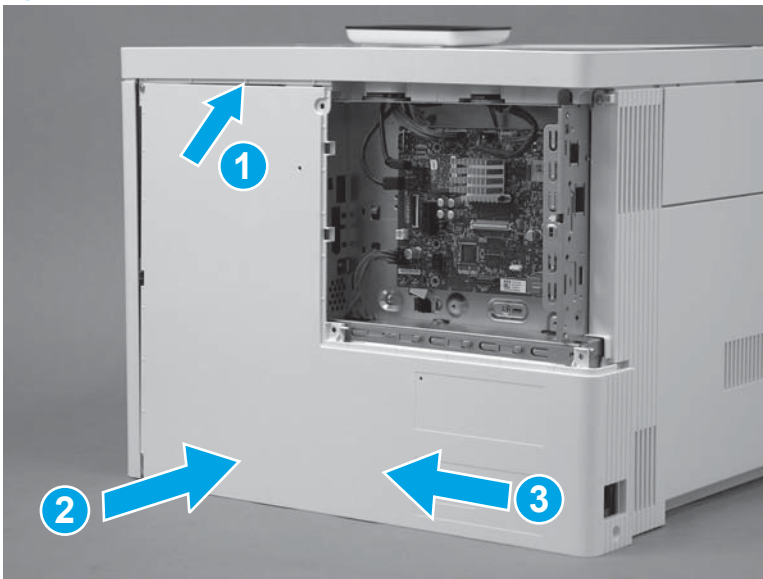

2. Install four screws (callout 1).

Figure 1-3456 Install four screws cover

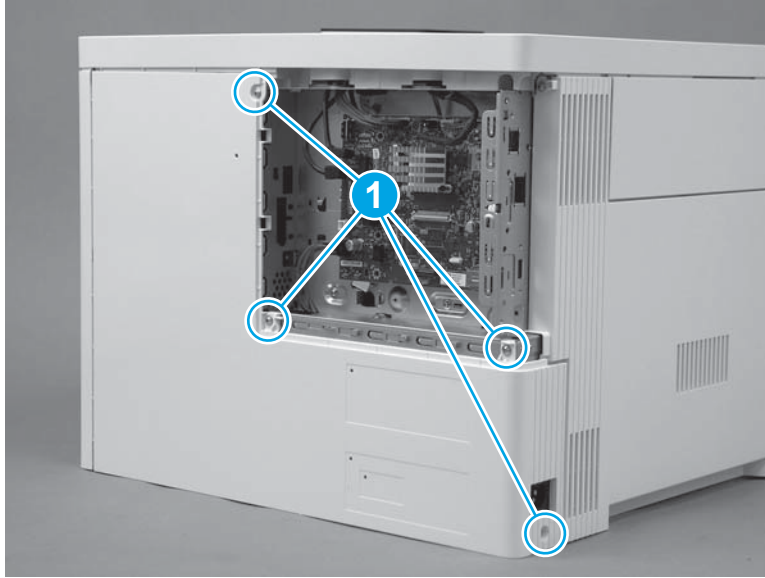

Step 52: Install the formatter (M577)

 **NOTE:** This step is for the M577 models. For the M552 and M553 models, skip this step and to go [Step 55: Install the formatter \(M552 and M553\) on page 1944](#).

 **CAUTION:**  ESD-sensitive part.

1. Position the formatter in the printer. Make sure that the network port (callout 1) fits through the opening (callout 2) in the formatter case.

Figure 1-3457 Install the formatter

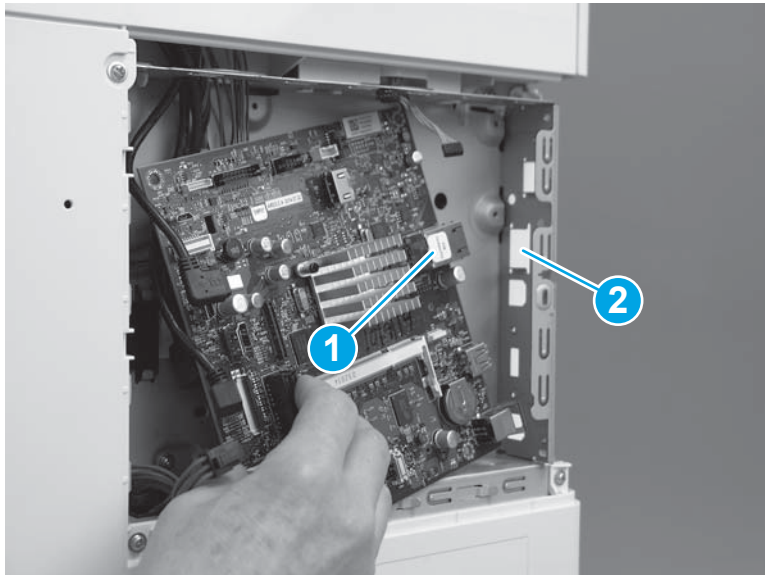

2. Install four screws (callout 1).

Figure 1-3458 Install four screws

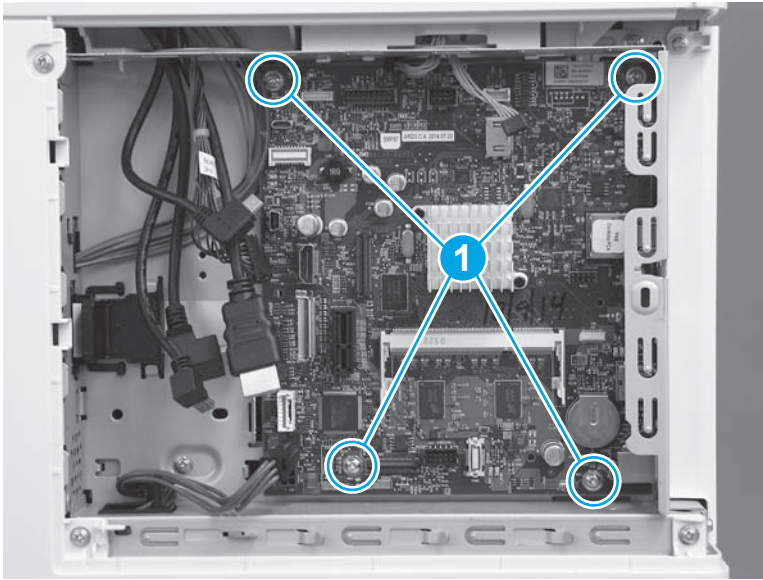

3. Connect all of the connectors on the formatter.

The following connectors are empty:

- All models: J1 (this connector is empty unless the optional DIMM is installed)
- All models: J3
- M577dn: J15 (this is the fax connector for the M577f/z/c models)
- All models: J21 (this connector is empty unless the optional internal USB ports component is installed)
- All models: J23
- All models: J24
- All models: J51
- All models: J57
- All models: J97
- All models: J98 (this connector is empty unless the optional trusted platform module (TPM) is installed)

 **IMPORTANT:** The flat-cable connector (callout 1) is a Zero Insertion Force (ZIF) connector that uses a hinged retainer to secure the flat cable. The hinged retainer must be opened to install the flat cable, and then closed after the cable is installed.

Figure 1-3459 Connect all connectors



Step 53: Install the fax PCA (M577c/f/z)

 **NOTE:** This step is for the M577c/f/z models. For the M577n model, skip this step and go to [Step 54: Install the HDD \(M577\) on page 1942](#).

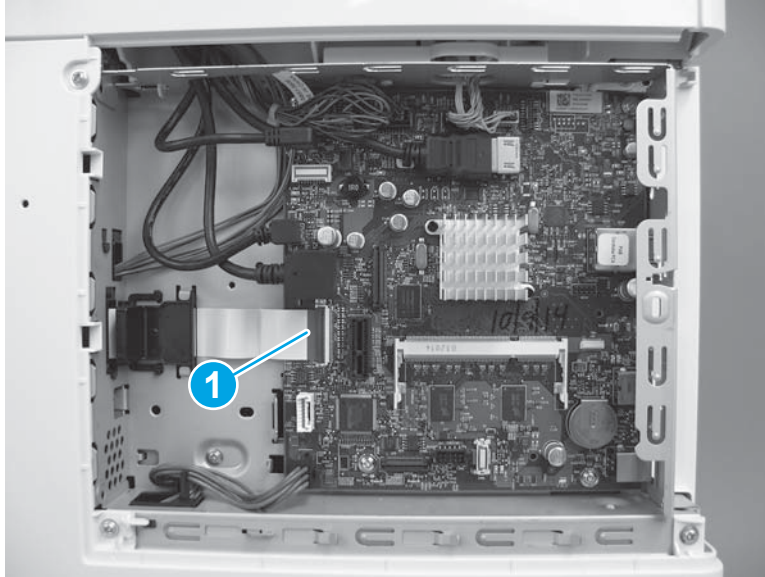
For the M552 and M553 models, skip this step and go to [Step 55: Install the formatter \(M552 and M553\) on page 1944](#).

 **CAUTION:**  ESD-sensitive part.

1. Position the tab and telephone port (callout 1) on the fax PCA in the slots (callout 2) in the formatter case.

Figure 1-3460 Position the fax PCA

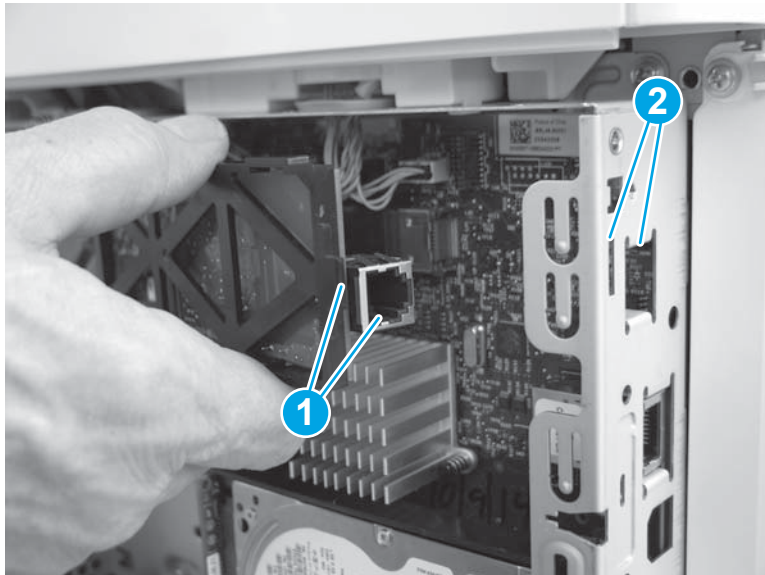

- Slide the fax PCA to the right (callout 1) until the tab and telephone port described in the previous step and seated in the formatter case. Position the retainer (callout 2) in the slot (callout 3) in the formatter. Rotate the end of the fax PCA toward the formatter (callout 4) until the retainer snaps into place.

Figure 1-3461 Install the fax PCA

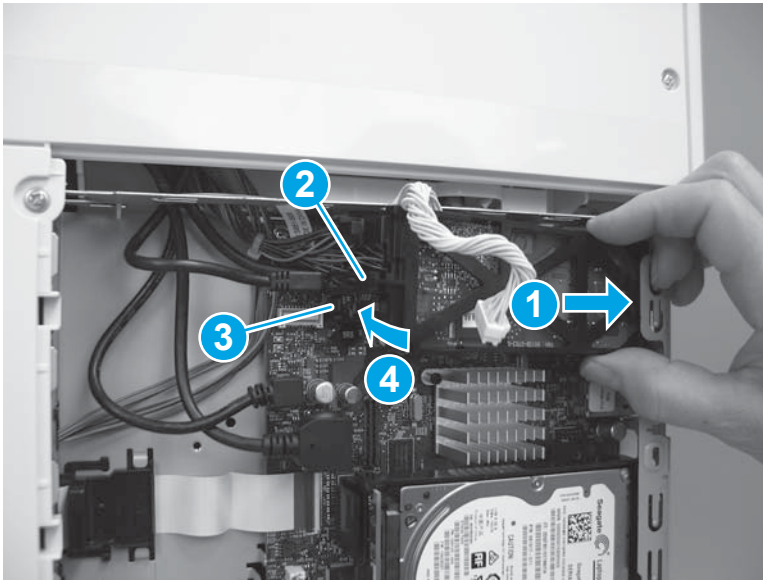

- Position the cable (callout 1) in the guide (callout 2), and then connect one connector (callout 3).

Figure 1-3462 Connect the connector

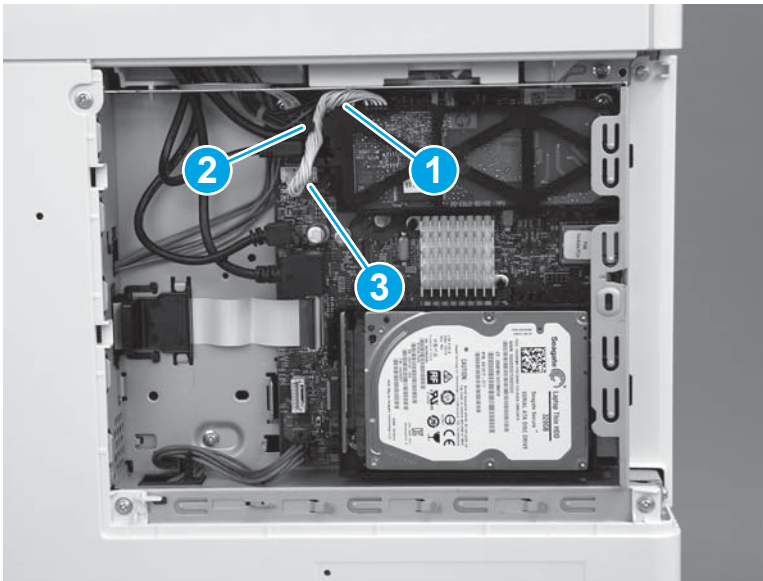

Step 54: Install the HDD (M577)

 **NOTE:** This step is for the M577 models. For the M552 and M553 models, skip this step and go to [Step 55: Install the formatter \(M552 and M553\) on page 1944.](#)

 **CAUTION:**  ESD-sensitive part.

1. Align the end of the bracket (callout 1) with the slot in the chassis (callout 2), and then slide the HDD into the printer (callout 3) to engage the bracket with the chassis.

Figure 1-3463 Install the holder

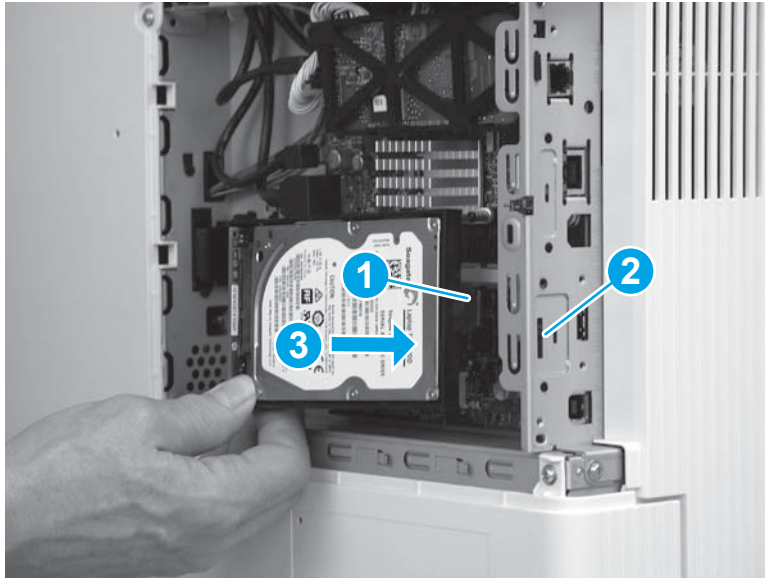

2. Hold the HDD connector latch (callout 1) in the released position, and then rotate the HDD down and into the connector on the formatter to install it.

 **NOTE:** Make sure that the tab (callout 2) snaps into place, and that the HDD is securely installed.

Figure 1-3464 Release the HDD

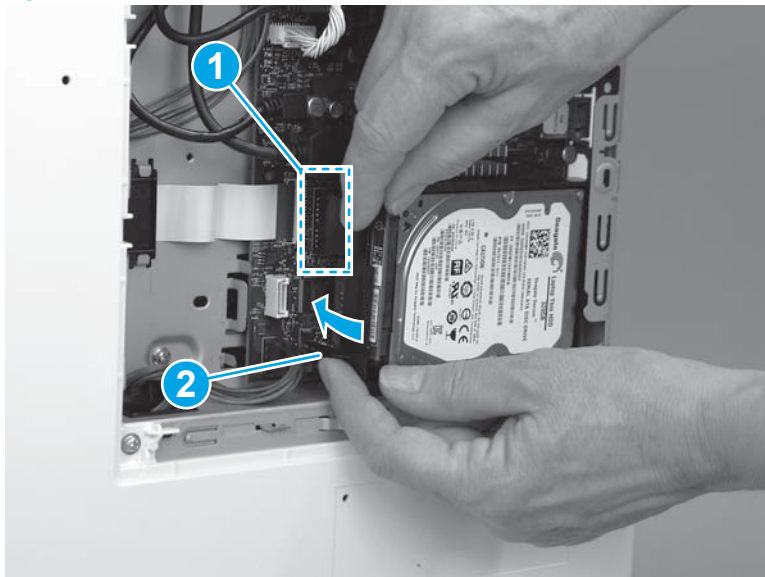

Step 55: Install the formatter (M552 and M553)

 **NOTE:** This step is for the M552 and M553 models. For the M577 models, skip this step and go to [Step 56: Install the formatter cover on page 1945](#).

If the optional hard-disk drive (HDD) was removed, do not forget to reinstall it after the formatter is reinstalled.

Engage the HDD holder with the chassis, rotate the HDD connector down and into the connector on the formatter. Make sure that the tabs snap into place.

 **CAUTION:**  ESD-sensitive part.

1. Position the formatter in the printer, and then install four screws (callout 1).

Figure 1-3465 Install the formatter

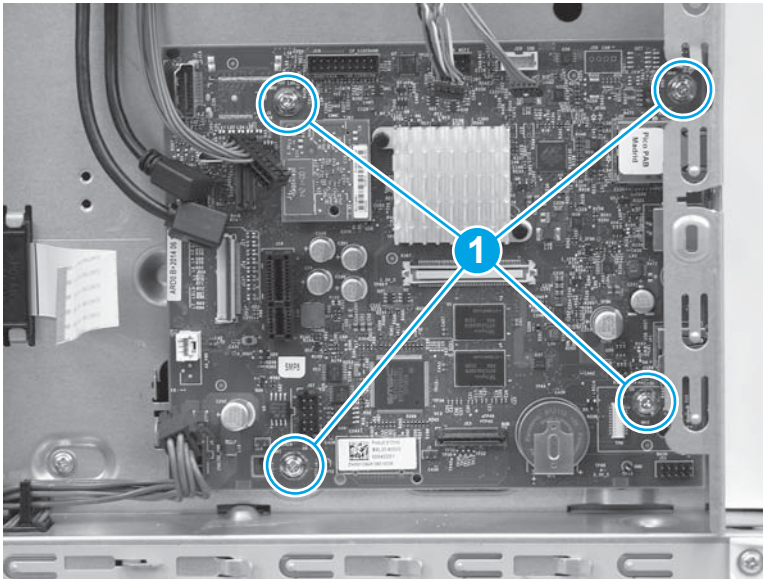

2. Connect all of the connectors on the formatter.

The following connectors are empty:

- All models: J1 (this connector is empty unless the optional DIMM is installed)
- M553n/dn and M552dn: J2 (callout 1; this is the touchscreen connector for the M553x model)
- All models: J9 (this connector is empty unless the optional internal USB ports component is installed)
- All models: J18 (this connector is empty unless the optional hard-disk-drive (HDD) is installed)
- All models: J23
- All models: J24
- M553n/dn and M552dn: J25 (this is the wireless connector for the M553x model)
- All models: J57
- All models: J98 (this connector is empty unless the optional trusted platform module (TPM) is installed)



 **IMPORTANT:** The flat-cable connector (callout 2) is a Zero Insertion Force (ZIF) connector that uses a hinged retainer to secure the flat cable. The hinged retainer must be opened to install the flat cable.

Figure 1-3466 Connect all connectors

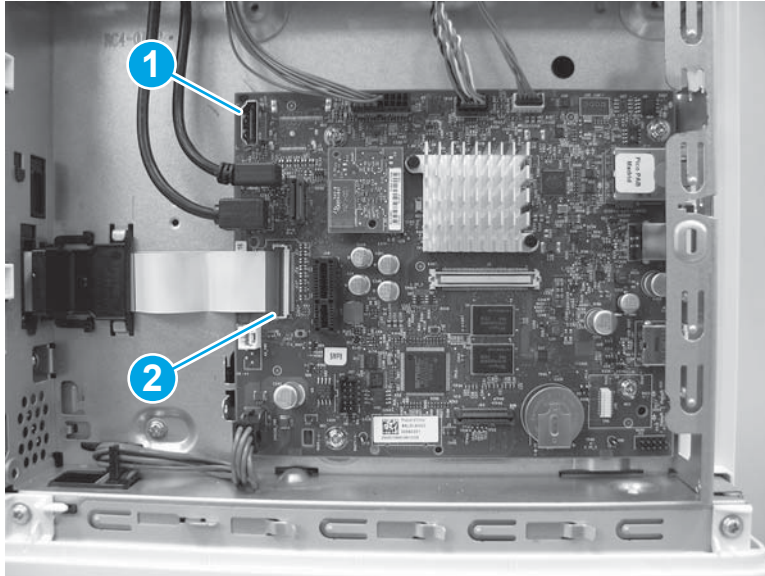

Step 56: Install the formatter cover

- ▲ Slide the cover onto the printer (callout 1) to install it.

 **NOTE:** Make sure that the tabs on the formatter cover align with the slots provided in the printer (callout 2). Tighten the two thumbscrews (callout 3).

 **TIP:** If needed, use the edge of a coin to turn the thumbscrews.

Figure 1-3467 Install the cover

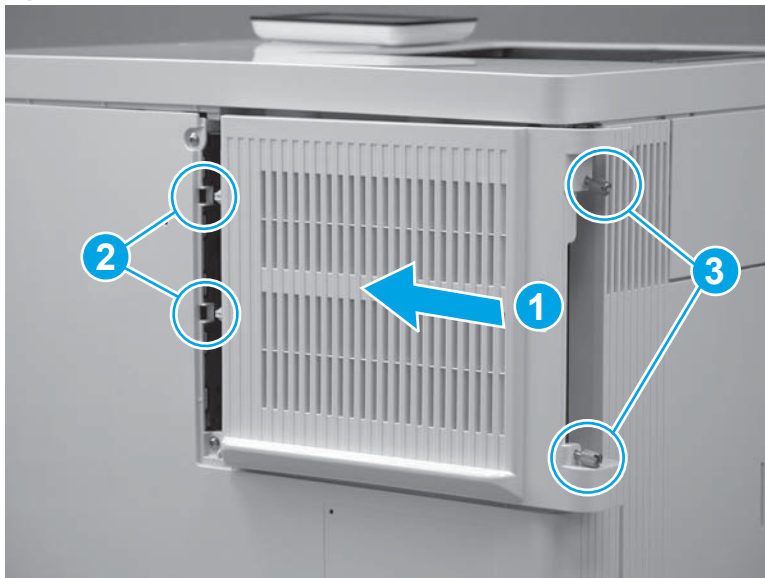

Step 57: Install the TCU

1. Verify that the toner collection hatch cover is in the closed position on the TCU.

Figure 1-3468 Verify that the toner collection hatch cover is closed

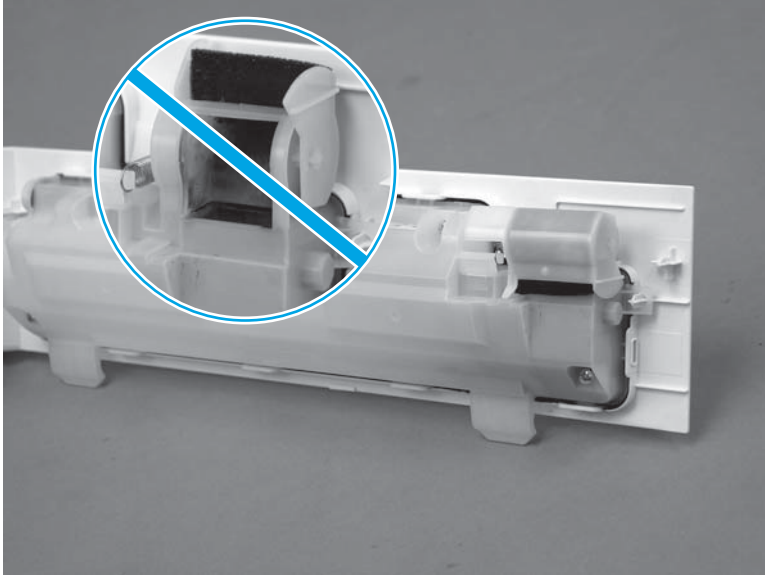

2. Position the TCU with the hinges in the slots provided in the printer (callout 1), and then rotate the TCU up and into the closed position.

 **NOTE:** The toner collection hatch cover automatically opens when the TCU is closed.

Figure 1-3469 Install the TCU



3. Close the front door.

Figure 1-3470 Close the front door

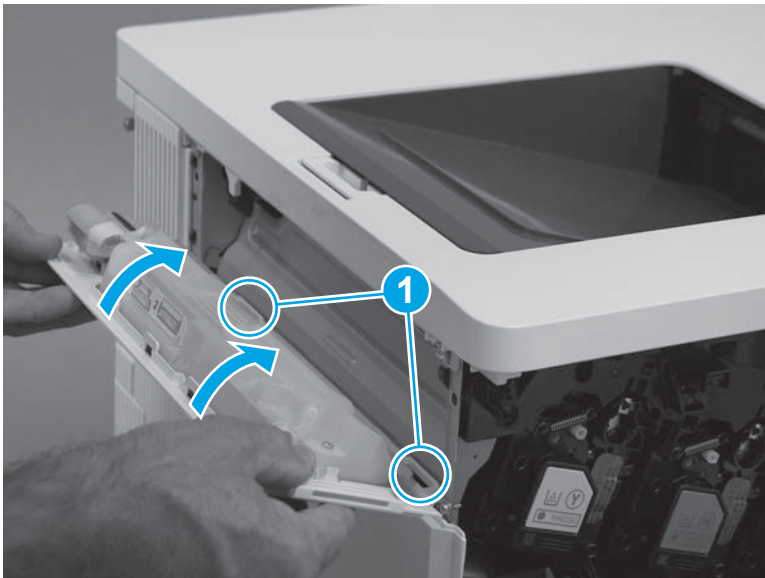

Step 58: Install the tray

1. With the front of the tray slightly lifted, align the sides of the tray with the rails in the printer, and then carefully slide the tray into the printer.

 **TIP:** As the tray slides into the printer, lower the front of it.

Figure 1-3471 Install the tray



2. Close the tray.

Figure 1-3472 Close the tray



Step 59: Install the control-panel assembly (M553x only)

 **NOTE:** For the M553n/dn and M552dn models, skip this step and go to [Step 61: Install the USB cover \(M552 and M553\) on page 1952](#).

For the M577 models, skip this step.

1. Place the control panel on the printer as shown.

Figure 1-3473 Place the control panel on the product

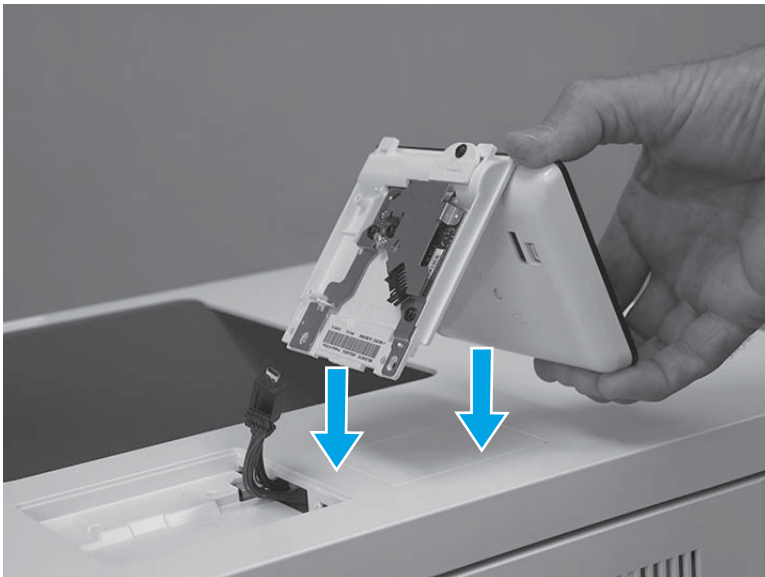

2. Connect one USB cable (callout 1), and one connector (callout 2).

 **IMPORTANT:** Take note of the location of the two mounting tabs (callout 3) on the control-panel assembly.

Figure 1-3474 Connect two connectors



3. Turn the control panel over, and then position the front edge tabs in the slots in the top cover.

Figure 1-3475 Turn the control panel over

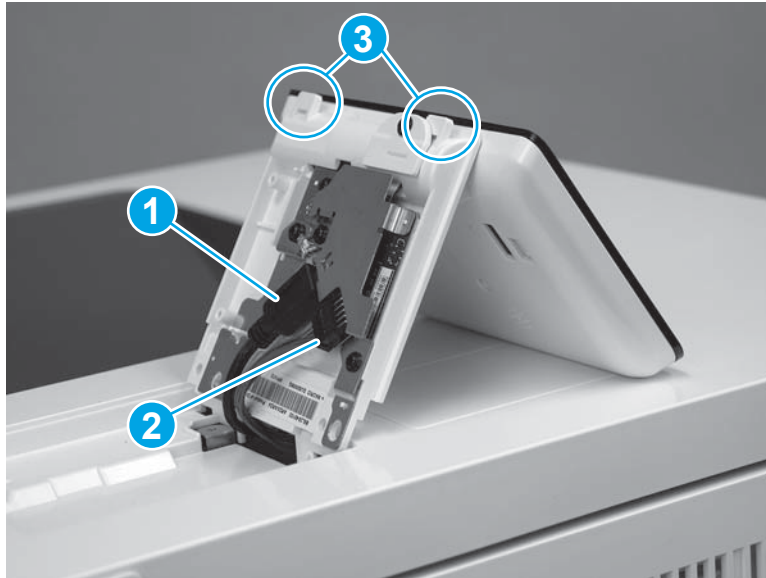
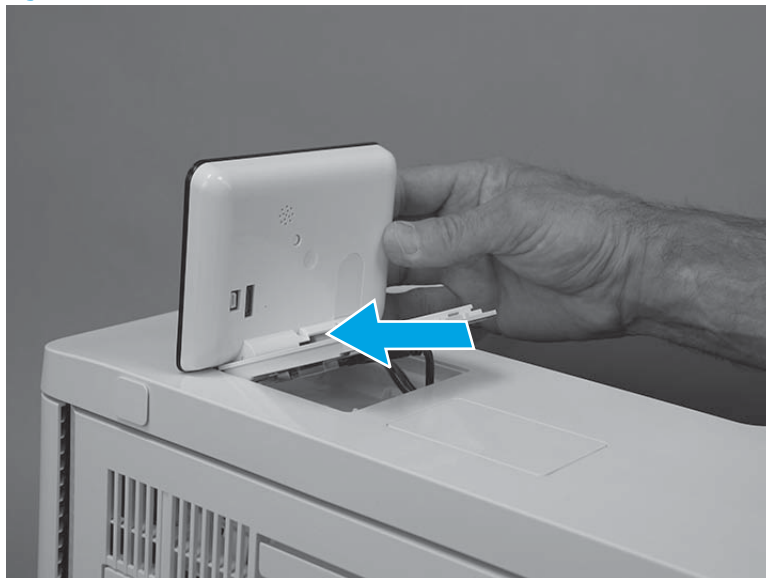

4. Rotate the control-panel base down onto the printer.

Figure 1-3476 Rotate the control-panel base down



5. Use a small Phillips screwdriver to install two screws (callout 1).

Figure 1-3477 Install two screws

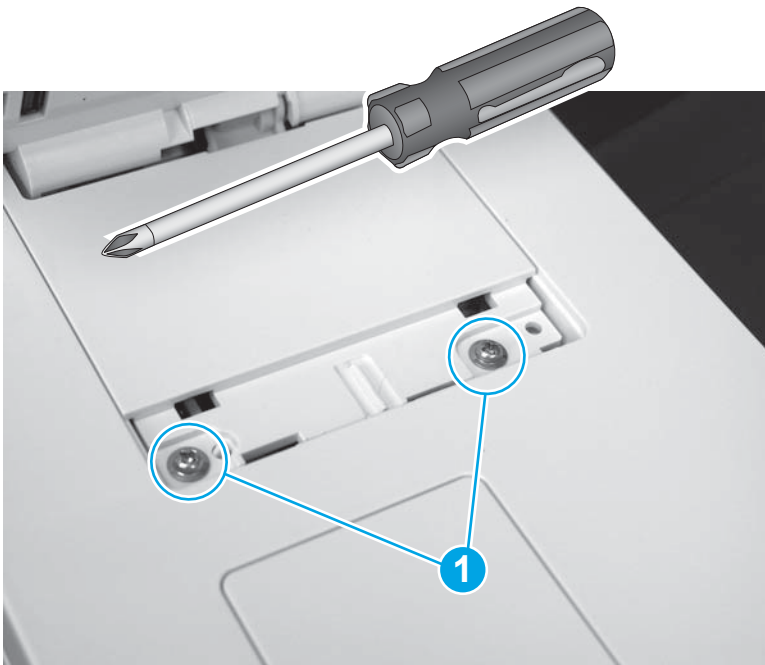

6. Position the screw cover mounting feet into the slots in the top cover (callout 1), and then rotate the cover down (callout 2) to install it.

 **NOTE:** Press down on the cover firmly to make sure that the tabs on the cover (callout 3) snap into place.

Figure 1-3478 Install the cover



Step 60: Install the fuser

1. Align the fuser with the opening in the printer.

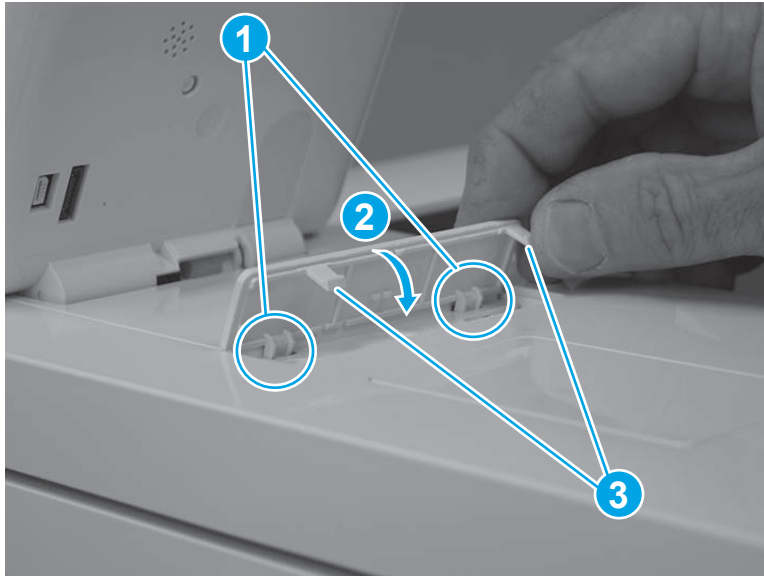
Figure 1-3479 Align the fuser with the opening

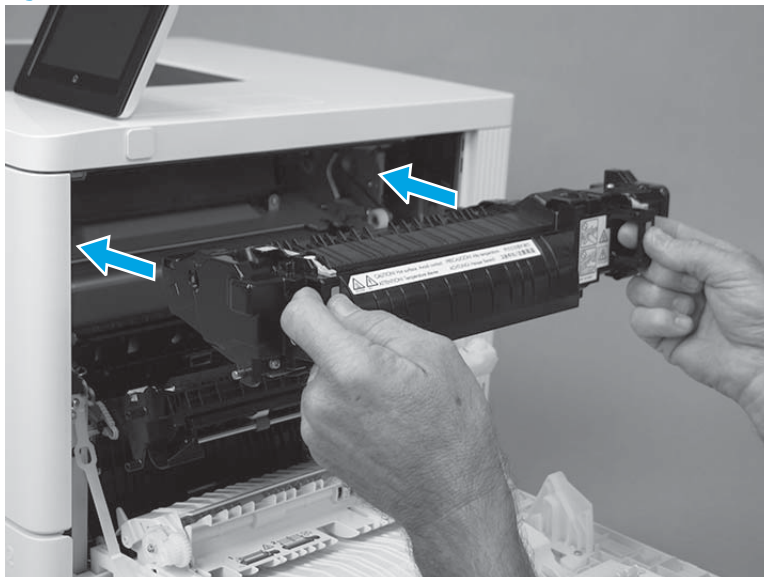

- Slide the fuser into the printer, push in to install it, and then make sure that it is fully seated.

TIP: When the fuser is fully seated, the two blue triggers on the handles make an audible click.

Figure 1-3480 Install the fuser

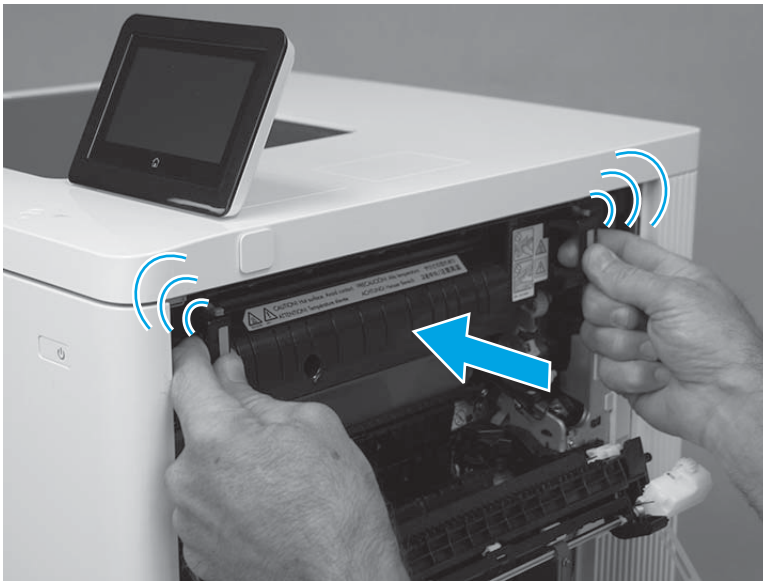

- Close the right door.

Figure 1-3481 Close the right door



Step 61: Install the USB cover (M552 and M553)

NOTE: This step is for the M552 and M553 models. For the M577 models, skip this step.

- Push the cover into the USB port to install it.

Figure 1-3482 Install the cover



2. Make sure that the USB cover is fully seated after installing it.

Figure 1-3483 Check the installation

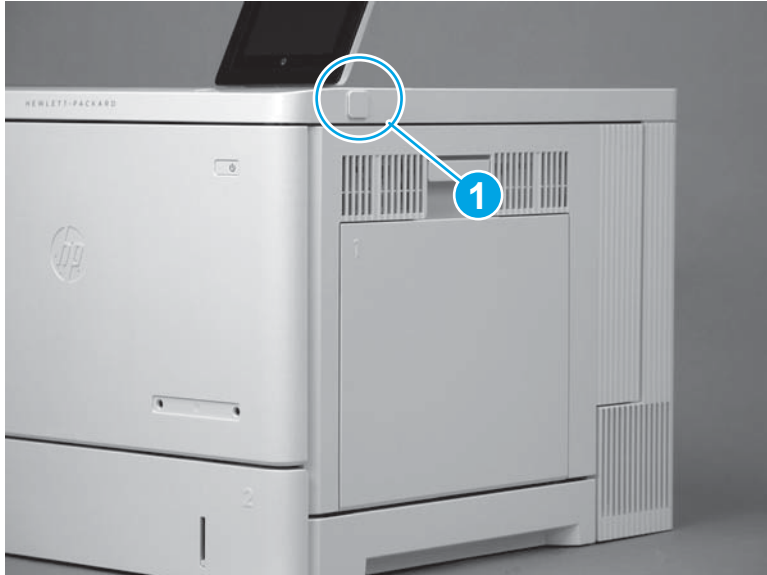

Removal and replacement: Duplex drive assembly and motor

- [Introduction](#)
- [Step 1: Remove the fuser](#)
- [Step 2: Remove the ITB](#)
- [Step 3: Remove the USB cover \(M552 and M553\)](#)
- [Step 4: Remove the control panel \(M553x only\)](#)
- [Step 5: Remove the tray](#)
- [Step 6: Remove the toner collection unit \(TCU\)](#)
- [Step 7: Remove the formatter cover](#)
- [Step 8: Remove the formatter \(M552 and M553\)](#)
- [Step 9: Remove the hard-disk drive \(HDD\) \(M577\)](#)
- [Step 10: Remove the fax PCA \(M577c/f/z\)](#)
- [Step 11: Remove the formatter \(M577\)](#)
- [Step 12: Remove the rear cover \(M552 and M553\)](#)
- [Step 13: Remove the rear upper cover \(M577\)](#)
- [Step 14: Remove the rear cover \(M577\)](#)
- [Step 15: Remove the left upper cover \(M577\)](#)
- [Step 16: Remove the right front upper cover \(M577dn\)](#)
- [Step 17: Remove the stapler cover assembly \(M577c/f/z\)](#)
- [Step 18: Remove the integrated scanner assembly \(ISA\) \(M577\)](#)
- [Step 19: Remove the stapler unit \(M577c/f/z\)](#)
- [Step 20: Remove the right upper cover \(M577\)](#)
- [Step 21: Remove the top rear cover \(M577\)](#)
- [Step 22: Remove the paper feed cover \(M577\)](#)
- [Step 23: Remove the top cover \(M577\)](#)
- [Step 24: Remove the top bracket \(M577\)](#)
- [Step 25: Remove the left cover](#)
- [Step 26: Remove the upper cover \(M552 and M553\)](#)
- [Step 27: Remove the control panel \(M553n/dn and M552dn only\)](#)
- [Step 28: Remove the output bin](#)
- [Step 29: Remove the formatter case](#)

- [Step 30: Remove the right rear cover](#)
- [Step 31: Remove the DC controller and sheet-metal bracket](#)
- [Step 32: Remove the high-voltage power supply T \(HVPST\)](#)
- [Step 33: Remove the fuser drive assembly](#)
- [Step 34: Remove the delivery assembly](#)
- [Step 35: Remove the duplex drive assembly and motor](#)
- [Step 36: Unpack the replacement assembly](#)
- [Step 37: Install the duplex drive assembly and motor](#)
- [Step 38: Install the delivery assembly](#)
- [Step 39: Install the fuser drive assembly](#)
- [Step 40: Install the HVPST](#)
- [Step 41: Install the DC controller and sheet-metal bracket](#)
- [Step 42: Install the right rear cover](#)
- [Step 43: Install the formatter case](#)
- [Step 44: Install the output bin](#)
- [Step 45: Install the control panel \(M553n/dn and M552dn only\)](#)
- [Step 46: Install the upper cover \(M552 and M553\)](#)
- [Step 47: Install the left cover](#)
- [Step 48: Install the top bracket \(M577\)](#)
- [Step 49: Install the top cover \(M577\)](#)
- [Step 50: Install the paper feed cover \(M577\)](#)
- [Step 51: Install the top rear cover \(M577\)](#)
- [Step 52: Install the right upper cover \(M577\)](#)
- [Step 53: Install the stapler unit \(M577c/f/z\)](#)
- [Step 54: Install the integrated scanner assembly \(ISA\) \(M577\)](#)
- [Step 55: Install the stapler cover assembly \(M577c/f/z\)](#)
- [Step 56: Install the right front upper cover \(M577dn\)](#)
- [Step 57: Install the left upper cover \(M577\)](#)
- [Step 58: Install the rear cover \(M577\)](#)
- [Step 59: Install the rear upper cover \(M577\)](#)
- [Step 60: Install the rear cover \(M552 and M553\)](#)

- [Step 61: Install the formatter \(M577\)](#)
- [Step 62: Install the fax PCA \(M577c/f/z\)](#)
- [Step 63: Install the HDD \(M577\)](#)
- [Step 64: Install the formatter \(M552 and M553\)](#)
- [Step 65: Install the formatter cover](#)
- [Step 66: Install the TCU](#)
- [Step 67: Install the tray](#)
- [Step 68: Install the control-panel assembly \(M553x only\)](#)
- [Step 69: Install the USB cover \(M552 and M553\)](#)
- [Step 70: Install the ITB](#)
- [Step 71: Install the fuser](#)

Introduction

This document provides the procedures to remove and replace the duplex drive assembly.



NOTE: The duplex drive assembly includes the duplex-drive motor (M8).

Before performing service



TIP: Some figures might show assemblies removed or installed that have not yet been removed or installed at that specific step. However, the procedures are correct for this printer and the target assembly. Always thoroughly read the instructions that accompany each figure.

Turn the printer power off

- Disconnect the power cable.



WARNING! To avoid damage to the printer, turn the printer off, wait 30 seconds, and then remove the power cord before attempting to service the printer.

Use the table below to identify the correct part number for your printer, and then go to <http://h20141.www2.hp.com/hpparts> to order the part.

Duplex drive assembly part number	
RM2-0006-000CN	Duplex drive assembly

Required tools

- #2 Phillips screwdriver with a magnetic tip

After performing service

Make sure that all of the connectors on the HVPST are fully seated.

Make sure that all of the connectors on the DC controller are fully seated.

Make sure that all of the connectors on the formatter are fully seated.

Make sure that the formatter cover is fully seated, and that the thumbscrews are finger tight after replacing it.

Turn the printer power on

- Connect the power cable.
- Use the power switch to turn the power on.

Post service test

Use the components test to test the (duplex) motor. For more information, see the printer troubleshooting manual.

Step 1: Remove the fuser

1. Open the right door.

⚠ CAUTION: The fuser is very hot. After turning the printer power off, allow the fuser to cool for at least 30 minutes before removing it.

Figure 1-3484 Open the right door



2. Grasp the two fuser handles, and then squeeze the two blue triggers on the handles to release the fuser.

Figure 1-3485 Release the fuser

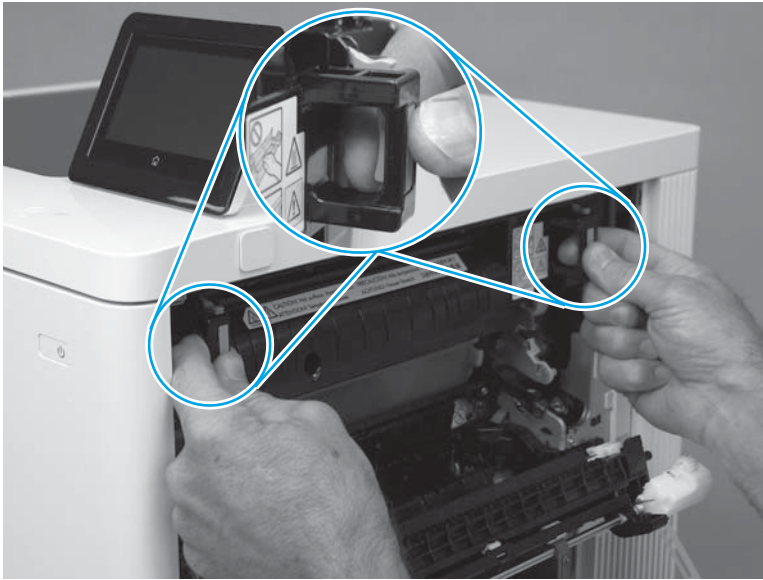

3. Slide the fuser straight out of the printer to remove it.

Figure 1-3486 Remove the fuser



Step 2: Remove the ITB

⚠ CAUTION: Do not touch the grey-plastic belt. Skin oils and fingerprints on the belt can cause print-quality problems.

1. Open the right door.

Figure 1-3487 Open the right door



2. Pull the blue lever to release the ITB drive coupling.

Figure 1-3488 Release the ITB drive coupling

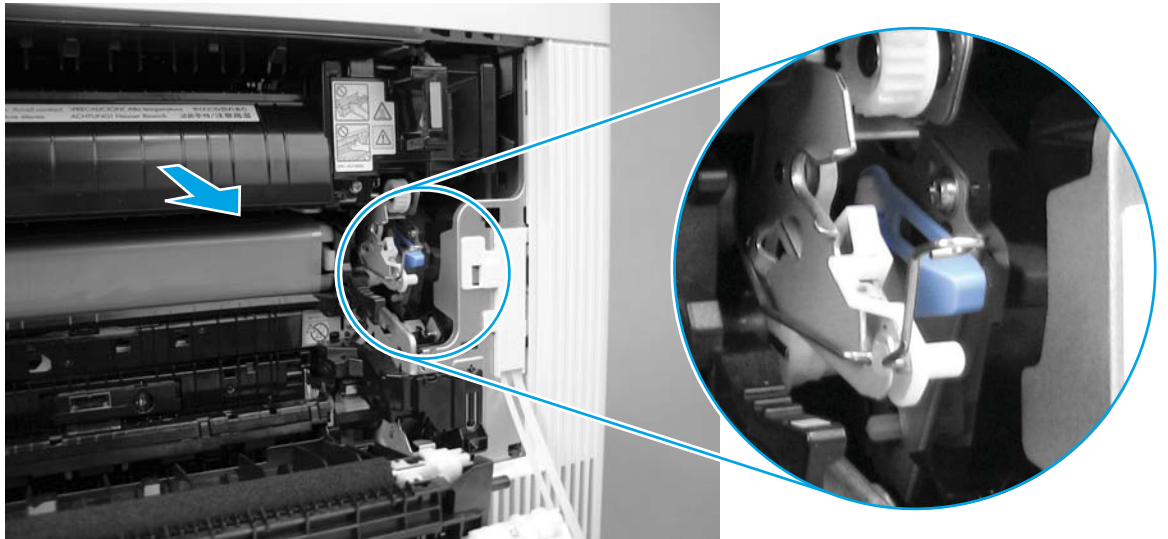

3. Push in on the blue arm to release the secondary transfer roller assembly, and then completely lower the assembly.

 **NOTE:** Press the blue arm on the secondary transfer roller assembly a second time to release the roller assembly when it stops at the halfway open position.

Figure 1-3489 Lower the secondary transfer roller assembly



4. Release the left-side ITB spring (callout 1) from the tab (callout 2).

Figure 1-3490 Release the front-side ITB spring

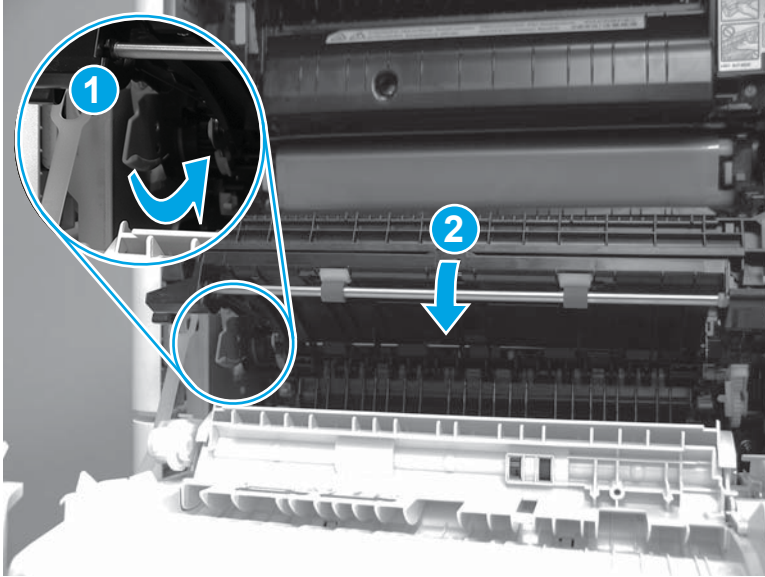
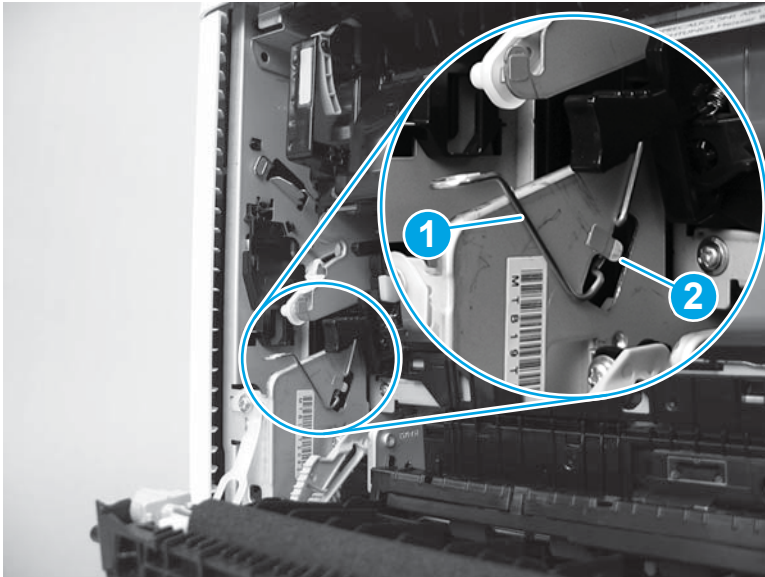

5. Place the left-side ITB spring on the holder to keep it out of the way.

 **TIP:** The holder is colored blue to help locate it.

Figure 1-3491 Place the spring on the holder

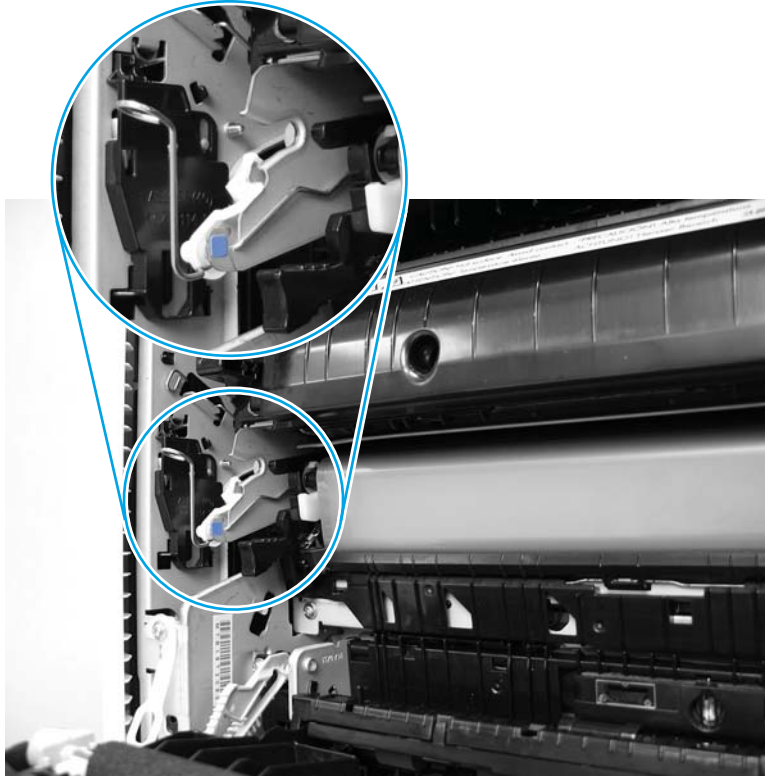

6. Release the right-side ITB spring (callout 1) from the tab (callout 2).

Figure 1-3492 Release the rear-side ITB spring

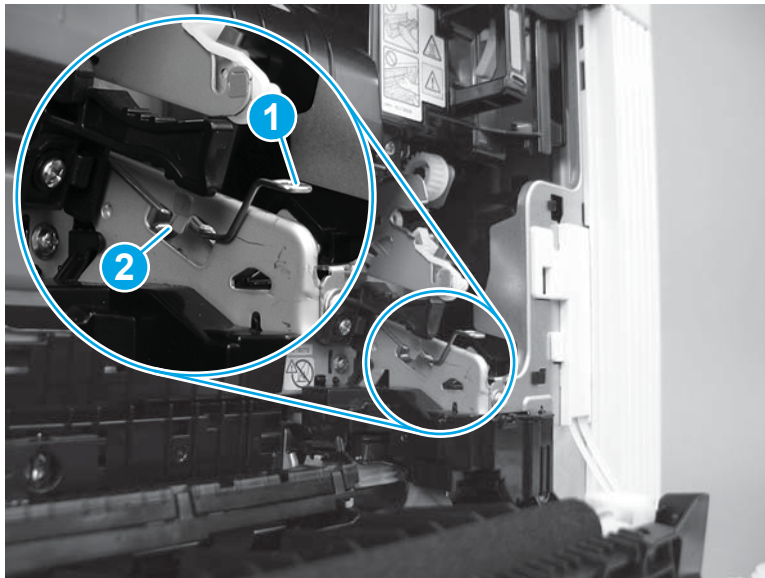

7. Place the right-side ITB spring on the holder to keep it out of the way.

 **TIP:** The holder is colored blue to help locate it.

Figure 1-3493 Place the spring on the holder

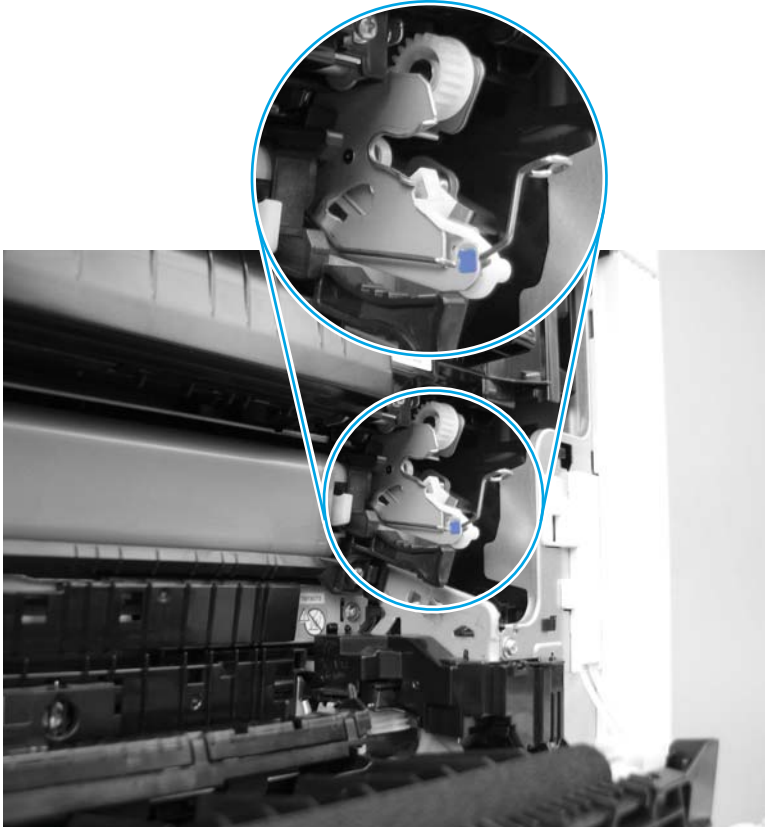

8. Grasp the two blue handles on the ITB.

⚠ CAUTION: If the ITB is removed to access other assemblies in the printer, use care. The ITB is a sensitive assembly. Be careful when handling the ITB so that it is not damaged. Always place the ITB in a safe and protected location.

Figure 1-3494 Grasp the ITB handles

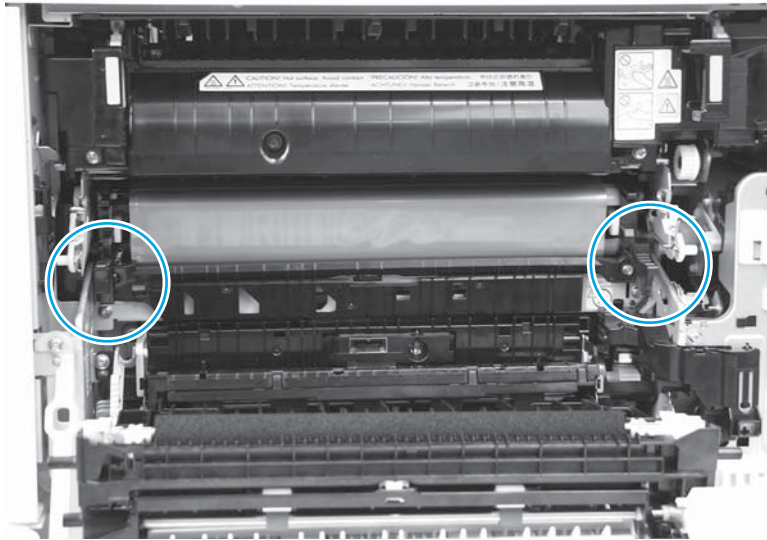

9. Pull the ITB out of the printer to remove it.

⚠ CAUTION: Do not touch the grey-plastic belt. Skin oils and fingerprints on the belt can cause print-quality problems.

Figure 1-3495 Remove the ITB

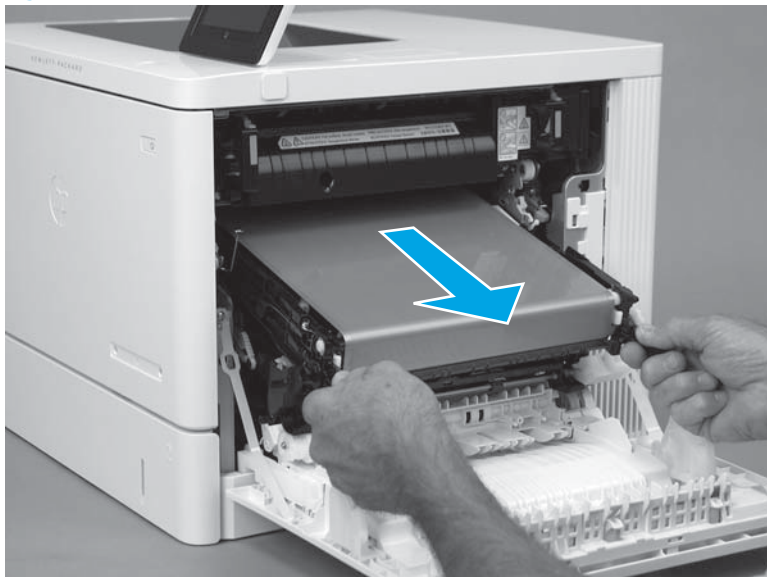

Step 3: Remove the USB cover (M552 and M553)

 **NOTE:** This step is for the M552 and M553 models. For the M577 models, skip this step and go to [Step 5: Remove the tray on page 1968](#).

1. Locate the USB cover.

Figure 1-3496 Locate the USB cover

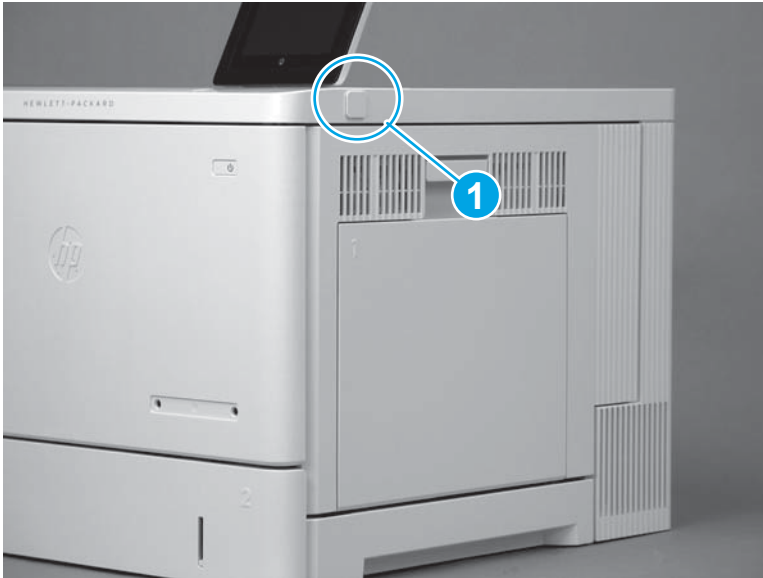

2. Pull the cover off of the printer to remove it.

Figure 1-3497 Remove the cover



Step 4: Remove the control panel (M553x only)

 **NOTE:** This step is for the M553x model. For the M553n/dn, M552dn, and M577 models, skip this step and go to [Step 5: Remove the tray on page 1968](#).

1. Tilt the control panel up.

Figure 1-3498 Tilt the control panel up



2. Use a small flat-blade screwdriver to release the control-panel screws cover tabs.

Figure 1-3499 Release the control-panel screws cover tabs

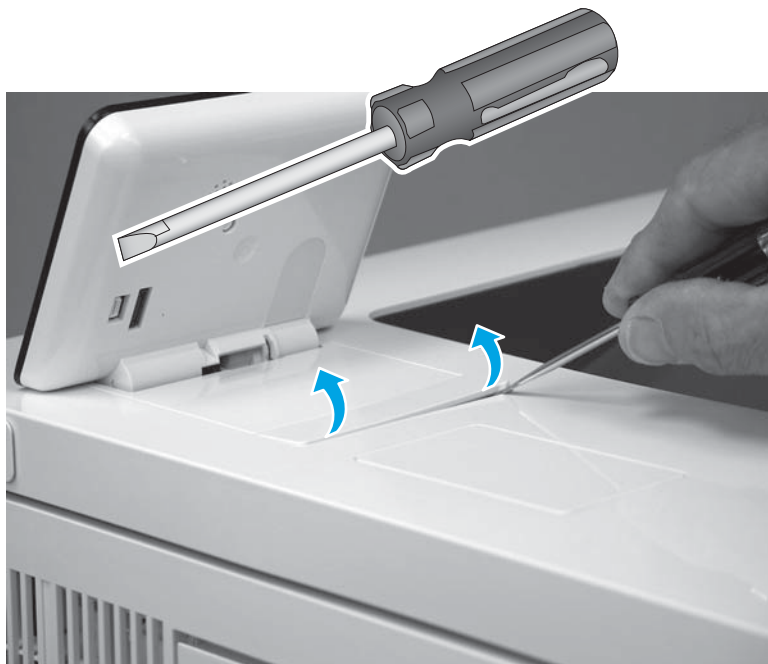

3. Rotate the cover up to remove it.

Figure 1-3500 Remove the cover

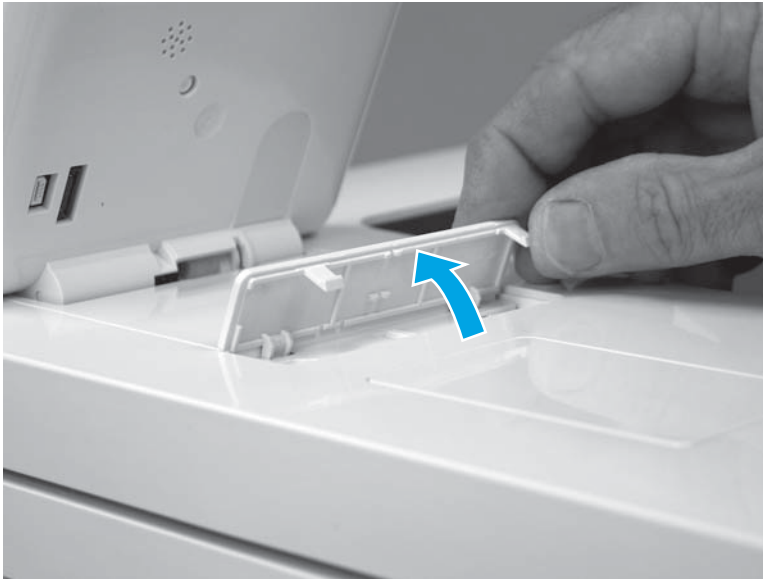

4. Use a small Phillips screwdriver to remove two screws (callout 1).

 **IMPORTANT:** Store the screws in a secure place where they cannot fall down into the printer.

Figure 1-3501 Remove two screws

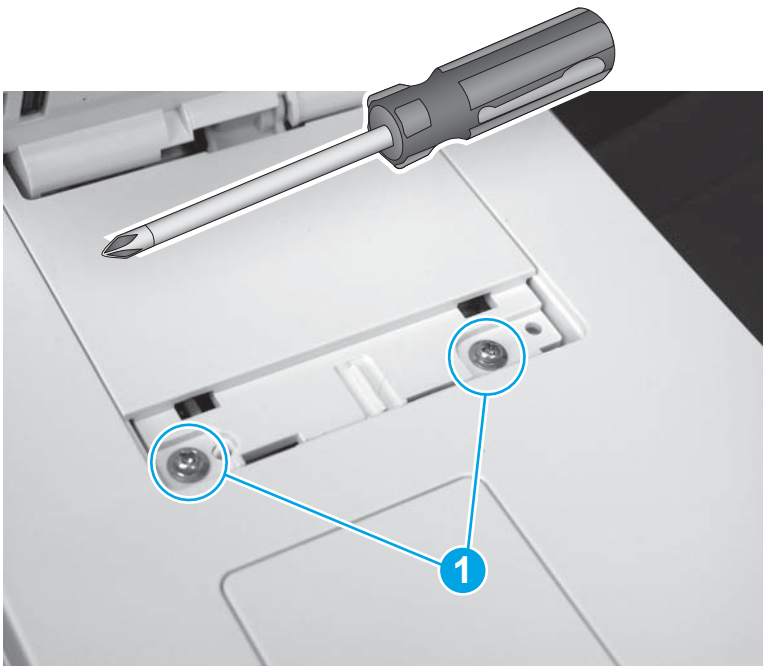

5. Rotate the control-panel base toward the front of the printer.

Figure 1-3502 Rotate the control-panel base up



6. Slightly slide the control-panel base toward the rear of the printer (callout 1) to release it, and then turn the control panel over (callout 2) to access the bottom side.

⚠ CAUTION: The control panel is still attached to the printer. Do not attempt to completely remove the control panel.

Figure 1-3503 Turn the control panel over

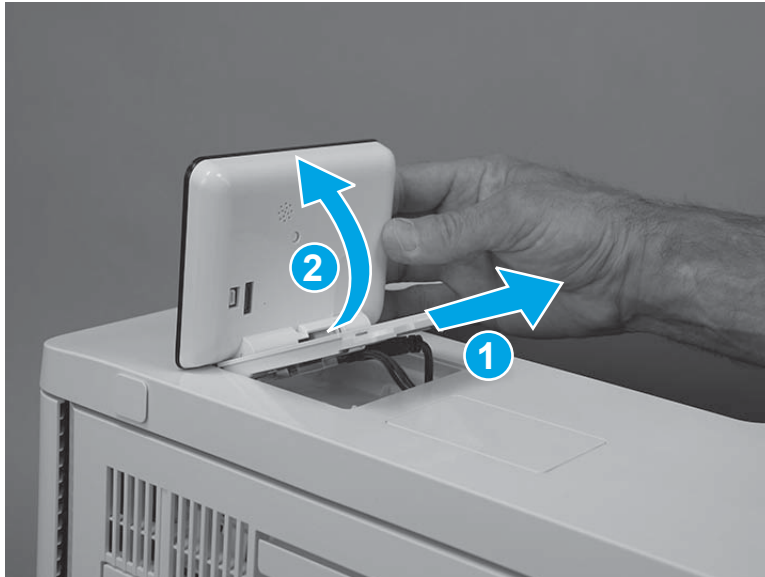

7. Disconnect one USB cable (callout 1), one connector (callout 2), and then remove the control panel.

Figure 1-3504 Disconnect two connectors

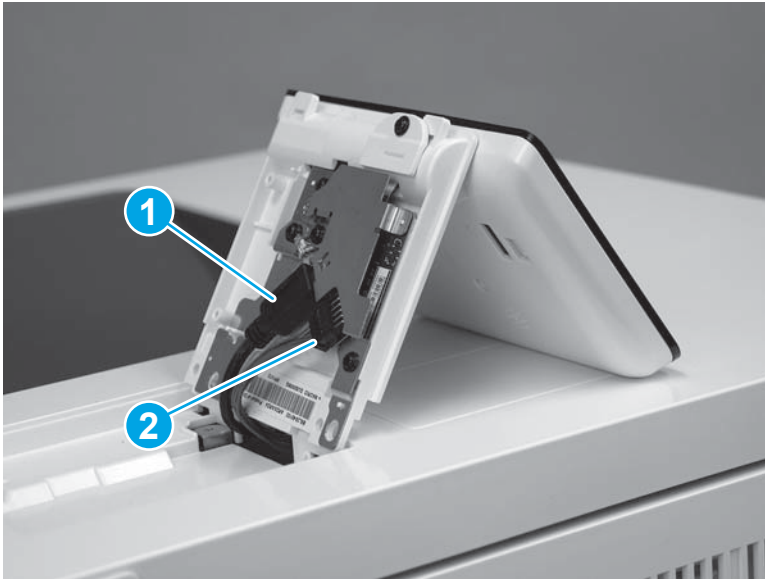

Step 5: Remove the tray

1. Pull the tray out until it stops.

Figure 1-3505 Pull the tray out



2. Lift the front of the tray, and then pull it out of the printer to remove it.

Figure 1-3506 Remove the tray

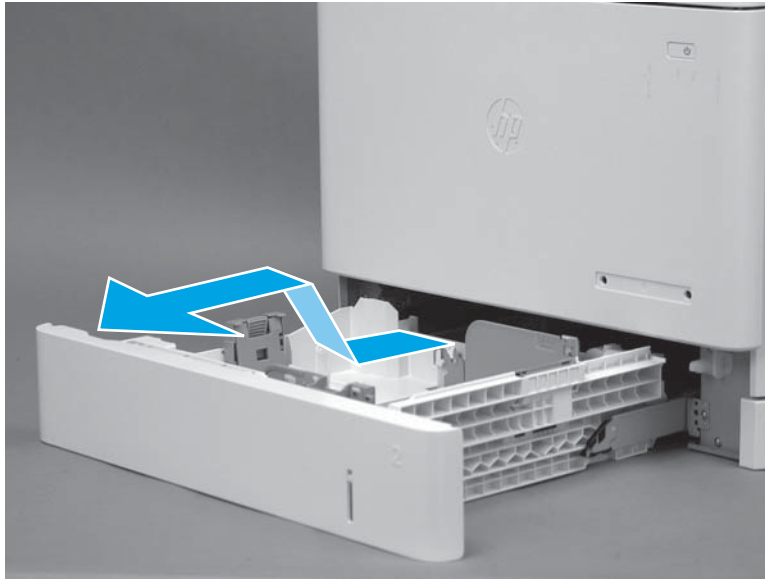

Step 6: Remove the toner collection unit (TCU)

1. Open the front door.

Figure 1-3507 Open the front door



2. Open the TCU.

 **NOTE:** The toner collection hatch cover automatically closes when the TCU is opened.

Figure 1-3508 Open the TCU



3. Pull the TCU away from the printer at an angle to remove it.

⚠ CAUTION: Do not open the toner collection hatch cover when handling the TCU. If toner gets on clothing, wipe it off by using a dry cloth and wash the clothes in cold water. Hot water sets toner into fabric.

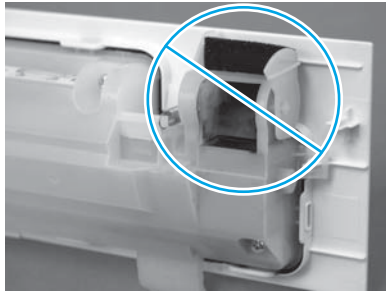
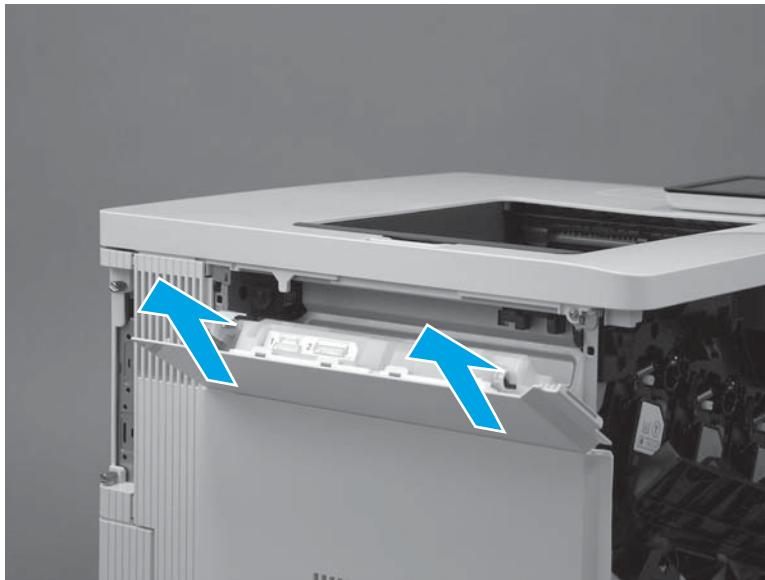

Figure 1-3509 Remove the TCU



Step 7: Remove the formatter cover

1. Locate the formatter cover.

Figure 1-3510 Locate the formatter cover

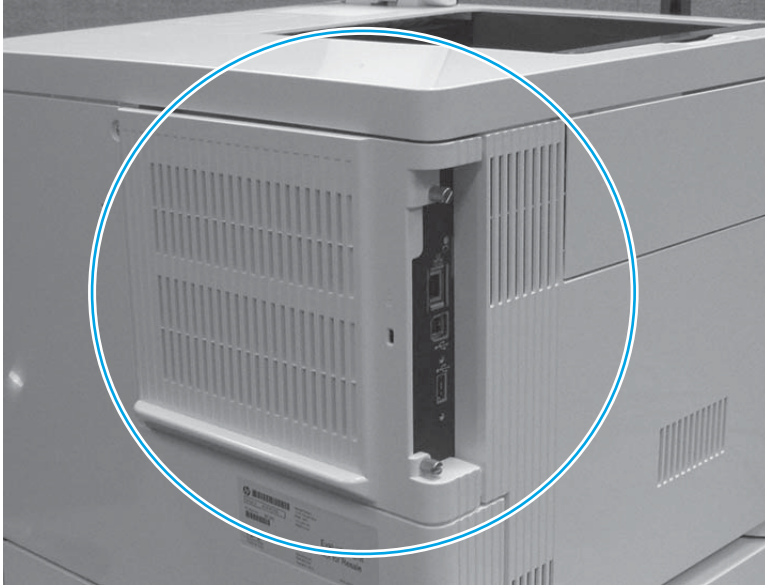

2. Loosen the two thumbscrews (callout 1). Grasp the two thumbscrews, and then slide the cover away from the printer (callout 2) to remove it.

 **TIP:** If needed, use the edge of a coin to turn the thumbscrews.

Figure 1-3511 Loosen the thumbscrews

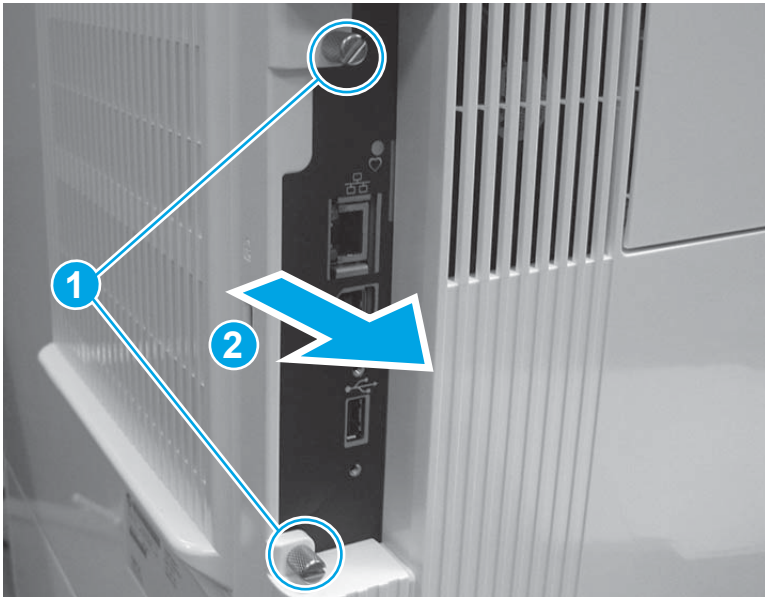

Step 8: Remove the formatter (M552 and M553)

 **NOTE:** This step is for the M552 and M553 models. For the M577 models, skip this step and go to [Step 9: Remove the hard-disk drive \(HDD\) \(M577\) on page 1974](#).

If the optional hard-disk drive (HDD) is installed, it must be removed to gain access to the formatter mounting screws.

Release two tabs along the left edge of the HDD, rotate the left edge away from the product, and then slide the HDD to the left to remove it.

 **CAUTION:**  ESD-sensitive part.

1. Disconnect all of the connectors on the formatter.

The following connectors are empty:

- All models: J1 (this connector is empty unless the optional DIMM is installed)
- M553n/dn and M552dn: J2 (callout 1; this is the touchscreen connector for the M553x model)
- All models: J9 (this connector is empty unless the optional internal USB ports component is installed)
- All models: J18 (this connector is empty unless the optional hard-disk-drive (HDD) is installed)
- All models: J23
- All models: J24
- M553n/dn and M552dn: J25 (this is the wireless connector for the M553x model)
- All models: J57
- All models: J98 (this connector is empty unless the optional trusted platform module (TPM) is installed)

 **IMPORTANT:** The flat-cable connector (callout 2) is a Zero Insertion Force (ZIF) connector that uses a hinged retainer to secure the flat cable. The hinged retainer must be opened to release the flat cable.

Figure 1-3512 Disconnect all connectors



2. Remove four screws (callout 1), and then remove the formatter.

Figure 1-3513 Remove the formatter

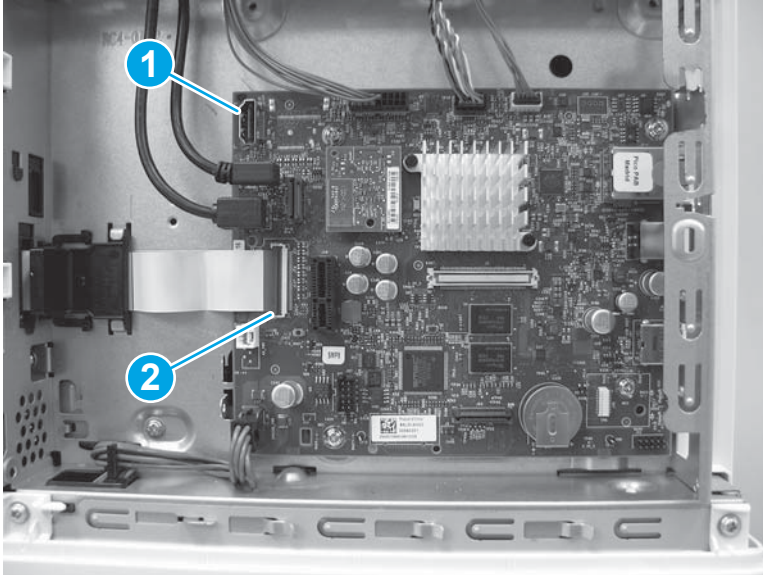
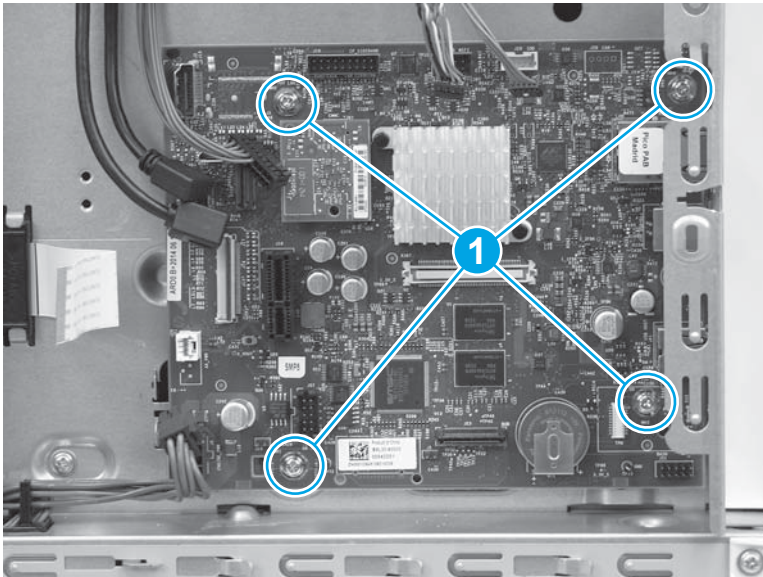

Step 9: Remove the hard-disk drive (HDD) (M577)

 **NOTE:** This step is for the M577 models. For the M552 and M553 models, skip this step and go to [Step 12: Remove the rear cover \(M552 and M553\) on page 1979](#).

 **CAUTION:**  ESD-sensitive part.

1. Release two tabs (callout 1). Hold the tabs in the released position, and then rotate the hard disk drive (HDD) up (callout 2) to release the connector from the formatter.

Figure 1-3514 Release the HDD

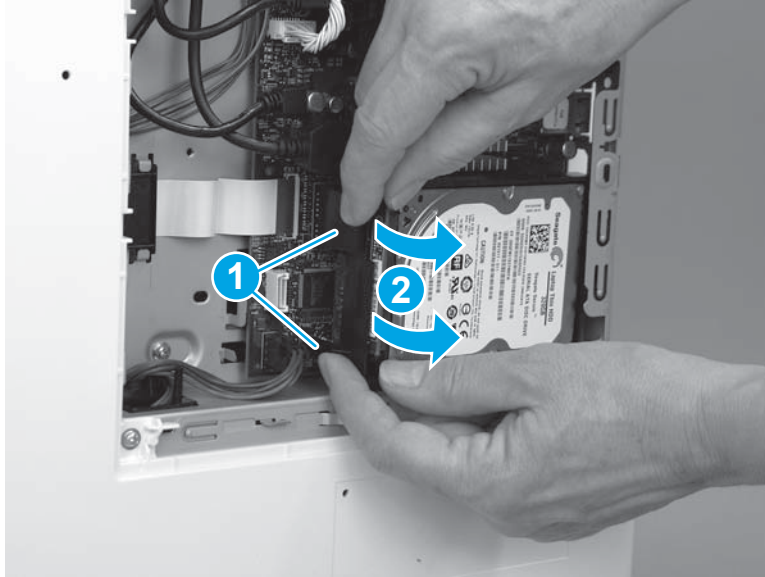

2. Slide the HDD away from the printer to remove it.

Figure 1-3515 Remove the HDD

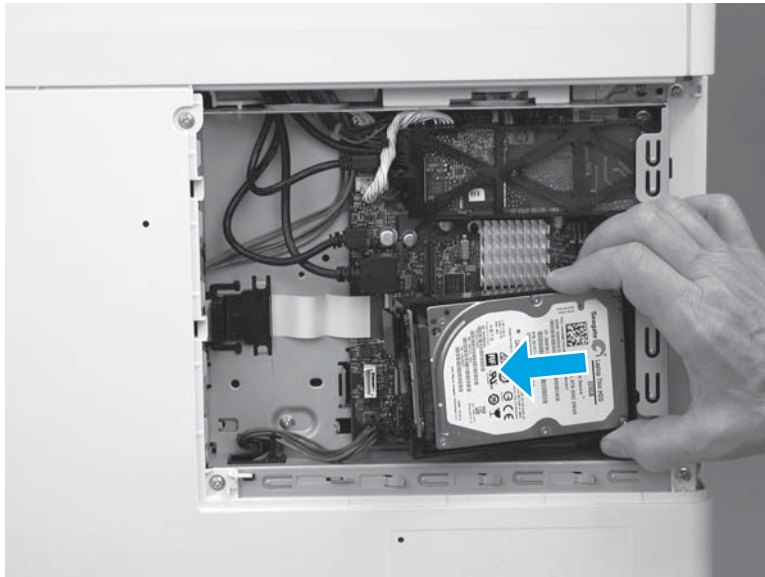

Step 10: Remove the fax PCA (M577c/f/z)

 **NOTE:** This step is for the M577c/f/z models. For the M577n model, skip this step and go to [Step 11: Remove the formatter \(M577\) on page 1977](#).

For the M552 and M553 models, skip this step and go to [Step 12: Remove the rear cover \(M552 and M553\) on page 1979](#).

 **CAUTION:**  ESD-sensitive part.

1. Locate the fax PCA component on the formatter.

Figure 1-3516 Locate the fax PCA

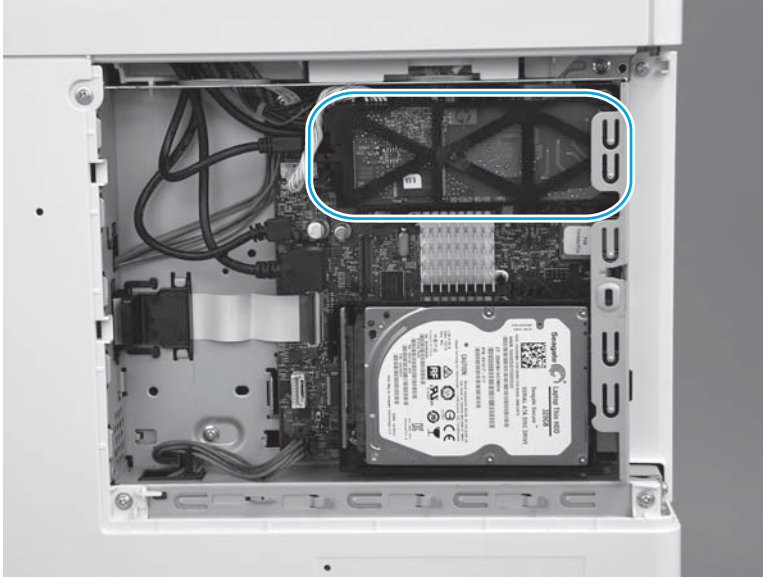

2. Release the connector latch (callout 1), and then pull the connector away from the formatter (callout 2) to disconnect it.

Figure 1-3517 Disconnect one connector

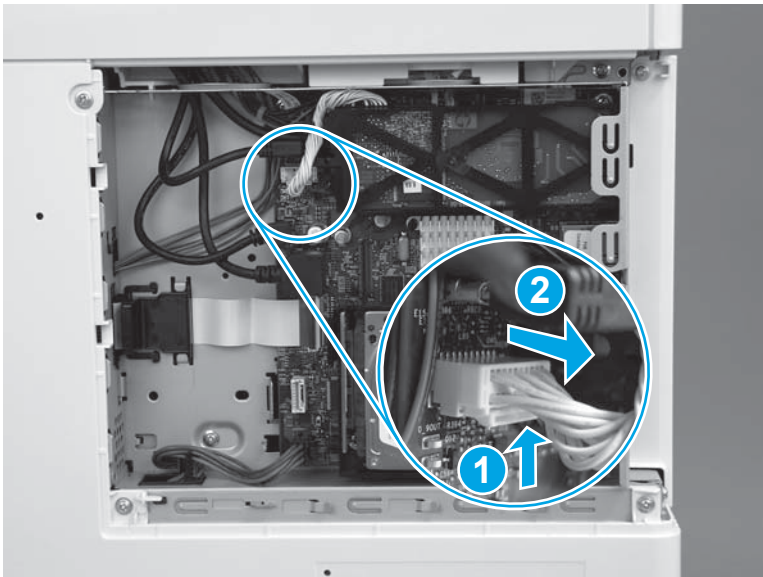

3. Release one retainer (callout 1) by pressing the bracket arms together.

Figure 1-3518 Release one latch

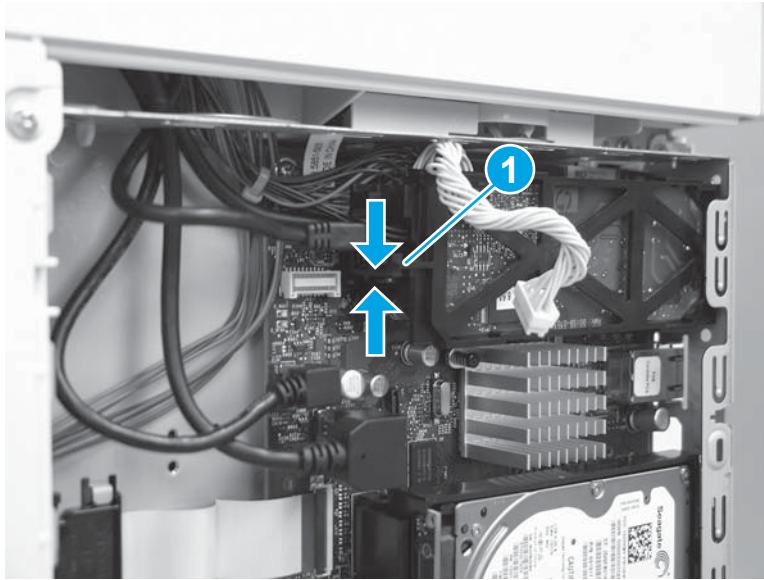

4. Rotate the end of the fax PCA (callout 1) away from the formatter, and then slide the PCA left (callout 2) to remove it.

Figure 1-3519 Remove the fax PCA

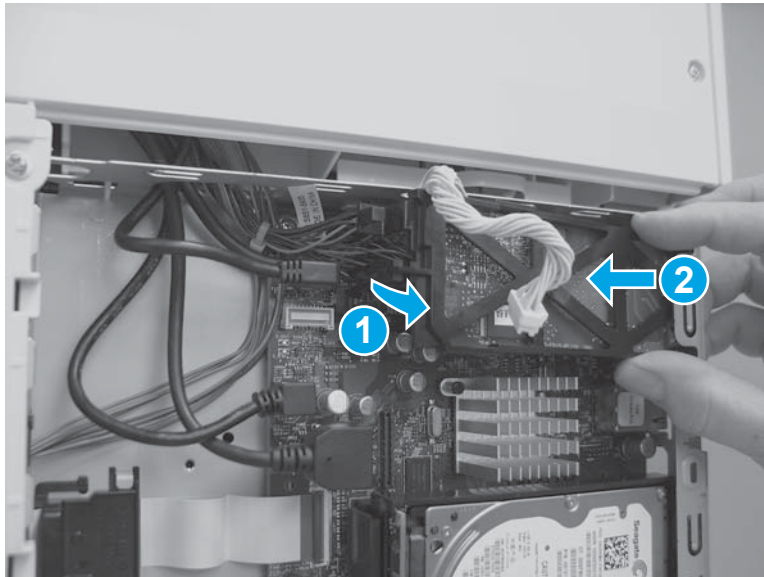

Step 11: Remove the formatter (M577)

 **NOTE:** This step is for the M577 models. For the M552 and M553 models, skip this step and go to [Step 12: Remove the rear cover \(M552 and M553\) on page 1979.](#)

 **CAUTION:**  ESD-sensitive part.

1. Disconnect all of the connectors on the formatter.

The following connectors are empty:

- All models: J1 (this connector is empty unless the optional DIMM is installed)
- All models: J3
- M577dn: J15 (this is the fax connector for the M577f/z/c models)
- All models: J21 (this connector is empty unless the optional internal USB ports component is installed)
- All models: J23
- All models: J24
- All models: J51
- All models: J57
- All models: J97
- All models: J98 (this connector is empty unless the optional trusted platform module (TPM) is installed)

 **IMPORTANT:** The flat-cable connector (callout 1) is a Zero Insertion Force (ZIF) connector that uses a hinged retainer to secure the flat cable. The hinged retainer must be opened to release the flat cable.

Figure 1-3520 Disconnect all connectors



2. Remove four screws (callout 1).

Figure 1-3521 Remove four screws

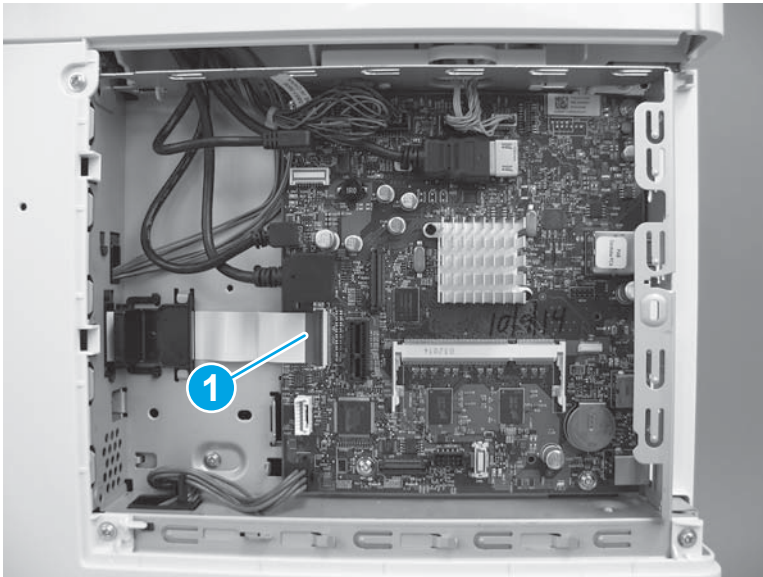
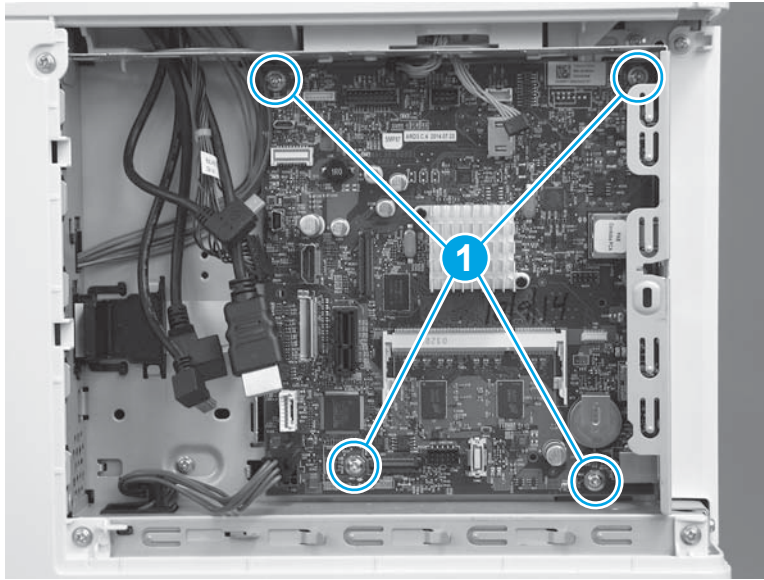

3. Remove the formatter.

Figure 1-3522 Remove the formatter

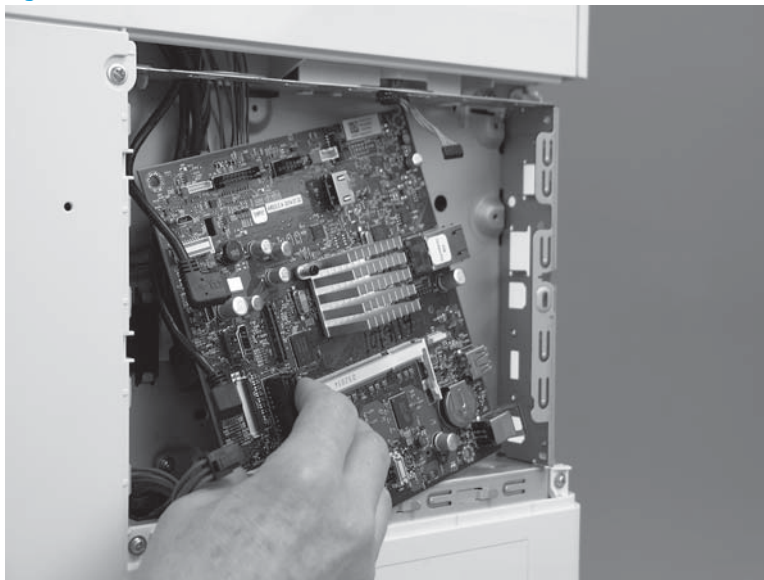

Step 12: Remove the rear cover (M552 and M553)

 **NOTE:** This step is for the M552 and M553 models. For the M577 models, skip this step and go to [Step 13: Remove the rear upper cover \(M577\) on page 1980.](#)

1. Remove four screws (callout 1).

Figure 1-3523 Remove four screws

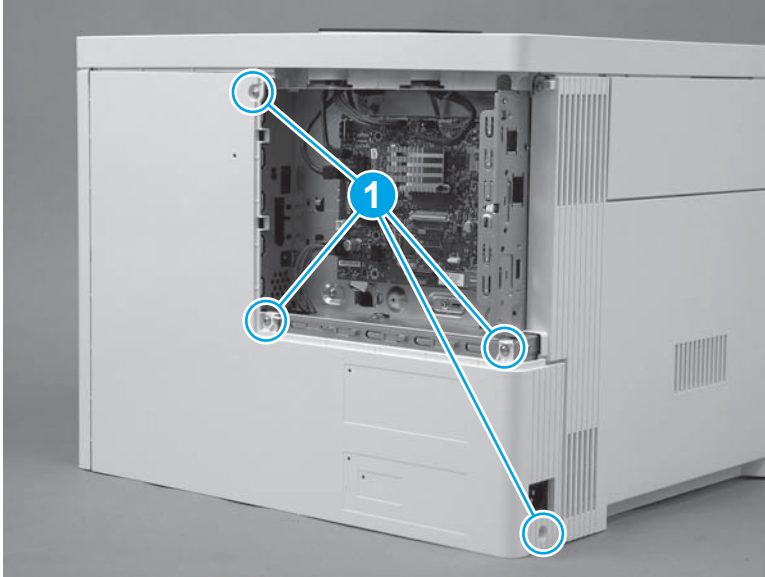

2. Slightly slide the cover to the right (callout 1), rotate the bottom of the cover away from the printer (callout 2), and then pull the top of the cover away from the printer (callout 3) to remove the cover.

Figure 1-3524 Remove the cover

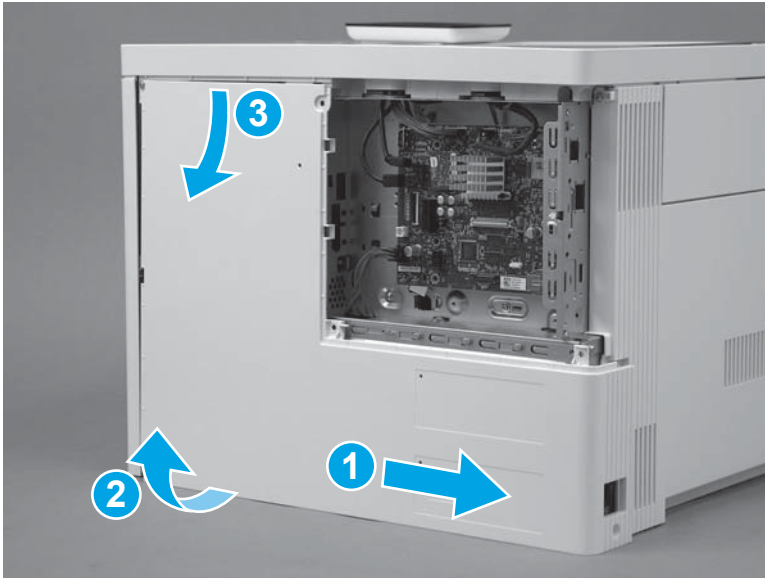

Step 13: Remove the rear upper cover (M577)

 **NOTE:** This step is for the M577 models. For the M552 and M553 models, skip this step and go to [Step 25: Remove the left cover on page 2000](#).

1. Remove two screws (callout 1).

 **Reinstallation tip:** These two screws are self-tapping screws for plastic. When reinstalling them, rotate the screws counterclockwise to align them with the existing thread pattern, and then carefully turn them clockwise to tighten. Do not overtighten. This will prevent stripping the threads inside the screw holes.

Figure 1-3525 Remove two screws



2. Use a small, flat blade screwdriver to release the right edge of the cover.

Figure 1-3526 Release the right edge

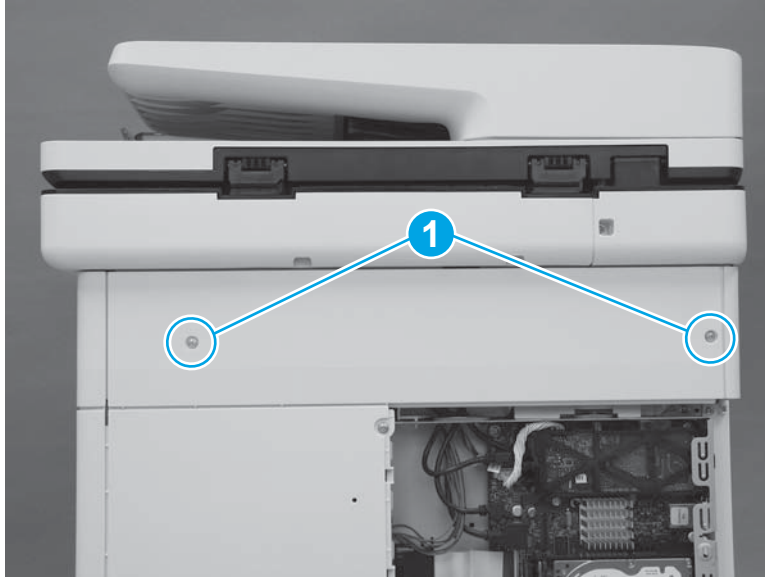
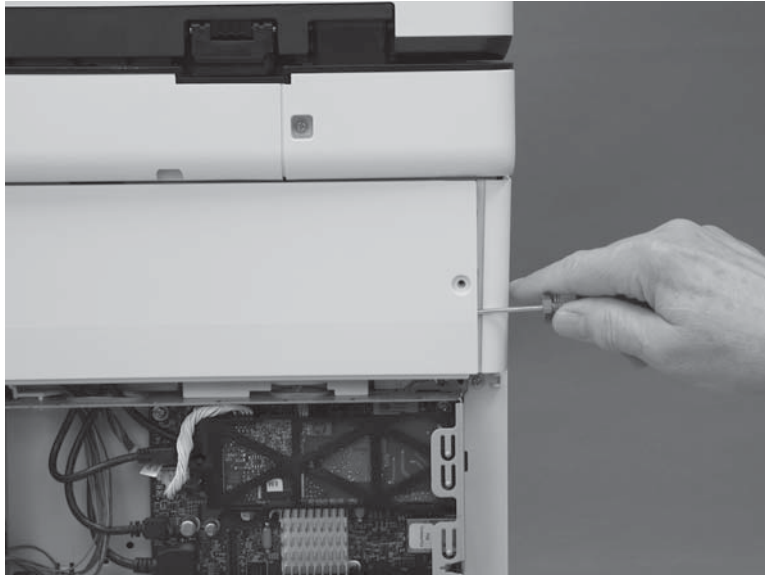

3. Pull the right edge of the cover (callout 1) away from the printer, and then slide the cover to the right (callout 2).

Figure 1-3527 Slide the cover right

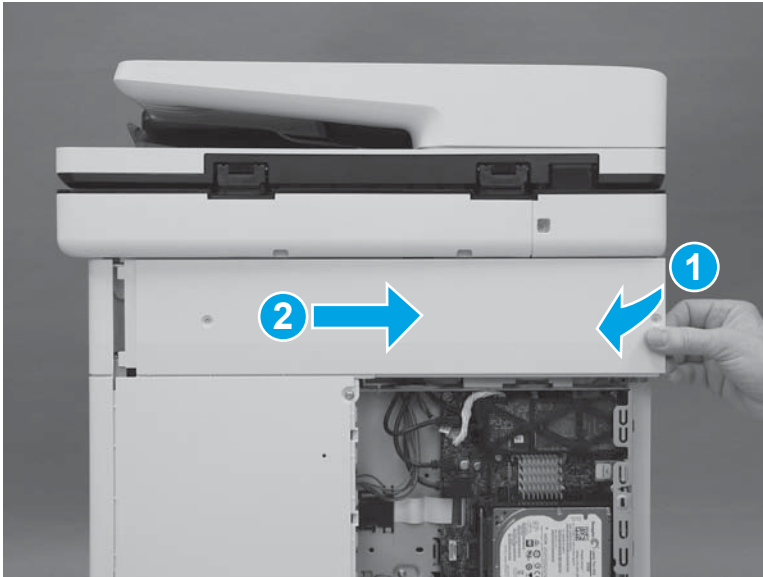

4. Remove the cover.

Figure 1-3528 Remove the cover

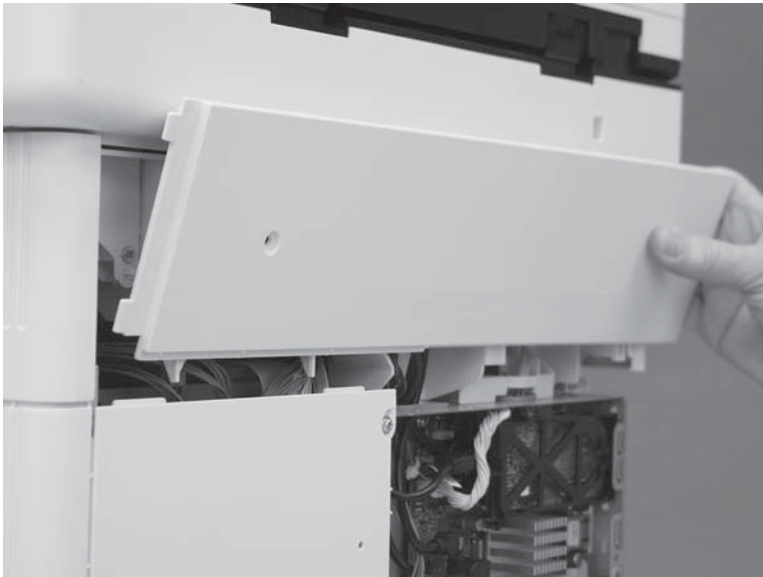

Step 14: Remove the rear cover (M577)

 **NOTE:** This step is for the M577 models. For the M552 and M553 models, skip this step and go to [Step 25: Remove the left cover on page 2000](#).

1. Remove four screws (callout 1).

Figure 1-3529 Remove four screws

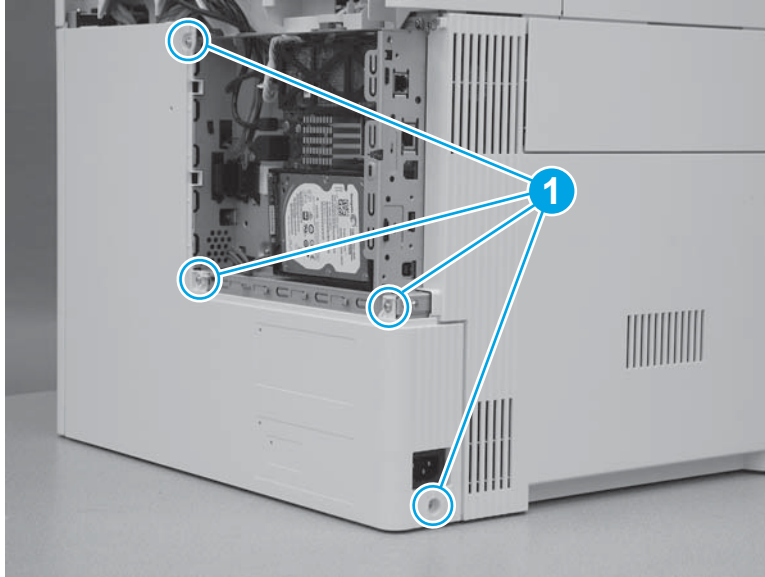

2. Slide the cover to the right to remove it.

Figure 1-3530 Remove the cover

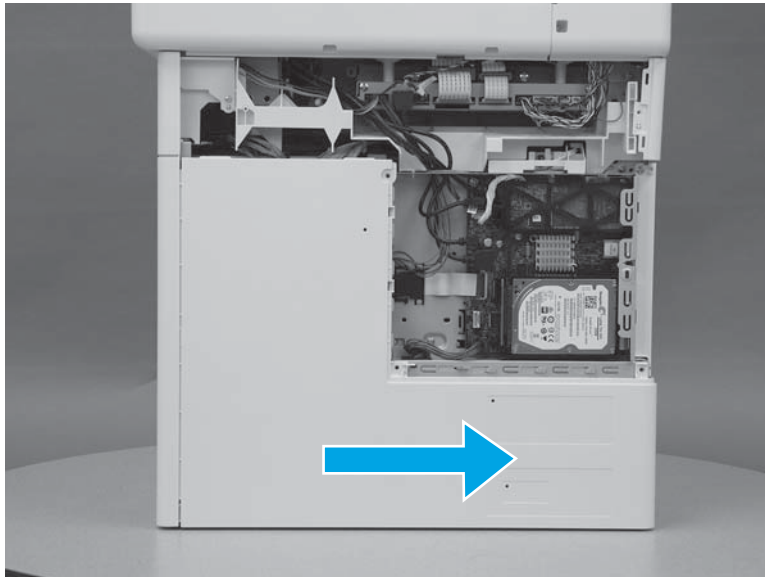

Step 15: Remove the left upper cover (M577)

 **NOTE:** This step is for the M577 models. For the M552 and M553 models, skip this step and go to [Step 25: Remove the left cover on page 2000](#).

1. At the left side of the printer, release one tab (callout 1).

Figure 1-3531 Release one tab

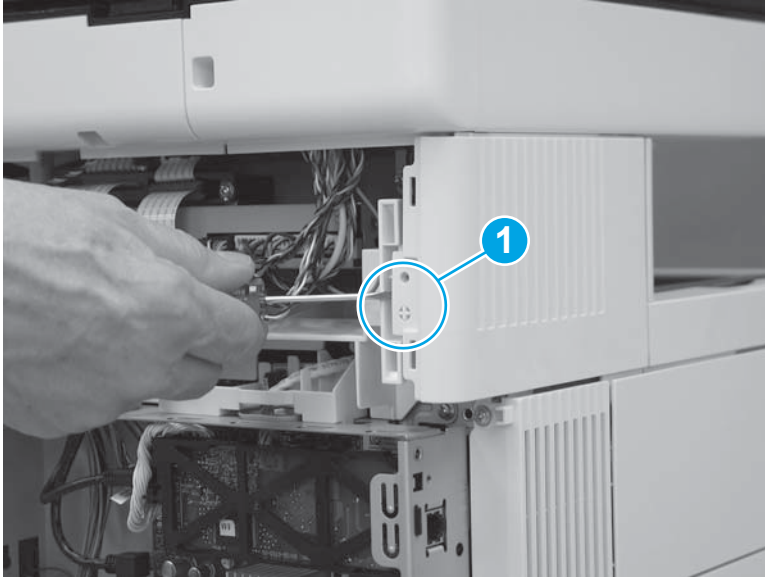

2. Slide the left upper cover toward the back of the printer.

Figure 1-3532 Slide the cover back

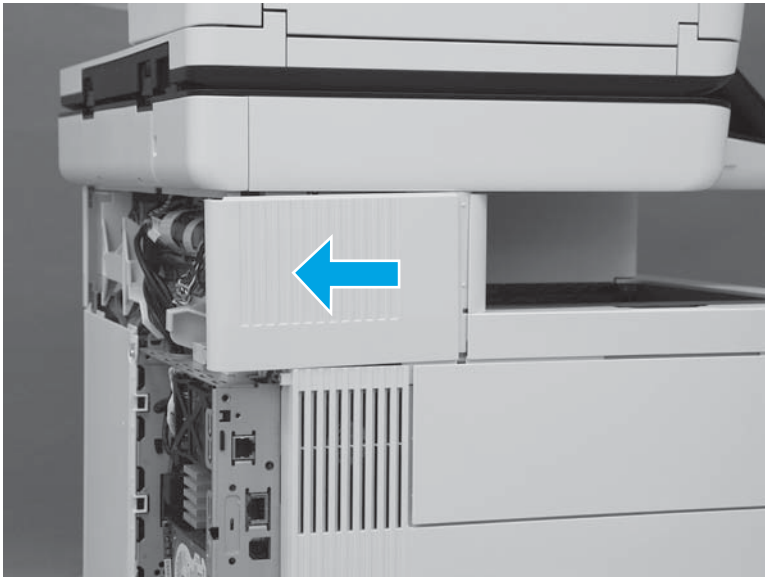

3. Rotate the cover up to remove it.

Figure 1-3533 Remove the left upper cover

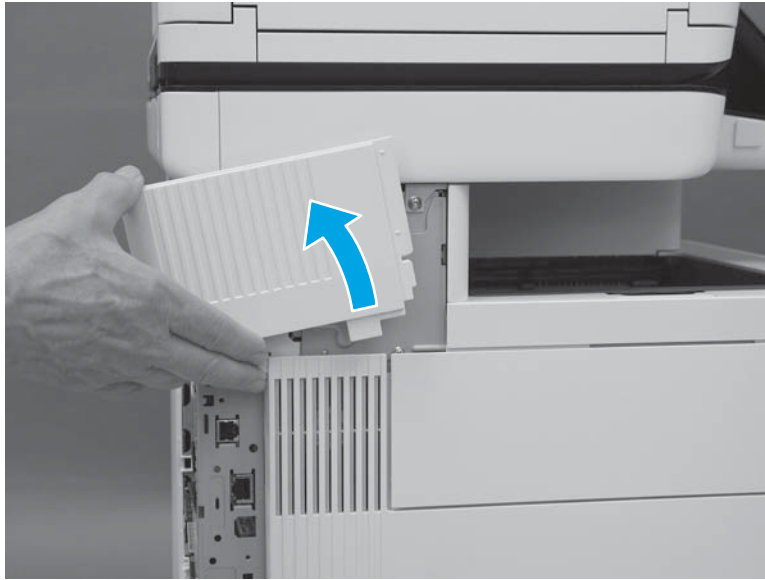

Step 16: Remove the right front upper cover (M577dn)

 **NOTE:** This step is for the M577dn model. For the M577c/f/z models, skip this step and to go [Step 17: Remove the stapler cover assembly \(M577c/f/z\) on page 1986](#).

For the M552 and M553 models, skip this step and go to [Step 25: Remove the left cover on page 2000](#).

1. Remove one screw (callout 1).

Figure 1-3534 Remove one screw

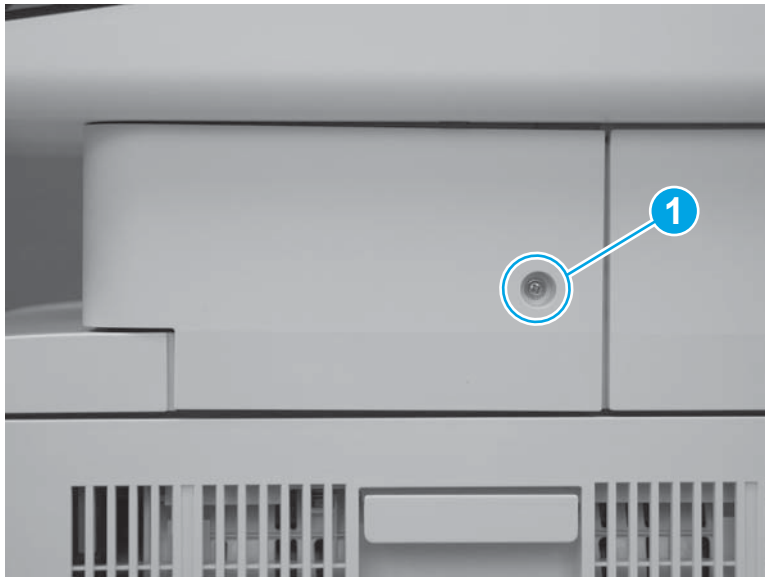

2. Release two tabs at the front edge of the cover (callout 1).

Figure 1-3535 Release two tabs



3. Rotate the front of the cover to the right to remove it.

Figure 1-3536 Rotate the cover



Step 17: Remove the stapler cover assembly (M577c/f/z)

 **NOTE:** This step is for the M577c/f/z models. For the M577dn model, skip this step and go to [Step 20: Remove the right upper cover \(M577\) on page 1992](#).

For the M552 and M553 models, skip this step and go to [Step 25: Remove the left cover on page 2000](#).

1. Remove one screw (callout 1).

 **Reinstallation tip:** This is a self-tapping screw for plastic. When reinstalling, rotate the screw counterclockwise to align it with the existing thread pattern, and then carefully turn it clockwise to tighten. Do not overtighten. This will prevent stripping the threads inside the screw hole.

Figure 1-3537 Remove one screw



2. Release two tabs at the front edge of the cover (callout 1).

Figure 1-3538 Release two tabs

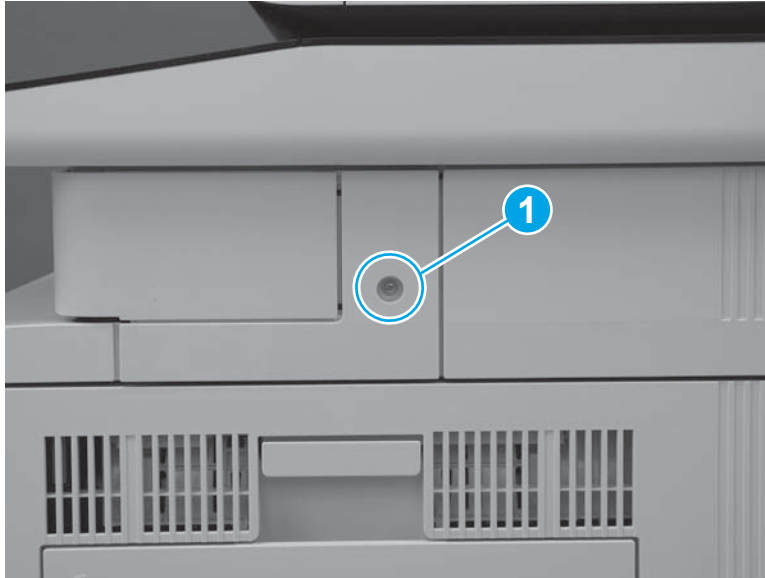

3. Release the back edge of the cover.

Figure 1-3539 Release the back edge of the cover

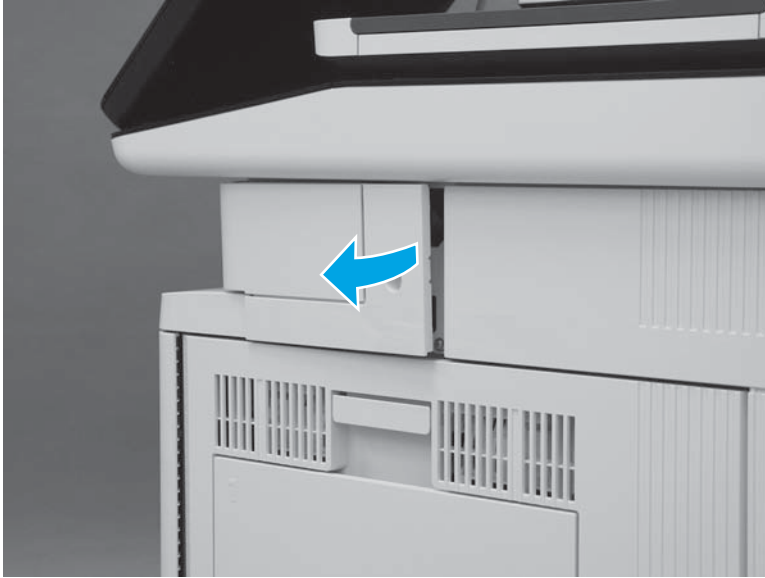



4. Rotate the cover away from the printer to remove it.

Figure 1-3540 Remove the cover



Step 18: Remove the integrated scanner assembly (ISA) (M577)

 **NOTE:** This step is for the M577 models. For the M552 and M553 models, skip this step and go to [Step 25: Remove the left cover on page 2000](#).

 **NOTE:** The ISA includes the document feeder, image scanner, scanner control board (SCB), control panel, keyboard (M577c/z) and NFC PCA (M577z).

1. At the left side of the printer, remove one screw (callout 1).

Figure 1-3541 Remove one screw

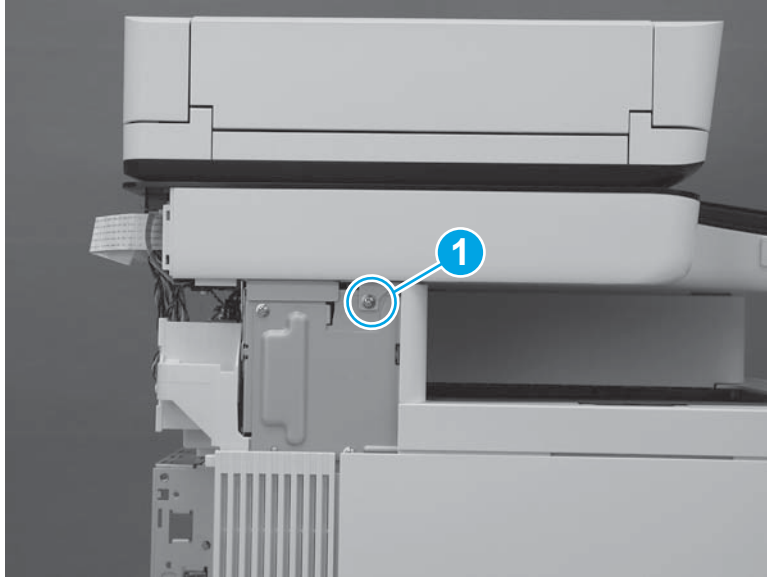

2. At the back side of the printer, remove two screws (callout 1).

Figure 1-3542 Remove two screws

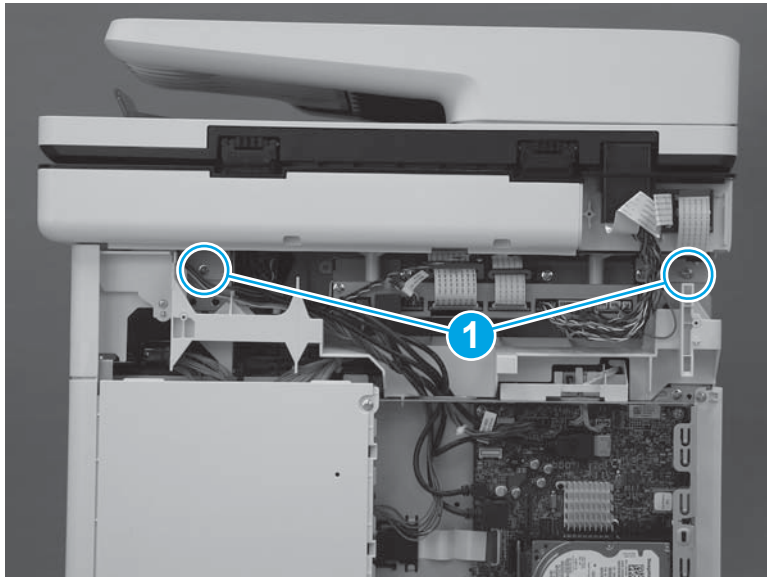

3. At the right side of the printer, remove one screw (callout 1).

Figure 1-3543 Remove one screw

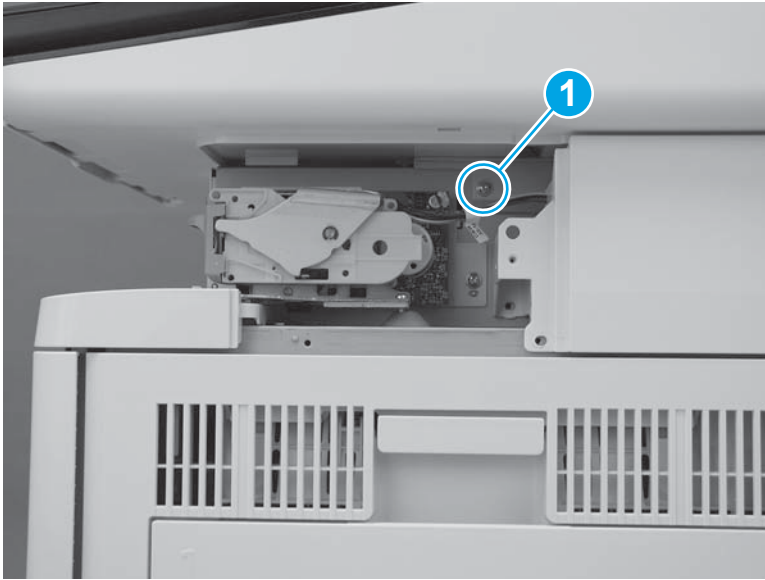

4. Disconnect two connectors on the scanner control board (callout 1).

M577c/f/z only: Disconnect one connector for the stapler on the scanner control board (callout 2).

Figure 1-3544 Disconnect connectors

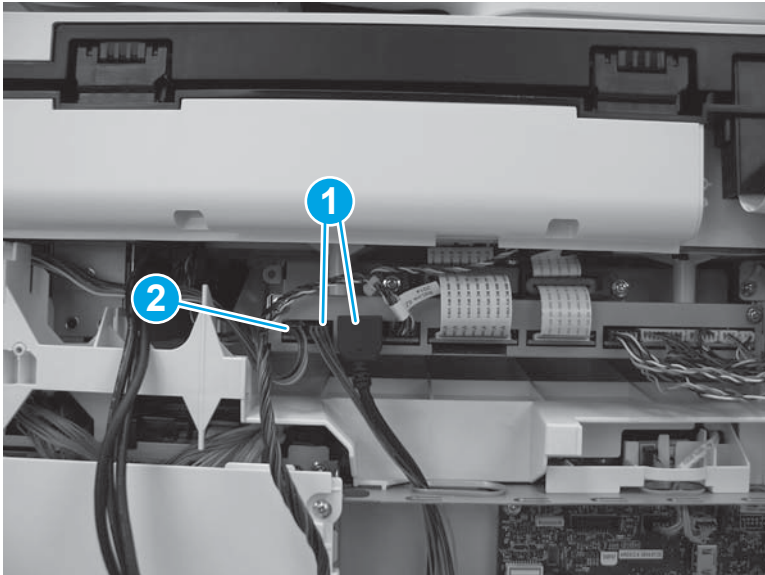

5. Slightly slide the ISA towards the back of the printer to release it.

Figure 1-3545 Slide the ISA towards the back of the printer

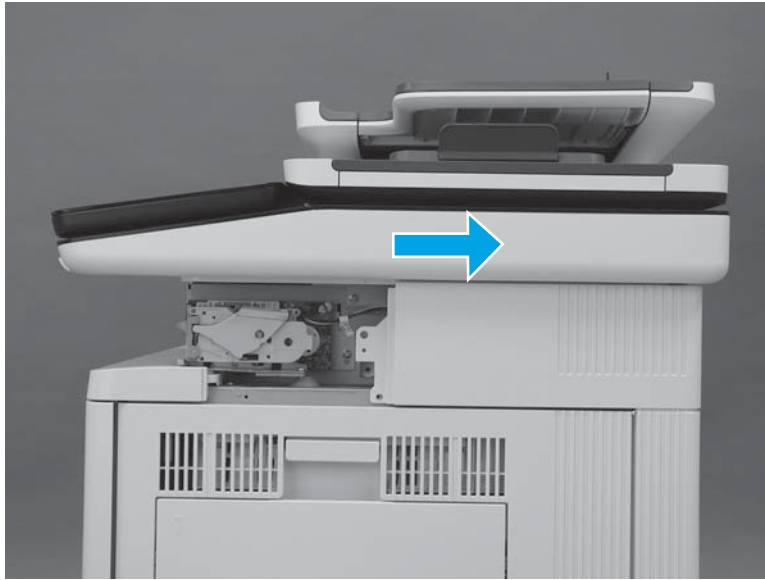

6. Lift the ISA up to remove it.

 **NOTE:** When lifting the ISA, carefully pass the cables through the opening in the top of the formatter case.

Figure 1-3546 Remove the ISA

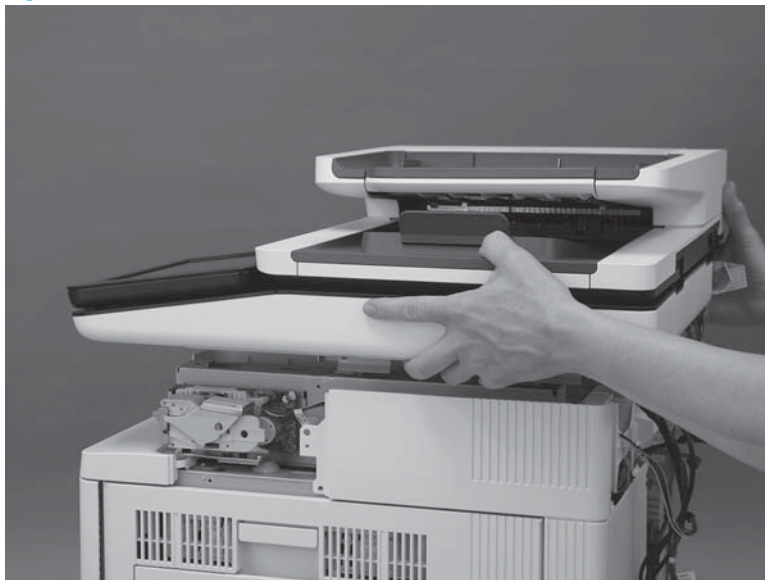

Step 19: Remove the stapler unit (M577c/f/z)

 **NOTE:** This step is for the M577c/f/z models. For the M577dn model, skip this step and to go [Step 21: Remove the top rear cover \(M577\) on page 1994](#).

For the M552 and M553 models, skip this step and go to [Step 25: Remove the left cover on page 2000](#).

1. Disconnect one connector (callout 1), and then remove two screws (callout 2).

Figure 1-3547 Disconnect connector and remove screws

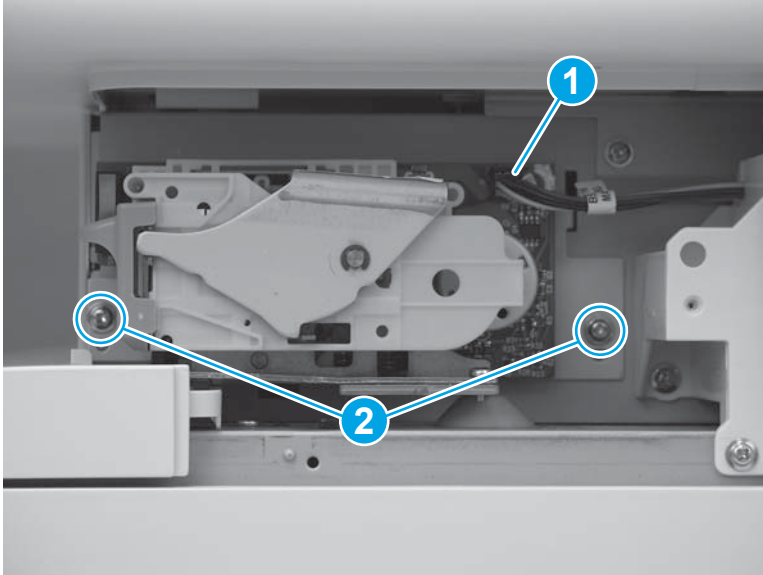

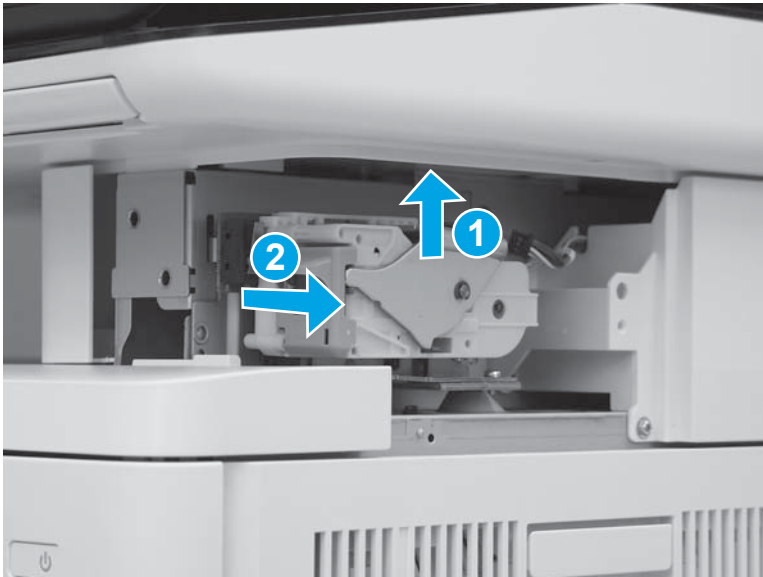

2. Slide the stapler unit up (callout 1), and then pull it away from the printer (callout 2) to remove it.

Figure 1-3548 Remove the stapler unit



Step 20: Remove the right upper cover (M577)

 **NOTE:** This step is for the M577 models. For the M552 and M553 models, skip this step and go to [Step 25: Remove the left cover on page 2000](#).

 **NOTE:** The figures below show the image scanner installed. The procedures for removing and installing the right upper cover are the same whether the image scanner is installed or removed."

1. At the right side of the printer, remove two screws (callout 1).

M577c/f/z only: Disconnect one connector (callout 2), if it was not already disconnected in a previous step.

Figure 1-3549 Remove two screws and one connector

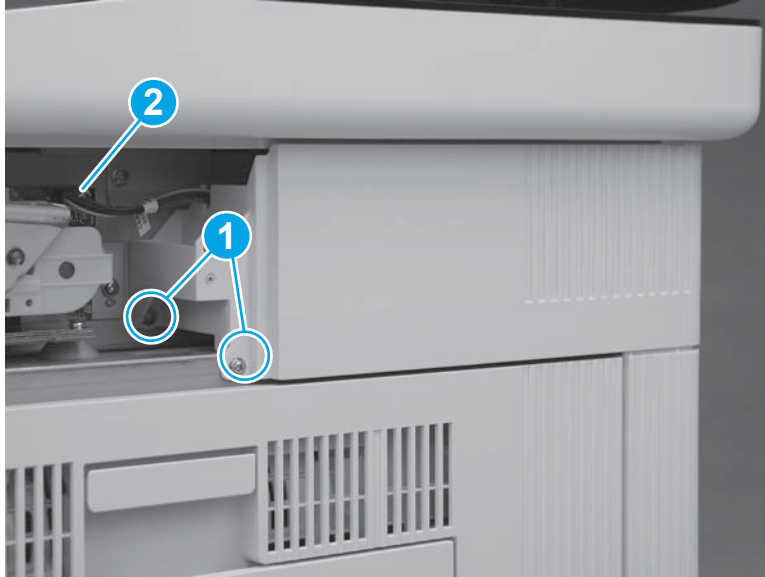

2. At the back of the printer, remove one screw (callout 1).

M577c/f/z only: Disconnect one connector (callout 2), if it was not already disconnected in a previous step.

 **Reinstallation tip:** This screw is smaller than the screws removed in the previous step. When reinstalling the right upper cover, make sure that this screw is installed in the correct position.

Figure 1-3550 Remove one screw and connector



3. Slide the cover toward the back of the printer.

Figure 1-3551 Slide the cover

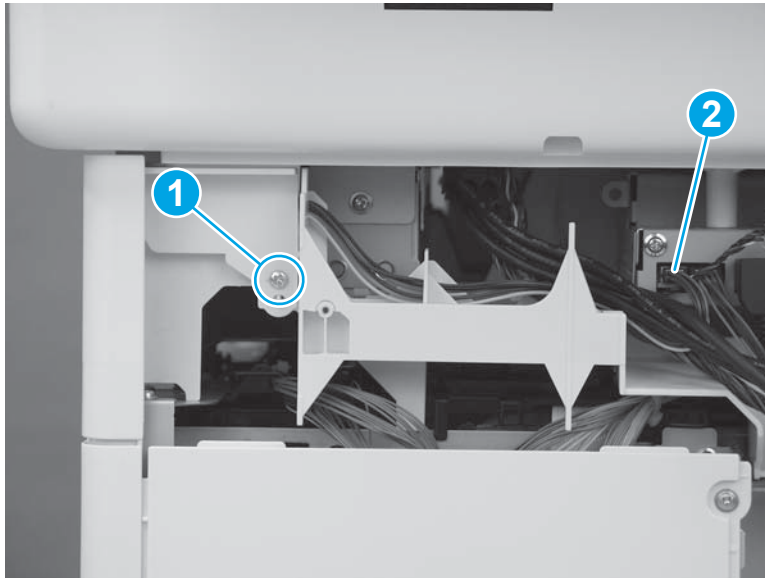
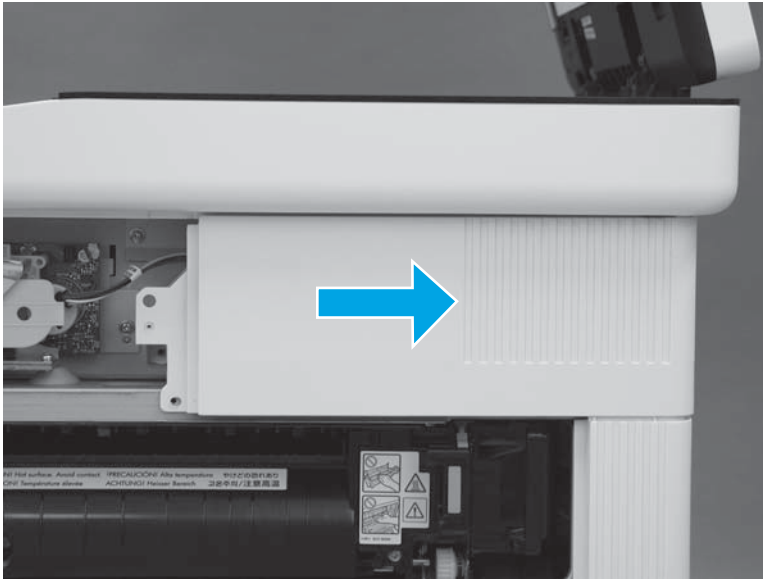

4. Lift the cover away from the printer to remove it.

M577c/f/z only: Release the cables (callout 1) through the slot (callout 2) in the printer.

Figure 1-3552 Remove the cover

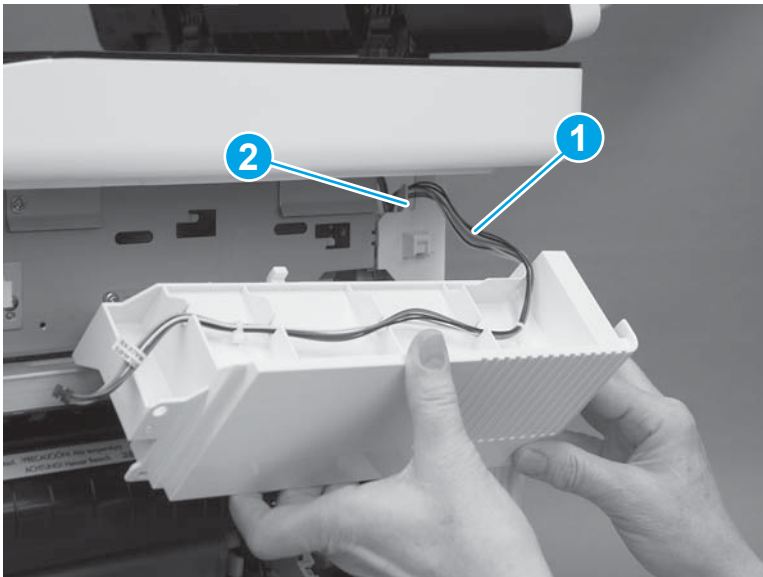

Step 21: Remove the top rear cover (M577)

 **NOTE:** This step is for the M577 models. For the M552 and M553 models, skip this step and go to [Step 25: Remove the left cover on page 2000](#).

1. At the top of the printer, remove five screws (callout 1).

Figure 1-3553 Remove five screws

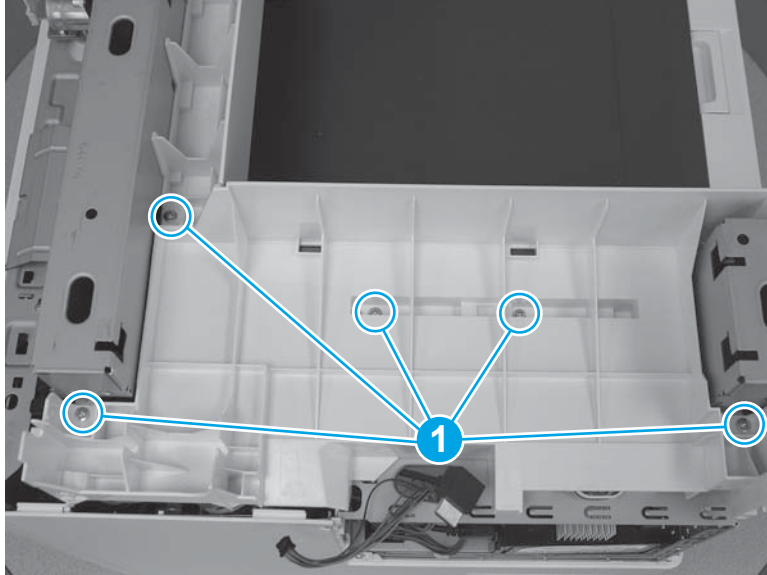

2. Release two tabs (callout 1) on the front edge of the cover.

Figure 1-3554 Release two tabs

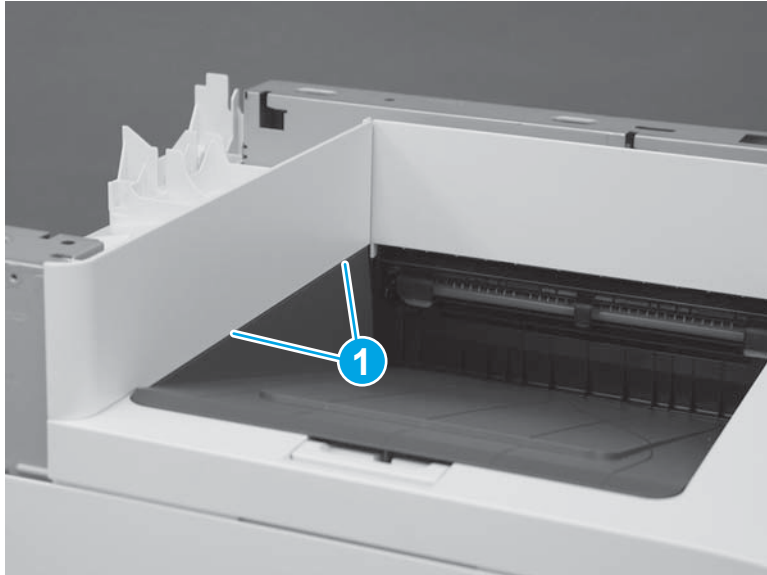

3. Remove the top rear cover.

Figure 1-3555 Remove the top rear cover

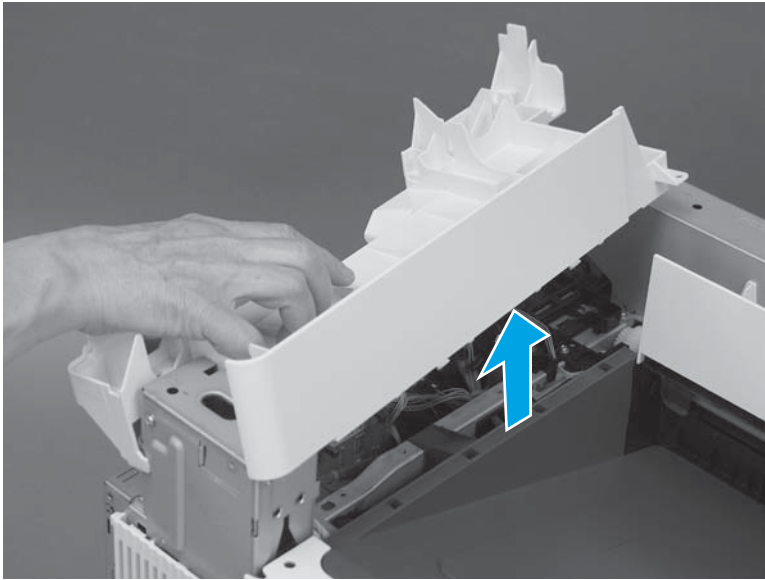

Step 22: Remove the paper feed cover (M577)

 **NOTE:** This step is for the M577 models. For the M552 and M553 models, skip this step and go to [Step 25: Remove the left cover on page 2000](#).

1. Remove one screw (callout 1).

Figure 1-3556 Remove one screw

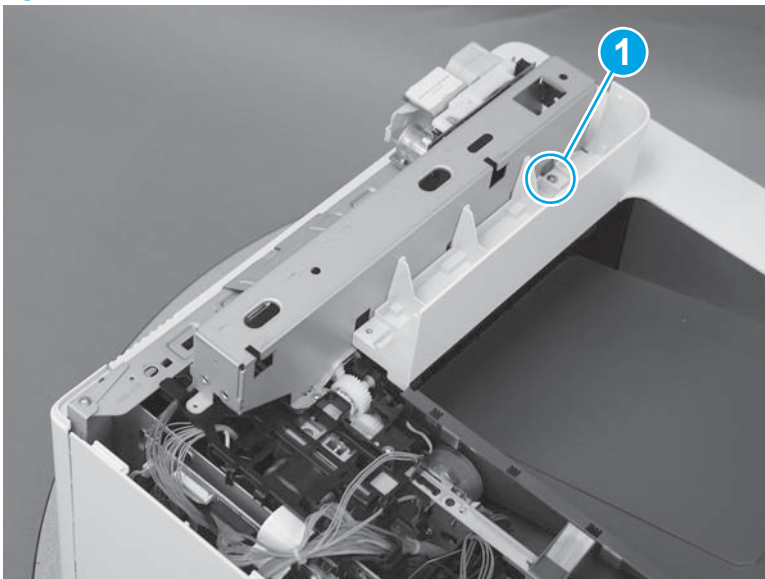

2. Lift the cover up to remove it.

Figure 1-3557 Remove the cover

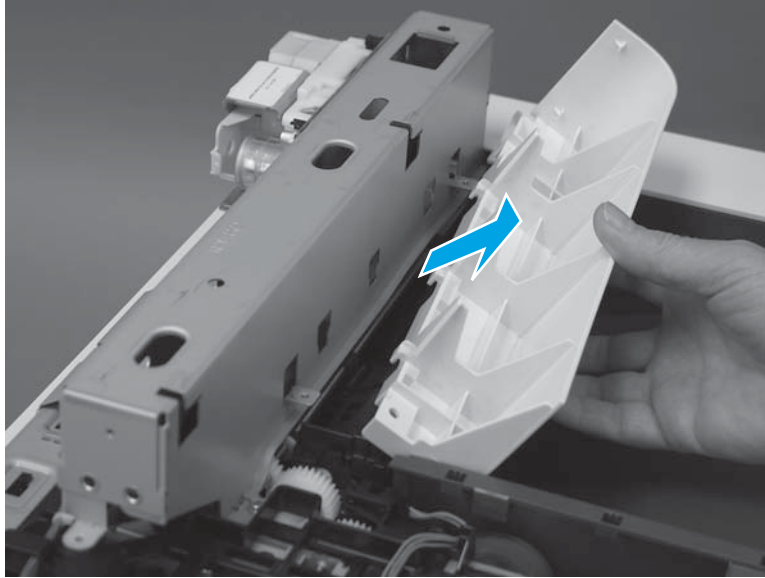

Step 23: Remove the top cover (M577)

 **NOTE:** This step is for the M577 models. For the M552 and M553 models, skip this step and go to [Step 25: Remove the left cover on page 2000](#).

1. At the front of the printer, remove one screw (callout 1).

 **Reinstallation tip:** This screw is longer and a different type of screw than the screw removed in the next step. When reinstalling the top cover, make sure that this screw is installed in the correct position.

Figure 1-3558 Remove one screw



2. At the left side of the printer, remove one screw (callout 1).

Figure 1-3559 Remove one screw

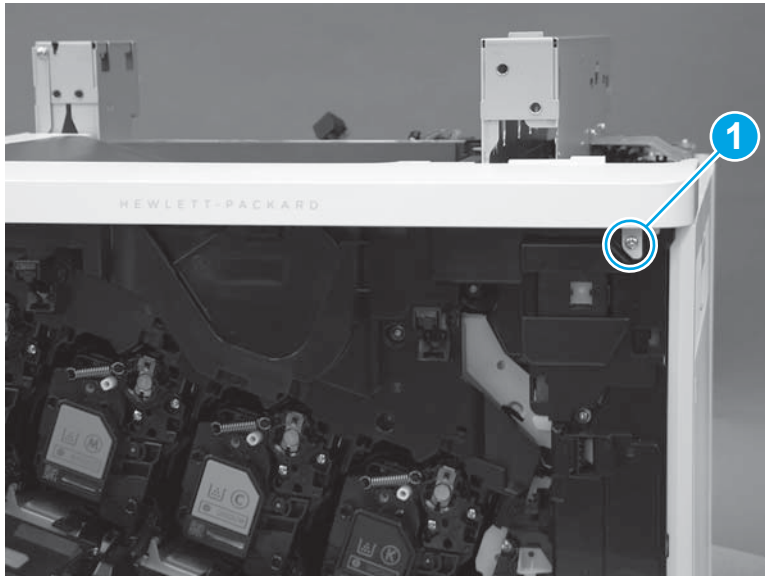
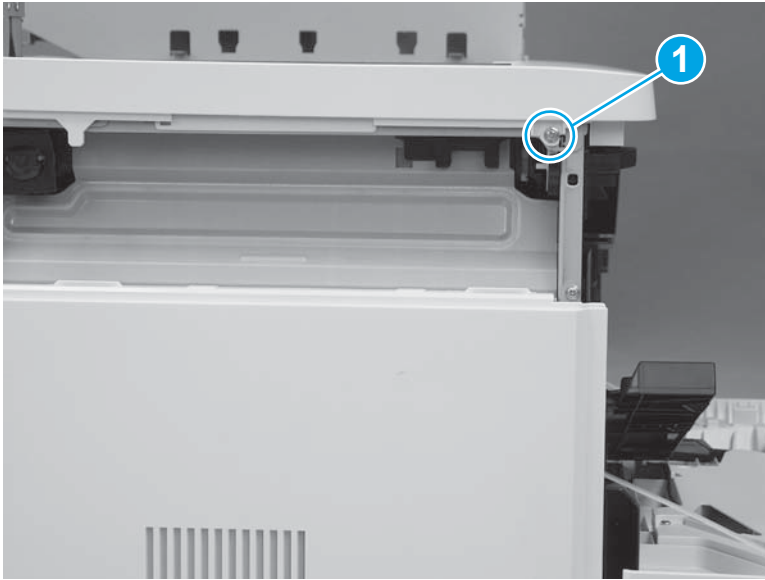

3. At the front of the printer, release one tab (callout 1).

Figure 1-3560 Release one tab

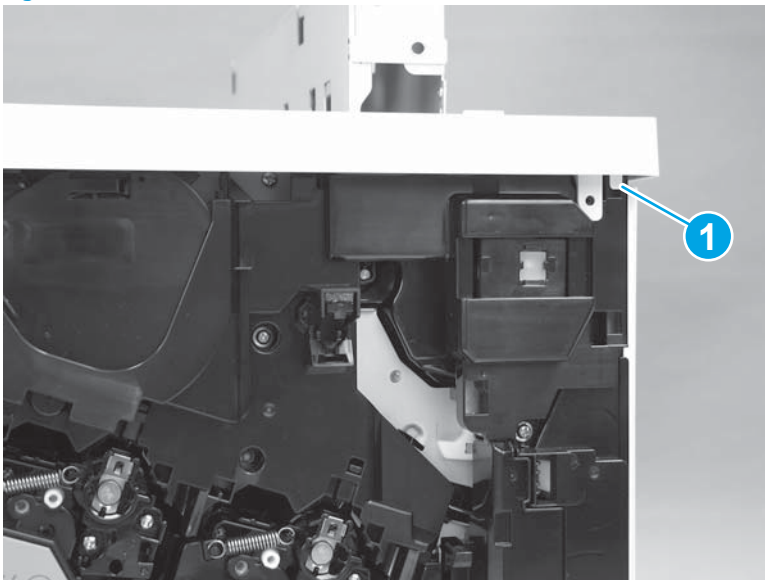

4. At the top of the printer, release two tabs (callout 1) next to the output bin, and then remove the top cover.

Figure 1-3561 Release two tabs

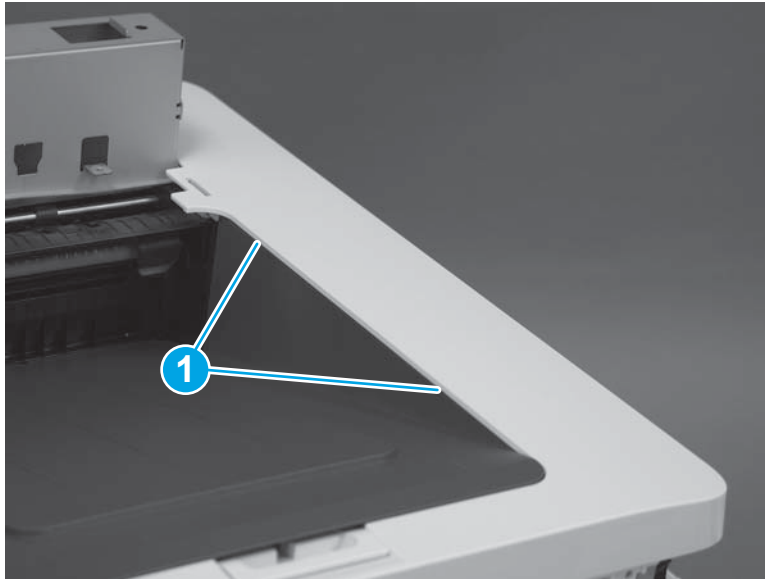

Step 24: Remove the top bracket (M577)

 **NOTE:** This step is for the M577 models. For the M552 and M553 models, skip this step and go to [Step 25: Remove the left cover on page 2000](#).

1. At the top of the printer, remove three screws (callout 1).

Figure 1-3562 Remove three screws

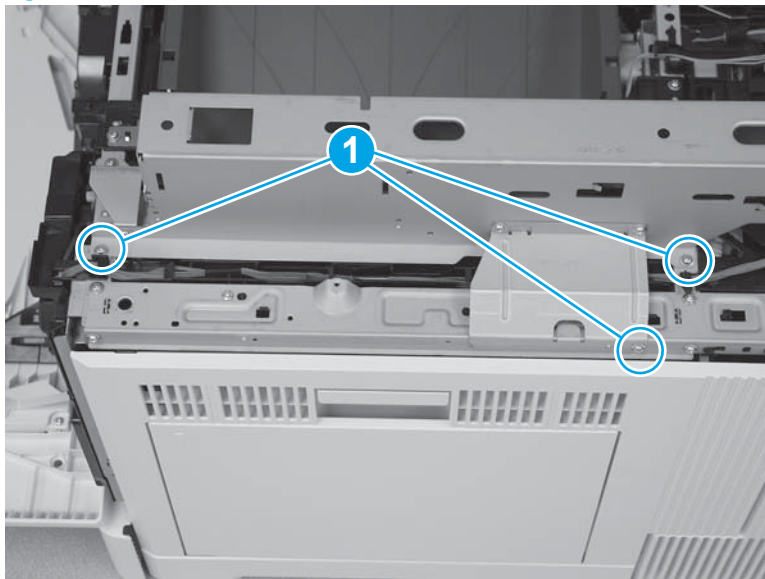

2. At the top of the printer, remove two screws (callout 1).

Figure 1-3563 Remove two screws

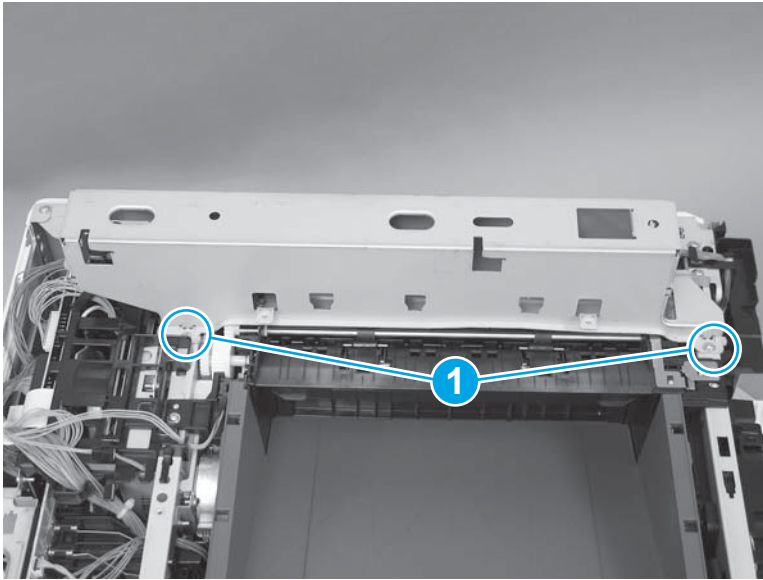

3. Lift the top bracket up to remove it.

Figure 1-3564 Remove the bracket

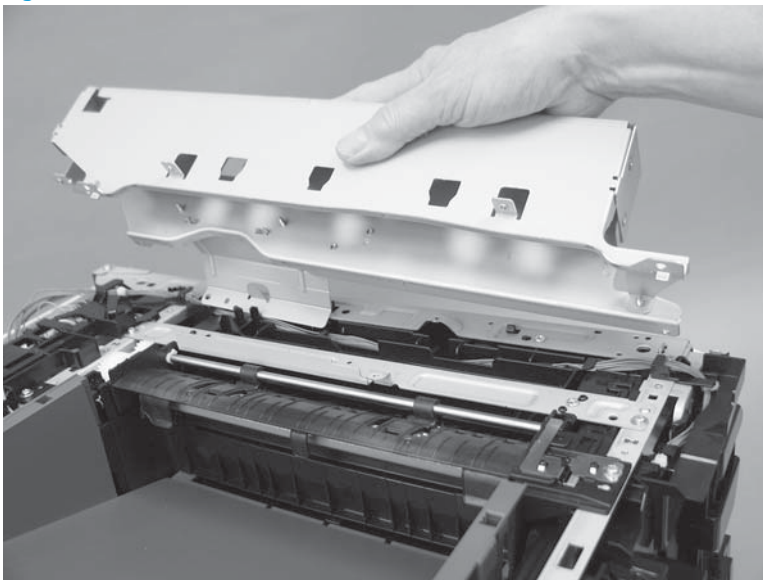

Step 25: Remove the left cover

1. At the left side of the printer, remove one screw (callout 1).

Figure 1-3565 Remove one screw



2. Release one tab (callout 1), rotate the front edge of the cover away from the printer (callout 2), and then slide the cover (callout 3) toward the rear of the printer to release it.

Figure 1-3566 Release the cover

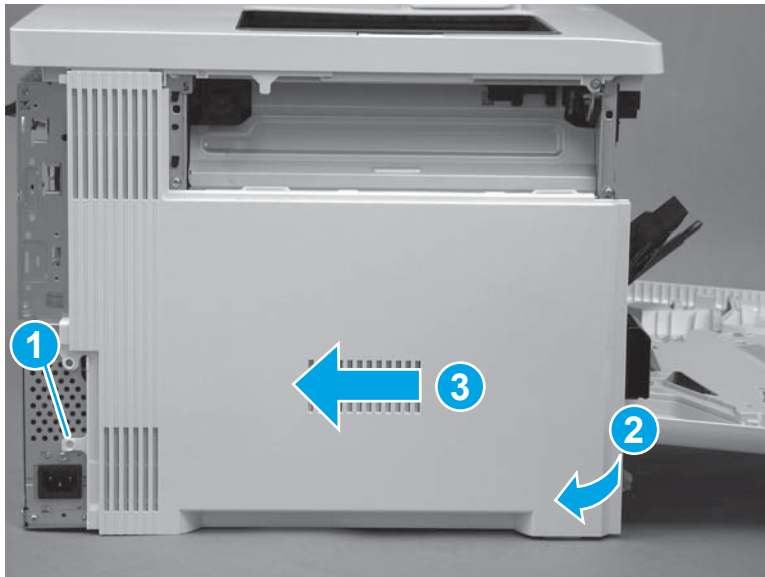

3. Remove the cover.

Figure 1-3567 Remove the cover

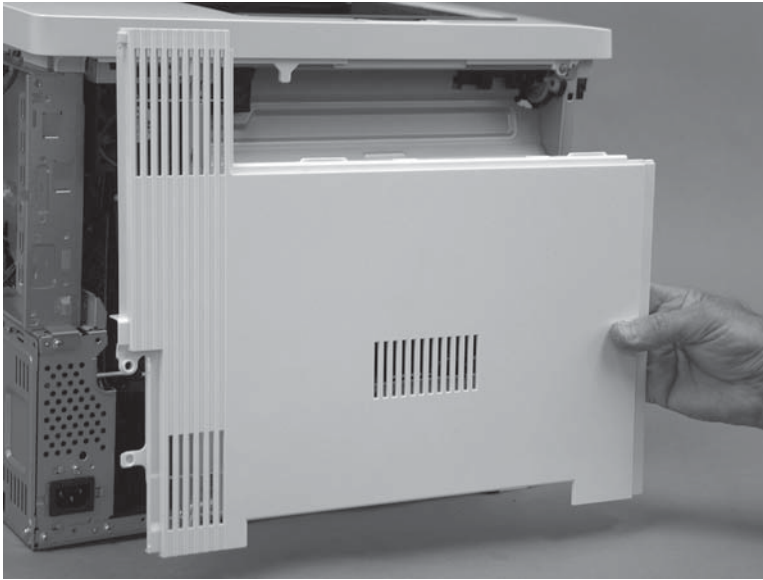

Step 26: Remove the upper cover (M552 and M553)

 **NOTE:** This step is for the M552 and M553 models. For the M577 models, skip this step and go to [Step 29: Remove the formatter case on page 2007](#).

1. Remove three screws (callout 1).

Figure 1-3568 Remove three screws

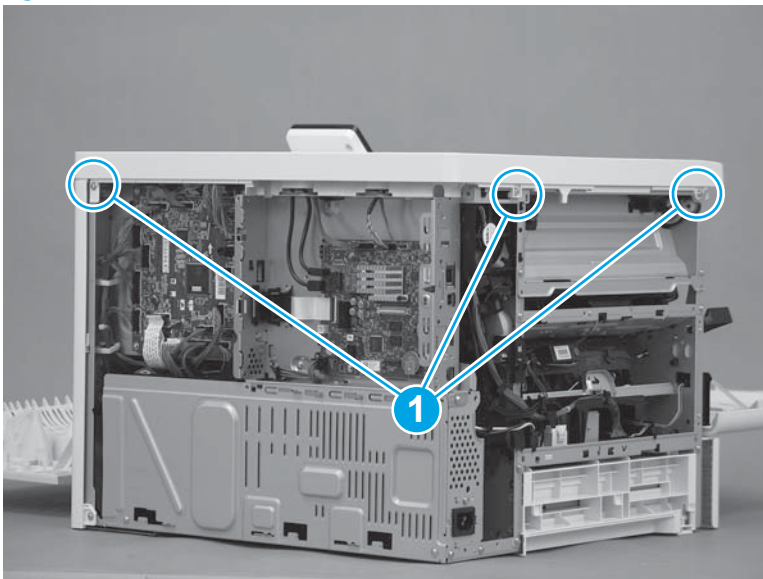

2. Remove one screw (callout 1), release one tab (callout 2), and then slightly separate the corner of the cover from the chassis.

 **NOTE:** This is a self-tapping plastic-thread screw. Make sure that this screw is used in this location when it is reinstalled.

Figure 1-3569 Remove one screw and release one tab



3. Release one tab (callout 1), and then lift up on the cover to release it.

 **NOTE:** If the cover does not release, check for addition tabs by locating the triangles embossed in the cover at tab locations.

Figure 1-3570 Release the cover



4. Remove the cover.

Figure 1-3571 Remove the cover

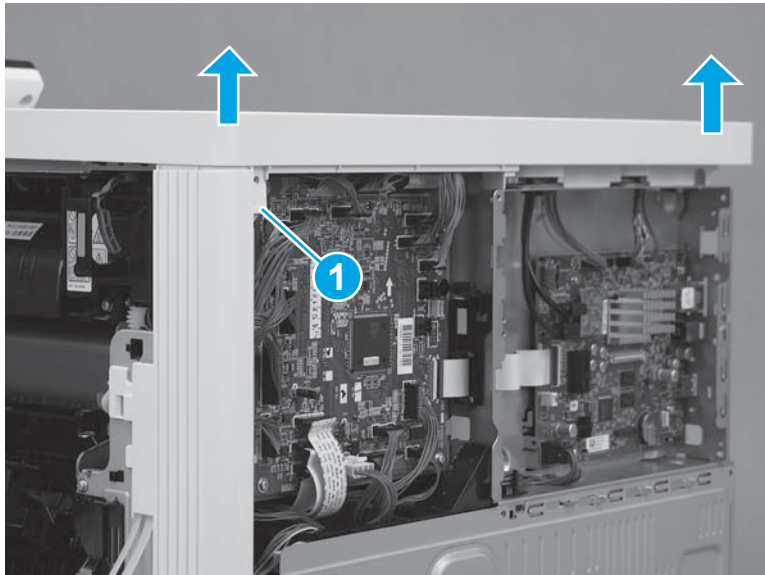
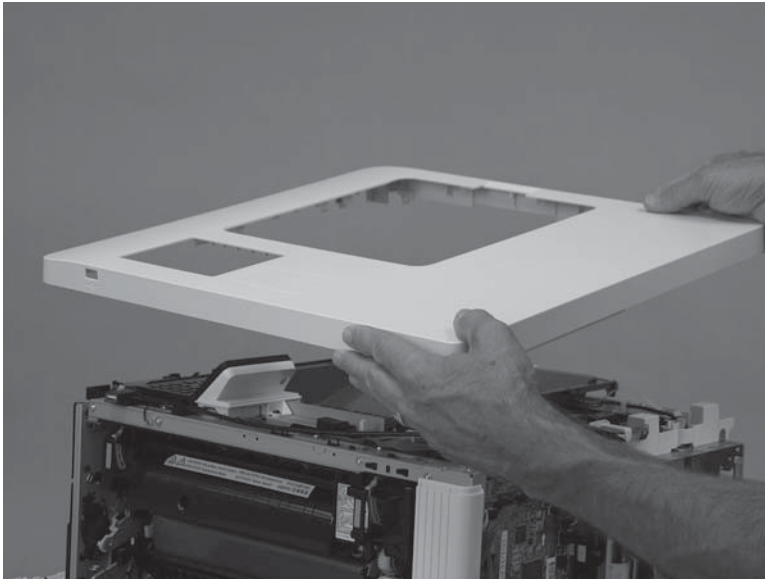

Step 27: Remove the control panel (M553n/dn and M552dn only)

 **NOTE:** This step is for the M553n/dn and M552dn models. For the M553x and M577 models, skip this step and go to [Step 28: Remove the output bin on page 2006](#).

1. Remove one screw (callout 1).

Figure 1-3572 Remove one screw

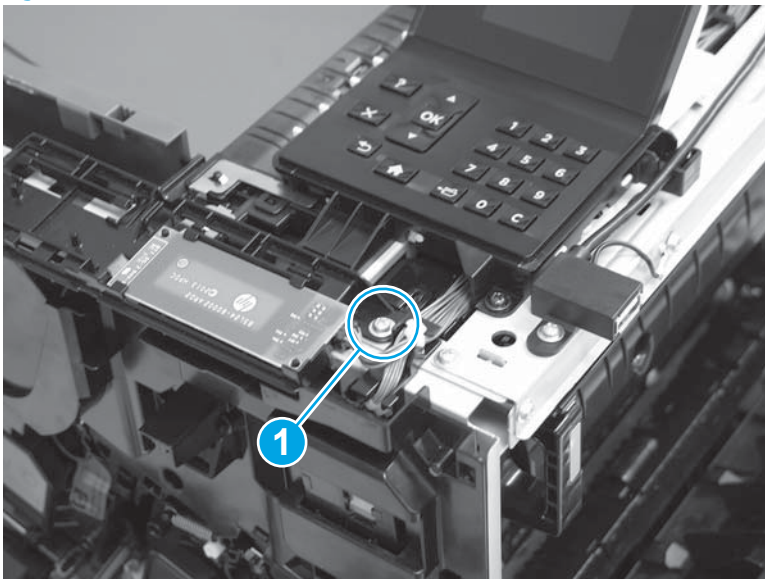

2. Disconnect one connector (callout 1). Rotate the near field communication (NFC) PCA holder up (callout 2), and then slide it to the right (callout 3) to remove it.

Figure 1-3573 Remove the PCA holder

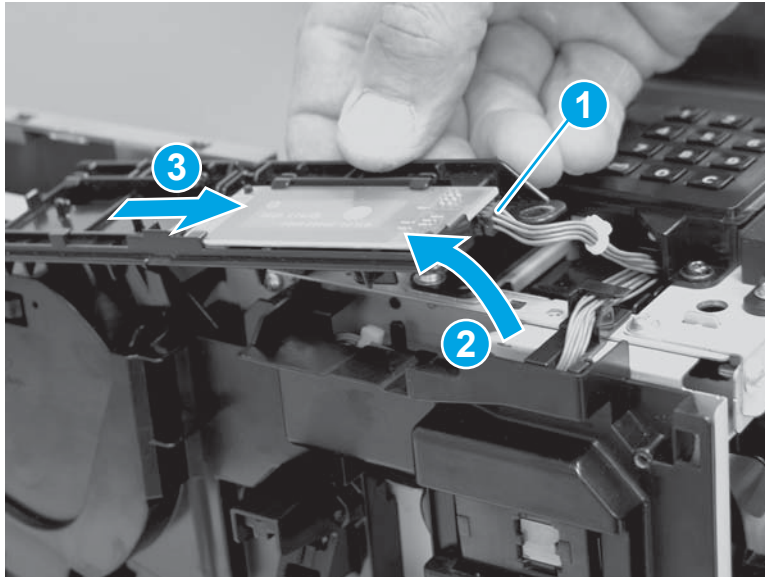

3. Remove one cable from the guide.

Figure 1-3574 Remove one cable



4. Remove four screws (callout 1), and then turn the control panel over (callout 2) to access the bottom side.

⚠ CAUTION: The control panel is still attached to the printer. Do not attempt to completely remove the control panel.

Figure 1-3575 Remove four screws

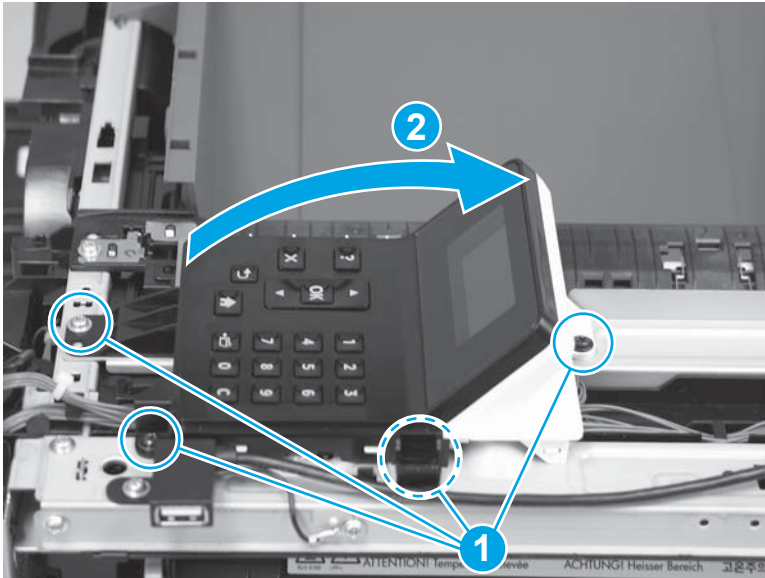

5. Disconnect one connector (callout 1), and then remove the control panel.

Figure 1-3576 Remove the control panel

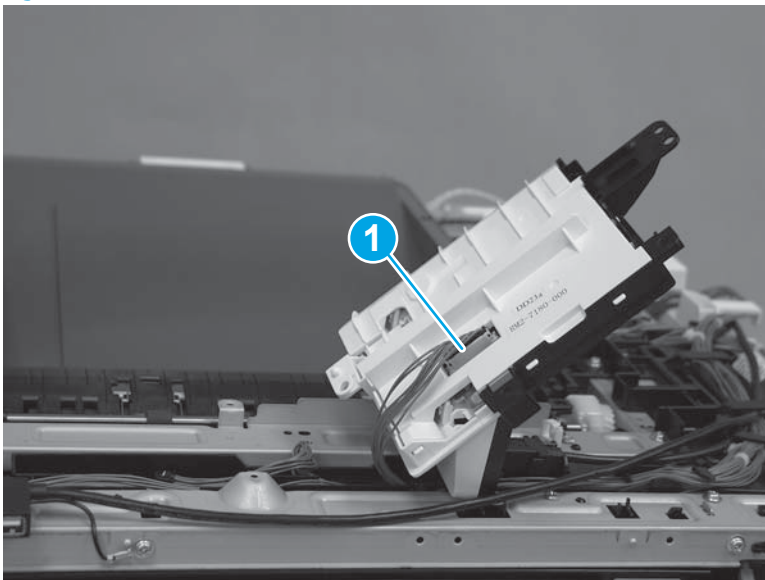

Step 28: Remove the output bin

1. Slightly slide and lift the cover to release it.

Figure 1-3577 Release the cover

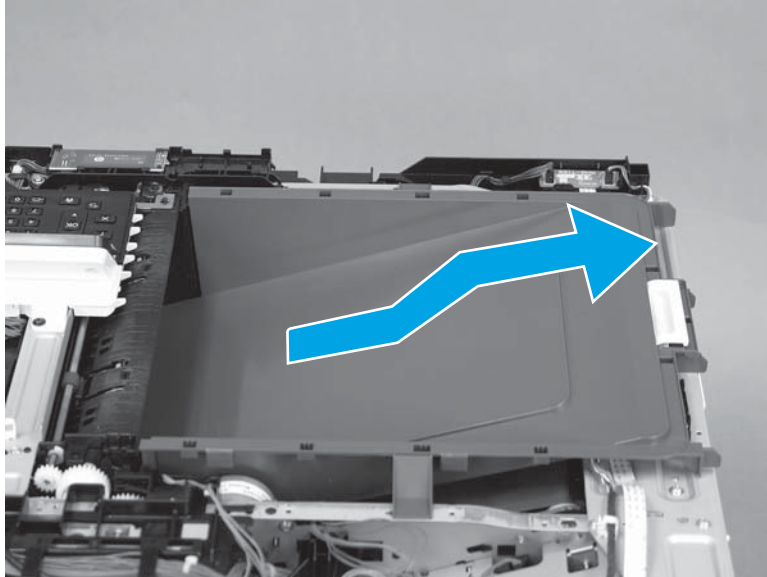

2. Remove the cover.

Figure 1-3578 Remove the cover

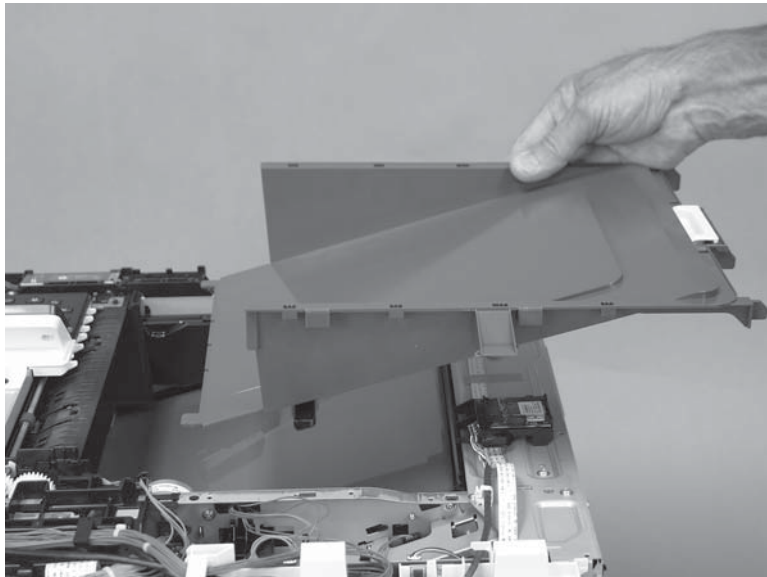

Step 29: Remove the formatter case

1. **M577 only:** Disconnect one connector (callout 1), and then pass the wire harness (callout 2) through two openings in the formatter case (callout 3).

Figure 1-3579 Disconnect one connector

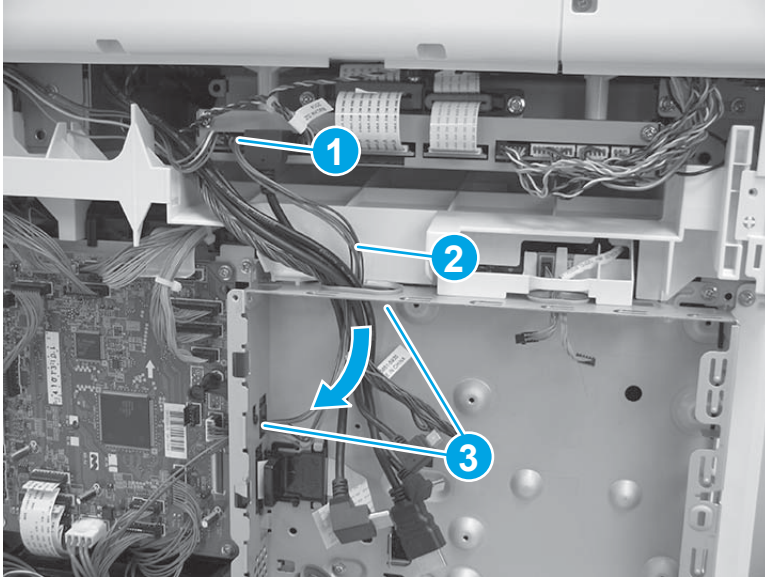

2. Release two tabs (callout 1) on the black plastic bracket. Hold the tabs in the released position, and then slide the bracket (callout 2) to the right to remove it from the formatter case.

Figure 1-3580 Remove the bracket

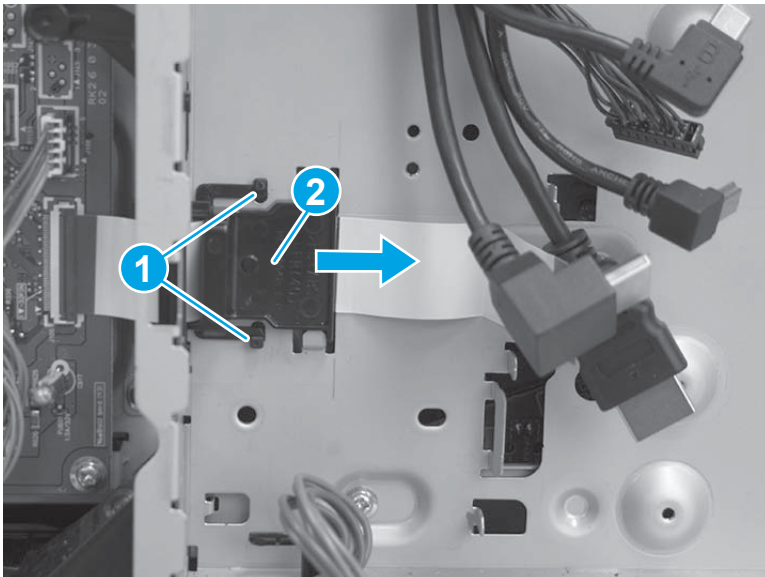

3. Remove two screws (callout 1), and then slide the low-voltage power supply (LVPS) cover to the right to remove it.

Figure 1-3581 Remove the LVPS cover

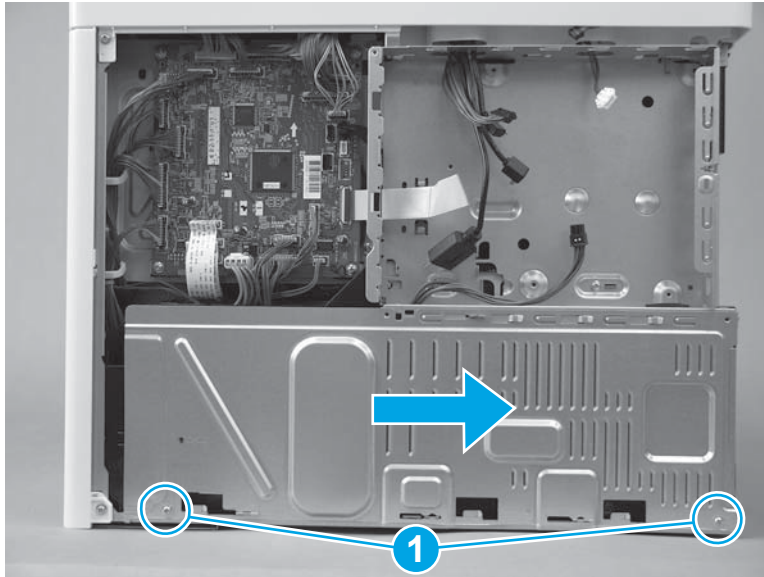

4. Pass two wire harnesses and one flat cable (callout 1) through the opening in the formatter case, and then release one wire harness from the retainer (callout 2).

⚠ CAUTION: The flat cable might be attached to the formatter case with double-sided tape. Make sure that this tape is released, so that the flat cable is not damaged when the formatter case is removed.

Figure 1-3582 Release wire harnesses and flat cable

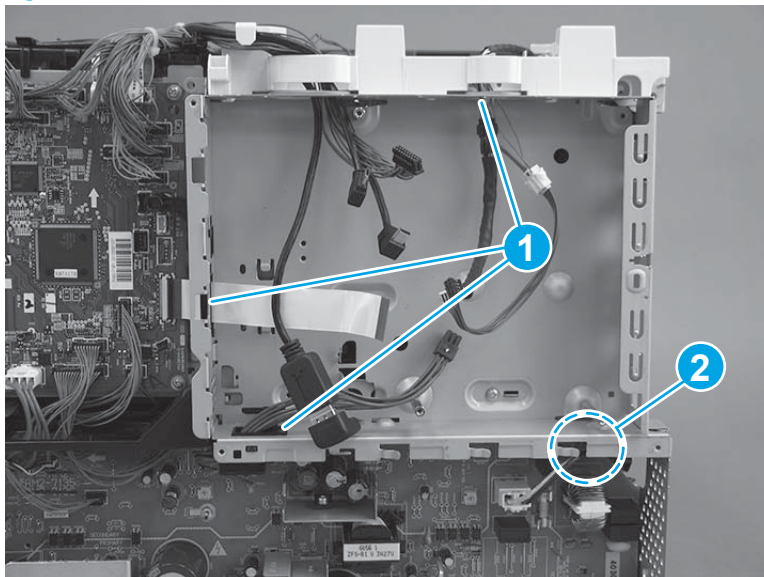

5. Remove six screws (callout 1).

Figure 1-3583 Remove six screws

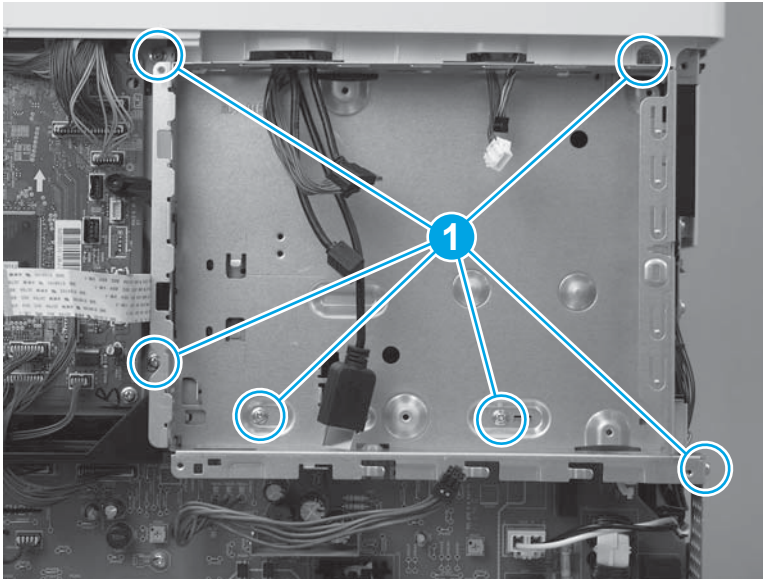

6. Rotate the bottom of the formatter case away from the printer (callout 1), and then pull it down (callout 2) to release it.

Figure 1-3584 Release the formatter case

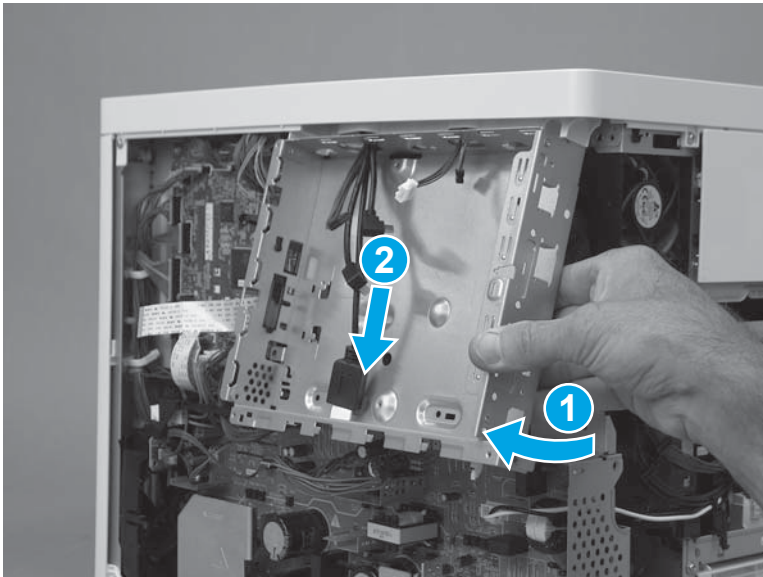

7. Pass the wire harnesses through the opening in the formatter case to remove it.

 **IMPORTANT:** If the formatter case is removed so that it can be replaced, make sure to transfer the memory PCA (island of data) and plastic bracket (callout 1) to the replacement case.

Figure 1-3585 Remove the formatter case



Step 30: Remove the right rear cover

1. Remove one screw (callout 1), and then slide the cover toward the rear of the printer (callout 2) to release it.

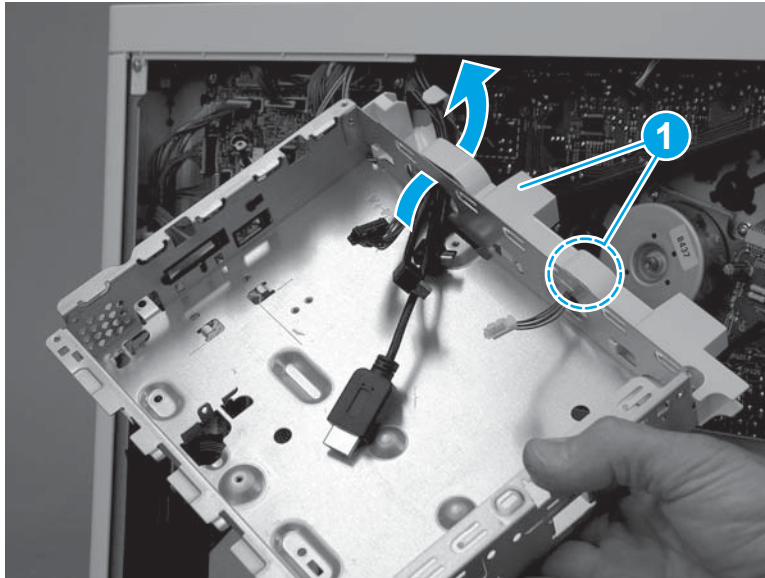
 **TIP:** If the right door is closed, open it now.

Figure 1-3586 Release the cover



2. Remove the cover.

Figure 1-3587 Remove the cover

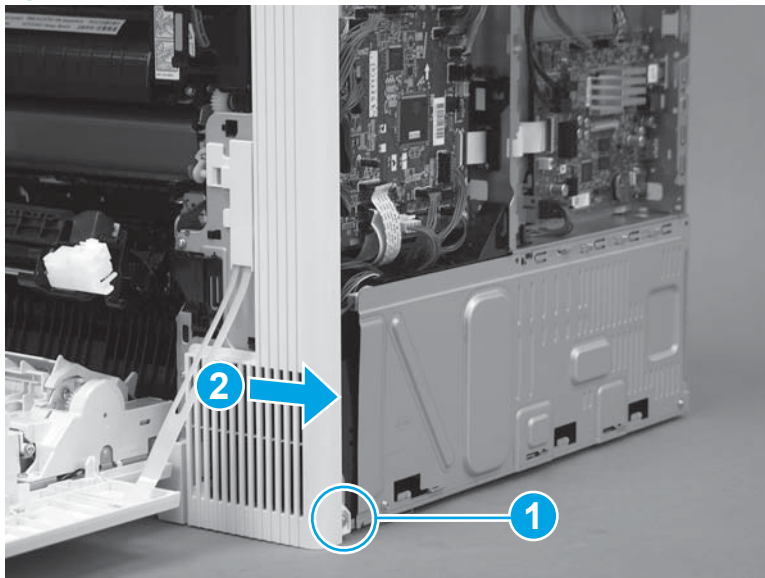
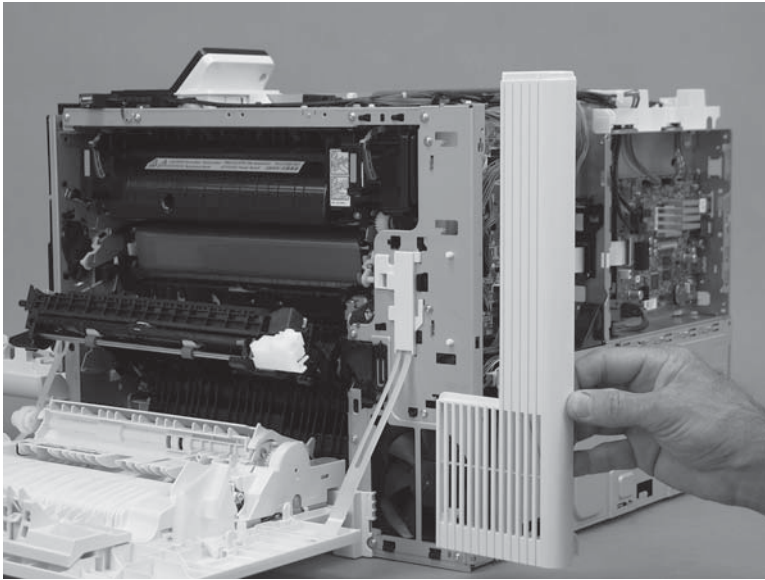

Step 31: Remove the DC controller and sheet-metal bracket

 **NOTE:** Some of the connectors shown in this procedure might already be disconnected. Disconnect all remaining connectors to remove the DC controller.

 **CAUTION:**  ESD sensitive part.

1. Disconnect all of the connectors, and then remove two screws (callout 1).

The following connectors are empty:

- J140, J141, and J143

Figure 1-3588 Remove two screws

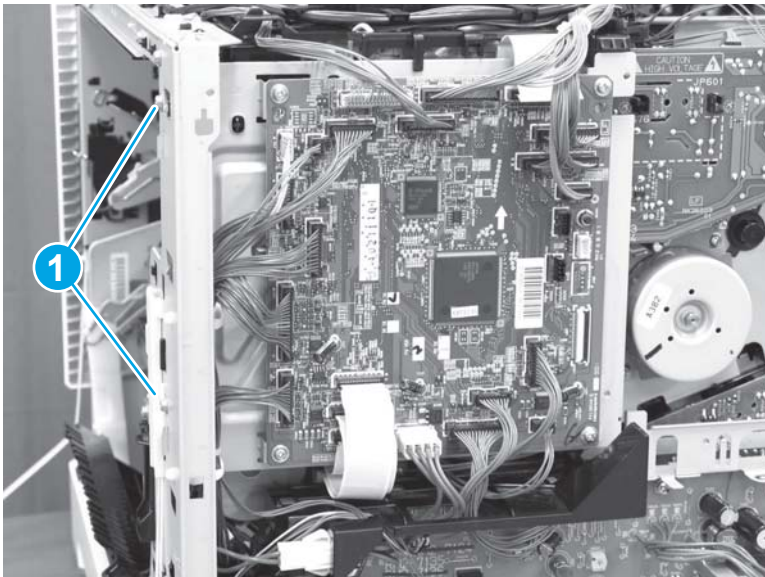

2. Lift up on the DC controller and sheet-metal plate to remove it.

Figure 1-3589 Remove the plate

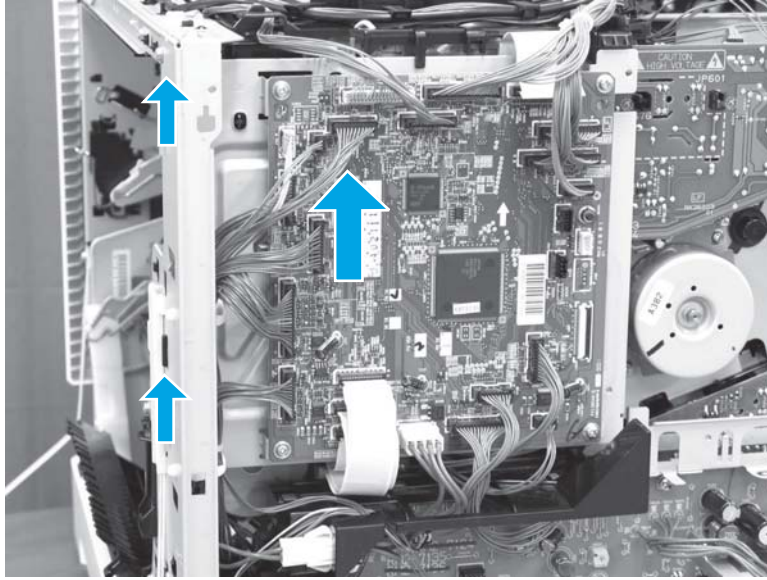

Step 32: Remove the high-voltage power supply T (HVPST)

 **CAUTION:**  ESD-sensitive part.

1. Disconnect five connectors (callout 1), and then disconnect one flat cable (callout 2).

Figure 1-3590 Disconnect five connectors and one flat cable

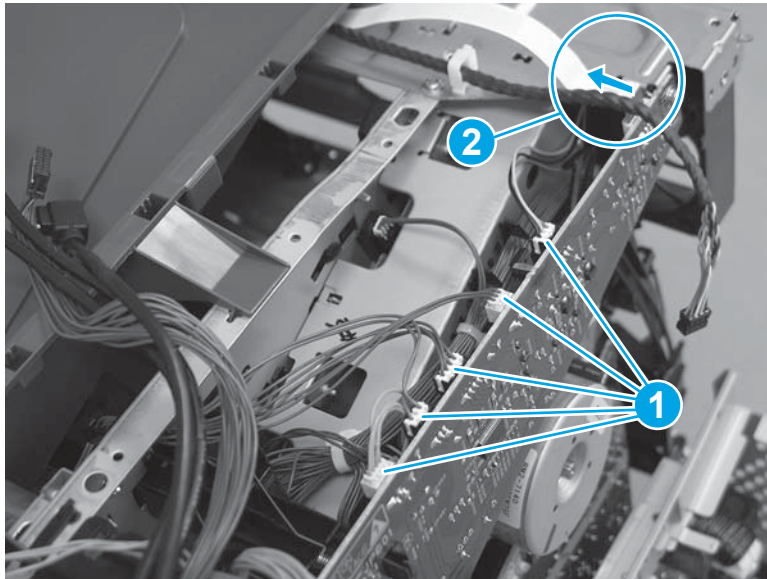

2. Remove one screw (callout 1).

Figure 1-3591 Remove one screw

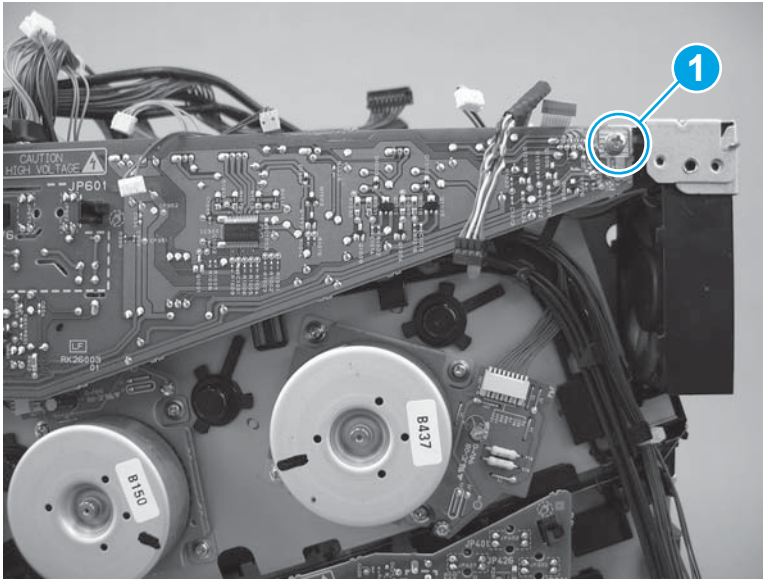

3. Release two tabs (callout 1), and then separate the HVPST from the printer.

⚠ CAUTION: Do not attempt to completely remove the HVPST. It is still connected to the printer by ground wire harness.

Figure 1-3592 Release the HVPST

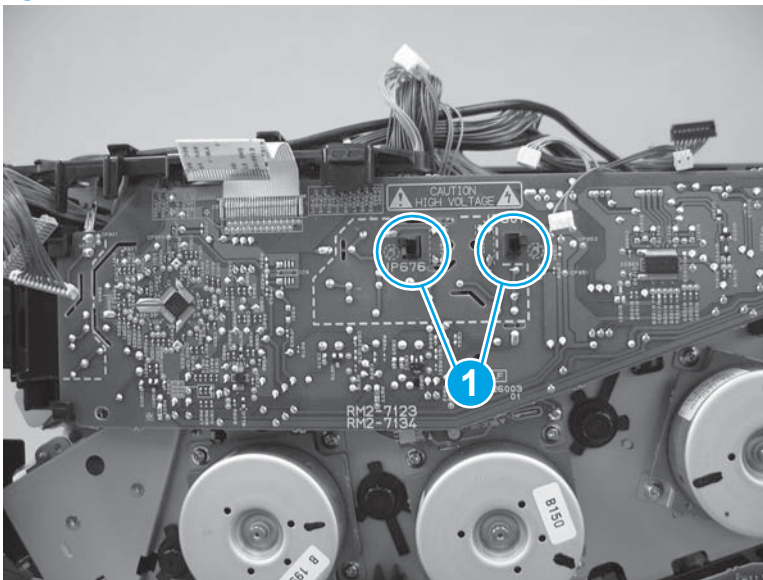

4. Release one ground wire connector (callout 1), and then remove the HVPST.

Figure 1-3593 Remove the HVPST

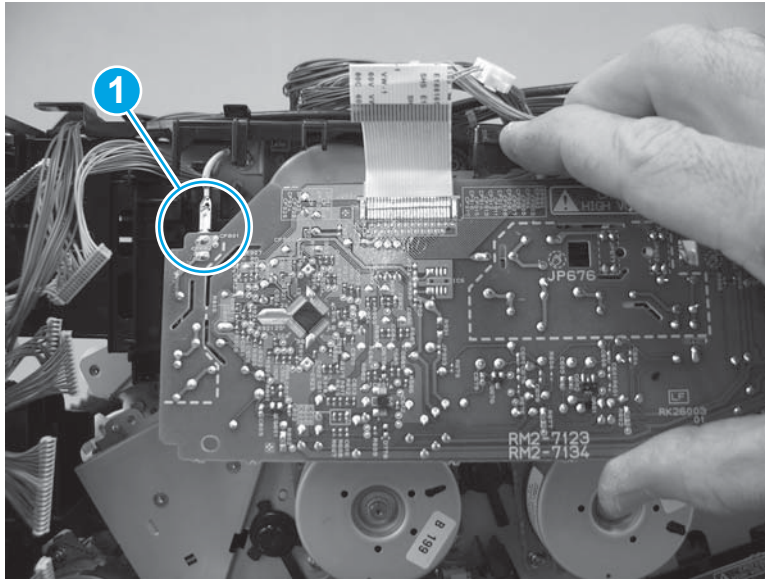

Step 33: Remove the fuser drive assembly

1. Release one tab (callout 1), slide the guide to release it (callout 2), and then rotate the guide up and away from the chassis to move it out of the way (callout 3).

⚠ CAUTION: One wire harnesses in the guide is still attached to the fuser motor. Do not attempt to completely remove the guide.

Figure 1-3594 Move the guide out of the way

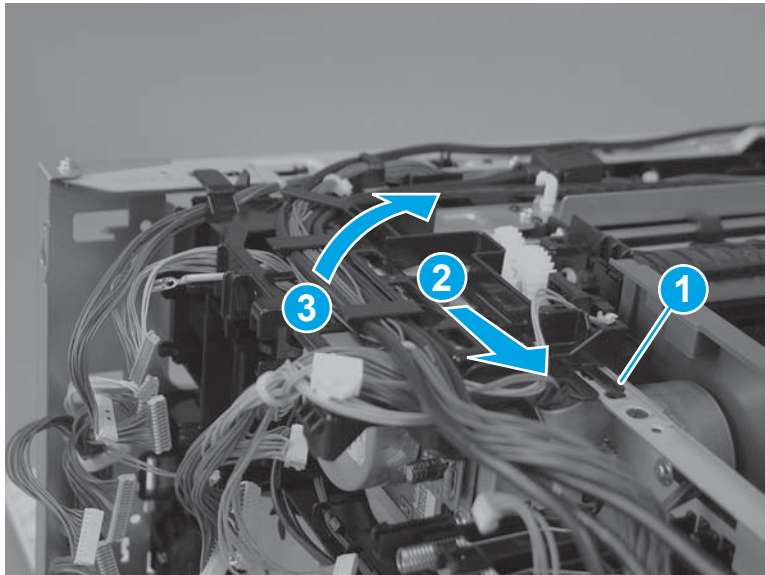

2. Disconnect one connector (callout 1).

Figure 1-3595 Disconnect one connector

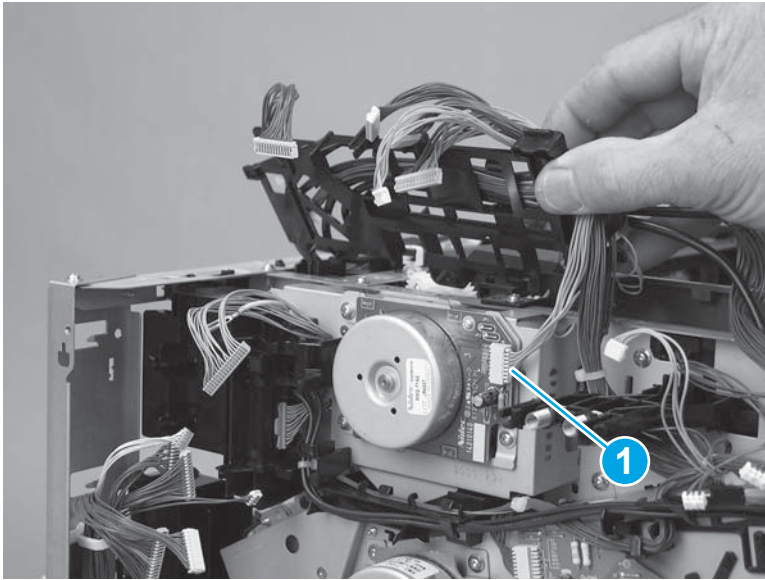

3. Remove one screw (callout 1).

Figure 1-3596 Remove one screw

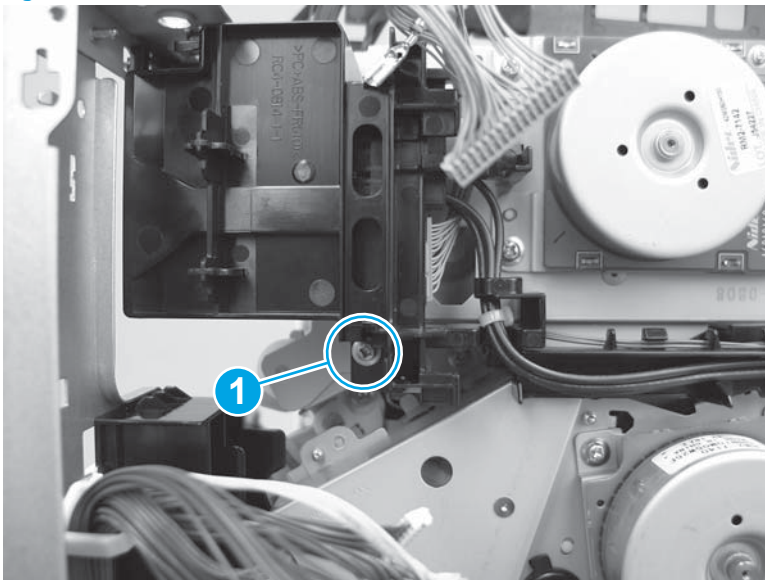

4. Release one tab (callout 1), slide the guide down to release it (callout 2), and then rotate the guide away from the chassis to remove it (callout 3).

Figure 1-3597 Remove the guide

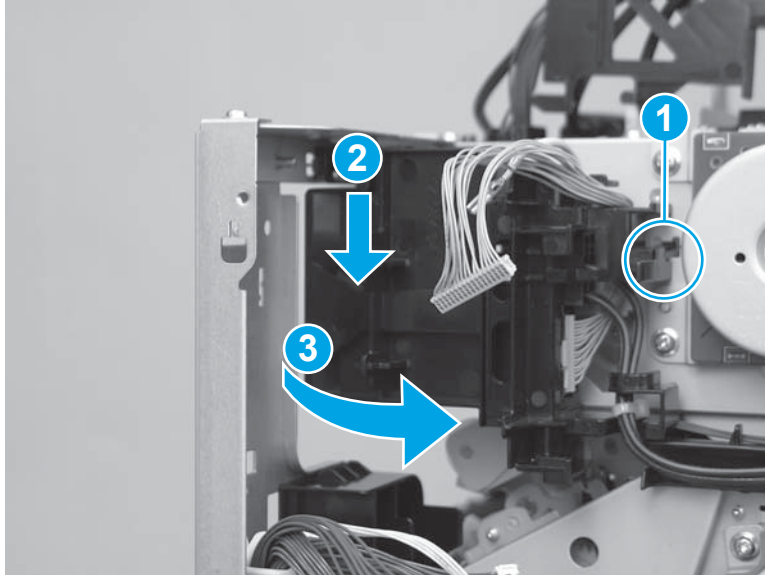

5. Remove three screws (callout 1).

Figure 1-3598 Remove three screws

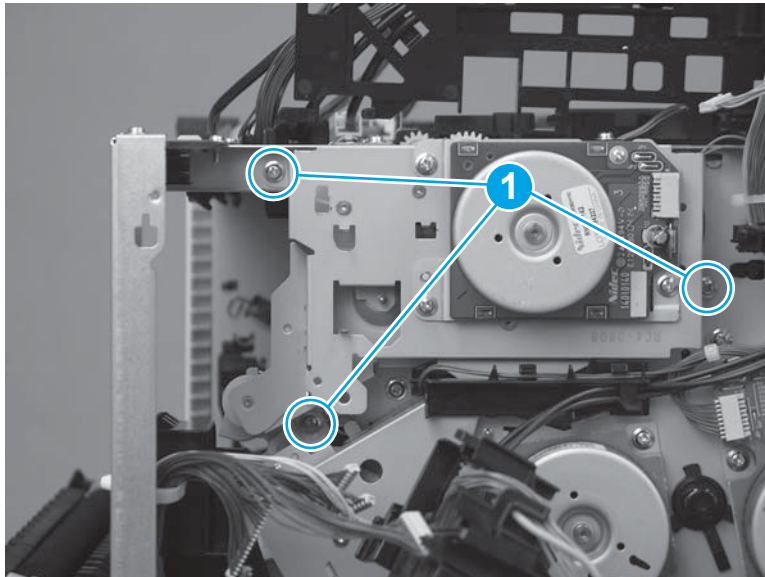

6. Remove the assembly.

⚠ CAUTION: Two gears on the back side of the assembly are not captive. Handle the assembly carefully.

Figure 1-3599 Remove the assembly

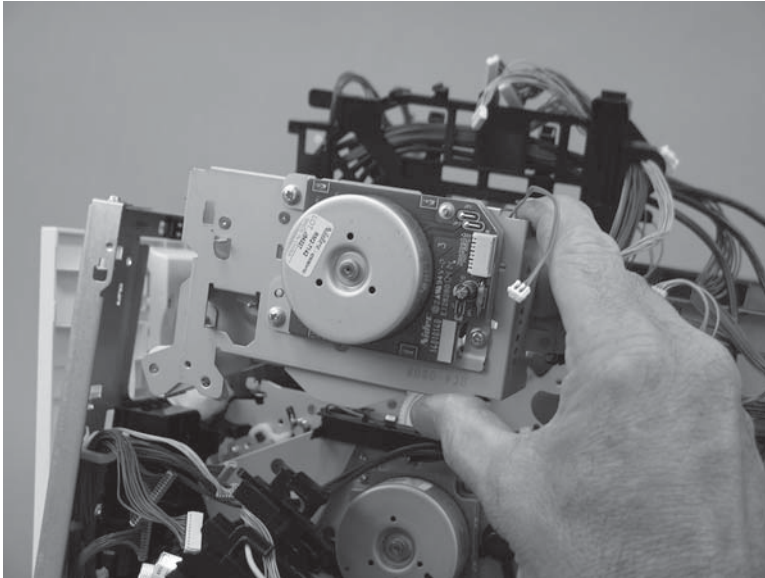

Step 34: Remove the delivery assembly

1. At the right side of the printer, remove two screws (callout 1).

📝 NOTE: These two screws are the self-tapping type.

Figure 1-3600 Remove two screws

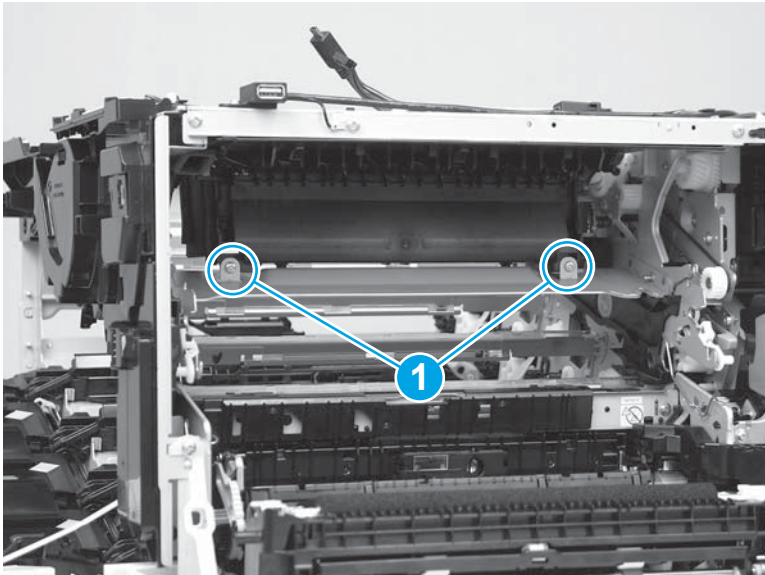

2. **M553x only:** At the top-front-right corner of the printer, disconnect one connector (callout 1), remove one screw (callout 2), and then remove the near field communication (NFC) PCA and holder by sliding them to the right (callout 3).

Figure 1-3601 Remove the PCA

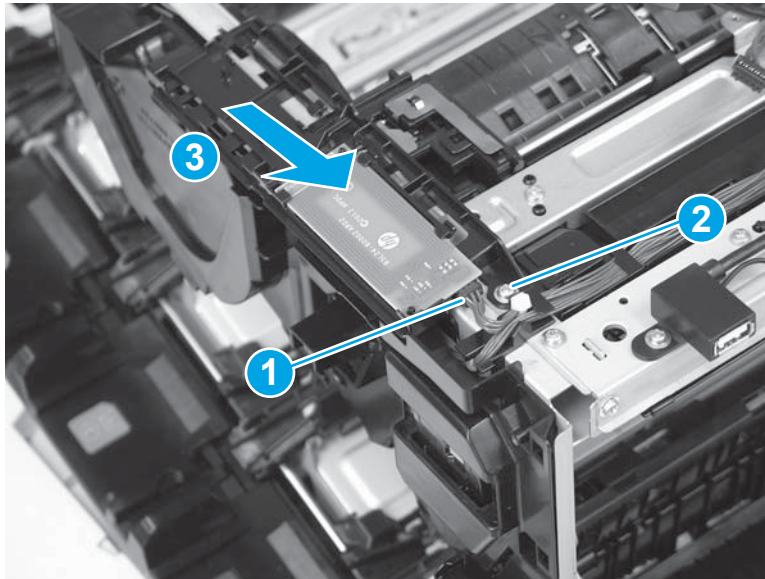

3. Release two retainers (callout 1), remove the USB cable (callout 2) from the retainers, and then disconnect one connector (callout 3).

Figure 1-3602 Release two retainers and disconnect one connector

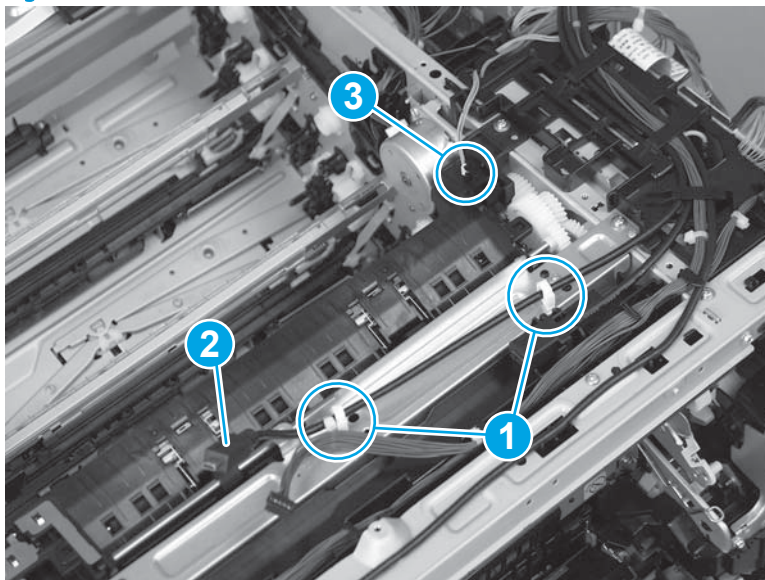

4. Remove four screws (callout 1).

Figure 1-3603 Remove four screws

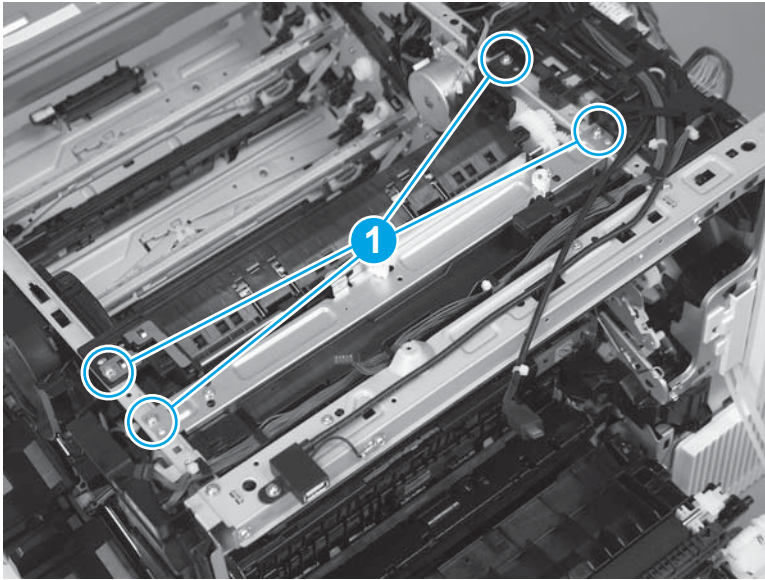

5. Remove the delivery assembly.

 **NOTE:** The solenoid plunger and arm (callout 1) located on the right side of the assembly are not captive. Do not lose the plunger and arm when handling the assembly.

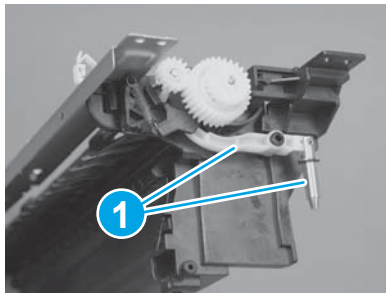
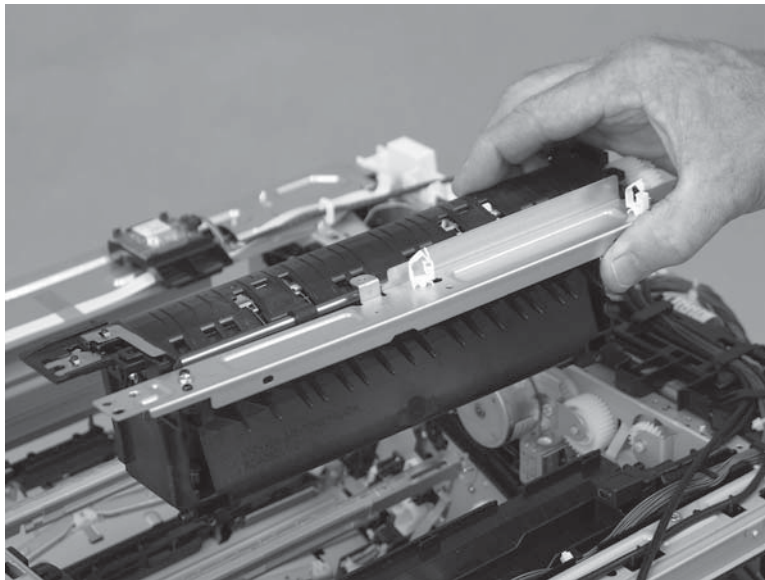

Figure 1-3604 Remove the assembly



Step 35: Remove the duplex drive assembly and motor

1. Remove two screws (callout 1).

Figure 1-3605 Remove two screws

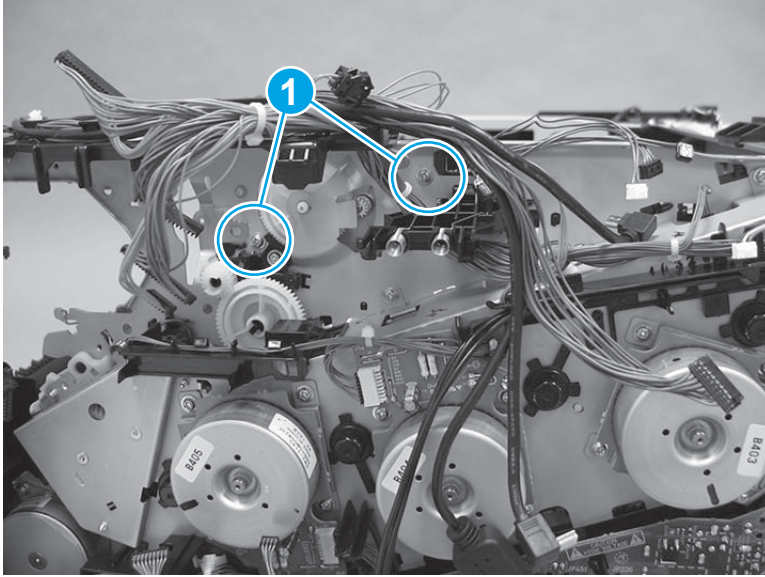

2. Remove the duplex drive assembly.

 **NOTE:** Feed two wire harnesses through the opening in the chassis as the assembly is removed.

Figure 1-3606 Remove the duplex drive assembly

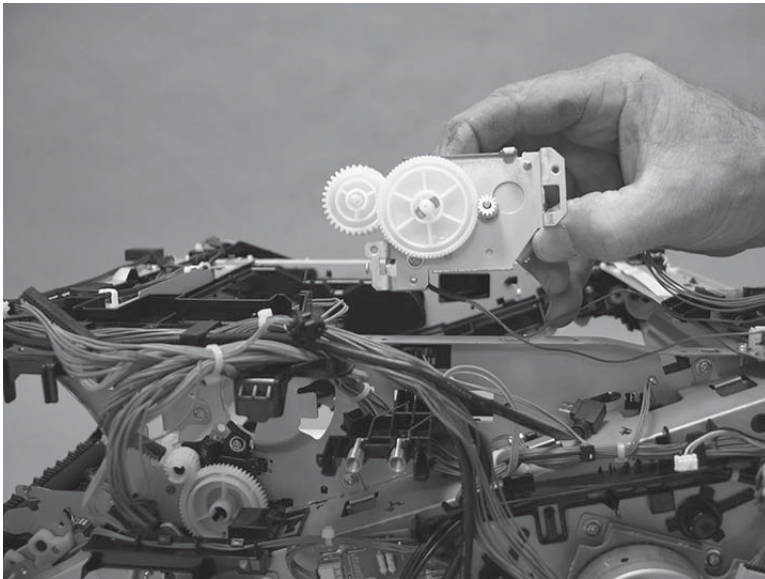

Step 36: Unpack the replacement assembly

Unpack the replacement assembly from the packaging.

For complete information on HP's recycling programs, go to [Product return and recycling](#).

 **NOTE:** HP recommends responsible disposal of the defective assembly.

Figure 1-3607 Recycle and unpack

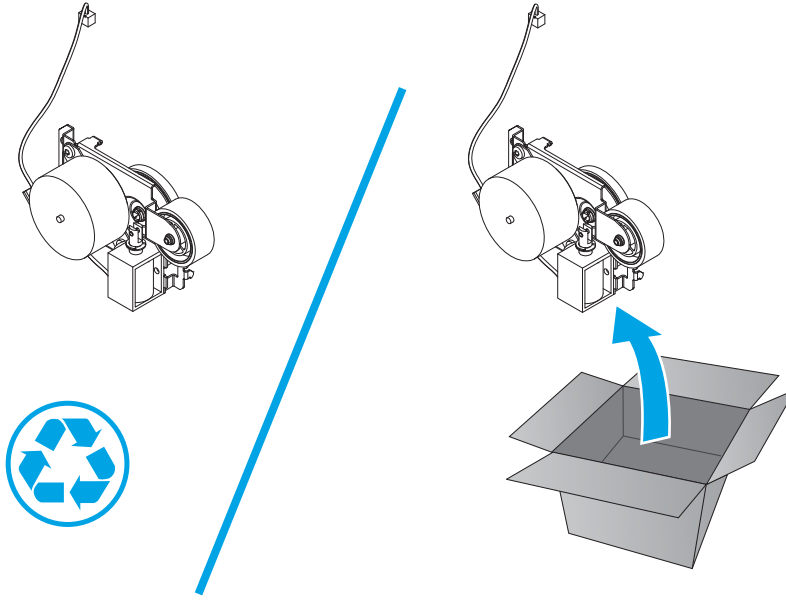

Step 37: Install the duplex drive assembly and motor

1. Install the duplex drive assembly in the printer.

 **NOTE:** Feed two wire harnesses through the opening in the chassis as the assembly is installed.

Make sure that the assembly is tight up against the sheet metal chassis. There should be no gaps between the assembly and the chassis.

Figure 1-3608 Install the duplex drive assembly

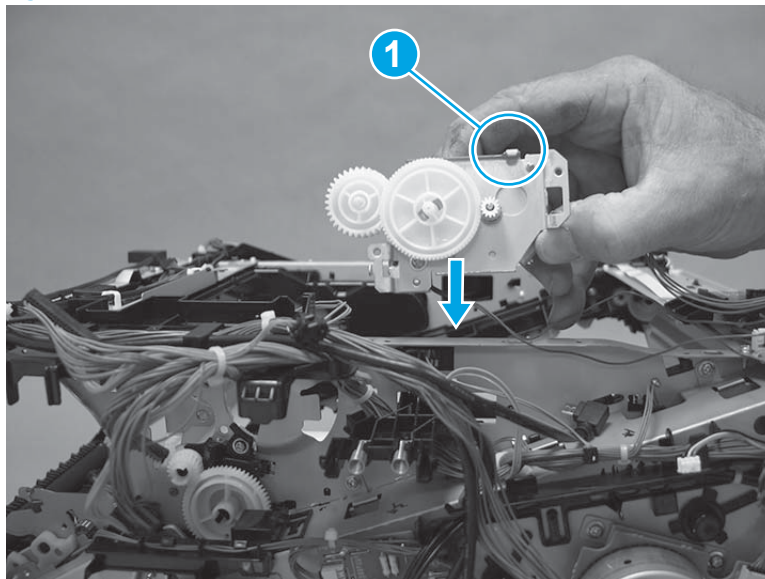

2. Install two screws (callout 1).

Figure 1-3609 Install two screws

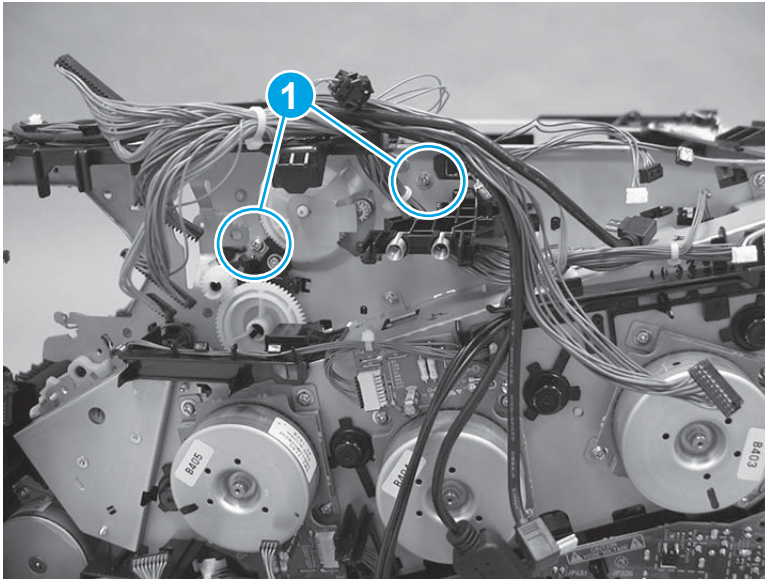

Step 38: Install the delivery assembly

1. Position the delivery assembly on the printer—make sure that the solenoid plunger is placed into the solenoid when the assembly is installed.

Figure 1-3610 Install the assembly

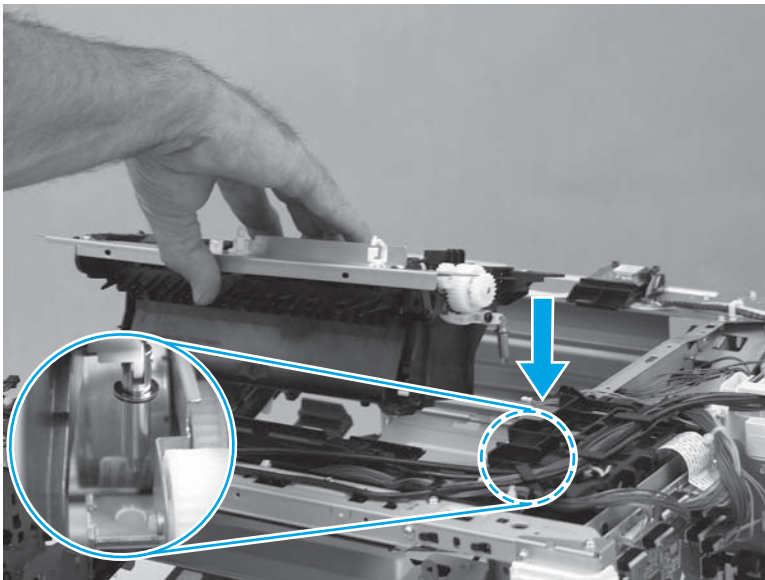

2. Install four screws (callout 1).

Figure 1-3611 Install four screws

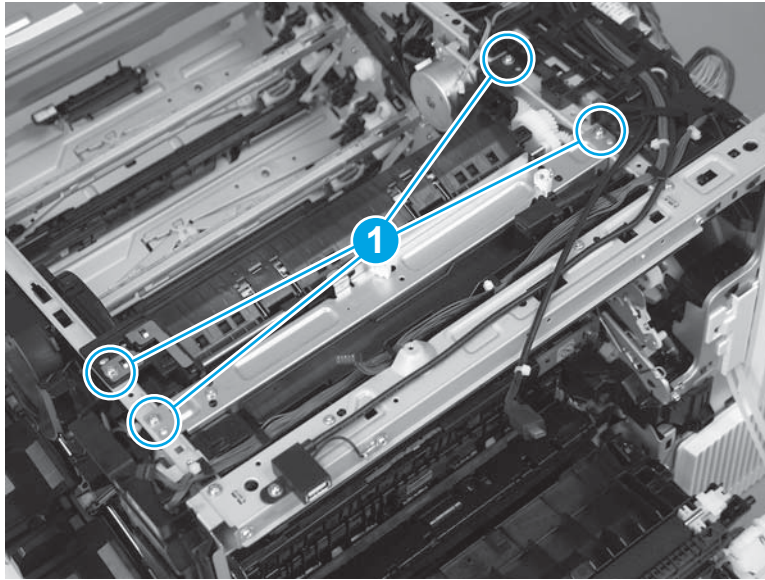

3. Connect one connector (callout 1), and then place the USB cable (callout 2) in the retainers (callout 3).

Figure 1-3612 Connect one connector

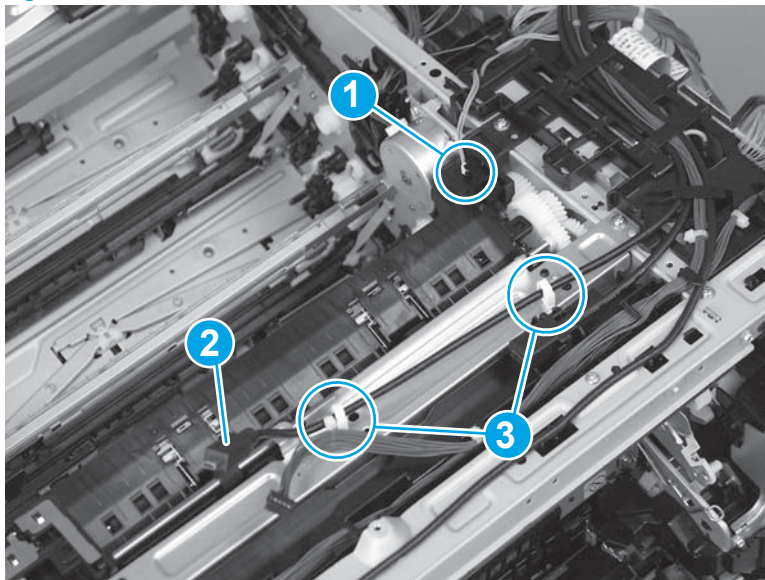

4. **M553x only:** At the top-front-right corner of the printer, install the tab on the NFC PCA holder (callout 1) in the slot (callout 2) in the chassis.

Figure 1-3613 Install the PCA holder

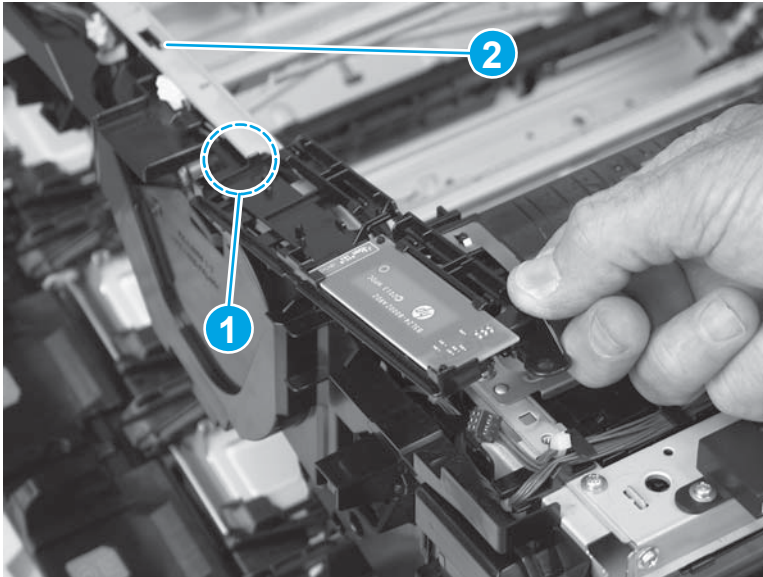

5. **M553x only:** Rotate the NFC PCA holder down (callout 1) to install it, and then install one screw (callout 2).

Figure 1-3614 Install one screw

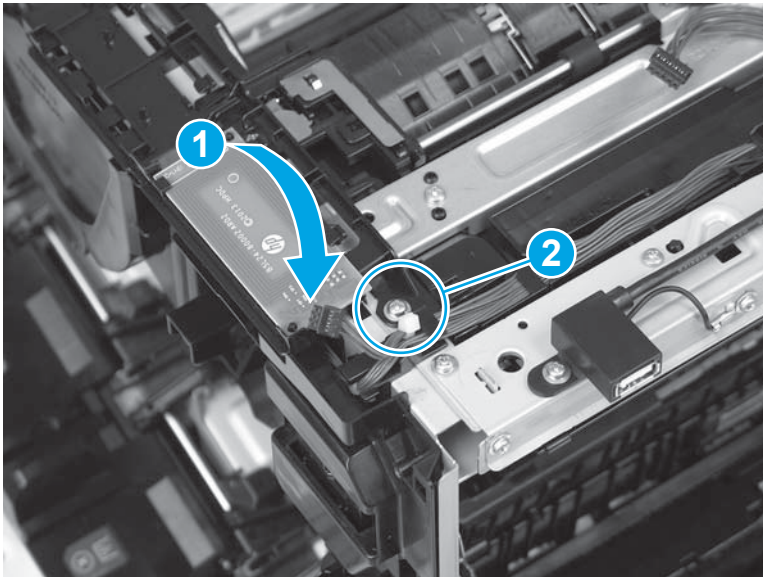

6. **M553x only:** Connect one connector (callout 1) on the NFC PCA.

Figure 1-3615 Connect one connector

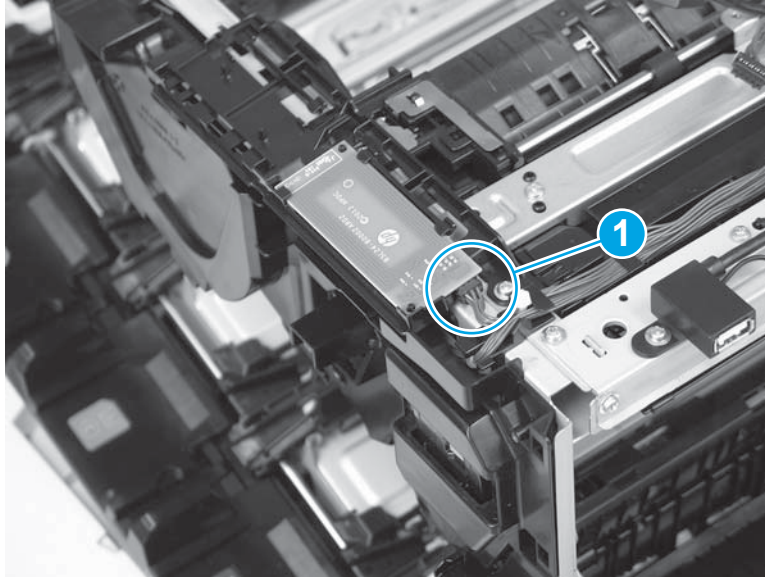

7. At the right side of the printer, install two screws (callout 1).

 **NOTE:** These two screws are the self-tapping type.

Figure 1-3616 Install two screws

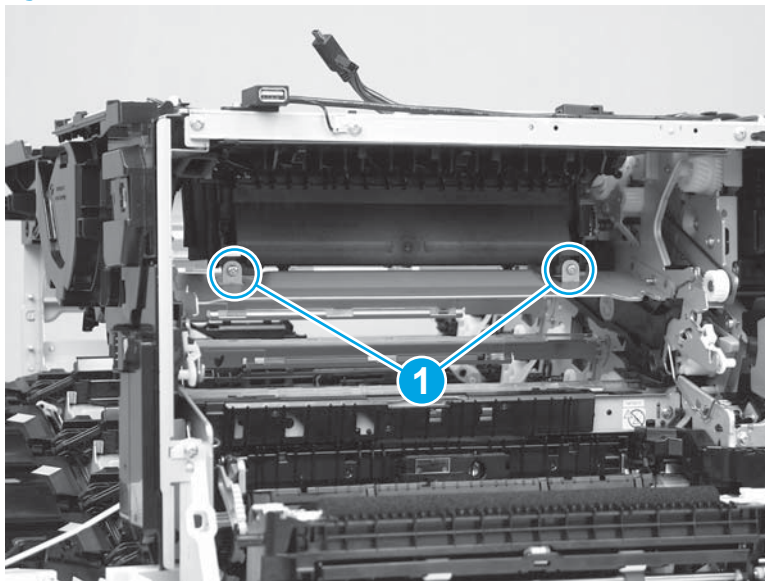

Step 39: Install the fuser drive assembly

1. Two gears (callout 1) on the back side of the assembly are not captive. If the gears are dislodged, install them as shown.

 **CAUTION:** Handle the assembly carefully.

Figure 1-3617 Check the gears on the assembly

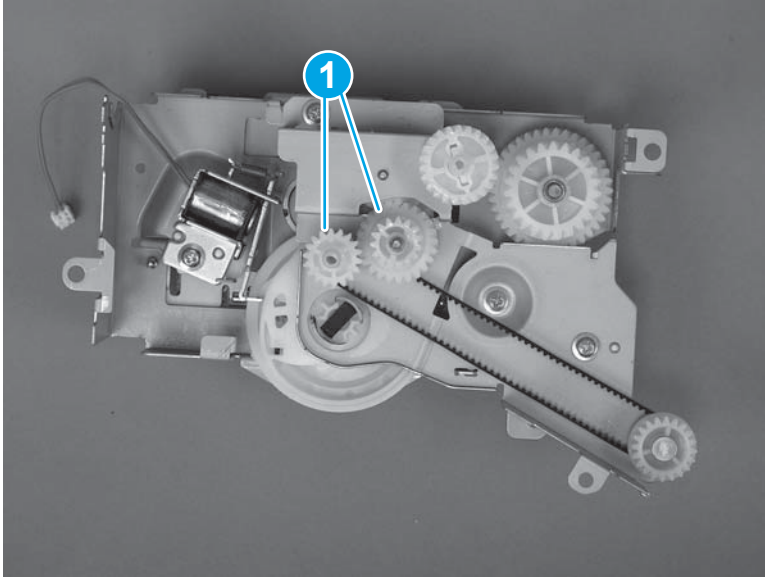

2. Position the assembly on the chassis, and then install three screws (callout 1).

Figure 1-3618 Install three screws

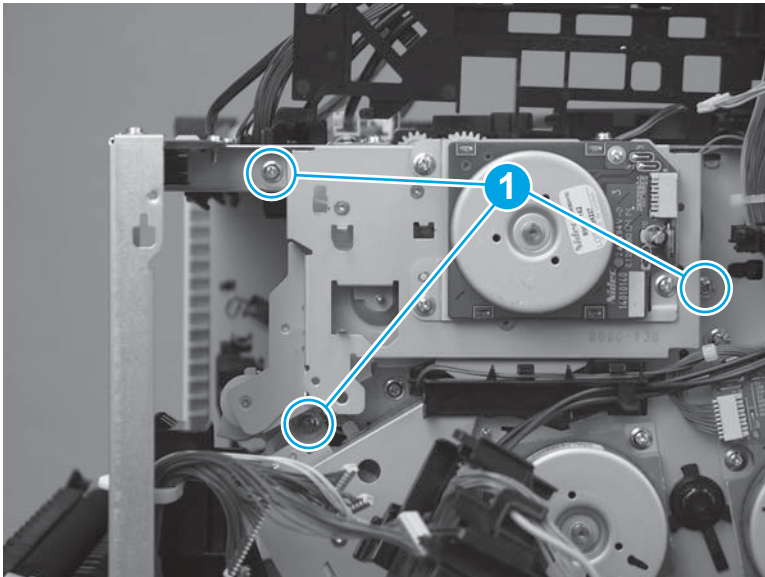

3. Position the guide on the chassis (callout 1), slide the guide up to engage it (callout 2), and then verify that the tab (callout 3) snaps into place.

Figure 1-3619 Install the guide

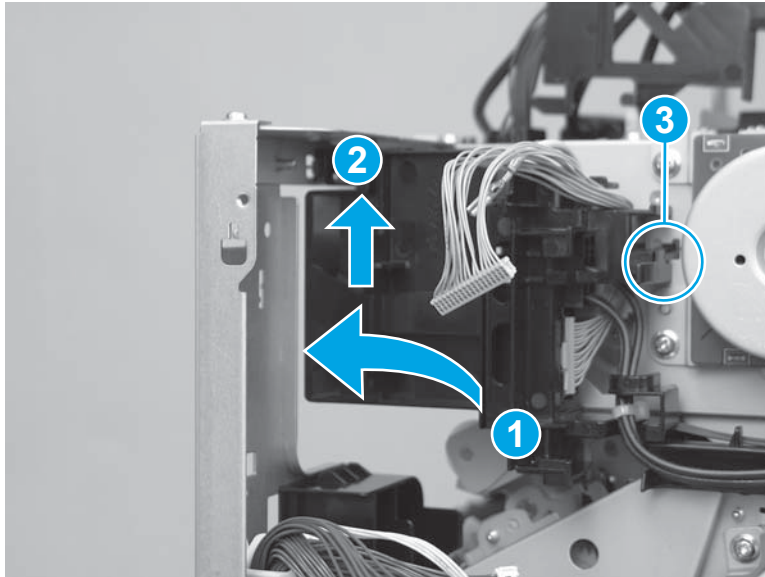

4. Install one screw (callout 1).

Figure 1-3620 Install one screw

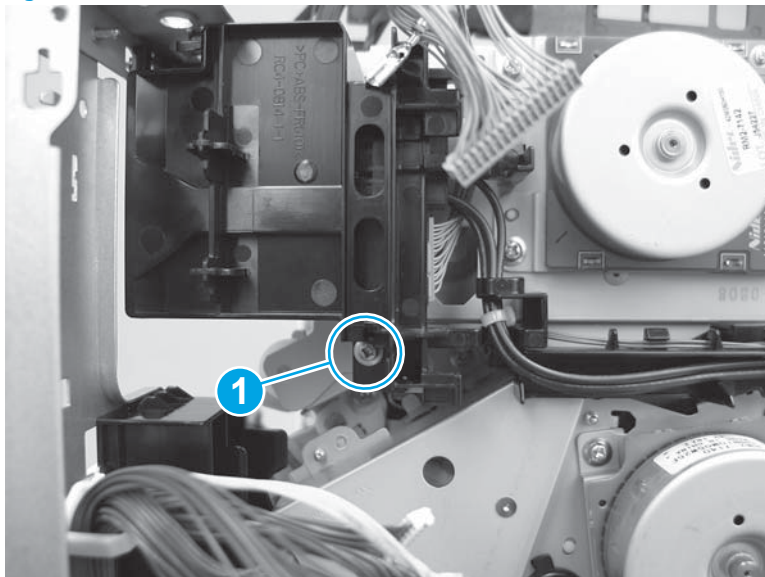

5. Connect one connector (callout 1).

Figure 1-3621 Connect one connector

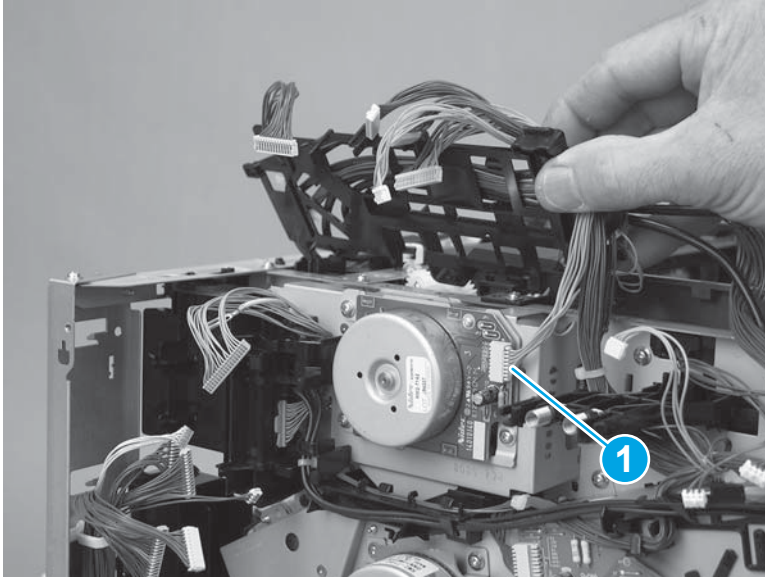

6. Rotate the guide down and onto the chassis (callout 1), slide the guide to engage it (callout 2), and then make sure that the tab (callout 3) snaps into place.

CAUTION: Do not dislodge the fuser motor connector when installing the guide.

Figure 1-3622 Install the guide

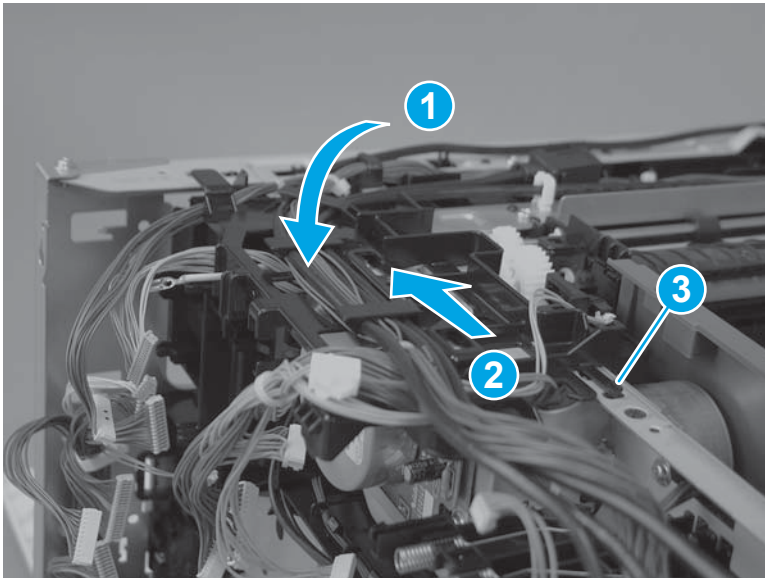

Step 40: Install the HVPST

CAUTION:  ESD-sensitive part.

1. Connect one ground wire connector (callout 1).

Figure 1-3623 Connect one ground wire

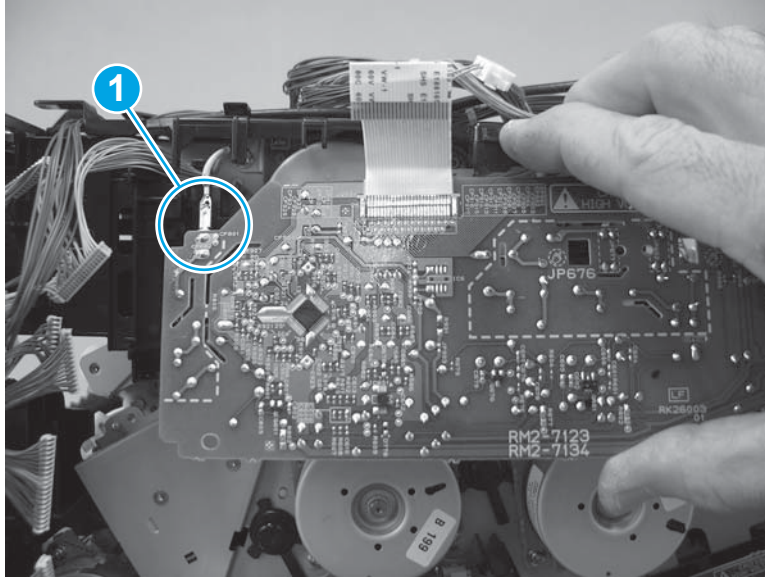

2. Position the HVPST on the printer, and then push in to engage two tabs (callout 1).

 **NOTE:** Make sure that the tabs snap into place.

Figure 1-3624 Install the HVPST



3. Install one screw (callout 1).

Figure 1-3625 Install one screw

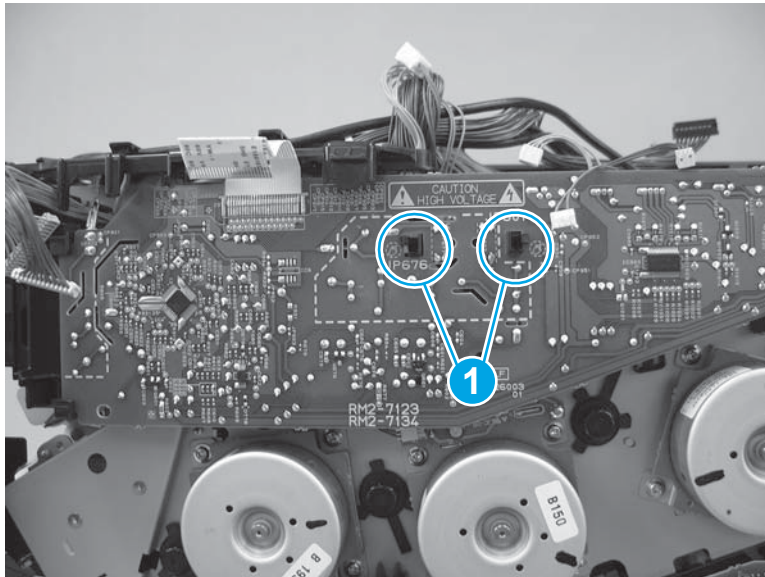
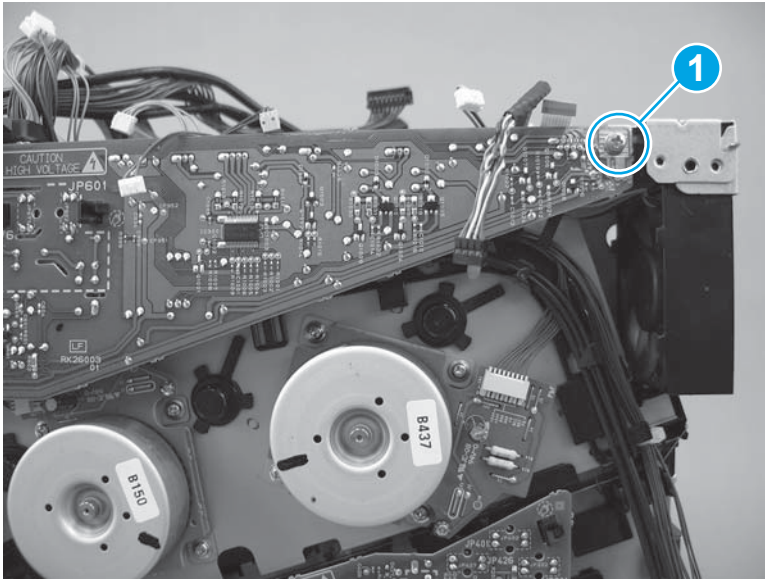

4. Connect five connectors (callout 1), and then connect one flat cable (callout 2).

Figure 1-3626 Connect five connectors and one flat cable

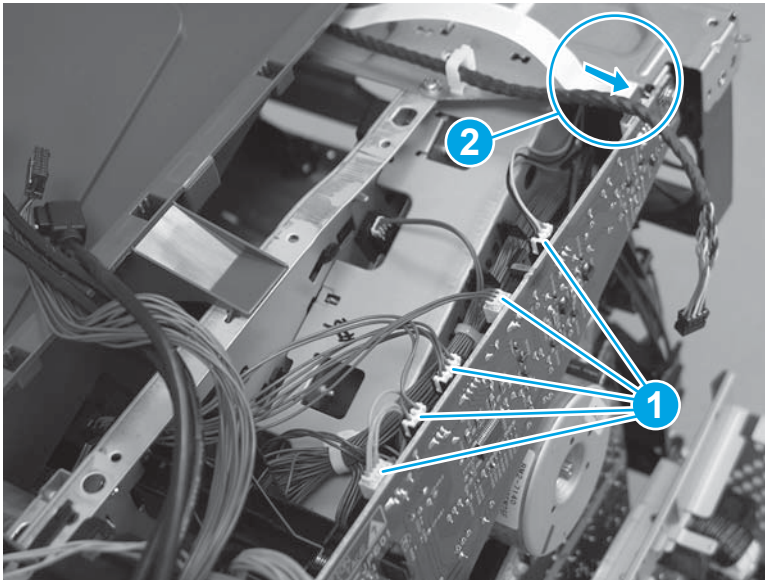

Step 41: Install the DC controller and sheet-metal bracket

 **NOTE:** Some of the connectors shown in this procedure might be connected in subsequent steps as other assemblies are reinstalled. Connect all available connectors to install the DC controller now.

 **CAUTION:**  ESD-sensitive part.

1. Position the DC controller and sheet-metal plate on the printer, and then push down to engage the plate with the chassis.

Figure 1-3627 Install the plate

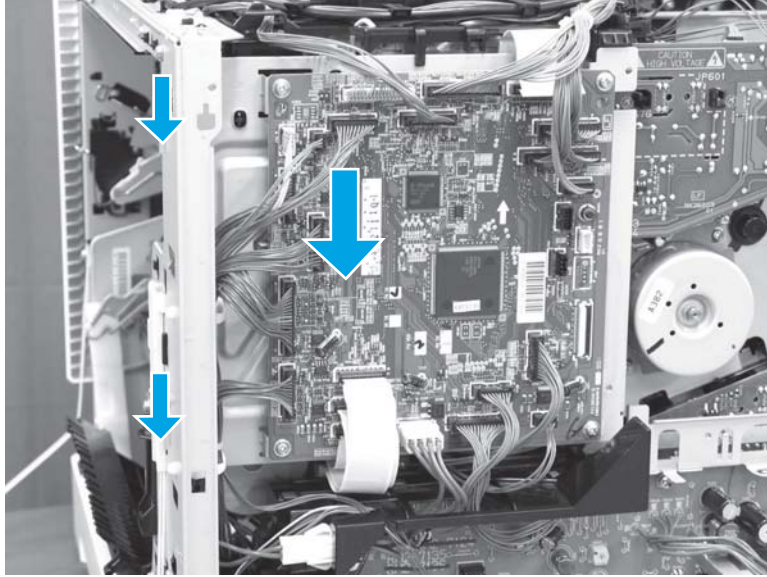

2. Install two screws (callout 1), and then connect all of the connectors.

The following connectors are empty:

- J140, J141, and J143

Figure 1-3628 Install two screws

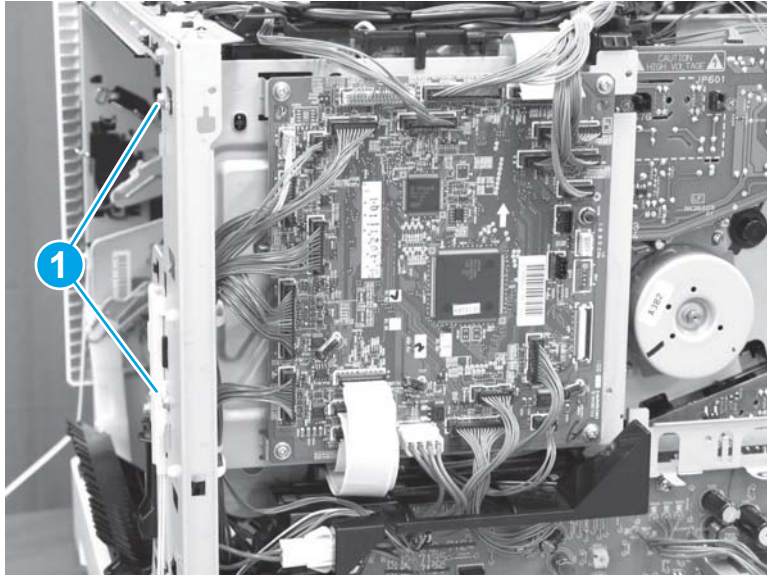

Step 42: Install the right rear cover

1. Position the cover on the printer.

Figure 1-3629 Install the cover

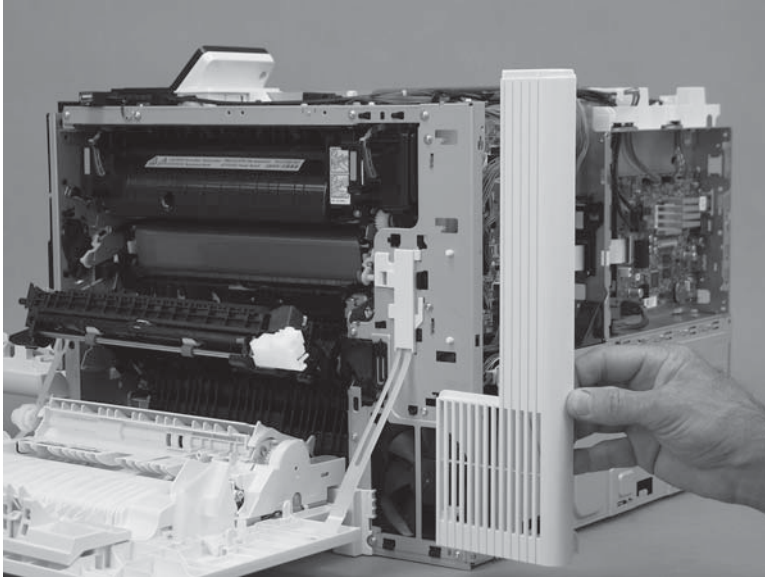

2. Slide the cover toward the right door (callout 1) to engage it with the printer, and then install one screw (callout 2).

Figure 1-3630 Install one screw

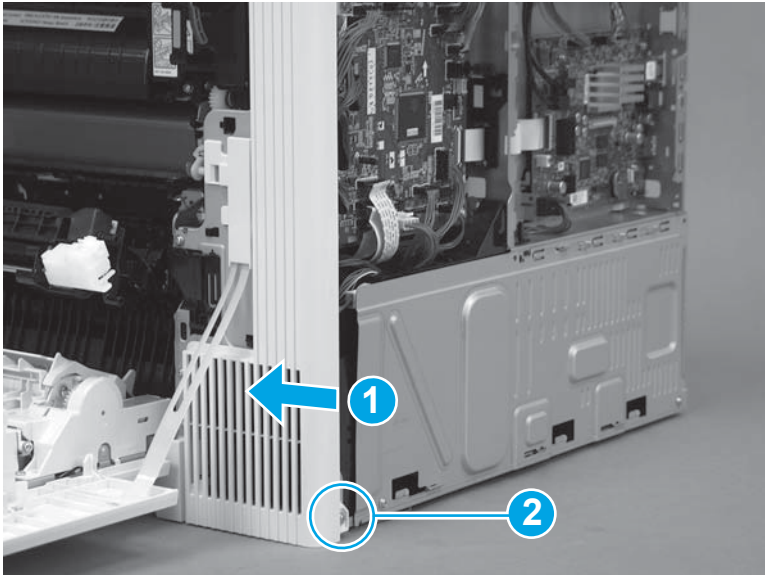

Step 43: Install the formatter case

1. Pass the wire harnesses through the opening in the formatter case.

Figure 1-3631 Pass the wire harnesses through the opening

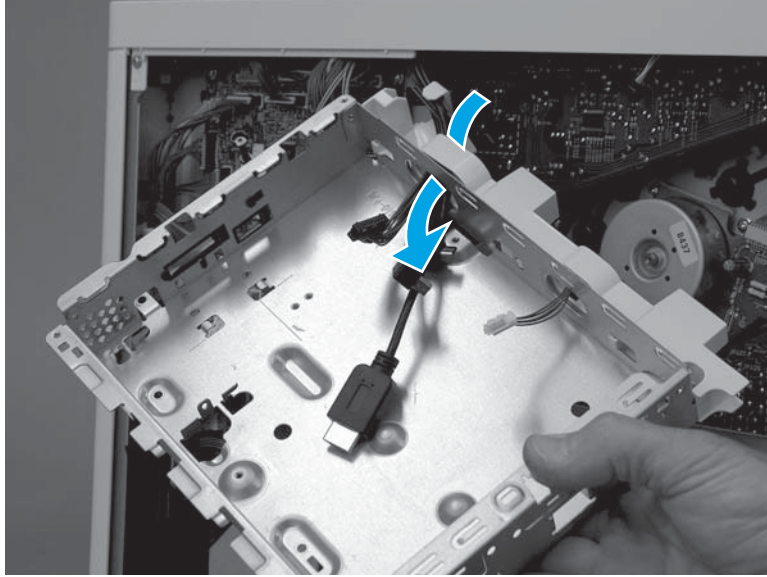

2. Position the top of the formatter case on the printer (callout 1), and then rotate the bottom of the case (callout 2) into the printer.

Figure 1-3632 Install the formatter case

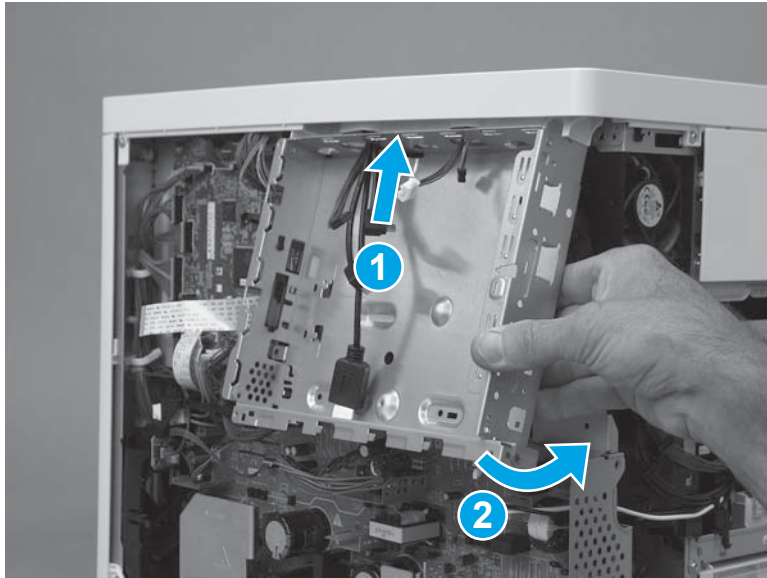

3. Install six screws (callout 1).

Figure 1-3633 Install six screws

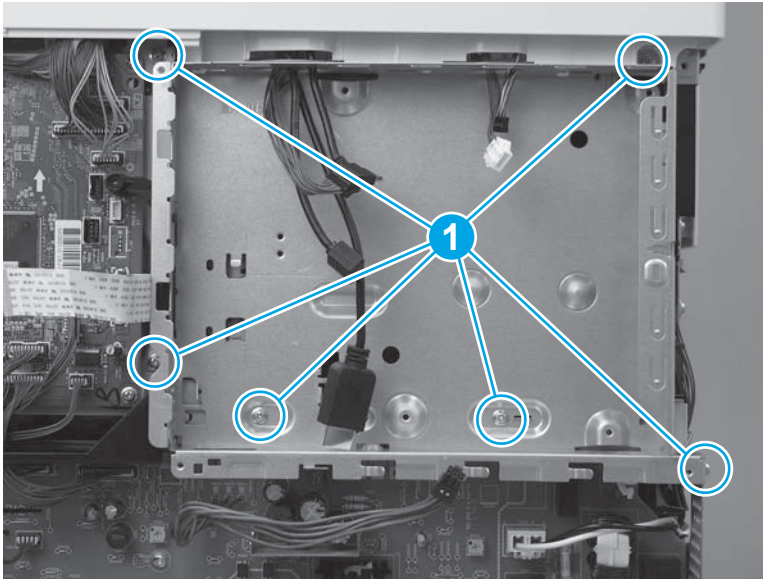

4. Pass two wire harnesses and one flat cable (callout 1) through the opening in the formatter case, and then install one wire harness in the retainer (callout 2).

 **IMPORTANT:** Make sure that the flat cable is securely fastened to the DC controller, and was not dislodged when the formatter case was removed.

Figure 1-3634 Install wire harnesses and flat cable

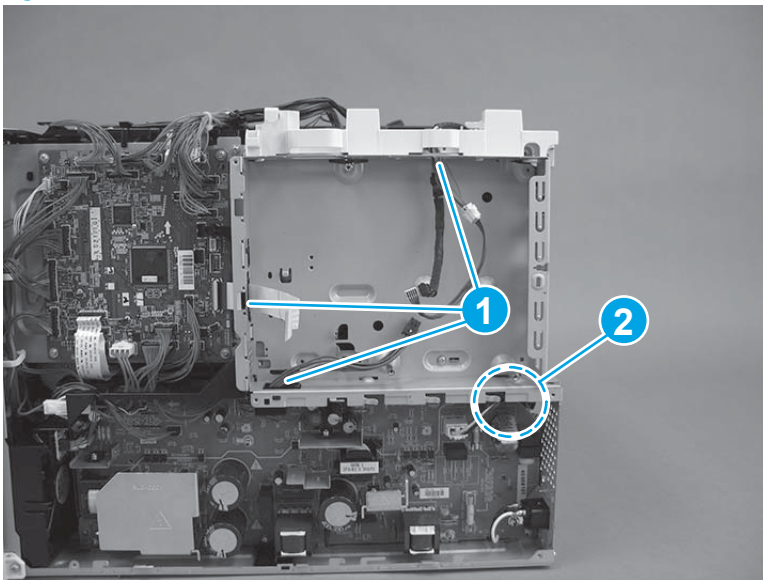

5. Position the LVPS cover on the printer, slide the cover to the left to install it, and then install two screws (callout 1).

Figure 1-3635 Install the LVPS cover

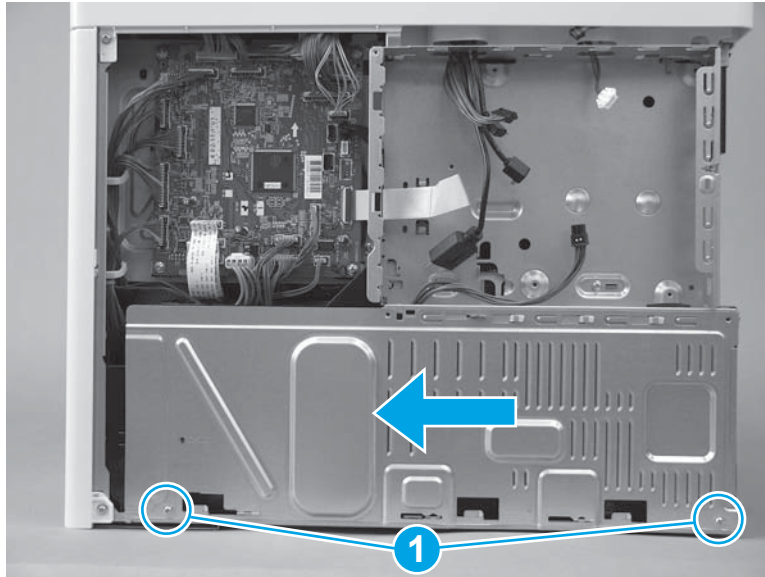

6. If no tape is affixed to the back of the flat cable, skip this step. If double-sided tape is affixed to the back of the flat cable, align the line (callout 1) on the cable with the edge (callout 2) of the opening in the sheet metal. Press to attach the flat cable to the formatter case.

Figure 1-3636 Attach the flat cable

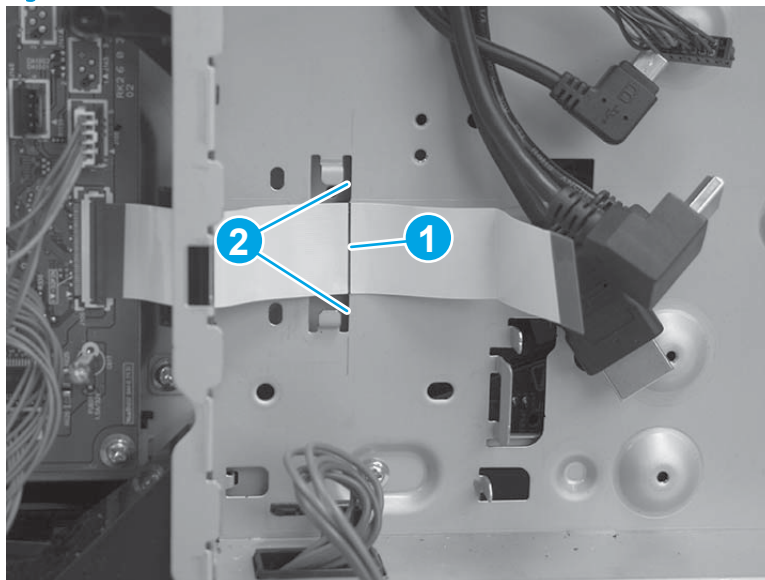

7. Position the bracket over the flat cable, and then slide the bracket to the left to install it. Make sure that the edges of the bracket fit under the sheet metal tabs (callout 1) on the formatter case and that the tabs (callout 2) snap into place.

Figure 1-3637 Position the bracket

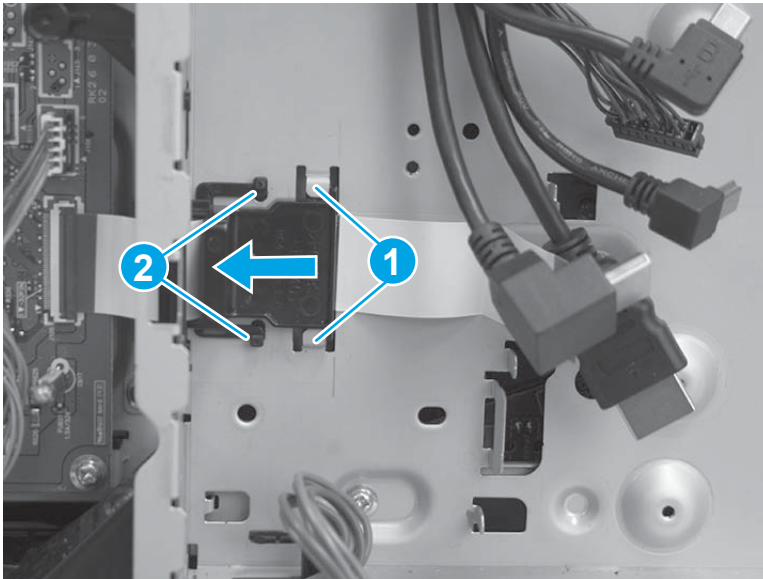

8. **M577 only:** Pass the wire harness (callout 1) through the openings in the formatter case (callout 2), and then connect one connector (callout 3).

Figure 1-3638 Connect one connector

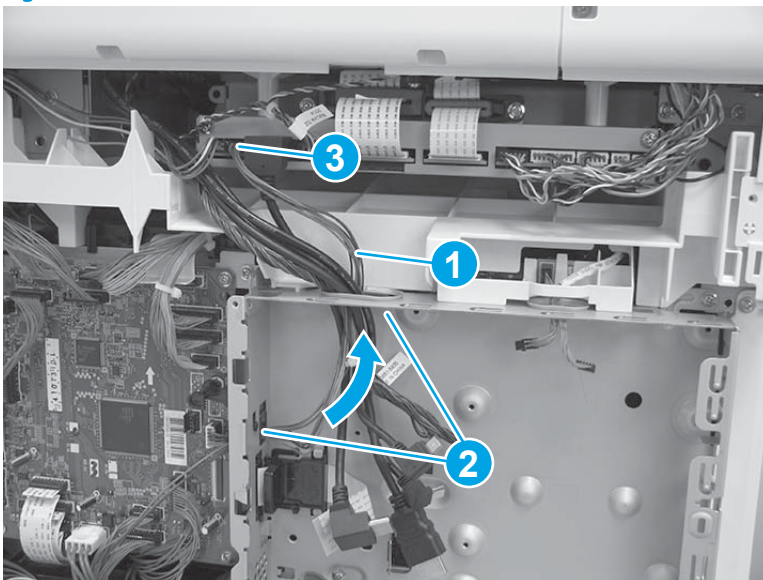

Step 44: Install the output bin

1. Position the cover near the printer.

Figure 1-3639 Install the cover

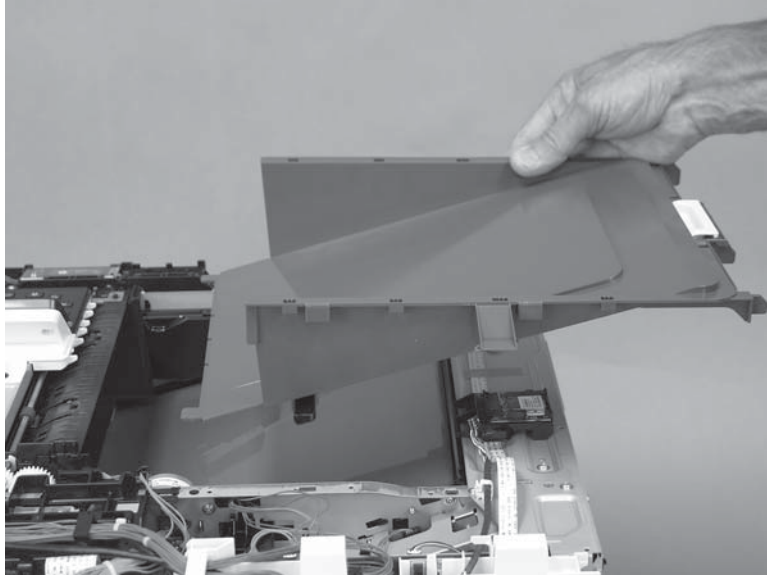

2. Align the tabs on the cover with the slots in the printer.

Figure 1-3640 Align the tabs

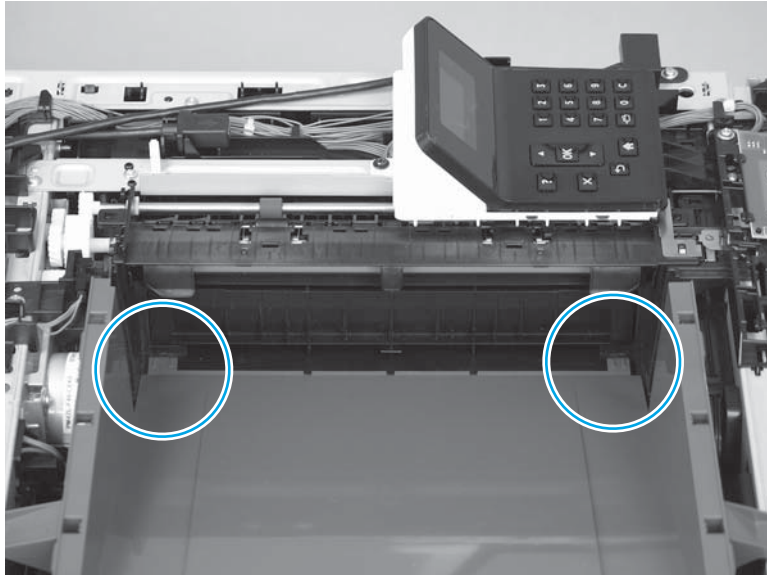

3. Slide and lower the cover onto the printer to install it.

Figure 1-3641 Release the cover

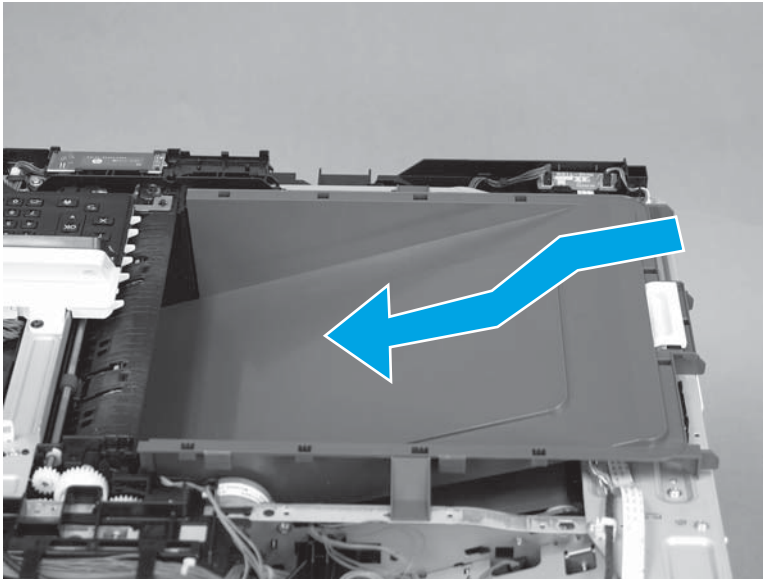

4. Verify that the tabs on the front- and rear-side of the cover are correctly installed in the slots in the chassis.

Figure 1-3642 Verify the installation

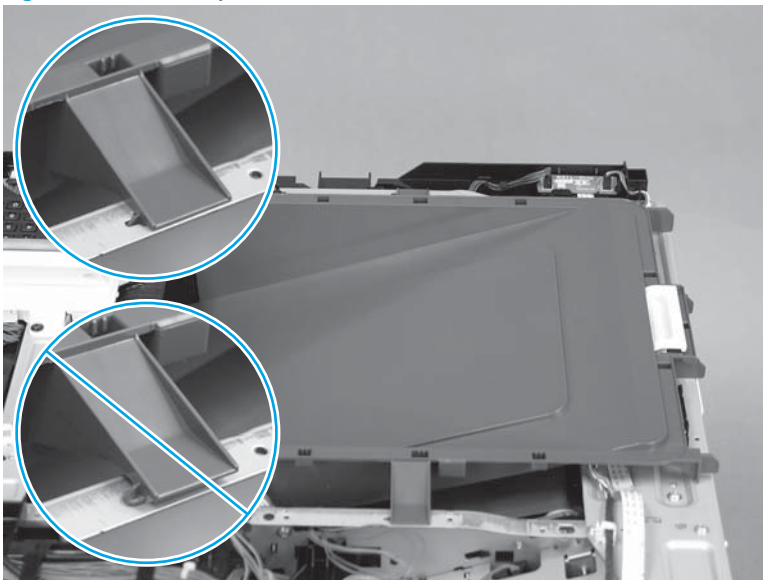

Step 45: Install the control panel (M553n/dn and M552dn only)

 **NOTE:** This step is for the M553n/dn and M552dn models. For the M553x model, skip this step and go to [Step 46: Install the upper cover \(M552 and M553\) on page 2043](#).

For the M577 models, skip this step and go to [Step 47: Install the left cover on page 2045](#).

1. Position the control panel on the printer, and then connect one connector (callout 1).

Figure 1-3643 Connect one connector

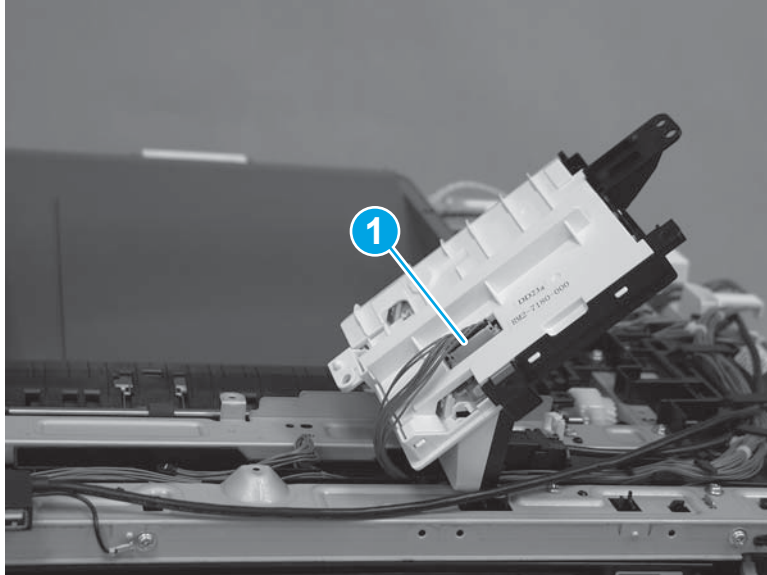

2. Turn the control panel over (callout 1), and then install four screws (callout 2).

Figure 1-3644 Install four screws

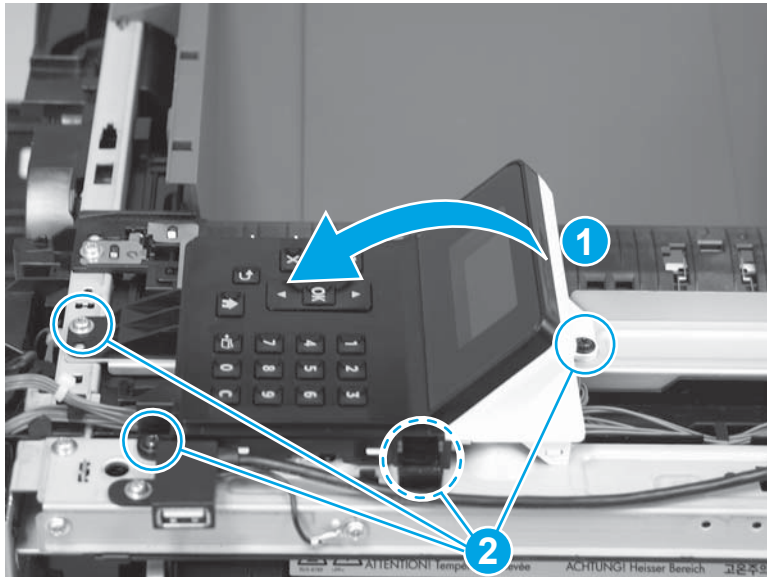

3. Place one cable in the guide.

Figure 1-3645 Place one cable in the guide



4. Install the tab on the NFC PCA holder (callout 1) in the slot (callout 2) in the chassis.

Figure 1-3646 Install the tab

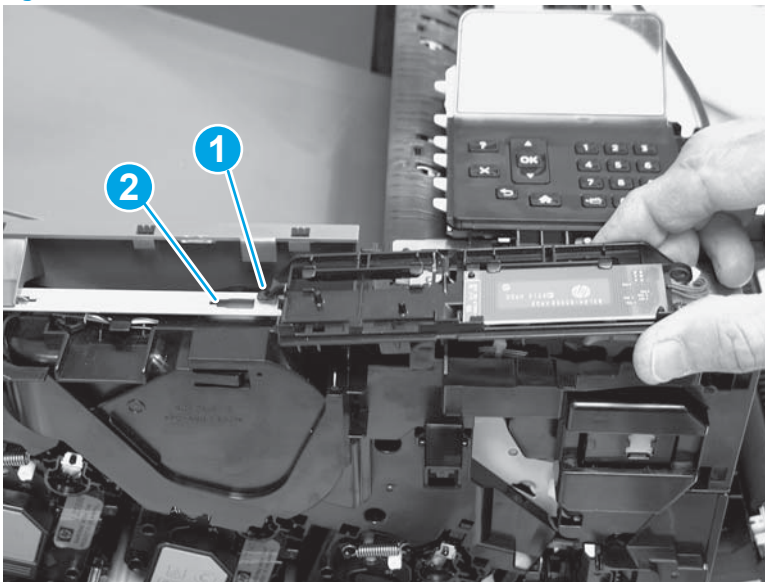

5. Rotate the NFC PCA holder down (callout 1) to install it, connect one connector (callout 2), and then install one screw (callout 3).

Figure 1-3647 Install one screw

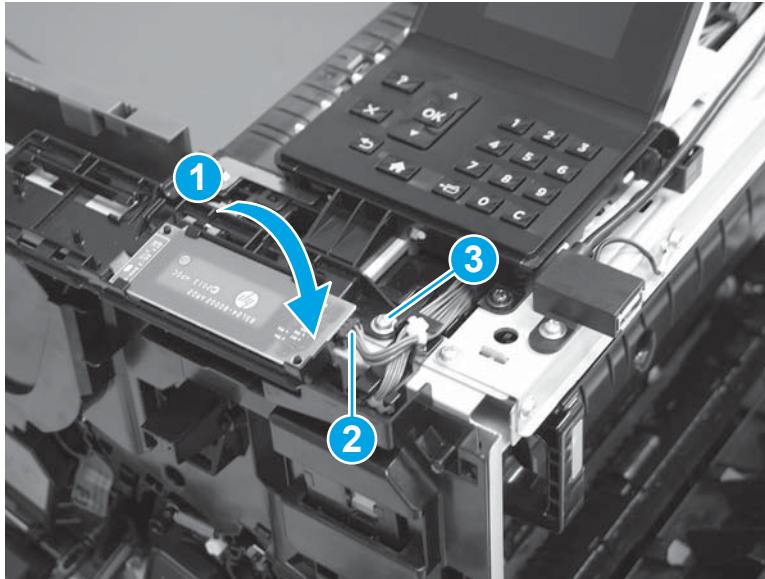

Step 46: Install the upper cover (M552 and M553)

 **NOTE:** This step is for the M552 and M553 models. For the M577 models, skip this step and go to [Step 47: Install the left cover on page 2045](#).

1. Position the cover on the printer.

 **NOTE:** For the M553x model, do not forget to pass the control-panel wire harness and USB cable through the opening in the cover.

Figure 1-3648 Install the cover



2. Push down on the rear corner of the cover to engage one tab (callout 1).

Figure 1-3649 Engage one tab

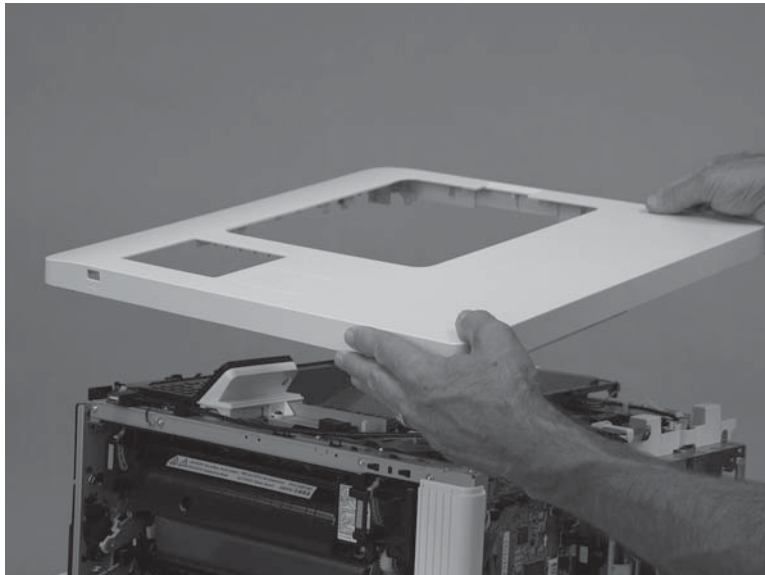
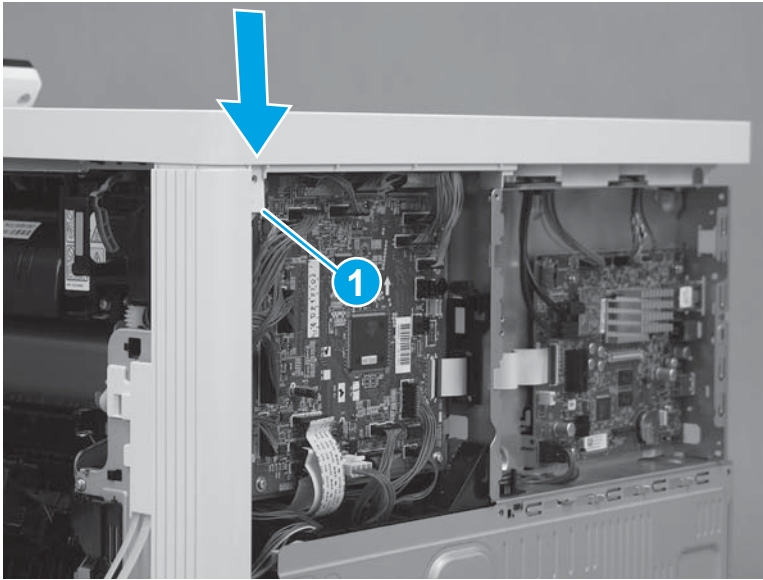

3. Push down on the front corner of the cover to engage one tab (callout 1), and then install one screw (callout 2).

 **NOTE:** This is a self-tapping plastic-thread screw. Make sure that this screw is used in this location when it is reinstalled.

Figure 1-3650 Engage one tab and install one screw



4. Install three screws (callout 1).

Figure 1-3651 Install three screws

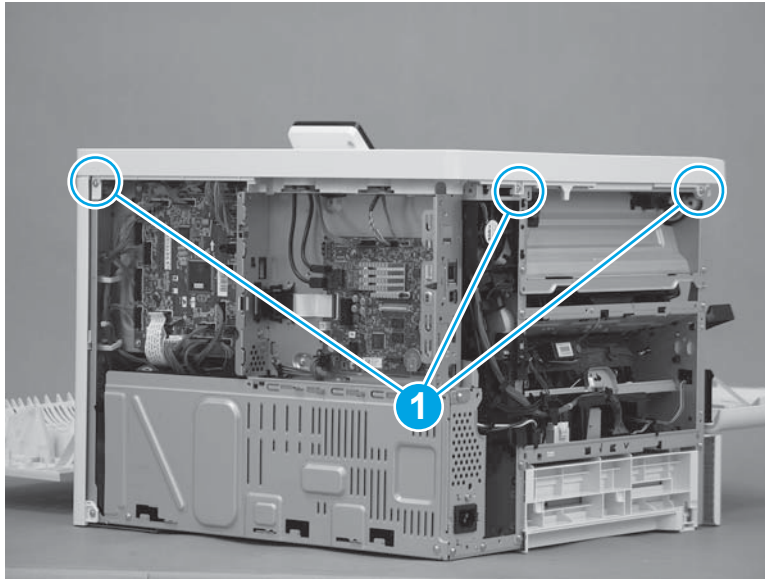

Step 47: Install the left cover

1. Position the cover on the printer.

 **NOTE:** Slightly offset the cover toward the rear of the printer.

Figure 1-3652 Install the cover

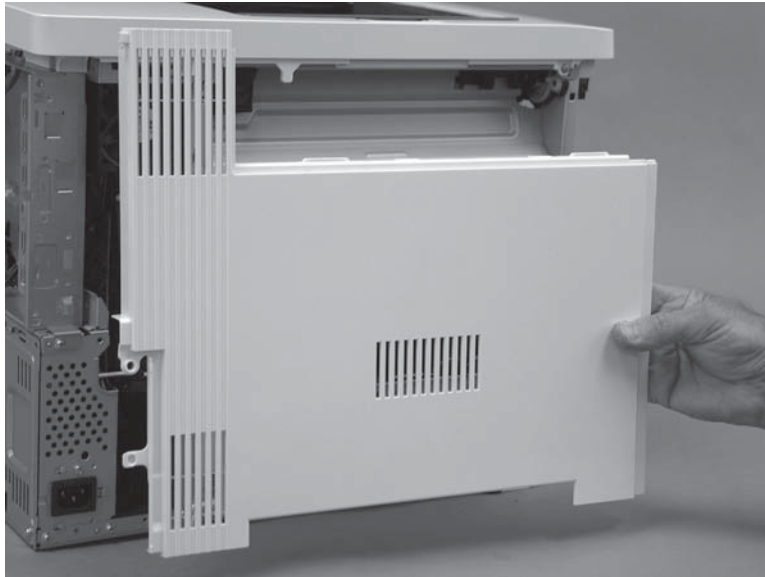

- Slide the cover (callout 1) toward the front of the printer to engage it. Make sure that the tab (callout 2) snaps into place.

 **NOTE:** Locate the alignment pin (callout 3) on the cover from the front door side of the printer, and then make sure that it is fully engaged in the slot in the chassis.

 **TIP:** While sliding the cover into place, push in on the center of the cover (callout 1) to make sure that the hooks on the back of the cover engage with the slots in the chassis.

Figure 1-3653 Engage the cover



- At the left side of the printer, install one screw (callout 1).

Figure 1-3654 Install one screw

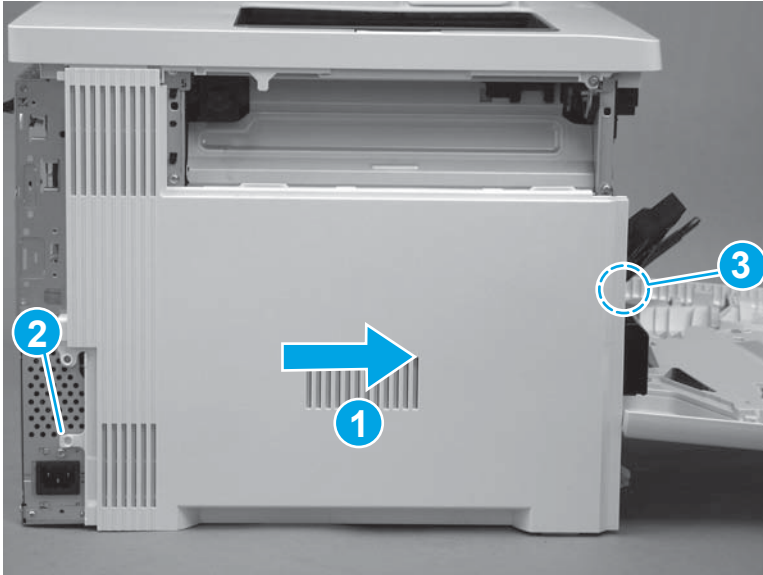
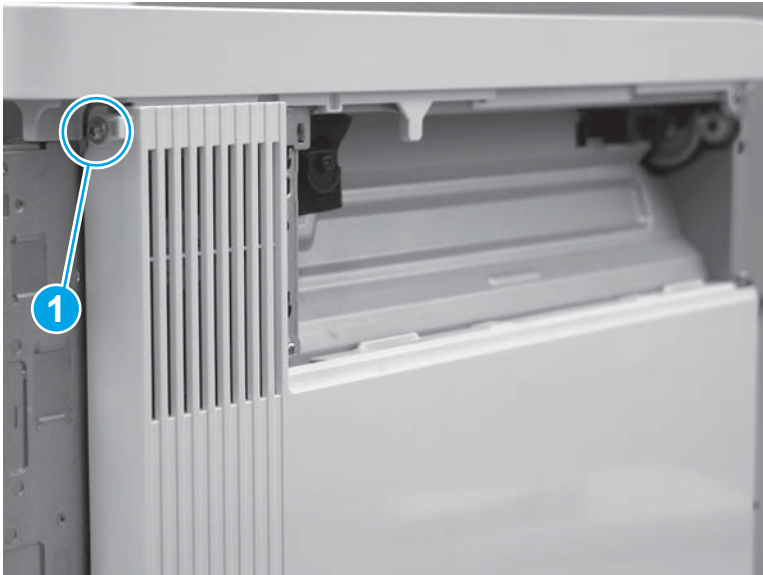

Step 48: Install the top bracket (M577)

 **NOTE:** This step is for the M577 models. For the M552 and M553 models, skip this step and go to [Step 60: Install the rear cover \(M552 and M553\) on page 2068](#).

1. Position the tabs (callout 1) on the bracket in the slots (callout 2) in the printer.

Figure 1-3655 Position the tabs in the slots

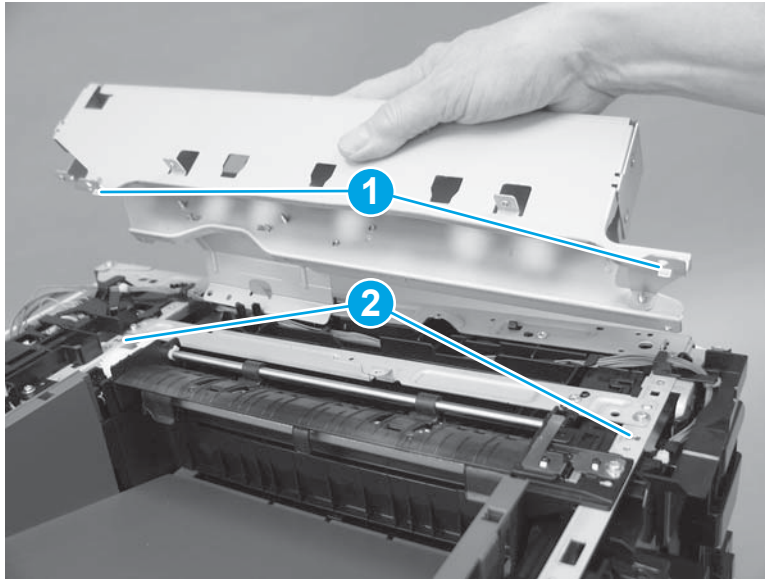

2. At the top of the printer, install two screws (callout 1).

Figure 1-3656 Install two screws

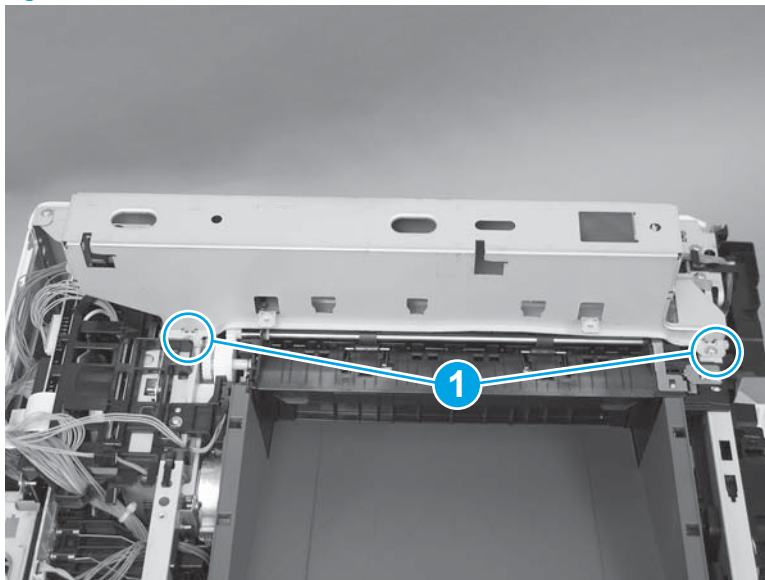

3. At the top of the printer, install three screws (callout 1).

Figure 1-3657 Install three screws

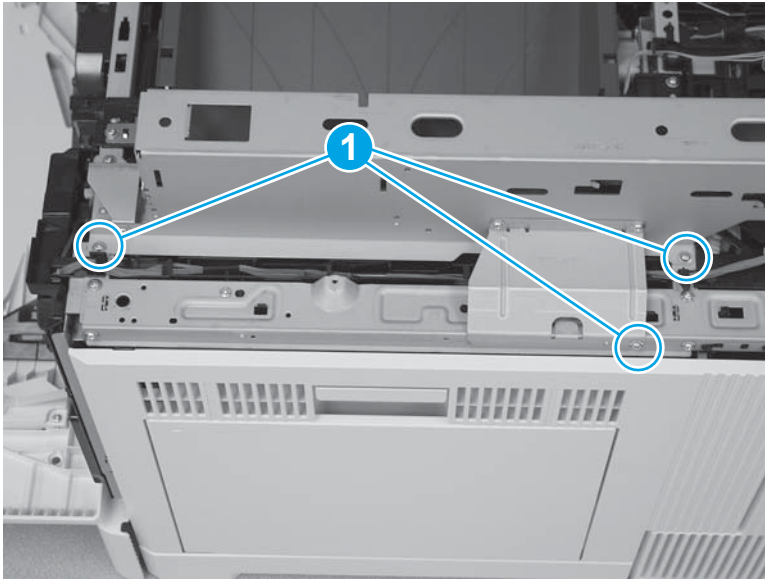

Step 49: Install the top cover (M577)

 **NOTE:** This step is for the M577 models. For the M552 and M553 models, skip this step and go to [Step 60: Install the rear cover \(M552 and M553\) on page 2068](#).

1. Position the locator pins (callout 1) on the cover in the slots (callout 2) in the printer.

Figure 1-3658 Position the locator pins

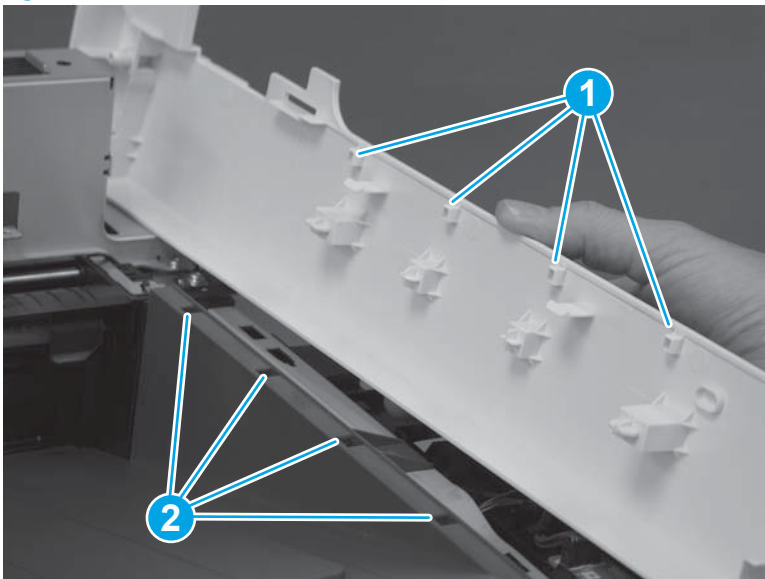

2. Press down on the cover to install it. Make sure that the tabs (callout 1) snap into place.

Figure 1-3659 Press down on the cover

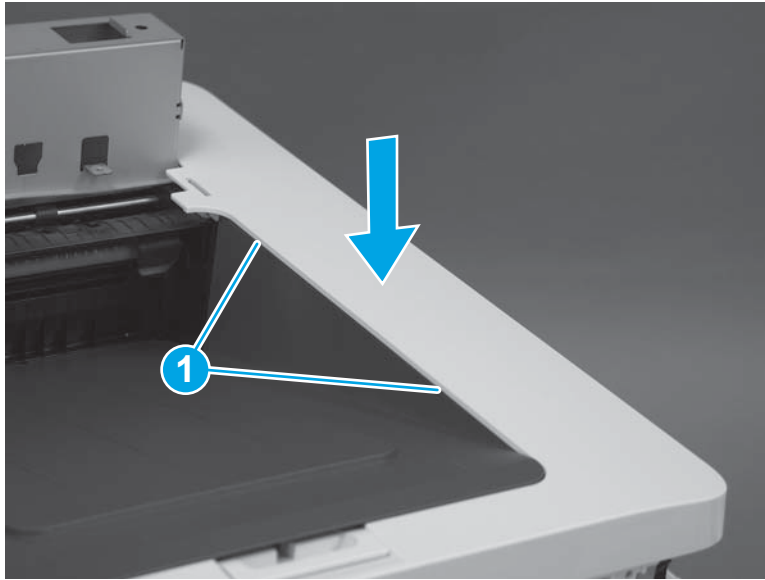

3. At the front of the printer, install one screw (callout 1).

 **Reinstallation tip:** This screw is longer and a different type of screw than the screw installed in the next step. Make sure that this screw is installed in the correct position.

Figure 1-3660 Install one screw



4. At the left side of the printer, install one screw (callout 1).

Figure 1-3661 Install one screw

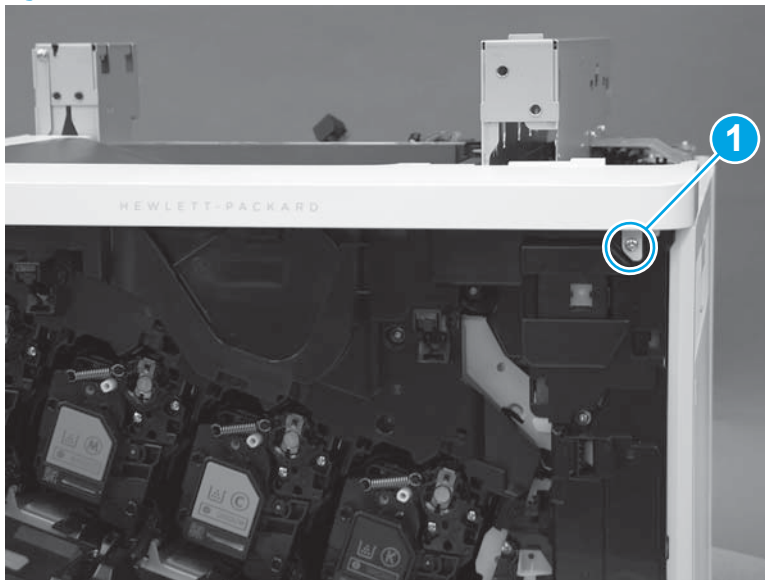
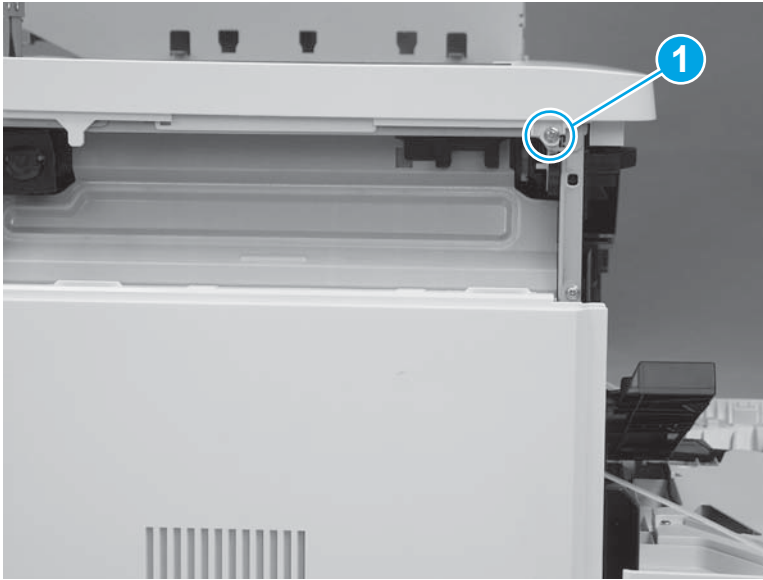

Step 50: Install the paper feed cover (M577)



NOTE: This step is for the M577 models. For the M552 and M553 models, skip this step and go to [Step 60: Install the rear cover \(M552 and M553\) on page 2068](#).

1. Position the locator tabs (callout 1) on the cover in the slots (callout 2) in the printer. Press down until the cover snaps into place.

Figure 1-3662 Install the cover

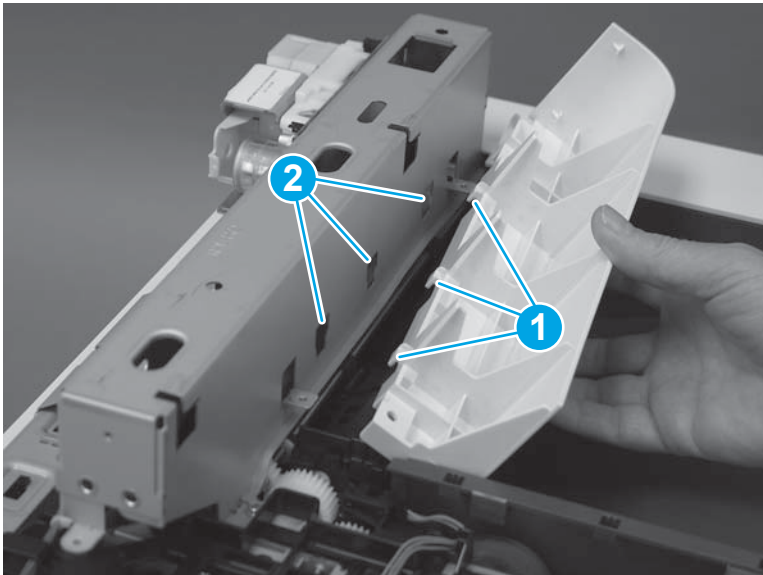

2. Install one screw (callout 1).

Figure 1-3663 Install one screw

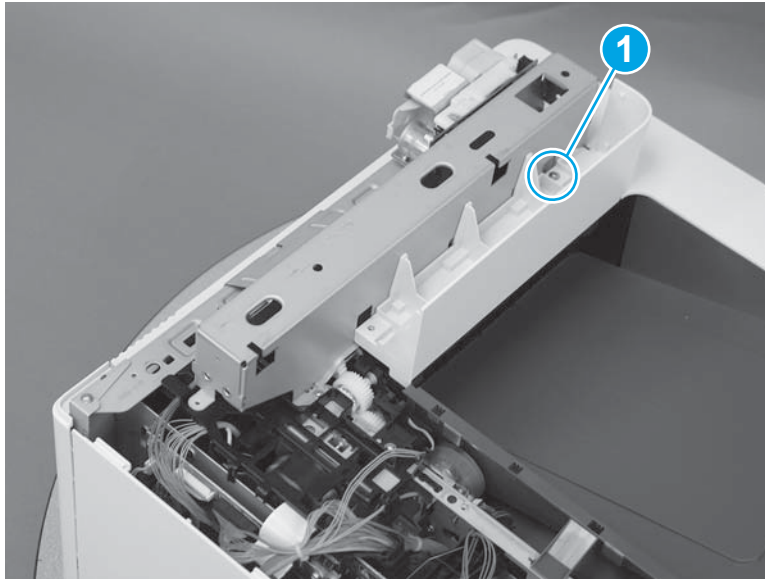

Step 51: Install the top rear cover (M577)

 **NOTE:** This step is for the M577 models. For the M552 and M553 models, skip this step and go to [Step 60: Install the rear cover \(M552 and M553\) on page 2068](#).

1. Align the locator tabs (callout 1) on the cover with the slots (callout 2) in the printer.

Figure 1-3664 Align the locator tabs

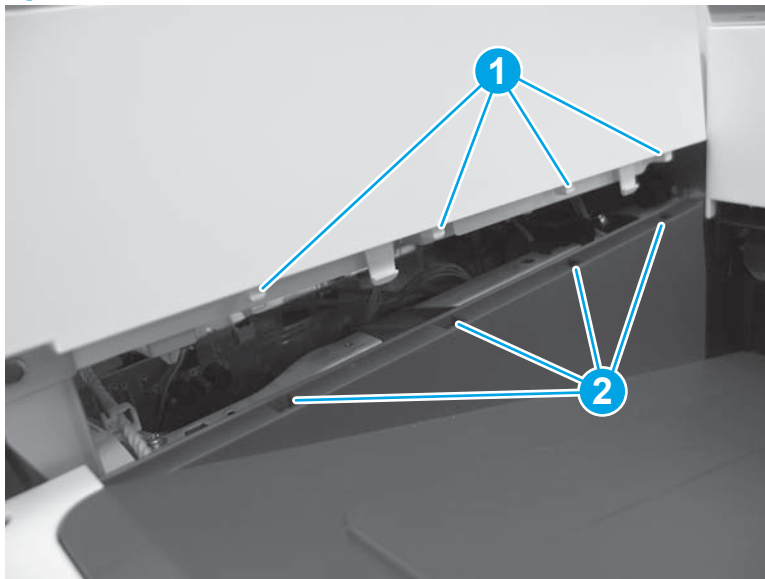

2. Press down to install the cover. Make sure that the tabs snap into place.

Figure 1-3665 Install the cover

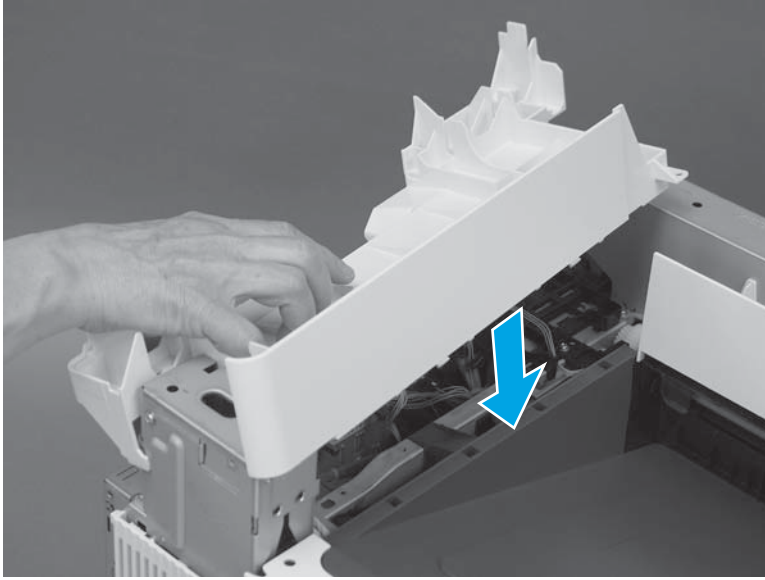

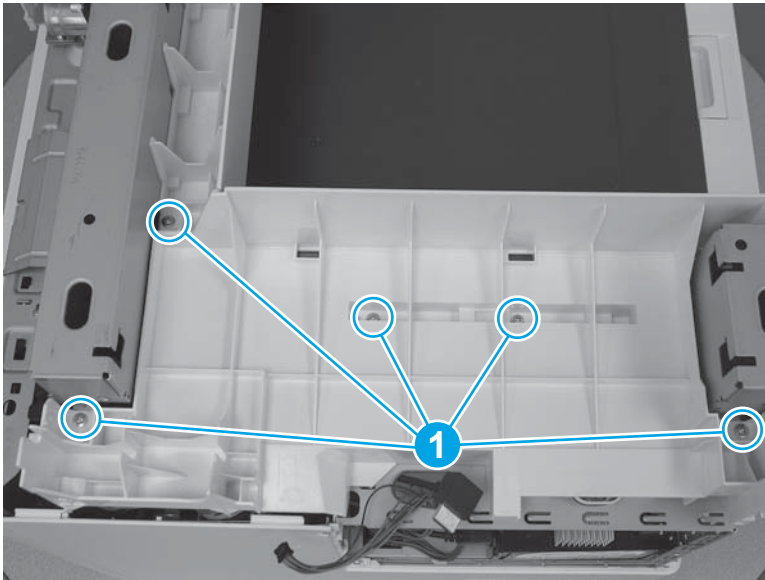

3. At the top of the printer, install five screws (callout 1).

Figure 1-3666 Install five screws



Step 52: Install the right upper cover (M577)

 **NOTE:** This step is for the M577 models. For the M552 and M553 models, skip this step and go to [Step 60: Install the rear cover \(M552 and M553\) on page 2068](#).

 **NOTE:** The figures below show the image scanner installed. The procedures for removing and installing the right upper cover are the same whether the image scanner is installed or removed."

1. **M577c/f/z only:** Install the cables (callout 1) through the slot (callout 2) in the printer.

Figure 1-3667 Install the cables

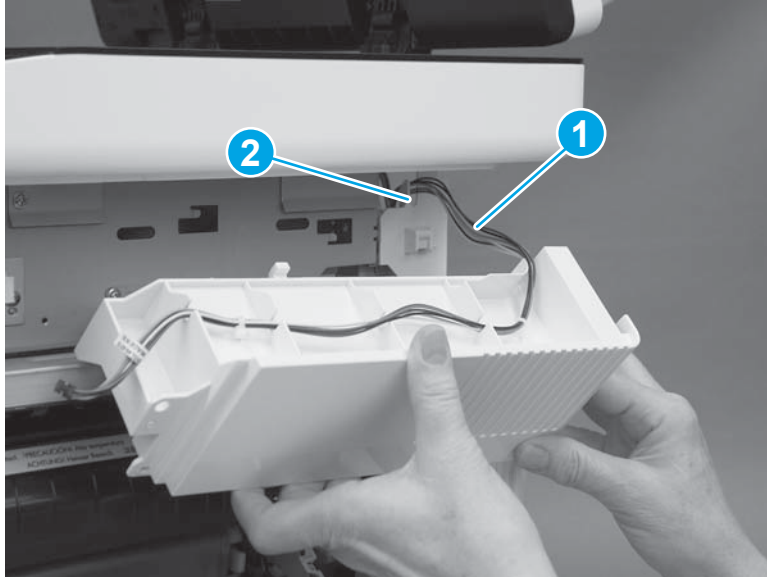

2. Position the hooks (callout 1) on the cover in the slots (callout 2) in the printer.

Figure 1-3668 Position the hooks

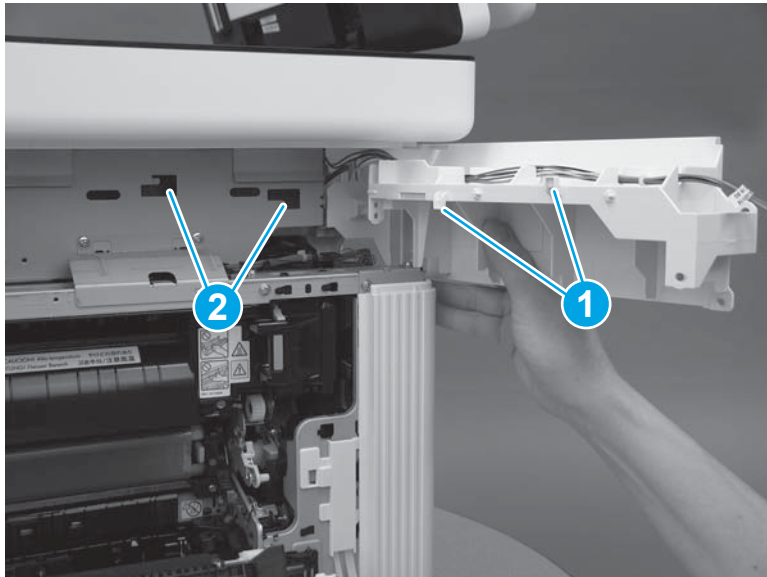

3. Slide the cover toward the front of the printer to install it.

Figure 1-3669 Install the cover

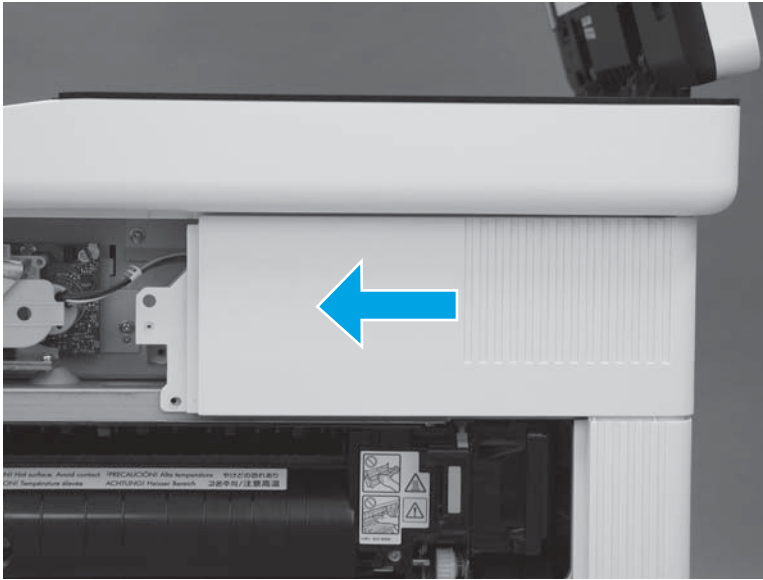

4. At the back of the printer, install one screw (callout 1).

M577c/f/z only: Connect one connector (callout 2), if the integrated scanner assembly is installed.

TIP: This screw is smaller than the screws installed in the next step. Make sure that this screw is installed in the correct position.

Figure 1-3670 Install one screw and connector

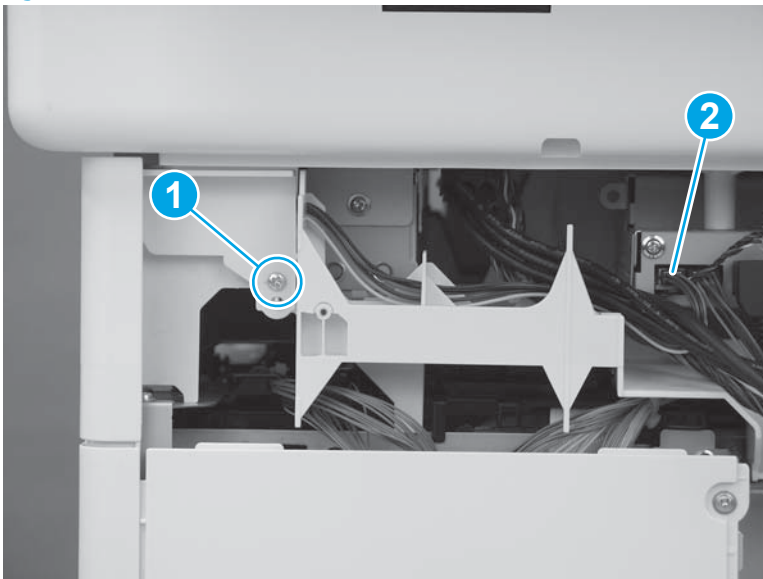

5. At the right side of the printer, install two screws (callout 1).

M577c/f/z only: Connect one connector (callout 2), if the stapler is installed.

Figure 1-3671 Install one screw and connector

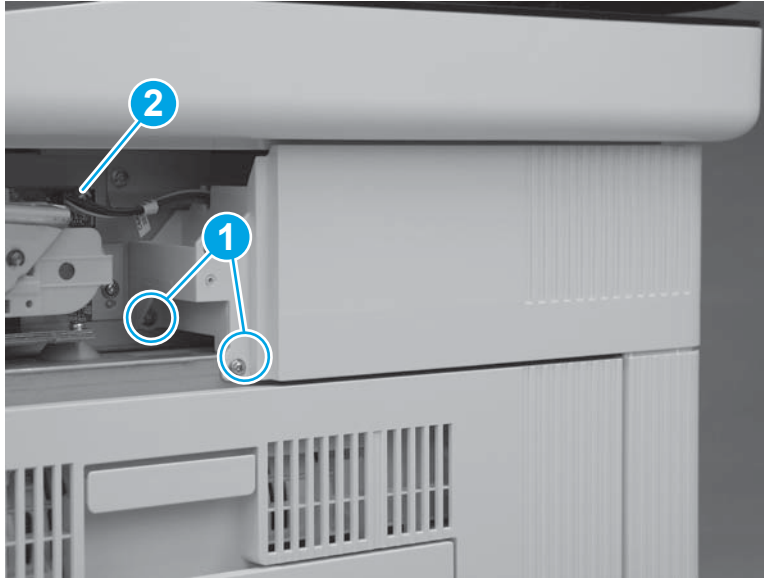

Step 53: Install the stapler unit (M577c/f/z)

 **NOTE:** This step is for the M577c/f/z models. For the M577dn model, skip this step and go to [Step 54: Install the integrated scanner assembly \(ISA\) \(M577\) on page 2056](#).

For the M552 and M553 models, skip this step and go to [Step 60: Install the rear cover \(M552 and M553\) on page 2068](#).

1. Position the hooks (callout 1) on the stapler unit in the slots (callout 2) in the printer.

Figure 1-3672 Position the hooks in the slots

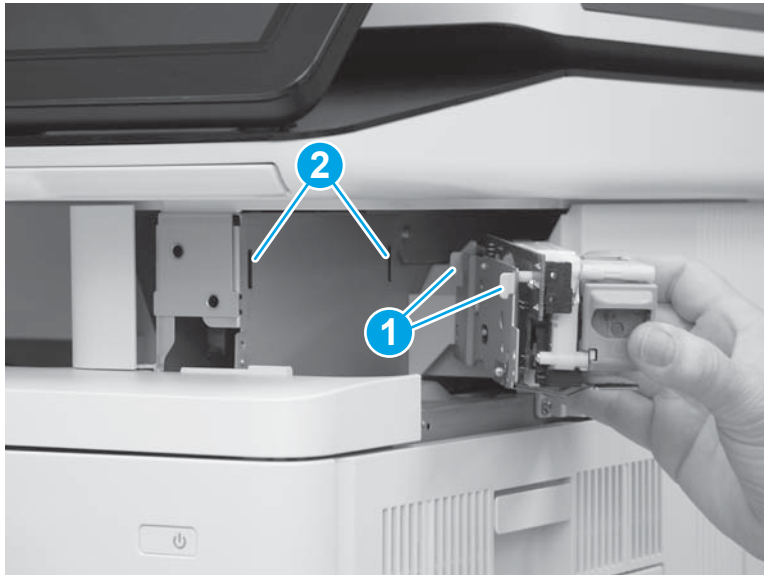

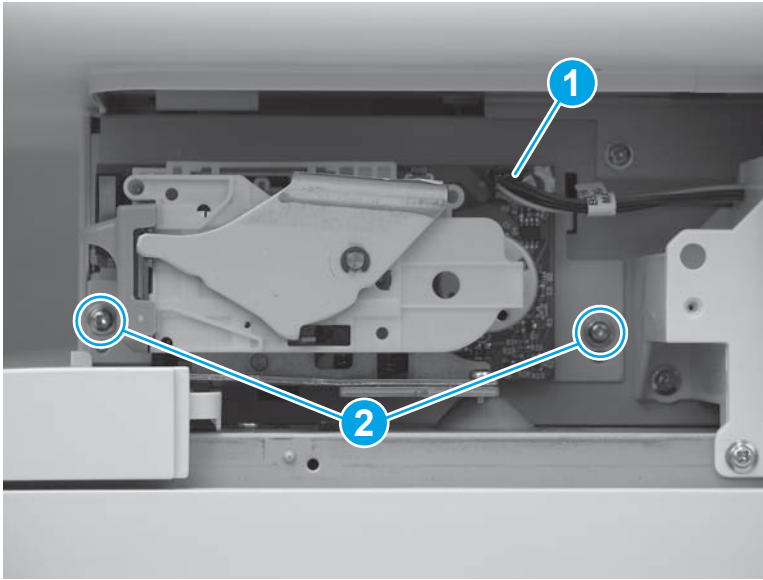

2. Connect one connector (callout 1), and then install two screws (callout 2).

Figure 1-3673 Connect connector and install screws



Step 54: Install the integrated scanner assembly (ISA) (M577)

 **NOTE:** This step is for the M577 models. For the M552 and M553 models, skip this step and go to [Step 60: Install the rear cover \(M552 and M553\) on page 2068](#).

 **NOTE:** The ISA includes the document feeder, image scanner, scanner control board (SCB), control panel, keyboard (M577c/z) and NFC PCA (M577z).

1. Before proceeding, locate the mounting pins (callout 1) on the bottom of the ISA and the slots (callout 2) on the printer base.

Figure 1-3674 Locate the ISA mounting pins and slots

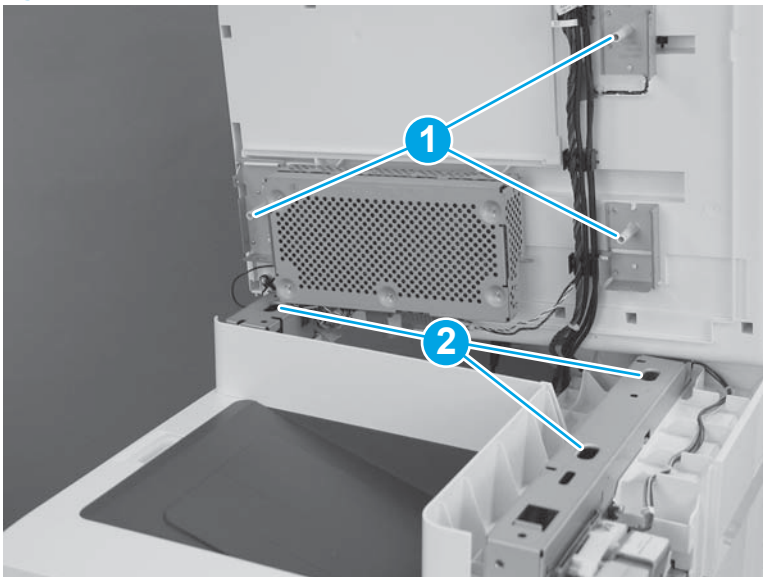

2. Position the ISA on the printer base with the pins in the slots.

 **NOTE:** To locate the pins and slots, see [Figure 1-395 Locate the ISA mounting pins and slots on page 249](#).

When installing the ISA, carefully pass the cables through the opening in the top of the formatter case.

Figure 1-3675 Install the ISA

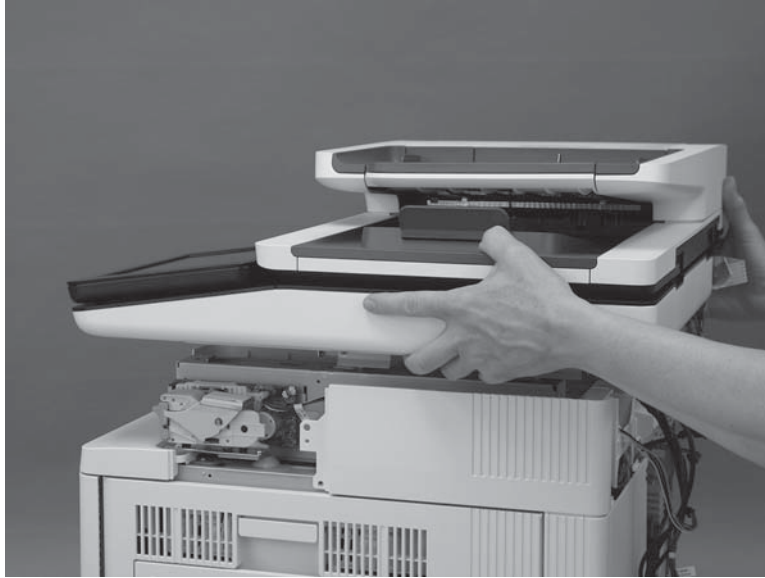

3. Slightly slide the ISA towards the front of the printer to engage it.

Figure 1-3676 Slide the ISA towards the front of the printer

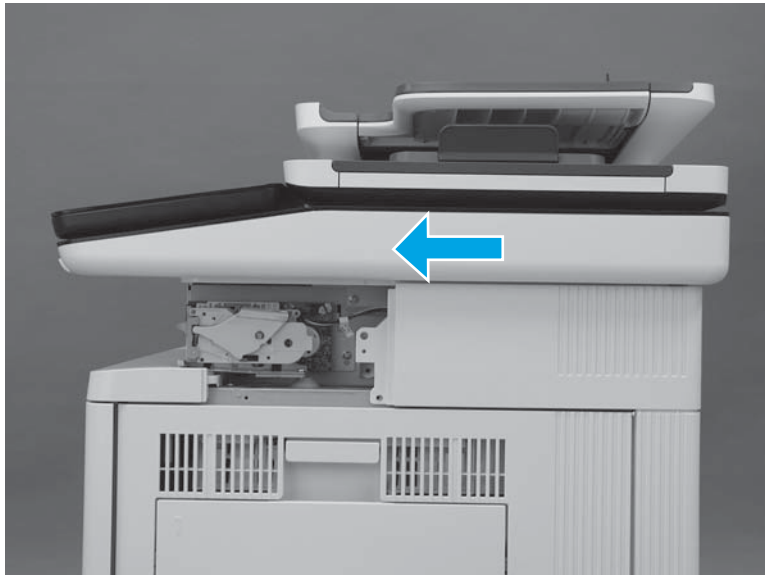

4. At the left side of the printer, install one screw (callout 1).

Figure 1-3677 Install one screw

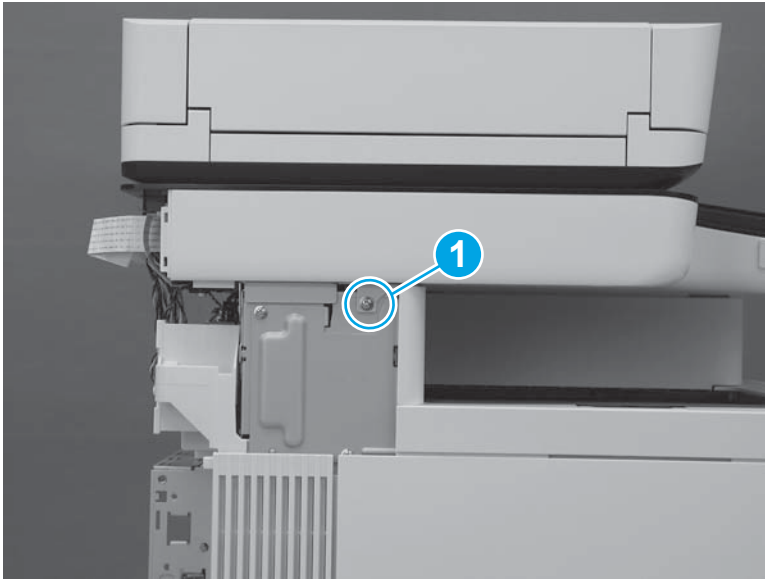

5. At the back of the printer, install two screws (callout 1).

Figure 1-3678 Install two screws

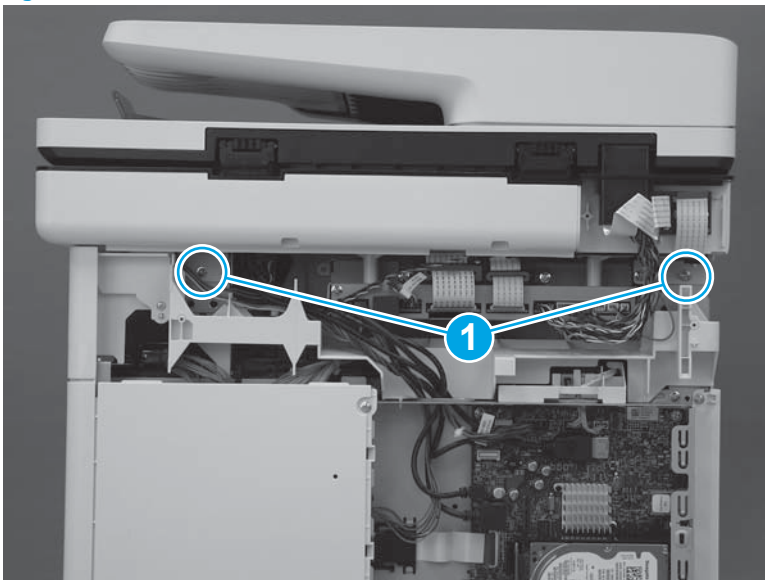

6. At the right side of the printer, install one screw (callout 1).

Figure 1-3679 Install one screw

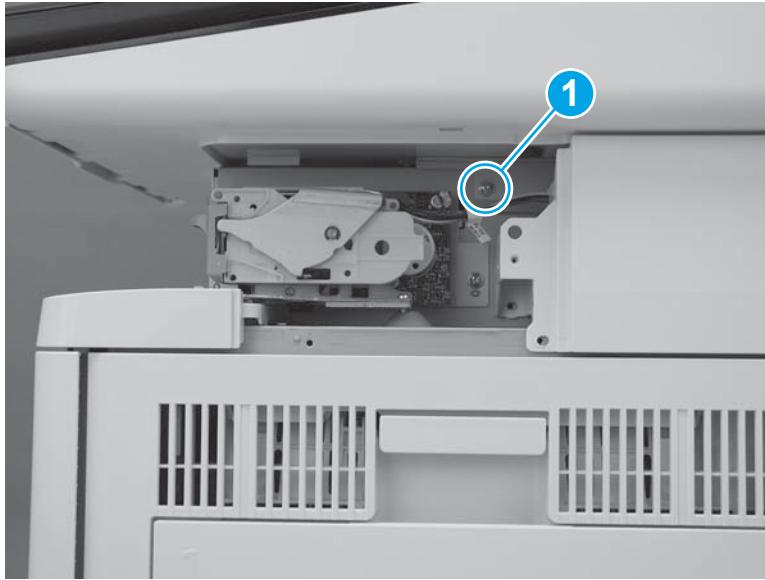

7. Connect two connectors on the scanner control board (callout 1).

M577c/f/z only: Connect one connector for the stapler on the scanner control board (callout 2).

Figure 1-3680 Connect connectors

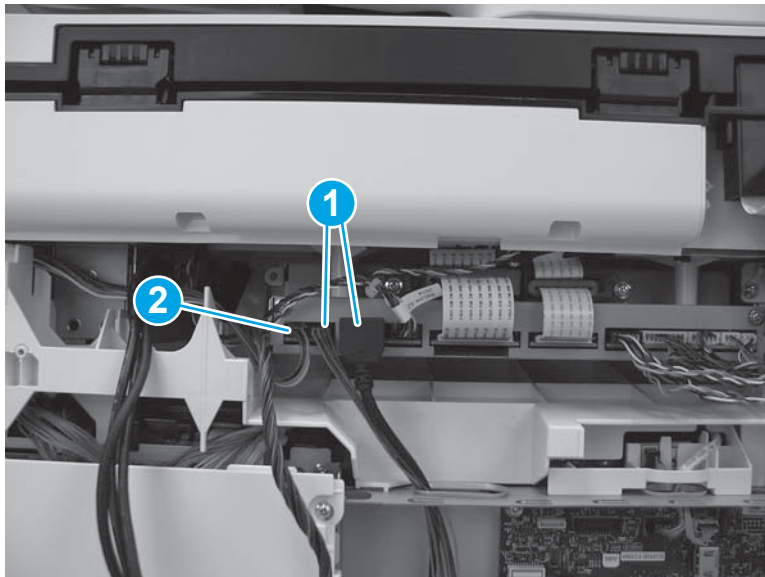

Step 55: Install the stapler cover assembly (M577c/f/z)

 **NOTE:** This step is for the M577c/f/z models only. For the M577dn model, skip this step and go to [Step 56: Install the right front upper cover \(M577dn\) on page 2061](#).

For the M552 and M553 models, skip this step and go to [Step 60: Install the rear cover \(M552 and M553\) on page 2068](#).

1. Install the tabs (callout 1) on the cover in the slots (callout 2) in the printer.

Figure 1-3681 Install two tabs



2. Press the cover toward the left side of the printer until it snaps into place.

Figure 1-3682 Install the cover assembly



3. Install one screw (callout 1).



 **IMPORTANT:** This is a self-tapping screw for plastic. Rotate it counterclockwise to align it with the existing thread pattern, and then carefully turn it clockwise to tighten. Do not overtighten. This will prevent stripping the threads inside the screw hole.

Figure 1-3683 Install one screw

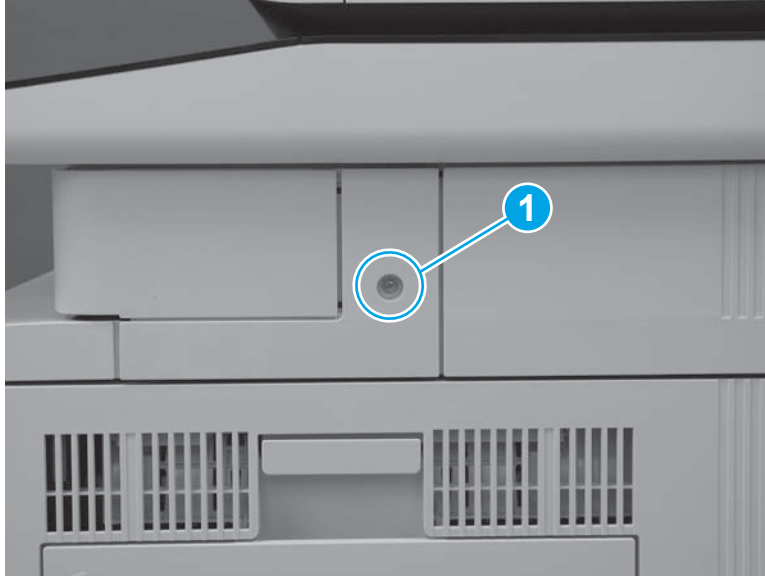

Step 56: Install the right front upper cover (M577dn)

 **NOTE:** This step is for the M577dn model only. For the M577c/f/z models, skip this step and go to [Step 57: Install the left upper cover \(M577\) on page 2063](#).

For the M552 and M553 models, skip this step and go to [Step 60: Install the rear cover \(M552 and M553\) on page 2068](#).

1. Slide the cover toward the left side of the printer to install it. Make sure that the slots (callout 1) in the cover fit over the tabs (callout 2) on the inside of the paper feeder cover.

Figure 1-3684 Install the cover



2. Press the right front upper cover (callout 1) and the paper feeder cover (callout 2) together until the tabs on the inside of the covers snap into place.

Figure 1-3685 Press the cover



3. Install one screw (callout 1).

Figure 1-3686 Install one screw

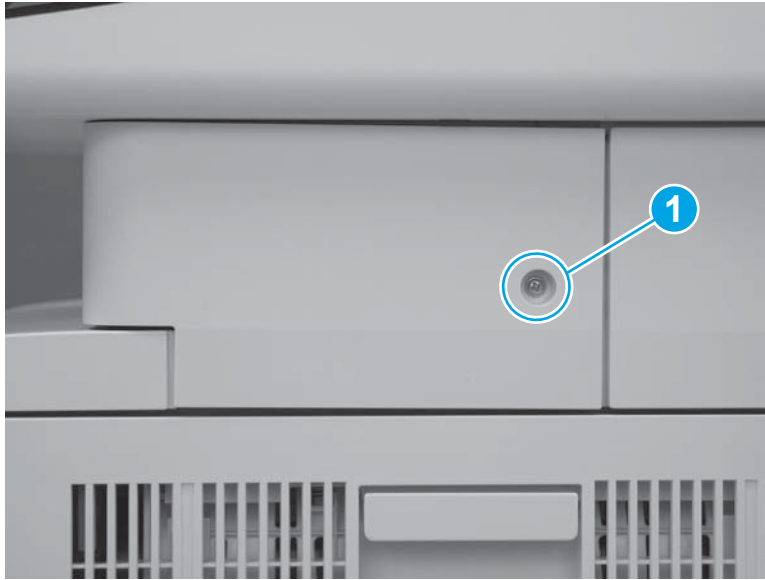

Step 57: Install the left upper cover (M577)

 **NOTE:** This step is for the M577 models. For the M552 and M553 models, skip this step and go to [Step 60: Install the rear cover \(M552 and M553\) on page 2068](#).

1. Position the tab (callout 1) on the lower edge of the cover behind the left cover (callout 2).

Figure 1-3687 Position the tab

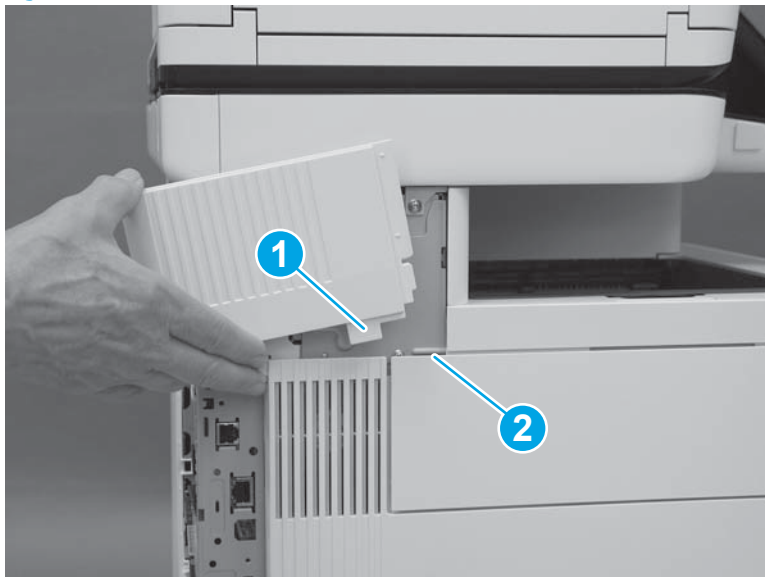

2. Slide the cover toward the front of the printer to install it. Make sure that the edge (callout 1) of the cover fits behind the edge (callout 2) of the top rear cover.

Figure 1-3688 Slide the cover

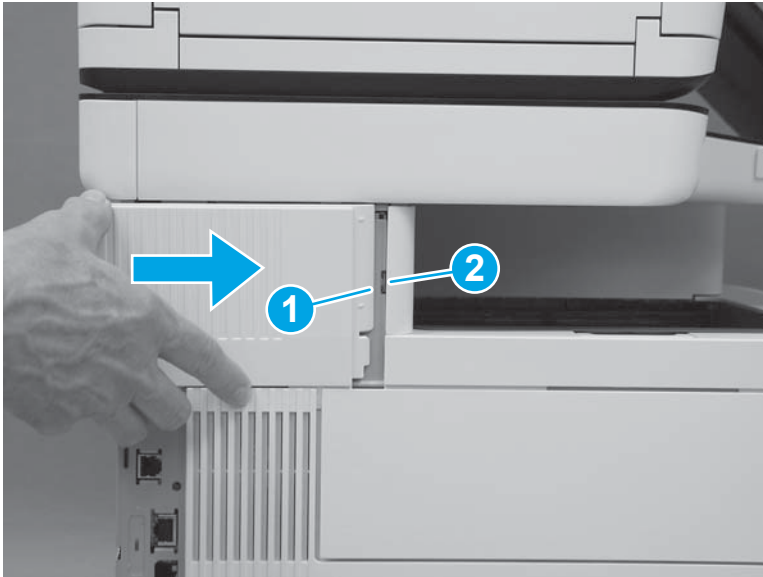

3. Make sure that the tab (callout 1) is fully installed.

Figure 1-3689 Check the tab

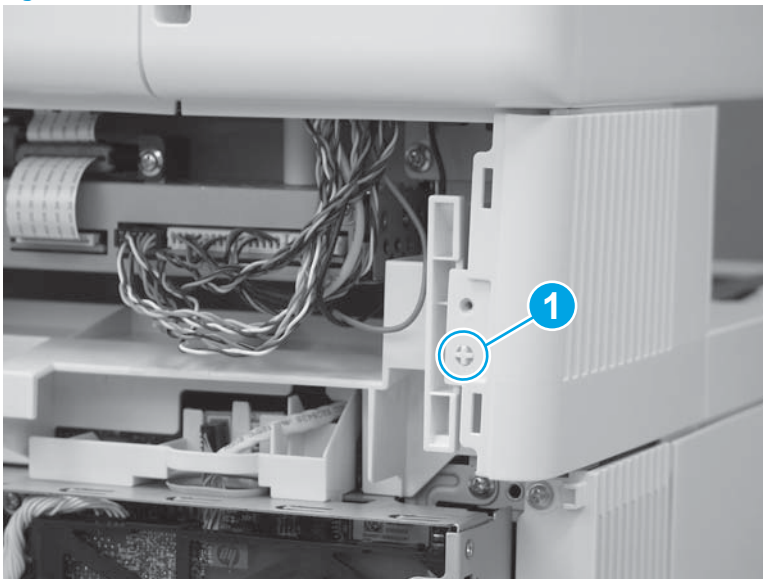

Step 58: Install the rear cover (M577)

 **NOTE:** This step is for the M577 models. For the M552 and M553 models, skip this step and go to [Step 60: Install the rear cover \(M552 and M553\) on page 2068](#).

1. Position the hooks (callout 1) on the cover in the slots (callout 2) in the printer.

Figure 1-3690 Position the hooks

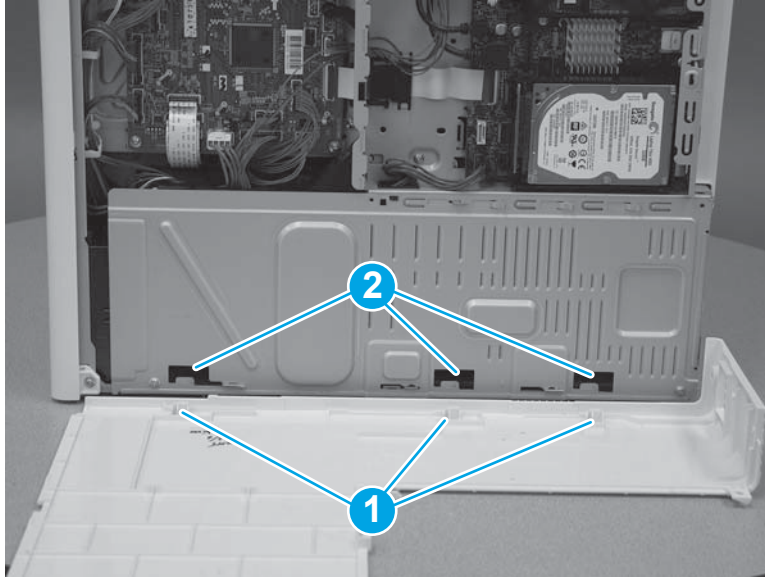

2. Position the back edge (callout 1) of the rear cover behind the edge (callout 2) of the right rear cover. Slide the cover to the left to install it.

Figure 1-3691 Install the cover

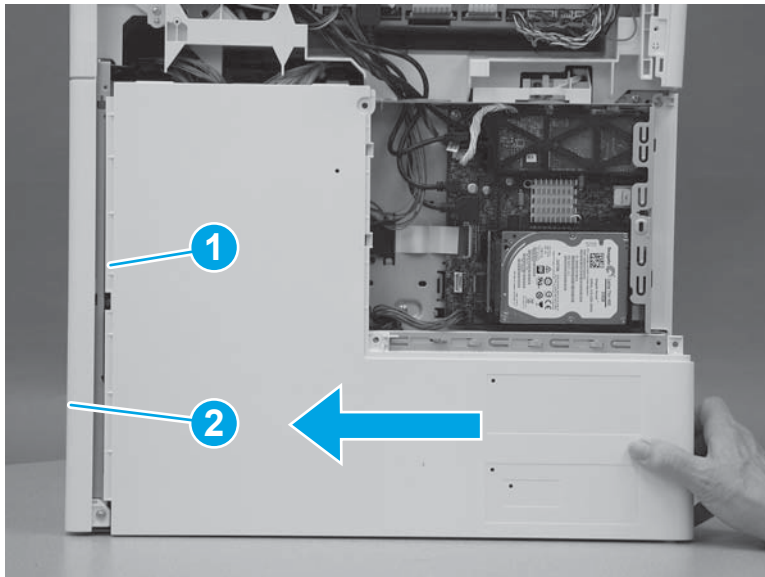

3. Install four screws (callout 1).

Figure 1-3692 Install four screws cover

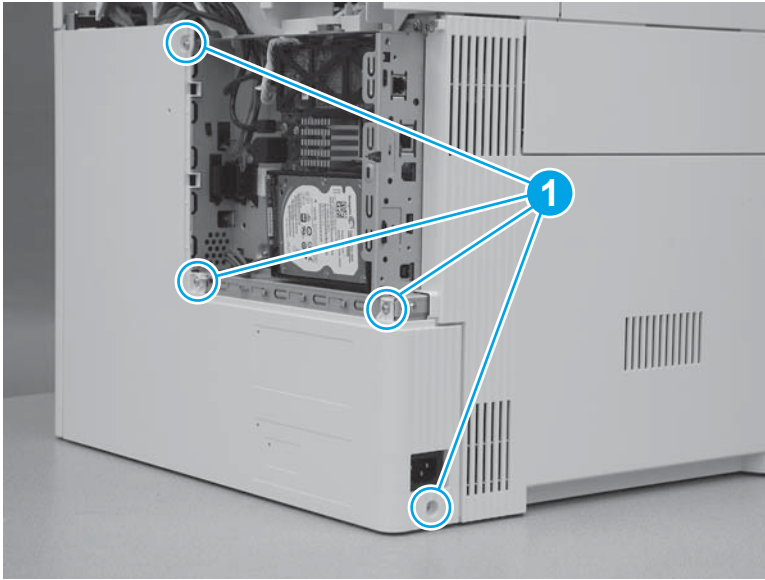

Step 59: Install the rear upper cover (M577)



NOTE: This step is for the M577 models. For the M552 and M553 models, skip this step and go to [Step 60: Install the rear cover \(M552 and M553\) on page 2068](#).

1. Align the ridge (callout 1) on the lower edge of the rear upper cover in front of the tabs (callout 2) on the top edge of the rear cover.

Figure 1-3693 Align the cover

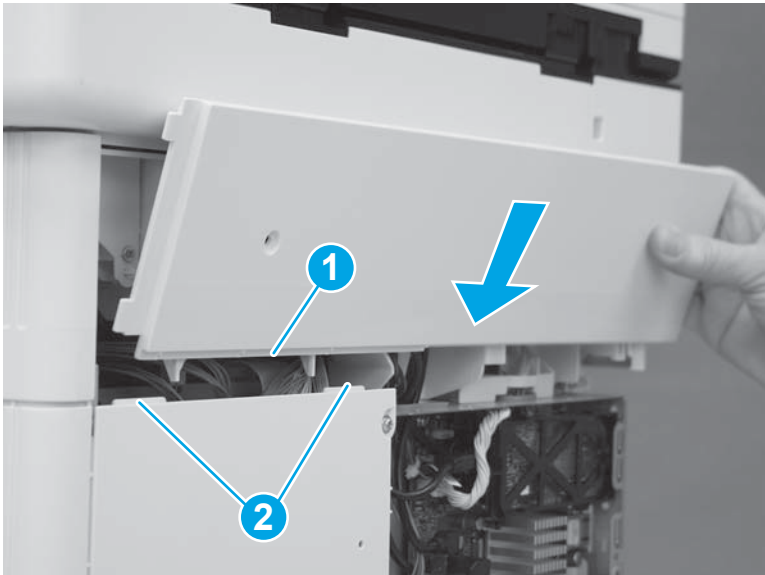

2. Rotate the top of the cover toward the printer.

Figure 1-3694 Rotate the top of the cover

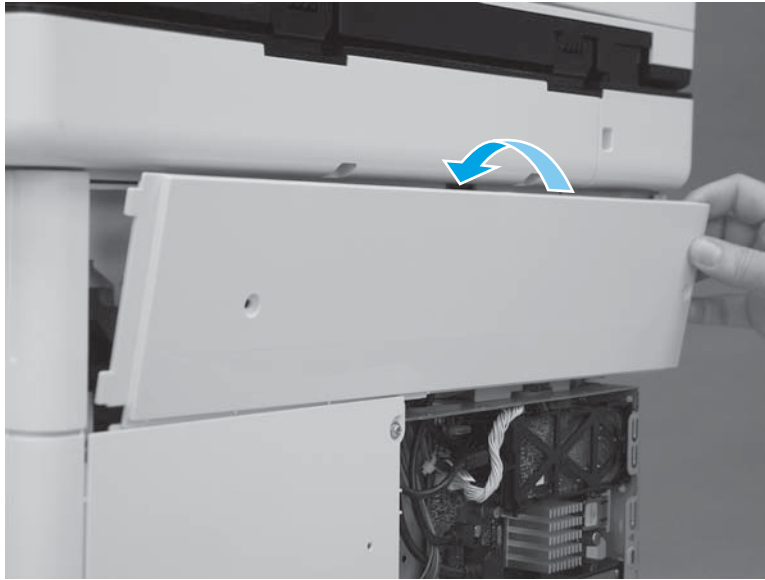

3. Slide the cover to the left (callout 1). Make sure that the tabs (callout 2) on the upper rear cover slide behind the edge (callout 3) of the right upper cover. Make sure that the cover is fully seated.

Figure 1-3695 Slide the cover

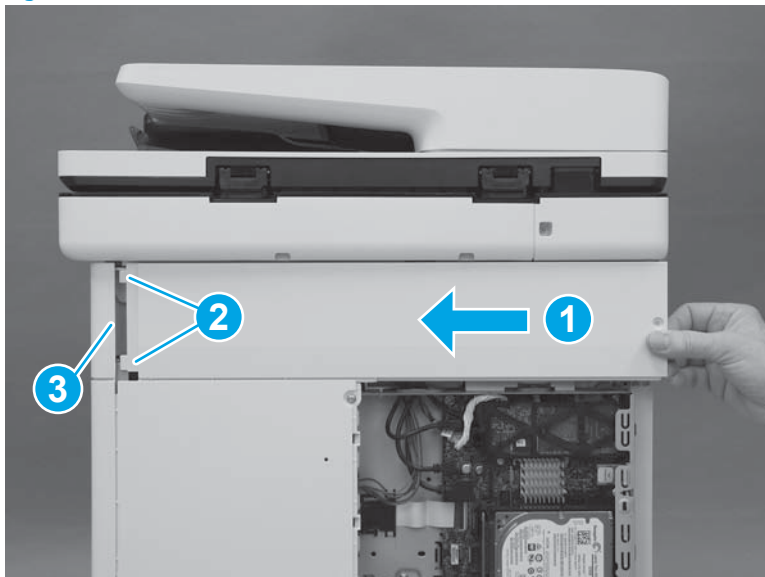

4. Install two screws (callout 1).



 **IMPORTANT:** These two screws are self-tapping screws for plastic. Rotate them counterclockwise to align them with the existing thread pattern, and then carefully turn them clockwise to tighten. Do not overtighten. This will prevent stripping the threads inside the screw holes.

Figure 1-3696 Install two screws

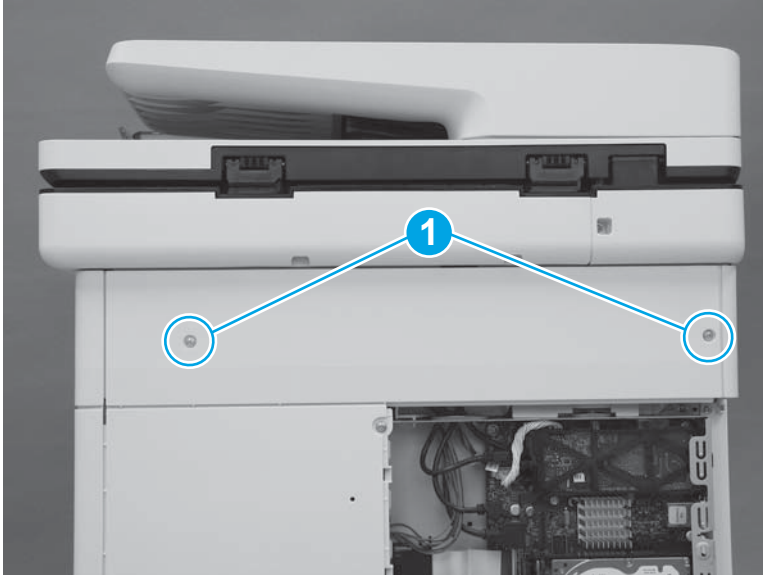

Step 60: Install the rear cover (M552 and M553)

 **NOTE:** This step is for the M552 and M553 models. For the M577 models, skip this step and go to [Step 61: Install the formatter \(M577\) on page 2069](#).

1. Position the top of the cover under the upper cover (callout 1), rotate the bottom of the cover onto the chassis (callout 2), and then slide the cover to the left (callout 3) to install it.

Figure 1-3697 Install the cover

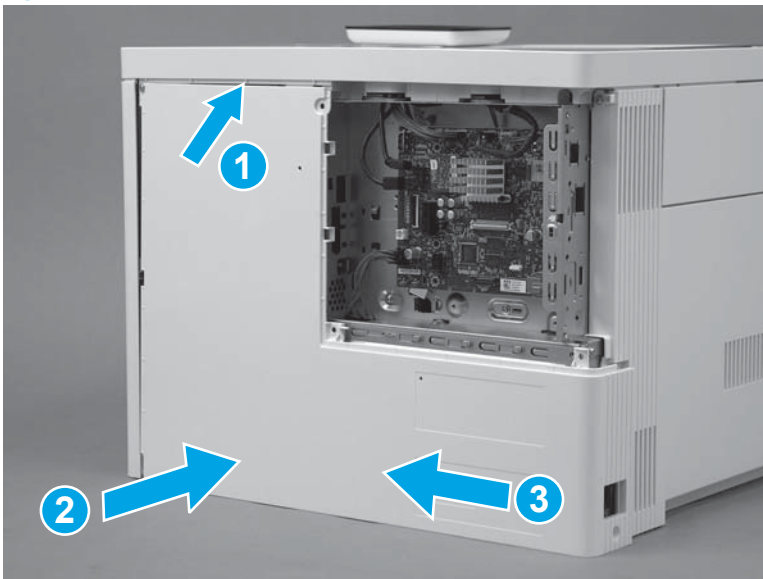

2. Install four screws (callout 1).

Figure 1-3698 Install four screws cover

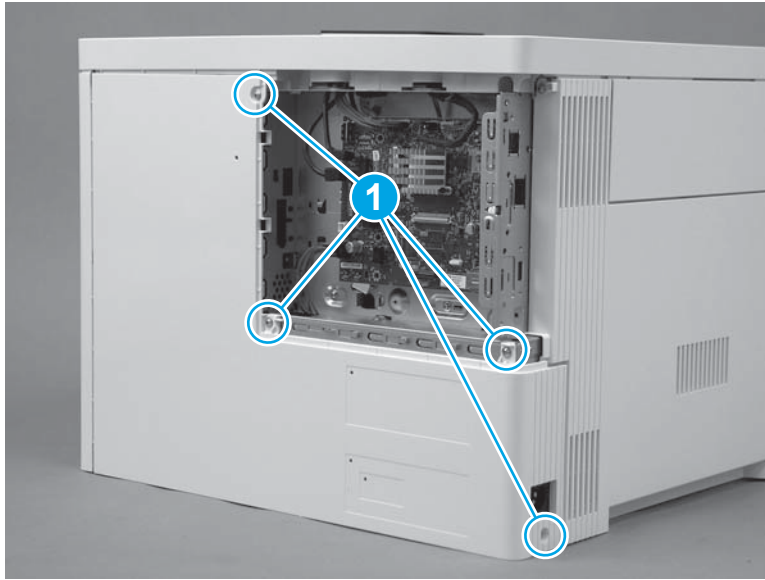

Step 61: Install the formatter (M577)

 **NOTE:** This step is for the M577 models. For the M552 and M553 models, skip this step and to go [Step 64: Install the formatter \(M552 and M553\) on page 2074](#).

 **CAUTION:**  ESD-sensitive part.

1. Position the formatter in the printer. Make sure that the network port (callout 1) fits through the opening (callout 2) in the formatter case.

Figure 1-3699 Install the formatter

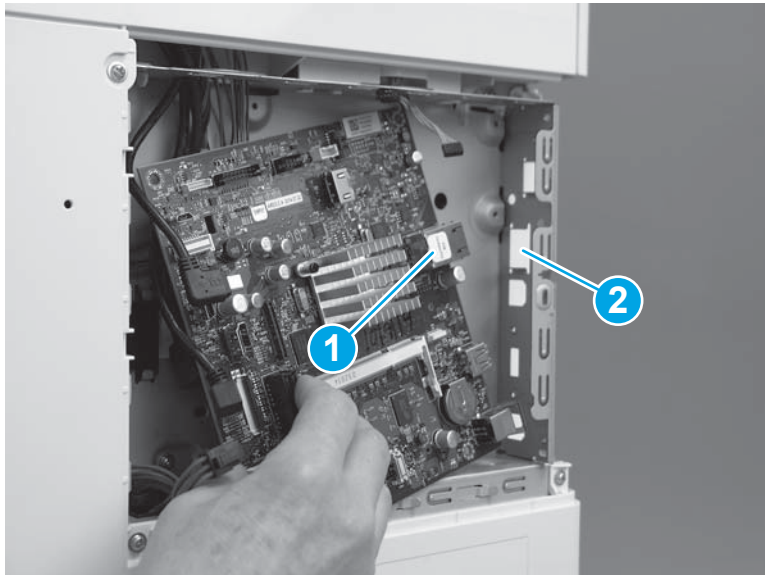

2. Install four screws (callout 1).

Figure 1-3700 Install four screws

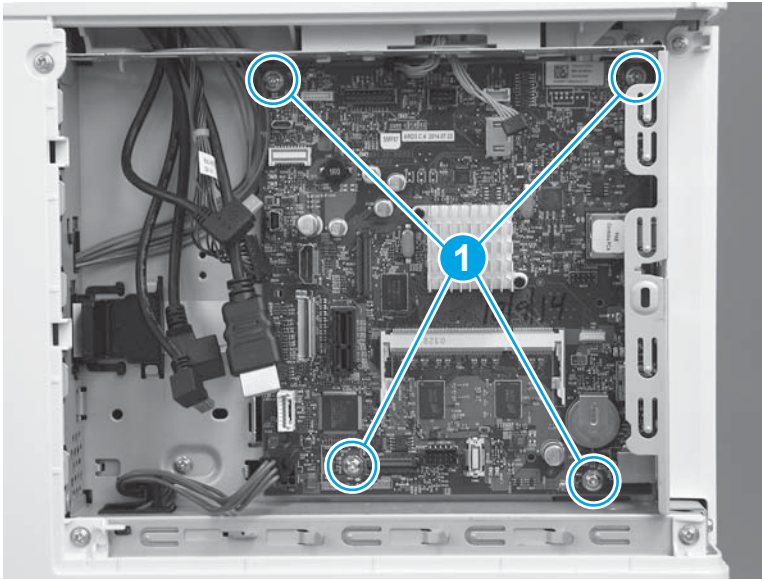

3. Connect all of the connectors on the formatter.

The following connectors are empty:

- All models: J1 (this connector is empty unless the optional DIMM is installed)
- All models: J3
- M577dn: J15 (this is the fax connector for the M577f/z/c models)
- All models: J21 (this connector is empty unless the optional internal USB ports component is installed)
- All models: J23
- All models: J24
- All models: J51
- All models: J57
- All models: J97
- All models: J98 (this connector is empty unless the optional trusted platform module (TPM) is installed)

IMPORTANT: The flat-cable connector (callout 1) is a Zero Insertion Force (ZIF) connector that uses a hinged retainer to secure the flat cable. The hinged retainer must be opened to install the flat cable, and then closed after the cable is installed.

Figure 1-3701 Connect all connectors

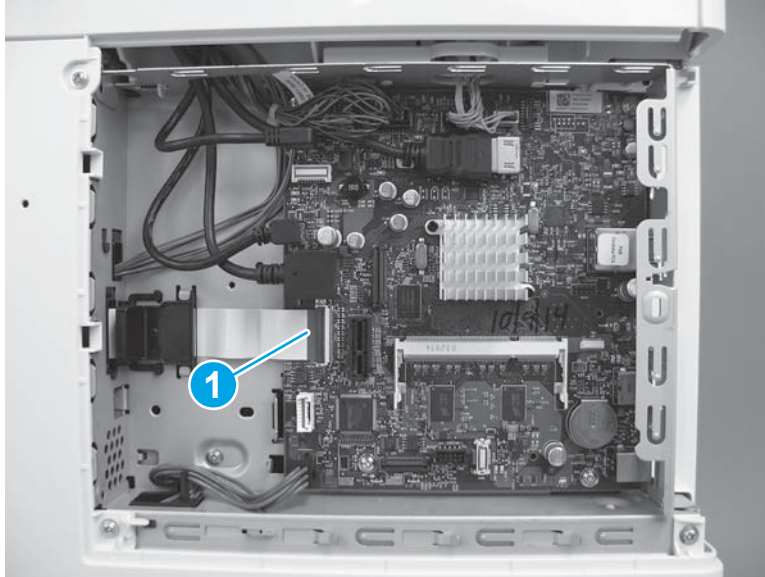

Step 62: Install the fax PCA (M577c/f/z)

 **NOTE:** This step is for the M577c/f/z models. For the M577n model, skip this step and go to [Step 63: Install the HDD \(M577\) on page 2072](#).

For the M552 and M553 models, skip this step and go to [Step 64: Install the formatter \(M552 and M553\) on page 2074](#).

 **CAUTION:**  ESD-sensitive part.

1. Position the tab and telephone port (callout 1) on the fax PCA in the slots (callout 2) in the formatter case.

Figure 1-3702 Position the fax PCA

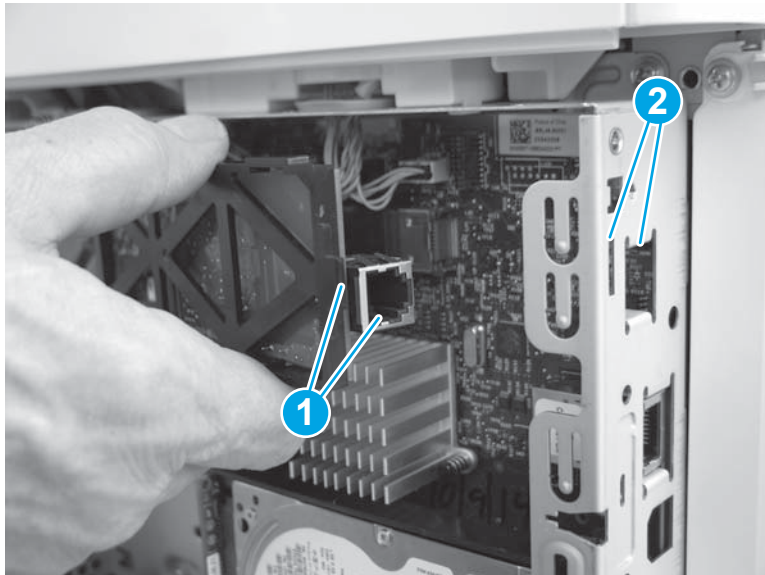

- Slide the fax PCA to the right (callout 1) until the tab and telephone port described in the previous step and seated in the formatter case. Position the retainer (callout 2) in the slot (callout 3) in the formatter. Rotate the end of the fax PCA toward the formatter (callout 4) until the retainer snaps into place.

Figure 1-3703 Install the fax PCA

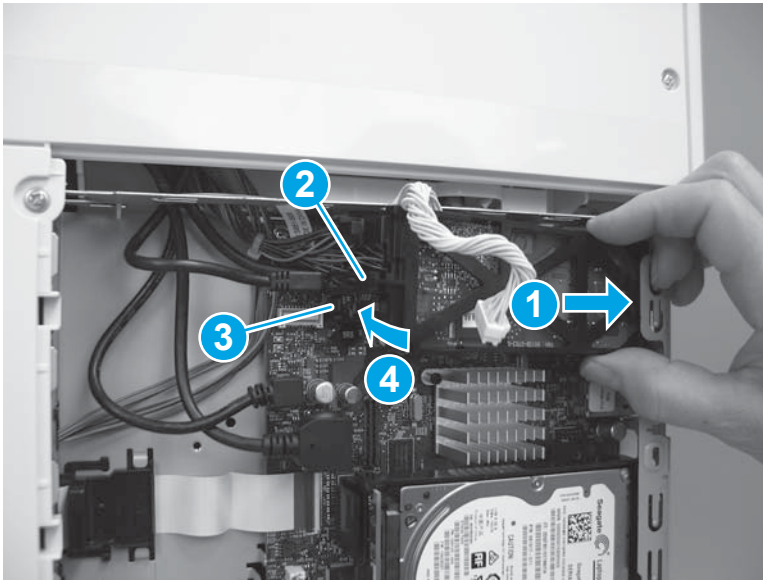

- Position the cable (callout 1) in the guide (callout 2), and then connect one connector (callout 3).

Figure 1-3704 Connect the connector

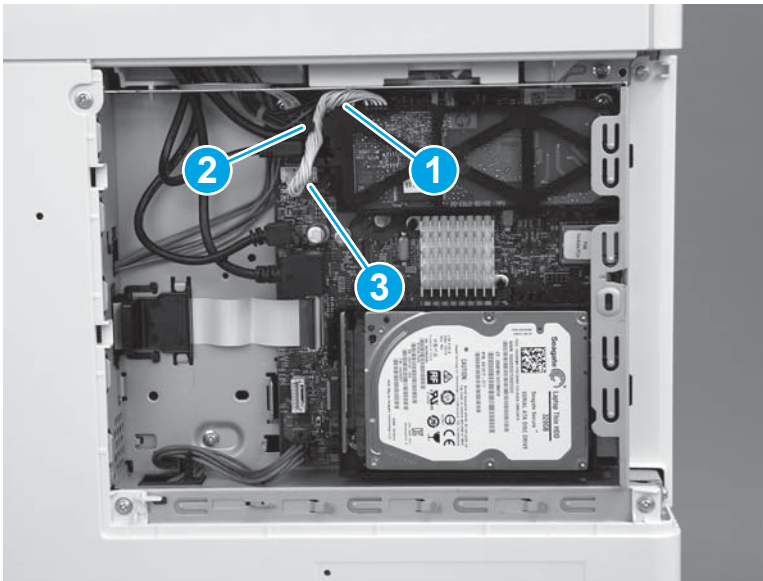

Step 63: Install the HDD (M577)

 **NOTE:** This step is for the M577 models. For the M552 and M553 models, skip this step and go to [Step 64: Install the formatter \(M552 and M553\) on page 2074](#).

 **CAUTION:**  ESD-sensitive part.

1. Align the end of the bracket (callout 1) with the slot in the chassis (callout 2), and then slide the HDD into the printer (callout 3) to engage the bracket with the chassis.

Figure 1-3705 Install the holder

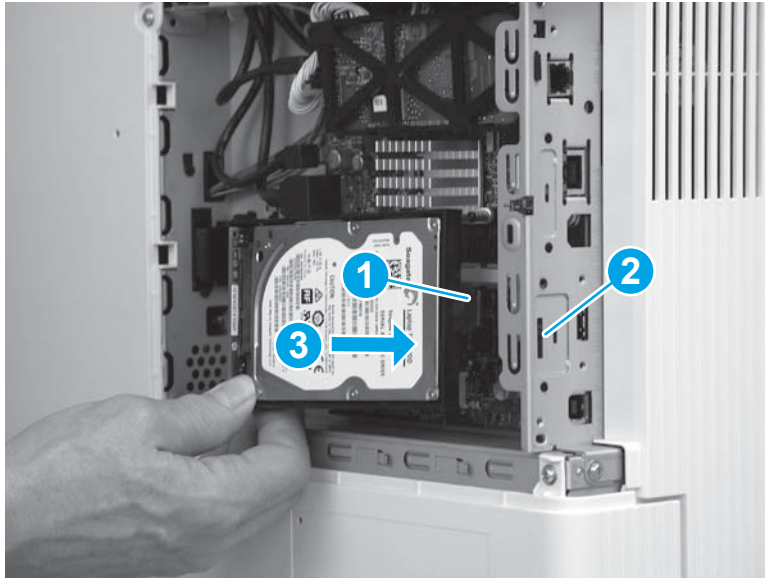

2. Hold the HDD connector latch (callout 1) in the released position, and then rotate the HDD down and into the connector on the formatter to install it.

 **NOTE:** Make sure that the tab (callout 2) snaps into place, and that the HDD is securely installed.

Figure 1-3706 Release the HDD

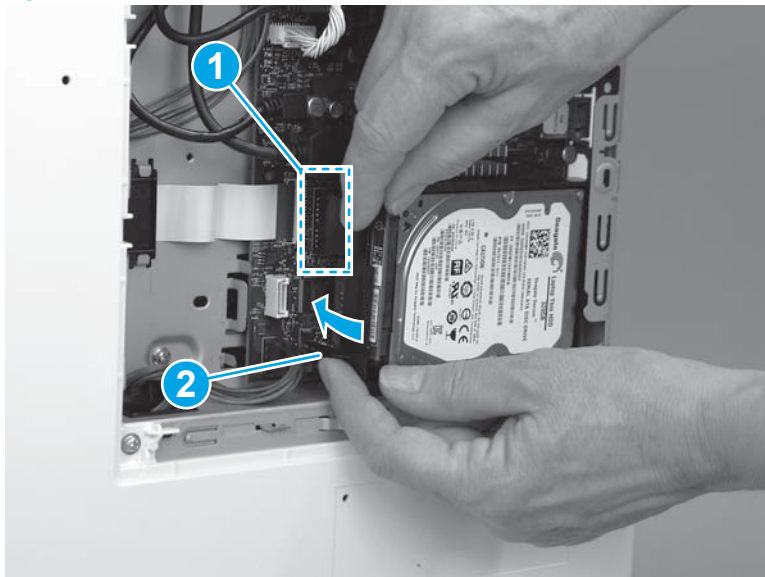

Step 64: Install the formatter (M552 and M553)

 **NOTE:** This step is for the M552 and M553 models. For the M577 models, skip this step and go to [Step 65: Install the formatter cover on page 2075](#).

If the optional hard-disk drive (HDD) was removed, do not forget to reinstall it after the formatter is reinstalled.

Engage the HDD holder with the chassis, rotate the HDD connector down and into the connector on the formatter. Make sure that the tabs snap into place.

 **CAUTION:**  ESD-sensitive part.

1. Position the formatter in the printer, and then install four screws (callout 1).

Figure 1-3707 Install the formatter

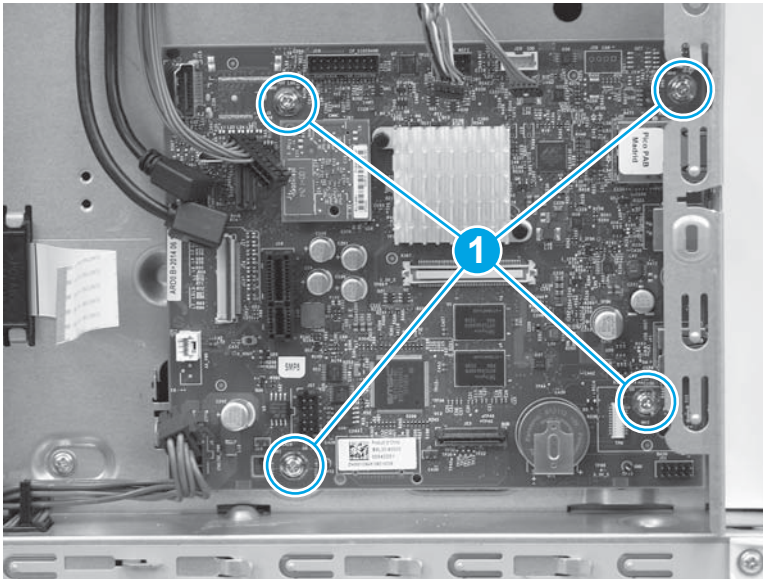

2. Connect all of the connectors on the formatter.

The following connectors are empty:

- All models: J1 (this connector is empty unless the optional DIMM is installed)
- M553n/dn and M552dn: J2 (callout 1; this is the touchscreen connector for the M553x model)
- All models: J9 (this connector is empty unless the optional internal USB ports component is installed)
- All models: J18 (this connector is empty unless the optional hard-disk-drive (HDD) is installed)
- All models: J23
- All models: J24
- M553n/dn and M552dn: J25 (this is the wireless connector for the M553x model)
- All models: J57
- All models: J98 (this connector is empty unless the optional trusted platform module (TPM) is installed)



 **IMPORTANT:** The flat-cable connector (callout 2) is a Zero Insertion Force (ZIF) connector that uses a hinged retainer to secure the flat cable. The hinged retainer must be opened to install the flat cable.

Figure 1-3708 Connect all connectors

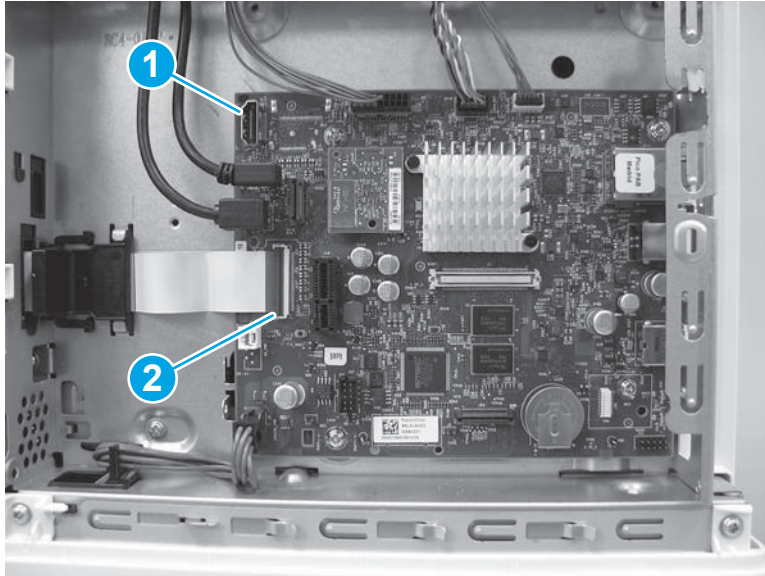

Step 65: Install the formatter cover

- ▲ Slide the cover onto the printer (callout 1) to install it.

 **NOTE:** Make sure that the tabs on the formatter cover align with the slots provided in the printer (callout 2). Tighten the two thumbscrews (callout 3).

 **TIP:** If needed, use the edge of a coin to turn the thumbscrews.

Figure 1-3709 Install the cover

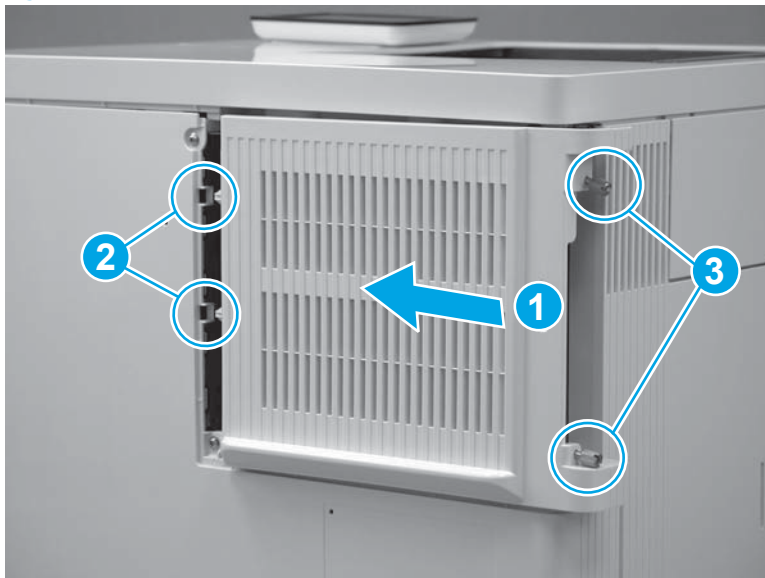

Step 66: Install the TCU

1. Verify that the toner collection hatch cover is in the closed position on the TCU.

Figure 1-3710 Verify that the toner collection hatch cover is closed

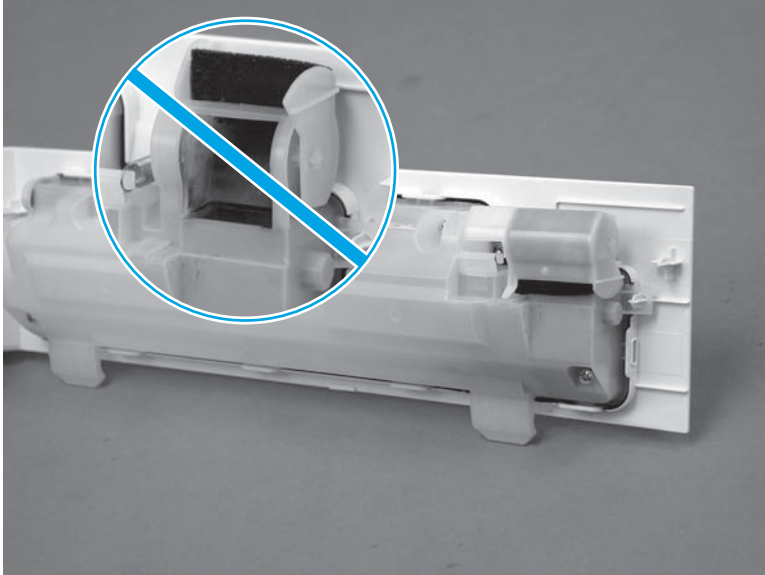

2. Position the TCU with the hinges in the slots provided in the printer (callout 1), and then rotate the TCU up and into the closed position.

 **NOTE:** The toner collection hatch cover automatically opens when the TCU is closed.

Figure 1-3711 Install the TCU



3. Close the front door.

Figure 1-3712 Close the front door

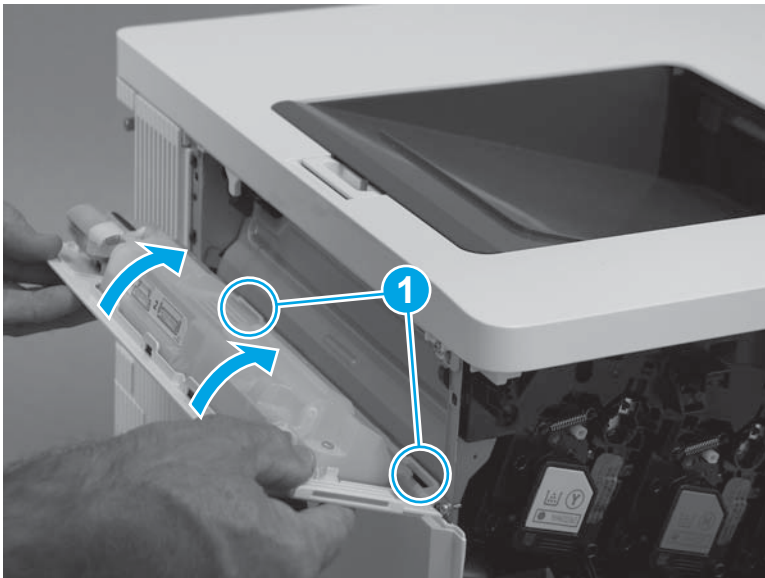

Step 67: Install the tray

1. With the front of the tray slightly lifted, align the sides of the tray with the rails in the printer, and then carefully slide the tray into the printer.

 **TIP:** As the tray slides into the printer, lower the front of it.

Figure 1-3713 Install the tray



2. Close the tray.

Figure 1-3714 Close the tray



Step 68: Install the control-panel assembly (M553x only)

 **NOTE:** For the M553n/dn and M552dn models, skip this step and go to [Step 69: Install the USB cover \(M552 and M553\) on page 2081](#).

For the M577 models, skip this step.

1. Place the control panel on the printer as shown.

Figure 1-3715 Place the control panel on the product

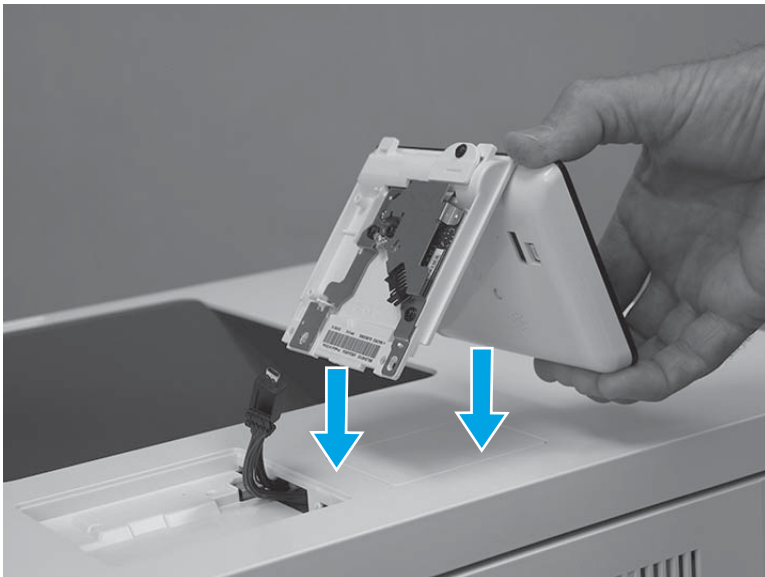

2. Connect one USB cable (callout 1), and one connector (callout 2).

 **IMPORTANT:** Take note of the location of the two mounting tabs (callout 3) on the control-panel assembly.

Figure 1-3716 Connect two connectors



3. Turn the control panel over, and then position the front edge tabs in the slots in the top cover.

Figure 1-3717 Turn the control panel over

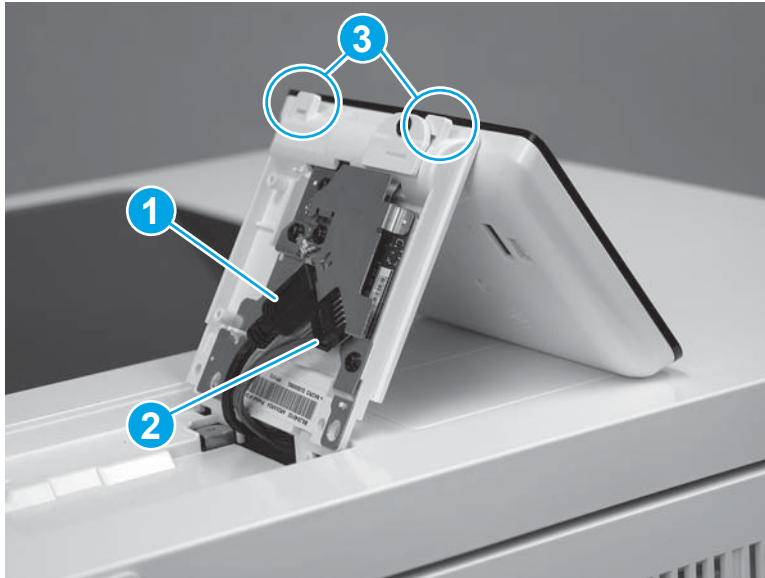
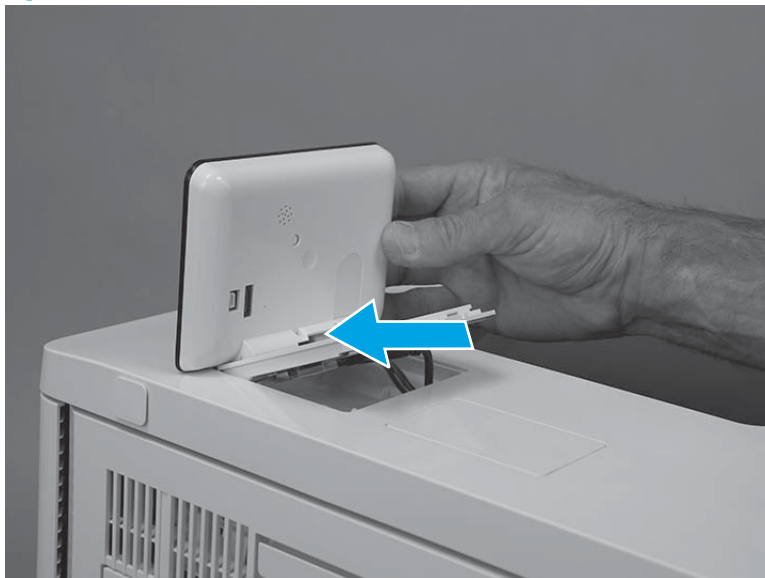

4. Rotate the control-panel base down onto the printer.

Figure 1-3718 Rotate the control-panel base down



5. Use a small Phillips screwdriver to install two screws (callout 1).

Figure 1-3719 Install two screws

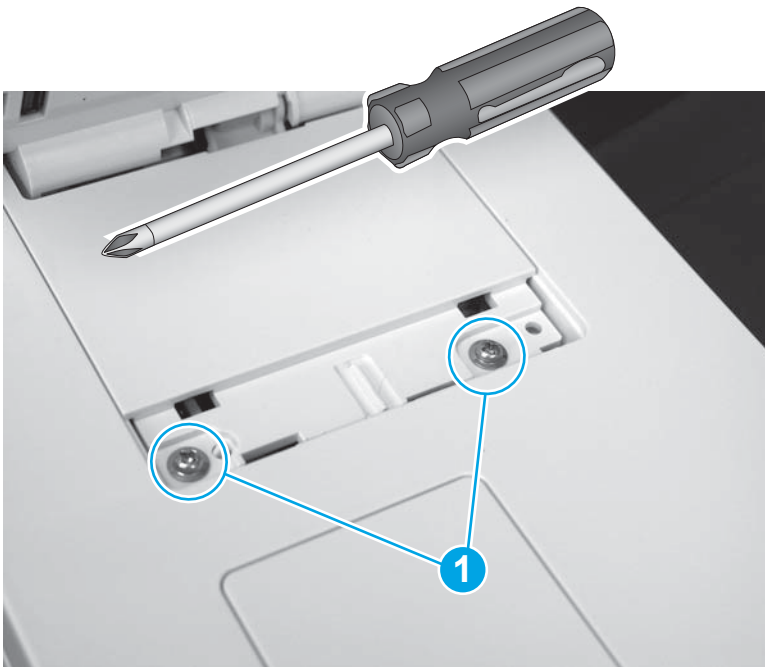

6. Position the screw cover mounting feet into the slots in the top cover (callout 1), and then rotate the cover down (callout 2) to install it.

 **NOTE:** Press down on the cover firmly to make sure that the tabs on the cover (callout 3) snap into place.

Figure 1-3720 Install the cover

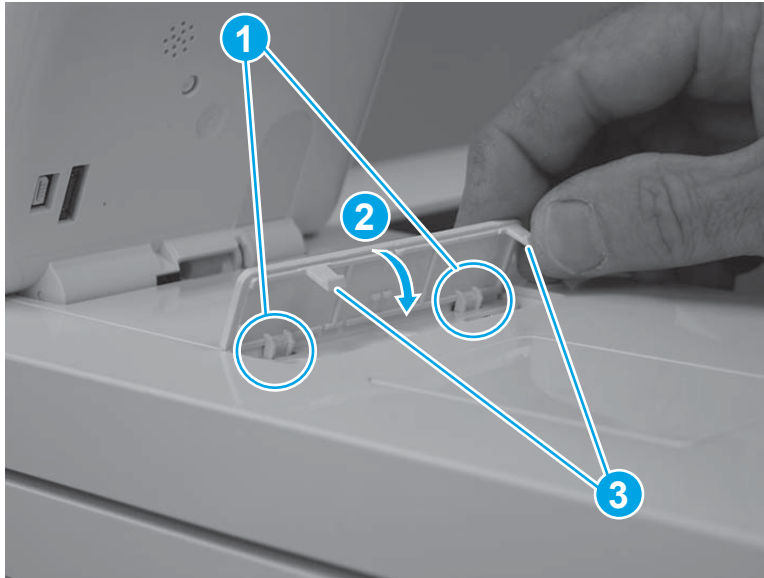

Step 69: Install the USB cover (M552 and M553)

 **NOTE:** This step is for the M552 and M553 models. For the M577 models, skip this step.

1. Push the cover into the USB port to install it.

Figure 1-3721 Install the cover



2. Make sure that the USB cover is fully seated after installing it.

Figure 1-3722 Check the installation

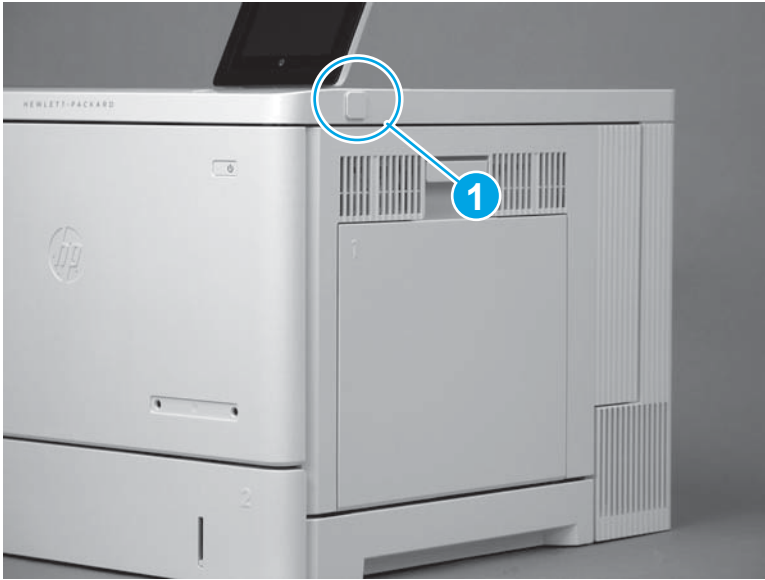

Step 70: Install the ITB

CAUTION: Do not touch the grey-plastic belt. Skin oils and fingerprints on the belt can cause print-quality problems.

1. Handle the ITB by the edges. Do not touch the grey-plastic belt. Skin oils and fingerprints on the belt can cause print-quality problems.

Figure 1-3723 Handle the ITB by the edges

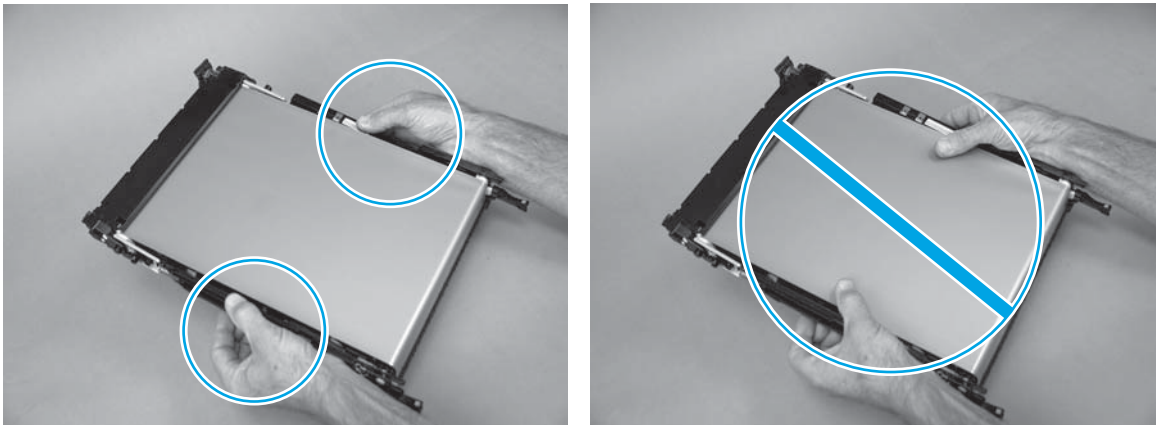

2. Align the ITB with the slots in the printer, and then carefully push it into the printer.

 **NOTE:** Be careful. Do not dislodge the ITB retainer springs from the holders on the chassis. The springs can interfere with installing the ITB.

Figure 1-3724 Align the ITB with the slots in the product



3. Continue to carefully push the ITB into the printer until it is fully installed.

Figure 1-3725 Install the ITB

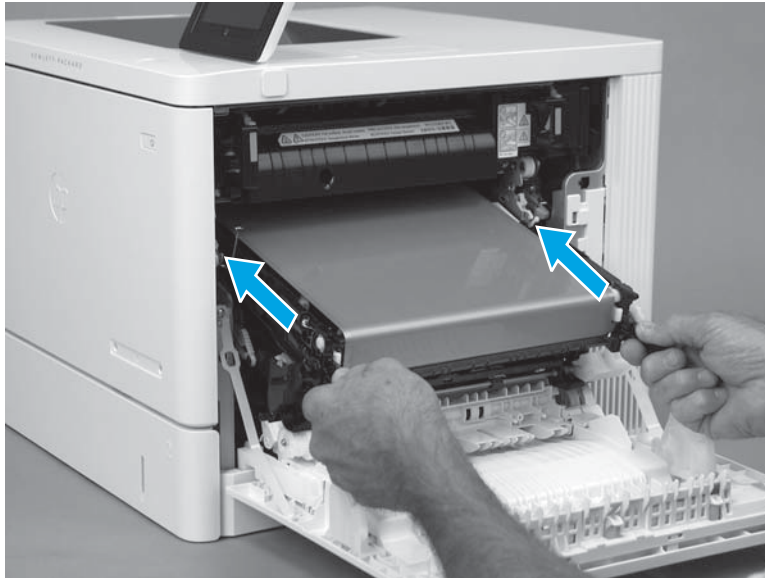
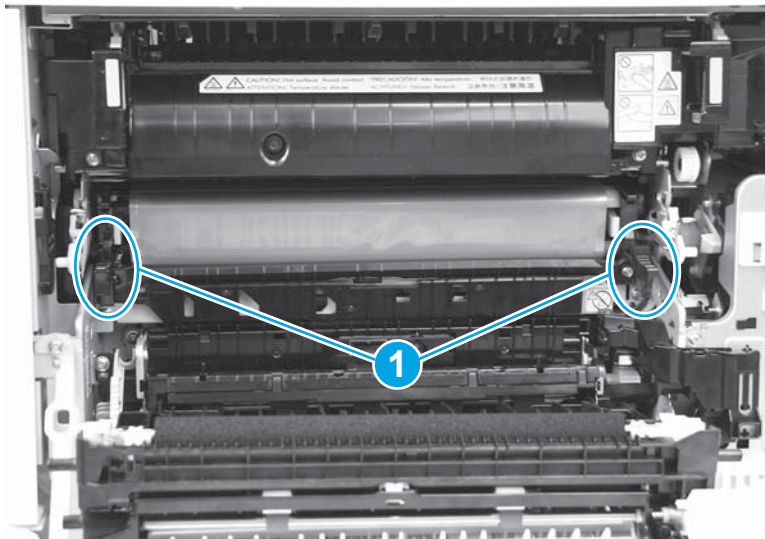

4. Remove the right-side ITB spring from the holder.

Figure 1-3726 Remove the spring from the holder



5. Fasten the right-side ITB spring (callout 1) under the tab (callout 2).

Figure 1-3727 Fasten the rear-side ITB spring

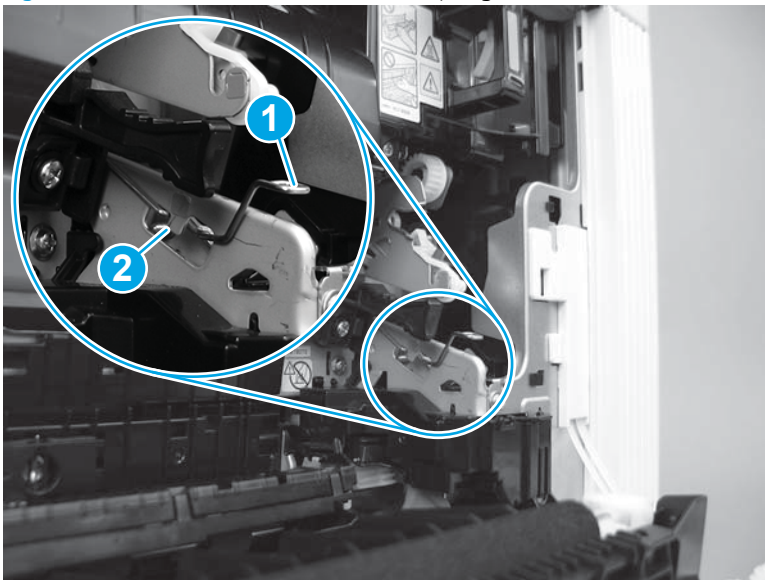

6. Remove the left-side ITB spring from the holder.

Figure 1-3728 Remove the spring from the holder

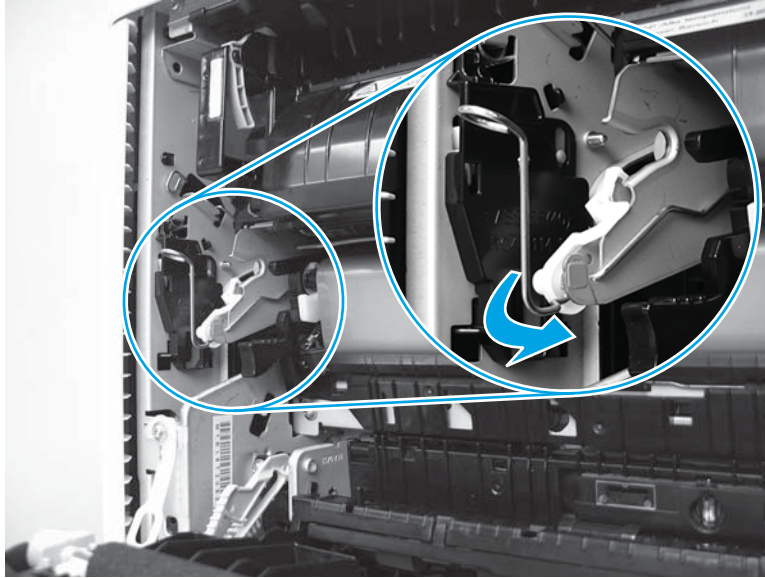

7. Fasten the left-side ITB spring (callout 1) under the tab (callout 2).

Figure 1-3729 Fasten the front-side ITB spring

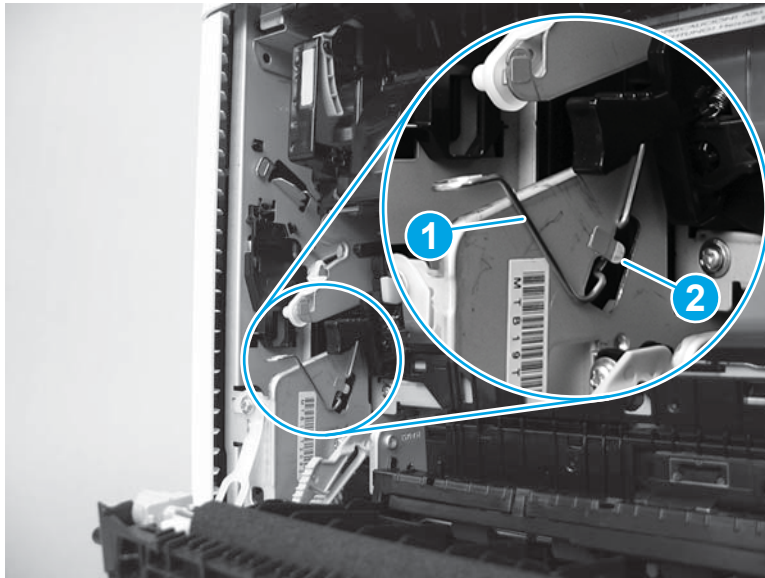

8. Push in the blue lever to engage the ITB drive coupling.

Figure 1-3730 Engage the ITB drive coupling

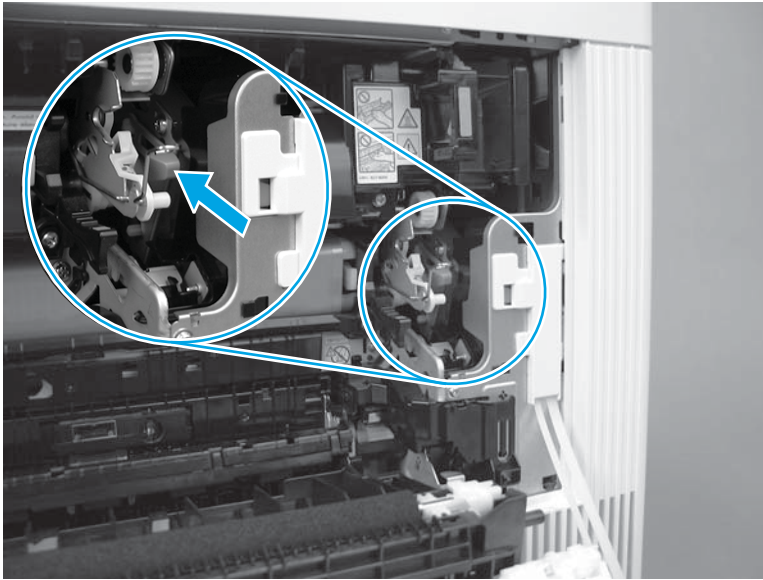

9. Close the right door.

 **TIP:** The right door should close easily if the ITB assembly is correctly installed.

Figure 1-3731 Close the right door



Step 71: Install the fuser

1. Align the fuser with the opening in the printer.

Figure 1-3732 Align the fuser with the opening

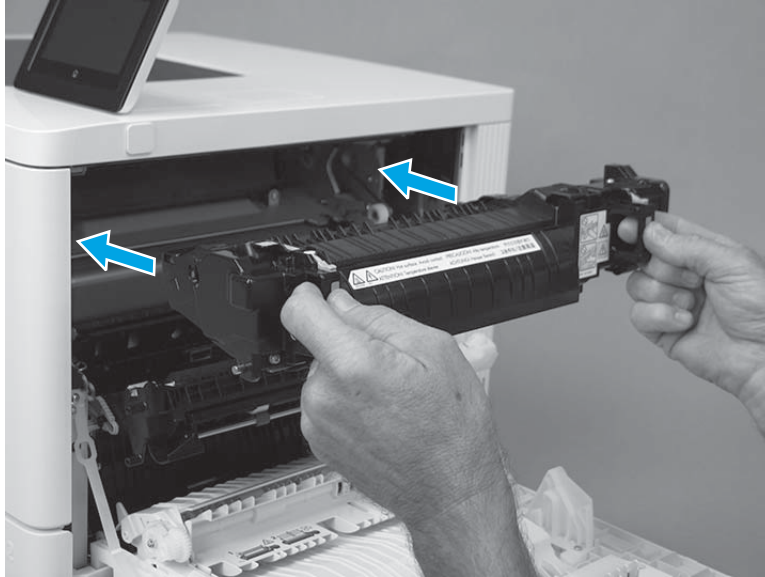

2. Slide the fuser into the printer, push in to install it, and then make sure that it is fully seated.

 **TIP:** When the fuser is fully seated, the two blue triggers on the handles make an audible click.

Figure 1-3733 Install the fuser

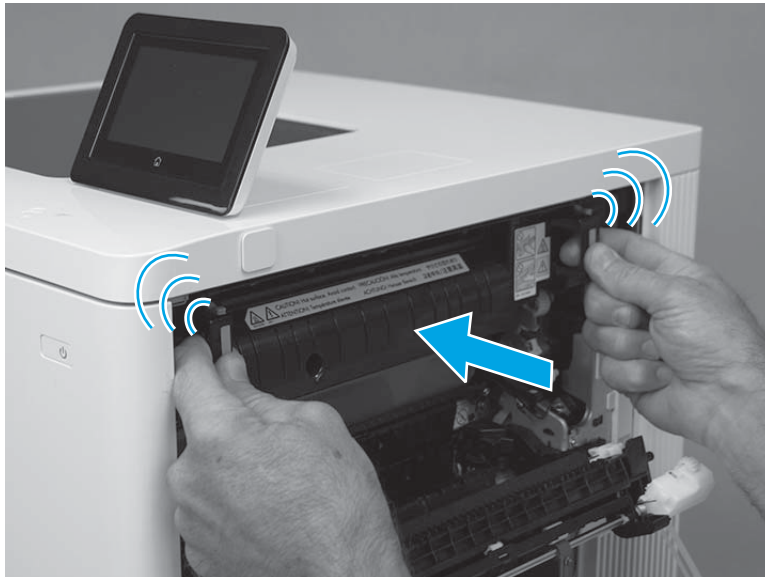

3. Close the right door.

Figure 1-3734 Close the right door



Removal and replacement: Pickup drive assembly and motor (M5)

- [Introduction](#)
- [Step 1: Remove the toner collection unit \(TCU\)](#)
- [Step 2: Remove the formatter cover](#)
- [Step 3: Remove the USB cover \(M552 and M553\)](#)
- [Step 4: Remove the control panel \(M553x only\)](#)
- [Step 5: Remove the formatter \(M552 and M553\)](#)
- [Step 6: Remove the hard-disk drive \(HDD\) \(M577\)](#)
- [Step 7: Remove the fax PCA \(M577c/f/z\)](#)
- [Step 8: Remove the formatter \(M577\)](#)
- [Step 9: Remove the rear cover \(M552 and M553\)](#)
- [Step 10: Remove the rear upper cover \(M577\)](#)
- [Step 11: Remove the rear cover \(M577\)](#)
- [Step 12: Remove the left upper cover \(M577\)](#)
- [Step 13: Remove the right front upper cover \(M577dn\)](#)
- [Step 14: Remove the stapler cover assembly \(M577c/f/z\)](#)
- [Step 15: Remove the integrated scanner assembly \(ISA\) \(M577\)](#)
- [Step 16: Remove the right upper cover \(M577\)](#)
- [Step 17: Remove the left cover](#)
- [Step 18: Remove the upper cover \(M552 and M553\)](#)
- [Step 19: Remove the right rear cover](#)
- [Step 20: Remove the formatter case](#)
- [Step 21: Remove the low-voltage power supply \(LVPS\)](#)
- [Step 22: Remove the power supply fan \(FM1\)](#)
- [Step 23: Remove the high-voltage power supply D \(HVPSD\)](#)
- [Step 24: Remove the lifter drive assembly](#)
- [Step 25: Remove the DC controller and sheet-metal bracket](#)
- [Step 26: Remove the pickup drive assembly and motor \(M5\)](#)
- [Step 27: Unpack the replacement assembly](#)
- [Step 28: Install the pickup drive assembly and motor \(M5\)](#)
- [Step 29: Install the DC controller and sheet-metal bracket](#)

- [Step 30: Install the lifter drive assembly](#)
- [Step 31: Install the HVPSD](#)
- [Step 32: Install the power-supply fan \(FM1\)](#)
- [Step 33: Install the LVPS](#)
- [Step 34: Install the formatter case](#)
- [Step 35: Install the right rear cover](#)
- [Step 36: Install the upper cover \(M552 and M553\)](#)
- [Step 37: Install the left cover](#)
- [Step 38: Install the right upper cover \(M577\)](#)
- [Step 39: Install the integrated scanner assembly \(ISA\) \(M577\)](#)
- [Step 40: Install the stapler cover assembly \(M577c/f/z\)](#)
- [Step 41: Install the right front upper cover \(M577dn\)](#)
- [Step 42: Install the left upper cover \(M577\)](#)
- [Step 43: Install the rear cover \(M577\)](#)
- [Step 44: Install the rear upper cover \(M577\)](#)
- [Step 45: Install the rear cover \(M552 and M553\)](#)
- [Step 46: Install the formatter \(M577\)](#)
- [Step 47: Install the fax PCA \(M577c/f/z\)](#)
- [Step 48: Install the HDD \(M577\)](#)
- [Step 49: Install the formatter \(M552 and M553\)](#)
- [Step 50: Install the control-panel assembly \(M553x only\)](#)
- [Step 51: Install the USB cover \(M552 and M553\)](#)
- [Step 52: Install the formatter cover](#)
- [Step 53: Install the TCU](#)

Introduction

This document provides the procedures to remove and replace the pickup drive assembly and pickup motor (M8).

Before performing service

 **TIP:** Some figures might show assemblies removed or installed that have not yet been removed or installed at that specific step. However, the procedures are correct for this printer and the target assembly. Always thoroughly read the instructions that accompany each figure.

Turn the printer power off

- Disconnect the power cable.

⚠ WARNING! To avoid damage to the printer, turn the printer off, wait 30 seconds, and then remove the power cord before attempting to service the printer.

Use the table below to identify the correct part number for your printer, and then go to <http://h20141.www2.hp.com/hpparts> to order the part.

Pickup drive assembly and motor (M5) part number	
RM2-0008-000CN	Pickup drive assembly and motor (M5)

Required tools

- #2 Phillips screwdriver with a magnetic tip

After performing service

Turn the printer power on

- Connect the power cable.
- Use the power switch to turn the power on.

Post service test

Use the components test to test the (pickup) motor. For more information, see the printer troubleshooting manual.

Step 1: Remove the toner collection unit (TCU)

1. Open the front door.

Figure 1-3735 Open the front door



2. Open the TCU.

 **NOTE:** The toner collection hatch cover automatically closes when the TCU is opened.

Figure 1-3736 Open the TCU



3. Pull the TCU away from the printer at an angle to remove it.

⚠ CAUTION: Do not open the toner collection hatch cover when handling the TCU. If toner gets on clothing, wipe it off by using a dry cloth and wash the clothes in cold water. Hot water sets toner into fabric.

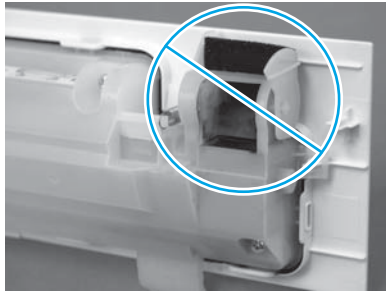
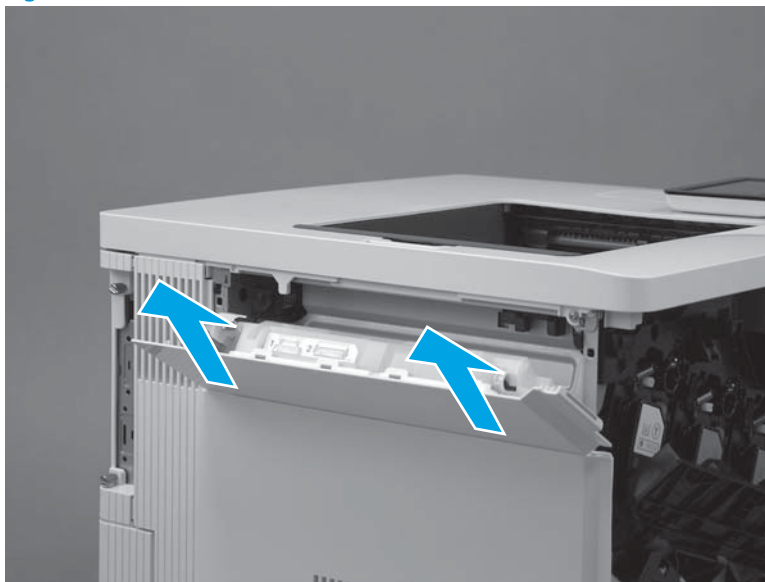

Figure 1-3737 Remove the TCU



Step 2: Remove the formatter cover

1. Locate the formatter cover.

Figure 1-3738 Locate the formatter cover

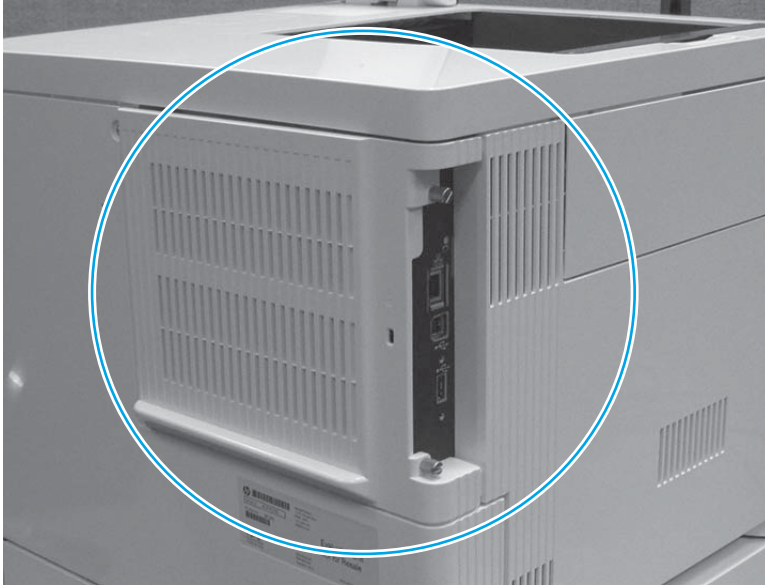

2. Loosen the two thumbscrews (callout 1). Grasp the two thumbscrews, and then slide the cover away from the printer (callout 2) to remove it.

 **TIP:** If needed, use the edge of a coin to turn the thumbscrews.

Figure 1-3739 Loosen the thumbscrews

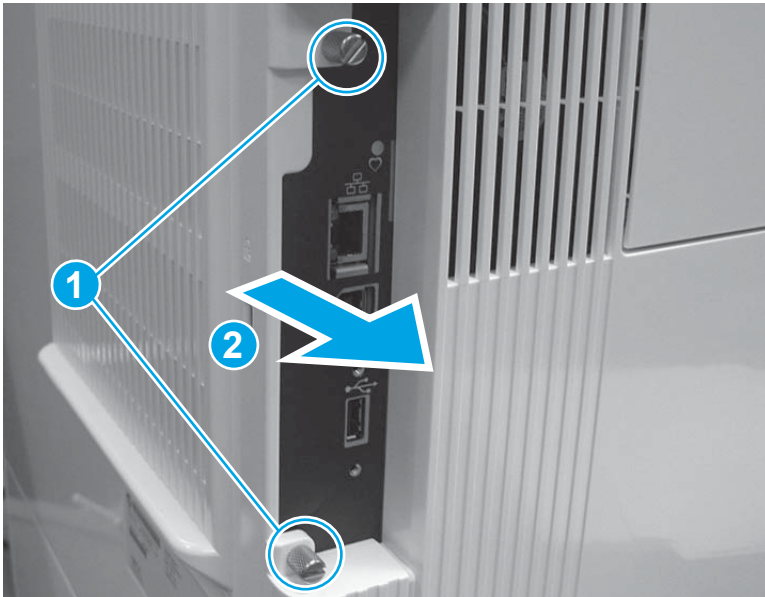

Step 3: Remove the USB cover (M552 and M553)

 **NOTE:** This step is for the M552 and M553 models. For the M577 models, skip this step and go to [Step 6: Remove the hard-disk drive \(HDD\) \(M577\) on page 2100.](#)

1. Locate the USB cover.

Figure 1-3740 Locate the USB cover



2. Pull the cover off of the printer to remove it.

Figure 1-3741 Remove the cover



Step 4: Remove the control panel (M553x only)

 **NOTE:** For the M553n/dn and M552dn models, skip this step and go to [Step 5: Remove the formatter \(M552 and M553\) on page 2099](#).

For the M577 models, skip this step and go to [Step 6: Remove the hard-disk drive \(HDD\) \(M577\) on page 2100](#).

1. Tilt the control panel up.

Figure 1-3742 Tilt the control panel up



2. Use a small flat-blade screwdriver to release the control-panel screws cover tabs.

Figure 1-3743 Release the control-panel screws cover tabs



3. Rotate the cover up to remove it.

Figure 1-3744 Remove the cover

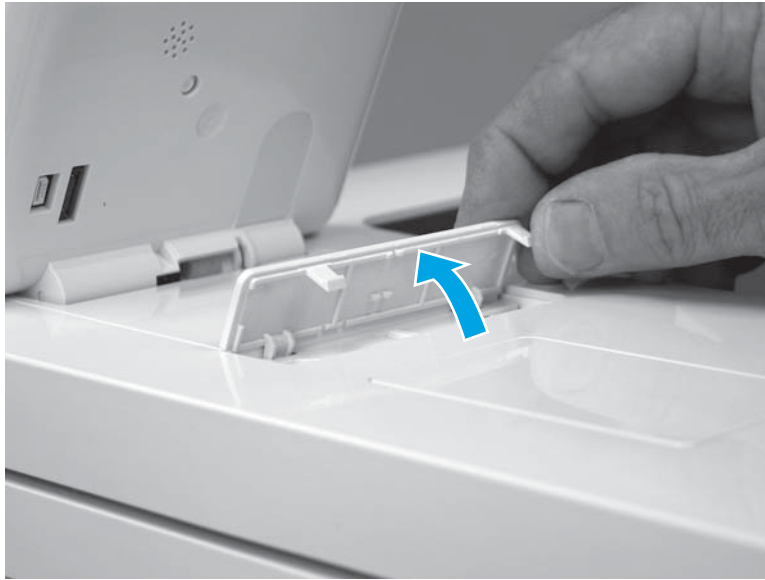

4. Use a small Phillips screwdriver to remove two screws (callout 1).

 **IMPORTANT:** Store the screws in a secure place where they cannot fall down into the printer.

Figure 1-3745 Remove two screws

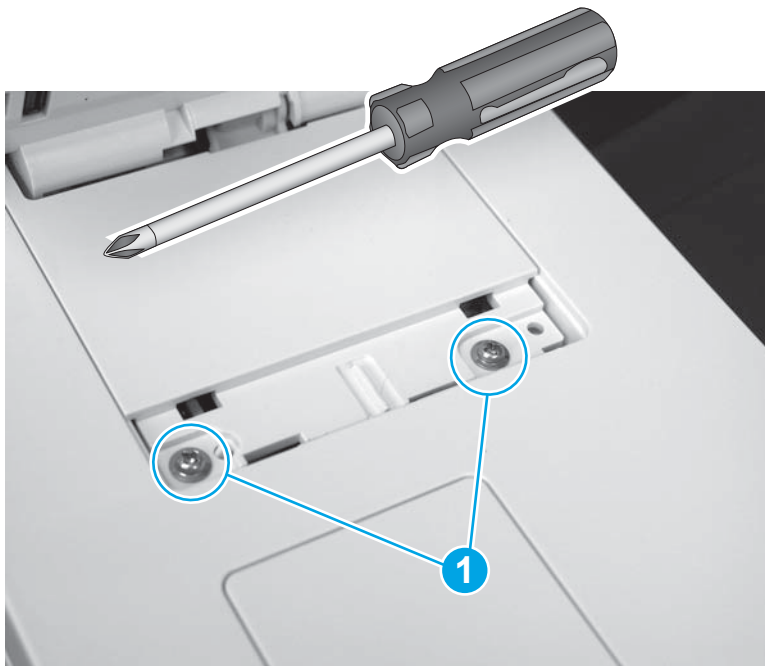

5. Rotate the control-panel base toward the front of the printer.

Figure 1-3746 Rotate the control-panel base up



6. Slightly slide the control-panel base toward the rear of the printer (callout 1) to release it, and then turn the control panel over (callout 2) to access the bottom side.

CAUTION: The control panel is still attached to the printer. Do not attempt to completely remove the control panel.

Figure 1-3747 Turn the control panel over

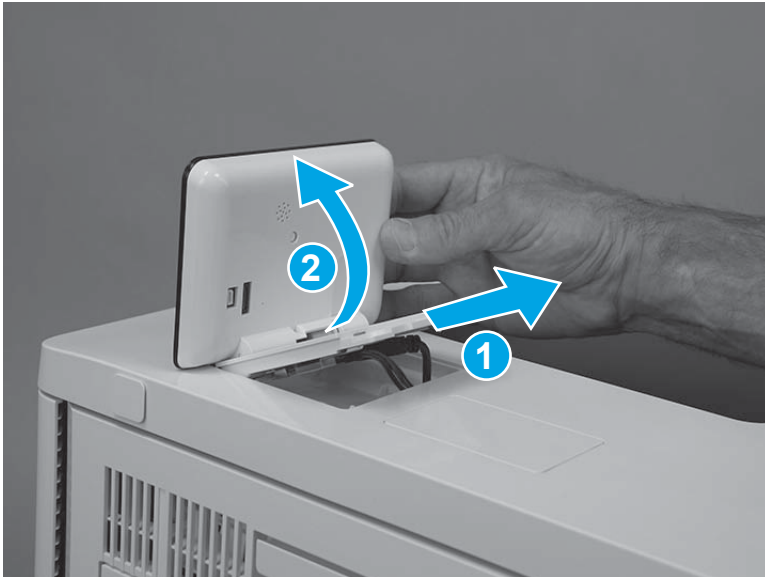

7. Disconnect one USB cable (callout 1), one connector (callout 2), and then remove the control panel.

Figure 1-3748 Disconnect two connectors

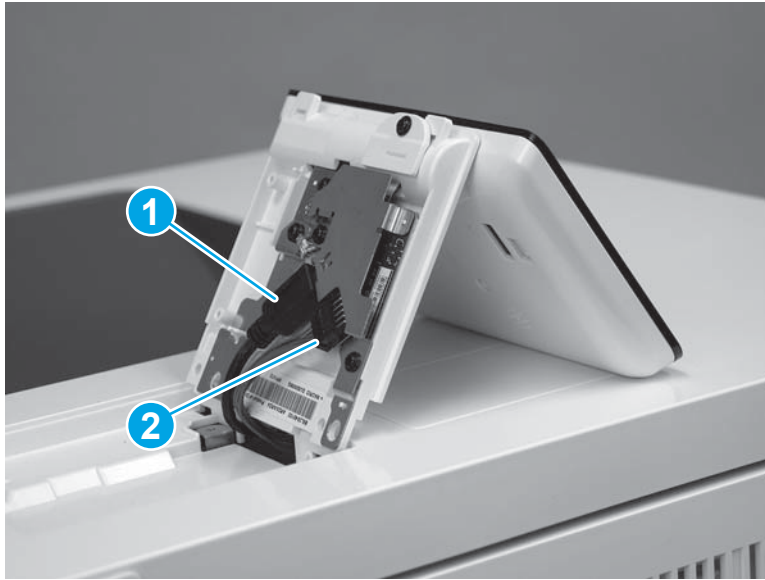

Step 5: Remove the formatter (M552 and M553)

 **NOTE:** This step is for the M552 and M553 models. For the M577 models, skip this step and go to [Step 6: Remove the hard-disk drive \(HDD\) \(M577\) on page 2100](#).

If the optional hard-disk drive (HDD) is installed, it must be removed to gain access to the formatter mounting screws.

Release two tabs along the left edge of the HDD, rotate the left edge away from the product, and then slide the HDD to the left to remove it.

 **CAUTION:**  ESD-sensitive part.

1. Disconnect all of the connectors on the formatter.

The following connectors are empty:

- All models: J1 (this connector is empty unless the optional DIMM is installed)
- M553n/dn and M552dn: J2 (callout 1; this is the touchscreen connector for the M553x model)
- All models: J9 (this connector is empty unless the optional internal USB ports component is installed)
- All models: J18 (this connector is empty unless the optional hard-disk-drive (HDD) is installed)
- All models: J23
- All models: J24
- M553n/dn and M552dn: J25 (this is the wireless connector for the M553x model)

- All models: J57
- All models: J98 (this connector is empty unless the optional trusted platform module (TPM) is installed)

 **IMPORTANT:** The flat-cable connector (callout 2) is a Zero Insertion Force (ZIF) connector that uses a hinged retainer to secure the flat cable. The hinged retainer must be opened to release the flat cable.

Figure 1-3749 Disconnect all connectors

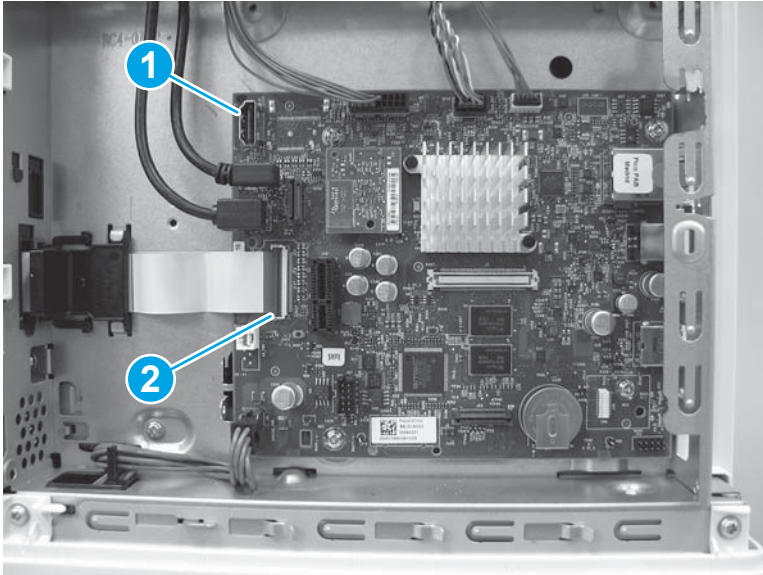

2. Remove four screws (callout 1), and then remove the formatter.

Figure 1-3750 Remove the formatter

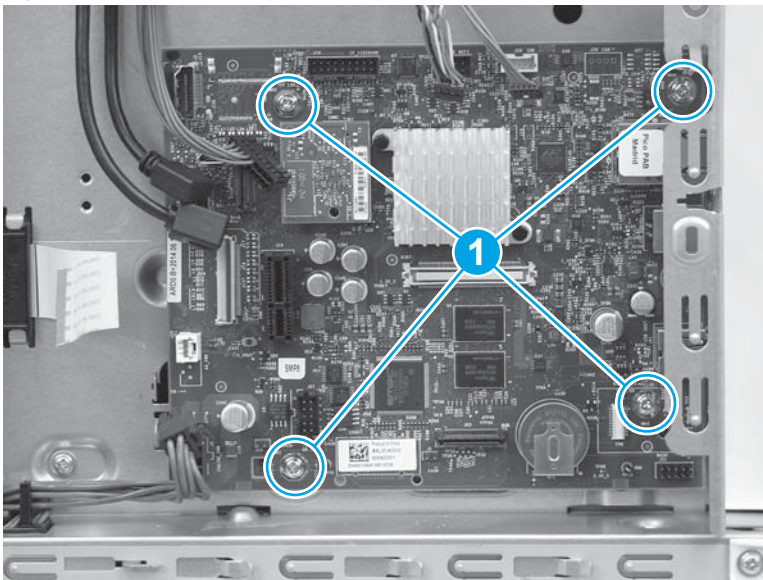

Step 6: Remove the hard-disk drive (HDD) (M577)

 **NOTE:** This step is for the M577 models. For the M552 and M553 models, skip this step and go to [Step 9: Remove the rear cover \(M552 and M553\) on page 2105](#).

CAUTION:  ESD-sensitive part.

1. Release two tabs (callout 1). Hold the tabs in the released position, and then rotate the hard disk drive (HDD) up (callout 2) to release the connector from the formatter.

Figure 1-3751 Release the HDD

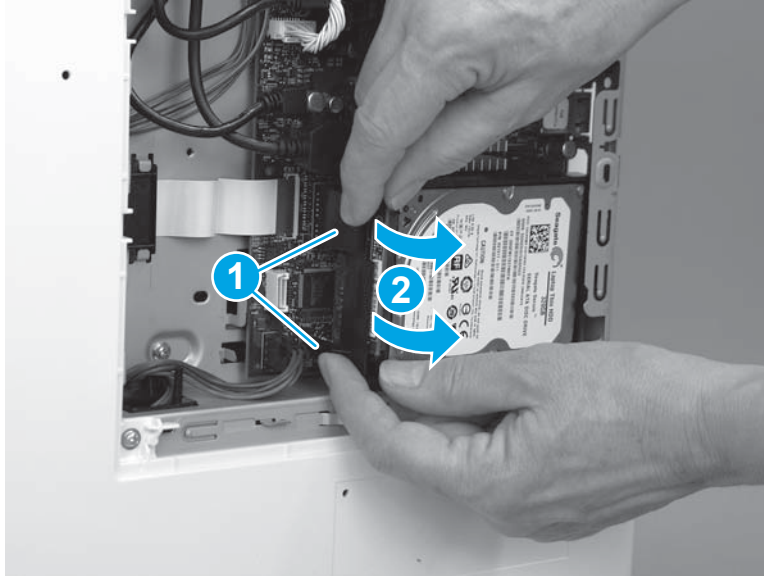

2. Slide the HDD away from the printer to remove it.

Figure 1-3752 Remove the HDD

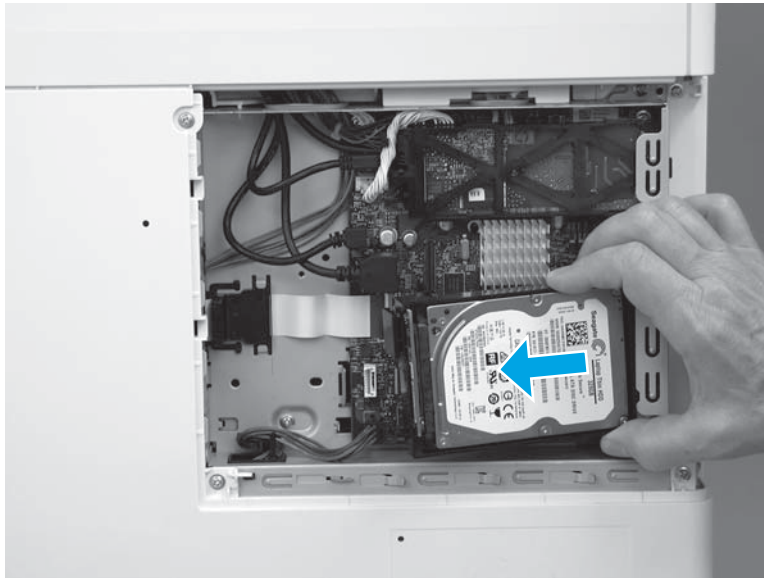

Step 7: Remove the fax PCA (M577c/f/z)

 **NOTE:** This step is for the M577c/f/z models. For the M577n model, skip this step and go to [Step 8: Remove the formatter \(M577\) on page 2103](#).

For the M552 and M553 models, skip this step and go to [Step 9: Remove the rear cover \(M552 and M553\) on page 2105](#).

 **CAUTION:**  ESD-sensitive part.

1. Locate the fax PCA component on the formatter.

Figure 1-3753 Locate the fax PCA

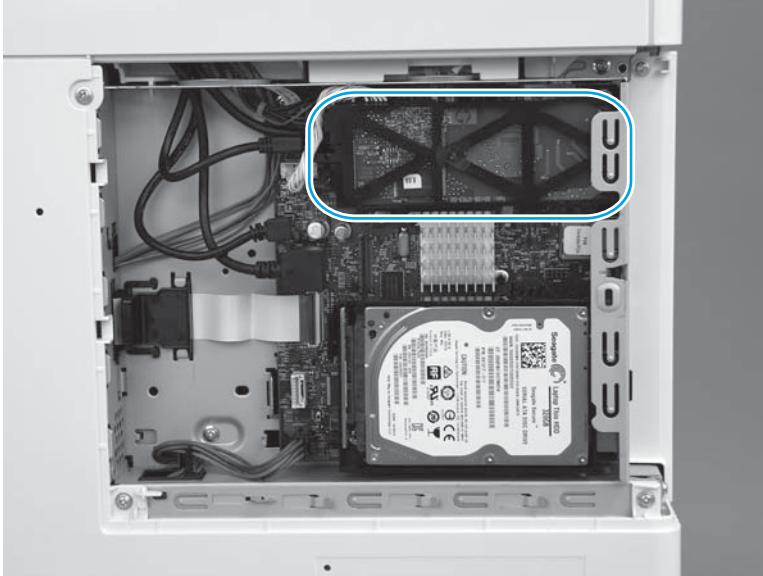

2. Release the connector latch (callout 1), and then pull the connector away from the formatter (callout 2) to disconnect it.

Figure 1-3754 Disconnect one connector

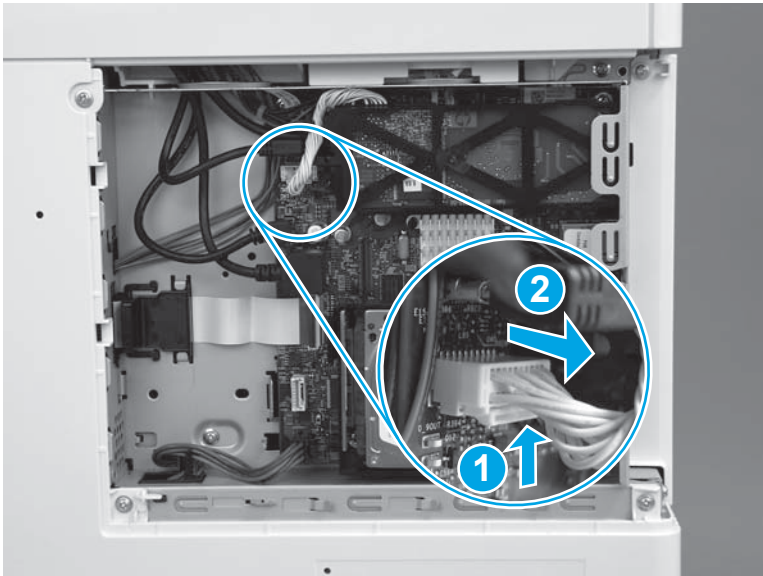

3. Release one retainer (callout 1) by pressing the bracket arms together.

Figure 1-3755 Release one latch

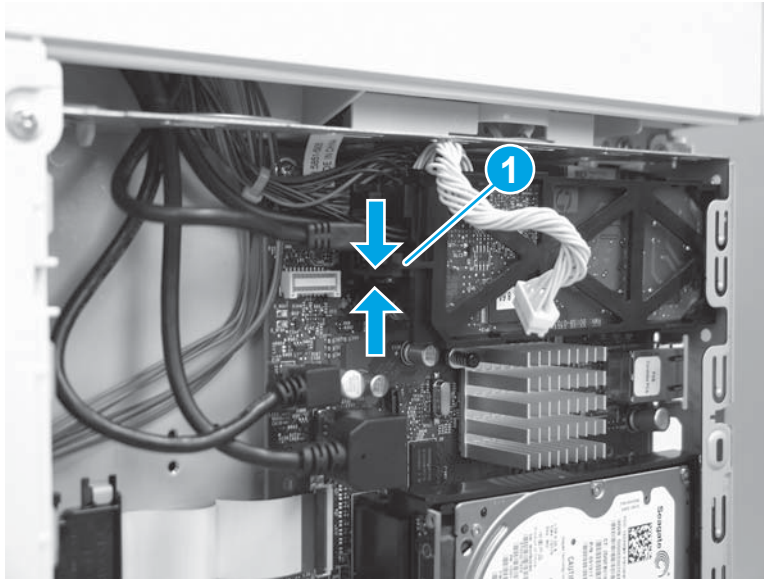

4. Rotate the end of the fax PCA (callout 1) away from the formatter, and then slide the PCA left (callout 2) to remove it.

Figure 1-3756 Remove the fax PCA

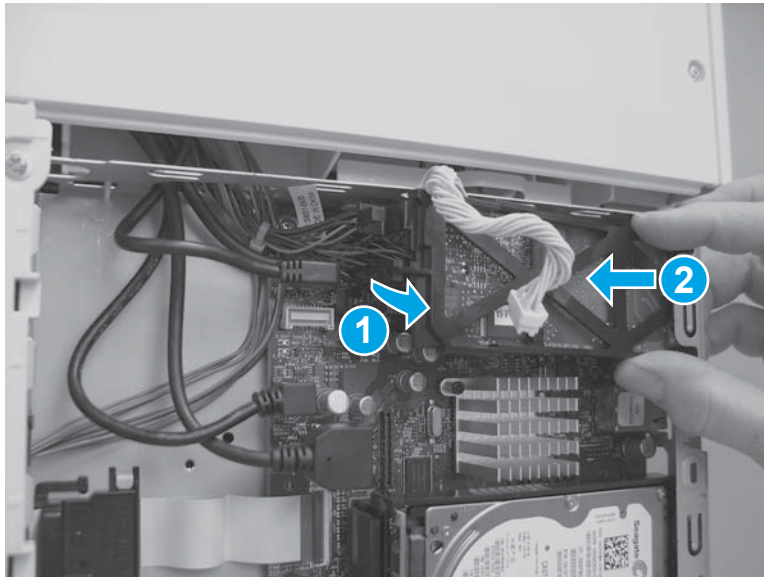

Step 8: Remove the formatter (M577)

 **NOTE:** This step is for the M577 models. For the M552 and M553 models, skip this step and go to [Step 9: Remove the rear cover \(M552 and M553\) on page 2105.](#)

 **CAUTION:**  ESD-sensitive part.

1. Disconnect all of the connectors on the formatter.

The following connectors are empty:

- All models: J1 (this connector is empty unless the optional DIMM is installed)
- All models: J3
- M577dn: J15 (this is the fax connector for the M577f/z/c models)
- All models: J21 (this connector is empty unless the optional internal USB ports component is installed)
- All models: J23
- All models: J24
- All models: J51
- All models: J57
- All models: J97
- All models: J98 (this connector is empty unless the optional trusted platform module (TPM) is installed)

 **IMPORTANT:** The flat-cable connector (callout 1) is a Zero Insertion Force (ZIF) connector that uses a hinged retainer to secure the flat cable. The hinged retainer must be opened to release the flat cable.

Figure 1-3757 Disconnect all connectors



2. Remove four screws (callout 1).

Figure 1-3758 Remove four screws

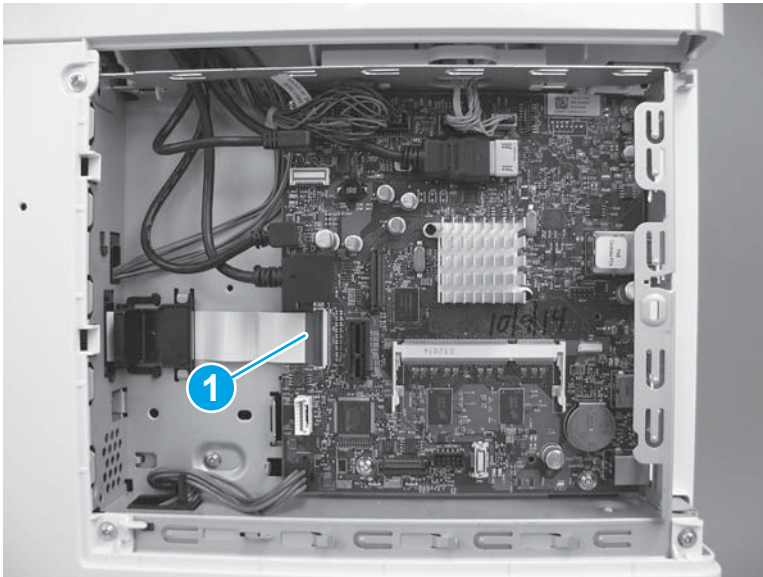
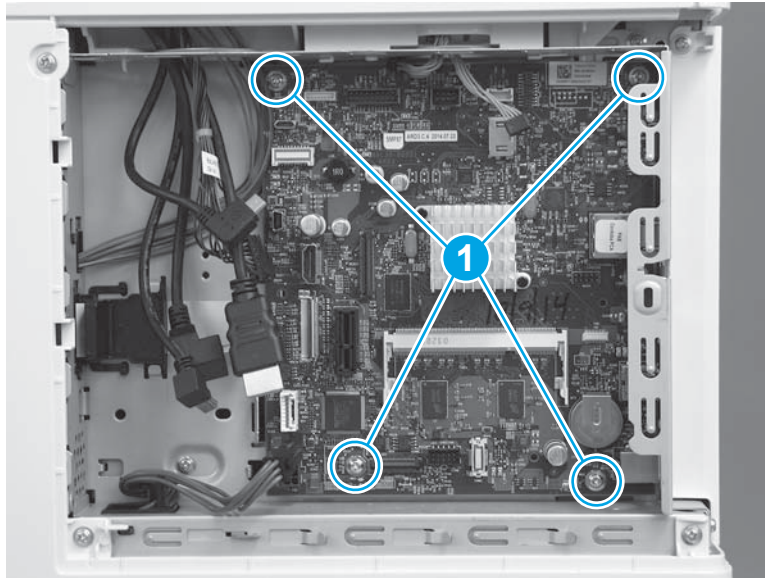

3. Remove the formatter.

Figure 1-3759 Remove the formatter

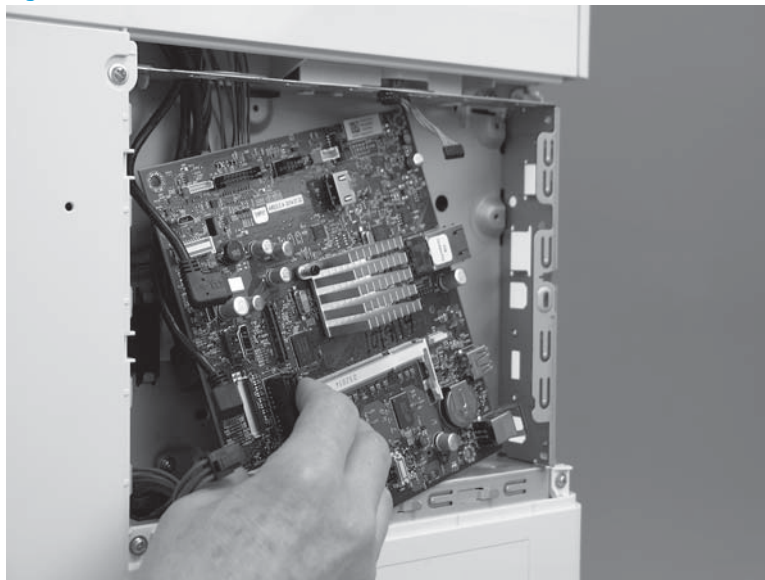

Step 9: Remove the rear cover (M552 and M553)

 **NOTE:** This step is for the M552 and M553 models. For the M577 models, skip this step and go to [Step 10: Remove the rear upper cover \(M577\) on page 2106.](#)

1. Remove four screws (callout 1).

Figure 1-3760 Remove four screws

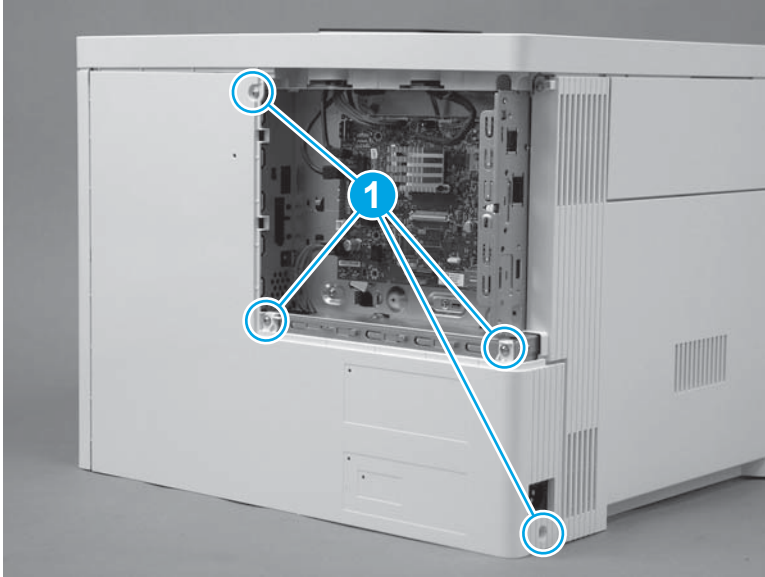

2. Slightly slide the cover to the right (callout 1), rotate the bottom of the cover away from the printer (callout 2), and then pull the top of the cover away from the printer (callout 3) to remove the cover.

Figure 1-3761 Remove the cover

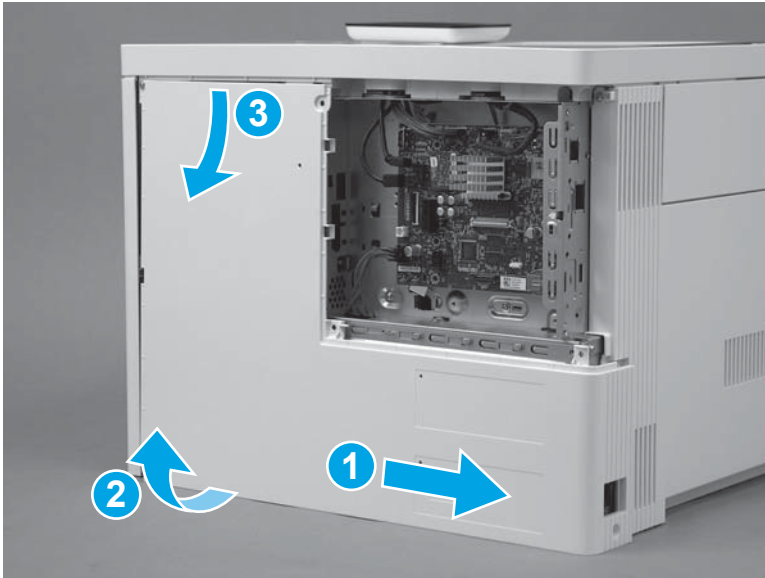

Step 10: Remove the rear upper cover (M577)

 **NOTE:** This step is for the M577 models. For the M552 and M553 models, skip this step and go to [Step 17: Remove the left cover on page 2119](#).

1. Remove two screws (callout 1).

 **Reinstallation tip:** These two screws are self-tapping screws for plastic. When reinstalling them, rotate the screws counterclockwise to align them with the existing thread pattern, and then carefully turn them clockwise to tighten. Do not overtighten. This will prevent stripping the threads inside the screw holes.

Figure 1-3762 Remove two screws



2. Use a small, flat blade screwdriver to release the right edge of the cover.

Figure 1-3763 Release the right edge

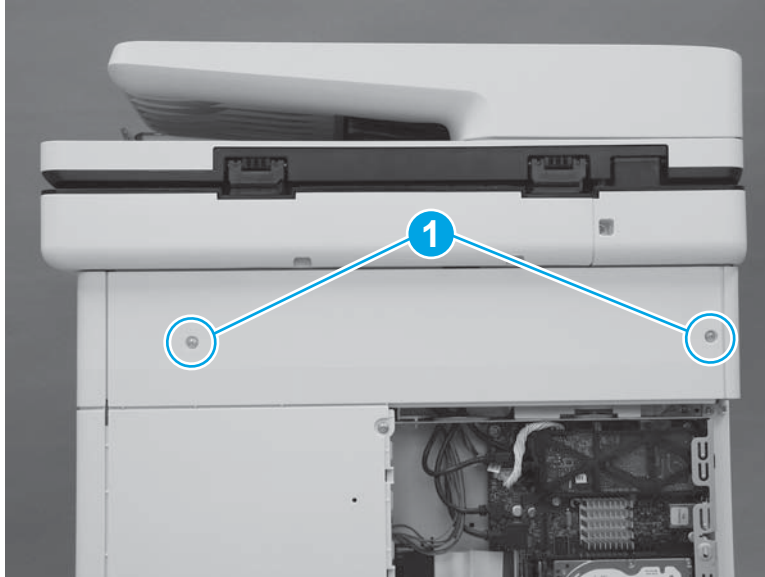
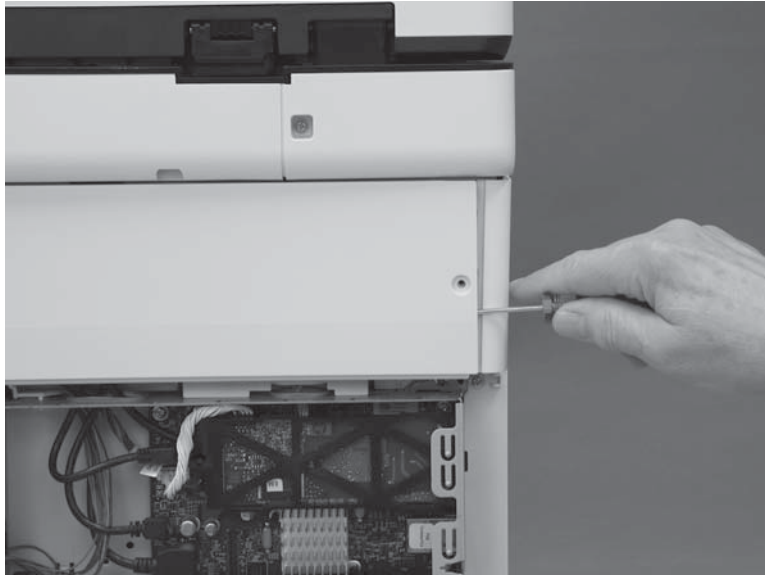

3. Pull the right edge of the cover (callout 1) away from the printer, and then slide the cover to the right (callout 2).

Figure 1-3764 Slide the cover right

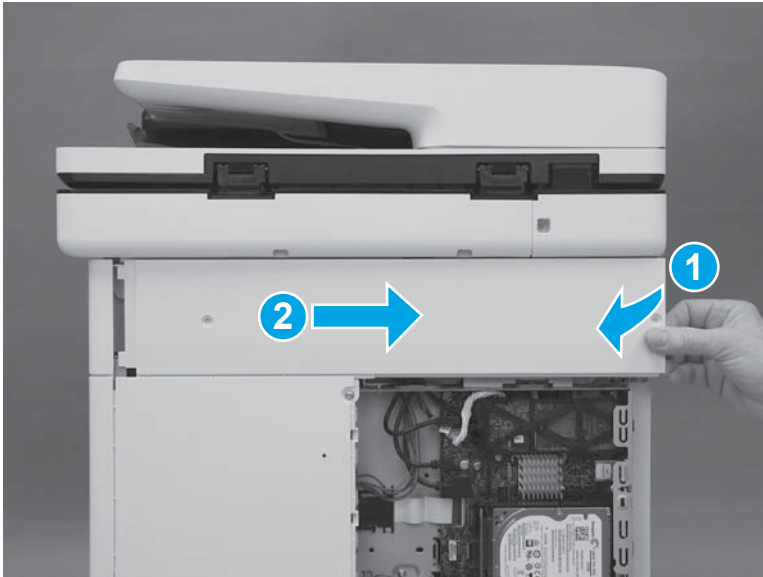

4. Remove the cover.

Figure 1-3765 Remove the cover

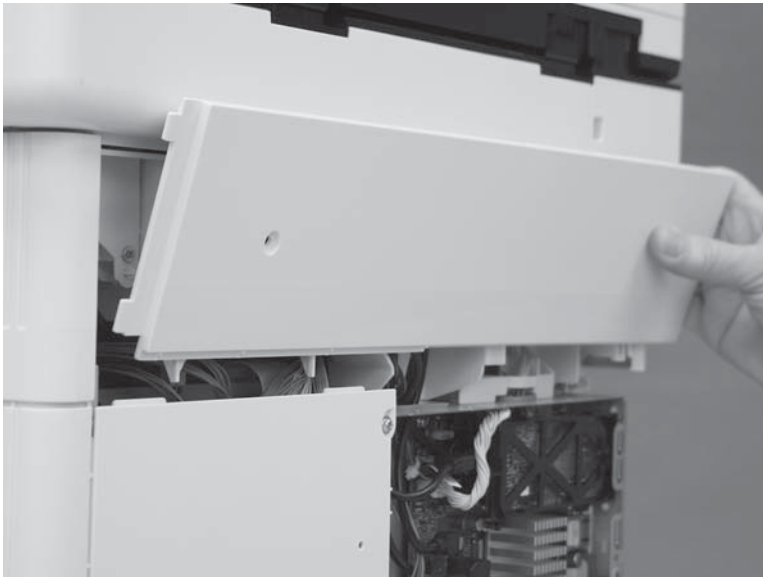

Step 11: Remove the rear cover (M577)

 **NOTE:** This step is for the M577 models. For the M552 and M553 models, skip this step and go to [Step 17: Remove the left cover on page 2119](#).

1. Remove four screws (callout 1).

Figure 1-3766 Remove four screws

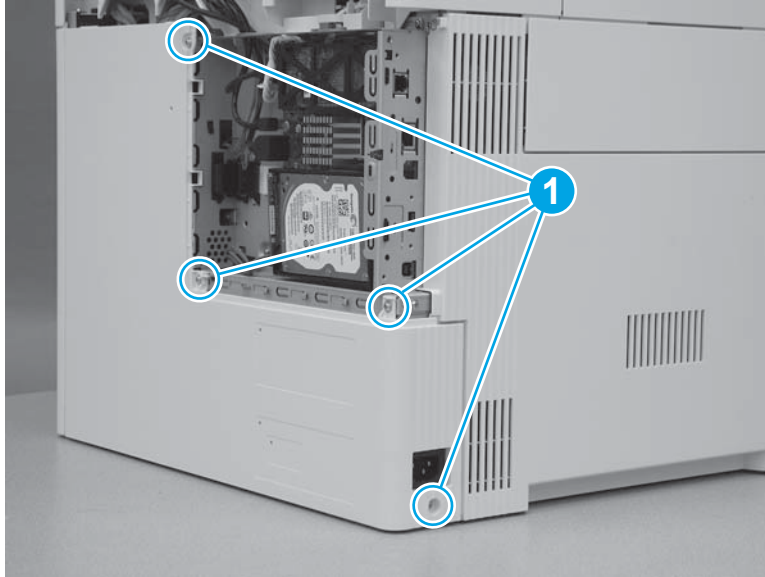

2. Slide the cover to the right to remove it.

Figure 1-3767 Remove the cover

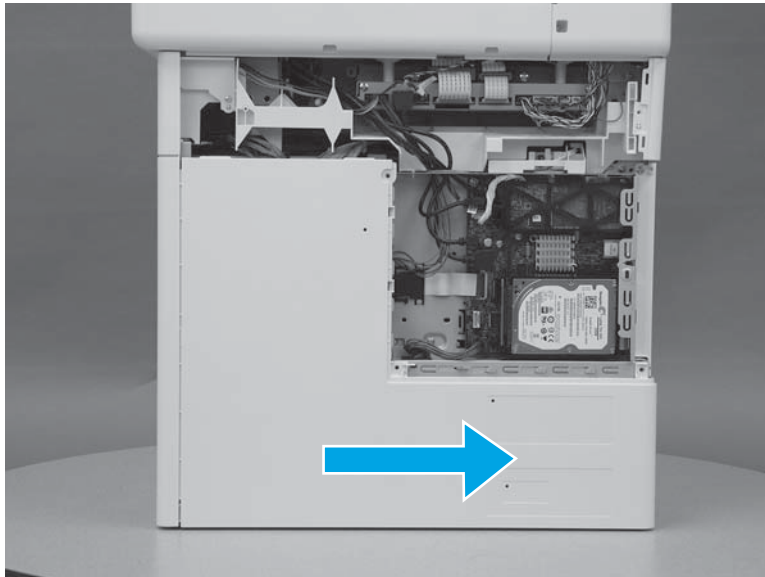

Step 12: Remove the left upper cover (M577)

 **NOTE:** This step is for the M577 models. For the M552 and M553 models, skip this step and go to [Step 17: Remove the left cover on page 2119](#).

1. At the left side of the printer, release one tab (callout 1).

Figure 1-3768 Release one tab

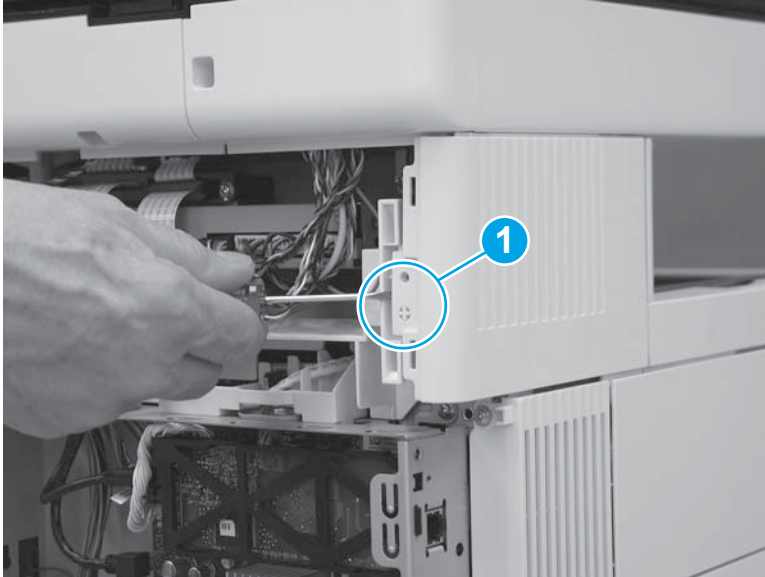

2. Slide the left upper cover toward the back of the printer.

Figure 1-3769 Slide the cover back

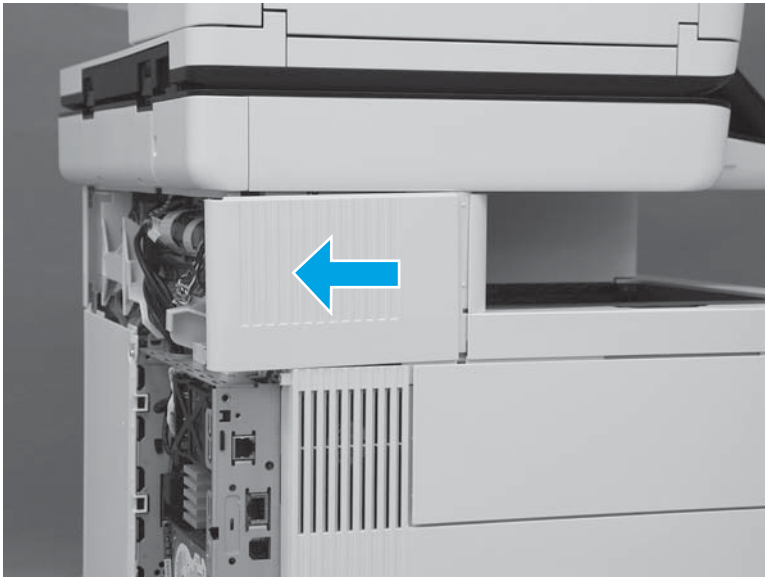

3. Rotate the cover up to remove it.

Figure 1-3770 Remove the left upper cover



Step 13: Remove the right front upper cover (M577dn)

 **NOTE:** This step is for the M577dn model. For the M577c/f/z models, skip this step and to go [Step 14: Remove the stapler cover assembly \(M577c/f/z\) on page 2112.](#)

For the M552 and M553 models, skip this step and go to [Step 17: Remove the left cover on page 2119.](#)

1. Remove one screw (callout 1).

Figure 1-3771 Remove one screw

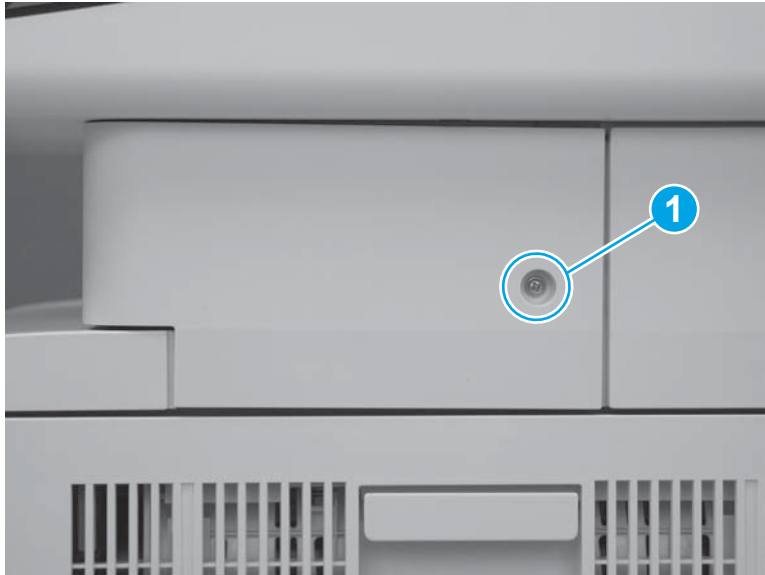

2. Release two tabs at the front edge of the cover (callout 1).

Figure 1-3772 Release two tabs



3. Rotate the front of the cover to the right to remove it.

Figure 1-3773 Rotate the cover



Step 14: Remove the stapler cover assembly (M577c/f/z)

 **NOTE:** This step is for the M577c/f/z models. For the M577dn model, skip this step and to go [Step 16: Remove the right upper cover \(M577\) on page 2117](#).

For the M552 and M553 models, skip this step and go to [Step 17: Remove the left cover on page 2119](#).

1. Remove one screw (callout 1).

 **Reinstallation tip:** This is a self-tapping screw for plastic. When reinstalling, rotate the screw counterclockwise to align it with the existing thread pattern, and then carefully turn it clockwise to tighten. Do not overtighten. This will prevent stripping the threads inside the screw hole.

Figure 1-3774 Remove one screw



2. Release two tabs at the front edge of the cover (callout 1).

Figure 1-3775 Release two tabs

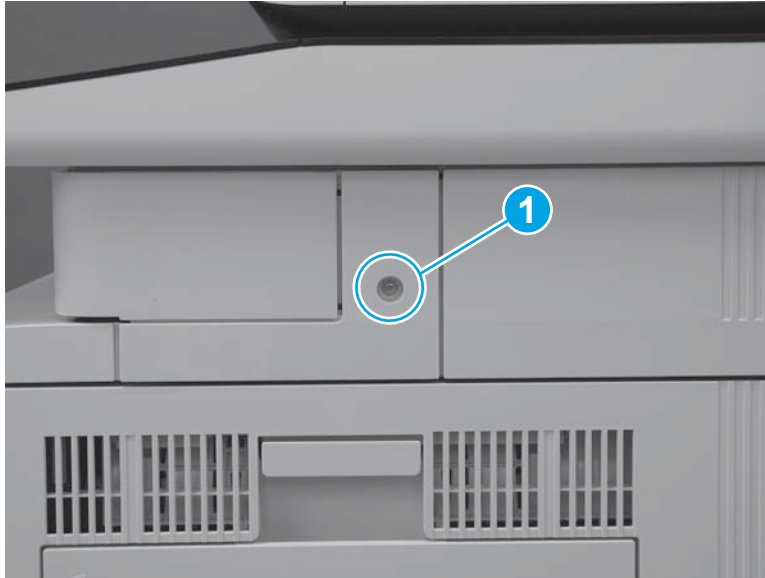

3. Release the back edge of the cover.

Figure 1-3776 Release the back edge of the cover

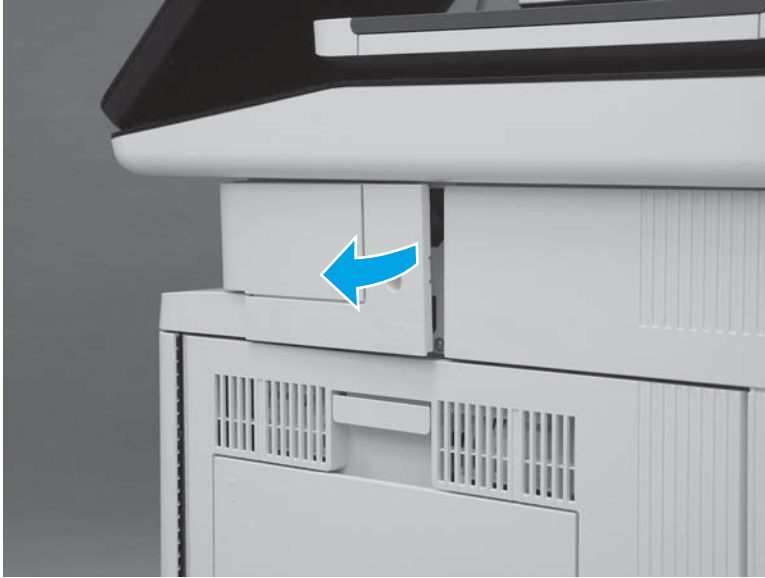

4. Rotate the cover away from the printer to remove it.

Figure 1-3777 Remove the cover



Step 15: Remove the integrated scanner assembly (ISA) (M577)

 **NOTE:** This step is for the M577 models. For the M552 and M553 models, skip this step and go to [Step 17: Remove the left cover on page 2119](#).

 **NOTE:** The ISA includes the document feeder, image scanner, scanner control board (SCB), control panel, keyboard (M577c/z) and NFC PCA (M577z).

1. At the left side of the printer, remove one screw (callout 1).

Figure 1-3778 Remove one screw

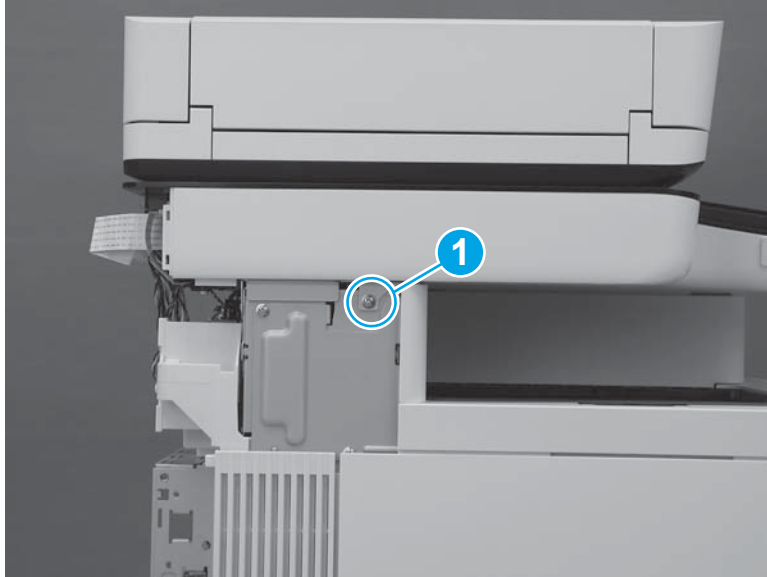

2. At the back side of the printer, remove two screws (callout 1).

Figure 1-3779 Remove two screws

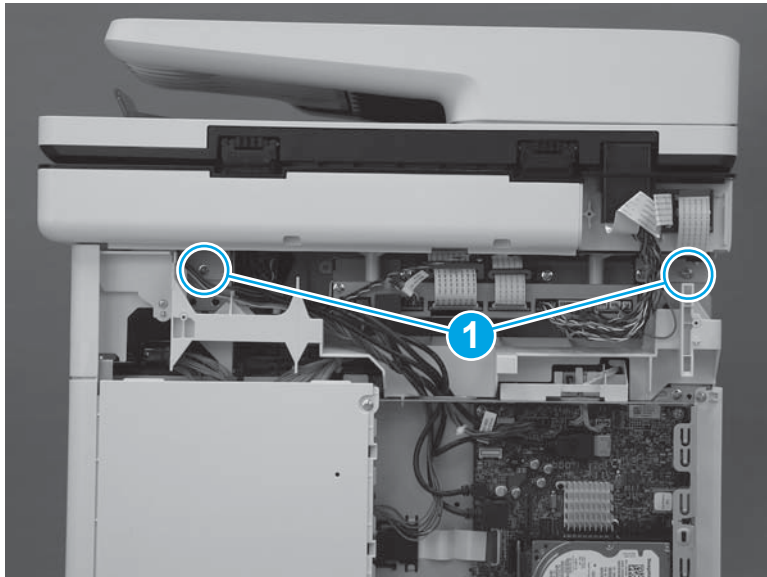

3. At the right side of the printer, remove one screw (callout 1).

Figure 1-3780 Remove one screw

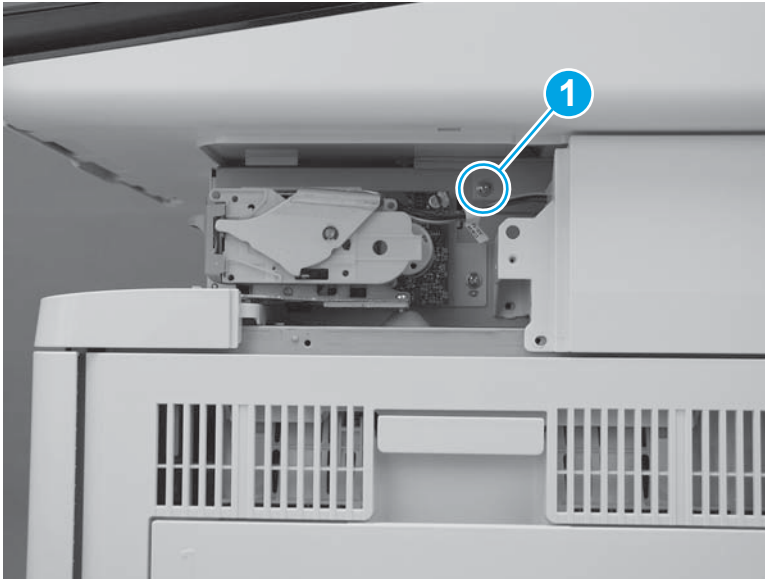

4. Disconnect two connectors on the scanner control board (callout 1).

M577c/f/z only: Disconnect one connector for the stapler on the scanner control board (callout 2).

Figure 1-3781 Disconnect connectors

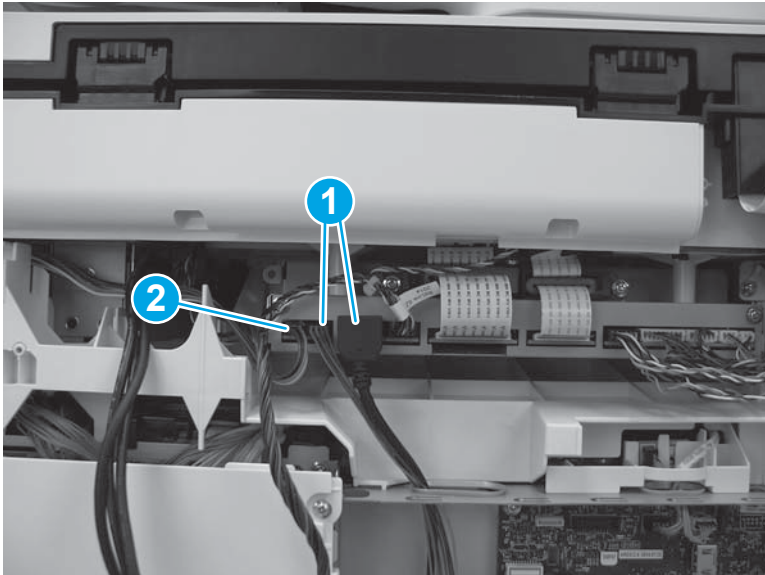

5. Slightly slide the ISA towards the back of the printer to release it.

Figure 1-3782 Slide the ISA towards the back of the printer

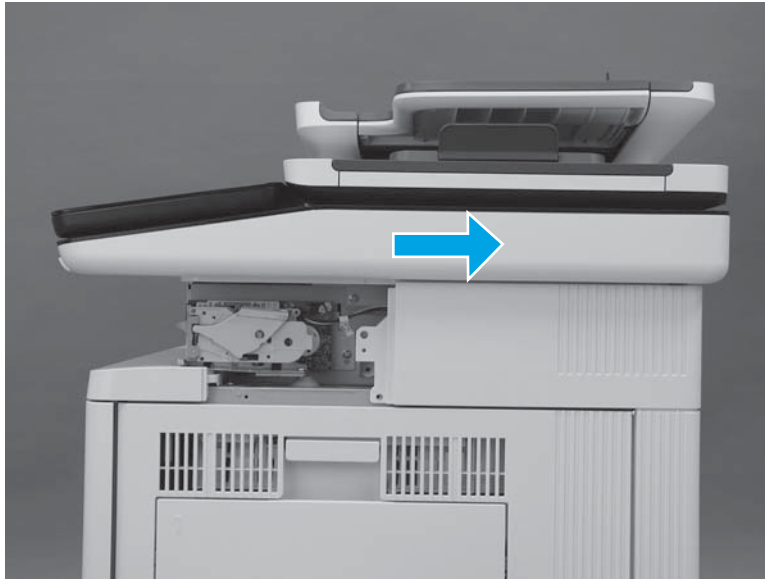

6. Lift the ISA up to remove it.

 **NOTE:** When lifting the ISA, carefully pass the cables through the opening in the top of the formatter case.

Figure 1-3783 Remove the ISA

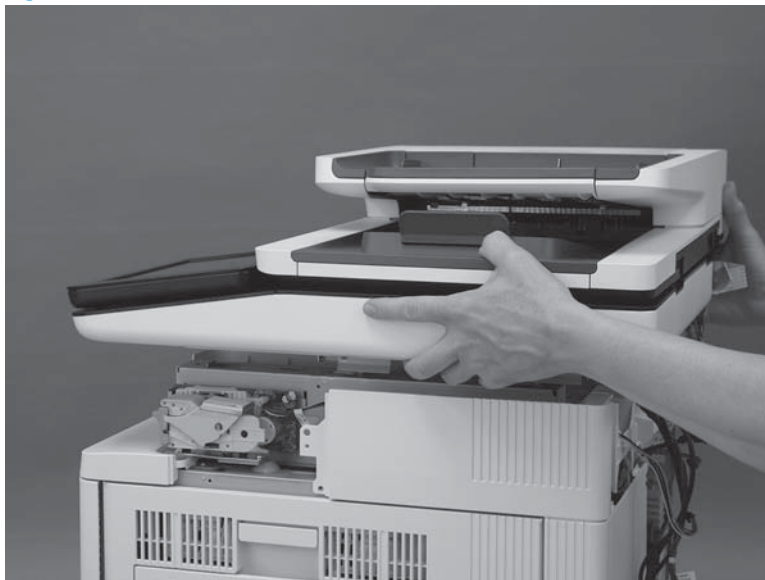

Step 16: Remove the right upper cover (M577)

 **NOTE:** This step is for the M577 models. For the M552 and M553 models, skip this step and go to [Step 17: Remove the left cover on page 2119](#).

 **NOTE:** The figures below show the image scanner installed. The procedures for removing and installing the right upper cover are the same whether the image scanner is installed or removed."

1. At the right side of the printer, remove two screws (callout 1).

M577c/f/z only: Disconnect one connector (callout 2), if it was not already disconnected in a previous step.

Figure 1-3784 Remove two screws and one connector

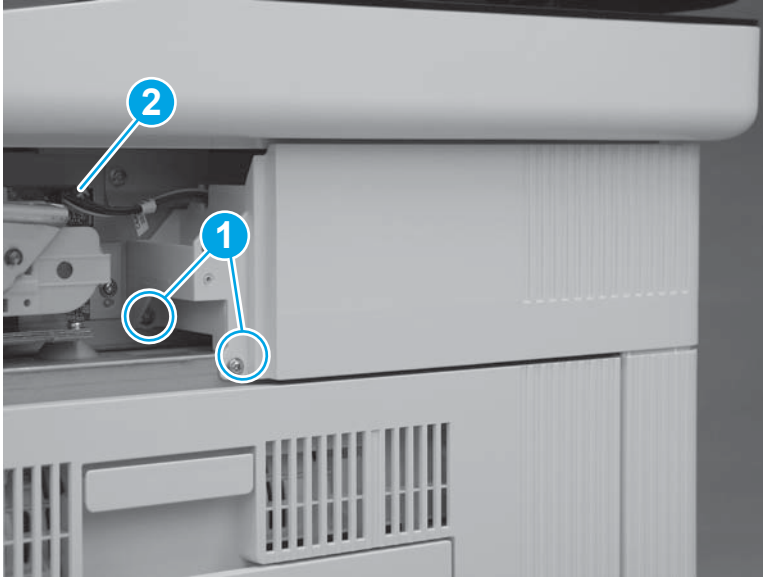

2. At the back of the printer, remove one screw (callout 1).

M577c/f/z only: Disconnect one connector (callout 2), if it was not already disconnected in a previous step.

 **Reinstallation tip:** This screw is smaller than the screws removed in the previous step. When reinstalling the right upper cover, make sure that this screw is installed in the correct position.

Figure 1-3785 Remove one screw and connector

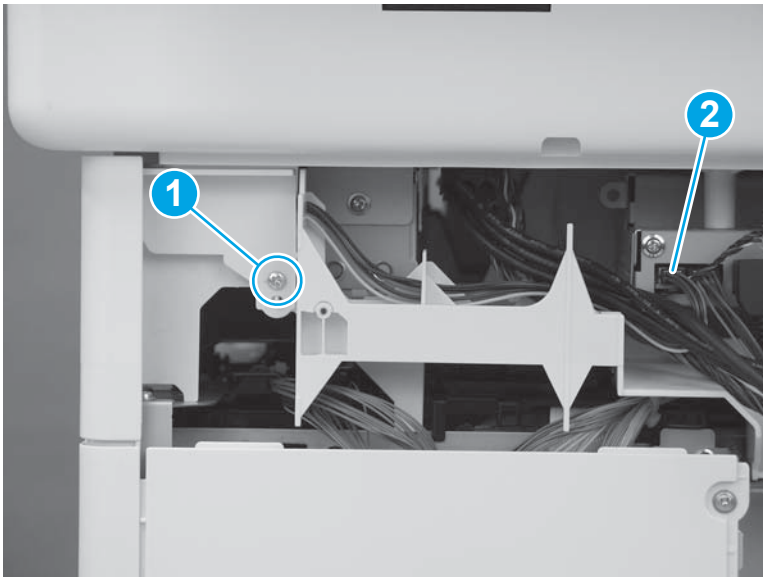

3. Slide the cover toward the back of the printer.

Figure 1-3786 Slide the cover

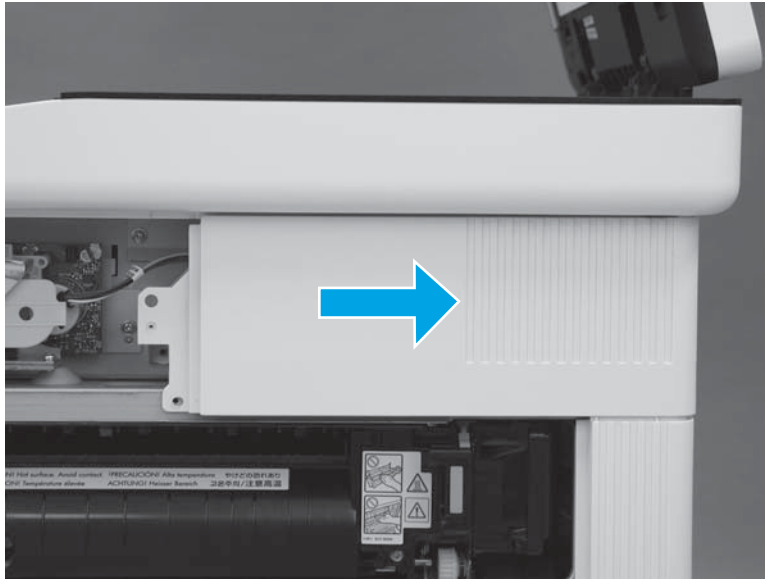

4. Lift the cover away from the printer to remove it.

M577c/f/z only: Release the cables (callout 1) through the slot (callout 2) in the printer.

Figure 1-3787 Remove the cover

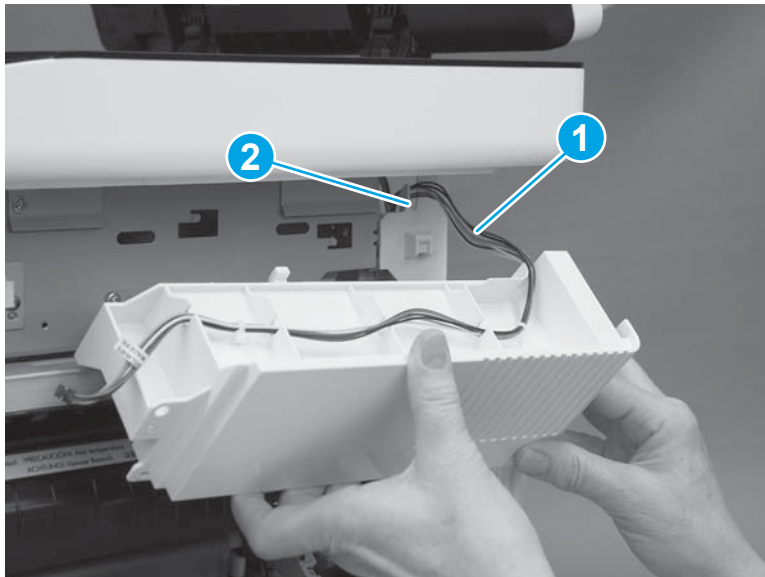

Step 17: Remove the left cover

1. At the left side of the printer, remove one screw (callout 1).

Figure 1-3788 Remove one screw



2. Release one tab (callout 1), rotate the front edge of the cover away from the printer (callout 2), and then slide the cover (callout 3) toward the rear of the printer to release it.

Figure 1-3789 Release the cover

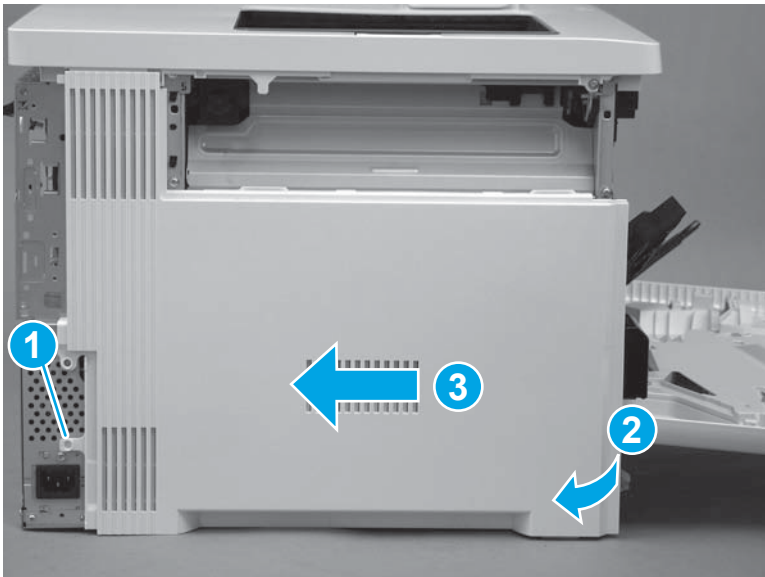

3. Remove the cover.

Figure 1-3790 Remove the cover

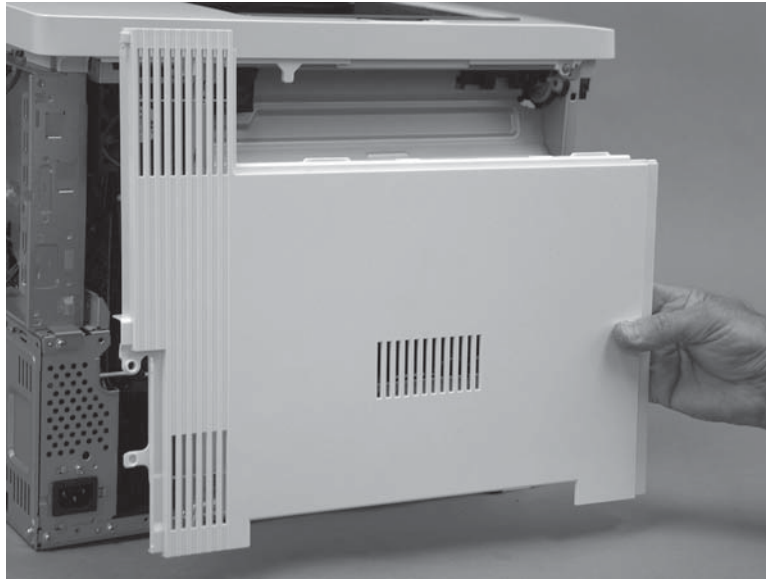

Step 18: Remove the upper cover (M552 and M553)

 **NOTE:** This step is for the M552 and M553 models. For the M577 models, skip this step and go to [Step 19: Remove the right rear cover on page 2123](#).

1. Remove three screws (callout 1).

Figure 1-3791 Remove three screws

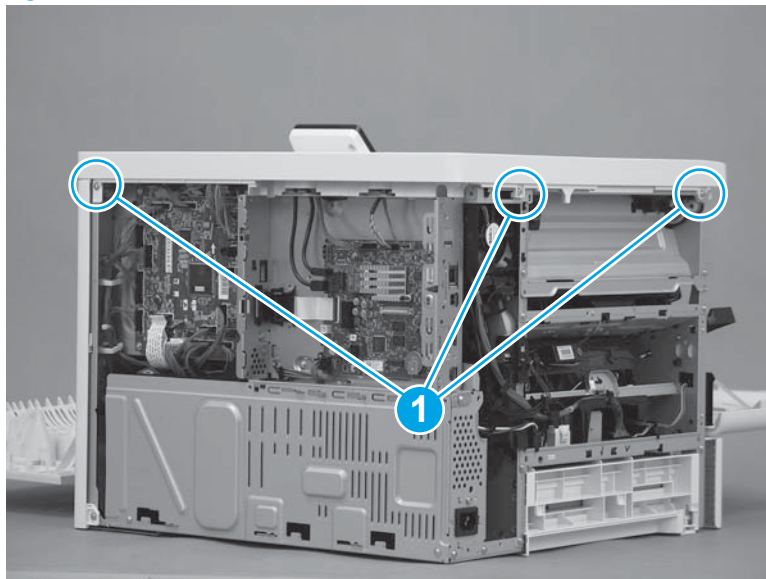

2. Remove one screw (callout 1), release one tab (callout 2), and then slightly separate the corner of the cover from the chassis.

 **NOTE:** This is a self-tapping plastic-thread screw. Make sure that this screw is used in this location when it is reinstalled.

Figure 1-3792 Remove one screw and release one tab



3. Release one tab (callout 1), and then lift up on the cover to release it.

 **NOTE:** If the cover does not release, check for addition tabs by locating the triangles embossed in the cover at tab locations.

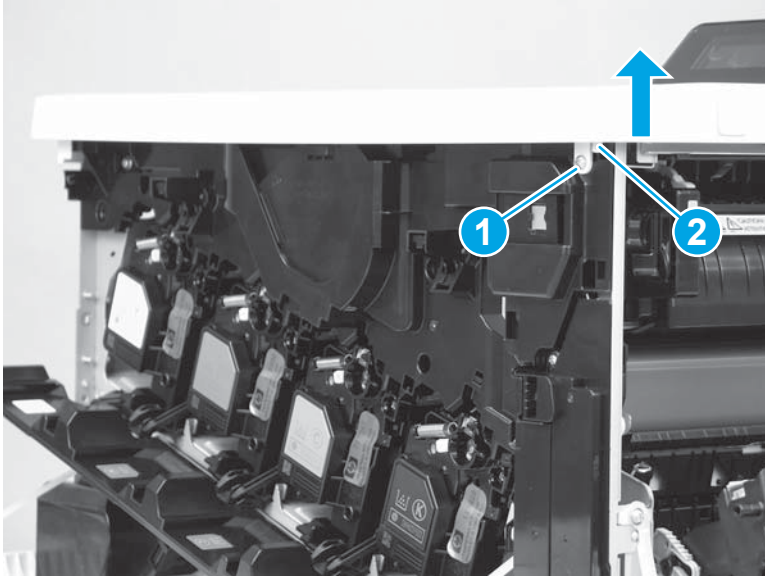
Figure 1-3793 Release the cover



4. Remove the cover.

Figure 1-3794 Remove the cover

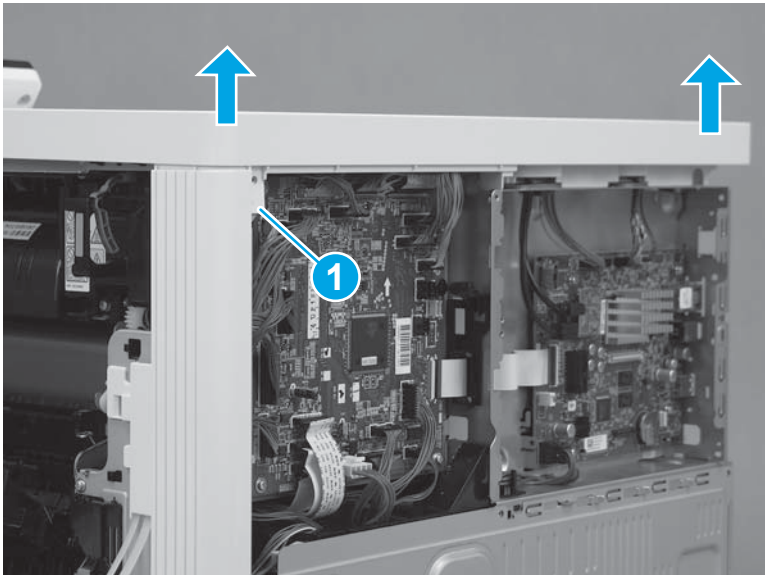
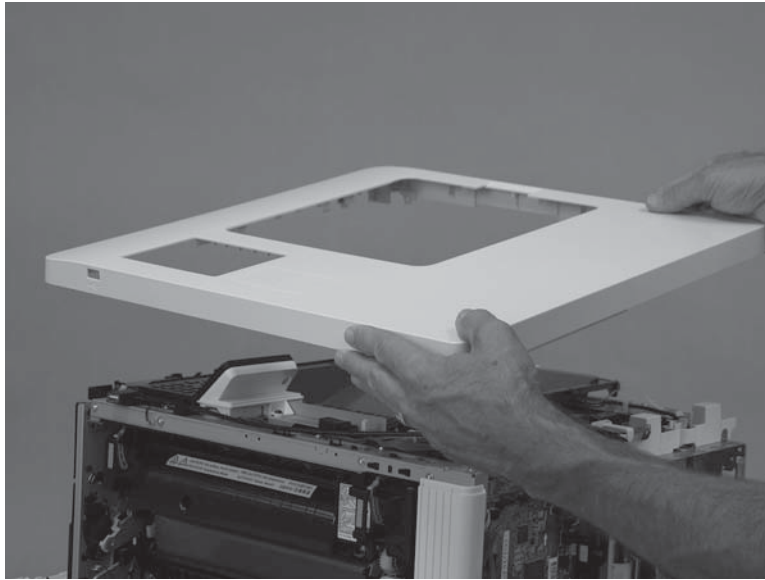

Step 19: Remove the right rear cover

1. Remove one screw (callout 1), and then slide the cover toward the rear of the printer (callout 2) to release it.

 **TIP:** If the right door is closed, open it now.

Figure 1-3795 Release the cover



2. Remove the cover.

Figure 1-3796 Remove the cover

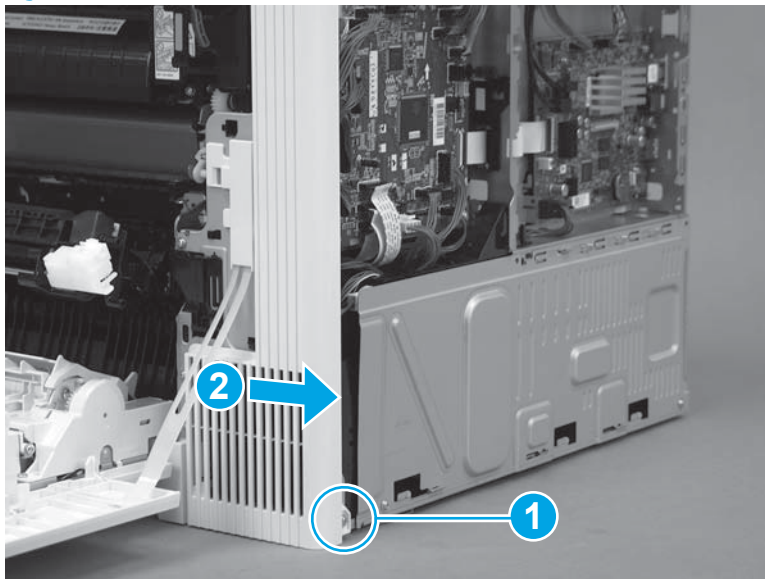
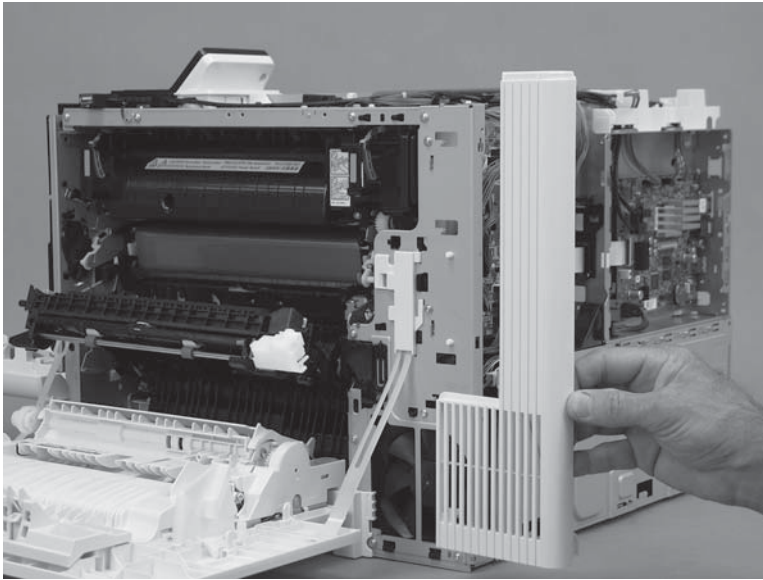

Step 20: Remove the formatter case

1. **M577 only:** Disconnect one connector (callout 1), and then pass the wire harness (callout 2) through two openings in the formatter case (callout 3).

Figure 1-3797 Disconnect one connector

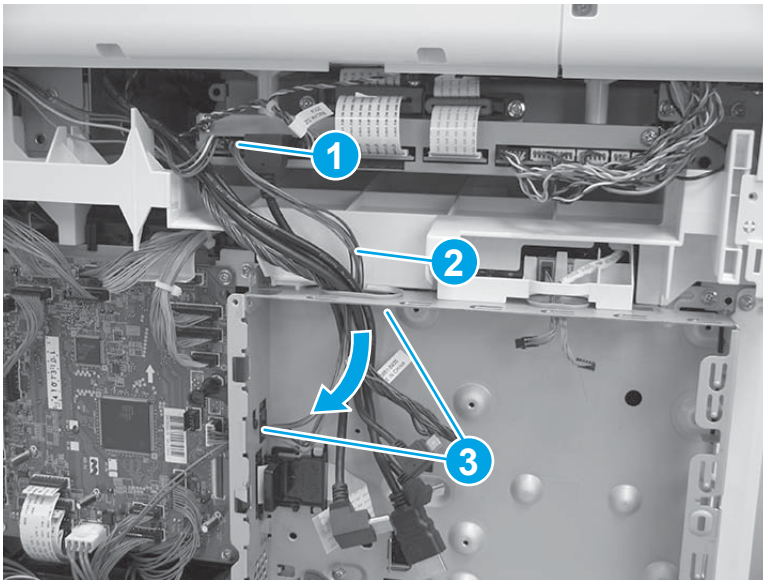

2. Release two tabs (callout 1) on the black plastic bracket. Hold the tabs in the released position, and then slide the bracket (callout 2) to the right to remove it from the formatter case.

Figure 1-3798 Remove the bracket

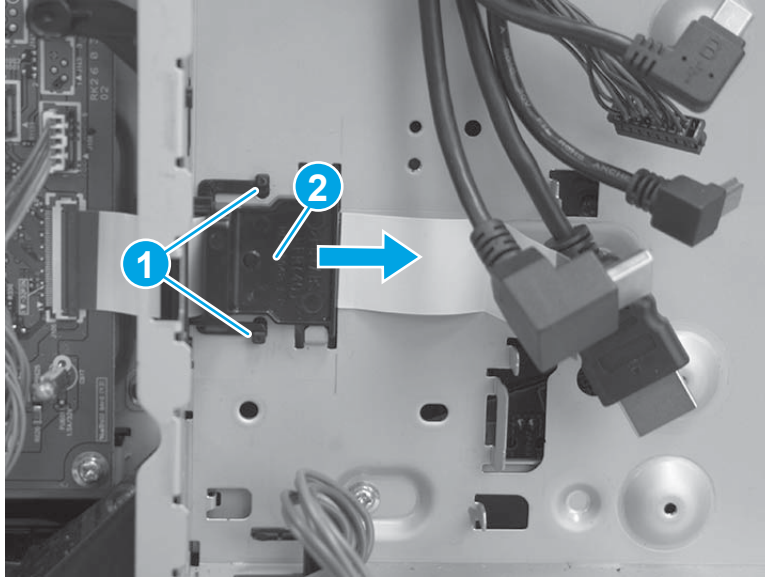

3. Remove two screws (callout 1), and then slide the low-voltage power supply (LVPS) cover to the right to remove it.

Figure 1-3799 Remove the LVPS cover

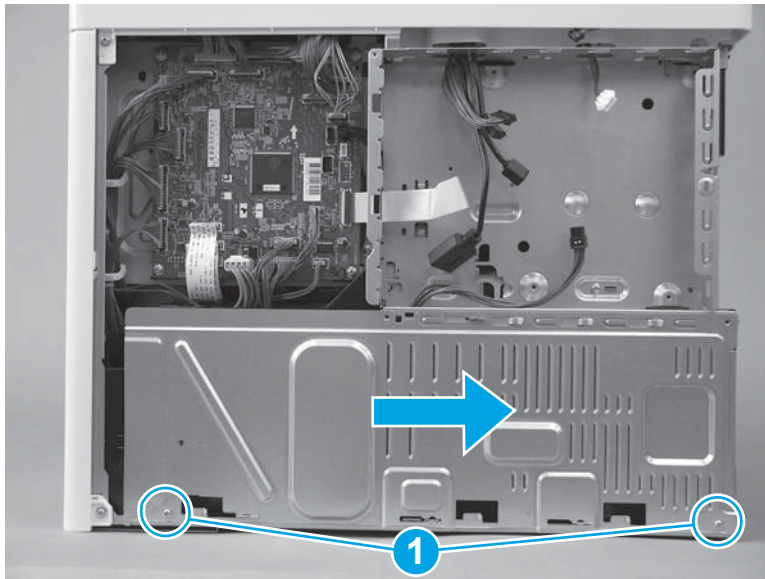

4. Pass two wire harnesses and one flat cable (callout 1) through the opening in the formatter case, and then release one wire harness from the retainer (callout 2).

⚠ CAUTION: The flat cable might be attached to the formatter case with double-sided tape. Make sure that this tape is released, so that the flat cable is not damaged when the formatter case is removed.

Figure 1-3800 Release wire harnesses and flat cable

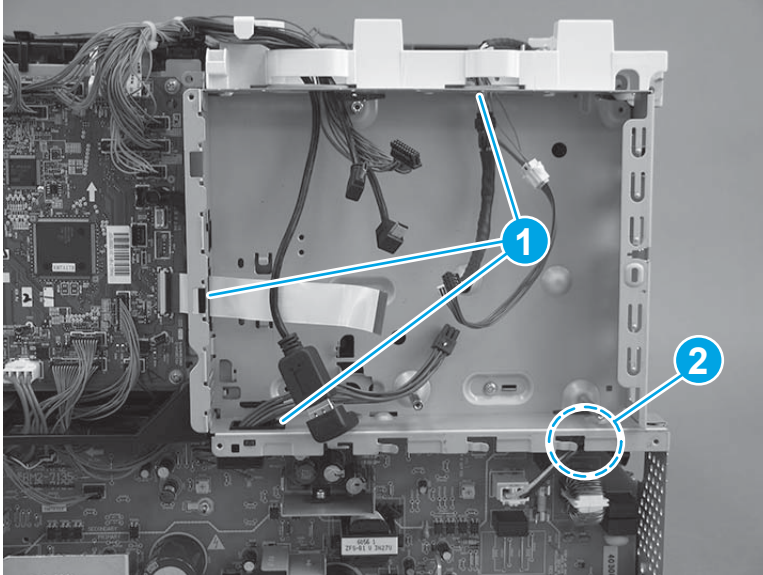

5. Remove six screws (callout 1).

Figure 1-3801 Remove six screws

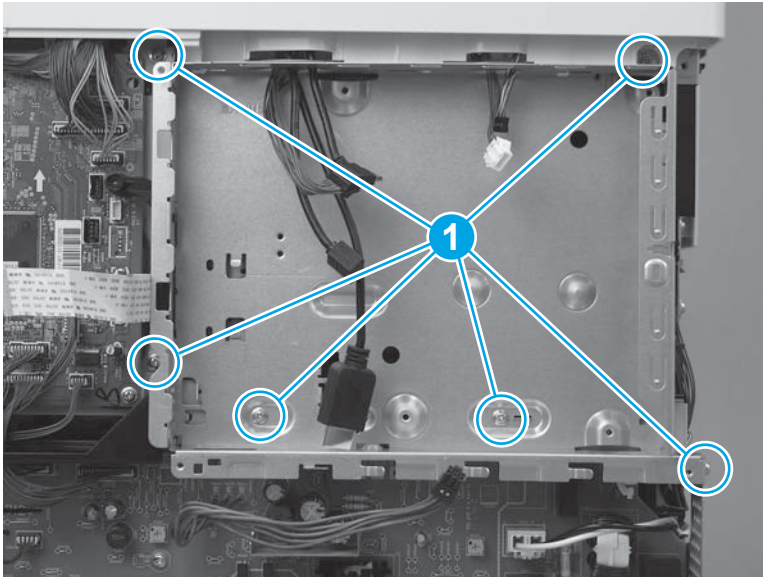

6. Rotate the bottom of the formatter case away from the printer (callout 1), and then pull it down (callout 2) to release it.

Figure 1-3802 Release the formatter case

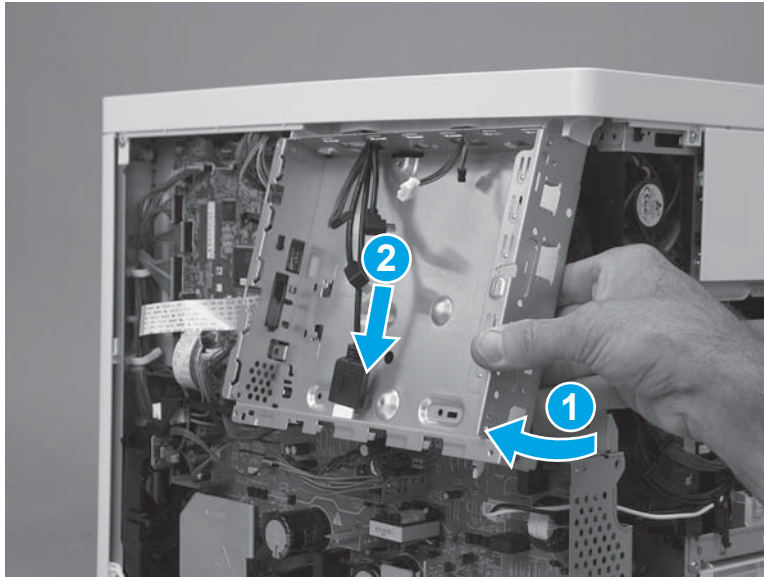

7. Pass the wire harnesses through the opening in the formatter case to remove it.

 **IMPORTANT:** If the formatter case is removed so that it can be replaced, make sure to transfer the memory PCA (island of data) and plastic bracket (callout 1) to the replacement case.

Figure 1-3803 Remove the formatter case



Step 21: Remove the low-voltage power supply (LVPS)

 **CAUTION:**  ESD-sensitive part.

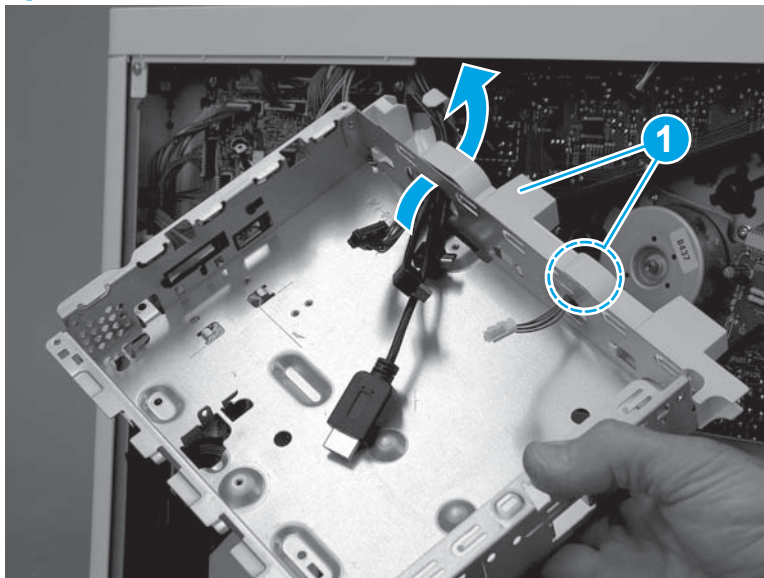
1. Disconnect one wire harness (callout 1), and then pass the wire harness through the opening (callout 2) in the chassis.

Figure 1-3804 Disconnect one wire harness

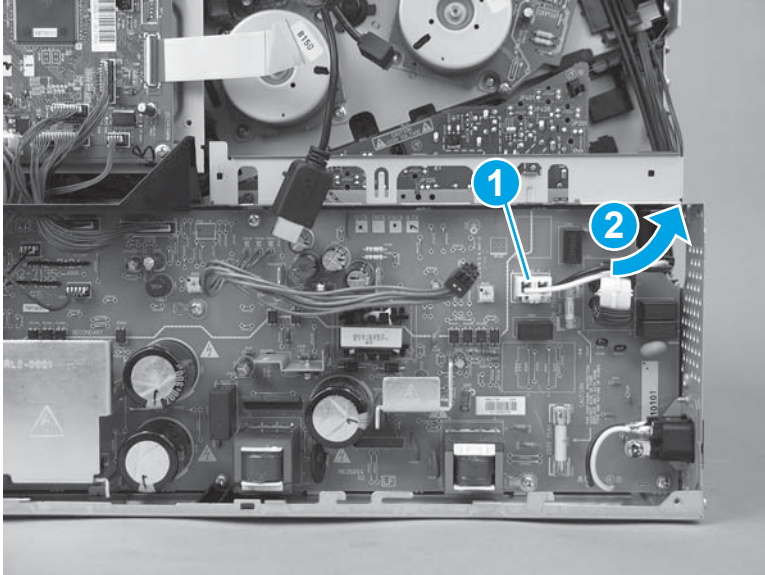

2. Disconnect three connectors on the DC controller (callout 1), and then disconnect four connectors (callout 2) on the LVPS.

Figure 1-3805 Disconnect seven connectors

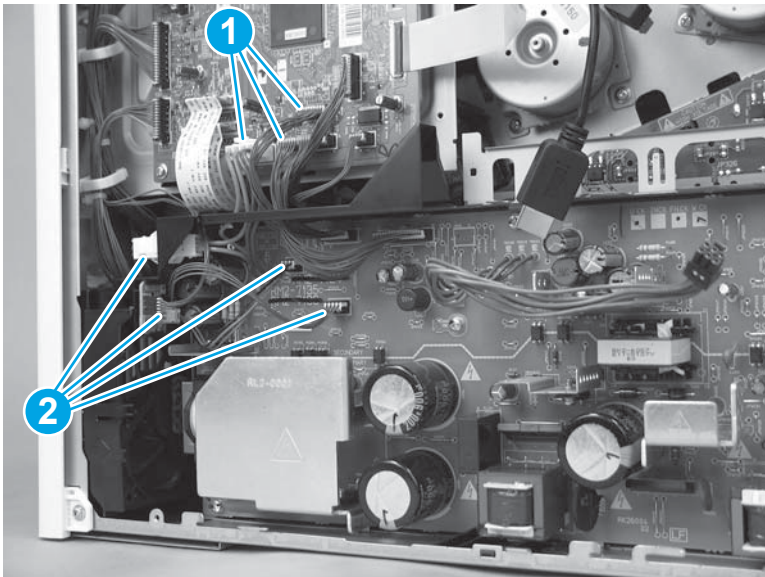

3. Pass the wire harnesses from the DC controller to the LVPS through the opening in the chassis (callout 1), and then release the wire harnesses from the retainer (callout 2).

Figure 1-3806 Pass the wire harnesses through the opening

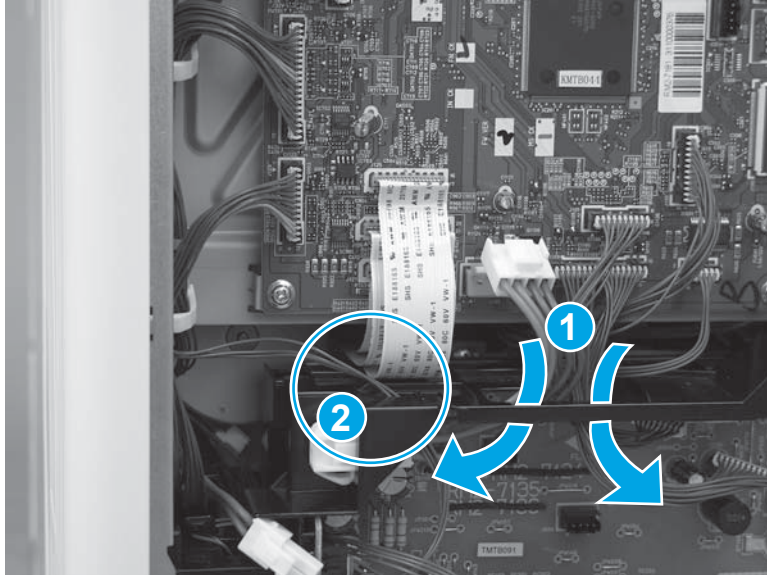

4. Remove three screws (callout 1).

Figure 1-3807 Remove three screws

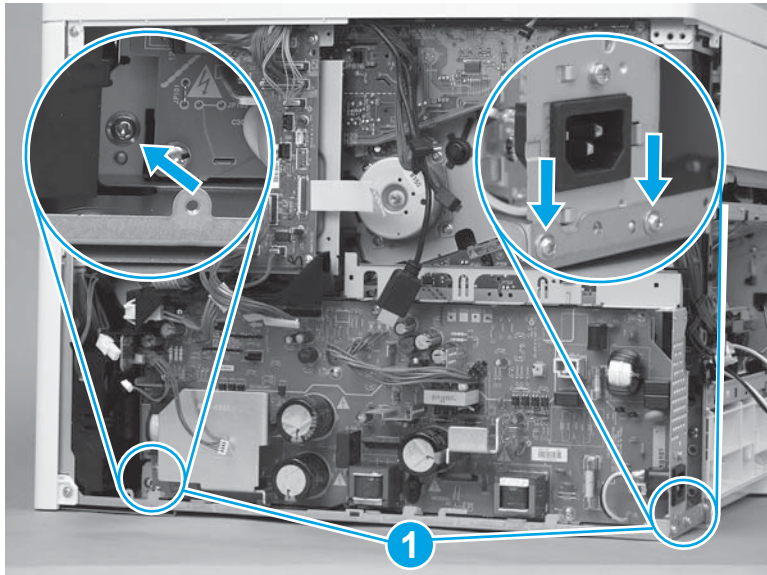

5. Rotate the top of the LVPS away from the printer (callout 1), and then slide it up and out (callout 2) of the printer to remove it.

Figure 1-3808 Remove the LVPS

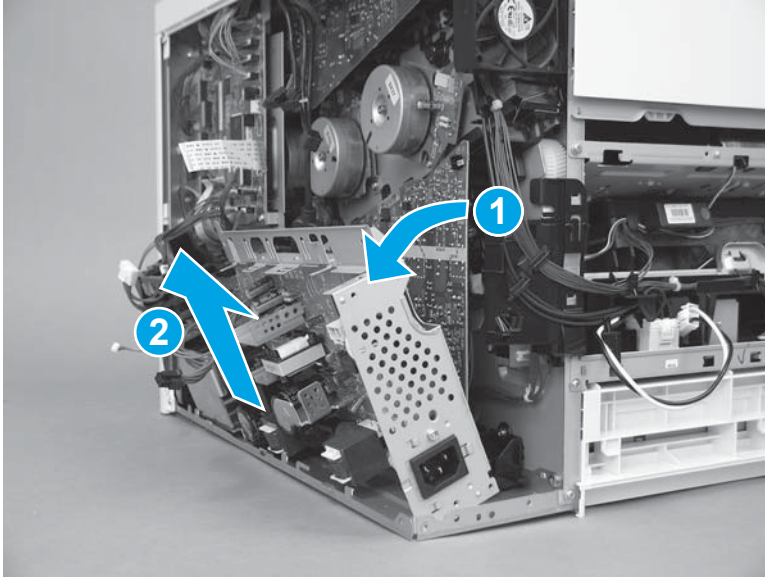

Step 22: Remove the power supply fan (FM1)

1. Remove one screw (callout 1).

Figure 1-3809 Remove one screw

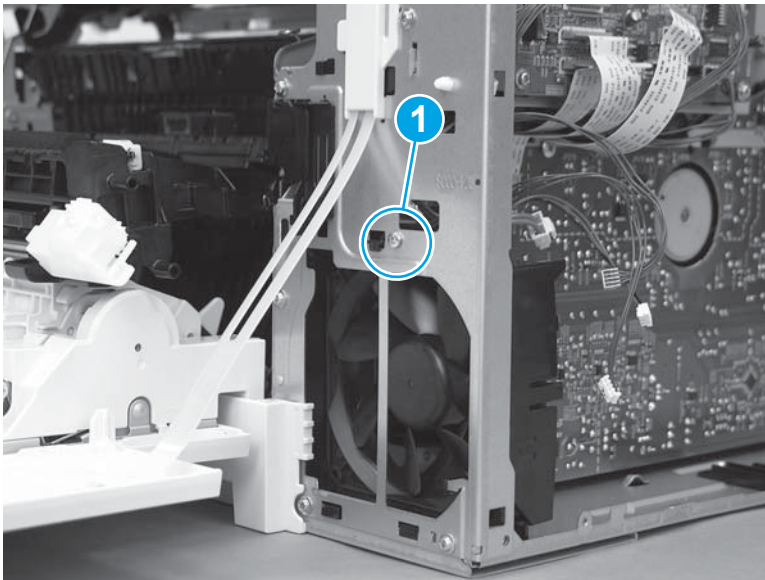

2. Release the wire harnesses from the retainer on the top of the fan bracket.

Figure 1-3810 Release the wire harnesses

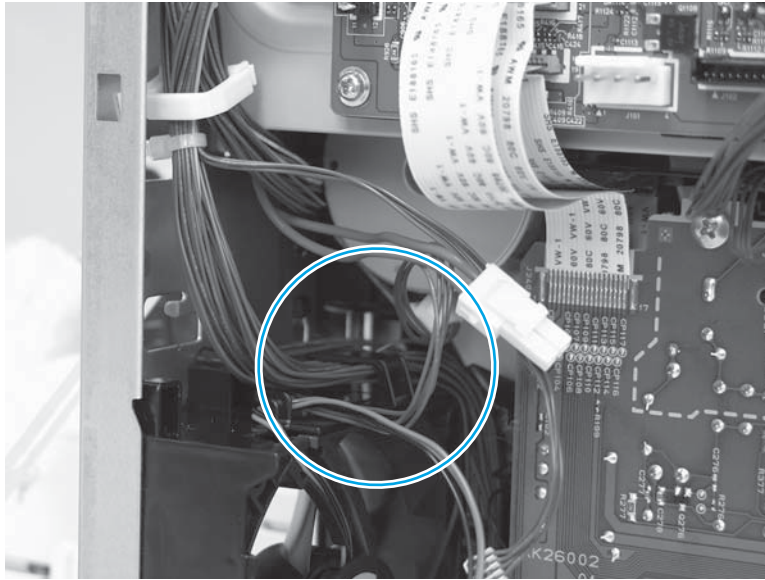

3. Lift the fan up (callout 1), and then slide it out of the printer (callout 2) to remove it.

Figure 1-3811 Remove the fan

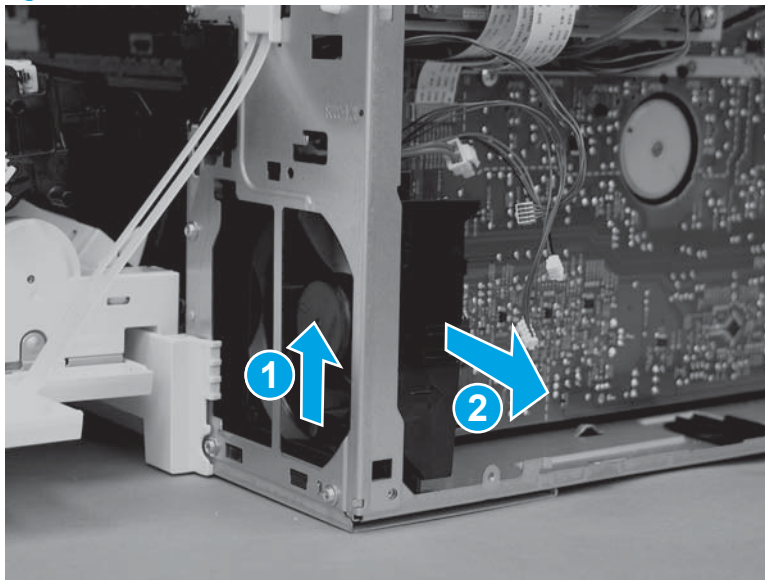

Step 23: Remove the high-voltage power supply D (HVPSD)

 **CAUTION:**  ESD-sensitive part.

1. Disconnect one flat cable (callout 1) on the DC controller.

Figure 1-3812 Disconnect one flat cable

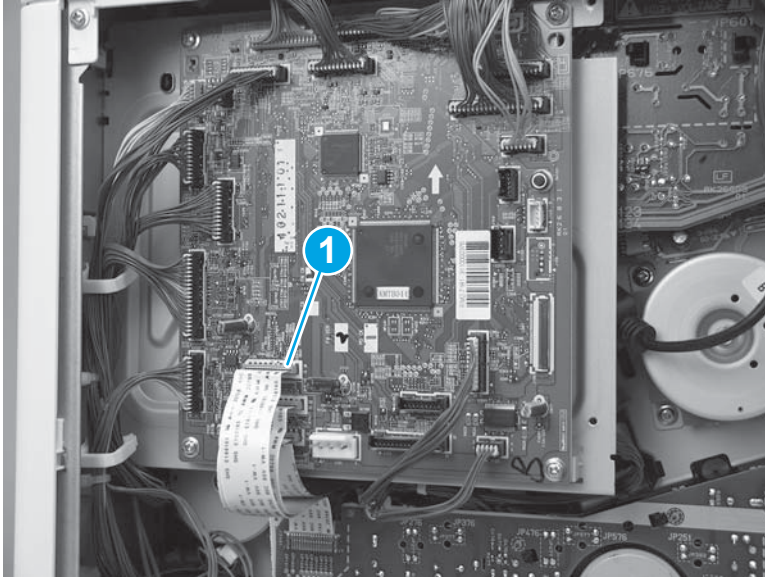

2. Remove two screws (callout 1), and then remove one self tapping screw (callout 2) on the HVPSD.

Figure 1-3813 Remove three screws

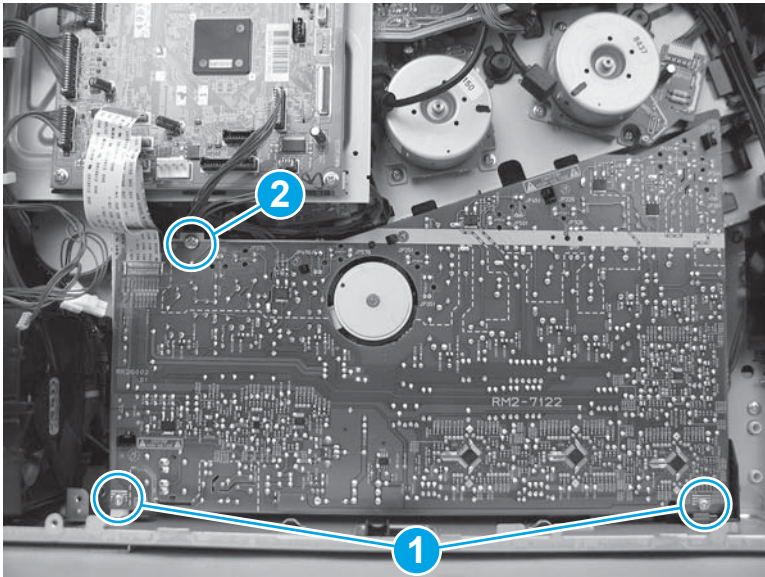

3. Release five tabs (callout 1), and then remove the HVPSD (callout 2).

Figure 1-3814 Remove the HVPSD

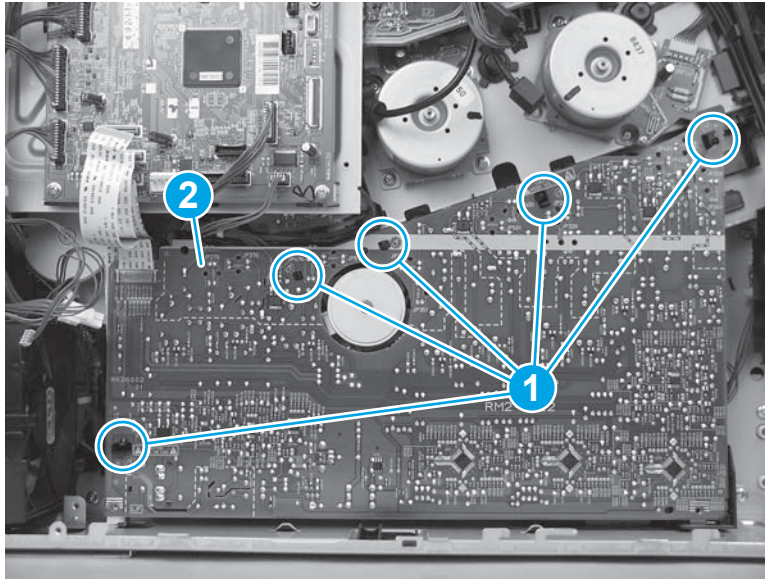

Step 24: Remove the lifter drive assembly

1. Disconnect two connectors (callout 1).

Figure 1-3815 Disconnect two connectors

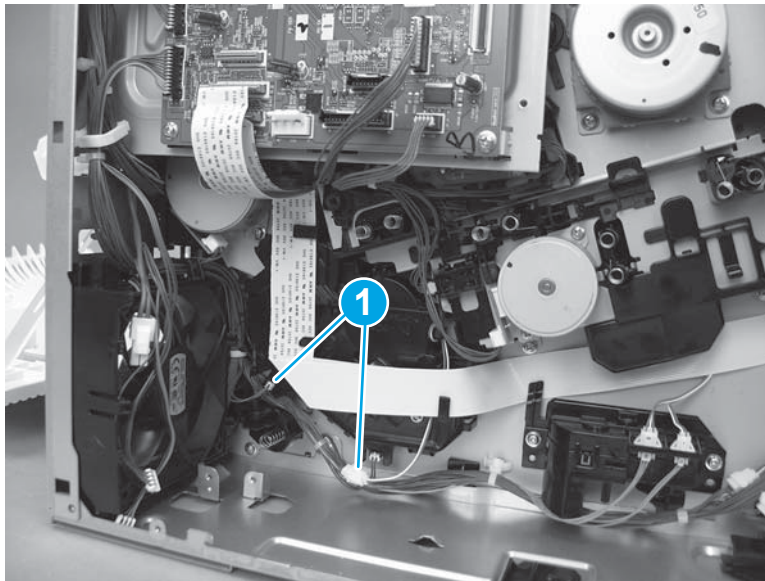

2. Disconnect two flat cables (callout 1), and then release them from the retainers (callout 2).

Figure 1-3816 Disconnect two flat cables

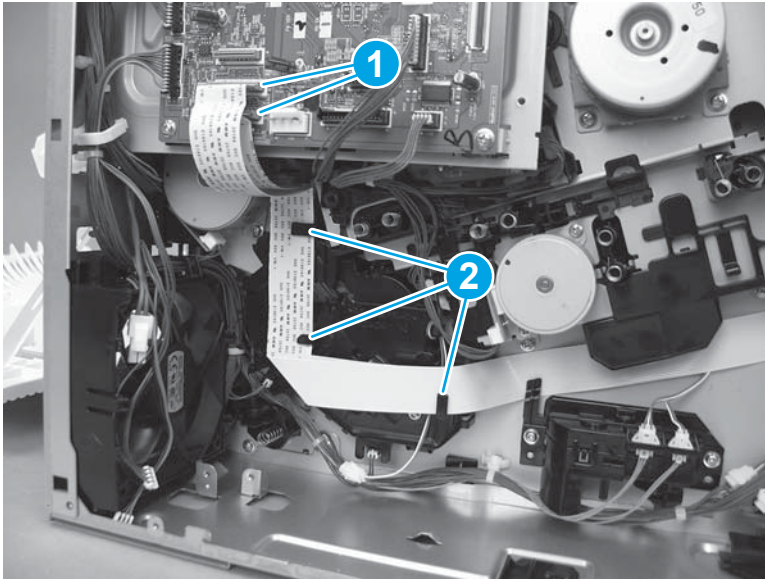

3. Remove two screws (callout 1), release one tab (callout 2), and then remove the lifter drive assembly (callout 3).

 **NOTE:** Release one wire harness from the retainer (callout 4) as the assembly is removed.

Figure 1-3817 Remove the assembly

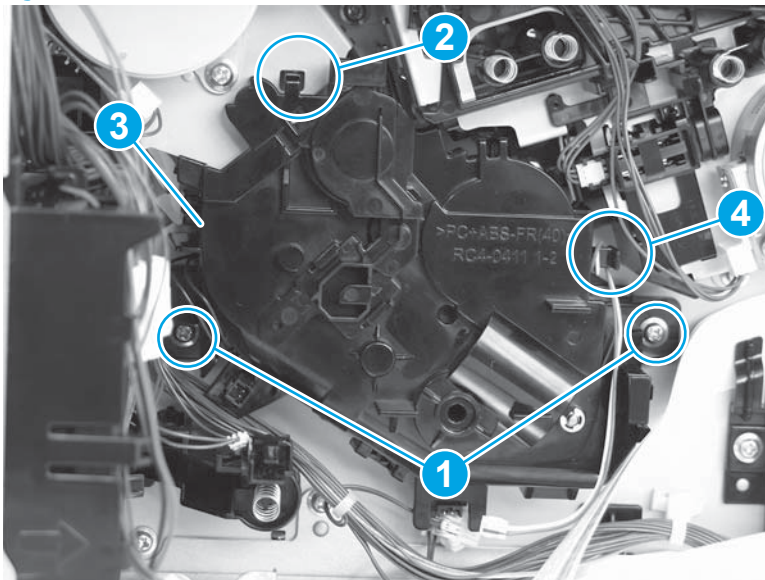

Step 25: Remove the DC controller and sheet-metal bracket

 **CAUTION:**  ESD sensitive part.

1. Disconnect all of the connectors, and then remove two screws (callout 1).

The following connectors are empty:

- J140, J141, and J143

Figure 1-3818 Remove two screws

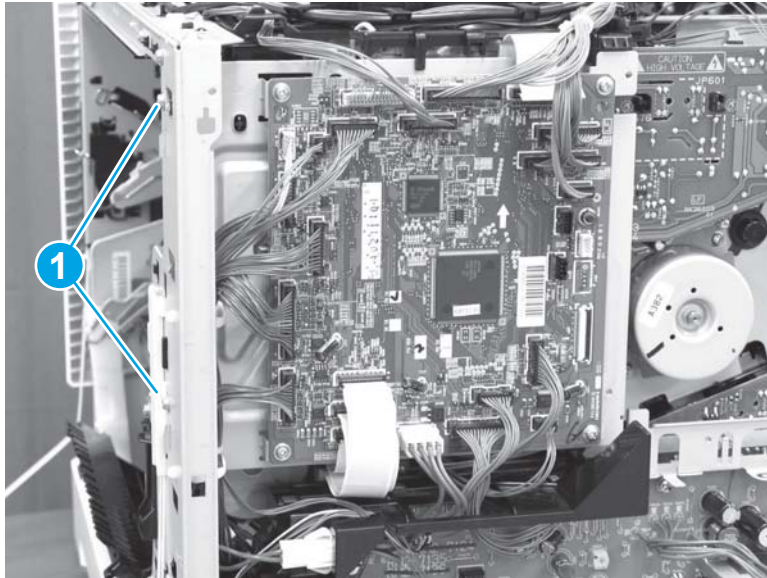

2. Lift up on the DC controller and sheet-metal plate to remove it.

Figure 1-3819 Remove the plate

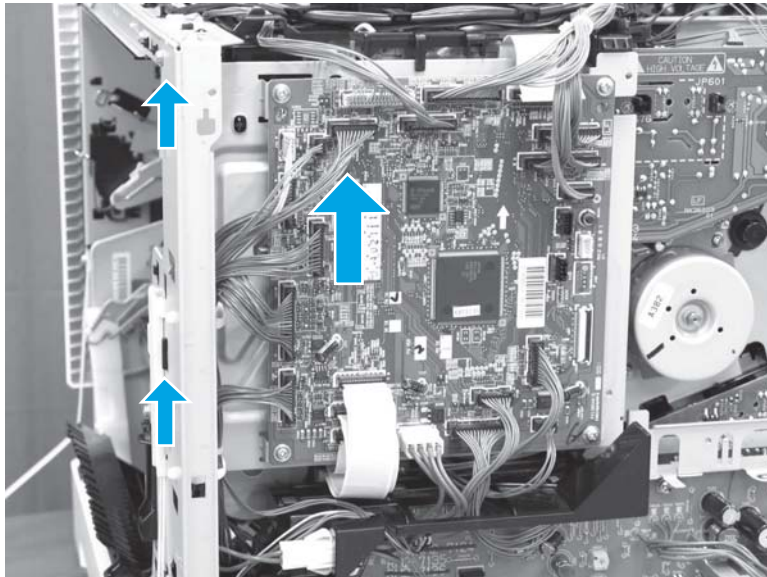

Step 26: Remove the pickup drive assembly and motor (M5)

1. Release one tab (callout 1), and then move the guide (callout 2) out of the way.

Figure 1-3820 Move the guide out of the way

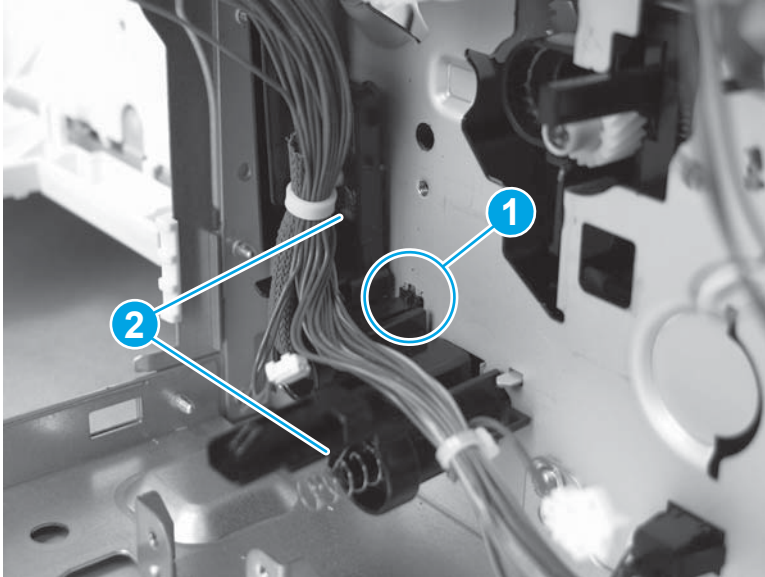

2. Remove three screws (callout 1).

Figure 1-3821 Remove three screws

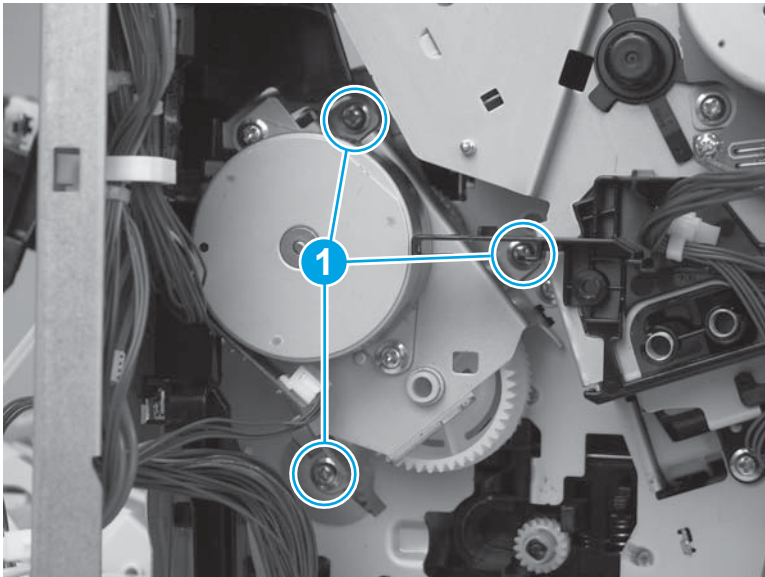

3. Remove the assembly.

CAUTION: One gear on the back side of the assembly is not captive. Handle the assembly carefully.

Figure 1-3822 Remove the assembly

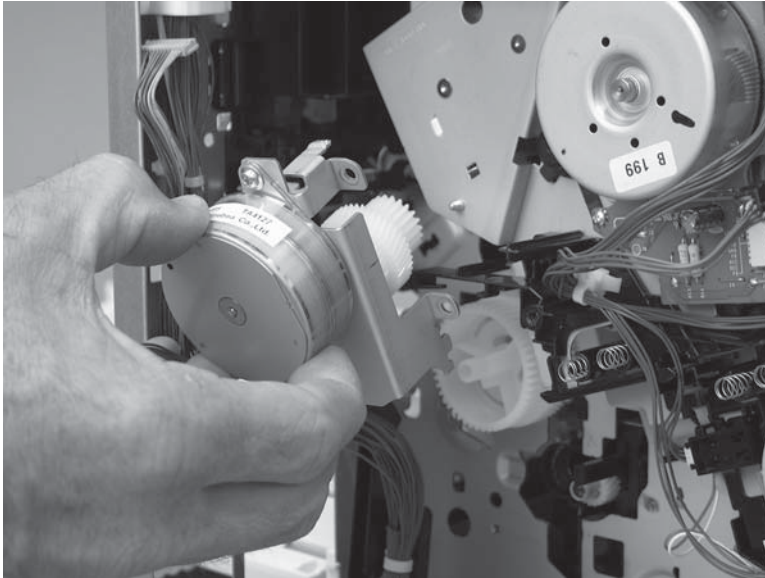

4. If the gear (callout 1) was not removed with the assembly in the previous step, remove it now.

Figure 1-3823 Remove the gear if installed

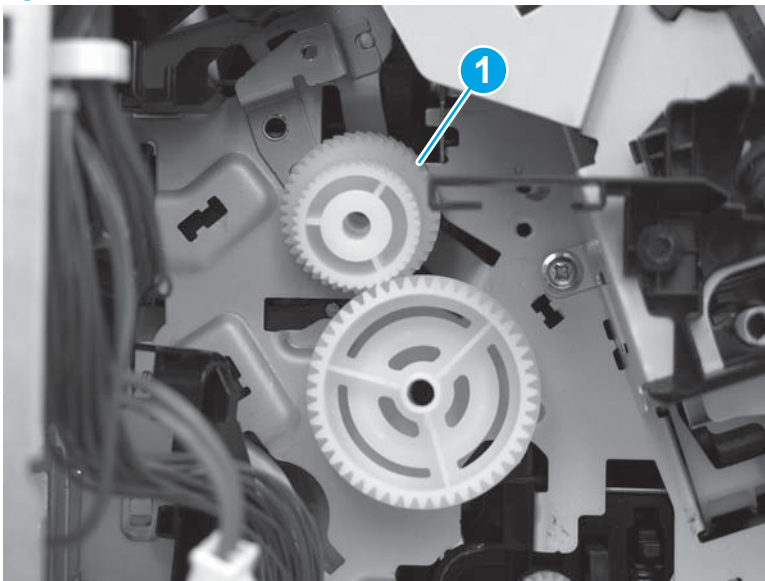

Step 27: Unpack the replacement assembly

Unpack the replacement assembly from the packaging.

For complete information on HP's recycling programs, go to [Product return and recycling](#).

⚠ CAUTION: One gear (callout 1) on the back side of the assembly is not captive. Handle the assembly carefully.

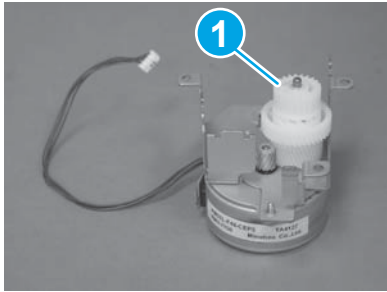

📝 NOTE: HP recommends responsible disposal of the defective assembly.

Figure 1-3824 Recycle and unpack

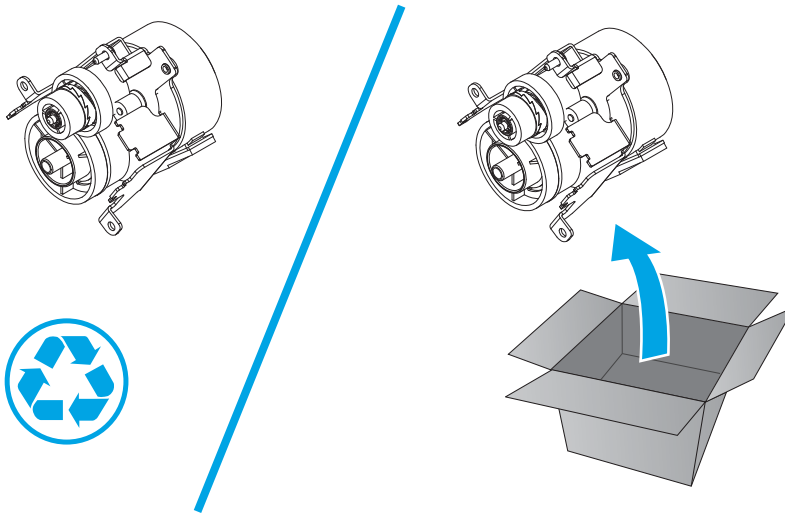

Step 28: Install the pickup drive assembly and motor (M5)

1. Before installing the assembly, check to see if a gap exists (callout 1) between the gears.

📝 NOTE: If no gap exists, go to step [3](#) in this section.

Figure 1-3825 Check the gears for a gap

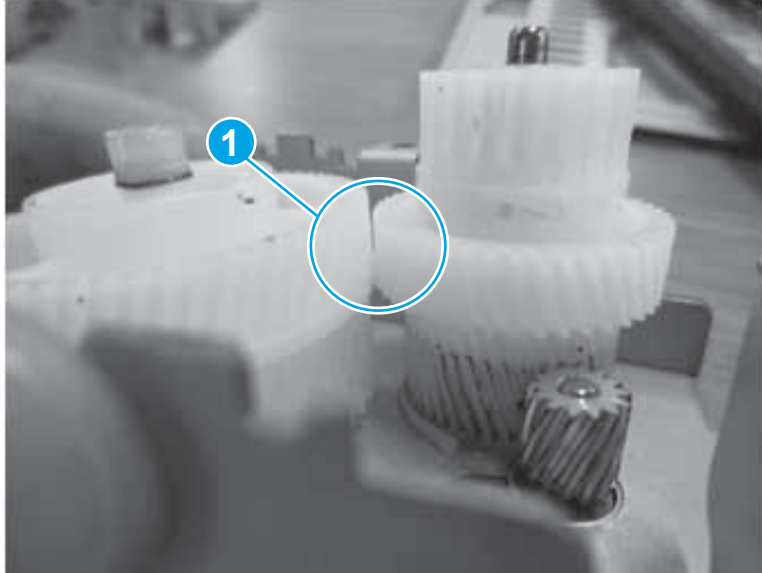

2. Adjust the gears on the assembly to remove the gap (callout 1).

Figure 1-3826 Adjust the gears

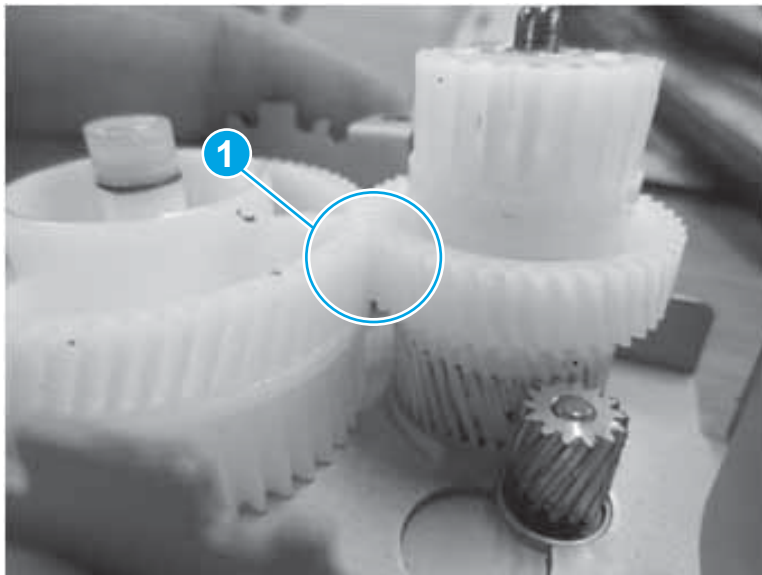

3. Align the tabs on the pickup drive assembly with the slots in the chassis, and then install the assembly on the printer.

 **IMPORTANT:** The figure below shows the large gear of the assembly already installed on the printer chassis. However it is easier to install the pickup drive assembly if the gear is installed on the assembly.

 **TIP:** With the right door open, look into the printer and verify that the mounting bracket for the assembly is correctly installed against the chassis.

Figure 1-3827 Install the assembly



4. Install three screws (callout 1).

Figure 1-3828 Install three screws

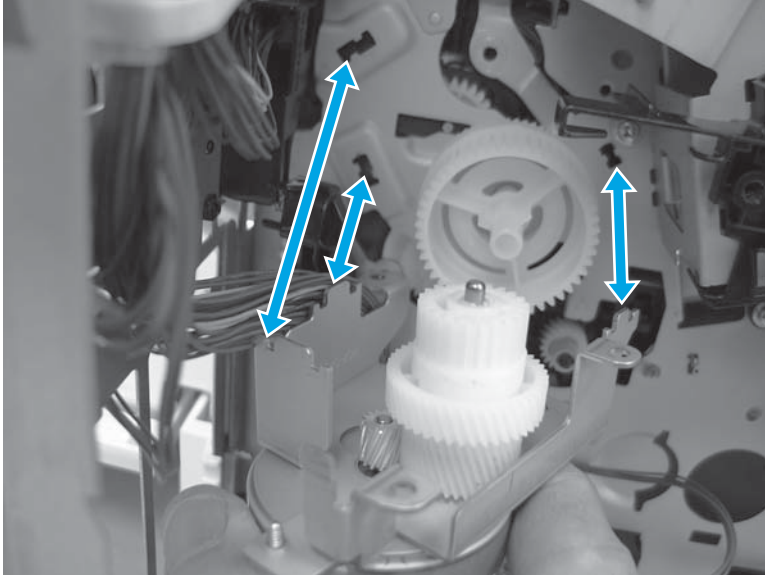
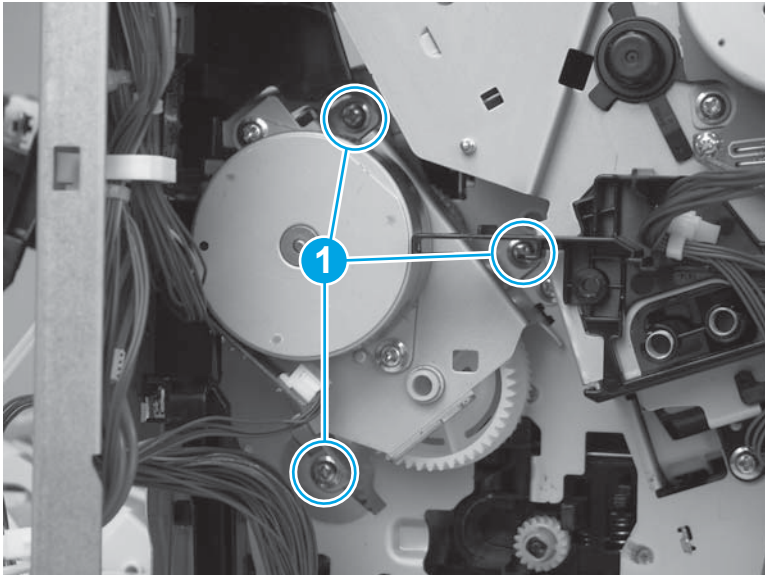

5. Install the guide (callout 1). Make sure that the tab (callout 2) snaps into place.

Figure 1-3829 Install the guide

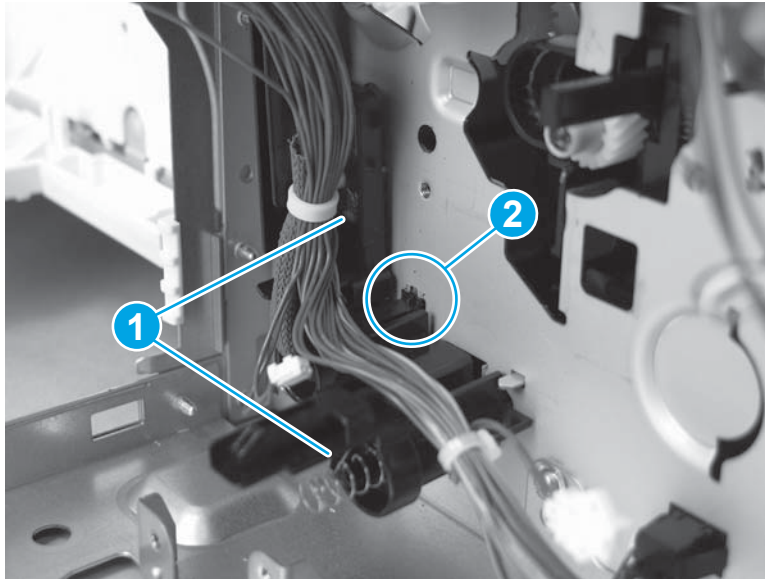

Step 29: Install the DC controller and sheet-metal bracket

 **CAUTION:**  ESD-sensitive part.

1. Position the DC controller and sheet-metal plate on the printer, and then push down to engage the plate with the chassis.

Figure 1-3830 Install the plate

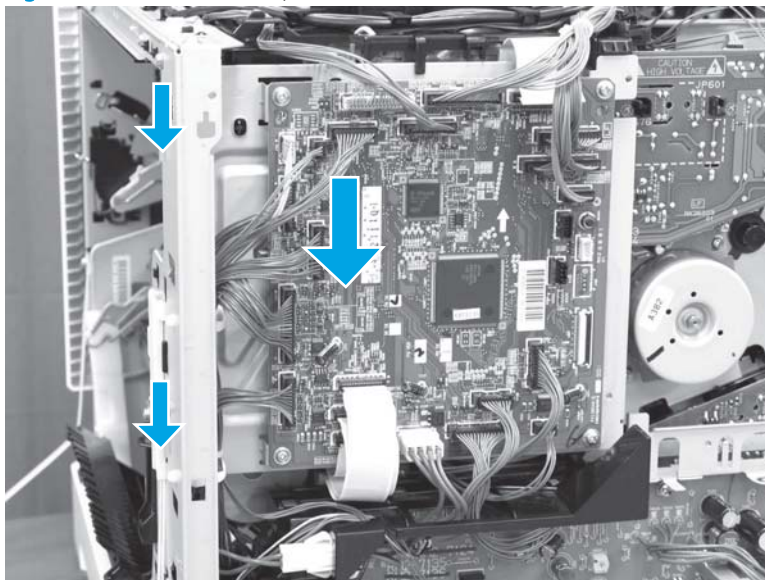

2. Install two screws (callout 1), and then connect all of the connectors.

The following connectors are empty:

- J140, J141, and J143

Figure 1-3831 Install two screws

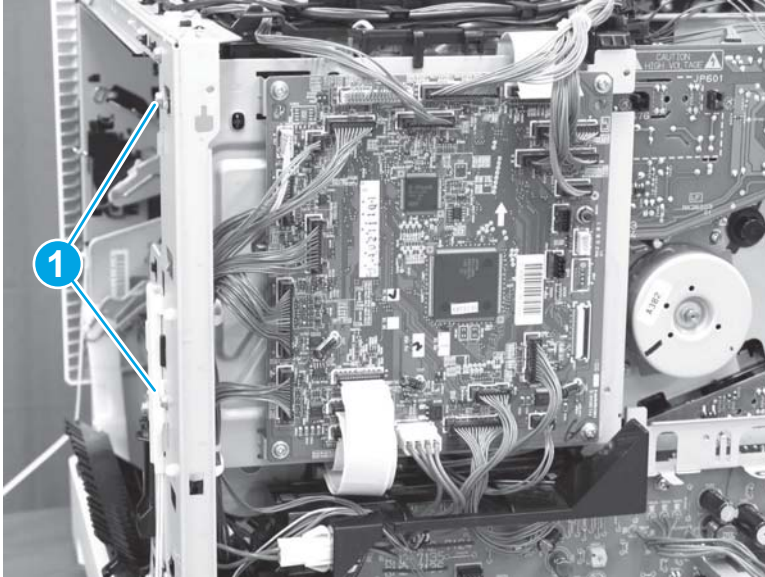

Step 30: Install the lifter drive assembly

1. Install one wire harness on the retainer (callout 1), position the lifter drive assembly in the printer (make sure that one tab (callout 2) snaps into place), and then install two screws (callout 3).

 **TIP:** It might be easier to install the assembly if the bottom of the assembly is installed first, and then the top of the assembly is rotated into place.

Figure 1-3832 Install the lifter drive



2. Connect two flat cables (callout 1), and then place them in the retainers (callout 2).

Figure 1-3833 Connect two flat cables

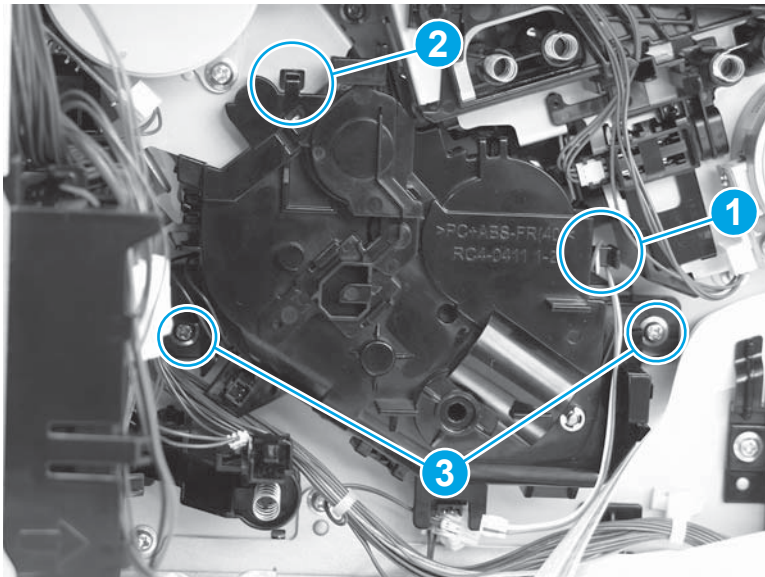
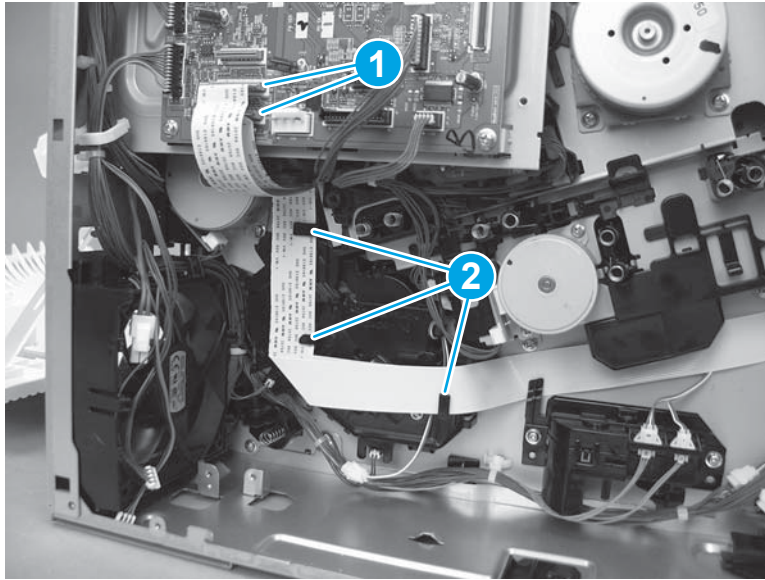

3. Connect two connectors (callout 1).

Figure 1-3834 Connect two connectors

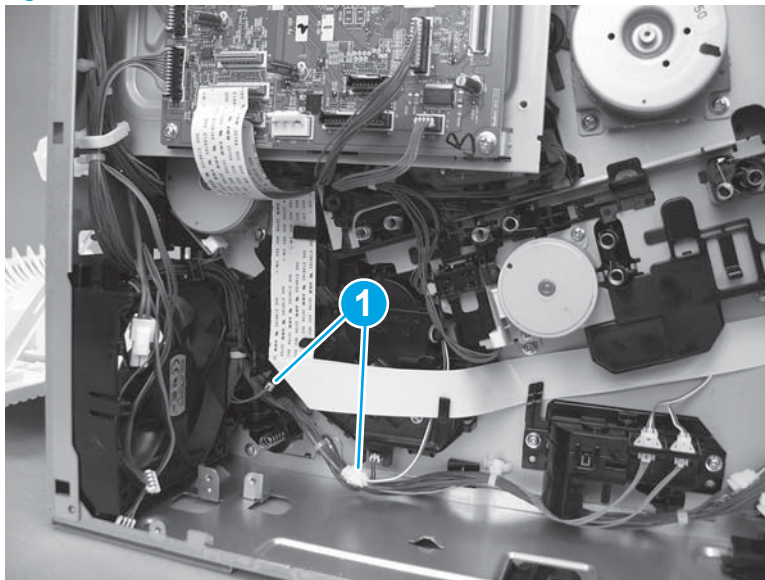

Step 31: Install the HVPSD

 **CAUTION:**  ESD-sensitive part.

1. Position the bottom right corner of the HVPSD (callout 1) behind the black tab, and then rotate it up and onto the printer (callout 2).

Figure 1-3835 Install the HVPSD

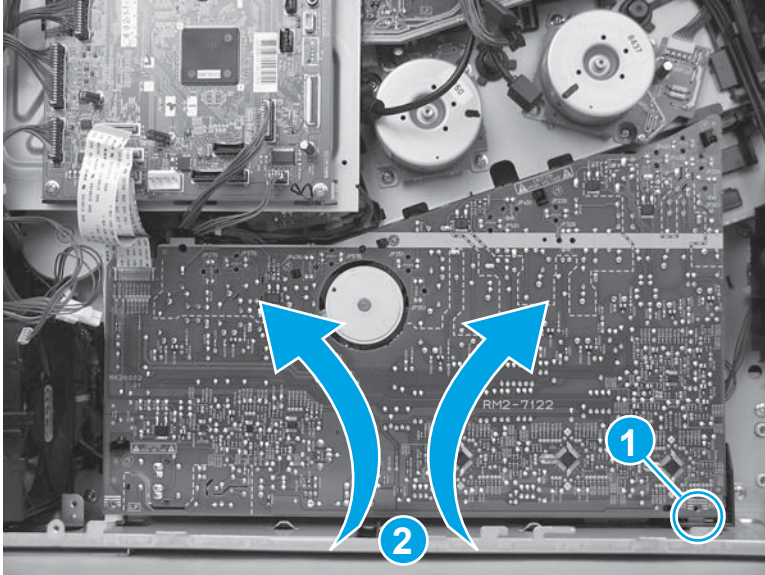

2. Press it onto five tabs (callout 2).

 **IMPORTANT:** Make sure that all five tabs snap into place.

Figure 1-3836 Press the tabs



3. Install two screws (callout 1), and then install one self tapping screw (callout 2) on the HVPSD.

Figure 1-3837 Install three screws

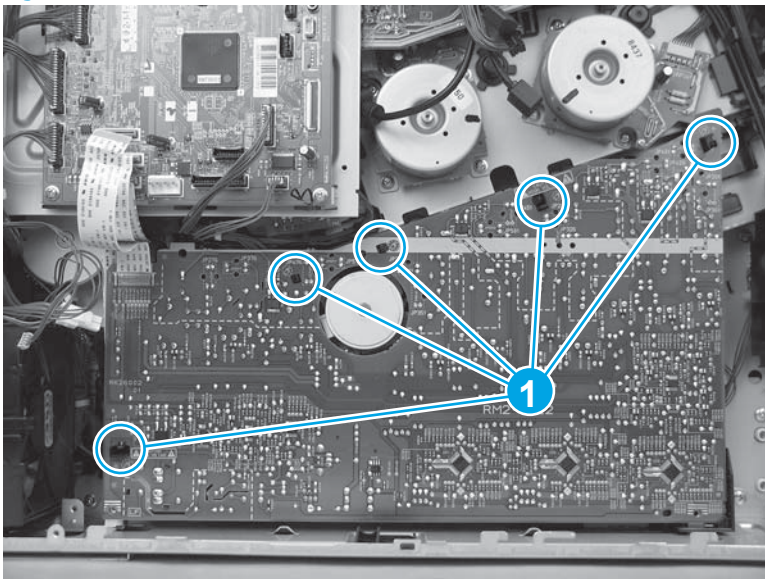
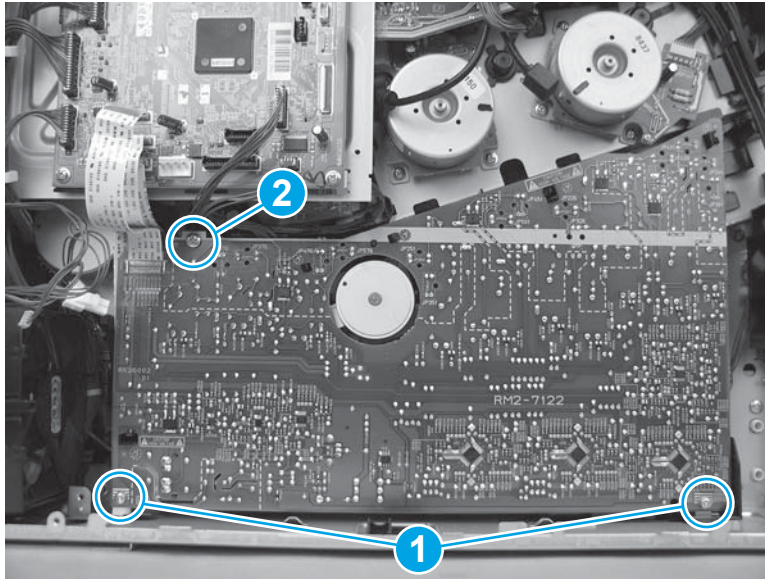

4. Connect one flat cable (callout 1) on the DC controller.

Figure 1-3838 Connect one flat cable

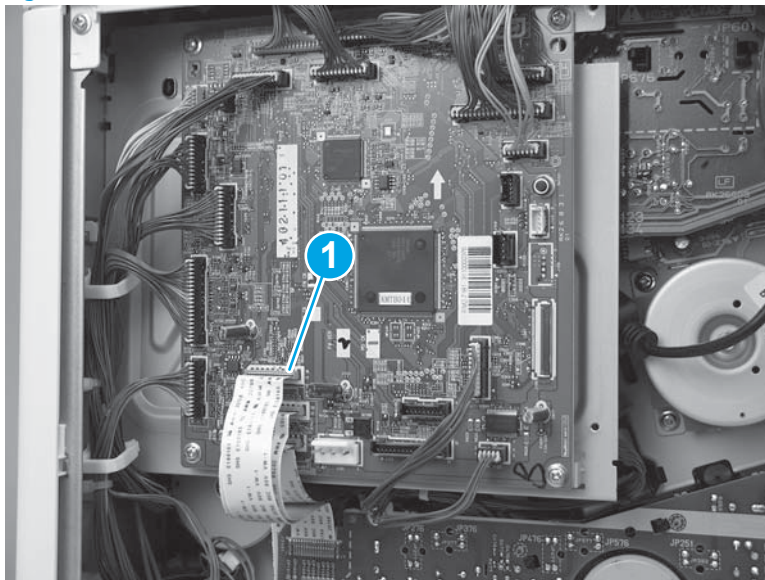

Step 32: Install the power-supply fan (FM1)

1. Slide the fan in (callout 1) and then down (callout 2) into the printer to install it.

 **NOTE:** Make sure that the arrow (callout 3) embossed on the fan holder faces into the printer.

Figure 1-3839 Install the fan



2. Place the wire harnesses in the retainer on the top of the fan bracket.

Figure 1-3840 Place the wire harnesses in the retainer

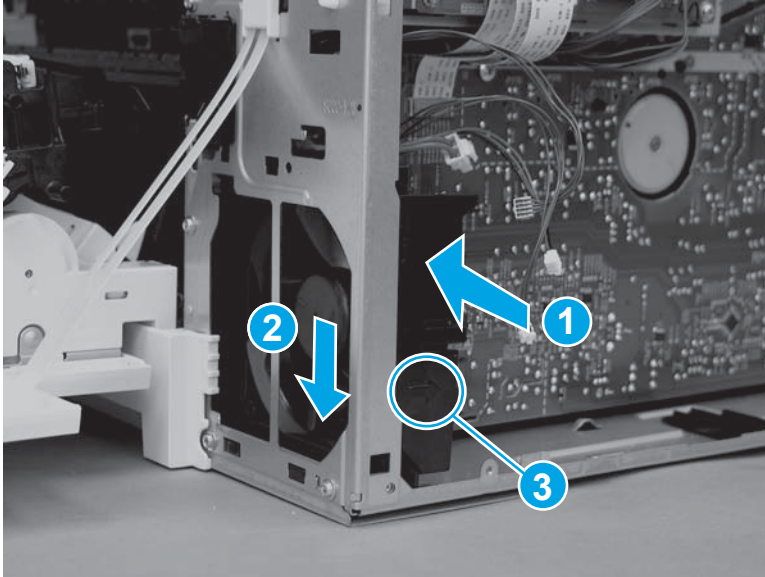
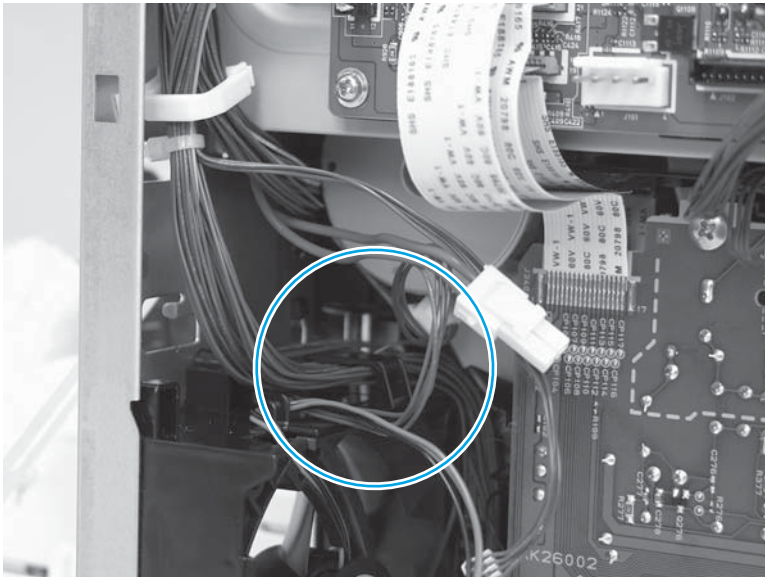

3. Install one screw (callout 1).

Figure 1-3841 Install one screw

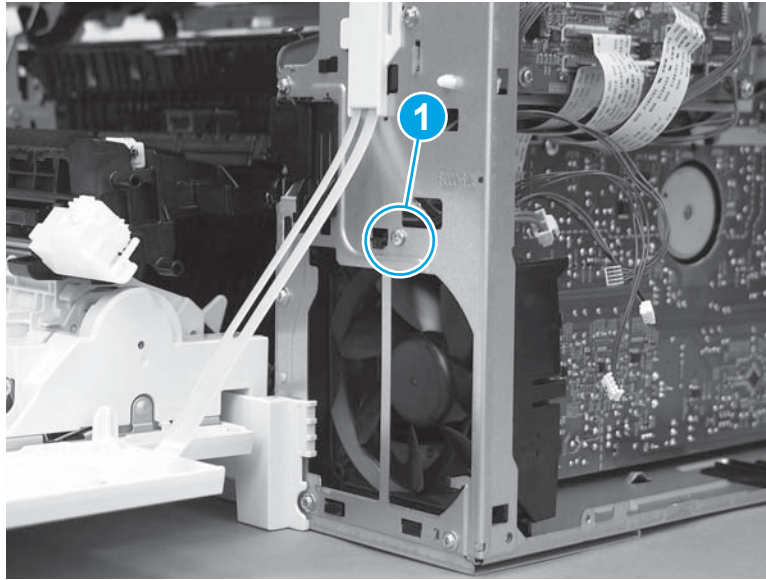

Step 33: Install the LVPS

 **CAUTION:**  ESD-sensitive part.

1. Position the bottom of the LVPS in the printer (callout 1) at a slight angle, and then rotate the top of it into the printer (callout 2) to install it.

Figure 1-3842 Install the LVPS

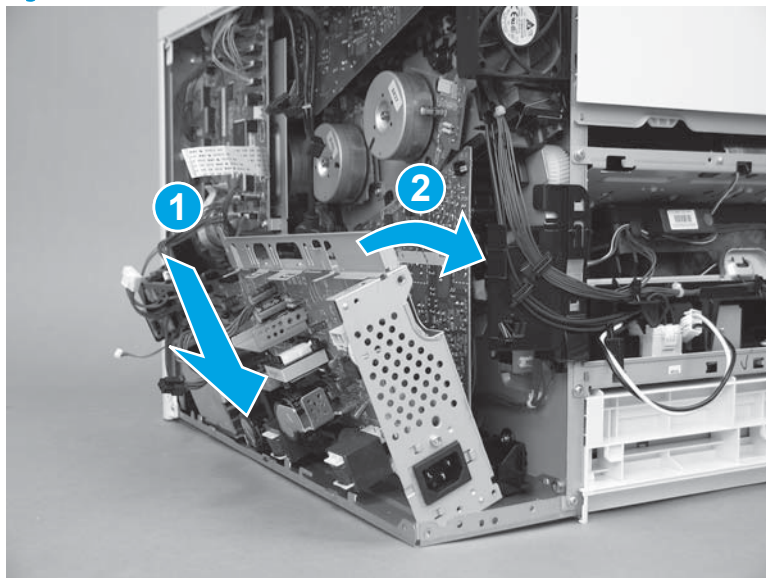

2. Install three screws (callout 1).

Figure 1-3843 Install three screws

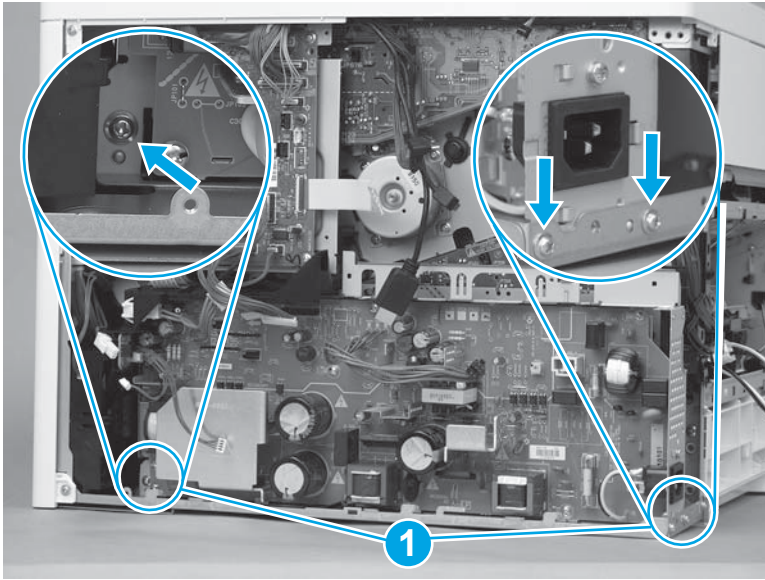

3. Pass the wire harnesses from the DC controller to the LVPS through the opening in the chassis (callout 1), and then install the wire harnesses in the retainer (callout 2).

Figure 1-3844 Pass the wire harnesses through the opening

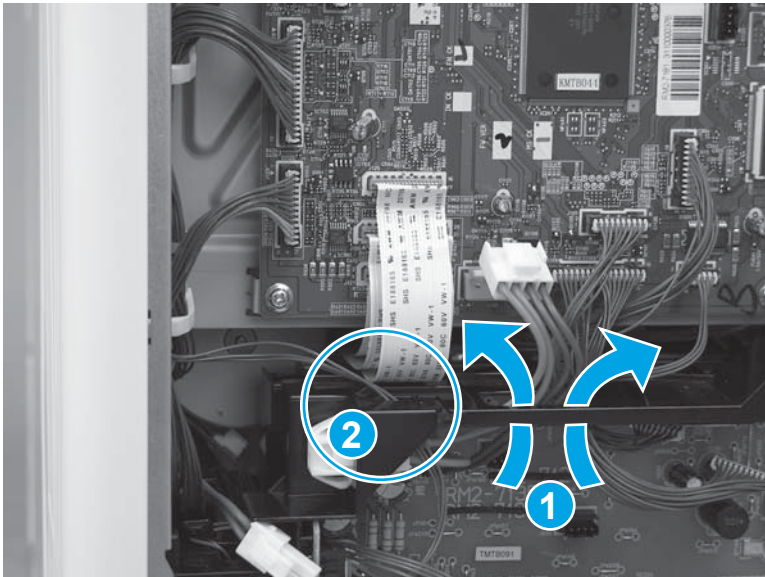

4. Connect three connectors on the DC controller (callout 1), and then connect four connectors (callout 2) on the LVPS.

Figure 1-3845 Connect seven connectors

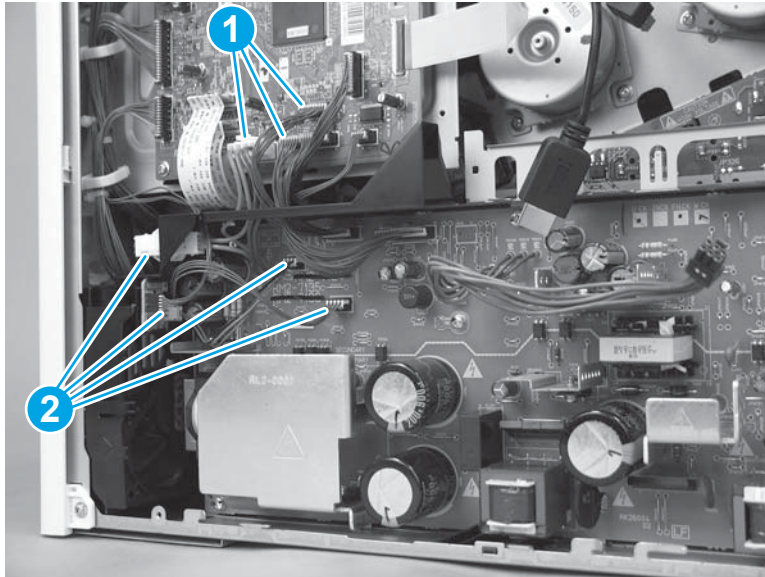

5. Pass the wire harness through the opening (callout 1) in the chassis, and then connect one wire harness (callout 2).

Figure 1-3846 Connect one wire harness

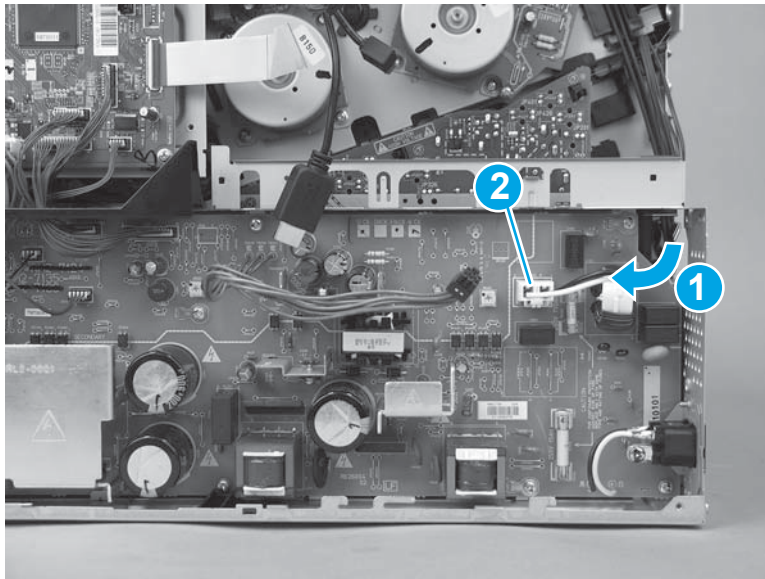

Step 34: Install the formatter case

1. Pass the wire harnesses through the opening in the formatter case.

Figure 1-3847 Pass the wire harnesses through the opening

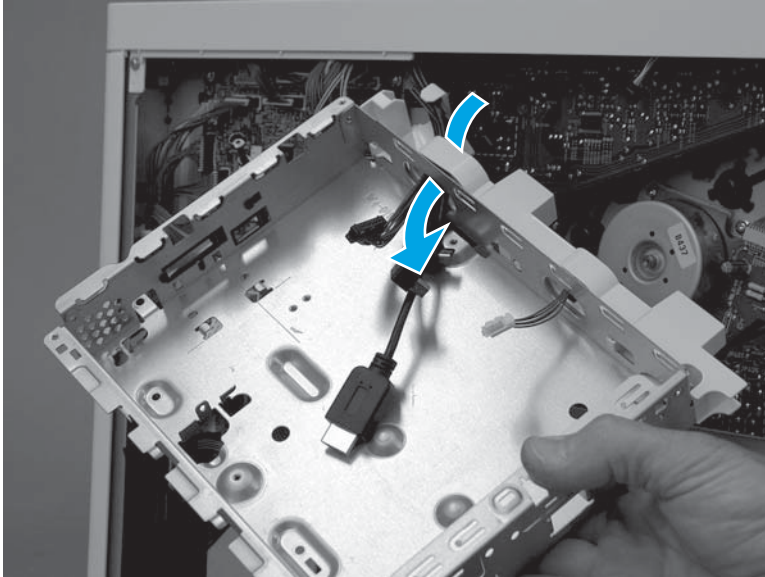

2. Position the top of the formatter case on the printer (callout 1), and then rotate the bottom of the case (callout 2) into the printer.

Figure 1-3848 Install the formatter case

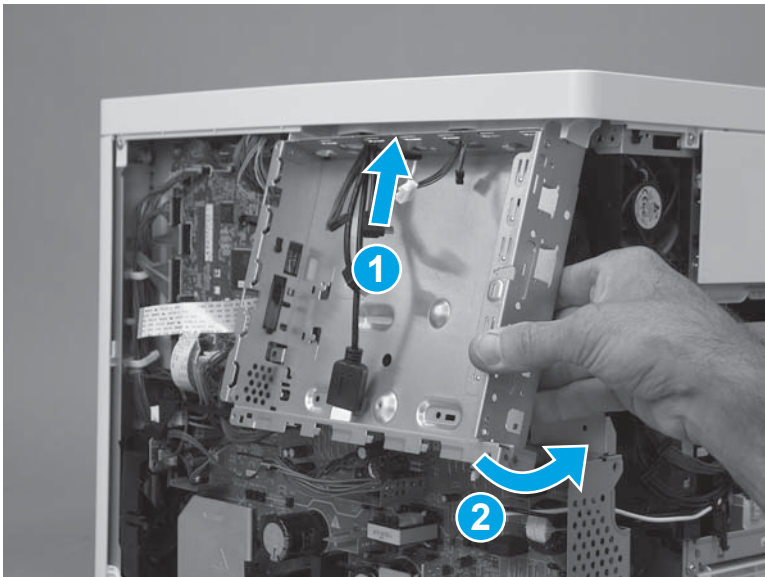

3. Install six screws (callout 1).

Figure 1-3849 Install six screws

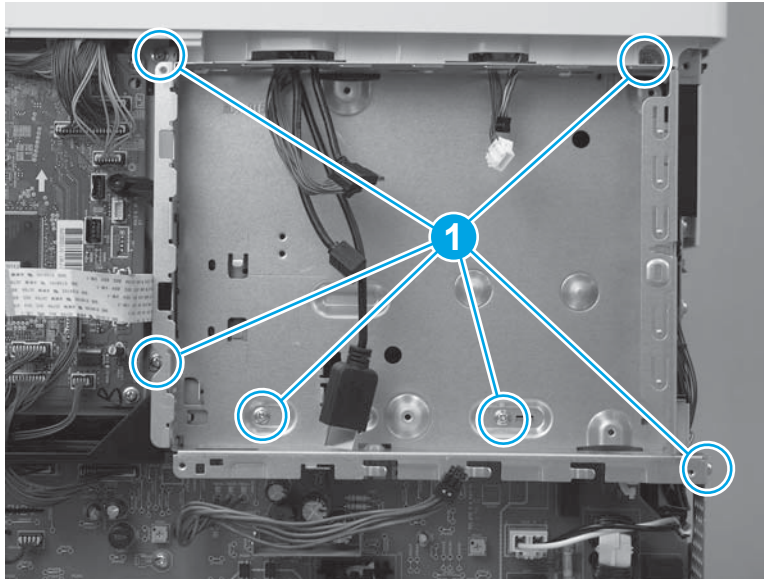

4. Pass two wire harnesses and one flat cable (callout 1) through the opening in the formatter case, and then install one wire harness in the retainer (callout 2).

 **IMPORTANT:** Make sure that the flat cable is securely fastened to the DC controller, and was not dislodged when the formatter case was removed.

Figure 1-3850 Install wire harnesses and flat cable

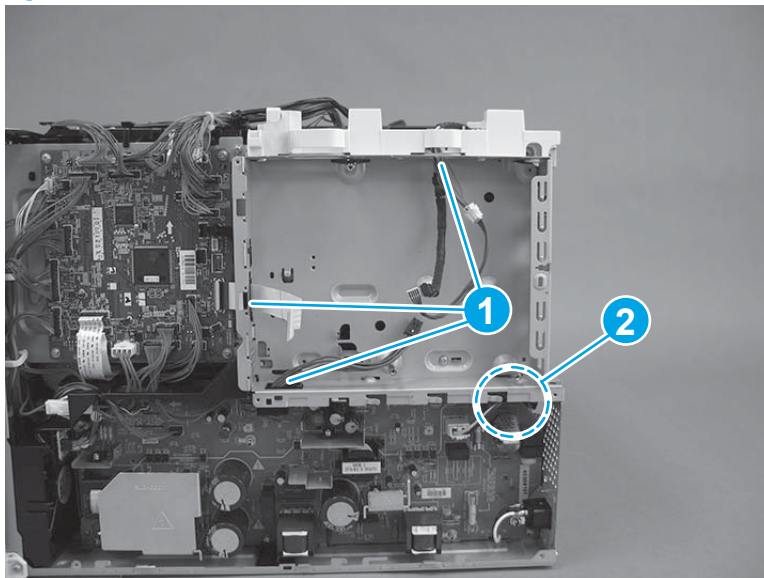

5. Position the LVPS cover on the printer, slide the cover to the left to install it, and then install two screws (callout 1).

Figure 1-3851 Install the LVPS cover

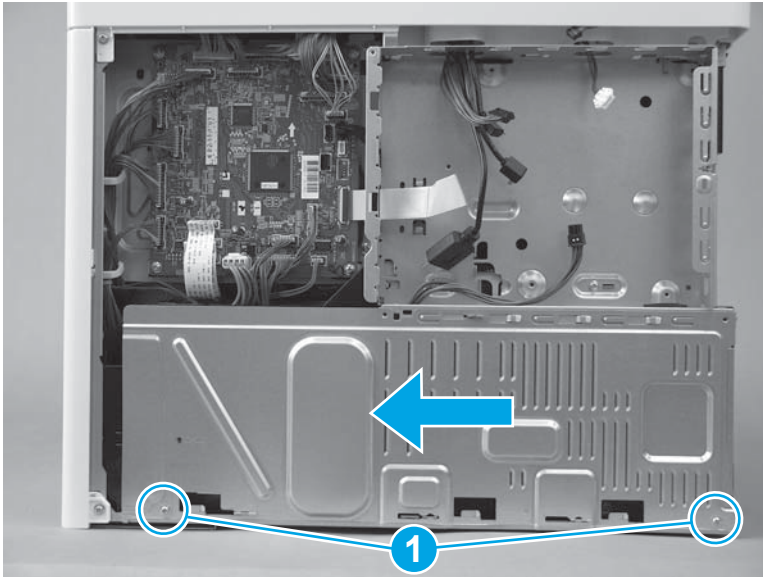

6. If no tape is affixed to the back of the flat cable, skip this step. If double-sided tape is affixed to the back of the flat cable, align the line (callout 1) on the cable with the edge (callout 2) of the opening in the sheet metal. Press to attach the flat cable to the formatter case.

Figure 1-3852 Attach the flat cable

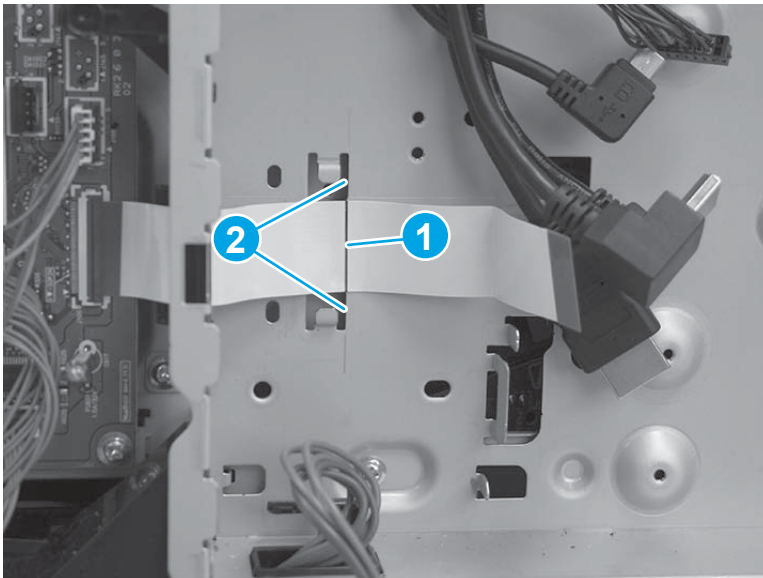

7. Position the bracket over the flat cable, and then slide the bracket to the left to install it. Make sure that the edges of the bracket fit under the sheet metal tabs (callout 1) on the formatter case and that the tabs (callout 2) snap into place.

Figure 1-3853 Position the bracket

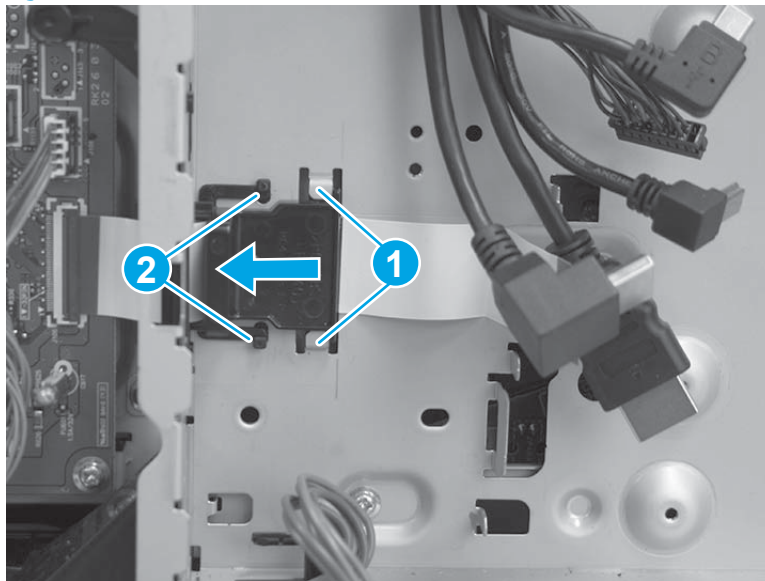

8. **M577 only:** Pass the wire harness (callout 1) through the openings in the formatter case (callout 2), and then connect one connector (callout 3).

Figure 1-3854 Connect one connector

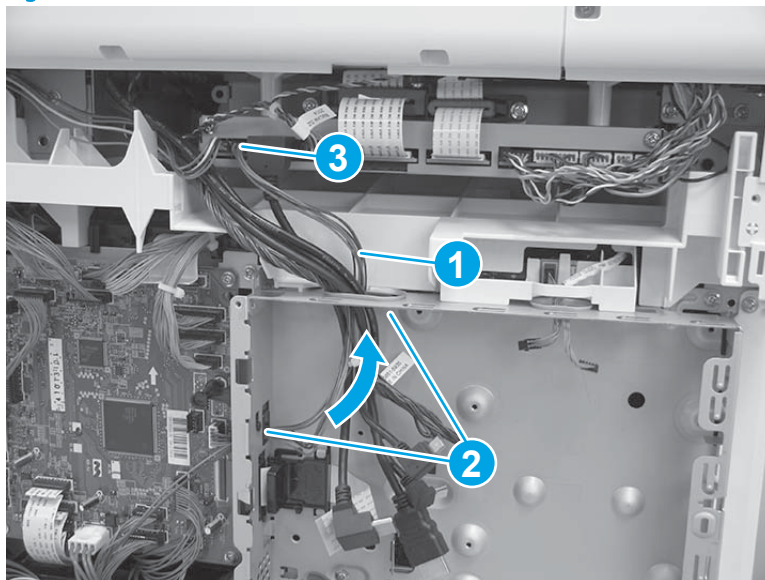

Step 35: Install the right rear cover

1. Position the cover on the printer.

Figure 1-3855 Install the cover

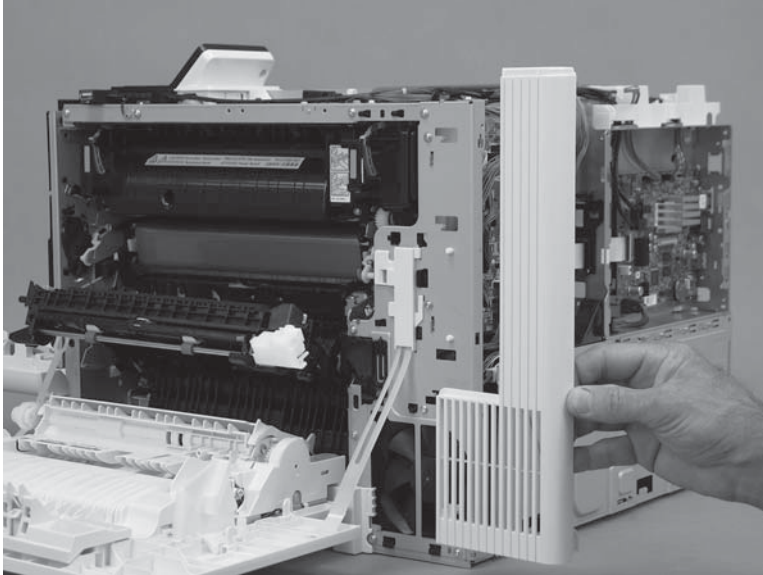

2. Slide the cover toward the right door (callout 1) to engage it with the printer, and then install one screw (callout 2).

Figure 1-3856 Install one screw

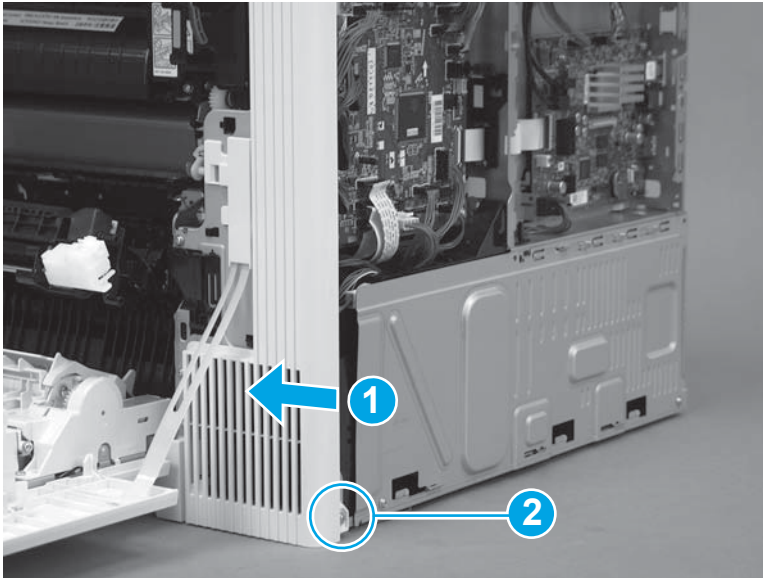

Step 36: Install the upper cover (M552 and M553)

 **NOTE:** This step is for the M552 and M553 models. For the M577 models, skip this step and go to [Step 37: Install the left cover on page 2156](#).

1. Position the cover on the printer.

 **NOTE:** For the M553x model, do not forget to pass the control-panel wire harness and USB cable through the opening in the cover.

Figure 1-3857 Install the cover



2. Push down on the rear corner of the cover to engage one tab (callout 1).

Figure 1-3858 Engage one tab

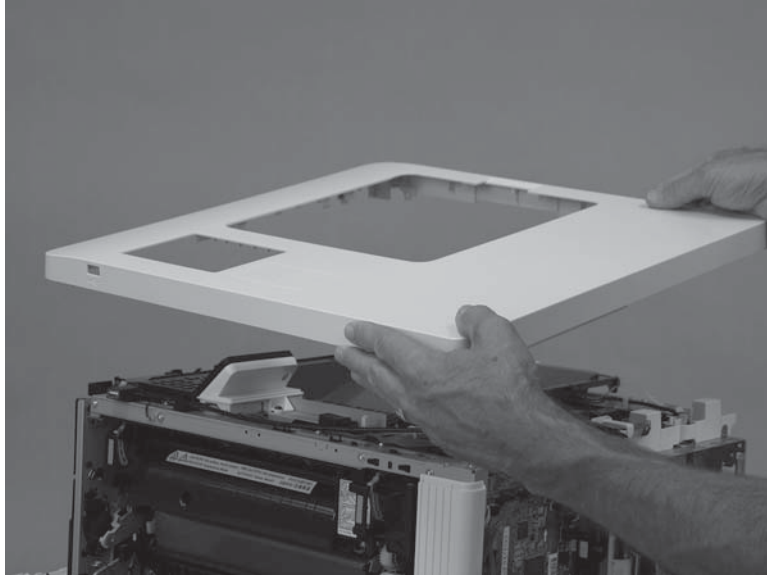
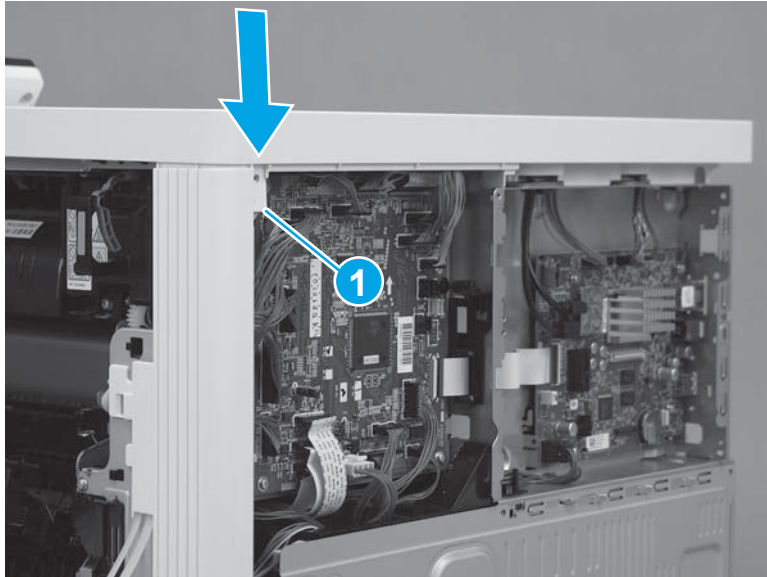

3. Push down on the front corner of the cover to engage one tab (callout 1), and then install one screw (callout 2).

 **NOTE:** This is a self-tapping plastic-thread screw. Make sure that this screw is used in this location when it is reinstalled.

Figure 1-3859 Engage one tab and install one screw



4. Install three screws (callout 1).

Figure 1-3860 Install three screws

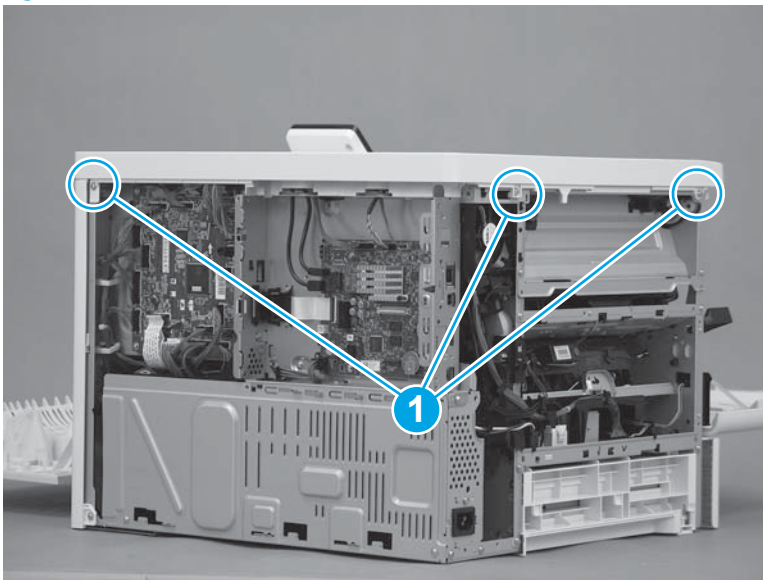

Step 37: Install the left cover

1. Position the cover on the printer.

 **NOTE:** Slightly offset the cover toward the rear of the printer.

Figure 1-3861 Install the cover

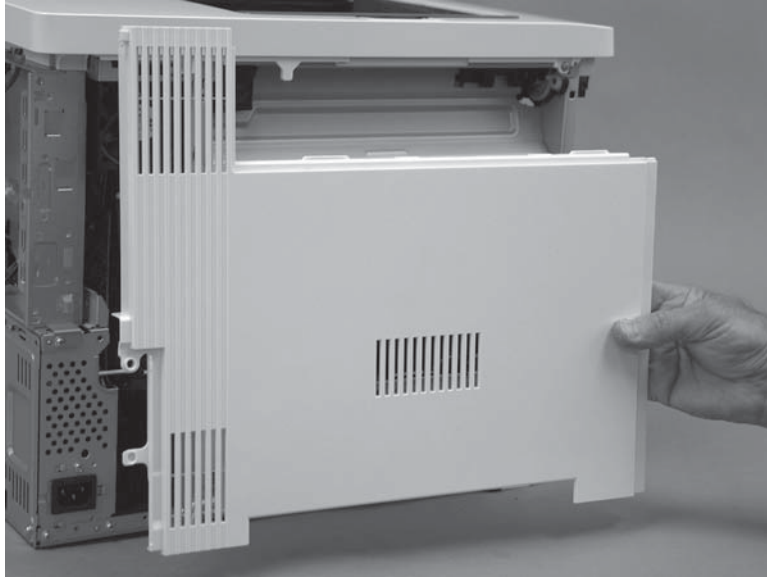

2. Slide the cover (callout 1) toward the front of the printer to engage it. Make sure that the tab (callout 2) snaps into place.

 **NOTE:** Locate the alignment pin (callout 3) on the cover from the front door side of the printer, and then make sure that it is fully engaged in the slot in the chassis.

 **TIP:** While sliding the cover into place, push in on the center of the cover (callout 1) to make sure that the hooks on the back of the cover engage with the slots in the chassis.

Figure 1-3862 Engage the cover



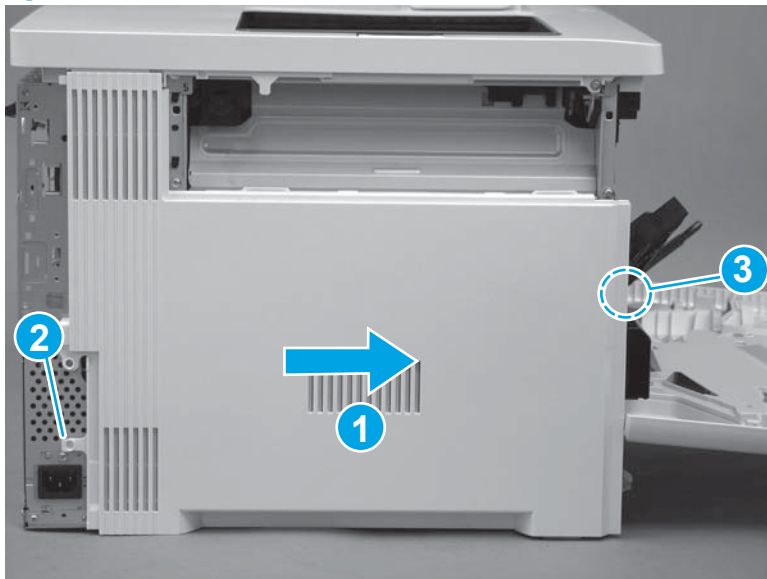
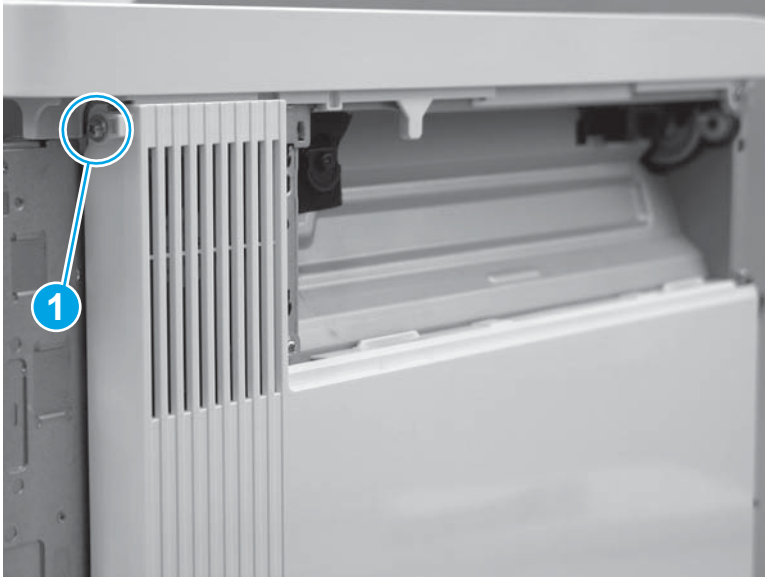

3. At the left side of the printer, install one screw (callout 1).

Figure 1-3863 Install one screw



Step 38: Install the right upper cover (M577)

 **NOTE:** This step is for the M577 models. For the M552 and M553 models, skip this step and go to [Step 45: Install the rear cover \(M552 and M553\) on page 2172.](#)

 **NOTE:** The figures below show the image scanner installed. The procedures for removing and installing the right upper cover are the same whether the image scanner is installed or removed."

1. **M577c/f/z only:** Install the cables (callout 1) through the slot (callout 2) in the printer.

Figure 1-3864 Install the cables

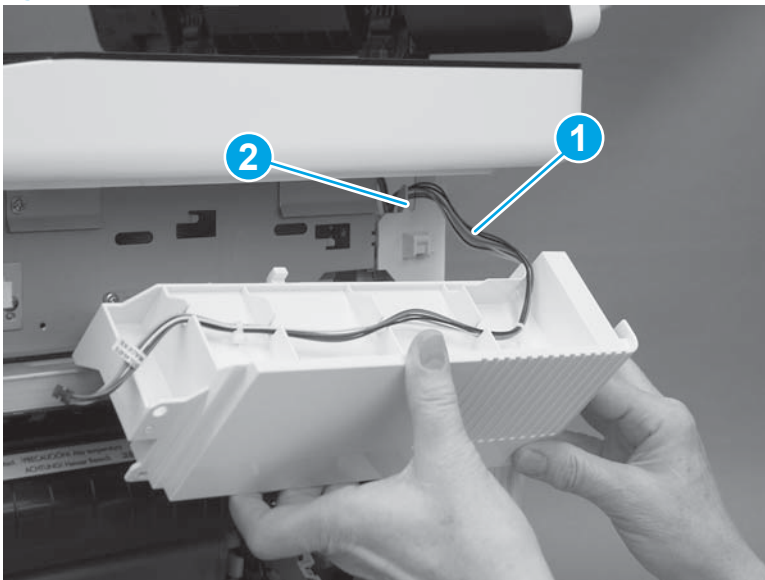

2. Position the hooks (callout 1) on the cover in the slots (callout 2) in the printer.

Figure 1-3865 Position the hooks

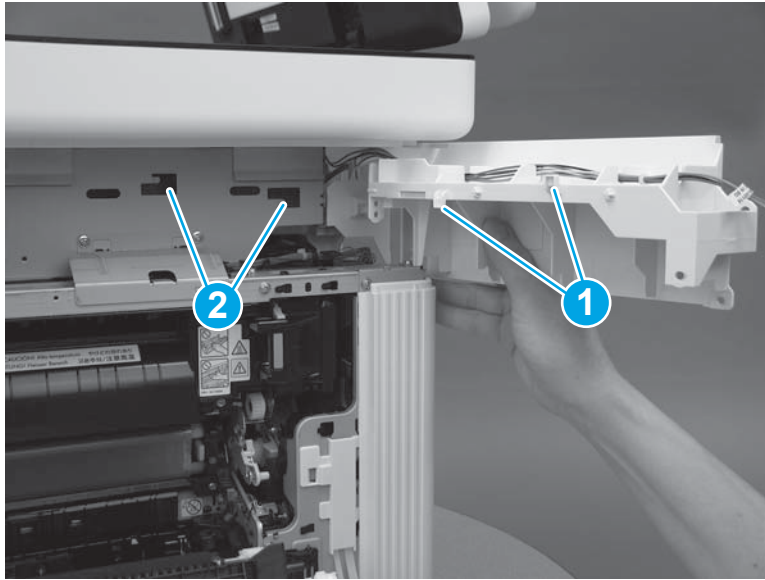

3. Slide the cover toward the front of the printer to install it.

Figure 1-3866 Install the cover

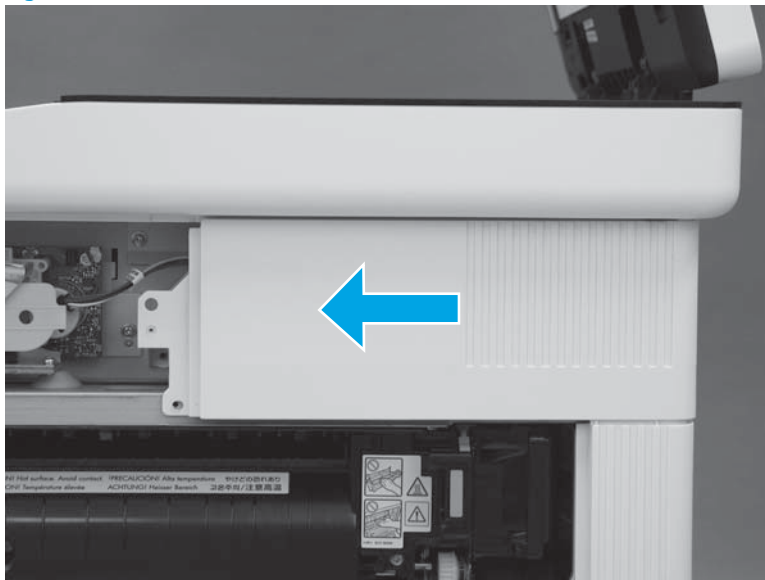

4. At the back of the printer, install one screw (callout 1).

M577c/f/z only: Connect one connector (callout 2), if the integrated scanner assembly is installed.

TIP: This screw is smaller than the screws installed in the next step. Make sure that this screw is installed in the correct position.

Figure 1-3867 Install one screw and connector



5. At the right side of the printer, install two screws (callout 1).

M577c/f/z only: Connect one connector (callout 2), if the stapler is installed.

Figure 1-3868 Install one screw and connector

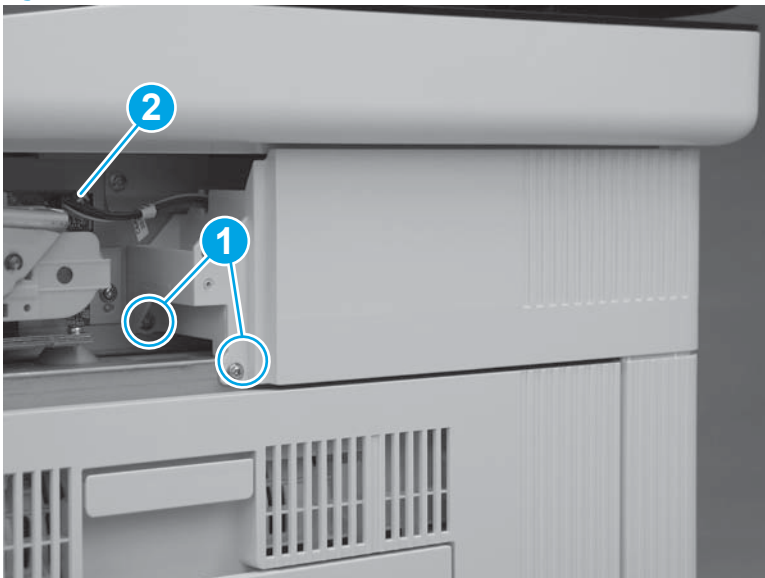

Step 39: Install the integrated scanner assembly (ISA) (M577)

NOTE: This step is for the M577 models. For the M552 and M553 models, skip this step and go to [Step 45: Install the rear cover \(M552 and M553\) on page 2172](#).

 **NOTE:** The ISA includes the document feeder, image scanner, scanner control board (SCB), control panel, keyboard (M577c/z) and NFC PCA (M577z).

1. Before proceeding, locate the mounting pins (callout 1) on the bottom of the ISA and the slots (callout 2) on the printer base.

Figure 1-3869 Locate the ISA mounting pins and slots

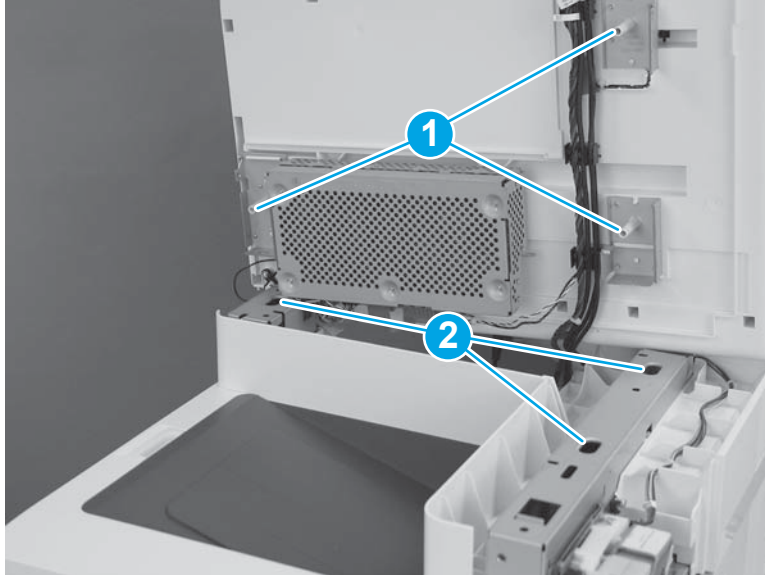

2. Position the ISA on the printer base with the pins in the slots.

 **NOTE:** To locate the pins and slots, see [Figure 1-395 Locate the ISA mounting pins and slots on page 249](#).

When installing the ISA, carefully pass the cables through the opening in the top of the formatter case.

Figure 1-3870 Install the ISA

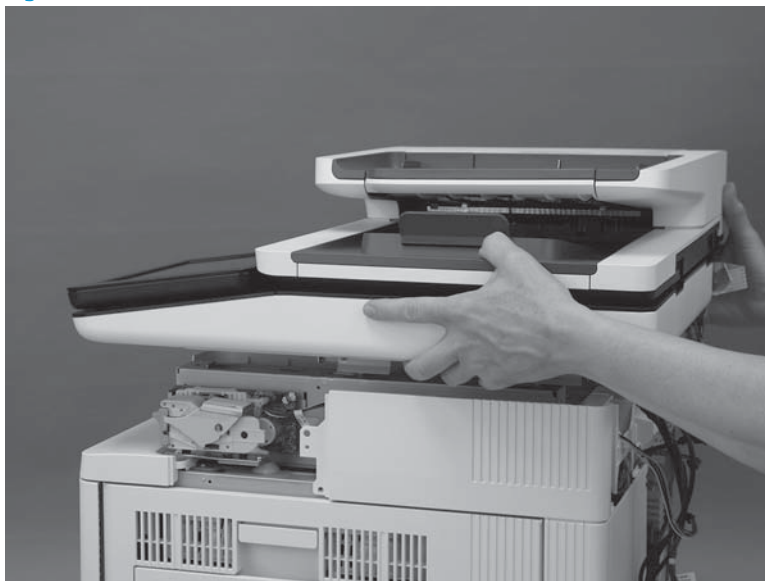

3. Slightly slide the ISA towards the front of the printer to engage it.

Figure 1-3871 Slide the ISA towards the front of the printer

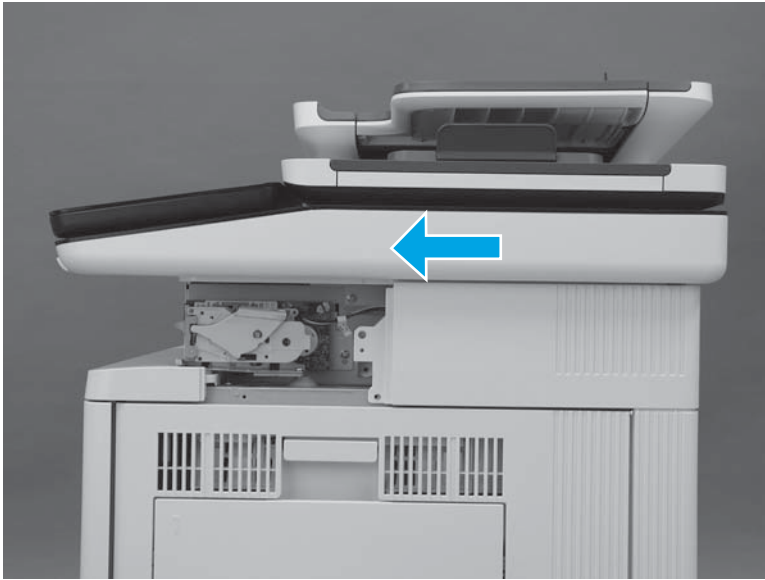

4. At the left side of the printer, install one screw (callout 1).

Figure 1-3872 Install one screw

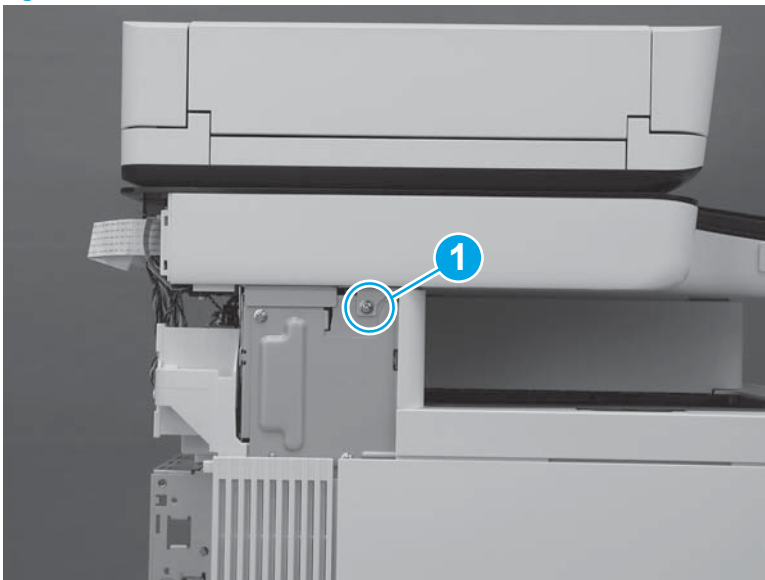

5. At the back of the printer, install two screws (callout 1).

Figure 1-3873 Install two screws

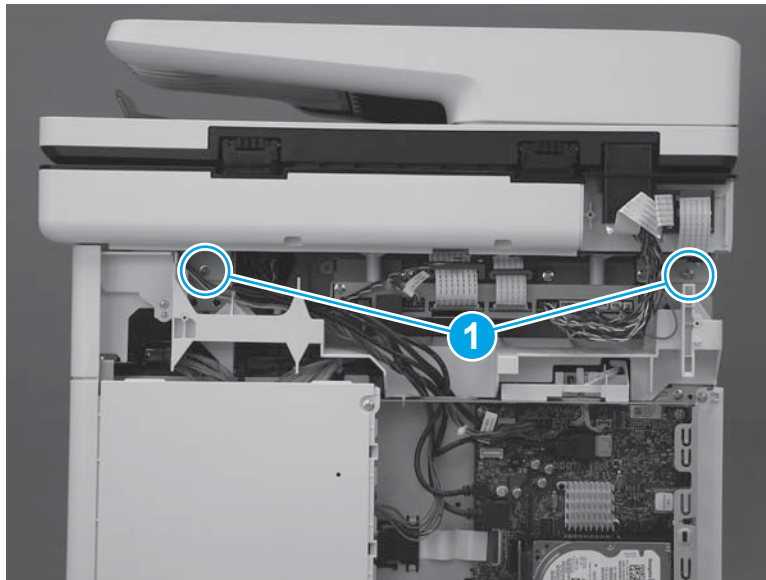

6. At the right side of the printer, install one screw (callout 1).

Figure 1-3874 Install one screw

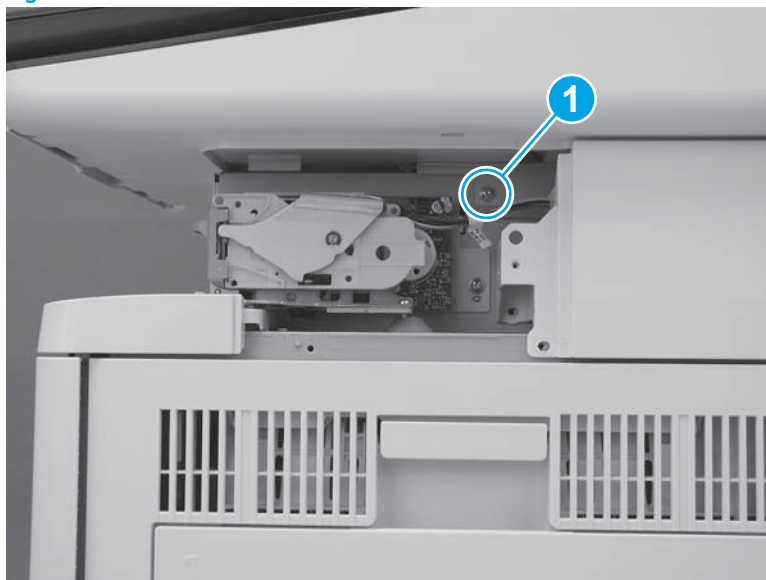

7. Connect two connectors on the scanner control board (callout 1).

M577c/f/z only: Connect one connector for the stapler on the scanner control board (callout 2).

Figure 1-3875 Connect connectors

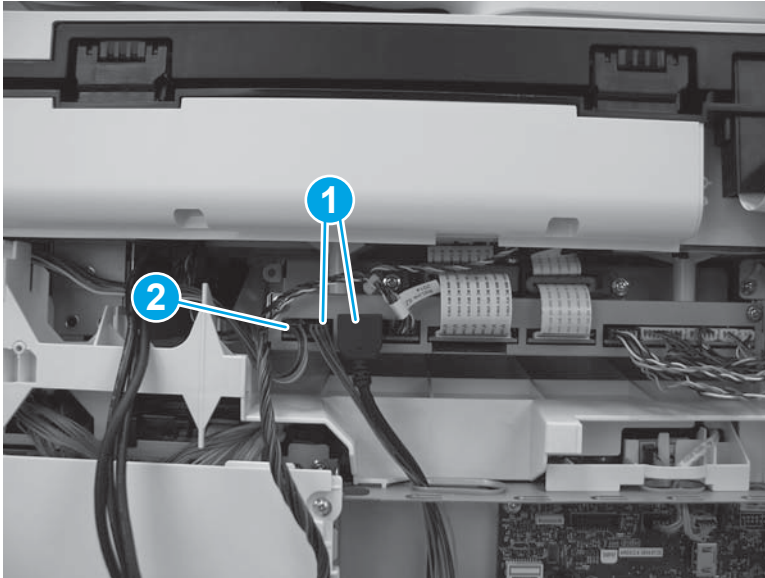

Step 40: Install the stapler cover assembly (M577c/f/z)

 **NOTE:** This step is for the M577c/f/z models only. For the M577dn model, skip this step and go to [Step 41: Install the right front upper cover \(M577dn\) on page 2165](#).

For the M552 and M553 models, skip this step and go to [Step 45: Install the rear cover \(M552 and M553\) on page 2172](#).

1. Install the tabs (callout 1) on the cover in the slots (callout 2) in the printer.

Figure 1-3876 Install two tabs



2. Press the cover toward the left side of the printer until it snaps into place.

Figure 1-3877 Install the cover assembly



3. Install one screw (callout 1).



 **IMPORTANT:** This is a self-tapping screw for plastic. Rotate it counterclockwise to align it with the existing thread pattern, and then carefully turn it clockwise to tighten. Do not overtighten. This will prevent stripping the threads inside the screw hole.

Figure 1-3878 Install one screw

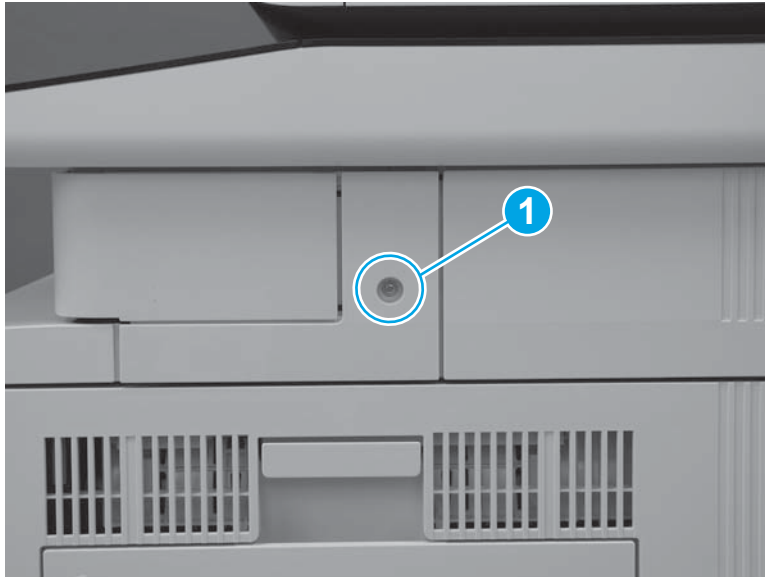

Step 41: Install the right front upper cover (M577dn)

 **NOTE:** This step is for the M577dn model only. For the M577c/f/z models, skip this step and go to [Step 42: Install the left upper cover \(M577\) on page 2167](#).

For the M552 and M553 models, skip this step and go to [Step 45: Install the rear cover \(M552 and M553\) on page 2172](#).

1. Slide the cover toward the left side of the printer to install it. Make sure that the slots (callout 1) in the cover fit over the tabs (callout 2) on the inside of the paper feeder cover.

Figure 1-3879 Install the cover



2. Press the right front upper cover (callout 1) and the paper feeder cover (callout 2) together until the tabs on the inside of the covers snap into place.

Figure 1-3880 Press the cover



3. Install one screw (callout 1).

Figure 1-3881 Install one screw

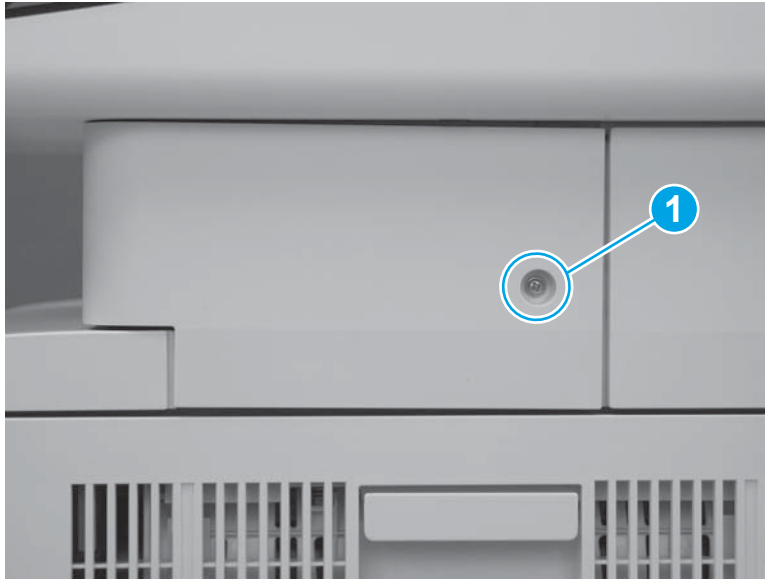

Step 42: Install the left upper cover (M577)

 **NOTE:** This step is for the M577 models. For the M552 and M553 models, skip this step and go to [Step 45: Install the rear cover \(M552 and M553\) on page 2172](#).

1. Position the tab (callout 1) on the lower edge of the cover behind the left cover (callout 2).

Figure 1-3882 Position the tab

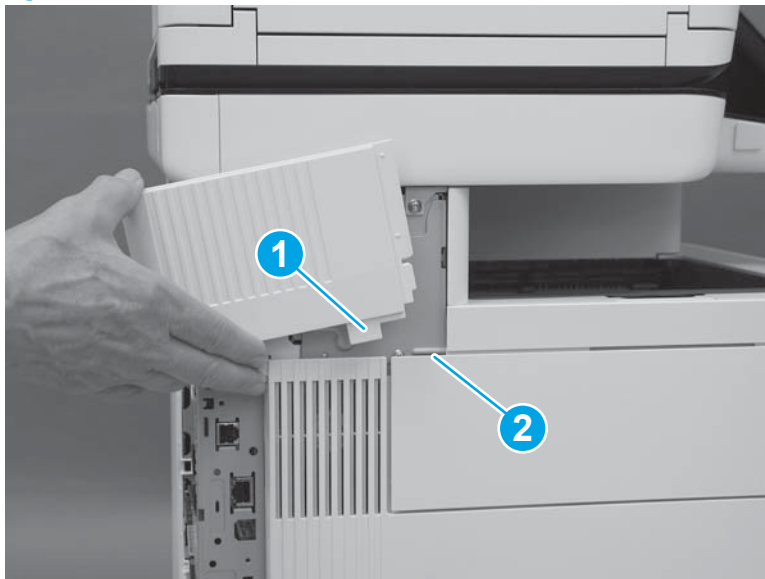

2. Slide the cover toward the front of the printer to install it. Make sure that the edge (callout 1) of the cover fits behind the edge (callout 2) of the top rear cover.

Figure 1-3883 Slide the cover

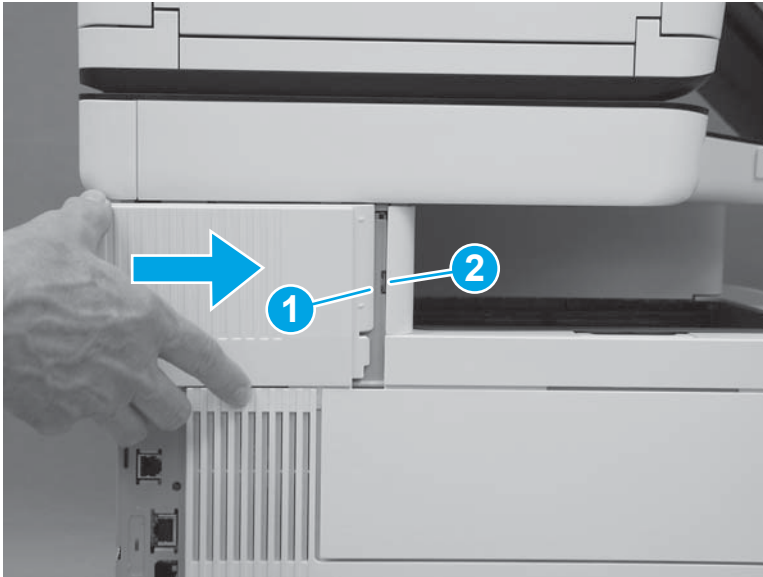

3. Make sure that the tab (callout 1) is fully installed.

Figure 1-3884 Check the tab

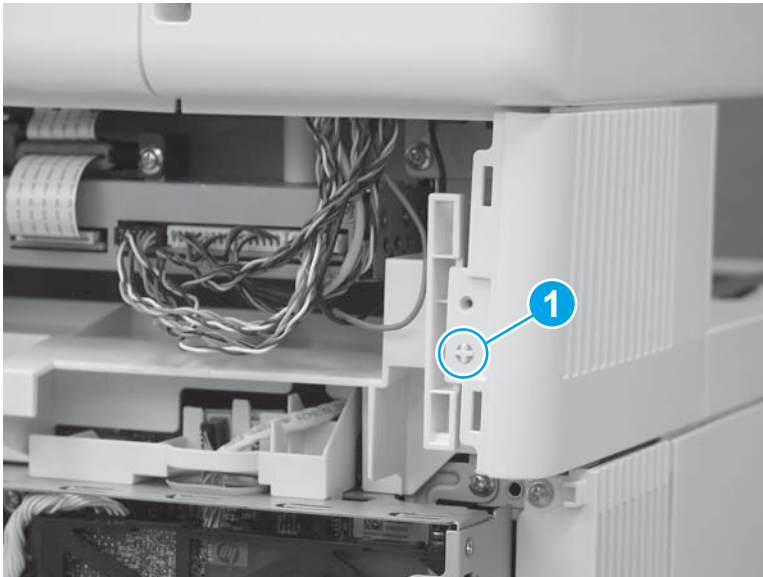

Step 43: Install the rear cover (M577)

 **NOTE:** This step is for the M577 models. For the M552 and M553 models, skip this step and go to [Step 45: Install the rear cover \(M552 and M553\) on page 2172](#).

1. Position the hooks (callout 1) on the cover in the slots (callout 2) in the printer.

Figure 1-3885 Position the hooks

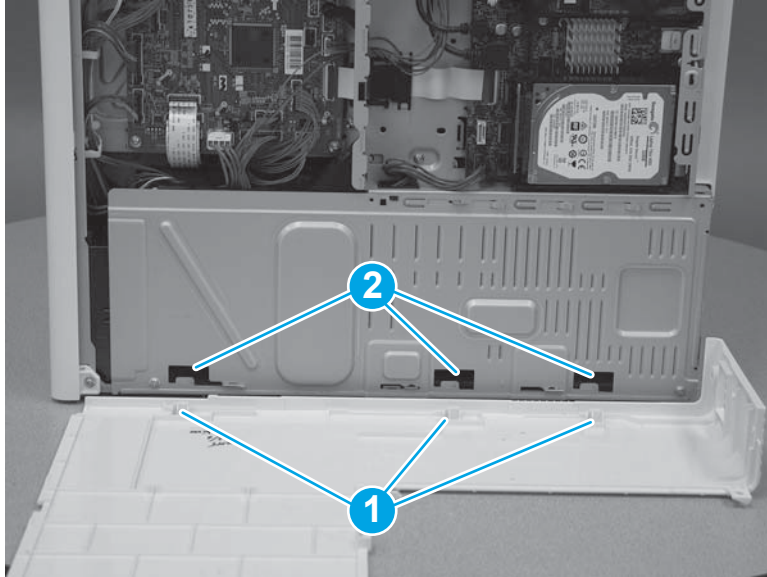

2. Position the back edge (callout 1) of the rear cover behind the edge (callout 2) of the right rear cover. Slide the cover to the left to install it.

Figure 1-3886 Install the cover

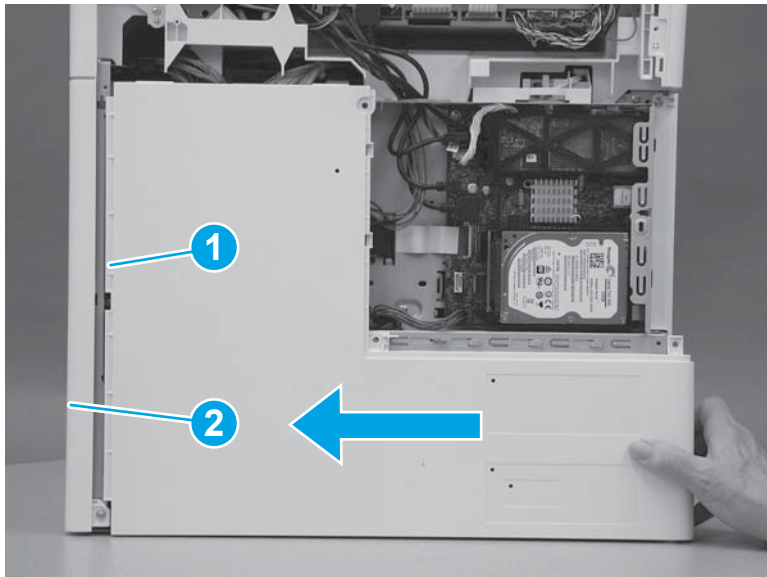

3. Install four screws (callout 1).

Figure 1-3887 Install four screws cover

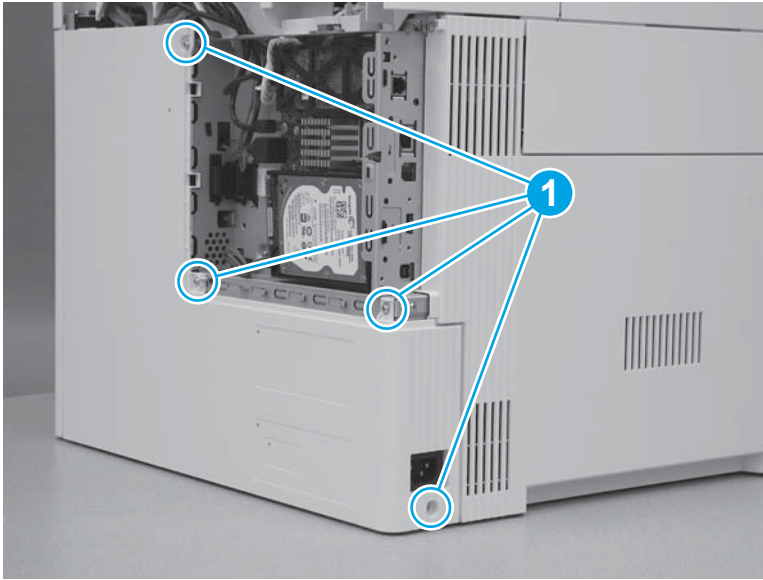

Step 44: Install the rear upper cover (M577)

 **NOTE:** This step is for the M577 models. For the M552 and M553 models, skip this step and go to [Step 45: Install the rear cover \(M552 and M553\) on page 2172](#).

1. Align the ridge (callout 1) on the lower edge of the rear upper cover in front of the tabs (callout 2) on the top edge of the rear cover.

Figure 1-3888 Align the cover

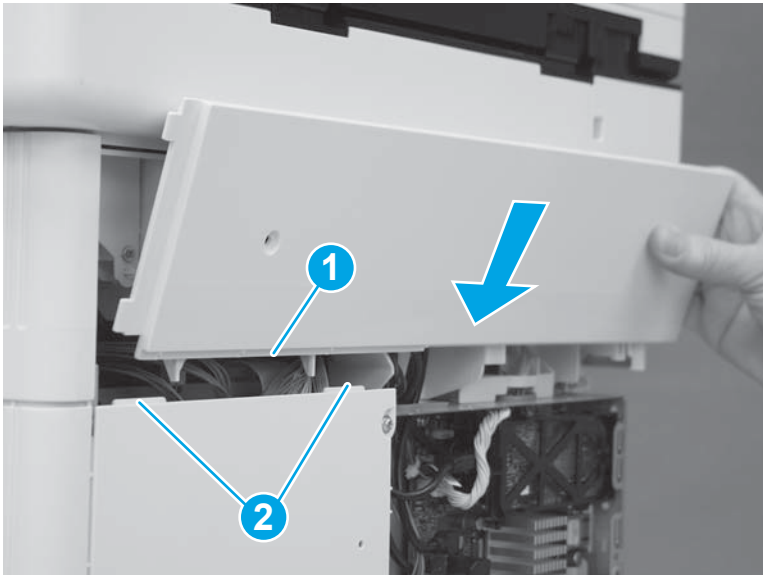

2. Rotate the top of the cover toward the printer.

Figure 1-3889 Rotate the top of the cover

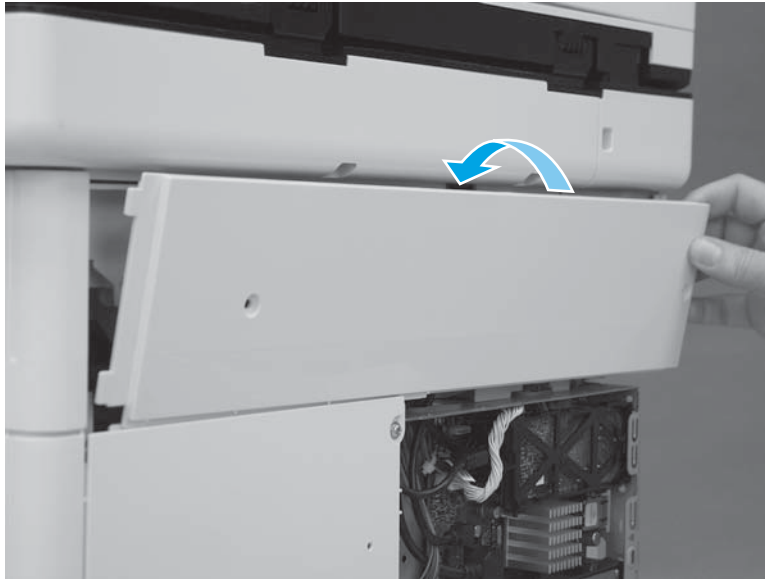

3. Slide the cover to the left (callout 1). Make sure that the tabs (callout 2) on the upper rear cover slide behind the edge (callout 3) of the right upper cover. Make sure that the cover is fully seated.

Figure 1-3890 Slide the cover

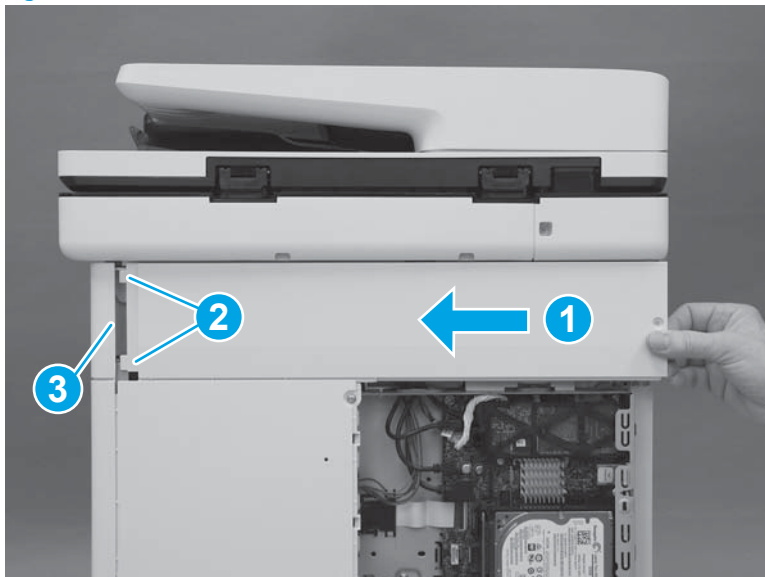

4. Install two screws (callout 1).



 **IMPORTANT:** These two screws are self-tapping screws for plastic. Rotate them counterclockwise to align them with the existing thread pattern, and then carefully turn them clockwise to tighten. Do not overtighten. This will prevent stripping the threads inside the screw holes.

Figure 1-3891 Install two screws

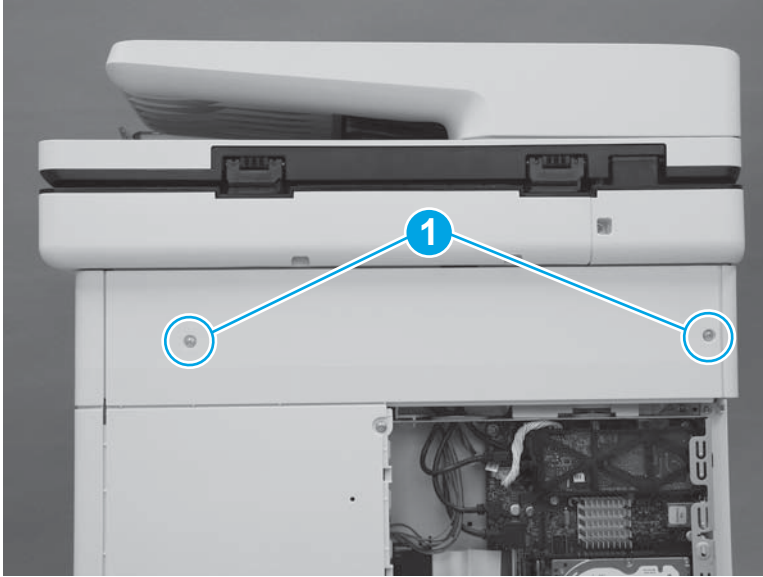

Step 45: Install the rear cover (M552 and M553)

 **NOTE:** This step is for the M552 and M553 models. For the M577 models, skip this step and go to [Step 46: Install the formatter \(M577\) on page 2173](#).

1. Position the top of the cover under the upper cover (callout 1), rotate the bottom of the cover onto the chassis (callout 2), and then slide the cover to the left (callout 3) to install it.

Figure 1-3892 Install the cover

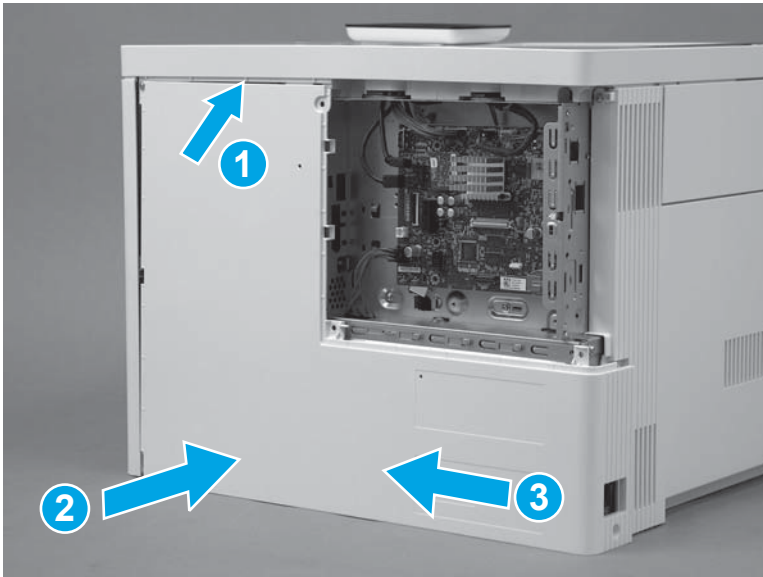

2. Install four screws (callout 1).

Figure 1-3893 Install four screws cover

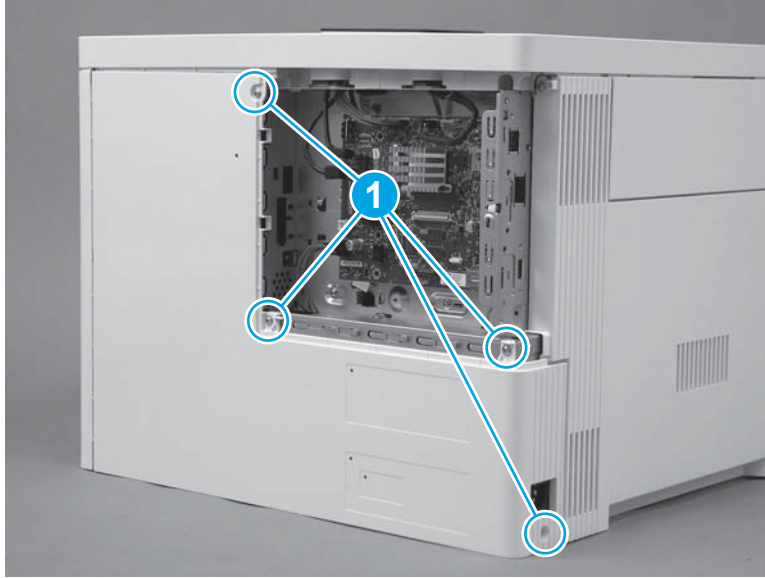

Step 46: Install the formatter (M577)

 **NOTE:** This step is for the M577 models. For the M552 and M553 models, skip this step and to go [Step 49: Install the formatter \(M552 and M553\) on page 2178](#).

 **CAUTION:**  ESD-sensitive part.

1. Position the formatter in the printer. Make sure that the network port (callout 1) fits through the opening (callout 2) in the formatter case.

Figure 1-3894 Install the formatter

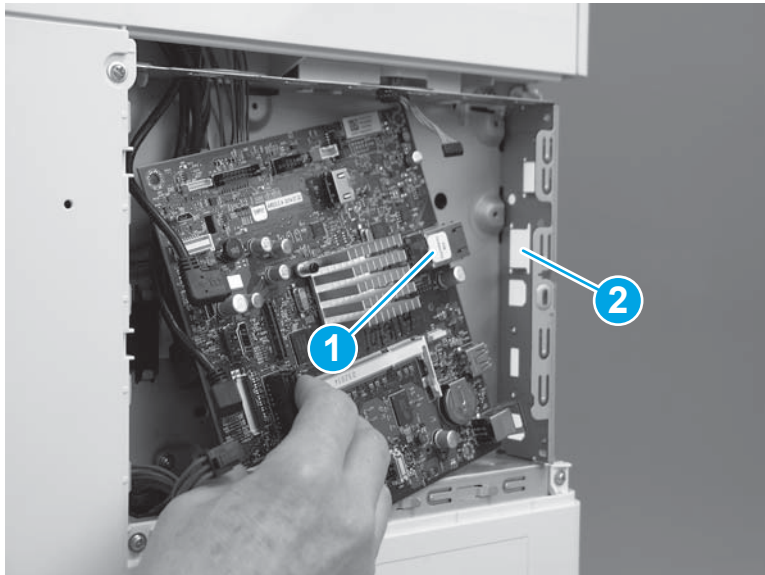

2. Install four screws (callout 1).

Figure 1-3895 Install four screws

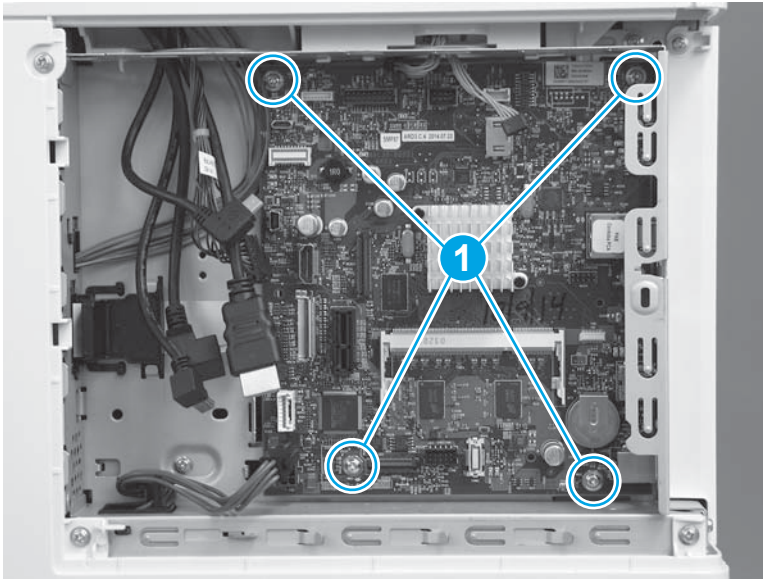

3. Connect all of the connectors on the formatter.

The following connectors are empty:

- All models: J1 (this connector is empty unless the optional DIMM is installed)
- All models: J3
- M577dn: J15 (this is the fax connector for the M577f/z/c models)
- All models: J21 (this connector is empty unless the optional internal USB ports component is installed)
- All models: J23
- All models: J24
- All models: J51
- All models: J57
- All models: J97
- All models: J98 (this connector is empty unless the optional trusted platform module (TPM) is installed)

 **IMPORTANT:** The flat-cable connector (callout 1) is a Zero Insertion Force (ZIF) connector that uses a hinged retainer to secure the flat cable. The hinged retainer must be opened to install the flat cable, and then closed after the cable is installed.

Figure 1-3896 Connect all connectors



Step 47: Install the fax PCA (M577c/f/z)

 **NOTE:** This step is for the M577c/f/z models. For the M577n model, skip this step and go to [Step 48: Install the HDD \(M577\) on page 2176](#).

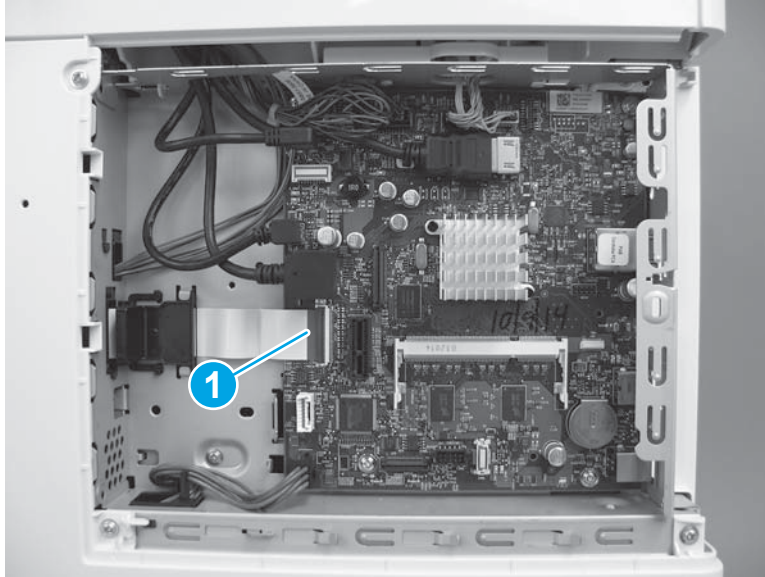
For the M552 and M553 models, skip this step and go to [Step 49: Install the formatter \(M552 and M553\) on page 2178](#).

 **CAUTION:**  ESD-sensitive part.

1. Position the tab and telephone port (callout 1) on the fax PCA in the slots (callout 2) in the formatter case.

Figure 1-3897 Position the fax PCA

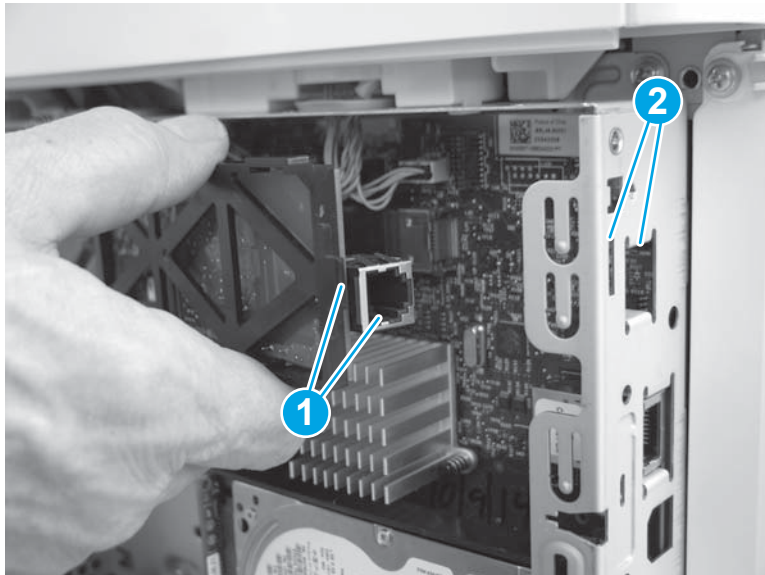

- Slide the fax PCA to the right (callout 1) until the tab and telephone port described in the previous step and seated in the formatter case. Position the retainer (callout 2) in the slot (callout 3) in the formatter. Rotate the end of the fax PCA toward the formatter (callout 4) until the retainer snaps into place.

Figure 1-3898 Install the fax PCA

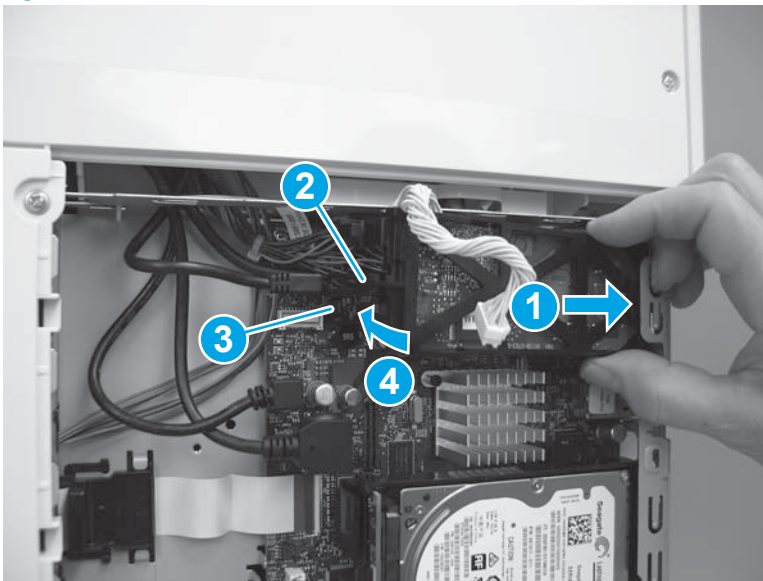

- Position the cable (callout 1) in the guide (callout 2), and then connect one connector (callout 3).

Figure 1-3899 Connect the connector

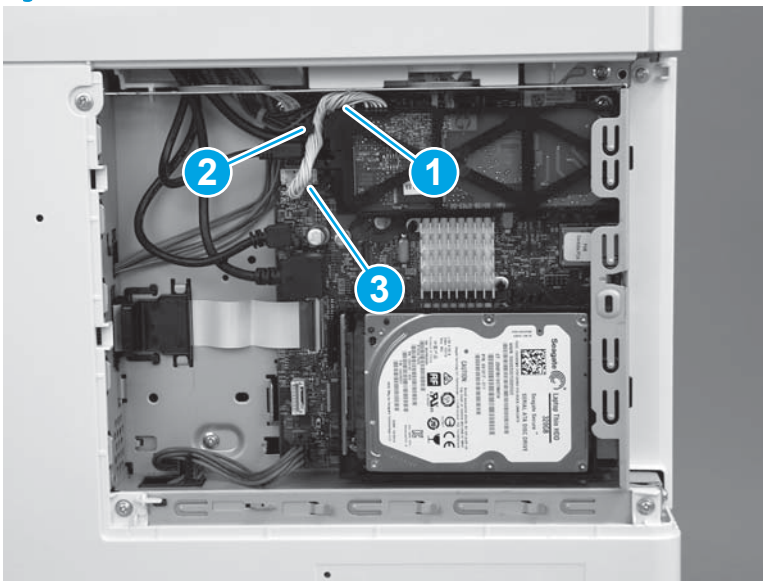

Step 48: Install the HDD (M577)

 **NOTE:** This step is for the M577 models. For the M552 and M553 models, skip this step and go to [Step 49: Install the formatter \(M552 and M553\) on page 2178](#).

 **CAUTION:**  ESD-sensitive part.

1. Align the end of the bracket (callout 1) with the slot in the chassis (callout 2), and then slide the HDD into the printer (callout 3) to engage the bracket with the chassis.

Figure 1-3900 Install the holder

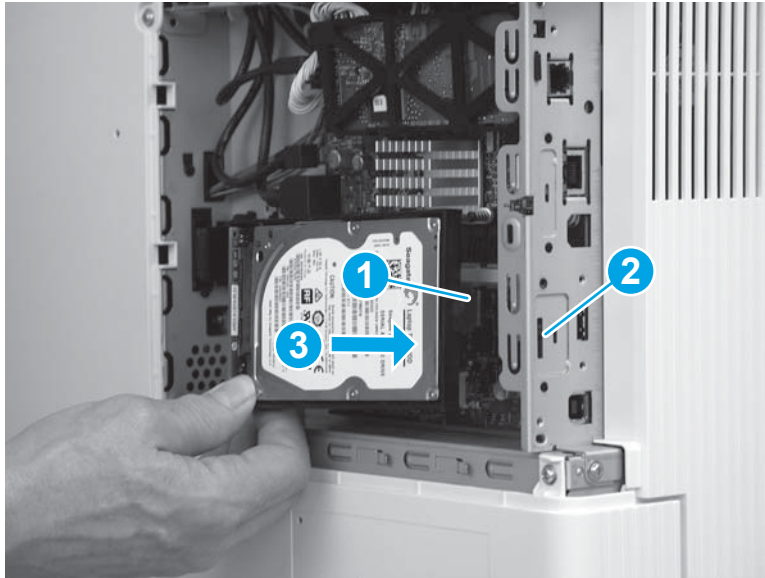

2. Hold the HDD connector latch (callout 1) in the released position, and then rotate the HDD down and into the connector on the formatter to install it.

 **NOTE:** Make sure that the tab (callout 2) snaps into place, and that the HDD is securely installed.

Figure 1-3901 Release the HDD

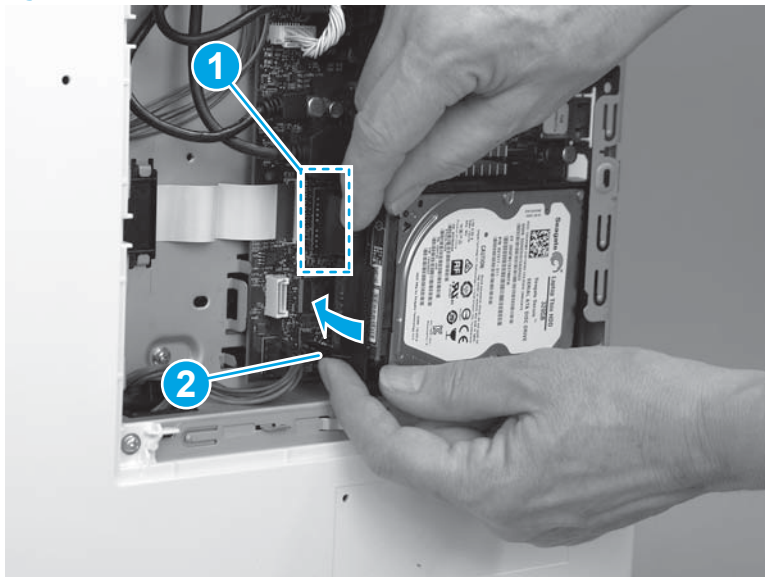

Step 49: Install the formatter (M552 and M553)

 **NOTE:** This step is for the M552 and M553 models. For the M577 models, skip this step and go to [Step 52: Install the formatter cover on page 2183](#).

If the optional hard-disk drive (HDD) was removed, do not forget to reinstall it after the formatter is reinstalled.

Engage the HDD holder with the chassis, rotate the HDD connector down and into the connector on the formatter. Make sure that the tabs snap into place.

 **CAUTION:**  ESD-sensitive part.

1. Position the formatter in the printer, and then install four screws (callout 1).

Figure 1-3902 Install the formatter

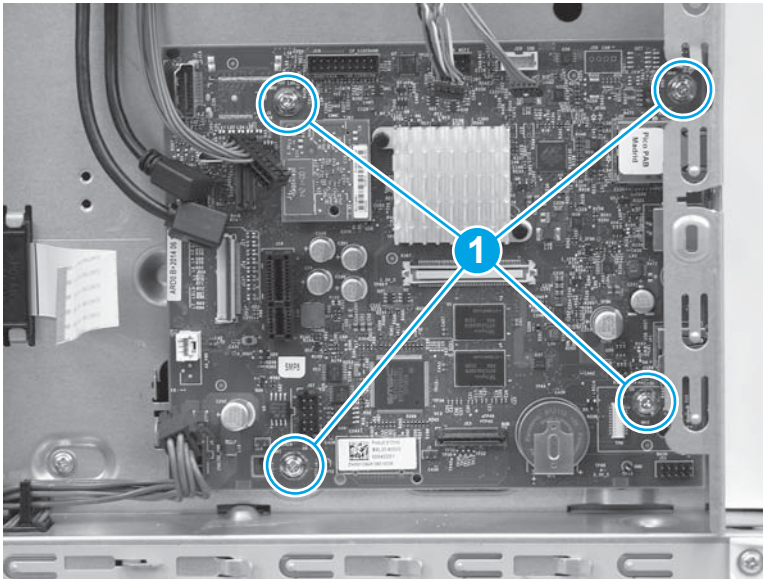

2. Connect all of the connectors on the formatter.

The following connectors are empty:

- All models: J1 (this connector is empty unless the optional DIMM is installed)
- M553n/dn and M552dn: J2 (callout 1; this is the touchscreen connector for the M553x model)
- All models: J9 (this connector is empty unless the optional internal USB ports component is installed)
- All models: J18 (this connector is empty unless the optional hard-disk-drive (HDD) is installed)
- All models: J23
- All models: J24
- M553n/dn and M552dn: J25 (this is the wireless connector for the M553x model)
- All models: J57
- All models: J98 (this connector is empty unless the optional trusted platform module (TPM) is installed)



 **IMPORTANT:** The flat-cable connector (callout 2) is a Zero Insertion Force (ZIF) connector that uses a hinged retainer to secure the flat cable. The hinged retainer must be opened to install the flat cable.

Figure 1-3903 Connect all connectors

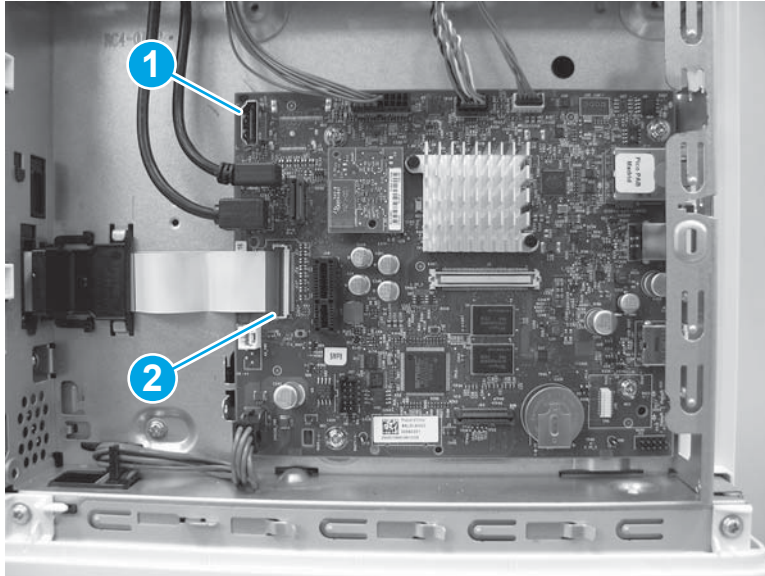

Step 50: Install the control-panel assembly (M553x only)

 **NOTE:** This step is for the M553x model. For the M553n/dn and M552dn models, skip this step and go to [Step 51: Install the USB cover \(M552 and M553\) on page 2182](#).

For the M577 models, skip this step and go to [Step 52: Install the formatter cover on page 2183](#).

1. Place the control panel on the printer as shown.

Figure 1-3904 Place the control panel on the product

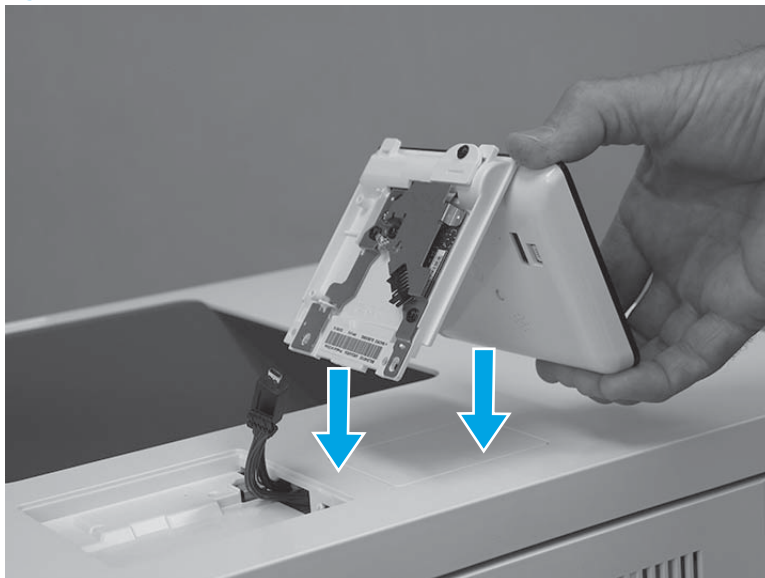

2. Connect one USB cable (callout 1), and one connector (callout 2).

 **IMPORTANT:** Take note of the location of the two mounting tabs (callout 3) on the control-panel assembly.

Figure 1-3905 Connect two connectors



3. Turn the control panel over, and then position the front edge tabs in the slots in the top cover.

Figure 1-3906 Turn the control panel over

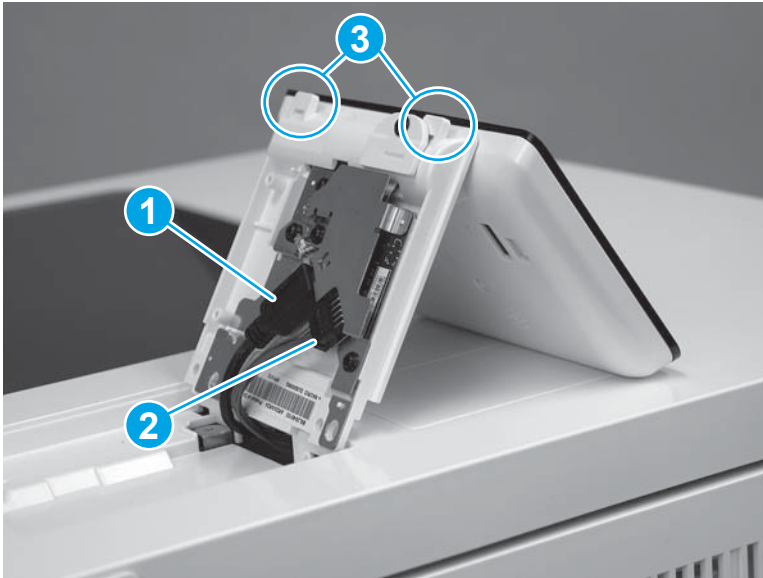
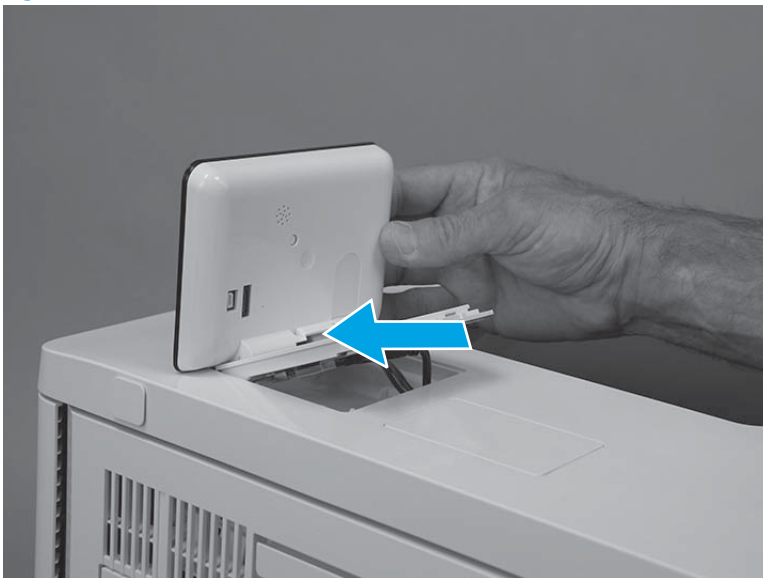

4. Rotate the control-panel base down onto the printer.

Figure 1-3907 Rotate the control-panel base down



5. Use a small Phillips screwdriver to install two screws (callout 1).

Figure 1-3908 Install two screws

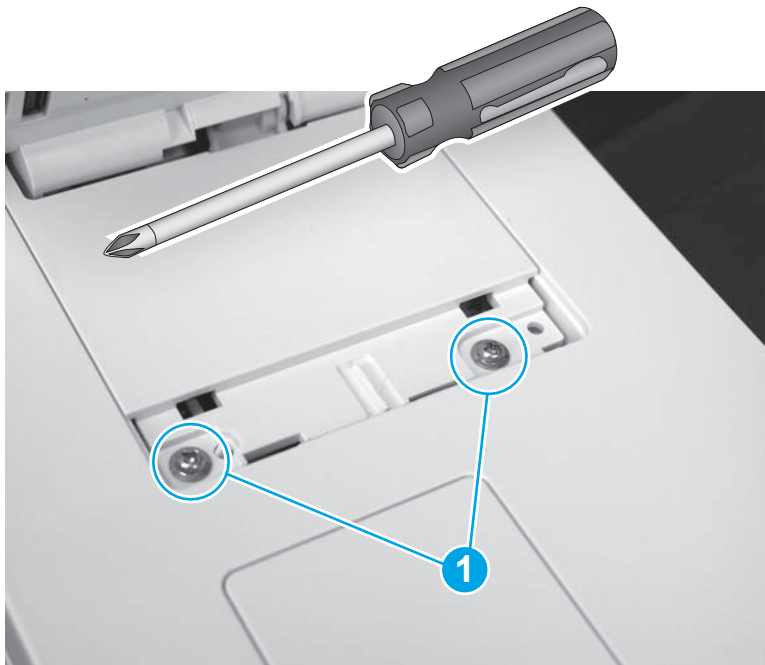

6. Position the screw cover mounting feet into the slots in the top cover (callout 1), and then rotate the cover down (callout 2) to install it.

 **NOTE:** Press down on the cover firmly to make sure that the tabs on the cover (callout 3) snap into place.

Figure 1-3909 Install the cover



Step 51: Install the USB cover (M552 and M553)

 **NOTE:** This step is for the M552 and M553 models. For the M577 models, skip this step and go to [Step 52: Install the formatter cover on page 2183](#).

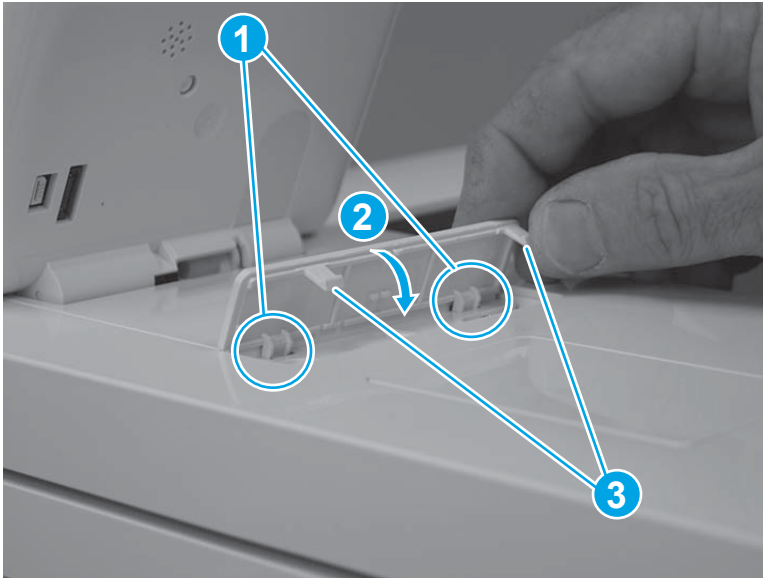
1. Push the cover into the USB port to install it.

Figure 1-3910 Install the cover



2. Make sure that the USB cover is fully seated after installing it.

Figure 1-3911 Check the installation

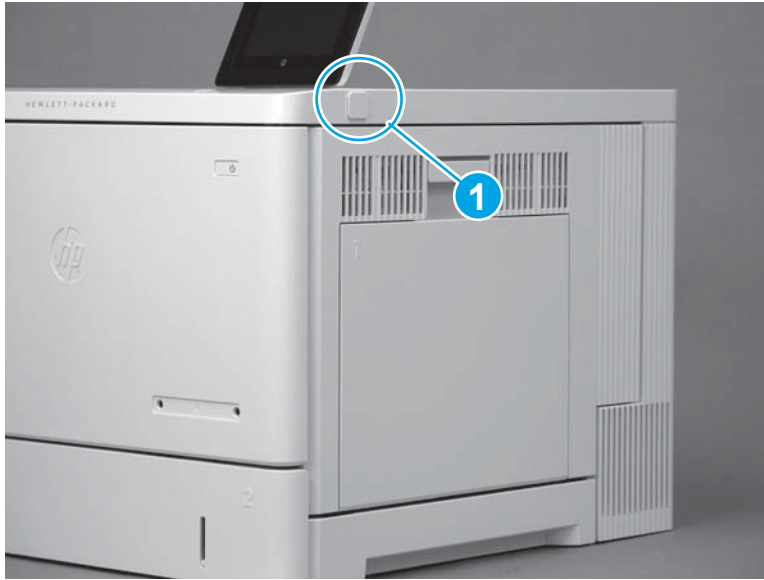

Step 52: Install the formatter cover

- ▲ Slide the cover onto the printer (callout 1) to install it.

 **NOTE:** Make sure that the tabs on the formatter cover align with the slots provided in the printer (callout 2). Tighten the two thumbscrews (callout 3).

 **TIP:** If needed, use the edge of a coin to turn the thumbscrews.

Figure 1-3912 Install the cover



Step 53: Install the TCU

1. Verify that the toner collection hatch cover is in the closed position on the TCU.

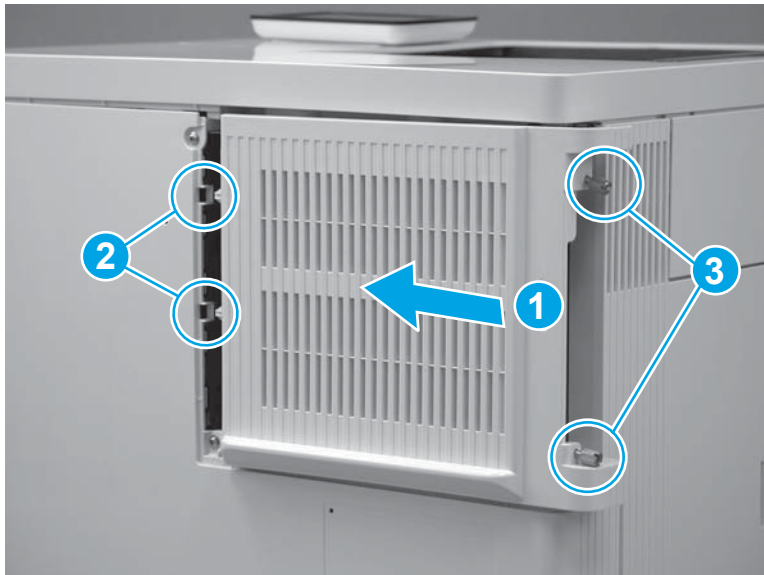
Figure 1-3913 Verify that the toner collection hatch cover is closed

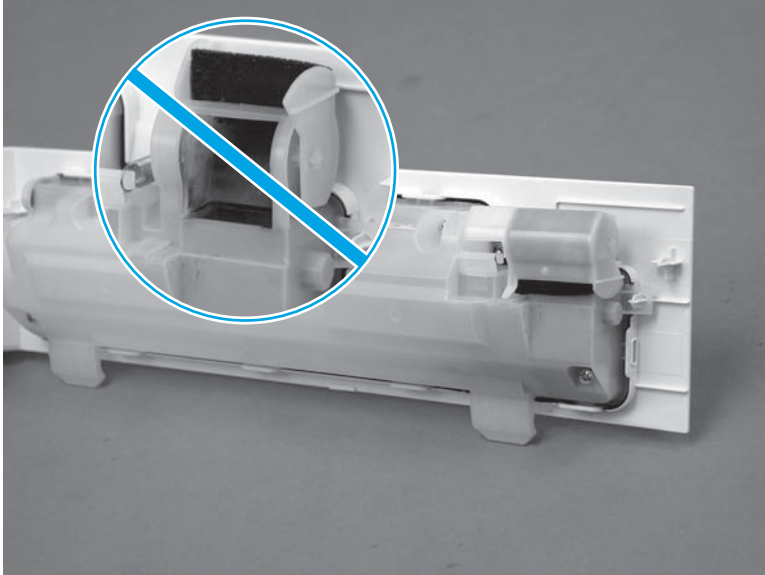

2. Position the TCU with the hinges in the slots provided in the printer (callout 1), and then rotate the TCU up and into the closed position.

 **NOTE:** The toner collection hatch cover automatically opens when the TCU is closed.

Figure 1-3914 Install the TCU



3. Close the front door.

Figure 1-3915 Close the front door

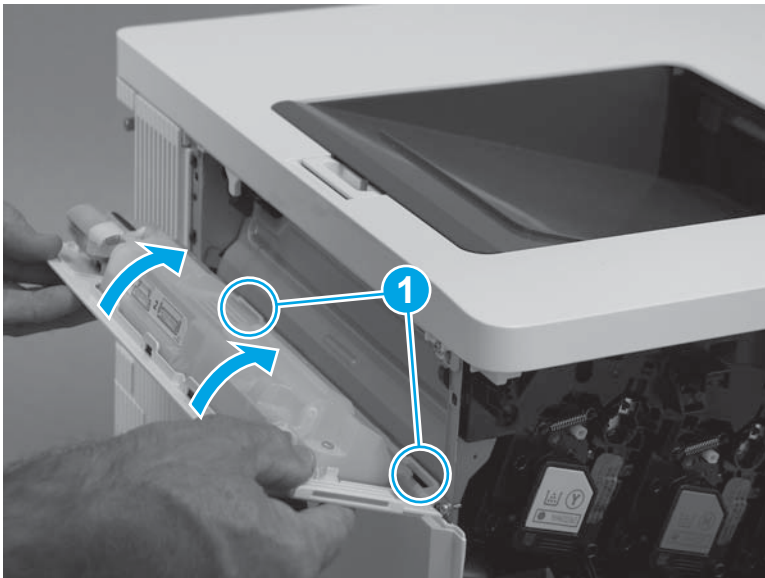

Removal and replacement: Registration assembly

- [Introduction](#)
- [Step 1: Remove the secondary transfer assembly](#)
- [Step 2: Remove the ITB](#)
- [Step 3: Remove the tray](#)
- [Step 4: Remove the toner collection unit \(TCU\)](#)
- [Step 5: Remove the formatter cover](#)
- [Step 6: Remove the USB cover \(M552 and M553\)](#)
- [Step 7: Remove the control panel \(M553x only\)](#)
- [Step 8: Remove the formatter \(M552 and M553\)](#)
- [Step 9: Remove the hard-disk drive \(HDD\) \(M577\)](#)
- [Step 10: Remove the fax PCA \(M577c/f/z\)](#)
- [Step 11: Remove the formatter \(M577\)](#)
- [Step 12: Remove the rear cover \(M552 and M553\)](#)
- [Step 13: Remove the rear upper cover \(M577\)](#)
- [Step 14: Remove the rear cover \(M577\)](#)
- [Step 15: Remove the left upper cover \(M577\)](#)
- [Step 16: Remove the right front upper cover \(M577dn\)](#)
- [Step 17: Remove the stapler cover assembly \(M577c/f/z\)](#)
- [Step 18: Remove the integrated scanner assembly \(ISA\) \(M577\)](#)
- [Step 19: Remove the right upper cover \(M577\)](#)
- [Step 20: Remove the left cover](#)
- [Step 21: Remove the upper cover \(M552 and M553\)](#)
- [Step 22: Remove the right rear cover](#)
- [Step 23: Remove the formatter case](#)
- [Step 24: Remove the low-voltage power supply \(LVPS\)](#)
- [Step 25: Remove the power supply fan \(FM1\)](#)
- [Step 26: Remove the high-voltage power supply D \(HVPSD\)](#)
- [Step 27: Remove the lifter drive assembly](#)
- [Step 28: Remove the DC controller and sheet-metal bracket](#)
- [Step 29: Remove the pickup drive assembly and motor \(M5\)](#)

- [Step 30: Remove the registration assembly](#)
- [Step 31: Unpack the replacement assembly](#)
- [Step 32: Install the registration assembly](#)
- [Step 33: Install the pickup drive assembly and motor \(M5\)](#)
- [Step 34: Install the DC controller and sheet-metal bracket](#)
- [Step 35: Install the lifter drive assembly](#)
- [Step 36: Install the HVPSD](#)
- [Step 37: Install the power-supply fan \(FM1\)](#)
- [Step 38: Install the LVPS](#)
- [Step 39: Install the formatter case](#)
- [Step 40: Install the right rear cover](#)
- [Step 41: Install the upper cover \(M552 and M553\)](#)
- [Step 42: Install the left cover](#)
- [Step 43: Install the right upper cover \(M577\)](#)
- [Step 44: Install the integrated scanner assembly \(ISA\) \(M577\)](#)
- [Step 45: Install the stapler cover assembly \(M577c/f/z\)](#)
- [Step 46: Install the right front upper cover \(M577dn\)](#)
- [Step 47: Install the left upper cover \(M577\)](#)
- [Step 48: Install the rear cover \(M577\)](#)
- [Step 49: Install the rear upper cover \(M577\)](#)
- [Step 50: Install the rear cover \(M552 and M553\)](#)
- [Step 51: Install the formatter \(M577\)](#)
- [Step 52: Install the fax PCA \(M577c/f/z\)](#)
- [Step 53: Install the HDD \(M577\)](#)
- [Step 54: Install the formatter \(M552 and M553\)](#)
- [Step 55: Install the control-panel assembly \(M553x only\)](#)
- [Step 56: Install the USB cover \(M552 and M553\)](#)
- [Step 57: Install the formatter cover](#)
- [Step 58: Install the TCU](#)
- [Step 59: Install the tray](#)
- [Step 60: Install the ITB](#)

- [Step 61: Install the secondary transfer roller assembly](#)

Introduction

This document provides the procedures to remove and replace the registration assembly.

Before performing service

 **TIP:** Some figures might show assemblies removed or installed that have not yet been removed or installed at that specific step. However, the procedures are correct for this printer and the target assembly. Always thoroughly read the instructions that accompany each figure.

Turn the printer power off

- Disconnect the power cable.

 **WARNING!** To avoid damage to the printer, turn the printer off, wait 30 seconds, and then remove the power cord before attempting to service the printer.

Use the table below to identify the correct part number for your printer, and then go to <http://h20141.www2.hp.com/hpparts> to order the part.

Registration assembly part number	
RM2-0093-000CN	Registration assembly (M553n)
RM20018-000CN	Registration assembly (M552dn, M553dn, M553x, M577)

Required tools

- #2 Phillips screwdriver with a magnetic tip

After performing service

Make sure that all of the connectors on the LVPS are fully seated.

Make sure that all of the connectors on the DC controller are fully seated.

Make sure that the TCU is fully closed after replacing it.

Make sure that all of the connectors on the formatter are fully seated.

Make sure that the formatter cover is fully seated, and that the thumbscrews are finger tight after replacing it.

Turn the printer power on

- Connect the power cable.
- Use the power switch to turn the power on.

Post service test

Print a configuration page to make sure that the printer is functioning correctly.

Step 1: Remove the secondary transfer assembly

1. Open the right door.

Figure 1-3916 Open the right door



2. Release the blue arm, and then let the secondary transfer assembly rotate down to the half-way open position.

 **NOTE:** The assembly should stop at the halfway down point—the pin will stop at the notch in the slot in the blue arm.

Figure 1-3917 Release the secondary transfer roller assembly



3. Carefully flex the top portion of the blue arm—as shown in the figure—to start to disengage it from the pin.

Figure 1-3918 Carefully flex the top portion of the blue arm

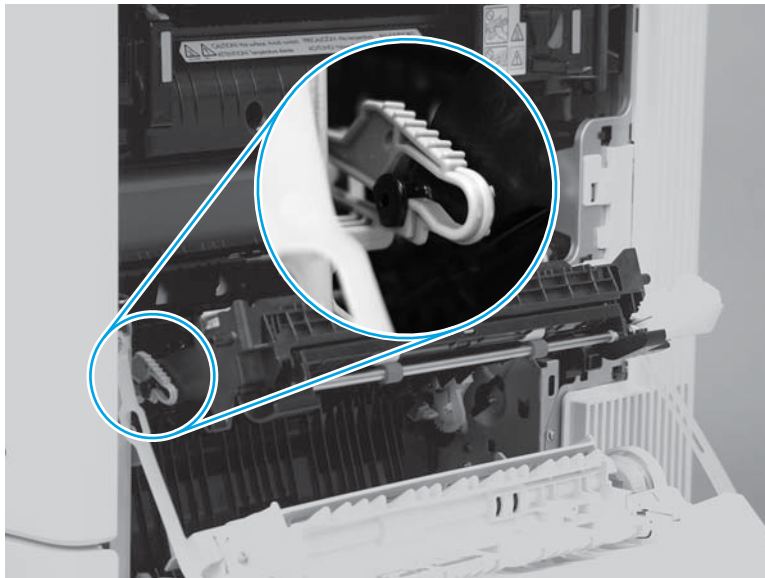

4. Continue to flex the blue arm until it disengages from the pin.

Figure 1-3919 Disengage the blue arm and pin



5. Slide the assembly toward the front of the printer to release it (callout 1), and then rotate it down and away from the printer to remove it (callout 2).



 **Reinstallation tip:** Before removing the assembly, take note of where the assembly hinge pins fit into the holes provided in the printer.

Figure 1-3920 Remove the secondary transfer roller assembly

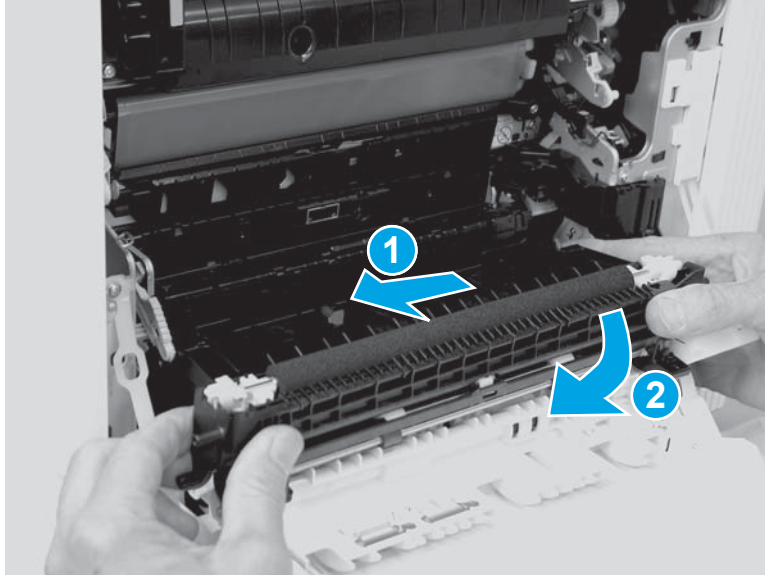

Step 2: Remove the ITB

 **CAUTION:** Do not touch the grey-plastic belt. Skin oils and fingerprints on the belt can cause print-quality problems.

1. Open the right door.

Figure 1-3921 Open the right door



2. Pull the blue lever to release the ITB drive coupling.

Figure 1-3922 Release the ITB drive coupling

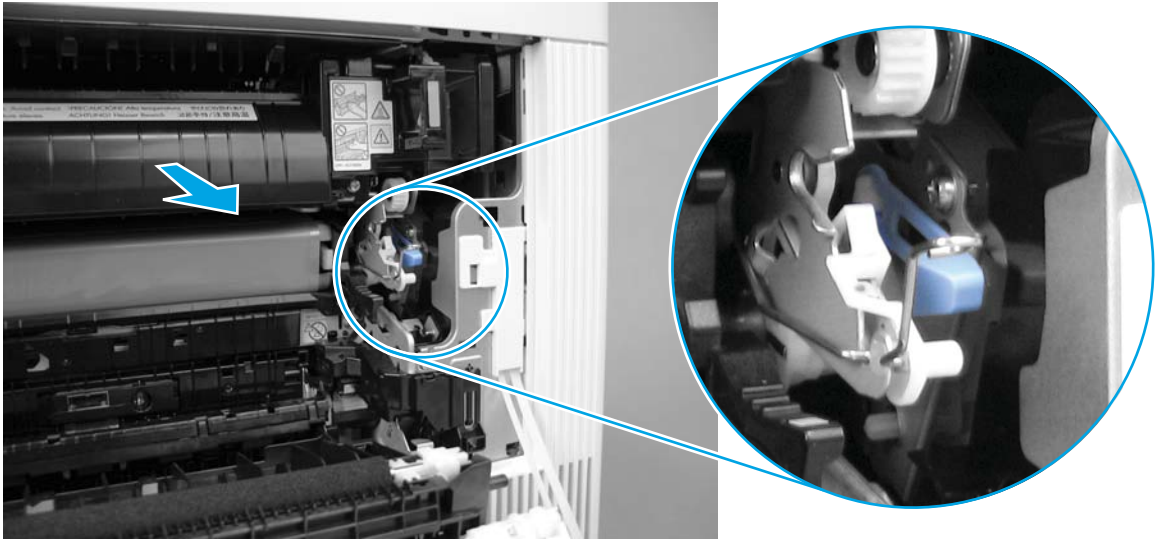

3. Push in on the blue arm to release the secondary transfer roller assembly, and then completely lower the assembly.

 **NOTE:** Press the blue arm on the secondary transfer roller assembly a second time to release the roller assembly when it stops at the halfway open position.

Figure 1-3923 Lower the secondary transfer roller assembly



4. Release the left-side ITB spring (callout 1) from the tab (callout 2).

Figure 1-3924 Release the front-side ITB spring

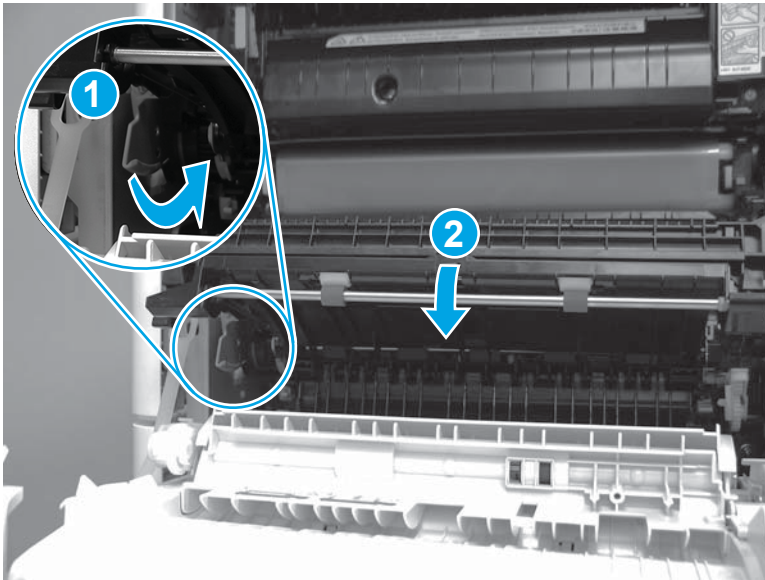
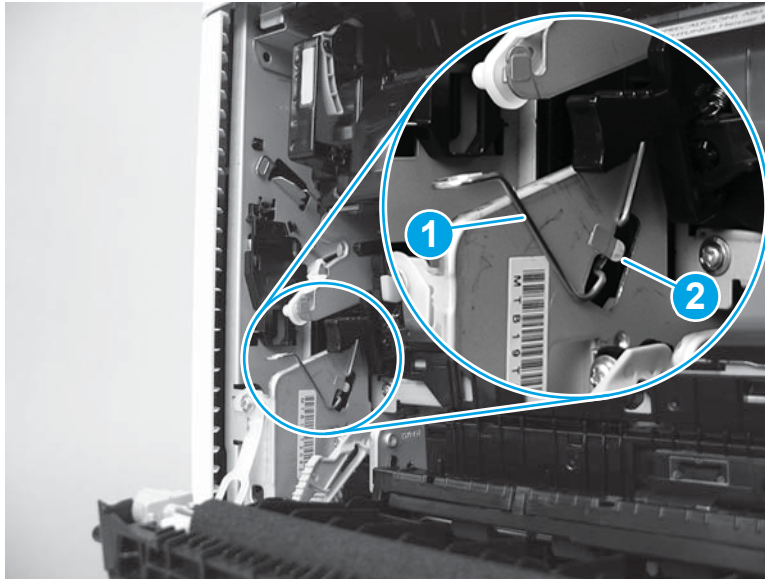

5. Place the left-side ITB spring on the holder to keep it out of the way.

 **TIP:** The holder is colored blue to help locate it.

Figure 1-3925 Place the spring on the holder

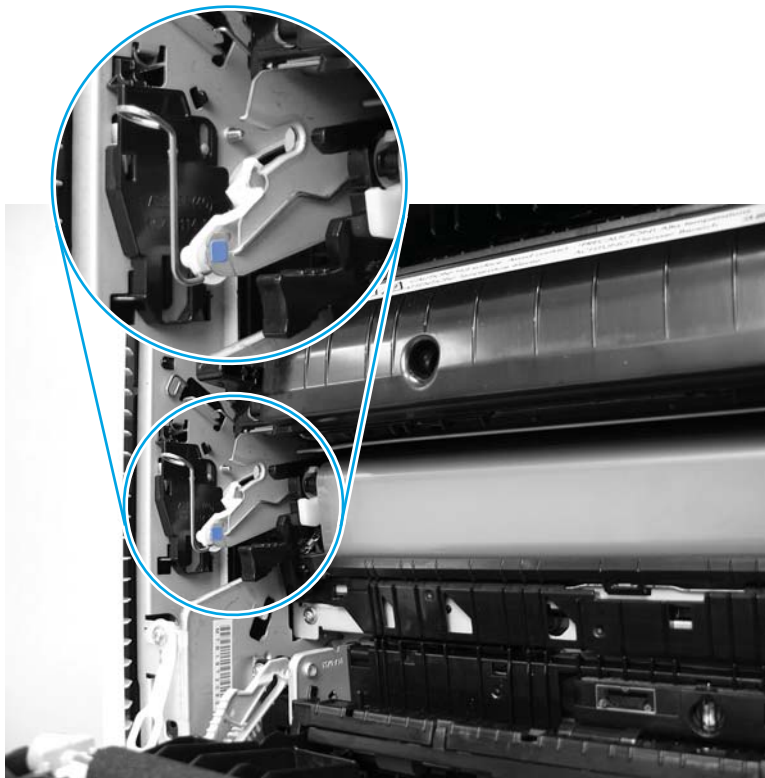

6. Release the right-side ITB spring (callout 1) from the tab (callout 2).

Figure 1-3926 Release the rear-side ITB spring

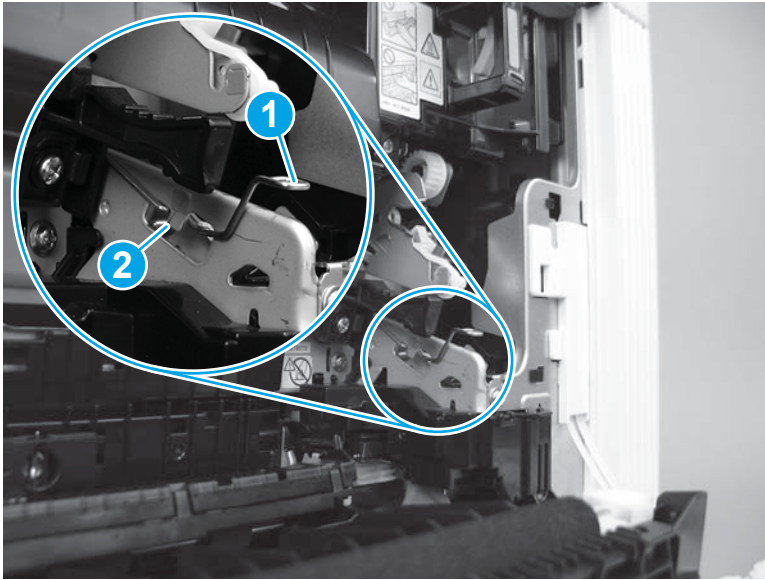

7. Place the right-side ITB spring on the holder to keep it out of the way.

 **TIP:** The holder is colored blue to help locate it.

Figure 1-3927 Place the spring on the holder

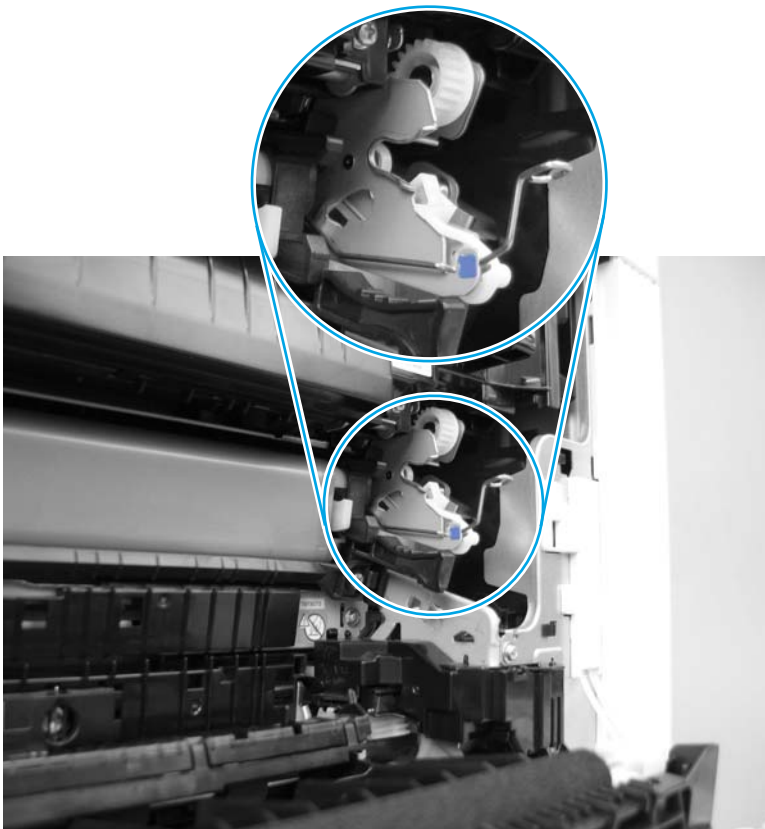

8. Grasp the two blue handles on the ITB.

⚠ CAUTION: If the ITB is removed to access other assemblies in the printer, use care. The ITB is a sensitive assembly. Be careful when handling the ITB so that it is not damaged. Always place the ITB in a safe and protected location.

Figure 1-3928 Grasp the ITB handles

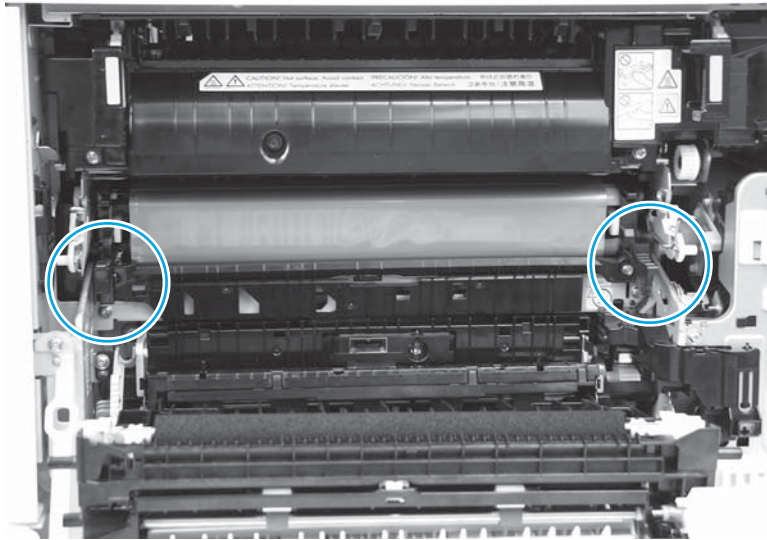

9. Pull the ITB out of the printer to remove it.

⚠ CAUTION: Do not touch the grey-plastic belt. Skin oils and fingerprints on the belt can cause print-quality problems.

Figure 1-3929 Remove the ITB

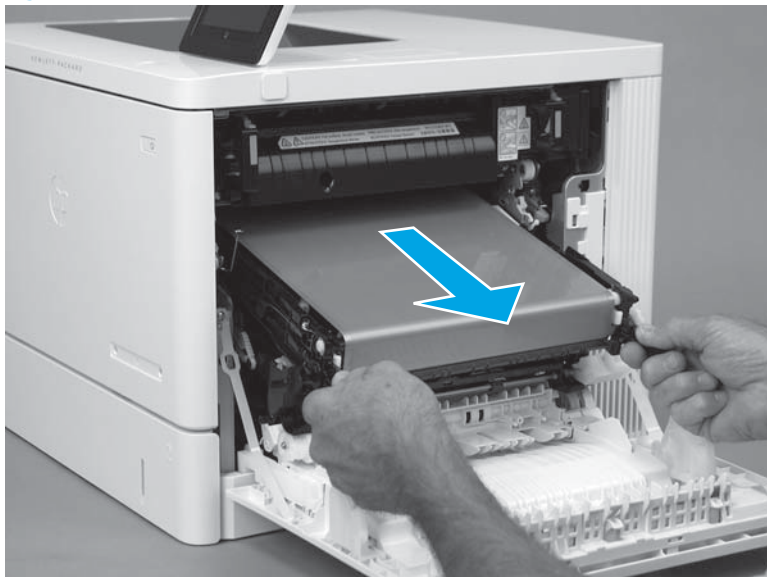

Step 3: Remove the tray

1. Pull the tray out until it stops.

Figure 1-3930 Pull the tray out



2. Lift the front of the tray, and then pull it out of the printer to remove it.

Figure 1-3931 Remove the tray

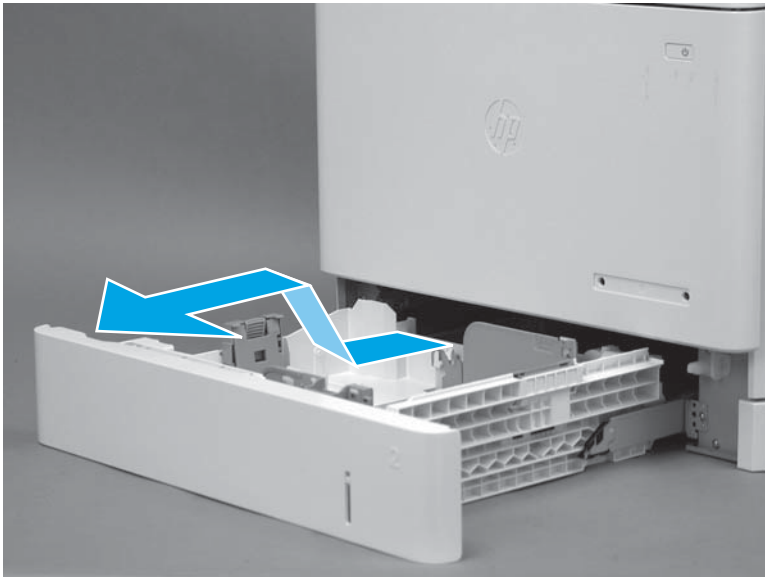

Step 4: Remove the toner collection unit (TCU)

1. Open the front door.

Figure 1-3932 Open the front door



2. Open the TCU.

 **NOTE:** The toner collection hatch cover automatically closes when the TCU is opened.

Figure 1-3933 Open the TCU



3. Pull the TCU away from the printer at an angle to remove it.

⚠ CAUTION: Do not open the toner collection hatch cover when handling the TCU. If toner gets on clothing, wipe it off by using a dry cloth and wash the clothes in cold water. Hot water sets toner into fabric.

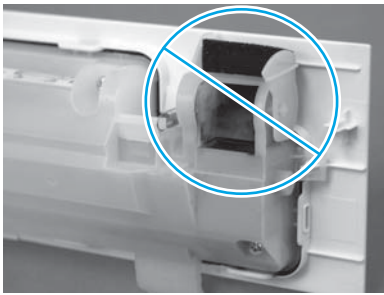
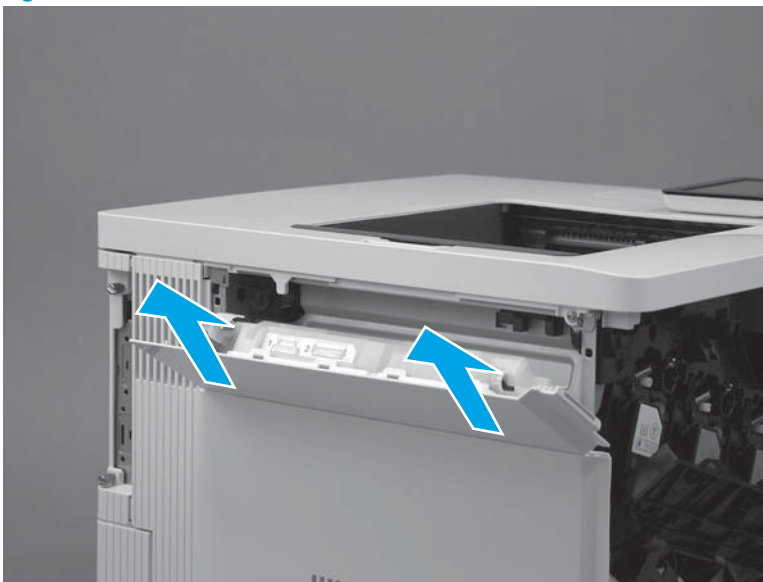

Figure 1-3934 Remove the TCU



Step 5: Remove the formatter cover

1. Locate the formatter cover.

Figure 1-3935 Locate the formatter cover

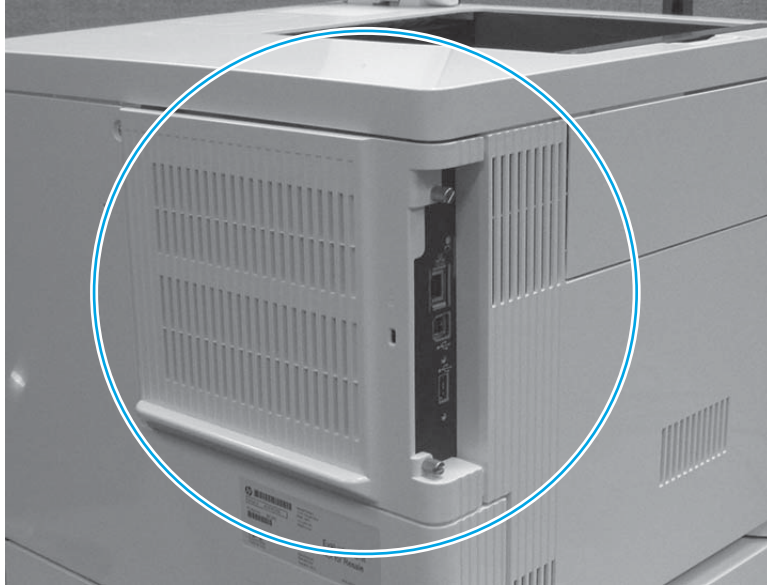

2. Loosen the two thumbscrews (callout 1). Grasp the two thumbscrews, and then slide the cover away from the printer (callout 2) to remove it.

 **TIP:** If needed, use the edge of a coin to turn the thumbscrews.

Figure 1-3936 Loosen the thumbscrews

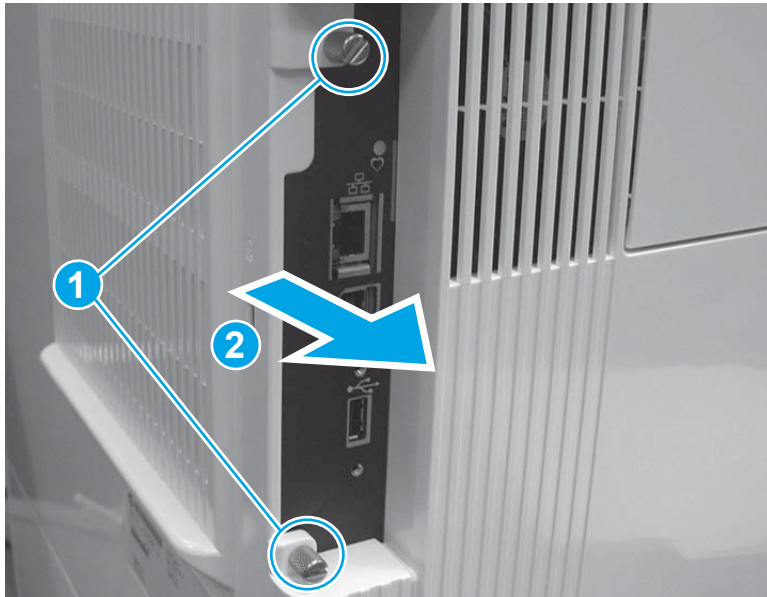

Step 6: Remove the USB cover (M552 and M553)

 **NOTE:** This step is for the M552 and M553 models. For the M577 models, skip this step and go to [Step 9: Remove the hard-disk drive \(HDD\) \(M577\) on page 2205.](#)

1. Locate the USB cover.

Figure 1-3937 Locate the USB cover



2. Pull the cover off of the printer to remove it.

Figure 1-3938 Remove the cover



Step 7: Remove the control panel (M553x only)

 **NOTE:** For the M553n/dn and M552dn models, skip this step and go to [Step 8: Remove the formatter \(M552 and M553\) on page 2204](#).

For the M577 models, skip this step and go to [Step 9: Remove the hard-disk drive \(HDD\) \(M577\) on page 2205](#).

1. Tilt the control panel up.

Figure 1-3939 Tilt the control panel up



2. Use a small flat-blade screwdriver to release the control-panel screws cover tabs.

Figure 1-3940 Release the control-panel screws cover tabs

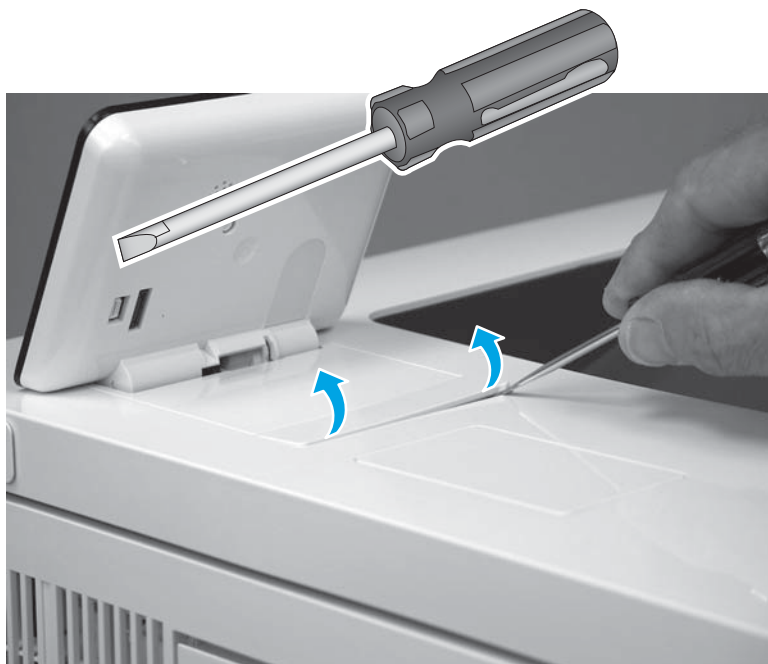

3. Rotate the cover up to remove it.

Figure 1-3941 Remove the cover

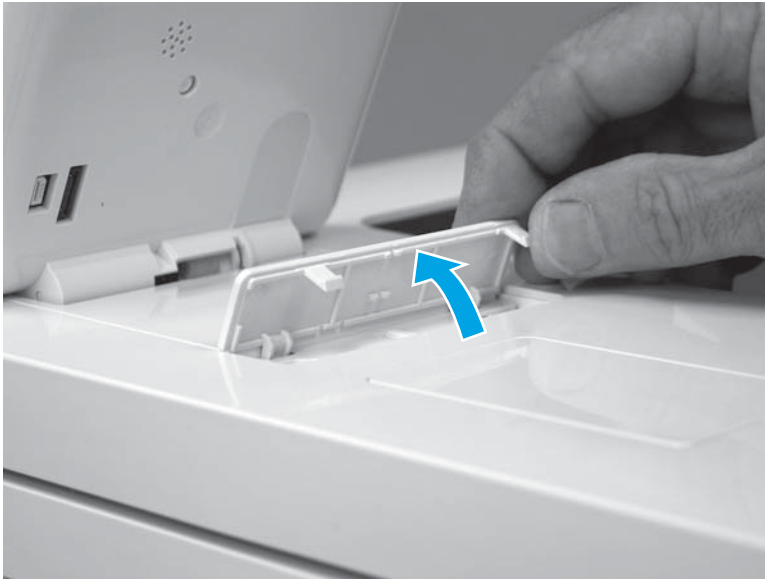

4. Use a small Phillips screwdriver to remove two screws (callout 1).

 **IMPORTANT:** Store the screws in a secure place where they cannot fall down into the printer.

Figure 1-3942 Remove two screws

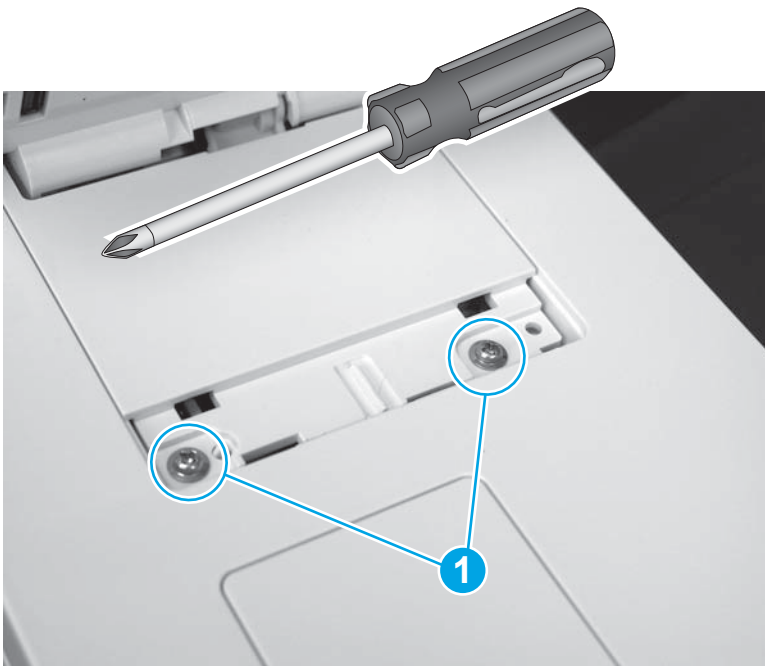

5. Rotate the control-panel base toward the front of the printer.

Figure 1-3943 Rotate the control-panel base up



6. Slightly slide the control-panel base toward the rear of the printer (callout 1) to release it, and then turn the control panel over (callout 2) to access the bottom side.

⚠ CAUTION: The control panel is still attached to the printer. Do not attempt to completely remove the control panel.

Figure 1-3944 Turn the control panel over

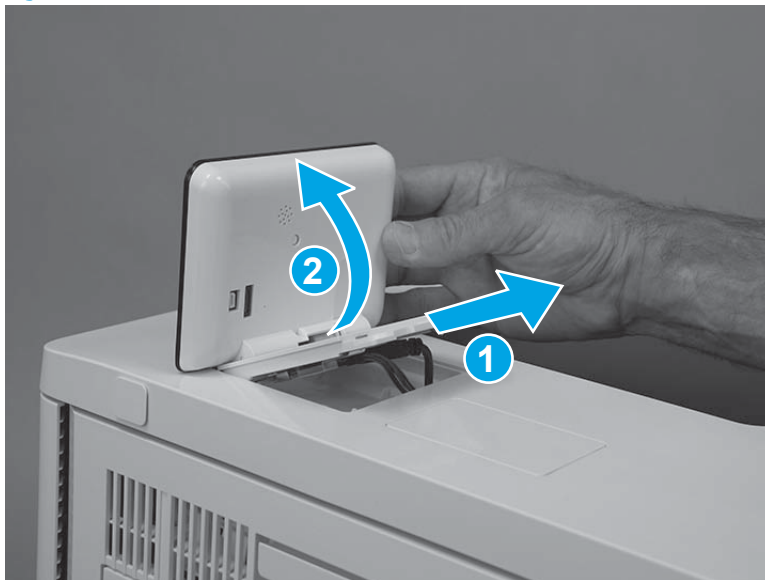

7. Disconnect one USB cable (callout 1), one connector (callout 2), and then remove the control panel.

Figure 1-3945 Disconnect two connectors

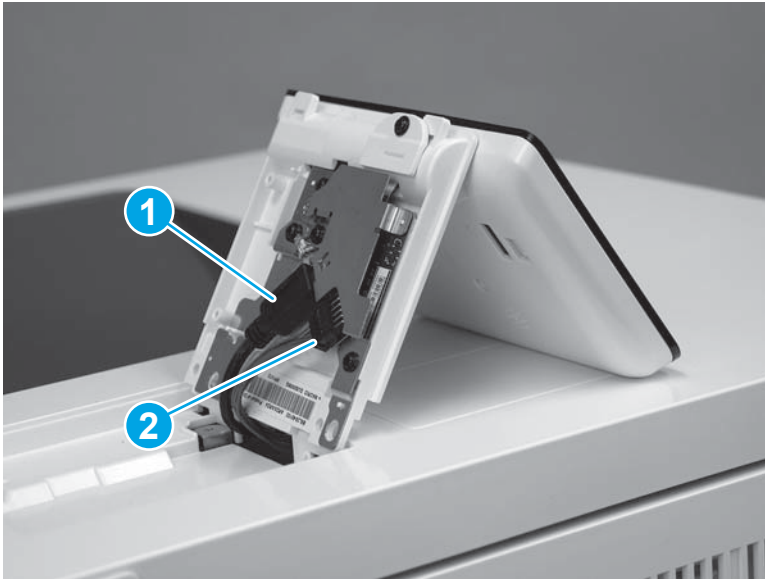

Step 8: Remove the formatter (M552 and M553)



NOTE: This step is for the M552 and M553 models. For the M577 models, skip this step and go to [Step 9: Remove the hard-disk drive \(HDD\) \(M577\) on page 2205](#).

If the optional hard-disk drive (HDD) is installed, it must be removed to gain access to the formatter mounting screws.

Release two tabs along the left edge of the HDD, rotate the left edge away from the product, and then slide the HDD to the left to remove it.



CAUTION:  ESD-sensitive part.

1. Disconnect all of the connectors on the formatter.

The following connectors are empty:

- All models: J1 (this connector is empty unless the optional DIMM is installed)
- M553n/dn and M552dn: J2 (callout 1; this is the touchscreen connector for the M553x model)
- All models: J9 (this connector is empty unless the optional internal USB ports component is installed)
- All models: J18 (this connector is empty unless the optional hard-disk-drive (HDD) is installed)
- All models: J23
- All models: J24
- M553n/dn and M552dn: J25 (this is the wireless connector for the M553x model)

- All models: J57
- All models: J98 (this connector is empty unless the optional trusted platform module (TPM) is installed)

 **IMPORTANT:** The flat-cable connector (callout 2) is a Zero Insertion Force (ZIF) connector that uses a hinged retainer to secure the flat cable. The hinged retainer must be opened to release the flat cable.

Figure 1-3946 Disconnect all connectors

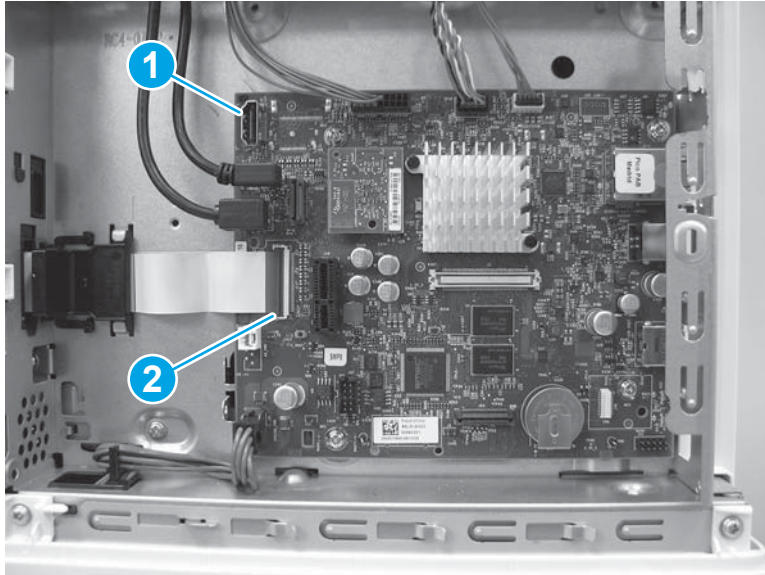

2. Remove four screws (callout 1), and then remove the formatter.

Figure 1-3947 Remove the formatter

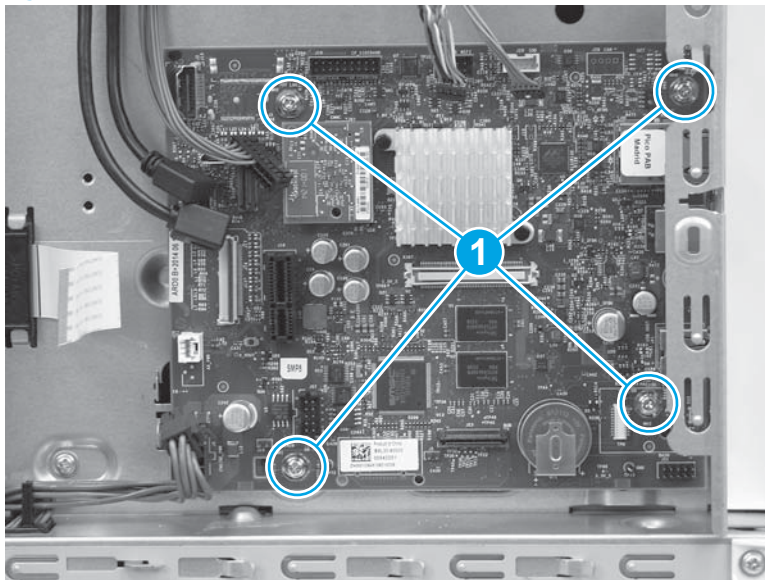

Step 9: Remove the hard-disk drive (HDD) (M577)

 **NOTE:** This step is for the M577 models. For the M552 and M553 models, skip this step and go to [Step 12: Remove the rear cover \(M552 and M553\)](#) on page 2210.

 **CAUTION:**  ESD-sensitive part.

1. Release two tabs (callout 1). Hold the tabs in the released position, and then rotate the hard disk drive (HDD) up (callout 2) to release the connector from the formatter.

Figure 1-3948 Release the HDD

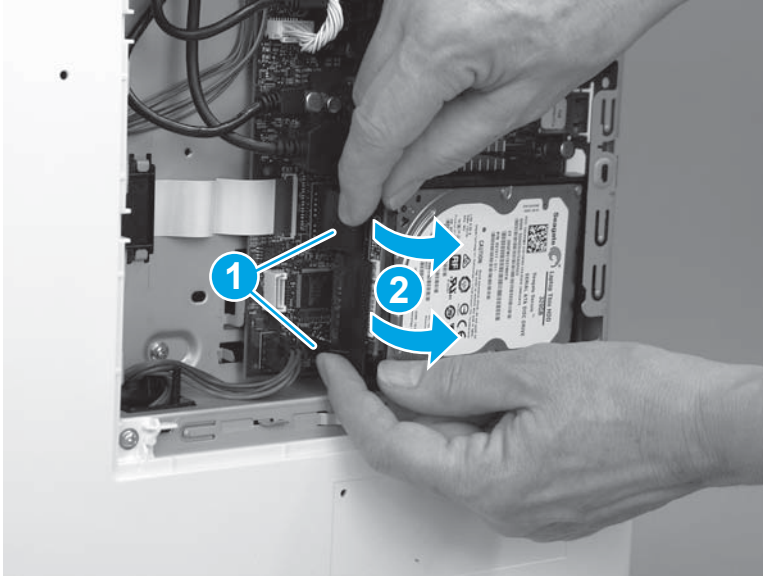

2. Slide the HDD away from the printer to remove it.

Figure 1-3949 Remove the HDD



Step 10: Remove the fax PCA (M577c/f/z)

 **NOTE:** This step is for the M577c/f/z models. For the M577n model, skip this step and go to [Step 11: Remove the formatter \(M577\) on page 2208](#).

For the M552 and M553 models, skip this step and go to [Step 12: Remove the rear cover \(M552 and M553\) on page 2210](#).

 **CAUTION:**  ESD-sensitive part.

1. Locate the fax PCA component on the formatter.

Figure 1-3950 Locate the fax PCA

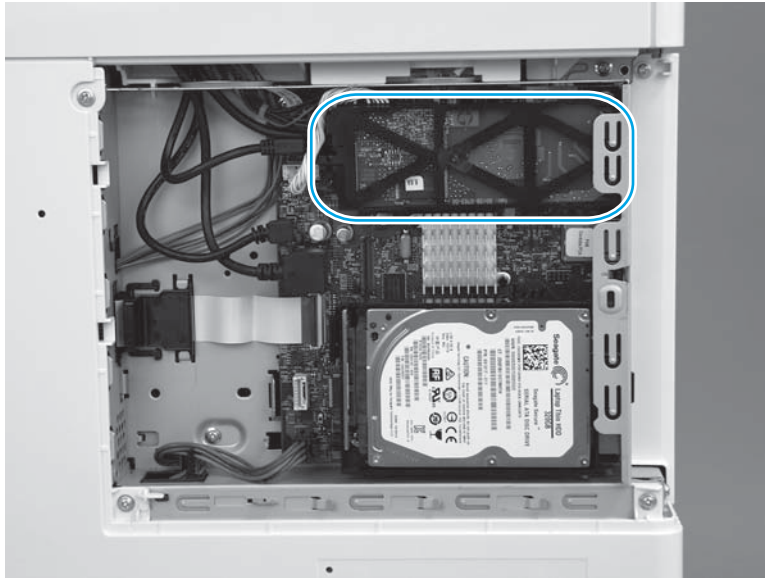

2. Release the connector latch (callout 1), and then pull the connector away from the formatter (callout 2) to disconnect it.

Figure 1-3951 Disconnect one connector

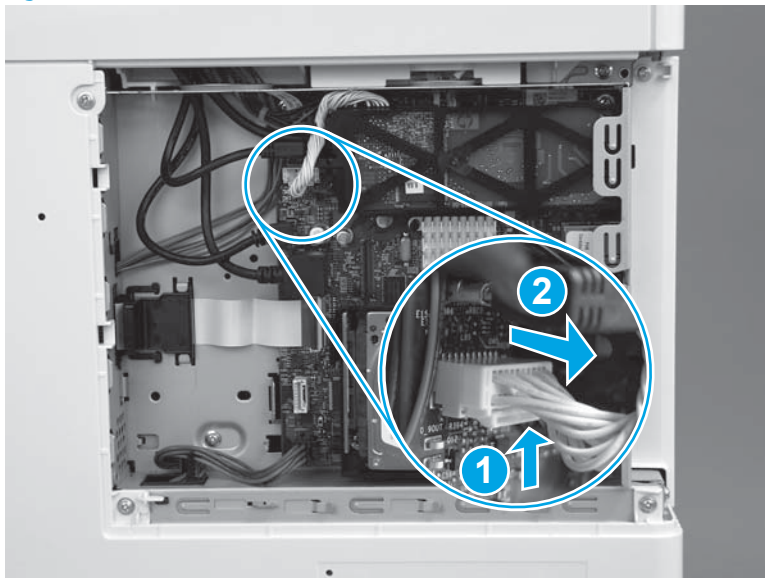

3. Release one retainer (callout 1) by pressing the bracket arms together.

Figure 1-3952 Release one latch

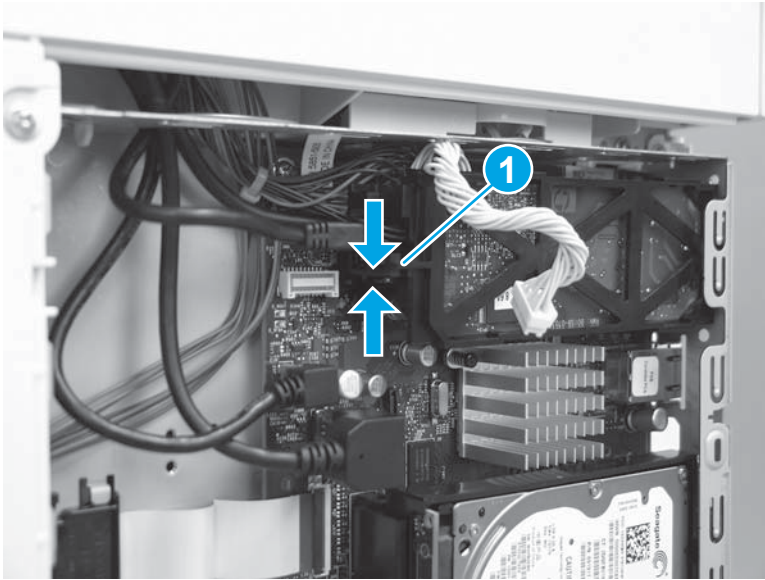

4. Rotate the end of the fax PCA (callout 1) away from the formatter, and then slide the PCA left (callout 2) to remove it.

Figure 1-3953 Remove the fax PCA

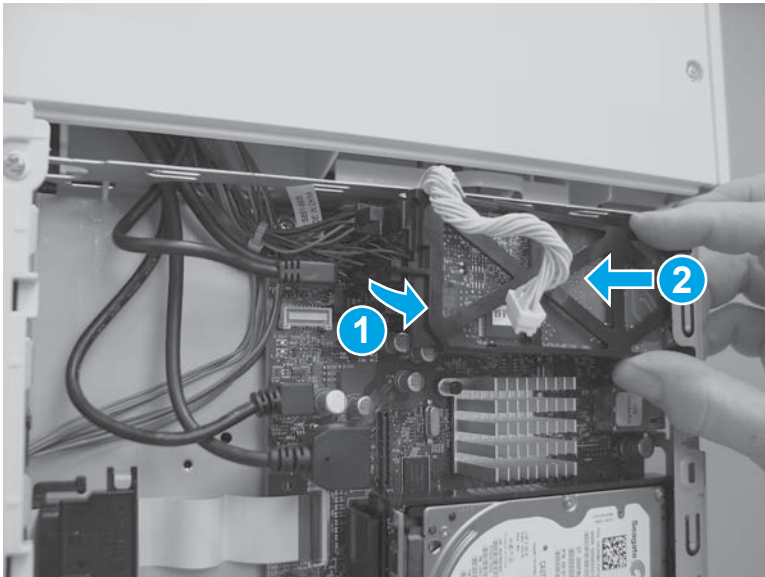

Step 11: Remove the formatter (M577)

 **NOTE:** This step is for the M577 models. For the M552 and M553 models, skip this step and go to [Step 12: Remove the rear cover \(M552 and M553\) on page 2210.](#)

 **CAUTION:**  ESD-sensitive part.

1. Disconnect all of the connectors on the formatter.

The following connectors are empty:

- All models: J1 (this connector is empty unless the optional DIMM is installed)
- All models: J3
- M577dn: J15 (this is the fax connector for the M577f/z/c models)
- All models: J21 (this connector is empty unless the optional internal USB ports component is installed)
- All models: J23
- All models: J24
- All models: J51
- All models: J57
- All models: J97
- All models: J98 (this connector is empty unless the optional trusted platform module (TPM) is installed)

 **IMPORTANT:** The flat-cable connector (callout 1) is a Zero Insertion Force (ZIF) connector that uses a hinged retainer to secure the flat cable. The hinged retainer must be opened to release the flat cable.

Figure 1-3954 Disconnect all connectors



2. Remove four screws (callout 1).

Figure 1-3955 Remove four screws

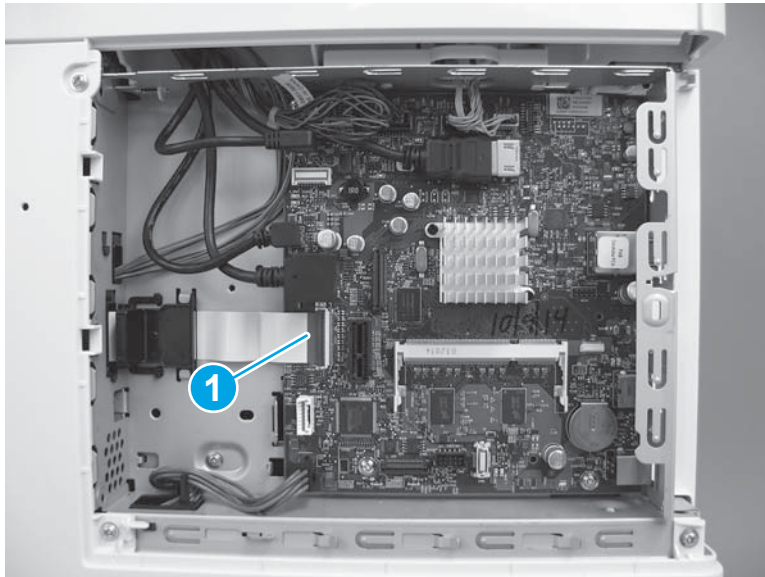
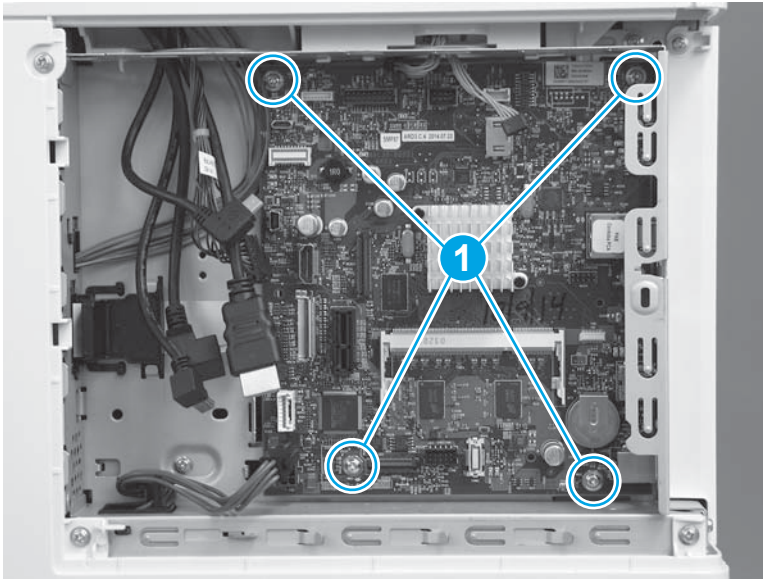

3. Remove the formatter.

Figure 1-3956 Remove the formatter

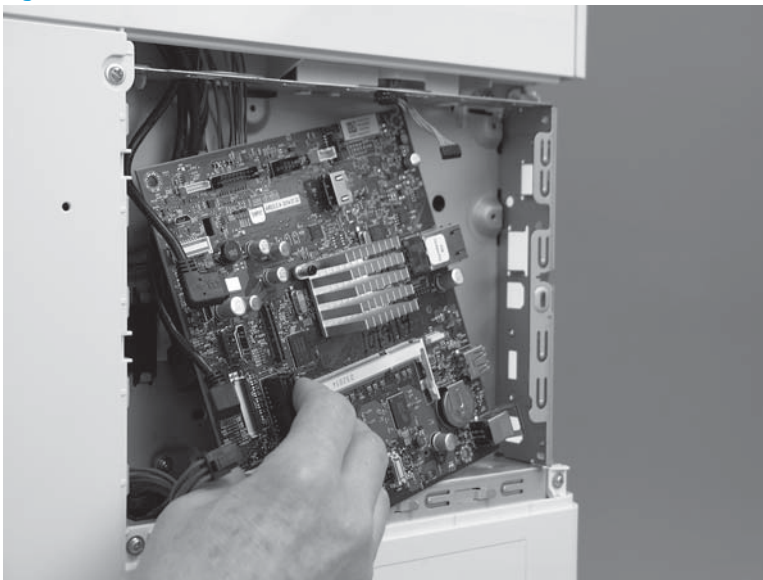

Step 12: Remove the rear cover (M552 and M553)

 **NOTE:** This step is for the M552 and M553 models. For the M577 models, skip this step and go to [Step 13: Remove the rear upper cover \(M577\) on page 2211](#).

1. Remove four screws (callout 1).

Figure 1-3957 Remove four screws

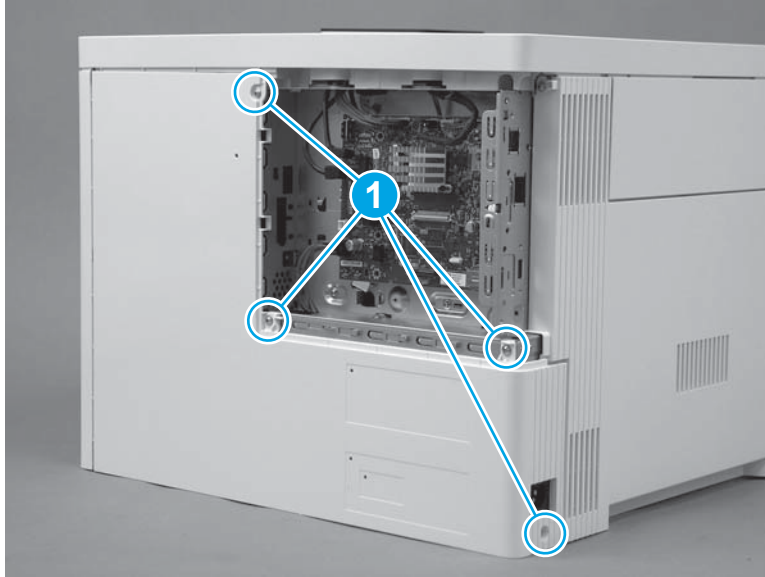

2. Slightly slide the cover to the right (callout 1), rotate the bottom of the cover away from the printer (callout 2), and then pull the top of the cover away from the printer (callout 3) to remove the cover.

Figure 1-3958 Remove the cover

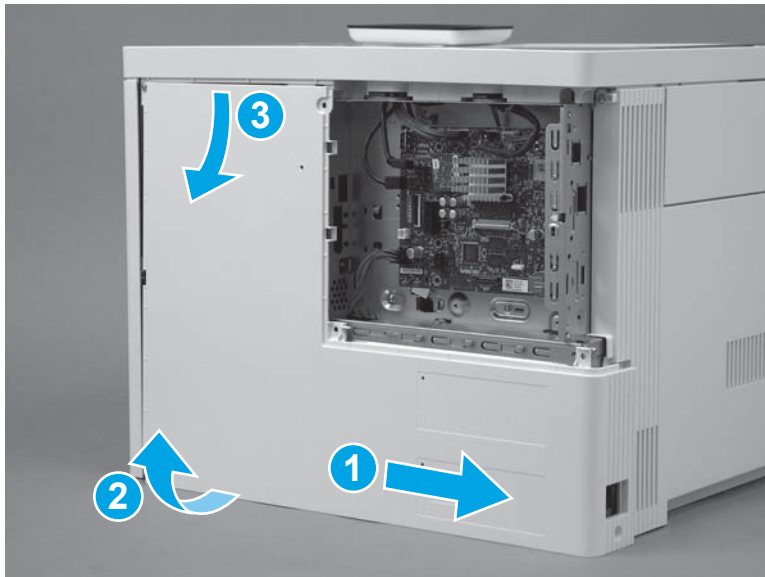

Step 13: Remove the rear upper cover (M577)

 **NOTE:** This step is for the M577 models. For the M552 and M553 models, skip this step and go to [Step 20: Remove the left cover on page 2224](#).

1. Remove two screws (callout 1).

 **Reinstallation tip:** These two screws are self-tapping screws for plastic. When reinstalling them, rotate the screws counterclockwise to align them with the existing thread pattern, and then carefully turn them clockwise to tighten. Do not overtighten. This will prevent stripping the threads inside the screw holes.

Figure 1-3959 Remove two screws



2. Use a small, flat blade screwdriver to release the right edge of the cover.

Figure 1-3960 Release the right edge

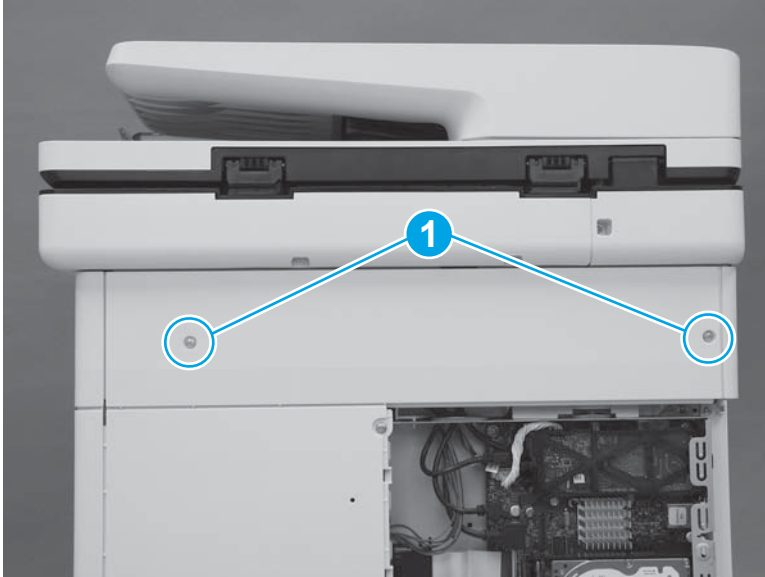
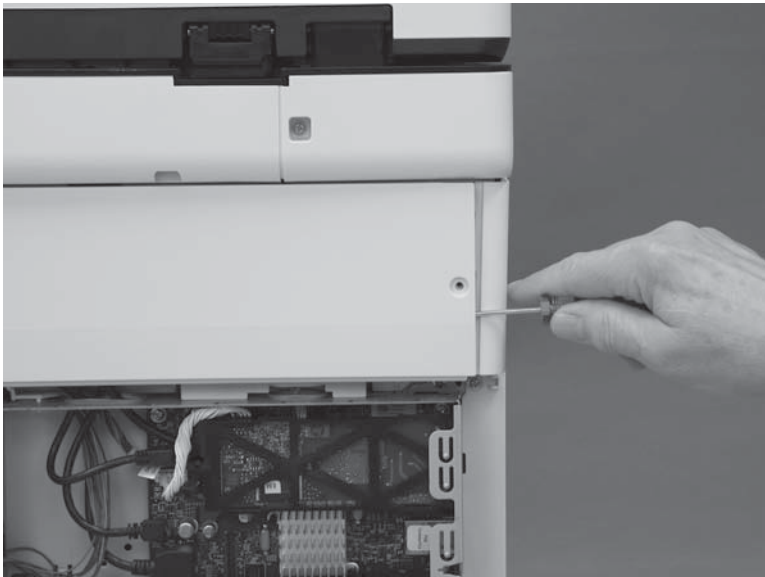

3. Pull the right edge of the cover (callout 1) away from the printer, and then slide the cover to the right (callout 2).

Figure 1-3961 Slide the cover right

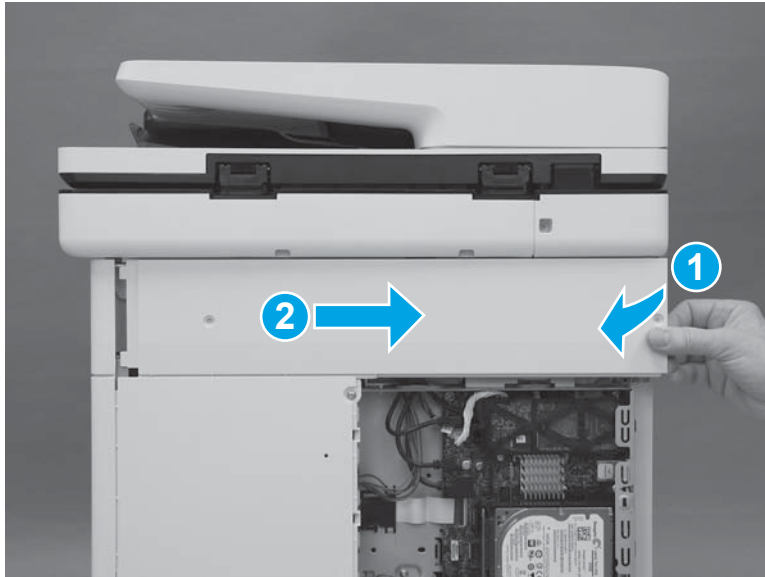

4. Remove the cover.

Figure 1-3962 Remove the cover

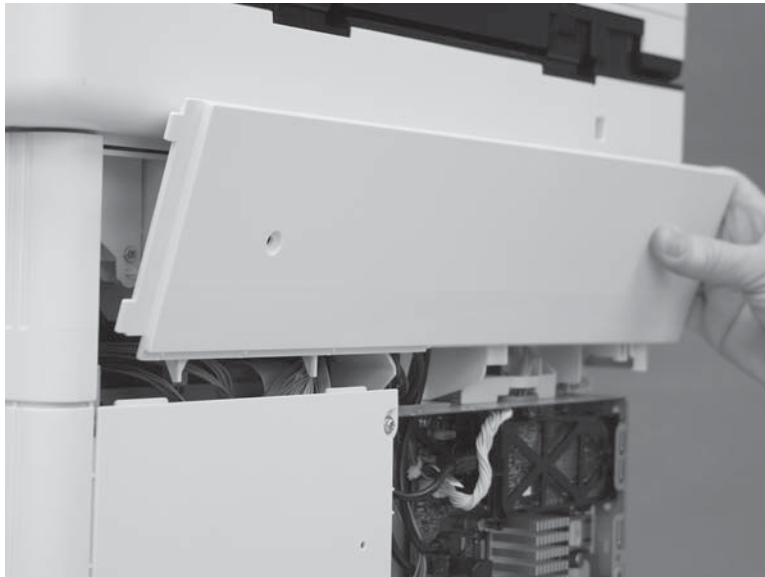

Step 14: Remove the rear cover (M577)

 **NOTE:** This step is for the M577 models. For the M552 and M553 models, skip this step and go to [Step 20: Remove the left cover on page 2224](#).

1. Remove four screws (callout 1).

Figure 1-3963 Remove four screws

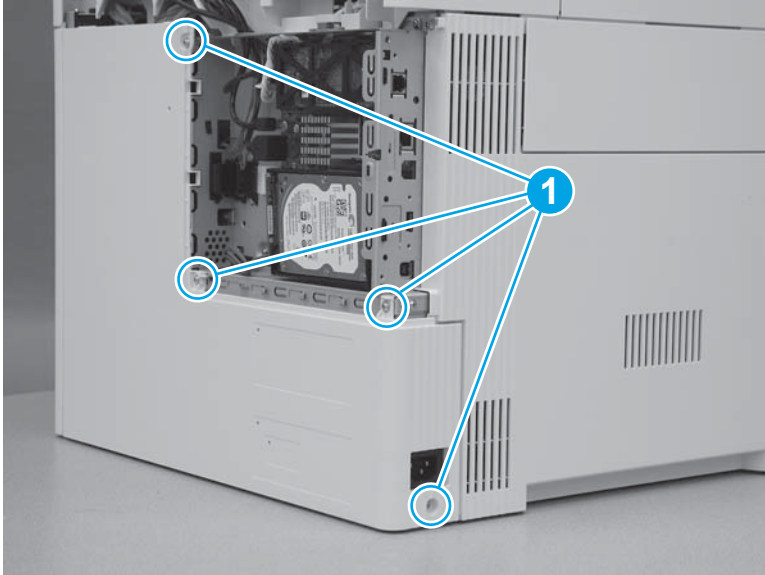

2. Slide the cover to the right to remove it.

Figure 1-3964 Remove the cover

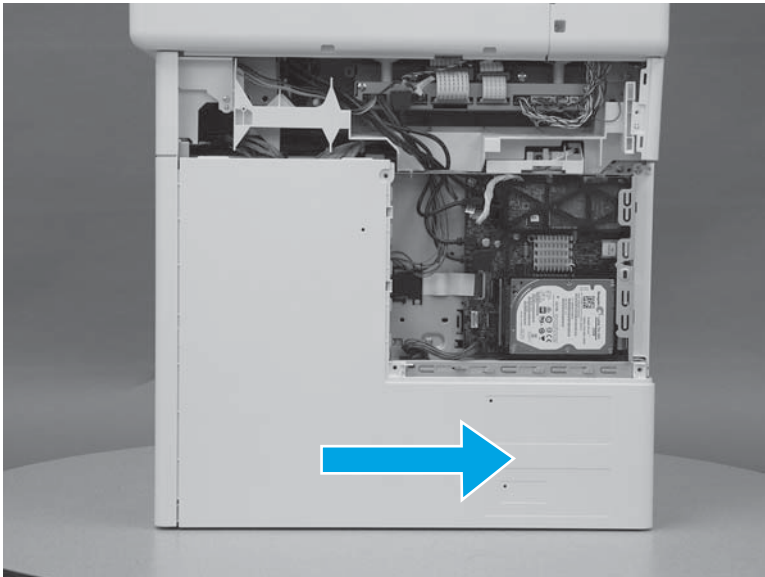

Step 15: Remove the left upper cover (M577)

 **NOTE:** This step is for the M577 models. For the M552 and M553 models, skip this step and go to [Step 20: Remove the left cover on page 2224](#).

1. At the left side of the printer, release one tab (callout 1).

Figure 1-3965 Release one tab

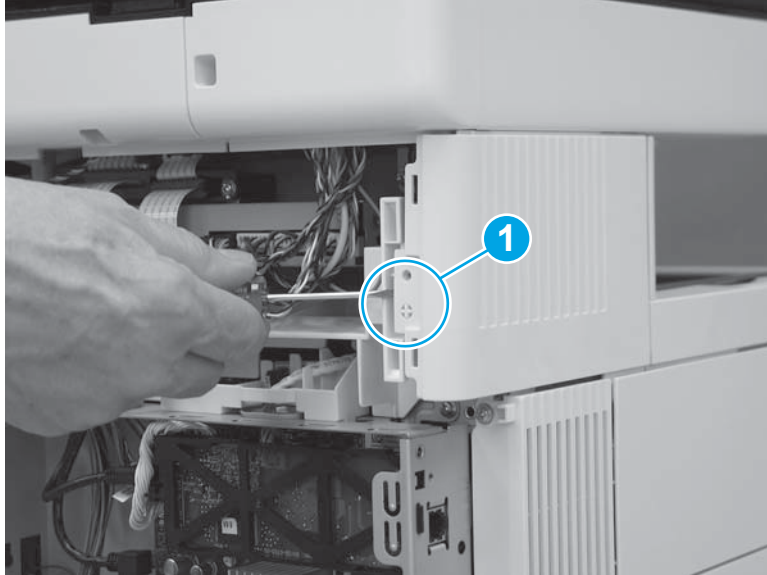

2. Slide the left upper cover toward the back of the printer.

Figure 1-3966 Slide the cover back

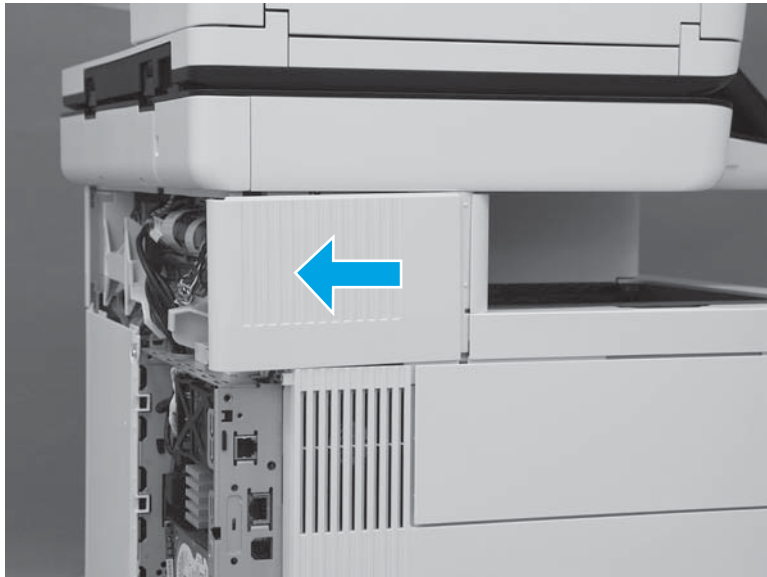

3. Rotate the cover up to remove it.

Figure 1-3967 Remove the left upper cover

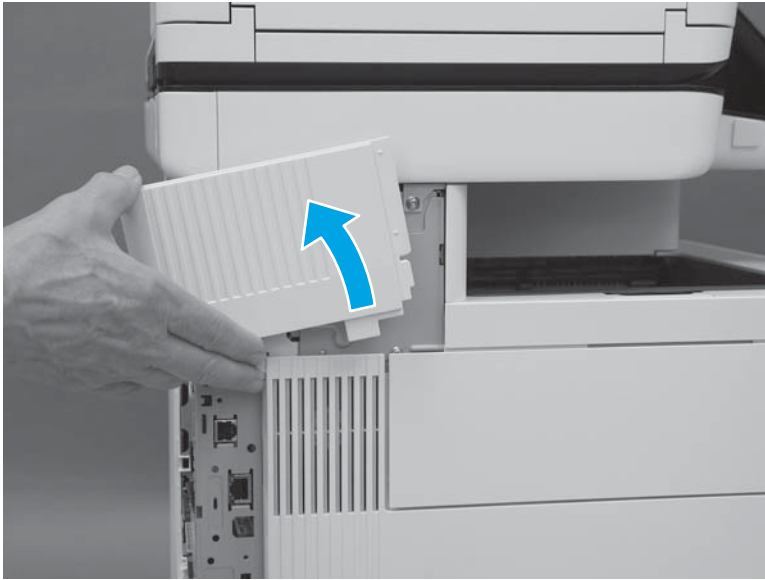

Step 16: Remove the right front upper cover (M577dn)

 **NOTE:** This step is for the M577dn model. For the M577c/f/z models, skip this step and to go [Step 17: Remove the stapler cover assembly \(M577c/f/z\) on page 2217.](#)

For the M552 and M553 models, skip this step and go to [Step 20: Remove the left cover on page 2224.](#)

1. Remove one screw (callout 1).

Figure 1-3968 Remove one screw

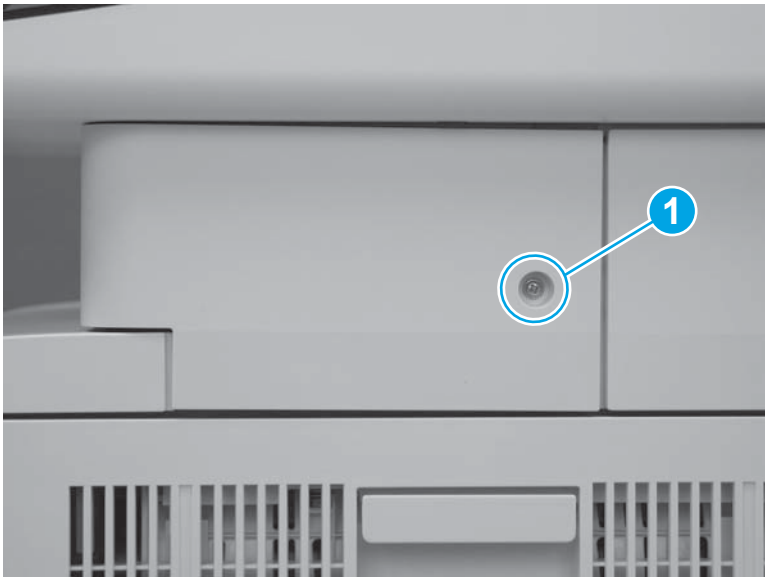

2. Release two tabs at the front edge of the cover (callout 1).

Figure 1-3969 Release two tabs



3. Rotate the front of the cover to the right to remove it.

Figure 1-3970 Rotate the cover



Step 17: Remove the stapler cover assembly (M577c/f/z)

 **NOTE:** This step is for the M577c/f/z models. For the M577dn model, skip this step and to go [Step 19: Remove the right upper cover \(M577\) on page 2222](#).

For the M552 and M553 models, skip this step and go to [Step 20: Remove the left cover on page 2224](#).

1. Remove one screw (callout 1).

 **Reinstallation tip:** This is a self-tapping screw for plastic. When reinstalling, rotate the screw counterclockwise to align it with the existing thread pattern, and then carefully turn it clockwise to tighten. Do not overtighten. This will prevent stripping the threads inside the screw hole.

Figure 1-3971 Remove one screw



2. Release two tabs at the front edge of the cover (callout 1).

Figure 1-3972 Release two tabs

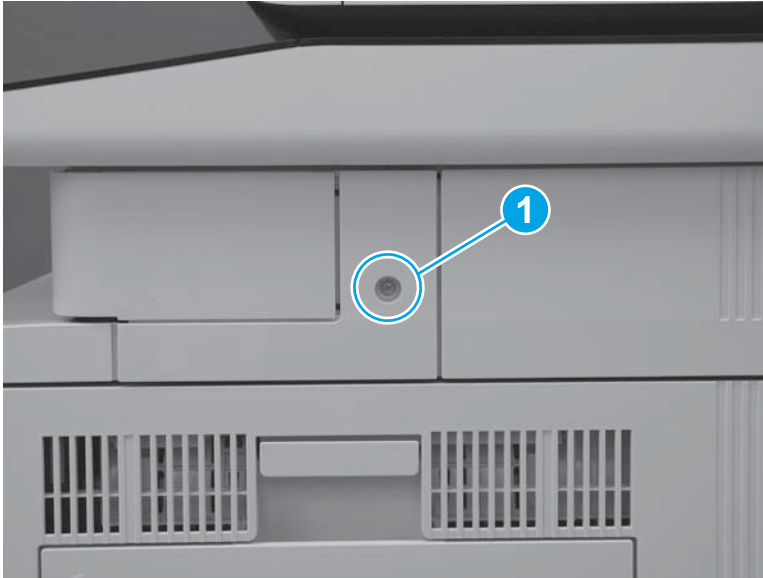

3. Release the back edge of the cover.

Figure 1-3973 Release the back edge of the cover





4. Rotate the cover away from the printer to remove it.

Figure 1-3974 Remove the cover



Step 18: Remove the integrated scanner assembly (ISA) (M577)

 **NOTE:** This step is for the M577 models. For the M552 and M553 models, skip this step and go to [Step 20: Remove the left cover on page 2224](#).

 **NOTE:** The ISA includes the document feeder, image scanner, scanner control board (SCB), control panel, keyboard (M577c/z) and NFC PCA (M577z).

1. At the left side of the printer, remove one screw (callout 1).

Figure 1-3975 Remove one screw

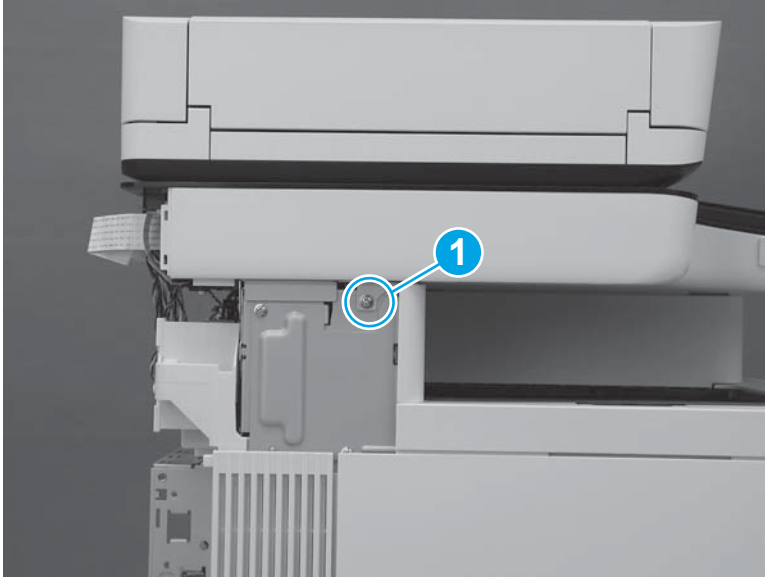

2. At the back side of the printer, remove two screws (callout 1).

Figure 1-3976 Remove two screws

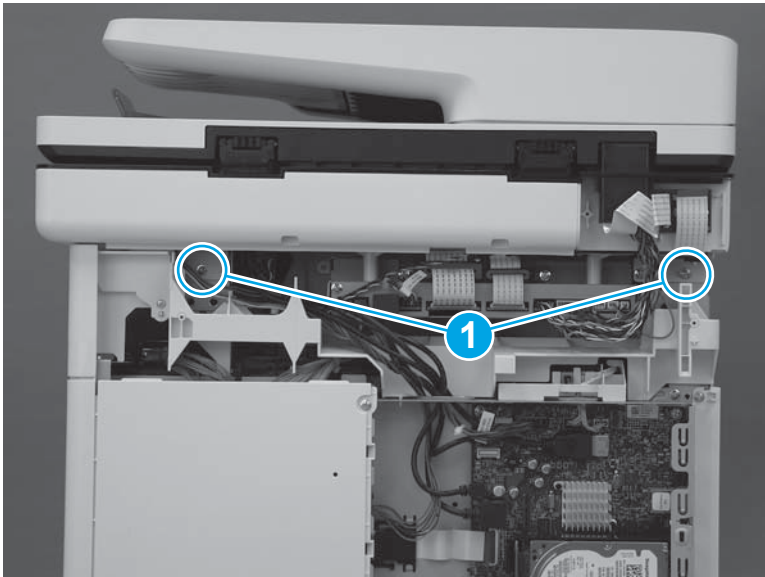

3. At the right side of the printer, remove one screw (callout 1).

Figure 1-3977 Remove one screw

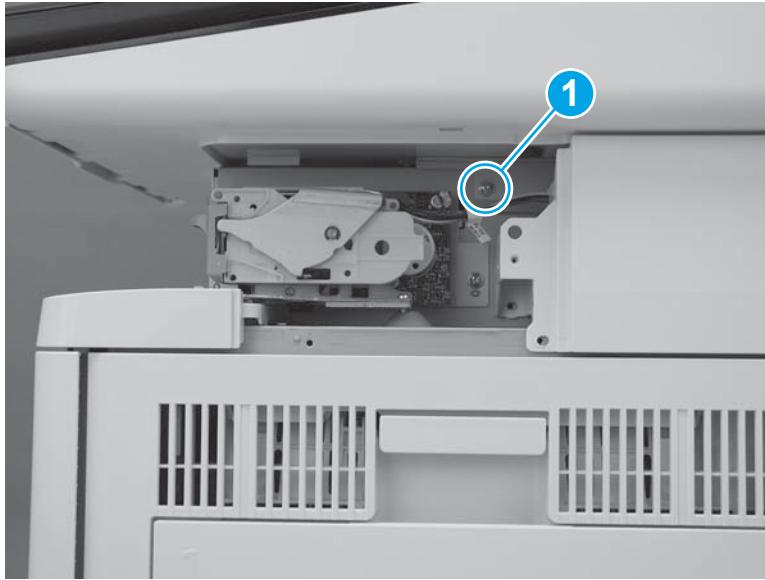

4. Disconnect two connectors on the scanner control board (callout 1).

M577c/f/z only: Disconnect one connector for the stapler on the scanner control board (callout 2).

Figure 1-3978 Disconnect connectors

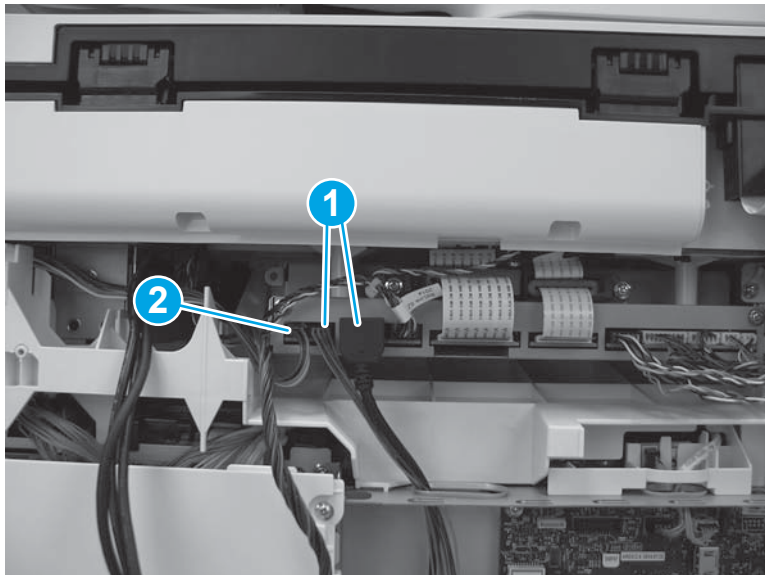

5. Slightly slide the ISA towards the back of the printer to release it.

Figure 1-3979 Slide the ISA towards the back of the printer

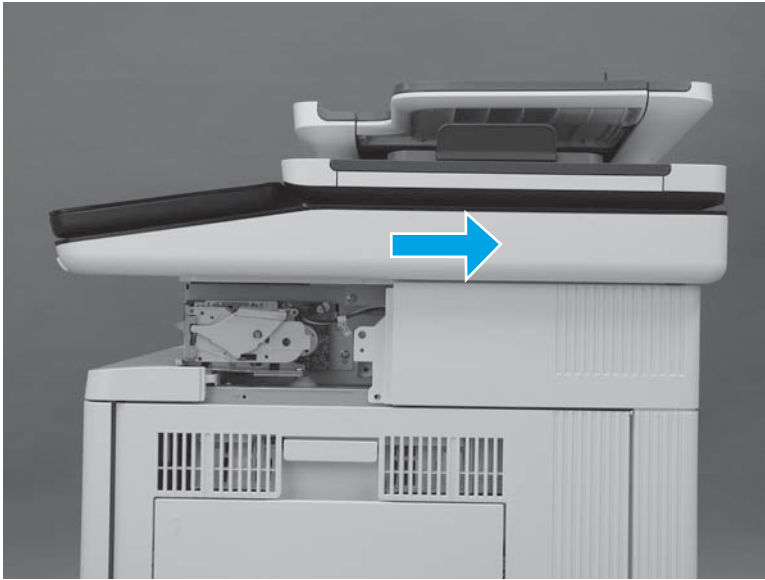

6. Lift the ISA up to remove it.

 **NOTE:** When lifting the ISA, carefully pass the cables through the opening in the top of the formatter case.

Figure 1-3980 Remove the ISA



Step 19: Remove the right upper cover (M577)

 **NOTE:** This step is for the M577 models. For the M552 and M553 models, skip this step and go to [Step 20: Remove the left cover on page 2224](#).

 **NOTE:** The figures below show the image scanner installed. The procedures for removing and installing the right upper cover are the same whether the image scanner is installed or removed."

1. At the right side of the printer, remove two screws (callout 1).

M577c/f/z only: Disconnect one connector (callout 2), if it was not already disconnected in a previous step.

Figure 1-3981 Remove two screws and one connector

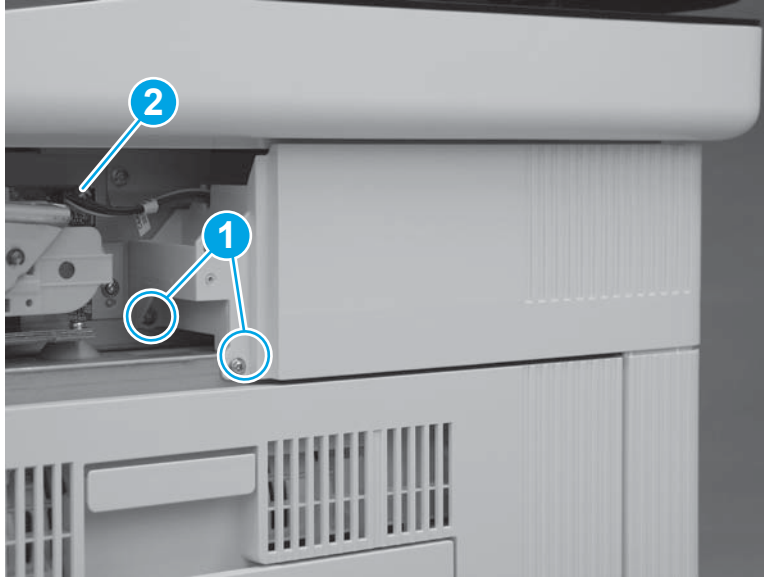

2. At the back of the printer, remove one screw (callout 1).

M577c/f/z only: Disconnect one connector (callout 2), if it was not already disconnected in a previous step.

 **Reinstallation tip:** This screw is smaller than the screws removed in the previous step. When reinstalling the right upper cover, make sure that this screw is installed in the correct position.

Figure 1-3982 Remove one screw and connector



3. Slide the cover toward the back of the printer.

Figure 1-3983 Slide the cover

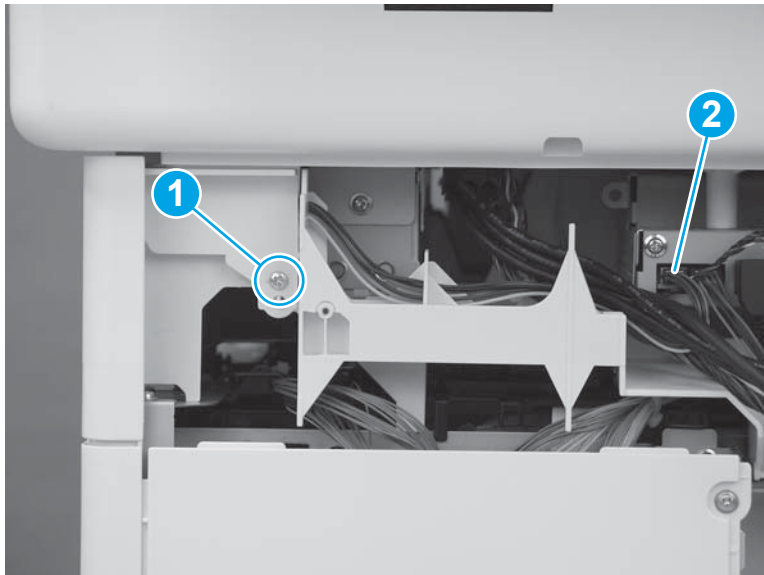
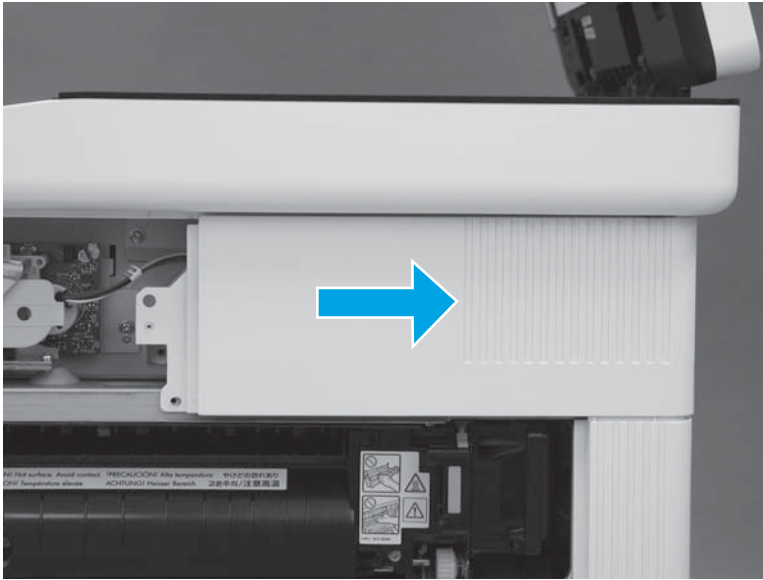

4. Lift the cover away from the printer to remove it.

M577c/f/z only: Release the cables (callout 1) through the slot (callout 2) in the printer.

Figure 1-3984 Remove the cover

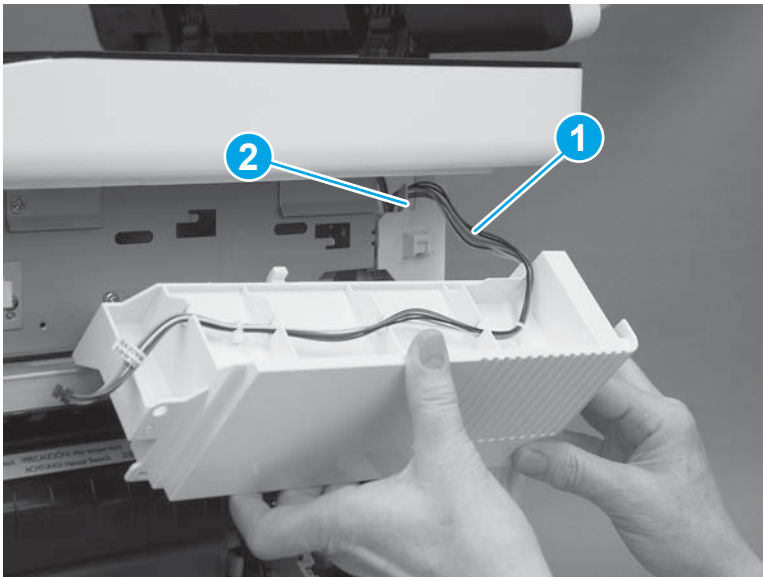

Step 20: Remove the left cover

1. At the left side of the printer, remove one screw (callout 1).

Figure 1-3985 Remove one screw



2. Release one tab (callout 1), rotate the front edge of the cover away from the printer (callout 2), and then slide the cover (callout 3) toward the rear of the printer to release it.

Figure 1-3986 Release the cover

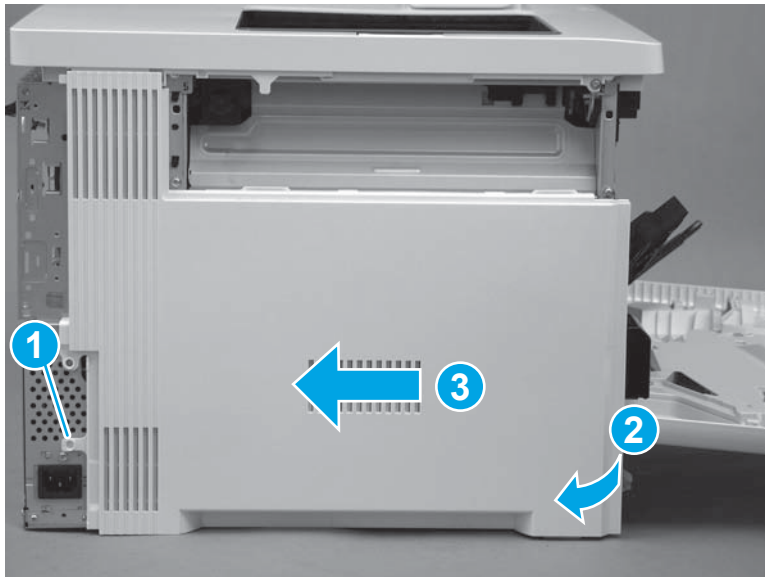

3. Remove the cover.

Figure 1-3987 Remove the cover

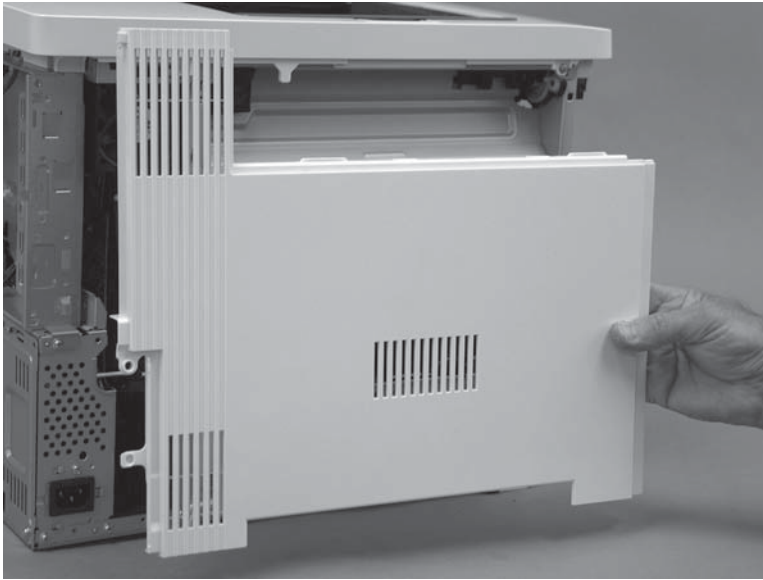

Step 21: Remove the upper cover (M552 and M553)

 **NOTE:** This step is for the M552 and M553 models. For the M577 models, skip this step and go to [Step 22: Remove the right rear cover on page 2228.](#)

1. Remove three screws (callout 1).

Figure 1-3988 Remove three screws

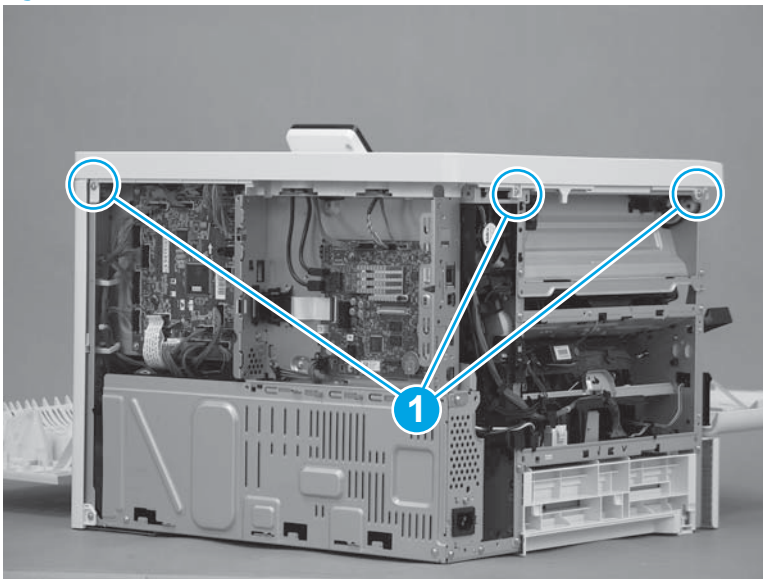

2. Remove one screw (callout 1), release one tab (callout 2), and then slightly separate the corner of the cover from the chassis.

 **NOTE:** This is a self-tapping plastic-thread screw. Make sure that this screw is used in this location when it is reinstalled.

Figure 1-3989 Remove one screw and release one tab



3. Release one tab (callout 1), and then lift up on the cover to release it.

 **NOTE:** If the cover does not release, check for addition tabs by locating the triangles embossed in the cover at tab locations.

Figure 1-3990 Release the cover



4. Remove the cover.

Figure 1-3991 Remove the cover

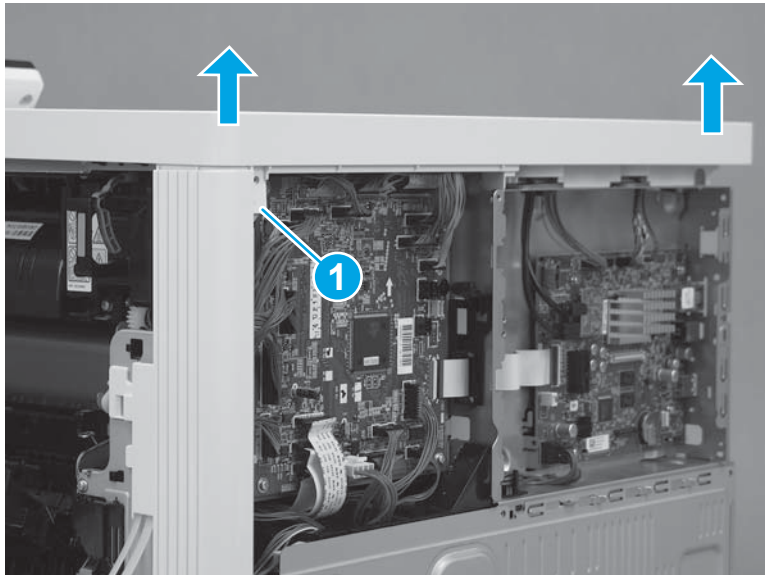
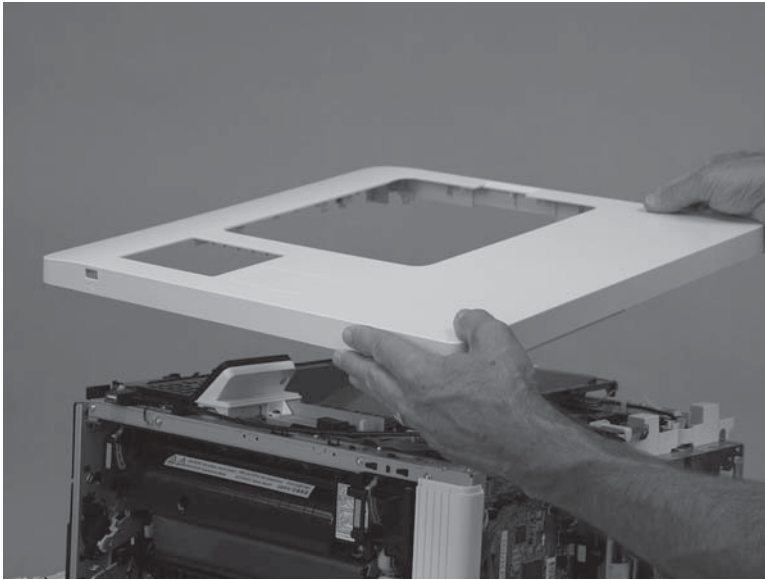

Step 22: Remove the right rear cover

1. Remove one screw (callout 1), and then slide the cover toward the rear of the printer (callout 2) to release it.

 **TIP:** If the right door is closed, open it now.

Figure 1-3992 Release the cover



2. Remove the cover.

Figure 1-3993 Remove the cover

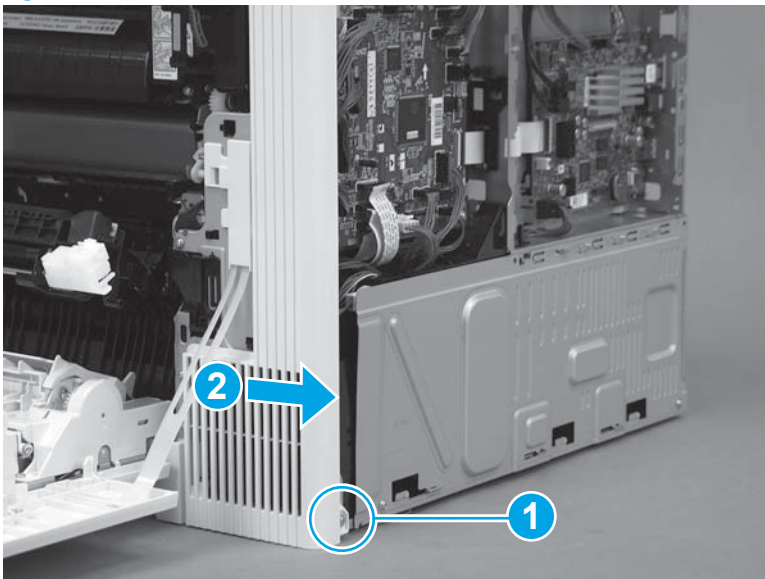
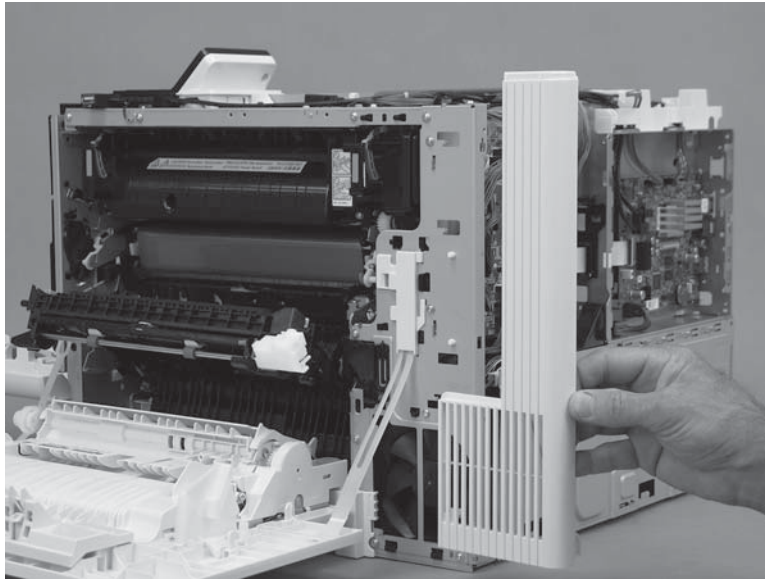

Step 23: Remove the formatter case

1. **M577 only:** Disconnect one connector (callout 1), and then pass the wire harness (callout 2) through two openings in the formatter case (callout 3).

Figure 1-3994 Disconnect one connector

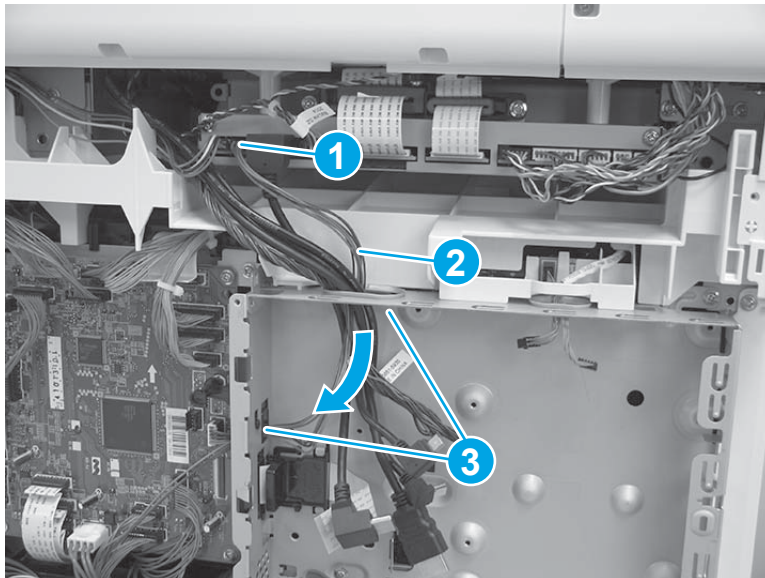

2. Release two tabs (callout 1) on the black plastic bracket. Hold the tabs in the released position, and then slide the bracket (callout 2) to the right to remove it from the formatter case.

Figure 1-3995 Remove the bracket

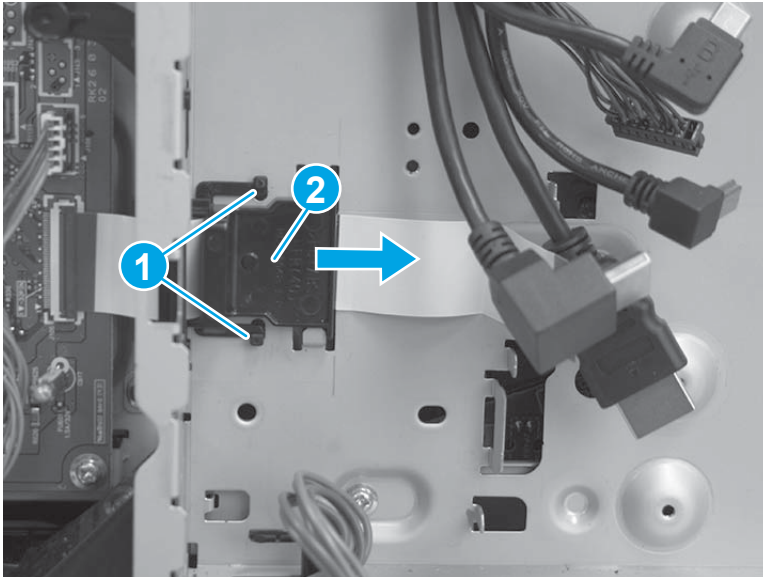

3. Remove two screws (callout 1), and then slide the low-voltage power supply (LVPS) cover to the right to remove it.

Figure 1-3996 Remove the LVPS cover

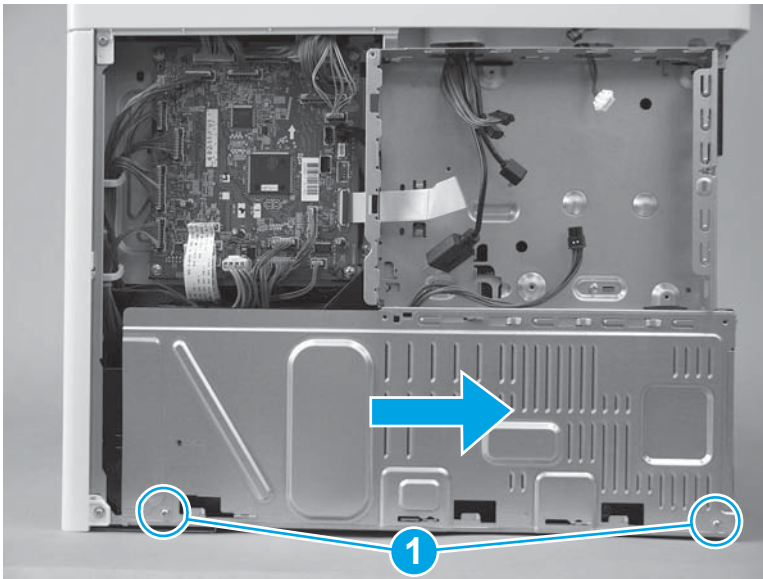

4. Pass two wire harnesses and one flat cable (callout 1) through the opening in the formatter case, and then release one wire harness from the retainer (callout 2).

⚠ CAUTION: The flat cable might be attached to the formatter case with double-sided tape. Make sure that this tape is released, so that the flat cable is not damaged when the formatter case is removed.

Figure 1-3997 Release wire harnesses and flat cable

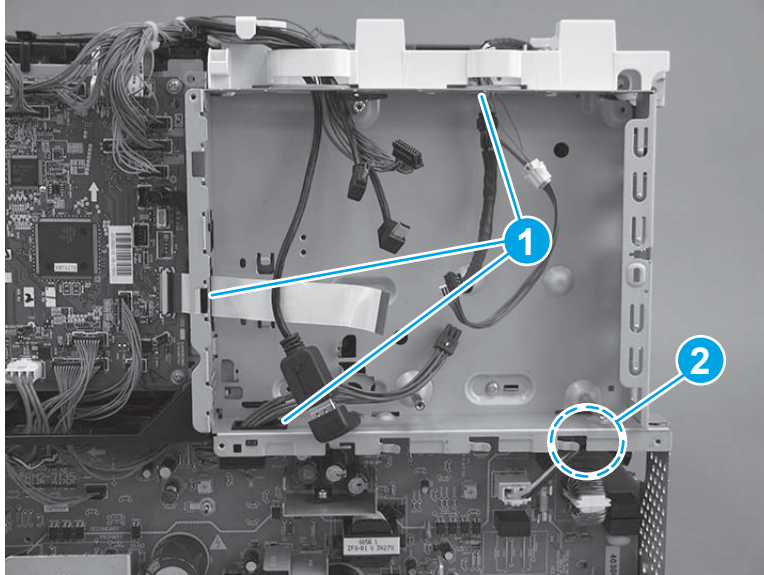

5. Remove six screws (callout 1).

Figure 1-3998 Remove six screws

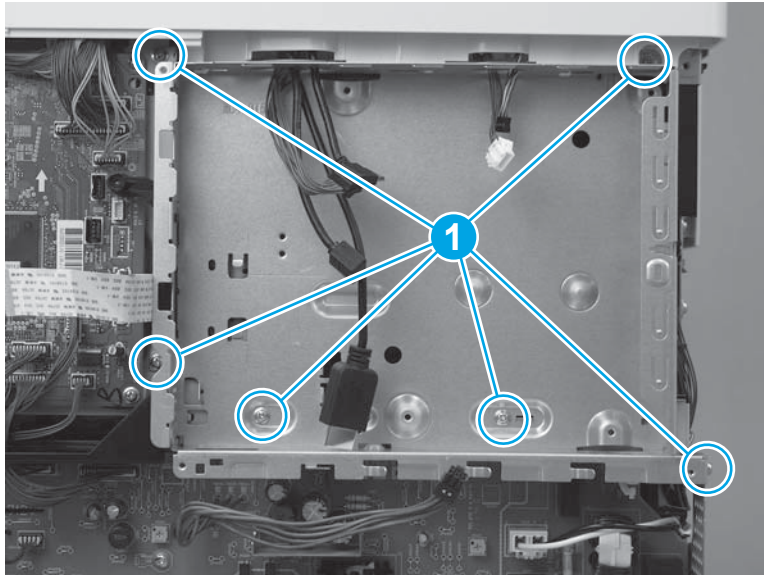

6. Rotate the bottom of the formatter case away from the printer (callout 1), and then pull it down (callout 2) to release it.

Figure 1-3999 Release the formatter case

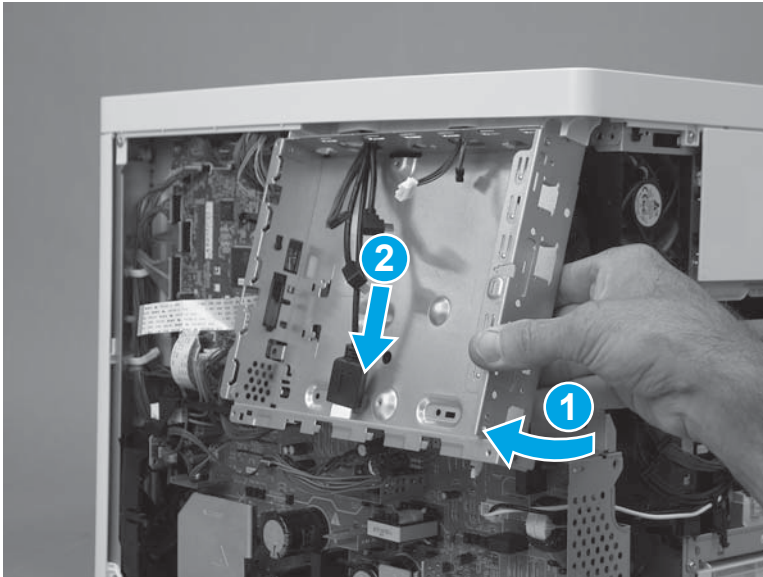

7. Pass the wire harnesses through the opening in the formatter case to remove it.

 **IMPORTANT:** If the formatter case is removed so that it can be replaced, make sure to transfer the memory PCA (island of data) and plastic bracket (callout 1) to the replacement case.

Figure 1-4000 Remove the formatter case

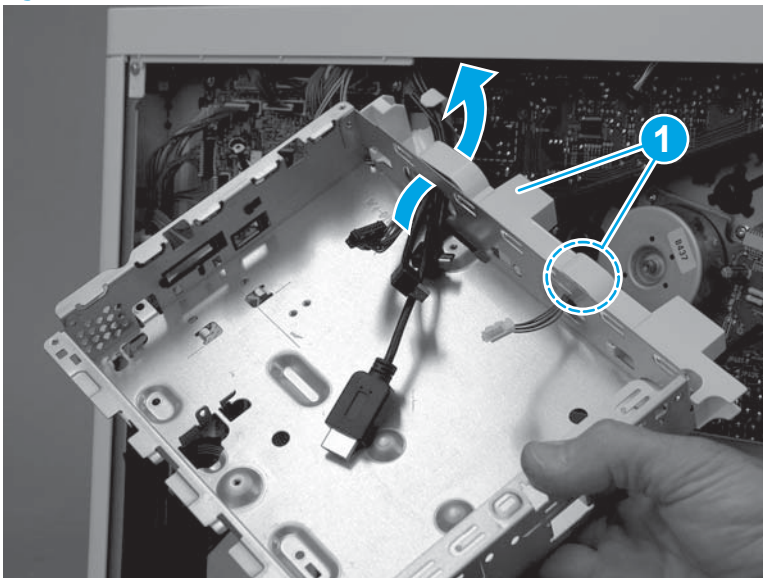

Step 24: Remove the low-voltage power supply (LVPS)

 **CAUTION:**  ESD-sensitive part.

1. Disconnect one wire harness (callout 1), and then pass the wire harness through the opening (callout 2) in the chassis.

Figure 1-4001 Disconnect one wire harness

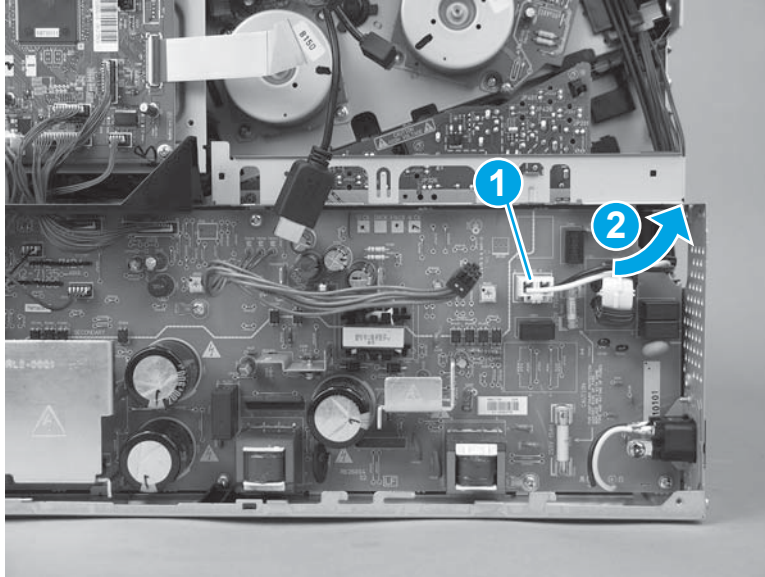

2. Disconnect three connectors on the DC controller (callout 1), and then disconnect four connectors (callout 2) on the LVPS.

Figure 1-4002 Disconnect seven connectors

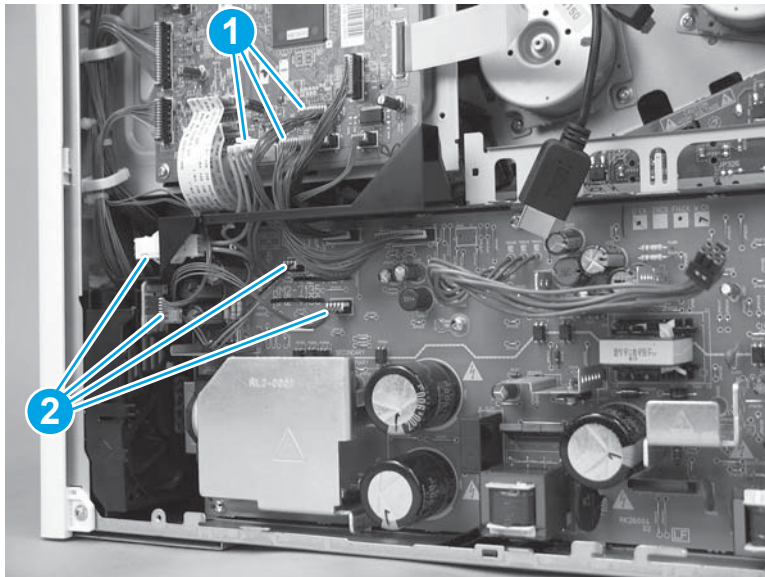

3. Pass the wire harnesses from the DC controller to the LVPS through the opening in the chassis (callout 1), and then release the wire harnesses from the retainer (callout 2).

Figure 1-4003 Pass the wire harnesses through the opening

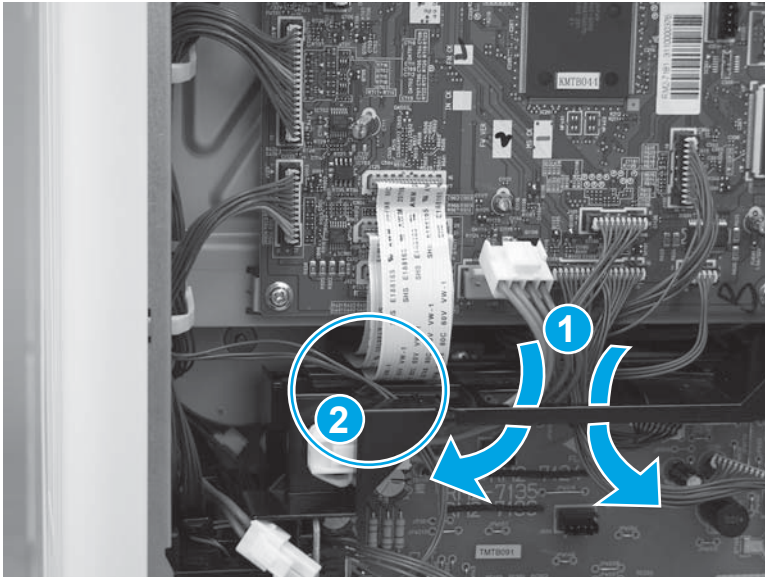

4. Remove three screws (callout 1).

Figure 1-4004 Remove three screws

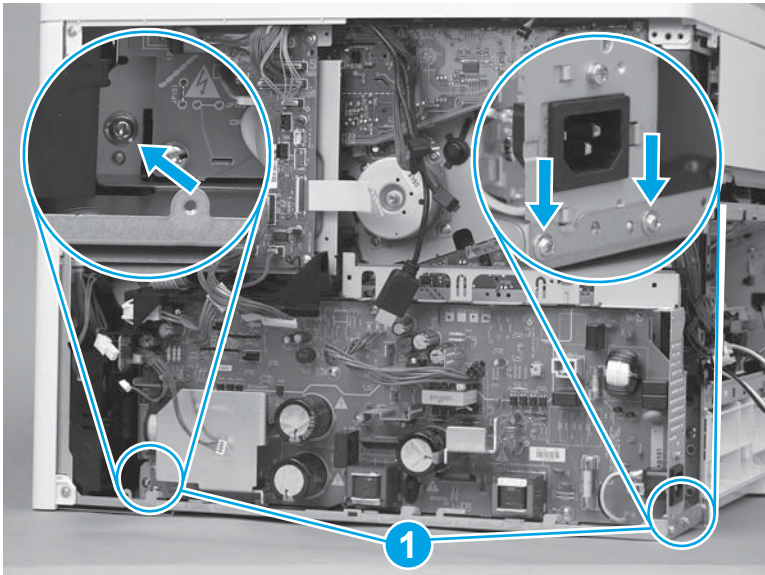

5. Rotate the top of the LVPS away from the printer (callout 1), and then slide it up and out (callout 2) of the printer to remove it.

Figure 1-4005 Remove the LVPS

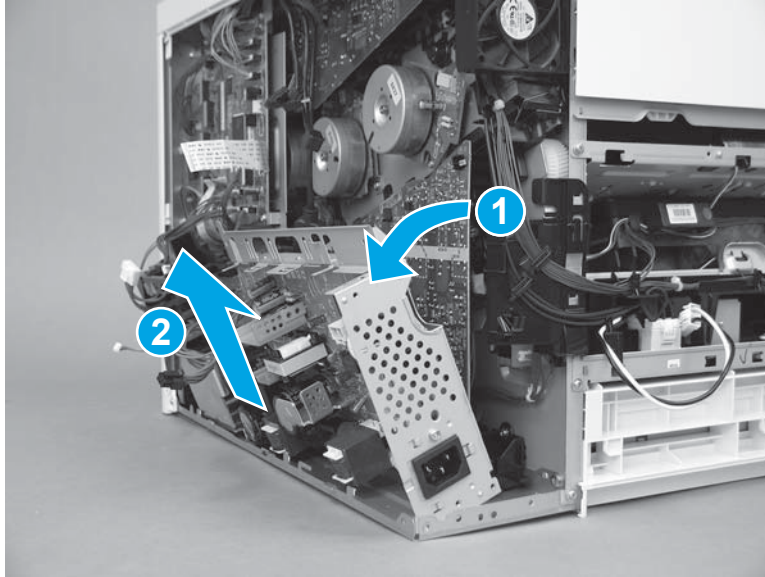

Step 25: Remove the power supply fan (FM1)

1. Remove one screw (callout 1).

Figure 1-4006 Remove one screw

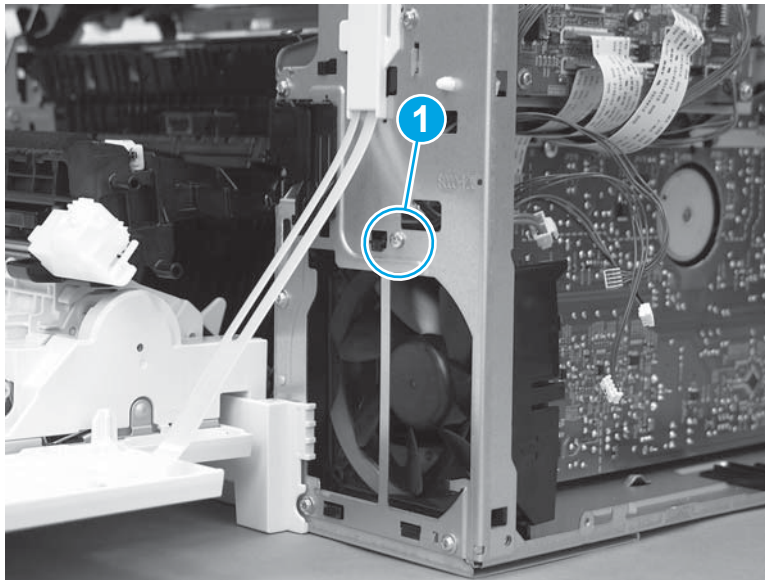

2. Release the wire harnesses from the retainer on the top of the fan bracket.

Figure 1-4007 Release the wire harnesses

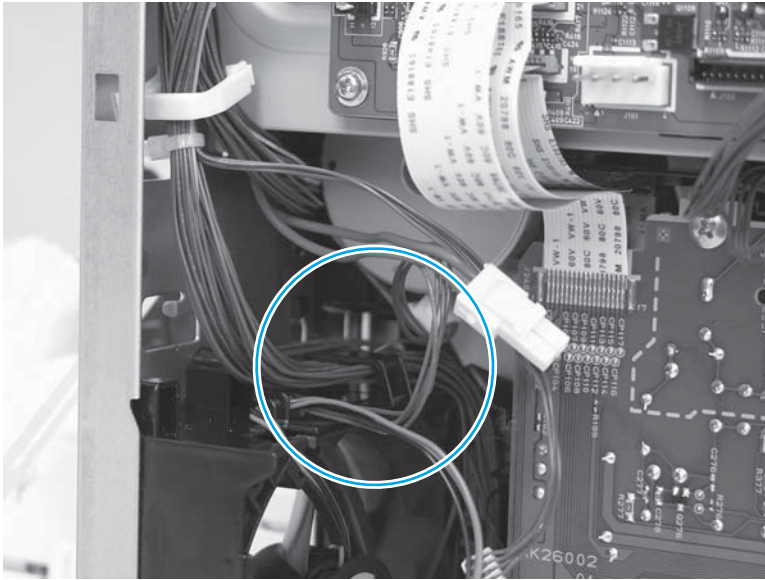

3. Lift the fan up (callout 1), and then slide it out of the printer (callout 2) to remove it.

Figure 1-4008 Remove the fan

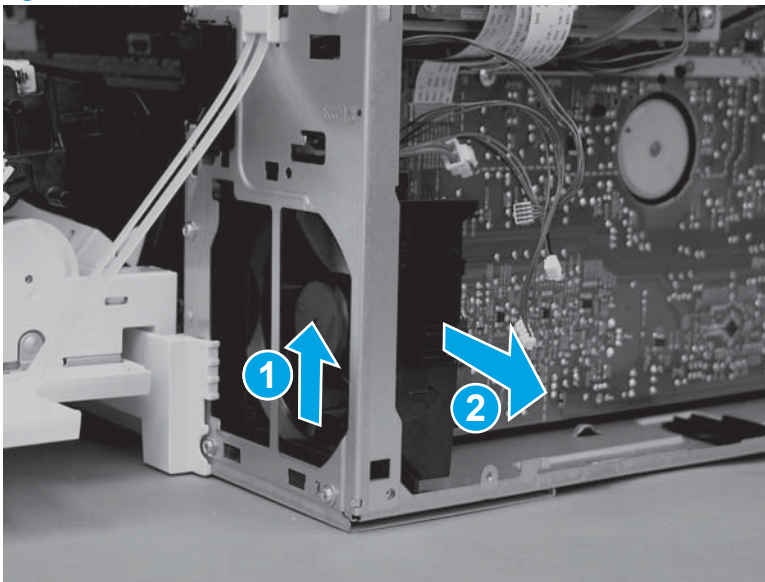

Step 26: Remove the high-voltage power supply D (HVPSD)

 **CAUTION:**  ESD-sensitive part.

1. Disconnect one flat cable (callout 1) on the DC controller.

Figure 1-4009 Disconnect one flat cable

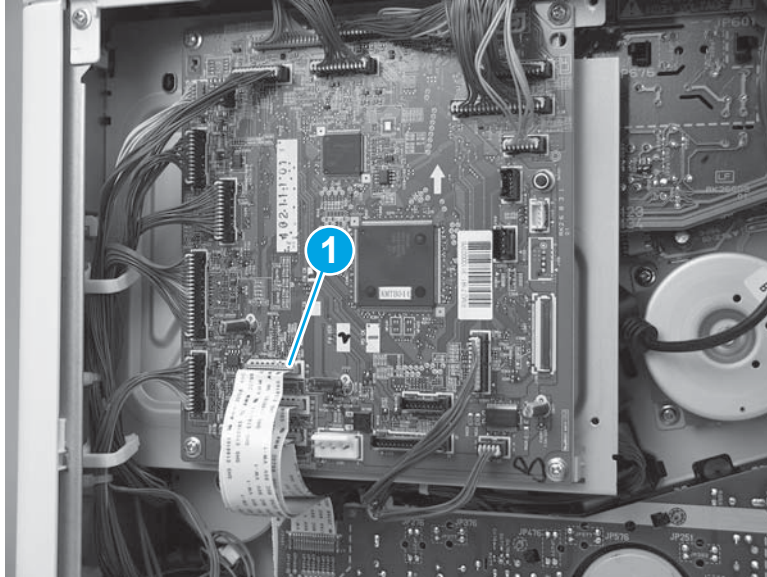

2. Remove two screws (callout 1), and then remove one self tapping screw (callout 2) on the HVPSD.

Figure 1-4010 Remove three screws

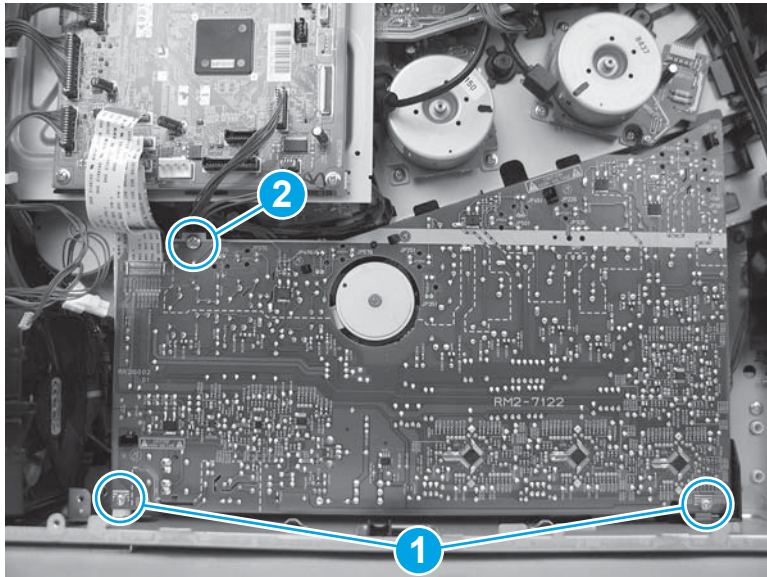

3. Release five tabs (callout 1), and then remove the HVPSD (callout 2).

Figure 1-4011 Remove the HVPSD

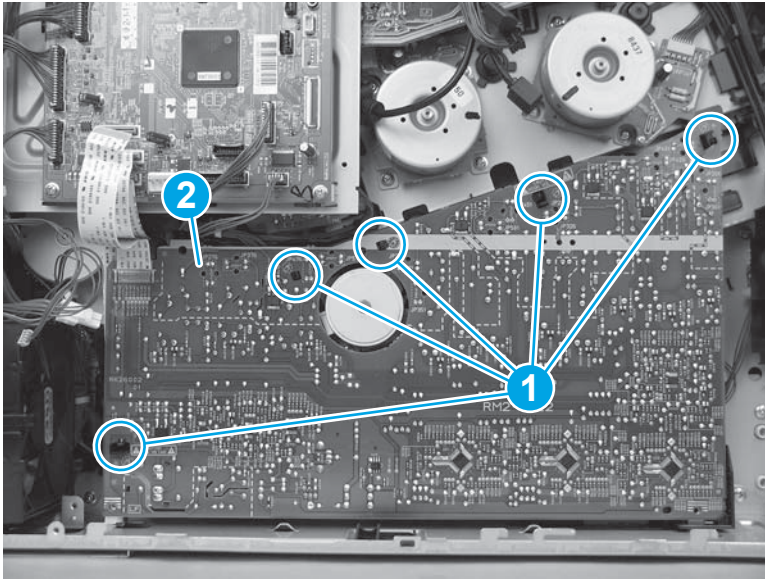

Step 27: Remove the lifter drive assembly

1. Disconnect two connectors (callout 1).

Figure 1-4012 Disconnect two connectors

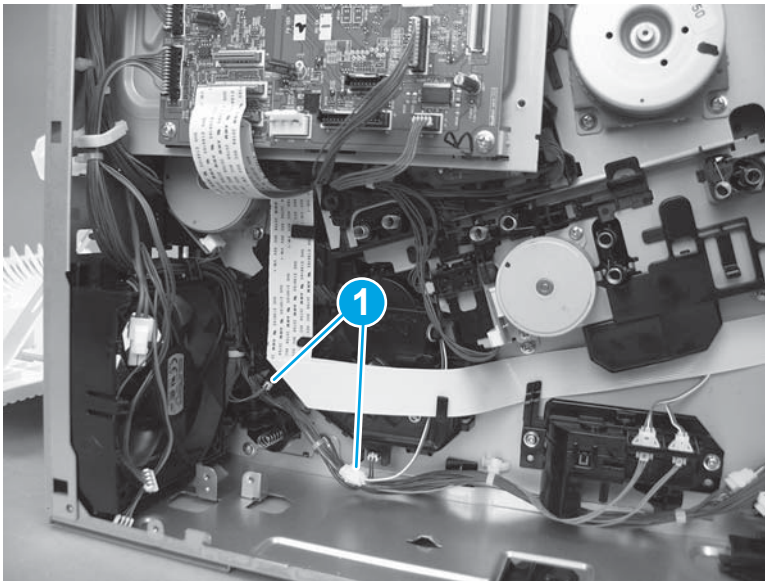

2. Disconnect two flat cables (callout 1), and then release them from the retainers (callout 2).

Figure 1-4013 Disconnect two flat cables

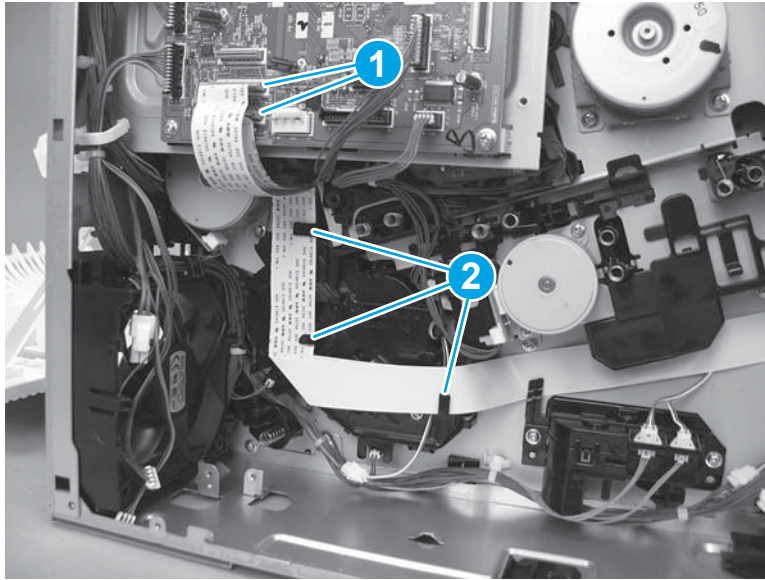

3. Remove two screws (callout 1), release one tab (callout 2), and then remove the lifter drive assembly (callout 3).

 **NOTE:** Release one wire harness from the retainer (callout 4) as the assembly is removed.

Figure 1-4014 Remove the assembly

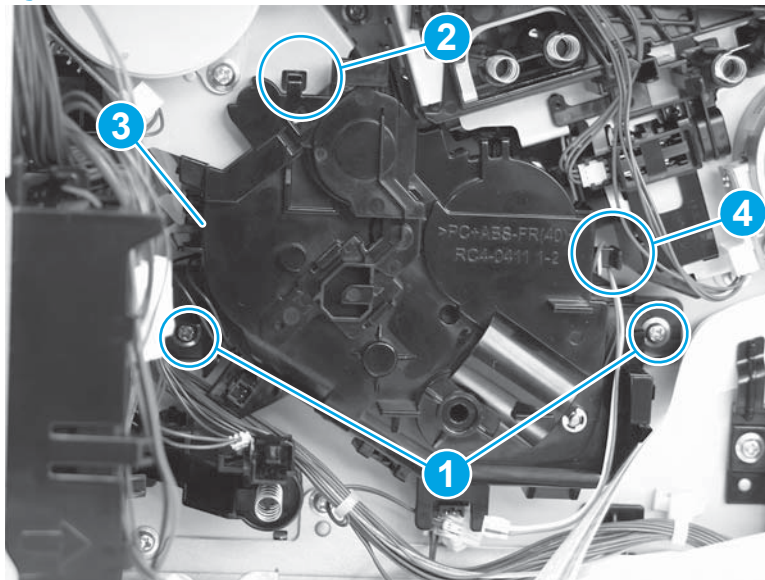

Step 28: Remove the DC controller and sheet-metal bracket

 **CAUTION:**  ESD sensitive part.

1. Disconnect all of the connectors, and then remove two screws (callout 1).

The following connectors are empty:

- J140, J141, and J143

Figure 1-4015 Remove two screws

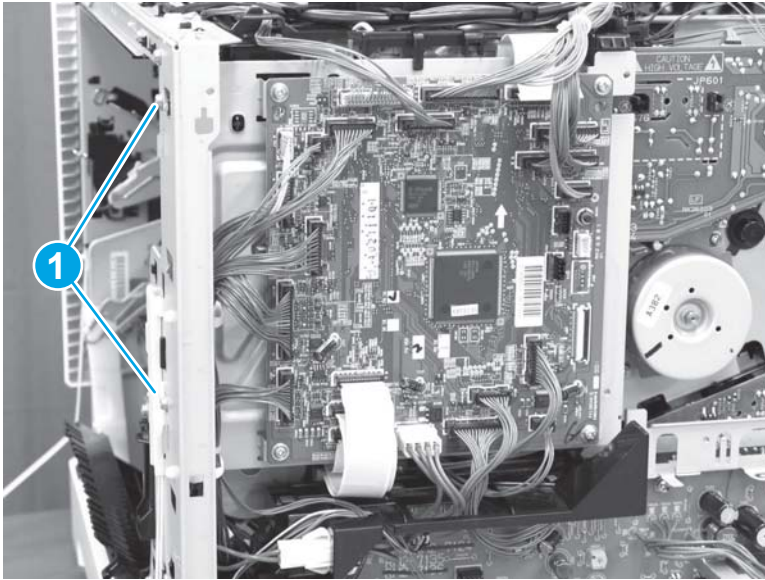

2. Lift up on the DC controller and sheet-metal plate to remove it.

Figure 1-4016 Remove the plate

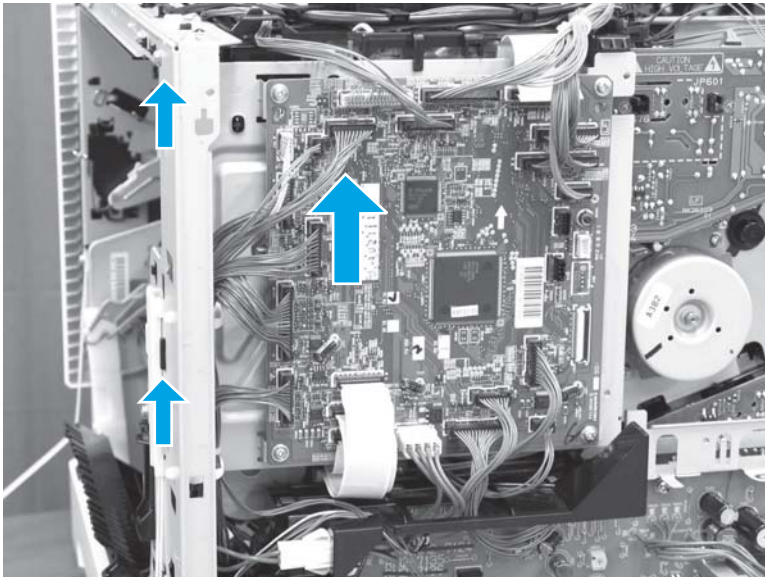

Step 29: Remove the pickup drive assembly and motor (M5)

1. Release one tab (callout 1), and then move the guide (callout 2) out of the way.

Figure 1-4017 Move the guide out of the way

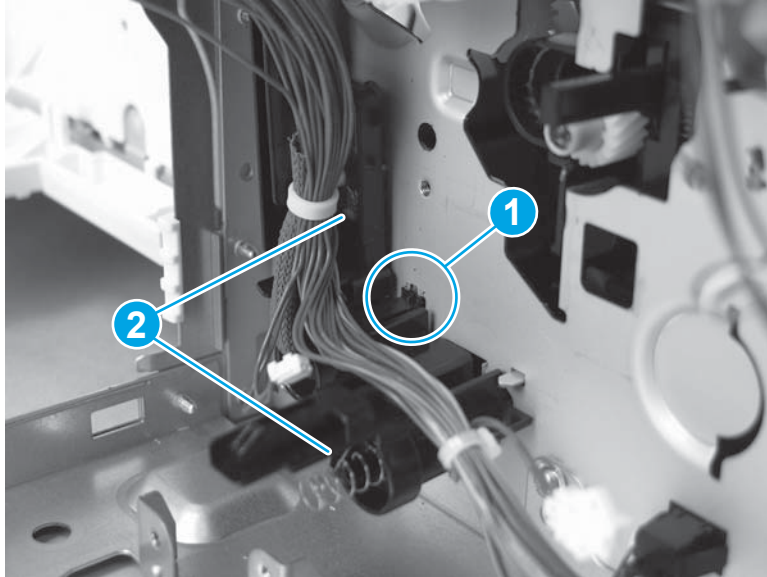

2. Remove three screws (callout 1).

Figure 1-4018 Remove three screws

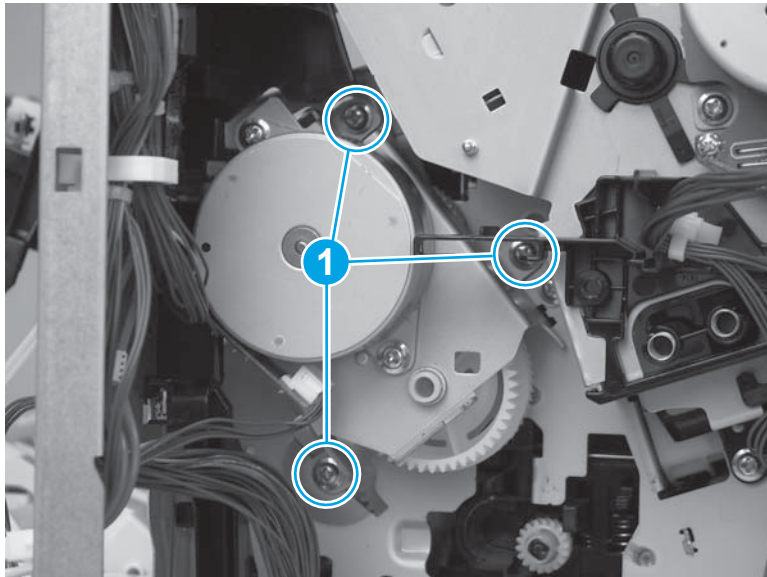

3. Remove the assembly.

⚠ CAUTION: One gear on the back side of the assembly is not captive. Handle the assembly carefully.

Figure 1-4019 Remove the assembly

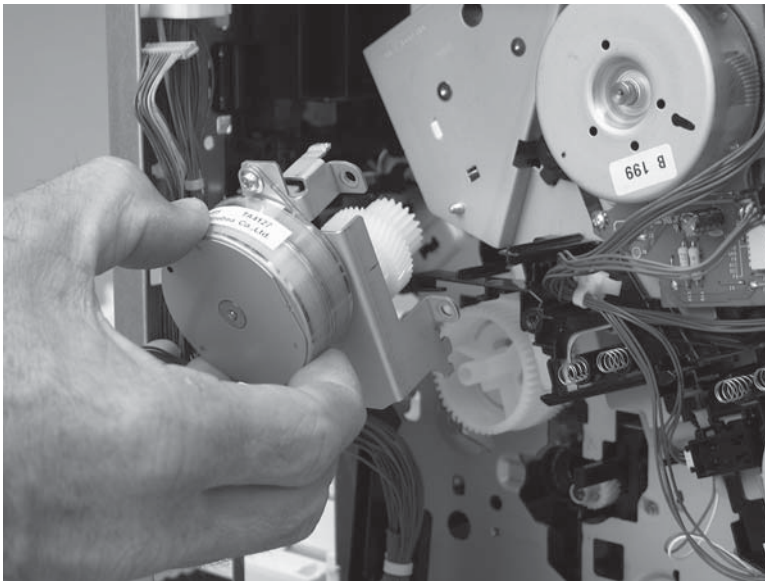

4. If the gear (callout 1) was not removed with the assembly in the previous step, remove it now.

Figure 1-4020 Remove the gear if installed

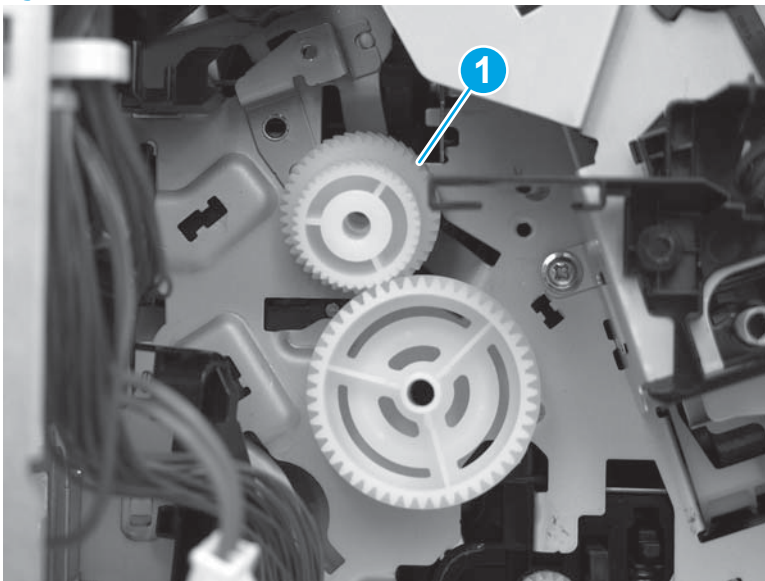

Step 30: Remove the registration assembly

1. At the right side of the printer, release one tab (callout 1).

Figure 1-4021 Release one tab

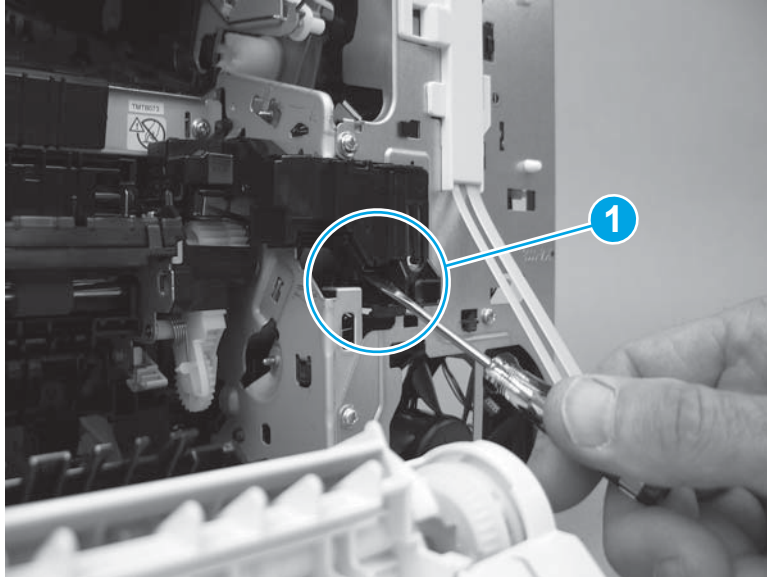

2. Remove the cover.

Figure 1-4022 Remove the cover

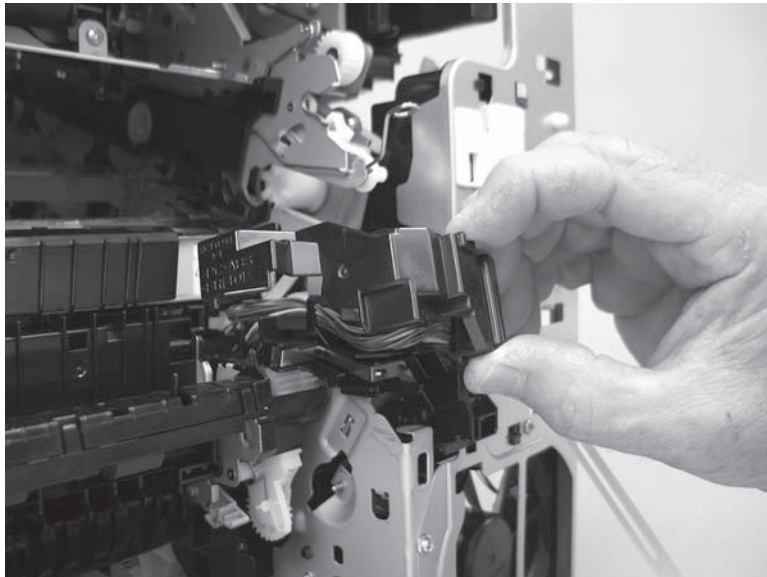

3. Release one tab (callout 1), and then push down on the guide (callout 2) to release it.

Figure 1-4023 Release the guide

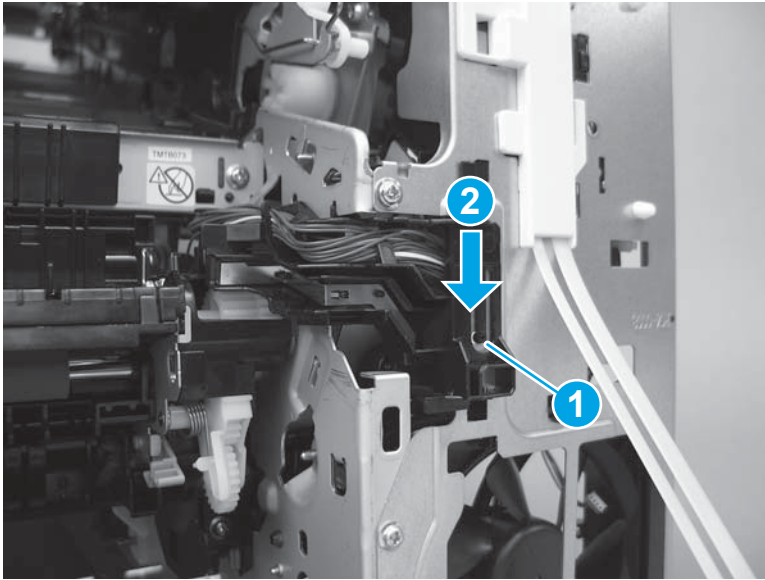

4. Move the guide out of the way.

Figure 1-4024 Move the guide out of the way

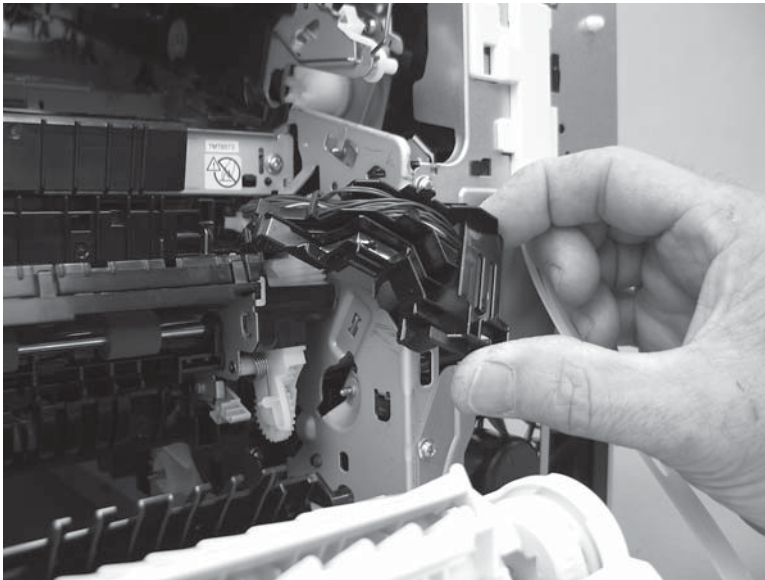

5. Remove three screws (callout 1).

Figure 1-4025 Remove three screws

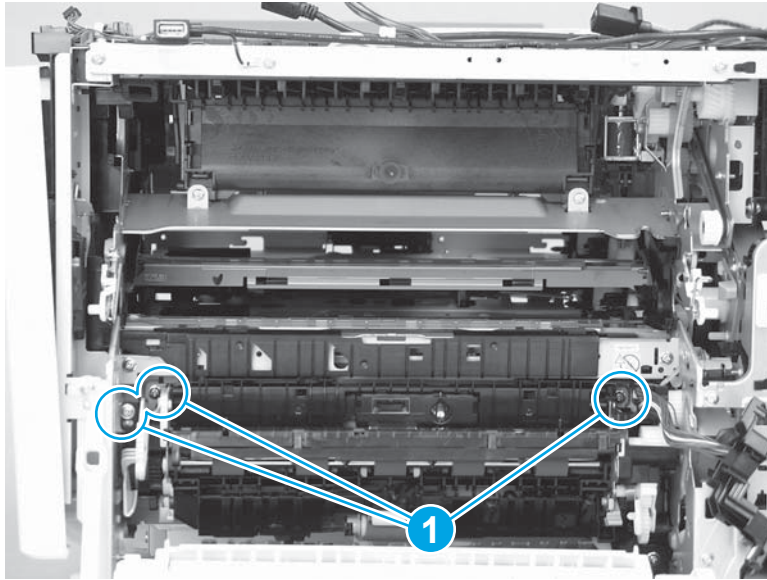

6. Before proceeding, locate the sheet metal portion (callout 1) of the assembly. When handling the assembly, use the sheet metal as handles.

Figure 1-4026 Locate the sheet metal portion of the assembly

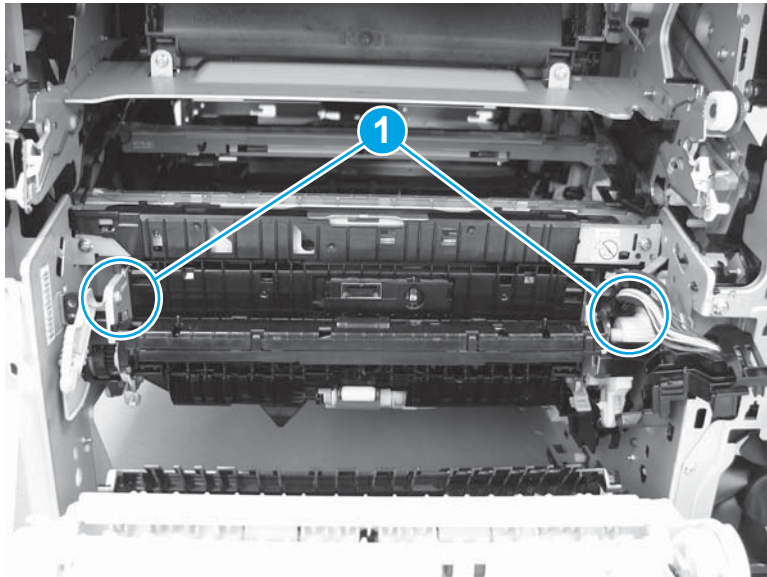

7. Before proceeding, take note of the sheet-metal tabs (callout 1) on the back of the assembly—the figure shows the assembly removed so the tabs can be viewed—that fasten it to the chassis.

Figure 1-4027 Take note of the sheet-metal tabs

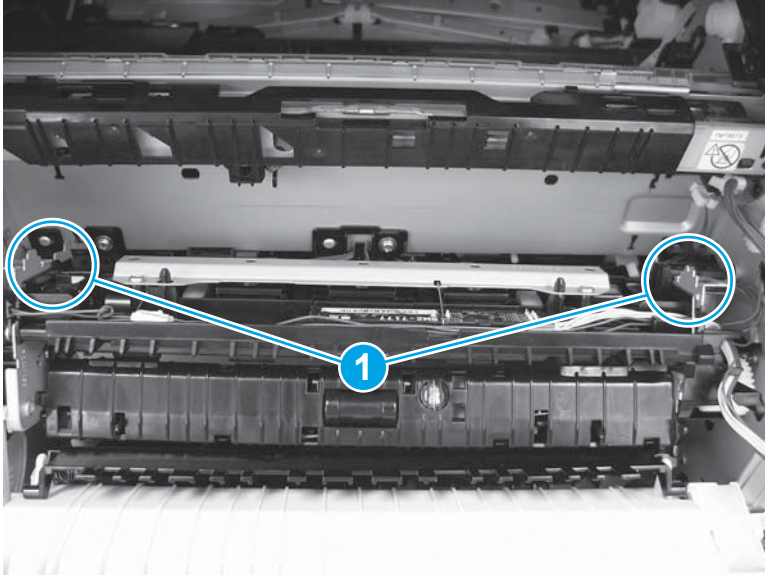

8. Grasp the sheet-metal handles (callout 1), and then rotate the top of the assembly away from the chassis (callout 2) to release the top tabs.

Figure 1-4028 Rotate the top of the assembly away from the chassis

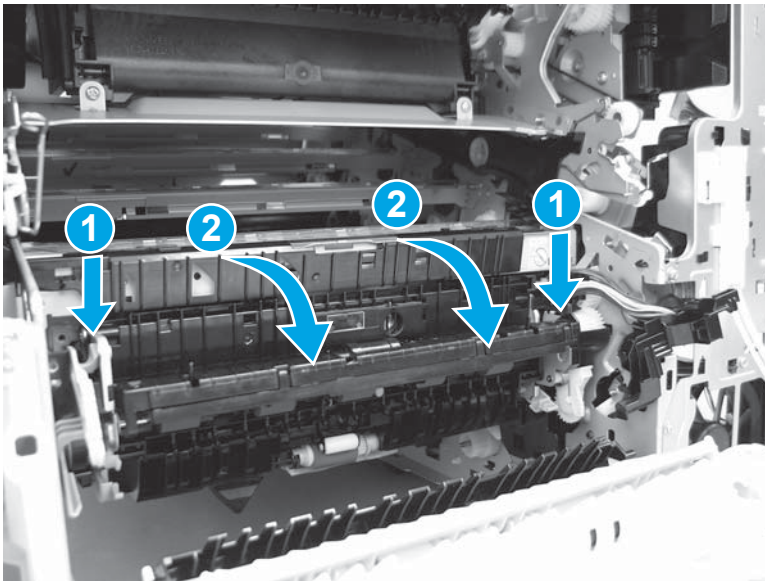

9. Pull up on the assembly to release the bottom tabs.

CAUTION: The assembly is still attached to the printer by a wire harness. Do not attempt to completely remove the assembly.

Figure 1-4029 Release the bottom tabs

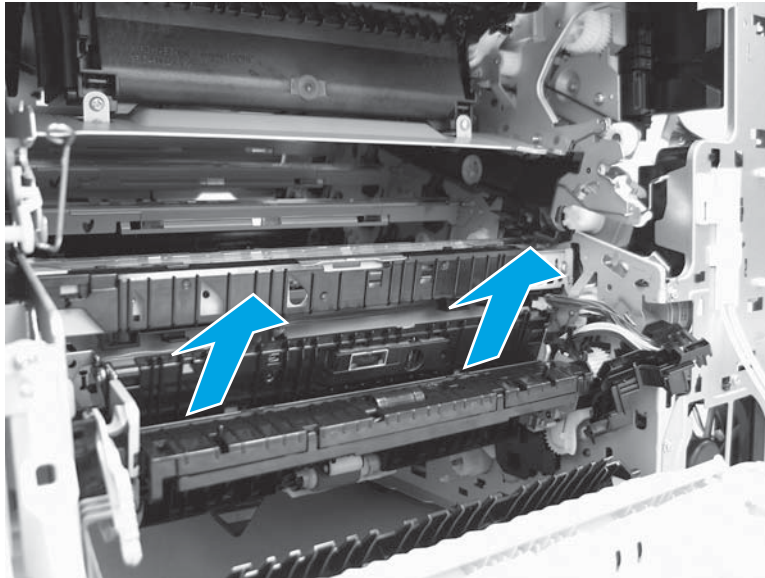

10. Turn the registration assembly over to access the back side, disconnect three connectors (callout 1), and then remove the assembly.

Figure 1-4030 Remove the assembly

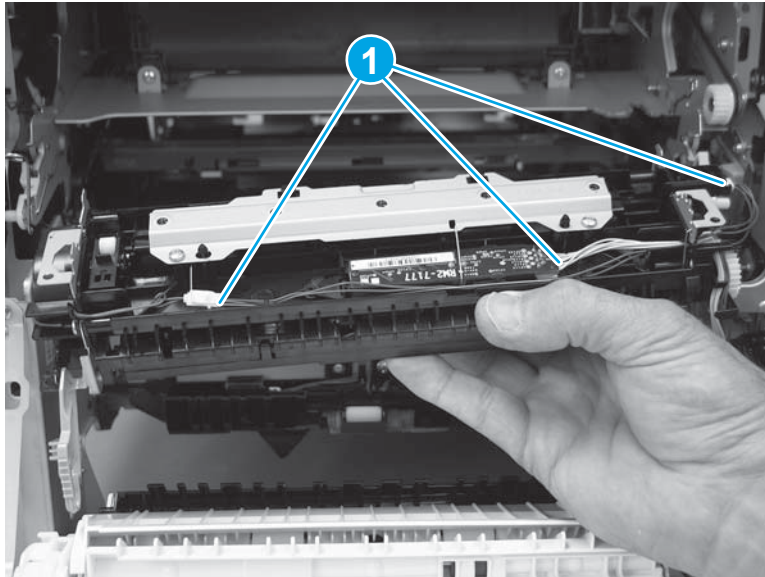

Step 31: Unpack the replacement assembly

Unpack the replacement assembly from the packaging.

For complete information on HP's recycling programs, go to [Product return and recycling](#).

NOTE: HP recommends responsible disposal of the defective assembly.

Figure 1-4031 Recycle and unpack

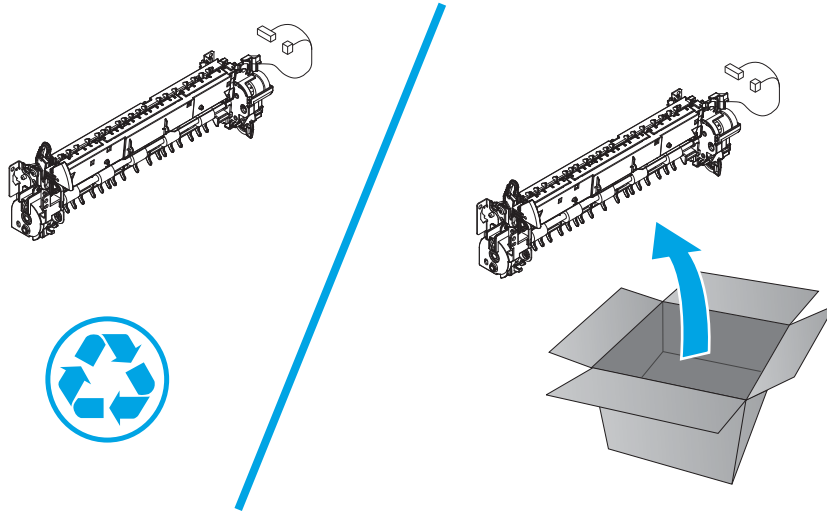

Step 32: Install the registration assembly

1. Turn the registration assembly over to access the back side, and then connect three connectors (callout 1).

Figure 1-4032 Connect three connectors

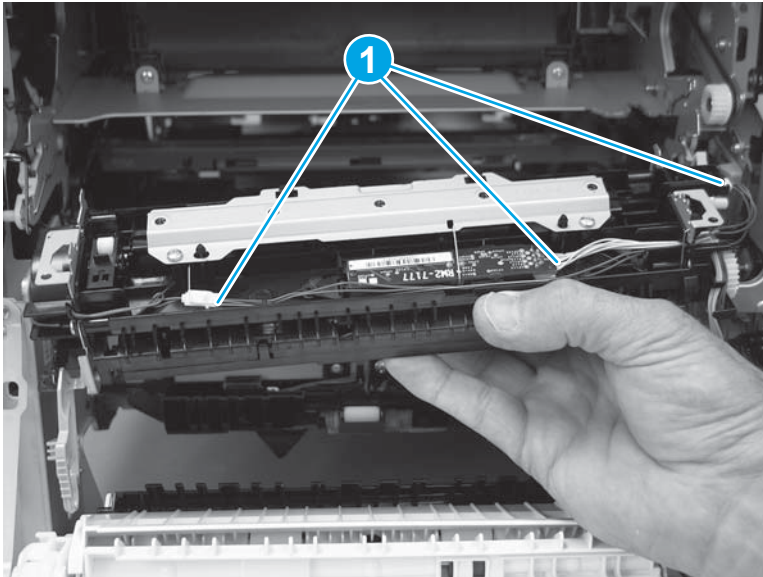

2. Align the tabs on the assembly with the slots in the chassis.

Figure 1-4033 Align the tabs on the assembly with the slots

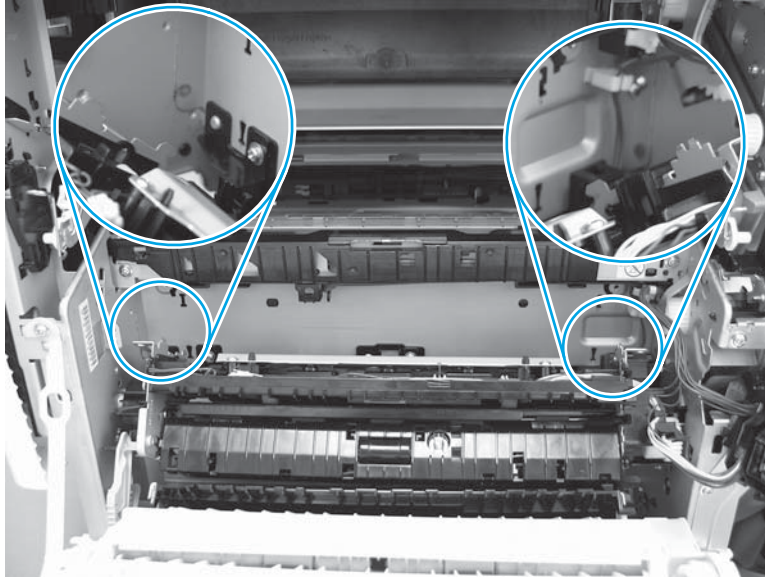

3. Position the bottom tabs in the appropriate slots, and then push down on the assembly to engage them.

Figure 1-4034 Install the bottom tabs

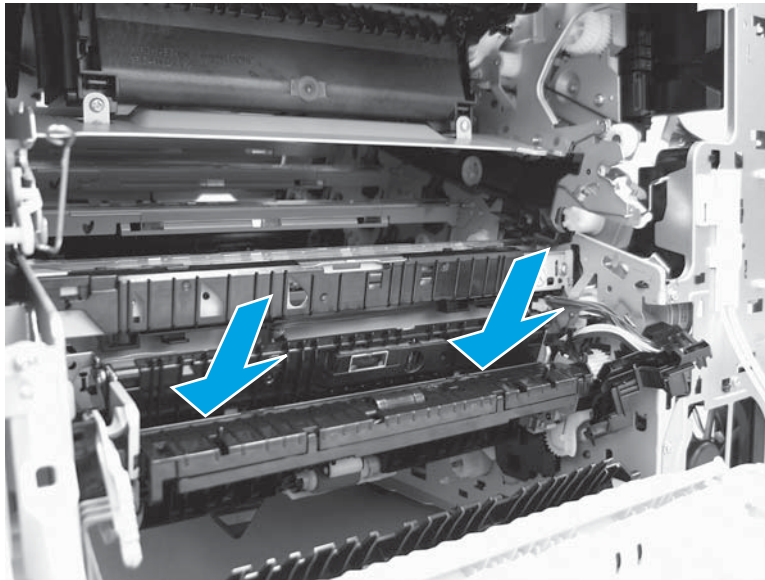

4. Grasp the sheet-metal handles (callout 1) to rotate the top of the assembly toward the chassis (callout 2) to install the top tabs.

Figure 1-4035 Install the top tabs

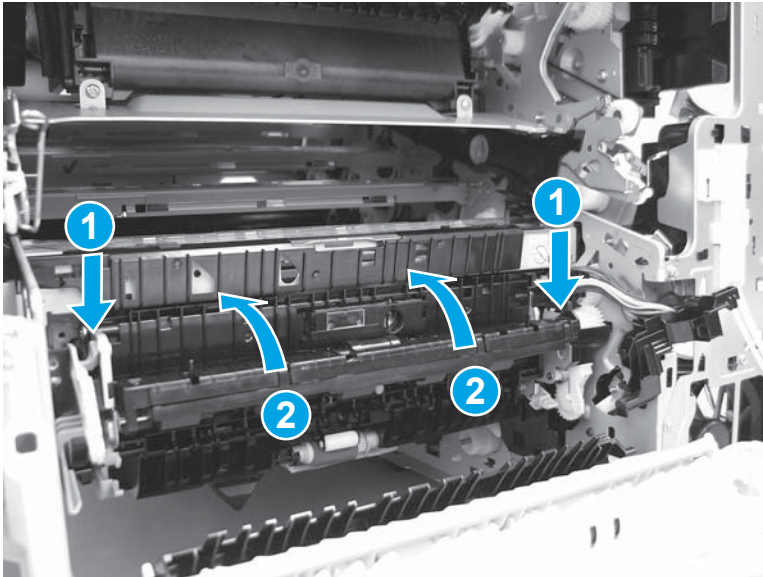

5. Install three screws (callout 1).

Figure 1-4036 Install three screws

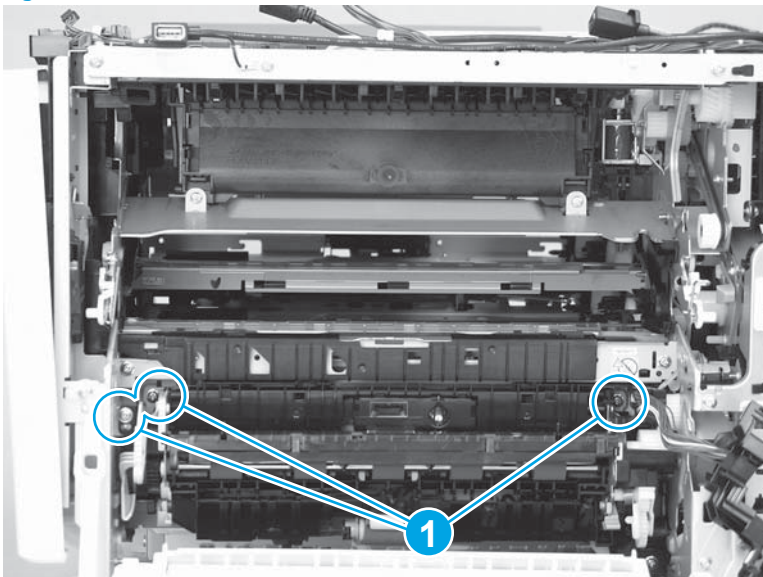

6. Position the guide on the chassis.

Figure 1-4037 Position the guide on the product

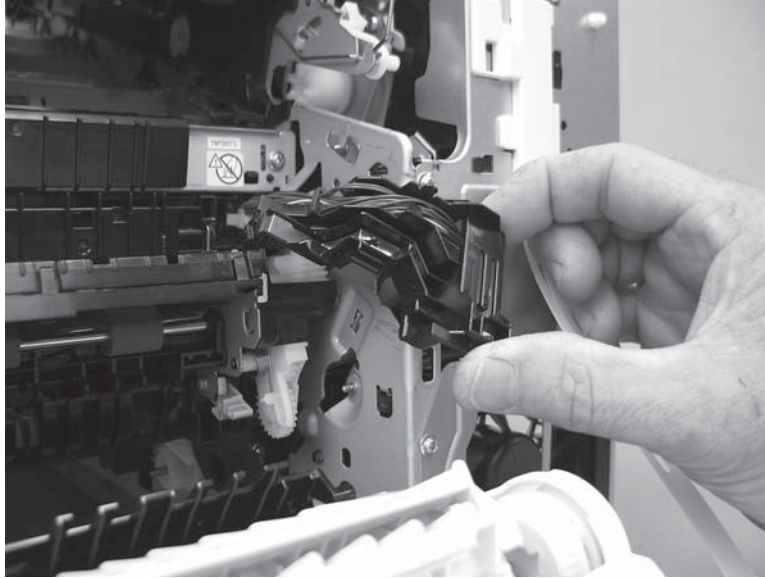

7. Slide the guide up to install it (callout 1), and then make sure that the tab (callout 2) snaps into place.

Figure 1-4038 Install the guide

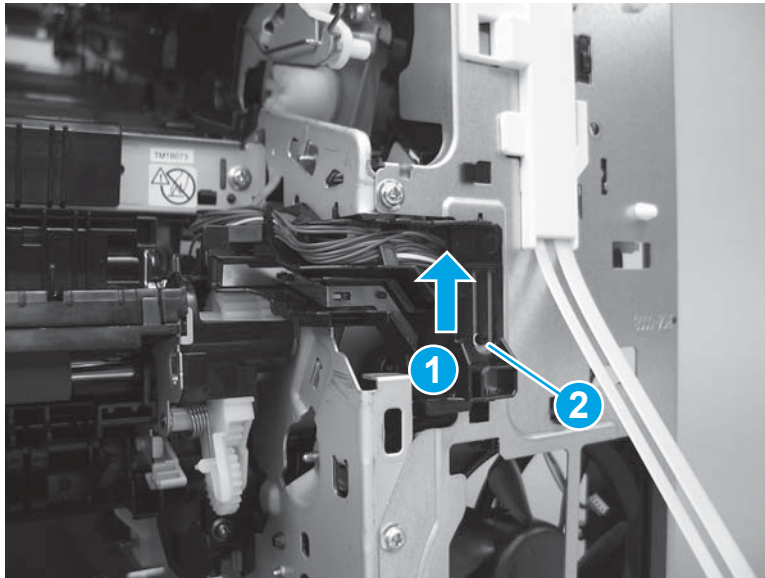

8. Position the cover on the printer.

Figure 1-4039 Position the cover on the product

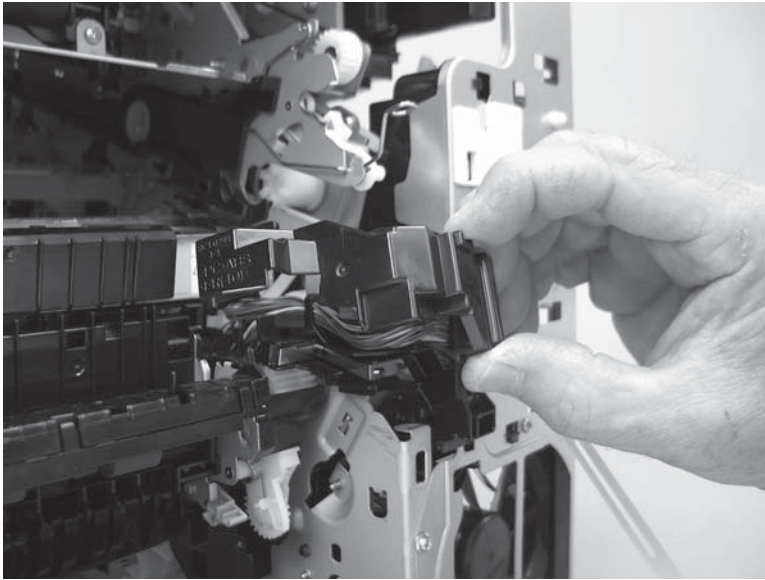

9. Install the cover, and then make sure that the tab (callout 1) snaps into place.

Figure 1-4040 Install the cover

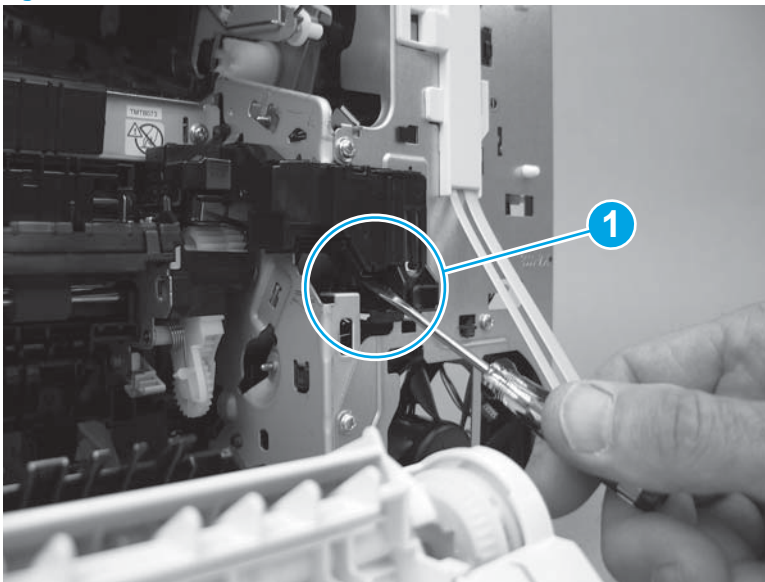

Step 33: Install the pickup drive assembly and motor (M5)

1. Before installing the assembly, check to see if a gap exists (callout 1) between the gears.

 **NOTE:** If no gap exists, go to step [3](#) in this section.

Figure 1-4041 Check the gears for a gap

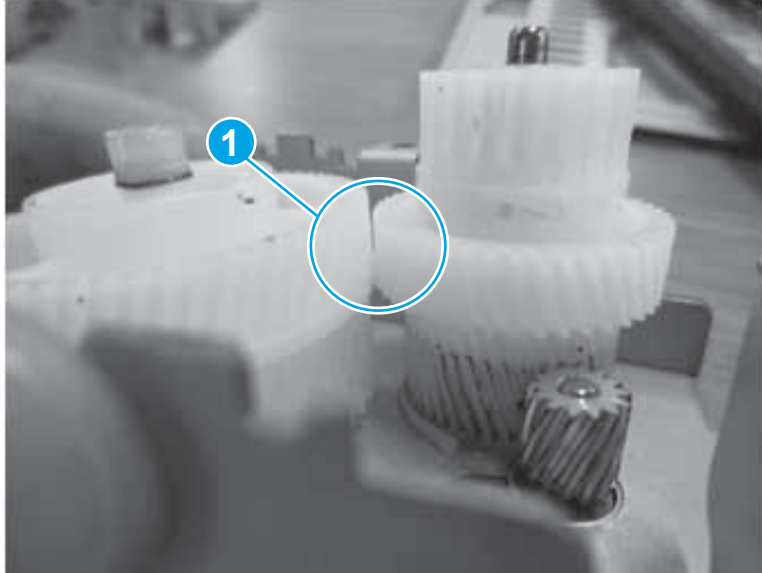

2. Adjust the gears on the assembly to remove the gap (callout 1).

Figure 1-4042 Adjust the gears

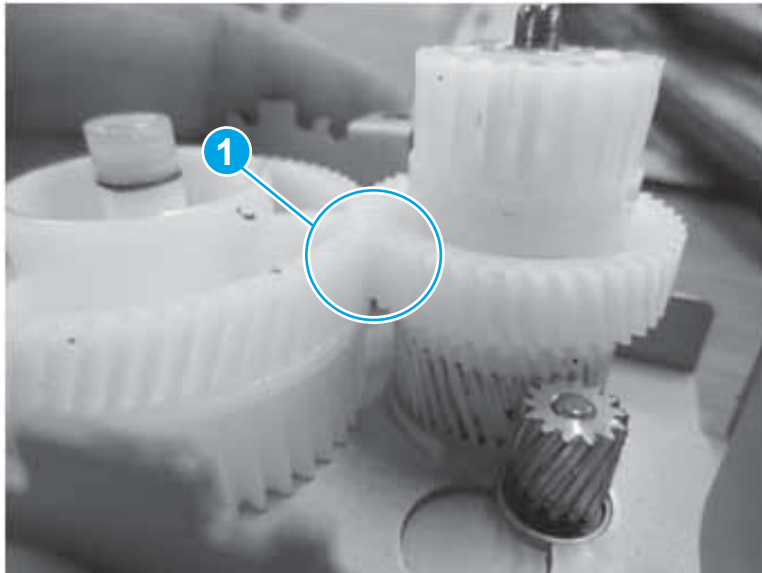

3. Align the tabs on the pickup drive assembly with the slots in the chassis, and then install the assembly on the printer.

 **IMPORTANT:** The figure below shows the large gear of the assembly already installed on the printer chassis. However it is easier to install the pickup drive assembly if the gear is installed on the assembly.

 **TIP:** With the right door open, look into the printer and verify that the mounting bracket for the assembly is correctly installed against the chassis.

Figure 1-4043 Install the assembly



4. Install three screws (callout 1).

Figure 1-4044 Install three screws

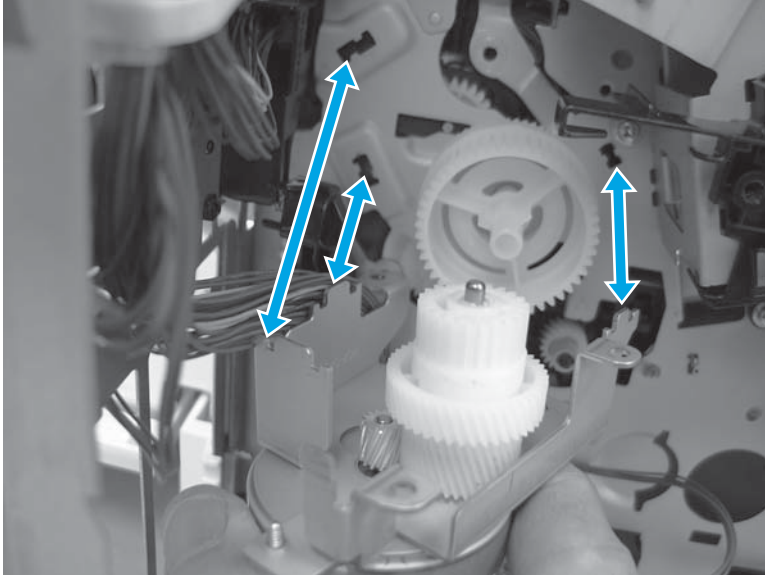
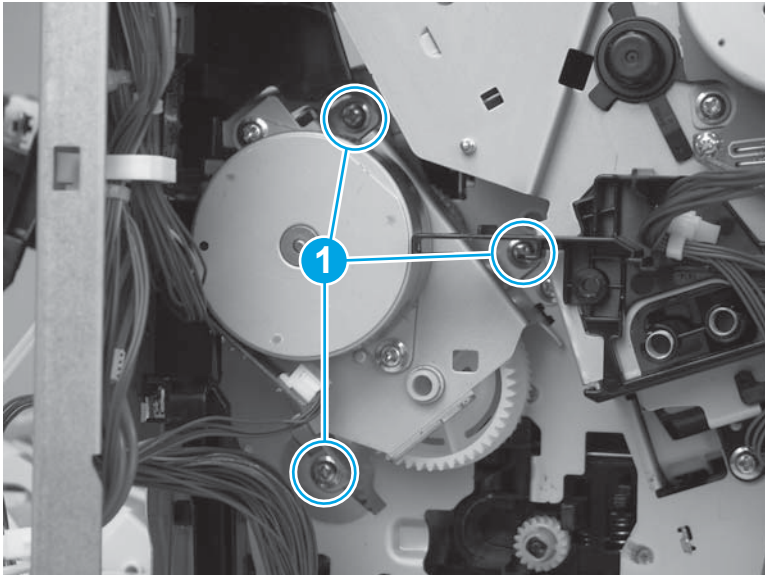

5. Install the guide (callout 1). Make sure that the tab (callout 2) snaps into place.

Figure 1-4045 Install the guide

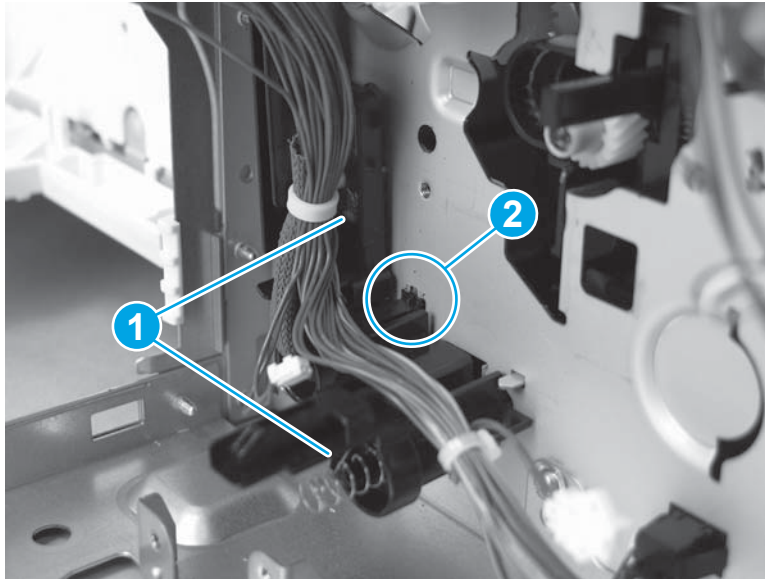

Step 34: Install the DC controller and sheet-metal bracket

 **CAUTION:**  ESD-sensitive part.

1. Position the DC controller and sheet-metal plate on the printer, and then push down to engage the plate with the chassis.

Figure 1-4046 Install the plate

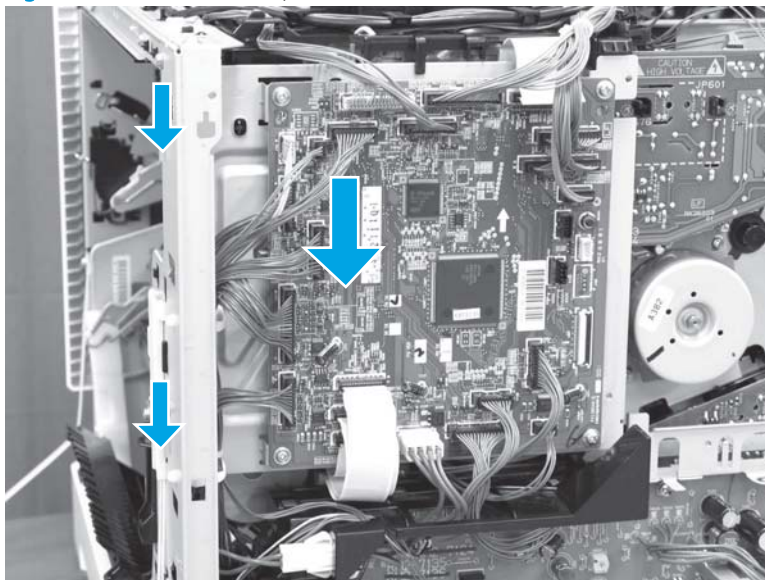

2. Install two screws (callout 1), and then connect all of the connectors.

The following connectors are empty:

- J140, J141, and J143

Figure 1-4047 Install two screws

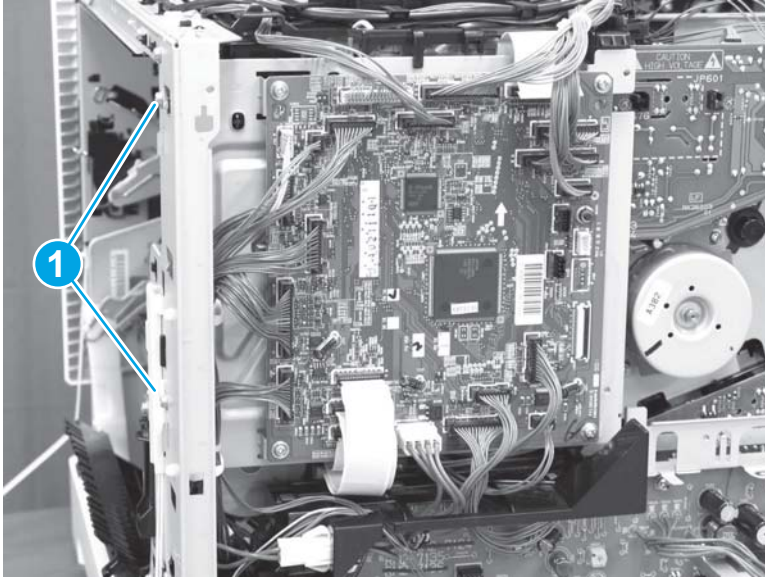

Step 35: Install the lifter drive assembly

1. Install one wire harness on the retainer (callout 1), position the lifter drive assembly in the printer (make sure that one tab (callout 2) snaps into place), and then install two screws (callout 3).

 **TIP:** It might be easier to install the assembly if the bottom of the assembly is installed first, and then the top of the assembly is rotated into place.

Figure 1-4048 Install the lifter drive



2. Connect two flat cables (callout 1), and then place them in the retainers (callout 2).

Figure 1-4049 Connect two flat cables

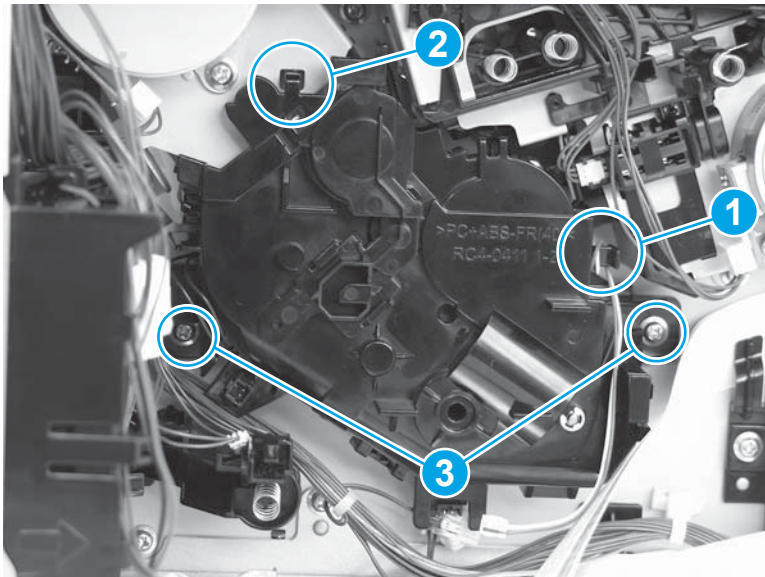
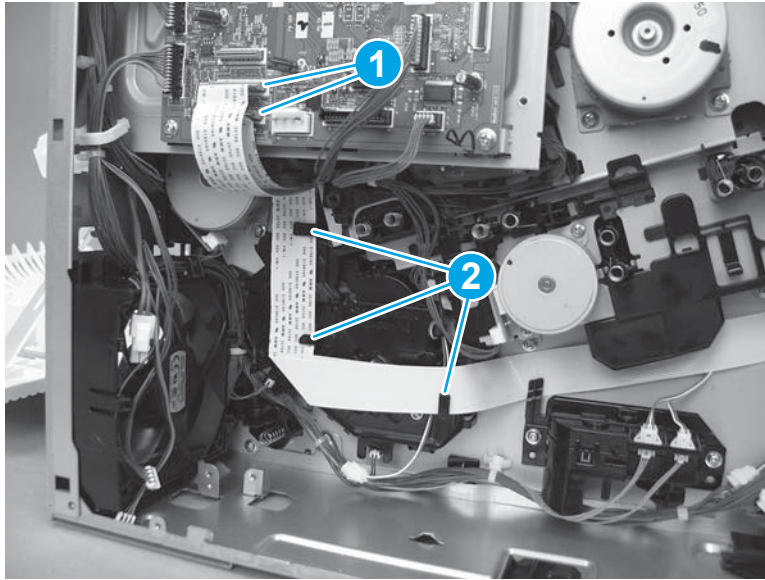

3. Connect two connectors (callout 1).

Figure 1-4050 Connect two connectors

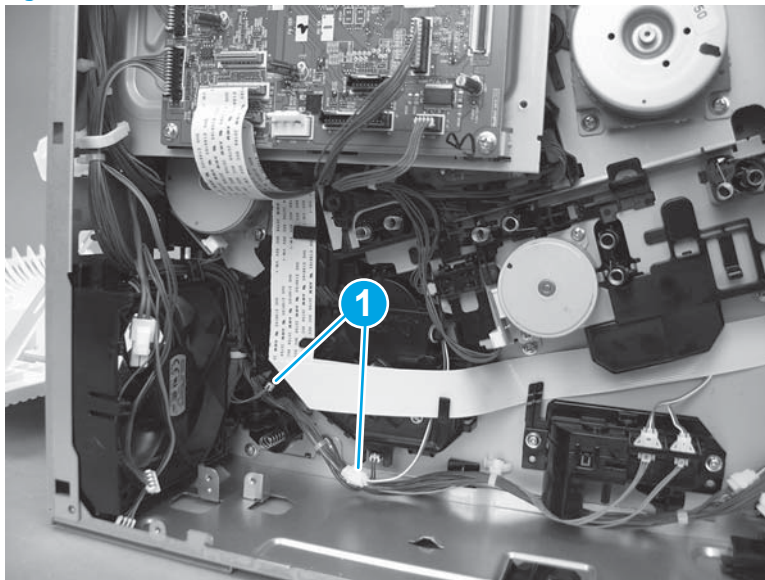

Step 36: Install the HVPSD

 **CAUTION:**  ESD-sensitive part.

1. Position the bottom right corner of the HVPSD (callout 1) behind the black tab, and then rotate it up and onto the printer (callout 2).

Figure 1-4051 Install the HVPSD

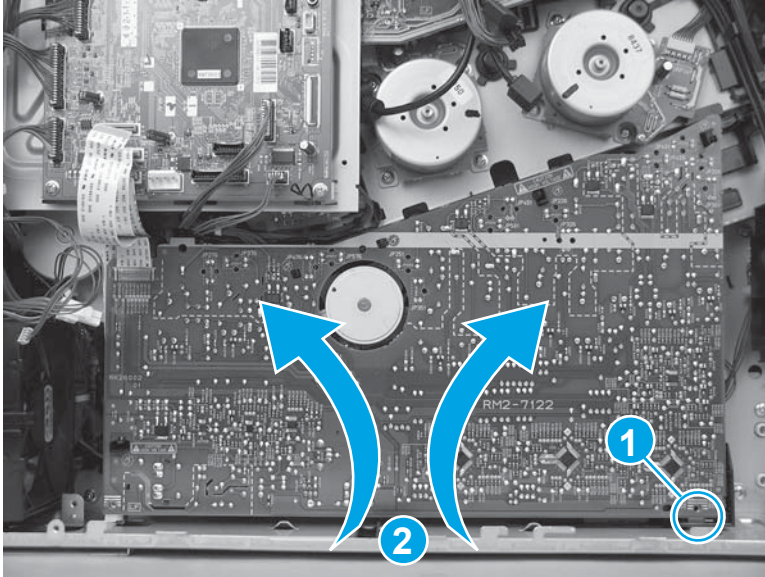

2. Press it onto five tabs (callout 2).

 **IMPORTANT:** Make sure that all five tabs snap into place.

Figure 1-4052 Press the tabs



3. Install two screws (callout 1), and then install one self tapping screw (callout 2) on the HVPSD.

Figure 1-4053 Install three screws

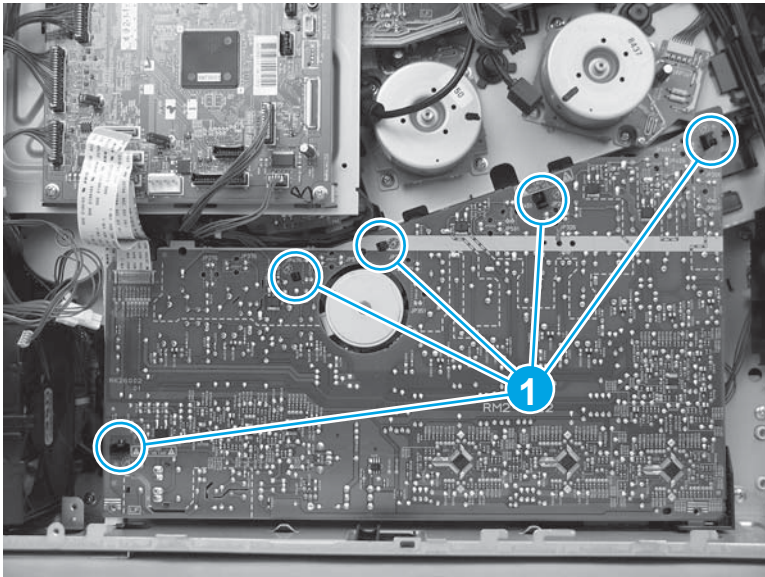
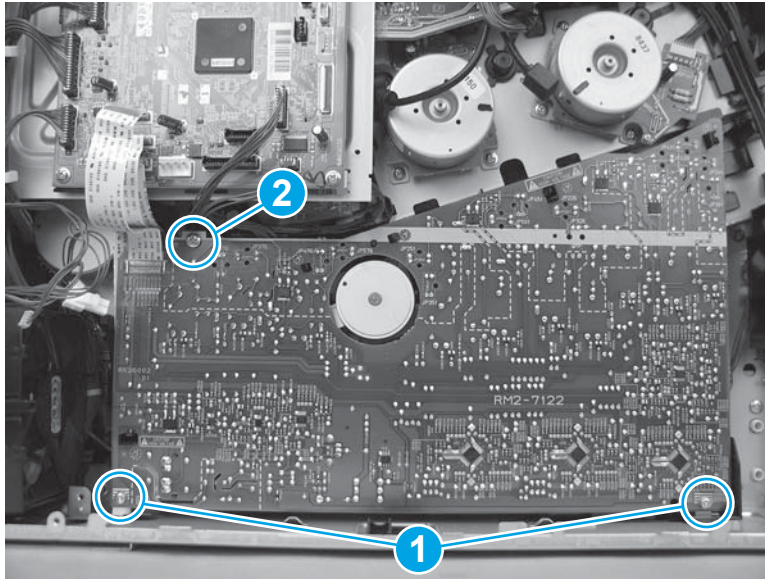

4. Connect one flat cable (callout 1) on the DC controller.

Figure 1-4054 Connect one flat cable

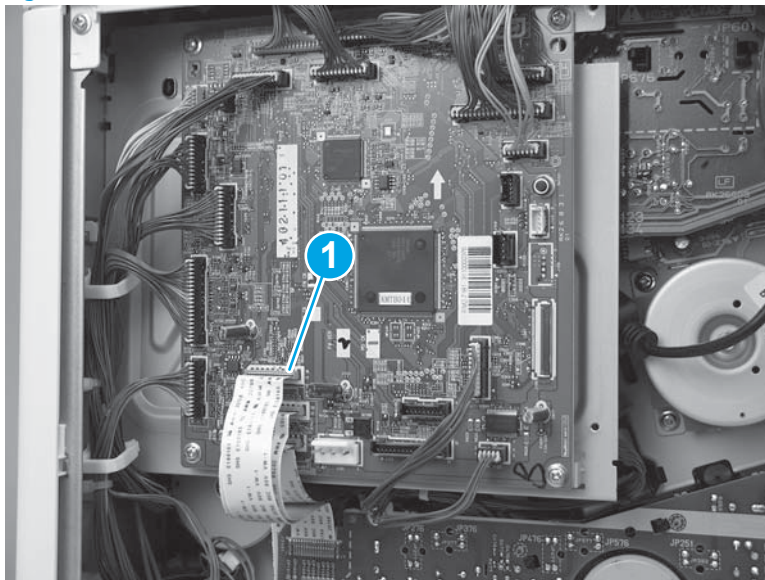

Step 37: Install the power-supply fan (FM1)

1. Slide the fan in (callout 1) and then down (callout 2) into the printer to install it.

 **NOTE:** Make sure that the arrow (callout 3) embossed on the fan holder faces into the printer.

Figure 1-4055 Install the fan



2. Place the wire harnesses in the retainer on the top of the fan bracket.

Figure 1-4056 Place the wire harnesses in the retainer

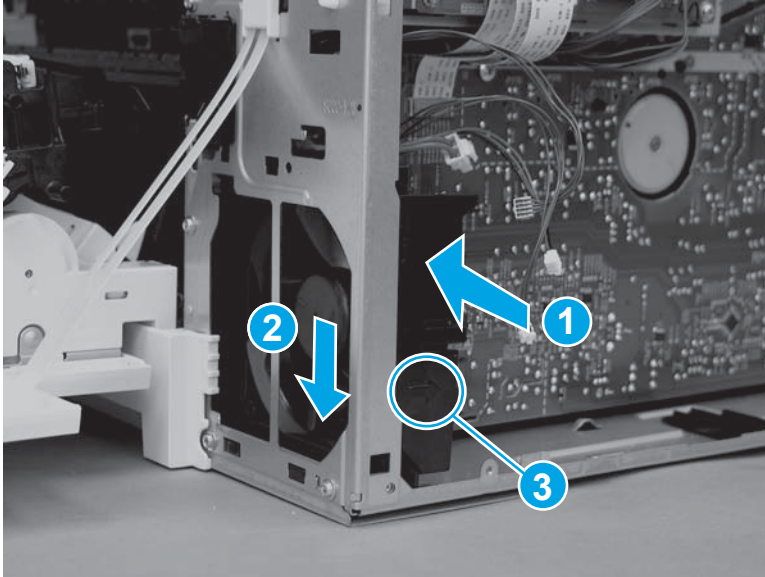
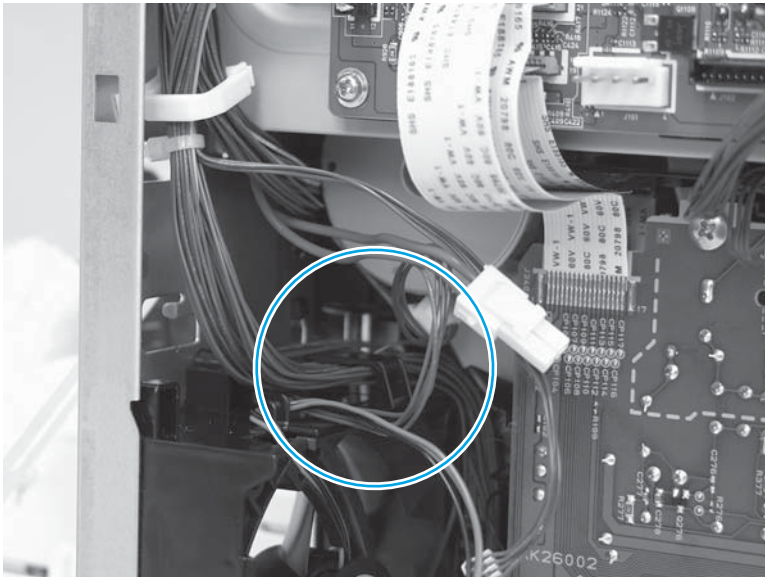

3. Install one screw (callout 1).

Figure 1-4057 Install one screw

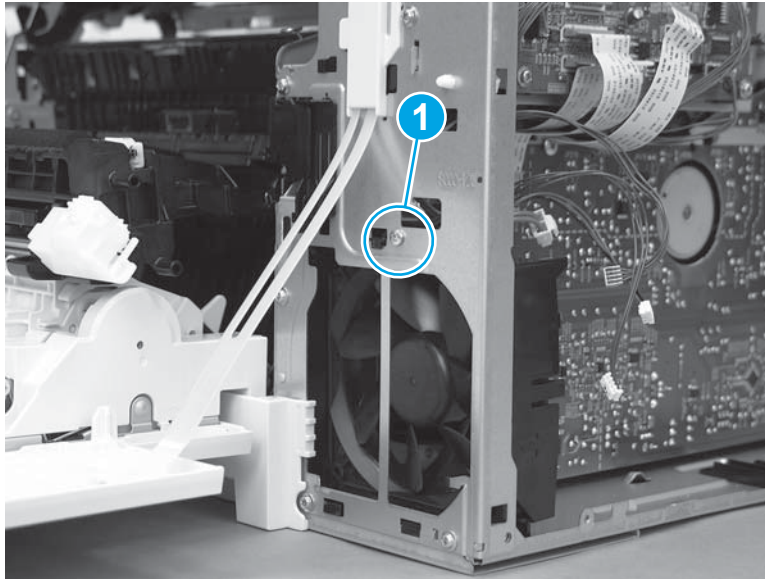

Step 38: Install the LVPS

 **CAUTION:**  ESD-sensitive part.

1. Position the bottom of the LVPS in the printer (callout 1) at a slight angle, and then rotate the top of it into the printer (callout 2) to install it.

Figure 1-4058 Install the LVPS

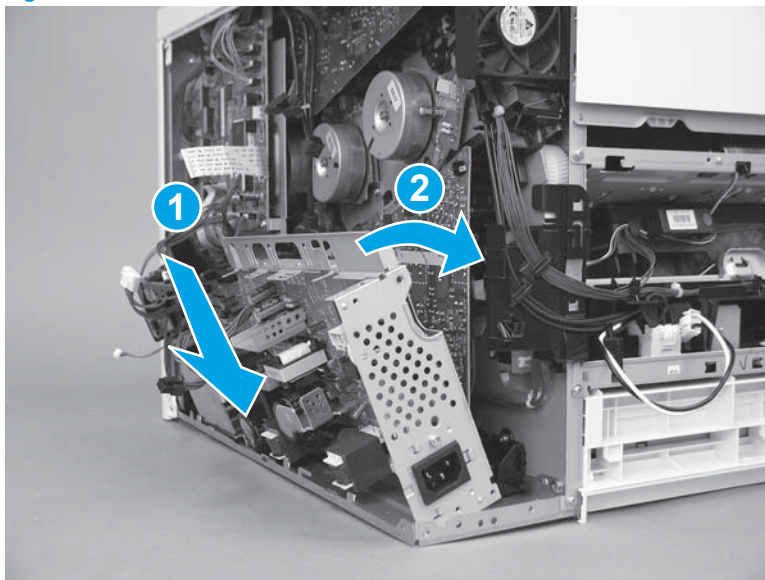

2. Install three screws (callout 1).

Figure 1-4059 Install three screws

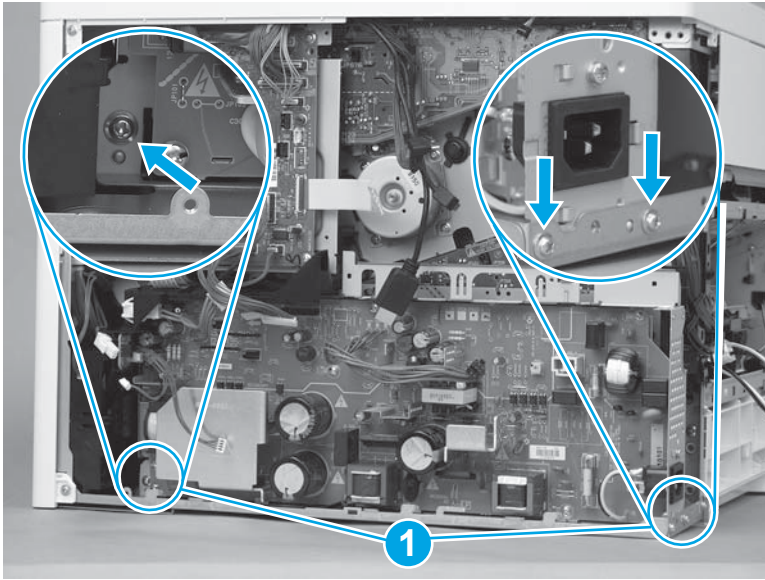

3. Pass the wire harnesses from the DC controller to the LVPS through the opening in the chassis (callout 1), and then install the wire harnesses in the retainer (callout 2).

Figure 1-4060 Pass the wire harnesses through the opening

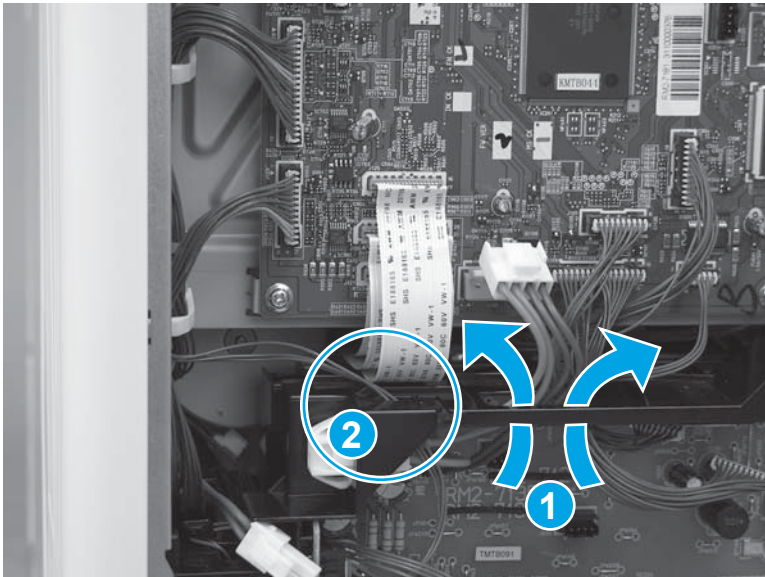

4. Connect three connectors on the DC controller (callout 1), and then connect four connectors (callout 2) on the LVPS.

Figure 1-4061 Connect seven connectors

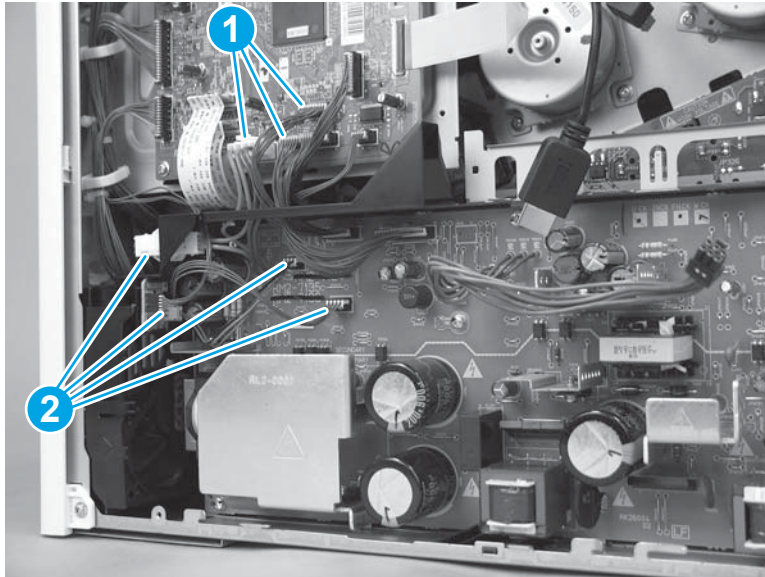

5. Pass the wire harness through the opening (callout 1) in the chassis, and then connect one wire harness (callout 2).

Figure 1-4062 Connect one wire harness

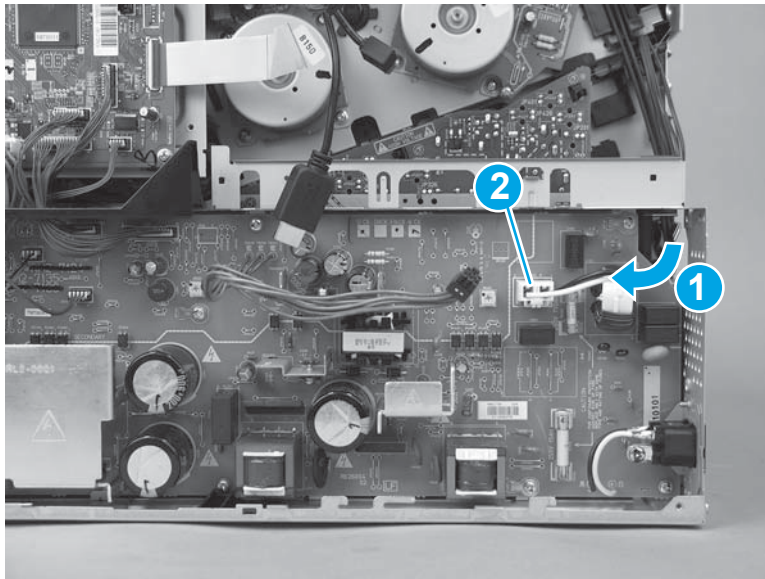

Step 39: Install the formatter case

1. Pass the wire harnesses through the opening in the formatter case.

Figure 1-4063 Pass the wire harnesses through the opening

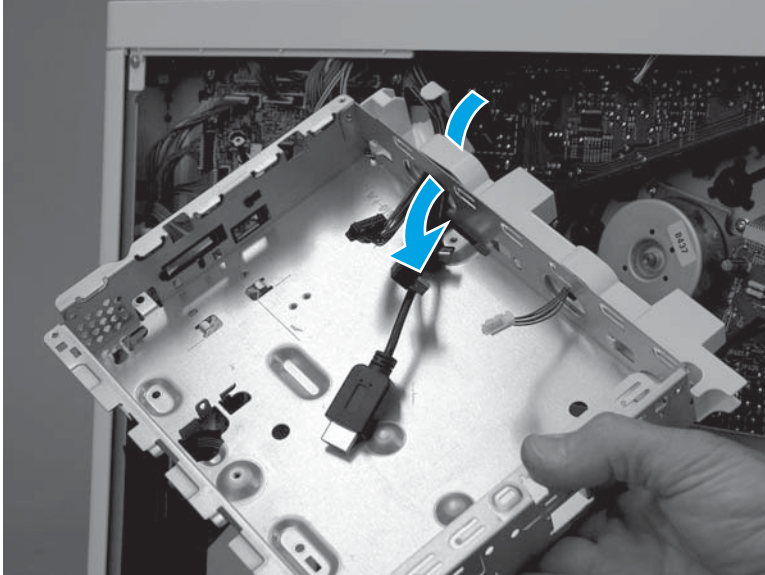

2. Position the top of the formatter case on the printer (callout 1), and then rotate the bottom of the case (callout 2) into the printer.

Figure 1-4064 Install the formatter case

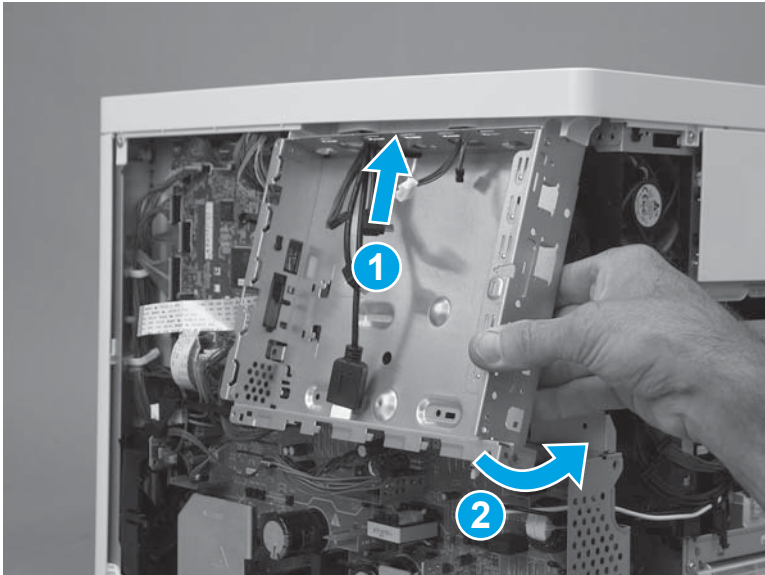

3. Install six screws (callout 1).

Figure 1-4065 Install six screws

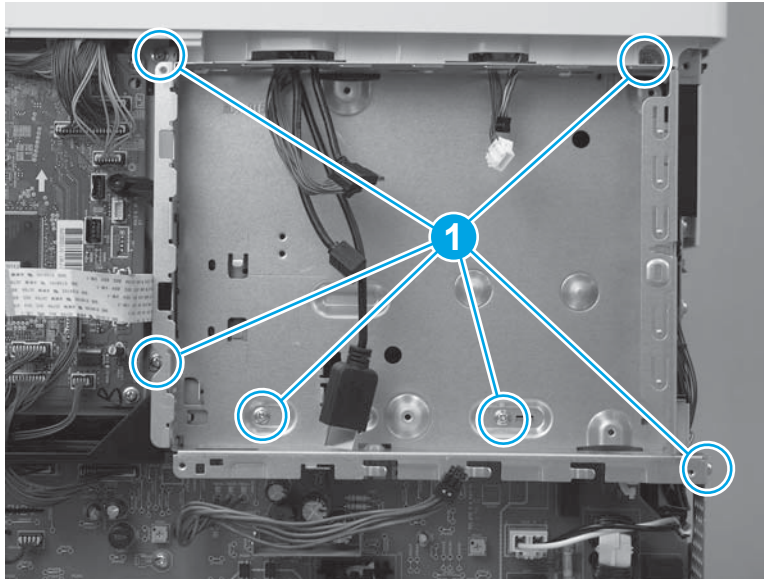

4. Pass two wire harnesses and one flat cable (callout 1) through the opening in the formatter case, and then install one wire harness in the retainer (callout 2).

 **IMPORTANT:** Make sure that the flat cable is securely fastened to the DC controller, and was not dislodged when the formatter case was removed.

Figure 1-4066 Install wire harnesses and flat cable

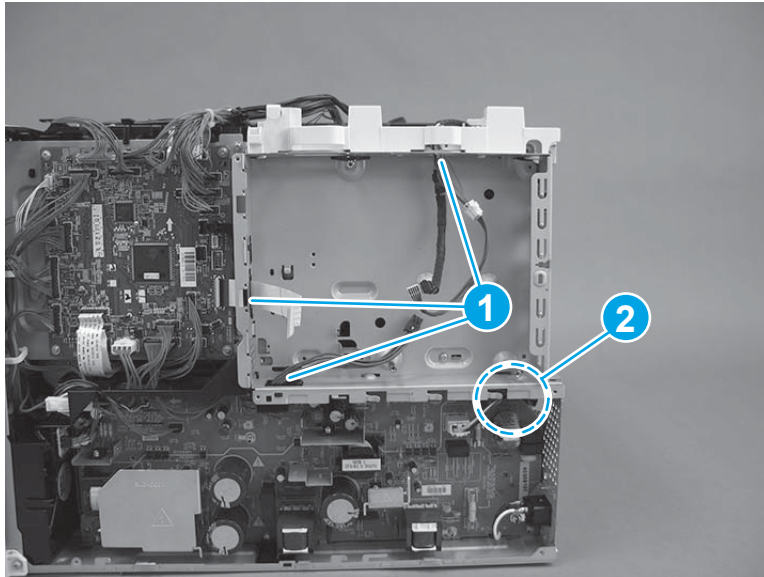

5. Position the LVPS cover on the printer, slide the cover to the left to install it, and then install two screws (callout 1).

Figure 1-4067 Install the LVPS cover

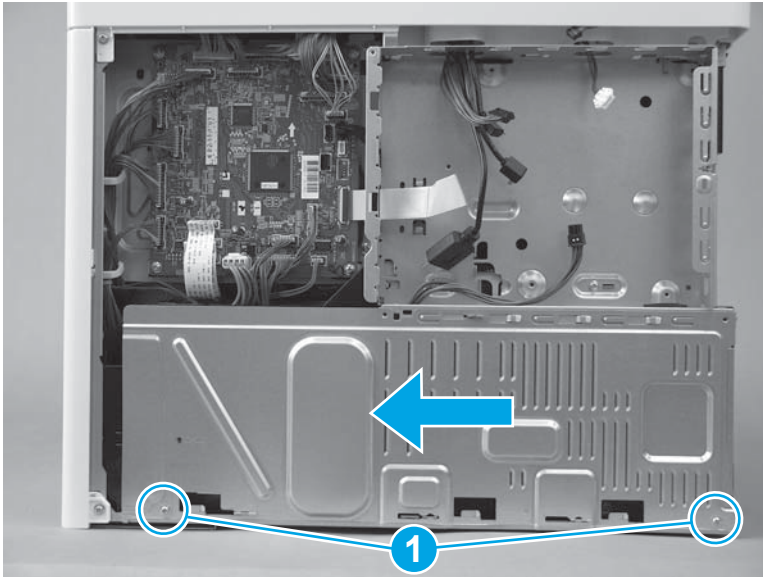

6. If no tape is affixed to the back of the flat cable, skip this step. If double-sided tape is affixed to the back of the flat cable, align the line (callout 1) on the cable with the edge (callout 2) of the opening in the sheet metal. Press to attach the flat cable to the formatter case.

Figure 1-4068 Attach the flat cable

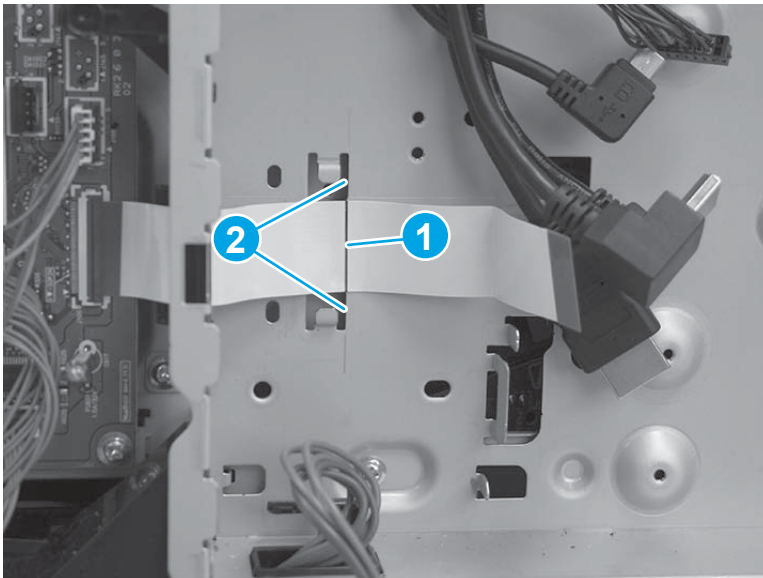

7. Position the bracket over the flat cable, and then slide the bracket to the left to install it. Make sure that the edges of the bracket fit under the sheet metal tabs (callout 1) on the formatter case and that the tabs (callout 2) snap into place.

Figure 1-4069 Position the bracket

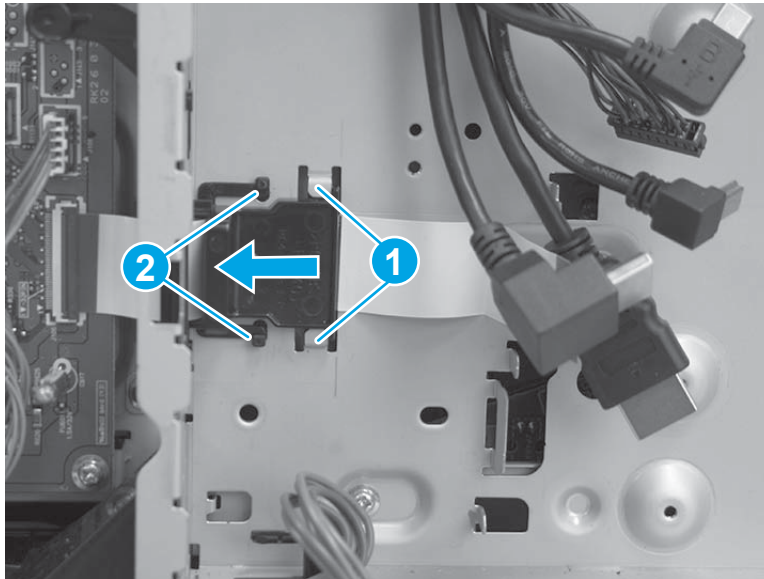

8. **M577 only:** Pass the wire harness (callout 1) through the openings in the formatter case (callout 2), and then connect one connector (callout 3).

Figure 1-4070 Connect one connector

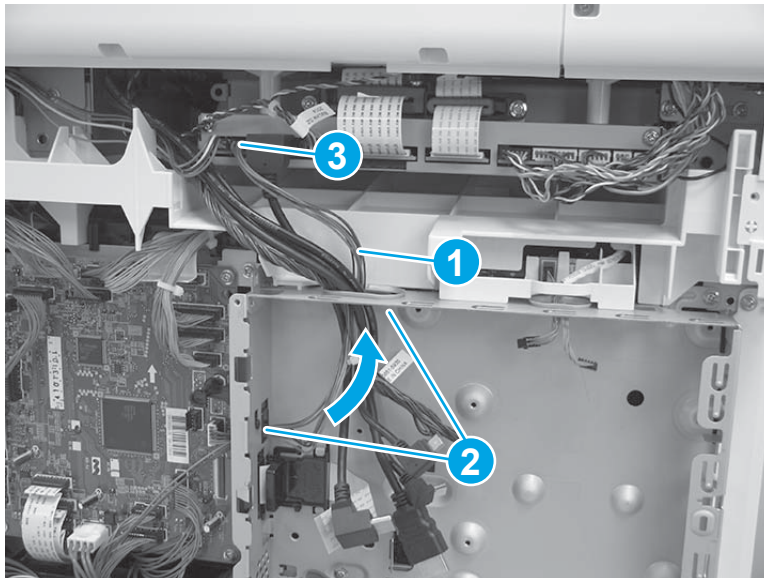

Step 40: Install the right rear cover

1. Position the cover on the printer.

Figure 1-4071 Install the cover

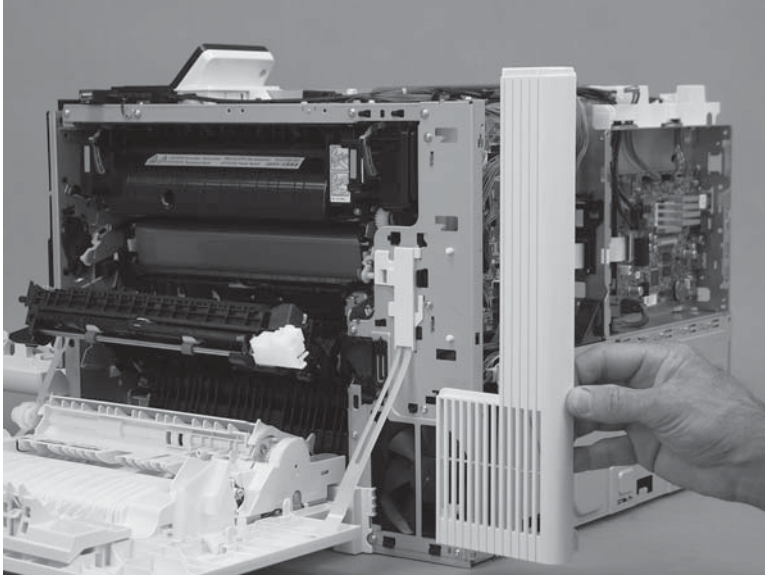

2. Slide the cover toward the right door (callout 1) to engage it with the printer, and then install one screw (callout 2).

Figure 1-4072 Install one screw

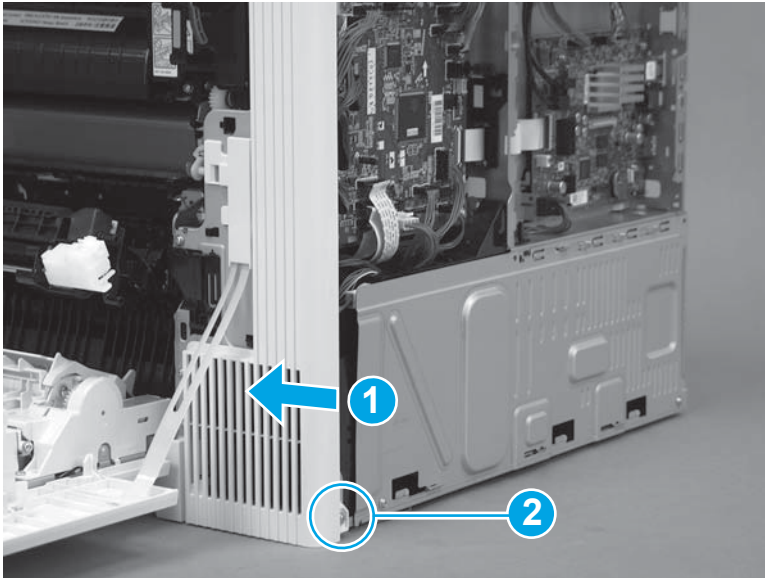

Step 41: Install the upper cover (M552 and M553)

 **NOTE:** This step is for the M552 and M553 models. For the M577 models, skip this step and go to [Step 42: Install the left cover on page 2270](#).

1. Position the cover on the printer.

 **NOTE:** For the M553x model, do not forget to pass the control-panel wire harness and USB cable through the opening in the cover.

Figure 1-4073 Install the cover



2. Push down on the rear corner of the cover to engage one tab (callout 1).

Figure 1-4074 Engage one tab

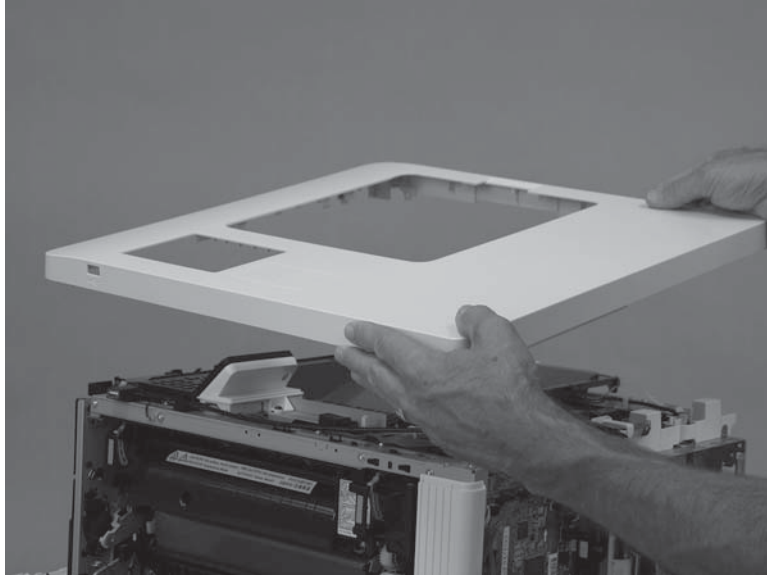
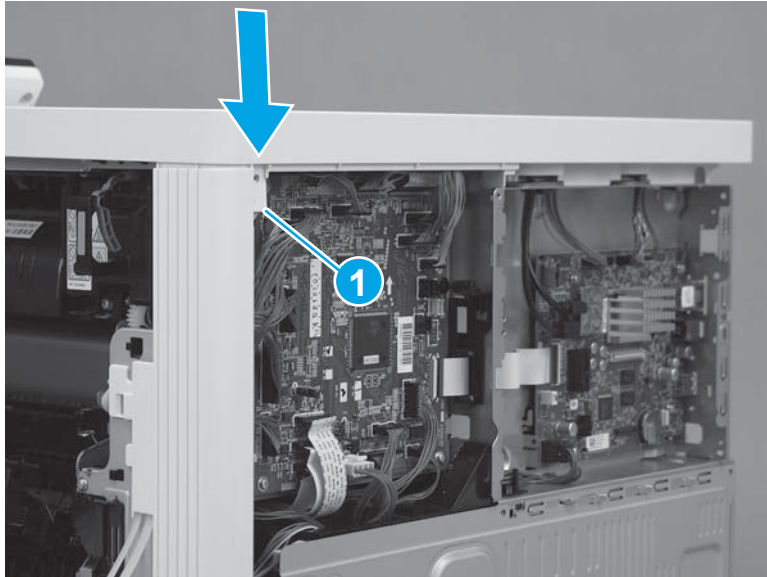

3. Push down on the front corner of the cover to engage one tab (callout 1), and then install one screw (callout 2).

 **NOTE:** This is a self-tapping plastic-thread screw. Make sure that this screw is used in this location when it is reinstalled.

Figure 1-4075 Engage one tab and install one screw



4. Install three screws (callout 1).

Figure 1-4076 Install three screws

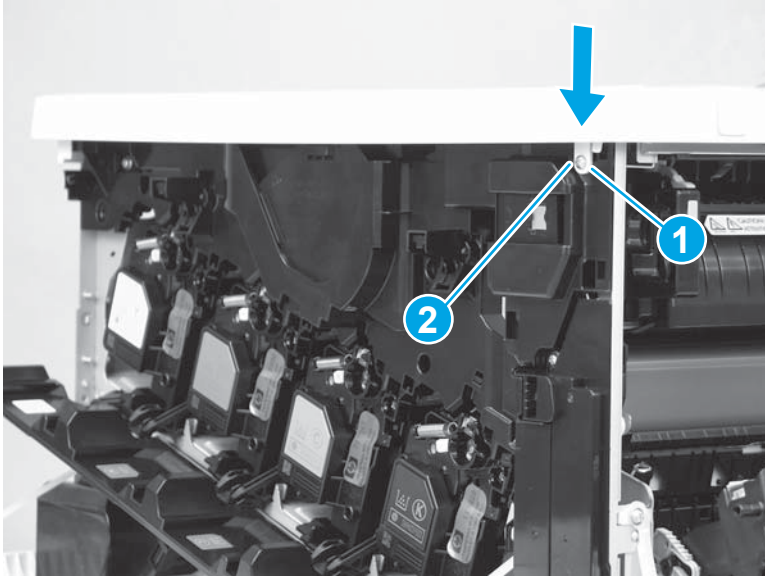
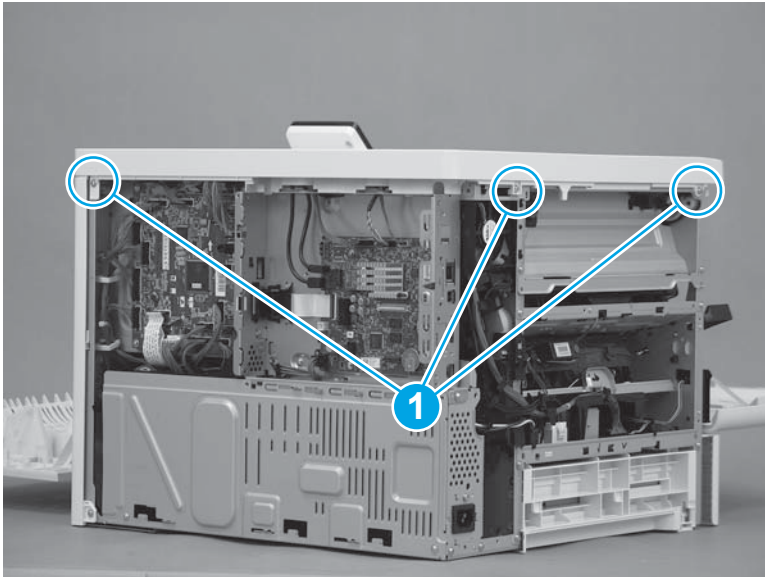

Step 42: Install the left cover

1. Position the cover on the printer.

 **NOTE:** Slightly offset the cover toward the rear of the printer.

Figure 1-4077 Install the cover

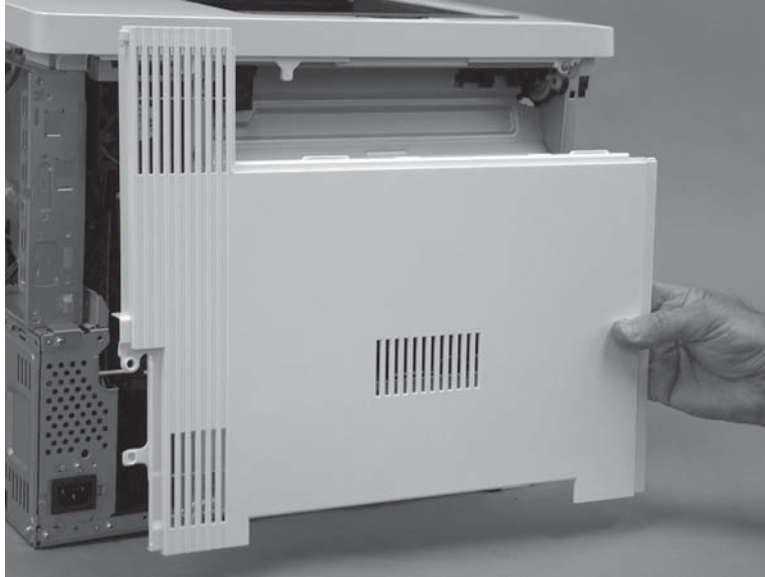

2. Slide the cover (callout 1) toward the front of the printer to engage it. Make sure that the tab (callout 2) snaps into place.

 **NOTE:** Locate the alignment pin (callout 3) on the cover from the front door side of the printer, and then make sure that it is fully engaged in the slot in the chassis.

 **TIP:** While sliding the cover into place, push in on the center of the cover (callout 1) to make sure that the hooks on the back of the cover engage with the slots in the chassis.

Figure 1-4078 Engage the cover

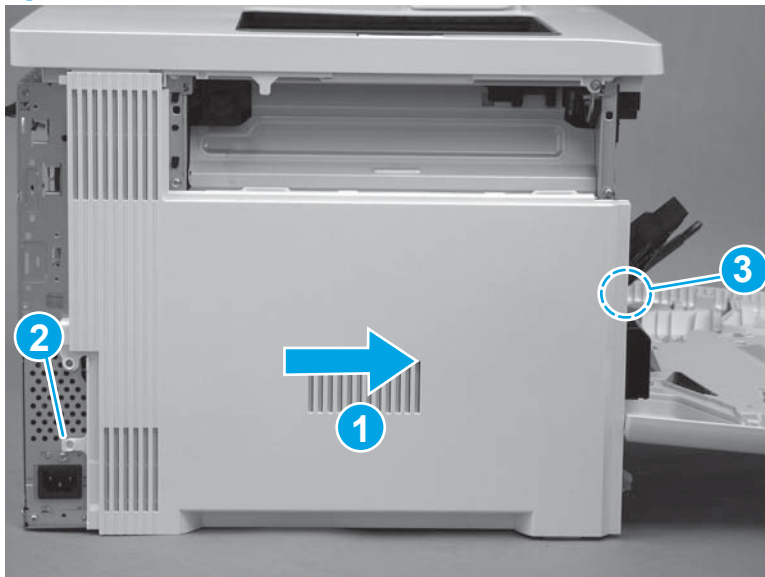

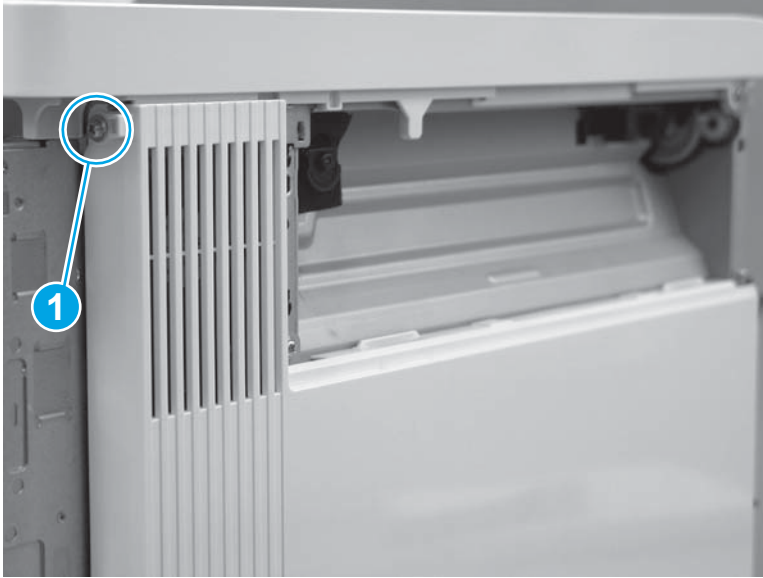

3. At the left side of the printer, install one screw (callout 1).

Figure 1-4079 Install one screw



Step 43: Install the right upper cover (M577)

 **NOTE:** This step is for the M577 models. For the M552 and M553 models, skip this step and go to [Step 50: Install the rear cover \(M552 and M553\) on page 2286](#).

 **NOTE:** The figures below show the image scanner installed. The procedures for removing and installing the right upper cover are the same whether the image scanner is installed or removed."

1. **M577c/f/z only:** Install the cables (callout 1) through the slot (callout 2) in the printer.

Figure 1-4080 Install the cables

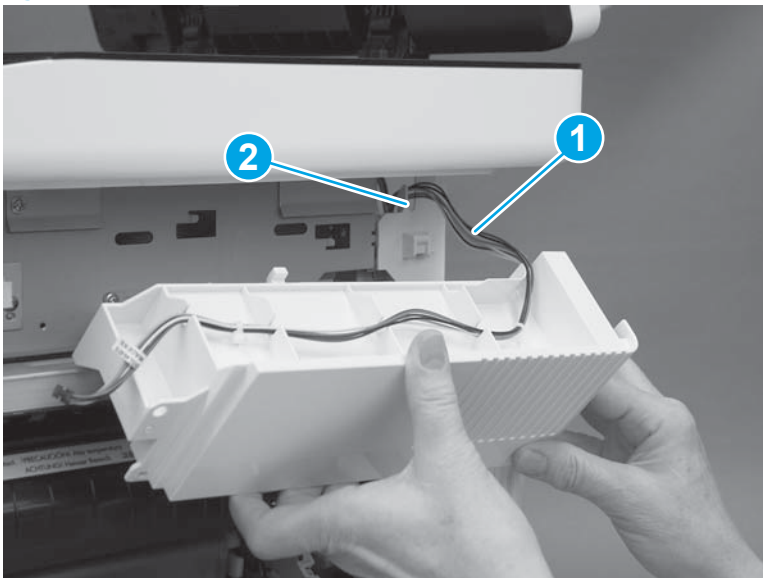

2. Position the hooks (callout 1) on the cover in the slots (callout 2) in the printer.

Figure 1-4081 Position the hooks

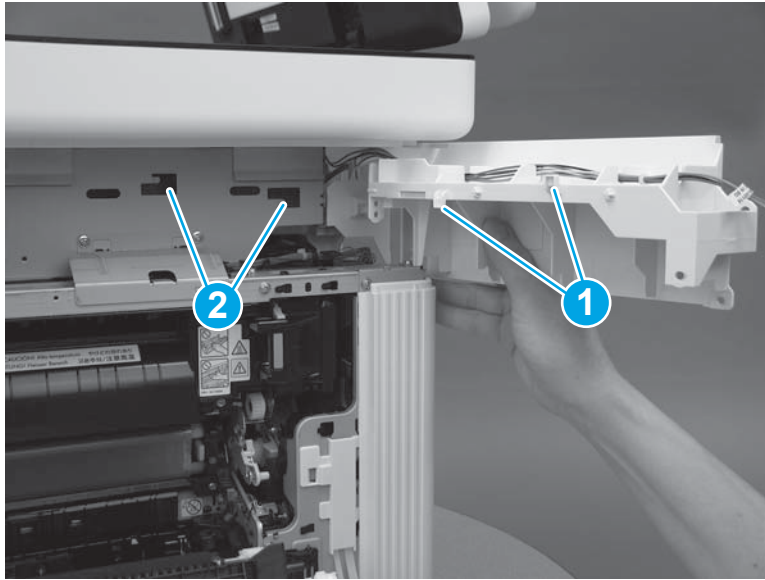

3. Slide the cover toward the front of the printer to install it.

Figure 1-4082 Install the cover

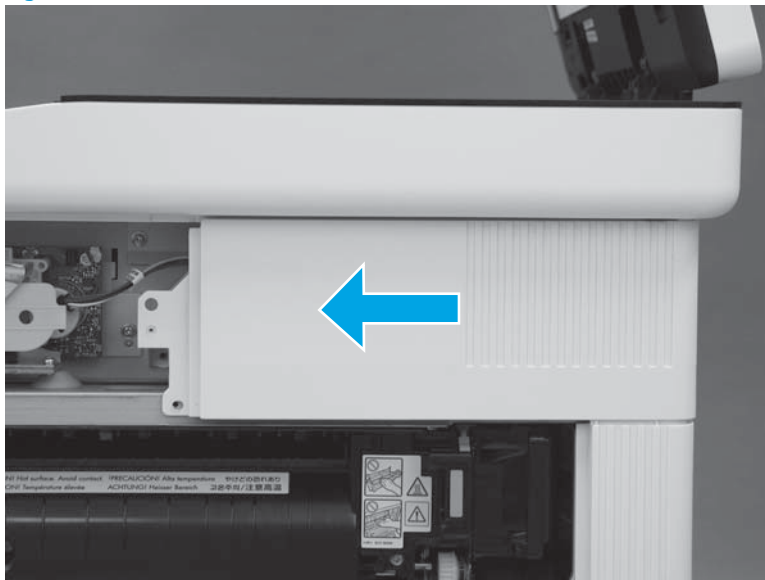

4. At the back of the printer, install one screw (callout 1).

M577c/f/z only: Connect one connector (callout 2), if the integrated scanner assembly is installed.

TIP: This screw is smaller than the screws installed in the next step. Make sure that this screw is installed in the correct position.

Figure 1-4083 Install one screw and connector



5. At the right side of the printer, install two screws (callout 1).

M577c/f/z only: Connect one connector (callout 2), if the stapler is installed.

Figure 1-4084 Install one screw and connector

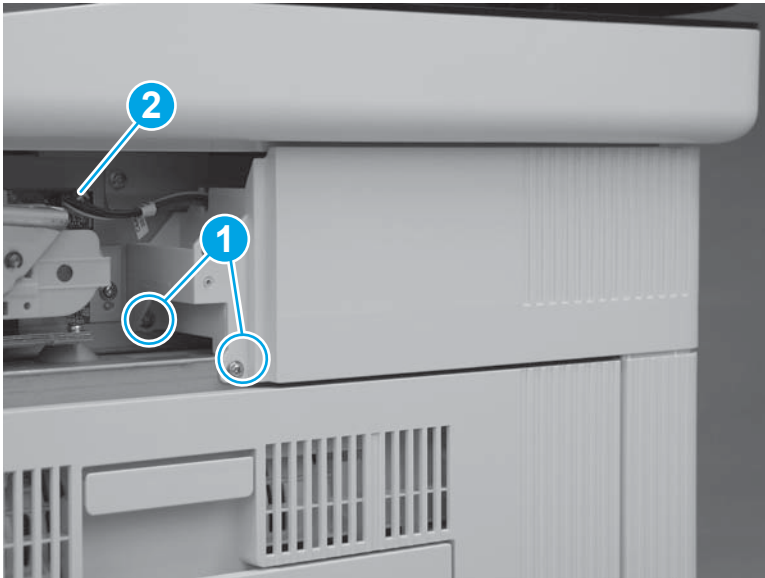

Step 44: Install the integrated scanner assembly (ISA) (M577)

NOTE: This step is for the M577 models. For the M552 and M553 models, skip this step and go to [Step 50: Install the rear cover \(M552 and M553\) on page 2286](#).

 **NOTE:** The ISA includes the document feeder, image scanner, scanner control board (SCB), control panel, keyboard (M577c/z) and NFC PCA (M577z).

1. Before proceeding, locate the mounting pins (callout 1) on the bottom of the ISA and the slots (callout 2) on the printer base.

Figure 1-4085 Locate the ISA mounting pins and slots

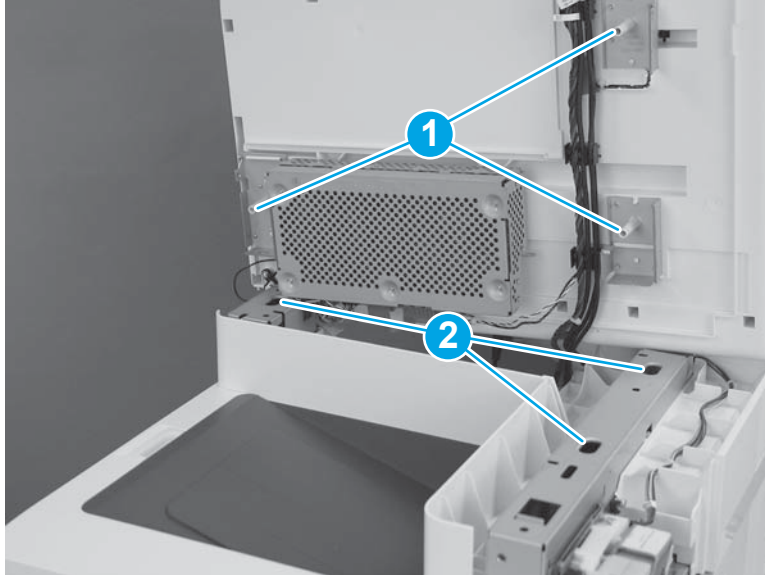

2. Position the ISA on the printer base with the pins in the slots.

 **NOTE:** To locate the pins and slots, see [Figure 1-395 Locate the ISA mounting pins and slots on page 249](#).

When installing the ISA, carefully pass the cables through the opening in the top of the formatter case.

Figure 1-4086 Install the ISA

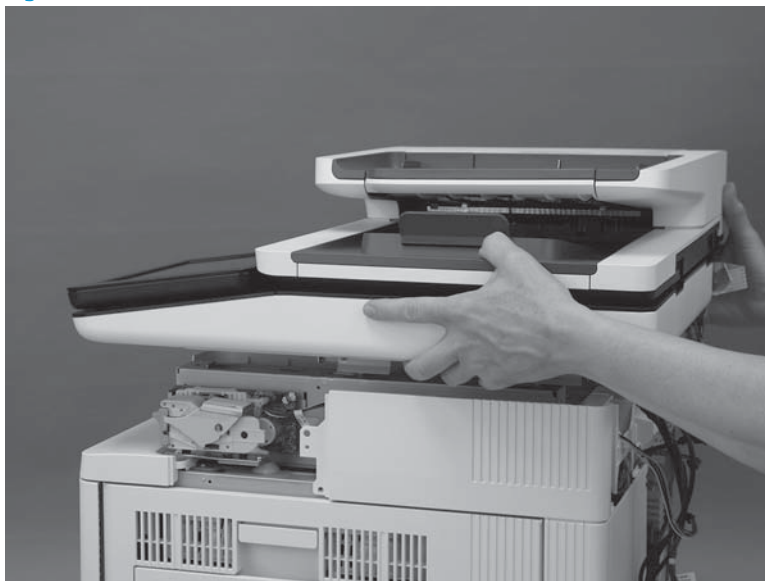

3. Slightly slide the ISA towards the front of the printer to engage it.

Figure 1-4087 Slide the ISA towards the front of the printer

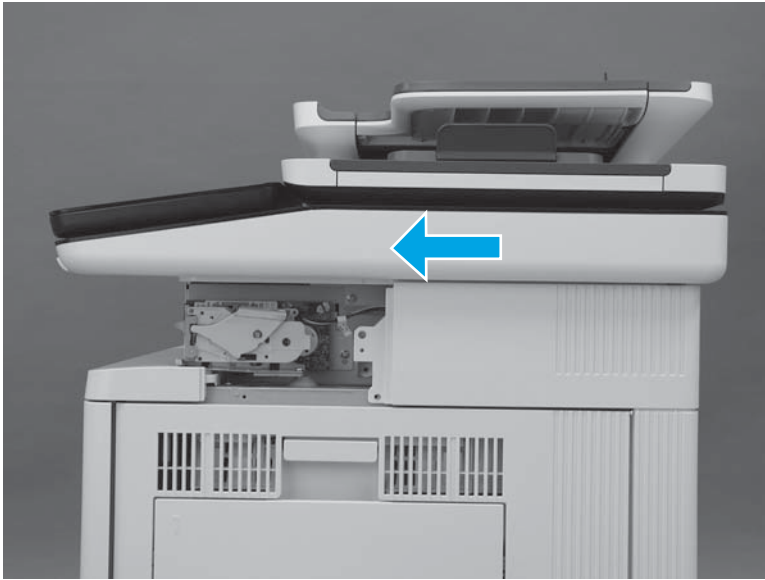

4. At the left side of the printer, install one screw (callout 1).

Figure 1-4088 Install one screw

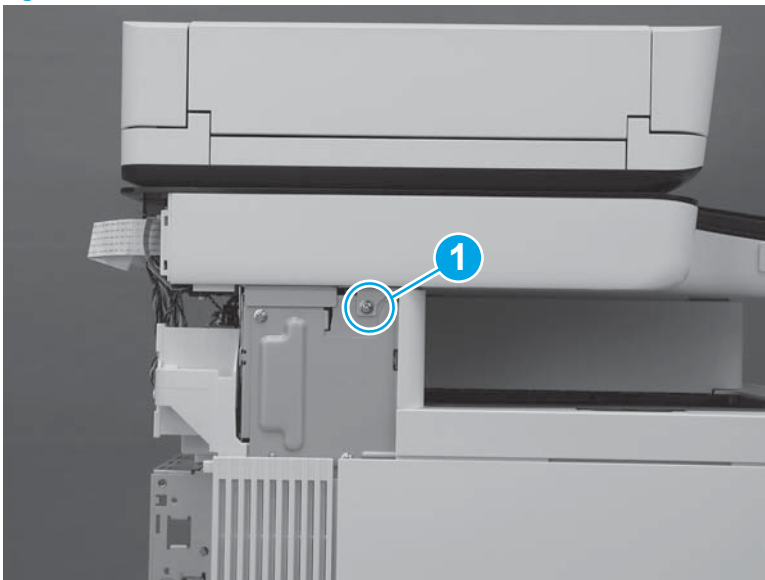

5. At the back of the printer, install two screws (callout 1).

Figure 1-4089 Install two screws

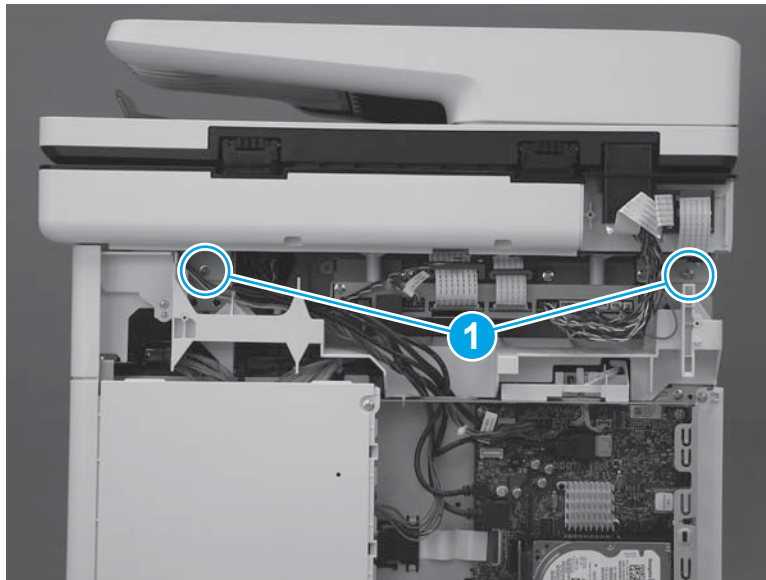

6. At the right side of the printer, install one screw (callout 1).

Figure 1-4090 Install one screw

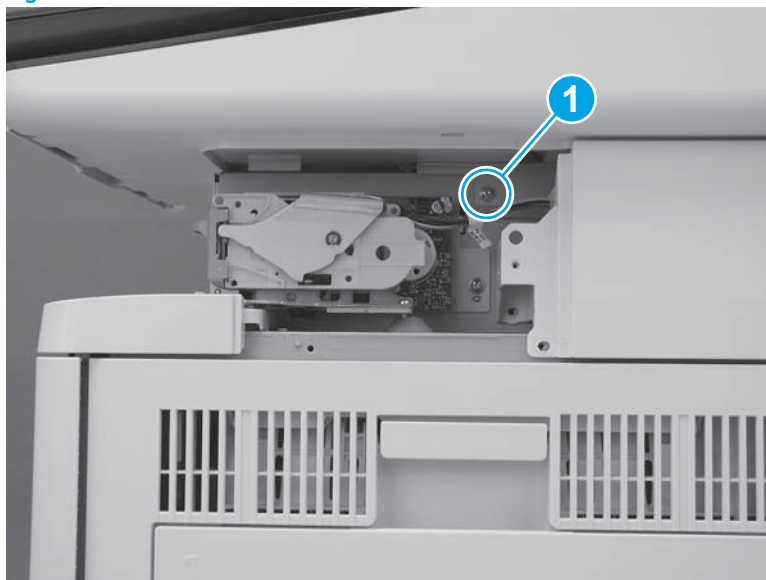

7. Connect two connectors on the scanner control board (callout 1).

M577c/f/z only: Connect one connector for the stapler on the scanner control board (callout 2).

Figure 1-4091 Connect connectors

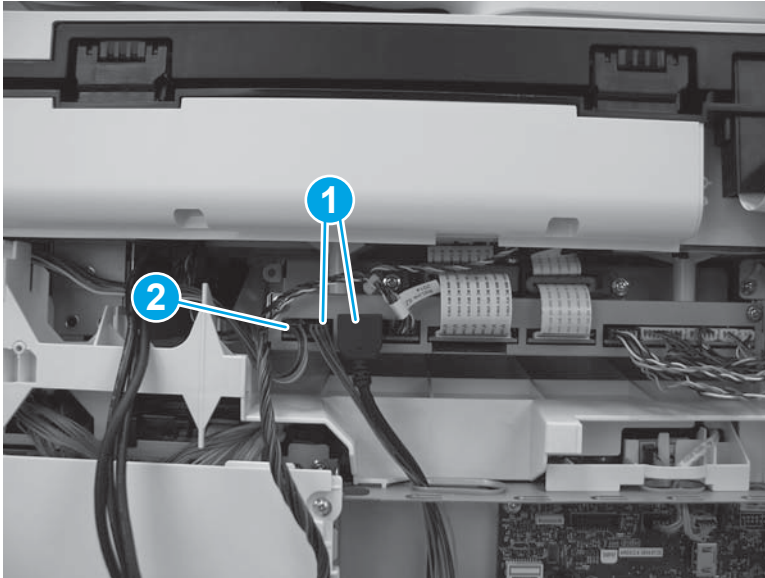

Step 45: Install the stapler cover assembly (M577c/f/z)

 **NOTE:** This step is for the M577c/f/z models only. For the M577dn model, skip this step and go to [Step 46: Install the right front upper cover \(M577dn\) on page 2279](#).

For the M552 and M553 models, skip this step and go to [Step 50: Install the rear cover \(M552 and M553\) on page 2286](#).

1. Install the tabs (callout 1) on the cover in the slots (callout 2) in the printer.

Figure 1-4092 Install two tabs



2. Press the cover toward the left side of the printer until it snaps into place.

Figure 1-4093 Install the cover assembly



3. Install one screw (callout 1).



 **IMPORTANT:** This is a self-tapping screw for plastic. Rotate it counterclockwise to align it with the existing thread pattern, and then carefully turn it clockwise to tighten. Do not overtighten. This will prevent stripping the threads inside the screw hole.

Figure 1-4094 Install one screw

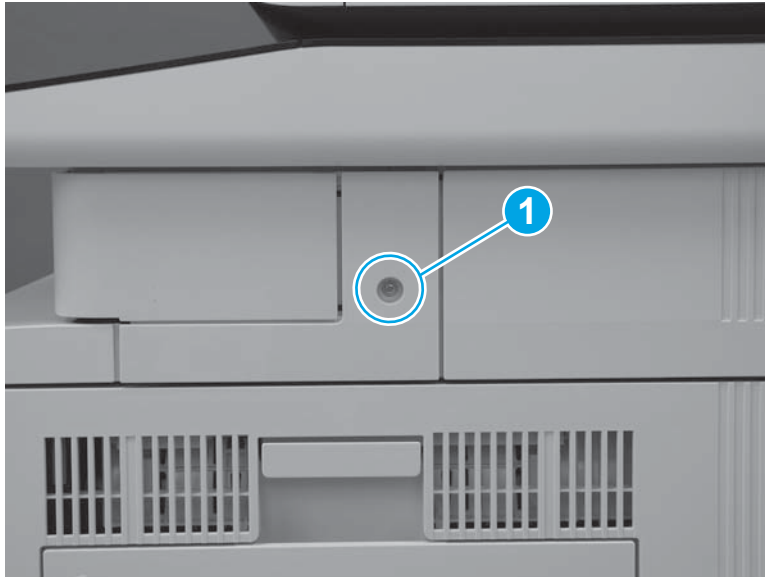

Step 46: Install the right front upper cover (M577dn)

 **NOTE:** This step is for the M577dn model only. For the M577c/f/z models, skip this step and go to [Step 47: Install the left upper cover \(M577\) on page 2281](#).

For the M552 and M553 models, skip this step and go to [Step 50: Install the rear cover \(M552 and M553\) on page 2286](#).

1. Slide the cover toward the left side of the printer to install it. Make sure that the slots (callout 1) in the cover fit over the tabs (callout 2) on the inside of the paper feeder cover.

Figure 1-4095 Install the cover



2. Press the right front upper cover (callout 1) and the paper feeder cover (callout 2) together until the tabs on the inside of the covers snap into place.

Figure 1-4096 Press the cover



3. Install one screw (callout 1).

Figure 1-4097 Install one screw

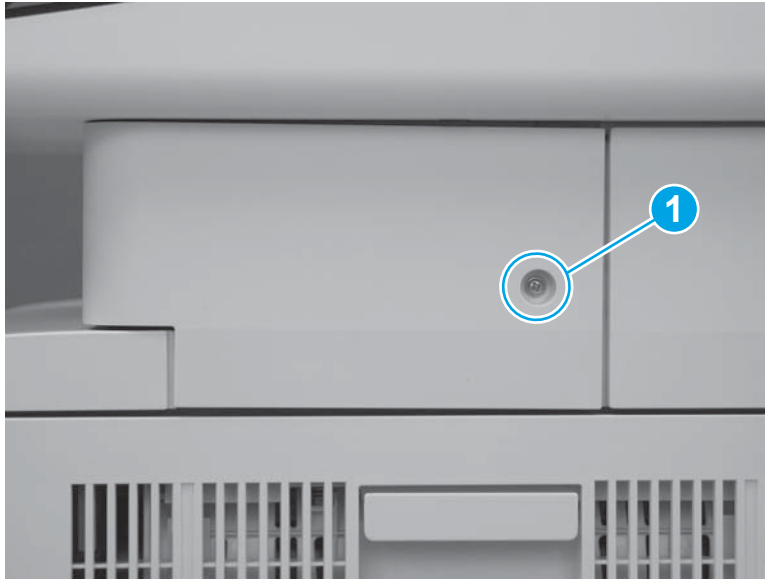

Step 47: Install the left upper cover (M577)

 **NOTE:** This step is for the M577 models. For the M552 and M553 models, skip this step and go to [Step 50: Install the rear cover \(M552 and M553\) on page 2286](#).

1. Position the tab (callout 1) on the lower edge of the cover behind the left cover (callout 2).

Figure 1-4098 Position the tab

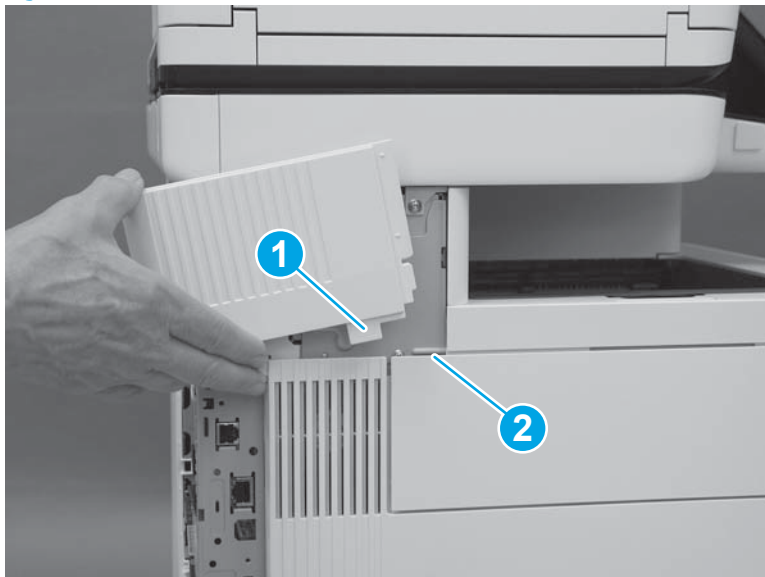

2. Slide the cover toward the front of the printer to install it. Make sure that the edge (callout 1) of the cover fits behind the edge (callout 2) of the top rear cover.

Figure 1-4099 Slide the cover

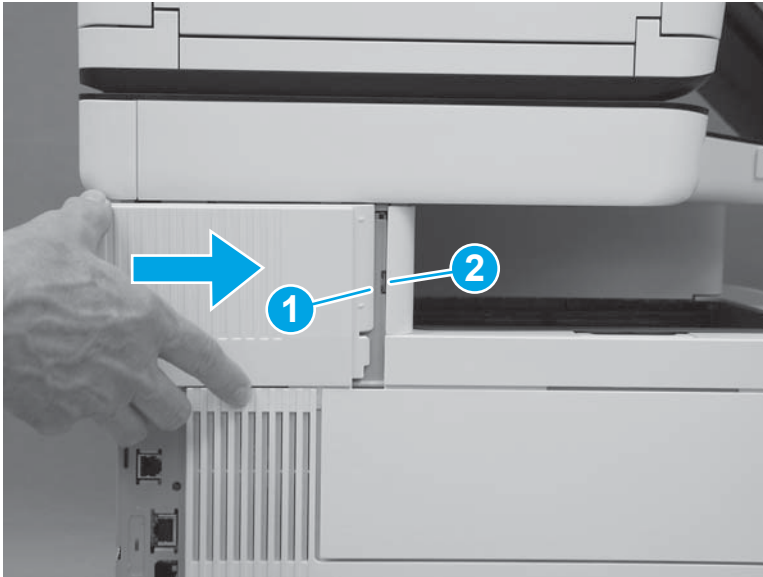

3. Make sure that the tab (callout 1) is fully installed.

Figure 1-4100 Check the tab

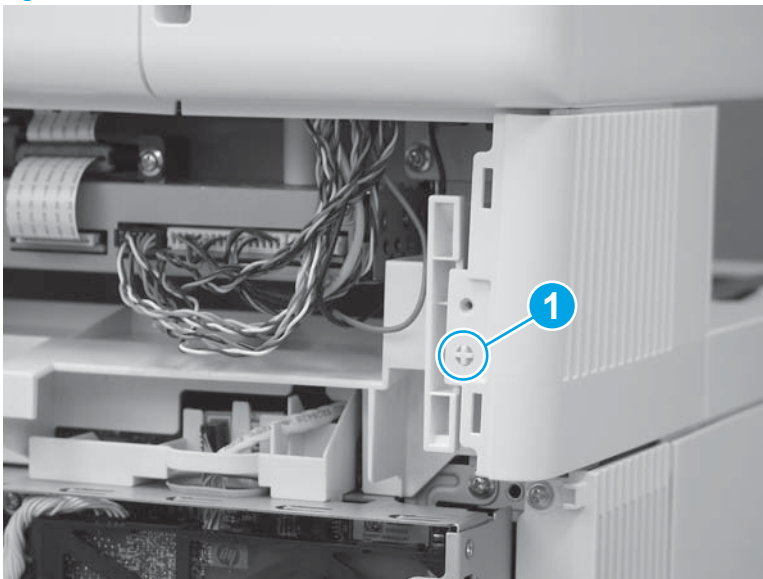

Step 48: Install the rear cover (M577)

 **NOTE:** This step is for the M577 models. For the M552 and M553 models, skip this step and go to [Step 50: Install the rear cover \(M552 and M553\) on page 2286](#).

1. Position the hooks (callout 1) on the cover in the slots (callout 2) in the printer.

Figure 1-4101 Position the hooks

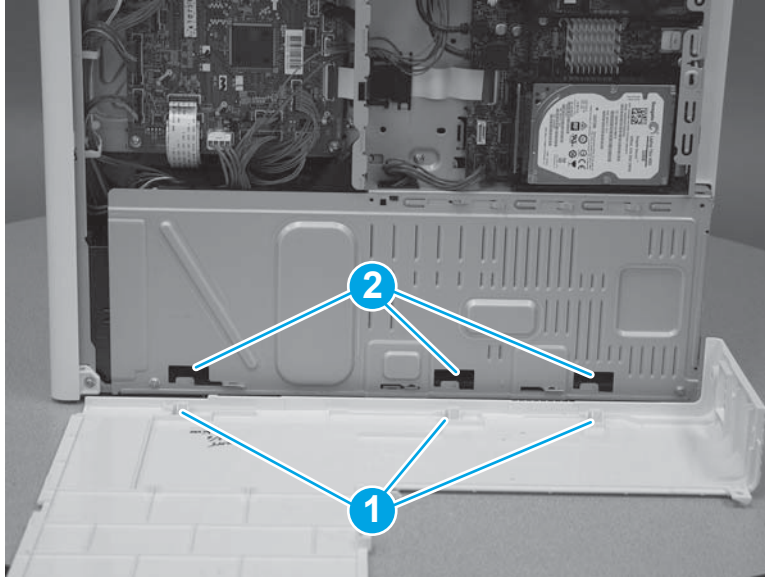

2. Position the back edge (callout 1) of the rear cover behind the edge (callout 2) of the right rear cover. Slide the cover to the left to install it.

Figure 1-4102 Install the cover

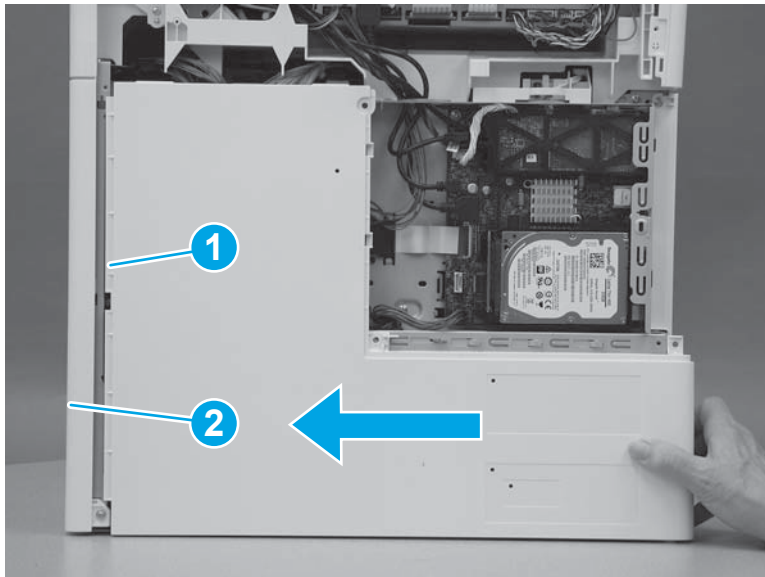

3. Install four screws (callout 1).

Figure 1-4103 Install four screws cover

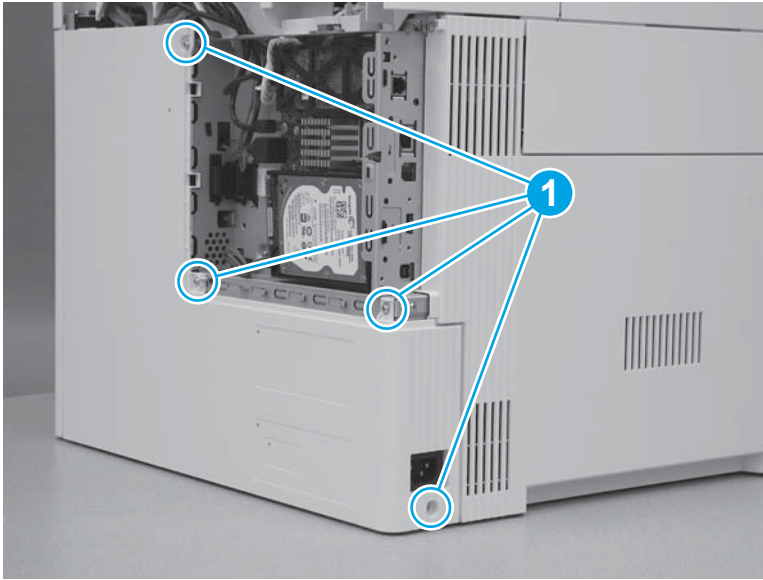

Step 49: Install the rear upper cover (M577)

 **NOTE:** This step is for the M577 models. For the M552 and M553 models, skip this step and go to [Step 50: Install the rear cover \(M552 and M553\) on page 2286](#).

1. Align the ridge (callout 1) on the lower edge of the rear upper cover in front of the tabs (callout 2) on the top edge of the rear cover.

Figure 1-4104 Align the cover

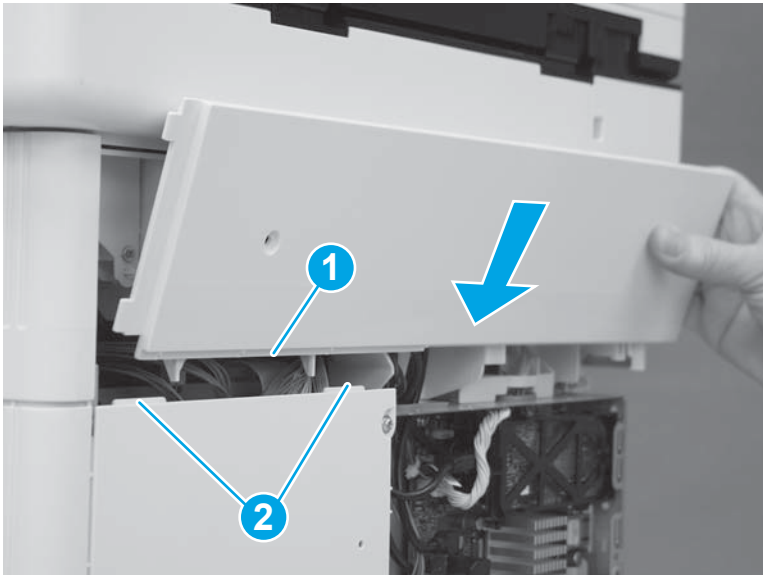

2. Rotate the top of the cover toward the printer.

Figure 1-4105 Rotate the top of the cover

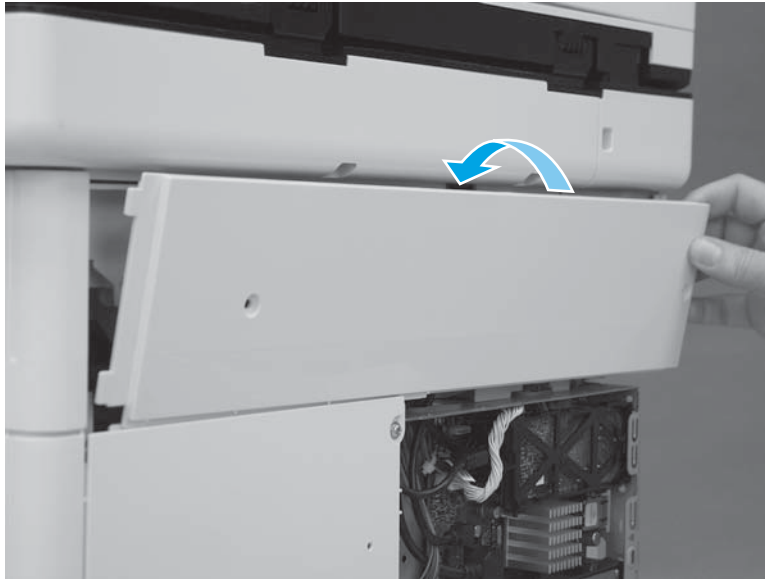

3. Slide the cover to the left (callout 1). Make sure that the tabs (callout 2) on the upper rear cover slide behind the edge (callout 3) of the right upper cover. Make sure that the cover is fully seated.

Figure 1-4106 Slide the cover

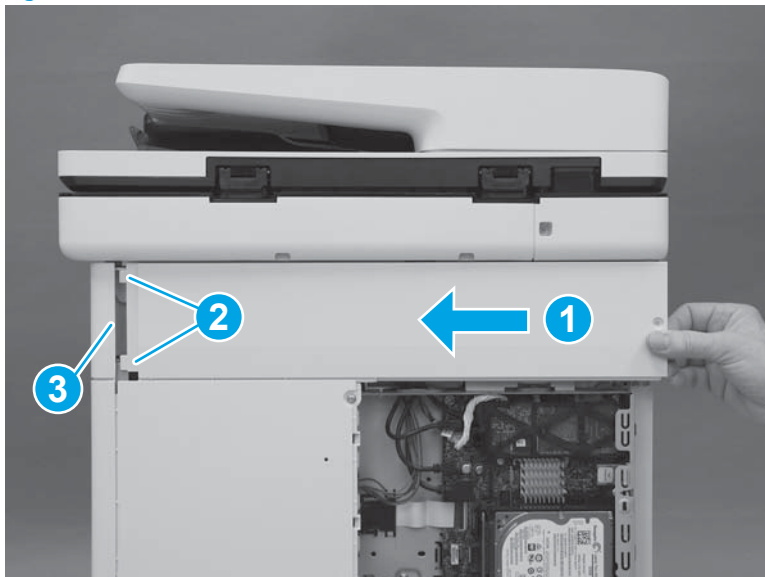

4. Install two screws (callout 1).



 **IMPORTANT:** These two screws are self-tapping screws for plastic. Rotate them counterclockwise to align them with the existing thread pattern, and then carefully turn them clockwise to tighten. Do not overtighten. This will prevent stripping the threads inside the screw holes.

Figure 1-4107 Install two screws

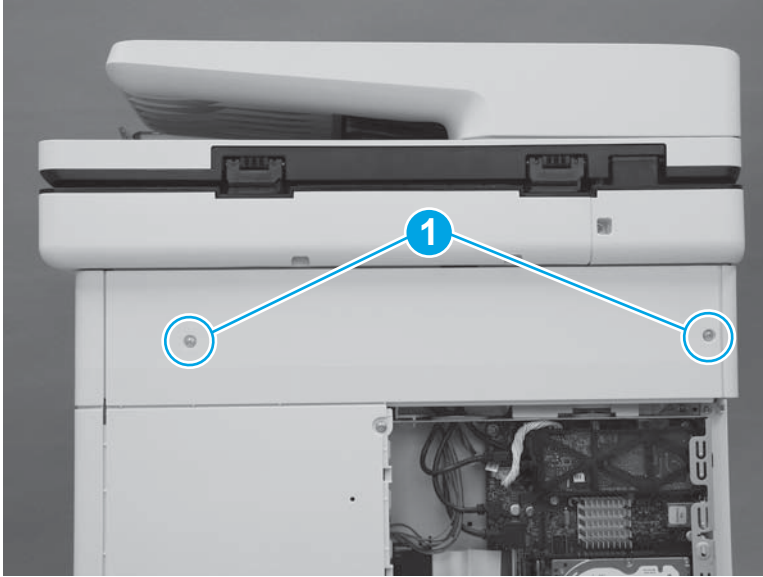

Step 50: Install the rear cover (M552 and M553)

 **NOTE:** This step is for the M552 and M553 models. For the M577 models, skip this step and go to [Step 51: Install the formatter \(M577\) on page 2287](#).

1. Position the top of the cover under the upper cover (callout 1), rotate the bottom of the cover onto the chassis (callout 2), and then slide the cover to the left (callout 3) to install it.

Figure 1-4108 Install the cover

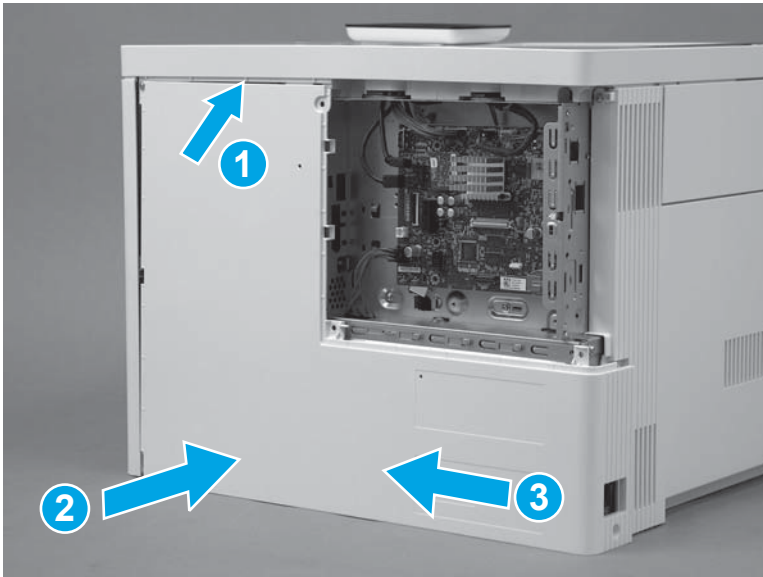

2. Install four screws (callout 1).

Figure 1-4109 Install four screws cover

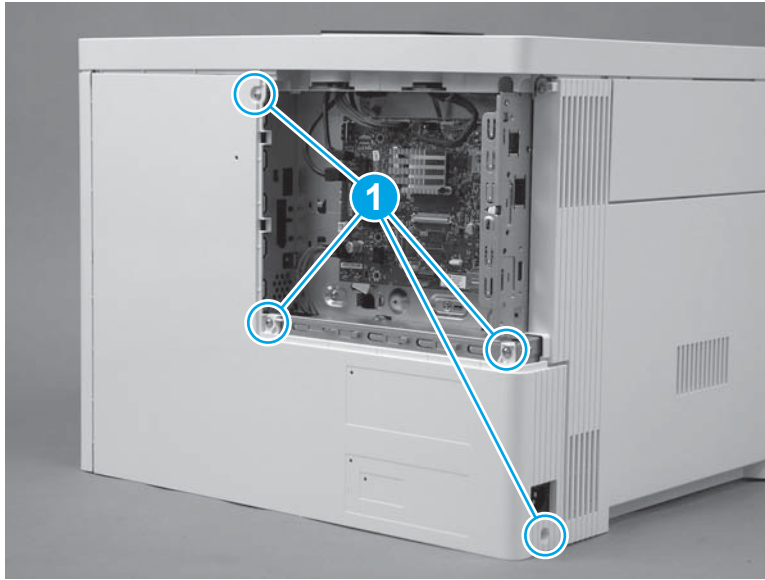

Step 51: Install the formatter (M577)

 **NOTE:** This step is for the M577 models. For the M552 and M553 models, skip this step and to go [Step 54: Install the formatter \(M552 and M553\) on page 2292](#).

 **CAUTION:**  ESD-sensitive part.

1. Position the formatter in the printer. Make sure that the network port (callout 1) fits through the opening (callout 2) in the formatter case.

Figure 1-4110 Install the formatter

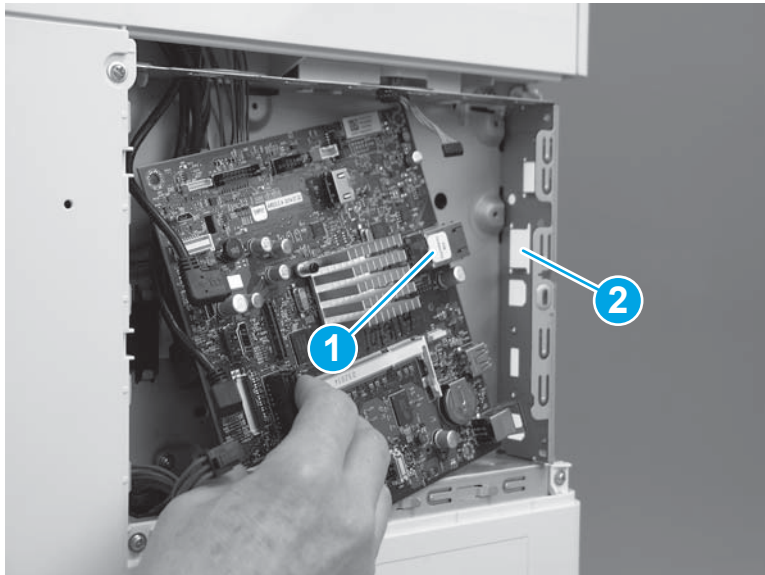

2. Install four screws (callout 1).

Figure 1-4111 Install four screws

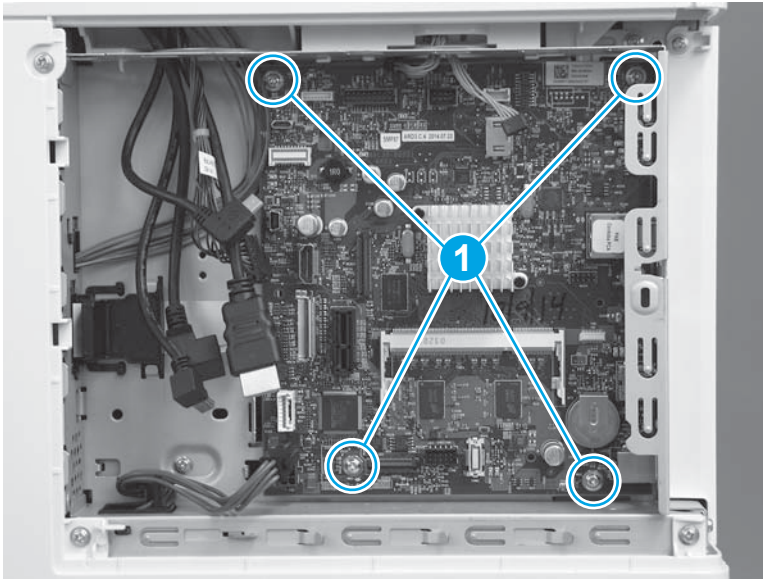

3. Connect all of the connectors on the formatter.

The following connectors are empty:

- All models: J1 (this connector is empty unless the optional DIMM is installed)
- All models: J3
- M577dn: J15 (this is the fax connector for the M577f/z/c models)
- All models: J21 (this connector is empty unless the optional internal USB ports component is installed)
- All models: J23
- All models: J24
- All models: J51
- All models: J57
- All models: J97
- All models: J98 (this connector is empty unless the optional trusted platform module (TPM) is installed)

 **IMPORTANT:** The flat-cable connector (callout 1) is a Zero Insertion Force (ZIF) connector that uses a hinged retainer to secure the flat cable. The hinged retainer must be opened to install the flat cable, and then closed after the cable is installed.

Figure 1-4112 Connect all connectors



Step 52: Install the fax PCA (M577c/f/z)

 **NOTE:** This step is for the M577c/f/z models. For the M577n model, skip this step and go to [Step 53: Install the HDD \(M577\) on page 2290](#).

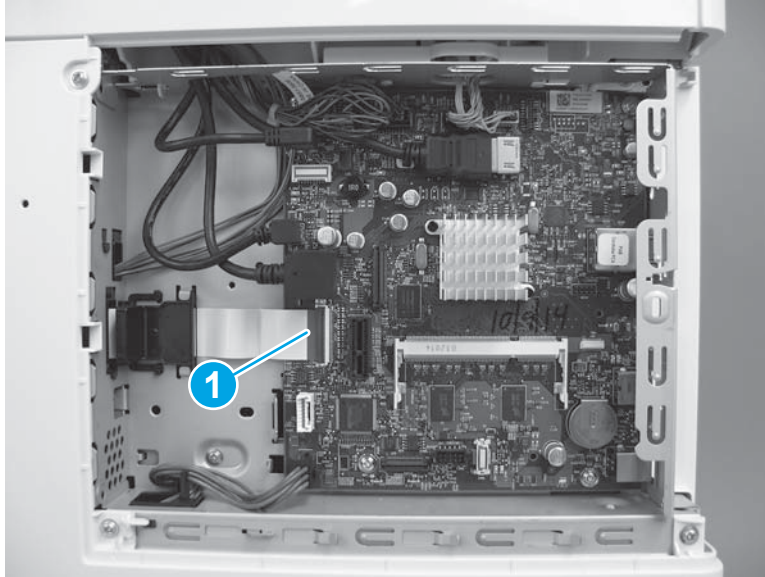
For the M552 and M553 models, skip this step and go to [Step 54: Install the formatter \(M552 and M553\) on page 2292](#).

 **CAUTION:**  ESD-sensitive part.

1. Position the tab and telephone port (callout 1) on the fax PCA in the slots (callout 2) in the formatter case.

Figure 1-4113 Position the fax PCA

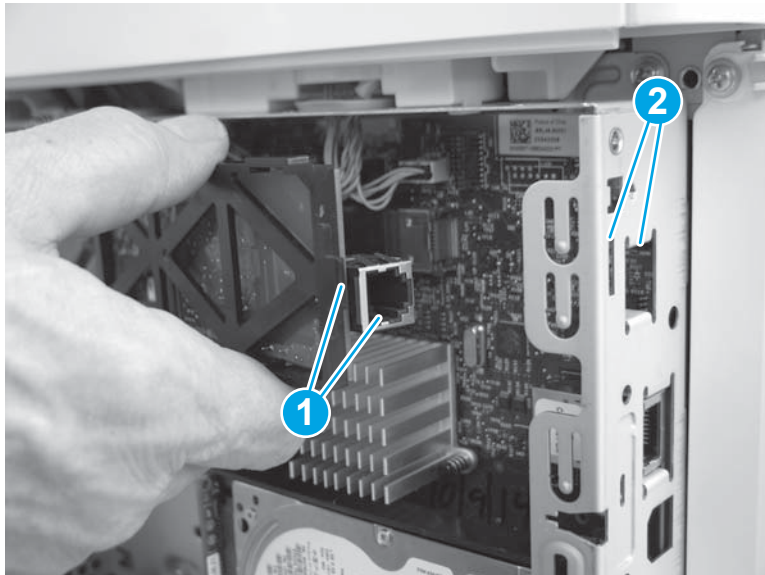

- Slide the fax PCA to the right (callout 1) until the tab and telephone port described in the previous step and seated in the formatter case. Position the retainer (callout 2) in the slot (callout 3) in the formatter. Rotate the end of the fax PCA toward the formatter (callout 4) until the retainer snaps into place.

Figure 1-4114 Install the fax PCA

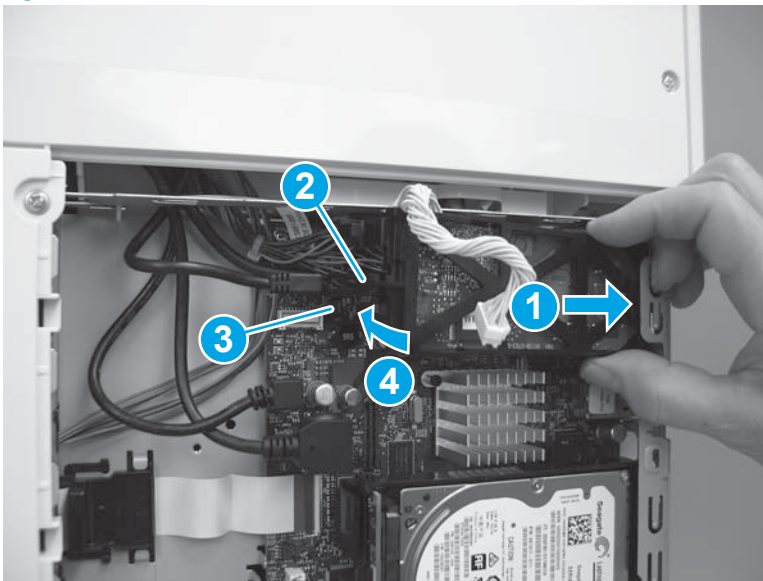

- Position the cable (callout 1) in the guide (callout 2), and then connect one connector (callout 3).

Figure 1-4115 Connect the connector

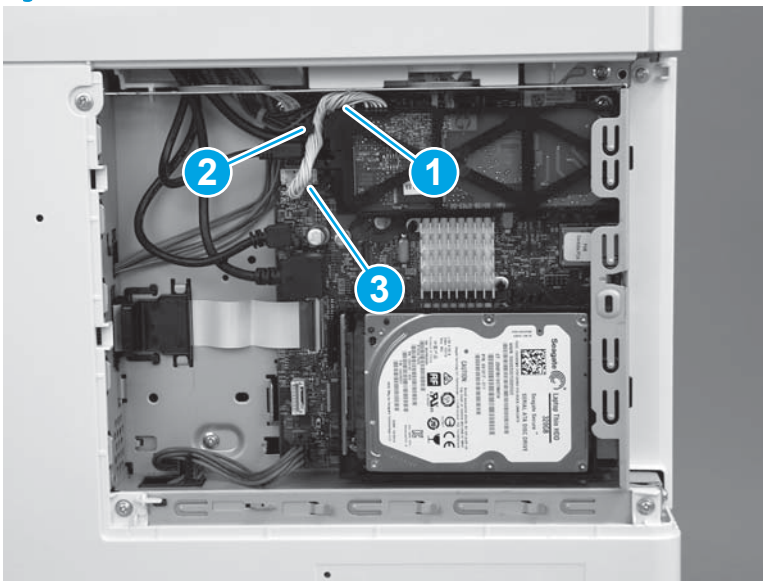

Step 53: Install the HDD (M577)

 **NOTE:** This step is for the M577 models. For the M552 and M553 models, skip this step and go to [Step 54: Install the formatter \(M552 and M553\) on page 2292](#).

 **CAUTION:**  ESD-sensitive part.

1. Align the end of the bracket (callout 1) with the slot in the chassis (callout 2), and then slide the HDD into the printer (callout 3) to engage the bracket with the chassis.

Figure 1-4116 Install the holder

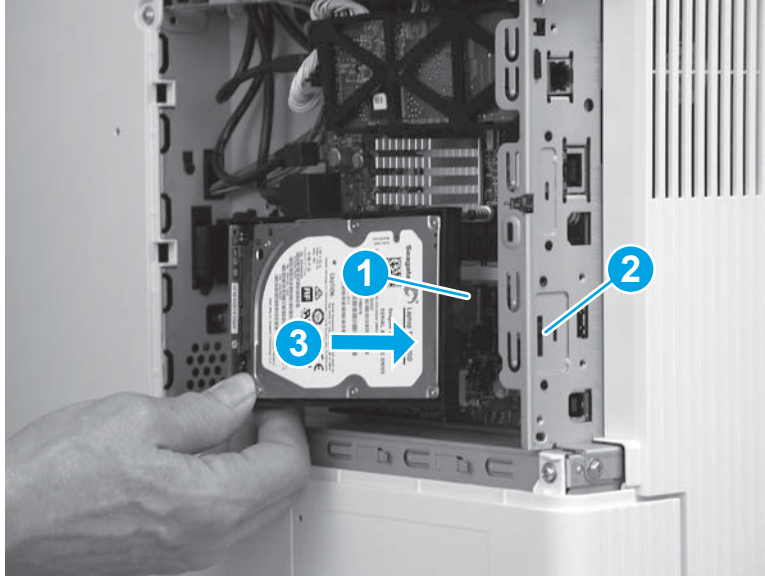

2. Hold the HDD connector latch (callout 1) in the released position, and then rotate the HDD down and into the connector on the formatter to install it.

 **NOTE:** Make sure that the tab (callout 2) snaps into place, and that the HDD is securely installed.

Figure 1-4117 Release the HDD

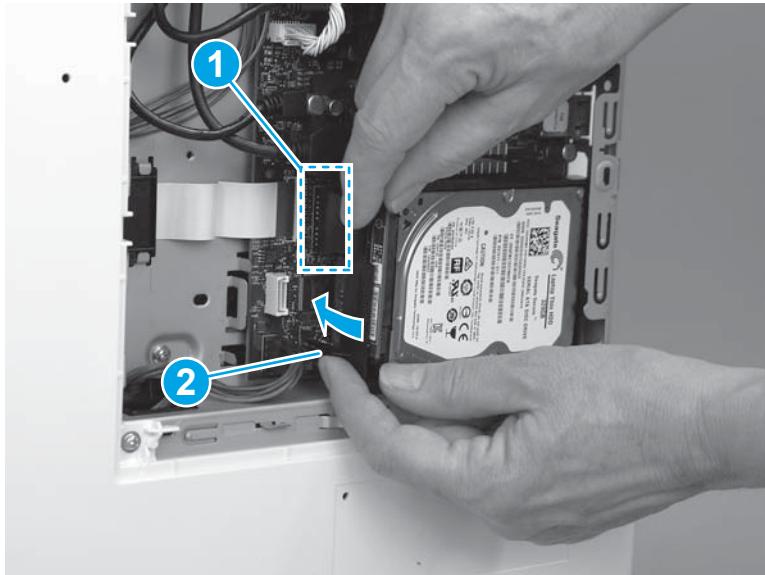

Step 54: Install the formatter (M552 and M553)

 **NOTE:** This step is for the M552 and M553 models. For the M577 models, skip this step and go to [Step 57: Install the formatter cover on page 2297](#).

If the optional hard-disk drive (HDD) was removed, do not forget to reinstall it after the formatter is reinstalled.

Engage the HDD holder with the chassis, rotate the HDD connector down and into the connector on the formatter. Make sure that the tabs snap into place.

 **CAUTION:**  ESD-sensitive part.

1. Position the formatter in the printer, and then install four screws (callout 1).

Figure 1-4118 Install the formatter

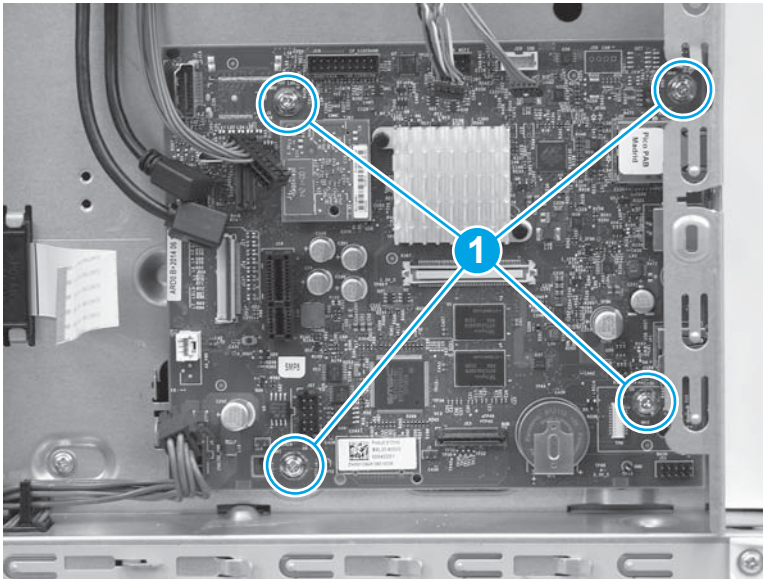

2. Connect all of the connectors on the formatter.

The following connectors are empty:

- All models: J1 (this connector is empty unless the optional DIMM is installed)
- M553n/dn and M552dn: J2 (callout 1; this is the touchscreen connector for the M553x model)
- All models: J9 (this connector is empty unless the optional internal USB ports component is installed)
- All models: J18 (this connector is empty unless the optional hard-disk-drive (HDD) is installed)
- All models: J23
- All models: J24
- M553n/dn and M552dn: J25 (this is the wireless connector for the M553x model)
- All models: J57
- All models: J98 (this connector is empty unless the optional trusted platform module (TPM) is installed)



 **IMPORTANT:** The flat-cable connector (callout 2) is a Zero Insertion Force (ZIF) connector that uses a hinged retainer to secure the flat cable. The hinged retainer must be opened to install the flat cable.

Figure 1-4119 Connect all connectors

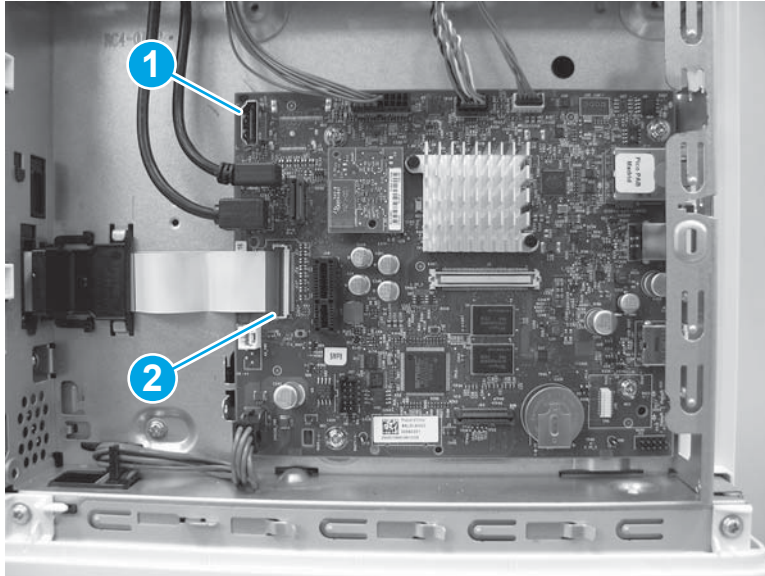

Step 55: Install the control-panel assembly (M553x only)

 **NOTE:** This step is for the M553x model. For the M553n/dn and M552dn models, skip this step and go to [Step 56: Install the USB cover \(M552 and M553\) on page 2296](#).

For the M577 models, skip this step and go to [Step 57: Install the formatter cover on page 2297](#).

1. Place the control panel on the printer as shown.

Figure 1-4120 Place the control panel on the product

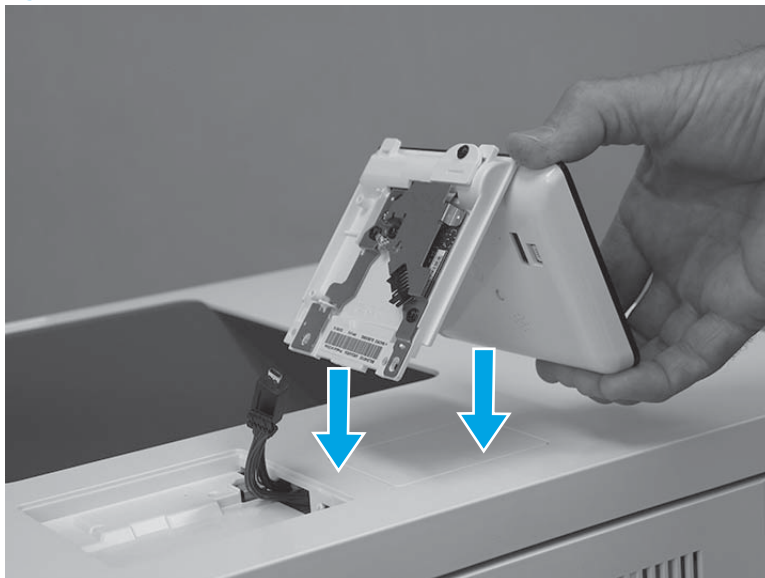

2. Connect one USB cable (callout 1), and one connector (callout 2).

 **IMPORTANT:** Take note of the location of the two mounting tabs (callout 3) on the control-panel assembly.

Figure 1-4121 Connect two connectors



3. Turn the control panel over, and then position the front edge tabs in the slots in the top cover.

Figure 1-4122 Turn the control panel over

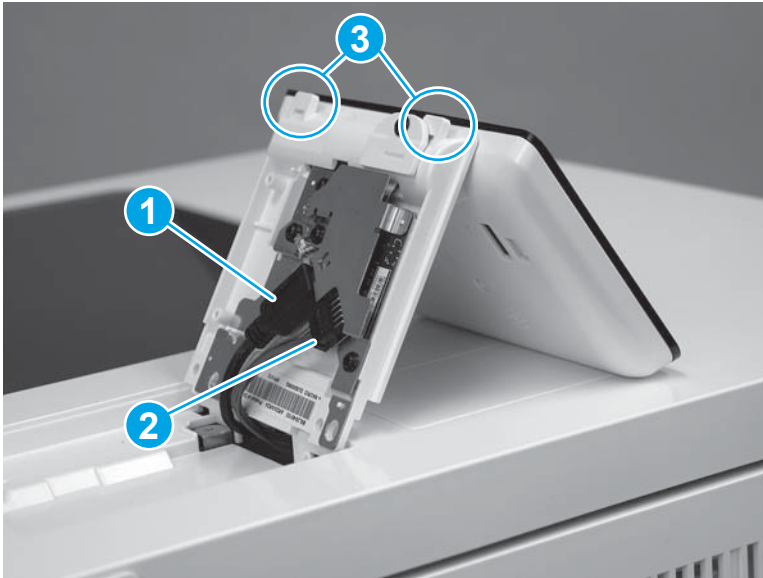
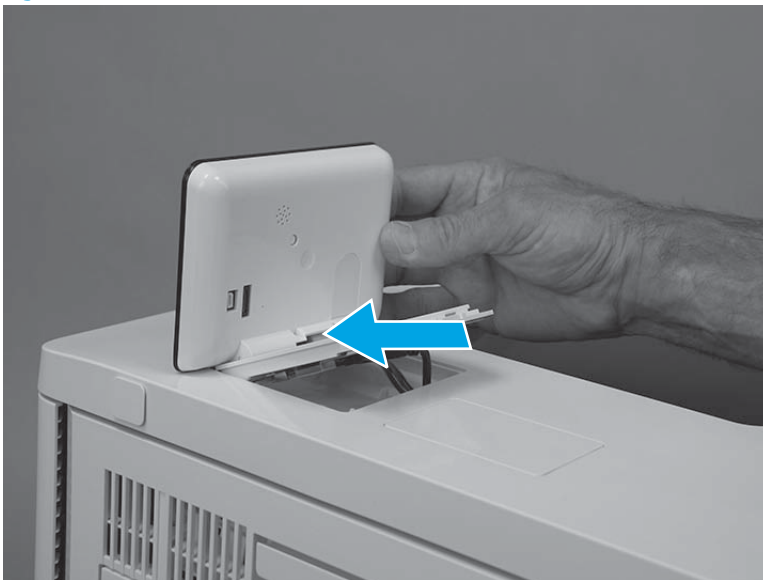

4. Rotate the control-panel base down onto the printer.

Figure 1-4123 Rotate the control-panel base down



5. Use a small Phillips screwdriver to install two screws (callout 1).

Figure 1-4124 Install two screws

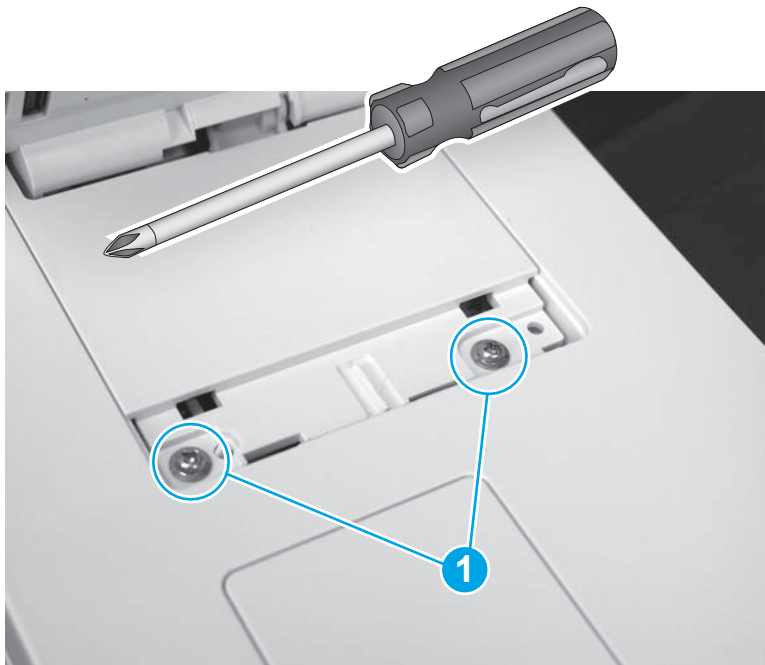

6. Position the screw cover mounting feet into the slots in the top cover (callout 1), and then rotate the cover down (callout 2) to install it.



 **NOTE:** Press down on the cover firmly to make sure that the tabs on the cover (callout 3) snap into place.

Figure 1-4125 Install the cover

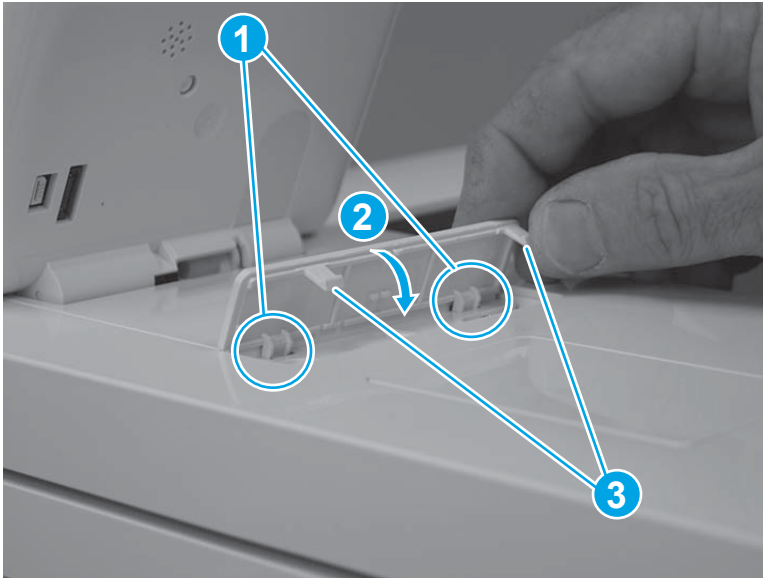

Step 56: Install the USB cover (M552 and M553)

 **NOTE:** This step is for the M552 and M553 models. For the M577 models, skip this step and go to [Step 57: Install the formatter cover on page 2297](#).

1. Push the cover into the USB port to install it.

Figure 1-4126 Install the cover



2. Make sure that the USB cover is fully seated after installing it.

Figure 1-4127 Check the installation

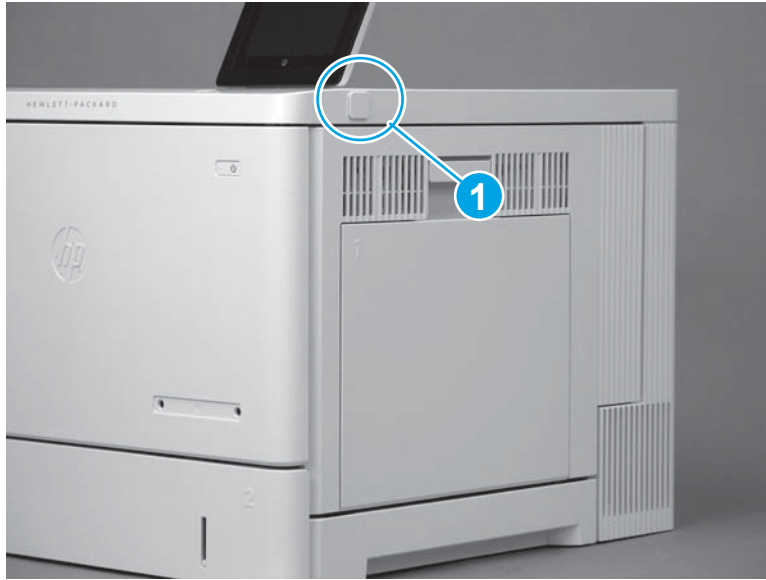

Step 57: Install the formatter cover

- ▲ Slide the cover onto the printer (callout 1) to install it.

 **NOTE:** Make sure that the tabs on the formatter cover align with the slots provided in the printer (callout 2). Tighten the two thumbscrews (callout 3).

 **TIP:** If needed, use the edge of a coin to turn the thumbscrews.

Figure 1-4128 Install the cover

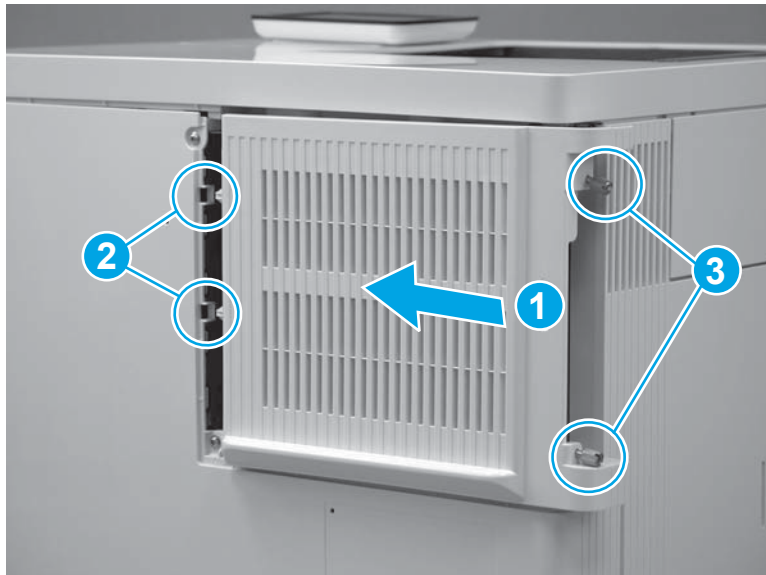

Step 58: Install the TCU

1. Verify that the toner collection hatch cover is in the closed position on the TCU.

Figure 1-4129 Verify that the toner collection hatch cover is closed

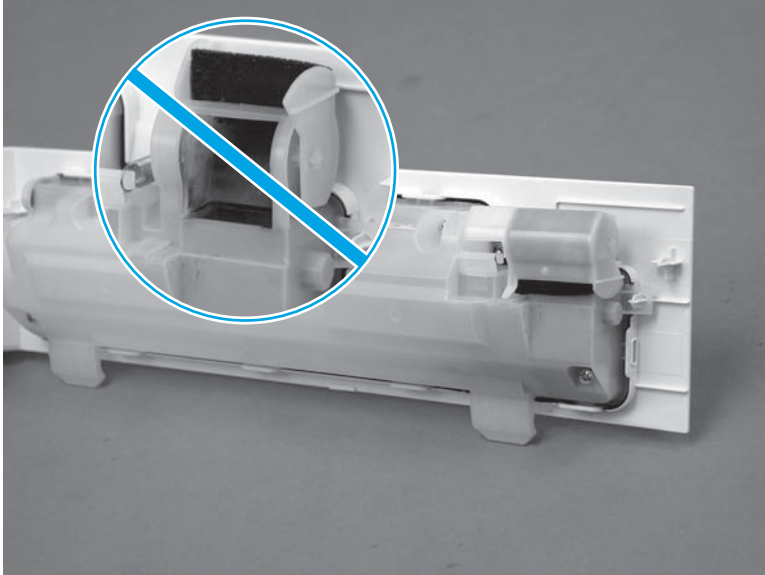

2. Position the TCU with the hinges in the slots provided in the printer (callout 1), and then rotate the TCU up and into the closed position.

 **NOTE:** The toner collection hatch cover automatically opens when the TCU is closed.

Figure 1-4130 Install the TCU



3. Close the front door.

Figure 1-4131 Close the front door

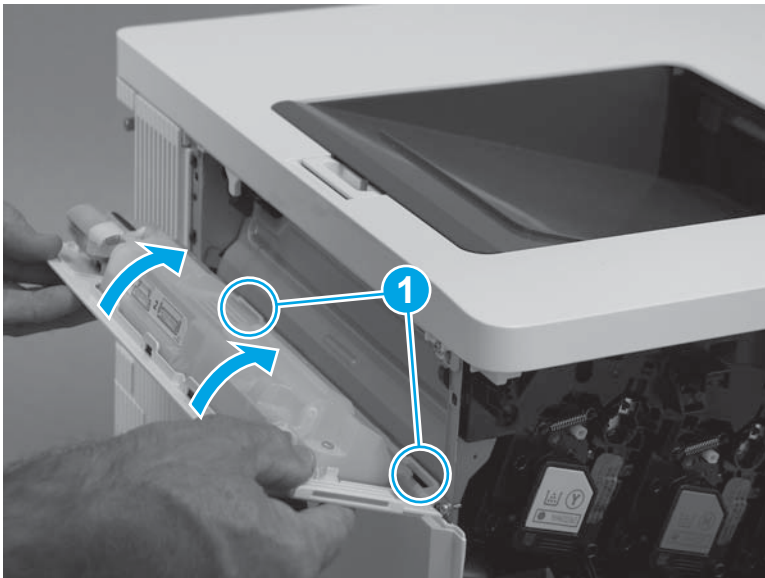

Step 59: Install the tray

1. With the front of the tray slightly lifted, align the sides of the tray with the rails in the printer, and then carefully slide the tray into the printer.

 **TIP:** As the tray slides into the printer, lower the front of it.

Figure 1-4132 Install the tray



2. Close the tray.

Figure 1-4133 Close the tray



Step 60: Install the ITB

CAUTION: Do not touch the grey-plastic belt. Skin oils and fingerprints on the belt can cause print-quality problems.

1. Handle the ITB by the edges. Do not touch the grey-plastic belt. Skin oils and fingerprints on the belt can cause print-quality problems.

Figure 1-4134 Handle the ITB by the edges

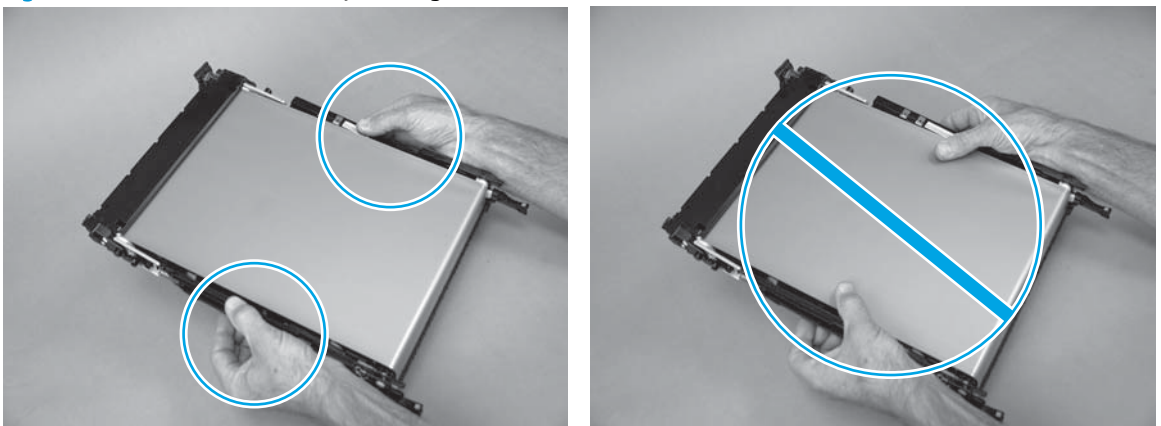

2. Align the ITB with the slots in the printer, and then carefully push it into the printer.

 **NOTE:** Be careful. Do not dislodge the ITB retainer springs from the holders on the chassis. The springs can interfere with installing the ITB.

Figure 1-4135 Align the ITB with the slots in the product



3. Continue to carefully push the ITB into the printer until it is fully installed.

Figure 1-4136 Install the ITB

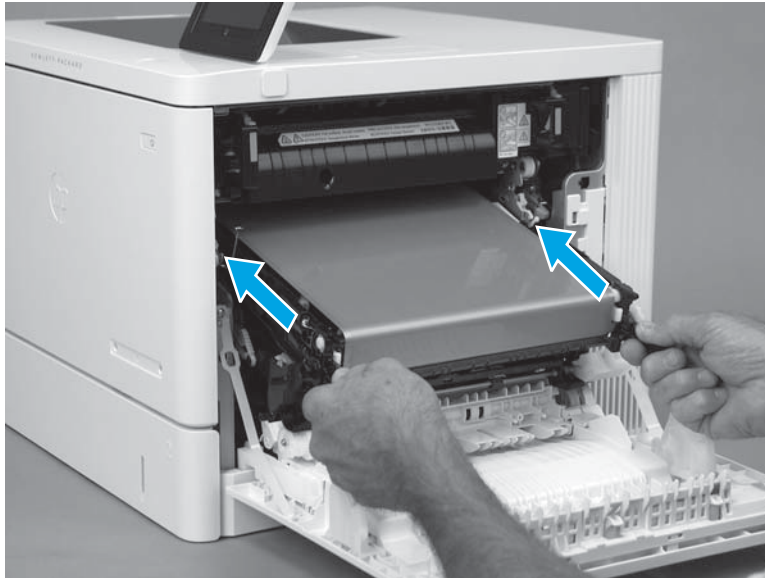
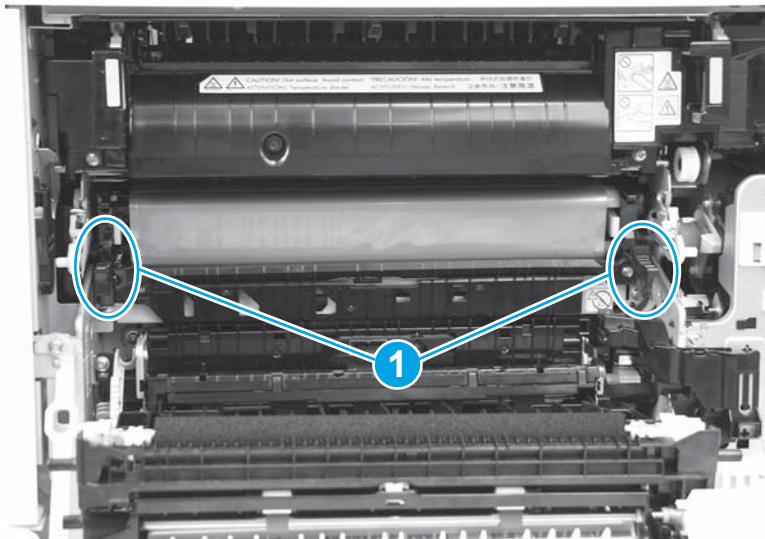

4. Remove the right-side ITB spring from the holder.

Figure 1-4137 Remove the spring from the holder



5. Fasten the right-side ITB spring (callout 1) under the tab (callout 2).

Figure 1-4138 Fasten the rear-side ITB spring

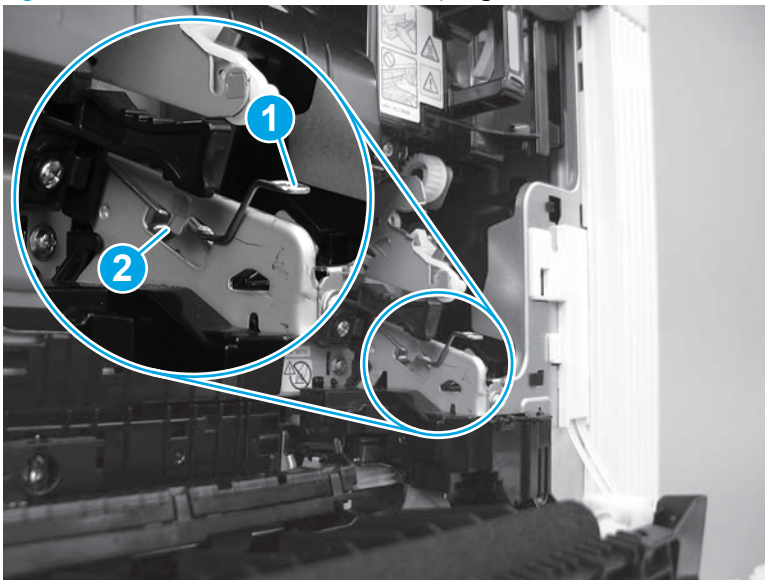

6. Remove the left-side ITB spring from the holder.

Figure 1-4139 Remove the spring from the holder

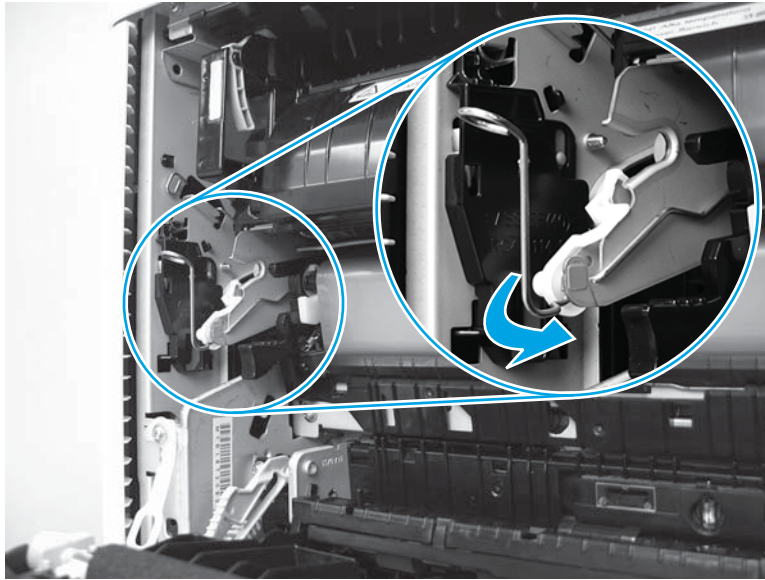

7. Fasten the left-side ITB spring (callout 1) under the tab (callout 2).

Figure 1-4140 Fasten the front-side ITB spring

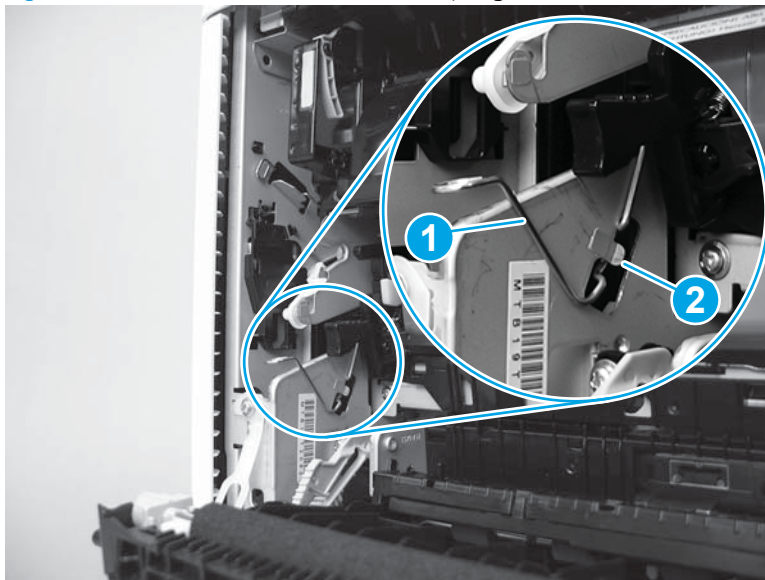

8. Push in the blue lever to engage the ITB drive coupling.

Figure 1-4141 Engage the ITB drive coupling

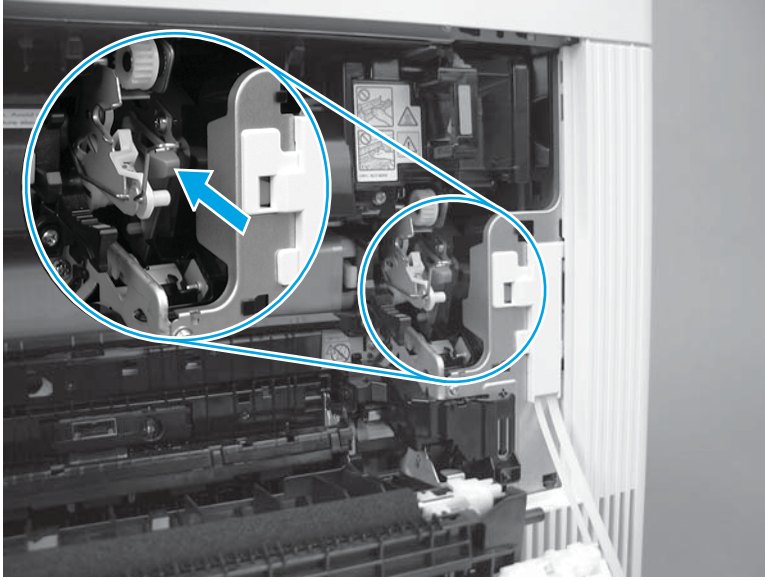

9. Close the right door.

 **TIP:** The right door should close easily if the ITB assembly is correctly installed.

Figure 1-4142 Close the right door



Step 61: Install the secondary transfer roller assembly

1. Move the registration sensor assembly (callout 1) out of the way, and then position the secondary transfer assembly right hinge (callout 2) into the hole provided in the printer.

Figure 1-4143 Install the right hinge

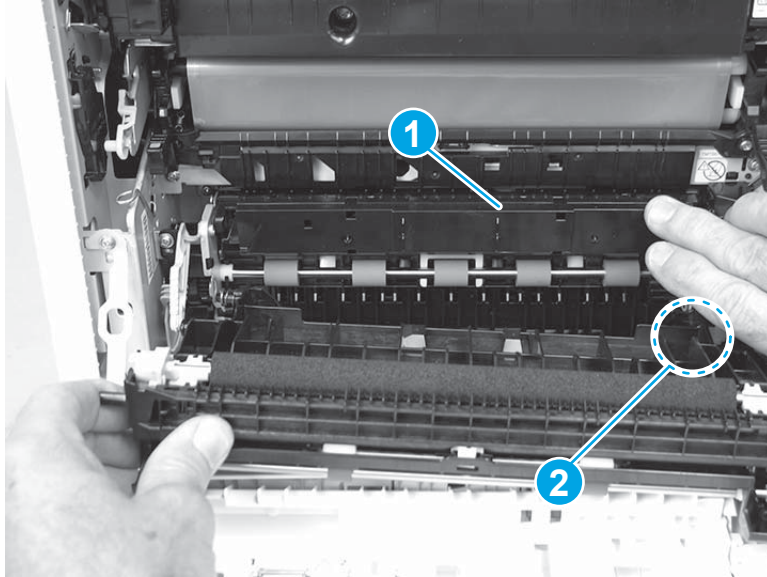

2. Position the assembly left-side hinge near the hole provided in the printer, and then slide the assembly toward the front of the printer to install the hinge in the hole.

Figure 1-4144 Install the left hinge

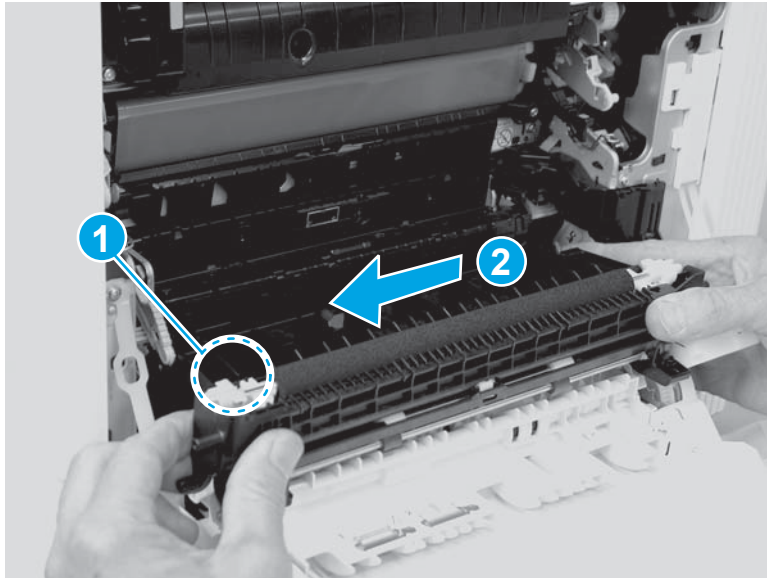

- Carefully flex the blue arm, and then push it over the pin on the assembly to engage it.

 **NOTE:** Make sure that the pin is correctly installed in the slot on the blue arm.

Figure 1-4145 Engage the blue arm with the pin

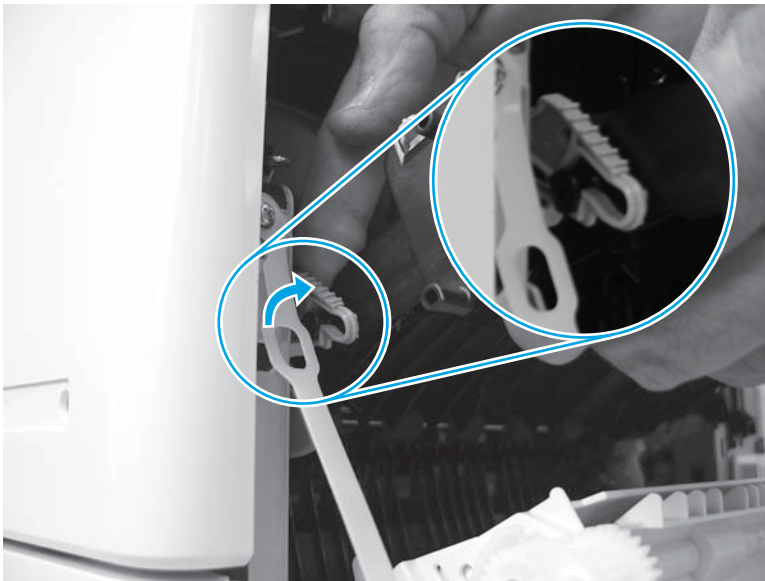

- Close the right door.

 **TIP:** The right door should close easily if the secondary transfer assembly is correctly installed.

Figure 1-4146 Close the right door



Removal and replacement: Paper pickup assembly

- [Introduction](#)
- [Step 1: Remove the secondary transfer assembly](#)
- [Step 2: Remove the ITB](#)
- [Step 3: Remove the tray](#)
- [Step 4: Remove the toner collection unit \(TCU\)](#)
- [Step 5: Remove the formatter cover](#)
- [Step 6: Remove the USB cover \(M552 and M553\)](#)
- [Step 7: Remove the control panel \(M553x only\)](#)
- [Step 8: Remove the formatter \(M552 and M553\)](#)
- [Step 9: Remove the hard-disk drive \(HDD\) \(M577\)](#)
- [Step 10: Remove the fax PCA \(M577c/f/z\)](#)
- [Step 11: Remove the formatter \(M577\)](#)
- [Step 12: Remove the rear cover \(M552 and M553\)](#)
- [Step 13: Remove the rear upper cover \(M577\)](#)
- [Step 14: Remove the rear cover \(M577\)](#)
- [Step 15: Remove the left upper cover \(M577\)](#)
- [Step 16: Remove the right front upper cover \(M577dn\)](#)
- [Step 17: Remove the stapler cover assembly \(M577c/f/z\)](#)
- [Step 18: Remove the integrated scanner assembly \(ISA\) \(M577\)](#)
- [Step 19: Remove the right upper cover \(M577\)](#)
- [Step 20: Remove the left cover](#)
- [Step 21: Remove the upper cover \(M552 and M553\)](#)
- [Step 22: Remove the right rear cover](#)
- [Step 23: Remove the formatter case](#)
- [Step 24: Remove the low-voltage power supply \(LVPS\)](#)
- [Step 25: Remove the power supply fan \(FM1\)](#)
- [Step 26: Remove the high-voltage power supply D \(HVPSD\)](#)
- [Step 27: Remove the lifter drive assembly](#)
- [Step 28: Remove the DC controller and sheet-metal bracket](#)
- [Step 29: Remove the pickup drive assembly and motor \(M5\)](#)

- [Step 30: Remove the registration assembly](#)
- [Step 31: Remove the paper pickup assembly](#)
- [Step 32: Unpack the replacement assembly](#)
- [Step 33: Install the paper pickup assembly](#)
- [Step 34: Install the registration assembly](#)
- [Step 35: Install the pickup drive assembly and motor \(M5\)](#)
- [Step 36: Install the DC controller and sheet-metal bracket](#)
- [Step 37: Install the lifter drive assembly](#)
- [Step 38: Install the HVPSD](#)
- [Step 39: Install the power-supply fan \(FM1\)](#)
- [Step 40: Install the LVPS](#)
- [Step 41: Install the formatter case](#)
- [Step 42: Install the right rear cover](#)
- [Step 43: Install the upper cover \(M552 and M553\)](#)
- [Step 44: Install the left cover](#)
- [Step 45: Install the right upper cover \(M577\)](#)
- [Step 46: Install the integrated scanner assembly \(ISA\) \(M577\)](#)
- [Step 47: Install the stapler cover assembly \(M577c/f/z\)](#)
- [Step 48: Install the right front upper cover \(M577dn\)](#)
- [Step 49: Install the left upper cover \(M577\)](#)
- [Step 50: Install the rear cover \(M577\)](#)
- [Step 51: Install the rear upper cover \(M577\)](#)
- [Step 52: Install the rear cover \(M552 and M553\)](#)
- [Step 53: Install the formatter \(M577\)](#)
- [Step 54: Install the fax PCA \(M577c/f/z\)](#)
- [Step 55: Install the HDD \(M577\)](#)
- [Step 56: Install the formatter \(M552 and M553\)](#)
- [Step 57: Install the control-panel assembly \(M553x only\)](#)
- [Step 58: Install the USB cover \(M552 and M553\)](#)
- [Step 59: Install the formatter cover](#)
- [Step 60: Install the TCU](#)

- [Step 61: Install the tray](#)
- [Step 62: Install the ITB](#)
- [Step 63: Install the secondary transfer roller assembly](#)

Introduction

This document provides the procedures to remove and replace the paper pickup assembly.

Before performing service

 **TIP:** Some figures might show assemblies removed or installed that have not yet been removed or installed at that specific step. However, the procedures are correct for this printer and the target assembly. Always thoroughly read the instructions that accompany each figure.

Turn the printer power off

- Disconnect the power cable.

 **WARNING!** To avoid damage to the printer, turn the printer off, wait 30 seconds, and then remove the power cord before attempting to service the printer.

Use the table below to identify the correct part number for your printer, and then go to <http://h20141.www2.hp.com/hpparts> to order the part.

Paper pickup assembly part number	
RM2-0017-000CN	Paper pickup assembly (includes the Tray 2 paper pickup roller assembly)

Required tools

- #2 Phillips screwdriver with a magnetic tip

After performing service

Make sure that all of the connectors on the LVPS are fully seated.

Make sure that all of the connectors on the DC controller are fully seated.

Make sure that the TCU is fully closed after replacing it.

Make sure that all of the connectors on the formatter are fully seated.

Make sure that the formatter cover is fully seated, and that the thumbscrews are finger tight after replacing it.

Turn the printer power on

- Connect the power cable.
- Use the power switch to turn the power on.

Post service test

Print a configuration page to make sure that the printer is functioning correctly.

Step 1: Remove the secondary transfer assembly

1. Open the right door.

Figure 1-4147 Open the right door



2. Release the blue arm, and then let the secondary transfer assembly rotate down to the half-way open position.

 **NOTE:** The assembly should stop at the halfway down point—the pin will stop at the notch in the slot in the blue arm.

Figure 1-4148 Release the secondary transfer roller assembly



- Carefully flex the top portion of the blue arm—as shown in the figure—to start to disengage it from the pin.

Figure 1-4149 Carefully flex the top portion of the blue arm

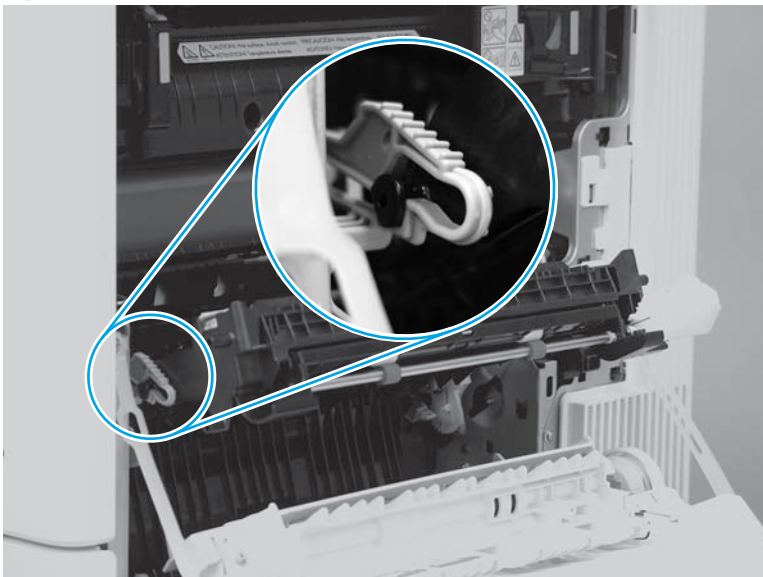

- Continue to flex the blue arm until it disengages from the pin.

Figure 1-4150 Disengage the blue arm and pin



5. Slide the assembly toward the front of the printer to release it (callout 1), and then rotate it down and away from the printer to remove it (callout 2).



 **Reinstallation tip:** Before removing the assembly, take note of where the assembly hinge pins fit into the holes provided in the printer.

Figure 1-4151 Remove the secondary transfer roller assembly

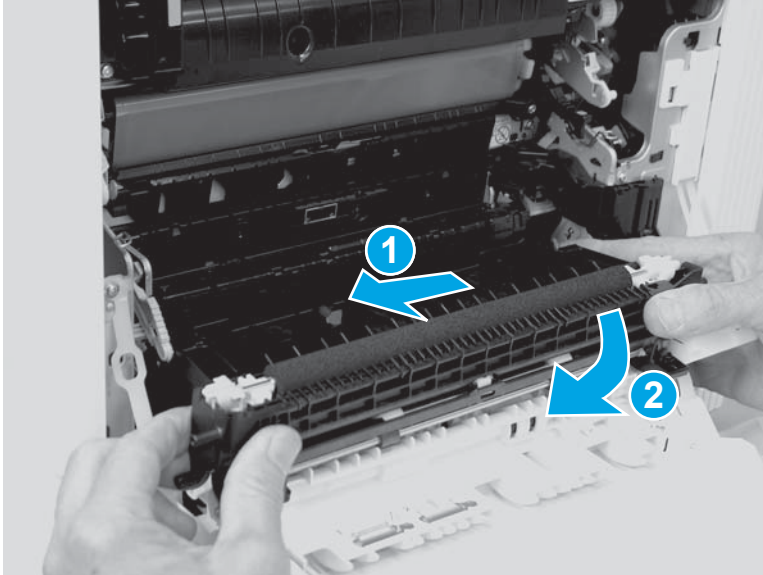

Step 2: Remove the ITB

 **CAUTION:** Do not touch the grey-plastic belt. Skin oils and fingerprints on the belt can cause print-quality problems.

1. Open the right door.

Figure 1-4152 Open the right door



2. Pull the blue lever to release the ITB drive coupling.

Figure 1-4153 Release the ITB drive coupling

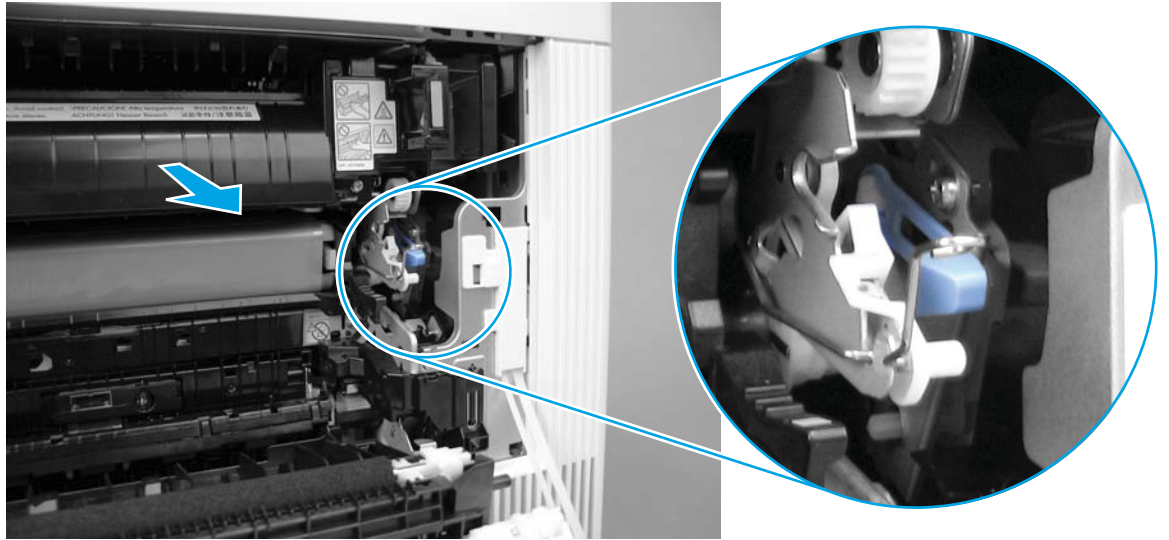

3. Push in on the blue arm to release the secondary transfer roller assembly, and then completely lower the assembly.

 **NOTE:** Press the blue arm on the secondary transfer roller assembly a second time to release the roller assembly when it stops at the halfway open position.

Figure 1-4154 Lower the secondary transfer roller assembly



4. Release the left-side ITB spring (callout 1) from the tab (callout 2).

Figure 1-4155 Release the front-side ITB spring

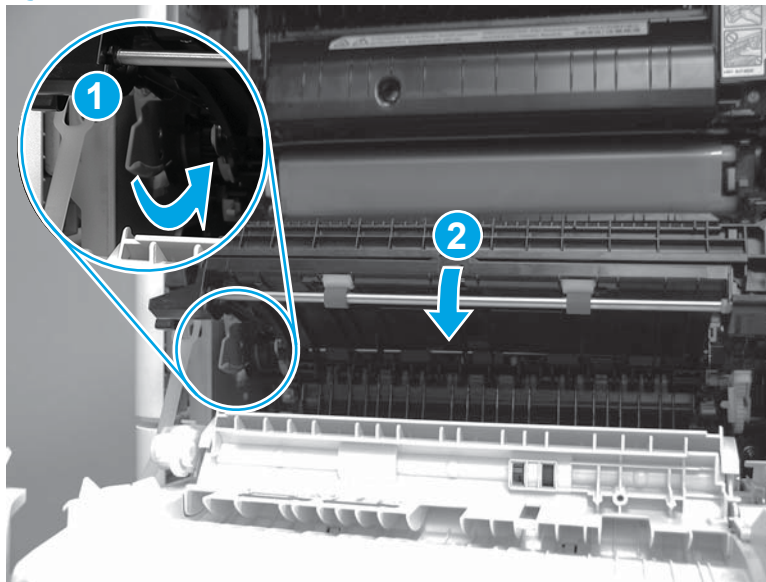
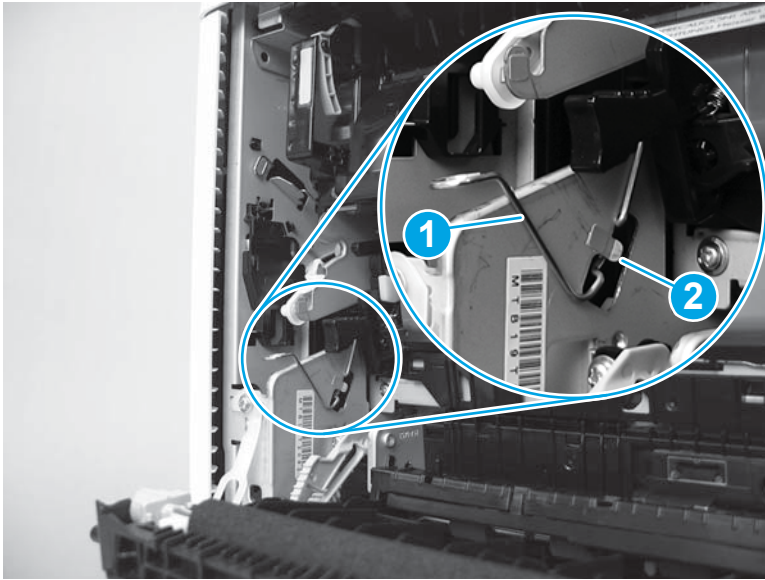

5. Place the left-side ITB spring on the holder to keep it out of the way.

 **TIP:** The holder is colored blue to help locate it.

Figure 1-4156 Place the spring on the holder

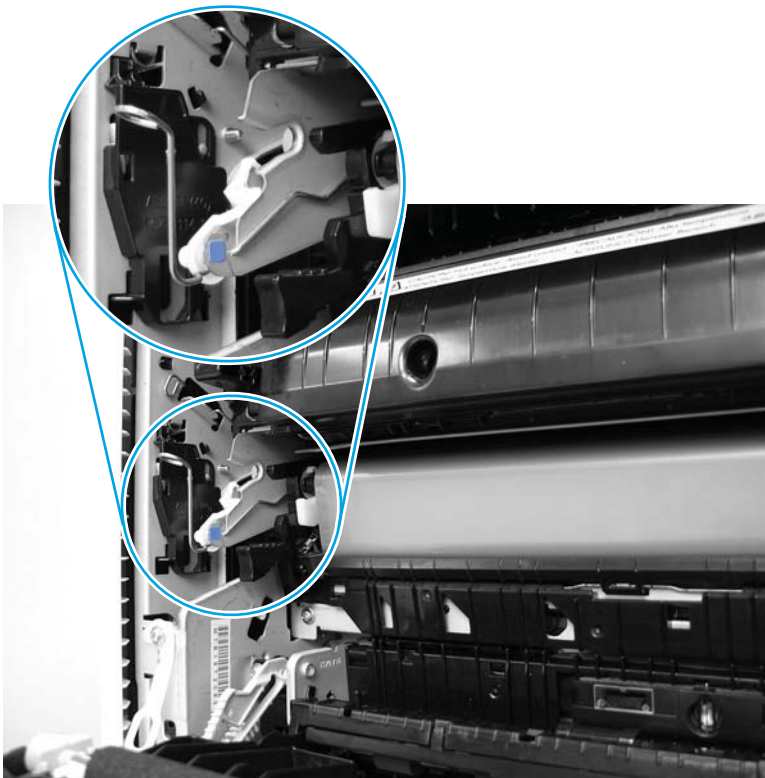

6. Release the right-side ITB spring (callout 1) from the tab (callout 2).

Figure 1-4157 Release the rear-side ITB spring

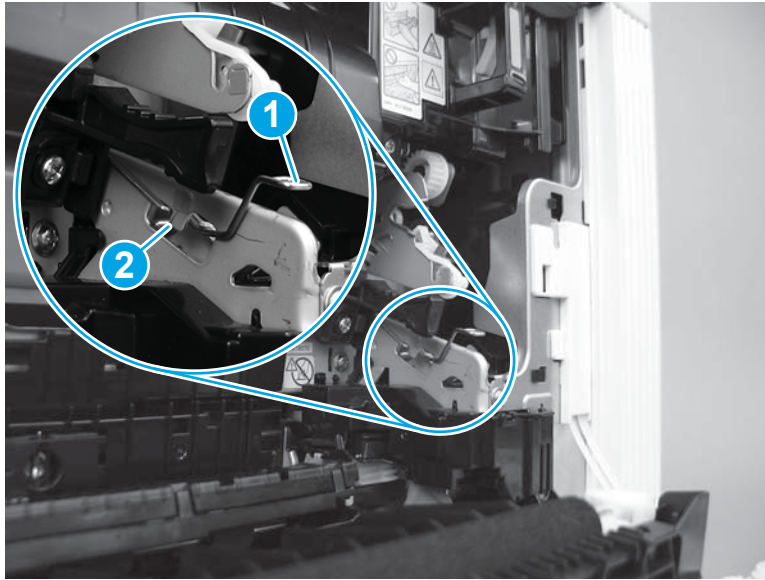

7. Place the right-side ITB spring on the holder to keep it out of the way.

 **TIP:** The holder is colored blue to help locate it.

Figure 1-4158 Place the spring on the holder

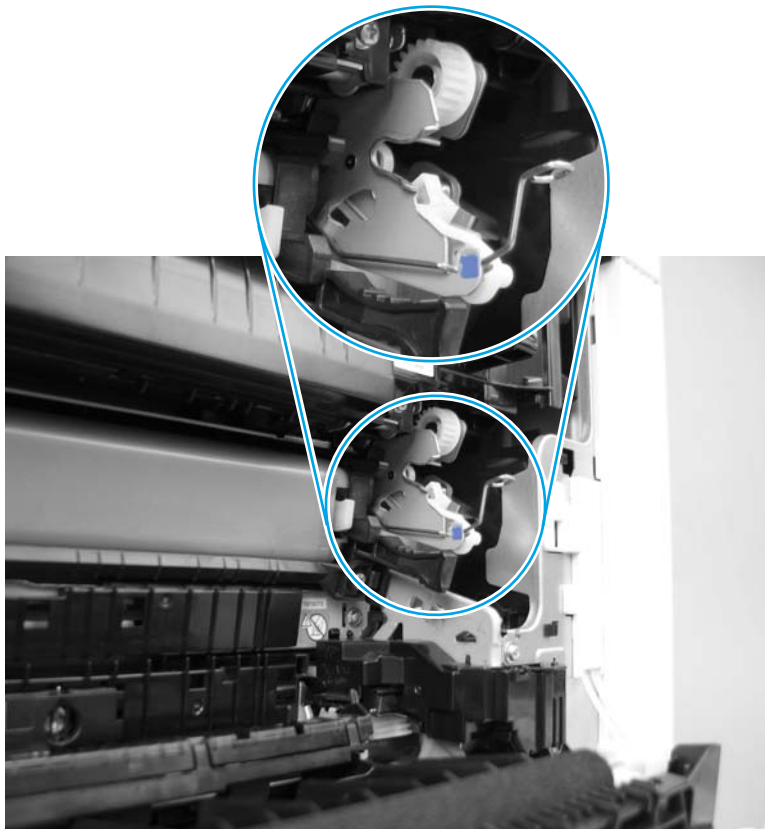

8. Grasp the two blue handles on the ITB.

⚠ CAUTION: If the ITB is removed to access other assemblies in the printer, use care. The ITB is a sensitive assembly. Be careful when handling the ITB so that it is not damaged. Always place the ITB in a safe and protected location.

Figure 1-4159 Grasp the ITB handles

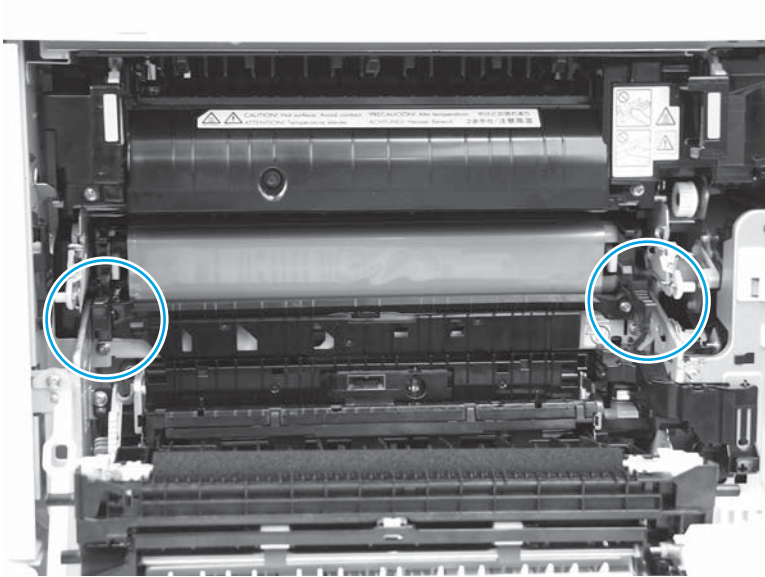

9. Pull the ITB out of the printer to remove it.

⚠ CAUTION: Do not touch the grey-plastic belt. Skin oils and fingerprints on the belt can cause print-quality problems.

Figure 1-4160 Remove the ITB

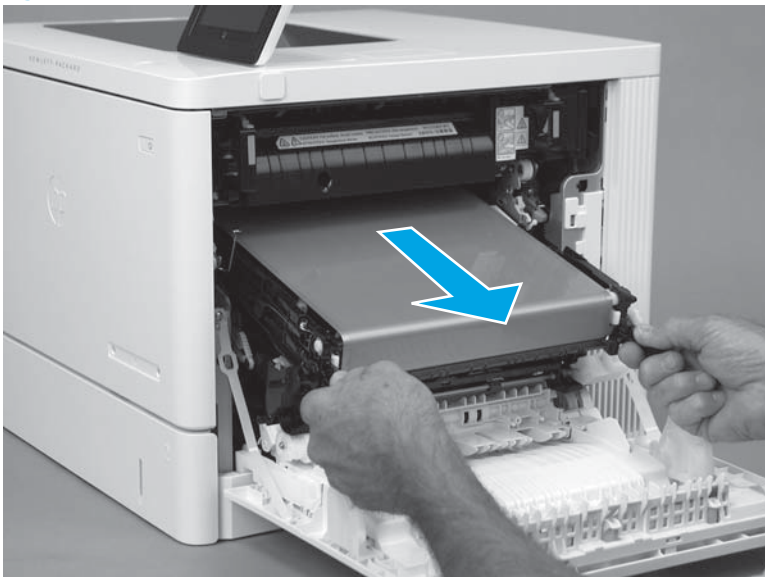

Step 3: Remove the tray

1. Pull the tray out until it stops.

Figure 1-4161 Pull the tray out



2. Lift the front of the tray, and then pull it out of the printer to remove it.

Figure 1-4162 Remove the tray

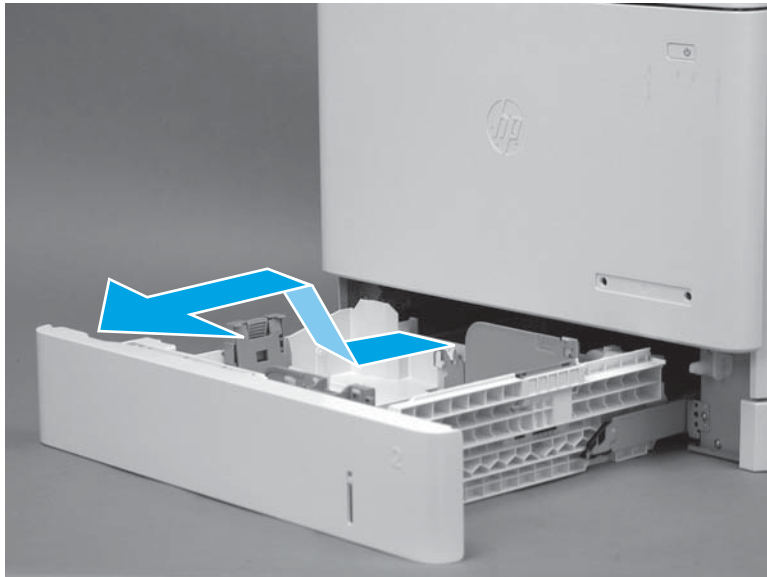

Step 4: Remove the toner collection unit (TCU)

1. Open the front door.

Figure 1-4163 Open the front door



2. Open the TCU.

 **NOTE:** The toner collection hatch cover automatically closes when the TCU is opened.

Figure 1-4164 Open the TCU



3. Pull the TCU away from the printer at an angle to remove it.

⚠ CAUTION: Do not open the toner collection hatch cover when handling the TCU. If toner gets on clothing, wipe it off by using a dry cloth and wash the clothes in cold water. Hot water sets toner into fabric.

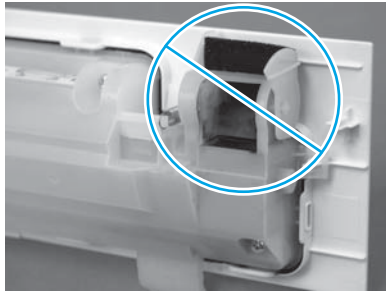
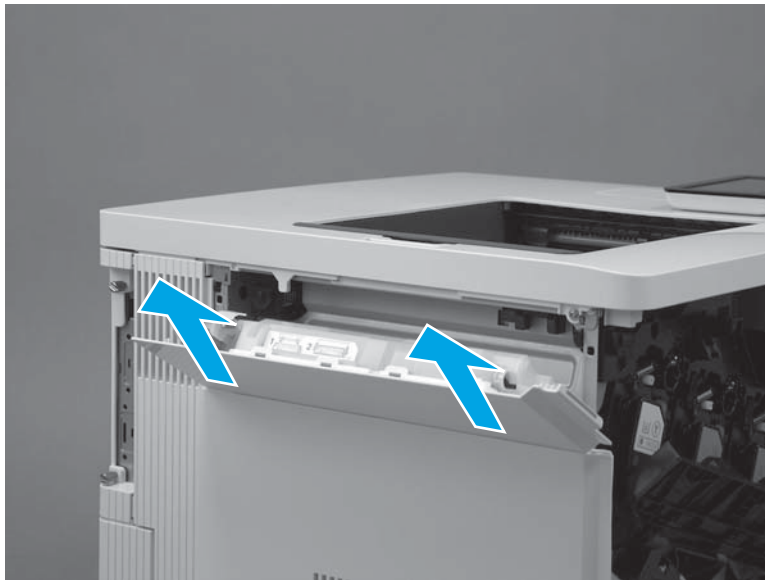

Figure 1-4165 Remove the TCU



Step 5: Remove the formatter cover

1. Locate the formatter cover.

Figure 1-4166 Locate the formatter cover

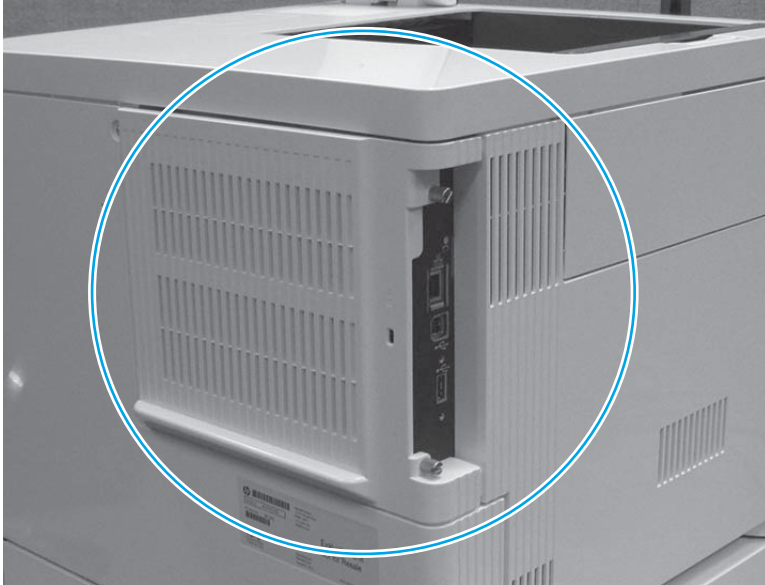

2. Loosen the two thumbscrews (callout 1). Grasp the two thumbscrews, and then slide the cover away from the printer (callout 2) to remove it.

 **TIP:** If needed, use the edge of a coin to turn the thumbscrews.

Figure 1-4167 Loosen the thumbscrews

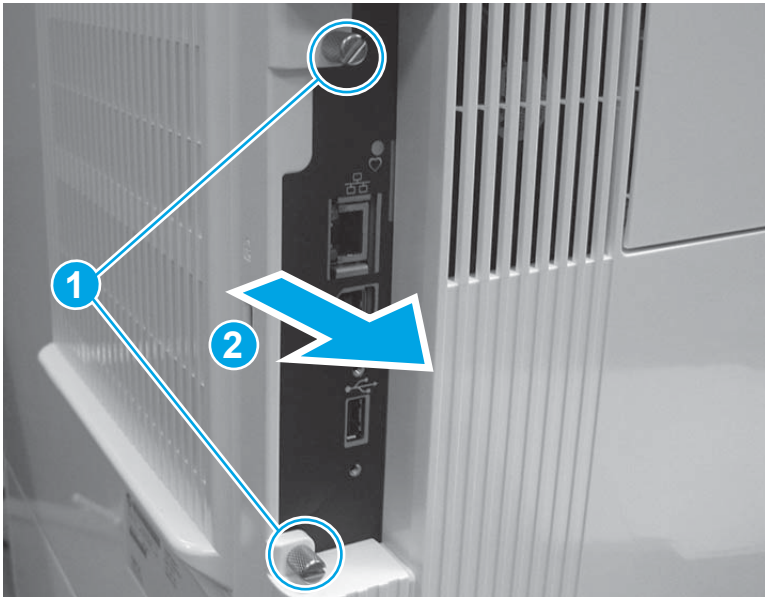

Step 6: Remove the USB cover (M552 and M553)

 **NOTE:** This step is for the M552 and M553 models. For the M577 models, skip this step and go to [Step 9: Remove the hard-disk drive \(HDD\) \(M577\) on page 2326](#).

1. Locate the USB cover.

Figure 1-4168 Locate the USB cover



2. Pull the cover off of the printer to remove it.

Figure 1-4169 Remove the cover



Step 7: Remove the control panel (M553x only)

 **NOTE:** For the M553n/dn and M552dn models, skip this step and go to [Step 8: Remove the formatter \(M552 and M553\) on page 2325](#).

For the M577 models, skip this step and go to [Step 9: Remove the hard-disk drive \(HDD\) \(M577\) on page 2326](#).

1. Tilt the control panel up.

Figure 1-4170 Tilt the control panel up



2. Use a small flat-blade screwdriver to release the control-panel screws cover tabs.

Figure 1-4171 Release the control-panel screws cover tabs



3. Rotate the cover up to remove it.

Figure 1-4172 Remove the cover

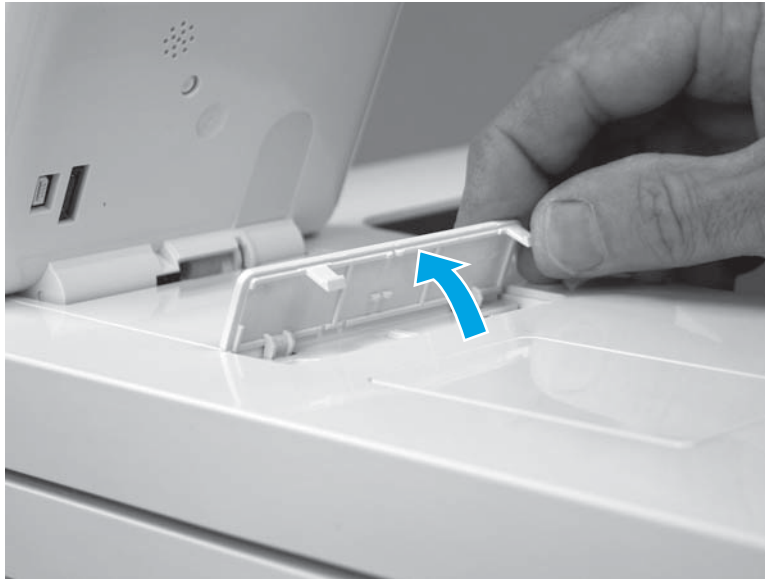

4. Use a small Phillips screwdriver to remove two screws (callout 1).

 **IMPORTANT:** Store the screws in a secure place where they cannot fall down into the printer.

Figure 1-4173 Remove two screws

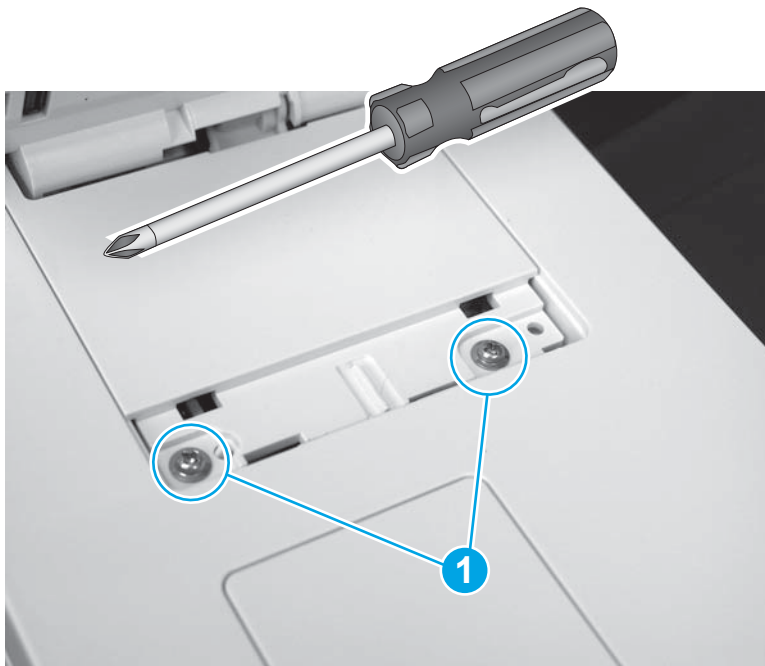

5. Rotate the control-panel base toward the front of the printer.

Figure 1-4174 Rotate the control-panel base up



6. Slightly slide the control-panel base toward the rear of the printer (callout 1) to release it, and then turn the control panel over (callout 2) to access the bottom side.

⚠ CAUTION: The control panel is still attached to the printer. Do not attempt to completely remove the control panel.

Figure 1-4175 Turn the control panel over

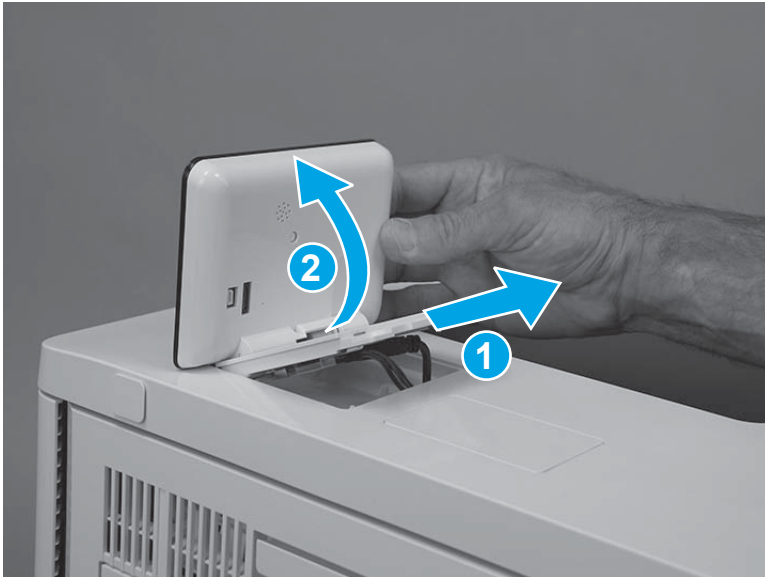

7. Disconnect one USB cable (callout 1), one connector (callout 2), and then remove the control panel.

Figure 1-4176 Disconnect two connectors

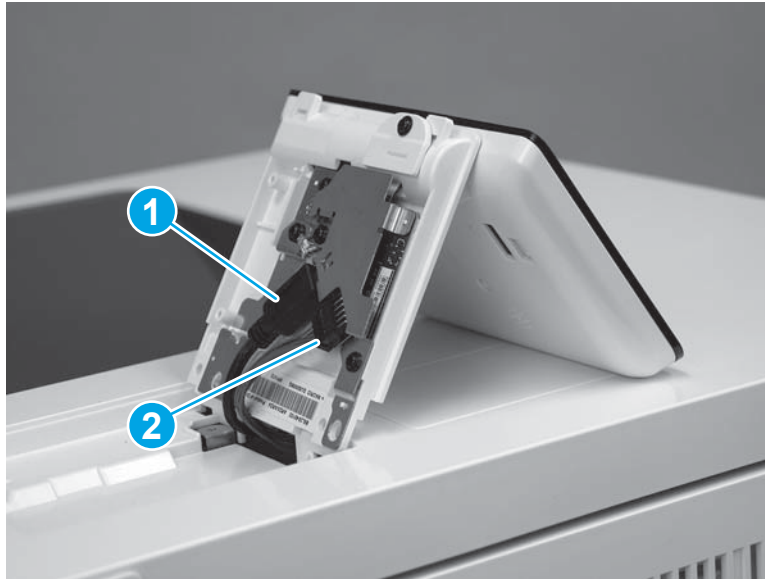

Step 8: Remove the formatter (M552 and M553)

 **NOTE:** This step is for the M552 and M553 models. For the M577 models, skip this step and go to [Step 9: Remove the hard-disk drive \(HDD\) \(M577\) on page 2326](#).

If the optional hard-disk drive (HDD) is installed, it must be removed to gain access to the formatter mounting screws.

Release two tabs along the left edge of the HDD, rotate the left edge away from the product, and then slide the HDD to the left to remove it.

 **CAUTION:**  ESD-sensitive part.

1. Disconnect all of the connectors on the formatter.

The following connectors are empty:

- All models: J1 (this connector is empty unless the optional DIMM is installed)
- M553n/dn and M552dn: J2 (callout 1; this is the touchscreen connector for the M553x model)
- All models: J9 (this connector is empty unless the optional internal USB ports component is installed)
- All models: J18 (this connector is empty unless the optional hard-disk-drive (HDD) is installed)
- All models: J23
- All models: J24
- M553n/dn and M552dn: J25 (this is the wireless connector for the M553x model)

- All models: J57
- All models: J98 (this connector is empty unless the optional trusted platform module (TPM) is installed)

 **IMPORTANT:** The flat-cable connector (callout 2) is a Zero Insertion Force (ZIF) connector that uses a hinged retainer to secure the flat cable. The hinged retainer must be opened to release the flat cable.

Figure 1-4177 Disconnect all connectors

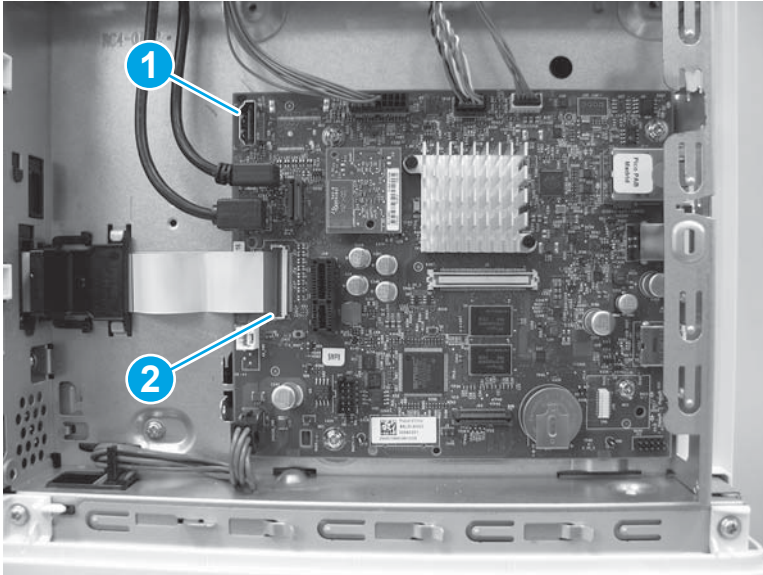

2. Remove four screws (callout 1), and then remove the formatter.

Figure 1-4178 Remove the formatter

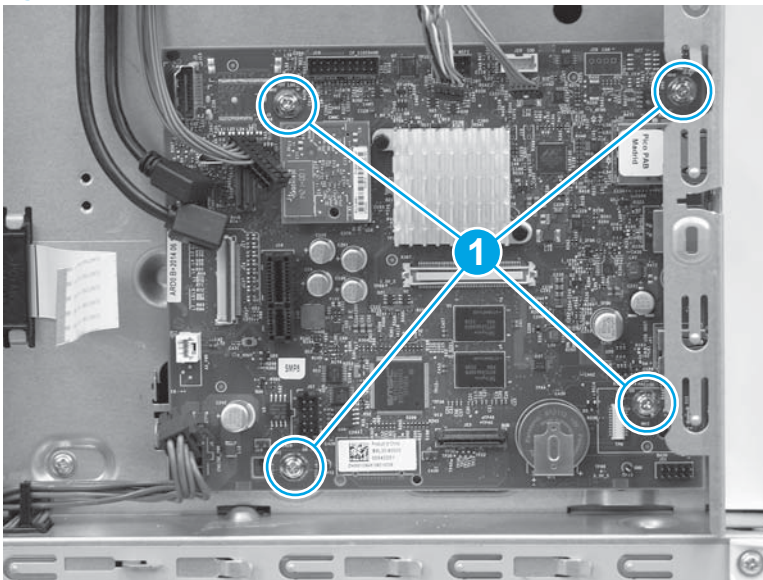

Step 9: Remove the hard-disk drive (HDD) (M577)

 **NOTE:** This step is for the M577 models. For the M552 and M553 models, skip this step and go to [Step 12: Remove the rear cover \(M552 and M553\) on page 2331](#).

 **CAUTION:**  ESD-sensitive part.

1. Release two tabs (callout 1). Hold the tabs in the released position, and then rotate the hard disk drive (HDD) up (callout 2) to release the connector from the formatter.

Figure 1-4179 Release the HDD

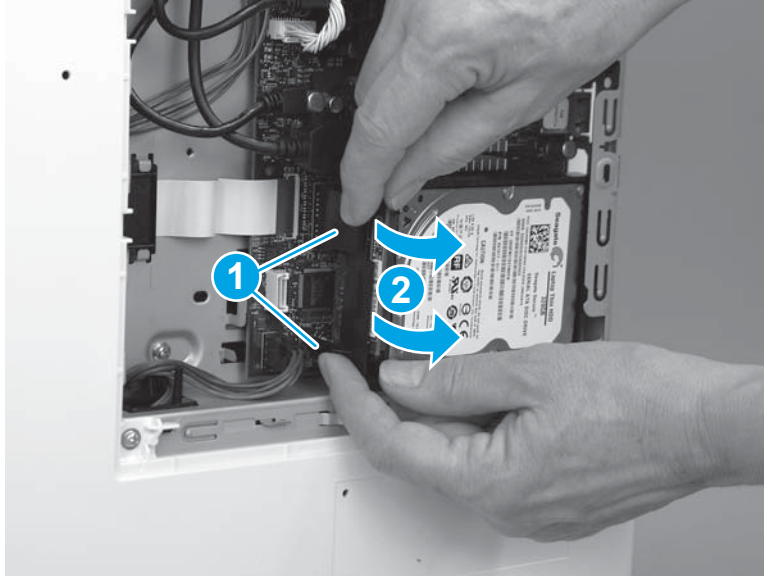

2. Slide the HDD away from the printer to remove it.

Figure 1-4180 Remove the HDD

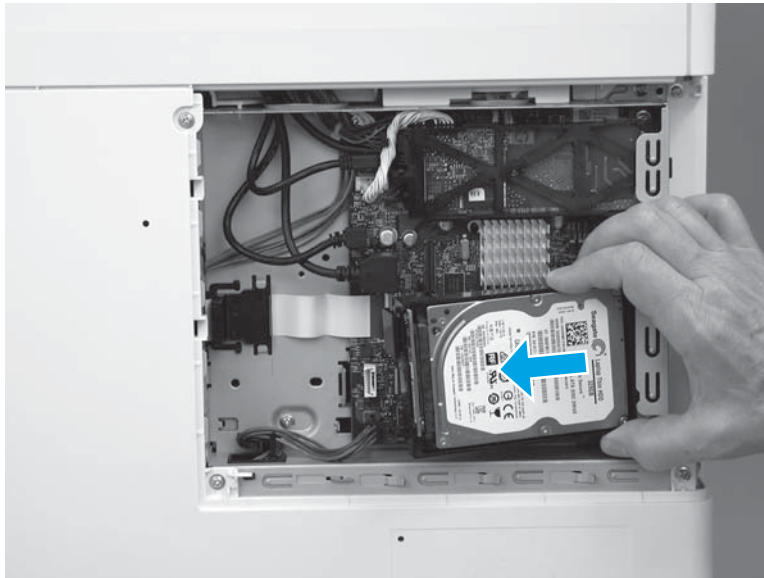

Step 10: Remove the fax PCA (M577c/f/z)

 **NOTE:** This step is for the M577c/f/z models. For the M577n model, skip this step and go to [Step 11: Remove the formatter \(M577\) on page 2329](#).

For the M552 and M553 models, skip this step and go to [Step 12: Remove the rear cover \(M552 and M553\) on page 2331](#).

 **CAUTION:**  ESD-sensitive part.

1. Locate the fax PCA component on the formatter.

Figure 1-4181 Locate the fax PCA

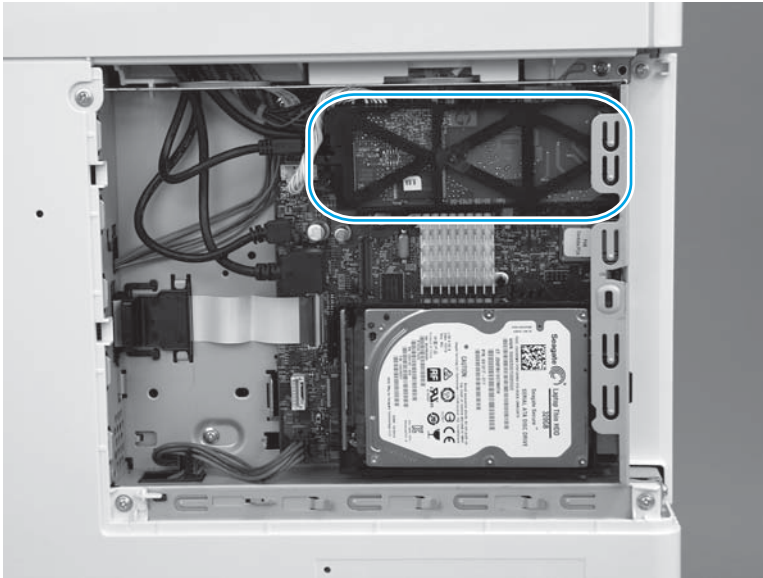

2. Release the connector latch (callout 1), and then pull the connector away from the formatter (callout 2) to disconnect it.

Figure 1-4182 Disconnect one connector

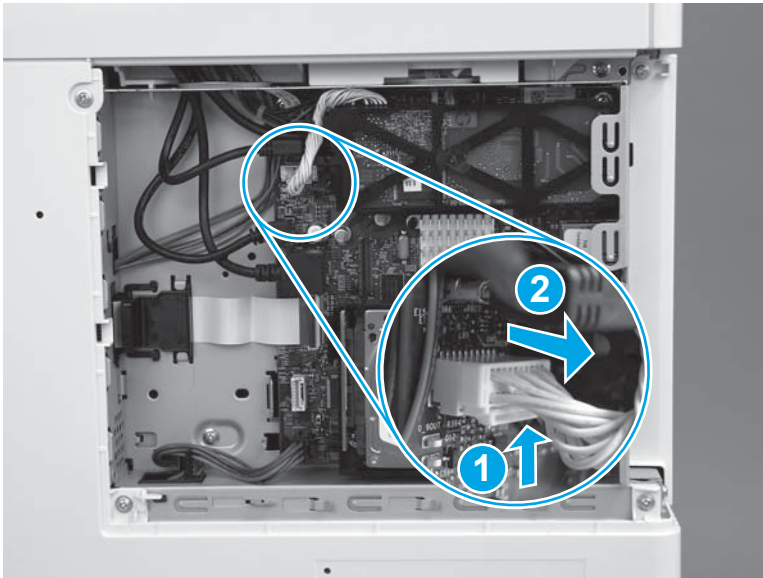

3. Release one retainer (callout 1) by pressing the bracket arms together.

Figure 1-4183 Release one latch

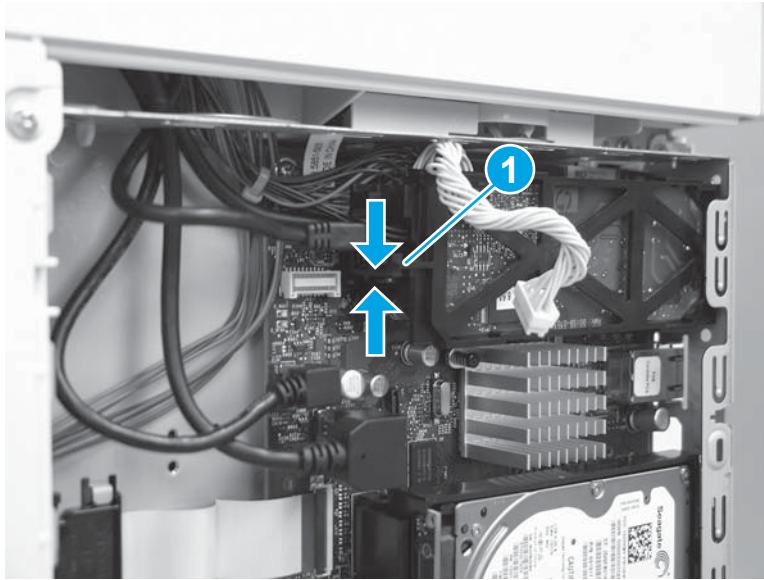

4. Rotate the end of the fax PCA (callout 1) away from the formatter, and then slide the PCA left (callout 2) to remove it.

Figure 1-4184 Remove the fax PCA

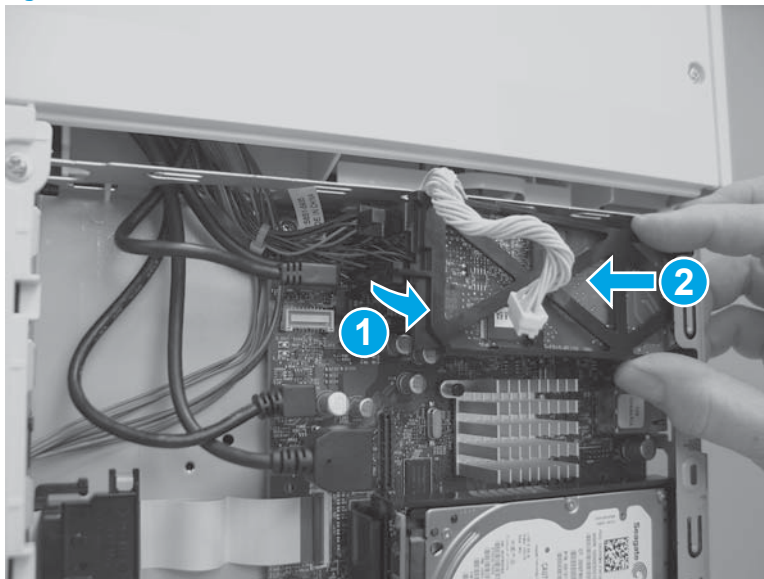

Step 11: Remove the formatter (M577)

 **NOTE:** This step is for the M577 models. For the M552 and M553 models, skip this step and go to [Step 12: Remove the rear cover \(M552 and M553\) on page 2331.](#)

 **CAUTION:**  ESD-sensitive part.

1. Disconnect all of the connectors on the formatter.

The following connectors are empty:

- All models: J1 (this connector is empty unless the optional DIMM is installed)
- All models: J3
- M577dn: J15 (this is the fax connector for the M577f/z/c models)
- All models: J21 (this connector is empty unless the optional internal USB ports component is installed)
- All models: J23
- All models: J24
- All models: J51
- All models: J57
- All models: J97
- All models: J98 (this connector is empty unless the optional trusted platform module (TPM) is installed)

 **IMPORTANT:** The flat-cable connector (callout 1) is a Zero Insertion Force (ZIF) connector that uses a hinged retainer to secure the flat cable. The hinged retainer must be opened to release the flat cable.

Figure 1-4185 Disconnect all connectors



2. Remove four screws (callout 1).

Figure 1-4186 Remove four screws

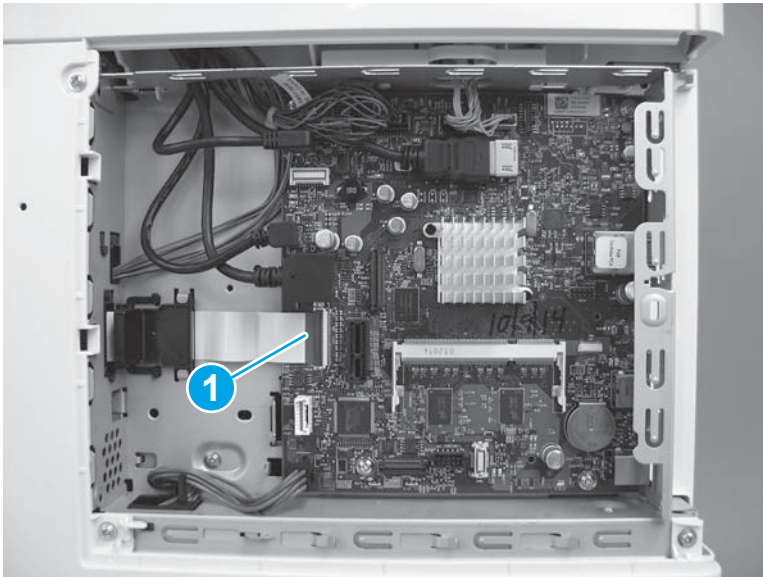
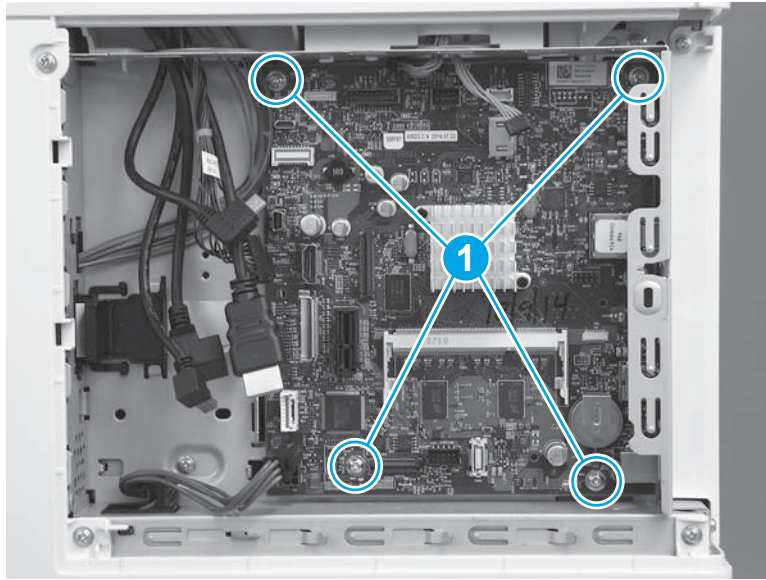

3. Remove the formatter.

Figure 1-4187 Remove the formatter

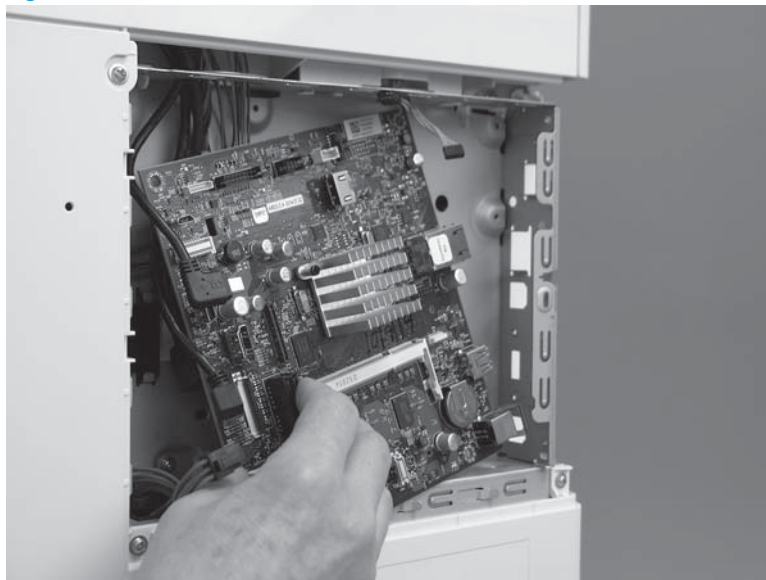

Step 12: Remove the rear cover (M552 and M553)

 **NOTE:** This step is for the M552 and M553 models. For the M577 models, skip this step and go to [Step 13: Remove the rear upper cover \(M577\) on page 2332.](#)

1. Remove four screws (callout 1).

Figure 1-4188 Remove four screws

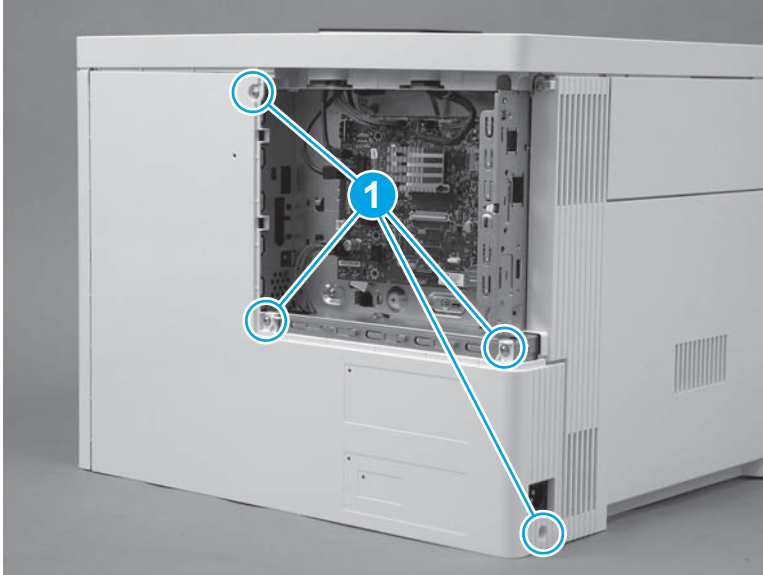

2. Slightly slide the cover to the right (callout 1), rotate the bottom of the cover away from the printer (callout 2), and then pull the top of the cover away from the printer (callout 3) to remove the cover.

Figure 1-4189 Remove the cover

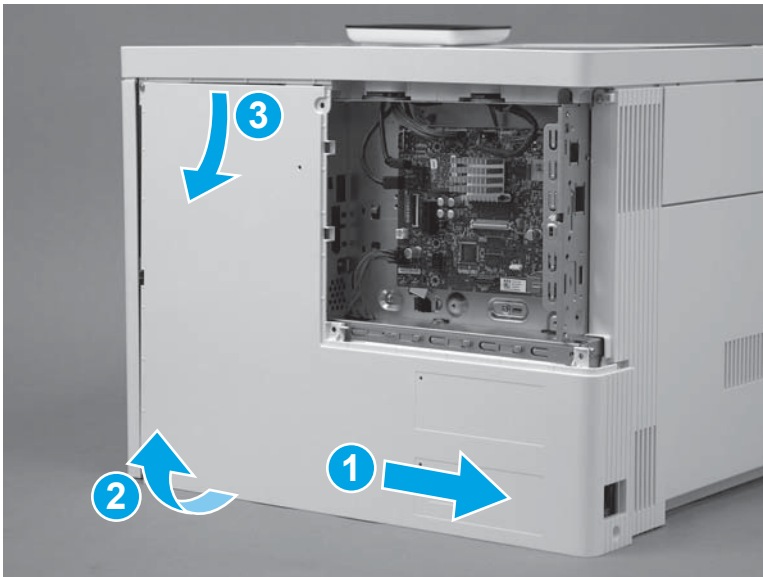

Step 13: Remove the rear upper cover (M577)

 **NOTE:** This step is for the M577 models. For the M552 and M553 models, skip this step and go to [Step 20: Remove the left cover on page 2345](#).

1. Remove two screws (callout 1).

 **Reinstallation tip:** These two screws are self-tapping screws for plastic. When reinstalling them, rotate the screws counterclockwise to align them with the existing thread pattern, and then carefully turn them clockwise to tighten. Do not overtighten. This will prevent stripping the threads inside the screw holes.

Figure 1-4190 Remove two screws



2. Use a small, flat blade screwdriver to release the right edge of the cover.

Figure 1-4191 Release the right edge

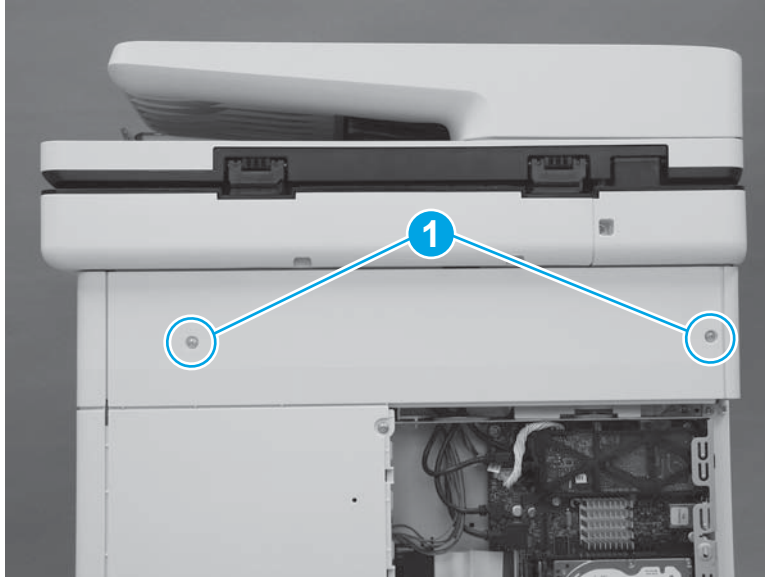
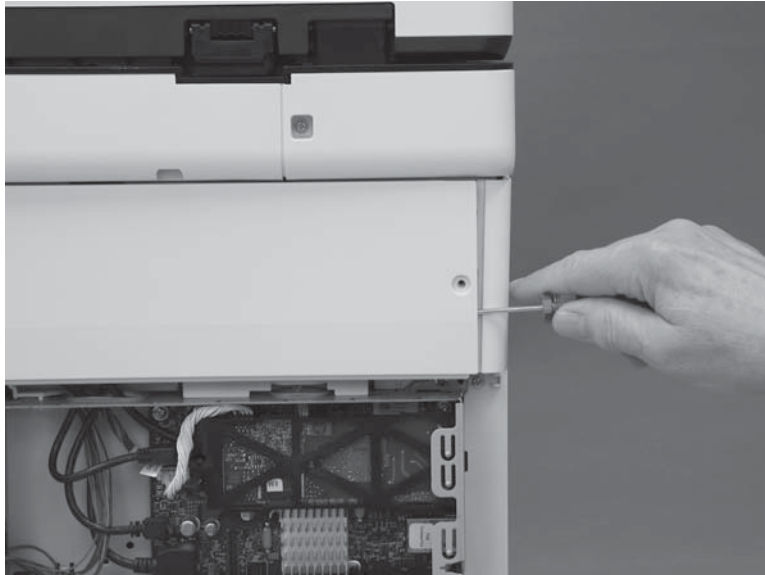

3. Pull the right edge of the cover (callout 1) away from the printer, and then slide the cover to the right (callout 2).

Figure 1-4192 Slide the cover right

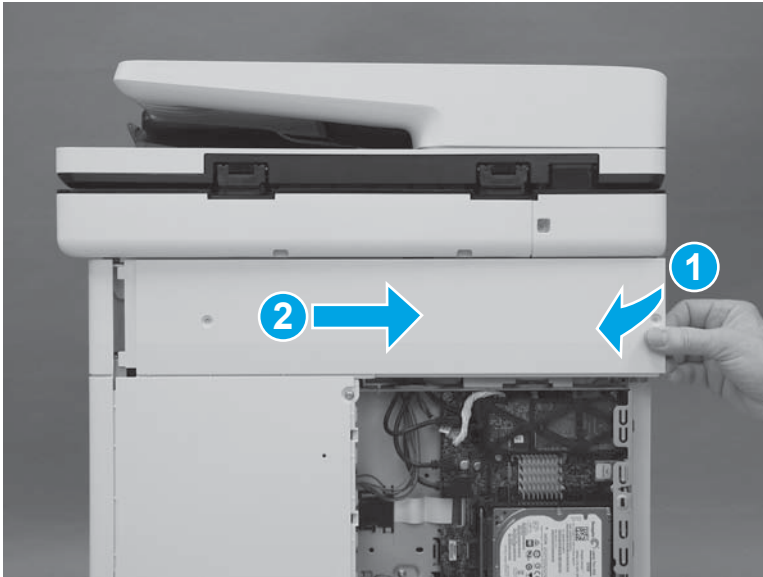

4. Remove the cover.

Figure 1-4193 Remove the cover

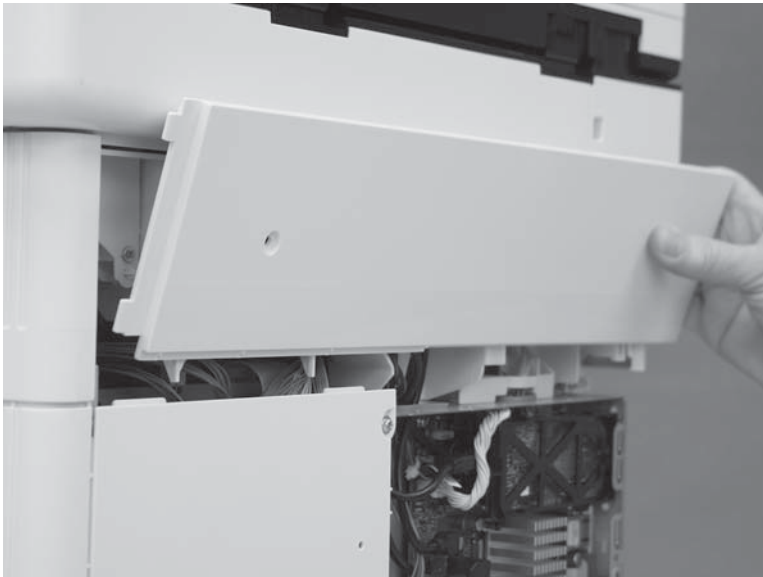

Step 14: Remove the rear cover (M577)

 **NOTE:** This step is for the M577 models. For the M552 and M553 models, skip this step and go to [Step 20: Remove the left cover on page 2345](#).

1. Remove four screws (callout 1).

Figure 1-4194 Remove four screws

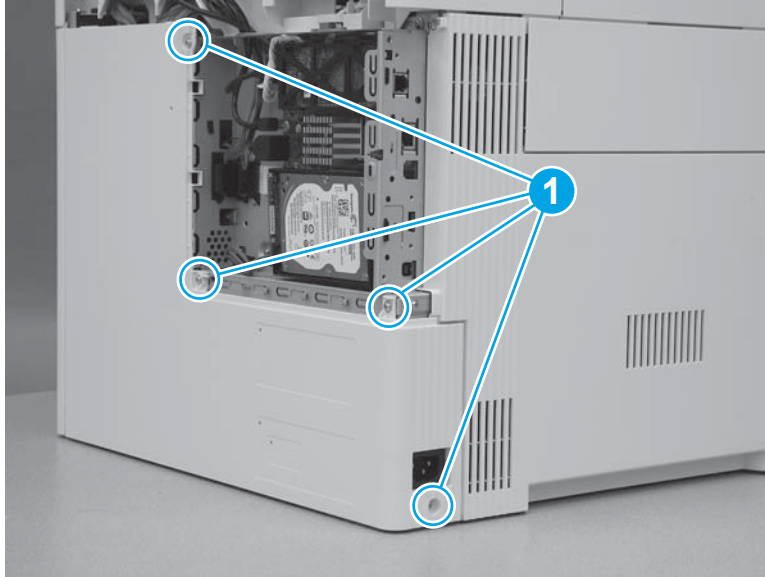

2. Slide the cover to the right to remove it.

Figure 1-4195 Remove the cover

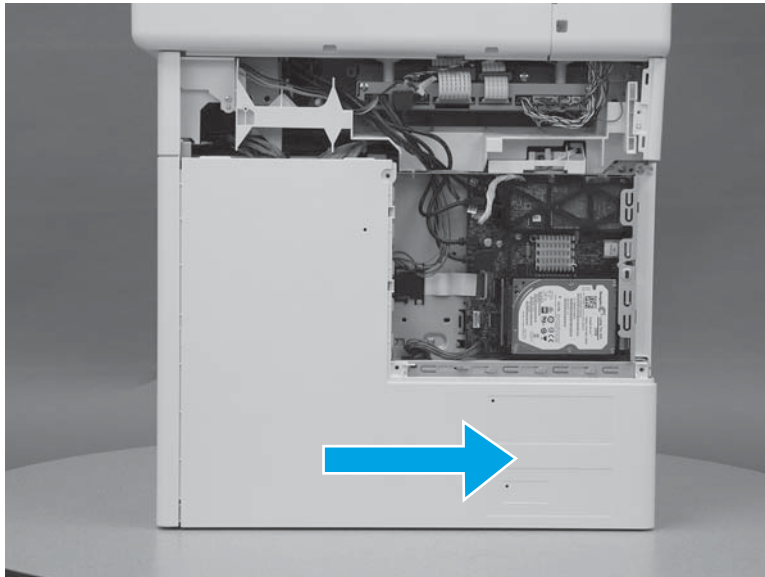

Step 15: Remove the left upper cover (M577)

 **NOTE:** This step is for the M577 models. For the M552 and M553 models, skip this step and go to [Step 20: Remove the left cover on page 2345](#).

1. At the left side of the printer, release one tab (callout 1).

Figure 1-4196 Release one tab

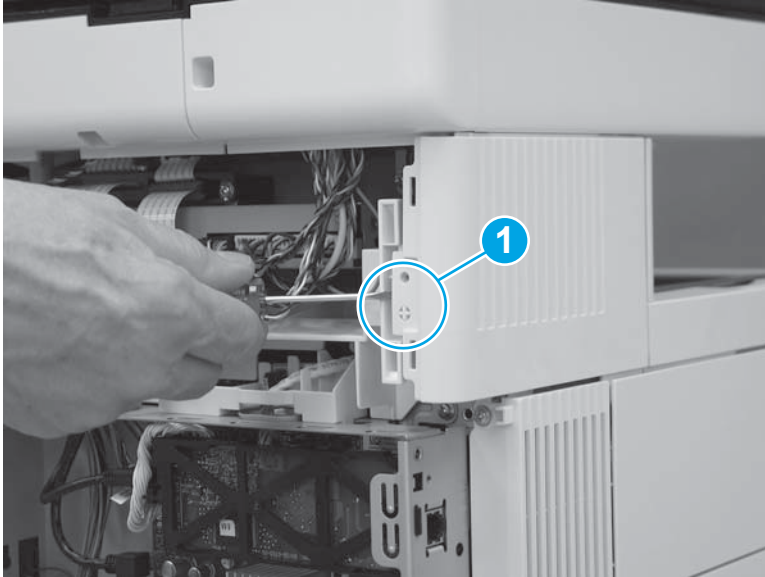

2. Slide the left upper cover toward the back of the printer.

Figure 1-4197 Slide the cover back

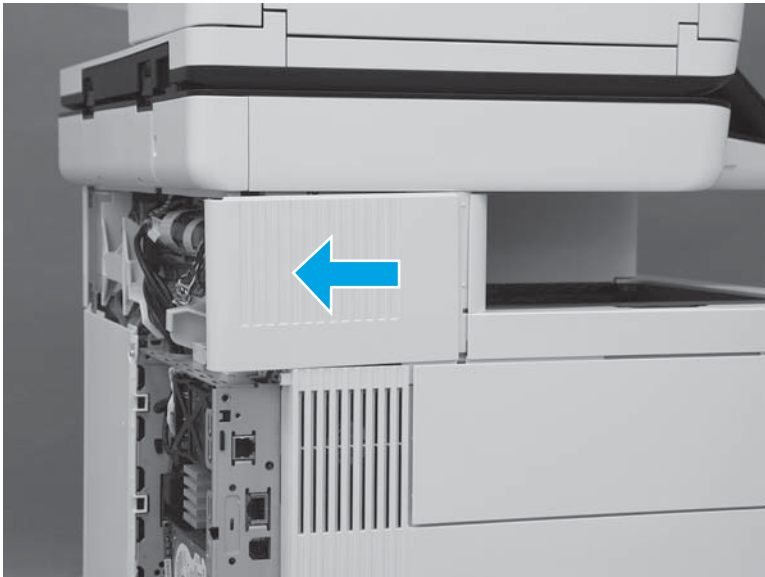

3. Rotate the cover up to remove it.

Figure 1-4198 Remove the left upper cover



Step 16: Remove the right front upper cover (M577dn)

 **NOTE:** This step is for the M577dn model. For the M577c/f/z models, skip this step and to go [Step 17: Remove the stapler cover assembly \(M577c/f/z\) on page 2338](#).

For the M552 and M553 models, skip this step and go to [Step 20: Remove the left cover on page 2345](#).

1. Remove one screw (callout 1).

Figure 1-4199 Remove one screw

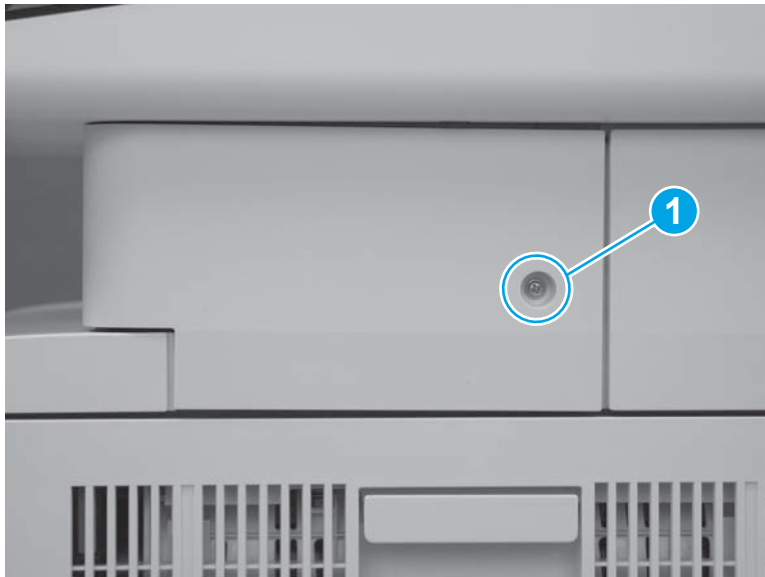

2. Release two tabs at the front edge of the cover (callout 1).

Figure 1-4200 Release two tabs



3. Rotate the front of the cover to the right to remove it.

Figure 1-4201 Rotate the cover



Step 17: Remove the stapler cover assembly (M577c/f/z)

 **NOTE:** This step is for the M577c/f/z models. For the M577dn model, skip this step and to go [Step 19: Remove the right upper cover \(M577\) on page 2343](#).

For the M552 and M553 models, skip this step and go to [Step 20: Remove the left cover on page 2345](#).

1. Remove one screw (callout 1).

 **Reinstallation tip:** This is a self-tapping screw for plastic. When reinstalling, rotate the screw counterclockwise to align it with the existing thread pattern, and then carefully turn it clockwise to tighten. Do not overtighten. This will prevent stripping the threads inside the screw hole.

Figure 1-4202 Remove one screw



2. Release two tabs at the front edge of the cover (callout 1).

Figure 1-4203 Release two tabs

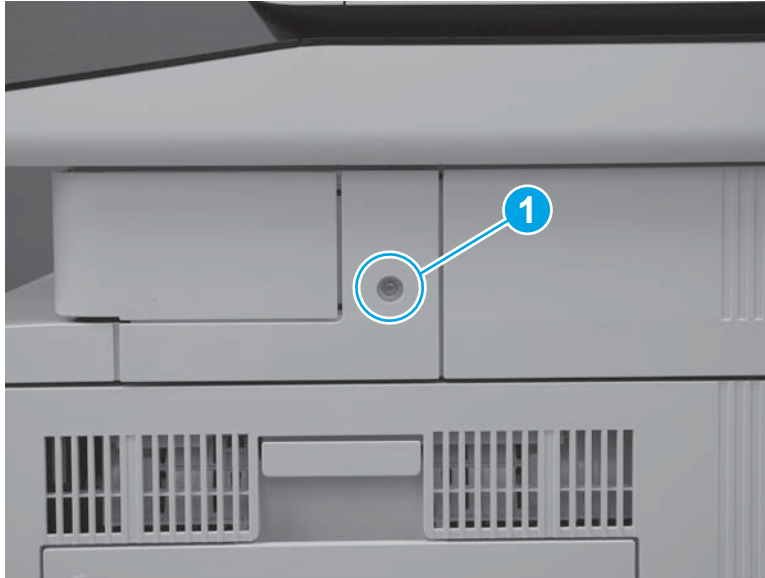

3. Release the back edge of the cover.

Figure 1-4204 Release the back edge of the cover

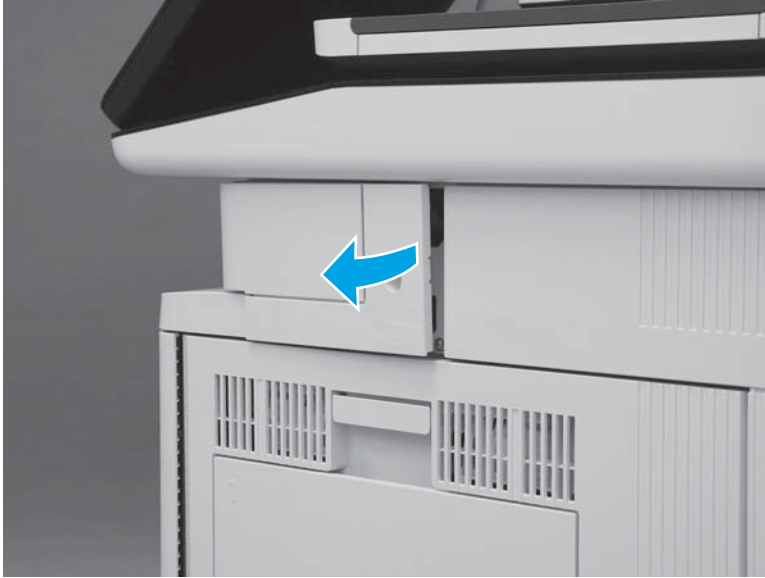

4. Rotate the cover away from the printer to remove it.

Figure 1-4205 Remove the cover



Step 18: Remove the integrated scanner assembly (ISA) (M577)

 **NOTE:** This step is for the M577 models. For the M552 and M553 models, skip this step and go to [Step 20: Remove the left cover on page 2345](#).

 **NOTE:** The ISA includes the document feeder, image scanner, scanner control board (SCB), control panel, keyboard (M577c/z) and NFC PCA (M577z).

1. At the left side of the printer, remove one screw (callout 1).

Figure 1-4206 Remove one screw

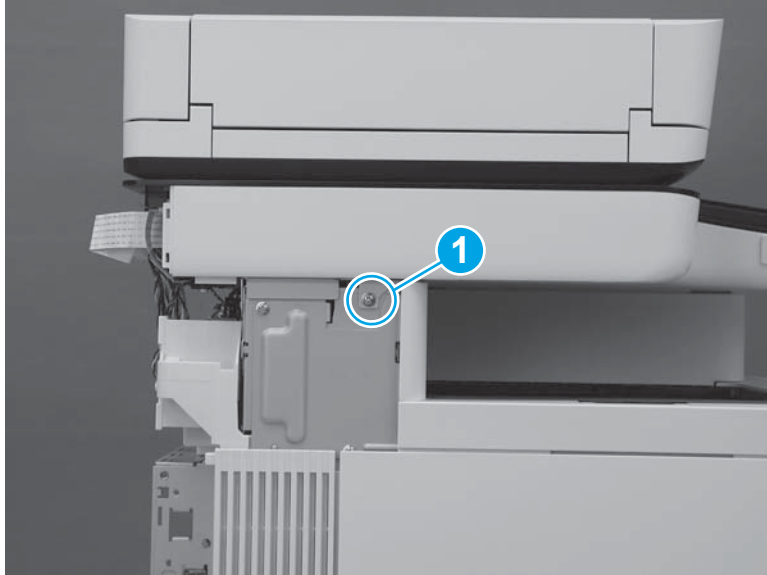

2. At the back side of the printer, remove two screws (callout 1).

Figure 1-4207 Remove two screws

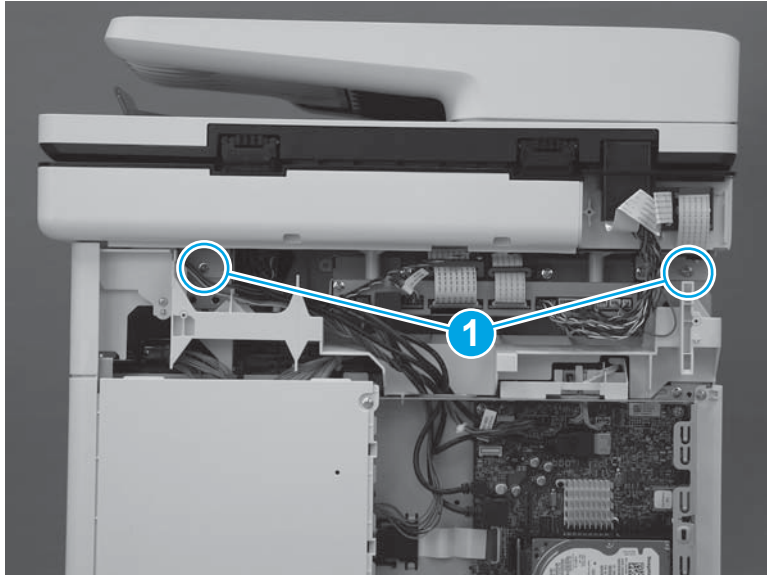

3. At the right side of the printer, remove one screw (callout 1).

Figure 1-4208 Remove one screw

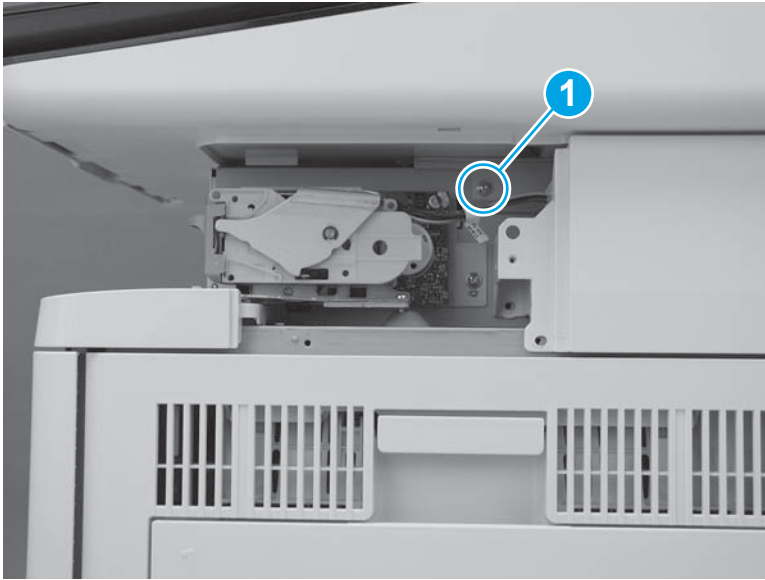

4. Disconnect two connectors on the scanner control board (callout 1).

M577c/f/z only: Disconnect one connector for the stapler on the scanner control board (callout 2).

Figure 1-4209 Disconnect connectors

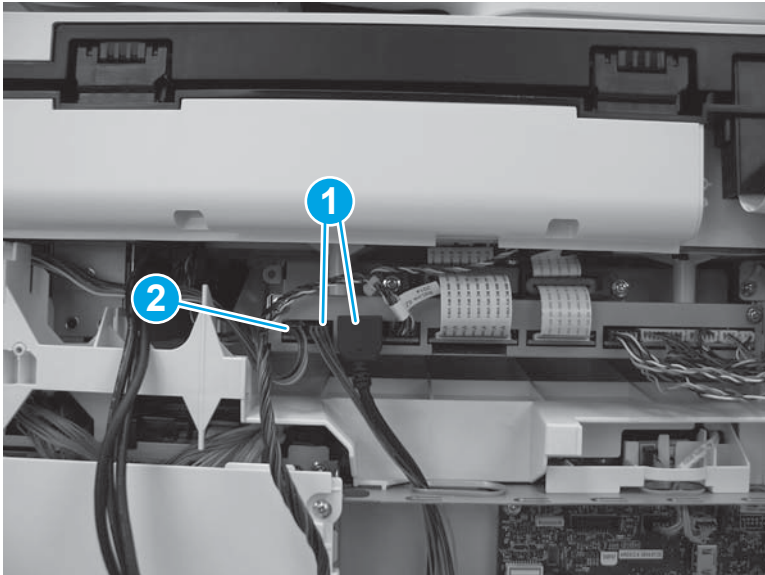

5. Slightly slide the ISA towards the back of the printer to release it.

Figure 1-4210 Slide the ISA towards the back of the printer

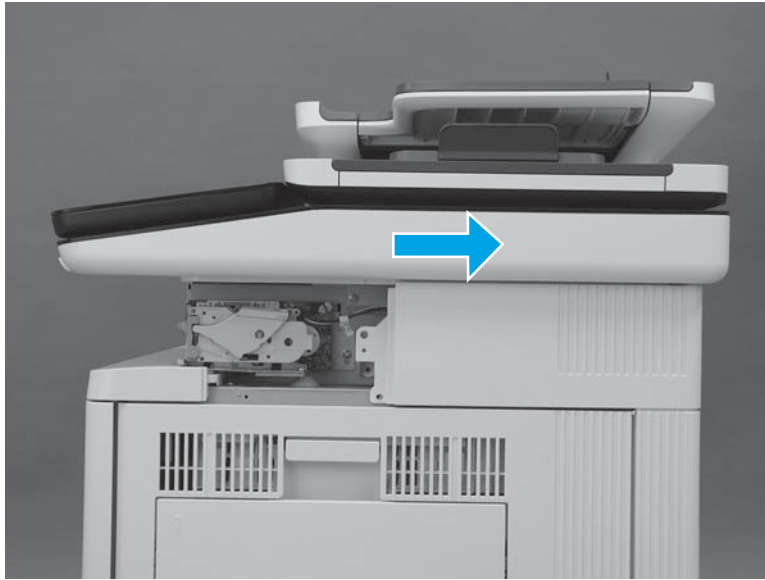

6. Lift the ISA up to remove it.

 **NOTE:** When lifting the ISA, carefully pass the cables through the opening in the top of the formatter case.

Figure 1-4211 Remove the ISA

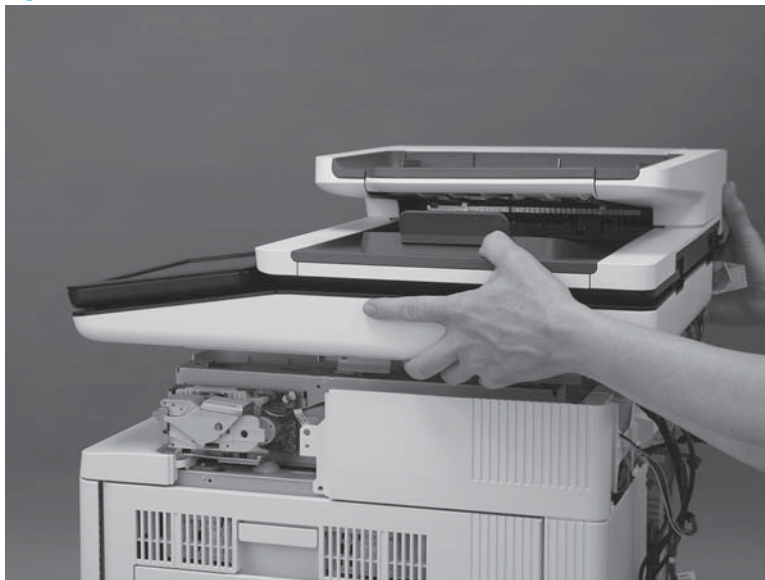

Step 19: Remove the right upper cover (M577)

 **NOTE:** This step is for the M577 models. For the M552 and M553 models, skip this step and go to [Step 20: Remove the left cover on page 2345](#).

 **NOTE:** The figures below show the image scanner installed. The procedures for removing and installing the right upper cover are the same whether the image scanner is installed or removed."

1. At the right side of the printer, remove two screws (callout 1).

M577c/f/z only: Disconnect one connector (callout 2), if it was not already disconnected in a previous step.

Figure 1-4212 Remove two screws and one connector

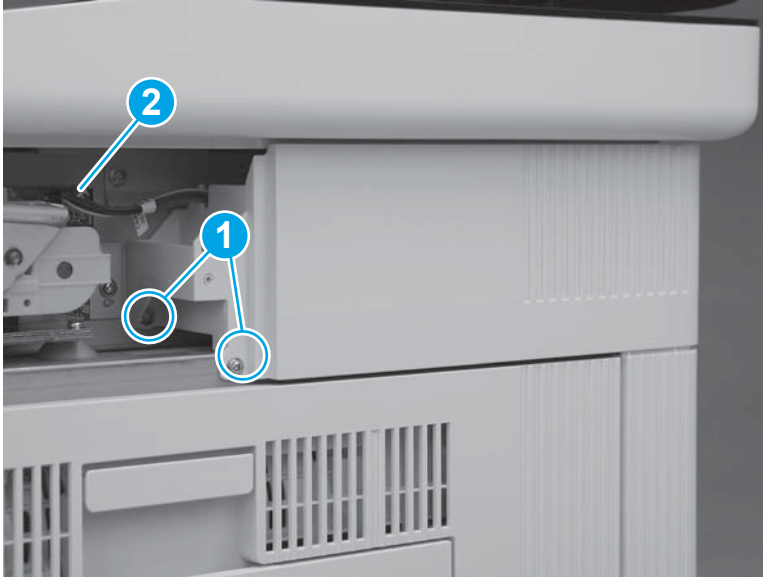

2. At the back of the printer, remove one screw (callout 1).

M577c/f/z only: Disconnect one connector (callout 2), if it was not already disconnected in a previous step.

 **Reinstallation tip:** This screw is smaller than the screws removed in the previous step. When reinstalling the right upper cover, make sure that this screw is installed in the correct position.

Figure 1-4213 Remove one screw and connector



3. Slide the cover toward the back of the printer.

Figure 1-4214 Slide the cover

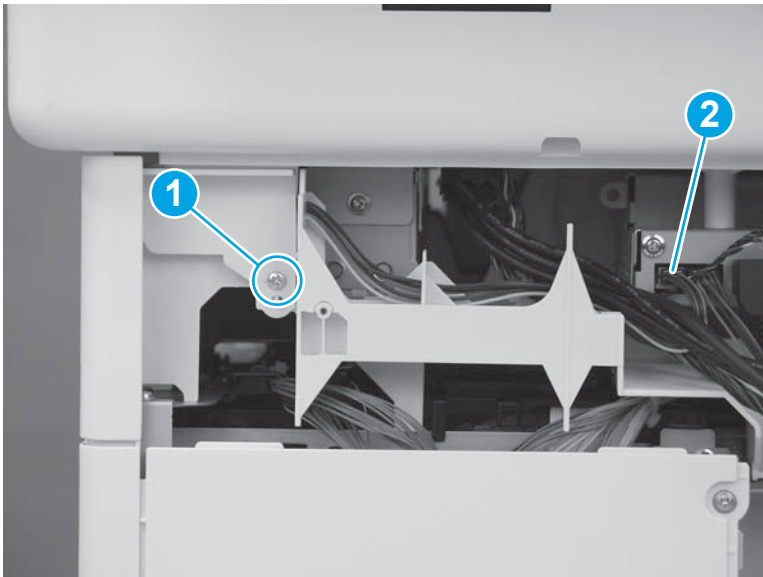
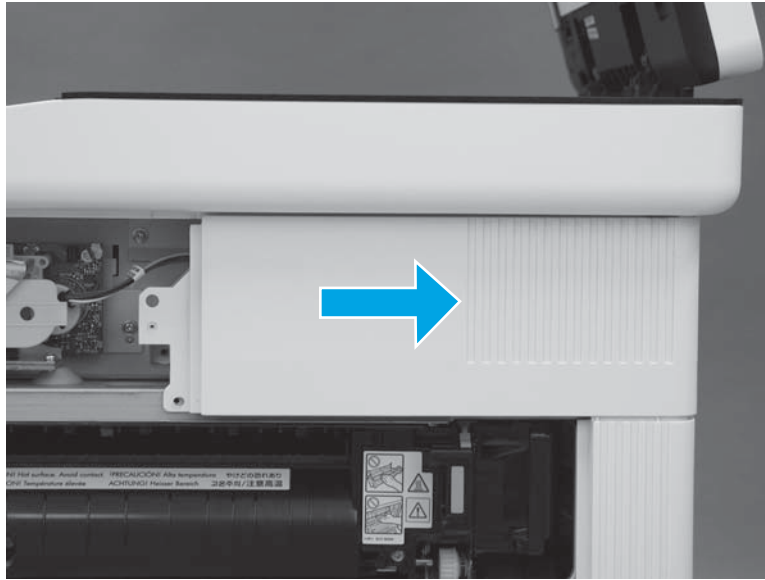

4. Lift the cover away from the printer to remove it.

M577c/f/z only: Release the cables (callout 1) through the slot (callout 2) in the printer.

Figure 1-4215 Remove the cover

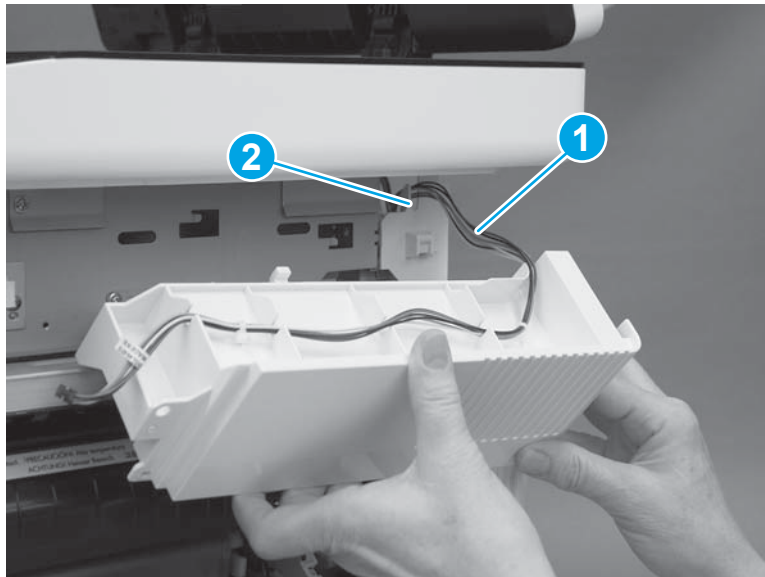

Step 20: Remove the left cover

1. At the left side of the printer, remove one screw (callout 1).

Figure 1-4216 Remove one screw



2. Release one tab (callout 1), rotate the front edge of the cover away from the printer (callout 2), and then slide the cover (callout 3) toward the rear of the printer to release it.

Figure 1-4217 Release the cover

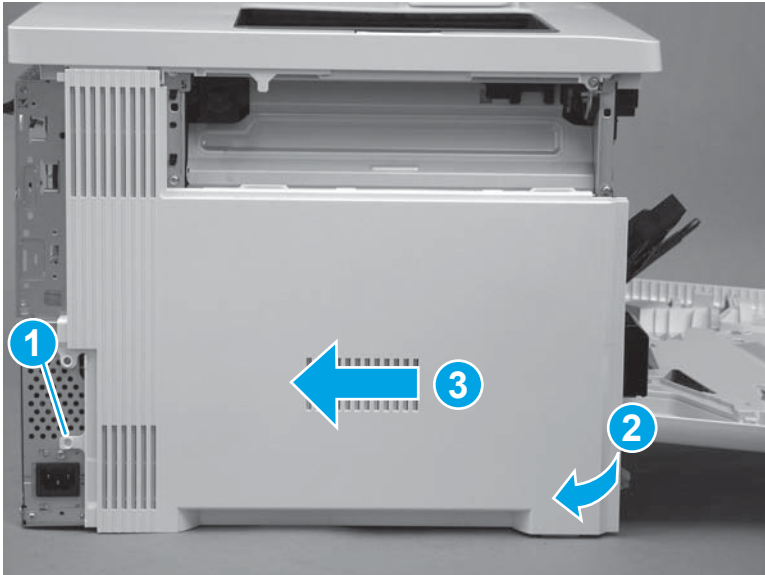

3. Remove the cover.

Figure 1-4218 Remove the cover

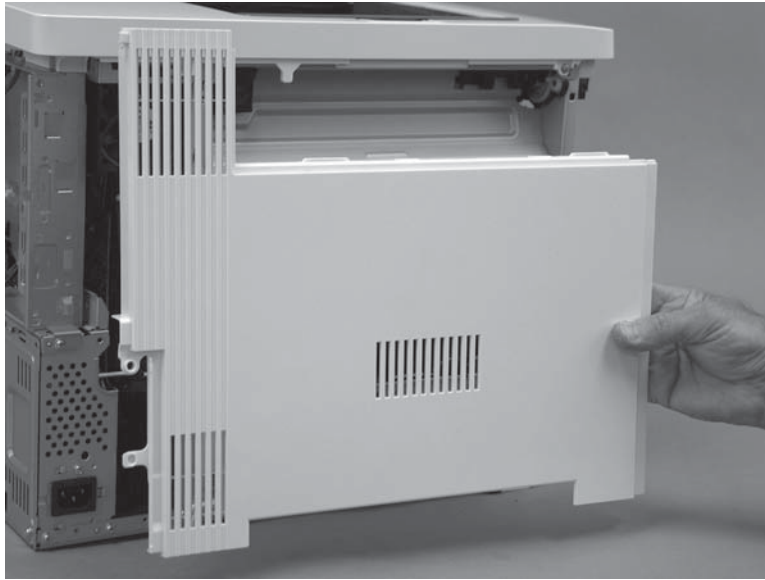

Step 21: Remove the upper cover (M552 and M553)

 **NOTE:** This step is for the M552 and M553 models. For the M577 models, skip this step and go to [Step 22: Remove the right rear cover on page 2349](#).

1. Remove three screws (callout 1).

Figure 1-4219 Remove three screws

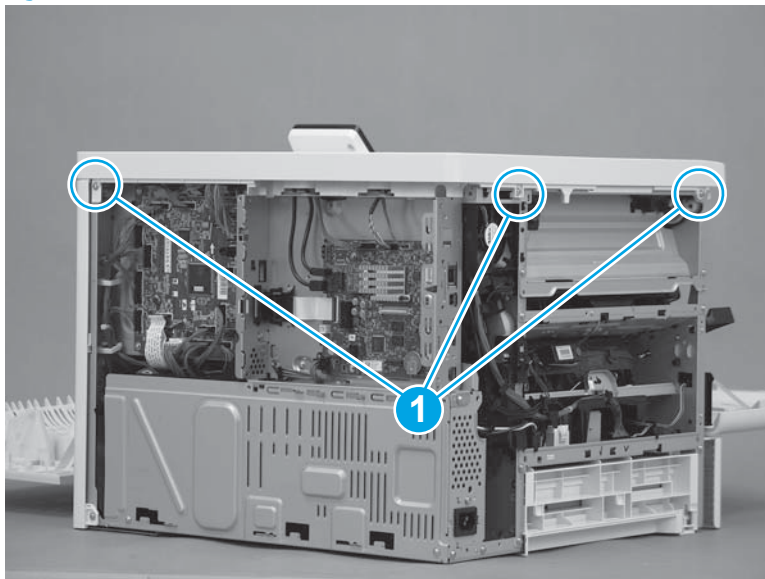

2. Remove one screw (callout 1), release one tab (callout 2), and then slightly separate the corner of the cover from the chassis.

 **NOTE:** This is a self-tapping plastic-thread screw. Make sure that this screw is used in this location when it is reinstalled.

Figure 1-4220 Remove one screw and release one tab



3. Release one tab (callout 1), and then lift up on the cover to release it.

 **NOTE:** If the cover does not release, check for addition tabs by locating the triangles embossed in the cover at tab locations.

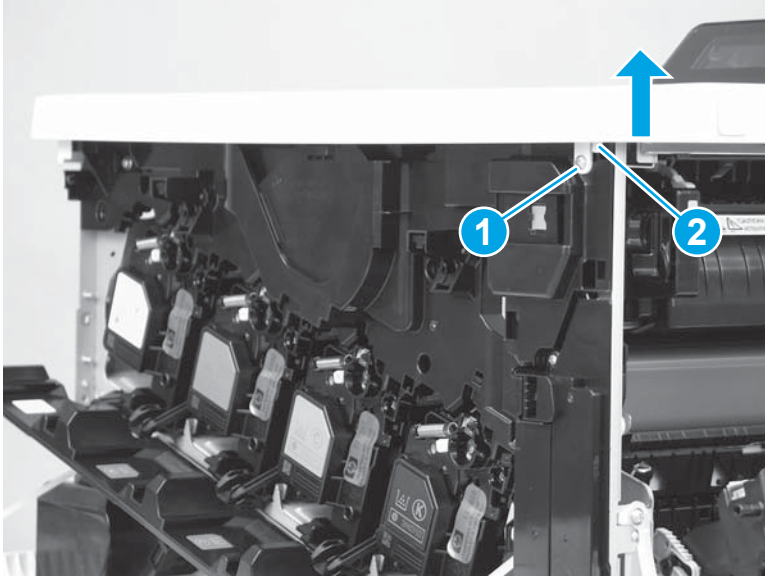
Figure 1-4221 Release the cover



4. Remove the cover.

Figure 1-4222 Remove the cover

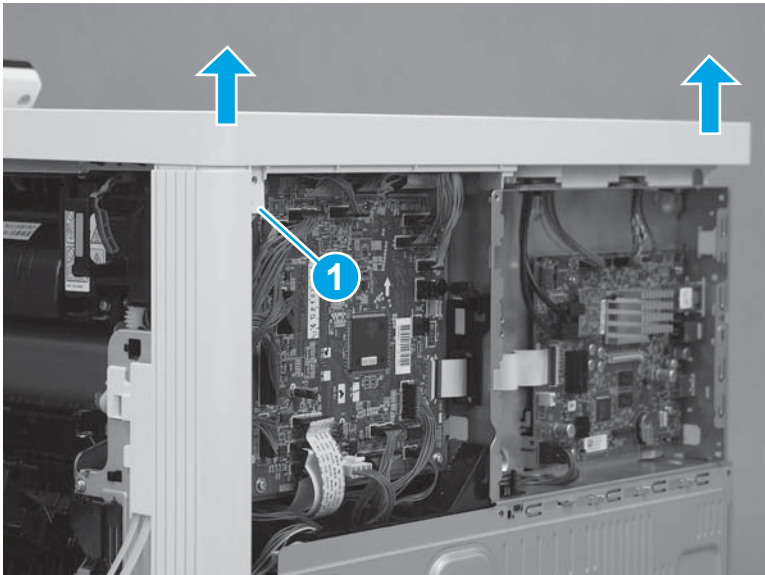
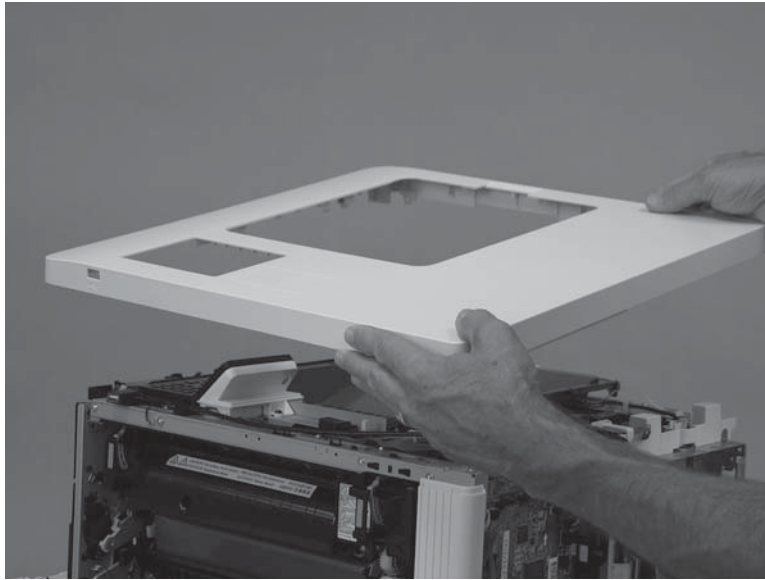

Step 22: Remove the right rear cover

1. Remove one screw (callout 1), and then slide the cover toward the rear of the printer (callout 2) to release it.

 **TIP:** If the right door is closed, open it now.

Figure 1-4223 Release the cover



2. Remove the cover.

Figure 1-4224 Remove the cover

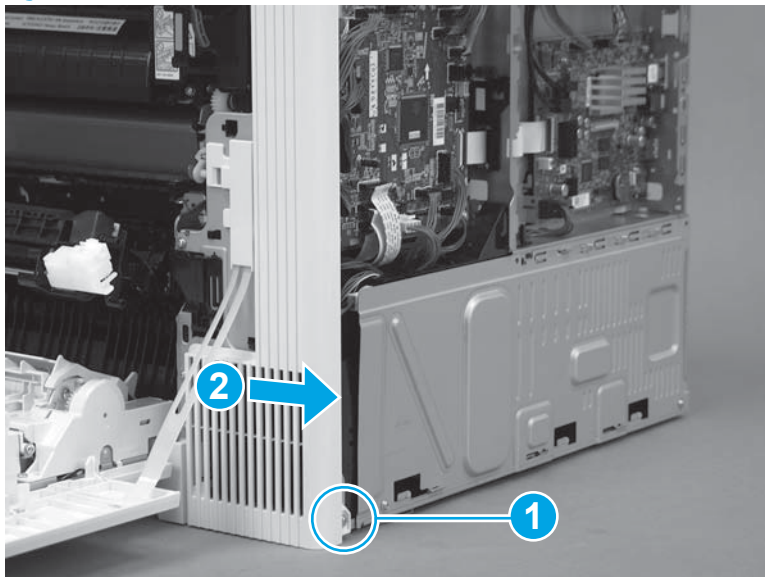
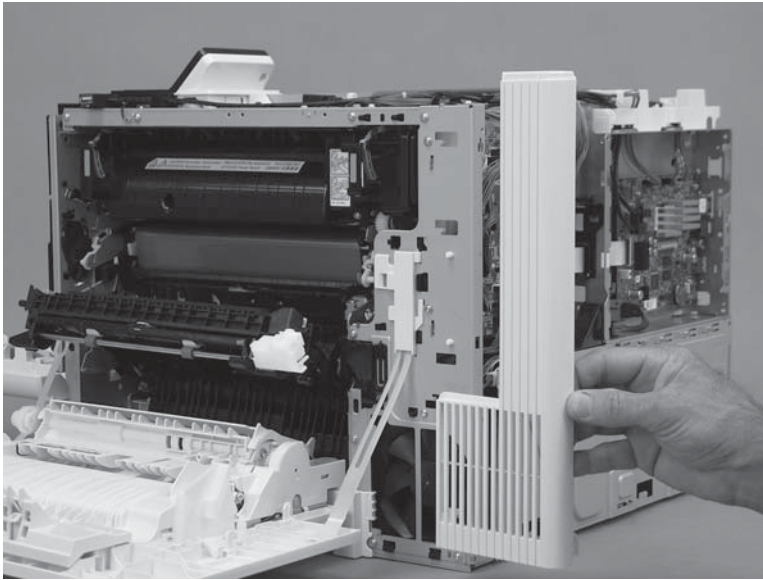

Step 23: Remove the formatter case

1. **M577 only:** Disconnect one connector (callout 1), and then pass the wire harness (callout 2) through two openings in the formatter case (callout 3).

Figure 1-4225 Disconnect one connector

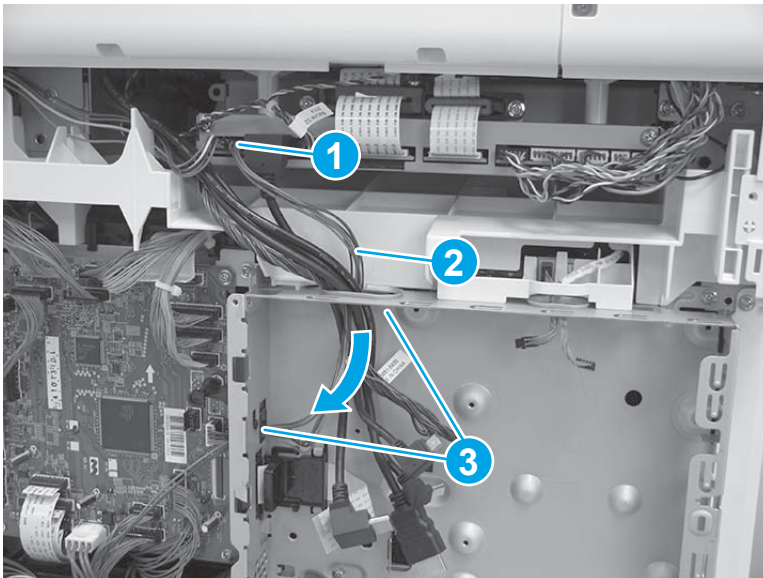

2. Release two tabs (callout 1) on the black plastic bracket. Hold the tabs in the released position, and then slide the bracket (callout 2) to the right to remove it from the formatter case.

Figure 1-4226 Remove the bracket

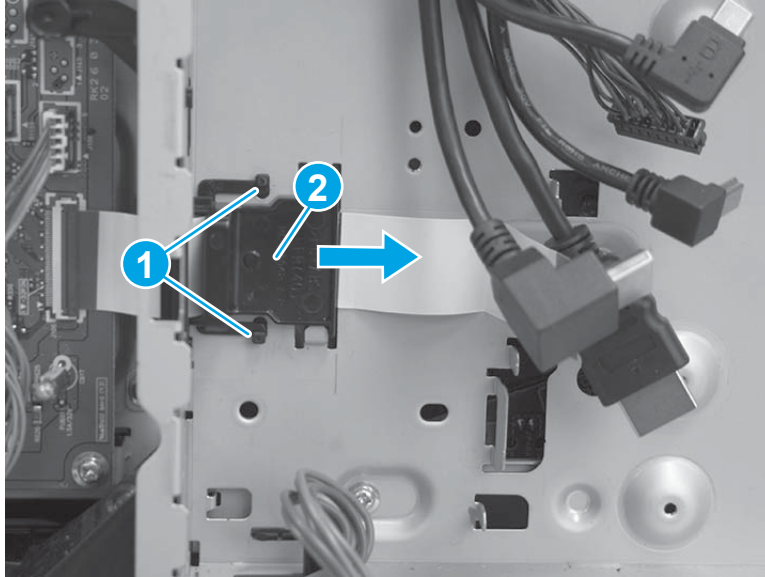

3. Remove two screws (callout 1), and then slide the low-voltage power supply (LVPS) cover to the right to remove it.

Figure 1-4227 Remove the LVPS cover

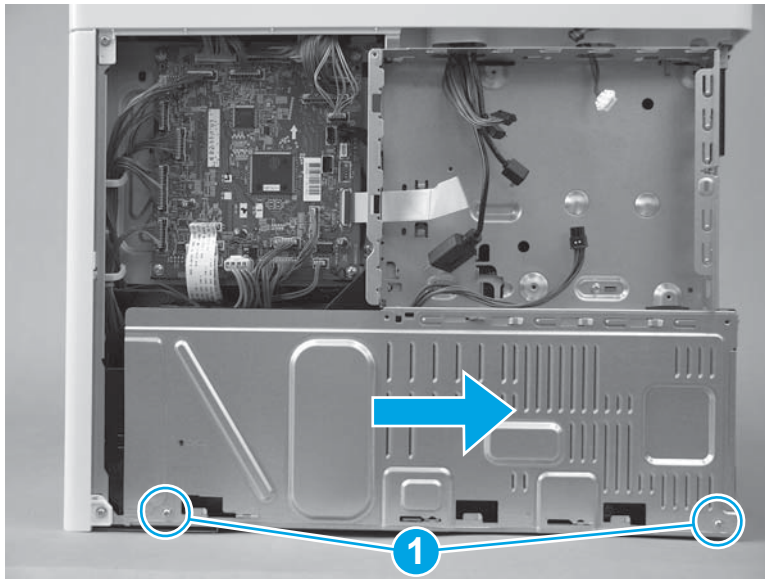

4. Pass two wire harnesses and one flat cable (callout 1) through the opening in the formatter case, and then release one wire harness from the retainer (callout 2).

⚠ CAUTION: The flat cable might be attached to the formatter case with double-sided tape. Make sure that this tape is released, so that the flat cable is not damaged when the formatter case is removed.

Figure 1-4228 Release wire harnesses and flat cable

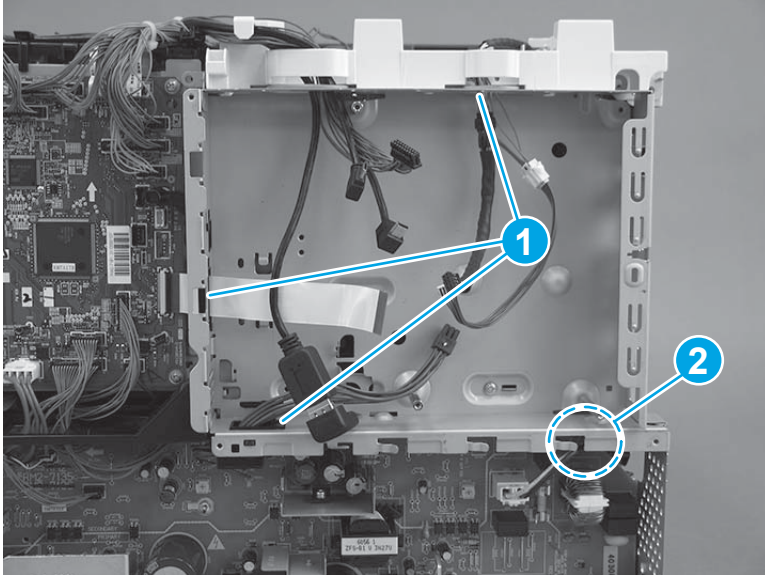

5. Remove six screws (callout 1).

Figure 1-4229 Remove six screws

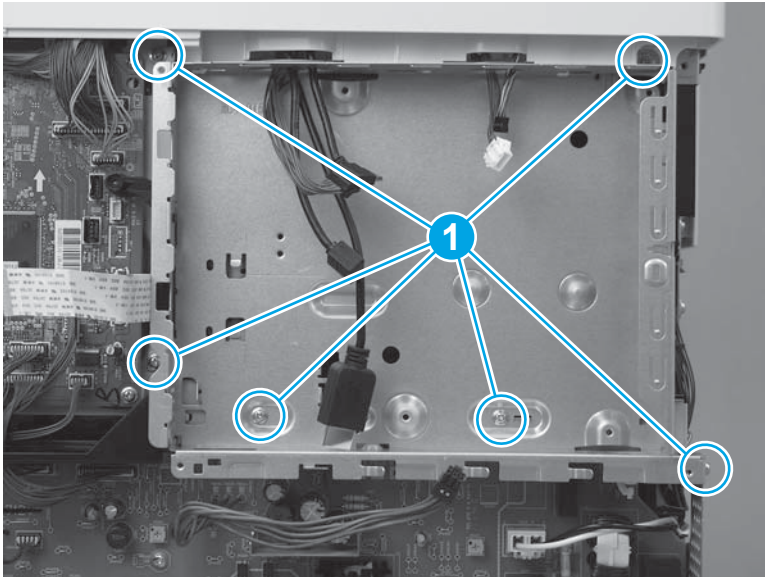

6. Rotate the bottom of the formatter case away from the printer (callout 1), and then pull it down (callout 2) to release it.

Figure 1-4230 Release the formatter case

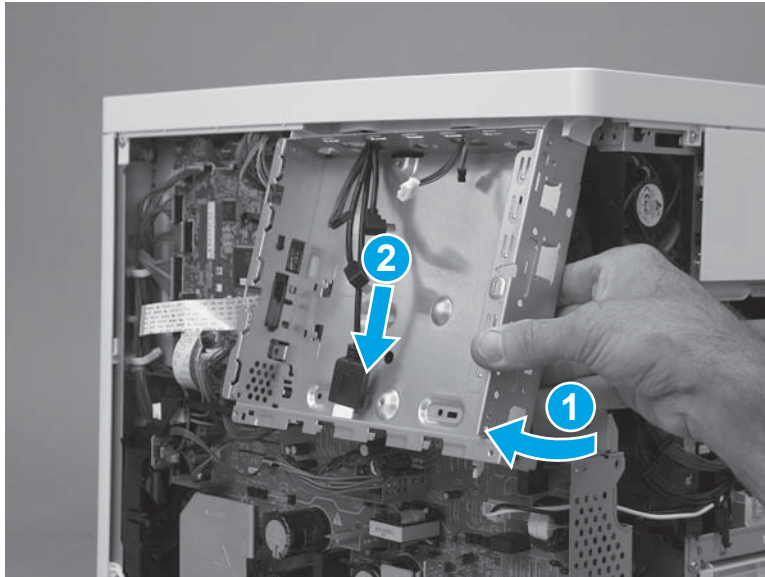

7. Pass the wire harnesses through the opening in the formatter case to remove it.

 **IMPORTANT:** If the formatter case is removed so that it can be replaced, make sure to transfer the memory PCA (island of data) and plastic bracket (callout 1) to the replacement case.

Figure 1-4231 Remove the formatter case



Step 24: Remove the low-voltage power supply (LVPS)

 **CAUTION:**  ESD-sensitive part.

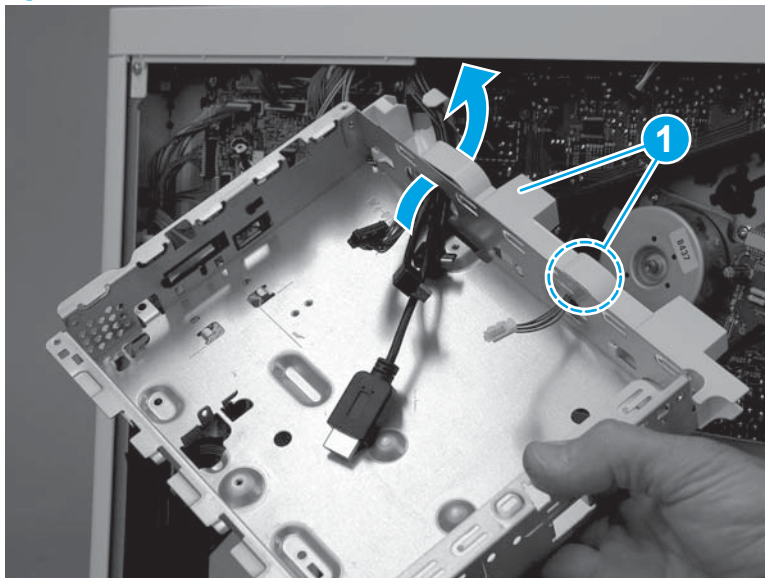
1. Disconnect one wire harness (callout 1), and then pass the wire harness through the opening (callout 2) in the chassis.

Figure 1-4232 Disconnect one wire harness

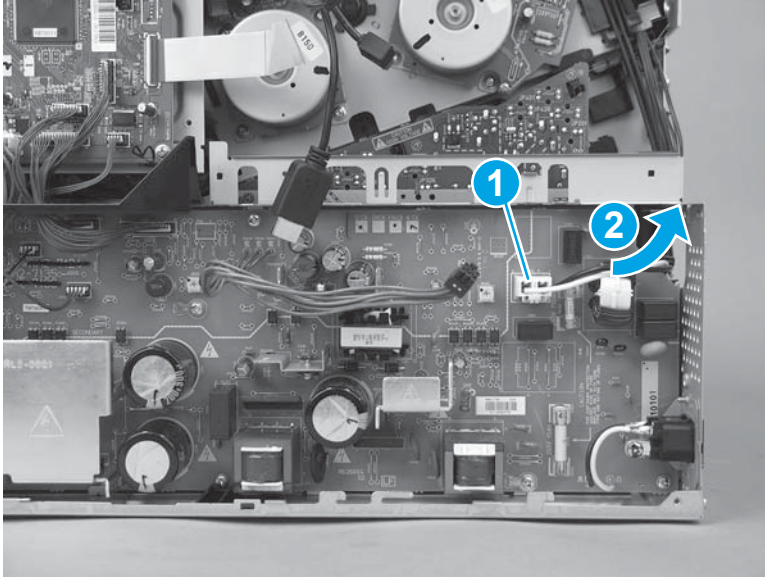

2. Disconnect three connectors on the DC controller (callout 1), and then disconnect four connectors (callout 2) on the LVPS.

Figure 1-4233 Disconnect seven connectors

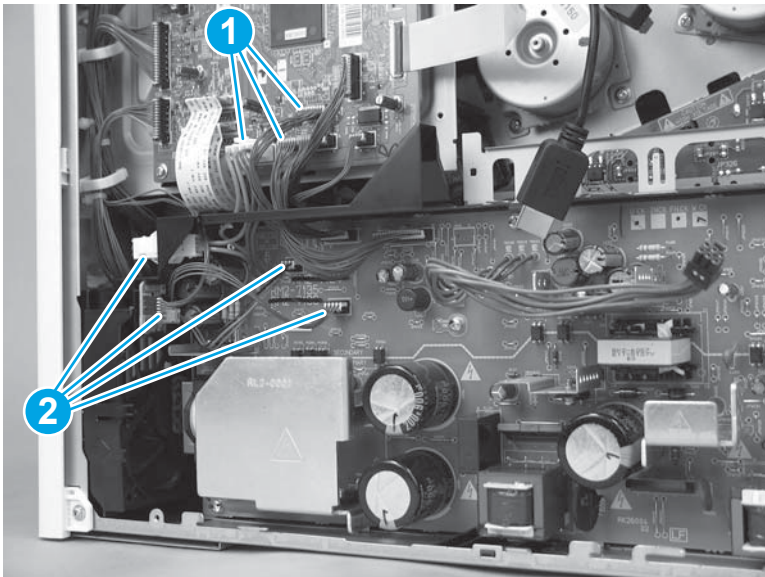

3. Pass the wire harnesses from the DC controller to the LVPS through the opening in the chassis (callout 1), and then release the wire harnesses from the retainer (callout 2).

Figure 1-4234 Pass the wire harnesses through the opening

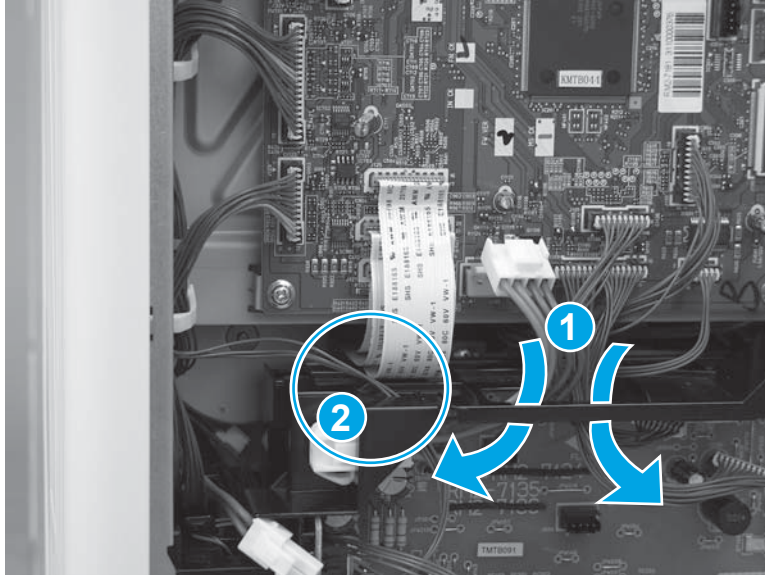

4. Remove three screws (callout 1).

Figure 1-4235 Remove three screws

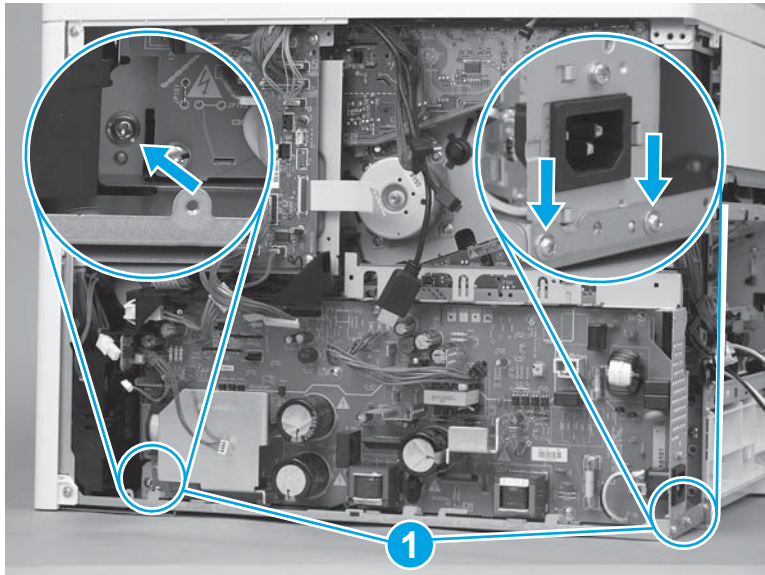

5. Rotate the top of the LVPS away from the printer (callout 1), and then slide it up and out (callout 2) of the printer to remove it.

Figure 1-4236 Remove the LVPS

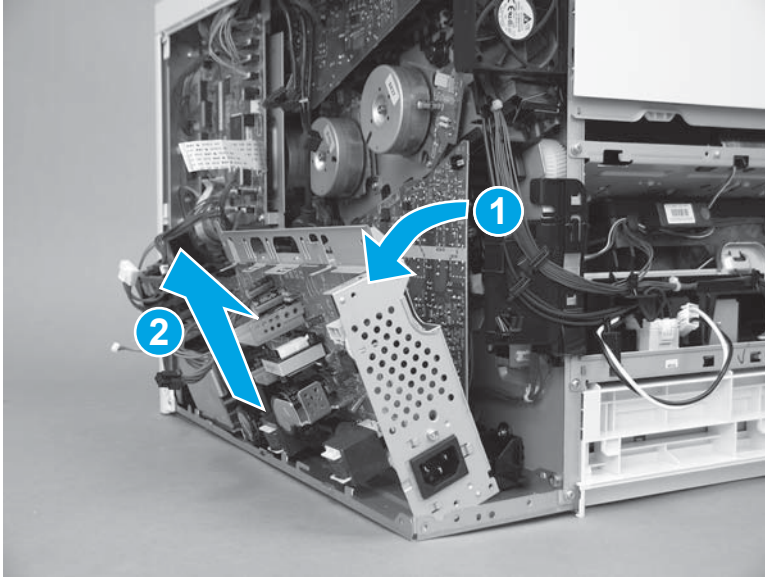

Step 25: Remove the power supply fan (FM1)

1. Remove one screw (callout 1).

Figure 1-4237 Remove one screw

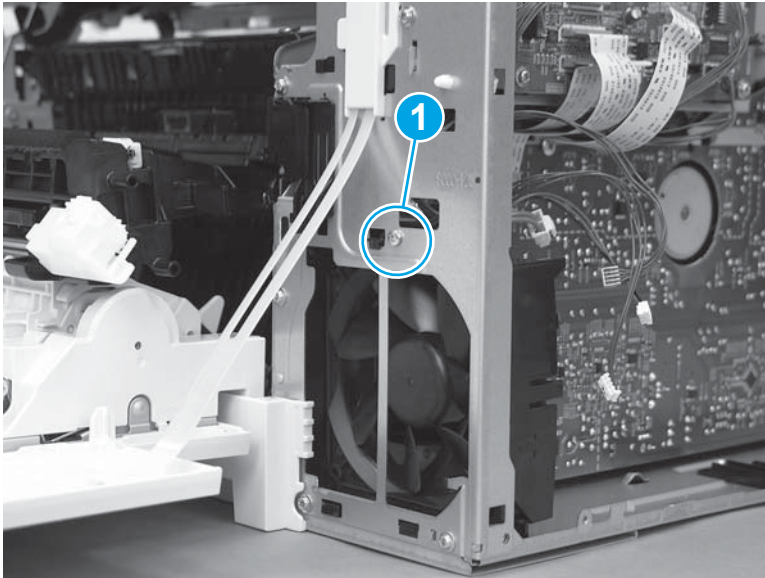

2. Release the wire harnesses from the retainer on the top of the fan bracket.

Figure 1-4238 Release the wire harnesses

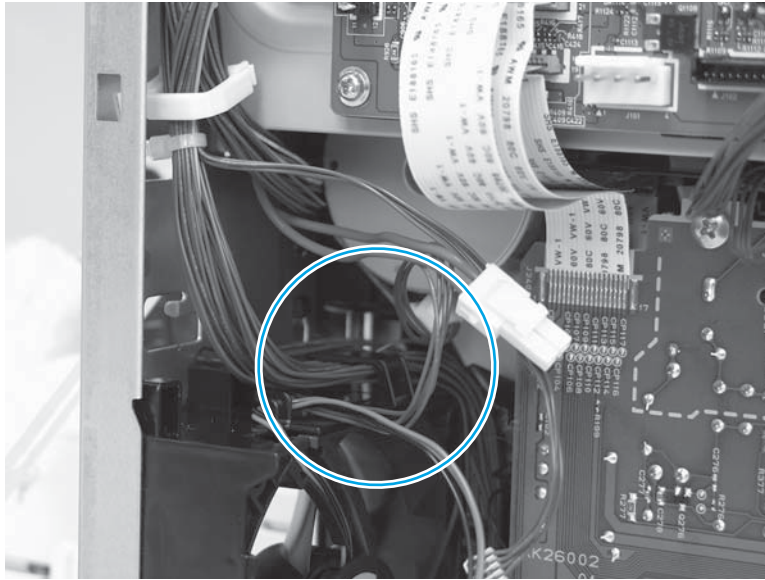

3. Lift the fan up (callout 1), and then slide it out of the printer (callout 2) to remove it.

Figure 1-4239 Remove the fan

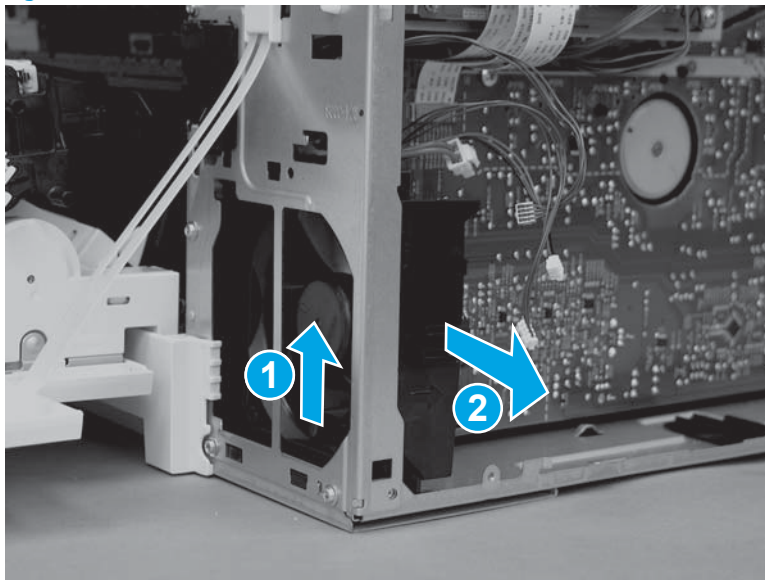

Step 26: Remove the high-voltage power supply D (HVPSD)

 **CAUTION:**  ESD-sensitive part.

1. Disconnect one flat cable (callout 1) on the DC controller.

Figure 1-4240 Disconnect one flat cable

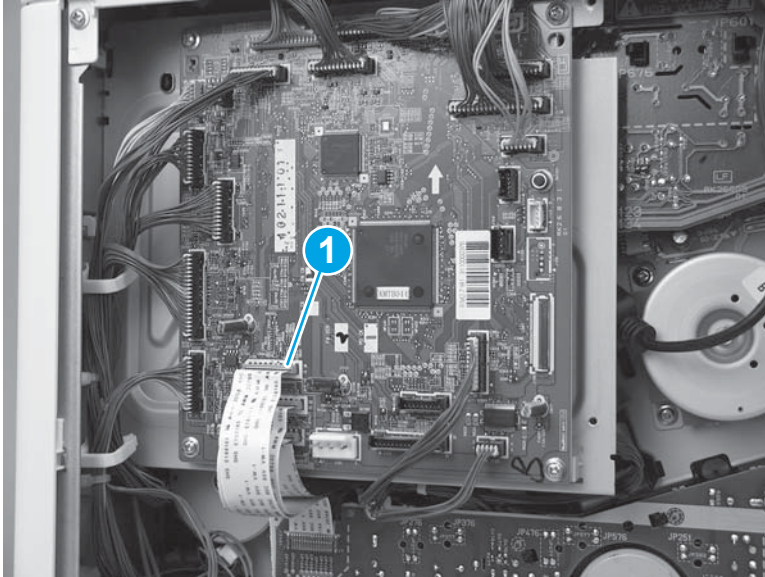

2. Remove two screws (callout 1), and then remove one self tapping screw (callout 2) on the HVPSD.

Figure 1-4241 Remove three screws

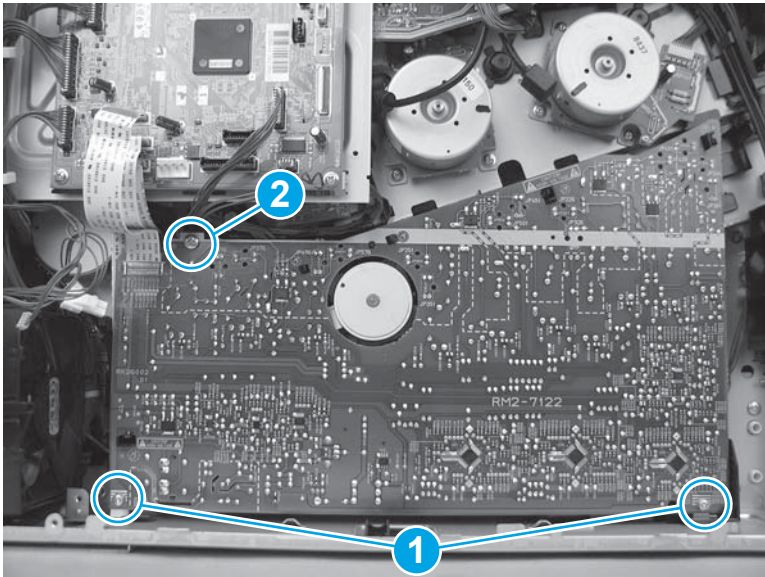

3. Release five tabs (callout 1), and then remove the HVPSD (callout 2).

Figure 1-4242 Remove the HVPSD

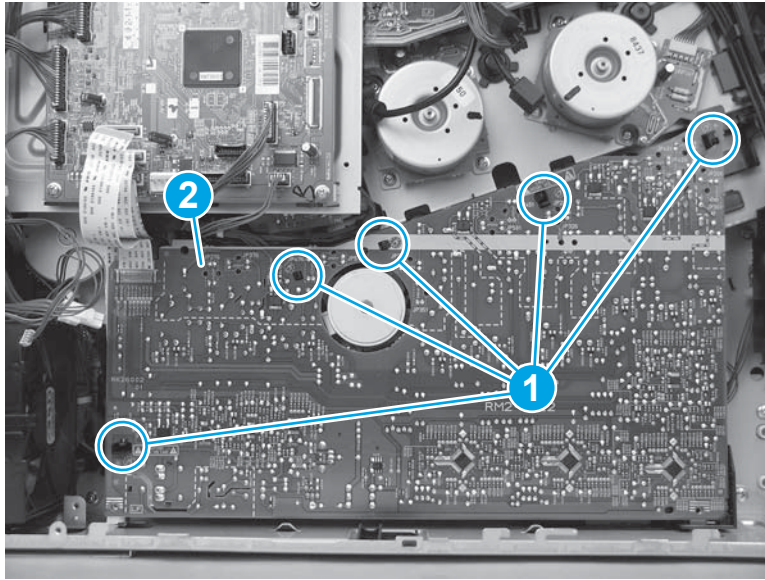

Step 27: Remove the lifter drive assembly

1. Disconnect two connectors (callout 1).

Figure 1-4243 Disconnect two connectors

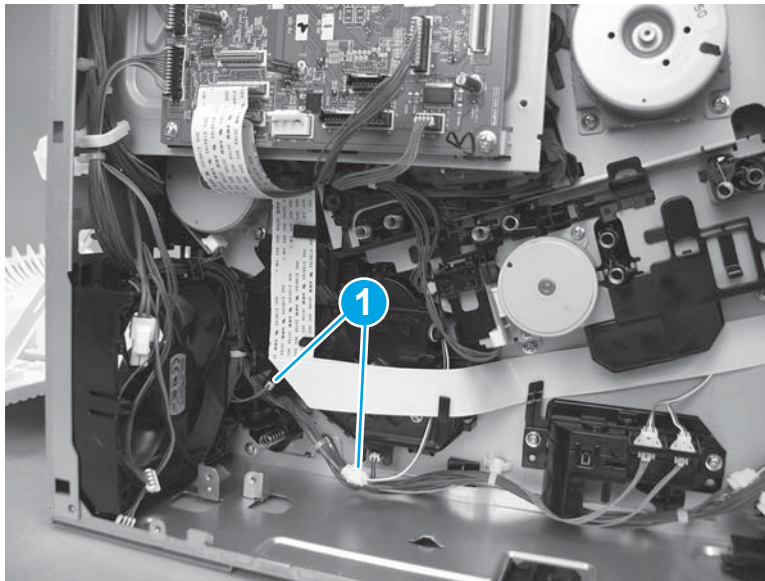

2. Disconnect two flat cables (callout 1), and then release them from the retainers (callout 2).

Figure 1-4244 Disconnect two flat cables

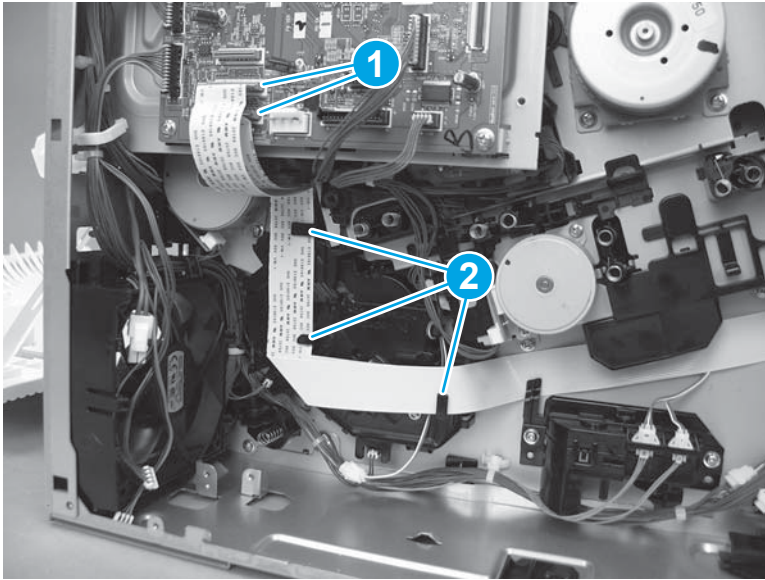

3. Remove two screws (callout 1), release one tab (callout 2), and then remove the lifter drive assembly (callout 3).

 **NOTE:** Release one wire harness from the retainer (callout 4) as the assembly is removed.

Figure 1-4245 Remove the assembly

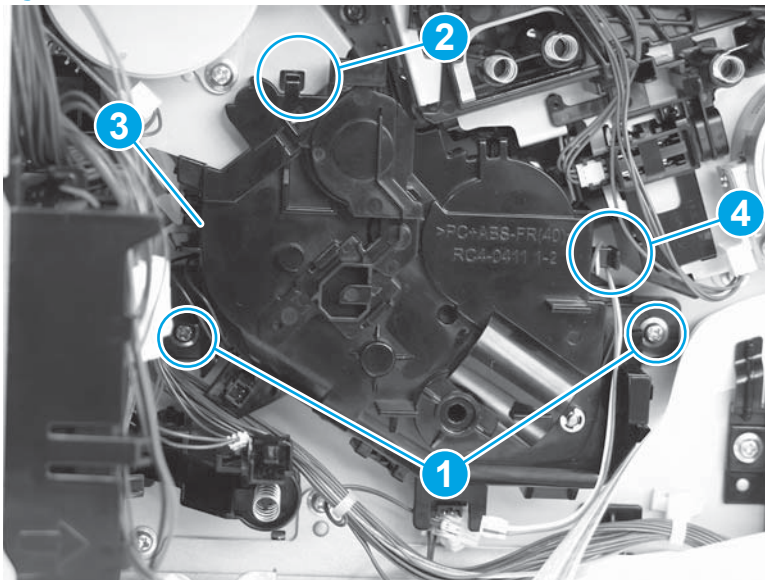

Step 28: Remove the DC controller and sheet-metal bracket

 **CAUTION:**  ESD sensitive part.

1. Disconnect all of the connectors, and then remove two screws (callout 1).

The following connectors are empty:

- J140, J141, and J143

Figure 1-4246 Remove two screws

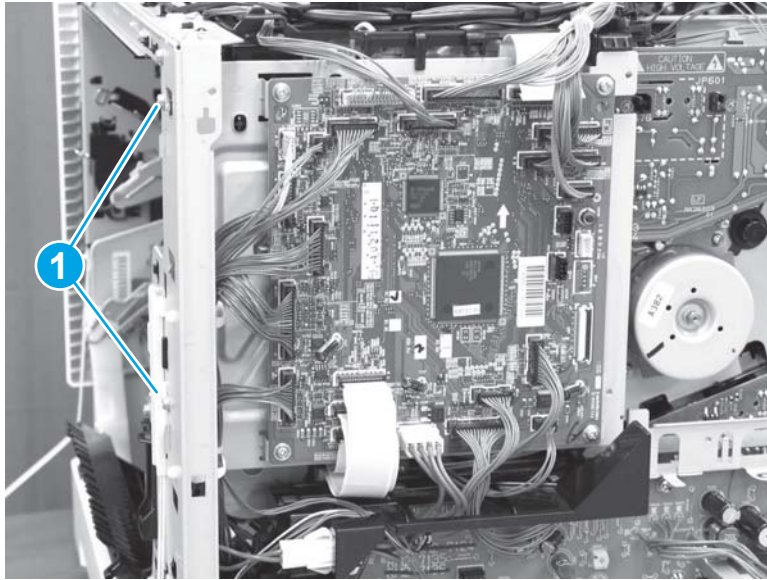

2. Lift up on the DC controller and sheet-metal plate to remove it.

Figure 1-4247 Remove the plate

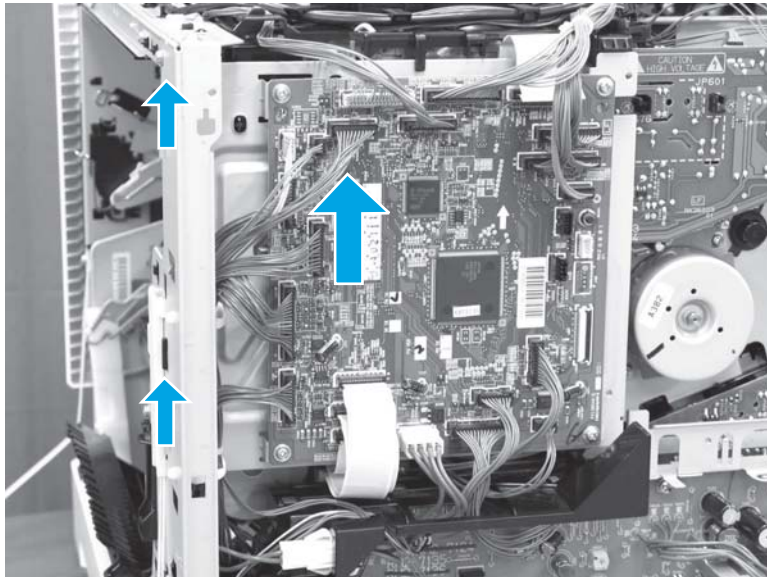

Step 29: Remove the pickup drive assembly and motor (M5)

1. Release one tab (callout 1), and then move the guide (callout 2) out of the way.

Figure 1-4248 Move the guide out of the way

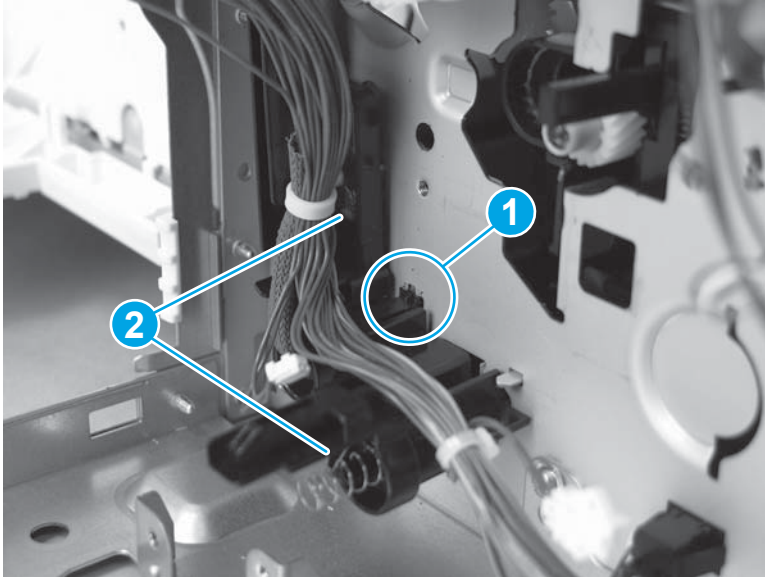

2. Remove three screws (callout 1).

Figure 1-4249 Remove three screws

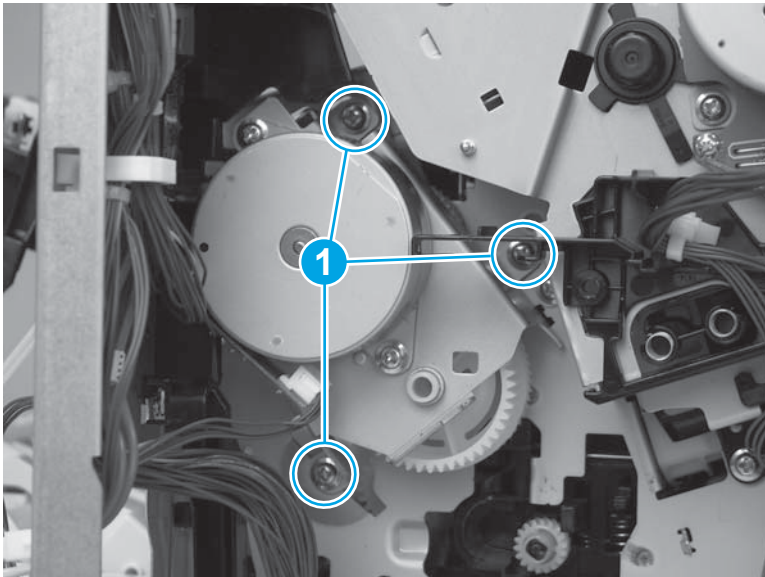

3. Remove the assembly.

CAUTION: One gear on the back side of the assembly is not captive. Handle the assembly carefully.

Figure 1-4250 Remove the assembly

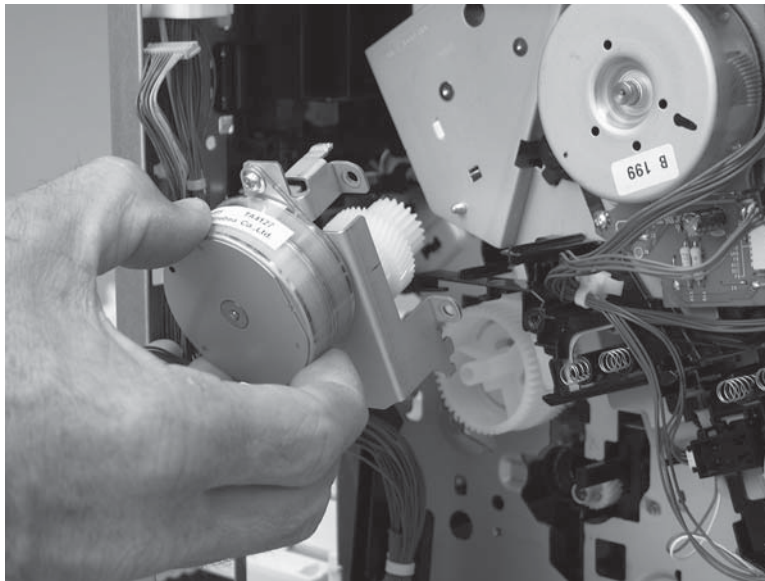

4. If the gear (callout 1) was not removed with the assembly in the previous step, remove it now.

Figure 1-4251 Remove the gear if installed

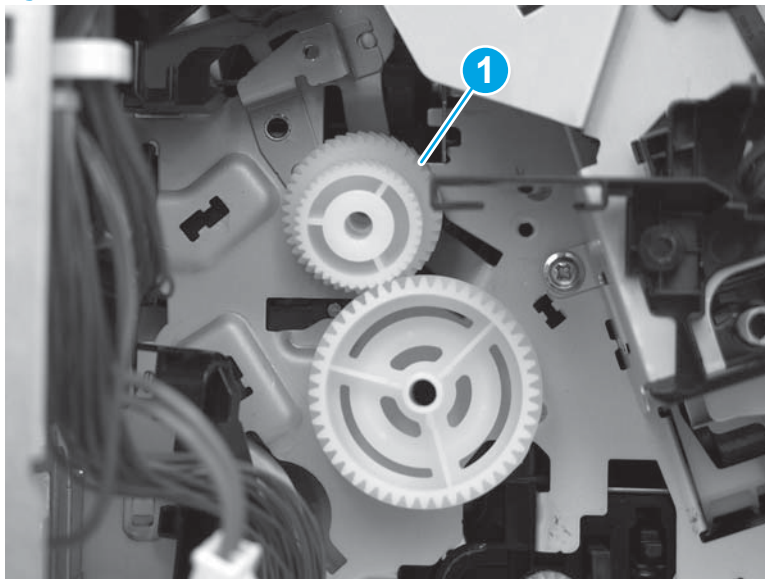

Step 30: Remove the registration assembly

1. At the right side of the printer, release one tab (callout 1).

Figure 1-4252 Release one tab

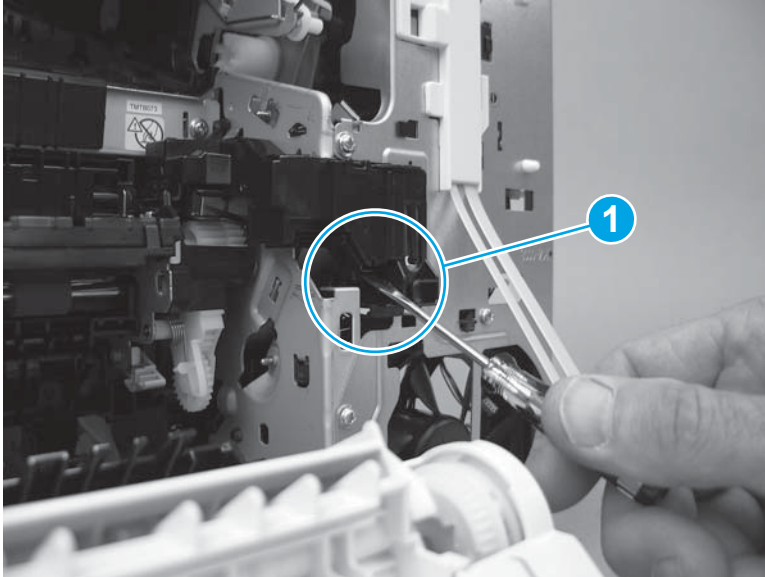

2. Remove the cover.

Figure 1-4253 Remove the cover

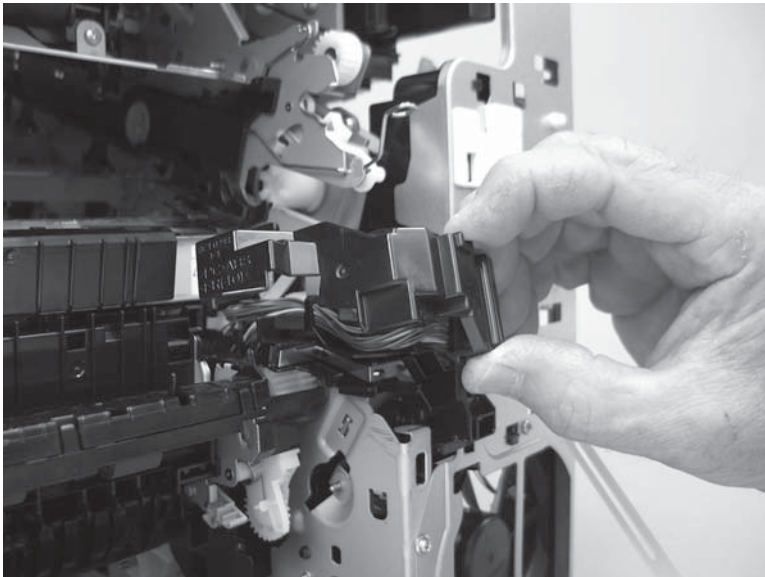

3. Release one tab (callout 1), and then push down on the guide (callout 2) to release it.

Figure 1-4254 Release the guide

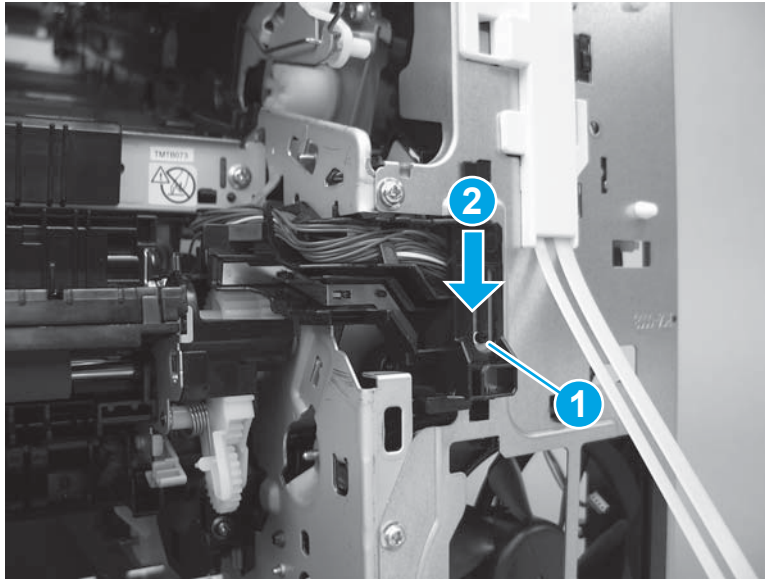

4. Move the guide out of the way.

Figure 1-4255 Move the guide out of the way

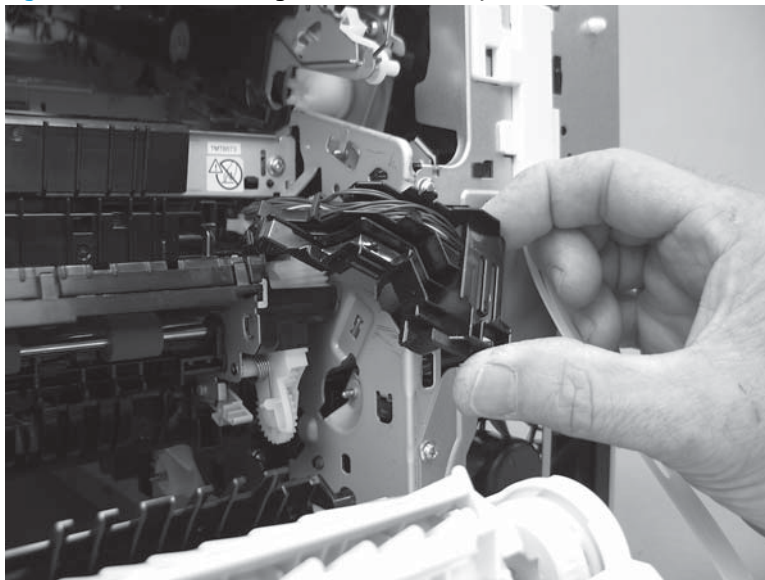

5. Remove three screws (callout 1).

Figure 1-4256 Remove three screws

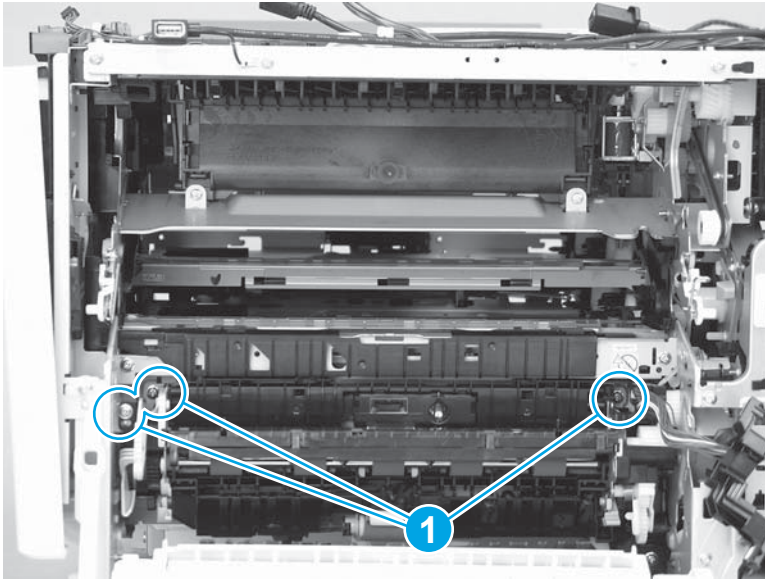

6. Before proceeding, locate the sheet metal portion (callout 1) of the assembly. When handling the assembly, use the sheet metal as handles.

Figure 1-4257 Locate the sheet metal portion of the assembly

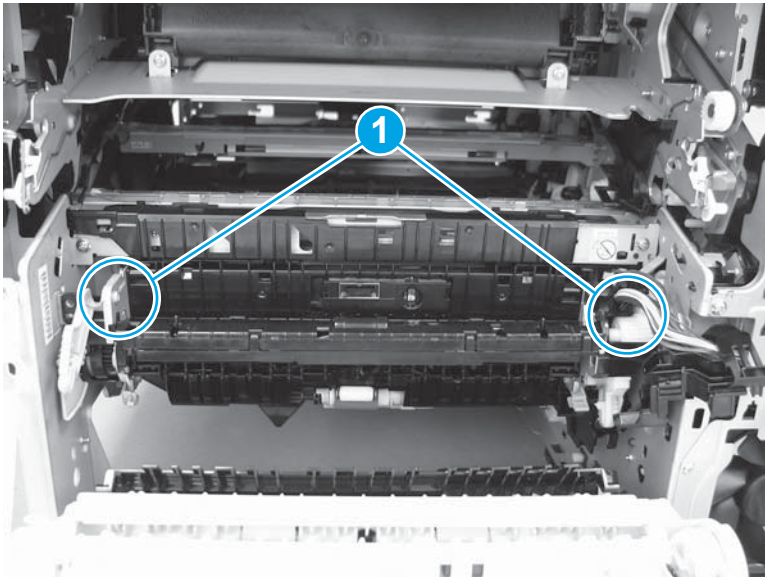

7. Before proceeding, take note of the sheet-metal tabs (callout 1) on the back of the assembly—the figure shows the assembly removed so the tabs can be viewed—that fasten it to the chassis.

Figure 1-4258 Take note of the sheet-metal tabs

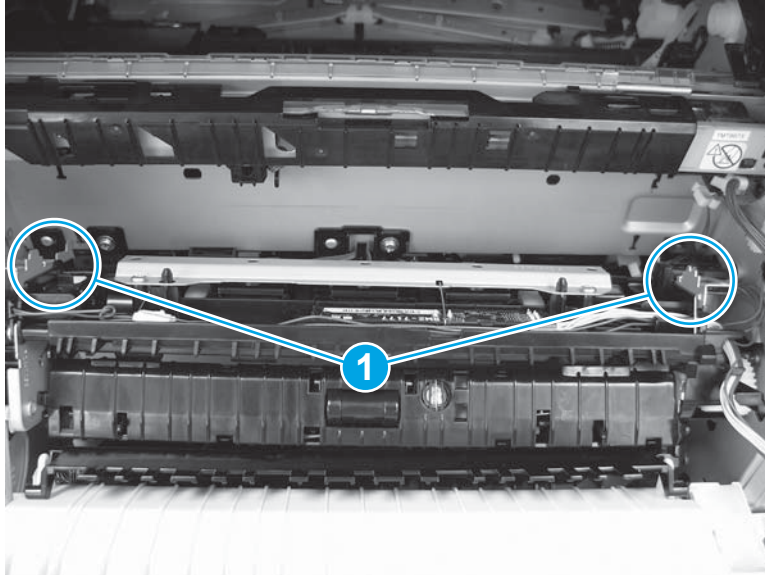

8. Grasp the sheet-metal handles (callout 1), and then rotate the top of the assembly away from the chassis (callout 2) to release the top tabs.

Figure 1-4259 Rotate the top of the assembly away from the chassis

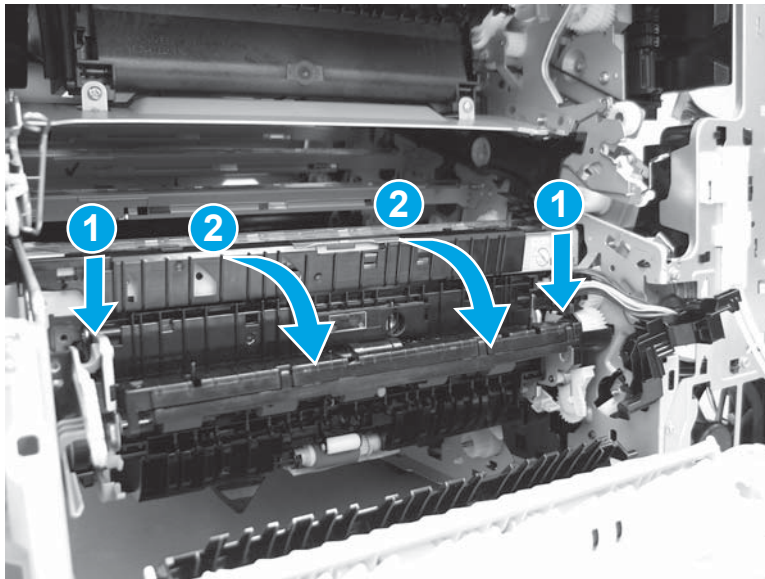

9. Pull up on the assembly to release the bottom tabs.

⚠ CAUTION: The assembly is still attached to the printer by a wire harness. Do not attempt to completely remove the assembly.

Figure 1-4260 Release the bottom tabs

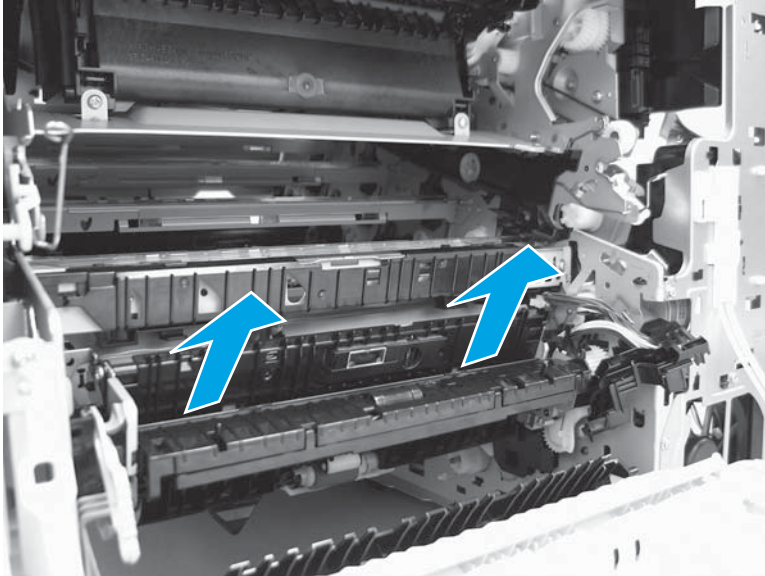

10. Turn the registration assembly over to access the back side, disconnect three connectors (callout 1), and then remove the assembly.

Figure 1-4261 Remove the assembly

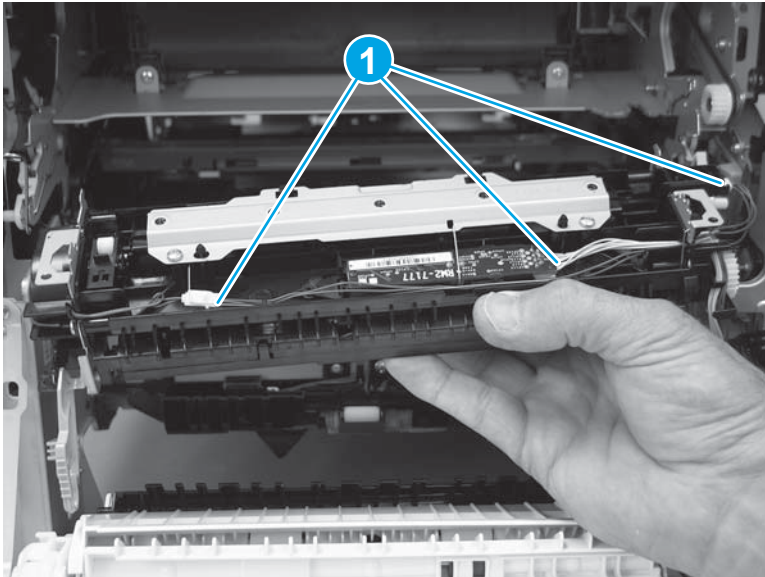

Step 31: Remove the paper pickup assembly

1. At the right side of the printer, remove four screws (callout 1).

Figure 1-4262 Remove four screws

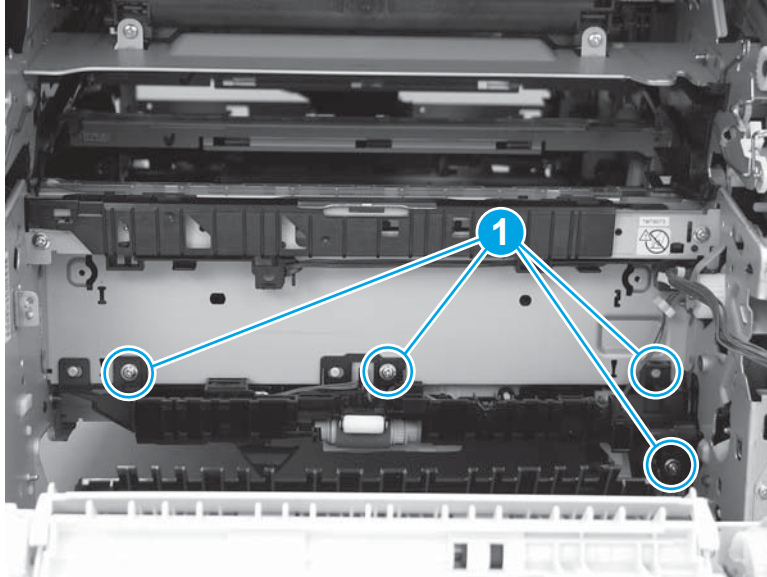

2. Slightly separate the left end of the assembly from the chassis to release it.

Figure 1-4263 Release the left end of the assembly

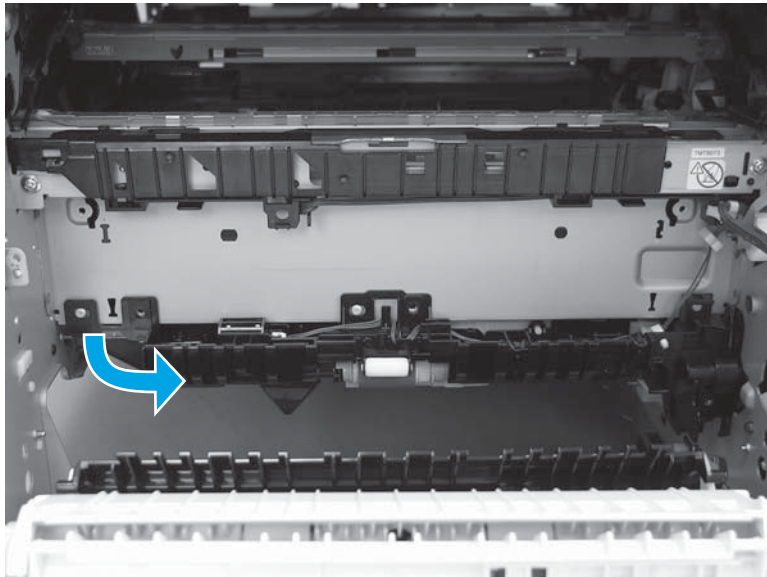

3. Slide the assembly to the left (callout 1), and then continue to rotate the left end of it out and away from the chassis (callout 2).

Figure 1-4264 Slide the assembly to the left

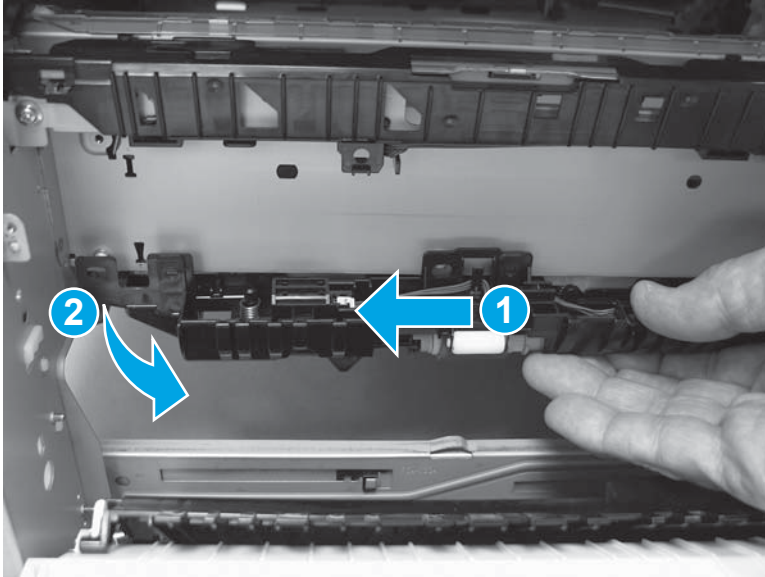

4. Remove the assembly.

⚠ CAUTION: The assembly is still attached to the printer by a wire harness. Do not attempt to completely remove the assembly.

Figure 1-4265 Remove the assembly

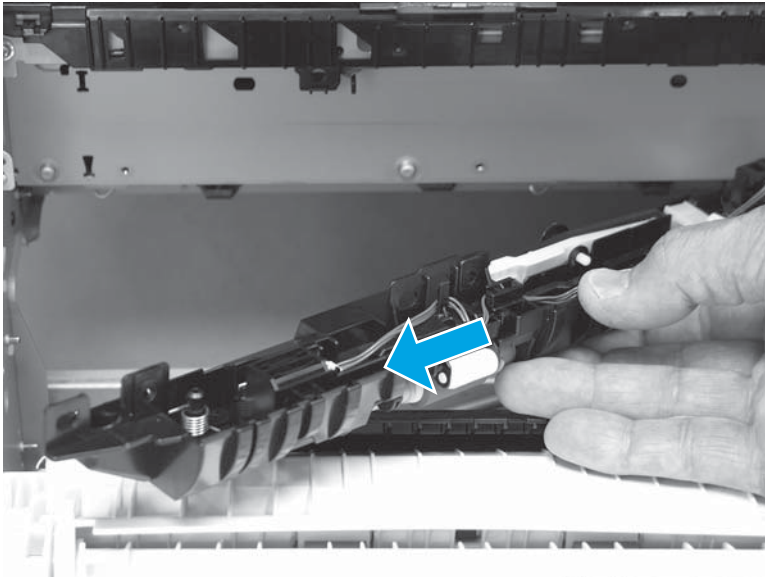

5. Turn the paper pickup assembly over to access the back side, release one connector (callout 1), release the wire harness from the guide (callout 2), and then release it from the retainer (callout 3).

Figure 1-4266 Disconnect one connector

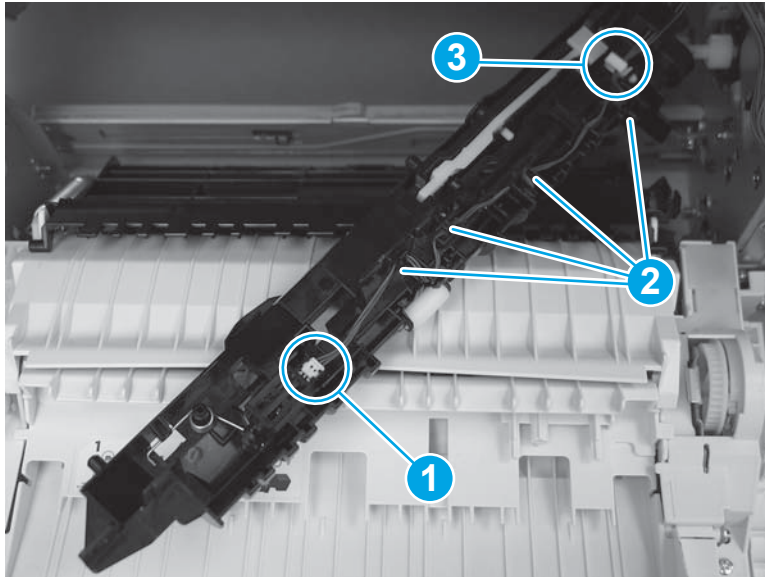

6. On the paper pickup assembly, slide the tray pickup roller assembly to the left to compress the spring loaded shaft (callout 1), and then rotate the right end of the roller assembly up and away from the pickup assembly (callout 2) to remove it.

Figure 1-4267 Remove the tray pickup roller assembly

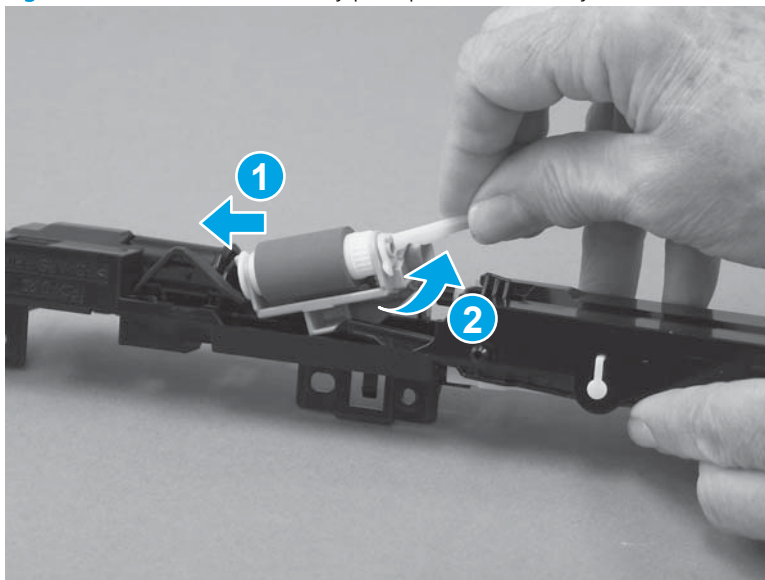

7. Locate the feed bushing (callout 1).

Figure 1-4268 Locate the feed bushing

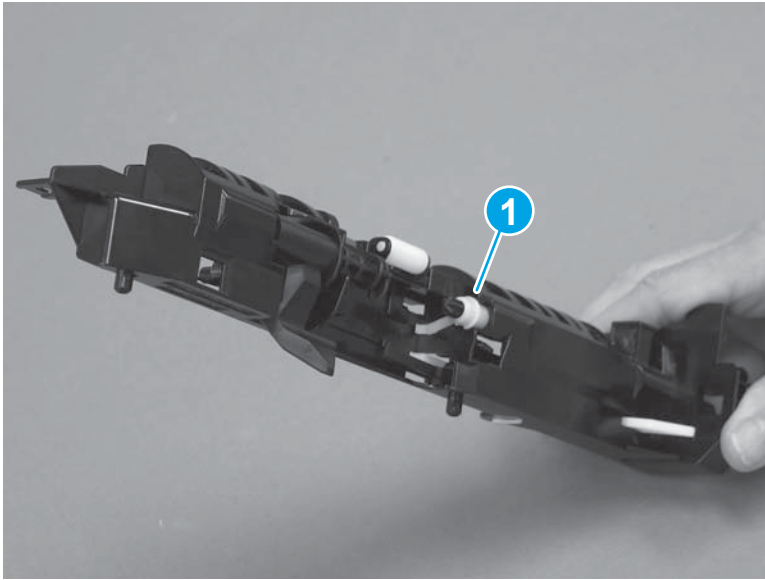

8. Use a small, flat-blade screwdriver to release one tab on the bushing (callout 1), and then rotate the bushing clockwise (callout 2).

Figure 1-4269 Release one tab and rotate the bushing

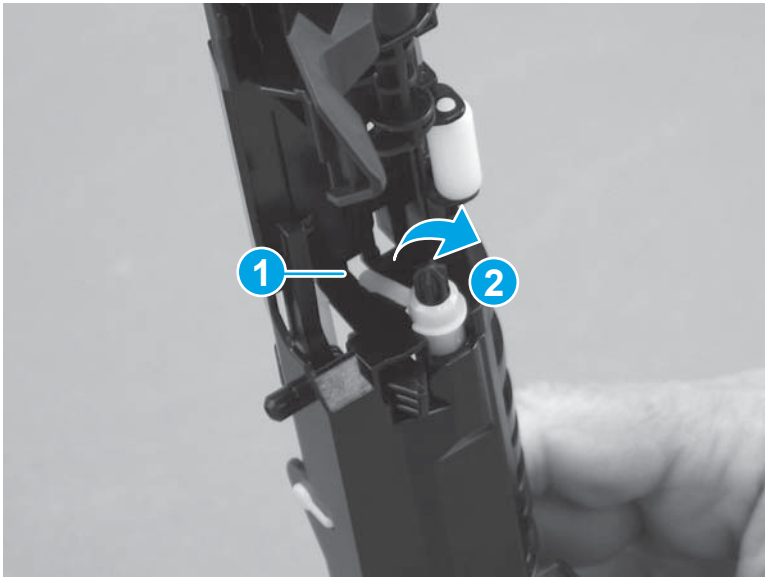

9. Lift the bushing (callout 1) off of the shaft.

Figure 1-4270 Remove the bushing

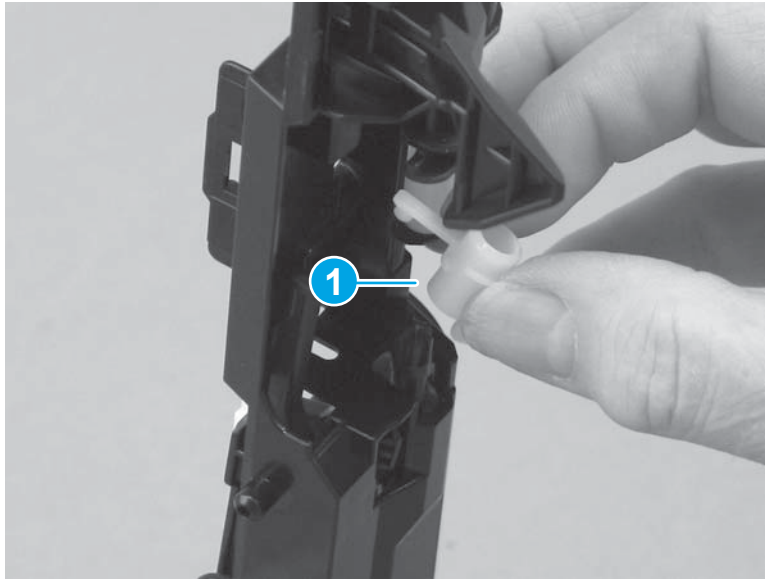

10. At the end of the paper pickup assembly, slide the shaft with the gear on the end (callout 1) slightly out of the assembly.



 **NOTE:** Try not to remove the grease from the gear when handling the shaft and gear.

Figure 1-4271 Slide the shaft out

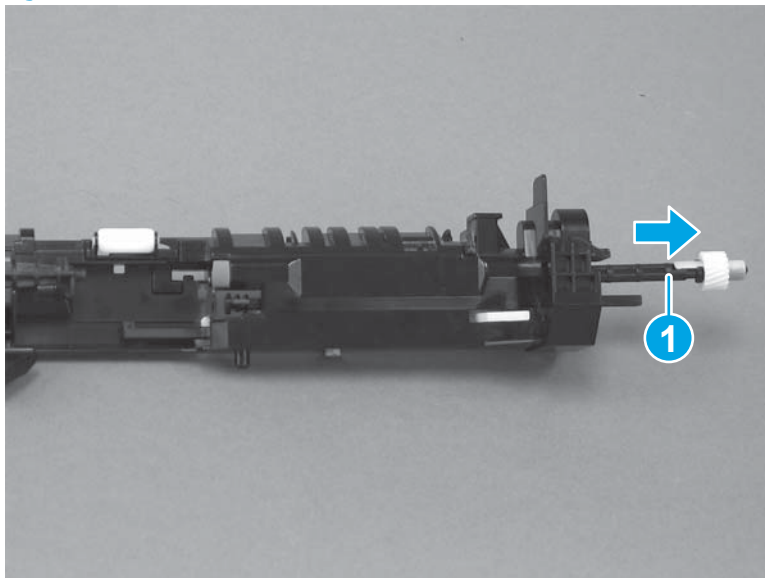

11. Release one tab (callout 1), and then slide the gear (callout 2) off of the shaft.

 **NOTE:** Try not to remove the grease from the gear when handling it.

 **TIP:** Set the gear aside for installation on the replacement paper pickup assembly.

Figure 1-4272 Remove the gear



Step 32: Unpack the replacement assembly

Unpack the replacement assembly from the packaging.

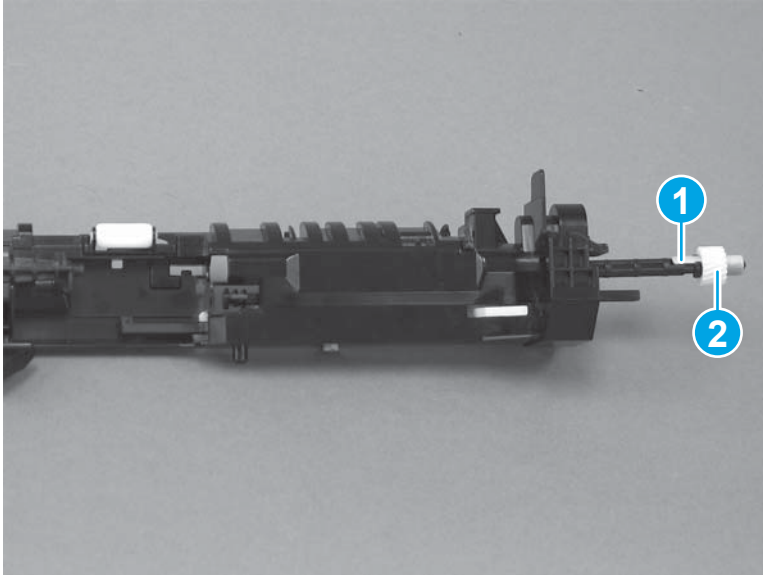
For complete information on HP's recycling programs, go to [Product return and recycling](#).

 **NOTE:** HP recommends responsible disposal of the defective assembly.

Figure 1-4273 Recycle and unpack

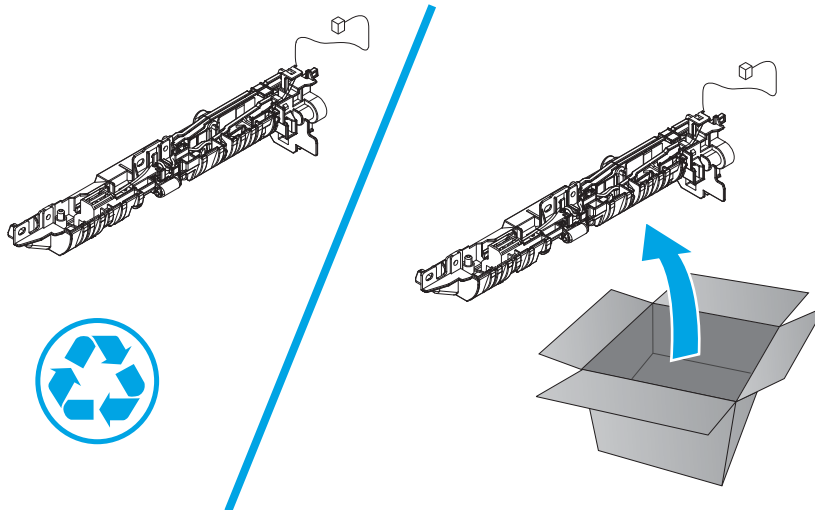

Step 33: Install the paper pickup assembly

1. On the replacement paper pickup assembly, slide the tray pickup roller assembly to the left to compress the spring loaded shaft (callout 1), and then rotate the right end of the roller assembly up and away from the pickup assembly (callout 2) to remove it.

Figure 1-4274 Remove the tray pickup roller assembly

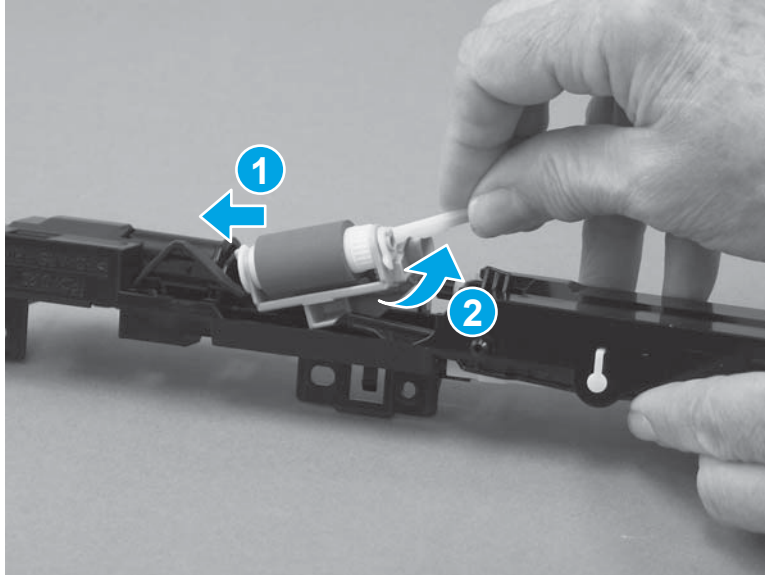

2. Locate the feed bushing (callout 1).

Figure 1-4275 Locate the feed bushing

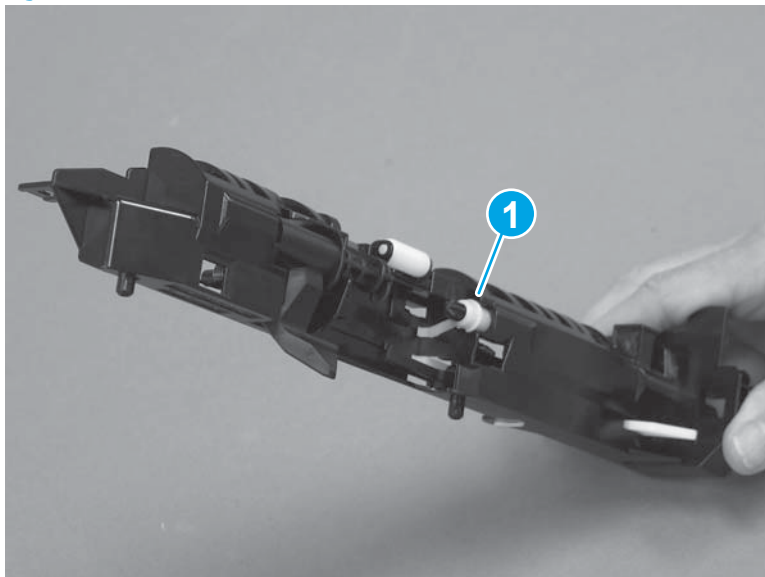

3. Use a small, flat-blade screwdriver to release one tab on the bushing (callout 1), and then rotate the bushing clockwise (callout 2).

Figure 1-4276 Release one tab and rotate the bushing

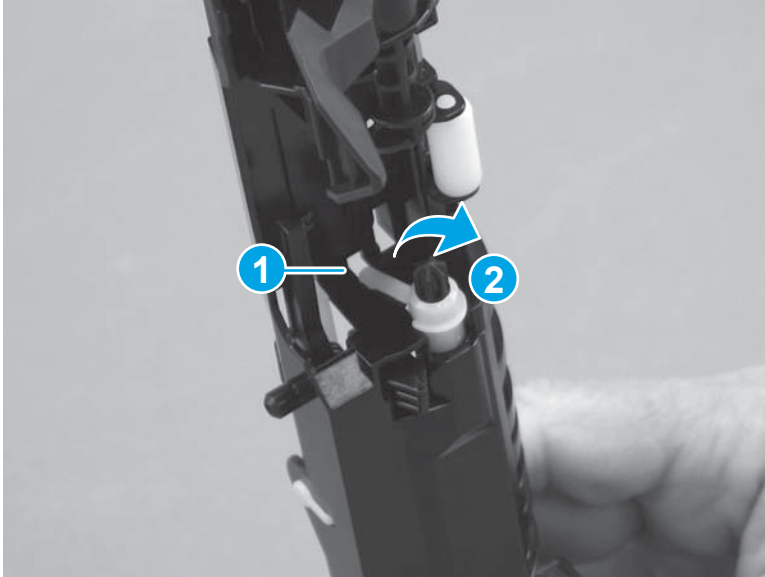

4. Lift the bushing (callout 1) off of the shaft.

Figure 1-4277 Remove the bushing

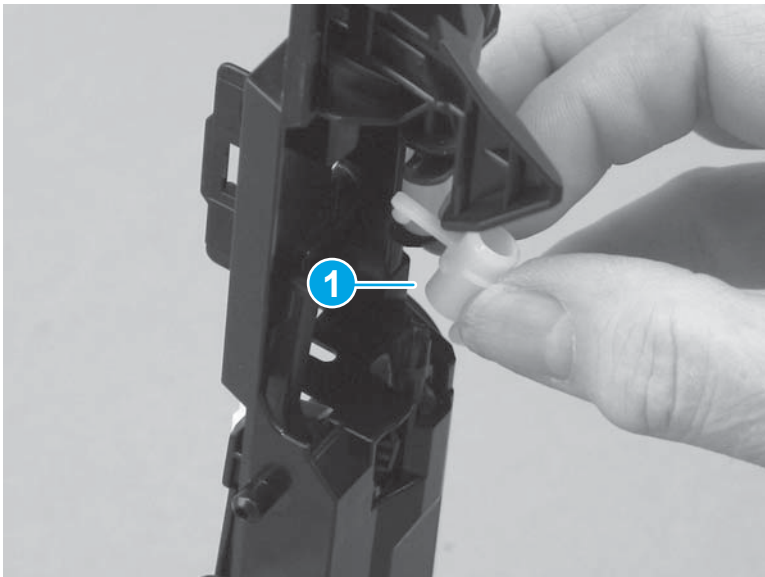

5. At the end of the paper pickup assembly, slide the shaft (callout 1) slightly out of the assembly.

Figure 1-4278 Slide the shaft out

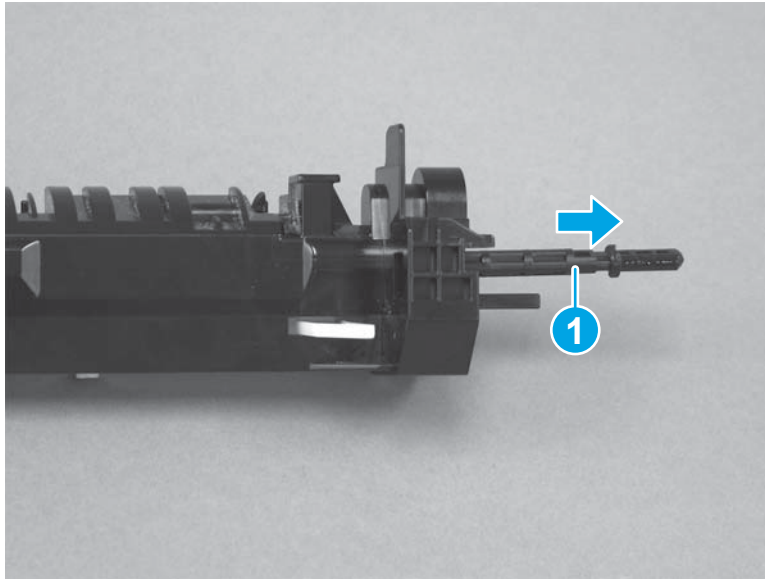

6. Position the gear (callout 1) removed from the discarded paper pickup assembly on the shaft (callout 2) of the replacement pickup assembly.

 **NOTE:** The hole in the center of the gear is keyed to match the end of the shaft.

 **NOTE:** Try not to remove the grease from the gear when handling it.

Figure 1-4279 Position the gear

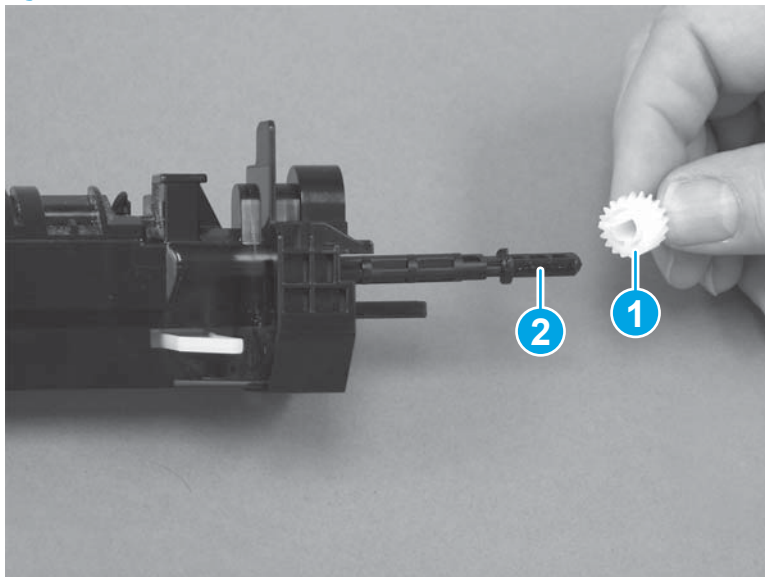

7. Slide the gear (callout 1) onto the shaft. Make sure that the tab (callout 2) snaps into place.

Figure 1-4280 Install the gear

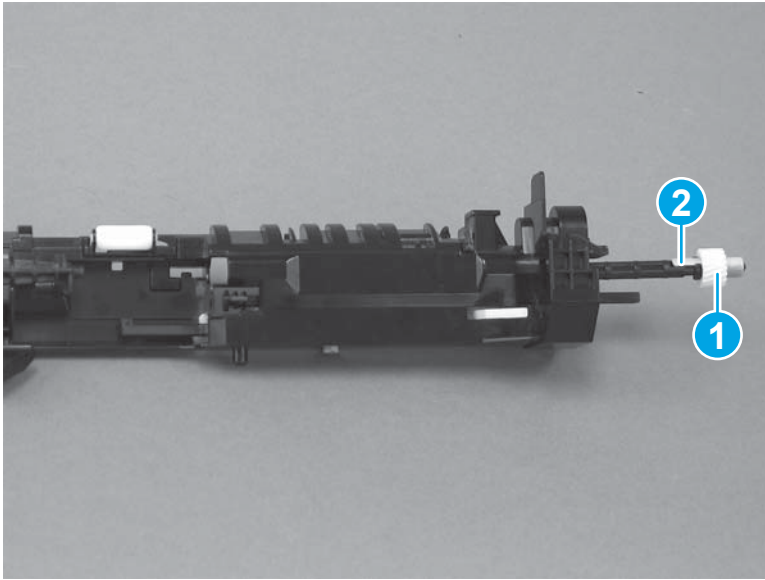

8. Slide the shaft into the paper pickup assembly.

Figure 1-4281 Install the shaft

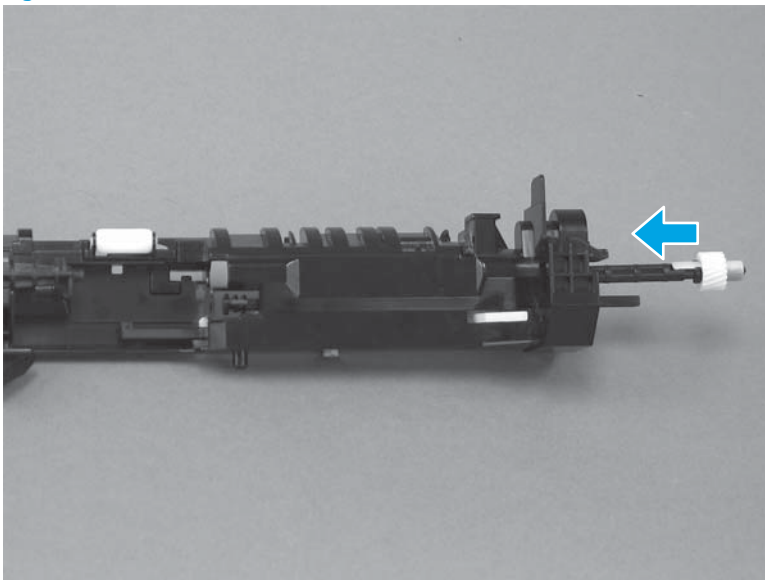

9. Make sure that the ridge on the shaft (callout 1) fits into the slot (callout 2) in the paper pickup assembly.

 **TIP:** Hold the shaft in place with one finger while installing the feed bushing in the next step.

Figure 1-4282 Check shaft alignment



10. Position the feed bushing (callout 1) over the end of the shaft (callout 2). Align the ridge (callout 3) on the bushing with the opening (callout 4) in the paper pickup assembly.

Figure 1-4283 Position the feed bushing

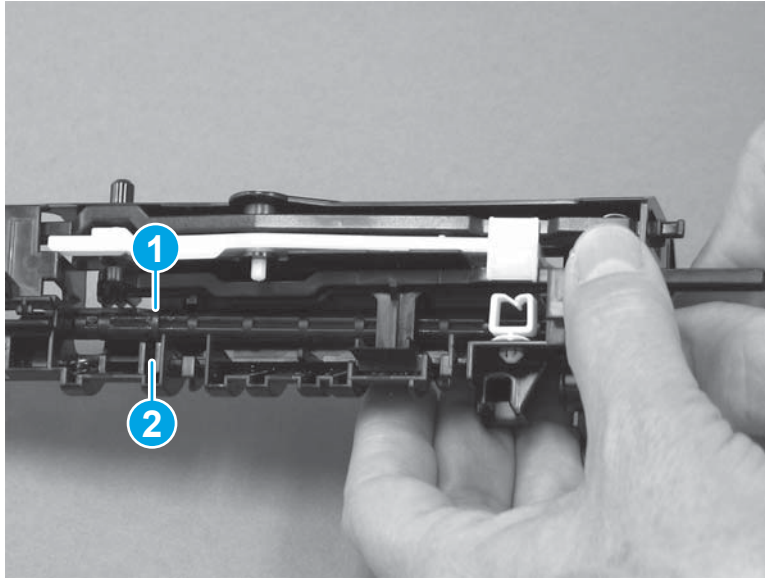
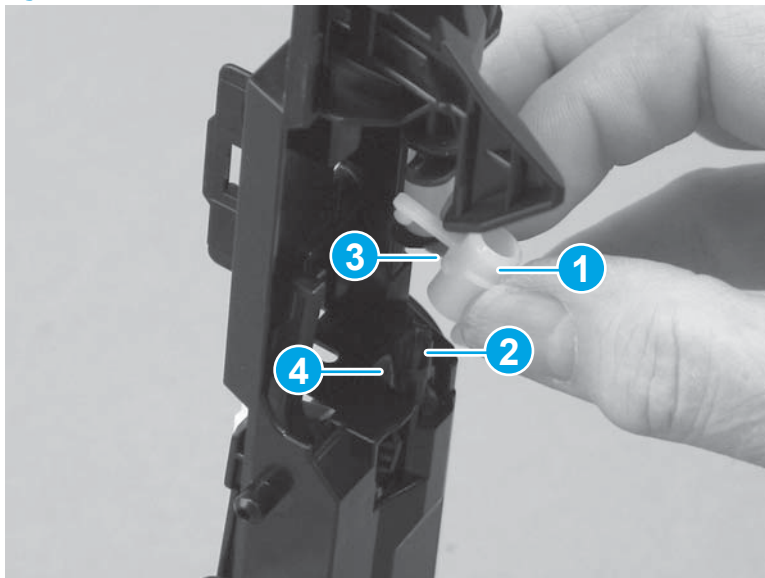

11. Press down on the bushing (callout 1) while rotating it counterclockwise (callout 2) until the tab (callout 3) fits into the slot (callout 4).

Figure 1-4284 Install the feed bushing

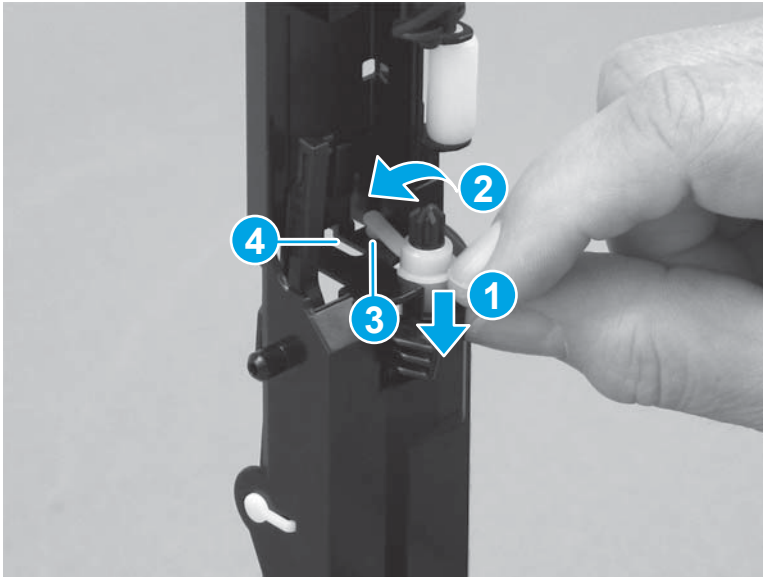

12. Before proceeding, check to make sure that the ridge on the shaft is still positioned in the slot in the pickup assembly (callout 1). If the shaft is not positioned correctly, remove the feed bushing and reinstall the shaft in the correct position.

Figure 1-4285 Check shaft alignment

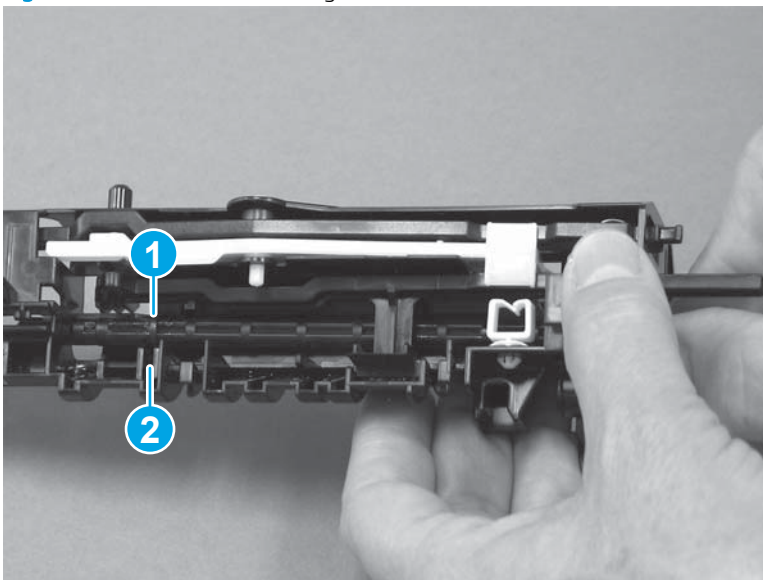

13. Position the roller assembly in the paper pickup assembly so that the hole (callout 1) in the roller assembly fits over the shaft (callout 2) on the pickup assembly and the tab (callout 3) on the roller assembly fits over the hook (callout 4) in the pickup assembly.

Figure 1-4286 Position the roller assembly

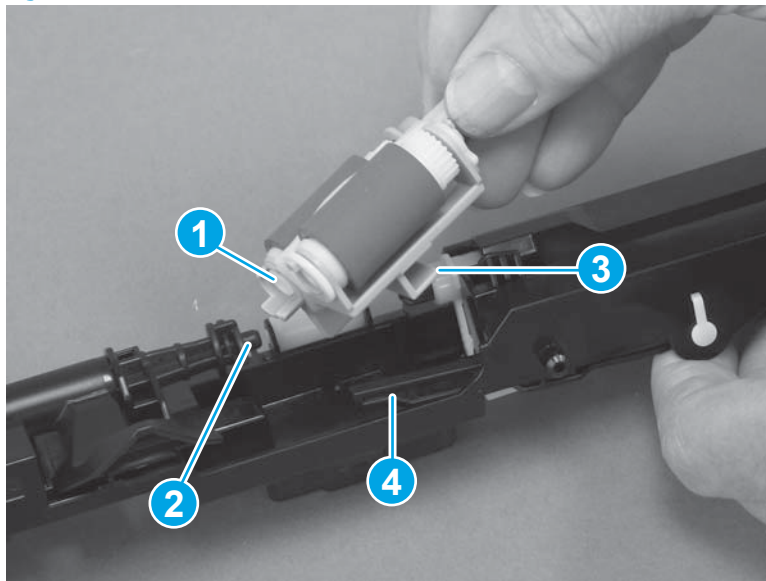

14. Slide the roller assembly to the left (callout 1) to compress the spring-loaded shaft. Rotate the roller assembly toward the pickup assembly (callout 2), making sure that the collar on the roller (callout 3) fits over the shaft on the pickup assembly (callout 4).

Figure 1-4287 Install the roller assembly

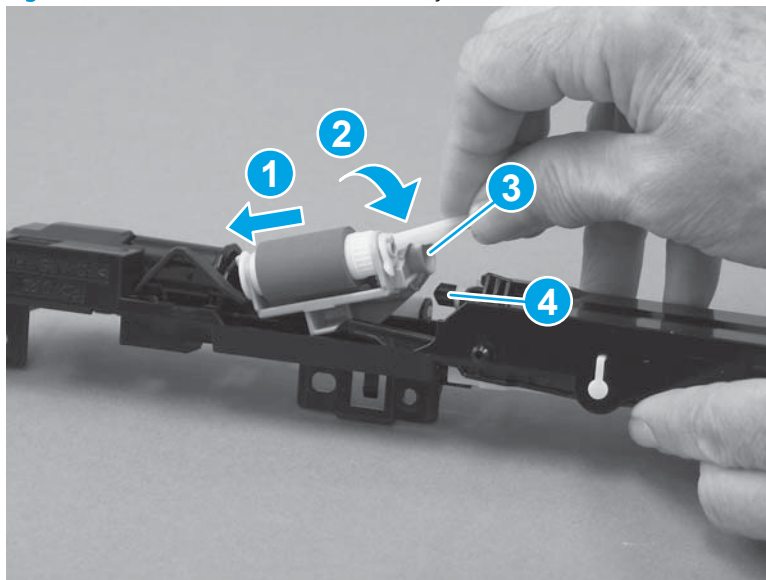

- Carefully release the spring-loaded shaft with the roller assembly in place.

Figure 1-4288 Release the spring loaded shaft

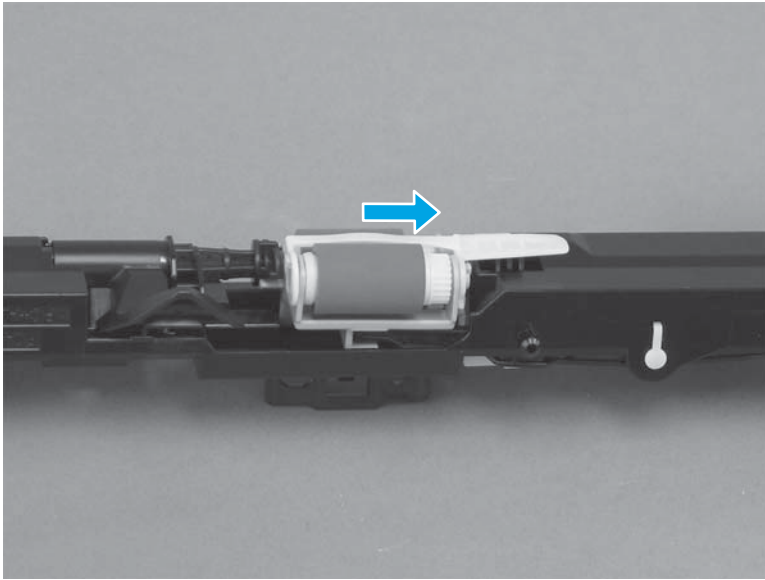

- When the paper pickup assembly is installed, the right end must be correctly engaged with the drive gear (callout 1) or the assembly will not be able to be correctly installed.

Figure 1-4289 Remove three screws

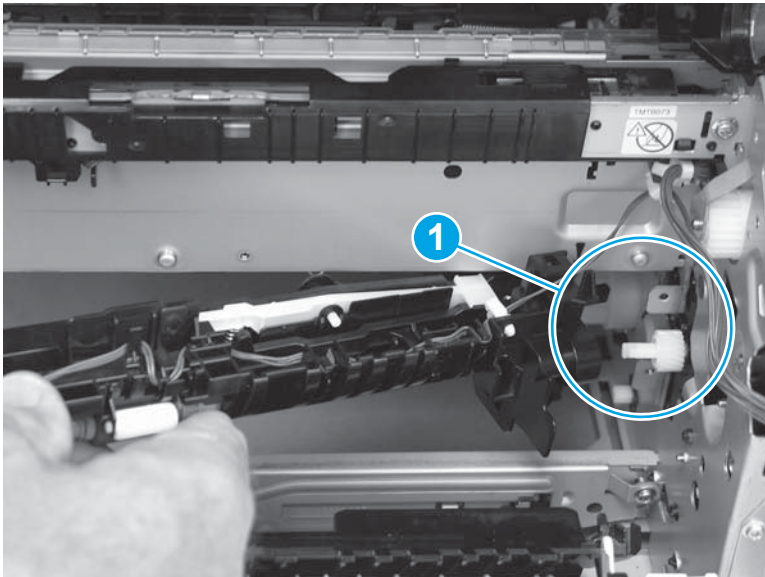

17. Turn the paper pickup assembly over to access the back side, connect one connector (callout 1), position the wire harness in the guide (callout 2), and then secure it in the retainer (callout 3).

Figure 1-4290 Connect one connector

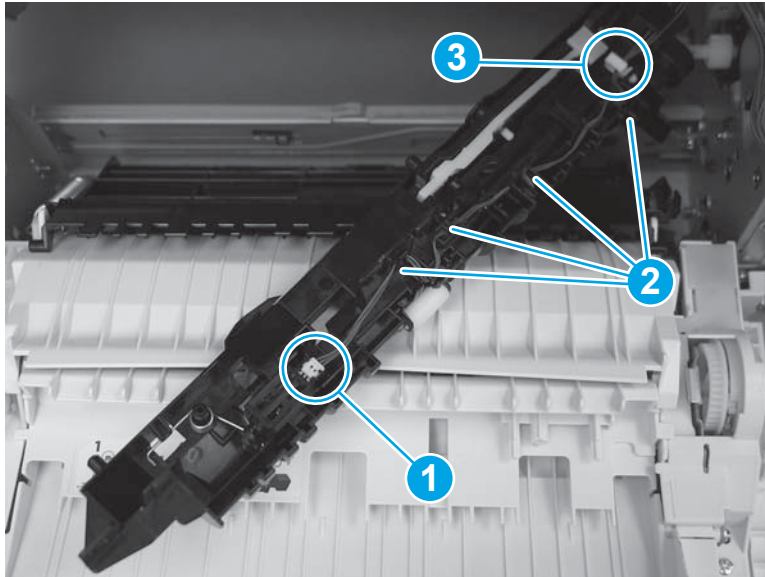

18. Position the right end of the assembly in the printer at a slight angle and engaged with the drive gear.

 **NOTE:** The right end of the assembly must be correctly engaged with the drive gear or the assembly will not be able to be correctly installed.

Figure 1-4291 Position the assembly in the product



19. Slide the assembly to the right (callout 1), and then to rotate the left end of it toward the chassis (callout 2).

Figure 1-4292 Slide the assembly to the right

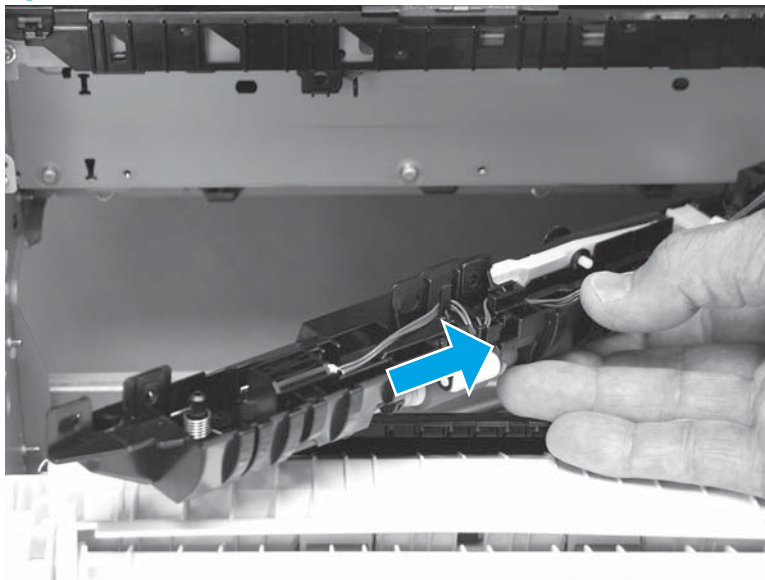
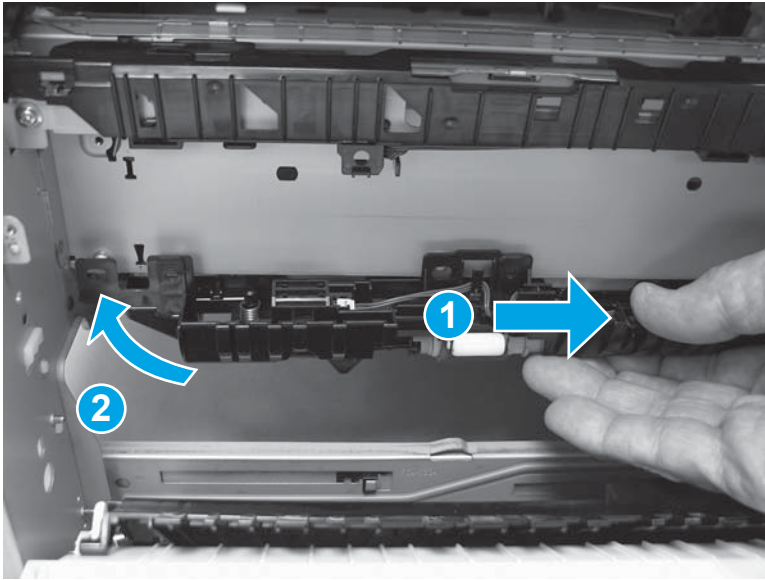

20. Continue to rotate the left end of the assembly toward the chassis to install it.

Figure 1-4293 Install the assembly

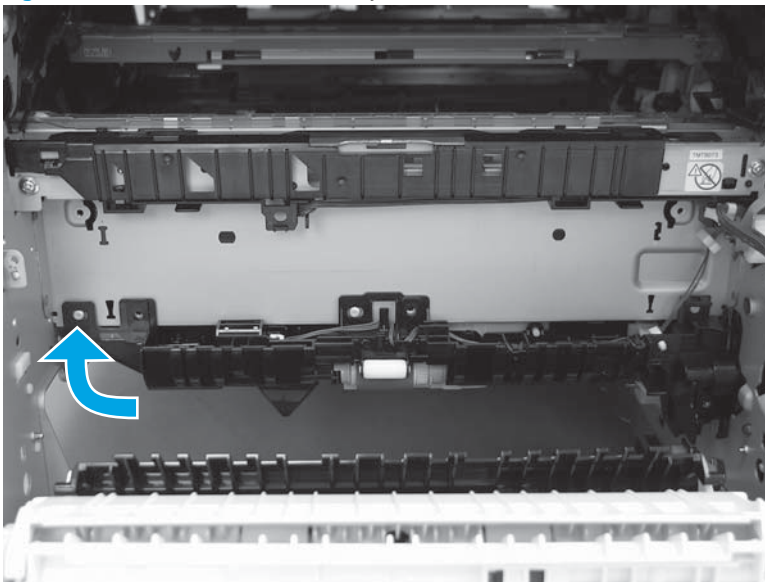

21. Install four screws (callout 1).

Figure 1-4294 Install four screws

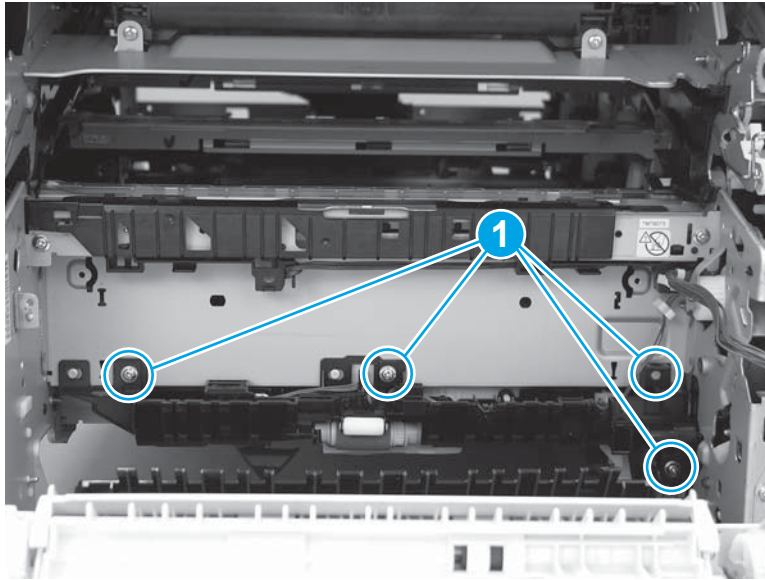

Step 34: Install the registration assembly

1. Turn the registration assembly over to access the back side, and then connect three connectors (callout 1).

Figure 1-4295 Connect three connectors

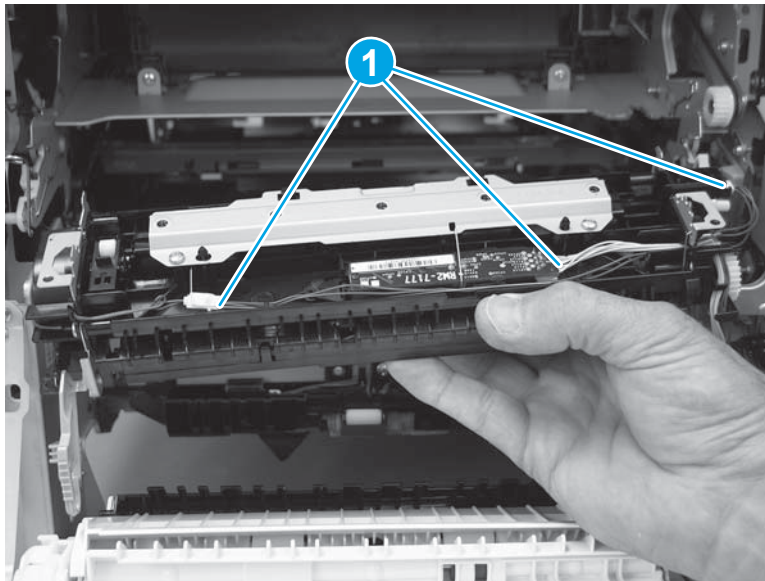

2. Align the tabs on the assembly with the slots in the chassis.

Figure 1-4296 Align the tabs on the assembly with the slots

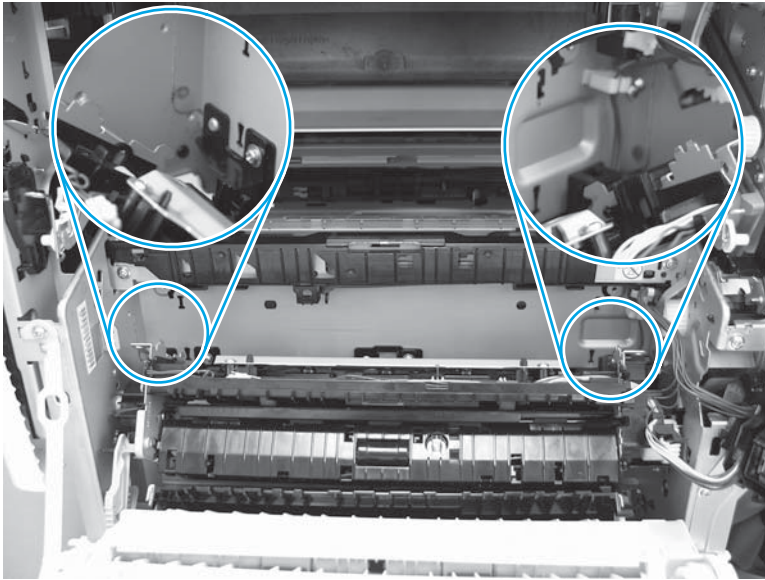

3. Position the bottom tabs in the appropriate slots, and then push down on the assembly to engage them.

Figure 1-4297 Install the bottom tabs

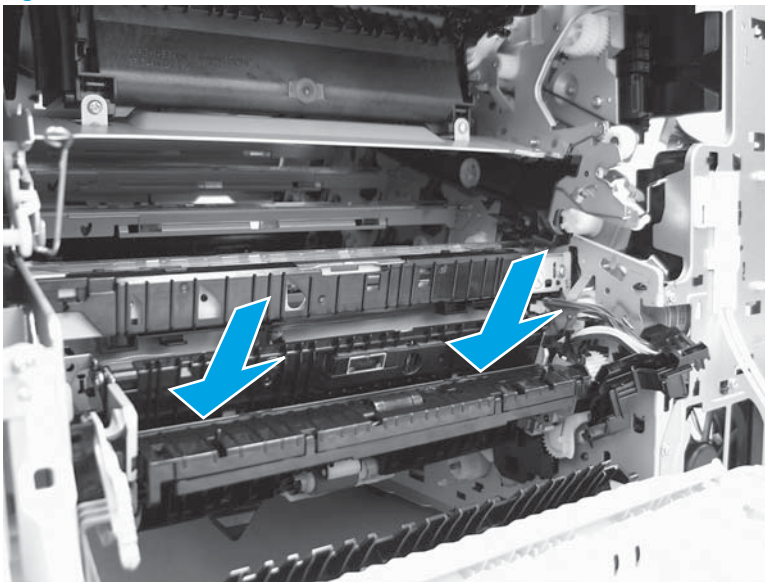

4. Grasp the sheet-metal handles (callout 1) to rotate the top of the assembly toward the chassis (callout 2) to install the top tabs.

Figure 1-4298 Install the top tabs

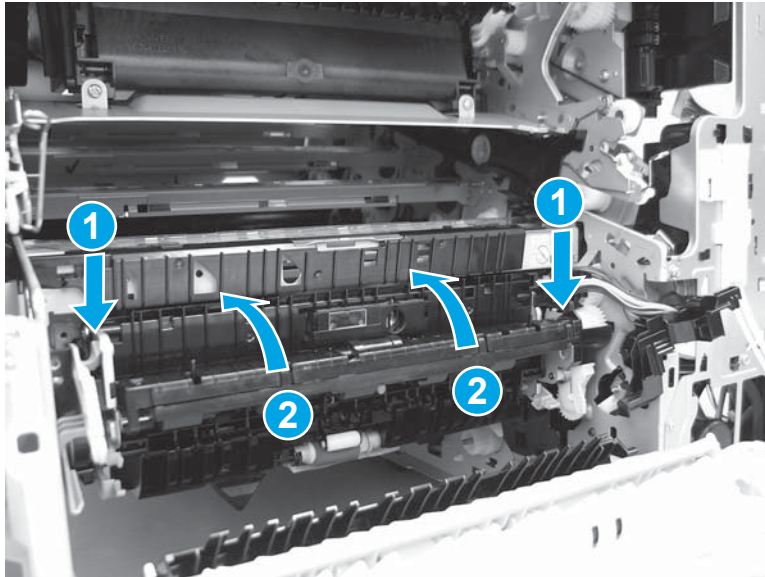

5. Install three screws (callout 1).

Figure 1-4299 Install three screws

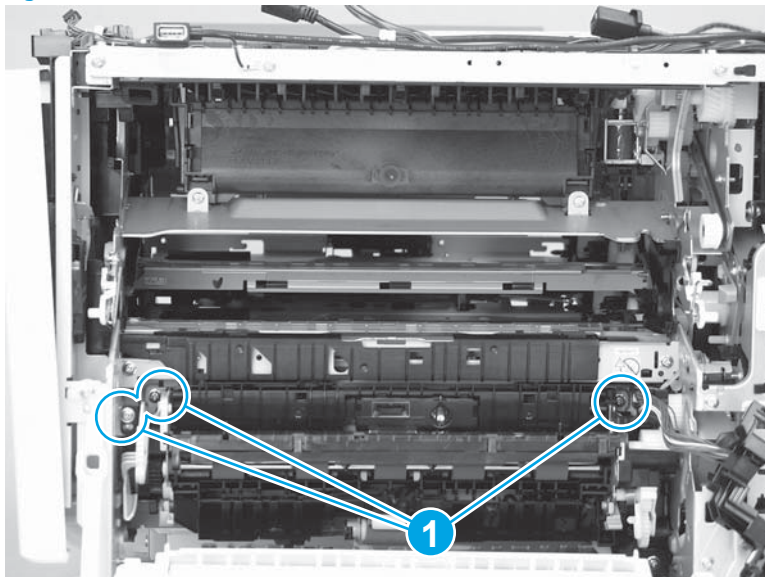

6. Position the guide on the chassis.

Figure 1-4300 Position the guide on the product

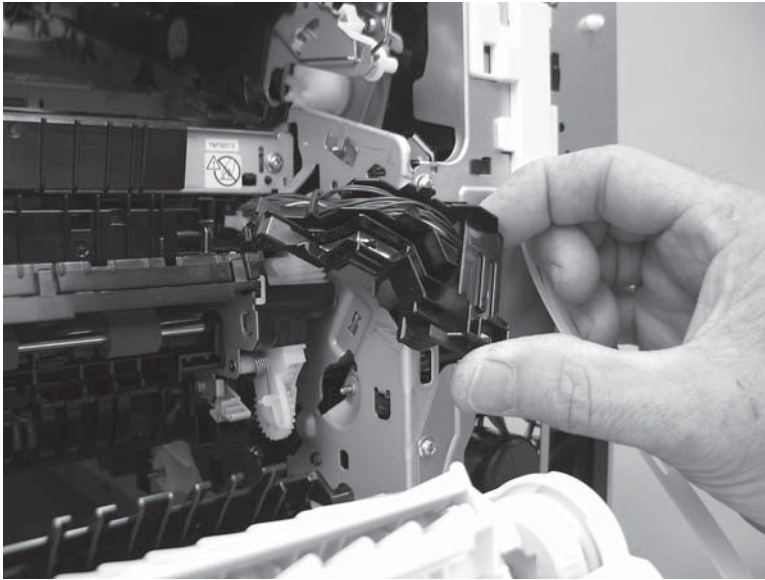

7. Slide the guide up to install it (callout 1), and then make sure that the tab (callout 2) snaps into place.

Figure 1-4301 Install the guide

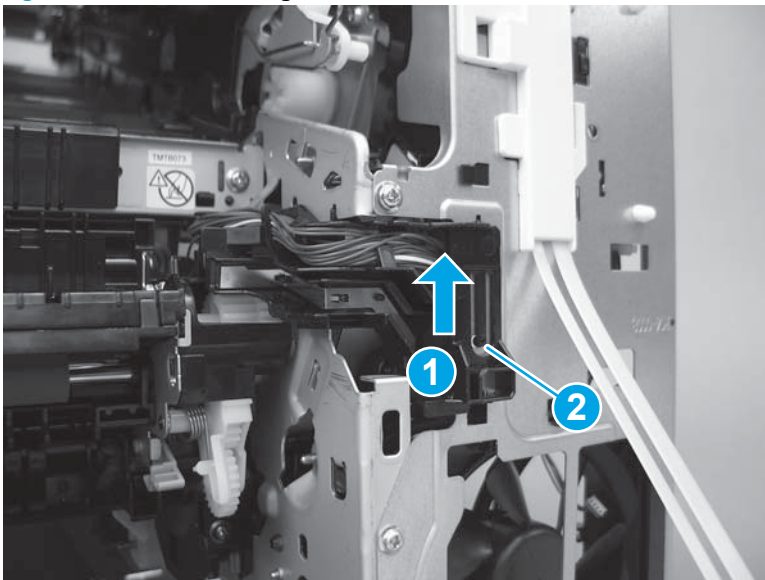

8. Position the cover on the printer.

Figure 1-4302 Position the cover on the product

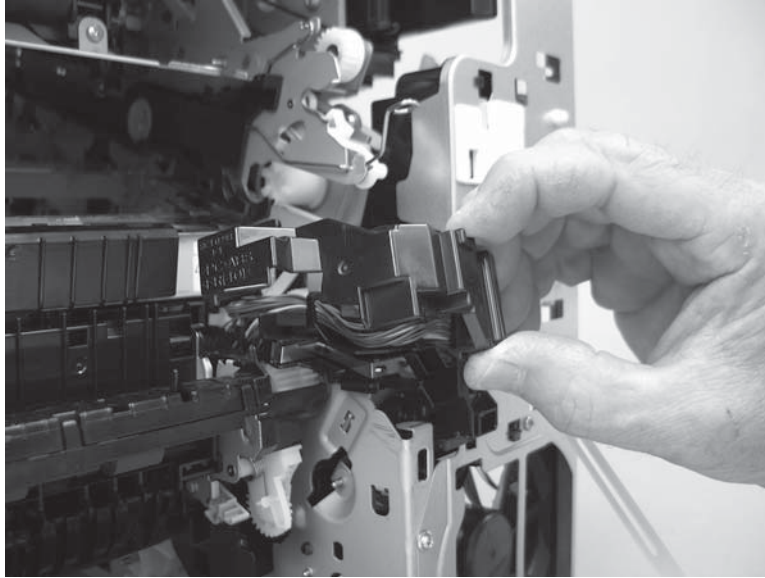

9. Install the cover, and then make sure that the tab (callout 1) snaps into place.

Figure 1-4303 Install the cover

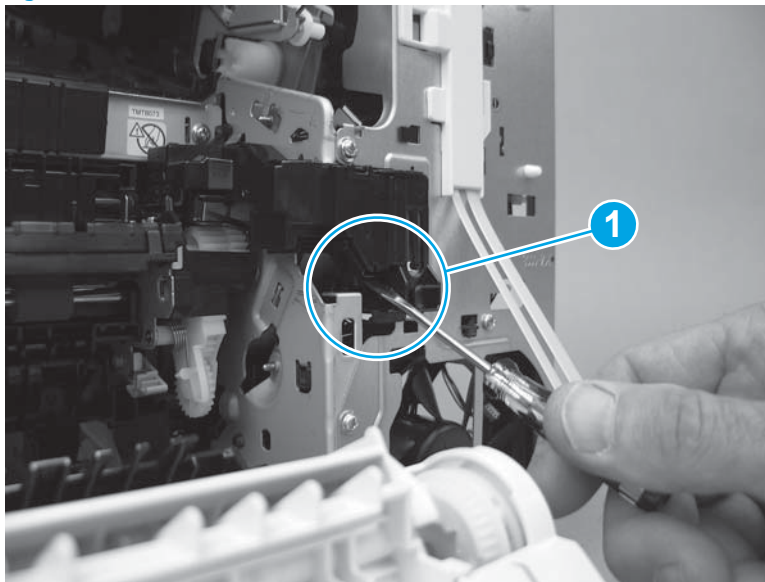

Step 35: Install the pickup drive assembly and motor (M5)

1. Before installing the assembly, check to see if a gap exists (callout 1) between the gears.

 **NOTE:** If no gap exists, go to step [3](#) in this section.

Figure 1-4304 Check the gears for a gap

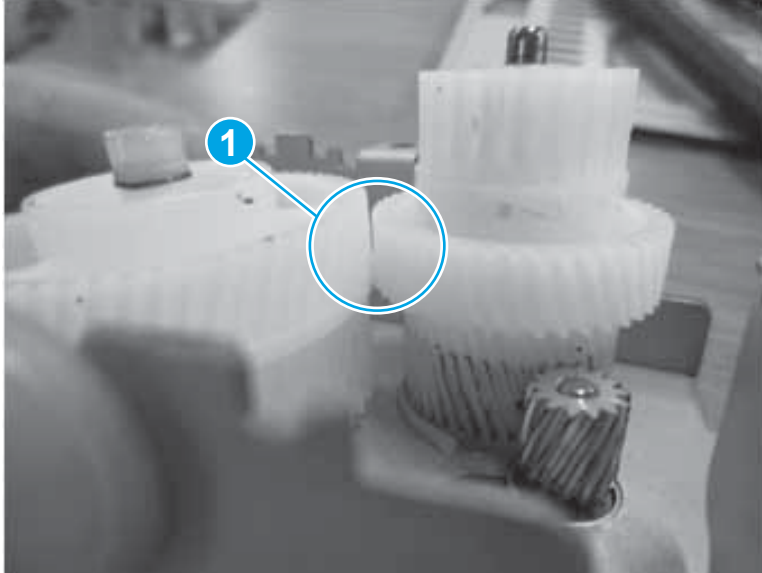

2. Adjust the gears on the assembly to remove the gap (callout 1).

Figure 1-4305 Adjust the gears

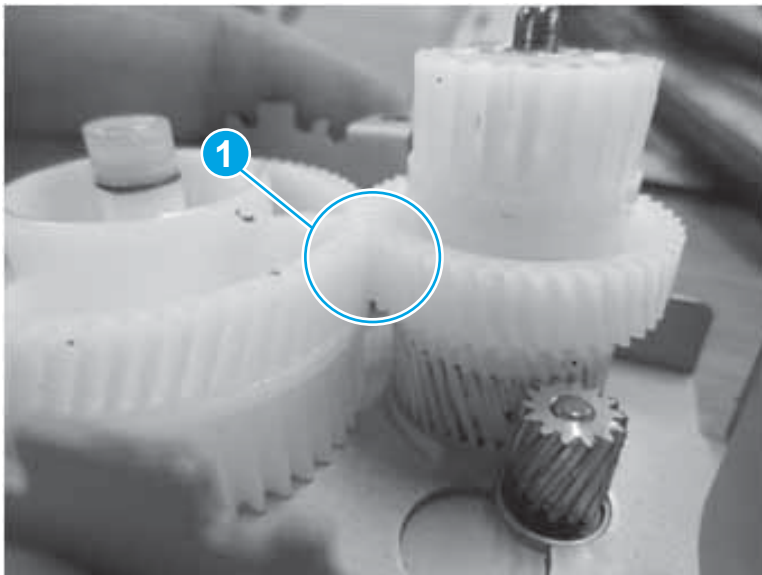

3. Align the tabs on the pickup drive assembly with the slots in the chassis, and then install the assembly on the printer.

 **IMPORTANT:** The figure below shows the large gear of the assembly already installed on the printer chassis. However it is easier to install the pickup drive assembly if the gear is installed on the assembly.

 **TIP:** With the right door open, look into the printer and verify that the mounting bracket for the assembly is correctly installed against the chassis.

Figure 1-4306 Install the assembly



4. Install three screws (callout 1).

Figure 1-4307 Install three screws

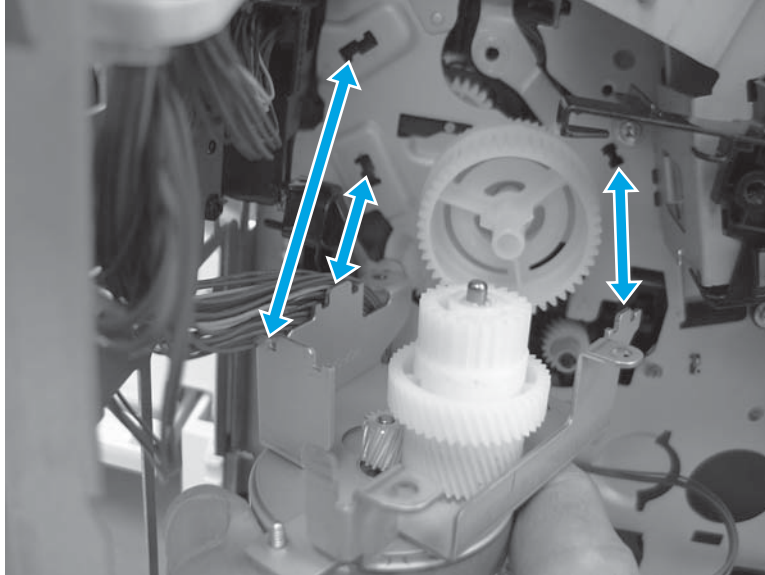
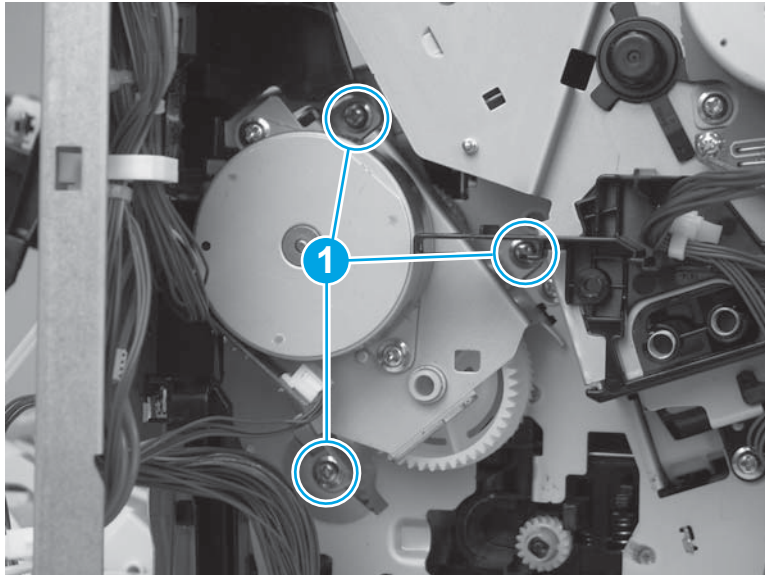

5. Install the guide (callout 1). Make sure that the tab (callout 2) snaps into place.

Figure 1-4308 Install the guide

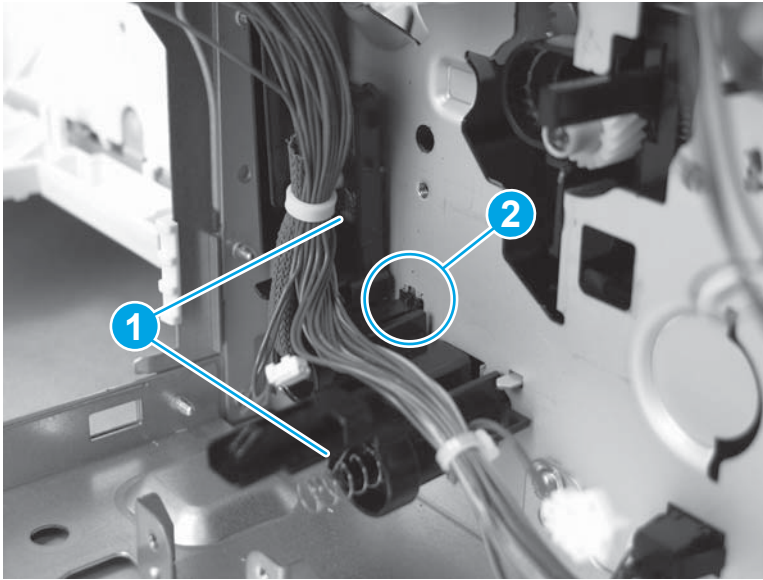

Step 36: Install the DC controller and sheet-metal bracket

 **CAUTION:**  ESD-sensitive part.

1. Position the DC controller and sheet-metal plate on the printer, and then push down to engage the plate with the chassis.

Figure 1-4309 Install the plate

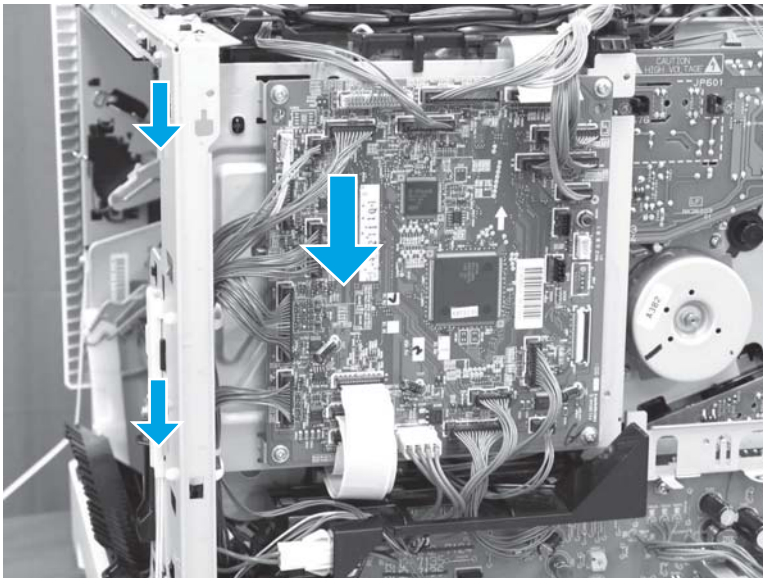

2. Install two screws (callout 1), and then connect all of the connectors.

The following connectors are empty:

- J140, J141, and J143

Figure 1-4310 Install two screws

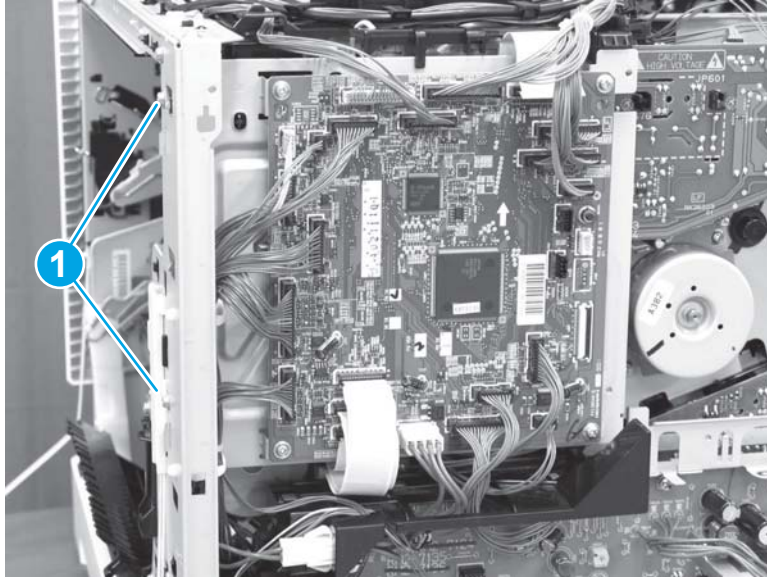

Step 37: Install the lifter drive assembly

1. Install one wire harness on the retainer (callout 1), position the lifter drive assembly in the printer (make sure that one tab (callout 2) snaps into place), and then install two screws (callout 3).

 **TIP:** It might be easier to install the assembly if the bottom of the assembly is installed first, and then the top of the assembly is rotated into place.

Figure 1-4311 Install the lifter drive



2. Connect two flat cables (callout 1), and then place them in the retainers (callout 2).

Figure 1-4312 Connect two flat cables

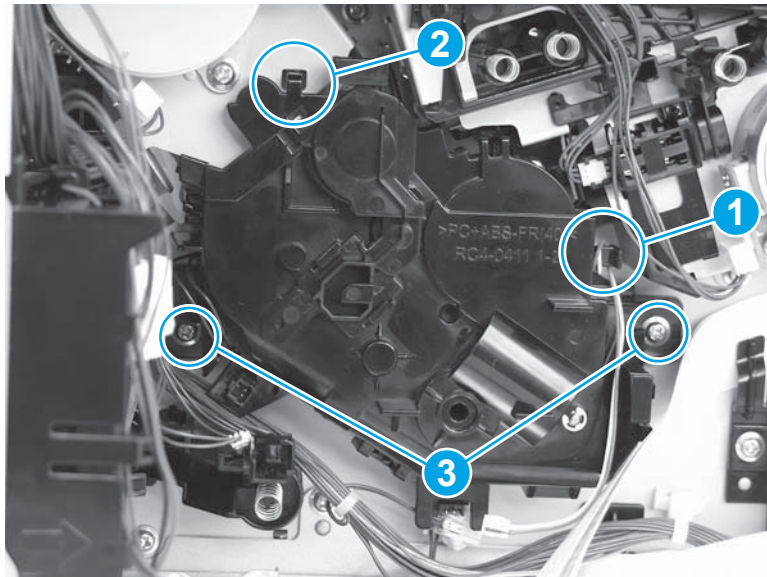
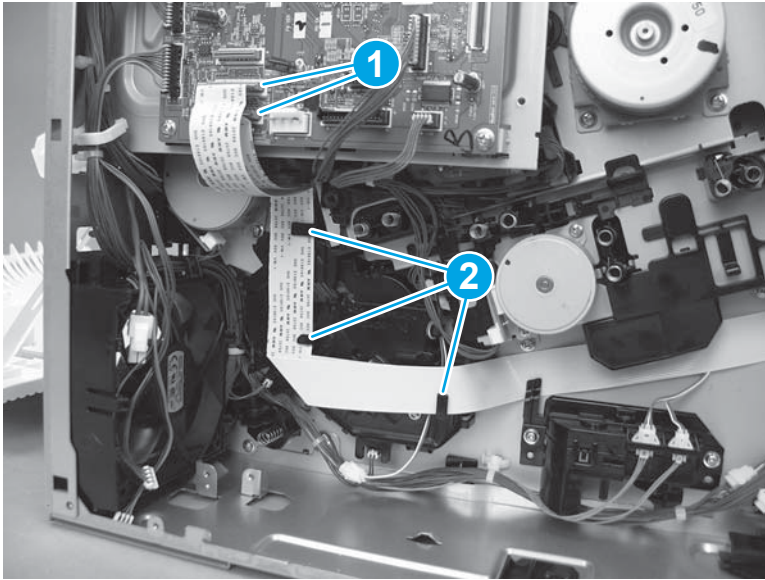

3. Connect two connectors (callout 1).

Figure 1-4313 Connect two connectors

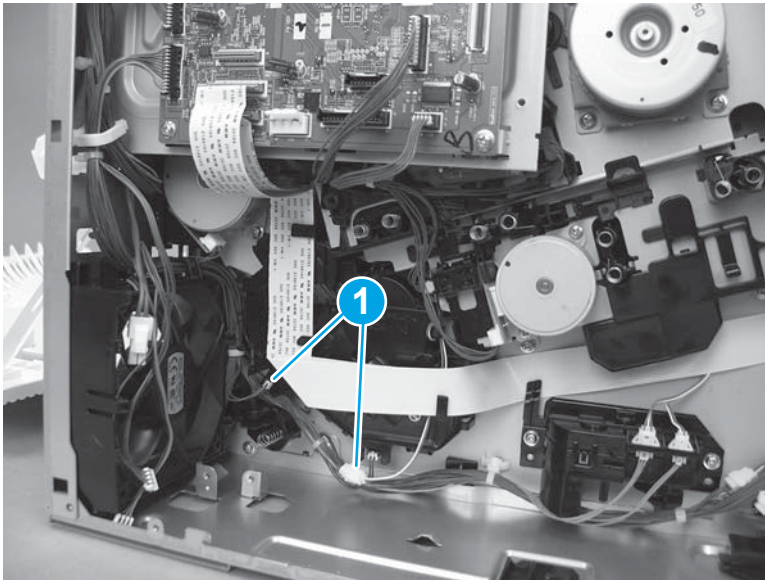

Step 38: Install the HVPSD

 **CAUTION:**  ESD-sensitive part.

1. Position the bottom right corner of the HVPSD (callout 1) behind the black tab, and then rotate it up and onto the printer (callout 2).

Figure 1-4314 Install the HVPSD

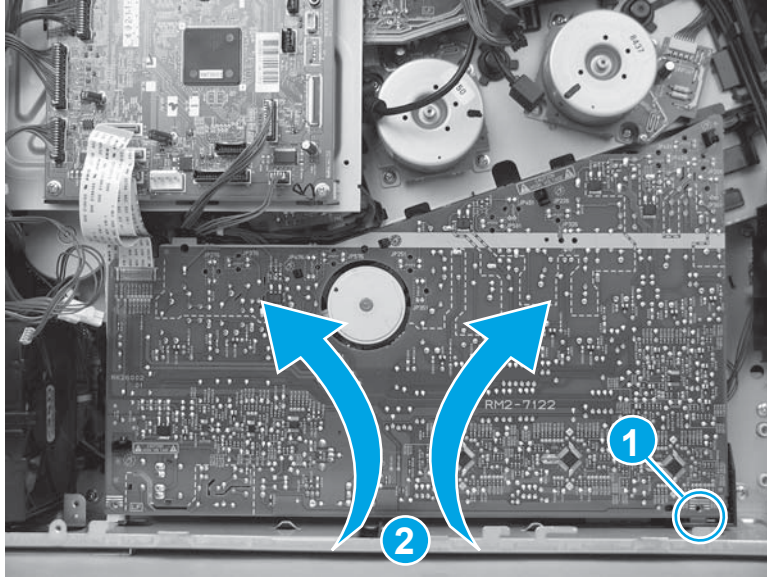

2. Press it onto five tabs (callout 2).

 **IMPORTANT:** Make sure that all five tabs snap into place.

Figure 1-4315 Press the tabs



3. Install two screws (callout 1), and then install one self tapping screw (callout 2) on the HVPSD.

Figure 1-4316 Install three screws

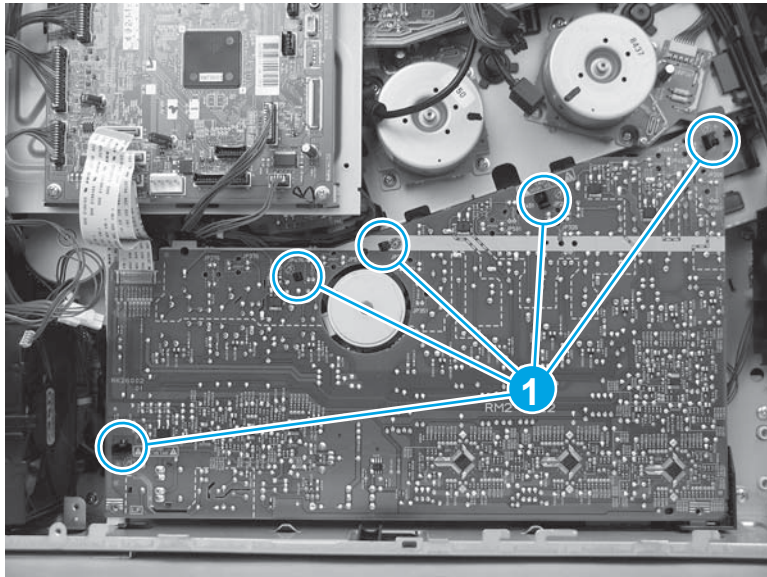
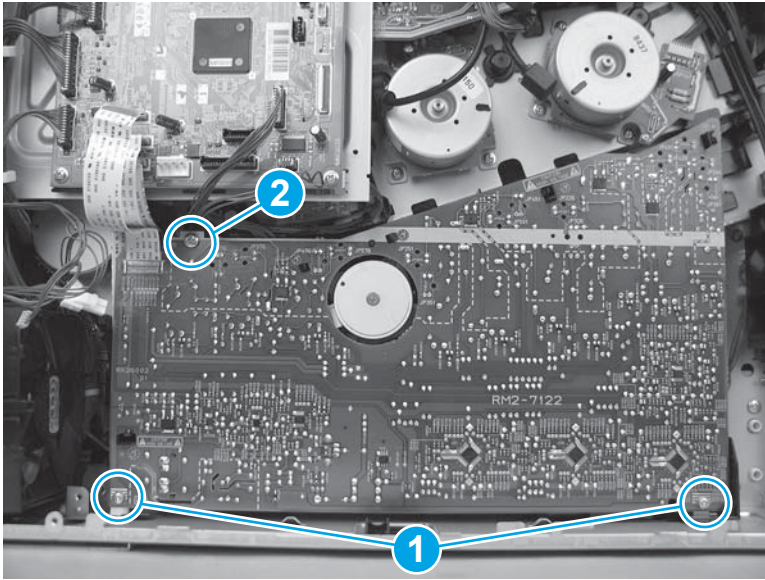

4. Connect one flat cable (callout 1) on the DC controller.

Figure 1-4317 Connect one flat cable

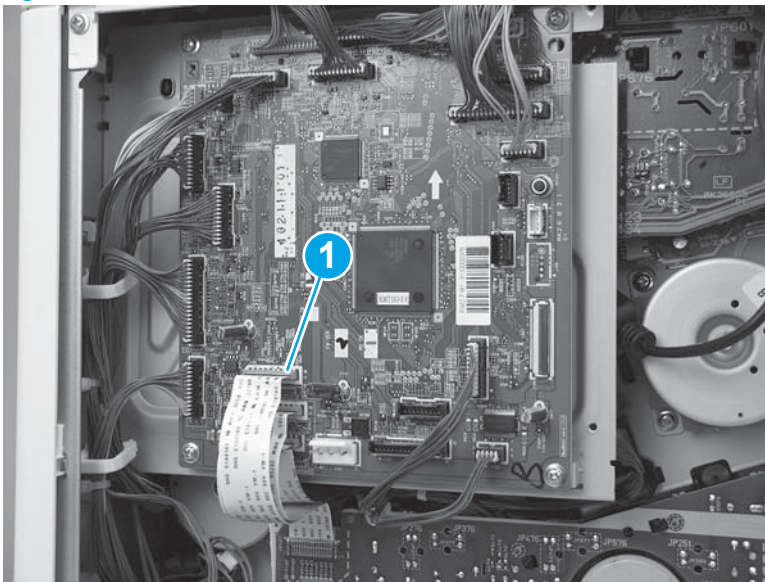

Step 39: Install the power-supply fan (FM1)

1. Slide the fan in (callout 1) and then down (callout 2) into the printer to install it.

 **NOTE:** Make sure that the arrow (callout 3) embossed on the fan holder faces into the printer.

Figure 1-4318 Install the fan



2. Place the wire harnesses in the retainer on the top of the fan bracket.

Figure 1-4319 Place the wire harnesses in the retainer

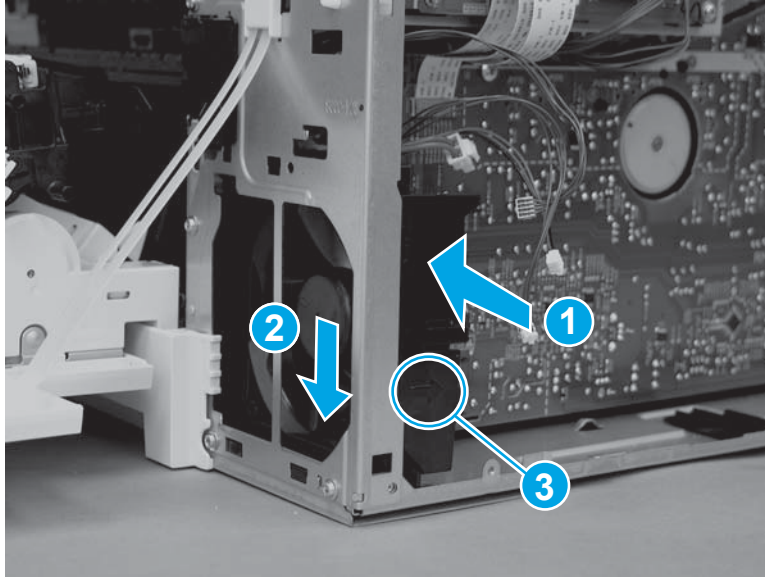
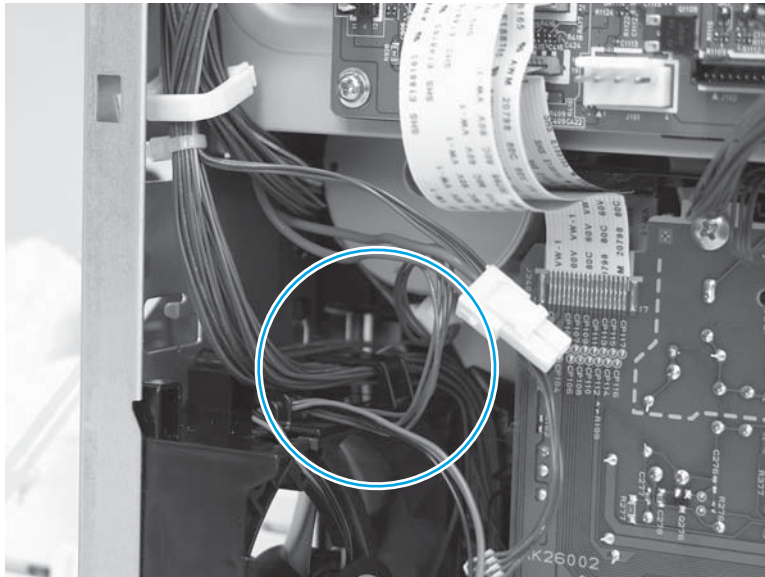

3. Install one screw (callout 1).

Figure 1-4320 Install one screw

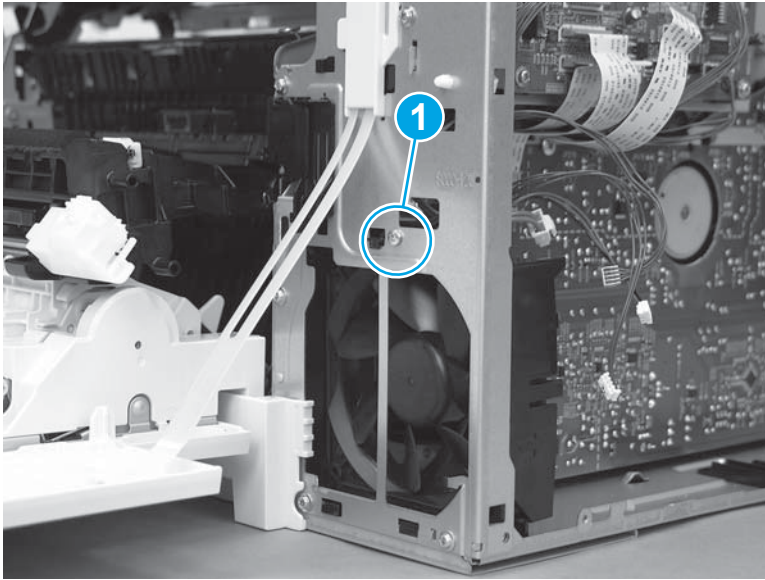

Step 40: Install the LVPS

 **CAUTION:**  ESD-sensitive part.

1. Position the bottom of the LVPS in the printer (callout 1) at a slight angle, and then rotate the top of it into the printer (callout 2) to install it.

Figure 1-4321 Install the LVPS

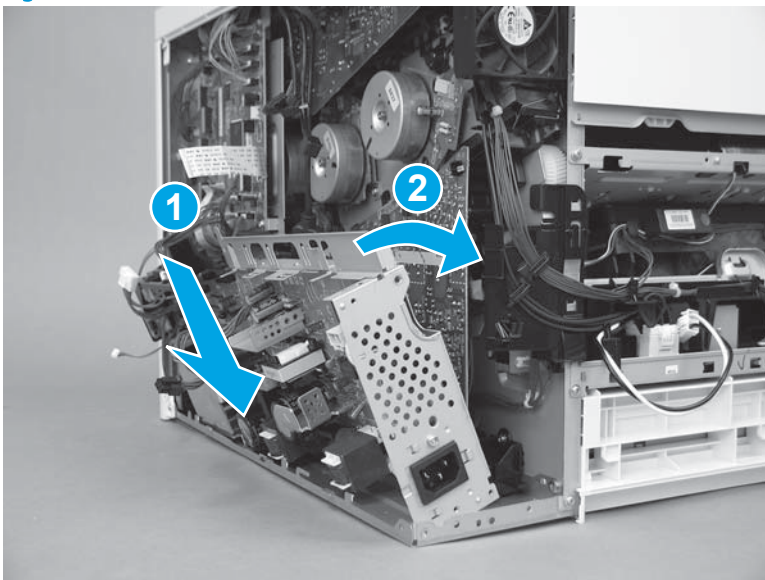

2. Install three screws (callout 1).

Figure 1-4322 Install three screws

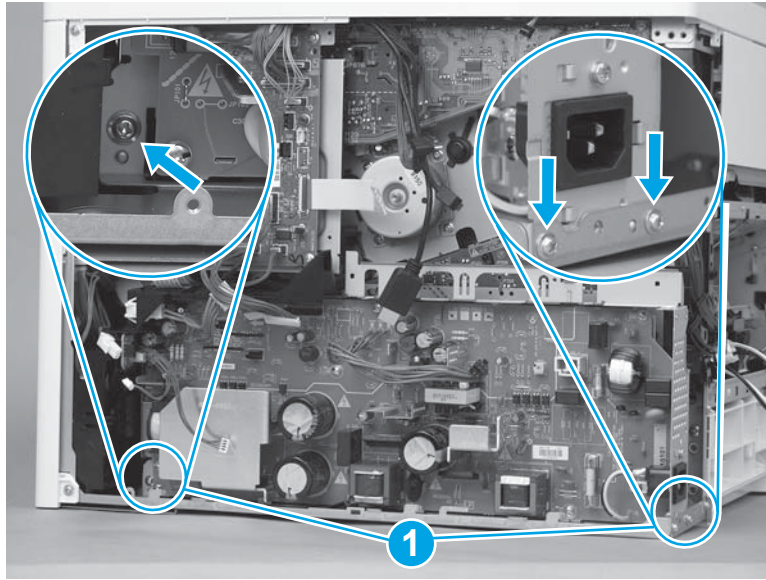

3. Pass the wire harnesses from the DC controller to the LVPS through the opening in the chassis (callout 1), and then install the wire harnesses in the retainer (callout 2).

Figure 1-4323 Pass the wire harnesses through the opening

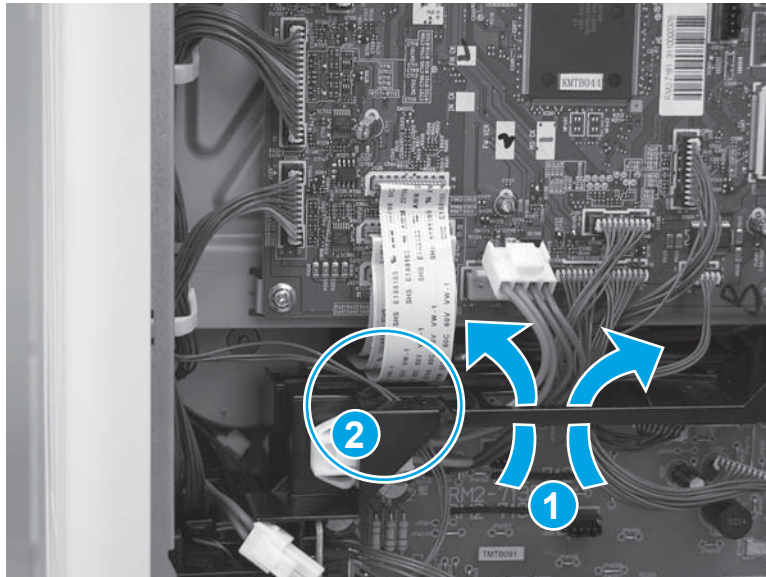

4. Connect three connectors on the DC controller (callout 1), and then connect four connectors (callout 2) on the LVPS.

Figure 1-4324 Connect seven connectors

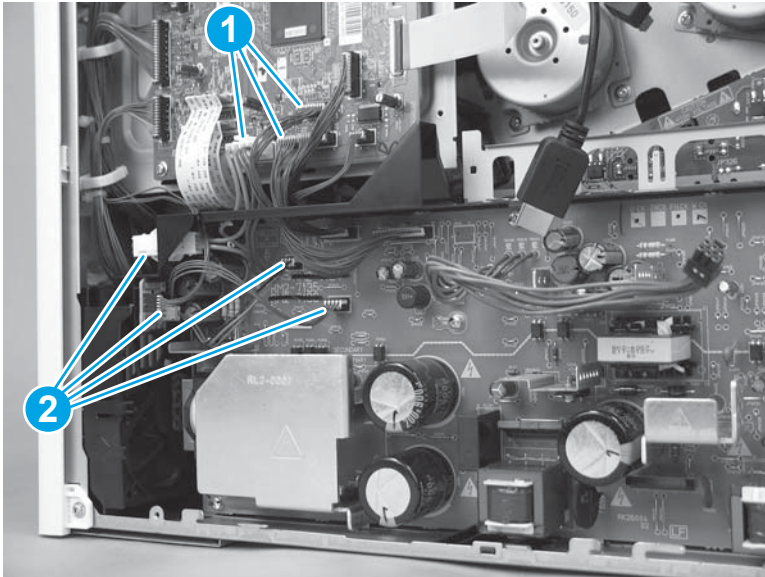

5. Pass the wire harness through the opening (callout 1) in the chassis, and then connect one wire harness (callout 2).

Figure 1-4325 Connect one wire harness

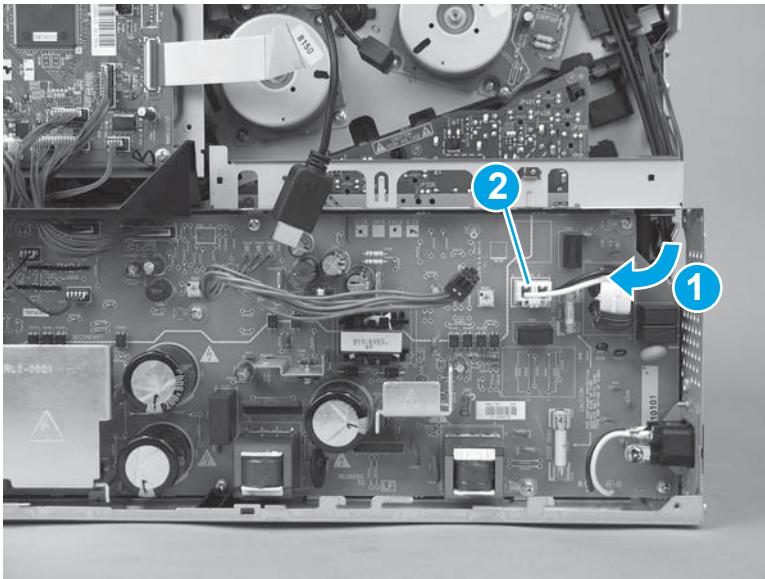

Step 41: Install the formatter case

1. Pass the wire harnesses through the opening in the formatter case.

Figure 1-4326 Pass the wire harnesses through the opening

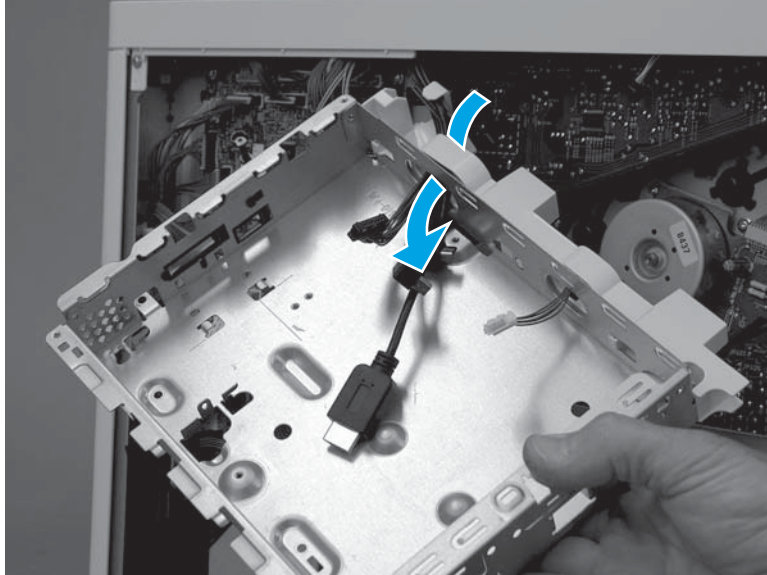

2. Position the top of the formatter case on the printer (callout 1), and then rotate the bottom of the case (callout 2) into the printer.

Figure 1-4327 Install the formatter case

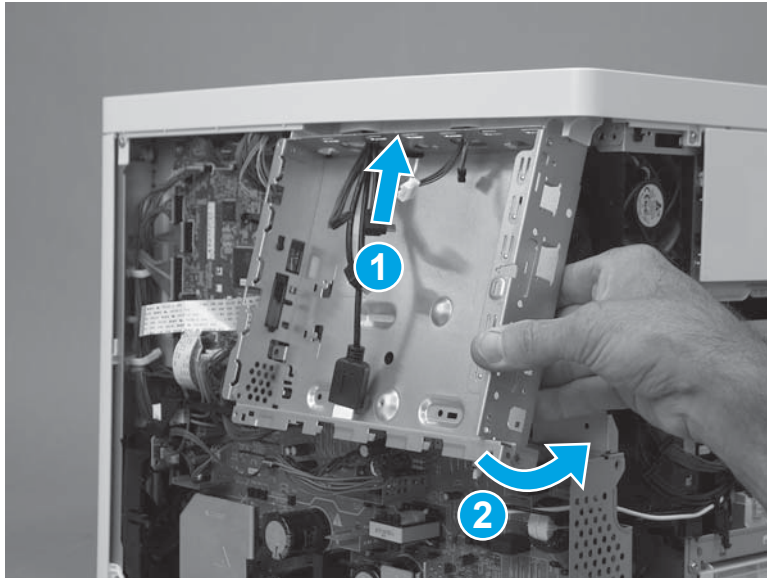

3. Install six screws (callout 1).

Figure 1-4328 Install six screws

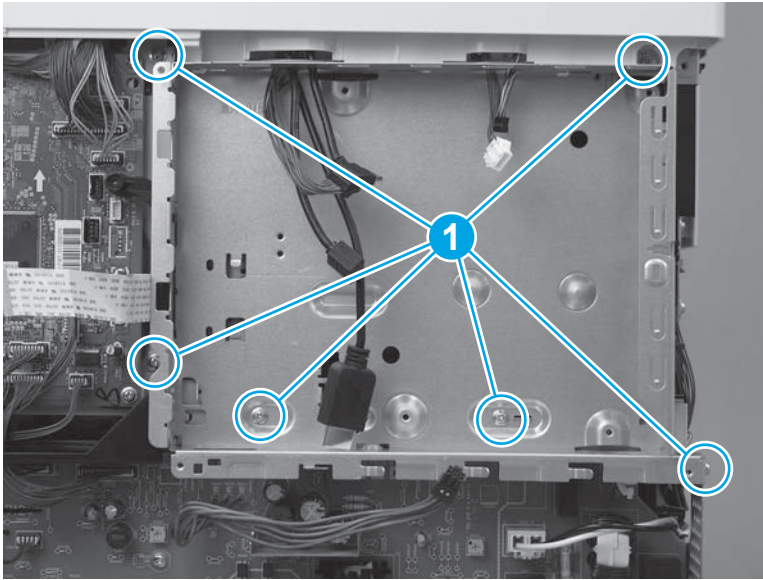

4. Pass two wire harnesses and one flat cable (callout 1) through the opening in the formatter case, and then install one wire harness in the retainer (callout 2).

 **IMPORTANT:** Make sure that the flat cable is securely fastened to the DC controller, and was not dislodged when the formatter case was removed.

Figure 1-4329 Install wire harnesses and flat cable

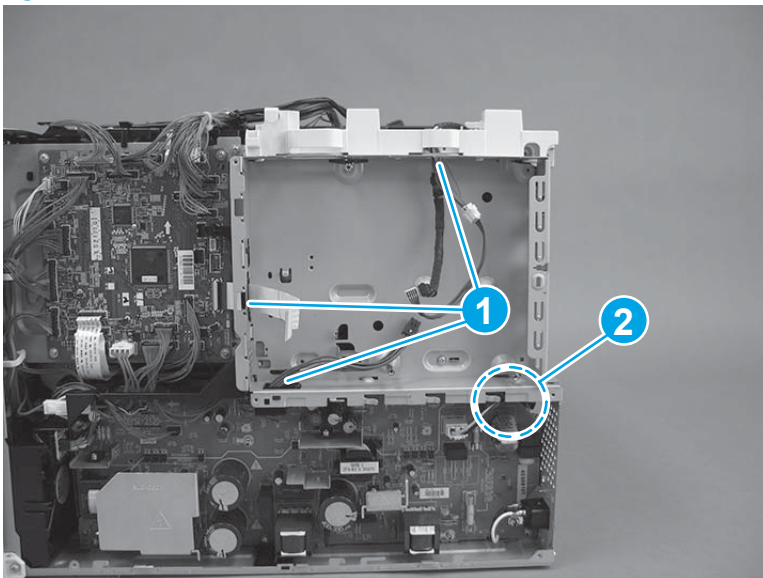

5. Position the LVPS cover on the printer, slide the cover to the left to install it, and then install two screws (callout 1).

Figure 1-4330 Install the LVPS cover

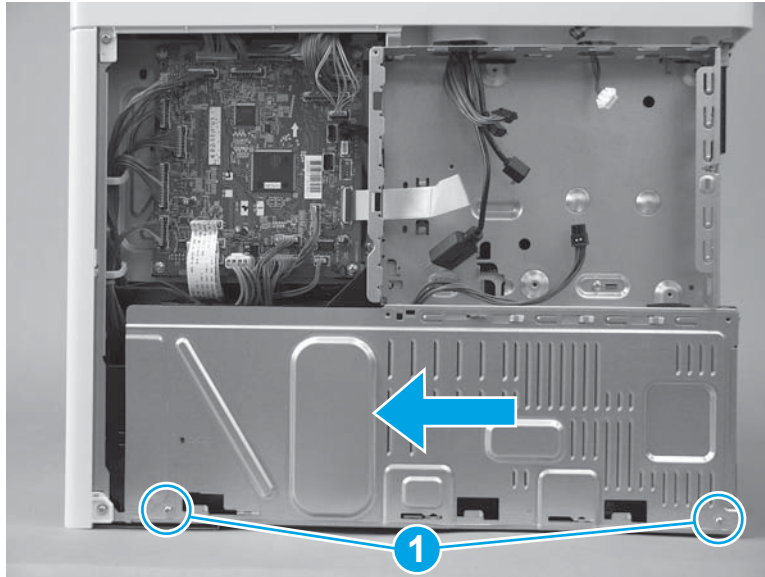

6. If no tape is affixed to the back of the flat cable, skip this step. If double-sided tape is affixed to the back of the flat cable, align the line (callout 1) on the cable with the edge (callout 2) of the opening in the sheet metal. Press to attach the flat cable to the formatter case.

Figure 1-4331 Attach the flat cable

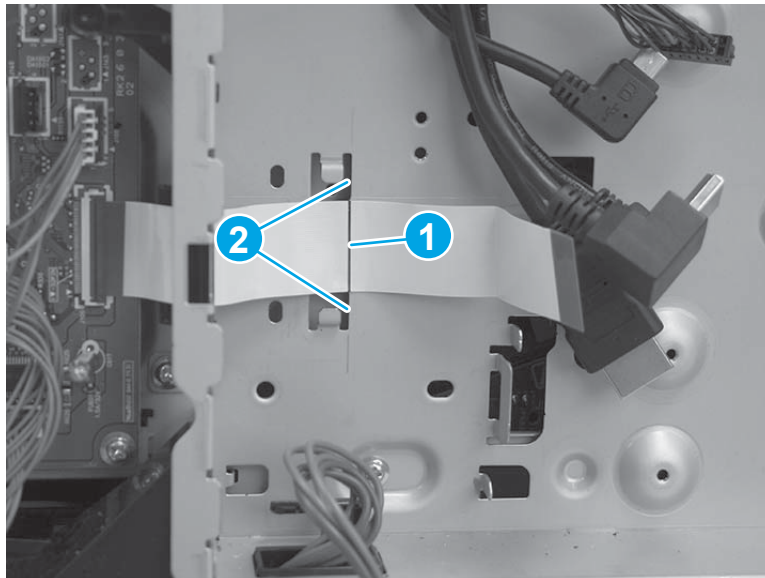

7. Position the bracket over the flat cable, and then slide the bracket to the left to install it. Make sure that the edges of the bracket fit under the sheet metal tabs (callout 1) on the formatter case and that the tabs (callout 2) snap into place.

Figure 1-4332 Position the bracket

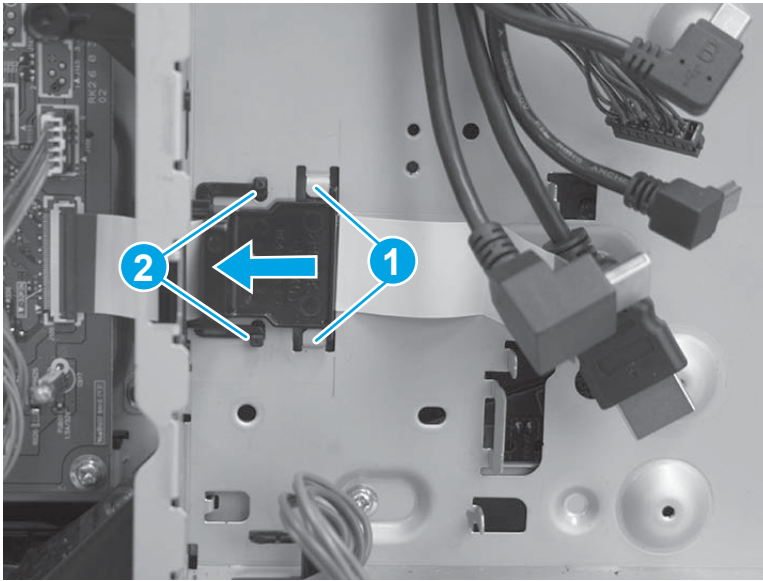

8. **M577 only:** Pass the wire harness (callout 1) through the openings in the formatter case (callout 2), and then connect one connector (callout 3).

Figure 1-4333 Connect one connector

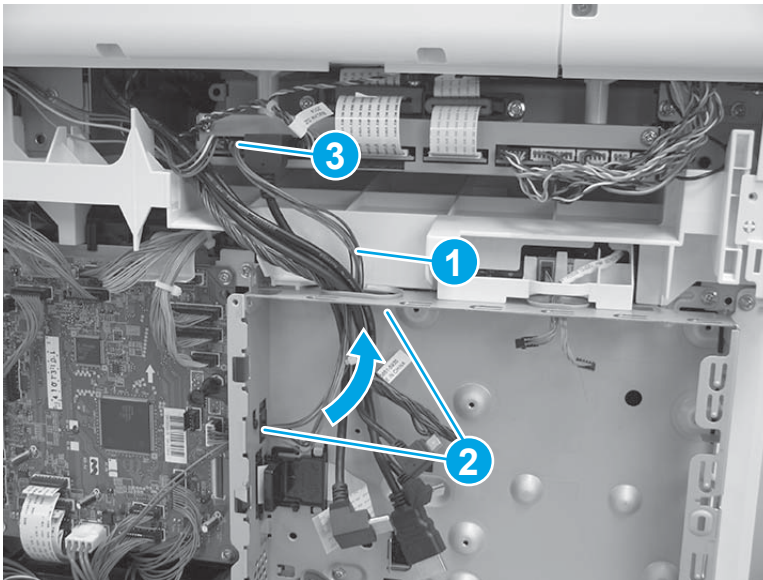

Step 42: Install the right rear cover

1. Position the cover on the printer.

Figure 1-4334 Install the cover

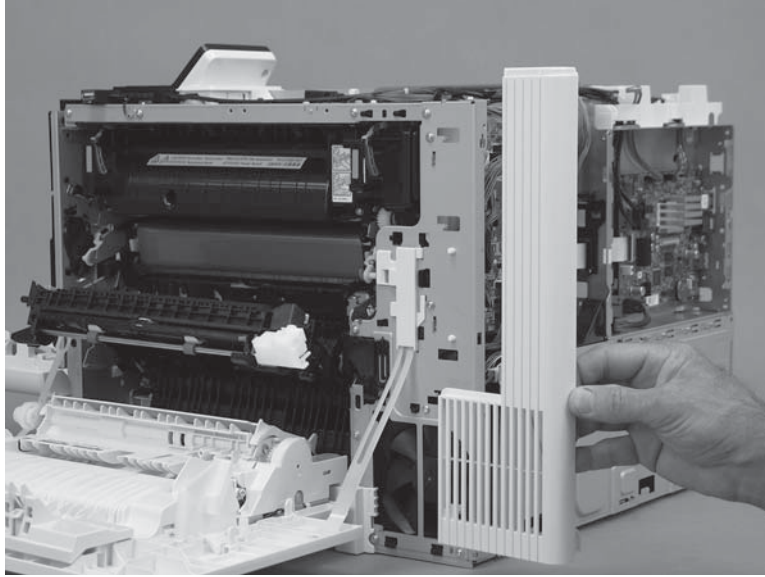

2. Slide the cover toward the right door (callout 1) to engage it with the printer, and then install one screw (callout 2).

Figure 1-4335 Install one screw

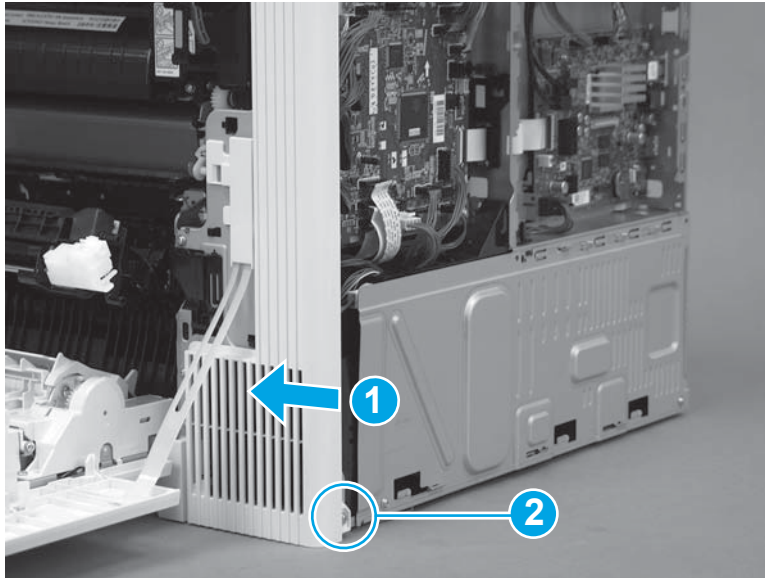

Step 43: Install the upper cover (M552 and M553)

 **NOTE:** This step is for the M552 and M553 models. For the M577 models, skip this step and go to [Step 44: Install the left cover on page 2407](#).

1. Position the cover on the printer.

 **NOTE:** For the M553x model, do not forget to pass the control-panel wire harness and USB cable through the opening in the cover.

Figure 1-4336 Install the cover



2. Push down on the rear corner of the cover to engage one tab (callout 1).

Figure 1-4337 Engage one tab

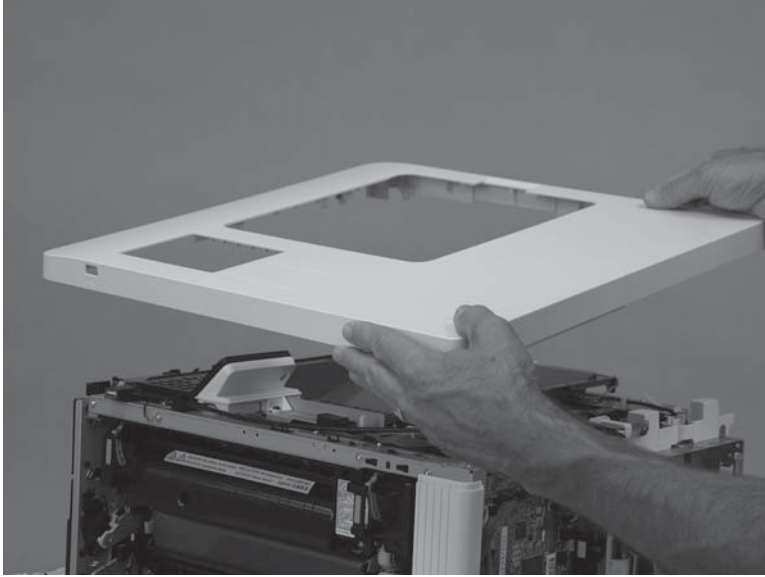
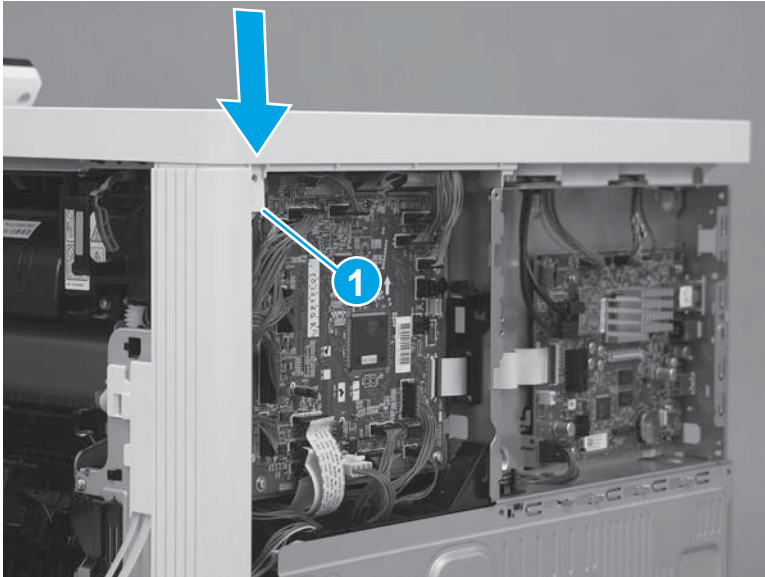

3. Push down on the front corner of the cover to engage one tab (callout 1), and then install one screw (callout 2).

 **NOTE:** This is a self-tapping plastic-thread screw. Make sure that this screw is used in this location when it is reinstalled.

Figure 1-4338 Engage one tab and install one screw



4. Install three screws (callout 1).

Figure 1-4339 Install three screws

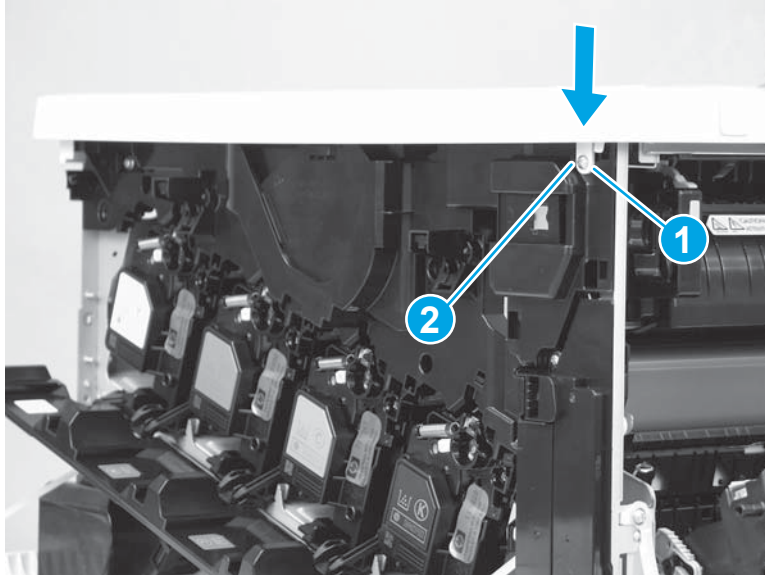
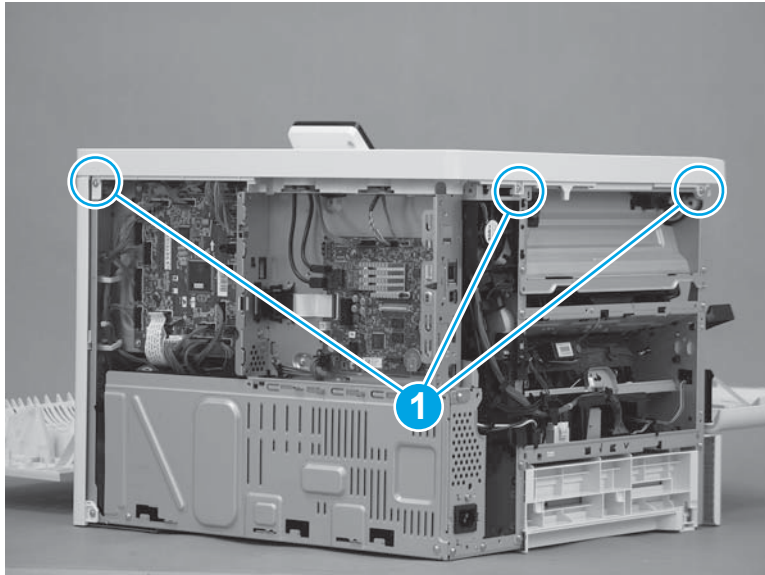

Step 44: Install the left cover

1. Position the cover on the printer.

 **NOTE:** Slightly offset the cover toward the rear of the printer.

Figure 1-4340 Install the cover

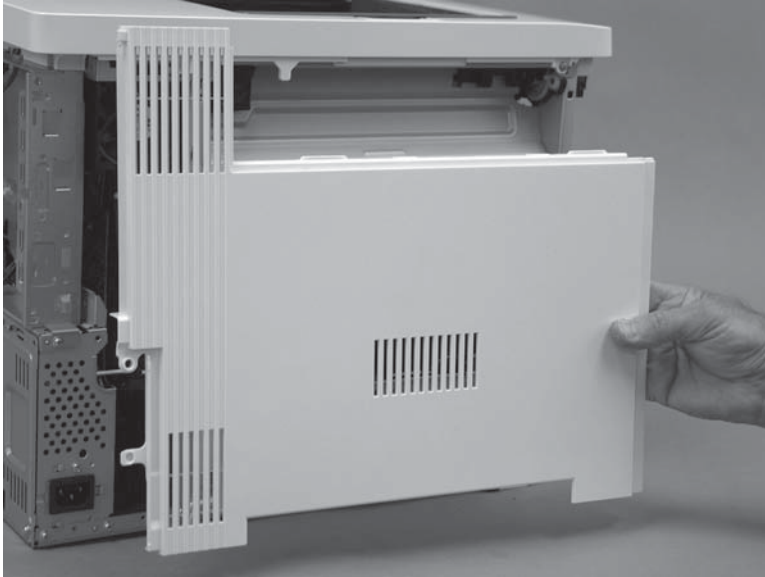

2. Slide the cover (callout 1) toward the front of the printer to engage it. Make sure that the tab (callout 2) snaps into place.

 **NOTE:** Locate the alignment pin (callout 3) on the cover from the front door side of the printer, and then make sure that it is fully engaged in the slot in the chassis.

 **TIP:** While sliding the cover into place, push in on the center of the cover (callout 1) to make sure that the hooks on the back of the cover engage with the slots in the chassis.

Figure 1-4341 Engage the cover

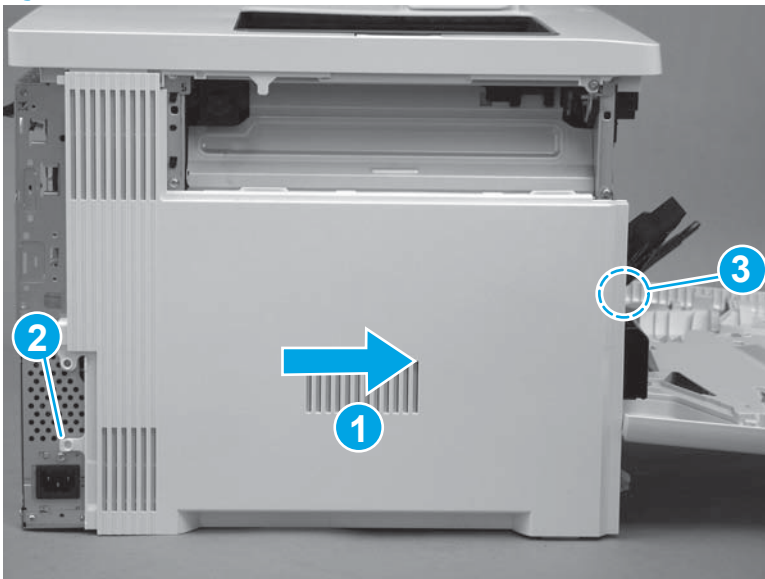



3. At the left side of the printer, install one screw (callout 1).

Figure 1-4342 Install one screw



Step 45: Install the right upper cover (M577)

 **NOTE:** This step is for the M577 models. For the M552 and M553 models, skip this step and go to [Step 52: Install the rear cover \(M552 and M553\) on page 2423](#).

 **NOTE:** The figures below show the image scanner installed. The procedures for removing and installing the right upper cover are the same whether the image scanner is installed or removed."

1. **M577c/f/z only:** Install the cables (callout 1) through the slot (callout 2) in the printer.

Figure 1-4343 Install the cables

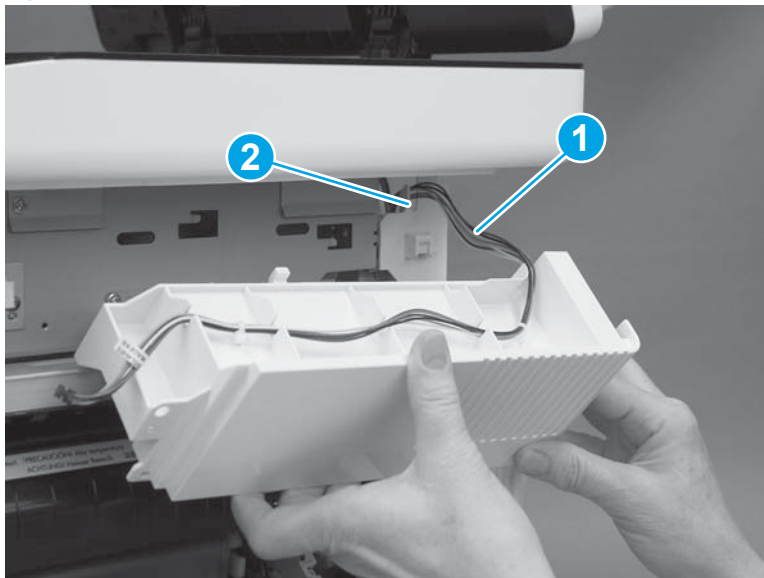

2. Position the hooks (callout 1) on the cover in the slots (callout 2) in the printer.

Figure 1-4344 Position the hooks

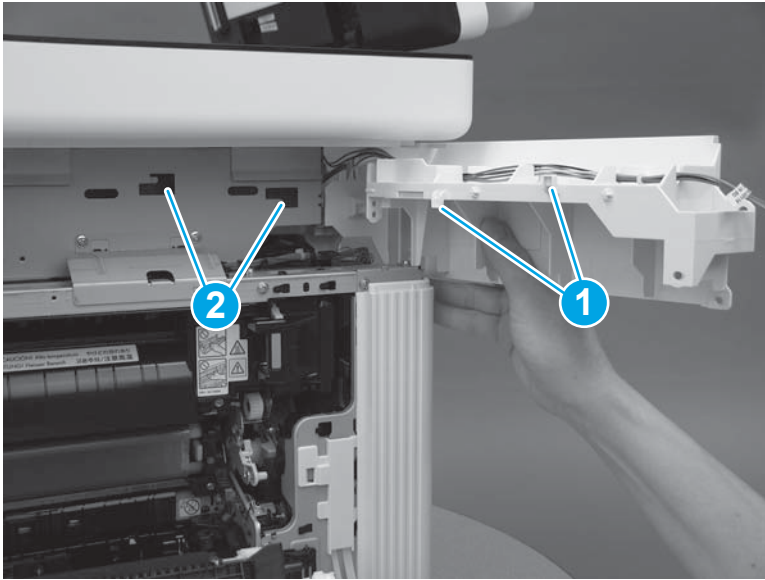

3. Slide the cover toward the front of the printer to install it.

Figure 1-4345 Install the cover

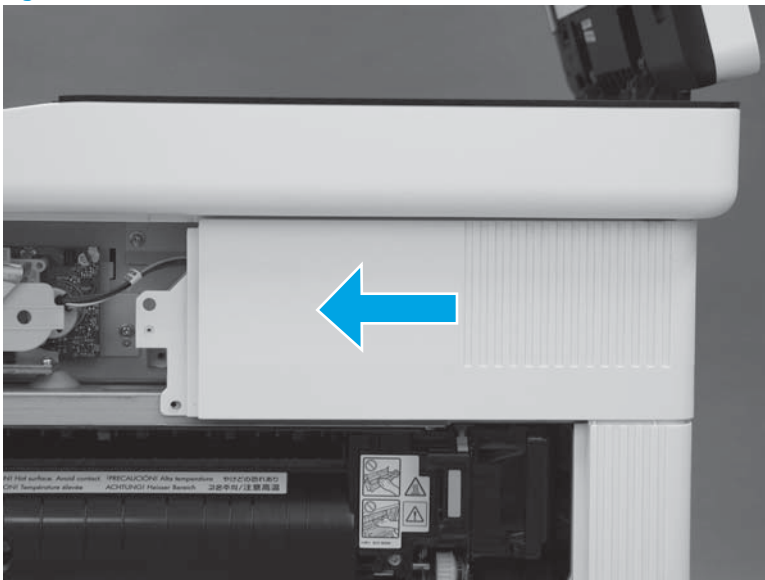

4. At the back of the printer, install one screw (callout 1).

M577c/f/z only: Connect one connector (callout 2), if the integrated scanner assembly is installed.

 **TIP:** This screw is smaller than the screws installed in the next step. Make sure that this screw is installed in the correct position.

Figure 1-4346 Install one screw and connector



5. At the right side of the printer, install two screws (callout 1).

M577c/f/z only: Connect one connector (callout 2), if the stapler is installed.

Figure 1-4347 Install one screw and connector

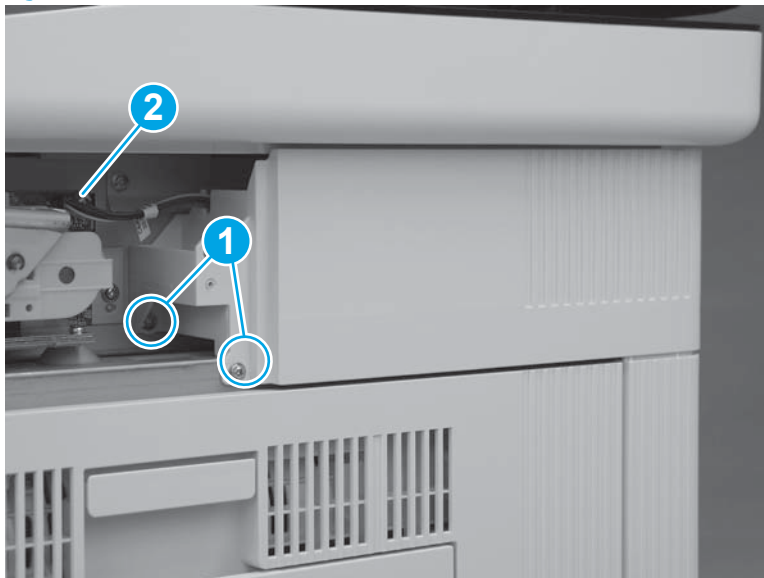

Step 46: Install the integrated scanner assembly (ISA) (M577)

 **NOTE:** This step is for the M577 models. For the M552 and M553 models, skip this step and go to [Step 52: Install the rear cover \(M552 and M553\) on page 2423](#).

 **NOTE:** The ISA includes the document feeder, image scanner, scanner control board (SCB), control panel, keyboard (M577c/z) and NFC PCA (M577z).

1. Before proceeding, locate the mounting pins (callout 1) on the bottom of the ISA and the slots (callout 2) on the printer base.

Figure 1-4348 Locate the ISA mounting pins and slots

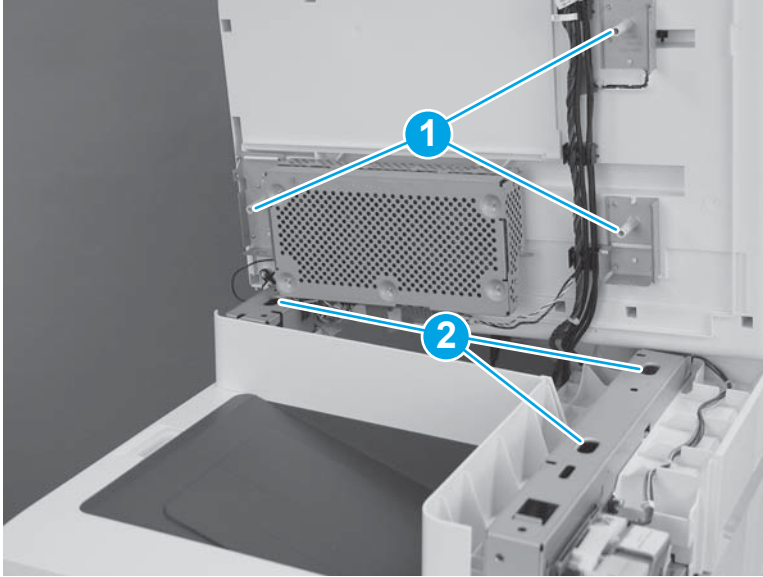

2. Position the ISA on the printer base with the pins in the slots.

 **NOTE:** To locate the pins and slots, see [Figure 1-395 Locate the ISA mounting pins and slots on page 249](#).

When installing the ISA, carefully pass the cables through the opening in the top of the formatter case.

Figure 1-4349 Install the ISA

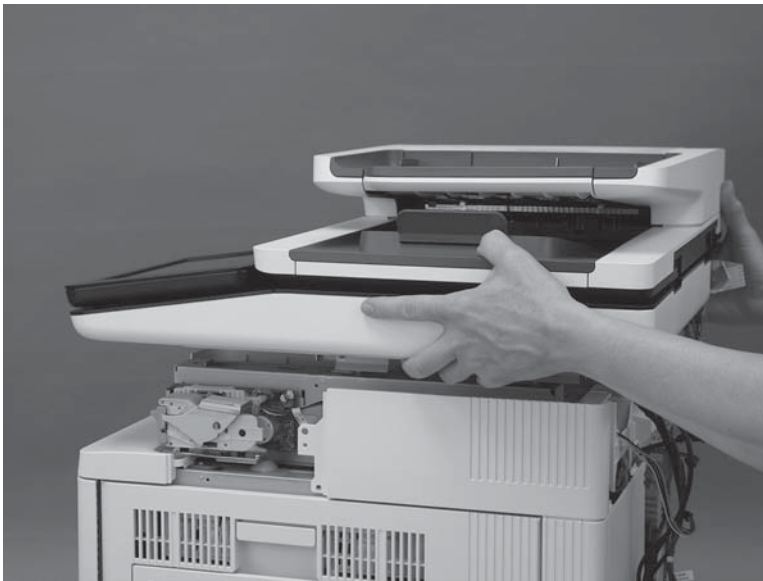

3. Slightly slide the ISA towards the front of the printer to engage it.

Figure 1-4350 Slide the ISA towards the front of the printer

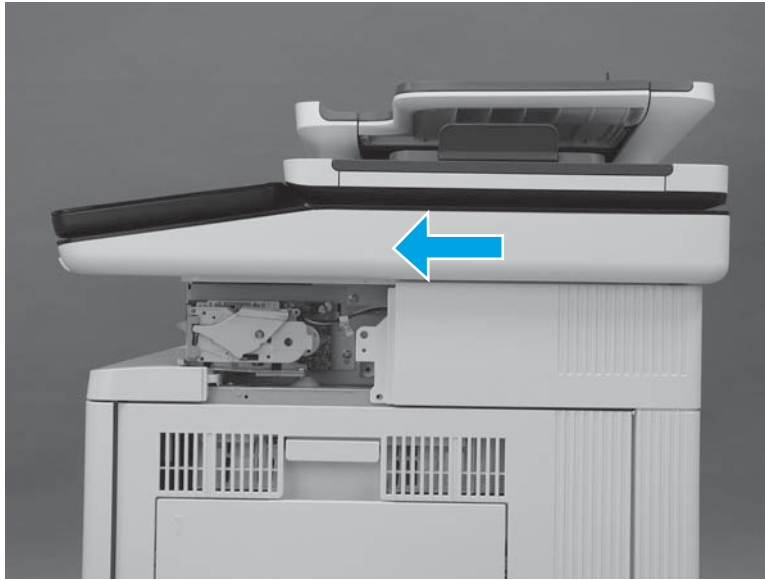

4. At the left side of the printer, install one screw (callout 1).

Figure 1-4351 Install one screw

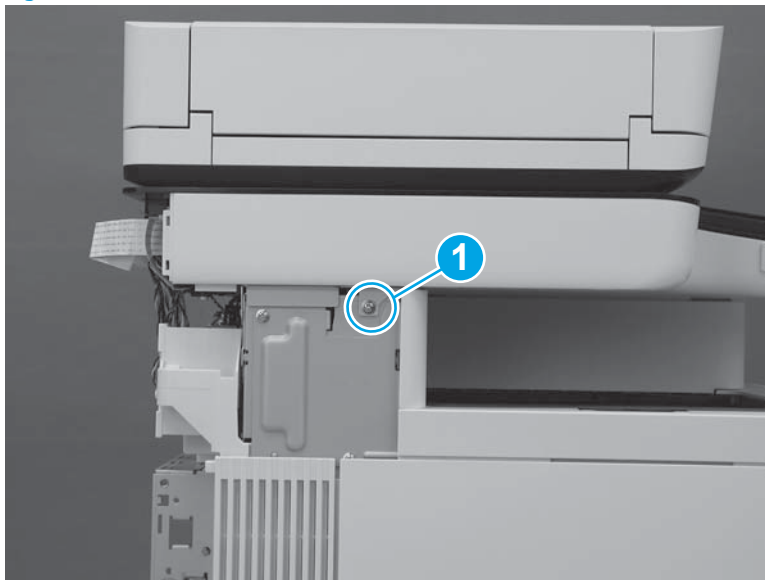

5. At the back of the printer, install two screws (callout 1).

Figure 1-4352 Install two screws

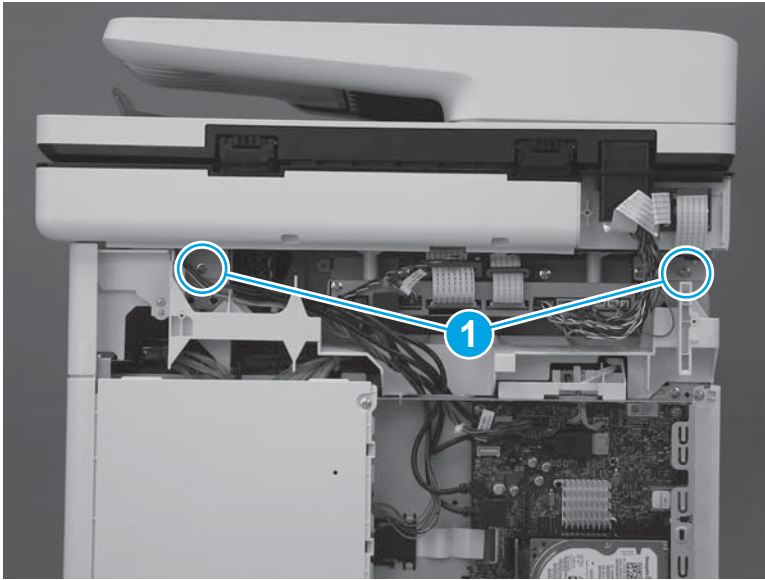

6. At the right side of the printer, install one screw (callout 1).

Figure 1-4353 Install one screw

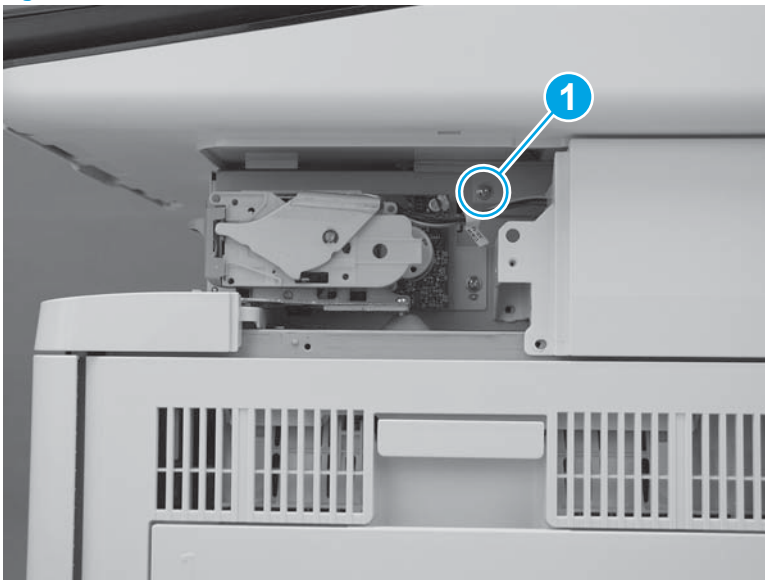

7. Connect two connectors on the scanner control board (callout 1).

M577c/f/z only: Connect one connector for the stapler on the scanner control board (callout 2).

Figure 1-4354 Connect connectors

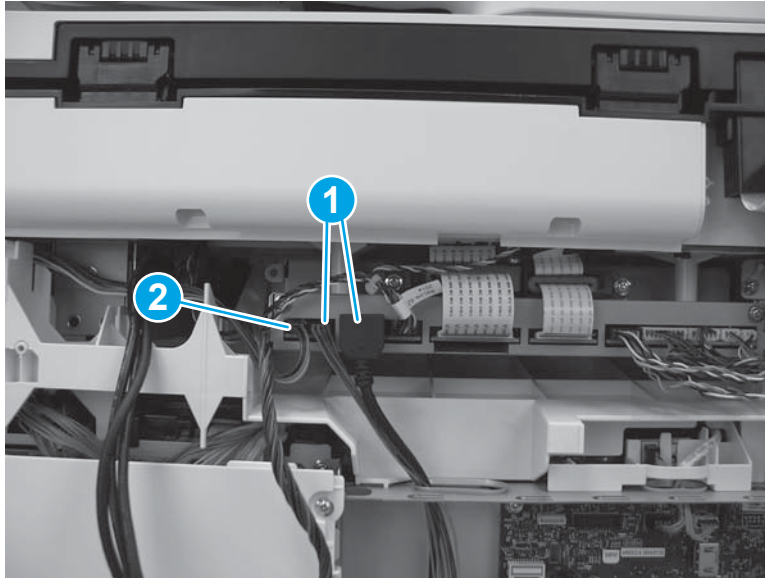

Step 47: Install the stapler cover assembly (M577c/f/z)

 **NOTE:** This step is for the M577c/f/z models only. For the M577dn model, skip this step and go to [Step 48: Install the right front upper cover \(M577dn\) on page 2416](#).

For the M552 and M553 models, skip this step and go to [Step 52: Install the rear cover \(M552 and M553\) on page 2423](#).

1. Install the tabs (callout 1) on the cover in the slots (callout 2) in the printer.

Figure 1-4355 Install two tabs



2. Press the cover toward the left side of the printer until it snaps into place.

Figure 1-4356 Install the cover assembly



3. Install one screw (callout 1).



 **IMPORTANT:** This is a self-tapping screw for plastic. Rotate it counterclockwise to align it with the existing thread pattern, and then carefully turn it clockwise to tighten. Do not overtighten. This will prevent stripping the threads inside the screw hole.

Figure 1-4357 Install one screw

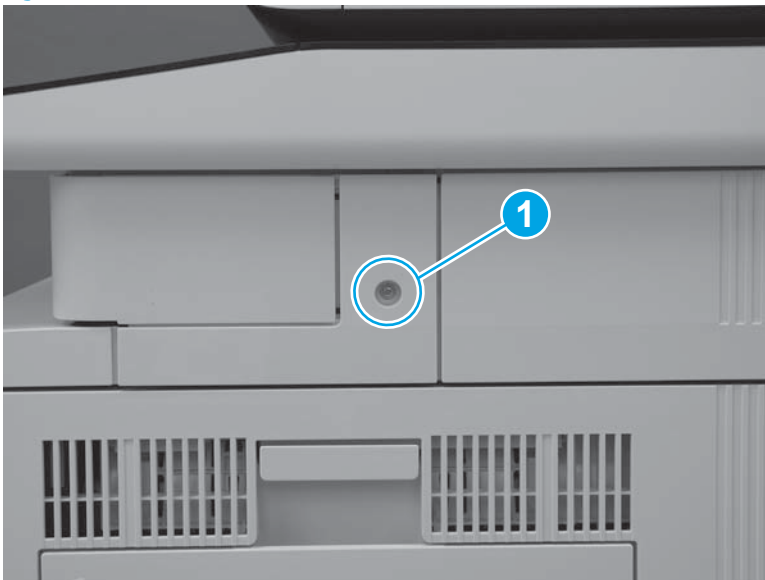

Step 48: Install the right front upper cover (M577dn)

 **NOTE:** This step is for the M577dn model only. For the M577c/f/z models, skip this step and go to [Step 49: Install the left upper cover \(M577\) on page 2418](#).

For the M552 and M553 models, skip this step and go to [Step 52: Install the rear cover \(M552 and M553\) on page 2423](#).

1. Slide the cover toward the left side of the printer to install it. Make sure that the slots (callout 1) in the cover fit over the tabs (callout 2) on the inside of the paper feeder cover.

Figure 1-4358 Install the cover

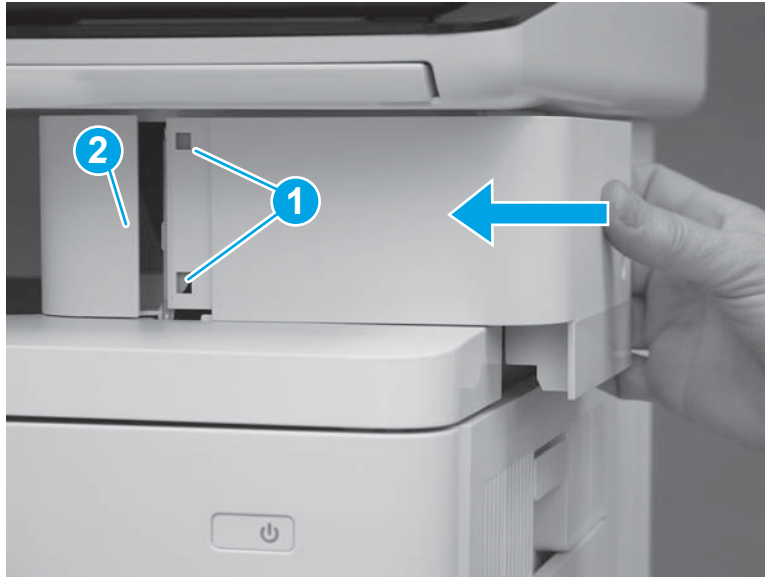

2. Press the right front upper cover (callout 1) and the paper feeder cover (callout 2) together until the tabs on the inside of the covers snap into place.

Figure 1-4359 Press the cover



3. Install one screw (callout 1).

Figure 1-4360 Install one screw

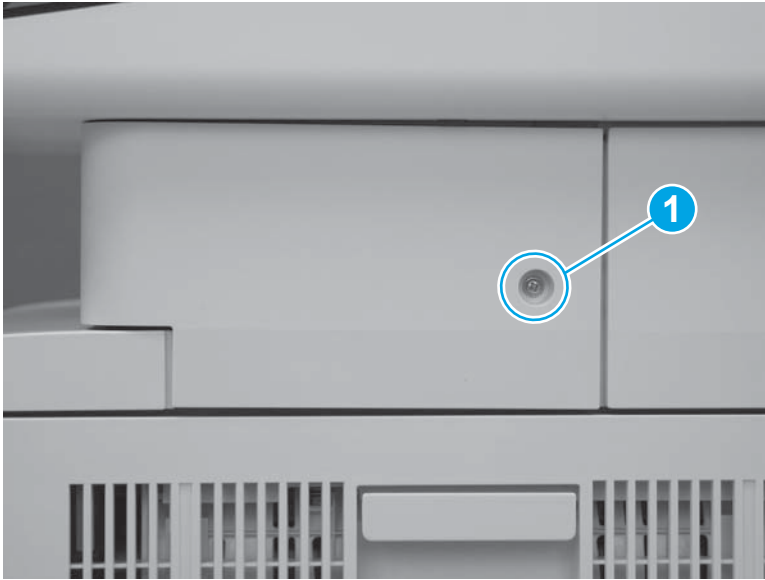

Step 49: Install the left upper cover (M577)

 **NOTE:** This step is for the M577 models. For the M552 and M553 models, skip this step and go to [Step 52: Install the rear cover \(M552 and M553\) on page 2423](#).

1. Position the tab (callout 1) on the lower edge of the cover behind the left cover (callout 2).

Figure 1-4361 Position the tab

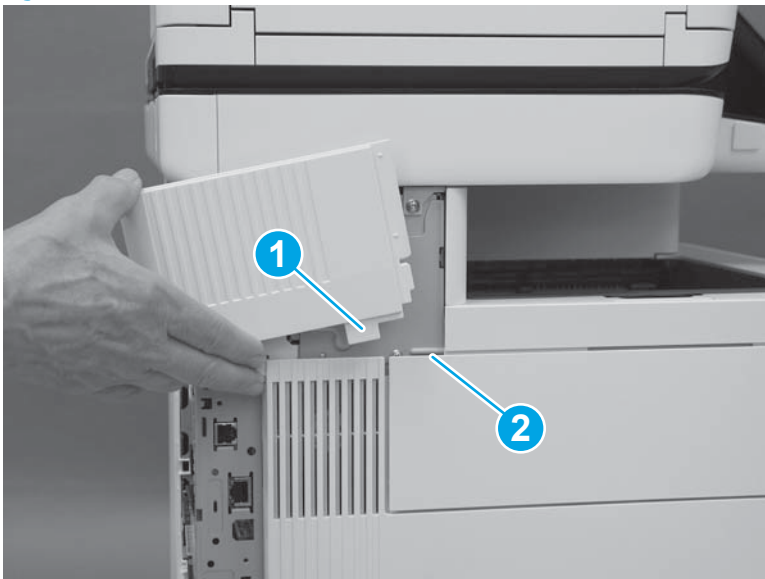

2. Slide the cover toward the front of the printer to install it. Make sure that the edge (callout 1) of the cover fits behind the edge (callout 2) of the top rear cover.

Figure 1-4362 Slide the cover

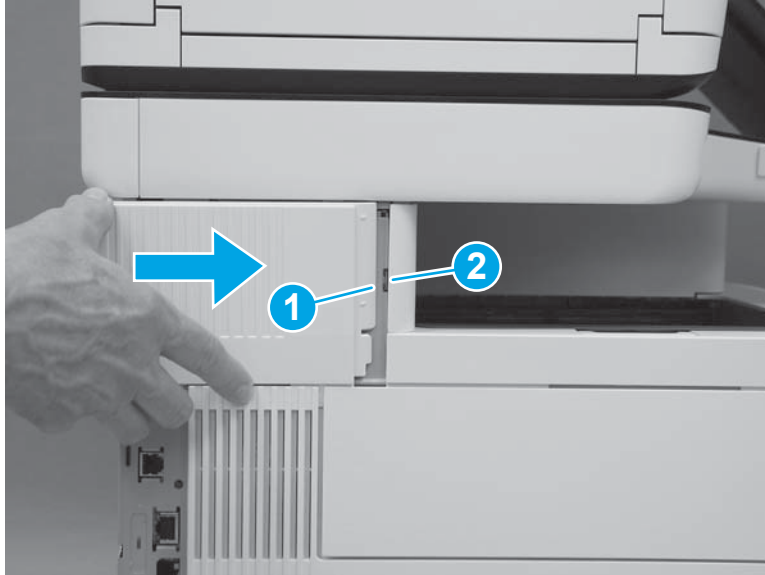

3. Make sure that the tab (callout 1) is fully installed.

Figure 1-4363 Check the tab

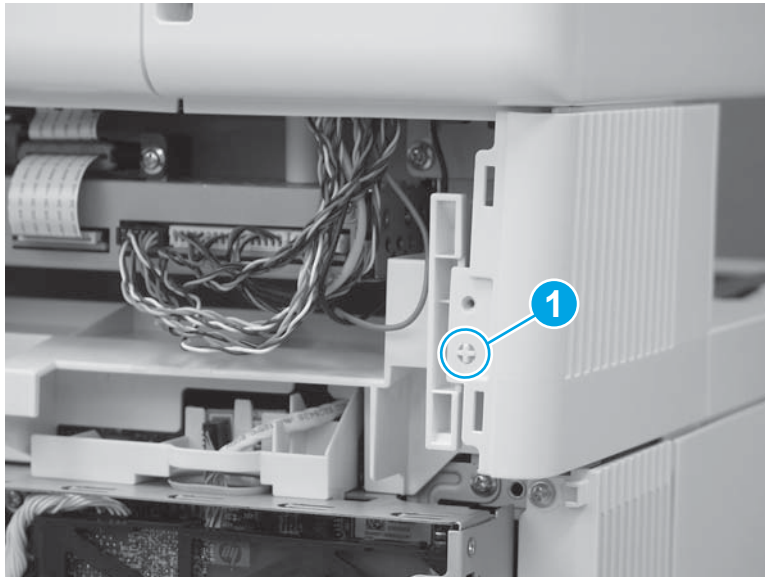

Step 50: Install the rear cover (M577)

 **NOTE:** This step is for the M577 models. For the M552 and M553 models, skip this step and go to [Step 52: Install the rear cover \(M552 and M553\) on page 2423](#).

1. Position the hooks (callout 1) on the cover in the slots (callout 2) in the printer.

Figure 1-4364 Position the hooks

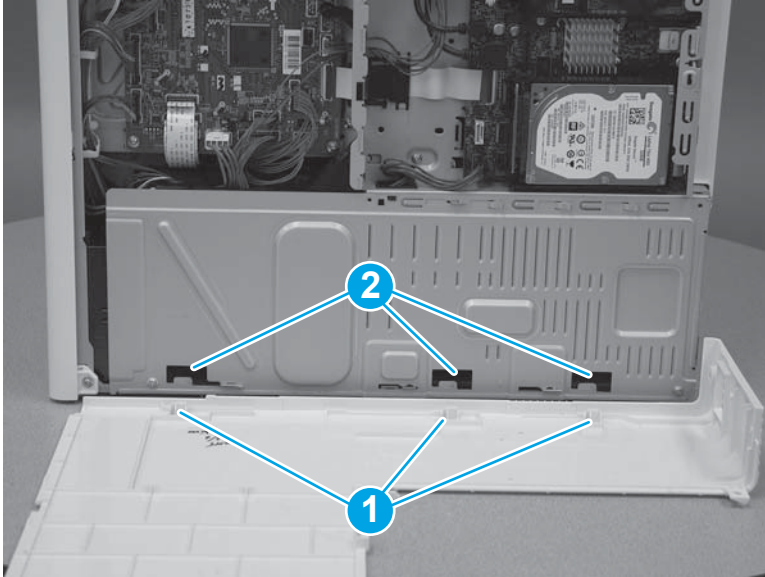

2. Position the back edge (callout 1) of the rear cover behind the edge (callout 2) of the right rear cover. Slide the cover to the left to install it.

Figure 1-4365 Install the cover

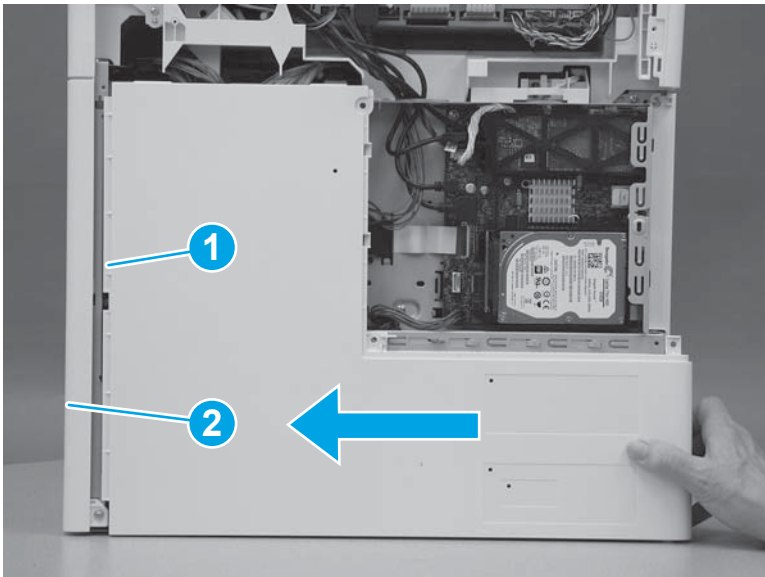

3. Install four screws (callout 1).

Figure 1-4366 Install four screws cover

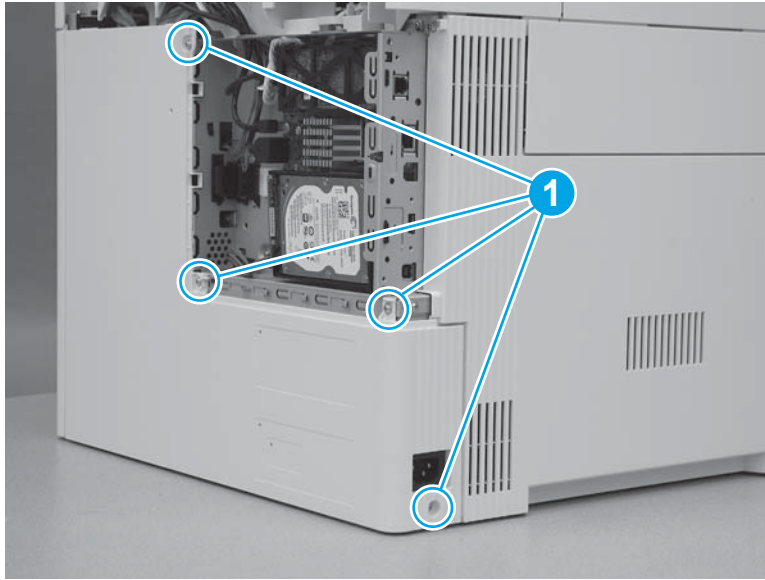

Step 51: Install the rear upper cover (M577)

 **NOTE:** This step is for the M577 models. For the M552 and M553 models, skip this step and go to [Step 52: Install the rear cover \(M552 and M553\) on page 2423](#).

1. Align the ridge (callout 1) on the lower edge of the rear upper cover in front of the tabs (callout 2) on the top edge of the rear cover.

Figure 1-4367 Align the cover

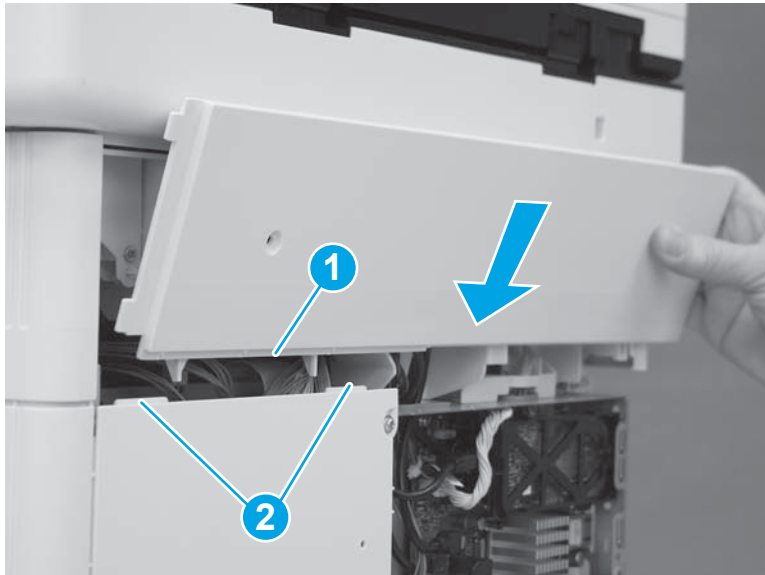

2. Rotate the top of the cover toward the printer.

Figure 1-4368 Rotate the top of the cover

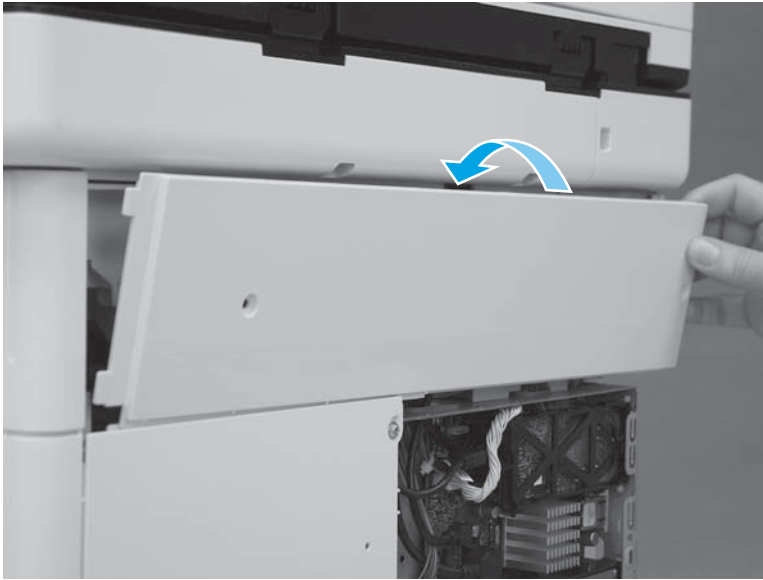

3. Slide the cover to the left (callout 1). Make sure that the tabs (callout 2) on the upper rear cover slide behind the edge (callout 3) of the right upper cover. Make sure that the cover is fully seated.

Figure 1-4369 Slide the cover

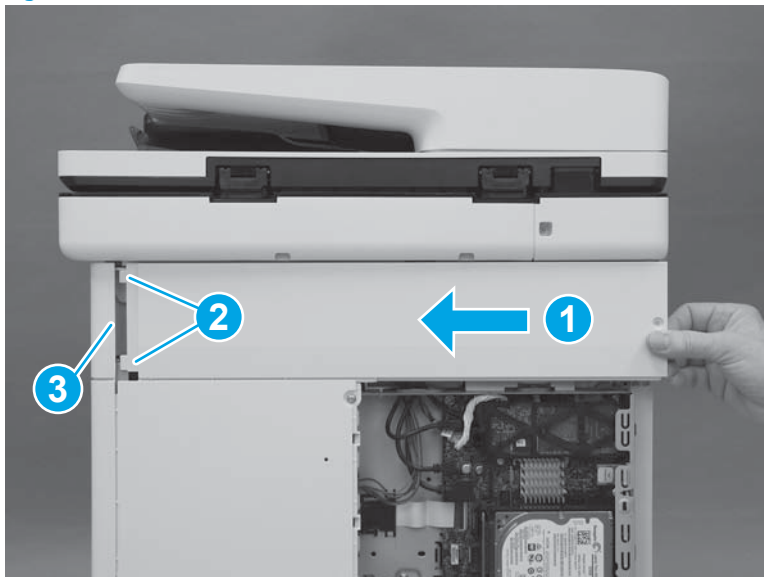

4. Install two screws (callout 1).



 **IMPORTANT:** These two screws are self-tapping screws for plastic. Rotate them counterclockwise to align them with the existing thread pattern, and then carefully turn them clockwise to tighten. Do not overtighten. This will prevent stripping the threads inside the screw holes.

Figure 1-4370 Install two screws

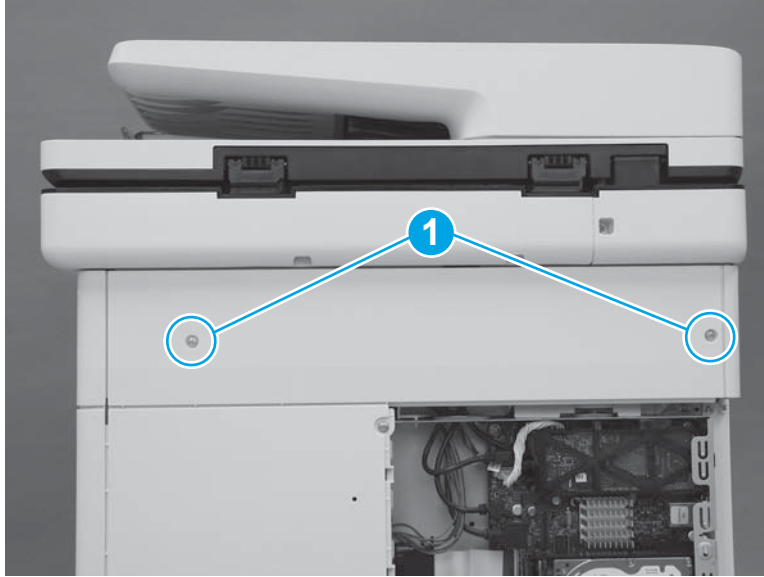

Step 52: Install the rear cover (M552 and M553)

 **NOTE:** This step is for the M552 and M553 models. For the M577 models, skip this step and go to [Step 53: Install the formatter \(M577\) on page 2424](#).

1. Position the top of the cover under the upper cover (callout 1), rotate the bottom of the cover onto the chassis (callout 2), and then slide the cover to the left (callout 3) to install it.

Figure 1-4371 Install the cover

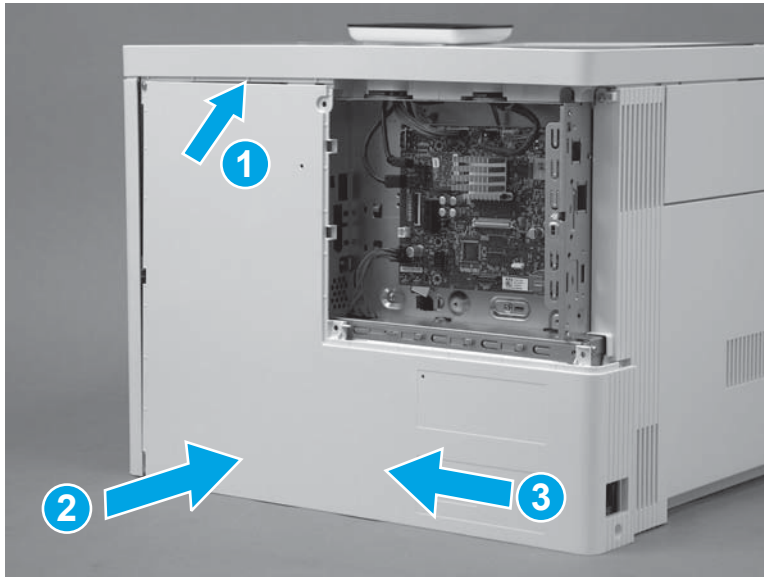

2. Install four screws (callout 1).

Figure 1-4372 Install four screws cover

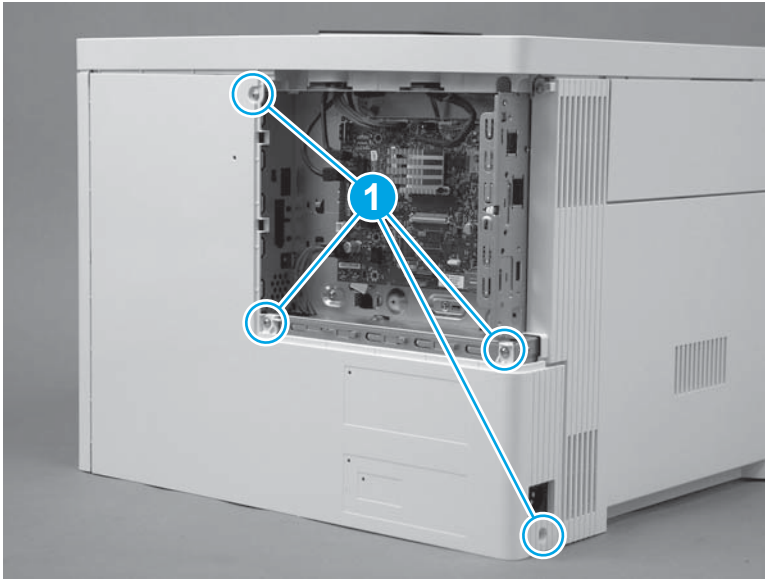

Step 53: Install the formatter (M577)

 **NOTE:** This step is for the M577 models. For the M552 and M553 models, skip this step and to go [Step 56: Install the formatter \(M552 and M553\) on page 2429](#).

 **CAUTION:**  ESD-sensitive part.

1. Position the formatter in the printer. Make sure that the network port (callout 1) fits through the opening (callout 2) in the formatter case.

Figure 1-4373 Install the formatter

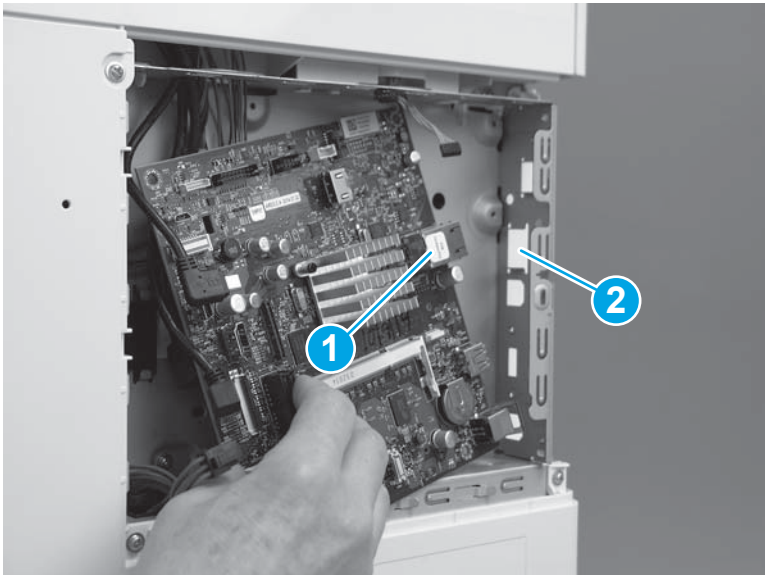

2. Install four screws (callout 1).

Figure 1-4374 Install four screws

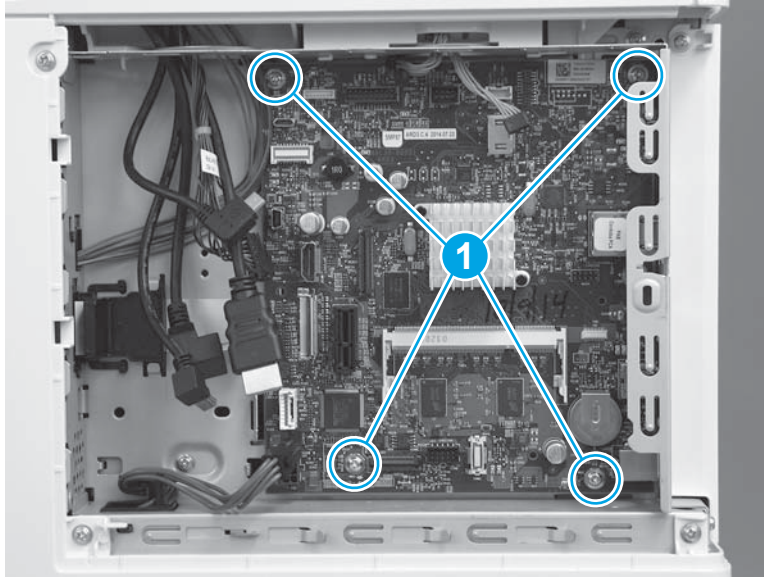

3. Connect all of the connectors on the formatter.

The following connectors are empty:

- All models: J1 (this connector is empty unless the optional DIMM is installed)
- All models: J3
- M577dn: J15 (this is the fax connector for the M577f/z/c models)
- All models: J21 (this connector is empty unless the optional internal USB ports component is installed)
- All models: J23
- All models: J24
- All models: J51
- All models: J57
- All models: J97
- All models: J98 (this connector is empty unless the optional trusted platform module (TPM) is installed)

 **IMPORTANT:** The flat-cable connector (callout 1) is a Zero Insertion Force (ZIF) connector that uses a hinged retainer to secure the flat cable. The hinged retainer must be opened to install the flat cable, and then closed after the cable is installed.

Figure 1-4375 Connect all connectors



Step 54: Install the fax PCA (M577c/f/z)

 **NOTE:** This step is for the M577c/f/z models. For the M577n model, skip this step and go to [Step 55: Install the HDD \(M577\) on page 2427](#).

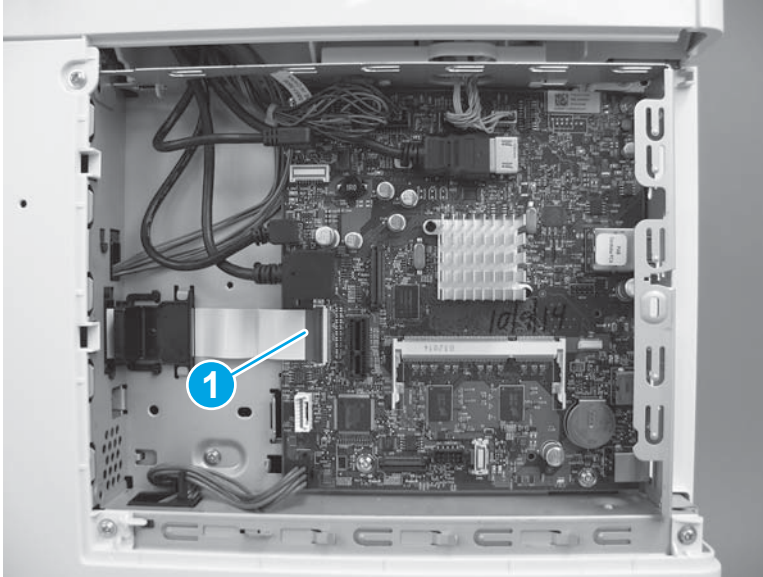
For the M552 and M553 models, skip this step and go to [Step 56: Install the formatter \(M552 and M553\) on page 2429](#).

 **CAUTION:**  ESD-sensitive part.

1. Position the tab and telephone port (callout 1) on the fax PCA in the slots (callout 2) in the formatter case.

Figure 1-4376 Position the fax PCA

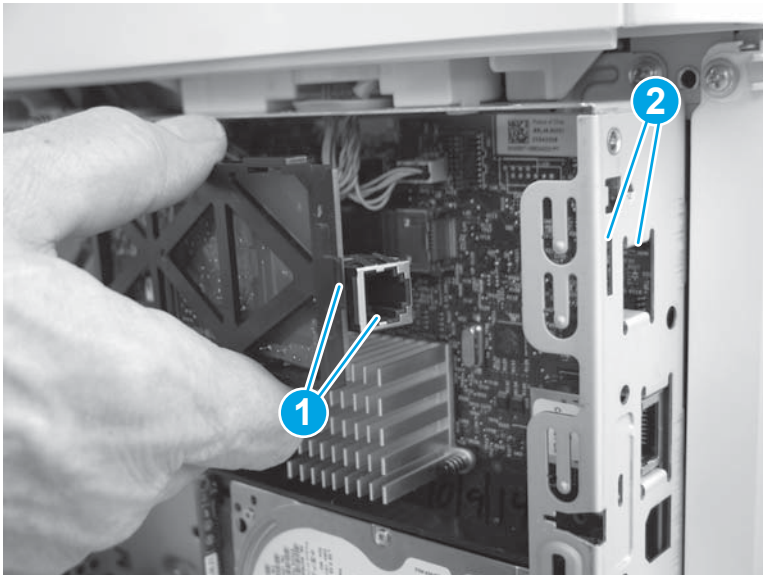

- Slide the fax PCA to the right (callout 1) until the tab and telephone port described in the previous step and seated in the formatter case. Position the retainer (callout 2) in the slot (callout 3) in the formatter. Rotate the end of the fax PCA toward the formatter (callout 4) until the retainer snaps into place.

Figure 1-4377 Install the fax PCA

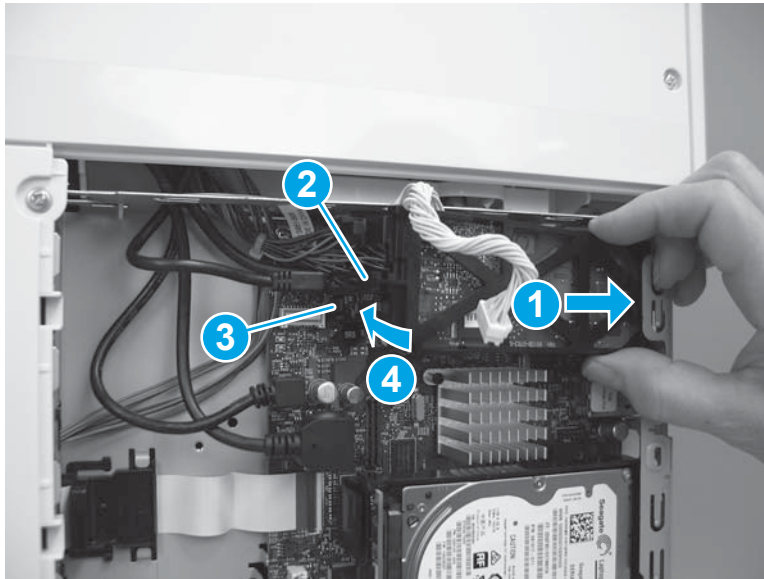

- Position the cable (callout 1) in the guide (callout 2), and then connect one connector (callout 3).

Figure 1-4378 Connect the connector

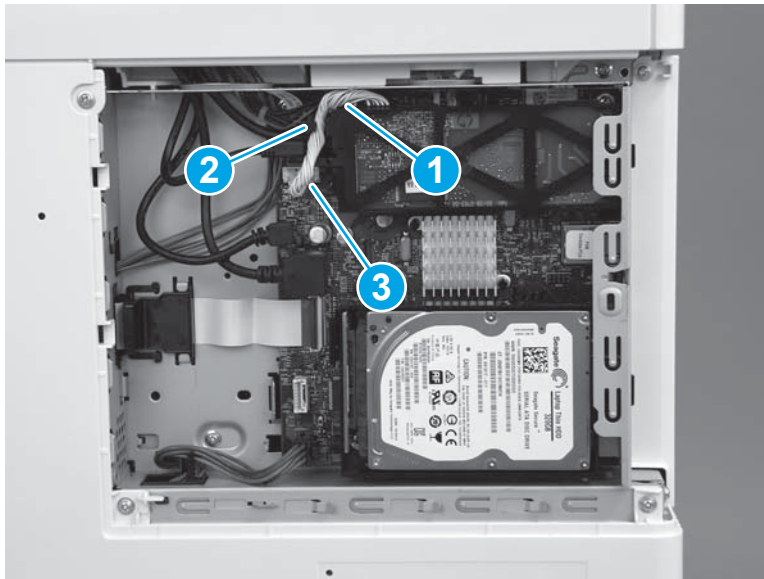

Step 55: Install the HDD (M577)

 **NOTE:** This step is for the M577 models. For the M552 and M553 models, skip this step and go to [Step 56: Install the formatter \(M552 and M553\) on page 2429.](#)

 **CAUTION:**  ESD-sensitive part.

1. Align the end of the bracket (callout 1) with the slot in the chassis (callout 2), and then slide the HDD into the printer (callout 3) to engage the bracket with the chassis.

Figure 1-4379 Install the holder

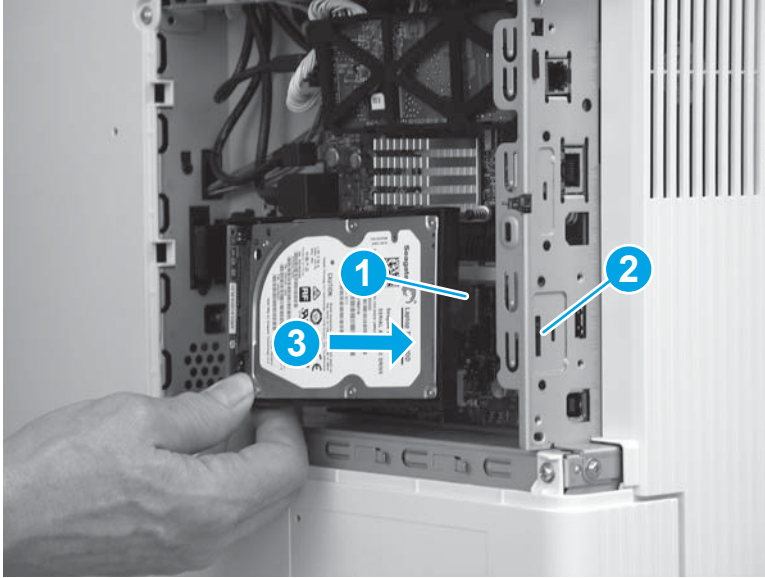

2. Hold the HDD connector latch (callout 1) in the released position, and then rotate the HDD down and into the connector on the formatter to install it.

 **NOTE:** Make sure that the tab (callout 2) snaps into place, and that the HDD is securely installed.

Figure 1-4380 Release the HDD



Step 56: Install the formatter (M552 and M553)

 **NOTE:** This step is for the M552 and M553 models. For the M577 models, skip this step and go to [Step 59: Install the formatter cover on page 2434](#).

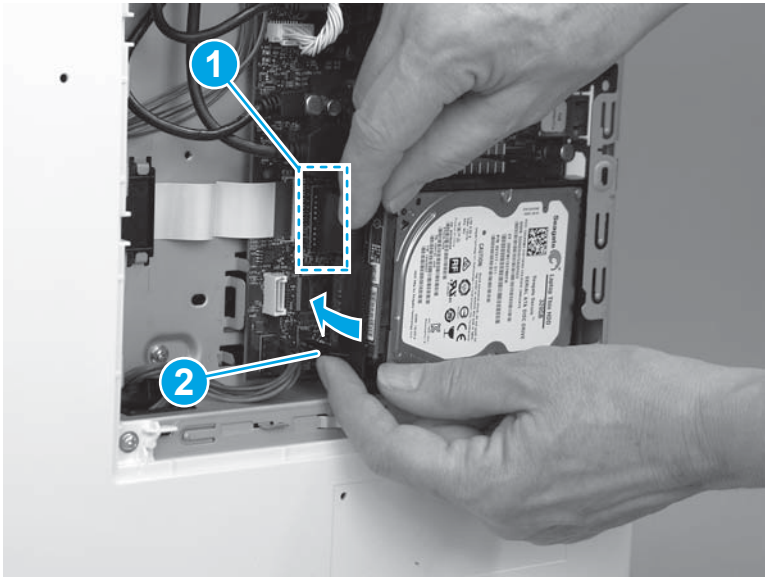
If the optional hard-disk drive (HDD) was removed, do not forget to reinstall it after the formatter is reinstalled.

Engage the HDD holder with the chassis, rotate the HDD connector down and into the connector on the formatter. Make sure that the tabs snap into place.

 **CAUTION:**  ESD-sensitive part.

1. Position the formatter in the printer, and then install four screws (callout 1).

Figure 1-4381 Install the formatter

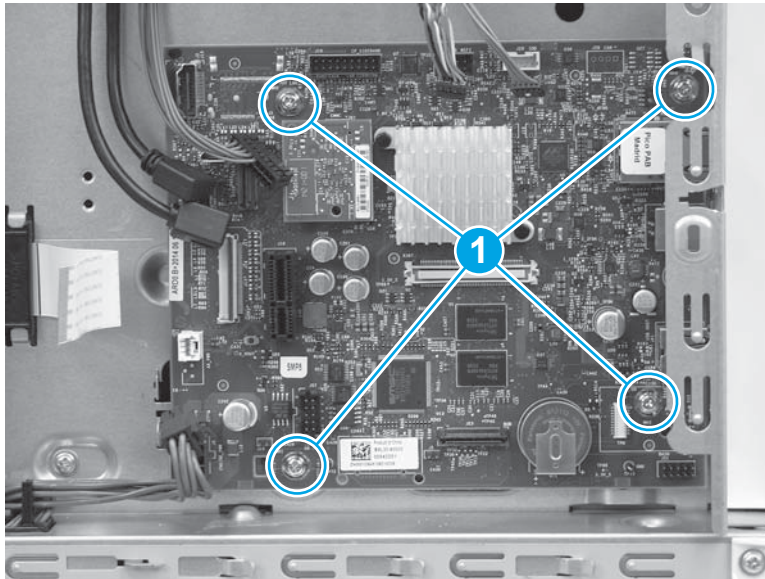

2. Connect all of the connectors on the formatter.

The following connectors are empty:

- All models: J1 (this connector is empty unless the optional DIMM is installed)
- M553n/dn and M552dn: J2 (callout 1; this is the touchscreen connector for the M553x model)
- All models: J9 (this connector is empty unless the optional internal USB ports component is installed)
- All models: J18 (this connector is empty unless the optional hard-disk-drive (HDD) is installed)
- All models: J23
- All models: J24
- M553n/dn and M552dn: J25 (this is the wireless connector for the M553x model)
- All models: J57
- All models: J98 (this connector is empty unless the optional trusted platform module (TPM) is installed)

 **IMPORTANT:** The flat-cable connector (callout 2) is a Zero Insertion Force (ZIF) connector that uses a hinged retainer to secure the flat cable. The hinged retainer must be opened to install the flat cable.

Figure 1-4382 Connect all connectors

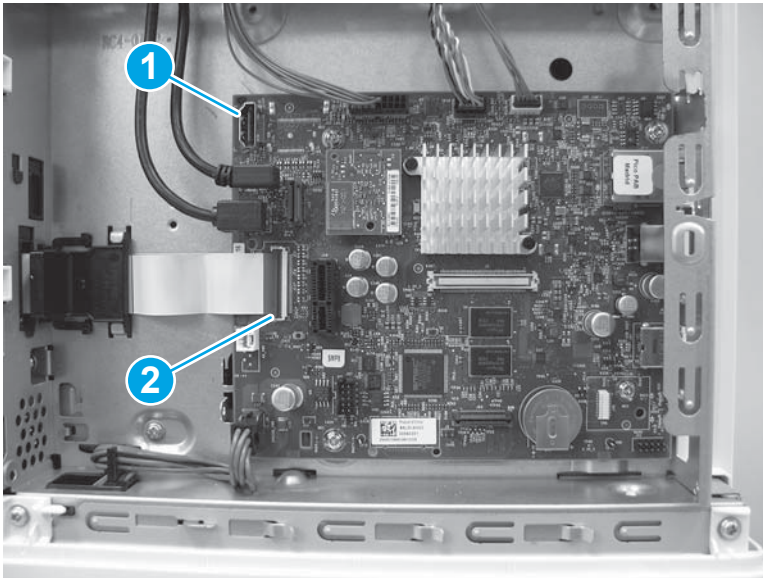

Step 57: Install the control-panel assembly (M553x only)

 **NOTE:** This step is for the M553x model. For the M553n/dn and M552dn models, skip this step and go to [Step 58: Install the USB cover \(M552 and M553\) on page 2433](#).

For the M577 models, skip this step and go to [Step 59: Install the formatter cover on page 2434](#).

1. Place the control panel on the printer as shown.

Figure 1-4383 Place the control panel on the product

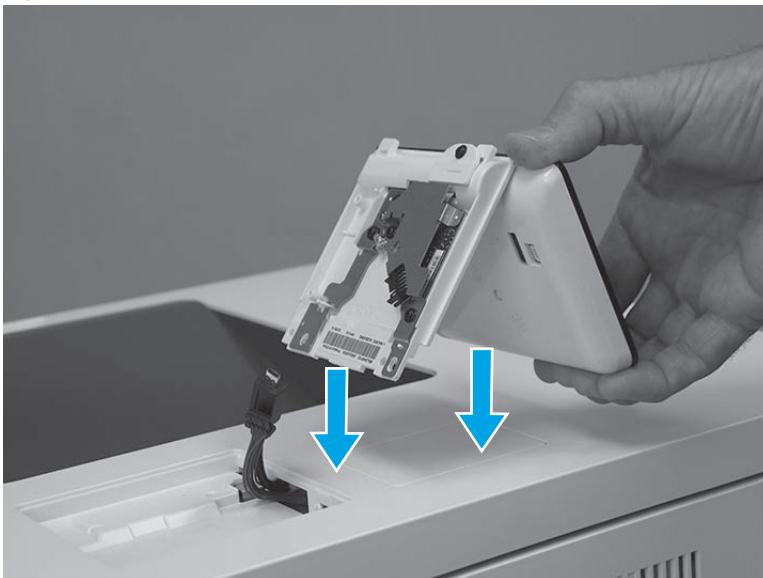

2. Connect one USB cable (callout 1), and one connector (callout 2).

 **IMPORTANT:** Take note of the location of the two mounting tabs (callout 3) on the control-panel assembly.

Figure 1-4384 Connect two connectors



3. Turn the control panel over, and then position the front edge tabs in the slots in the top cover.

Figure 1-4385 Turn the control panel over

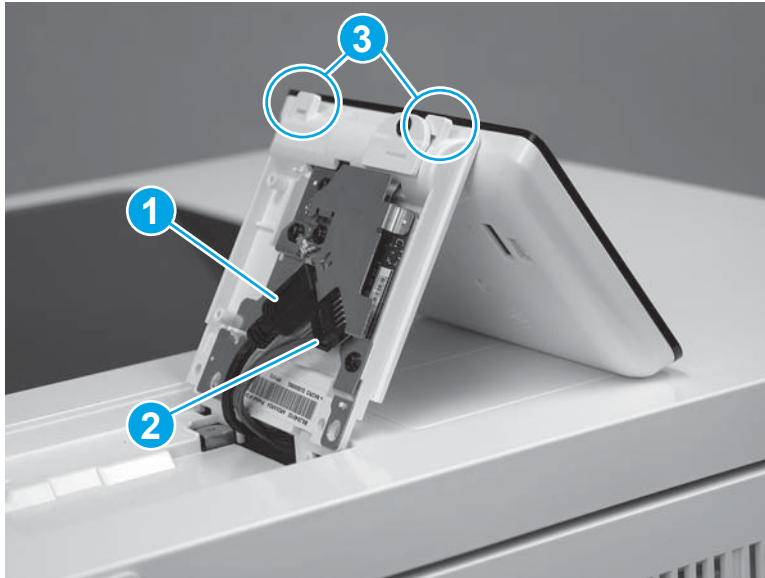
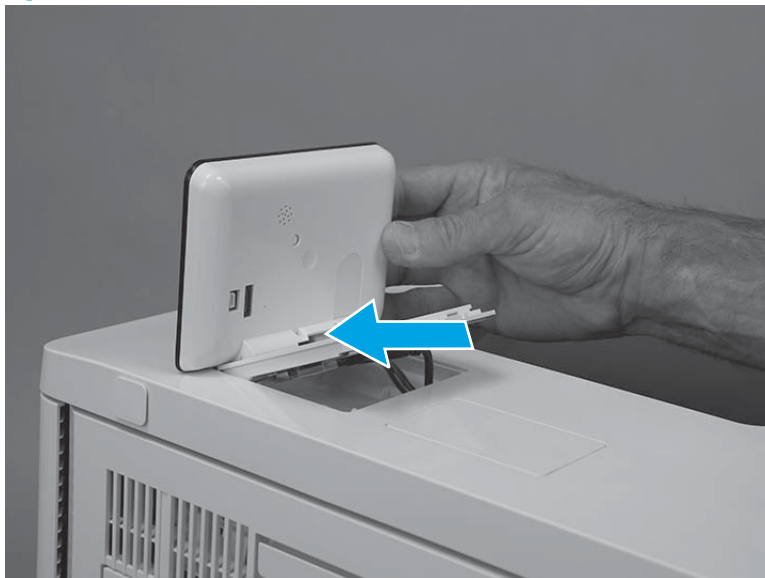

4. Rotate the control-panel base down onto the printer.

Figure 1-4386 Rotate the control-panel base down



5. Use a small Phillips screwdriver to install two screws (callout 1).

Figure 1-4387 Install two screws

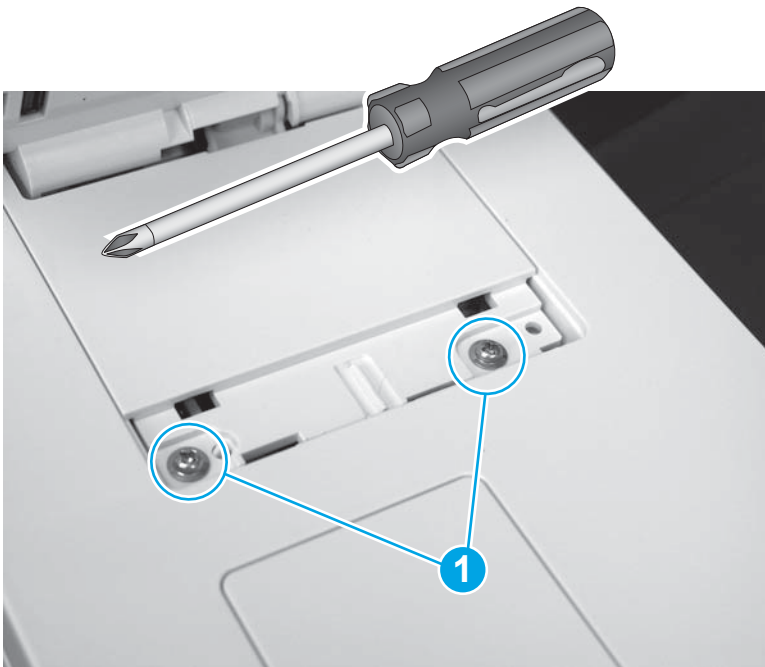

6. Position the screw cover mounting feet into the slots in the top cover (callout 1), and then rotate the cover down (callout 2) to install it.

 **NOTE:** Press down on the cover firmly to make sure that the tabs on the cover (callout 3) snap into place.

Figure 1-4388 Install the cover

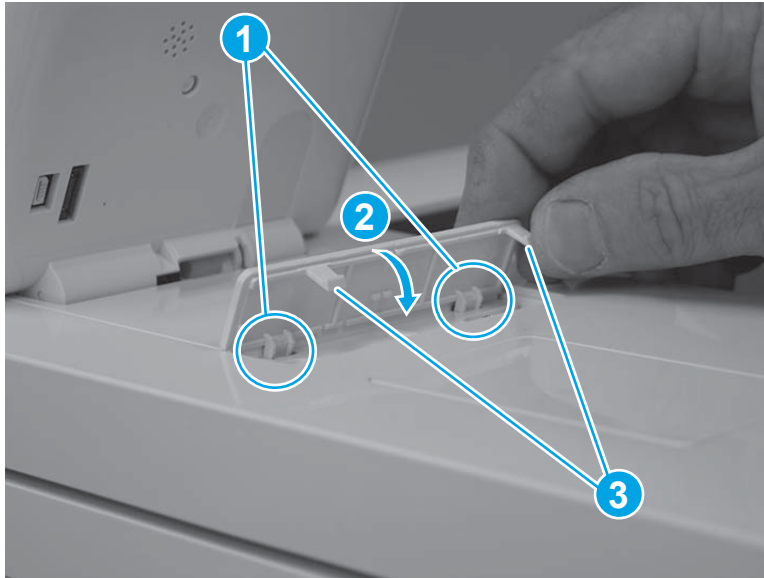

Step 58: Install the USB cover (M552 and M553)

 **NOTE:** This step is for the M552 and M553 models. For the M577 models, skip this step and go to [Step 59: Install the formatter cover on page 2434](#).

1. Push the cover into the USB port to install it.

Figure 1-4389 Install the cover



2. Make sure that the USB cover is fully seated after installing it.

Figure 1-4390 Check the installation

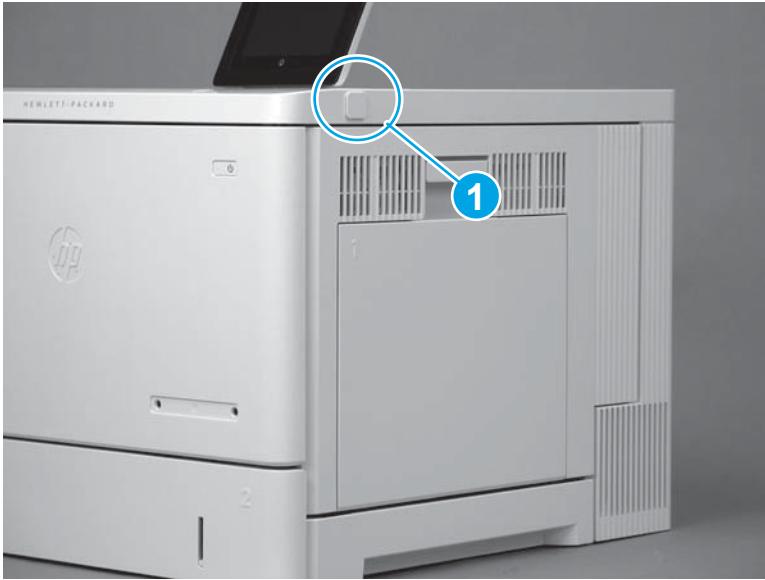

Step 59: Install the formatter cover

- ▲ Slide the cover onto the printer (callout 1) to install it.

 **NOTE:** Make sure that the tabs on the formatter cover align with the slots provided in the printer (callout 2). Tighten the two thumbscrews (callout 3).

 **TIP:** If needed, use the edge of a coin to turn the thumbscrews.

Figure 1-4391 Install the cover

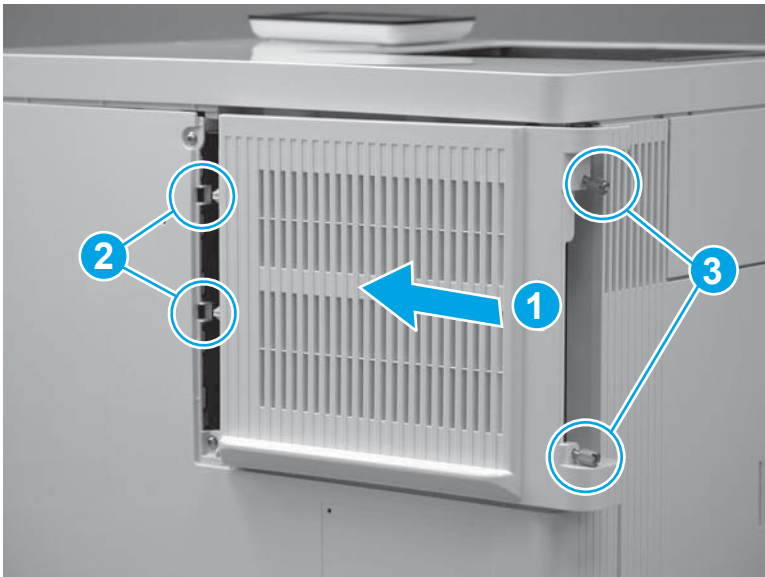

Step 60: Install the TCU

1. Verify that the toner collection hatch cover is in the closed position on the TCU.

Figure 1-4392 Verify that the toner collection hatch cover is closed

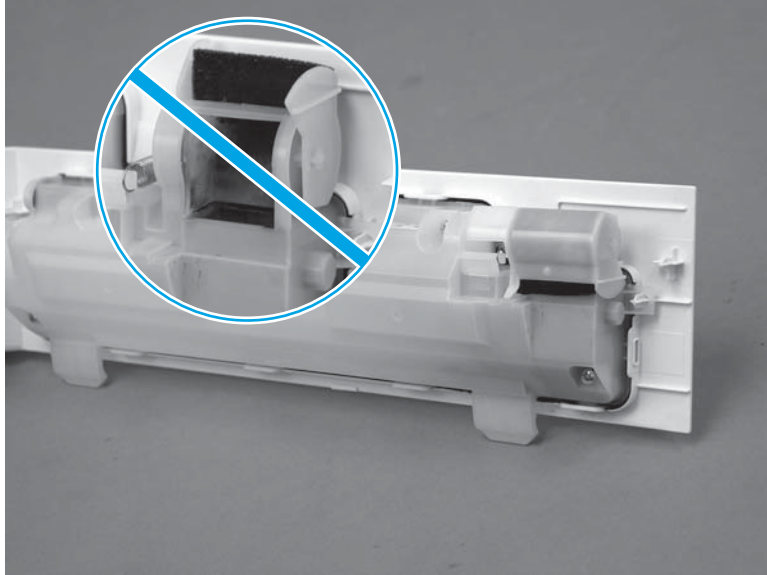

2. Position the TCU with the hinges in the slots provided in the printer (callout 1), and then rotate the TCU up and into the closed position.

 **NOTE:** The toner collection hatch cover automatically opens when the TCU is closed.

Figure 1-4393 Install the TCU

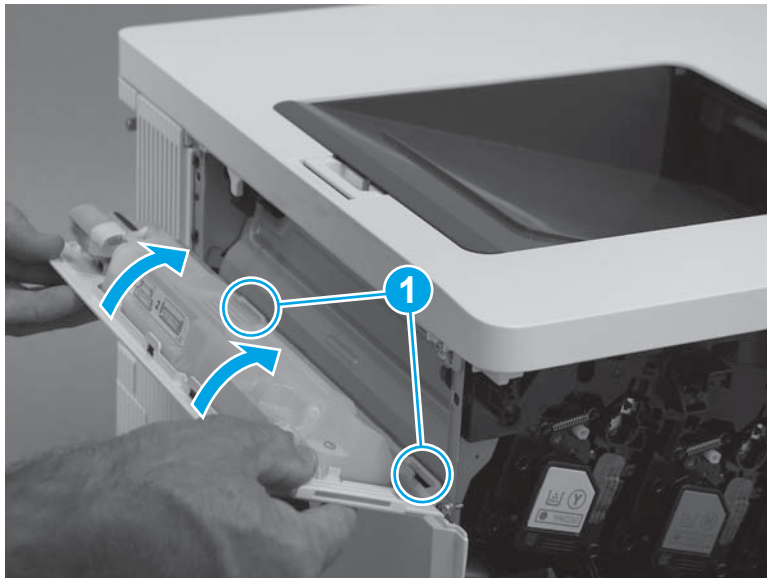

3. Close the front door.

Figure 1-4394 Close the front door



Step 61: Install the tray

1. With the front of the tray slightly lifted, align the sides of the tray with the rails in the printer, and then carefully slide the tray into the printer.

 **TIP:** As the tray slides into the printer, lower the front of it.

Figure 1-4395 Install the tray



2. Close the tray.

Figure 1-4396 Close the tray



Step 62: Install the ITB

⚠ CAUTION: Do not touch the grey-plastic belt. Skin oils and fingerprints on the belt can cause print-quality problems.

1. Handle the ITB by the edges. Do not touch the grey-plastic belt. Skin oils and fingerprints on the belt can cause print-quality problems.

Figure 1-4397 Handle the ITB by the edges

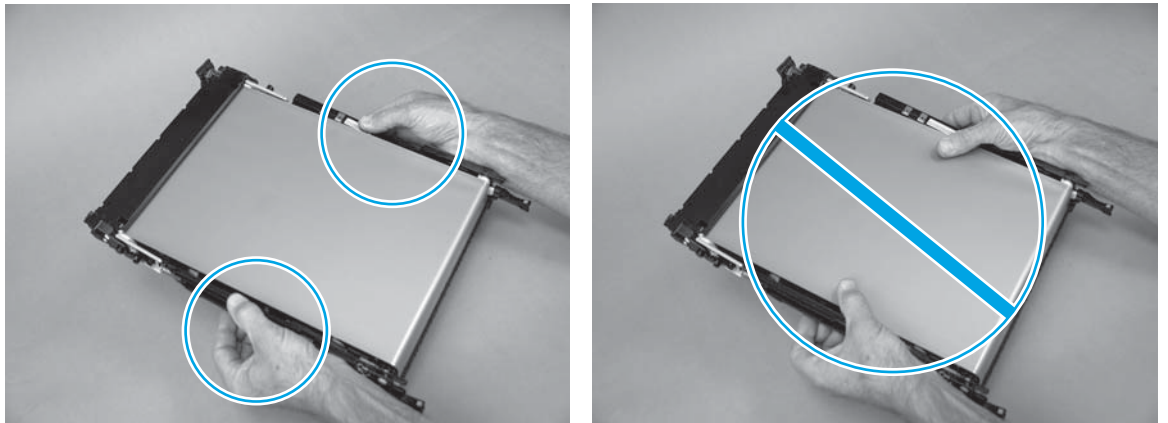

- Align the ITB with the slots in the printer, and then carefully push it into the printer.

NOTE: Be careful. Do not dislodge the ITB retainer springs from the holders on the chassis. The springs can interfere with installing the ITB.

Figure 1-4398 Align the ITB with the slots in the product

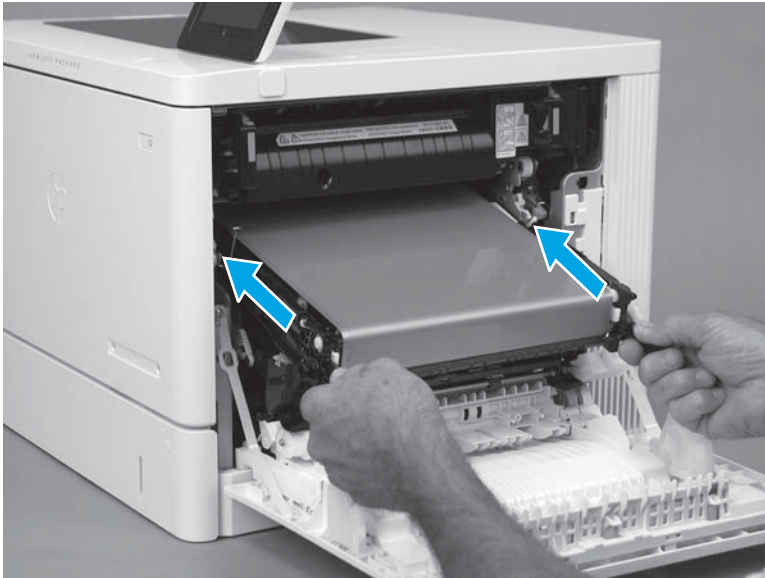

- Continue to carefully push the ITB into the printer until it is fully installed.

Figure 1-4399 Install the ITB

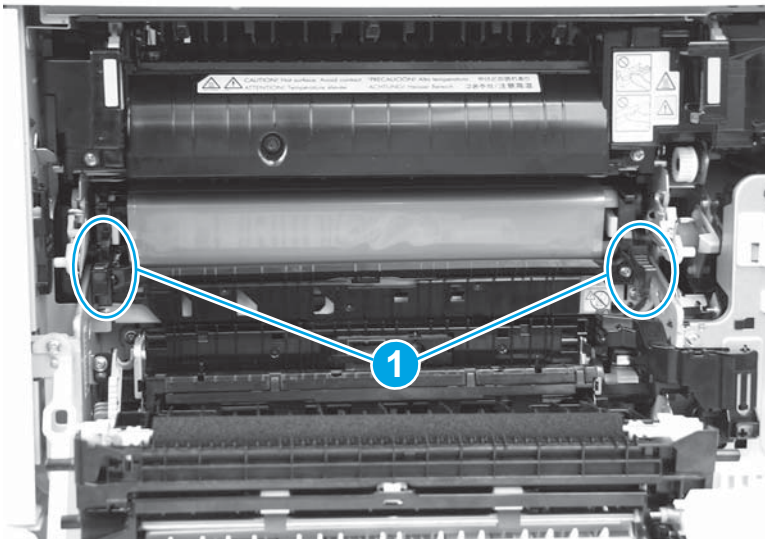

4. Remove the right-side ITB spring from the holder.

Figure 1-4400 Remove the spring from the holder



5. Fasten the right-side ITB spring (callout 1) under the tab (callout 2).

Figure 1-4401 Fasten the rear-side ITB spring

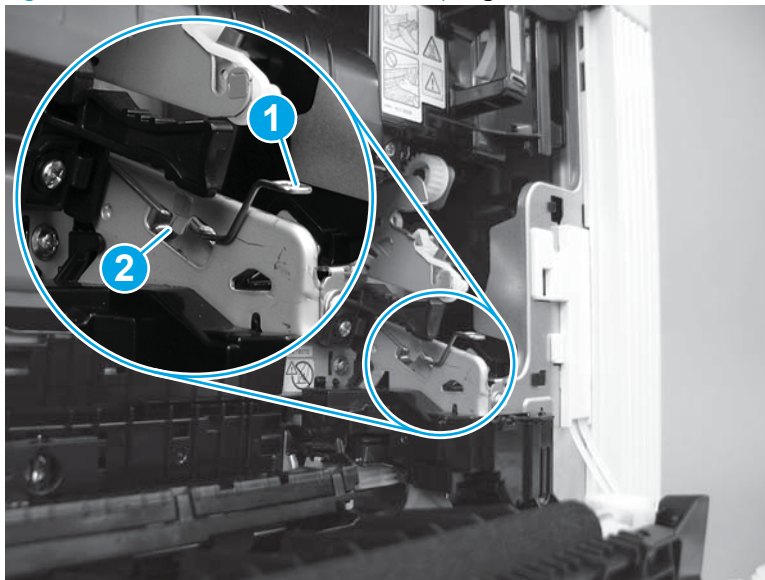

6. Remove the left-side ITB spring from the holder.

Figure 1-4402 Remove the spring from the holder

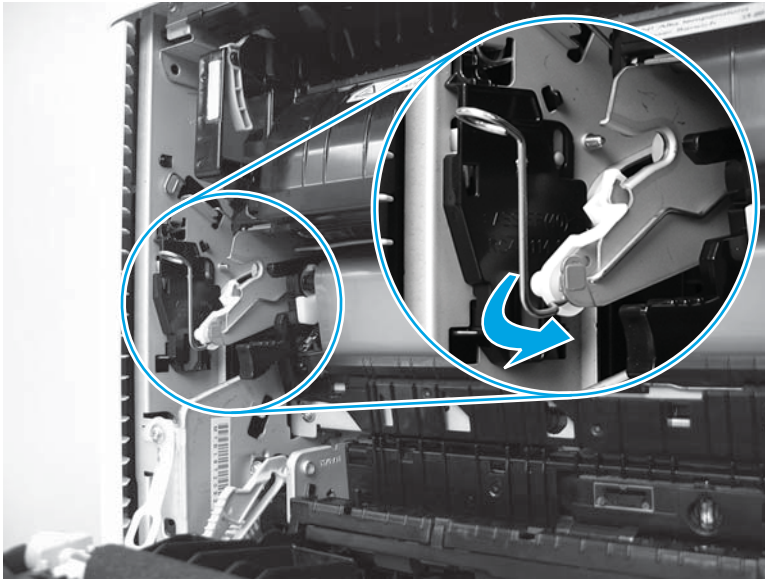

7. Fasten the left-side ITB spring (callout 1) under the tab (callout 2).

Figure 1-4403 Fasten the front-side ITB spring

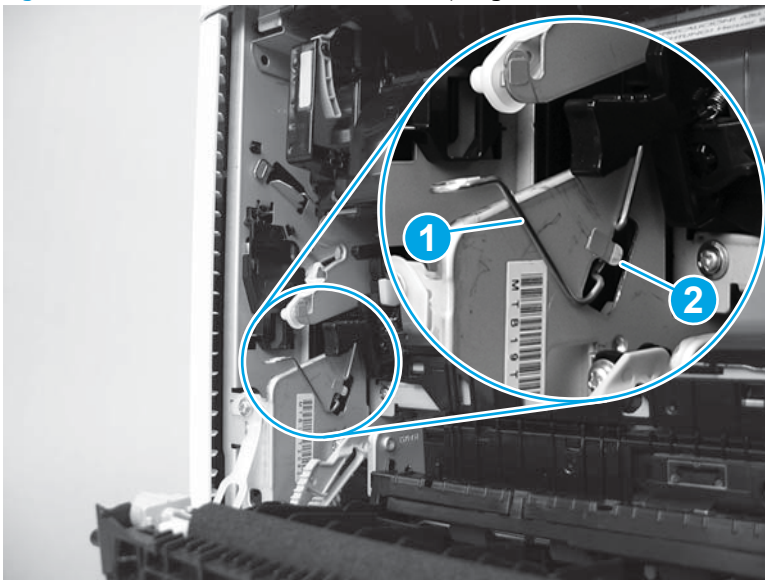

8. Push in the blue lever to engage the ITB drive coupling.

Figure 1-4404 Engage the ITB drive coupling

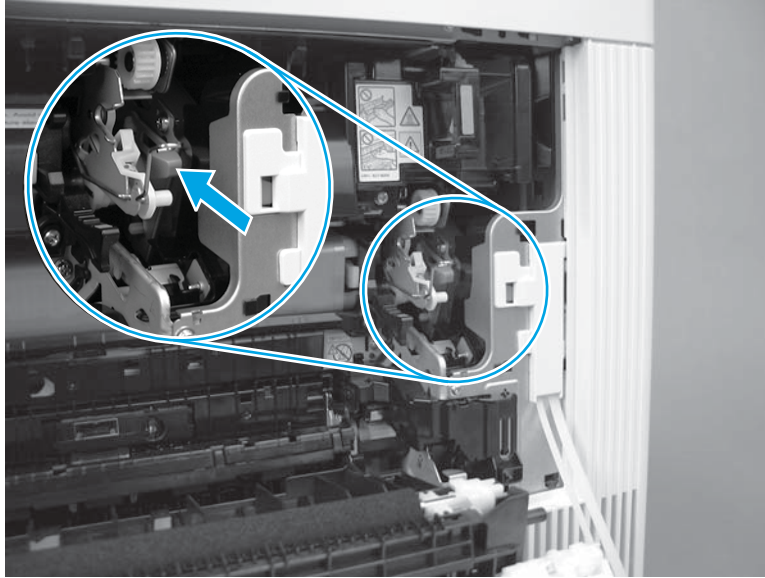

9. Close the right door.

 **TIP:** The right door should close easily if the ITB assembly is correctly installed.

Figure 1-4405 Close the right door



Step 63: Install the secondary transfer roller assembly

1. Move the registration sensor assembly (callout 1) out of the way, and then position the secondary transfer assembly right hinge (callout 2) into the hole provided in the printer.

Figure 1-4406 Install the right hinge

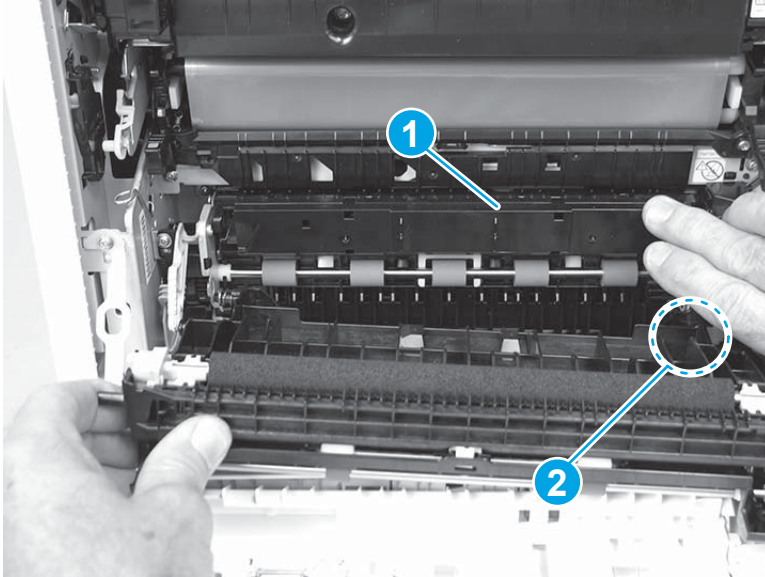

2. Position the assembly left-side hinge near the hole provided in the printer, and then slide the assembly toward the front of the printer to install the hinge in the hole.

Figure 1-4407 Install the left hinge

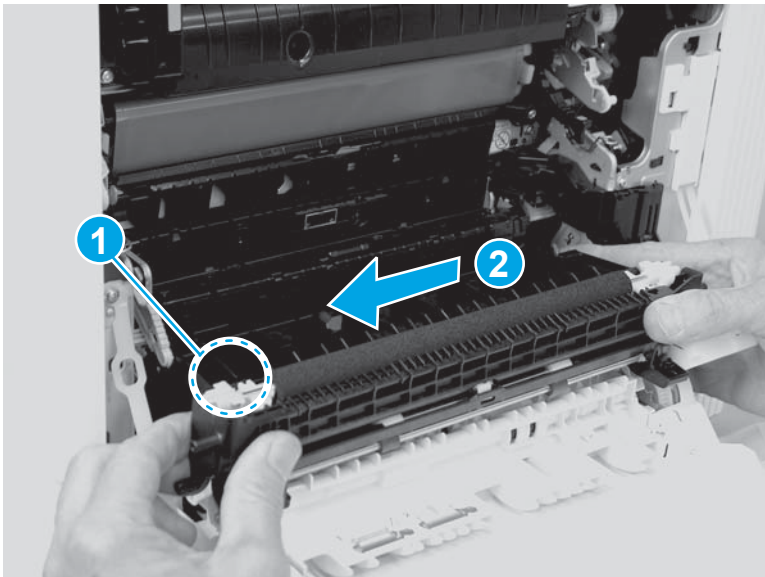

- Carefully flex the blue arm, and then push it over the pin on the assembly to engage it.

 **NOTE:** Make sure that the pin is correctly installed in the slot on the blue arm.

Figure 1-4408 Engage the blue arm with the pin



- Close the right door.

 **TIP:** The right door should close easily if the secondary transfer assembly is correctly installed.

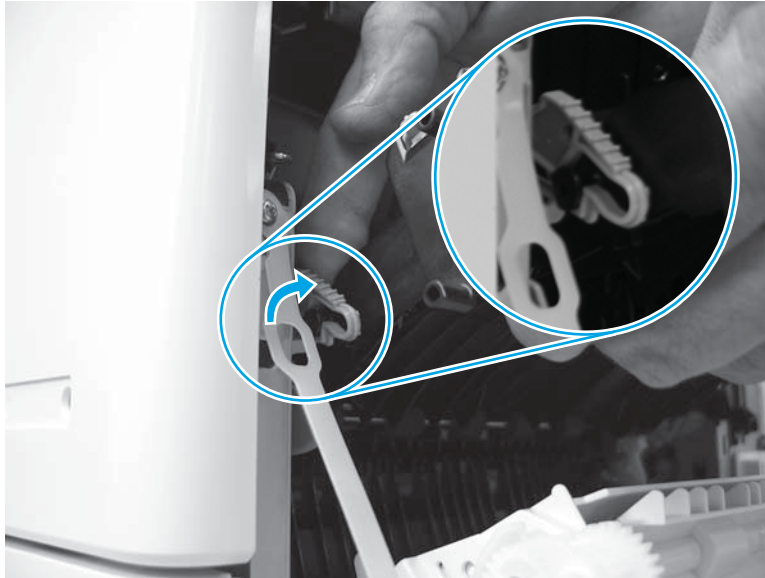
Figure 1-4409 Close the right door



Removal and replacement: Density-detect assembly

- [Introduction](#)
- [Step 1: Remove the secondary transfer roller assembly](#)
- [Step 2: Remove the ITB](#)
- [Step 3: Remove the tray](#)
- [Step 4: Remove the toner collection unit \(TCU\)](#)
- [Step 5: Remove the formatter cover](#)
- [Step 6: Remove the USB cover \(M552 and M553\)](#)
- [Step 7: Remove the control panel \(M553x only\)](#)
- [Step 8: Remove the formatter \(M552 and M553\)](#)
- [Step 9: Remove the hard-disk drive \(HDD\) \(M577\)](#)
- [Step 10: Remove the fax PCA \(M577c/f/z\)](#)
- [Step 11: Remove the formatter \(M577\)](#)
- [Step 12: Remove the rear cover \(M552 and M553\)](#)
- [Step 13: Remove the rear upper cover \(M577\)](#)
- [Step 14: Remove the rear cover \(M577\)](#)
- [Step 15: Remove the left upper cover \(M577\)](#)
- [Step 16: Remove the right front upper cover \(M577dn\)](#)
- [Step 17: Remove the stapler cover assembly \(M577c/f/z\)](#)
- [Step 18: Remove the integrated scanner assembly \(ISA\) \(M577\)](#)
- [Step 19: Remove the right upper cover \(M577dn\)](#)
- [Step 20: Remove the left cover](#)
- [Step 21: Remove the upper cover \(M552 and M553\)](#)
- [Step 22: Remove the right rear cover](#)
- [Step 23: Remove the formatter case](#)
- [Step 24: Remove the low-voltage power supply \(LVPS\)](#)
- [Step 25: Remove the power supply fan \(FM1\)](#)
- [Step 26: Remove the high-voltage power supply D \(HVPSD\)](#)
- [Step 27: Remove the lifter drive assembly](#)
- [Step 28: Remove the DC controller and sheet-metal bracket](#)
- [Step 29: Remove the pickup drive assembly and motor \(M5\)](#)

- [Step 30: Remove the registration assembly](#)
- [Step 31: Remove the density-detect assembly](#)
- [Step 32: Unpack the replacement assembly](#)
- [Step 33: Install the density-detect assembly](#)
- [Step 34: Install the registration assembly](#)
- [Step 35: Install the pickup drive assembly and motor \(M5\)](#)
- [Step 36: Install the DC controller and sheet-metal bracket](#)
- [Step 37: Install the lifter drive assembly](#)
- [Step 38: Install the HVPSD](#)
- [Step 39: Install the power-supply fan \(FM1\)](#)
- [Step 40: Install the LVPS](#)
- [Step 41: Install the formatter case](#)
- [Step 42: Install the right rear cover](#)
- [Step 43: Install the upper cover \(M552 and M553\)](#)
- [Step 44: Install the left cover](#)
- [Step 45: Install the right upper cover \(M577\)](#)
- [Step 46: Install the integrated scanner assembly \(ISA\) \(M577\)](#)
- [Step 47: Install the stapler cover assembly \(M577c/f/z\)](#)
- [Step 48: Install the right front upper cover \(M577dn\)](#)
- [Step 49: Install the left upper cover \(M577\)](#)
- [Step 50: Install the rear cover \(M577\)](#)
- [Step 51: Install the rear upper cover \(M577\)](#)
- [Step 52: Install the rear cover \(M552 and M553\)](#)
- [Step 53: Install the formatter \(M577\)](#)
- [Step 54: Install the fax PCA \(M577c/f/z\)](#)
- [Step 55: Install the HDD \(M577\)](#)
- [Step 56: Install the formatter \(M552 and M553\)](#)
- [Step 57: Install the control-panel assembly \(M553x only\)](#)
- [Step 58: Install the USB cover \(M552 and M553\)](#)
- [Step 59: Install the formatter cover](#)
- [Step 60: Install the TCU](#)

- [Step 61: Install the tray](#)
- [Step 62: Install the ITB](#)
- [Step 63: Install the secondary transfer roller assembly](#)

Introduction

This document provides the procedures to remove and replace the registration density-detect assembly.

Before performing service

 **TIP:** Some figures might show assemblies removed or installed that have not yet been removed or installed at that specific step. However, the procedures are correct for this printer and the target assembly. Always thoroughly read the instructions that accompany each figure.

Turn the printer power off

- Disconnect the power cable.

 **WARNING!** To avoid damage to the printer, turn the printer off, wait 30 seconds, and then remove the power cord before attempting to service the printer.

Use the table below to identify the correct part number for your printer, and then go to <http://h20141.www2.hp.com/hpparts> to order the part.

Density-detect assembly part number	
RM2-7160-000CN	Density-detect assembly

Required tools

- #2 Phillips screwdriver with a magnetic tip

After performing service

Make sure that all of the connectors on the LVPS are fully seated.

Make sure that all of the connectors on the HVPSD are fully seated.

Make sure that all of the connectors on the DC controller are fully seated.

Make sure that the TCU is fully closed after replacing it.

Make sure that all of the connectors on the formatter are fully seated.

Make sure that the formatter cover is fully seated, and that the thumbscrews are finger tight after replacing it.

Use the [Device Maintenance](#) menu to perform a [Full Calibration](#). For more information, see the printer troubleshooting manual.

Turn the printer power on

- Connect the power cable.
- Use the power switch to turn the power on.

Post service test

Use the [Troubleshooting](#) menu to perform a [Color Band Test](#). For more information, see the printer troubleshooting manual.

Print a configuration page to make sure that the printer is functioning correctly.

Step 1: Remove the secondary transfer roller assembly

1. Open the right door.

Figure 1-4410 Open the right door



2. Release the blue arm, and then let the secondary transfer assembly rotate down to the half-way open position.

 **NOTE:** The assembly should stop at the halfway down point—the pin will stop at the notch in the slot in the blue arm.

Figure 1-4411 Release the secondary transfer roller assembly



3. Carefully flex the top portion of the blue arm—as shown in the figure—to start to disengage it from the pin.

Figure 1-4412 Carefully flex the top portion of the blue arm

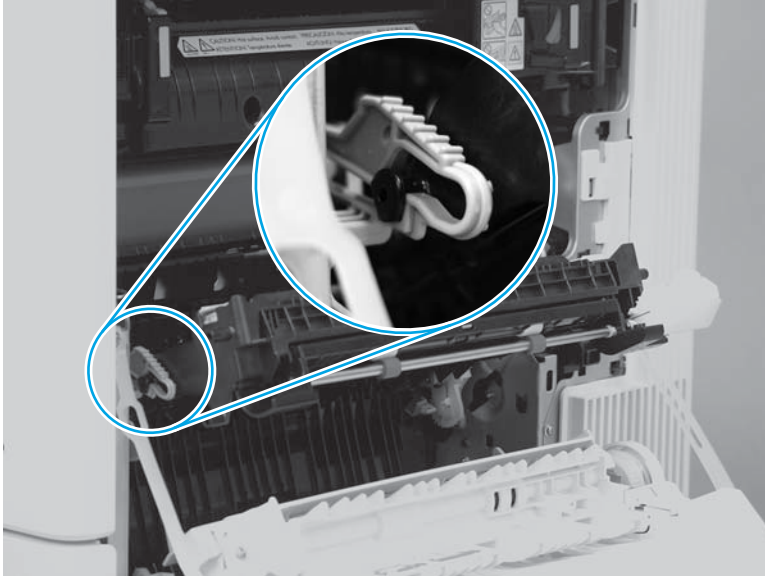

4. Continue to flex the blue arm until it disengages from the pin.

Figure 1-4413 Disengage the blue arm and pin



5. Slide the assembly toward the front of the printer to release it (callout 1), and then rotate it down and away from the printer to remove it (callout 2).



 **Reinstallation tip:** Before removing the assembly, take note of where the assembly hinge pins fit into the holes provided in the printer.

Figure 1-4414 Remove the secondary transfer roller assembly

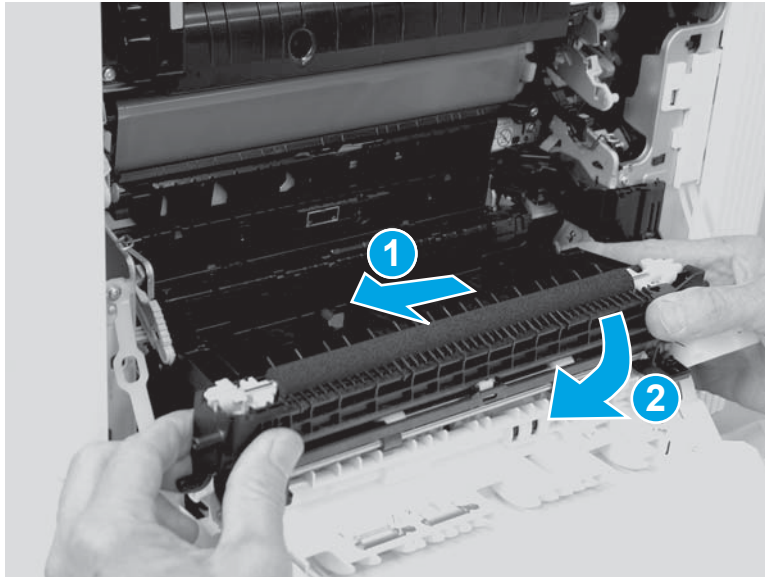

Step 2: Remove the ITB

 **CAUTION:** Do not touch the grey-plastic belt. Skin oils and fingerprints on the belt can cause print-quality problems.

1. Open the right door.

Figure 1-4415 Open the right door



2. Pull the blue lever to release the ITB drive coupling.

Figure 1-4416 Release the ITB drive coupling

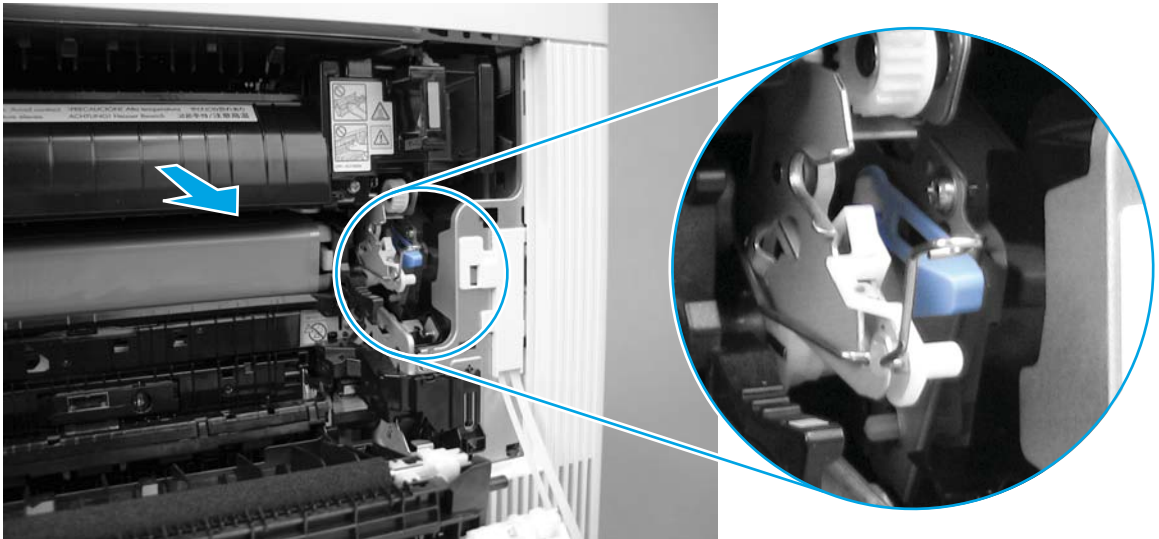

3. Push in on the blue arm to release the secondary transfer roller assembly, and then completely lower the assembly.

 **NOTE:** Press the blue arm on the secondary transfer roller assembly a second time to release the roller assembly when it stops at the halfway open position.

Figure 1-4417 Lower the secondary transfer roller assembly



4. Release the left-side ITB spring (callout 1) from the tab (callout 2).

Figure 1-4418 Release the front-side ITB spring

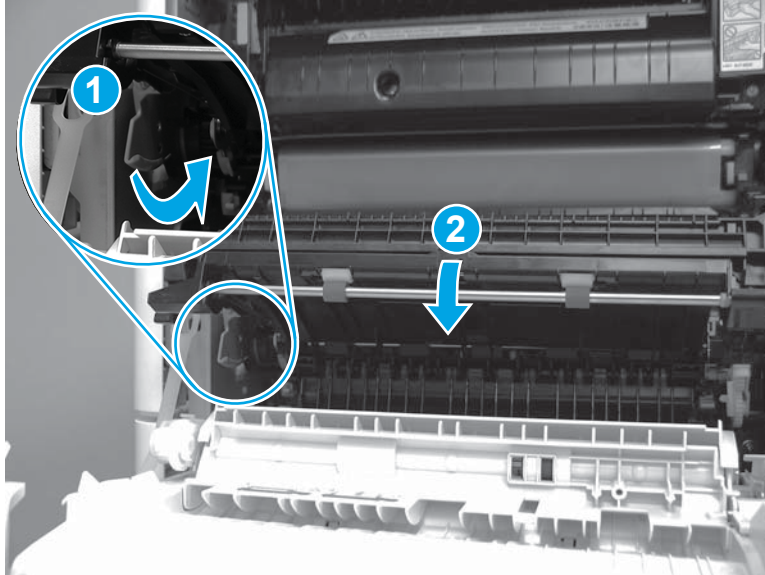
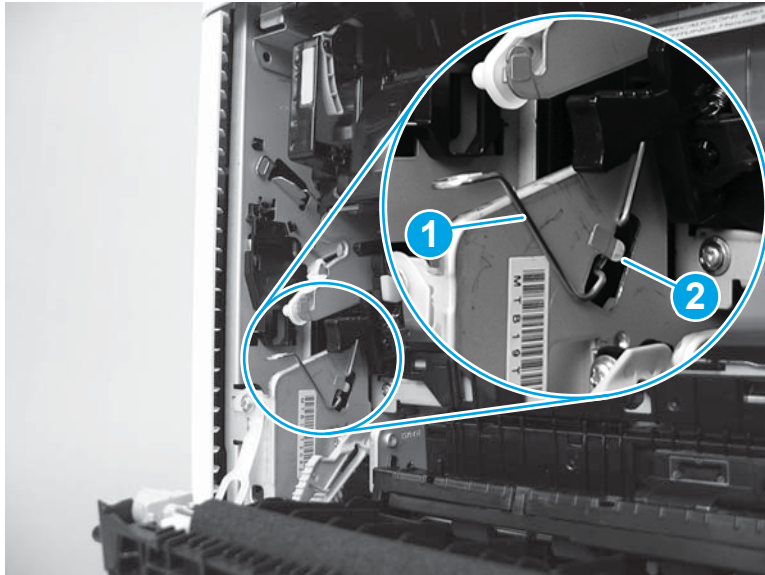

5. Place the left-side ITB spring on the holder to keep it out of the way.

 **TIP:** The holder is colored blue to help locate it.

Figure 1-4419 Place the spring on the holder

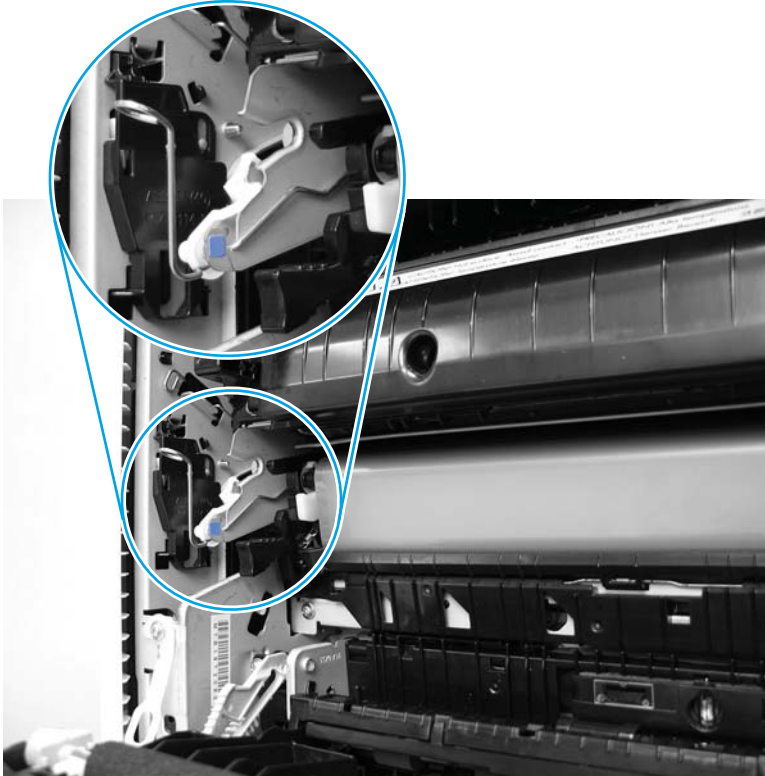

6. Release the right-side ITB spring (callout 1) from the tab (callout 2).

Figure 1-4420 Release the rear-side ITB spring

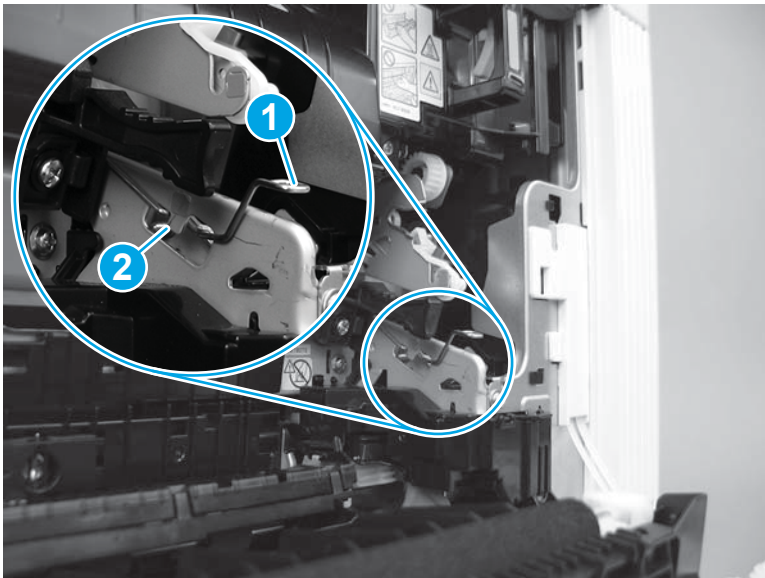

7. Place the right-side ITB spring on the holder to keep it out of the way.

 **TIP:** The holder is colored blue to help locate it.

Figure 1-4421 Place the spring on the holder

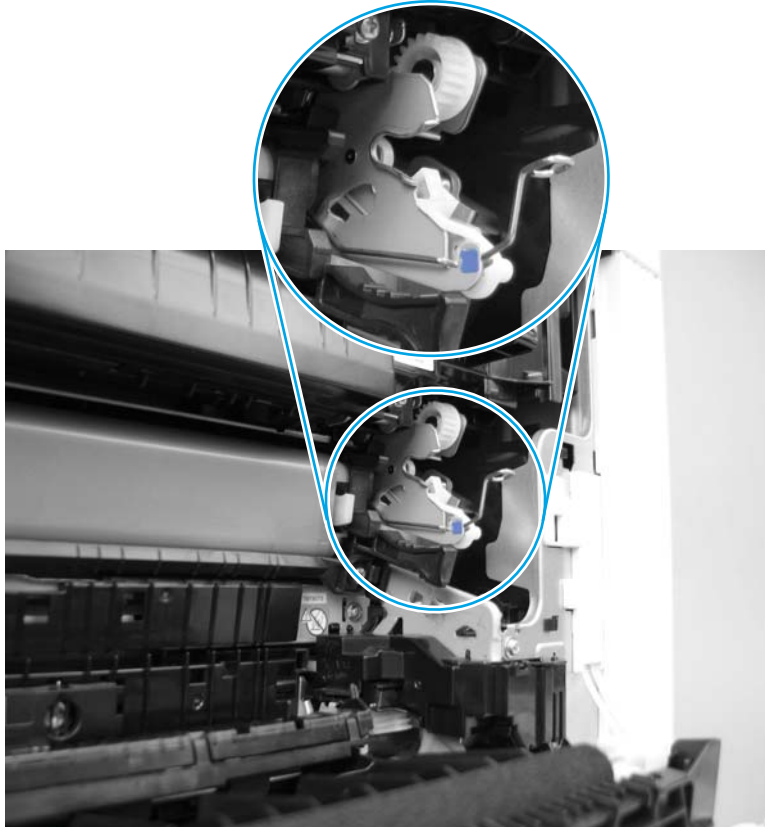

8. Grasp the two blue handles on the ITB.

⚠ CAUTION: If the ITB is removed to access other assemblies in the printer, use care. The ITB is a sensitive assembly. Be careful when handling the ITB so that it is not damaged. Always place the ITB in a safe and protected location.

Figure 1-4422 Grasp the ITB handles

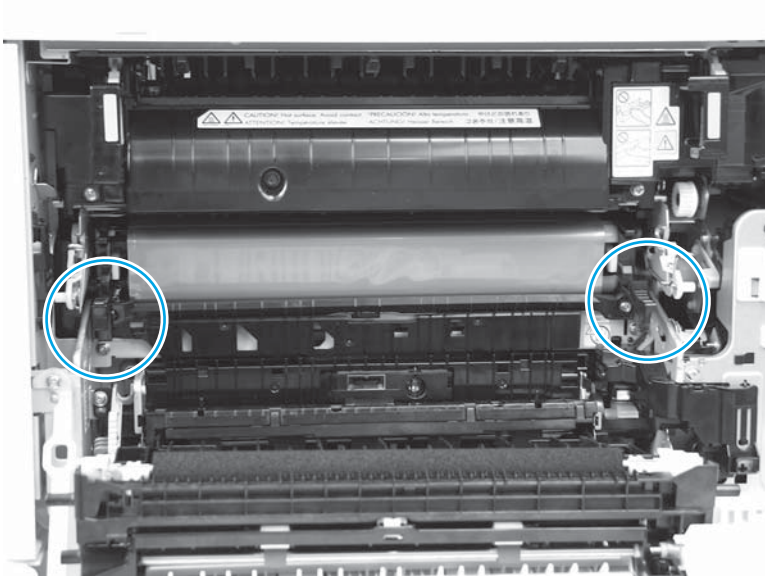

9. Pull the ITB out of the printer to remove it.

⚠ CAUTION: Do not touch the grey-plastic belt. Skin oils and fingerprints on the belt can cause print-quality problems.

Figure 1-4423 Remove the ITB

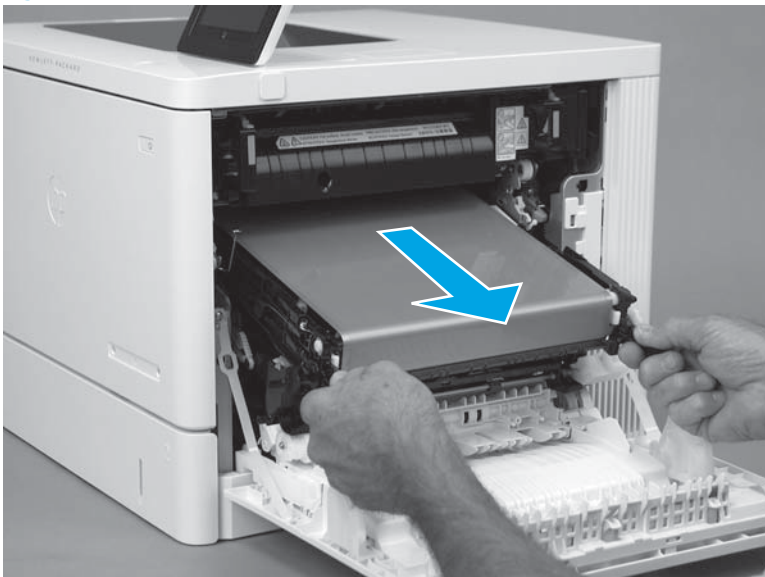

Step 3: Remove the tray

1. Pull the tray out until it stops.

Figure 1-4424 Pull the tray out



2. Lift the front of the tray, and then pull it out of the printer to remove it.

Figure 1-4425 Remove the tray

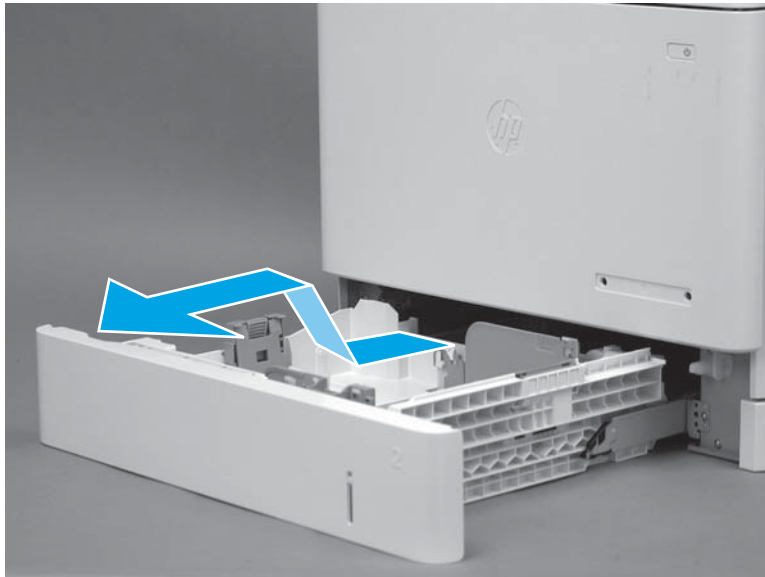

Step 4: Remove the toner collection unit (TCU)

1. Open the front door.

Figure 1-4426 Open the front door



2. Open the TCU.

 **NOTE:** The toner collection hatch cover automatically closes when the TCU is opened.

Figure 1-4427 Open the TCU



3. Pull the TCU away from the printer at an angle to remove it.

⚠ CAUTION: Do not open the toner collection hatch cover when handling the TCU. If toner gets on clothing, wipe it off by using a dry cloth and wash the clothes in cold water. Hot water sets toner into fabric.

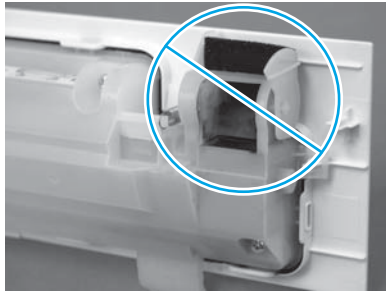
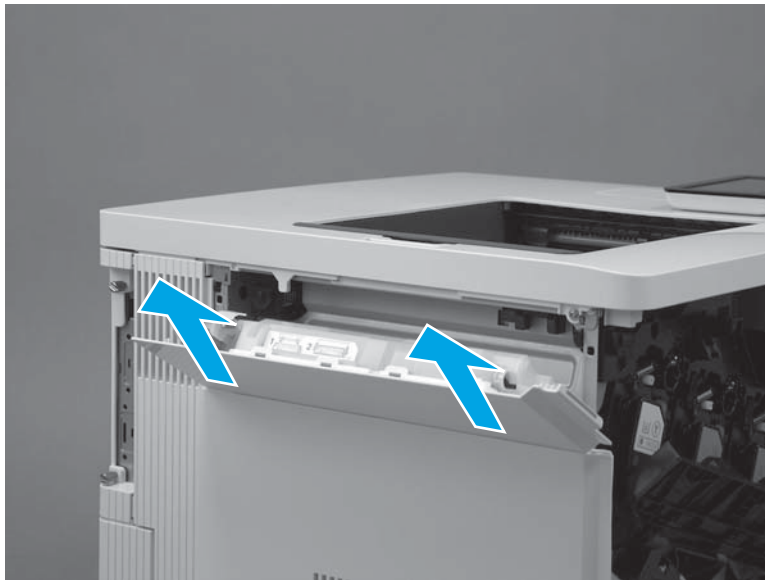

Figure 1-4428 Remove the TCU



Step 5: Remove the formatter cover

1. Locate the formatter cover.

Figure 1-4429 Locate the formatter cover

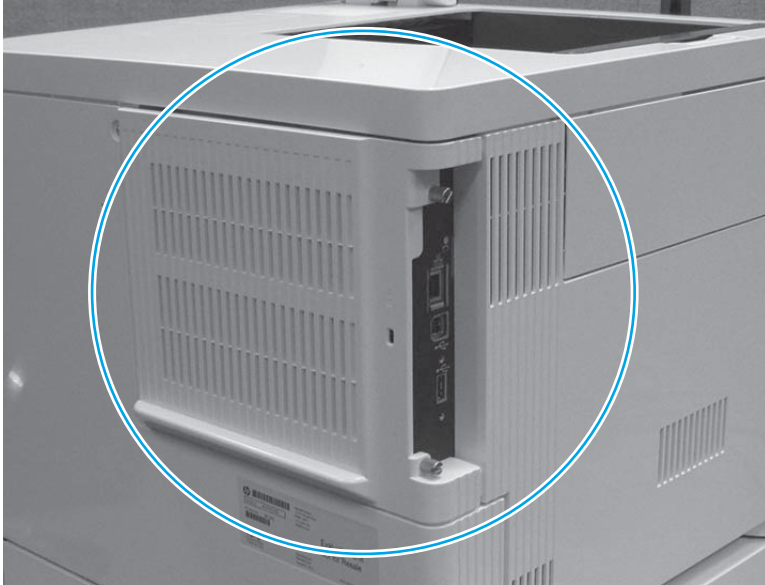

2. Loosen the two thumbscrews (callout 1). Grasp the two thumbscrews, and then slide the cover away from the printer (callout 2) to remove it.

 **TIP:** If needed, use the edge of a coin to turn the thumbscrews.

Figure 1-4430 Loosen the thumbscrews

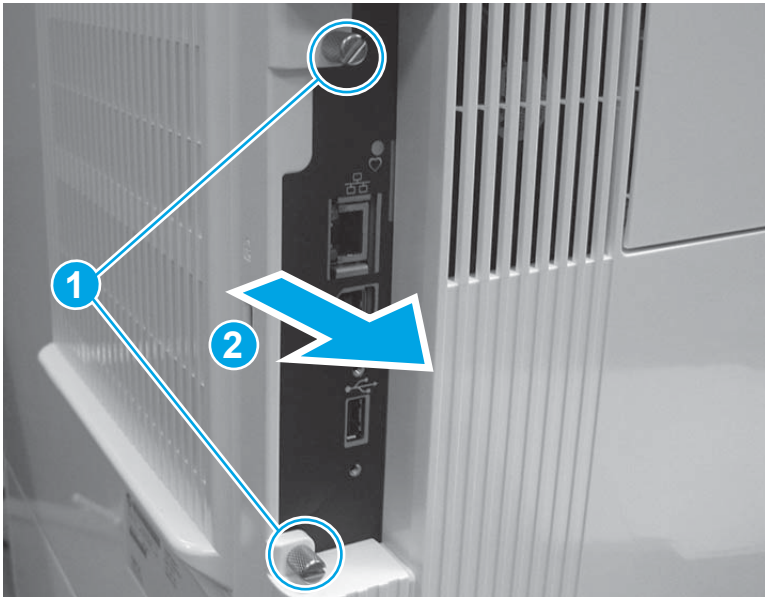

Step 6: Remove the USB cover (M552 and M553)

 **NOTE:** This step is for the M552 and M553 models. For the M577 models, skip this step and go to [Step 9: Remove the hard-disk drive \(HDD\) \(M577\) on page 2464.](#)

1. Locate the USB cover.

Figure 1-4431 Locate the USB cover



2. Pull the cover off of the printer to remove it.

Figure 1-4432 Remove the cover



Step 7: Remove the control panel (M553x only)

 **NOTE:** For the M553n/dn and M552dn models, skip this step and go to [Step 8: Remove the formatter \(M552 and M553\) on page 2463](#).

For the M577 models, skip this step and go to [Step 9: Remove the hard-disk drive \(HDD\) \(M577\) on page 2464](#).

1. Tilt the control panel up.

Figure 1-4433 Tilt the control panel up



2. Use a small flat-blade screwdriver to release the control-panel screws cover tabs.

Figure 1-4434 Release the control-panel screws cover tabs



3. Rotate the cover up to remove it.

Figure 1-4435 Remove the cover

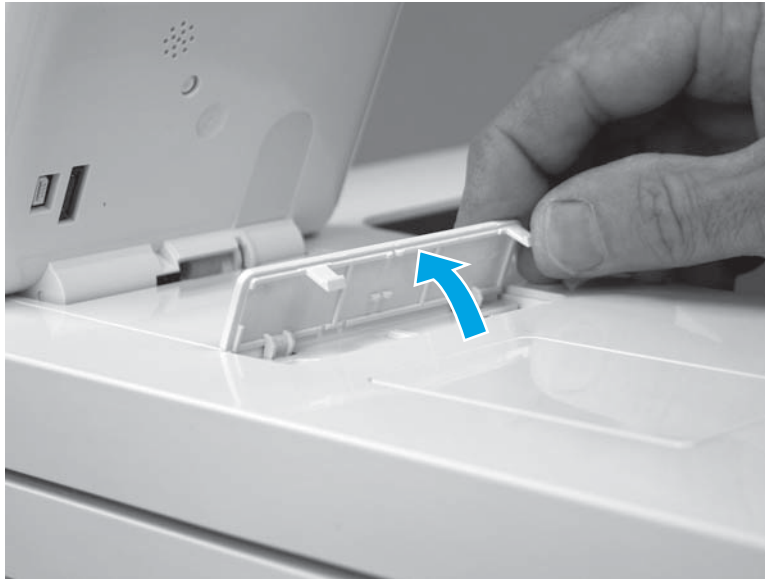

4. Use a small Phillips screwdriver to remove two screws (callout 1).

 **IMPORTANT:** Store the screws in a secure place where they cannot fall down into the printer.

Figure 1-4436 Remove two screws

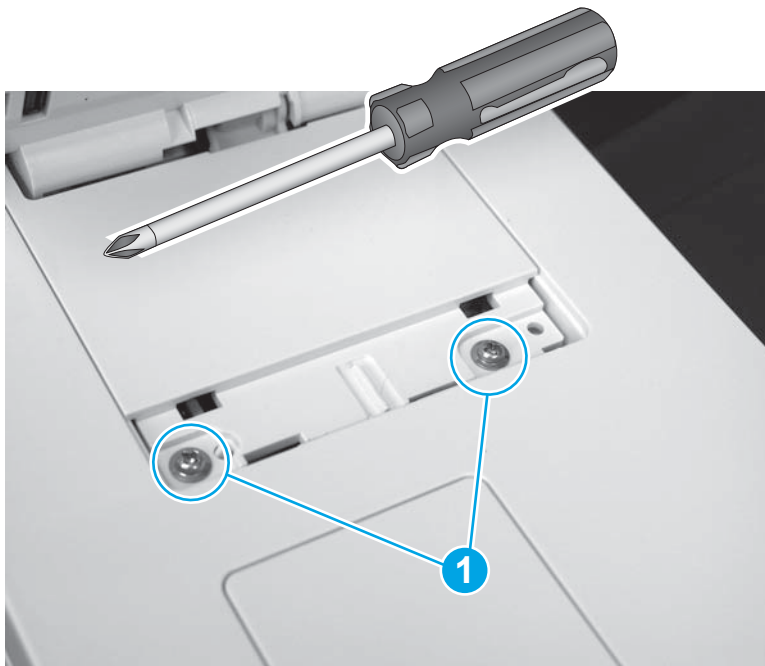

5. Rotate the control-panel base toward the front of the printer.

Figure 1-4437 Rotate the control-panel base up



6. Slightly slide the control-panel base toward the rear of the printer (callout 1) to release it, and then turn the control panel over (callout 2) to access the bottom side.

⚠ CAUTION: The control panel is still attached to the printer. Do not attempt to completely remove the control panel.

Figure 1-4438 Turn the control panel over

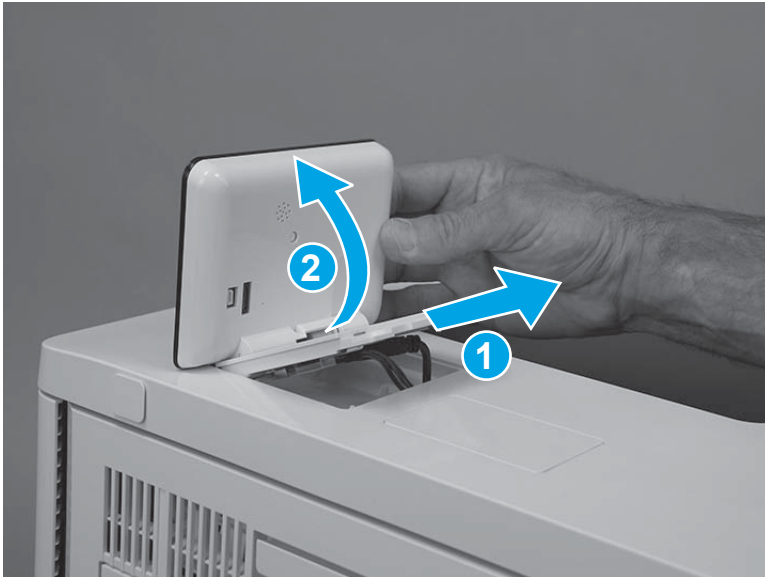

7. Disconnect one USB cable (callout 1), one connector (callout 2), and then remove the control panel.

Figure 1-4439 Disconnect two connectors

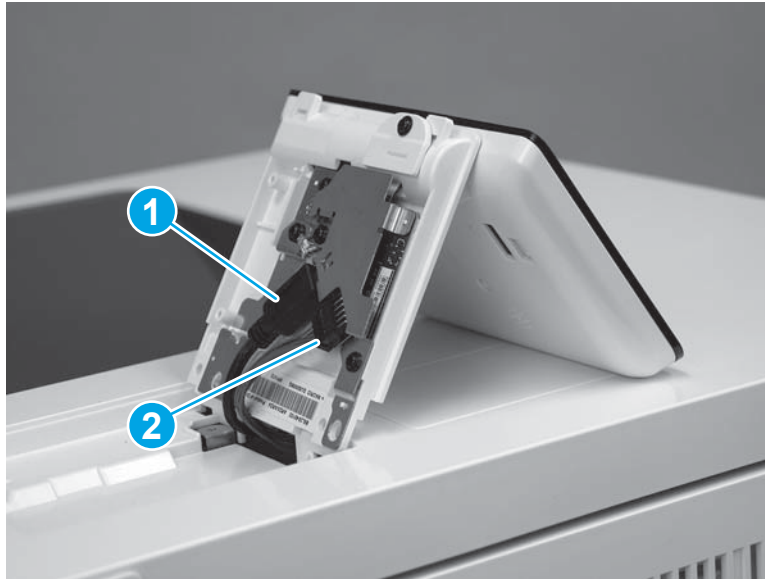

Step 8: Remove the formatter (M552 and M553)

 **NOTE:** This step is for the M552 and M553 models. For the M577 models, skip this step and go to [Step 9: Remove the hard-disk drive \(HDD\) \(M577\) on page 2464](#).

If the optional hard-disk drive (HDD) is installed, it must be removed to gain access to the formatter mounting screws.

Release two tabs along the left edge of the HDD, rotate the left edge away from the product, and then slide the HDD to the left to remove it.

 **CAUTION:**  ESD-sensitive part.

1. Disconnect all of the connectors on the formatter.

The following connectors are empty:

- All models: J1 (this connector is empty unless the optional DIMM is installed)
- M553n/dn and M552dn: J2 (callout 1; this is the touchscreen connector for the M553x model)
- All models: J9 (this connector is empty unless the optional internal USB ports component is installed)
- All models: J18 (this connector is empty unless the optional hard-disk-drive (HDD) is installed)
- All models: J23
- All models: J24
- M553n/dn and M552dn: J25 (this is the wireless connector for the M553x model)

- All models: J57
- All models: J98 (this connector is empty unless the optional trusted platform module (TPM) is installed)

 **IMPORTANT:** The flat-cable connector (callout 2) is a Zero Insertion Force (ZIF) connector that uses a hinged retainer to secure the flat cable. The hinged retainer must be opened to release the flat cable.

Figure 1-4440 Disconnect all connectors

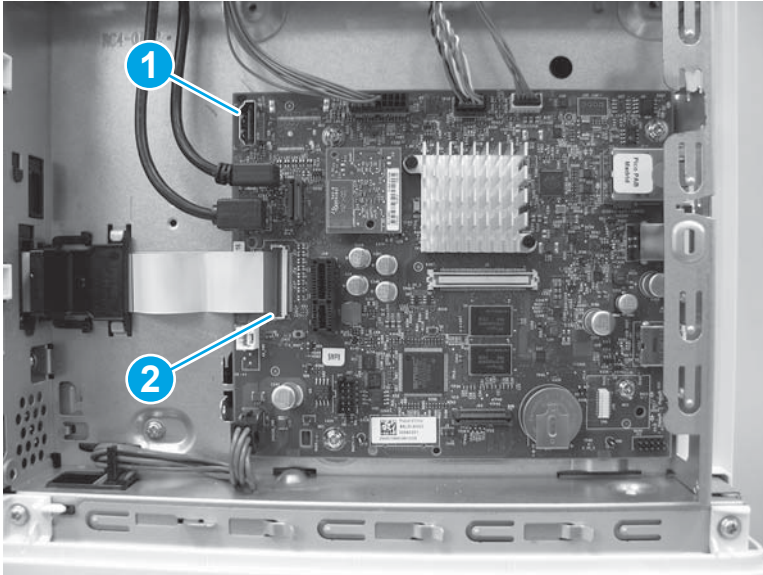

2. Remove four screws (callout 1), and then remove the formatter.

Figure 1-4441 Remove the formatter

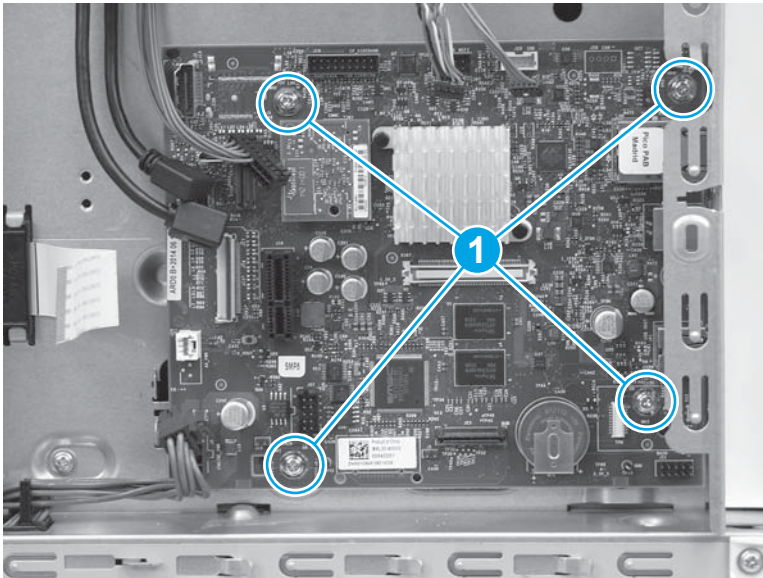

Step 9: Remove the hard-disk drive (HDD) (M577)

 **NOTE:** This step is for the M577 models. For the M552 and M553 models, skip this step and go to [Step 12: Remove the rear cover \(M552 and M553\) on page 2469](#).

 **CAUTION:**  ESD-sensitive part.

1. Release two tabs (callout 1). Hold the tabs in the released position, and then rotate the hard disk drive (HDD) up (callout 2) to release the connector from the formatter.

Figure 1-4442 Release the HDD

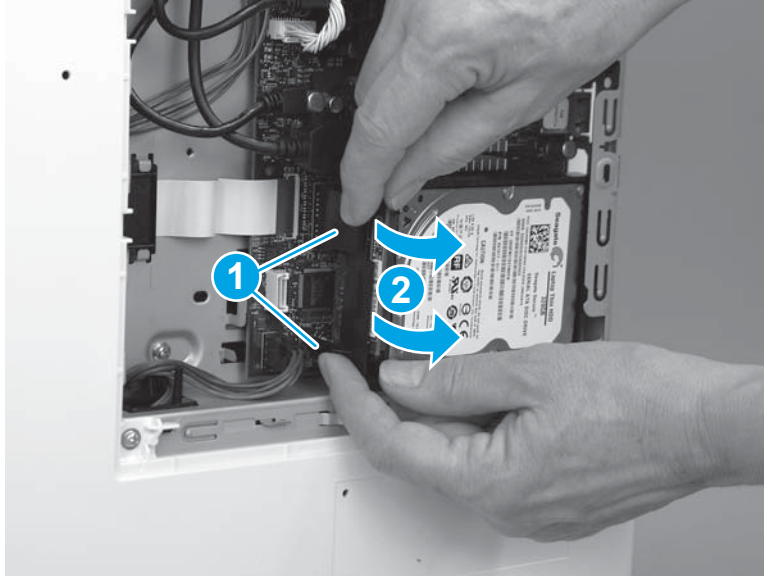

2. Slide the HDD away from the printer to remove it.

Figure 1-4443 Remove the HDD

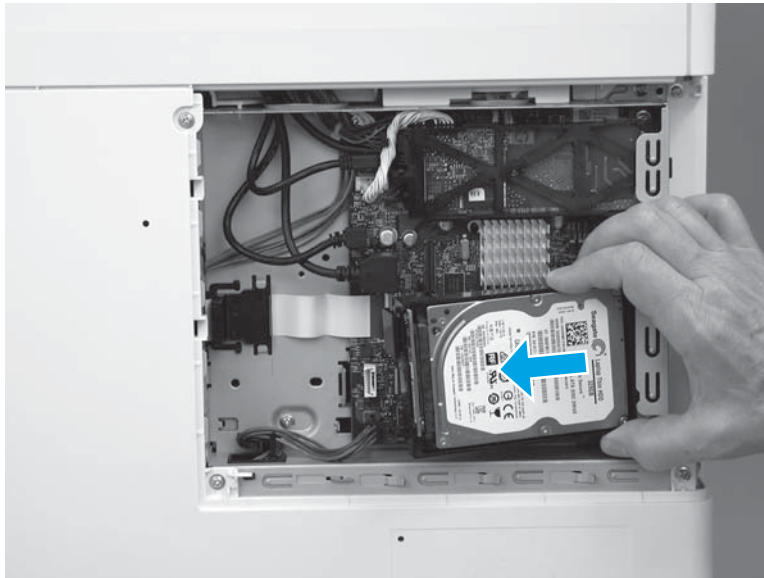

Step 10: Remove the fax PCA (M577c/f/z)

 **NOTE:** This step is for the M577c/f/z models. For the M577n model, skip this step and go to [Step 11: Remove the formatter \(M577\) on page 2467](#).

For the M552 and M553 models, skip this step and go to [Step 12: Remove the rear cover \(M552 and M553\) on page 2469](#).

 **CAUTION:**  ESD-sensitive part.

1. Locate the fax PCA component on the formatter.

Figure 1-4444 Locate the fax PCA

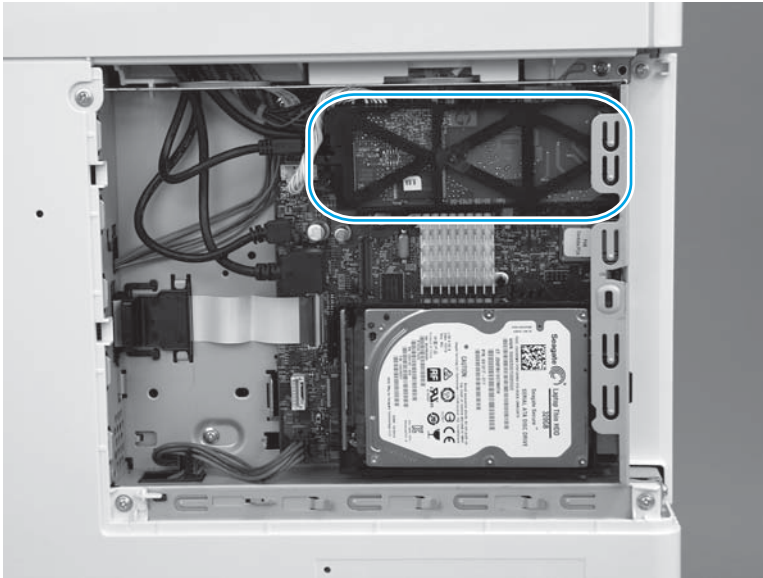

2. Release the connector latch (callout 1), and then pull the connector away from the formatter (callout 2) to disconnect it.

Figure 1-4445 Disconnect one connector

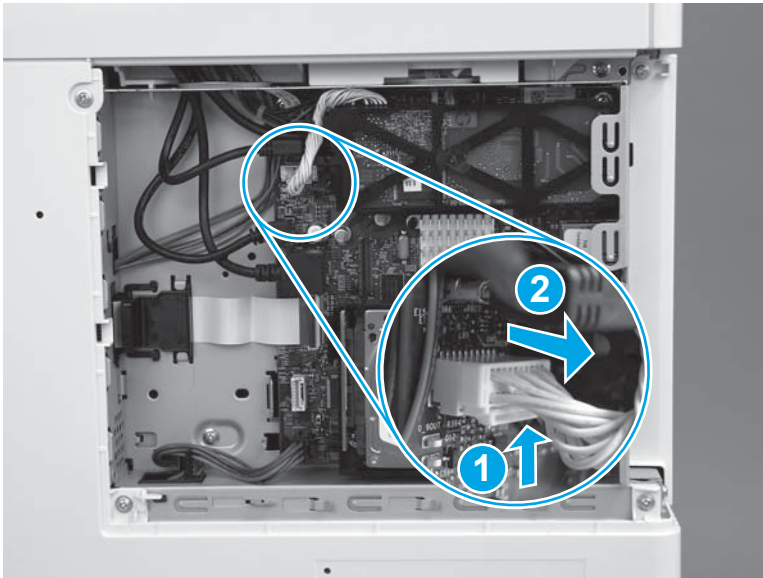

3. Release one retainer (callout 1) by pressing the bracket arms together.

Figure 1-4446 Release one latch

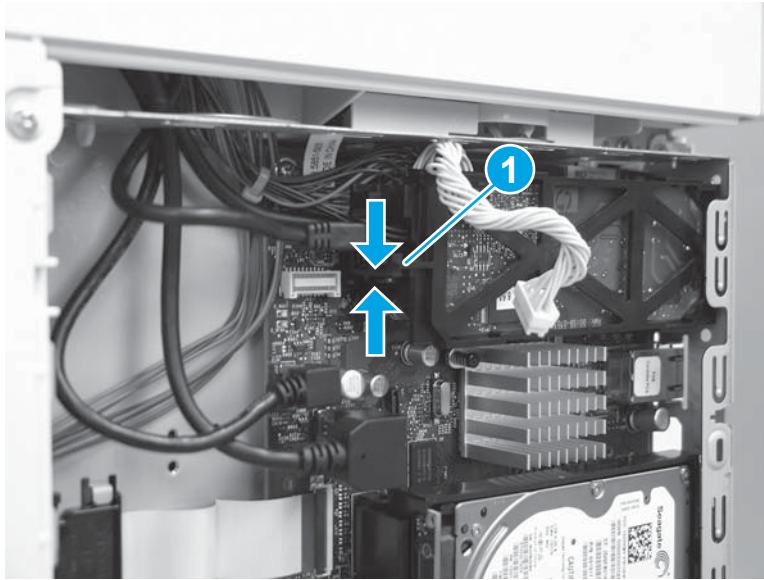

4. Rotate the end of the fax PCA (callout 1) away from the formatter, and then slide the PCA left (callout 2) to remove it.

Figure 1-4447 Remove the fax PCA

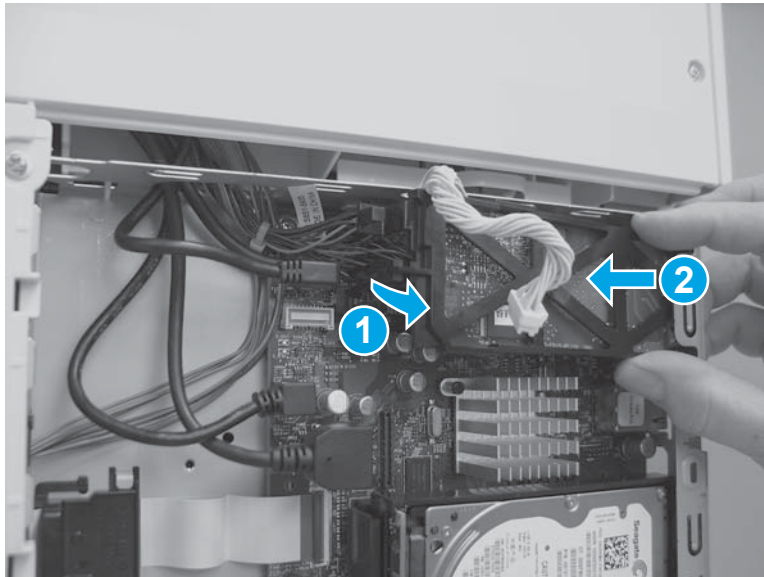

Step 11: Remove the formatter (M577)

 **NOTE:** This step is for the M577 models. For the M552 and M553 models, skip this step and go to [Step 12: Remove the rear cover \(M552 and M553\) on page 2469.](#)

 **CAUTION:**  ESD-sensitive part.

1. Disconnect all of the connectors on the formatter.

The following connectors are empty:

- All models: J1 (this connector is empty unless the optional DIMM is installed)
- All models: J3
- M577dn: J15 (this is the fax connector for the M577f/z/c models)
- All models: J21 (this connector is empty unless the optional internal USB ports component is installed)
- All models: J23
- All models: J24
- All models: J51
- All models: J57
- All models: J97
- All models: J98 (this connector is empty unless the optional trusted platform module (TPM) is installed)

 **IMPORTANT:** The flat-cable connector (callout 1) is a Zero Insertion Force (ZIF) connector that uses a hinged retainer to secure the flat cable. The hinged retainer must be opened to release the flat cable.

Figure 1-4448 Disconnect all connectors



2. Remove four screws (callout 1).

Figure 1-4449 Remove four screws

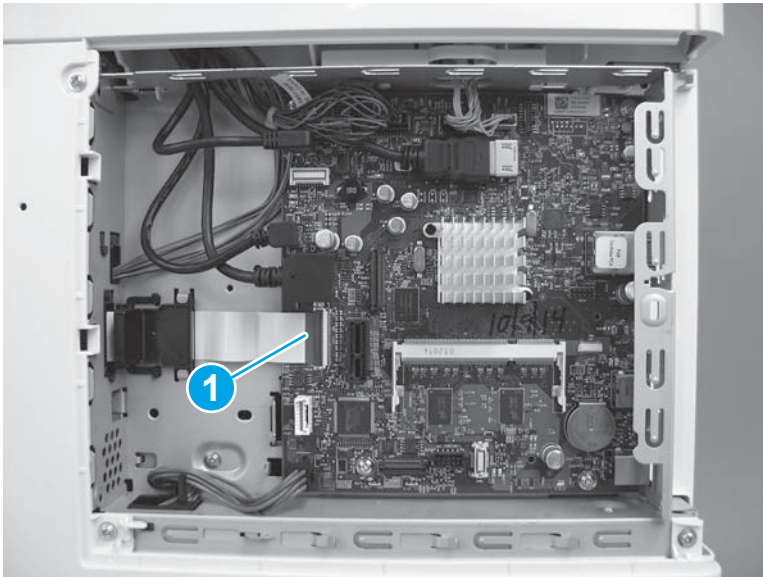
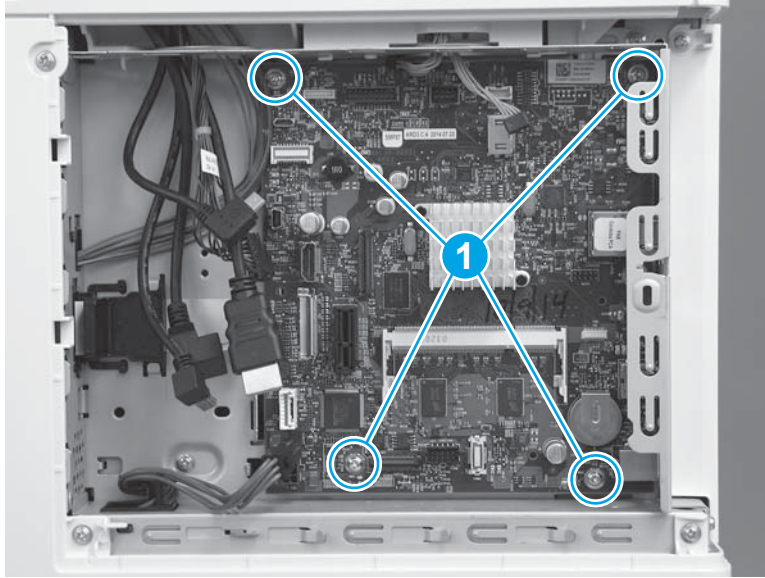

3. Remove the formatter.

Figure 1-4450 Remove the formatter

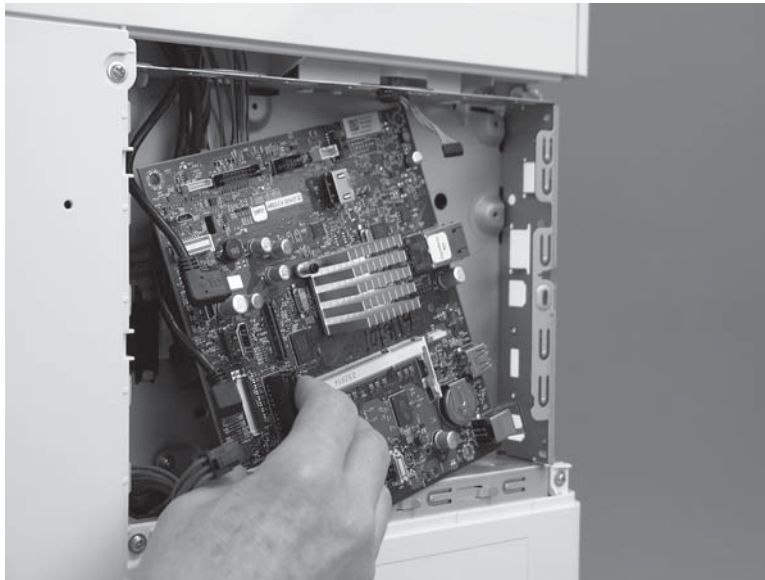

Step 12: Remove the rear cover (M552 and M553)

 **NOTE:** This step is for the M552 and M553 models. For the M577 models, skip this step and go to [Step 13: Remove the rear upper cover \(M577\) on page 2470.](#)

1. Remove four screws (callout 1).

Figure 1-4451 Remove four screws

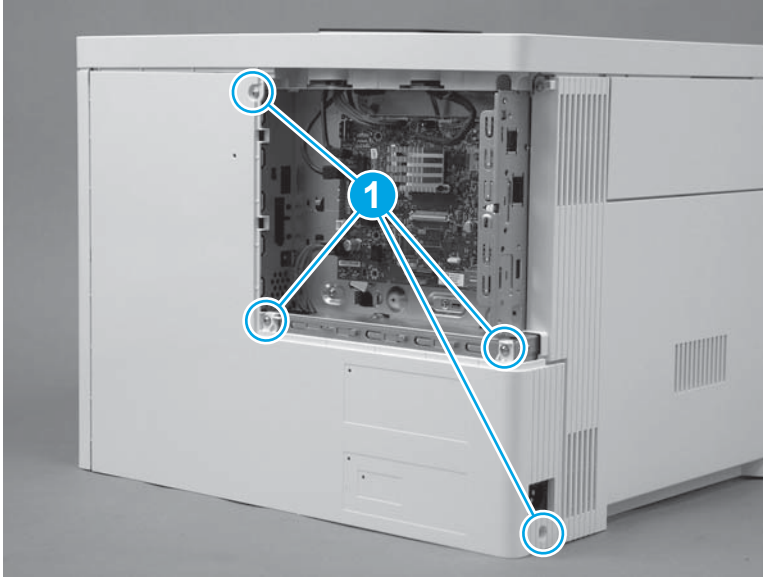

2. Slightly slide the cover to the right (callout 1), rotate the bottom of the cover away from the printer (callout 2), and then pull the top of the cover away from the printer (callout 3) to remove the cover.

Figure 1-4452 Remove the cover

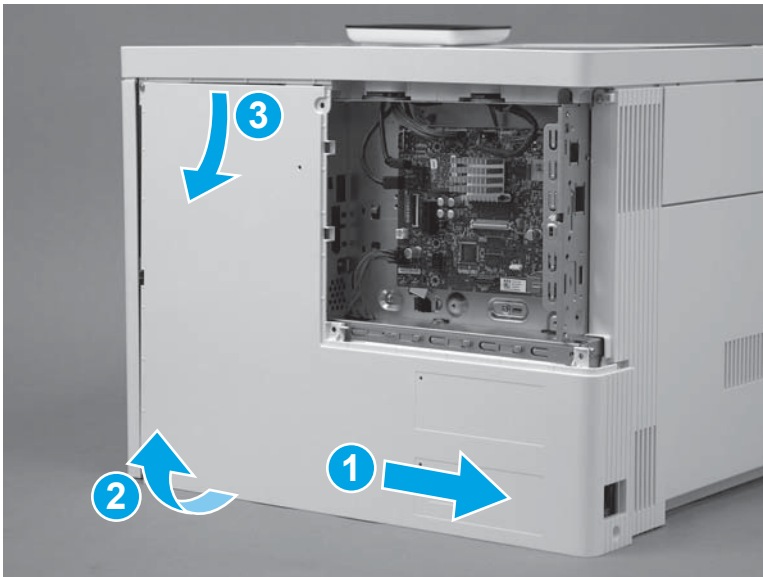

Step 13: Remove the rear upper cover (M577)

 **NOTE:** This step is for the M577 models. For the M552 and M553 models, skip this step and go to [Step 20: Remove the left cover on page 2483](#).

1. Remove two screws (callout 1).

 **Reinstallation tip:** These two screws are self-tapping screws for plastic. When reinstalling them, rotate the screws counterclockwise to align them with the existing thread pattern, and then carefully turn them clockwise to tighten. Do not overtighten. This will prevent stripping the threads inside the screw holes.

Figure 1-4453 Remove two screws



2. Use a small, flat blade screwdriver to release the right edge of the cover.

Figure 1-4454 Release the right edge

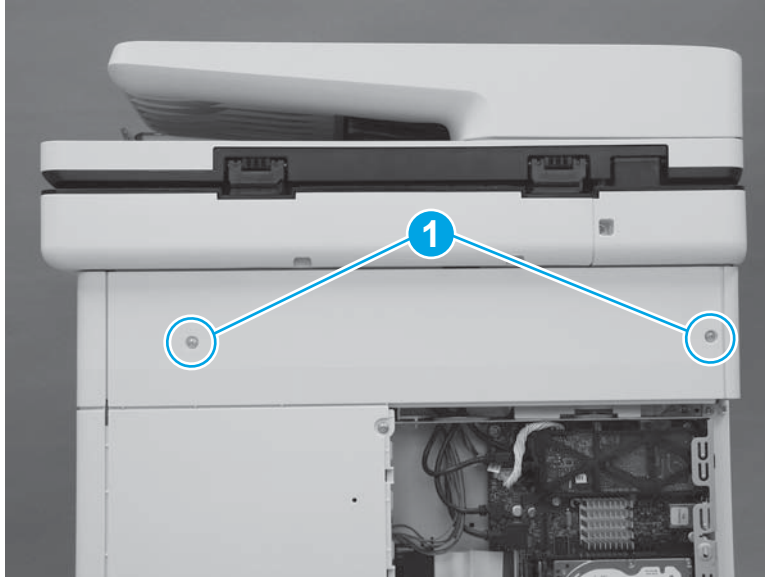
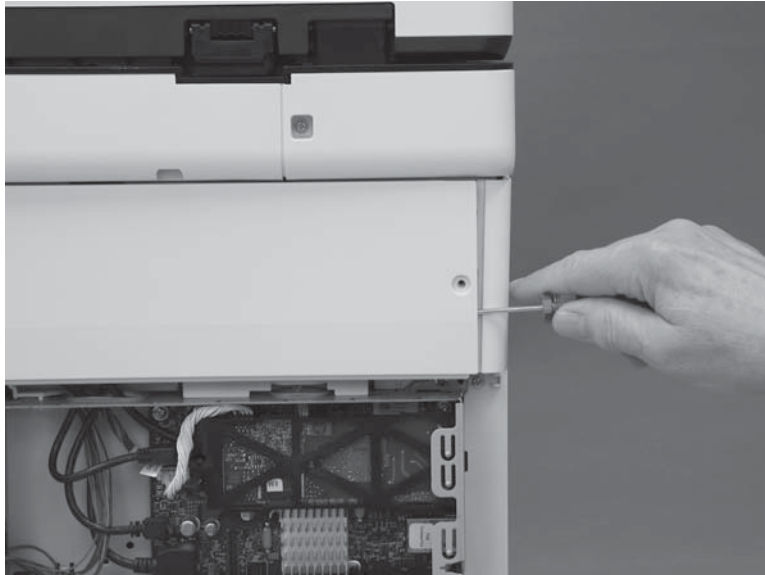

3. Pull the right edge of the cover (callout 1) away from the printer, and then slide the cover to the right (callout 2).

Figure 1-4455 Slide the cover right

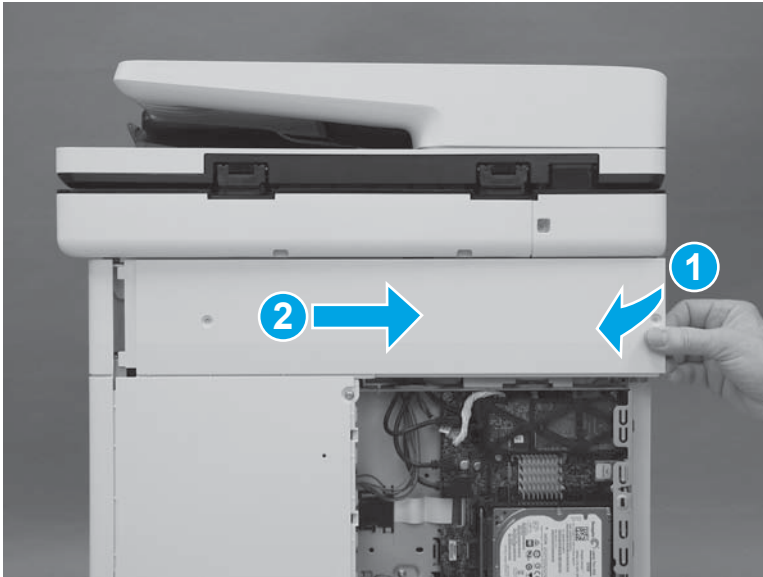

4. Remove the cover.

Figure 1-4456 Remove the cover

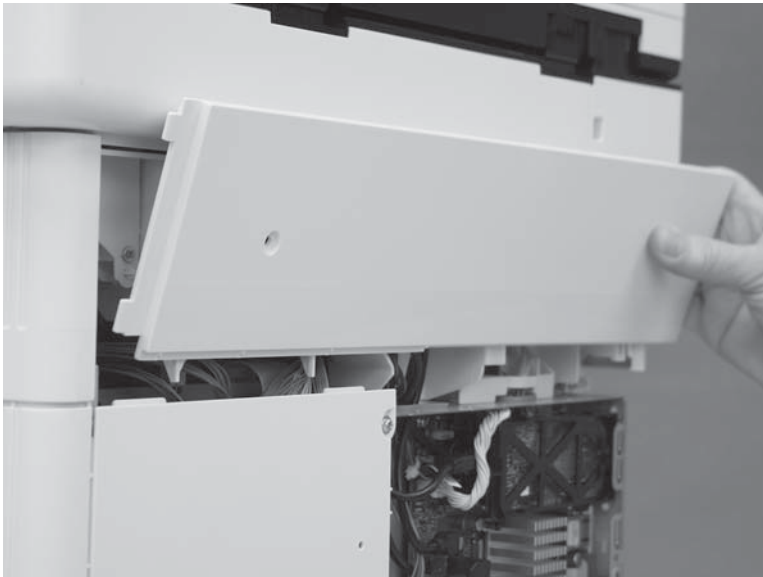

Step 14: Remove the rear cover (M577)

 **NOTE:** This step is for the M577 models. For the M552 and M553 models, skip this step and go to [Step 20: Remove the left cover on page 2483](#).

1. Remove four screws (callout 1).

Figure 1-4457 Remove four screws

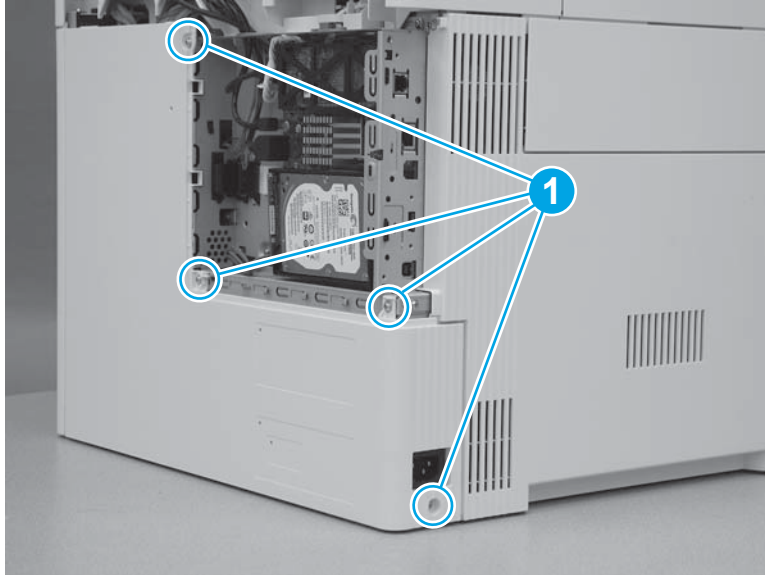

2. Slide the cover to the right to remove it.

Figure 1-4458 Remove the cover

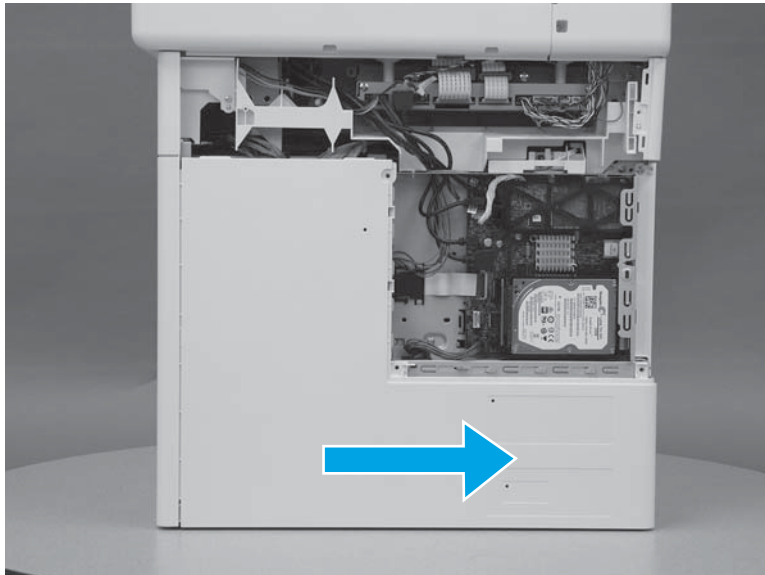

Step 15: Remove the left upper cover (M577)

 **NOTE:** This step is for the M577 models. For the M552 and M553 models, skip this step and go to [Step 20: Remove the left cover on page 2483](#).

1. At the left side of the printer, release one tab (callout 1).

Figure 1-4459 Release one tab

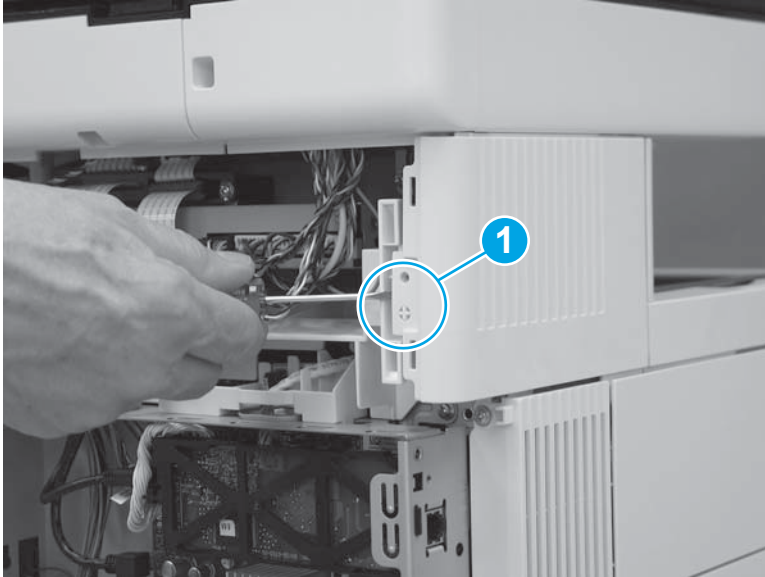

2. Slide the left upper cover toward the back of the printer.

Figure 1-4460 Slide the cover back

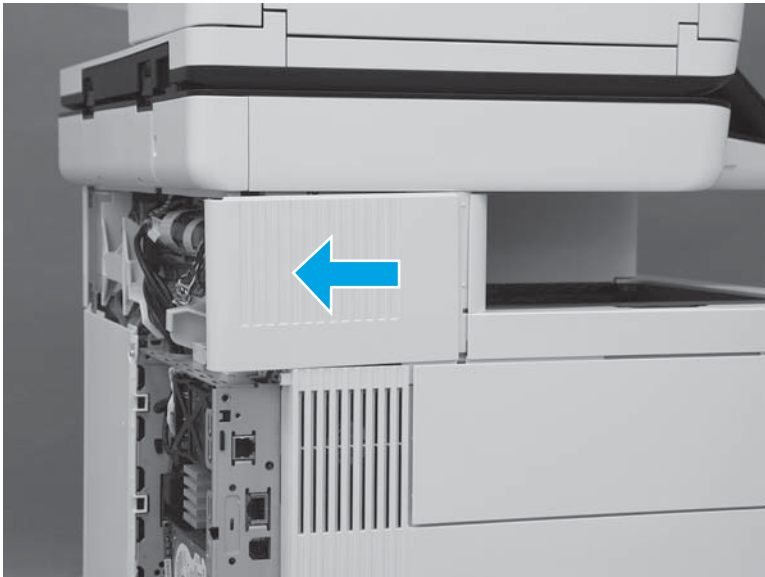

3. Rotate the cover up to remove it.

Figure 1-4461 Remove the left upper cover



Step 16: Remove the right front upper cover (M577dn)

 **NOTE:** This step is for the M577dn model. For the M577c/f/z models, skip this step and to go [Step 17: Remove the stapler cover assembly \(M577c/f/z\) on page 2476](#).

For the M552 and M553 models, skip this step and go to [Step 20: Remove the left cover on page 2483](#).

1. Slide the cover toward the left side of the printer to install it. Make sure that the slots (callout 1) in the cover fit over the tabs (callout 2) on the inside of the paper feeder cover.

Figure 1-4462 Install the cover



2. Press the right front upper cover (callout 1) and the paper feeder cover (callout 2) together until the tabs on the inside of the covers snap into place.

Figure 1-4463 Press the cover



3. Install one screw (callout 1).

Figure 1-4464 Install one screw

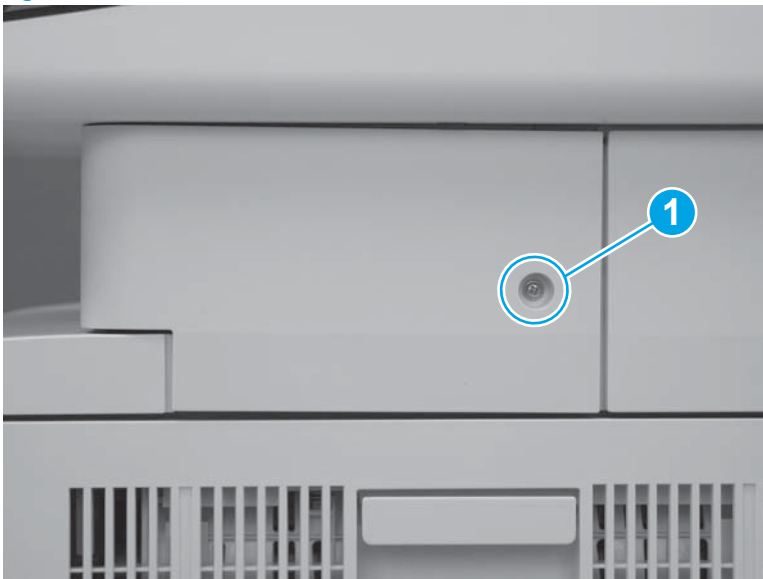

Step 17: Remove the stapler cover assembly (M577c/f/z)

 **NOTE:** This step is for the M577c/f/z models. For the M577dn model, skip this step and to go [Step 19: Remove the right upper cover \(M577dn\) on page 2481](#).

For the M552 and M553 models, skip this step and go to [Step 20: Remove the left cover on page 2483](#).

1. Remove one screw (callout 1).

 **Reinstallation tip:** This is a self-tapping screw for plastic. When reinstalling, rotate the screw counterclockwise to align it with the existing thread pattern, and then carefully turn it clockwise to tighten. Do not overtighten. This will prevent stripping the threads inside the screw hole.

Figure 1-4465 Remove one screw



2. Release two tabs at the front edge of the cover (callout 1).

Figure 1-4466 Release two tabs

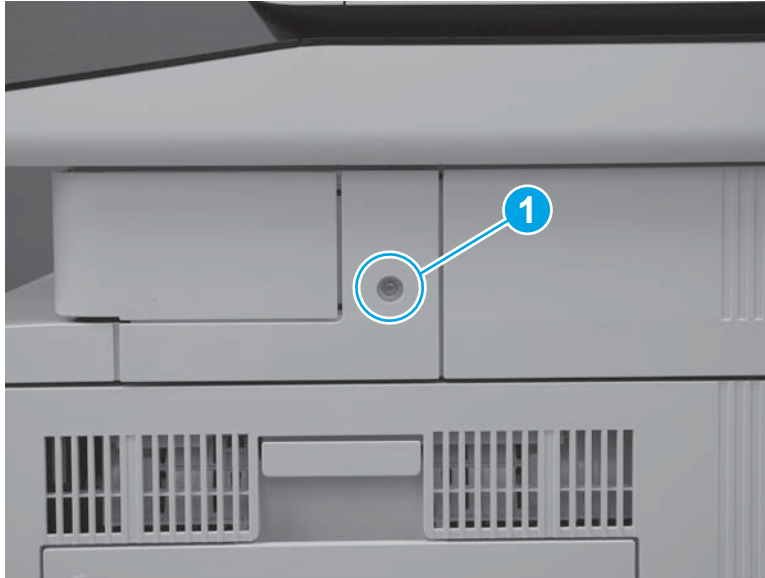

3. Release the back edge of the cover.

Figure 1-4467 Release the back edge of the cover

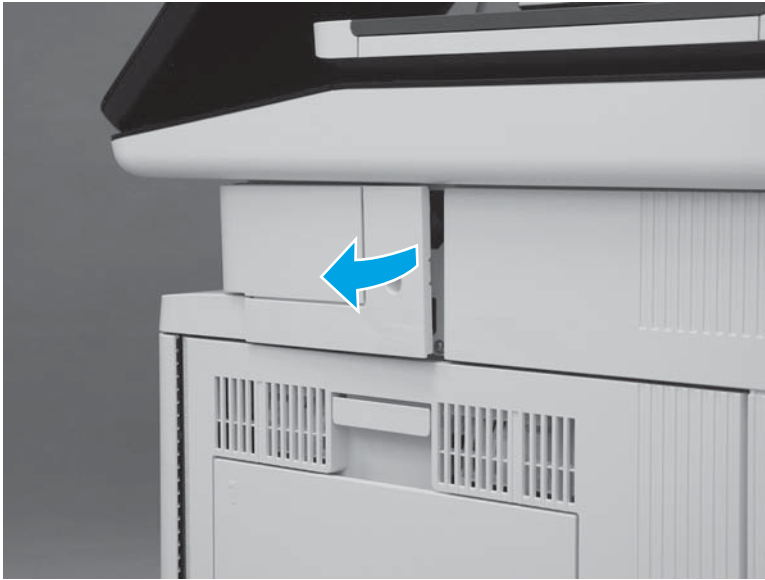



4. Rotate the cover away from the printer to remove it.

Figure 1-4468 Remove the cover



Step 18: Remove the integrated scanner assembly (ISA) (M577)

 **NOTE:** This step is for the M577 models. For the M552 and M553 models, skip this step and go to [Step 20: Remove the left cover on page 2483](#).

 **NOTE:** The ISA includes the document feeder, image scanner, scanner control board (SCB), control panel, keyboard (M577c/z) and NFC PCA (M577z).

1. At the left side of the printer, remove one screw (callout 1).

Figure 1-4469 Remove one screw

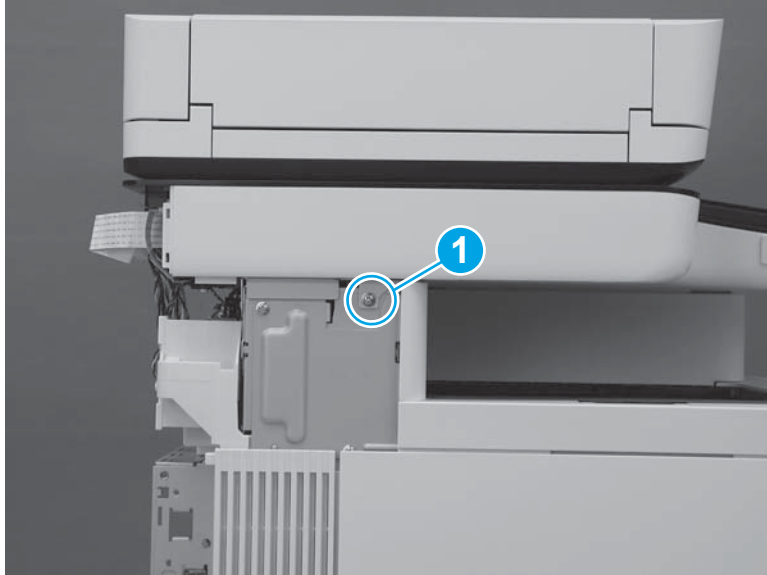

2. At the back side of the printer, remove two screws (callout 1).

Figure 1-4470 Remove two screws

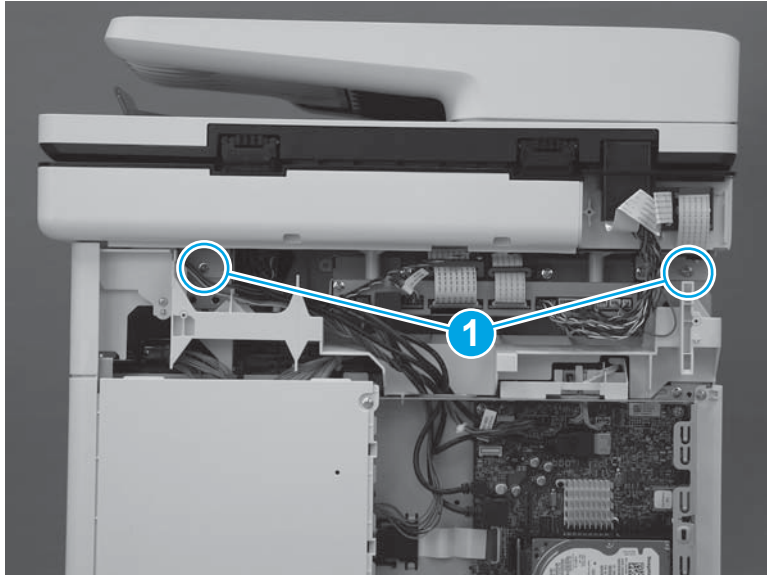

3. At the right side of the printer, remove one screw (callout 1).

Figure 1-4471 Remove one screw

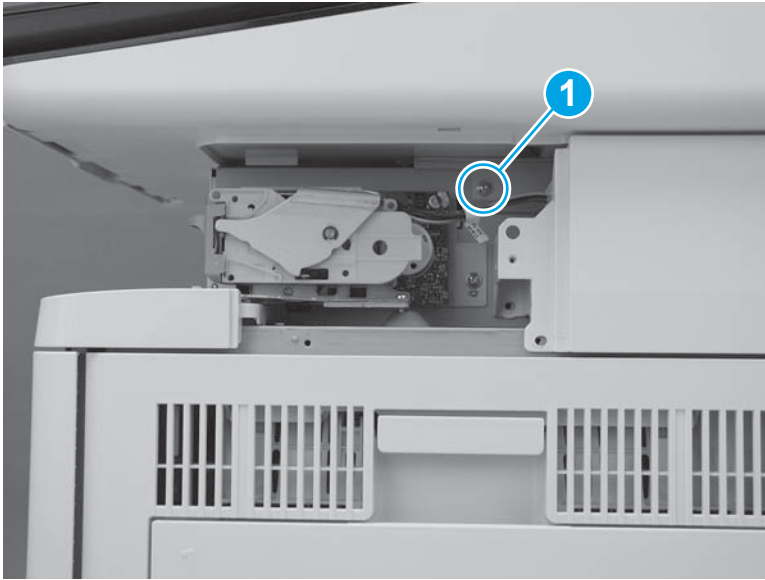

4. Disconnect two connectors on the scanner control board (callout 1).

M577c/f/z only: Disconnect one connector for the stapler on the scanner control board (callout 2).

Figure 1-4472 Disconnect connectors

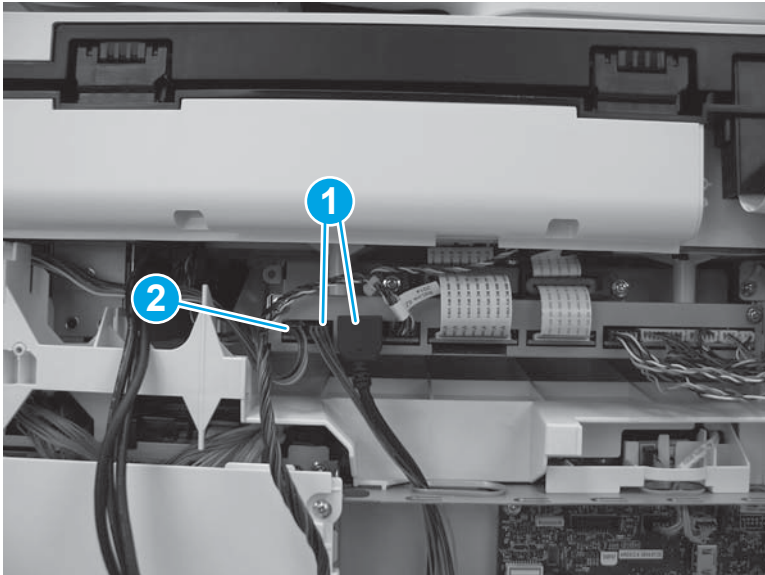

5. Slightly slide the ISA towards the back of the printer to release it.

Figure 1-4473 Slide the ISA towards the back of the printer

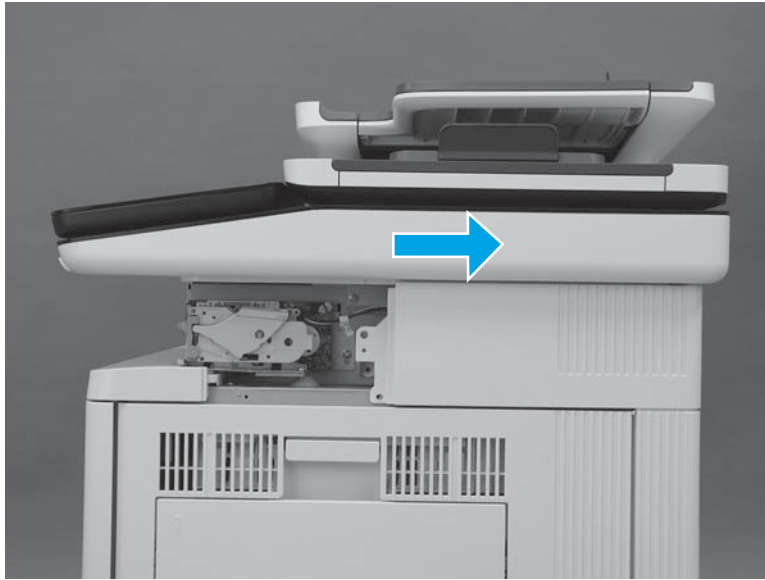

6. Lift the ISA up to remove it.

 **NOTE:** When lifting the ISA, carefully pass the cables through the opening in the top of the formatter case.

Figure 1-4474 Remove the ISA

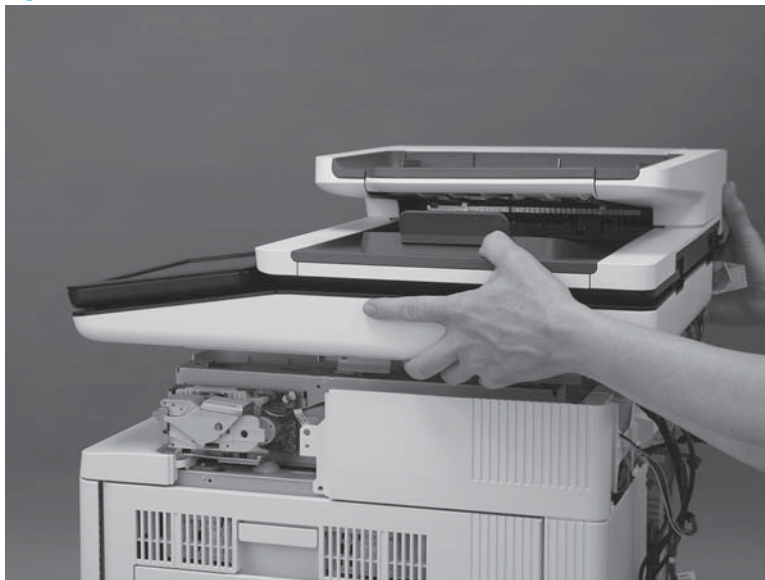

Step 19: Remove the right upper cover (M577dn)

 **NOTE:** This step is for the M577 models. For the M552 and M553 models, skip this step and go to [Step 20: Remove the left cover on page 2483](#).

 **NOTE:** The figures below show the image scanner installed. The procedures for removing and installing the right upper cover are the same whether the image scanner is installed or removed."

1. At the right side of the printer, remove two screws (callout 1).

M577c/f/z only: Disconnect one connector (callout 2), if it was not already disconnected in a previous step.

Figure 1-4475 Remove two screws and one connector

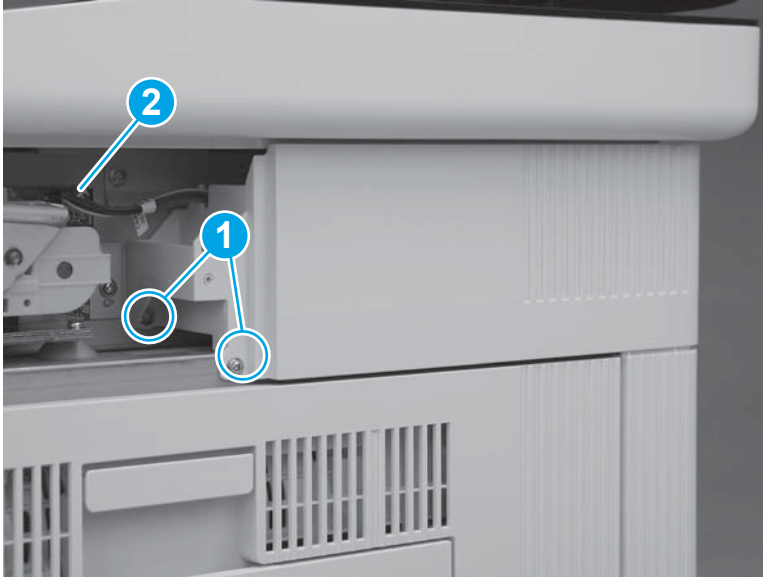

2. At the back of the printer, remove one screw (callout 1).

M577c/f/z only: Disconnect one connector (callout 2), if it was not already disconnected in a previous step.

 **Reinstallation tip:** This screw is smaller than the screws removed in the previous step. When reinstalling the right upper cover, make sure that this screw is installed in the correct position.

Figure 1-4476 Remove one screw and connector



3. Slide the cover toward the back of the printer.

Figure 1-4477 Slide the cover

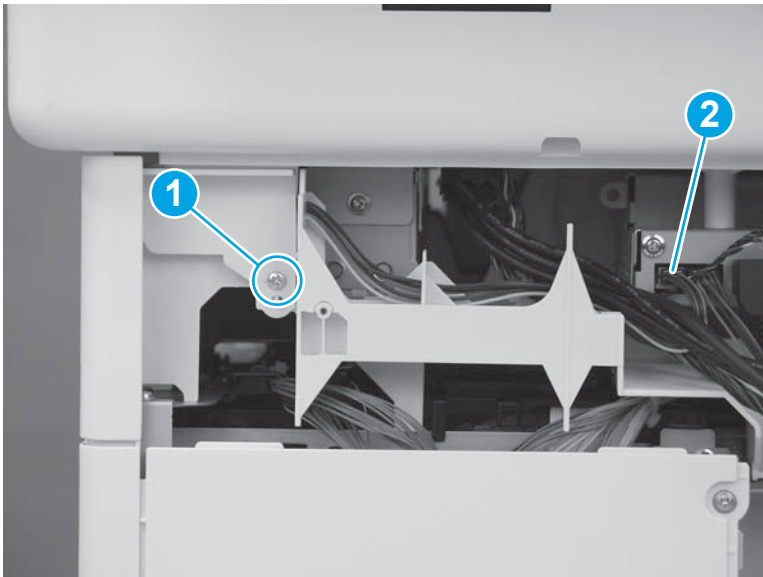
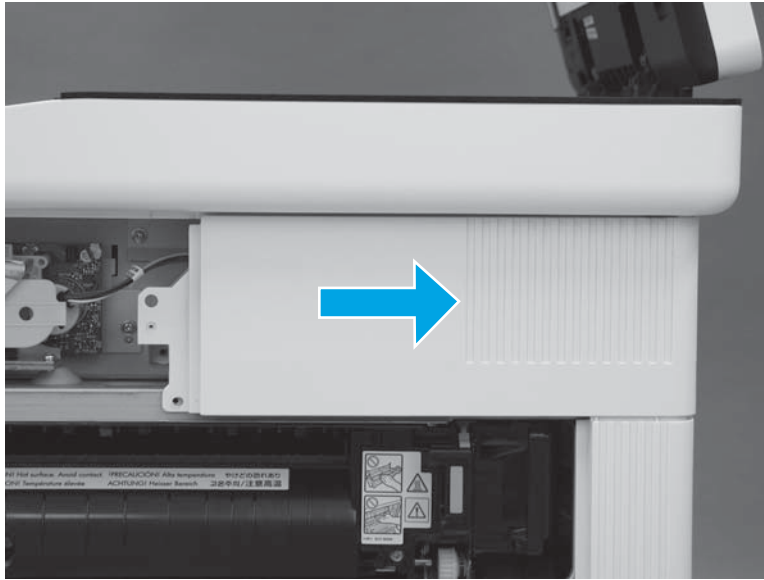

4. Lift the cover away from the printer to remove it.

M577c/f/z only: Release the cables (callout 1) through the slot (callout 2) in the printer.

Figure 1-4478 Remove the cover

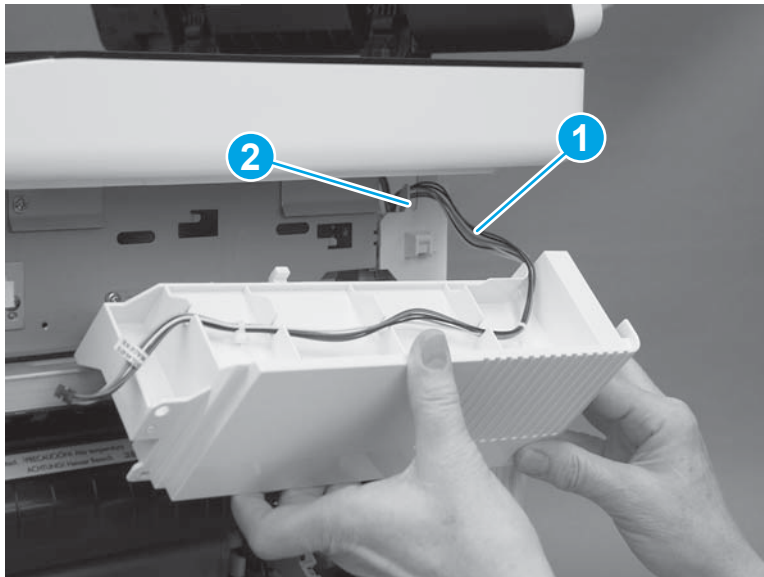

Step 20: Remove the left cover

1. At the left side of the printer, remove one screw (callout 1).

Figure 1-4479 Remove one screw



2. Release one tab (callout 1), rotate the front edge of the cover away from the printer (callout 2), and then slide the cover (callout 3) toward the rear of the printer to release it.

Figure 1-4480 Release the cover

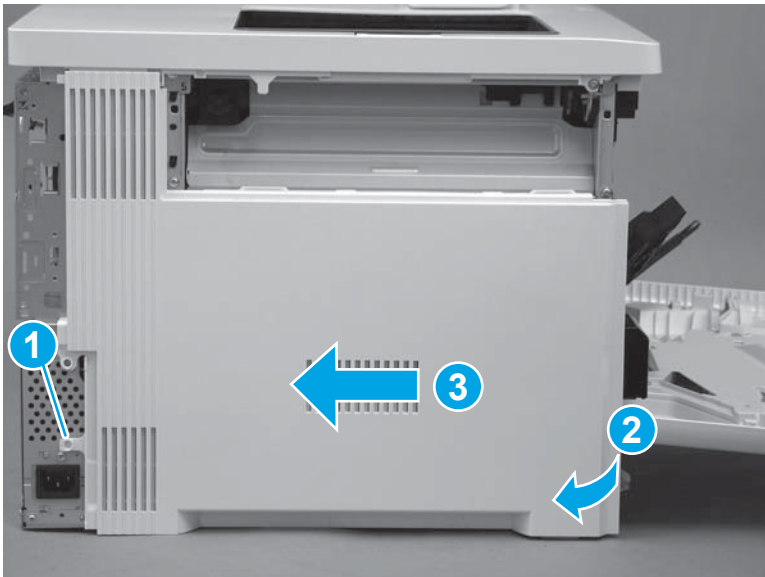

3. Remove the cover.

Figure 1-4481 Remove the cover

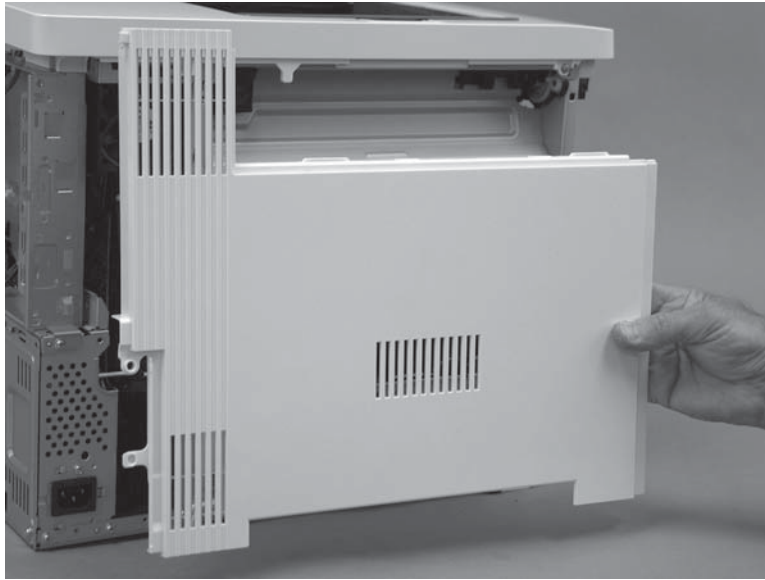

Step 21: Remove the upper cover (M552 and M553)

 **NOTE:** This step is for the M552 and M553 models. For the M577 models, skip this step and go to [Step 22: Remove the right rear cover on page 2487](#).

1. Remove three screws (callout 1).

Figure 1-4482 Remove three screws

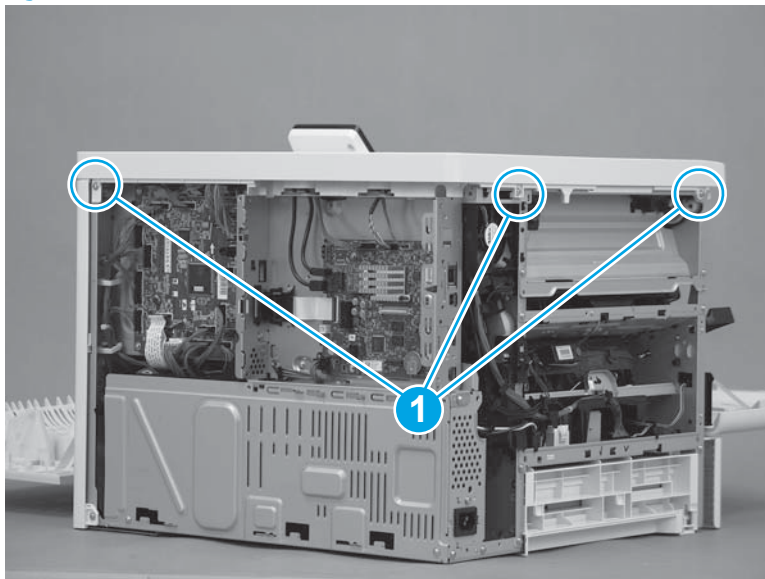

2. Remove one screw (callout 1), release one tab (callout 2), and then slightly separate the corner of the cover from the chassis.

 **NOTE:** This is a self-tapping plastic-thread screw. Make sure that this screw is used in this location when it is reinstalled.

Figure 1-4483 Remove one screw and release one tab



3. Release one tab (callout 1), and then lift up on the cover to release it.

 **NOTE:** If the cover does not release, check for addition tabs by locating the triangles embossed in the cover at tab locations.

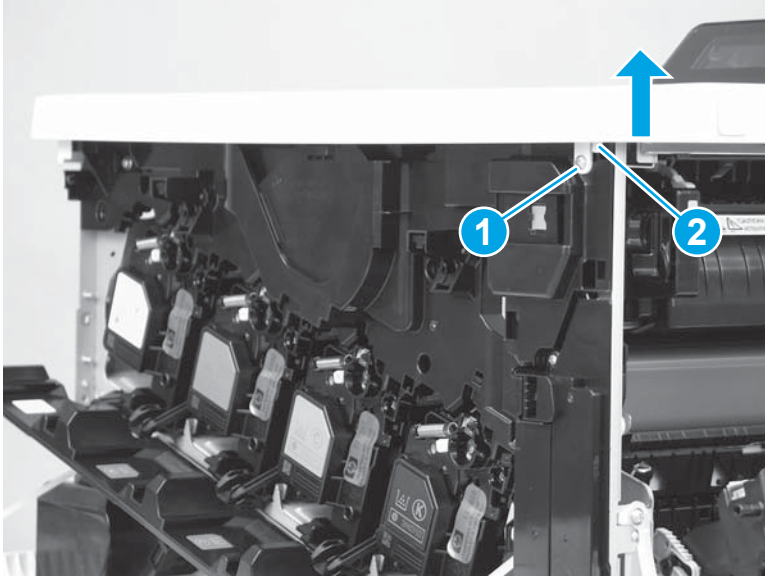
Figure 1-4484 Release the cover



4. Remove the cover.

Figure 1-4485 Remove the cover

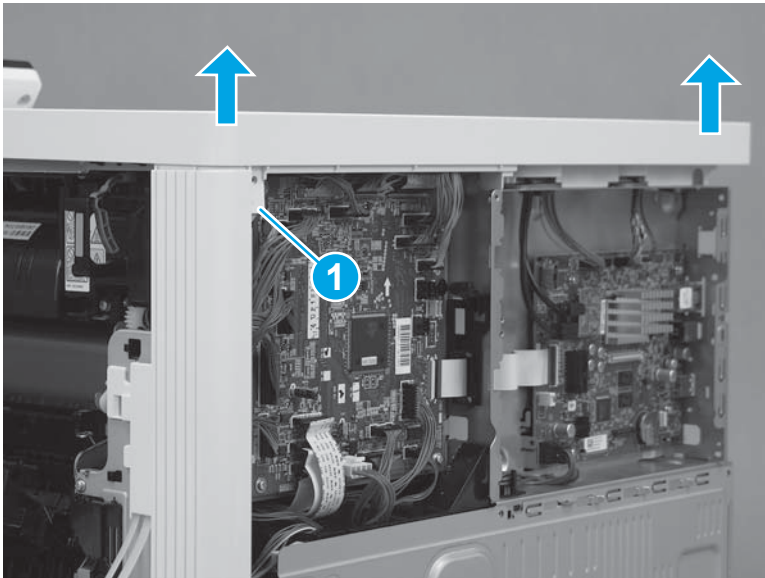
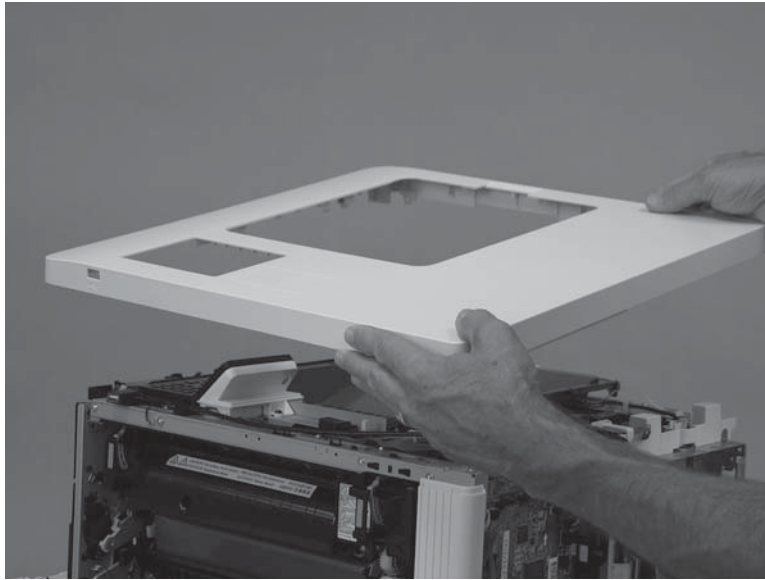

Step 22: Remove the right rear cover

1. Remove one screw (callout 1), and then slide the cover toward the rear of the printer (callout 2) to release it.

 **TIP:** If the right door is closed, open it now.

Figure 1-4486 Release the cover



2. Remove the cover.

Figure 1-4487 Remove the cover

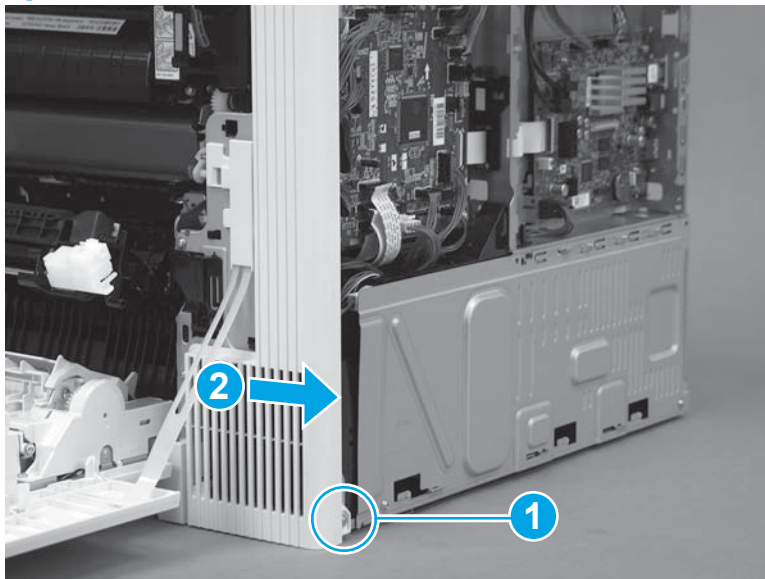
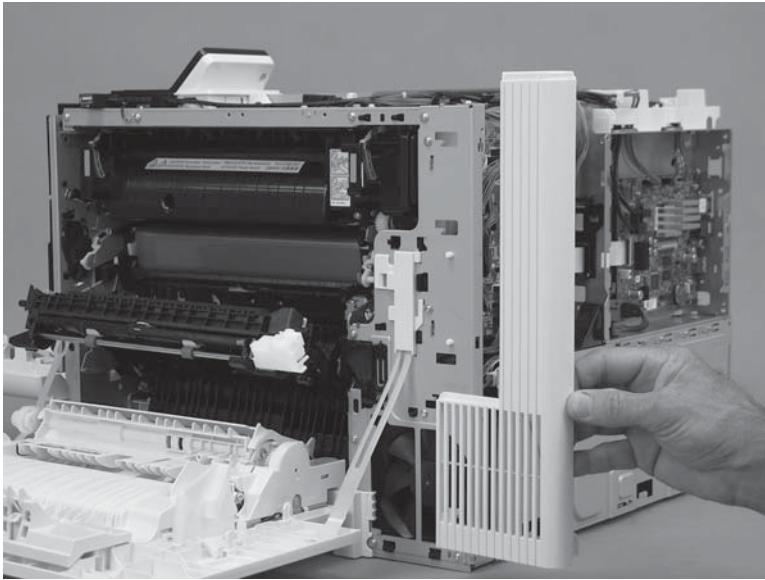

Step 23: Remove the formatter case

1. **M577 only:** Disconnect one connector (callout 1), and then pass the wire harness (callout 2) through two openings in the formatter case (callout 3).

Figure 1-4488 Disconnect one connector

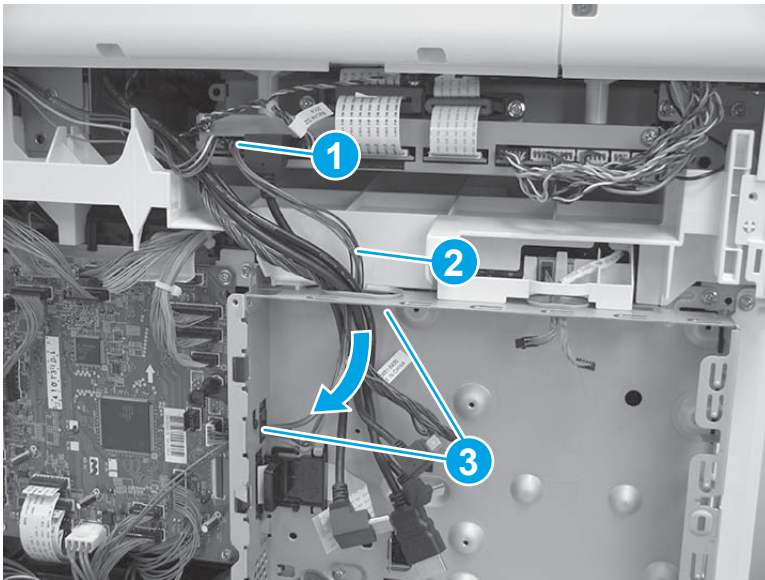

2. Release two tabs (callout 1) on the black plastic bracket. Hold the tabs in the released position, and then slide the bracket (callout 2) to the right to remove it from the formatter case.

Figure 1-4489 Remove the bracket

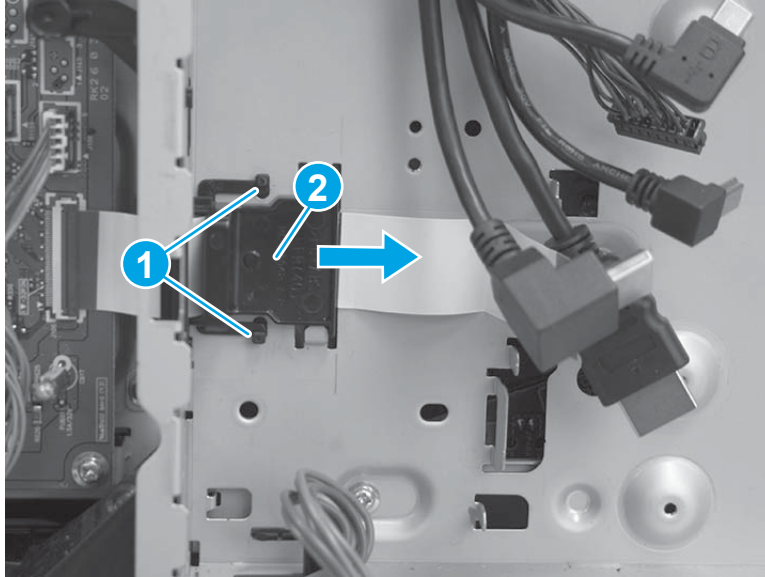

3. Remove two screws (callout 1), and then slide the low-voltage power supply (LVPS) cover to the right to remove it.

Figure 1-4490 Remove the LVPS cover

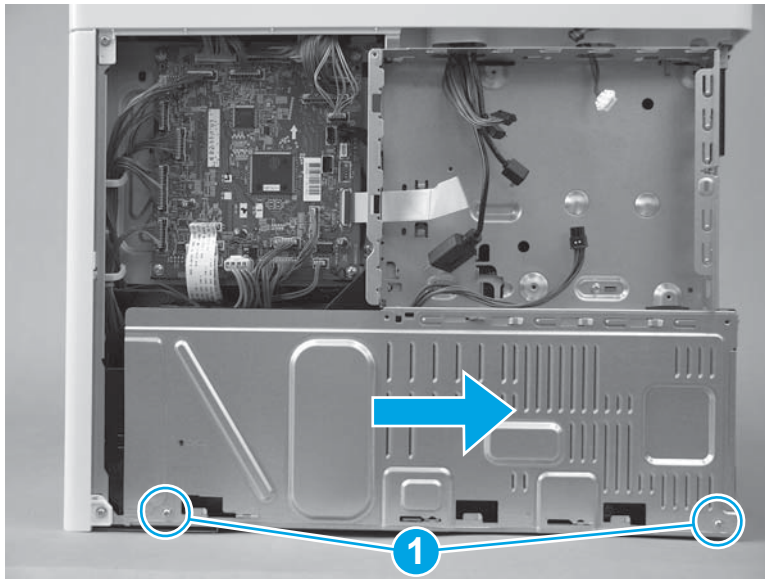

4. Pass two wire harnesses and one flat cable (callout 1) through the opening in the formatter case, and then release one wire harness from the retainer (callout 2).

⚠ CAUTION: The flat cable might be attached to the formatter case with double-sided tape. Make sure that this tape is released, so that the flat cable is not damaged when the formatter case is removed.

Figure 1-4491 Release wire harnesses and flat cable

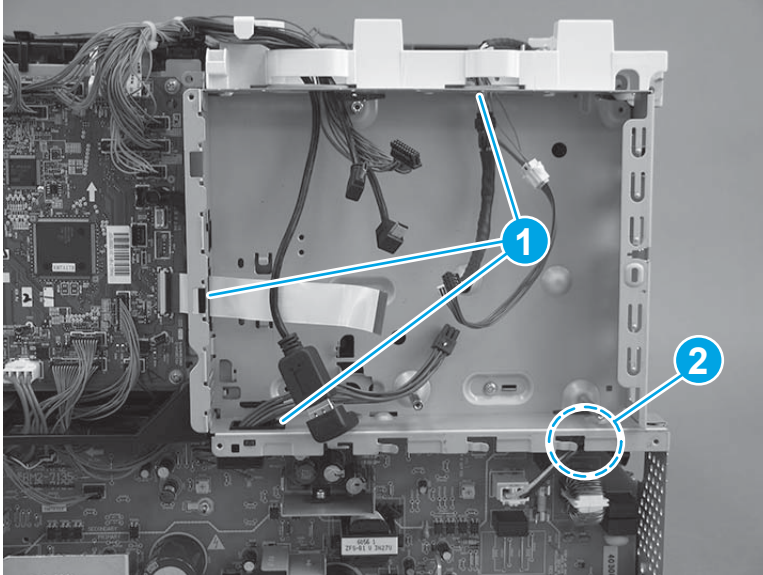

5. Remove six screws (callout 1).

Figure 1-4492 Remove six screws

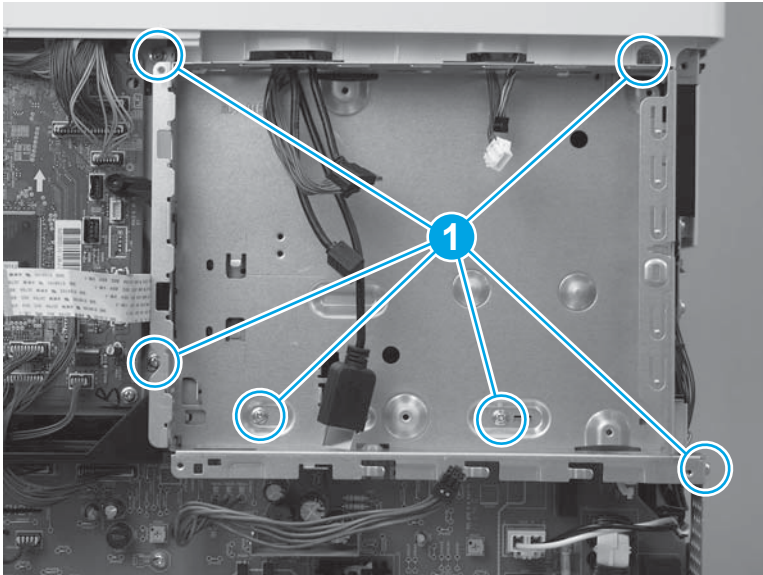

6. Rotate the bottom of the formatter case away from the printer (callout 1), and then pull it down (callout 2) to release it.

Figure 1-4493 Release the formatter case

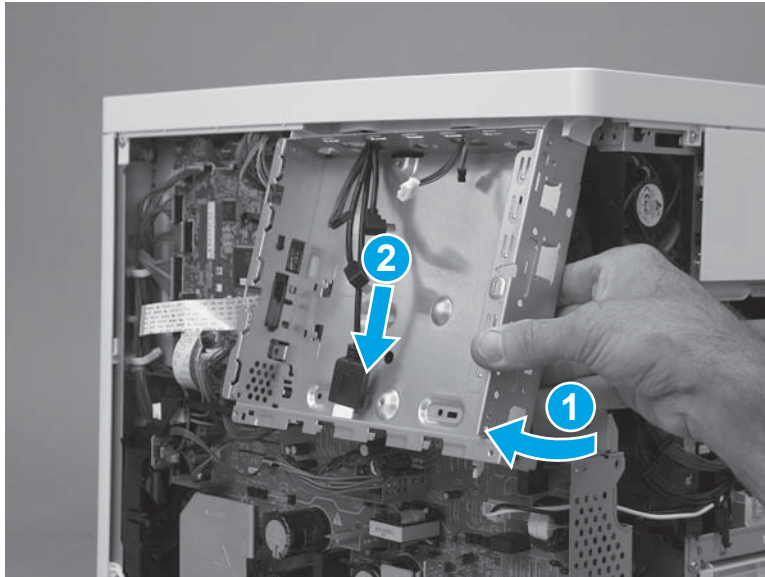

7. Pass the wire harnesses through the opening in the formatter case to remove it.

 **IMPORTANT:** If the formatter case is removed so that it can be replaced, make sure to transfer the memory PCA (island of data) and plastic bracket (callout 1) to the replacement case.

Figure 1-4494 Remove the formatter case



Step 24: Remove the low-voltage power supply (LVPS)

 **CAUTION:**  ESD-sensitive part.

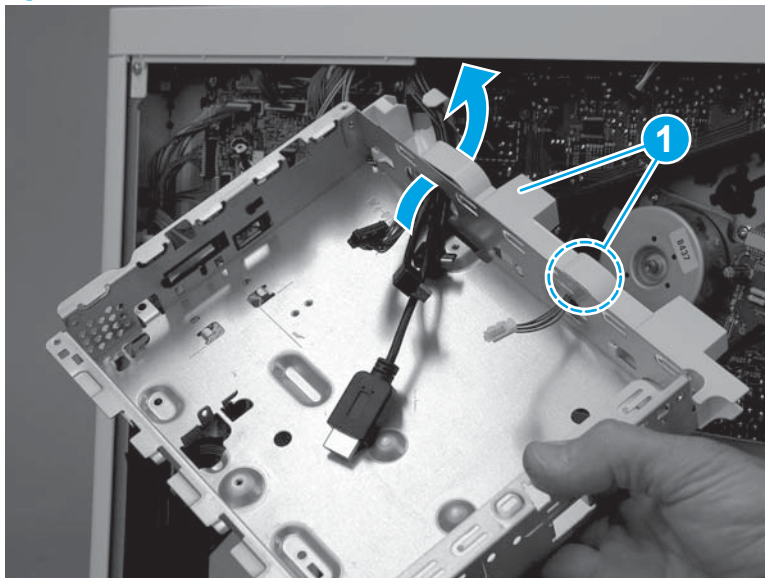
1. Disconnect one wire harness (callout 1), and then pass the wire harness through the opening (callout 2) in the chassis.

Figure 1-4495 Disconnect one wire harness

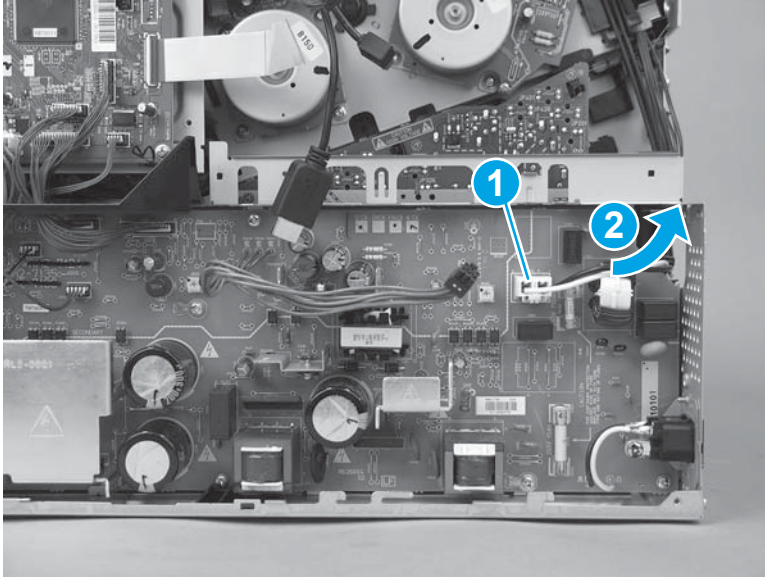

2. Disconnect three connectors on the DC controller (callout 1), and then disconnect four connectors (callout 2) on the LVPS.

Figure 1-4496 Disconnect seven connectors

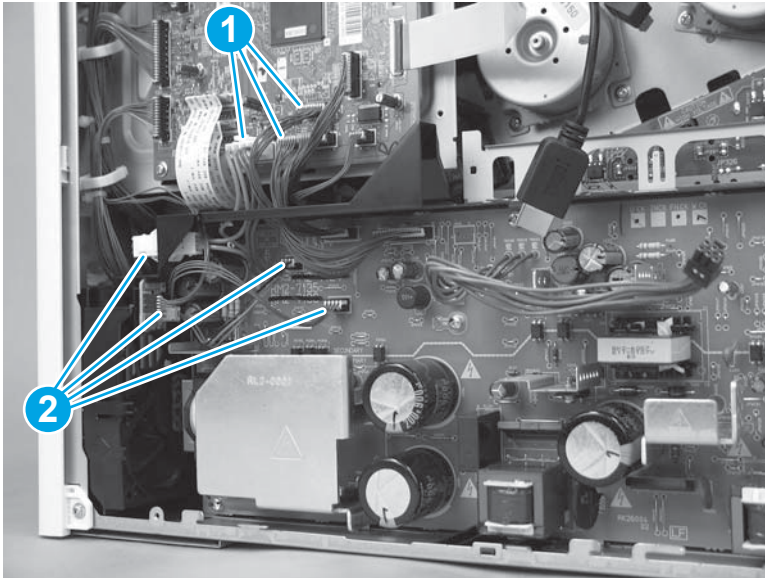

3. Pass the wire harnesses from the DC controller to the LVPS through the opening in the chassis (callout 1), and then release the wire harnesses from the retainer (callout 2).

Figure 1-4497 Pass the wire harnesses through the opening

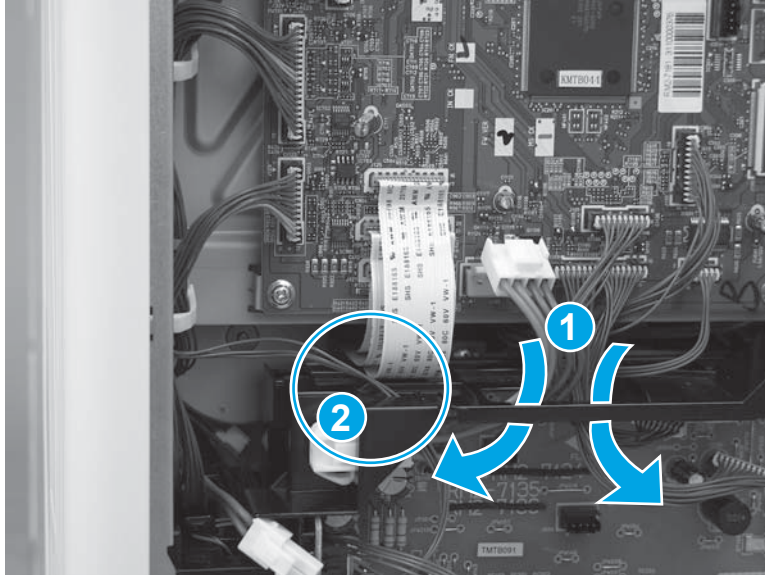

4. Remove three screws (callout 1).

Figure 1-4498 Remove three screws

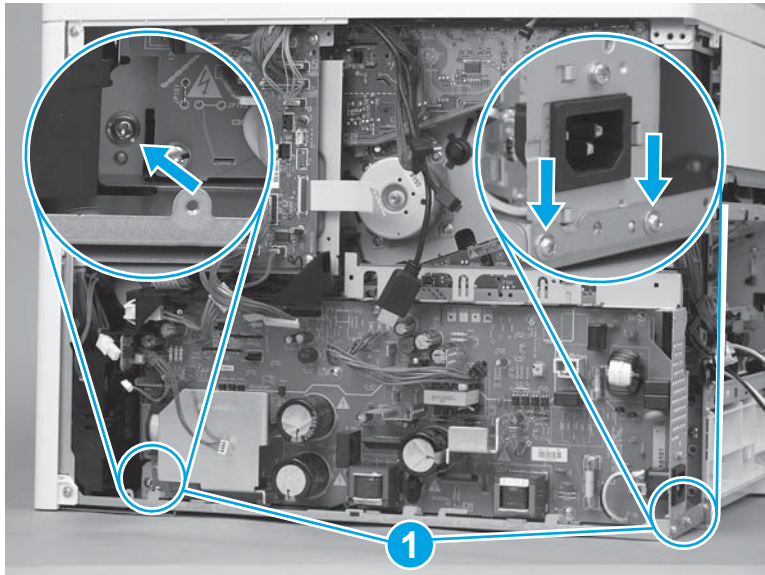

5. Rotate the top of the LVPS away from the printer (callout 1), and then slide it up and out (callout 2) of the printer to remove it.

Figure 1-4499 Remove the LVPS

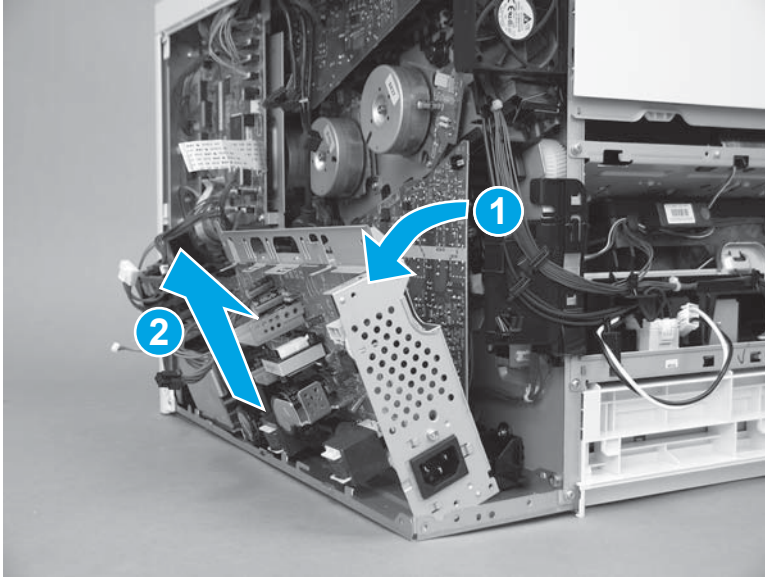

Step 25: Remove the power supply fan (FM1)

1. Remove one screw (callout 1).

Figure 1-4500 Remove one screw

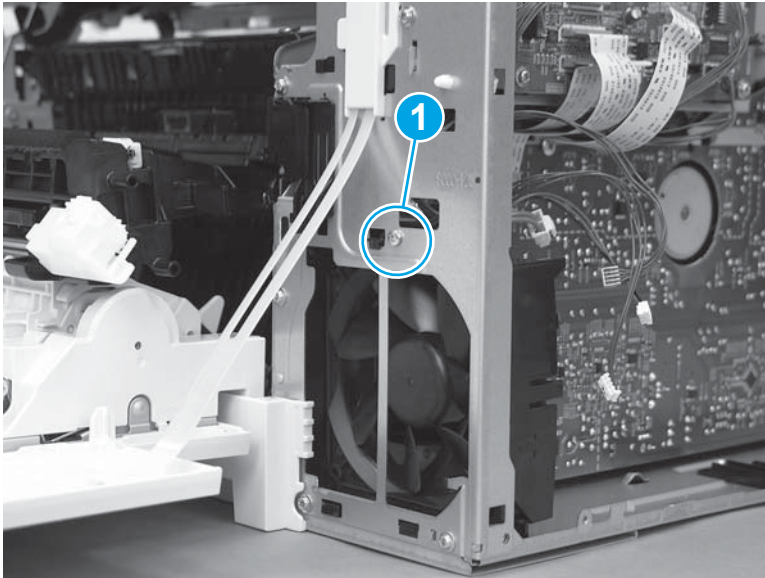

2. Release the wire harnesses from the retainer on the top of the fan bracket.

Figure 1-4501 Release the wire harnesses

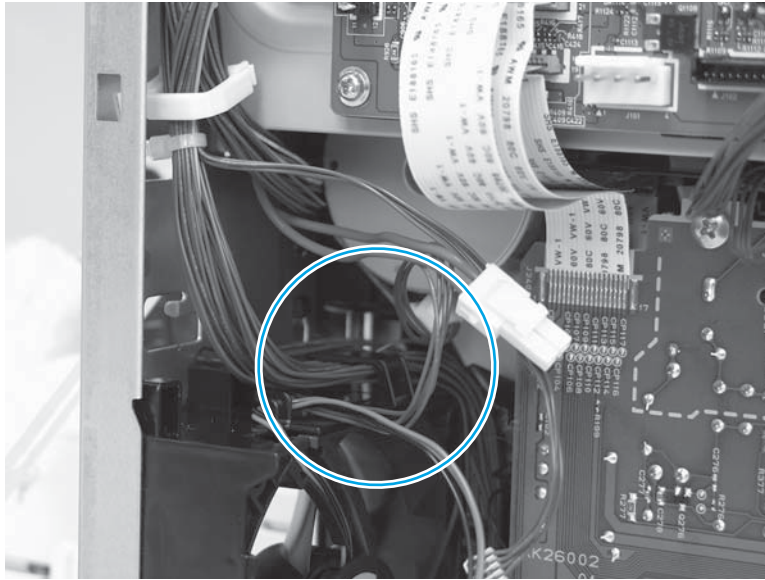

3. Lift the fan up (callout 1), and then slide it out of the printer (callout 2) to remove it.

Figure 1-4502 Remove the fan

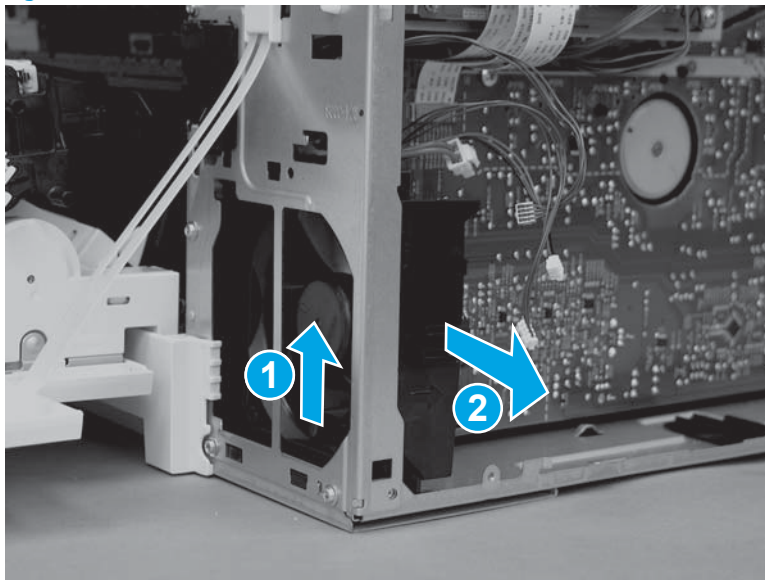

Step 26: Remove the high-voltage power supply D (HVPSD)

 **CAUTION:**  ESD-sensitive part.

1. Disconnect one flat cable (callout 1) on the DC controller.

Figure 1-4503 Disconnect one flat cable

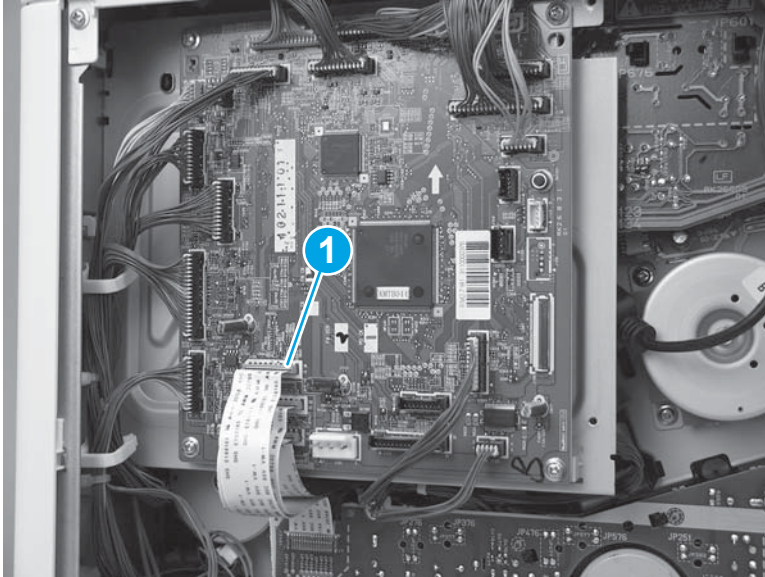

2. Remove two screws (callout 1), and then remove one self tapping screw (callout 2) on the HVPSD.

Figure 1-4504 Remove three screws

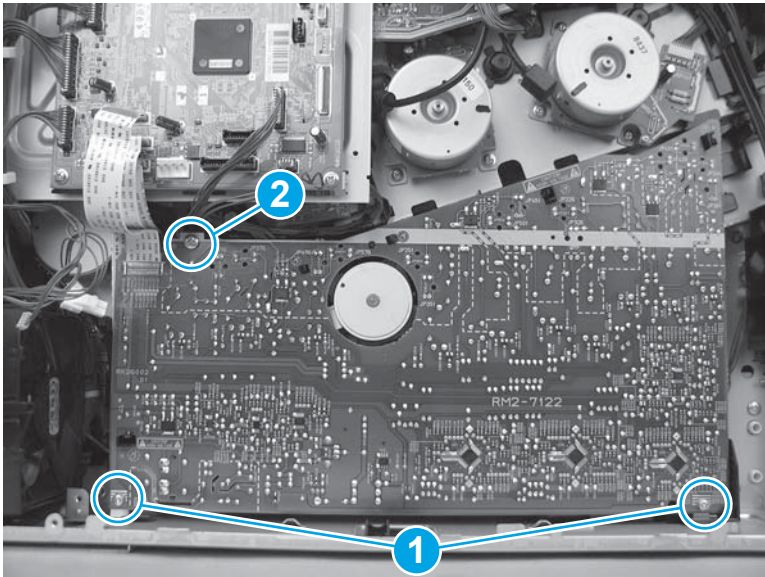

3. Release five tabs (callout 1), and then remove the HVPSD (callout 2).

Figure 1-4505 Remove the HVPSD

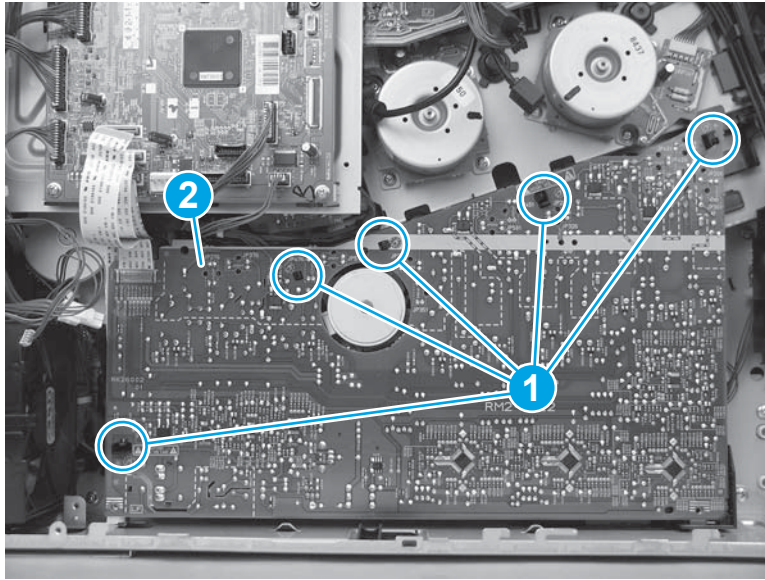

Step 27: Remove the lifter drive assembly

1. Disconnect two connectors (callout 1).

Figure 1-4506 Disconnect two connectors

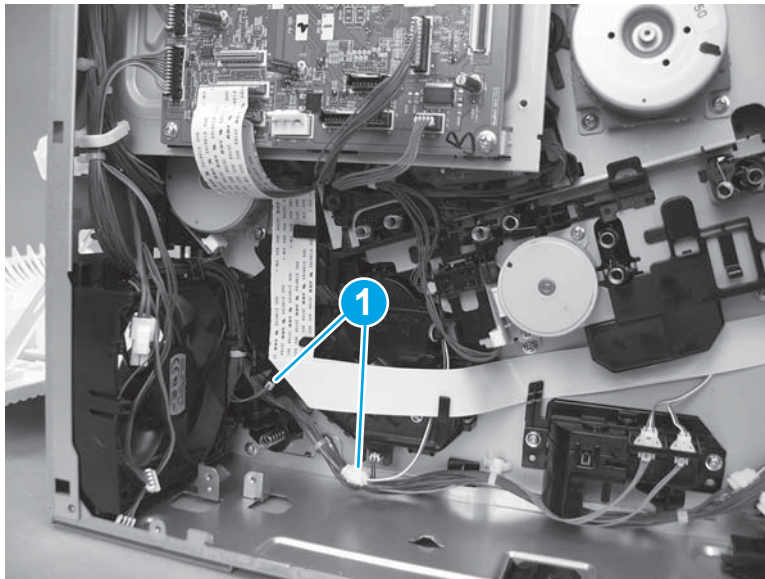

2. Disconnect two flat cables (callout 1), and then release them from the retainers (callout 2).

Figure 1-4507 Disconnect two flat cables

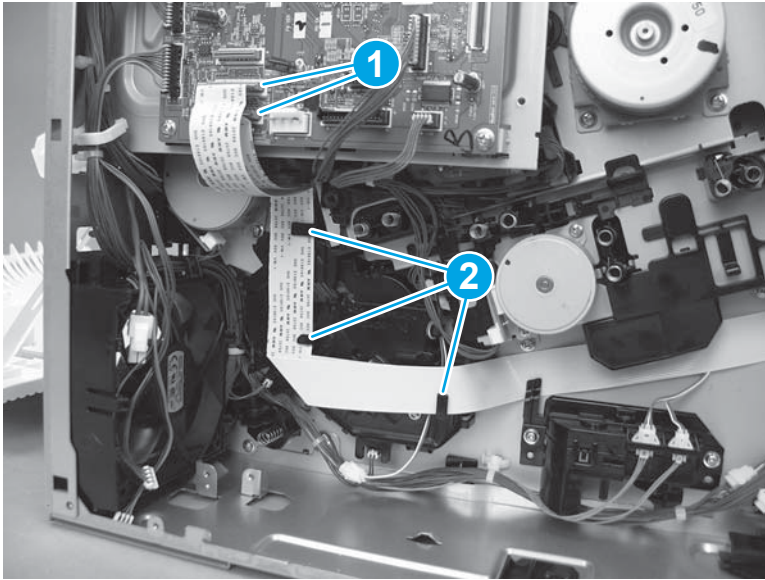

3. Remove two screws (callout 1), release one tab (callout 2), and then remove the lifter drive assembly (callout 3).

 **NOTE:** Release one wire harness from the retainer (callout 4) as the assembly is removed.

Figure 1-4508 Remove the assembly

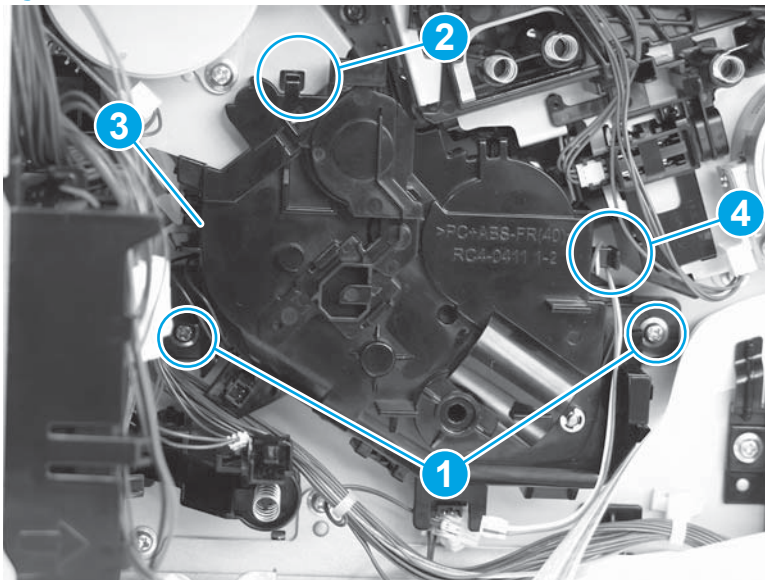

Step 28: Remove the DC controller and sheet-metal bracket

 **CAUTION:**  ESD sensitive part.

1. Disconnect all of the connectors, and then remove two screws (callout 1).

The following connectors are empty:

- J140, J141, and J143

Figure 1-4509 Remove two screws

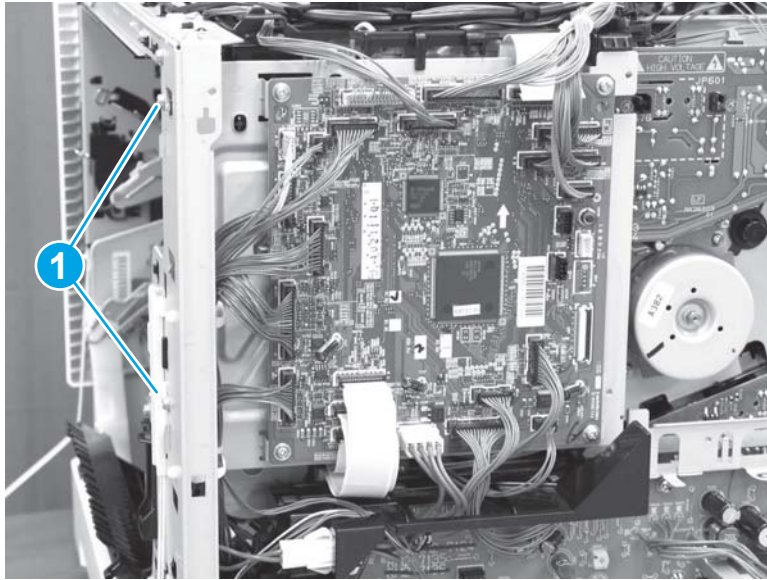

2. Lift up on the DC controller and sheet-metal plate to remove it.

Figure 1-4510 Remove the plate

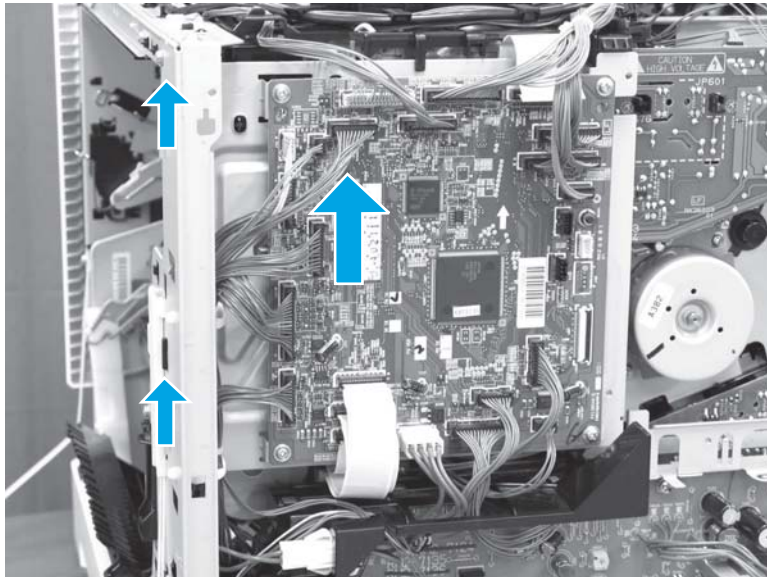

Step 29: Remove the pickup drive assembly and motor (M5)

1. Release one tab (callout 1), and then move the guide (callout 2) out of the way.

Figure 1-4511 Move the guide out of the way

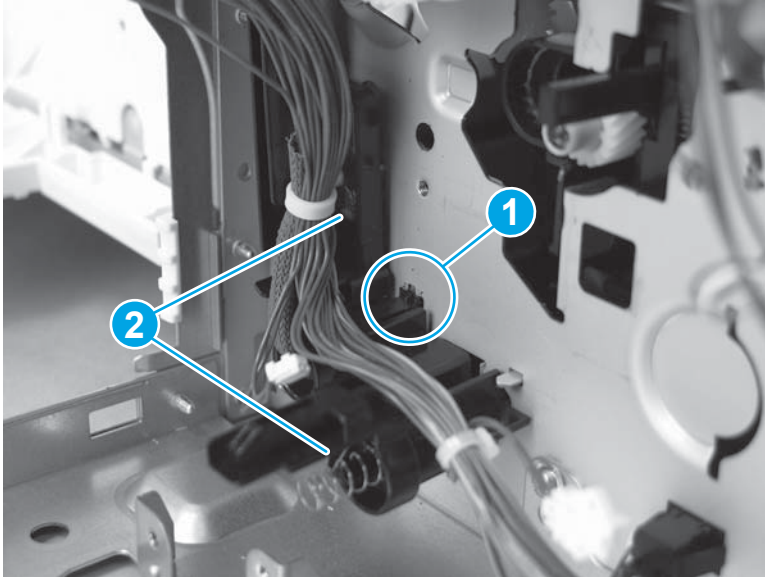

2. Remove three screws (callout 1).

Figure 1-4512 Remove three screws

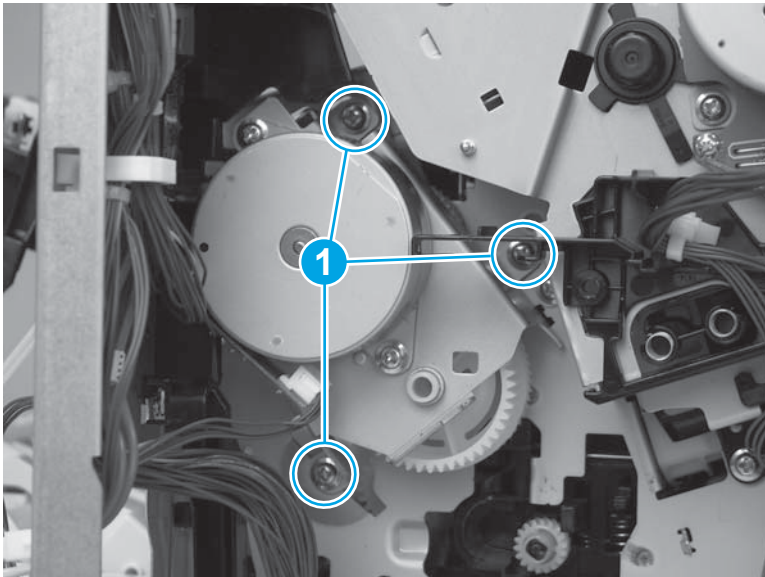

3. Remove the assembly.

CAUTION: One gear on the back side of the assembly is not captive. Handle the assembly carefully.

Figure 1-4513 Remove the assembly

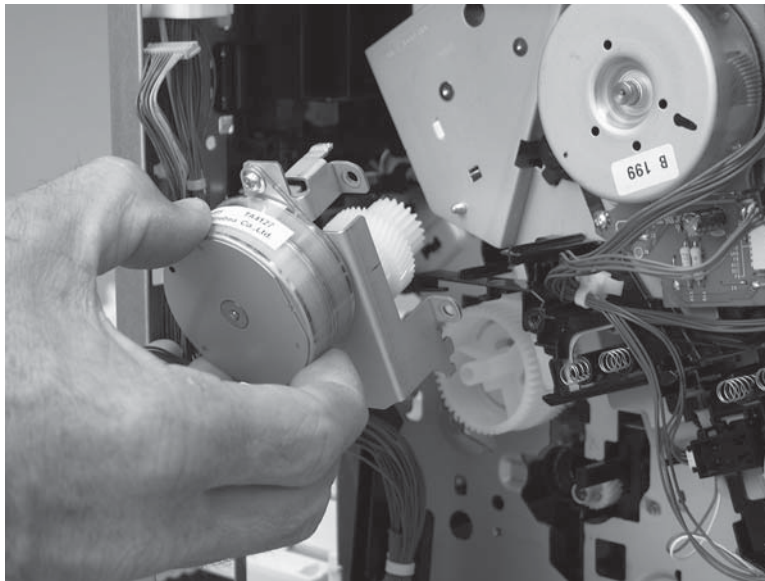

4. If the gear (callout 1) was not removed with the assembly in the previous step, remove it now.

Figure 1-4514 Remove the gear if installed

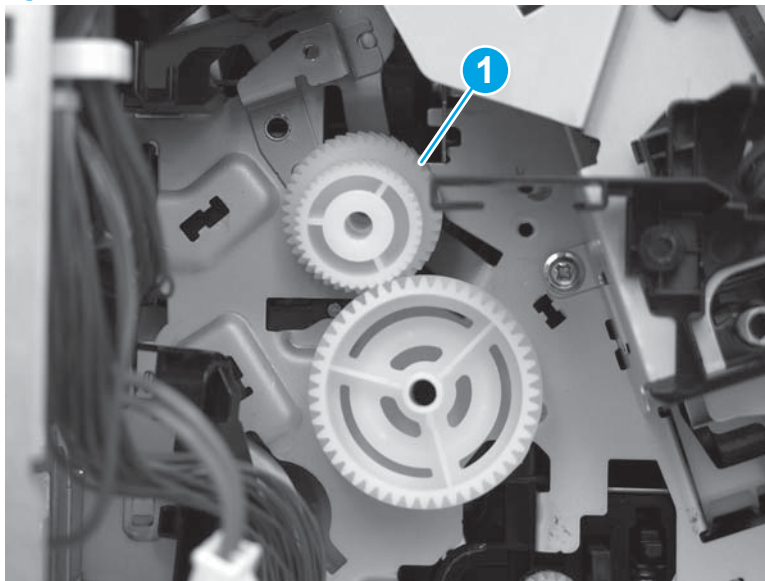

Step 30: Remove the registration assembly

1. At the right side of the printer, release one tab (callout 1).

Figure 1-4515 Release one tab

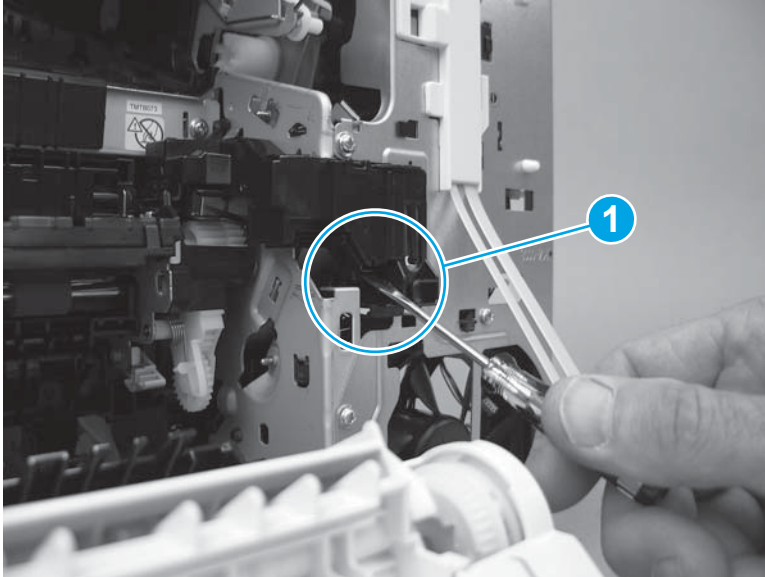

2. Remove the cover.

Figure 1-4516 Remove the cover

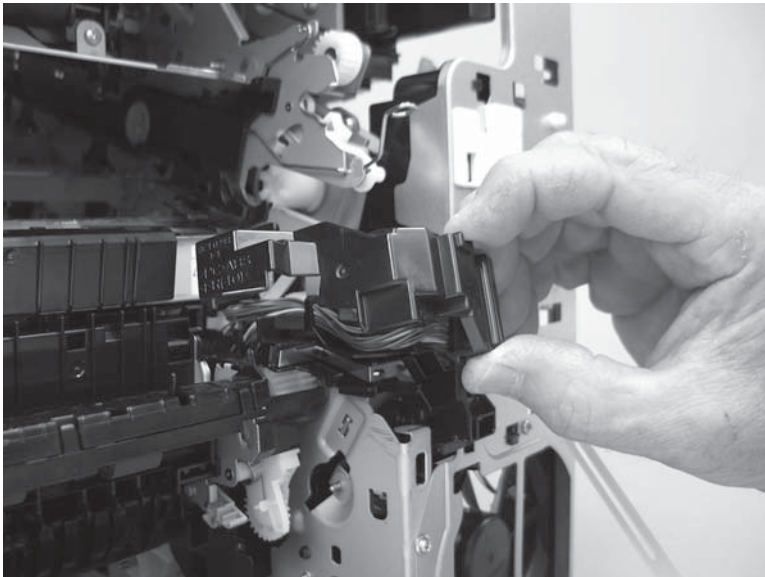

3. Release one tab (callout 1), and then push down on the guide (callout 2) to release it.

Figure 1-4517 Release the guide

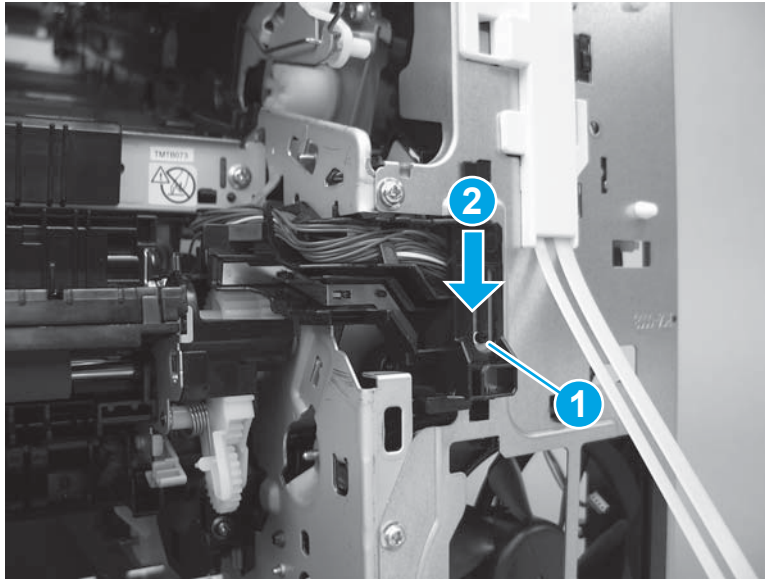

4. Move the guide out of the way.

Figure 1-4518 Move the guide out of the way

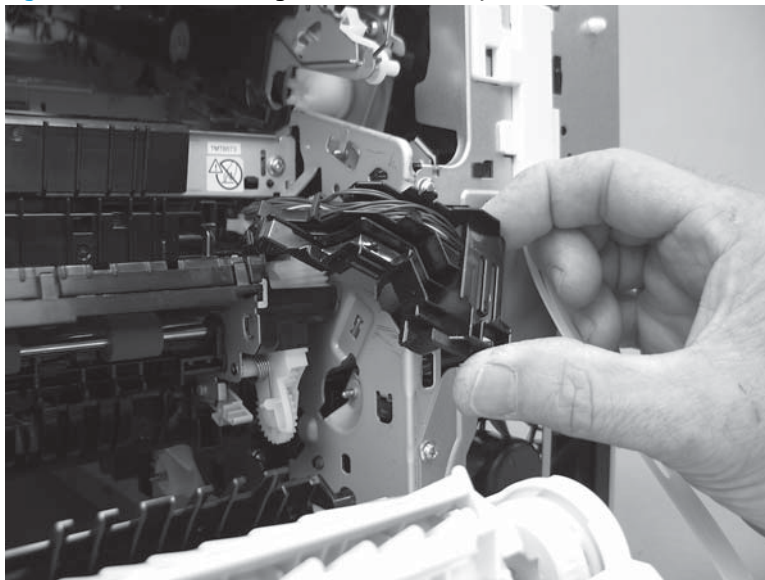

5. Remove three screws (callout 1).

Figure 1-4519 Remove three screws

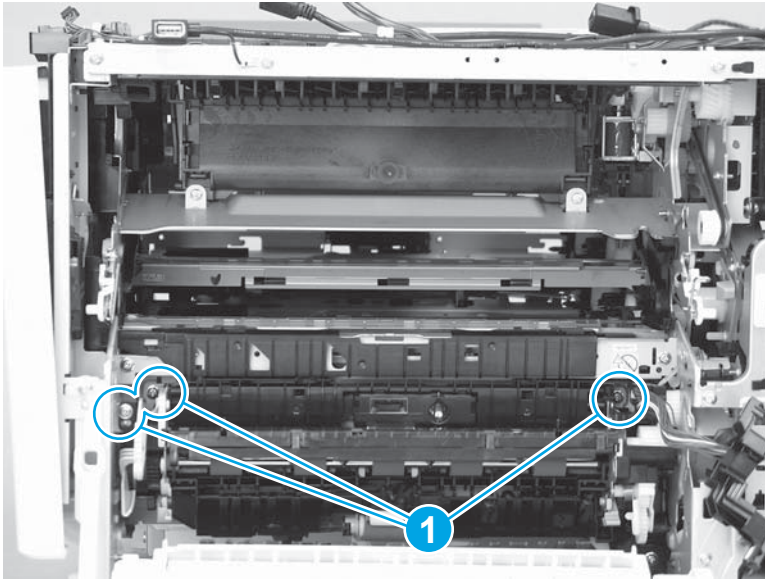

6. Before proceeding, locate the sheet metal portion (callout 1) of the assembly. When handling the assembly, use the sheet metal as handles.

Figure 1-4520 Locate the sheet metal portion of the assembly

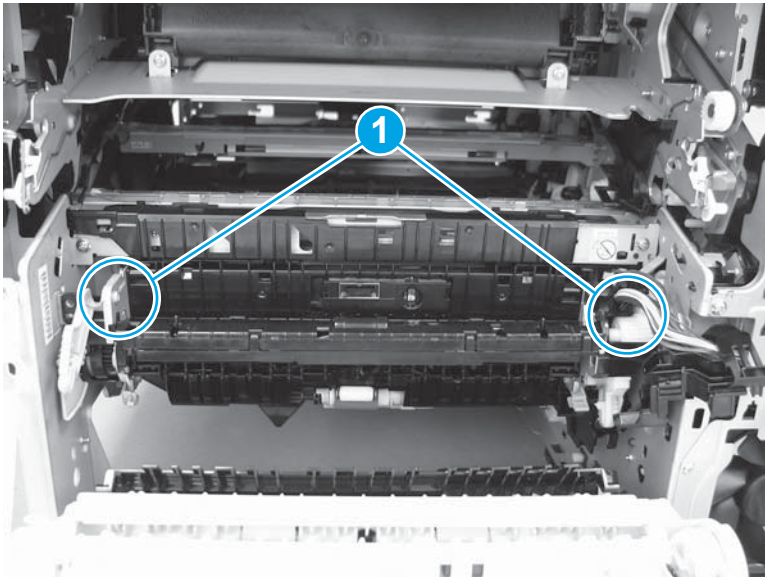

7. Before proceeding, take note of the sheet-metal tabs (callout 1) on the back of the assembly—the figure shows the assembly removed so the tabs can be viewed—that fasten it to the chassis.

Figure 1-4521 Take note of the sheet-metal tabs

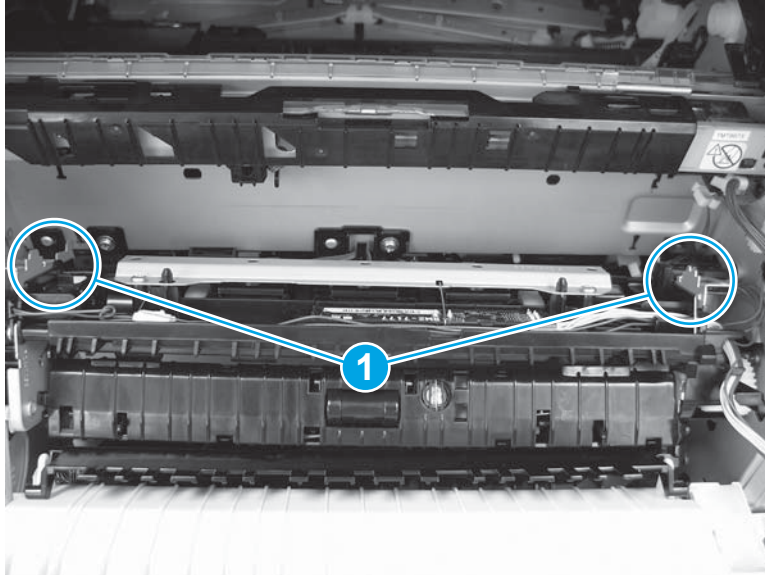

8. Grasp the sheet-metal handles (callout 1), and then rotate the top of the assembly away from the chassis (callout 2) to release the top tabs.

Figure 1-4522 Rotate the top of the assembly away from the chassis

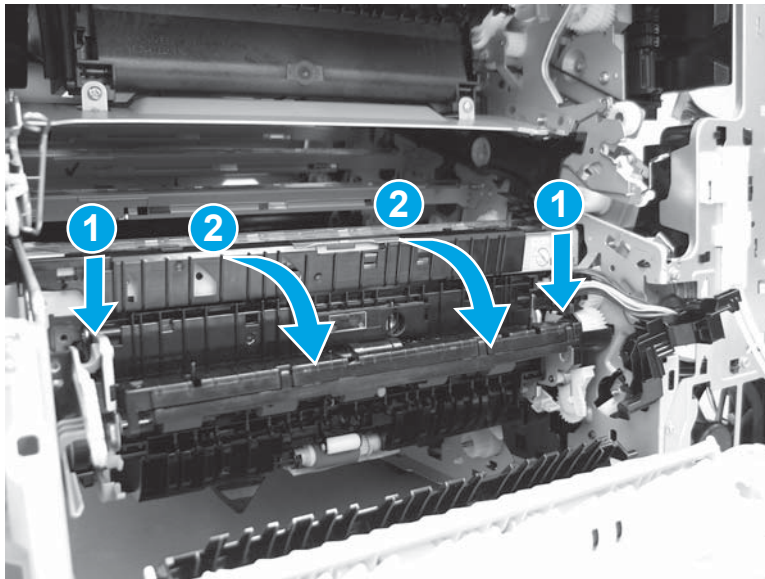

9. Pull up on the assembly to release the bottom tabs.

⚠ CAUTION: The assembly is still attached to the printer by a wire harness. Do not attempt to completely remove the assembly.

Figure 1-4523 Release the bottom tabs

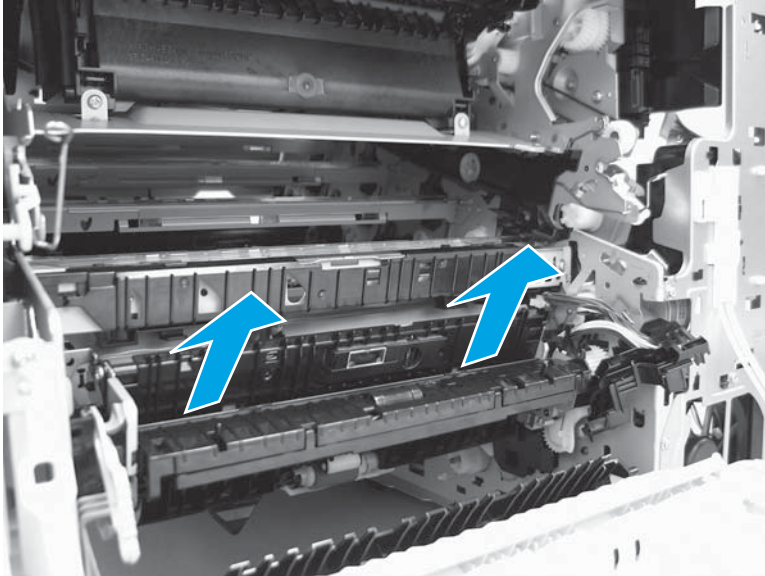

10. Turn the registration assembly over to access the back side, disconnect three connectors (callout 1), and then remove the assembly.

Figure 1-4524 Remove the assembly

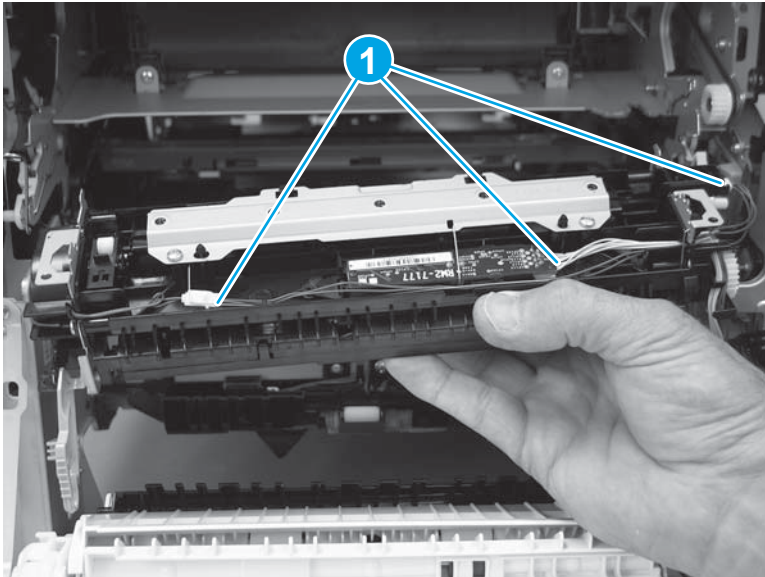

Step 31: Remove the density-detect assembly

1. Remove one screw (callout 1).

Figure 1-4525 Remove one screw

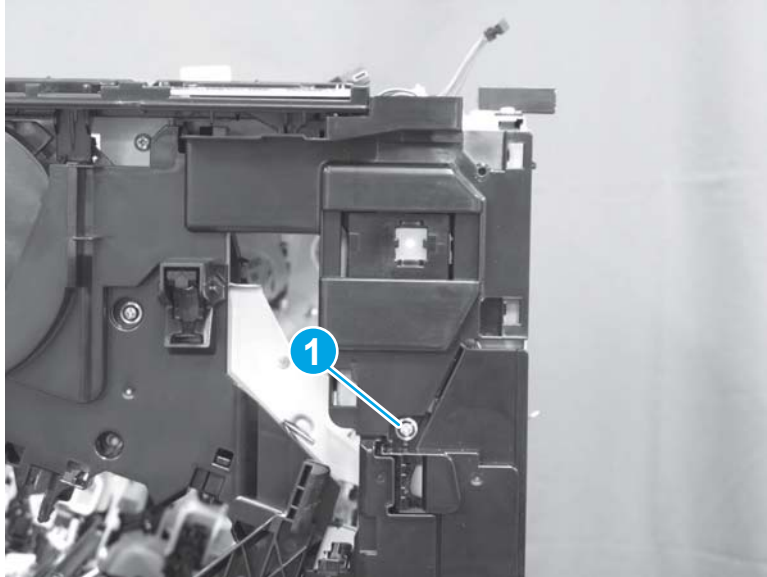

2. Release two tabs (callout 1), and then remove the cover (callout 2).

Figure 1-4526 Remove the cover

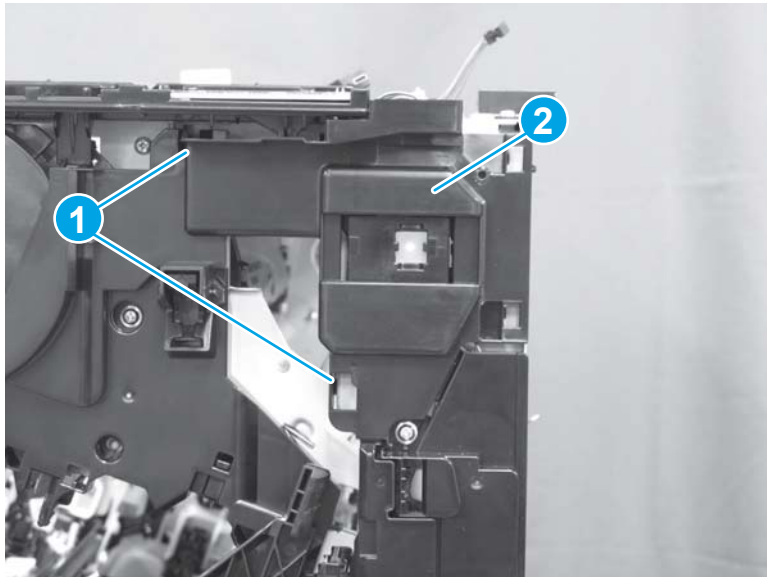

3. Remove one screw (callout 1), and then remove the cover (callout 2).

Figure 1-4527 Remove the cover

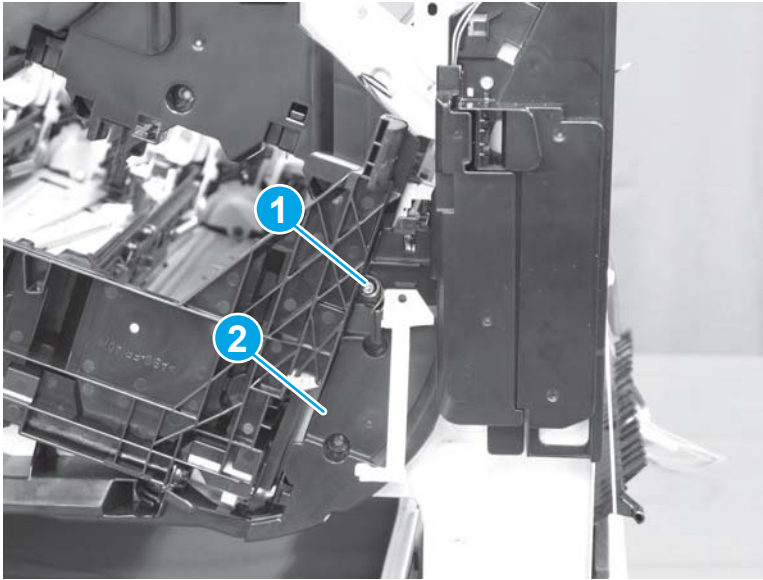

4. Remove two screws (callout 1), and then remove the density-detect assembly (callout 2).

Figure 1-4528 Remove the assembly

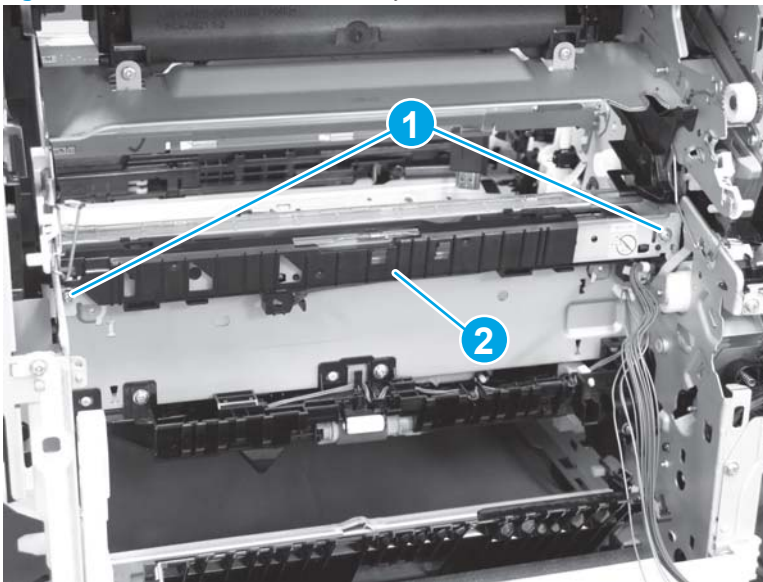

Step 32: Unpack the replacement assembly

Unpack the replacement assembly from the packaging.

For complete information on HP's recycling programs, go to [Product return and recycling](#).

CAUTION: When handling the assembly, take care not to wipe any of the grease off of the gears on the back side of the assembly.

NOTE: HP recommends responsible disposal of the defective assembly.

Figure 1-4529 Recycle and unpack

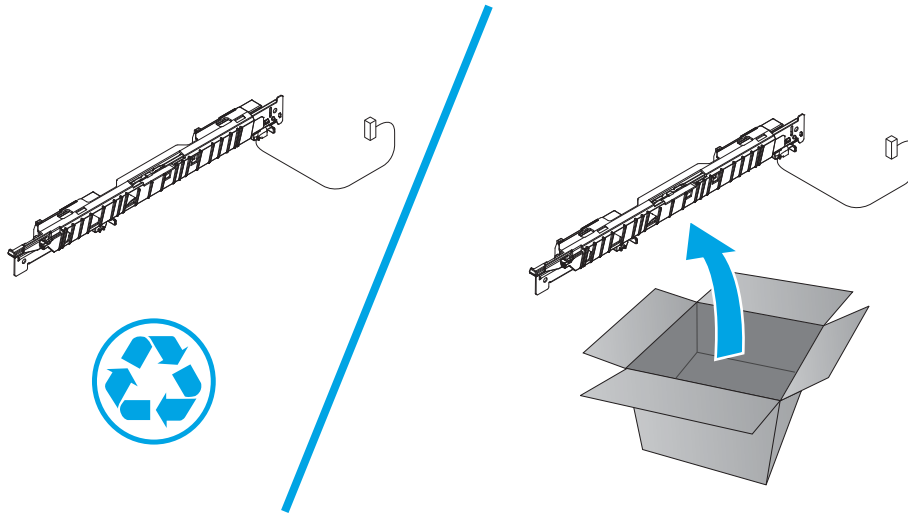

Step 33: Install the density-detect assembly

1. Position the density-detect assembly on the printer (callout 1), and then install two screws (callout 2).

Figure 1-4530 Install the assembly

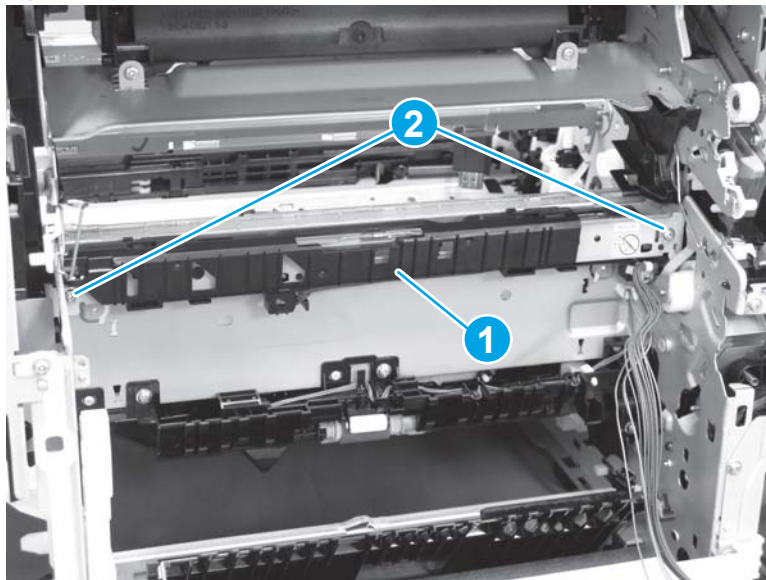

2. Install the cover (callout 1) on the printer, and then install one screw (callout 2).

Figure 1-4531 Install the cover

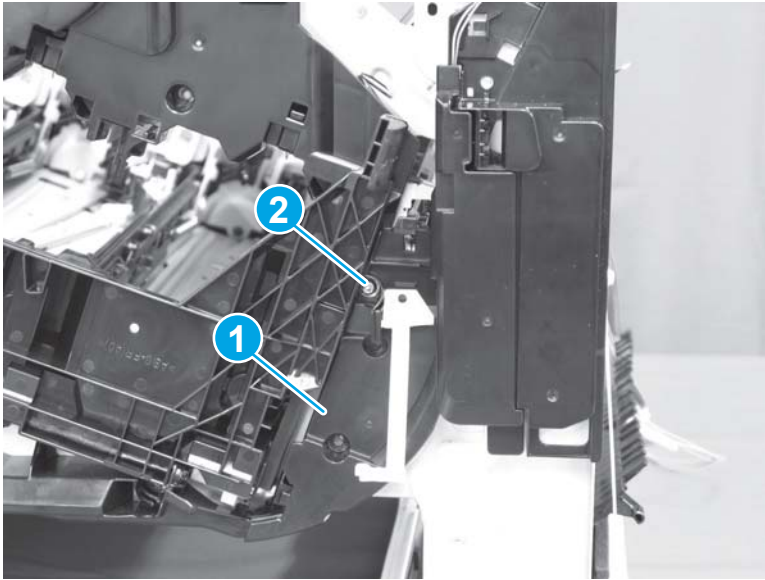

3. Install the cover (callout 1), and then make sure that two tabs (callout 2) snap into place.

Figure 1-4532 Install the cover

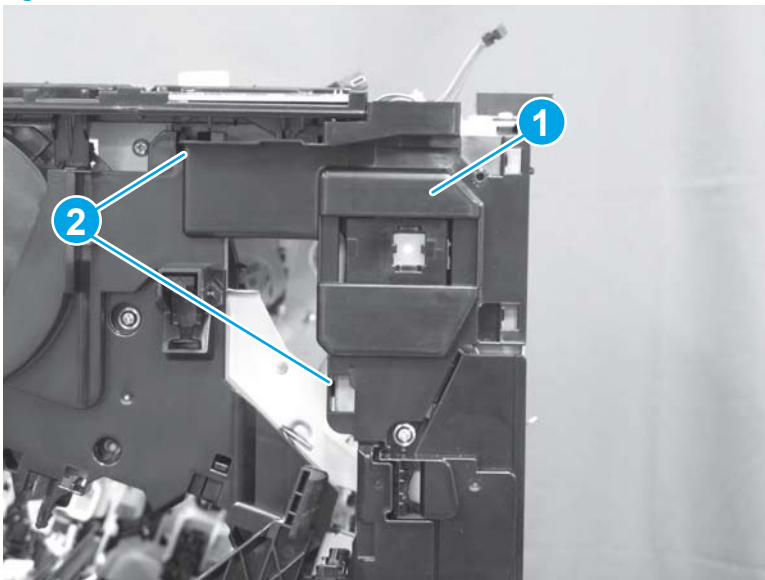

4. Install one screw (callout 1).

Figure 1-4533 Install one screw

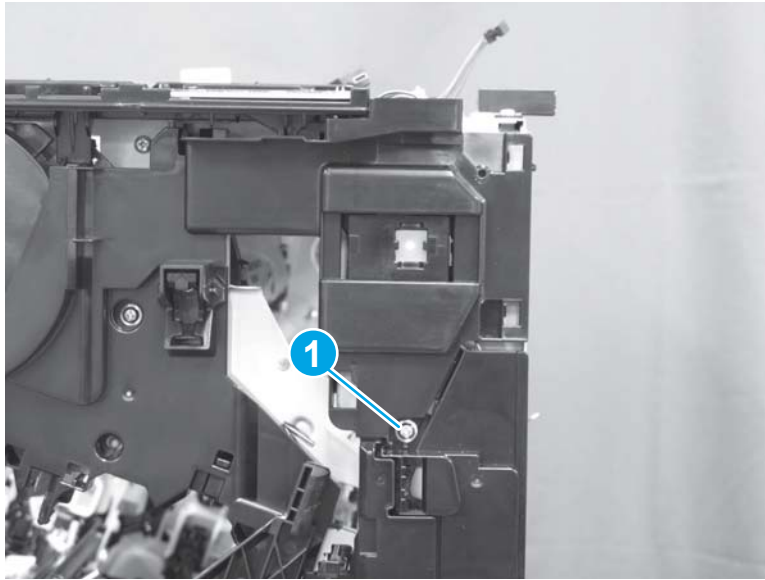

Step 34: Install the registration assembly

1. Turn the registration assembly over to access the back side, and then connect three connectors (callout 1).

Figure 1-4534 Connect three connectors

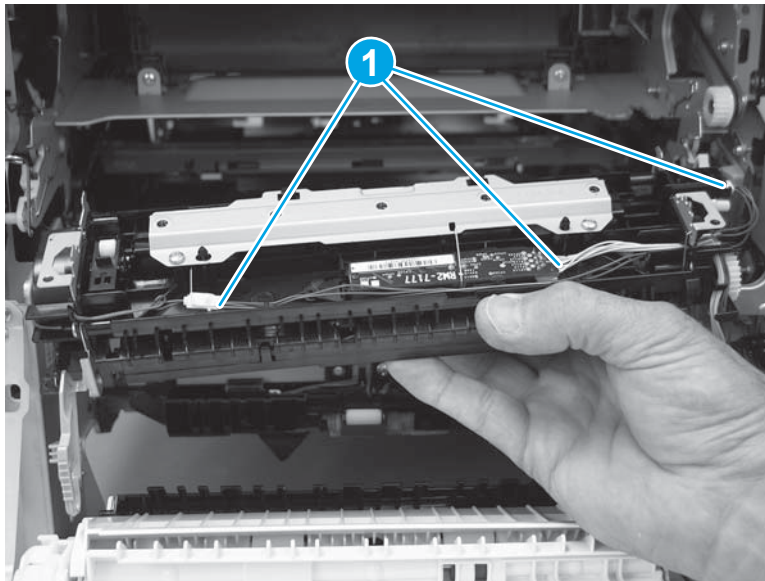

2. Align the tabs on the assembly with the slots in the chassis.

Figure 1-4535 Align the tabs on the assembly with the slots

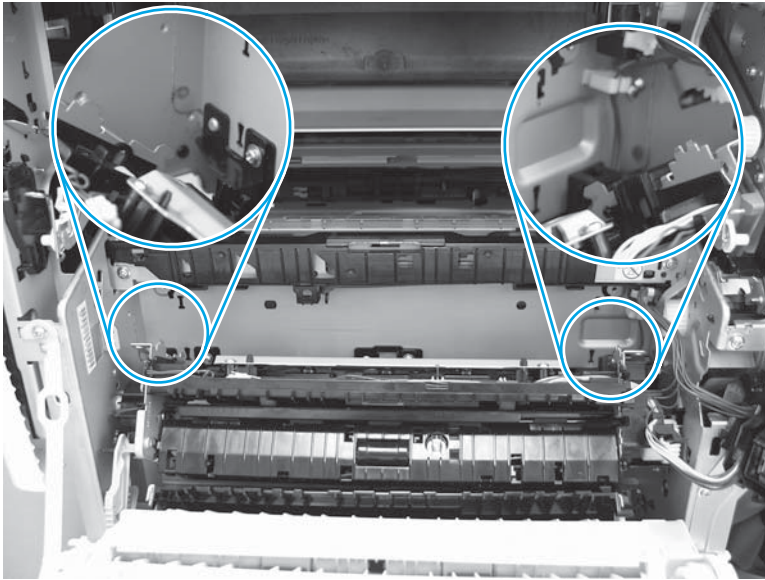

3. Position the bottom tabs in the appropriate slots, and then push down on the assembly to engage them.

Figure 1-4536 Install the bottom tabs

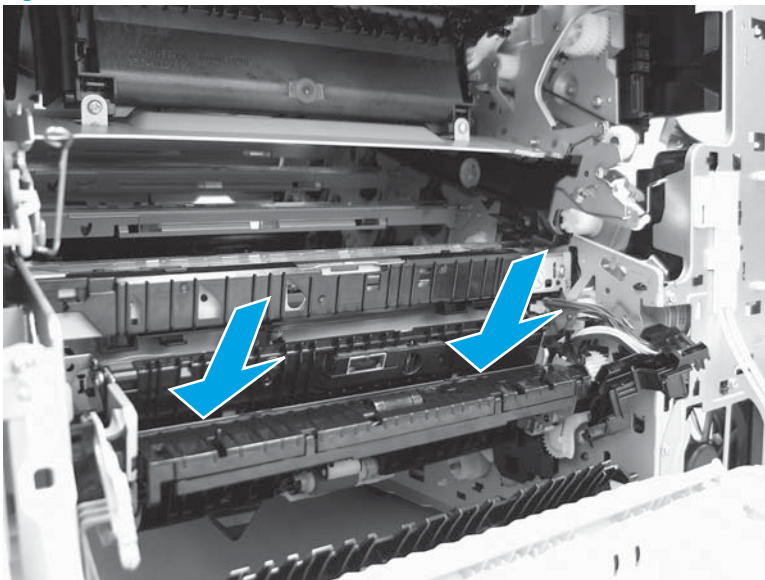

4. Grasp the sheet-metal handles (callout 1) to rotate the top of the assembly toward the chassis (callout 2) to install the top tabs.

Figure 1-4537 Install the top tabs

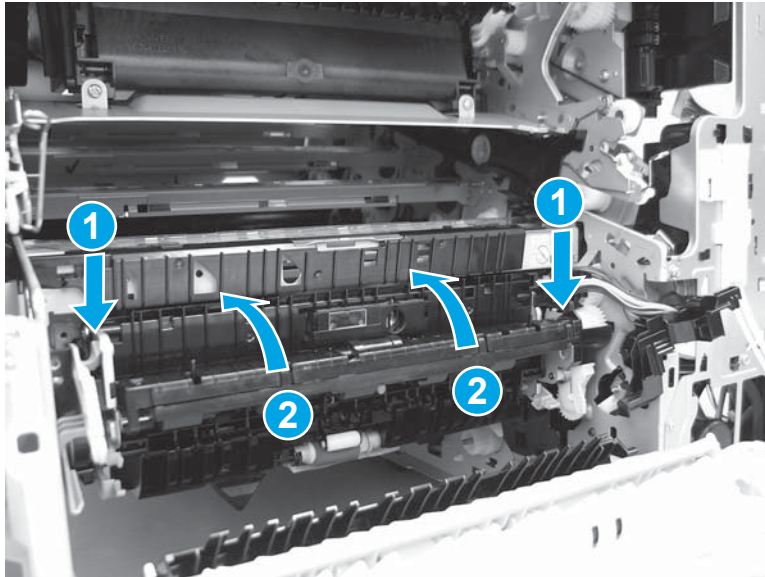

5. Install three screws (callout 1).

Figure 1-4538 Install three screws

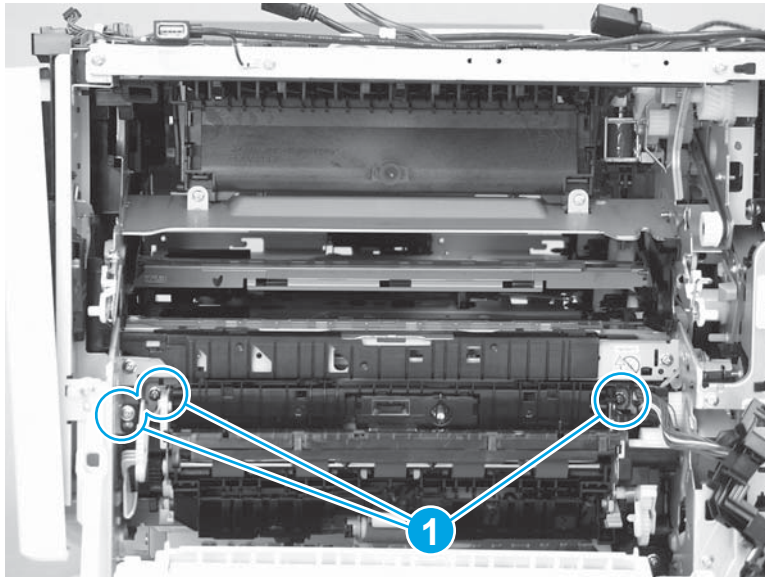

6. Position the guide on the chassis.

Figure 1-4539 Position the guide on the product

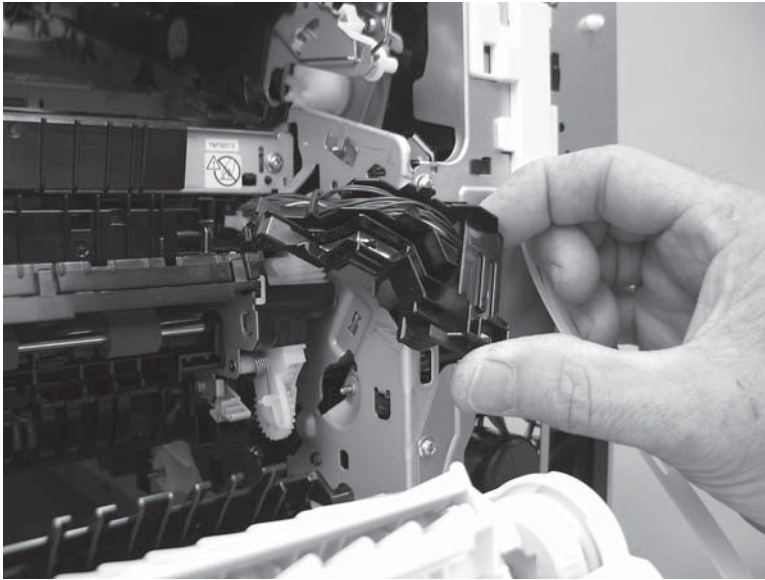

7. Slide the guide up to install it (callout 1), and then make sure that the tab (callout 2) snaps into place.

Figure 1-4540 Install the guide

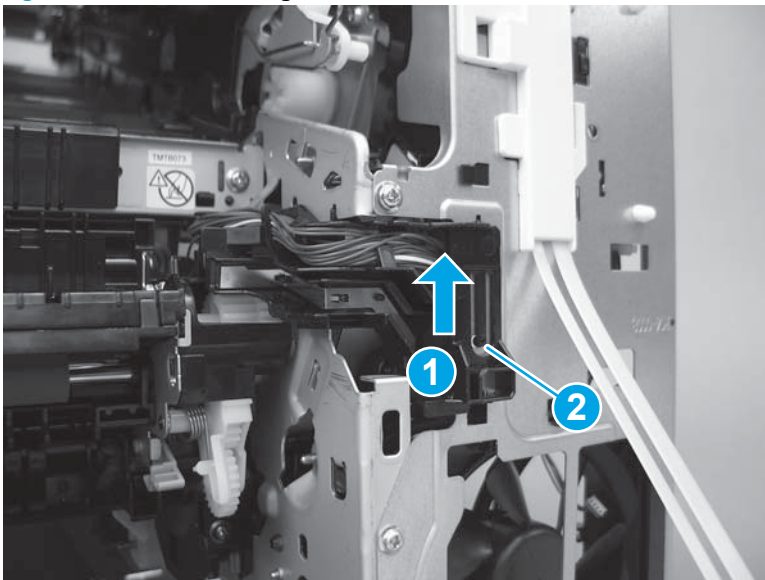

8. Position the cover on the printer.

Figure 1-4541 Position the cover on the product

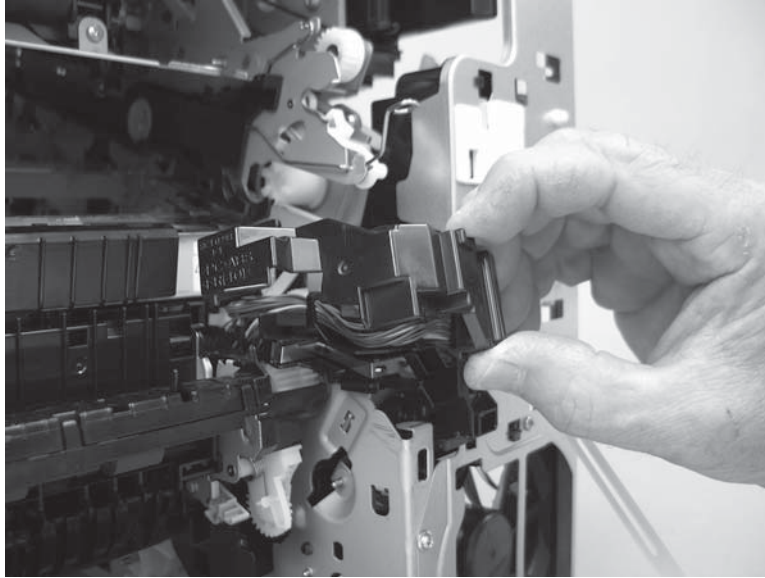

9. Install the cover, and then make sure that the tab (callout 1) snaps into place.

Figure 1-4542 Install the cover

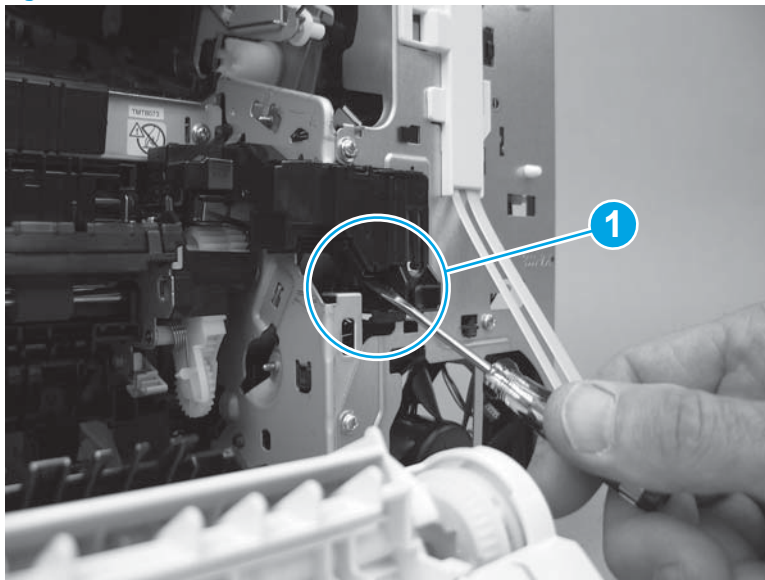

Step 35: Install the pickup drive assembly and motor (M5)

1. Before installing the assembly, check to see if a gap exists (callout 1) between the gears.

 **NOTE:** If no gap exists, go to step [3](#) in this section.

Figure 1-4543 Check the gears for a gap

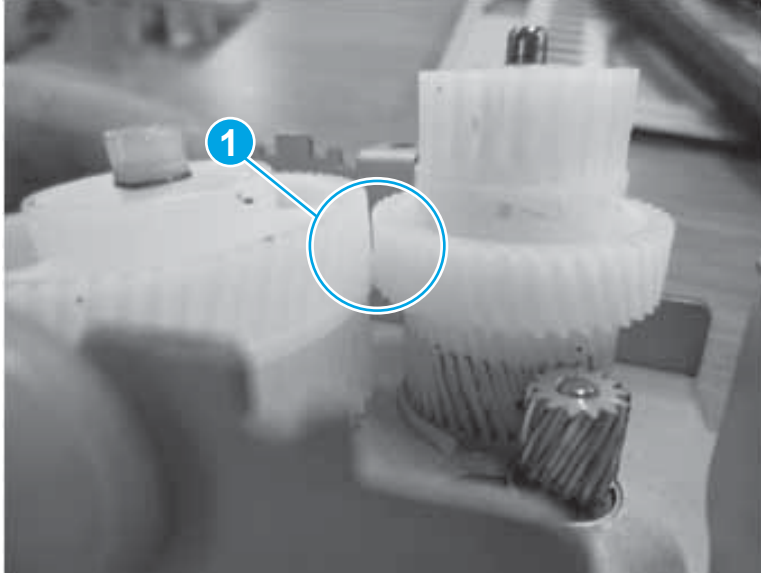

2. Adjust the gears on the assembly to remove the gap (callout 1).

Figure 1-4544 Adjust the gears

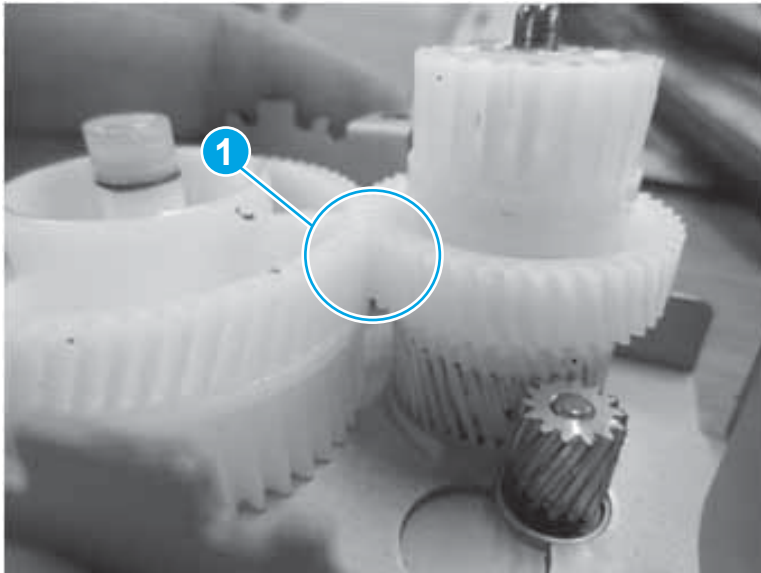

3. Align the tabs on the pickup drive assembly with the slots in the chassis, and then install the assembly on the printer.

 **IMPORTANT:** The figure below shows the large gear of the assembly already installed on the printer chassis. However it is easier to install the pickup drive assembly if the gear is installed on the assembly.

 **TIP:** With the right door open, look into the printer and verify that the mounting bracket for the assembly is correctly installed against the chassis.

Figure 1-4545 Install the assembly



4. Install three screws (callout 1).

Figure 1-4546 Install three screws

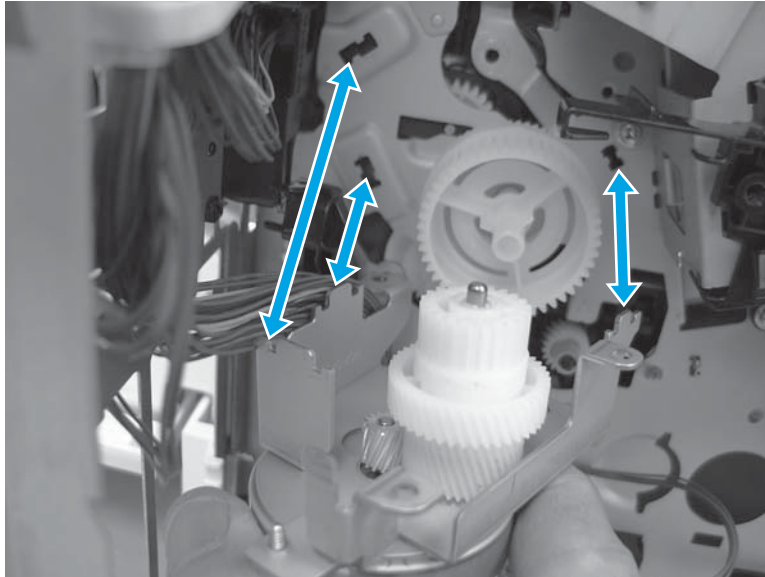
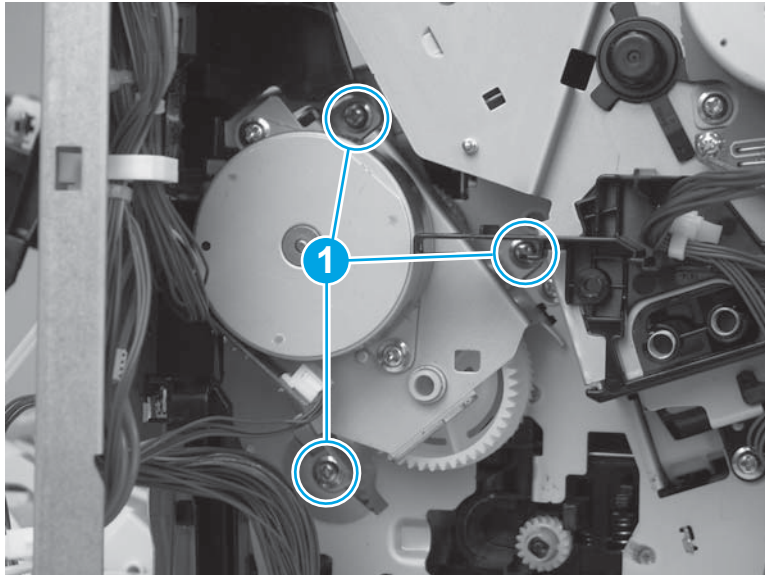

5. Install the guide (callout 1). Make sure that the tab (callout 2) snaps into place.

Figure 1-4547 Install the guide

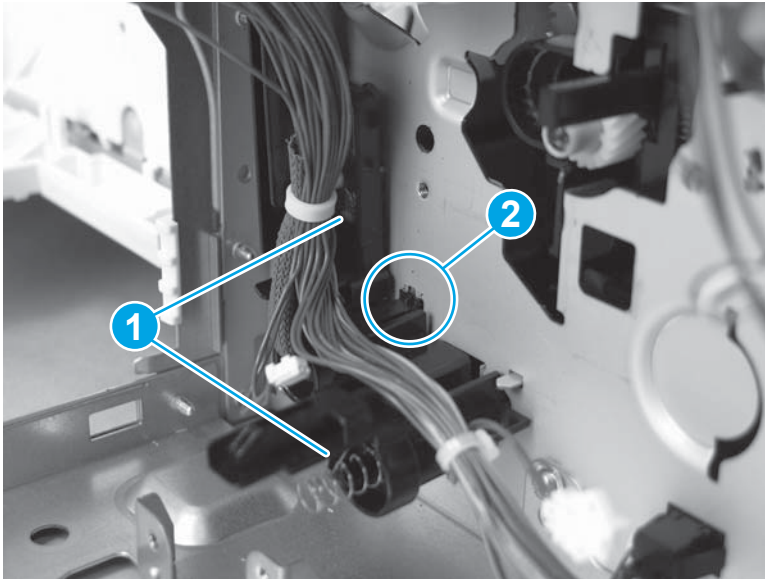

Step 36: Install the DC controller and sheet-metal bracket

 **CAUTION:**  ESD-sensitive part.

1. Position the DC controller and sheet-metal plate on the printer, and then push down to engage the plate with the chassis.

Figure 1-4548 Install the plate

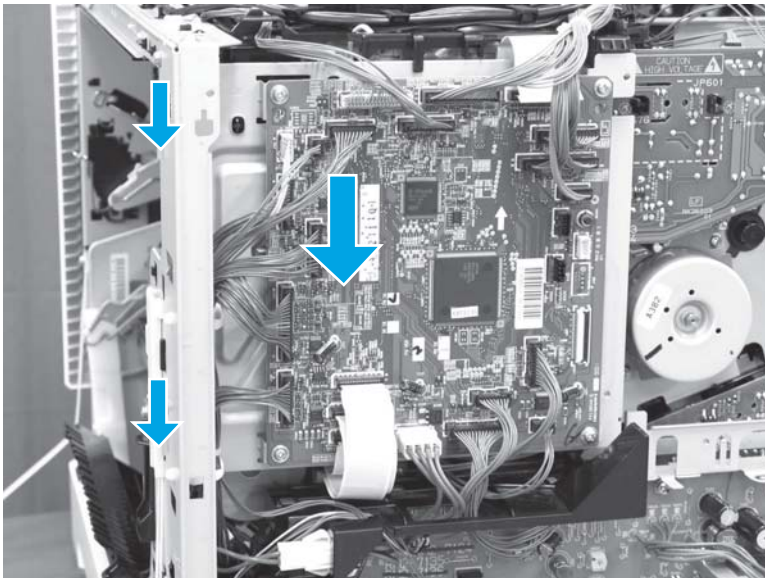

2. Install two screws (callout 1), and then connect all of the connectors.

The following connectors are empty:

- J140, J141, and J143

Figure 1-4549 Install two screws

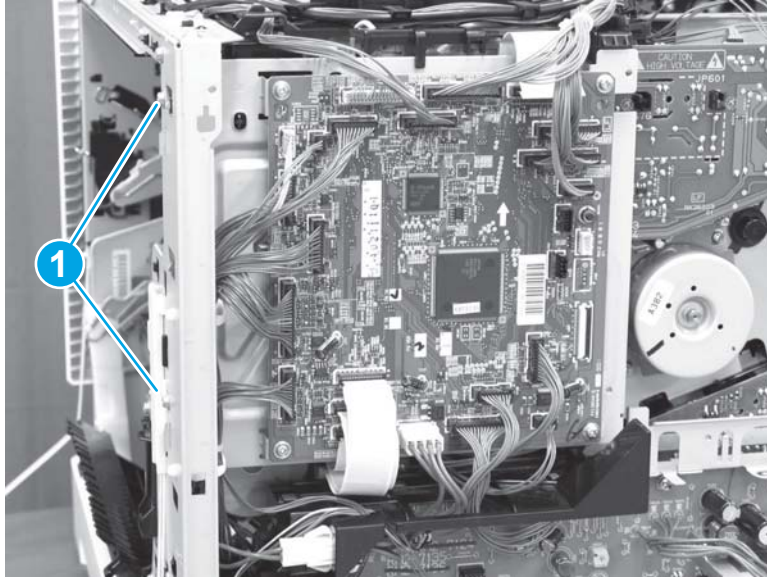

Step 37: Install the lifter drive assembly

1. Install one wire harness on the retainer (callout 1), position the lifter drive assembly in the printer (make sure that one tab (callout 2) snaps into place), and then install two screws (callout 3).

 **TIP:** It might be easier to install the assembly if the bottom of the assembly is installed first, and then the top of the assembly is rotated into place.

Figure 1-4550 Install the lifter drive



2. Connect two flat cables (callout 1), and then place them in the retainers (callout 2).

Figure 1-4551 Connect two flat cables

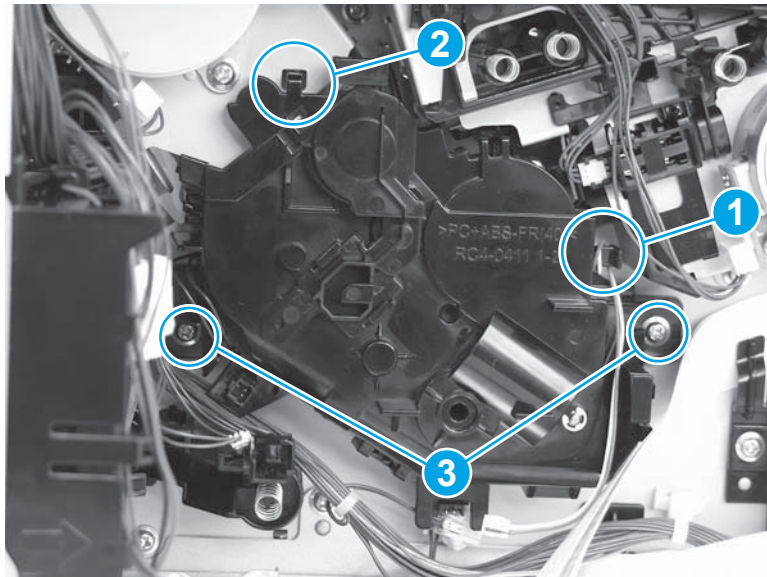
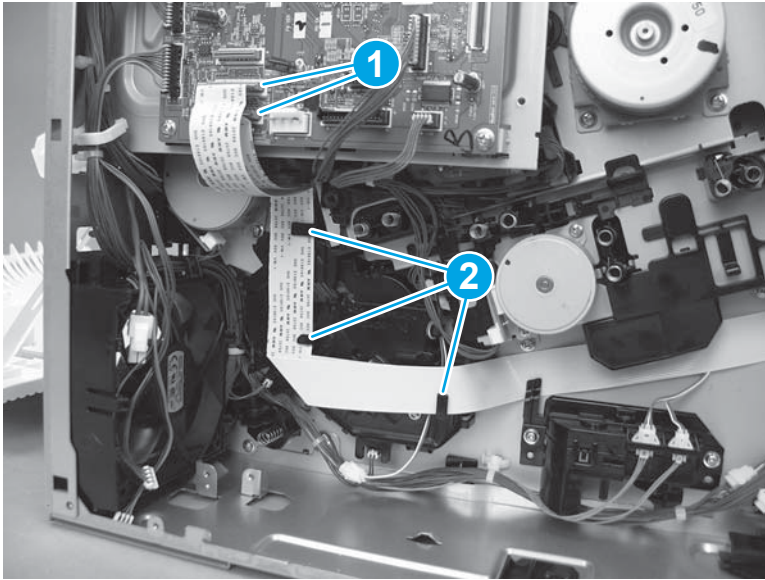

3. Connect two connectors (callout 1).

Figure 1-4552 Connect two connectors

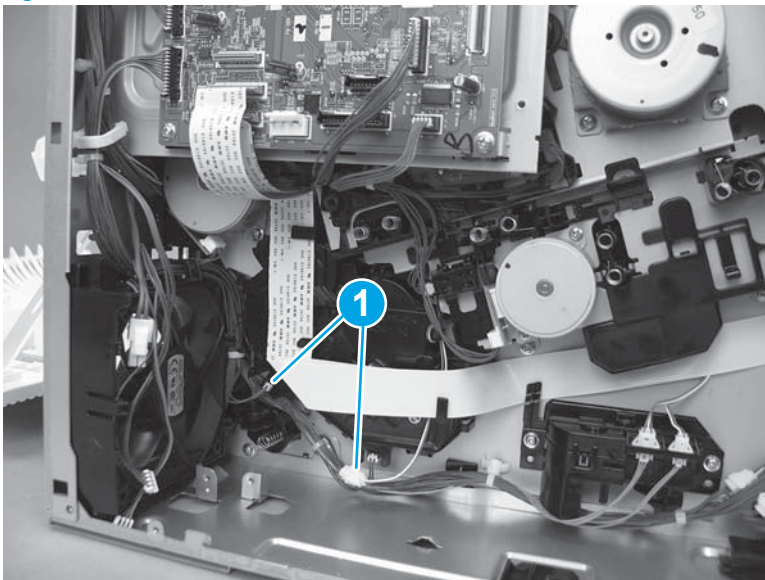

Step 38: Install the HVPDS

 **CAUTION:**  ESD-sensitive part.

1. Position the bottom right corner of the HVPDS (callout 1) behind the black tab, and then rotate it up and onto the printer (callout 2).

Figure 1-4553 Install the HVPSD

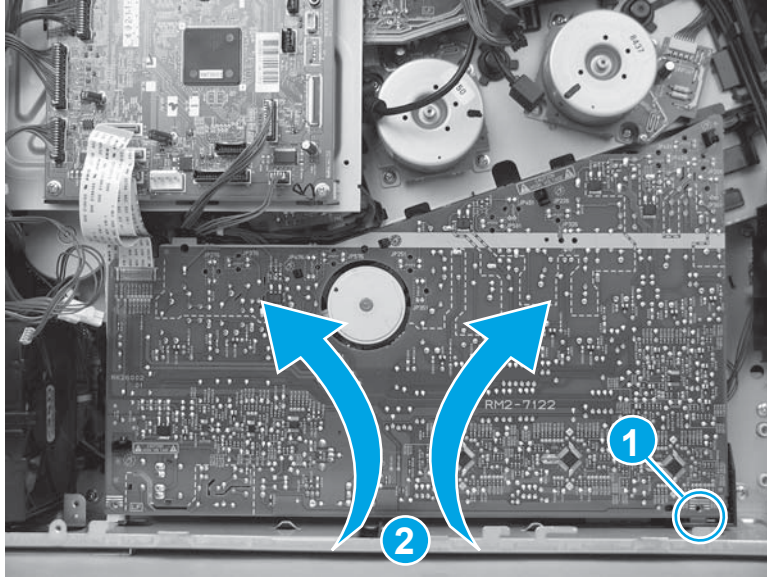

2. Press it onto five tabs (callout 2).

 **IMPORTANT:** Make sure that all five tabs snap into place.

Figure 1-4554 Press the tabs



3. Install two screws (callout 1), and then install one self tapping screw (callout 2) on the HVPSD.

Figure 1-4555 Install three screws

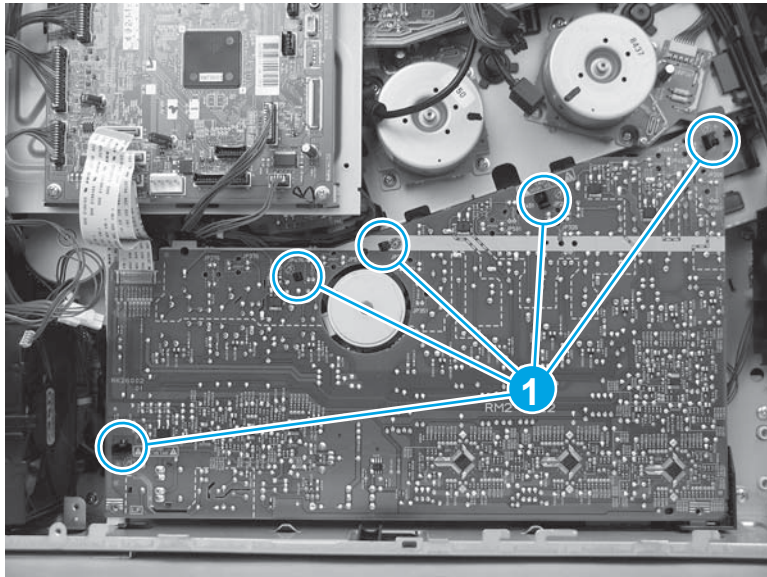
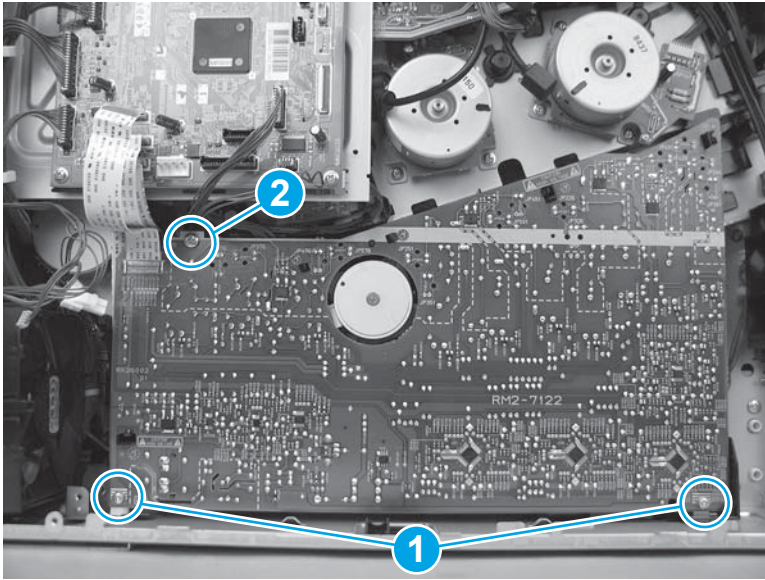

4. Connect one flat cable (callout 1) on the DC controller.

Figure 1-4556 Connect one flat cable

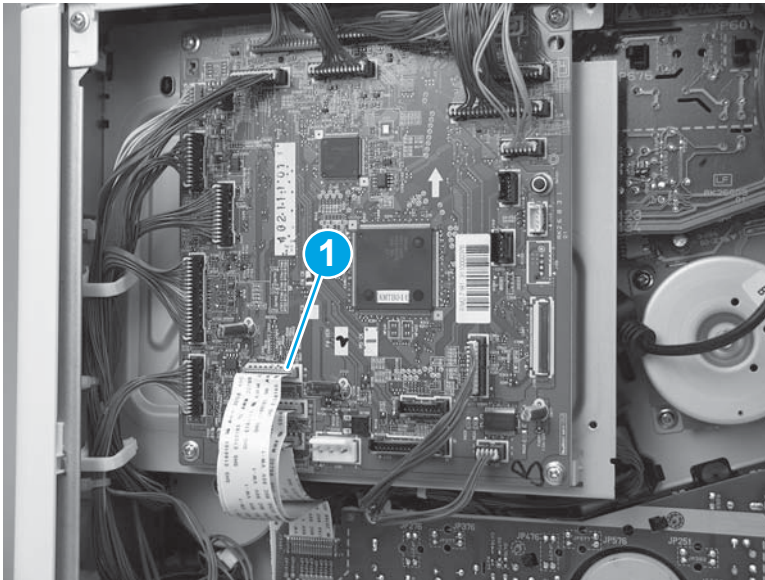

Step 39: Install the power-supply fan (FM1)

1. Slide the fan in (callout 1) and then down (callout 2) into the printer to install it.

 **NOTE:** Make sure that the arrow (callout 3) embossed on the fan holder faces into the printer.

Figure 1-4557 Install the fan



2. Place the wire harnesses in the retainer on the top of the fan bracket.

Figure 1-4558 Place the wire harnesses in the retainer

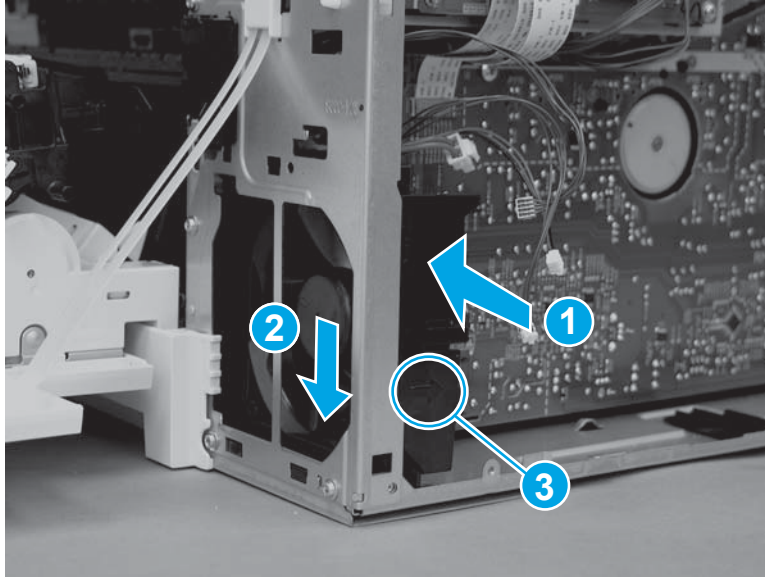
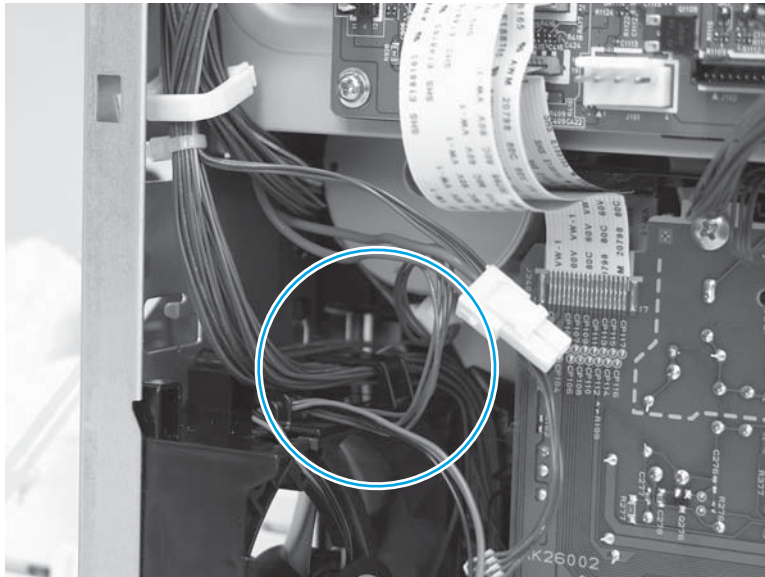

3. Install one screw (callout 1).

Figure 1-4559 Install one screw

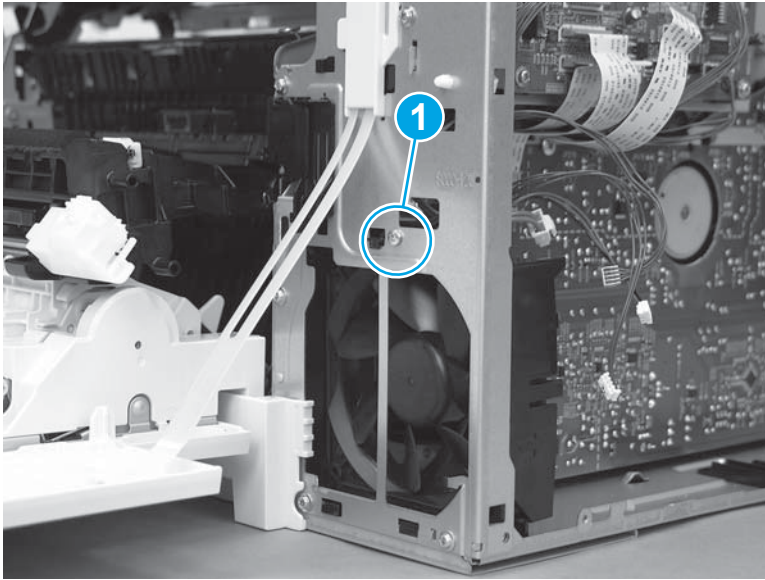

Step 40: Install the LVPS

 **CAUTION:**  ESD-sensitive part.

1. Position the bottom of the LVPS in the printer (callout 1) at a slight angle, and then rotate the top of it into the printer (callout 2) to install it.

Figure 1-4560 Install the LVPS

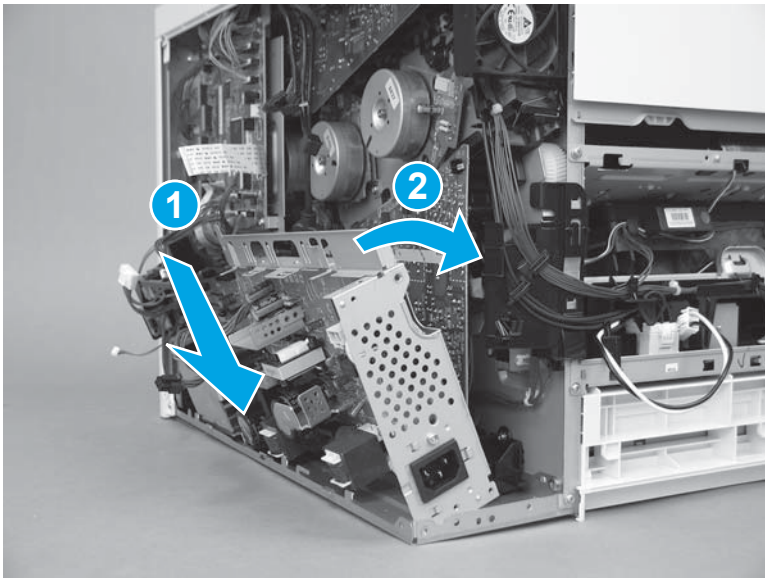

2. Install three screws (callout 1).

Figure 1-4561 Install three screws

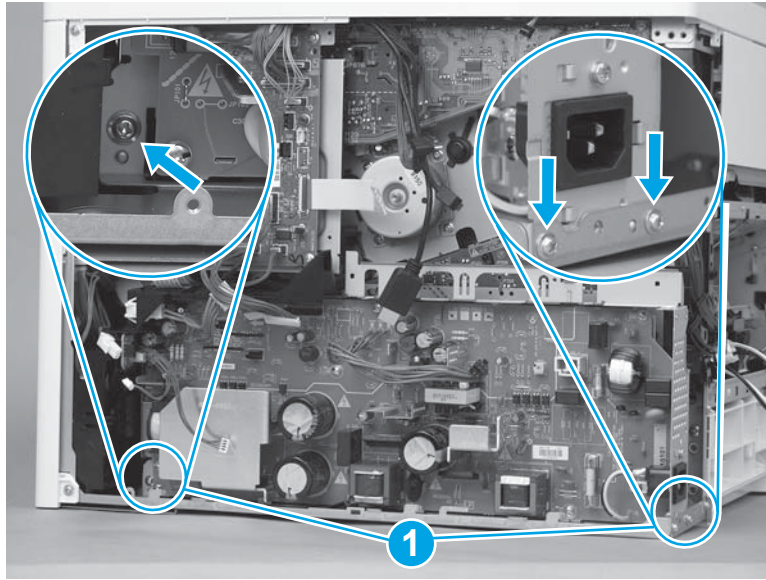

3. Pass the wire harnesses from the DC controller to the LVPS through the opening in the chassis (callout 1), and then install the wire harnesses in the retainer (callout 2).

Figure 1-4562 Pass the wire harnesses through the opening

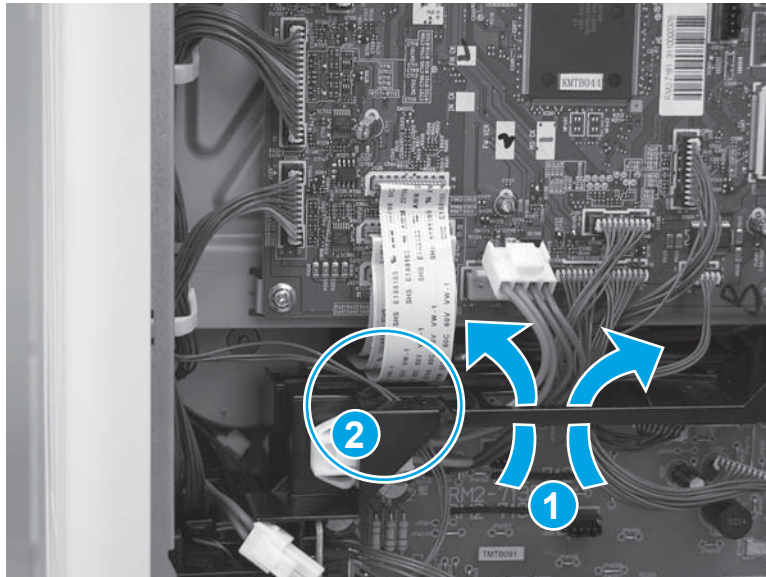

4. Connect three connectors on the DC controller (callout 1), and then connect four connectors (callout 2) on the LVPS.

Figure 1-4563 Connect seven connectors

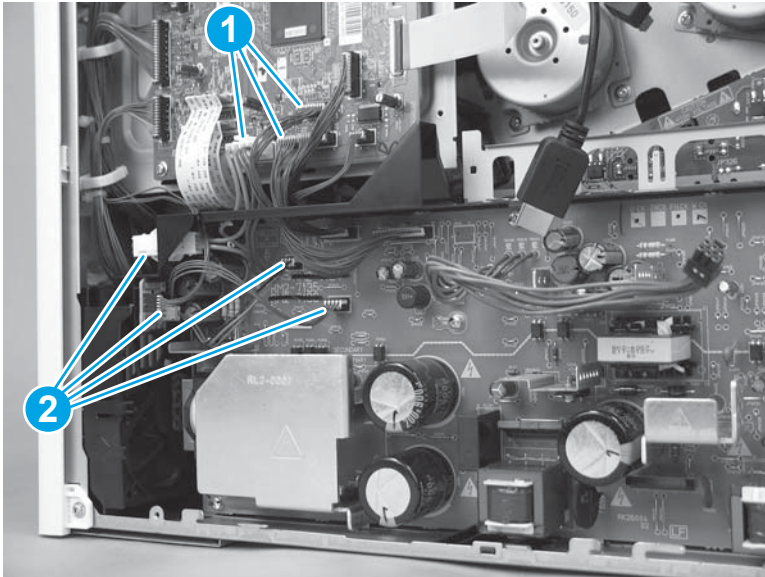

5. Pass the wire harness through the opening (callout 1) in the chassis, and then connect one wire harness (callout 2).

Figure 1-4564 Connect one wire harness

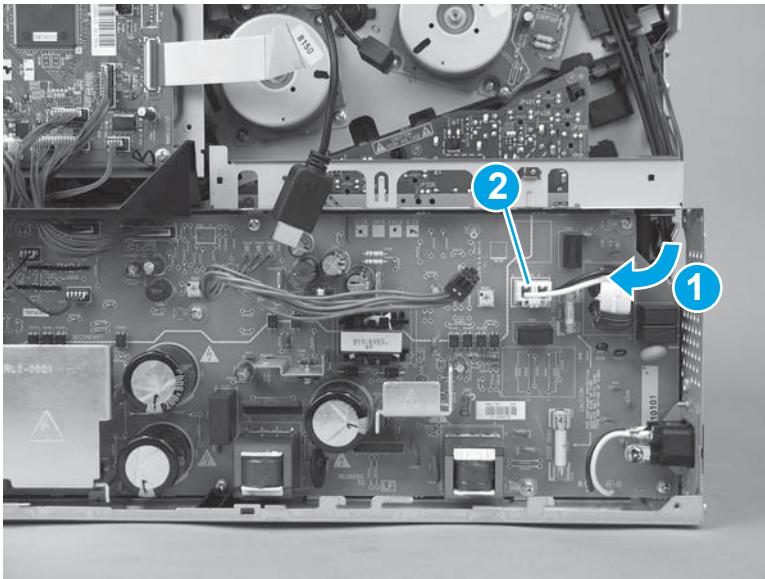

Step 41: Install the formatter case

1. Pass the wire harnesses through the opening in the formatter case.

Figure 1-4565 Pass the wire harnesses through the opening

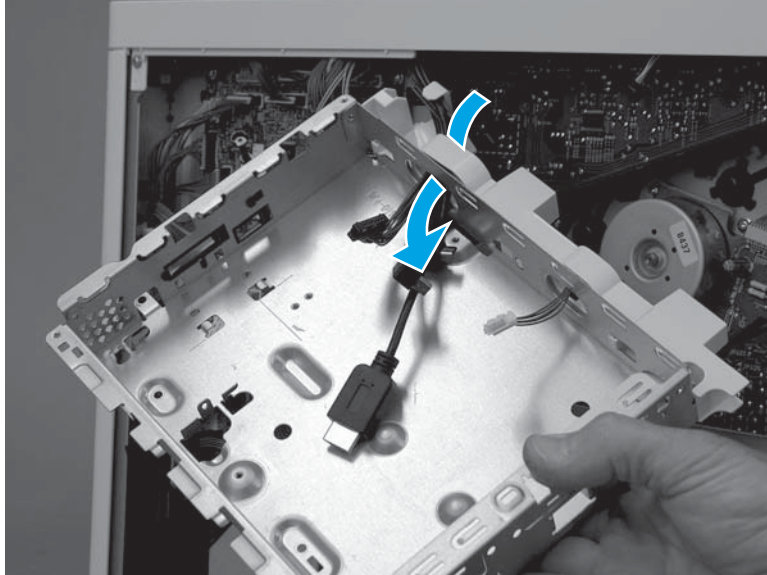

2. Position the top of the formatter case on the printer (callout 1), and then rotate the bottom of the case (callout 2) into the printer.

Figure 1-4566 Install the formatter case

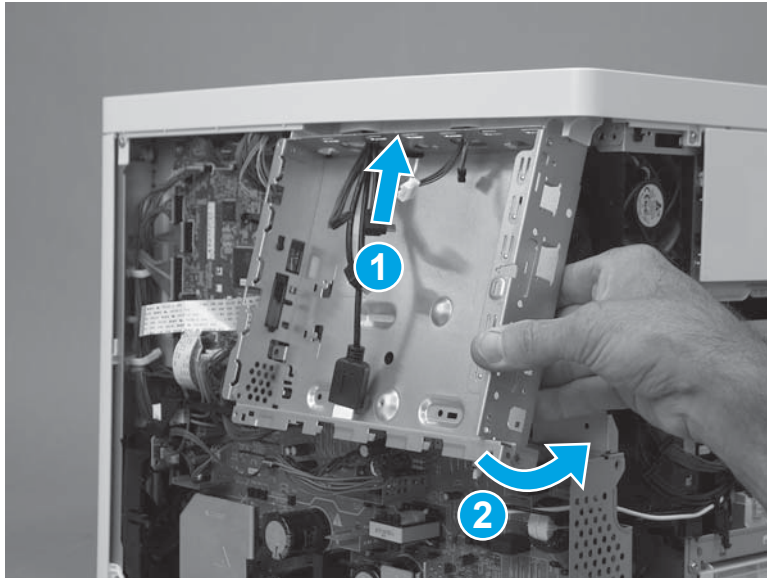

3. Install six screws (callout 1).

Figure 1-4567 Install six screws

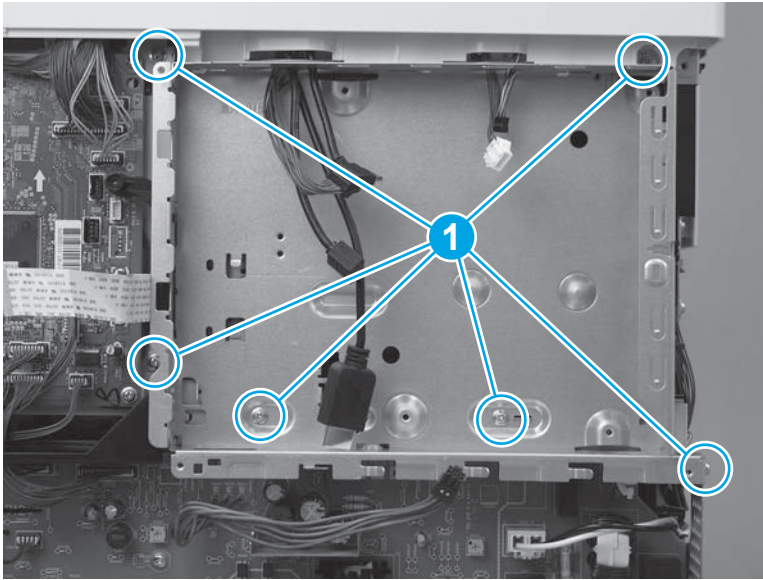

4. Pass two wire harnesses and one flat cable (callout 1) through the opening in the formatter case, and then install one wire harness in the retainer (callout 2).

 **IMPORTANT:** Make sure that the flat cable is securely fastened to the DC controller, and was not dislodged when the formatter case was removed.

Figure 1-4568 Install wire harnesses and flat cable

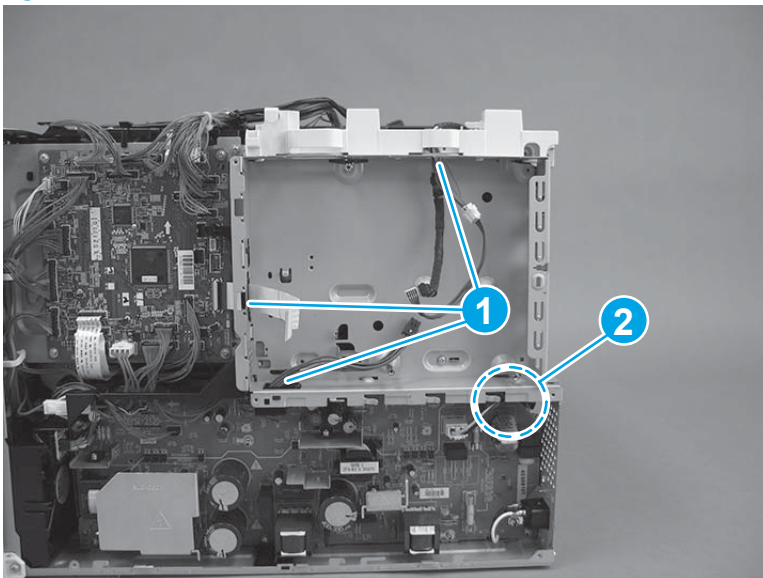

5. Position the LVPS cover on the printer, slide the cover to the left to install it, and then install two screws (callout 1).

Figure 1-4569 Install the LVPS cover

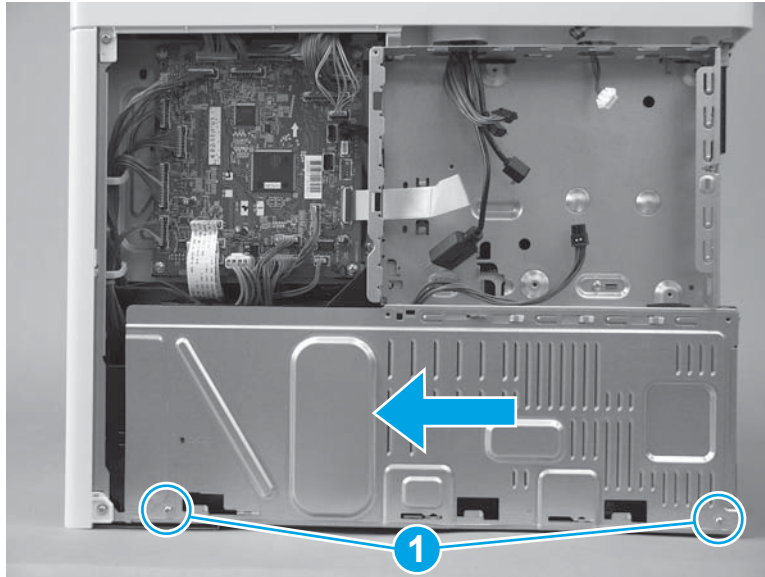

6. If no tape is affixed to the back of the flat cable, skip this step. If double-sided tape is affixed to the back of the flat cable, align the line (callout 1) on the cable with the edge (callout 2) of the opening in the sheet metal. Press to attach the flat cable to the formatter case.

Figure 1-4570 Attach the flat cable

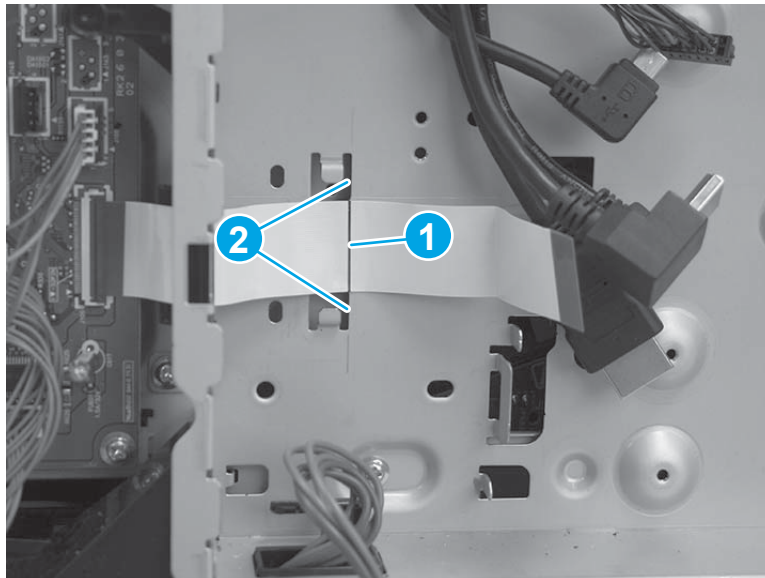

7. Position the bracket over the flat cable, and then slide the bracket to the left to install it. Make sure that the edges of the bracket fit under the sheet metal tabs (callout 1) on the formatter case and that the tabs (callout 2) snap into place.

Figure 1-4571 Position the bracket

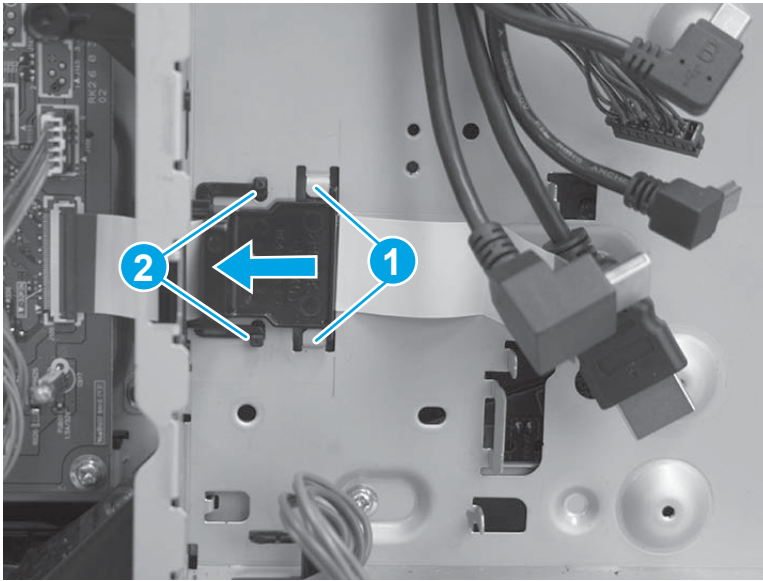

8. **M577 only:** Pass the wire harness (callout 1) through the openings in the formatter case (callout 2), and then connect one connector (callout 3).

Figure 1-4572 Connect one connector

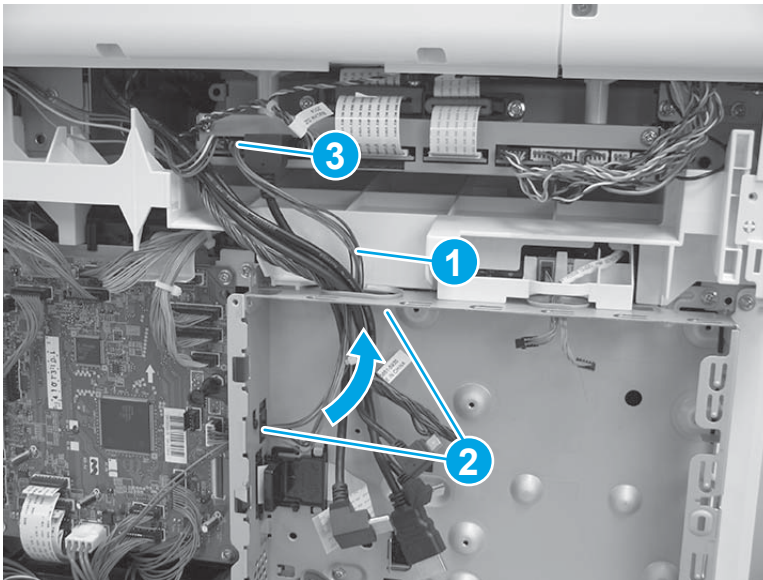

Step 42: Install the right rear cover

1. Position the cover on the printer.

Figure 1-4573 Install the cover

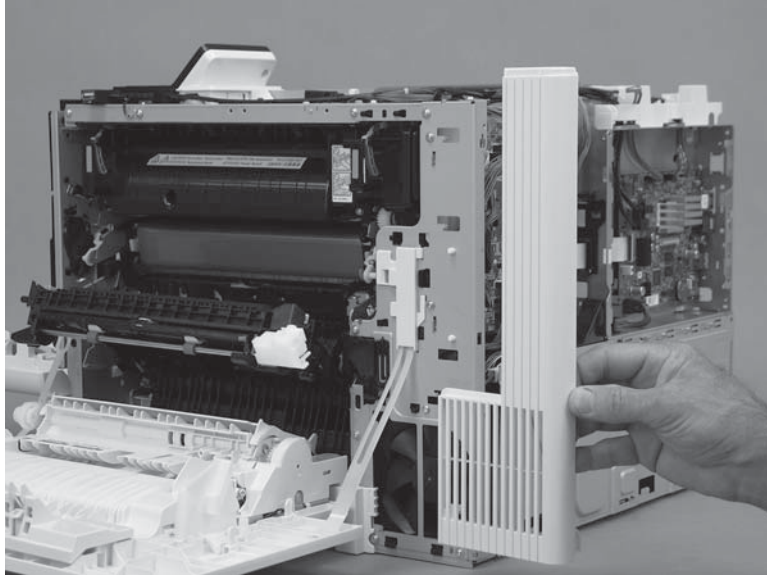

2. Slide the cover toward the right door (callout 1) to engage it with the printer, and then install one screw (callout 2).

Figure 1-4574 Install one screw

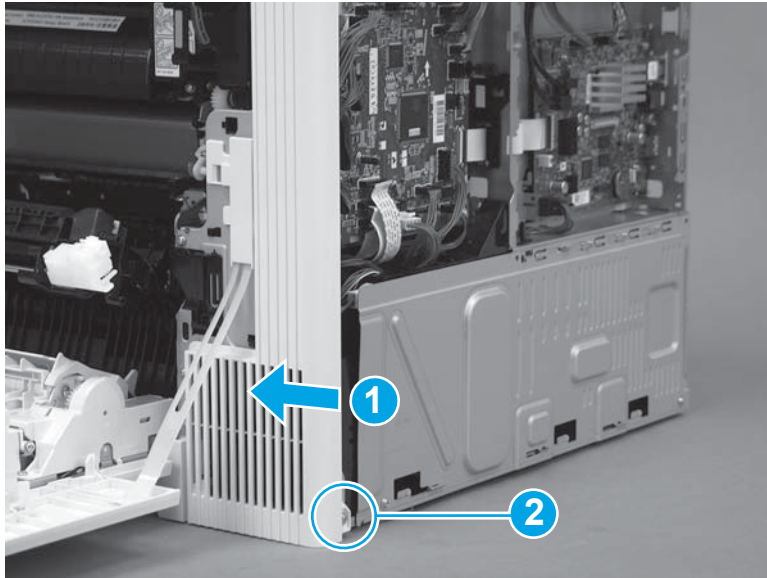

Step 43: Install the upper cover (M552 and M553)

 **NOTE:** This step is for the M552 and M553 models. For the M577 models, skip this step and go to [Step 44: Install the left cover on page 2533](#).

1. Position the cover on the printer.

 **NOTE:** For the M553x model, do not forget to pass the control-panel wire harness and USB cable through the opening in the cover.

Figure 1-4575 Install the cover



2. Push down on the rear corner of the cover to engage one tab (callout 1).

Figure 1-4576 Engage one tab

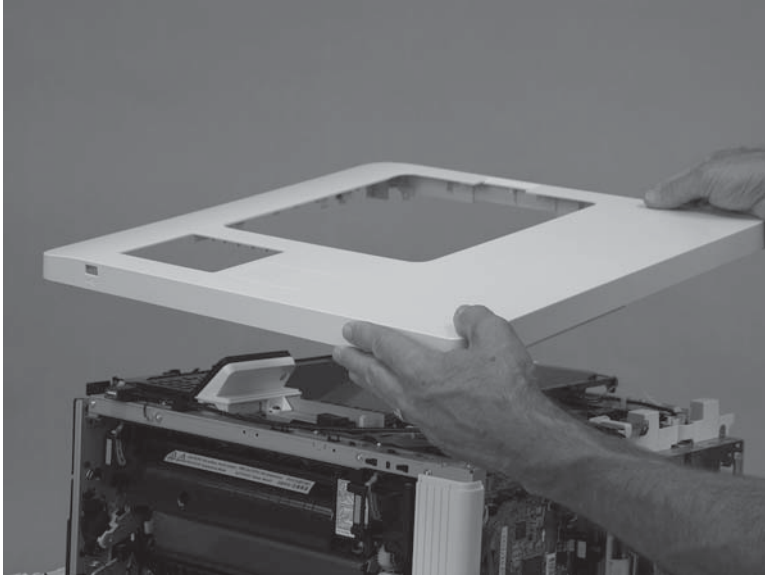
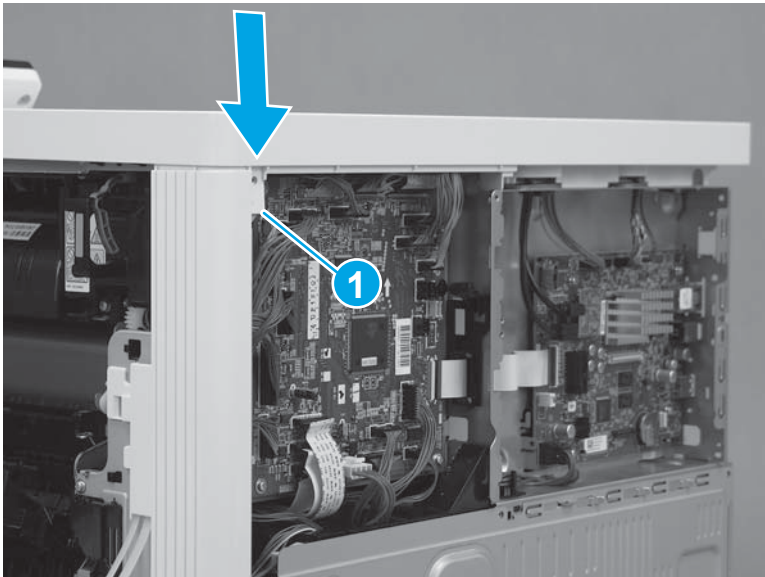

3. Push down on the front corner of the cover to engage one tab (callout 1), and then install one screw (callout 2).

 **NOTE:** This is a self-tapping plastic-thread screw. Make sure that this screw is used in this location when it is reinstalled.

Figure 1-4577 Engage one tab and install one screw



4. Install three screws (callout 1).

Figure 1-4578 Install three screws

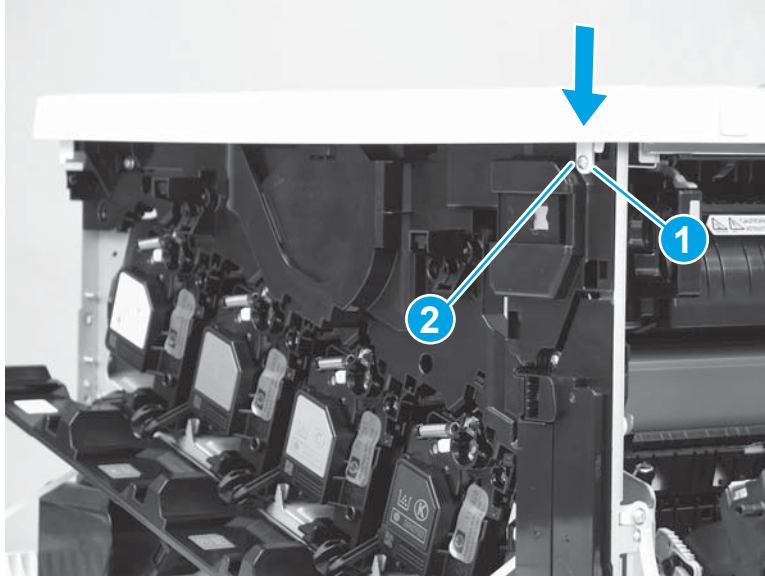
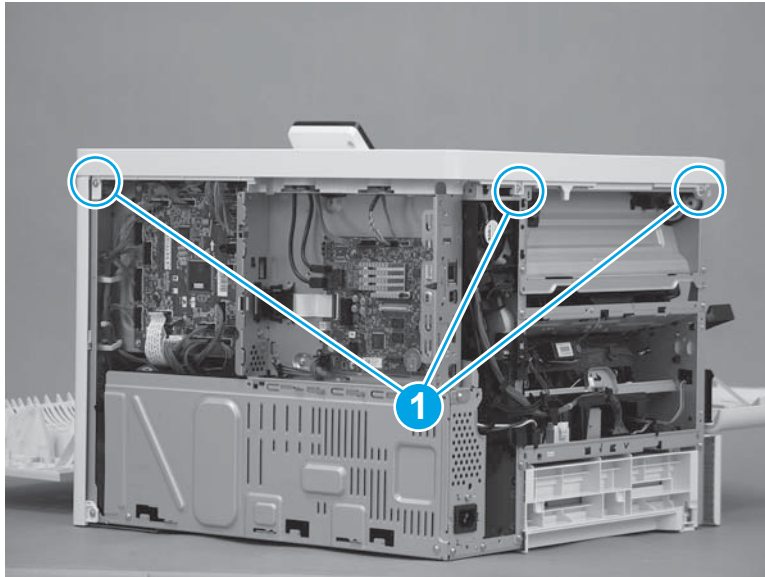

Step 44: Install the left cover

1. Position the cover on the printer.

 **NOTE:** Slightly offset the cover toward the rear of the printer.

Figure 1-4579 Install the cover

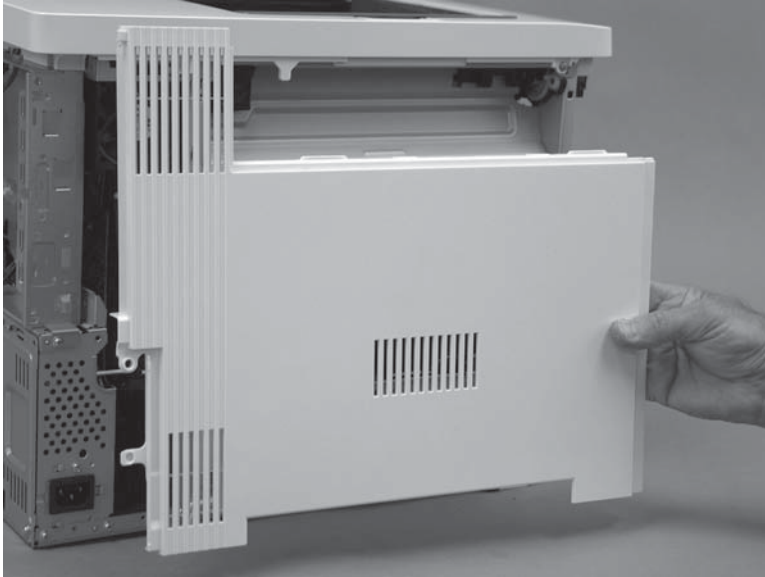

2. Slide the cover (callout 1) toward the front of the printer to engage it. Make sure that the tab (callout 2) snaps into place.

 **NOTE:** Locate the alignment pin (callout 3) on the cover from the front door side of the printer, and then make sure that it is fully engaged in the slot in the chassis.

 **TIP:** While sliding the cover into place, push in on the center of the cover (callout 1) to make sure that the hooks on the back of the cover engage with the slots in the chassis.

Figure 1-4580 Engage the cover

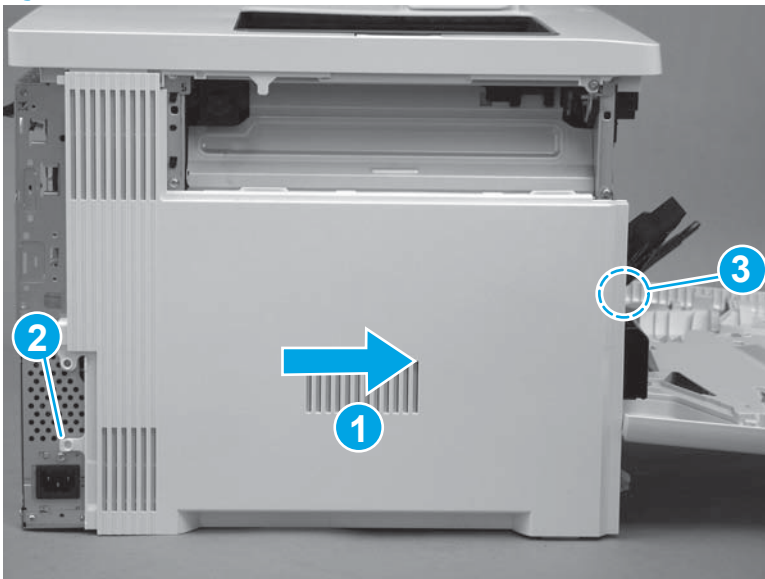

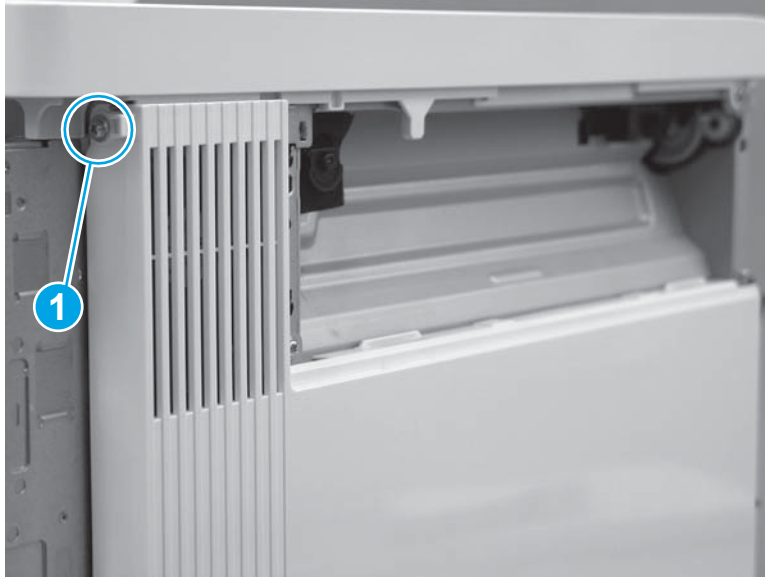

3. At the left side of the printer, install one screw (callout 1).

Figure 1-4581 Install one screw



Step 45: Install the right upper cover (M577)

 **NOTE:** This step is for the M577 models. For the M552 and M553 models, skip this step and go to [Step 52: Install the rear cover \(M552 and M553\) on page 2549](#).

 **NOTE:** The figures below show the image scanner installed. The procedures for removing and installing the right upper cover are the same whether the image scanner is installed or removed."

1. **M577c/f/z only:** Install the cables (callout 1) through the slot (callout 2) in the printer.

Figure 1-4582 Install the cables

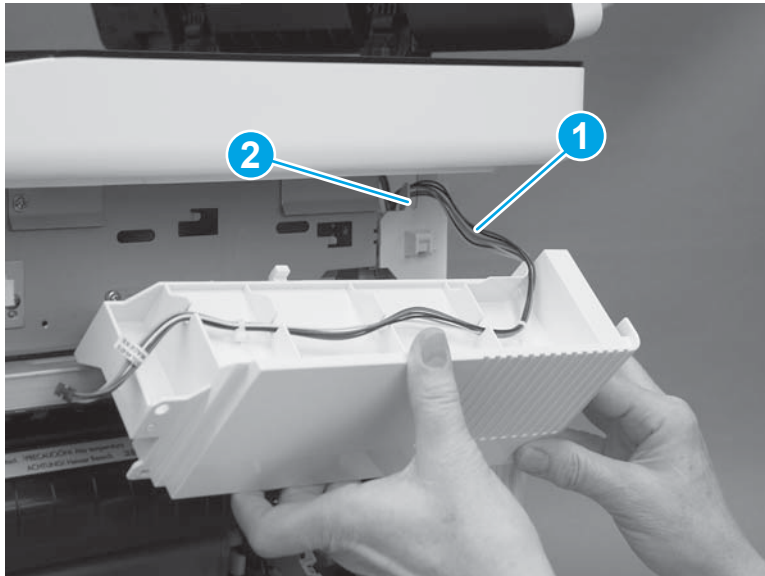

2. Position the hooks (callout 1) on the cover in the slots (callout 2) in the printer.

Figure 1-4583 Position the hooks

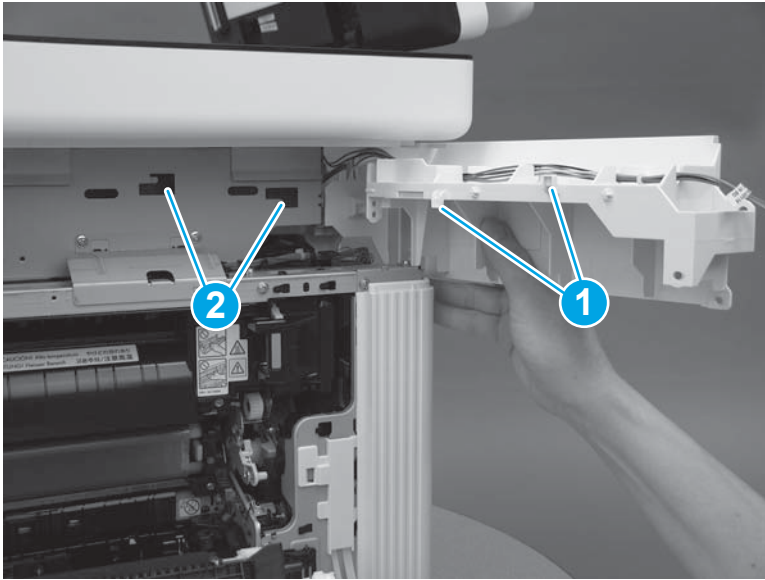

3. Slide the cover toward the front of the printer to install it.

Figure 1-4584 Install the cover

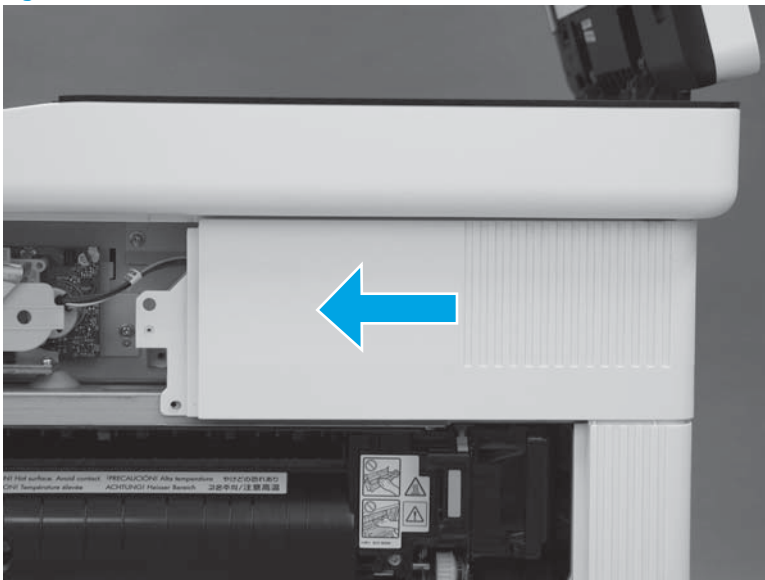

4. At the back of the printer, install one screw (callout 1).

M577c/f/z only: Connect one connector (callout 2), if the integrated scanner assembly is installed.

 **TIP:** This screw is smaller than the screws installed in the next step. Make sure that this screw is installed in the correct position.

Figure 1-4585 Install one screw and connector



5. At the right side of the printer, install two screws (callout 1).

M577c/f/z only: Connect one connector (callout 2), if the stapler is installed.

Figure 1-4586 Install one screw and connector

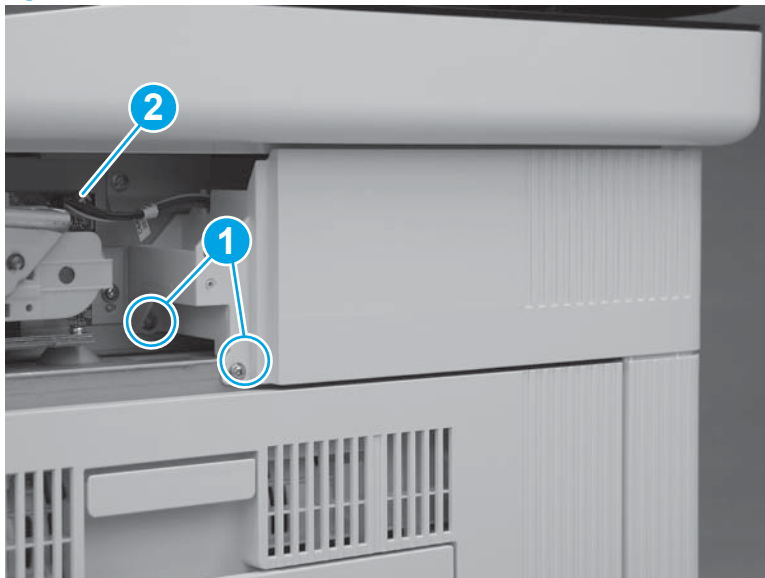

Step 46: Install the integrated scanner assembly (ISA) (M577)

 **NOTE:** This step is for the M577 models. For the M552 and M553 models, skip this step and go to [Step 52: Install the rear cover \(M552 and M553\) on page 2549](#).

 **NOTE:** The ISA includes the document feeder, image scanner, scanner control board (SCB), control panel, keyboard (M577c/z) and NFC PCA (M577z).

1. Before proceeding, locate the mounting pins (callout 1) on the bottom of the ISA and the slots (callout 2) on the printer base.

Figure 1-4587 Locate the ISA mounting pins and slots

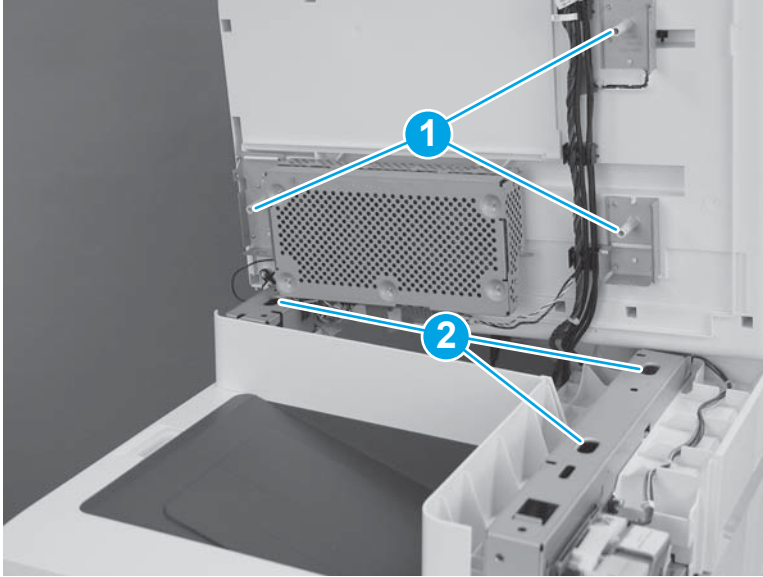

2. Position the ISA on the printer base with the pins in the slots.

 **NOTE:** To locate the pins and slots, see [Figure 1-395 Locate the ISA mounting pins and slots on page 249](#).

When installing the ISA, carefully pass the cables through the opening in the top of the formatter case.

Figure 1-4588 Install the ISA



3. Slightly slide the ISA towards the front of the printer to engage it.

Figure 1-4589 Slide the ISA towards the front of the printer

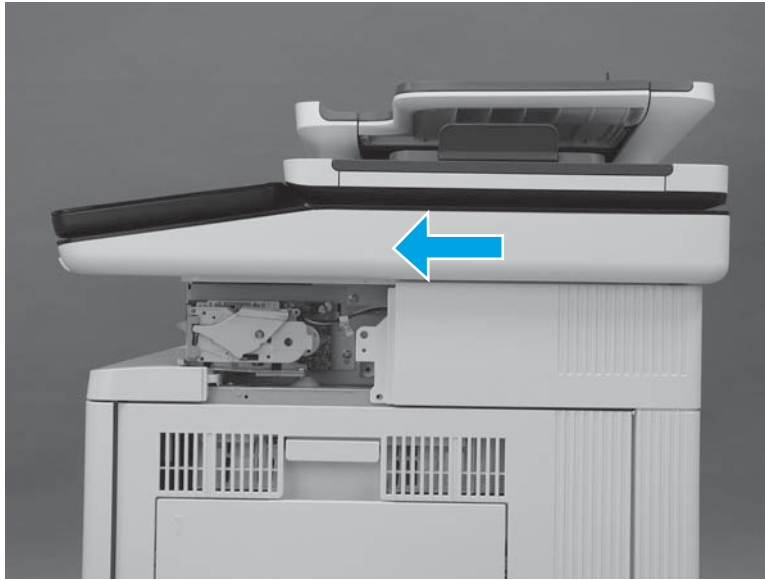

4. At the left side of the printer, install one screw (callout 1).

Figure 1-4590 Install one screw

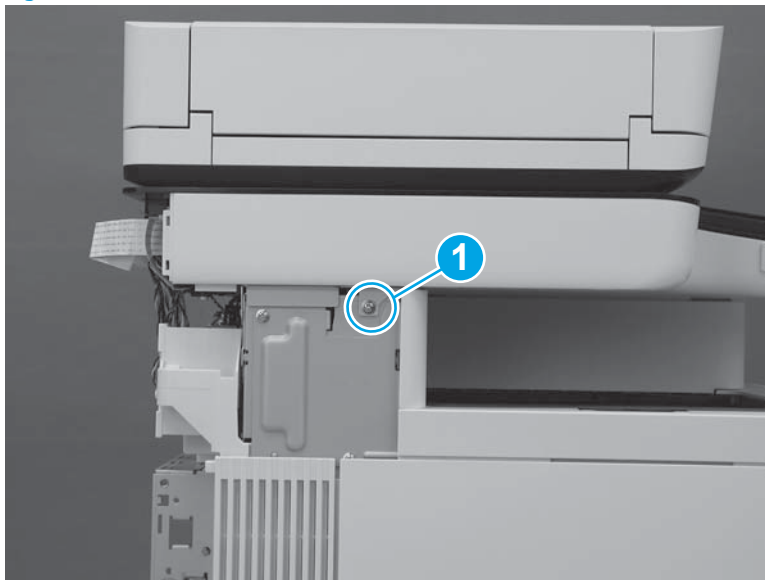

5. At the back of the printer, install two screws (callout 1).

Figure 1-4591 Install two screws

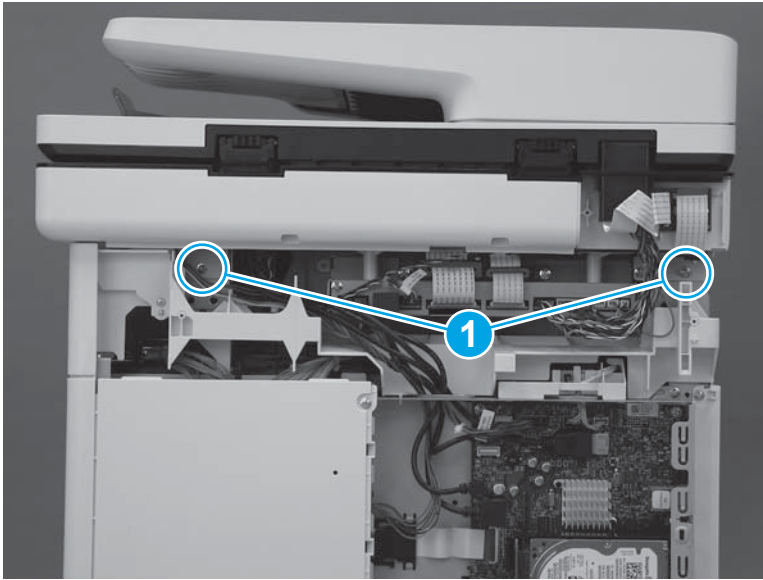

6. At the right side of the printer, install one screw (callout 1).

Figure 1-4592 Install one screw

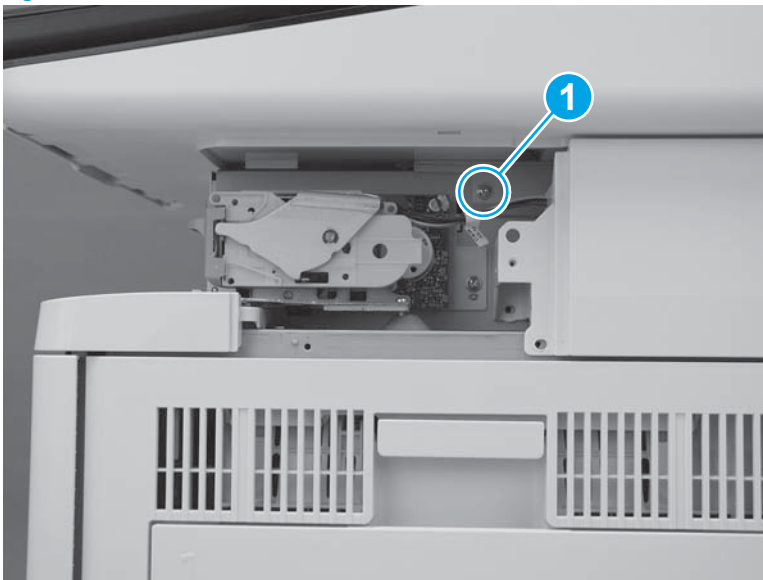

7. Connect two connectors on the scanner control board (callout 1).

M577c/f/z only: Connect one connector for the stapler on the scanner control board (callout 2).

Figure 1-4593 Connect connectors

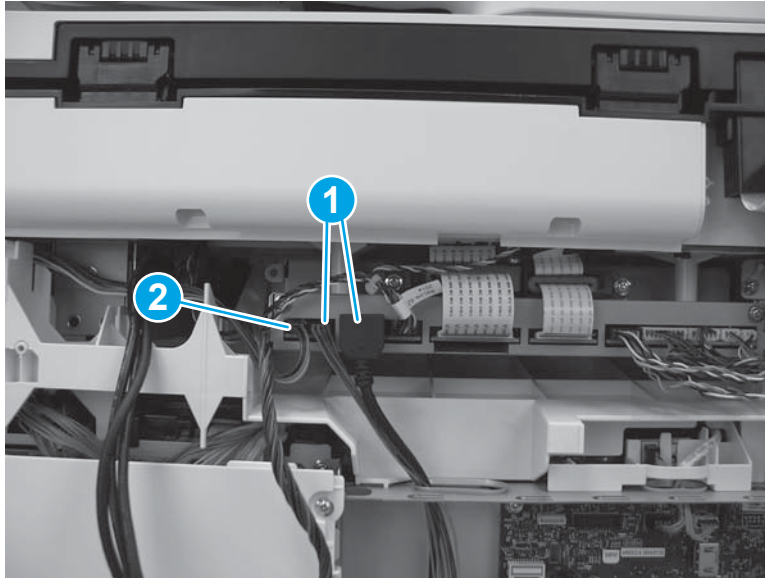

Step 47: Install the stapler cover assembly (M577c/f/z)

 **NOTE:** This step is for the M577c/f/z models only. For the M577dn model, skip this step and go to [Step 48: Install the right front upper cover \(M577dn\) on page 2542.](#)

For the M552 and M553 models, skip this step and go to [Step 52: Install the rear cover \(M552 and M553\) on page 2549.](#)

1. Install the tabs (callout 1) on the cover in the slots (callout 2) in the printer.

Figure 1-4594 Install two tabs



2. Press the cover toward the left side of the printer until it snaps into place.

Figure 1-4595 Install the cover assembly



3. Install one screw (callout 1).



 **IMPORTANT:** This is a self-tapping screw for plastic. Rotate it counterclockwise to align it with the existing thread pattern, and then carefully turn it clockwise to tighten. Do not overtighten. This will prevent stripping the threads inside the screw hole.

Figure 1-4596 Install one screw

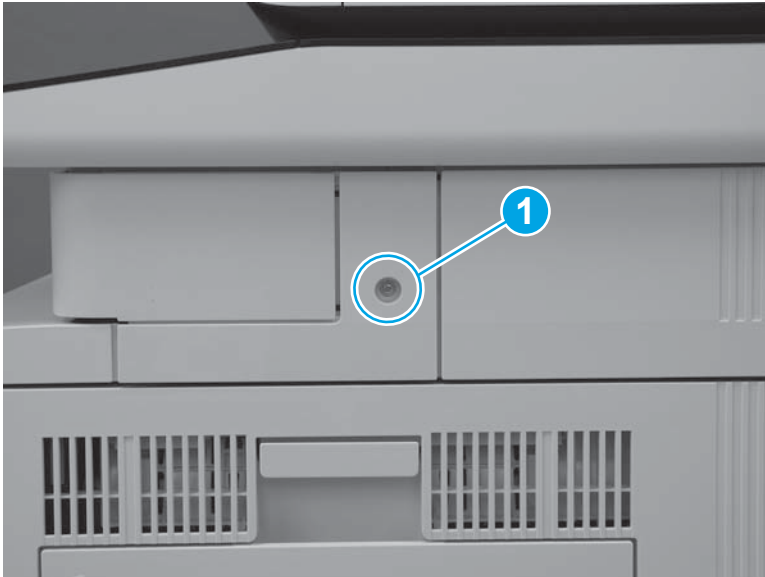

Step 48: Install the right front upper cover (M577dn)

 **NOTE:** This step is for the M577dn model only. For the M577c/f/z models, skip this step and go to [Step 49: Install the left upper cover \(M577\) on page 2544](#).

For the M552 and M553 models, skip this step and go to [Step 52: Install the rear cover \(M552 and M553\) on page 2549](#).

1. Slide the cover toward the left side of the printer to install it. Make sure that the slots (callout 1) in the cover fit over the tabs (callout 2) on the inside of the paper feeder cover.

Figure 1-4597 Install the cover

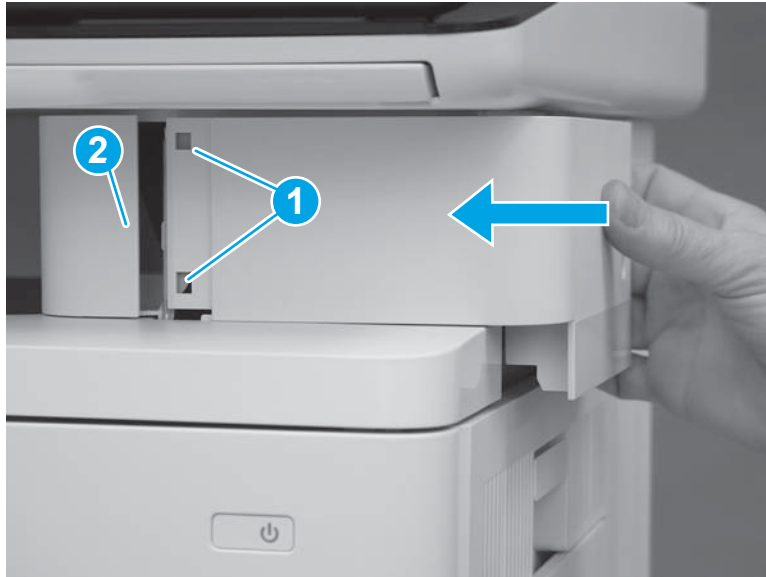

2. Press the right front upper cover (callout 1) and the paper feeder cover (callout 2) together until the tabs on the inside of the covers snap into place.

Figure 1-4598 Press the cover



3. Install one screw (callout 1).

Figure 1-4599 Install one screw

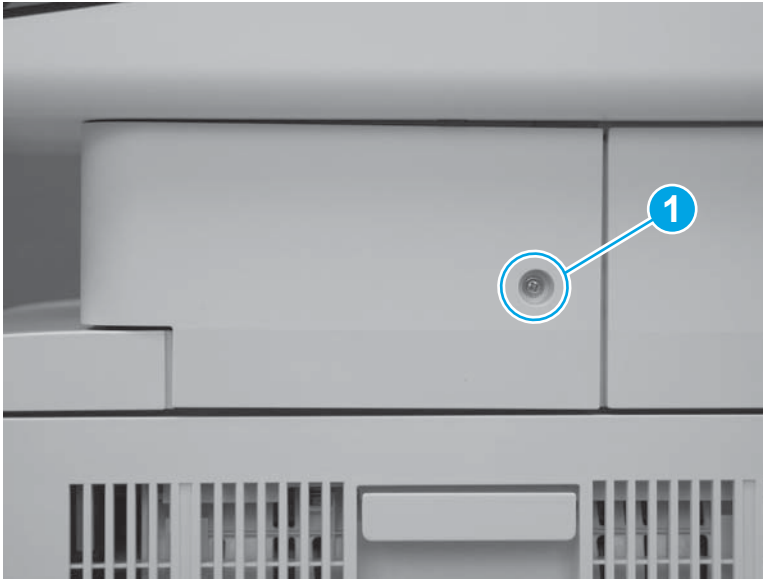

Step 49: Install the left upper cover (M577)

 **NOTE:** This step is for the M577 models. For the M552 and M553 models, skip this step and go to [Step 52: Install the rear cover \(M552 and M553\) on page 2549](#).

1. Position the tab (callout 1) on the lower edge of the cover behind the left cover (callout 2).

Figure 1-4600 Position the tab

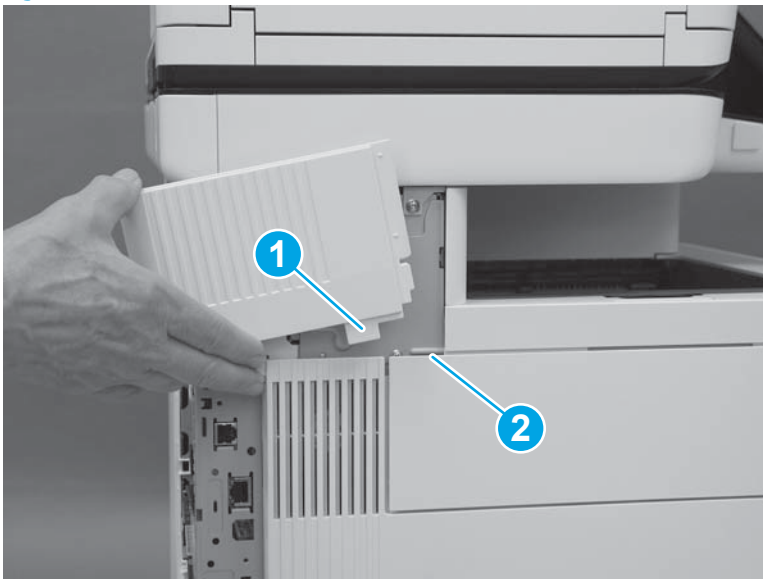

2. Slide the cover toward the front of the printer to install it. Make sure that the edge (callout 1) of the cover fits behind the edge (callout 2) of the top rear cover.

Figure 1-4601 Slide the cover

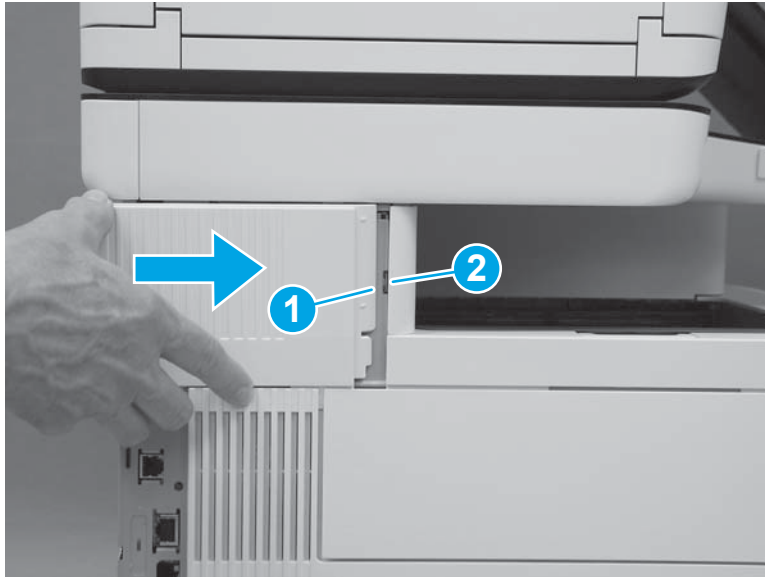

3. Make sure that the tab (callout 1) is fully installed.

Figure 1-4602 Check the tab

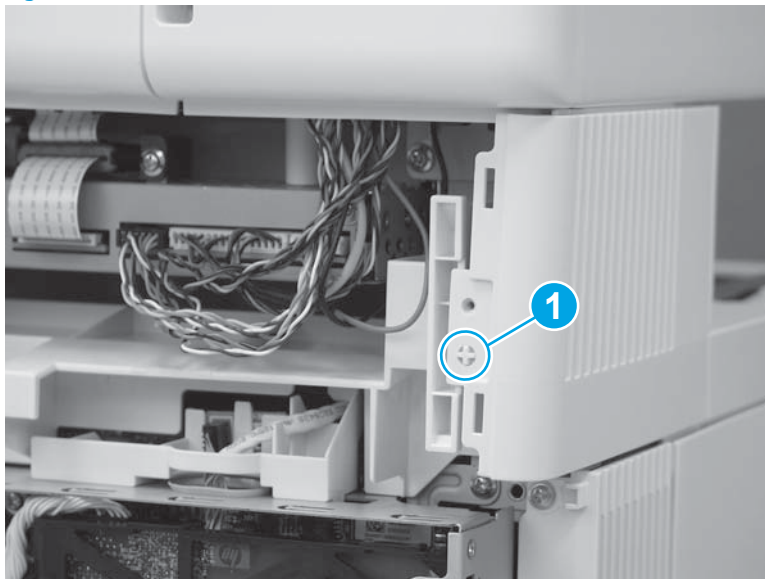

Step 50: Install the rear cover (M577)

 **NOTE:** This step is for the M577 models. For the M552 and M553 models, skip this step and go to [Step 52: Install the rear cover \(M552 and M553\) on page 2549](#).

1. Position the hooks (callout 1) on the cover in the slots (callout 2) in the printer.

Figure 1-4603 Position the hooks

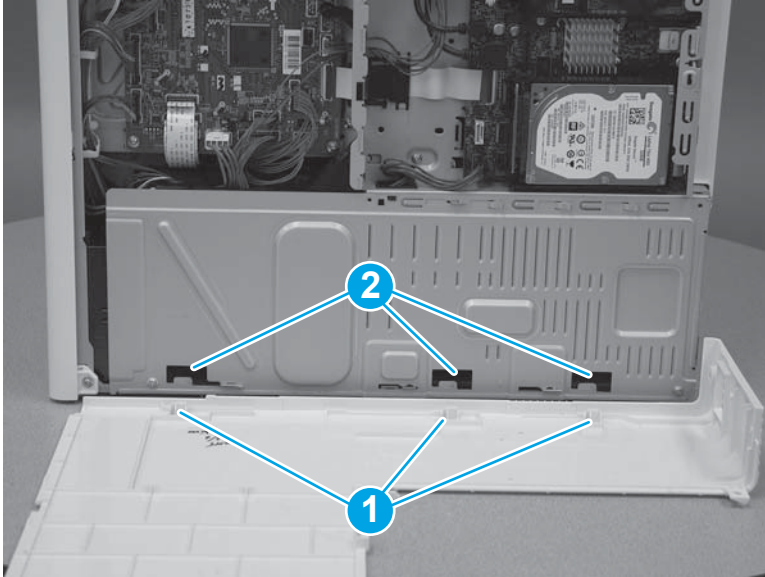

2. Position the back edge (callout 1) of the rear cover behind the edge (callout 2) of the right rear cover. Slide the cover to the left to install it.

Figure 1-4604 Install the cover

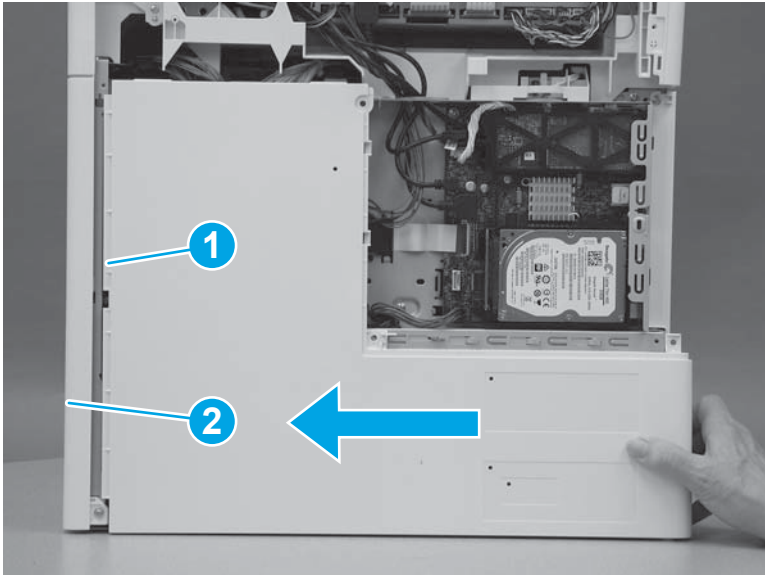

3. Install four screws (callout 1).

Figure 1-4605 Install four screws cover

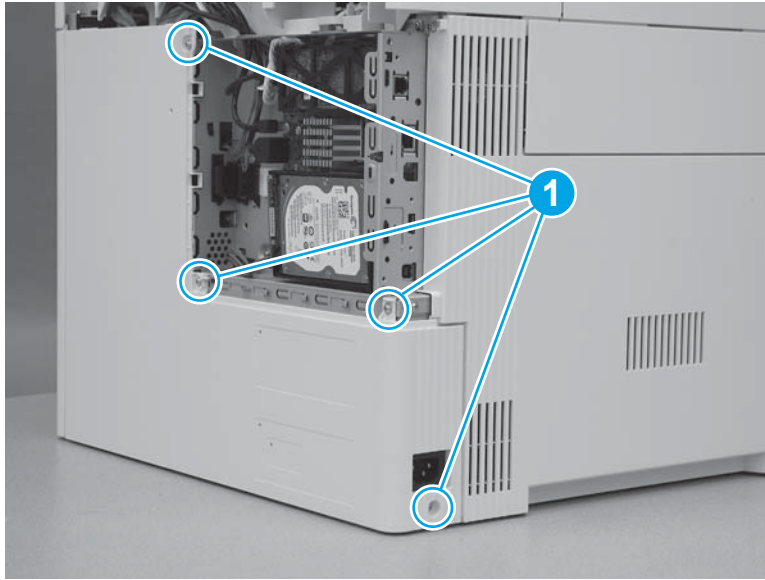

Step 51: Install the rear upper cover (M577)

 **NOTE:** This step is for the M577 models. For the M552 and M553 models, skip this step and go to [Step 52: Install the rear cover \(M552 and M553\) on page 2549](#).

1. Align the ridge (callout 1) on the lower edge of the rear upper cover in front of the tabs (callout 2) on the top edge of the rear cover.

Figure 1-4606 Align the cover

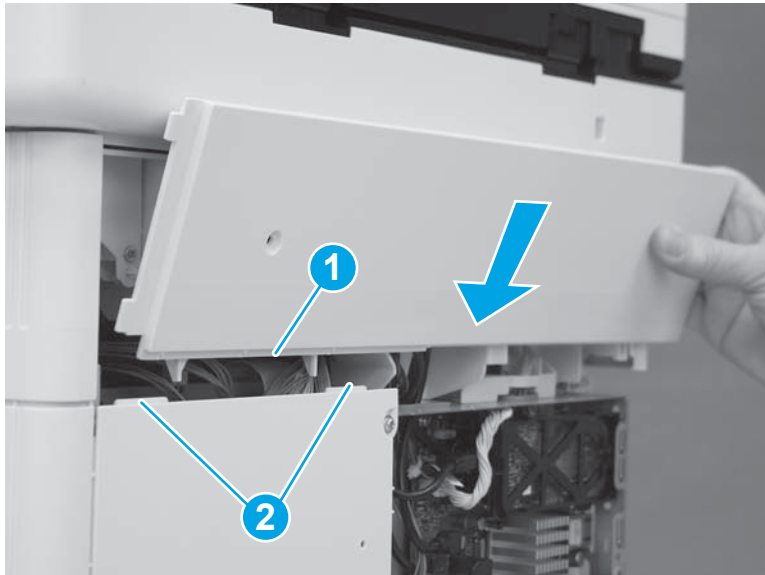

2. Rotate the top of the cover toward the printer.

Figure 1-4607 Rotate the top of the cover

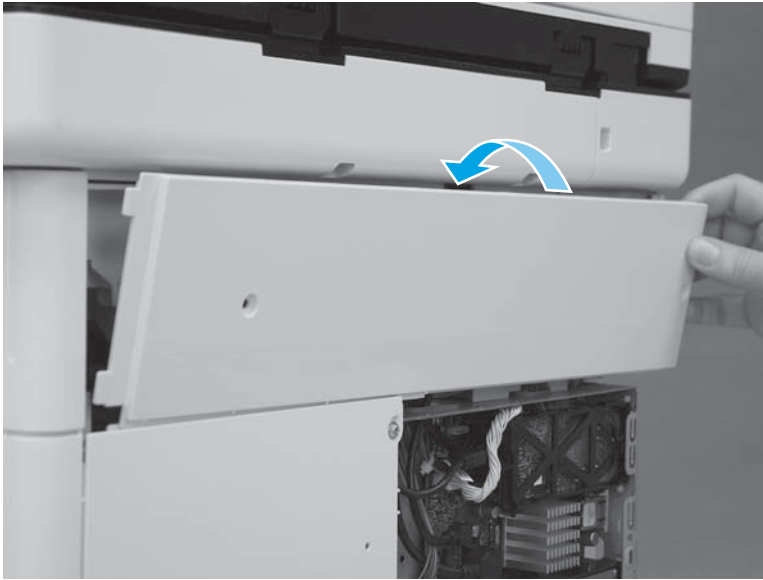

3. Slide the cover to the left (callout 1). Make sure that the tabs (callout 2) on the upper rear cover slide behind the edge (callout 3) of the right upper cover. Make sure that the cover is fully seated.

Figure 1-4608 Slide the cover

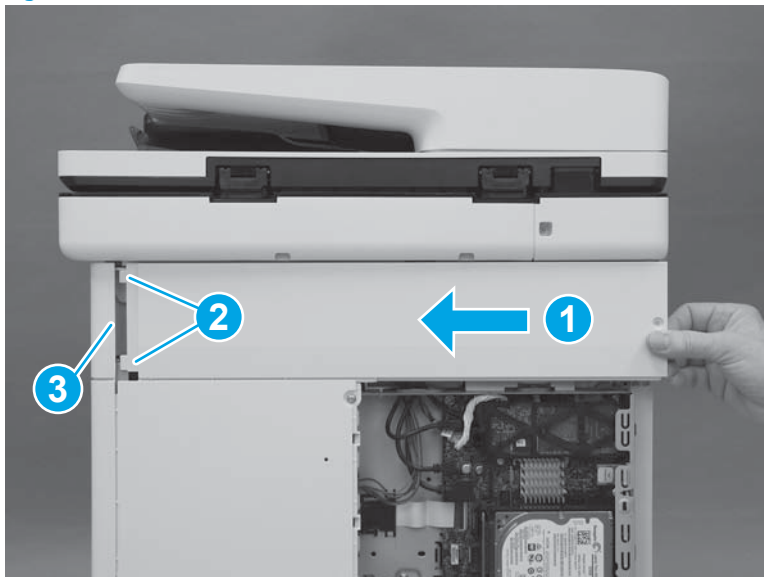

4. Install two screws (callout 1).

 **IMPORTANT:** These two screws are self-tapping screws for plastic. Rotate them counterclockwise to align them with the existing thread pattern, and then carefully turn them clockwise to tighten. Do not overtighten. This will prevent stripping the threads inside the screw holes.

Figure 1-4609 Install two screws



Step 52: Install the rear cover (M552 and M553)

 **NOTE:** This step is for the M552 and M553 models. For the M577 models, skip this step and go to [Step 53: Install the formatter \(M577\) on page 2550](#).

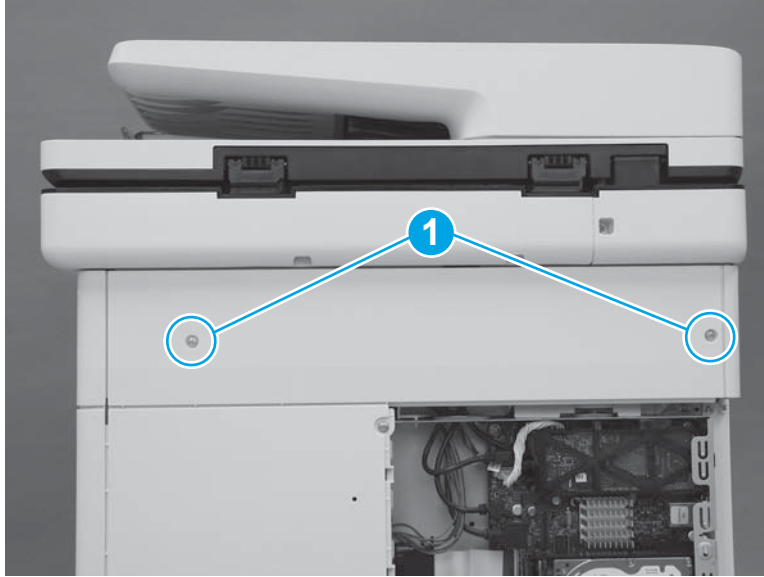
1. Position the top of the cover under the upper cover (callout 1), rotate the bottom of the cover onto the chassis (callout 2), and then slide the cover to the left (callout 3) to install it.

Figure 1-4610 Install the cover

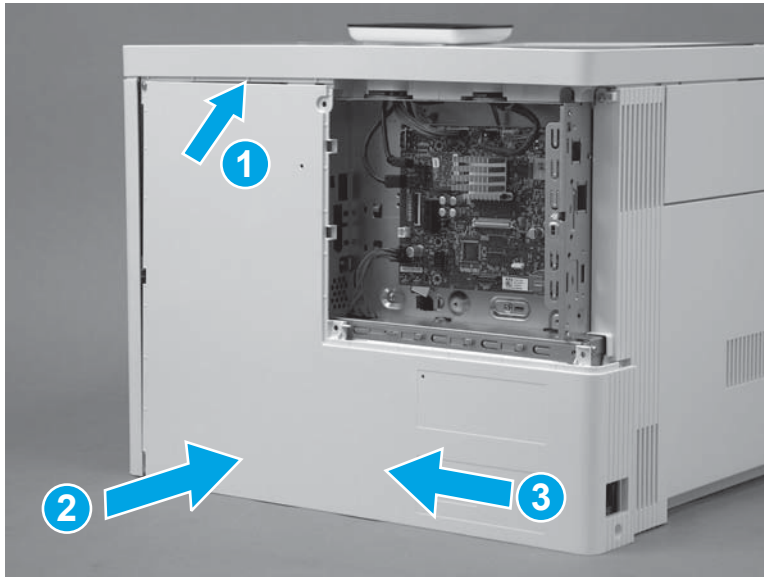

2. Install four screws (callout 1).

Figure 1-4611 Install four screws cover

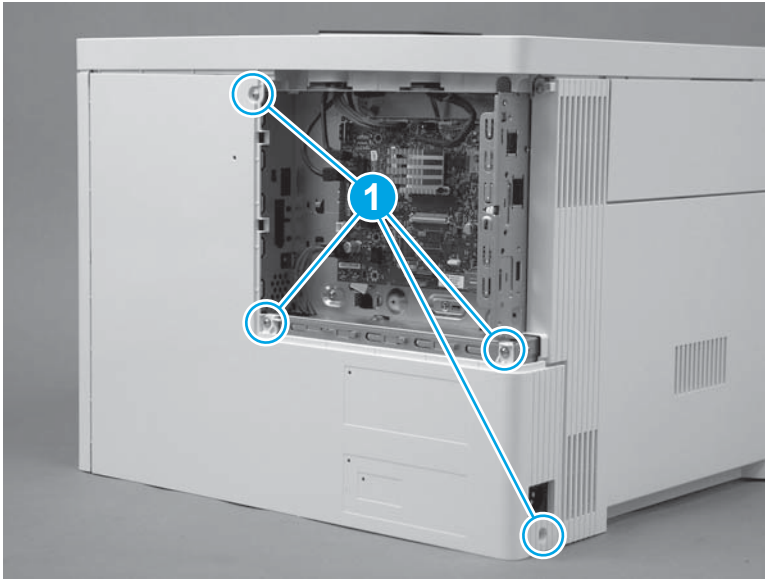

Step 53: Install the formatter (M577)

 **NOTE:** This step is for the M577 models. For the M552 and M553 models, skip this step and to go [Step 56: Install the formatter \(M552 and M553\) on page 2555](#).

 **CAUTION:**  ESD-sensitive part.

1. Position the formatter in the printer. Make sure that the network port (callout 1) fits through the opening (callout 2) in the formatter case.

Figure 1-4612 Install the formatter

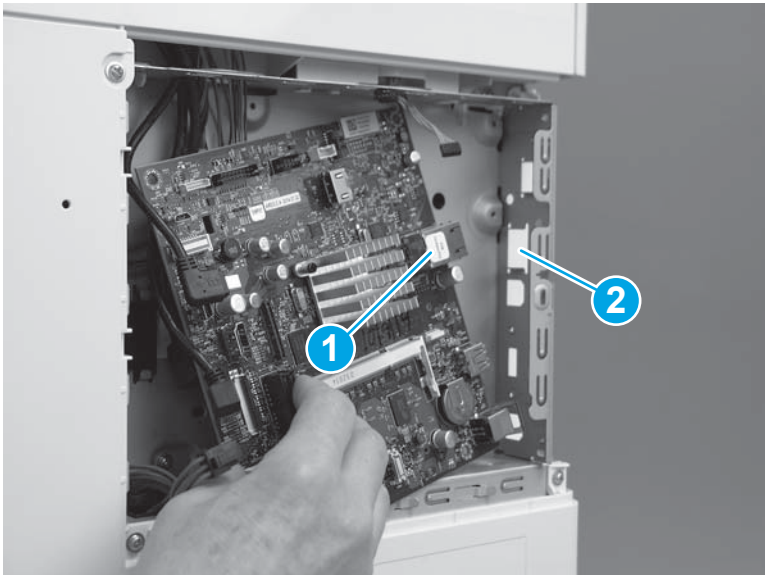

2. Install four screws (callout 1).

Figure 1-4613 Install four screws

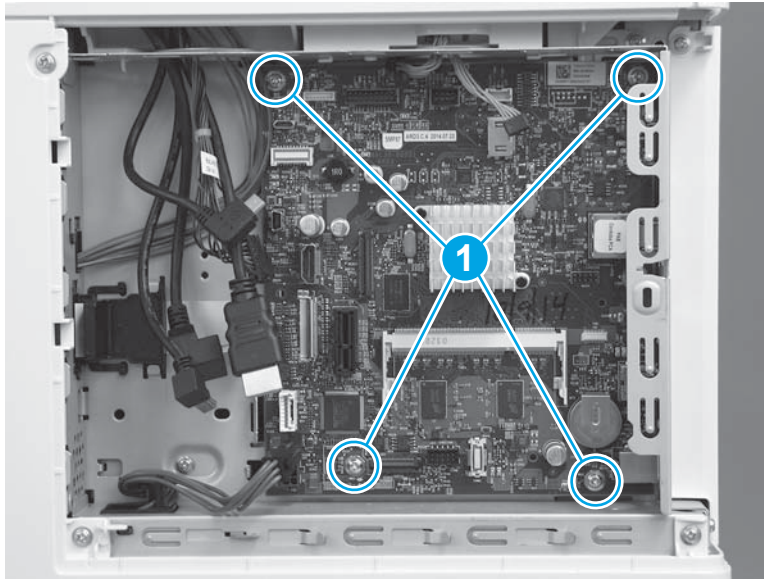

3. Connect all of the connectors on the formatter.

The following connectors are empty:

- All models: J1 (this connector is empty unless the optional DIMM is installed)
- All models: J3
- M577dn: J15 (this is the fax connector for the M577f/z/c models)
- All models: J21 (this connector is empty unless the optional internal USB ports component is installed)
- All models: J23
- All models: J24
- All models: J51
- All models: J57
- All models: J97
- All models: J98 (this connector is empty unless the optional trusted platform module (TPM) is installed)

 **IMPORTANT:** The flat-cable connector (callout 1) is a Zero Insertion Force (ZIF) connector that uses a hinged retainer to secure the flat cable. The hinged retainer must be opened to install the flat cable, and then closed after the cable is installed.

Figure 1-4614 Connect all connectors



Step 54: Install the fax PCA (M577c/f/z)

 **NOTE:** This step is for the M577c/f/z models. For the M577n model, skip this step and go to [Step 55: Install the HDD \(M577\) on page 2553](#).

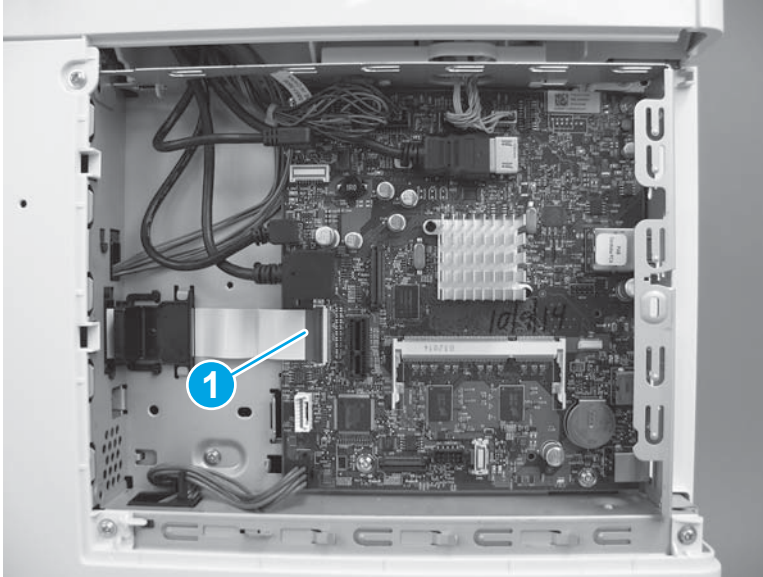
For the M552 and M553 models, skip this step and go to [Step 56: Install the formatter \(M552 and M553\) on page 2555](#).

 **CAUTION:**  ESD-sensitive part.

1. Position the tab and telephone port (callout 1) on the fax PCA in the slots (callout 2) in the formatter case.

Figure 1-4615 Position the fax PCA

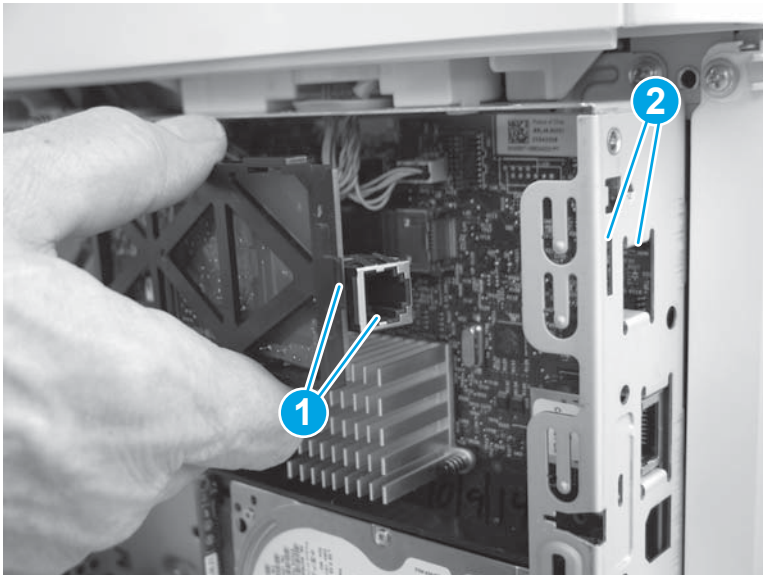

- Slide the fax PCA to the right (callout 1) until the tab and telephone port described in the previous step and seated in the formatter case. Position the retainer (callout 2) in the slot (callout 3) in the formatter. Rotate the end of the fax PCA toward the formatter (callout 4) until the retainer snaps into place.

Figure 1-4616 Install the fax PCA

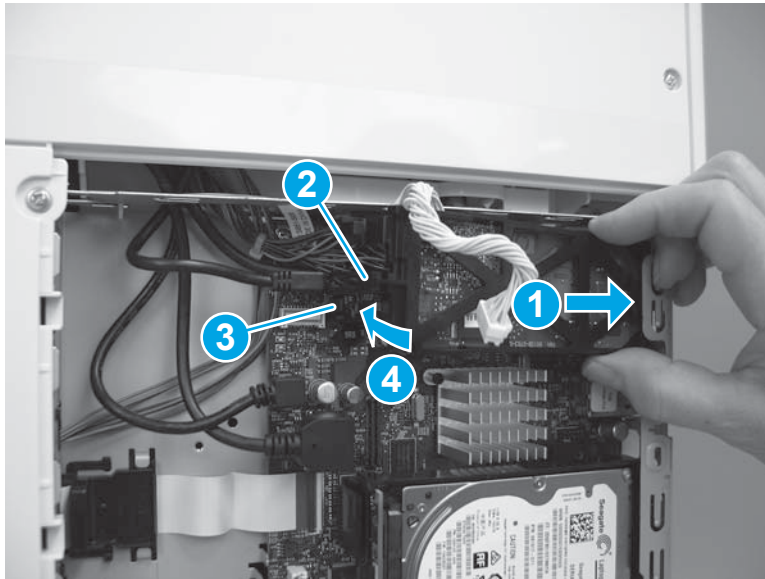

- Position the cable (callout 1) in the guide (callout 2), and then connect one connector (callout 3).

Figure 1-4617 Connect the connector

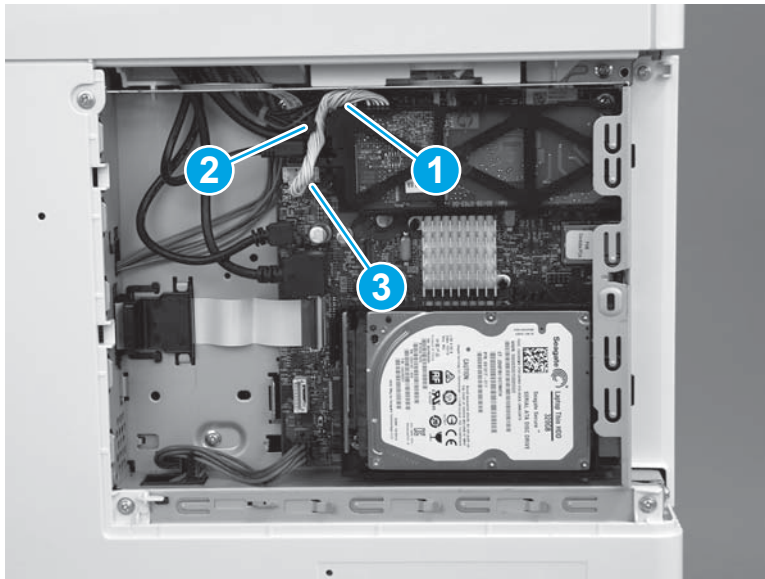

Step 55: Install the HDD (M577)

 **NOTE:** This step is for the M577 models. For the M552 and M553 models, skip this step and go to [Step 56: Install the formatter \(M552 and M553\) on page 2555](#).

 **CAUTION:**  ESD-sensitive part.

1. Align the end of the bracket (callout 1) with the slot in the chassis (callout 2), and then slide the HDD into the printer (callout 3) to engage the bracket with the chassis.

Figure 1-4618 Install the holder

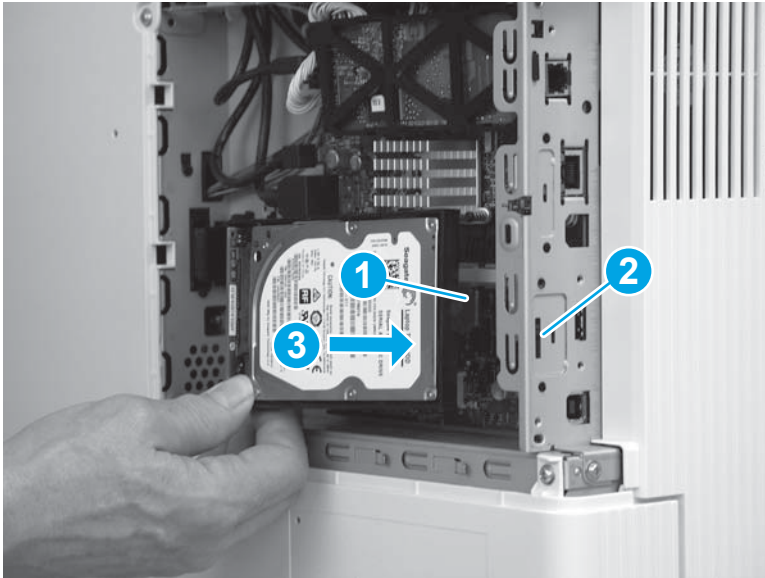

2. Hold the HDD connector latch (callout 1) in the released position, and then rotate the HDD down and into the connector on the formatter to install it.



 **NOTE:** Make sure that the tab (callout 2) snaps into place, and that the HDD is securely installed.

Figure 1-4619 Release the HDD

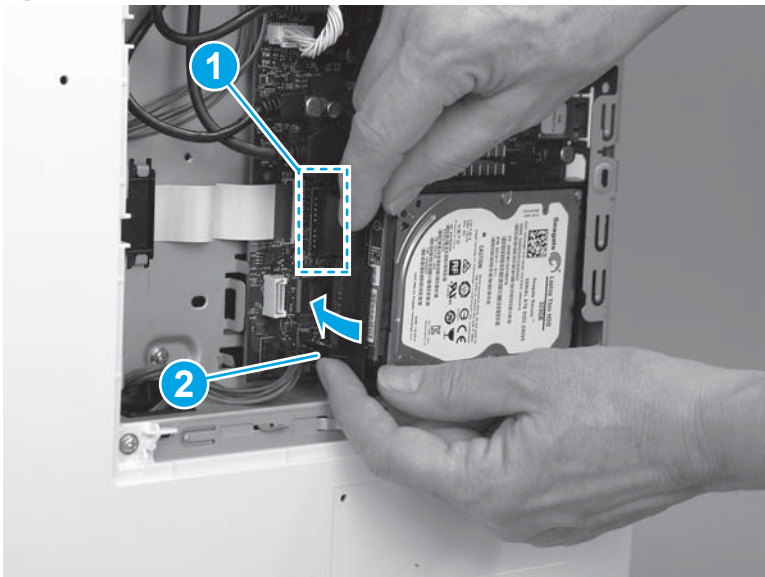

Step 56: Install the formatter (M552 and M553)

 **NOTE:** This step is for the M552 and M553 models. For the M577 models, skip this step and go to [Step 59: Install the formatter cover on page 2560](#).

If the optional hard-disk drive (HDD) was removed, do not forget to reinstall it after the formatter is reinstalled.

Engage the HDD holder with the chassis, rotate the HDD connector down and into the connector on the formatter. Make sure that the tabs snap into place.

 **CAUTION:**  ESD-sensitive part.

1. Position the formatter in the printer, and then install four screws (callout 1).

Figure 1-4620 Install the formatter

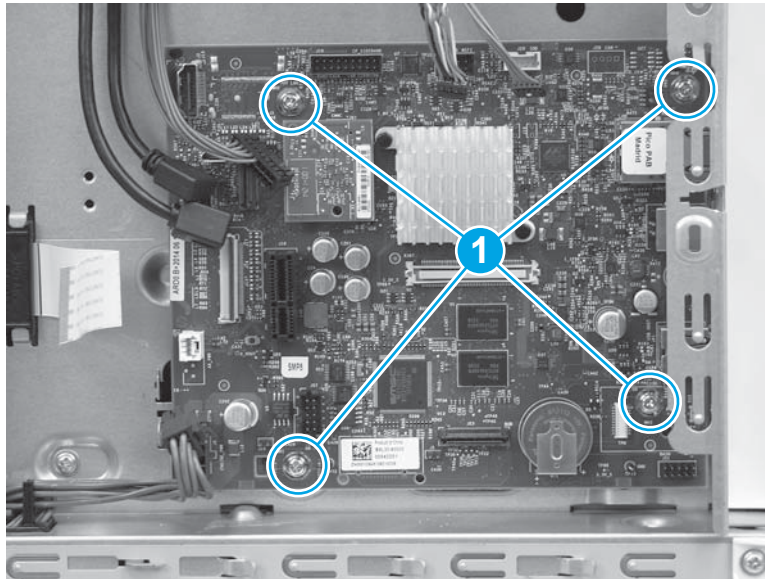

2. Connect all of the connectors on the formatter.

The following connectors are empty:

- All models: J1 (this connector is empty unless the optional DIMM is installed)
- M553n/dn and M552dn: J2 (callout 1; this is the touchscreen connector for the M553x model)
- All models: J9 (this connector is empty unless the optional internal USB ports component is installed)
- All models: J18 (this connector is empty unless the optional hard-disk-drive (HDD) is installed)
- All models: J23
- All models: J24
- M553n/dn and M552dn: J25 (this is the wireless connector for the M553x model)
- All models: J57
- All models: J98 (this connector is empty unless the optional trusted platform module (TPM) is installed)

 **IMPORTANT:** The flat-cable connector (callout 2) is a Zero Insertion Force (ZIF) connector that uses a hinged retainer to secure the flat cable. The hinged retainer must be opened to install the flat cable.

Figure 1-4621 Connect all connectors

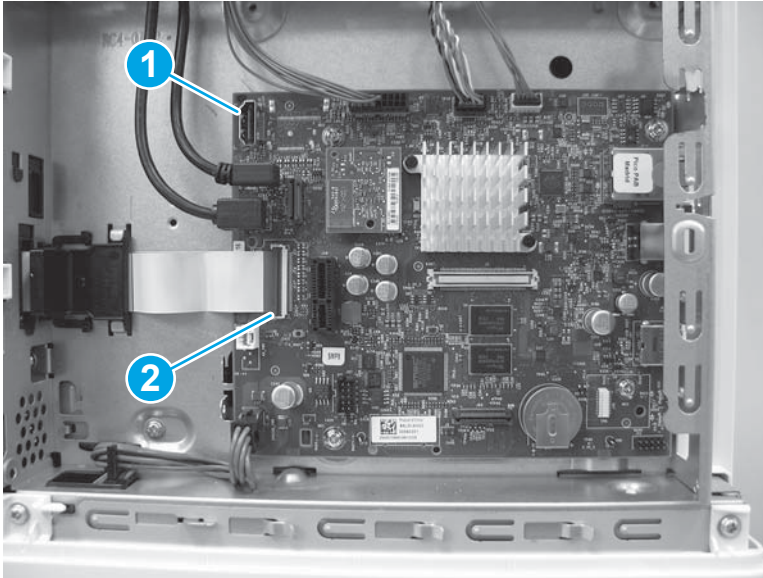

Step 57: Install the control-panel assembly (M553x only)

 **NOTE:** This step is for the M553x model. For the M553n/dn and M552dn models, skip this step and go to [Step 58: Install the USB cover \(M552 and M553\) on page 2559](#).

For the M577 models, skip this step and go to [Step 59: Install the formatter cover on page 2560](#).

1. Place the control panel on the printer as shown.

Figure 1-4622 Place the control panel on the product

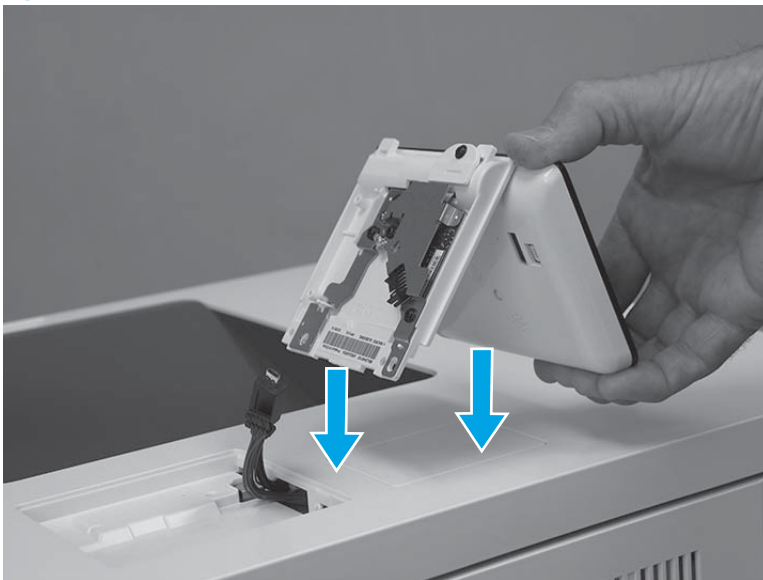

2. Connect one USB cable (callout 1), and one connector (callout 2).

 **IMPORTANT:** Take note of the location of the two mounting tabs (callout 3) on the control-panel assembly.

Figure 1-4623 Connect two connectors



3. Turn the control panel over, and then position the front edge tabs in the slots in the top cover.

Figure 1-4624 Turn the control panel over

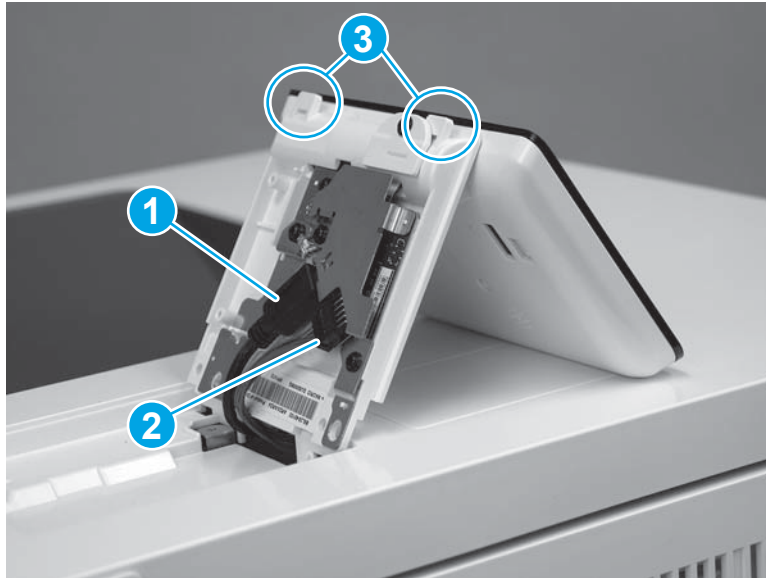
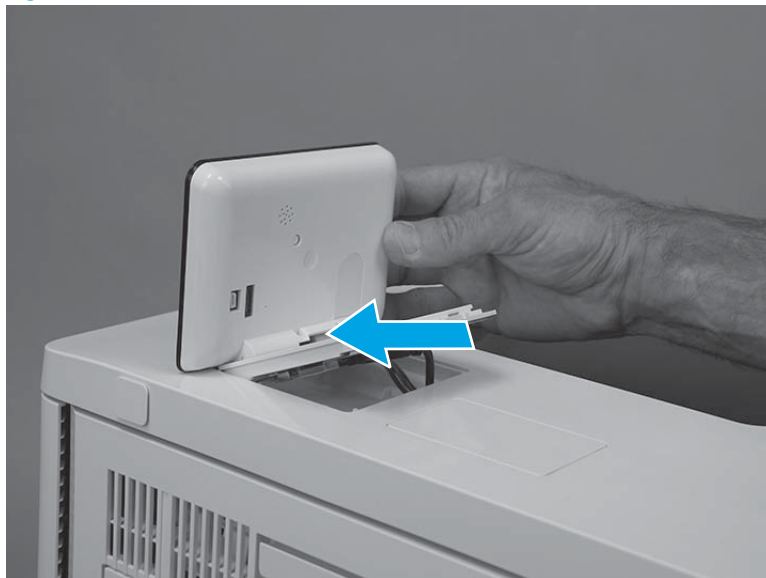

4. Rotate the control-panel base down onto the printer.

Figure 1-4625 Rotate the control-panel base down



5. Use a small Phillips screwdriver to install two screws (callout 1).

Figure 1-4626 Install two screws

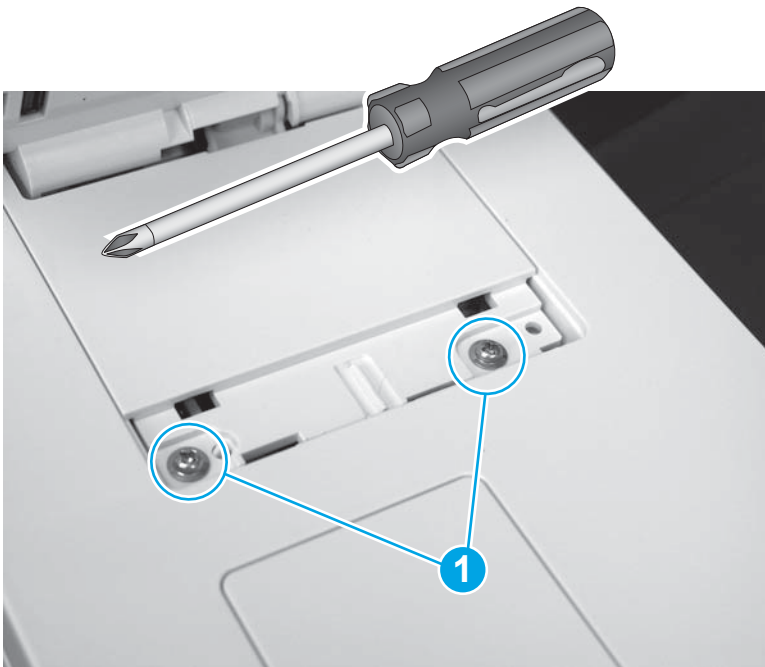

6. Position the screw cover mounting feet into the slots in the top cover (callout 1), and then rotate the cover down (callout 2) to install it.



 **NOTE:** Press down on the cover firmly to make sure that the tabs on the cover (callout 3) snap into place.

Figure 1-4627 Install the cover

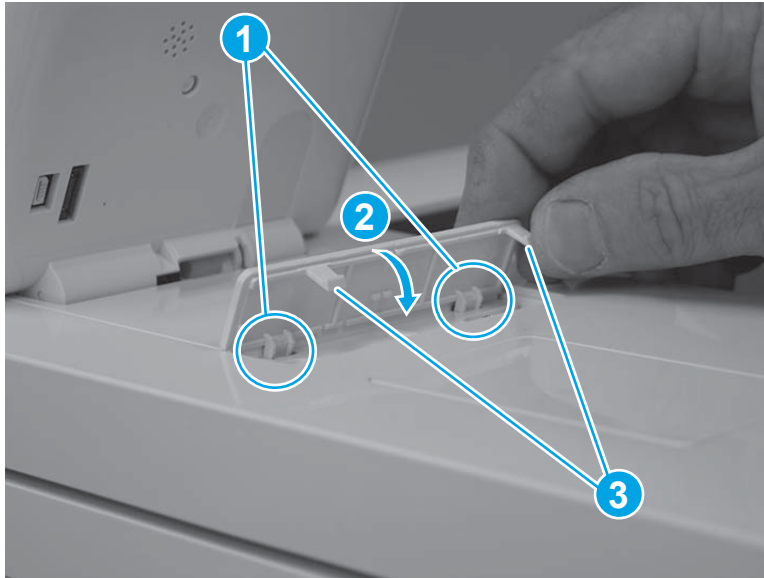

Step 58: Install the USB cover (M552 and M553)

 **NOTE:** This step is for the M552 and M553 models. For the M577 models, skip this step and go to [Step 59: Install the formatter cover on page 2560](#).

1. Push the cover into the USB port to install it.

Figure 1-4628 Install the cover



2. Make sure that the USB cover is fully seated after installing it.

Figure 1-4629 Check the installation

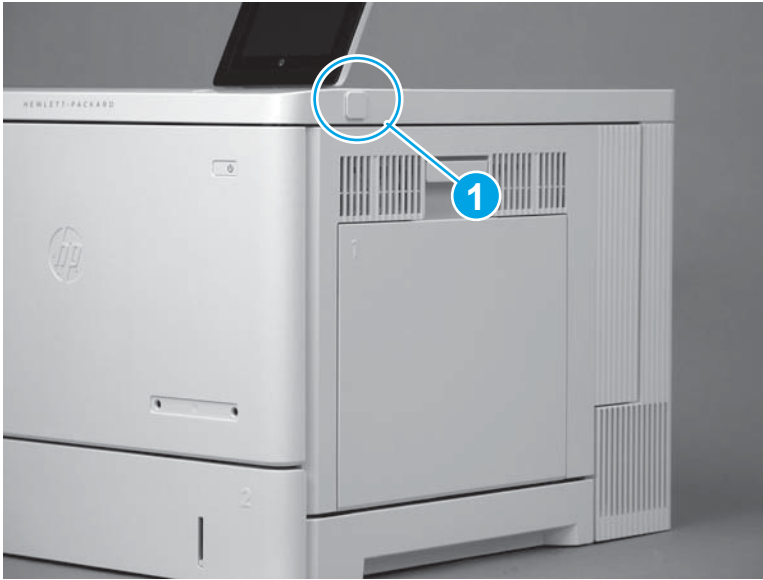

Step 59: Install the formatter cover

- ▲ Slide the cover onto the printer (callout 1) to install it.

 **NOTE:** Make sure that the tabs on the formatter cover align with the slots provided in the printer (callout 2). Tighten the two thumbscrews (callout 3).

 **TIP:** If needed, use the edge of a coin to turn the thumbscrews.

Figure 1-4630 Install the cover

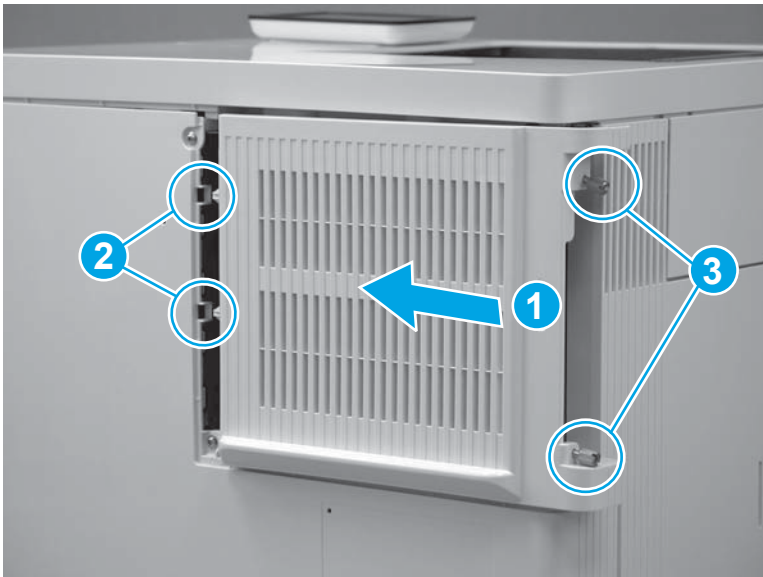

Step 60: Install the TCU

1. Verify that the toner collection hatch cover is in the closed position on the TCU.

Figure 1-4631 Verify that the toner collection hatch cover is closed

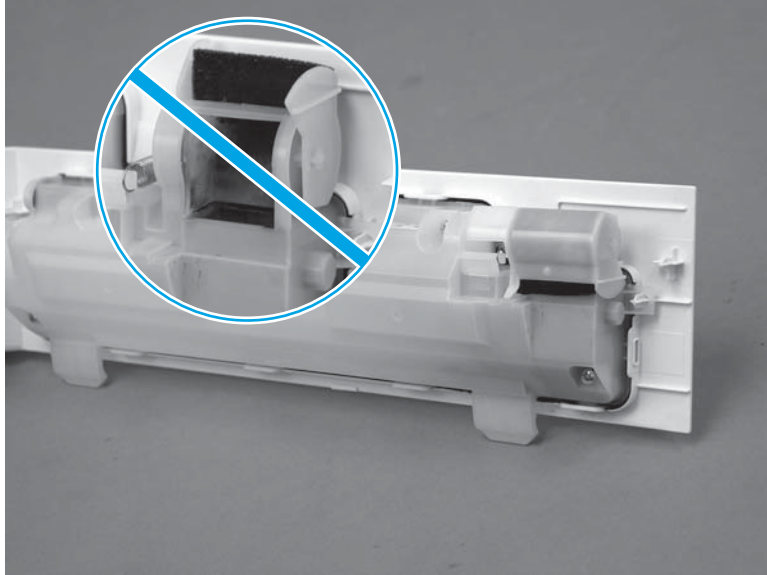

2. Position the TCU with the hinges in the slots provided in the printer (callout 1), and then rotate the TCU up and into the closed position.

 **NOTE:** The toner collection hatch cover automatically opens when the TCU is closed.

Figure 1-4632 Install the TCU

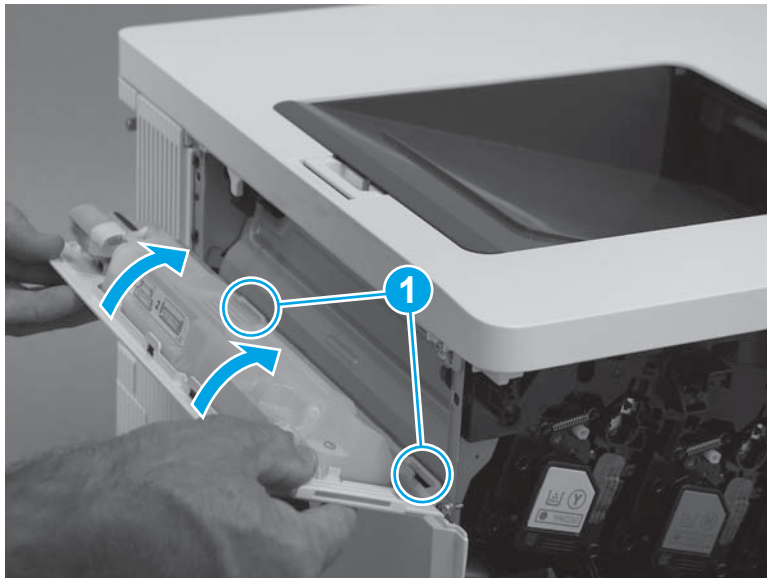

3. Close the front door.

Figure 1-4633 Close the front door



Step 61: Install the tray

1. With the front of the tray slightly lifted, align the sides of the tray with the rails in the printer, and then carefully slide the tray into the printer.

 **TIP:** As the tray slides into the printer, lower the front of it.

Figure 1-4634 Install the tray



2. Close the tray.

Figure 1-4635 Close the tray



Step 62: Install the ITB

CAUTION: Do not touch the grey-plastic belt. Skin oils and fingerprints on the belt can cause print-quality problems.

1. Handle the ITB by the edges. Do not touch the grey-plastic belt. Skin oils and fingerprints on the belt can cause print-quality problems.

Figure 1-4636 Handle the ITB by the edges

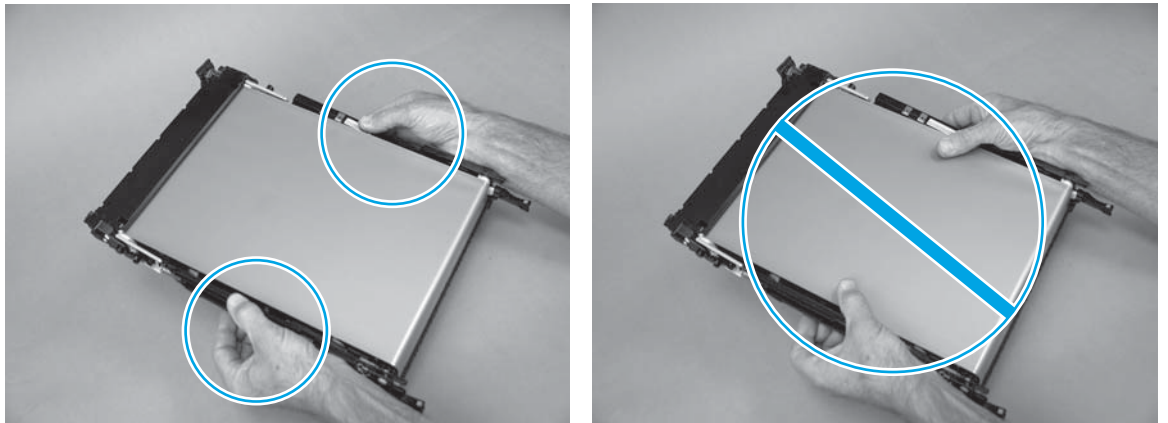

- Align the ITB with the slots in the printer, and then carefully push it into the printer.

 **NOTE:** Be careful. Do not dislodge the ITB retainer springs from the holders on the chassis. The springs can interfere with installing the ITB.

Figure 1-4637 Align the ITB with the slots in the product



- Continue to carefully push the ITB into the printer until it is fully installed.

Figure 1-4638 Install the ITB

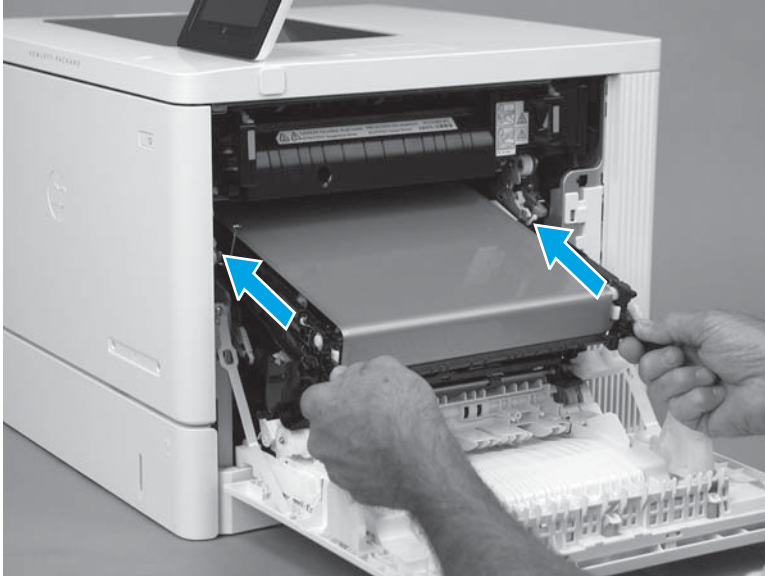
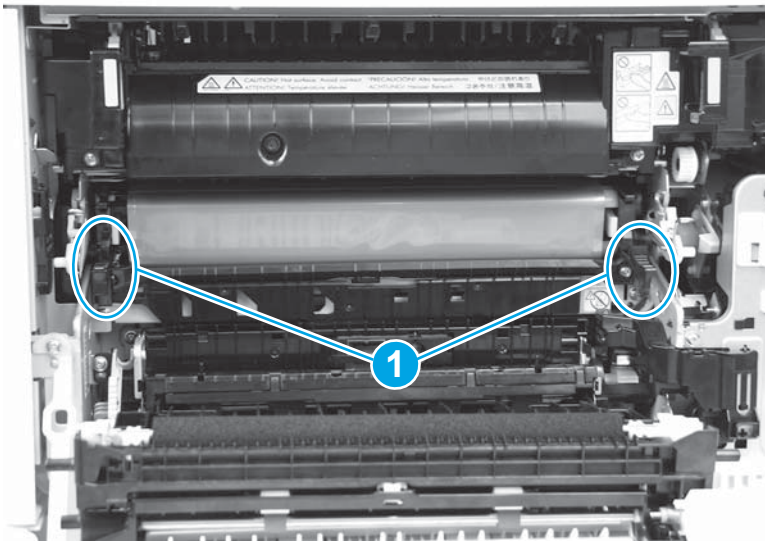

4. Remove the right-side ITB spring from the holder.

Figure 1-4639 Remove the spring from the holder



5. Fasten the right-side ITB spring (callout 1) under the tab (callout 2).

Figure 1-4640 Fasten the rear-side ITB spring

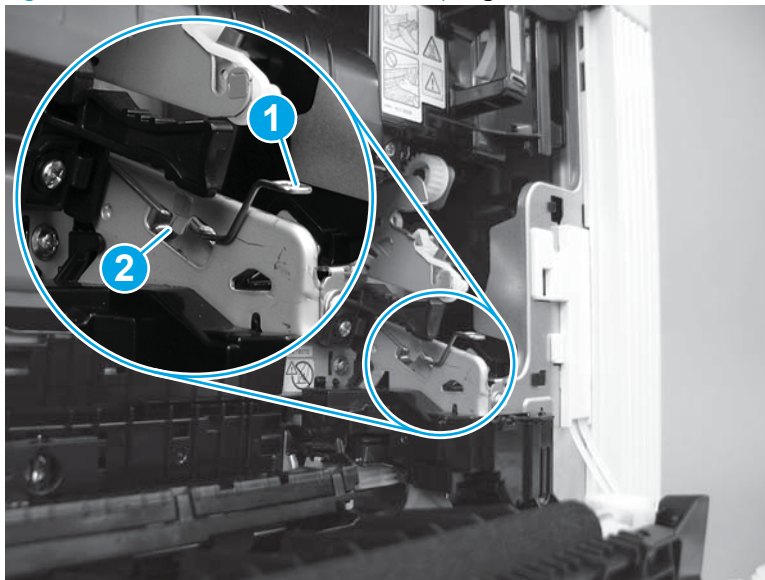

6. Remove the left-side ITB spring from the holder.

Figure 1-4641 Remove the spring from the holder

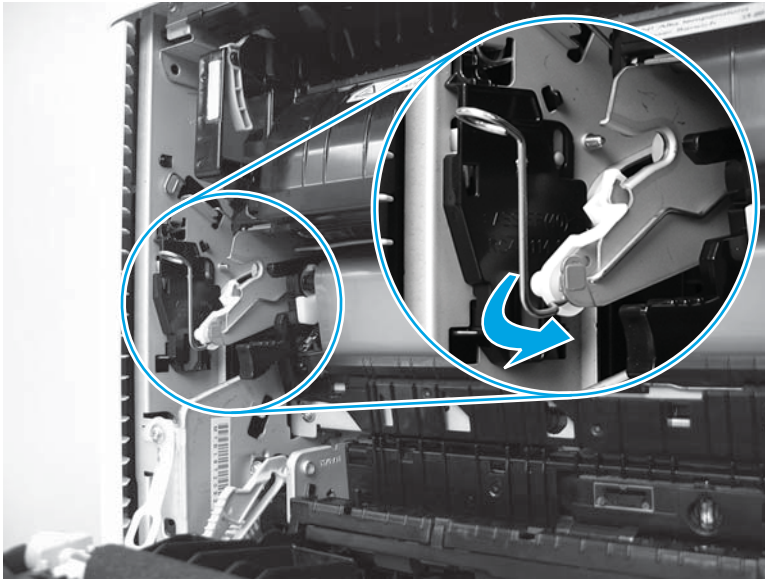

7. Fasten the left-side ITB spring (callout 1) under the tab (callout 2).

Figure 1-4642 Fasten the front-side ITB spring

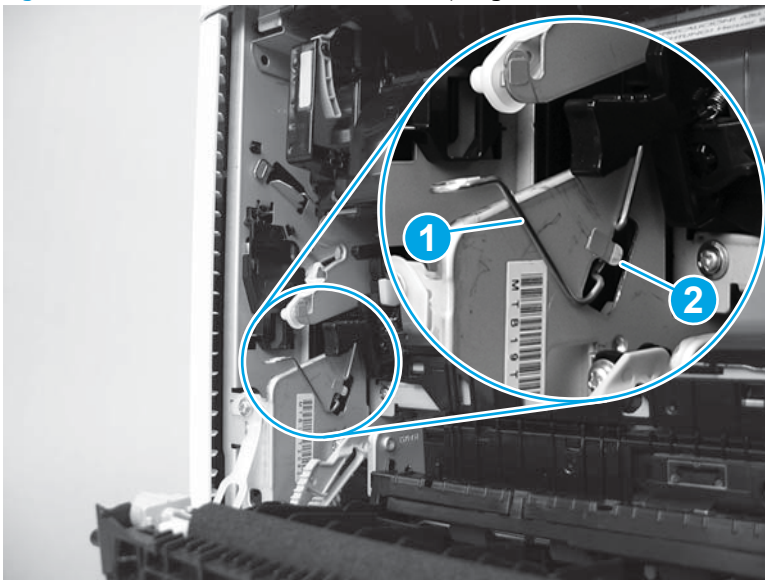

8. Push in the blue lever to engage the ITB drive coupling.

Figure 1-4643 Engage the ITB drive coupling

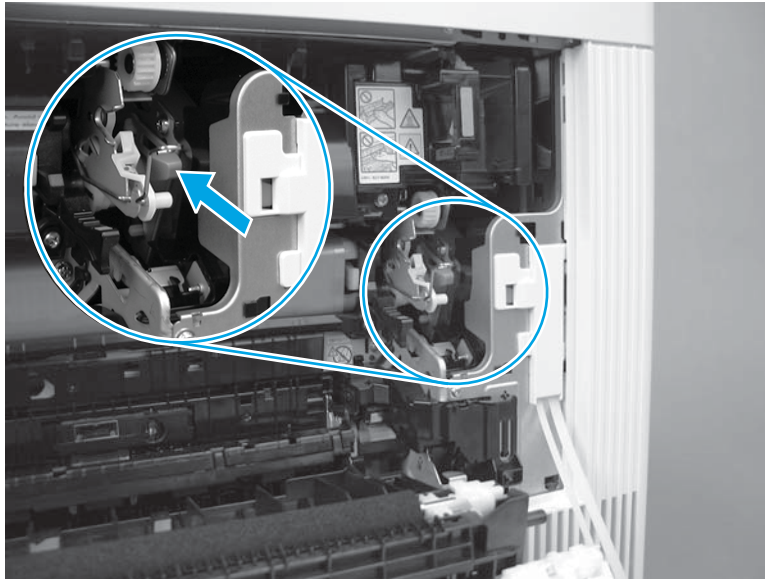

9. Close the right door.

 **TIP:** The right door should close easily if the ITB assembly is correctly installed.

Figure 1-4644 Close the right door



Step 63: Install the secondary transfer roller assembly

1. Move the registration sensor assembly (callout 1) out of the way, and then position the secondary transfer assembly right hinge (callout 2) into the hole provided in the printer.

Figure 1-4645 Install the right hinge

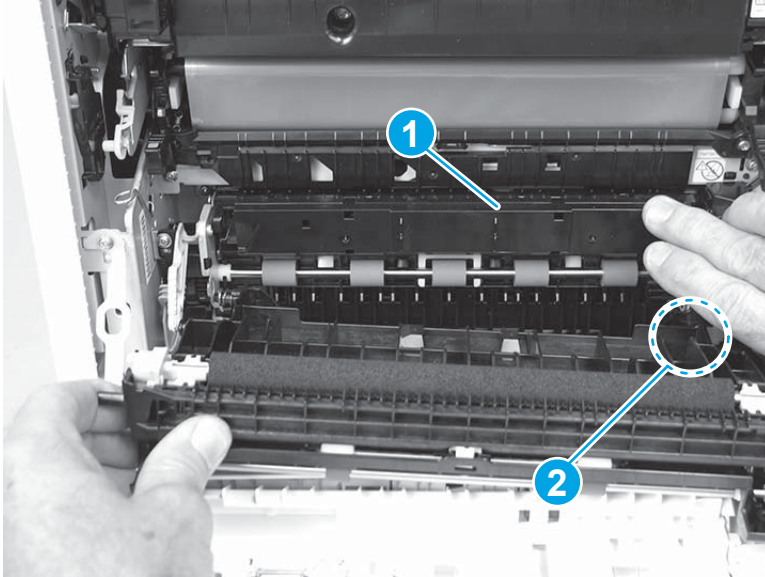

2. Position the assembly left-side hinge near the hole provided in the printer, and then slide the assembly toward the front of the printer to install the hinge in the hole.

Figure 1-4646 Install the left hinge

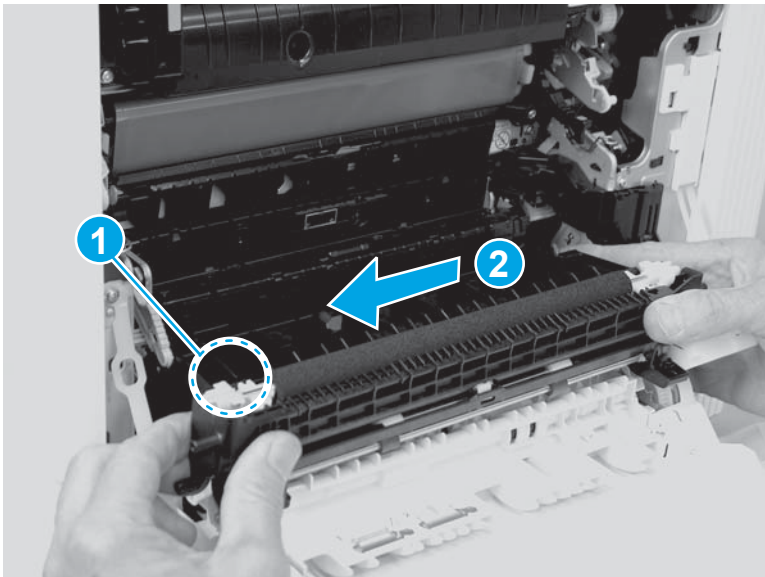

- Carefully flex the blue arm, and then push it over the pin on the assembly to engage it.

 **NOTE:** Make sure that the pin is correctly installed in the slot on the blue arm.

Figure 1-4647 Engage the blue arm with the pin



- Close the right door.

 **TIP:** The right door should close easily if the secondary transfer assembly is correctly installed.

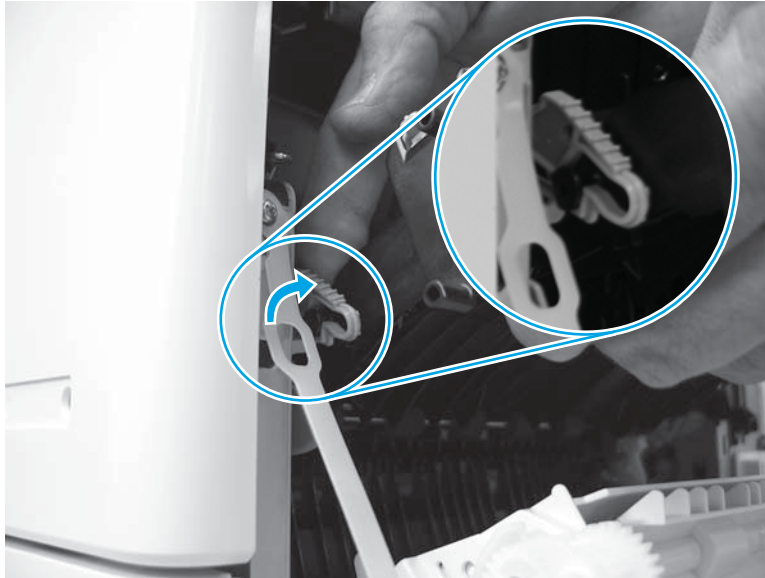
Figure 1-4648 Close the right door



Removal and replacement: Main drive assembly

- [Introduction](#)
- [Step 1: Remove the USB cover \(M552 and M553\)](#)
- [Step 2: Remove the fuser](#)
- [Step 3: Remove the ITB](#)
- [Step 4: Remove the control panel \(M553x only\)](#)
- [Step 5: Remove the tray](#)
- [Step 6: Remove the toner collection unit \(TCU\)](#)
- [Step 7: Remove the formatter cover](#)
- [Step 8: Remove the formatter \(M552 and M553\)](#)
- [Step 9: Remove the hard-disk drive \(HDD\) \(M577\)](#)
- [Step 10: Remove the fax PCA \(M577c/f/z\)](#)
- [Step 11: Remove the formatter \(M577\)](#)
- [Step 12: Remove the rear cover \(M552 and M553\)](#)
- [Step 13: Remove the rear upper cover \(M577\)](#)
- [Step 14: Remove the rear cover \(M577\)](#)
- [Step 15: Remove the left upper cover \(M577\)](#)
- [Step 16: Remove the right front upper cover \(M577dn\)](#)
- [Step 17: Remove the stapler cover assembly \(M577c/f/z\)](#)
- [Step 18: Remove the integrated scanner assembly \(ISA\) \(M577\)](#)
- [Step 19: Remove the stapler unit \(M577c/f/z\)](#)
- [Step 20: Remove the right upper cover \(M577\)](#)
- [Step 21: Remove the top rear cover \(M577\)](#)
- [Step 22: Remove the paper feed cover \(M577\)](#)
- [Step 23: Remove the top cover \(M577\)](#)
- [Step 24: Remove the top bracket \(M577\)](#)
- [Step 25: Remove the left cover](#)
- [Step 26: Remove the upper cover \(M552 and M553\)](#)
- [Step 27: Remove the formatter case](#)
- [Step 28: Remove the right rear cover](#)
- [Step 29: Remove the low-voltage power supply \(LVPS\)](#)



- [Step 30: Remove the power supply fan \(FM1\)](#)
- [Step 31: Remove the high-voltage power supply D \(HVPST\)](#)
- [Step 32: Remove the lifter drive assembly](#)
- [Step 33: Remove the DC controller and sheet-metal bracket](#)
- [Step 34: Remove the high-voltage power supply T \(HVPST\)](#)
- [Step 35: Remove the fuser drive assembly](#)
- [Step 36: Remove the main-drive assembly](#)
- [Step 37: Unpack the replacement assembly](#)
- [Step 38: Install the main-drive assembly](#)
- [Step 39: Install the fuser drive assembly](#)
- [Step 40: Install the HVPST](#)
- [Step 41: Install the DC controller and sheet-metal bracket](#)
- [Step 42: Install the lifter drive assembly](#)
- [Step 43: Install the HVPST](#)
- [Step 44: Install the power-supply fan \(FM1\)](#)
- [Step 45: Install the LVPS](#)
- [Step 46: Install the right rear cover](#)
- [Step 47: Install the formatter case](#)
- [Step 48: Install the upper cover \(M552 and M553\)](#)
- [Step 49: Install the left cover](#)
- [Step 50: Install the top bracket \(M577\)](#)
- [Step 51: Install the top cover \(M577\)](#)
- [Step 52: Install the paper feed cover \(M577\)](#)
- [Step 53: Install the top rear cover \(M577\)](#)
- [Step 54: Install the right upper cover \(M577\)](#)
- [Step 55: Install the stapler unit \(M577c/f/z\)](#)
- [Step 56: Install the integrated scanner assembly \(ISA\) \(M577\)](#)
- [Step 57: Install the stapler cover assembly \(M577c/f/z\)](#)
- [Step 58: Install the right front upper cover \(M577dn\)](#)
- [Step 59: Install the left upper cover \(M577\)](#)
- [Step 60: Install the rear cover \(M577\)](#)

- [Step 61: Install the rear upper cover \(M577\)](#)
- [Step 62: Install the rear cover \(M552 and M553\)](#)
- [Step 63: Install the formatter \(M577\)](#)
- [Step 64: Install the fax PCA \(M577c/ff/z\)](#)
- [Step 65: Install the HDD \(M577\)](#)
- [Step 66: Install the formatter \(M552 and M553\)](#)
- [Step 67: Install the formatter cover](#)
- [Step 68: Install the TCU](#)
- [Step 69: Install the tray](#)
- [Step 70: Install the control-panel assembly \(M553x only\)](#)
- [Step 71: Install the ITB](#)
- [Step 72: Install the fuser](#)
- [Step 73: Install the USB cover \(M552 and M553\)](#)
- [Step 74: Calibrate the printer](#)
- [Step 75: Perform a color band test](#)

Introduction

This document provides the procedures to remove and replace the main-drive assembly.

Before performing service

 **CAUTION:**  This part contains components that are electrostatic discharge (ESD) sensitive. To reduce the possibility of ESD damage, always touch the sheet-metal chassis to ground yourself before touching an ESD sensitive part.

 **IMPORTANT:** Some figures might show assemblies removed or installed that have not yet been removed or installed at that specific step. However, the procedures are correct for this printer and the target assembly. Always thoroughly read the instructions that accompany each figure.

 **NOTE:** HP does not recommend that this procedure be performed at the customer's location. This procedure can take two hours to complete.

Turn the printer power off

- Disconnect the power cable.

 **WARNING!** To avoid damage to the printer, turn the printer off, wait 30 seconds, and then remove the power cord before attempting to service the printer.

 **IMPORTANT:** If the toner cartridges have not already been removed prior to servicing the printer, remove them now.

The toner cartridges are sensitive to strong light. Set them aside and cover them with paper to protect them.

Use the table below to identify the correct part number for your printer, and then go to <http://h20141.www2.hp.com/hpparts> to order the part.

Main-drive assembly part number	
B5L25-67902	Main-drive assembly with instruction guide

Required tools

- #2 Phillips screwdriver with a magnetic tip

After performing service

Make sure that all of the connectors on the HVPST are fully seated.

Make sure that all of the connectors on the HVPSD are fully seated.

Make sure that all of the connectors on the LVPS are fully seated.

Make sure that all of the connectors on the DC controller are fully seated.

Make sure that the TCU is fully closed after replacing it.

Make sure that all of the connectors on the formatter are fully seated.

Make sure that the formatter cover is fully seated, and that the thumbscrews are finger tight after replacing it. For more information, see the printer troubleshooting manual.

Reinstall the toner cartridges.

Use the [Device Maintenance](#) menu to perform a [Full Calibration](#). For more information, see the printer troubleshooting manual.

Use the [Troubleshooting](#) menu to perform a [Color Band Test](#). For more information, see the printer troubleshooting manual.

Turn the printer power on

- Connect the power cable.
- Use the power switch to turn the power on.

Post service test

Use the [Troubleshooting](#) menu to perform a [Color Band Test](#). For more information, see the printer troubleshooting manual.

Print a configuration page to make sure that the printer is functioning correctly.

Step 1: Remove the USB cover (M552 and M553)



NOTE: This step is for the M552 and M553 models. For the M577 models, skip this step and go to [Step 5: Remove the tray on page 2584](#).

1. Locate the USB cover.

Figure 1-4649 Locate the USB cover



2. Pull the cover off of the printer to remove it.

Figure 1-4650 Remove the cover



Step 2: Remove the fuser

1. Open the right door.

⚠ CAUTION: The fuser is very hot. After turning the printer power off, allow the fuser to cool for at least 30 minutes before removing it.

Figure 1-4651 Open the right door



2. Grasp the two fuser handles, and then squeeze the two blue triggers on the handles to release the fuser.

Figure 1-4652 Release the fuser

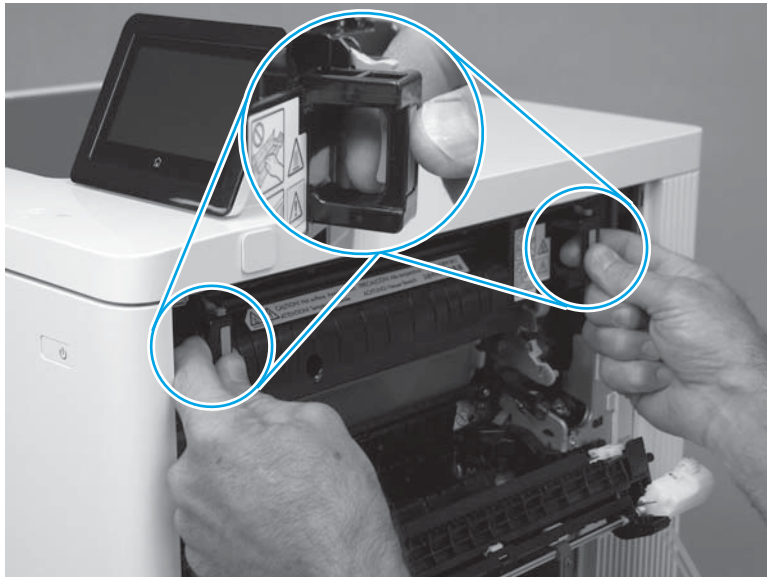

3. Slide the fuser straight out of the printer to remove it.

Figure 1-4653 Remove the fuser



Step 3: Remove the ITB

CAUTION: Do not touch the grey-plastic belt. Skin oils and fingerprints on the belt can cause print-quality problems.

1. Pull the blue lever to release the ITB drive coupling.

Figure 1-4654 Release the ITB drive coupling

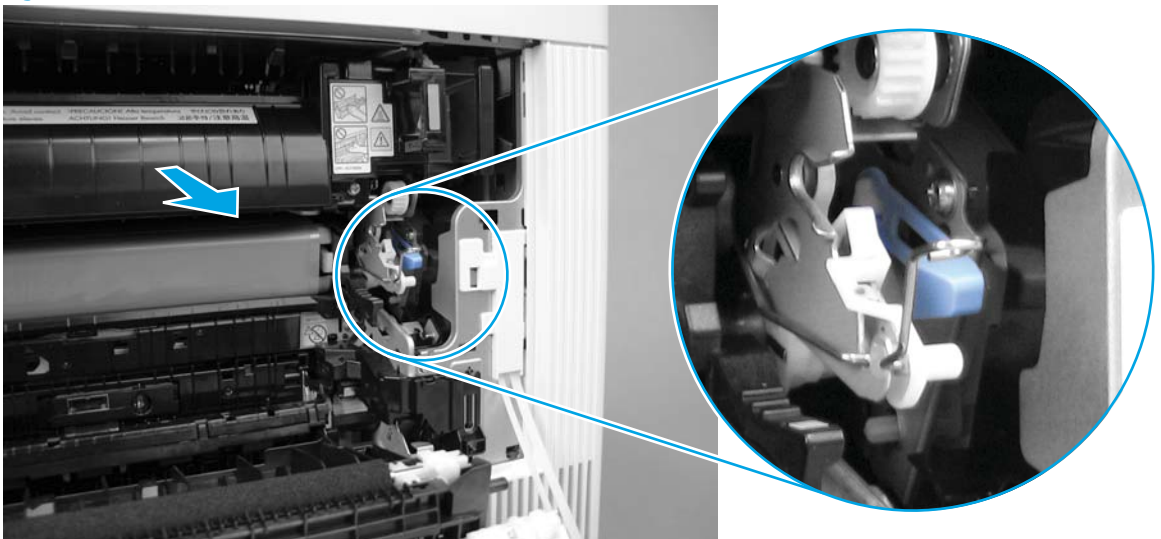

2. Push in on the blue arm to release the secondary transfer roller assembly, and then completely lower the assembly.

 **NOTE:** Press the blue arm on the secondary transfer roller assembly a second time to release the roller assembly when it stops at the halfway open position.

Figure 1-4655 Lower the secondary transfer roller assembly



3. Release the left-side ITB spring (callout 1) from the tab (callout 2).

Figure 1-4656 Release the front-side ITB spring

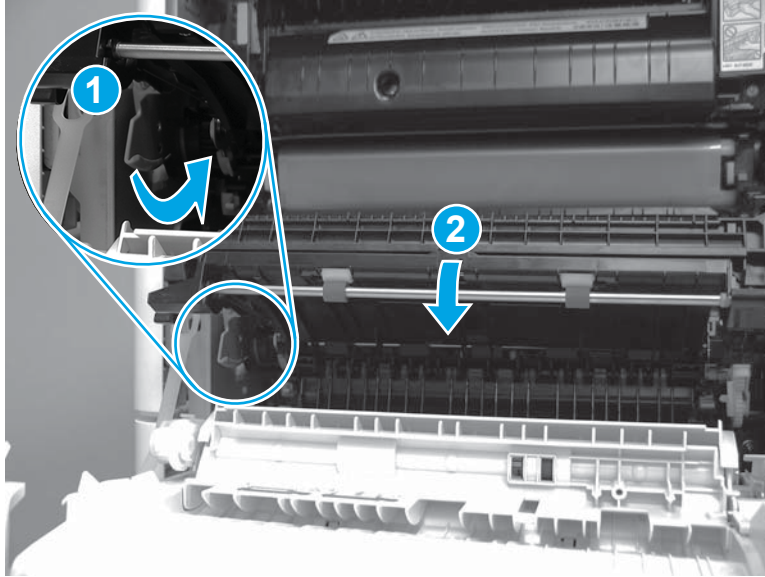
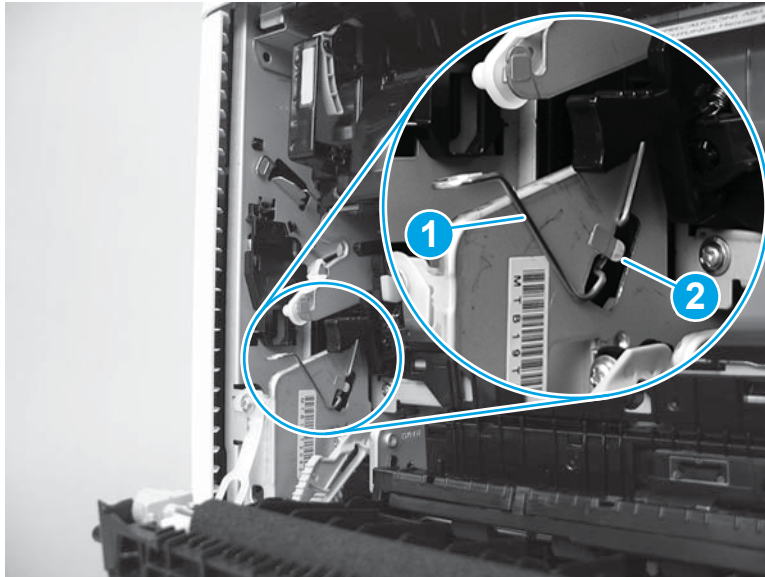

4. Place the left-side ITB spring on the holder to keep it out of the way.

 **TIP:** The holder is colored blue to help locate it.

Figure 1-4657 Place the spring on the holder

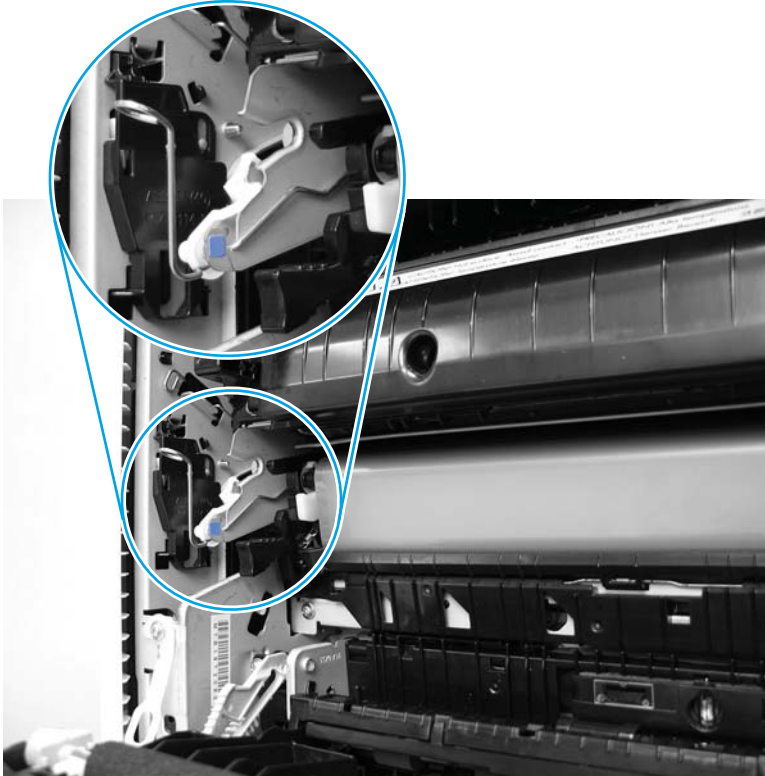

5. Release the right-side ITB spring (callout 1) from the tab (callout 2).

Figure 1-4658 Release the rear-side ITB spring

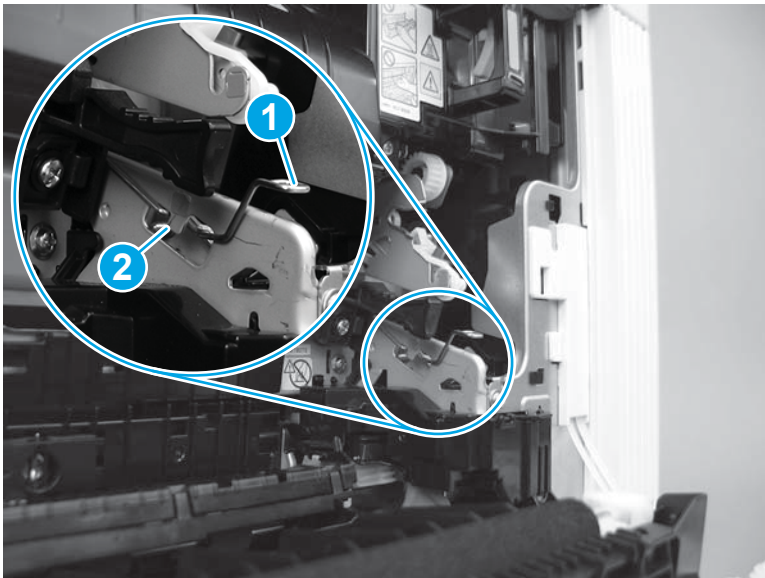

6. Place the right-side ITB spring on the holder to keep it out of the way.

 **TIP:** The holder is colored blue to help locate it.

Figure 1-4659 Place the spring on the holder

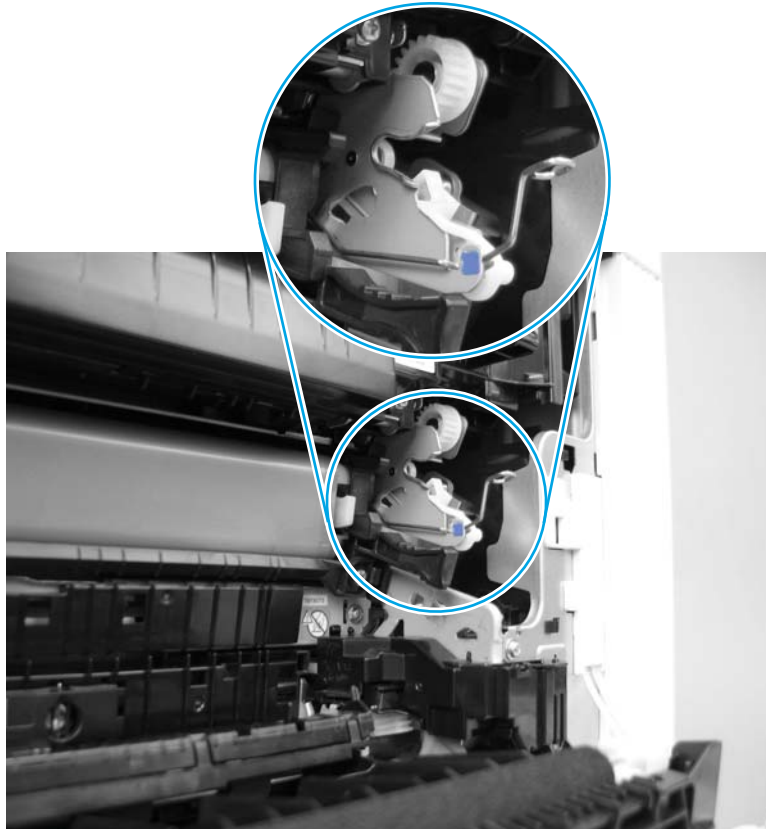

7. Grasp the two blue handles on the ITB.

⚠ CAUTION: If the ITB is removed to access other assemblies in the printer, use care. The ITB is a sensitive assembly. Be careful when handling the ITB so that it is not damaged. Always place the ITB in a safe and protected location.

Figure 1-4660 Grasp the ITB handles

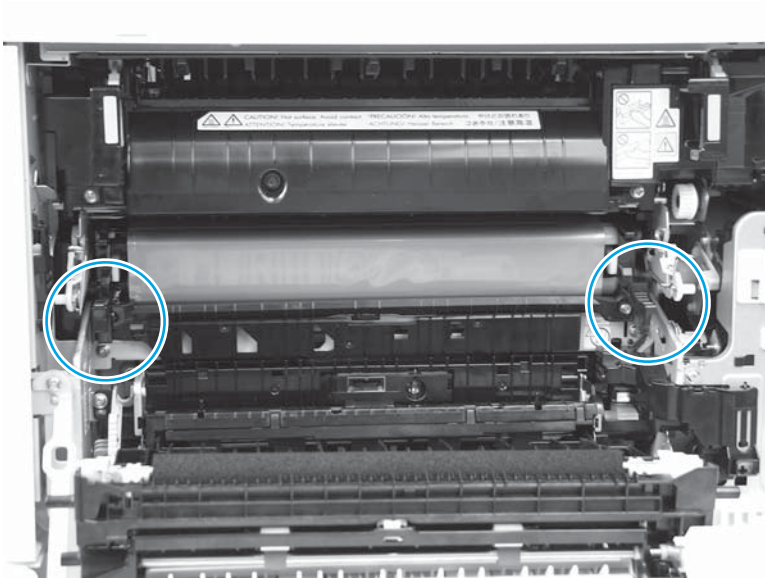

8. Pull the ITB out of the printer to remove it.

⚠ CAUTION: Do not touch the grey-plastic belt. Skin oils and fingerprints on the belt can cause print-quality problems.

Figure 1-4661 Remove the ITB

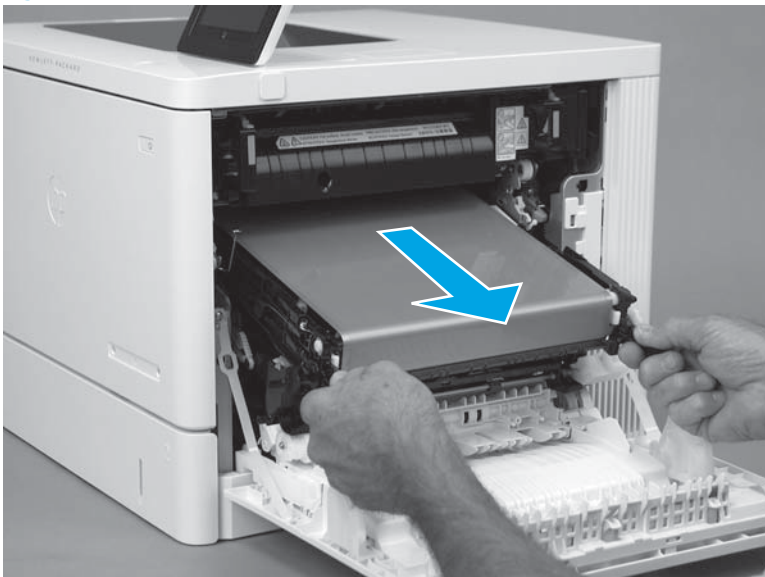

Step 4: Remove the control panel (M553x only)

 **NOTE:** This step is for the M553x model. For the M553n/dn, M552dn, and M577 models, skip this step and go to [Step 5: Remove the tray on page 2584](#).

1. Tilt the control panel up.

Figure 1-4662 Tilt the control panel up



2. Use a small flat-blade screwdriver to release the control-panel screws cover tabs.

Figure 1-4663 Release the control-panel screws cover tabs

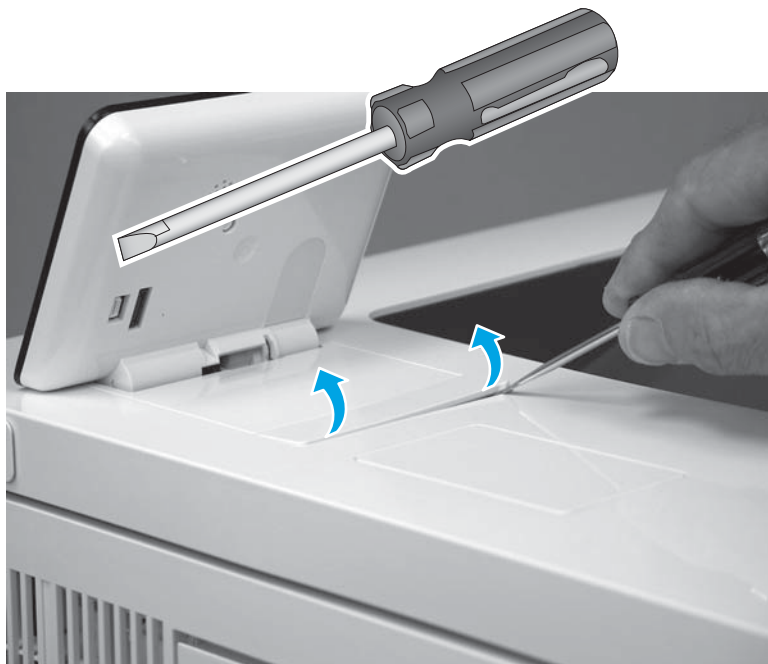

3. Rotate the cover up to remove it.

Figure 1-4664 Remove the cover

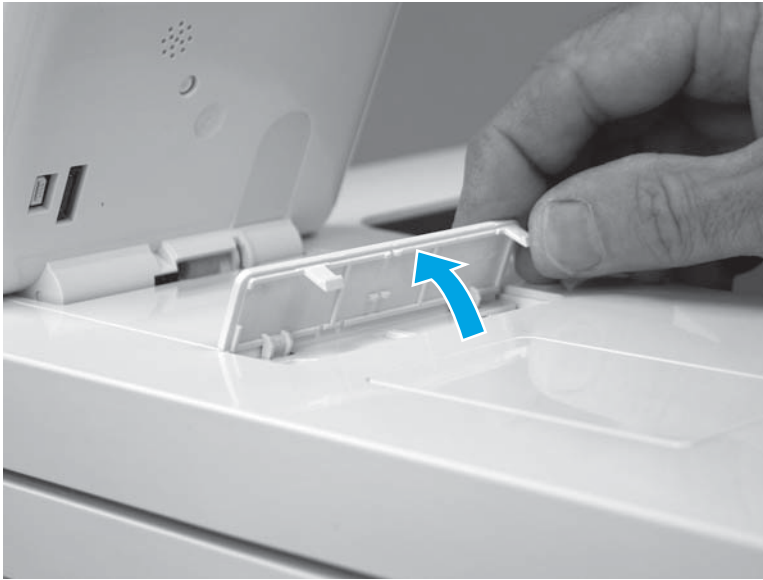

4. Use a small Phillips screwdriver to remove two screws (callout 1).

 **IMPORTANT:** Store the screws in a secure place where they cannot fall down into the printer.

Figure 1-4665 Remove two screws

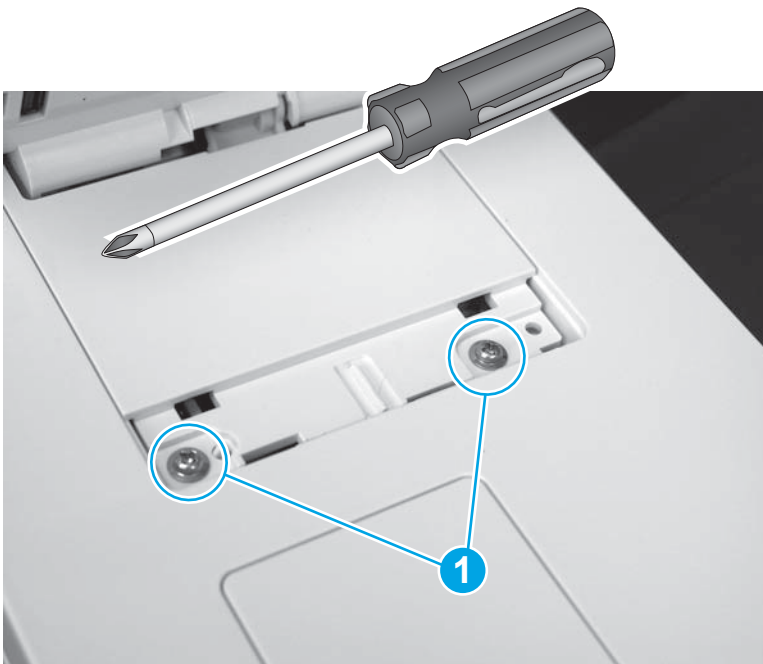

5. Rotate the control-panel base toward the front of the printer.

Figure 1-4666 Rotate the control-panel base up



6. Slightly slide the control-panel base toward the rear of the printer (callout 1) to release it, and then turn the control panel over (callout 2) to access the bottom side.

⚠ CAUTION: The control panel is still attached to the printer. Do not attempt to completely remove the control panel.

Figure 1-4667 Turn the control panel over

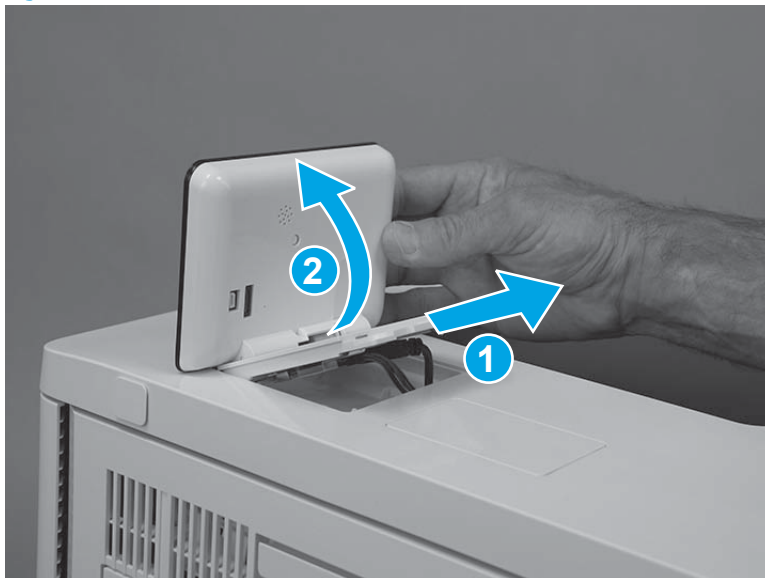

7. Disconnect one USB cable (callout 1), one connector (callout 2), and then remove the control panel.

Figure 1-4668 Disconnect two connectors

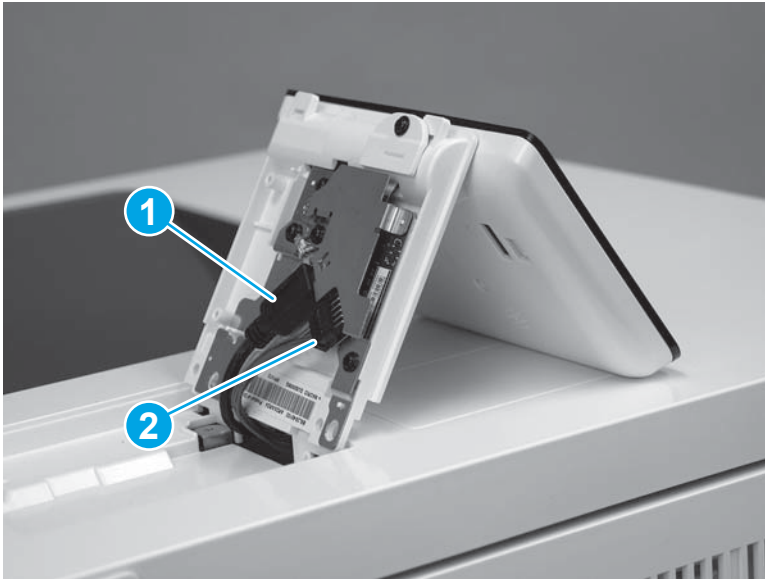

Step 5: Remove the tray

1. Pull the tray out until it stops.

Figure 1-4669 Pull the tray out



2. Lift the front of the tray, and then pull it out of the printer to remove it.

Figure 1-4670 Remove the tray

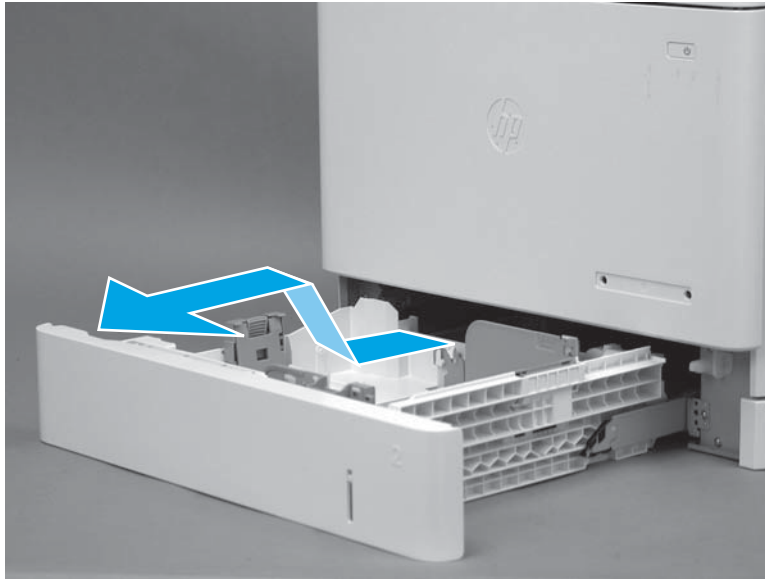

Step 6: Remove the toner collection unit (TCU)

1. Open the front door.

Figure 1-4671 Open the front door



2. Open the TCU.

 **NOTE:** The toner collection hatch cover automatically closes when the TCU is opened.

Figure 1-4672 Open the TCU



3. Pull the TCU away from the printer at an angle to remove it.

⚠ CAUTION: Do not open the toner collection hatch cover when handling the TCU. If toner gets on clothing, wipe it off by using a dry cloth and wash the clothes in cold water. Hot water sets toner into fabric.

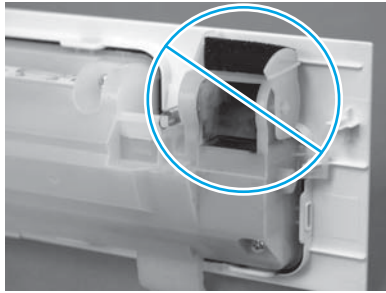
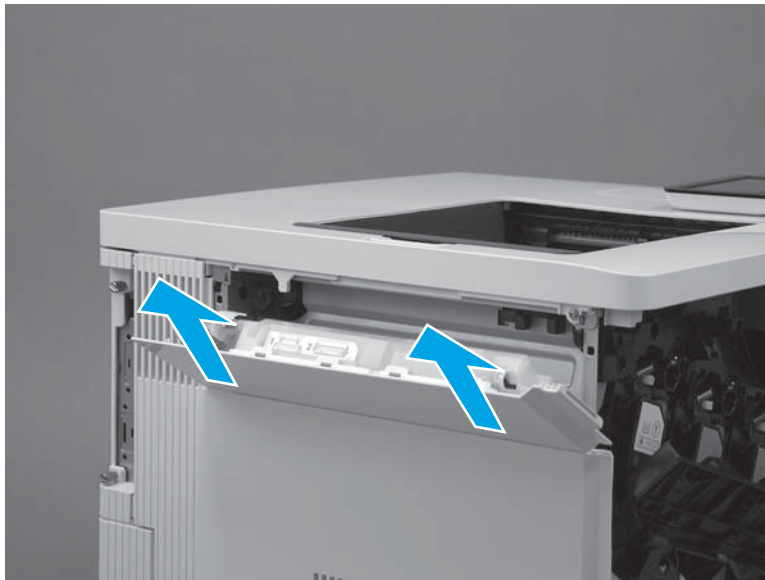

Figure 1-4673 Remove the TCU



Step 7: Remove the formatter cover

1. Locate the formatter cover.

Figure 1-4674 Locate the formatter cover

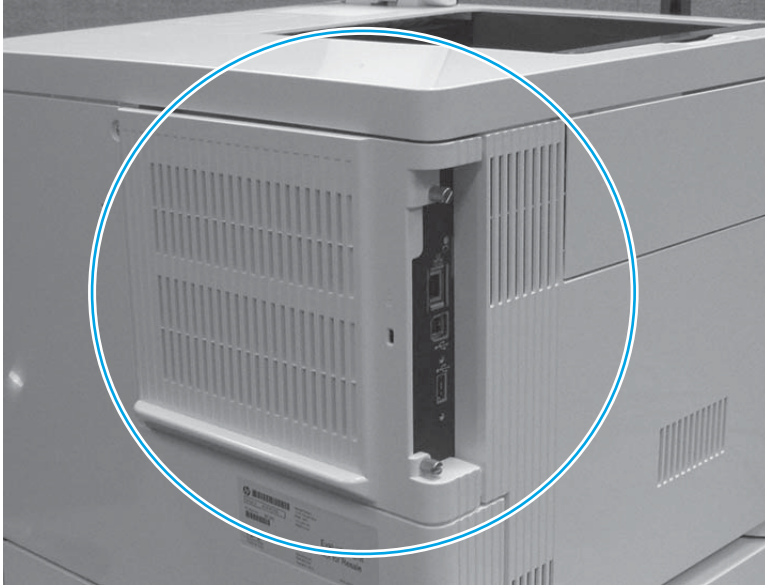

2. Loosen the two thumbscrews (callout 1). Grasp the two thumbscrews, and then slide the cover away from the printer (callout 2) to remove it.

 **TIP:** If needed, use the edge of a coin to turn the thumbscrews.

Figure 1-4675 Loosen the thumbscrews

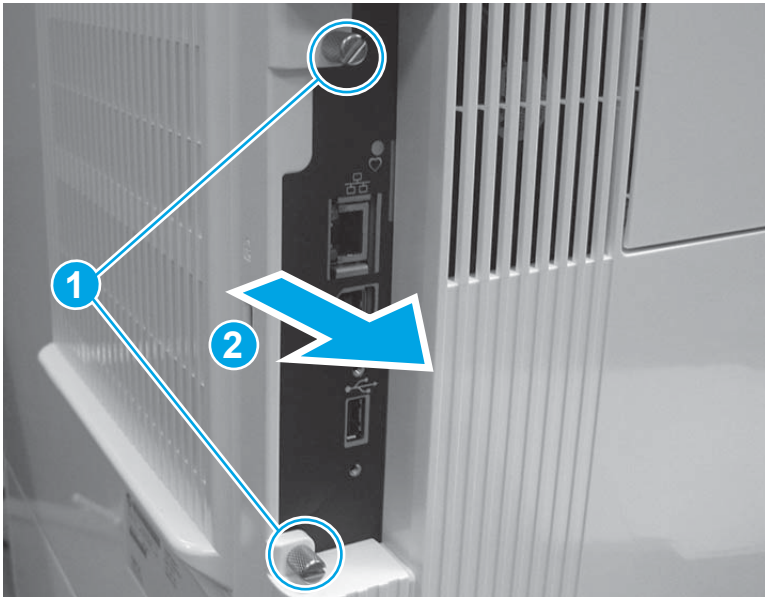

Step 8: Remove the formatter (M552 and M553)

 **NOTE:** This step is for the M552 and M553 models. For the M577 models, skip this step and go to [Step 9: Remove the hard-disk drive \(HDD\) \(M577\) on page 2590](#).

If the optional hard-disk drive (HDD) is installed, it must be removed to gain access to the formatter mounting screws.

Release two tabs along the left edge of the HDD, rotate the left edge away from the product, and then slide the HDD to the left to remove it.

 **CAUTION:**  ESD-sensitive part.

1. Disconnect all of the connectors on the formatter.

The following connectors are empty:

- All models: J1 (this connector is empty unless the optional DIMM is installed)
- M553n/dn and M552dn: J2 (callout 1; this is the touchscreen connector for the M553x model)
- All models: J9 (this connector is empty unless the optional internal USB ports component is installed)
- All models: J18 (this connector is empty unless the optional hard-disk-drive (HDD) is installed)
- All models: J23
- All models: J24
- M553n/dn and M552dn: J25 (this is the wireless connector for the M553x model)
- All models: J57
- All models: J98 (this connector is empty unless the optional trusted platform module (TPM) is installed)

 **IMPORTANT:** The flat-cable connector (callout 2) is a Zero Insertion Force (ZIF) connector that uses a hinged retainer to secure the flat cable. The hinged retainer must be opened to release the flat cable.

Figure 1-4676 Disconnect all connectors



2. Remove four screws (callout 1), and then remove the formatter.

Figure 1-4677 Remove the formatter

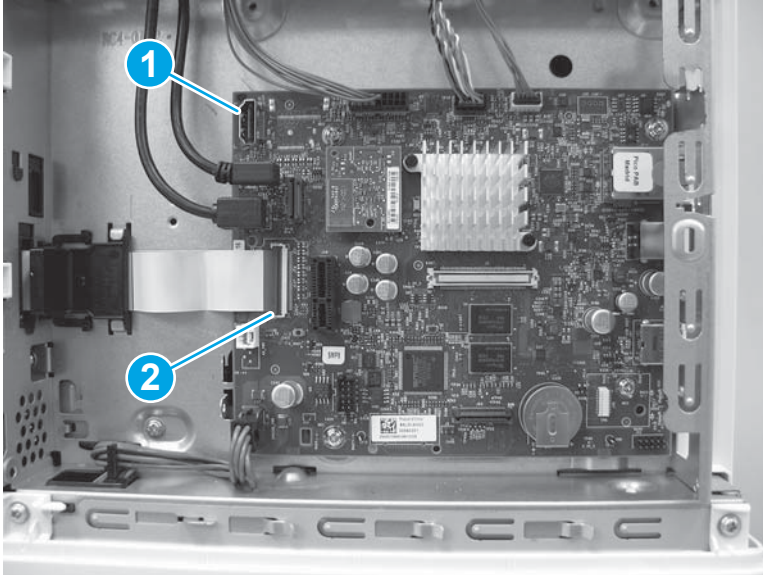
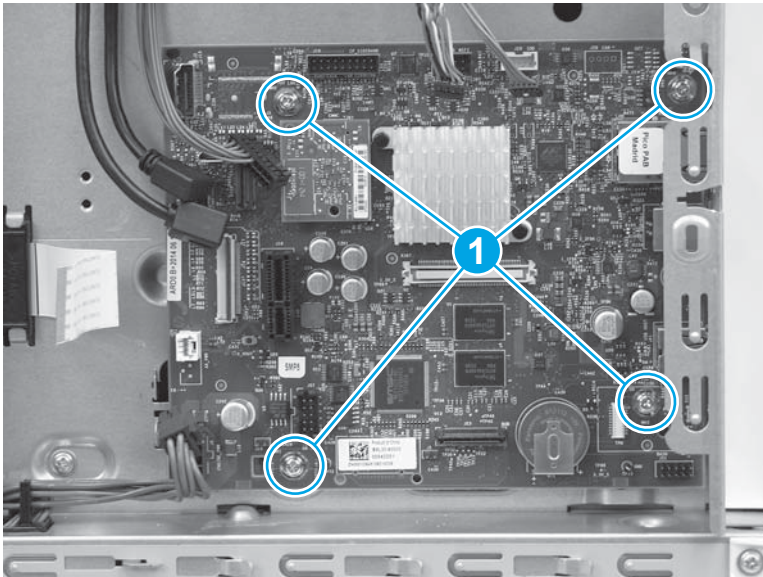

Step 9: Remove the hard-disk drive (HDD) (M577)

 **NOTE:** This step is for the M577 models. For the M552 and M553 models, skip this step and go to [Step 12: Remove the rear cover \(M552 and M553\) on page 2595](#).

 **CAUTION:**  ESD-sensitive part.

1. Release two tabs (callout 1). Hold the tabs in the released position, and then rotate the hard disk drive (HDD) up (callout 2) to release the connector from the formatter.

Figure 1-4678 Release the HDD

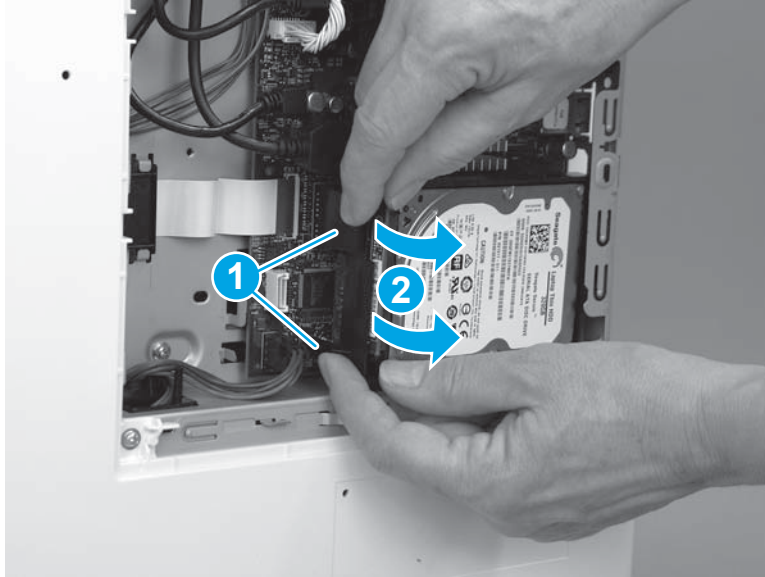

2. Slide the HDD away from the printer to remove it.

Figure 1-4679 Remove the HDD

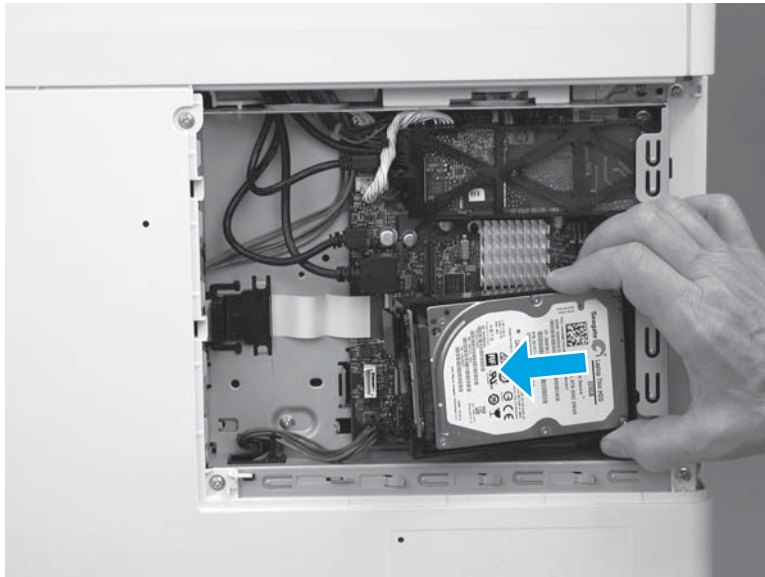

Step 10: Remove the fax PCA (M577c/f/z)

 **NOTE:** This step is for the M577c/f/z models. For the M577dn model, skip this step and go to [Step 11: Remove the formatter \(M577\) on page 2593](#).

For the M552 and M553 models, skip this step and go to [Step 12: Remove the rear cover \(M552 and M553\) on page 2595](#).

 **CAUTION:**  ESD-sensitive part.

1. Locate the fax PCA component on the formatter.

Figure 1-4680 Locate the fax PCA

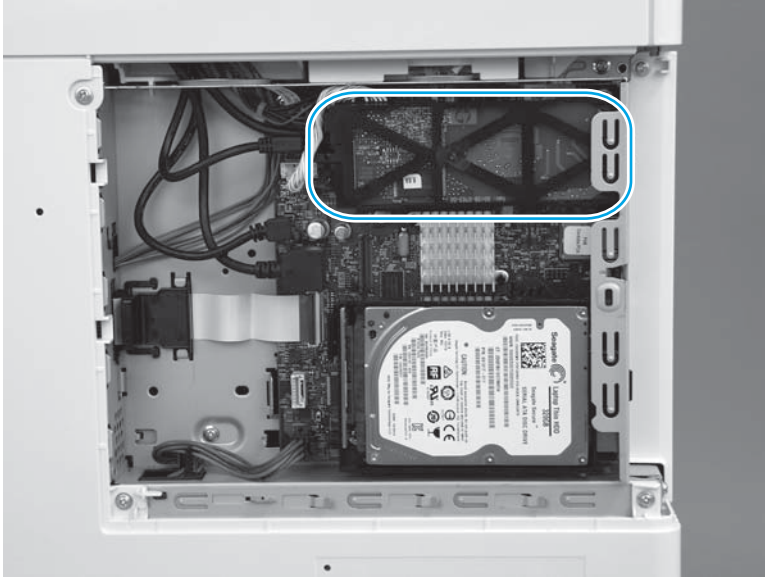

2. Release the connector latch (callout 1), and then pull the connector away from the formatter (callout 2) to disconnect it.

Figure 1-4681 Disconnect one connector

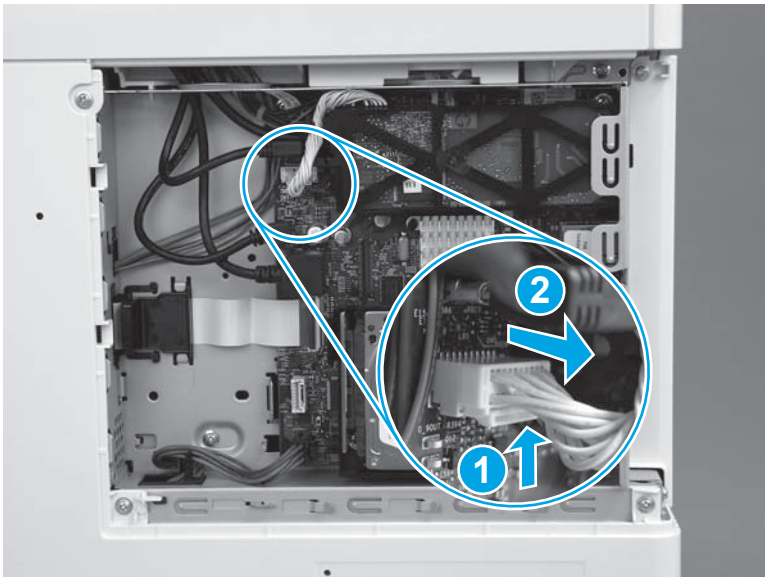

3. Release one retainer (callout 1) by pressing the bracket arms together.

Figure 1-4682 Release one latch

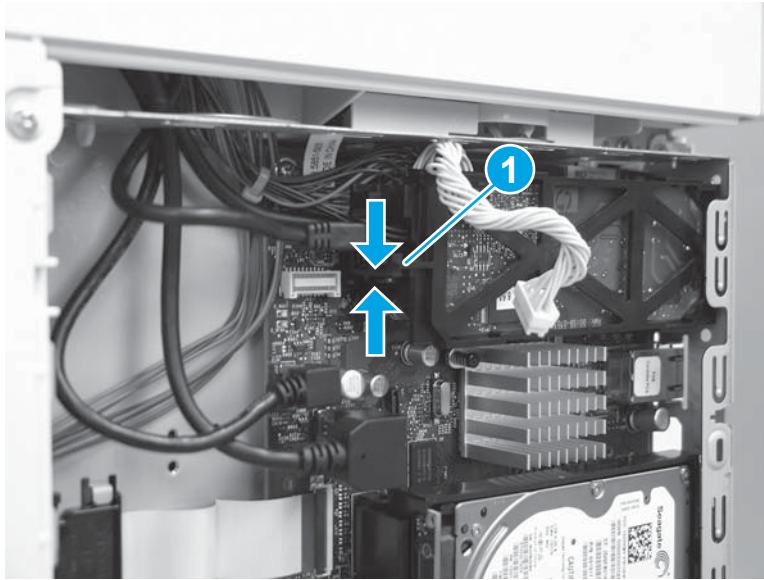

4. Rotate the end of the fax PCA (callout 1) away from the formatter, and then slide the PCA left (callout 2) to remove it.

Figure 1-4683 Remove the fax PCA

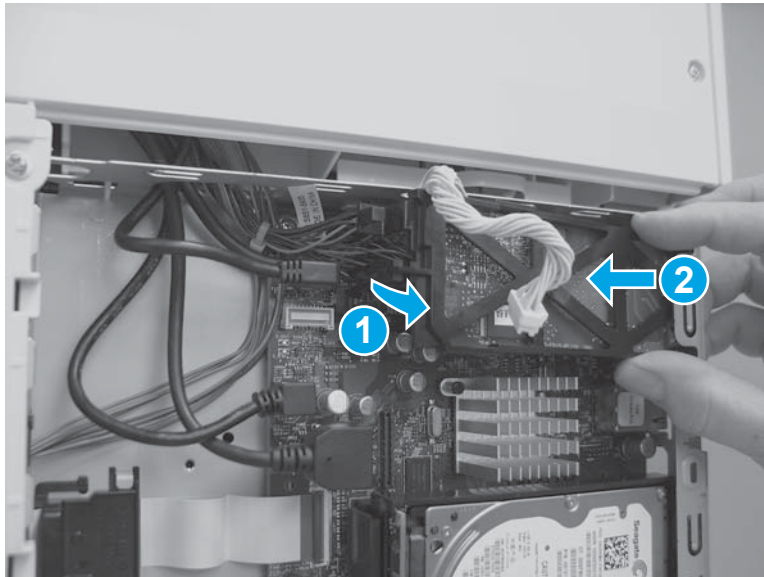

Step 11: Remove the formatter (M577)

 **NOTE:** This step is for the M577 models. For the M552 and M553 models, skip this step and go to [Step 12: Remove the rear cover \(M552 and M553\) on page 2595.](#)

 **CAUTION:**  ESD-sensitive part.

1. Disconnect all of the connectors on the formatter.

The following connectors are empty:

- All models: J1 (this connector is empty unless the optional DIMM is installed)
- All models: J3
- M577dn: J15 (this is the fax connector for the M577f/z/c models)
- All models: J21 (this connector is empty unless the optional internal USB ports component is installed)
- All models: J23
- All models: J24
- All models: J51
- All models: J57
- All models: J97
- All models: J98 (this connector is empty unless the optional trusted platform module (TPM) is installed)

 **IMPORTANT:** The flat-cable connector (callout 1) is a Zero Insertion Force (ZIF) connector that uses a hinged retainer to secure the flat cable. The hinged retainer must be opened to release the flat cable.

Figure 1-4684 Disconnect all connectors



2. Remove four screws (callout 1).

Figure 1-4685 Remove four screws

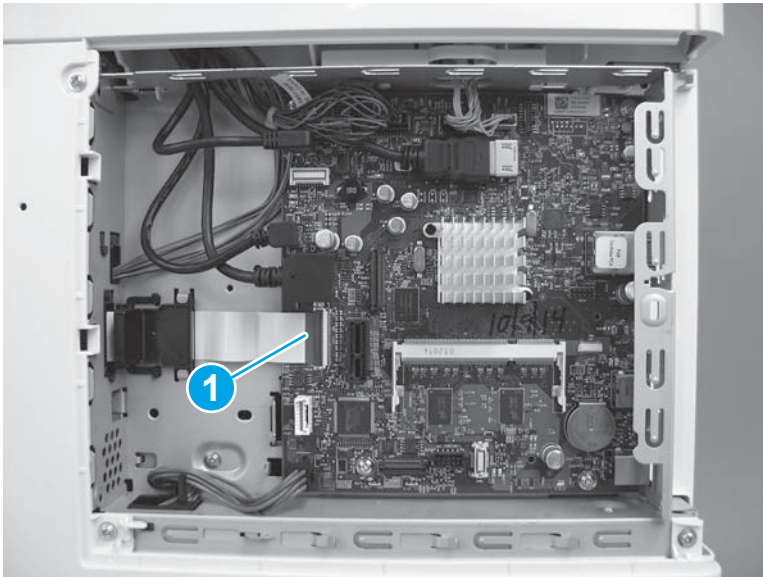
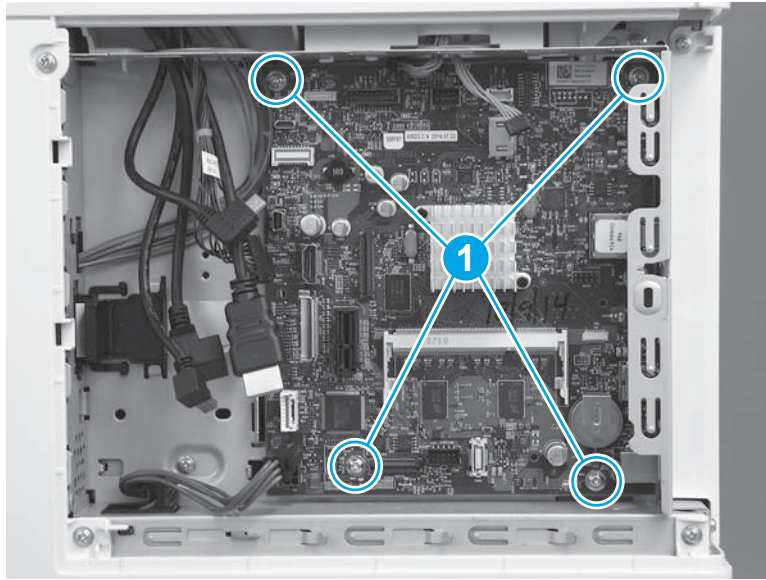

3. Remove the formatter.

Figure 1-4686 Remove the formatter

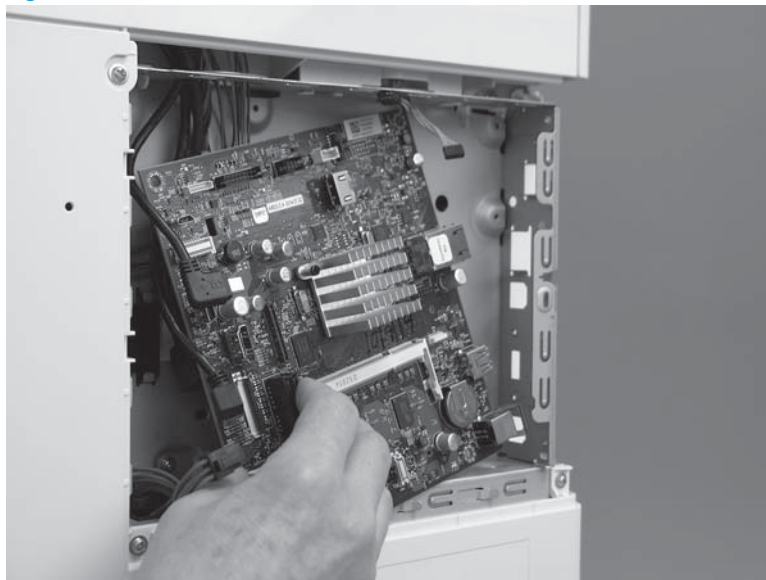

Step 12: Remove the rear cover (M552 and M553)

 **NOTE:** This step is for the M552 and M553 models. For the M577 models, skip this step and go to [Step 13: Remove the rear upper cover \(M577\) on page 2596.](#)

1. Remove four screws (callout 1).

Figure 1-4687 Remove four screws

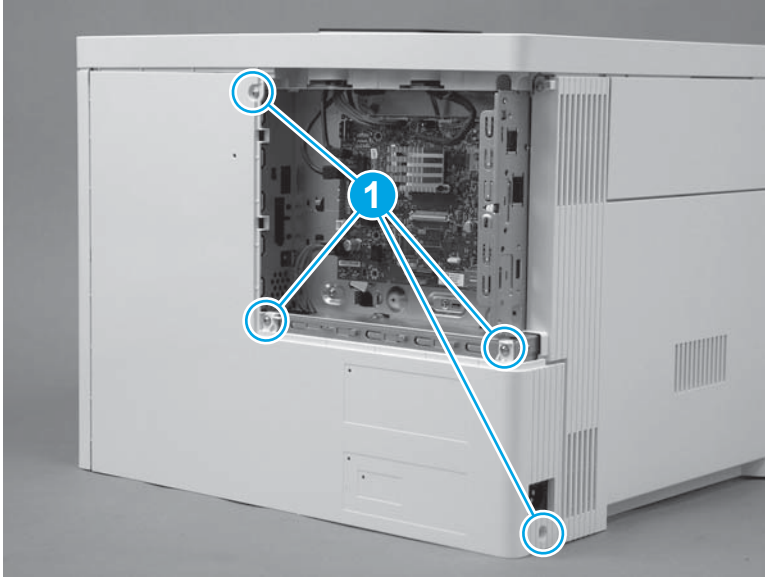

2. Slightly slide the cover to the right (callout 1), rotate the bottom of the cover away from the printer (callout 2), and then pull the top of the cover away from the printer (callout 3) to remove the cover.

Figure 1-4688 Remove the cover

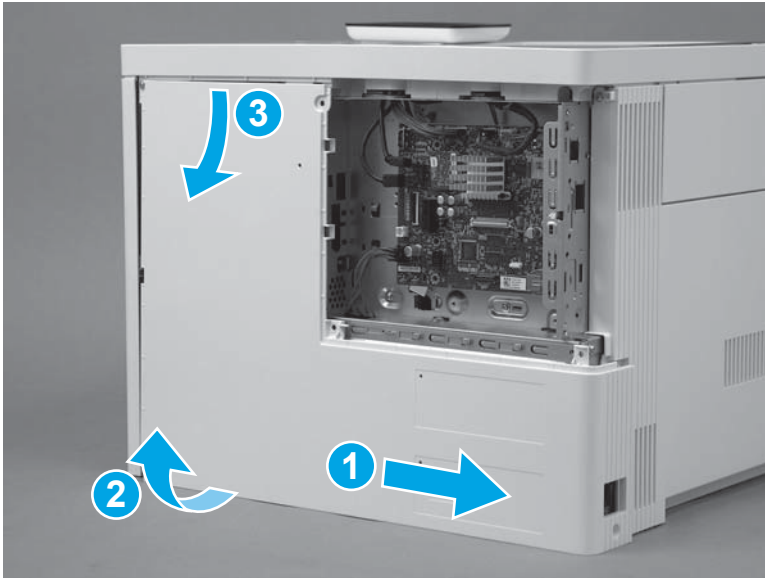

Step 13: Remove the rear upper cover (M577)

 **NOTE:** This step is for the M577 models. For the M552 and M553 models, skip this step and go to [Step 25: Remove the left cover on page 2616](#).

1. Remove two screws (callout 1).

 **Reinstallation tip:** These two screws are self-tapping screws for plastic. When reinstalling them, rotate the screws counterclockwise to align them with the existing thread pattern, and then carefully turn them clockwise to tighten. Do not overtighten. This will prevent stripping the threads inside the screw holes.

Figure 1-4689 Remove two screws



2. Use a small, flat blade screwdriver to release the right edge of the cover.

Figure 1-4690 Release the right edge

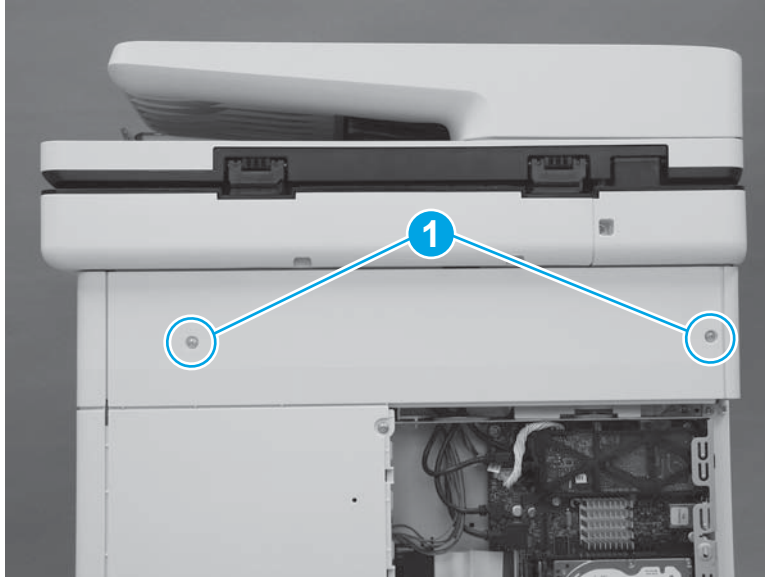
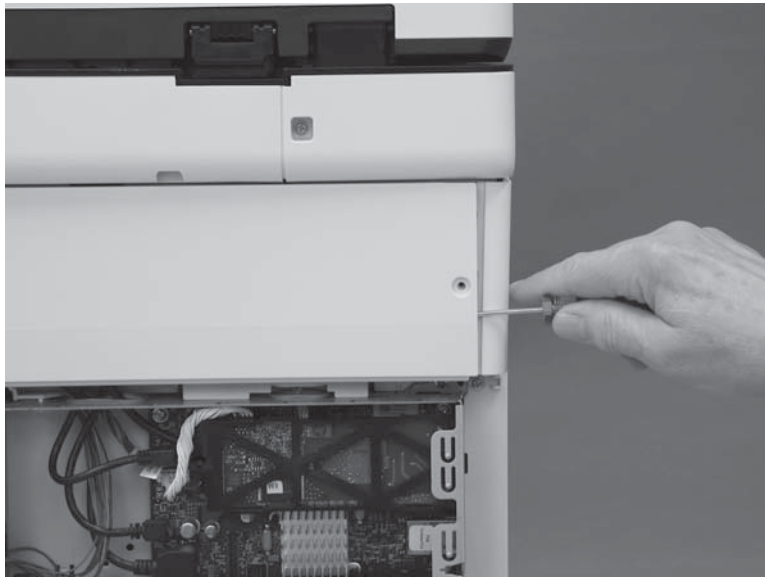

3. Pull the right edge of the cover (callout 1) away from the printer, and then slide the cover to the right (callout 2).

Figure 1-4691 Slide the cover right

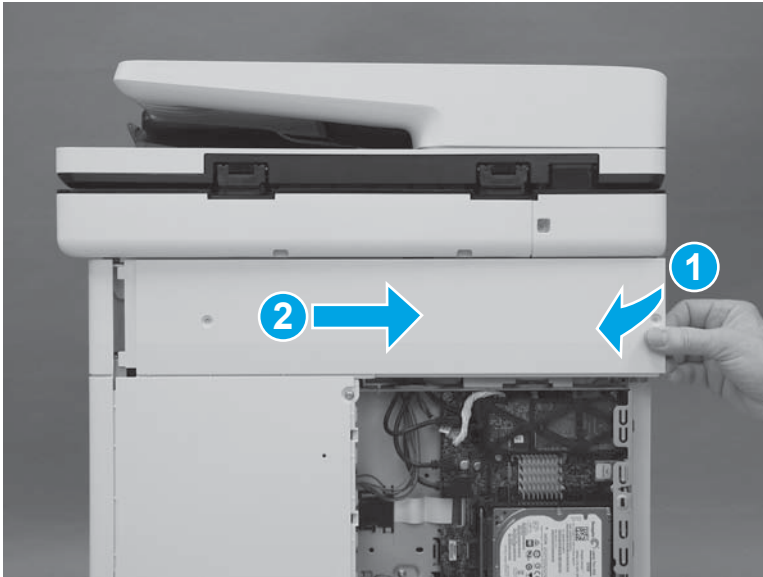

4. Remove the cover.

Figure 1-4692 Remove the cover

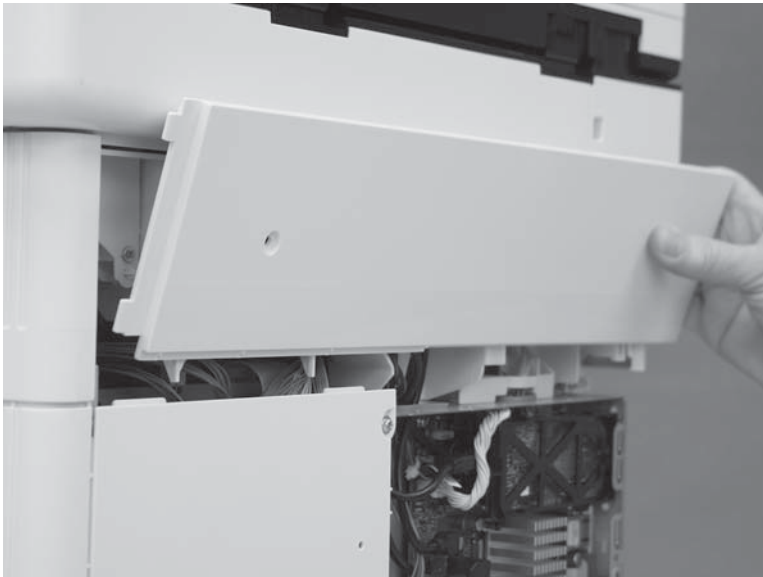

Step 14: Remove the rear cover (M577)

 **NOTE:** This step is for the M577 models. For the M552 and M553 models, skip this step and go to [Step 25: Remove the left cover on page 2616](#).

1. Remove four screws (callout 1).

Figure 1-4693 Remove four screws

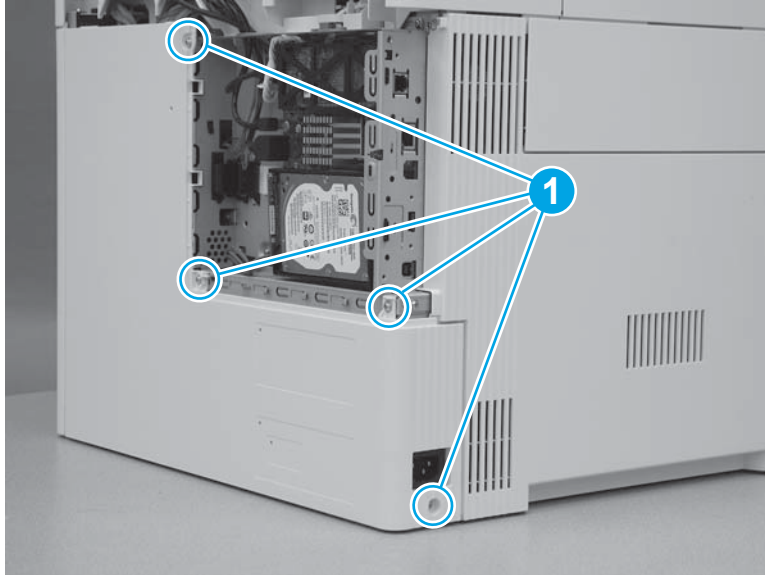

2. Slide the cover to the right to remove it.

Figure 1-4694 Remove the cover

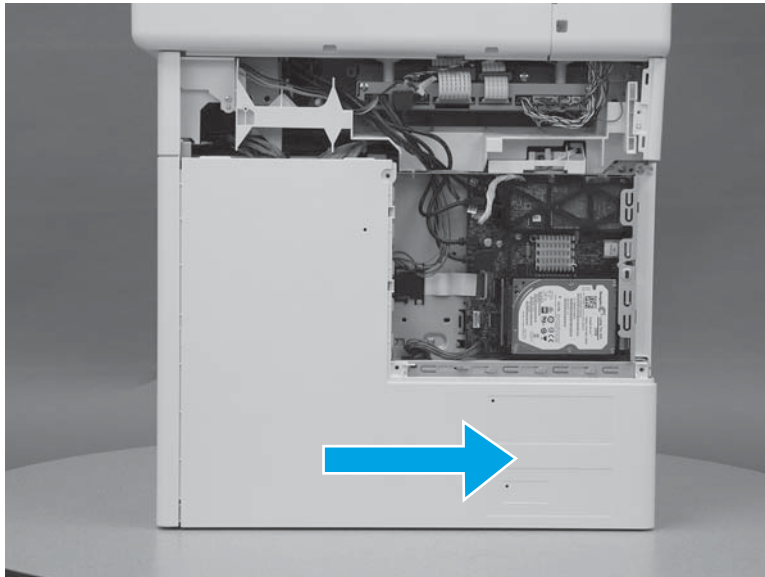

Step 15: Remove the left upper cover (M577)

 **NOTE:** This step is for the M577 models. For the M552 and M553 models, skip this step and go to [Step 25: Remove the left cover on page 2616](#).

1. At the left side of the printer, release one tab (callout 1).

Figure 1-4695 Release one tab

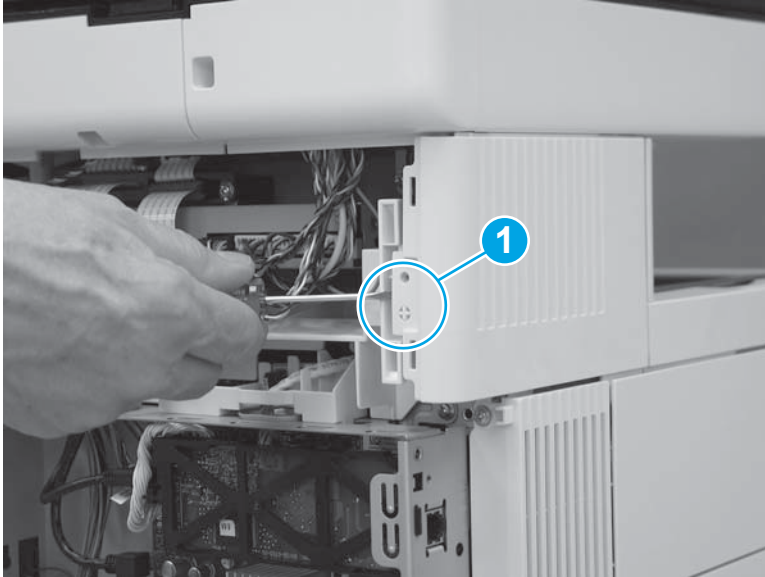

2. Slide the left upper cover toward the back of the printer.

Figure 1-4696 Slide the cover back

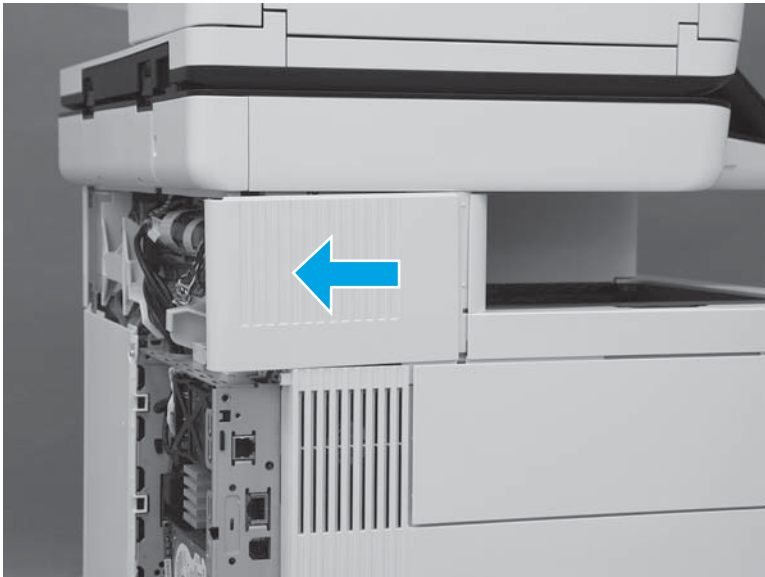

3. Rotate the cover up to remove it.

Figure 1-4697 Remove the left upper cover



Step 16: Remove the right front upper cover (M577dn)

 **NOTE:** This step is for the M577dn model. For the M577c/f/z models, skip this step and to go [Step 17: Remove the stapler cover assembly \(M577c/f/z\) on page 2602](#).

For the M552 and M553 models, skip this step and go to [Step 25: Remove the left cover on page 2616](#).

1. Remove one screw (callout 1).

Figure 1-4698 Remove one screw

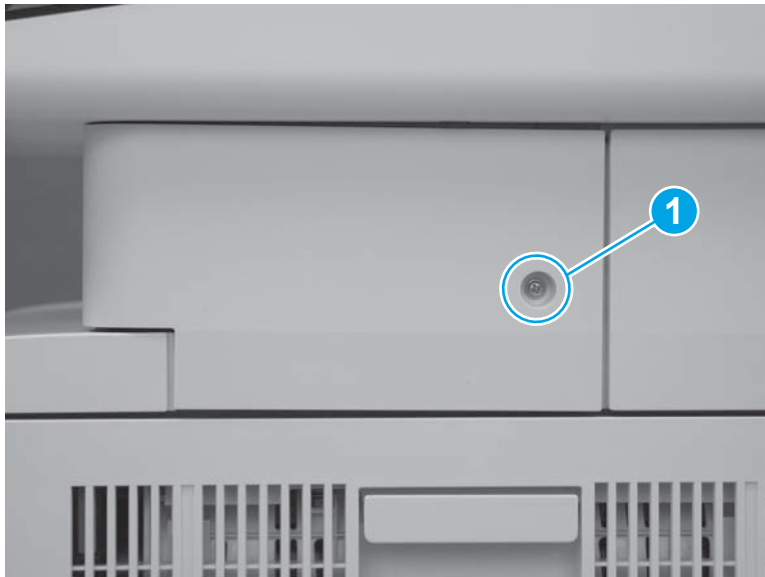

2. Release two tabs at the front edge of the cover (callout 1).

Figure 1-4699 Release two tabs



3. Rotate the front of the cover to the right to remove it.

Figure 1-4700 Rotate the cover



Step 17: Remove the stapler cover assembly (M577c/f/z)

 **NOTE:** This step is for the M577c/f/z models. For the M577dn model, skip this step and go to [Step 20: Remove the right upper cover \(M577\) on page 2608](#).

For the M552 and M553 models, skip this step and go to [Step 25: Remove the left cover on page 2616](#).

1. Remove one screw (callout 1).

 **Reinstallation tip:** This is a self-tapping screw for plastic. When reinstalling, rotate the screw counterclockwise to align it with the existing thread pattern, and then carefully turn it clockwise to tighten. Do not overtighten. This will prevent stripping the threads inside the screw hole.

Figure 1-4701 Remove one screw



2. Release two tabs at the front edge of the cover (callout 1).

Figure 1-4702 Release two tabs

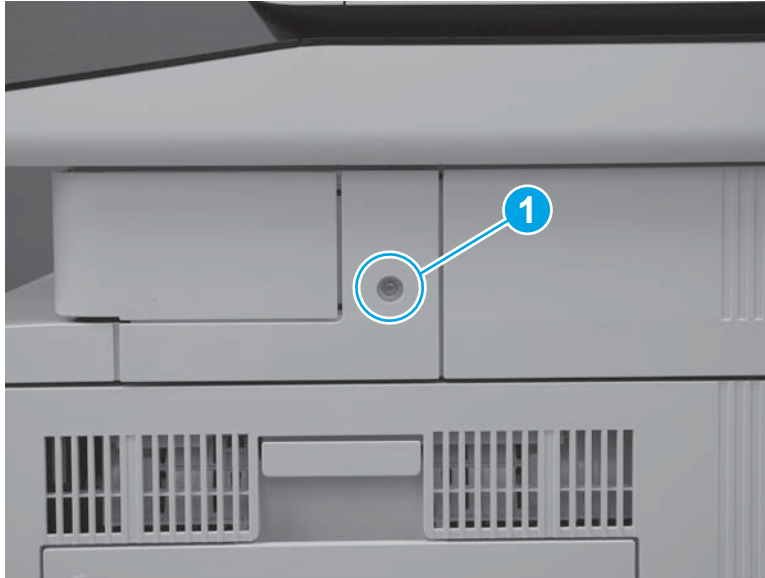

3. Release the back edge of the cover.

Figure 1-4703 Release the back edge of the cover

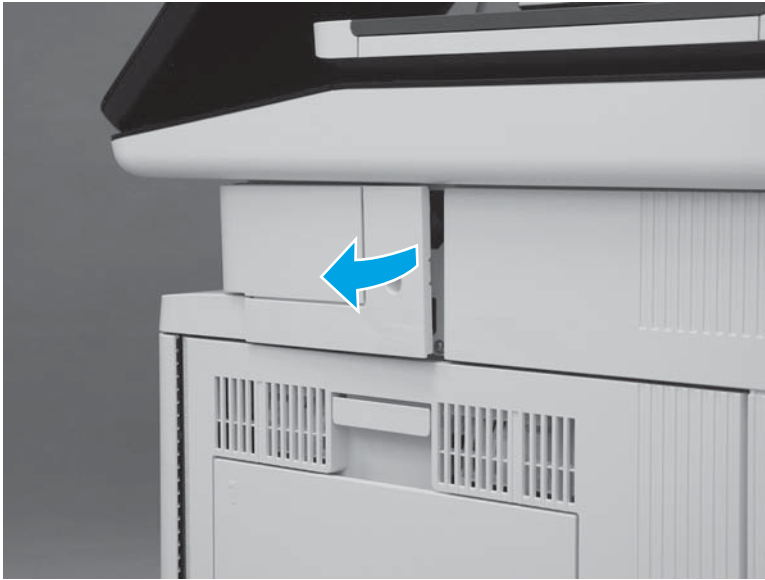



4. Rotate the cover away from the printer to remove it.

Figure 1-4704 Remove the cover



Step 18: Remove the integrated scanner assembly (ISA) (M577)

 **NOTE:** This step is for the M577 models. For the M552 and M553 models, skip this step and go to [Step 25: Remove the left cover on page 2616](#).

 **NOTE:** The ISA includes the document feeder, image scanner, scanner control board (SCB), control panel, keyboard (M577c/z) and NFC PCA (M577z).

1. At the left side of the printer, remove one screw (callout 1).

Figure 1-4705 Remove one screw

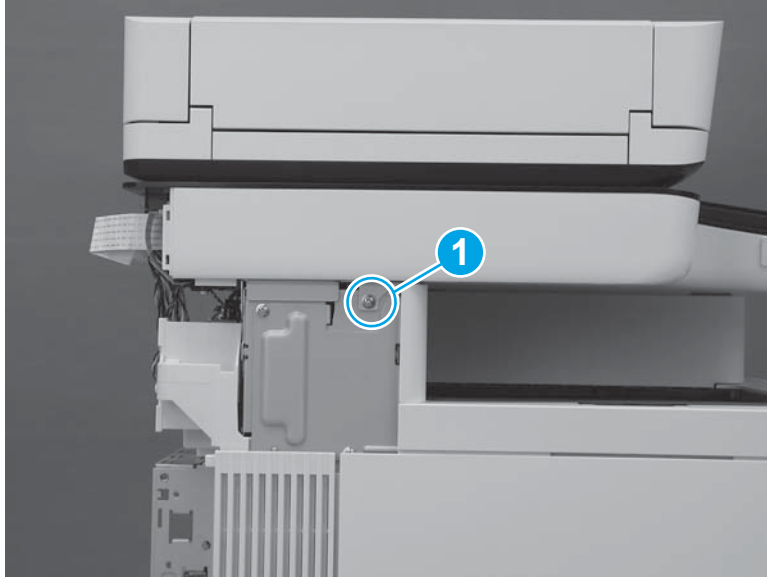

2. At the back side of the printer, remove two screws (callout 1).

Figure 1-4706 Remove two screws

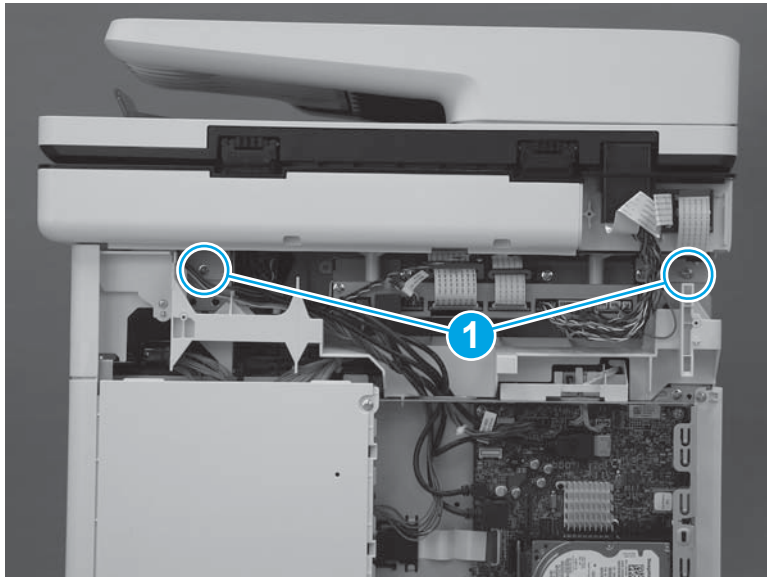

3. At the right side of the printer, remove one screw (callout 1).

Figure 1-4707 Remove one screw

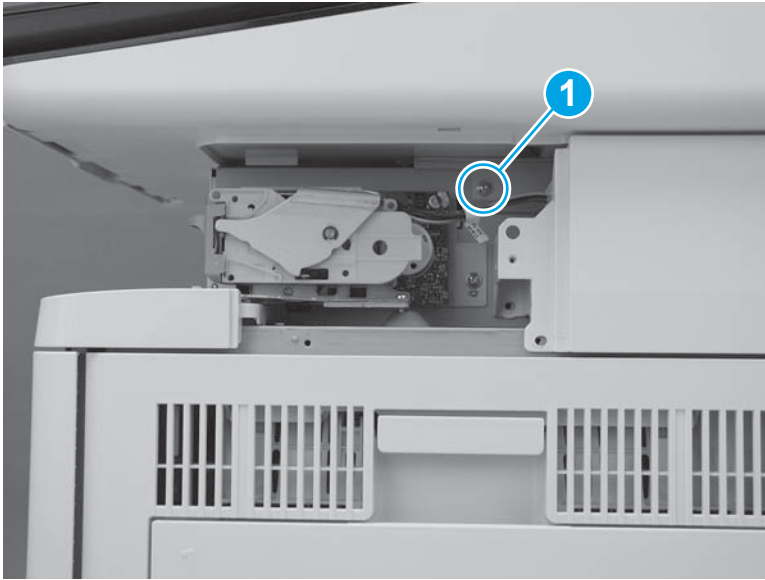

4. Disconnect two connectors on the scanner control board (callout 1).

M577c/f/z only: Disconnect one connector for the stapler on the scanner control board (callout 2).

Figure 1-4708 Disconnect connectors

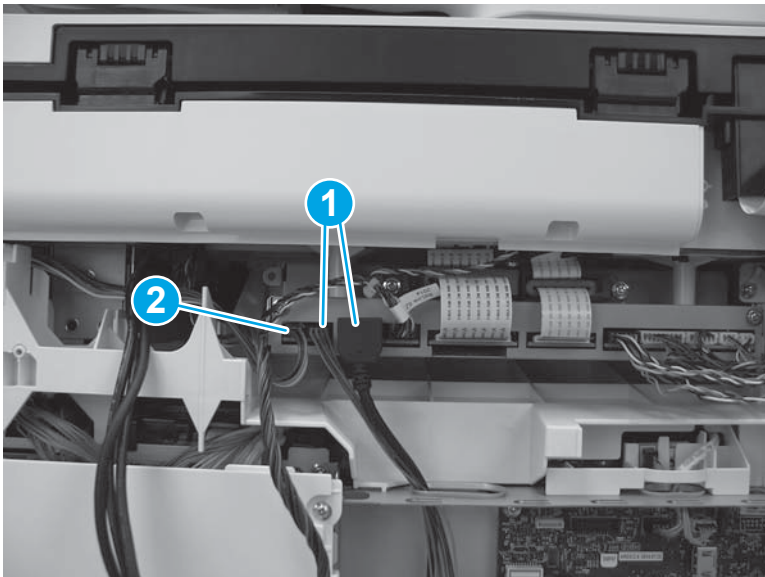

5. Slightly slide the ISA towards the back of the printer to release it.

Figure 1-4709 Slide the ISA towards the back of the printer

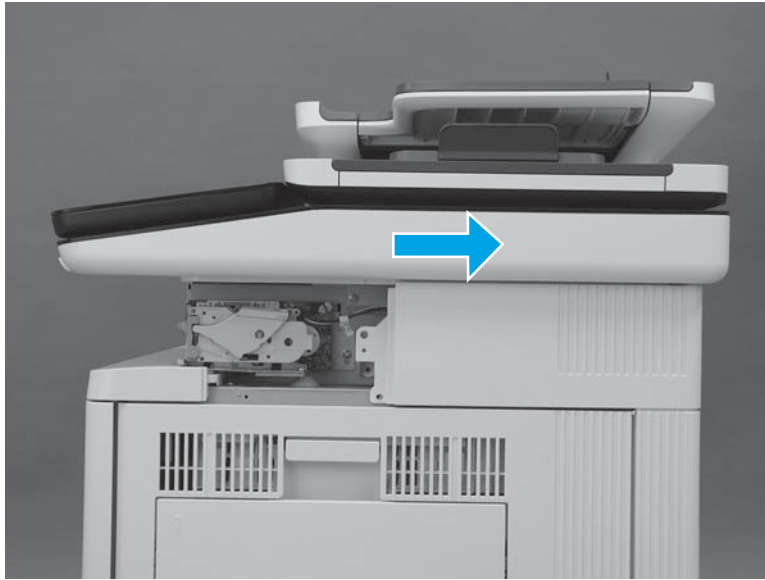

6. Lift the ISA up to remove it.

 **NOTE:** When lifting the ISA, carefully pass the cables through the opening in the top of the formatter case.

Figure 1-4710 Remove the ISA

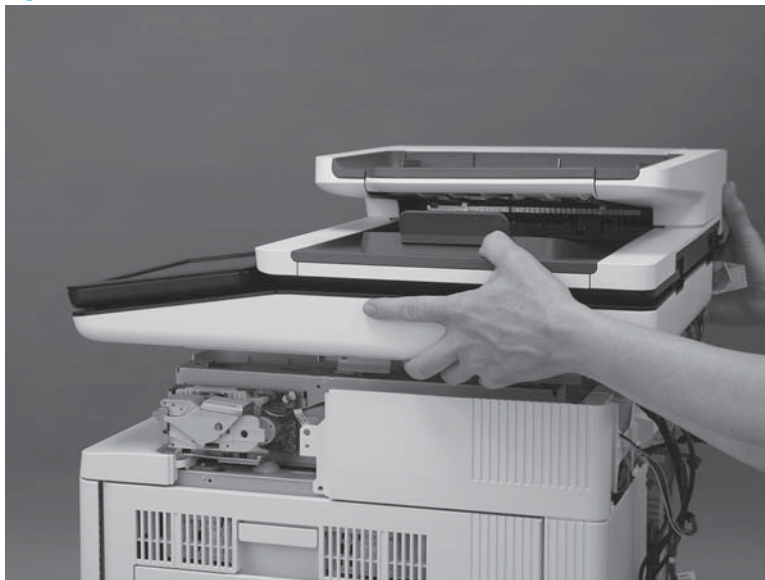

Step 19: Remove the stapler unit (M577c/f/z)

 **NOTE:** This step is for the M577c/f/z models. For the M577dn model, skip this step and to go [Step 21: Remove the top rear cover \(M577\) on page 2610](#).

For the M552 and M553 models, skip this step and go to [Step 25: Remove the left cover on page 2616](#).

1. Disconnect one connector (callout 1), and then remove two screws (callout 2).

Figure 1-4711 Disconnect connector and remove screws

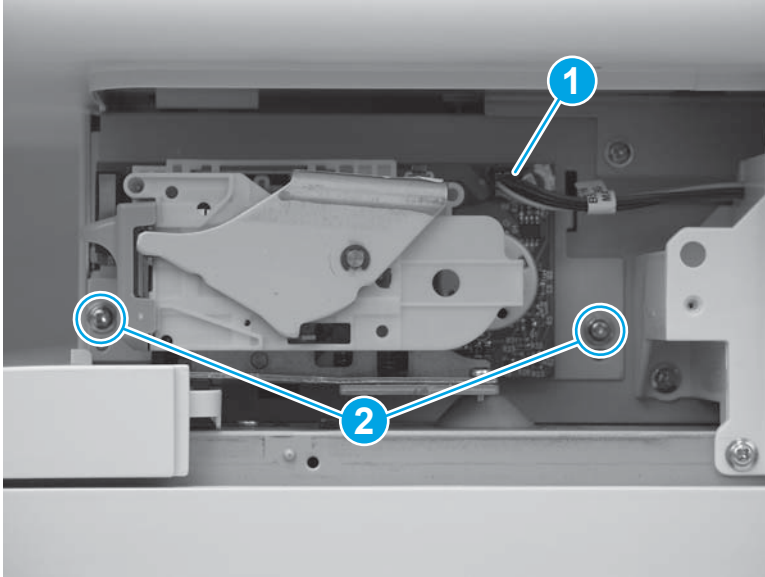

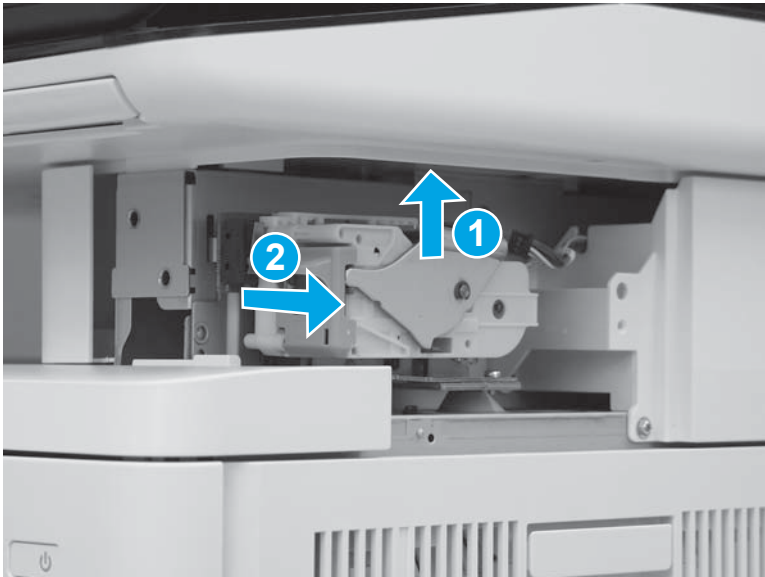

2. Slide the stapler unit up (callout 1), and then pull it away from the printer (callout 2) to remove it.

Figure 1-4712 Remove the stapler unit



Step 20: Remove the right upper cover (M577)

 **NOTE:** This step is for the M577 models. For the M552 and M553 models, skip this step and go to [Step 25: Remove the left cover on page 2616](#).

 **NOTE:** The figures below show the image scanner installed. The procedures for removing and installing the right upper cover are the same whether the image scanner is installed or removed."

1. At the right side of the printer, remove two screws (callout 1).

M577c/f/z only: Disconnect one connector (callout 2), if it was not already disconnected in a previous step.

Figure 1-4713 Remove two screws and one connector

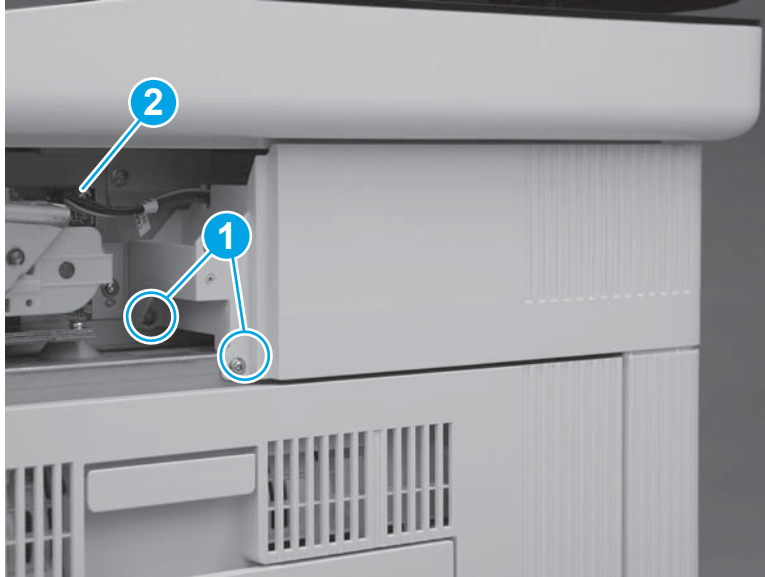

2. At the back of the printer, remove one screw (callout 1).

M577c/f/z only: Disconnect one connector (callout 2), if it was not already disconnected in a previous step.

 **Reinstallation tip:** This screw is smaller than the screws removed in the previous step. When reinstalling the right upper cover, make sure that this screw is installed in the correct position.

Figure 1-4714 Remove one screw and connector



3. Slide the cover toward the back of the printer.

Figure 1-4715 Slide the cover

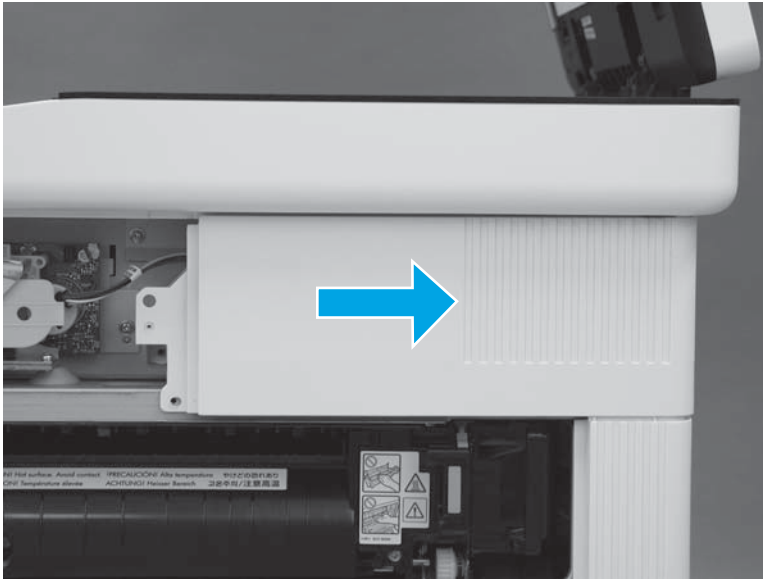

4. Lift the cover away from the printer to remove it.

M577c/f/z only: Release the cables (callout 1) through the slot (callout 2) in the printer.

Figure 1-4716 Remove the cover

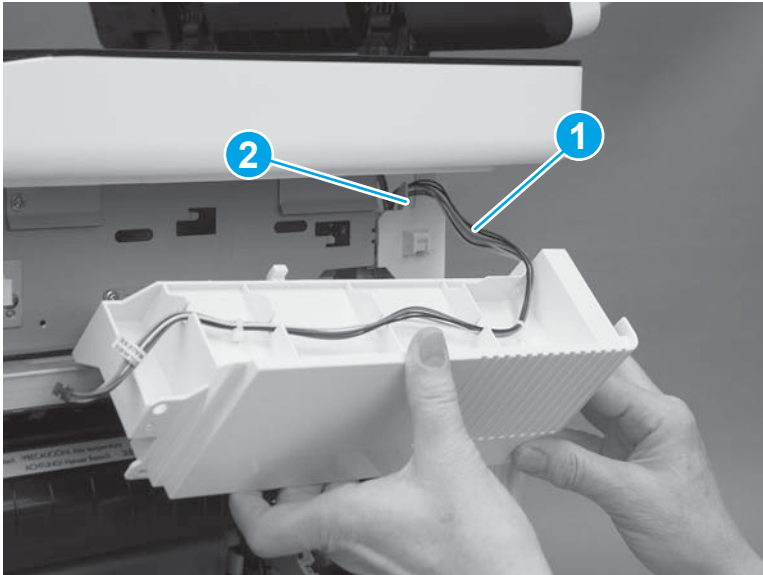

Step 21: Remove the top rear cover (M577)

 **NOTE:** This step is for the M577 models. For the M552 and M553 models, skip this step and go to [Step 25: Remove the left cover on page 2616](#).

1. At the top of the printer, remove five screws (callout 1).

Figure 1-4717 Remove five screws

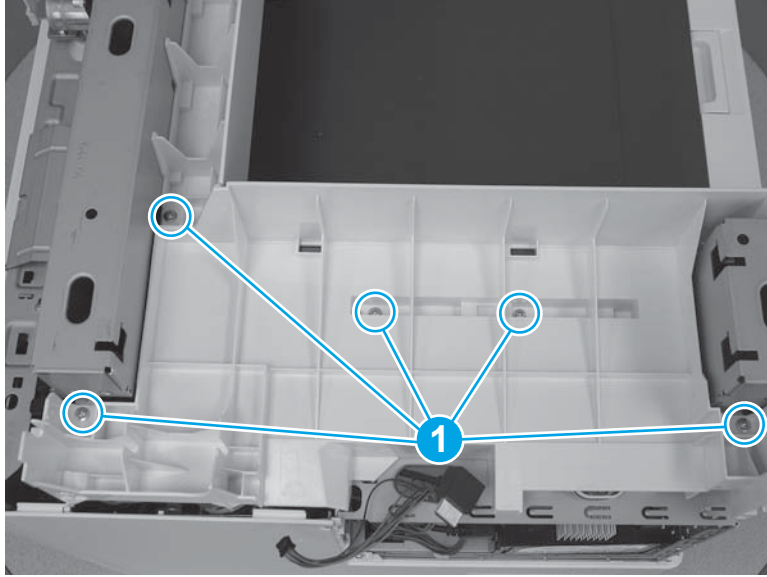

2. Release two tabs (callout 1) on the front edge of the cover.

Figure 1-4718 Release two tabs

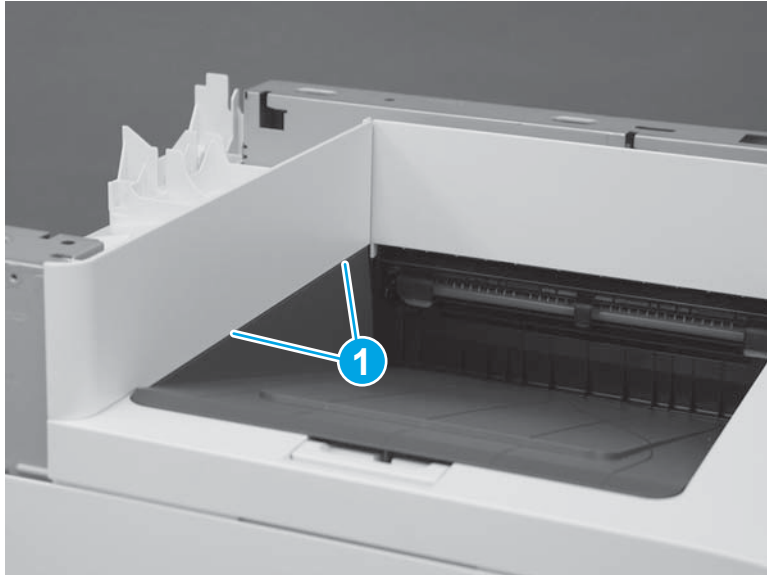

3. Remove the top rear cover.

Figure 1-4719 Remove the top rear cover

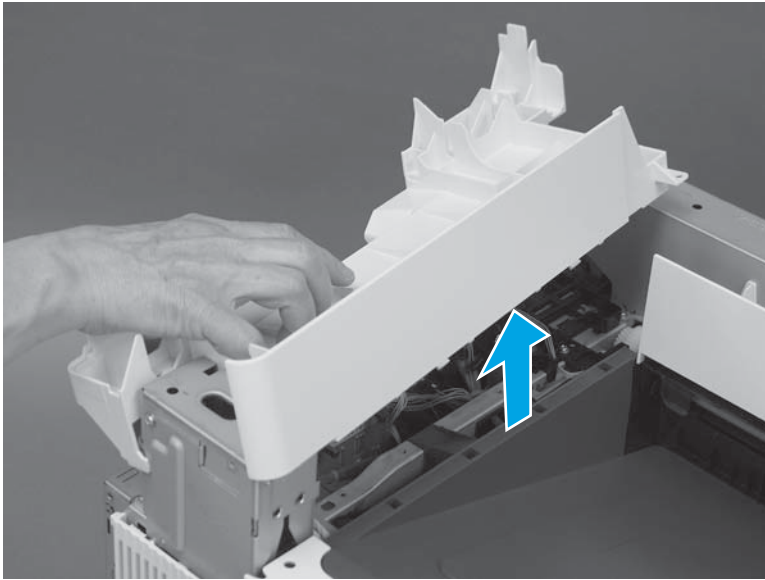

Step 22: Remove the paper feed cover (M577)

 **NOTE:** This step is for the M577 models. For the M552 and M553 models, skip this step and go to [Step 25: Remove the left cover on page 2616](#).

1. Remove one screw (callout 1).

Figure 1-4720 Remove one screw

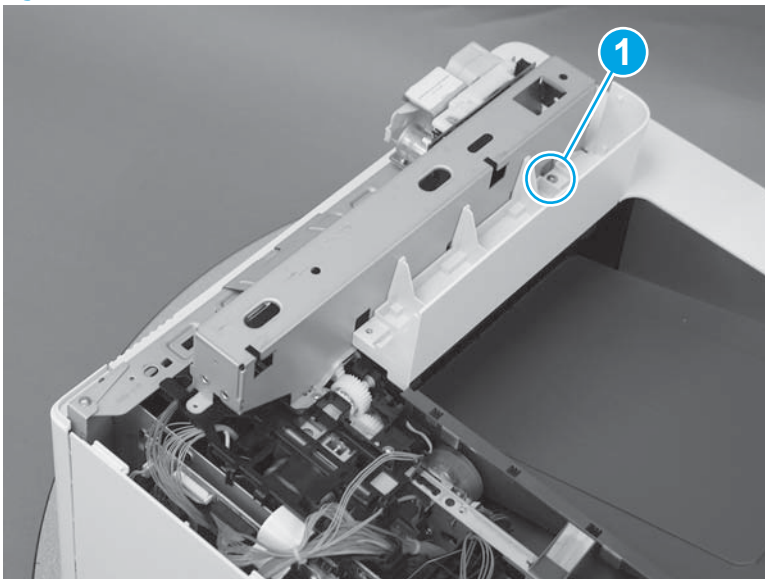

2. Lift the cover up to remove it.

Figure 1-4721 Remove the cover

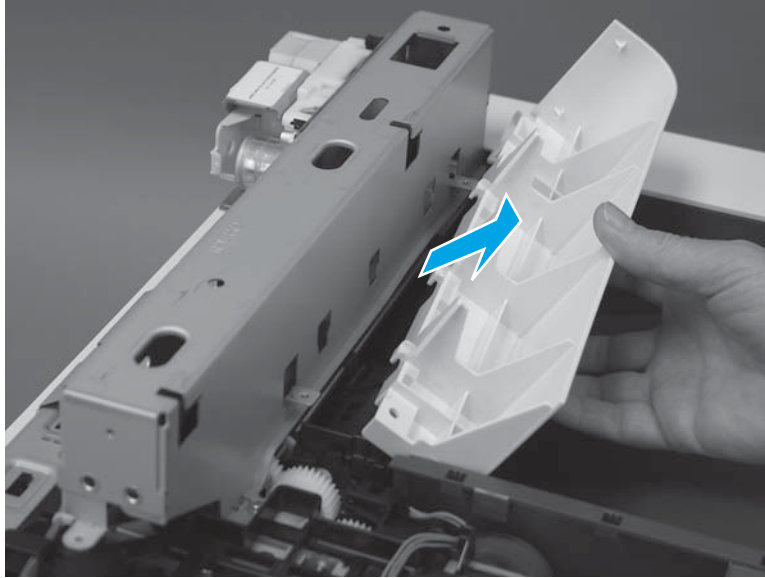

Step 23: Remove the top cover (M577)

 **NOTE:** This step is for the M577 models. For the M552 and M553 models, skip this step and go to [Step 25: Remove the left cover on page 2616](#).

1. At the front of the printer, remove one screw (callout 1).

 **Reinstallation tip:** This screw is longer and a different type of screw than the screw removed in the next step. When reinstalling the top cover, make sure that this screw is installed in the correct position.

Figure 1-4722 Remove one screw



2. At the left side of the printer, remove one screw (callout 1).

Figure 1-4723 Remove one screw

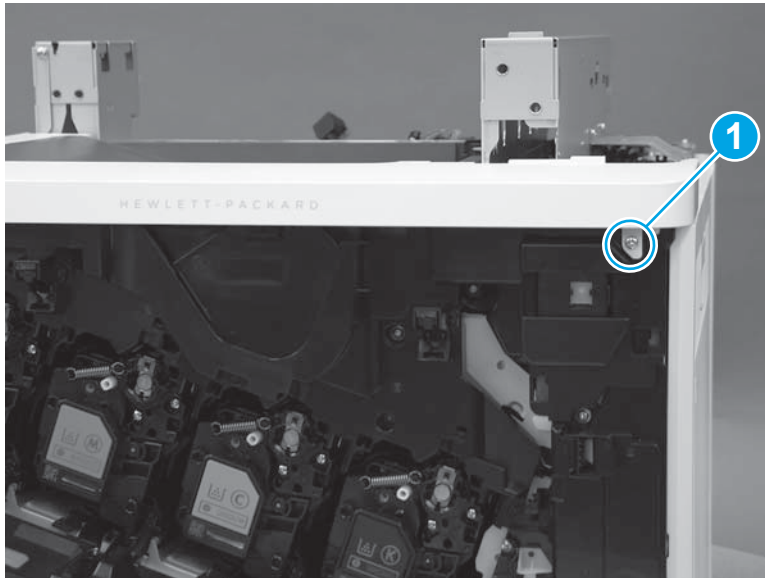
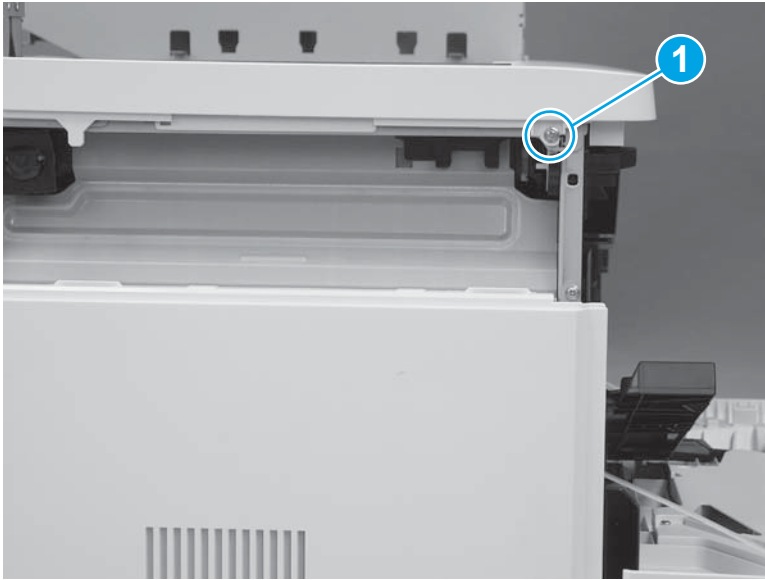

3. At the front of the printer, release one tab (callout 1).

Figure 1-4724 Release one tab

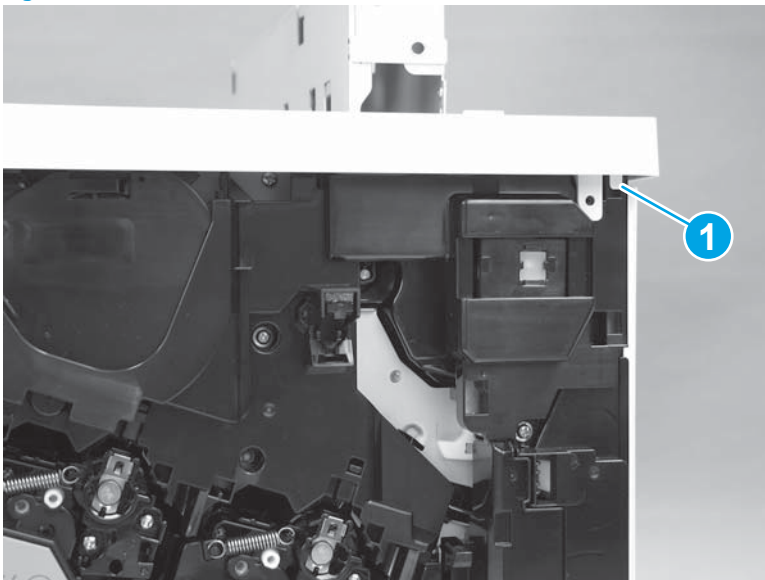

4. At the top of the printer, release two tabs (callout 1) next to the output bin, and then remove the top cover.

Figure 1-4725 Release two tabs

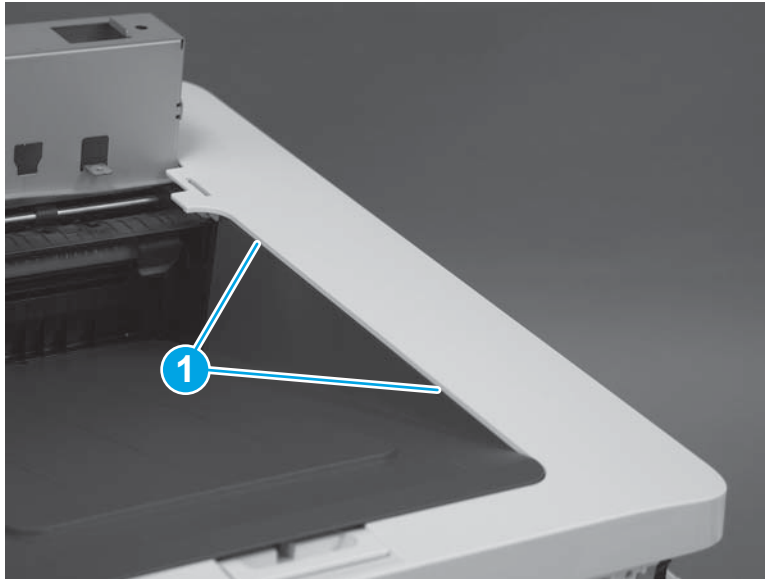

Step 24: Remove the top bracket (M577)

 **NOTE:** This step is for the M577 models. For the M552 and M553 models, skip this step and go to [Step 25: Remove the left cover on page 2616](#).

1. At the top of the printer, remove three screws (callout 1).

Figure 1-4726 Remove three screws

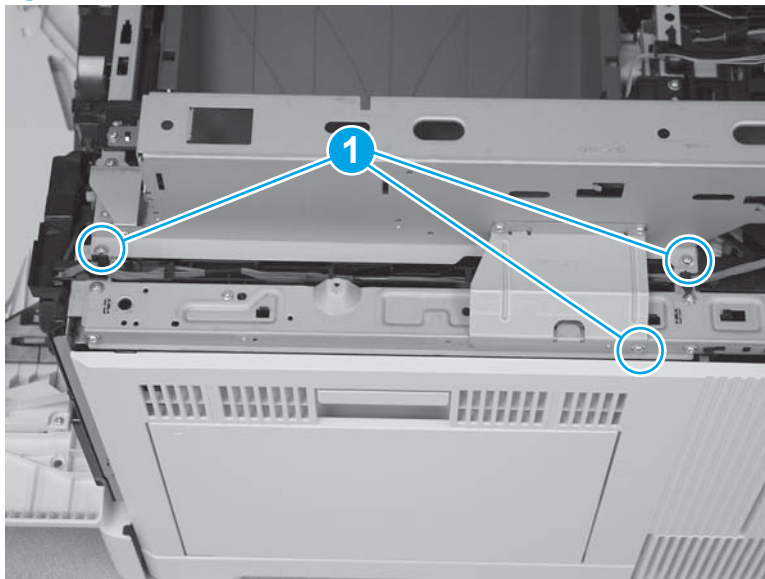

2. At the top of the printer, remove two screws (callout 1).

Figure 1-4727 Remove two screws

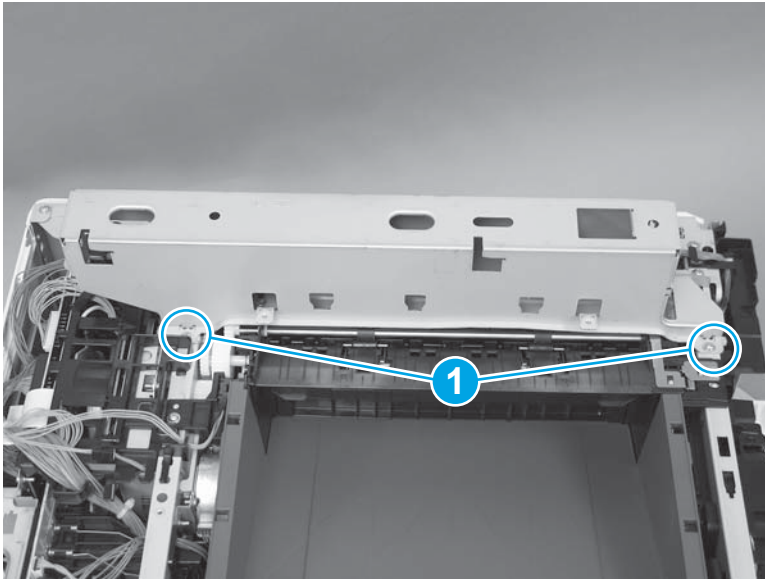

3. Lift the top bracket up to remove it.

Figure 1-4728 Remove the bracket

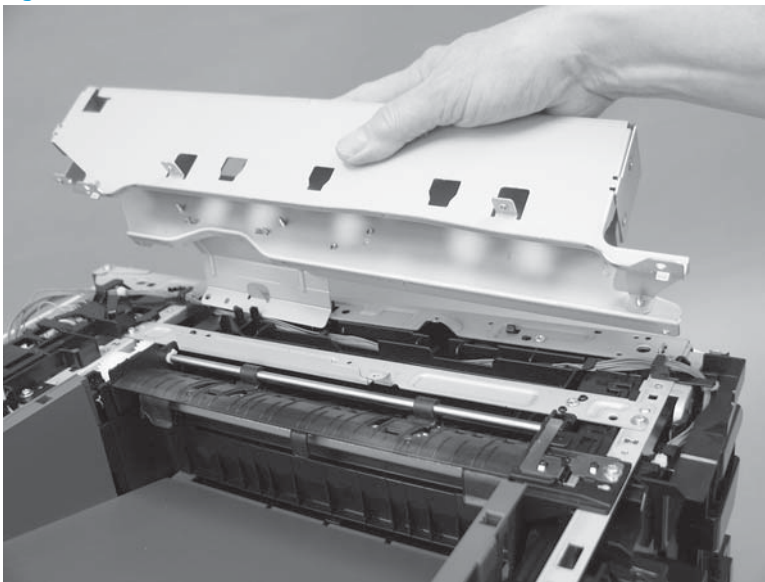

Step 25: Remove the left cover

1. At the left side of the printer, remove one screw (callout 1).

Figure 1-4729 Remove one screw



2. Release one tab (callout 1), rotate the front edge of the cover away from the printer (callout 2), and then slide the cover (callout 3) toward the rear of the printer to release it.

Figure 1-4730 Release the cover

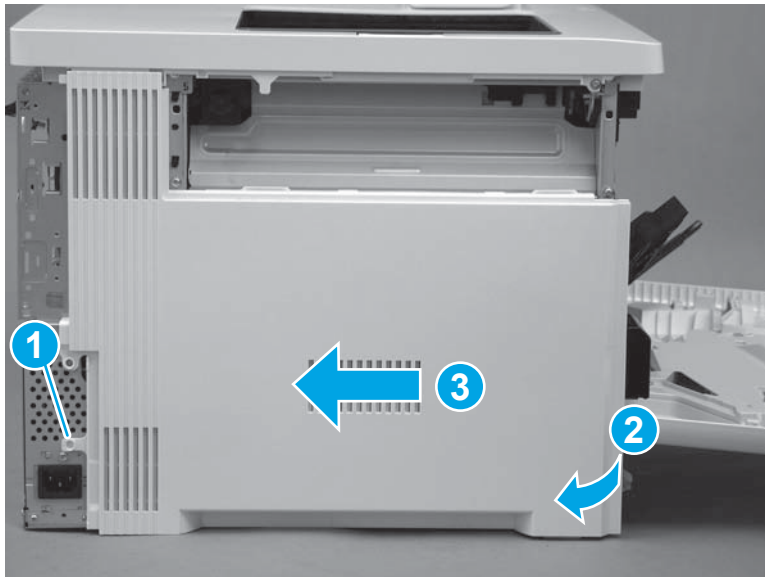

3. Remove the cover.

Figure 1-4731 Remove the cover

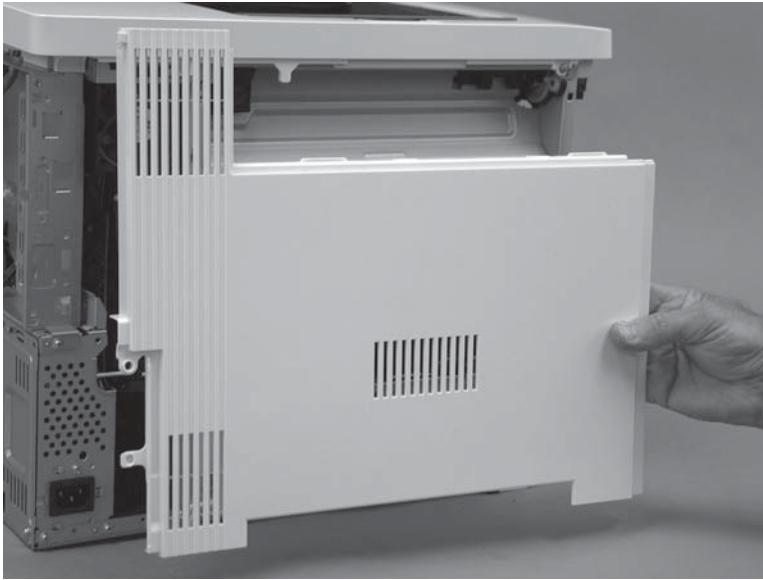

Step 26: Remove the upper cover (M552 and M553)

 **NOTE:** This step is for the M552 and M553 models. For the M577 models, skip this step and go to [Step 27: Remove the formatter case on page 2620](#).

1. Remove three screws (callout 1).

Figure 1-4732 Remove three screws

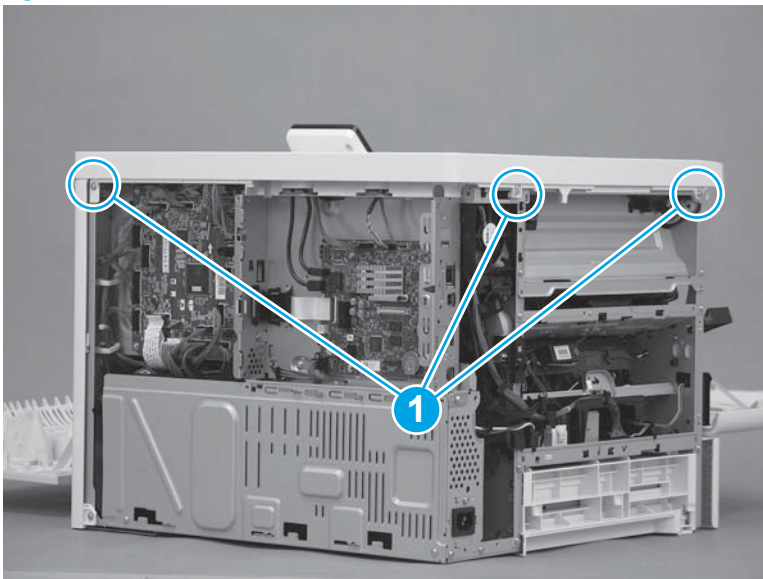

2. Remove one screw (callout 1), release one tab (callout 2), and then slightly separate the corner of the cover from the chassis.

 **NOTE:** This is a self-tapping plastic-thread screw. Make sure that this screw is used in this location when it is reinstalled.

Figure 1-4733 Remove one screw and release one tab



3. Release one tab (callout 1), and then lift up on the cover to release it.

 **NOTE:** If the cover does not release, check for addition tabs by locating the triangles embossed in the cover at tab locations.

Figure 1-4734 Release the cover



4. Remove the cover.

Figure 1-4735 Remove the cover

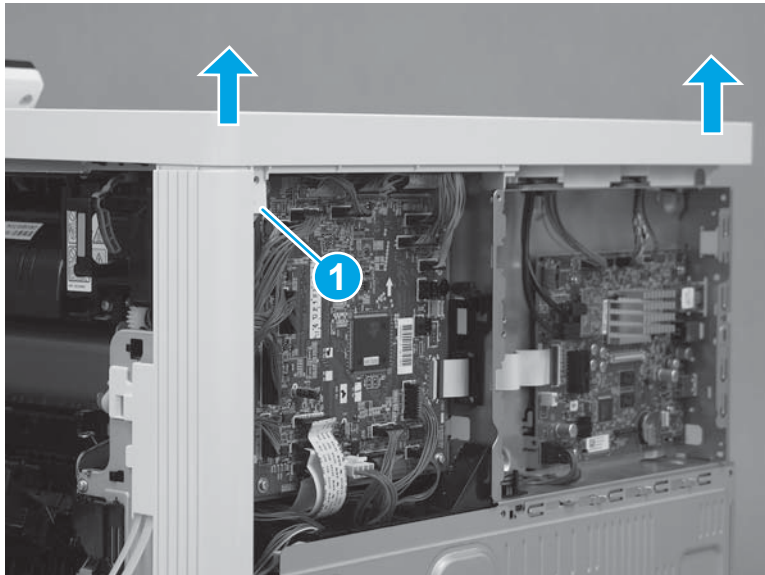
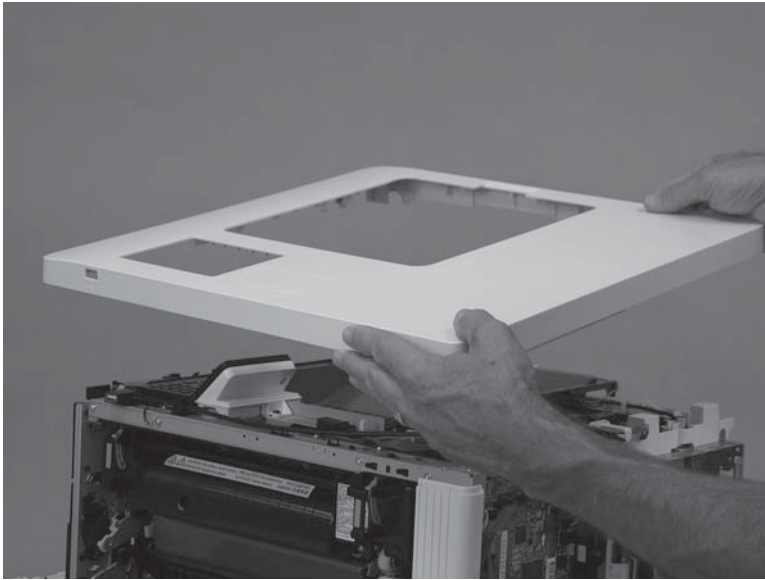

Step 27: Remove the formatter case

1. **M577 only:** Disconnect one connector (callout 1), and then pass the wire harness (callout 2) through two openings in the formatter case (callout 3).

Figure 1-4736 Disconnect one connector

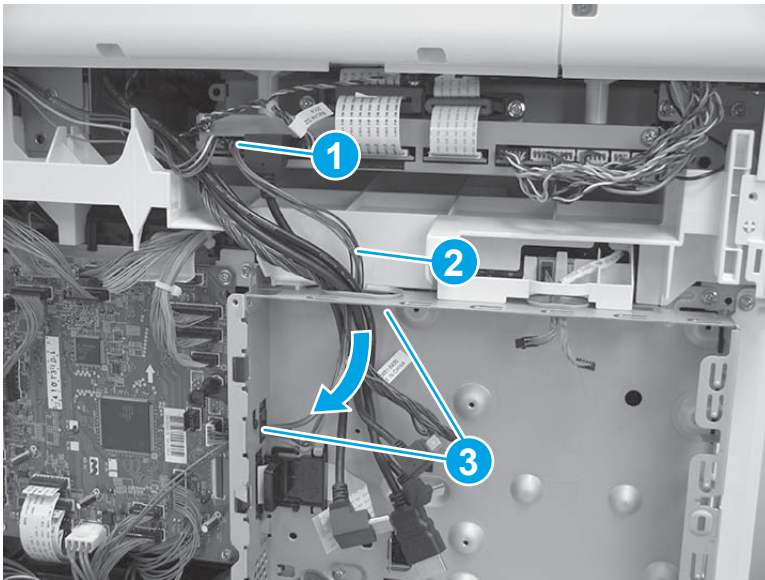

2. Release two tabs (callout 1) on the black plastic bracket. Hold the tabs in the released position, and then slide the bracket (callout 2) to the right to remove it from the formatter case.

Figure 1-4737 Remove the bracket

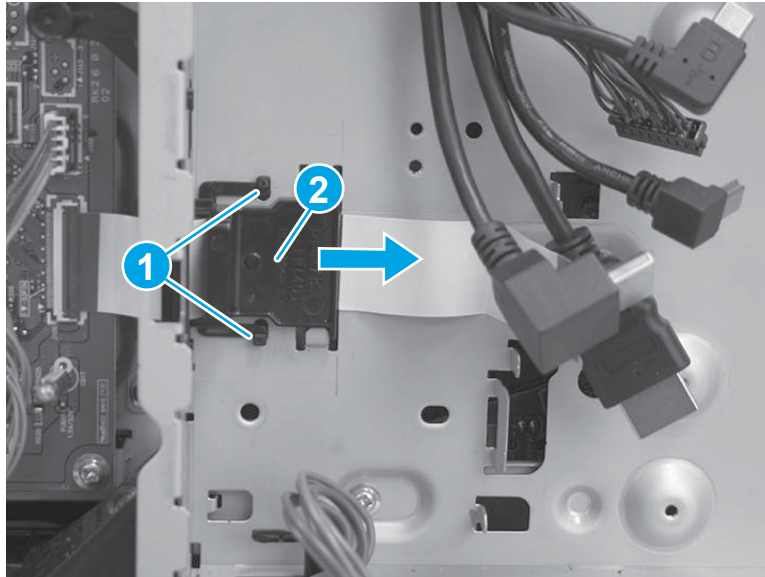

3. Remove two screws (callout 1), and then slide the low-voltage power supply (LVPS) cover to the right to remove it.

Figure 1-4738 Remove the LVPS cover

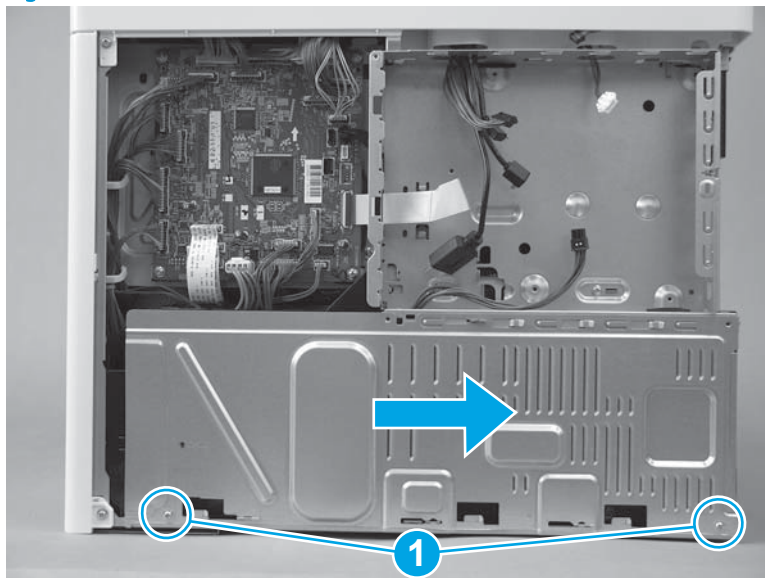

4. Pass two wire harnesses and one flat cable (callout 1) through the opening in the formatter case, and then release one wire harness from the retainer (callout 2).

⚠ CAUTION: The flat cable might be attached to the formatter case with double-sided tape. Make sure that this tape is released, so that the flat cable is not damaged when the formatter case is removed.

Figure 1-4739 Release wire harnesses and flat cable

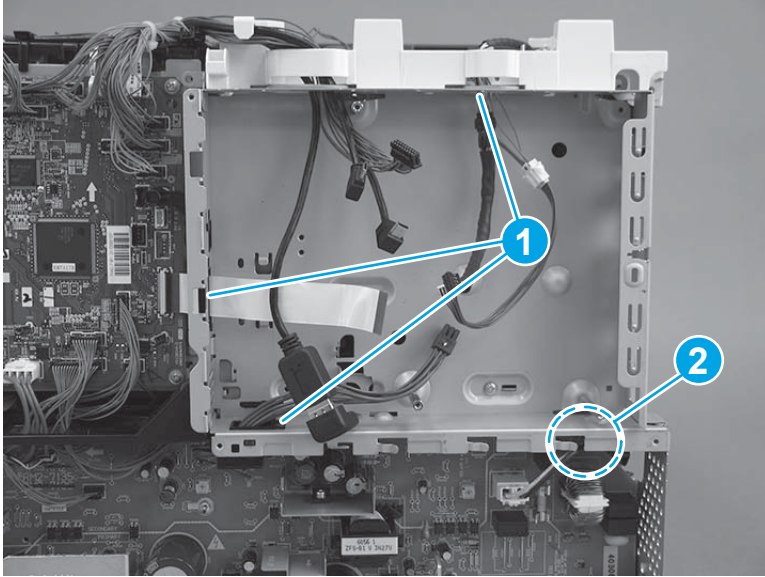

5. Remove six screws (callout 1).

Figure 1-4740 Remove six screws

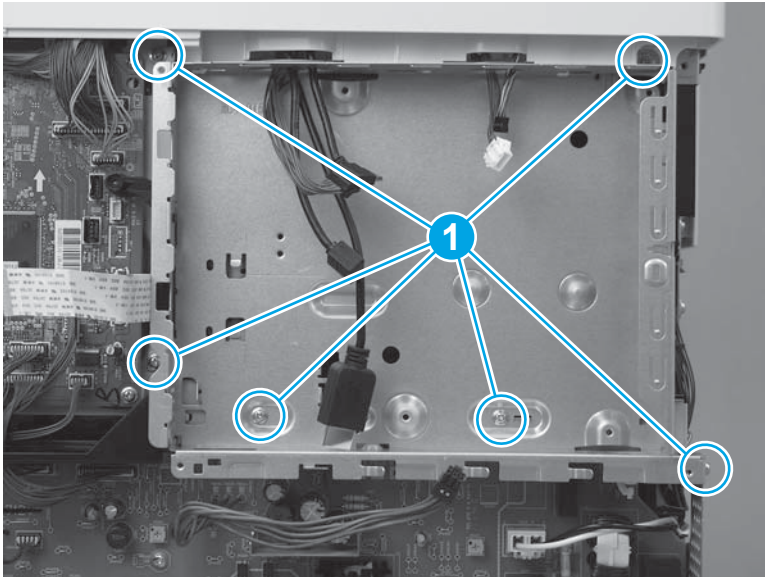

6. Rotate the bottom of the formatter case away from the printer (callout 1), and then pull it down (callout 2) to release it.

Figure 1-4741 Release the formatter case

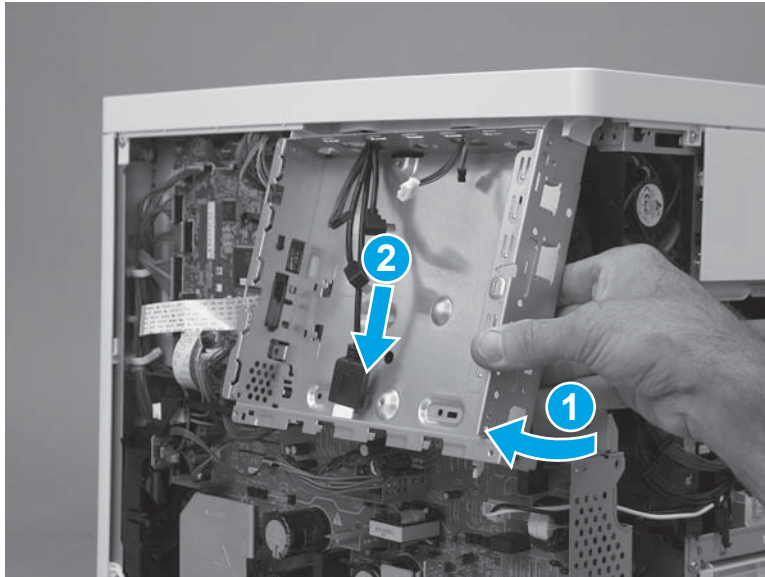

7. Pass the wire harnesses through the opening in the formatter case to remove it.

 **IMPORTANT:** If the formatter case is removed so that it can be replaced, make sure to transfer the memory PCA (island of data) and plastic bracket (callout 1) to the replacement case.

Figure 1-4742 Remove the formatter case



Step 28: Remove the right rear cover

1. Remove one screw (callout 1), and then slide the cover toward the rear of the printer (callout 2) to release it.

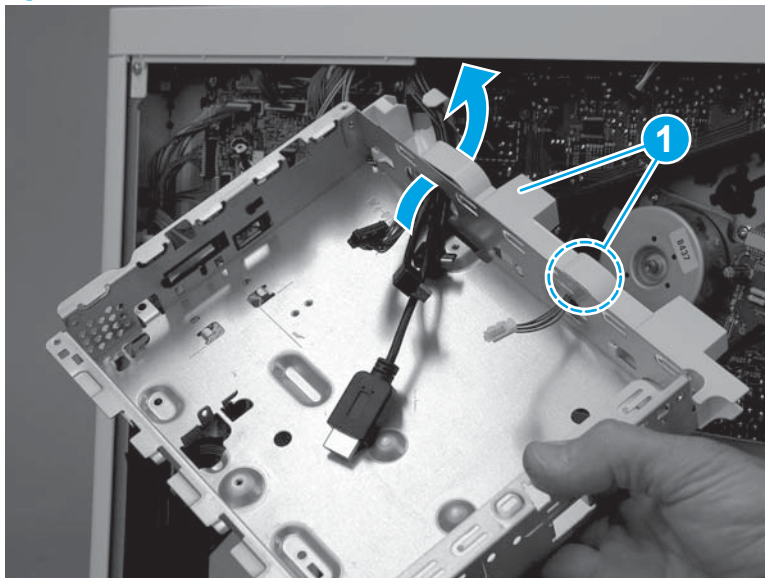
 **TIP:** If the right door is closed, open it now.

Figure 1-4743 Release the cover

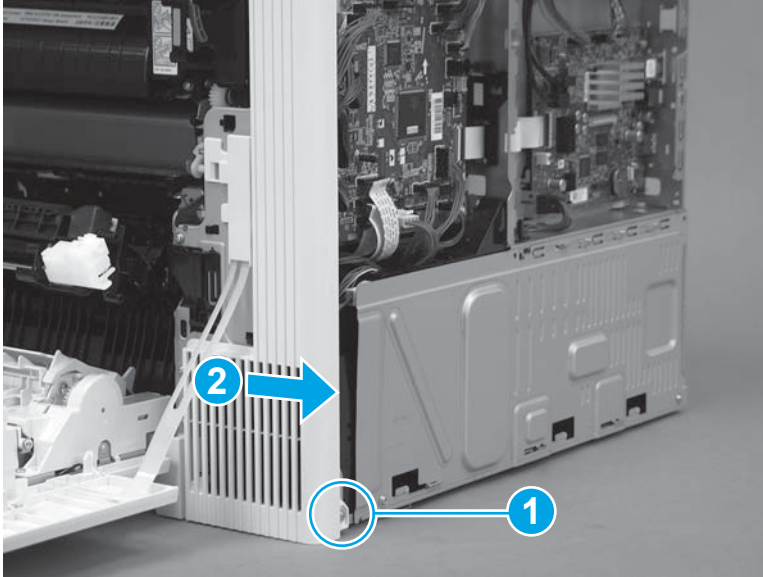

2. Remove the cover.

Figure 1-4744 Remove the cover

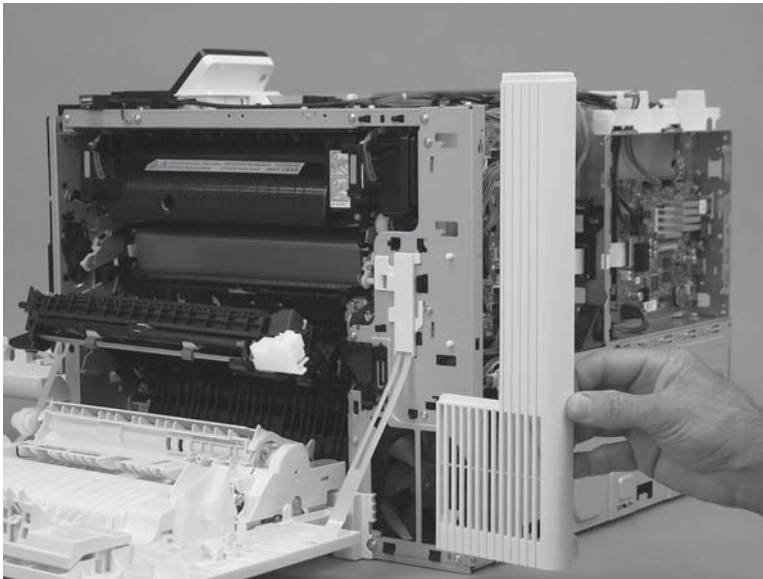

Step 29: Remove the low-voltage power supply (LVPS)

 **IMPORTANT:** Some figures might show assemblies removed or installed that have not yet been removed or installed at that specific step. However, the procedures are correct for this printer and the target assembly. Always thoroughly read the instructions that accompany each figure.

 **CAUTION:**  ESD-sensitive part.

1. Disconnect one wire harness (callout 1), and then pass the wire harness through the opening (callout 2) in the chassis.

Figure 1-4745 Disconnect one wire harness

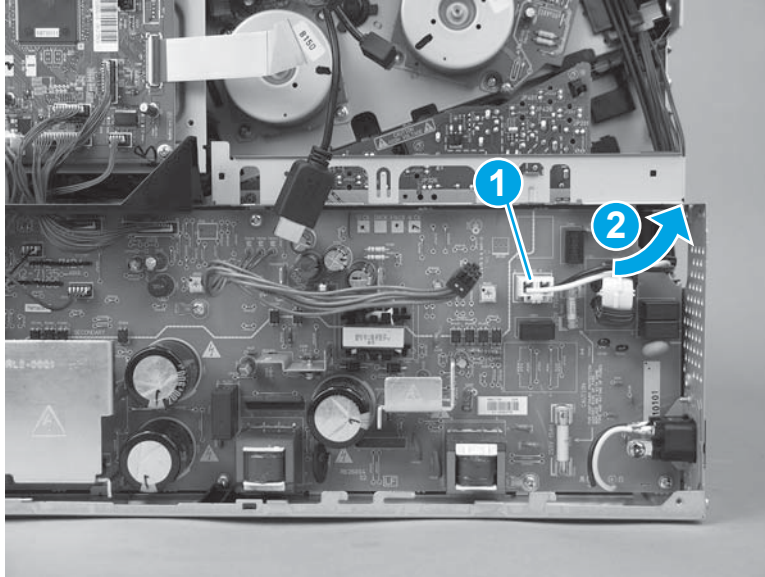

2. Disconnect three connectors on the DC controller (callout 1), and then disconnect four connectors (callout 2) on the LVPS.

Figure 1-4746 Disconnect seven connectors

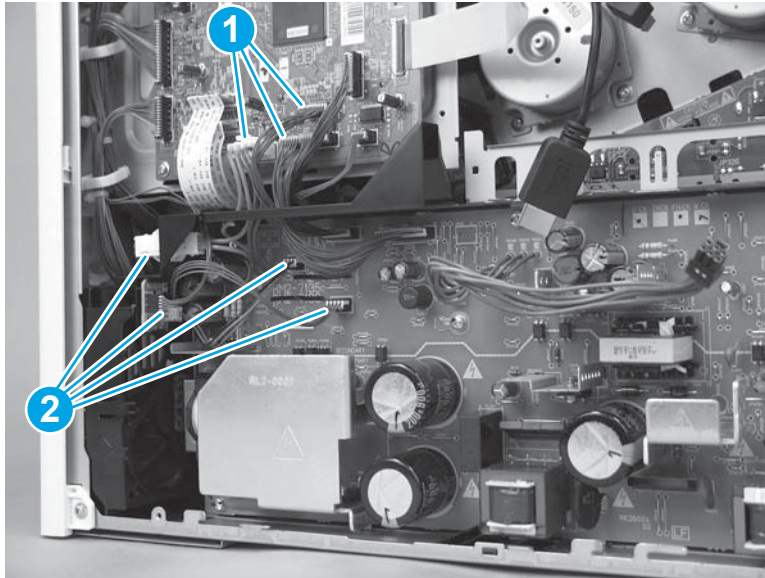

3. Pass the wire harnesses from the DC controller to the LVPS through the opening in the chassis (callout 1), and then release the wire harnesses from the retainer (callout 2).

Figure 1-4747 Pass the wire harnesses through the opening

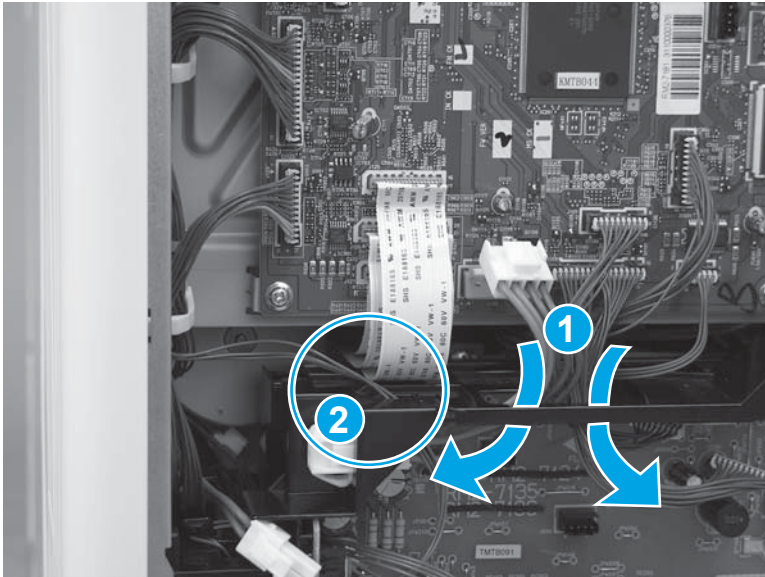

4. Remove three screws (callout 1).

Figure 1-4748 Remove three screws

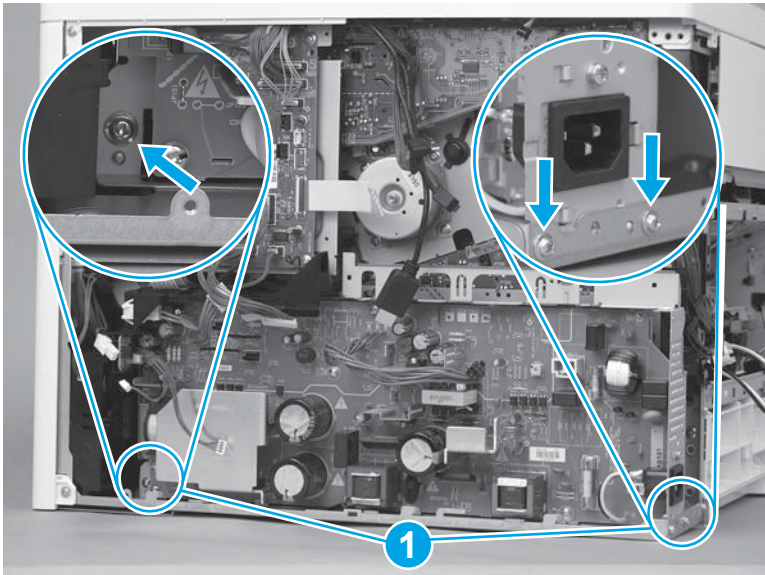

5. Rotate the top of the LVPS away from the printer (callout 1), and then slide it up and out (callout 2) of the printer to remove it.

Figure 1-4749 Remove the LVPS

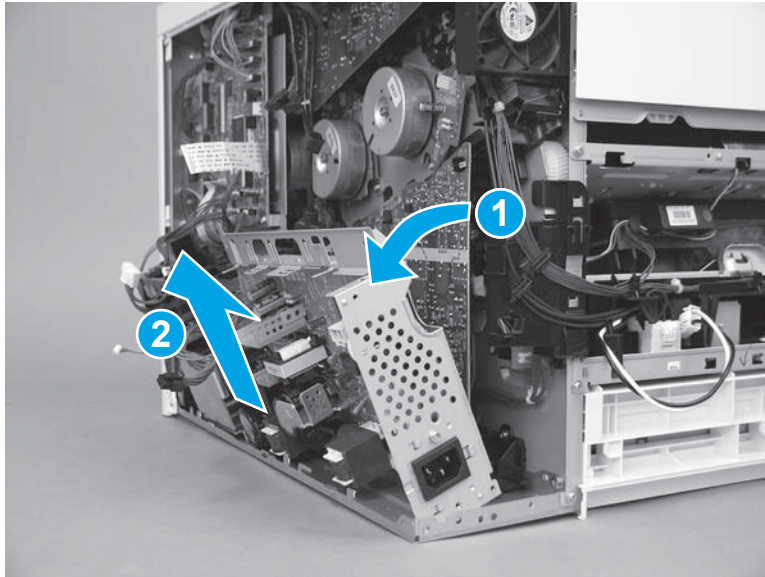

Step 30: Remove the power supply fan (FM1)

 **IMPORTANT:** Some figures might show assemblies removed or installed that have not yet been removed or installed at that specific step. However, the procedures are correct for this printer and the target assembly. Always thoroughly read the instructions that accompany each figure.

1. Remove one screw (callout 1).

Figure 1-4750 Remove one screw

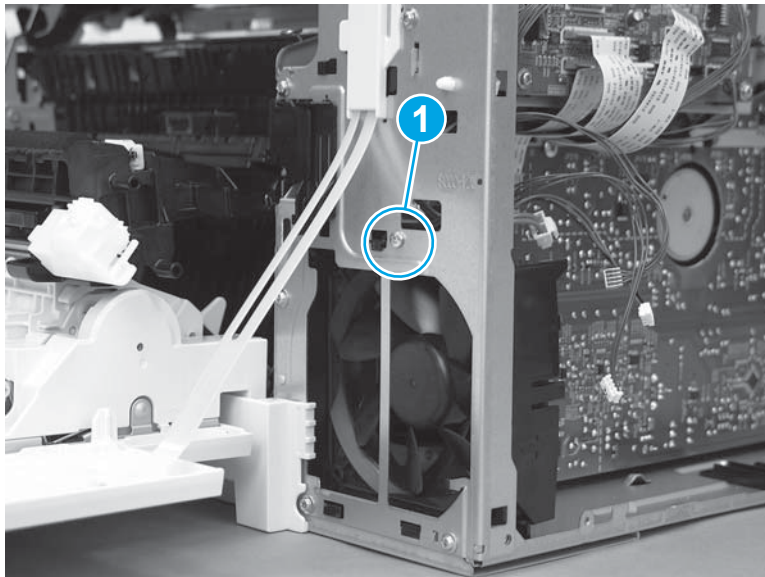

2. Release the wire harnesses from the retainer on the top of the fan bracket.

Figure 1-4751 Release the wire harnesses

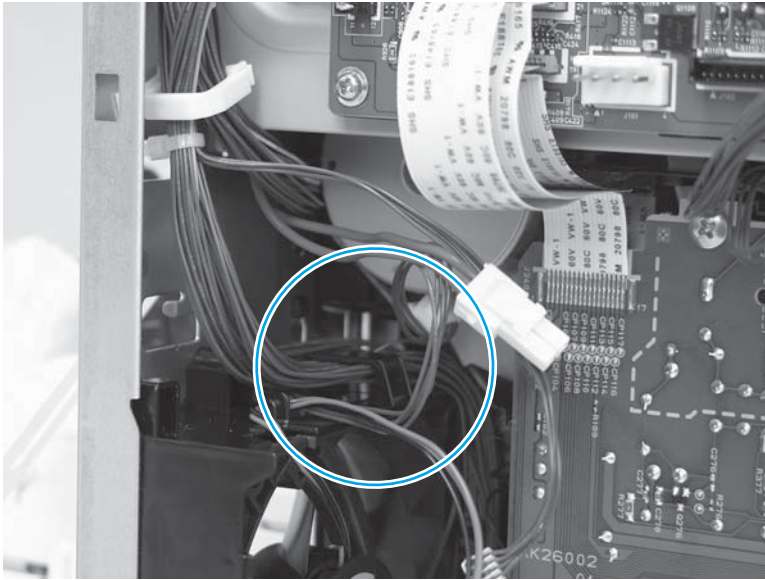

3. Lift the fan up (callout 1), and then slide it out of the printer (callout 2) to remove it.

Figure 1-4752 Remove the fan

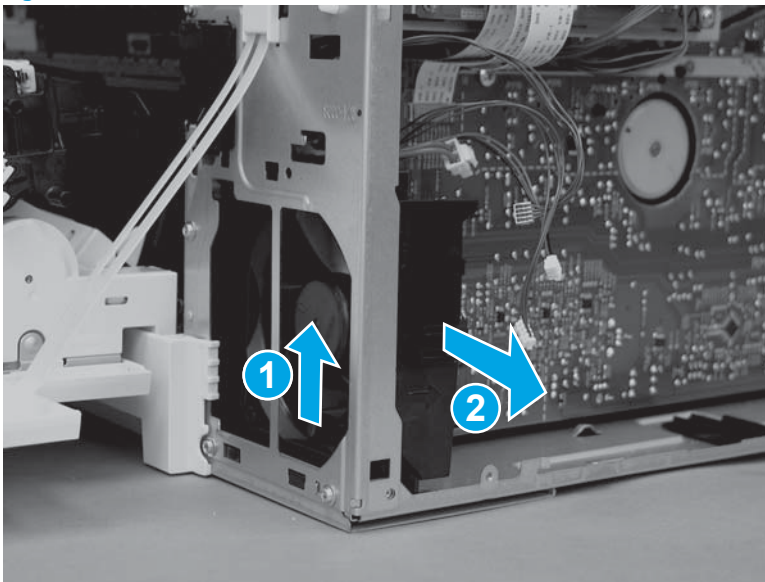

Step 31: Remove the high-voltage power supply D (HVPSD)

 **IMPORTANT:** Some figures might show assemblies removed or installed that have not yet been removed or installed at that specific step. However, the procedures are correct for this printer and the target assembly. Always thoroughly read the instructions that accompany each figure.

 **CAUTION:**  ESD-sensitive part.

1. Disconnect one flat cable (callout 1) on the DC controller.

Figure 1-4753 Disconnect one flat cable

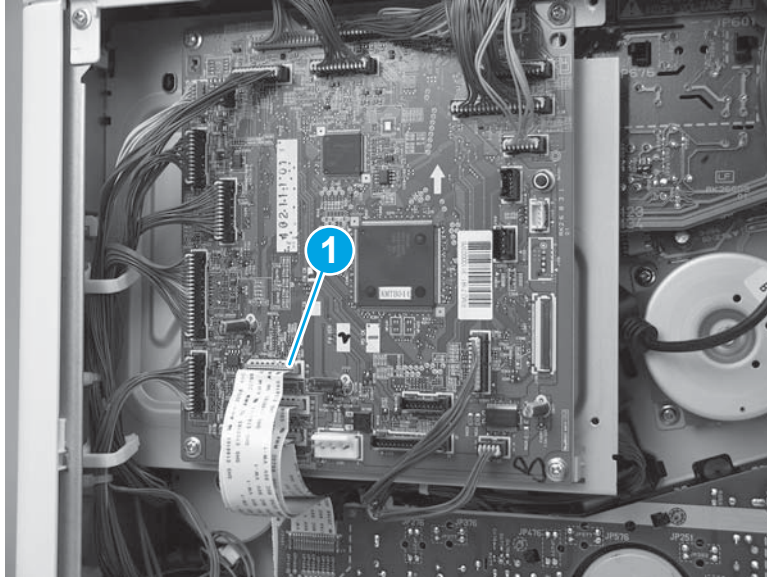

2. Remove two screws (callout 1), and then remove one self tapping screw (callout 2) on the HVPSD.

Figure 1-4754 Remove three screws

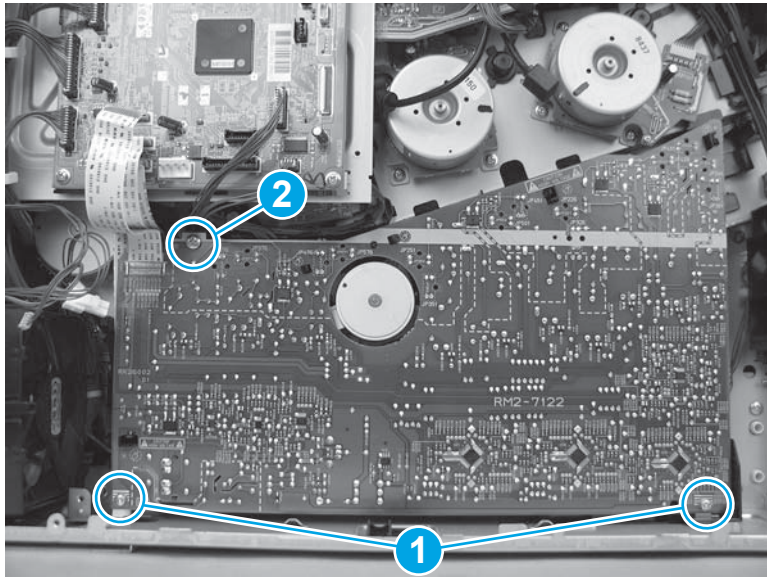

3. Release five tabs (callout 1), and then remove the HVPSD (callout 2).

Figure 1-4755 Remove the HVPSD

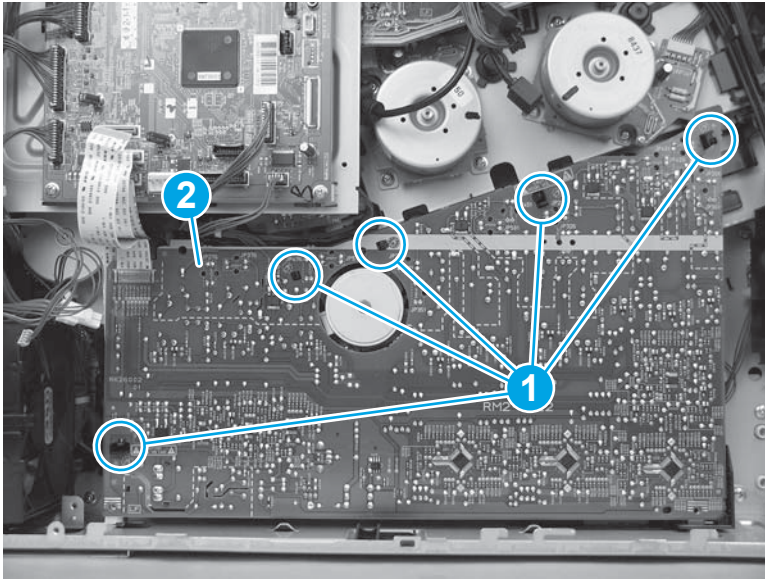

Step 32: Remove the lifter drive assembly

 **IMPORTANT:** Some figures might show assemblies removed or installed that have not yet been removed or installed at that specific step. However, the procedures are correct for this printer and the target assembly. Always thoroughly read the instructions that accompany each figure.

1. Disconnect two connectors (callout 1).

Figure 1-4756 Disconnect two connectors

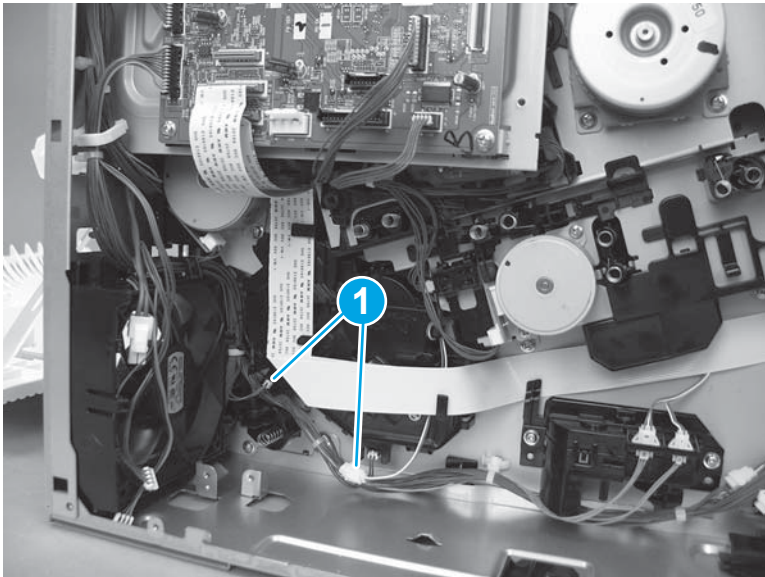

2. Disconnect two flat cables (callout 1), and then release them from the retainers (callout 2).

Figure 1-4757 Disconnect two flat cables

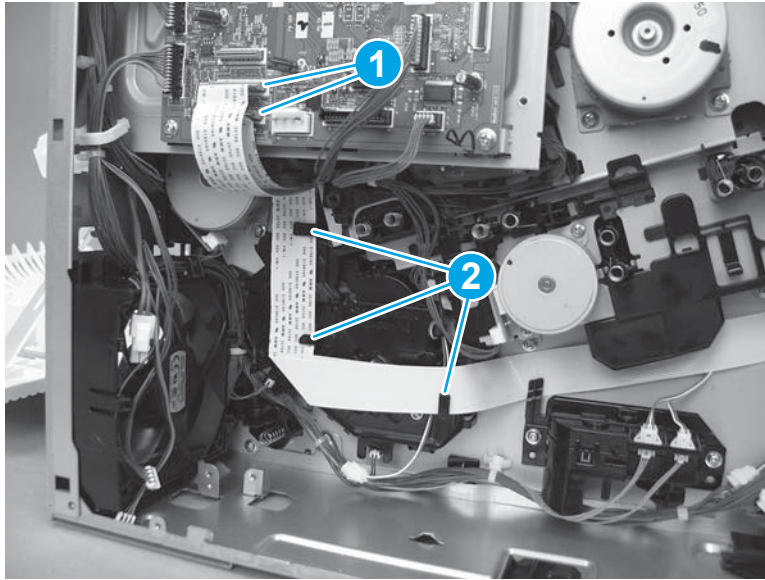

3. Remove two screws (callout 1), release one tab (callout 2), and then remove the lifter drive assembly (callout 3).

 **NOTE:** Release one wire harness from the retainer (callout 4) as the assembly is removed.

Figure 1-4758 Remove the assembly

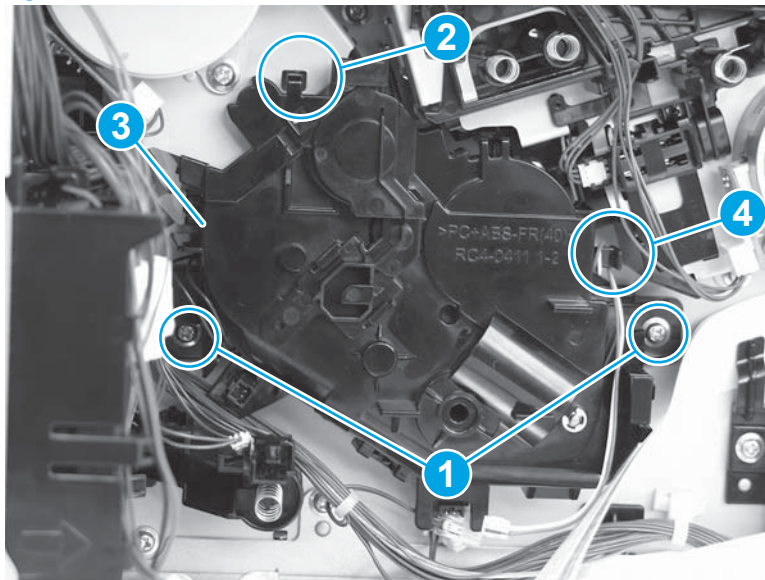

Step 33: Remove the DC controller and sheet-metal bracket

 **CAUTION:**  ESD sensitive part.

1. Disconnect all of the connectors, and then remove two screws (callout 1).

The following connectors are empty:

- J140, J141, and J143

Figure 1-4759 Remove two screws

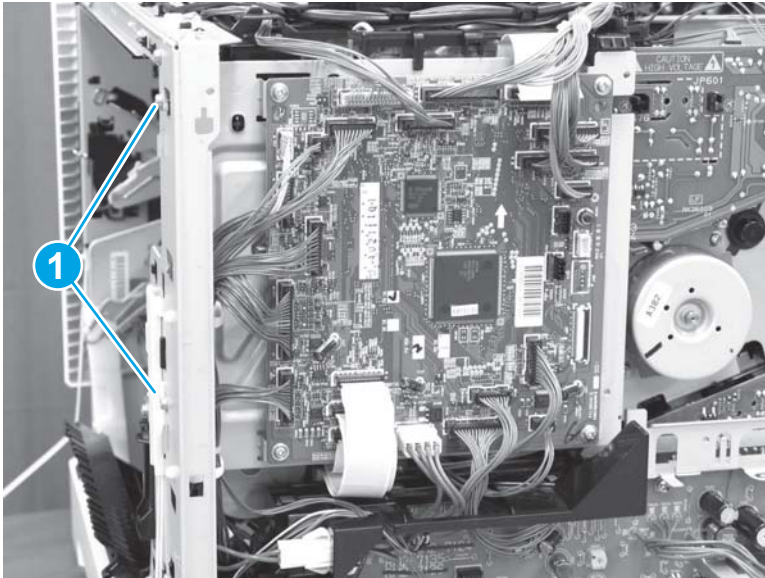

2. Lift up on the DC controller and sheet-metal plate to remove it.

Figure 1-4760 Remove the plate

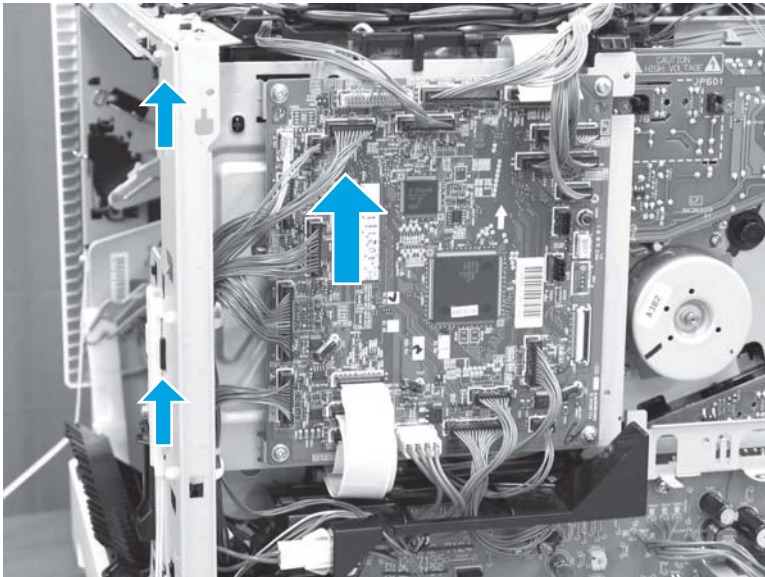

Step 34: Remove the high-voltage power supply T (HVPST)

 **CAUTION:**  ESD-sensitive part.

1. Disconnect five connectors (callout 1), and then disconnect one flat cable (callout 2).

Figure 1-4761 Disconnect five connectors and one flat cable

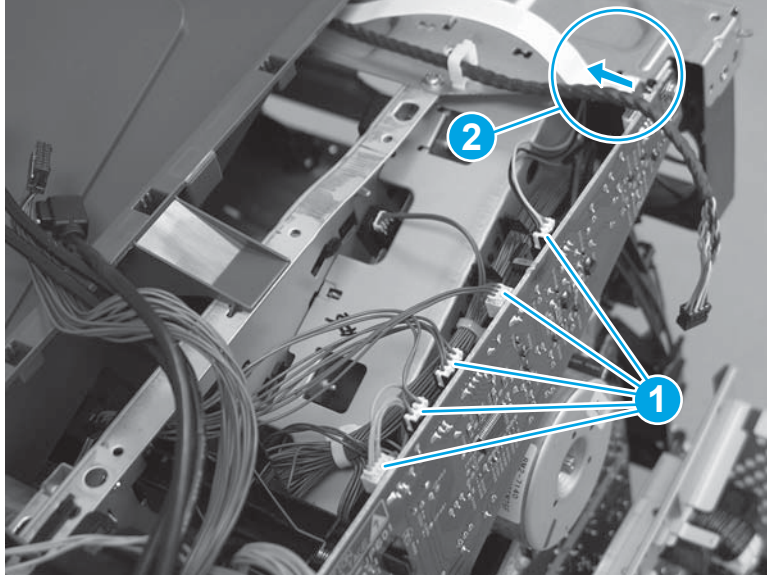

2. Remove one screw (callout 1).

Figure 1-4762 Remove one screw

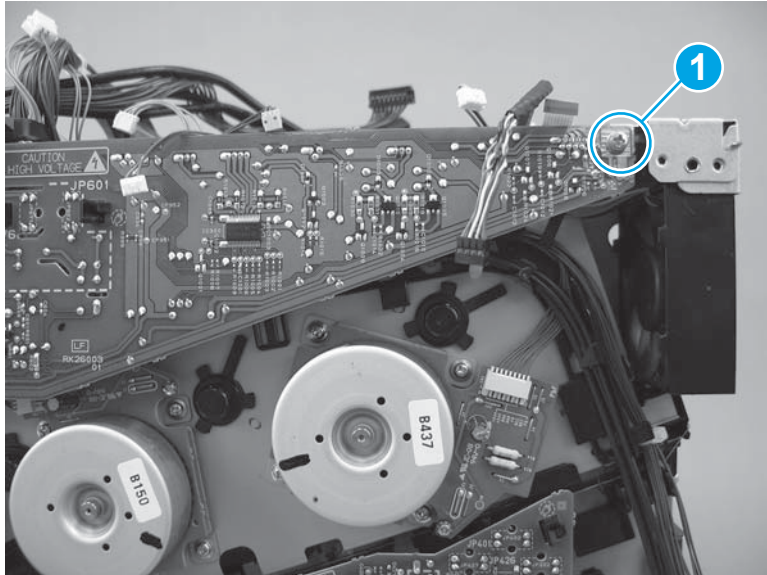

3. Release two tabs (callout 1), and then separate the HVPST from the printer.

⚠ CAUTION: Do not attempt to completely remove the HVPST. It is still connected to the printer by ground wire harness.

Figure 1-4763 Release the HVPST

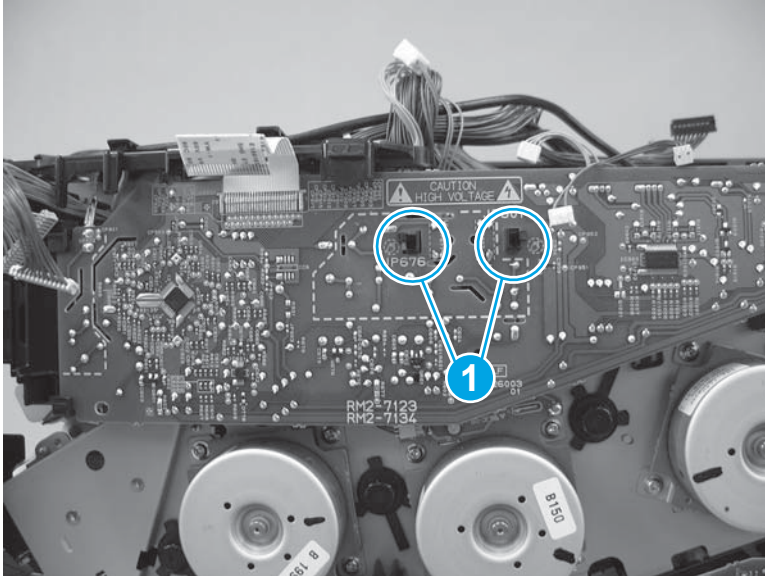

4. Release one ground wire connector (callout 1), and then remove the HVPST.

Figure 1-4764 Remove the HVPST

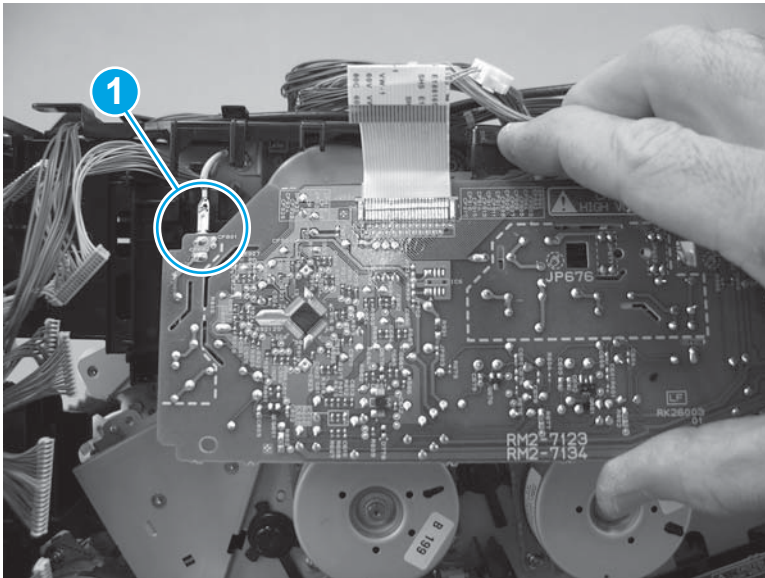

Step 35: Remove the fuser drive assembly

1. Release one tab (callout 1), slide the guide to release it (callout 2), and then rotate the guide up and away from the chassis to move it out of the way (callout 3).

⚠ CAUTION: One wire harnesses in the guide is still attached to the fuser motor. Do not attempt to completely remove the guide.

Figure 1-4765 Move the guide out of the way

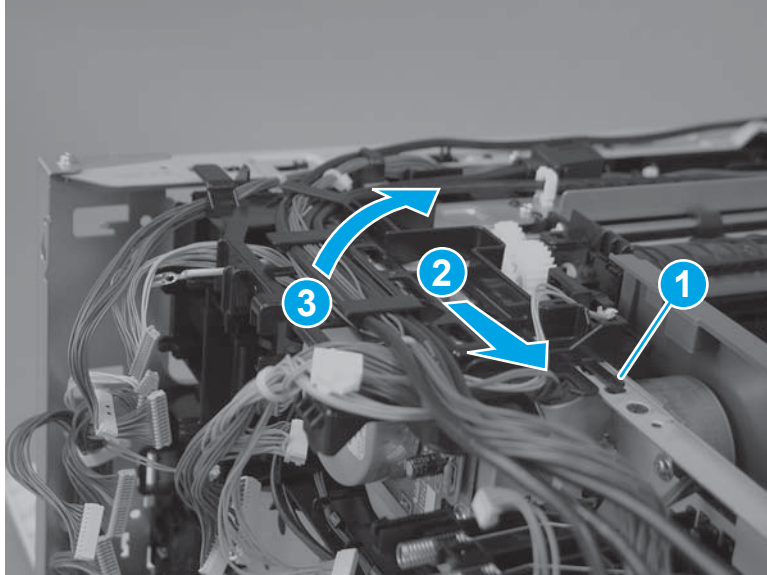

2. Disconnect one connector (callout 1).

Figure 1-4766 Disconnect one connector

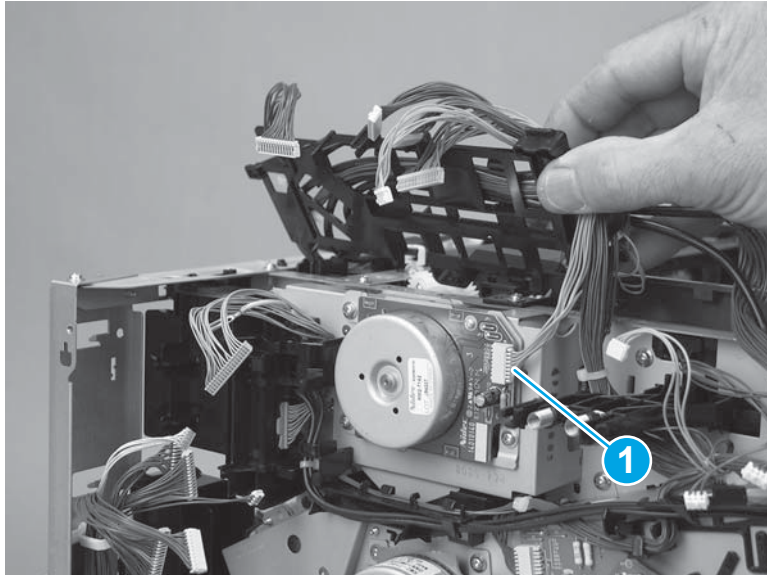

3. Remove one screw (callout 1).

Figure 1-4767 Remove one screw

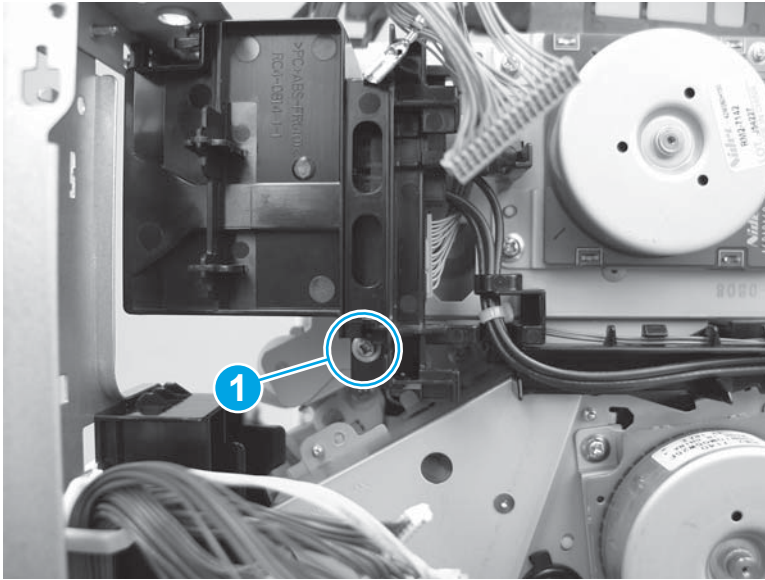

4. Release one tab (callout 1), slide the guide down to release it (callout 2), and then rotate the guide away from the chassis to remove it (callout 3).

Figure 1-4768 Remove the guide

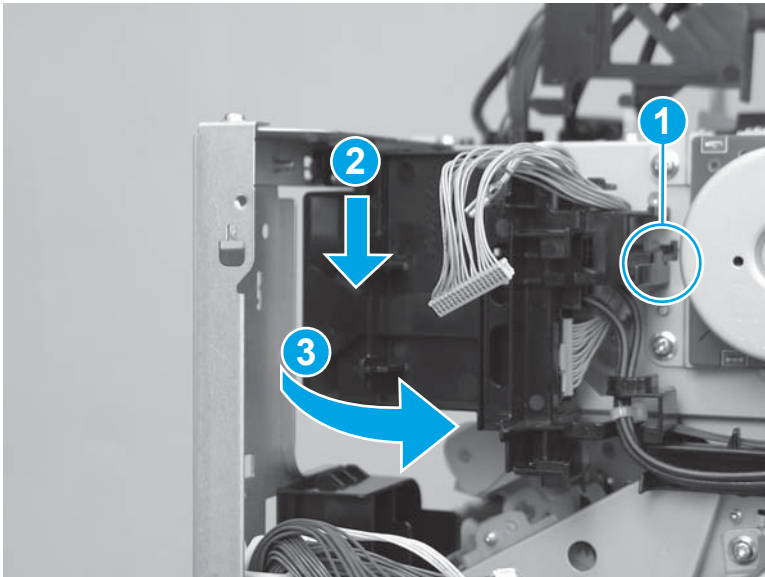

5. Remove three screws (callout 1).

Figure 1-4769 Remove three screws

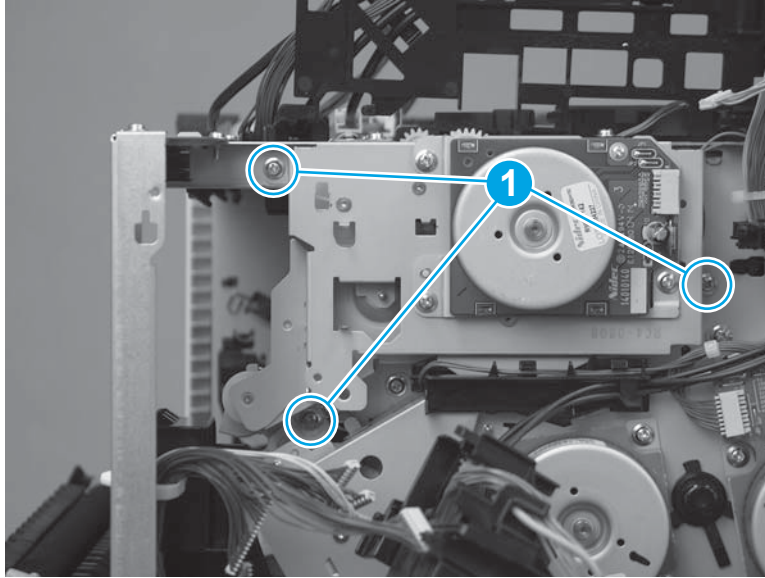

6. Remove the assembly.

⚠ CAUTION: Two gears on the back side of the assembly are not captive. Handle the assembly carefully.

Figure 1-4770 Remove the assembly

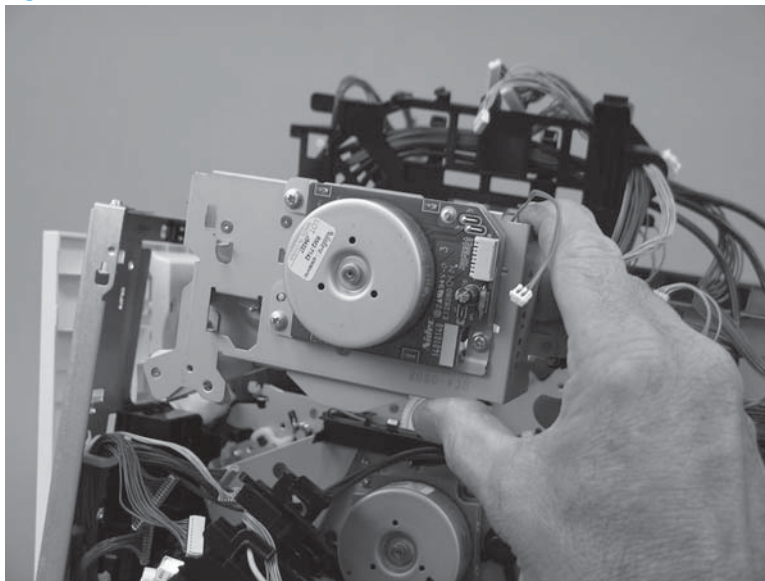

Step 36: Remove the main-drive assembly

📄 IMPORTANT: If the toner cartridges have not already been removed prior to servicing the product, remove them now.

The toner cartridges are sensitive to strong light. Set them aside and cover them with paper to protect them.

1. At the rear side of the printer, remove one screw (callout 1).

Figure 1-4771 Remove one screw

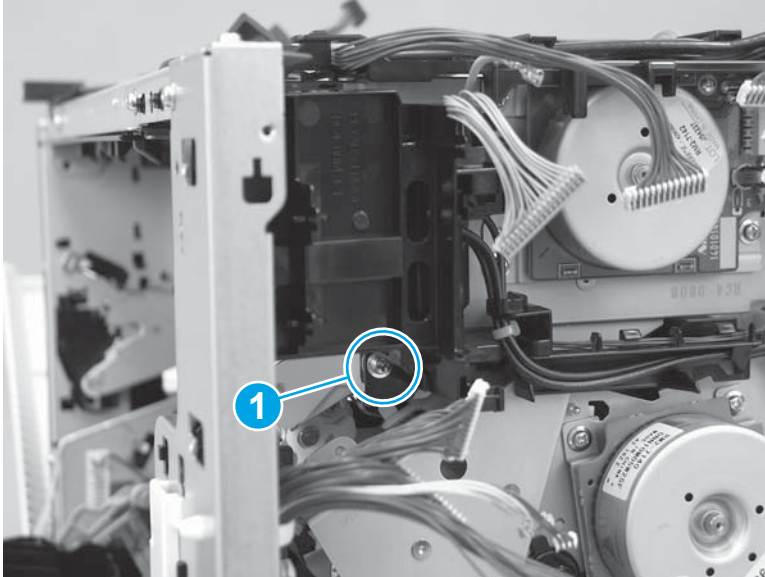

2. Release one tab (callout 1), push down on the cover (callout 2), and then rotate the cover away (callout 3) from the printer to remove it.

Figure 1-4772 Remove the cover

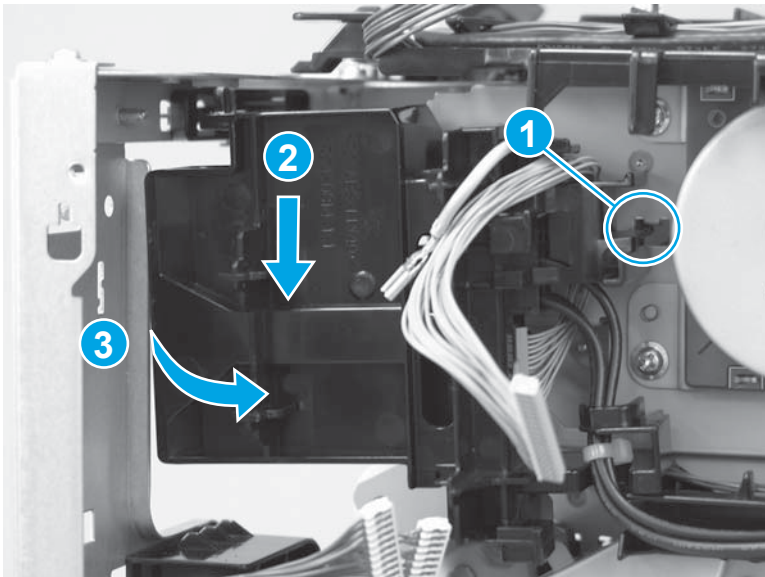

3. Release the wire harnesses from the guides (callout 1).

Figure 1-4773 Release the wire harnesses

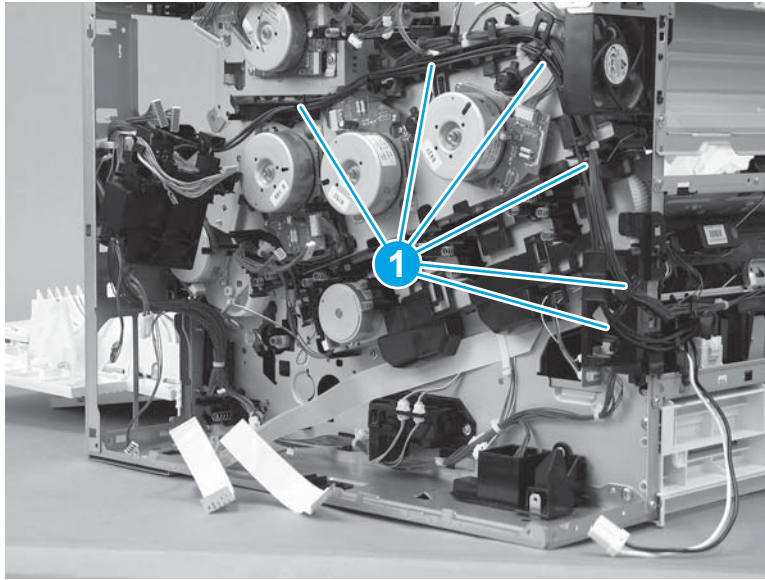

4. At the top of the printer, disconnect two connectors (callout 1).

Figure 1-4774 Disconnect two connectors

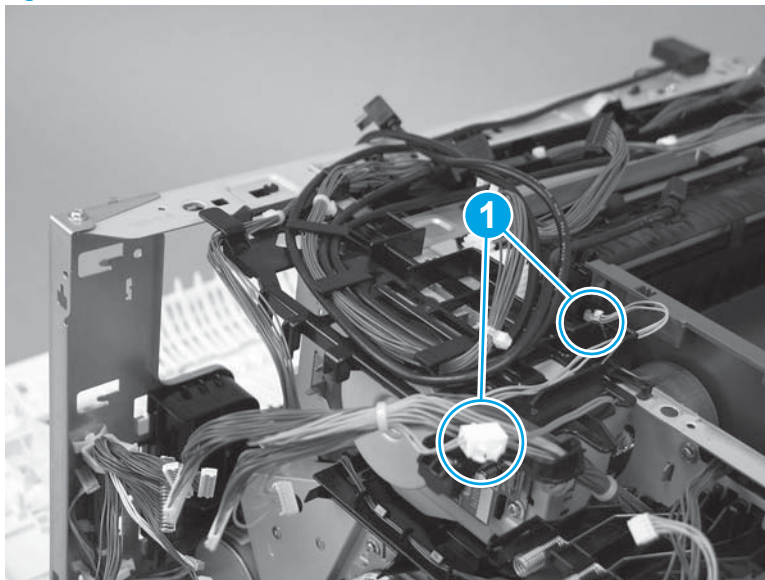

5. Release the wire harnesses (callout 1) from the retainers (callout 2).

Figure 1-4775 Release the wire harnesses

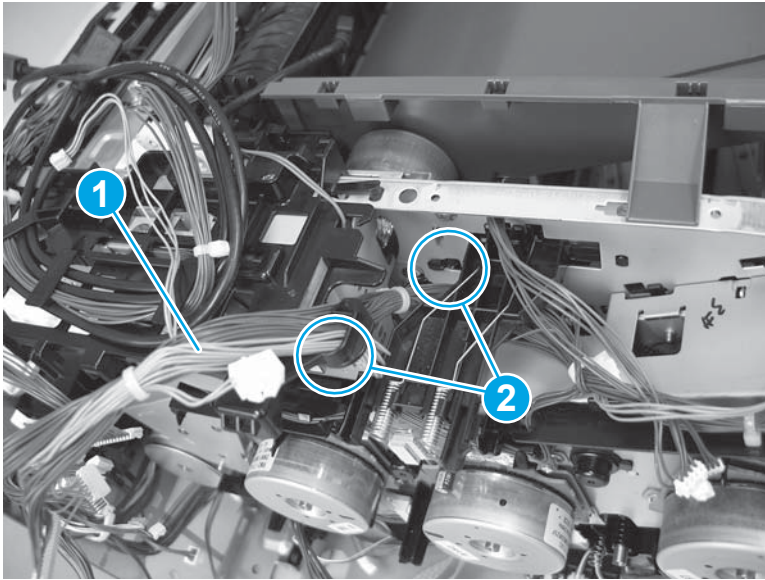

6. At the left side of the printer, disconnect one connector (callout 1), and then release the wire harnesses from the retainers (callout 2).

Figure 1-4776 Disconnect one connector

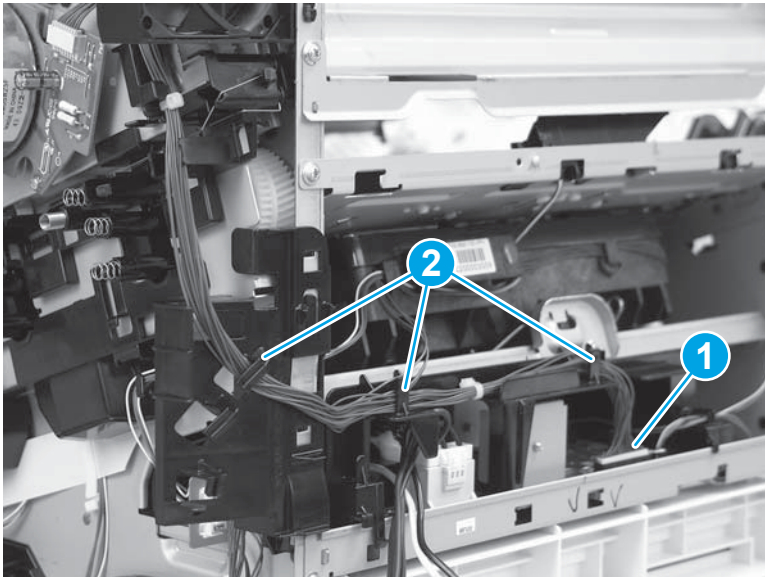

7. Release one tab (callout 1), and then push up on the guide (callout 2) to release it.

Figure 1-4777 Release the guide

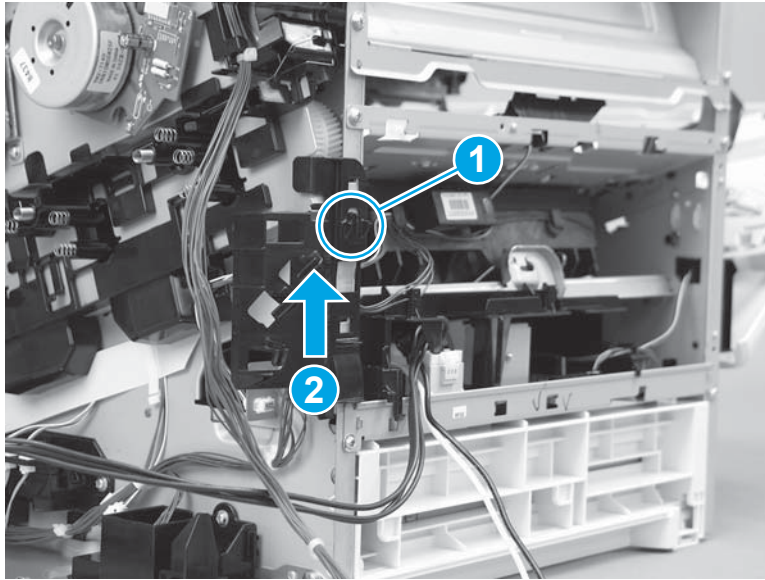

8. Remove the guide.

Figure 1-4778 Remove the guide

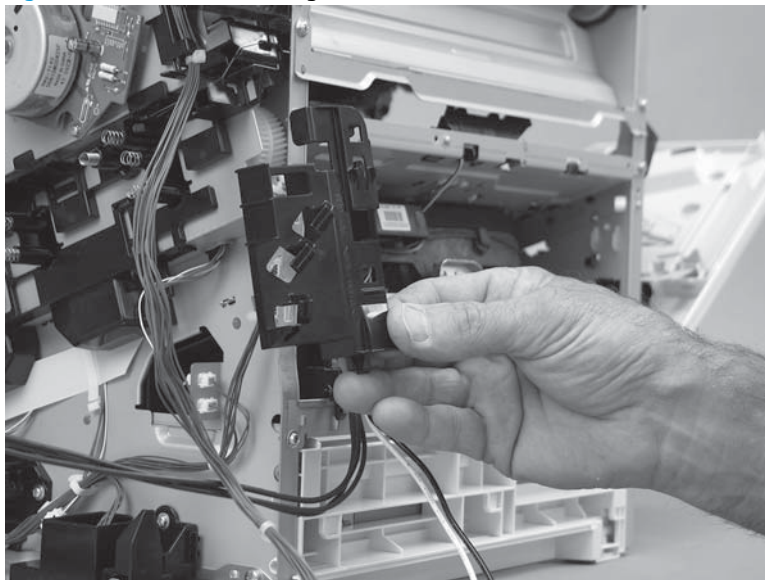

9. Release one wire harness (callout 1) from the retainer.

Figure 1-4779 Release one wire harness

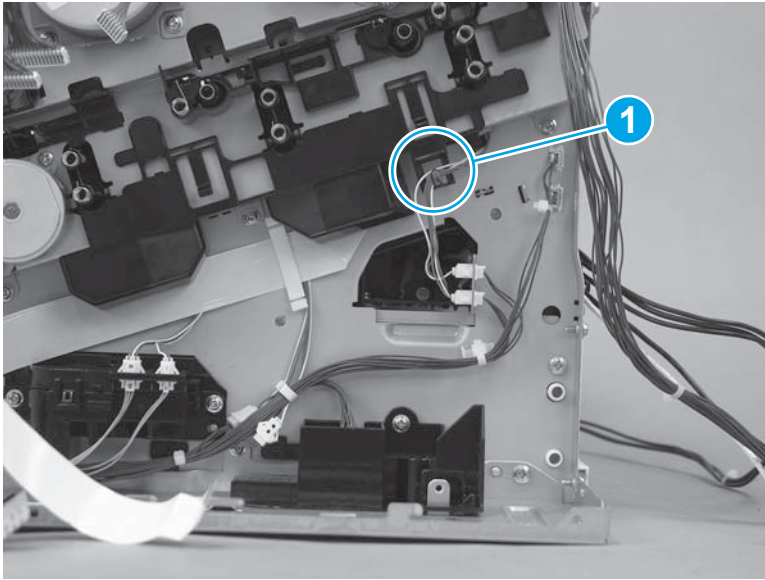

10. Release two tabs (callout 1), and then pull down on the guide (callout 2) to release it.

Figure 1-4780 Release the guide

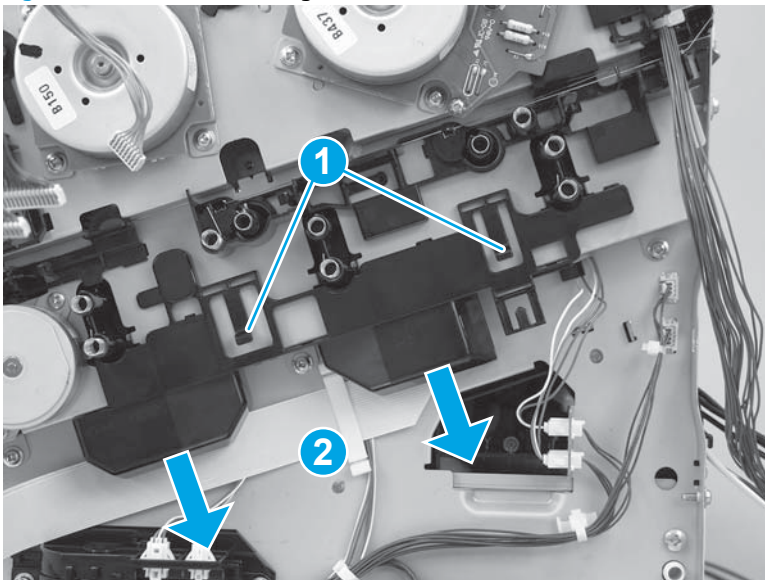

11. Remove the guide.

Figure 1-4781 Remove the guide

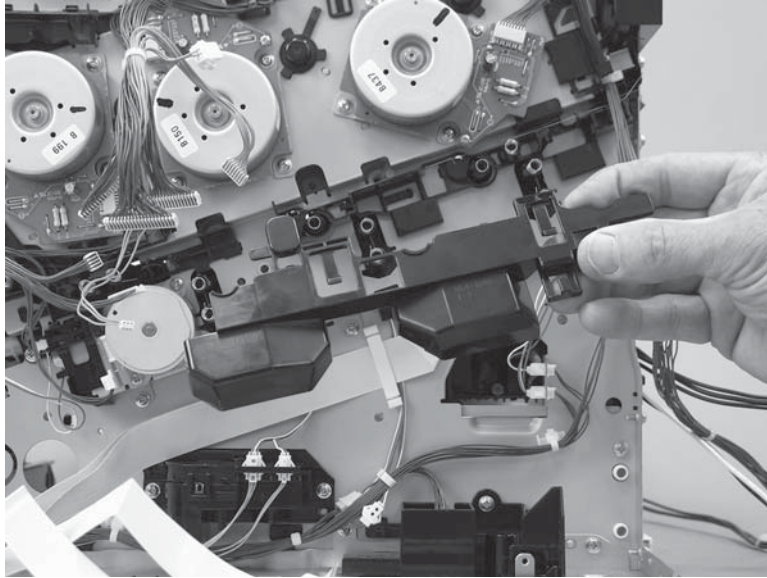

12. Remove seven screws (callout 1).

Figure 1-4782 Remove seven screws

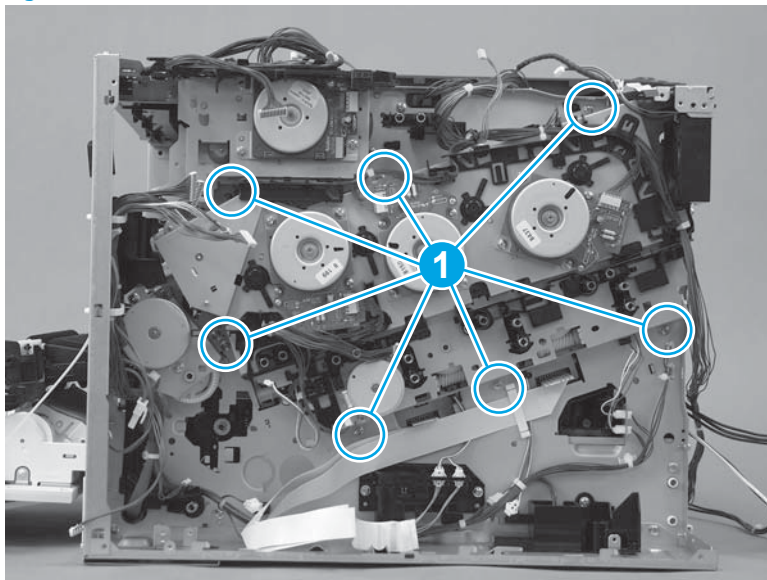

- Carefully remove the main-drive assembly.

Figure 1-4783 Remove the main-drive assembly

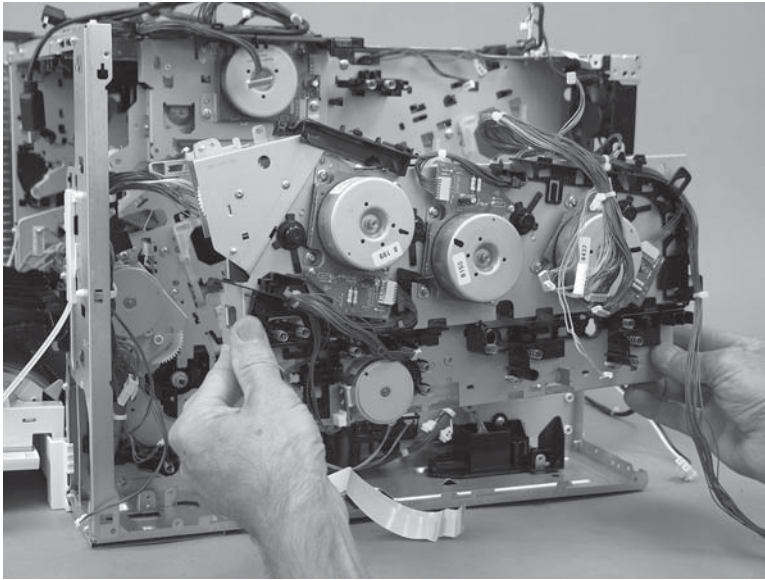

Step 37: Unpack the replacement assembly

Unpack the replacement assembly from the packaging.

For complete information on HP's recycling programs, go to [Product return and recycling](#).

CAUTION: When handling the assembly, take care not to wipe any of the grease off of the gears on the back side of the assembly.

NOTE: HP recommends responsible disposal of the defective assembly.

Figure 1-4784 Recycle and unpack

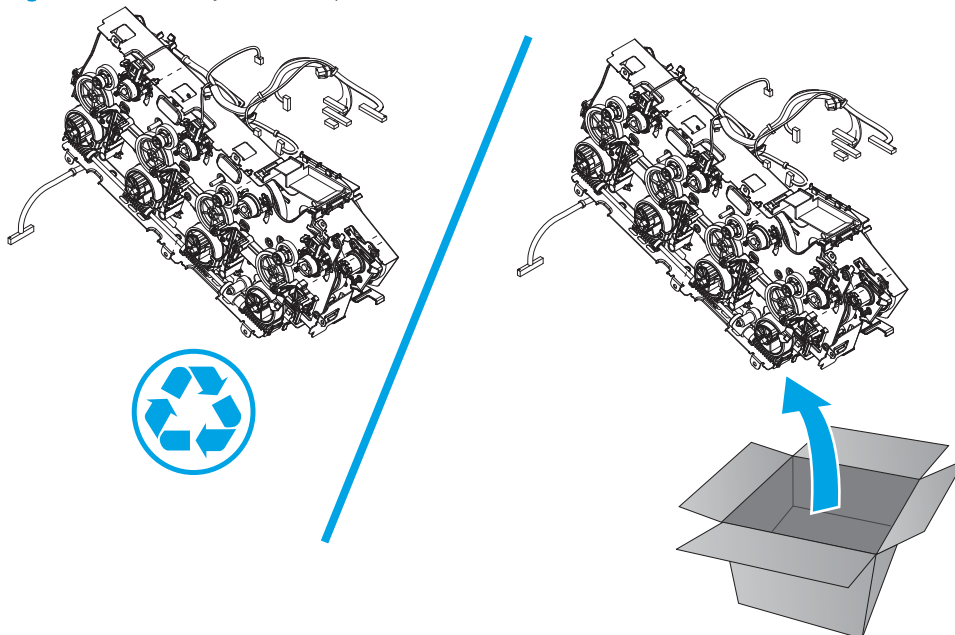

Check the main drive cam alignment

The cams on the back side of the assembly must be correctly aligned before the replacement assembly is installed.

1. Locate the 4 gears and cams (callouts 1-4) on the back side of the assembly.

Figure 1-4785 Main drive gear and cam locations

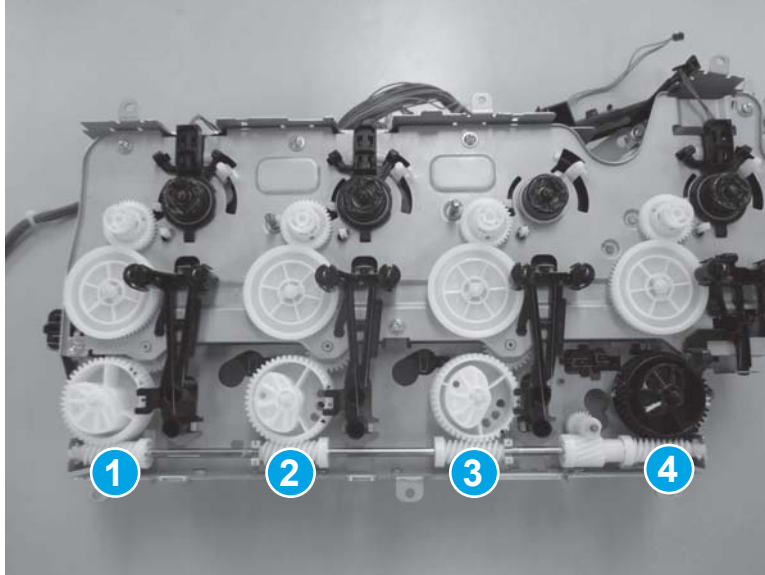

2. Verify the alignment of the holes in the 4 gears with the holes in the assembly chassis as shown.

 **TIP:** Rotate the shaft under the gears to change the alignment if necessary.

Figure 1-4786 Main drive gear and cam alignment

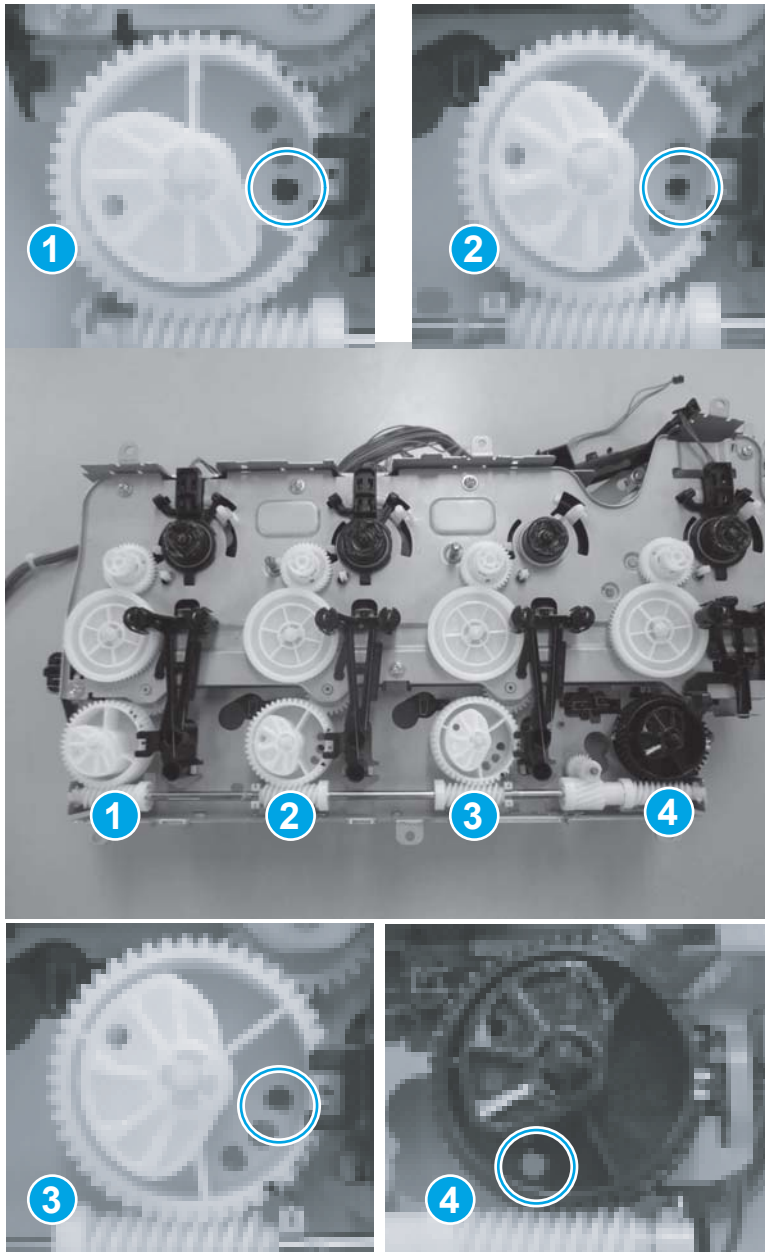

Step 38: Install the main-drive assembly

 **CAUTION:** When handling the assembly, take care not to wipe any of the grease off of the gears on the back side of the assembly.

1. Before proceeding, make sure that the blue ITB drive handle is in the locked (callout 1; pushed in) position on the replacement main-drive assembly.



 **NOTE:** If the drive handle is in the unlocked (callout 2; pulled out) position it will be difficult to install assembly.

Figure 1-4787 Check the blue ITB drive handle

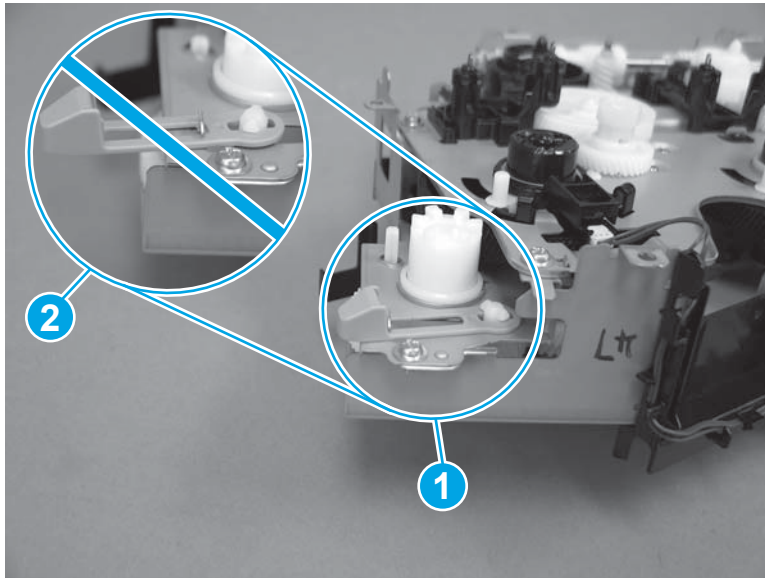

2. With the front door in the closed position, carefully position the replacement main-drive assembly on the printer.

 **CAUTION:** When handling the assembly, take care not to wipe any of the grease off of the gears on the back side of the assembly.

 **TIP:** Place the bottom of the assembly on the printer first, and then rotate the top of the assembly onto the printer.

Make sure that the entire assembly fits flush up against the chassis.

Figure 1-4788 Install the main-drive assembly

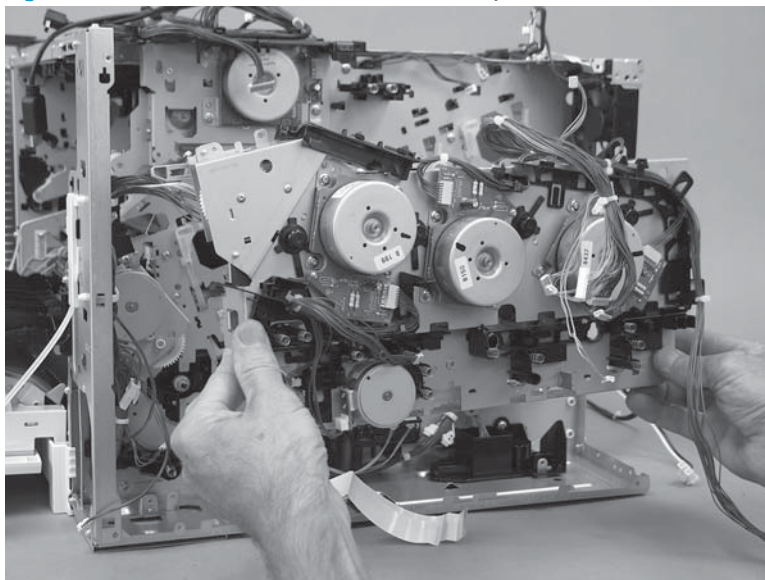

3. Install seven screws (callout 1).

Figure 1-4789 Install seven screws

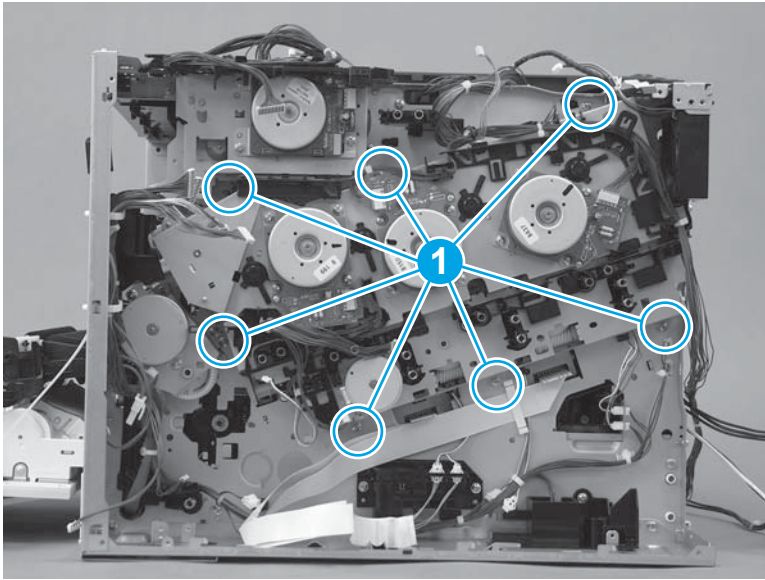

4. To verify that the assembly is correctly fastened to the chassis, open and close the front door while observing the cartridge drive gears (callout 1). The gears must freely move in and out when the door is opened and closed.

 **NOTE:** If the gears do not move freely, remove the assembly, reposition it on the chassis, and then verify that the gears move freely.

Figure 1-4790 Verify that the assembly is correctly fastened



5. Position the guide on the assembly, push up to install it, and then make sure that the two tabs (callout 1) snap into place.

Figure 1-4791 Install the guide

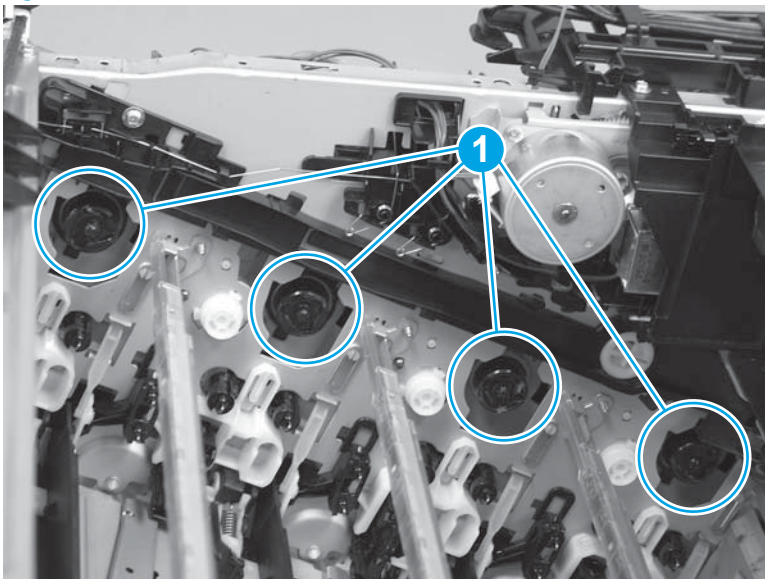
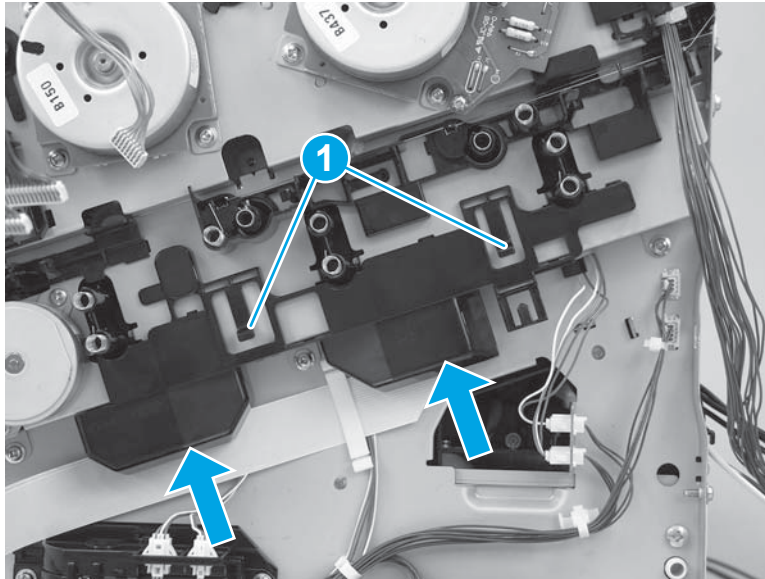

6. Install one wire harness (callout 1) on the retainer.

Figure 1-4792 Install one wire harness

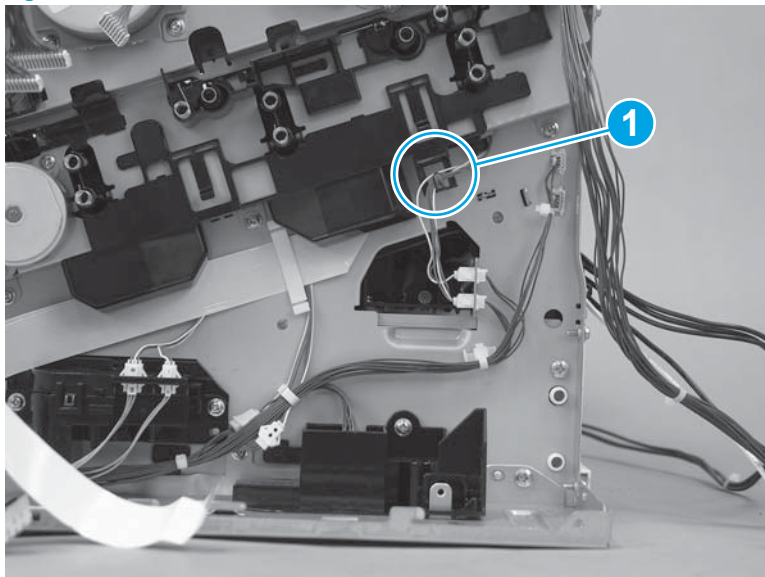

7. Position the guide on the assembly, push up to install it, and then make sure that the two tabs (callout 1) snap into place.

Figure 1-4793 Install the guide

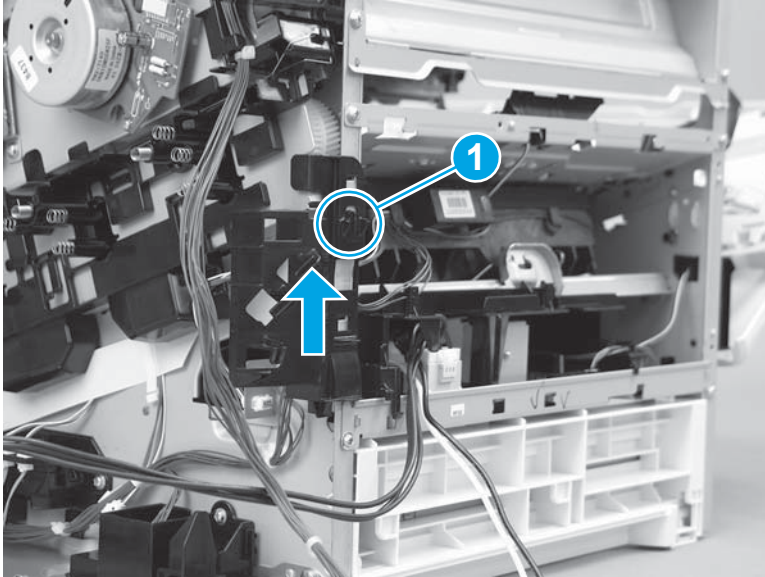

8. At the left side of the printer, connect one connector (callout 1), and then install the wire harnesses in the retainers (callout 2).

Figure 1-4794 Connect one connector

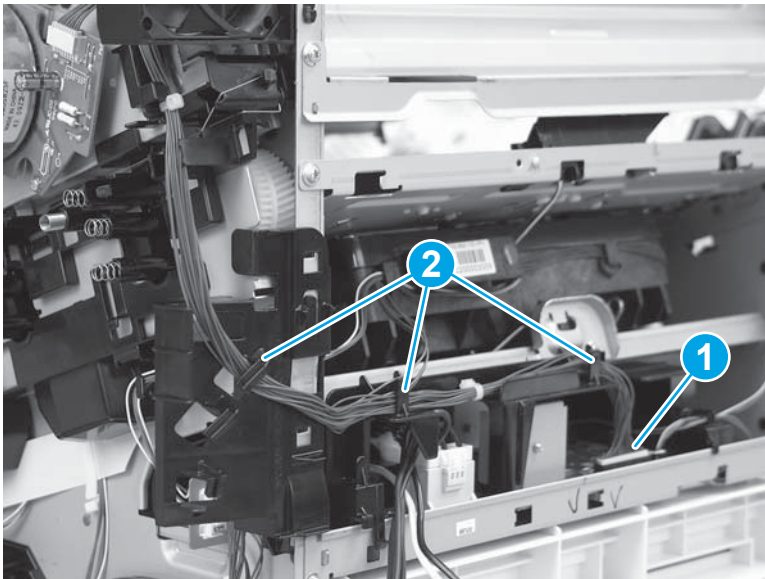

9. At the top of the printer, install the wire harnesses (callout 1) in the retainers (callout 2).

Figure 1-4795 Install the wire harnesses

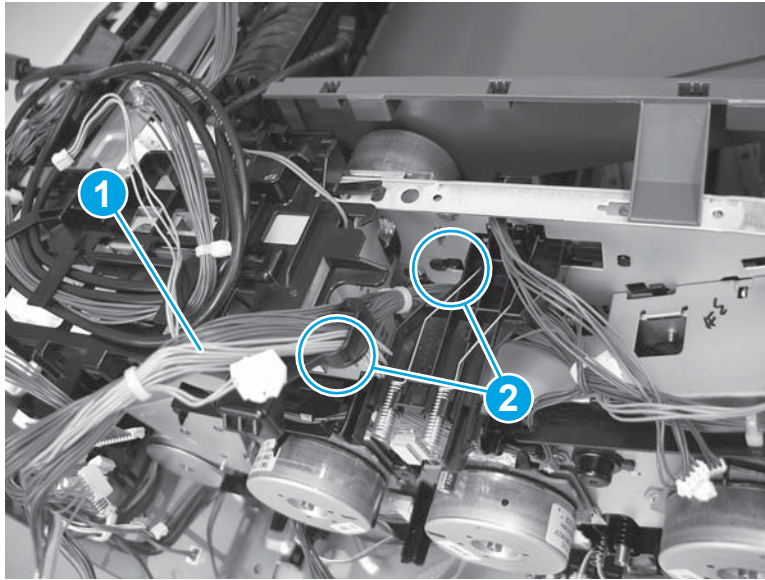

10. Connect two connectors (callout 1).

Figure 1-4796 Connect two connectors

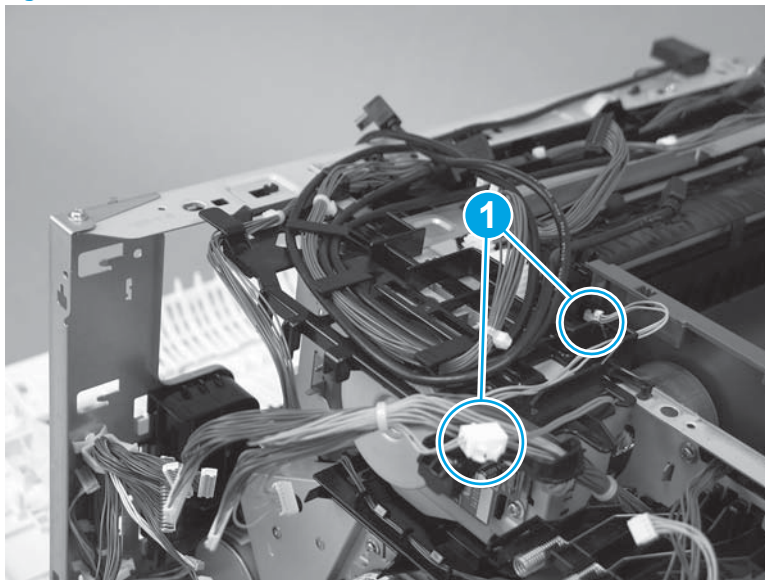

11. Install the wire harnesses in the guides (callout 1).

Figure 1-4797 Install the wire harnesses

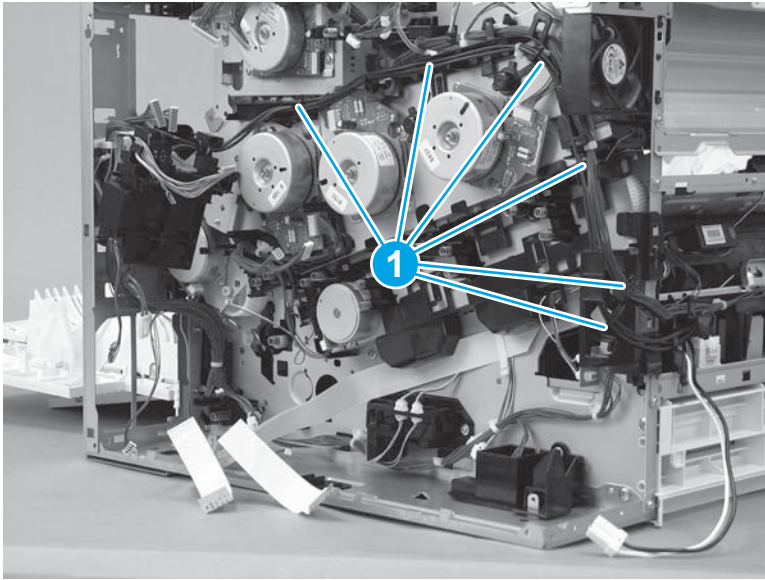

12. At the rear side of the printer do the following:
 - a. Position the right edge of the cover on the printer.
 - b. Rotate the left edge of the cover toward (callout 1) the printer to install it.
 - c. Push up on the cover (callout 2) to engage it.
 - d. Make sure that one tab (callout 3) snaps into place

Figure 1-4798 Install the cover

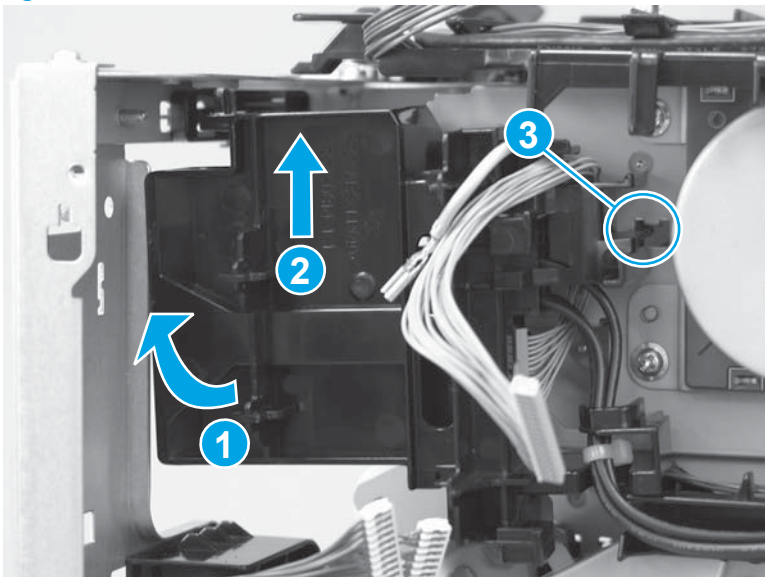

13. Install one screw (callout 1).

Figure 1-4799 Install one screw

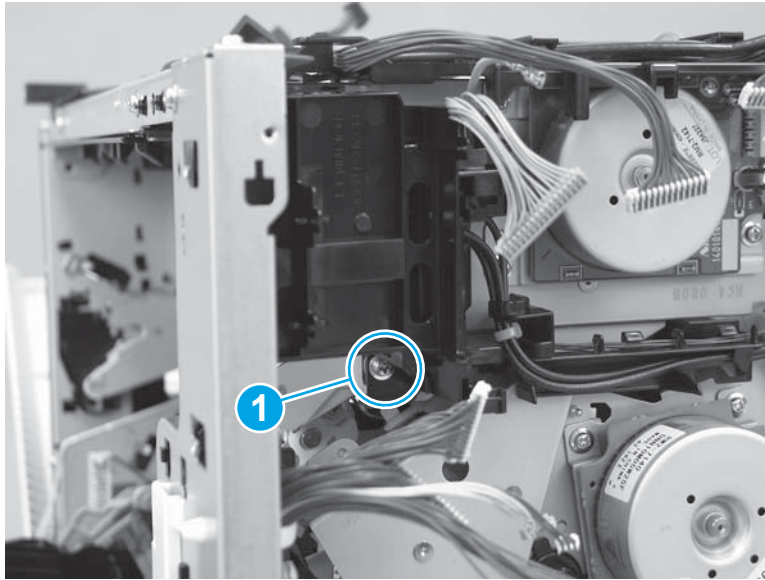

Step 39: Install the fuser drive assembly

1. Two gears (callout 1) on the back side of the assembly are not captive. If the gears are dislodged, install them as shown.

⚠ CAUTION: Handle the assembly carefully.

Figure 1-4800 Check the gears on the assembly

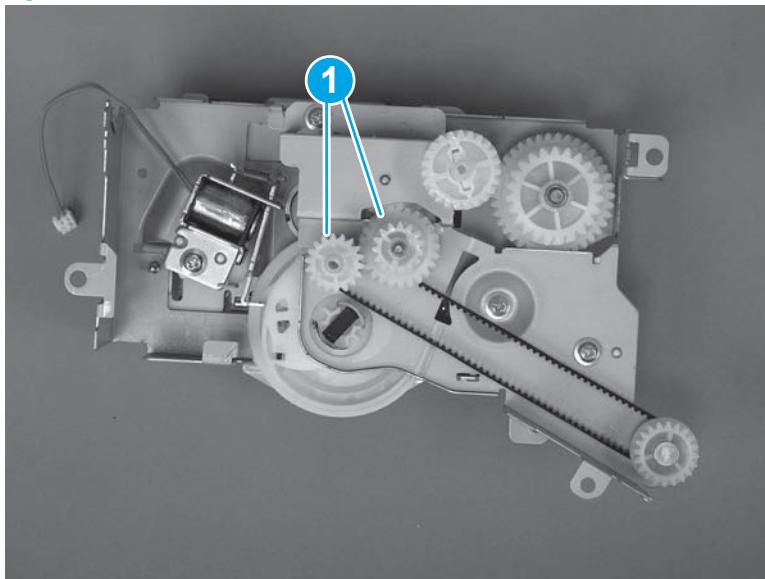

2. Position the assembly on the chassis, and then install three screws (callout 1).

Figure 1-4801 Install three screws

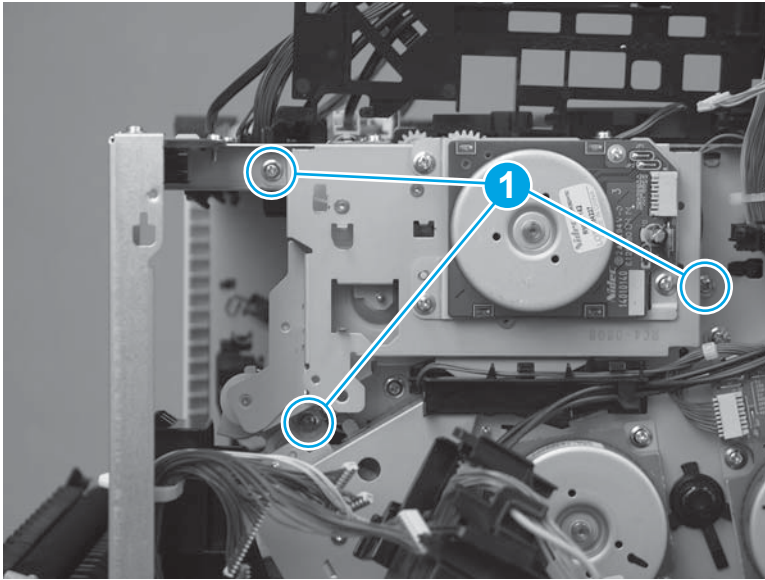

3. Position the guide on the chassis (callout 1), slide the guide up to engage it (callout 2), and then verify that the tab (callout 1) snaps into place.

Figure 1-4802 Install the guide

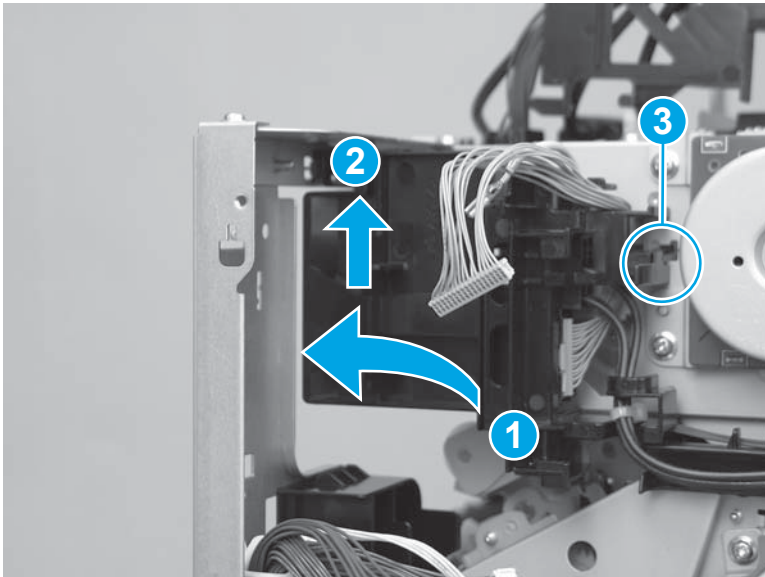

4. Install one screw (callout 1).

Figure 1-4803 Install one screw

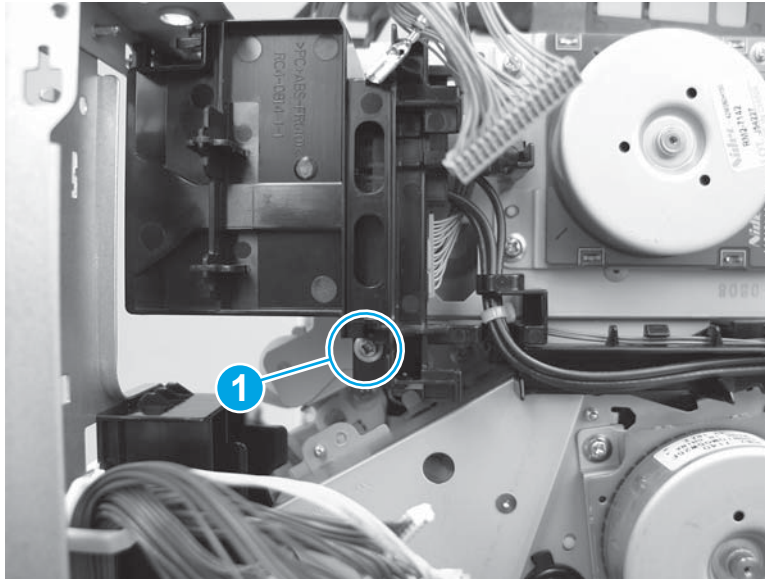

5. Connect one connector (callout 1).

Figure 1-4804 Connect one connector

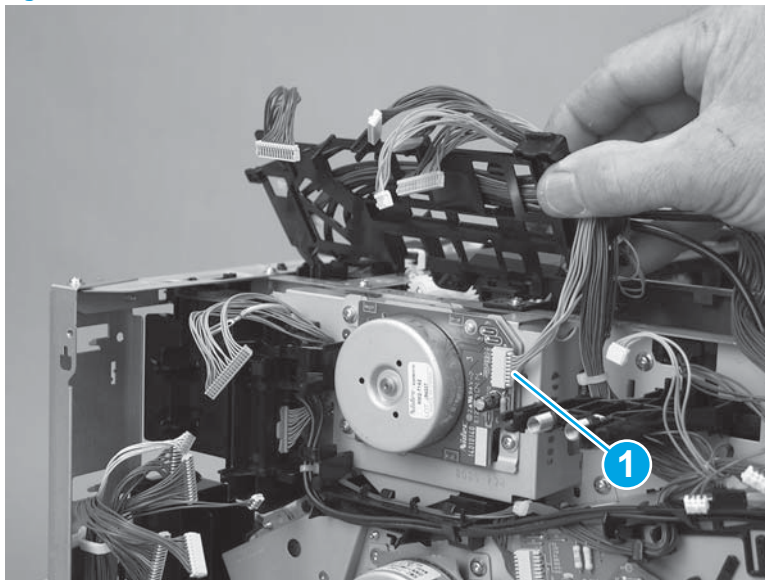

6. Rotate the guide down and onto the chassis (callout 1), slide the guide to engage it (callout 2), and then make sure that the tab (callout 3) snaps into place.

⚠ CAUTION: Do not dislodge the fuser motor connector when installing the guide.

Figure 1-4805 Install the guide

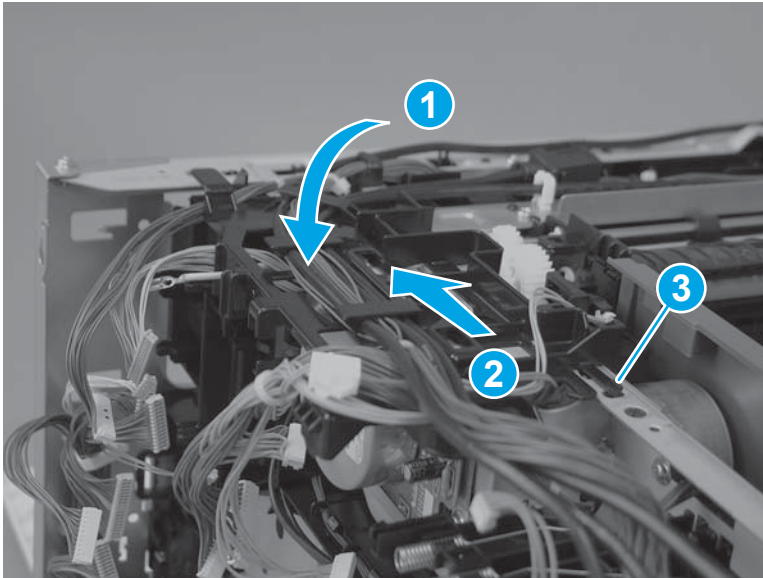

Step 40: Install the HVPST

⚠ CAUTION:  ESD-sensitive part.

1. Connect one ground wire connector (callout 1).

Figure 1-4806 Connect one ground wire

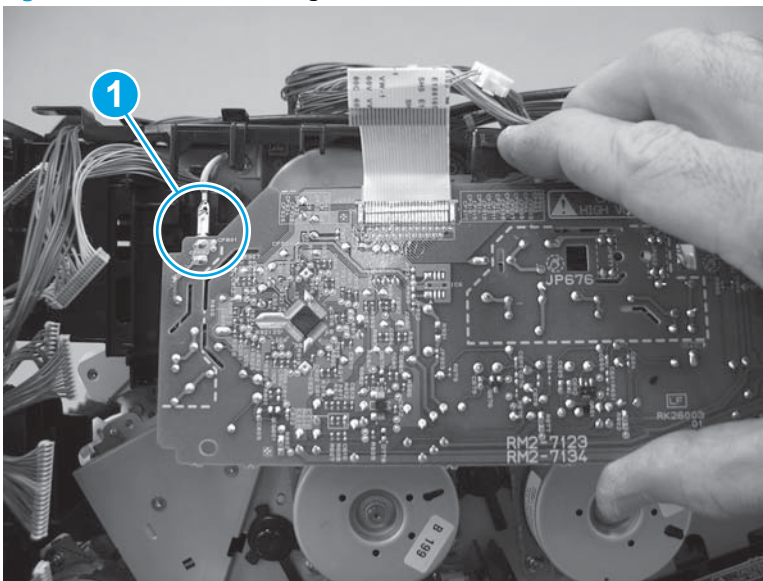

2. Position the HVPST on the printer, and then push in to engage two tabs (callout 1).

 **NOTE:** Make sure that the tabs snap into place.

Figure 1-4807 Install the HVPST



3. Install one screw (callout 1).

Figure 1-4808 Install one screw

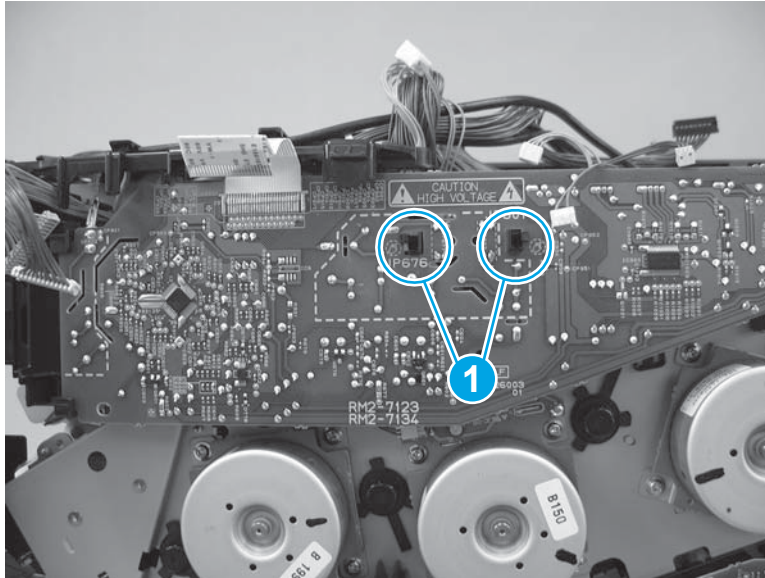
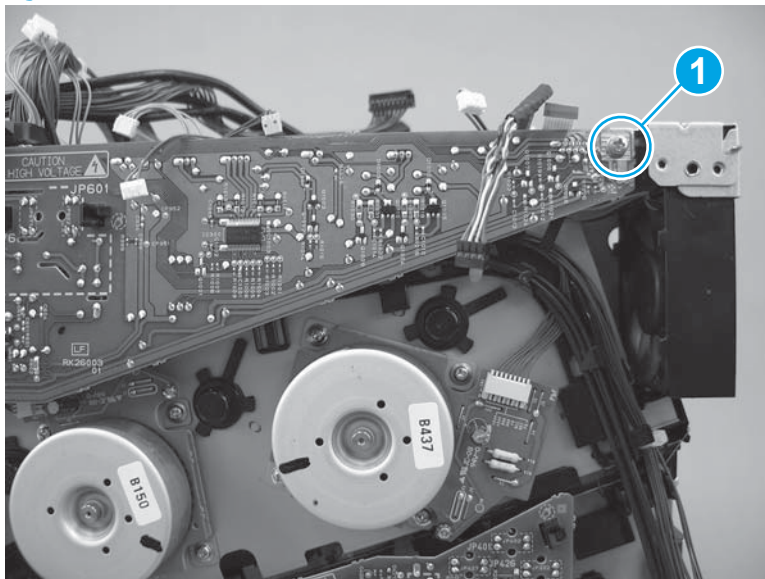

4. Connect five connectors (callout 1), and then connect one flat cable (callout 2).

Figure 1-4809 Connect five connectors and one flat cable

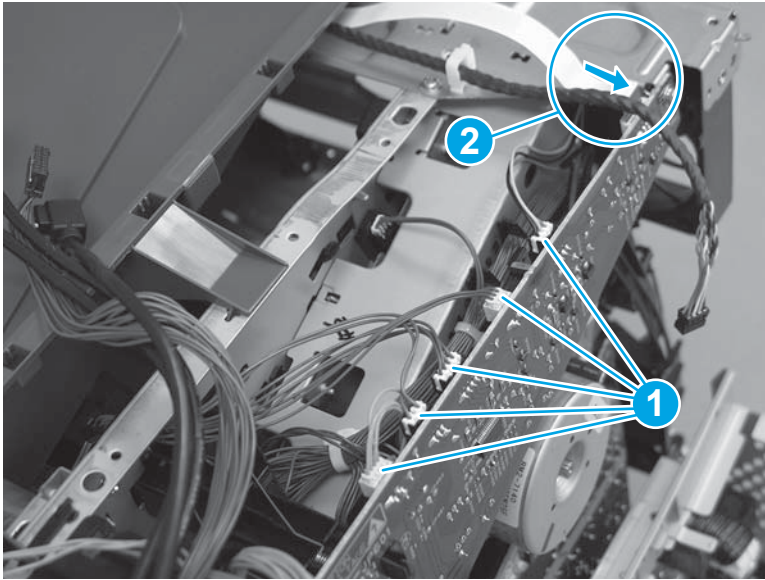

Step 41: Install the DC controller and sheet-metal bracket

 **CAUTION:**  ESD-sensitive part.

1. Position the DC controller and sheet-metal plate on the printer, and then push down to engage the plate with the chassis.

Figure 1-4810 Install the plate

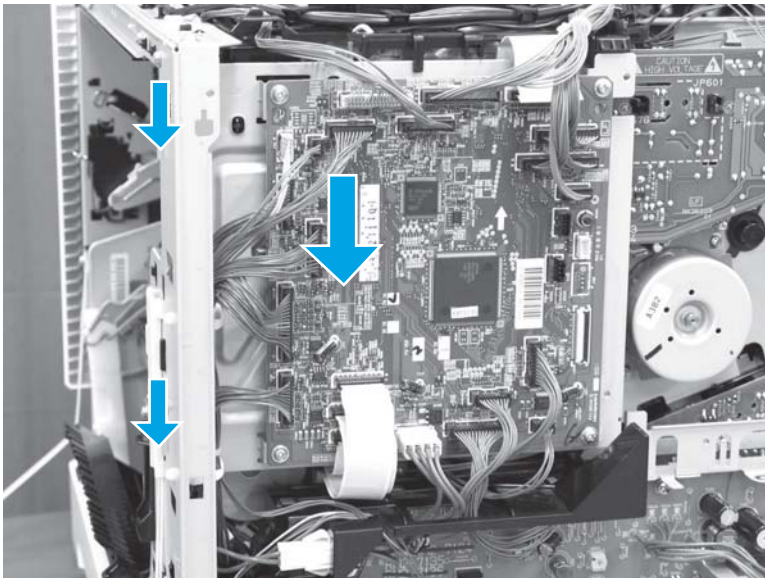

2. Install two screws (callout 1), and then connect all of the connectors.

The following connectors are empty:

- J140, J141, and J143

Figure 1-4811 Install two screws

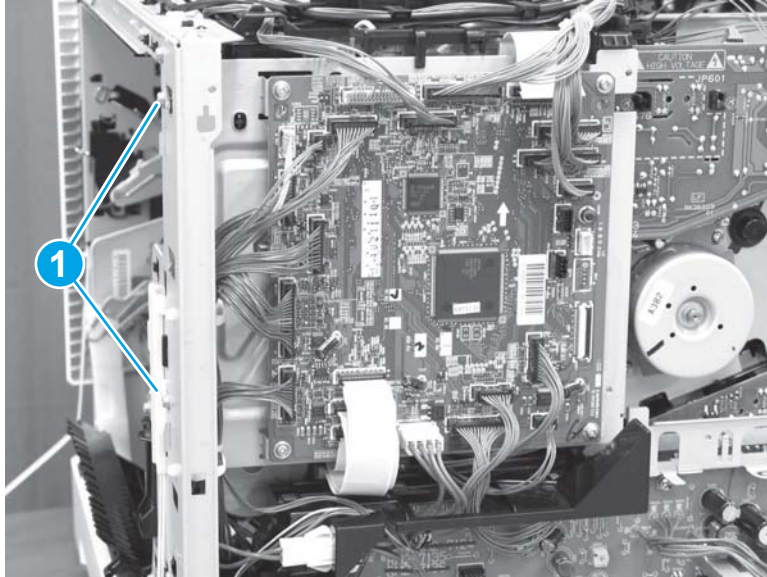

Step 42: Install the lifter drive assembly

1. Install one wire harness on the retainer (callout 1), position the lifter drive assembly in the printer (make sure that one tab (callout 2) snaps into place), and then install two screws (callout 3).

 **TIP:** It might be easier to install the assembly if the bottom of the assembly is installed first, and then the top of the assembly is rotated into place.

Figure 1-4812 Install the lifter drive



2. Connect two flat cables (callout 1), and then place them in the retainers (callout 2).

Figure 1-4813 Connect two flat cables

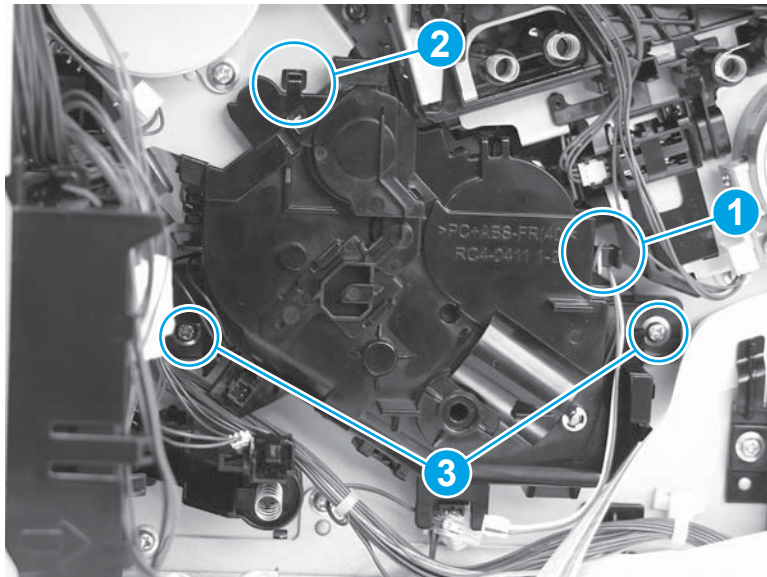
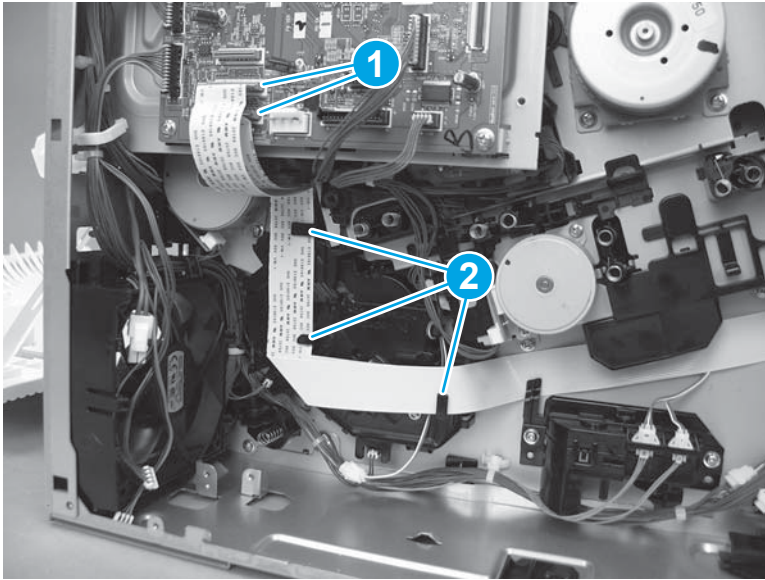

3. Connect two connectors (callout 1).

Figure 1-4814 Connect two connectors

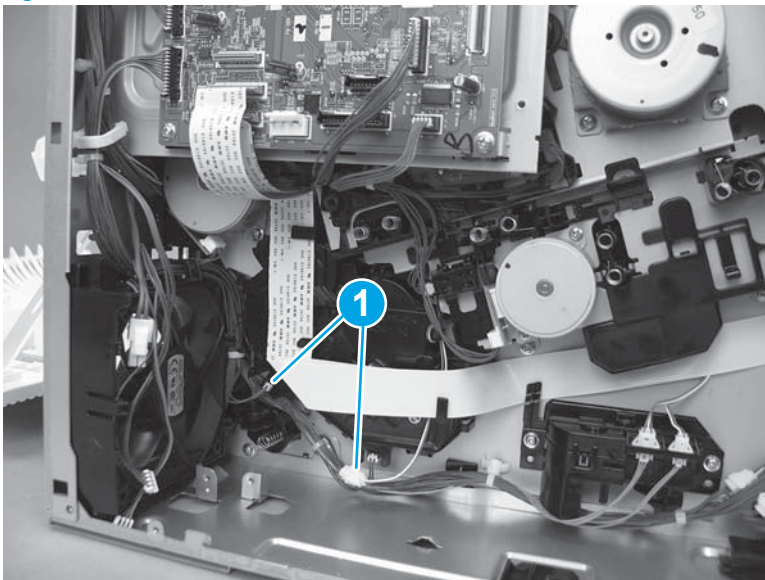

Step 43: Install the HVPSD

 **CAUTION:**  ESD-sensitive part.

1. Position the bottom right corner of the HVPSD (callout 1) behind the black tab, and then rotate it up and onto the printer (callout 2).

Figure 1-4815 Install the HVPSD

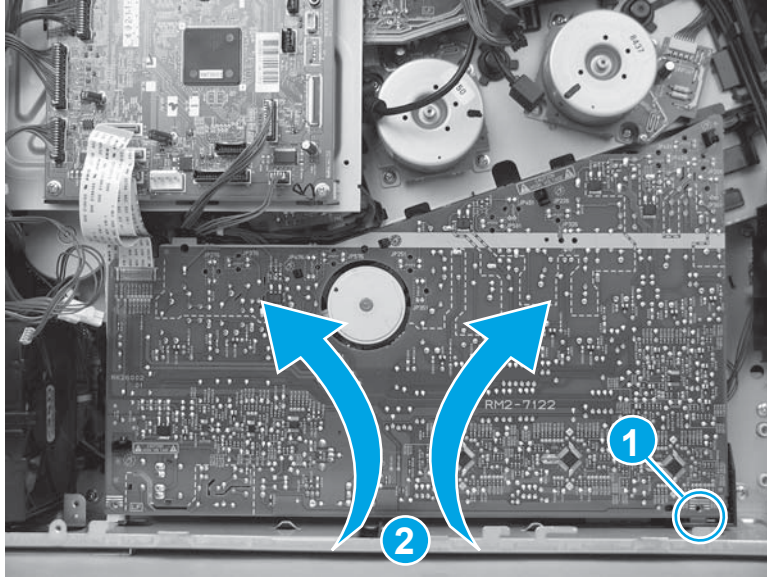

2. Press it onto five tabs (callout 2).

 **IMPORTANT:** Make sure that all five tabs snap into place.

Figure 1-4816 Press the tabs



3. Install two screws (callout 1), and then install one self tapping screw (callout 2) on the HVPSD.

Figure 1-4817 Install three screws

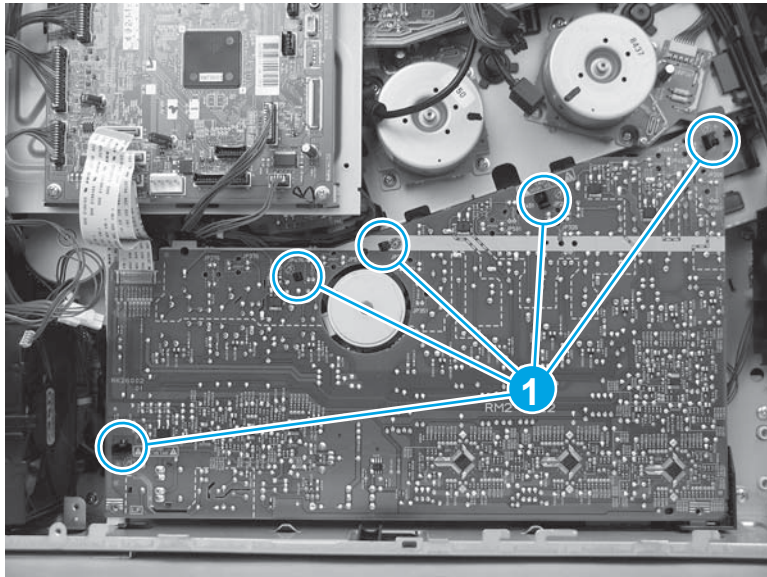
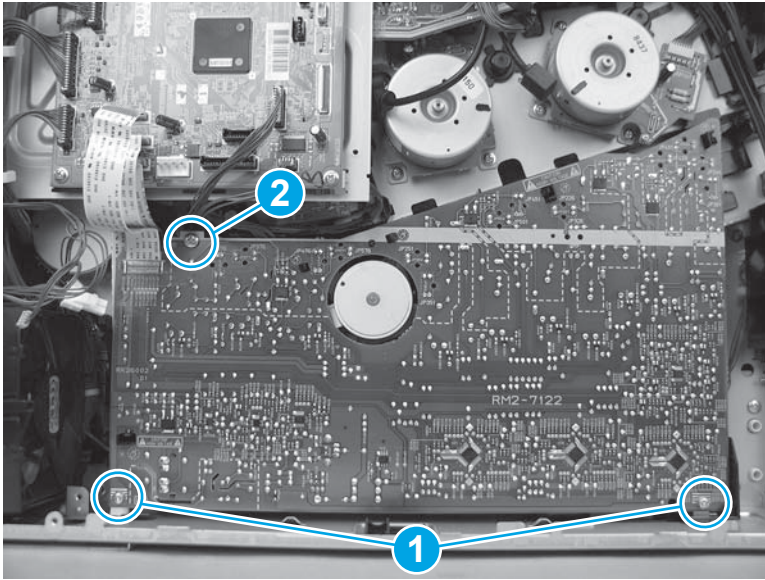

4. Connect one flat cable (callout 1) on the DC controller.

Figure 1-4818 Connect one flat cable

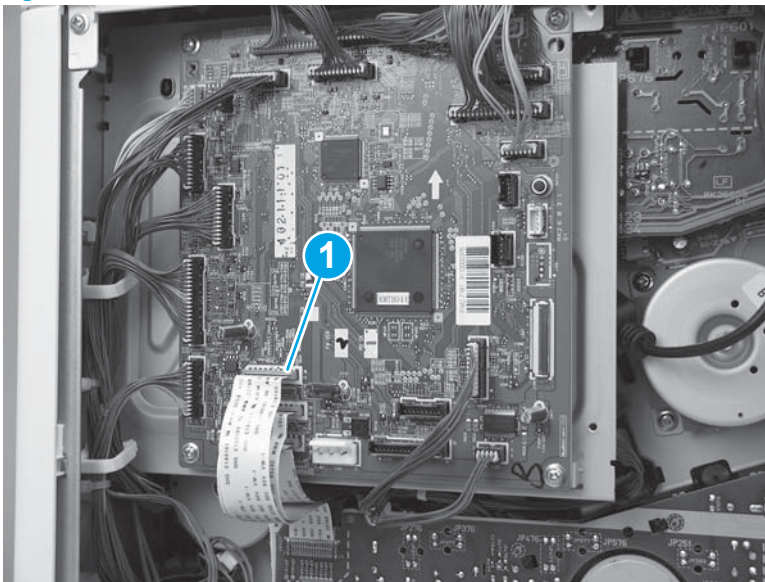

Step 44: Install the power-supply fan (FM1)

1. Slide the fan in (callout 1) and then down (callout 2) into the printer to install it.

 **NOTE:** Make sure that the arrow (callout 3) embossed on the fan holder faces into the printer.

Figure 1-4819 Install the fan



2. Place the wire harnesses in the retainer on the top of the fan bracket.

Figure 1-4820 Place the wire harnesses in the retainer

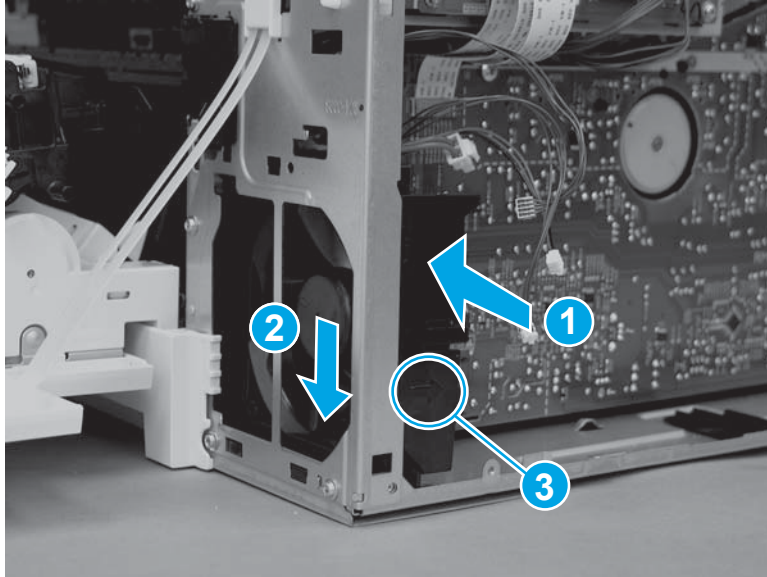
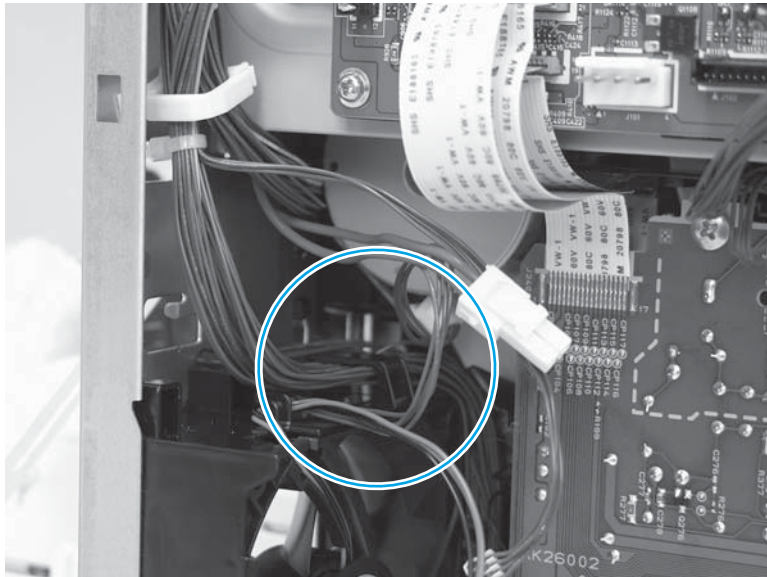

3. Install one screw (callout 1).

Figure 1-4821 Install one screw

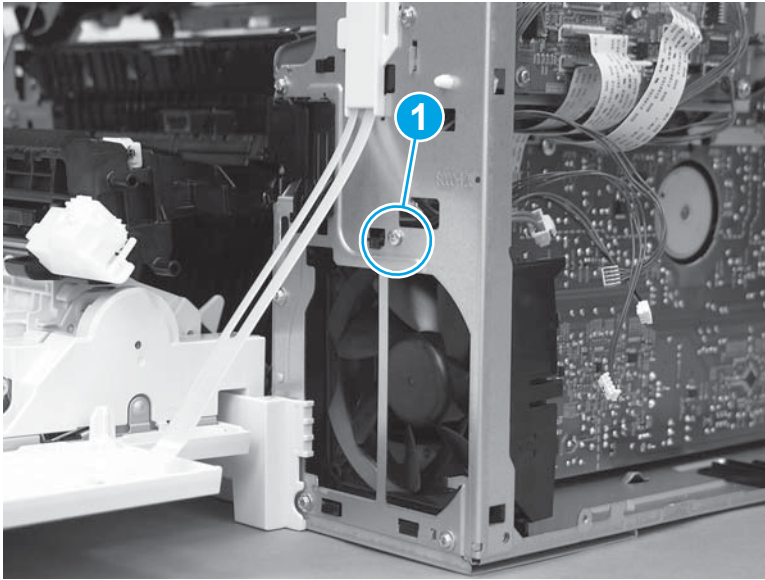

Step 45: Install the LVPS

 **IMPORTANT:** Some figures might show assemblies removed or installed that have not yet been removed or installed at that specific step. However, the procedures are correct for this printer and the target assembly. Always thoroughly read the instructions that accompany each figure.

 **CAUTION:**  ESD-sensitive part.

1. Position the bottom of the LVPS in the printer (callout 1) at a slight angle, and then rotate the top of it into the printer (callout 2) to install it.

Figure 1-4822 Install the LVPS

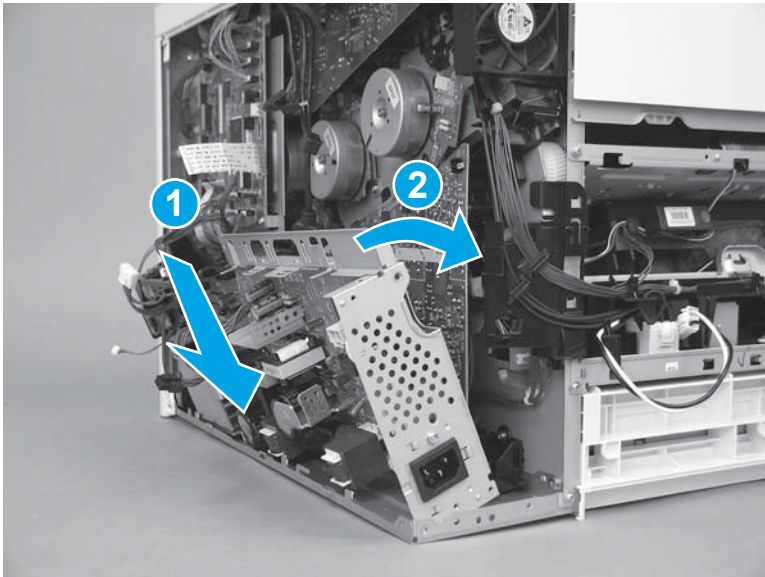

2. Install three screws (callout 1).

Figure 1-4823 Install three screws

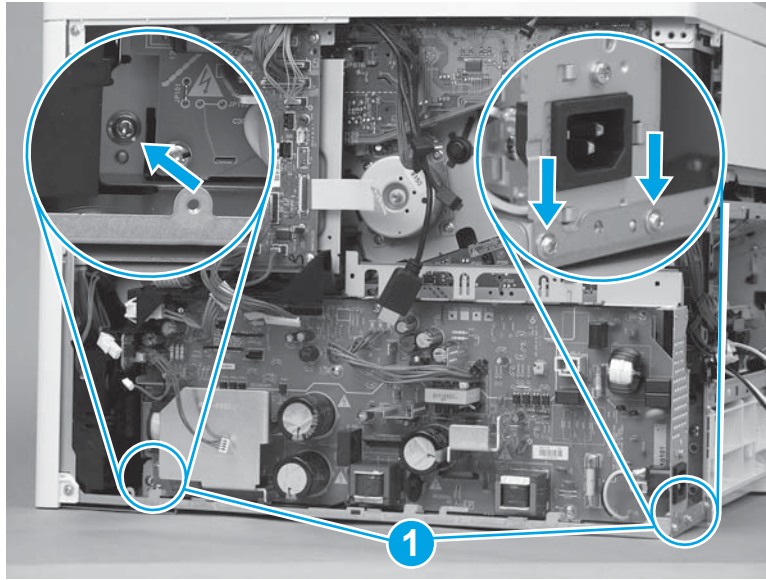

3. Pass the wire harnesses from the DC controller to the LVPS through the opening in the chassis (callout 1), and then install the wire harnesses in the retainer (callout 2).

Figure 1-4824 Pass the wire harnesses through the opening

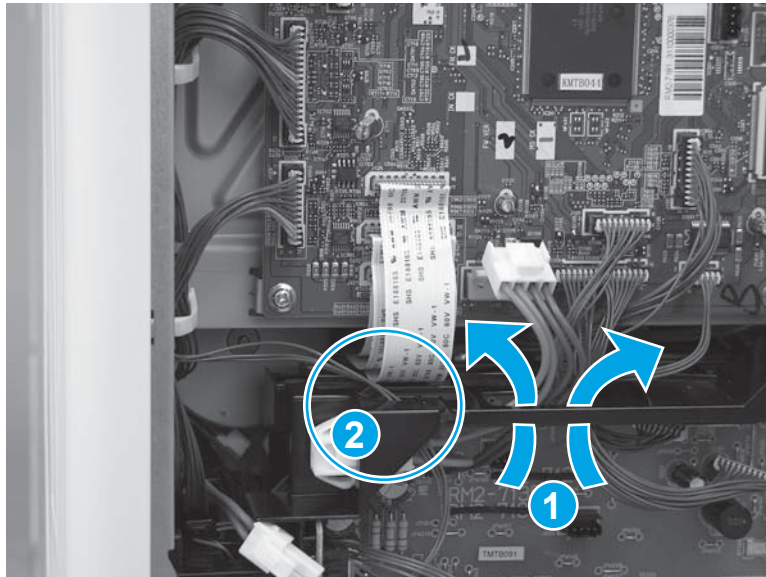

4. Connect three connectors on the DC controller (callout 1), and then connect four connectors (callout 2) on the LVPS.

Figure 1-4825 Connect seven connectors

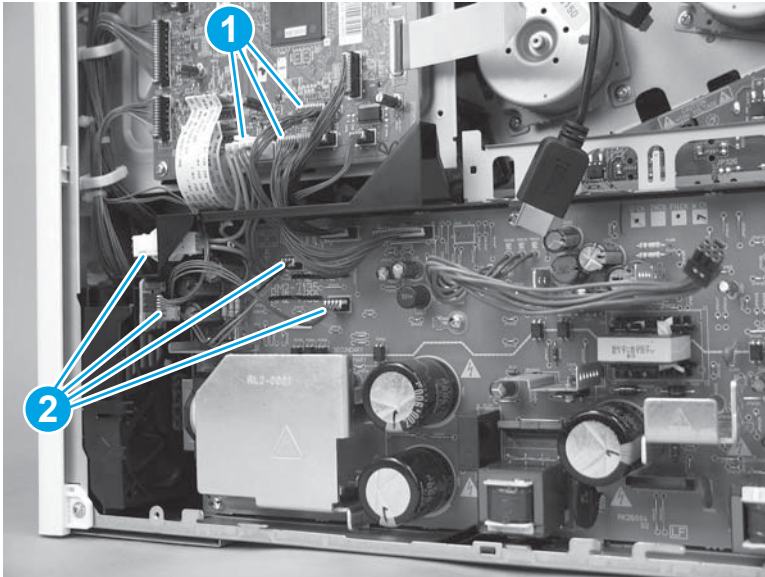

5. Pass the wire harness through the opening (callout 1) in the chassis, and then connect one wire harness (callout 2).

Figure 1-4826 Connect one wire harness

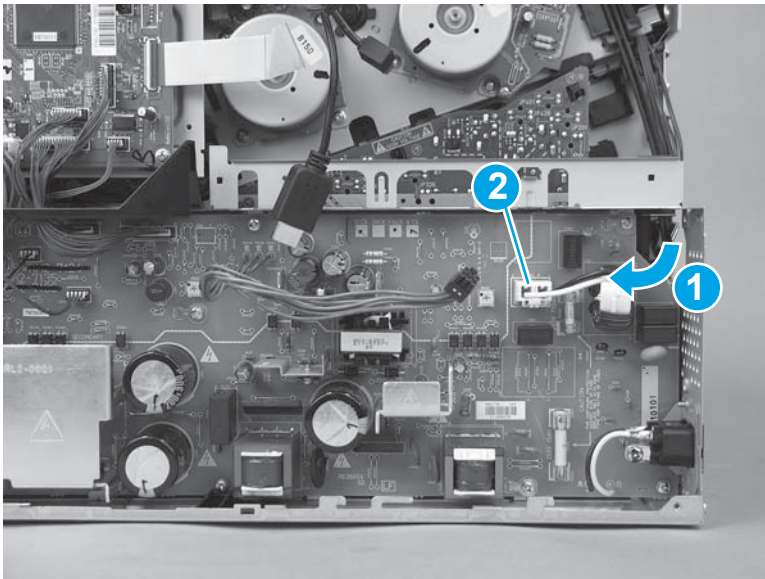

Step 46: Install the right rear cover

1. Position the cover on the printer.

Figure 1-4827 Install the cover

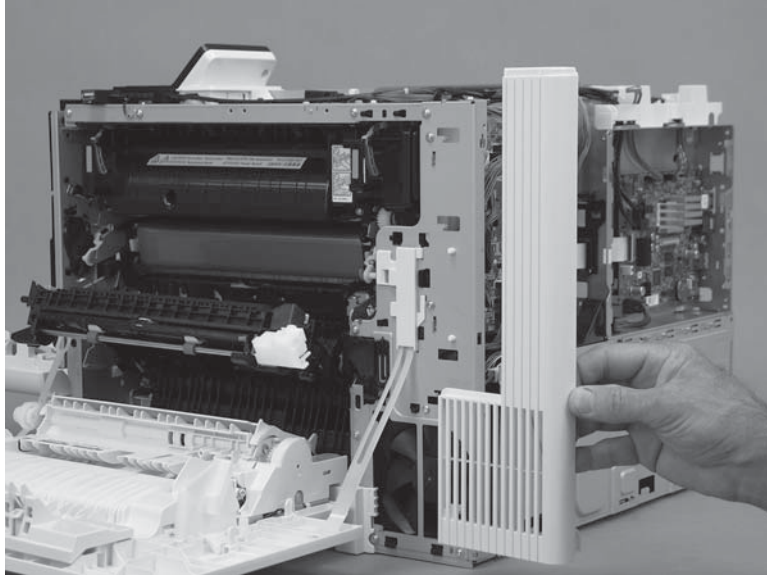

2. Slide the cover toward the right door (callout 1) to engage it with the printer, and then install one screw (callout 2).

Figure 1-4828 Install one screw

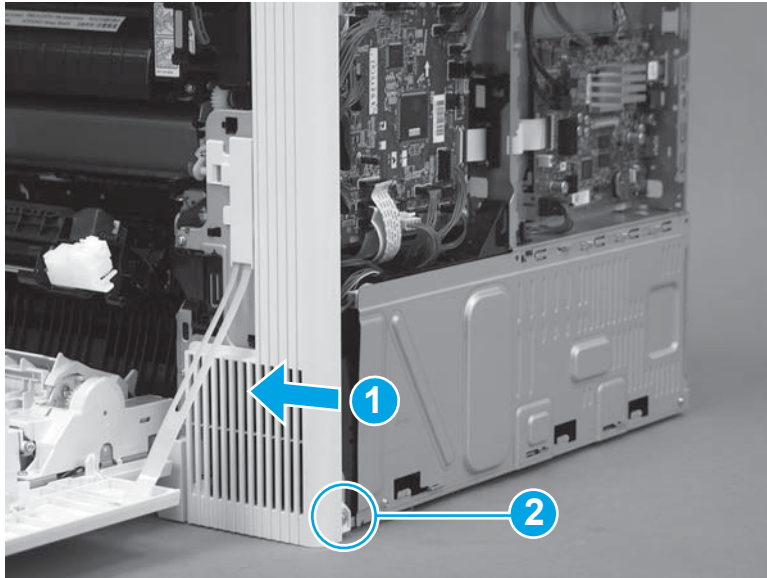

Step 47: Install the formatter case

1. Pass the wire harnesses through the opening in the formatter case.

Figure 1-4829 Pass the wire harnesses through the opening

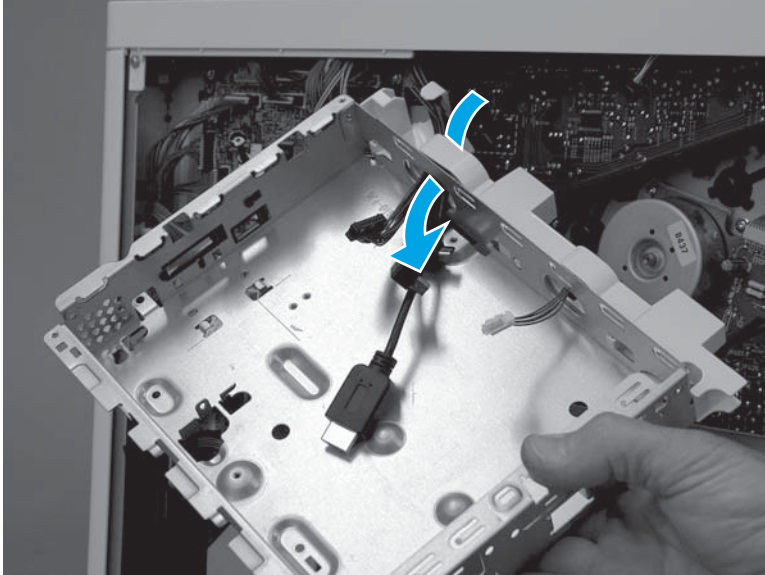

2. Position the top of the formatter case on the printer (callout 1), and then rotate the bottom of the case (callout 2) into the printer.

Figure 1-4830 Install the formatter case

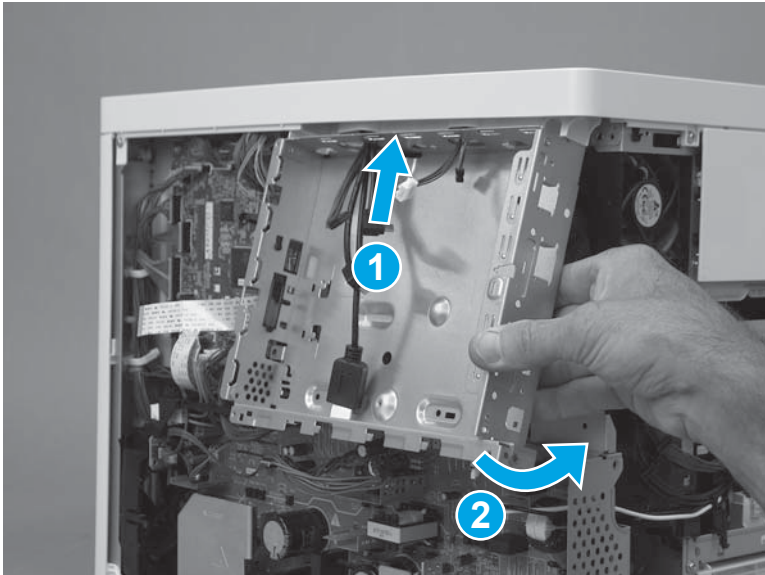

3. Install six screws (callout 1).

Figure 1-4831 Install six screws

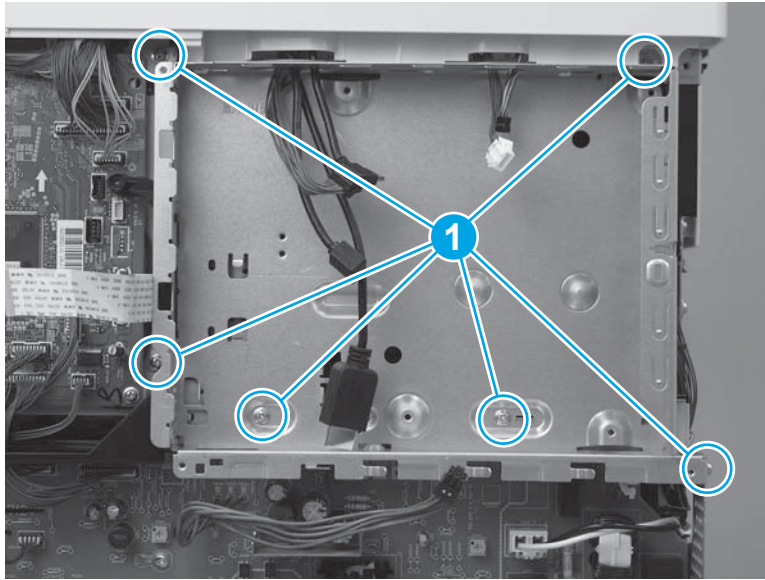

4. Pass two wire harnesses and one flat cable (callout 1) through the opening in the formatter case, and then install one wire harness in the retainer (callout 2).

 **IMPORTANT:** Make sure that the flat cable is securely fastened to the DC controller, and was not dislodged when the formatter case was removed.

Figure 1-4832 Install wire harnesses and flat cable

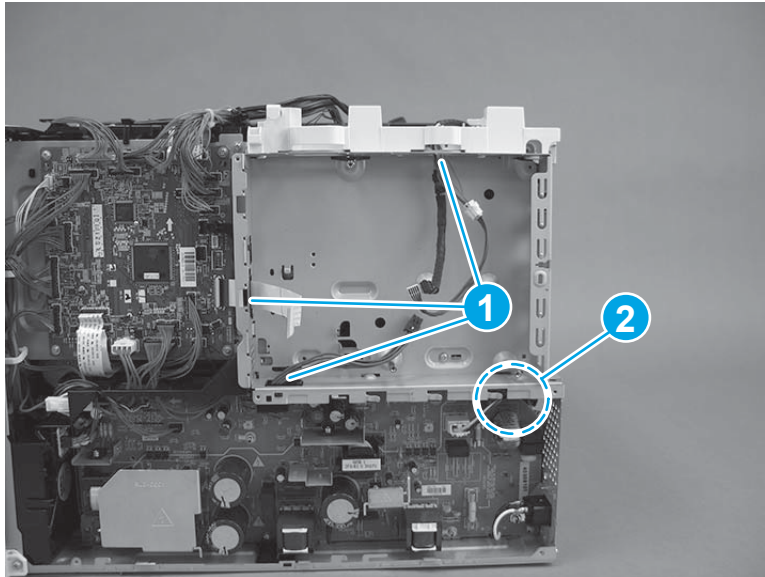

5. Position the LVPS cover on the printer, slide the cover to the left to install it, and then install two screws (callout 1).

Figure 1-4833 Install the LVPS cover

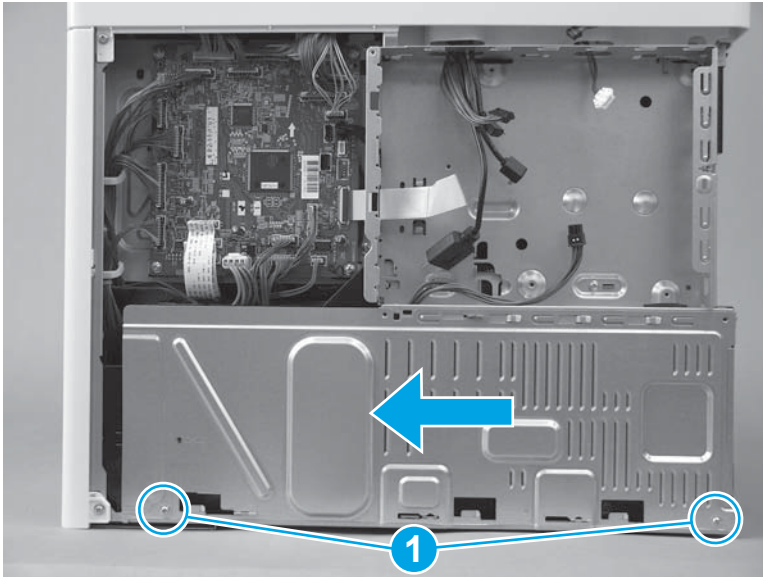

6. If no tape is affixed to the back of the flat cable, skip this step. If double-sided tape is affixed to the back of the flat cable, align the line (callout 1) on the cable with the edge (callout 2) of the opening in the sheet metal. Press to attach the flat cable to the formatter case.

Figure 1-4834 Attach the flat cable

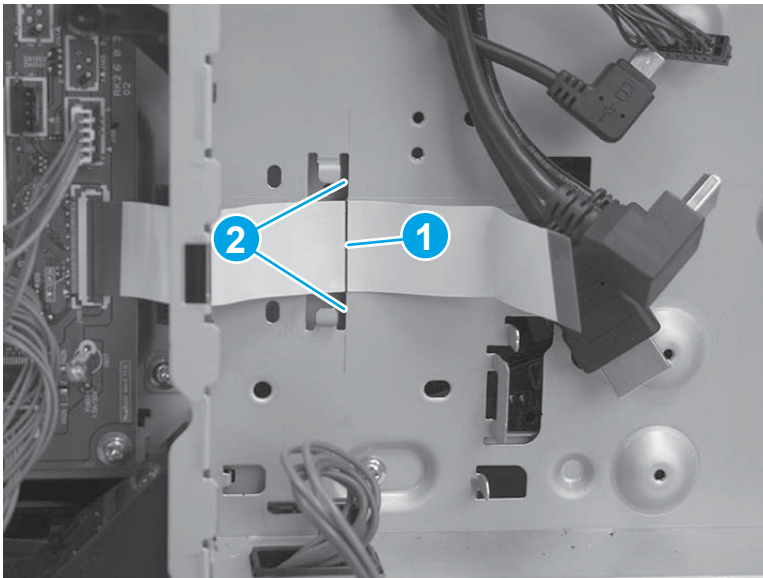

7. Position the bracket over the flat cable, and then slide the bracket to the left to install it. Make sure that the edges of the bracket fit under the sheet metal tabs (callout 1) on the formatter case and that the tabs (callout 2) snap into place.

Figure 1-4835 Position the bracket

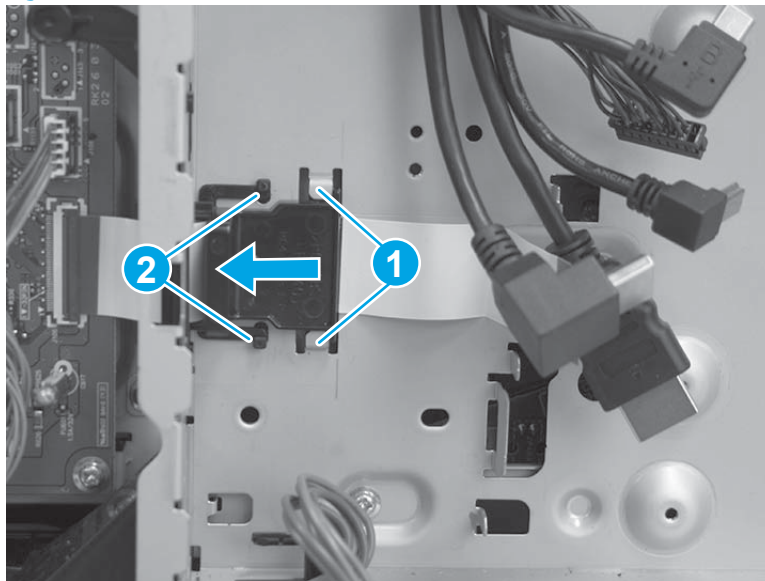

8. **M577 only:** Pass the wire harness (callout 1) through the openings in the formatter case (callout 2), and then connect one connector (callout 3).

Figure 1-4836 Connect one connector

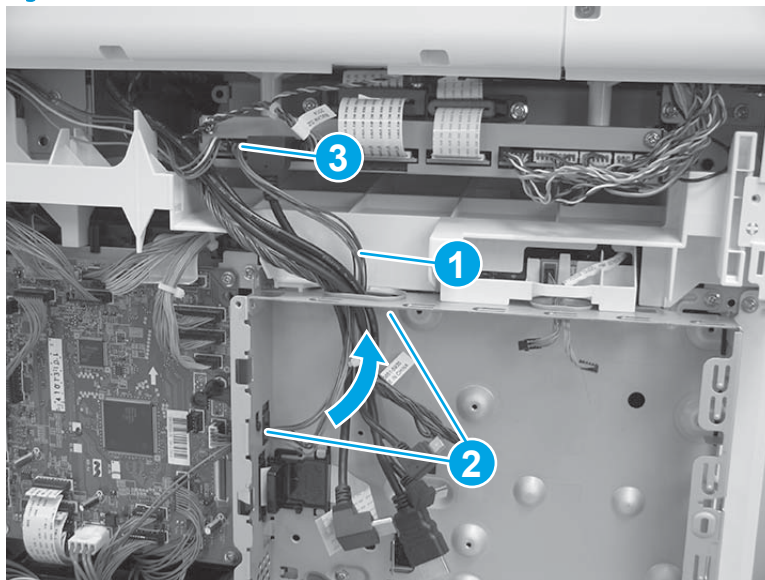

Step 48: Install the upper cover (M552 and M553)

 **NOTE:** This step is for the M552 and M553 models. For the M577 models, skip this step and go to [Step 49: Install the left cover on page 2673](#).

1. Position the cover on the printer.

 **NOTE:** For the M553x model, do not forget to pass the control-panel wire harness and USB cable through the opening in the cover.

Figure 1-4837 Install the cover



2. Push down on the rear corner of the cover to engage one tab (callout 1).

Figure 1-4838 Engage one tab

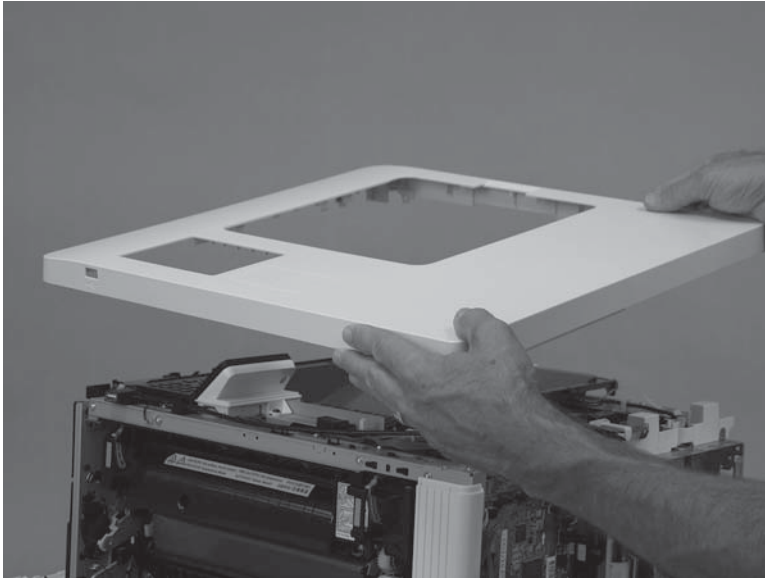
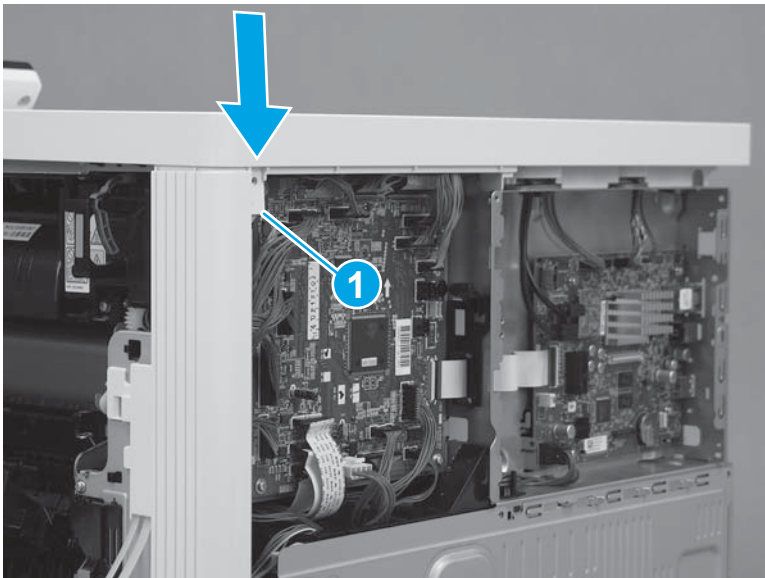

3. Push down on the front corner of the cover to engage one tab (callout 1), and then install one screw (callout 2).

 **NOTE:** This is a self-tapping plastic-thread screw. Make sure that this screw is used in this location when it is reinstalled.

Figure 1-4839 Engage one tab and install one screw



4. Install three screws (callout 1).

Figure 1-4840 Install three screws

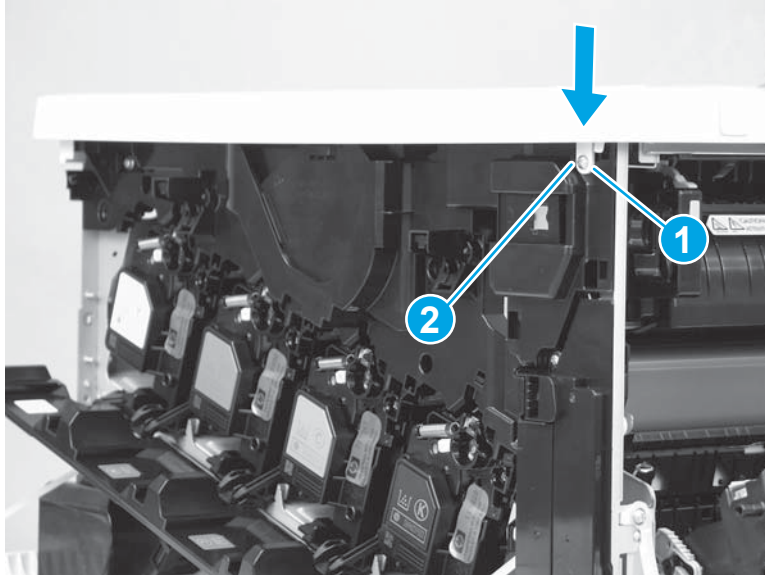
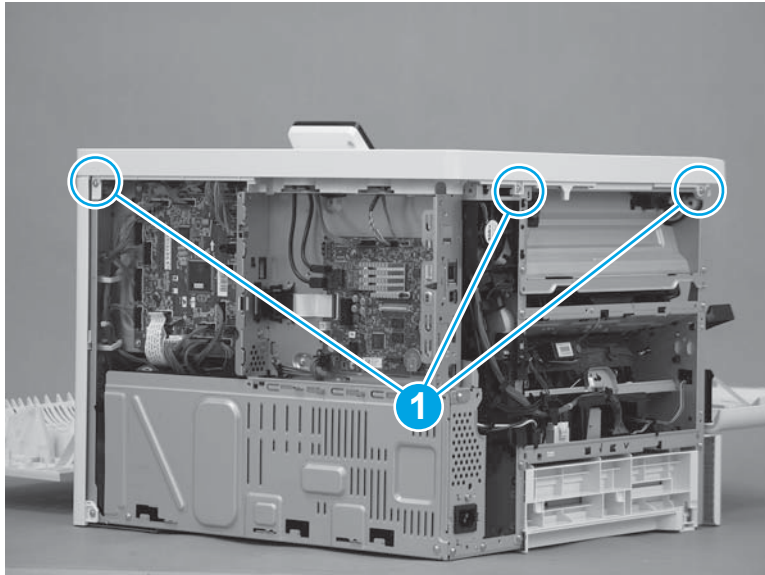

Step 49: Install the left cover

1. Position the cover on the printer.

 **NOTE:** Slightly offset the cover toward the rear of the printer.

Figure 1-4841 Install the cover

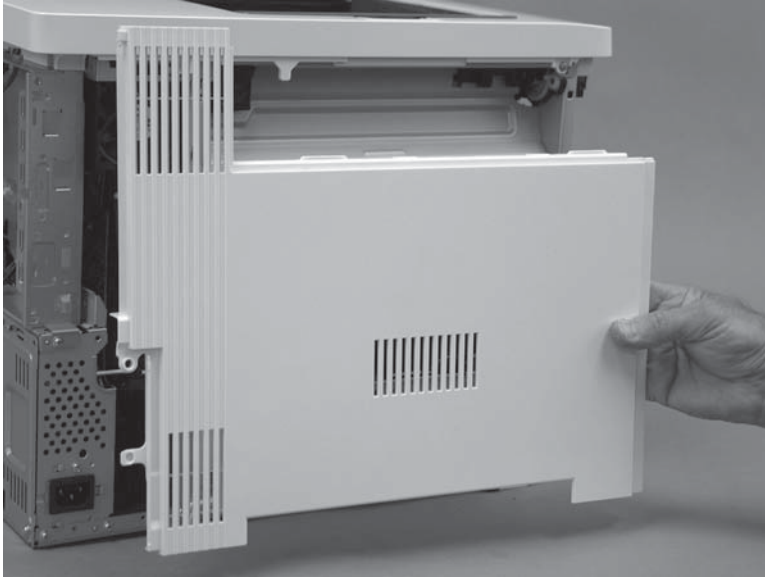

2. Slide the cover (callout 1) toward the front of the printer to engage it. Make sure that the tab (callout 2) snaps into place.

 **NOTE:** Locate the alignment pin (callout 3) on the cover from the front door side of the printer, and then make sure that it is fully engaged in the slot in the chassis.

 **TIP:** While sliding the cover into place, push in on the center of the cover (callout 1) to make sure that the hooks on the back of the cover engage with the slots in the chassis.

Figure 1-4842 Engage the cover



3. At the left side of the printer, install one screw (callout 1).

Figure 1-4843 Install one screw

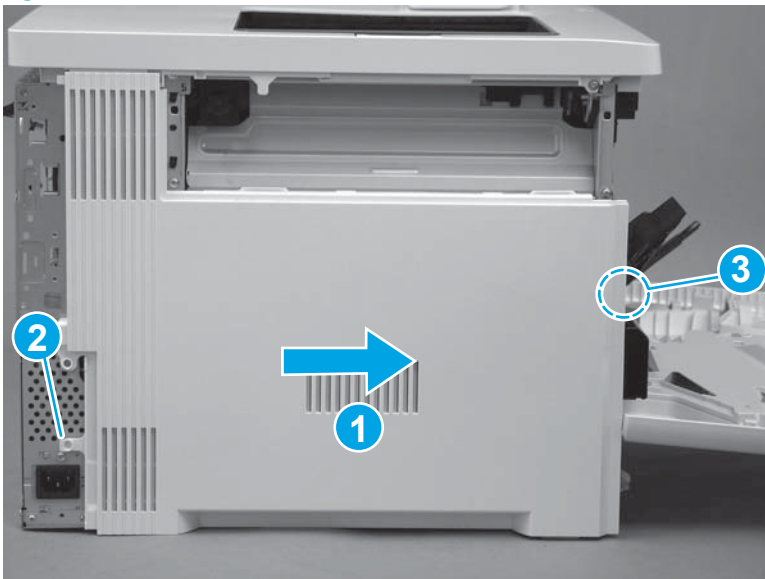

Step 50: Install the top bracket (M577)

 **NOTE:** This step is for the M577 models. For the M552 and M553 models, skip this step and go to [Step 62: Install the rear cover \(M552 and M553\) on page 2697](#).

1. Position the tabs (callout 1) on the bracket in the slots (callout 2) in the printer.

Figure 1-4844 Position the tabs in the slots

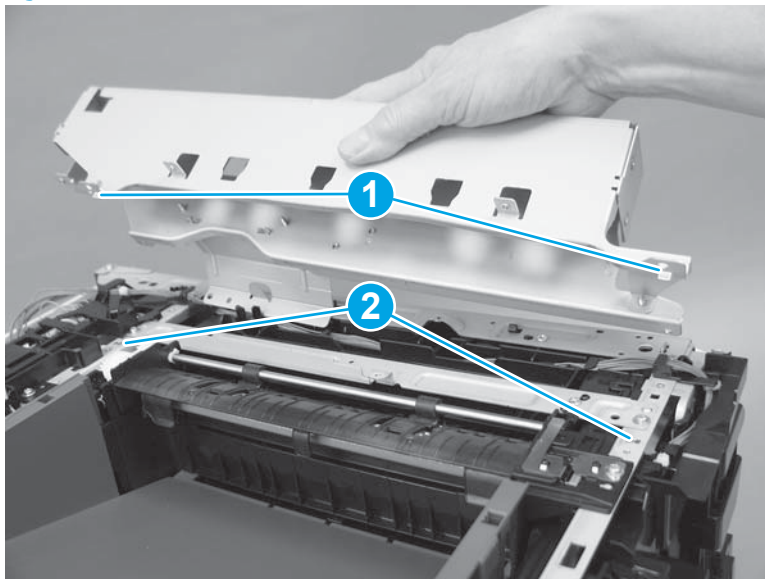

2. At the top of the printer, install two screws (callout 1).

Figure 1-4845 Install two screws

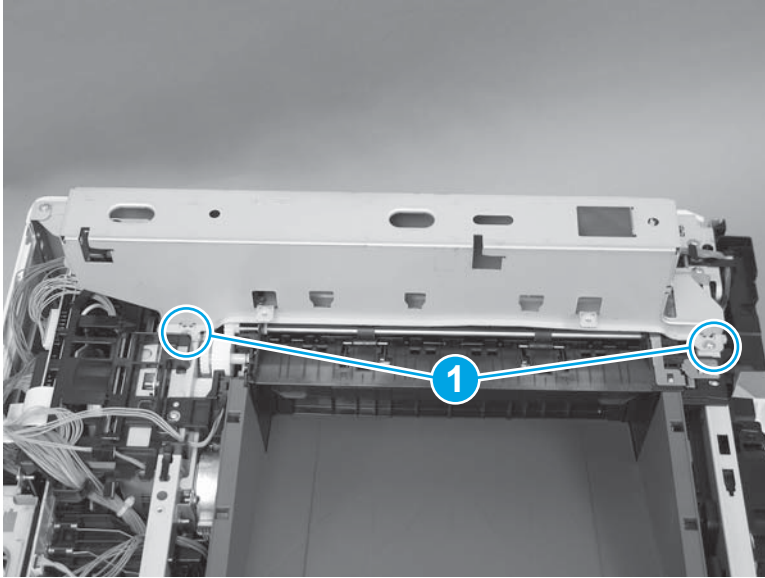

3. At the top of the printer, install three screws (callout 1).

Figure 1-4846 Install three screws

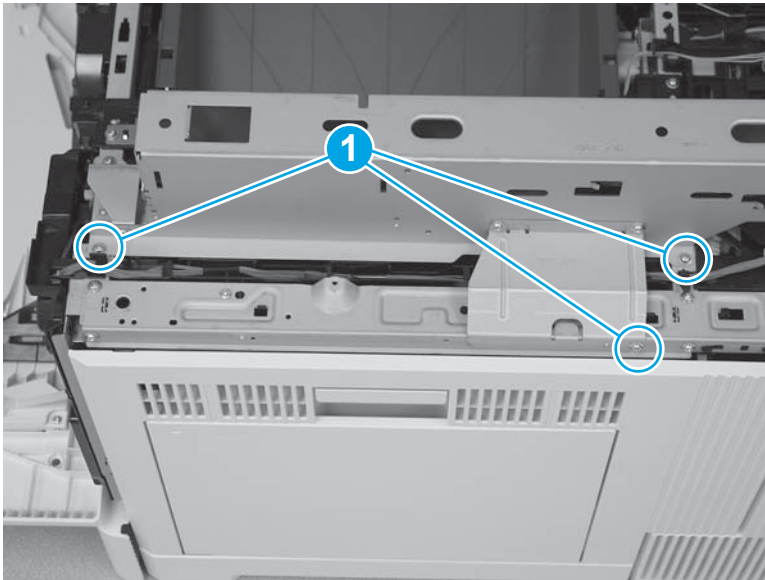

Step 51: Install the top cover (M577)

 **NOTE:** This step is for the M577 models. For the M552 and M553 models, skip this step and go to [Step 62: Install the rear cover \(M552 and M553\) on page 2697.](#)

1. Position the locator pins (callout 1) on the cover in the slots (callout 2) in the printer.

Figure 1-4847 Position the locator pins

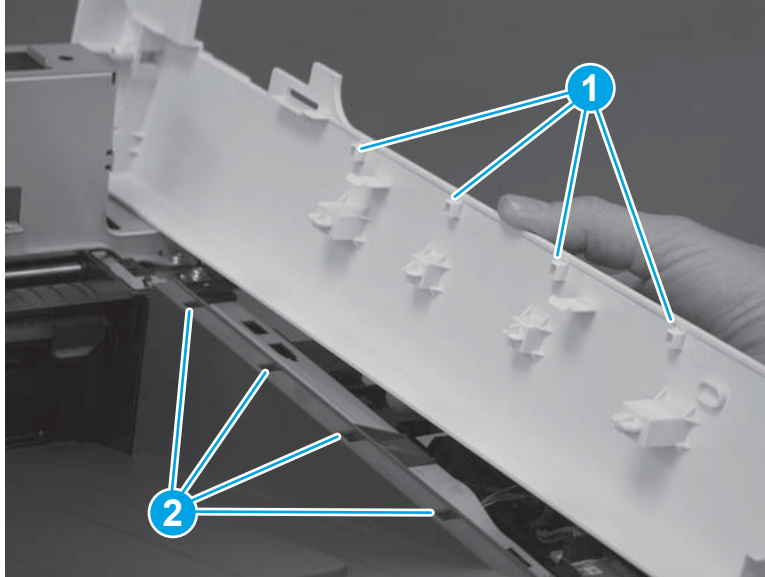

2. Press down on the cover to install it. Make sure that the tabs (callout 1) snap into place.

Figure 1-4848 Press down on the cover

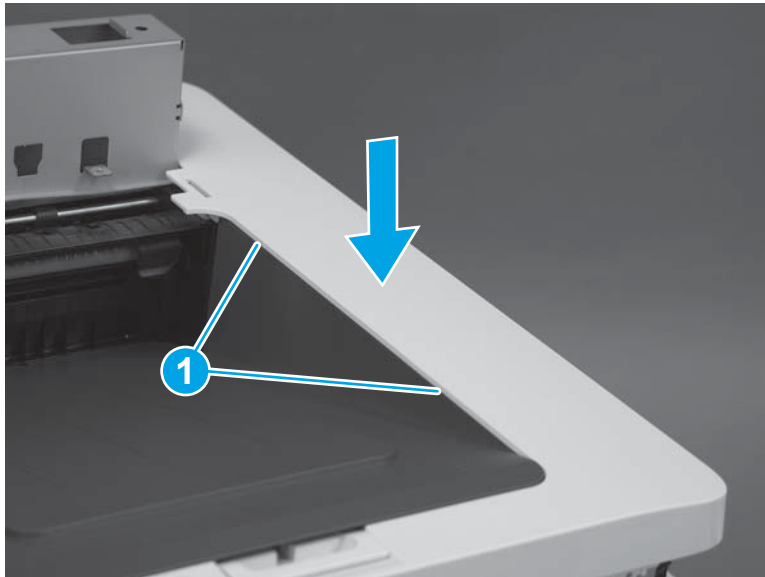

3. At the front of the printer, install one screw (callout 1).

 **Reinstallation tip:** This screw is longer and a different type of screw than the screw installed in the next step. Make sure that this screw is installed in the correct position.

Figure 1-4849 Install one screw



4. At the left side of the printer, install one screw (callout 1).

Figure 1-4850 Install one screw

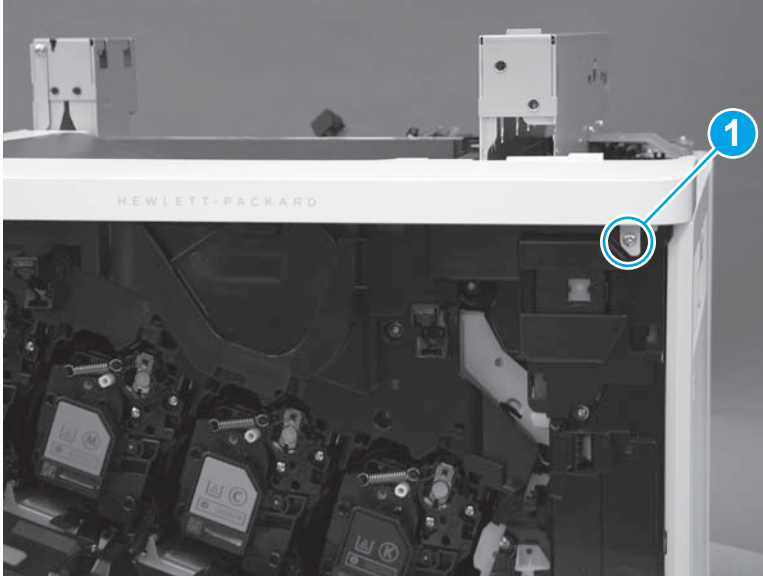
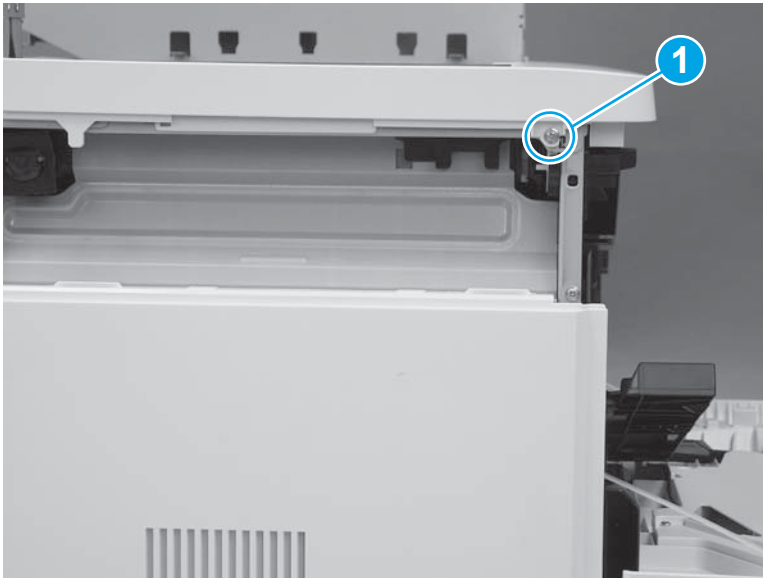

Step 52: Install the paper feed cover (M577)

 **NOTE:** This step is for the M577 models. For the M552 and M553 models, skip this step and go to [Step 62: Install the rear cover \(M552 and M553\) on page 2697](#).

1. Position the locator tabs (callout 1) on the cover in the slots (callout 2) in the printer. Press down until the cover snaps into place.

Figure 1-4851 Install the cover

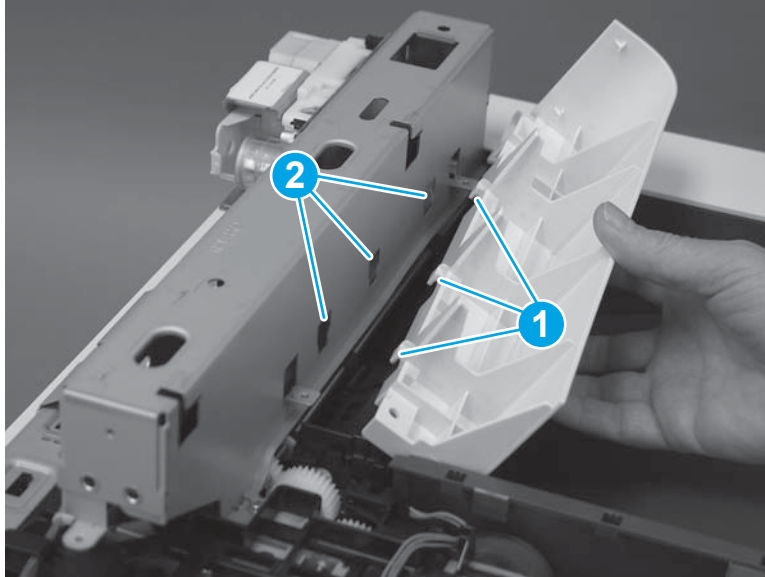

2. Install one screw (callout 1).

Figure 1-4852 Install one screw

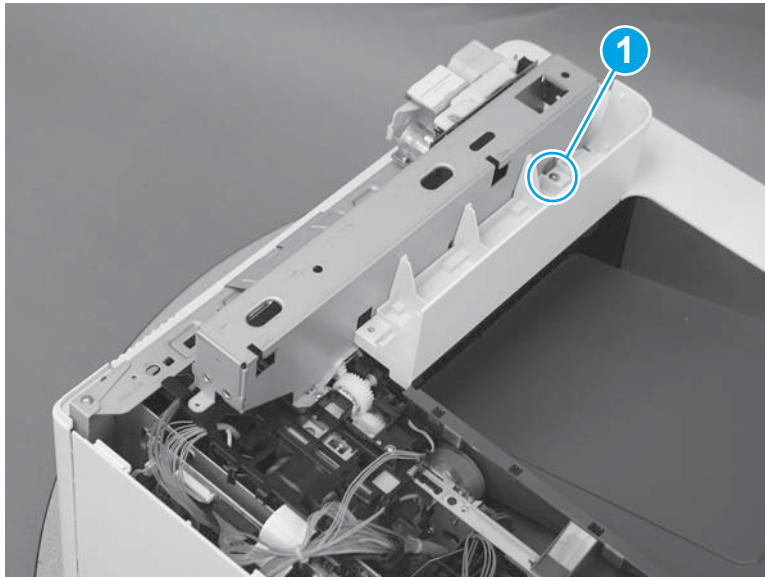

Step 53: Install the top rear cover (M577)

 **NOTE:** This step is for the M577 models. For the M552 and M553 models, skip this step and go to [Step 62: Install the rear cover \(M552 and M553\) on page 2697](#).

1. Align the locator tabs (callout 1) on the cover with the slots (callout 2) in the printer.

Figure 1-4853 Align the locator tabs

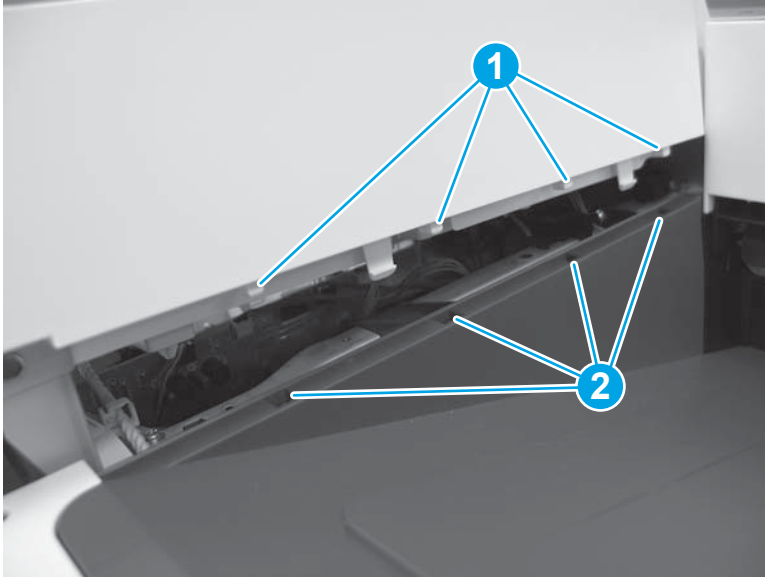

2. Press down to install the cover. Make sure that the tabs snap into place.

Figure 1-4854 Install the cover

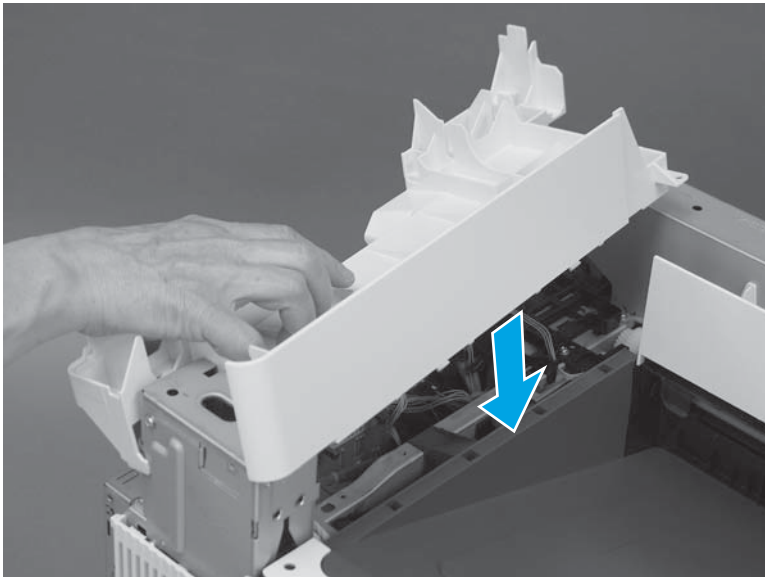

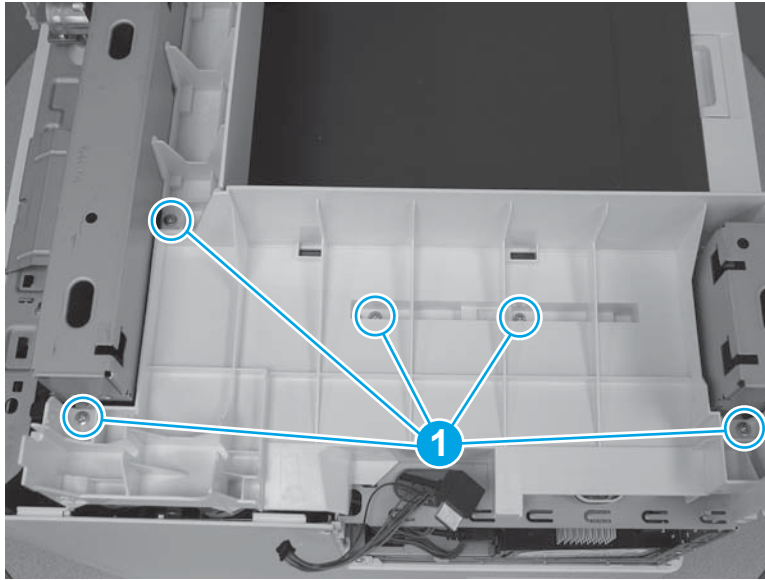

3. At the top of the printer, install five screws (callout 1).

Figure 1-4855 Install five screws



Step 54: Install the right upper cover (M577)

 **NOTE:** This step is for the M577 models. For the M552 and M553 models, skip this step and go to [Step 62: Install the rear cover \(M552 and M553\) on page 2697](#).

 **NOTE:** The figures below show the image scanner installed. The procedures for removing and installing the right upper cover are the same whether the image scanner is installed or removed."

1. **M577c/f/z only:** Install the cables (callout 1) through the slot (callout 2) in the printer.

Figure 1-4856 Install the cables

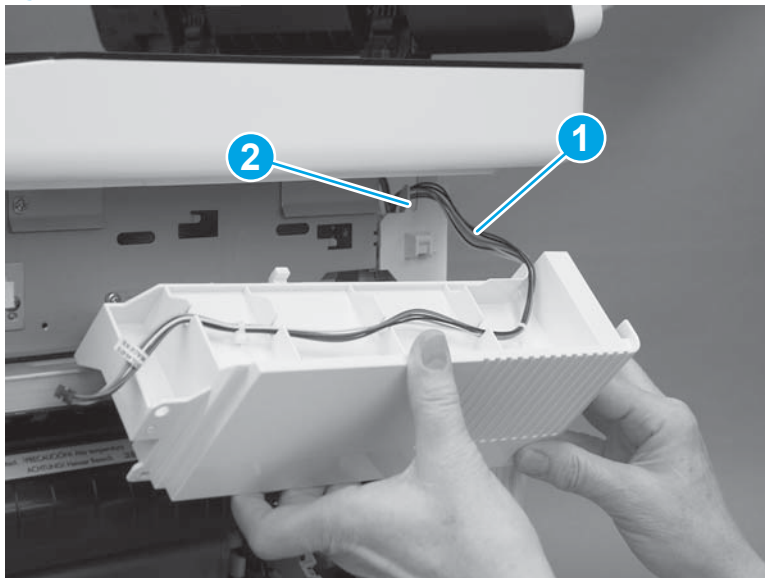

2. Position the hooks (callout 1) on the cover in the slots (callout 2) in the printer.

Figure 1-4857 Position the hooks

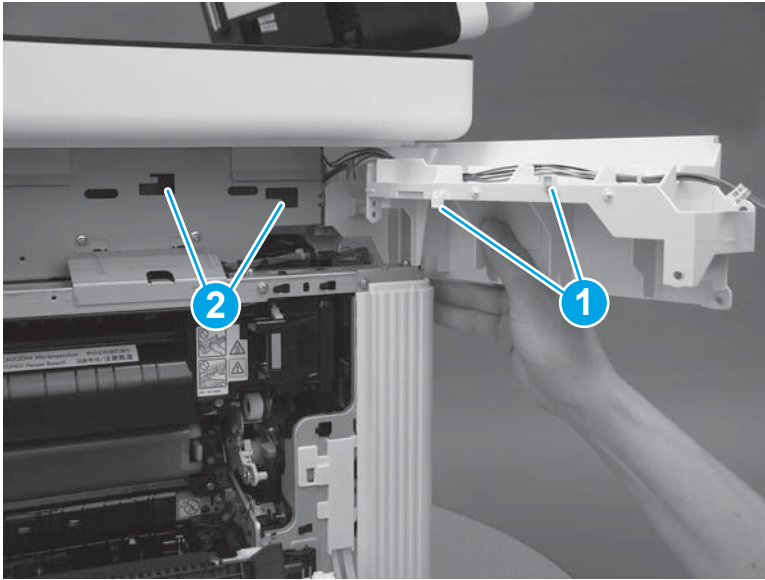

3. Slide the cover toward the front of the printer to install it.

Figure 1-4858 Install the cover

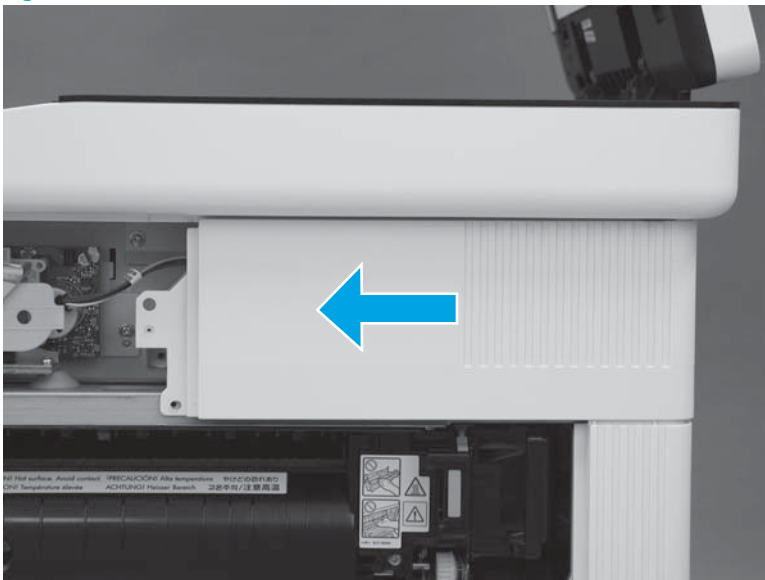

4. At the back of the printer, install one screw (callout 1).

M577c/f/z only: Connect one connector (callout 2), if the integrated scanner assembly is installed.

 **TIP:** This screw is smaller than the screws installed in the next step. Make sure that this screw is installed in the correct position.

Figure 1-4859 Install one screw and connector



5. At the right side of the printer, install two screws (callout 1).

M577c/f/z only: Connect one connector (callout 2), if the stapler is installed.

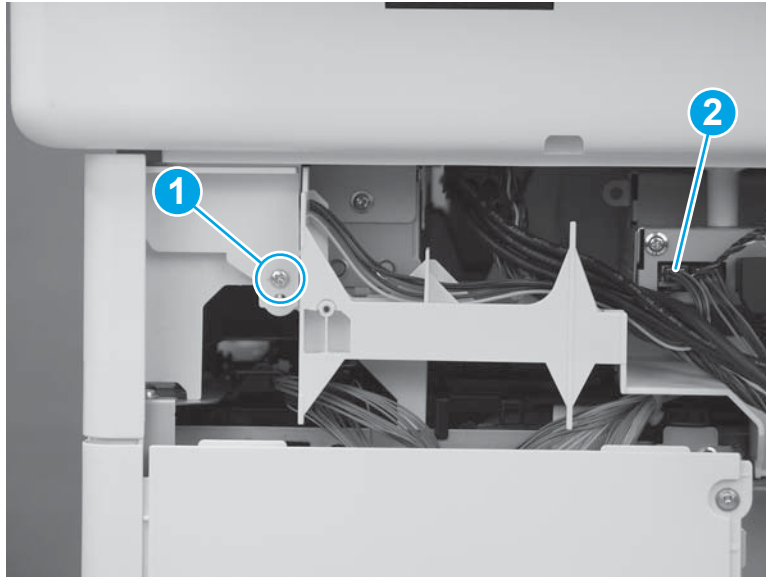
Figure 1-4860 Install one screw and connector

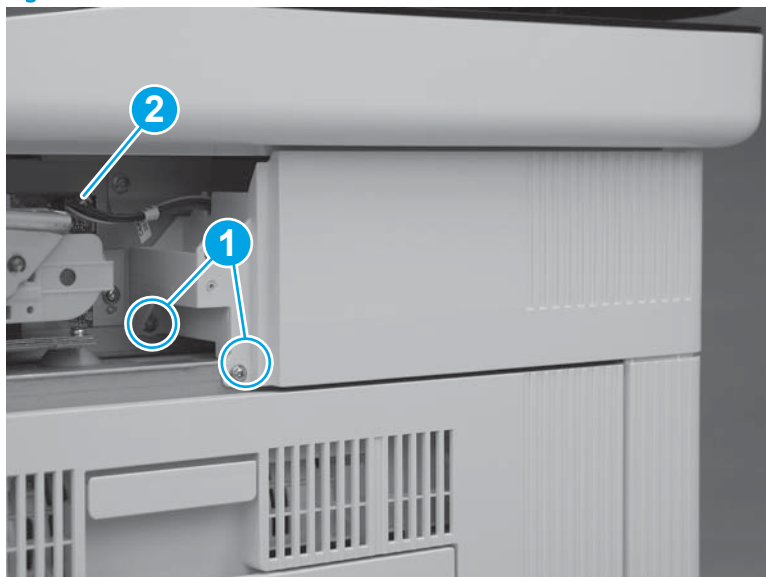

Step 55: Install the stapler unit (M577c/f/z)

 **NOTE:** This step is for the M577c/f/z models. For the M577dn model, skip this step and to go [Step 56: Install the integrated scanner assembly \(ISA\) \(M577\) on page 2685](#).

For the M552 and M553 models, skip this step and go to [Step 62: Install the rear cover \(M552 and M553\) on page 2697](#).

1. Position the hooks (callout 1) on the stapler unit in the slots (callout 2) in the printer.

Figure 1-4861 Position the hooks in the slots

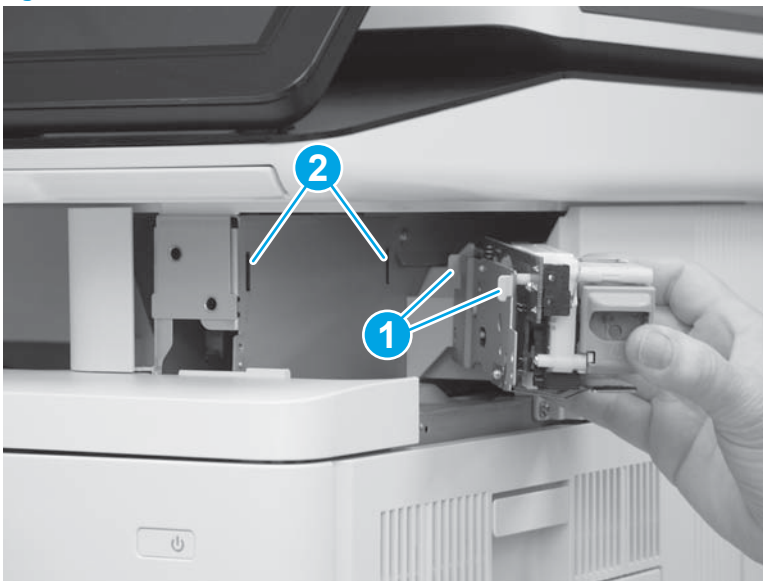

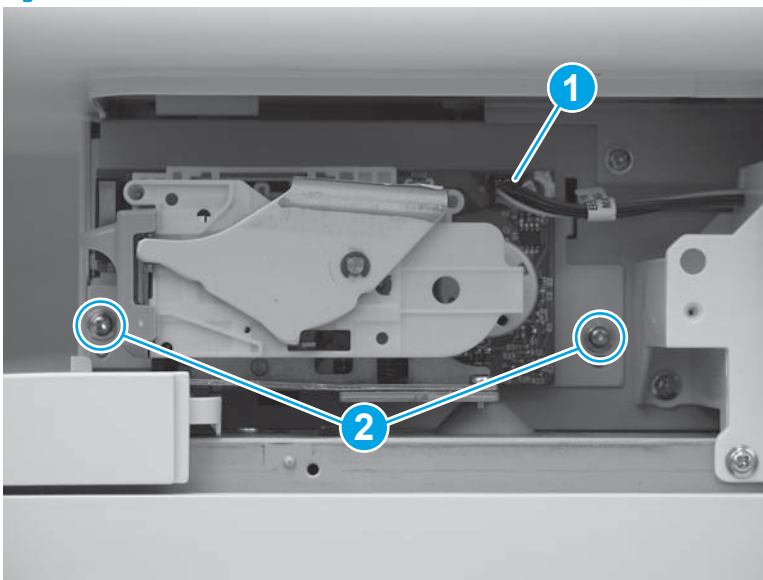

2. Connect one connector (callout 1), and then install two screws (callout 2).

Figure 1-4862 Connect connector and install screws



Step 56: Install the integrated scanner assembly (ISA) (M577)

 **NOTE:** This step is for the M577 models. For the M552 and M553 models, skip this step and go to [Step 62: Install the rear cover \(M552 and M553\) on page 2697](#).

 **NOTE:** The ISA includes the document feeder, image scanner, scanner control board (SCB), control panel, keyboard (M577c/z) and NFC PCA (M577z).

1. Before proceeding, locate the mounting pins (callout 1) on the bottom of the ISA and the slots (callout 2) on the printer base.

Figure 1-4863 Locate the ISA mounting pins and slots

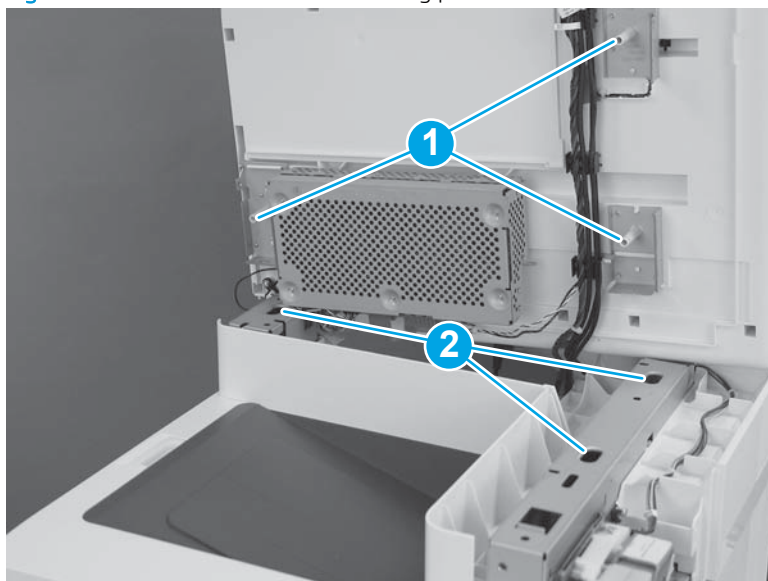

2. Position the ISA on the printer base with the pins in the slots.

 **NOTE:** To locate the pins and slots, see [Figure 1-395 Locate the ISA mounting pins and slots on page 249](#).

When installing the ISA, carefully pass the cables through the opening in the top of the formatter case.

Figure 1-4864 Install the ISA

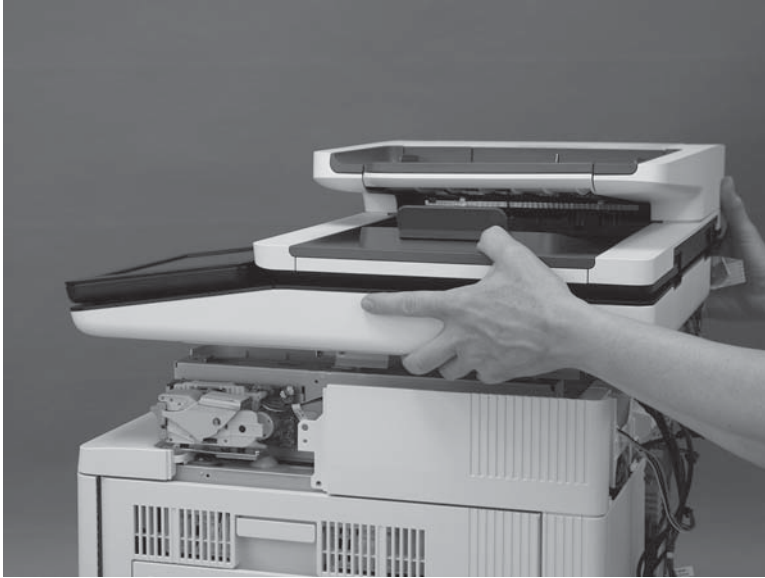

3. Slightly slide the ISA towards the front of the printer to engage it.

Figure 1-4865 Slide the ISA towards the front of the printer

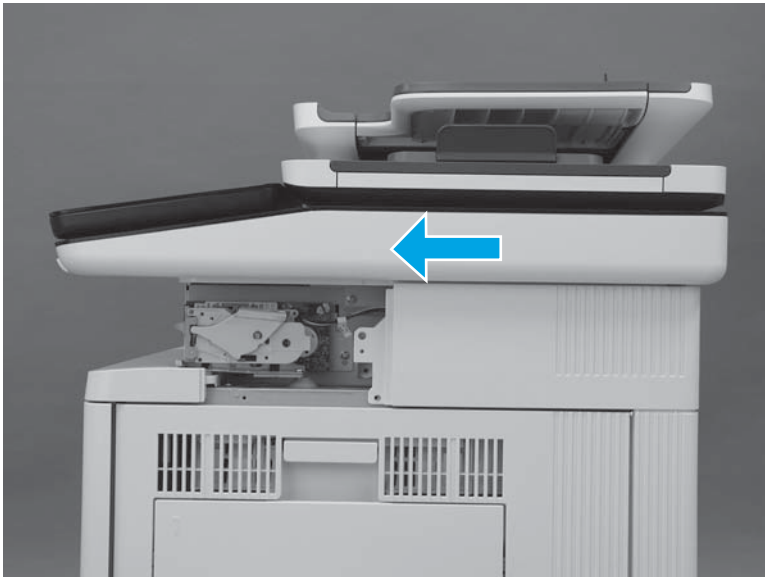

4. At the left side of the printer, install one screw (callout 1).

Figure 1-4866 Install one screw

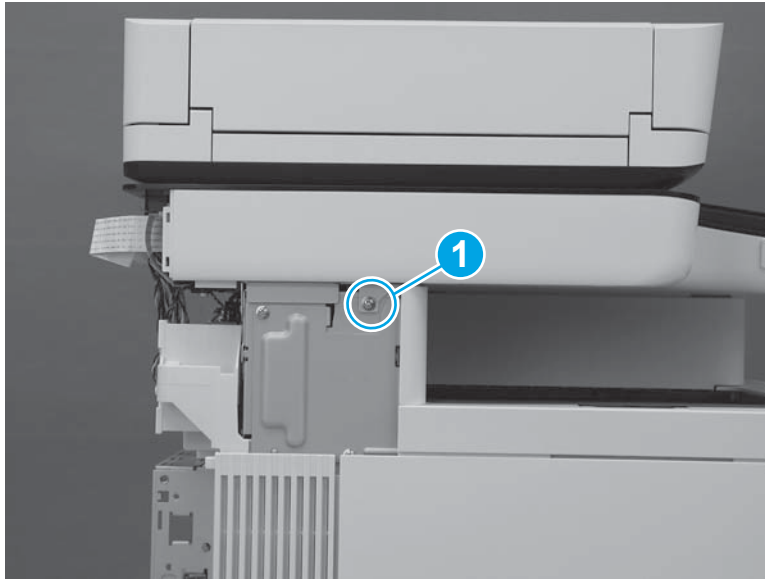

5. At the back of the printer, install two screws (callout 1).

Figure 1-4867 Install two screws

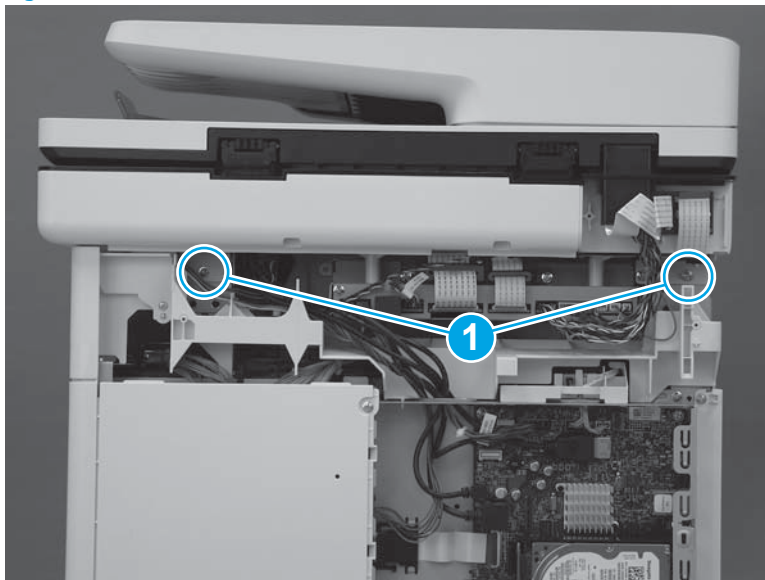

6. At the right side of the printer, install one screw (callout 1).

Figure 1-4868 Install one screw

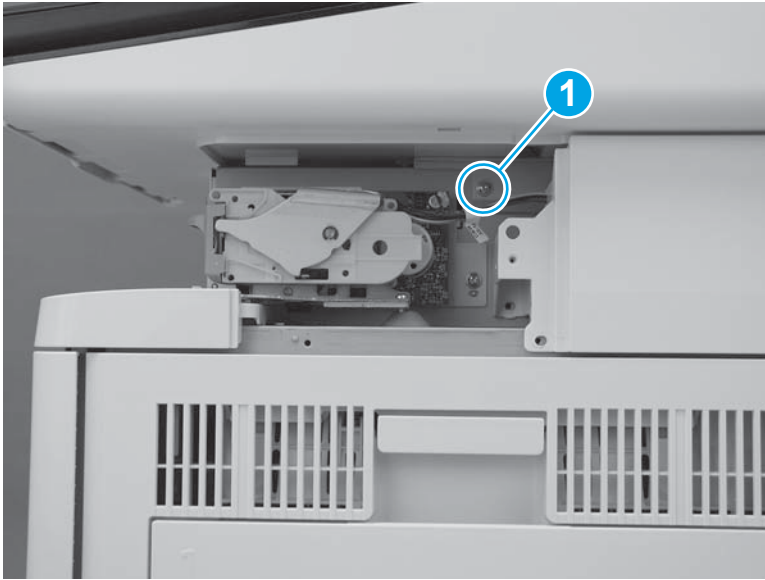

7. Connect two connectors on the scanner control board (callout 1).

M577c/f/z only: Connect one connector for the stapler on the scanner control board (callout 2).

Figure 1-4869 Connect connectors

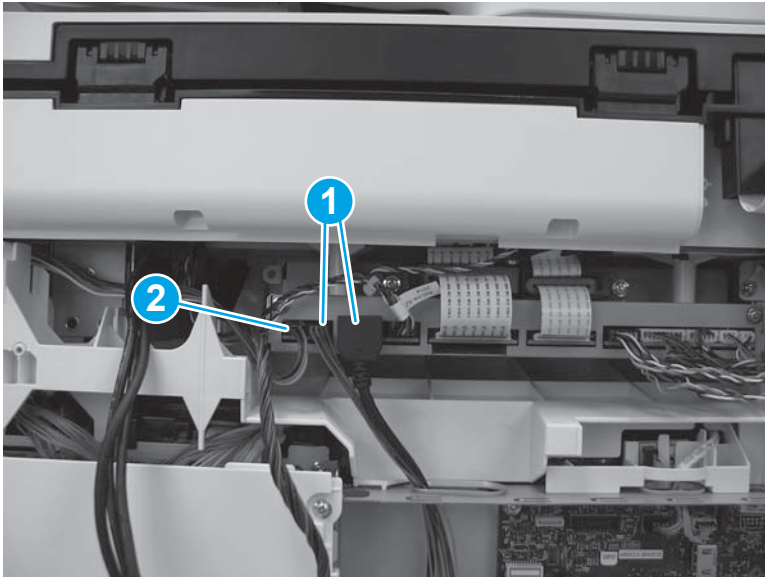

Step 57: Install the stapler cover assembly (M577c/f/z)

 **NOTE:** This step is for the M577c/f/z models only. For the M577dn model, skip this step and go to [Step 58: Install the right front upper cover \(M577dn\) on page 2690](#).

For the M552 and M553 models, skip this step and go to [Step 62: Install the rear cover \(M552 and M553\) on page 2697](#).

1. Install the tabs (callout 1) on the cover in the slots (callout 2) in the printer.

Figure 1-4870 Install two tabs



2. Press the cover toward the left side of the printer until it snaps into place.

Figure 1-4871 Install the cover assembly



3. Install one screw (callout 1).



 **IMPORTANT:** This is a self-tapping screw for plastic. Rotate it counterclockwise to align it with the existing thread pattern, and then carefully turn it clockwise to tighten. Do not overtighten. This will prevent stripping the threads inside the screw hole.

Figure 1-4872 Install one screw

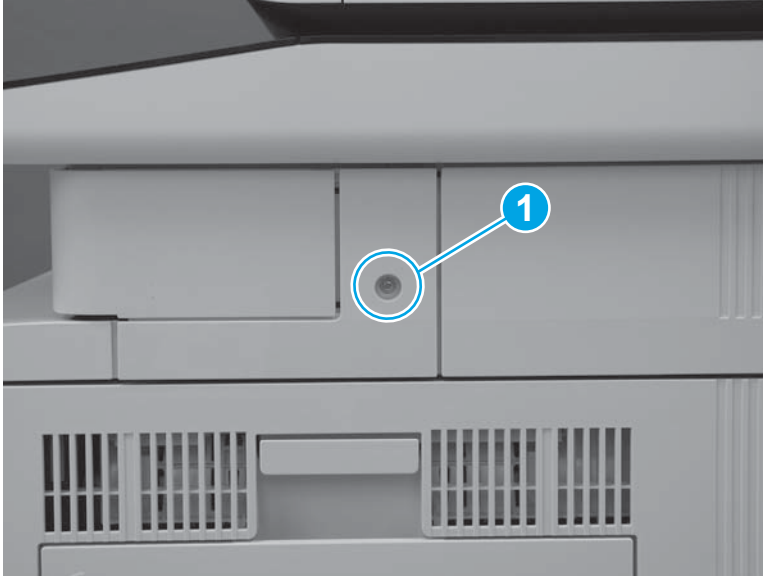

Step 58: Install the right front upper cover (M577dn)

 **NOTE:** This step is for the M577dn model only. For the M577c/f/z models, skip this step and go to [Step 59: Install the left upper cover \(M577\) on page 2692](#).

For the M552 and M553 models, skip this step and go to [Step 62: Install the rear cover \(M552 and M553\) on page 2697](#).

1. Slide the cover toward the left side of the printer to install it. Make sure that the slots (callout 1) in the cover fit over the tabs (callout 2) on the inside of the paper feeder cover.

Figure 1-4873 Install the cover



2. Press the right front upper cover (callout 1) and the paper feeder cover (callout 2) together until the tabs on the inside of the covers snap into place.

Figure 1-4874 Press the cover



3. Install one screw (callout 1).

Figure 1-4875 Install one screw

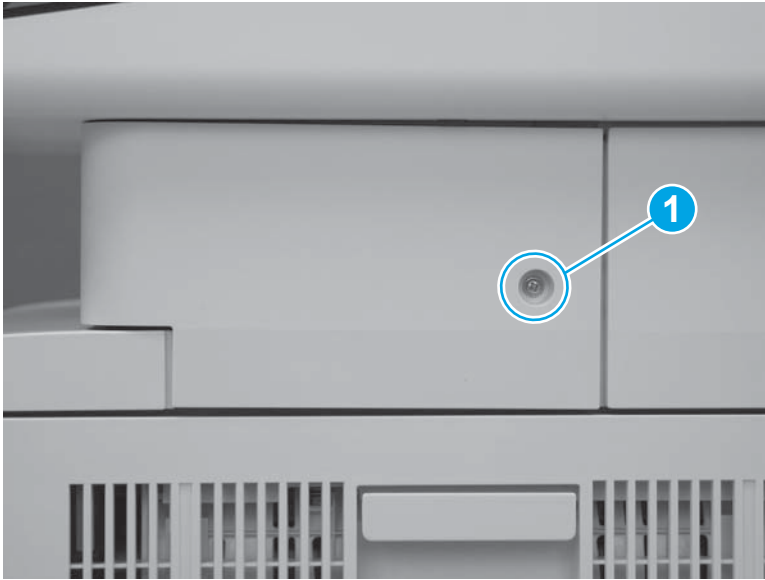

Step 59: Install the left upper cover (M577)

 **NOTE:** This step is for the M577 models. For the M552 and M553 models, skip this step and go to [Step 62: Install the rear cover \(M552 and M553\) on page 2697](#).

1. Position the tab (callout 1) on the lower edge of the cover behind the left cover (callout 2).

Figure 1-4876 Position the tab

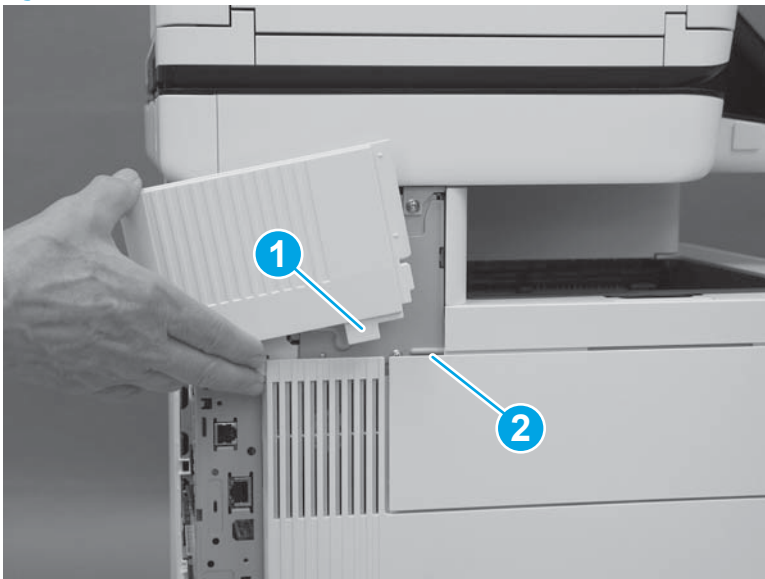

2. Slide the cover toward the front of the printer to install it. Make sure that the edge (callout 1) of the cover fits behind the edge (callout 2) of the top rear cover.

Figure 1-4877 Slide the cover

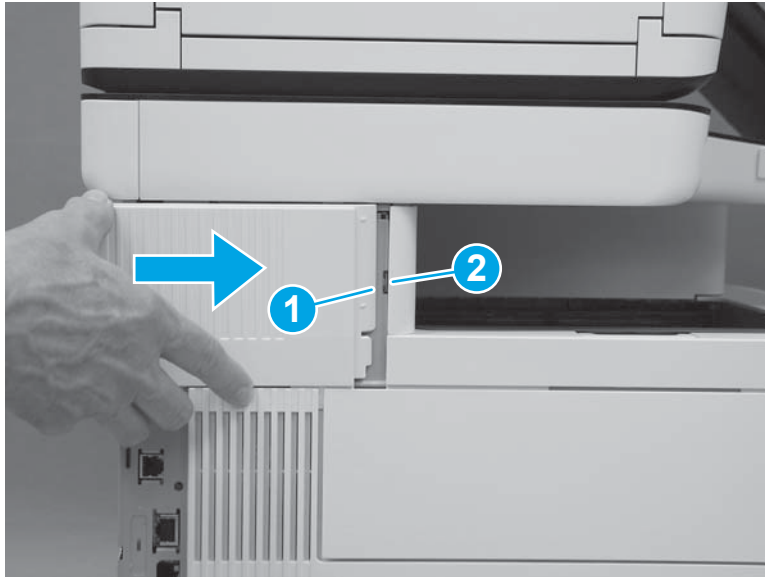

3. Make sure that the tab (callout 1) is fully installed.

Figure 1-4878 Check the tab

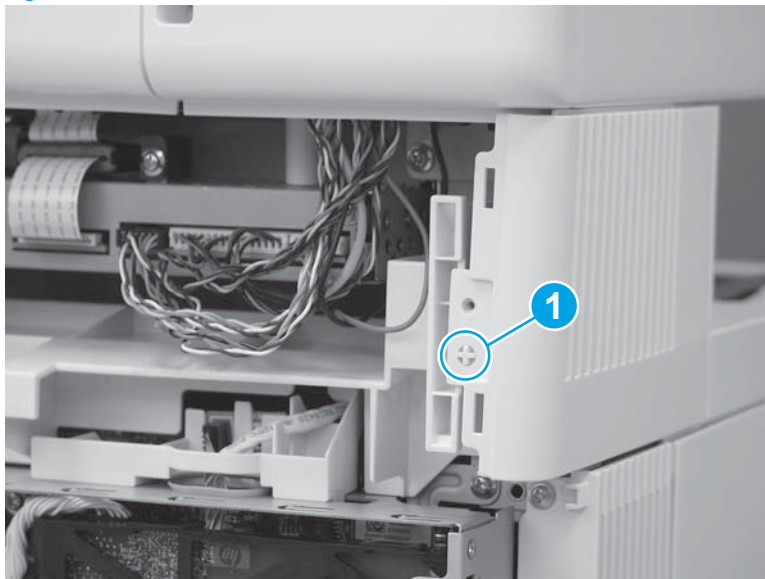

Step 60: Install the rear cover (M577)

 **NOTE:** This step is for the M577 models. For the M552 and M553 models, skip this step and go to [Step 62: Install the rear cover \(M552 and M553\) on page 2697](#).

1. Position the hooks (callout 1) on the cover in the slots (callout 2) in the printer.

Figure 1-4879 Position the hooks

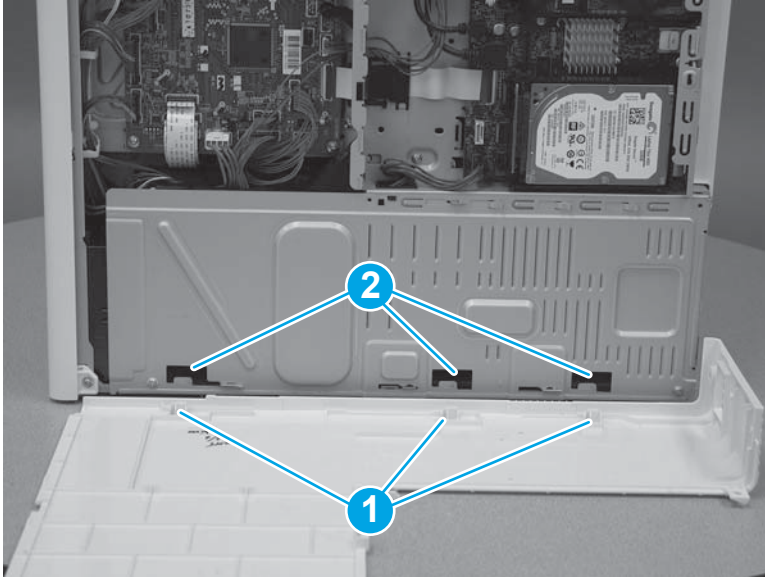

2. Position the back edge (callout 1) of the rear cover behind the edge (callout 2) of the right rear cover. Slide the cover to the left to install it.

Figure 1-4880 Install the cover

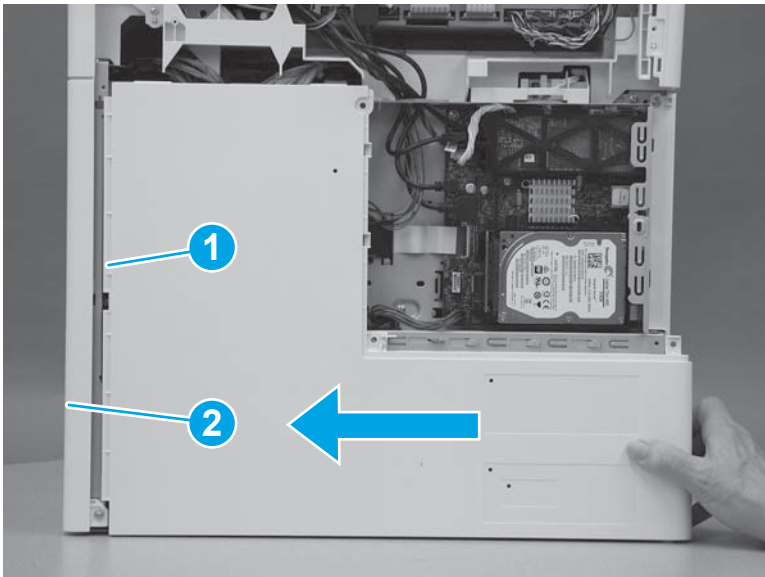

3. Install four screws (callout 1).

Figure 1-4881 Install four screws cover

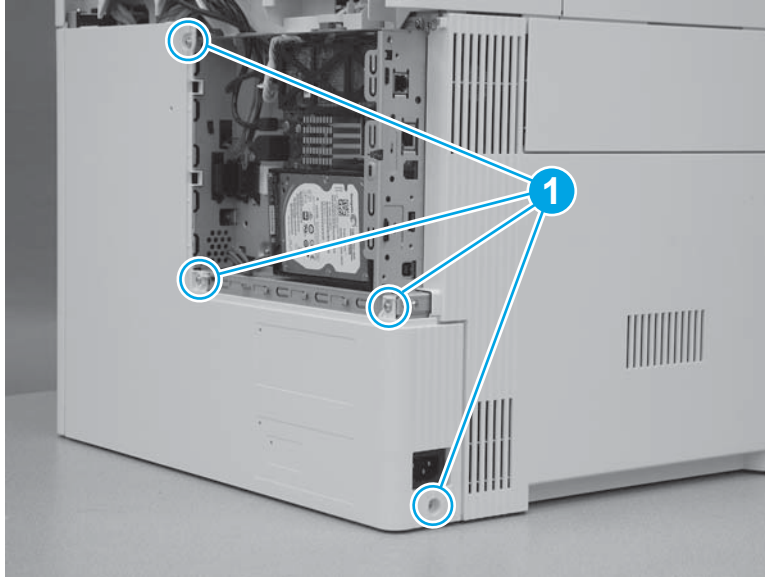

Step 61: Install the rear upper cover (M577)

 **NOTE:** This step is for the M577 models. For the M552 and M553 models, skip this step and go to [Step 62: Install the rear cover \(M552 and M553\) on page 2697](#).

1. Align the ridge (callout 1) on the lower edge of the rear upper cover in front of the tabs (callout 2) on the top edge of the rear cover.

Figure 1-4882 Align the cover

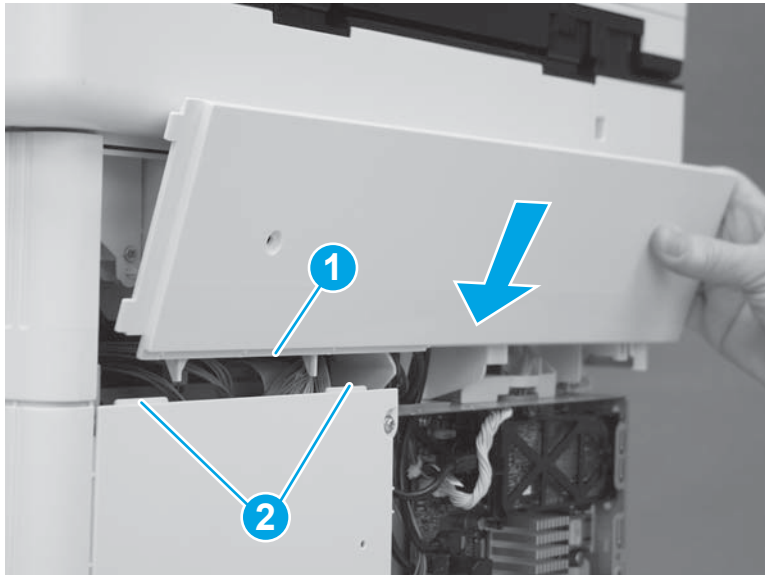

2. Rotate the top of the cover toward the printer.

Figure 1-4883 Rotate the top of the cover

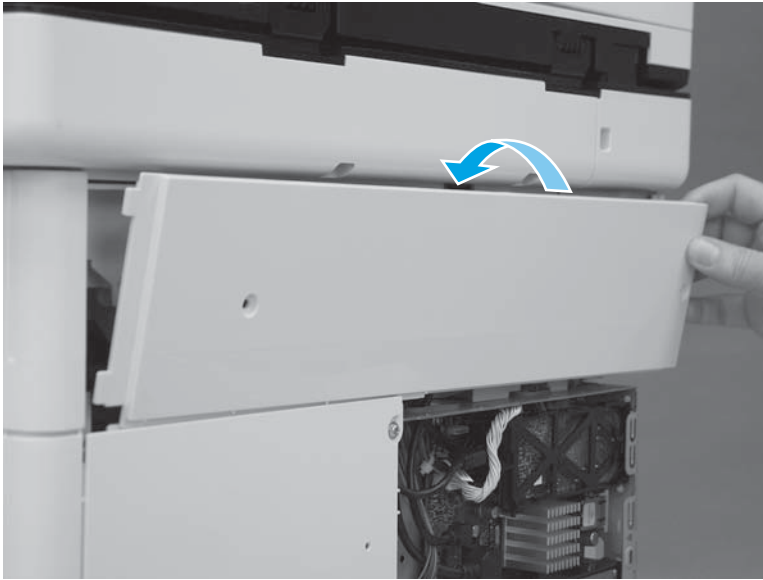

3. Slide the cover to the left (callout 1). Make sure that the tabs (callout 2) on the upper rear cover slide behind the edge (callout 3) of the right upper cover. Make sure that the cover is fully seated.

Figure 1-4884 Slide the cover

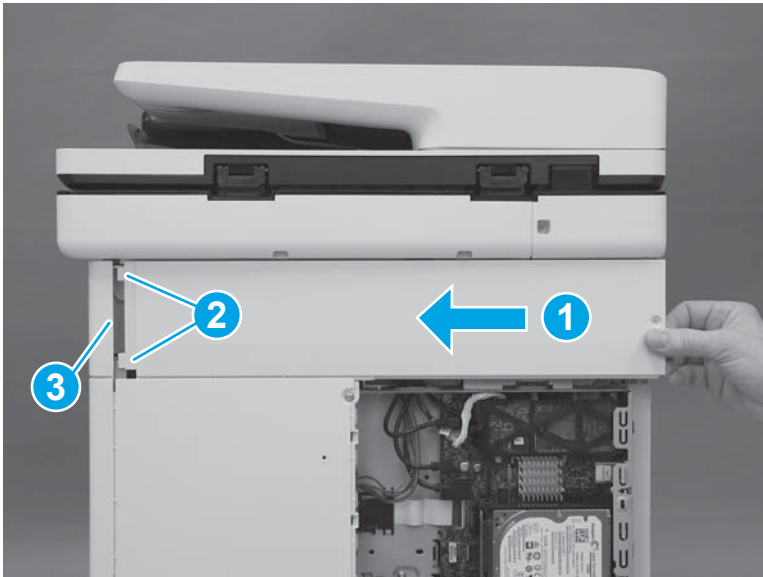

4. Install two screws (callout 1).

 **IMPORTANT:** These two screws are self-tapping screws for plastic. Rotate them counterclockwise to align them with the existing thread pattern, and then carefully turn them clockwise to tighten. Do not overtighten. This will prevent stripping the threads inside the screw holes.

Figure 1-4885 Install two screws



Step 62: Install the rear cover (M552 and M553)

 **NOTE:** This step is for the M552 and M553 models. For the M577 models, skip this step and go to [Step 63: Install the formatter \(M577\) on page 2698](#).

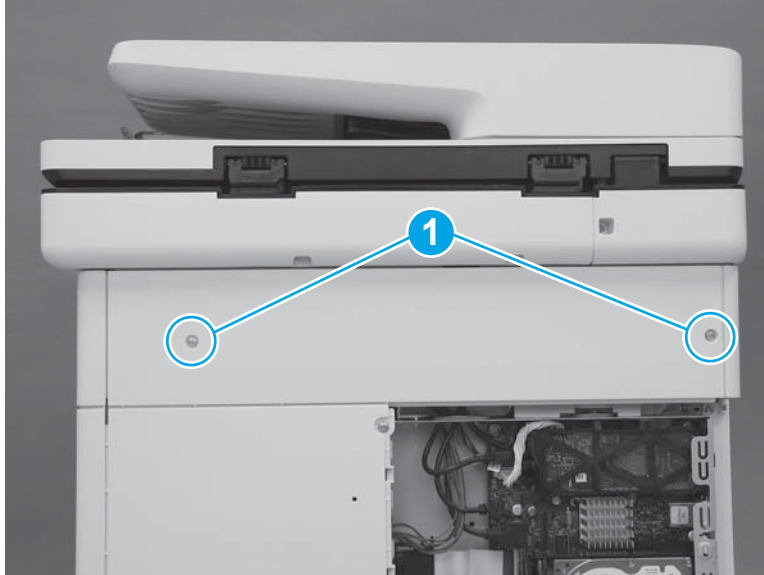
1. Position the top of the cover under the upper cover (callout 1), rotate the bottom of the cover onto the chassis (callout 2), and then slide the cover to the left (callout 3) to install it.

Figure 1-4886 Install the cover

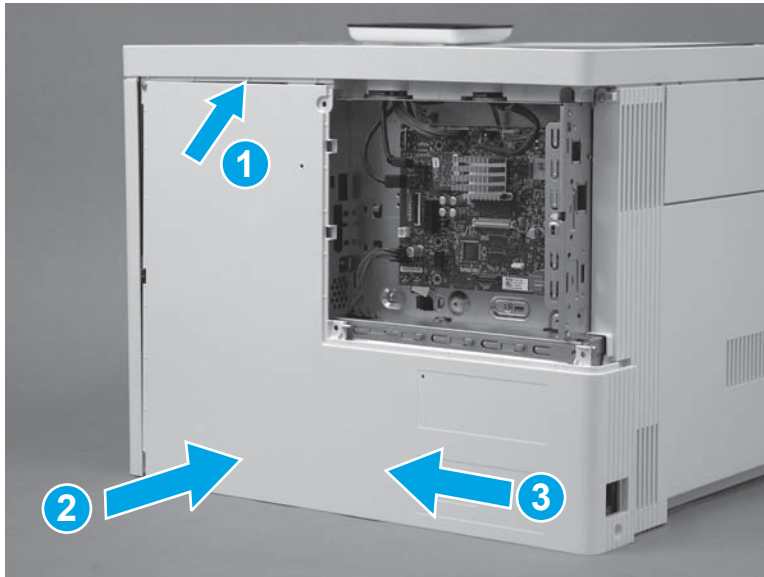

2. Install four screws (callout 1).

Figure 1-4887 Install four screws cover

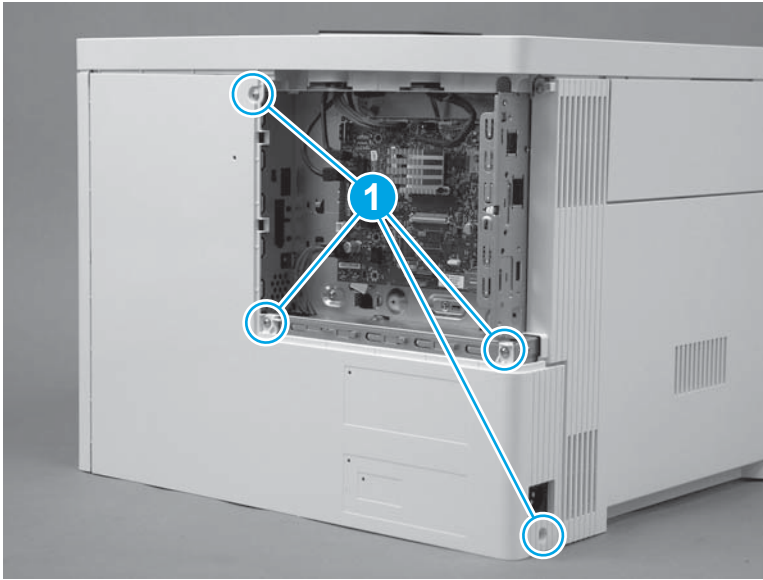

Step 63: Install the formatter (M577)

 **NOTE:** This step is for the M577 models. For the M552 and M553 models, skip this step and to go [Step 66: Install the formatter \(M552 and M553\) on page 2703](#).

 **CAUTION:**  ESD-sensitive part.

1. Position the formatter in the printer. Make sure that the network port (callout 1) fits through the opening (callout 2) in the formatter case.

Figure 1-4888 Install the formatter

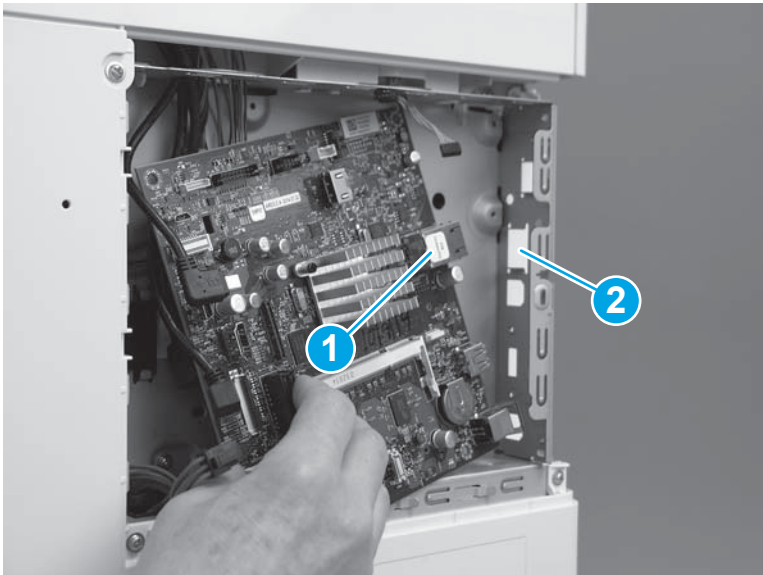

2. Install four screws (callout 1).

Figure 1-4889 Install four screws

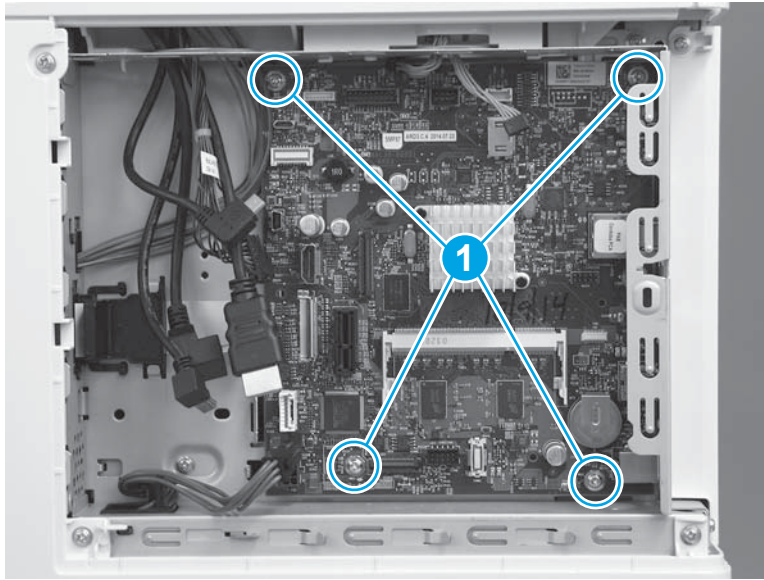

3. Connect all of the connectors on the formatter.

The following connectors are empty:

- All models: J1 (this connector is empty unless the optional DIMM is installed)
- All models: J3
- M577dn: J15 (this is the fax connector for the M577f/z/c models)
- All models: J21 (this connector is empty unless the optional internal USB ports component is installed)
- All models: J23
- All models: J24
- All models: J51
- All models: J57
- All models: J97
- All models: J98 (this connector is empty unless the optional trusted platform module (TPM) is installed)



 **IMPORTANT:** The flat-cable connector (callout 1) is a Zero Insertion Force (ZIF) connector that uses a hinged retainer to secure the flat cable. The hinged retainer must be opened to install the flat cable, and then closed after the cable is installed.

Figure 1-4890 Connect all connectors

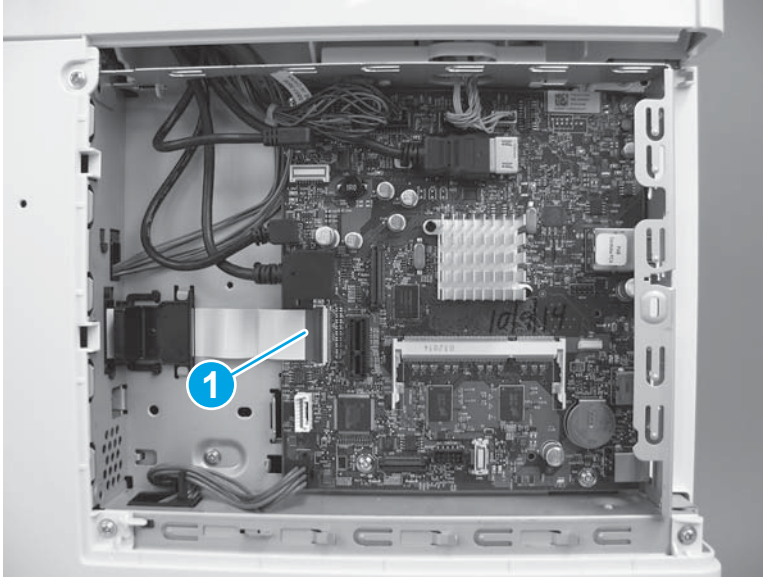

Step 64: Install the fax PCA (M577c/f/z)

 **NOTE:** This step is for the M577c/f/z models. For the M577nn model, skip this step and go to [Step 65: Install the HDD \(M577\) on page 2701](#).

For the M552 and M553 models, skip this step and go to [Step 66: Install the formatter \(M552 and M553\) on page 2703](#).

 **CAUTION:**  ESD-sensitive part.

1. Position the tab and telephone port (callout 1) on the fax PCA in the slots (callout 2) in the formatter case.

Figure 1-4891 Position the fax PCA

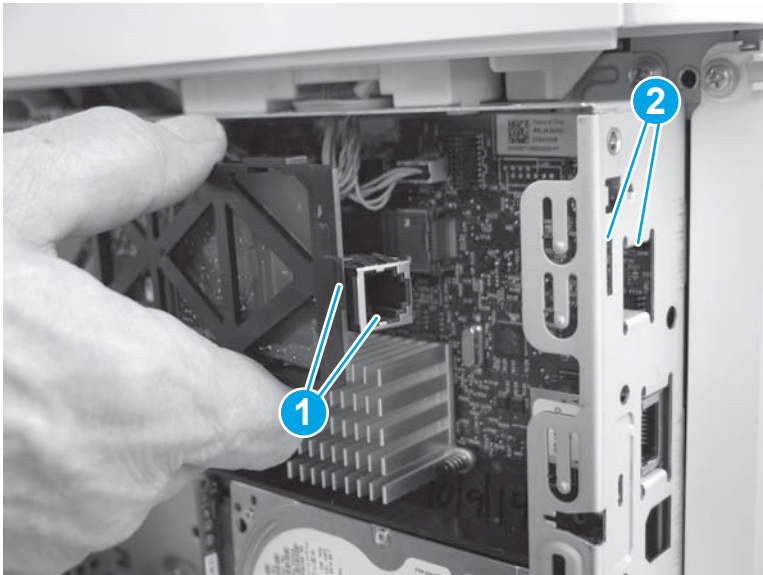

- Slide the fax PCA to the right (callout 1) until the tab and telephone port described in the previous step and seated in the formatter case. Position the retainer (callout 2) in the slot (callout 3) in the formatter. Rotate the end of the fax PCA toward the formatter (callout 4) until the retainer snaps into place.

Figure 1-4892 Install the fax PCA

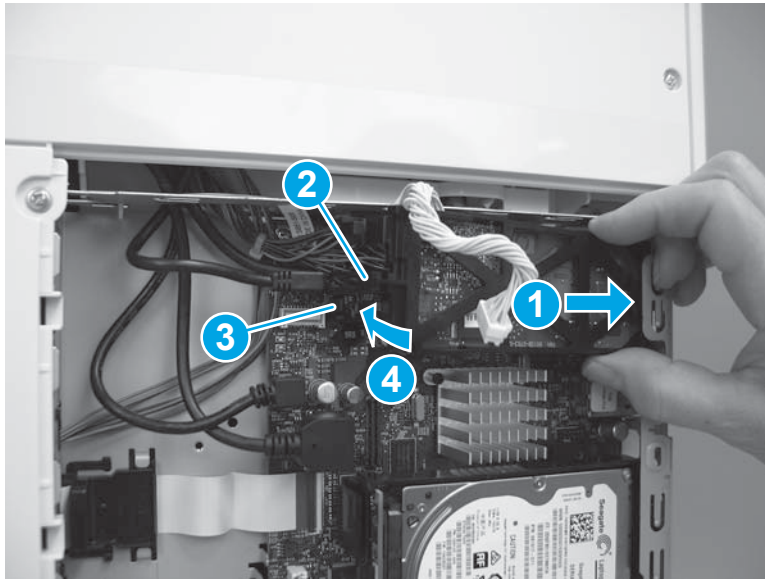

- Position the cable (callout 1) in the guide (callout 2), and then connect one connector (callout 3).

Figure 1-4893 Connect the connector

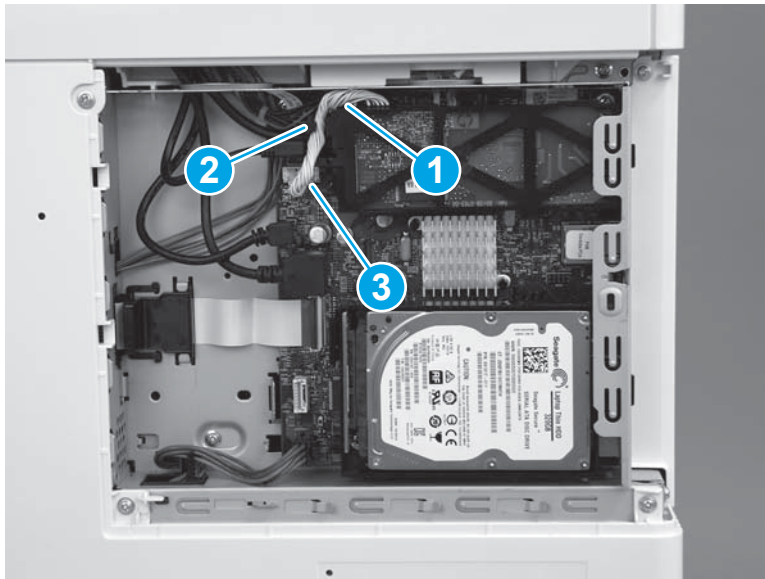

Step 65: Install the HDD (M577)

 **NOTE:** This step is for the M577 models. For the M552 and M553 models, skip this step and go to [Step 66: Install the formatter \(M552 and M553\) on page 2703](#).

 **CAUTION:**  ESD-sensitive part.

1. Align the end of the bracket (callout 1) with the slot in the chassis (callout 2), and then slide the HDD into the printer (callout 3) to engage the bracket with the chassis.

Figure 1-4894 Install the holder

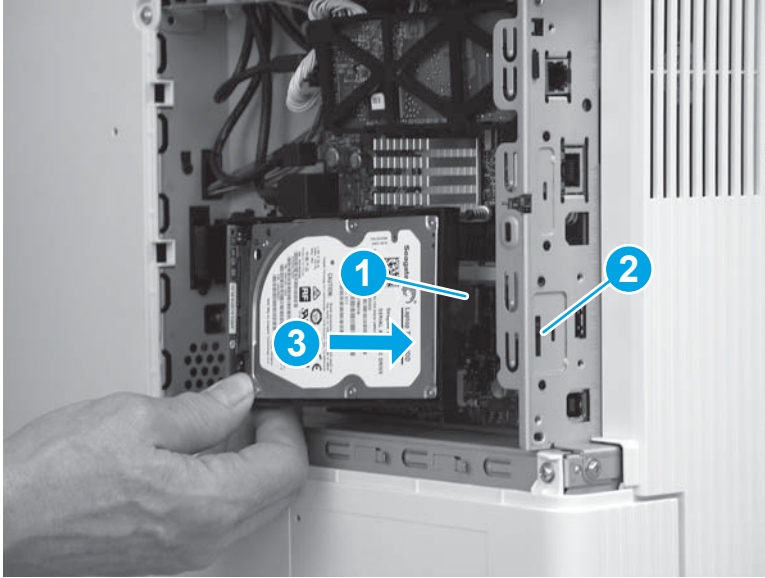

2. Hold the HDD connector latch (callout 1) in the released position, and then rotate the HDD down and into the connector on the formatter to install it.

 **NOTE:** Make sure that the tab (callout 2) snaps into place, and that the HDD is securely installed.

Figure 1-4895 Release the HDD



Step 66: Install the formatter (M552 and M553)

 **NOTE:** This step is for the M552 and M553 models. For the M577 models, skip this step and go to [Step 67: Install the formatter cover on page 2704](#).

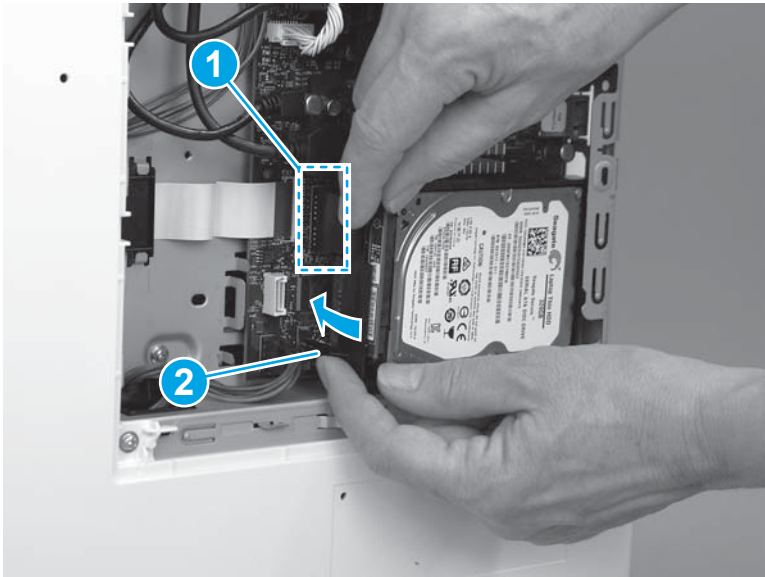
If the optional hard-disk drive (HDD) was removed, do not forget to reinstall it after the formatter is reinstalled.

Engage the HDD holder with the chassis, rotate the HDD connector down and into the connector on the formatter. Make sure that the tabs snap into place.

 **CAUTION:**  ESD-sensitive part.

1. Position the formatter in the printer, and then install four screws (callout 1).

Figure 1-4896 Install the formatter

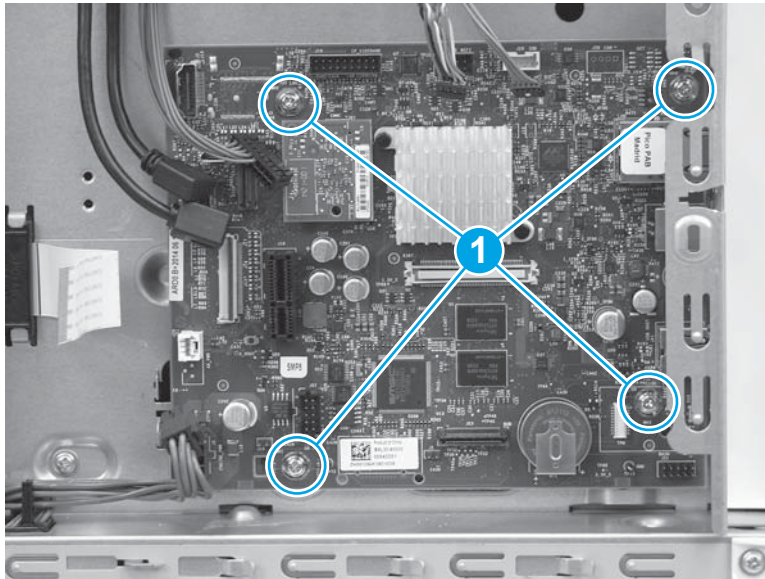

2. Connect all of the connectors on the formatter.

The following connectors are empty:

- All models: J1 (this connector is empty unless the optional DIMM is installed)
- M553n/dn and M552dn: J2 (callout 1; this is the touchscreen connector for the M553x model)
- All models: J9 (this connector is empty unless the optional internal USB ports component is installed)
- All models: J18 (this connector is empty unless the optional hard-disk-drive (HDD) is installed)
- All models: J23
- All models: J24
- M553n/dn and M552dn: J25 (this is the wireless connector for the M553x model)
- All models: J57
- All models: J98 (this connector is empty unless the optional trusted platform module (TPM) is installed)

 **IMPORTANT:** The flat-cable connector (callout 2) is a Zero Insertion Force (ZIF) connector that uses a hinged retainer to secure the flat cable. The hinged retainer must be opened to install the flat cable.

Figure 1-4897 Connect all connectors

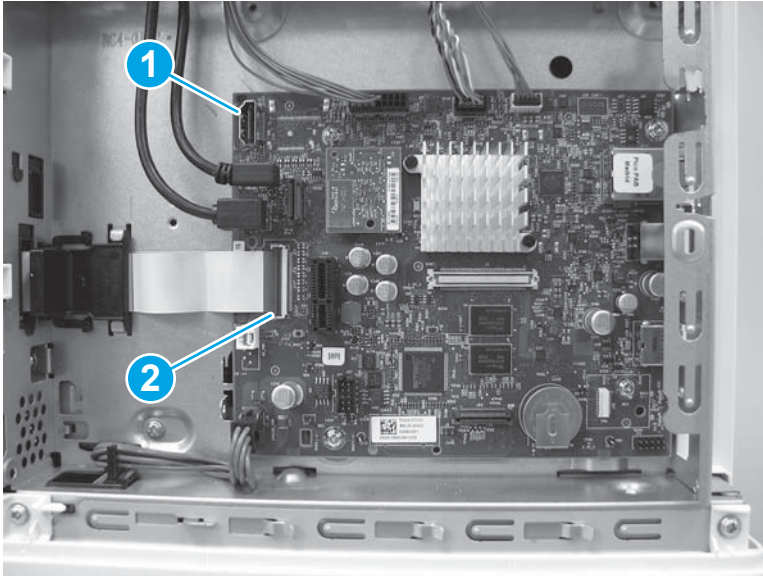

Step 67: Install the formatter cover

- ▲ Slide the cover onto the printer (callout 1) to install it.

 **NOTE:** Make sure that the tabs on the formatter cover align with the slots provided in the printer (callout 2). Tighten the two thumbscrews (callout 3).

 **TIP:** If needed, use the edge of a coin to turn the thumbscrews.

Figure 1-4898 Install the cover

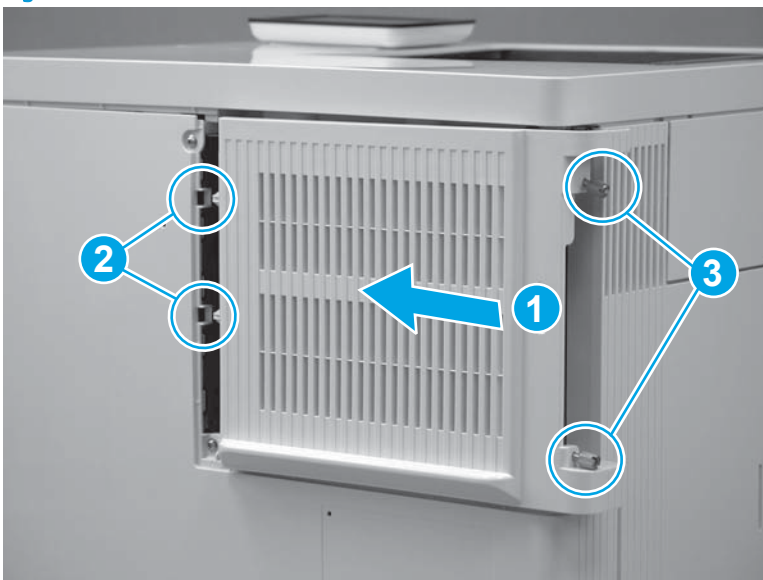

Step 68: Install the TCU

1. Verify that the toner collection hatch cover is in the closed position on the TCU.

Figure 1-4899 Verify that the toner collection hatch cover is closed

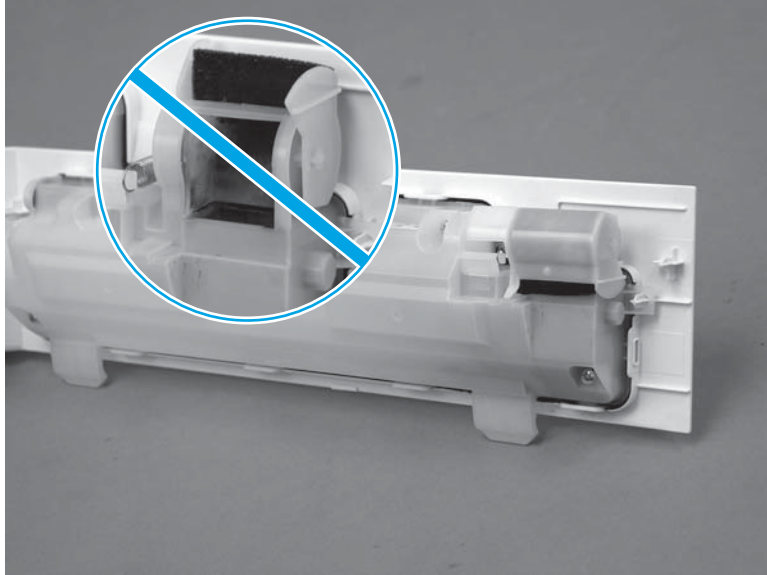

2. Position the TCU with the hinges in the slots provided in the printer (callout 1), and then rotate the TCU up and into the closed position.

 **NOTE:** The toner collection hatch cover automatically opens when the TCU is closed.

Figure 1-4900 Install the TCU

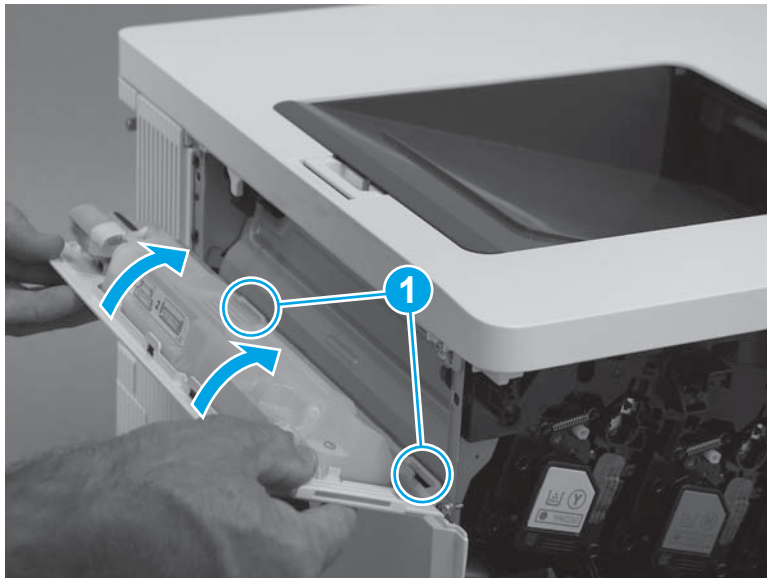

3. Close the front door.

Figure 1-4901 Close the front door



Step 69: Install the tray

1. With the front of the tray slightly lifted, align the sides of the tray with the rails in the printer, and then carefully slide the tray into the printer.

 **TIP:** As the tray slides into the printer, lower the front of it.

Figure 1-4902 Install the tray



2. Close the tray.

Figure 1-4903 Close the tray



Step 70: Install the control-panel assembly (M553x only)

 **NOTE:** For the M553n/dn and M552dn models, skip this step and go to [Step 73: Install the USB cover \(M552 and M553\) on page 2715](#).

For the M577 models, skip this step.

1. Place the control panel on the printer as shown.

Figure 1-4904 Place the control panel on the product

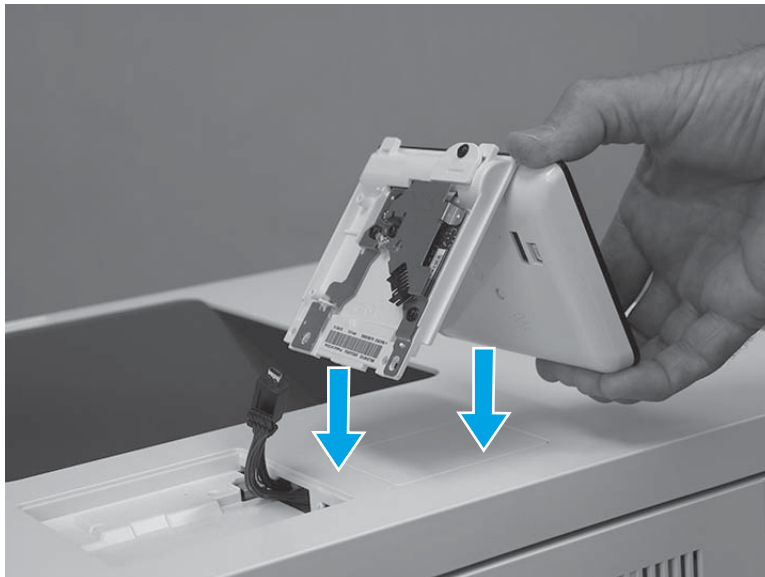

2. Connect one USB cable (callout 1), and one connector (callout 2).

 **IMPORTANT:** Take note of the location of the two mounting tabs (callout 3) on the control-panel assembly.

Figure 1-4905 Connect two connectors



3. Turn the control panel over, and then position the front edge tabs in the slots in the top cover.

Figure 1-4906 Turn the control panel over

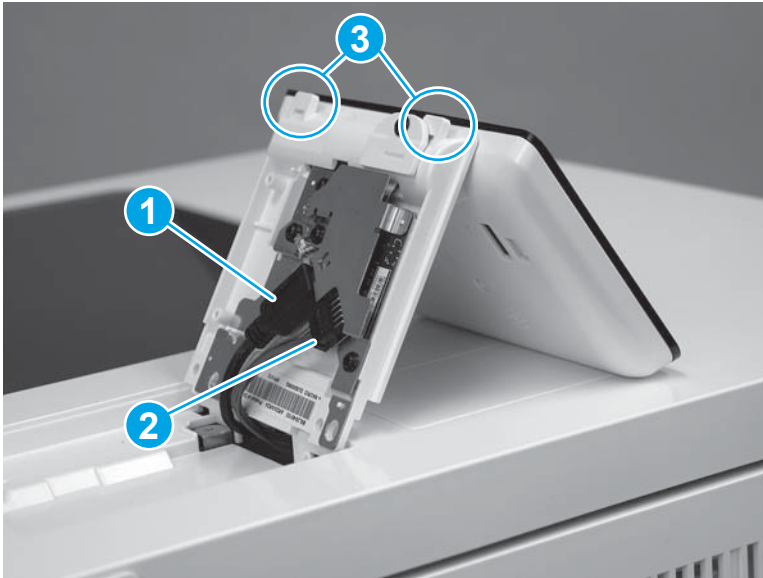
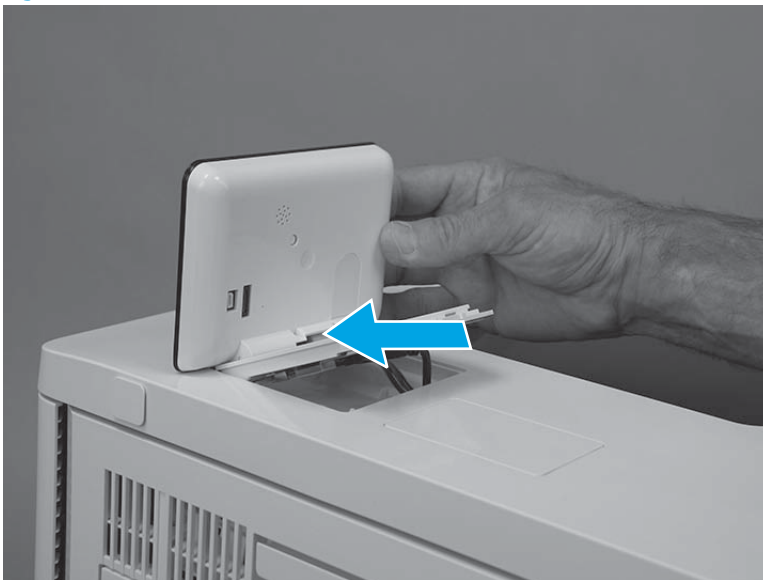

4. Rotate the control-panel base down onto the printer.

Figure 1-4907 Rotate the control-panel base down



5. Use a small Phillips screwdriver to install two screws (callout 1).

Figure 1-4908 Install two screws

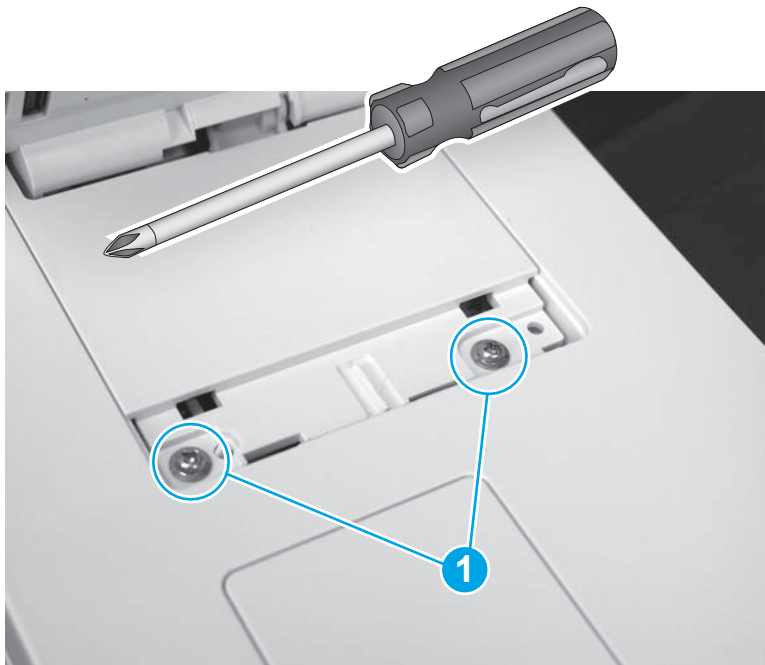

6. Position the screw cover mounting feet into the slots in the top cover (callout 1), and then rotate the cover down (callout 2) to install it.

 **NOTE:** Press down on the cover firmly to make sure that the tabs on the cover (callout 3) snap into place.

Figure 1-4909 Install the cover



Step 71: Install the ITB

 **CAUTION:** Do not touch the grey-plastic belt. Skin oils and fingerprints on the belt can cause print-quality problems.

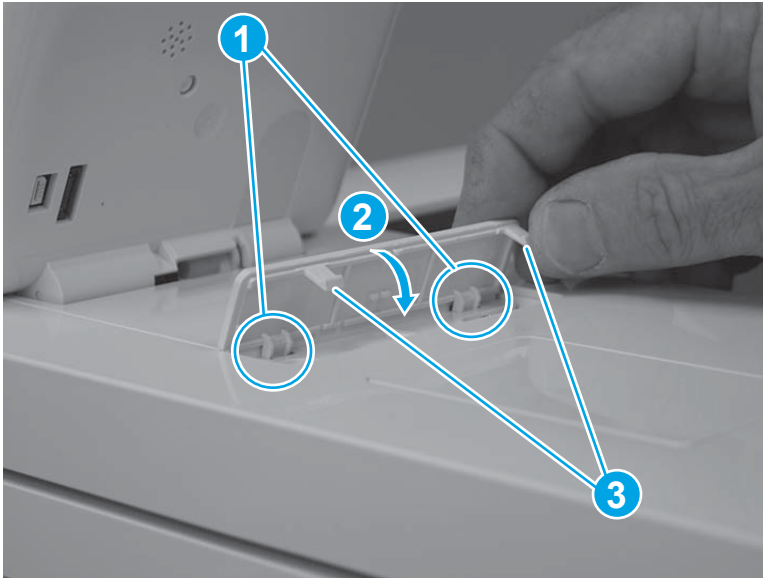
1. Handle the replacement ITB by the edges. Do not touch the grey-plastic belt. Skin oils and fingerprints on the belt can cause print-quality problems.

Figure 1-4910 Handle the ITB by the edges

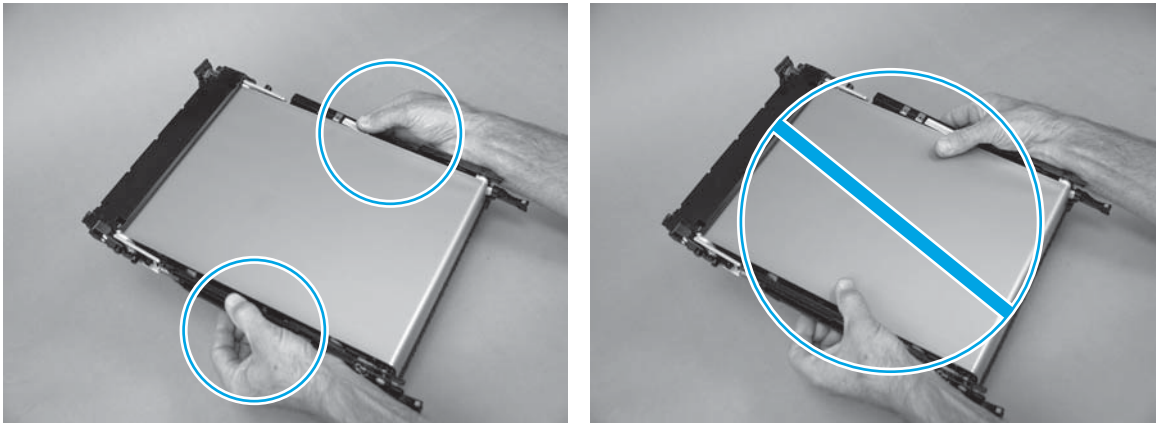

2. Align the ITB with the slots in the printer, and then carefully push it into the printer.

 **NOTE:** Be careful. Do not dislodge the ITB retainer springs from the holders on the chassis. The springs can interfere with installing the ITB.

Figure 1-4911 Align the ITB with the slots in the product



3. Continue to carefully push the ITB into the printer until it is fully installed.

Figure 1-4912 Install the ITB

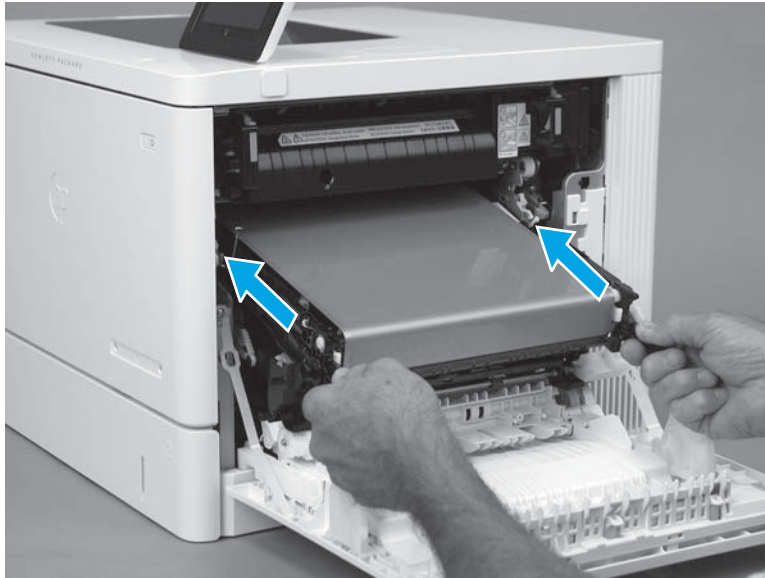
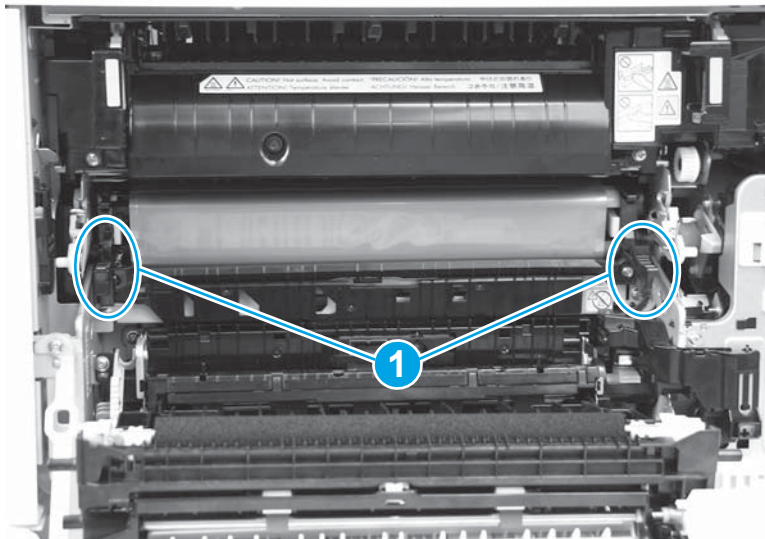

4. Remove the right-side ITB spring from the holder.

Figure 1-4913 Remove the spring from the holder



5. Fasten the right-side ITB spring (callout 1) under the tab (callout 2).

Figure 1-4914 Fasten the rear-side ITB spring

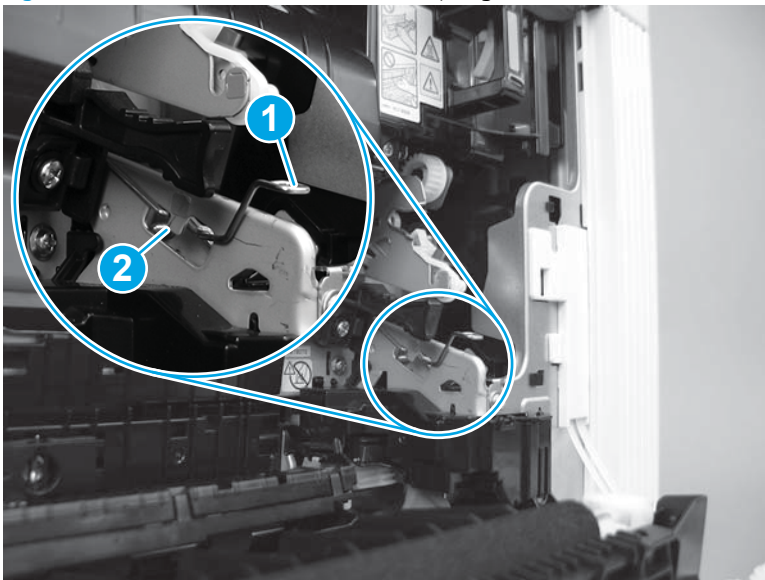

6. Remove the left-side ITB spring from the holder.

Figure 1-4915 Remove the spring from the holder

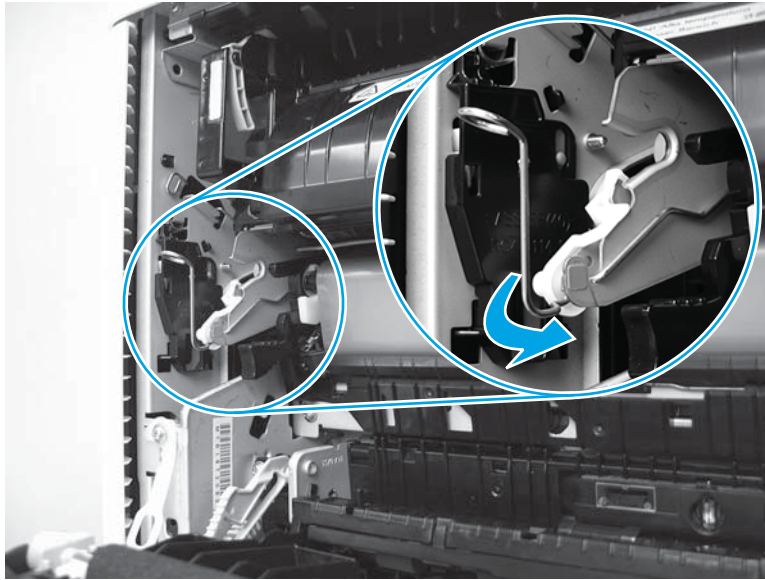

7. Fasten the left-side ITB spring (callout 1) under the tab (callout 2).

Figure 1-4916 Fasten the front-side ITB spring

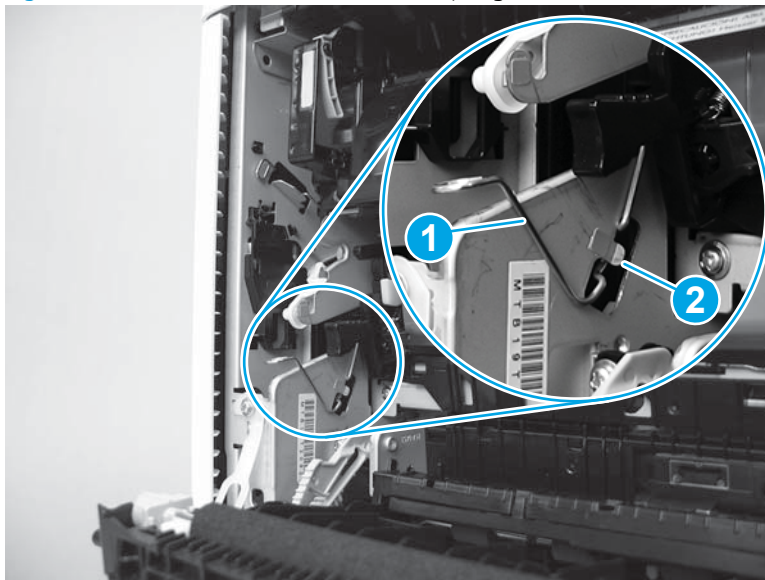

8. Push in the blue lever to engage the ITB drive coupling.

Figure 1-4917 Engage the ITB drive coupling

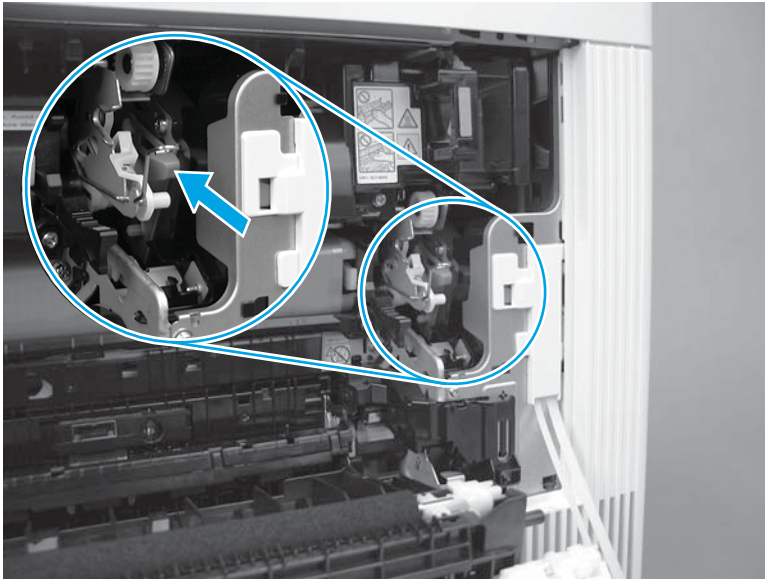

Step 72: Install the fuser

1. Align the fuser with the opening in the printer.

Figure 1-4918 Align the fuser with the opening

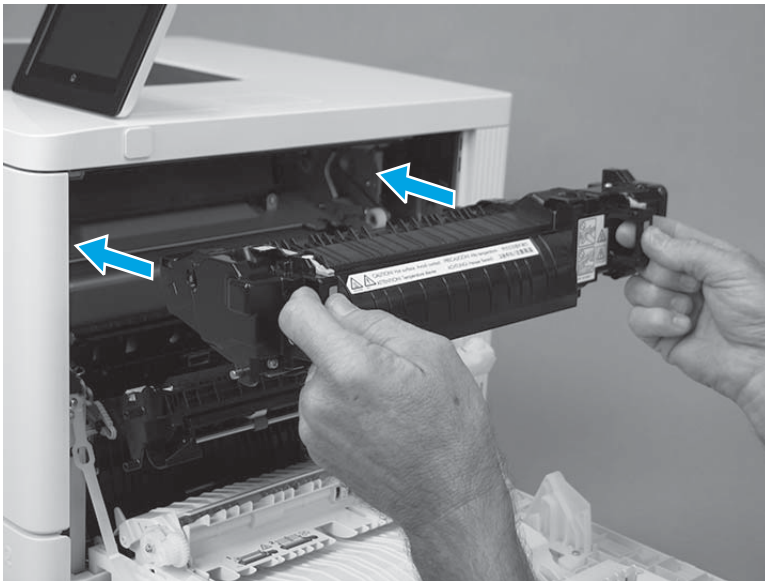

2. Slide the fuser into the printer, push in to install it, and then make sure that it is fully seated.

 **TIP:** When the fuser is fully seated, the two blue triggers on the handles make an audible click.

Figure 1-4919 Install the fuser

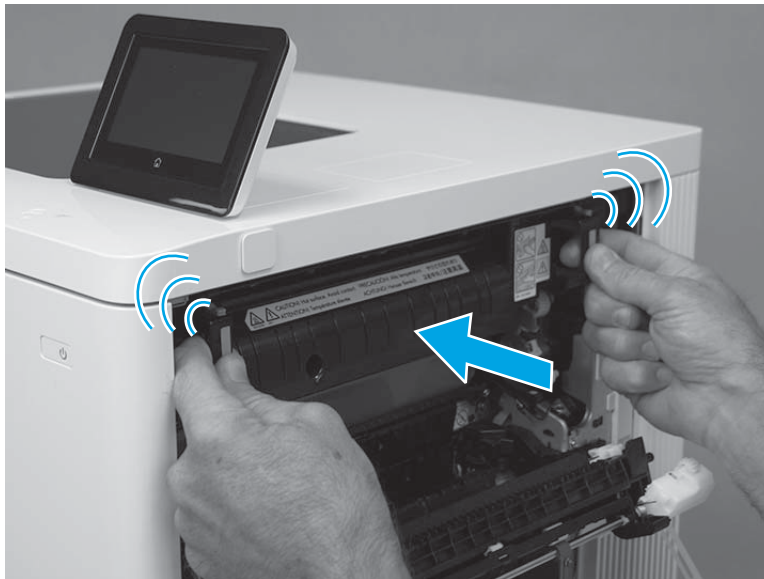

3. Close the right door.

Figure 1-4920 Close the right door



Step 73: Install the USB cover (M552 and M553)

 **NOTE:** This step is for the M552 and M553 models. For the M577 models, skip this step.

1. Push the cover into the USB port to install it.

Figure 1-4921 Install the cover



2. Make sure that the USB cover is fully seated after installing it.

Figure 1-4922 Check the installation



Step 74: Calibrate the printer

Calibrate the printer from a touchscreen control panel

1. From the [Home](#) screen on the printer control panel, scroll to and touch the [Device Maintenance](#) button.
2. Open the following menus:
 - [Calibration/Cleaning](#)
3. Touch [Full Calibrate](#) or [Quick Calibrate](#) to start the calibration process.
4. Wait while the printer calibrates, and then try printing again.

Calibrate the printer from an LCD control panel

1. From the [Home](#) screen on the printer control panel, use the down arrow ▼ button to scroll to [Device Maintenance](#), and then press the [OK](#) button.
2. Use the down arrow ▼ button to scroll to [Calibration/Cleaning](#), and then press the [OK](#) button.
3. If necessary, use the down arrow ▼ button to scroll to [Full Calibrate](#) or [Quick Calibrate](#), and then press the [OK](#) button to start the calibration process.
4. Wait while the printer calibrates, and then try printing again.

Step 75: Perform a color band test

Access the color band test from a touchscreen control panel

1. From the [Home](#) screen on the printer control panel, scroll to and touch the [Administration](#) button.
2. Open the following menus:
 - [Troubleshooting](#)
 - [Print Quality Pages](#)
 - [Color Band Test](#)
3. Touch the [Print Test page](#) button, and then touch the [Print](#) button to print the pages.

Access the color band test from an LCD control panel

1. From the [Home](#) screen on the printer control panel, use the down arrow ▼ button to scroll to [Administration](#), and then press the [OK](#) button.
2. Use the down arrow ▼ button to scroll to [Troubleshooting](#), and then press the [OK](#) button to select it.
3. Use the down arrow ▼ button to scroll to [Print Quality Pages](#), and then press the [OK](#) button to select it.
4. Use the down arrow ▼ button to scroll to [Color Band Test](#), and then press the [OK](#) button to select it.

Removal and replacement: Document feeder and image scanner assemblies (M577)

- [Removal and replacement: Document feeder \(M577\)](#)
- [Removal and replacement: Scanner control board \(SCB\) \(M577\)](#)
- [Removal and replacement: Image scanner \(M577\)](#)

Removal and replacement: Document feeder (M577)

- [Introduction](#)
- [Step 1: Remove the formatter cover](#)
- [Step 2: Remove the rear upper cover](#)
- [Step 3: Remove the left upper cover](#)
- [Step 4: Remove the document feeder](#)
- [Step 5: Unpack the replacement assembly](#)
- [Step 6: Install the document feeder](#)
- [Step 7: Install the left upper cover](#)
- [Step 8: Install the rear upper cover](#)
- [Step 9: Install the formatter cover](#)
- [Step 10: Reset the firmware counter](#)

Introduction

This document provides the procedures to remove and replace the M577 document feeder .

Before performing service

Turn the printer power off

- Disconnect the power cable.

 **WARNING!** To avoid damage to the printer, turn the printer off, wait 30 seconds, and then remove the power cord before attempting to service the printer.

Use the table below to identify the correct part number for your printer. To order the part, go to www.hp.com/buy/parts.

Document feeder (M577) part numbers	
B5L47-67901	ADF whole unit kit (M577dn/f)
B5L47-67902	ADF whole unit kit (M577c/z)

Required tools

- #2 Phillips screwdriver with a magnetic tip.
- Small flat-blade screwdriver.

After performing service

Turn the printer power on

- Connect the power cable.
- Use the power switch to turn the power on.

Post service test

Use the document feeder to make a copy to make sure that it is properly functioning.

Step 1: Remove the formatter cover

1. Locate the formatter cover.

Figure 1-4923 Locate the formatter cover

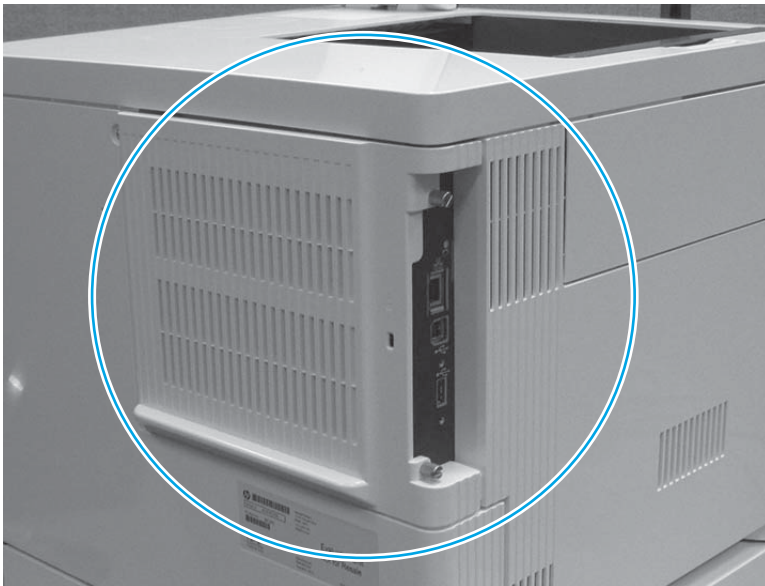

2. Loosen the two thumbscrews (callout 1). Grasp the two thumbscrews, and then slide the cover away from the printer (callout 2) to remove it.

 **TIP:** If needed, use the edge of a coin to turn the thumbscrews.

Figure 1-4924 Loosen the thumbscrews

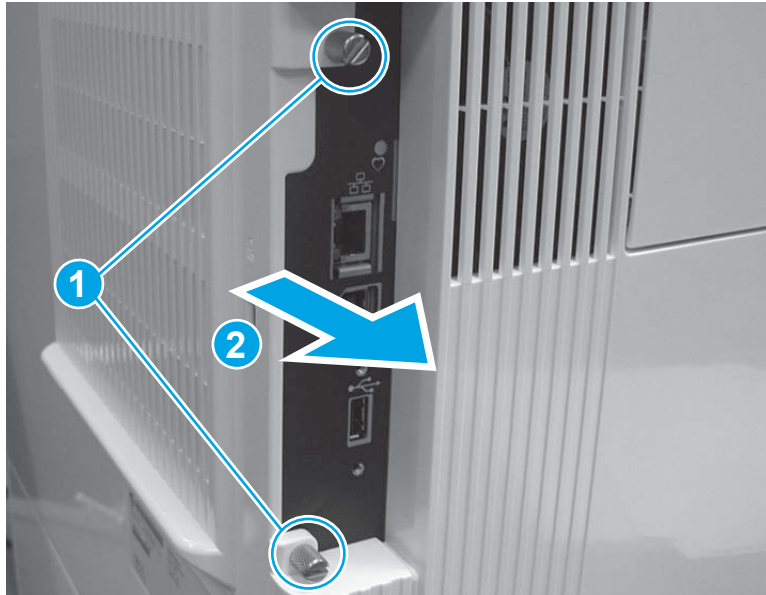

Step 2: Remove the rear upper cover

1. Remove two screws (callout 1).

 **Reinstallation tip:** These two screws are self-tapping screws for plastic. When reinstalling them, rotate the screws counterclockwise to align them with the existing thread pattern, and then carefully turn them clockwise to tighten. Do not overtighten. This will prevent stripping the threads inside the screw holes.

Figure 1-4925 Remove two screws



2. Use a small, flat blade screwdriver to release the right edge of the cover.

Figure 1-4926 Release the right edge

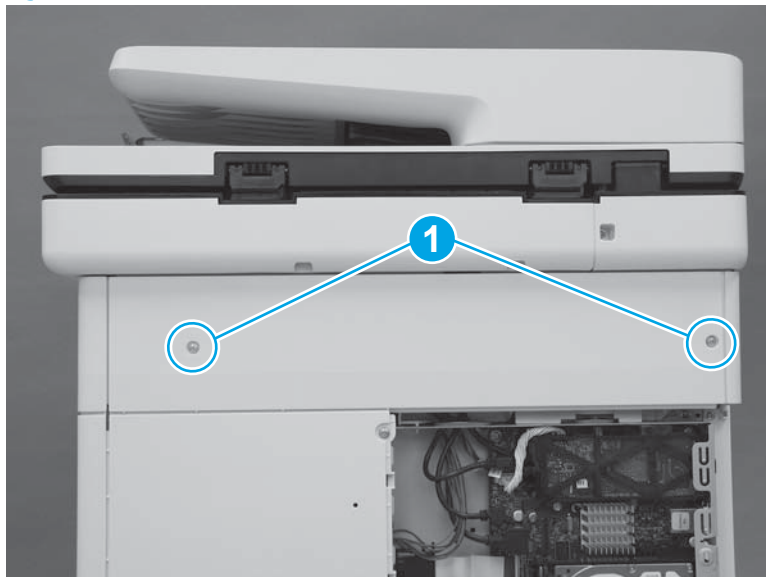
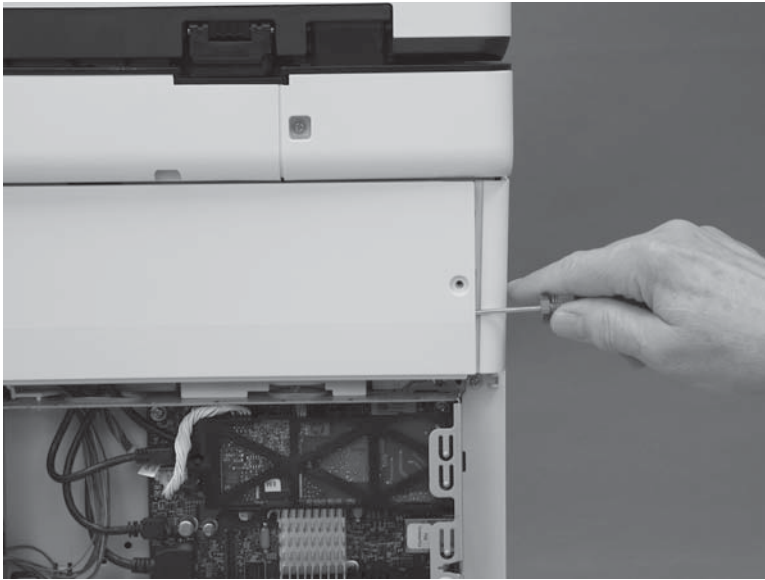

3. Pull the right edge of the cover (callout 1) away from the printer, and then slide the cover to the right (callout 2).

Figure 1-4927 Slide the cover right

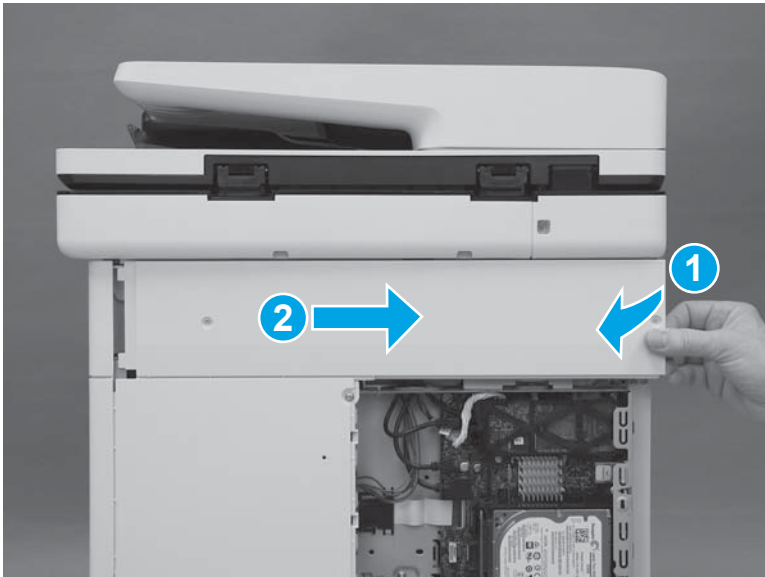

4. Remove the cover.

Figure 1-4928 Remove the cover

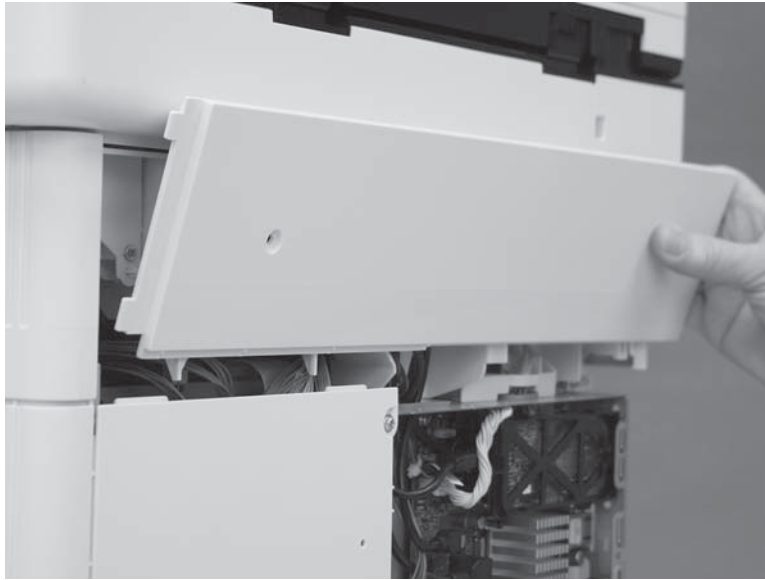

Step 3: Remove the left upper cover

1. At the left side of the printer, release one tab (callout 1).

Figure 1-4929 Release one tab

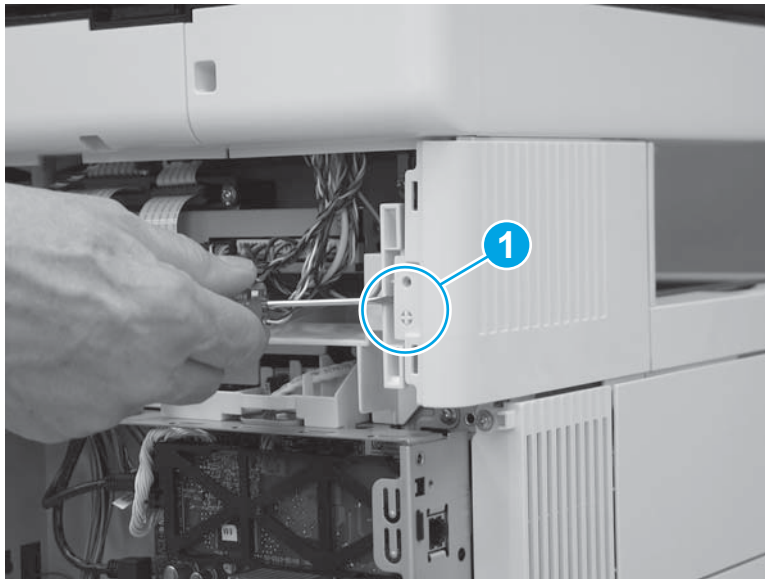

2. Slide the left upper cover toward the back of the printer.

Figure 1-4930 Slide the cover back

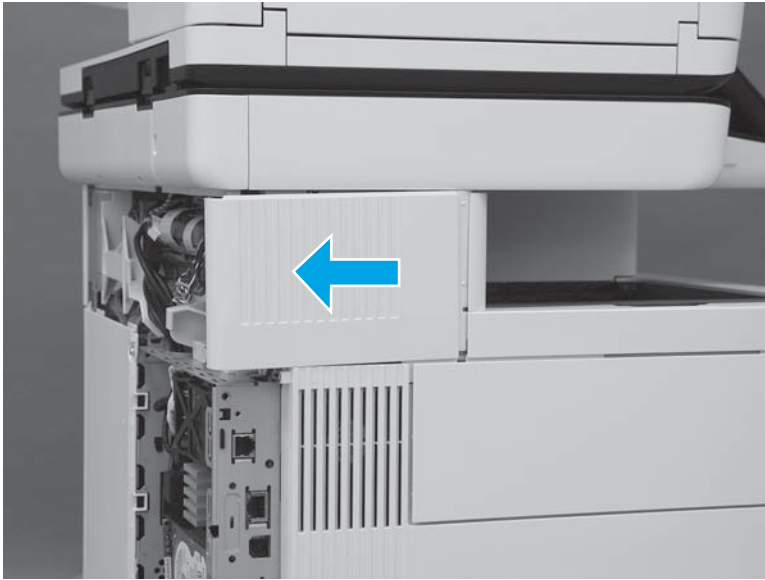

3. Rotate the cover up to remove it.

Figure 1-4931 Remove the left upper cover

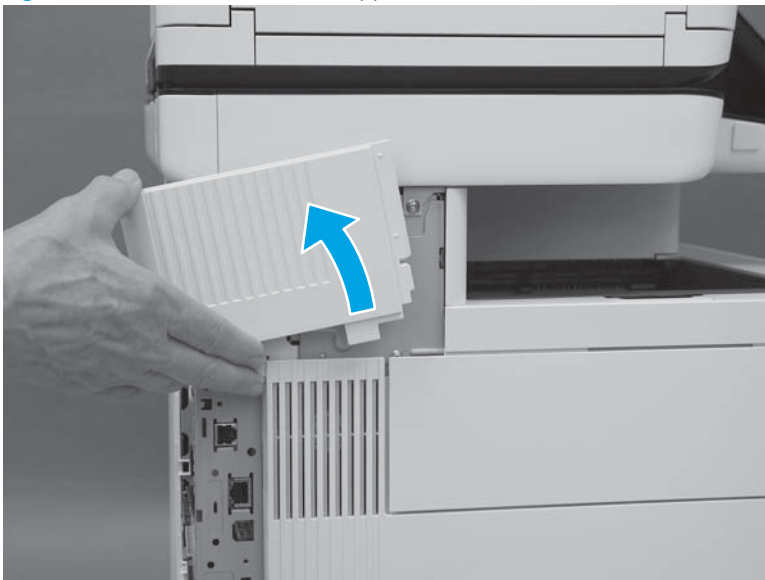

Step 4: Remove the document feeder

1. Remove one screw (callout 1).

 **Reinstallation tip:** This is a self-tapping screw for plastic. When reinstalling, rotate the screw in reverse a few turns to align the threads before installing it. This will prevent stripping the threads inside the hole in the plastic part.

Figure 1-4932 Remove one screw



2. Rotate the cover away from the printer to remove it.

Figure 1-4933 Remove the cover

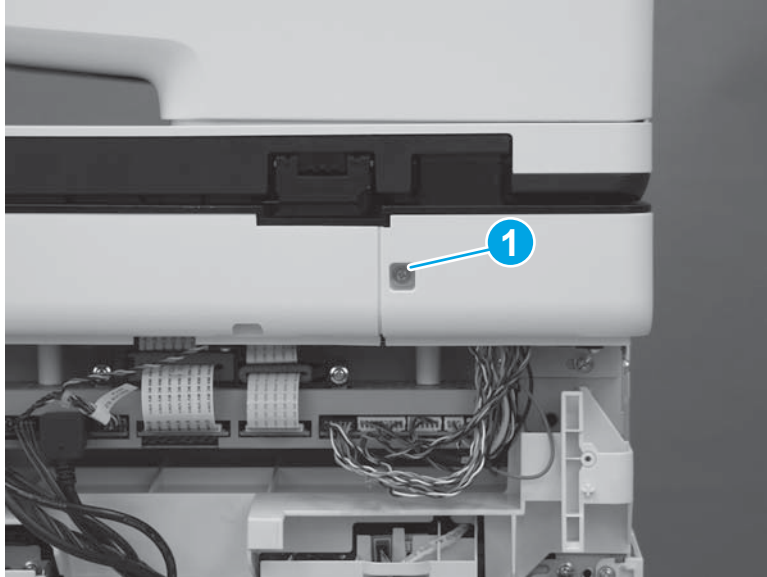
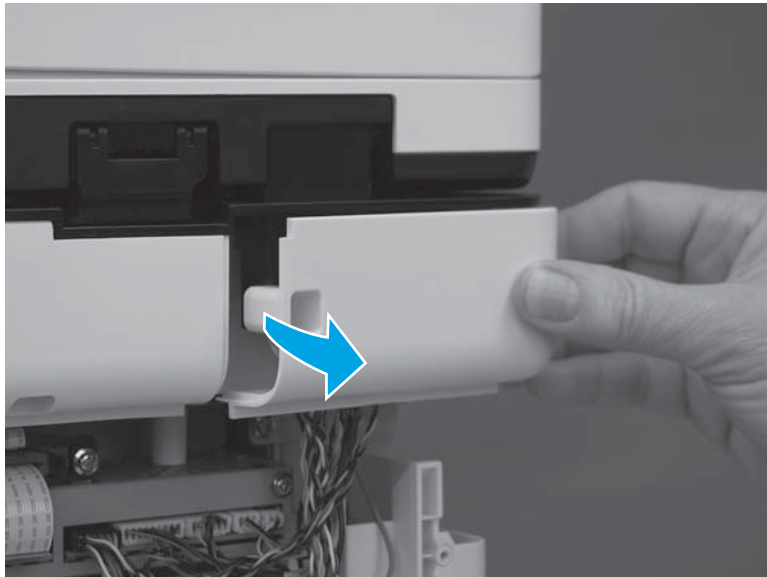

3. Disconnect one flat cable (callout 1), remove one ground screw (callout 2) to release the grounding cable, and then disconnect five connectors (callout 3).

Figure 1-4934 Disconnect the flat cable, ground cable, and connectors

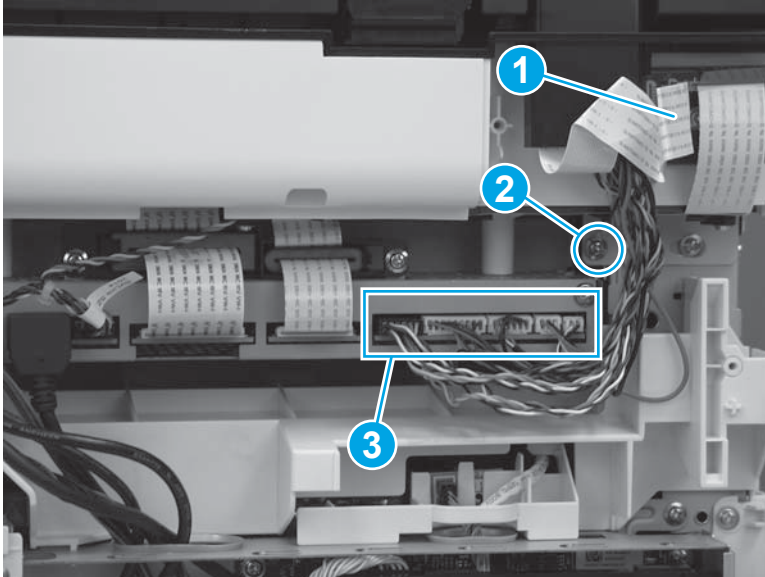

4. Open the document feeder.

Figure 1-4935 Open the document feeder



5. Tilt the document feeder back until it stops (callout 1), and then lift it off of the scanner until it stops (callout 2).

Figure 1-4936 Raise the document feeder



6. Support the document feeder, and then use a small flat-blade screwdriver to release two tabs on the document feeder hinges.

Figure 1-4937 Release two tabs



7. Lift the document feeder up top remove it.

 **NOTE:** While removing the document feeder, carefully pass the wire harnesses and the FFC through the opening in the scanner.

Figure 1-4938 Remove the document feeder



Step 5: Unpack the replacement assembly

Unpack the replacement assembly from the packaging.

For complete information on HP's recycling programs, go to [Product return and recycling](#).

 **NOTE:** HP recommends responsible disposal of the defective part.

Figure 1-4939 Recycle and unpack



Step 6: Install the document feeder

1. Pass the flat cable and wire harnesses on the replacement document feeder through the hole in the scanner chassis (callout 1), and then align the hinges (callout 2) with the slots (callout 3) in the chassis.

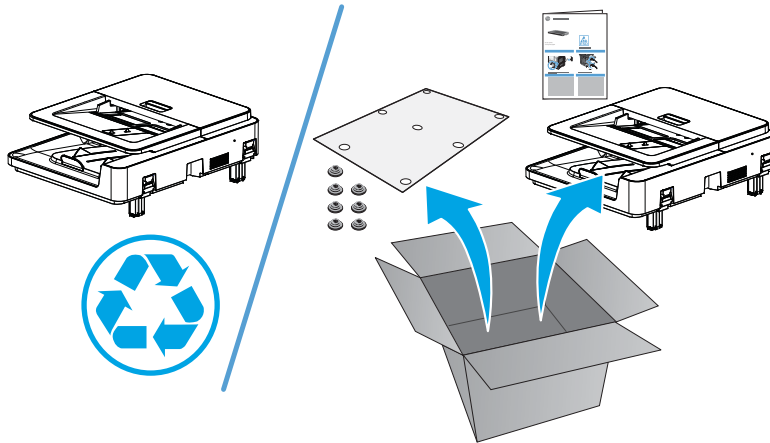
Figure 1-4940 Install the document feeder

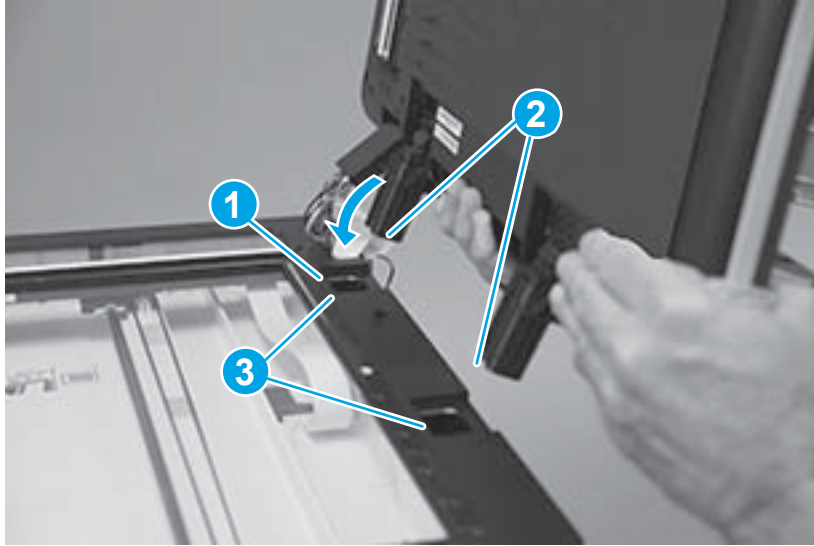

2. Continue to pass the flat cable and wire harnesses through the opening in the chassis (callout 1), and then insert the hinges (callout 2) into the slots.

⚠ CAUTION: Do not damage the flat cable or wire harnesses when the cable guide (callout 1) is installed in its slot.

Figure 1-4941 Lower the document feeder



3. Install the seven retention clips (supplied in this kit) in the document feeder. Position the clip (callout 1) in the opening (callout 2) in the document feeder. Repeat this step for the remaining retention clips.

Figure 1-4942 Install the retention clip

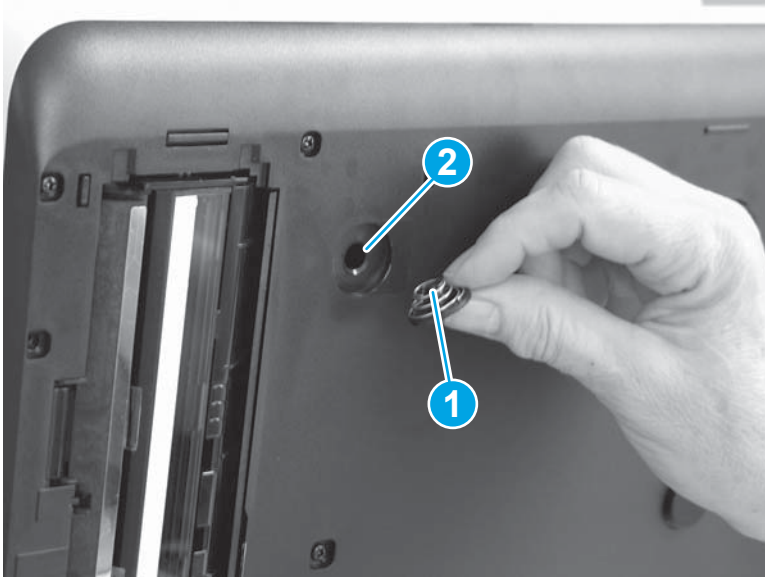

4. Press the clip to make sure it is securely installed. Repeat this step for the remaining retention clips.

Figure 1-4943 Press the retention clip

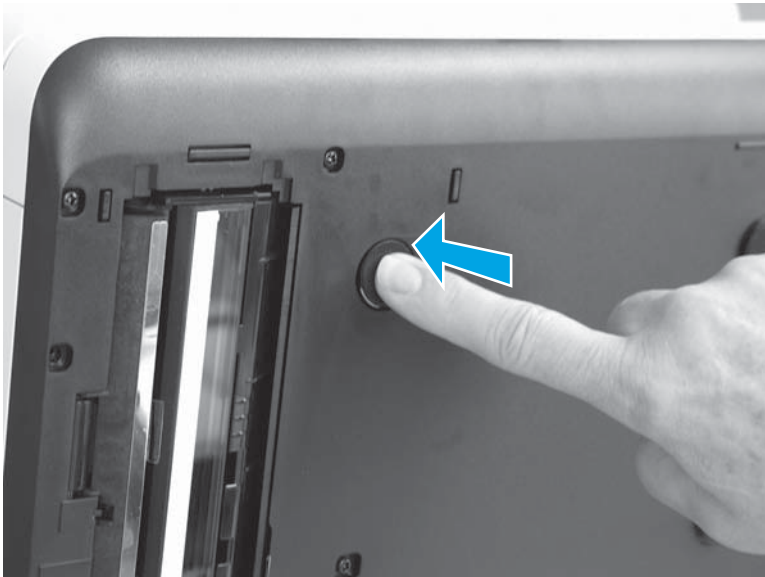

5. Place the replacement white backing (supplied in this kit), on the flatbed scanner glass as shown.

 **NOTE:** Place the corner of the backing that does not have a hook-and-loop fastener in the upper-left corner of the scanner glass.

Figure 1-4944 Install the white backing



6. Close the document feeder to attach the white backing.

Figure 1-4945 Attach the white backing

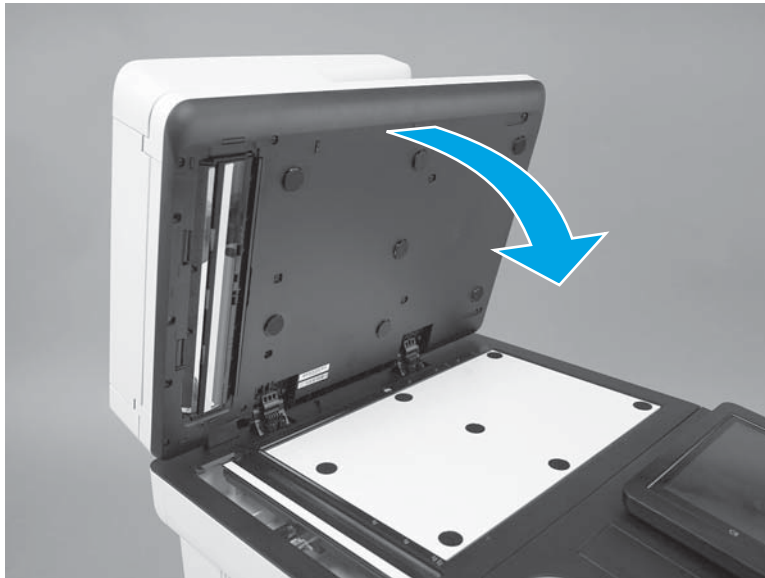

7. Open the document feeder and make sure that the white backing is securely attached.

Figure 1-4946 Check the white backing



8. Close the document feeder.

Figure 1-4947 Close the document feeder



9. Connect one flat cable (callout 1), install the grounding cable behind one ground screw (callout 2), and then connect five connectors (callout 3).

Figure 1-4948 Connect the flat cable, ground cable, and connectors

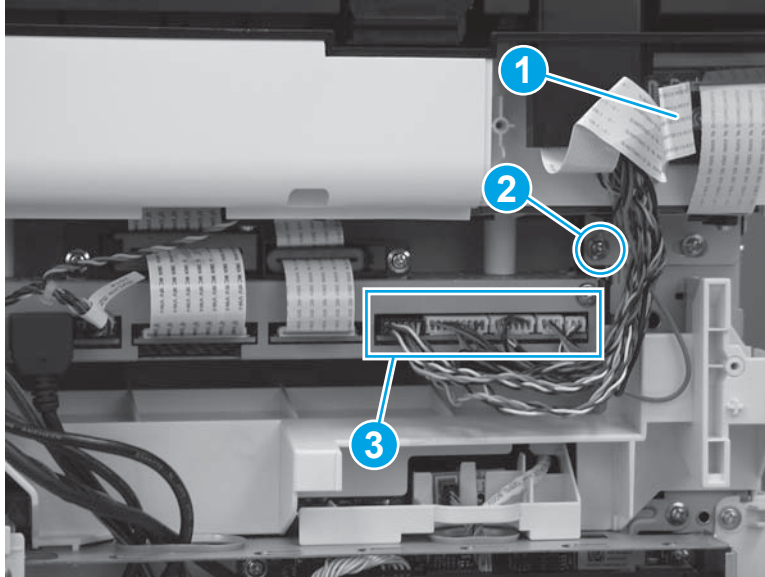

10. Position the tabs (callout 1) on the cover in the slots (callout 2) in the printer.

Figure 1-4949 Position the tabs

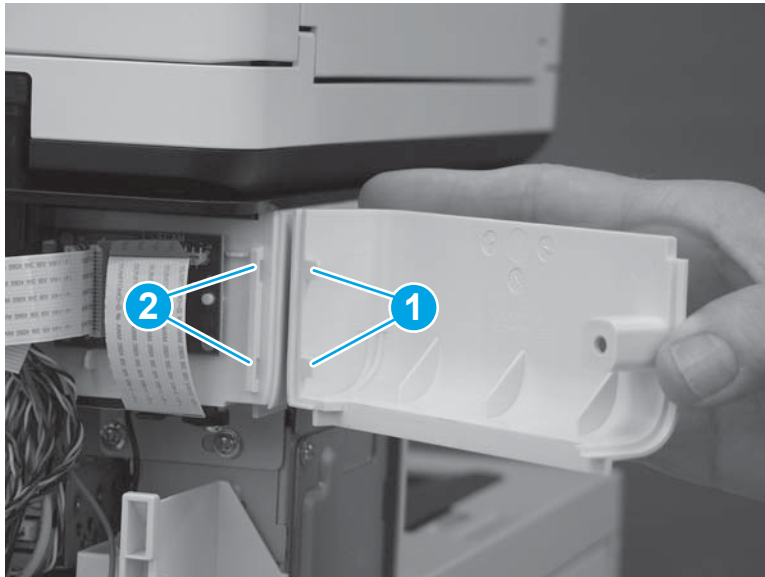

11. Rotate the cover toward the printer to install it.

Figure 1-4950 Install the cover

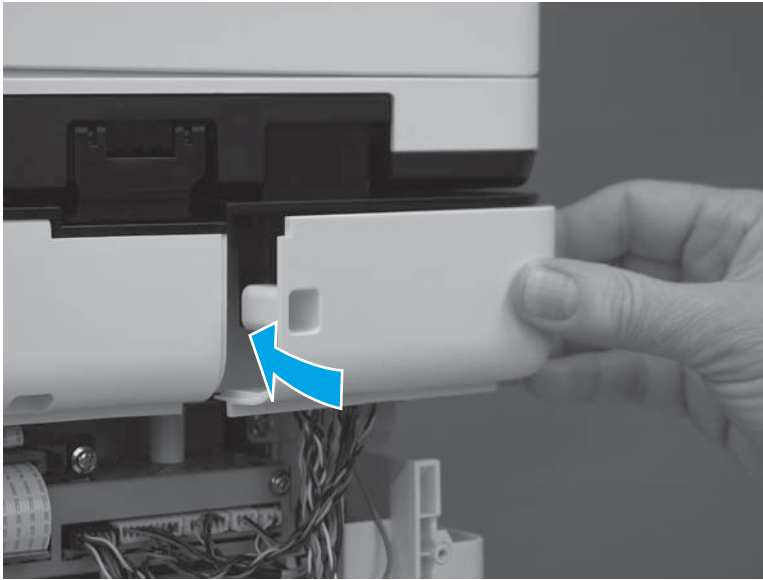

12. Install one screw (callout 1).

 **IMPORTANT:** This is a self-tapping screw for plastic. Rotate the screw in reverse a few turns to align the threads before installing it. This will prevent stripping the threads inside the hole in the plastic part.

Figure 1-4951 Install one screw



Step 7: Install the left upper cover

1. Position the tab (callout 1) on the lower edge of the cover behind the left cover (callout 2).

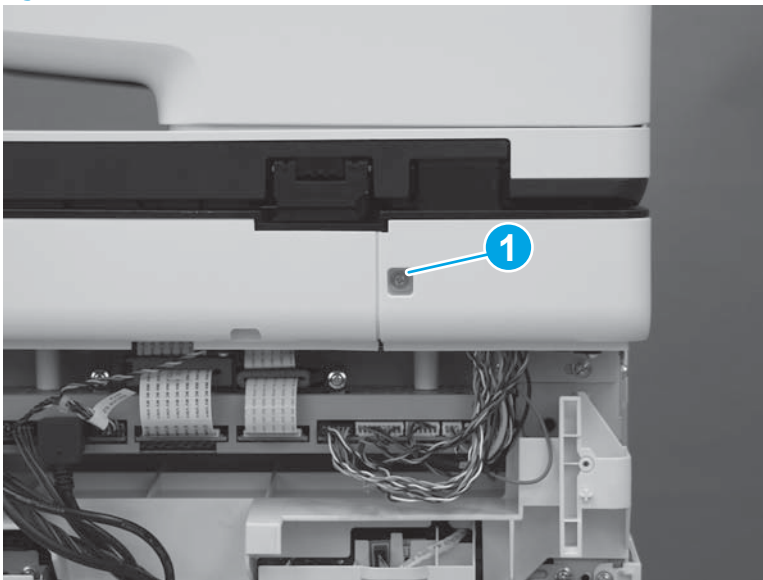
Figure 1-4952 Position the tab

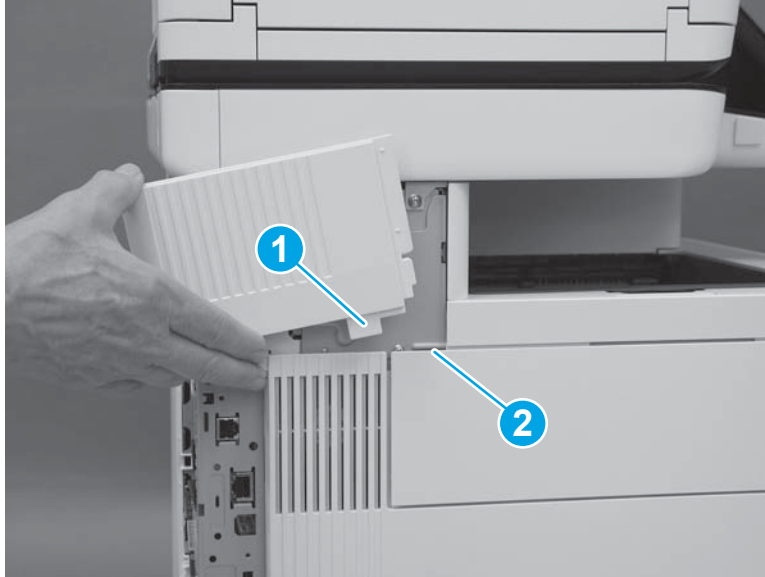

2. Slide the cover toward the front of the printer to install it. Make sure that the edge (callout 1) of the cover fits behind the edge (callout 2) of the top rear cover.

Figure 1-4953 Slide the cover

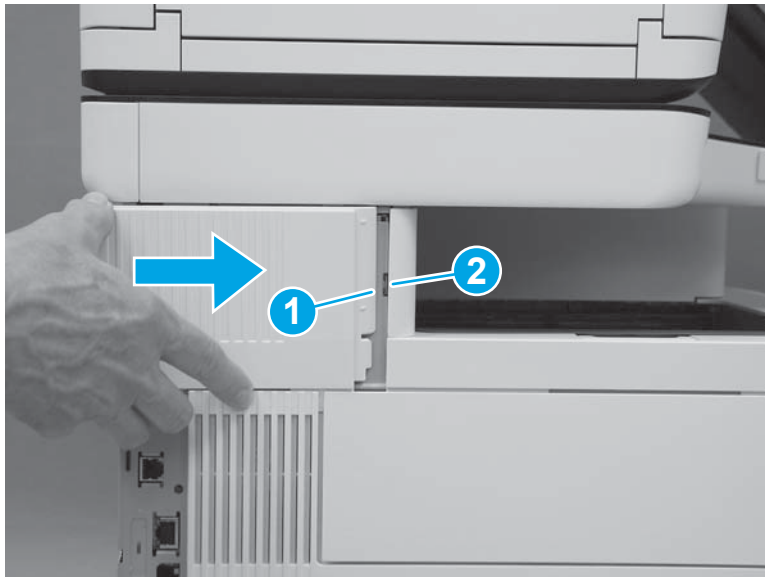

3. Make sure that the tab (callout 1) is fully installed.

Figure 1-4954 Check the tab

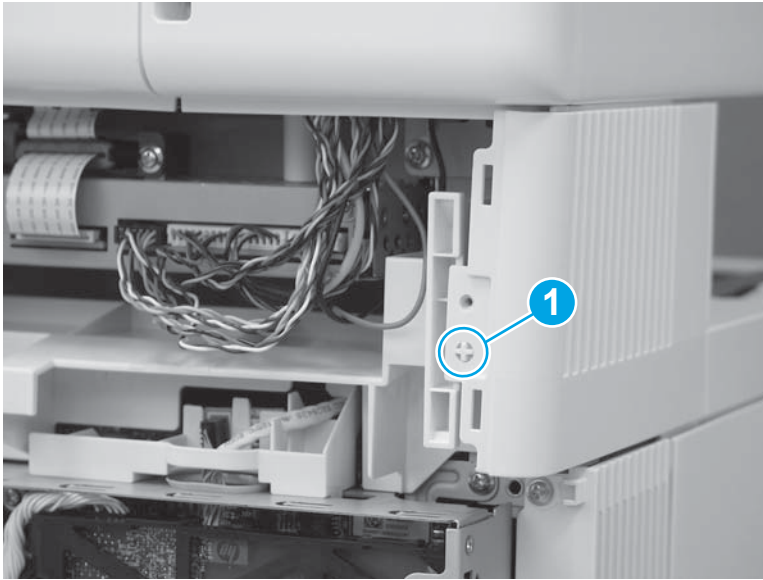

Step 8: Install the rear upper cover

1. Align the ridge (callout 1) on the lower edge of the rear upper cover in front of the tabs (callout 2) on the top edge of the rear cover.

Figure 1-4955 Align the cover

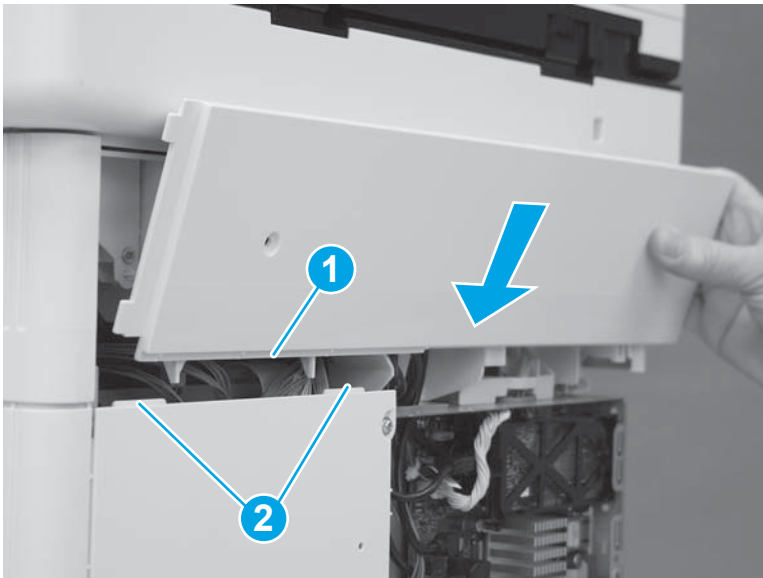

2. Rotate the top of the cover toward the printer.

Figure 1-4956 Rotate the top of the cover

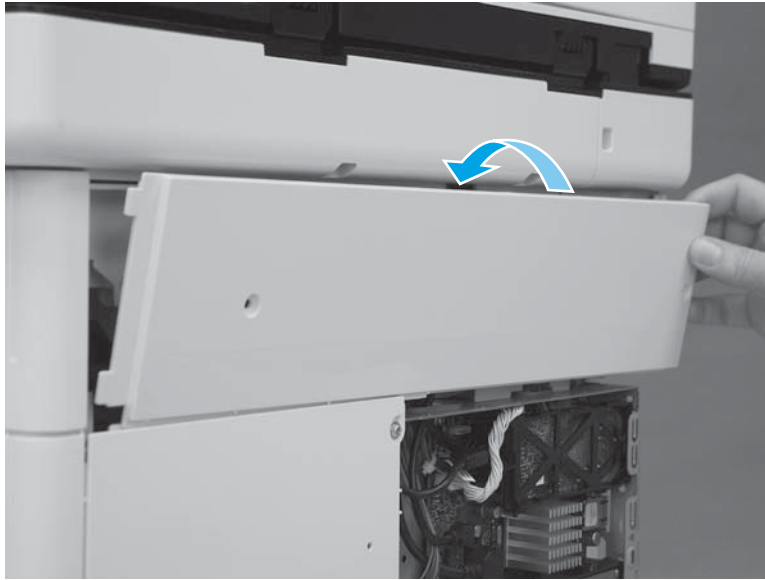

3. Slide the cover to the left (callout 1). Make sure that the tabs (callout 2) on the upper rear cover slide behind the edge (callout 3) of the right upper cover. Make sure that the cover is fully seated.

Figure 1-4957 Slide the cover

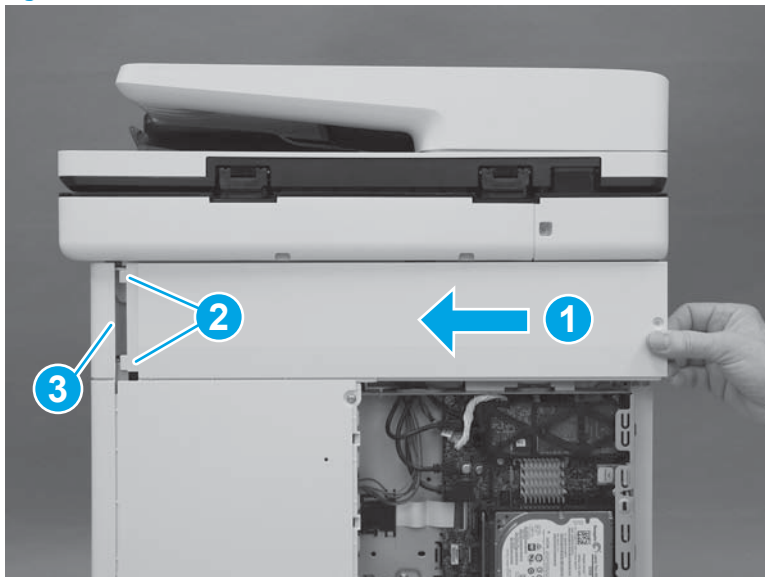

4. Install two screws (callout 1).

 **IMPORTANT:** These two screws are self-tapping screws for plastic. Rotate them counterclockwise to align them with the existing thread pattern, and then carefully turn them clockwise to tighten. Do not overtighten. This will prevent stripping the threads inside the screw holes.

Figure 1-4958 Install two screws



Step 9: Install the formatter cover

- ▲ Slide the cover onto the printer (callout 1) to install it.

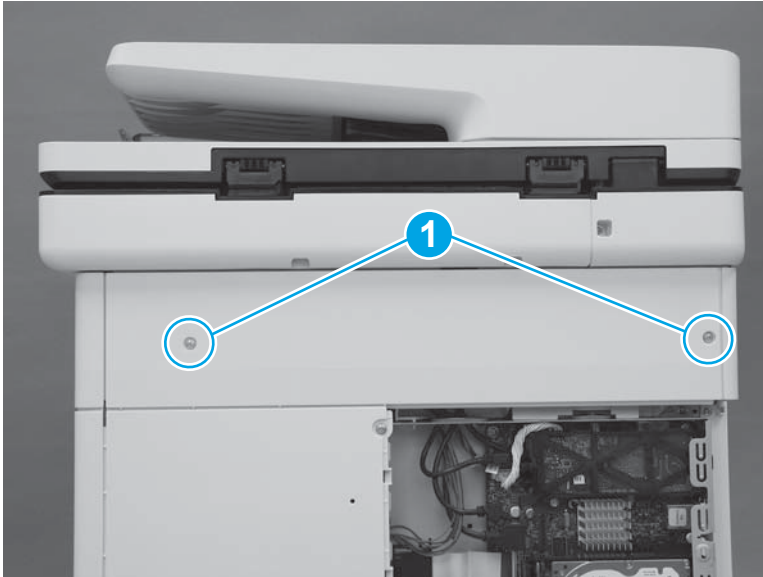
 **NOTE:** Make sure that the tabs on the formatter cover align with the slots provided in the printer (callout 2). Tighten the two thumbscrews (callout 3).

 **TIP:** If needed, use the edge of a coin to turn the thumbscrews.

Figure 1-4959 Install the cover

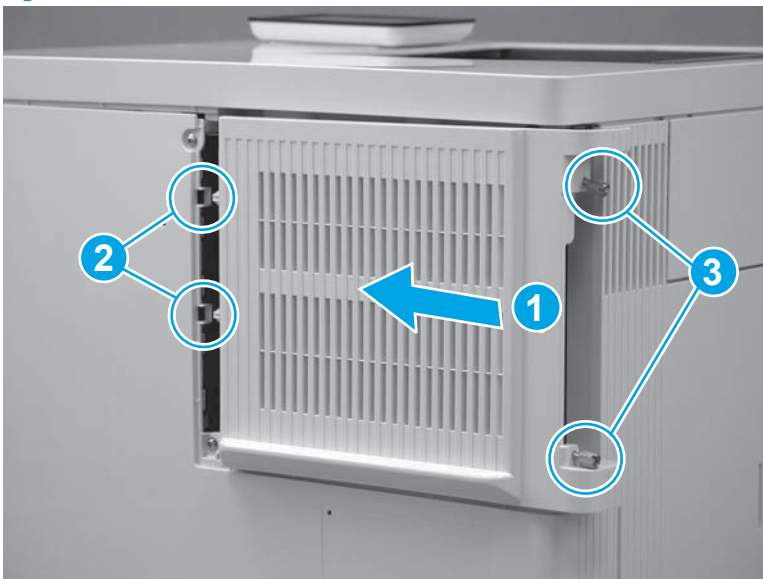

Step 10: Reset the firmware counter

1. From the Home screen on the control panel, scroll to and touch the [Device Maintenance](#) button.
2. Scroll to and touch the [Service](#) button.
3. On the sign-in screen, select the [Service Access Code](#) option from the drop-down list.
4. Enter the following service access code for this printer: 11057715.
5. Scroll to and touch the [Cycle Counts](#) Item.
6. Reset the following items:
 - [Document Feeder Kit Interval](#); set to zero
 - [ADF Count](#); set to zero

Removal and replacement: Scanner control board (SCB) (M577)

- [Introduction](#)
- [Step 1: Remove the formatter cover](#)
- [Step 2: Remove the rear upper cover](#)
- [Step 3: Remove the scanner control board \(SCB\)](#)
- [Step 4: Unpack the replacement assembly](#)
- [Step 5: Install the SCB](#)
- [Step 6: Install the rear upper cover](#)
- [Step 7: Install the formatter cover](#)

Introduction

This document provides the procedures to remove and replace the scanner control board (SCB) (M577).

Before performing service

Turn the printer power off

- Disconnect the power cable.

⚠ WARNING! To avoid damage to the printer, turn the printer off, wait 30 seconds, and then remove the power cord before attempting to service the printer.

Use the table below to identify the correct part number for your printer. To order the part, go to www.hp.com/buy/parts.

Scanner control board (M577) part number

B5L47-67903Scanner control board (M577) kit with instruction guide

Required tools

- No special tools are required for this assembly.

After performing service

Turn the printer power on

- Connect the power cable.
- Use the power switch to turn the power on.

Post service test

Print a configuration page to make sure that the printer is functioning correctly.

Step 1: Remove the formatter cover

1. Locate the formatter cover.

Figure 1-4960 Locate the formatter cover

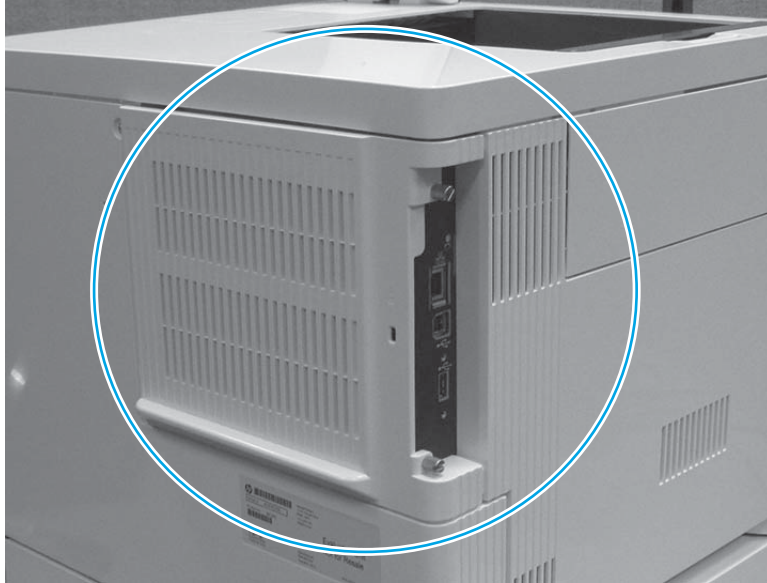

2. Loosen the two thumbscrews (callout 1). Grasp the two thumbscrews, and then slide the cover away from the printer (callout 2) to remove it.

 **TIP:** If needed, use the edge of a coin to turn the thumbscrews.

Figure 1-4961 Loosen the thumbscrews

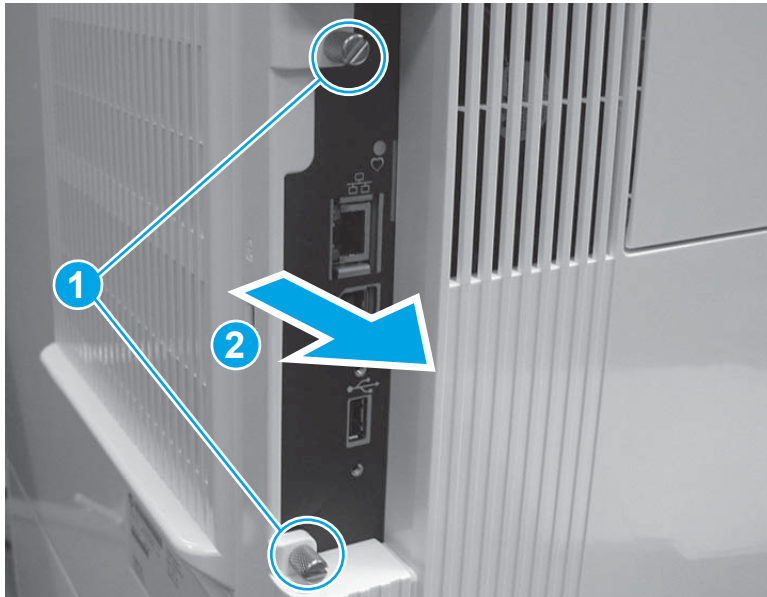

Step 2: Remove the rear upper cover

1. Remove two screws (callout 1).

 **Reinstallation tip:** These two screws are self-tapping screws for plastic. When reinstalling them, rotate the screws counterclockwise to align them with the existing thread pattern, and then carefully turn them clockwise to tighten. Do not overtighten. This will prevent stripping the threads inside the screw holes.

Figure 1-4962 Remove two screws



2. Use a small, flat blade screwdriver to release the right edge of the cover.

Figure 1-4963 Release the right edge

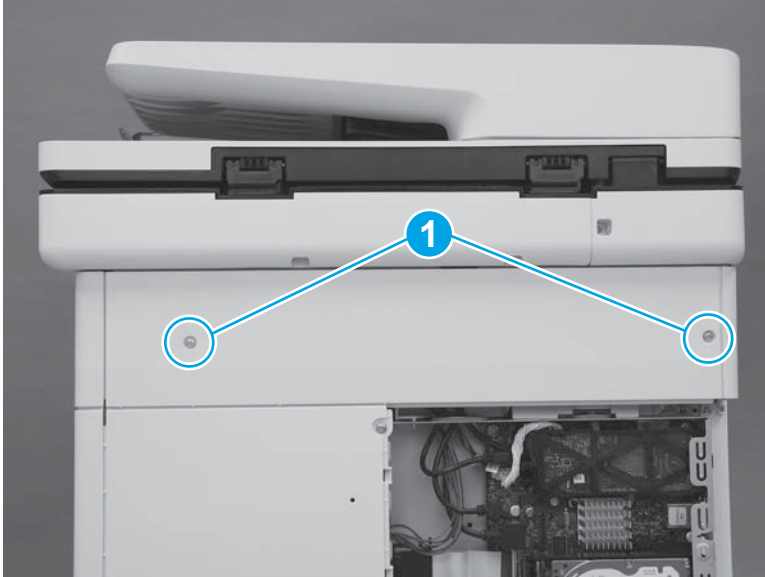
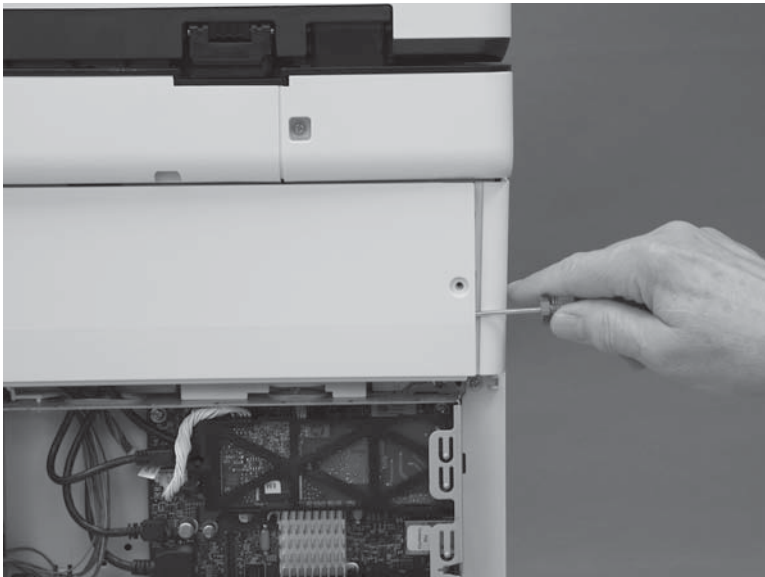

3. Pull the right edge of the cover (callout 1) away from the printer, and then slide the cover to the right (callout 2).

Figure 1-4964 Slide the cover right

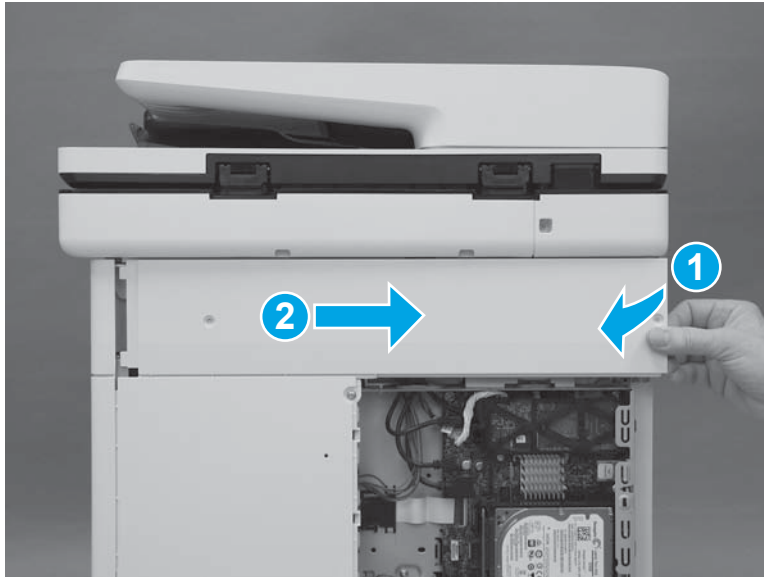

4. Remove the cover.

Figure 1-4965 Remove the cover

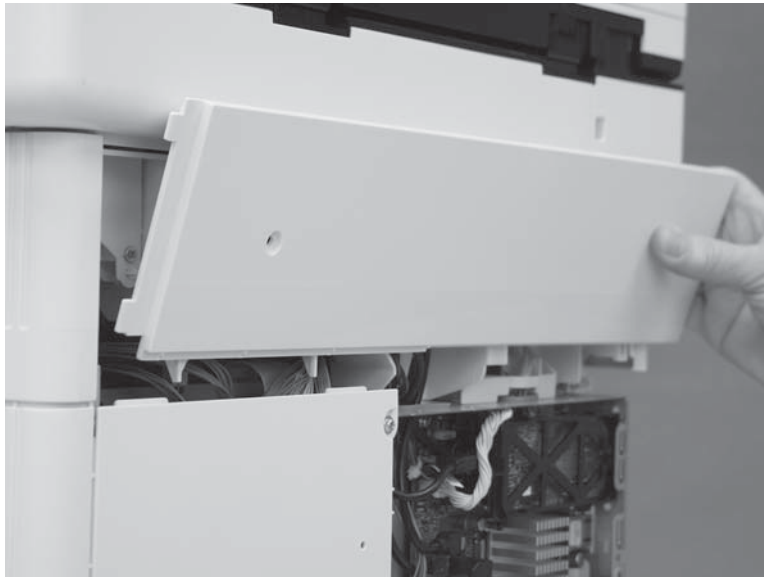

Step 3: Remove the scanner control board (SCB)

1. Disconnect all of the connectors (callout 1) from the SCB.

 **Reinstallation tip:** There are eight wire-harness connectors, two flat cables, and one high-definition multimedia interface (HDMI) cable connector.

Figure 1-4966 Disconnect all of the connectors



2. Disconnect three connectors (callout 1) from the formatter, and then release three black cables through the opening (callout 2) in the formatter case.

Figure 1-4967 Disconnect three connectors

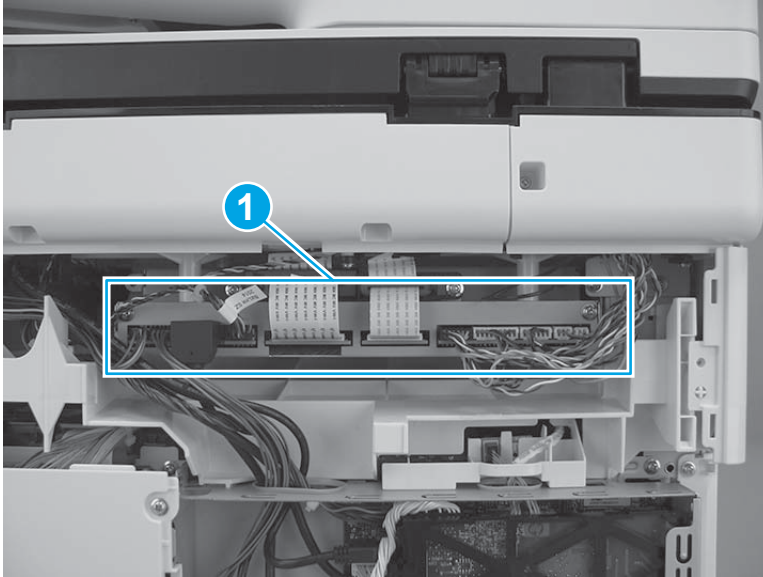
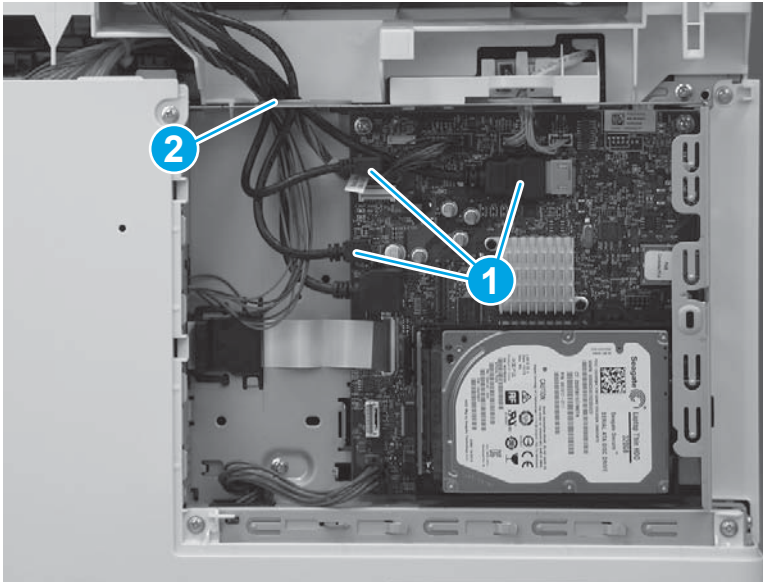

3. Remove two screws (callout 1).

Figure 1-4968 Remove two screws

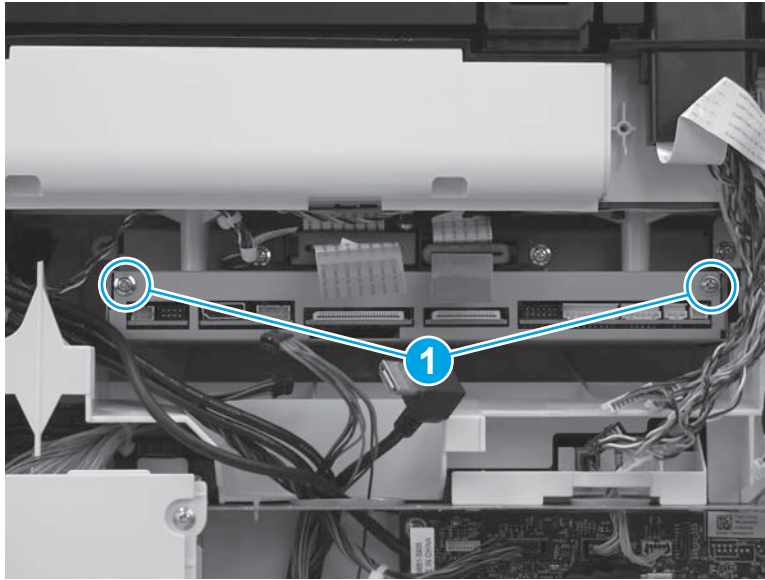

4. Remove the cables (callout 1) from the guide (callout 2), and then lower the SCB (callout 3).

Figure 1-4969 Slide the SCB out

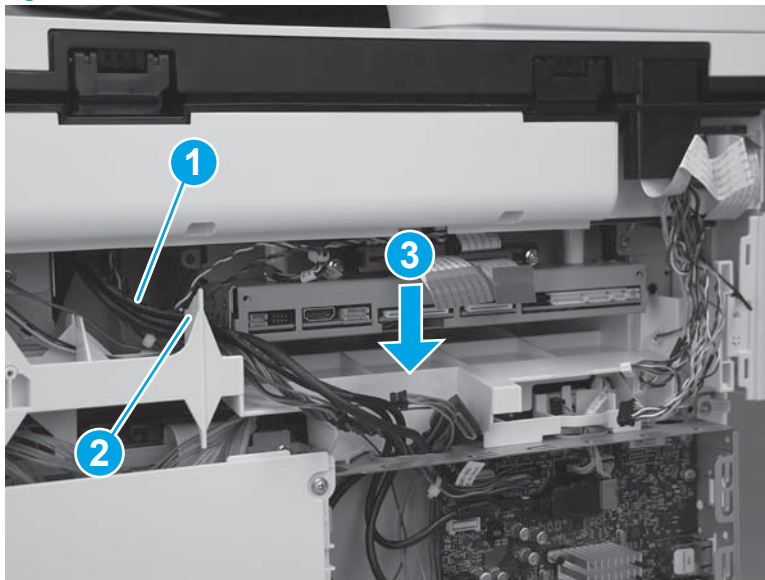

5. Rotate the SCB up and out of the printer. Make sure that the heat sink (callout 1) on the SCB does not get caught on the edge of the sheet metal (callout 2).

Figure 1-4970 Remove the SCB

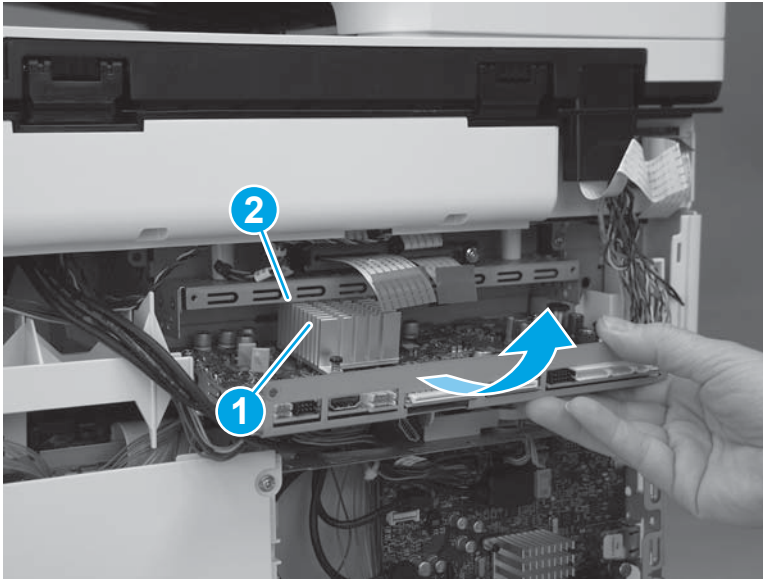

Step 4: Unpack the replacement assembly

Unpack the replacement assembly from the packaging.

For complete information on HP's recycling programs, go to [Product return and recycling](#).

 **NOTE:** HP recommends responsible disposal of the defective part.

Figure 1-4971 Recycle and unpack

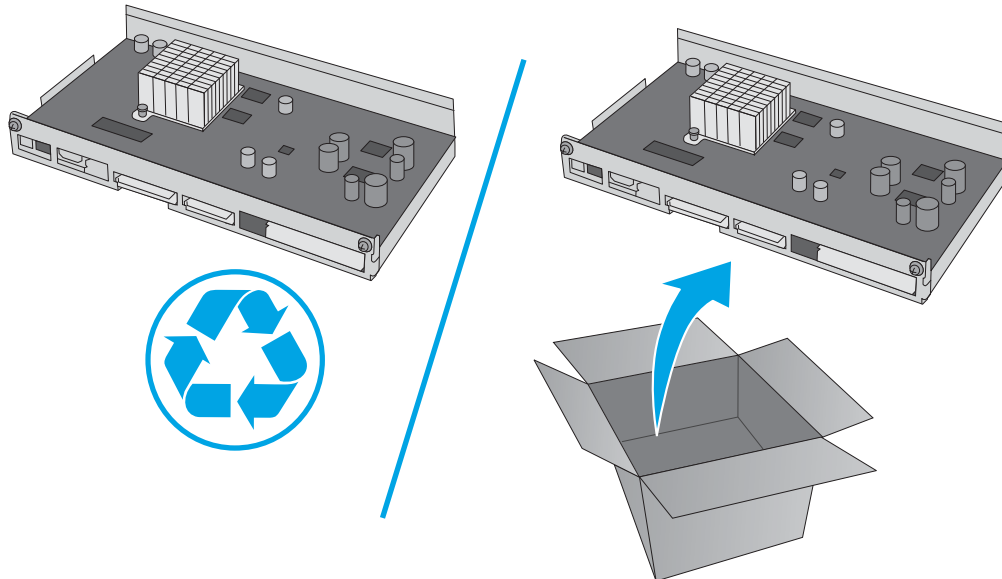

Step 5: Install the SCB

1. Align the slots on the SCB (callout 1) with the tabs (callout 2) inside the printer.

Figure 1-4972 Install the SCB

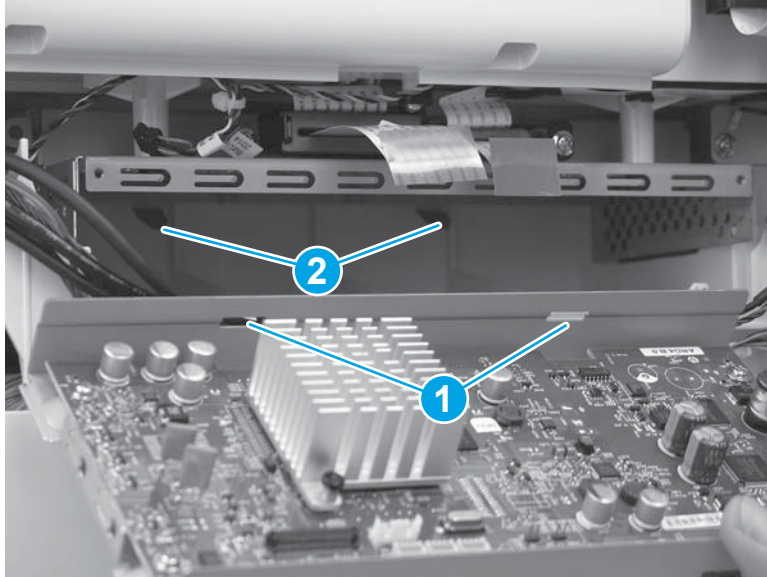

2. Slide the SCB into the printer until it stops. Make sure that the heat sink (callout 1) on the SCB does not get caught on the edge of the sheet metal (callout 2).

Figure 1-4973 Slide the SCB in

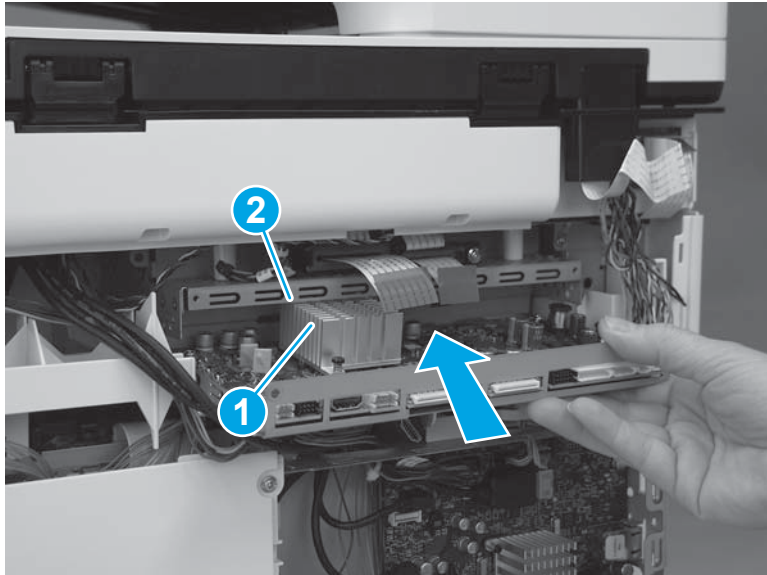

3. Raise the SCB up (callout 1), and then install the cables (callout 2) in the guide (callout 3).

Figure 1-4974 Raise the SCB and install cables

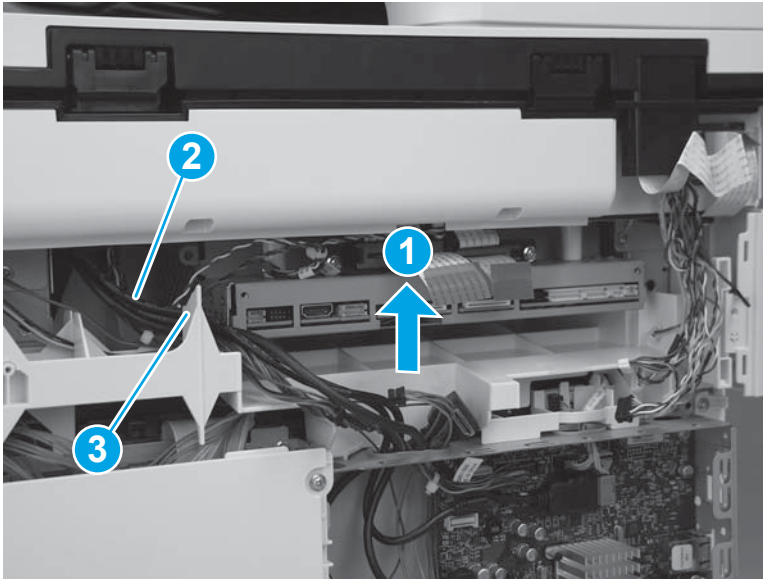

4. Install two screws (callout 1).

Figure 1-4975 Install two screws

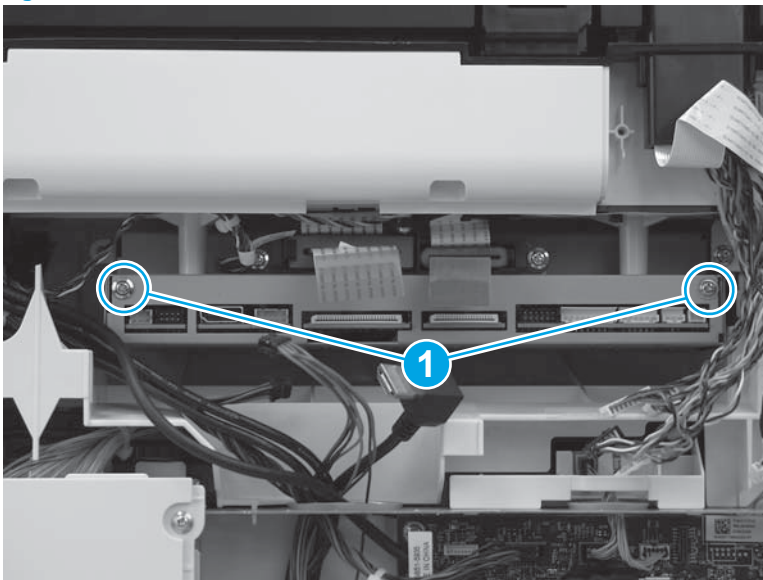

5. Install three black cables through the opening in the formatter case (callout 1), and then connect three connectors on the formatter (callout 2).

Figure 1-4976 Connect three connectors

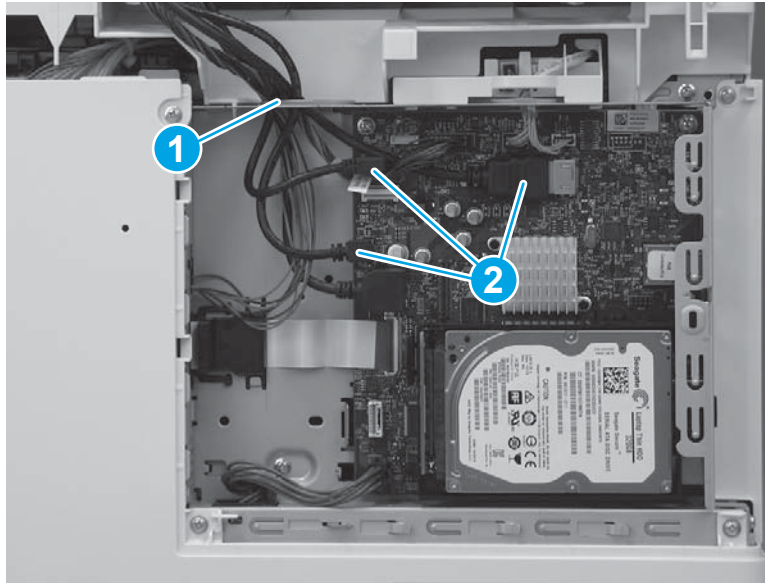

6. Connect all of the connectors (callout 1) to the SCB.

 **Reinstallation tip:** There are eight wire-harness connectors, two flat cables, and one high-definition multimedia interface (HDMI) cable connector.

Figure 1-4977 Connect all of the connectors



Step 6: Install the rear upper cover

1. Align the ridge (callout 1) on the lower edge of the rear upper cover in front of the tabs (callout 2) on the top edge of the rear cover.

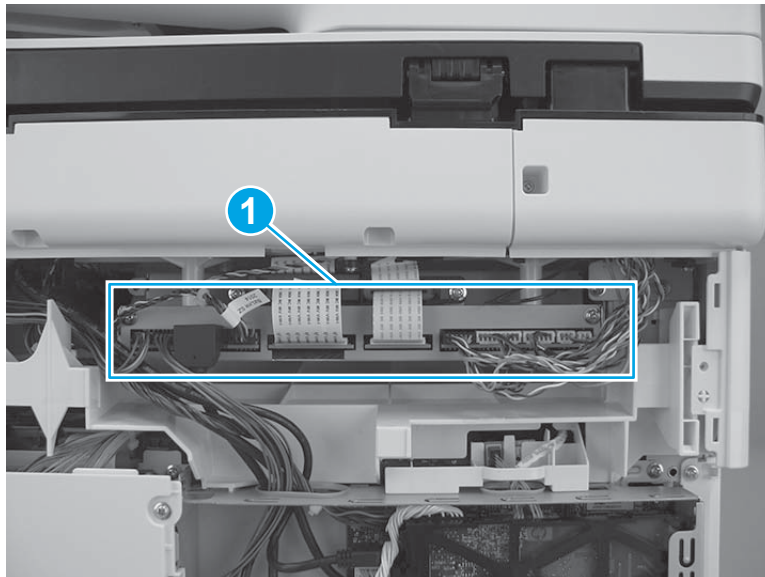
Figure 1-4978 Align the cover

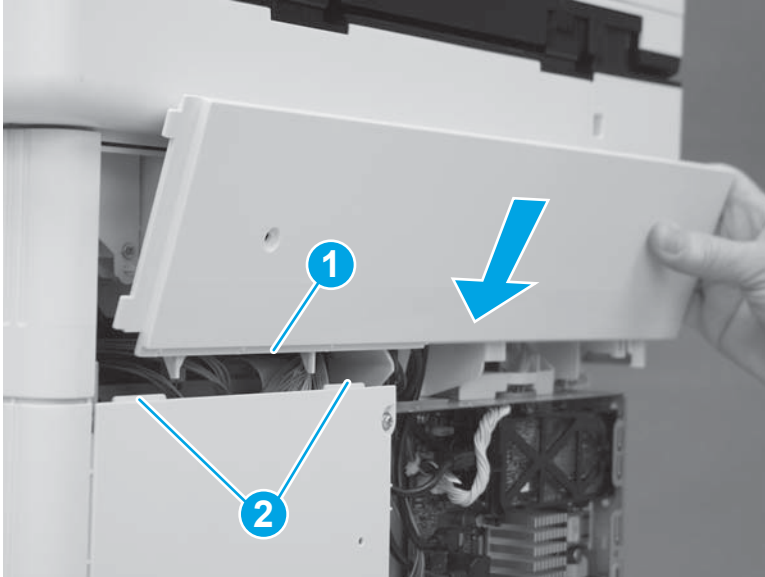

2. Rotate the top of the cover toward the printer.

Figure 1-4979 Rotate the top of the cover

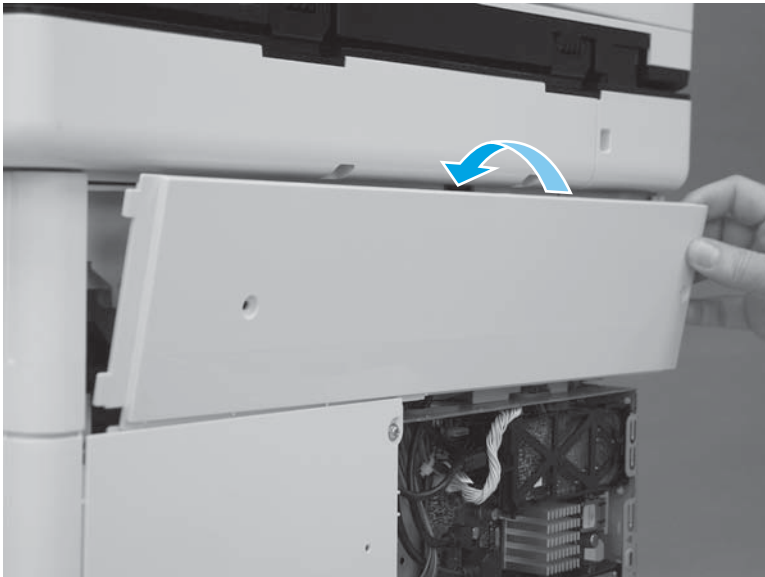

- Slide the cover to the left (callout 1). Make sure that the tabs (callout 2) on the upper rear cover slide behind the edge (callout 3) of the right upper cover. Make sure that the cover is fully seated.

Figure 1-4980 Slide the cover

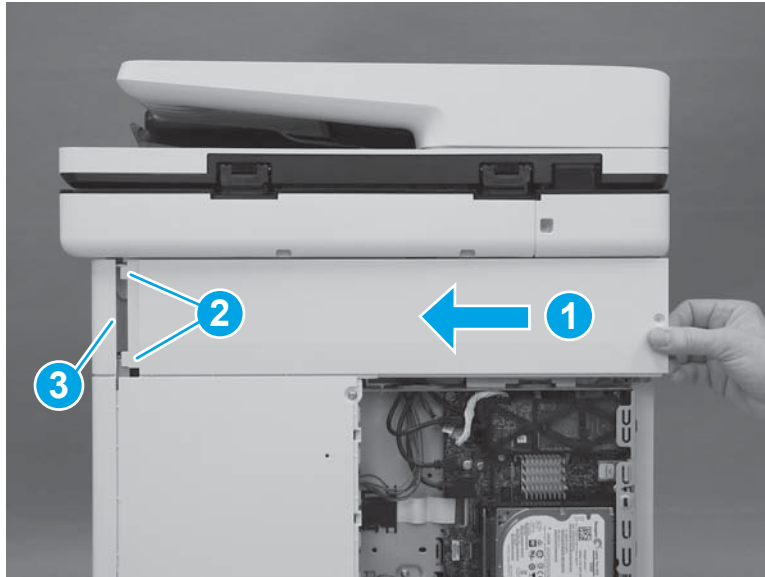

- Install two screws (callout 1).

 **IMPORTANT:** These two screws are self-tapping screws for plastic. Rotate them counterclockwise to align them with the existing thread pattern, and then carefully turn them clockwise to tighten. Do not overtighten. This will prevent stripping the threads inside the screw holes.

Figure 1-4981 Install two screws



Step 7: Install the formatter cover

- Slide the cover onto the printer (callout 1) to install it.

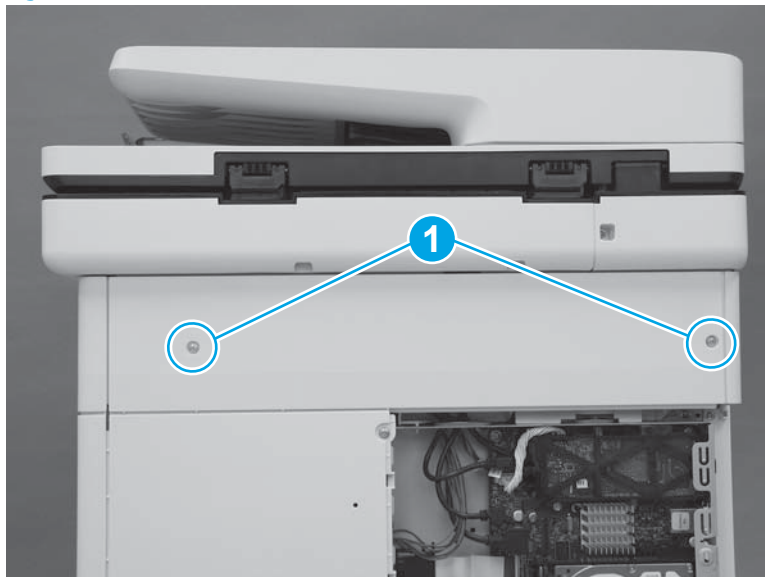
 **NOTE:** Make sure that the tabs on the formatter cover align with the slots provided in the printer (callout 2). Tighten the two thumbscrews (callout 3).

 **TIP:** If needed, use the edge of a coin to turn the thumbscrews.

Figure 1-4982 Install the cover



Removal and replacement: Image scanner (M577)

- [Introduction](#)
- [Step 1: Remove the control-panel cover \(M577\)](#)
- [Step 2: Remove the white backing \(M577\)](#)
- [Step 3: Remove the keyboard \(M577c/z\)](#)
- [Step 4: Remove the control panel \(M577\)](#)
- [Step 5: Remove the formatter cover](#)
- [Step 6: Remove the fax PCA \(M577c/f/z\)](#)
- [Step 7: Remove the rear upper cover \(M577\)](#)
- [Step 8: Remove the left upper cover \(M577\)](#)
- [Step 9: Remove the right front upper cover \(M577dn\)](#)
- [Step 10: Remove the stapler cover assembly \(M577c/f/z\)](#)
- [Step 11: Remove the document feeder \(M577\)](#)
- [Step 12: Remove the scanner control board \(SCB\) \(M577\)](#)
- [Step 13: Remove the image scanner assembly \(M577\)](#)
- [Step 14: Unpack the replacement assembly](#)
- [Step 15: Install the image scanner assembly \(M577\)](#)
- [Step 16: Install the scanner control board \(M577\)](#)
- [Step 17: Install the document feeder \(M577\)](#)
- [Step 18: Install the stapler cover assembly \(M577c/f/z\)](#)
- [Step 19: Install the right front upper cover \(M577dn\)](#)
- [Step 20: Install the left upper cover \(M577\)](#)
- [Step 21: Install the rear upper cover \(M577\)](#)
- [Step 22: Install the fax PCA \(M577c/f/z\)](#)
- [Step 23: Install the formatter cover](#)
- [Step 24: Install the control panel \(M577\)](#)
- [Step 25: Install the keyboard \(M577c/z\)](#)
- [Step 26: Install the white backing \(M577\)](#)
- [Step 27: Install the control-panel cover \(M577\)](#)

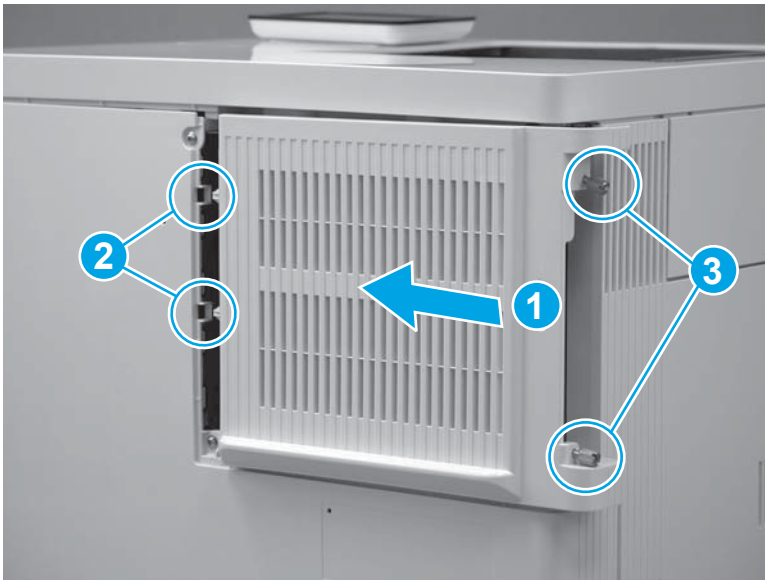
Introduction

This document provides the procedures to remove and replace the image scanner.

Before performing service

Turn the printer power off

- Disconnect the power cable.

 **WARNING!** To avoid damage to the printer, turn the printer off, wait 30 seconds, and then remove the power cord before attempting to service the printer.

Use the table below to identify the correct part number for your printer. To order the part, go to www.hp.com/buy/parts.

Image scanner part number	
---------------------------	--

B5L46-67904

Image scanner whole unit kit with instruction guide

Required tools

- Small flat-blade screwdriver.
- #2 Phillips screwdriver with a magnetic tip.

After performing service

Turn the printer power on

- Connect the power cable.
- Use the power switch to turn the power on.

Post service test

Print a configuration page, and then make a copy using the flatbed glass to make sure that it is properly functioning.

Print a configuration page, and then make a copy using the document feeder to make sure that it is properly functioning.

Step 1: Remove the control-panel cover (M577)

1. Open the document feeder (callout 1).

 **NOTE:** If the control panel is not fully tilted forward, tilt it forward now until it stops (callout 2).

Figure 1-4983 Open the document feeder



2. Beginning at the right side of the control-panel cover, carefully release five tabs along the top edge of the cover.

 **NOTE:** The thin, black plastic cover will separate from the white plastic control-panel base.

Figure 1-4984 Release five tabs



3. Continue to lift the top edge of the cover away from the printer, and then remove the cover.

Figure 1-4985 Remove the cover



Step 2: Remove the white backing (M577)

 **IMPORTANT:** When a replacement image scanner is installed, the white backing on the document feeder must be removed, and then a replacement white backing (supplied in the kit) must be installed.

1. Remove the white backing.

Figure 1-4986 Remove the white backing



2. One or more of the retention clips (callout 1) that fit in the openings (callout 2) in the document feeder might remain attached to the white backing when it is removed. If this happens, remove the clip from the white backing.

 **NOTE:** If none of the retention clips remain attached to the white backing, skip the remaining sub-steps in this removal procedure.

Figure 1-4987 Check the retention clips



3. If a spring comes off of a retention clip, make sure that it is correctly repositioned on the clip.

 **NOTE:** If any of the retention clips or springs are damaged, replace them with the clips supplied in this kit.

Figure 1-4988 Check the retention clip spring



4. Install the clip (callout 1) in the opening (callout 2) in the document feeder.

Figure 1-4989 Install the retention clip

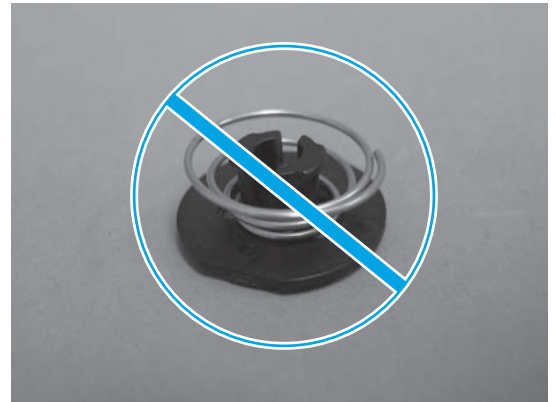
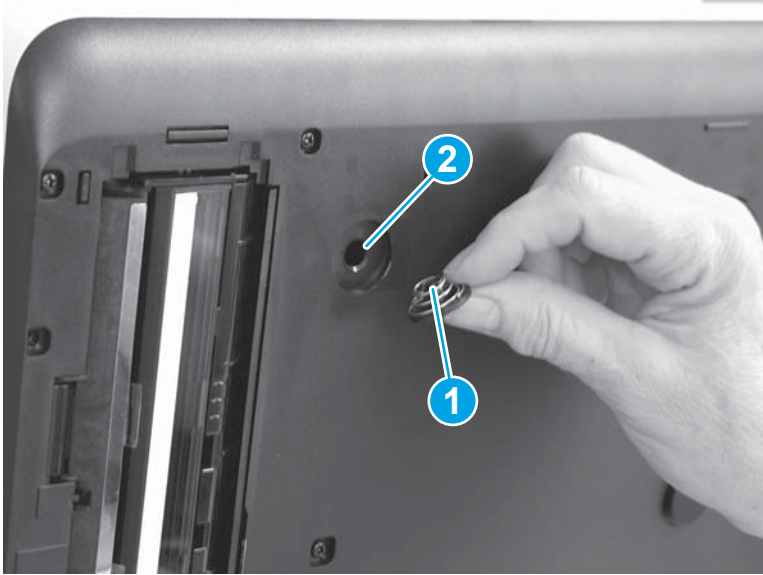

5. Press the clip to make sure it is securely installed.

Figure 1-4990 Press the retention clip

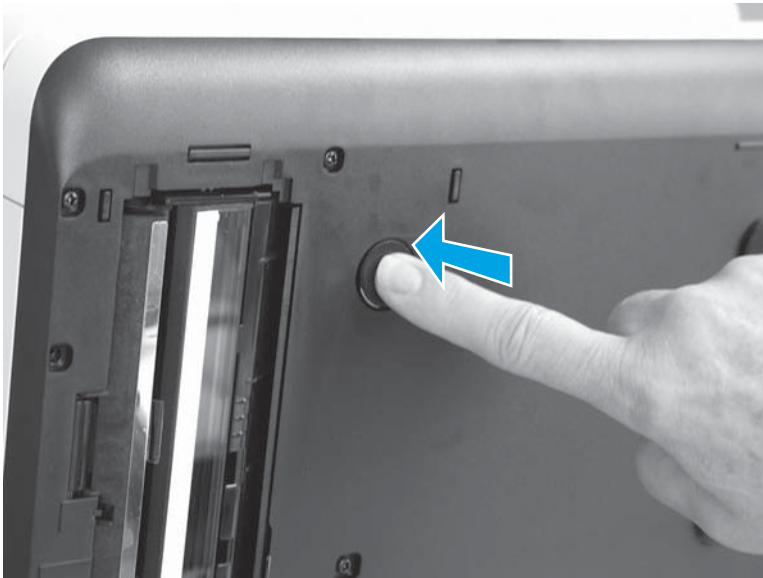

Step 3: Remove the keyboard (M577c/z)

 **NOTE:** This step is for the M577c/z models. For the M577dn/f models, skip this step and go to [Step 4: Remove the control panel \(M577\) on page 2760](#).

1. Open the latch (callout 1) to release the keyboard flat cable.

 **CAUTION:** The latch must be opened to release the cable.

Figure 1-4991 Disconnect the keyboard flat cable



2. Slide the keyboard tray out until it stops.

Figure 1-4992 Slide the keyboard out

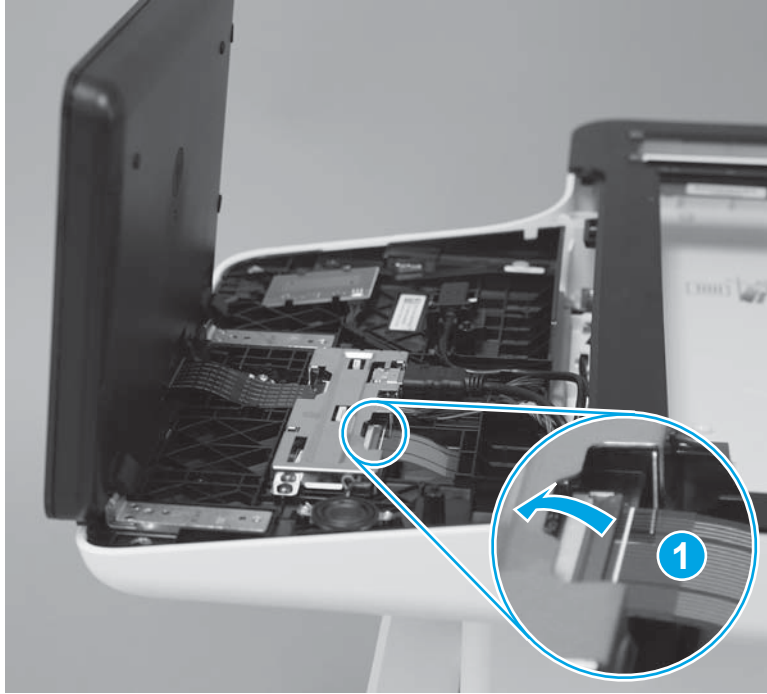

3. Push up on the keyboard tray to release two tabs on the bottom of the tray, and then slide the tray toward the front of the printer to disengage the tabs.

Figure 1-4993 Release two tabs

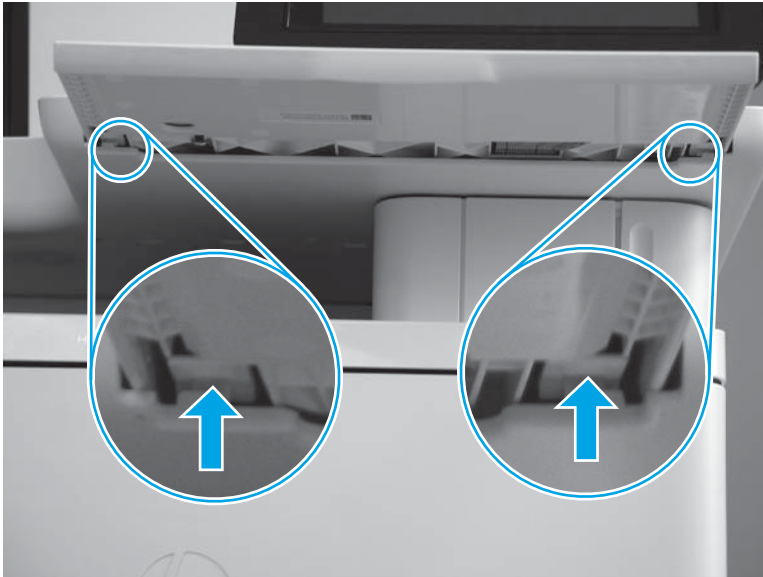

4. Slide the keyboard (callout 1) all of the way out of the printer to remove it.

Figure 1-4994 Remove the keyboard



Step 4: Remove the control panel (M577)

1. Disconnect one HDMI cable (callout 1) and one connector (callout 2).

Figure 1-4995 Disconnect connectors



2. Remove the USB cable (callout 1) from the holder.
M577z only: Disconnect one connector (callout 2).

Figure 1-4996 Disconnect connectors

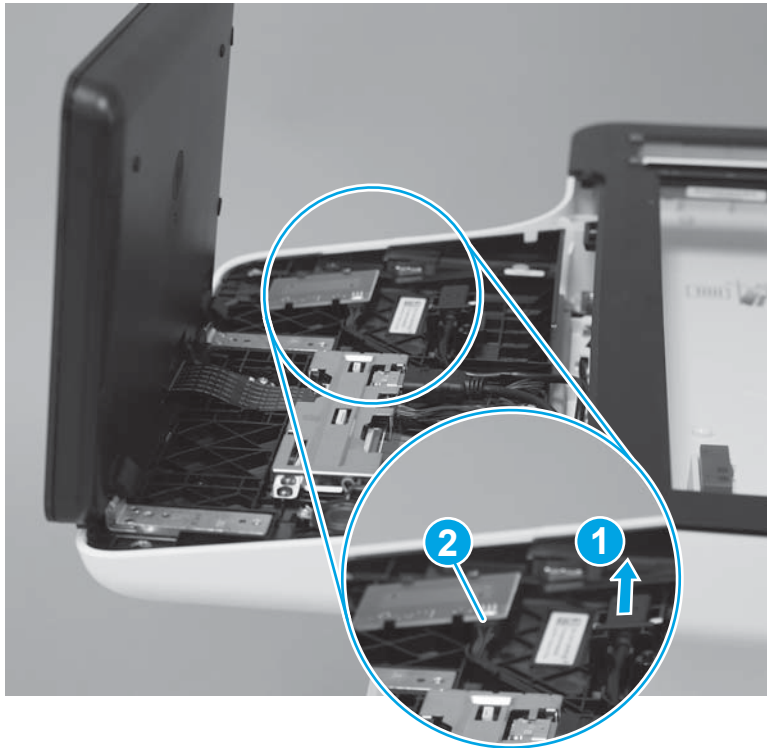

3. Remove three screws (callout 1).

Figure 1-4997 Remove three screws

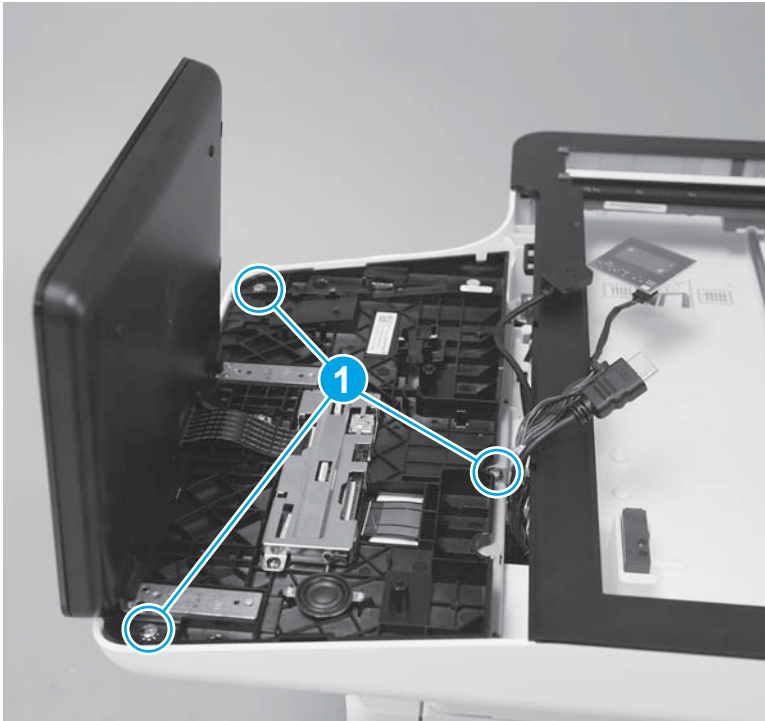

4. Lift the front of the control panel off of the printer (callout 1), and then slide it towards the front of the printer (callout 2) to remove it.

Figure 1-4998 Remove the control panel



Step 5: Remove the formatter cover

1. Locate the formatter cover.

Figure 1-4999 Locate the formatter cover

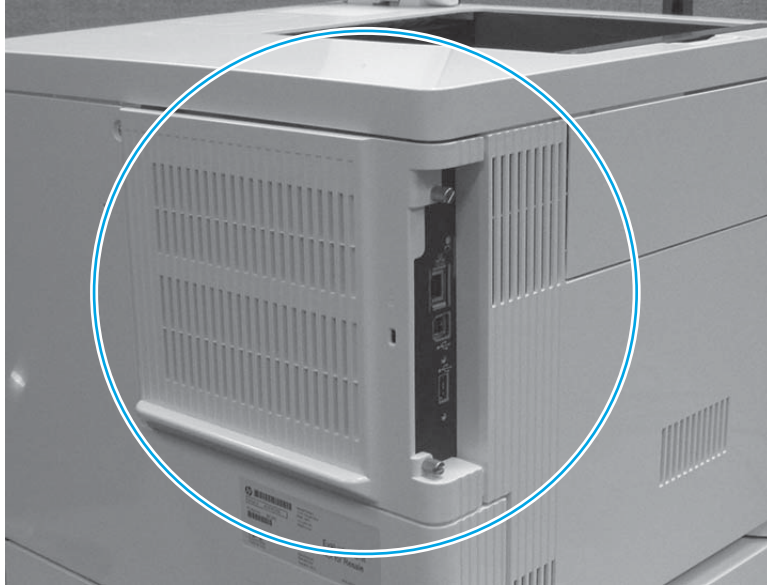

2. Loosen the two thumbscrews (callout 1). Grasp the two thumbscrews, and then slide the cover away from the printer (callout 2) to remove it.

 **TIP:** If needed, use the edge of a coin to turn the thumbscrews.

Figure 1-5000 Loosen the thumbscrews

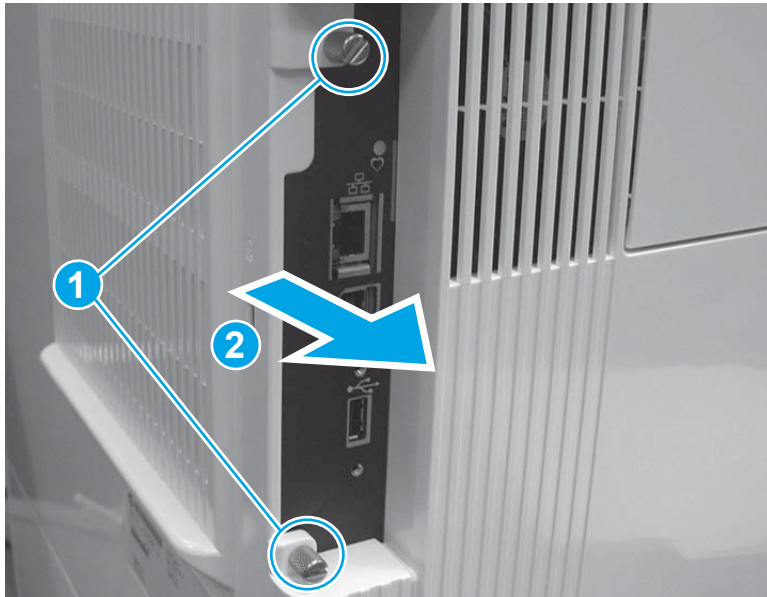

Step 6: Remove the fax PCA (M577c/f/z)

 **NOTE:** This step is for the M577c/f/z models. For the M577dn model, skip this step and go to [Step 7: Remove the rear upper cover \(M577\)](#) on page 2765.

 **CAUTION:**  ESD-sensitive part.

1. Locate the fax PCA component on the formatter.

Figure 1-5001 Locate the fax PCA

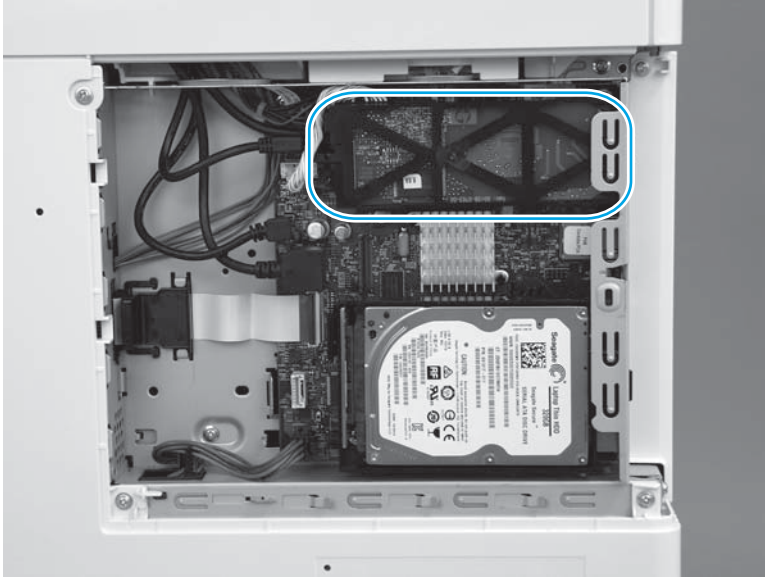

2. Release the connector latch (callout 1), and then pull the connector away from the formatter (callout 2) to disconnect it.

Figure 1-5002 Disconnect one connector

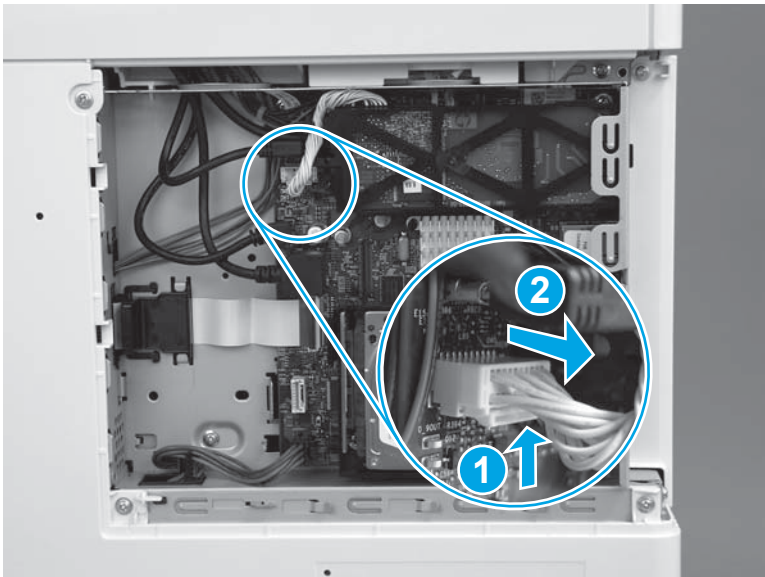

3. Release one retainer (callout 1) by pressing the bracket arms together.

Figure 1-5003 Release one latch

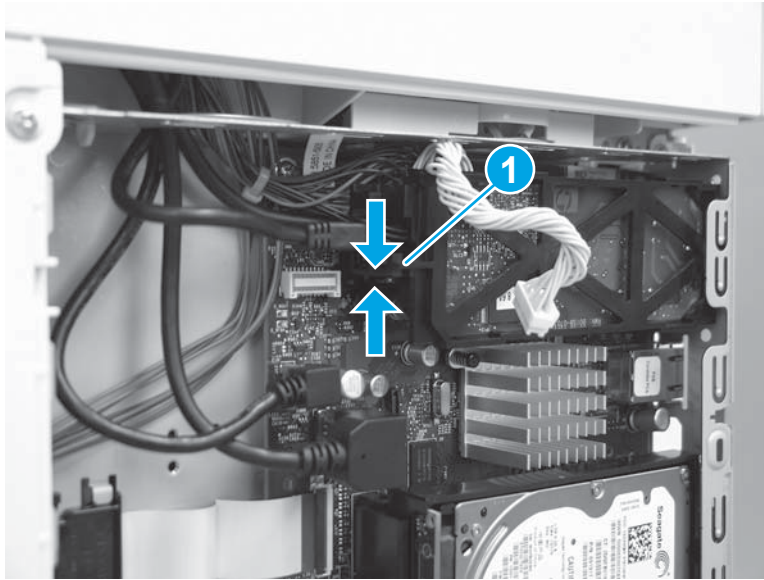

4. Rotate the end of the fax PCA (callout 1) away from the formatter, and then slide the PCA left (callout 2) to remove it.

Figure 1-5004 Remove the fax PCA

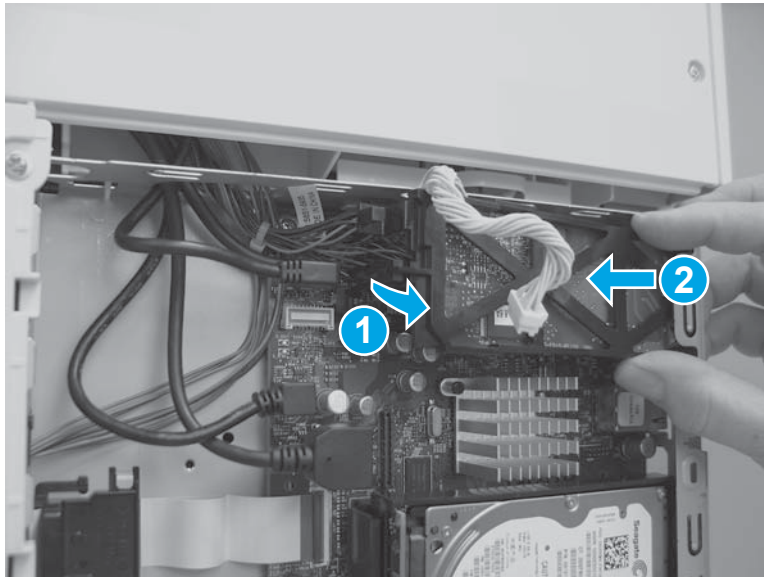

Step 7: Remove the rear upper cover (M577)

1. Remove two screws (callout 1).

 **Reinstallation tip:** These two screws are self-tapping screws for plastic. When reinstalling them, rotate the screws counterclockwise to align them with the existing thread pattern, and then carefully turn them clockwise to tighten. Do not overtighten. This will prevent stripping the threads inside the screw holes.

Figure 1-5005 Remove two screws



2. Use a small, flat blade screwdriver to release the right edge of the cover.

Figure 1-5006 Release the right edge

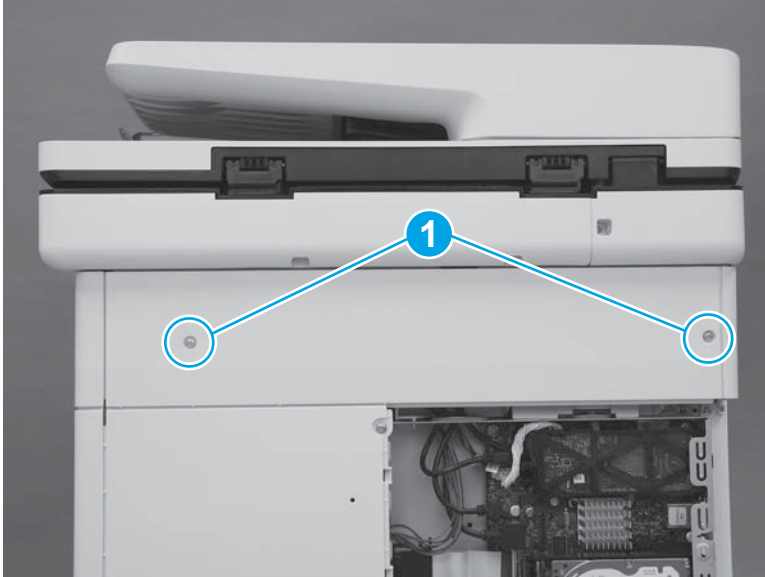
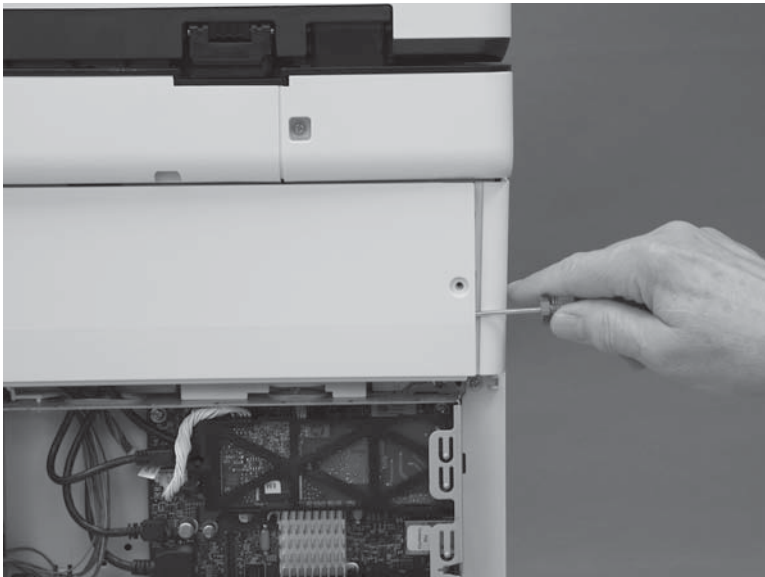

3. Pull the right edge of the cover (callout 1) away from the printer, and then slide the cover to the right (callout 2).

Figure 1-5007 Slide the cover right

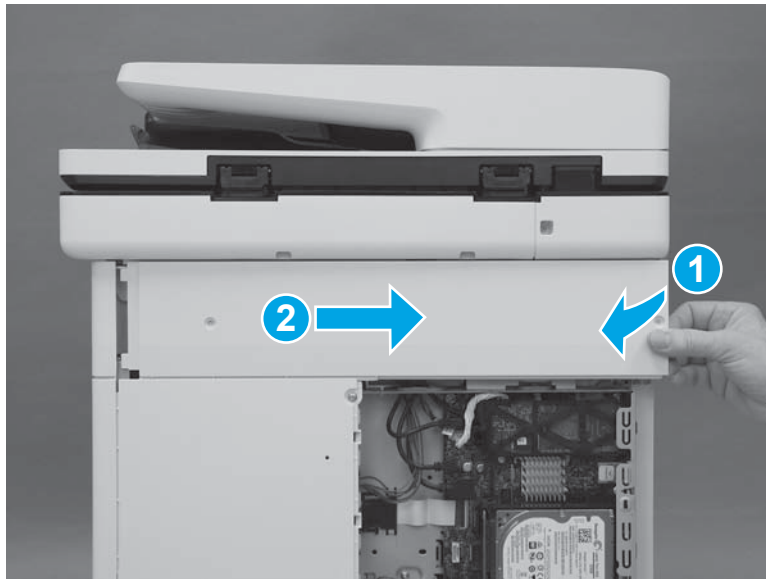

4. Remove the cover.

Figure 1-5008 Remove the cover

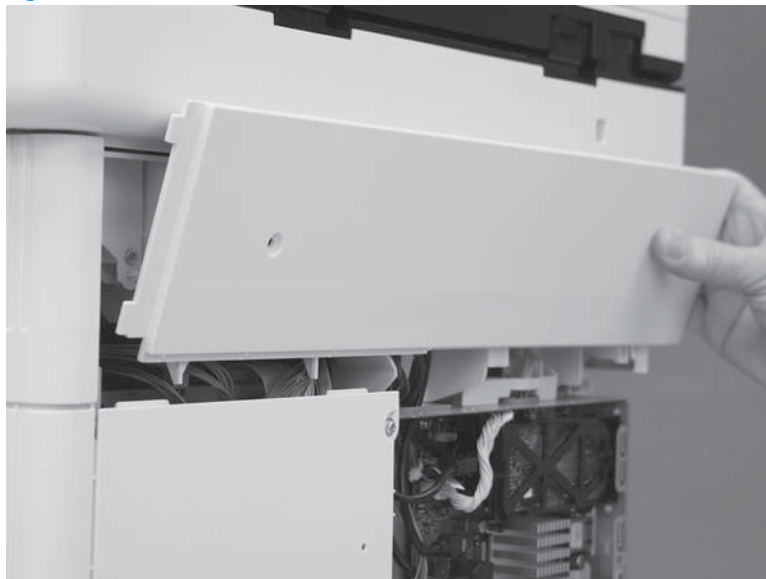

Step 8: Remove the left upper cover (M577)

1. At the left side of the printer, release one tab (callout 1).

Figure 1-5009 Release one tab

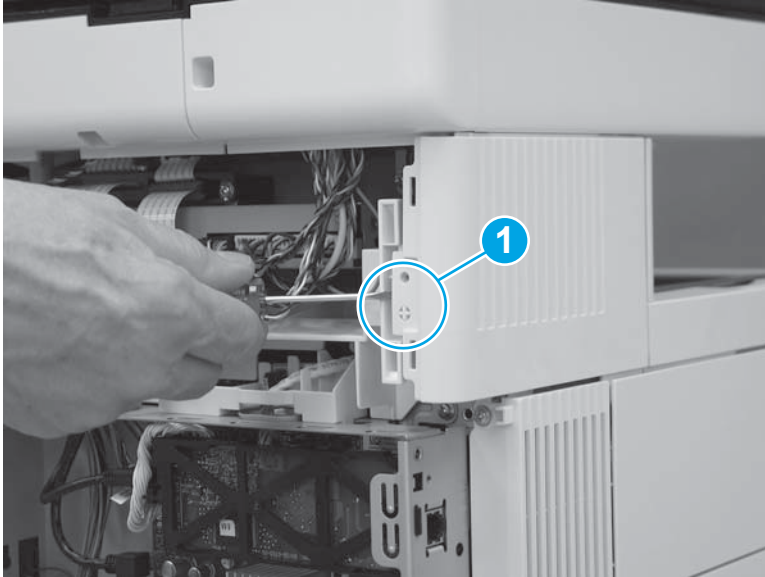

2. Slide the left upper cover toward the back of the printer.

Figure 1-5010 Slide the cover back

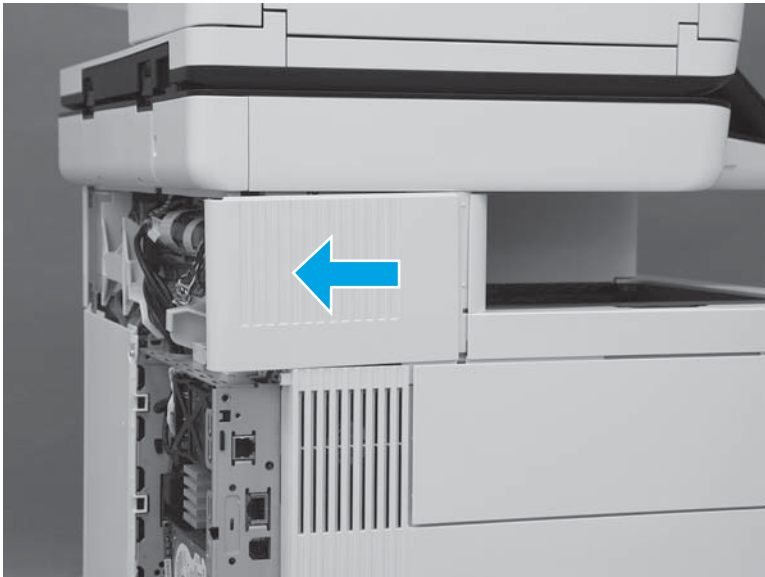

3. Rotate the cover up to remove it.

Figure 1-5011 Remove the left upper cover



Step 9: Remove the right front upper cover (M577dn)

 **NOTE:** This step is for the M577dn model. For the M577c/f/z models, skip this step and go to [Step 10: Remove the stapler cover assembly \(M577c/f/z\) on page 2770](#).

1. Remove one screw (callout 1).

Figure 1-5012 Remove one screw

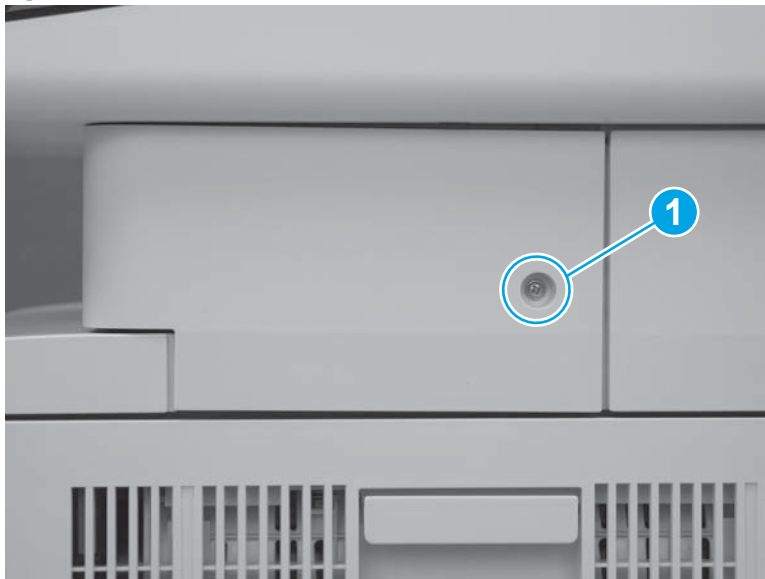

2. Release two tabs at the front edge of the cover (callout 1).

Figure 1-5013 Release two tabs



3. Rotate the front of the cover to the right to remove it.

Figure 1-5014 Rotate the cover



Step 10: Remove the stapler cover assembly (M577c/f/z)



NOTE: This step is for the M577c/f/z models. For the M577dn model, skip this step and go to [Step 11: Remove the document feeder \(M577\) on page 2772](#).

1. Remove one screw (callout 1).



Reinstallation tip: This is a self-tapping screw for plastic. When reinstalling, rotate the screw counterclockwise to align it with the existing thread pattern, and then carefully turn it clockwise to tighten. Do not overtighten. This will prevent stripping the threads inside the screw hole.

Figure 1-5015 Remove one screw

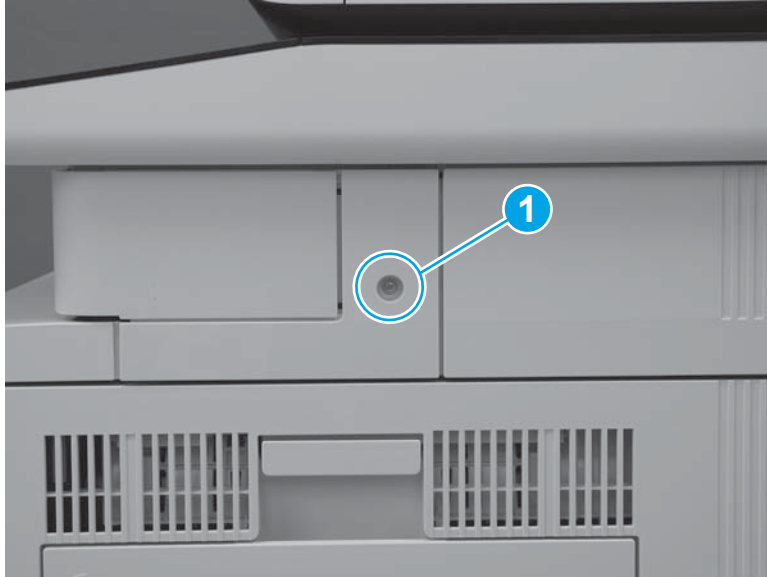

2. Release two tabs at the front edge of the cover (callout 1).

Figure 1-5016 Release two tabs



3. Release the back edge of the cover.

Figure 1-5017 Release the back edge of the cover

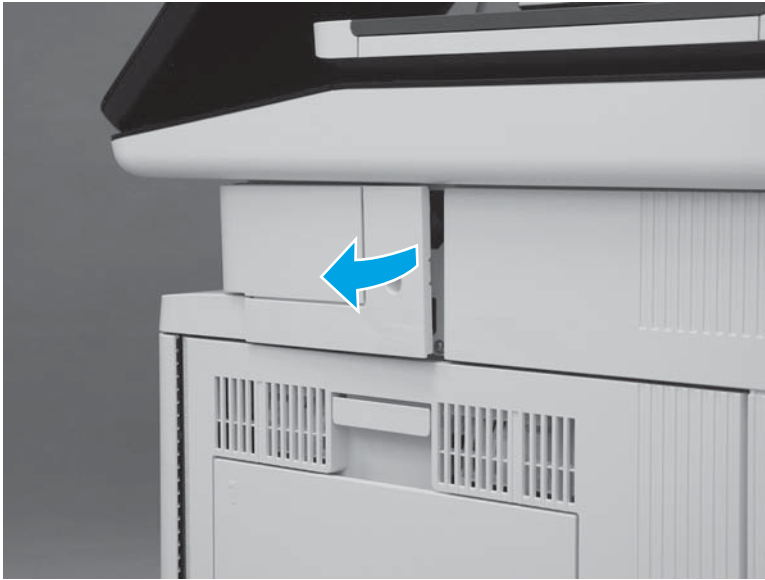

4. Rotate the cover away from the printer to remove it.

Figure 1-5018 Remove the cover



Step 11: Remove the document feeder (M577)

1. Remove one screw (callout 1).

 **Reinstallation tip:** This is a self-tapping screw for plastic. When reinstalling, rotate the screw counterclockwise to align it with the existing thread pattern, and then carefully turn it clockwise to tighten. Do not overtighten. This will prevent stripping the threads inside the screw hole.

Figure 1-5019 Remove one screw

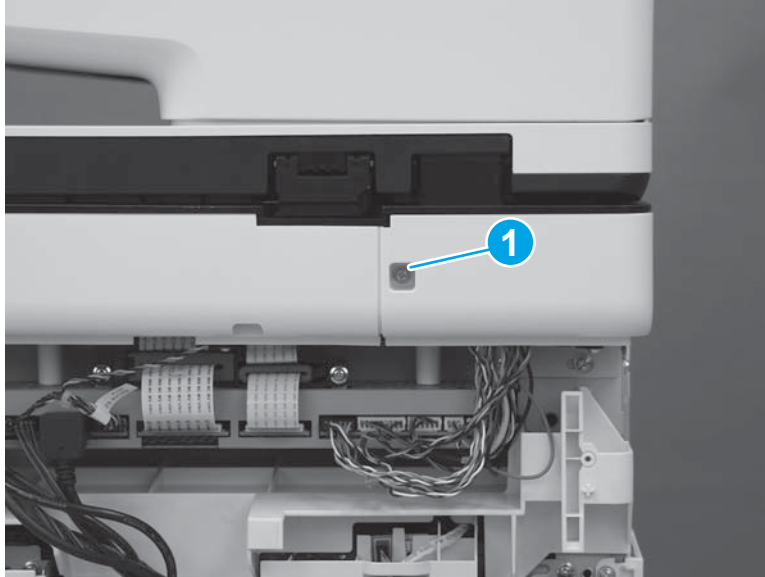

2. Rotate the cover away from the printer to remove it.

Figure 1-5020 Remove the cover

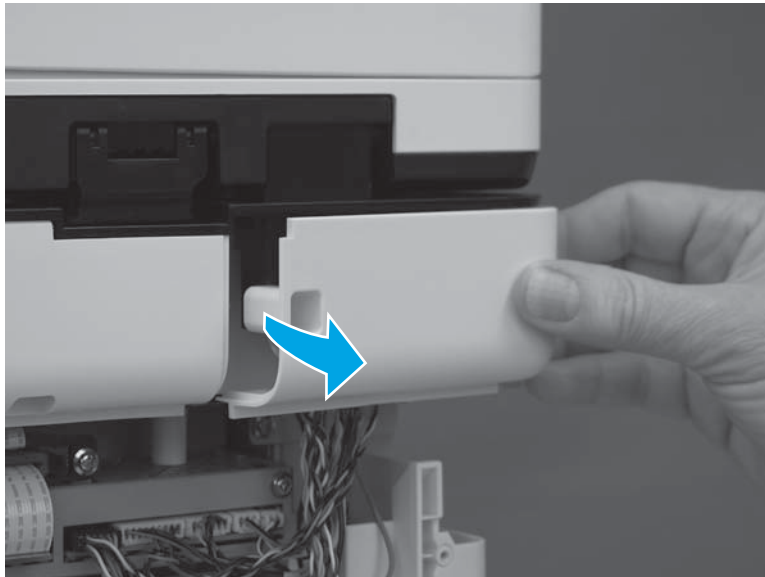

3. Disconnect one flat cable (callout 1), remove one ground screw (callout 2) to release the grounding cable, and then disconnect all of the connectors (callout 3) on the scanner control board.

 **Reinstallation tip:** There are eight wire-harness connectors, two flat cables, and one high-definition multimedia interface (HDMI) cable connector.

Figure 1-5021 Disconnect the flat cable, ground cable, and connectors

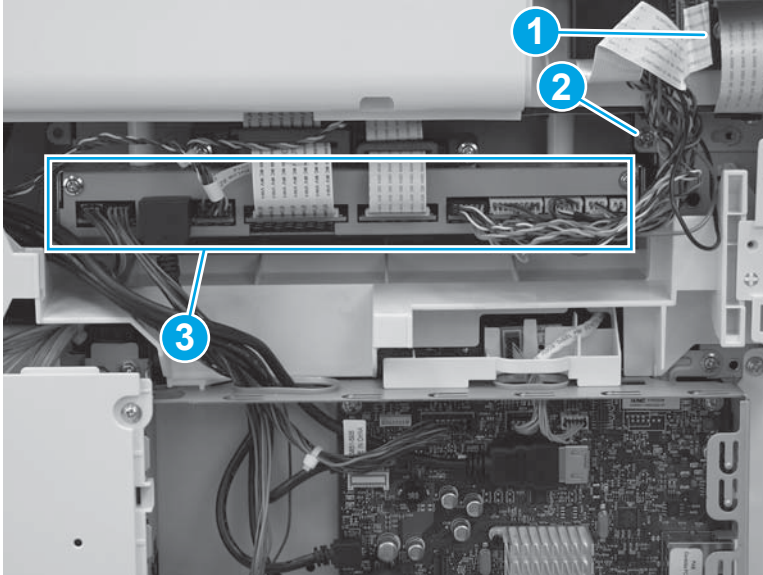

4. Disconnect three connectors (callout 1) from the formatter, and then release three black cables through the opening (callout 2) in the formatter case.

Figure 1-5022 Disconnect three connectors

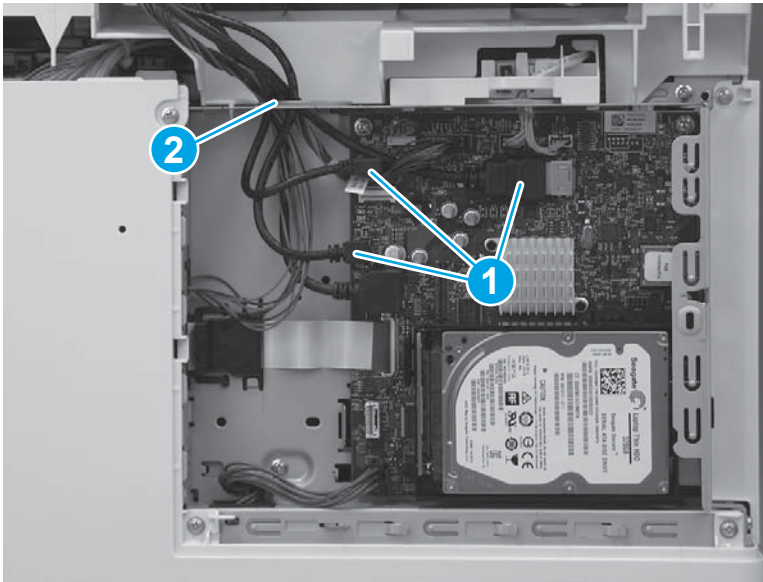

5. Open the document feeder.

Figure 1-5023 Open the document feeder



6. Tilt the document feeder back until it stops (callout 1), and then lift it off of the scanner until it stops (callout 2).

Figure 1-5024 Raise the document feeder



7. Support the document feeder, and then use a small flat-blade screwdriver to release two tabs on the document feeder hinges.

Figure 1-5025 Release two tabs



8. Lift the document feeder up to remove it.

 **NOTE:** While removing the document feeder, carefully pass the wire harnesses and the flat cable through the opening in the scanner.

Figure 1-5026 Remove the document feeder



Step 12: Remove the scanner control board (SCB) (M577)

1. Remove two screws (callout 1).

Figure 1-5027 Remove two screws

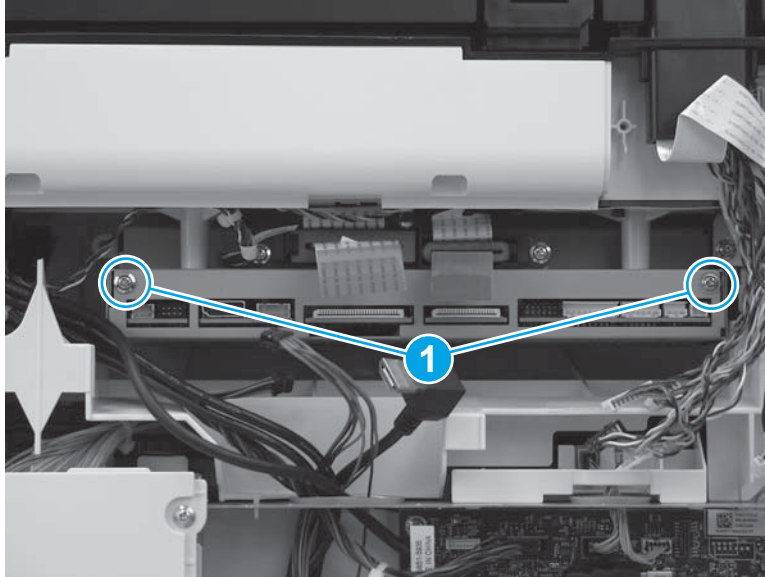

2. Remove the cables (callout 1) from the guide (callout 2), and then lower the SCB (callout 3).

Figure 1-5028 Slide the SCB out

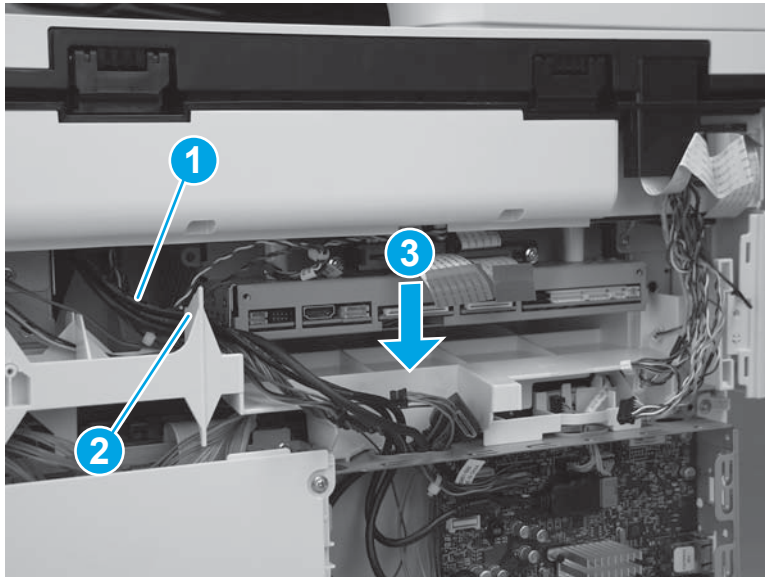

3. Rotate the SCB up and out of the printer. Make sure that the heat sink (callout 1) on the SCB does not get caught on the edge of the sheet metal (callout 2).

Figure 1-5029 Remove the SCB

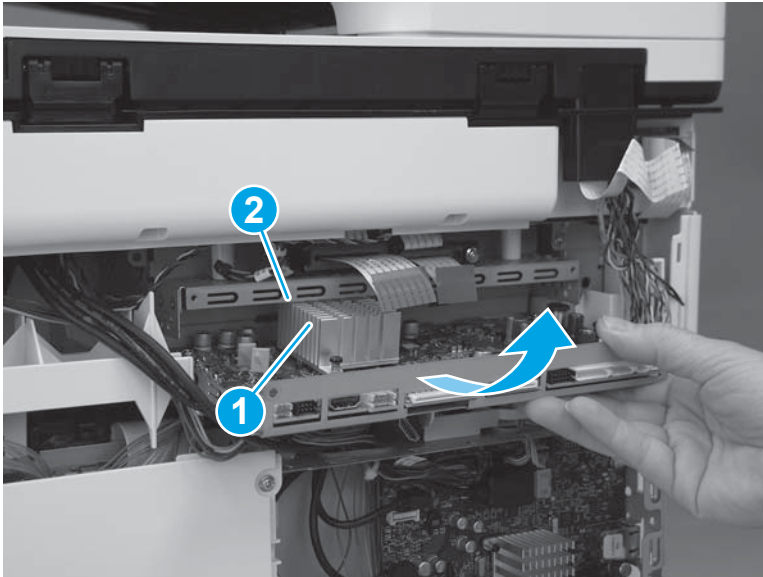

Step 13: Remove the image scanner assembly (M577)

1. Disconnect four connectors (callout 1) on the formatter, and then pass the wire harnesses and cables through the top opening in the formatter case (callout 2).

Figure 1-5030 Disconnect cables and connectors

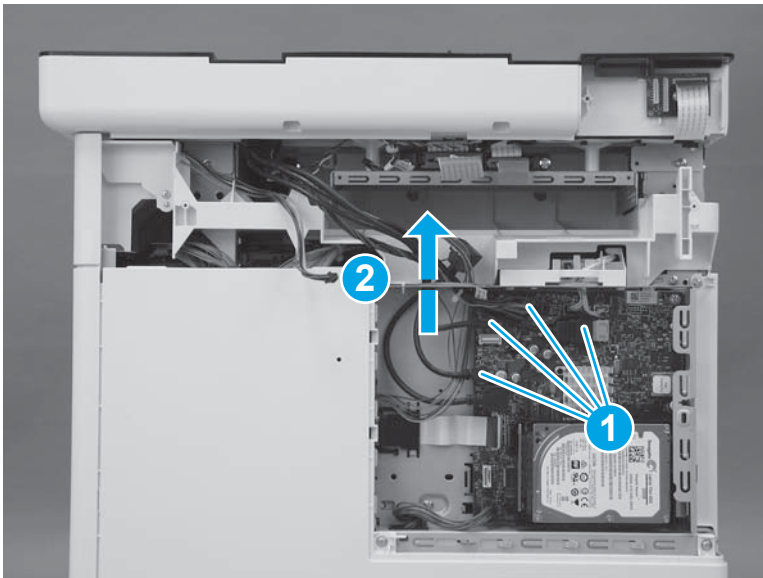

2. At the right side of the printer, remove one screw (callout 1).

 **NOTE:** The M577z is shown in the figure below. The procedure is correct for all M577 models.

Figure 1-5031 Remove one screw

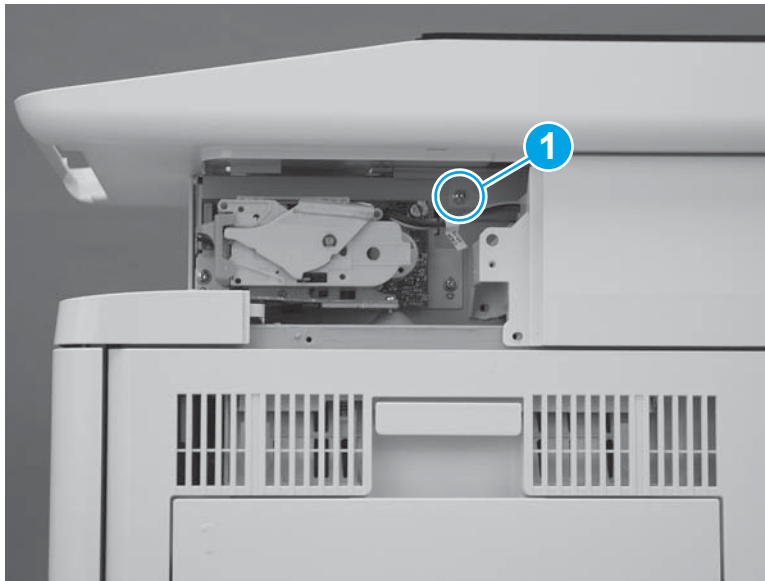

3. At the back of the printer, remove two screws (callout 1).

Figure 1-5032 Remove two screws

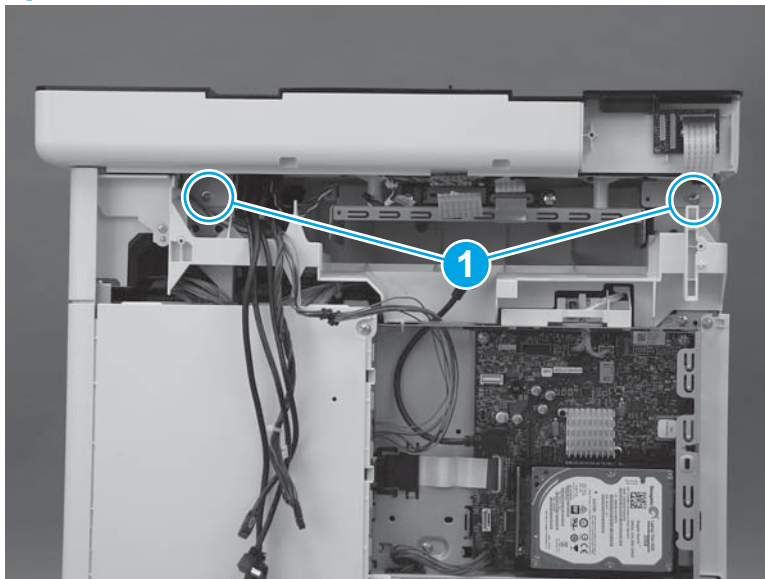

4. At the left side of the printer, remove one screw (callout 1).

Figure 1-5033 Remove one screw

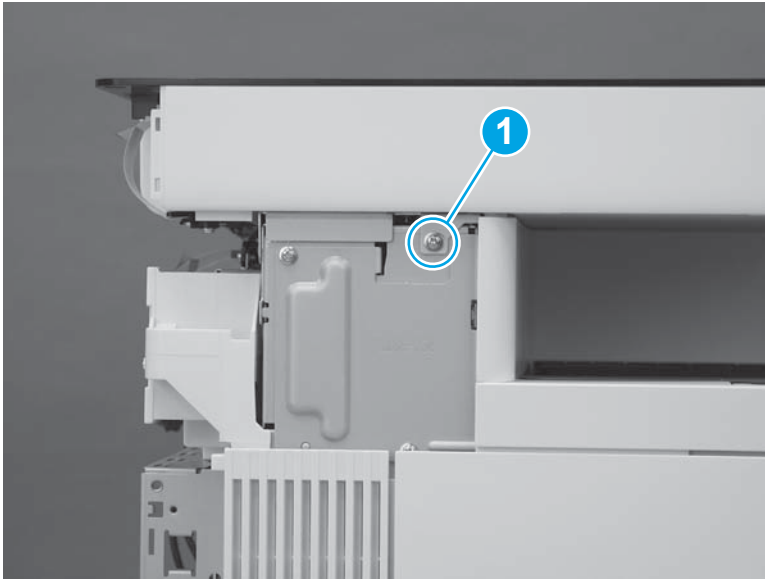

5. Slide the image scanner toward the back of the printer to release it.

Figure 1-5034 Release the image scanner

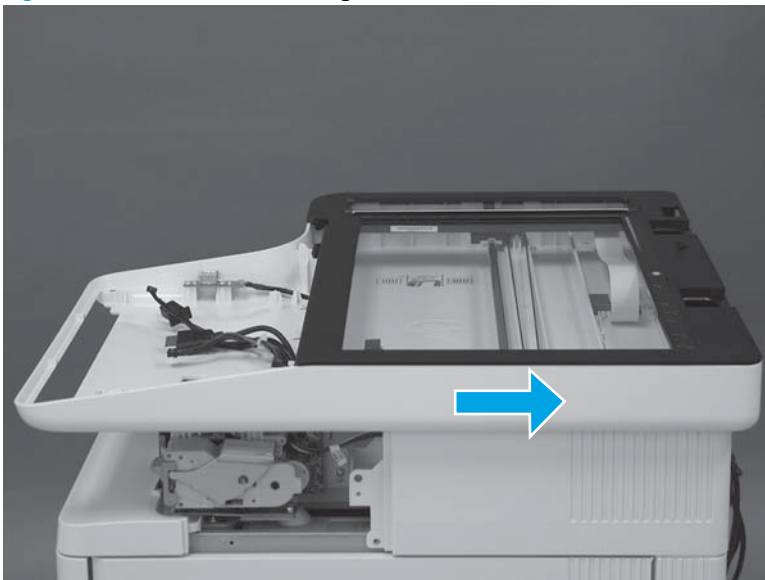

6. Lift the image scanner straight up to remove it.

Figure 1-5035 Remove the image scanner

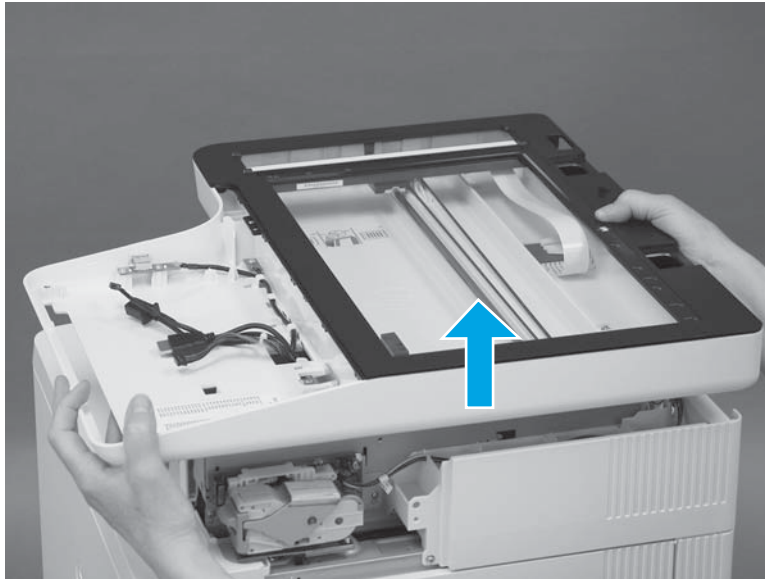

Step 14: Unpack the replacement assembly

Unpack the replacement assembly from the packaging.

For complete information on HP's recycling programs, go to [Product return and recycling](#).

 **NOTE:** HP recommends responsible disposal of the defective part.

Figure 1-5036 Recycle and unpack

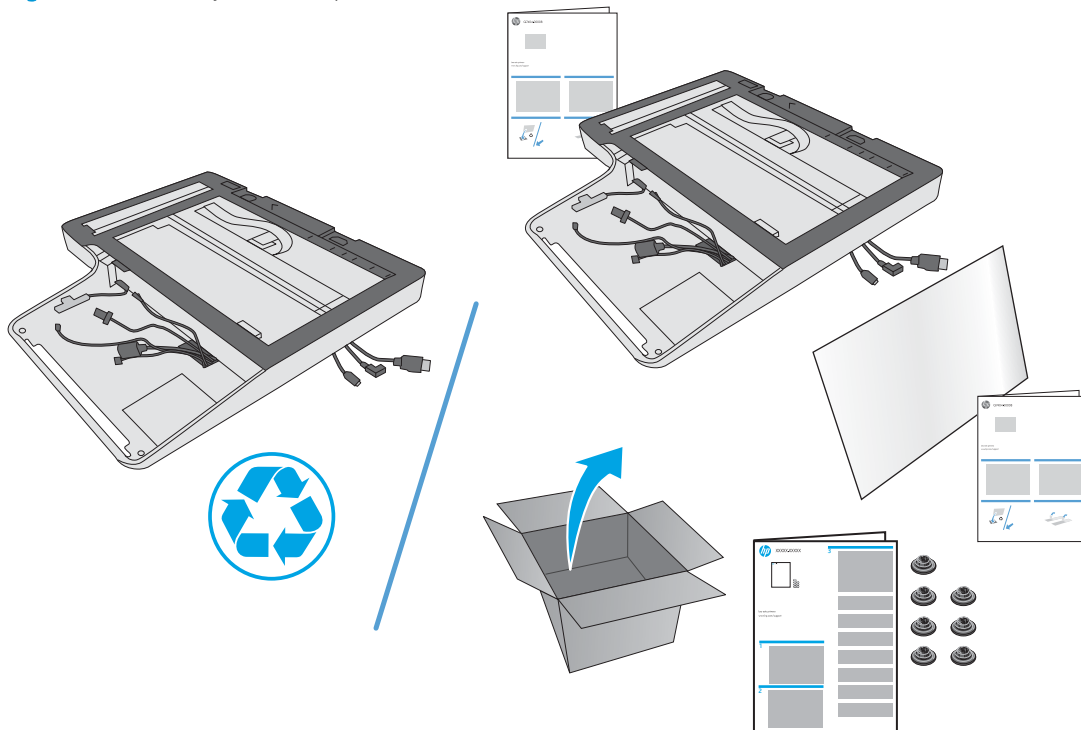

Step 15: Install the image scanner assembly (M577)

1. Before proceeding, locate the mounting pins (callout 1) on the bottom of the image scanner and the slots (callout 2) on the printer base.

Figure 1-5037 Locate the image scanner mounting pins and slots

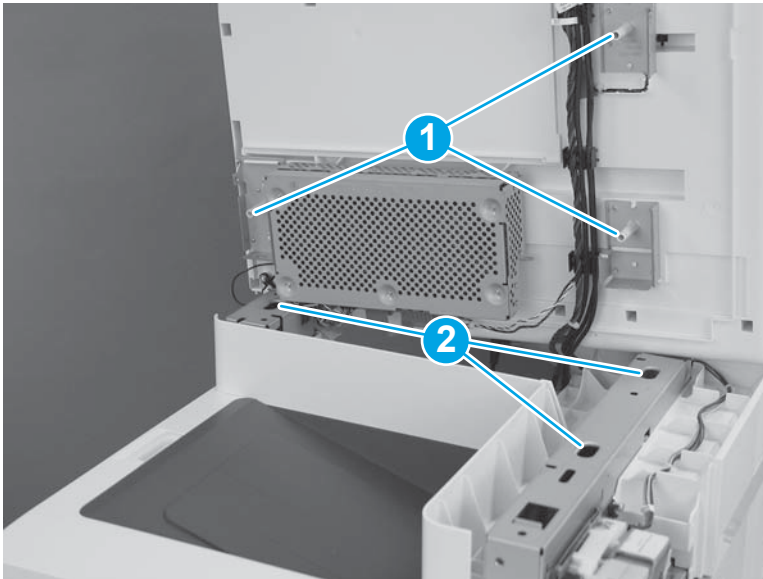

2. Position the image scanner on the printer base with the pins in the slots.

 **NOTE:** To locate the pins and slots, see [Figure 1-5037 Locate the image scanner mounting pins and slots on page 2782](#).

Figure 1-5038 Install the image scanner



3. Slide the image scanner toward the front of the printer to engage it with the printer base.

Figure 1-5039 Engage the image scanner

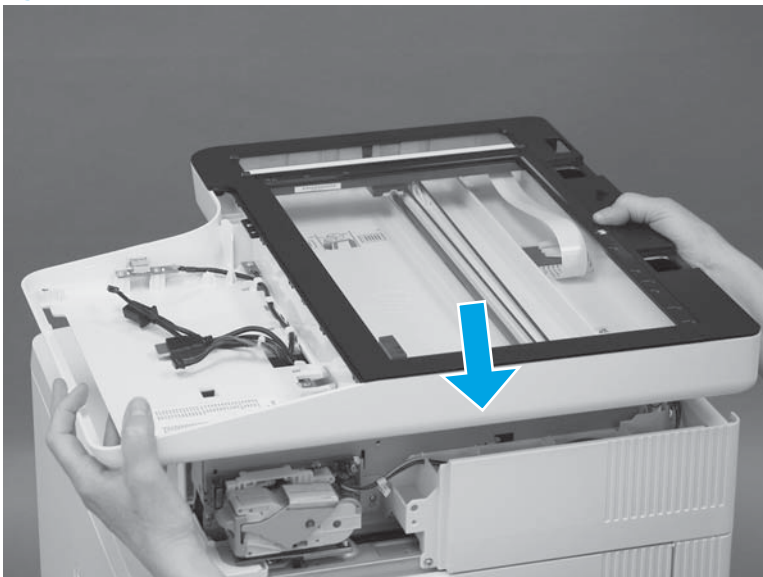
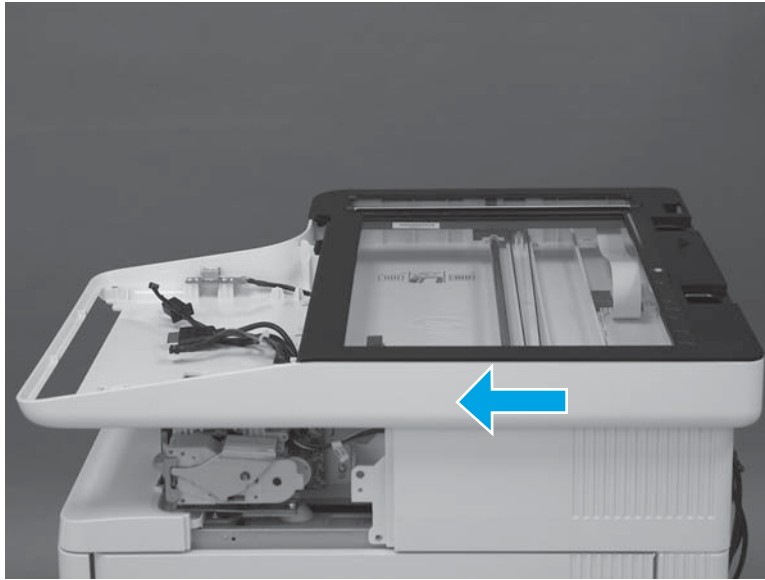

4. At the left side of the printer, install 1 screw (callout 1).

Figure 1-5040 Install one screw

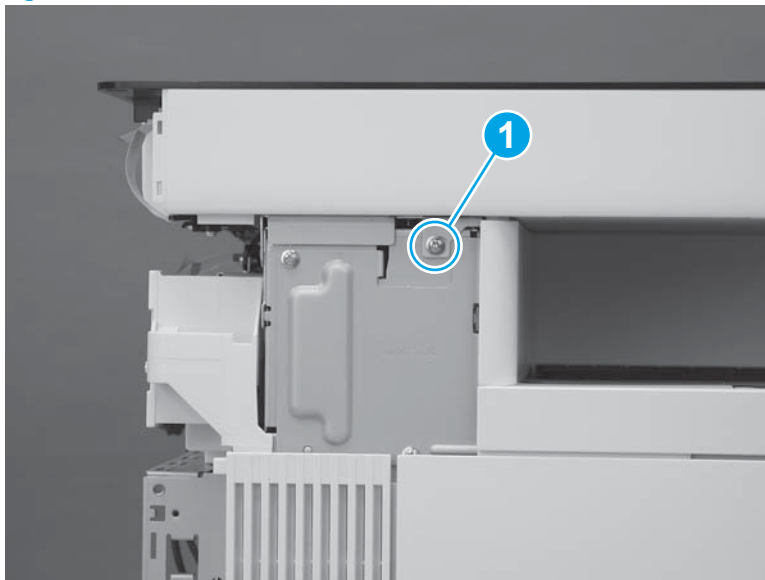

5. At the back of the printer, install two screws (callout 1).

Figure 1-5041 Install two screws

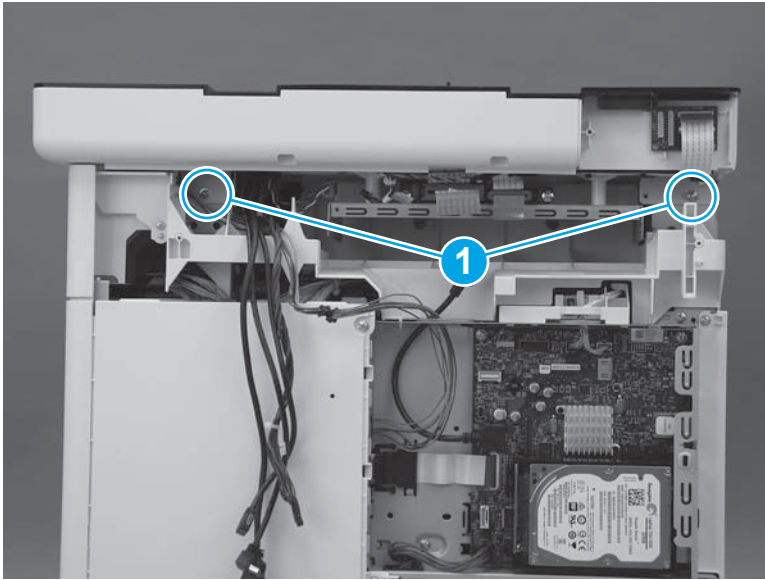

6. At the right side of the printer, install one screw (callout 1).

Figure 1-5042 Install one screw

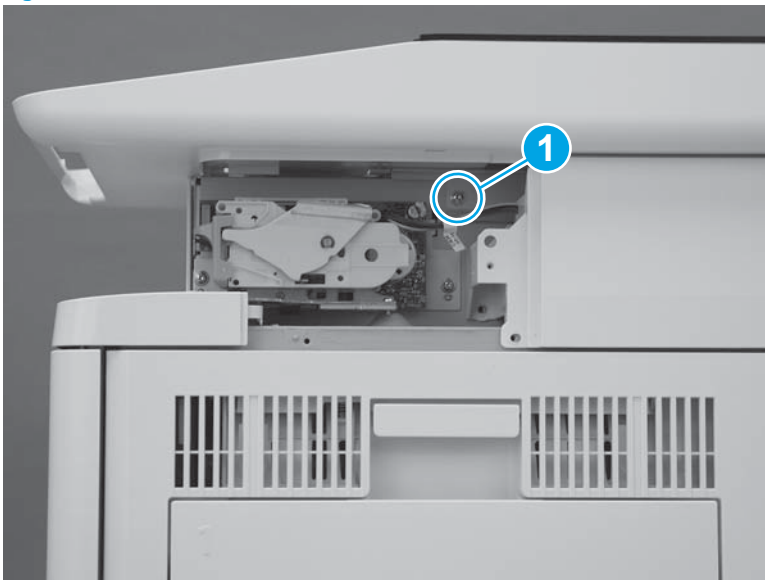

7. Install the wire harnesses and cables through the opening in the top of the formatter cover (callout 1), and then connect four connectors (callout 2).

Figure 1-5043 Connect connectors

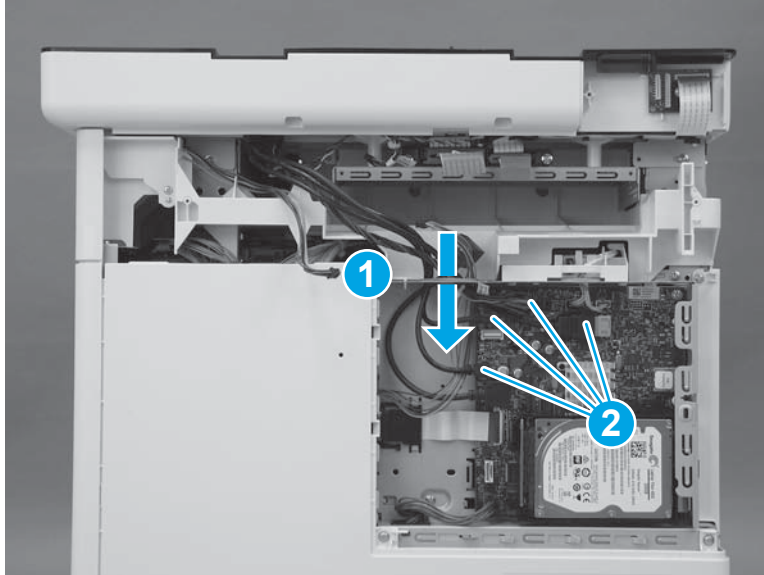

8. M577dn and M577f only: Do the following:
 - a. Before proceeding, take note of mounting slots and tabs on the keyboard cover (supplied in the kit).

Figure 1-5044 Keyboard cover mounting slots and tabs (M577dn and M577f)

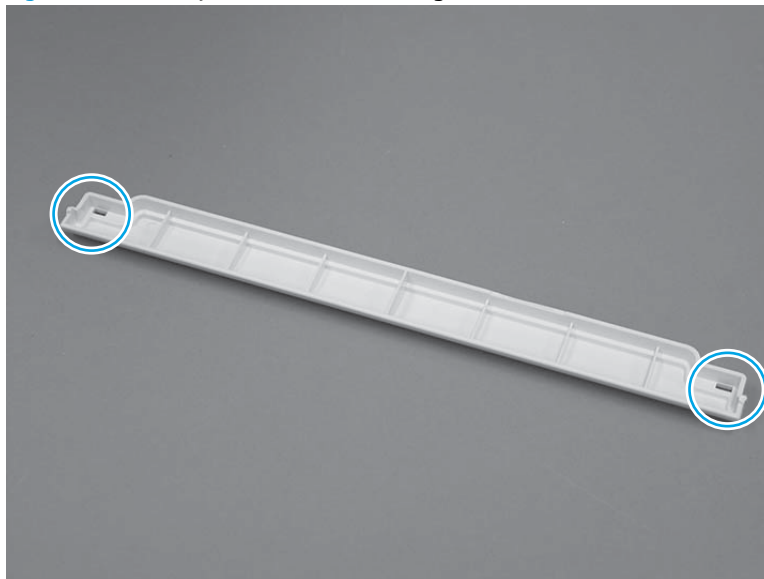

- b. Position the keyboard cover in the opening on the replacement image scanner, and then rotate it until it snaps into place.

Figure 1-5045 Install the keyboard cover (M577dn and M577f)

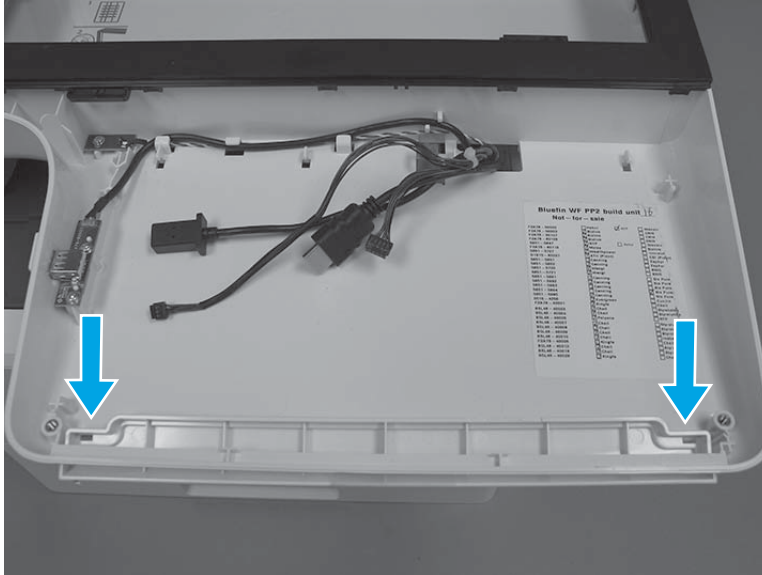

- c. Make sure that the cover is properly installed—the tabs snap into place and the slots snap over the bosses.

Figure 1-5046 Check the keyboard cover (M577dn and M577f)

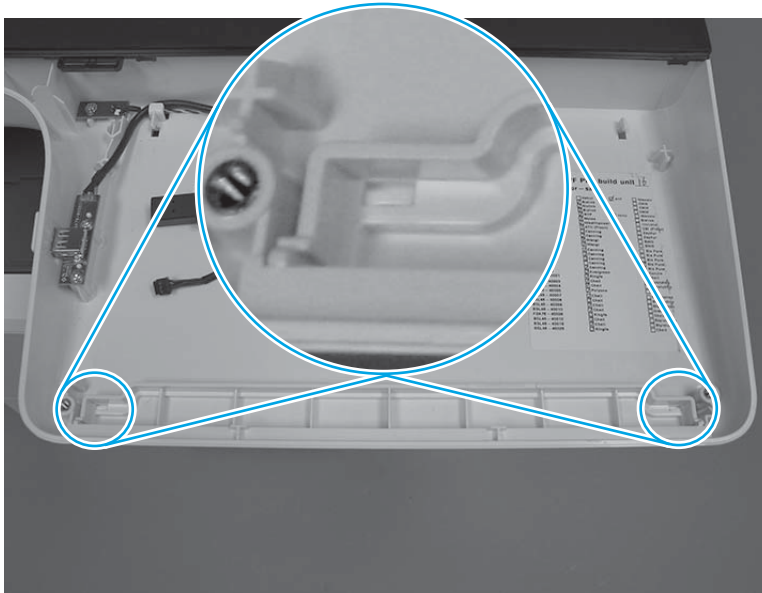

Step 16: Install the scanner control board (M577)

1. Align the slots on the SCB (callout 1) with the tabs (callout 2) inside the printer.

Figure 1-5047 Install the SCB

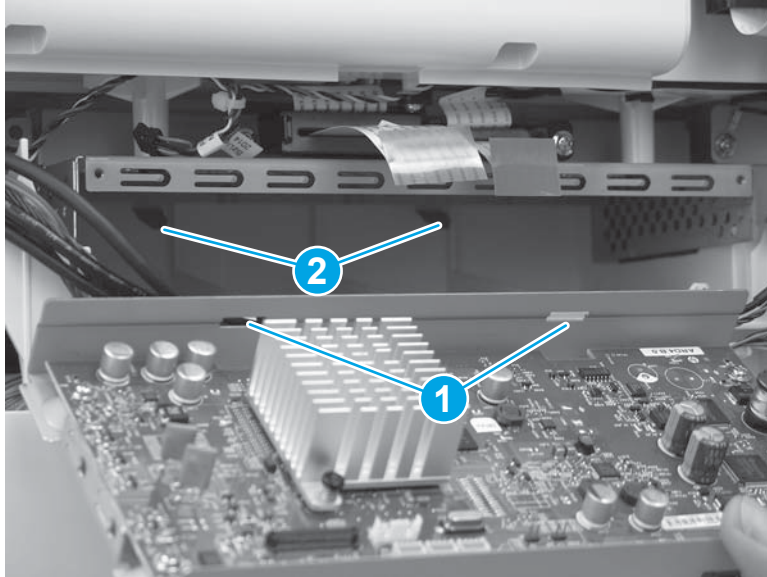

2. Slide the SCB into the printer until it stops. Make sure that the heat sink (callout 1) on the SCB does not get caught on the edge of the sheet metal (callout 2).

Figure 1-5048 Slide the SCB in

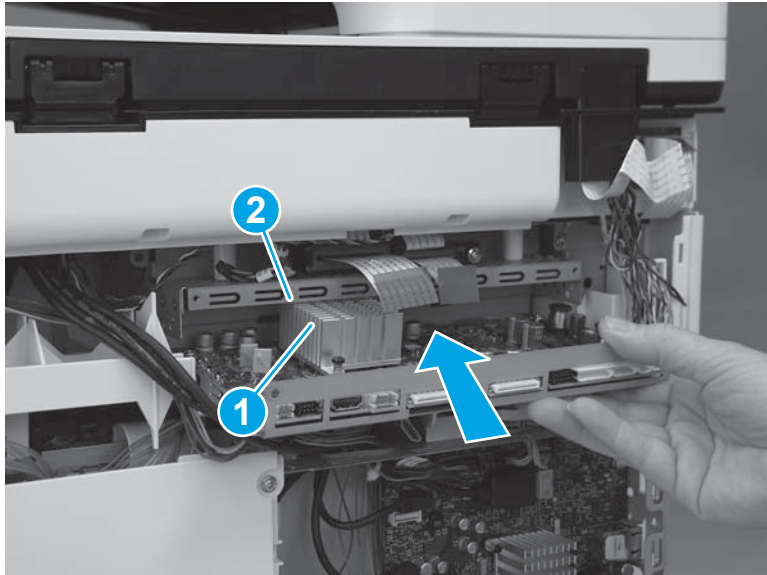

3. Raise the SCB up (callout 1), and then install the cables (callout 2) in the guide (callout 3).

Figure 1-5049 Raise the SCB and install cables

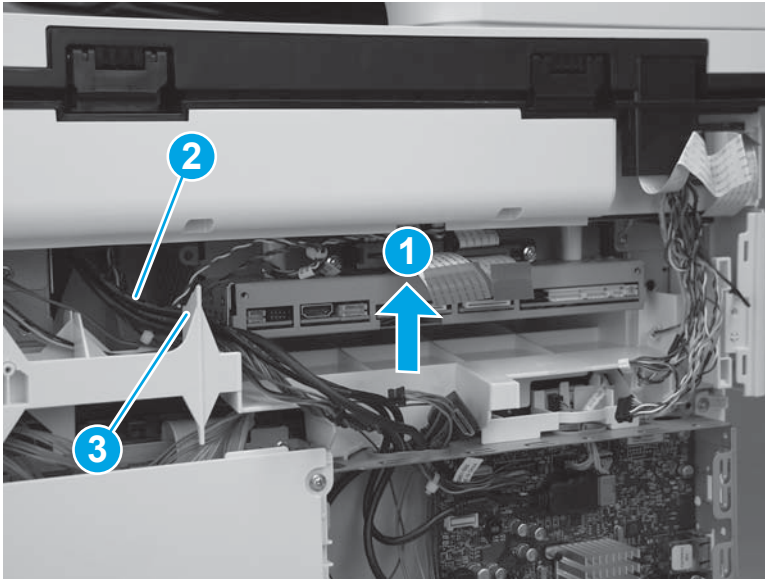

4. Install two screws (callout 1).

Figure 1-5050 Install two screws

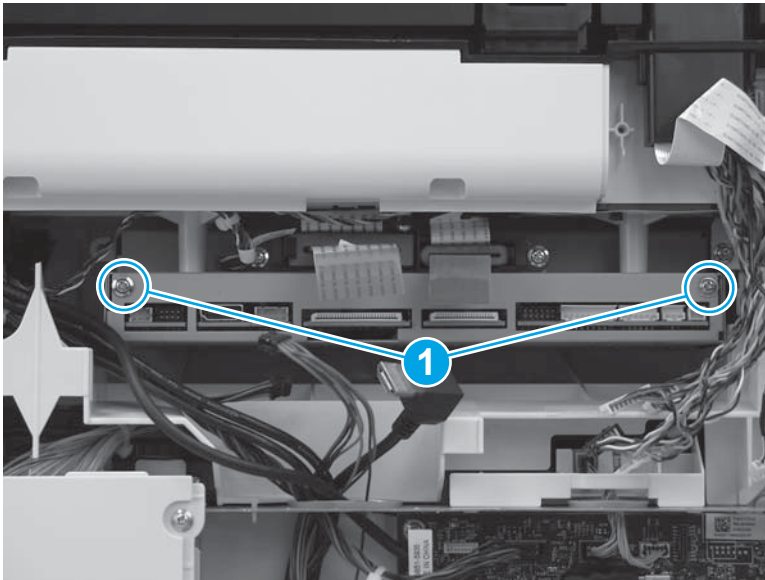

Step 17: Install the document feeder (M577)

1. Pass the flat cable and wire harness on the replacement document feeder through the hole in the scanner chassis (callout 1), and then align the hinges (callout 2) with the slots (callout 3) in the chassis.

Figure 1-5051 Install the document feeder

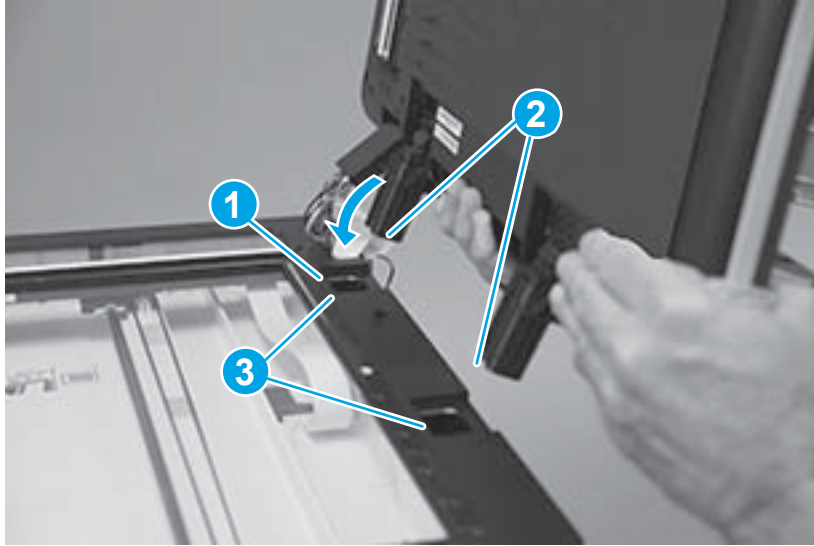

2. Continue to pass the flat cable and wire through the opening in the chassis (callout 1), and then insert the hinges (callout 2) into the slots.

⚠ CAUTION: Do not damage the flat cable or wire harnesses when the cable guide (callout 1) is installed in its slot.

Figure 1-5052 Lower the document feeder



3. Close the document feeder.

Figure 1-5053 Close the document feeder



4. Install three black cables through the opening in the formatter case (callout 1), and then connect three connectors on the formatter (callout 2).

Figure 1-5054 Connect three connectors

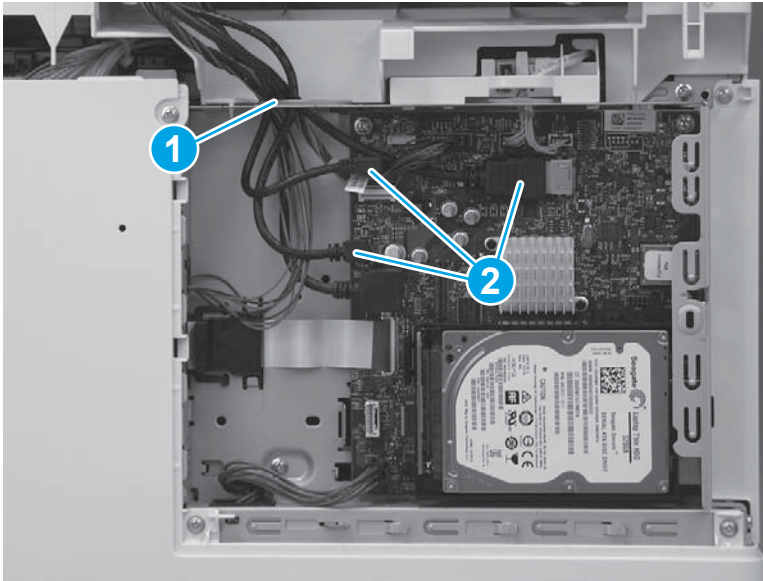

5. Connect one flat cable (callout 1), install the grounding cable behind one ground screw (callout 2), and then connect all of the connectors (callout 3) on the scanner control board.

 **Reinstallation tip:** There are eight wire-harness connectors, two flat cables, and one high-definition multimedia interface (HDMI) cable connector.

Figure 1-5055 Connect the flat cable, ground cable, and connectors



6. Position the tabs (callout 1) on the cover in the slots (callout 2) in the printer.

Figure 1-5056 Position the tabs

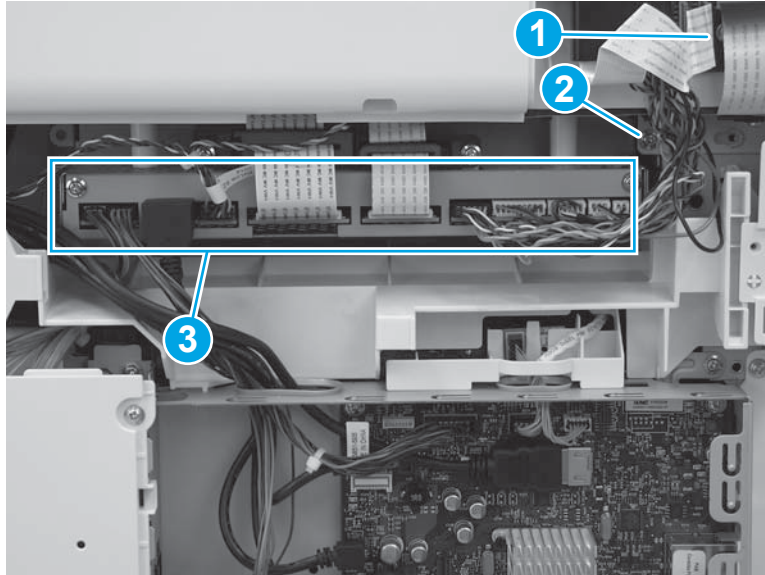
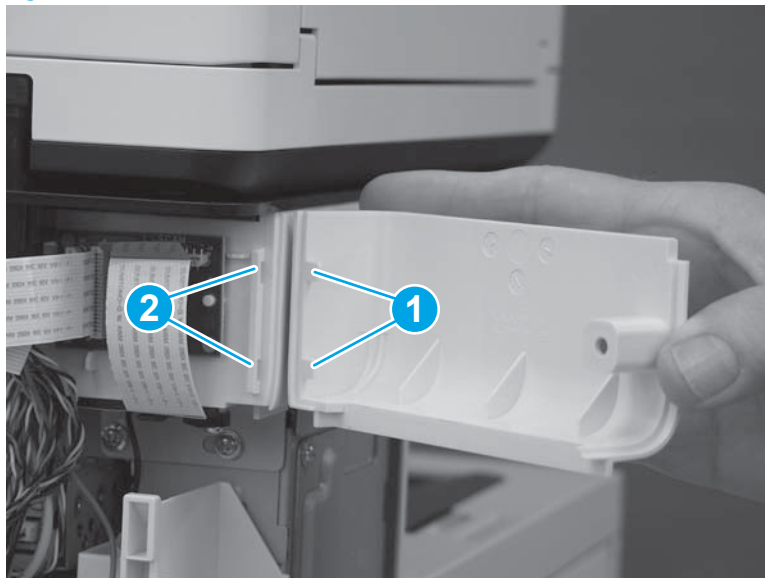

7. Rotate the cover toward the printer to install it.

Figure 1-5057 Install the cover

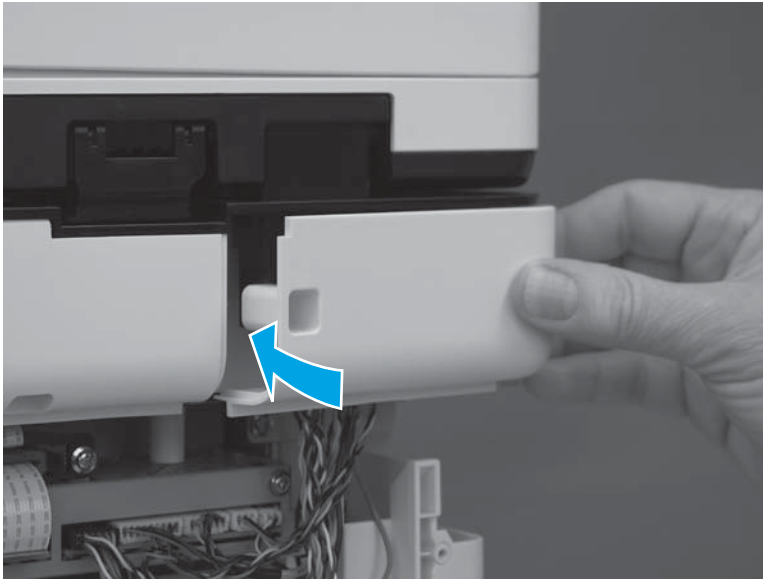

8. Install one screw (callout 1).



 **IMPORTANT:** This is a self-tapping screw for plastic. Rotate it counterclockwise to align it with the existing thread pattern, and then carefully turn it clockwise to tighten. Do not overtighten. This will prevent stripping the threads inside the screw hole.

Figure 1-5058 Install one screw

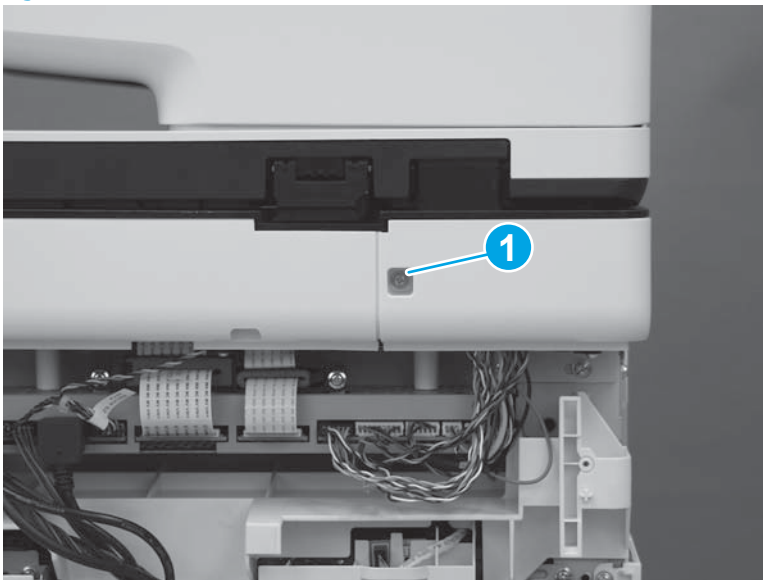

Step 18: Install the stapler cover assembly (M577c/f/z)

 **NOTE:** This step is for the M577c/f/z models. For the M577dn model, skip this step and go to [Step 19: Install the right front upper cover \(M577dn\) on page 2794](#).

1. Install the tabs (callout 1) on the cover in the slots (callout 2) in the printer.

Figure 1-5059 Install two tabs



2. Press the cover toward the left side of the printer until it snaps into place.

Figure 1-5060 Install the cover assembly



3. Install one screw (callout 1).



 **IMPORTANT:** This is a self-tapping screw for plastic. Rotate it counterclockwise to align it with the existing thread pattern, and then carefully turn it clockwise to tighten. Do not overtighten. This will prevent stripping the threads inside the screw hole.

Figure 1-5061 Install one screw

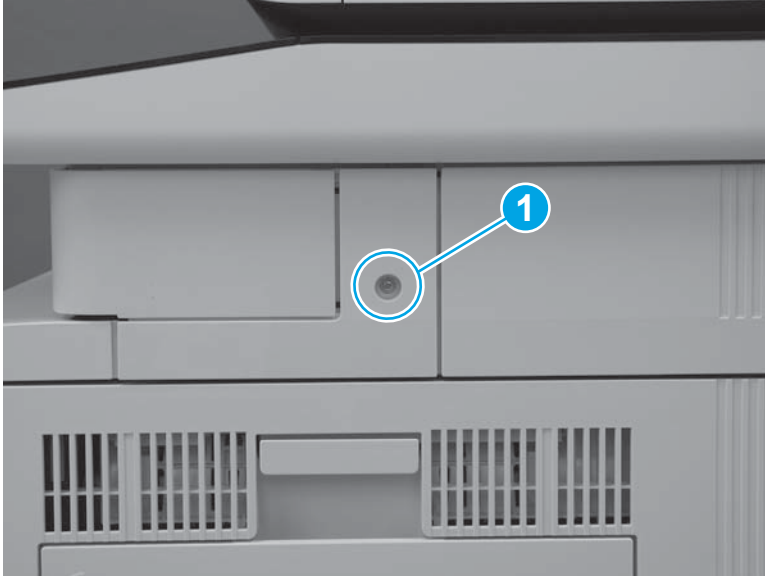

Step 19: Install the right front upper cover (M577dn)

 **NOTE:** This step is for the M577dn model. For the M577c/f/z models, skip this step and go to [Step 20: Install the left upper cover \(M577\) on page 2795](#).

1. Slide the cover toward the left side of the printer to install it. Make sure that the slots (callout 1) in the cover fit over the tabs (callout 2) on the inside of the paper feeder cover.

Figure 1-5062 Install the cover

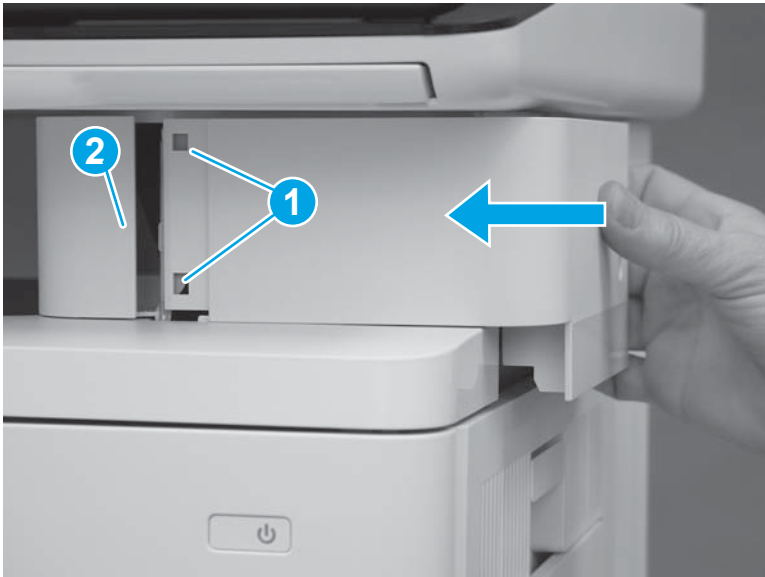

2. Press the right front upper cover (callout 1) and the paper feeder cover (callout 2) together until the tabs on the inside of the covers snap into place.

Figure 1-5063 Press the cover



3. Install one screw (callout 1).

Figure 1-5064 Install one screw

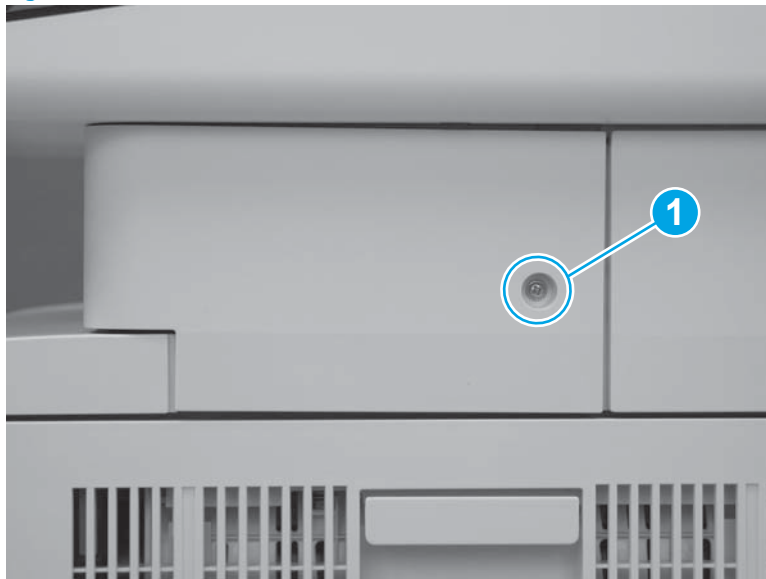

Step 20: Install the left upper cover (M577)

1. Position the tab (callout 1) on the lower edge of the cover behind the left cover (callout 2).

Figure 1-5065 Position the tab

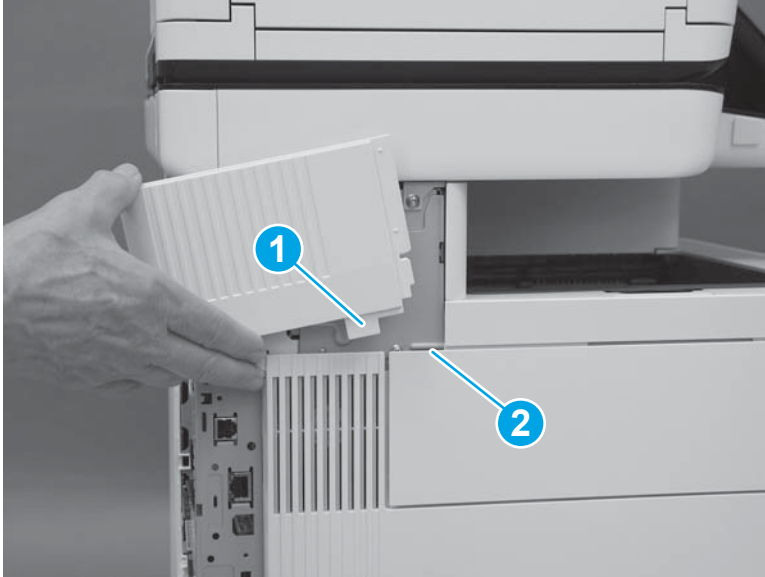

2. Slide the cover toward the front of the printer to install it. Make sure that the edge (callout 1) of the cover fits behind the edge (callout 2) of the top rear cover.

Figure 1-5066 Slide the cover

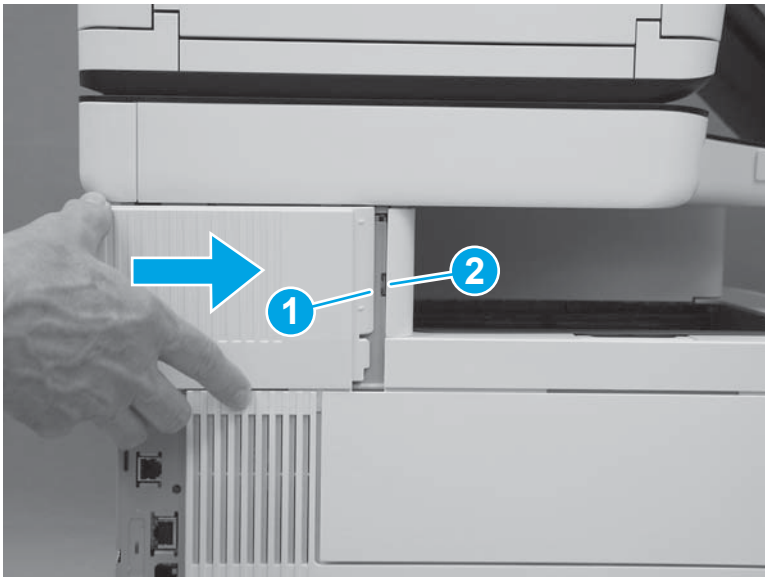

3. Make sure that the tab (callout 1) is fully installed.

Figure 1-5067 Check the tab

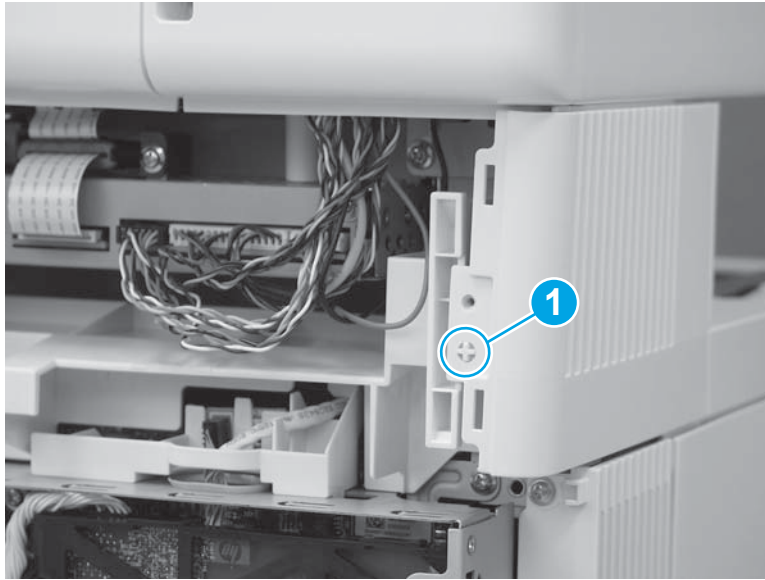

Step 21: Install the rear upper cover (M577)

1. Align the ridge (callout 1) on the lower edge of the rear upper cover in front of the tabs (callout 2) on the top edge of the rear cover.

Figure 1-5068 Align the cover

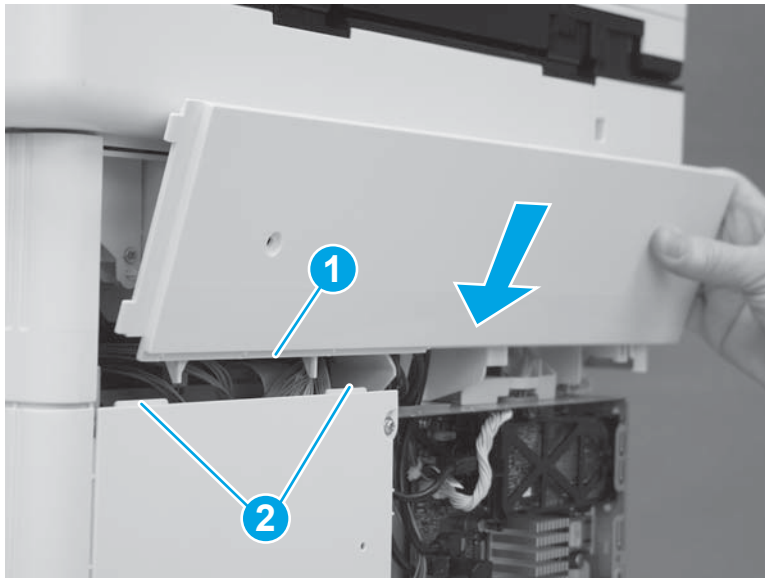

2. Rotate the top of the cover toward the printer.

Figure 1-5069 Rotate the top of the cover

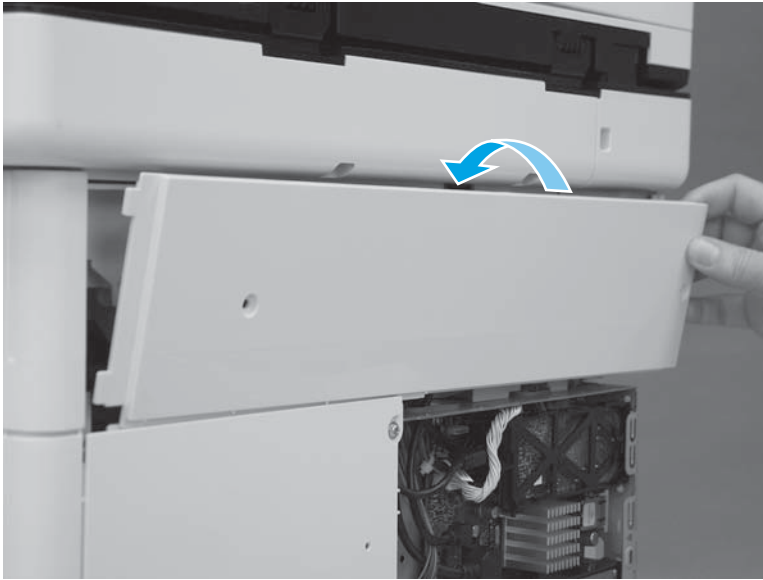

3. Slide the cover to the left (callout 1). Make sure that the tabs (callout 2) on the upper rear cover slide behind the edge (callout 3) of the right upper cover. Make sure that the cover is fully seated.

Figure 1-5070 Slide the cover

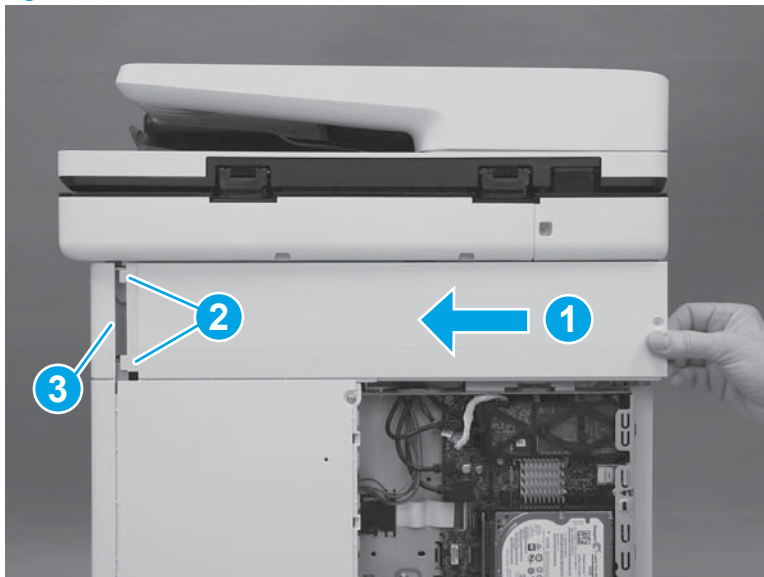

4. Install two screws (callout 1).



 **IMPORTANT:** These two screws are self-tapping screws for plastic. Rotate them counterclockwise to align them with the existing thread pattern, and then carefully turn them clockwise to tighten. Do not overtighten. This will prevent stripping the threads inside the screw holes.

Figure 1-5071 Install two screws

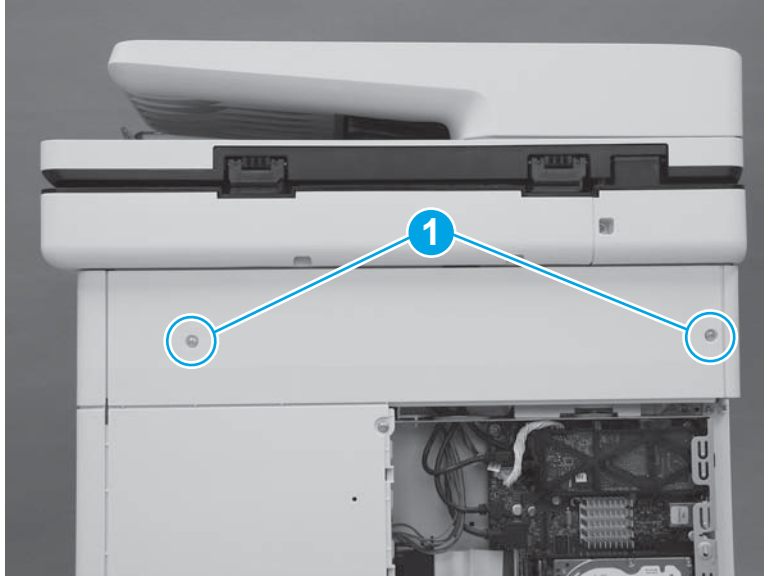

Step 22: Install the fax PCA (M577c/f/z)

 **NOTE:** This step is for the M577c/f/z models. For the M577dn model, skip this step and go to [Step 23: Install the formatter cover on page 2801](#).

 **CAUTION:**  ESD-sensitive part.

1. Position the tab and telephone port (callout 1) on the fax PCA in the slots (callout 2) in the formatter case.

Figure 1-5072 Position the fax PCA

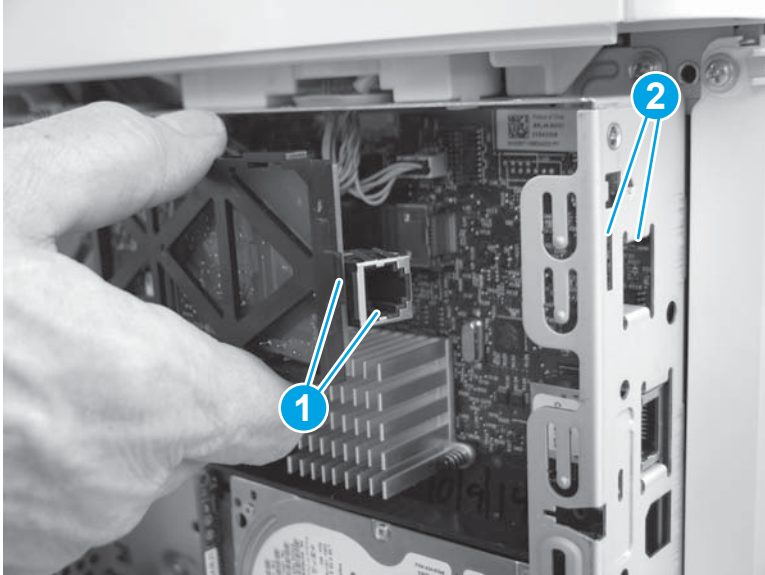

2. Slide the fax PCA to the right (callout 1) until the tab and telephone port described in the previous step and seated in the formatter case. Position the retainer (callout 2) in the slot (callout 3) in the formatter. Rotate the end of the fax PCA toward the formatter (callout 4) until the retainer snaps into place.

Figure 1-5073 Install the fax PCA

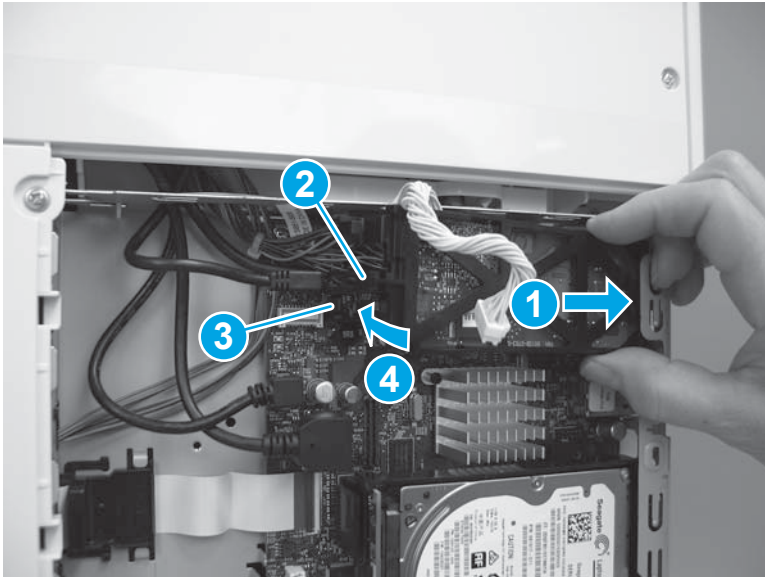

3. Position the cable (callout 1) in the guide (callout 2), and then connect one connector (callout 3).

Figure 1-5074 Connect the connector

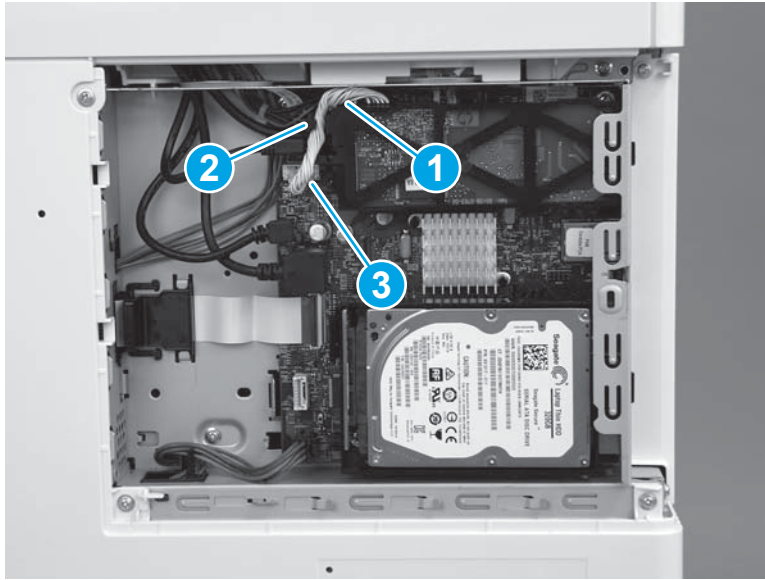

Step 23: Install the formatter cover

- ▲ Slide the cover onto the printer (callout 1) to install it.

 **NOTE:** Make sure that the tabs on the formatter cover align with the slots provided in the printer (callout 2). Tighten the two thumbscrews (callout 3).

 **TIP:** If needed, use the edge of a coin to turn the thumbscrews.

Figure 1-5075 Install the cover



Step 24: Install the control panel (M577)

1. Tilt the control panel away from the base plate.

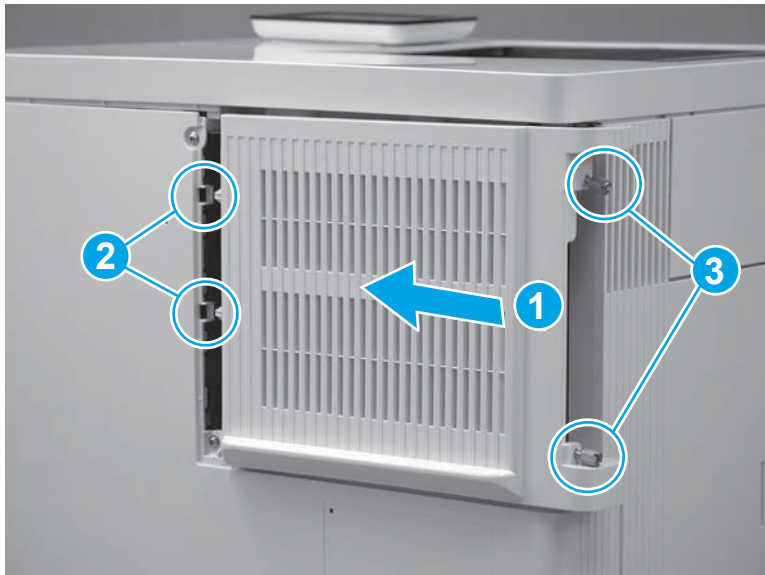
Figure 1-5076 Open the control panel

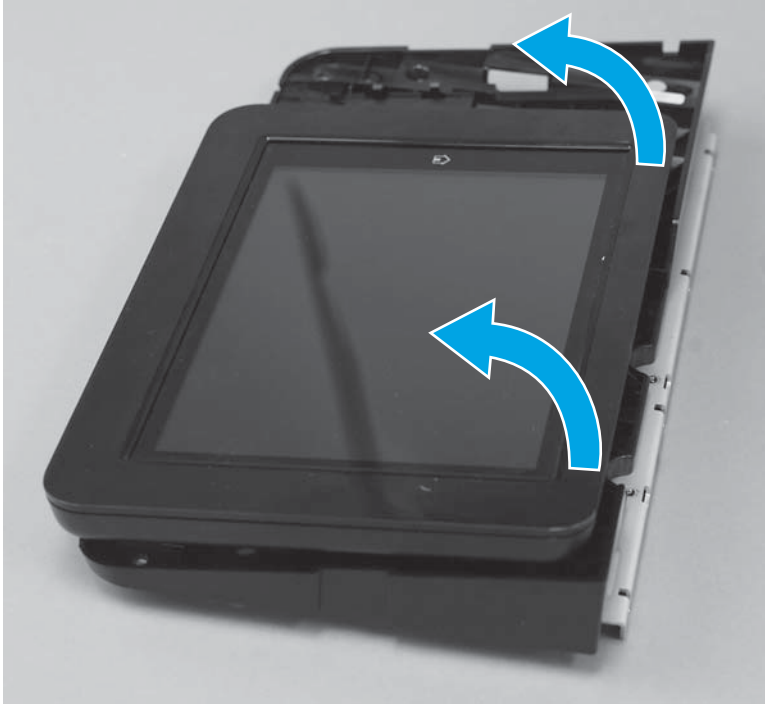

2. Locate the four hooks on the printer and matching slots in the control-panel base (callout 1). The hooks fit into the slots (callout 2) when the assembly is installed.

 **NOTE:** Make sure that the grounding clip (callout 3) is on top of the assembly base when it is installed.

Figure 1-5077 Locate hooks and grounding clip



3. Position the rear edge of the control panel in the printer (callout 1), and then lower the front edge down (callout 2) to install it.

 **NOTE:** If the control panel is difficult to install, make sure that the hooks, slots, and grounding clip are correctly engaged. See [Figure 1-138 Locate hooks and grounding clip on page 97](#).

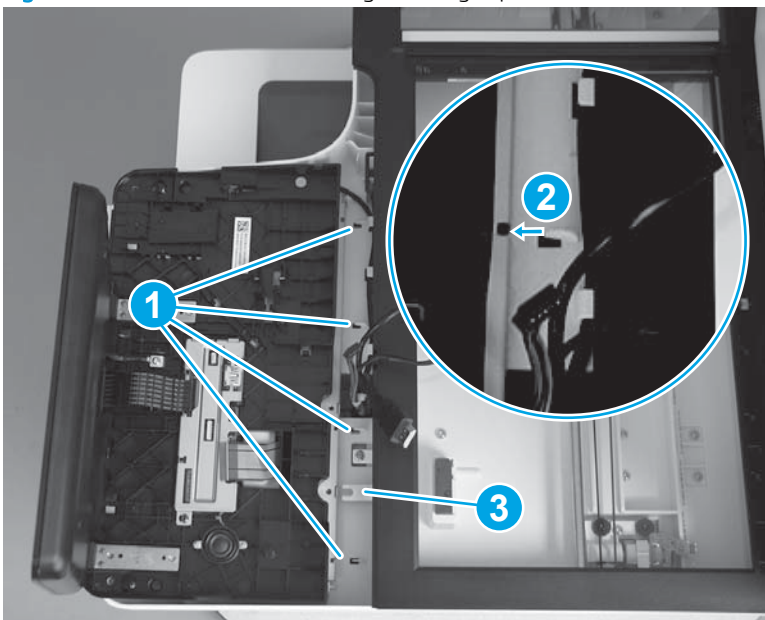
Figure 1-5078 Install the control-panel



4. Install three screws (callout 1), making sure that the grounding clip is correctly installed (callout 2).

Figure 1-5079 Install three screws

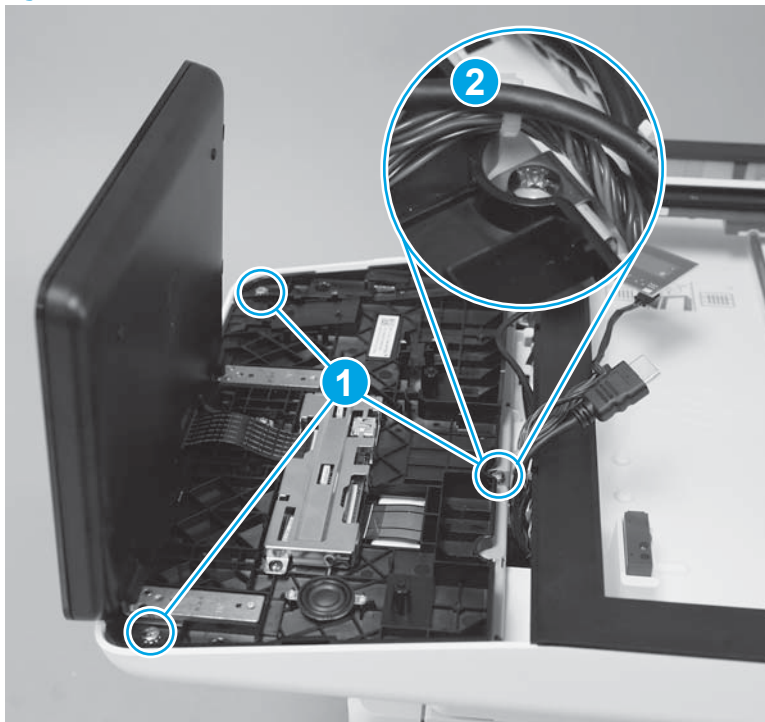

5. Connect one HDMI cable (callout 1), and one connector (callout 2).

Figure 1-5080 Connect connectors



6. Install the USB cable (callout 1) in the holder.
M577z only: Connect one connector (callout 2).

Figure 1-5081 Connect connectors

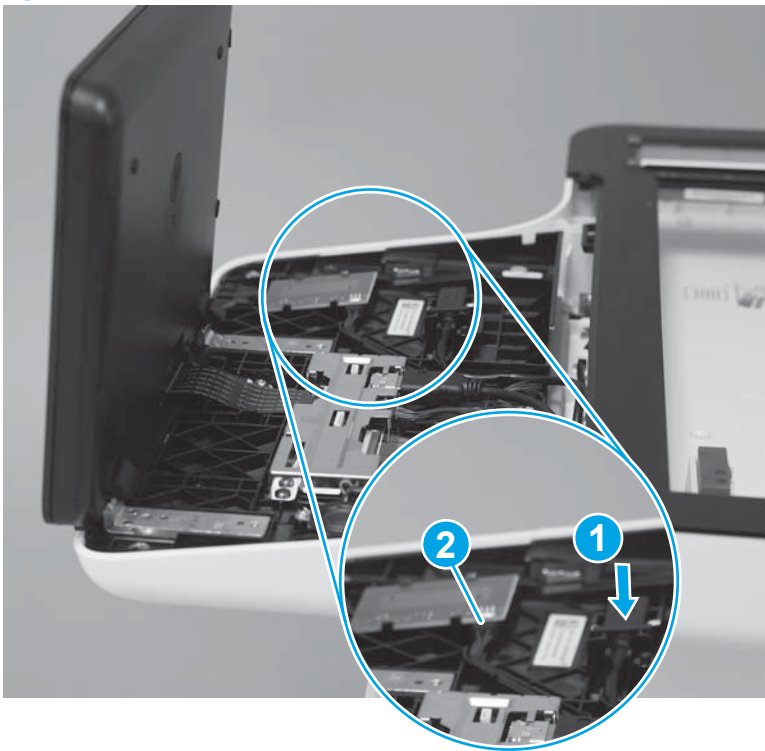

Step 25: Install the keyboard (M577c/z)

 **NOTE:** This step is for the M577c/z models. For the M577dn/f models, skip this step and go to [Step 26: Install the white backing \(M577\) on page 2807](#).

1. Position the flat cable (callout 1) on the keyboard into the keyboard slot (callout 2).

Figure 1-5082 Install the flat cable through the slot

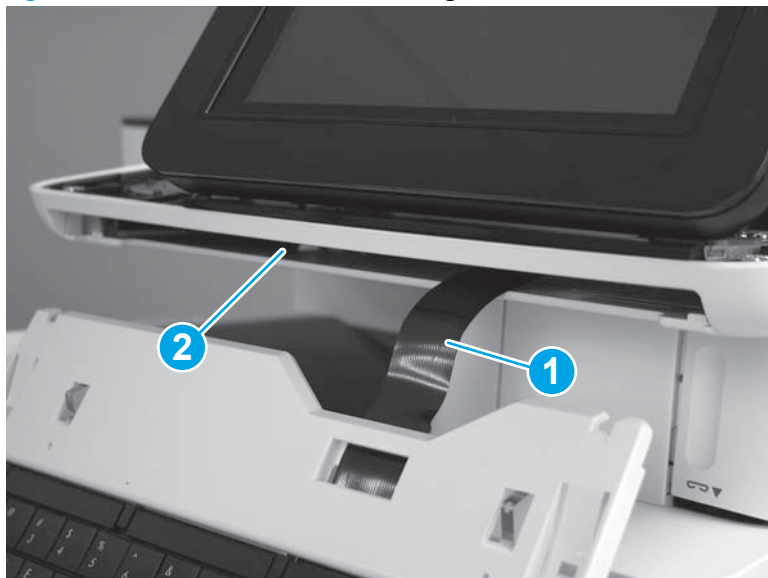

2. Slide the keyboard tray into the slot.

 **NOTE:** Only slide the tray halfway into the opening. This makes connecting the cable in the next step easier.

Figure 1-5083 Slide the keyboard into the slot



3. If the flat cable (callout 1) is not in the opening (callout 2) in the control panel base, carefully reach in and thread the flat cable through the opening.

Figure 1-5084 Check the flat cable

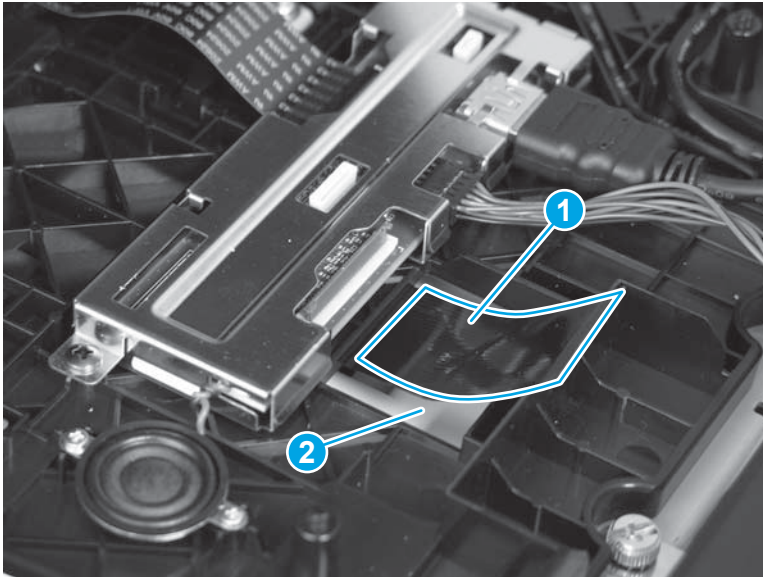

4. Position the keyboard flat cable in the connector, and then close the connector latch.

 **IMPORTANT:** Slightly tug on the cable to make sure that it is fully captured in the connector.

 **NOTE:** When the connector latch is closed and the cable is correctly installed, the white line on the cable is parallel to the connector latch.

Figure 1-5085 Connect the flat cable

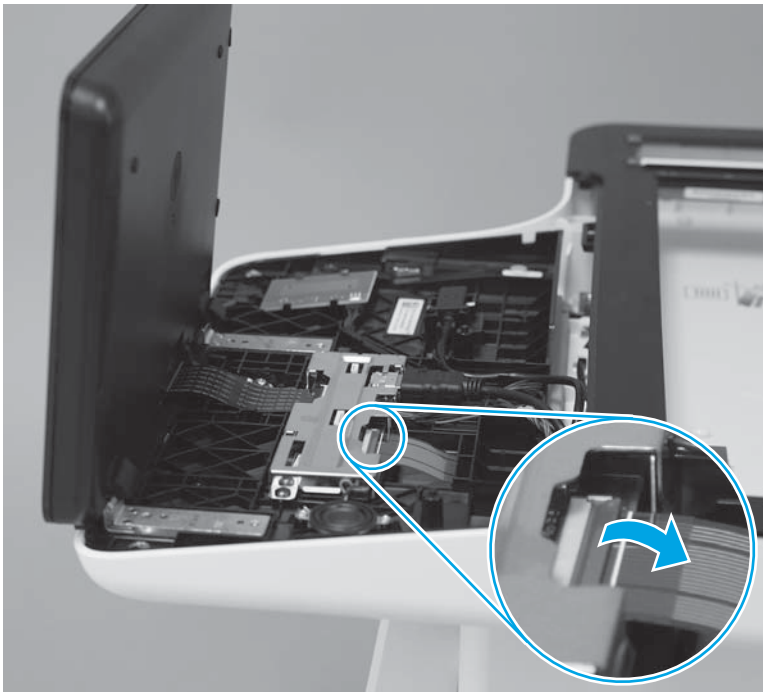

Step 26: Install the white backing (M577)

 **IMPORTANT:** When a replacement image scanner is installed, the white backing on the document feeder must be removed, and then a replacement white backing (supplied in the kit) must be installed.

1. Open the document feeder, and then place the replacement white backing on the flatbed scanner glass, as shown.

 **NOTE:** Place the corner of the backing that does not have a hook-and-loop fastener in the upper-left corner of the scanner glass.

Figure 1-5086 Install the white backing



2. Close the document feeder.

Figure 1-5087 Close the document feeder

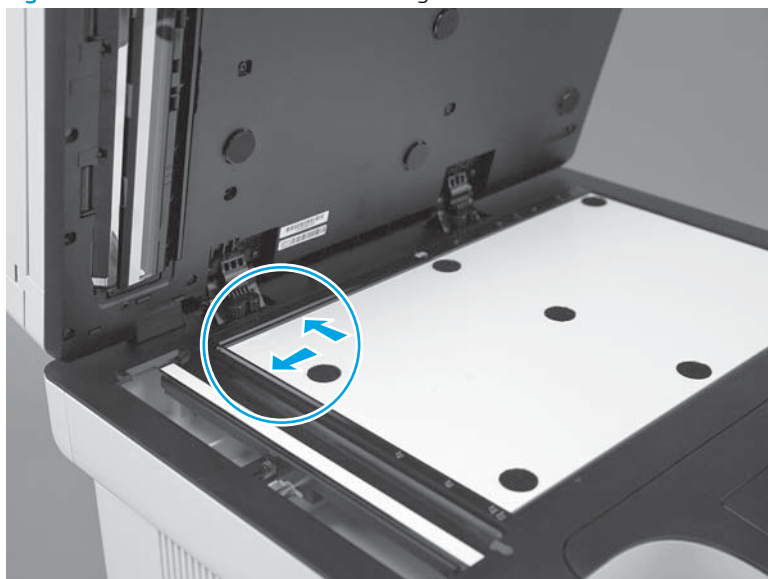
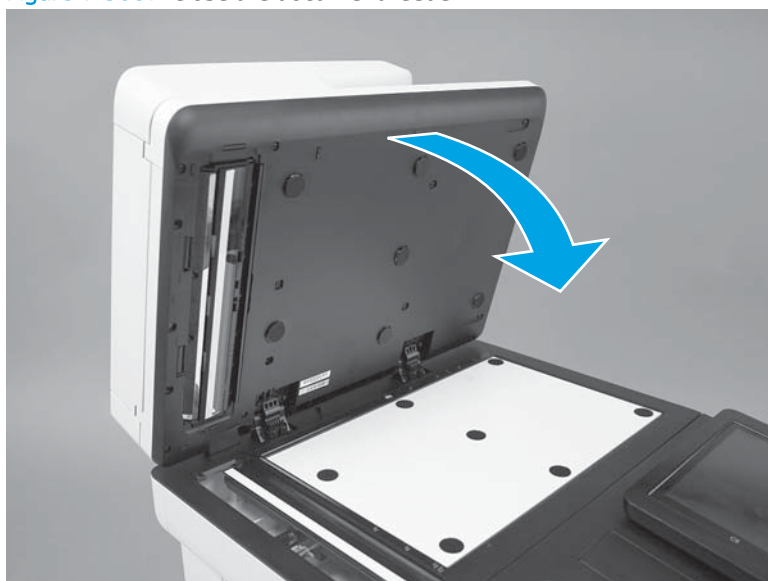

3. Open the document feeder and make sure that the white backing is securely attached.

Figure 1-5088 Check the white backing



Step 27: Install the control-panel cover (M577)

1. Position the control-panel cover on the printer.

Figure 1-5089 Position the control-panel cover on the printer



2. Beginning at the left side of the control-panel cover, carefully push down along the top edge of the cover to engage five tabs.

Figure 1-5090 Engage five tabs

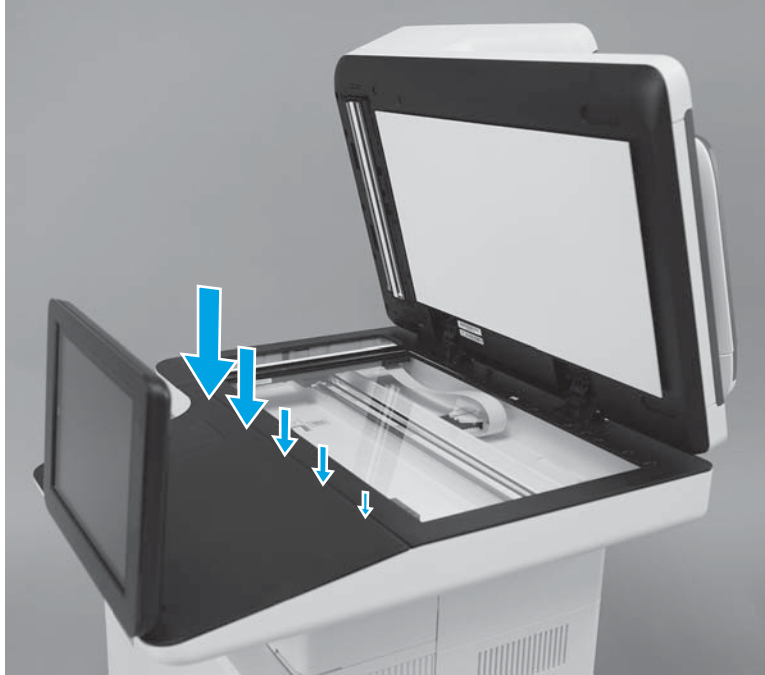

3. Close the document feeder.

 **NOTE:** Adjust the control panel to the desired angle.

Figure 1-5091 Close the document feeder



Removal and replacement: Trays

- [Removal and replacement: Tray 2](#)
- [Removal and replacement: Tray 3, Tray 4, or Tray 5](#)

Removal and replacement: Tray 2

- [Introduction](#)
- [Step 1: Remove the tray](#)
- [Step 2: Unpack the replacement assembly](#)
- [Step 3: Install the tray](#)

Introduction

This document provides the procedures to remove and replace Tray 2.

Before performing service

Use the table below to identify the correct part number for your printer, and then go to <http://h20141.www2.hp.com/hpparts> to order the part.

Tray 2 part number	
RM2-0007-000CN	Tray 2

Required tools

No special tools are required to install this part.

After performing service

Make sure that Tray 2 is fully closed after replacing it.

Post service test

Print a configuration page to make sure that the printer is functioning correctly.

Step 1: Remove the tray

1. Pull the tray out until it stops.

Figure 1-5092 Pull the tray out



2. Lift the front of the tray, and then pull it out of the printer to remove it.

Figure 1-5093 Remove the tray

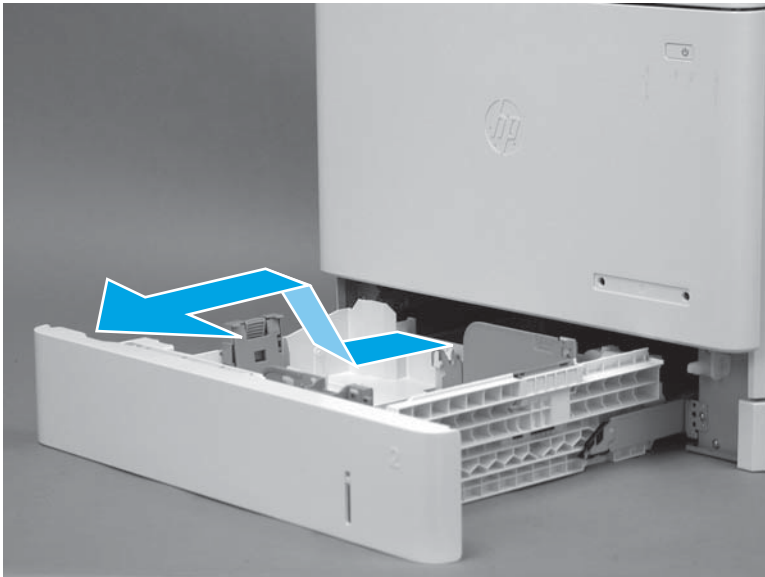

 **NOTE:** If the tray has Fixed Tray Guides installed and are still required, move hardware to new tray. If necessary, order new kit: 3GY25-67901 Kit - Fixed Tray Guide. Only one kit required per engine.

Step 2: Unpack the replacement assembly

Unpack the replacement assembly from the packaging.

For complete information on HP's recycling programs, go to [Product return and recycling](#).

 **NOTE:** HP recommends responsible disposal of the defective assembly.

Figure 1-5094 Recycle and unpack

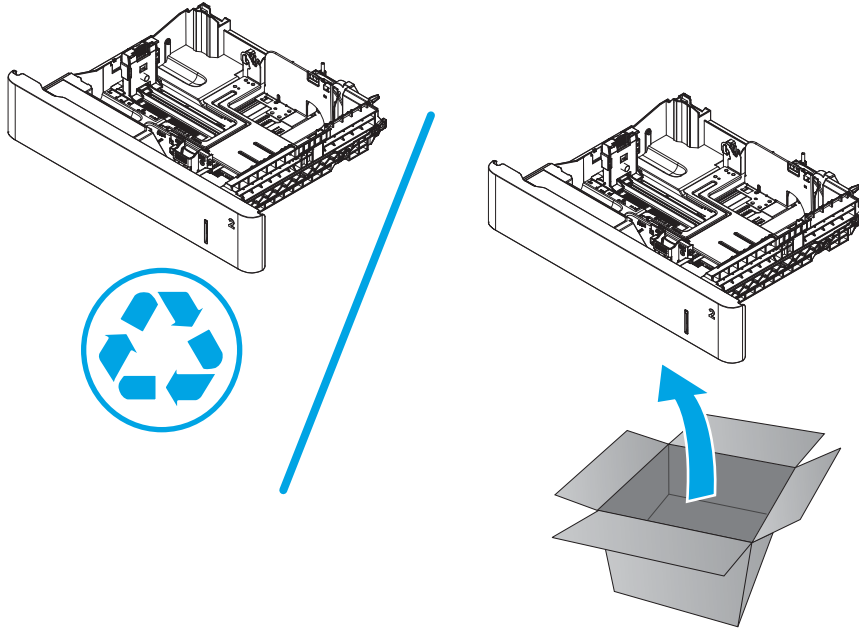

Step 3: Install the tray

1. With the front of the tray slightly lifted, align the sides of the tray with the rails in the printer, and then carefully slide the tray into the printer.

 **TIP:** As the tray slides into the printer, lower the front of it.

Figure 1-5095 Install the tray



2. Close the tray.

Figure 1-5096 Close the tray



Removal and replacement: Tray 3, Tray 4, or Tray 5

- [Introduction](#)
- [Step 1: Remove the tray](#)
- [Step 2: Unpack the replacement assembly](#)
- [Step 3: Install the tray](#)

Introduction

This document provides the procedures to remove and replace Tray 3, Tray 4, or Tray 5.

Before performing service

Use the table below to identify the correct part number for your printer, and then go to <http://h20141.www2.hp.com/hpparts> to order the part.

Tray 3/4/5 part number	
RM2-5150-000CN	Tray 3, Tray 4, or Tray 5

Required tools

No special tools are required to install this part.

After performing service

Make sure that Tray 3/4/5 is fully closed after replacing it.

Post service test

Print a page from a host computer using the appropriate tray as the source tray.

Step 1: Remove the tray

1. Pull the tray out until it stops.

Figure 1-5097 Pull the tray out

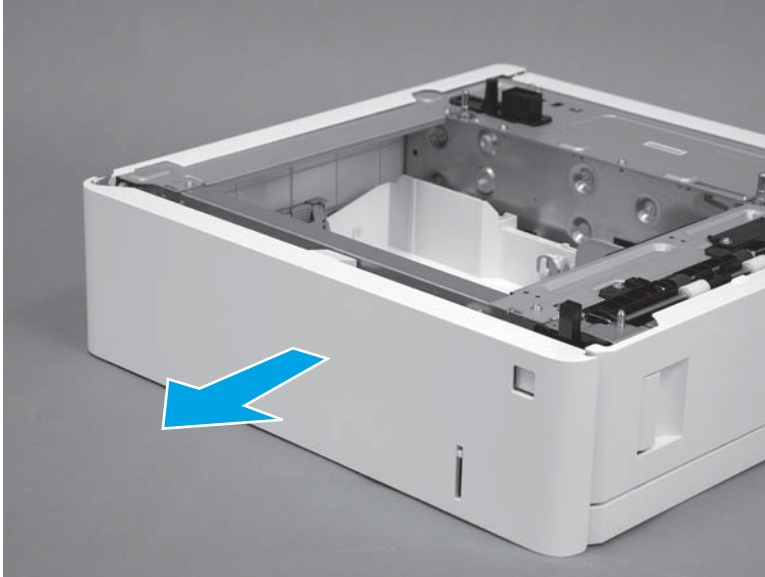

2. Lift the front of the tray, and then pull it out of the printer to remove it.

Figure 1-5098 Remove the tray

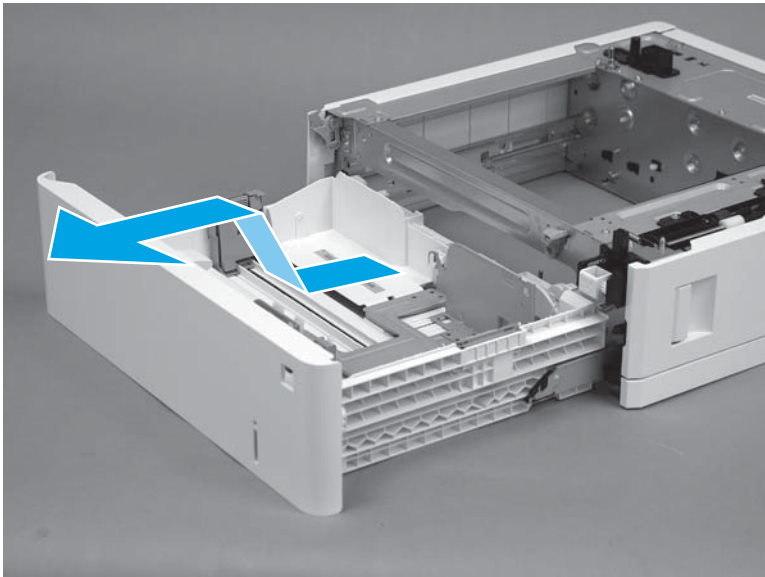

 **NOTE:** If the tray has Fixed Tray Guides installed and are still required, move hardware to new tray. If necessary, order new kit: 3GY25-67901 Kit - Fixed Tray Guide. Only one kit required per engine.

Step 2: Unpack the replacement assembly

Unpack the replacement assembly from the packaging.

For complete information on HP's recycling programs, go to [Product return and recycling](#).

 **NOTE:** HP recommends responsible disposal of the defective assembly.

Figure 1-5099 Recycle and unpack

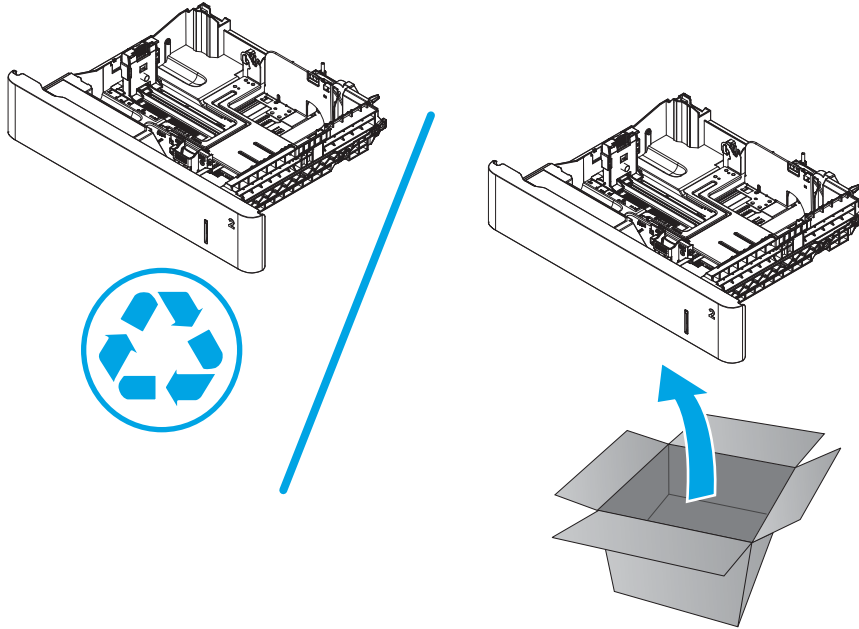

Step 3: Install the tray

1. With the front of the tray slightly lifted, align the sides of the tray with the rails in the printer, and then carefully slide the tray into the printer.

 **TIP:** As the tray slides into the accessory, lower the front of it.

Figure 1-5100 Install the tray



2. Close the tray.

Figure 1-5101 Close the tray

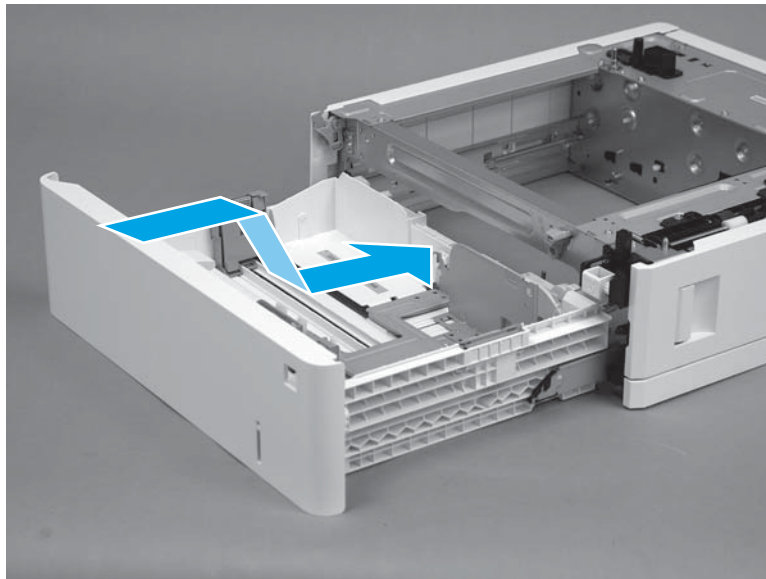
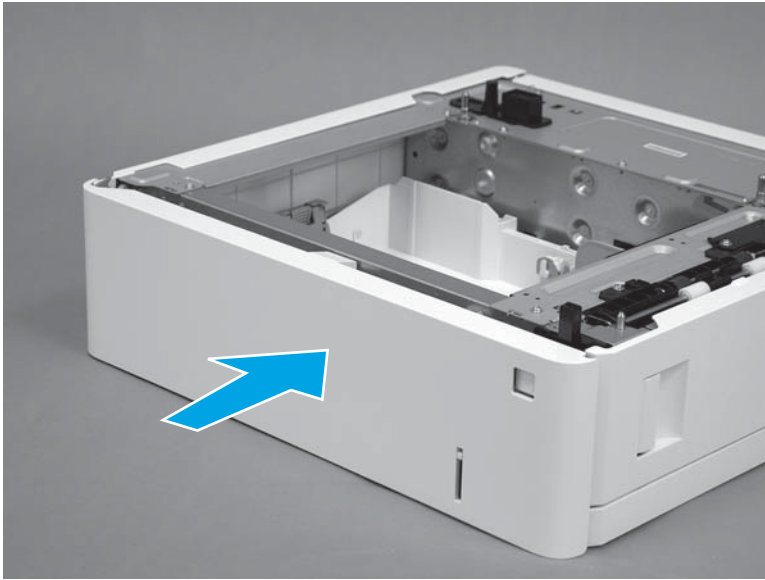

Removal and replacement: Accessories

- [Removal and replacement: 1x550-sheet paper feeder](#)
- [Removal and replacement: Trusted platform module \(M552 and M553\)](#)
- [Removal and replacement: Trusted platform module \(M577\)](#)
- [Removal and replacement: Internal USB ports \(M552 and M553\)](#)
- [Removal and replacement: Internal USB ports \(M577\)](#)
- [Removal and replacement: Fax PCA \(M577c/f/z\)](#)

Removal and replacement: 1x550-sheet paper feeder



NOTE: HP recommends removing the accessories from the product before servicing them.

- [Removal and replacement: Rear cover \(1x550-sheet paper feeder\)](#)
- [Removal and replacement: Right door \(1x550-sheet paper feeder\)](#)
- [Removal and replacement: Right door hinge bracket \(1x550-sheet paper feeder\)](#)
- [Removal and replacement: Right-lower cover \(1x550-sheet paper feeder\)](#)
- [Removal and replacement: Right-door link \(1x550-sheet paper feeder\)](#)
- [Removal and replacement: Left cover \(1x550-sheet paper feeder\)](#)
- [Removal and replacement: OP Drawer holder \(1x550-sheet paper feeder\)](#)
- [Removal and replacement: Auto close assembly \(1x550-sheet paper feeder\)](#)
- [Removal and replacement: Switch button \(SW12\) \(1x550-sheet paper feeder\)](#)
- [Removal and replacement: Drawer connector holder \(1x550-sheet paper feeder\)](#)
- [Removal and replacement: Paper-feeder drive PCA \(1x550-sheet paper feeder\)](#)
- [Removal and replacement: Paper feed assembly \(1x550-sheet paper feeder\)](#)
- [Removal and replacement: Paper pickup assembly \(1x550-sheet paper feeder\)](#)
- [Removal and replacement: Feeder drive assembly \(1x550-sheet paper feeder\)](#)
- [Removal and replacement: Lifter drive assembly \(1x550-sheet paper feeder\)](#)

Removal and replacement: Rear cover (1x550-sheet paper feeder)

- [Introduction](#)
- [Step 1: Remove the rear cover](#)
- [Step 2: Unpack the replacement assembly](#)
- [Step 3: Install the rear cover](#)

Introduction

This document provides the procedures to remove and replace the 1x550-sheet paper feeder rear cover.

Before performing service

Use the table below to identify the correct part number for your printer, and then go to <http://h20141.www2.hp.com/hpparts> to order the part.

Rear cover (1x550-sheet paper feeder) part number	
RC4-1792-000CN	Rear cover (1x550-sheet paper feeder)

Required tools

No special tools are required to install this part.

After performing service

Make sure that the rear cover is flush against the chassis after replacing it.

Step 1: Remove the rear cover

1. Release three tabs (callout 1).

Figure 1-5102 Release three tabs

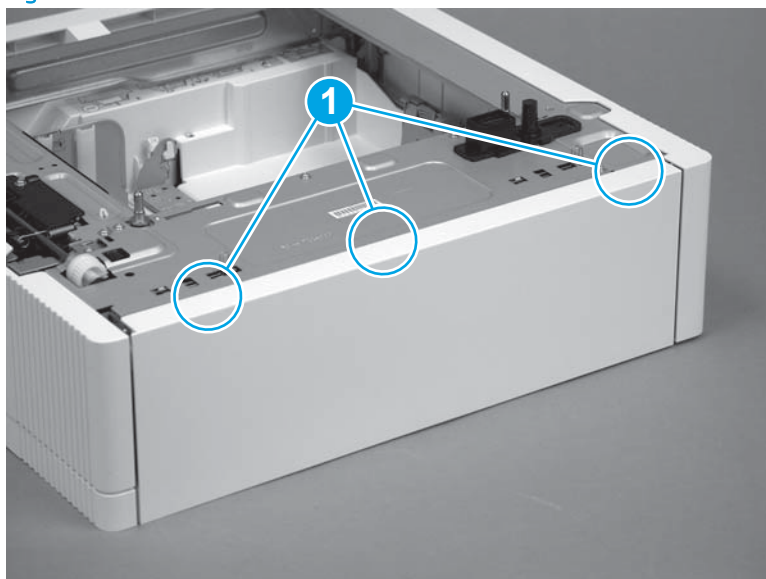

2. Rotate the top of the cover away from the accessory (callout 1), and then lift it up to remove it (callout 2).

Figure 1-5103 Remove the cover

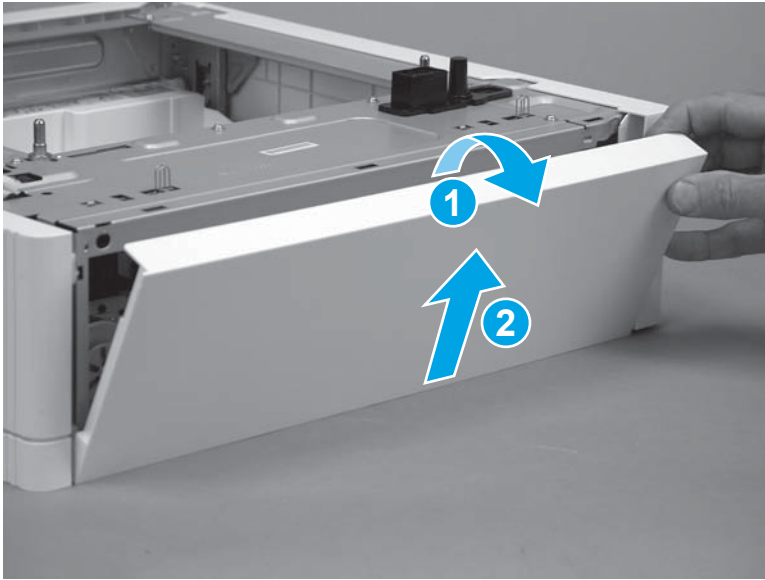

Step 2: Unpack the replacement assembly

Unpack the replacement assembly from the packaging.

For complete information on HP's recycling programs, go to [Product return and recycling](#).

 **NOTE:** HP recommends responsible disposal of the defective assembly.

Figure 1-5104 Recycle and unpack

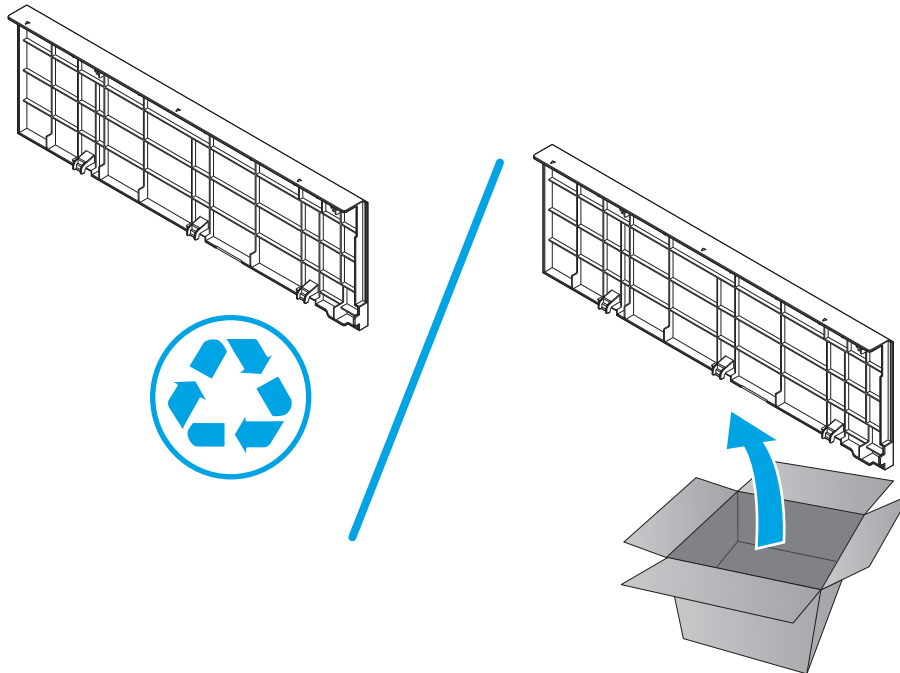

Step 3: Install the rear cover

1. Align the three mounting tabs (callout 1) on the cover with the slots in the chassis.

Figure 1-5105 Position the cover on the chassis

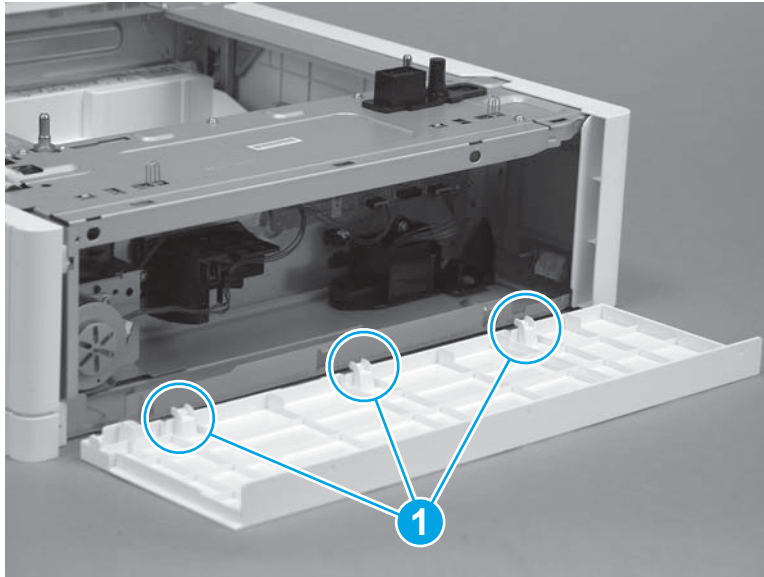

2. Position the cover on the accessory (callout 1), and then rotate the top of the cover up and onto the chassis (callout 2) to install it.

Figure 1-5106 Install the cover

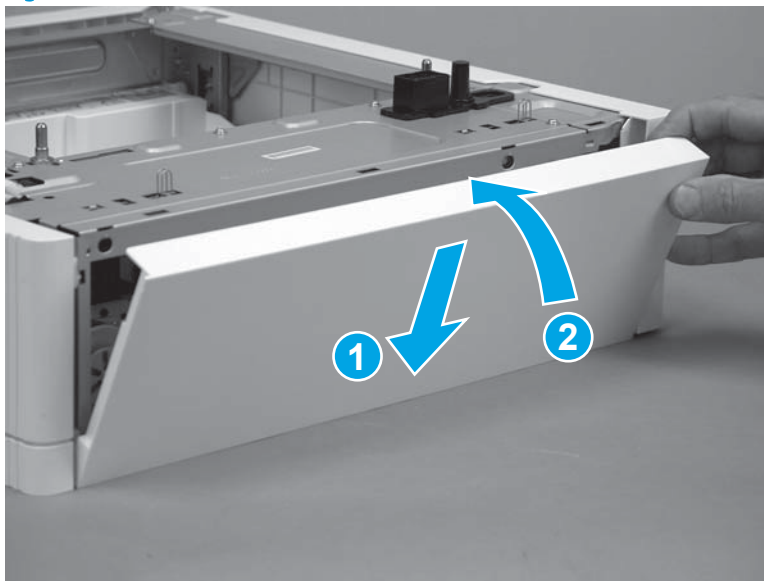

3. Make sure that the three tabs (callout 1) snap into place.

Figure 1-5107 Check the three tabs

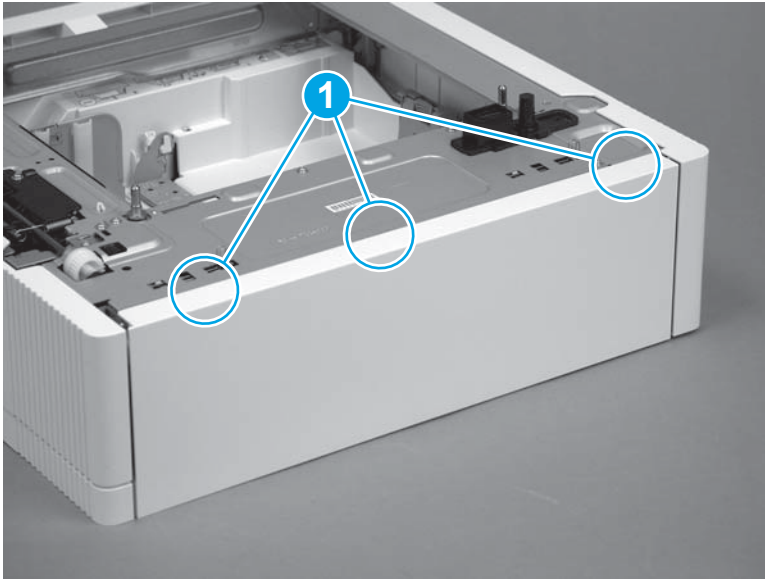

Removal and replacement: Right door (1x550-sheet paper feeder)

- [Introduction](#)
- [Step 1: Remove the rear cover](#)
- [Step 2: Remove the right door](#)
- [Step 3: Unpack the replacement assembly](#)
- [Step 4: Install the right door](#)
- [Step 5: Install the rear cover](#)

Introduction

This document provides the procedures to remove and replace the 1x550-sheet paper feeder right door.

Before performing service

Use the table below to identify the correct part number for your printer, and then go to <http://h20141.www2.hp.com/hpparts> to order the part.

Right door (1x550-sheet paper feeder) part number	
RM2-5146-000CN	Right door (1x550-sheet paper feeder)

Required tools

No special tools are required to install this part.

After performing service

Make sure that the right door latches correctly when closed after replacing it.

Step 1: Remove the rear cover

1. Release three tabs (callout 1).

Figure 1-5108 Release three tabs

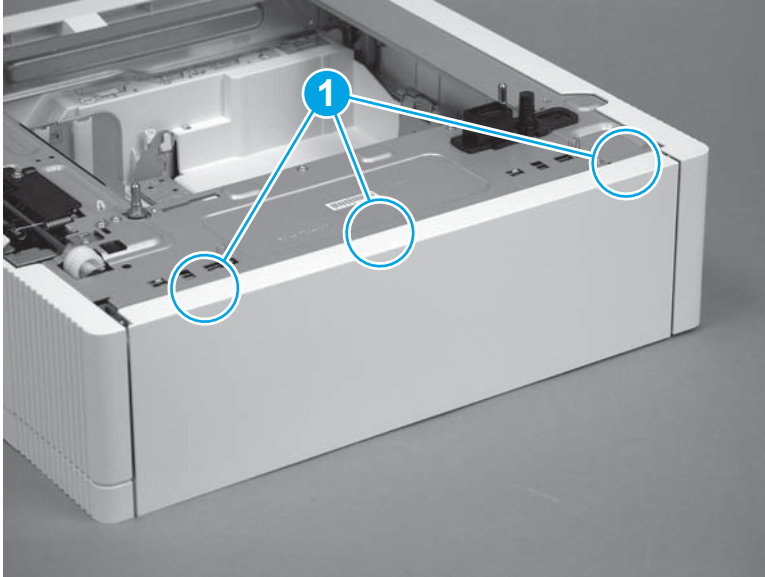

2. Rotate the top of the cover away from the accessory (callout 1), and then lift it up to remove it (callout 2).

Figure 1-5109 Remove the cover

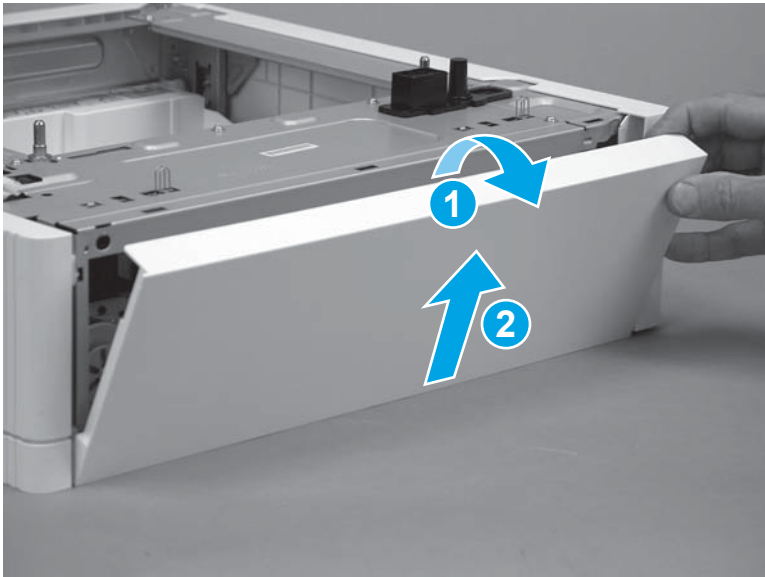

Step 2: Remove the right door

1. Open the door.

Figure 1-5110 Open the door

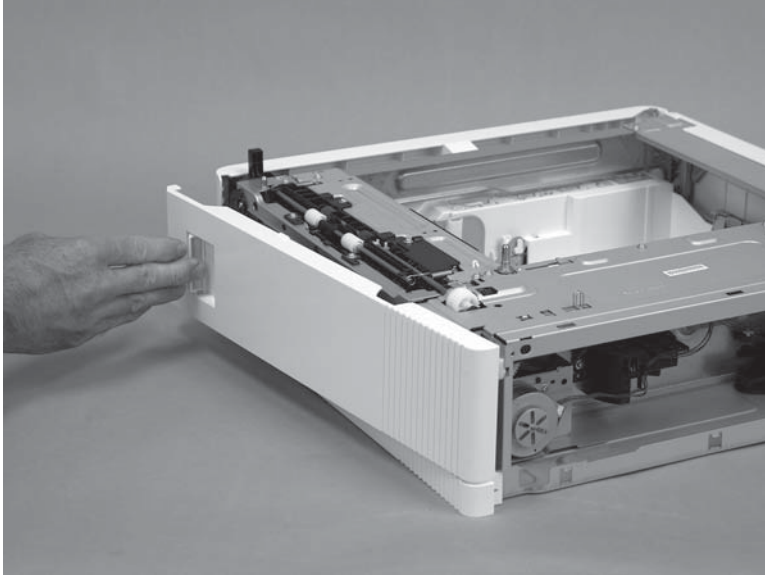

2. Release one tab (callout 1), and then slide the door-hinge bracket away from the chassis (callout 2) to release it.

Figure 1-5111 Release the hinge bracket

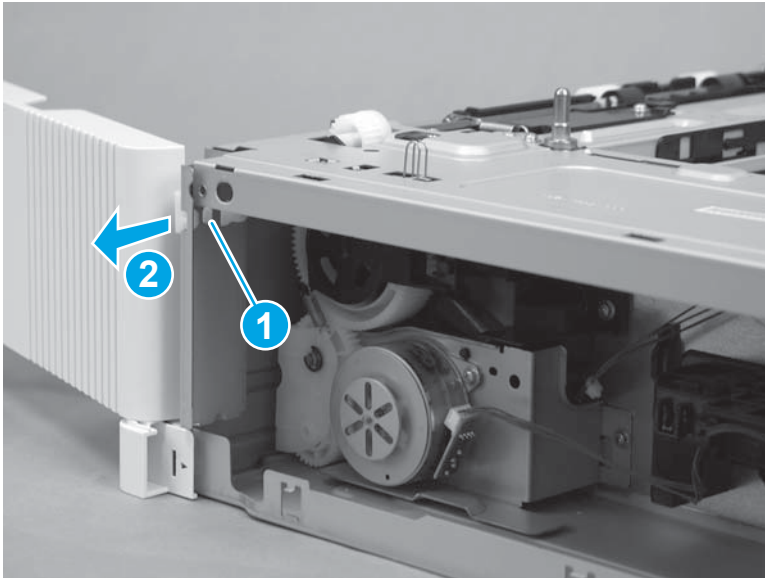

3. Remove the door-hinge bracket from the chassis.

⚠ CAUTION: The door is still attached to the accessory by the door link. Do not attempt to completely remove the door.

The door hinge bracket is not captive. Do not lose it when handling the door.

Figure 1-5112 Remove the hinge bracket

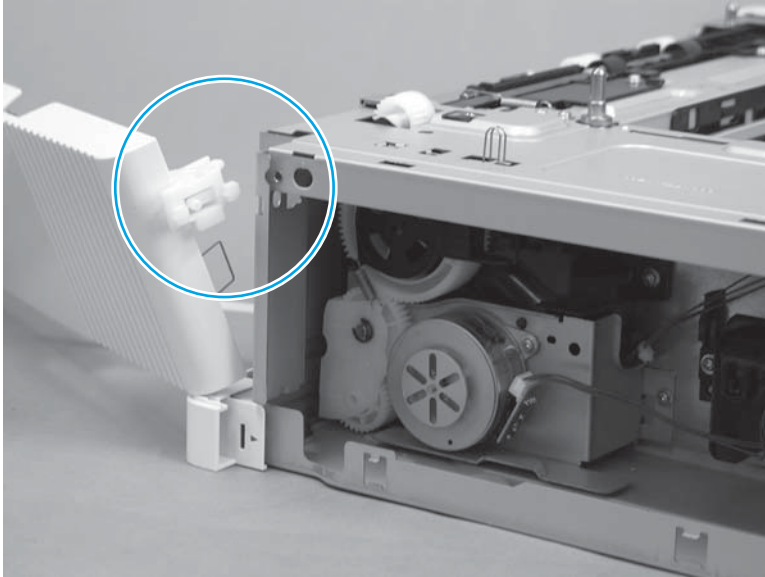

4. Release the door link from the slot in the door to remove the right door.

Figure 1-5113 Release the door link

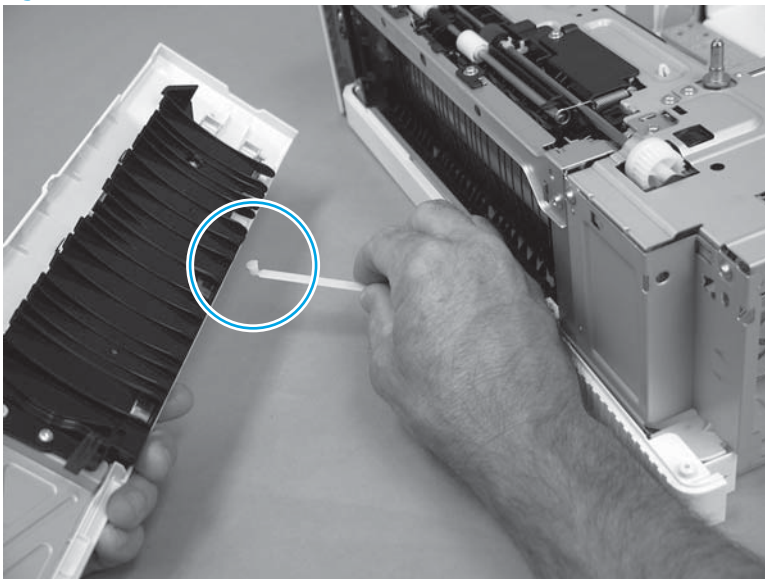

Step 3: Unpack the replacement assembly

Unpack the replacement assembly from the packaging.

For complete information on HP's recycling programs, go to [Product return and recycling](#).

 **NOTE:** HP recommends responsible disposal of the defective assembly.

Figure 1-5114 Recycle and unpack

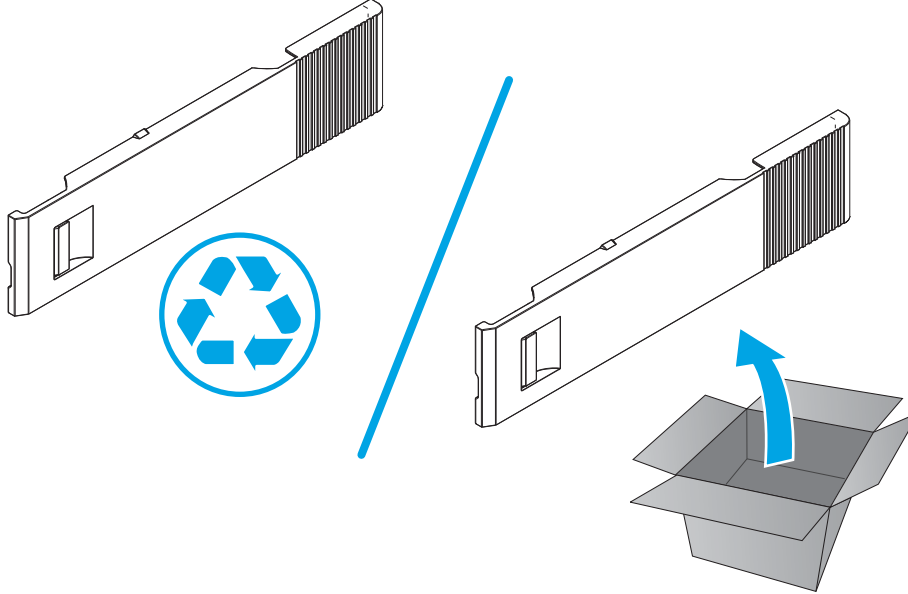

Step 4: Install the right door

 **NOTE:** If a replacement right door is installed, remove the right door hinge bracket from the discarded door, and then install it on the replacement door.

1. Install the door link in the slot in the door to attach the door.

Figure 1-5115 Install the door link

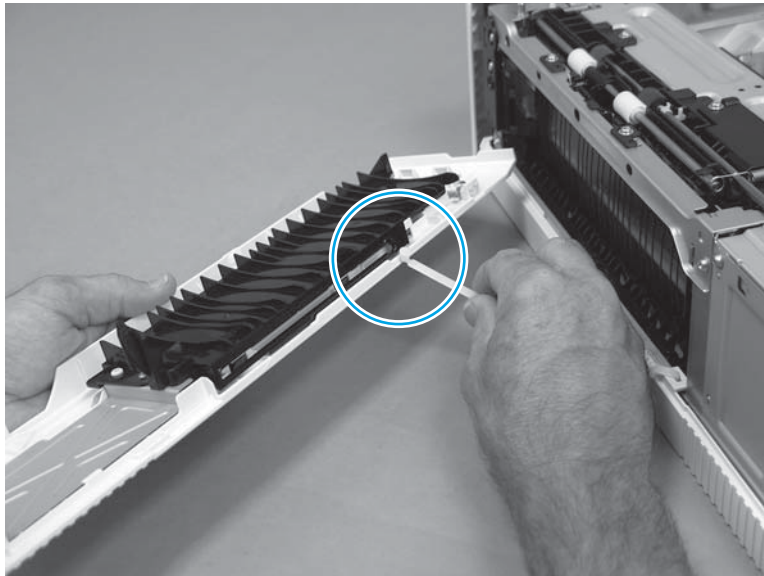

2. Position the lower hinge hole on the door (callout 2) on the lower hinge pin (callout 2) on the right-lower cover.

Figure 1-5116 Position the door on the lower hinge

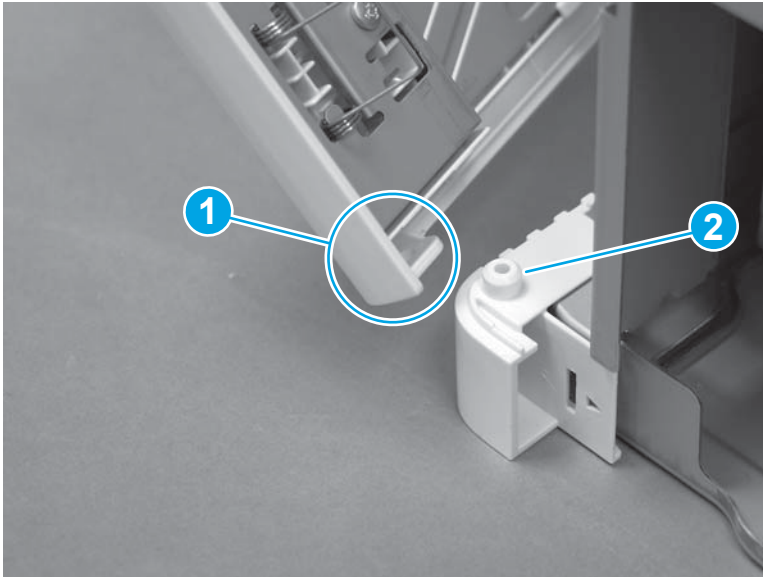

3. Align the pin of the door-hinge bracket (callout 1) with the hole in the chassis, and then align the mounting tabs (callout 2 and callout 3) with the slots in the chassis.

Figure 1-5117 Engage the hinge bracket

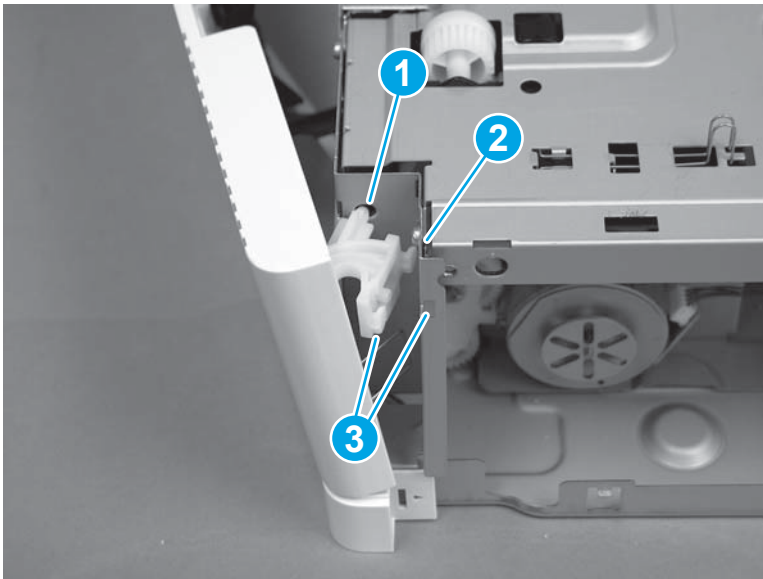

4. Push in on the door-hinge bracket (callout 1), and then slide it toward the chassis (callout 2) to install it.

Figure 1-5118 Install the hinge bracket

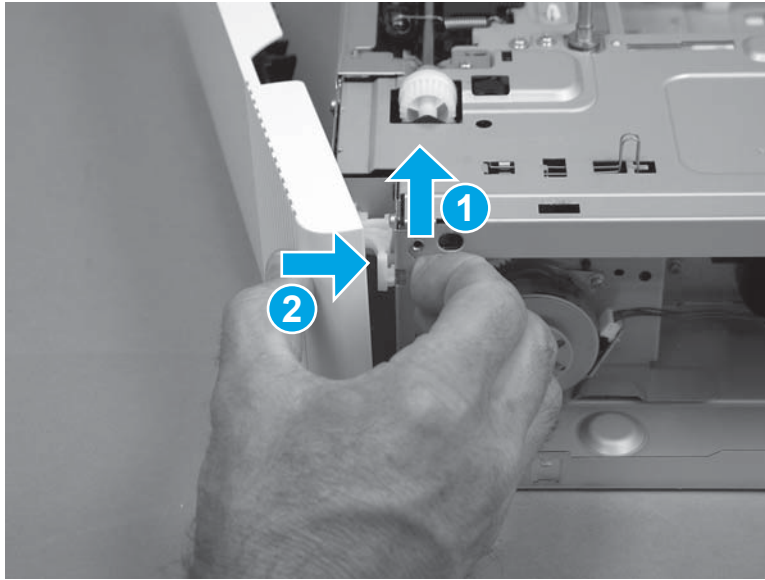

5. Close the door.

Figure 1-5119 Close the door

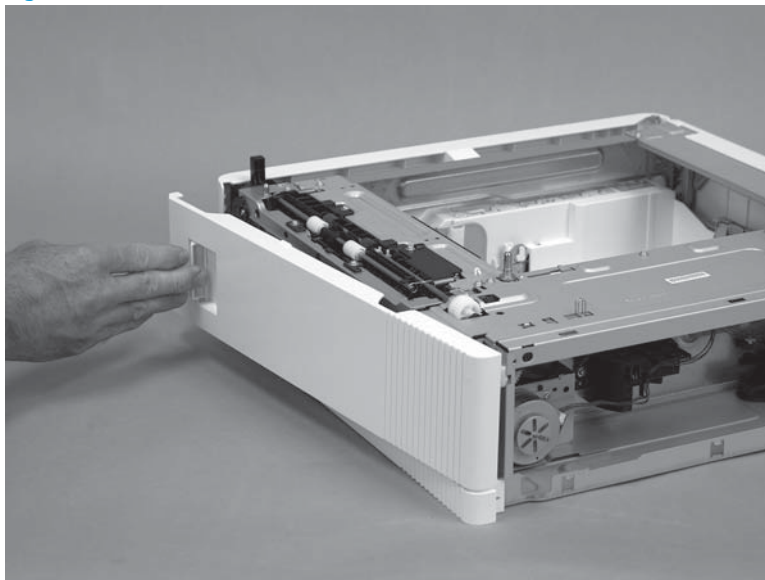

Step 5: Install the rear cover

1. Align the three mounting tabs (callout 1) on the cover with the slots in the chassis.

Figure 1-5120 Position the cover on the chassis

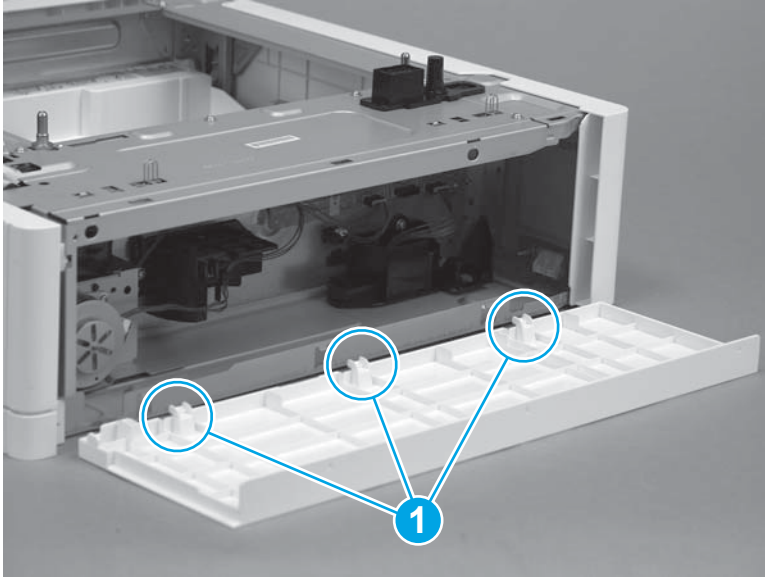

2. Position the cover on the accessory (callout 1), and then rotate the top of the cover up and onto the chassis (callout 2) to install it.

Figure 1-5121 Install the cover

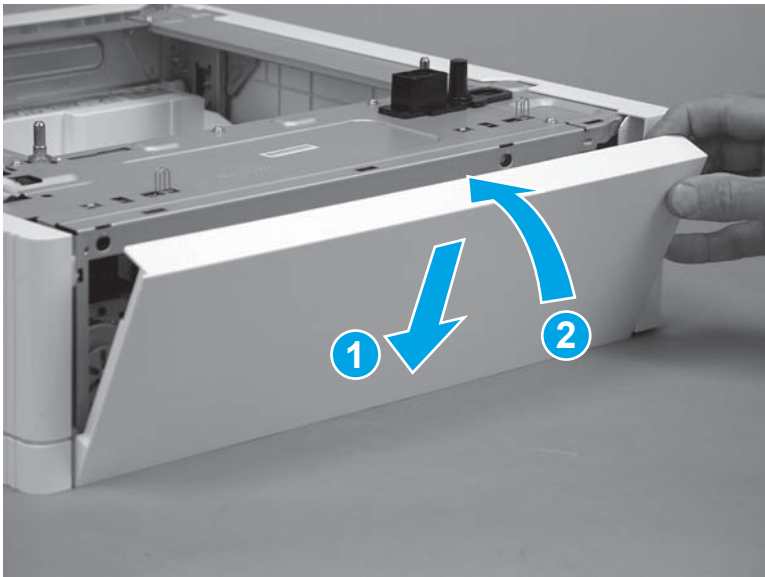

3. Make sure that the three tabs (callout 1) snap into place.

Figure 1-5122 Check the three tabs

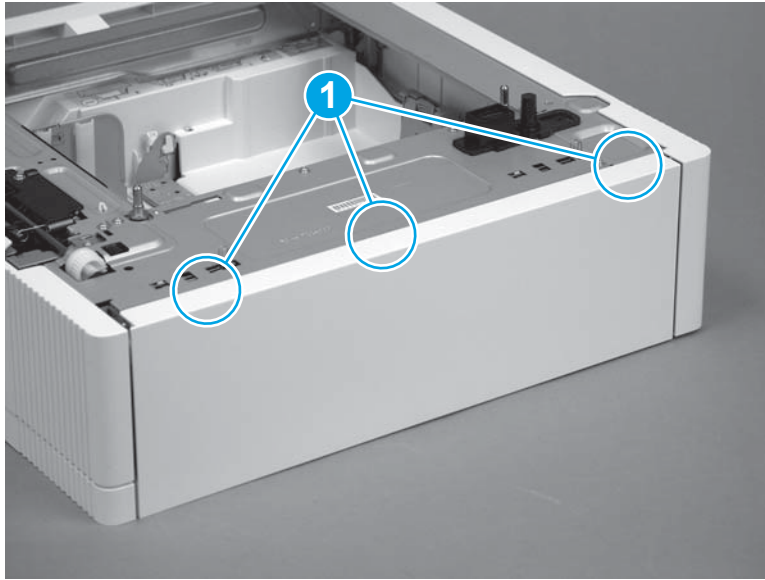

Removal and replacement: Right door hinge bracket (1x550-sheet paper feeder)

- [Introduction](#)
- [Step 1: Remove the rear cover](#)
- [Step 2: Remove the right door](#)
- [Step 3: Remove the right door hinge bracket](#)
- [Step 4: Unpack the replacement assembly](#)
- [Step 5: Install the right door hinge bracket](#)
- [Step 6: Install the right door](#)
- [Step 7: Install the rear cover](#)

Introduction

This document provides the procedures to remove and replace the 1x550-sheet paper feeder right door hinge bracket.

Before performing service

Use the table below to identify the correct part number for your printer, and then go to <http://h20141.www2.hp.com/hpparts> to order the part.

Right door hinge bracket (1x550-sheet paper feeder) part number	
RC4-1781-000CN	Right door hinge bracket (1x550-sheet paper feeder)

Required tools

No special tools are required to install this part.

After performing service

Make sure that the right door latches correctly when closed after replacing it.

Step 1: Remove the rear cover

1. Release three tabs (callout 1).

Figure 1-5123 Release three tabs

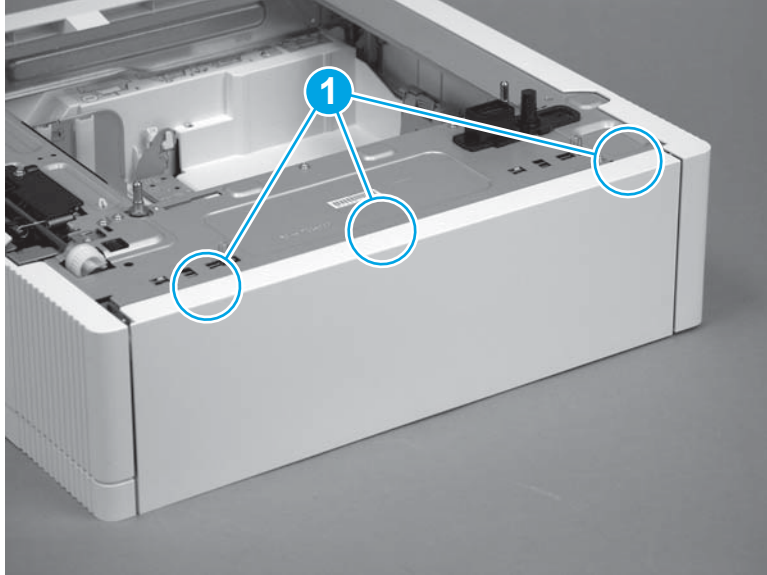

2. Rotate the top of the cover away from the accessory (callout 1), and then lift it up to remove it (callout 2).

Figure 1-5124 Remove the cover

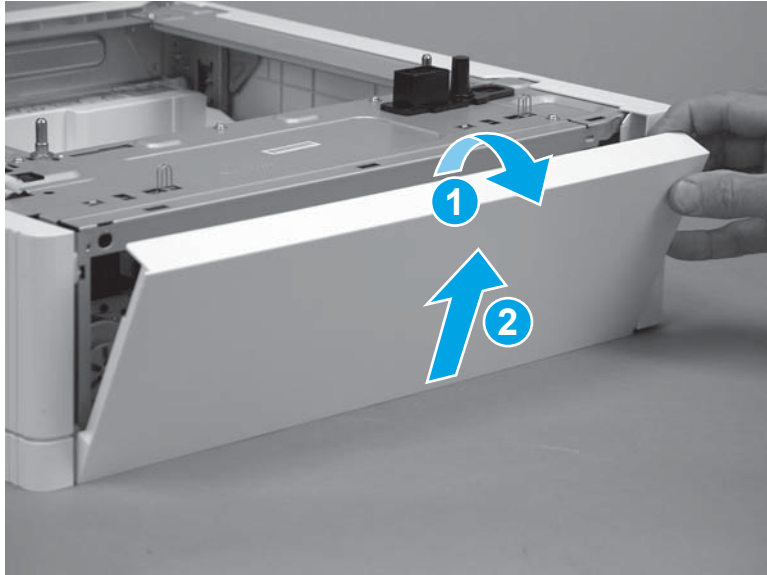

Step 2: Remove the right door

1. Open the door.

Figure 1-5125 Open the door

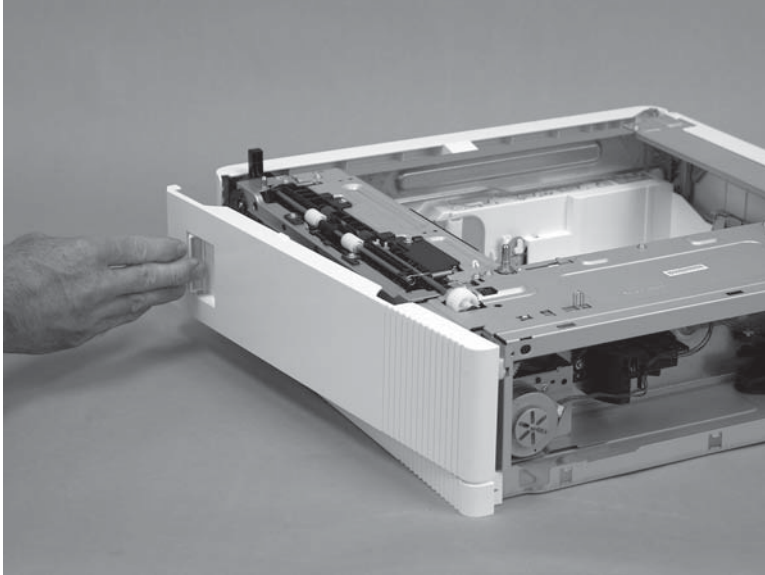

2. Release one tab (callout 1), and then slide the door-hinge bracket away from the chassis (callout 2) to release it.

Figure 1-5126 Release the hinge bracket

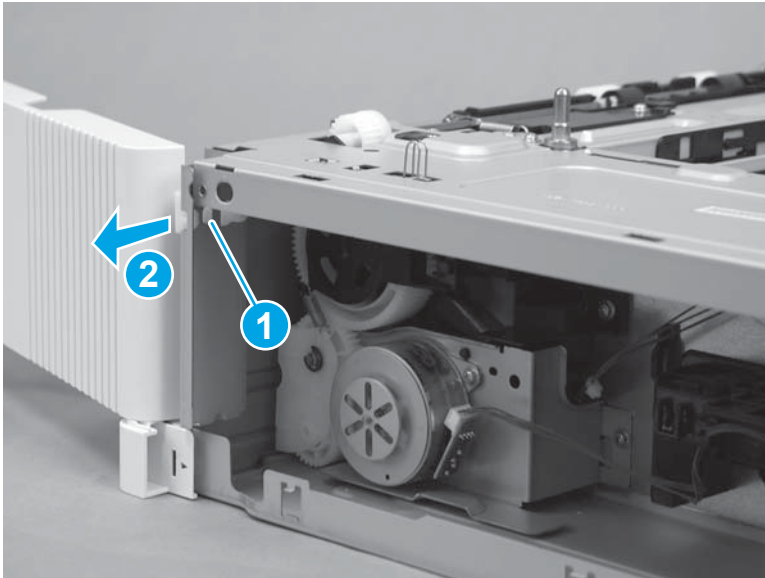

3. Remove the door-hinge bracket from the chassis.

⚠ CAUTION: The door is still attached to the accessory by the door link. Do not attempt to completely remove the door.

The door hinge bracket is not captive. Do not lose it when handling the door.

Figure 1-5127 Remove the hinge bracket

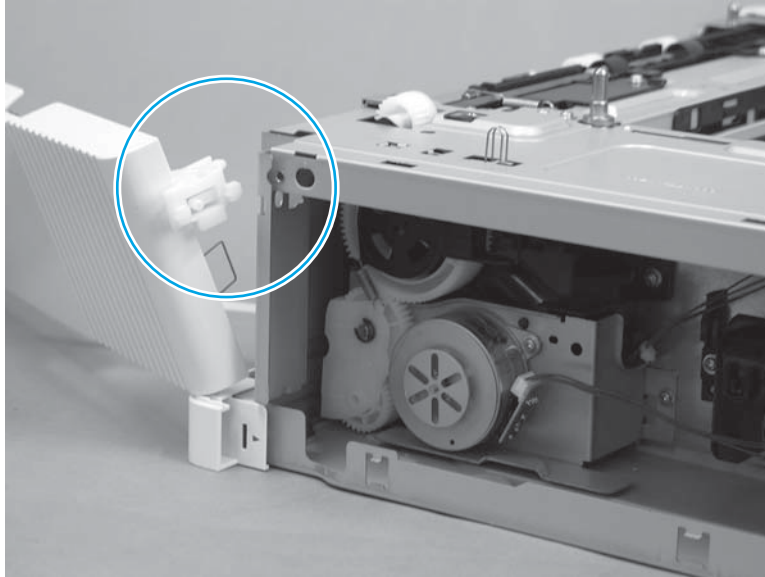

4. Release the door link from the slot in the door to remove the right door.

Figure 1-5128 Release the door link

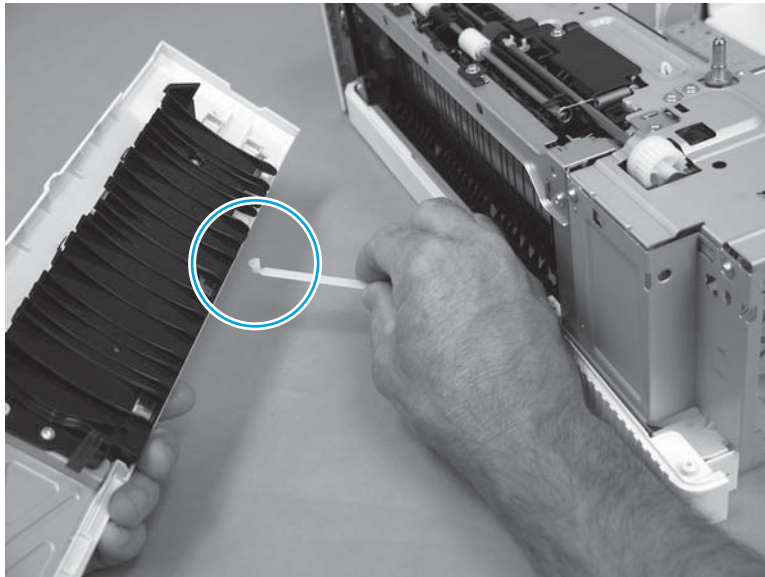

Step 3: Remove the right door hinge bracket

- ▲ Separate the right door hinge bracket from the door to remove it.

Figure 1-5129 Remove the hinge bracket

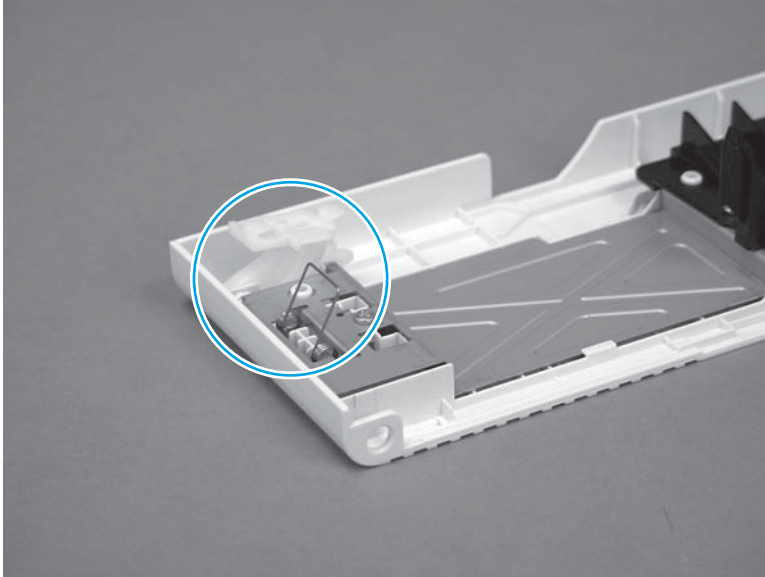

Step 4: Unpack the replacement assembly

Unpack the replacement assembly from the packaging.

For complete information on HP's recycling programs, go to [Product return and recycling](#).

 **NOTE:** HP recommends responsible disposal of the defective assembly.

Figure 1-5130 Recycle and unpack

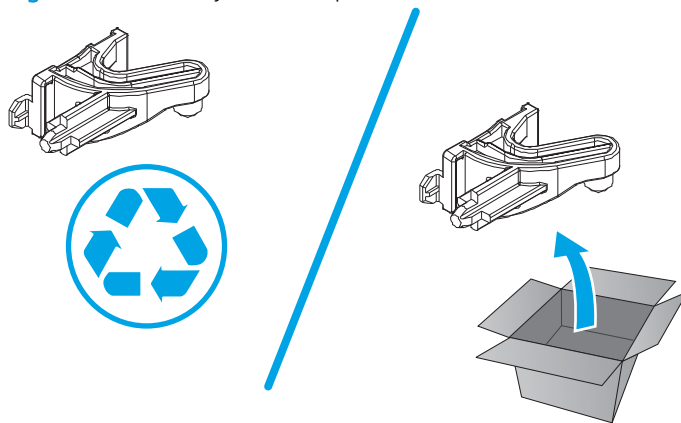

Step 5: Install the right door hinge bracket

- ▲ Install the right door hinge bracket on the door as shown.

Figure 1-5131 Install the hinge bracket



Step 6: Install the right door

1. Install the door link in the slot in the door to attach the door.

Figure 1-5132 Install the door link

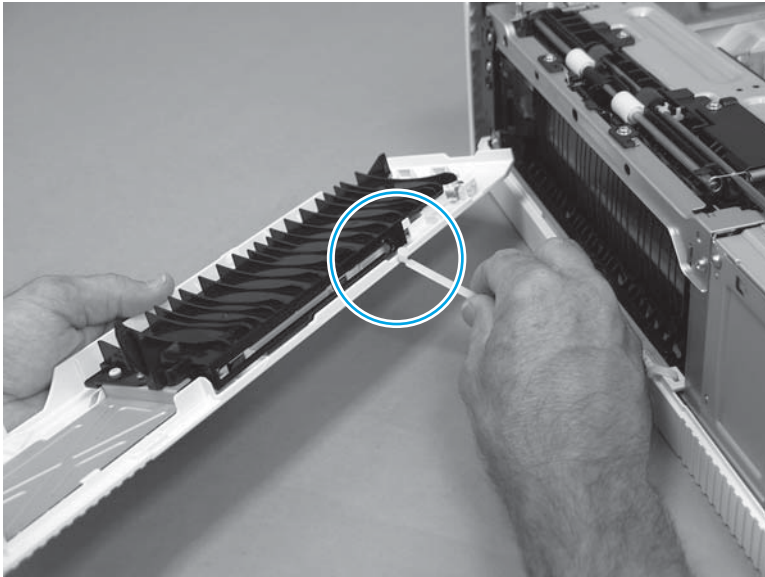

2. Position the lower hinge hole on the door (callout 2) on the lower hinge pin (callout 2) on the right-lower cover.

Figure 1-5133 Position the door on the lower hinge

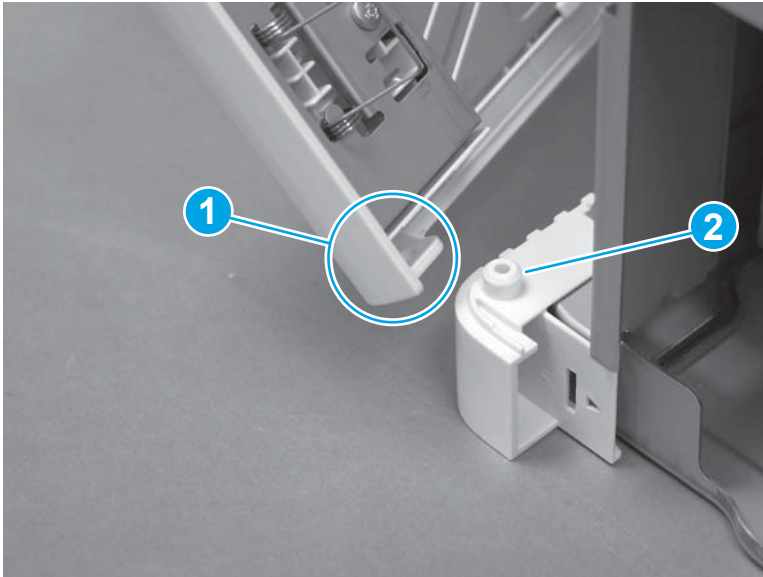

3. Align the pin of the door-hinge bracket (callout 1) with the hole in the chassis, and then align the mounting tabs (callout 2 and callout 3) with the slots in the chassis.

Figure 1-5134 Engage the hinge bracket

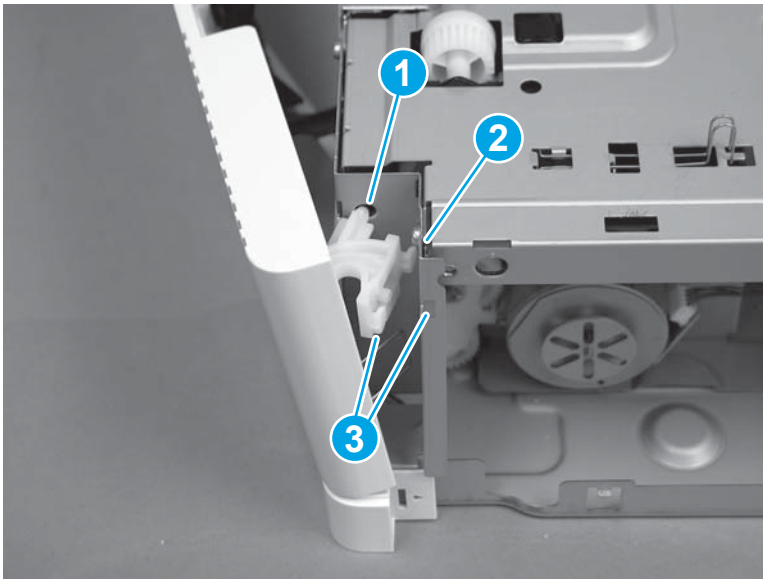

4. Push in on the door-hinge bracket (callout 1), and then slide it toward the chassis (callout 2) to install it.

Figure 1-5135 Install the hinge bracket

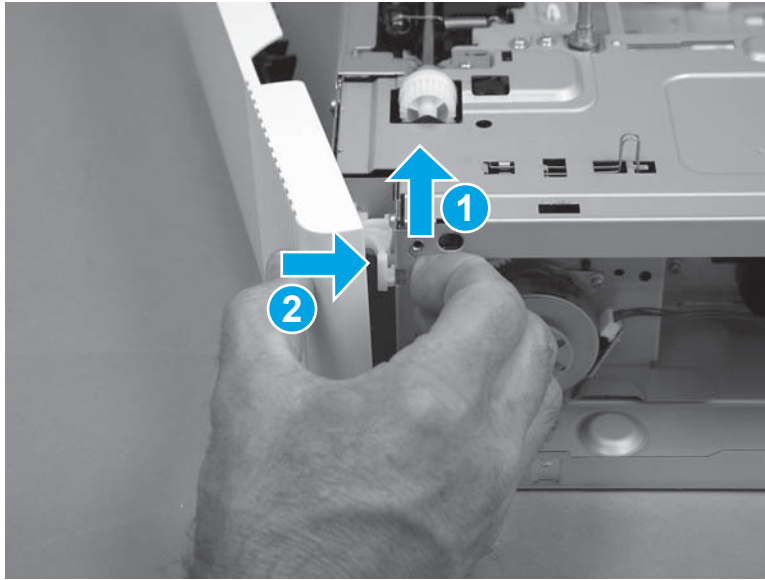

5. Close the door.

Figure 1-5136 Close the door

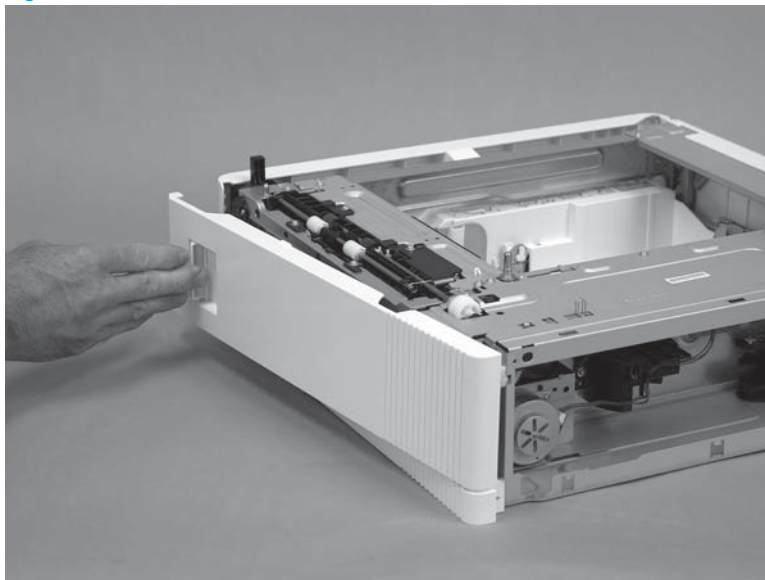

Step 7: Install the rear cover

1. Align the three mounting tabs (callout 1) on the cover with the slots in the chassis.

Figure 1-5137 Position the cover on the chassis

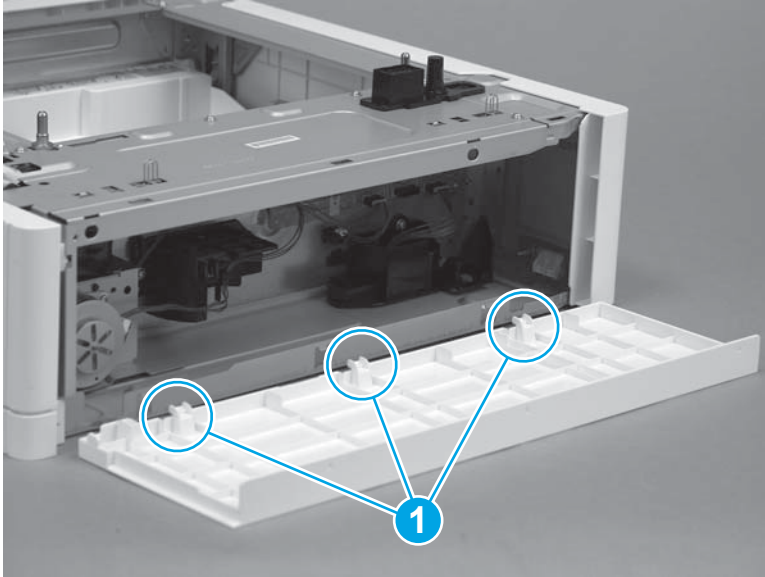

2. Position the cover on the accessory (callout 1), and then rotate the top of the cover up and onto the chassis (callout 2) to install it.

Figure 1-5138 Install the cover

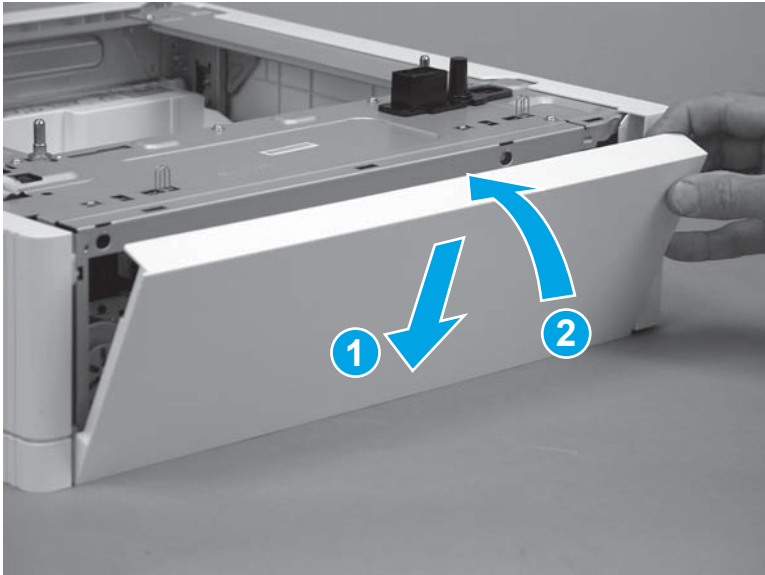

3. Make sure that the three tabs (callout 1) snap into place.

Figure 1-5139 Check the three tabs

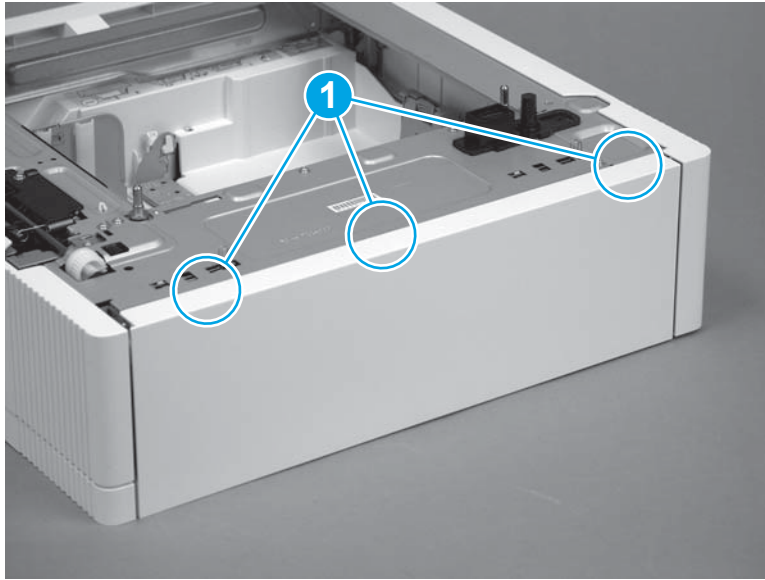

Removal and replacement: Right-lower cover (1x550-sheet paper feeder)

- [Introduction](#)
- [Step 1: Remove the rear cover](#)
- [Step 2: Remove the right door](#)
- [Step 3: Remove the right-lower cover](#)
- [Step 4: Remove the right-door link](#)
- [Step 5: Unpack the replacement assembly](#)
- [Step 6: Install the right-door link](#)
- [Step 7: Install the right-lower cover](#)
- [Step 8: Install the right door](#)
- [Step 9: Install the rear cover](#)

Introduction

This document provides the procedures to remove and replace the 1x550-sheet right-lower cover.

Before performing service

Use the table below to identify the correct part number for your printer, and then go to <http://h20141.www2.hp.com/hpparts> to order the part.

Right-lower cover (1x550-sheet paper feeder) part number	
RC4-1793-000CN	Right-lower cover (1x550-sheet paper feeder)

Required tools

No special tools are required to install this part.

After performing service

Make sure that the rear cover is flush against the chassis after replacing it.

Make sure that the right door latches correctly when closed after replacing it.

Step 1: Remove the rear cover

1. Release three tabs (callout 1).

Figure 1-5140 Release three tabs

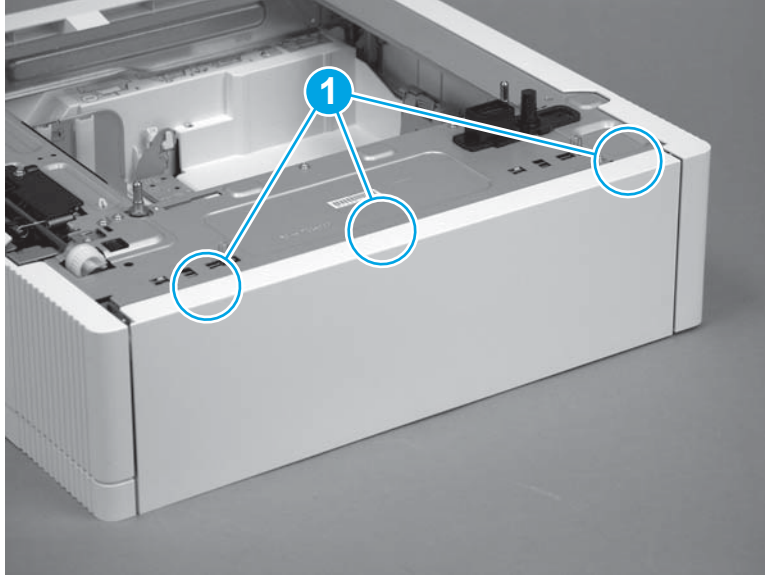

2. Rotate the top of the cover away from the accessory (callout 1), and then lift it up to remove it (callout 2).

Figure 1-5141 Remove the cover

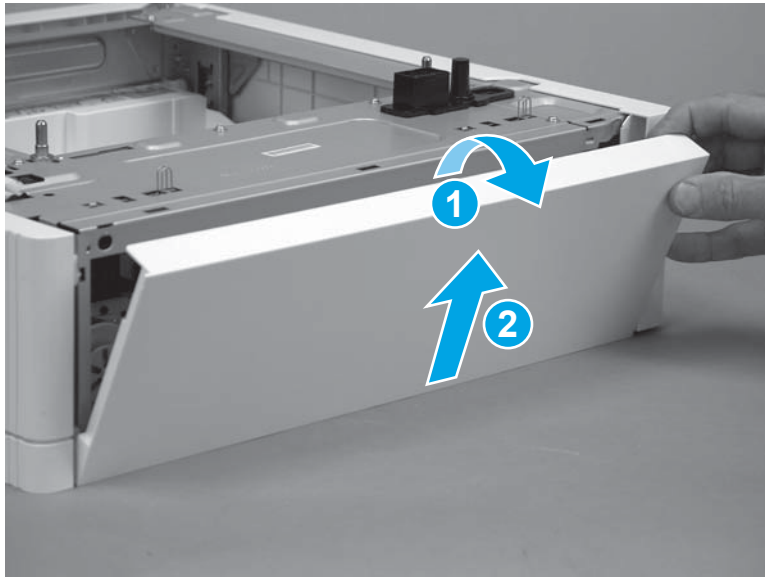

Step 2: Remove the right door

1. Open the door.

Figure 1-5142 Open the door

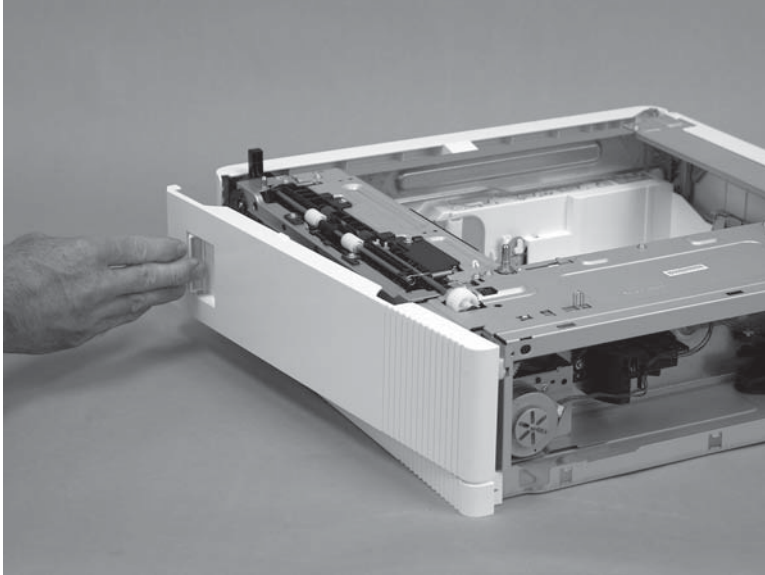

2. Release one tab (callout 1), and then slide the door-hinge bracket away from the chassis (callout 2) to release it.

Figure 1-5143 Release the hinge bracket

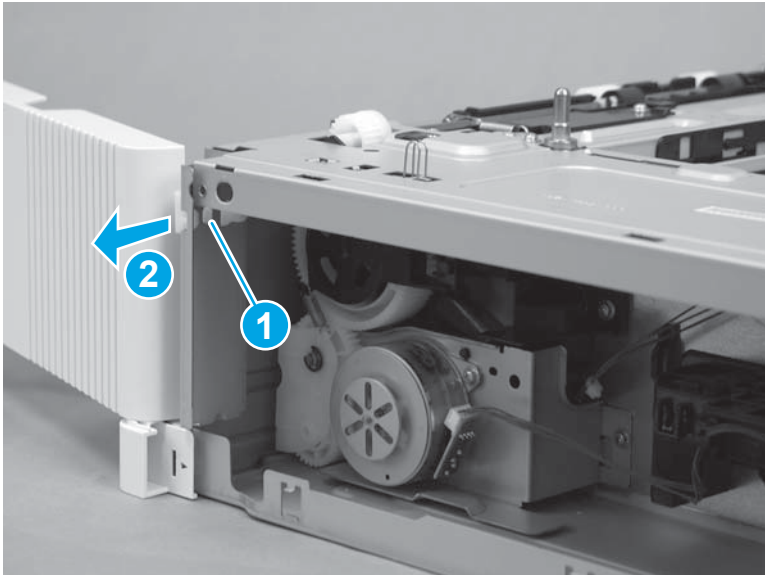

3. Remove the door-hinge bracket from the chassis.

⚠ CAUTION: The door is still attached to the accessory by the door link. Do not attempt to completely remove the door.

The door hinge bracket is not captive. Do not lose it when handling the door.

Figure 1-5144 Remove the hinge bracket

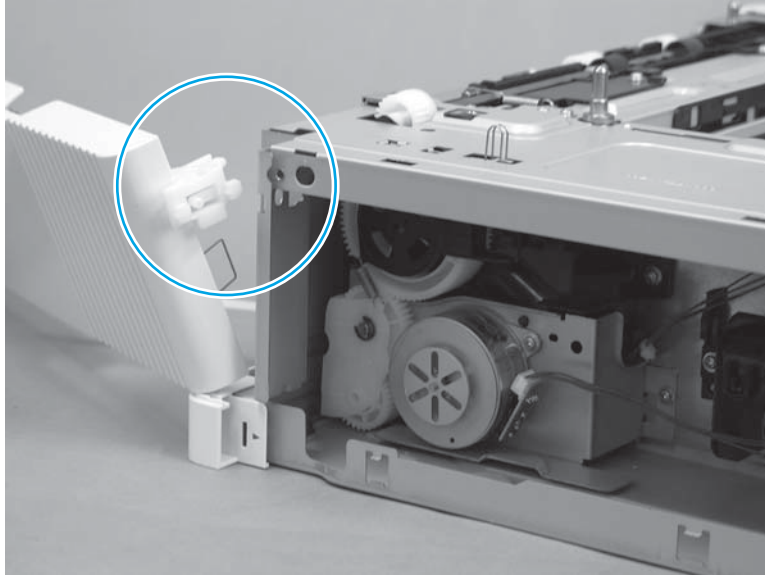

4. Release the door link from the slot in the door to remove the right door.

Figure 1-5145 Release the door link

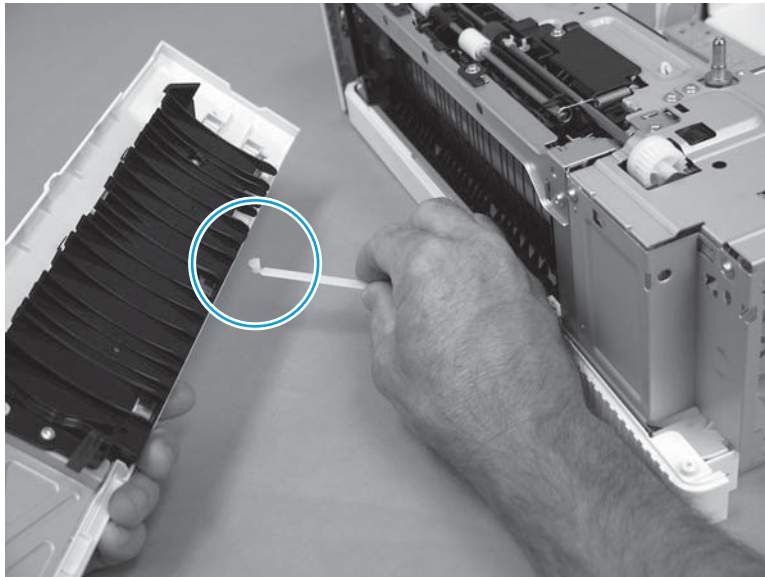

Step 3: Remove the right-lower cover

1. Before proceeding, take note of the location of the three mounting tabs on the back side of the cover.

Figure 1-5146 Cover mounting tabs

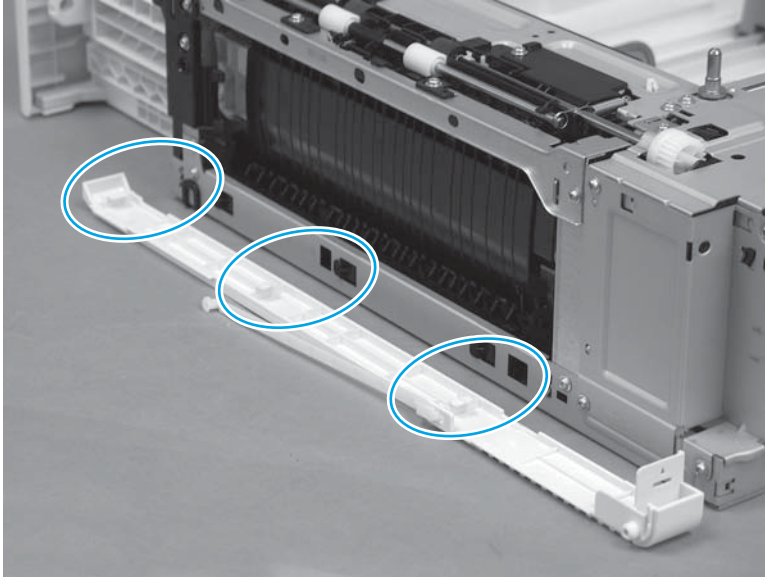

2. Partially open the tray, slightly flex the end of the cover away from the accessory (callout 1), and then slide it towards the front of the accessory (callout 2) to release it.

⚠ CAUTION: The three mounting tabs on the back side of the cover are easily damaged. Do not over flex the end of the cover when it is released. Push in on the middle tab to protect it when removing the cover.

Figure 1-5147 Release the cover

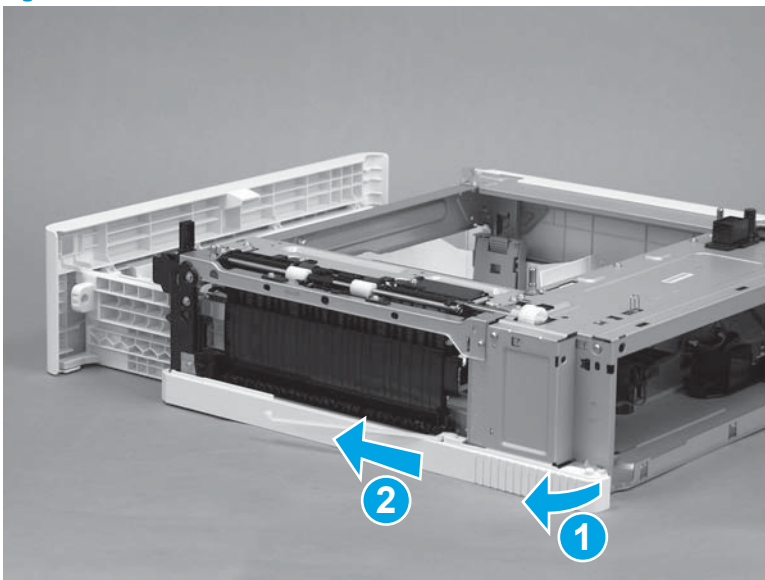

3. Remove the right-lower cover.

Figure 1-5148 Remove the right-lower cover

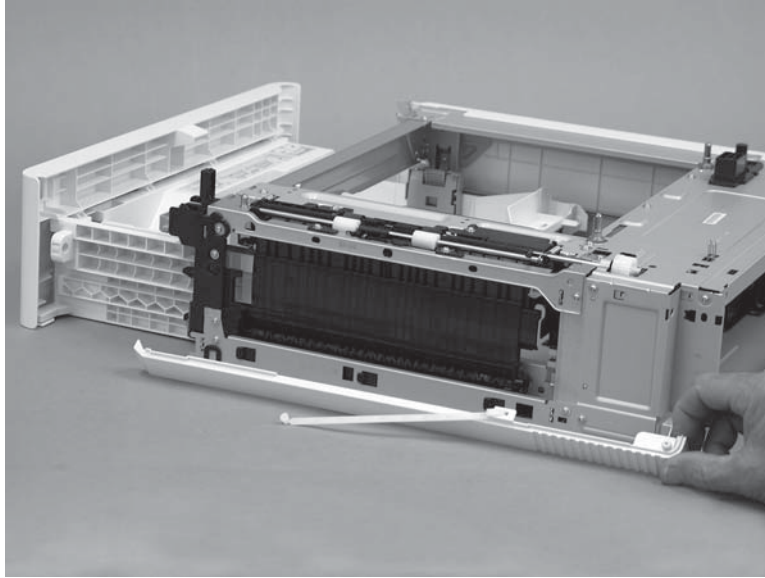

Step 4: Remove the right-door link

- ▲ Rotate the door link to align the keyed end of the link to pass through the keyed portion of the right-lower cover to remove it.

Figure 1-5149 Remove the right-door link

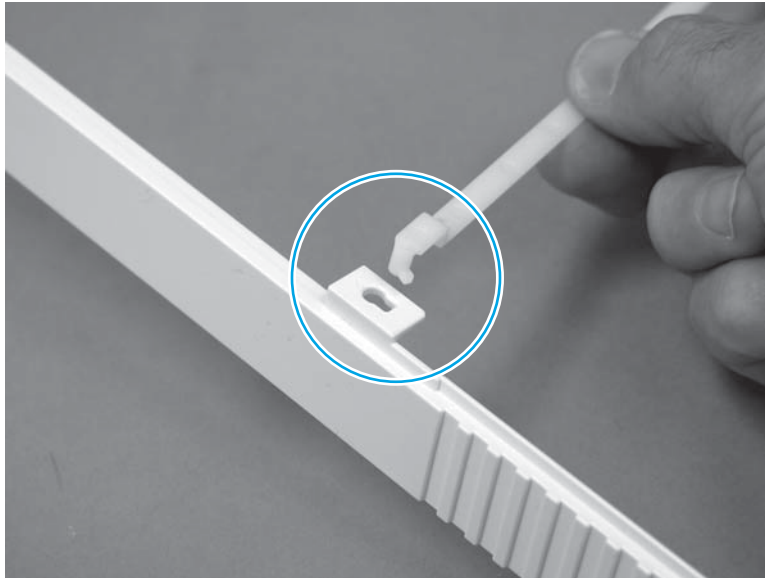

Step 5: Unpack the replacement assembly

Unpack the replacement assembly from the packaging.

For complete information on HP's recycling programs, go to [Product return and recycling](#).

 **NOTE:** HP recommends responsible disposal of the defective assembly.

Figure 1-5150 Recycle and unpack

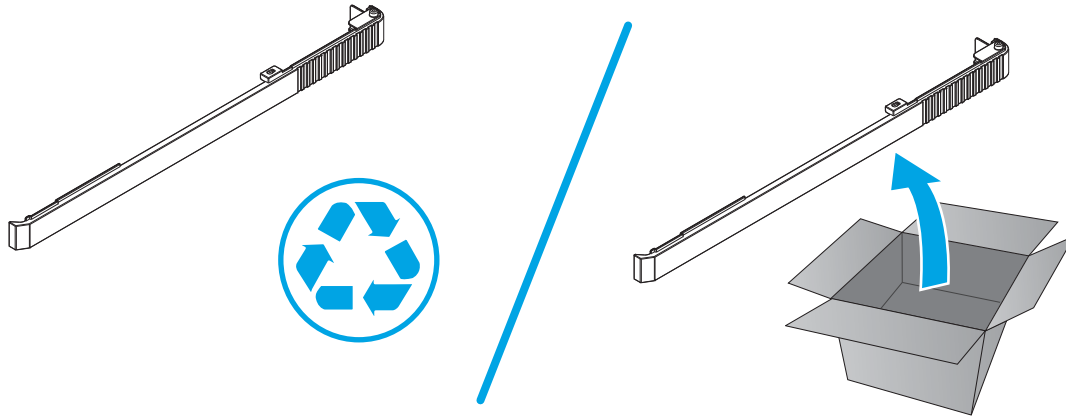

Step 6: Install the right-door link

- ▲ Rotate the door link to align the keyed end of the link to pass through the keyed portion of the right-lower cover to install it.

Figure 1-5151 Remove the right-door link

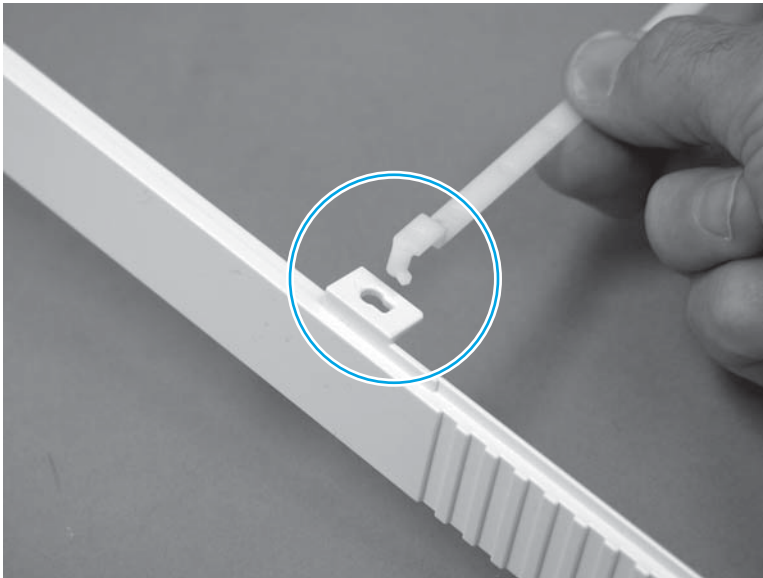

Step 7: Install the right-lower cover

1. Before proceeding, take note of the location of the three mounting tabs on the back side of the cover.

Figure 1-5152 Cover mounting tabs

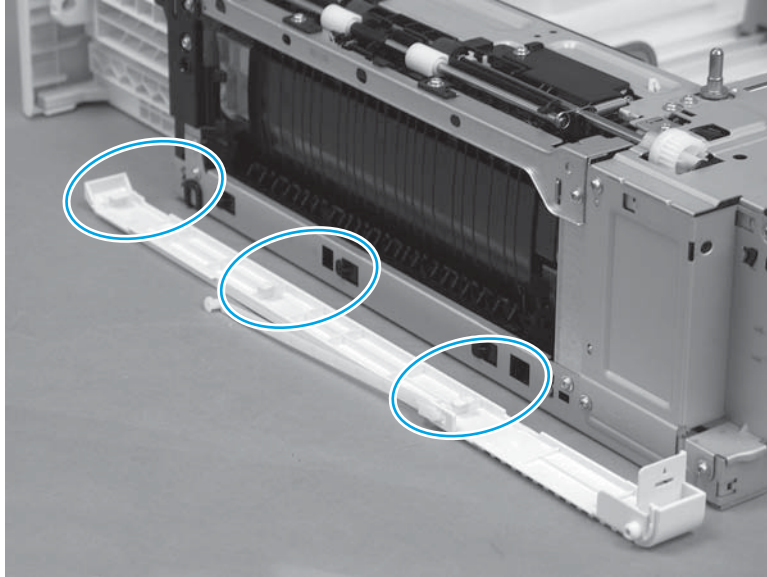

2. Align the three mounting tabs on the back side of the cover with the slots in the chassis.

Figure 1-5153 Install the right-lower cover

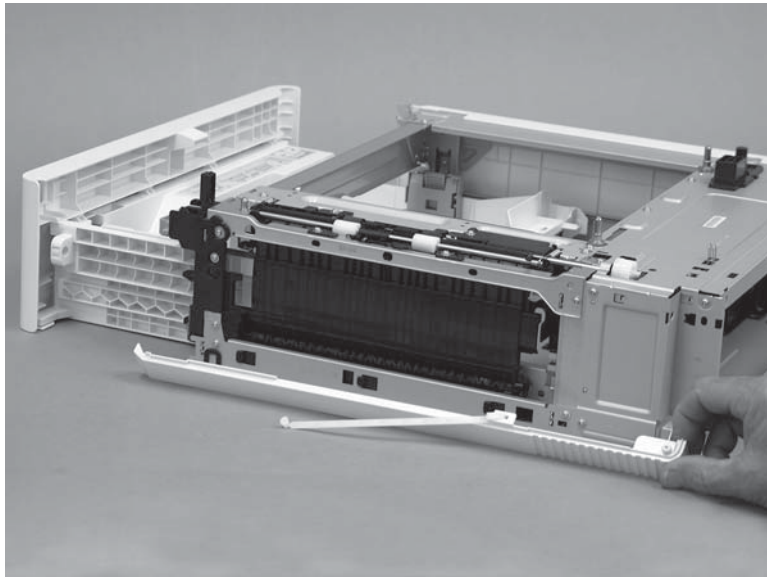

3. Press in on the middle tab (callout 1), slightly flex the end of the cover away from the accessory, and then slide it towards the rear of the accessory (callout 2) to engage the tabs with the slots.

⚠ CAUTION: The three mounting tabs on the back side of the cover are easily damaged. Do not over flex the end of the cover when it is installed.

Figure 1-5154 Engage the cover

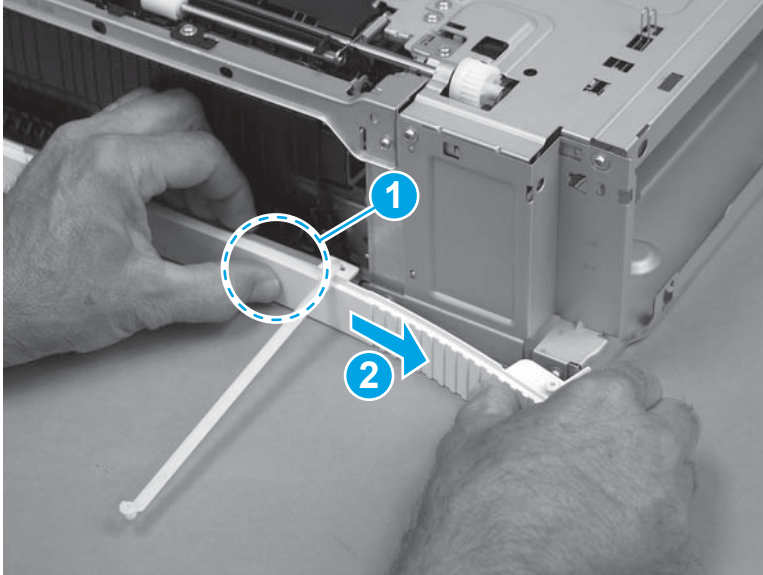

4. Verify that the end of the cover near the tray is correctly engaged with the chassis after installing the cover.

Figure 1-5155 Check the cover

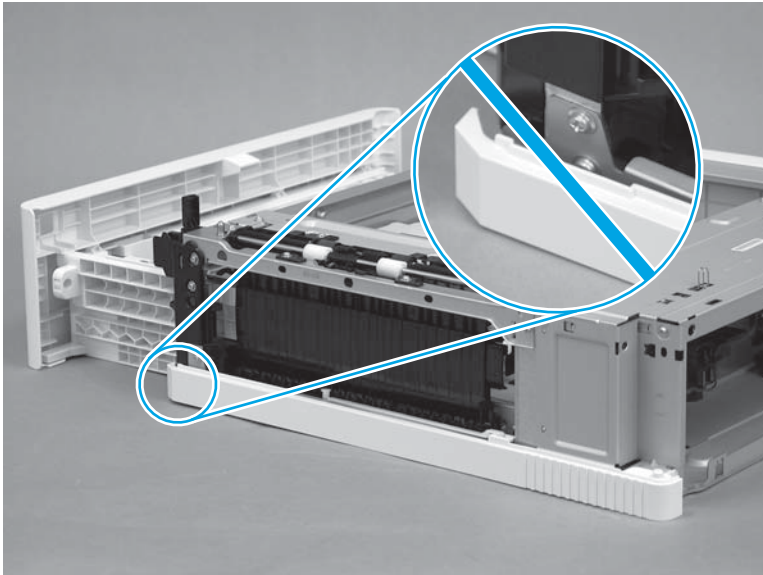

Step 8: Install the right door

1. Install the door link in the slot in the door to attach the door.

Figure 1-5156 Install the door link

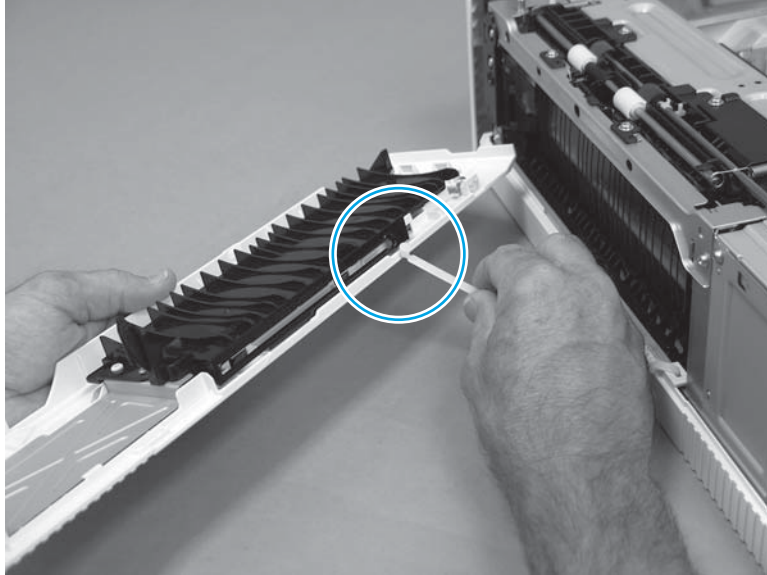

2. Position the lower hinge hole on the door (callout 2) on the lower hinge pin (callout 2) on the right-lower cover.

Figure 1-5157 Position the door on the lower hinge

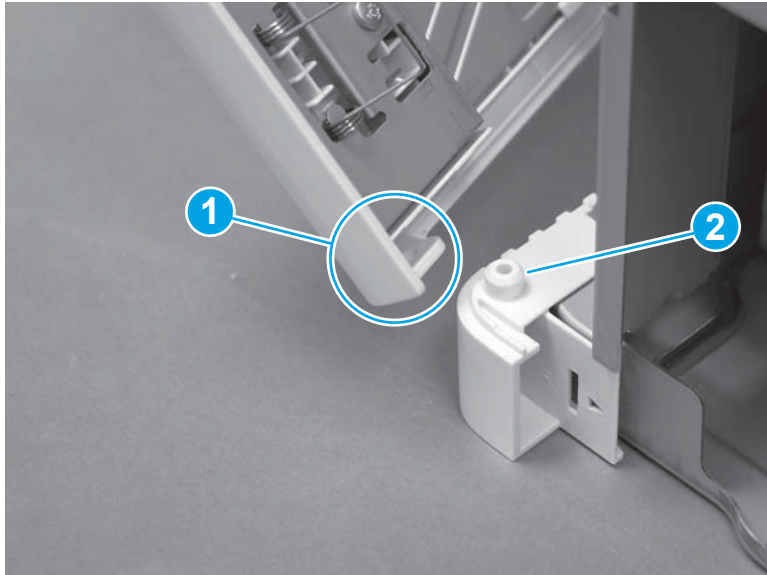

3. Align the pin of the door-hinge bracket (callout 1) with the hole in the chassis, and then align the mounting tabs (callout 2 and callout 3) with the slots in the chassis.

Figure 1-5158 Engage the hinge bracket

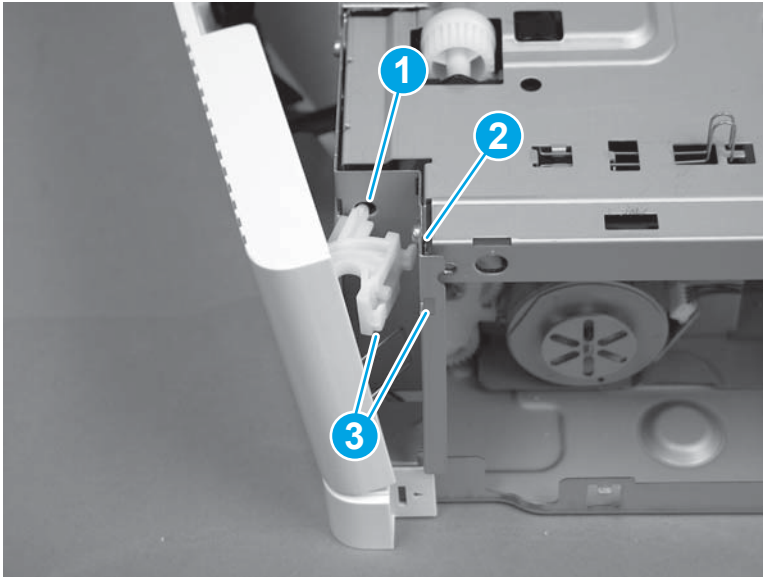

4. Push in on the door-hinge bracket (callout 1), and then slide it toward the chassis (callout 2) to install it.

Figure 1-5159 Install the hinge bracket

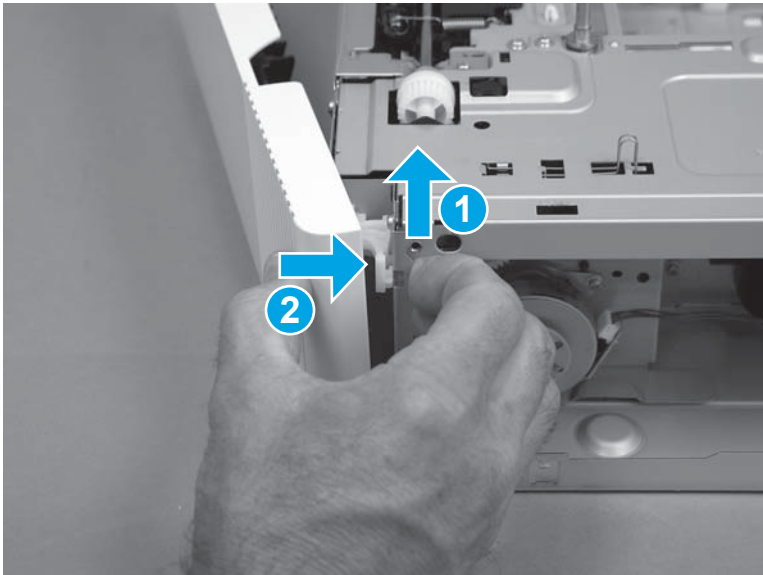

5. Close the door.

Figure 1-5160 Close the door

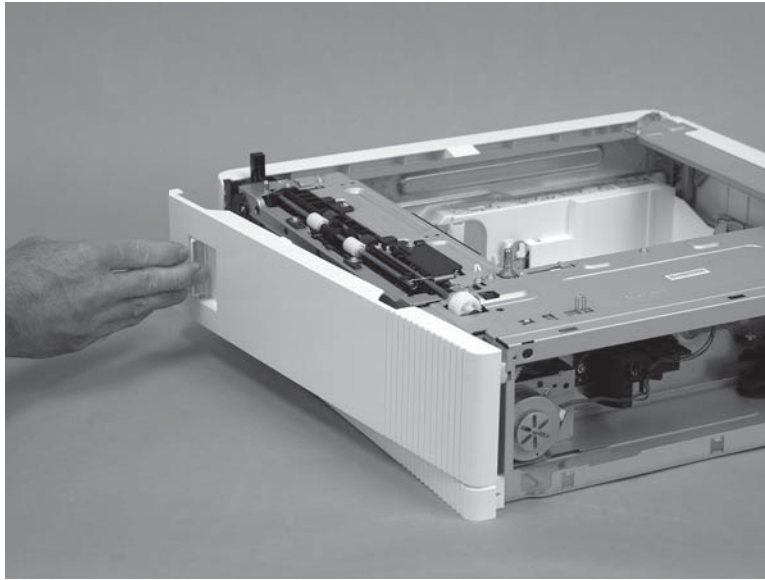

Step 9: Install the rear cover

1. Align the three mounting tabs (callout 1) on the cover with the slots in the chassis.

Figure 1-5161 Position the cover on the chassis

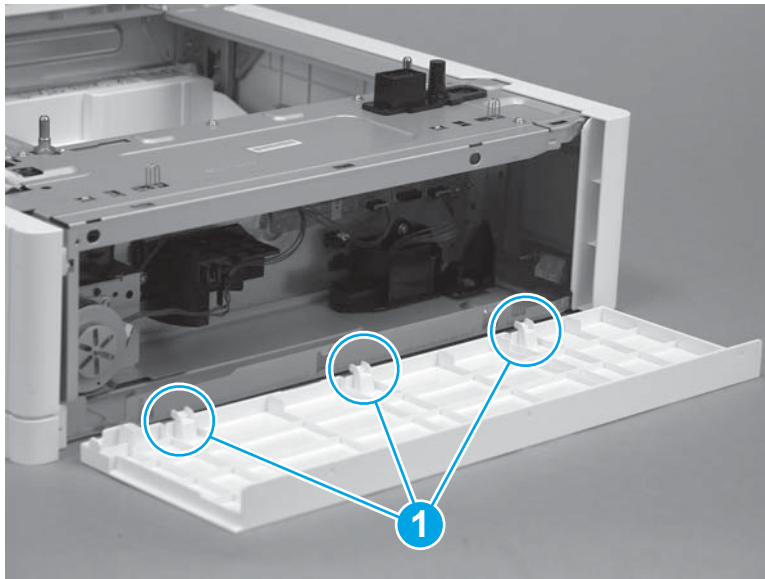

2. Position the cover on the accessory (callout 1), and then rotate the top of the cover up and onto the chassis (callout 2) to install it.

Figure 1-5162 Install the cover

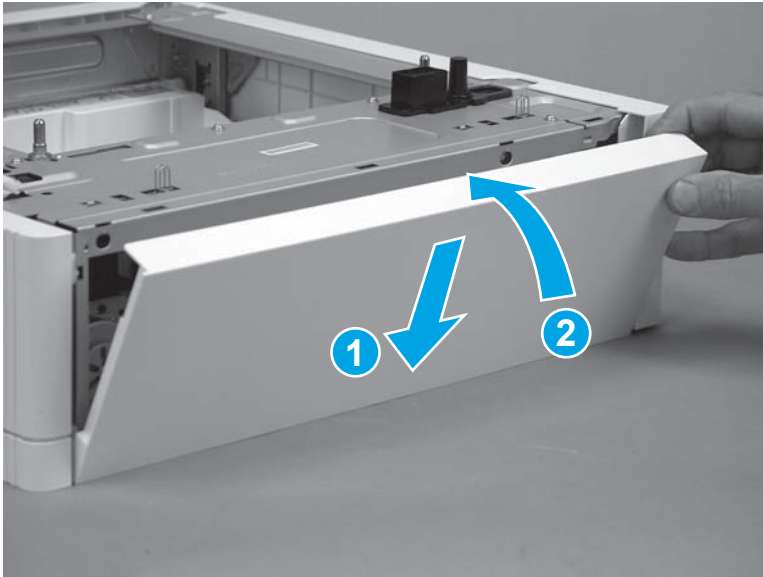

3. Make sure that the three tabs (callout 1) snap into place.

Figure 1-5163 Check the three tabs

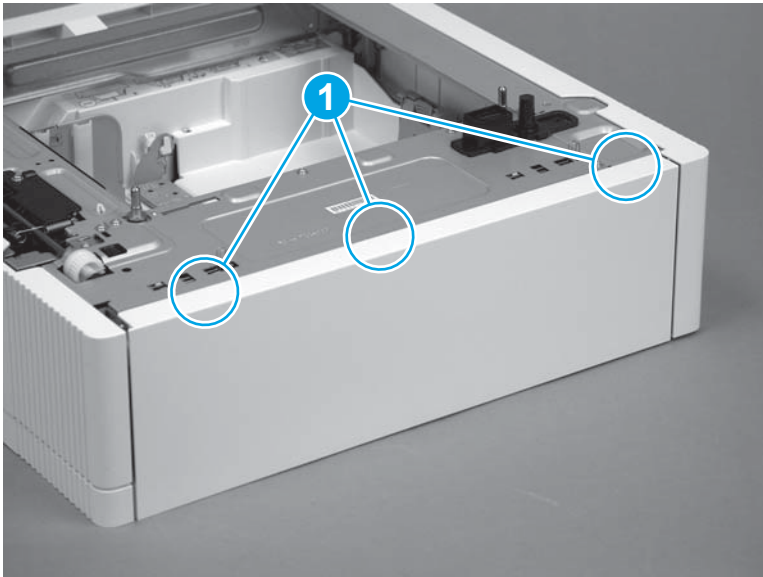

Removal and replacement: Right-door link (1x550-sheet paper feeder)

- [Introduction](#)
- [Step 1: Remove the rear cover](#)
- [Step 2: Remove the right door](#)
- [Step 3: Remove the right-lower cover](#)
- [Step 4: Remove the right-door link](#)
- [Step 5: Unpack the replacement assembly](#)
- [Step 6: Install the right-door link](#)
- [Step 7: Install the right-lower cover](#)
- [Step 8: Install the right door](#)
- [Step 9: Install the rear cover](#)

Introduction

This document provides the procedures to remove and replace the 1x550-sheet right-door link.

Before performing service

Use the table below to identify the correct part number for your printer, and then go to <http://h20141.www2.hp.com/hpparts> to order the part.

Right-door link (1x550-sheet paper feeder) part number	
RC4-1778-000CN	Right-door link (1x550-sheet paper feeder)

Required tools

No special tools are required to install this part.

After performing service

Make sure that the rear cover is flush against the chassis after replacing it.

Make sure that the right door latches correctly when closed after replacing it.

Step 1: Remove the rear cover

1. Release three tabs (callout 1).

Figure 1-5164 Release three tabs

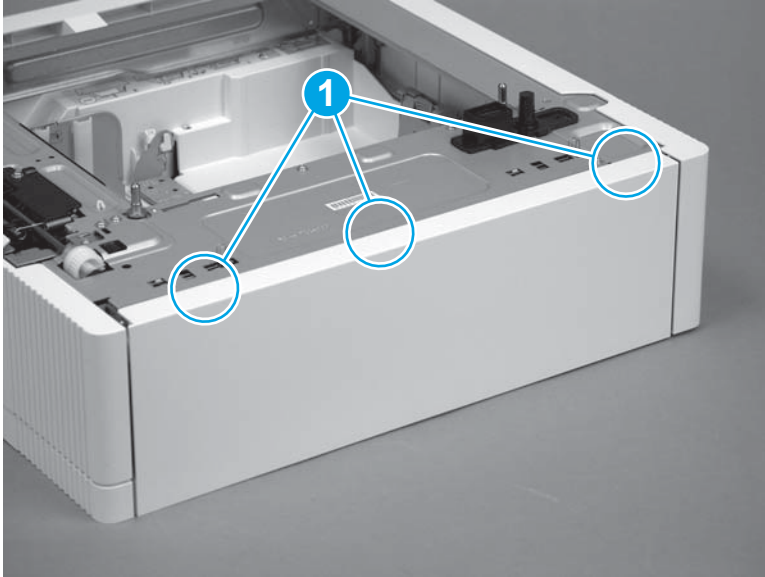

2. Rotate the top of the cover away from the accessory (callout 1), and then lift it up to remove it (callout 2).

Figure 1-5165 Remove the cover

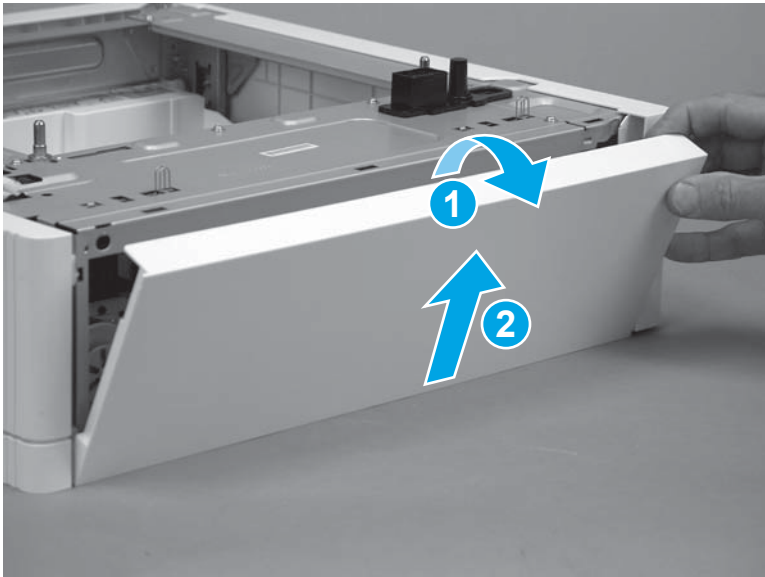

Step 2: Remove the right door

1. Open the door.

Figure 1-5166 Open the door

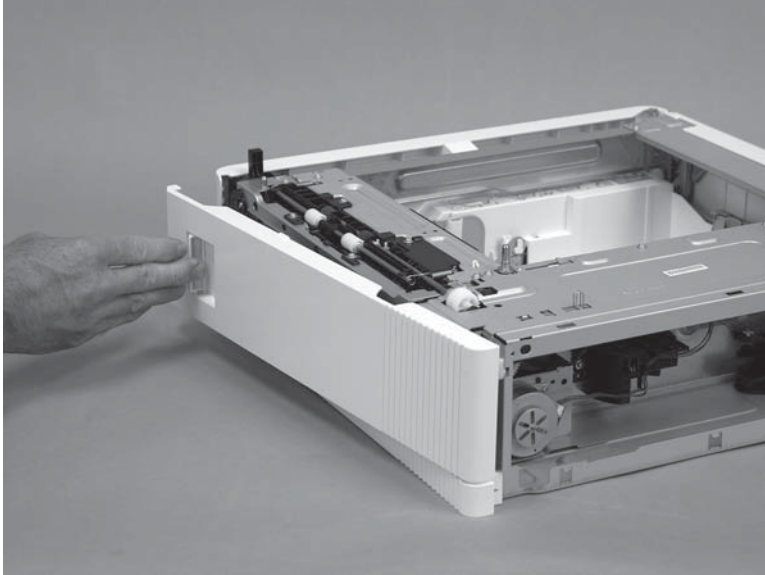

2. Release one tab (callout 1), and then slide the door-hinge bracket away from the chassis (callout 2) to release it.

Figure 1-5167 Release the hinge bracket

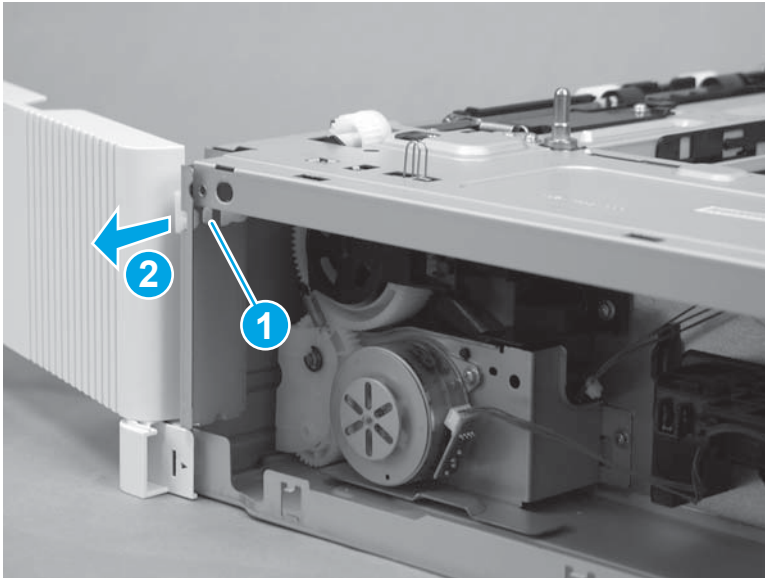

3. Remove the door-hinge bracket from the chassis.

⚠ CAUTION: The door is still attached to the accessory by the door link. Do not attempt to completely remove the door.

The door hinge bracket is not captive. Do not lose it when handling the door.

Figure 1-5168 Remove the hinge bracket

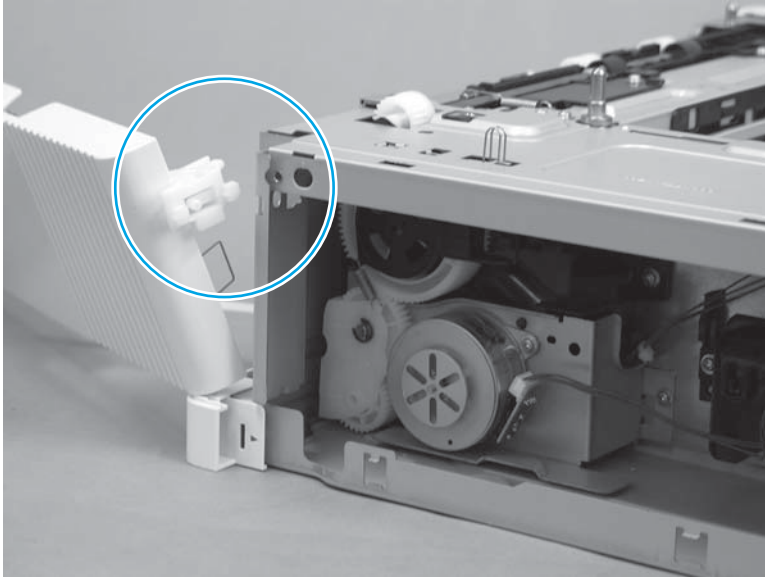

4. Release the door link from the slot in the door to remove the right door.

Figure 1-5169 Release the door link

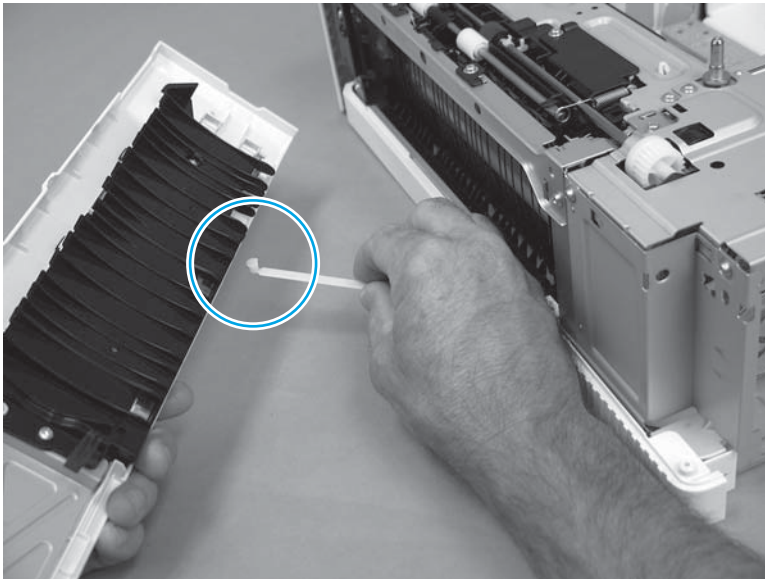

Step 3: Remove the right-lower cover

1. Before proceeding, take note of the location of the three mounting tabs on the back side of the cover.

Figure 1-5170 Cover mounting tabs

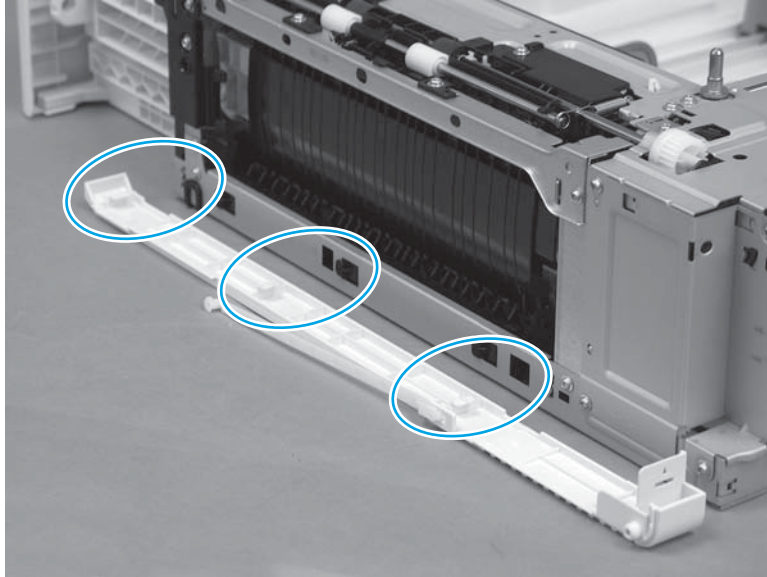

2. Partially open the tray, slightly flex the end of the cover away from the accessory (callout 1), and then slide it towards the front of the accessory (callout 2) to release it.

⚠ CAUTION: The three mounting tabs on the back side of the cover are easily damaged. Do not over flex the end of the cover when it is released. Push in on the middle tab to protect it when removing the cover.

Figure 1-5171 Release the cover

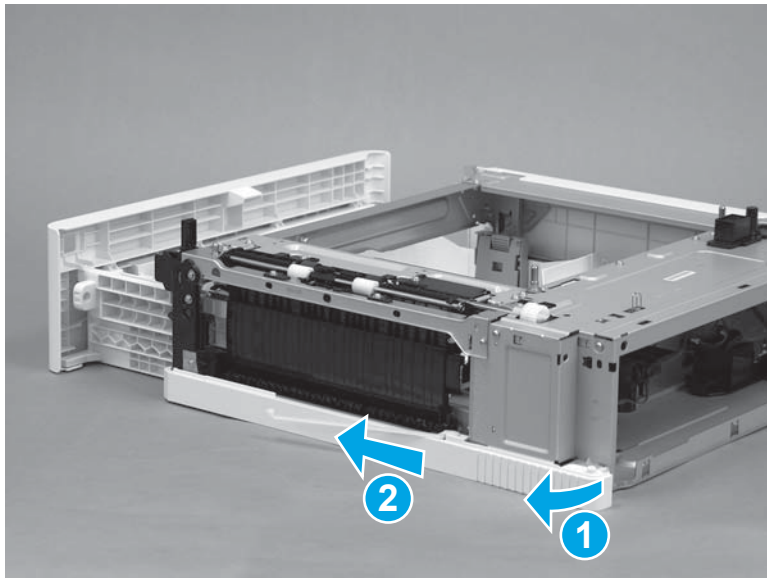

3. Remove the right-lower cover.

Figure 1-5172 Remove the right-lower cover

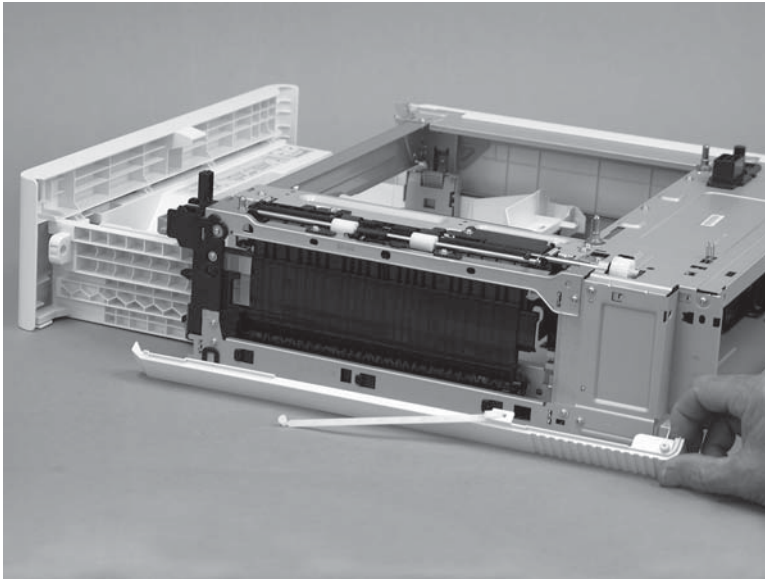

Step 4: Remove the right-door link

- ▲ Rotate the door link to align the keyed end of the link to pass through the keyed portion of the right-lower cover to remove it.

Figure 1-5173 Remove the right-door link

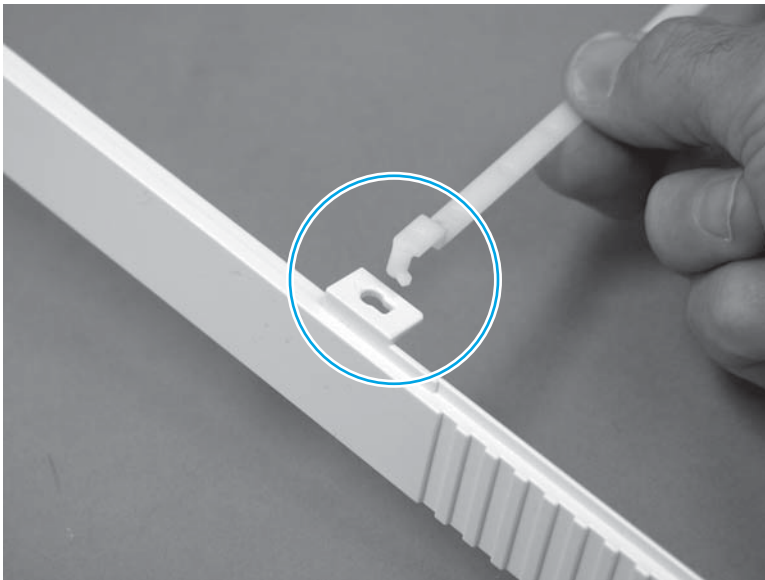

Step 5: Unpack the replacement assembly

Unpack the replacement assembly from the packaging.

For complete information on HP's recycling programs, go to [Product return and recycling](#).

 **NOTE:** HP recommends responsible disposal of the defective assembly.

Figure 1-5174 Recycle and unpack

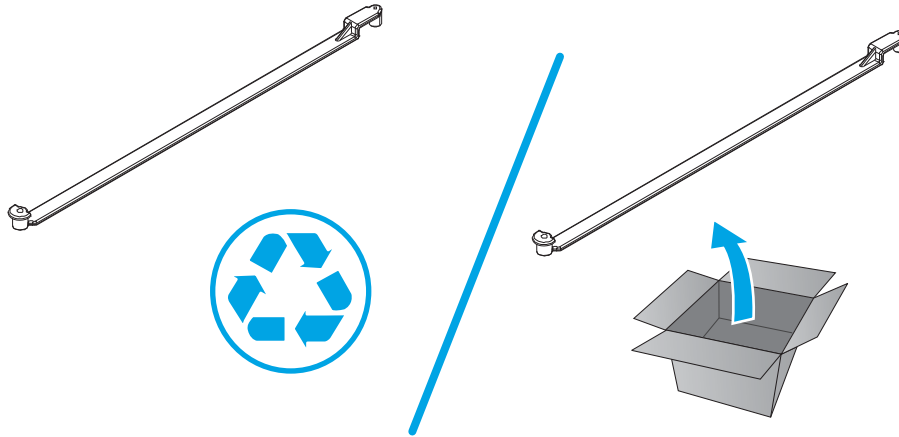

Step 6: Install the right-door link

- ▲ Rotate the door link to align the keyed end of the link to pass through the keyed portion of the right-lower cover to install it.

Figure 1-5175 Remove the right-door link

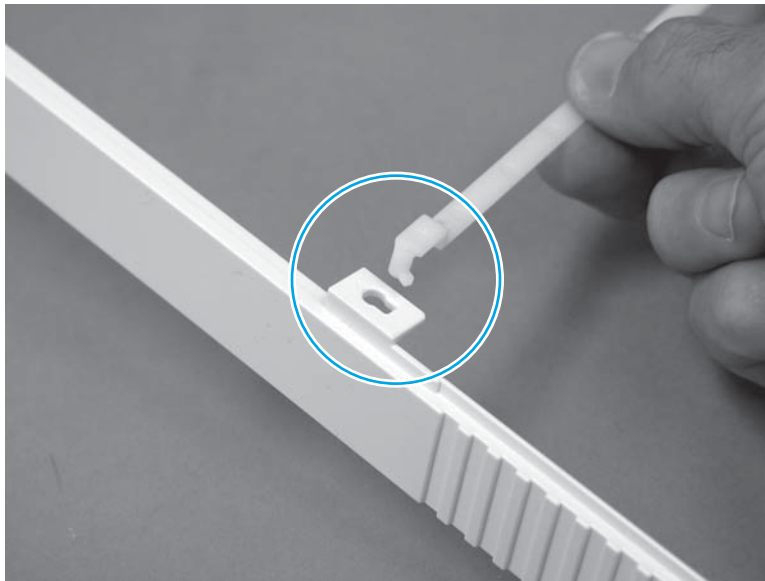

Step 7: Install the right-lower cover

1. Before proceeding, take note of the location of the three mounting tabs on the back side of the cover.

Figure 1-5176 Cover mounting tabs

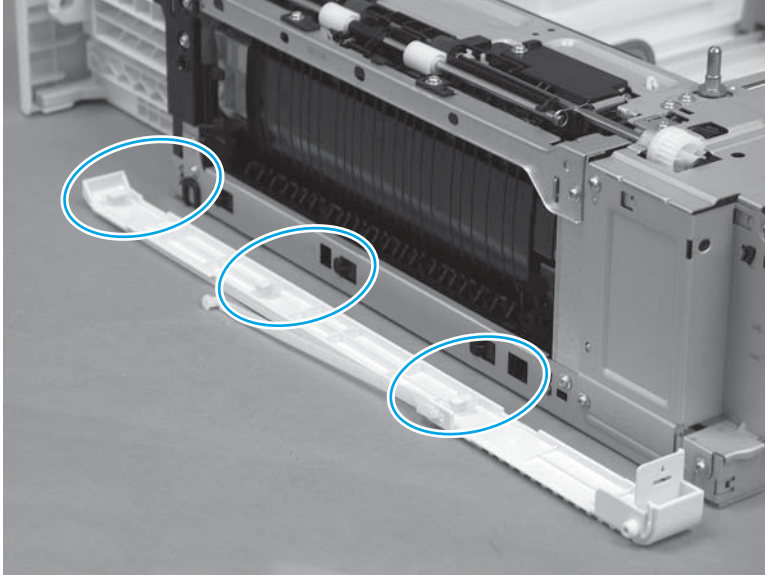

2. Align the three mounting tabs on the back side of the cover with the slots in the chassis.

Figure 1-5177 Install the right-lower cover

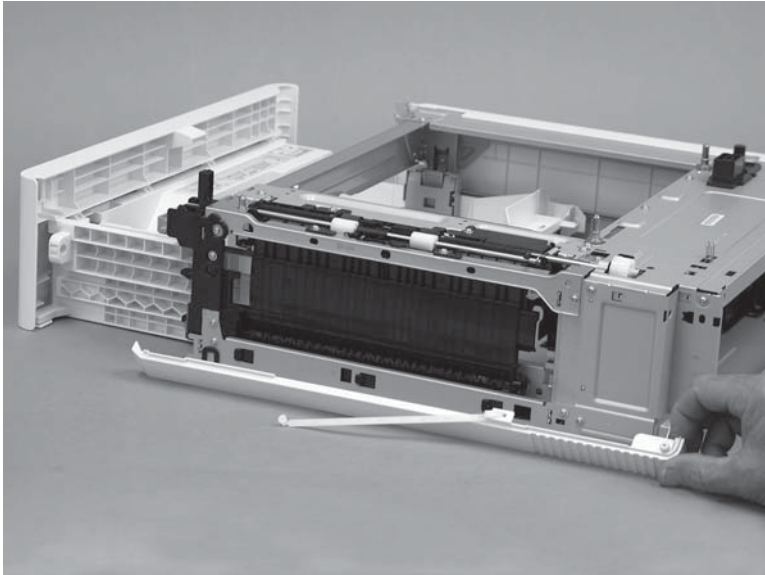

3. Press in on the middle tab (callout 1), slightly flex the end of the cover away from the accessory, and then slide it towards the rear of the accessory (callout 2) to engage the tabs with the slots.

CAUTION: The three mounting tabs on the back side of the cover are easily damaged. Do not over flex the end of the cover when it is installed.

Figure 1-5178 Engage the cover

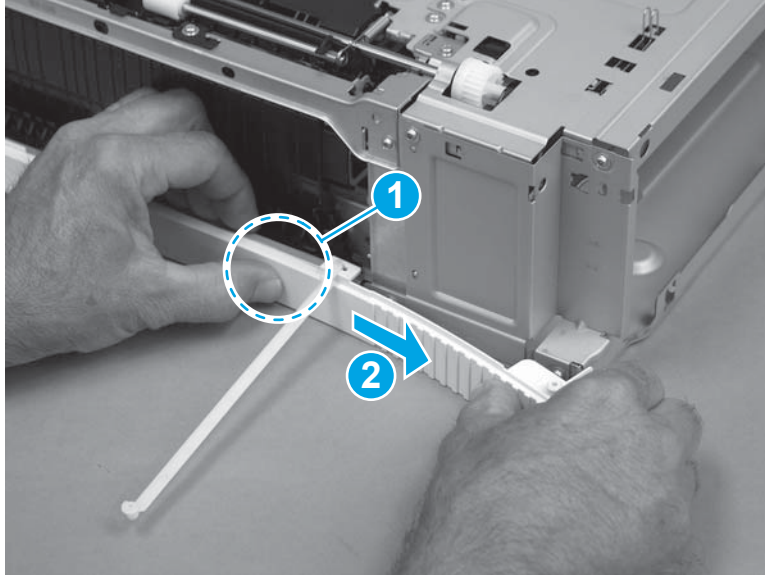

4. Verify that the end of the cover near the tray is correctly engaged with the chassis after installing the cover.

Figure 1-5179 Check the cover

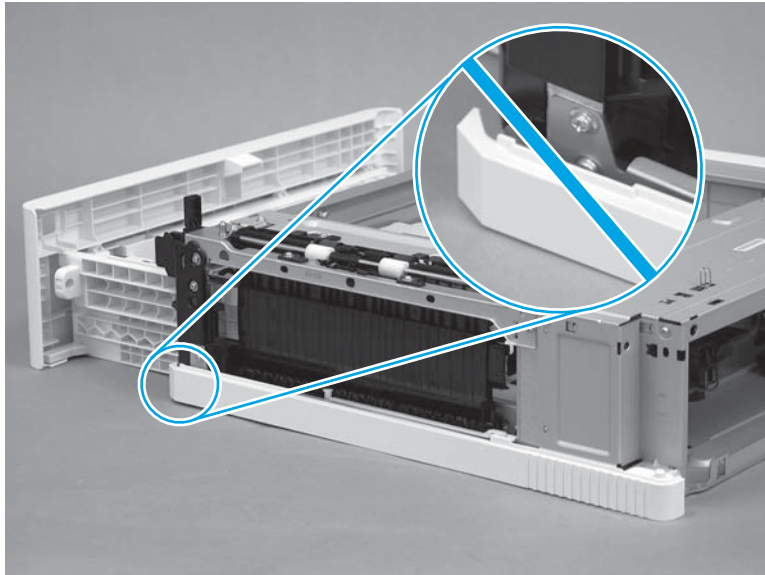

Step 8: Install the right door

1. Install the door link in the slot in the door to attach the door.

Figure 1-5180 Install the door link

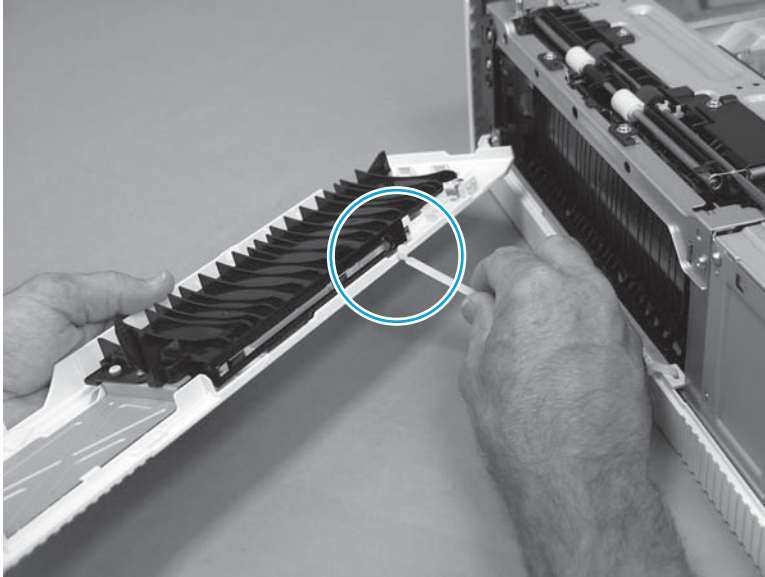

2. Position the lower hinge hole on the door (callout 2) on the lower hinge pin (callout 2) on the right-lower cover.

Figure 1-5181 Position the door on the lower hinge

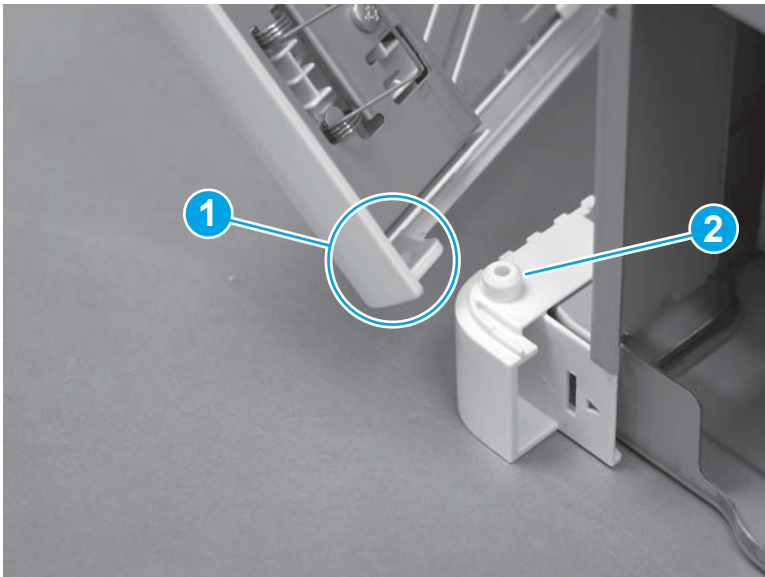

3. Align the pin of the door-hinge bracket (callout 1) with the hole in the chassis, and then align the mounting tabs (callout 2 and callout 3) with the slots in the chassis.

Figure 1-5182 Engage the hinge bracket

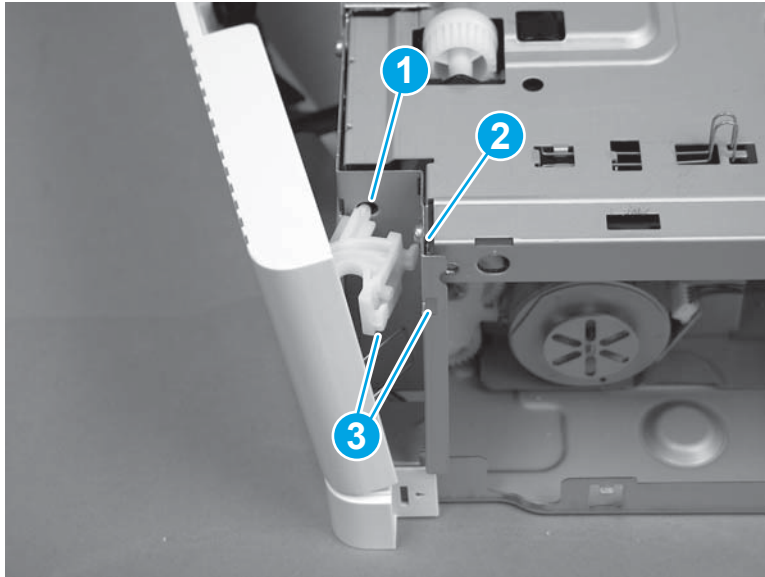

4. Push in on the door-hinge bracket (callout 1), and then slide it toward the chassis (callout 2) to install it.

Figure 1-5183 Install the hinge bracket

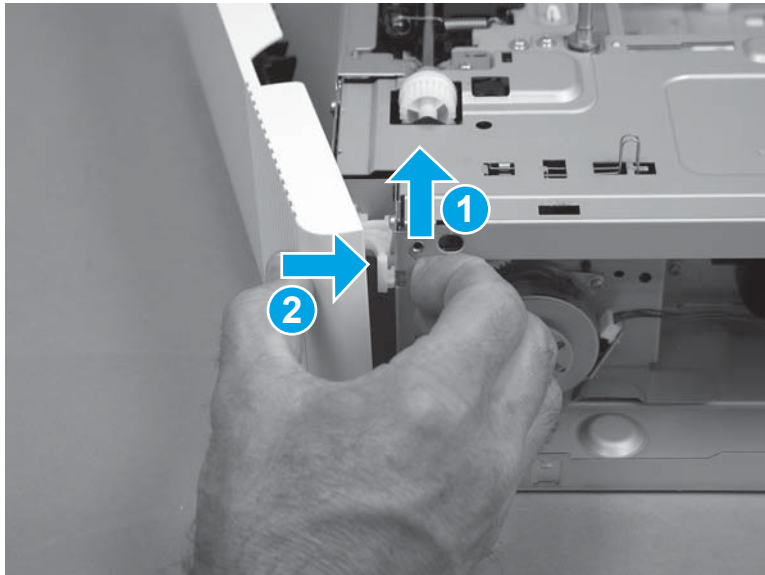

5. Close the door.

Figure 1-5184 Close the door

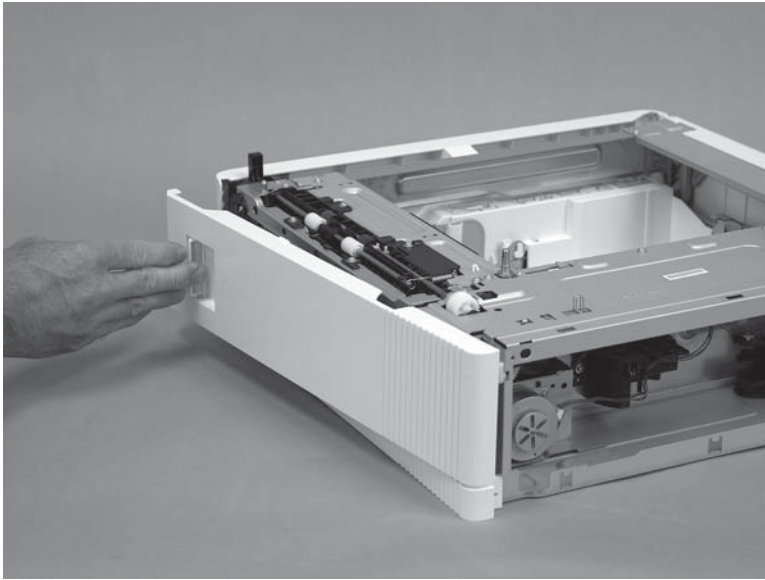

Step 9: Install the rear cover

1. Align the three mounting tabs (callout 1) on the cover with the slots in the chassis.

Figure 1-5185 Position the cover on the chassis

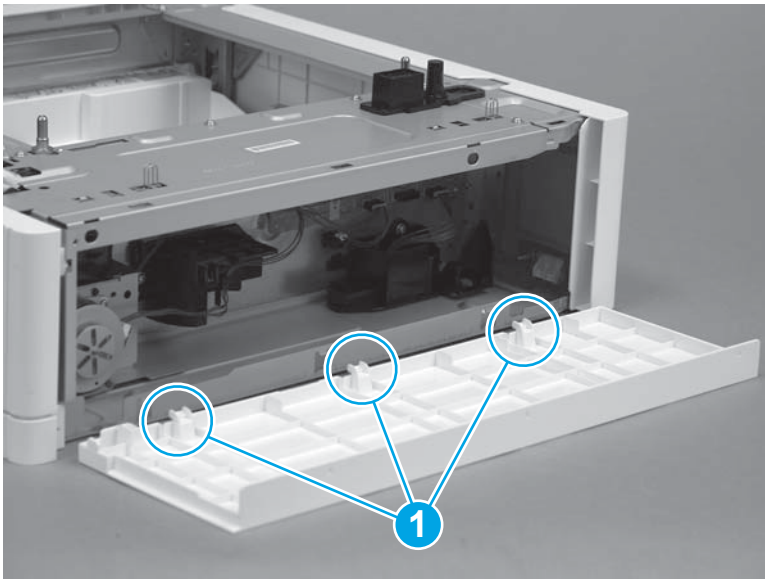

2. Position the cover on the accessory (callout 1), and then rotate the top of the cover up and onto the chassis (callout 2) to install it.

Figure 1-5186 Install the cover

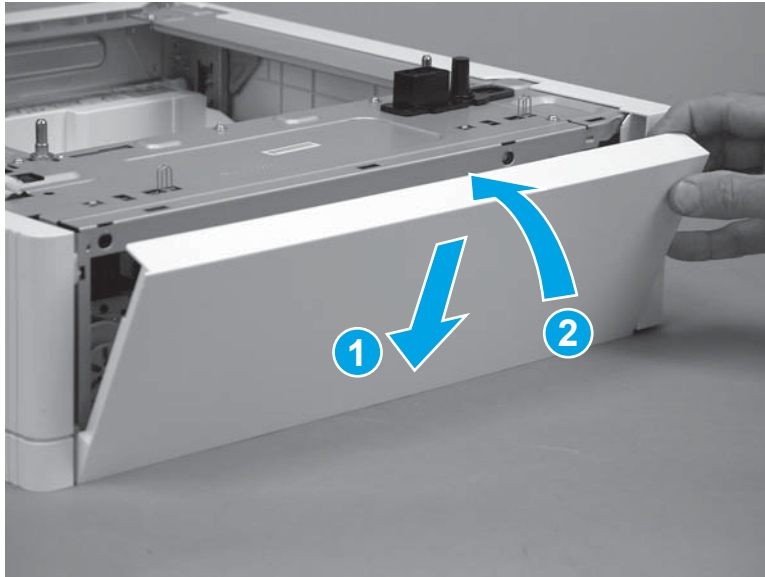

3. Make sure that the three tabs (callout 1) snap into place.

Figure 1-5187 Check the three tabs

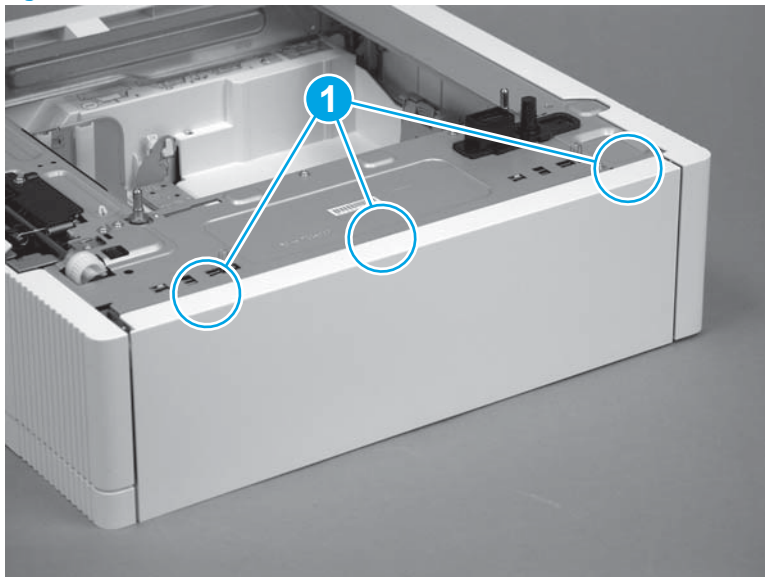

Removal and replacement: Left cover (1x550-sheet paper feeder)

- [Introduction](#)
- [Step 1: Remove the left cover](#)
- [Step 2: Unpack the replacement assembly](#)
- [Step 3: Install the left cover](#)

Introduction

This document provides the procedures to remove and replace the 1x550-sheet paper feeder left cover.

Before performing service

Use the table below to identify the correct part number for your printer, and then go to <http://h20141.www2.hp.com/hpparts> to order the part.

Left cover (1x550-sheet paper feeder) part number	
RC4-1791-000CN	Left cover (1x550-sheet paper feeder)

Required tools

No special tools are required to install this part.

After performing service

Make sure that the left cover is flush against the chassis after replacing it.

Step 1: Remove the left cover

1. Partially pull the tray out of the accessory, and then release three tabs (callout 1).

Figure 1-5188 Release three tabs

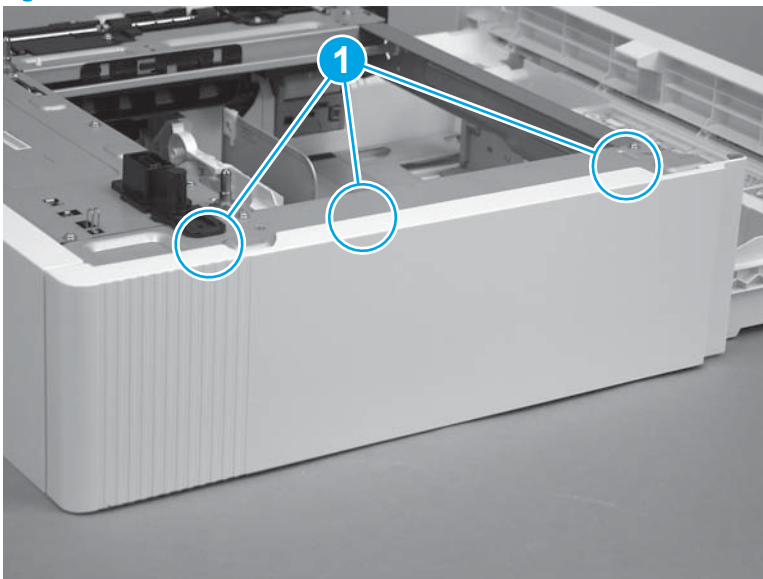

2. Rotate the top of the cover away from the accessory (callout 1), and then lift up the cover to remove it (callout 2).

Figure 1-5189 Remove the cover

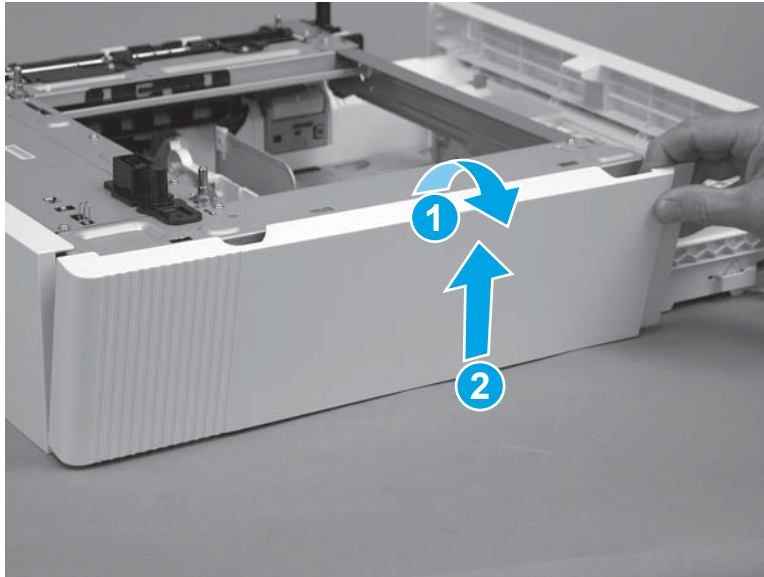

Step 2: Unpack the replacement assembly

Unpack the replacement assembly from the packaging.

For complete information on HP's recycling programs, go to [Product return and recycling](#).

 **NOTE:** HP recommends responsible disposal of the defective assembly.

Figure 1-5190 Recycle and unpack

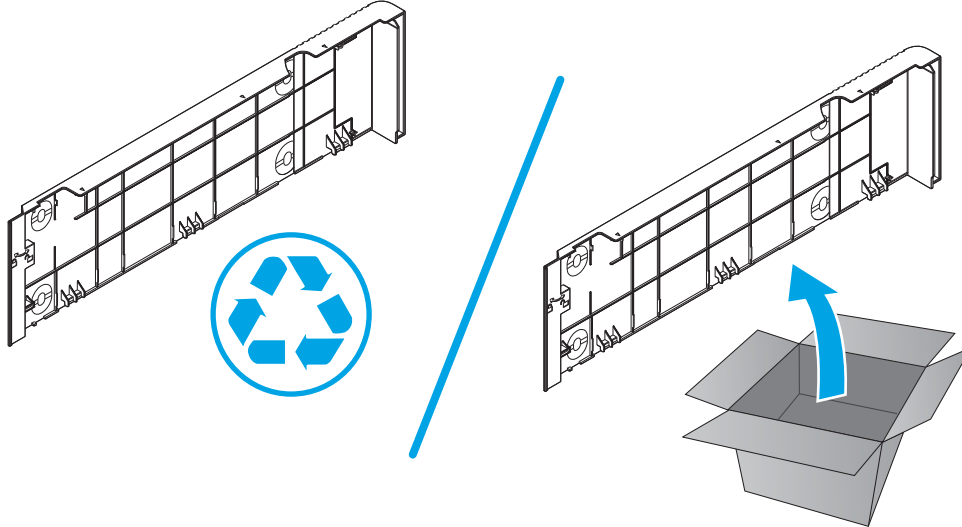

Step 3: Install the left cover

1. Align the three mounting tabs (callout 1) on the cover with the slots in the chassis.

Figure 1-5191 Position the cover on the chassis

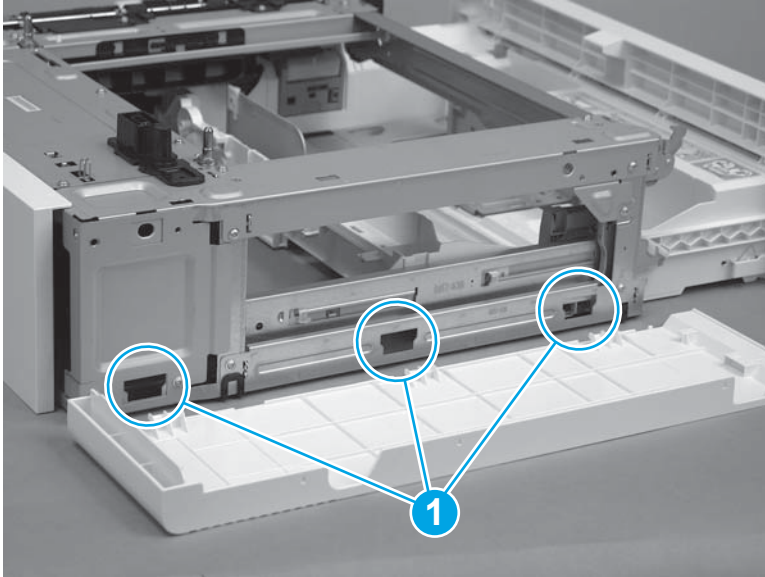

2. Place the bottom of the cover in position (callout 1), and then rotate the top of the cover up and onto the chassis (callout 2) to install it.

Figure 1-5192 Install the cover

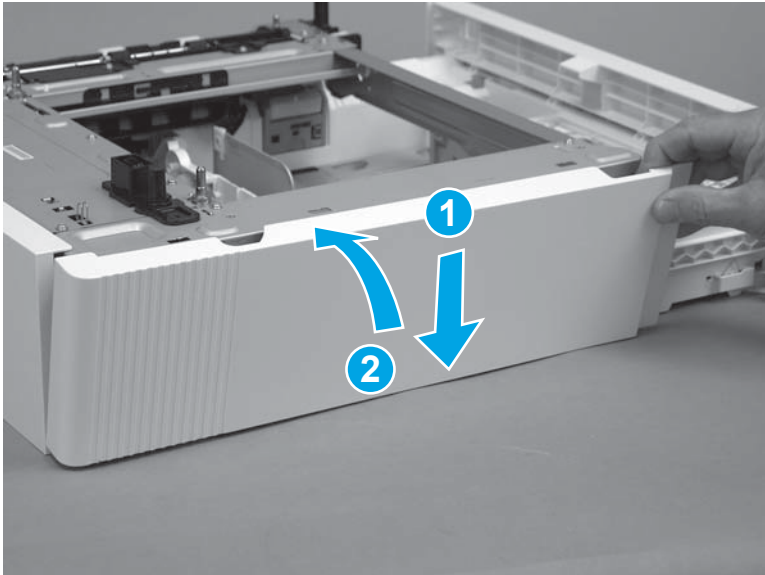

3. Make sure that the three tabs (callout 1) snap into place.

Figure 1-5193 Check the three tabs

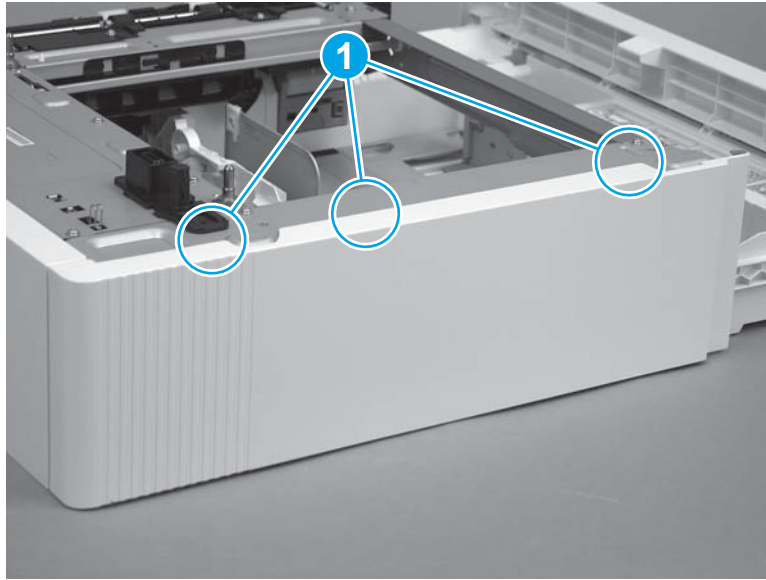

Removal and replacement: OP Drawer holder (1x550-sheet paper feeder)

- [Introduction](#)
- [Step 1: Remove the rear cover](#)
- [Step 2: Remove the OP drawer holder](#)
- [Step 3: Unpack the replacement assembly](#)
- [Step 4: Install the OP drawer holder](#)
- [Step 5: Install the rear cover](#)

Introduction

This document provides the procedures to remove and replace the 1x550-sheet paper feeder OP drawer holder.

Before performing service

Use the table below to identify the correct part number for your printer, and then go to <http://h20141.www2.hp.com/hpparts> to order the part.

OP drawer holder (1x550-sheet paper feeder) part number	
RC4-0445-000CN	OIP drawer holder (1x550-sheet paper feeder)

Required tools

- #2 Phillips screwdriver with a magnetic tip and a 152-mm (6-in) shaft length

After performing service

Make sure that the rear cover is flush against the chassis after replacing it.

Post service test

Print a page from a host computer using the appropriate tray as the source tray.

Step 1: Remove the rear cover

1. Release three tabs (callout 1).

Figure 1-5194 Release three tabs

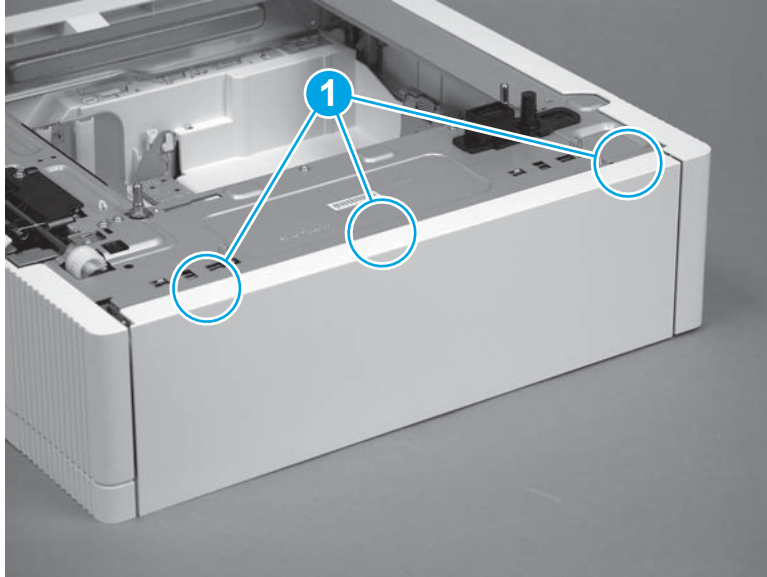

2. Rotate the top of the cover away from the accessory (callout 1), and then lift it up to remove it (callout 2).

Figure 1-5195 Remove the cover

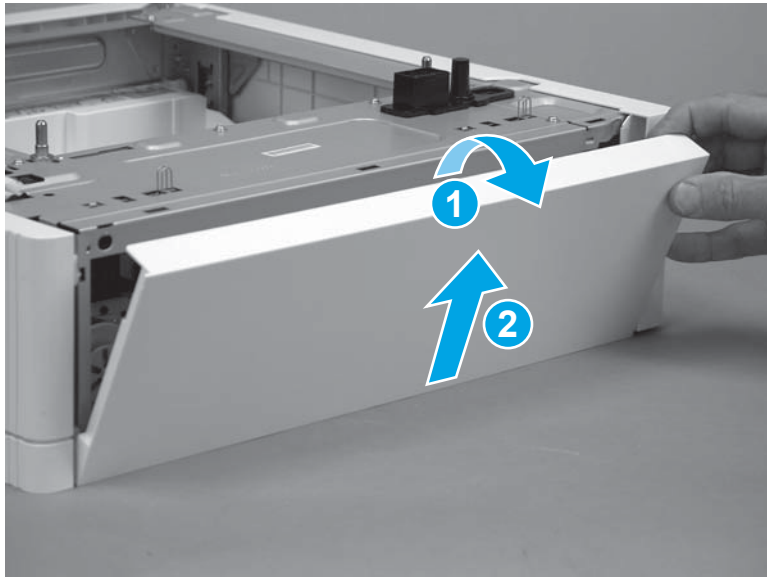

Step 2: Remove the OP drawer holder

1. Disconnect one connector (callout 1).

Figure 1-5196 Disconnect one connector

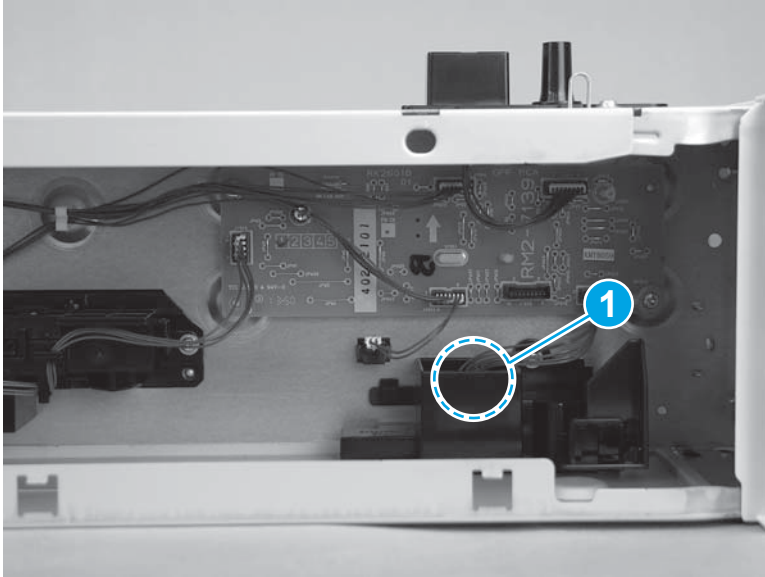

2. Remove one screw (callout 1), release one tab (callout 2), and then slide the OP drawer holder as shown (callout 3) to remove it.

Figure 1-5197 Remove the drawer holder

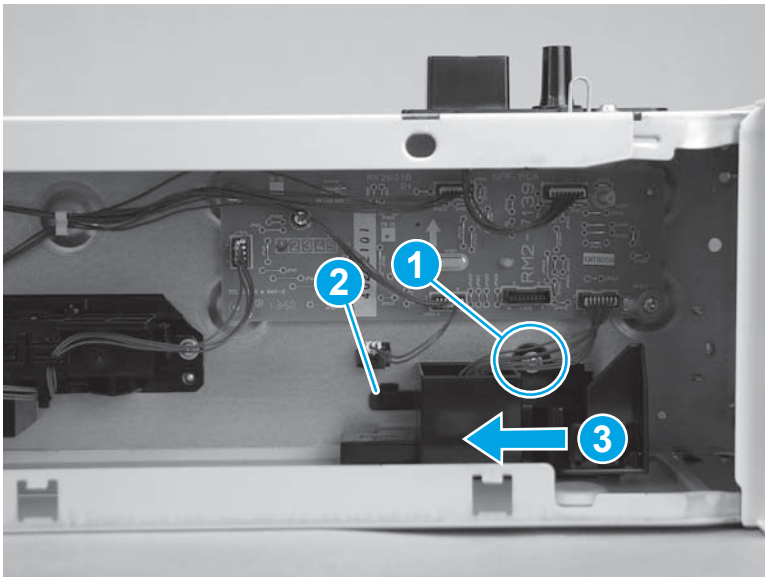

Step 3: Unpack the replacement assembly

Unpack the replacement assembly from the packaging.

For complete information on HP's recycling programs, go to [Product return and recycling](#).

 **NOTE:** HP recommends responsible disposal of the defective assembly.

Figure 1-5198 Recycle and unpack

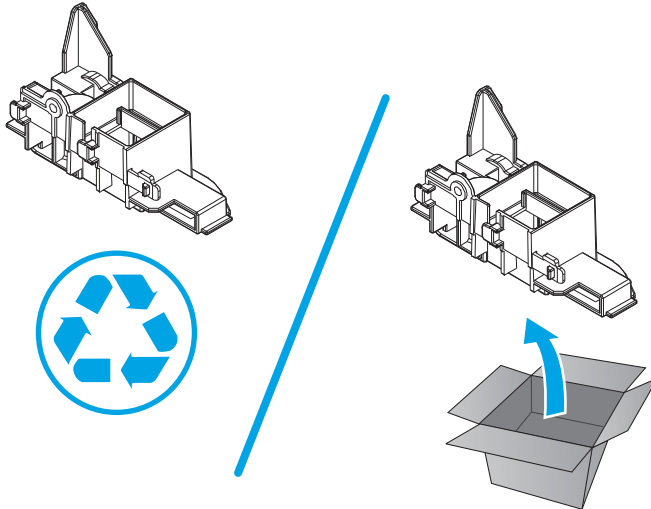

Step 4: Install the OP drawer holder

1. Position the OP drawer holder on the chassis and slide it as shown (callout 1) to install it, and then install one screw (callout 2). The tab (callout 3) on the holder fits into a slot in the chassis.

 **NOTE:** Remove the drawer connector from the holder, and install it in the replacement drawer holder.

Figure 1-5199 Install the drawer holder

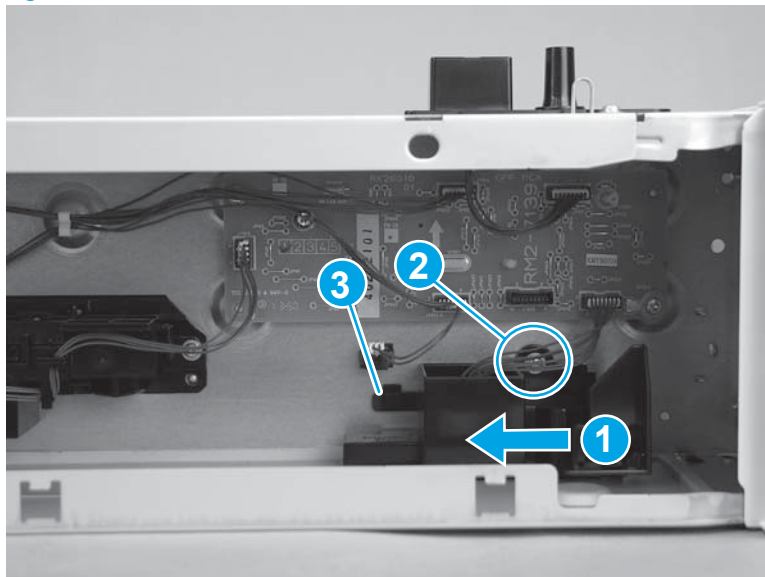

2. Connect one connector (callout 1).

Figure 1-5200 Connect one connector

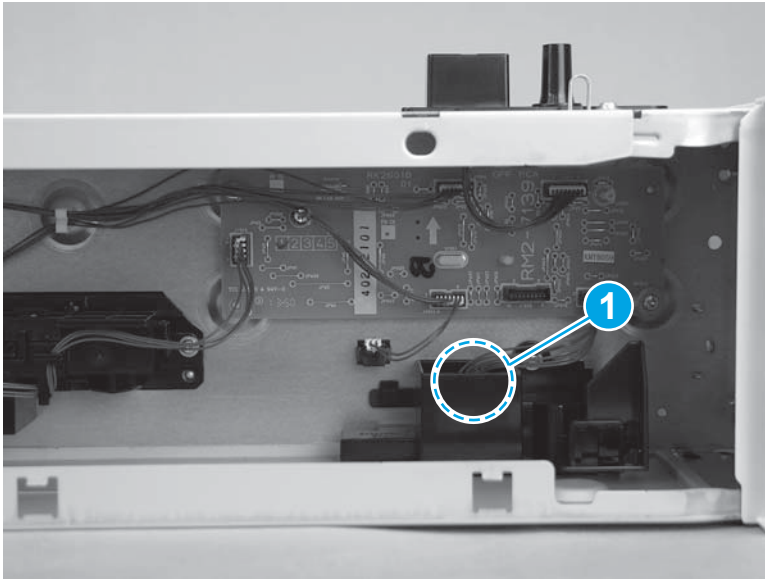

Step 5: Install the rear cover

1. Align the three mounting tabs (callout 1) on the cover with the slots in the chassis.

Figure 1-5201 Position the cover on the chassis

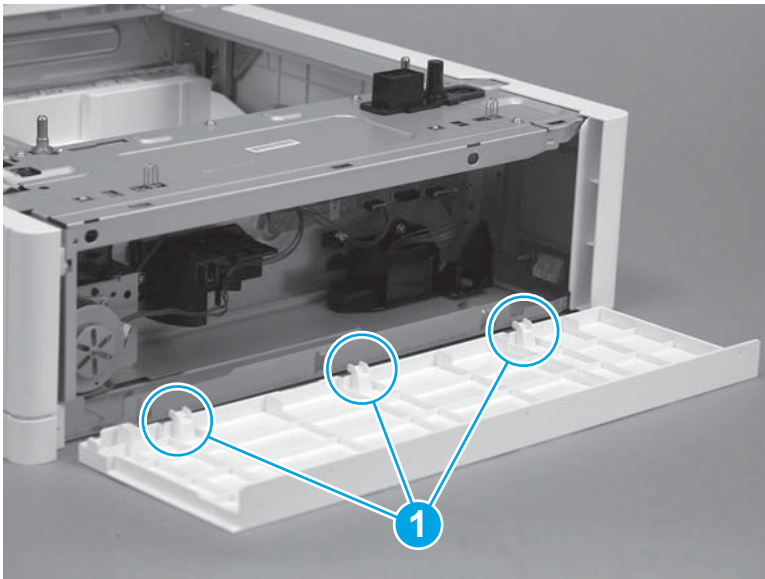

2. Position the cover on the accessory (callout 1), and then rotate the top of the cover up and onto the chassis (callout 2) to install it.

Figure 1-5202 Install the cover

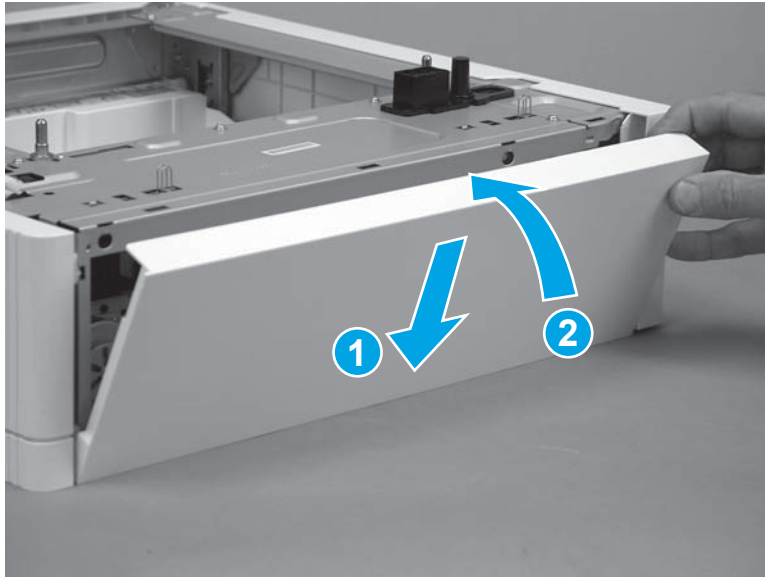

3. Make sure that the three tabs (callout 1) snap into place.

Figure 1-5203 Check the three tabs

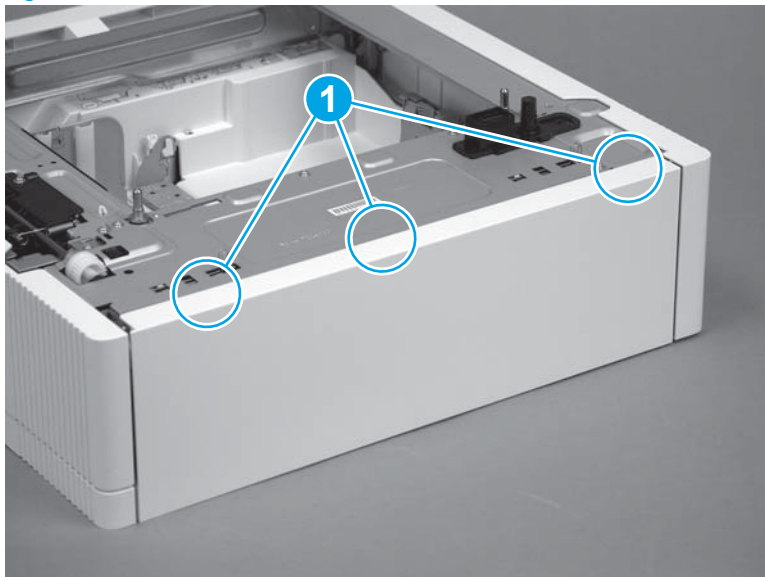

Removal and replacement: Auto close assembly (1x550-sheet paper feeder)

- [Introduction](#)
- [Step 1: Remove the tray](#)
- [Step 2: Remove the rear cover](#)
- [Step 3: Remove the auto close assembly](#)
- [Step 4: Unpack the replacement assembly](#)
- [Step 5: Install the auto close assembly](#)
- [Step 6: Install the rear cover](#)
- [Step 7: Install the tray](#)

Introduction

This document provides the procedures to remove and replace the 1x550-sheet paper feeder auto close assembly.

Before performing service

Use the table below to identify the correct part number for your printer, and then go to <http://h20141.www2.hp.com/hpparts> to order the part.

Right door hinge (1x550-sheet paper feeder) part number	
RM2-5147-000CN	Auto close assembly (1x550-sheet paper feeder)

Required tools

- #2 Phillips screwdriver with a magnetic tip

After performing service

Make sure that the rear cover is flush against the chassis after replacing it.

Make sure that the right door latches correctly when closed after replacing it.

Make sure that Tray 3 is fully closed after replacing it.

Post service test

Print a page from a host computer using the appropriate tray as the source tray.

Step 1: Remove the tray

1. Pull the tray out until it stops.

Figure 1-5204 Pull the tray out

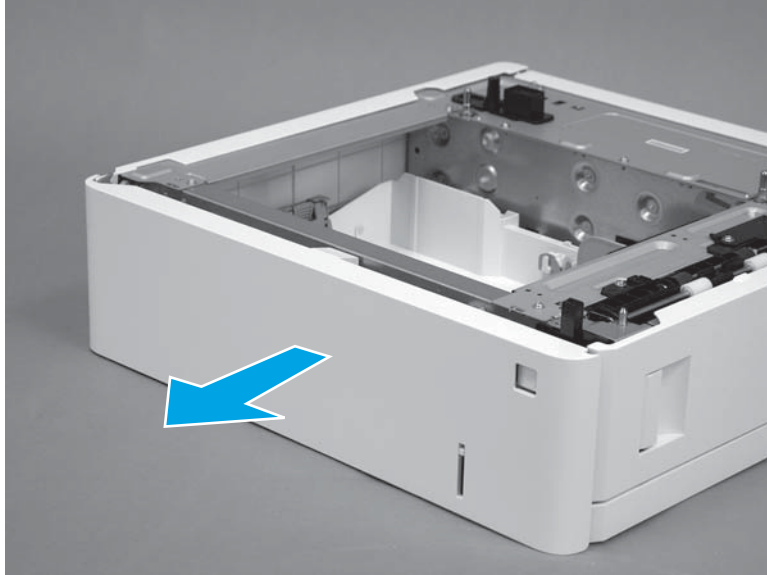

2. Lift the front of the tray, and then pull it out of the printer to remove it.

Figure 1-5205 Remove the tray

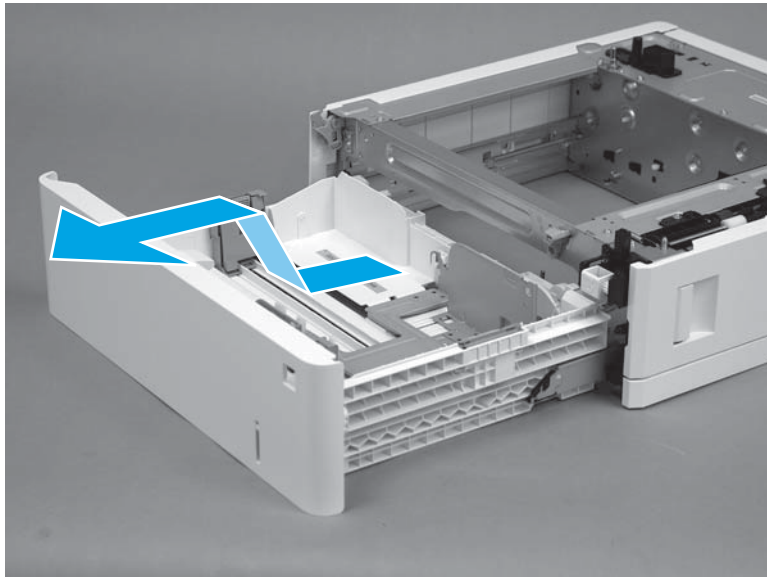

Step 2: Remove the rear cover

1. Release three tabs (callout 1).

Figure 1-5206 Release three tabs

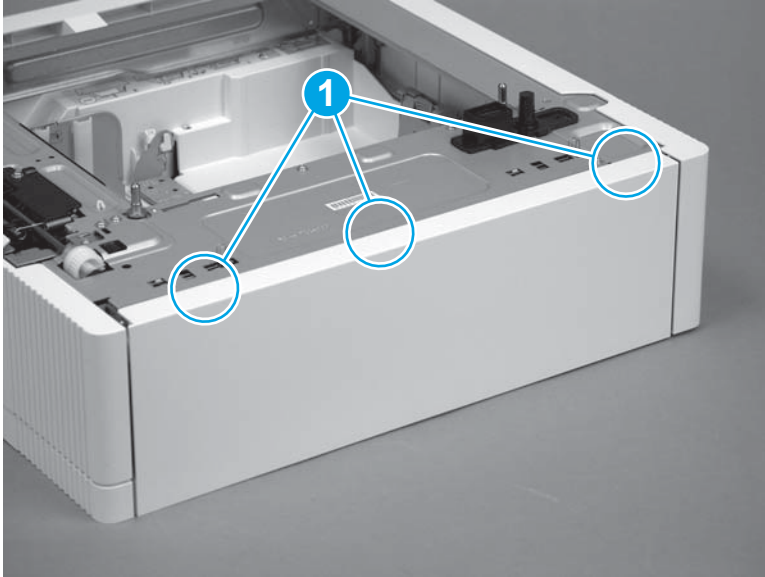

2. Rotate the top of the cover away from the accessory (callout 1), and then lift it up to remove it (callout 2).

Figure 1-5207 Remove the cover

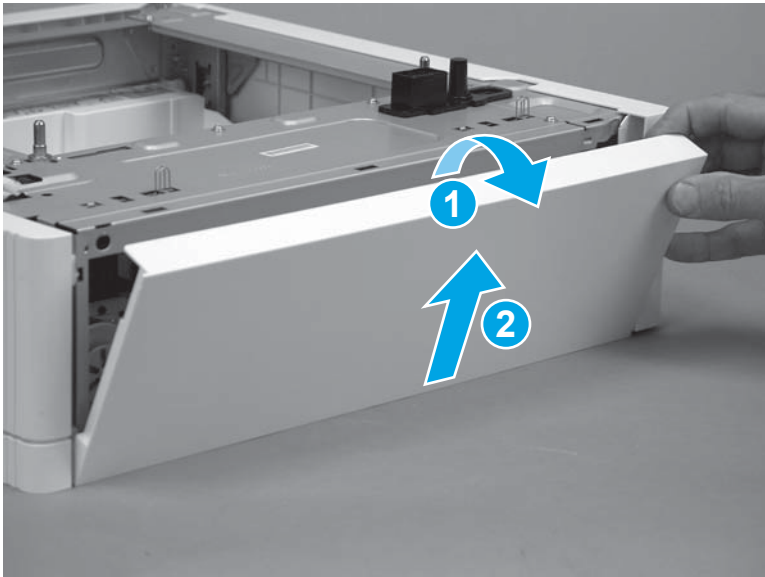

Step 3: Remove the auto close assembly

1. Disconnect one connector (callout 1; J903), and then release the wire harness from the retainer (callout 2).

Figure 1-5208 Disconnect one connector

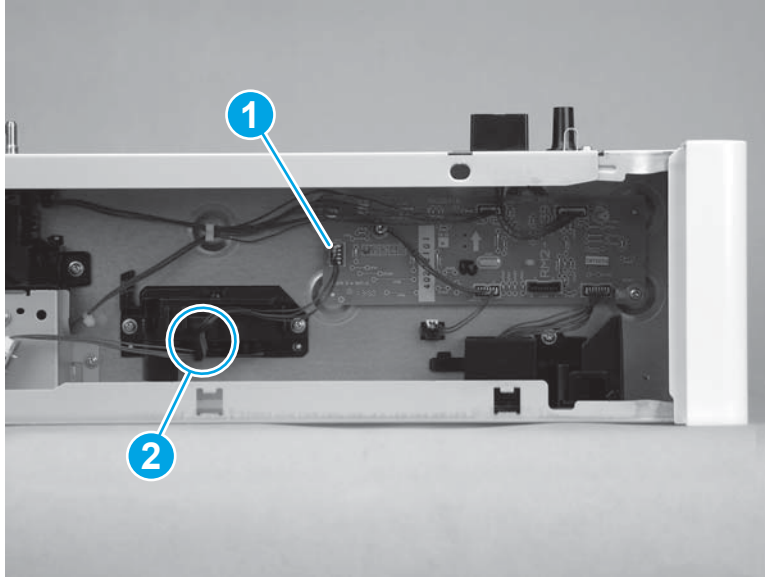

2. Remove two screws (callout 1).

Figure 1-5209 Remove two screws

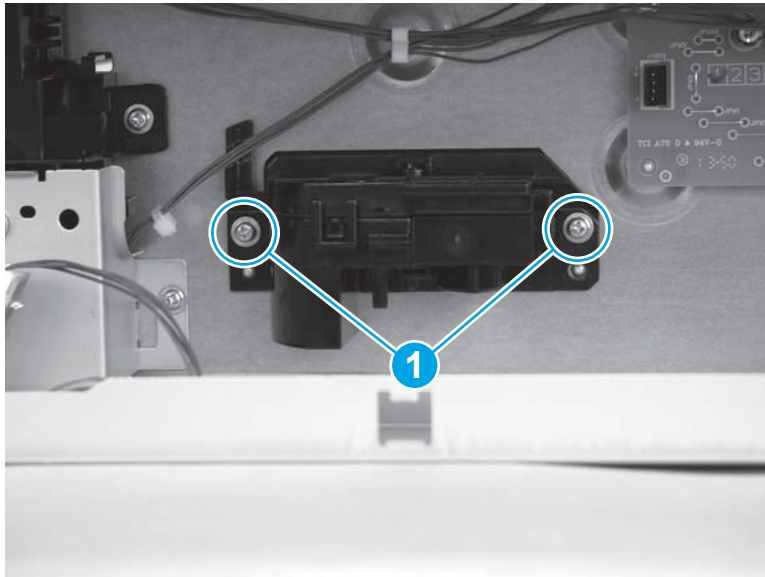

3. Lift up on the assembly to release it.

Figure 1-5210 Release the assembly

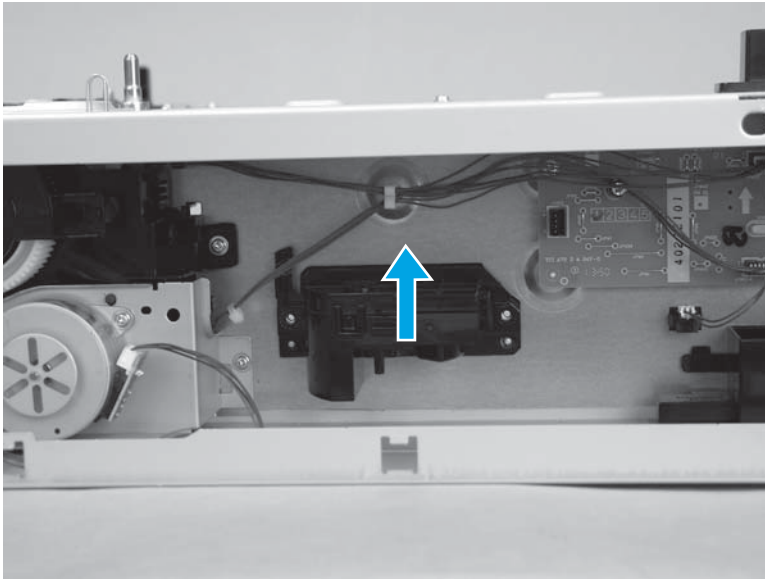

4. Remove the auto close assembly.

Figure 1-5211 Remove the assembly

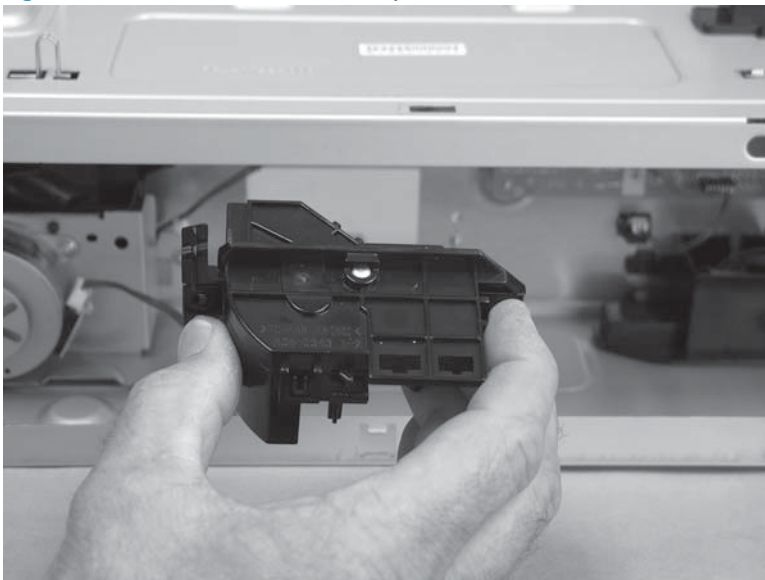

Step 4: Unpack the replacement assembly

Unpack the replacement assembly from the packaging.

For complete information on HP's recycling programs, go to [Product return and recycling](#).



NOTE: HP recommends responsible disposal of the defective assembly.

Figure 1-5212 Recycle and unpack

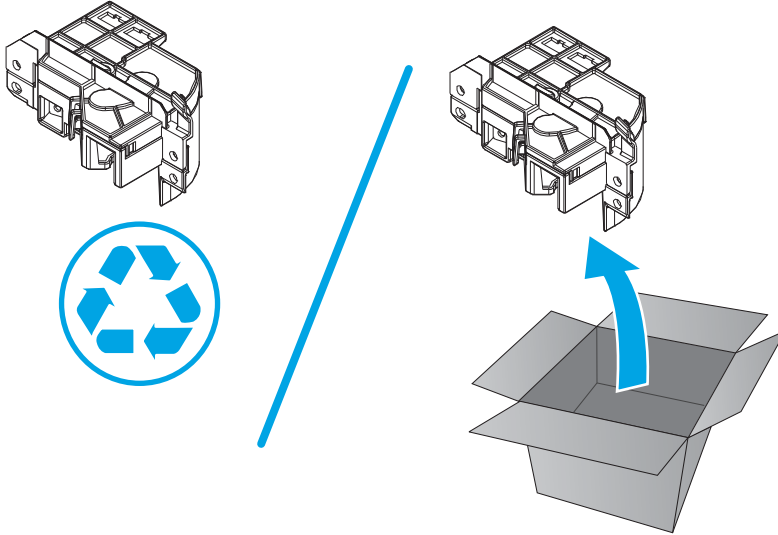

Step 5: Install the auto close assembly

1. Position the auto close assembly in the hole in the chassis.

Figure 1-5213 Install the assembly



2. Push down on the assembly to engage it.

Figure 1-5214 Engage the assembly

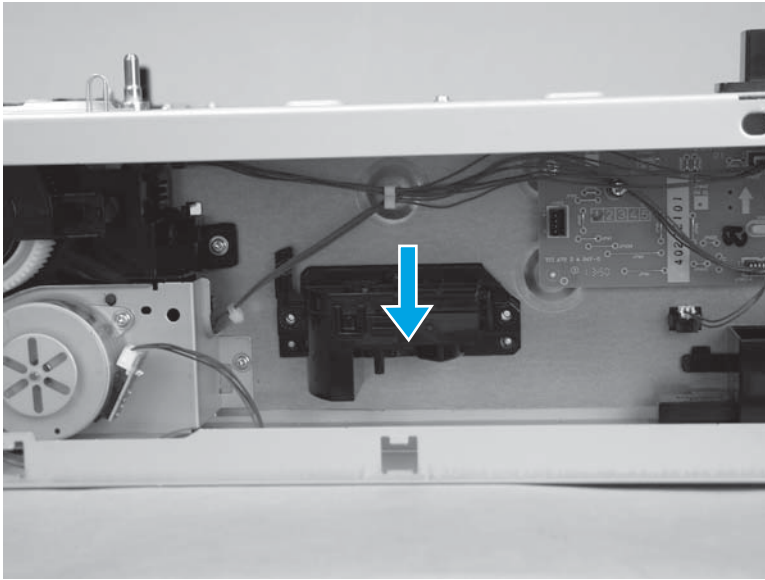

3. Install two screws (callout 1).

Figure 1-5215 Install two screws

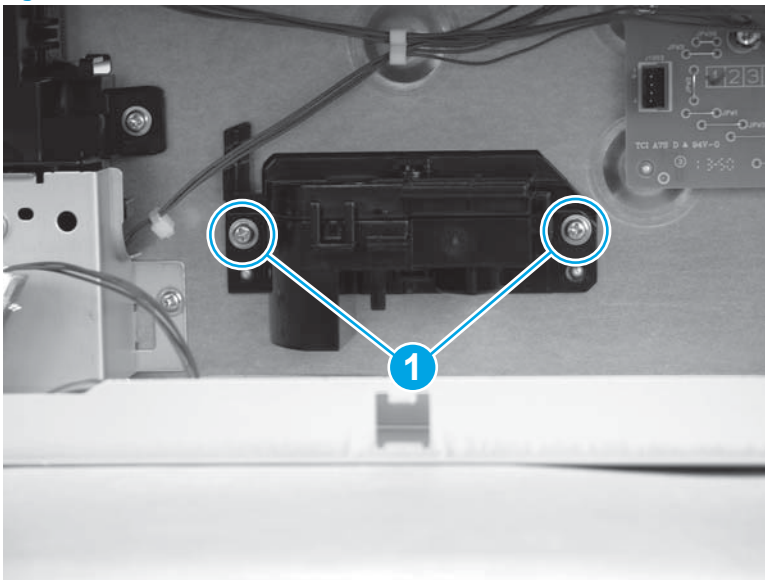

4. Install the wire harness in the retainer (callout 1) , and then connect one connector (callout 2; J903).

Figure 1-5216 Disconnect one connector

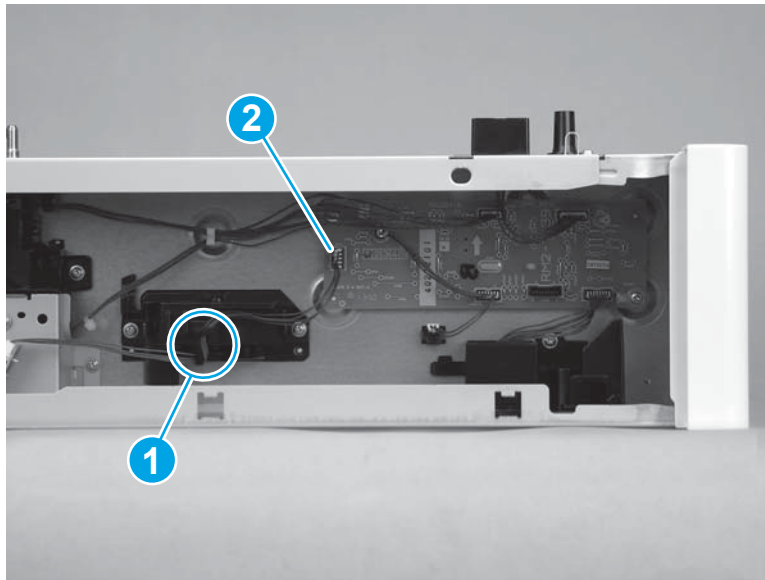

Step 6: Install the rear cover

1. Align the three mounting tabs (callout 1) on the cover with the slots in the chassis.

Figure 1-5217 Position the cover on the chassis

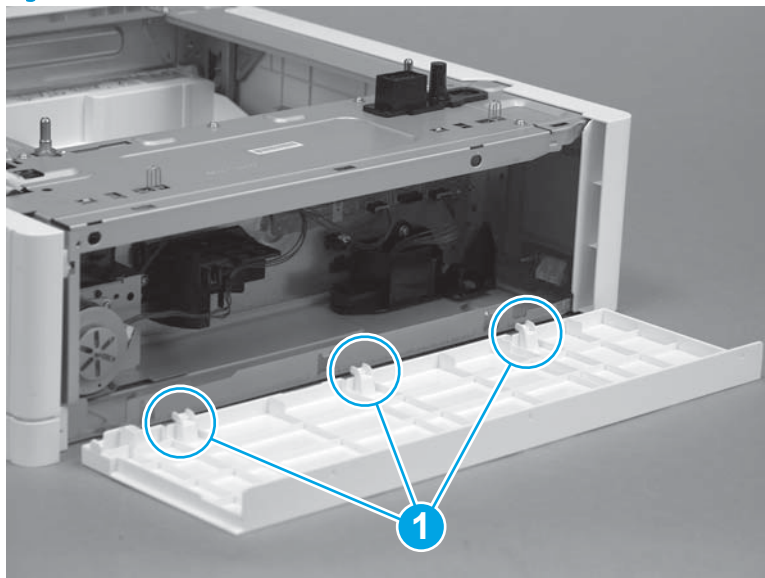

2. Position the cover on the accessory (callout 1), and then rotate the top of the cover up and onto the chassis (callout 2) to install it.

Figure 1-5218 Install the cover

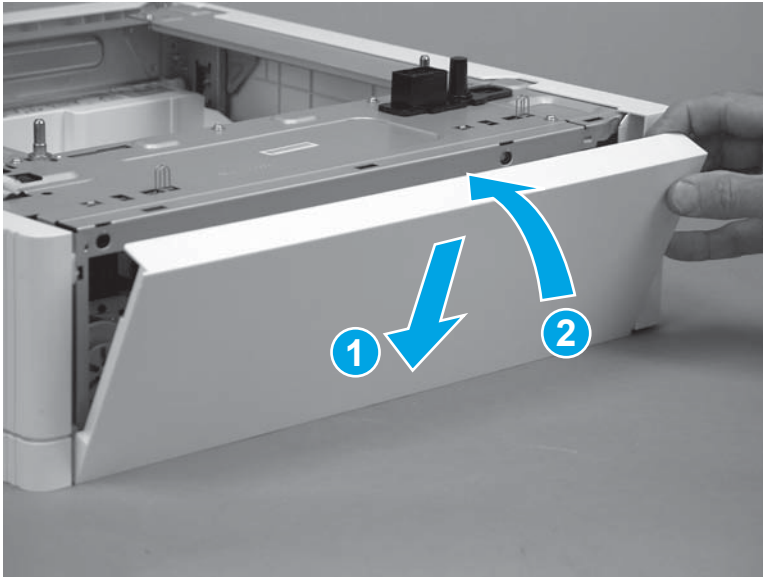

3. Make sure that the three tabs (callout 1) snap into place.

Figure 1-5219 Check the three tabs

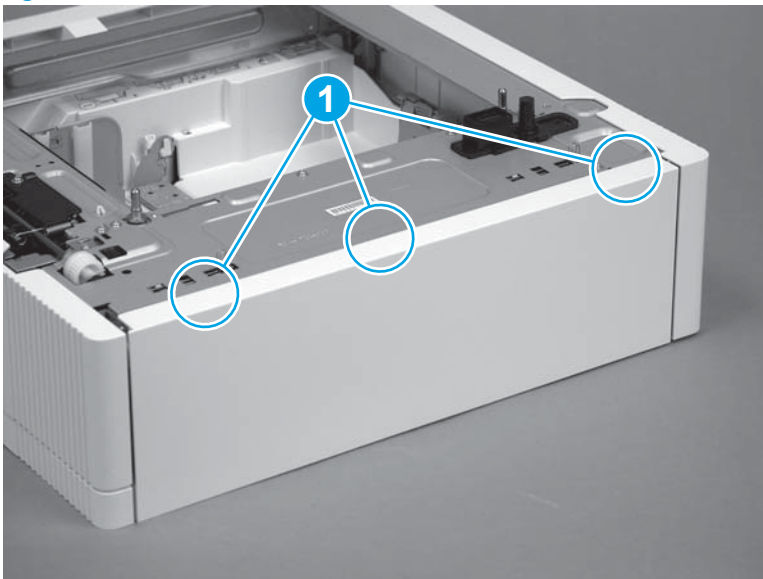

Step 7: Install the tray

1. With the front of the tray slightly lifted, align the sides of the tray with the rails in the printer, and then carefully slide the tray into the printer.

 **TIP:** As the tray slides into the accessory, lower the front of it.

Figure 1-5220 Install the tray



2. Close the tray.

Figure 1-5221 Close the tray

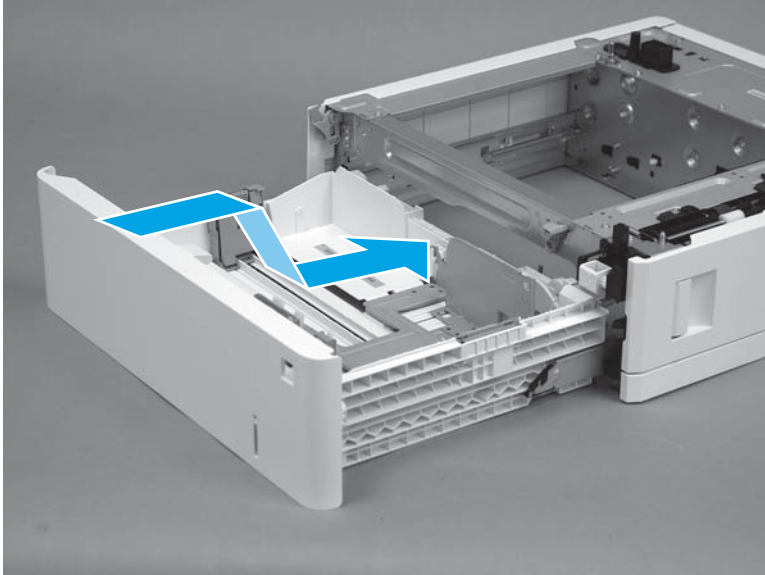
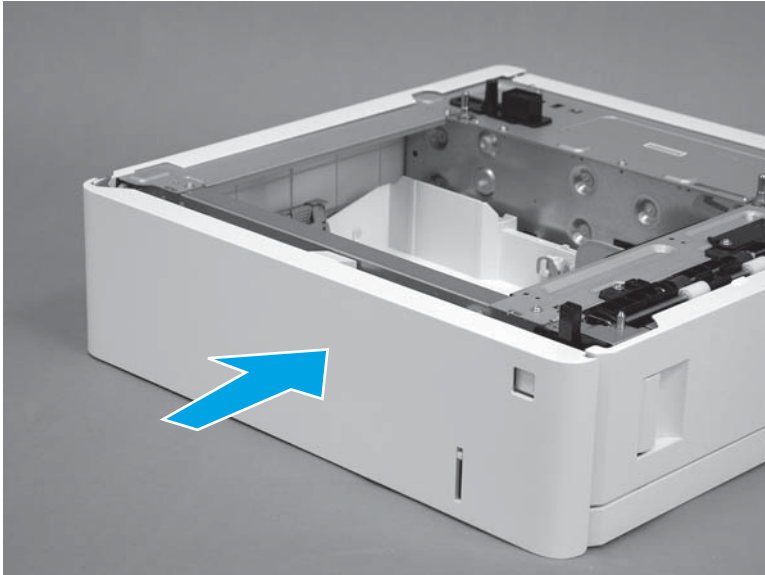

Removal and replacement: Switch button (SW12) (1x550-sheet paper feeder)

- [Introduction](#)
- [Step 1: Remove the tray](#)
- [Step 2: Remove the rear cover](#)
- [Step 3: Remove the switch button \(SW12\)](#)
- [Step 4: Unpack the replacement assembly](#)
- [Step 5: Install the switch button \(SW12\)](#)
- [Step 6: Install the rear cover](#)
- [Step 7: Install the tray](#)

Introduction

This document provides the procedures to remove and replace the 1x550-sheet paper feeder switch button (SW12).

Before performing service

Use the table below to identify the correct part number for your printer, and then go to <http://h20141.www2.hp.com/hpparts> to order the part.

Switch button (SW12) (1x550-sheet paper feeder) part number	
WC2-5806-000CN	Switch button (SW12) (1x550-sheet paper feeder)

Required tools

No special tools are required to install this part.

After performing service

Make sure that the rear cover is flush against the chassis after replacing it.

Make sure that Tray 3 is fully closed after replacing it.

Post service test

Print a page from a host computer using the appropriate tray as the source tray.

Step 1: Remove the tray

1. Pull the tray out until it stops.

Figure 1-5222 Pull the tray out

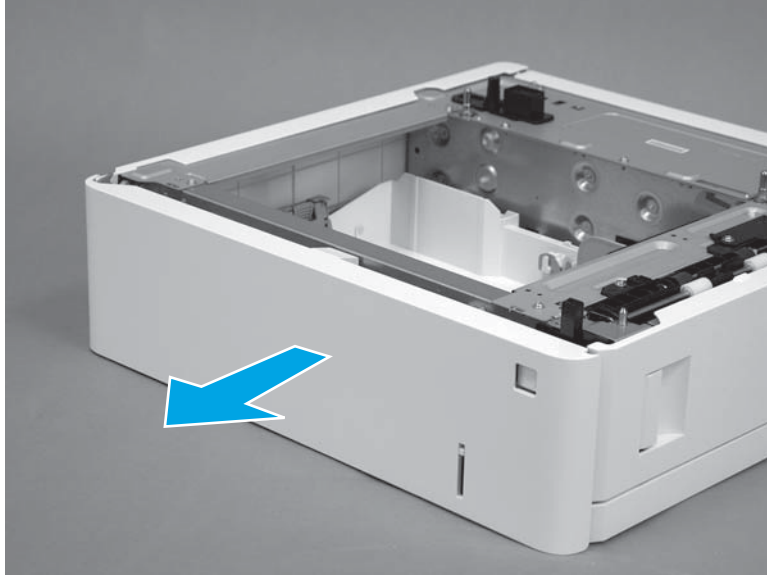

2. Lift the front of the tray, and then pull it out of the printer to remove it.

Figure 1-5223 Remove the tray

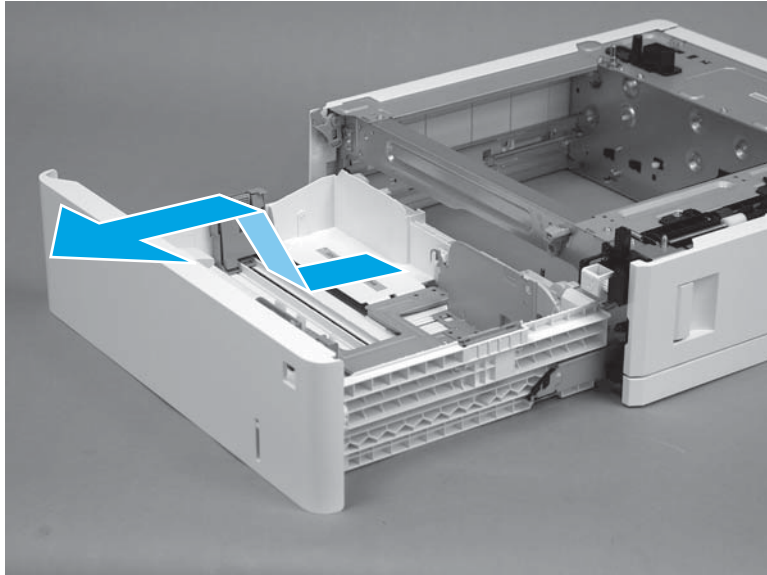

Step 2: Remove the rear cover

1. Release three tabs (callout 1).

Figure 1-5224 Release three tabs

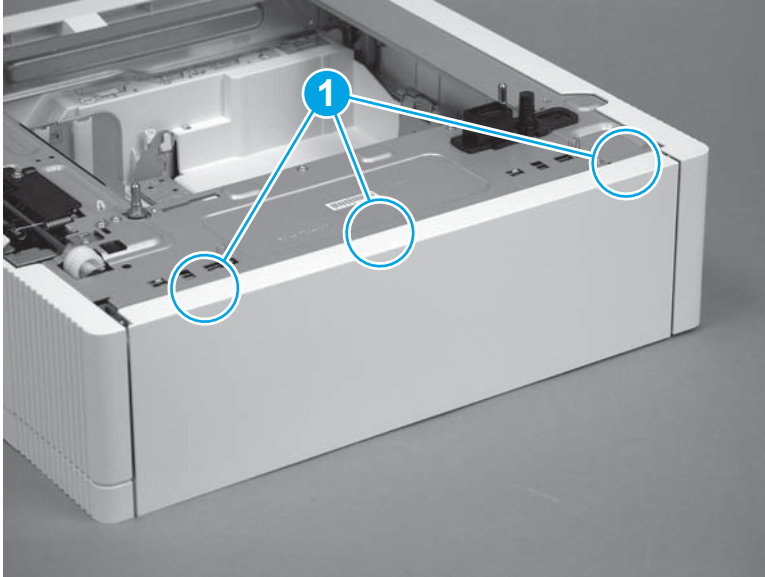

2. Rotate the top of the cover away from the accessory (callout 1), and then lift it up to remove it (callout 2).

Figure 1-5225 Remove the cover

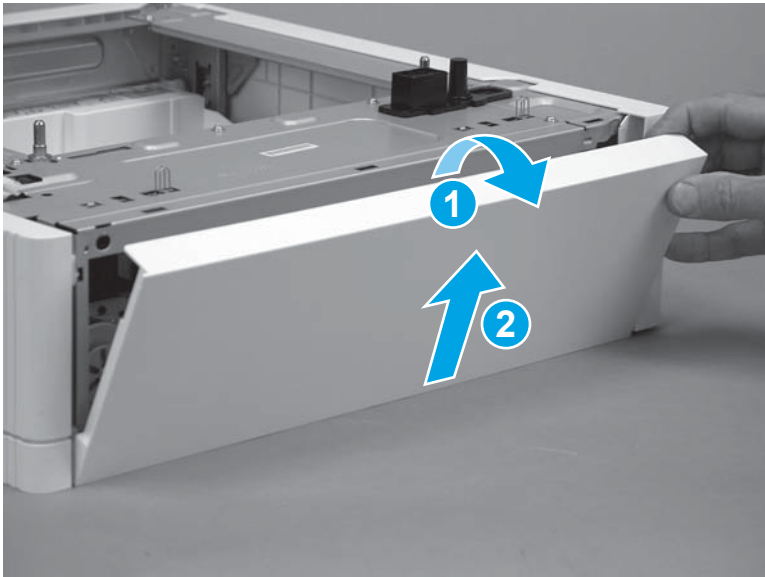

Step 3: Remove the switch button (SW12)

1. Disconnect one connector (callout 1).

Figure 1-5226 Disconnect one connector

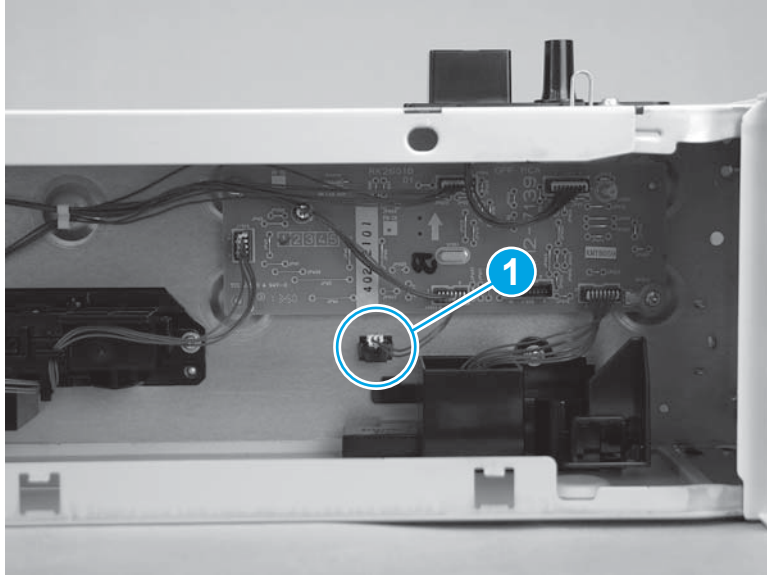

2. Squeeze two tabs to release them, and then push the switch through the opening in the chassis into the tray cavity.

Figure 1-5227 Squeeze two tabs

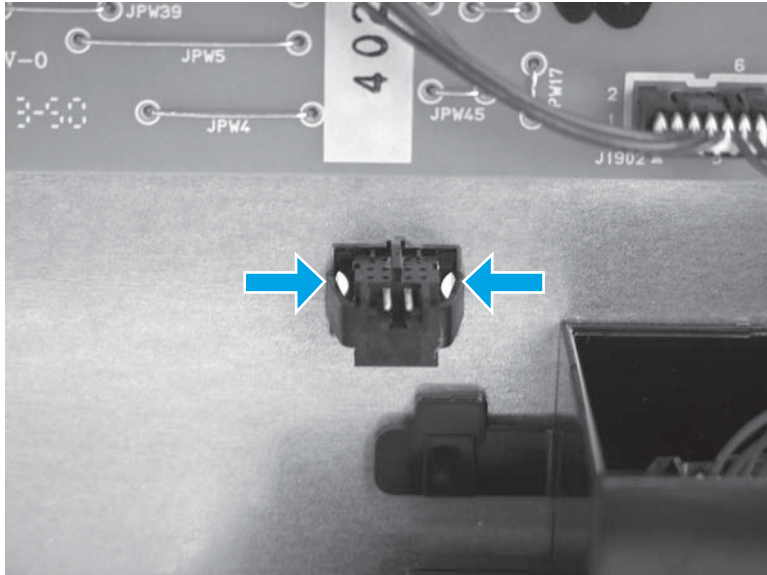

3. Remove the switch button (SW12).

Figure 1-5228 Remove the switch button (SW12)

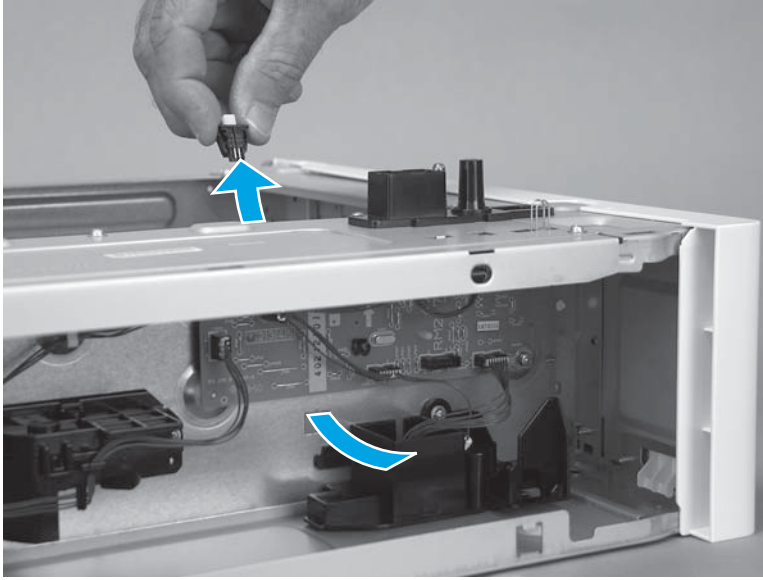

Step 4: Unpack the replacement assembly

Unpack the replacement assembly from the packaging.

For complete information on HP's recycling programs, go to [Product return and recycling](#).

 **NOTE:** HP recommends responsible disposal of the defective assembly.

Figure 1-5229 Recycle and unpack

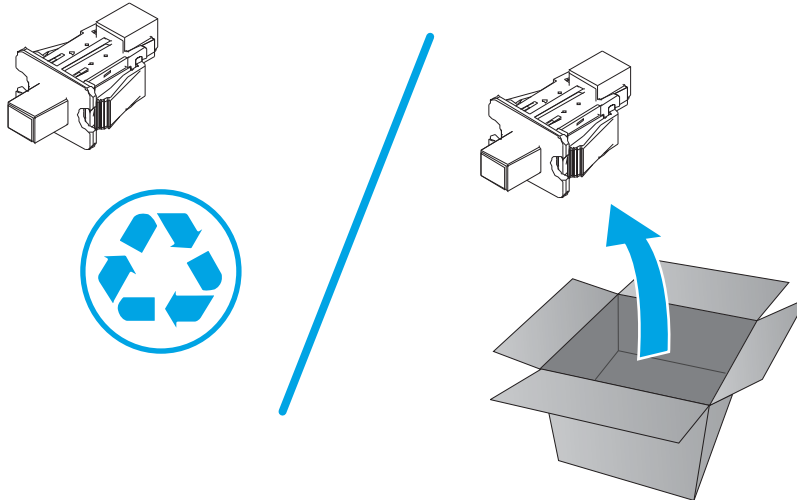

Step 5: Install the switch button (SW12)

1. From inside the tray cavity, push the switch through the opening in the chassis.

 **NOTE:** Orientate the switch button (SW12) with the contact pins face up.

Figure 1-5230 Install the switch button (SW12)



2. Make sure that the two tabs snap into place.

Figure 1-5231 Install the switch button (SW12)

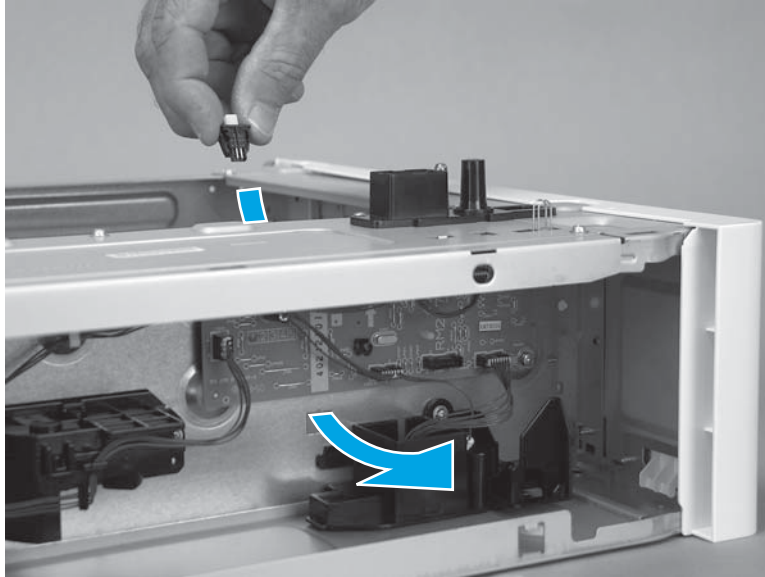
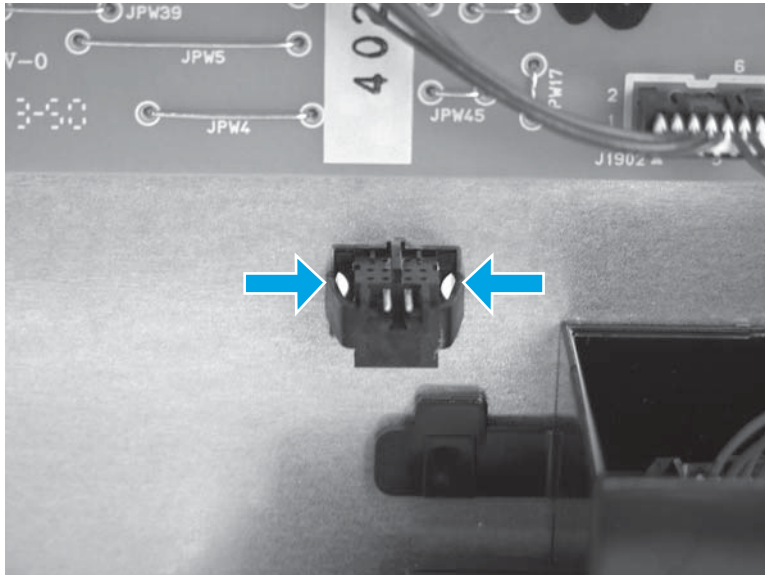

3. Connect one connector (callout 1).

Figure 1-5232 Connect one connector

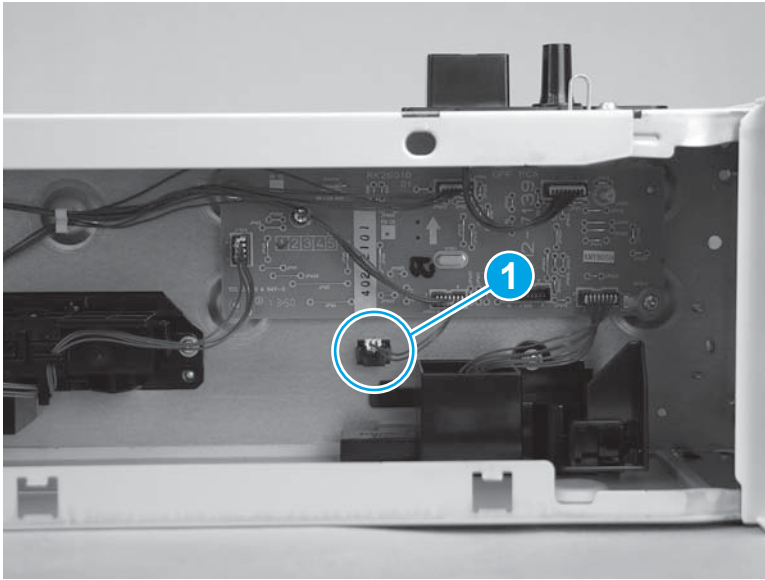

Step 6: Install the rear cover

1. Align the three mounting tabs (callout 1) on the cover with the slots in the chassis.

Figure 1-5233 Position the cover on the chassis

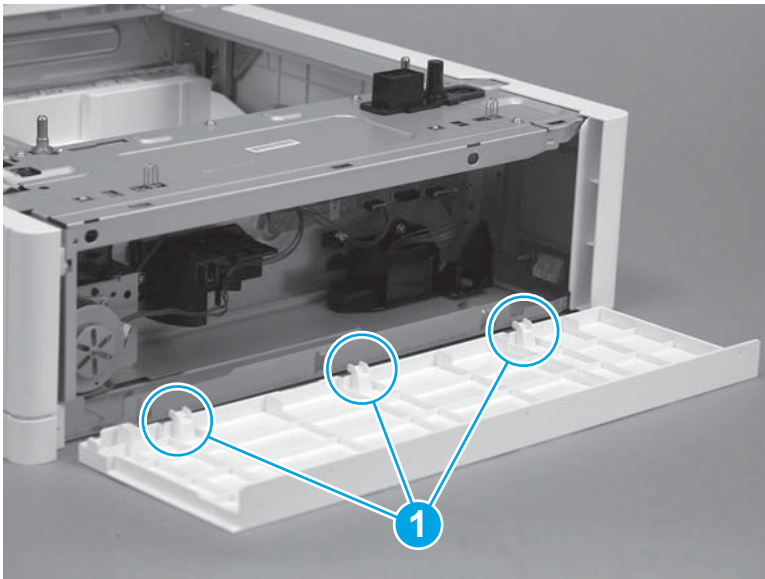

2. Position the cover on the accessory (callout 1), and then rotate the top of the cover up and onto the chassis (callout 2) to install it.

Figure 1-5234 Install the cover

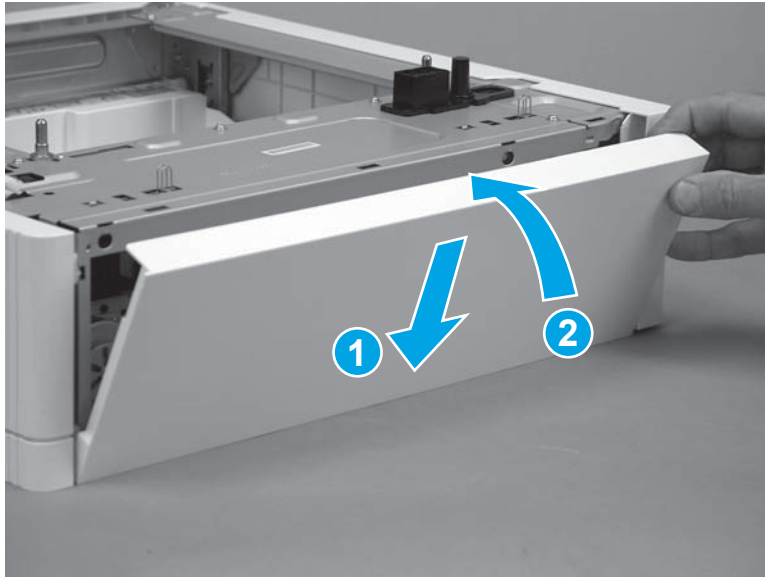

3. Make sure that the three tabs (callout 1) snap into place.

Figure 1-5235 Check the three tabs

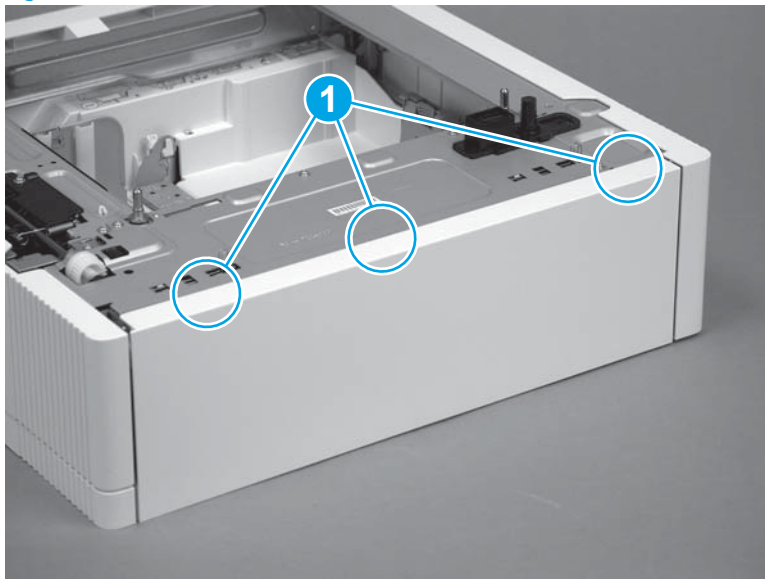

Step 7: Install the tray

1. With the front of the tray slightly lifted, align the sides of the tray with the rails in the printer, and then carefully slide the tray into the printer.

 **TIP:** As the tray slides into the accessory, lower the front of it.

Figure 1-5236 Install the tray



2. Close the tray.

Figure 1-5237 Close the tray

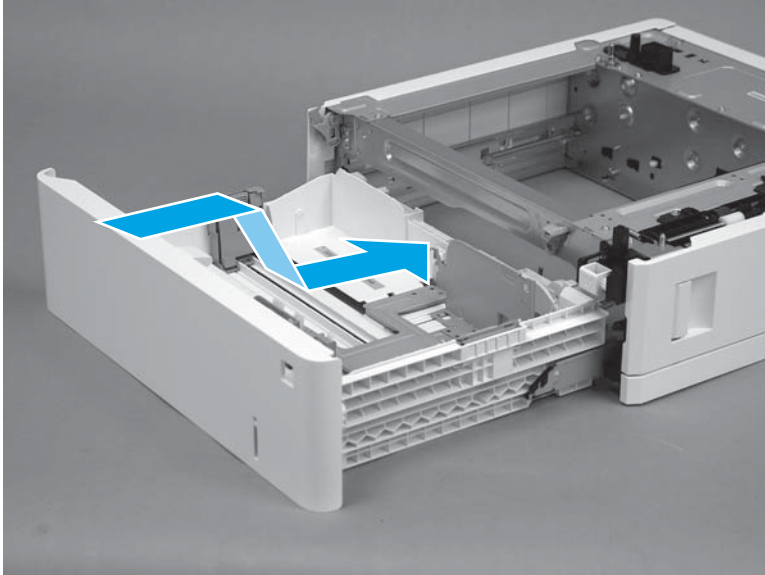
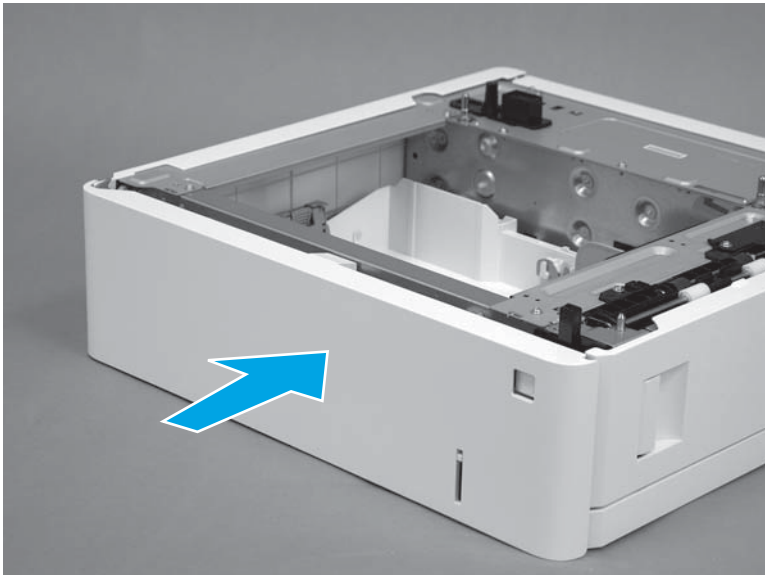

Removal and replacement: Drawer connector holder (1x550-sheet paper feeder)

- [Introduction](#)
- [Step 1: Remove the rear cover](#)
- [Step 2: Remove the drawer connector holder](#)
- [Step 3: Unpack the replacement assembly](#)
- [Step 4: Install the drawer connector holder](#)
- [Step 5: Install the rear cover](#)

Introduction

This document provides the procedures to remove and replace the 1x550-sheet paper feeder drawer connector holder.

Before performing service

Use the table below to identify the correct part number for your printer, and then go to <http://h20141.www2.hp.com/hpparts> to order the part.

Drawer connector holder (1x550-sheet paper feeder) part number	
RC4-1741-000CN	Drawer connector holder (1x550-sheet paper feeder)

Required tools

No special tools are required to install this part.

After performing service

Make sure that the rear cover is flush against the chassis after replacing it.

Post service test

Print a page from a host computer using the appropriate tray as the source tray.

Step 1: Remove the rear cover

1. Release three tabs (callout 1).

Figure 1-5238 Release three tabs

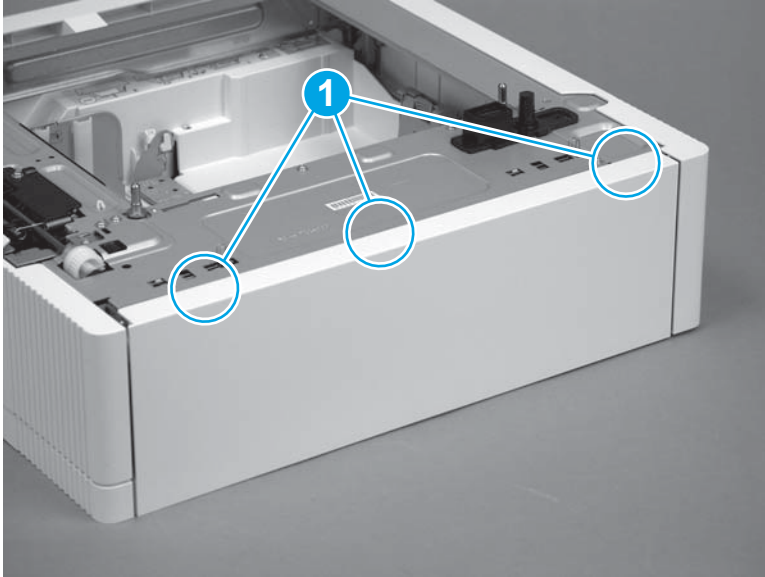

2. Rotate the top of the cover away from the accessory (callout 1), and then lift it up to remove it (callout 2).

Figure 1-5239 Remove the cover

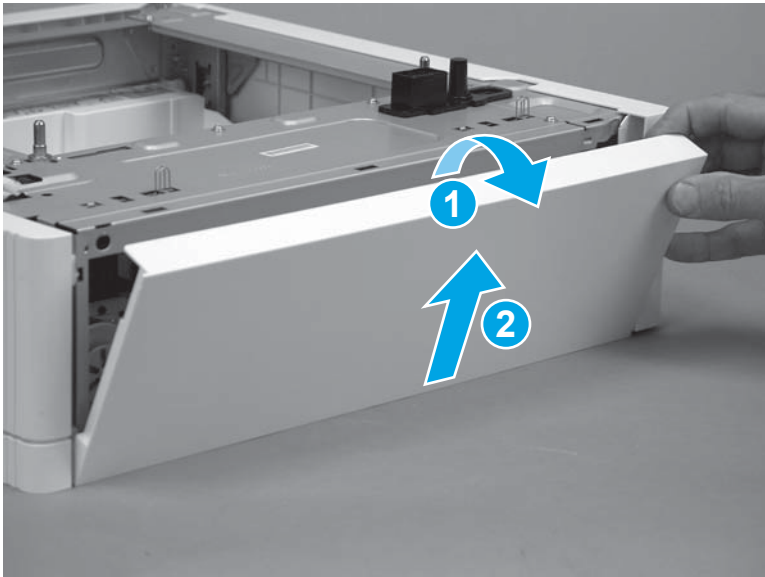

Step 2: Remove the drawer connector holder

1. Disconnect one connector (callout 1; J901).

Figure 1-5240 Disconnect one connector

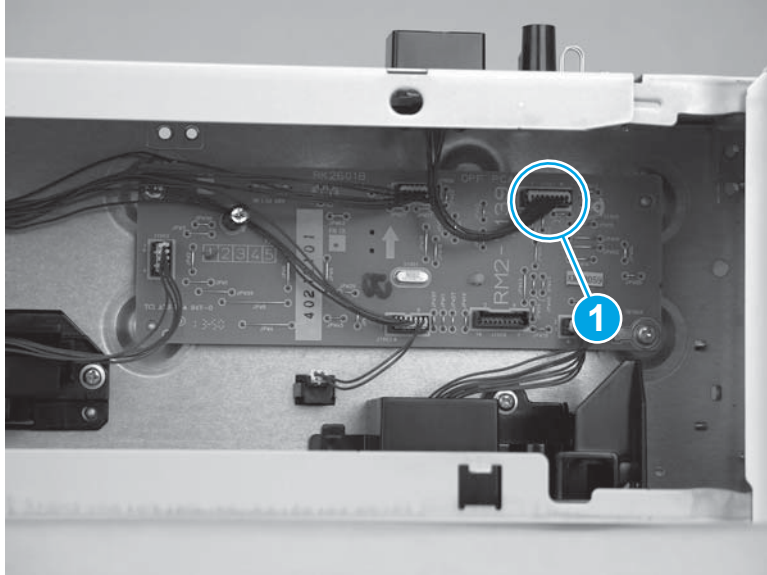

2. Release one tab (callout 1), and then slide the drawer connector holder as shown (callout 2) to release it.

Figure 1-5241 Release one tab

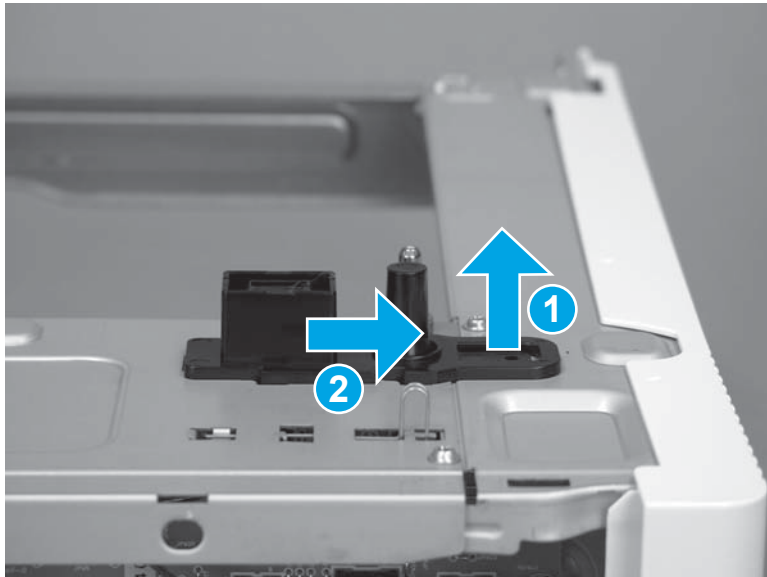

3. Remove the drawer connector holder.

Figure 1-5242 Remove the tray connector

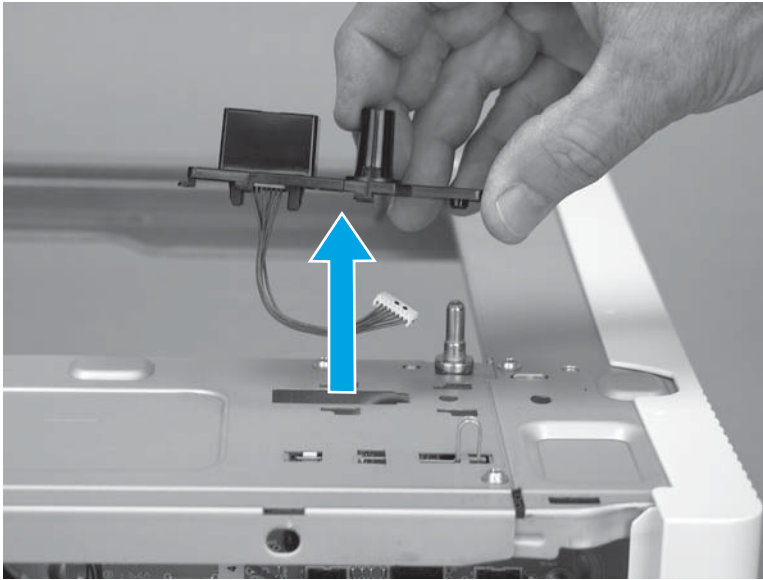

Step 3: Unpack the replacement assembly

Unpack the replacement assembly from the packaging.

For complete information on HP's recycling programs, go to [Product return and recycling](#).

 **NOTE:** HP recommends responsible disposal of the defective assembly.

Figure 1-5243 Recycle and unpack

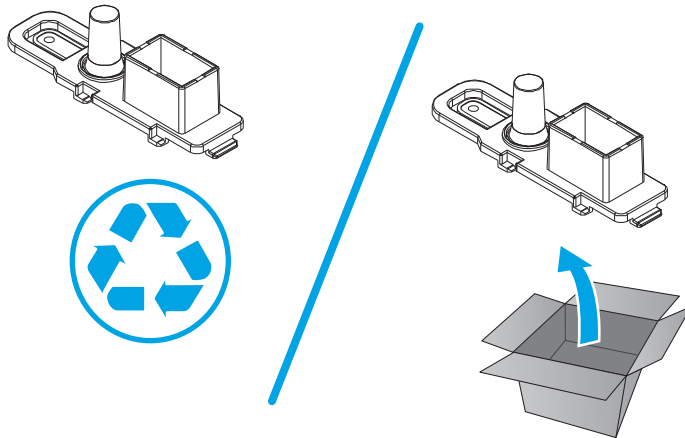

Step 4: Install the drawer connector holder

1. Position the drawer connector holder on the chassis.

 **NOTE:** Make sure that the wire harness (callout 1) was transferred from the discarded assembly to the replacement assembly.

Figure 1-5244 Place the tray connector on the accessory



2. Slide the drawer connector holder as shown (callout 1) to install it, and then make sure that one tab (callout 2) snaps into place .

Figure 1-5245 Install the tray connector

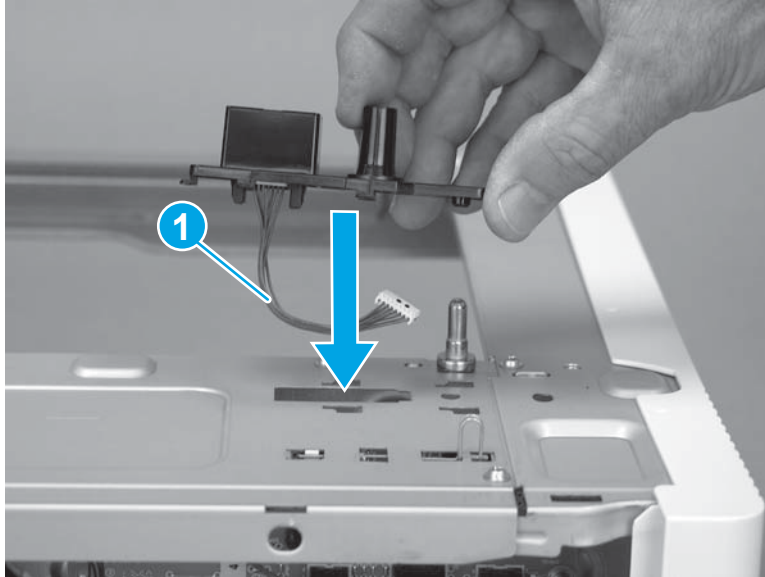
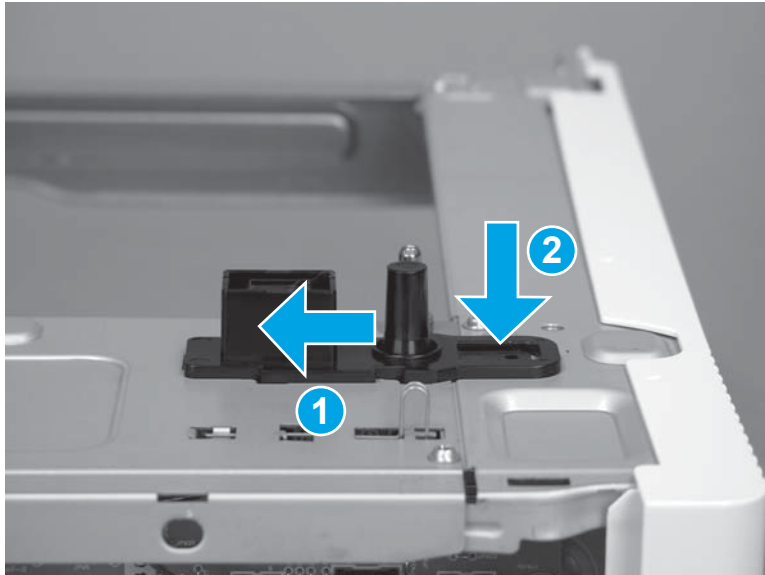

3. Connect one connector (callout 1; J901).

Figure 1-5246 Connect one connector

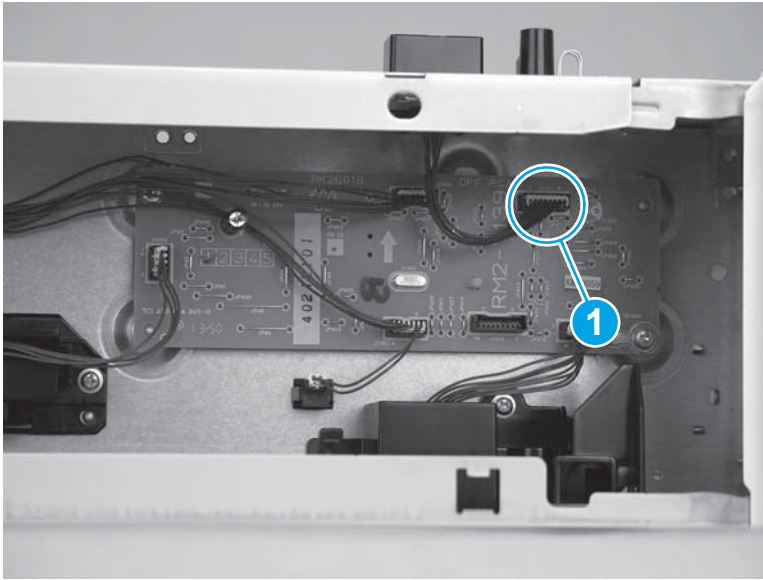

Step 5: Install the rear cover

1. Align the three mounting tabs (callout 1) on the cover with the slots in the chassis.

Figure 1-5247 Position the cover on the chassis

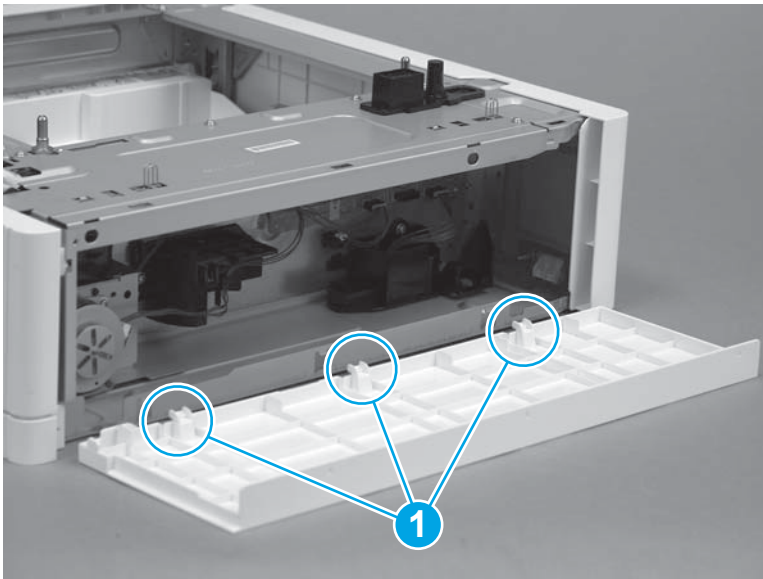

2. Position the cover on the accessory (callout 1), and then rotate the top of the cover up and onto the chassis (callout 2) to install it.

Figure 1-5248 Install the cover

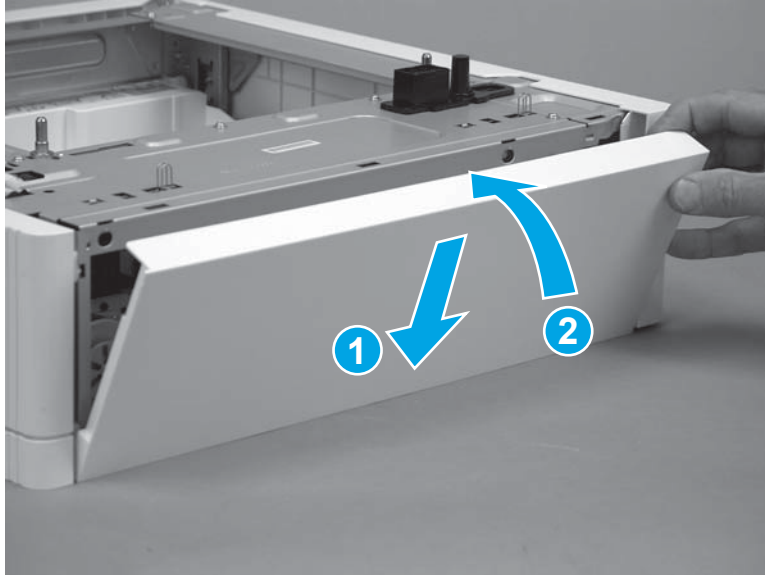

3. Make sure that the three tabs (callout 1) snap into place.

Figure 1-5249 Check the three tabs

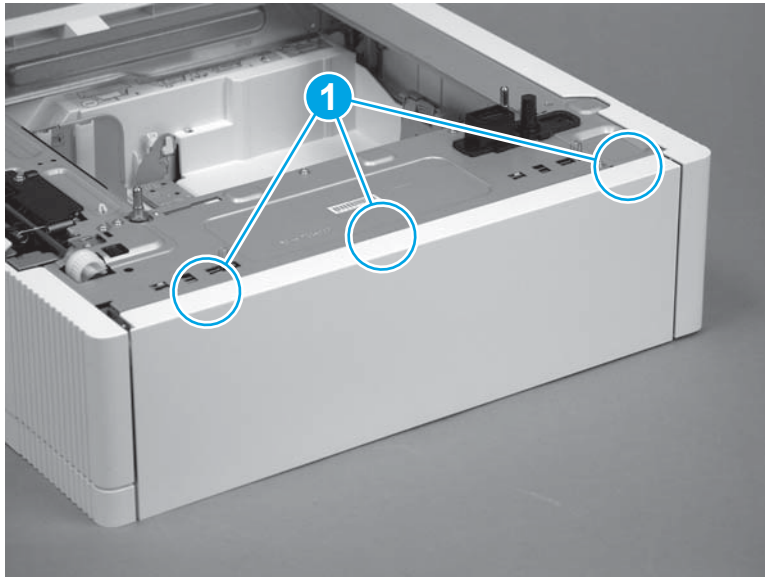



Removal and replacement: Paper-feeder drive PCA (1x550-sheet paper feeder)

- [Introduction](#)
- [Step 1: Remove the rear cover](#)
- [Step 2: Remove the paper-feeder drive PCA](#)
- [Step 3: Unpack the replacement assembly](#)
- [Step 4: Install the paper-feeder-drive PCA](#)
- [Step 5: Install the rear cover](#)

Introduction

This document provides the procedures to remove and replace the 1x550-sheet paper feeder paper-feeder drive PCA.

Before performing service

 **CAUTION:**  This part contains components that are electrostatic discharge (ESD) sensitive. To reduce the possibility of ESD damage, always touch the sheet-metal chassis to ground yourself before touching an ESD sensitive part.

Use the table below to identify the correct part number for your printer, and then go to <http://h20141.www2.hp.com/hpparts> to order the part.

Paper-feeder drive PCA (1x550-sheet paper feeder) part number	
---	--

RM2-7139-000CN

Paper-feeder drive PCA (1x550-sheet paper feeder)

Required tools

- #2 Phillips screwdriver with a magnetic tip

After performing service

Make sure that all of the connectors on the paper-feeder drive PCA are fully seated after replacing it.

Make sure that the rear cover is flush against the chassis after replacing it.

Post service test

Print a page from a host computer using the appropriate tray as the source tray.

Step 1: Remove the rear cover

1. Release three tabs (callout 1).

Figure 1-5250 Release three tabs

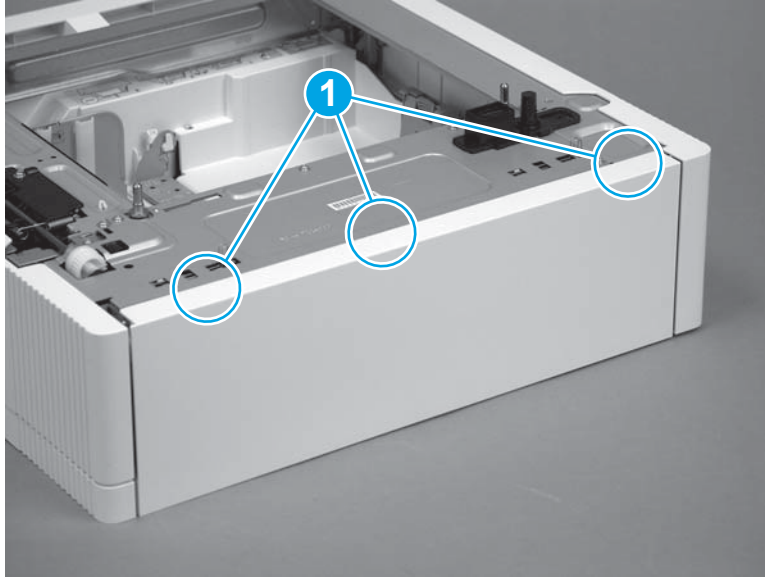

2. Rotate the top of the cover away from the accessory (callout 1), and then lift it up to remove it (callout 2).

Figure 1-5251 Remove the cover

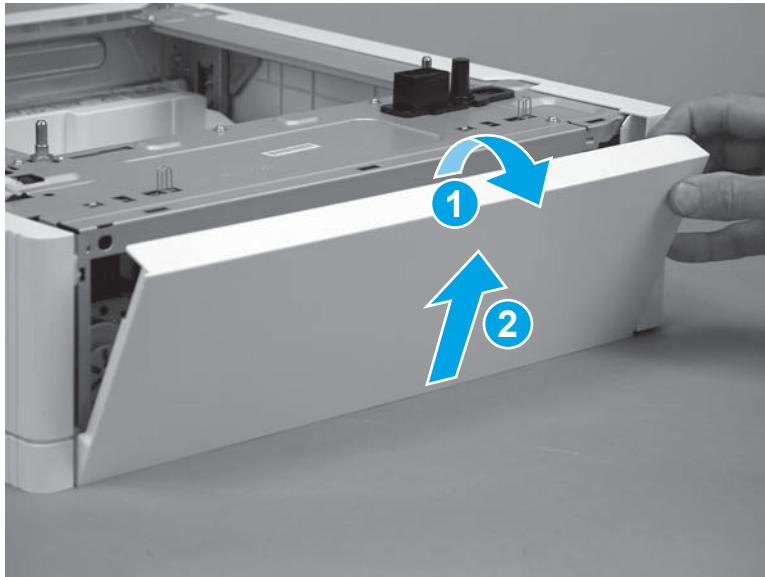

Step 2: Remove the paper-feeder drive PCA

 **CAUTION:**  ESD-sensitive part.

1. Disconnect 5 connectors (callout 1).
The following connectors are empty:
 - J908

Figure 1-5252 Disconnect all of the connectors

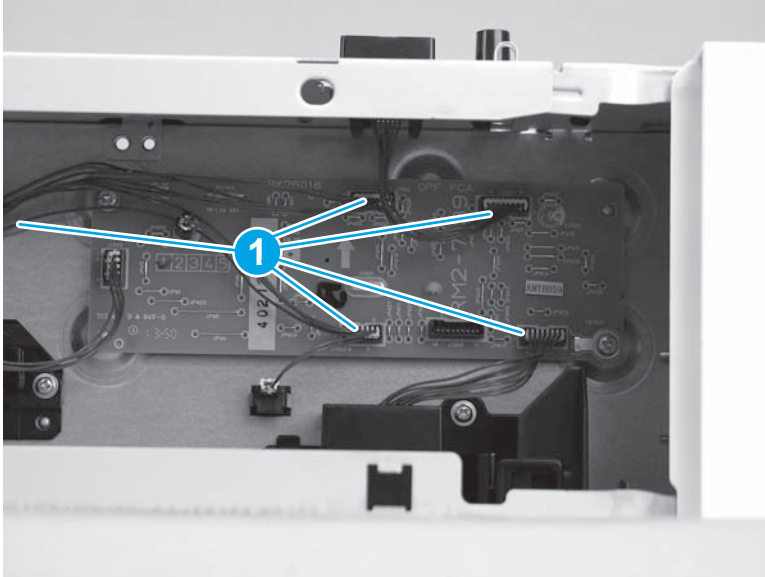

2. Remove two screws (callout 1), and then remove the paper-feeder drive PCA (callout 2).

Figure 1-5253 Remove the PCA

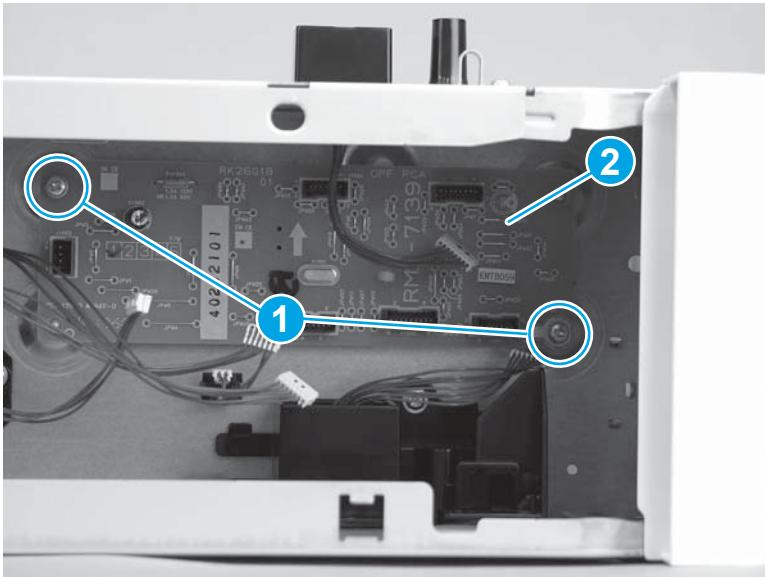

Step 3: Unpack the replacement assembly

Unpack the replacement assembly from the packaging.

 **CAUTION:**  ESD-sensitive part.

For complete information on HP's recycling programs, go to [Product return and recycling](#).

 **NOTE:** HP recommends responsible disposal of the defective assembly.

Figure 1-5254 Recycle and unpack

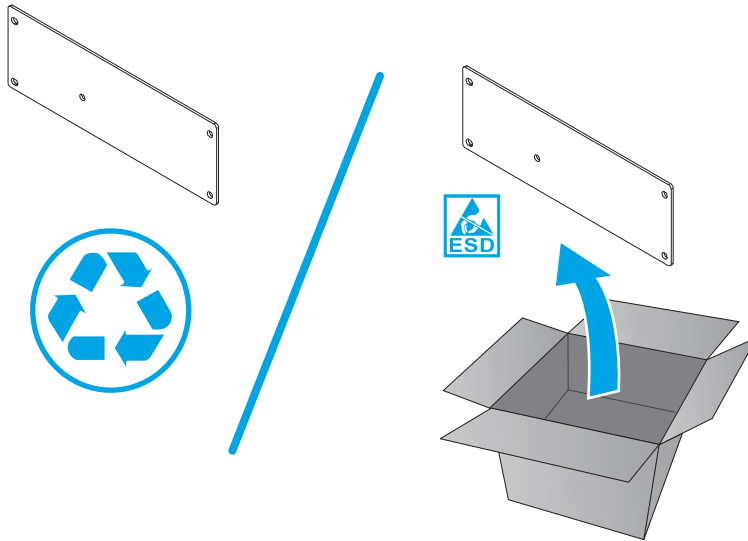

Step 4: Install the paper-feeder-drive PCA

 **CAUTION:**  ESD-sensitive part.

1. Position the paper-feeder drive PCA (callout 1) in the chassis, and then install two screws (callout 2).

Figure 1-5255 Install the PCA

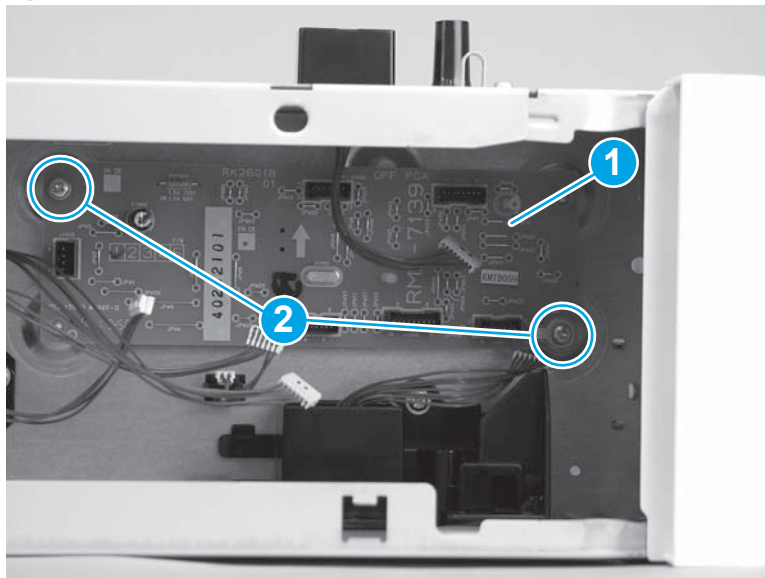

2. Connect 5 connectors (callout 1).

The following connectors are empty:

- J908

Figure 1-5256 Connect all of the connectors

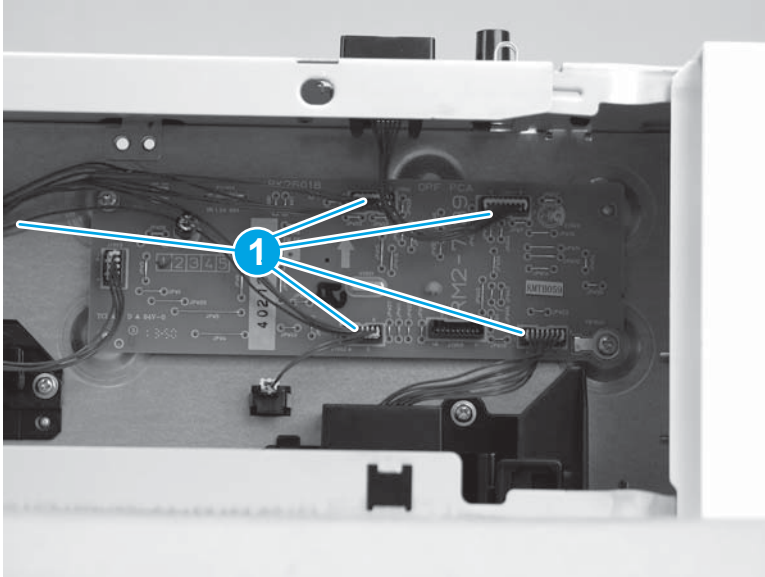

Step 5: Install the rear cover

1. Align the three mounting tabs (callout 1) on the cover with the slots in the chassis.

Figure 1-5257 Position the cover on the chassis

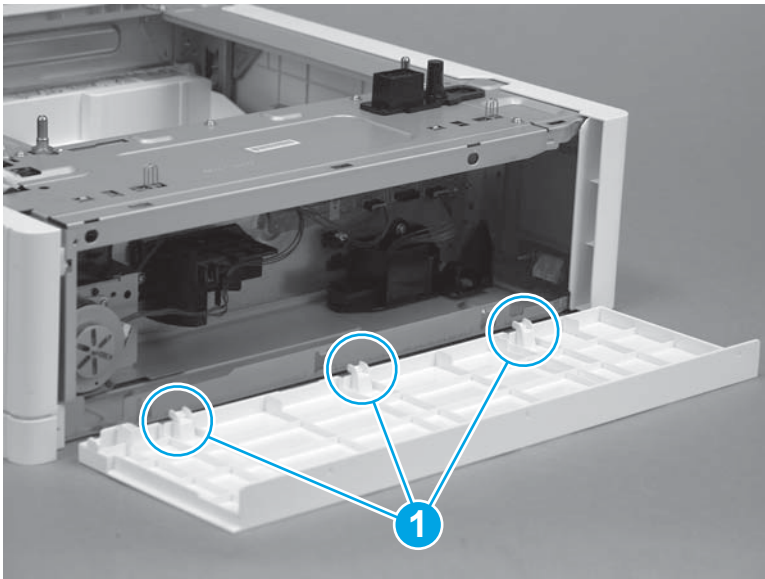

2. Position the cover on the accessory (callout 1), and then rotate the top of the cover up and onto the chassis (callout 2) to install it.

Figure 1-5258 Install the cover

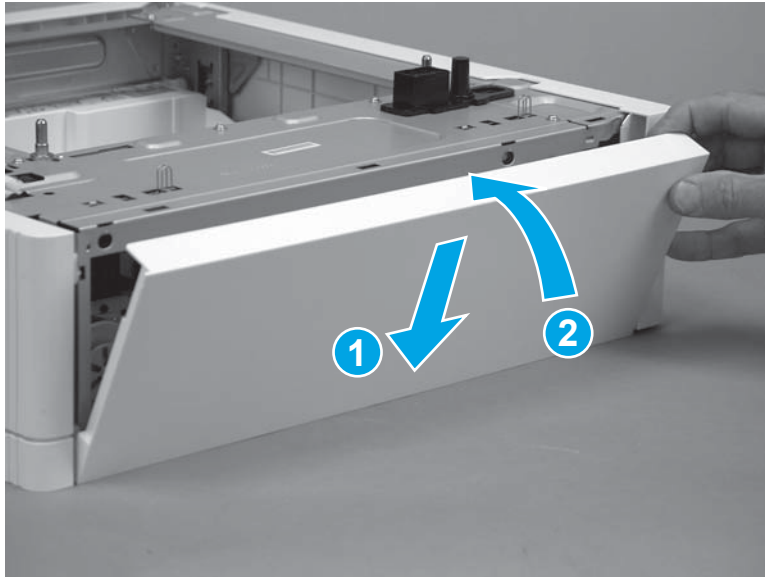

3. Make sure that the three tabs (callout 1) snap into place.

Figure 1-5259 Check the three tabs

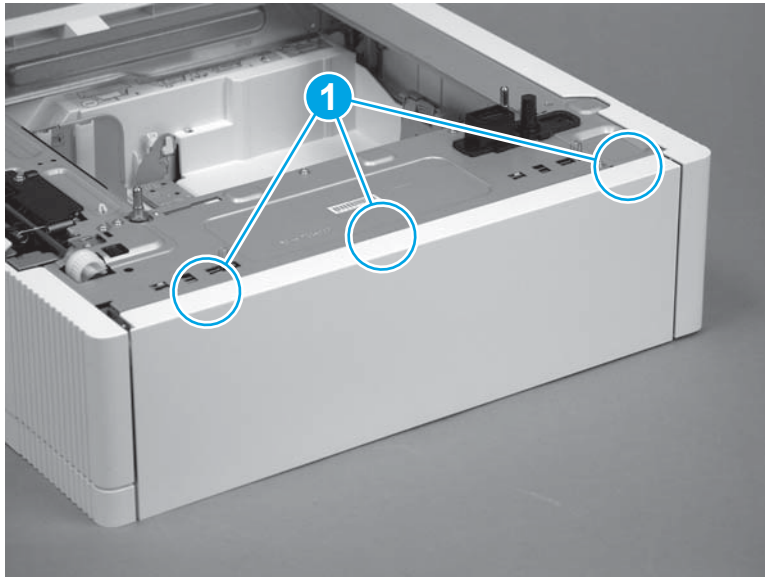

Removal and replacement: Paper feed assembly (1x550-sheet paper feeder)

- [Introduction](#)
- [Step 1: Remove the tray](#)
- [Step 2: Remove the rear cover](#)
- [Step 3: Remove the right door](#)
- [Step 4: Remove the drawer connector holder](#)
- [Step 5: Remove the paper feed assembly](#)
- [Step 6: Unpack the replacement assembly](#)
- [Step 7: Install the paper feed assembly](#)
- [Step 8: Install the drawer connector holder](#)
- [Step 9: Install the right door](#)
- [Step 10: Install the rear cover](#)
- [Step 11: Install the tray](#)

Introduction

This document provides the procedures to remove and replace the 1x550-sheet paper feeder paper feed assembly.

Before performing service

Use the table below to identify the correct part number for your printer, and then go to <http://h20141.www2.hp.com/hpparts> to order the part.

Paper feed assembly (1x550-sheet paper feeder) part number	
RM2-5145-000CN	Paper feed assembly (1x550-sheet paper feeder)

Required tools

- #2 Phillips screwdriver with a magnetic tip and a 152-mm (6-in) shaft length
- Small flat blade screwdriver

After performing service

Make sure that the rear cover is flush against the chassis after replacing it.

Make sure that the right door latches correctly when closed after replacing it.

Make sure that the tray is fully closed after replacing it.

Post service test

Print a page from a host computer using the appropriate tray as the source tray.

Step 1: Remove the tray

1. Pull the tray out until it stops.

Figure 1-5260 Pull the tray out

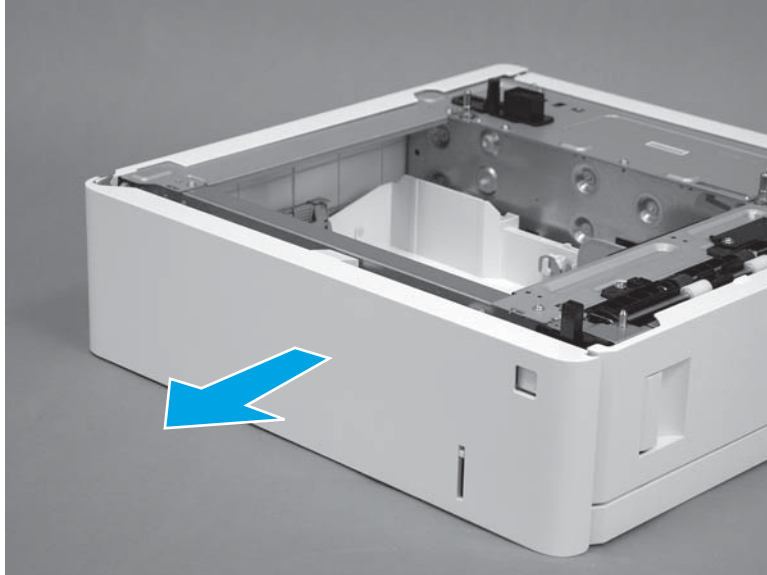

2. Lift the front of the tray, and then pull it out of the printer to remove it.

Figure 1-5261 Remove the tray

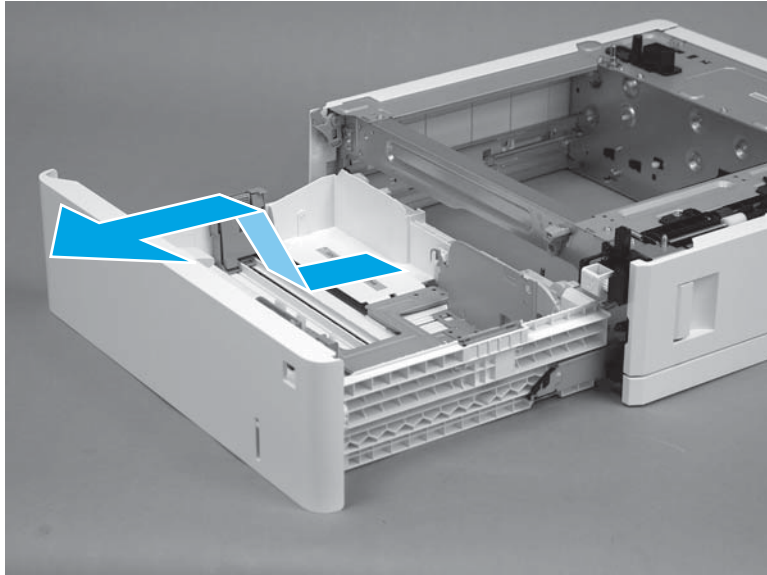

Step 2: Remove the rear cover

1. Release three tabs (callout 1).

Figure 1-5262 Release three tabs

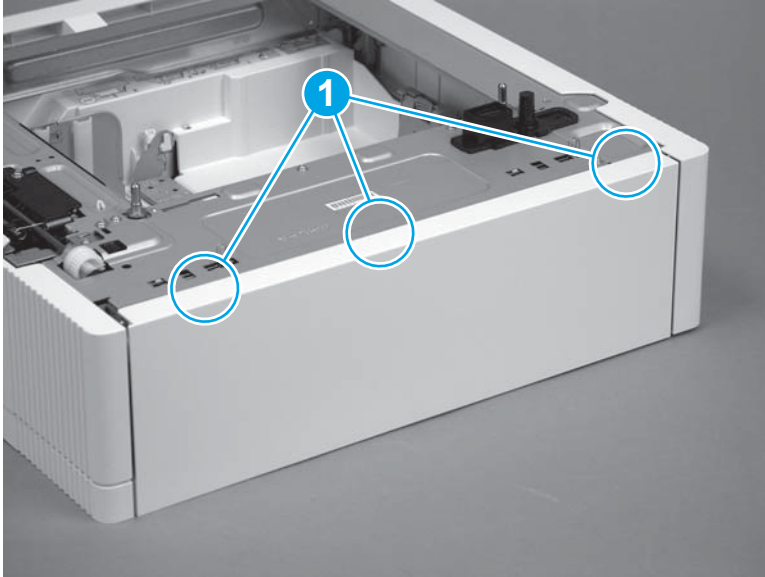

2. Rotate the top of the cover away from the accessory (callout 1), and then lift it up to remove it (callout 2).

Figure 1-5263 Remove the cover

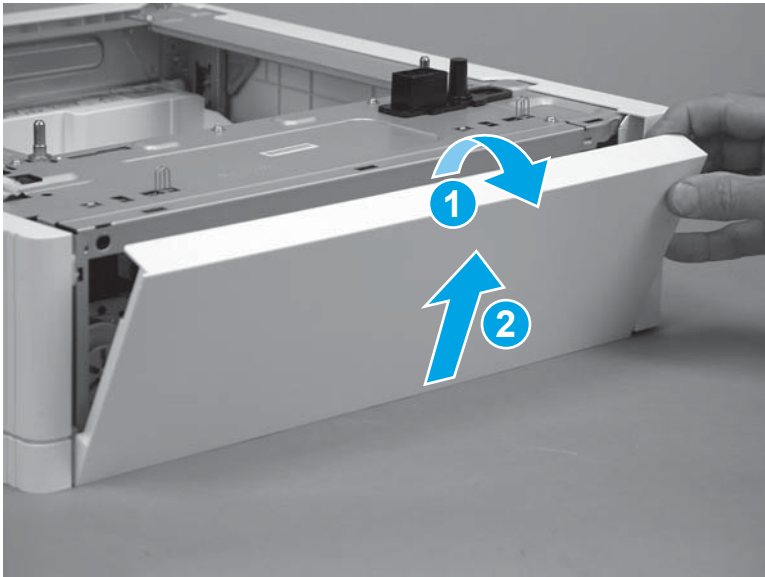

Step 3: Remove the right door

1. Open the door.

Figure 1-5264 Open the door

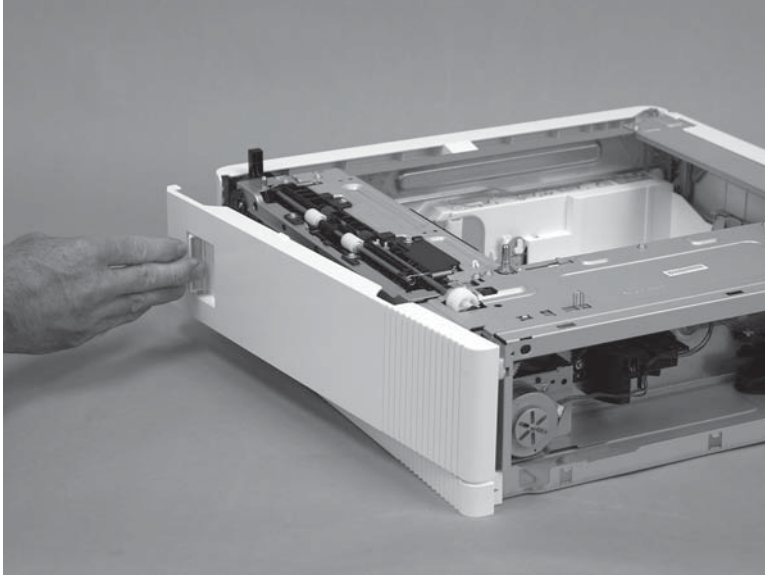

2. Release one tab (callout 1), and then slide the door-hinge bracket away from the chassis (callout 2) to release it.

Figure 1-5265 Release the hinge bracket

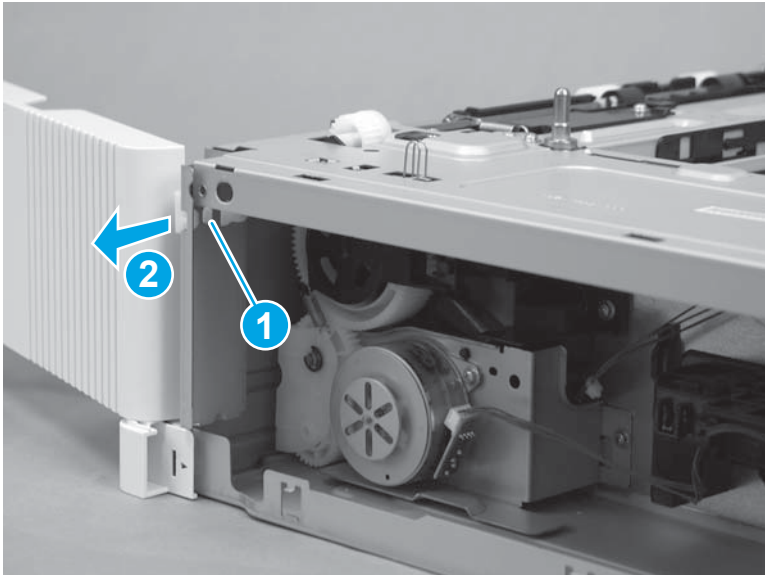

3. Remove the door-hinge bracket from the chassis.

⚠ CAUTION: The door is still attached to the accessory by the door link. Do not attempt to completely remove the door.

The door hinge bracket is not captive. Do not lose it when handling the door.

Figure 1-5266 Remove the hinge bracket

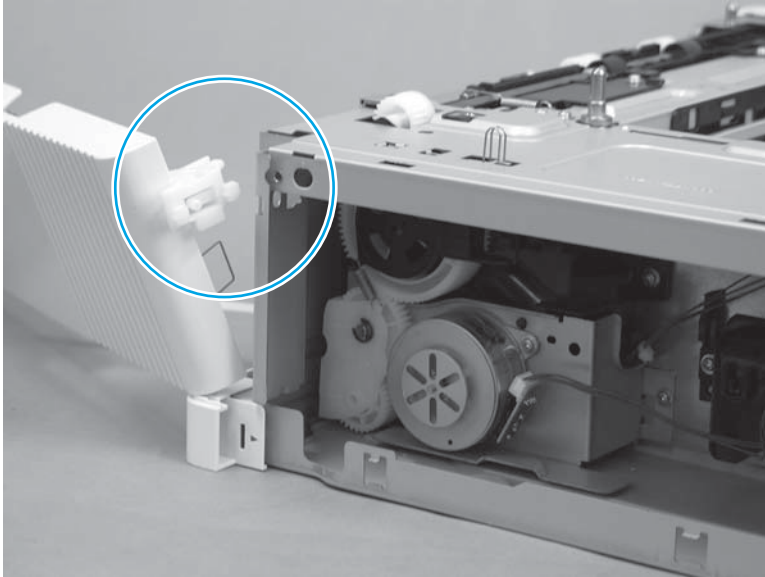

4. Release the door link from the slot in the door to remove the right door.

Figure 1-5267 Release the door link

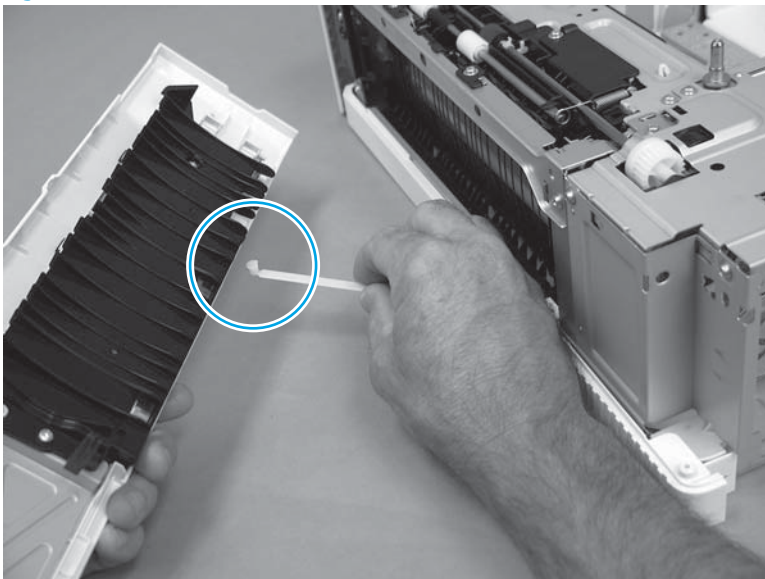

Step 4: Remove the drawer connector holder

1. Disconnect one connector (callout 1; J901).

Figure 1-5268 Disconnect one connector

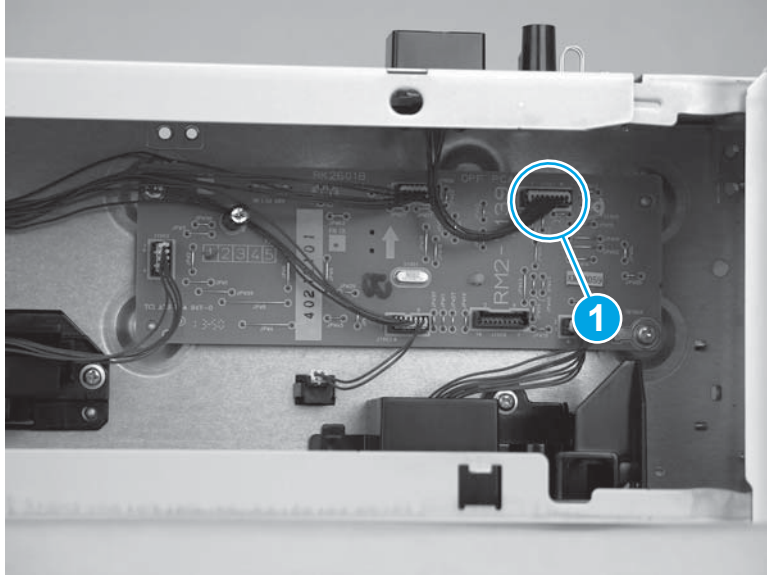

2. Release one tab (callout 1), and then slide the drawer connector holder as shown (callout 2) to release it.

Figure 1-5269 Release one tab

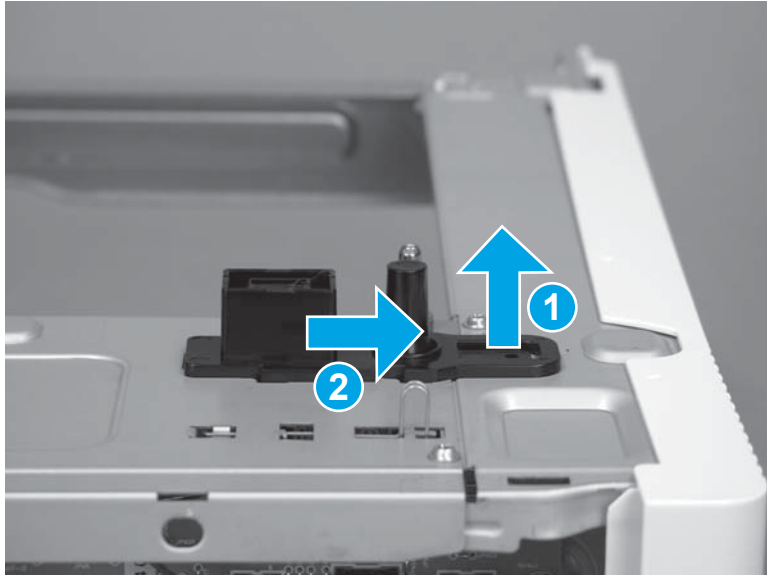

3. Remove the drawer connector holder.

Figure 1-5270 Remove the tray connector

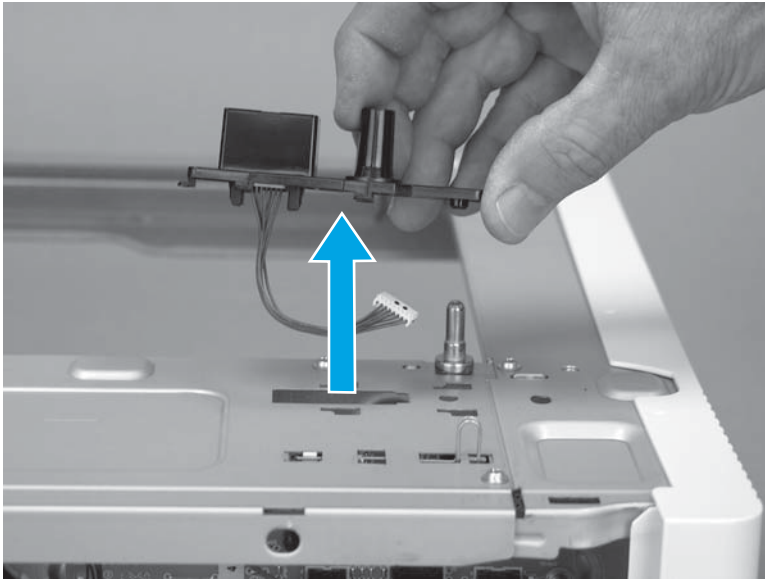

Step 5: Remove the paper feed assembly

1. Remove six screws (callout 1).

Figure 1-5271 Remove six screws

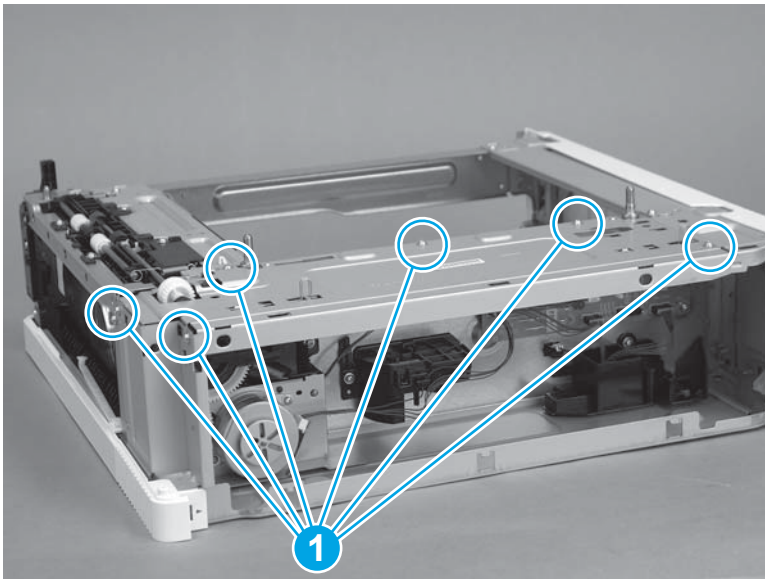

2. Remove the sheet-metal plate.

Figure 1-5272 Remove the sheet-metal plate

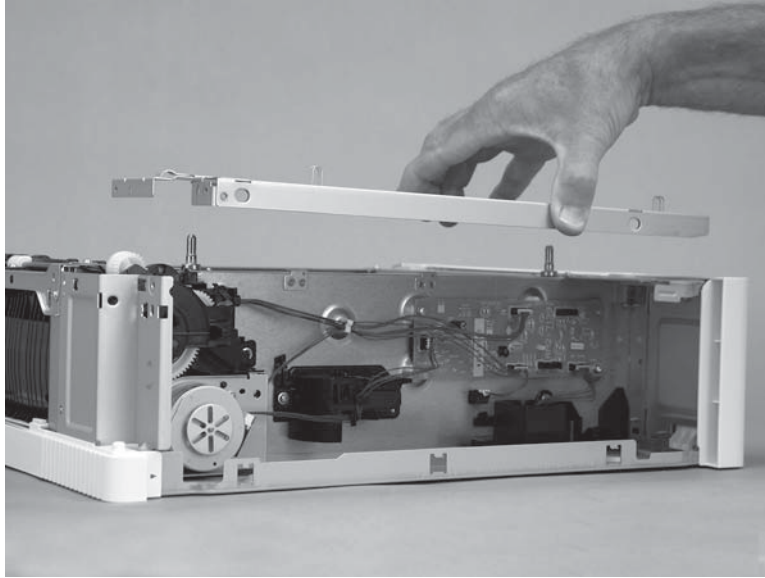

3. Release the green jam handle (callout 1), and then rotate the paper feed guide down (callout 2) and out of the way.

Figure 1-5273 Release the paper feed guide

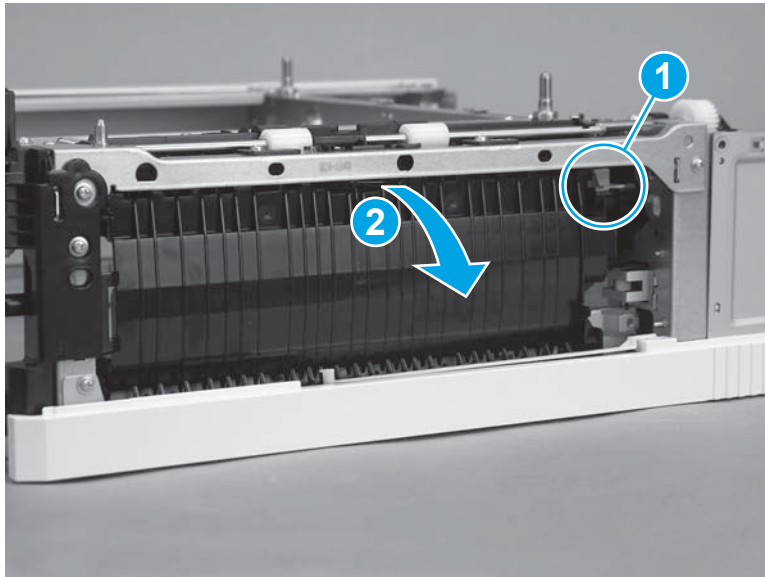

4. Remove one screw (callout 1), release one tab (callout 2), and then remove the cover (callout 3).

Figure 1-5274 Remove the cover

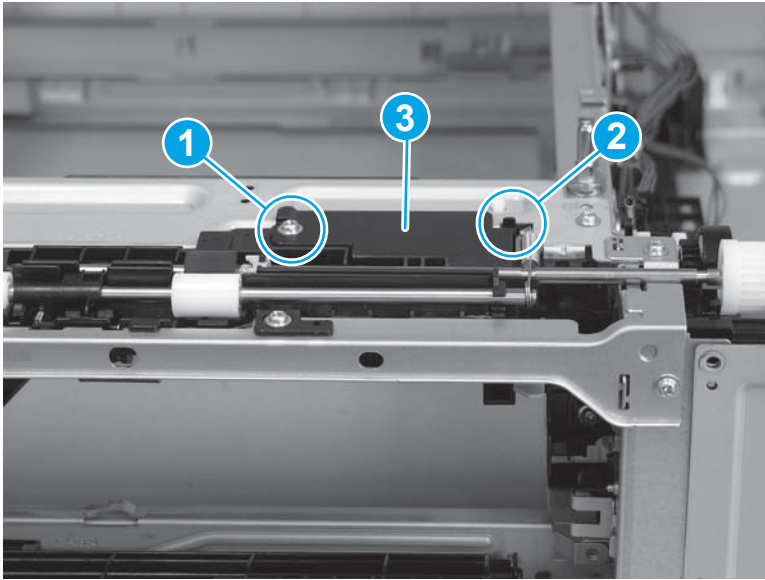

5. Disconnect one connector (callout 1).

Figure 1-5275 Disconnect one connector

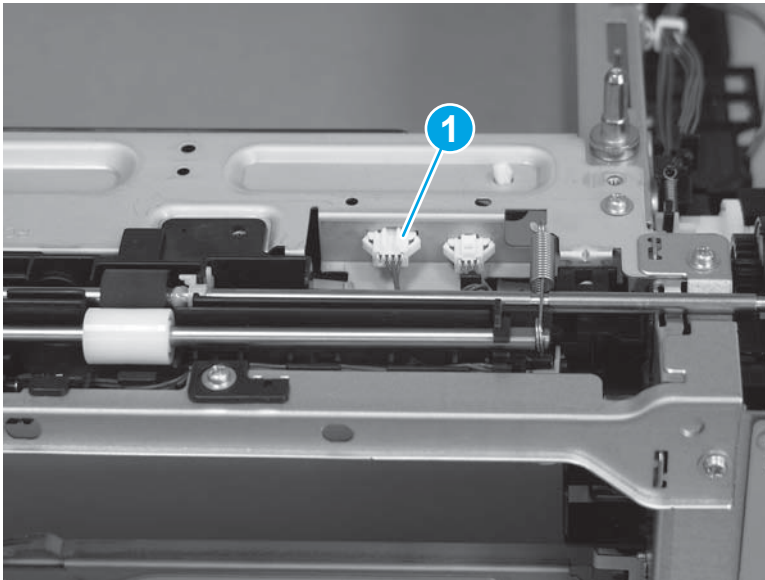

6. Remove two springs (callout 1).

Figure 1-5276 Remove two springs

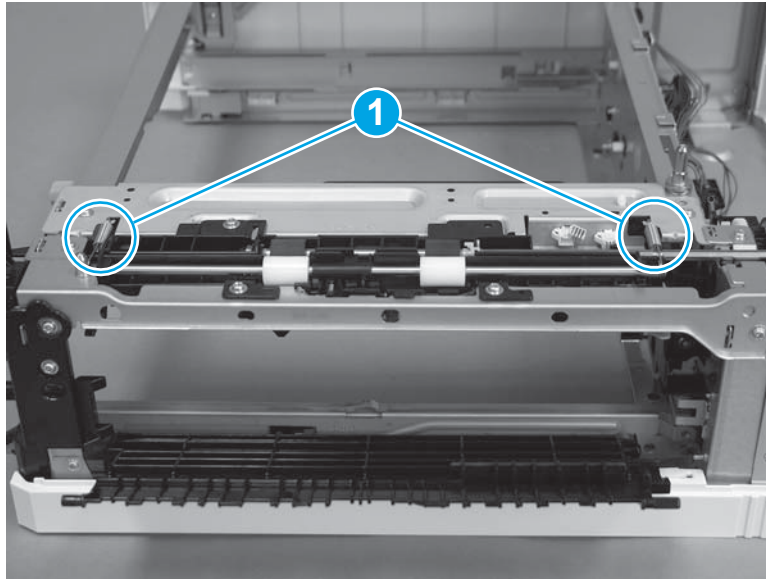

7. Remove three screws (callout 1).

Figure 1-5277 Remove three screws

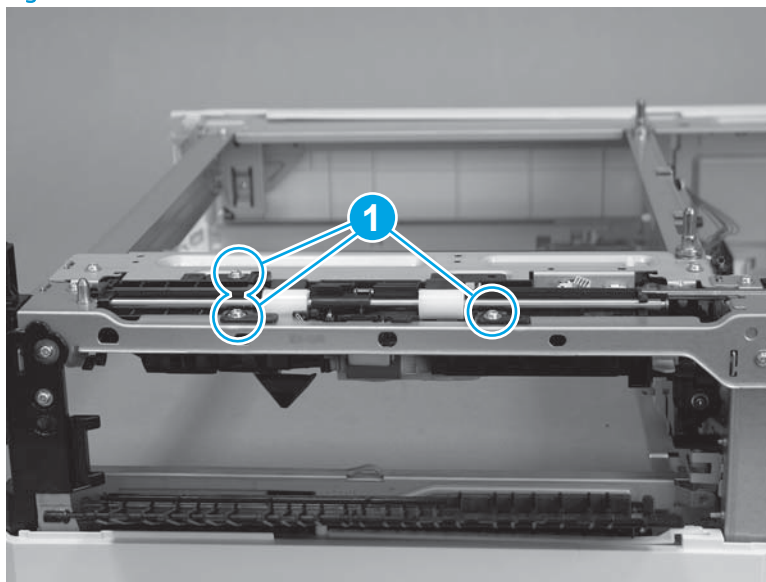

8. Slightly raise the tray end of the assembly, and then release two alignment pins (callout 1).

Figure 1-5278 Release two alignment pins

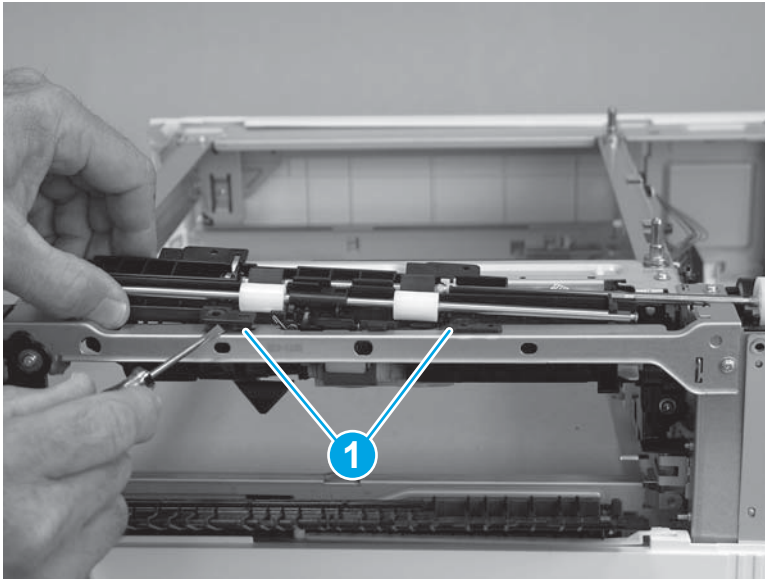

9. Release one tab on the gear (callout 1), slide the assembly away (callout 2) from the lifter drive assembly to release the shaft from the gear, and then remove the paper feed assembly.

Figure 1-5279 Remove the paper feed assembly

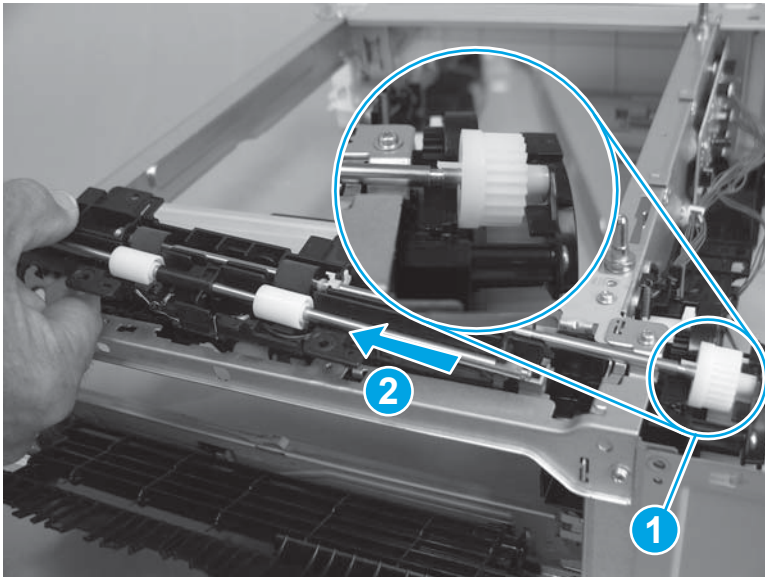

Step 6: Unpack the replacement assembly

Unpack the replacement assembly from the packaging.

For complete information on HP's recycling programs, go to [Product return and recycling](#).



NOTE: HP recommends responsible disposal of the defective assembly.

Figure 1-5280 Recycle and unpack

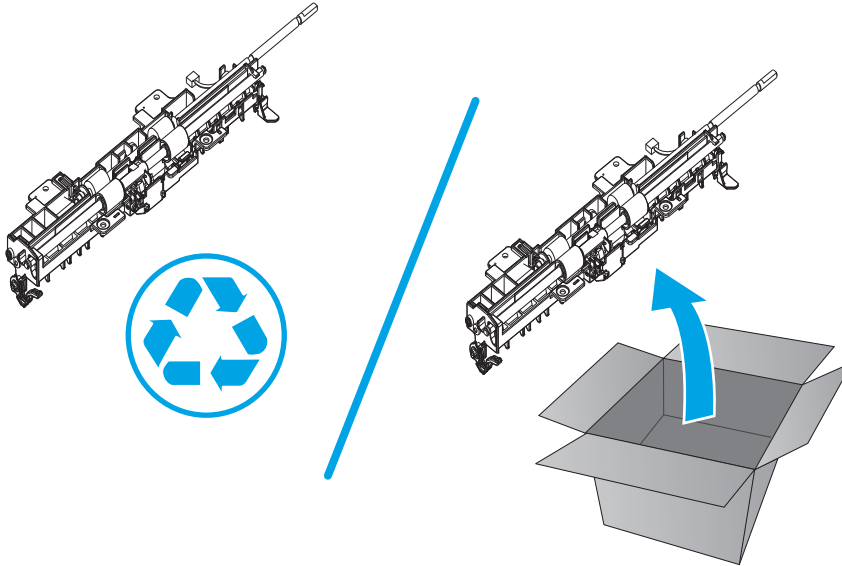

Step 7: Install the paper feed assembly

1. Be careful when handling the assembly. The left side flag (callout 1) is easily dislodged.

Figure 1-5281 Left side flag

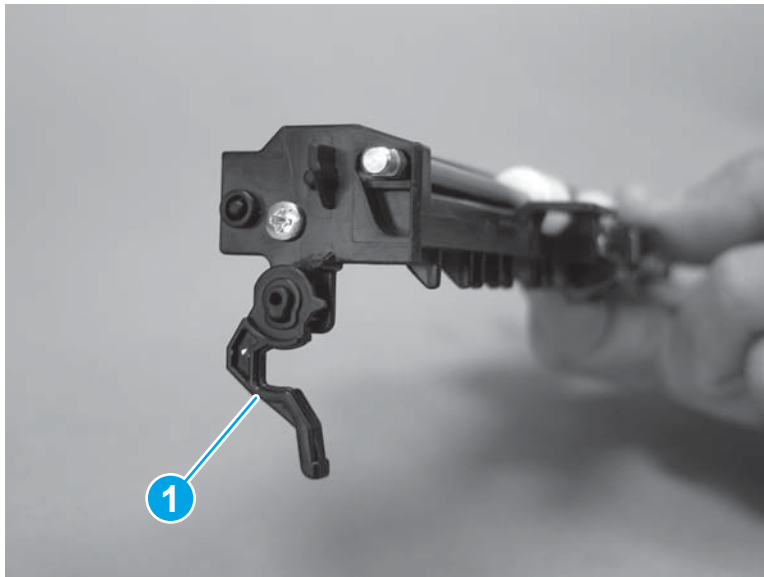

2. Insert the keyed end of the shaft (callout 1) into the gear (callout 2) on the lifter drive assembly—turn the shaft on the paper feed assembly or the gear on the lifter drive assembly to align the keyed shaft with the gear.

 **IMPORTANT:** Make sure that the tab on the gear snaps into place on the shaft.

Figure 1-5282 Install the assembly



3. Lower the tray end of the assembly into the chassis, and then make sure that the alignment pins (callout 1) are fully seated—the assembly must fit flush up against the chassis.

Figure 1-5283 Check the alignment pins

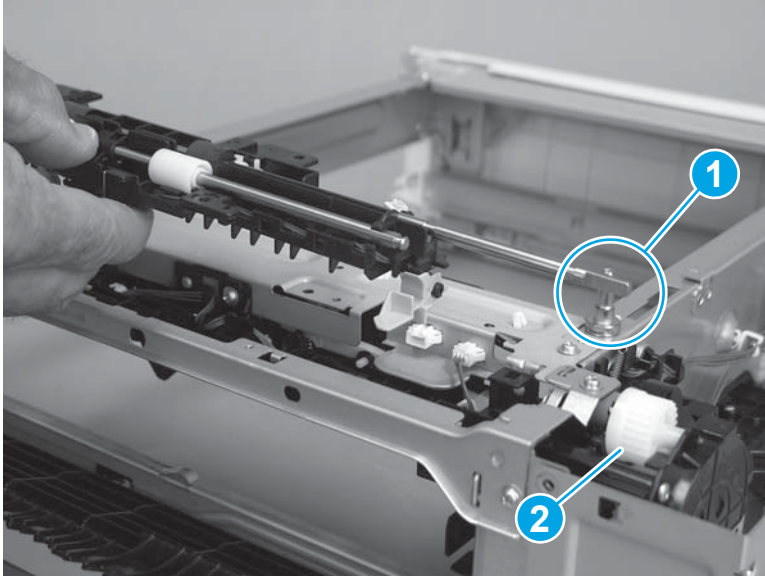
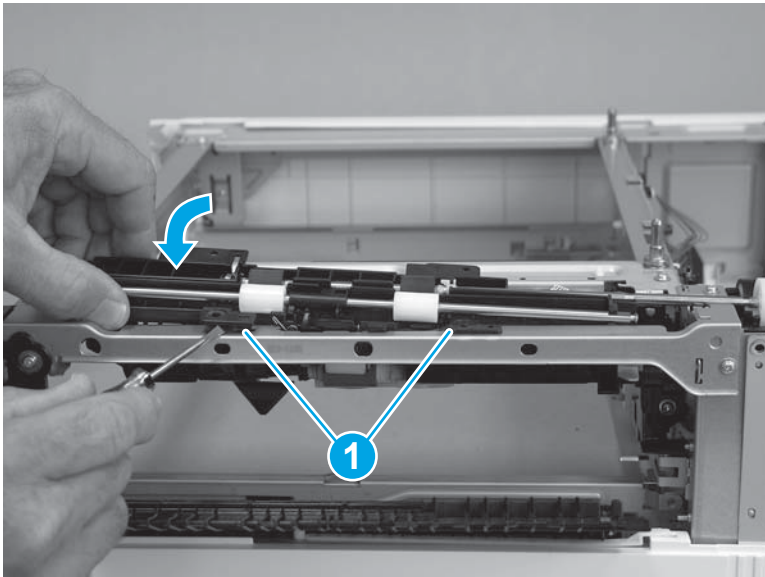

4. Install three screws (callout 1).

Figure 1-5284 Install three screws

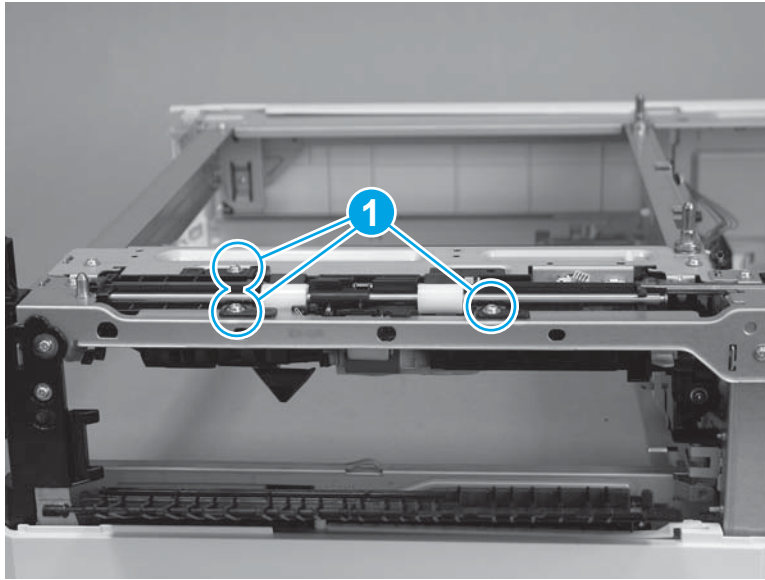

5. Install two springs (callout 1).

Figure 1-5285 Install two springs

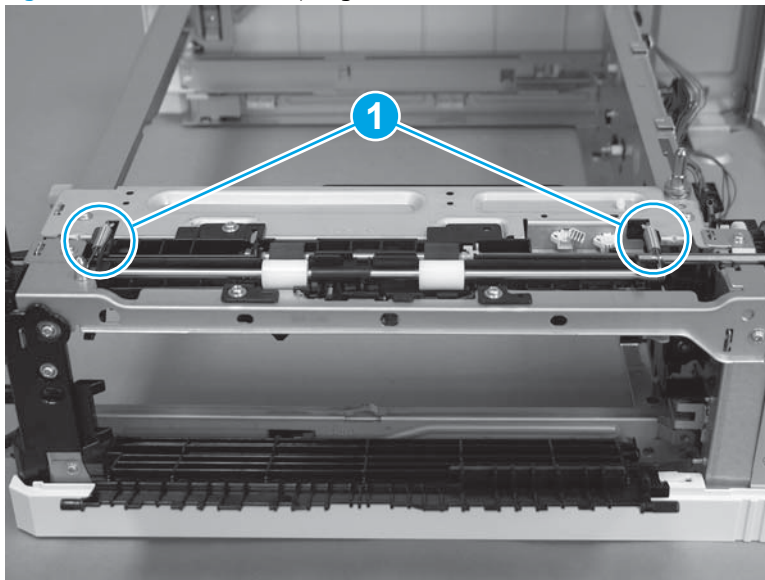

6. Connect one connector (callout 1).

Figure 1-5286 Connect one connector

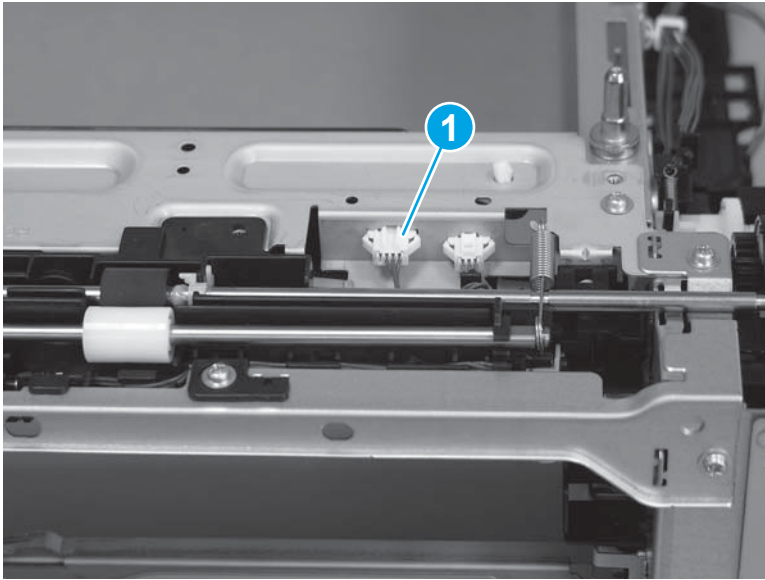

7. Position the cover (callout 1) on the chassis, make sure that the one tab (callout 2) snaps into place, and then install one screw (callout 3).

Figure 1-5287 Install the cover

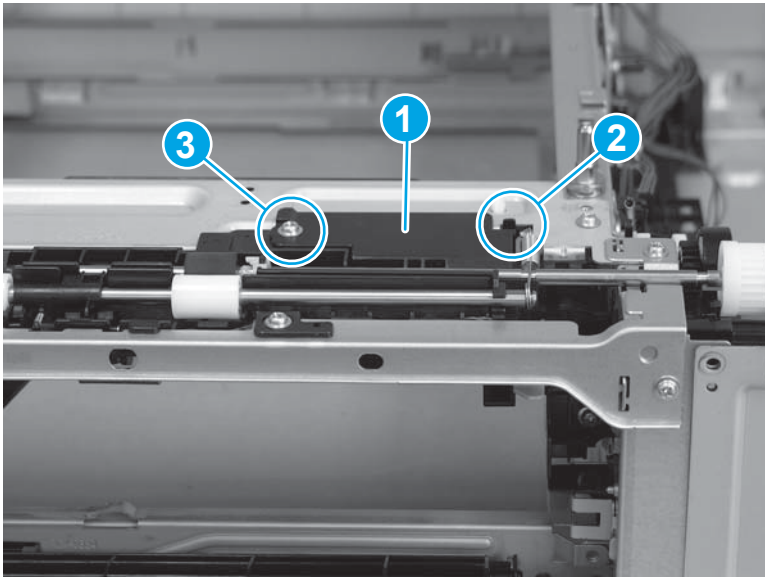

8. Rotate the paper feed guide up into position (callout 1)—the right side (green) jam handle (callout 2) automatically locks the guide in place.

Figure 1-5288 Raise the paper feed guide

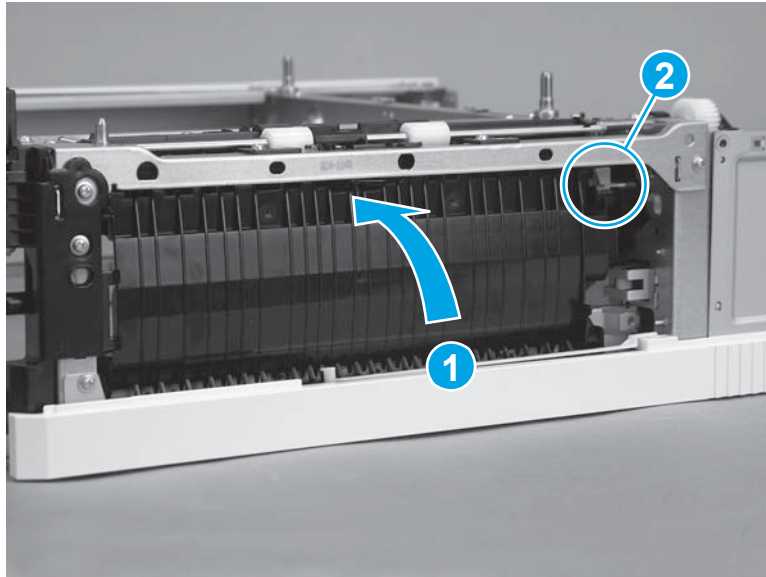

9. Position the sheet-metal plate on the chassis.

Figure 1-5289 Install the sheet-metal plate

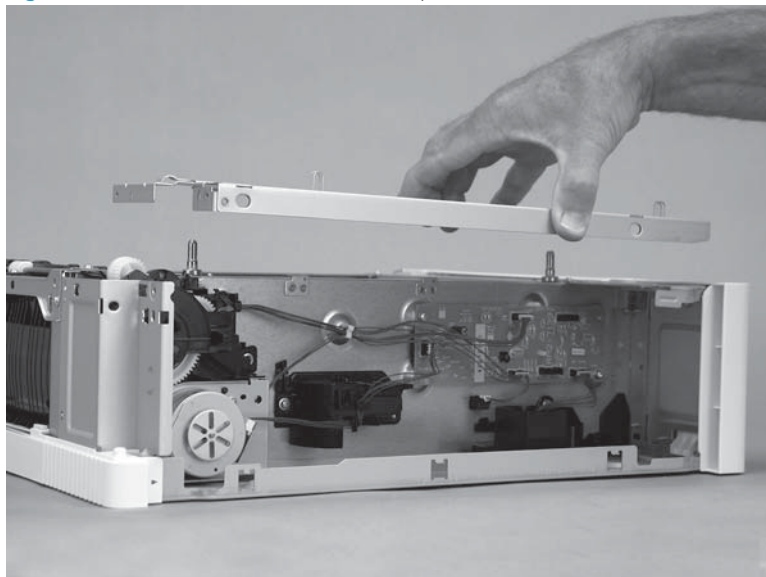

10. Install six screws (callout 1).

Figure 1-5290 Install six screws

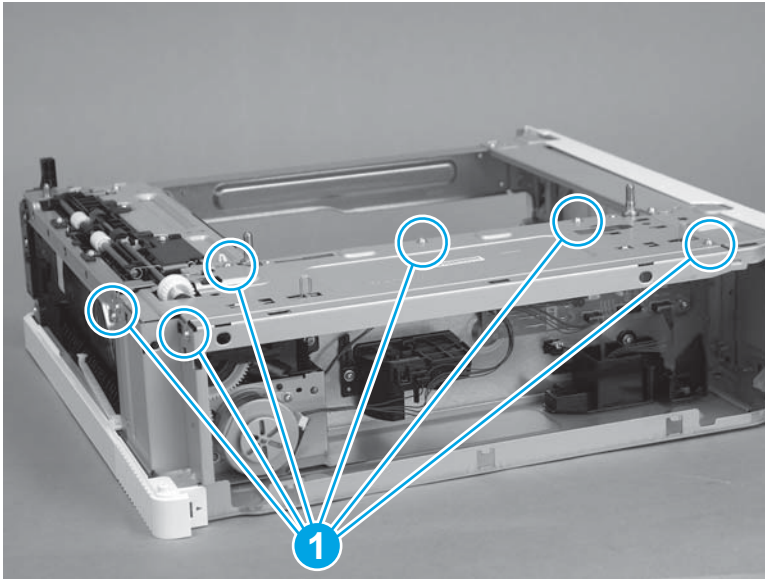

Step 8: Install the drawer connector holder

1. Position the drawer connector holder on the chassis.

 **NOTE:** Make sure that the wire harness (callout 1) was transferred from the discarded assembly to the replacement assembly.

Figure 1-5291 Place the tray connector on the accessory



2. Slide the drawer connector holder as shown (callout 1) to install it, and then make sure that one tab (callout 2) snaps into place .

Figure 1-5292 Install the tray connector

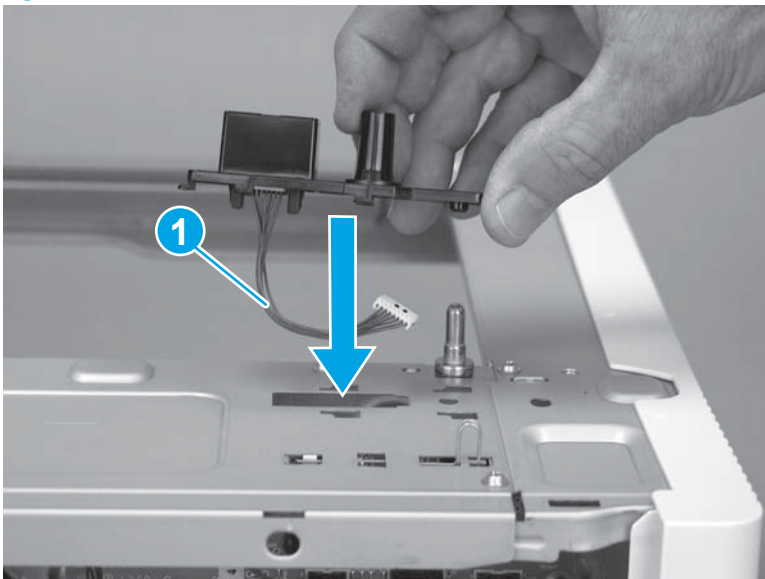
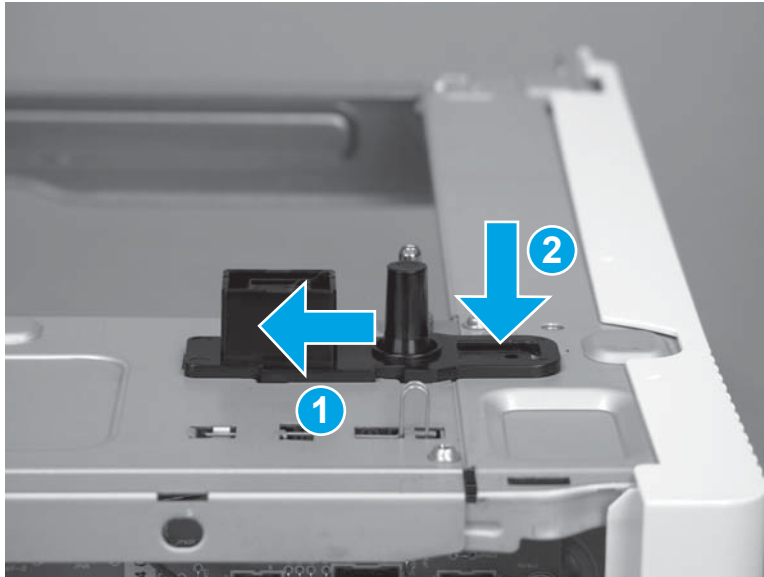

3. Connect one connector (callout 1; J901).

Figure 1-5293 Connect one connector

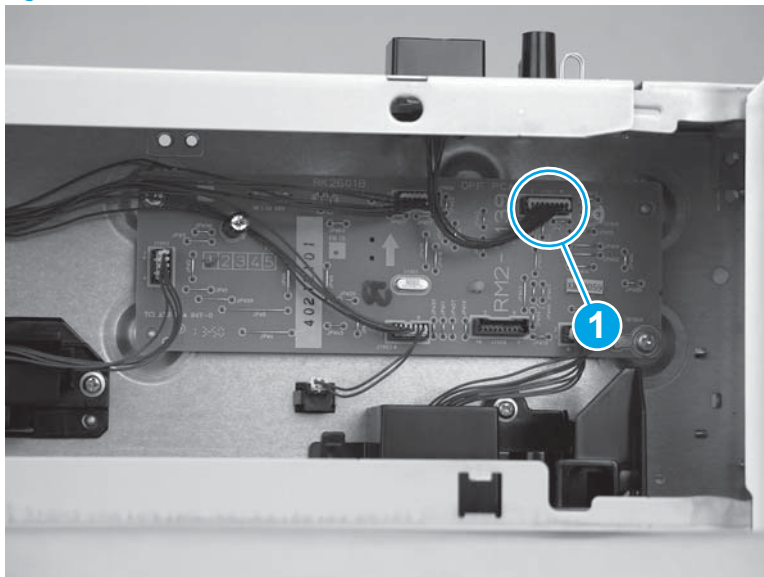

Step 9: Install the right door

1. Install the door link in the slot in the door to attach the door.

Figure 1-5294 Install the door link

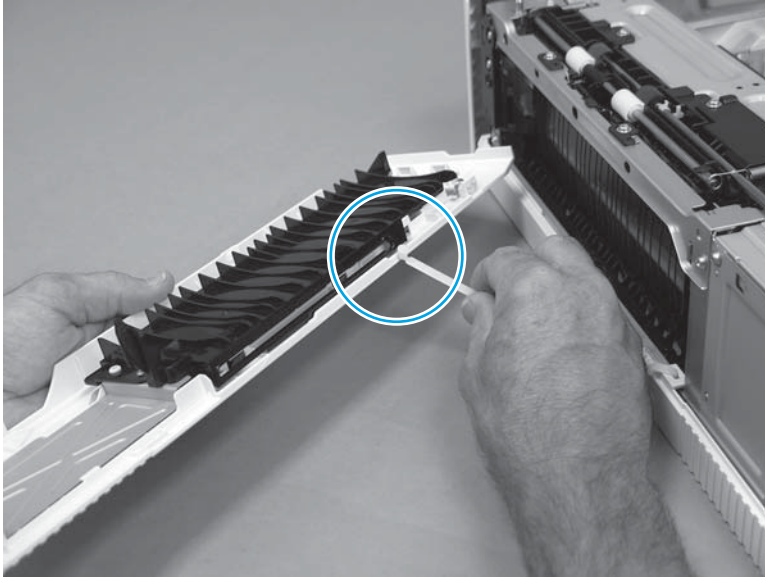

2. Position the lower hinge hole on the door (callout 2) on the lower hinge pin (callout 2) on the right-lower cover.

Figure 1-5295 Position the door on the lower hinge

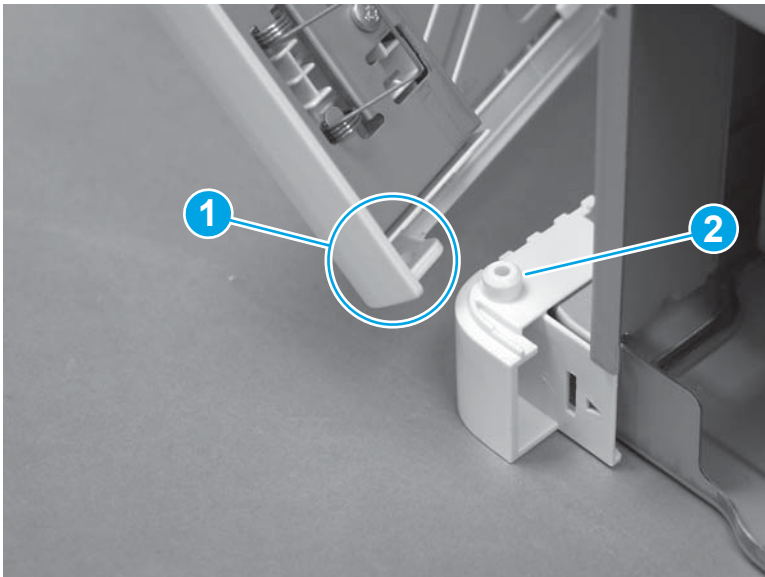

3. Align the pin of the door-hinge bracket (callout 1) with the hole in the chassis, and then align the mounting tabs (callout 2 and callout 3) with the slots in the chassis.

Figure 1-5296 Engage the hinge bracket

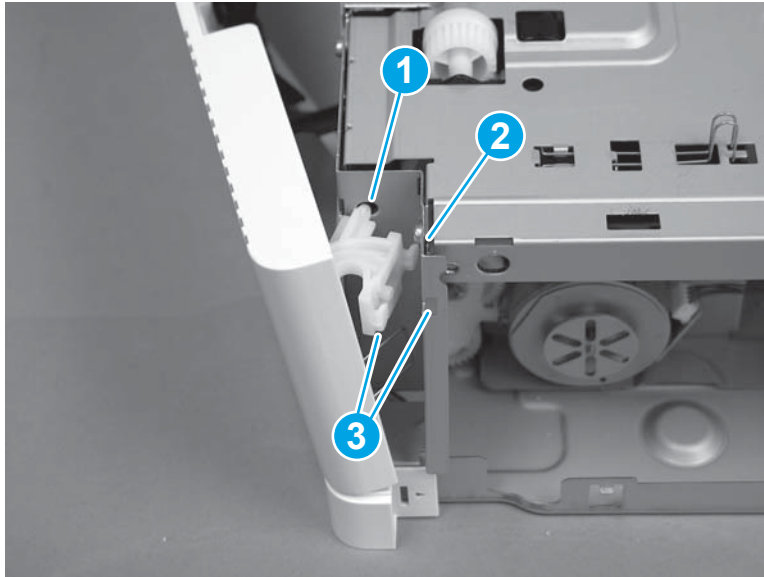

4. Push in on the door-hinge bracket (callout 1), and then slide it toward the chassis (callout 2) to install it.

Figure 1-5297 Install the hinge bracket

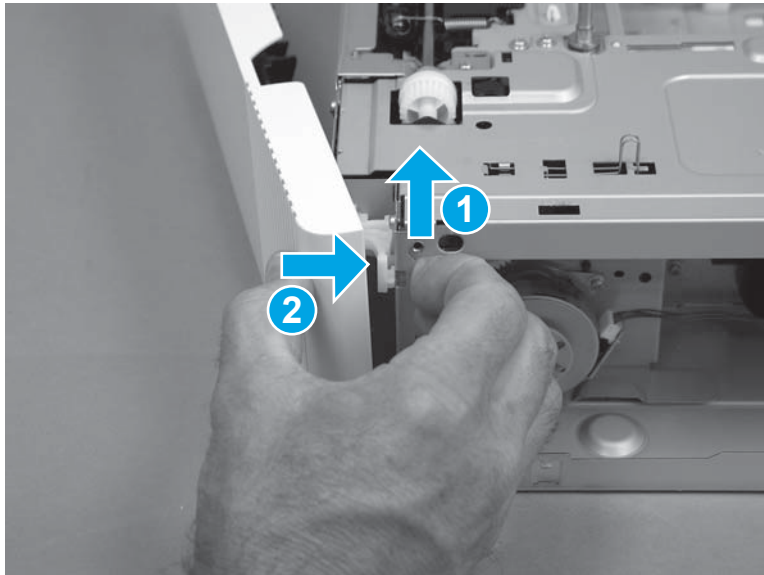

5. Close the door.

Figure 1-5298 Close the door

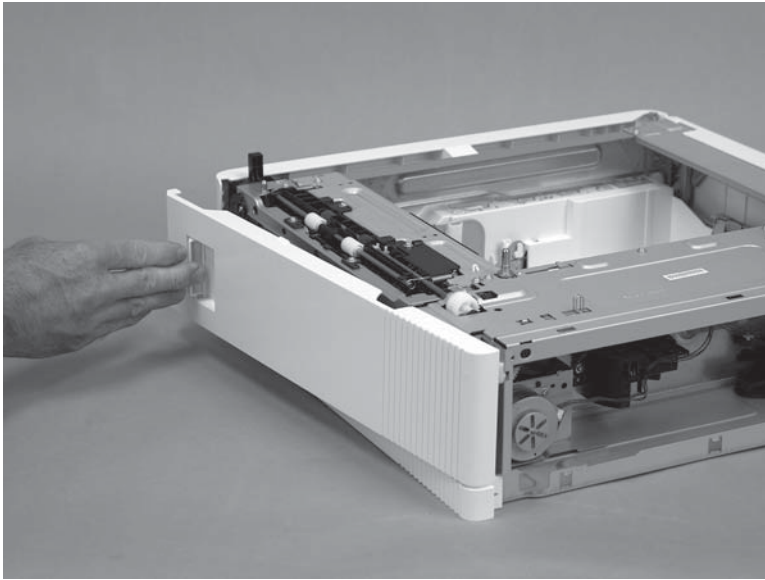

Step 10: Install the rear cover

1. Align the three mounting tabs (callout 1) on the cover with the slots in the chassis.

Figure 1-5299 Position the cover on the chassis

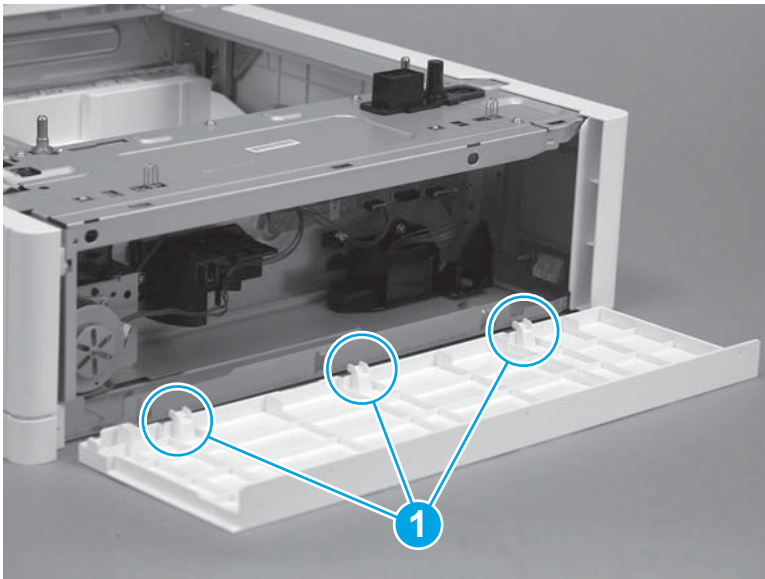

2. Position the cover on the accessory (callout 1), and then rotate the top of the cover up and onto the chassis (callout 2) to install it.

Figure 1-5300 Install the cover

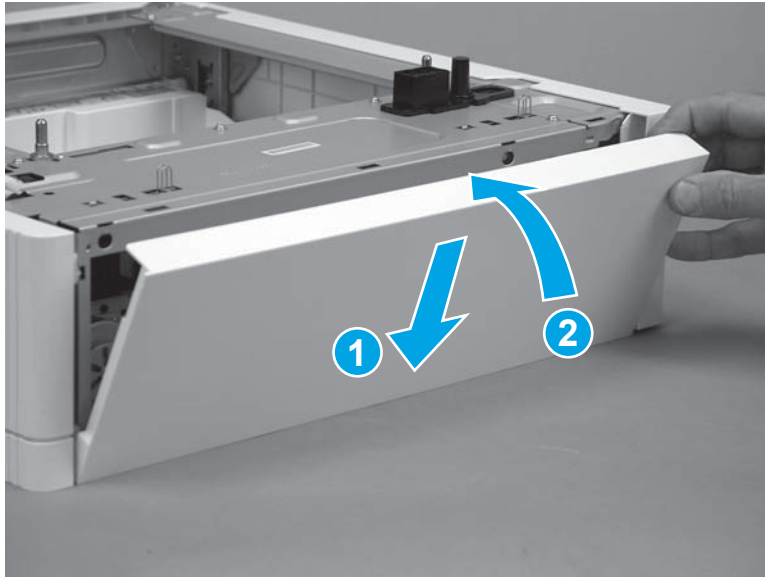

3. Make sure that the three tabs (callout 1) snap into place.

Figure 1-5301 Check the three tabs

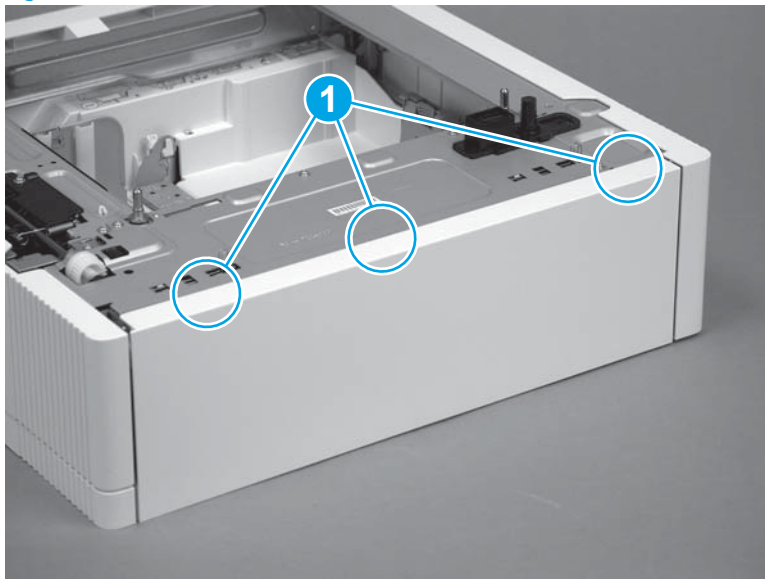

Step 11: Install the tray

1. With the front of the tray slightly lifted, align the sides of the tray with the rails in the printer, and then carefully slide the tray into the printer.

 **TIP:** As the tray slides into the accessory, lower the front of it.

Figure 1-5302 Install the tray



2. Close the tray.

Figure 1-5303 Close the tray

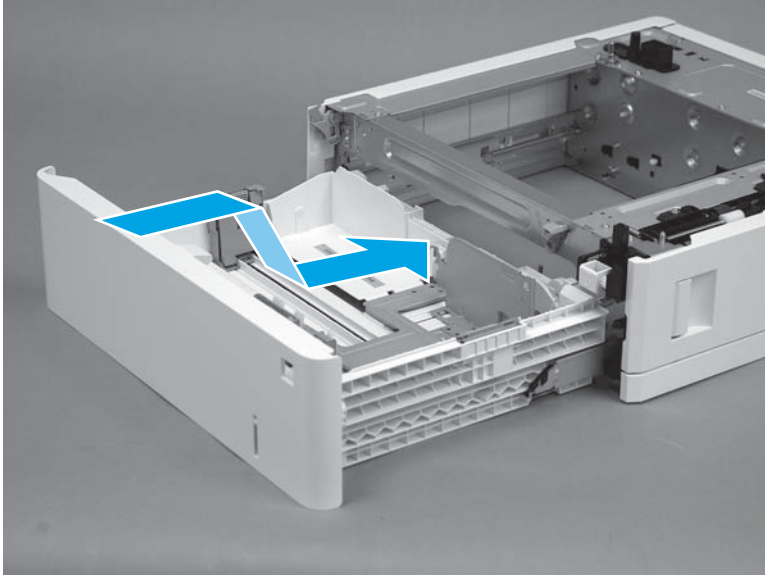
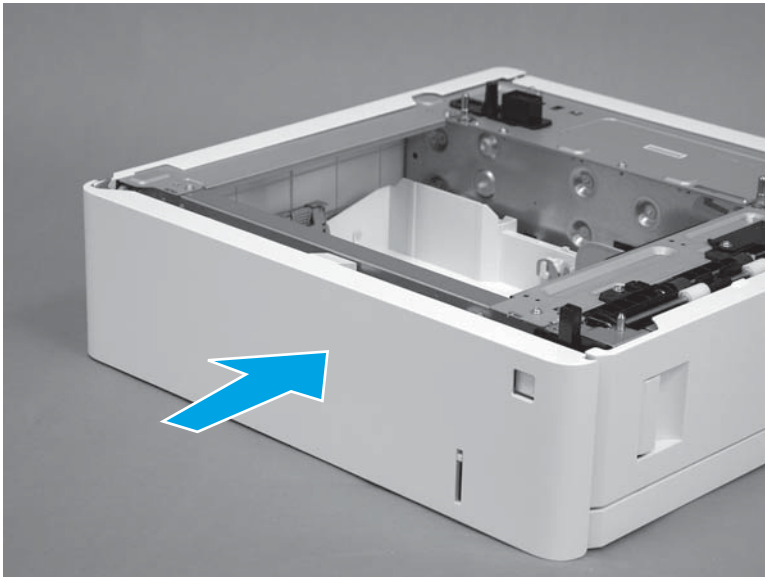

Removal and replacement: Paper pickup assembly (1x550-sheet paper feeder)

- [Introduction](#)
- [Step 1: Remove the tray](#)
- [Step 2: Remove the rear cover](#)
- [Step 3: Remove the right door](#)
- [Step 4: Remove the drawer connector holder](#)
- [Step 5: Remove the paper feed assembly](#)
- [Step 6: Remove the paper pickup assembly](#)
- [Step 7: Unpack the replacement assembly](#)
- [Step 8: Install the paper pickup assembly](#)
- [Step 9: Install the paper feed assembly](#)
- [Step 10: Install the drawer connector holder](#)
- [Step 11: Install the right door](#)
- [Step 12: Install the rear cover](#)
- [Step 13: Install the tray](#)

Introduction

This document provides the procedures to remove and replace the 1x550-sheet paper feeder paper pickup assembly.

Before performing service

Use the table below to identify the correct part number for your printer, and then go to <http://h20141.www2.hp.com/hpparts> to order the part.

Paper pickup assembly (1x550-sheet paper feeder) part number	
RM2-5154-000CN	Paper pickup assembly (1x550-sheet paper feeder)
	NOTE: The tray pickup and separation roller assembly is included with the paper pickup assembly.

Required tools

- #2 Phillips screwdriver with a magnetic tip and a 152-mm (6-in) shaft length
- Small, flat-blade screwdriver

After performing service

Make sure that the rear cover is flush against the chassis after replacing it.

Make sure that the right door latches correctly when closed after replacing it.

Make sure that the tray is fully closed after replacing it.

Post service test

Print a page from a host computer using the appropriate tray as the source tray.

Step 1: Remove the tray

1. Pull the tray out until it stops.

Figure 1-5304 Pull the tray out

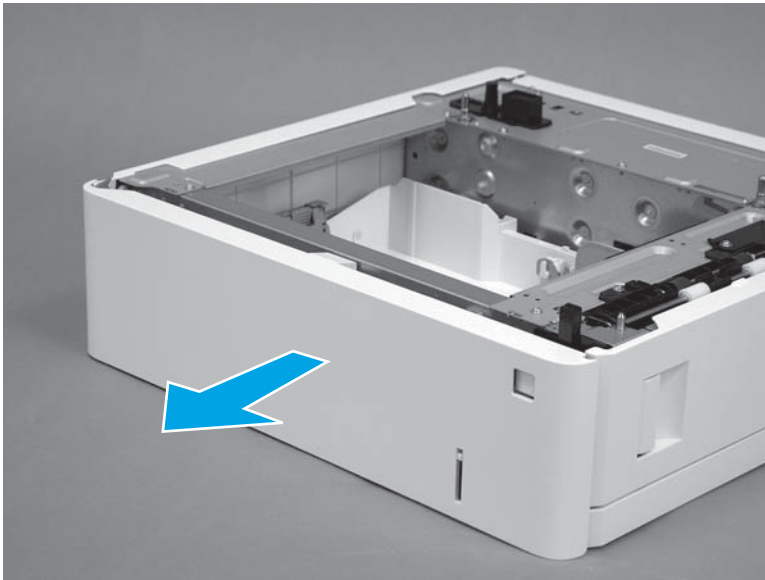

2. Lift the front of the tray, and then pull it out of the printer to remove it.

Figure 1-5305 Remove the tray

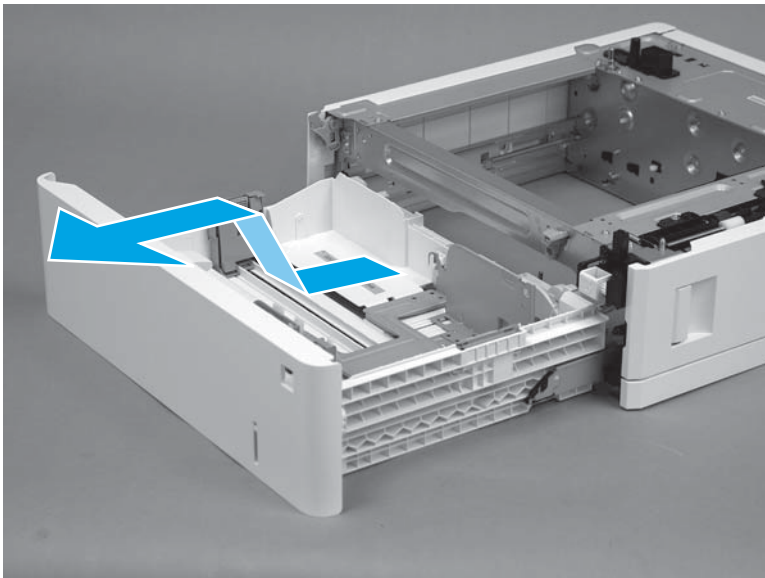

Step 2: Remove the rear cover

1. Release three tabs (callout 1).

Figure 1-5306 Release three tabs

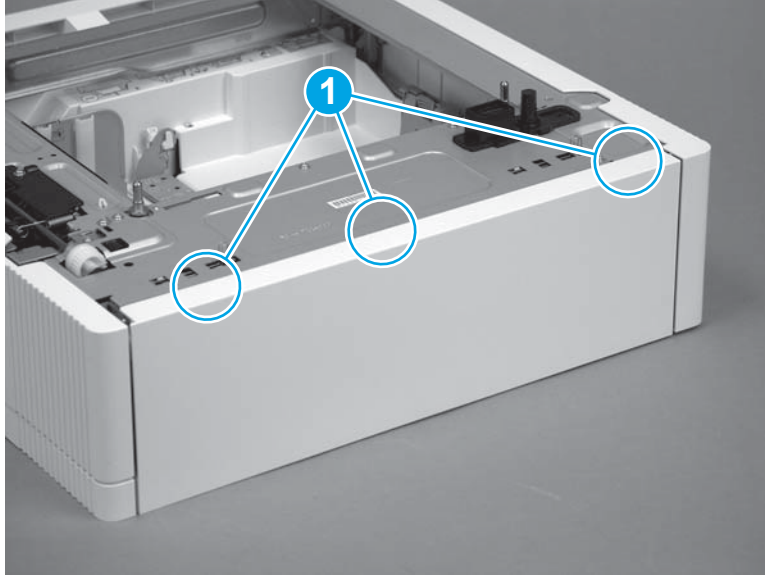

2. Rotate the top of the cover away from the accessory (callout 1), and then lift it up to remove it (callout 2).

Figure 1-5307 Remove the cover

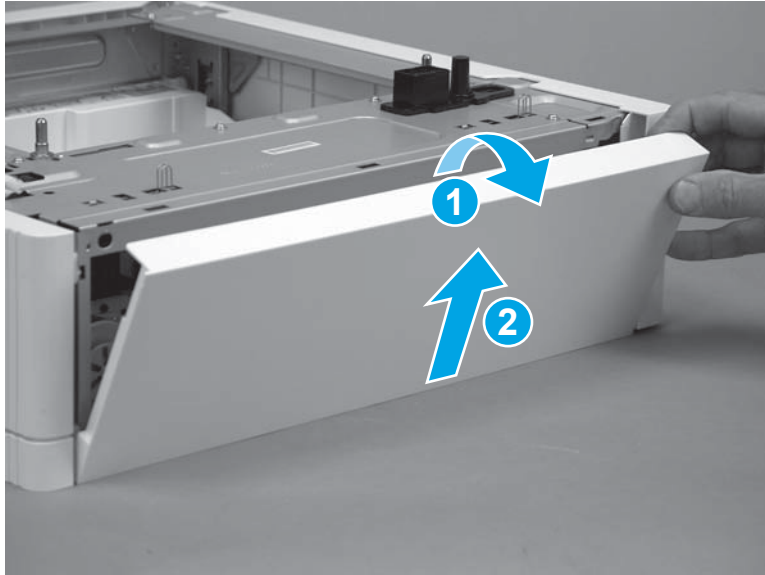

Step 3: Remove the right door

1. Open the door.

Figure 1-5308 Open the door

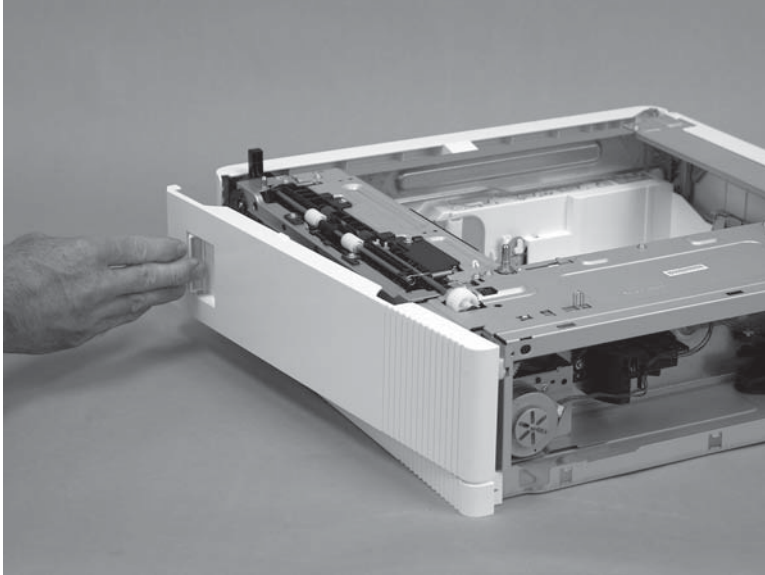

2. Release one tab (callout 1), and then slide the door-hinge bracket away from the chassis (callout 2) to release it.

Figure 1-5309 Release the hinge bracket

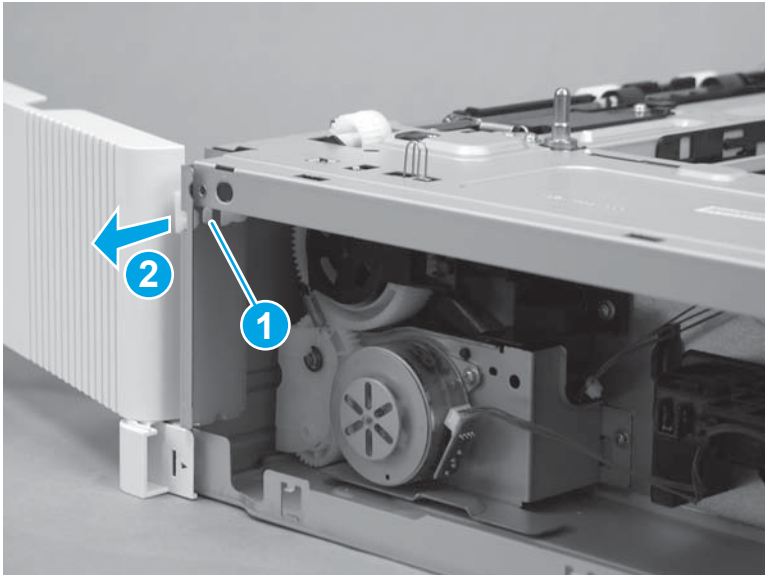

3. Remove the door-hinge bracket from the chassis.

⚠ CAUTION: The door is still attached to the accessory by the door link. Do not attempt to completely remove the door.

The door hinge bracket is not captive. Do not lose it when handling the door.

Figure 1-5310 Remove the hinge bracket

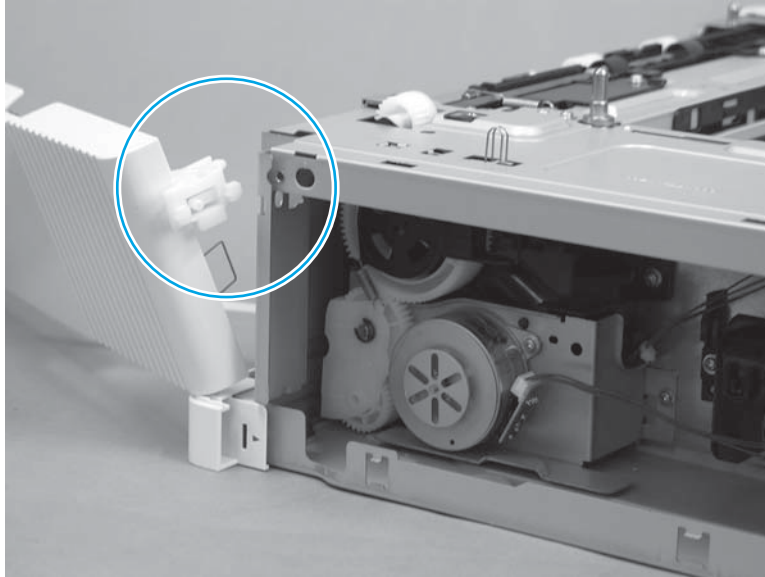

4. Release the door link from the slot in the door to remove the right door.

Figure 1-5311 Release the door link

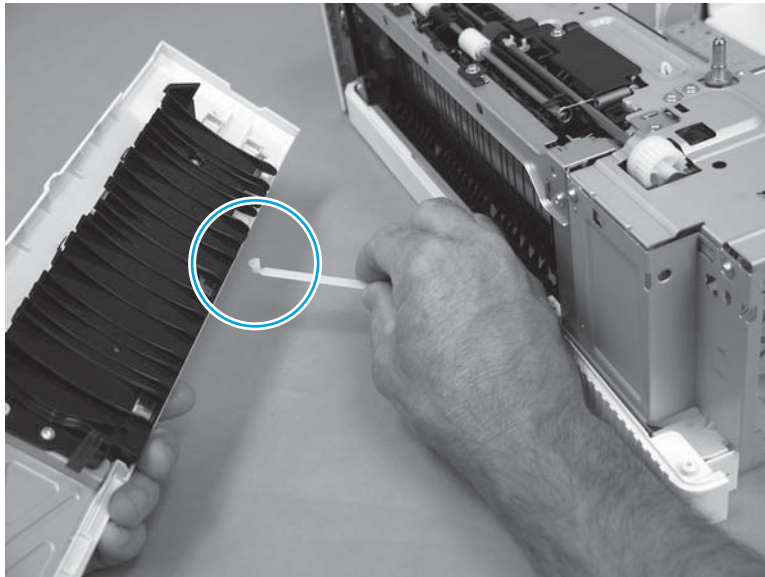

Step 4: Remove the drawer connector holder

1. Disconnect one connector (callout 1; J901).

Figure 1-5312 Disconnect one connector

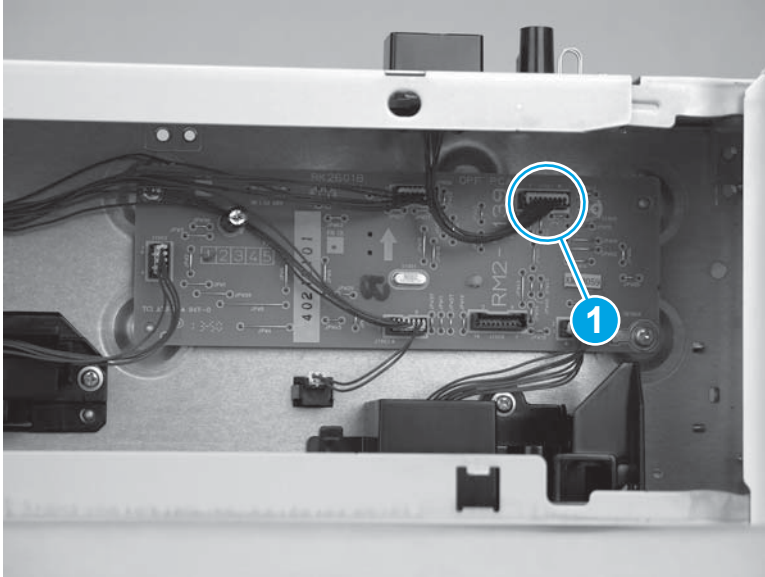

2. Release one tab (callout 1), and then slide the drawer connector holder as shown (callout 2) to release it.

Figure 1-5313 Release one tab

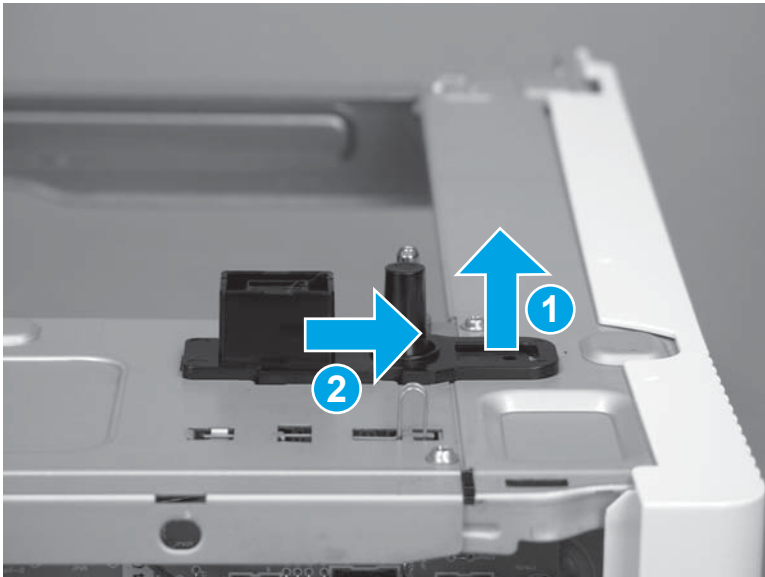

3. Remove the drawer connector holder.

Figure 1-5314 Remove the tray connector

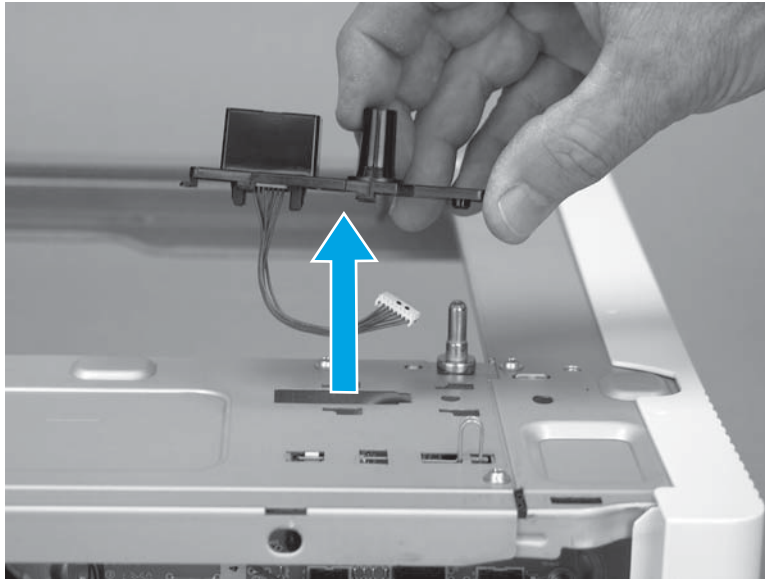

Step 5: Remove the paper feed assembly

1. Remove six screws (callout 1).

Figure 1-5315 Remove six screws

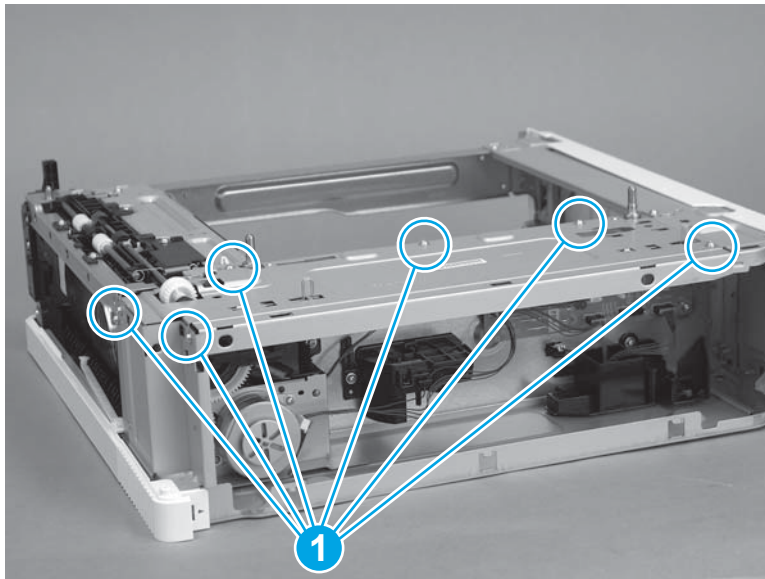

2. Remove the sheet-metal plate.

Figure 1-5316 Remove the sheet-metal plate

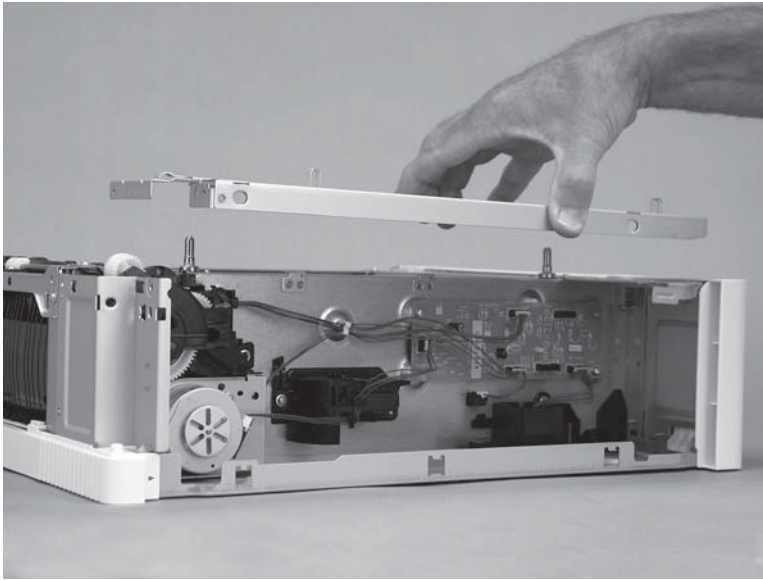

3. Release the green jam handle (callout 1), and then rotate the paper feed guide down (callout 2) and out of the way.

Figure 1-5317 Release the paper feed guide

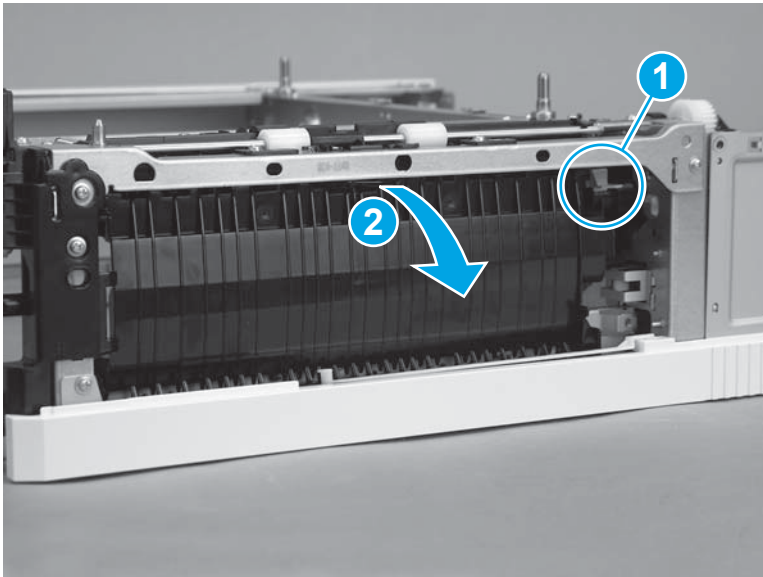

4. Remove one screw (callout 1), release one tab (callout 2), and then remove the cover (callout 3).

Figure 1-5318 Remove the cover

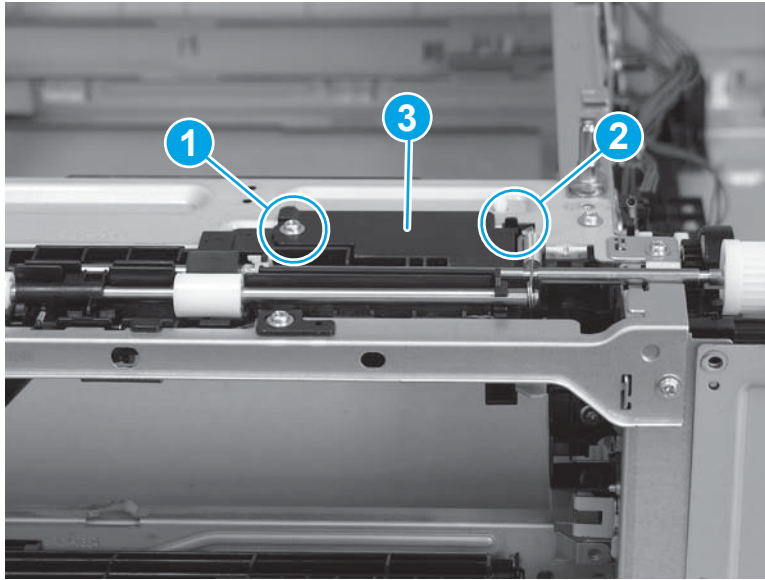

5. Disconnect one connector (callout 1).

Figure 1-5319 Disconnect one connector

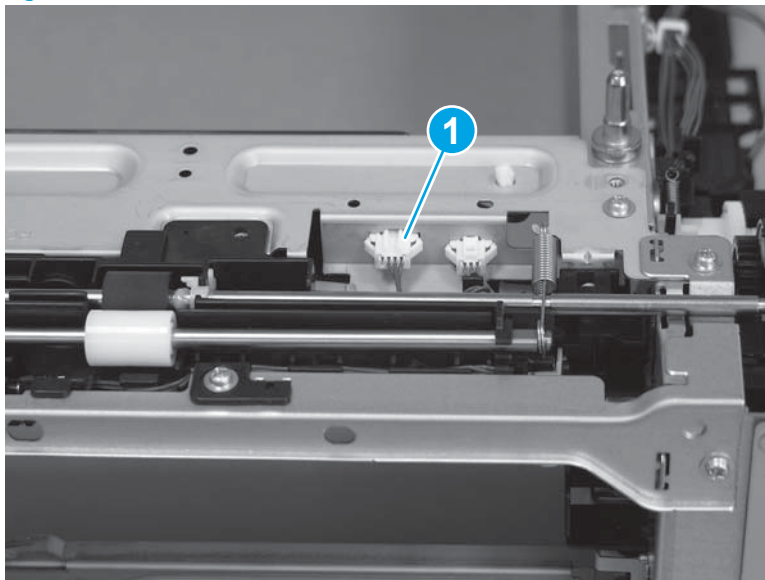

6. Remove two springs (callout 1).

Figure 1-5320 Remove two springs

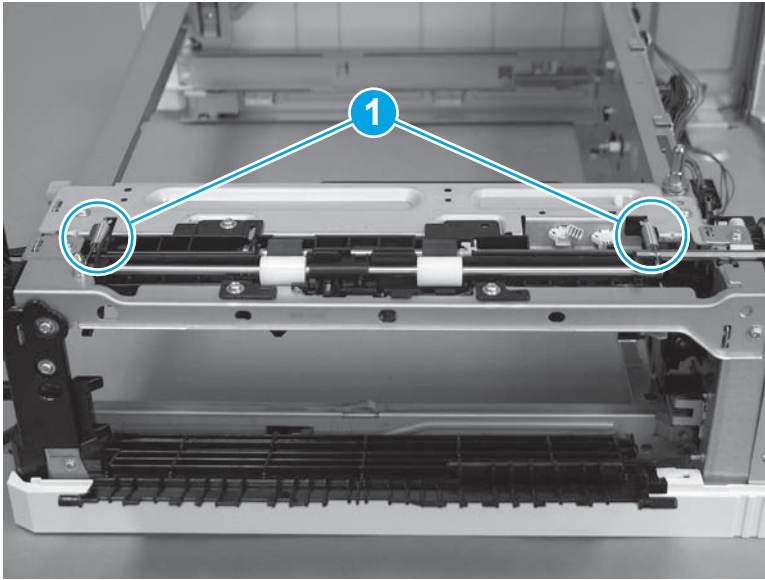

7. Remove three screws (callout 1).

Figure 1-5321 Remove three screws

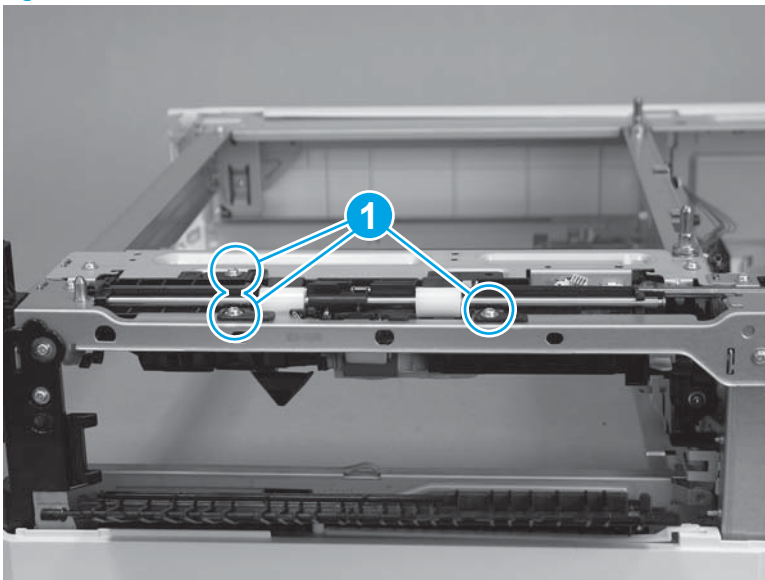

8. Slightly raise the tray end of the assembly, and then release two alignment pins (callout 1).

Figure 1-5322 Release two alignment pins

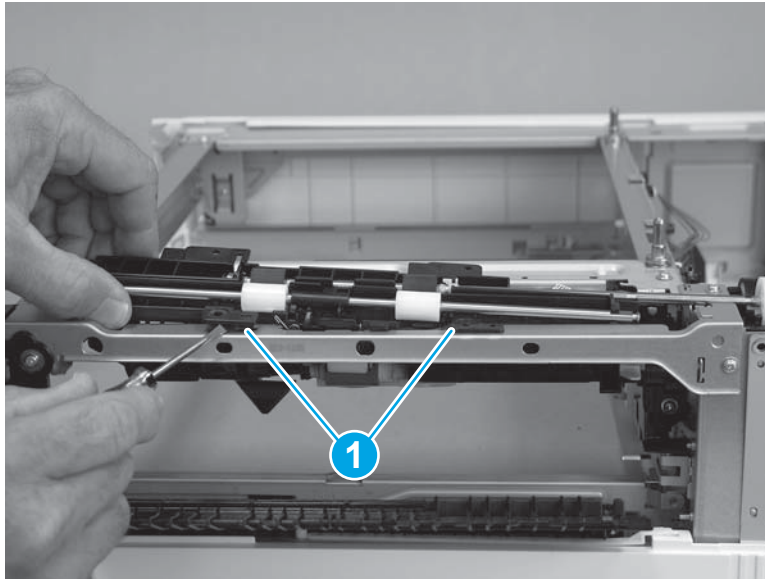

9. Release one tab on the gear (callout 1), slide the assembly away (callout 2) from the lifter drive assembly to release the shaft from the gear, and then remove the paper feed assembly.

Figure 1-5323 Remove the paper feed assembly

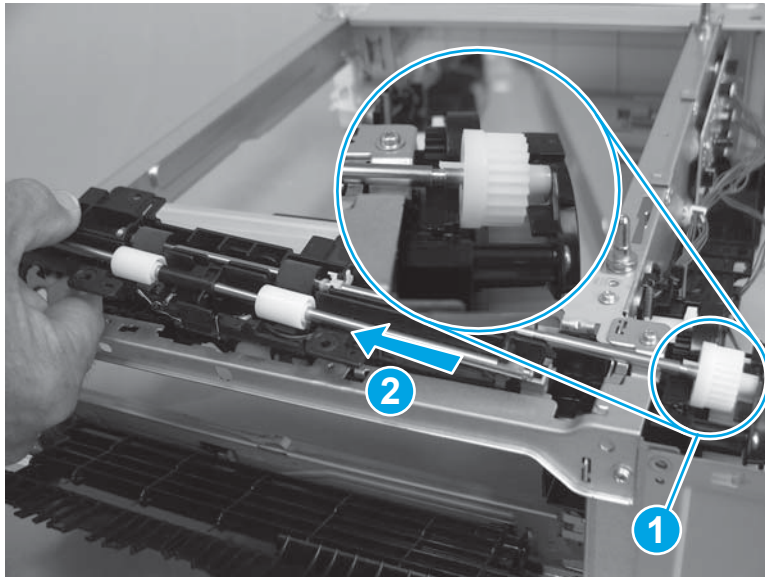

Step 6: Remove the paper pickup assembly

1. Disconnect one connector (callout 1).

Figure 1-5324 Disconnect one connector

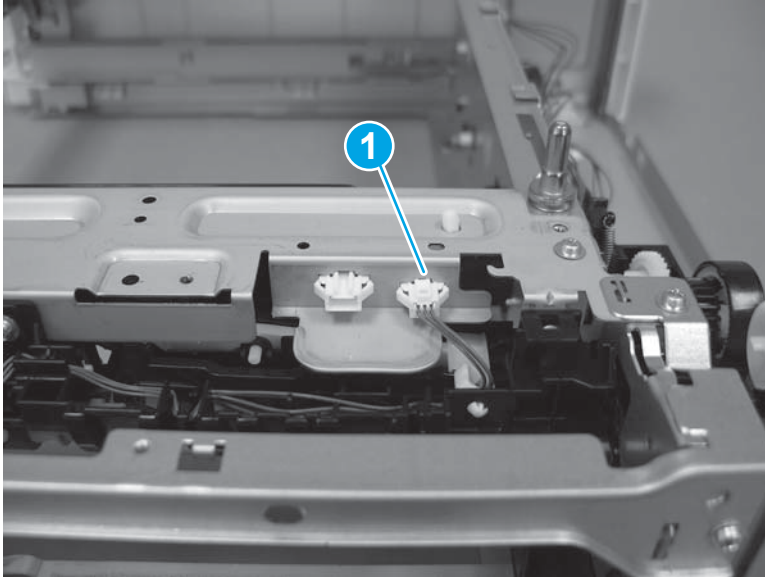

2. Remove three screws (callout 1).

Figure 1-5325 Remove three screws

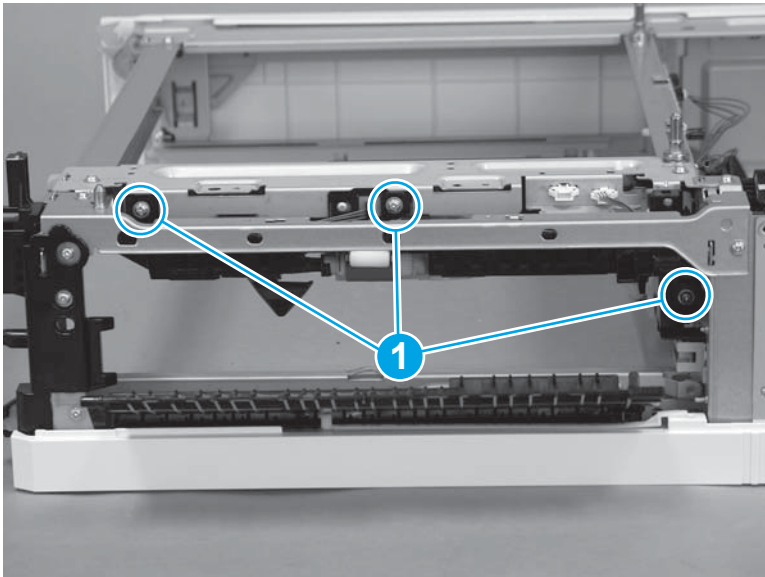

3. Release one alignment pins (callout 1), and then lower the left end of the assembly (callout 2)—the end near the tray cavity.

Figure 1-5326 Lower the end of the assembly

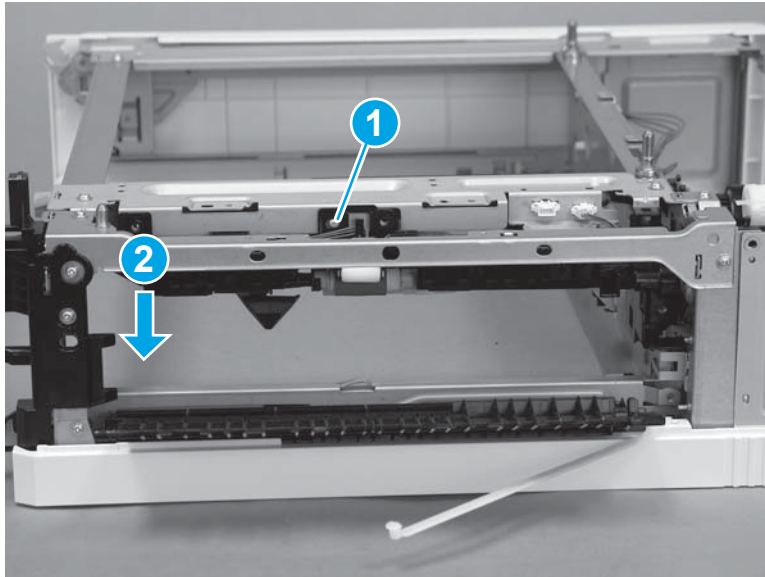

4. Slide the paper pickup assembly to the left to release it from the drive gear on the lifter drive assembly.

Figure 1-5327 Release the assembly from the drive gear

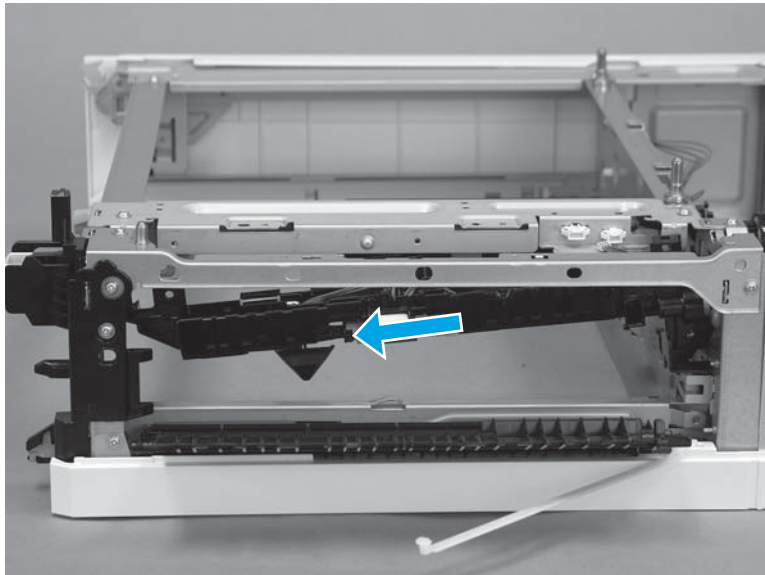

5. Remove the paper pickup assembly through the tray cavity.

Figure 1-5328 Remove the assembly

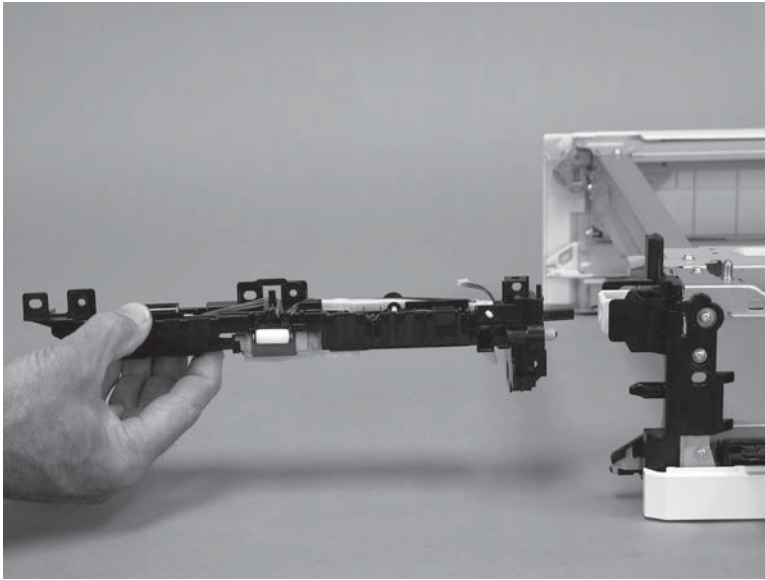

Step 7: Unpack the replacement assembly

Unpack the replacement assembly from the packaging.

CAUTION: Avoid touching the surface of the rollers on the replacement assembly. Skin oils on the rollers can cause print-quality problems. Thoroughly wash your hands with soap and water to remove skin oils, and then completely dry them.

For complete information on HP's recycling programs, go to [Product return and recycling](#).

NOTE: HP recommends responsible disposal of the defective assembly.

Figure 1-5329 Recycle and unpack

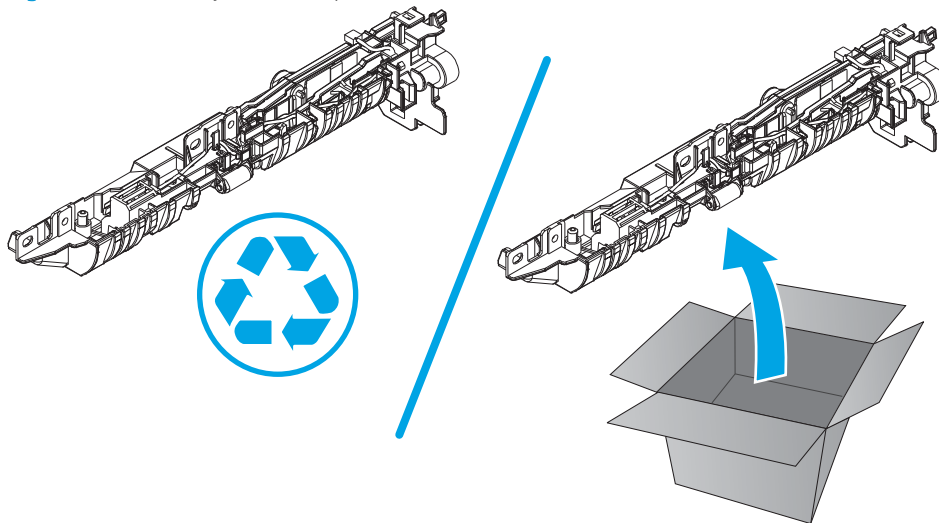

Step 8: Install the paper pickup assembly

1. Install the paper pickup assembly through the tray cavity, and then slide the assembly to the right to engage it with the drive gear on the lifter drive assembly.

⚠ CAUTION: Avoid touching the surface of the rollers on the replacement assembly. Skin oils on the rollers can cause print-quality problems. Thoroughly wash your hands with soap and water to remove skin oils, and then completely dry them.

📝 NOTE: If a replacement assembly is installed, remove the white drive gear from the discarded assembly, and then install it on the replacement paper pickup assembly.

Figure 1-5330 Install the assembly

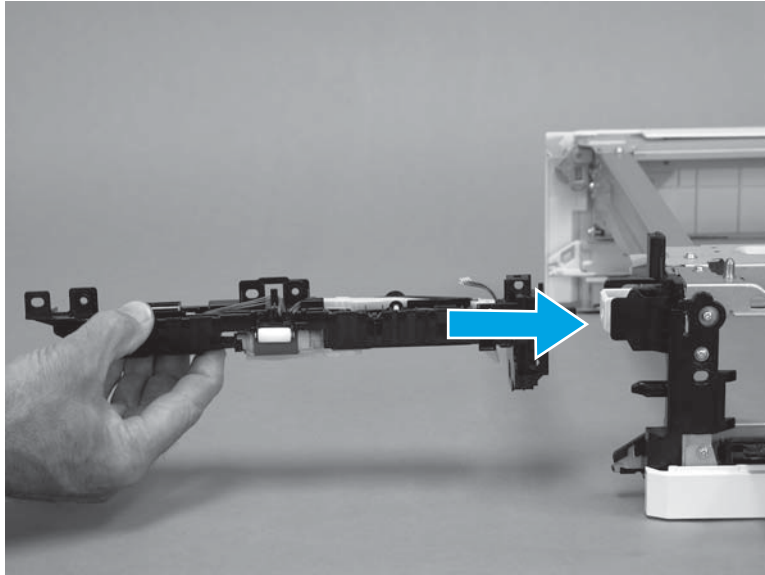

2. Raise the left end of the assembly (callout 1)—the end near the tray cavity—and engage one alignment pin (callout 2).

Figure 1-5331 Raise the end of the assembly

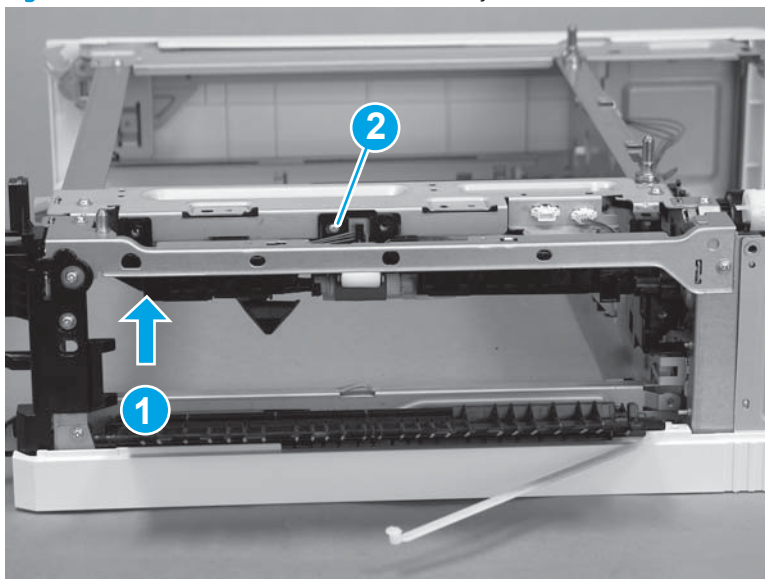

3. Install three screws (callout 1).

Figure 1-5332 Install three screws

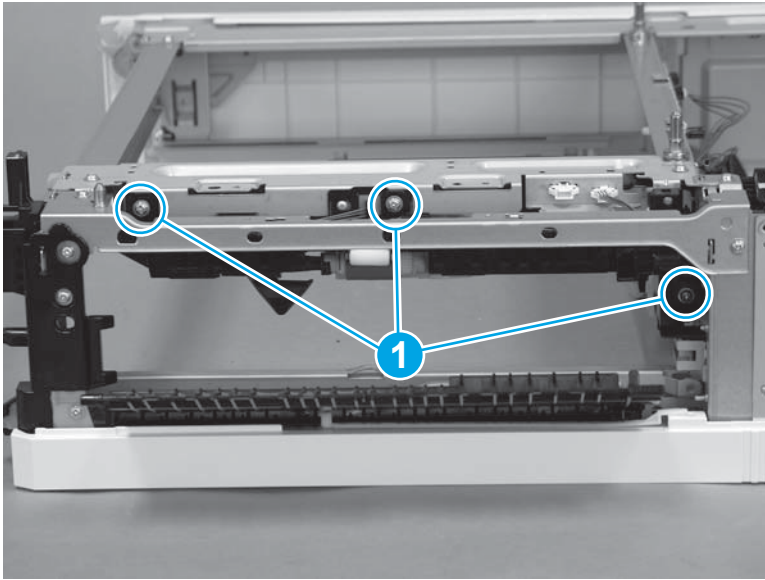

4. Connect one connector (callout 1).

Figure 1-5333 Connect one connector

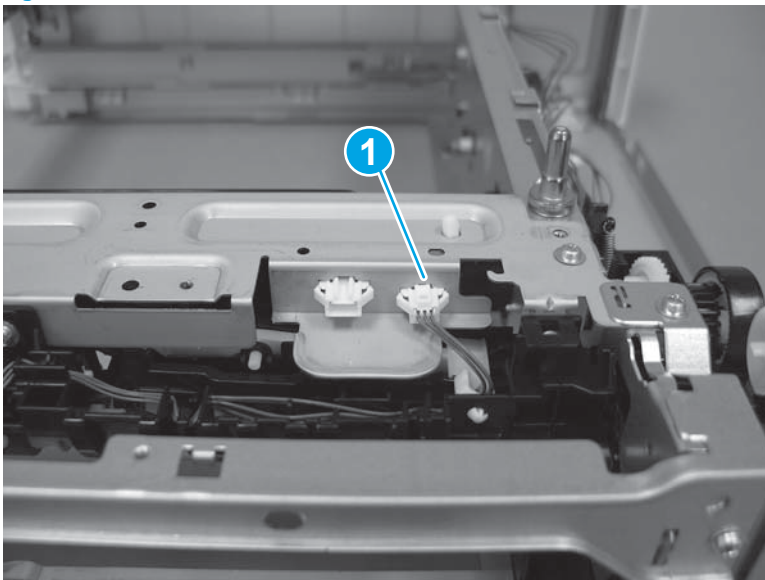

Step 9: Install the paper feed assembly

1. Be careful when handling the assembly. The left side flag (callout 1) is easily dislodged.

Figure 1-5334 Left side flag

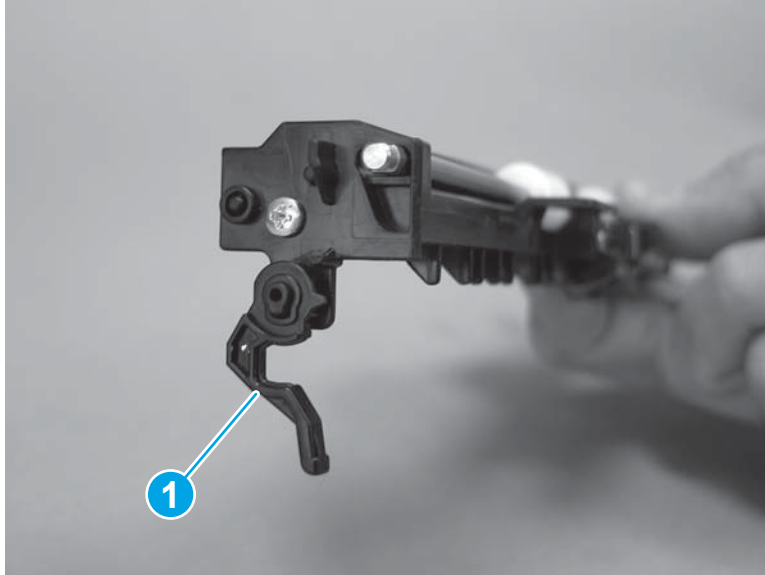

2. Insert the keyed end of the shaft (callout 1) into the gear (callout 2) on the lifter drive assembly—turn the shaft on the paper feed assembly or the gear on the lifter drive assembly to align the keyed shaft with the gear.

 **IMPORTANT:** Make sure that the tab on the gear snaps into place on the shaft.

Figure 1-5335 Install the assembly



3. Lower the tray end of the assembly into the chassis, and then make sure that the alignment pins (callout 1) are fully seated—the assembly must fit flush up against the chassis.

Figure 1-5336 Check the alignment pins

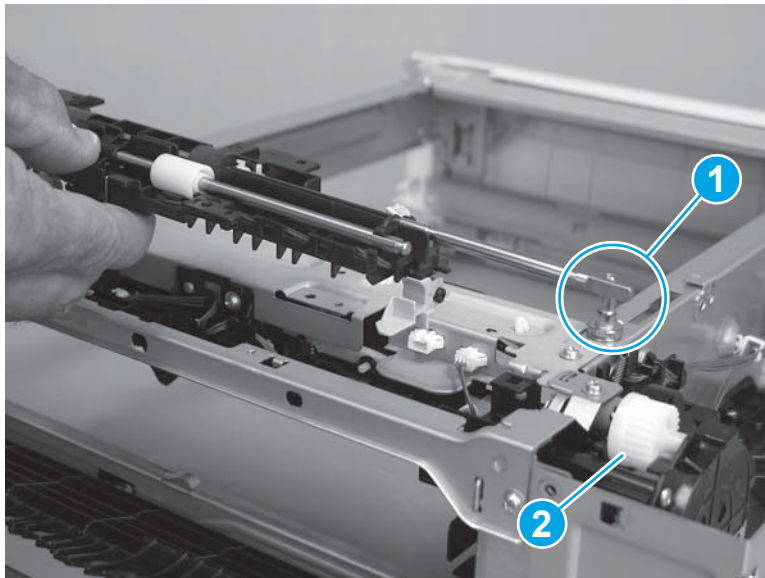
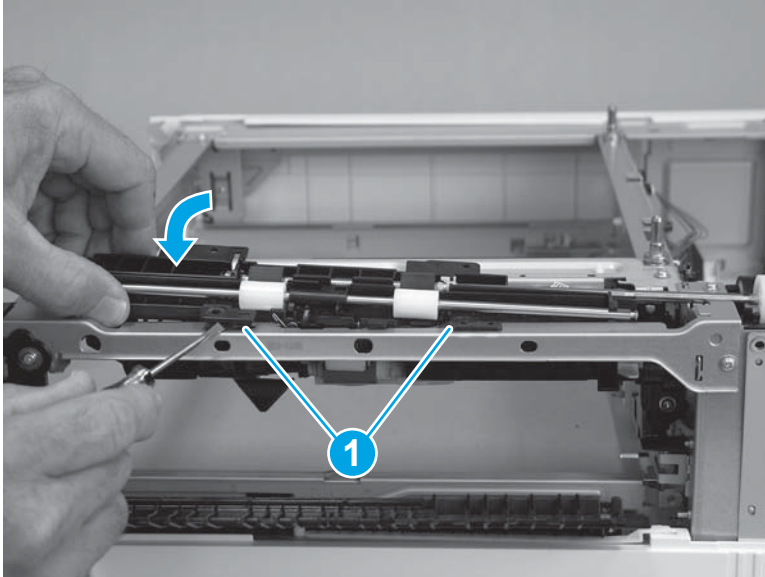

4. Install three screws (callout 1).

Figure 1-5337 Install three screws

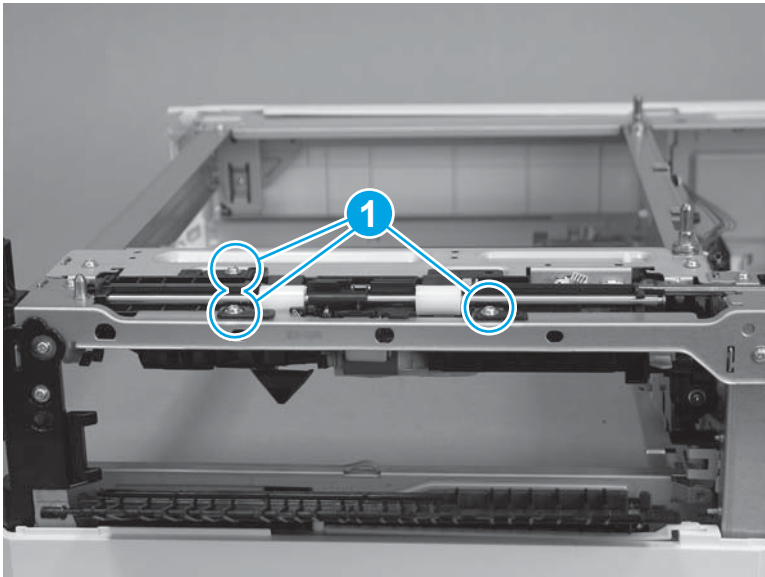

5. Install two springs (callout 1).

Figure 1-5338 Install two springs

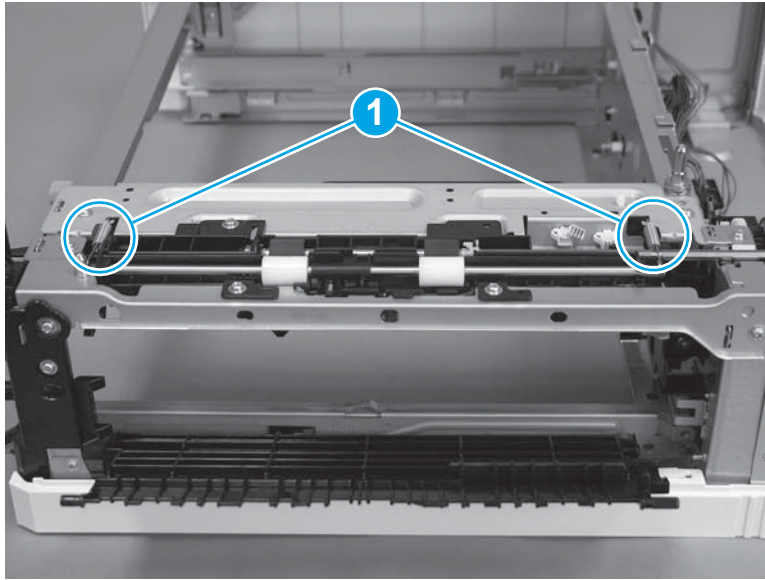

6. Connect one connector (callout 1).

Figure 1-5339 Connect one connector

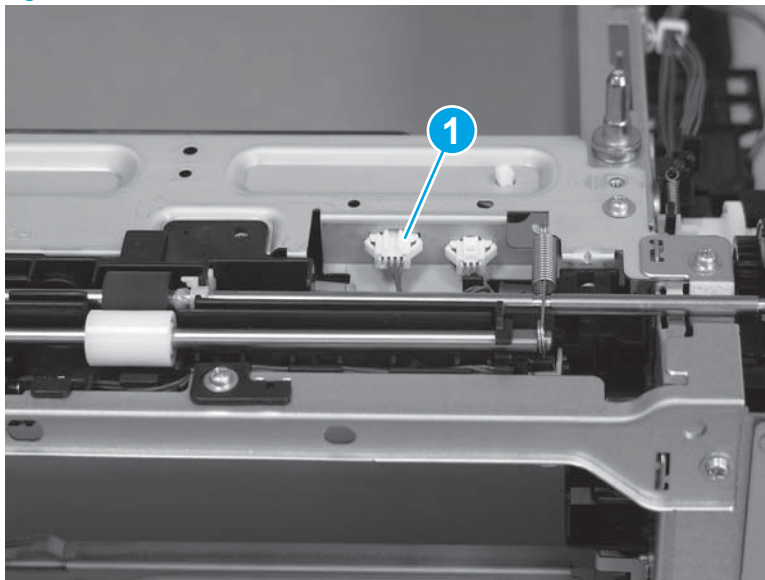

7. Position the cover (callout 1) on the chassis, make sure that the one tab (callout 2) snaps into place, and then install one screw (callout 3).

Figure 1-5340 Install the cover

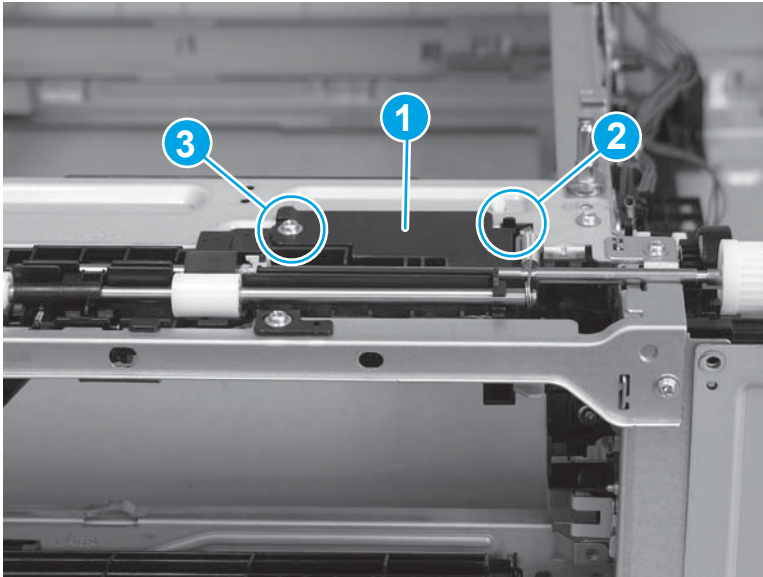

8. Rotate the paper feed guide up into position (callout 1)—the right side (green) jam handle (callout 2) automatically locks the guide in place.

Figure 1-5341 Raise the paper feed guide

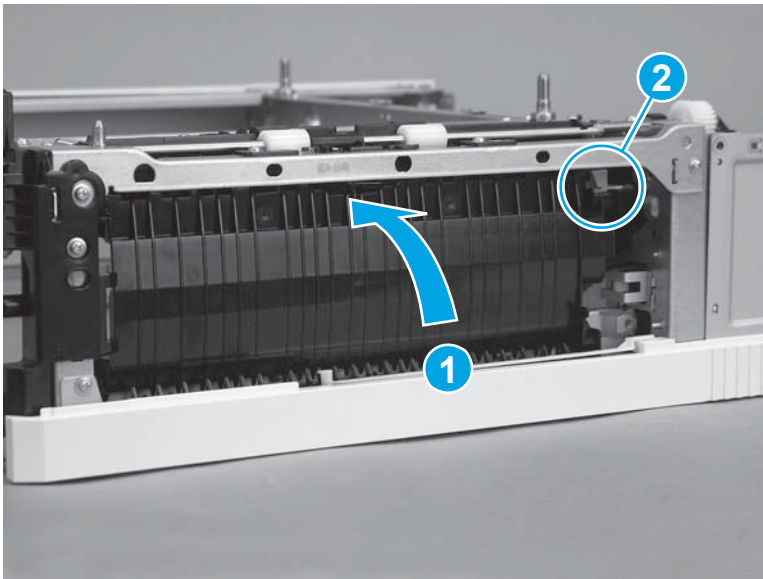

9. Position the sheet-metal plate on the chassis.

Figure 1-5342 Install the sheet-metal plate

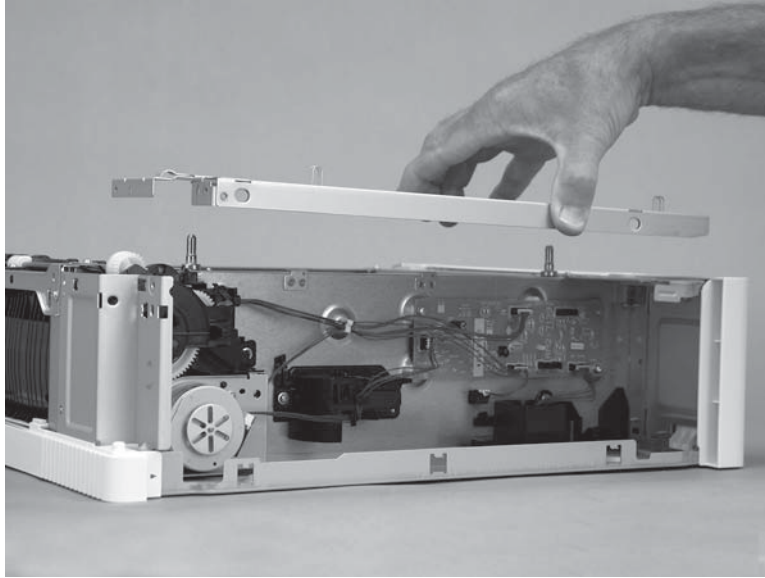

10. Install six screws (callout 1).

Figure 1-5343 Install six screws

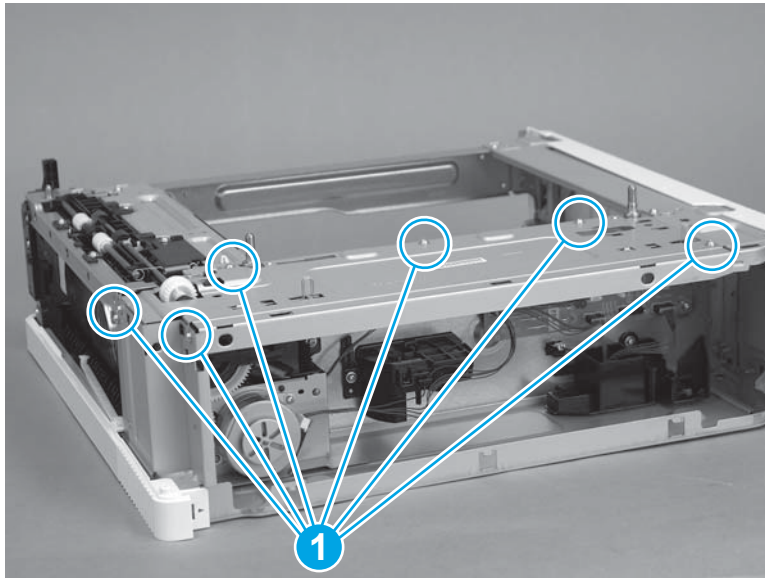

Step 10: Install the drawer connector holder

1. Position the drawer connector holder on the chassis.

 **NOTE:** Make sure that the wire harness (callout 1) was transferred from the discarded assembly to the replacement assembly.

Figure 1-5344 Place the tray connector on the accessory



2. Slide the drawer connector holder as shown (callout 1) to install it, and then make sure that one tab (callout 2) snaps into place .

Figure 1-5345 Install the tray connector

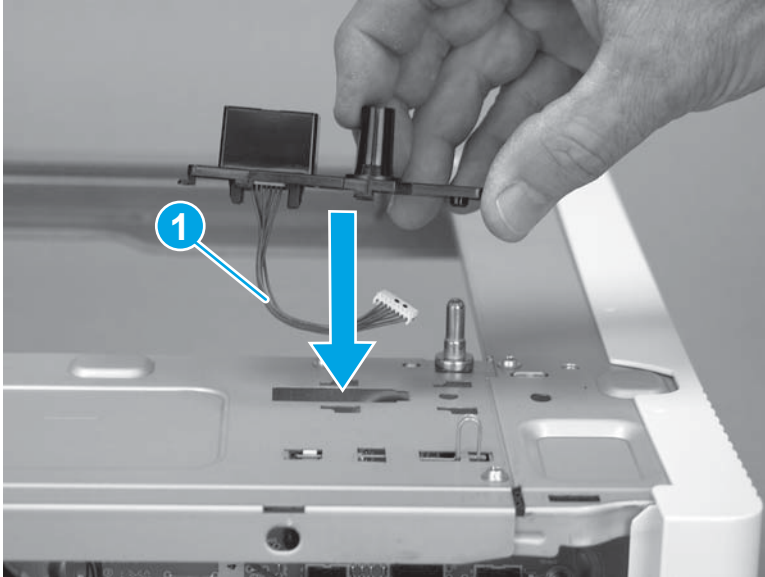
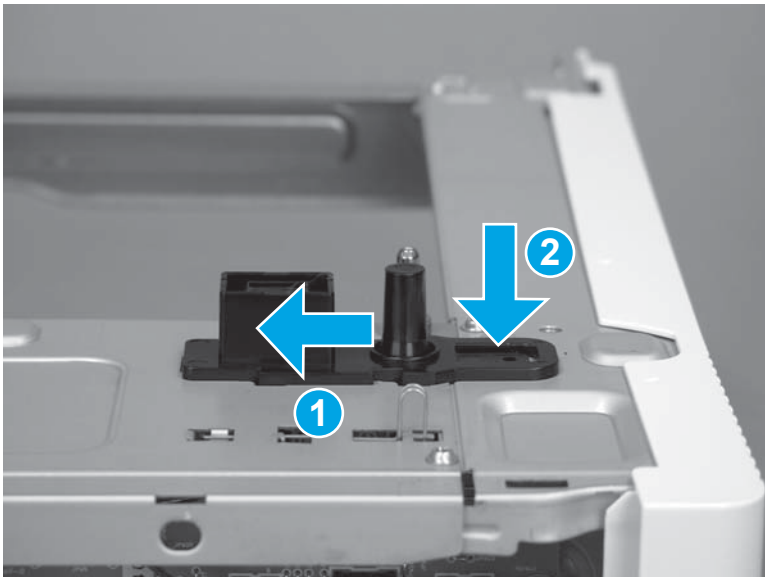

3. Connect one connector (callout 1; J901).

Figure 1-5346 Connect one connector

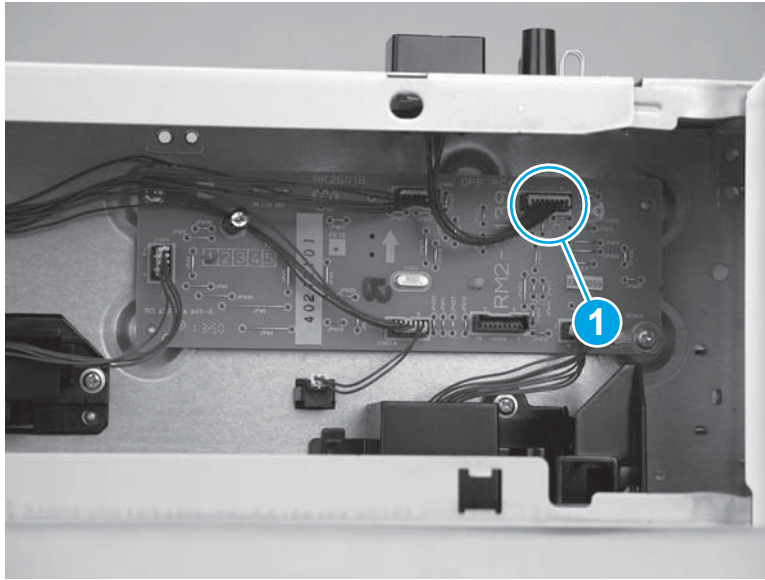

Step 11: Install the right door

1. Install the door link in the slot in the door to attach the door.

Figure 1-5347 Install the door link

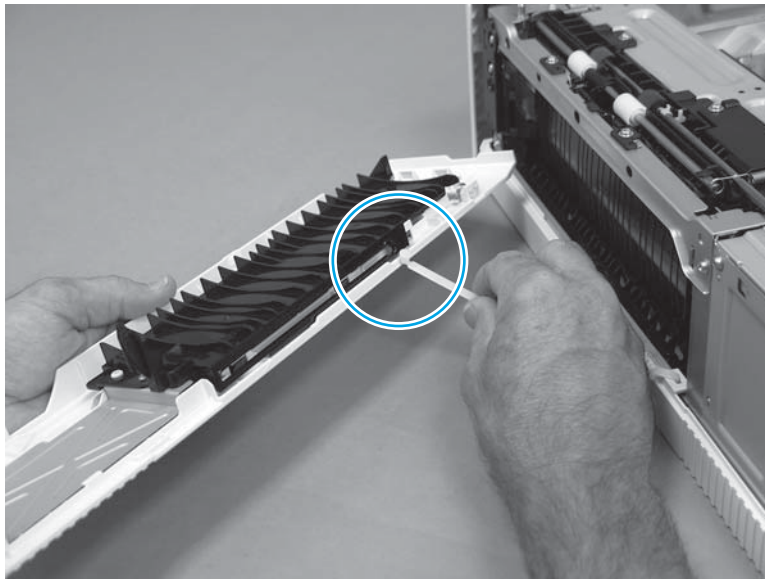

2. Position the lower hinge hole on the door (callout 2) on the lower hinge pin (callout 2) on the right-lower cover.

Figure 1-5348 Position the door on the lower hinge

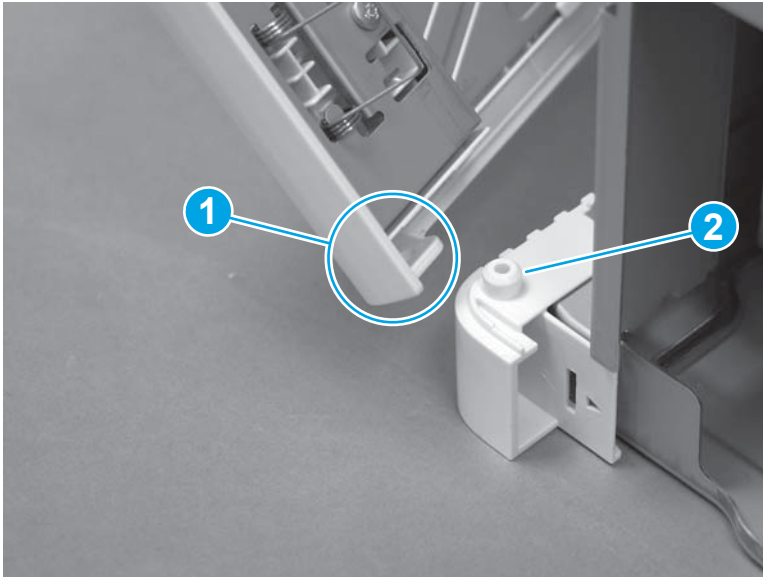

3. Align the pin of the door-hinge bracket (callout 1) with the hole in the chassis, and then align the mounting tabs (callout 2 and callout 3) with the slots in the chassis.

Figure 1-5349 Engage the hinge bracket

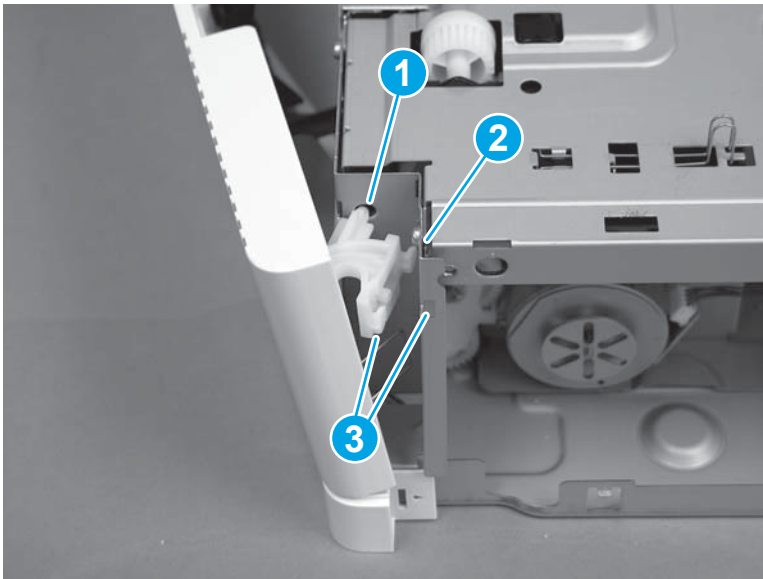

4. Push in on the door-hinge bracket (callout 1), and then slide it toward the chassis (callout 2) to install it.

Figure 1-5350 Install the hinge bracket

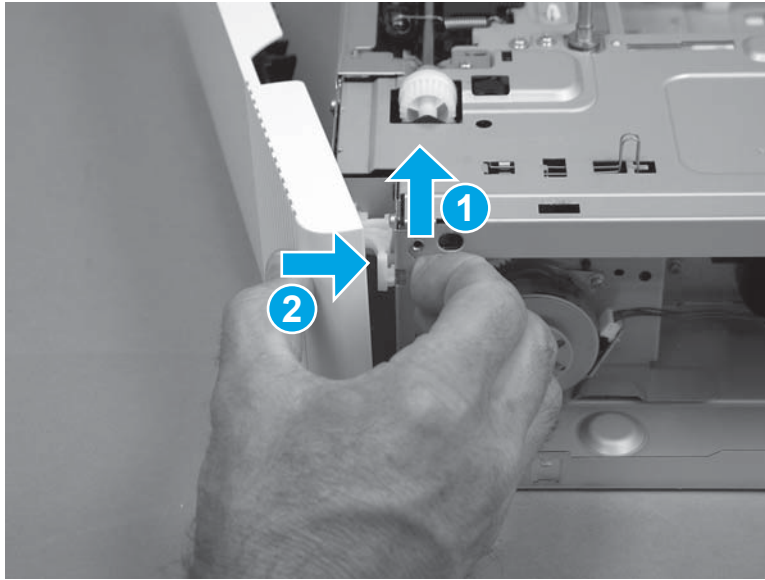

5. Close the door.

Figure 1-5351 Close the door

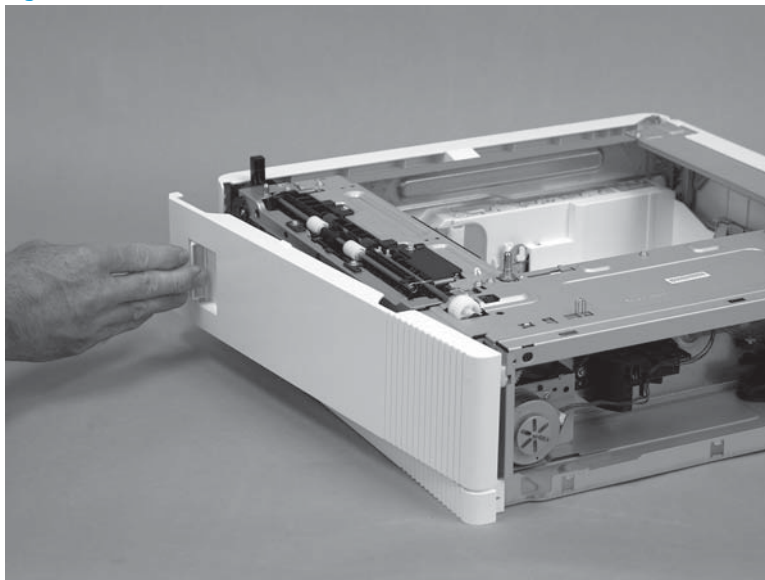

Step 12: Install the rear cover

1. Align the three mounting tabs (callout 1) on the cover with the slots in the chassis.

Figure 1-5352 Position the cover on the chassis

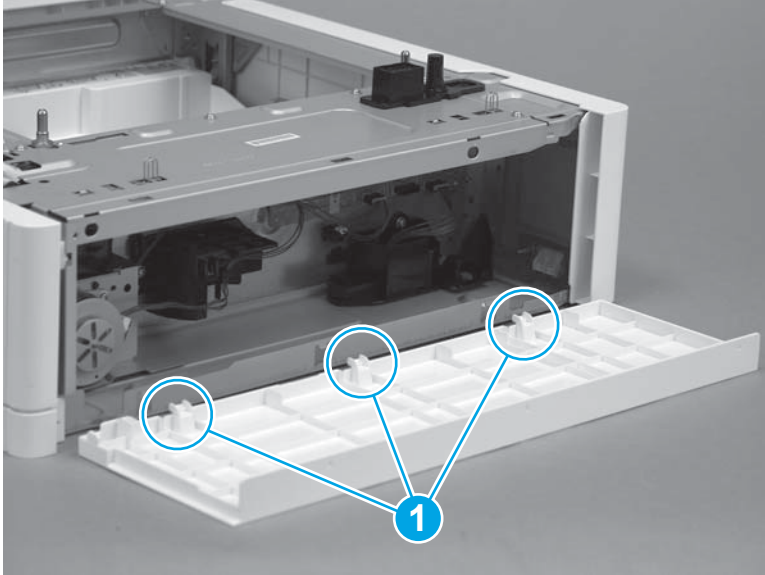

2. Position the cover on the accessory (callout 1), and then rotate the top of the cover up and onto the chassis (callout 2) to install it.

Figure 1-5353 Install the cover

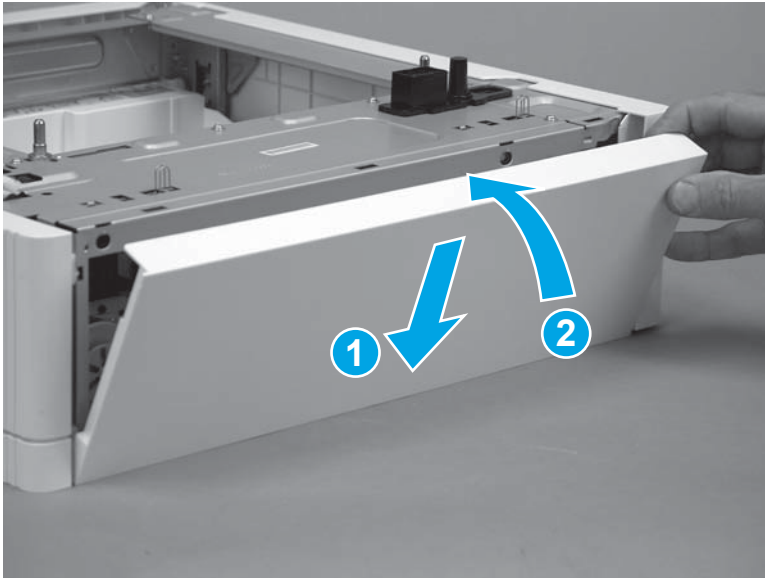

3. Make sure that the three tabs (callout 1) snap into place.

Figure 1-5354 Check the three tabs

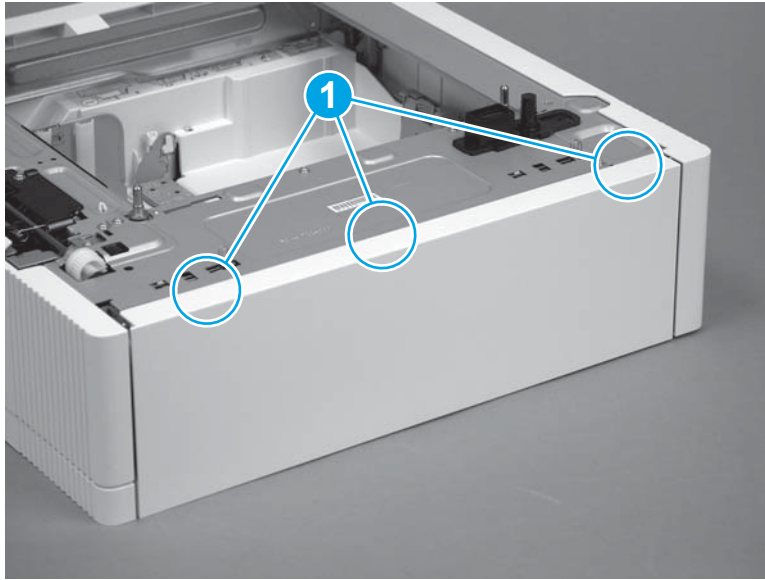

Step 13: Install the tray

1. With the front of the tray slightly lifted, align the sides of the tray with the rails in the printer, and then carefully slide the tray into the printer.

 **TIP:** As the tray slides into the accessory, lower the front of it.

Figure 1-5355 Install the tray



2. Close the tray.

Figure 1-5356 Close the tray

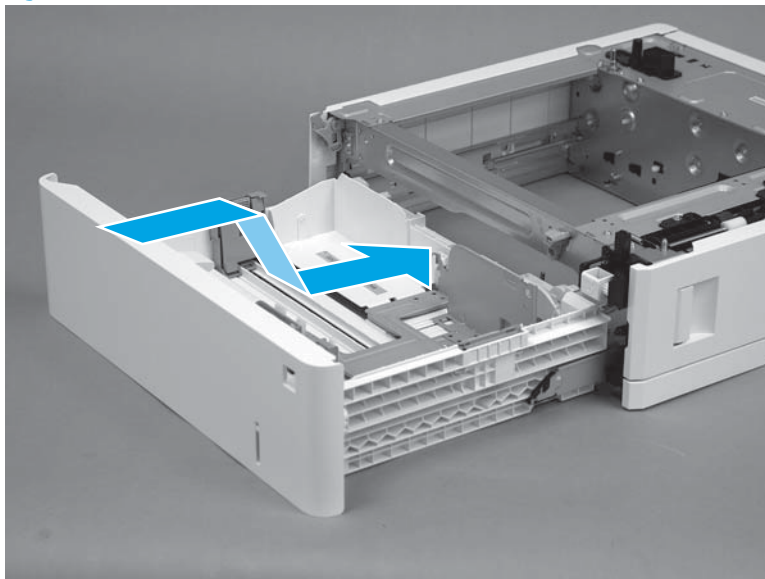
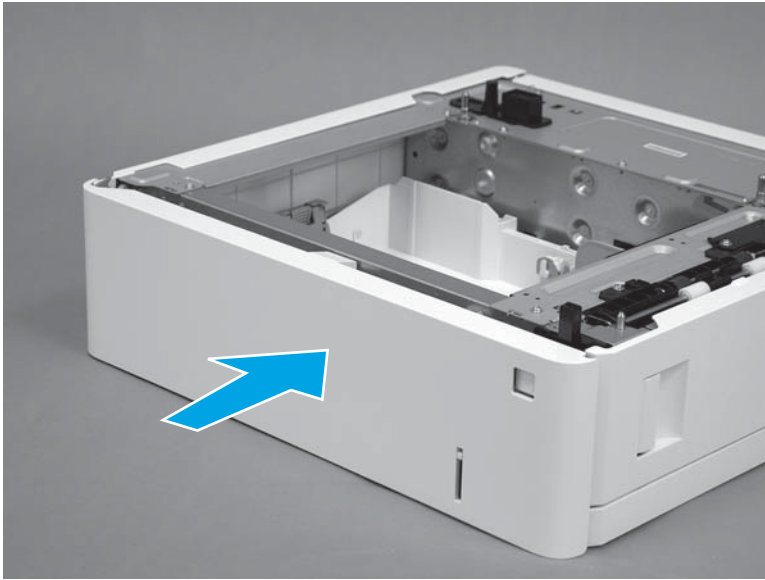

Removal and replacement: Feeder drive assembly (1x550-sheet paper feeder)

- [Introduction](#)
- [Step 1: Remove the tray](#)
- [Step 2: Remove the rear cover](#)
- [Step 3: Remove the right door](#)
- [Step 4: Remove the lower-right cover](#)
- [Step 5: Remove the drawer connector holder](#)
- [Step 6: Remove the feeder drive assembly](#)
- [Step 7: Unpack the replacement assembly](#)
- [Step 8: Install the feeder drive assembly](#)
- [Step 9: Install the drawer connector holder](#)
- [Step 10: Install the lower-right cover](#)
- [Step 11: Install the right door](#)
- [Step 12: Install the rear cover](#)
- [Step 13: Install the tray](#)

Introduction

This document provides the procedures to remove and replace the 1x550-sheet paper feeder drive assembly.

Before performing service

Use the table below to identify the correct part number for your printer, and then go to <http://h20141.www2.hp.com/hpparts> to order the part.

Feeder drive assembly (1x550-sheet paper feeder) part number	
RM2-5148-000CN	Feeder drive assembly (1x550-sheet paper feeder)

Required tools

- #2 Phillips screwdriver with a magnetic tip and a 152-mm (6-in) shaft length
- Small, flat-blade screwdriver

After performing service

Make sure that the rear cover is flush against the chassis after replacing it.

Make sure that the right door latches correctly when closed after replacing it.

Make sure that Tray 3 is fully closed after replacing it.

Post service test

Print a page from a host computer using the appropriate tray as the source tray.

Step 1: Remove the tray

1. Pull the tray out until it stops.

Figure 1-5357 Pull the tray out

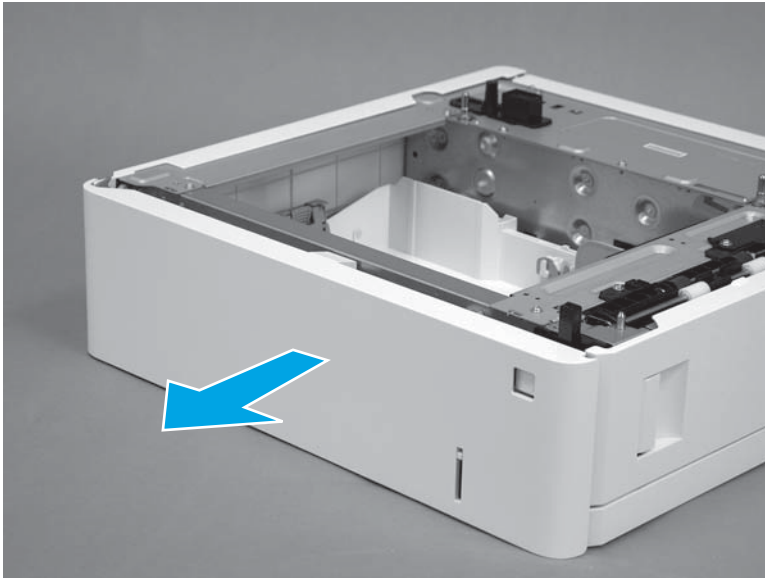

2. Lift the front of the tray, and then pull it out of the printer to remove it.

Figure 1-5358 Remove the tray

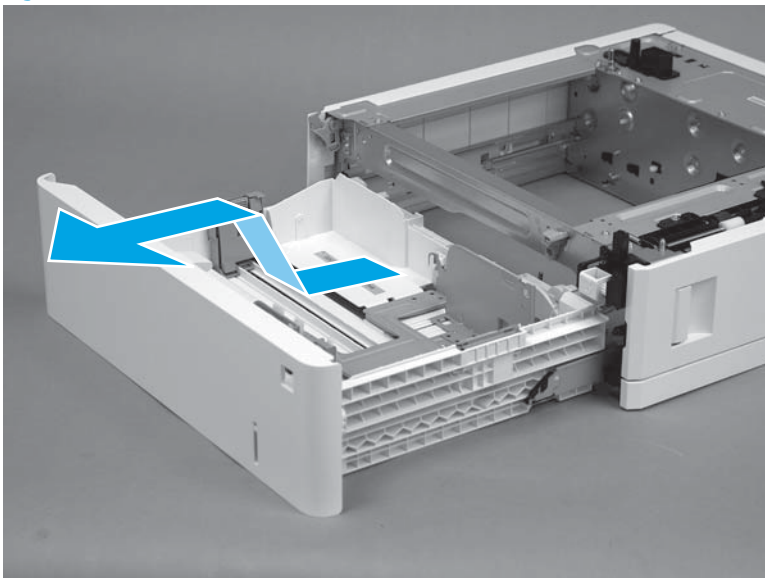

Step 2: Remove the rear cover

1. Release three tabs (callout 1).

Figure 1-5359 Release three tabs

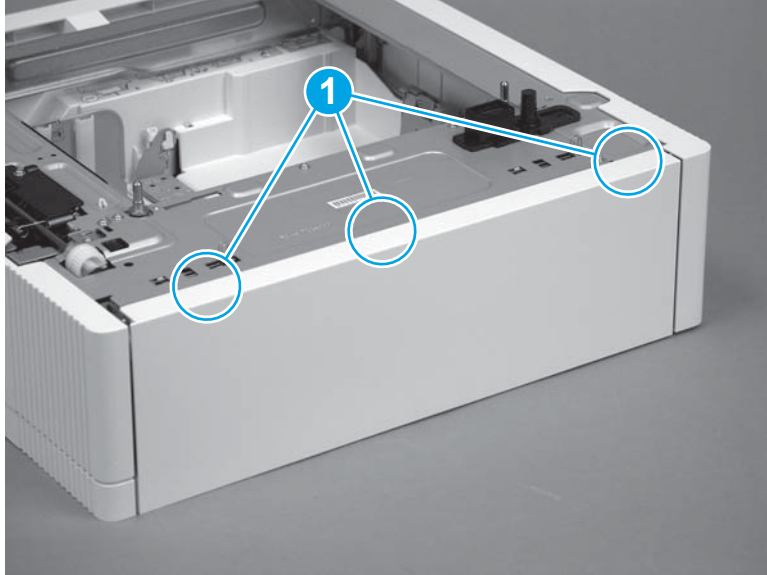

2. Rotate the top of the cover away from the accessory (callout 1), and then lift it up to remove it (callout 2).

Figure 1-5360 Remove the cover

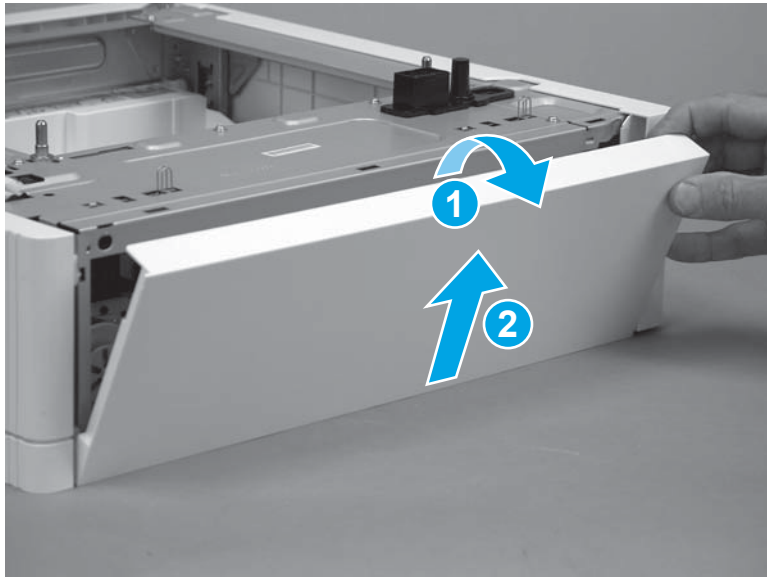

Step 3: Remove the right door

1. Open the door.

Figure 1-5361 Open the door

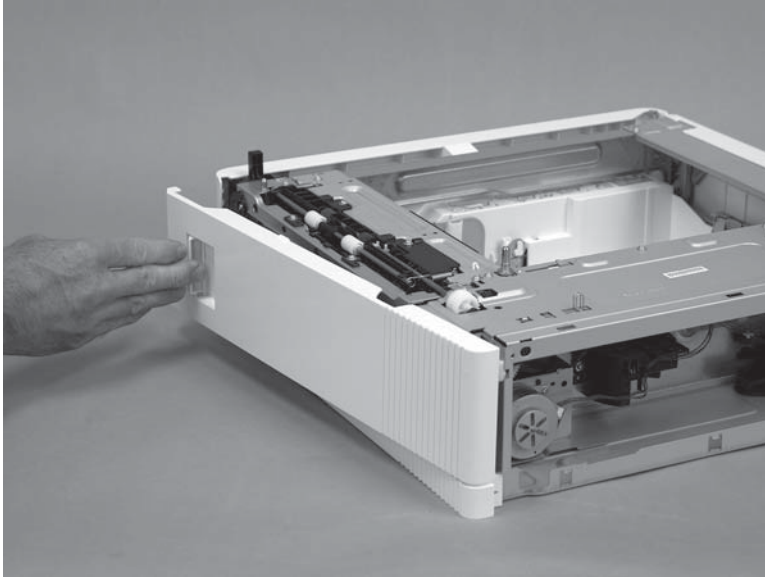

2. Release one tab (callout 1), and then slide the door-hinge bracket away from the chassis (callout 2) to release it.

Figure 1-5362 Release the hinge bracket

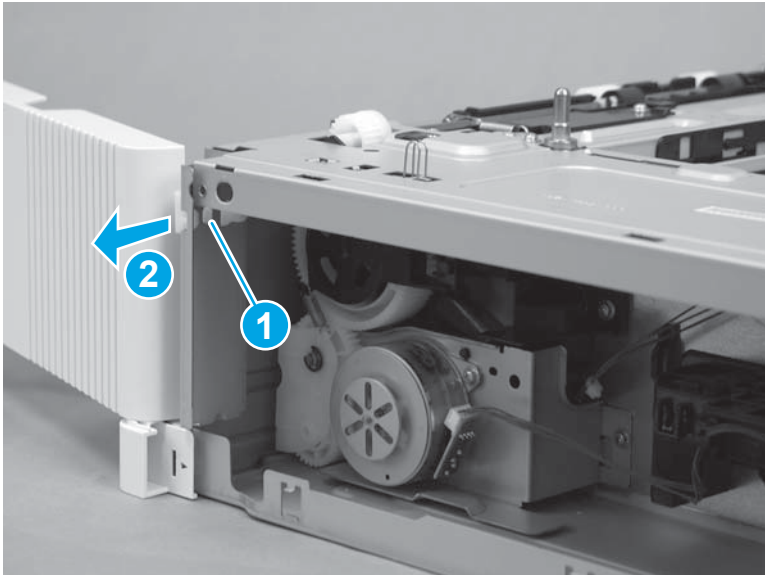

3. Remove the door-hinge bracket from the chassis.

⚠ CAUTION: The door is still attached to the accessory by the door link. Do not attempt to completely remove the door.

The door hinge bracket is not captive. Do not lose it when handling the door.

Figure 1-5363 Remove the hinge bracket

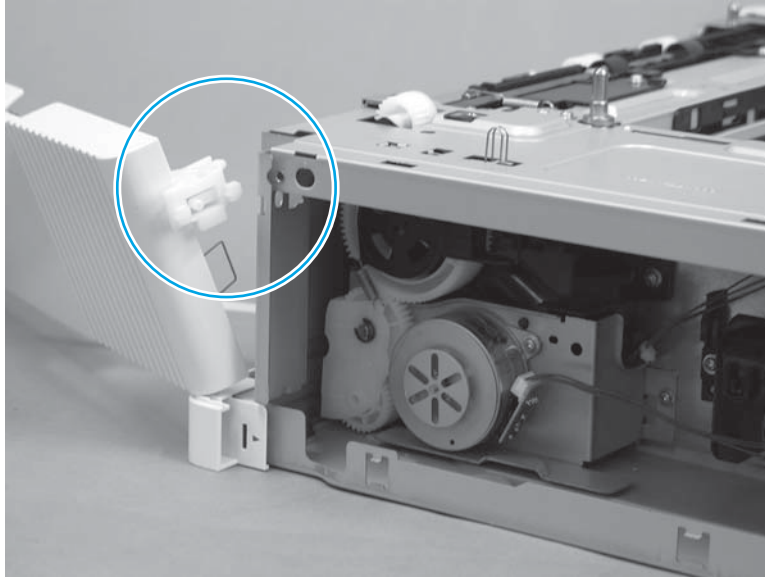

4. Release the door link from the slot in the door to remove the right door.

Figure 1-5364 Release the door link

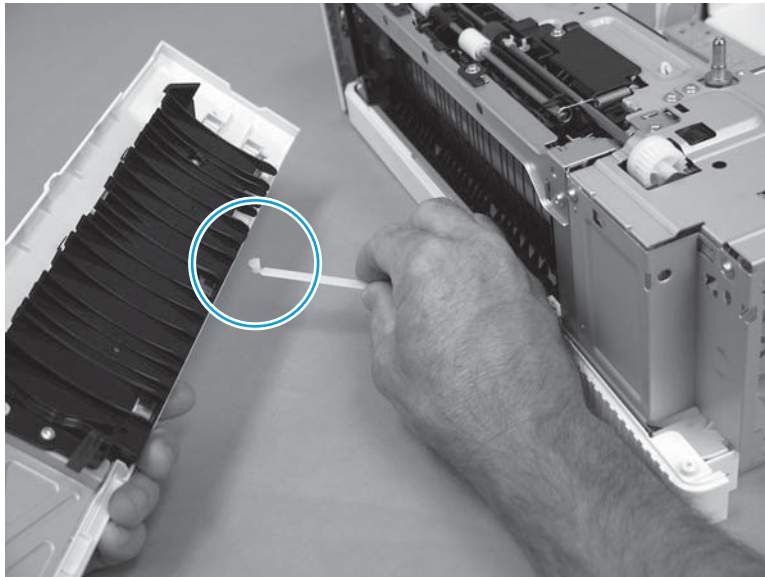

Step 4: Remove the lower-right cover

1. Before proceeding, take note of the location of the three mounting tabs on the back side of the cover.

Figure 1-5365 Cover mounting tabs

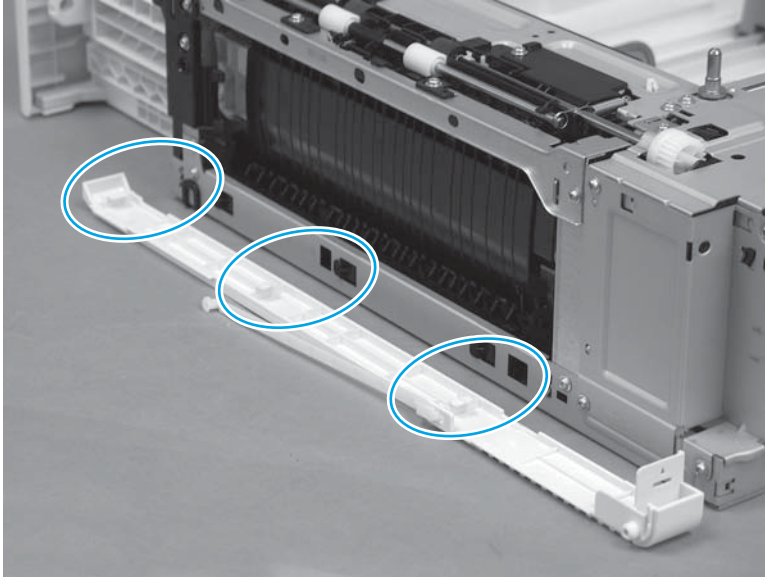

2. Partially open the tray, slightly flex the end of the cover away from the accessory (callout 1), and then slide it towards the front of the accessory (callout 2) to release it.

⚠ CAUTION: The three mounting tabs on the back side of the cover are easily damaged. Do not over flex the end of the cover when it is released. Push in on the middle tab to protect it when removing the cover.

Figure 1-5366 Release the cover

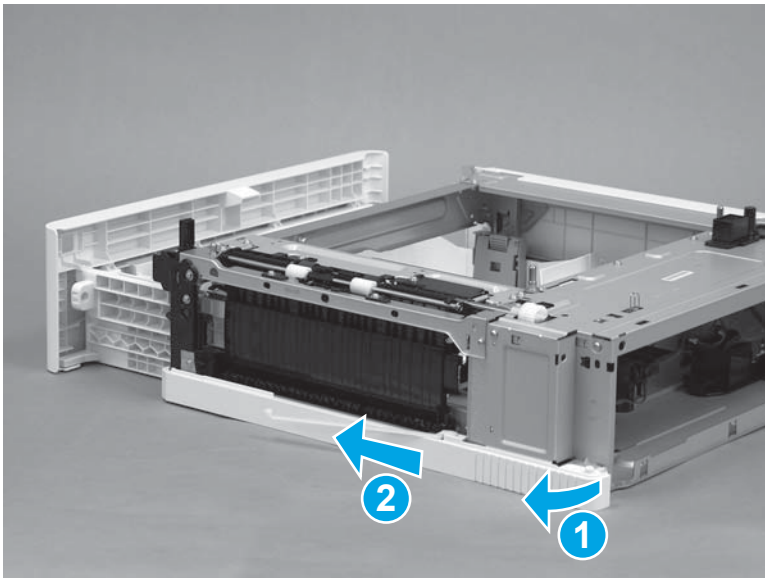

3. Remove the right-lower cover.

Figure 1-5367 Remove the right-lower cover

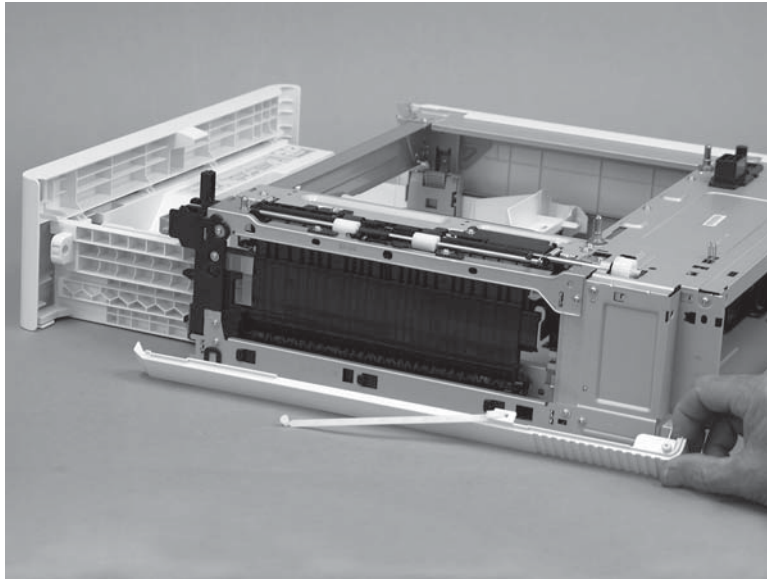

Step 5: Remove the drawer connector holder

1. Disconnect one connector (callout 1; J901).

Figure 1-5368 Disconnect one connector

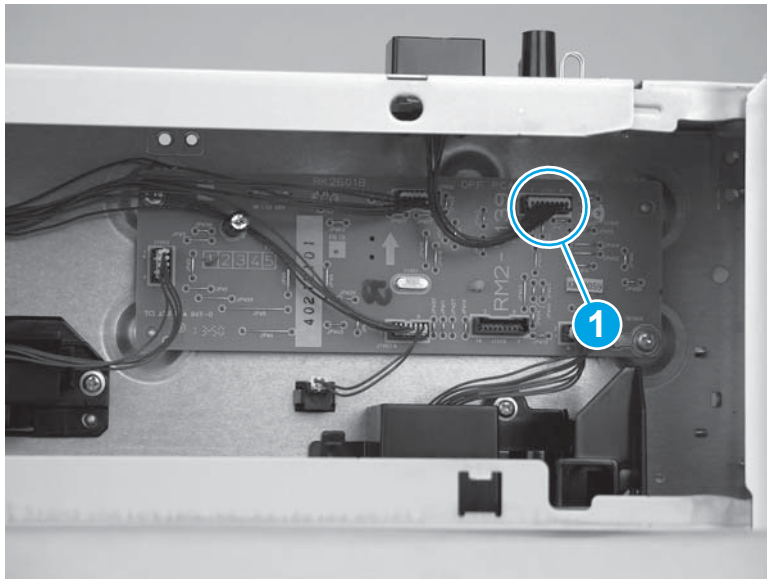

2. Release one tab (callout 1), and then slide the drawer connector holder as shown (callout 2) to release it.

Figure 1-5369 Release one tab

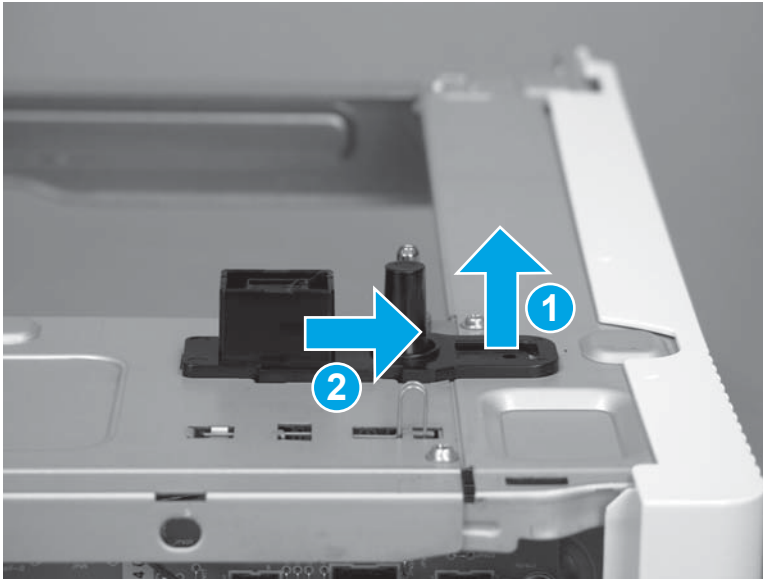

3. Remove the drawer connector holder.

Figure 1-5370 Remove the tray connector

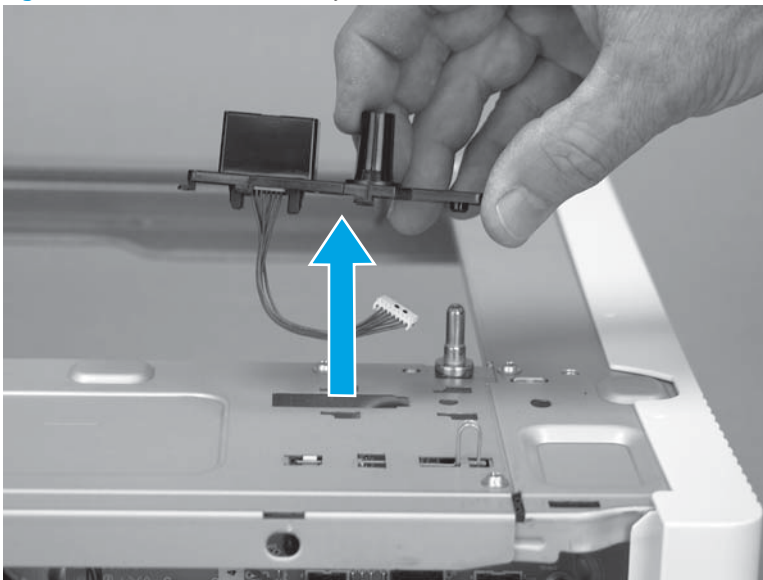

Step 6: Remove the feeder drive assembly

1. Remove six screws (callout 1).

Figure 1-5371 Remove six screws

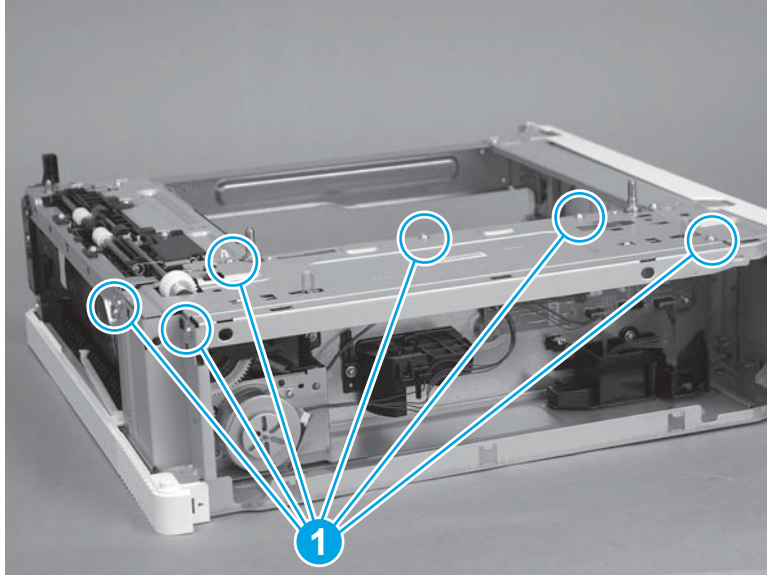

2. Remove the sheet-metal plate.

Figure 1-5372 Remove the sheet-metal plate

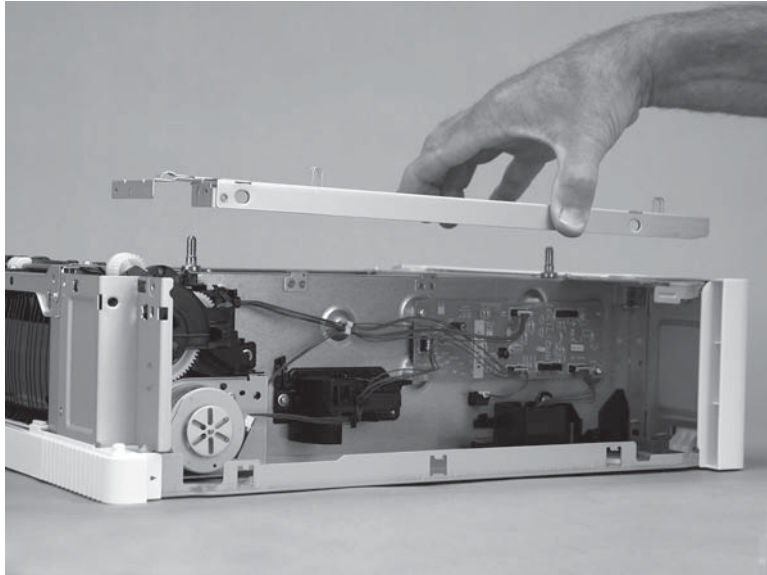

3. Remove two screws (callout 1).

Figure 1-5373 Remove two screws

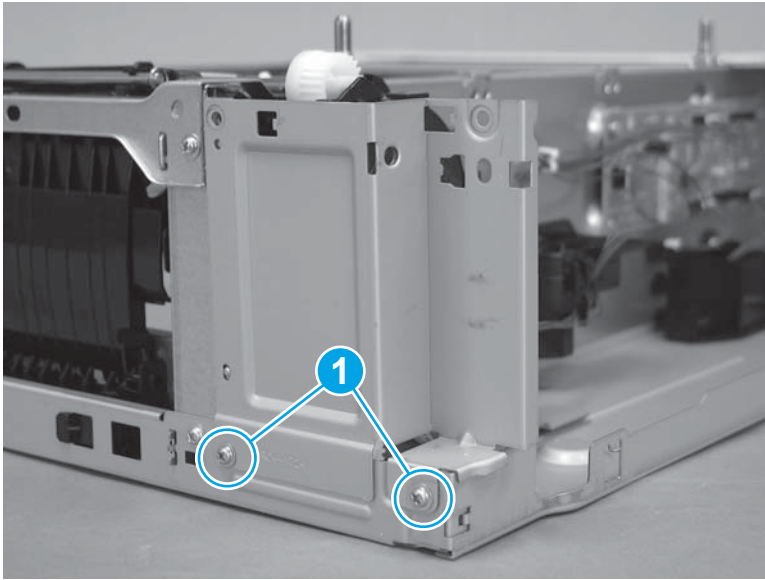

4. Remove the sheet-metal plate.

Figure 1-5374 Remove the sheet-metal plate

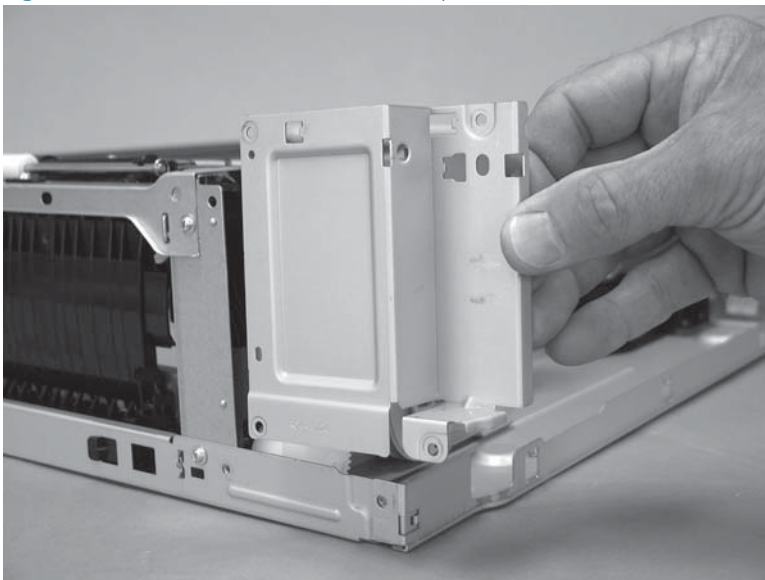

5. Disconnect one connector (callout 1).

Figure 1-5375 Disconnect one connector

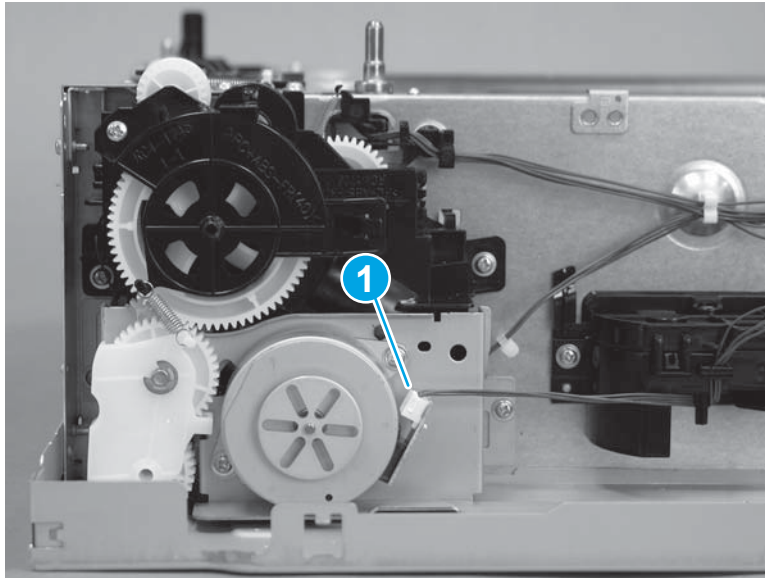

6. Remove one spring (callout 1).

Figure 1-5376 Remove one spring

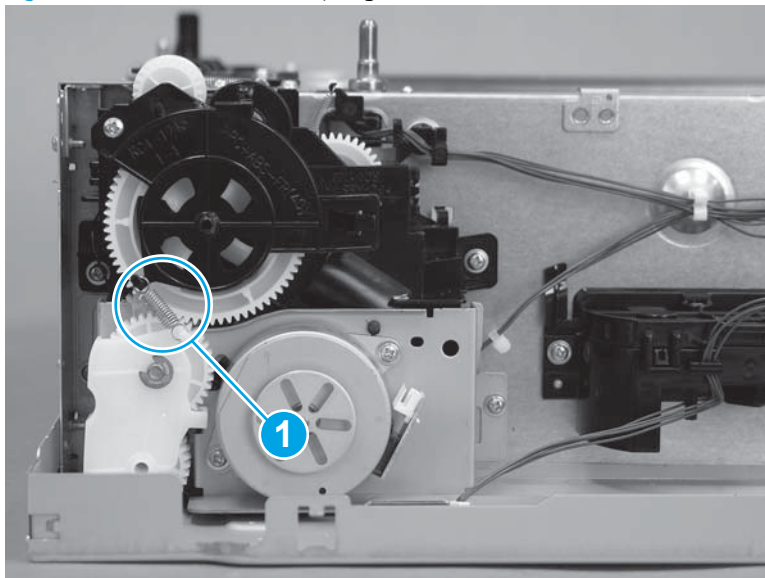

7. Remove two screws (callout 1).

Figure 1-5377 Remove two screws

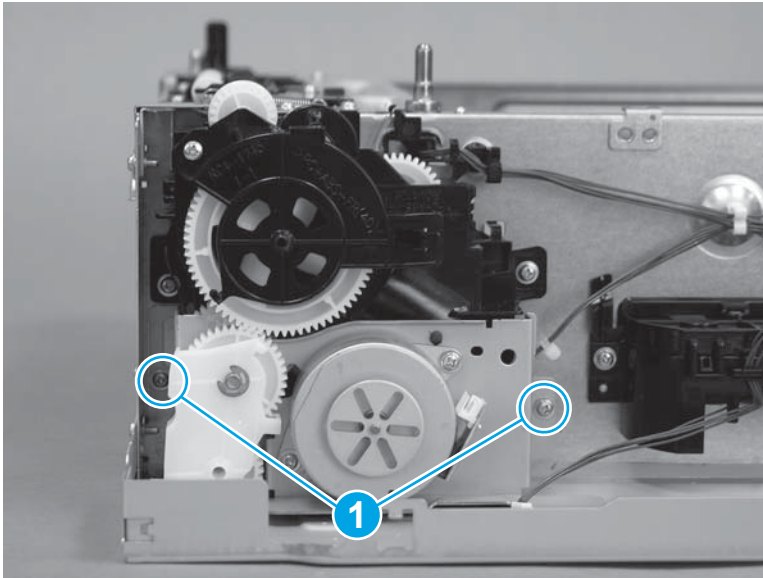

8. Remove the feeder drive assembly.

CAUTION: If the assembly is being removed to access another part, take care not to wipe any of the grease off of the gears.

Figure 1-5378 Remove the assembly

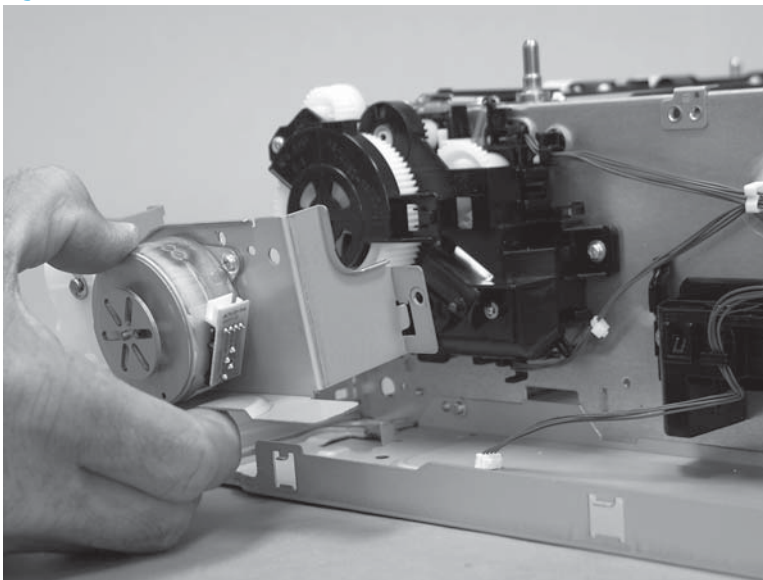

Step 7: Unpack the replacement assembly

Unpack the replacement assembly from the packaging.

For complete information on HP's recycling programs, go to [Product return and recycling](#).

CAUTION: When handling the replacement assembly, take care not to wipe any of the grease off of the gears.

 **NOTE:** HP recommends responsible disposal of the defective assembly.

Figure 1-5379 Recycle and unpack

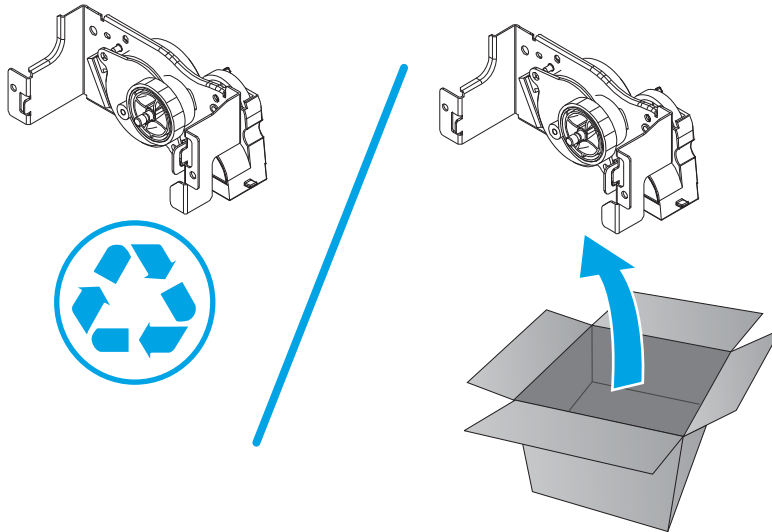

Step 8: Install the feeder drive assembly

1. Position the feeder drive assembly in the chassis.

 **CAUTION:** When handling the assembly, take care not to wipe any of the grease off of the gears.

Figure 1-5380 Install the assembly

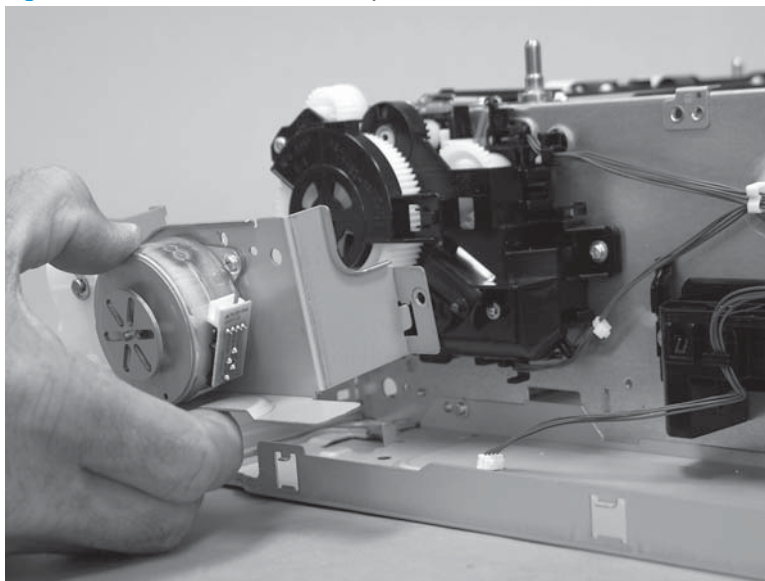

2. Install two screws (callout 1).

Figure 1-5381 Install two screws

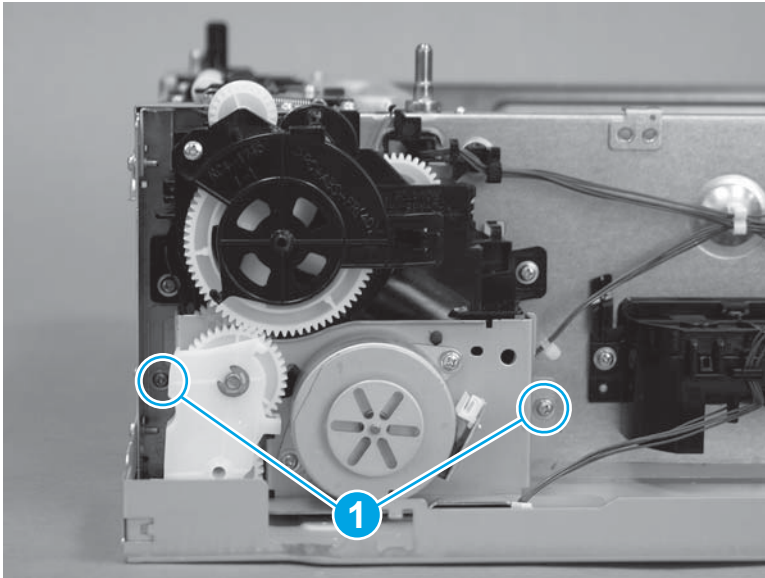

3. Install one spring (callout 1).

Figure 1-5382 Install one spring

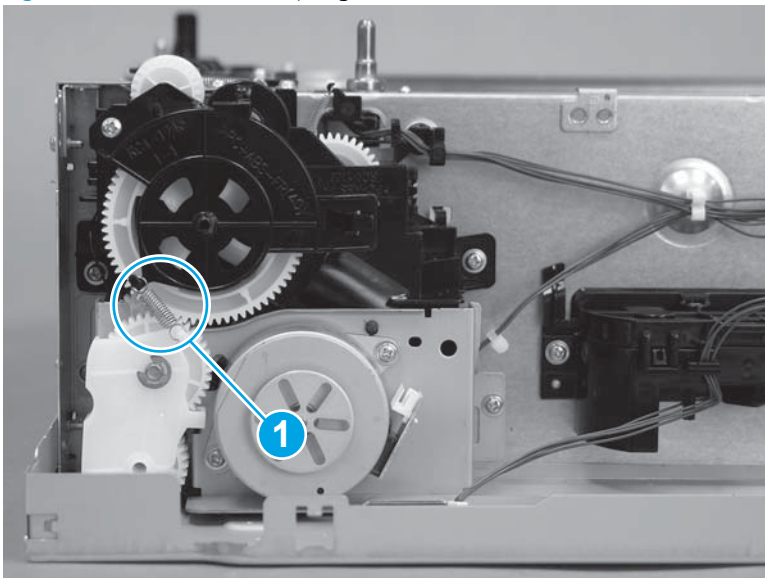

4. Connect one connector (callout 1).

Figure 1-5383 Connect one connector

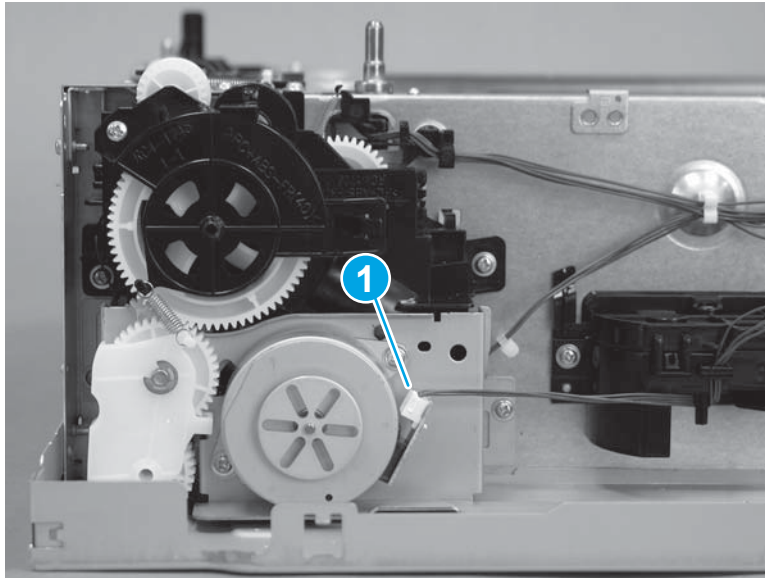

5. Position the sheet-metal plate on the chassis.

Figure 1-5384 Install the sheet-metal plate

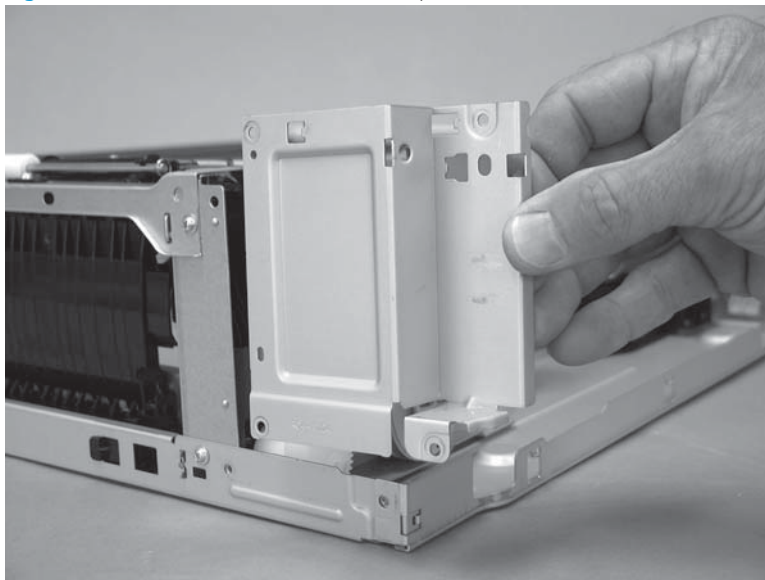

6. Install two screws (callout 1).

Figure 1-5385 Install two screws

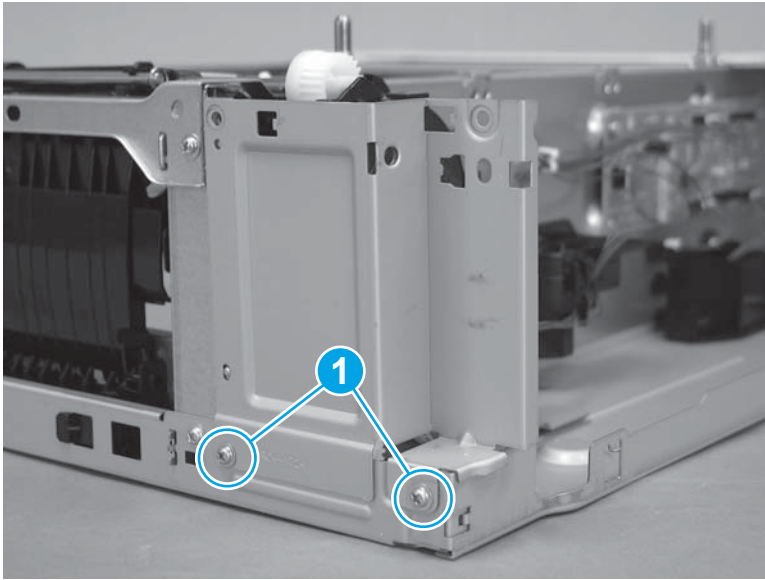

7. Position the sheet-metal plate on the chassis.

Figure 1-5386 Install the sheet-metal plate

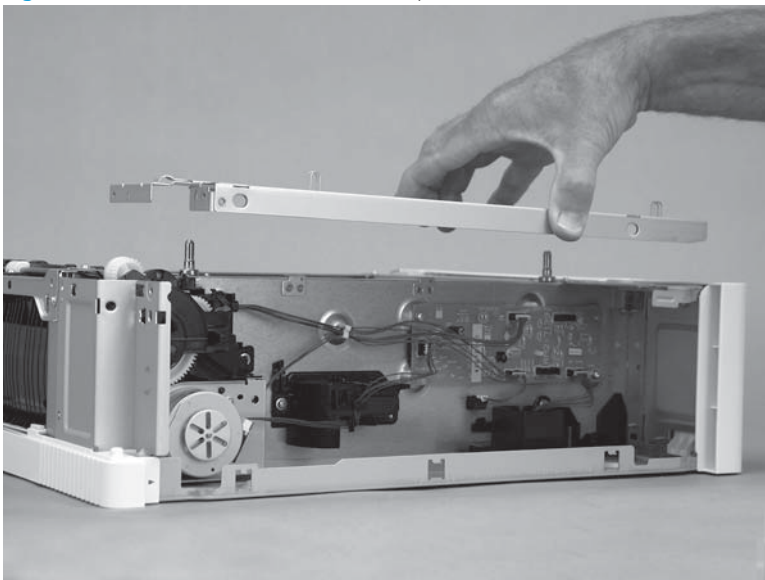

8. Install six screws (callout 1).

Figure 1-5387 Install six screws

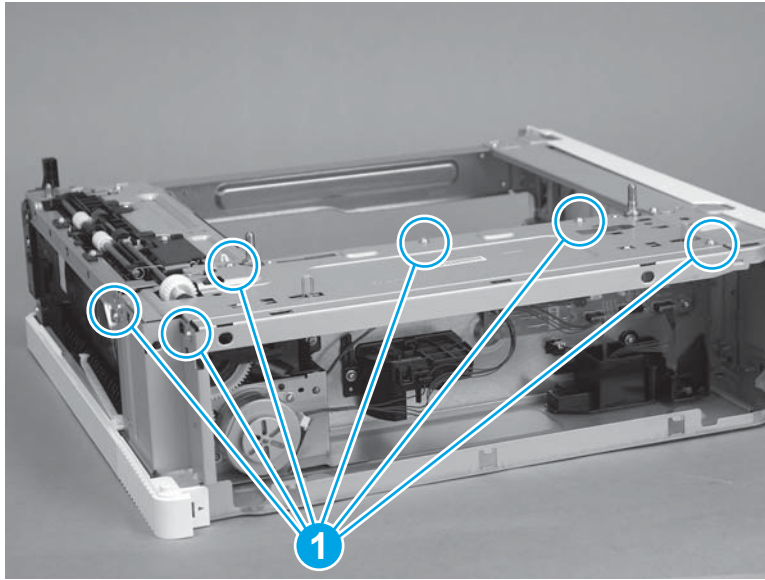

Step 9: Install the drawer connector holder

1. Position the drawer connector holder on the chassis.

 **NOTE:** Make sure that the wire harness (callout 1) was transferred from the discarded assembly to the replacement assembly.

Figure 1-5388 Place the tray connector on the accessory



2. Slide the drawer connector holder as shown (callout 1) to install it, and then make sure that one tab (callout 2) snaps into place .

Figure 1-5389 Install the tray connector

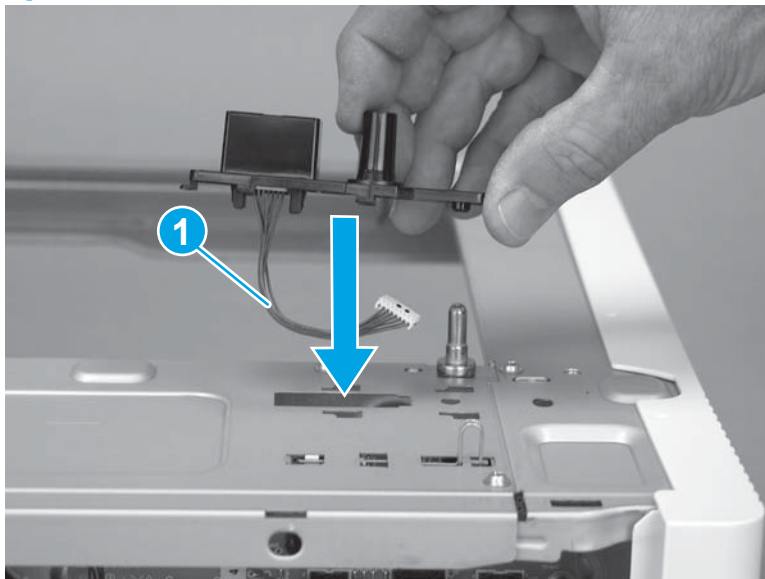
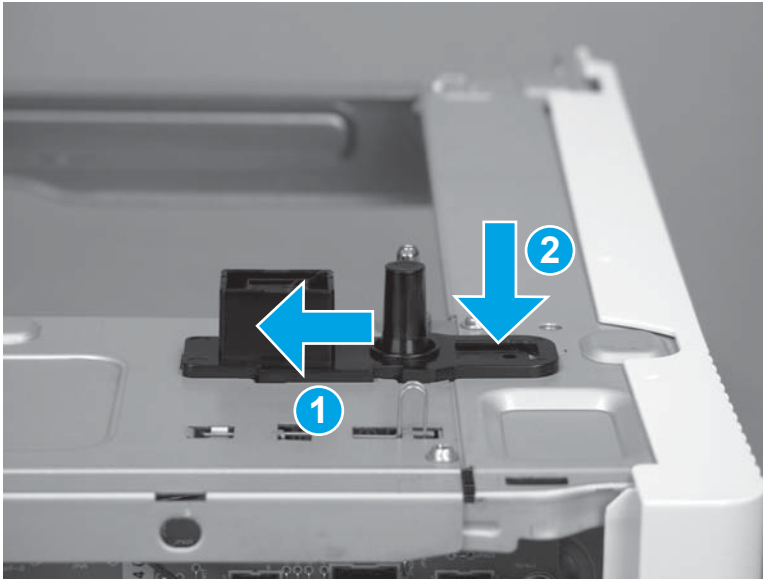

3. Connect one connector (callout 1; J901).

Figure 1-5390 Connect one connector

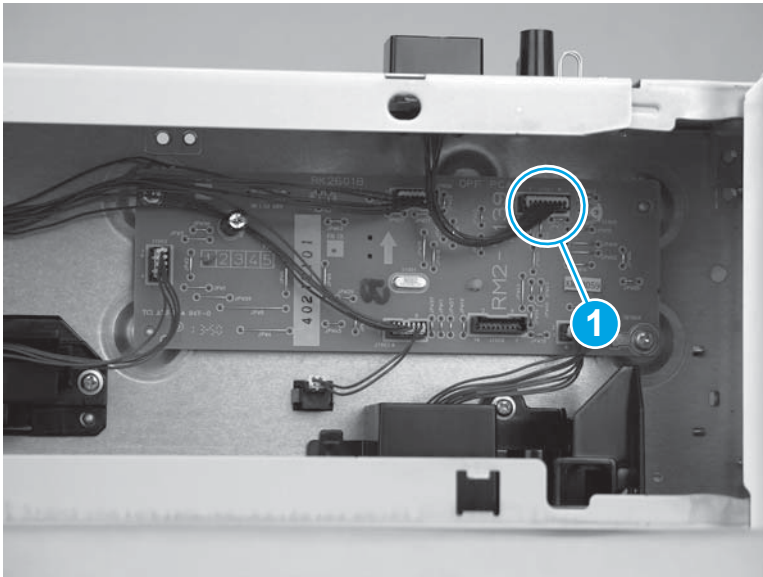

Step 10: Install the lower-right cover

1. Before proceeding, take note of the location of the three mounting tabs on the back side of the cover.

Figure 1-5391 Cover mounting tabs

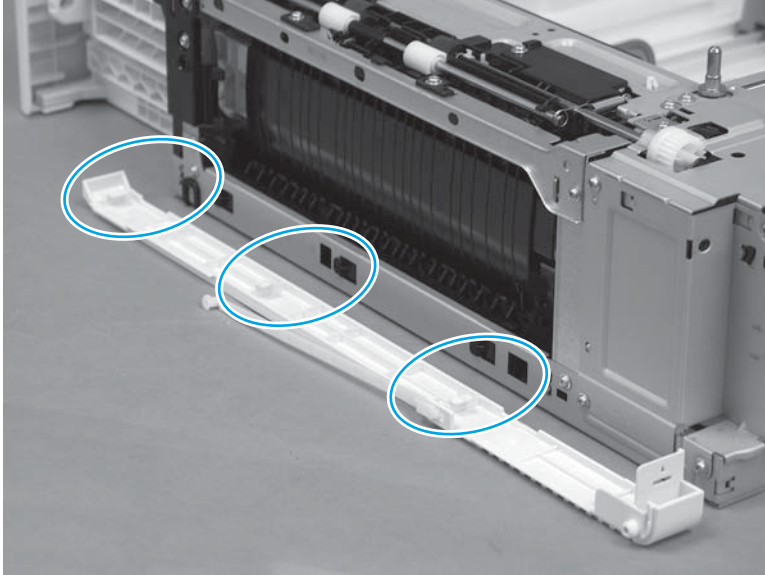

2. Align the three mounting tabs on the back side of the cover with the slots in the chassis.

Figure 1-5392 Install the right-lower cover

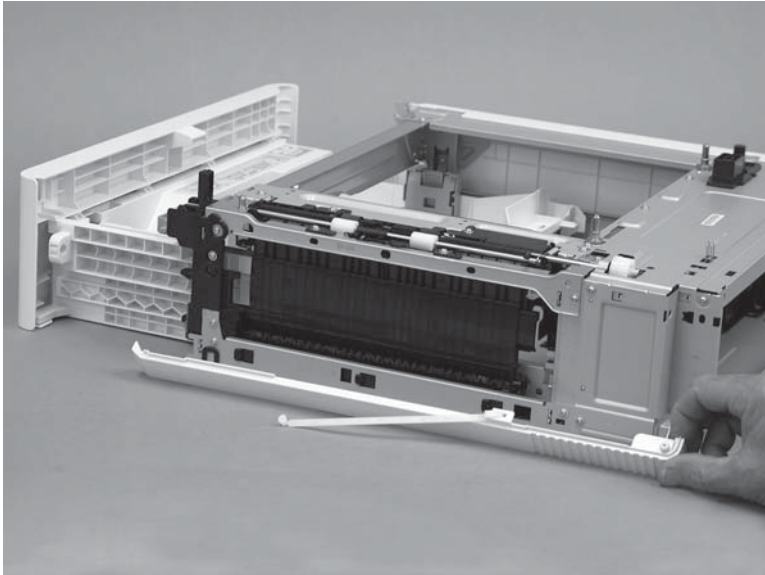

3. Press in on the middle tab (callout 1), slightly flex the end of the cover away from the accessory, and then slide it towards the rear of the accessory (callout 2) to engage the tabs with the slots.

⚠ CAUTION: The three mounting tabs on the back side of the cover are easily damaged. Do not over flex the end of the cover when it is installed.

Figure 1-5393 Engage the cover

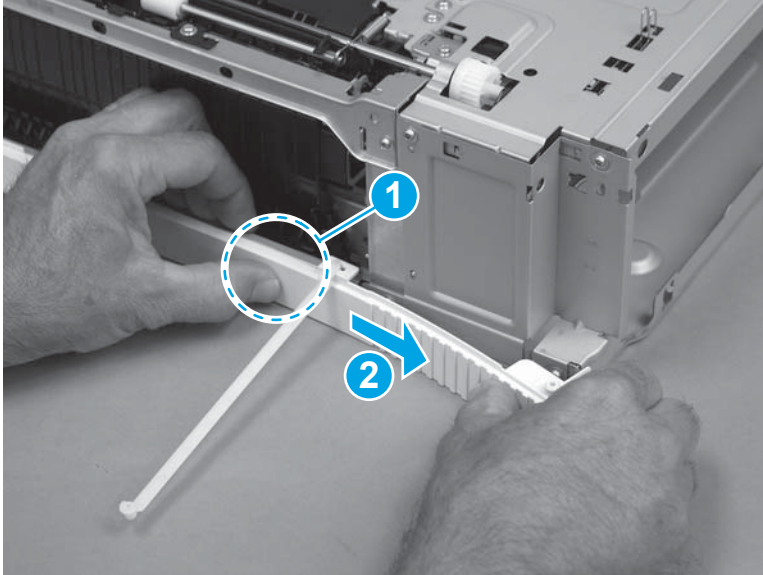

4. Verify that the end of the cover near the tray is correctly engaged with the chassis after installing the cover.

Figure 1-5394 Check the cover

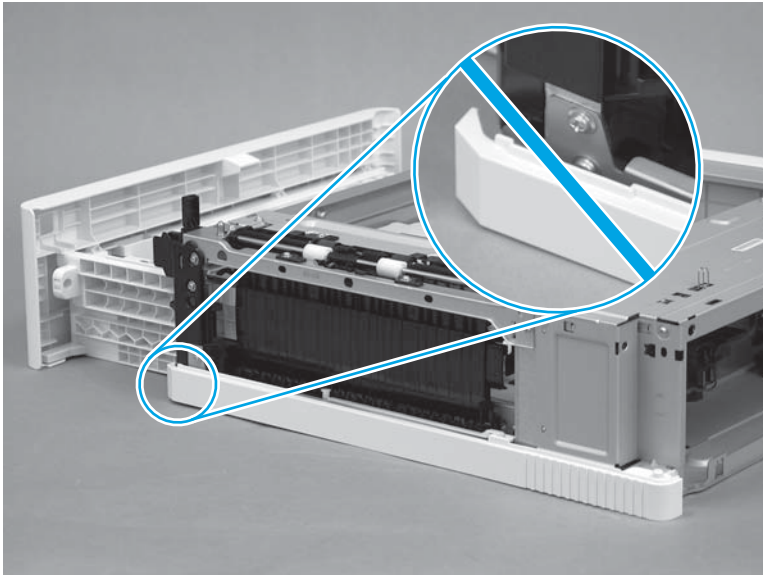

Step 11: Install the right door

1. Install the door link in the slot in the door to attach the door.

Figure 1-5395 Install the door link

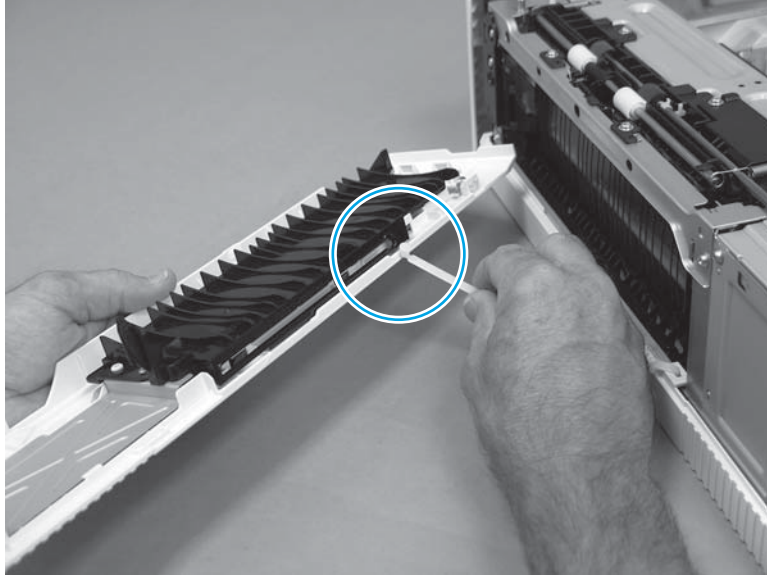

2. Position the lower hinge hole on the door (callout 2) on the lower hinge pin (callout 2) on the right-lower cover.

Figure 1-5396 Position the door on the lower hinge

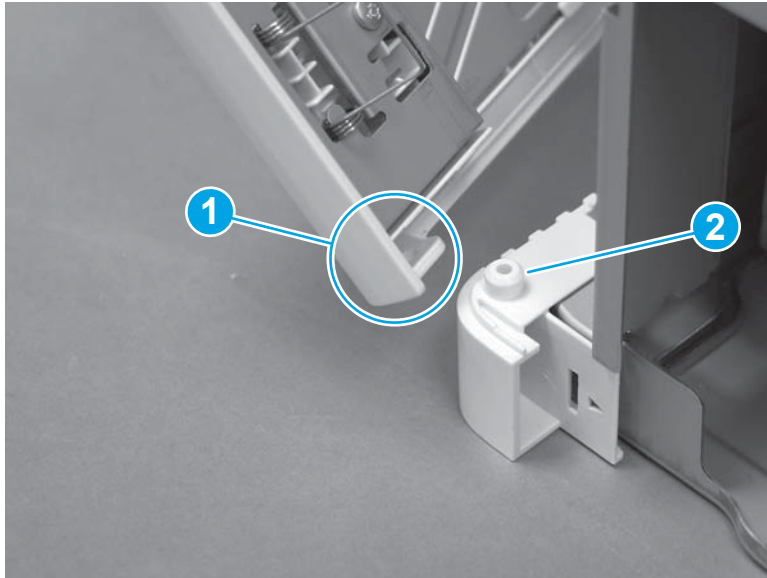

3. Align the pin of the door-hinge bracket (callout 1) with the hole in the chassis, and then align the mounting tabs (callout 2 and callout 3) with the slots in the chassis.

Figure 1-5397 Engage the hinge bracket

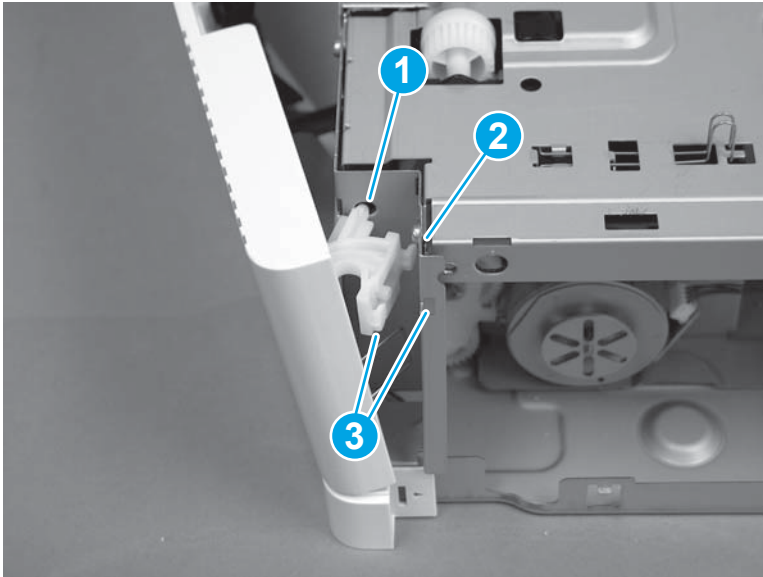

4. Push in on the door-hinge bracket (callout 1), and then slide it toward the chassis (callout 2) to install it.

Figure 1-5398 Install the hinge bracket

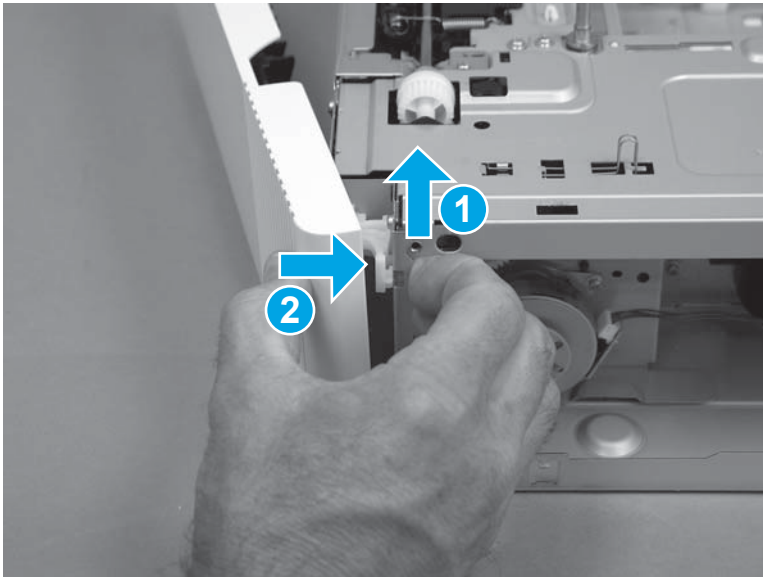

5. Close the door.

Figure 1-5399 Close the door

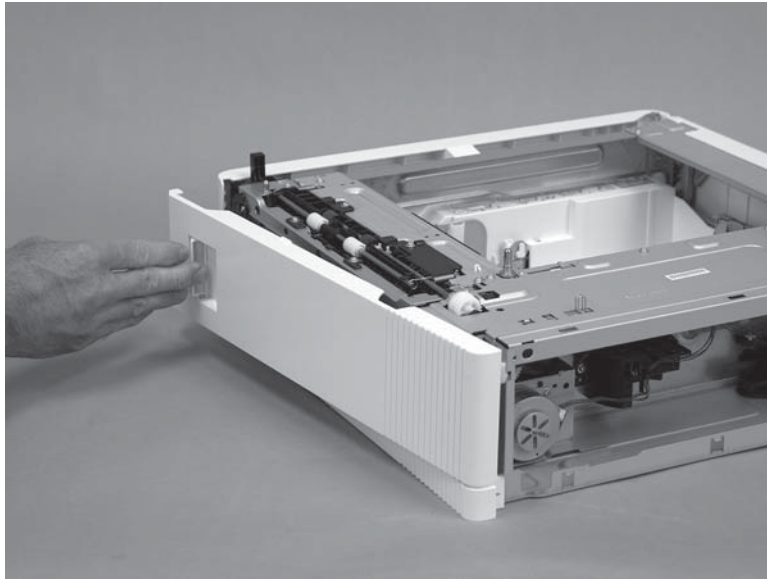

Step 12: Install the rear cover

1. Align the three mounting tabs (callout 1) on the cover with the slots in the chassis.

Figure 1-5400 Position the cover on the chassis

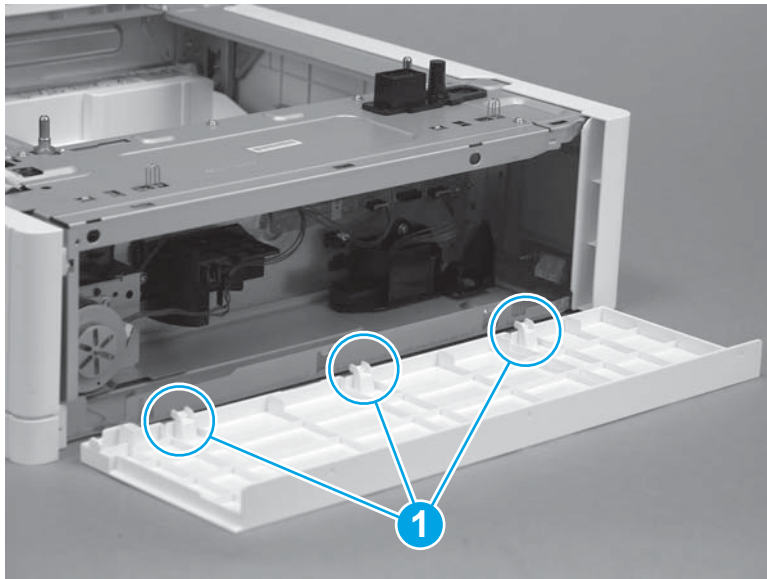

2. Position the cover on the accessory (callout 1), and then rotate the top of the cover up and onto the chassis (callout 2) to install it.

Figure 1-5401 Install the cover

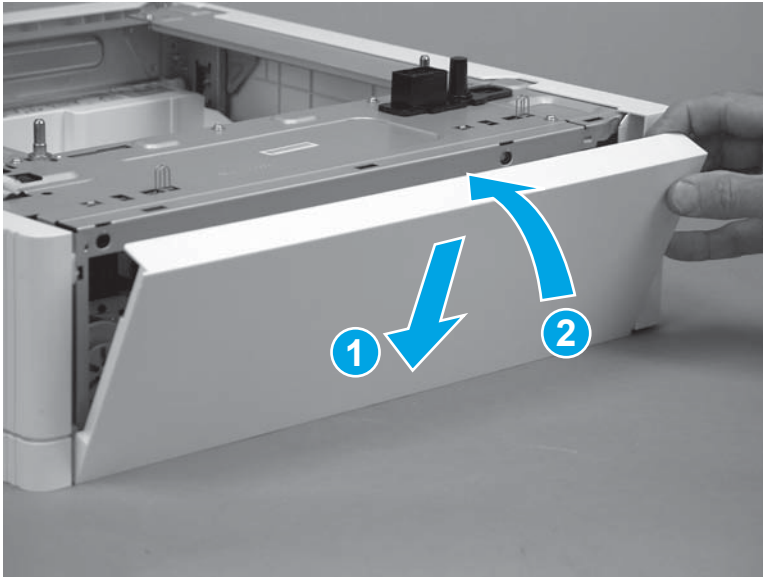

3. Make sure that the three tabs (callout 1) snap into place.

Figure 1-5402 Check the three tabs

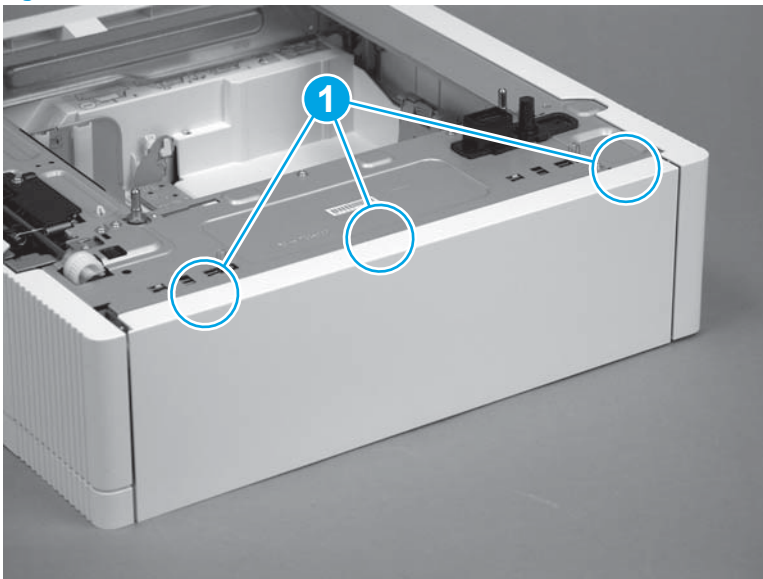

Step 13: Install the tray

1. With the front of the tray slightly lifted, align the sides of the tray with the rails in the printer, and then carefully slide the tray into the printer.

 **TIP:** As the tray slides into the accessory, lower the front of it.

Figure 1-5403 Install the tray



2. Close the tray.

Figure 1-5404 Close the tray

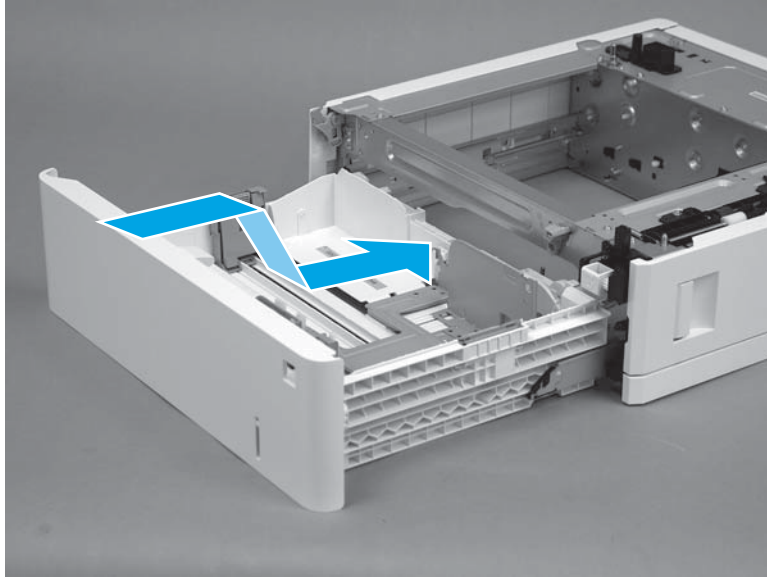
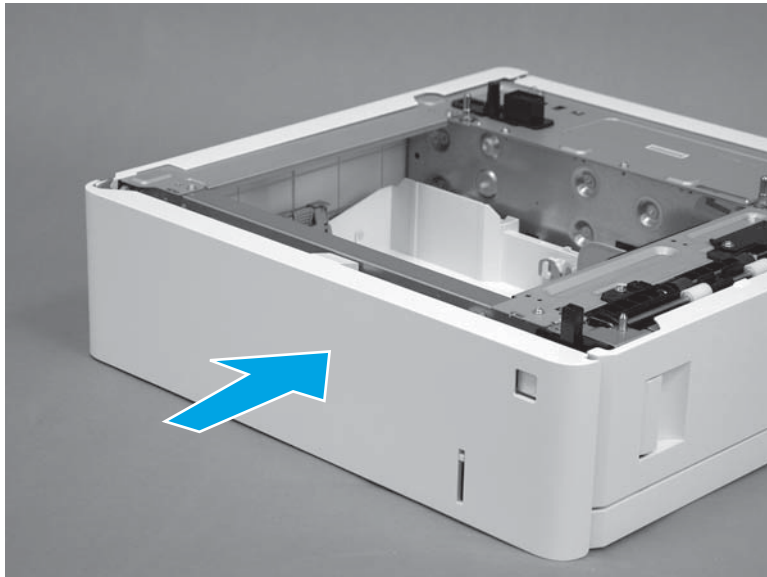

Removal and replacement: Lifter drive assembly (1x550-sheet paper feeder)

- [Introduction](#)
- [Step 1: Remove the tray](#)
- [Step 2: Remove the rear cover](#)
- [Step 3: Remove the right door](#)
- [Step 4: Remove the lower-right cover](#)
- [Step 5: Remove the drawer connector holder](#)
- [Step 6: Remove the feeder drive assembly](#)
- [Step 7: Remove the lifter drive assembly](#)
- [Step 8: Unpack the replacement assembly](#)
- [Step 9: Install the lifter drive assembly](#)
- [Step 10: Install the feeder drive assembly](#)
- [Step 11: Install the drawer connector holder](#)
- [Step 12: Install the lower-right cover](#)
- [Step 13: Install the right door](#)
- [Step 14: Install the rear cover](#)
- [Step 15: Install the tray](#)

Introduction

This document provides the procedures to remove and replace the 1x550-sheet paper feeder lifter drive assembly.

Before performing service

Use the table below to identify the correct part number for your printer, and then go to <http://h20141.www2.hp.com/hpparts> to order the part.

Lifter drive assembly (1x550-sheet paper feeder) part number

RM2-5149-000CNLifter drive assembly (1x550-sheet paper feeder)

Required tools

- #2 Phillips screwdriver with a magnetic tip and a 152-mm (6-in) shaft length
- Small, flat-blade screwdriver

After performing service

Make sure that the rear cover is flush against the chassis after replacing it.

Make sure that the right door latches correctly when closed after replacing it.

Make sure that Tray 3 is fully closed after replacing it.

Post service test

Print a page from a host computer using the appropriate tray as the source tray.

Step 1: Remove the tray

1. Pull the tray out until it stops.

Figure 1-5405 Pull the tray out

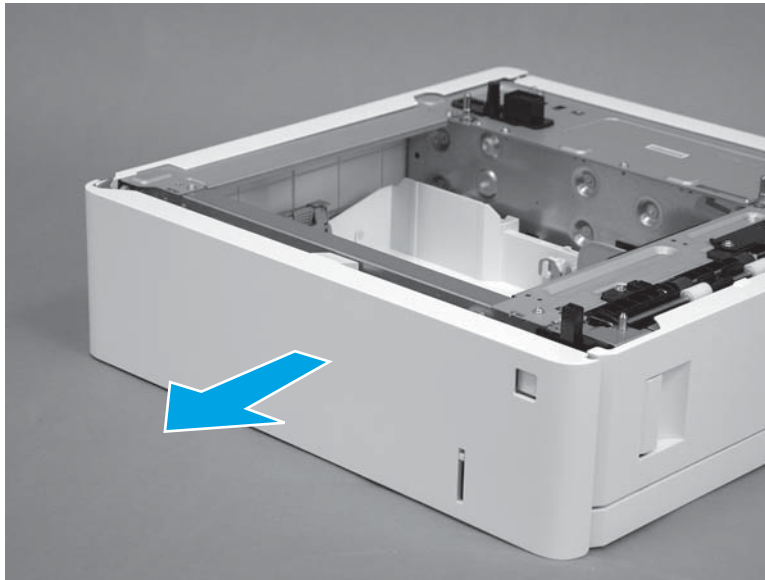

2. Lift the front of the tray, and then pull it out of the printer to remove it.

Figure 1-5406 Remove the tray

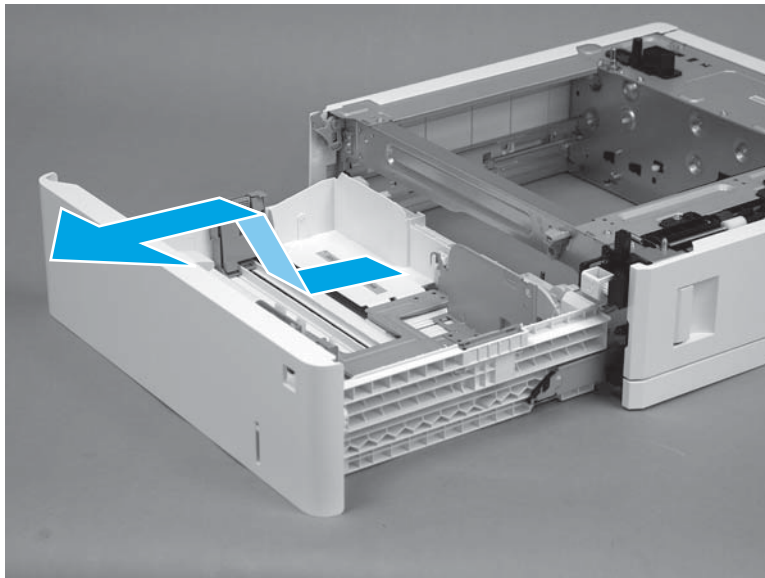

Step 2: Remove the rear cover

1. Release three tabs (callout 1).

Figure 1-5407 Release three tabs

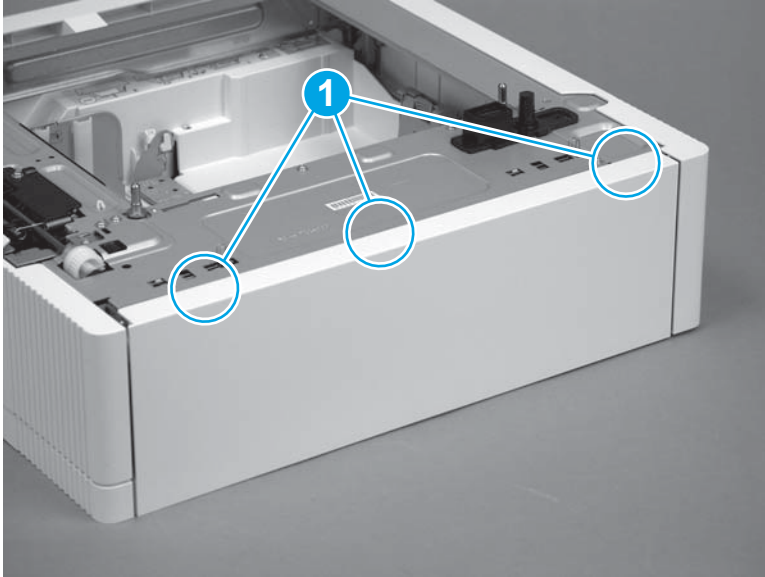

2. Rotate the top of the cover away from the accessory (callout 1), and then lift it up to remove it (callout 2).

Figure 1-5408 Remove the cover

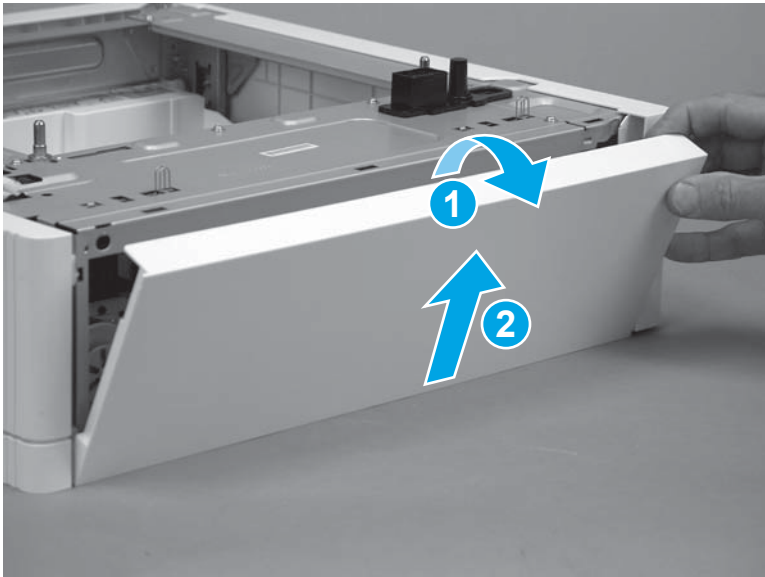

Step 3: Remove the right door

1. Open the door.

Figure 1-5409 Open the door

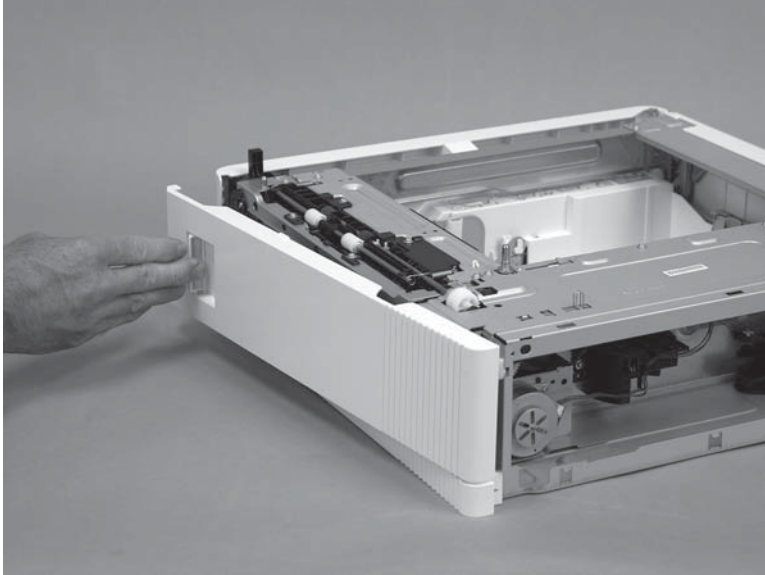

2. Release one tab (callout 1), and then slide the door-hinge bracket away from the chassis (callout 2) to release it.

Figure 1-5410 Release the hinge bracket

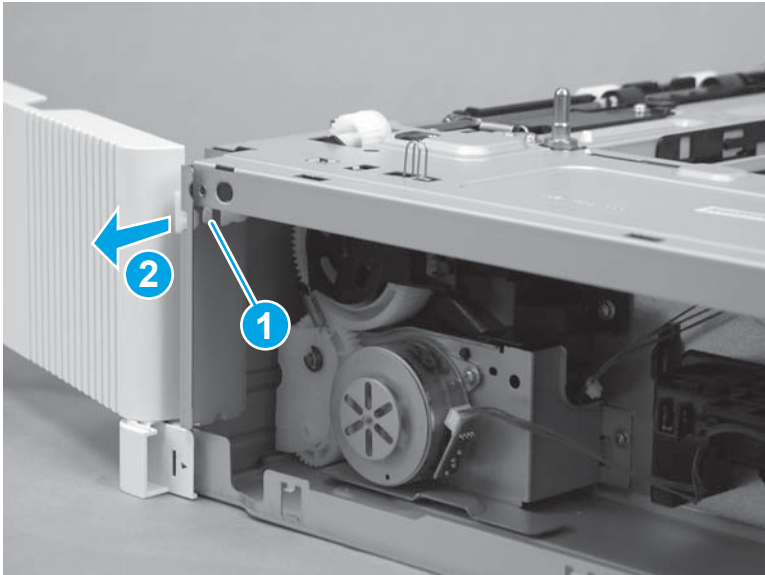

3. Remove the door-hinge bracket from the chassis.

⚠ CAUTION: The door is still attached to the accessory by the door link. Do not attempt to completely remove the door.

The door hinge bracket is not captive. Do not lose it when handling the door.

Figure 1-5411 Remove the hinge bracket

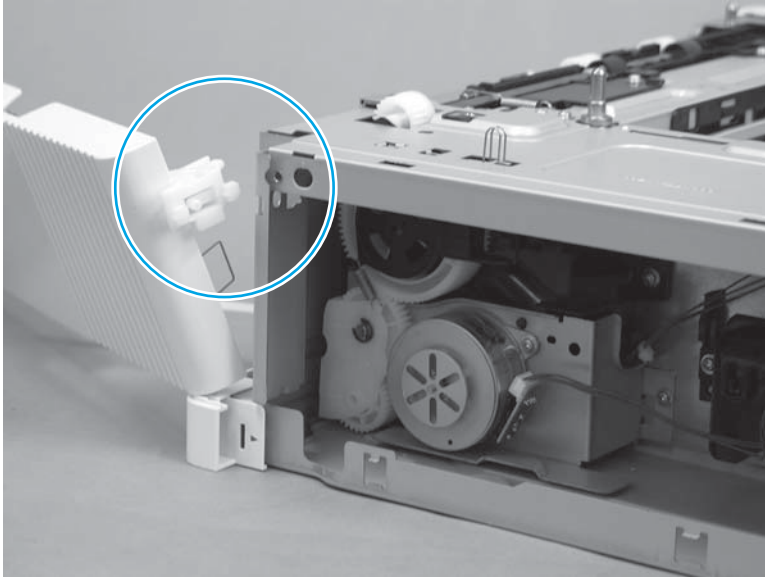

4. Release the door link from the slot in the door to remove the right door.

Figure 1-5412 Release the door link

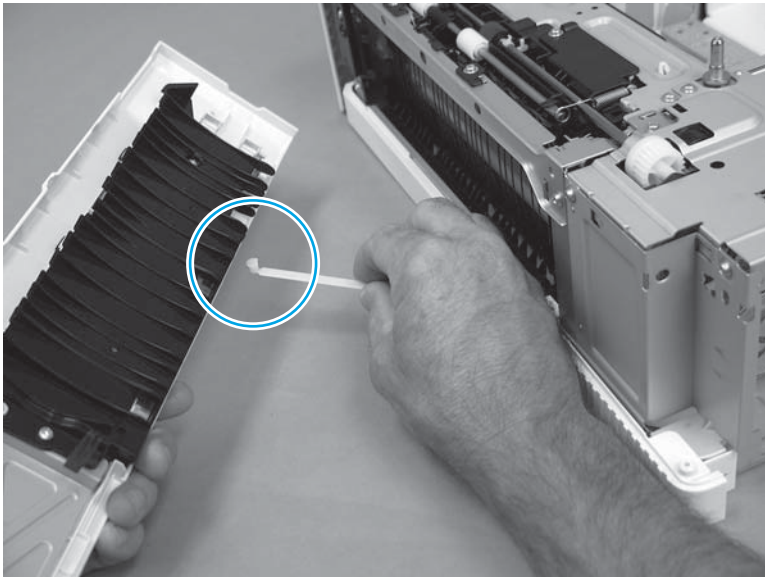

Step 4: Remove the lower-right cover

1. Before proceeding, take note of the location of the three mounting tabs on the back side of the cover.

Figure 1-5413 Cover mounting tabs

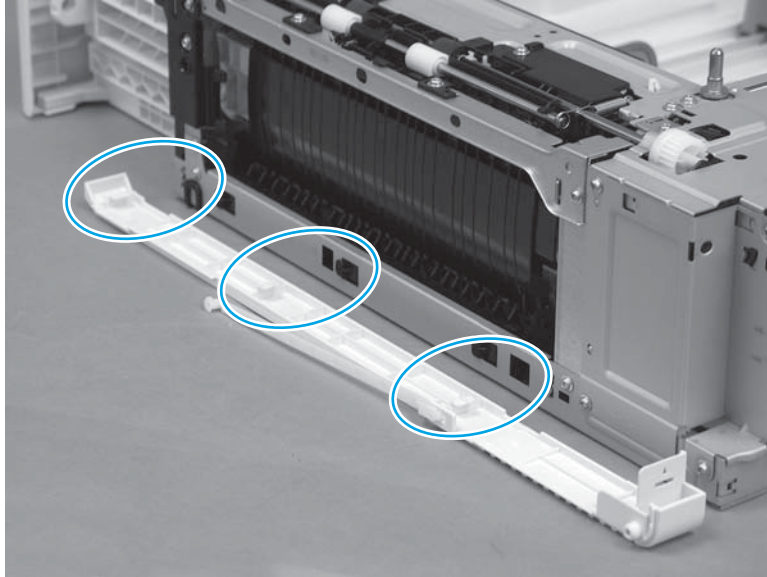

2. Partially open the tray, slightly flex the end of the cover away from the accessory (callout 1), and then slide it towards the front of the accessory (callout 2) to release it.

⚠ CAUTION: The three mounting tabs on the back side of the cover are easily damaged. Do not over flex the end of the cover when it is released. Push in on the middle tab to protect it when removing the cover.

Figure 1-5414 Release the cover

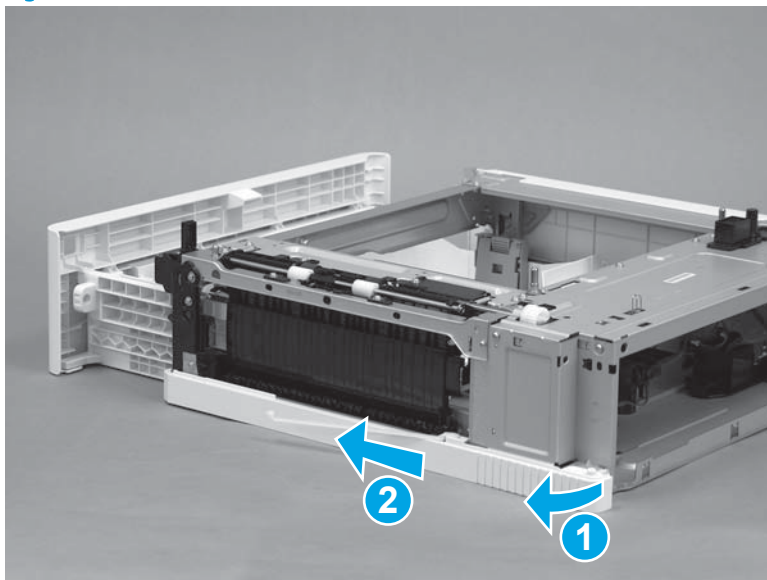

3. Remove the right-lower cover.

Figure 1-5415 Remove the right-lower cover

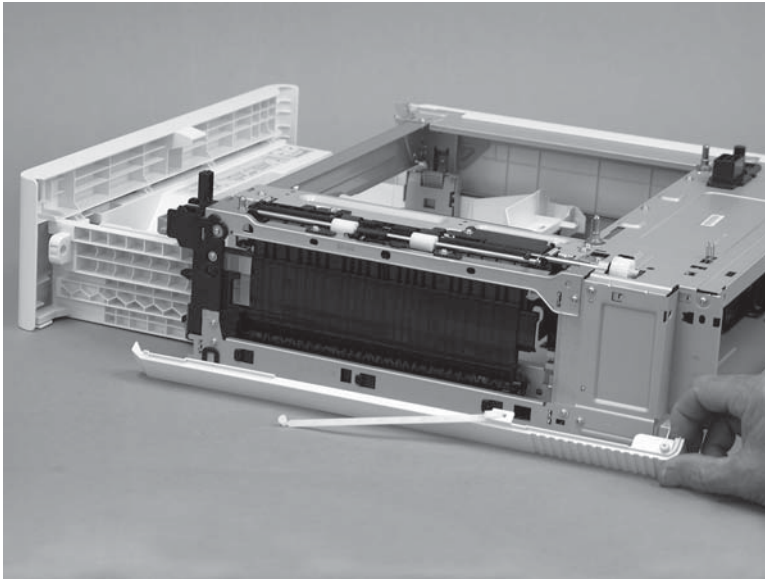

Step 5: Remove the drawer connector holder

1. Disconnect one connector (callout 1; J901).

Figure 1-5416 Disconnect one connector

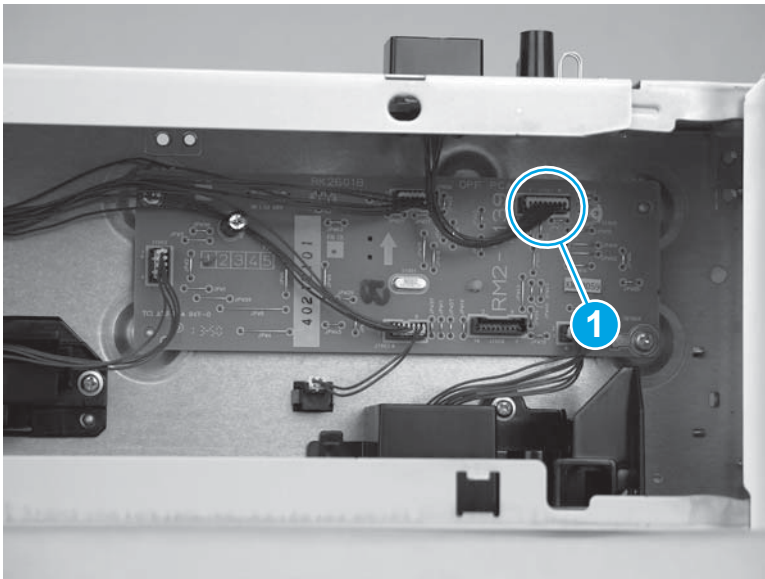

2. Release one tab (callout 1), and then slide the drawer connector holder as shown (callout 2) to release it.

Figure 1-5417 Release one tab

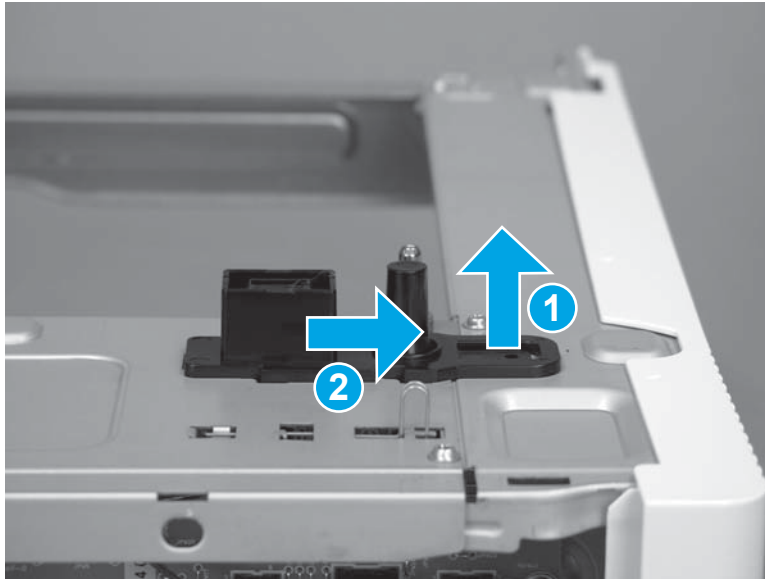

3. Remove the drawer connector holder.

Figure 1-5418 Remove the tray connector

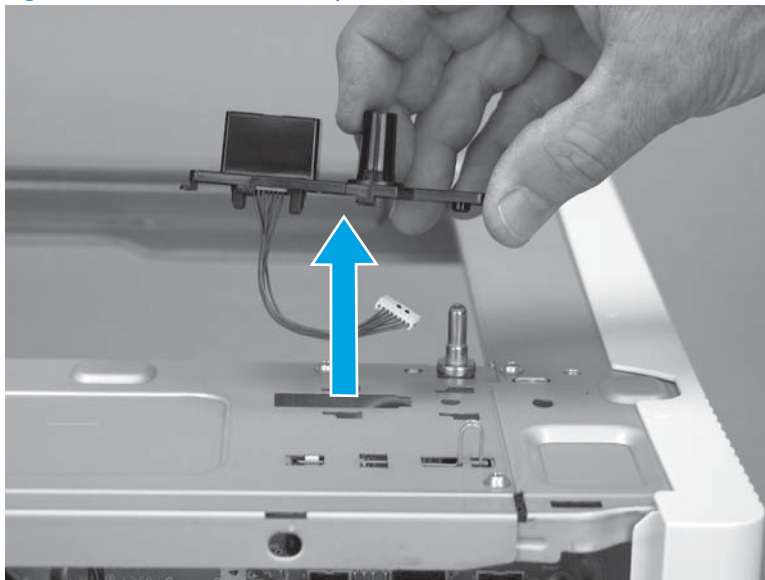

Step 6: Remove the feeder drive assembly

1. Remove six screws (callout 1).

Figure 1-5419 Remove six screws

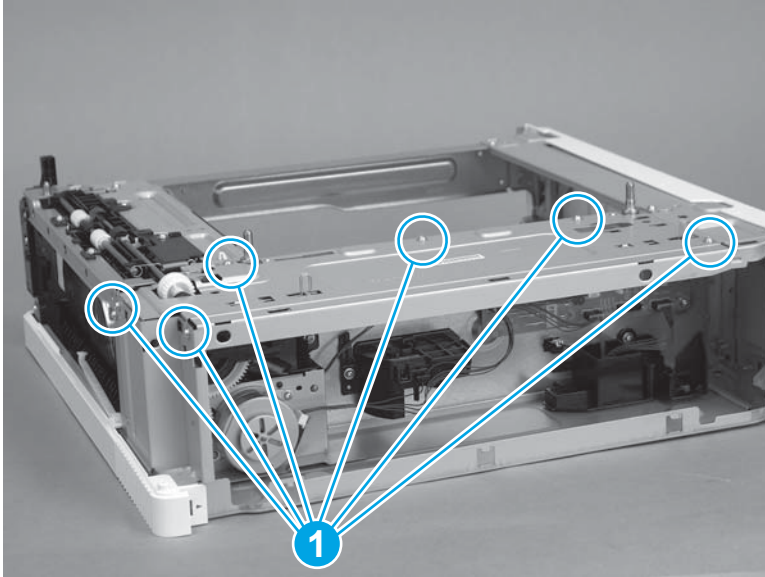

2. Remove the sheet-metal plate.

Figure 1-5420 Remove the sheet-metal plate

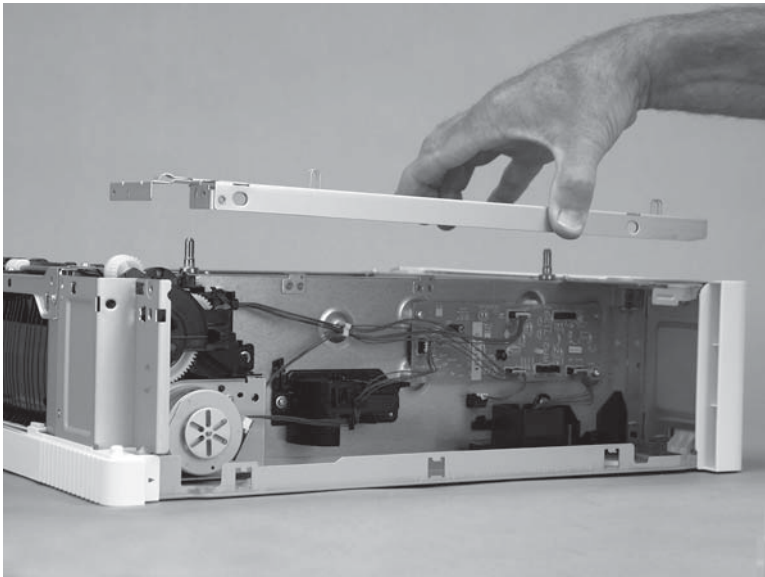

3. Remove two screws (callout 1).

Figure 1-5421 Remove two screws

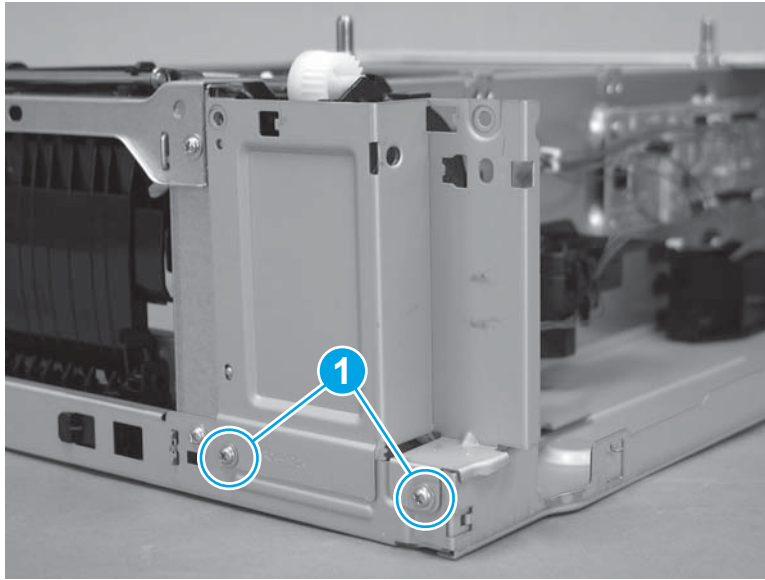

4. Remove the sheet-metal plate.

Figure 1-5422 Remove the sheet-metal plate

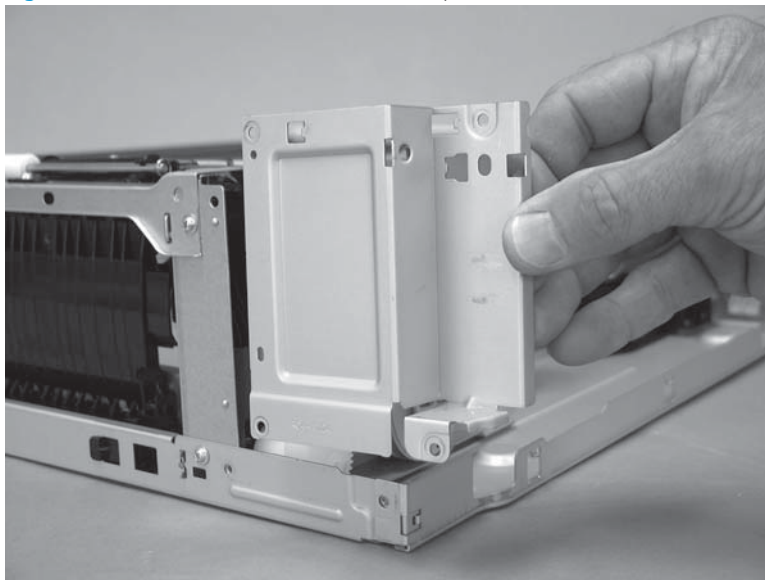

5. Disconnect one connector (callout 1).

Figure 1-5423 Disconnect one connector

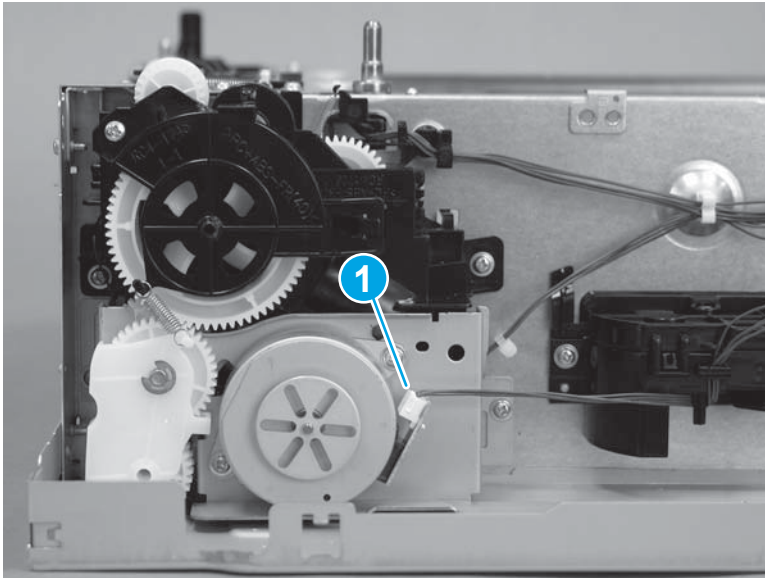

6. Remove one spring (callout 1).

Figure 1-5424 Remove one spring

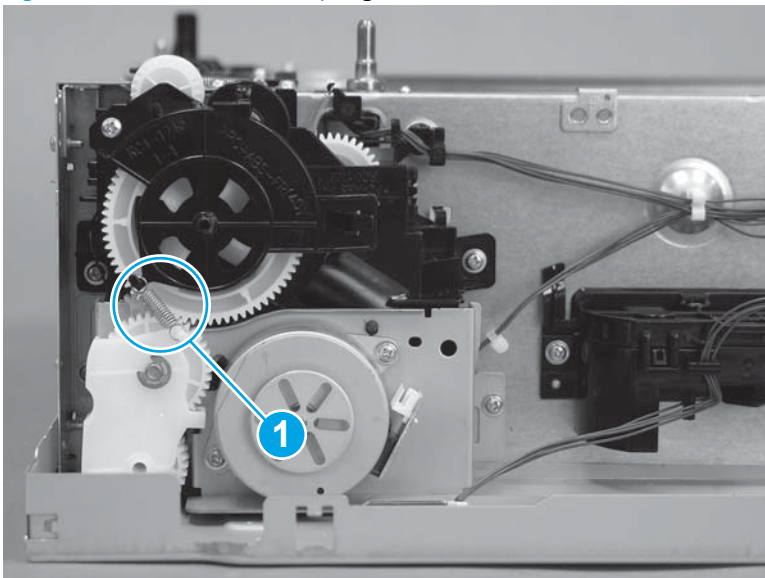

7. Remove two screws (callout 1).

Figure 1-5425 Remove two screws

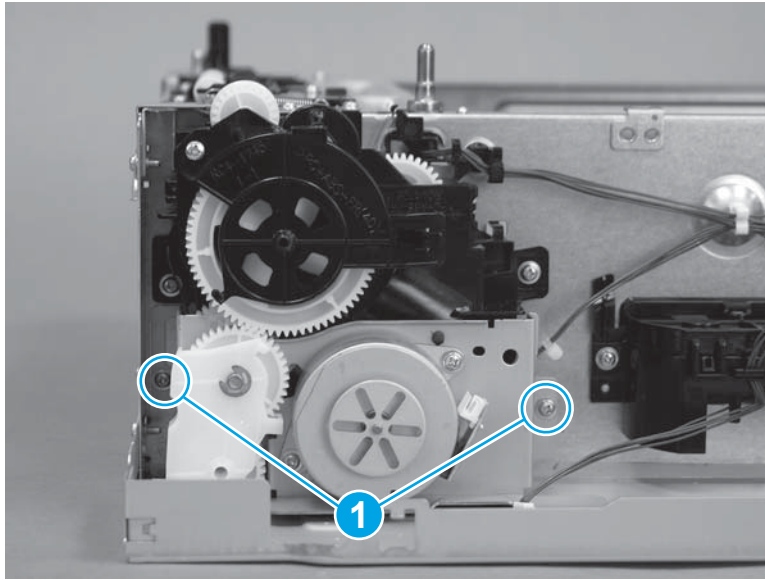

8. Remove the feeder drive assembly.

⚠ CAUTION: If the assembly is being removed to access another part, take care not to wipe any of the grease off of the gears.

Figure 1-5426 Remove the assembly

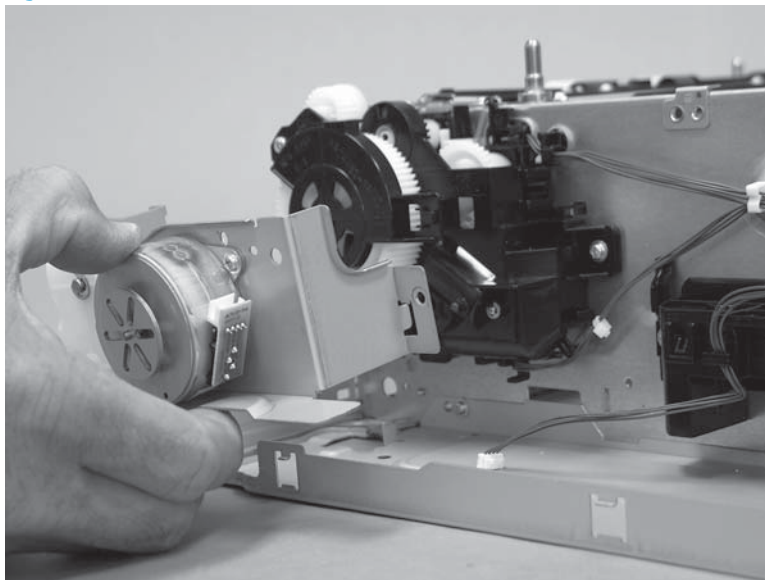

Step 7: Remove the lifter drive assembly

1. Disconnect one connector (callout 1; J904), and then release the wire harness from the retainer (callout 2) and the guide (callout 3).

Figure 1-5427 Disconnect one connector

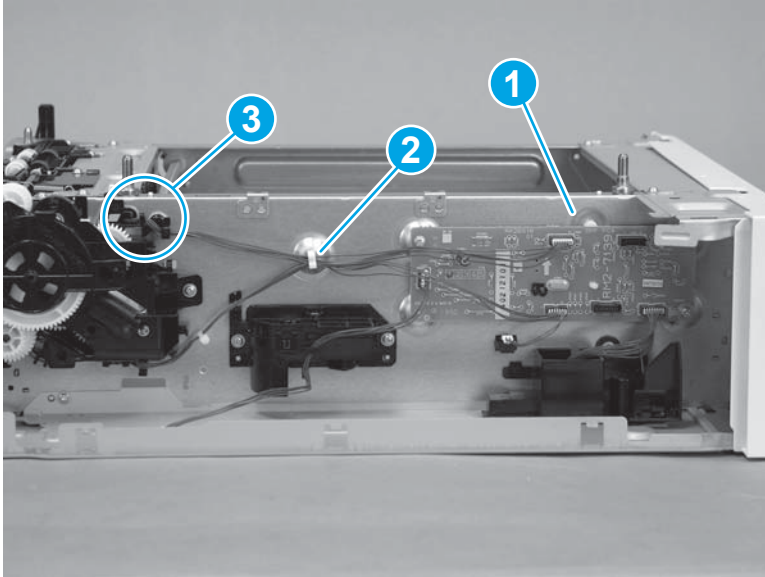

2. Disconnect two connectors (callout 1; J902 and the switch button), and then release the wire harness from the retainer (callout 2).

Figure 1-5428 Disconnect two connectors

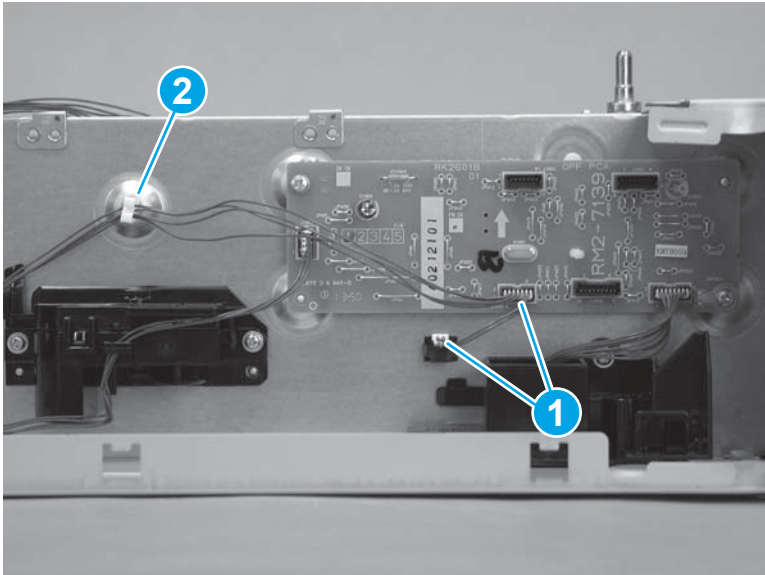

3. Remove two screws (callout 1).

Figure 1-5429 Remove two screws

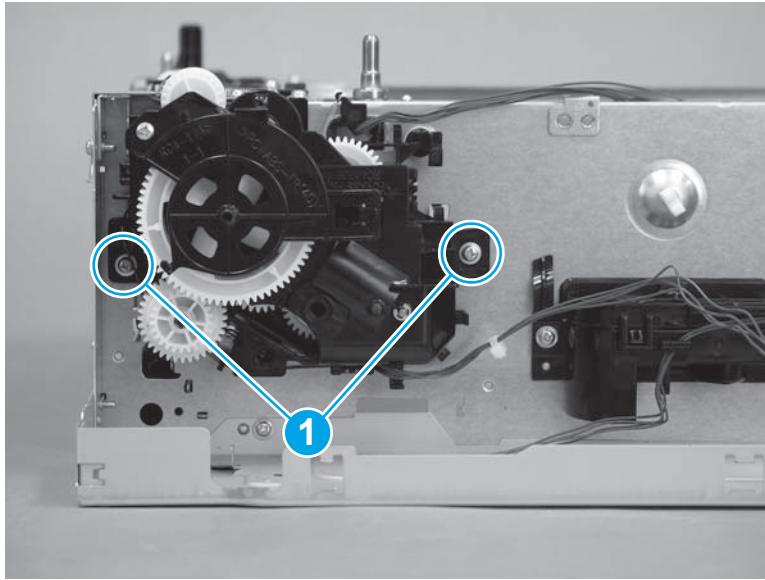

4. Release one tab (callout 1), and then slightly pull the lifter drive assembly away from the chassis to release one gear (callout 2).

Figure 1-5430 Release one tab

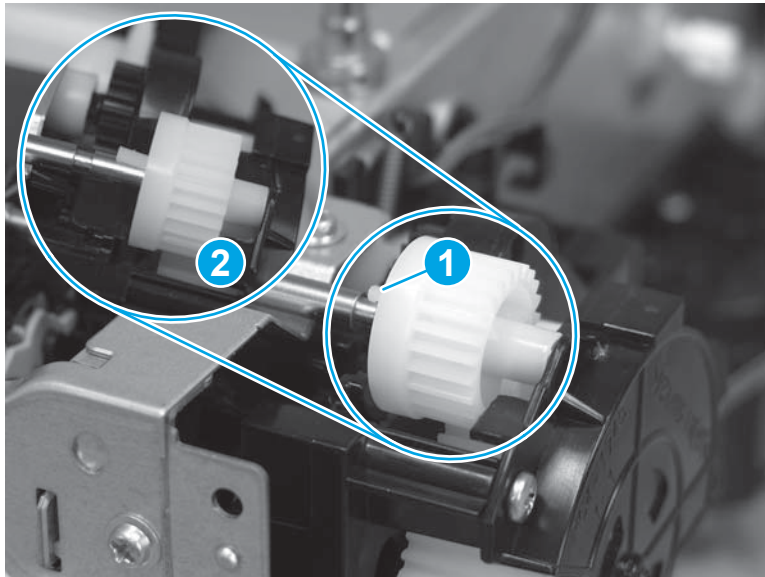

5. Release two tabs (callout 1), and then rotate the assembly—as shown—away from the chassis (callout 2) to release it.

Figure 1-5431 Release two tabs

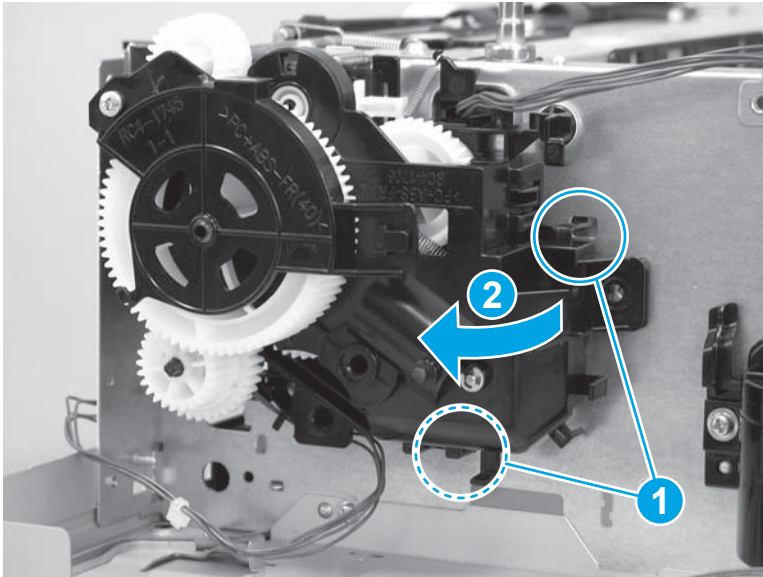

6. To remove the lifter drive assembly, feed the wire harness through the opening (callout 1) in the assembly.

 **Reinstallation tip:** If a replacement assembly is installed, transfer the gear (callout 2) to the replacement assembly.

Figure 1-5432 Remove the assembly

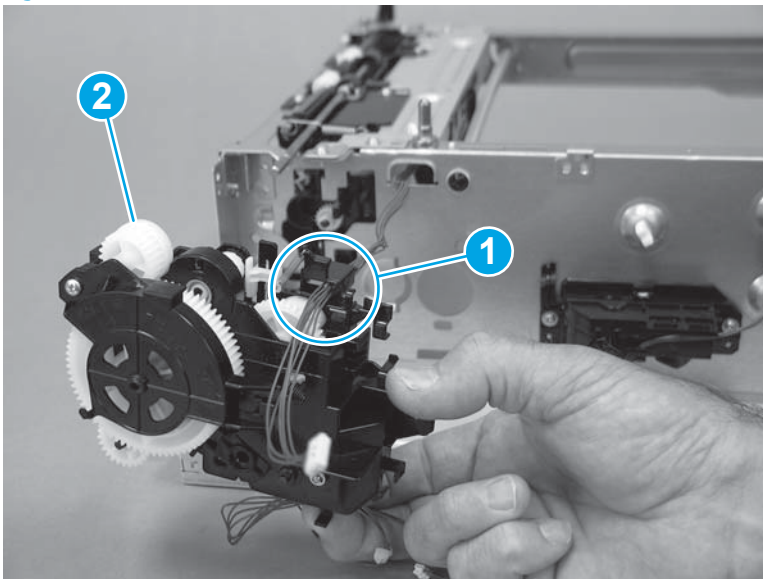

Step 8: Unpack the replacement assembly

Unpack the replacement assembly from the packaging.

For complete information on HP's recycling programs, go to [Product return and recycling](#).

CAUTION: When handling the replacement assembly, take care not to wipe any of the grease off of the gears.

NOTE: HP recommends responsible disposal of the defective assembly.

Figure 1-5433 Recycle and unpack

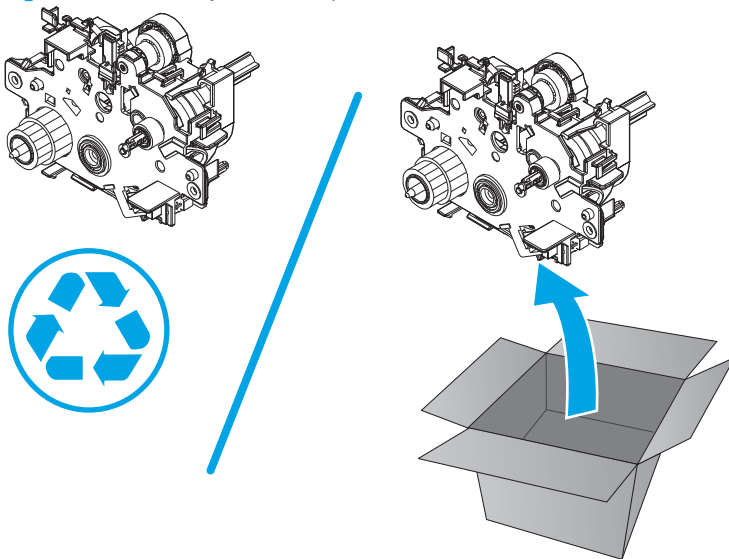

Step 9: Install the lifter drive assembly

1. Feed the wire harness through the opening in the assembly (callout 1), and then position the lifter drive assembly near the chassis to install it.

TIP: Make sure that the gear (callout 2) was transferred from the discarded assembly to the replacement assembly.

Figure 1-5434 Install the assembly

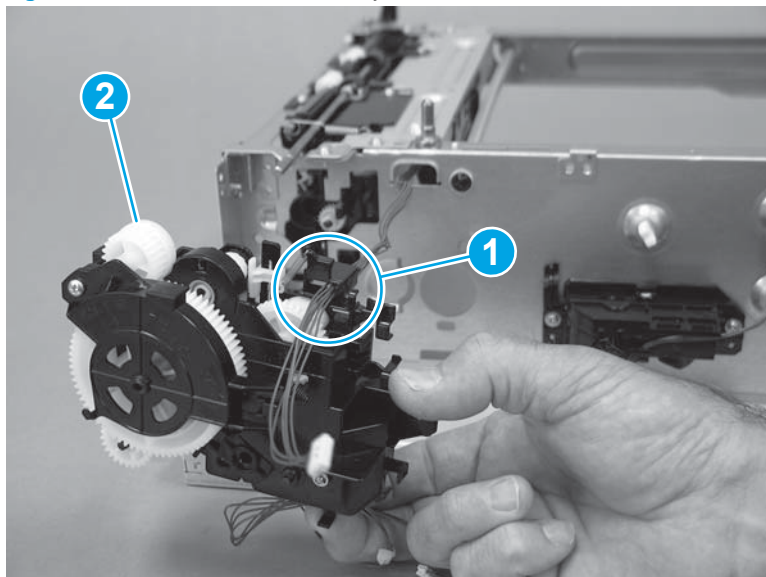

2. Insert the keyed end of the shaft into the gear (callout 1) on the lifter drive assembly—turn the shaft on the paper feed assembly or the gear on the lifter drive assembly to align the keyed shaft with the gear.

 **IMPORTANT:** When the assembly is fully installed, the tab on the gear snaps into place.

Figure 1-5435 Install the gear on the shaft



3. Install the assembly on the chassis, and then make sure that the two tabs (callout 1) snap into place.

Figure 1-5436 Install the assembly

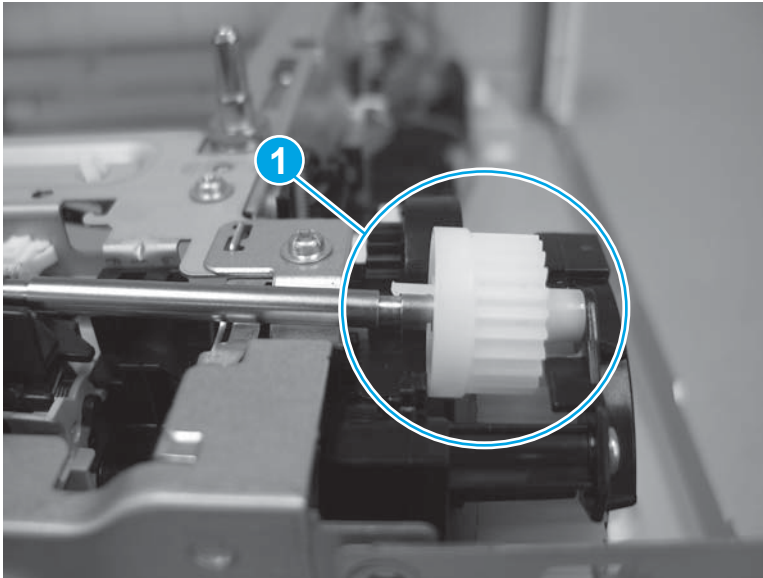
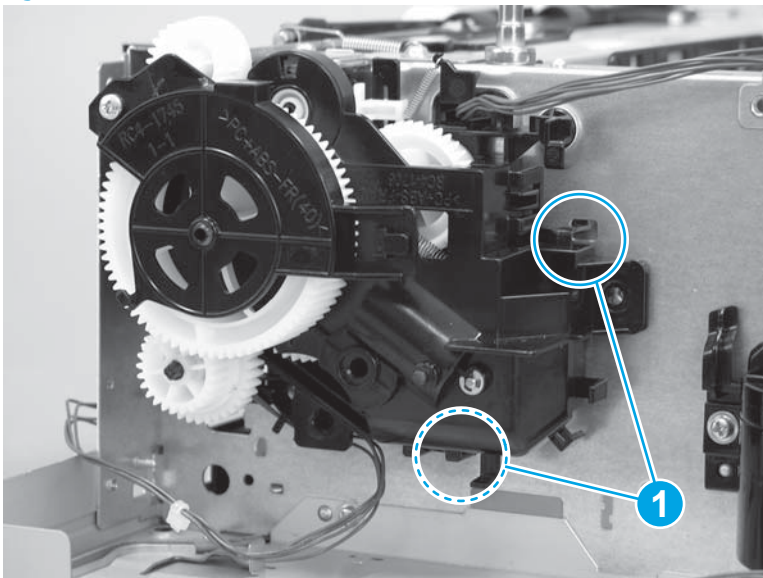

4. Install two screws (callout 1).

Figure 1-5437 Install two screws

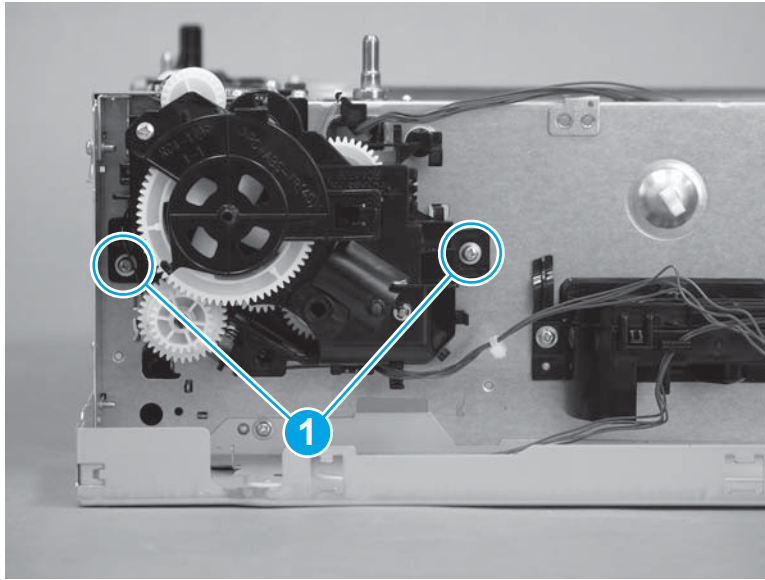

5. Install the wire harness in the retainer (callout 1), and then connect two connectors (callout 2; J902 and the switch button).

Figure 1-5438 Connect two connectors

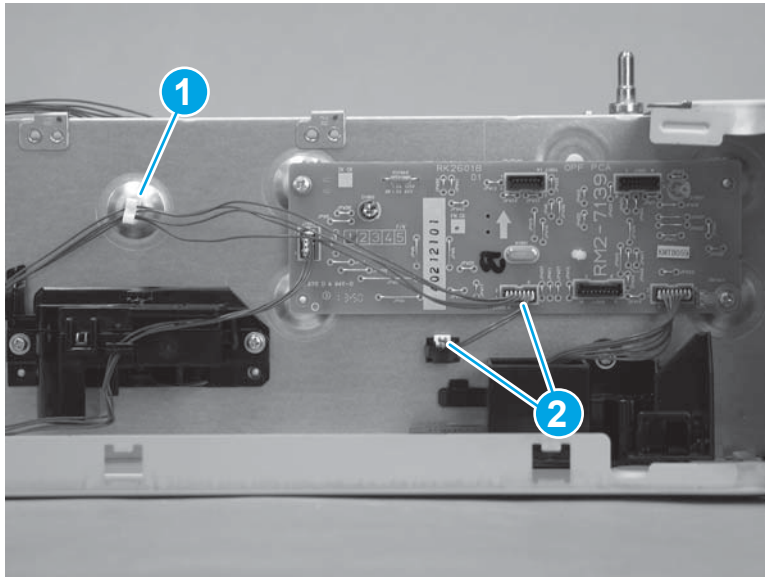

6. Install the wire harness in the guide (callout 1) and retainer (callout 2), and then connect one connector (callout 3; J904).

Figure 1-5439 Connect one connector

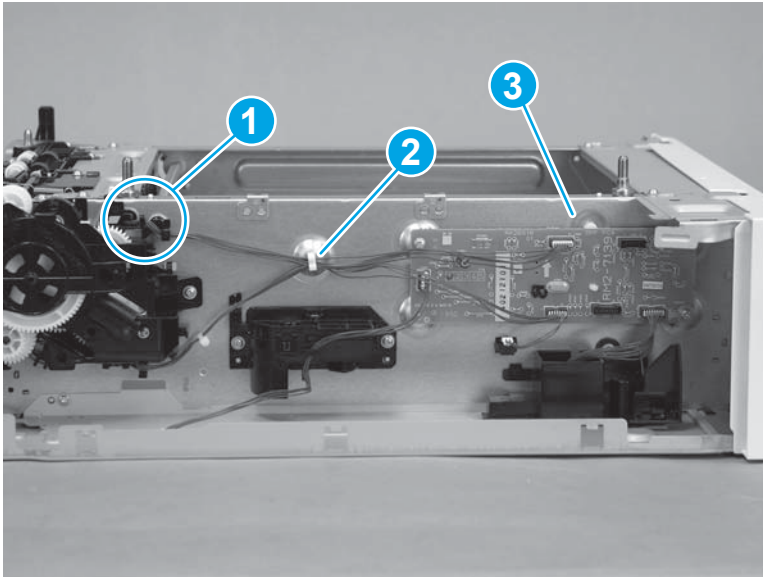

Step 10: Install the feeder drive assembly

1. Position the feeder drive assembly in the chassis.

⚠ CAUTION: When handling the assembly, take care not to wipe any of the grease off of the gears.

Figure 1-5440 Install the assembly

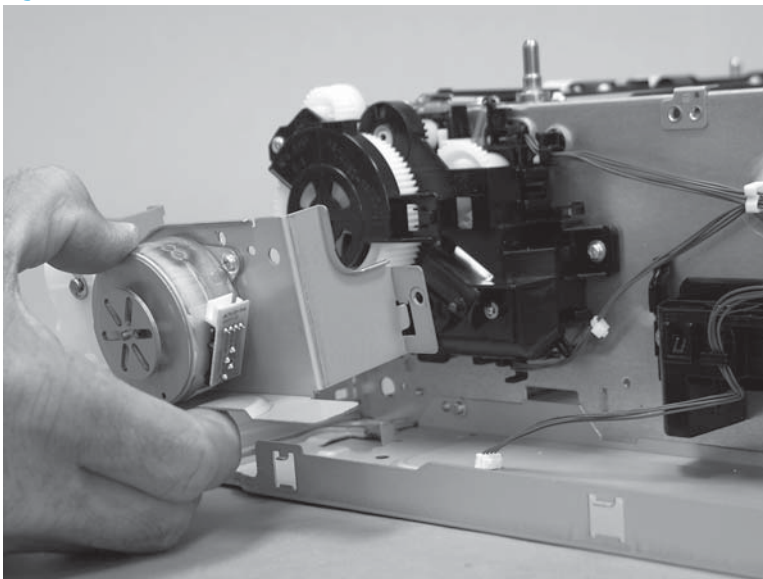

2. Install two screws (callout 1).

Figure 1-5441 Install two screws

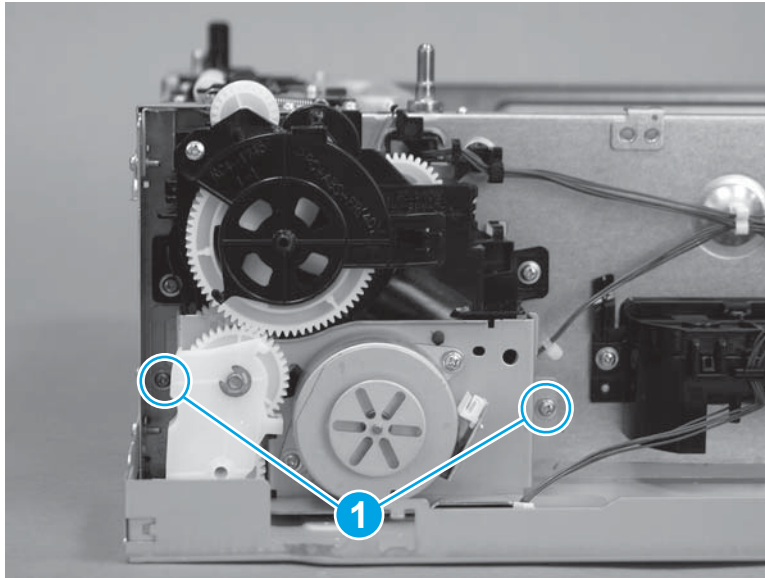

3. Install one spring (callout 1).

Figure 1-5442 Install one spring

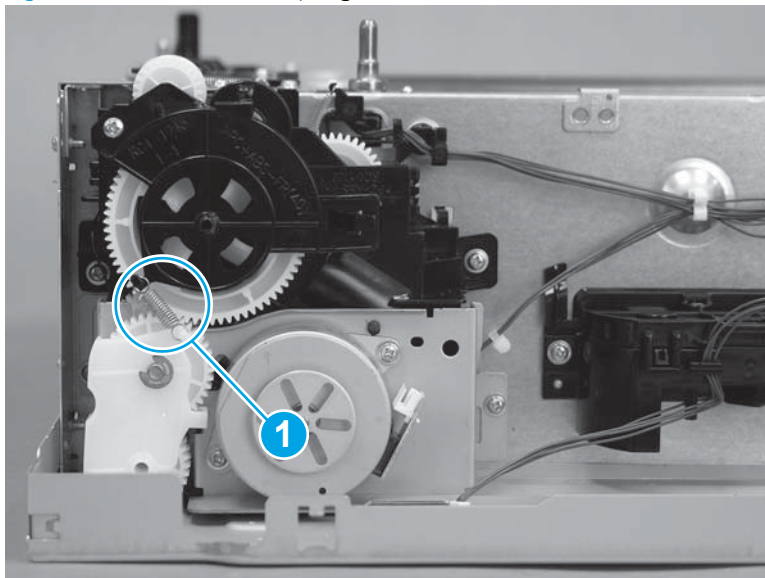

4. Connect one connector (callout 1).

Figure 1-5443 Connect one connector

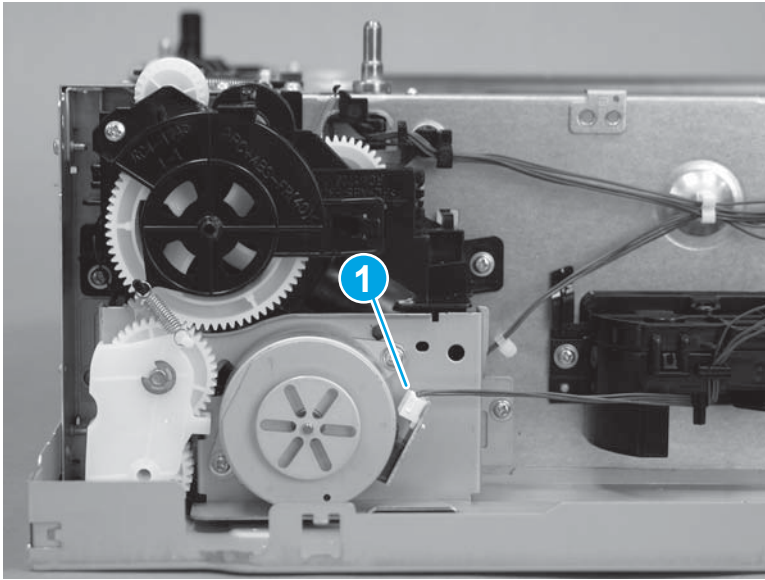

5. Position the sheet-metal plate on the chassis.

Figure 1-5444 Install the sheet-metal plate

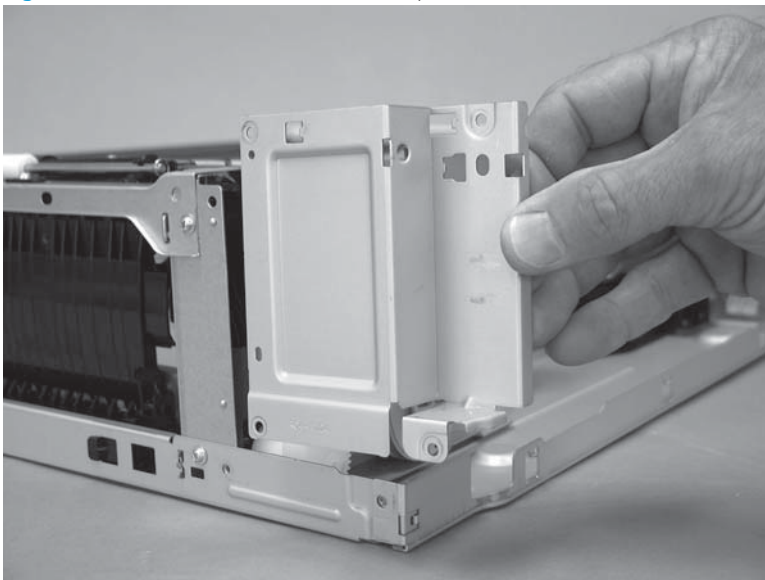

6. Install two screws (callout 1).

Figure 1-5445 Install two screws

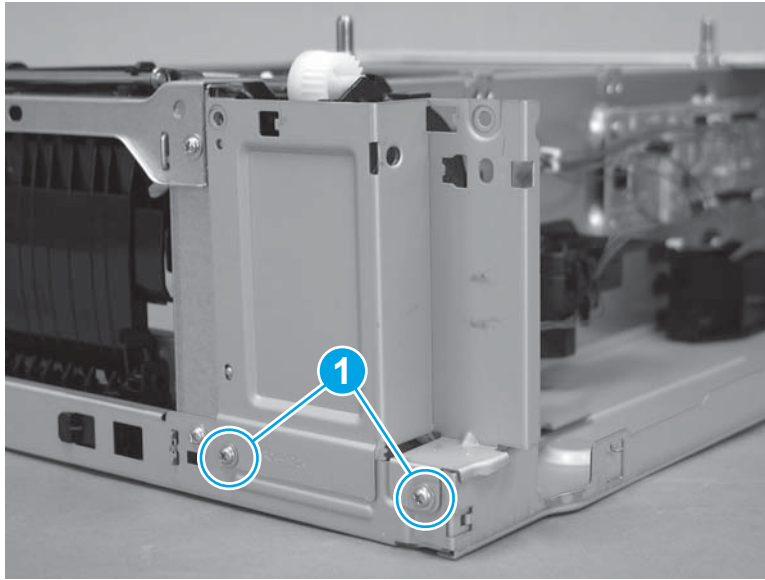

7. Position the sheet-metal plate on the chassis.

Figure 1-5446 Install the sheet-metal plate

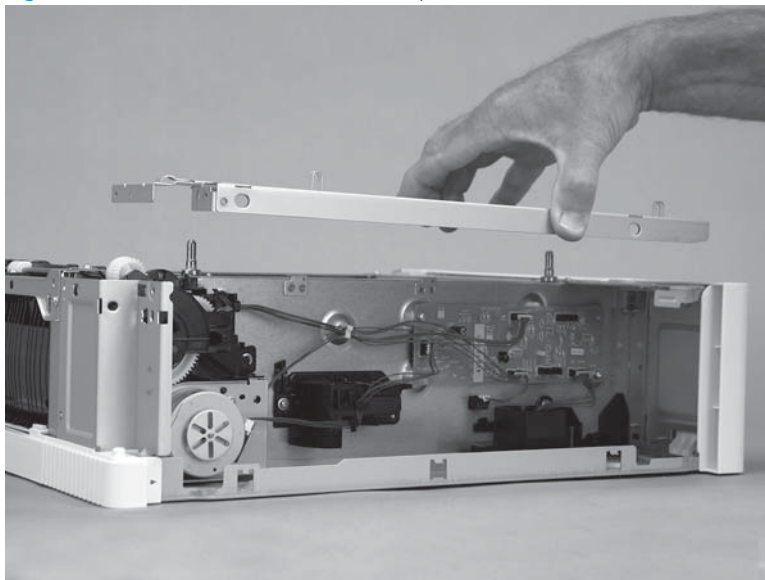

8. Install six screws (callout 1).

Figure 1-5447 Install six screws

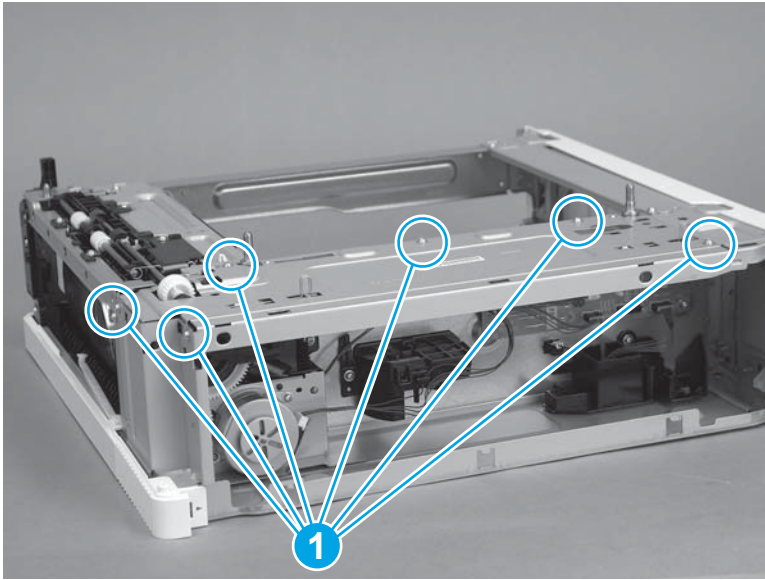

Step 11: Install the drawer connector holder

1. Position the drawer connector holder on the chassis.

 **NOTE:** Make sure that the wire harness (callout 1) was transferred from the discarded assembly to the replacement assembly.

Figure 1-5448 Place the tray connector on the accessory



2. Slide the drawer connector holder as shown (callout 1) to install it, and then make sure that one tab (callout 2) snaps into place .

Figure 1-5449 Install the tray connector

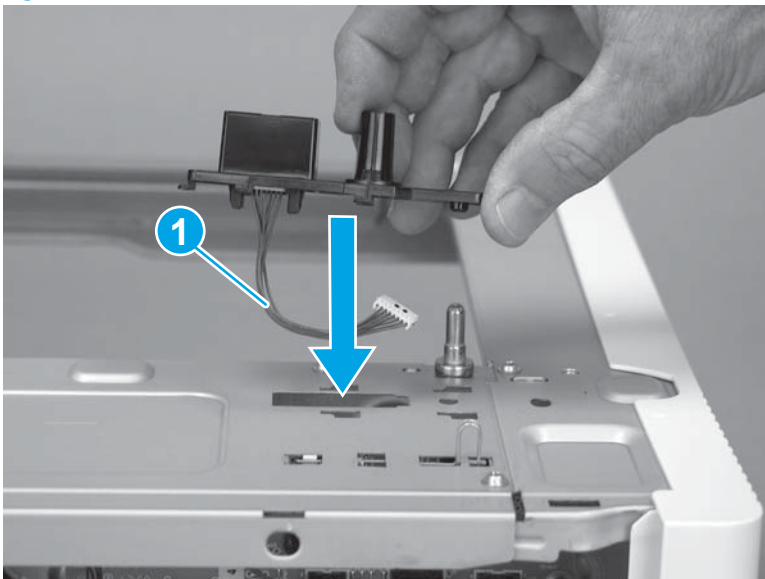
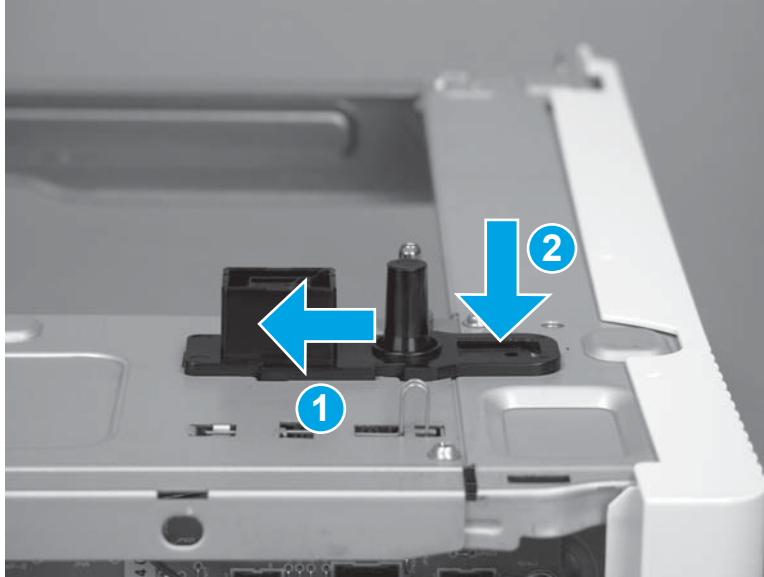

3. Connect one connector (callout 1; J901).

Figure 1-5450 Connect one connector

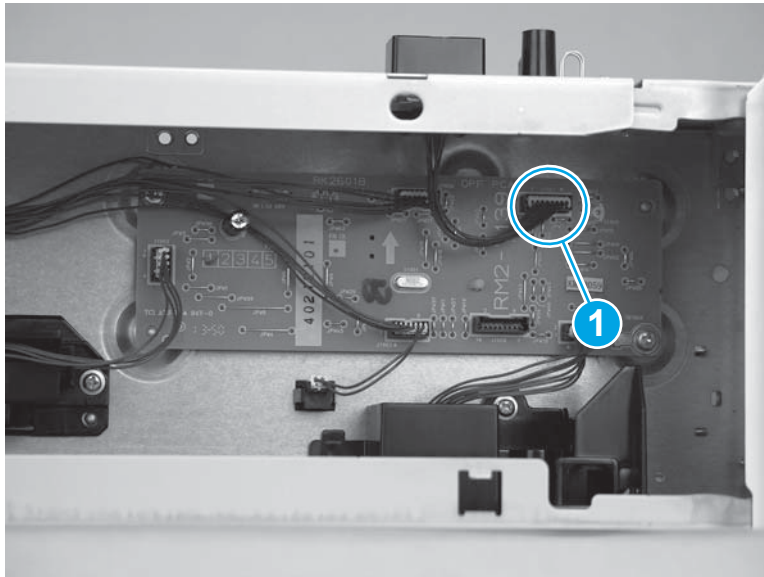

Step 12: Install the lower-right cover

1. Before proceeding, take note of the location of the three mounting tabs on the back side of the cover.

Figure 1-5451 Cover mounting tabs

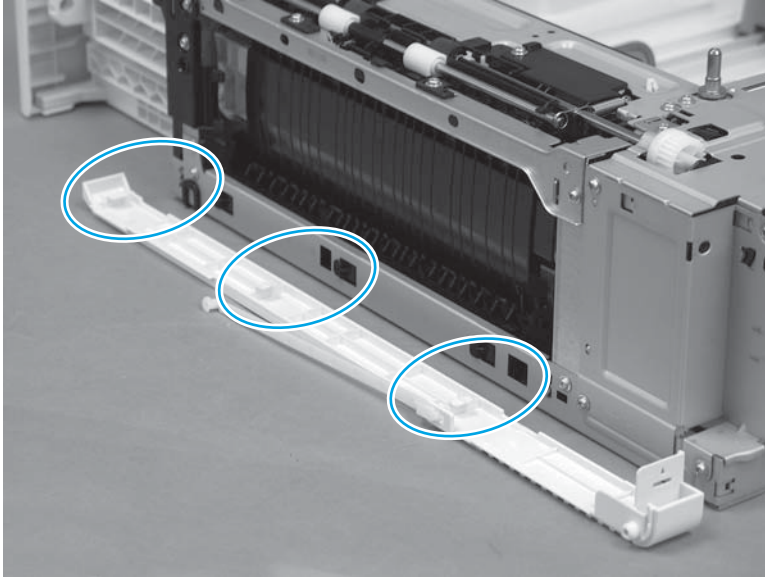

2. Align the three mounting tabs on the back side of the cover with the slots in the chassis.

Figure 1-5452 Install the right-lower cover

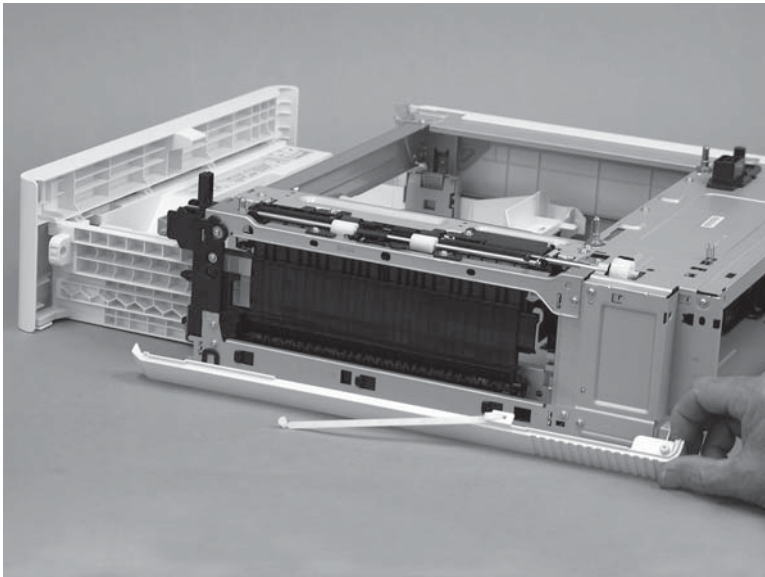

3. Press in on the middle tab (callout 1), slightly flex the end of the cover away from the accessory, and then slide it towards the rear of the accessory (callout 2) to engage the tabs with the slots.

CAUTION: The three mounting tabs on the back side of the cover are easily damaged. Do not over flex the end of the cover when it is installed.

Figure 1-5453 Engage the cover

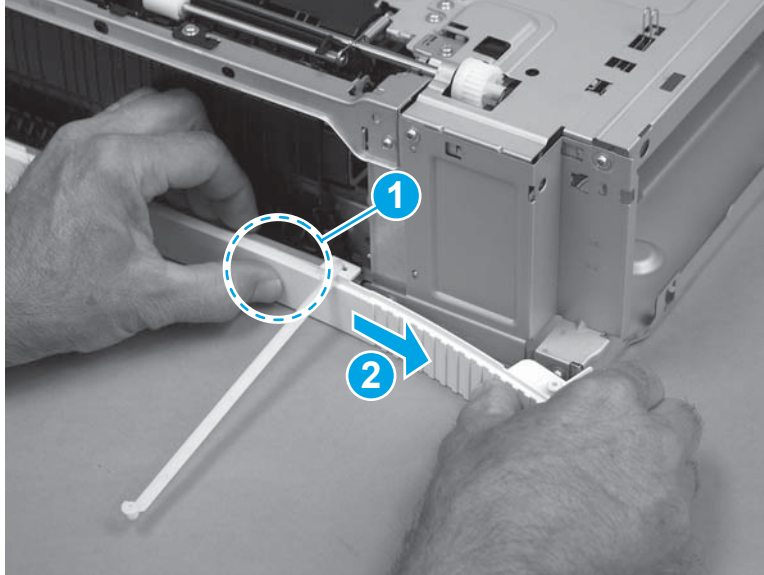

4. Verify that the end of the cover near the tray is correctly engaged with the chassis after installing the cover.

Figure 1-5454 Check the cover

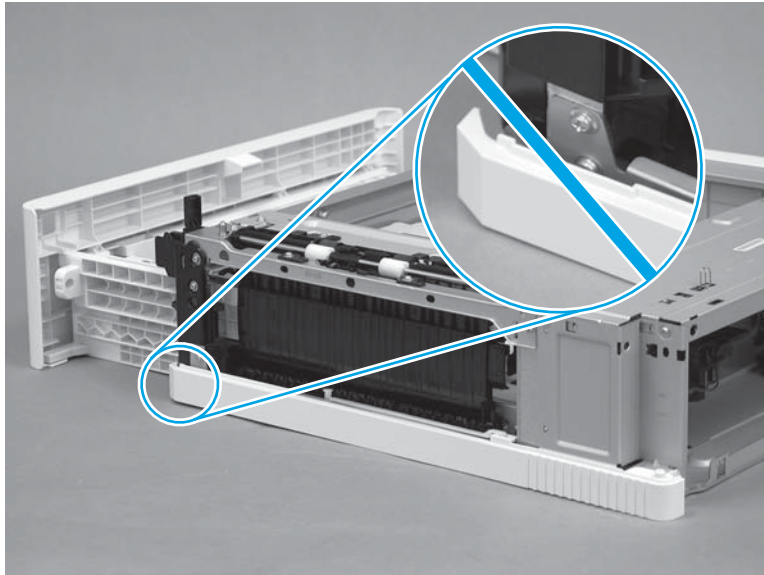

Step 13: Install the right door

1. Install the door link in the slot in the door to attach the door.

Figure 1-5455 Install the door link

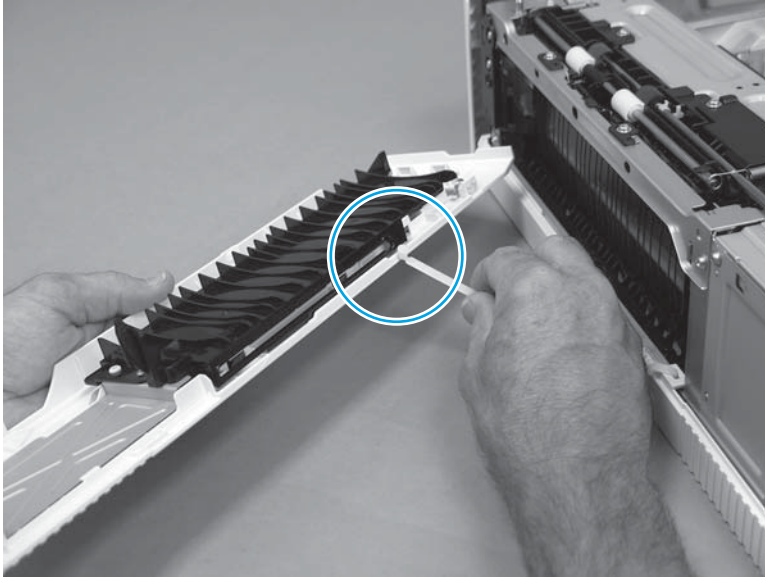

2. Position the lower hinge hole on the door (callout 2) on the lower hinge pin (callout 2) on the right-lower cover.

Figure 1-5456 Position the door on the lower hinge

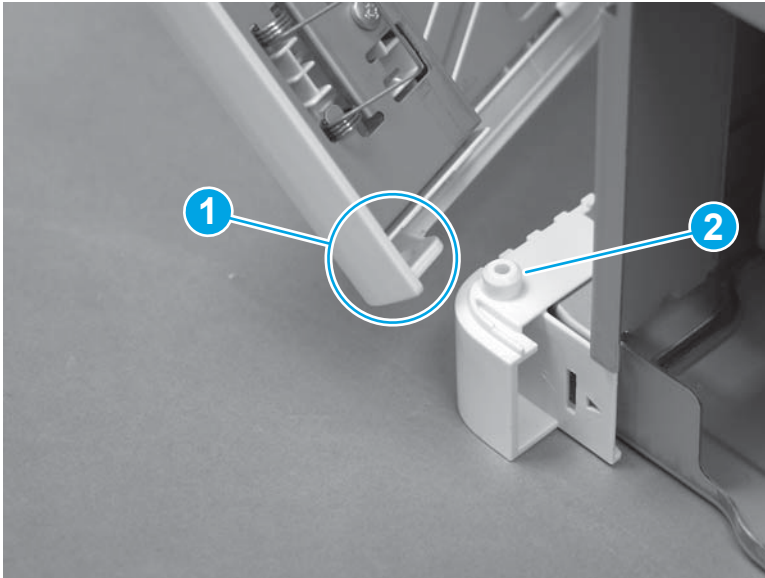

3. Align the pin of the door-hinge bracket (callout 1) with the hole in the chassis, and then align the mounting tabs (callout 2 and callout 3) with the slots in the chassis.

Figure 1-5457 Engage the hinge bracket

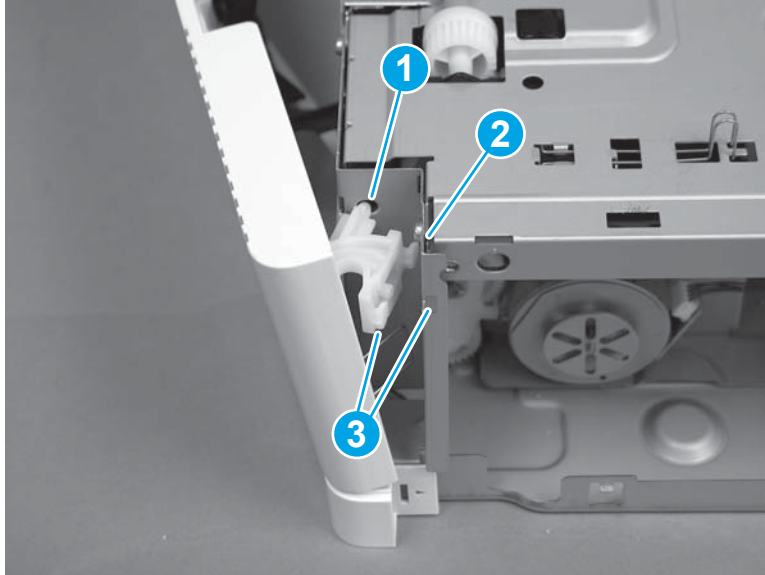

4. Push in on the door-hinge bracket (callout 1), and then slide it toward the chassis (callout 2) to install it.

Figure 1-5458 Install the hinge bracket

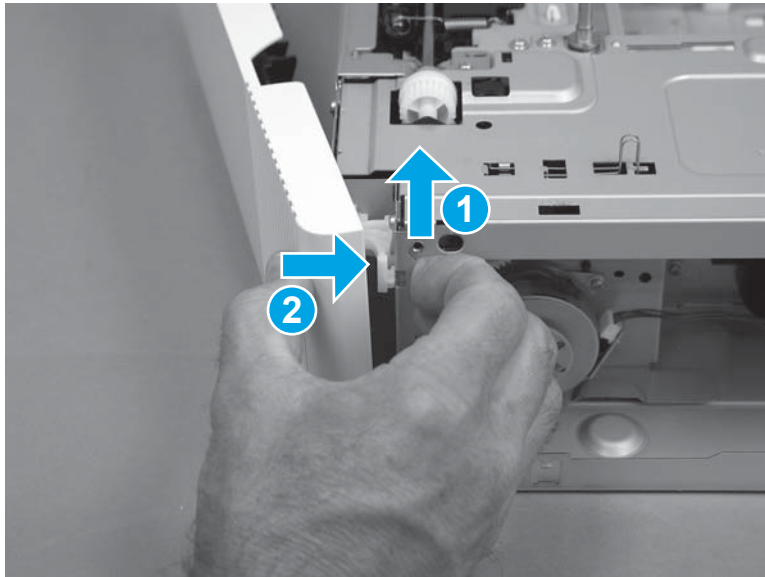

5. Close the door.

Figure 1-5459 Close the door

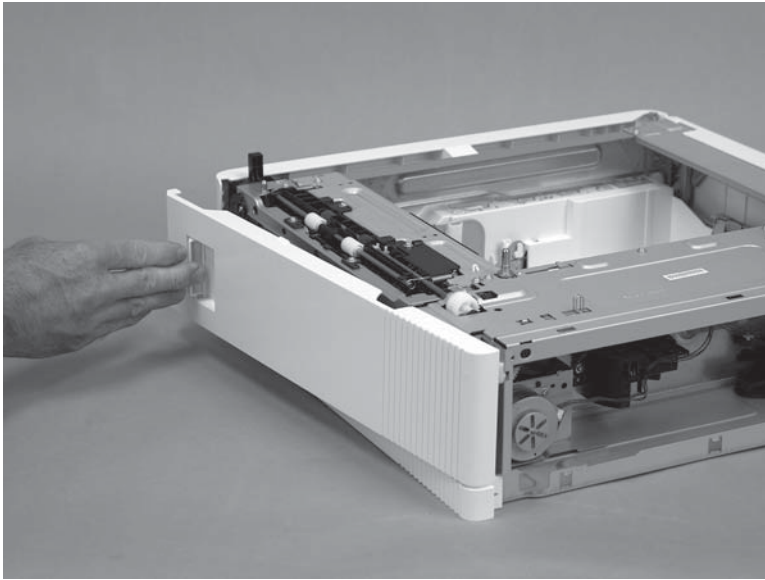

Step 14: Install the rear cover

1. Align the three mounting tabs (callout 1) on the cover with the slots in the chassis.

Figure 1-5460 Position the cover on the chassis

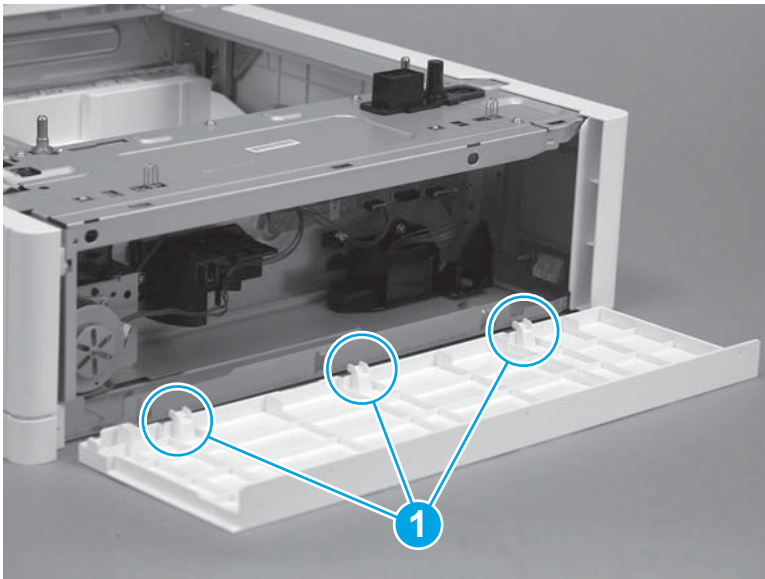

2. Position the cover on the accessory (callout 1), and then rotate the top of the cover up and onto the chassis (callout 2) to install it.

Figure 1-5461 Install the cover

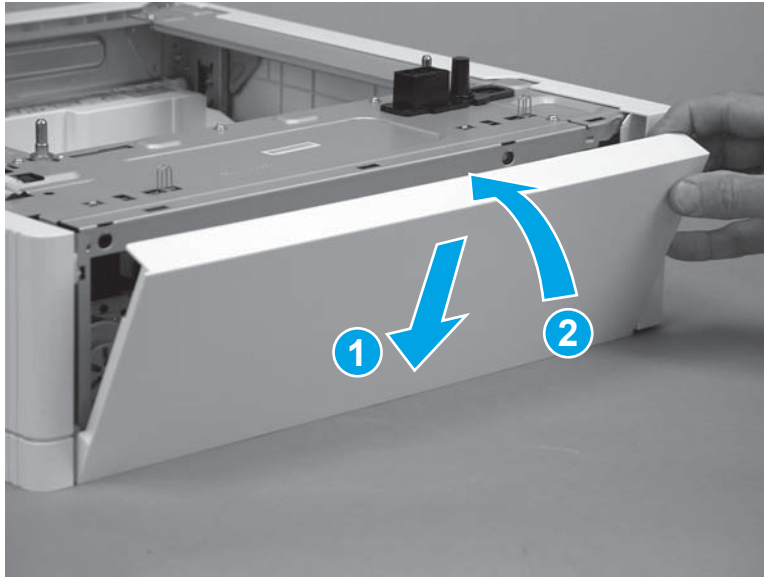

3. Make sure that the three tabs (callout 1) snap into place.

Figure 1-5462 Check the three tabs

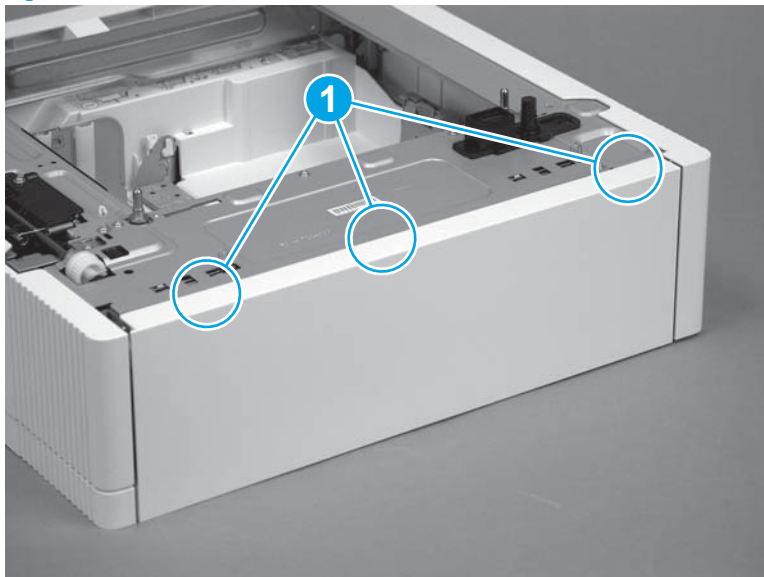

Step 15: Install the tray

1. With the front of the tray slightly lifted, align the sides of the tray with the rails in the printer, and then carefully slide the tray into the printer.

 **TIP:** As the tray slides into the accessory, lower the front of it.

Figure 1-5463 Install the tray



2. Close the tray.

Figure 1-5464 Close the tray

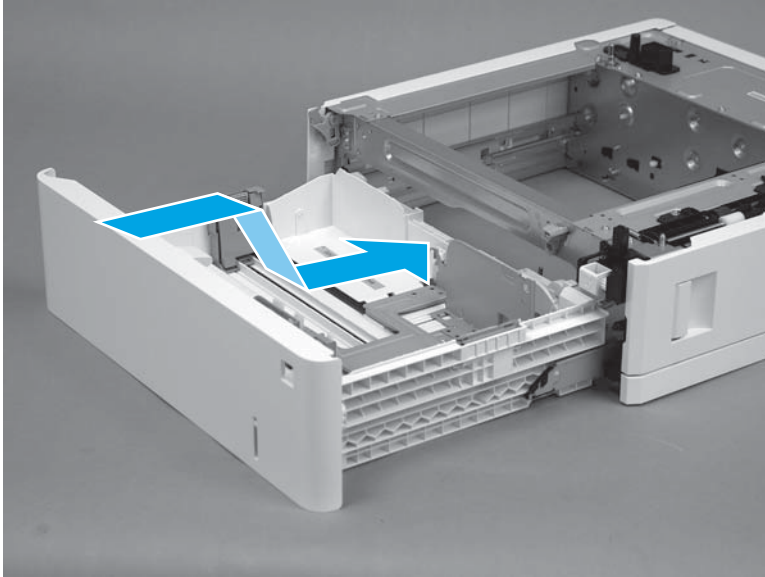
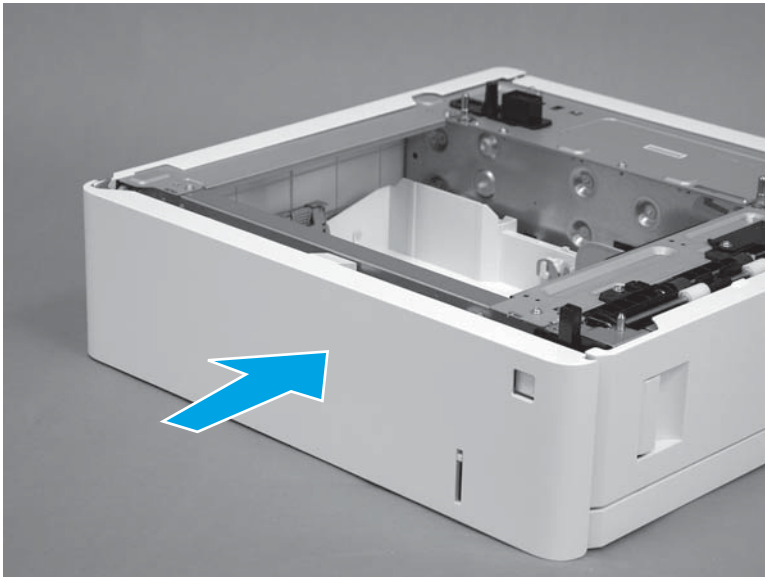

Removal and replacement: Trusted platform module (M552 and M553)

- [Introduction](#)
- [Step 1: Remove the formatter cover](#)
- [Step 2: Remove the hard-disk drive \(HDD\)](#)
- [Step 3: Remove the trusted platform module \(TPM\)](#)
- [Step 4: Unpack the replacement assembly](#)
- [Step 5: Install the TPM](#)
- [Step 6: Install the hard-disk drive \(HDD\)](#)
- [Step 7: Install the formatter cover](#)

Introduction



This document provides the procedures to remove and replace the trusted platform module (TPM).

Before performing service

Turn the printer power off

- Disconnect the power cable.

 **WARNING!** To avoid damage to the printer, turn the printer off, wait 30 seconds, and then remove the power cord before attempting to service the printer.

 **CAUTION:**  This part contains components that are electrostatic discharge (ESD) sensitive. To reduce the possibility of ESD damage, always touch the sheet-metal chassis to ground yourself before touching an ESD sensitive part.

Use the table below to identify the correct part number for your printer, and then go to <http://h20141.www2.hp.com/hpparts> to order the part.

TPM kit number	
F5S62-61001	Trusted platform module (TPM) with instruction guide

Required tools

- No special tools are required to install this kit.

After performing service

Make sure that the formatter cover is fully seated, and that the thumbscrews are finger tight after replacing it.

Turn the printer power on

- Connect the power cable.
- Use the power switch to turn the power on.

Post service test

Print a configuration page to make sure that the printer is functioning correctly.

Step 1: Remove the formatter cover

1. Locate the formatter cover.

Figure 1-5465 Locate the formatter cover

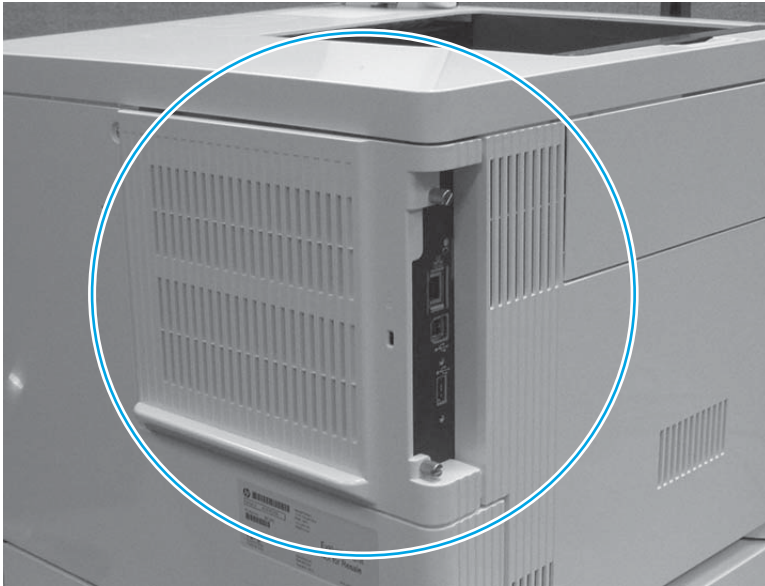

2. Loosen the two thumbscrews (callout 1). Grasp the two thumbscrews, and then slide the cover away from the printer (callout 2) to remove it.

 **TIP:** If needed, use the edge of a coin to turn the thumbscrews.

Figure 1-5466 Loosen the thumbscrews

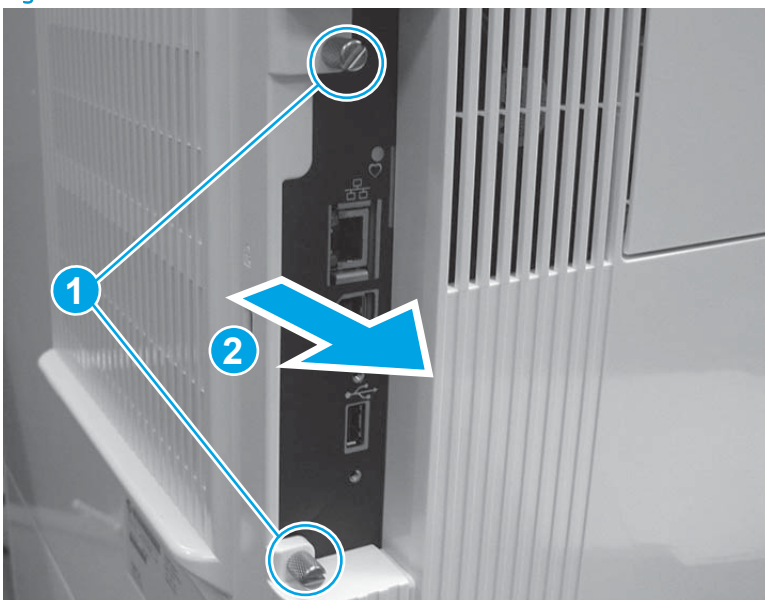

Step 2: Remove the hard-disk drive (HDD)

 **NOTE:** If the optional HDD is not installed, do one of the following:

- If this is a first-time installation of the optional TPM, skip this step and go to [Step 4: Unpack the replacement assembly on page 3023](#).
- If this is a replacement TPM installation, skip this step and go to [Step 3: Remove the trusted platform module \(TPM\) on page 3022](#).

 **CAUTION:**  ESD-sensitive part.

1. Release one tab (callout 1), grasp the HDD mounting bracket, and then rotate the connector end of the bracket up (callout 2) and away from the formatter to release it.

Figure 1-5467 Release the HDD

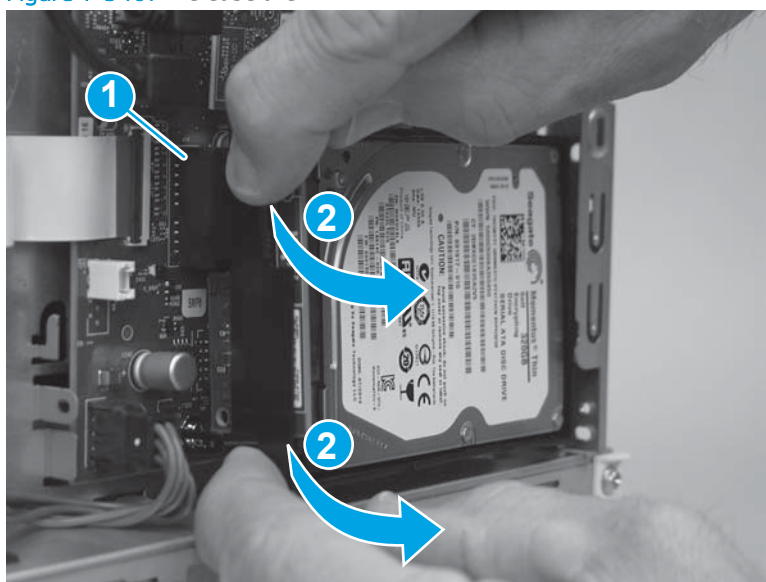

2. Slide the HDD away from the printer to remove it.

Figure 1-5468 Remove the HDD

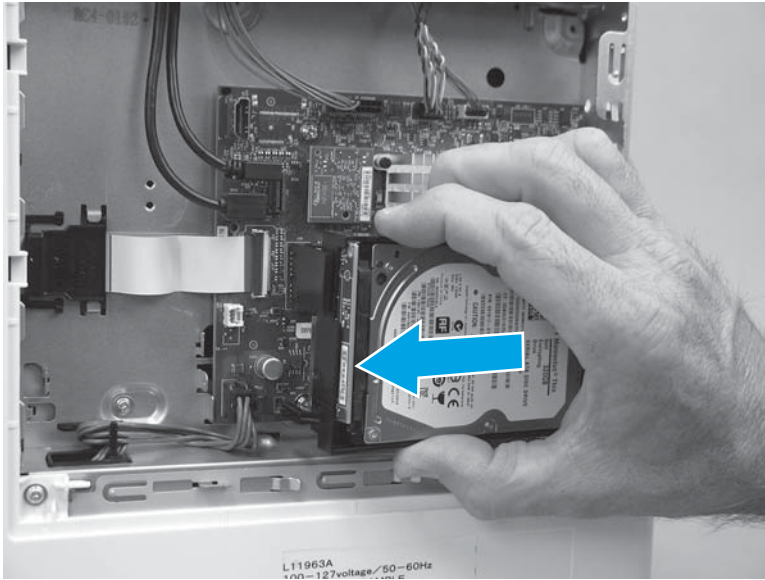

Step 3: Remove the trusted platform module (TPM)

 **NOTE:** If this is a first-time installation of the optional TPM, skip this step and go to [Step 4: Unpack the replacement assembly on page 3023](#).

 **CAUTION:**  ESD-sensitive part.

1. Locate the TPM component on the formatter.

Figure 1-5469 Locate the TPM

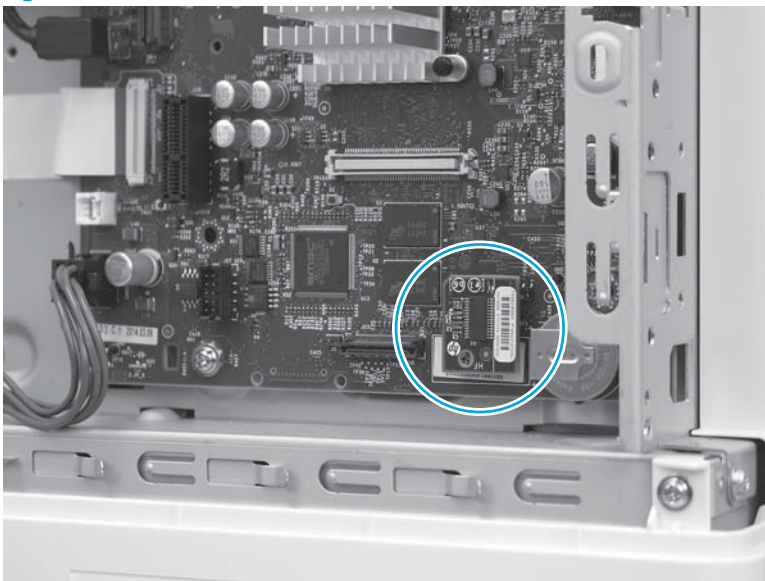

2. Pull the TPM straight off of the formatter to remove it.

Figure 1-5470 Remove the TPM

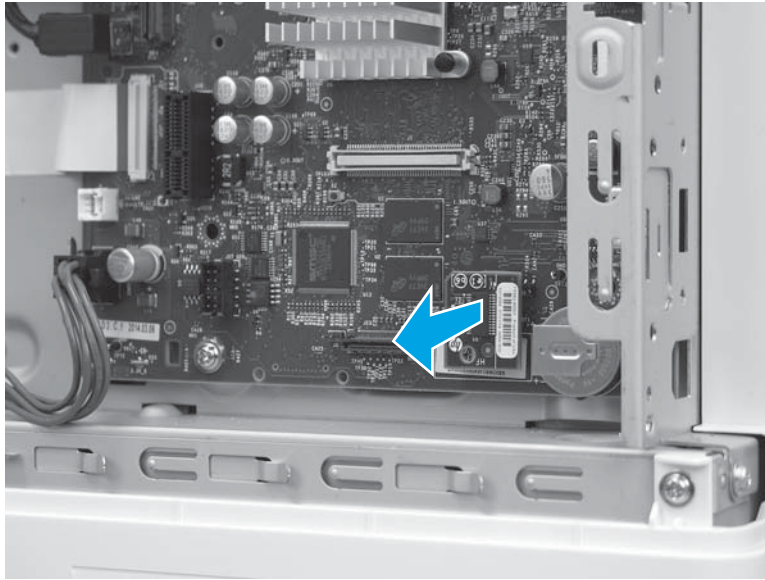

Step 4: Unpack the replacement assembly

Unpack the replacement assembly from the packaging.

 **CAUTION:**  ESD-sensitive part.

For complete information on HP's recycling programs, go to [Product return and recycling](#).

 **NOTE:** HP recommends responsible disposal of the defective assembly.

Figure 1-5471 Recycle and unpack

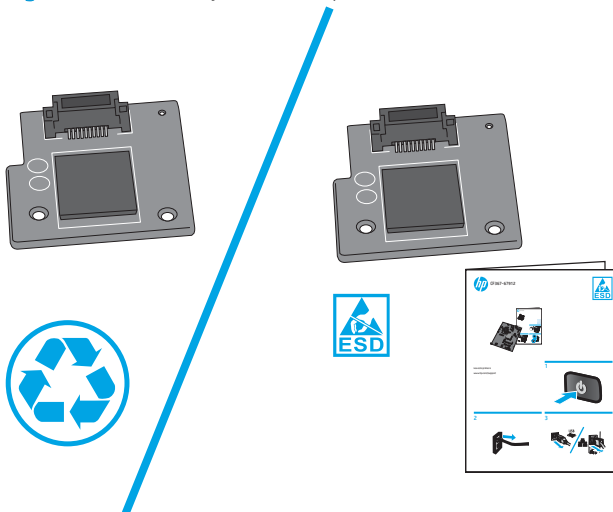

Step 5: Install the TPM

 **CAUTION:**  ESD-sensitive part.

1. Align the connector on the TPM (callout 1) with the connector on the formatter (callout 2), and then push the TPM onto the formatter to install it.

 **NOTE:** The TPM can only be install in one direction on the formatter.

Figure 1-5472 Install the TPM

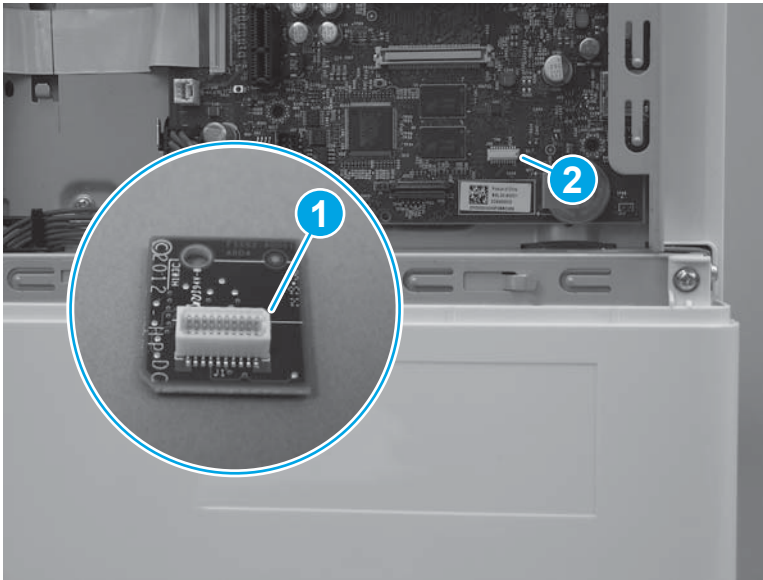

2. Verify that the TPM is fully seated in the connector.

Figure 1-5473 Verify that the TPM is fully seated

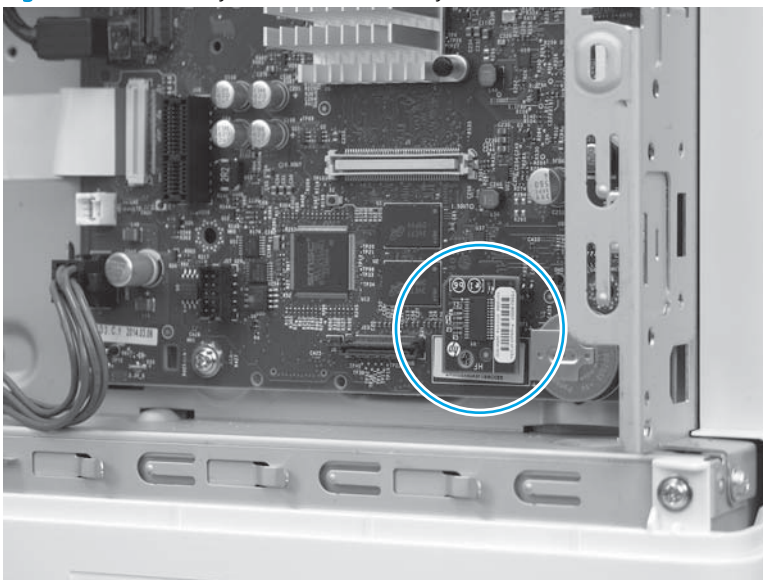

Step 6: Install the hard-disk drive (HDD)

 **NOTE:** If the optional HDD is not installed, skip this step and go to [Step 7: Install the formatter cover](#) on page 3026.

 **CAUTION:**  ESD-sensitive part.

1. Align the end of the holder (callout 1) with the slot in the chassis (callout 2), and then slide the HDD into the printer (callout 3) to engage the holder with the chassis.

Figure 1-5474 Install the holder

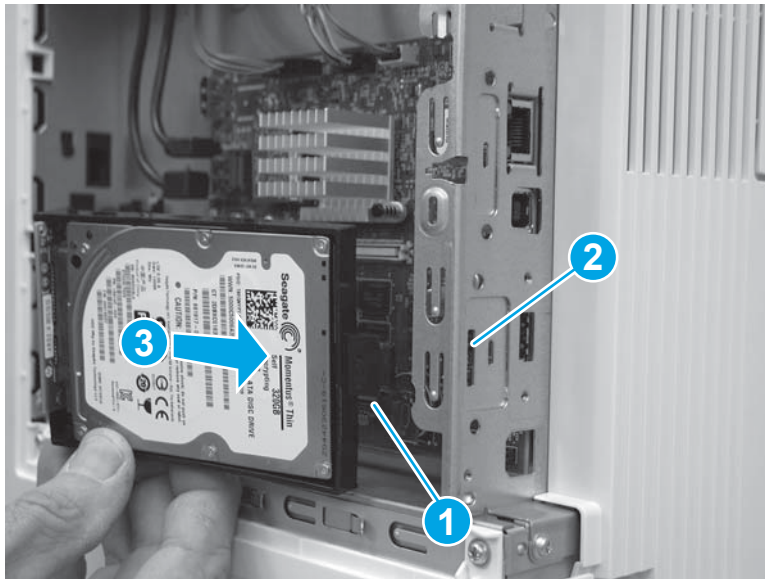

2. Rotate the HDD connector (callout 1) down and into the connector on the formatter to install it.

 **NOTE:** Make sure that the tabs (callout 2) snap into place, and that the HDD is securely installed.

Figure 1-5475 Release the HDD



Step 7: Install the formatter cover

- ▲ Slide the cover onto the printer (callout 1) to install it.

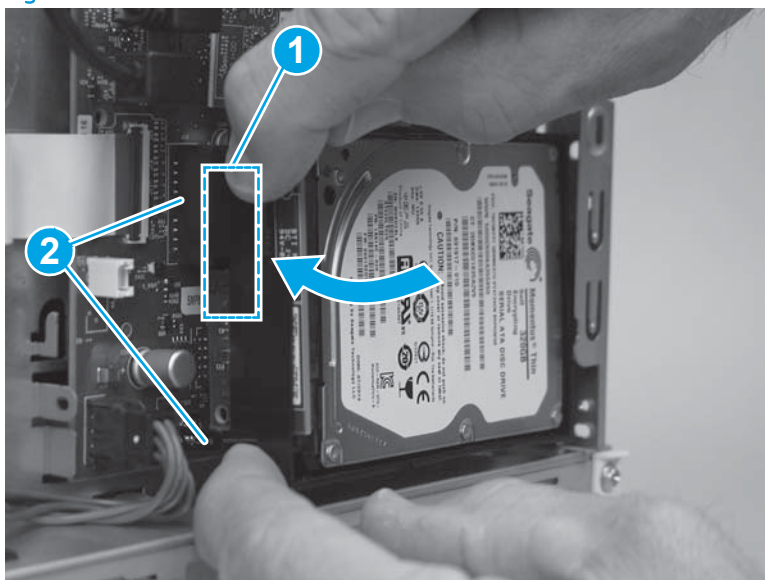
 **NOTE:** Make sure that the tabs on the formatter cover align with the slots provided in the printer (callout 2). Tighten the two thumbscrews (callout 3).

 **TIP:** If needed, use the edge of a coin to turn the thumbscrews.

Figure 1-5476 Install the cover

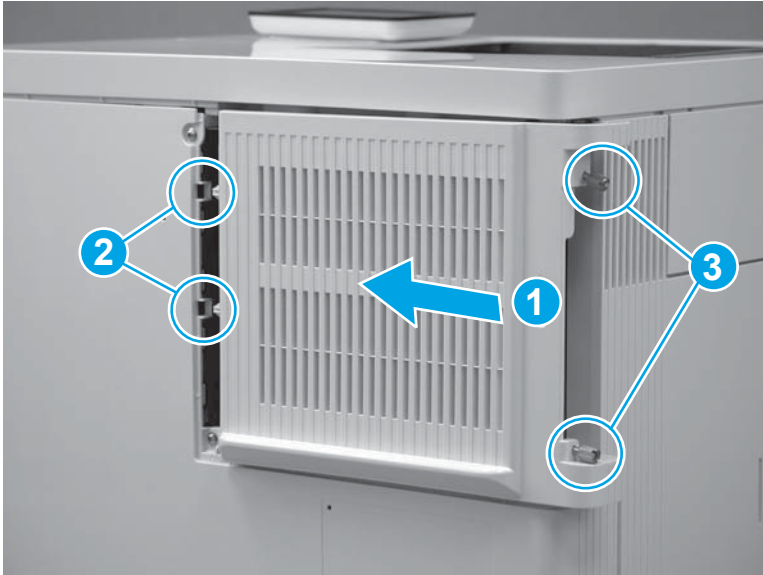

Removal and replacement: Trusted platform module (M577)

- [Introduction](#)
- [Step 1: Remove the formatter cover](#)
- [Step 2: Remove the hard-disk drive \(HDD; M577\)](#)
- [Step 3: Remove the trusted platform module \(TPM\)](#)
- [Step 4: Unpack the replacement assembly](#)
- [Step 5: Install the TPM](#)
- [Step 6: Install the hard-disk drive \(HDD; M577\)](#)
- [Step 7: Install the formatter cover](#)

Introduction



This document provides the procedures to remove and replace the trusted platform module (TPM).

Before performing service

Turn the printer power off

- Disconnect the power cable.

 **WARNING!** To avoid damage to the printer, turn the printer off, wait 30 seconds, and then remove the power cord before attempting to service the printer.

 **CAUTION:**  This part contains components that are electrostatic discharge (ESD) sensitive. To reduce the possibility of ESD damage, always touch the sheet-metal chassis to ground yourself before touching an ESD sensitive part.

Use the table below to identify the correct part number for your printer, and then go to <http://h20141.www2.hp.com/hpparts> to order the part.

TPM kit number	
F5S62-61001	Trusted platform module (TPM) with instruction guide

Required tools

- No special tools are required to install this kit.

After performing service

Make sure that the formatter cover is fully seated, and that the thumbscrews are finger tight after replacing it.

Turn the printer power on

- Connect the power cable.
- Use the power switch to turn the power on.

Post service test

Print a configuration page to make sure that the printer is functioning correctly.

Step 1: Remove the formatter cover

1. Locate the formatter cover.

Figure 1-5477 Locate the formatter cover

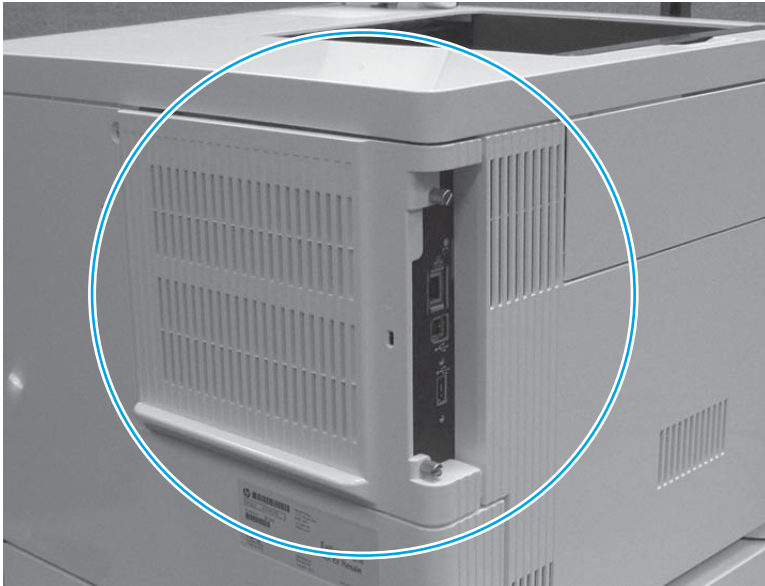

2. Loosen the two thumbscrews (callout 1). Grasp the two thumbscrews, and then slide the cover away from the printer (callout 2) to remove it.

 **TIP:** If needed, use the edge of a coin to turn the thumbscrews.

Figure 1-5478 Loosen the thumbscrews

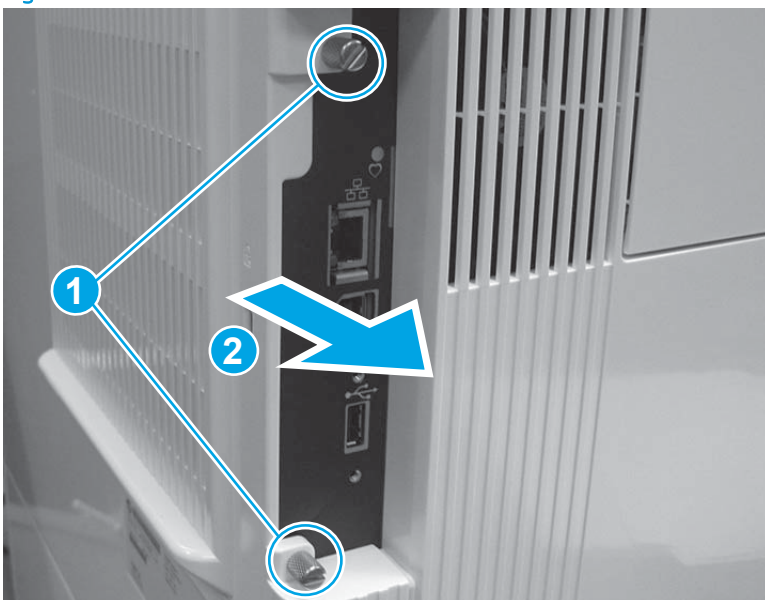

Step 2: Remove the hard-disk drive (HDD; M577)

 **CAUTION:**  ESD-sensitive part.

1. Release two tabs (callout 1). Hold the tabs in the released position, and then rotate the hard disk drive (HDD) up (callout 2) to release the connector from the formatter.

Figure 1-5479 Release the HDD

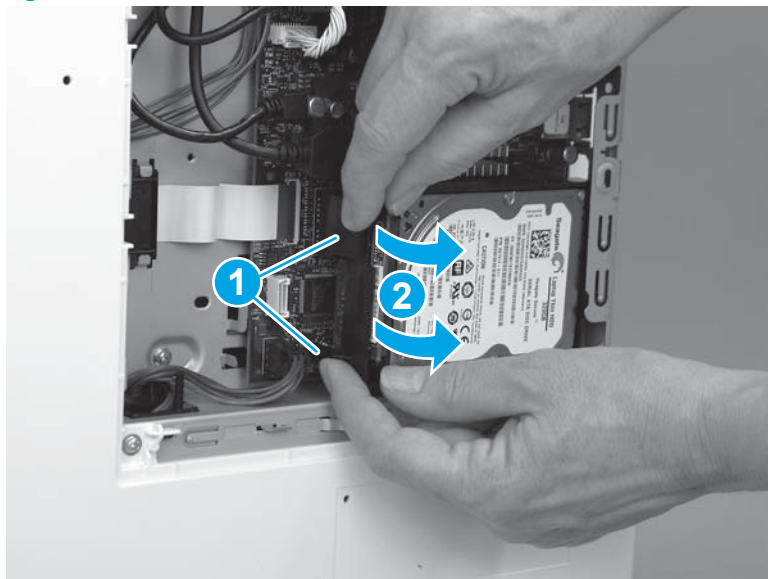

2. Slide the HDD away from the printer to remove it.

Figure 1-5480 Remove the HDD



Step 3: Remove the trusted platform module (TPM)

 **NOTE:** If this is a first-time installation of the optional TPM, skip this step and go to [Step 4: Unpack the replacement assembly on page 3030](#).

CAUTION:  ESD-sensitive part.

1. Locate the TPM component on the formatter.

Figure 1-5481 Locate the TPM

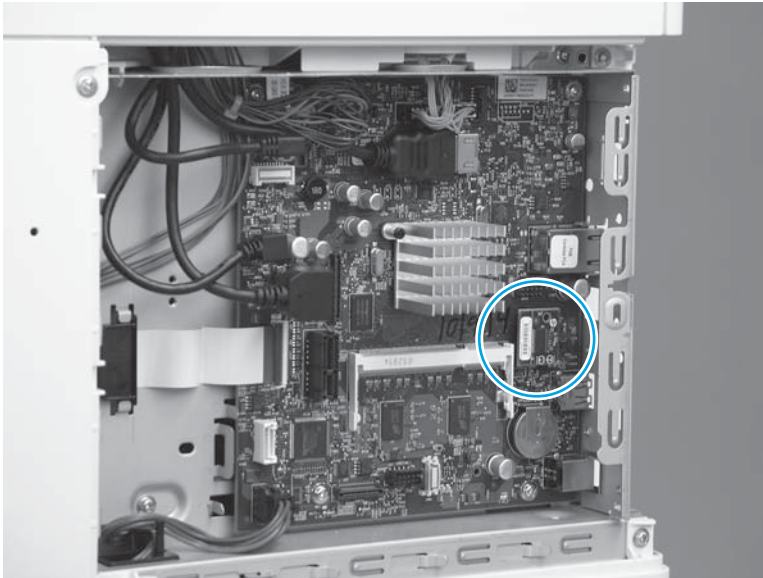

2. Pull the TPM straight off of the formatter to remove it.

Figure 1-5482 Remove the TPM

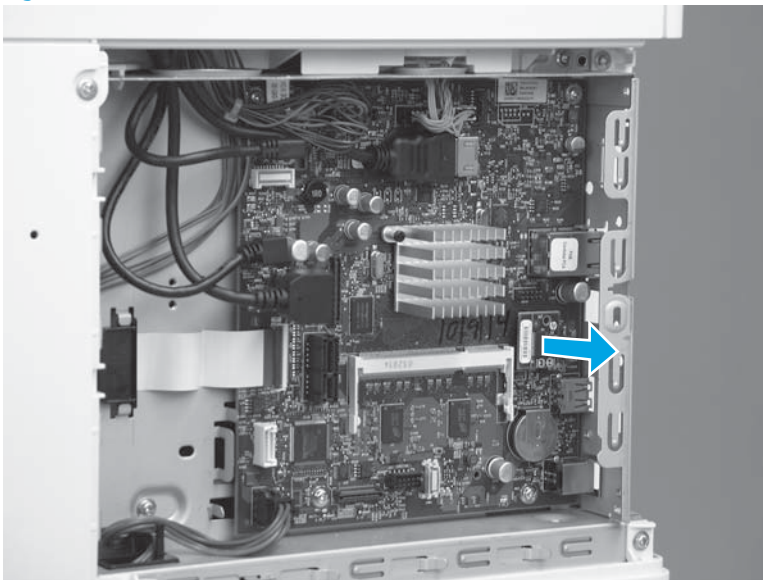

Step 4: Unpack the replacement assembly

Unpack the replacement assembly from the packaging.

CAUTION:  ESD-sensitive part.

For complete information on HP's recycling programs, go to [Product return and recycling](#).

 **NOTE:** HP recommends responsible disposal of the defective assembly.

Figure 1-5483 Recycle and unpack

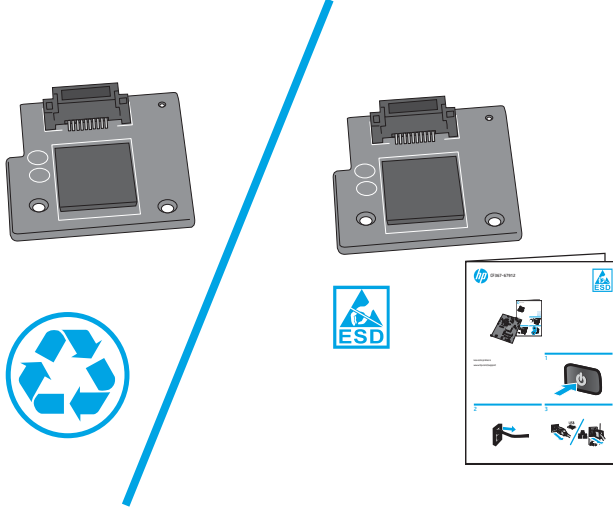

Step 5: Install the TPM

 **CAUTION:**  ESD-sensitive part.

1. Align the connector on the TPM (callout 1) with the connector on the formatter (callout 2), and then push the TPM onto the formatter to install it.

 **NOTE:** The TPM can only be install in one direction on the formatter.

Figure 1-5484 Install the TPM

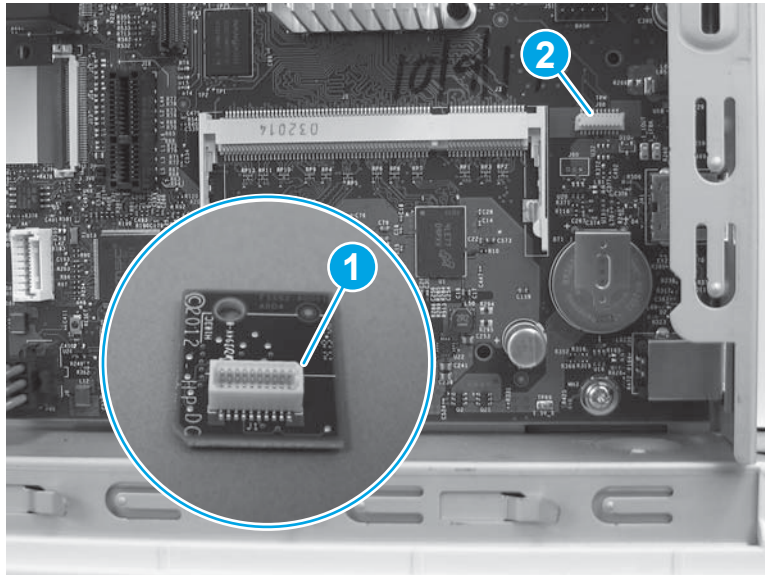

2. Verify that the TPM is fully seated in the connector.

Figure 1-5485 Verify that the TPM is fully seated

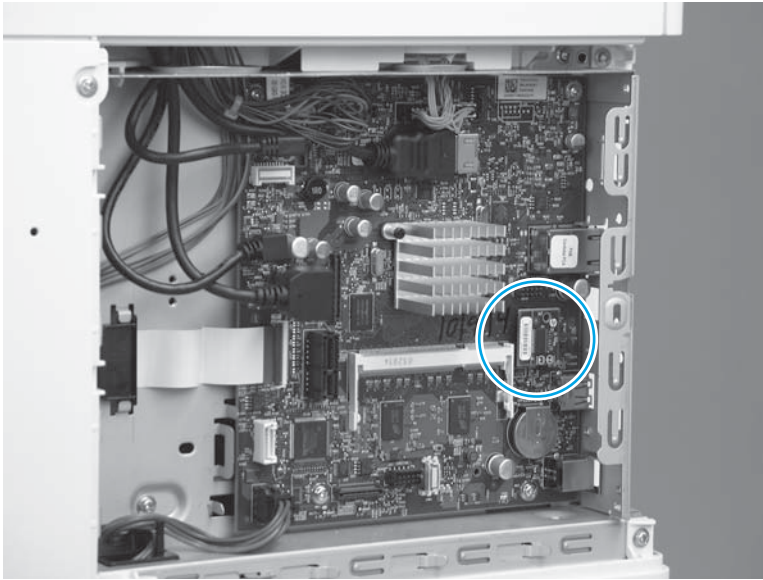

Step 6: Install the hard-disk drive (HDD; M577)

 **NOTE:** If the optional HDD is not installed, skip this step and go to [Step 7: Install the formatter cover on page 3026](#).

 **CAUTION:**  ESD-sensitive part.

1. Align the end of the bracket (callout 1) with the slot in the chassis (callout 2), and then slide the HDD into the printer (callout 3) to engage the bracket with the chassis.

Figure 1-5486 Install the holder

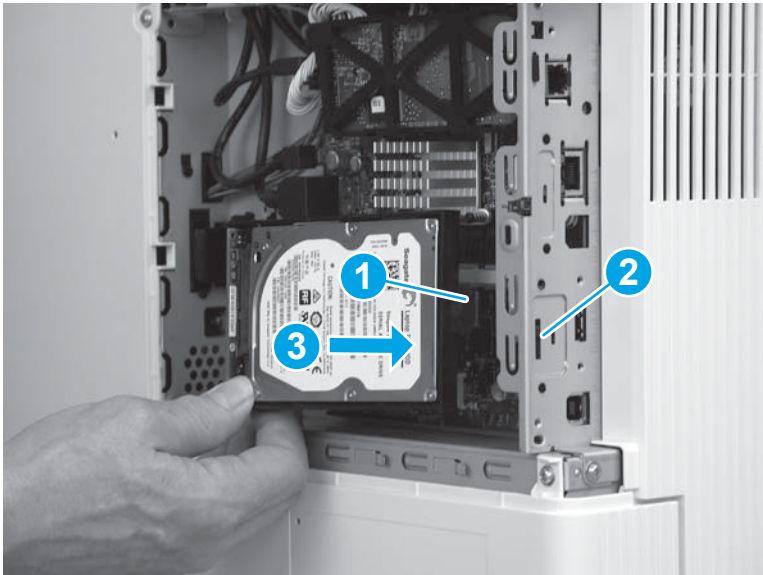

2. Hold the HDD connector latch (callout 1) in the released position, and then rotate the HDD down and into the connector on the formatter to install it.

 **NOTE:** Make sure that the tab (callout 2) snaps into place, and that the HDD is securely installed.

Figure 1-5487 Release the HDD

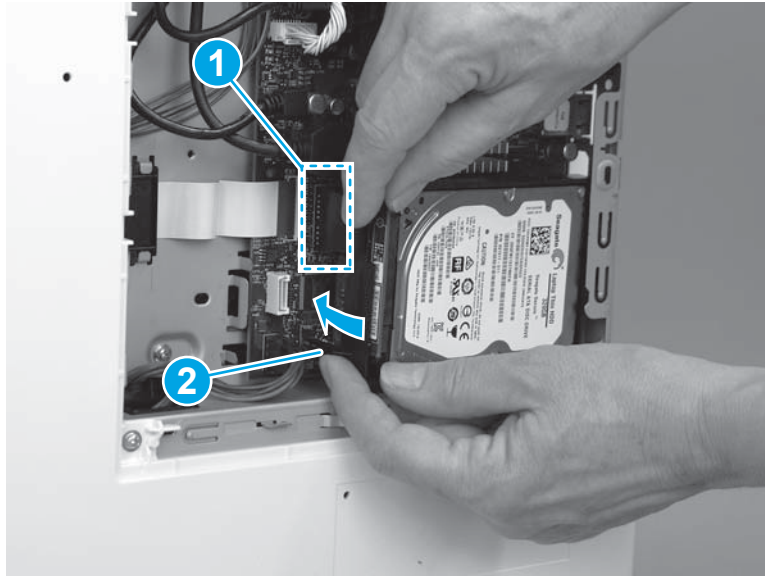

Step 7: Install the formatter cover

- ▲ Slide the cover onto the printer (callout 1) to install it.

 **NOTE:** Make sure that the tabs on the formatter cover align with the slots provided in the printer (callout 2). Tighten the two thumbscrews (callout 3).

 **TIP:** If needed, use the edge of a coin to turn the thumbscrews.

Figure 1-5488 Install the cover

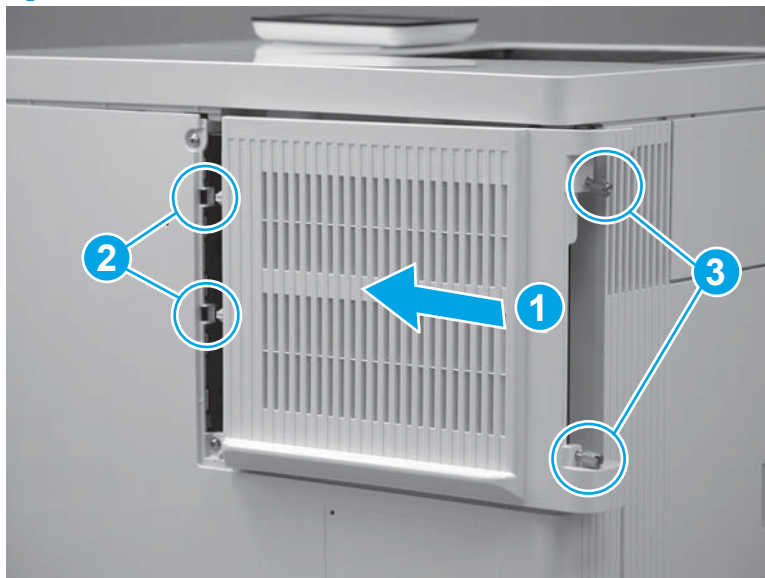

Removal and replacement: Internal USB ports (M552 and M553)

- [Introduction](#)
- [Step 1: Remove the formatter cover](#)
- [Step 2: Remove the internal USB ports module \(M552 and M553\)](#)
- [Step 3: Unpack the replacement assembly](#)
- [Step 4: Install the internal USB ports module \(M552 and M553\)](#)
- [Step 5: Install the formatter cover](#)

Introduction



This document provides the procedures to remove and replace the internal USB ports.

Before performing service

Turn the printer power off

- Disconnect the power cable.

 **WARNING!** To avoid damage to the printer, turn the printer off, wait 30 seconds, and then remove the power cord before attempting to service the printer.

 **CAUTION:**  This part contains components that are electrostatic discharge (ESD) sensitive. To reduce the possibility of ESD damage, always touch the sheet-metal chassis to ground yourself before touching an ESD sensitive part.

Use the table below to identify the correct part number for your printer. To order the part, go to www.hp.com/buy/parts.

Internal USB ports part number	
--------------------------------	--

B5L28-67902

Internal USB ports

Required tools

No special tools are required to install this part.

After performing service

Turn the printer power on

- Connect the power cable.
- Use the power switch to turn the power on.

Post service test

Print a configuration page to make sure that the printer is functioning correctly.

Step 1: Remove the formatter cover

1. Locate the formatter cover.

Figure 1-5489 Locate the formatter cover

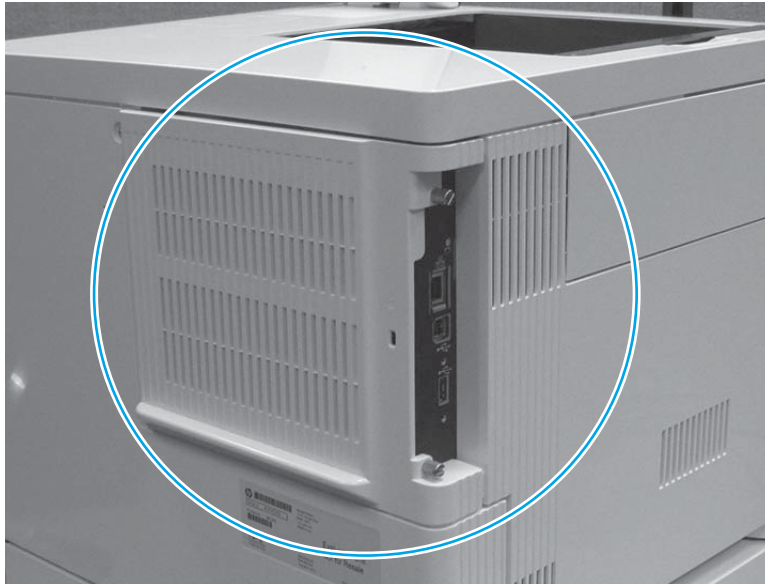

2. Loosen the two thumbscrews (callout 1). Grasp the two thumbscrews, and then slide the cover away from the printer (callout 2) to remove it.

 **TIP:** If needed, use the edge of a coin to turn the thumbscrews.

Figure 1-5490 Loosen the thumbscrews

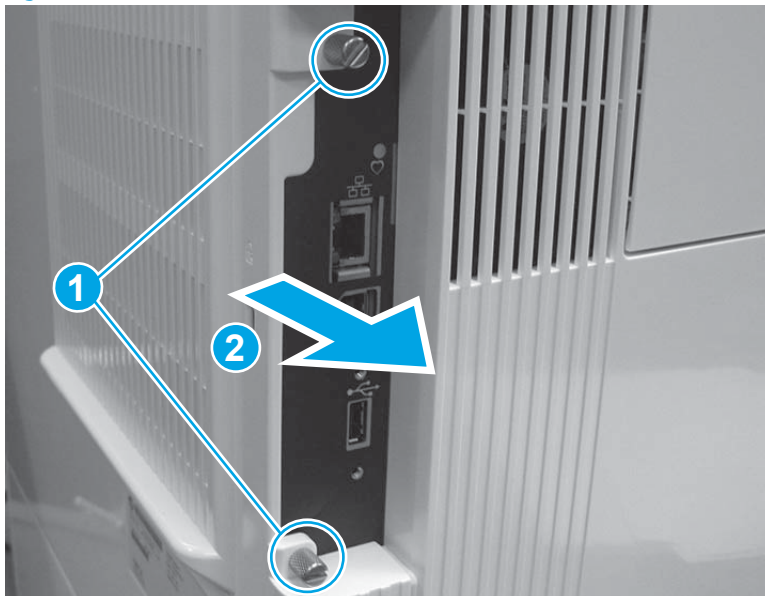

Step 2: Remove the internal USB ports module (M552 and M553)

 **CAUTION:**  ESD-sensitive part.

1. Locate the internal USB ports module on the formatter.

Figure 1-5491 Locate the USB ports module

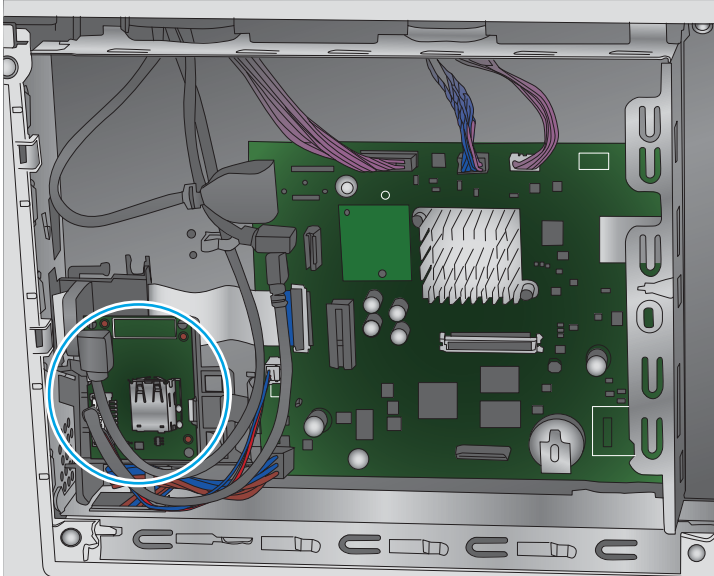

2. Disconnect one connector (callout 1).

Figure 1-5492 Disconnect one connector

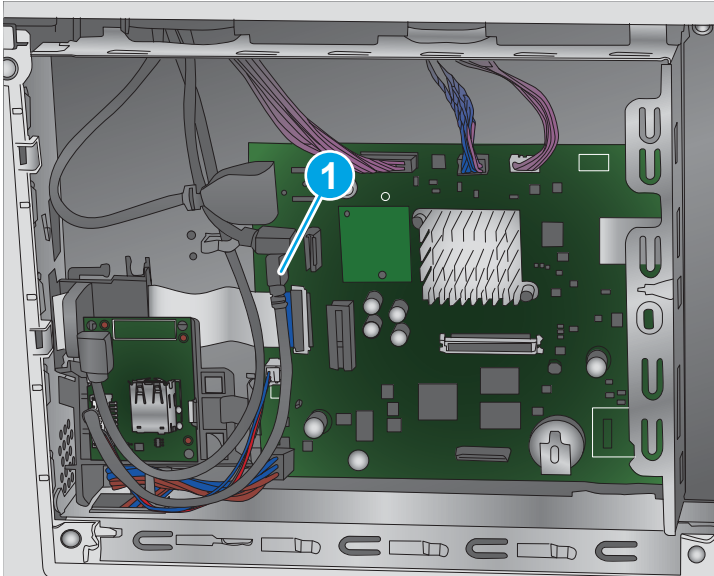

3. Disconnect one connector (callout 1).

Figure 1-5493 Disconnect one connector

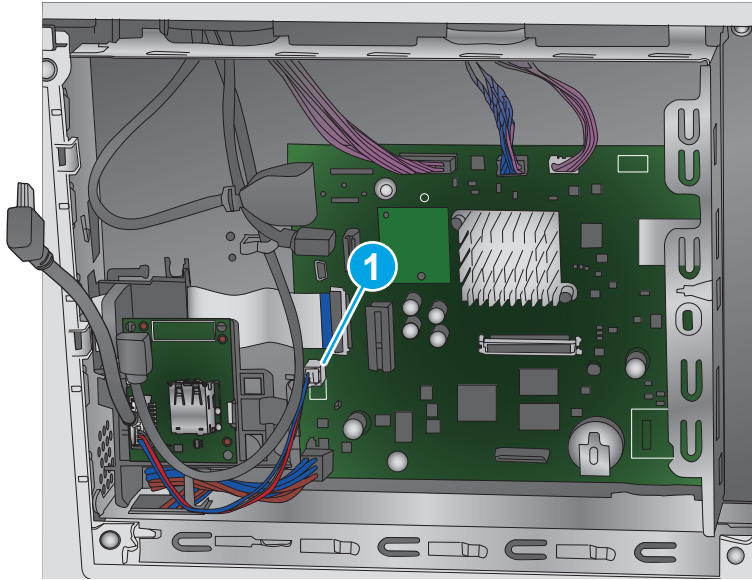

4. Disconnect one connector (callout 1).

Figure 1-5494 Disconnect one connector

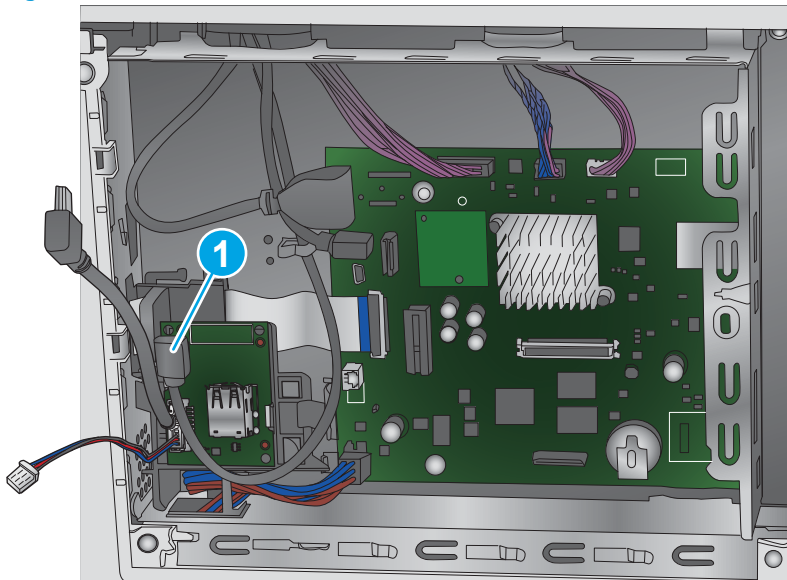

5. Release two tabs (callout 1), and then remove the internal USB ports module (callout 2).

Figure 1-5495 Remove the module

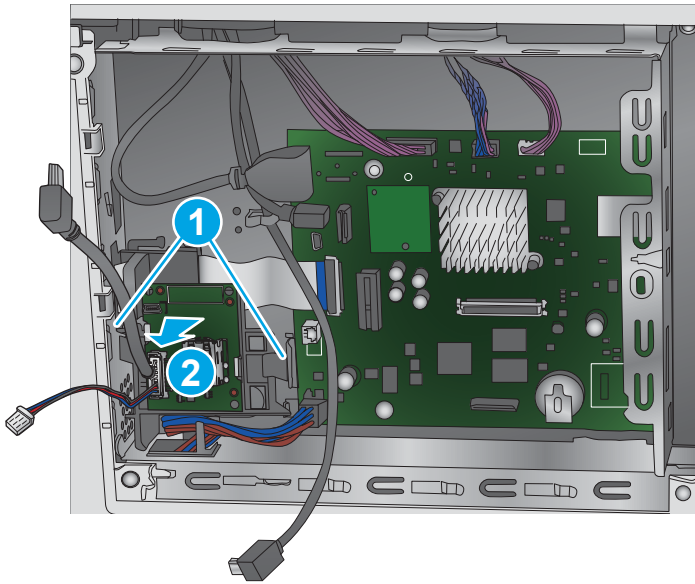

Step 3: Unpack the replacement assembly

Unpack the replacement assembly from the packaging.

 **CAUTION:**  ESD-sensitive part.

For complete information on HP's recycling programs, go to [Product return and recycling](#).

 **NOTE:** HP recommends responsible disposal of the defective part.

Figure 1-5496 Recycle and unpack



Step 4: Install the internal USB ports module (M552 and M553)

 **CAUTION:**  ESD-sensitive part.

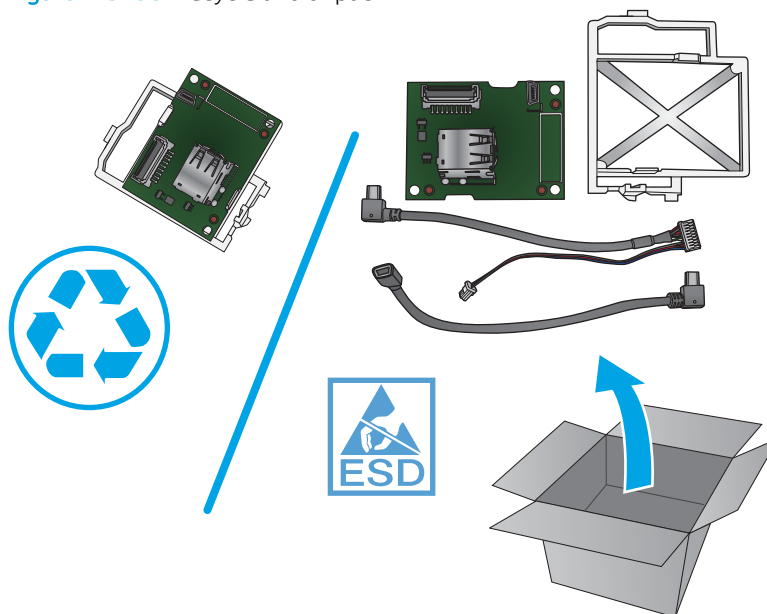
1. Position the notches on the internal USB ports PCA over the clips on the PCA holder and press down to attach the PCA to the holder. Make sure that the clips snap into place.

Figure 1-5497 Install the PCA in the holder

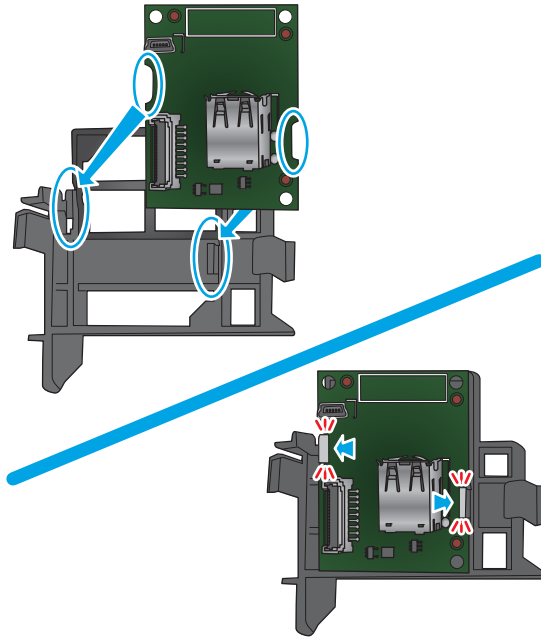

2. Connect the cable harness to the PCA.

Figure 1-5498 Connect the cable harness

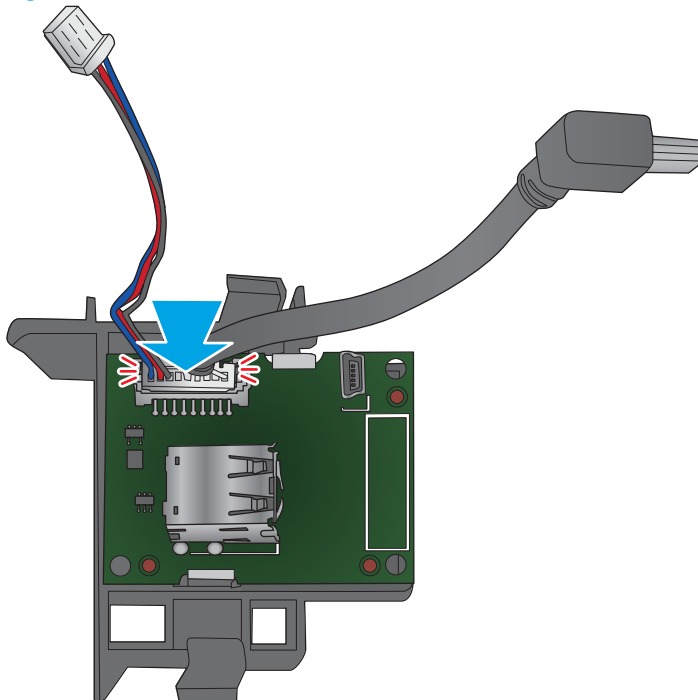

3. Press the internal USB ports module toward the formatter case until the clips snap into place.

Figure 1-5499 Install the internal USB ports module

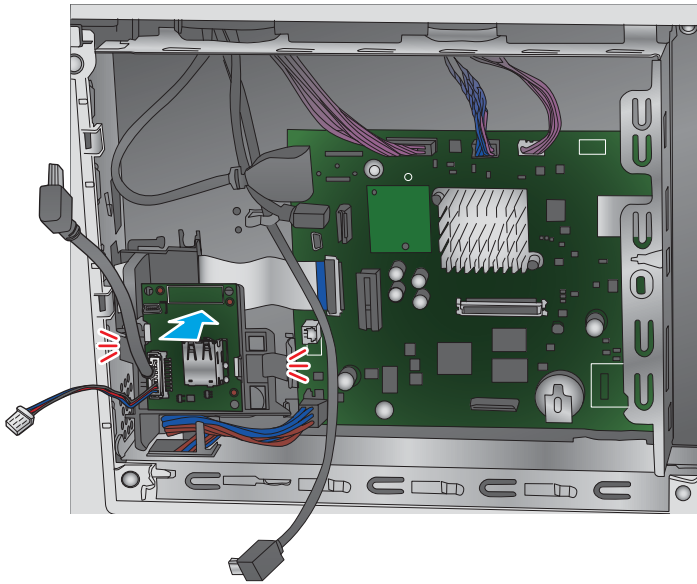

4. Connect one connector (callout 1).

Figure 1-5500 Connect one connector

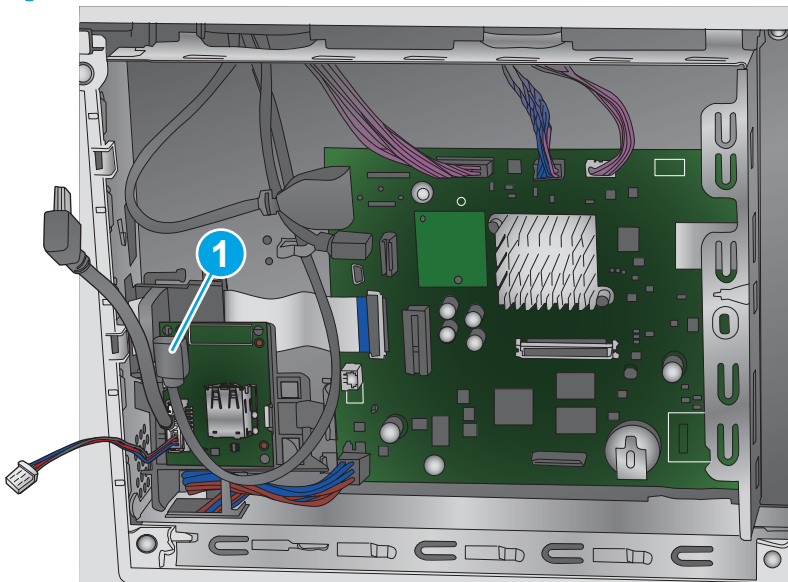

5. Connect one connector (callout 1).

Figure 1-5501 Connect one connector

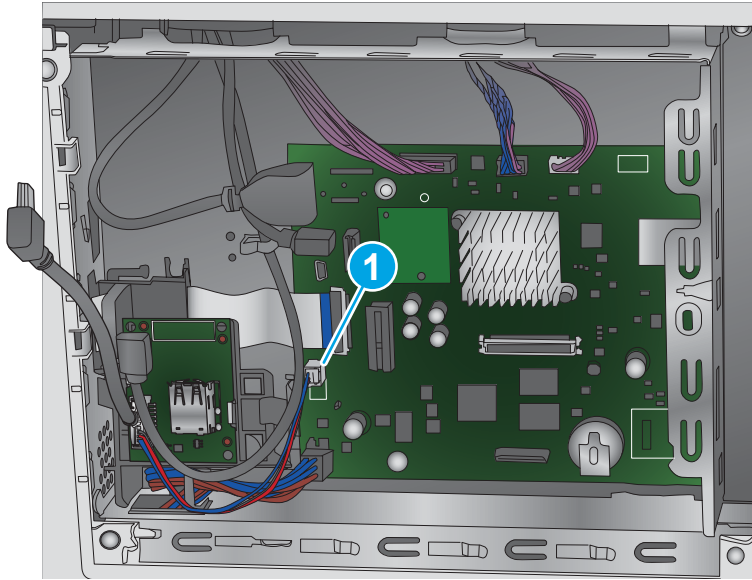

6. Connect one connector (callout 1).

Figure 1-5502 Connect one connector

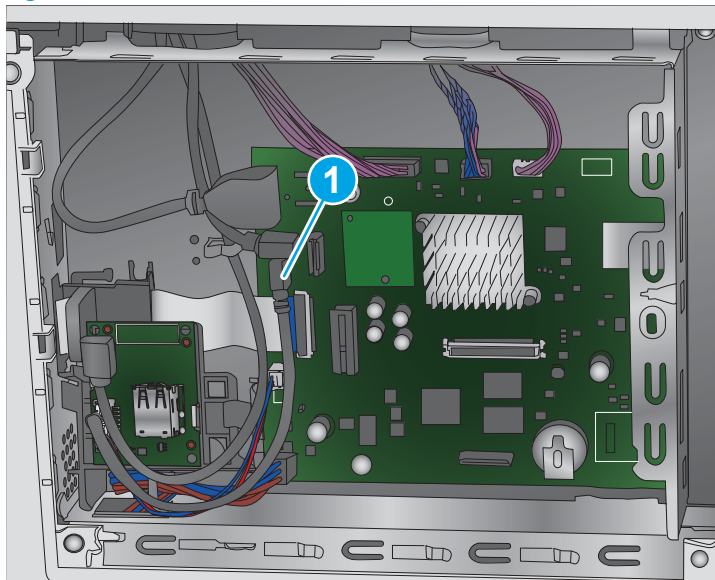

Step 5: Install the formatter cover

- ▲ Slide the cover onto the printer (callout 1) to install it.

 **NOTE:** Make sure that the tabs on the formatter cover align with the slots provided in the printer (callout 2). Tighten the two thumbscrews (callout 3).

 **TIP:** If needed, use the edge of a coin to turn the thumbscrews.

Figure 1-5503 Install the cover

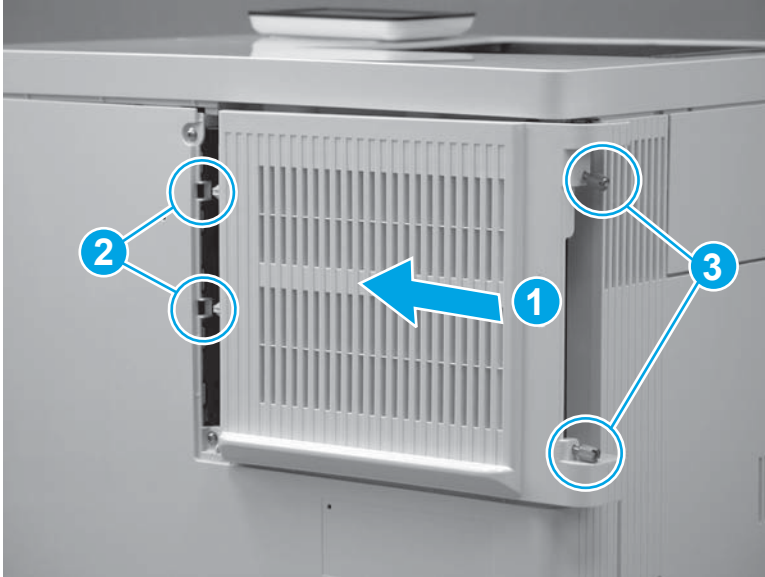

Removal and replacement: Internal USB ports (M577)

- [Introduction](#)
- [Step 1: Remove the formatter cover](#)
- [Step 2: Remove the internal USB ports module \(M577\)](#)
- [Step 3: Unpack the replacement assembly](#)
- [Step 4: Install the internal USB ports module \(M577\)](#)
- [Step 5: Install the formatter cover](#)

Introduction



This document provides the procedures to remove and replace the internal USB ports.

Before performing service

Turn the printer power off

- Disconnect the power cable.

 **WARNING!** To avoid damage to the printer, turn the printer off, wait 30 seconds, and then remove the power cord before attempting to service the printer.

 **CAUTION:**  This part contains components that are electrostatic discharge (ESD) sensitive. To reduce the possibility of ESD damage, always touch the sheet-metal chassis to ground yourself before touching an ESD sensitive part.

Use the table below to identify the correct part number for your printer. To order the part, go to www.hp.com/buy/parts.

Internal USB ports part number	
B5L28-67902	Internal USB ports

Required tools

No special tools are required to install this part.

After performing service

Turn the printer power on

- Connect the power cable.
- Use the power switch to turn the power on.

Post service test

Print a configuration page to make sure that the printer is functioning correctly.

Step 1: Remove the formatter cover

1. Locate the formatter cover.

Figure 1-5504 Locate the formatter cover

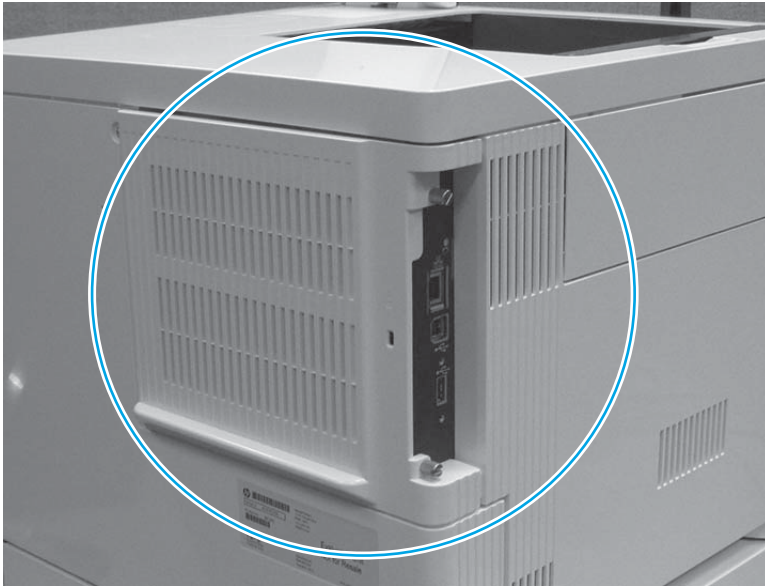

2. Loosen the two thumbscrews (callout 1). Grasp the two thumbscrews, and then slide the cover away from the printer (callout 2) to remove it.

 **TIP:** If needed, use the edge of a coin to turn the thumbscrews.

Figure 1-5505 Loosen the thumbscrews

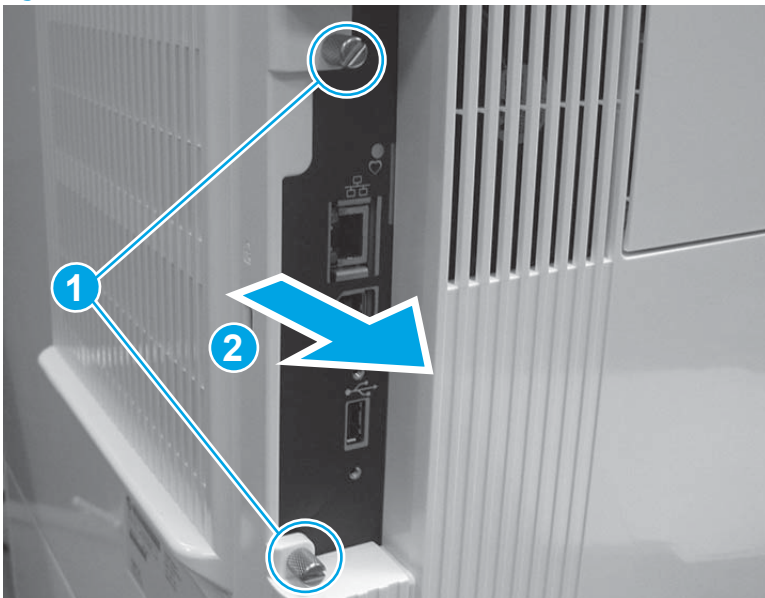

Step 2: Remove the internal USB ports module (M577)

 **CAUTION:**  ESD-sensitive part.

1. Locate the internal USB ports module on the formatter.

Figure 1-5506 Locate the USB ports module

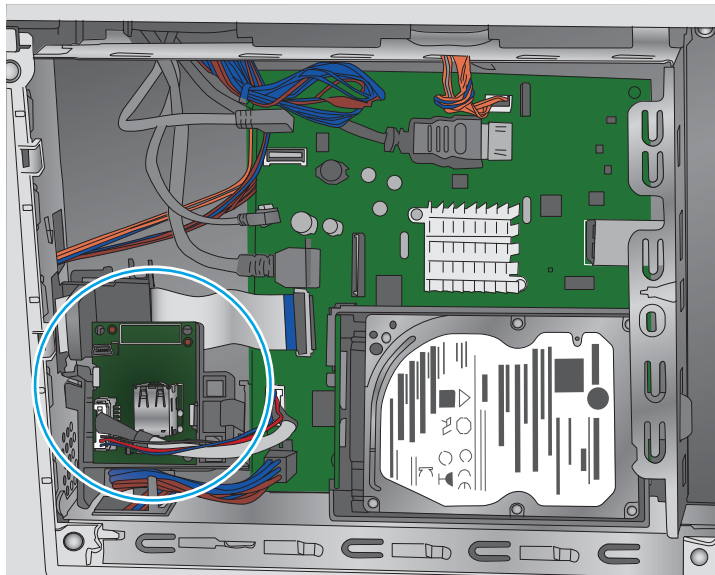

2. Disconnect one connector (callout 1).

Figure 1-5507 Disconnect one connector

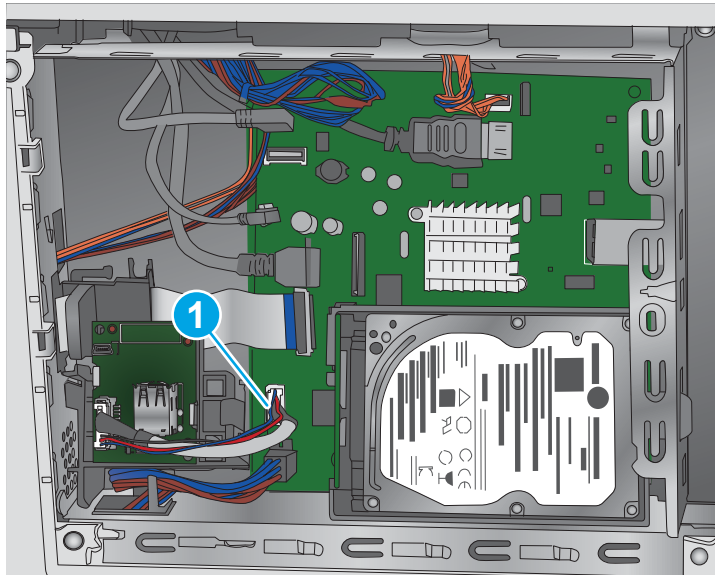

3. Release two tabs (callout 1), and then remove the internal USB ports module (callout 2).

Figure 1-5508 Remove the module

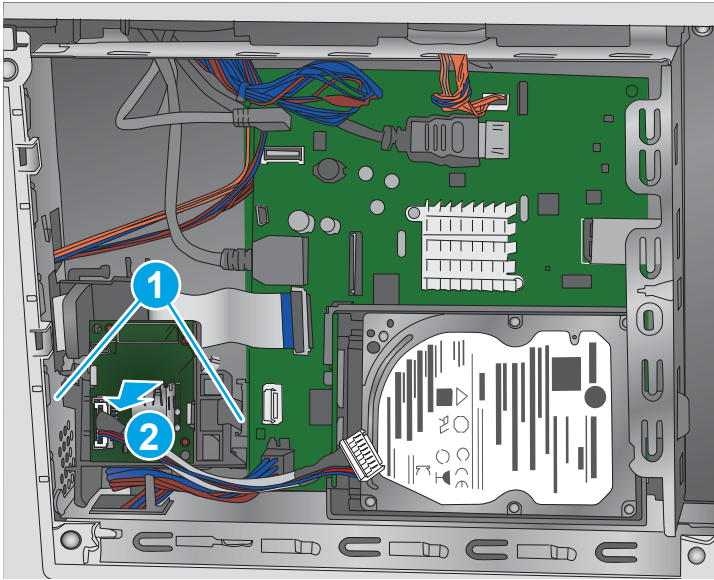

Step 3: Unpack the replacement assembly

Unpack the replacement assembly from the packaging.

CAUTION:  ESD-sensitive part.

For complete information on HP's recycling programs, go to [Product return and recycling](#).

NOTE:  HP recommends responsible disposal of the defective part.

Figure 1-5509 Recycle and unpack



Step 4: Install the internal USB ports module (M577)

 **CAUTION:**  ESD-sensitive part.

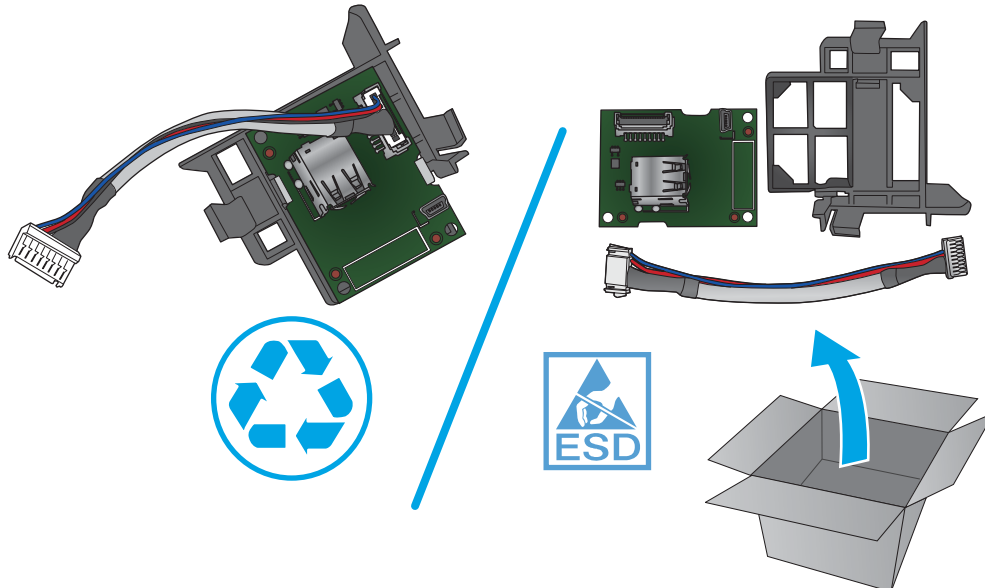
1. Position the notches on the internal USB ports PCA over the clips on the PCA holder and press down to attach the PCA to the holder. Make sure that the clips snap into place.

Figure 1-5510 Install the PCA in the holder

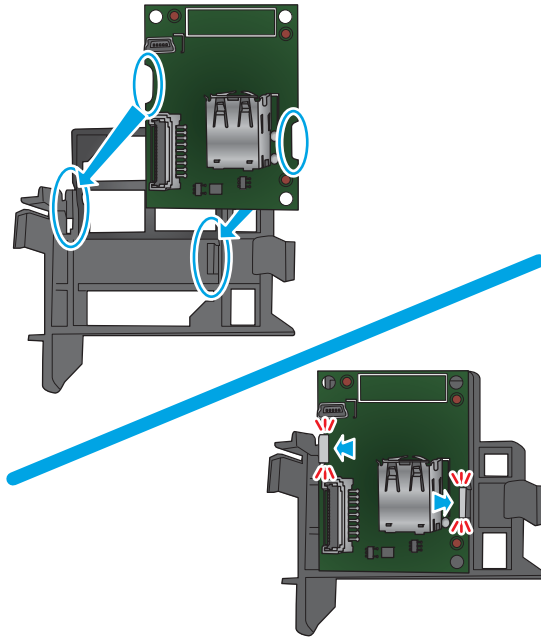

2. Connect one cable to the PCA.

Figure 1-5511 Connect one cable

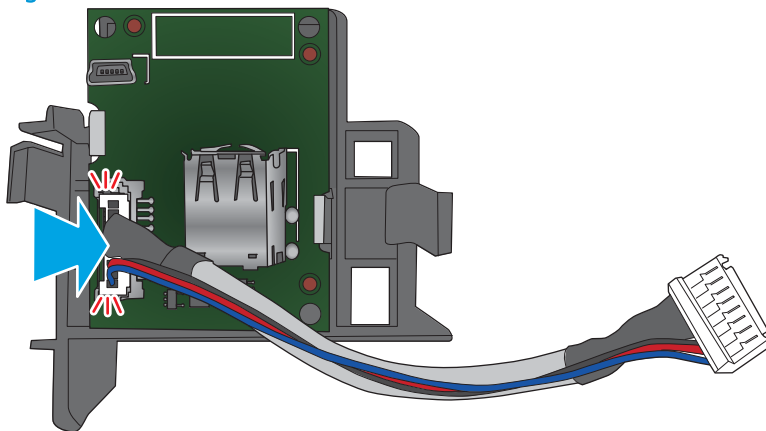

3. Position the clips and locator pins on the internal USB ports module holder (callout 1) in the holes (callout 2) in the formatter case.

Figure 1-5512 Position the internal USB ports module

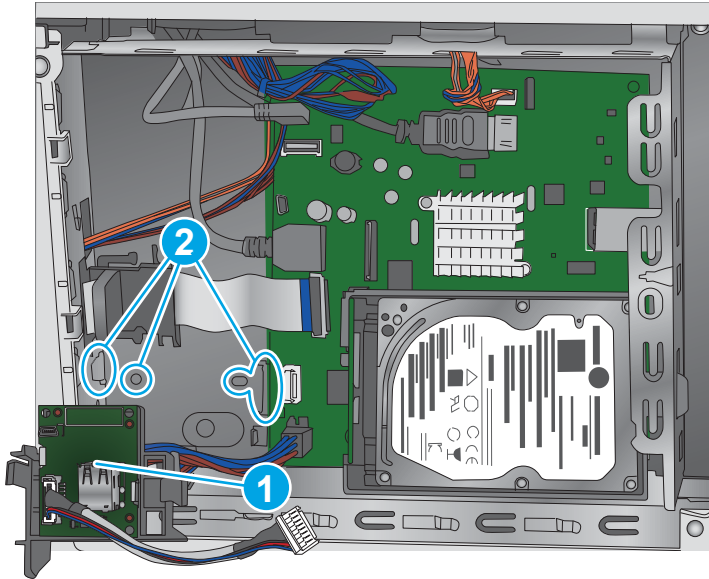

4. Press the internal USB ports module toward the formatter case until the clips snap into place.

Figure 1-5513 Install the internal USB ports module

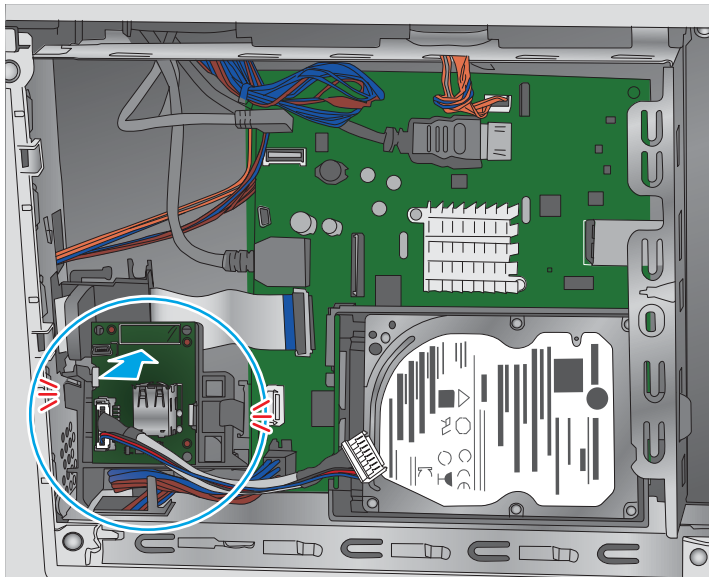

5. Connect one connector (callout 1).

Figure 1-5514 Connect one connector

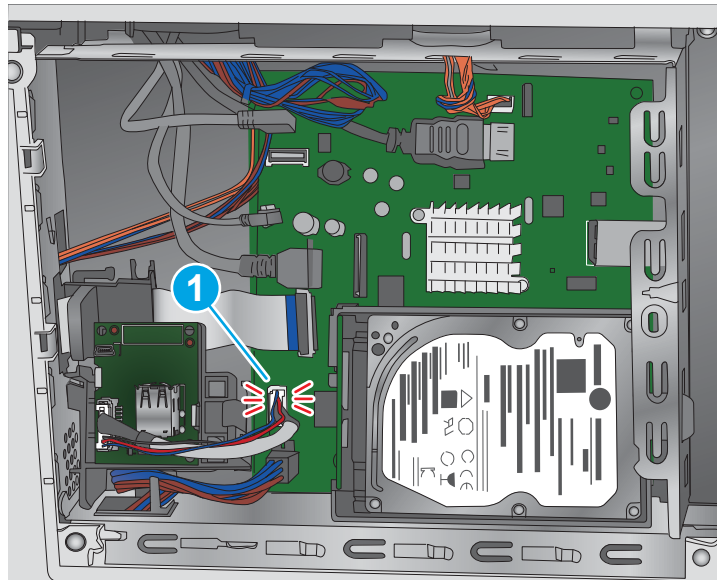

Step 5: Install the formatter cover

- ▲ Slide the cover onto the printer (callout 1) to install it.

 **NOTE:** Make sure that the tabs on the formatter cover align with the slots provided in the printer (callout 2). Tighten the two thumbscrews (callout 3).

 **TIP:** If needed, use the edge of a coin to turn the thumbscrews.

Figure 1-5515 Install the cover

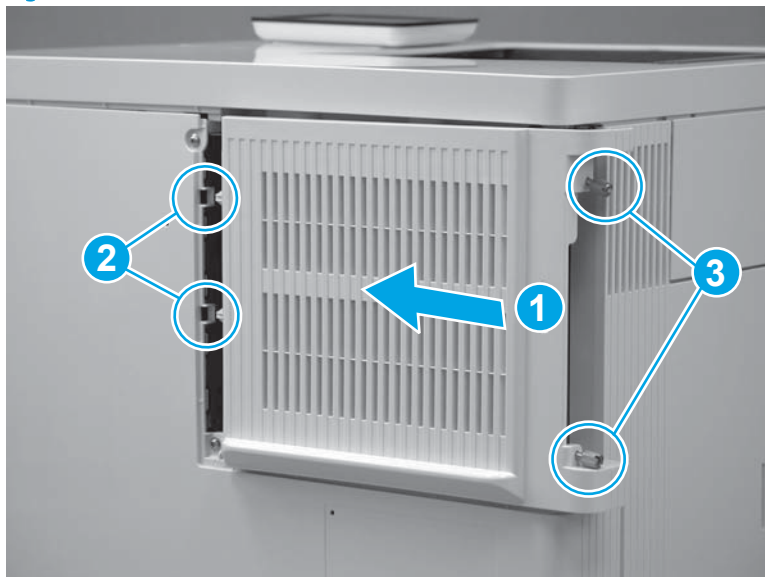

Removal and replacement: Fax PCA (M577c/f/z)

- [Introduction](#)
- [Step 1: Remove the formatter cover](#)
- [Step 2: Remove the fax PCA](#)
- [Step 3: Unpack the replacement assembly](#)
- [Step 4: Install the fax PCA](#)
- [Step 5: Install the formatter cover](#)

Introduction



This document provides the procedures to remove and replace the fax PCA.

Before performing service

Turn the printer power off

- Disconnect the power cable.

 **WARNING!** To avoid damage to the printer, turn the printer off, wait 30 seconds, and then remove the power cord before attempting to service the printer.

 **CAUTION:**  This part contains components that are electrostatic discharge (ESD) sensitive. To reduce the possibility of ESD damage, always touch the sheet-metal chassis to ground yourself before touching an ESD sensitive part.

Use the table below to identify the correct part number for your printer. To order the part, go to www.hp.com/buy/parts.

Fax PCA part number	
---------------------	--

B5L53-67901

Analog FAX 600 kit

Required tools

No special tools are required to install this part.

After performing service

Turn the printer power on

- Connect the power cable.
- Use the power switch to turn the power on.

Post service test

Print a configuration page to make sure that the printer is functioning correctly.

Step 1: Remove the formatter cover

1. Locate the formatter cover.

Figure 1-5516 Locate the formatter cover

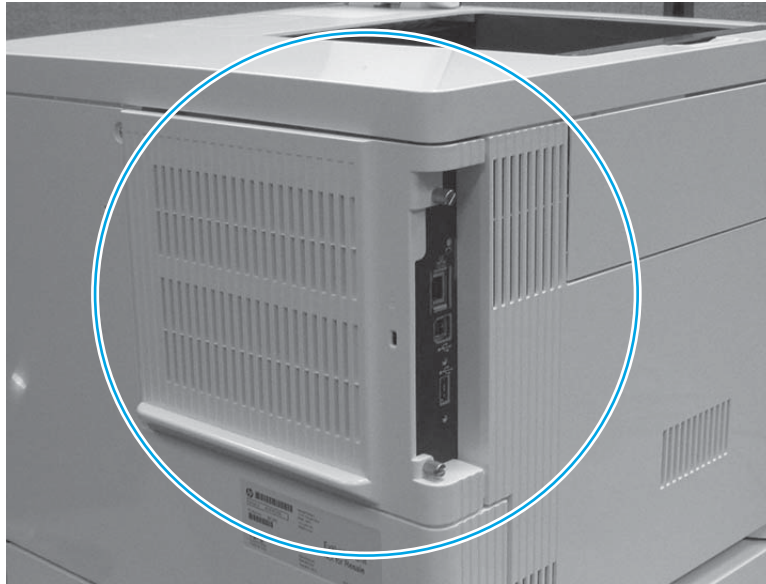

2. Loosen the two thumbscrews (callout 1). Grasp the two thumbscrews, and then slide the cover away from the printer (callout 2) to remove it.

 **TIP:** If needed, use the edge of a coin to turn the thumbscrews.

Figure 1-5517 Loosen the thumbscrews

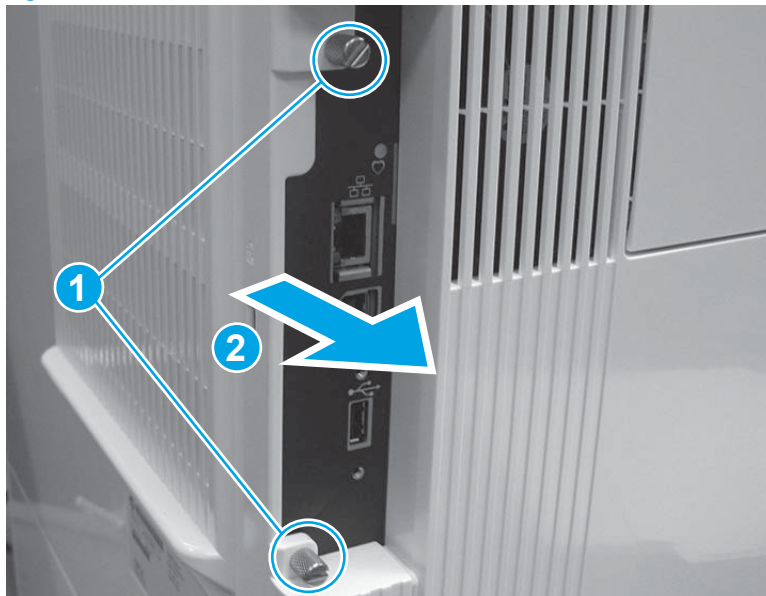

Step 2: Remove the fax PCA

 **CAUTION:**  ESD-sensitive part.

1. Locate the fax PCA component on the formatter.

Figure 1-5518 Locate the fax PCA

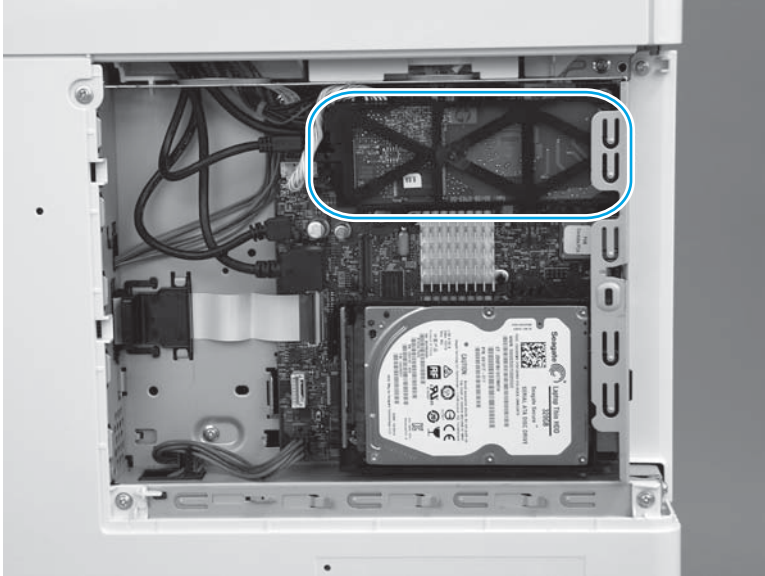

2. Release the connector latch (callout 1), and then pull the connector away from the formatter (callout 2) to disconnect it.

Figure 1-5519 Disconnect one connector

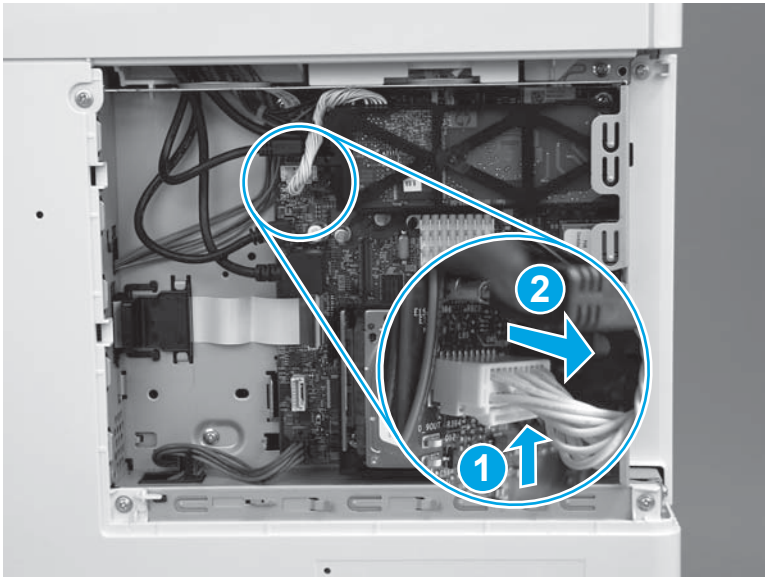

3. Release one retainer (callout 1) by pressing the bracket arms together.

Figure 1-5520 Release one latch

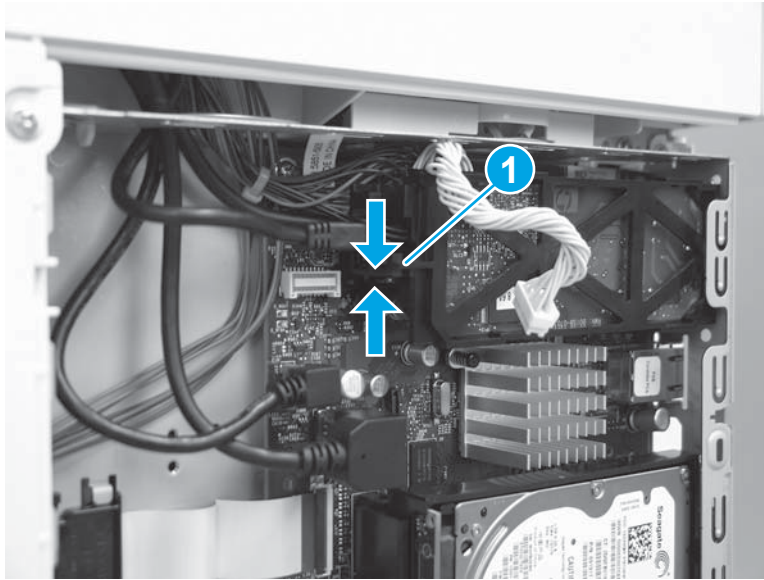

4. Rotate the end of the fax PCA (callout 1) away from the formatter, and then slide the PCA left (callout 2) to remove it.

Figure 1-5521 Remove the fax PCA

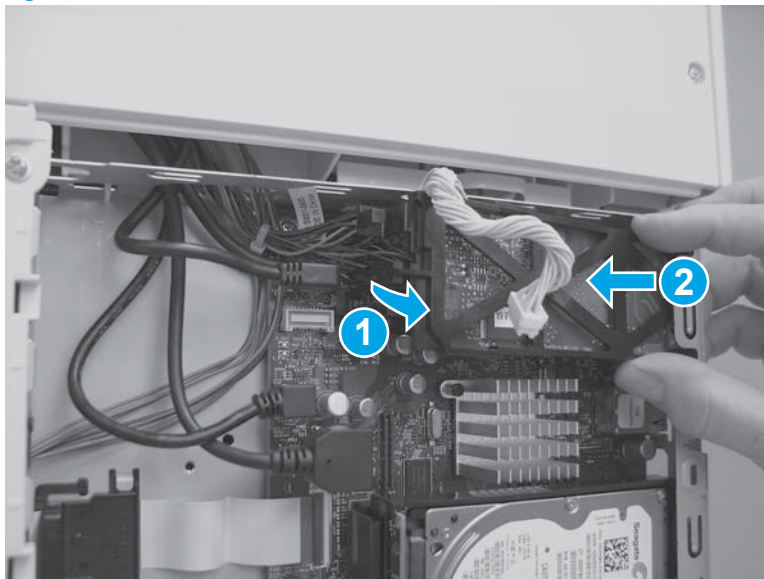

Step 3: Unpack the replacement assembly

Unpack the replacement assembly from the packaging.

 **CAUTION:**  ESD-sensitive part.

For complete information on HP's recycling programs, go to [Product return and recycling](#).

 **NOTE:** HP recommends responsible disposal of the defective part.

Figure 1-5522 Recycle and unpack

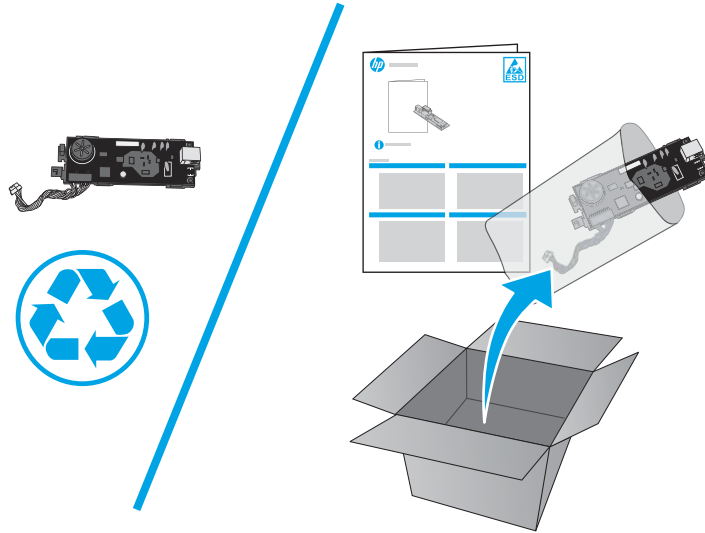

Step 4: Install the fax PCA

 **CAUTION:**  ESD-sensitive part.

1. Position the tab and telephone port (callout 1) on the fax PCA in the slots (callout 2) in the formatter case.

Figure 1-5523 Position the fax PCA

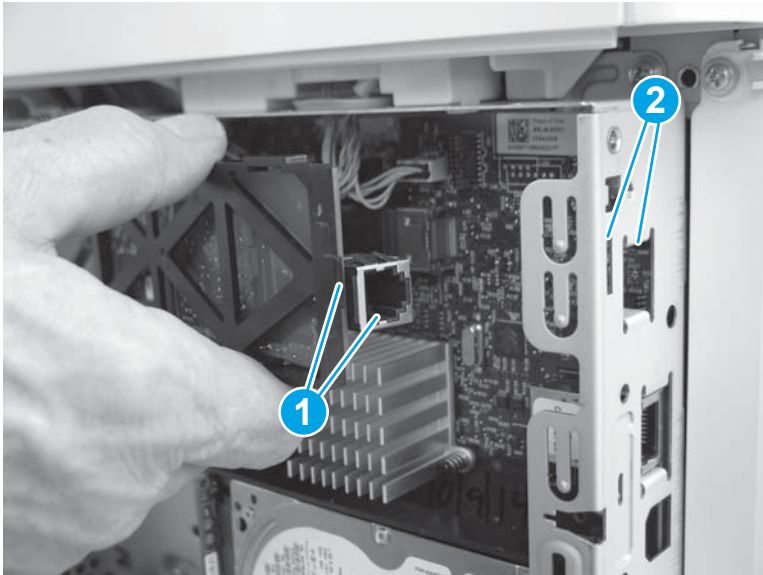

2. Slide the fax PCA to the right (callout 1) until the tab and telephone port described in the previous step and seated in the formatter case. Position the retainer (callout 2) in the slot (callout 3) in the formatter. Rotate the end of the fax PCA toward the formatter (callout 4) until the retainer snaps into place.

Figure 1-5524 Install the fax PCA

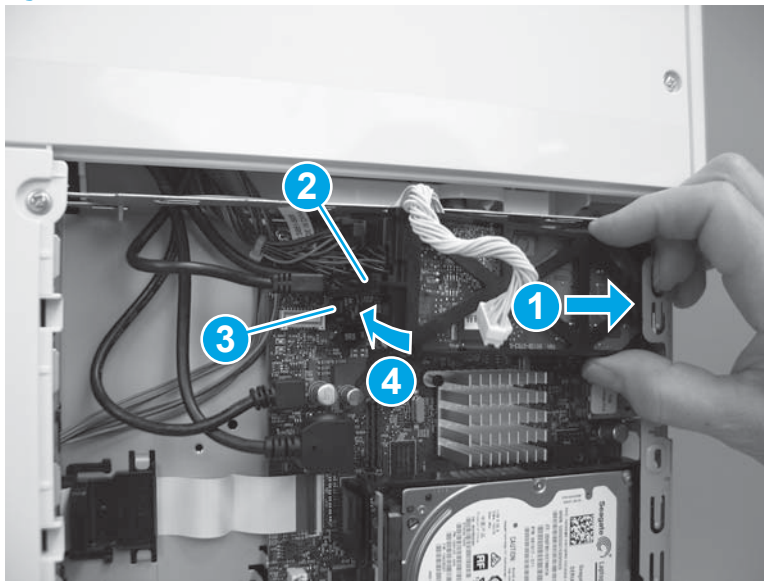

3. Position the cable (callout 1) in the guide (callout 2), and then connect one connector (callout 3).

Figure 1-5525 Connect the connector

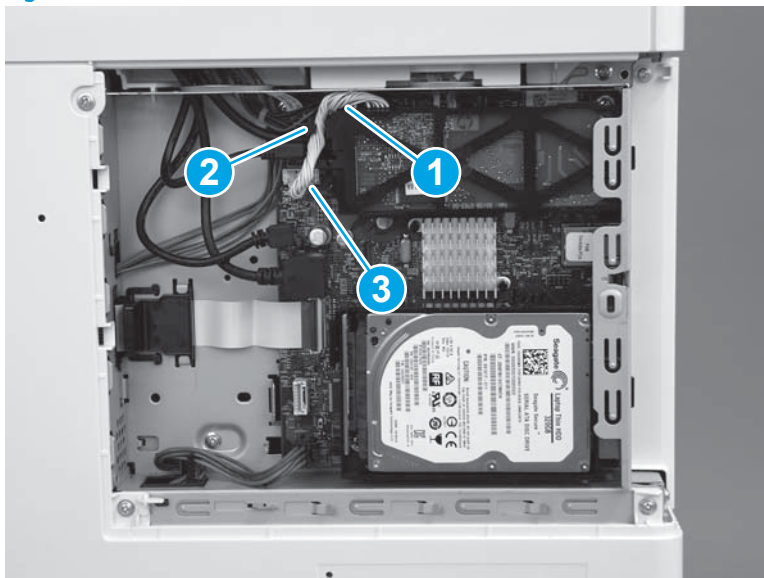

Step 5: Install the formatter cover

- ▲ Slide the cover onto the printer (callout 1) to install it.

 **NOTE:** Make sure that the tabs on the formatter cover align with the slots provided in the printer (callout 2). Tighten the two thumbscrews (callout 3).

 **TIP:** If needed, use the edge of a coin to turn the thumbscrews.

Figure 1-5526 Install the cover

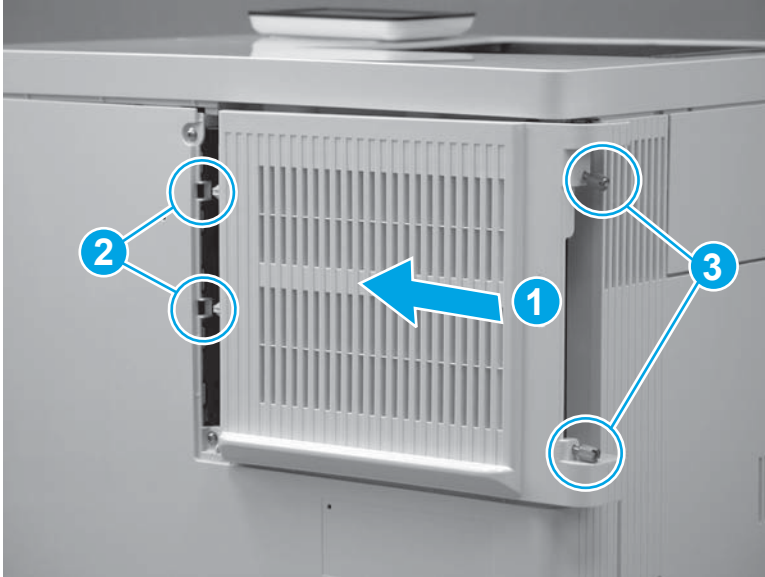

2 Parts and diagrams

- [For additional service and support](#)
- [Assembly locations](#)
- [Order parts, accessories, and supplies](#)
- [How to use the parts lists and diagrams](#)
- [Parts and diagrams: Document feeder and scanner whole units](#)
- [Parts and diagrams: Covers](#)
- [Parts and diagrams: Internal components](#)
- [Parts and diagrams: 550-sheet paper feeder](#)
- [Alphabetical parts list](#)
- [Numerical parts list](#)

For additional service and support

HP service personnel, go to one of the following Web-based Interactive Search Engines (WISE) sites:

AMS

- <https://support.hp.com/wise/home/ams-en>
- <https://support.hp.com/wise/home/ams-es>
- <https://support.hp.com/wise/home/ams-pt>

APJ

- <https://support.hp.com/wise/home/apj-en>
- <https://support.hp.com/wise/home/apj-ja>
- <https://support.hp.com/wise/home/apj-ko>
- <https://support.hp.com/wise/home/apj-zh-Hans>
- <https://support.hp.com/wise/home/apj-zh-Hant>

EMEA

- <https://support.hp.com/wise/home/emea-en>

Channel partners, go to HP Channel Services Network (CSN) at www.hp.com/partners/csn.

At these locations, find information on the following topics:

- Install and configure
- Printer specifications
- Up-to-date control panel message (CPMD) troubleshooting
- Solutions for printer issues and emerging issues
- Remove and replace part instructions and videos
- Service advisories
- Warranty and regulatory information

Channel partners, access training materials in the HP University and Partner Learning Center at <https://content.ext.hp.com/sites/LMS/HPU.page>.

To access HP PartSurfer information from any mobile device, go to <http://partsurfermobile.hp.com/>.

Assembly locations

Product front view (M552 and M553 models)

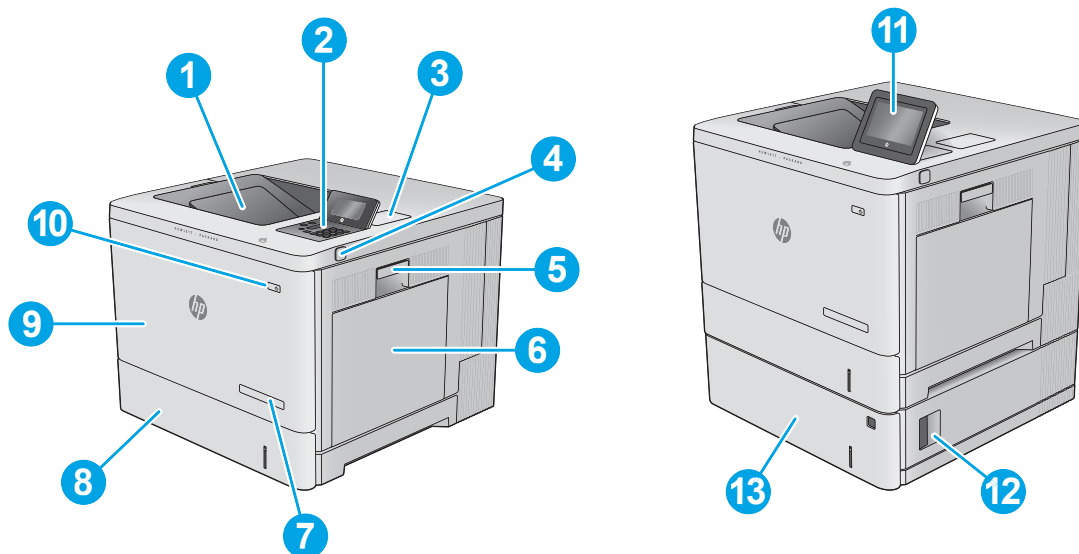

1	Standard output bin
2	4-line LCD control panel with keypad (n and dn models only)
3	Hardware integration pocket for connecting accessory and third-party devices (dn and x models only)
4	Easy-access USB port
5	Right door (access to the fuser and for clearing jams)
6	Tray 1
7	Model name
8	Tray 2
9	Front door (access to the toner cartridges)
10	On/off button
11	Control panel with color touchscreen display (x model only)
12	Lower-right door for the 550-sheet paper feeder (access for clearing jams)
13	550-sheet paper feeder, Tray 3 (included with the x model, optional for the other models)

NOTE: The M552 model accepts one 550-sheet paper feeder. The M553 models accept up to three 550-sheet paper feeders.

Product back view (M552 and M553 models)

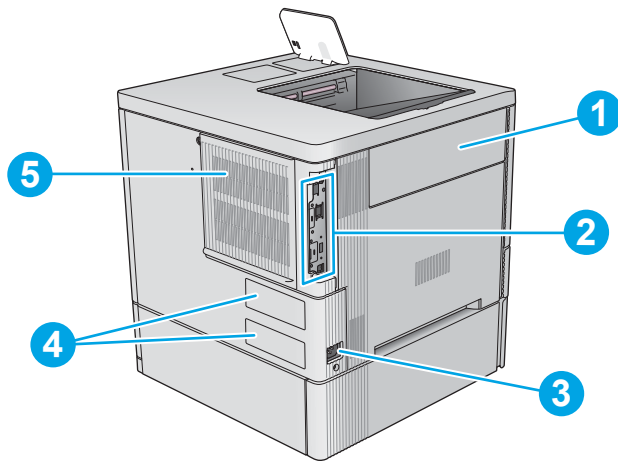

1	Toner-collection-unit door
2	Formatter (contains the interface ports)
3	Power connection
4	Serial number and product number label
5	Formatter cover

Product front view (M577 models)

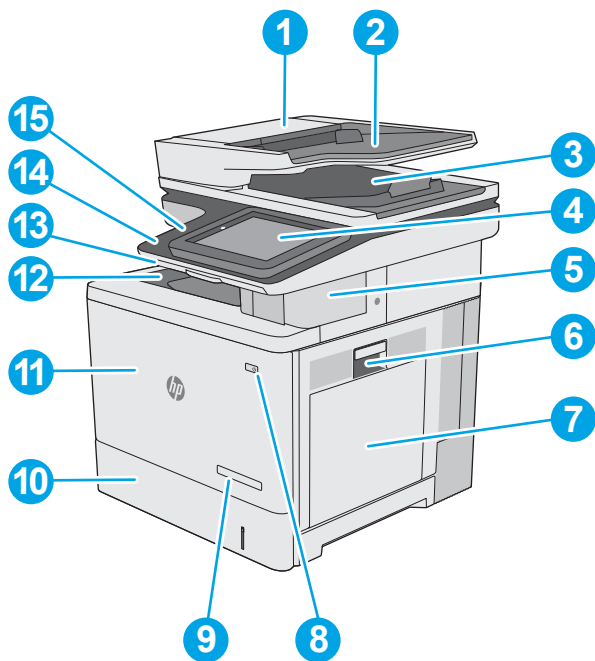

1	Document-feeder cover (access for clearing jams)
2	Document-feeder input tray
3	Document-feeder output bin
4	Control panel with color touchscreen display
5	Convenience stapler (M577c/f/z models only)
6	Right door (access to the fuser and for clearing jams)
7	Tray 1
8	On/off button
9	Model name
10	Tray 2
11	Front door (access to the toner cartridges)
12	Standard output bin
13	Physical keyboard (M577c/z models only)
14	Easy-access USB port (on the side of the control panel)
15	Hardware integration pocket (for connecting accessory and third-party devices)

Product back view (M577 models)

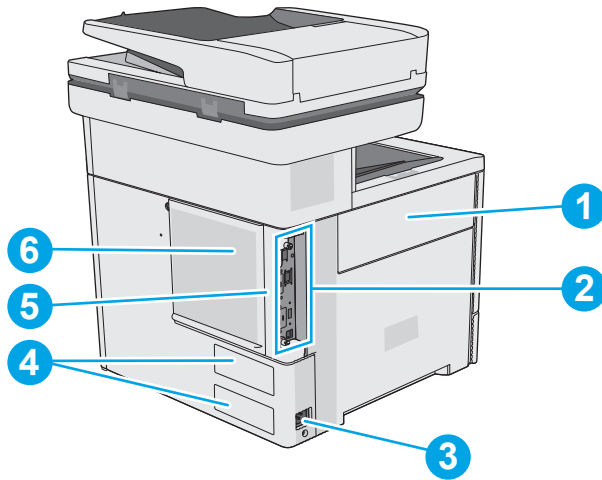

1	Toner-collection-unit door
2	Formatter (contains the interface ports)
3	Power connection
4	Serial number and product number label
5	Slot for a cable-type security lock (on the rear cover of the printer)
6	Formatter cover

Order parts, accessories, and supplies

Ordering

Order supplies and paper	www.hp.com/go/suresupply
Order genuine HP parts or accessories	www.hp.com/buy/parts or partsurfer.hp.com
Order through service or support providers	Contact an HP-authorized service or support provider.
Order using the HP Embedded Web Server (EWS)	To access, in a supported Web browser on your computer, enter the product IP address or host name in the address/URL field. The EWS contains a link to the HP SureSupply Web site, which provides options for purchasing Original HP supplies.

Orderable parts

Not all of the parts shown in the diagrams in this chapter can be ordered. Refer to the table following the diagram or the parts lists at the end of this chapter to determine if a part is orderable.

Supplies

Following are the part numbers for the supplies available for the product.

Table 2-1 Supplies

Item	Description	Part number
HP 508A Black Original LaserJet Toner Cartridge	Standard-capacity replacement black toner cartridge	CF360A (new)
		CF360-67901 (service)
HP 508X High Yield Black Original LaserJet Toner Cartridge	High-capacity replacement black toner cartridge	CF360X (new)
		CF360-67902 (service)
HP 508A Cyan Original LaserJet Toner Cartridge	Standard-capacity replacement cyan cartridge	CF361A (new)
		CF361-67901 (service)
HP 508X High Yield Cyan Original LaserJet Toner Cartridge	High-capacity replacement cyan toner cartridge	CF361X (new)
		CF361-67902 (service)
HP 508A Yellow Original LaserJet Toner Cartridge	Standard-capacity replacement yellow toner cartridge	CF362A (new)
		CF362-67901 (service)
HP 508X High Yield Yellow Original LaserJet Toner Cartridge	High-capacity replacement yellow toner cartridge	CF362X (new)
		CF362-67902 (service)
HP 508A Magenta Original LaserJet Toner Cartridge	Standard-capacity replacement magenta toner cartridge	CF363A (new)
		CF363-67901 (service)

Table 2-1 Supplies (continued)

Item	Description	Part number
HP 508X High Yield Magenta Original LaserJet Toner Cartridge	High-capacity replacement magenta toner cartridge	CF363X (new)
		CF363-67902 (service)
SVC Cartridge LJ Black Managed Toner	Managed black toner cartridge	W9060-67901
SVC Cartridge LJ Cyan Managed Toner	Managed cyan toner cartridge	W9061-67901
SVC Cartridge LJ Yellow Managed Toner	Managed yellow toner cartridge	W9062-67901
SVC Cartridge LJ Magenta Managed Toner	Managed magenta toner cartridge	W9063-67901
HP toner-collection unit	Replacement toner-collection unit with attached door	B5L37A (new)
		B5L37-67901 (service)
HP Staple Cartridge Pack (M577f and M577z)	Replacement staple cartridges. Contains two staple cartridges of 1500 staples each.	Q7432A
HP LaserJet 200 ADF Roller Replacement Kit (M577)	Replacement feed rollers for the document feeder	B5L52A (new)
		B5L52-67903 (service)
Fuser kit (110V)	Fuser (110V)	B5L35A (new)
		B5L35-67902 (service)
Fuser kit (220V)	Fuser (220V)	B5L36A (new)
		B5L36-67902 (service)

Accessories

Following are the part numbers for the accessories available for the printers.

Table 2-2 Accessories (M552 and M553)

Item	Description	Part number
550-sheet paper feeder	Optional 550-sheet paper feeder (included with the x model)	B5L34A (new)
		B5L34-67901 (service)
	NOTE: The M552 model accepts one 550-sheet paper feeder. The M553 models accept up to three 550-sheet paper feeders.	
Kit - Fixed Tray Guide	Fixed tray guide kit for cassette trays.	3GY25-67901
Printer stand and cabinet	Optional stand with storage cabinet to support the printer	B5L51A (new)
		B5L51-67901 (service)
	Recommended when using multiple optional paper feeders.	
HP secure 500 GB high-performance hard disk drive	Optional hard drive	B5L29A (new)
		B5L29-67903 (service)
	NOTE: Not supported for the M552dn.	
1GB DDR3 slim memory DIMM	Optional DIMM for expanding the memory	G6W84A (new)
		5851-6422 (service)
	NOTE: M553 only	

Table 2-2 Accessories (M552 and M553) (continued)

Item	Description	Part number
HP internal USB ports	Two optional USB ports for connecting third-party devices	B5L28A (new)
		B5L28-67902 (service)
HP Trusted Platform Module (TPM)	Automatically encrypts all data that passes through the product	F5S62A (new)
		F5S62-61001 (service)

Table 2-3 Accessories (M577)

Item	Description	Part number
550-sheet paper feeder	Optional 550-sheet paper feeder NOTE: The printer supports up to three 550-sheet paper feeders.	B5L34A (new)
		B5L34-67901 (service)
Kit-Color Fixed Tray Guide	Fixed tray guide kit for cassette trays.	3GY25-67901
Printer stand and cabinet	Optional stand with storage cabinet to support the printer	B5L51A (new)
	Recommended when using multiple optional paper feeders.	B5L51-67901 (service)
HP LaserJet Keyboard Overlay Kit for Simplified Chinese & Traditional Chinese	Language-specific, adhesive overlay for the physical keyboard	A7W12A
HP LaserJet Keyboard Overlay Kit for Swedish	Language-specific, adhesive overlay for the physical keyboard	A7W14A
HP secure 500 GB high-performance hard disk drive	Optional 500 GB hard drive	B5L29A (new)
		B5L29-67903 (service)
1GB DDR3 x32 144-Pin 800MHz SODIMM (M577)	Optional DIMM for expanding the memory	E5K48A (new)
		E5K48-67902 (service)
HP internal USB ports	Two optional USB ports for connecting third-party devices	B5L28A (new)
		B5L28-67902 (service)
HP Smartcard NIPRNet Solution for US Government	Nonsecure Internet Protocol (IP) Router Network for transmitting non-classified information	CC543B
HP Smartcard NIPRNet Solution for US Government	Secret Internet Protocol (IP) Router Network for transmitting classified information	F8B30A
HP Trusted Platform Module (TPM)	Automatically encrypts all data that passes through the product	F5S62A (new)
		F5S62-61001 (service)
HP Foreign Interface Harness	Optional port for connecting third-party devices	B5L31A (new)
		B5L31-67902 (service)

Table 2-3 Accessories (M577) (continued)

Item	Description	Part number
HP LaserJet MFP Analog Fax Accessory 600	Optional fax accessory for the dn model	B5L53A (new) B5L53-67901 (service)
HP Jetdirect 2900nw Print Server	USB wireless print server accessory	J8031A
HP Jetdirect 3000w NFC/Wireless Accessory	Wi-Fi direct accessory for “touch” printing from mobile devices	J8030A

Customer self-repair kits

Following are the customer-replaceable kits available for the product. Each kit includes parts and installation instructions.

The customer self-repair (CSR) level indicates the expected difficulty the customer will experience when replacing this part:

- **A:** Easy
- **B:** Difficult

Item	Description	CSR level	Part number
Control panel kit (M553x only)	• Control panel	A	B5L24-67903
Control panel kit (M577 only)	• Control panel	A	B5L47-67018
Secondary transfer roller kit	• Secondary transfer roller	A	B5L24-67902
Intermediate transfer belt (ITB) and secondary transfer roller kit	• ITB • Secondary transfer roller	B	B5L24-67901
Tray 2-5 roller kit	• Rollers for Tray 2 and the optional 550-sheet paper feeders	A	B5L24-67904
ADF roller replacement Kit (M577)	Replacement feed rollers for the document feeder	A	B5L52-67903
Fuser kit (110V)	• Fuser (110V)	A	B5L35-67902
Fuser kit (220V)	• Fuser (220V)	A	B5L36-67902
embedded MultiMedia Card (eMMC) kit (M552 and M553 only)	• eMMC module	A	5851-6436
320GB encrypted hard disk drive kit (M577 only)	• Replacement hard disk drive	A	5851-6712
White backing kit (M577 only)	• White backing for the document feeder • Retention clips for the document feeder white backing	A	5851-6570
Retention clip kit (M577 only)	• Retention clips for the document feeder white backing	A	5851-6573
Keyboard kit (M577c/z only)	• Keyboard	A	B5L47-67019 (US) B5L47-67020 (UK)
Keyboard overlay kit (FR, IT, RU, DE, ES: UK Kybd) (M577c/z only)	• Keyboard overlay	A	5851-6019
Keyboard overlay kit (FR-CN, ES-LA, ES: US Kybd)(M577c/z only)	• Keyboard overlay	A	5851-6020
Keyboard overlay kit (FR-SW, DE-SW, DA: UK Kybd) (M577c/z only)	• Keyboard overlay	A	5851-6021
Keyboard overlay kit (ZHTW, ZHCN) (M577c/z only)	• Keyboard overlay	A	5851-6022

Item	Description	CSR level	Part number
Keyboard overlay kit (ES, PT) (M577c/z only)	<ul style="list-style-type: none"> Keyboard overlay 	A	5851-6023
Keyboard overlay kit (JA-KG, JA-KT) (M577c/z only)	<ul style="list-style-type: none"> Keyboard overlay 	A	5851-6024

Related documentation and software

HP service personnel, go to the Service Access Work Bench (SAW) at <http://h41302.www4.hp.com/km/saw/home.do>.

Channel partners, go to HP Channel Services Network (CSN) at www.hp.com/partners/csn.

How to use the parts lists and diagrams

The figures in this chapter show the major subassemblies in the product and their component parts. A parts list table follows each exploded view assembly diagram. Each table lists the item number, the associated part number, and the description of each part. If a part is not listed in the table, then it is not a field replacement unit (FRU).

 **CAUTION:** Be sure to order the correct part. When looking for part numbers for electrical components, pay careful attention to the voltage that is listed in the description column. Doing so will ensure that the part number selected is for the correct model.

 **NOTE:** In this manual, the abbreviation “PCA” stands for “printed circuit-board assembly.” Components described as a PCA might consist of a single circuit board or a circuit board plus other parts, such as cables and sensors.

Parts and diagrams: Document feeder and scanner whole units

Figure 2-1 Document feeder and scanner whole units (M577 only)

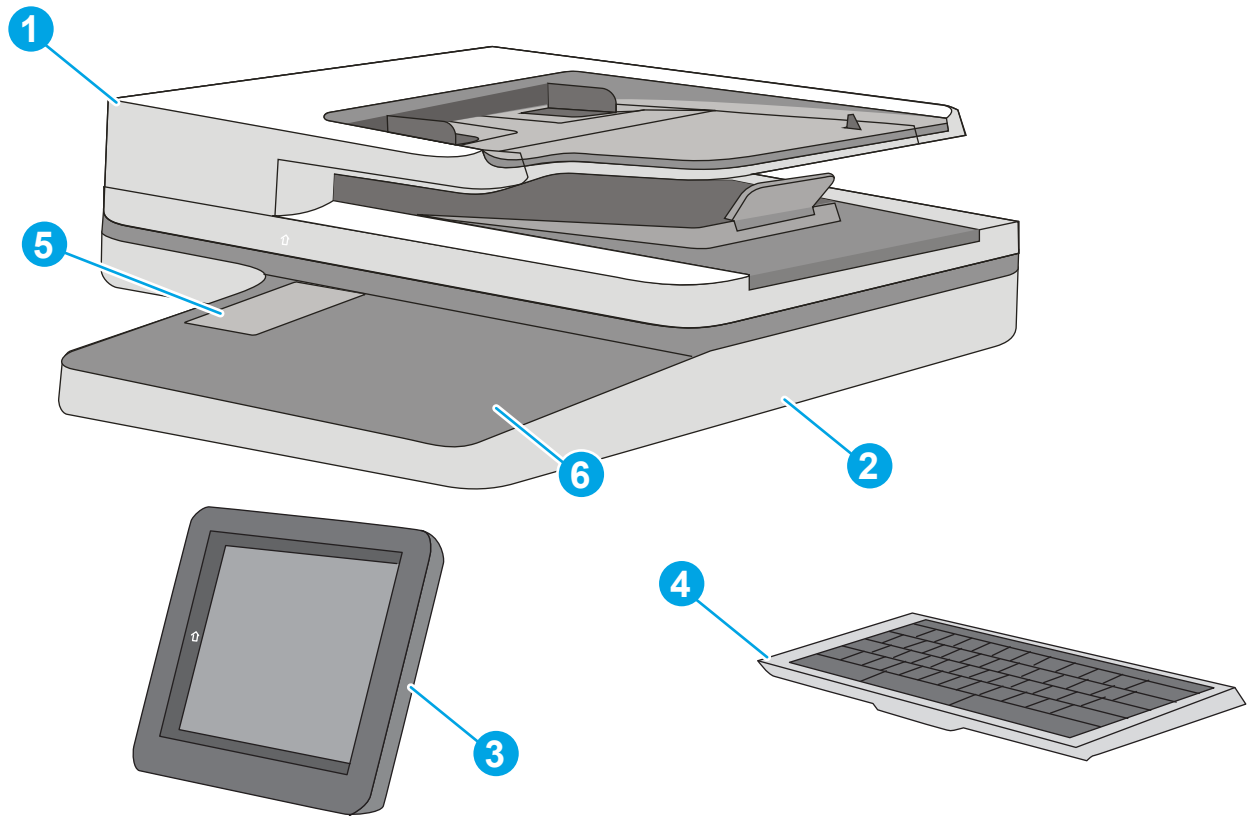

Table 2-4 Document feeder and scanner whole units (M577 only)

Ref	Description	Part number	Qty
1	Document feeder (M577dn/f) kit; includes white backing and retention clips	B5L47-67901	1
1	Document feeder (M577c/z) kit; includes white backing and retention clips	B5L47-67902	1
2	Image scanner (M577) kit; includes white backing and retention clips	B5L46-67904	1
3	Control panel (M577) kit	B5L47-67018	1
4	Keyboard US (M577c/z)	B5L47-67019	1
4	Keyboard UK (M577c/z)	B5L47-67020	1
5	Cover, HIP (M577)	B5L46-40021	1
6	Bezel, control panel with NFC icon (M577)	B5L46-40026	1
6	Bezel, control panel without NFC icon (M577)	B5L46-40020	1
Not shown	Scan control board	B5L47-67902	1
Not shown	Cover, keyboard (M577dn/f)	B5L46-40002	1
Not shown	Cover, rear (image scanner; M577)	B5L46-40011	1
Not shown	Cover, USB (M577)	B5L46-40028	1
Not shown	Cover, right front upper (M577dn)	B5L46-40024	1
Not shown	Cover assembly, stapler (M577c/f/z)	B5L46-60121	1
Not shown	Stapler (M577c/f/z)	B5L46-60102	1
Not shown	Hinge, left document feeder (M577)	COM39-60064	1
Not shown	Hinge, right document feeder (M577)	COM39-60065	1
Not shown	Cable, stapler (M577)	B5L46-60121	1
Not shown	Cable, WU USB control panel (M577)	5851-5939	1
Not shown	Cable, HIP USB control panel (M577)	5851-5938	1
Not shown	Cable, HDMI control panel (M577)	5851-5936	1
Not shown	Cable, 18-pin control panel (M577)	5851-5935	1
Not shown	Cable, HDMI PAB to SCAM (M577)	B5L46-60114	1
Not shown	Keyboard overlay kit (FR, IT, RU, DE, ES: UK Kybd)	5851-6019	1
Not shown	Keyboard overlay kit (FR-CN, ES-LA, ES: US Kybd)	5851-6020	1
Not shown	Keyboard overlay kit (FR-SW, DE-SW, DA: UK Kybd)	5851-6021	1
Not shown	Keyboard overlay kit (ZHTW, ZHCN)	5851-6022	1
Not shown	Keyboard overlay kit (ES, PT)	5851-6023	1
Not shown	Keyboard overlay kit (JA-KG, JA-KT)	5851-6024	1

Parts and diagrams: Covers

Covers (M552 and M553)

Figure 2-2 Covers (M552, M553)

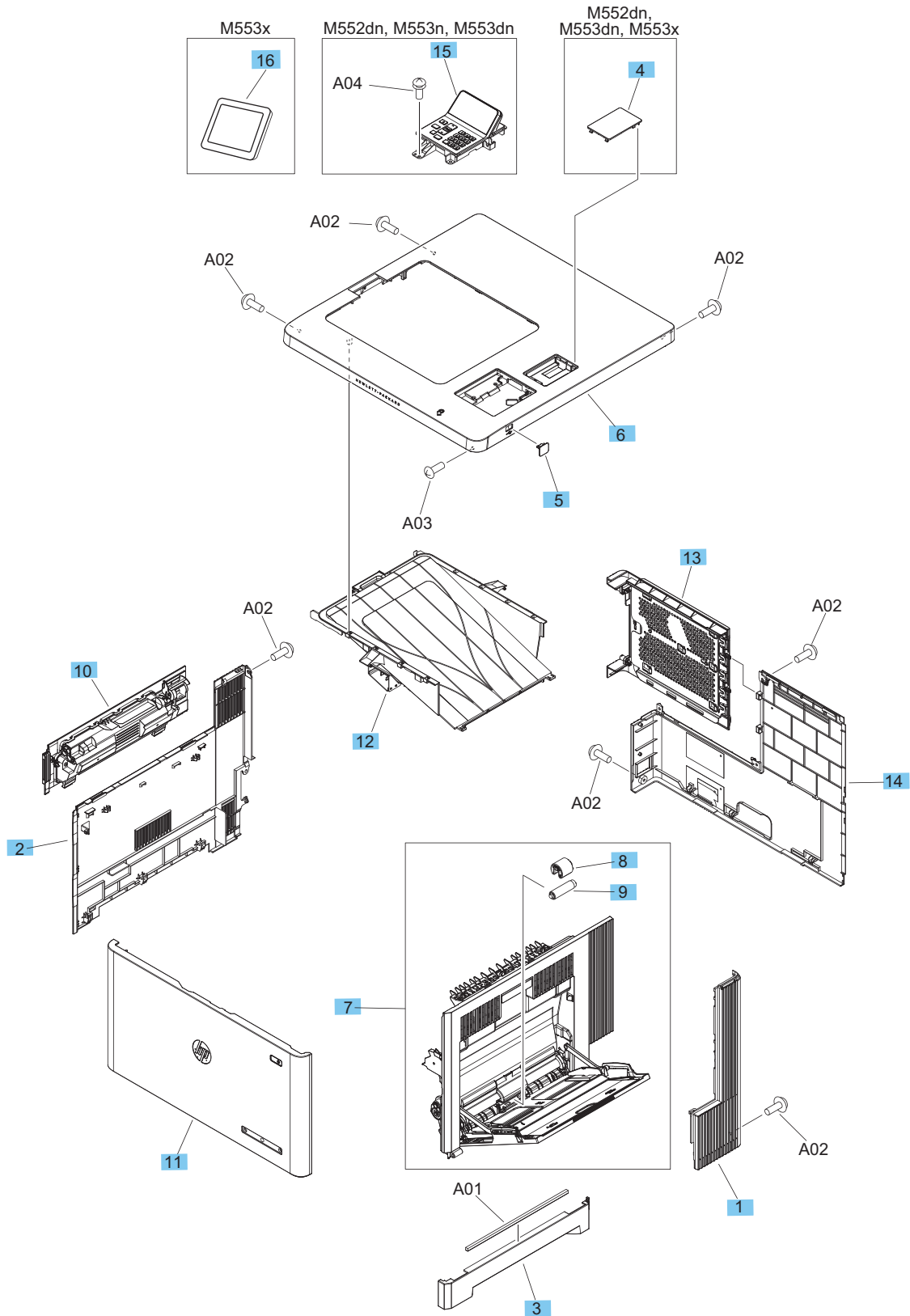

Table 2-5 Covers (M552, M553)

Ref	Description	Part number	Qty
1	Cover, right rear	RC4-0178-000CN	1
2	Cover, left	RC4-0179-000CN	1
3	Handle, right	RC4-0183-000CN	1
4	Cover, HIP (M552dn, M553dn, M553x)	RC4-0213-000CN	1
5	Cover, USB	RC4-0214-000CN	1
6	Cover, upper (M553n)	RL2-0096-000CN	1
6	Cover, upper (M553x)	RL2-0097-000CN	1
6	Cover, upper (M552dn, M553dn)	RL2-0098-000CN	1
7	Door assembly, right	RM2-0019-000CN	1
8	Roller, pickup, Tray 1 (part of Tray 1 roller kit)	B5L24-67905	1
9	Roller, separation, Tray 1 (part of Tray 1 roller kit)	B5L24-67905	1
10	Toner collection unit	B5L37-67901	1
11	Cover, front (M552, M553)	B5L25-67901	1
12	Output bin	RM2-0044-000CN	1
13	Cover, formatter	RM2-0084-000CN	1
14	Cover, rear	RM2-0085-000CN	1
15	Control panel (M552dn, M553n, M553dn)	RM2-7180-000CN	1
16	Control panel (M553x)	B5L24-67903	1

Covers (M577)

Figure 2-3 Covers (M577)

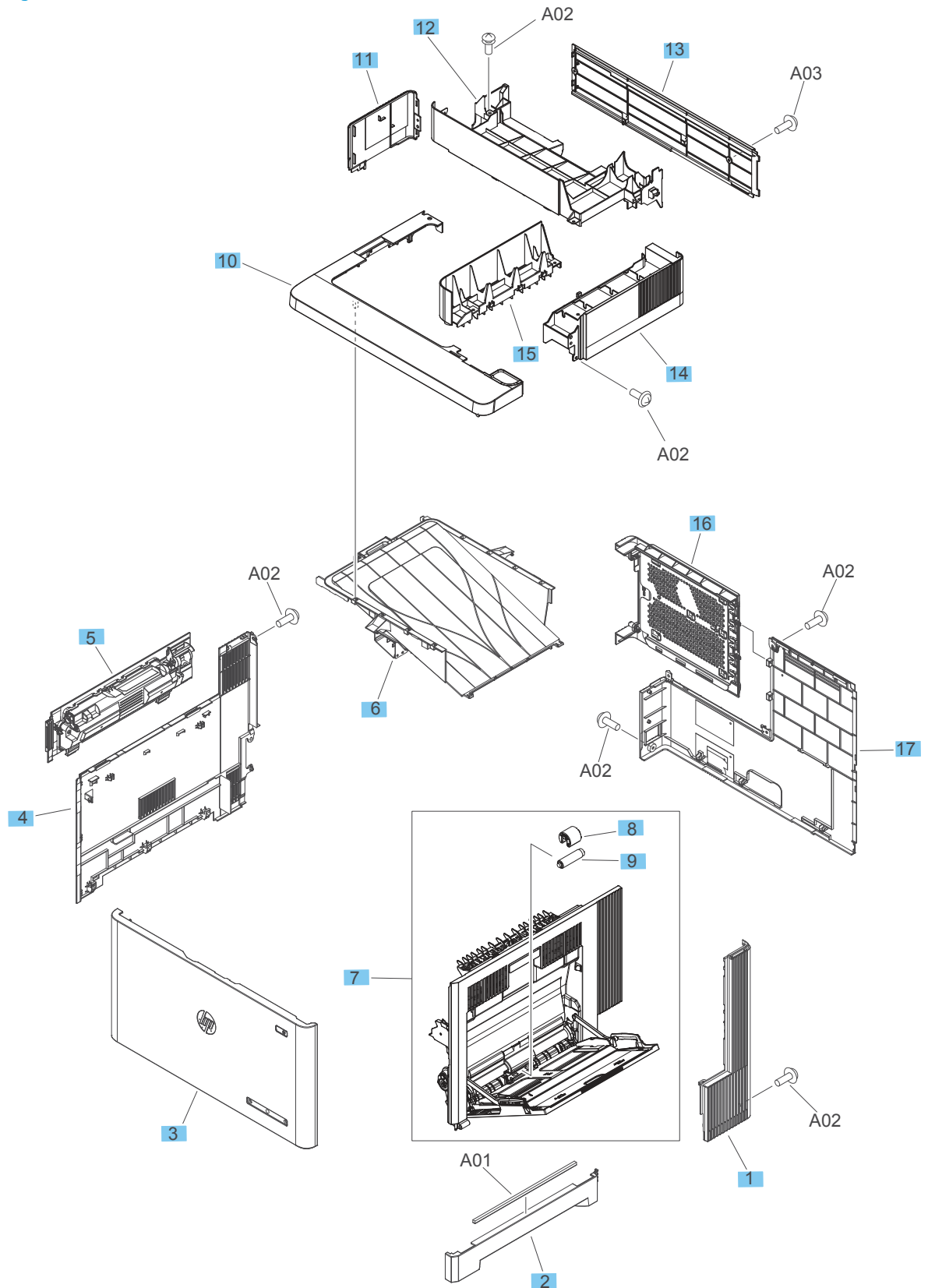

Table 2-6 Covers (M577)

Ref	Description	Part number	Qty
1	Cover, right rear	RC4-0178-000CN	1
2	Handle, right	RC4-0183-000CN	1
3	Cover, front (M577)	B5L46-67906	1
4	Cover, left	RC4-0179-000CN	1
5	Toner collection unit	B5L37-67901	1
6	Output bin	RM2-0044-000CN	1
7	Right door assembly	RM2-0019-000CN	1
8	Roller, pickup, Tray 1 (part of Tray 1 roller kit)	B5L24-67905	1
9	Roller, separation, Tray 1 (part of Tray 1 roller kit)	B5L24-67905	1
10	Cover, top (M577)	RL2-0769-000CN	1
11	Cover, left upper (M577)	RL2-0770-000CN	1
12	Cover, top rear (M577)	RC4-3383-000CN	1
13	Cover, rear upper (M577)	RL2-0771-000CN	1
14	Cover, right upper (M577)	RL2-0772-000CN	1
15	Cover, paper feed (M577)	RC4-3382-000CN	1
16	Cover, formatter	RM2-0084-000CN	1
17	Cover, rear	RM2-0085-000CN	1

Parts and diagrams: Internal components

Internal components (1 of 5)

Figure 2-4 Internal components (1 of 5)

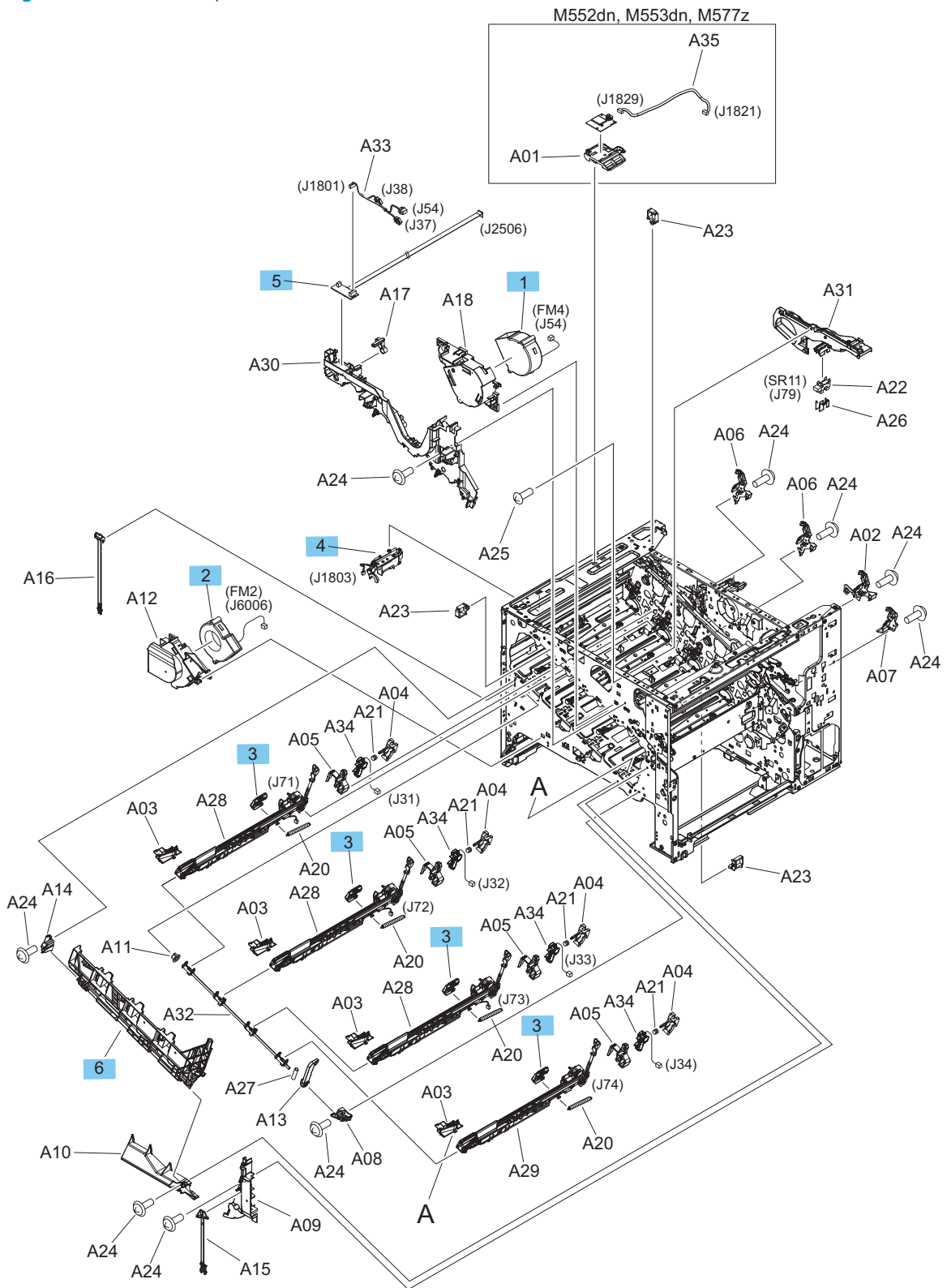

Table 2-7 Internal components (1 of 5)

Ref	Description	Part number	Qty
1	Fan, fuser (FM4)	RK2-2418-000CN	1
2	Fan, cartridge (FM2)	RK2-6124-000CN	1
3	Glass cleaner assembly, dust-proof	RM2-0086-000CN	4
4	Waste toner detect PCA assembly	RM2-7130-000CN	1
5	Connecting PCA assembly	RM2-7156-000CN	1
6	Inner door	RL2-0013-010CN	1
Not shown	Wireless PCA, embedded	1150-7968	1
Not shown	Near field communication (NFC) PCA, embedded (M553x)	B5L24-60002	1
Not shown	Near field communication (NFC) PCA, embedded (M577z)	B5L24-60001	1

Internal components (2 of 5)

Figure 2-5 Internal components (2 of 5)

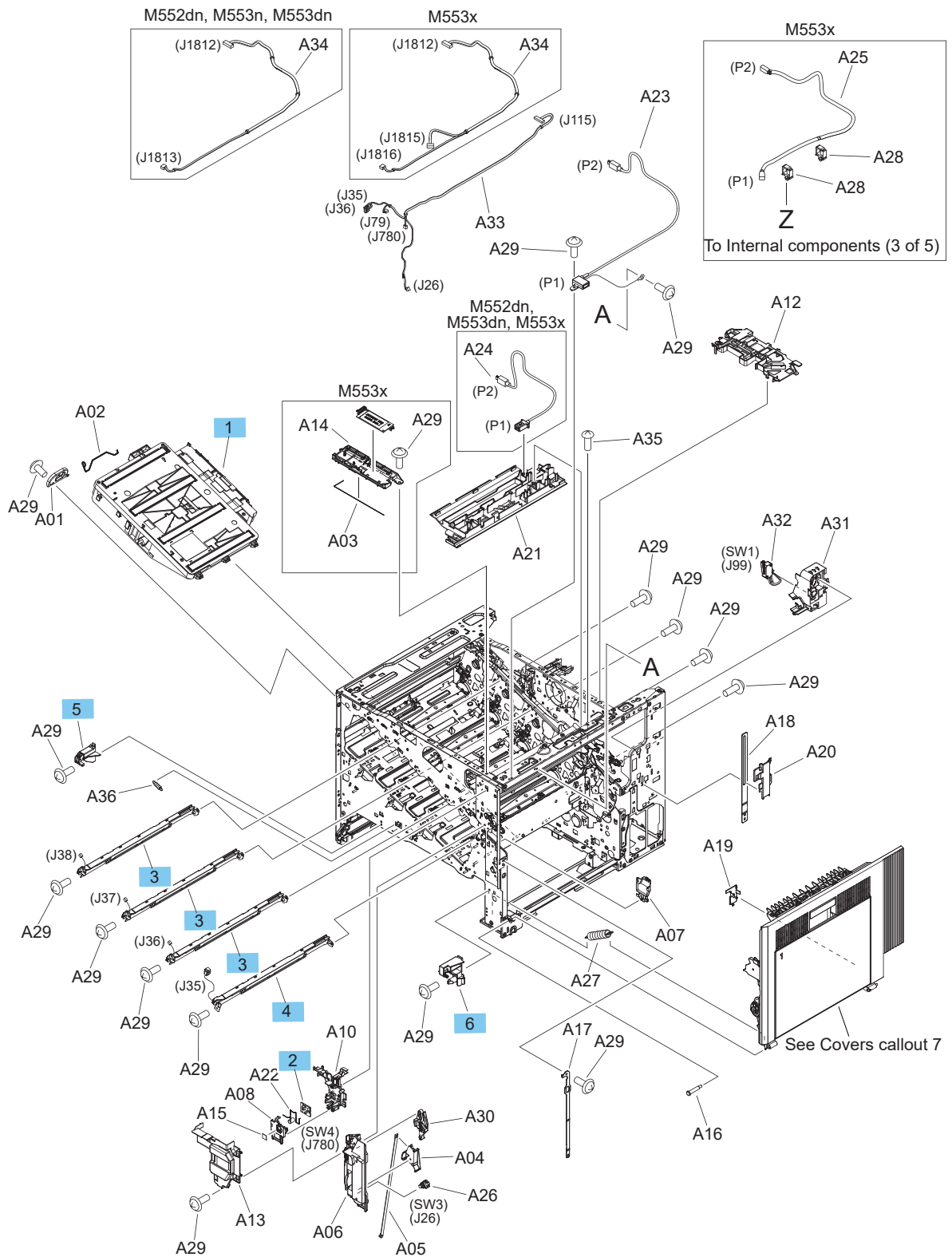

Table 2-8 Internal components (2 of 5)

Ref	Description	Part number	Qty
1	Laser/scanner assembly	RM2-6545-000CN	1
2	Switch PCA assembly (SW4)	RM2-7133-000CN	1
3	Pre-exposure PCA assembly	RM2-7168-000CN	3
4	Pre-exposure PCA assembly	RM2-7169-000CN	1
5	Hinge, cover, front	RC4-0132-000CN	1
6	Hinge, cover, front	RC4-0159-000CN	1

Internal components (3 of 5)

Figure 2-6 Internal components (3 of 5)

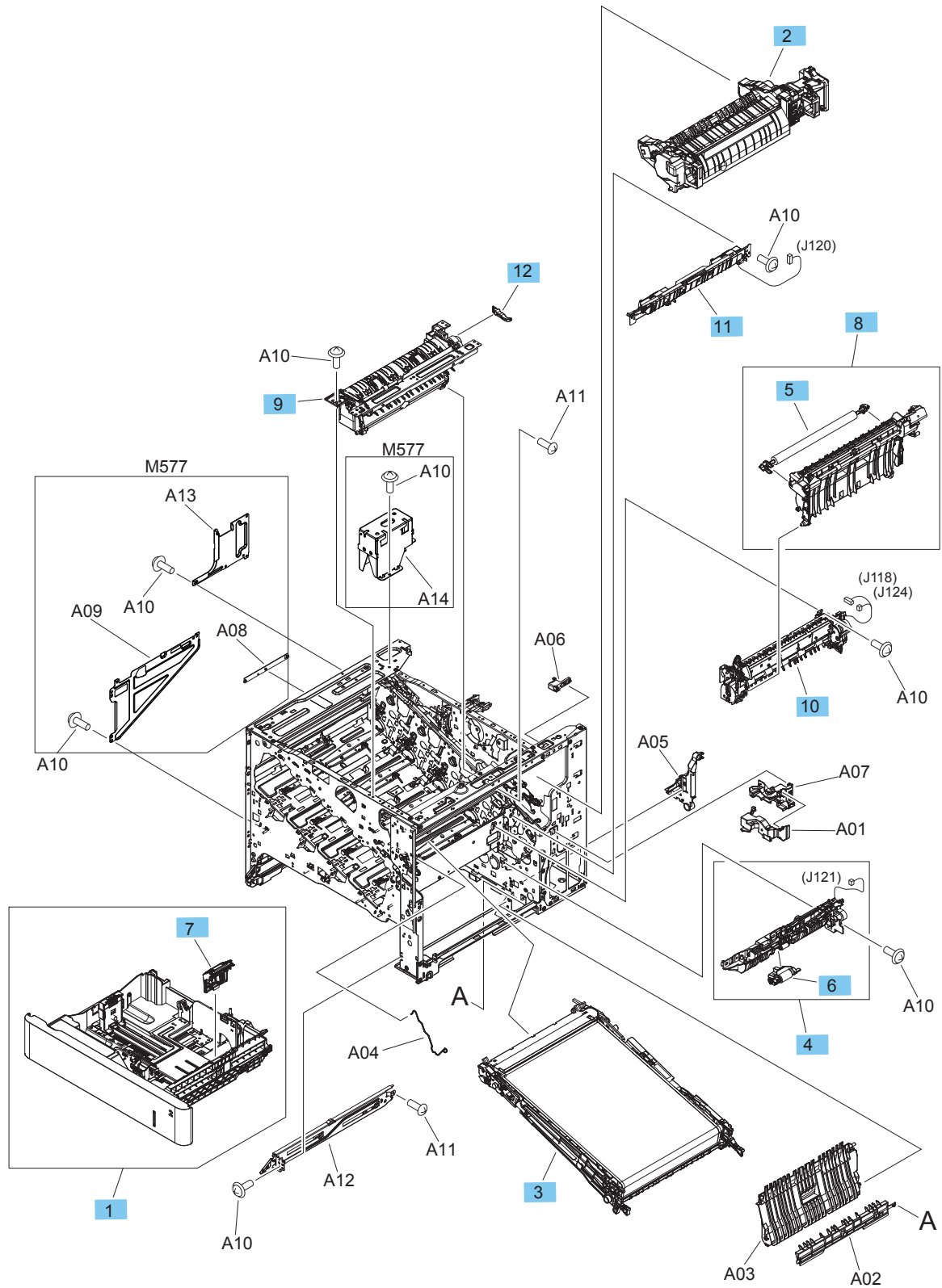

Table 2-9 Internal components (3 of 5)

Ref	Description	Part number	Qty
1	Cassette (Tray 2)	RM2-0007-000CN	1
2	Fuser kit (110V)	B5L35-67902	1
2	Fuser kit (220V)	B5L36-67902	1
2	Fuser service kit (110V)	B5L35-67902	1
2	Fuser service kit (220V)	B5L36-67902	1
3	ITB (part of ITB and secondary transfer roller kit)	B5L24-67901	1
4	Paper pickup assembly	RM2-0017-000CN	1
5	Roller, secondary transfer	B5L24-67902	1
6	Roller, paper pickup (part of Tray 2-5 roller kit)	B5L24-67904	1
7	Roller, separation (part of Tray 2-5 roller kit)	B5L24-67904	1
8	Secondary transfer assembly (M553n)	RM2-0090-000CN	1
8	Secondary transfer assembly (M552dn, M553dn, M553x, M577)	RM2-0022-000CN	1
9	Paper delivery assembly (M553n)	RM2-0092-000CN	1
9	Paper delivery assembly (M552dn, M553dn, M553x, M577)	RM2-0016-000CN	1
10	Registration assembly (M553n)	RM2-0093-000CN	1
10	Registration assembly (M552dn, M553dn, M553x, M577)	RM2-0018-000CN	1
11	Density detect assembly	RM2-7160-000CN	1
12	Arm, solenoid	RC4-0830-000CN	1

Internal components (4 of 5)

Figure 2-7 Internal components (4 of 5)

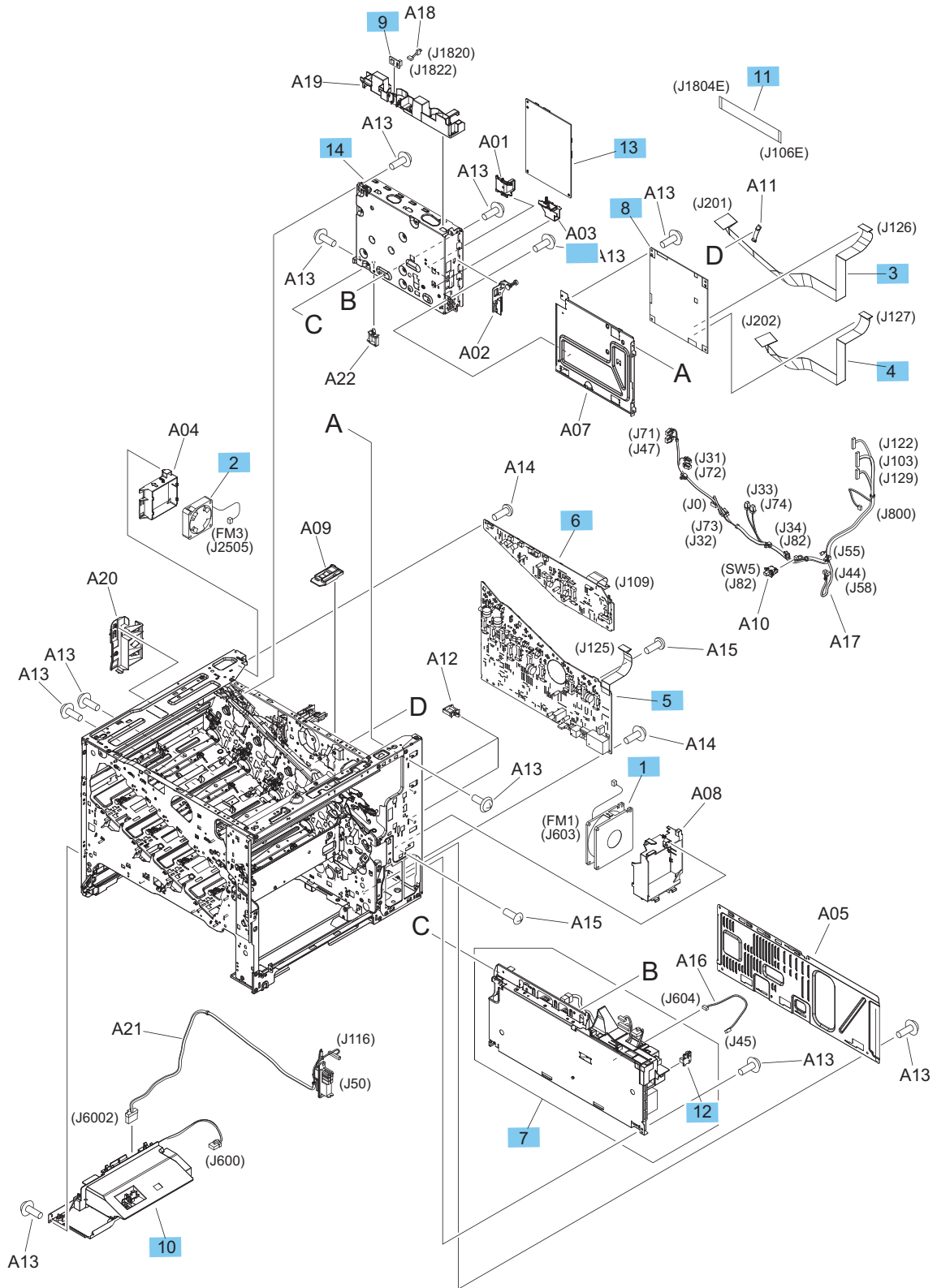

Table 2-10 Internal components (4 of 5)

Ref	Description	Part number	Qty
1	Fan, power-supply (FM1)	RK2-2416-000CN	1
2	Fan, delivery (FM3)	RK2-2728-000CN	1
3	Cable, flexible flat	RK2-6101-000CN	1
4	Cable, flexible flat	RK2-6103-000CN	1
5	HVPS (D) PCA assembly	RM2-7122-000CN	1
6	HVPS (T) PCA assembly (M553n)	RM2-7134-000CN	1
6	HVPS (T) PCA assembly (M552dn, M553dn, M553x, M577)	RM2-7123-000CN	1
7	LVPS PCA assembly	RM2-7164-000CN	1
8	DC controller PCA assembly (M552, M553))	RM2-7186-000CN	1
8	DC controller PCA assembly (M577)	RM2-7187-000CN	1
9	Memory PCA assembly	RM2-7138-000CN	1
10	Fuser power supply PCA assembly	RM2-7125-000CN	1
11	Cable, flexible flat	RK2-6111-000CN	1
12	Environmental sensor PCA assembly	RM2-7154-000CN	1
13	Formatter (M552)	B5L23-67903	1
13	Formatter (M552 India and China only)	B5L23-67904	1
13	Formatter (M553n, M553dn, M553dh)	B5L24-67909	1
13	Formatter (M553n, M553dn, M553dh India and China only)	B5L24-67908	1
13	Formatter (M553x)	B5L26-67901	1
13	Formatter (M553x India and China only)	B5L26-67902	1
13	Formatter (M577)	B5L46-67909	1
13	Formatter (M577 India and China only)	B5L46-67911	1
14	Formatter case	RC4-0152-000CN	1
Not shown	Fax PCA (M577f, M577z)	B5L53-67901	1

Internal components (5 of 5)

Figure 2-8 Internal components (5 of 5)

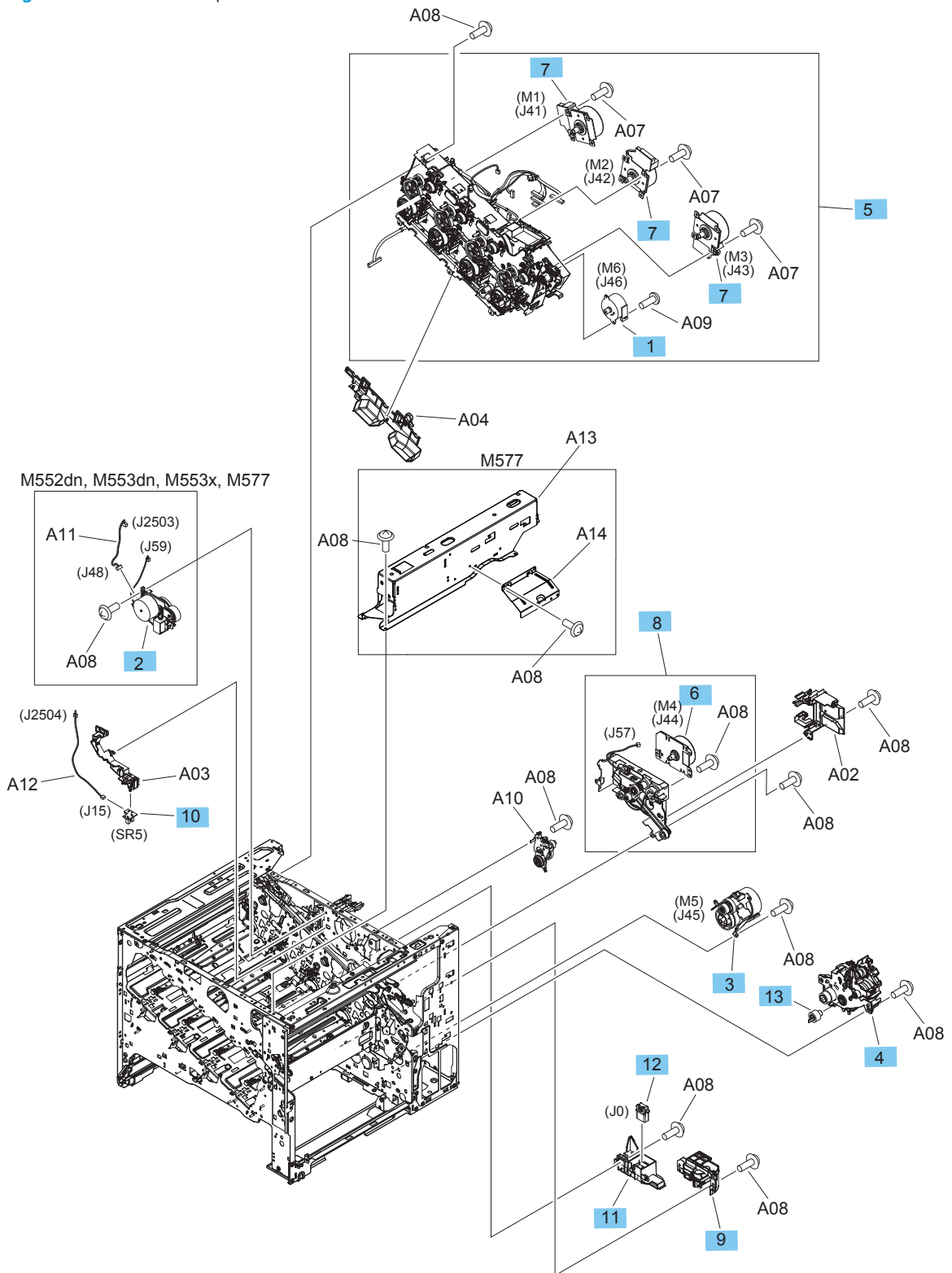

Table 2-11 Internal components (5 of 5)

Ref	Description	Part number	Qty
1	Motor, stepping (M6)	RK2-6027-000CN	1
2	Duplexing drive assembly (M7, CL2; M552dn, M553dn, M553x)	RM2-0006-000CN	1
3	Paper pickup drive assembly (M5)	RM2-0008-000CN	1
4	Lifter drive assembly (CL1)	RM2-0010-000CN	1
5	Main motor drive assembly	B5L25-67902	1
6	Motor assembly, fuser (M4)	RM2-0077-000CN	1
7	Motor assembly, drum (M1, M2, M3)	RM2-0078-000CN	3
8	Fuser drive assembly (M553n)	RM2-0091-000CN	1
8	Fuser drive assembly (M552dn, M553dn, M553x, M577)	RM2-0009-000CN	1
9	Auto close assembly	RM2-5147-000CN	1
10	Estrangement detect PCA assembly (SR5)	RM2-7157-000CN	1
11	Holder, OP Drawer	RC4-0445-000CN	1
12	Connector, drawer	VS1-7258-000CN	1
13	Gear 18T	RU8-0577-000CN	1

Parts and diagrams: 550-sheet paper feeder

550-sheet paper feeder covers

Figure 2-9 550-sheet paper feeder covers

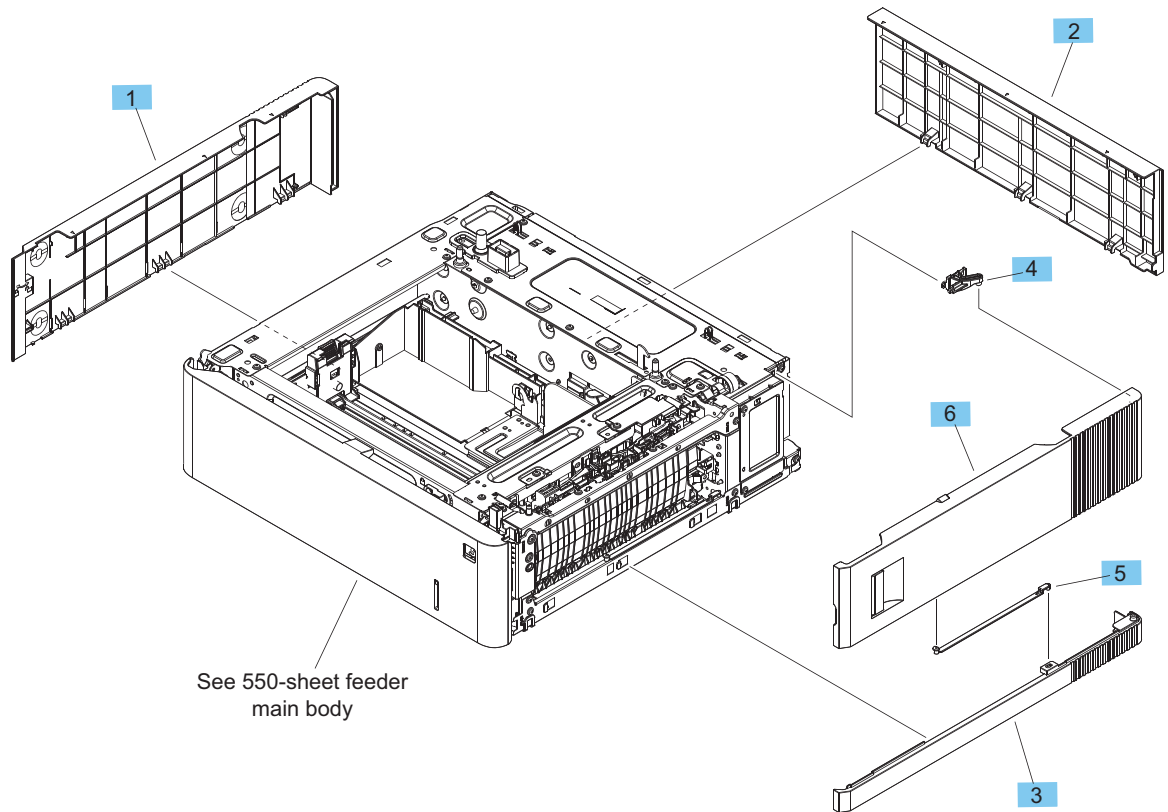

Table 2-12 550-sheet paper feeder covers

Ref	Description	Part number	Qty
1	Cover, left (550-sheet feeder)	RC4-1791-000CN	1
2	Cover, rear (550-sheet feeder)	RC4-1792-000CN	1
3	Cover, right lower (550-sheet feeder)	RC4-1793-000CN	1
4	Hinge, door, right (550-sheet feeder)	RC4-1781-000CN	1
5	Link, door, right (550-sheet feeder)	RC4-1778-000CN	1
6	Door assembly, right (550-sheet feeder)	RM2-5146-000CN	1

550-sheet paper feeder main body

Figure 2-10 550-sheet paper feeder main body

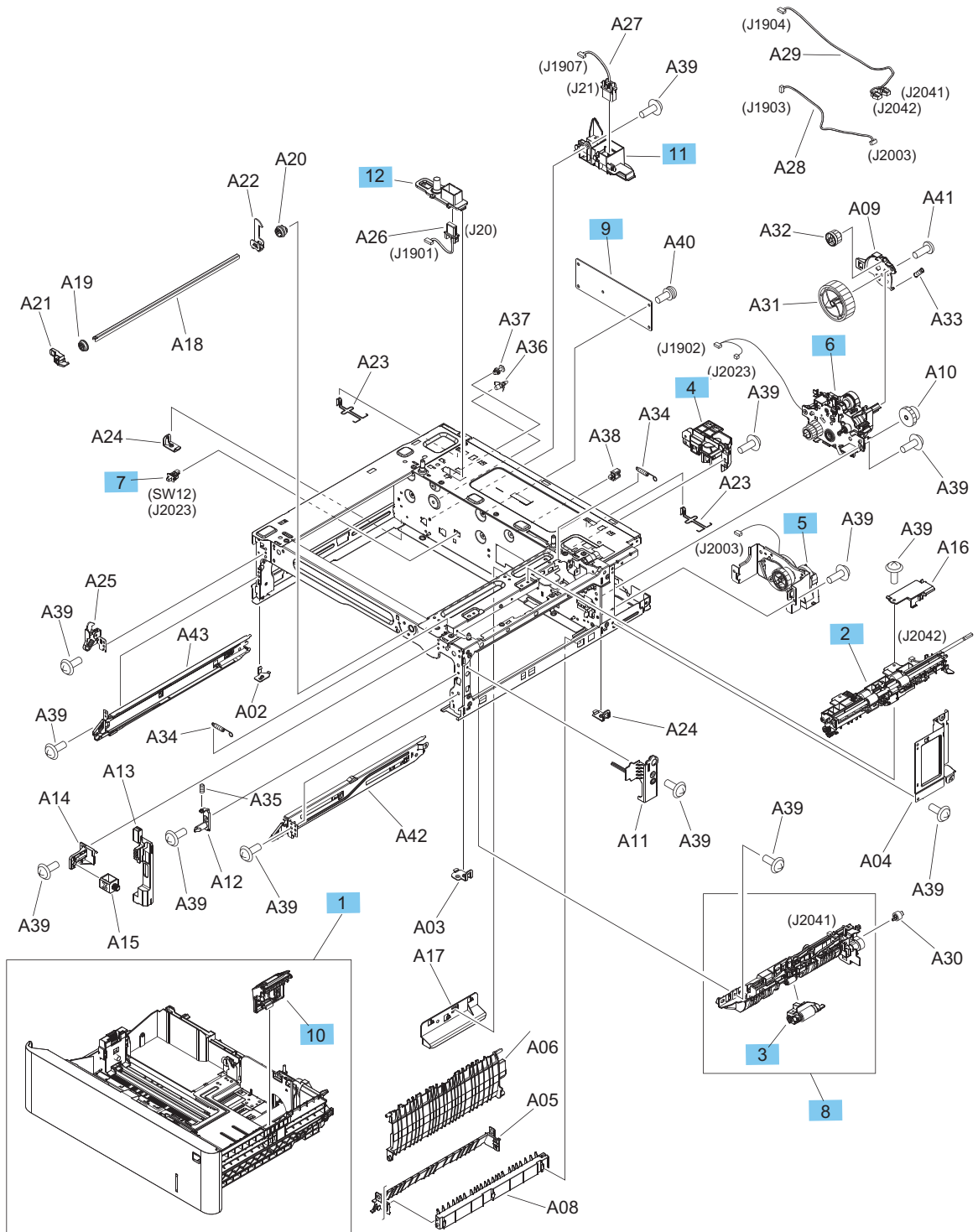

Table 2-13 550-sheet paper feeder covers

Ref	Description	Part number	Qty
1	Cassette (tray; 550-sheet feeder)	RM2-5150-000CN	1
2	Paper feed assembly (550-sheet feeder)	RM2-5145-000CN	1
3	Roller, pickup (550-sheet feeder; part of Tray 2-5 roller kit)	B5L24-67904	1
4	Auto close assembly (550-sheet feeder)	RM2-5147-000CN	1
5	Feed drive assembly (550-sheet feeder)	RM2-5148-000CN	1
6	Lifter drive assembly (550-sheet feeder)	RM2-5149-000CN	1
7	Switch button (SW21; 550-sheet feeder)	WC2-5806-000CN	1
8	Paper pickup assembly (550-sheet feeder)	RM2-5154-000CN	1
9	Paper feed drive PCA assembly (550-sheet feeder)	RM2-7139-000CN	1
10	Roller, separation (550-sheet feeder; part of Tray 2-5 roller kit)	B5L24-67904	1
11	Holder, OP drawer (550-sheet feeder)	RC4-0445-000CN	1
12	Holder, drawer connector (550-sheet feeder)	RC4-1741-000CN	1

Alphabetical parts list

Table 2-14 Alphabetical parts list

Description	Part number	Table and page
Arm, solenoid	RC4-0830-000CN	Internal components (3 of 5) on page 3081
Auto close assembly	RM2-5147-000CN	Internal components (5 of 5) on page 3085
Auto close assembly (550-sheet feeder)	RM2-5147-000CN	550-sheet paper feeder covers on page 3089
Bezel, control panel with NFC icon (M577)	B5L46-40026	Document feeder and scanner whole units (M577 only) on page 3071
Bezel, control panel without NFC icon (M577)	B5L46-40020	Document feeder and scanner whole units (M577 only) on page 3071
Cable, 18-pin control panel (M577)	5851-5935	Document feeder and scanner whole units (M577 only) on page 3071
Cable, flexible flat	RK2-6101-000CN	Internal components (4 of 5) on page 3083
Cable, flexible flat	RK2-6103-000CN	Internal components (4 of 5) on page 3083
Cable, flexible flat	RK2-6111-000CN	Internal components (4 of 5) on page 3083
Cable, HDMI control panel (M577)	5851-5936	Document feeder and scanner whole units (M577 only) on page 3071
Cable, HDMI PAB to SCAM (M577)	B5L46-60114	Document feeder and scanner whole units (M577 only) on page 3071
Cable, HIP USB control panel (M577)	5851-5938	Document feeder and scanner whole units (M577 only) on page 3071
Cable, stapler (M577)	B5L46-60121	Document feeder and scanner whole units (M577 only) on page 3071
Cable, WU USB control panel (M577)	5851-5939	Document feeder and scanner whole units (M577 only) on page 3071
Cassette (Tray 2)	RM2-0007-000CN	Internal components (3 of 5) on page 3081
Cassette (tray; 550-sheet feeder)	RM2-5150-000CN	550-sheet paper feeder covers on page 3089
Connecting PCA assembly	RM2-7156-000CN	Internal components (1 of 5) on page 3077
Connector, drawer	VS1-7258-000CN	Internal components (5 of 5) on page 3085

Table 2-14 Alphabetical parts list (continued)

Description	Part number	Table and page
Control panel (M552dn, M553n, M553dn)	RM2-7180-000CN	Covers (M552, M553) on page 3073
Control panel (M553x)	B5L24-67903	Covers (M552, M553) on page 3073
Control panel (M577) kit	B5L47-67018	Document feeder and scanner whole units (M577 only) on page 3071
Cover assembly, stapler (M577c/f/z)	B5L46-60121	Document feeder and scanner whole units (M577 only) on page 3071
Cover, formatter	RM2-0084-000CN	Covers (M552, M553) on page 3073
Cover, formatter	RM2-0084-000CN	Covers (M577) on page 3075
Cover, front (M552, M553)	B5L25-67901	Covers (M552, M553) on page 3073
Cover, front (M577)	B5L46-67906	Covers (M577) on page 3075
Cover, HIP (M552dn, M553dn, M553x)	RC4-0213-000CN	Covers (M552, M553) on page 3073
Cover, HIP (M577)	B5L46-40021	Document feeder and scanner whole units (M577 only) on page 3071
Cover, keyboard (M577dn/f)	B5L46-40002	Document feeder and scanner whole units (M577 only) on page 3071
Cover, left	RC4-0179-000CN	Covers (M552, M553) on page 3073
Cover, left	RC4-0179-000CN	Covers (M577) on page 3075
Cover, left (550-sheet feeder)	RC4-1791-000CN	550-sheet paper feeder covers on page 3087
Cover, left upper (M577)	RL2-0770-000CN	Covers (M577) on page 3075
Cover, paper feed (M577)	RC4-3382-000CN	Covers (M577) on page 3075
Cover, rear	RM2-0085-000CN	Covers (M552, M553) on page 3073
Cover, rear	RM2-0085-000CN	Covers (M577) on page 3075
Cover, rear (550-sheet feeder)	RC4-1792-000CN	550-sheet paper feeder covers on page 3087
Cover, rear (image scanner; M577)	B5L46-40011	Document feeder and scanner whole units (M577 only) on page 3071
Cover, rear upper (M577)	RL2-0771-000CN	Covers (M577) on page 3075
Cover, right front upper (M577dn)	B5L46-40024	Document feeder and scanner whole units (M577 only) on page 3071

Table 2-14 Alphabetical parts list (continued)

Description	Part number	Table and page
Cover, right lower (550-sheet feeder)	RC4-1793-000CN	550-sheet paper feeder covers on page 3087
Cover, right rear	RC4-0178-000CN	Covers (M552, M553) on page 3073
Cover, right rear	RC4-0178-000CN	Covers (M577) on page 3075
Cover, right upper (M577)	RL2-0772-000CN	Covers (M577) on page 3075
Cover, top (M577)	RL2-0769-000CN	Covers (M577) on page 3075
Cover, top rear (M577)	RC4-3383-000CN	Covers (M577) on page 3075
Cover, upper (M552dn, M553dn)	RL2-0098-000CN	Covers (M552, M553) on page 3073
Cover, upper (M553n)	RL2-0096-000CN	Covers (M552, M553) on page 3073
Cover, upper (M553x)	RL2-0097-000CN	Covers (M552, M553) on page 3073
Cover, USB	RC4-0214-000CN	Covers (M552, M553) on page 3073
Cover, USB (M577)	B5L46-40028	Document feeder and scanner whole units (M577 only) on page 3071
DC controller PCA assembly (M552, M553))	RM2-7186-000CN	Internal components (4 of 5) on page 3083
DC controller PCA assembly (M577)	RM2-7187-000CN	Internal components (4 of 5) on page 3083
Density detect assembly	RM2-7160-000CN	Internal components (3 of 5) on page 3081
Document feeder (M577c/z) kit; includes white backing and retention clips	B5L47-67902	Document feeder and scanner whole units (M577 only) on page 3071
Document feeder (M577dn/f) kit; includes white backing and retention clips	B5L47-67901	Document feeder and scanner whole units (M577 only) on page 3071
Door assembly, right	RM2-0019-000CN	Covers (M552, M553) on page 3073
Door assembly, right (550-sheet feeder)	RM2-5146-000CN	550-sheet paper feeder covers on page 3087
Duplexing drive assembly (M7, CL2; M552dn, M553dn, M553x)	RM2-0006-000CN	Internal components (5 of 5) on page 3085
Environmental sensor PCA assembly	RM2-7154-000CN	Internal components (4 of 5) on page 3083
Estrangement detect PCA assembly (SR5)	RM2-7157-000CN	Internal components (5 of 5) on page 3085
Fan, cartridge (FM2)	RK2-6124-000CN	Internal components (1 of 5) on page 3077

Table 2-14 Alphabetical parts list (continued)

Description	Part number	Table and page
Fan, delivery (FM3)	RK2-2728-000CN	Internal components (4 of 5) on page 3083
Fan, fuser (FM4)	RK2-2418-000CN	Internal components (1 of 5) on page 3077
Fan, power-supply (FM1)	RK2-2416-000CN	Internal components (4 of 5) on page 3083
Fax PCA (M577f, M577z)	B5L53-67901	Internal components (4 of 5) on page 3083
Feed drive assembly (550-sheet feeder)	RM2-5148-000CN	550-sheet paper feeder covers on page 3089
Formatter (M552 India and China only)	B5L23-67904	Internal components (4 of 5) on page 3083
Formatter (M552)	B5L23-67903	Internal components (4 of 5) on page 3083
Formatter (M553n, M553dn, M553dh India and China only)	B5L24-67908	Internal components (4 of 5) on page 3083
Formatter (M553n, M553dn, M553dh)	B5L24-67909	Internal components (4 of 5) on page 3083
Formatter (M553x India and China only)	B5L26-67902	Internal components (4 of 5) on page 3083
Formatter (M553x)	B5L26-67901	Internal components (4 of 5) on page 3083
Formatter (M577 India and China only)	B5L46-67911	Internal components (4 of 5) on page 3083
Formatter (M577)	B5L46-67909	Internal components (4 of 5) on page 3083
Formatter case	RC4-0152-000CN	Internal components (4 of 5) on page 3083
Fuser drive assembly (M552dn, M553dn, M553x, M577)	RM2-0009-000CN	Internal components (5 of 5) on page 3085
Fuser drive assembly (M553n)	RM2-0091-000CN	Internal components (5 of 5) on page 3085
Fuser kit (110V)	B5L35-67902	Internal components (3 of 5) on page 3081
Fuser kit (220V)	B5L36-67902	Internal components (3 of 5) on page 3081
Fuser power supply PCA assembly	RM2-7125-000CN	Internal components (4 of 5) on page 3083
Fuser service kit (110V)	B5L35-67902	Internal components (3 of 5) on page 3081
Fuser service kit (220V)	B5L36-67902	Internal components (3 of 5) on page 3081

Table 2-14 Alphabetical parts list (continued)

Description	Part number	Table and page
Gear 18T	RU8-0577-000CN	Internal components (5 of 5) on page 3085
Glass cleaner assembly, dust-proof	RM2-0086-000CN	Internal components (1 of 5) on page 3077
Handle, right	RC4-0183-000CN	Covers (M552, M553) on page 3073
Handle, right	RC4-0183-000CN	Covers (M577) on page 3075
Hinge, cover, front	RC4-0132-000CN	Internal components (2 of 5) on page 3079
Hinge, cover, front	RC4-0159-000CN	Internal components (2 of 5) on page 3079
Hinge, door, right (550-sheet feeder)	RC4-1781-000CN	550-sheet paper feeder covers on page 3087
Hinge, left document feeder (M577)	COM39-60064	Document feeder and scanner whole units (M577 only) on page 3071
Hinge, right document feeder (M577)	COM39-60065	Document feeder and scanner whole units (M577 only) on page 3071
Holder, drawer connector (550-sheet feeder)	RC4-1741-000CN	550-sheet paper feeder covers on page 3089
Holder, OP Drawer	RC4-0445-000CN	Internal components (5 of 5) on page 3085
Holder, OP drawer (550-sheet feeder)	RC4-0445-000CN	550-sheet paper feeder covers on page 3089
HVPS (D) PCA assembly	RM2-7122-000CN	Internal components (4 of 5) on page 3083
HVPS (T) PCA assembly (M552dn, M553dn, M553x, M577)	RM2-7123-000CN	Internal components (4 of 5) on page 3083
HVPS (T) PCA assembly (M553n)	RM2-7134-000CN	Internal components (4 of 5) on page 3083
Image scanner (M577) kit; includes white backing and retention clips	B5L46-67904	Document feeder and scanner whole units (M577 only) on page 3071
Inner door	RL2-0013-010CN	Internal components (1 of 5) on page 3077
ITB (part of ITB and secondary transfer roller kit)	B5L24-67901	Internal components (3 of 5) on page 3081
Keyboard overlay kit (ES, PT)	5851-6023	Document feeder and scanner whole units (M577 only) on page 3071
Keyboard overlay kit (FR, IT, RU, DE, ES: UK Kybd)	5851-6019	Document feeder and scanner whole units (M577 only) on page 3071

Table 2-14 Alphabetical parts list (continued)

Description	Part number	Table and page
Keyboard overlay kit (FR-CN, ES-LA, ES: US Kybd)	5851-6020	Document feeder and scanner whole units (M577 only) on page 3071
Keyboard overlay kit (FR-SW, DE-SW, DA: UK Kybd)	5851-6021	Document feeder and scanner whole units (M577 only) on page 3071
Keyboard overlay kit (JA-KG, JA-KT)	5851-6024	Document feeder and scanner whole units (M577 only) on page 3071
Keyboard overlay kit (ZHTW, ZHCN)	5851-6022	Document feeder and scanner whole units (M577 only) on page 3071
Keyboard UK (M577c/z)	B5L47-67020	Document feeder and scanner whole units (M577 only) on page 3071
Keyboard US (M577c/z)	B5L47-67019	Document feeder and scanner whole units (M577 only) on page 3071
Laser/scanner assembly	RM2-6545-000CN	Internal components (2 of 5) on page 3079
Lifter drive assembly (550-sheet feeder)	RM2-5149-000CN	550-sheet paper feeder covers on page 3089
Lifter drive assembly (CL1)	RM2-0010-000CN	Internal components (5 of 5) on page 3085
Link, door, right (550-sheet feeder)	RC4-1778-000CN	550-sheet paper feeder covers on page 3087
LVPS PCA assembly	RM2-7164-000CN	Internal components (4 of 5) on page 3083
Main motor drive assembly	B5L25-67902	Internal components (5 of 5) on page 3085
Memory PCA assembly	RM2-7138-000CN	Internal components (4 of 5) on page 3083
Motor assembly, drum (M1, M2, M3)	RM2-0078-000CN	Internal components (5 of 5) on page 3085
Motor assembly, fuser (M4)	RM2-0077-000CN	Internal components (5 of 5) on page 3085
Motor, stepping (M6)	RK2-6027-000CN	Internal components (5 of 5) on page 3085
Near field communication (NFC) PCA, embedded (M553x)	B5L24-60002	Internal components (1 of 5) on page 3077
Near field communication (NFC) PCA, embedded (M577z)	B5L24-60001	Internal components (1 of 5) on page 3077
Output bin	RM2-0044-000CN	Covers (M552, M553) on page 3073
Output bin	RM2-0044-000CN	Covers (M577) on page 3075

Table 2-14 Alphabetical parts list (continued)

Description	Part number	Table and page
Paper delivery assembly (M552dn, M553dn, M553x, M577)	RM2-0016-000CN	Internal components (3 of 5) on page 3081
Paper delivery assembly (M553n)	RM2-0092-000CN	Internal components (3 of 5) on page 3081
Paper feed assembly (550-sheet feeder)	RM2-5145-000CN	550-sheet paper feeder covers on page 3089
Paper feed drive PCA assembly (550-sheet feeder)	RM2-7139-000CN	550-sheet paper feeder covers on page 3089
Paper pickup assembly	RM2-0017-000CN	Internal components (3 of 5) on page 3081
Paper pickup assembly (550-sheet feeder)	RM2-5154-000CN	550-sheet paper feeder covers on page 3089
Paper pickup drive assembly (M5)	RM2-0008-000CN	Internal components (5 of 5) on page 3085
Pre-exposure PCA assembly	RM2-7168-000CN	Internal components (2 of 5) on page 3079
Pre-exposure PCA assembly	RM2-7169-000CN	Internal components (2 of 5) on page 3079
Registration assembly (M552dn, M553dn, M553x, M577)	RM2-0018-000CN	Internal components (3 of 5) on page 3081
Registration assembly (M553n)	RM2-0093-000CN	Internal components (3 of 5) on page 3081
Right door assembly	RM2-0019-000CN	Covers (M577) on page 3075
Roller, paper pickup (part of Tray 2-5 roller kit)	B5L24-67904	Internal components (3 of 5) on page 3081
Roller, pickup (550-sheet feeder; part of Tray 2-5 roller kit)	B5L24-67904	550-sheet paper feeder covers on page 3089
Roller, pickup, Tray 1 (part of Tray 1 roller kit)	B5L24-67905	Covers (M552, M553) on page 3073
Roller, pickup, Tray 1 (part of Tray 1 roller kit)	B5L24-67905	Covers (M577) on page 3075
Roller, secondary transfer	B5L24-67902	Internal components (3 of 5) on page 3081
Roller, separation (550-sheet feeder; part of Tray 2-5 roller kit)	B5L24-67904	550-sheet paper feeder covers on page 3089
Roller, separation (part of Tray 2-5 roller kit)	B5L24-67904	Internal components (3 of 5) on page 3081
Roller, separation, Tray 1 (part of Tray 1 roller kit)	B5L24-67905	Covers (M552, M553) on page 3073
Roller, separation, Tray 1 (part of Tray 1 roller kit)	B5L24-67905	Covers (M577) on page 3075
Scan control board	B5L47-67902	Document feeder and scanner whole units (M577 only) on page 3071

Table 2-14 Alphabetical parts list (continued)

Description	Part number	Table and page
Secondary transfer assembly (M552dn, M553dn, M553x, M577)	RM2-0022-000CN	Internal components (3 of 5) on page 3081
Secondary transfer assembly (M553n)	RM2-0090-000CN	Internal components (3 of 5) on page 3081
Stapler (M577c/f/z)	B5L46-60102	Document feeder and scanner whole units (M577 only) on page 3071
Switch button (SW21; 550-sheet feeder)	WC2-5806-000CN	550-sheet paper feeder covers on page 3089
Switch PCA assembly (SW4)	RM2-7133-000CN	Internal components (2 of 5) on page 3079
Toner collection unit	B5L37-67901	Covers (M552, M553) on page 3073
Toner collection unit	B5L37-67901	Covers (M577) on page 3075
Waste toner detect PCA assembly	RM2-7130-000CN	Internal components (1 of 5) on page 3077
Wireless PCA, embedded	1150-7968	Internal components (1 of 5) on page 3077

Numerical parts list

Table 2-15 Numerical parts list

Part number	Description	Table and page
1150-7968	Wireless PCA, embedded	Internal components (1 of 5) on page 3077
5851-5935	Cable, 18-pin control panel (M577)	Document feeder and scanner whole units (M577 only) on page 3071
5851-5936	Cable, HDMI control panel (M577)	Document feeder and scanner whole units (M577 only) on page 3071
5851-5938	Cable, HIP USB control panel (M577)	Document feeder and scanner whole units (M577 only) on page 3071
5851-5939	Cable, WU USB control panel (M577)	Document feeder and scanner whole units (M577 only) on page 3071
5851-6019	Keyboard overlay kit (FR, IT, RU, DE, ES: UK Kybd)	Document feeder and scanner whole units (M577 only) on page 3071
5851-6020	Keyboard overlay kit (FR-CN, ES-LA, ES: US Kybd)	Document feeder and scanner whole units (M577 only) on page 3071
5851-6021	Keyboard overlay kit (FR-SW, DE-SW, DA: UK Kybd)	Document feeder and scanner whole units (M577 only) on page 3071
5851-6022	Keyboard overlay kit (ZHTW, ZHCN)	Document feeder and scanner whole units (M577 only) on page 3071
5851-6023	Keyboard overlay kit (ES, PT)	Document feeder and scanner whole units (M577 only) on page 3071
5851-6024	Keyboard overlay kit (JA-KG, JA-KT)	Document feeder and scanner whole units (M577 only) on page 3071
B5L23-67903	Formatter (M552)	Internal components (4 of 5) on page 3083
B5L23-67904	Formatter (M552 India and China only)	Internal components (4 of 5) on page 3083
B5L24-60001	Near field communication (NFC) PCA, embedded (M577z)	Internal components (1 of 5) on page 3077
B5L24-60002	Near field communication (NFC) PCA, embedded (M553x)	Internal components (1 of 5) on page 3077
B5L24-67901	ITB (part of ITB and secondary transfer roller kit)	Internal components (3 of 5) on page 3081
B5L24-67902	Roller, secondary transfer	Internal components (3 of 5) on page 3081

Table 2-15 Numerical parts list (continued)

Part number	Description	Table and page
B5L24-67903	Control panel (M553x)	Covers (M552, M553) on page 3073
B5L24-67904	Roller, paper pickup (part of Tray 2-5 roller kit)	Internal components (3 of 5) on page 3081
B5L24-67904	Roller, separation (part of Tray 2-5 roller kit)	Internal components (3 of 5) on page 3081
B5L24-67904	Roller, pickup (550-sheet feeder; part of Tray 2-5 roller kit)	550-sheet paper feeder covers on page 3089
B5L24-67904	Roller, separation (550-sheet feeder; part of Tray 2-5 roller kit)	550-sheet paper feeder covers on page 3089
B5L24-67905	Roller, pickup, Tray 1 (part of Tray 1 roller kit)	Covers (M552, M553) on page 3073
B5L24-67905	Roller, separation, Tray 1 (part of Tray 1 roller kit)	Covers (M552, M553) on page 3073
B5L24-67905	Roller, pickup, Tray 1 (part of Tray 1 roller kit)	Covers (M577) on page 3075
B5L24-67905	Roller, separation, Tray 1 (part of Tray 1 roller kit)	Covers (M577) on page 3075
B5L24-67908	Formatter (M553n, M553dn, M553dh India and China only)	Internal components (4 of 5) on page 3083
B5L24-67909	Formatter (M553n, M553dn, M553dh)	Internal components (4 of 5) on page 3083
B5L25-67901	Cover, front (M552, M553)	Covers (M552, M553) on page 3073
B5L25-67902	Main motor drive assembly	Internal components (5 of 5) on page 3085
B5L26-67901	Formatter (M553x)	Internal components (4 of 5) on page 3083
B5L26-67902	Formatter (M553x India and China only)	Internal components (4 of 5) on page 3083
B5L35-67902	Fuser kit (110V)	Internal components (3 of 5) on page 3081
B5L35-67902	Fuser service kit (110V)	Internal components (3 of 5) on page 3081
B5L36-67902	Fuser kit (220V)	Internal components (3 of 5) on page 3081
B5L36-67902	Fuser service kit (220V)	Internal components (3 of 5) on page 3081
B5L37-67901	Toner collection unit	Covers (M552, M553) on page 3073
B5L37-67901	Toner collection unit	Covers (M577) on page 3075
B5L46-40002	Cover, keyboard (M577dn/f)	Document feeder and scanner whole units (M577 only) on page 3071

Table 2-15 Numerical parts list (continued)

Part number	Description	Table and page
B5L46-40011	Cover, rear (image scanner; M577)	Document feeder and scanner whole units (M577 only) on page 3071
B5L46-40020	Bezel, control panel without NFC icon (M577)	Document feeder and scanner whole units (M577 only) on page 3071
B5L46-40021	Cover, HIP (M577)	Document feeder and scanner whole units (M577 only) on page 3071
B5L46-40024	Cover, right front upper (M577dn)	Document feeder and scanner whole units (M577 only) on page 3071
B5L46-40026	Bezel, control panel with NFC icon (M577)	Document feeder and scanner whole units (M577 only) on page 3071
B5L46-40028	Cover, USB (M577)	Document feeder and scanner whole units (M577 only) on page 3071
B5L46-60102	Stapler (M577c/f/z)	Document feeder and scanner whole units (M577 only) on page 3071
B5L46-60114	Cable, HDMI PAB to SCAM (M577)	Document feeder and scanner whole units (M577 only) on page 3071
B5L46-60121	Cover assembly, stapler (M577c/f/z)	Document feeder and scanner whole units (M577 only) on page 3071
B5L46-60121	Cable, stapler (M577)	Document feeder and scanner whole units (M577 only) on page 3071
B5L46-67904	Image scanner (M577) kit; includes white backing and retention clips	Document feeder and scanner whole units (M577 only) on page 3071
B5L46-67906	Cover, front (M577)	Covers (M577) on page 3075
B5L46-67909	Formatter (M577)	Internal components (4 of 5) on page 3083
B5L46-67911	Formatter (M577 India and China only)	Internal components (4 of 5) on page 3083
B5L47-67018	Control panel (M577) kit	Document feeder and scanner whole units (M577 only) on page 3071
B5L47-67019	Keyboard US (M577c/z)	Document feeder and scanner whole units (M577 only) on page 3071
B5L47-67020	Keyboard UK (M577c/z)	Document feeder and scanner whole units (M577 only) on page 3071

Table 2-15 Numerical parts list (continued)

Part number	Description	Table and page
B5L47-67901	Document feeder (M577dn/f) kit; includes white backing and retention clips	Document feeder and scanner whole units (M577 only) on page 3071
B5L47-67902	Document feeder (M577c/z) kit; includes white backing and retention clips	Document feeder and scanner whole units (M577 only) on page 3071
B5L47-67902	Scan control board	Document feeder and scanner whole units (M577 only) on page 3071
B5L53-67901	Fax PCA (M577f, M577z)	Internal components (4 of 5) on page 3083
COM39-60064	Hinge, left document feeder (M577)	Document feeder and scanner whole units (M577 only) on page 3071
COM39-60065	Hinge, right document feeder (M577)	Document feeder and scanner whole units (M577 only) on page 3071
RC4-0132-000CN	Hinge, cover, front	Internal components (2 of 5) on page 3079
RC4-0152-000CN	Formatter case	Internal components (4 of 5) on page 3083
RC4-0159-000CN	Hinge, cover, front	Internal components (2 of 5) on page 3079
RC4-0178-000CN	Cover, right rear	Covers (M552, M553) on page 3073
RC4-0178-000CN	Cover, right rear	Covers (M577) on page 3075
RC4-0179-000CN	Cover, left	Covers (M552, M553) on page 3073
RC4-0179-000CN	Cover, left	Covers (M577) on page 3075
RC4-0183-000CN	Handle, right	Covers (M552, M553) on page 3073
RC4-0183-000CN	Handle, right	Covers (M577) on page 3075
RC4-0213-000CN	Cover, HIP (M552dn, M553dn, M553x)	Covers (M552, M553) on page 3073
RC4-0214-000CN	Cover, USB	Covers (M552, M553) on page 3073
RC4-0445-000CN	Holder, OP Drawer	Internal components (5 of 5) on page 3085
RC4-0445-000CN	Holder, OP drawer (550-sheet feeder)	550-sheet paper feeder covers on page 3089
RC4-0830-000CN	Arm, solenoid	Internal components (3 of 5) on page 3081
RC4-1741-000CN	Holder, drawer connector (550-sheet feeder)	550-sheet paper feeder covers on page 3089

Table 2-15 Numerical parts list (continued)

Part number	Description	Table and page
RC4-1778-000CN	Link, door, right (550-sheet feeder)	550-sheet paper feeder covers on page 3087
RC4-1781-000CN	Hinge, door, right (550-sheet feeder)	550-sheet paper feeder covers on page 3087
RC4-1791-000CN	Cover, left (550-sheet feeder)	550-sheet paper feeder covers on page 3087
RC4-1792-000CN	Cover, rear (550-sheet feeder)	550-sheet paper feeder covers on page 3087
RC4-1793-000CN	Cover, right lower (550-sheet feeder)	550-sheet paper feeder covers on page 3087
RC4-3382-000CN	Cover, paper feed (M577)	Covers (M577) on page 3075
RC4-3383-000CN	Cover, top rear (M577)	Covers (M577) on page 3075
RK2-2416-000CN	Fan, power-supply (FM1)	Internal components (4 of 5) on page 3083
RK2-2418-000CN	Fan, fuser (FM4)	Internal components (1 of 5) on page 3077
RK2-2728-000CN	Fan, delivery (FM3)	Internal components (4 of 5) on page 3083
RK2-6027-000CN	Motor, stepping (M6)	Internal components (5 of 5) on page 3085
RK2-6101-000CN	Cable, flexible flat	Internal components (4 of 5) on page 3083
RK2-6103-000CN	Cable, flexible flat	Internal components (4 of 5) on page 3083
RK2-6111-000CN	Cable, flexible flat	Internal components (4 of 5) on page 3083
RK2-6124-000CN	Fan, cartridge (FM2)	Internal components (1 of 5) on page 3077
RL2-0013-010CN	Inner door	Internal components (1 of 5) on page 3077
RL2-0096-000CN	Cover, upper (M553n)	Covers (M552, M553) on page 3073
RL2-0097-000CN	Cover, upper (M553x)	Covers (M552, M553) on page 3073
RL2-0098-000CN	Cover, upper (M552dn, M553dn)	Covers (M552, M553) on page 3073
RL2-0769-000CN	Cover, top (M577)	Covers (M577) on page 3075
RL2-0770-000CN	Cover, left upper (M577)	Covers (M577) on page 3075
RL2-0771-000CN	Cover, rear upper (M577)	Covers (M577) on page 3075
RL2-0772-000CN	Cover, right upper (M577)	Covers (M577) on page 3075
RM2-0006-000CN	Duplexing drive assembly (M7, CL2; M552dn, M553dn, M553x)	Internal components (5 of 5) on page 3085

Table 2-15 Numerical parts list (continued)

Part number	Description	Table and page
RM2-0007-000CN	Cassette (Tray 2)	Internal components (3 of 5) on page 3081
RM2-0008-000CN	Paper pickup drive assembly (M5)	Internal components (5 of 5) on page 3085
RM2-0009-000CN	Fuser drive assembly (M552dn, M553dn, M553x, M577)	Internal components (5 of 5) on page 3085
RM2-0010-000CN	Lifter drive assembly (CL1)	Internal components (5 of 5) on page 3085
RM2-0016-000CN	Paper delivery assembly (M552dn, M553dn, M553x, M577)	Internal components (3 of 5) on page 3081
RM2-0017-000CN	Paper pickup assembly	Internal components (3 of 5) on page 3081
RM2-0018-000CN	Registration assembly (M552dn, M553dn, M553x, M577)	Internal components (3 of 5) on page 3081
RM2-0019-000CN	Door assembly, right	Covers (M552, M553) on page 3073
RM2-0019-000CN	Right door assembly	Covers (M577) on page 3075
RM2-0022-000CN	Secondary transfer assembly (M552dn, M553dn, M553x, M577)	Internal components (3 of 5) on page 3081
RM2-0044-000CN	Output bin	Covers (M552, M553) on page 3073
RM2-0044-000CN	Output bin	Covers (M577) on page 3075
RM2-0077-000CN	Motor assembly, fuser (M4)	Internal components (5 of 5) on page 3085
RM2-0078-000CN	Motor assembly, drum (M1, M2, M3)	Internal components (5 of 5) on page 3085
RM2-0084-000CN	Cover, formatter	Covers (M552, M553) on page 3073
RM2-0084-000CN	Cover, formatter	Covers (M577) on page 3075
RM2-0085-000CN	Cover, rear	Covers (M552, M553) on page 3073
RM2-0085-000CN	Cover, rear	Covers (M577) on page 3075
RM2-0086-000CN	Glass cleaner assembly, dust-proof	Internal components (1 of 5) on page 3077
RM2-0090-000CN	Secondary transfer assembly (M553n)	Internal components (3 of 5) on page 3081
RM2-0091-000CN	Fuser drive assembly (M553n)	Internal components (5 of 5) on page 3085
RM2-0092-000CN	Paper delivery assembly (M553n)	Internal components (3 of 5) on page 3081
RM2-0093-000CN	Registration assembly (M553n)	Internal components (3 of 5) on page 3081

Table 2-15 Numerical parts list (continued)

Part number	Description	Table and page
RM2-5145-000CN	Paper feed assembly (550-sheet feeder)	550-sheet paper feeder covers on page 3089
RM2-5146-000CN	Door assembly, right (550-sheet feeder)	550-sheet paper feeder covers on page 3087
RM2-5147-000CN	Auto close assembly	Internal components (5 of 5) on page 3085
RM2-5147-000CN	Auto close assembly (550-sheet feeder)	550-sheet paper feeder covers on page 3089
RM2-5148-000CN	Feed drive assembly (550-sheet feeder)	550-sheet paper feeder covers on page 3089
RM2-5149-000CN	Lifter drive assembly (550-sheet feeder)	550-sheet paper feeder covers on page 3089
RM2-5150-000CN	Cassette (tray; 550-sheet feeder)	550-sheet paper feeder covers on page 3089
RM2-5154-000CN	Paper pickup assembly (550-sheet feeder)	550-sheet paper feeder covers on page 3089
RM2-6545-000CN	Laser/scanner assembly	Internal components (2 of 5) on page 3079
RM2-7122-000CN	HVPS (D) PCA assembly	Internal components (4 of 5) on page 3083
RM2-7123-000CN	HVPS (T) PCA assembly (M552dn, M553dn, M553x, M577)	Internal components (4 of 5) on page 3083
RM2-7125-000CN	Fuser power supply PCA assembly	Internal components (4 of 5) on page 3083
RM2-7130-000CN	Waste toner detect PCA assembly	Internal components (1 of 5) on page 3077
RM2-7133-000CN	Switch PCA assembly (SW4)	Internal components (2 of 5) on page 3079
RM2-7134-000CN	HVPS (T) PCA assembly (M553n)	Internal components (4 of 5) on page 3083
RM2-7138-000CN	Memory PCA assembly	Internal components (4 of 5) on page 3083
RM2-7139-000CN	Paper feed drive PCA assembly (550-sheet feeder)	550-sheet paper feeder covers on page 3089
RM2-7154-000CN	Environmental sensor PCA assembly	Internal components (4 of 5) on page 3083
RM2-7156-000CN	Connecting PCA assembly	Internal components (1 of 5) on page 3077
RM2-7157-000CN	Estrangement detect PCA assembly (SR5)	Internal components (5 of 5) on page 3085
RM2-7160-000CN	Density detect assembly	Internal components (3 of 5) on page 3081

Table 2-15 Numerical parts list (continued)

Part number	Description	Table and page
RM2-7164-000CN	LVPS PCA assembly	Internal components (4 of 5) on page 3083
RM2-7168-000CN	Pre-exposure PCA assembly	Internal components (2 of 5) on page 3079
RM2-7169-000CN	Pre-exposure PCA assembly	Internal components (2 of 5) on page 3079
RM2-7180-000CN	Control panel (M552dn, M553n, M553dn)	Covers (M552, M553) on page 3073
RM2-7186-000CN	DC controller PCA assembly (M552, M553))	Internal components (4 of 5) on page 3083
RM2-7187-000CN	DC controller PCA assembly (M577)	Internal components (4 of 5) on page 3083
RU8-0577-000CN	Gear 18T	Internal components (5 of 5) on page 3085
VS1-7258-000CN	Connector, drawer	Internal components (5 of 5) on page 3085
WC2-5806-000CN	Switch button (SW21; 550-sheet feeder)	550-sheet paper feeder covers on page 3089

Index

Symbols/Numerics

500-sheet feeder
parts lists and diagrams 3086

A

after-service checklist 6
auto close assembly
removing and replacing 1230
auto close assembly (1x550-sheet
paper feeder)
removing and replacing 2880
auto close assembly, removing and
replacing 1230

B

before-service checklist 6

C

cartridge
ordering 3063
part numbers 3063
cartridges
removing and replacing 9
cautions iii
Channel partners support
HP Channel Services Network
(CSN) 2, 3058
connectors
OP drawer holder (1x550-sheet
paper feeder), removing 2874
Control panel (M553n/dn and M552dn
only)
removing and replacing 540
Control panel (M553n/dn and M552dn
only), removing and replacing 540
control panel (M577)
removing and replacing 91
control panel (M577), removing and
replacing 91

conventions, document iii
covers
left cover (1x550-sheet paper
feeder), removing 2870
parts lists and diagrams 3072
rear cover (1x550-sheet paper
feeder), removing 2821
right-door link (1x550-sheet paper
feeder), removing 2857
right-lower cover (1x550-sheet
paper feeder), removing 2844
covers (M506)
part numbers 3072
covers (M577)
part numbers 3074

D

DC controller
removing and replacing 767
DC controller, removing and
replacing 767
delivery fan (FM3), removing and
replacing 1390
delivery fan (FM3)
removing and replacing 1390
density-detect assembly
removing and replacing 2444
density-detect assembly, removing
and replacing 2444
developing disengagement motor (M6)
removing and replacing 1180
developing disengagement motor
(M6), removing and replacing 1180
DIMM
removing and replacing 44, 52
document conventions iii
document feeder
removing and replacing rollers
(M577) 127
document feeder (M577)
removing and replacing 2719
document feeder (M577), removing
and replacing 2719
document feeder and scanner whole
units
parts lists and diagrams 3070
document feeder rollers (M577)
removing and replacing 127
document feeder rollers (M577),
removing and replacing 127
door link (1x550-sheet paper feeder)
removing and replacing 2857
doors
door link (1x550-sheet paper
feeder), removing 2857
right door (1x550-sheet paper
feeder), removing 2825
drawer connector holder (1x550-sheet
paper feeder)
removing and replacing 2899
drum motor 1 (M1)
removing and replacing 1065
drum motor 1 (M1), removing and
replacing 1065
drum motor 2 (M2)
removing and replacing 1563
drum motor 2 (M2), removing and
replacing 1563
drum motor 3 (M3)
removing and replacing 1652
drum motor 3 (M3), removing and
replacing 1652
dual in-line memory module (DIMM)
removing and replacing 52
duplex drive assembly, removing and
replacing 1954

- E**
- electrostatic discharge (ESD) 4
- embedded MultiMedia Card (eMMC)
 - removing and replacing 60
- environmental sensor PCA
 - removing and replacing 1830
- environmental sensor PCA, removing and replacing 1830
- ESD electrostatic discharge (ESD) 4
- F**
- fax PCA
 - removing and replacing 3050
- feeder drive assembly (1x550-sheet paper feeder)
 - removing and replacing 2963
- field-replaceable units (FRUs)
 - replacing 3
- formatter
 - removing and replacing 876, 891
- formatter case assembly
 - removing and replacing 907
- formatter case assembly, removing and replacing 907
- Formatter cover
 - removing and replacing 357
- Formatter cover, removing and replacing 357
- formatter, removing and replacing 876, 891
- front door
 - removing and replacing 347
- FRUs (field-replaceable units)
 - replacing 3
- fuser
 - removing and replacing 23
- fuser drive assembly, removing and replacing 1845
- fuser motor (M4)
 - removing and replacing 1741
- fuser motor (M4), removing and replacing 1741
- fuser power supply
 - removing and replacing 947
- fuser power supply, removing and replacing 947
- H**
- hard disk drive (HDD)
 - removing and replacing 28, 34
- high-voltage power supply D (HVPSD)
 - removing and replacing 1016
- high-voltage power supply D (HVPSD), removing and replacing 1016
- High-voltage power supply T (HVPST)
 - removing and replacing 1475
- High-voltage power supply T (HVPST), removing and replacing 1475
- hinge bracket
 - right door hinge bracket (1x550-sheet paper feeder), removing 2834
- HIP cover
 - removing and replacing 74, 78
- HIP cover, removing and replacing 74, 78
- HP Channel Services Network (CSN)
 - Channel partners support 2, 3058
- I**
- image scanner (M577)
 - removing and replacing 2753
- installation 5
 - screws 5
 - See also* replacing parts
- intermediate transfer belt (ITB)
 - removing 152
- internal components, product parts lists and diagrams 3076
- internal USB ports (M552 and M553)
 - removing and replacing 3034
- internal USB ports (M577)
 - removing and replacing 3043
- ITB
 - removing 152
- K**
- kit
 - instructions, embedded MultiMedia Card (eMMC) 60
 - instructions, front door 347
 - instructions, fuser 23
 - instructions, hard disk drive (HDD) 28, 34
 - instructions, memory DIMM 44
 - instructions, secondary transfer roller and ITB 165
 - instructions, secondary transfer roller assembly 578
 - instructions, toner cartridges 9
 - instructions, tray 1 pickup and separation rollers 566
 - instructions, tray 2-X pickup and separation rollers 137
- L**
- laser scanner
 - warnings for servicing 3
- laser/scanner assembly
 - removing and replacing 1332
- laser/scanner assembly, removing and replacing 1332
- left cover
 - removing and replacing 375
- left cover (1x550-sheet paper feeder)
 - removing and replacing 2870
- left cover, removing and replacing 375
- lifter drive assembly
 - removing and replacing 1280
- lifter drive assembly (1x550-sheet paper feeder)
 - removing and replacing 2988
- lifter drive assembly, removing and replacing 1280
- low-voltage power supply (LVPS)
 - removing and replacing 971
- low-voltage power supply (LVPS), removing and replacing 971
- M**
- main drive assembly)
 - removing and replacing 2570
- main drive assembly, removing and replacing 2570
- memory DIMM
 - removing and replacing 44
- N**
- near field communication PCA (NFC) (M553x)
 - removing and replacing 584
- near field communication PCA (NFC) (M553x), removing and replacing 584
- near field communication PCA (NFC) (M577z)
 - removing and replacing 611

near field communication PCA (NFC (M577z), removing and replacing 611

notes iii

O

OP drawer holder (1x550-sheet paper feeder)

removing and replacing 2874

ordering

toner cartridge 3063

output bin

removing and replacing 422

output bin, removing and replacing 422

P

paper feed assembly (1x550-sheet paper feeder)

removing and replacing 2912

paper feeder

auto close assembly (1x550-sheet paper feeder), removing 2880

auto close assembly, removing 2880

door link, removing 2857

drawer connector holder (1x550-sheet paper feeder), removing 2899

drawer connector holder, removing 2899

feeder drive assembly (1x550-sheet paper feeder), removing 2963

feeder drive assembly, removing 2963

lifter drive assembly (1x550-sheet paper feeder), removing 2988

lifter drive assembly, removing 2988

OP drawer holder, removing 2874

paper feed assembly (1x550-sheet paper feeder), removing 2912

paper feed assembly, removing 2912

paper pickup assembly, removing 2935

paper-feeder drive PCA (1x550-sheet paper feeder), removing 2906

paper-feeder drive PCA, removing 2906

rear cover, removing 2821, 2870

right door hinge bracket, removing 2834

right door, removing 2825

right-door link, removing 2857

right-lower cover, removing 2844

switch button (SW12) (1x550-sheet paper feeder), removing 2890

switch button (SW12), removing 2890

paper pickup

paper pickup assembly (1x550-sheet paper feeder), removing 2935

paper pickup assembly

removing and replacing 2307

paper pickup assembly (1x550-sheet paper feeder)

removing and replacing 2935

paper pickup assembly, removing and replacing 2307

paper-feeder drive PCA (1x550-sheet paper feeder)

removing and replacing 2906

part numbers

covers (M506) 3072

covers (M577) 3074

toner cartridge 3063

parts lists and diagrams 3057

500-sheet feeder 3086

covers 3072

document feeder and scanner whole units 3070

internal components, product 3076

using 3069

pickup and separation rollers, replacing tray 1 566

pickup and separation rollers, replacing tray 2-X 137

pickup drive assembly and motor (M5) removing and replacing 2089

pickup drive assembly and motor (M5), removing and replacing 2089

power-supply fan (FM1)

removing and replacing 1106

power-supply fan (FM1), removing and replacing 1106

R

Rear cover

removing and replacing 360, 365

rear cover (1x550-sheet paper feeder) removing and replacing 2821

Rear cover, removing and replacing 360, 365

rear right cover

removing and replacing 489, 517

rear right cover, removing and replacing 489, 517

registration assembly

removing and replacing 2186

registration assembly, removing and replacing 2186

removal orientation

removing orientation 7

removal strategy

removing and replacing 2

removing and replacing

auto close assembly (1x550-sheet paper feeder) 2880

control panel (M577) 91

document feeder (M577) 2719

document feeder rollers (M577) 127

door link (1x550-sheet paper feeder) 2857

drawer connector holder (1x550-sheet paper feeder) 2899

dual in-line memory module (DIMM) 52

duplex drive assembly 1954

embedded MultiMedia Card (eMMC) 60

fax PCA 3050

feeder drive assembly (1x550-sheet paper feeder) 2963

front door 347

fuser 23

fuser drive assembly 1845

hard disk drive (HDD) 28, 34

image scanner (M577) 2753

- internal USB ports (M552 and M553) 3034
 - internal USB ports (M577) 3043
 - left cover (1x550-sheet paper feeder) 2870
 - lifter drive assembly (1x550-sheet paper feeder) 2988
 - memory DIMM 44
 - OP drawer holder (1x550-sheet paper feeder) 2874
 - paper feed assembly (1x550-sheet paper feeder) 2912
 - paper pickup assembly (1x550-sheet paper feeder) 2935
 - paper-feeder drive PCA (1x550-sheet paper feeder) 2906
 - rear cover (1x550-sheet paper feeder) 2821
 - right door 338
 - right door (1x550-sheet paper feeder) 2825
 - right door hinge (1x550-sheet paper feeder) 2834
 - right-door link (1x550-sheet paper feeder) 2857
 - right-lower cover (1x550-sheet paper feeder) 2844
 - rollers, document feeder (M577) 127
 - scanner control board (M577) 2740
 - SCB (M577) 2740
 - secondary transfer assembly 578
 - secondary transfer roller and ITB 165
 - staple cartridge (M577c/f/z) 19
 - switch button (SW12) (1x550-sheet paper feeder) 2890
 - toner cartridges 9
 - tray 1 pickup and separation rollers 566
 - tray 2-X pickup and separation rollers 137
 - white backing (M527) 119
 - white backing (M577) 112
 - removing parts
 - after-service checklist 6
 - before-service checklist 6
 - tools, required 4
 - replacing parts
 - about 3
 - after-service checklist 6
 - before-service checklist 6
 - screws 5
 - tools, required 4
 - right door
 - removing and replacing 338
 - right door (1x550-sheet paper feeder)
 - removing and replacing 2825
 - right door hinge bracket (1x550-sheet paper feeder)
 - removing and replacing 2834
 - right-door link (1x550-sheet paper feeder)
 - removing and replacing 2857
 - right-lower cover (1x550-sheet paper feeder)
 - removing and replacing 2844
 - rollers
 - assembly, secondary transfer
 - removing and replacing 578
 - secondary transfer, removing and replacing 165
 - tray 1 pickup and separation rollers, replacing 566
 - tray 2-X pickup and separation rollers, replacing 137
 - rollers, document feeder (M527), removing and replacing 127
 - rollers, document feeder (M577) removing and replacing 127
- S**
- scan control board (M577), removing and replacing 2740
 - scanner control board (M577) removing and replacing 2740
 - SCB (M577) removing and replacing 2740
 - SCB (M577), removing and replacing 2740
 - screwdrivers, required 4
 - screws
 - installing 5
 - types of 5
 - secondary transfer assembly, removing and replacing 578
 - secondary transfer roller and ITB removing and replacing 165
 - secondary transfer roller and ITB, removing and replacing 165
 - service and support information v, 3068
 - WISE and CSN 2, 3058
 - service approach
 - removing and replacing 6
 - staple cartridge (M577c/f/z) removing and replacing 19
 - staple cartridge (M577c/f/z), removing and replacing 19
 - static, precautions for 4
 - switch (SW4) PC board assembly removing and replacing 686
 - switch (SW4) PC board assembly, removing and replacing 686
 - switch button (SW12) (1x550-sheet paper feeder) removing and replacing 2890
- T**
- tips iii
 - toner cartridge
 - ordering 3063
 - part numbers 3063
 - toner cartridges removing and replacing 9
 - toner collection unit (TCU) removing and replacing 14
 - toner collection unit (TCU), removing and replacing 14
 - tools, required 4
 - transfer
 - removing and replacing 578
 - tray 1
 - pickup and separation rollers, removing and replacing 566
 - tray 1 pickup and separation rollers removing and replacing 566
 - tray 2-X
 - pickup and separation rollers, removing and replacing 137
 - tray 2-X pickup and separation rollers removing and replacing 137
 - trusted platform module (M552 and M553) removing and replacing 3019
 - trusted platform module (M577) removing and replacing 3027

trusted platform module, removing
and replacing 3019, 3027

U

USB cover

removing and replacing 71

USB cover, removing and replacing

71

W

warnings iii

Web-based Interactive Search Engine

WISE 2, 3058

white backing (M527)

removing and replacing 119

white backing (M527), removing and

replacing 119

white backing (M577)

removing and replacing 112

white backing (M577), removing and

replacing 112

wireless PCA

removing and replacing 619

wireless PCA, removing and

replacing 619

WISE

Web-based Interactive Search

Engine 2, 3058

