

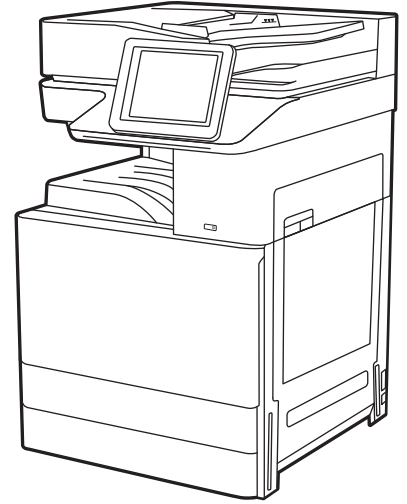

HP Color LaserJet Managed MFP E77422, E77428
HP Color LaserJet Managed MFP E78223, E78228

Service Manual

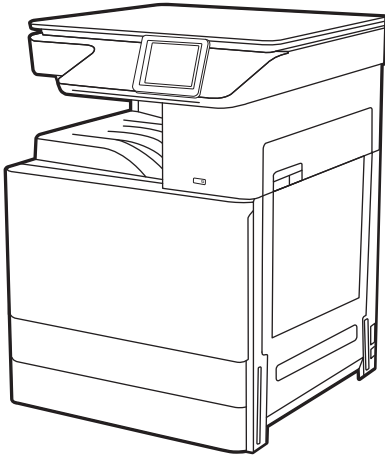

www.hp.com/videos/A3
www.hp.com/support/colorljE77422MFP
www.hp.com/support/ljE78223MFP



HP Color LaserJet Managed MFP E77422, E77428, E78223, E78228 - Service Manual

SUMMARY

Copyright and License

© Copyright 2020 HP Development Company, L.P.

Reproduction, adaptation, or translation without prior written permission is prohibited, except as allowed under the copyright laws.

The information contained herein is subject to change without notice.

The only warranties for HP products and services are set forth in the express warranty statements accompanying such products and services. Nothing herein should be construed as constituting an additional warranty. HP shall not be liable for technical or editorial errors or omissions contained herein.

Edition 4, 5/2020

Trademark Credits

Adobe®, Acrobat®, and PostScript® are trademarks of Adobe Systems Incorporated.

Microsoft®, Windows®, Windows® XP, and Windows Vista® are U.S. registered trademarks of Microsoft Corporation.

Revision History

Table -1 Revision History

Revision Number	Revision Date	Revision Notes
4.0	May, 2020	<p>Added the information for E78223, E78228 models in whole manual.</p> <p>Added the maintenance parts and supplies for E78223, E78228. See Maintenance and Consumable Life on page 20</p> <p>Added the Certificate of Volatility for E78223, E78228. See Certificate of Volatility (for E78223, E78228) on page 1260</p> <p>Updated the image quality troubleshooting for vertical white band. See Vertical white band, light band on page 607</p> <p>Added service part changes for EPA compliance. See Service parts changes For Environmental Protection Agency 3.0 Compliant Products on page 1265</p>
3.0	December, 2019	<p>Added optional Hard Disk Drive remove and replace procedure. See Removal and replacement: Optional Hard Disk Drive on page 425</p> <p>Added optional dual-cassette feeder(DCF) electrical and mechanical diagram. See Pickup motor 1/2, feed motor, paper size sensor 1/2 and cover open sensor (DCF) on page 680</p> <p>Minor changes to Technical specifications See Technical specifications on page 10</p>
2.0	April, 2019	Inner finisher chapter has been updated overall.
1.0	April, 2019	Service manual initial release

Conventions used in this guide

Learn what **Tips**, **Notes**, **Cautions**, and **Warnings** are.

 **TIP:** Tips provide helpful hints or shortcuts.

 **NOTE:** Notes provide important information to explain a concept or to complete a task.

 **CAUTION:** Cautions indicate procedures that you should follow to avoid losing data or damaging the product.

 **WARNING!** Warnings alert you to specific procedures that you should follow to avoid personal injury, catastrophic loss of data, or extensive damage to the product.

Table of contents

1 Product specifications and description	1
Printer views	2
Printer front view	2
Printer back view	5
Interface ports	5
Control-panel view	7
How to use the touchscreen control panel	9
Printer specifications	10
Technical specifications	10
Supported operating systems	13
Printer dimensions	15
Power consumption, electrical specifications, and acoustic emissions	16
Operating-environment range	16
Mobile printing solutions	16
General specifications	17
Print specifications	17
Scan specifications	18
Copy specifications	19
Maintenance and Consumable Life	20
Paper handling specifications	23
Configuration options	24
Pickup, feed, and delivery system	27
Feeding system overview	27
Main components and functions	27
Cassette (Tray 2, 3, 4, 5)	31
Pickup unit	31
Registration unit	32
Tray 1 feed assembly	33
Image formation system	35
Image formation process overview	35
Imaging unit	37
Imaging unit overview	37

Drum drive	37
Developer unit	38
Image Transfer Belt (ITB) Unit	40
Image transfer belt (ITB) unit overview	40
Image transfer belt (ITB) drive	41
Image transfer belt (ITB) cleaning	41
Fuser unit	43
Fuser unit overview	43
Fuser unit drive	44
Fuser unit temperature control	44
Laser scanning unit assembly (LSU)	46
Laser scanning unit assembly (LSU) overview	46
Laser scanner assembly overview	47
Laser synchronizing detectors	47
Automatic CPR adjustment	48
Drive system	52
Drive motors	52
Main drive unit (OPC/DEVE/ITB/Transfer Roller/Disengage/Engage motors)	53
Pickup drive	54
Registration/Tray 1 drive	55
Feed drive	55
Fuser/exit drive	56
Toner collection unit drive	57
Toner supply drive	58
Flatbed scanner system	59
Scanner system overview	59
Scanning system components	62
Full rate (FR) carriage components	62
Half rate (HR) carriage (mirror unit) components	63
Imaging unit components	64
Driving wire	64
Flatbed(Platen) glass	65
Drive motor	65
Timing belt	66
Automatic Paper Size(APS) sensor	66
Home sensor	66
Cover open sensor #1	66
Cover open sensor #2	66
ADF glass	66
Shading sheet	67
Precautions for unpacking and moving the scanner	67

Automatic document feeder (ADF)	69
Automatic document feeder (ADF) overview	69
Electrical parts location	69
Automatic document feeder drive system	71
Automatic document feeder(ADF) drive system overview	71
Automatic document feeder(ADF) original pickup assembly	71
Automatic document feeder(ADF) registration drive assembly	72
Automatic document feeder(ADF) feed drive assembly	73
Automatic document feeder(ADF) exit drive assembly	73
Automatic document feeder(ADF) original return drive assembly	74
Hardware configuration	76
Engine controller board(ECB)	76
Formatter	80
Low voltage power supply (LVPS; Type 5H) / Switching mode power supply (SMPS)	81
Fuser drive board (FDB)	83
High-voltage power supply (HVPS) PCA	84
Eraser PCA	85
Waste sensor PCA	85
Toner CRUM joint PCA	85
Paper size sensor PCA	86
Power key PCA	86
Walkup USB PCA	86
Dual cassette feeder	88
Dual cassette feeder (DCF) block diagram	88
Dual cassette feeder (DCF) components	88
Dual cassette feeder (DCF) paper path	89
Dual cassette feeder (DCF) electrical parts location	90
Dual cassette feeder (DCF) sensors and signals	91
Dual cassette feeder (DCF) paper feeding system	92
Dual cassette feeder (DCF) plug and jack locations	93
2 Parts, diagrams, removal and replacement	95
HP service and support	95
Order parts by authorized service providers	97
Ordering	97
Orderable parts	97
Related documentation and software	97
How to use the parts lists and diagrams	98
Electrostatic discharge	98
Service approach	99
Before performing service	99

After performing service	99
Post-service test	99
Maintenance	100
Clean the printer	101
Check the scanner glass for dirt and smudges (MFP)	101
Cleaning the laser scanner assembly window	102
Main parts	104
Main assembly 1 (Right side and rear side)	105
Main assembly 1 (Right side and rear side)	105
HP Color LaserJet Managed MFP E77422, E77428, E78223, and E78228 - Removal and replacement: Formatter PCA	107
HP Color LaserJet Managed MFP E77422, E77428, E78223, and E78228 - Removal and replacement: Engine controller board (ECB)	109
1st Exit assembly	116
1st Exit assembly	116
HP Color LaserJet Managed MFP E77422, E77428, E78223, and E78228 - Removal and replacement: 1st exit assembly	117
HP Color LaserJet Managed MFP E77422, E77428, E78223, and E78228 - Removal and replacement: Fuser unit	119
HP Color LaserJet Managed MFP E77422, E77428, E78223, and E78228 - Removal and replacement: Intermediate transfer belt (ITB) cleaner	122
HP Color LaserJet Managed MFP E77422, E77428, E78223, and E78228 - Removal and replacement: Intermediate transfer belt (ITB) unit	125
HP Color LaserJet Managed MFP E77422, E77428, E78223, and E78228 - Removal and replacement: LVPS fan	134
HP Color LaserJet Managed MFP E77422, E77428, E78223, and E78228 - Removal and replacement: LVPS board	137
HP Color LaserJet Managed MFP E77422, E77428, E78223, and E78228 - Removal and replacement: Fuser drive board (FDB)	140
Main assembly 2 (Front side and left side)	145
Main assembly 2 (Front side and left side)	145
Remove and replace the toner collection unit	146
Remove and replace the toner cartridge	148
HP Color LaserJet Managed MFP E77422, E77428, E78223, and E78228 - Removal and replacement: Laser scanning unit assembly (LSU)	150
HP Color LaserJet Managed MFP E77422, E77428, E78223, and E78228 - Removal and replacement: High-voltage power supply (HVPS) board	156
HP Color LaserJet Managed MFP E77422, E77428, E78223, and E78228 - Removal and replacement: Imaging drum unit	159
HP Color LaserJet Managed MFP E77422, E77428, E78223, and E78228 - Removal and replacement: Developer unit	164
Frame assembly	174
Main engine frame 1	175

Main engine frame (1/2)	175
Fuser & Exit drive assembly	178
HP Color LaserJet Managed MFP E77422, E77428, E78223, and E78228 - Removal and replacement: Pickup drive units	183
Registration & MP tray drive assembly	187
HP Color LaserJet Managed MFP E77422, E77428, E78223, and E78228 - Removal and replacement: Paper feed drive assembly	192
HP Color LaserJet Managed MFP E77422, E77428, E78223, and E78228 - Removal and replacement: Toner supply drive assembly	194
Main drive assembly	202
HP Color LaserJet Managed MFP E77422, E77428, E78223, and E78228 - Removal and replacement: Toner collection unit drive assembly	208
HP Color LaserJet Managed MFP E77422, E77428, E78223, and E78228 - Removal and replacement: Fan, type7 fuser	213
Main engine frame 2	218
Main engine frame (2/2)	218
HP Color LaserJet Managed MFP E77422, E77428, E78223, and E78228 - Removal and replacement: Toner duct assembly	219
Registration assembly	226
HP Color LaserJet Managed MFP E77422, E77428, E78223, and E78228 - Removal and replacement: Feed sensor 1	232
HP LaserJet Managed MFP E72425, E72430, E77422, E77428, E78223, E78228 - Removal and replacement: Feed sensor 2	236
Main frame pickup assembly	243
Main frame	254
Main frame parts	254
Front frame	256
Rear frame	277
Color plane registration (CPR) assembly	284
Frame main middle plate LSU	292
Covers	294
Control panel assembly	296
Control panel assembly (a,dv models only)	296
HP LaserJet Managed MFP E72425, E72430, E77422, E77428, E78223, E78228 - Control panel assembly (a,dv models only) , USB host PCA, and humidity & encoder sensor	297
Control panel assembly (dn models only)	304
HP LaserJet Managed MFP E72425, E72430, E77422, E77428, E78223, E78228 - Control panel assembly (dn models only), USB host PCA, and humidity & encoder sensor	305
Tray 1 (MP) right door assembly	310
Tray 1 (MP) right door parts	310

HP Color LaserJet Managed MFP E77422, E77428, E78223, and E78228 - Removal and replacement: Tray 1 (MP) right door assembly	312
Tray 1 (MP) parts	318
HP LaserJet Managed MFP E72425, E72430, E77422, E77428, E78223, E78228 - Removal and replacement: Tray 1 main rollers	319
HP LaserJet Managed MFP E72425, E72430, E77422, E77428, E78223, E78228 - Removal and replacement: Tray 1 (MP) unit and Tray 1 (MP) solenoid	322
Right door output	336
HP LaserJet Managed MFP E72425, E72430, E77422, E77428, E78223, E78228 - Removal and replacement: Fuser out sensor	336
Right door feed guide parts	346
HP Color LaserJet Managed MFP E77422, E77428, E78223, and E78228 - Removal and replacement: Transfer roller assembly	347
HP Color LaserJet Managed MFP E77422, E77428, E78223, and E78228 - Removal and replacement: Duplex sensor and loop sensor	349
Scanner assembly	356
Scanner assembly	356
HP Color LaserJet Managed MFP E77422, E77428, E78223, and E78228 - Removal and replacement: Scanner whole unit for control panel assembly (dn models only)	357
HP Color LaserJet Managed MFP E77422, E77428, E78223, and E78228 - Removal and replacement: Scanner whole unit for control panel assembly (a,dv models only) .	370
HP LaserJet Managed MFP E72425, E72430, E77422, E77428, E78223, E78228 - Removal and replacement: Scanner Glass	381
Scanner lower parts	386
HP LaserJet Managed MFP E72425, E72430, E77422, E77428, E78223, E78228 - Removal and replacement: Scanner imaging unit	387
HP LaserJet Managed MFP E72425, E72430, E77422, E77428, E78223, E78228 - Removal and replacement: Scanner APS sensor	390
Automatic document feeder (ADF) assembly	396
Automatic Document Feeder (ADF) upper parts	396
HP LaserJet Managed MFP E72425, E72430, E77422, E77428, E78223, E78228 - Removal and replacement: ADF whole unit	397
HP LaserJet Managed MFP E72425, E72430, E77422, E77428, E78223, E78228 - Removal and replacement: ADF open cover	400
HP LaserJet Managed MFP E72425, E72430, E77422, E77428, E78223, E78228 - Removal and replacement: ADF stacker	402
HP LaserJet Managed MFP E72425, E72430, E77422, E77428, E78223, E78228 - Removal and replacement: ADF PCA	406
Automatic Document Feeder (ADF) main frame parts	410
HP LaserJet Managed MFP E72425, E72430, E77422, E77428, E78223, E78228 - Removal and replacement: ADF registration, cover, and detect sensors	411
HP LaserJet Managed MFP E72425, E72430, E77422, E77428, E78223, E78228 - Removal and replacement: ADF motor	414

Document lid assembly	422
Document lid assembly	422
HP LaserJet Managed MFP E72425, E72430, E77422, E77428, E78223, E78228 - Removal and replacement: Document lid assembly	423
Removal and replacement: Optional Hard Disk Drive	425
Optional dual-cassette feeder (DCF)	438
Removal and replacement: Dual-cassette feeder (DCF) rear cover	438
Removal and replacement: Dual-cassette feeder (DCF) right door	439
Removal and replacement: Dual-cassette feeder (DCF) PCA	441
Removal and replacement: Dual-cassette feeder (DCF) motor	442
Removal and replacement: Dual-cassette feeder (DCF) motor	445
Removal and replacement: Dual-cassette feeder (DCF) motor	446
3 Problem solving	451
Error code and control panel message troubleshooting overview	452
Error codes	452
How to search for printer documentation	454
Troubleshooting process	458
Determine the problem source	459
Power subsystem	460
Power-on checks	461
Control panel checks	465
Control panel diagnostic flowcharts	466
Individual component diagnostics	471
Tools for troubleshooting: LED diagnostics	472
Tools for troubleshooting: Engine diagnostics	474
Tools for troubleshooting	476
Tools for troubleshooting	477
Problem-solving checklist	478
Step 1: Check that the printer power is on	478
Step 2: Check the control panel for error messages	478
Step 3: Test print functionality	478
Step 4: Test copy functionality	478
Step 5: Test the fax sending functionality	478
Step 6: Test the fax receiving functionality	479
Step 7: Try sending a print job from a computer	479
Step 8: Test the plug and print USB drive printing functionality	479
Factors that affect printer performance	479
Print menu map	480
Print current settings pages	480
Print event log	480

Pre-boot menu options	482
Open the Pre-boot menu from a touchscreen control panel	482
Cold reset using the Pre-boot menu from a touchscreen control panel	484
Remote Admin	491
Required software and network connection	492
Connect a remote connection	494
Disconnect a remote connection	497
Control panel menus	500
Reports menu	500
Settings menu	501
Copy menu (MFP only)	543
Scan menu (MFP only)	547
Fax menu (fax models only)	556
Print menu	559
Supplies menu	559
Trays menu	560
Troubleshooting menu	560
Maintenance menu	564
Backup/Restore menu	564
Calibration/Cleaning menu	564
USB Firmware Upgrade menu	565
Solve paper handling problems	566
Printer feeds incorrect page size	566
Printer pulls from incorrect tray	566
Printer will not duplex or duplexes incorrectly	566
Paper does not feed from Tray 2-X	567
Output is curled or wrinkled	567
Printer does not pick up paper or misfeeds	568
Clear paper jams	570
Paper jam locations	570
Clear paper jams in the document feeder - 31.13.yz	571
Clear paper jams in Tray 1 (multipurpose tray)—13.A1	572
Clear paper jams in Tray 2, Tray 3, and the optional 2 x 520-sheet trays – 13.A2, 13.A3, 13.A4	573
Clear paper jams in the output bin - 13.E1	575
Clear paper jams in the right door and fuser area—13.B9, 13.B2, 13.FF	575
Service mode (tech mode)	577
Entering service mode	577
Service mode menu tree	577
Information tab	582
General	582

Supply Status	582
Software Version	582
Fault Log	582
Print Reports	583
Maintenance Counts tab	584
Fault Count	584
Part Replacement Count	584
Diagnostics tab	586
Engine diagnostics	586
Scanner Diagnostics	590
Adjustment	594
Image management	598
Print Test Patterns	600
Service Functions tab	601
Main Memory Clear	601
Debug Log	601
Capture Log	601
TR Control Mode	601
Part Replacement Alert	602
Envelope Rotate	603
Drain	603
Print quality troubleshooting guide	604
Image quality problems and solutions	604
Vertical black band	606
Vertical white band, light band	607
Horizontal periodic black band or dot	610
Horizontal periodic light/dark band or dot	611
Foggy image	612
Light image	613
Blurred image	614
Incorrect color registration	615
Uneven pitch and jitter image	616
Skewed image	616
Blank copy	617
Poor fusing performance	618
Stain on back of paper	619
Duplex blur, white spot blur on color print-out	619
Setting standard tone	620
Red/Magenta hue printouts	621
Solve connectivity problems	623
Solve wired network problems	624

Introduction	624
Poor physical connection	624
The computer is unable to communicate with the printer	624
The printer is using incorrect link and duplex settings for the network	625
New software programs might be causing compatibility problems	625
The computer or workstation might be set up incorrectly	625
The printer is disabled, or other network settings are incorrect	625
Other Errors	626
Image system problem	626
Fuser problem	630
Scanner and ADF problems	630
Drive unit problem	633
Feeding system problem	633
Laser scanning unit assembly (LSU) problem	635
Electrical circuit problem	635
Firmware upgrades	637
Adjusting the laser scanning unit assembly (LSU) skew error	638
Adjusting the ADF skew	639
4 Electrical Mechanical Diagrams	643
PCAs, Boards, and Laser Scanning Unit(LSU)	644
Formatter	644
Low Voltage Power Supply (LVPS) and Fuser Drive Board (FDB)	645
High Voltage Power Supply (HVPS) and Laser Scanning Unit Assembly (LSU)	646
Temp/Humidity sensor (a,dv models only)	646
Temp/Humidity sensor (dn models only)	647
Exit section	649
Exit assembly	649
Drive section	650
Main drive assembly	650
Registration & Tray 1 (MP) drive assembly	651
Fuser & Exit drive assembly	652
Paper feed drive assembly	653
Toner supply drive assembly	654
Paper pickup drive assembly	656
Paper handling section	658
First & Second pickup assembly	658
Registration assembly	658
Frame section	660
Front frame	660
Rear frame	660

Color Plane Registration (CPR) assembly	662
Feed sensor	662
Fuser section	664
Fuser assembly	664
MP right door section	666
Right door assembly	666
Tray 1 (MP) assembly	668
Right door feed guide	669
Right door output	669
Scanner section	671
Scanner assembly (1/2)	671
Scanner assembly (2/2)	673
Automatic Document Feeder (ADF) section	674
Automatic Document Feeder (ADF) assembly (1/2)	674
Automatic Document Feeder (ADF) assembly (2/2)	675
Image formation section	676
Image transfer belt (ITB) assembly	676
Toner cartridges	676
TC Sensor	677
Toner crum & Eraser sensor	678
Optional dual-cassette feeder (DCF)	680
Pickup motor 1/2, feed motor, paper size sensor 1/2 and cover open sensor (DCF)	680
Feed sensor 1, empty sensor 1, and lift sensor 1 for tray 4 (DCF)	682
Feed sensor 2, empty sensor 2, and lift sensor 2 for tray 5 (DCF)	682

5 Inner finisher 685

Product Specification and Description	686
Inner finisher view	686
Specification	687
Inner finisher system	692
Overview	692
Punch unit (optional)	698
Entrance unit	701
Diverter unit	702
Exit unit	704
Paper support unit	707
Paddle unit	708
Tamper unit	711
End fence unit	714
Stapler unit	716
Ejector unit	718

Output tray & paper holding unit	722
PCA connection information	726
Service approach	730
Before performing service	730
ESD precautions	730
After performing service	730
Post-service test	731
Print-quality test	731
Order parts, accessories, and supplies	732
Ordering	732
Orderable parts	732
Parts, diagrams, removal and replacement (inner finisher)	733
Parts and diagrams (inner finisher)	734
Inner finisher (main)	734
Inner finisher (covers)	736
Inner finisher (main paddle unit, entrance unit, exit unit, paper holding unit, and output tray unit)	738
Inner finisher (paper support unit)	740
Inner finisher (tamper unit)	742
Inner finisher (stapler unit, end fence unit)	744
Inner finisher (stapler assembly, entrance unit)	746
Inner finisher (ejector unit)	748
Covers	750
Removal and replacement: Front cover (C1)	750
Removal and replacement: Rear cover (C8)	752
Removal and replacement: Middle cover (C3)	754
Removal and replacement: Top cover (C2)	757
Removal and replacement: PCA cover (C6)	760
Removal and replacement: Left cover (C7)	762
Entrance unit	773
Removal and replacement: Entrance sensor (S1)	773
Removal and replacement: Entrance motor (M10)	778
Exit unit	788
Removal and replacement: Exit sensor (S21)	788
Removal and replacement: Exit motor (M2)	796
Removal and replacement: Exit roller (R3)	798
Paper support unit	806
Removal and replacement: Front paper support	806
Rear paper support	827
Removal and replacement: Rear paper support	827
Removal and replacement: Paper support home sensor (S12)	847

Removal and replacement: Paper support motor (M8)	869
Paddle unit	889
Removal and replacement: Main paddle	889
Removal and replacement: Main paddle home sensor (S4)	892
Removal and replacement: Main paddle motor (M3)	895
Removal and replacement: Main paddle assembly	898
Removal and replacement: Sub paddle unit	905
Tamper unit	910
Front tamper	911
Removal and replacement: Front tamper	911
Removal and replacement: Front tamper home sensor (S5)	928
Removal and replacement: Front tamper motor (M9)	945
Rear tamper	964
Removal and replacement: Rear tamper	964
Removal and replacement: Rear tamper home sensor (S14)	981
Removal and replacement: Rear tamper motor (M5)	998
Stapler unit	1017
Removal and replacement: Stapler	1017
Removal and replacement: Stapler position sensor (S2)	1021
Removal and replacement: Stapler position motor (M1)	1033
Ejector unit	1043
Removal and replacement: Ejector & paper support assembly	1043
Removal and replacement: Ejector motor assembly (S11/ M6/ M7)	1062
Removal and replacement: Ejector assembly (include end fence, S10/ S16)	1084
End fence unit	1108
Removal and replacement: End fence sensor (S17)	1108
Output tray unit	1118
Removal and replacement: Output tray	1118
Removal and replacement: Output tray top of stack sensor (S8)	1124
Removal and replacement: Output tray lower limit switch (S7)	1133
Output tray motor assembly	1145
Removal and replacement: Output tray motor assembly (M4)	1145
Removal and replacement: Output tray motor sensor (S6)	1155
Removal and replacement: Output tray motor	1166
Paper holding unit	1178
Removal and replacement: Paper holding	1178
Removal and replacement: Paper holding sensor (S9)	1190
Removal and replacement: Paper holding solenoid (SL1)	1202
Punch unit	1222
Removal and replacement: Punch cover	1222
Removal and replacement: Punch waste full sensor (S19)	1226

Problem solving	1235
Control panel message document (CPMD)	1235
Electrical Mechanical Diagrams (Inner finisher)	1236
Inner finisher PCA	1236
Punch waste full sensor	1236
Punch waste box sensor and finisher docking sensor	1237
Entrance motor	1238
Entrance sensor	1239
Exit sensor	1240
Exit motor, main paddle motor & home sensor, output tray lower limit switch, and paper holding solenoid	1241
Paper support motor & home sensor	1242
Front tamper motor and home sensor	1243
Rear tamper motor and home sensor	1244
End fence sensor	1245
Stapler position motor and sensor	1246
Ejector 1 motor and home sensor, ejector 2 motor, motor sensor, and home sensor	1247
Output tray motor and sensor	1248
Output tray top of stack sensor	1249
Top cover switch	1250
Front cover switch	1251
Appendix A Glossary	1253
Glossary of terms	1253
Appendix B Certificate of Volatility	1257
Certificate of Volatility (for E77422, E77428)	1257
Certificate of Volatility (for E78223, E78228)	1260
Appendix C Service parts changes For Environmental Protection Agency 3.0 Compliant Products	1265
Index	1269

1 Product specifications and description

Printer views

Locate key features on the printer and the control panel.

Printer front view

Locate features on the front of the printer.

Figure 1-1 Printer front view (E77428dn, E77422dn, E78228dn, E78223dn)

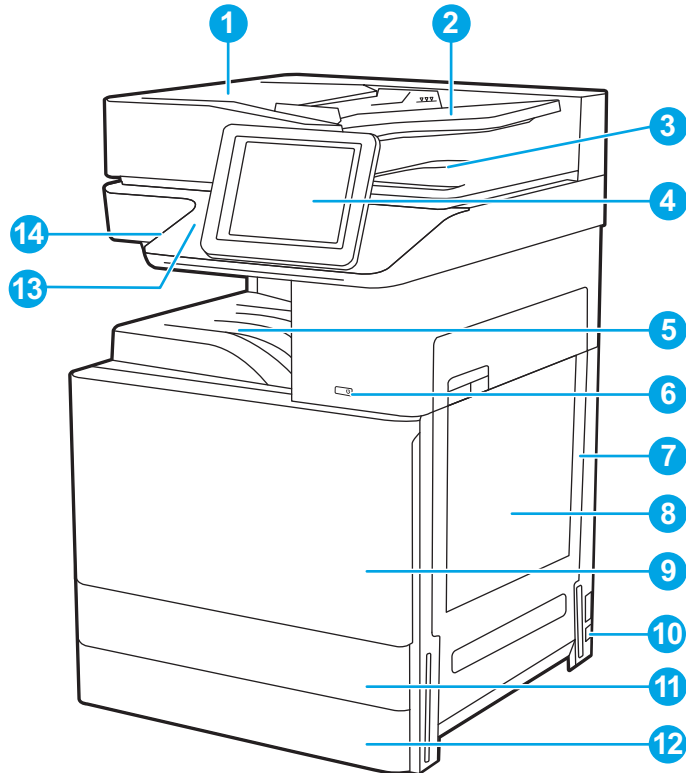

Item	Description
1	Automatic document feeder cover, for access for clearing jams
2	Automatic document feeder input tray
3	Automatic document feeder output tray
4	Control panel with color touchscreen display (tilts up for easier viewing)
5	Output bin
6	On/off button
7	Right door, for access for clearing jams
8	Tray 1 (multipurpose tray)
9	Front door, for access to the toner cartridges
10	Power connection
11	Tray 2
12	Tray 3

Item	Description
13	Hardware integration pocket (HIP), for connecting accessory and third-party devices
14	Easy-access USB port
	Insert a USB flash drive for printing or scanning without a computer or to update the printer firmware.
	NOTE: An administrator must enable this port before use.

Figure 1-2 Printer front view (E77422dv, E78223dv)

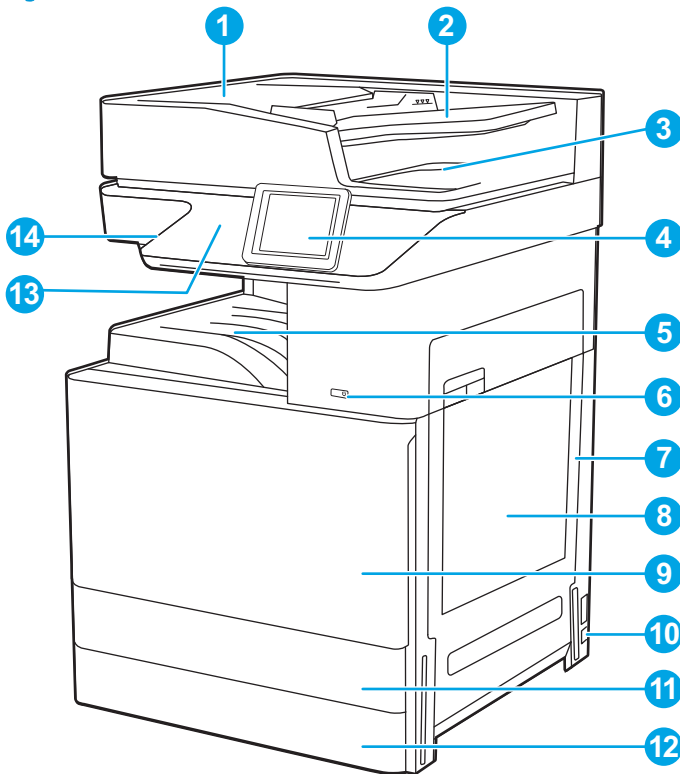

Item	Description
1	Automatic document feeder cover, for access for clearing jams
2	Automatic document feeder input tray
3	Automatic document feeder output tray
4	Control panel with color touchscreen display (tilts up for easier viewing)
5	Output bin
6	On/off button
7	Right door, for access for clearing jams
8	Tray 1 (multipurpose tray)
9	Front door, for access to the toner cartridges
10	Power connection
11	Tray 2

Item	Description
12	Tray 3
13	Hardware integration pocket (HIP), for connecting accessory and third-party devices
14	Easy-access USB port Insert a USB flash drive for printing or scanning without a computer or to update the printer firmware. NOTE: An administrator must enable this port before use.

Figure 1-3 Printer front view (E77422a)

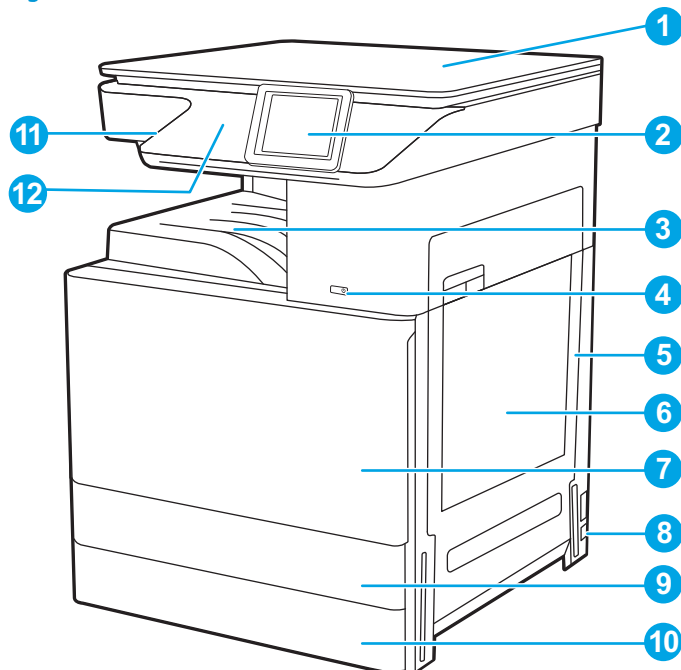

Item	Description
1	Scanner cover, for protect for scanning glass
2	Control panel with color touchscreen display (tilts up for easier viewing)
3	Output bin
4	On/off button
5	Right door, for access for clearing jams
6	Tray 1 (multipurpose tray)
7	Front door, for access to the toner cartridges
8	Power connection
9	Tray 2
10	Tray 3

Item	Description
11	Easy-access USB port Insert a USB flash drive for printing or scanning without a computer or to update the printer firmware. NOTE: An administrator must enable this port before use.
12	Hardware integration pocket (HIP), for connecting accessory and third-party devices

Printer back view

Locate features on the back of the printer.

Figure 1-4 Printer back view

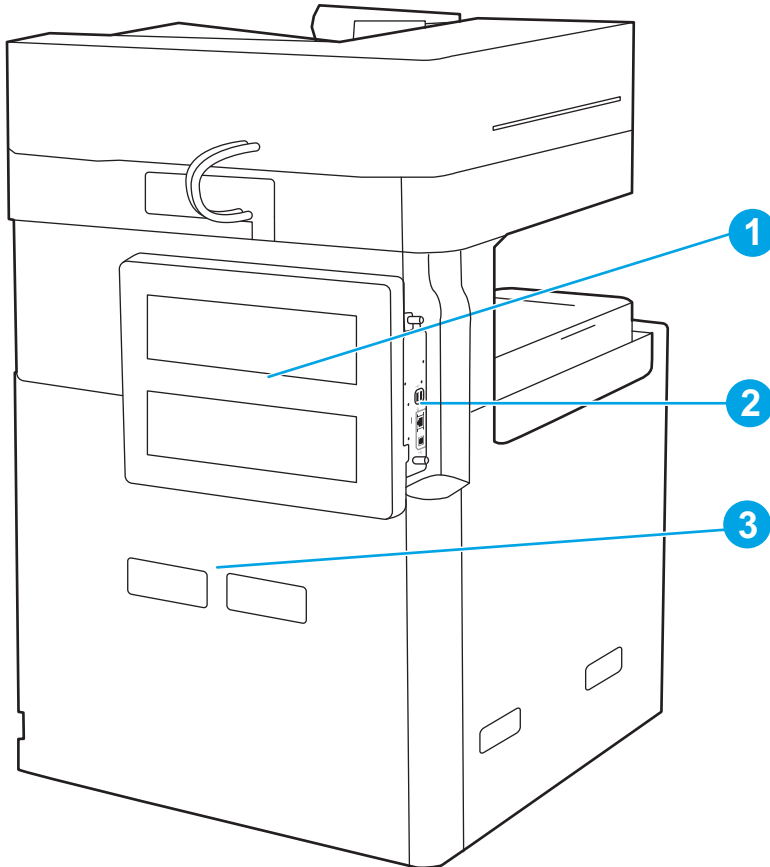

Item	Description
1	Formatter cover
2	Interface ports
3	Serial number and product number label

Interface ports

Locate the interface ports on the printer formatter.

Figure 1-5 Interface ports view

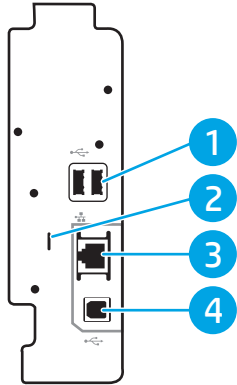



Item	Description
1	USB host ports for connecting external USB devices (these ports might be covered) NOTE: For easy-access USB printing, use the USB port near the control panel.
2	Slot for a cable-type security lock
3	Local area network (LAN) Ethernet (RJ-45) network port
4	Hi-Speed USB 2.0 printing port

Control-panel view

The control panel provides access to the printer features and indicates the current status of the printer.

 **NOTE:** Tilt the control panel for easier viewing.

The Home screen provides access to the printer features and indicates the current status of the printer.

Return to the Home screen at any time by touching the Home  button. Touch the Home  button on the left side of the printer control panel, or touch the Home button in the upper-left corner of most screens.



 **NOTE:** The features that appear on the Home screen can vary, depending on the printer configuration.

Figure 1-6 Control-panel view (E77428dn, E77422dn, E78228dn, E78223dn)

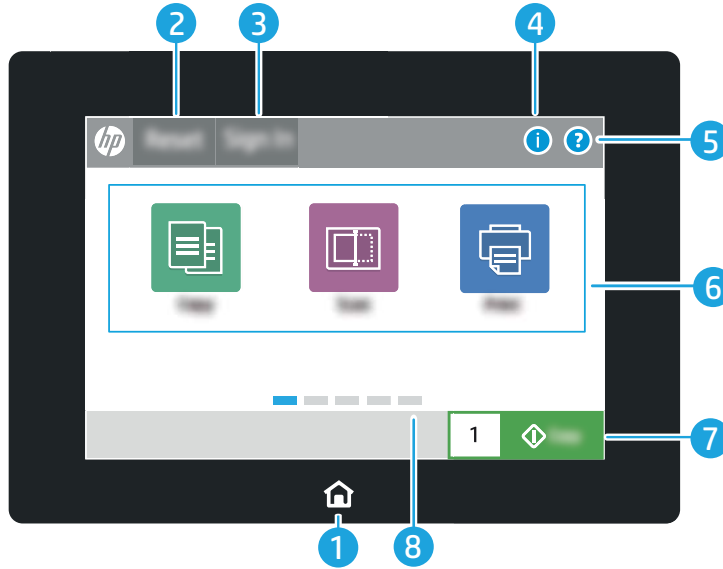

Figure 1-7 Control-panel view (E77422dv, E77422a, E78223dv)



Item	Control	Description
1	Home  button	Touch the Home button to return to the Home screen.
2	Reset button	The Reset button returns the printer to default settings and is always present if users are not logged in. The Reset button is not present when the Sign Out button is present. Touch the Reset button to resume and release jobs from the previous pause state and interrupt mode, reset the quick copy count in the copy count field, exit special modes, reset the display language and the keyboard layout.
3	Sign In or Sign Out button	Touch the Sign In button to access secured features. Touch the Sign Out button to sign out of the printer. The printer restores all options to the default settings. NOTE: This button displays only if the administrator has configured the printer to require permission for access to features.
4	Information  button	Touch the information button to access a screen that provides access to several types of printer information. Touch the buttons at the bottom of the screen for the following information: <ul style="list-style-type: none"> • Display Language: Change the language setting for the current user session. • Sleep Mode: Place the printer into sleep mode. • Wi-Fi Direct: View information for how to connect directly to the printer using a phone, tablet, or other device with Wi-Fi. • Wireless: View or change wireless connection settings (only when an optional wireless accessory is installed). • Ethernet: View or change Ethernet connection settings. • HP Web Services: View information to connect and print to the printer using HP Web Services (ePrint).
5	Help  button	Touch the Help button to open the embedded help system. The status line provides information about the overall printer status.

Item	Control	Description
6	Applications area	Touch any of the icons to open the application. Swipe the screen sideways to access more applications. NOTE: The available applications vary by printer. The administrator can configure which applications appear and the order in which they appear.
7	Copy button	Touch the Copy button to start a copy job.
8	Home-screen page indicator	Indicates the number of pages on the Home screen or in an application. The current page is highlighted. Swipe the screen sideways to scroll between pages.

How to use the touchscreen control panel

Perform the following actions to use the printer touchscreen control panel.

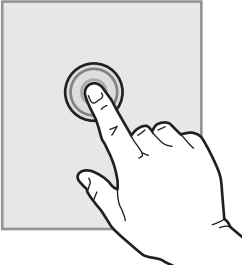
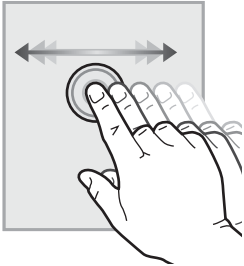
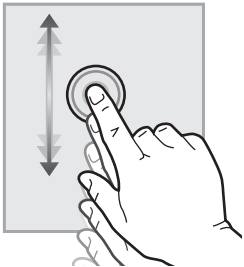
Action	Description	Example
<p>Touch</p> 	Touch an item on the screen to select that item or open that menu. Also, when scrolling through menus, briefly touch the screen to stop the scrolling.	Touch the Settings icon to open the Settings app.
<p>Swipe</p> 	Touch the screen and then move your finger horizontally to scroll the screen sideways.	Swipe until the Settings app displays.
<p>Scroll</p> 	Touch the screen and then move your finger vertically to scroll the screen up and down. When scrolling through menus, briefly touch the screen to stop the scrolling.	Scroll through the Settings app.

Printer specifications

Review hardware, software, and printer environment specifications in this section.



IMPORTANT: The following specifications are correct at the time of publication, but they are subject to change. For current information, see www.hp.com/support/colorjE77422MFP.

Technical specifications

Review the printer technical specifications.

Table 1-1 Paper handling specifications

Paper handling features	E77422a	E77422dv E78223dv	E77422dn E78223dn	E77428dn E78228dn
Tray 1 (100-sheet capacity)	✓	✓	✓	✓
Tray 2 (520-sheet capacity)	✓	✓	✓	✓
Tray 3 (520-sheet capacity)	✓	✓	✓	✓
2 x 520-sheet paper feeder	Optional	Optional	Optional	Optional
Printer stand	Optional	Optional	Optional	Optional
Inner finisher accessory	Optional	Optional	Optional	Optional
<ul style="list-style-type: none"> • 2/3 hole punch accessory 	Optional	Optional	Optional	Optional
<ul style="list-style-type: none"> • 2/4 hole punch accessory 	Optional	Optional	Optional	Optional
<ul style="list-style-type: none"> • Swedish hole punch accessory 	Optional	Optional	Optional	Optional
HP Job separator	Optional	Optional	Optional	Optional
HP Second exit	Optional	Optional	Optional	Optional
Automatic duplex printing	✓	✓	✓	✓

Table 1-2 Connectivity specifications

Connectivity features	E77422a	E77422dv E78223dv	E77422dn E78223dn	E77428dn E78228dn
10/100/1000 Ethernet LAN connection with IPv4 and IPv6	✓	✓	✓	✓
Hi-Speed USB 2.0	✓	✓	✓	✓
HP Jetdirect LAN Accessory (J8031A)	Optional	Optional	Optional	Optional

Table 1-2 Connectivity specifications (continued)

Connectivity features	E77422a	E77422dv	E77422dn	E77428dn
		E78223dv	E78223dn	E78228dn
Print server for wireless network connectivity	Optional	Optional	Optional	Optional
Walk-up USB port	✓	✓	✓	✓
Hardware Integration Pocket for connecting accessory and third-party devices	✓	✓	✓	✓
HP Internal USB Ports	Optional	Optional	Optional	Optional
HP Jetdirect 3100w BLE/NFC/Wireless Accessory	Optional	Optional	Optional	Optional
HP Jetdirect 2900nw Print Server accessory for wireless connectivity	Optional	Optional	Optional	Optional
Wi-Fi Bluetooth Low Energy (BLE) Direct	Not available	Not available	Not available	Not available

Table 1-3 Control-panel display specifications

Control-panel display features	E77422a	E77422dv	E77422dn	E77428dn
		E78223dv	E78223dn	E78228dn
Color touchscreen control panel	✓	✓	✓	✓

Table 1-4 Print specifications

Print features	E77422a	E77422dv	E77422dn	E77428dn
		E78223dv	E78223dn	E78228dn
Prints 22/23 pages per minute (ppm) on A4-size paper and on letter-size paper	✓	✓	✓	Not included
Prints 28 pages per minute (ppm) on A4-size paper and on letter-size paper	Not available	Not available	Not available	✓
USB printing	✓	✓	✓	✓
Mobile/cloud printing	Not available	Not available	Not available	Not available
Store jobs in the printer memory to print later or print privately	Not available	Not available	Not available	Not available

Table 1-5 Copy and scan specifications

Copy and scan features	E77422a	E77422dv	E77422dn	E77428dn
		E78223dv	E78223dn	E78228dn
Scans 35 pages per minute (ppm) on A4 and letter-size paper	Not available	✓	✓	✓
100-page document feeder with one-head scanning and separate paper-path for duplex copying and scanning	Not available	✓	✓	✓
HP EveryPage Technologies including ultrasonic multi-feed detection	Not available	Not available	Not available	Not available
Embedded optical character recognition (OCR) provides the ability to convert printed pages into text that can be edited or searched using a computer	Not available	Not available	Not included	Not included
SMART Label feature provides paper-edge detection for automatic page cropping	Not available	Not available	✓	✓
Automatic page orientation for pages that have at least 100 characters of text	Not available	Not available	✓	✓
Automatic tone adjustment sets contrast, brightness, and background removal for each page	Not available	Not available	✓	✓

Table 1-6 Digital Send specifications

Digital Send features	E77422a	E77422dv	E77422dn	E77428dn
		E78223dv	E78223dn	E78228dn
Send documents to E-mail, USB, and shared folders on a network	✓	✓	✓	✓
Send documents to SharePoint®	✓	✓	✓	✓

Table 1-7 Other specifications

Other features	E77422a	E77422dv E78223dv	E77422dn E78223dn	E77428dn E78228dn
4.25 GB base memory NOTE: The base memory is expandable to 6.25 GB by adding a DIMM memory module.	✓	✓	✓	✓
16 GB embedded Multi-Media Controller (eMMC)	✓	✓	✓	✓
500 GB HP Secure High-Performance Hard Disk	Optional	Optional	Optional	Optional
HP Trusted Platform Module for encrypting all data that passes through the printer	✓	✓	✓	✓
Fax	Optional	Optional	Optional	Optional

Supported operating systems

Use the following information to ensure printer compatibility with your computer operating system.

Linux: For information and print drivers for Linux, go to www.hp.com/go/linuxprinting.

UNIX: For information and print drivers for UNIX®, go to www.hp.com/go/unixmodelscripts.

The following information applies to the printer-specific Windows HP PCL 6 print drivers, HP print drivers for macOS, and to the software installer.

Windows: Download HP Easy Start from 123.hp.com/LaserJet to install the HP print driver. Or, go to the printer-support website for this printer, www.hp.com/support/colorljE77422MFP, to download the print driver or the software installer to install the HP print driver

macOS: Mac computers are supported with this printer. Download HP Easy Start either from 123.hp.com/LaserJet or from the Printer Support page, and then use HP Easy Start to install the HP print driver.

1. Go to 123.hp.com/LaserJet.
2. Follow the steps provided to download the printer software.

Table 1-8 Supported operating systems and print drivers

Operating system	Print driver installed (for Windows, or the installer on the web for macOS)	Notes
Windows 7, 32-bit and 64-bit	The "HP PCL 6" printer-specific print driver is installed for this operating system as part of the software installation.	
Windows 8.1, 32-bit and 64-bit	The "HP PCL-6" V4 printer-specific print driver is installed for this operating system as part of the software installation.	

Table 1-8 Supported operating systems and print drivers (continued)

Operating system	Print driver installed (for Windows, or the installer on the web for macOS)	Notes
Windows 10, 32-bit and 64-bit	The "HP PCL-6" V4 printer-specific print driver is installed for this operating system as part of the software installation.	
Windows Server 2008 R2, SP 1, 64-bit	The PCL 6 printer-specific print driver is available for download from the printer-support website. Download the driver, and then use the Microsoft Add Printer tool to install it.	
Windows Server 2012, 64-bit	The PCL 6 printer-specific print driver is available for download from the printer-support website. Download the driver, and then use the Microsoft Add Printer tool to install it.	
Windows Server 2012 R2, 64-bit	The PCL 6 printer-specific print driver is available for download from the printer-support website. Download the driver, and then use the Microsoft Add Printer tool to install it.	
Windows Server 2016, 64-bit	The PCL 6 printer-specific print driver is available for download from the printer-support website. Download the driver, and then use the Microsoft Add Printer tool to install it.	
macOS 10.14 Mojave, macOS 10.13 High Sierra	Download HP Easy Start from 123.hp.com/LaserJet , and then use it to install the print driver.	

 **NOTE:** Supported operating systems can change. For a current list of supported operating systems, go to www.hp.com/support/colorljE77422MFP for HP's all-inclusive help for the printer.

 **NOTE:** For details on client and server operating systems and for HP UPD driver support for this printer, go to www.hp.com/go/upd. Under **Additional information**, click the links.

Table 1-9 Minimum system requirements

Windows	macOS
<ul style="list-style-type: none"> • Internet connection • Dedicated USB 1.1 or 2.0 connection or a network connection • 2 GB of available hard-disk space • 1 GB RAM (32-bit) or 2 GB RAM (64-bit) 	<ul style="list-style-type: none"> • Internet connection • Dedicated USB 1.1 or 2.0 connection or a network connection • 1.5 GB of available hard-disk space

NOTE: The Windows software installer installs the HP Smart Device Agent Base service. The file size is approximately 100 kb. Its only function is to check for printers connected via USB hourly. No data is collected. If a USB printer is found, it then tries to locate a JetAdvantage Management Connector (JAMc) instance on the network. If a JAMc is found, the HP Smart Device Agent Base is securely upgraded to a full Smart Device Agent from JAMc, which will then allow printed pages to be accounted for in a Managed Print Services (MPS) account. The driver-only web packs downloaded from hp.com for the printer and installed through the Add Printer wizard do not install this service.

To uninstall the service, open the Windows Control Panel, select **Programs** or **Programs and Features**, and then select **Add/Remove Programs** or **Uninstall a Program** to remove the service. The file name is **HPSmartDeviceAgentBase**.

Printer dimensions

Make sure your printer environment is large enough to accommodate the printer.

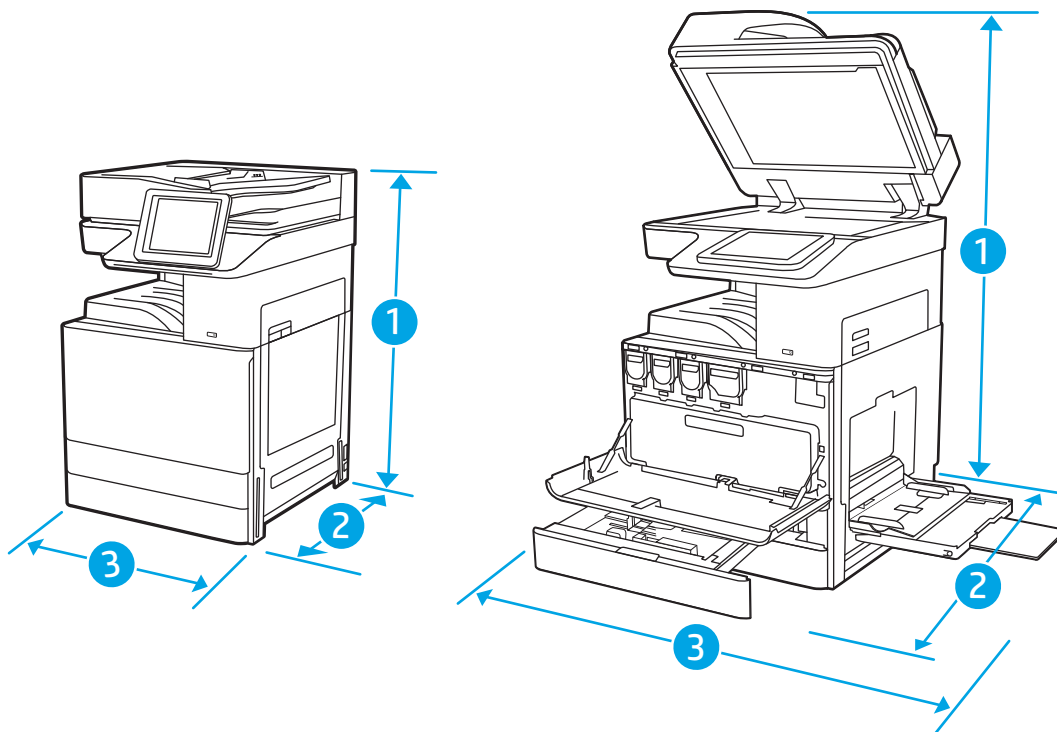

Table 1-10 Dimensions of the E77422, E77428, E78223, and E78228 models

Measurement	Printer fully closed	Printer fully opened
1. Height	a model: 783 mm (30.8 in) dv and dn models: 870 mm (34.3 in)	a model: 1250 mm (49.2 in) dv and dn models: 1262 mm (49.7 in)
2. Depth	a and dv models: 690 mm (27.2 in) dn model: 725 mm (28.5 in)	a model: 1074 mm (42.3 in) dv and dn models: 1113 mm (43.8 in)

Table 1-10 Dimensions of the E77422, E77428, E78223, and E78228 models (continued)

Measurement	Printer fully closed	Printer fully opened
3. Width	a model: 566 mm (22.3 in)	a model: 936 mm (36.9 in)
	dv and dn models: 566 mm (22.3 in)	dv and dn models: 936 mm (36.9 in)
Weight	a model: 77.7 kg (171.3 lb)	
	dv model: 81.5 kg (179.7 lb)	
	dn models: 82.9 kg (182.8 lb)	

Power consumption, electrical specifications, and acoustic emissions

See www.hp.com/support/colorljE77422MFP for current information.

CAUTION: Power requirements are based on the country/region where the printer is sold. Do not convert operating voltages. This will damage the printer and void the printer warranty.

Operating-environment range

In order to operate properly, the printer must be in an environment that meets certain specifications.

Table 1-11 Operating-environment specifications

Environment	Allowed
Temperature	15° to 32°C (59° to 90°F)
Relative humidity	10% to 80% RH

Mobile printing solutions

Learn about the mobile printing solutions.

HP offers multiple mobile and ePrint solutions to enable easy printing to an HP printer from a laptop, tablet, smartphone, or other mobile device. To see the full list and to determine the best choice, go to <http://www.hp.com/go/LaserJetMobilePrinting>.

- Wi-Fi Direct
- HP ePrint via email (Requires HP Web Services to be enabled and the printer to be registered with HP Connected)
- HP ePrint app (Available for Android, iOS, and Blackberry)
- HP All-in-One Remote app for iOS and Android devices
- HP ePrint software
- Google Cloud Print
- AirPrint
- Android Printing

General specifications

Learn about the general specifications.

Table 1-12 General specifications

Item		Specification
Memory		Maximum memory can be expanded to 6.25 GB (System memory) by adding optional memory module. 2GB Memory DIMM Kit (E5K49A) can be purchased separately.
Storage		Standard two 16 GB encrypted eMMCs (one is located on formatter board for stored jobs and solutions. another one is located on ECB for copy/scan function); Optional 500 GB Standard (located on ECB for copy/scan functions), embedded HP High-Performance Secure Hard Disk; AES 256 hardware encryption or greater; Secure erase capabilities (Secure File Erase-Temporary Job Files, Secure Erase-Job Data, Secure ATA Erase-Disk). NOTE: U.S. government SKU uses 500 GB FIPS 140-2 validated hard disk instead.
Interface	USB (Device)	Yes (Hi-Speed USB 2.0)
	USB (Host)	Yes (Hi-Speed USB 2.0)
	Wired LAN	Standard (Ethernet 10/100/1G Base TX)
Warm-up time		150 sec
Power Requirement		Input voltage: 110 to 127Vac (+/- 10%), 220 to 240Vac (+/- 10%), 50/60 Hz (+/- 3%)
Acoustic Pressure Emissions Bystander (active, printing)		<ul style="list-style-type: none"> 52 dB(A), printing color simplex A4 at 22 ppm 53 dB(A), printing color simplex A4 at 28 ppm
Recommended Monthly Page Volume		Up to 15,000 pages

Print specifications

Learn about the print specifications.

Table 1-13 Print specifications

Item		Specification
Print speed	(normal, A4/letter)	<ul style="list-style-type: none"> E77422 : 22 ppm E78223 : 23 ppm <p>NOTE: 25 ppm : For speed license model</p> <ul style="list-style-type: none"> E77428, E78228 : 28 ppm

Table 1-13 Print specifications (continued)

Item		Specification
	(normal, A3)	<ul style="list-style-type: none"> E77422, E78223 : 12 ppm E77428, E78228 : 15 ppm
	(duplex, A4/letter)	<ul style="list-style-type: none"> E77422, E78223 : 17 ipm E77428, E78228 : 20 ipm
First Page Out Black	(A4 Ready)	<ul style="list-style-type: none"> E77422, E78223 : 9 sec E77428, E78228 : 8.5 sec
	(Letter Ready)	<ul style="list-style-type: none"> E77422, E78223 : 9.6 sec E77428, E78228 : 8.4 sec
First Page Out Color	(A4 Ready)	<ul style="list-style-type: none"> E77422, E78223 : 11.7 sec E77428, E78228 : 10.5 sec
	(Letter Ready)	<ul style="list-style-type: none"> E77422, E78223 : 11.7 sec E77428, E78228 : 10.6 sec
Resolution		<ul style="list-style-type: none"> Normal (600 x 600 x 4 dpi) Best (1200 x 1200 x 1 dpi)
Print Languages		HP PCL 6, HP Postscript level 3 emulation, PDF (v 1.7), AirPrint™ compatible
Supported Network Protocols		<ul style="list-style-type: none"> IPv4/IPv6: Apple Bonjour Compatible (Mac OS 10.2.4 or higher), SNMPv1/v2c/v3, HTTP, HTTPS, FTP, TFTP, Port 9100, LPD, WS Discovery, IPP, Secure-IPP, IPsec/Firewall IPv6: DHCPv6, MLDv1, ICMPv6 IPv4: Auto-IP, SLP, Telnet, IGMPv2, BOOTP/DHCP, WINS, IP Direct Mode, WS Print Other: NetWare NDS, Bindery, NDPS, ePrint; Google Cloud Print 2.0

Scan specifications

Learn about the scan specifications.

Table 1-14 Scan specifications

Item		Specification
Scan Resolution	Optical	Up to 600 x 600 dpi

Table 1-14 Scan specifications (continued)

Item		Specification
Scan Speed	(normal, A4)	<ul style="list-style-type: none"> • E77422, E78223 : Up to 46 ipm/19 ipm (b&w), up to 46 ipm/19 ipm (color) • E77428, E78228 : Up to 47 ipm/19 ipm (b&w), up to 48 ipm/19 ipm (color)
	(normal, letter)	<ul style="list-style-type: none"> • E77422, E78223 : Up to 45 ipm/19 ipm (b&w), up to 45 ipm/19 ipm (color) • E77428, E78228 : Up to 45 ipm/19 ipm (b&w), up to 46 ipm/19 ipm (color)
	(normal, A3)	<ul style="list-style-type: none"> • E77422, E78223 : Up to 27 ipm/13 ipm (b&w), up to 27 ipm/ 13 ipm (color) • E77428, E78228 : Up to 28 ipm/13 ipm (b&w), up to 28 ipm/ 13 ipm (color)
Auto Document Feeder Capacity		75 gsm / 100 sheets
Grayscale Levels		256
Scan File Format		<ul style="list-style-type: none"> • Digital Send: PDF, Hi-Compression PDF, JPEG, TIFF, MTIFF, XPS, PDF/A • Scan to easy access USB: PDF, JPEG, TIFF, MTIFF, XPS, PDF/A • Print from easy access USB: PDF, PS, Print Ready files (.prn, .pcl, .cht)
Scan Size Maximum	(ADF, metric)	297 x 437 mm
	(ADF, Imperial)	11.7 x 17.2 in
	(flatbed, metric)	297 x 437 mm
	(flatbed, imperial)	11.7 x 17.2 in
Scan Size Minimum	(ADF, metric)	148 x 210 mm
	(ADF, Imperial)	5.5 x 8.5 in

Copy specifications

Learn about the copy specifications.

Table 1-15 Copy specifications

Item		Specification
Copy Speed (Normal, A4)	(default rate from flatbed or ADF)	<ul style="list-style-type: none"> E77422 : Up to 22 cpm E78223 : Up to 23 cpm E77428, E78228 : Up to 28 cpm
Copy Speed (Normal, letter)	(default rate from flatbed or ADF)	<ul style="list-style-type: none"> E77422 : Up to 22 cpm E78223 : Up to 23 cpm E77428, E78228 : Up to 28 cpm
Copy Speed (Normal, A3)	(default rate from flatbed or ADF)	<ul style="list-style-type: none"> E77422, E78223 : Up to 12 cpm E77428, E78228 : Up to 15 cpm
Copy Speed (Duplex, A4)		<ul style="list-style-type: none"> E77422, E78223 : Up to 16 cpm E77428, E78228 : Up to 19 cpm
Copy Speed (Duplex, letter)		<ul style="list-style-type: none"> E77422, E78223 : Up to 16 cpm E77428, E78228 : Up to 20 cpm
Copy Speed (Duplex, A3)		<ul style="list-style-type: none"> E77422, E78223 : Up to 8 cpm E77428, E78228 : Up to 10 cpm
First Copy Out Black	(Ready, A4)	<ul style="list-style-type: none"> E77422, E78223 : As fast as 8.0 sec E77428, E78228 : As fast as 6.7 sec
	(Ready, letter)	<ul style="list-style-type: none"> E77422, E78223 : As fast as 8.4 sec E77428, E78228 : As fast as 6.7 sec
First Copy Out Color	(Ready, A4)	<ul style="list-style-type: none"> E77422, E78223 : As fast as 9.7 sec E77428, E78228 : As fast as 7.7 sec
	(Ready, letter)	<ul style="list-style-type: none"> E77422, E78223 : As fast as 9.6 sec E77428, E78228 : As fast as 7.9 sec
Copy Resolution	Black Text	Up to 600 x 600 dpi
	Color Text and Graphics	Up to 600 x 600 dpi
Copier Reduce/enlarge	Flatbed	25 to 400%
	ADF	25 to 400%

Maintenance and Consumable Life

Learn about the estimated life of maintenance and consumable parts.

A customer or end user can install consumable items for a product.

In circumstances where a contract, CarePack, or other service uplift option exists, refer to the terms and conditions established by the service uplift document to determine how customer replaceable parts will be managed.

The rated life for each of these components is estimated. The rated life for each of the consumable components is listed in the following tables:

Table 1-16 Consumable Life: Cartridges and Miscellaneous parts

Product number ¹	Service part number ²	Description	Kit Components	Life (A4/letter images) ³
W9100MC	W9100-67901	Toner Cartridge (For E77422, E77428)	Black cartridge	25,000
W9220MC	W9220-67901	Toner Cartridge (For E78223, E78228)	Black cartridge	25,000
W9101MC	W9101-67901	Toner Cartridge (For E77422, E77428)	Cyan cartridge	20,000
W9221MC	W9221-67901	Toner Cartridge (For E78223, E78228)	Cyan cartridge	20,000
W9102MC	W9103-67901	Toner Cartridge (For E77422, E77428)	Yellow cartridge	20,000
W9222MC	W9222-67901	Toner Cartridge (For E78223, E78228)	Yellow cartridge	20,000
W9103MC	W9102-67901	Toner Cartridge (For E77422, E77428)	Magenta cartridge	20,000
W9223MC	W9223-67901	Toner Cartridge (For E78223, E78228)	Magenta cartridge	20,000
-	-	Starter black toner cartridge ^a	Black cartridge	8,000
-	-	Starter cyan toner cartridge ^a	Cyan cartridge	7,500
-	-	Starter yellow toner cartridge ^a	Yellow cartridge	7,500
-	-	Starter magenta toner cartridge ^a	Magenta cartridge	7,500
W9048MC	X3A83-67923	Toner collection unit	TCU	33,700

¹ All product numbers are subject to change.

² All part numbers are subject to change.

³ Print cartridge life is approximate, based on average A4 /Letter-size page count with ISO coverage. Declared cartridge yield value in accordance with ISO/IEC 19798. Actual yields vary considerably based on images printed and other factors. For more information, go to www.hp.com/go/learnaboutsupplies.

^a This toner cartridge is adopted to the followings countries: India, Indonesia, Malaysia, Thailand, Hong Kong, Philippines, Singapore and Vietnam

Table 1-17 Consumable Life: Fusers

Product number ¹	Part number ²	Description	Kit Components	Life (A4/letter images) ³
Z7Y77A	Z7Y77-67002	Fuser (110V)		250,000
Z9M03A	Z9M03-67002	Fuser (220V)		250,000

¹ All product numbers are subject to change.

² All part numbers are subject to change.

³ Some users might experience lower fuser life based on their usage (printing on small media, heavy media, etc.). The printer's control panel will notify the user when they need to replace the fuser.

Table 1-18 Consumable Life: Drum, Developer, and ITB/PTB

Product number ¹	Part number ²	Description	Kit Components	Life (A4/letter images) ³
W9044MC	X3A83-67905	Imaging drums (Cyan, Yellow, Magenta, and Black) (For E77422, E77428)	Drum	135,000
W9215MC	W9215-67901	Imaging drums (Cyan, Yellow, Magenta, and Black) (For E78223, E78228)	Drum	135,000
Z7Y91A	JC96-11663A	Yellow Developer (For E77422, E77428)	Developer	300,000
8JM72A	8JM72-67001	Yellow Developer (For E78223, E78228)	Developer	300,000
Z7Y82A	JC96-11664A	Magenta Developer (For E77422, E77428)	Developer	300,000
8JM73A	8JM73-67001	Magenta Developer (For E78223, E78228)	Developer	300,000
Z9M02A	JC96-11665A	Cyan Developer (For E77422, E77428)	Developer	300,000
8JM71A	8JM71-67001	Cyan Developer (For E78223, E78228)	Developer	300,000
Z7Y70A	JC96-11666A	Black Developer (For E77422, E77428)	Developer	300,000
8JM70A	8JM70-67001	Black Developer (For E78223, E78228)	Developer	300,000
Z7Y79A	JC98-00980D	Image transfer belt (ITB) (For E77422, E77428)	ITB unit	400,000
5PN63A	5PN63-67001	Image transfer belt (ITB) (For E78223, E78228)	ITB unit	400,000

Table 1-18 Consumable Life: Drum, Developer, and ITB/PTB (continued)

Product number ¹	Part number ²	Description	Kit Components	Life (A4/letter images) ³
Z7Y81A	JC96-06246A	Image transfer blade kit (For E77422, E77428)		200,000
5PN64A	5PN64-67001	Image transfer blade kit (For E78223, E78228)		200,000

¹ All product numbers are subject to change.

² All part numbers are subject to change.

³ Drum, Developer, and PTB life values are approximate based on letter/A4 equivalent simplex pages. These values might vary with environment, usage, media type, and average print job size.

Table 1-19 Consumable Life: Rollers

Product number ¹	Part number ²	Description	Kit Components	Life (A4/letter images) ³
Z7Y83A	JC93-00540A	Pick, reverse and feed roller Tray 2-5	Pick, Sep, and feed rollers	200,000
Z9M04A	JC95-01942A	T2 Transfer roller (For E77422, E77428)		150,000
8NB98A	5QJ90-61041	T2 Transfer roller (For E78223, E78228)		150,000
3KR69A	JC97-04009A	RADF Pick Up Roller Ass'y		100,000
3KR68A	JC97-04733A	RADF Friction Pad		50,000
Z7Y88A	JC93-00540B	Pick, reverse and feed roller, Tray1	Pick, Separation, and feed rollers	200,000

¹ All product numbers are subject to change.

² All part numbers are subject to change.

³ Roller replacement intervals are based on the total number of pages printed from a tray, not total page count. The number of pages printed from each tray is located on the printer's Usage Page. Roller life might vary based on media types used.

Paper handling specifications

Learn about the paper handling specifications.

Table 1-20 Paper handling specifications

Item		Specification
Input Capacity	Standard (Tray 2 & 3)	1040 sheets
	Tray 1	100 sheets
	Other Options	Dual Cassette Feeder (2 x 520-sheet)

Table 1-20 Paper handling specifications (continued)

Item		Specification
Custom Media Sizes	(metric)	<ul style="list-style-type: none"> Tray 1: 98 x 148 mm to 297 x 432 mm Tray 2: 139.7 x 210 mm to 297 x 364 mm Tray 3: 139.7 x 210 mm to 297 x 432 mm
	(imperial)	<ul style="list-style-type: none"> Tray 1: 3.86 x 5.83 to 11.69 x 17 in Tray 2: 5.48 x 8.27 to 11.69 x 14.33 in Tray 3: 5.48 x 8.27 to 11.69 x 17 in
Standard Media Size	Tray 1	A3, A4, A4R, A5, A5R, A6, RA4, SRA4, B4 (JIS), B5 (JIS), B6 (JIS), 10x15cm, Oficio, 8K, 16k, Postcard (JIS), Dpostcard (JIS), Envelope B5, Envelope C5, Envelope C6, Envelope DL
	Tray 2	Tray 2: A4, A4R, A5, RA4, SRA4, B4 (JIS), B5 (JIS), Oficio, 16k
	Tray 3	Tray 3: A3, A4, A4R, A5, RA4, SRA4, B4 (JIS), B5 (JIS), Oficio, 8K, 16k
Media Weights	(metric)	<ul style="list-style-type: none"> Tray 1: 16 to 46 lb bond Tray 2, 3: 16 to 58 lb bond
	(imperial)	<ul style="list-style-type: none"> Tray 1: 60 to 176 g/m² Tray 2, 3: 60 to 220 g/m²
Standard Media Size (ADF)		Legal, Oficio, Executive, Statement, Ledger, A3, A4, A4R, A5, B4, B5, 16K Width: 148 - 297 mm (5.8" - 11.7") Length: 148 - 432 mm (5.8" - 17")
Media Weights (ADF)	(metric)	<ul style="list-style-type: none"> Simplex: 60 to 128 g/m² Duplex: 60 to 128 g/m²
	(imperial)	<ul style="list-style-type: none"> Simplex: 16 to 28 lb Duplex: 16 to 28 lb
Standard Media Sizes (duplex)	(metric)	A3, A4, A5, 8K, 16K, B5, RA4, B4, Oficio
	(imperial)	Letter, Statement, Legal, Letter-R, Executive
Media Weights (duplex)	(metric)	60 to 176 g/m ²
	(imperial)	16 to 47 lb

Configuration options

Review configuration options

Figure 1-8 Configuration options



Table 1-21 Configuration options

Callout	Item	Model
1	HP LaserJet Workgroup Cabinet	Y1G17A
2	HP LaserJet Workgroup Dual Cassette Feeder (DCF)	Y1F97A
3	HP LaserJet Inner Finisher	Y1G00A
	HP LaserJet Inner Finisher Hole Punch 2/3	Y1G02A
	HP LaserJet Inner Finisher Hole Punch 2/4	Y1G03A
	HP LaserJet Inner Finisher Swedish Punch	Y1G04A
	HP LaserJet Inner Finisher and Booklet Maker Finisher Refill Staple Cartridge	Y1G13A
4	HP LaserJet Workgroup Job Separator	Y1G15A
5	HP LaserJet Second Exit	Y1G23A
		Required if installing an inner finisher.
Not shown	HP LaserJet Paper Tray Heaters Accessory Department (220V)	Y1G22A#B19
Not shown	HP LaserJet Paper Tray Heaters Accessory Department (110V)	Y1G22A#BGJ
Not shown	HP MFP Analog 700 Fax Accessory	2EH31A
Not shown	HP Accessibility Assistant	2MU47A
Not shown	HP Removable Hard Drive Enclosure	2NR12A
Not shown	HP Accessibility Kit	2TD64A
Not shown	HP JetDirect 3100w BLE/NFC/Wireless Accy	3JN69A
Not shown	HP Internal USB Ports	B5L28A
Not shown	HP Secure High Performance Hard Disk Drive	B5L29A
Not shown	HP Foreign Interface Harness	B5L31A
Not shown	HP MFP Analog 700 Fax Accessory	CC487A
Not shown	HP 2GB DDR3x32 144-Pin 800MHz SODIMM Accy	E5K49A
Not shown	HP JetDirect 3100w BLE/NFC/Wireless Accy	3JN69A
Not shown	HP Jetdirect 2900nw Print Server	J8031A ^b
Not shown	HP Jetdirect Lan Accessory	8FP31A ^c

Table 1-21 Configuration options (continued)

Callout	Item	Model
Not shown	HP USB Universal Card Reader	X3D03A
Not shown	HP LaserJet Hard disk drive : 500GB(This is only for ECB)	5YP34A

- ^a Required if installing an inner finisher.
- ^b This accessory will be discontinued in October 2020.
- ^c This accessory will be available on June 2020.



NOTE: Many part numbers vary based on where you are located. It is important to contact your local HP parts suppliers to ensure you have the most current part number available based on your location.

Pickup, feed, and delivery system

Feeding system overview

The feeding system picks up paper from the Tray2-X or Tray 1 and moves it to the printing mechanism inside the printer. The feeding system consists of the pickup unit, registration unit, transfer roller assembly, and exit unit.

Figure 1-9 Feeding system

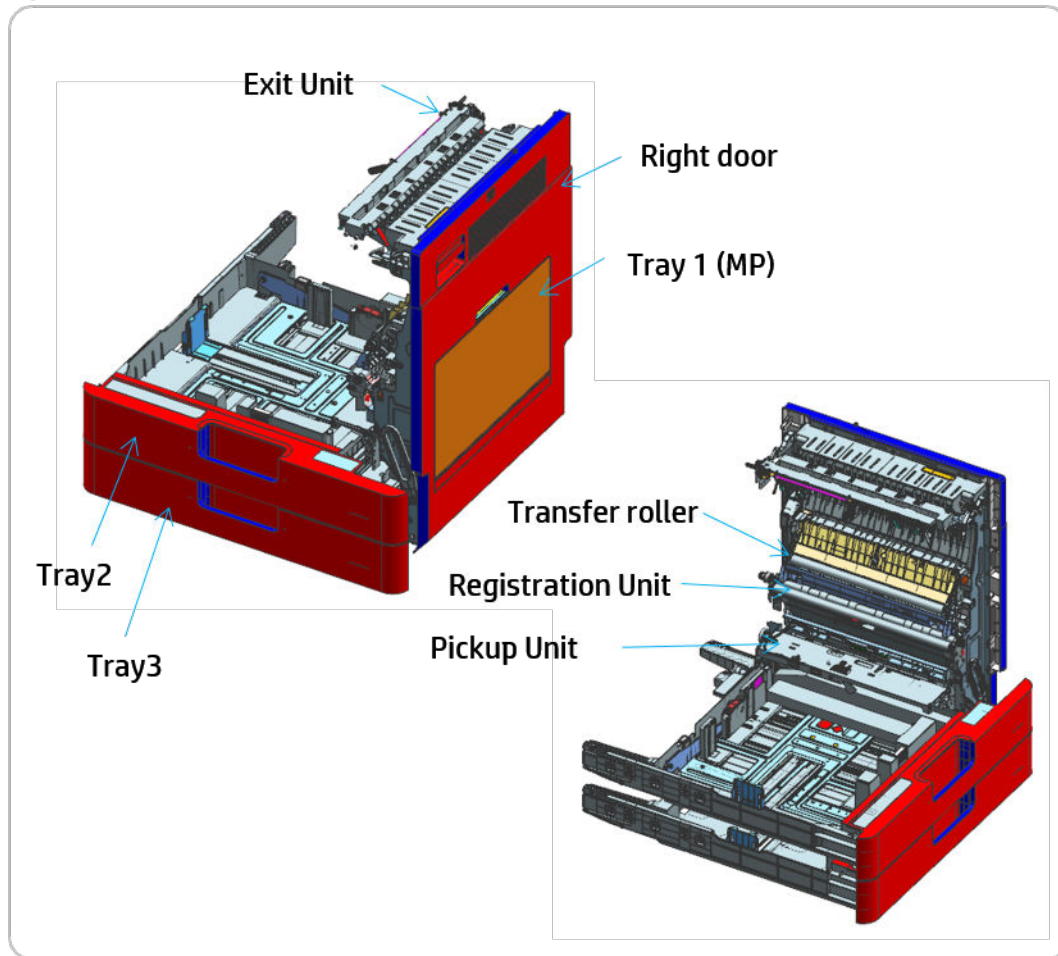

Main components and functions

a) Rollers

Figure 1-10 Feeding system rollers

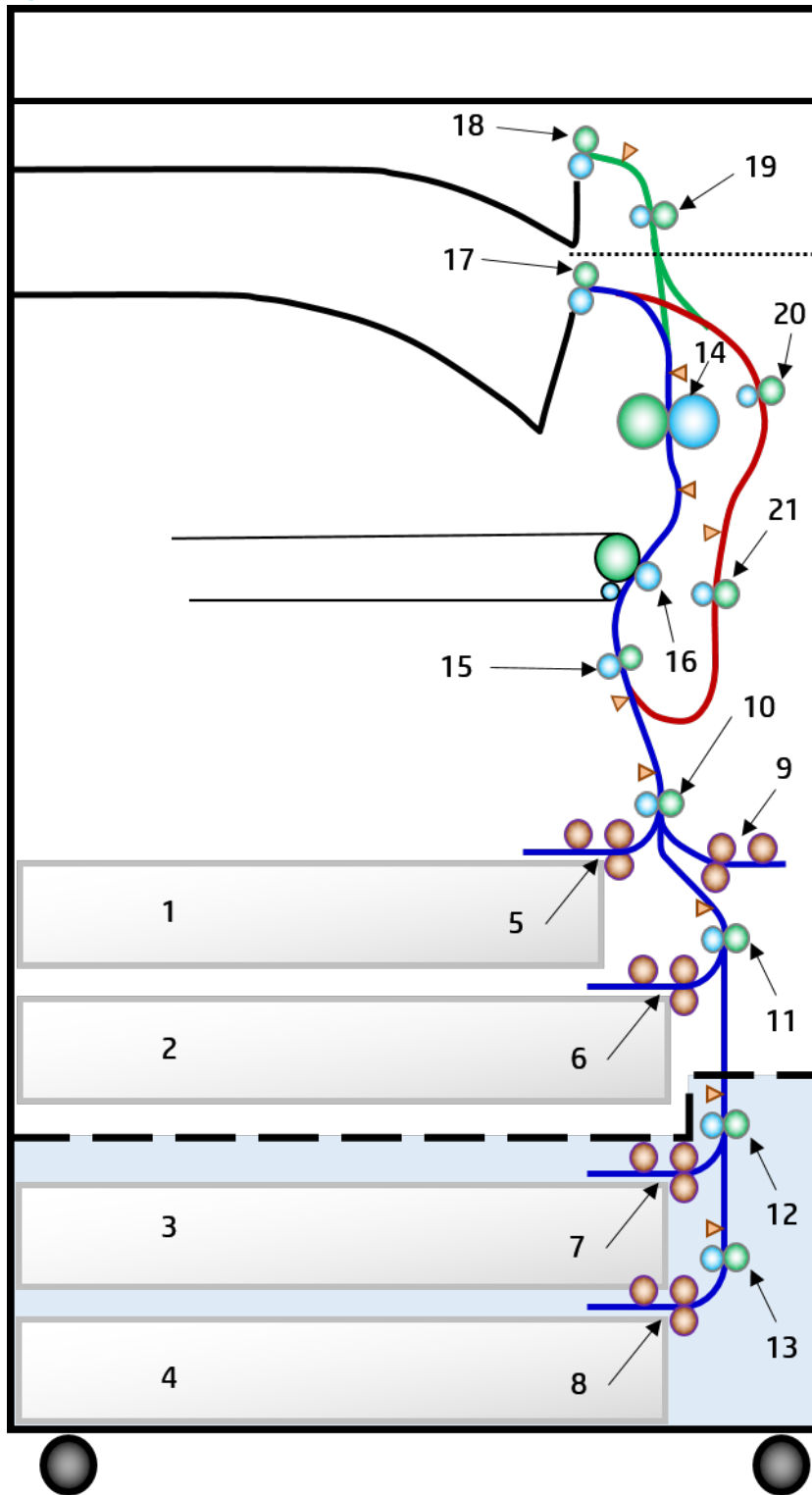

Table 1-22 Feeding system rollers

Item	Description
1	Tray 2

Table 1-22 Feeding system rollers (continued)

Item	Description
2	Tray 3
3	Tray 4 (optional)
4	Tray 5 (optional)
5	Tray 2 pick/separation/feed rollers
6	Tray 3 pick/separation/feed rollers
7	Tray 4 pick/separation/feed rollers (optional)
8	Tray 5 pick/separation/feed rollers (optional)
9	Tray 1 pick/separation/feed rollers
10	Tray 2 paper path feed roller
11	Tray 3 paper path feed roller
12	Tray 4 paper path feed roller (optional)
13	Tray 5 paper path feed roller (optional)
14	Pressure roller
15	Registration roller
16	Transfer roller
17	1st exit roller
18	2nd exit roller (optional)
19	Invert roller (optional)
20	Duplex 1 roller
21	Duplex 2 roller

- **Pick roller (Tray 1, 2, 3, 4, and 5)**
 - This roller picks up the paper from the tray.
- **Feed roller (Tray 1, 2, 3, 4, and 5)**
 - This roller is placed against the separation roller. It transfers the paper from the pick roller to the feed roller.
- **Separation roller (Tray 1, 2, 3, 4, and 5)**
 - This roller is placed against the feed roller and transfers only one sheet of paper to the feed roller. When two or more sheets of paper are being transferred from the pick roller, the load of the torque limiter of the separation roller is heavier than the frictional force between the sheets of paper. As a result, the separation roller is stopped and the lower sheet of paper is not transferred.
- **Feed roller**
 - This roller transfers the paper sent from the forward/separation roller to the registration roller.
- **Registration roller**

- This roller aligns the leading edge of the paper and transfers the paper to the transfer roller assembly.

b) Sensor, Motor, Solenoid

Figure 1-11 Feeding system sensor, motor, solenoid

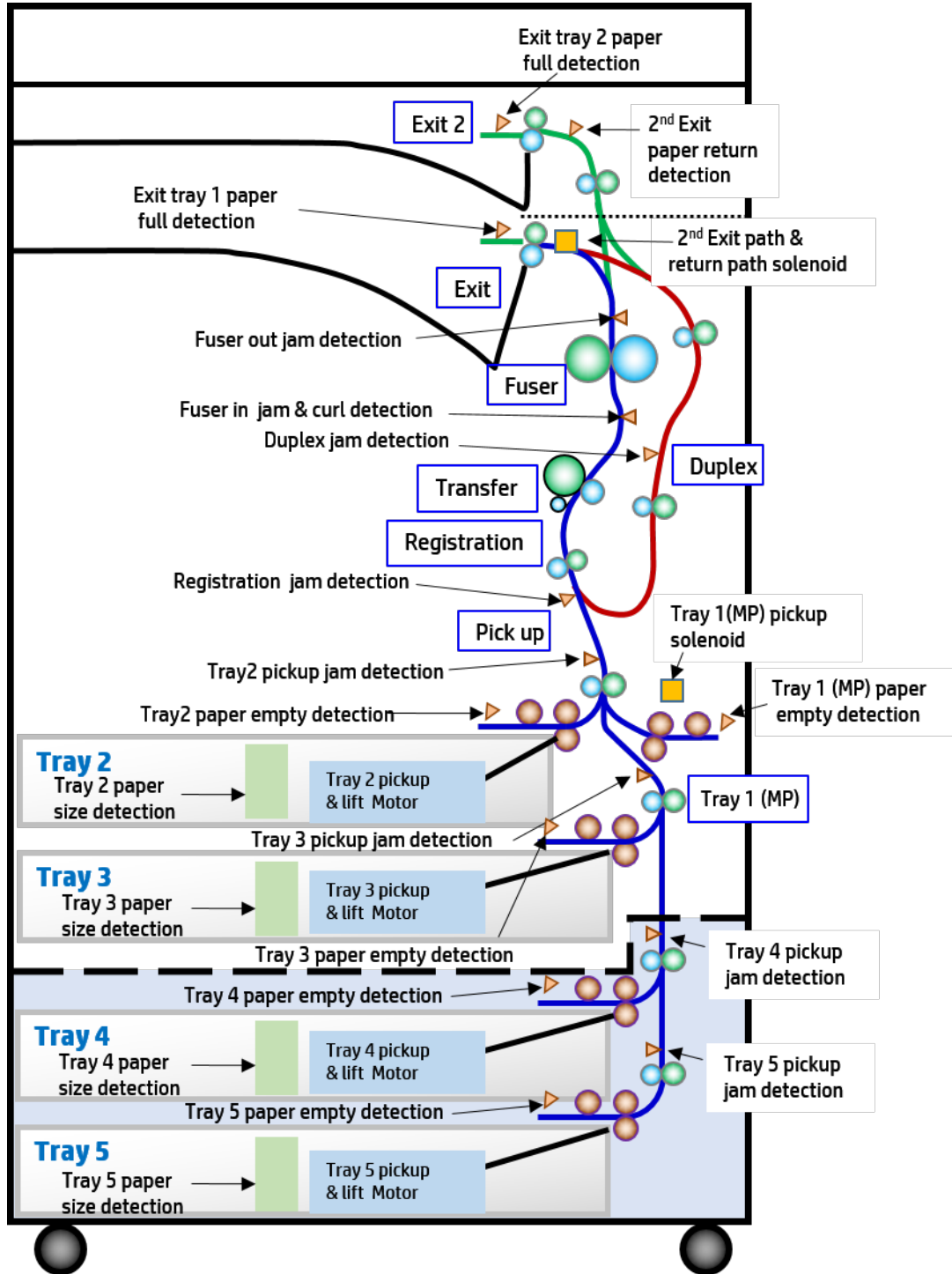

Cassette (Tray 2, 3, 4, 5)

The cassette stores paper. The paper size is set using the guides in each tray.

Basic Cassette

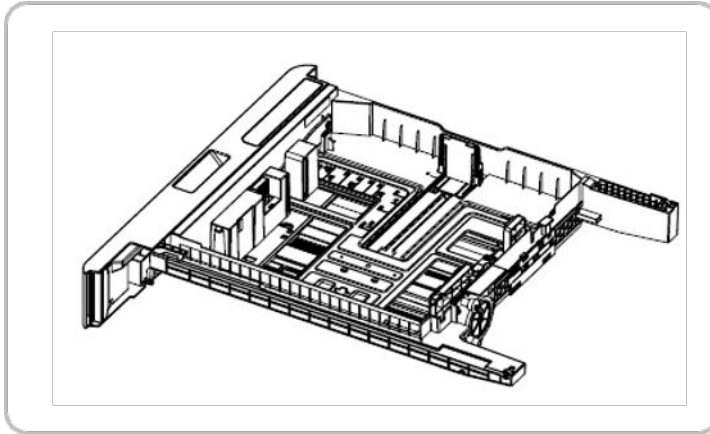

Cassette specification

- Structure: Drawer Type
- Capacity: 520 sheets (75 g/m²) paper standard)
- Paper type:
Plain paper: A5, A4, A3, B5, B4, Letter, 11 x 17 (Ledger), Statement, Legal

 **NOTE:** Tray 2 does not support A3 or 11 x 17 paper.

- Paper weight:
Plain paper: 60–220 g/m²
- Plate knock up lift type: Lift motor + Up limit sensor

Pickup unit

When paper pickup occurs, the pick roller moves down in order to come in contact with the surface of the paper. If the cassette is installed, the LEVER-INPUT CST is pushed and the pick roller moves down. The feed and separation rollers make sure that a single sheet of paper is moved into the paper path, and the feed roller moves the paper as far as the registration roller.

 **NOTE:** The pickup unit 1 and pickup unit 2 are not interchangeable.

Pickup unit 1

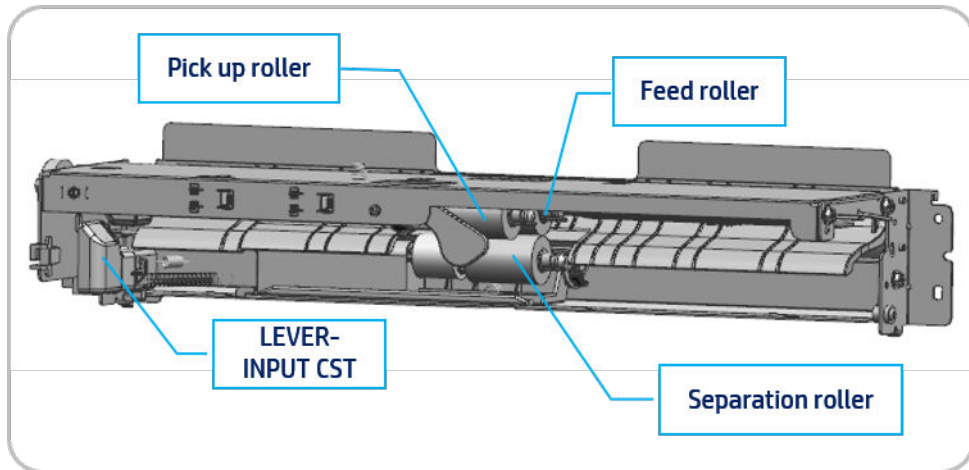

Pickup unit 2

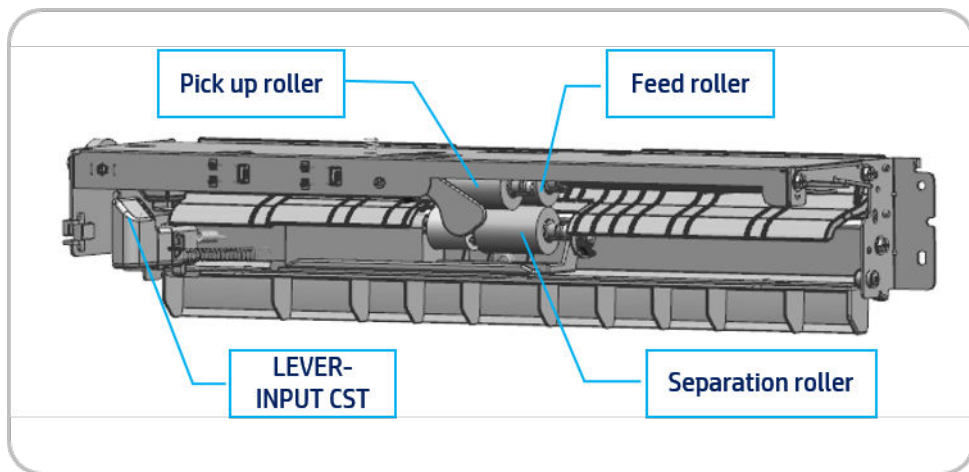

Registration unit

The registration roller is driven by the registration/multipurpose motor.

The registration roller clutch is located between the registration/Tray 1 motor and registration roller, or on the transfer belt (for color), and it controls power to the registration roller in order to match paper and an image on the drum at the predetermined registration point.

Figure 1-12 Registration unit

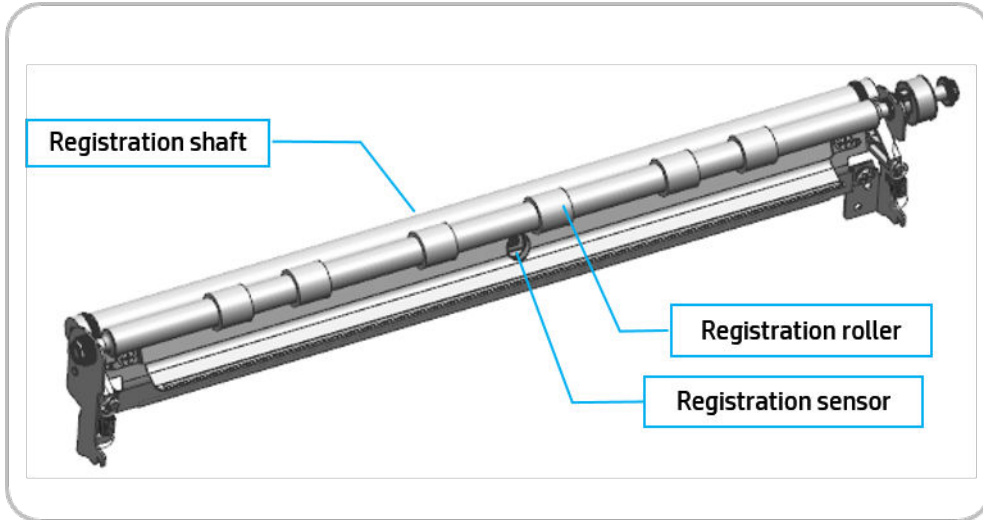

Tray 1 feed assembly

The Tray 1 feed assembly allows feeding of special media cardstock and custom size paper.

Tray 1 feed assembly (Bypass Tray)

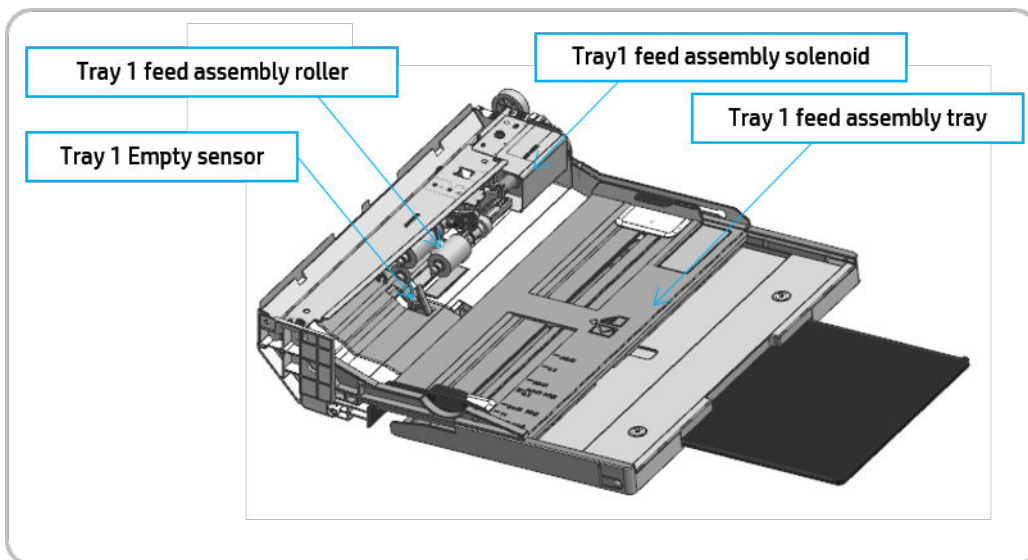

Specification

- Capacity: 100 sheets (75g/m² paper standard)
- Media size: Maximum 297 x 432 mm (11.7 x 17 in)/ Minimum 98 x 148 mm (3.87 x 5.8 in)
- Media weight: 60 to 176 g/m²
- Feeding speed: 28 ppm (E72428), 22 ppm (E72422) Letter/A4 LEF (long edge feeding)

Paper separation

Figure 1-13 Paper separation

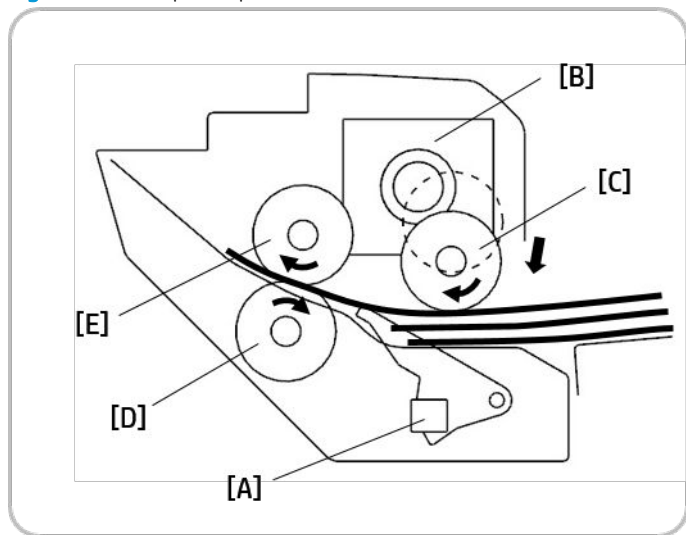

When the Tray 1 paper detection [A] sensor detects paper and the machine gets a Tray 1 printing job, the Tray 1 solenoid [B] drops the pick roller [C] onto the top of the paper stack in Tray 1.

This machine uses a feed and separation roller (FSR) system for feeding paper. The friction between the separation roller [D] and feed roller [E] separates the top sheet of paper from the stack.

Image formation system

Image formation process overview

This printer uses four imaging units and four lasers for color printing. Each imaging unit consists of a drum unit and a developer unit.

The drum unit has an OPC drum, charge roller, cleaning roller, and cleaning blade.

Figure 1-14 Image formation process overview

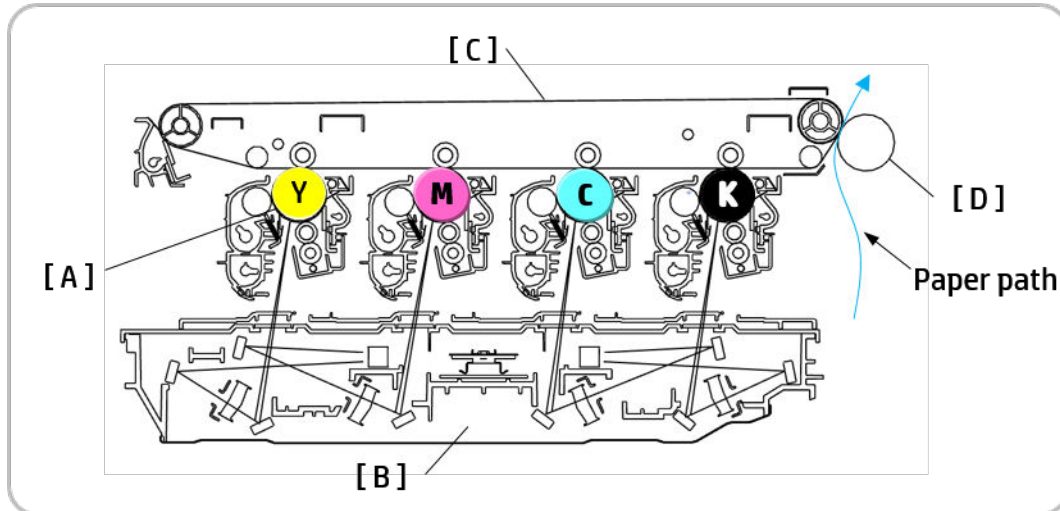

The OPC drum (A) is charged with a negative voltage and is exposed by the light from the laser scanning assembly (B).

The light produced by the laser creates a latent image by discharging on the surface of the OPC drum. The negatively charged toner is attracted to the latent drum image due to an electric field. The toner (real image) on each OPC drum is moved to the image transfer belt (ITB) (C) by the positive bias applied to the first transfer roller. All four toners (color image) are transferred to the paper by a positive charge applied to the second transfer roller (D).

1. **OPC drum charge** : The charge roller gives the drum a negative charge.
2. **Laser exposure** : Light produced by a laser diode hits the charged OPC through the lens and mirrors.
3. **Development** : The developing roller carries negatively charged toner to the latent image on the drum surface. This printer uses four independent imaging units (one for each color).
4. **Transfer** :
 - Image transfer: The first transfer roller opposite the OPC drums transfer toner from the drums to the ITB. Four toner images are super-imposed onto the belt.
 - Paper transfer: The second transfer roller transfers the toner from the ITB to the media.
5. **Cleaning for OPC drum** : The cleaning blade removes remaining toner on the drum surface after image transfer to the paper.

6. **Erasing for OPC drum:** Erasing is done by illuminating the whole area of the drum with the laser at the end of every job.
7. **Cleaning and erasing charges on the ITB:** The cleaning roller and blade clean the belt surface. The grounding roller inside the ITB unit removes the remaining charge from the belt.

Imaging unit

Imaging unit overview

This printer uses a two-part imaging unit. It uses four color development and one paper path to increase color printing productivity.

Each imaging unit consists of the drum unit and the developer unit. The developer units are not interchangeable. The drum units are interchangeable. The diameter of the drum is 30 mm with a circumference of about 94.2 mm.

The development gap between a drum and the corresponding magnetic roller cannot be adjusted. The customer-replaceable unit monitor (CRUM) is the subpart of the drum unit. The CRUM stores job count information and other data.

Figure 1-15 Imaging unit

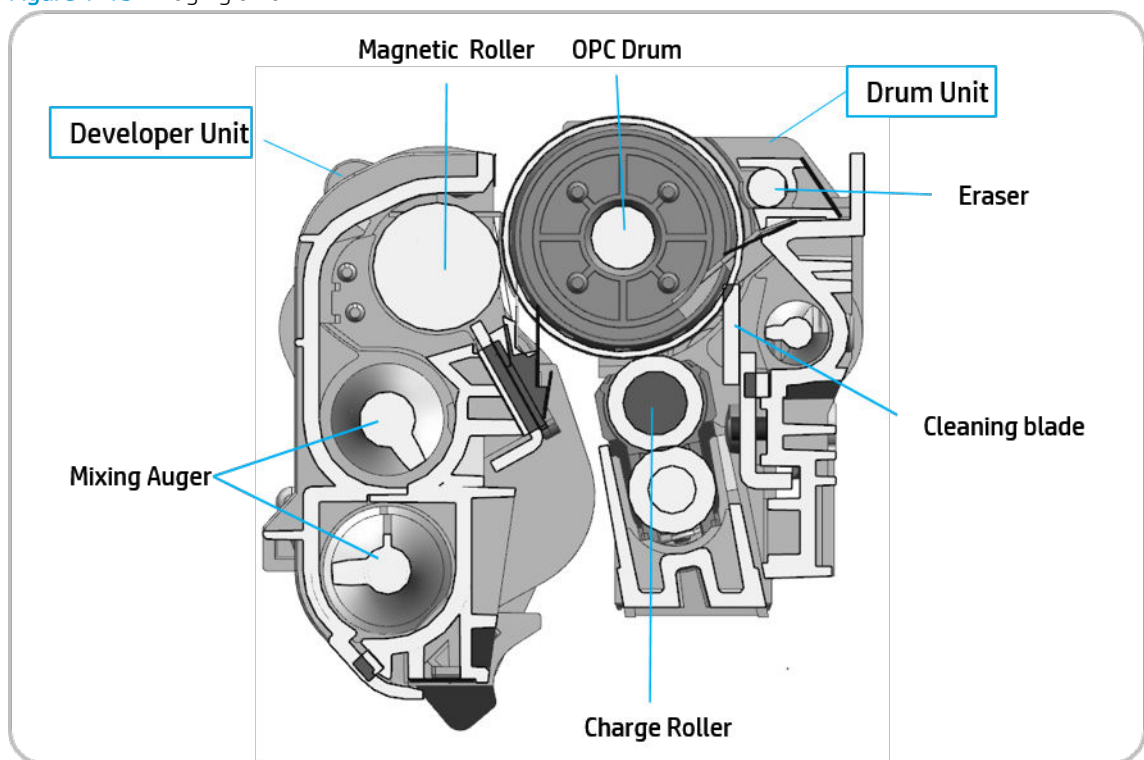

Drum drive

The color OPCs and magnetic roller are driven by each color motor. The OPC drum and magnetic roller are powered by the coupling.

The brushless direct current (BLDC) motor maintains constant speed. The speed sync for each color depends on the BLDC motor.

Phase sync for each OPC job prints the pattern on the image transfer belt (ITB) and is adjusted automatically.

Figure 1-16 Drum drive

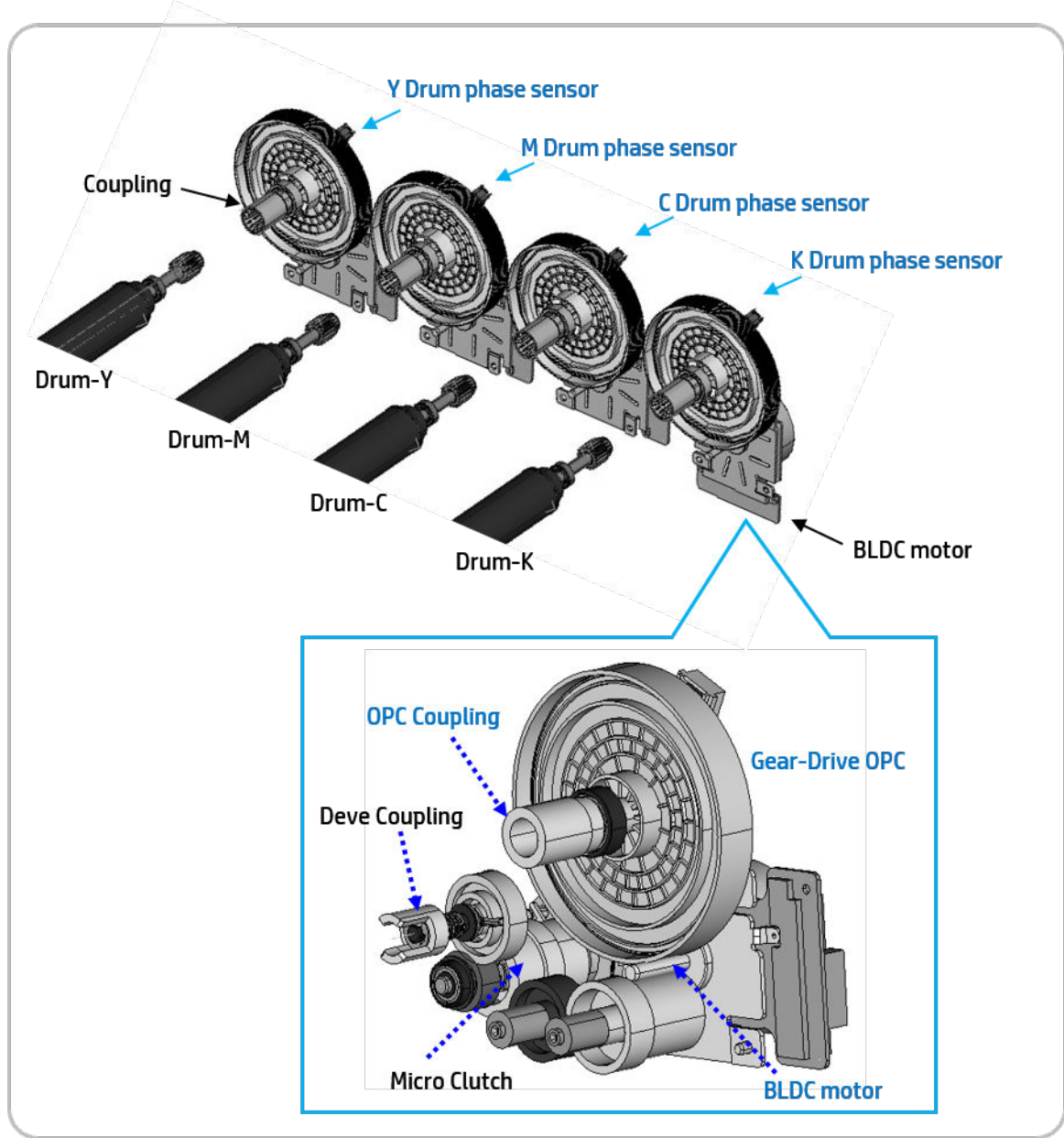

Developer unit

This printer uses a dual-component development system that has four developer units.

Each new unit contains 185 g of magnetic toner carrier. The developer in each unit is supplied to the magnetic (development) roller (A) by the two mixing augers (B). The diameter of the magnetic roller is 16 mm.

Each developer unit has a toner concentration (TC) sensor (C). The TC sensor is used for controlling the operating range of toner density.

Figure 1-17 Developer unit

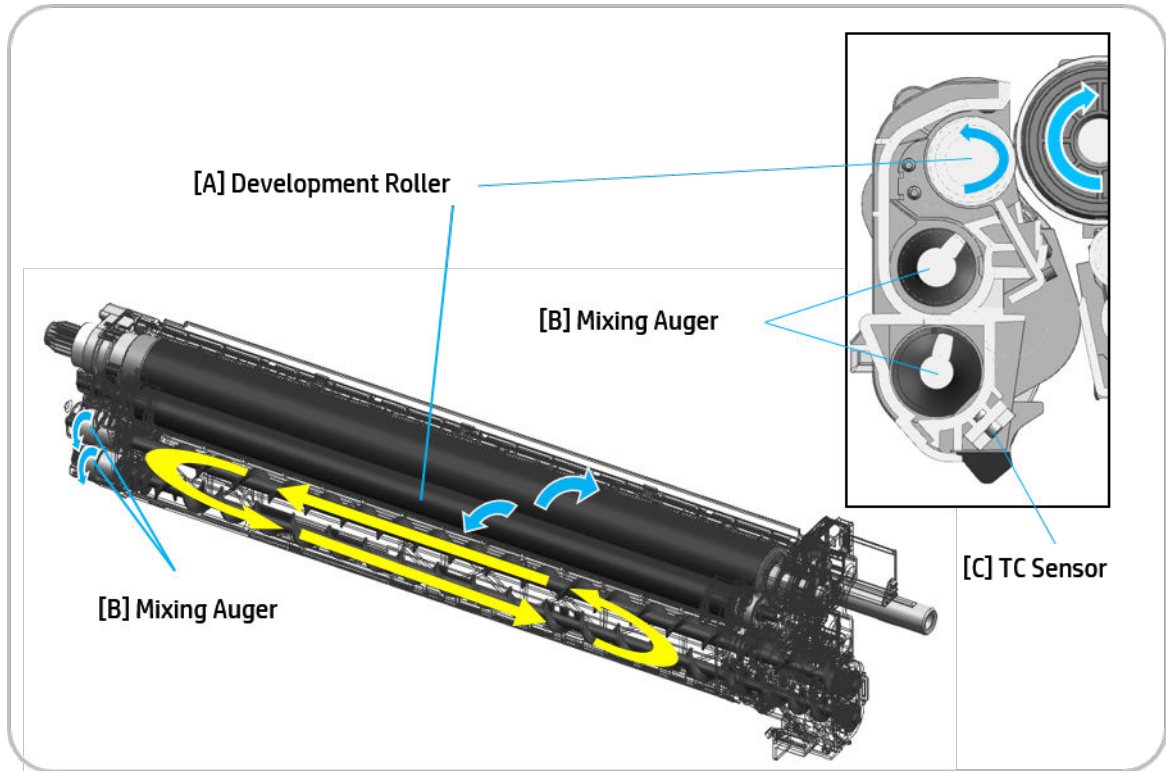

Developer Circulation

Two mixing augers (B) circulate the developer forward and backward in order to sufficiently mix the toner and carrier.

This occurs at the following times:

- During the process control self-checking
- During toner supply job
- During development job

The developer unit must be stored below 50°C (122°F) or the toner will harden and not work properly.

Image Transfer Belt (ITB) Unit

Image transfer belt (ITB) unit overview

The toner on the four drums is transferred to the image transfer belt (ITB) by the first transfer roller.

The image overlapped by four colors is transferred to the paper by the second transfer roller. The remaining toners is removed by the cleaning blade and transferred to the toner collection unit.

This process is completed with one rotation of the ITB. The arrow above the C and M drums on the following diagram shows the direction of the ITB rotation. The ITB is rotated by friction between the drive roller and the ITB. The tension roller provides tension to prevent slipping.

There are three color plane registration (CPR) sensors and one photo sensor. Two CPR sensors are for line position adjustment and one is for process control. The photo sensor monitors the position of the first transfer rollers.

Figure 1-18 ITB unit

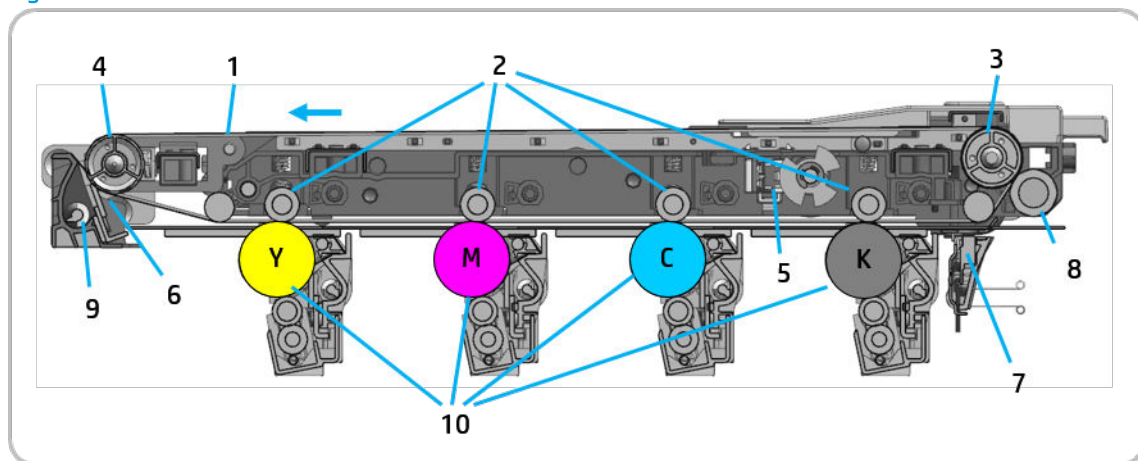

Table 1-23 ITB unit

No	Item
1	Image Transfer Belt (ITB)
2	First Transfer Roller
3	ITB Drive Roller
4	Tension Roller
5	First Transfer Roller Home Position Sensor
6	Cleaning Blade
7	Color Plane Registration (CPR) Sensor
8	Second Transfer Roller
9	Toner Collection Auger
10	Imaging Drum Unit

Image transfer belt (ITB) drive

The image transfer belt (ITB) drive motor (A) drives the ITB (B) by using gears and the ITB drive roller (C).

Figure 1-19 Image transfer belt drive

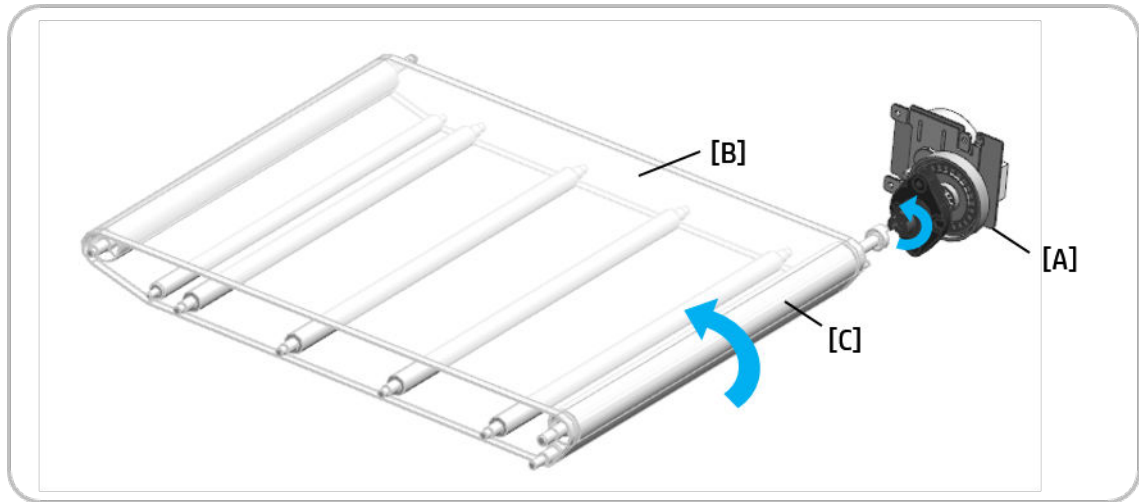

Image transfer belt (ITB) cleaning

The image transfer belt (ITB) cleaner removes toner during printing. Belt cleaning is completed while the ITB makes one rotation. The ITB drive motor drives the ITB cleaning motor.

The cleaning blade (A) always contacts the ITB (B). The cleaning blade removes the used toner from the ITB. The toner collection auger (C) transfers the waste toner to the toner collection unit.

The seal (D) on the ITB cleaner protects against toner contamination. The driving power of the driver roller is transferred to the tension roller (E). The toner collection auger gear (F) drives the gear (G) and collects the toner.

Figure 1-20 ITB cleaning

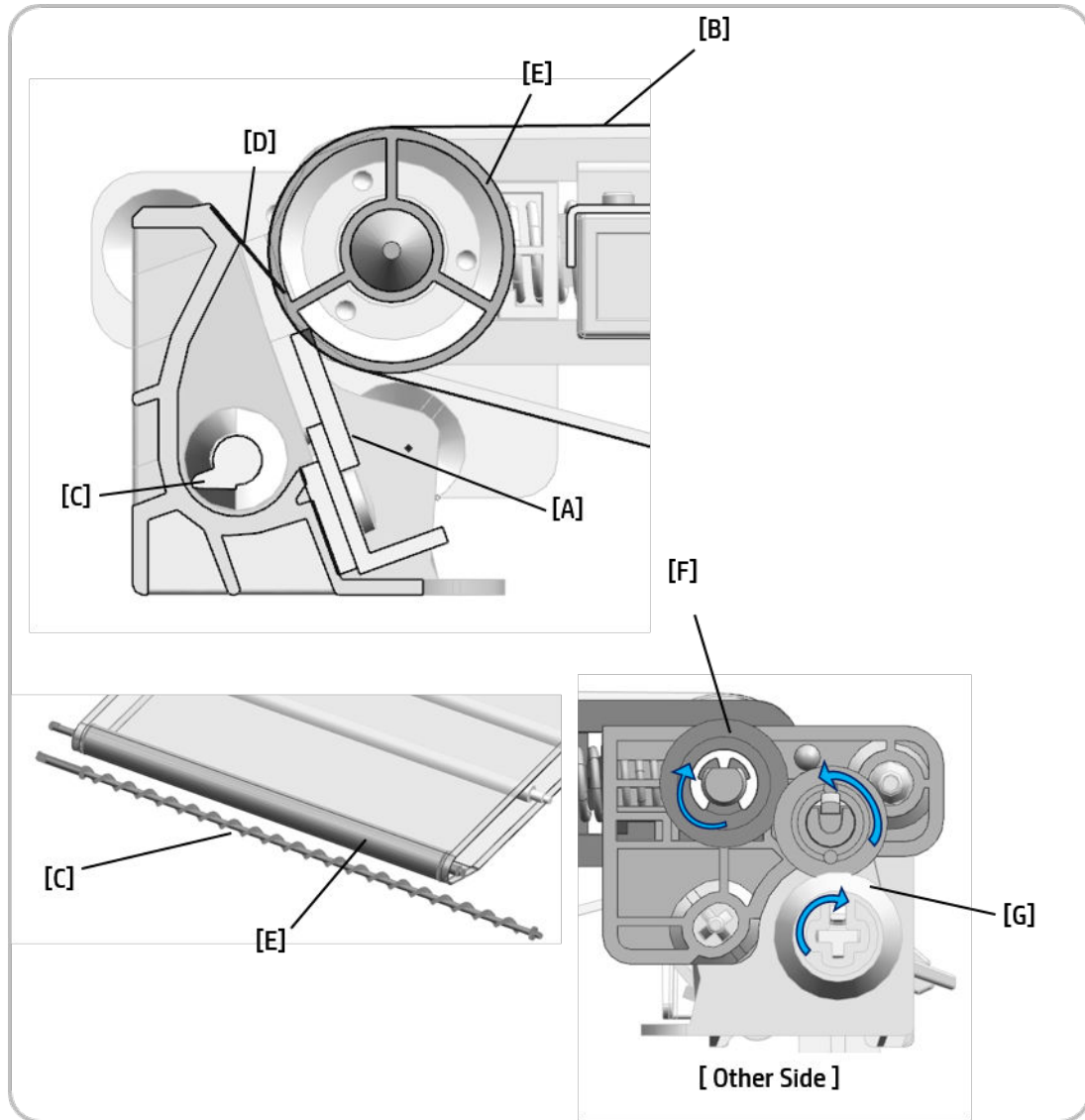

Fuser unit

This section describes the image fusing process used by the printer.

Fuser unit overview

This section describes the image fusing process used by the printer.

Figure 1-21 Fuser unit overview

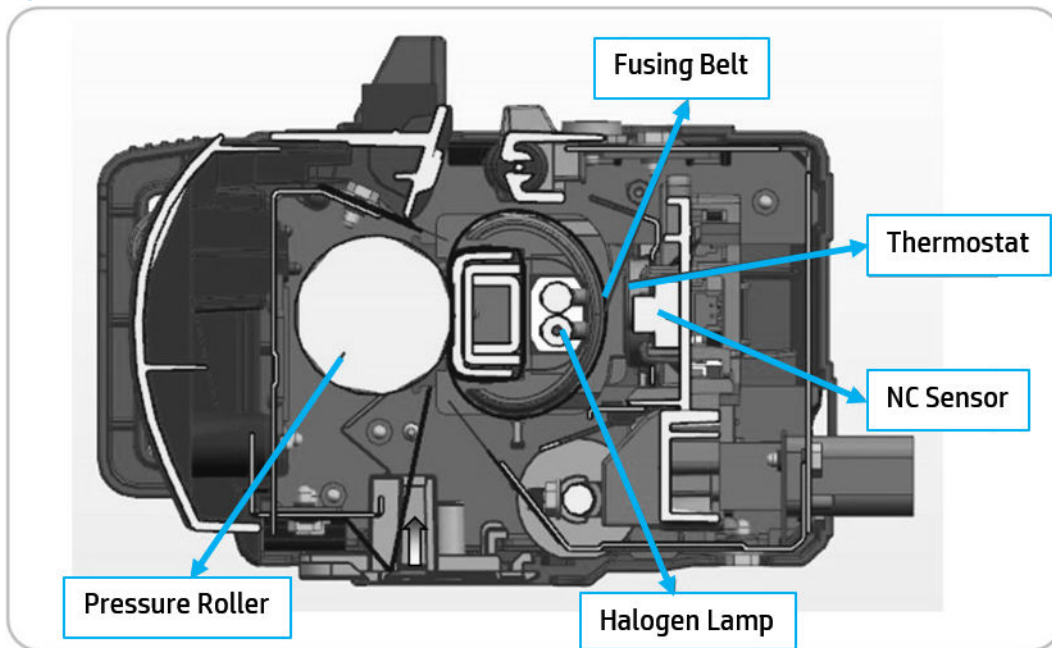

Table 1-24 Fuser unit overview

Item	Description
1	<p>Halogen Lamp</p> <p>The fuser unit has two halogen lamps. One lamp heats the center of the fusing belt, and the other lamp heats the end of axial direction. The halogen lamps are lit alternately to heat the fusing belt. Each lamp has its coil in a different location. The coil of the center heater lamp is in the center. The coils of the side heater lamp are located on both sides. The lamps are fixed inside of the fusing belt. The lamps do not rotate when the fusing belt rotates.</p>
2	<p>Fusing Belt</p> <p>The fusing belt receives heat from the halogen lamp and transfers it to the toner and paper. The fusing belt consists of three thin layers. The thin fusing belt reduces time needed to warm up and change modes. To prevent the fusing belt from adhering to the toner, the surface of the fusing belt is lubricated. There is a nip inside the fusing belt. A spring is used to maintain the proper nip between the fusing belt and pressure roller.</p>
3	<p>Pressure Roller</p> <p>The pressure roller is made of rubber and makes sure there is proper nip width between the pressure roller and the fusing belt. The pressure roller is powered by the drive system and drives the fusing belt.</p>

Table 1-24 Fuser unit overview (continued)

Item	Description
4	Non-Contact (NC) Sensor NC sensors (non-contact type thermistors) are located near the center and the end of the fusing belt and monitor the temperature of the fusing belt.
5	Thermostat The thermostat cuts off the power supply to the halogen lamp by opening the circuit when the heat roller becomes abnormally hot as a result of problems such as a NC sensor malfunction. The thermostats are used to prevent abnormal operation. When the thermostat is tripped, it cannot be reset and must be replaced (as well as the other damaged parts in the fuser unit).

Fuser unit drive

The fuser motor (A) drives the pressure roller (B) through the gear train. The fuser belt is driven by the pressure roller.

Figure 1-22 Fuser drive

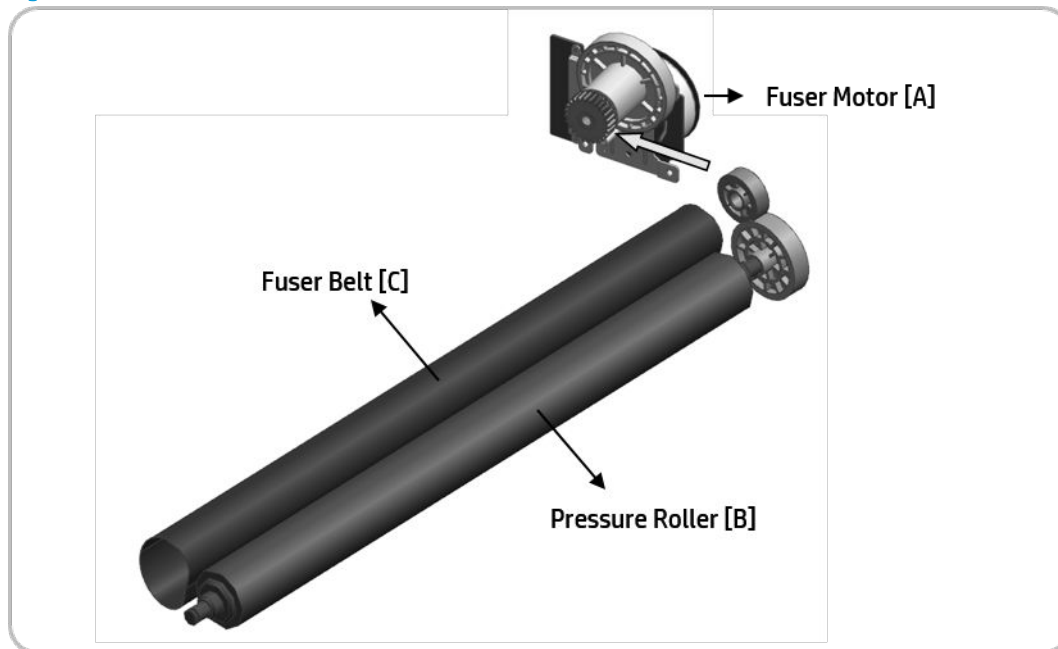

Fuser unit temperature control

When the main switch turns on, the CPU turns on the fusing lamp. The lamp stays on until the NC sensors detect the standby temperature. The CPU then raises the temperature up to the printing temperature.

Figure 1-23 Fuser unit temperature control

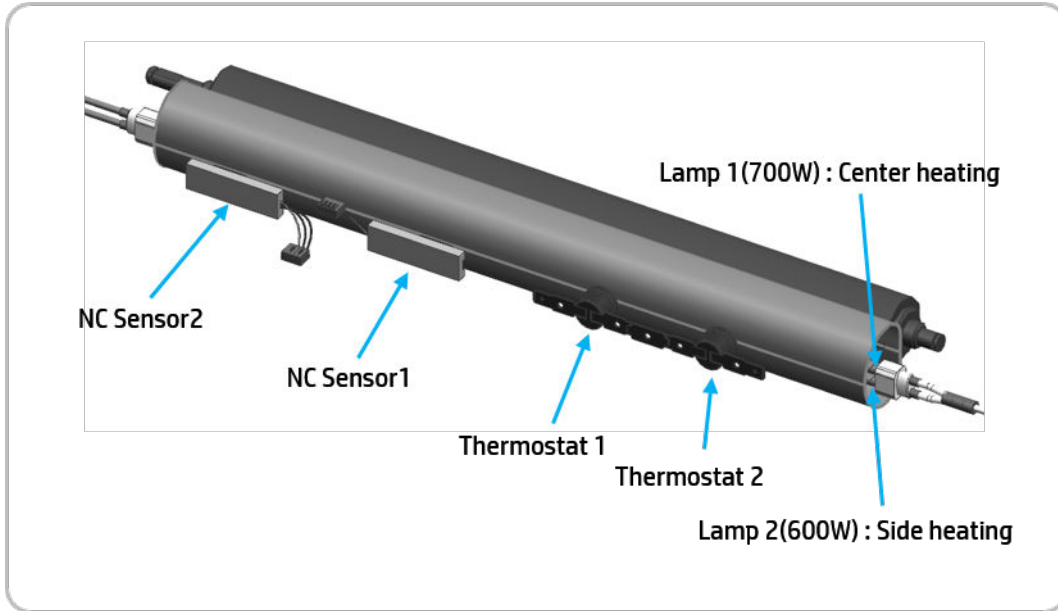

Overheat Protection

The CPU cuts power to the fusing lamp in the following cases:

- The temperature detected by the NC sensor stays higher than 240°C for 20 seconds.

The following components are used when thermistor overheat protection fails:

- Two thermostats are in line with the common ground wire of the fusing lamp.
- If one of the thermostat temperatures becomes higher than 195°C, power is cut to the fusing lamp. If the other thermostat temperature becomes higher than 195°C, it will also cut power to the fusing lamp.

Laser scanning unit assembly (LSU)

Laser scanning unit assembly (LSU) overview

The laser scanning unit assembly (LSU) consists of one polygon motor and four laser diodes (LD) units.

The laser scanning unit assembly (LSU) forms a latent image on the surface of four drums. For this process, the laser scanner assembly has a collimator lens, cylindrical lens, two F-Theta lenses, and two reflective mirrors on an optical path for each color.

This laser scanning unit assembly (LSU) uses the cross scan type scanning. K Color and C Color scan the laser from the rear to the front. M Color and Y Color scan the laser from the front to the rear.

The laser scanning unit assembly (LSU) has a skew adjustment which adjusts the scanning line. An automatic shutter is used to clean and protect the glass on the laser scanning unit assembly (LSU).

Figure 1-24 Laser scanning unit assembly (LSU) overview

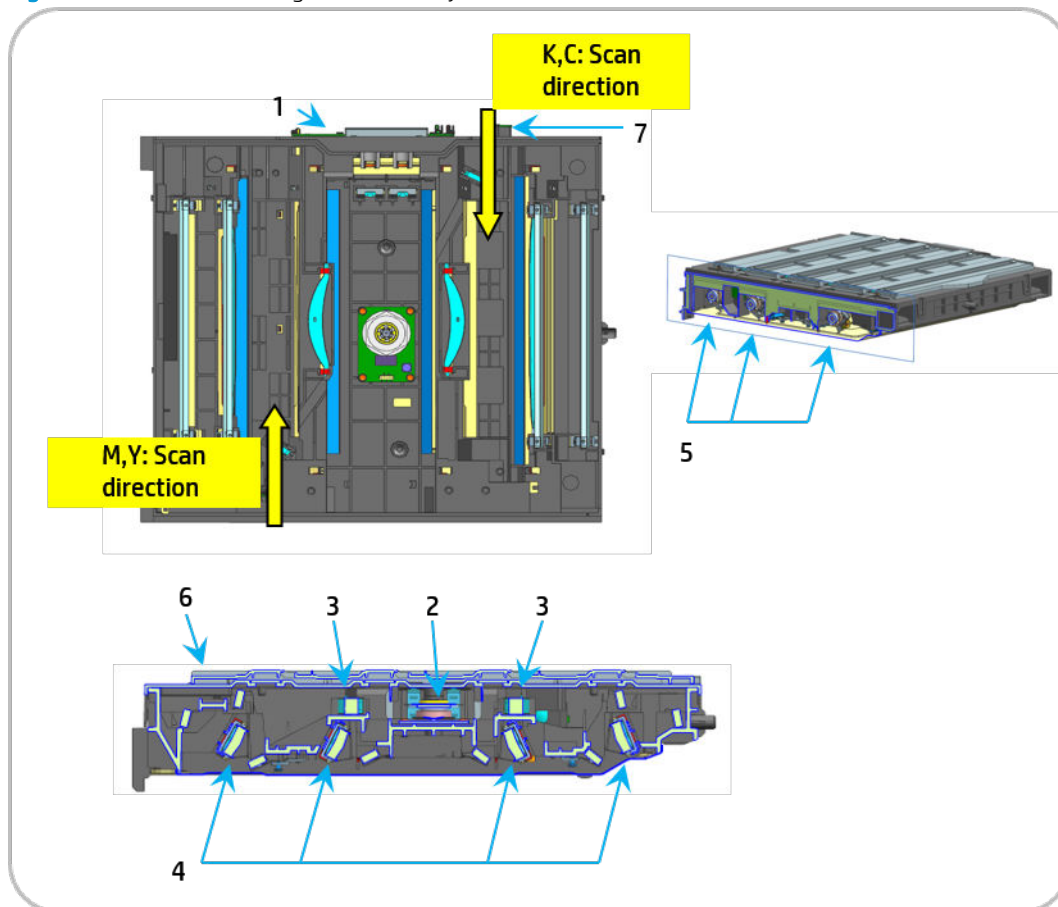

Table 1-25 Laser scanning unit assembly (LSU)

Item	Description
1	LD PCA
2	P/Mirror motor
3	F1 lens

Table 1-25 Laser scanning unit assembly (LSU) (continued)

Item	Description
4	F2 lens
5	Skew adjust assembly
6	Shutter
7	PD PCA

Laser scanner assembly overview

The laser from the laser scanner assembly is placed at intervals of 78 mm for each color. All colors use the same polygon motor for oblique incidence.

The F2 lens (A) determines the slope of the primary scanning line and the image position of the secondary scanning direction. This setting is adjusted by the manufacturer. The primary scanning line slope difference is adjusted by the skew adjustment in the laser scanner assembly.

Reflective mirrors (B) on each color path adjust the curvature of primary scanning. This setting is adjusted by the manufacturer.

Figure 1-25 Laser scanning optical path

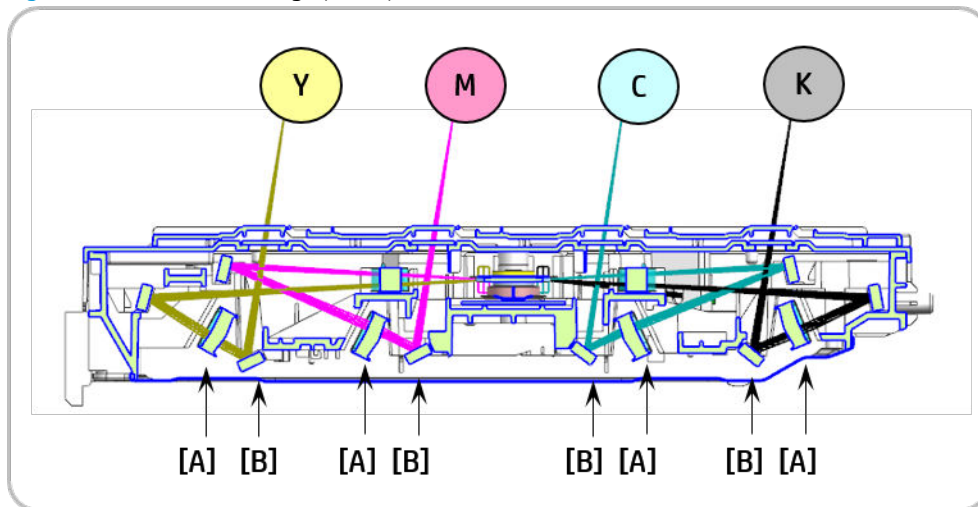

Laser synchronizing detectors

The laser scanner assembly has two beam detector sensor boards (PD PCA). The PD PCAs are located at each corner of the laser optics housing unit.

The two PD PCAs detect the following:

- (A): Scanning start position for black
- (B): Scanning start position for yellow

This printer recognizes each color from the time that they are detected.

Figure 1-26 Laser synchronizing detectors

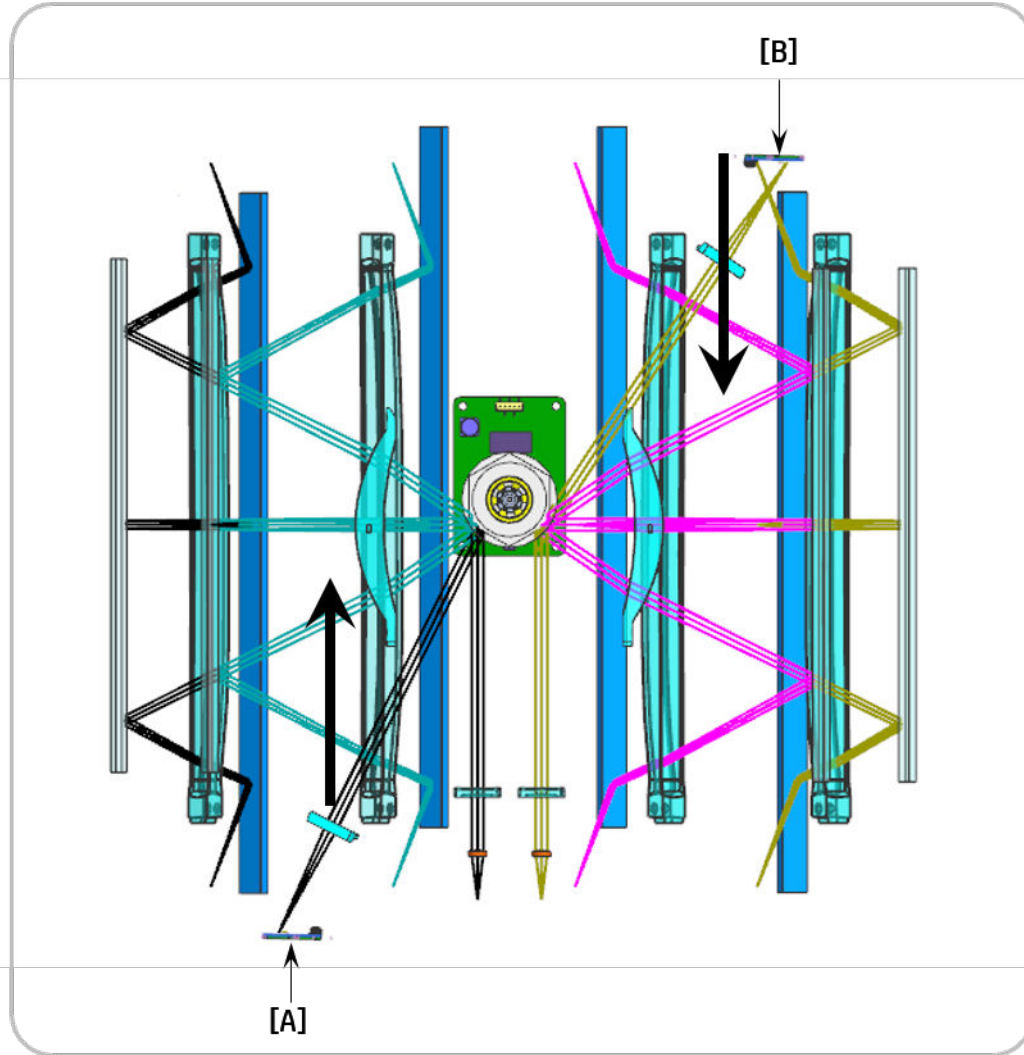

Main Scan Start Detection

The PD PCAs detect four beams at the scanning start point and create the horizontal sync (Hsync) signal. Data is scanned by Hsync.

The arrow in the previous diagram shows the data scanning direction for each color. Black/Cyan and Yellow/Magenta use the same polygon motor scanning in opposite directions.

Automatic CPR adjustment

During automatic CPR adjustment, the line patterns below are created eight times on the image transfer belt (ITB). The spaces between the lines (KK, CC, MM, YY, KC, KM, KY) are measured by the front, center, and rear CPR sensors. The controller takes the average of the spaces and then adjusts the following positions and magnification:

- Sub scan line position for CMY
- Main scan line position for CMY

- Magnification ratio for CMY
- Skew for CMY

The ITB cleaning unit cleans the ITB after the patterns are measured.

Figure 1-27 Automatic CPR adjustment

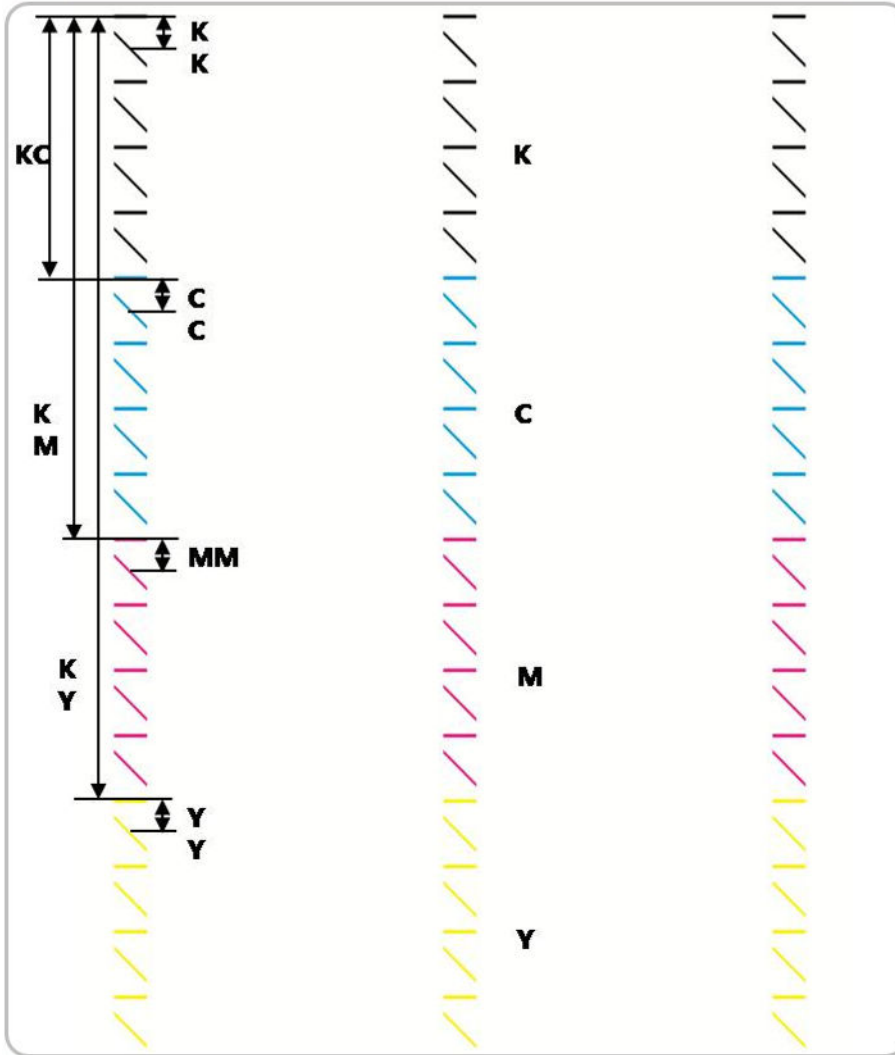

- KK, CC, MM, YY: Spaces between two lines of the same color.
- KC, KM, KY: Spaces between a black line and each color line.

Adjustment

- Sub Scan line position for CMY

The adjustment of the sub scan line position for CMY is based on the line position for K (black). The printer measures the gaps between the lines of each color in the pattern on the ITB. When the gaps for a color are

incorrect, the printer moves the image of the color up or down the sub scan axis. To do this, it changes the laser write timing for that color.

- **Main Scan line position for CMY**

When the printer detects that the image is out of position in the main scan direction, it changes the laser write start timing for each scan line.

- **Magnification Adjustment for CMY**

When the printer detects that magnification adjustment is necessary, it changes the LD clock frequency for the required color.

- **Skew for CMY**

The adjustment of the skew for CMY is based on the line position for K (black).

Adjustment Conditions

Line position adjustment can be turned on or off. However, it is normally recommended to turn on this function.

Line position adjustment timing depends on several settings. These settings include the following:

- ΔT = Temperature change of the laser scanner assembly between the temperature of the previous line position adjustment and the current temperature.
- Pages = Total printed pages after previous line position adjustment.

Interval During Print Job

Line position adjustment interrupts printing and then starts automatically when one of these conditions occurs when the printer checks at the sheet interval:

- $\Delta T >$ Temperature threshold (laser scanner assembly temperature: [default 3°C])
- Pages $>$ Output threshold for all outputs (default: 500 pages)

Toner Collection Unit Not-Installed/Installed

- Line position adjustment starts automatically when toner collection unit is removed and reinstalled.

Drum Unit or Developer Unit Replaced

- When the printer detects a new drum unit or developer unit, line position adjustment is automatically performed.

ITB Replaced

- When the printer detects a new ITB or other ITB, SVC engineers have to execute the adjustment manually.

Main Scan Skew Adjustment

The skew adjustment assembly (A) consists of two worm gears (1),(2). When color plane registration (CPR) executes, it detects and adjusts the scanning line slope manually.

The skew adjustment assembly for magenta, cyan, and yellow adjusts the skew angle of the F2 lens (B). This mechanism corrects main scan skew.

Figure 1-28 Main scan skew adjustment

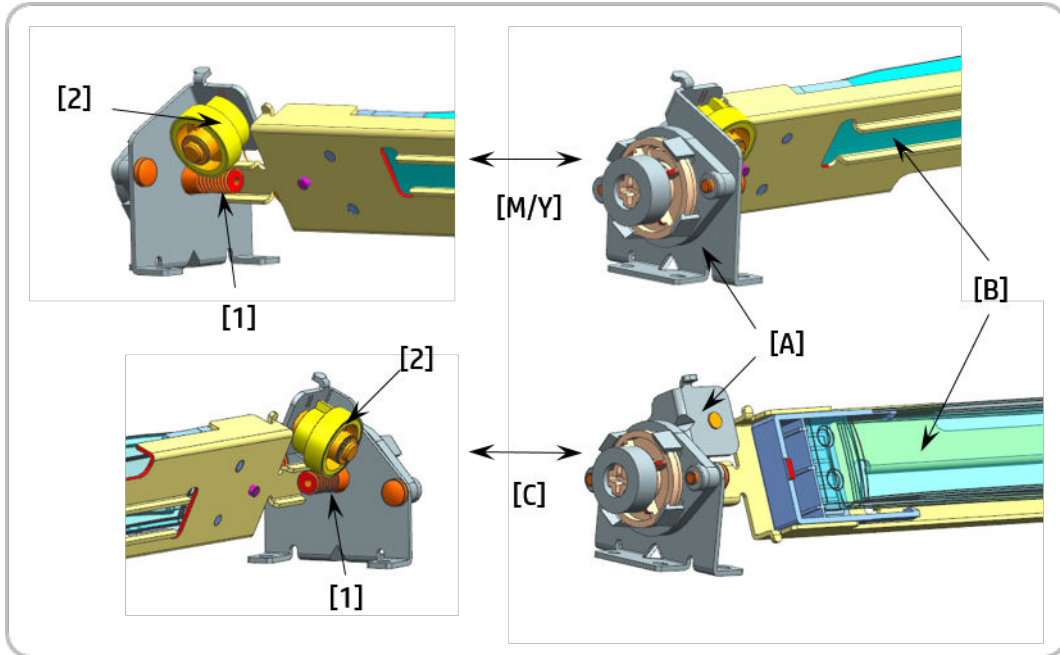

Drive system

Drive motors

The following diagram shows the location of the printer drive motors.

Figure 1-29 Drive motors

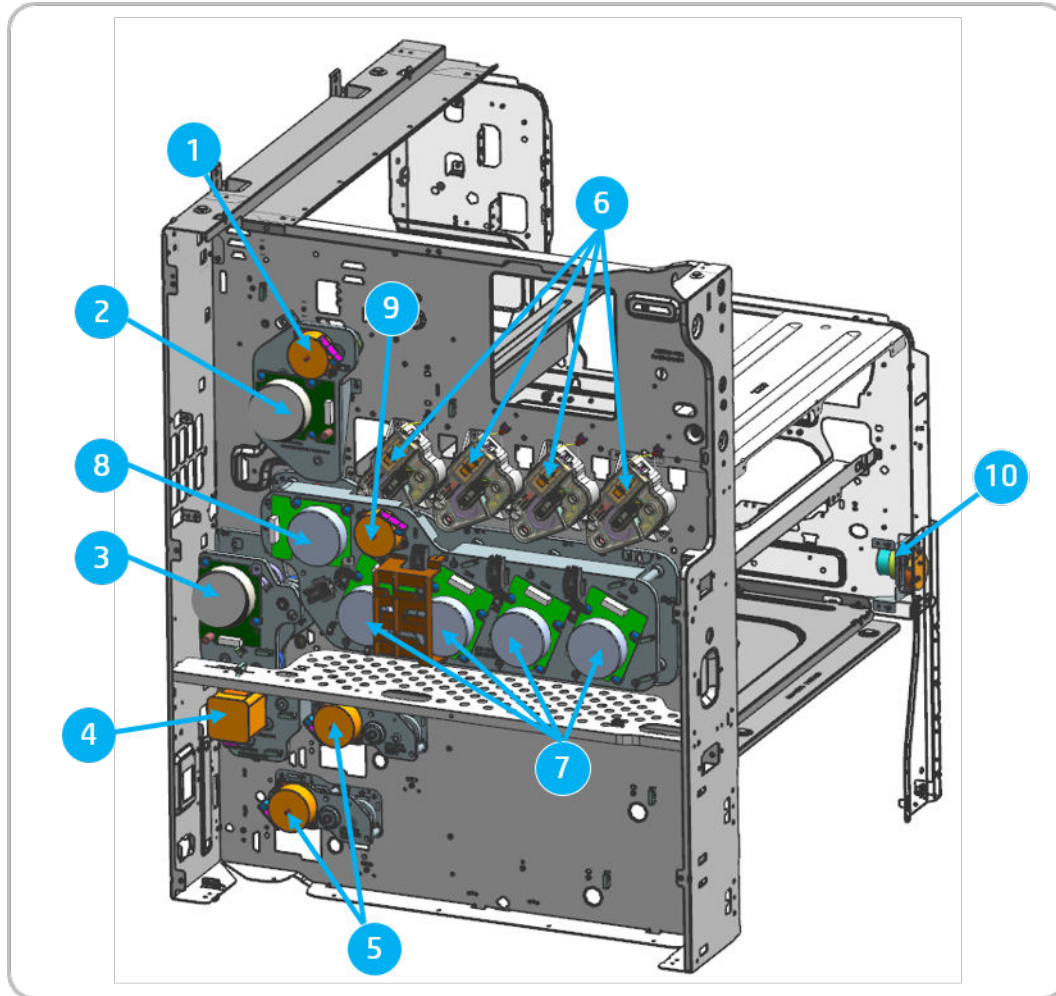

Table 1-26 Drive motors

No	Motor	Motor type	Function
1	Exit	PM-STEP	Exit drive (Reverse drive at duplex job)
2	Fuser	BLDC	Fuser drive/Fuser pressure mode (Reverse drive at pressure mode)
3	Registration/Tray 1	BLDC	Registration/Tray 1 drive
4	Feed	HB-STEP (Hybrid) Stepper Motor	Feed 1/2 roll drive

Table 1-26 Drive motors (continued)

No	Motor	Motor type	Function
5	Tray 2 and 3 Pickup	PM-STEP (Permanent Magnet) Stepper Motor	Pickup roller/tray lift drive
6	Toner supply	DC	Toner transfer in toner cartridge drive duct
7	OPC/DEVE	BLDC	OPC/DEVE drive
8	ITB	BLDC	ITB drive
9	ITB Engage/Disengage	PM-STEP	1st Transfer roller Engage/Disengage
10	Toner collection unit	PM-STEP	Toner collection unit leveling

Main drive unit (OPC/DEVE/ITB/Transfer Roller/Disengage/Engage motors)

The following diagram shows the front and rear views of the main drive unit.

Figure 1-30 Main drive unit - front view

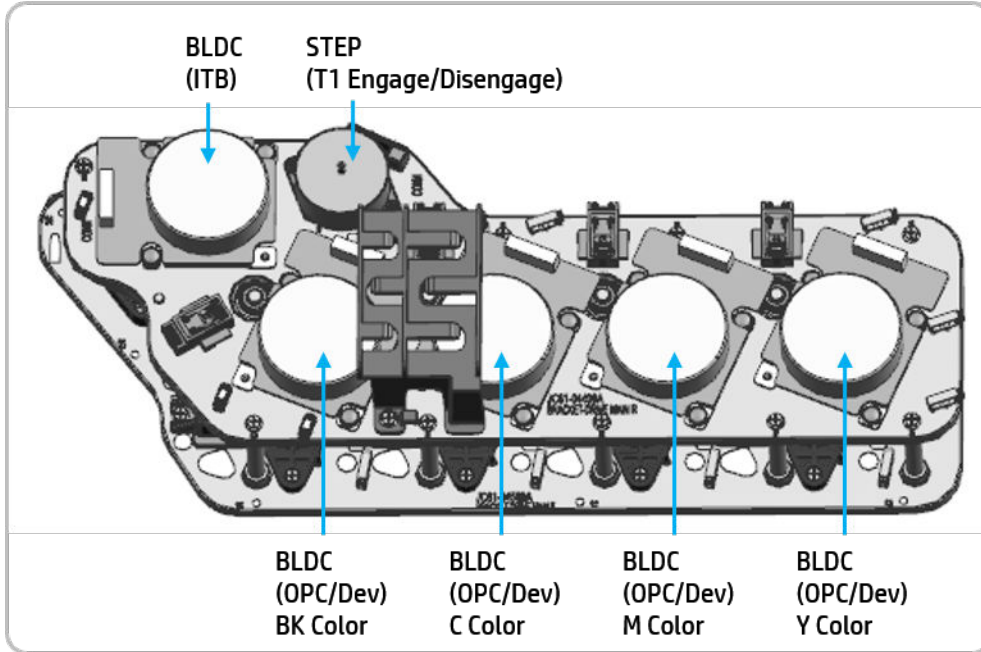
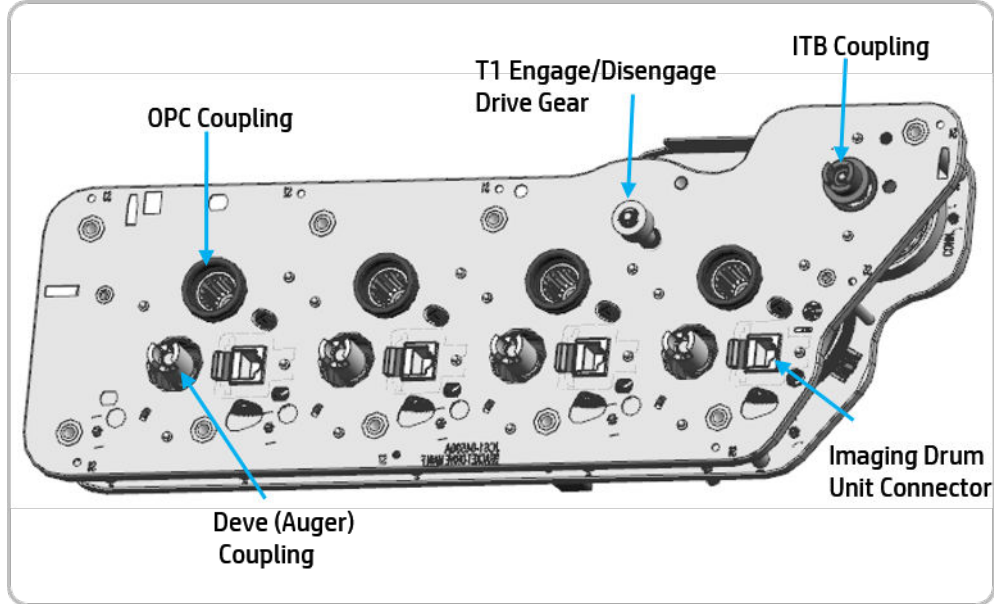

Figure 1-31 Main drive unit - rear view



Pickup drive

The following diagram shows the pick-up drive unit.

Figure 1-32 Pickup drive

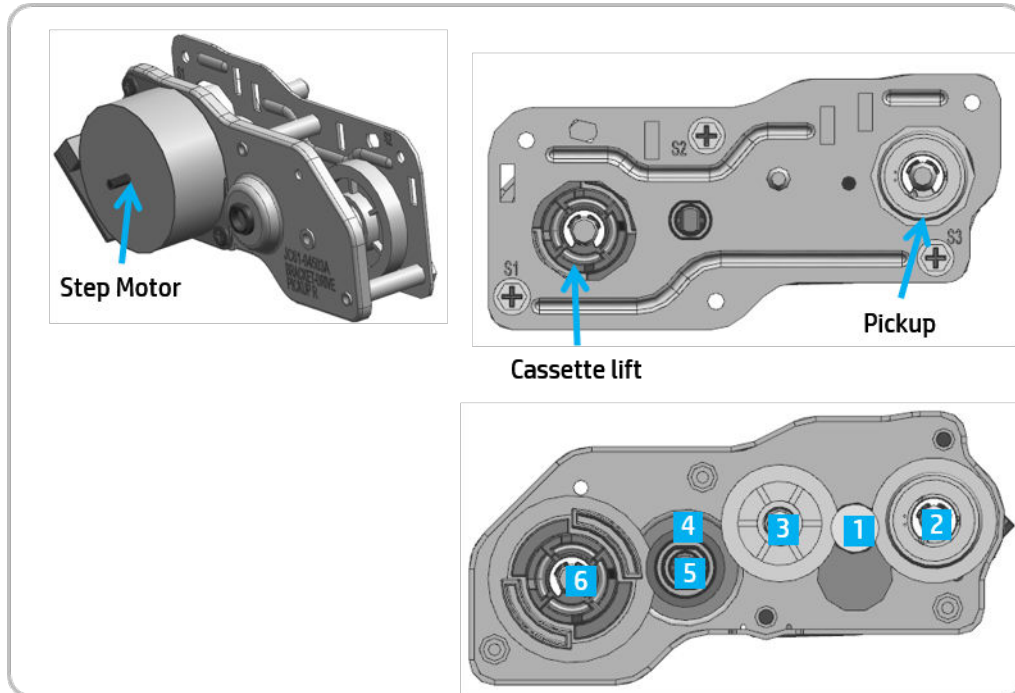

Table 1-27 Pickup drive

Power Train	Pickup: rotating (pickup/input)/counter rotating (tray lift input)
<ul style="list-style-type: none"> 1 Step → rotating → 2 gear (pickup drive) 	
<ul style="list-style-type: none"> 1 Step → counter rotating → 3 gear → 4 gear → 5 gear → 6 gear (tray lift drive) 	

Registration/Tray 1 drive

The following diagram shows the drives that power the registration/Tray 1 systems:

Figure 1-33 Registration/Tray 1 drive

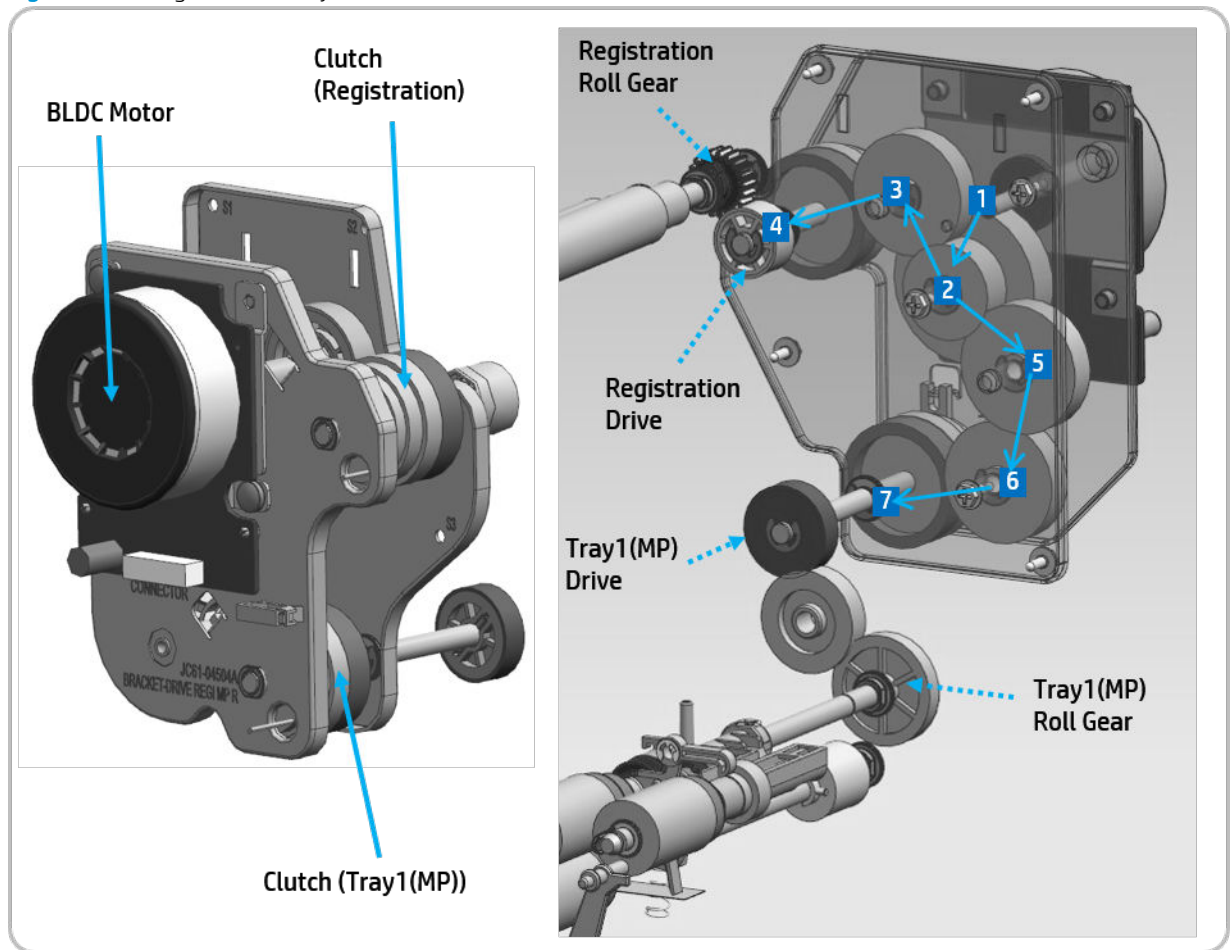

Table 1-28 Registration/Tray 1 drive

Power Train	Registration/Tray 1: BLDC motor drive, clutch drive control
<ul style="list-style-type: none"> 1 BLDC motor → 2 gear → 3 gear → 4 clutch/gear (Registration drive) 	
<ul style="list-style-type: none"> 1 BLDC motor → 2 gear → 5 gear → 6 gear → 7 clutch/gear (Tray 1 drive) 	

Feed drive

The following diagram shows the drives that power the feed systems:

Figure 1-34 Feed drive

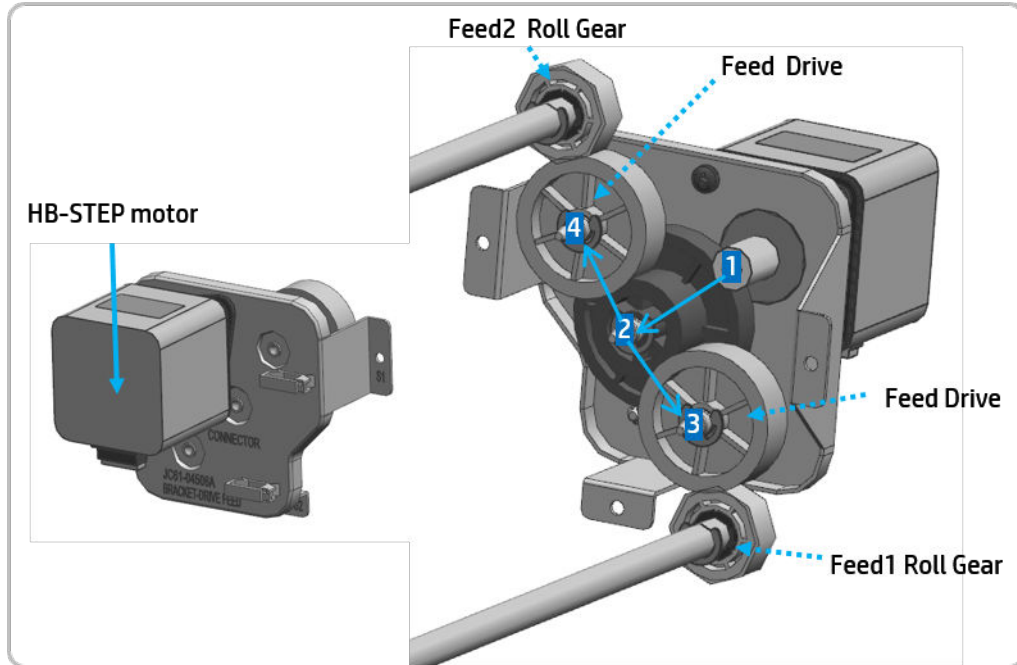

Table 1-29 Feed drive

Power Train	Feed: HB-STEP drive
<ul style="list-style-type: none"> 1 HB-STEP motor → 2 gear → 3 gear (feed 1 drive) 1 HB-STEP motor → 2 gear → 4 gear (feed 2 drive) 	

Fuser/exit drive

The following diagram shows the drives that power the fuser/exit drive systems:

Figure 1-35 Fuser/exit drive

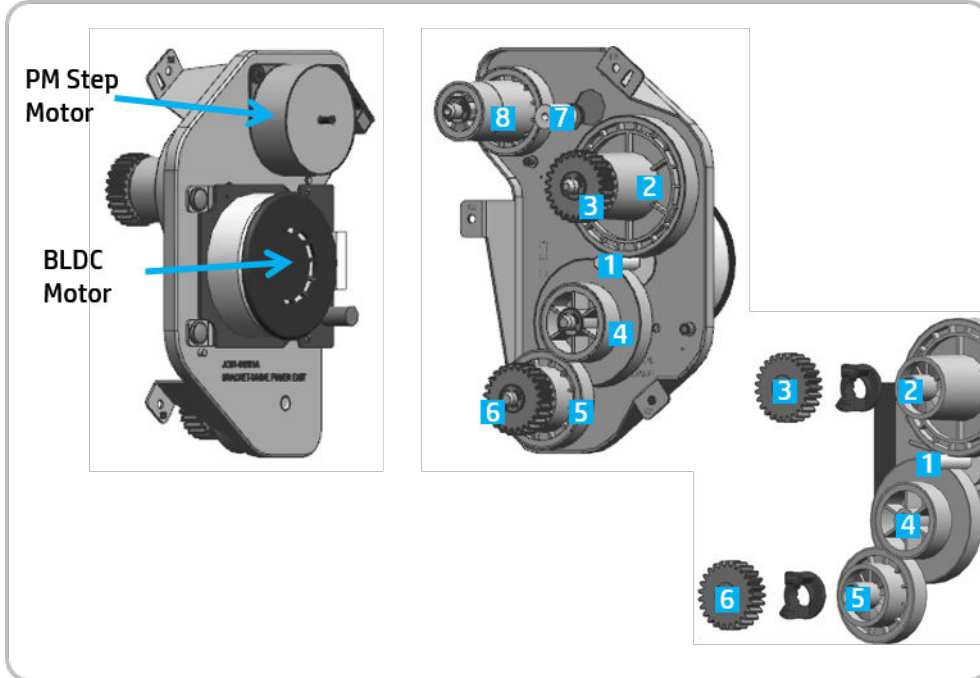

Table 1-30 Fuser/exit drive

<p>Power Train</p>	<ul style="list-style-type: none"> • Fuser/Fuser pressure mode: BLDC motor drive, reverse drive at fuser pressure mode • Exit: Step motor drive, reverse drive at duplex mode • Fuser and fuser release: One way gear is adopted
<ul style="list-style-type: none"> • 1 BLDC motor → rotation → 2 gear → 3 gear (fuser drive) • 1 BLDC motor → counter rotation → 4 gear → 5 gear → 6 gear (fuser pressure mode drive) • 7 PM step → 8 gear (exit drive) 	

Toner collection unit drive

The following diagram shows the drive that power the toner collection unit system:

Figure 1-36 Toner collection unit drive

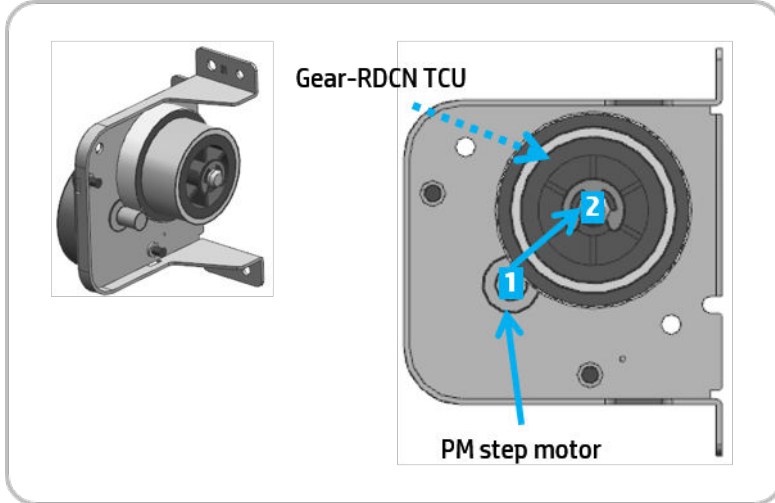

Table 1-31 Toner collection unit drive

Power Train	Step motor and Gear-DCN TCU: Toner collection unit drive
<ul style="list-style-type: none"> 1 PM step motor → 2 gear- TCU (toner collection unit drive) 	

Toner supply drive

The following diagram shows the drive that power the toner supply system:

Figure 1-37 Toner supply drive

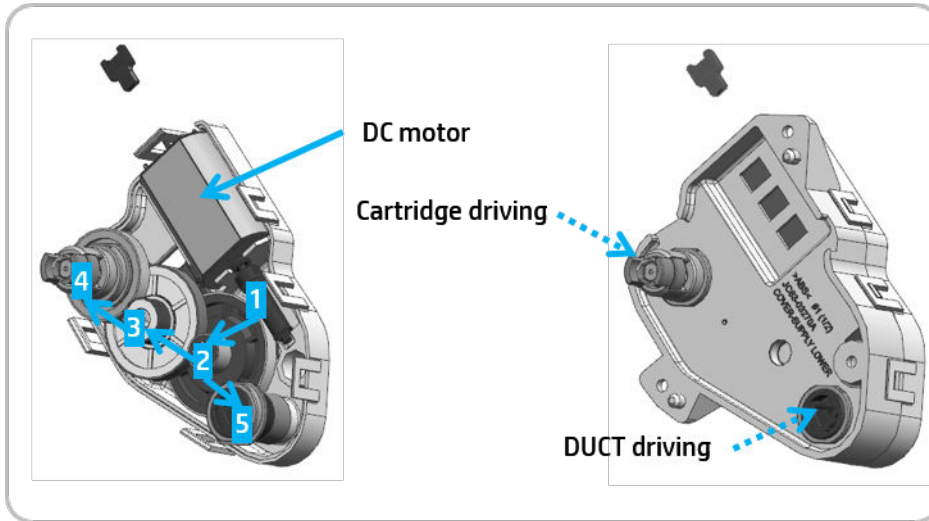

Table 1-32 Toner supply drive

Power Train	DUCT and cartridge drive
<ul style="list-style-type: none"> 1 DC motor → 2 gear supply → 5 gear DUCT (DUCT drive) 1 DC motor → 2 gear supply → 3 gear supply idle → 4 gear supply (cartridge drive) 	

Flatbed scanner system

This section describes the scanner system, parts, and functions

Scanner system overview

The scanner converts images into digital format using an imaging lens and a charge coupled device (CCD). It transfers the converted image to a storage location or sends it to the printer for printing. During a scan operation, the scanner uses the full rate (FR) carriage and the half rate (HR) carriage, both of which are moved by a wire. The HR carriage moves at half the distance and half the speed of the FR carriage. This ensures a regular gap between the original and the imaging lens. The scanner scans the original document on the scanner glass or through the automatic document feeder (ADF).

Scanning system modules

- **Full rate (FR) carriage:** Illuminates the original and reflects the light at a 90° angle.
- **Half rate (HR) carriage:** Transfers the reflected light from the FR carriage to the lens.
- **Imaging module:** Creates the image on the CCD.

Figure 1-38 Scanner system overview

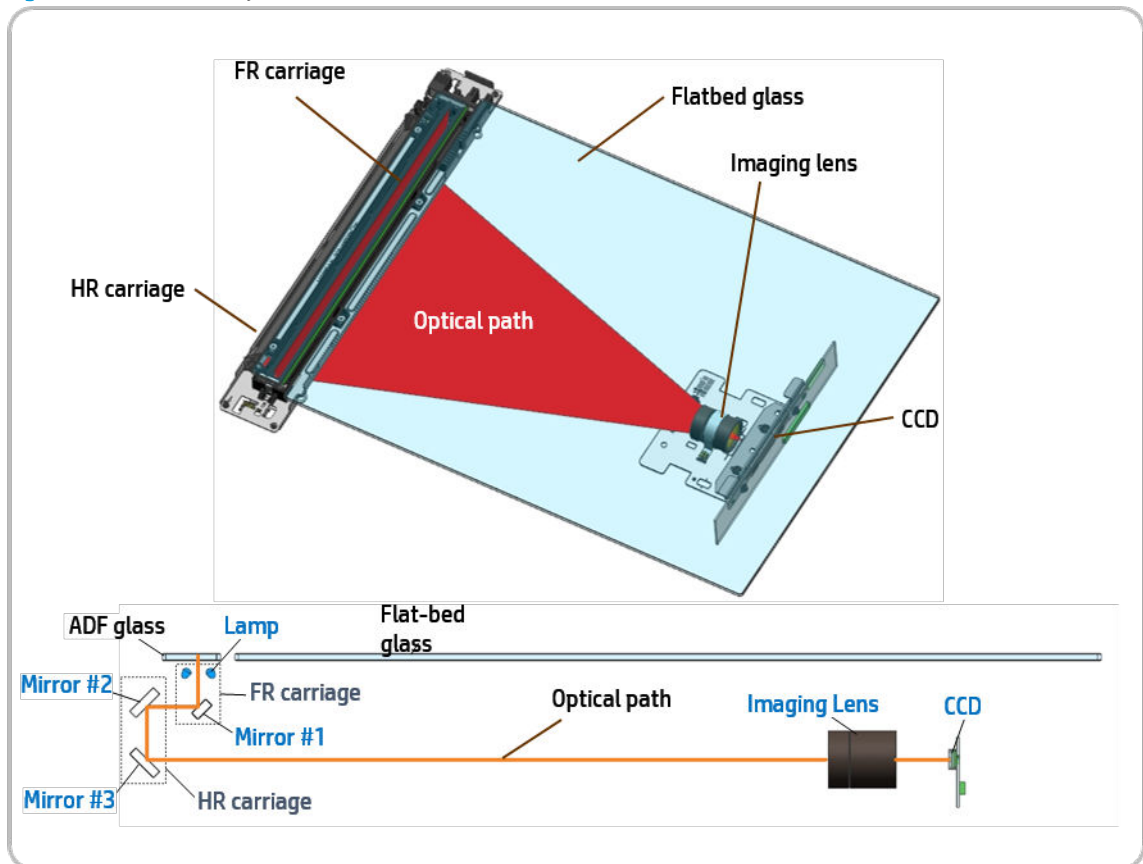

Scanning process

1. The lamp installed on the FR carriage illuminates the original document. The reflected light moves to mirror #1.
2. The reflected light from mirror #1 is sent to the imaging lens through mirrors #2 and #3.
3. The light becomes smaller and creates an optical image.
4. The optical image is converted to an electrical analog signal by the CCD sensor.

Figure 1-39 Scanning process

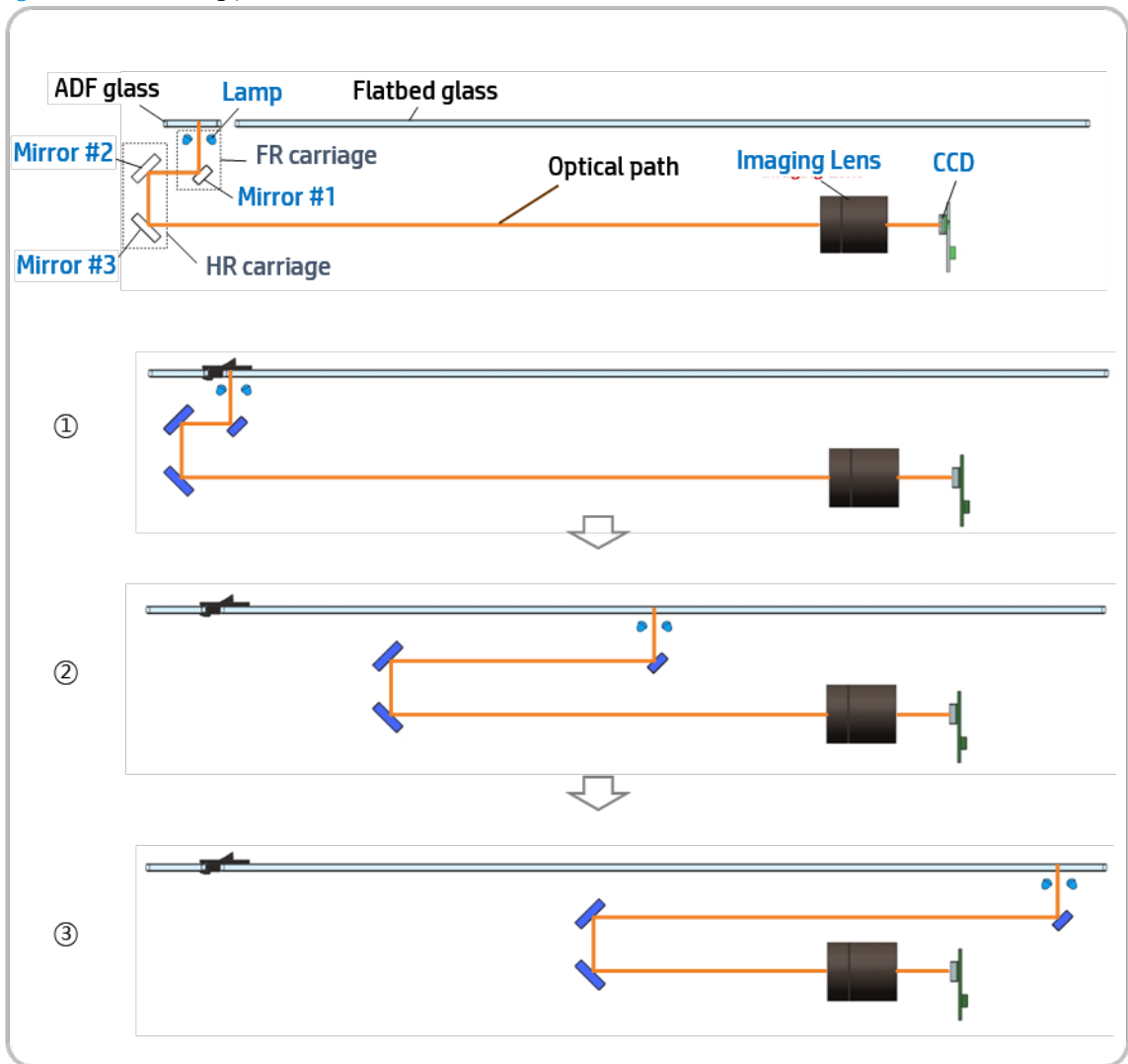

Charge coupled device (CCD) sensor operation

- Each color element signal in the optical image is separated by the CCD sensor into red, green, or blue. The red CCD sensor element extracts the red color from the optical image, the green CCD sensor element

extracts the green color from the optical image, and the blue CCD sensor element extracts the blue color from the optical image. After extraction, each color is converted to an electrical analog signal.

- The A/D converter converts the analog image signal to a digital image signal and transfers it to the processor.
- The CCD sensor performs an image scan in the main scanning direction. The CCD sensor consists of approximately 7,500 pixels. The FR carriage and HR carriage perform image scanning of the sub-scanning direction. These carriages are moved by a wire driven by the scan motor. Scan resolution is 600 dpi.

Figure 1-40 CCD sensor operation

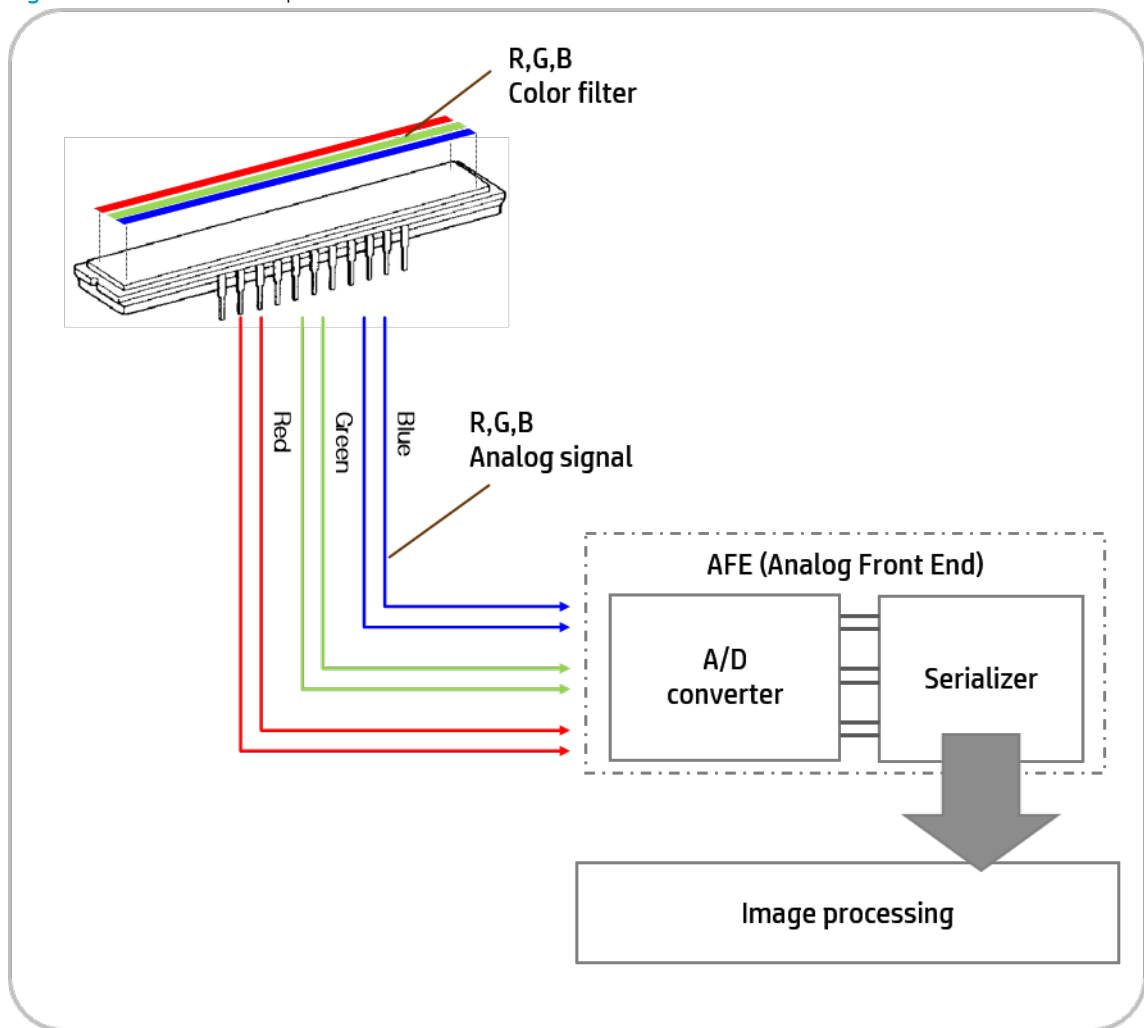

Scanning system components

This section describes the components and purpose of the scanning system.

To scan the original on the scan glass, two carriages, driven by the motor, move at a constant speed. The motor drives the timing belt, wire pulley, and wire. The wire pulley rolls and releases the wire in order to move the carriages.

The scanner consists of the scan glass, FR carriage, HR carriage, imaging unit, and driving unit.

Figure 1-41 Scanning system components

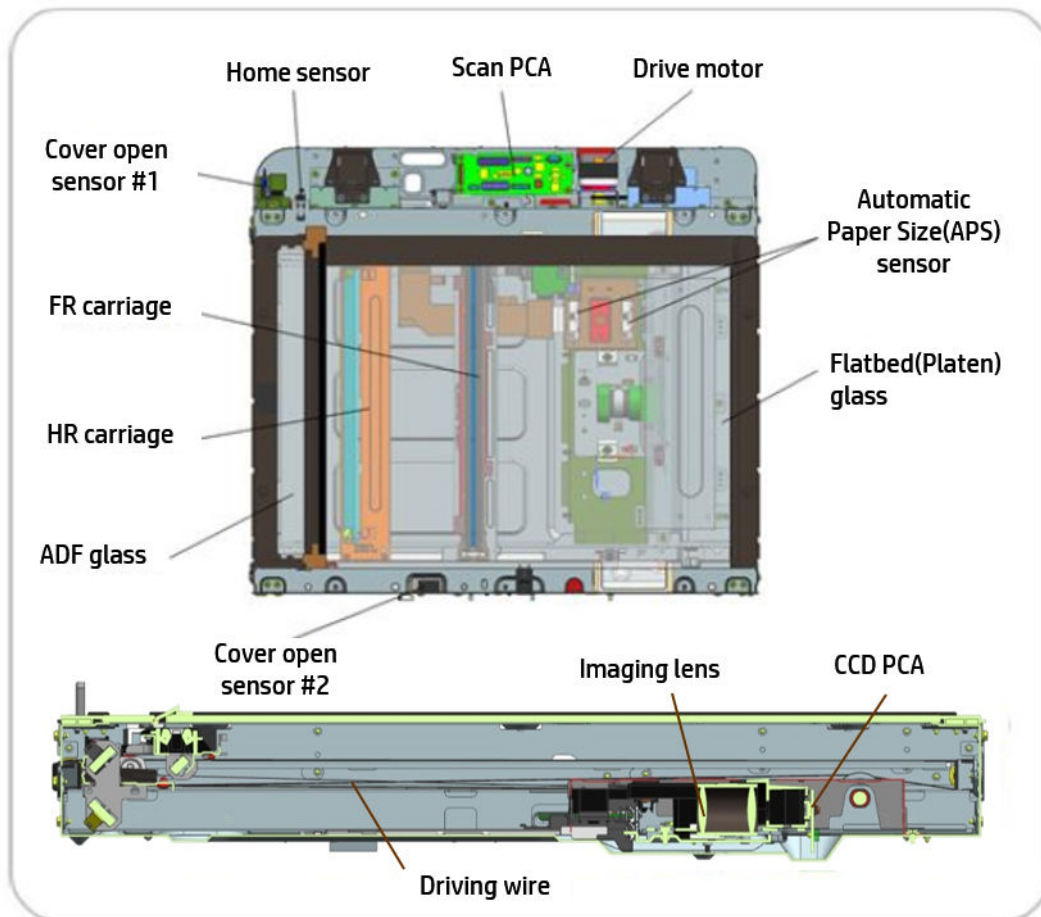

Full rate (FR) carriage components

1. **LED lamp module:** This module illuminates the light on the original document. Two white LEDs are attached to the side of the module. The light guide illuminates the original document. The head sink is attached to the LED PCB. When the heat sink is broke or it's life has expired, it must be replaced by an authorized service provider.

- **White LED:** This component transforms the light from a point to a line. It is composed of transparent resin and uniformly controls the amount of light in the scan area.
 - **Light guide:** This component emits white light. The heat sink attached to the PBA prevents heat deterioration.
 - **Reflection holder:** This component reflects the light through the light guide.
2. **Mirror #1:** This component changes the direction of reflected light at a 90° angle.

Figure 1-42 FR carriage components

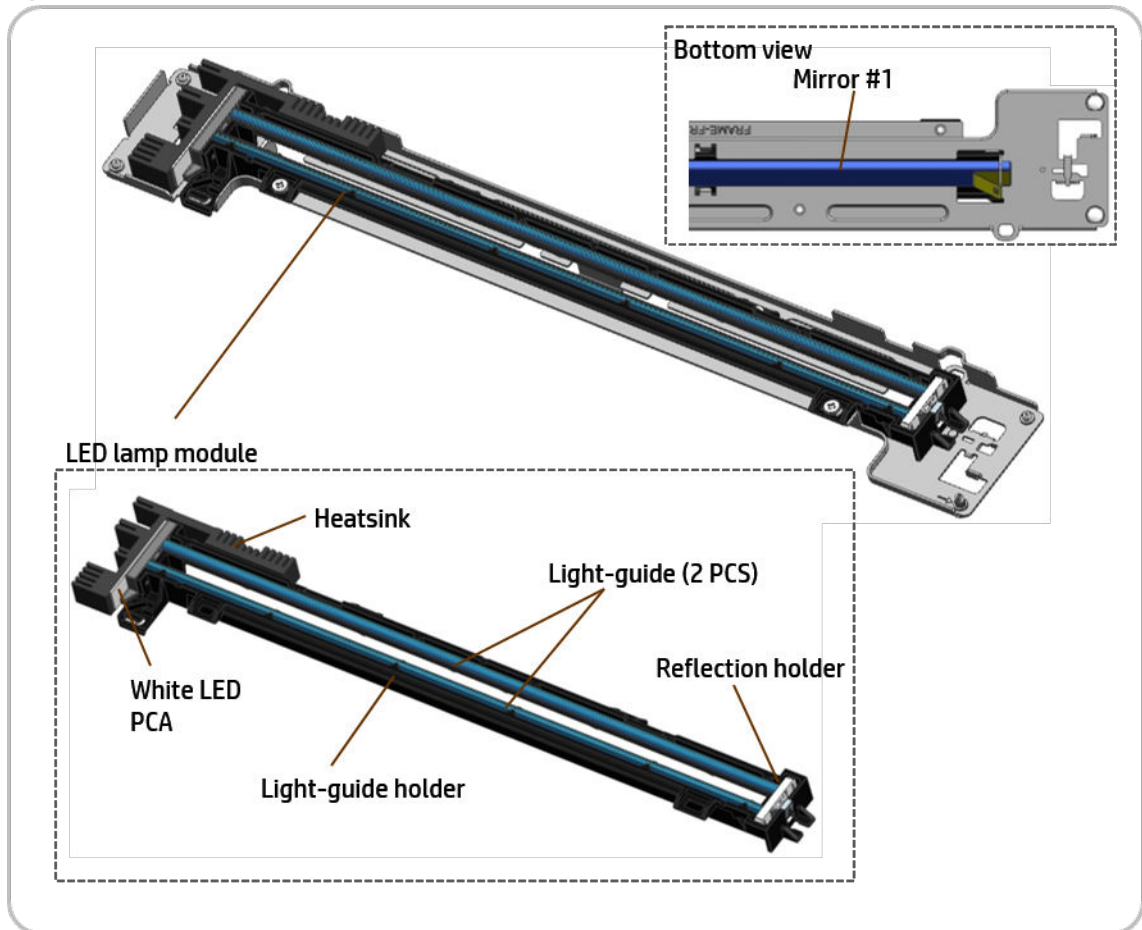

Half rate (HR) carriage (mirror unit) components

1. **Mirrors #2 and #3:** In order to change the direction of the light, mirrors #2 and #3 are assembled at a 45° angle. The reflected light from mirror #1 is sent to the imaging lens through mirrors #2 and #3.
2. **Pulley:** The pulley is a ball bearing design that rolls and releases the wire. This causes the HR carriage to move half the distance of the FR carriage.

Figure 1-43 HR carriage components

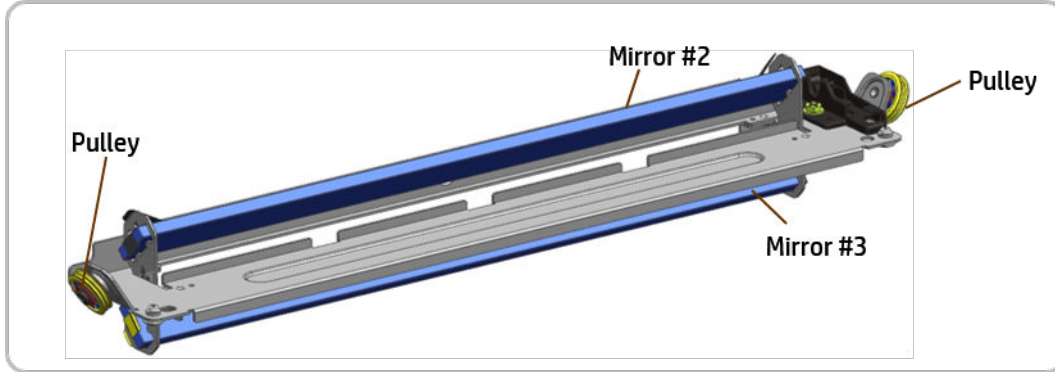

Imaging unit components

1. **Imaging lens:** The reflected light through the imaging lens is focused on the CCD. The image reduces to fit the CCD sensor and pixel size.
2. **CCD PCA:** The image created by the lens is converted to an electrical signal by the CCD, which consists of three sensors for color image creation. The brightness and darkness of the image is converted to the a voltage level from the CCD. The output voltage is converted to a digital signal. The digital signal creates the scanned image through the image process.

Figure 1-44 Imaging unit components

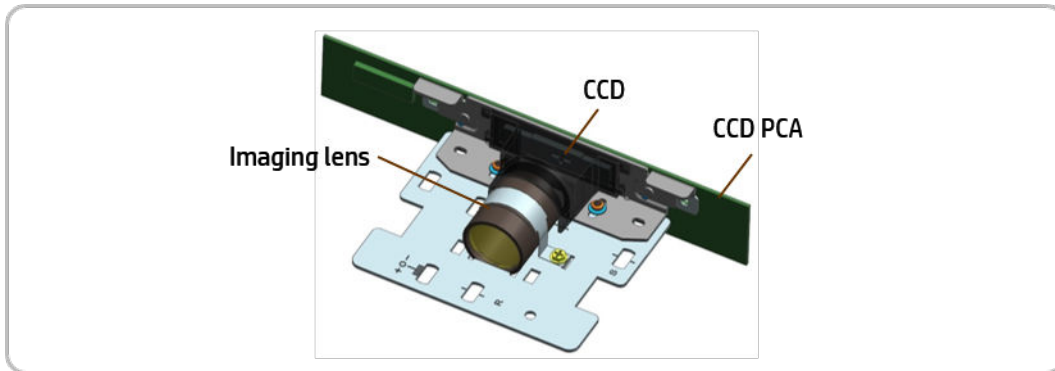

Driving wire

In order to move the carriage in a stable manner, the wire is assembled in the front and rear portions of the scanner. The pulley rolls and releases the wire in order to move the FR and HR carriages.

Figure 1-45 Wire driving

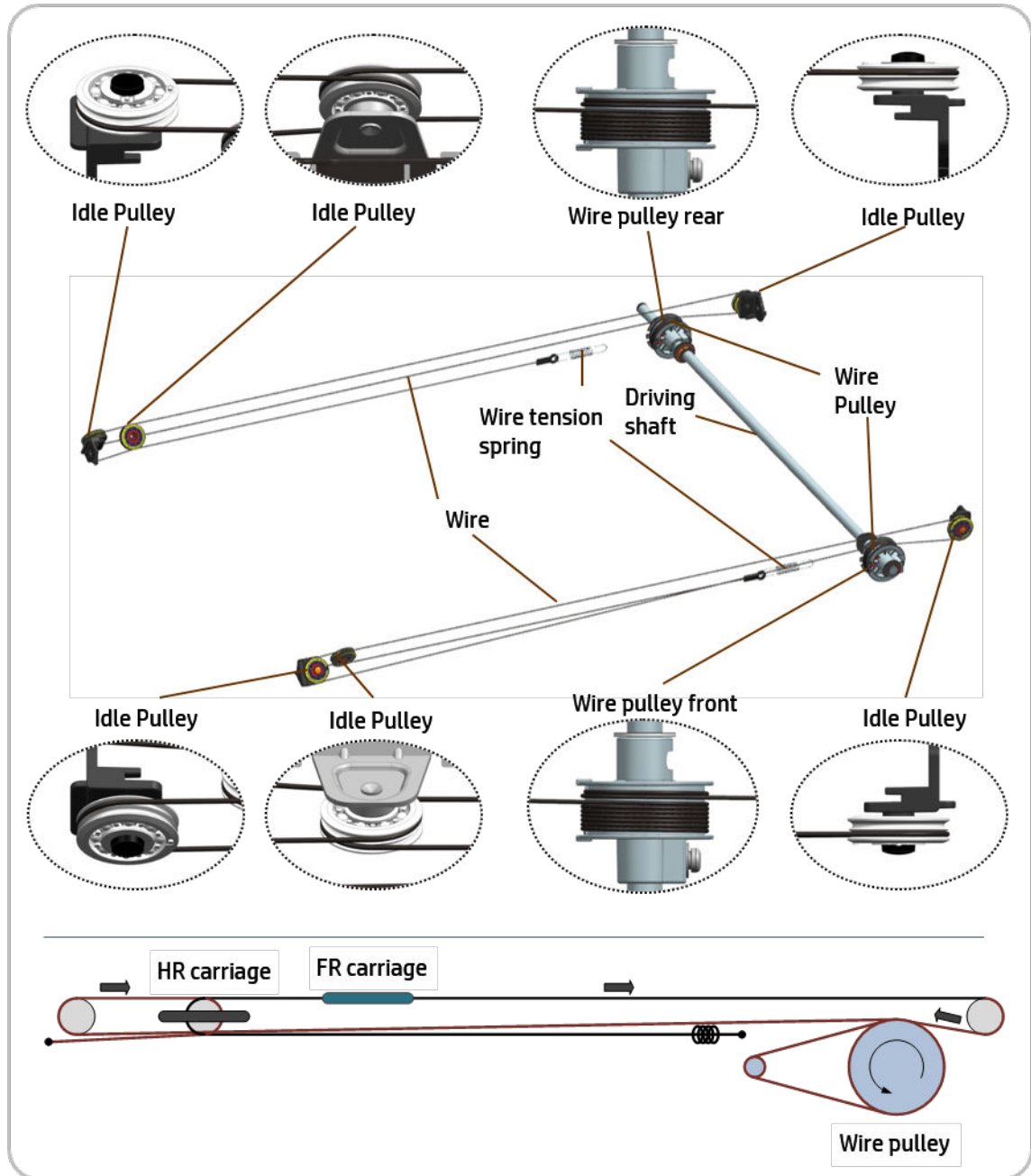

Flatbed(Platen) glass

The original is placed on the flatbed glass for scanning or copying. The glass is tempered and attached to the frame to prevent distortion.

Drive motor

The scanner drive system uses the drive motor to move the carriages. It controls the position and constant speed of the carriages. The motor power is transferred to the wire through the timing belt and pulley.

Timing belt

The timing belt is the standard sawtooth design and transfers the motor power to the pulley.

Figure 1-46 Timing belt

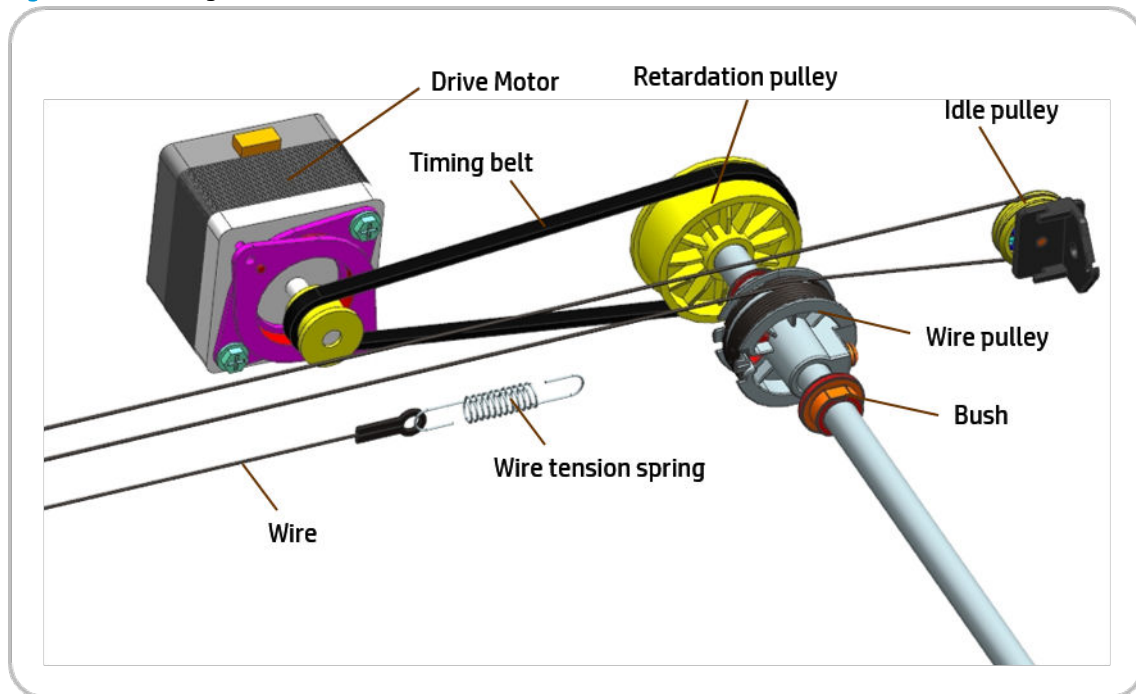

Automatic Paper Size(APS) sensor

The paper size sensor detects the paper size on the scan glass automatically. It contains two sensors and uses an infrared LED to detect dark originals.

Home sensor

The home sensor is a transmission photosensor and detects the FR carriage position.

Cover open sensor #1

When the ADF is opened and closed, this sensor is triggered to detect whether the paper size sensor is on or off. This sensor also detects the width of the original.

Cover open sensor #2

This is a reed switch that uses magnetic force to detect if the ADF unit is closed.

ADF glass

The ADF glass scans the originals fed through the ADF unit. When the original passes on over this glass, the FR carriage reads the original. If this glass is contaminated, horizontal black lines or white lines might be visible on the scanned copies.

Shading sheet

This sheet allows the scan module to detect the base for white color. Before every scan job, the scan module reads the shading sheet in order to scan the image at the same color and brightness. If the shading sheet is contaminated, a vertical line might be visible on the scanned copies.

Figure 1-47 Shading sheet

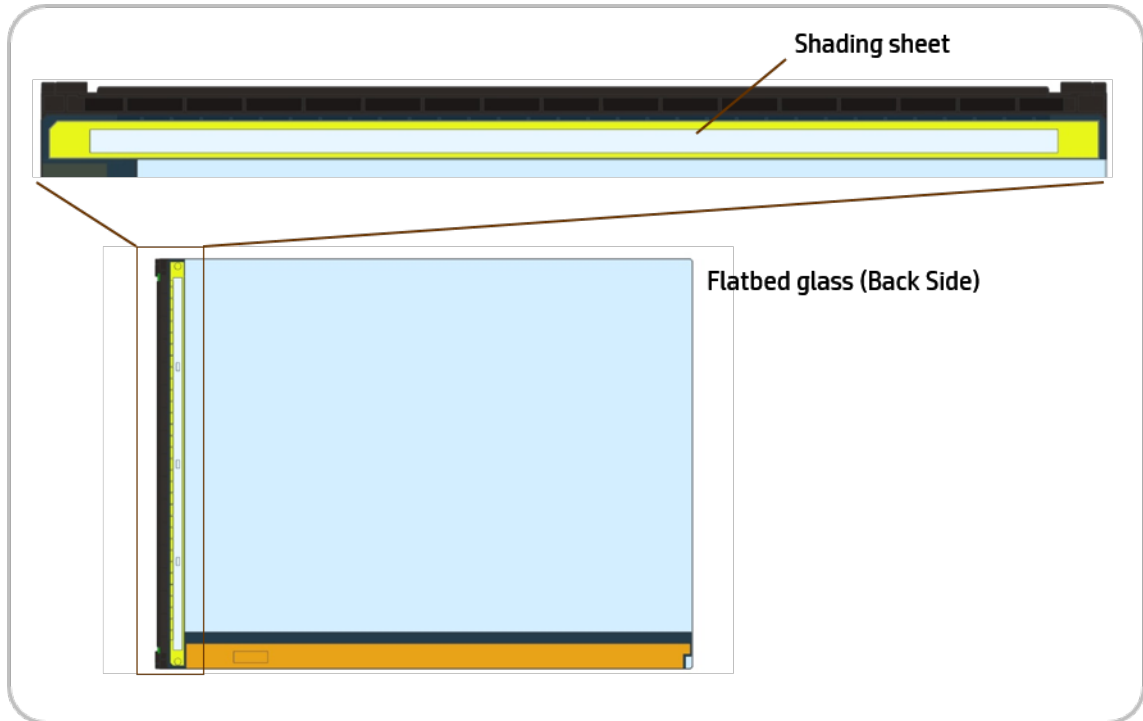

Precautions for unpacking and moving the scanner

When shipping or moving the printer, the FR and HR carriages in the scanner must be secured with a scan locking screw to prevent movement of these parts and possible damage to the scanner. This screw must be installed before moving the printer and then removed once the printer is positioned in place.

Remove the scan locking screw when installing the printer

1. Locate and remove the scan locking screw.



IMPORTANT: Failure to remove the scan lock screw will cause a scanner failure.

Figure 1-48 Remove the scan locking screw



2. After removing the screw, install the screw cap from the accessory package.

Installing the scan locking screw before moving the printer

1. Verify that the FR carriage is located in the home position.
2. Remove the screw cap.
3. Install the scan locking screw to secure the FR carriage.

 **IMPORTANT:** Failure to install the scan lock screw might cause damage to the scanner when the printer is moved or shipped.

Figure 1-49 Install the scan locking screw



Automatic document feeder (ADF)

This section contains details about the automatic document feeder (ADF) system.

Automatic document feeder (ADF) overview

Figure 1-50 Document feeder overview

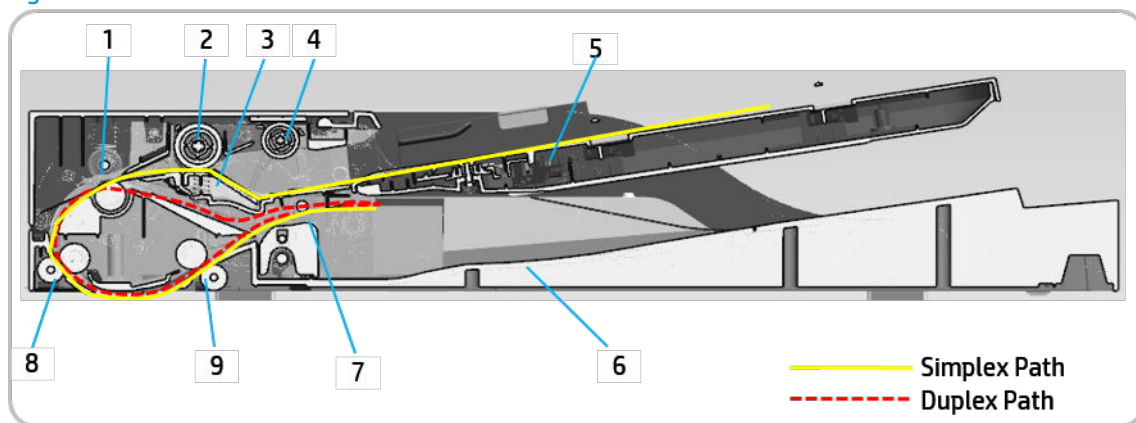

Callout	Part	Function
1	Simplex and duplex registration roller	Aligns the leading edge of the paper for registration.
2	Document feeder forward roller	Separates an original from the tray and transfers it to the paper path.
3	Document feeder friction pad	Prevents multi-feeds.
4	Document feeder pickup roller	Picks up an original from the tray.
5	Original document tray	Paper input tray
6	Exit tray	Paper output tray
7	Exit roller	Sends an original to the exit tray and forms the duplex reverse path.
8	Feed in roller	Feeds an original before scanning.
9	Feed out roller	Transfers a scanned original to the exit roller.

Electrical parts location

Figure 1-51 ADF electrical parts location

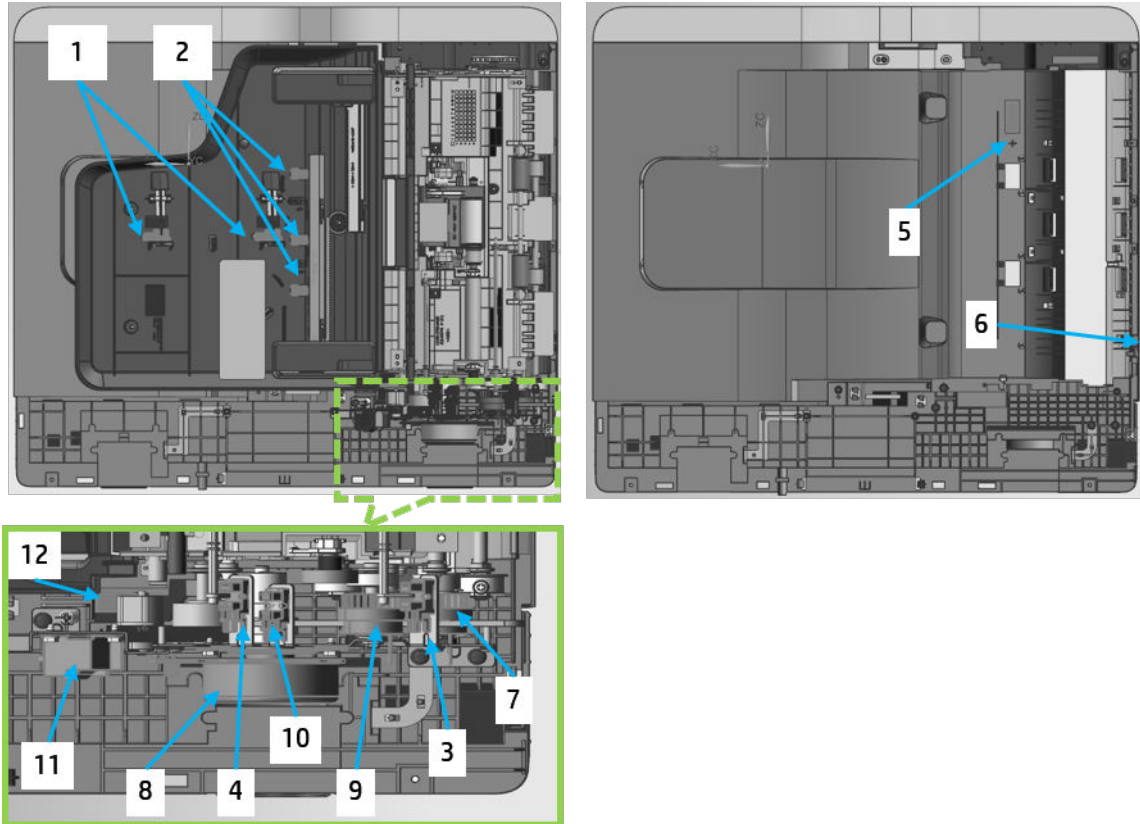

Table 1-33 ADF electrical parts

Callout	Description	Part code	Controller board
1	Photo-interrupter (Original length sensor)	0604-001393	PCA, ADF
2	Photo-interrupter (Original width sensor)	0604-001393	PCA, ADF
3	Photo-interrupter (Original registration sensor)	0604-001393	PCA, ADF
4	Photo-interrupter (Original existence detection Sensor)	0604-001393	PCA, ADF
5	Photo-interrupter (Original exit sensor)	0604-001393	PCA, ADF
6	Photo-interrupter (Scan sensor)	0604-001393	PCA, ADF
7	Clutch-electric (Registration clutch)	JC47-00033G	PCA, ADF
8	BLDC motor	JC31-00156A	PCA, ADF
9	Clutch-electric (Pickup clutch)	JC47-00033G	PCA, ADF
10	Photo-interrupter (Cover open/Close sensor)	0604-001393	PCA, ADF
11	Solenoid-pick up (Exit roller solenoid)	JC33-00007A	PCA, ADF
12	Photo-interrupter (Holder exit idle disengage/Engage sensor)	0604-001393	PCA, ADF

Automatic document feeder drive system

Automatic document feeder(ADF) drive system overview

The ADF consists of one motor and two clutches for paper transfer.

Figure 1-52 Document feeder drive system

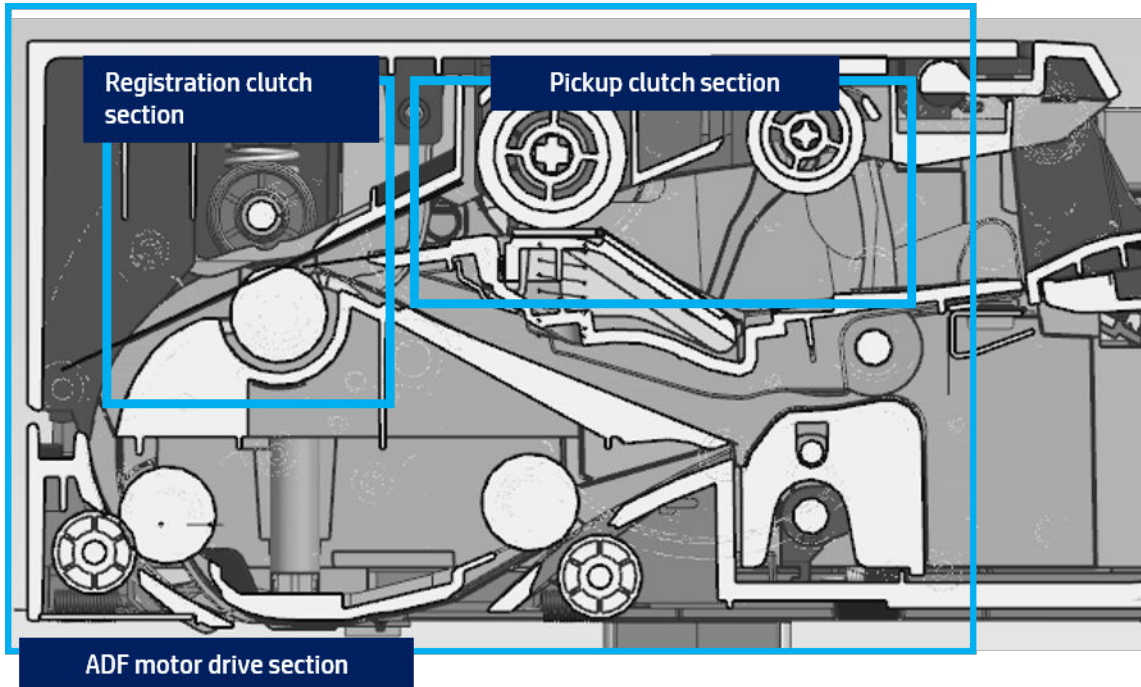

- A BLDC motor drives the system for simplex and duplex jobs.
- The pickup and registration clutch controls the drive power.
- The cam type gear and solenoid is used for duplex reverse.

Automatic document feeder(ADF) original pickup assembly

Figure 1-53 Automatic document feeder(ADF) original pickup assembly

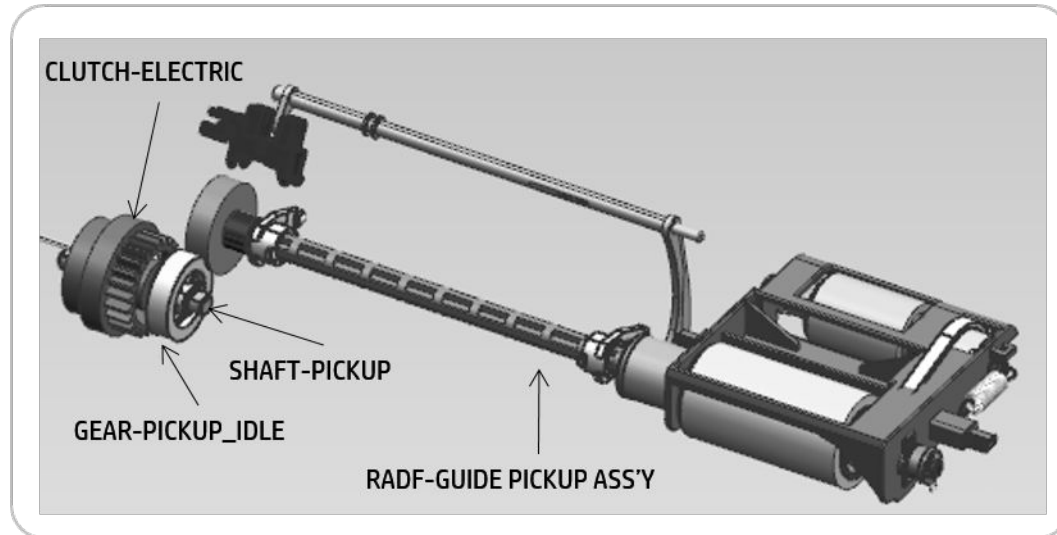

After detecting the paper, one motor controls the entire drive system.

The electric clutch provides the power to pick up the paper.

When the clutch stops rotating, the printer goes into standby mode in order to fix the problem.

The document feeder roller and pick-up roller are connected by the belt.

The ADF roller provides power when the paper is picked up and transferred to the registration roller. When the pickup drive is stopped and the registration roller is driven, the ADF roller becomes idle.

The normal process is:

- When the original is set up, the detect-sensor activates and starts the print job. The motor and pick-up clutch work and the pick-up roller moves down to contact an original in the tray.
- When the registration sensor detects the paper, the pickup clutch stops.
- When the detect-sensor detects that the tray is empty, the motor stops and the printer enters stand-by status.

Automatic document feeder(ADF) registration drive assembly

Figure 1-54 Automatic document feeder(ADF) registration drive assembly

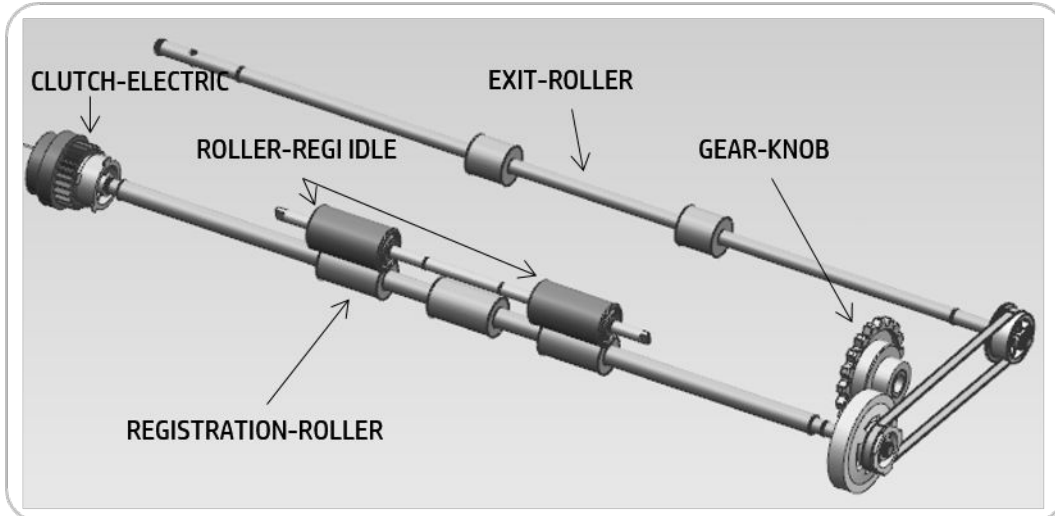

The registration drive uses the electric clutch to drive the registration roller, and transfers the original to the feed roller.

The registration roller aligns the leading edge of the original. When an original is placed in the nip, the roller is rotated for alignment.

The electric clutch repeats powering on and off to align each page.

Automatic document feeder(ADF) feed drive assembly

Figure 1-55 Automatic document feeder(ADF) feed drive assembly

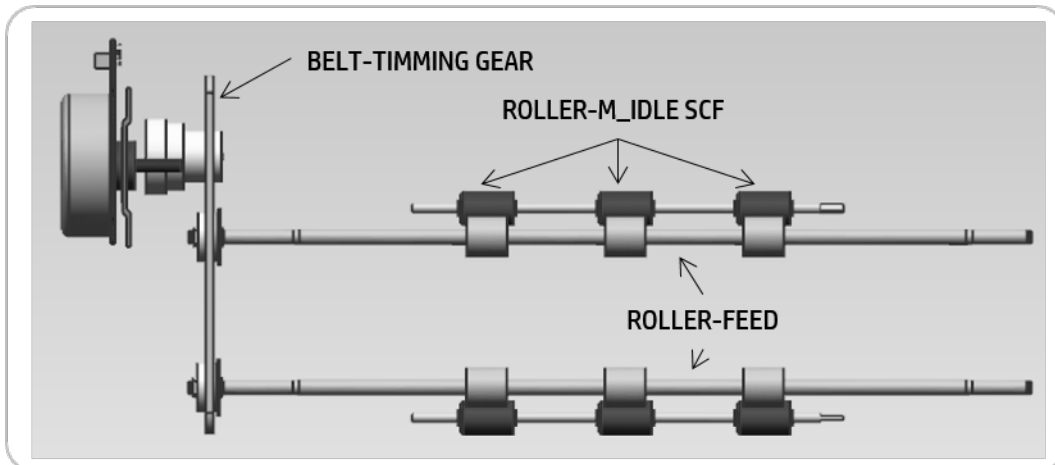

The feed roller is driven by the gears and belt-timing gear that are connected to the motor.

The feed roller and idle roller feed paper using spring pressure.

The motor transfers paper between the input feed roller and the output feed roller. When scanning, the motor is driven continually to maintain stable paper transfer.

Automatic document feeder(ADF) exit drive assembly

Figure 1-56 Automatic document feeder(ADF) exit drive assembly

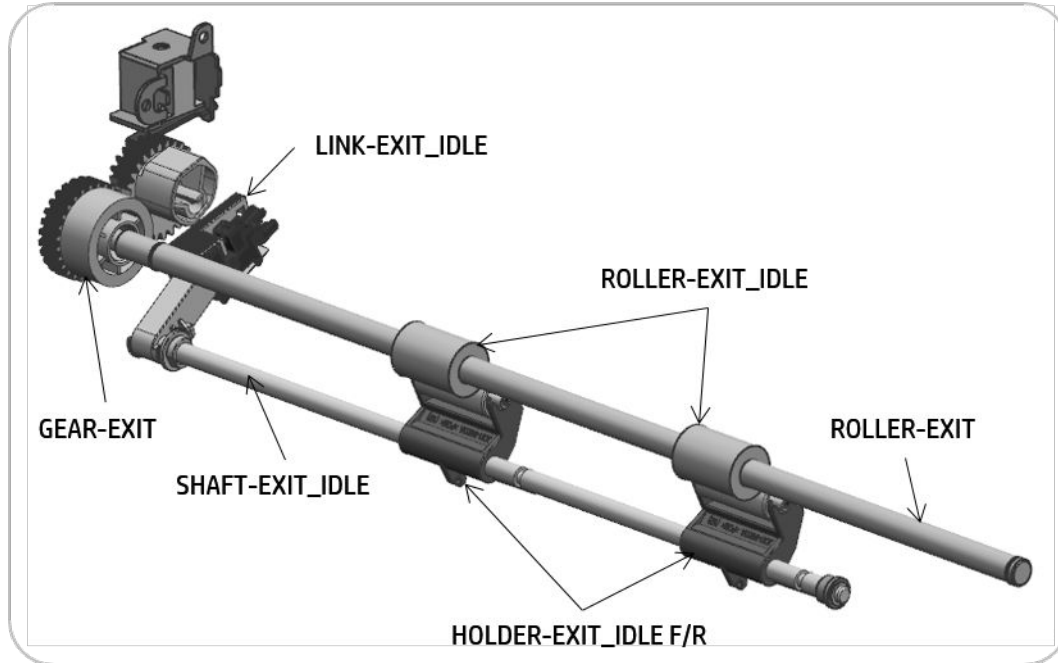

The power from the motor is transferred to the exit gear and exit roller to transfer the original to the exit tray. When in duplex mode, counterrotation occurs.

The roller-exit_idle spring keeps pressure on the exit roller. During duplexing, the roller-exit_idle spring is rotated in reverse to make space between the rollers and prevent jams.

The space between rollers is adjusted by link-exit_idle spring.

Automatic document feeder(ADF) original return drive assembly

Figure 1-57 Automatic document feeder(ADF) original return drive assembly

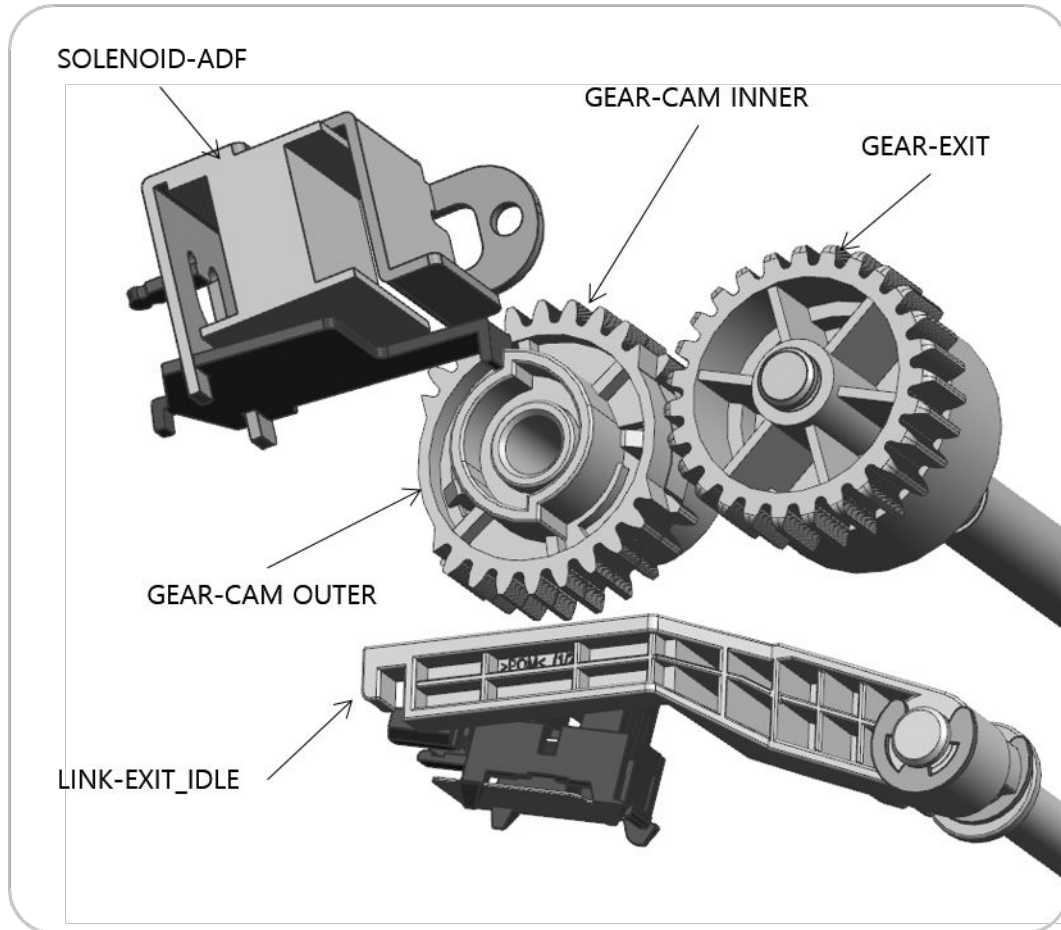

The solenoid works only during duplex mode.

During duplex mode, the motor rotates in reverse and the solenoid powers the gear-cam outer and gear-exit.

When the gear-exit rotates, the solenoid drives the gear-cam outer and gear-cam inner which makes space between the roller-exit and the idle roller.

Hardware configuration

The electronic circuit system consists of the following:

Figure 1-58 Electronic circuit diagram

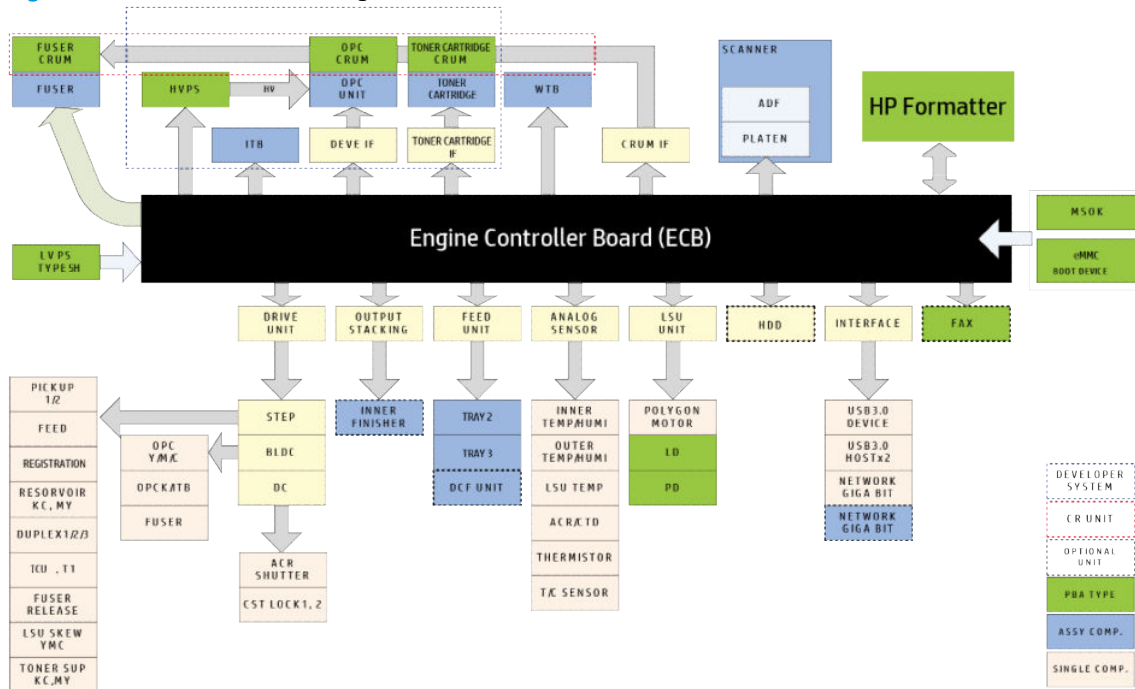

The engine controller board (ECB) handles the video controller, engine controller, and scan controller.

The engine controller board (ECB) receives print data from the host through the network or USB port and receives copy data from the scan controller. The engine controller board (ECB) uses this information to generate printable video bitmap data. It controls all modules required to print, including the laser scanner assembly, HVPS, FAN, fuser, and so on.

The engine controller board (ECB) communicates with the drive system and other devices through universal asynchronous receiver transmitter (UART). The engine controller board (ECB) communicates with and checks the life of the toner cartridge, drum, and developer units through I2C.

The engine controller board (ECB) uses Quad core CPU 1.5 GHz, DDR3 3 GB memory, eMMC 16 GB, and a 500 GB SATA HDD to control the engine drive, video signal processing, and user interface.

The HVPS board generates and controls high-voltage channels. The fuser drive assembly controls power to the fuser lamp. The LVPS (SMPS) board generates 5 V and 24 V power for the system.

Engine controller board (ECB)

The engine controller board (ECB) consists of the main processor (A3000), memory (DDR3 3GB), eMMC (16GB on board), 1G Ethernet PHY, USB 2.0 HUB fan/video/UI/fax signal interface connection, motor drive IC, engine signal interface connection, and power interface.

The main processor (Quad Core 1.5GHz CPU) controls video, engine, UI display, and communicates with various devices.

Figure 1-59 Hardware controller architecture

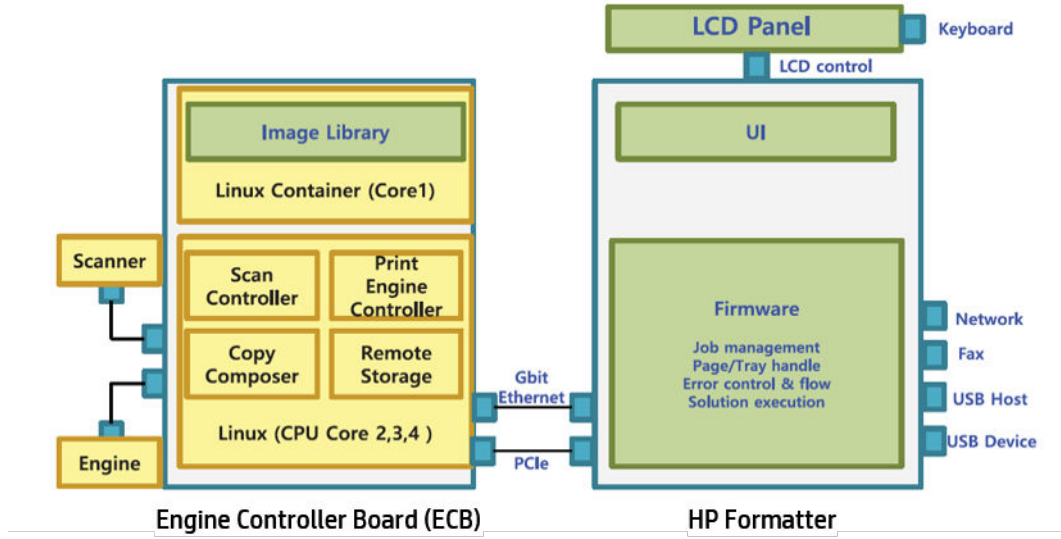
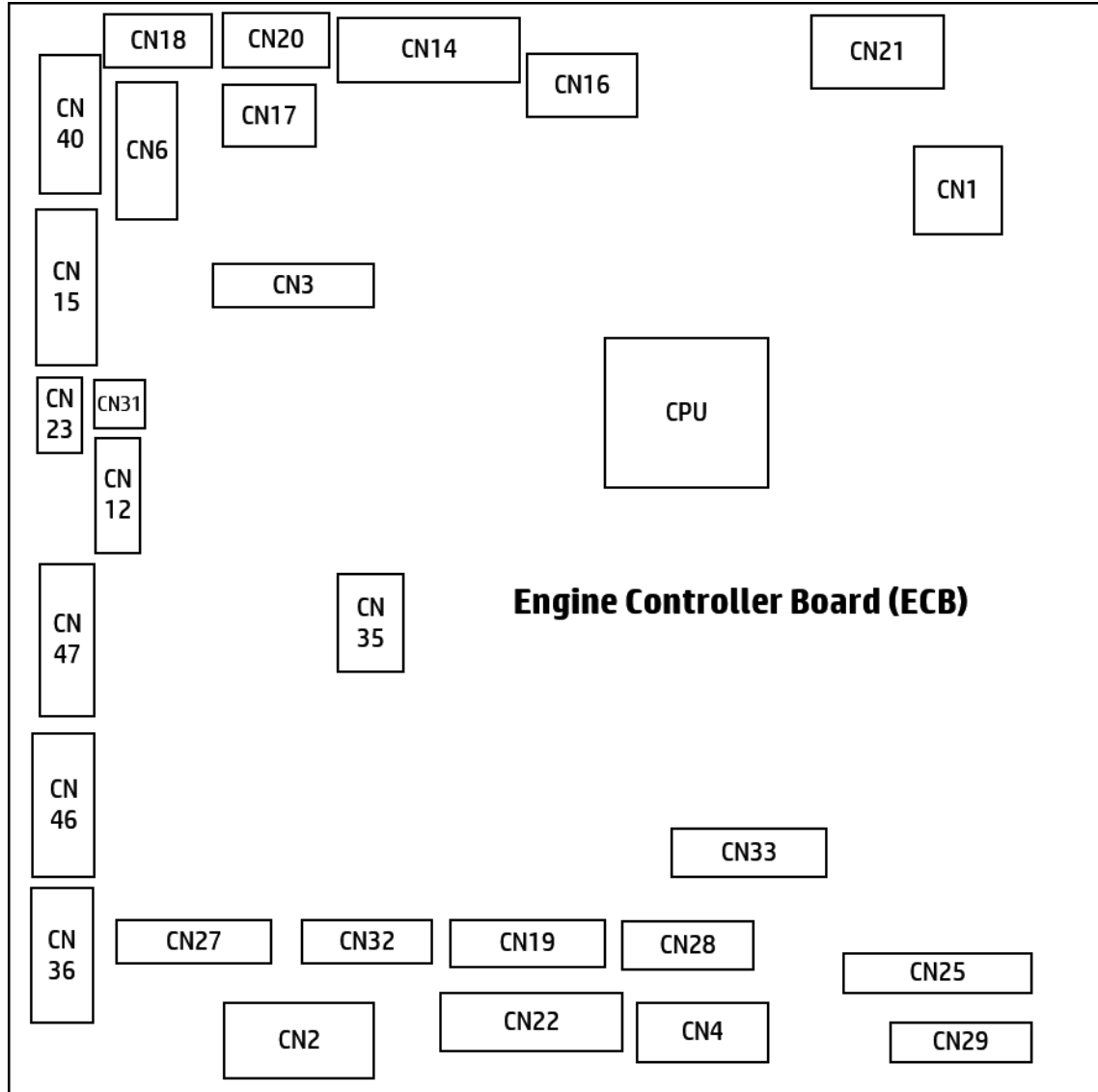

Figure 1-60 Main controller connections



- Connection

Table 1-34 Main controller connections

No	Connection
CN1	LAN interface (to formatter)
CN2	Power interface (LVPS)
CN3	Scanner interface
CN4	Fuser drive board(FDB) interface
CN6	Exit assembly
CN12	ID sensor
CN14	Image scanner CCDM
CN15	Toner interface

Table 1-34 Main controller connections (continued)

No	Connection
CN16	PCIe interface (to formatter)
CN17	Signal interface(to formatter)
CN18	SATA power
CN19	OPC sensor
CN20	SATA signal
CN21	24V scan power
CN22	OPC motor
CN23	ACR sensor shutter
CN25	HVPS
CN27	Dual cassette feeder interface
CN28	Finisher
CN29	Laser scanner assembly (LSU)
CN31	Humidity sensor
CN32	Front assembly
CN33	HVPS power/ LSU shutter/ Skew motor
CN35	MSOK interface
CN36	Right door
CN40	Fuser unit
CN46	Pickup unit
CN47	Paper handling drive unit

- **Information**

- Part Code
 - 3BE77-67001 (For E77422, E77428)
 - 8GS44-60001 (For E78223, E78228)
- Part Name : Engine Contorller Board (ECB)

Master system operation key (MSOK board)

The MSOK board is used to store all system information, and consists of serial flash memory, an EEPROM and an A-CRUM. The EEPROM (256 kb), and A-CRUM are used for all system operations (system parameter, device status, tech information, and service information).

 **NOTE:** When a main board needs to be replaced, the MSOK board must be reinstalled to the new main board to retain the system information.

Figure 1-61 MSOK board

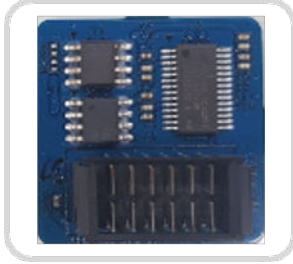

Formatter

Figure 1-62 Formatter connections

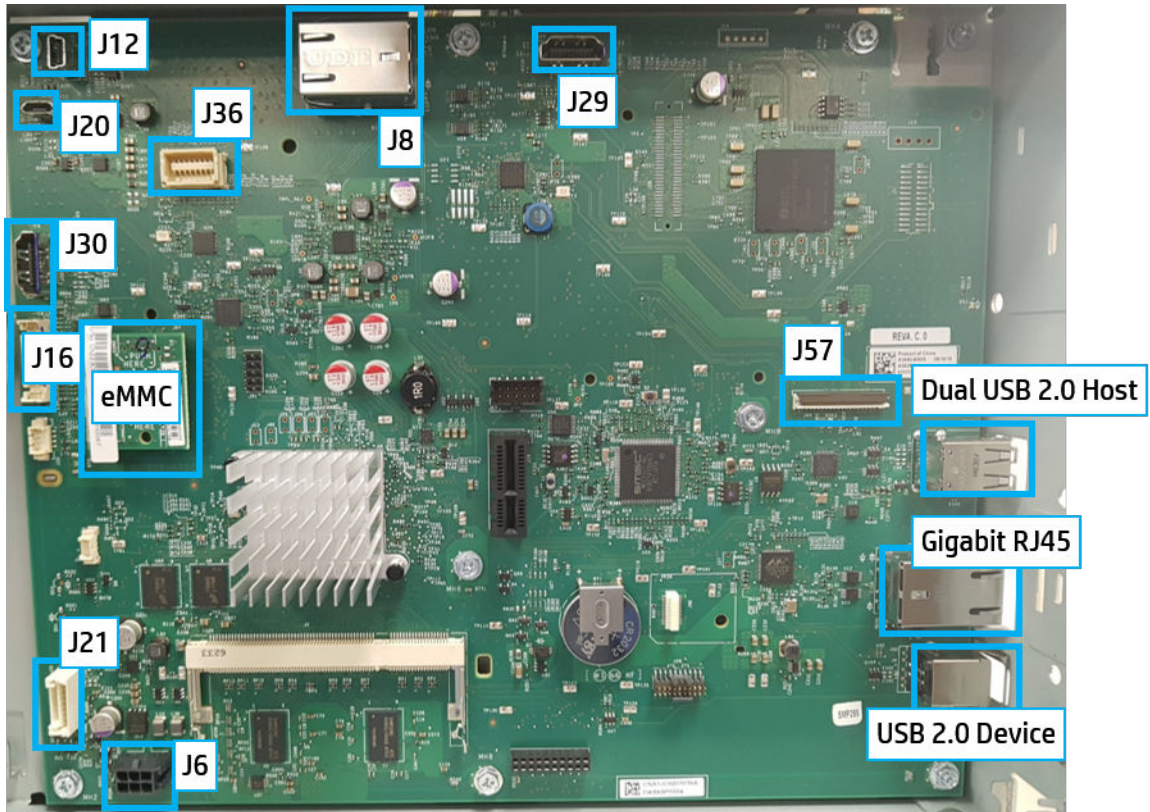

Table 1-35 Formatter connections

Cable	Jxx	From	To	Purpose
Engine HDMI	J29	Engine controller board (ECB)	Formatter	High speed print data (JC39-02552A)
Engine LAN	J8	Engine controller board (ECB)	Formatter	High speed print data (JC39-02567A)
Engine control	J36	Engine controller board (ECB)	Formatter	Low level engine control (JC39-02553A)

Table 1-35 Formatter connections (continued)

Cable	Jxx	From	To	Purpose
HIP2 USB	J12	Formatter	HIP	USB for HIP
Front walk-up USB	J20		Front of printer	USB for walk up
CP HDMI	J30		CP	Data to CP
				These three cables are wrapped together JC39-02554A
CP side band	J16	Formatter	CP	Power, reset, wake-lines, display power, keyboard. 3 cable assembly <ul style="list-style-type: none"> JC39-02705A (a,dv models only) JC39-02557A (dn models only)
Power button	J16	Formatter	Power button	Power ON/OFF
IOD	J16	Formatter	IOD	Data to/from island of data
Internal USB/AA	J21	Formatter	Accessory	Accessory
Engine power	J6	LVPS	Formatter	5V supply to formatter
STMS	J57	Formatter	STMS	Data to/from smart transducer monitoring system (STMS) (JC39-02594A)

Low voltage power supply (LVPS; Type 5H) / Switching mode power supply (SMPS)

The low voltage power supply (LVPS-SMPS) Type 5H PCA supplies electric power to the main PCA and other boards.

The voltage provided includes +5V, and +24V from a 110V/220V power input. It has safety protection modes for over current and overload.

Figure 1-63 LVPS (SMPS) Type 5H PCA

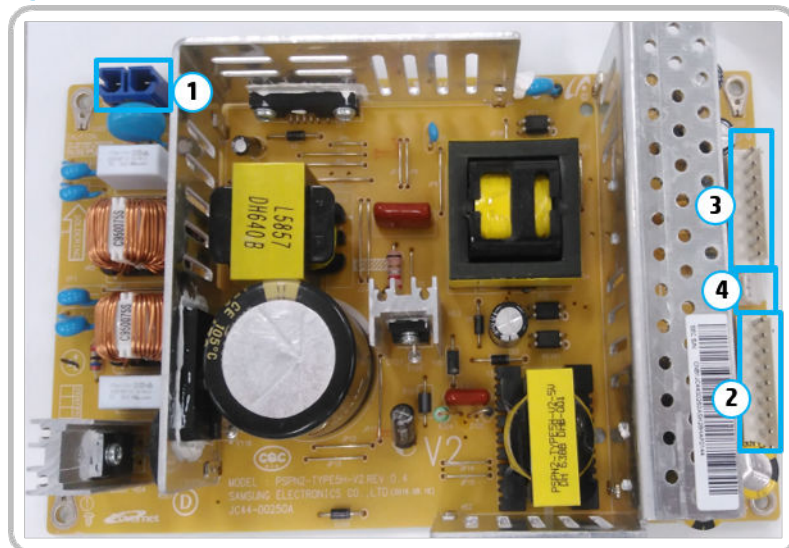

- **Specification**
General input/ Output voltage

- AC 110V (90V-135V)
- AC 220V (180V-270V)
- Input current: 13.7A (110V)/6.8A (220V)
- Output power: 1500W
 - DC 5V: 55W/DC 5VS: 30W/DC 24V: 432W

- **Information**

Table 1-36 LVPS part number

	110V	220V
Part number	JC44-00249A	JC44-00250A
Part name	LVPS 110V type 5H	LVPS 220V type 5H

- **Input / Output connector**

- **AC input connector (CN1)**

PIN Assign	PIN NO	Description
1	AC_L	AC input
2	AC_N	

- **DC input connector (CN2)**

PIN Assign	PIN Name	Description
1	+5V1	Power
2	GND	5V ground
3	+5V2	Power
4	GND	5V ground
5	+5V3	Power
6	GND	5V ground
7	+5V4	Power
8	GND	5V ground
9	+5V5	Power

- **DC input connector (CN3)**

PIN Assign	PIN Name	Description
1	+24V1	Power
2	GND	24V ground
3	+24V2	Power
4	GND	24V ground

PIN Assign	PIN Name	Description
5	+24V3	Power
6	GND	24V ground
7	+24V4	Power
8	GND	5V ground

– Signal connector (CN4)

PIN Assign	PIN Name	Description
1	GND	
2	24VOn_Off	Active low
3	GND	

Fuser drive board (FDB)

This PCA supplies voltage to the fuser AC, heater, and main PCA.

Fuser drive board (FDB)

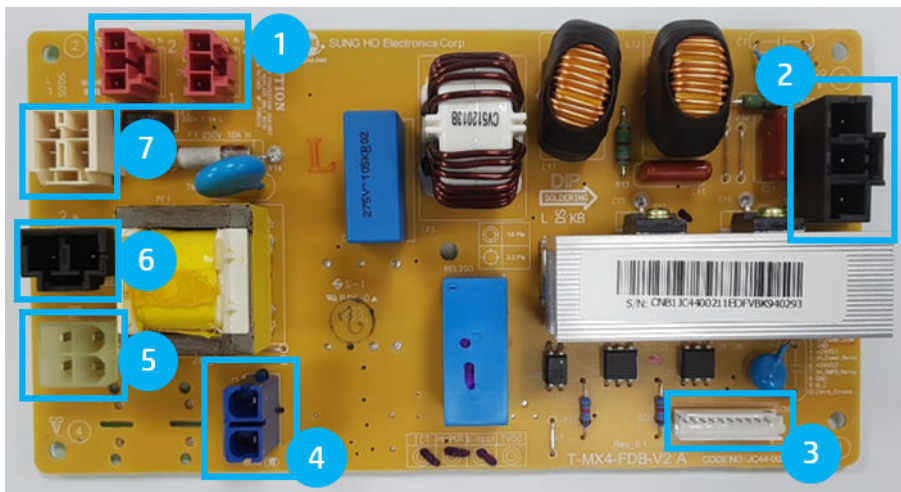

- Information

Table 1-37 Part Information

Part number	Description	Remark
JC44-00210E	FDB V1 (110V)	For E77422, E77428
JC44-00211E	FDB V2 (220V)	For E77422, E77428
8GR94-60001	FDB V1 (110V)	For E78223, E78228
8GR94-60002	FDB V2 (220V)	For E78223, E78228

- Connection

Table 1-38 Fuser drive board connection

No	Connection
1	Heater I/F
2	Fuser AC
3	Fuser drive PCA I/F
4	LVPS Type 5H
5	Main switch
6	Inlet
7	Heater switch

High-voltage power supply (HVPS) PCA

The HVPS PCA generates 15 high-voltage channels, including SAW, DEV AC/DC, 1T, 2T+/-, and MHV.

Figure 1-64 HVPS PCA

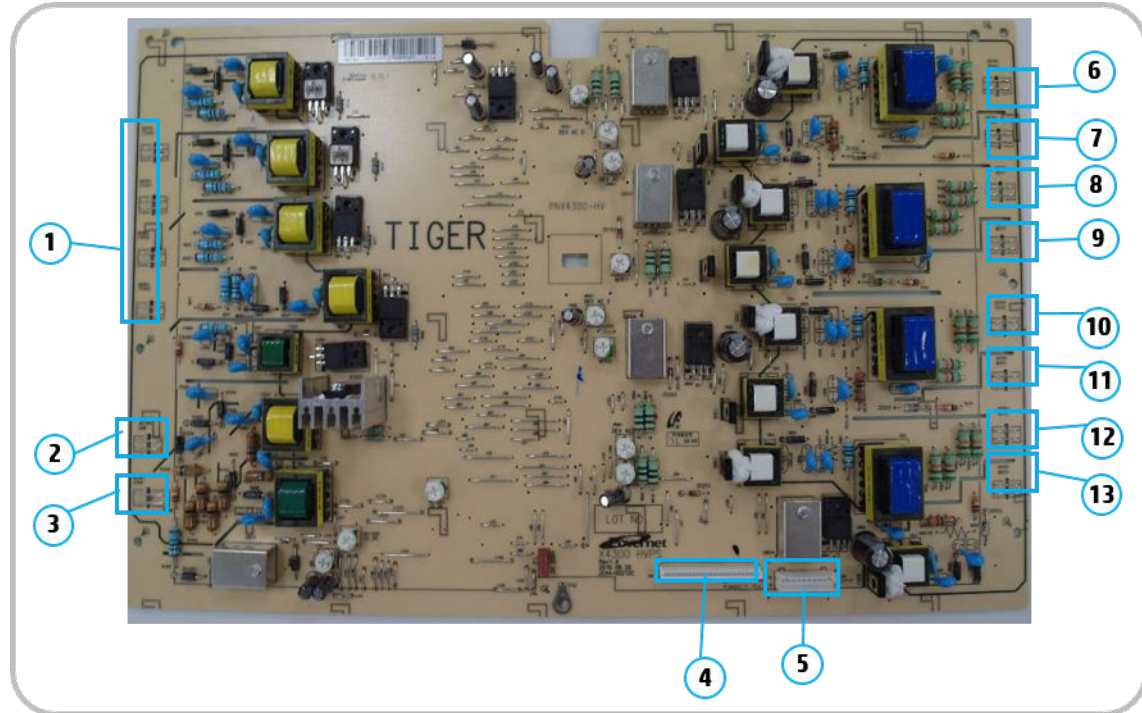

Connection Information

Table 1-39 HVPS connections

No	Connections
1	1THV Y/M/C/K
2	SAW
3	2THV+/-
4	HVPS I/F

Table 1-39 HVPS connections (continued)

No	Connections
5	HVPS voltage
6	DEV Y
7	MHV Y
8	DEV M
9	MHV M
10	DEV C
11	MHV C
12	DEV K
13	MHV K

Eraser PCA

The eraser PCA has one LED. The LED is used for erasing the negative charges on the surface of the drum after printing.

Figure 1-65 Eraser PCA

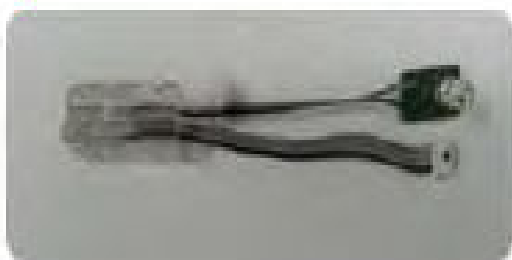

Waste sensor PCA

The waste sensor PCA detects the waste toner level inside the toner collection unit.

Figure 1-66 Waste sensor PCA



Toner CRUM joint PCA

The toner CRUM joint PCA is the interface PCA between the toner cartridge and the printer.

Figure 1-67 Toner CRUM joint PCA



Paper size sensor PCA

The paper size sensor PCA is used for detecting the size of the paper in the tray.

Figure 1-68 Paper size sensor PCA

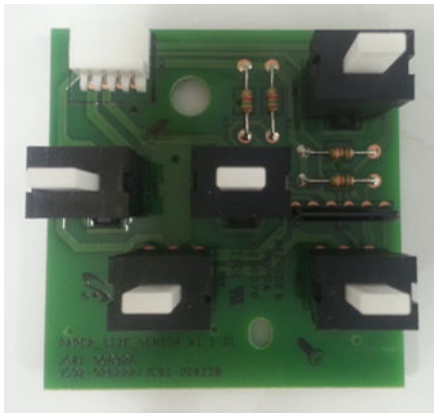

Power key PCA

The power key PCA has one switch. The switch is used for soft power Off.

Figure 1-69 Power key PCA

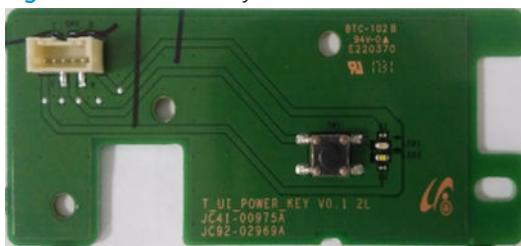

Walkup USB PCA

The walkup USB PCA is used to interface with main board, USB memory stick. It interfaces through USB communication.

Figure 1-70 Walkup USB PCA

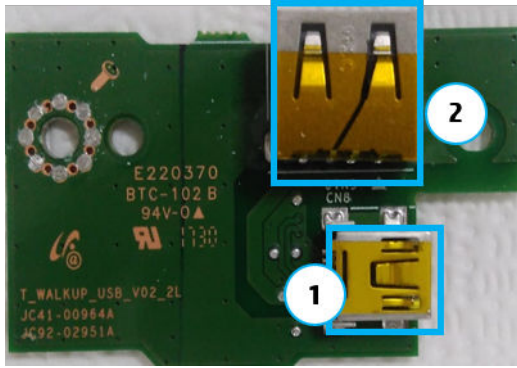

Dual cassette feeder

Dual cassette feeder (DCF) block diagram

The DCF board controls all functions for the dual cassette feeder. It consists of the CPU and the IC.

The Micom on the board receives information from the paper size sensor, empty sensor, feed sensor etc. and communicates with the printer main board through the UART.

When the DCF board receives a print job command from the interface connector (CN7) through UART, the DCF board drives the feed motor and pick up motor to pick-up a sheet of paper.

This board has two LEDs. The left LED is for checking the 5V power supply and the right LED is for checking the Micom concentrator operation.

Figure 1-71 DCF block diagram

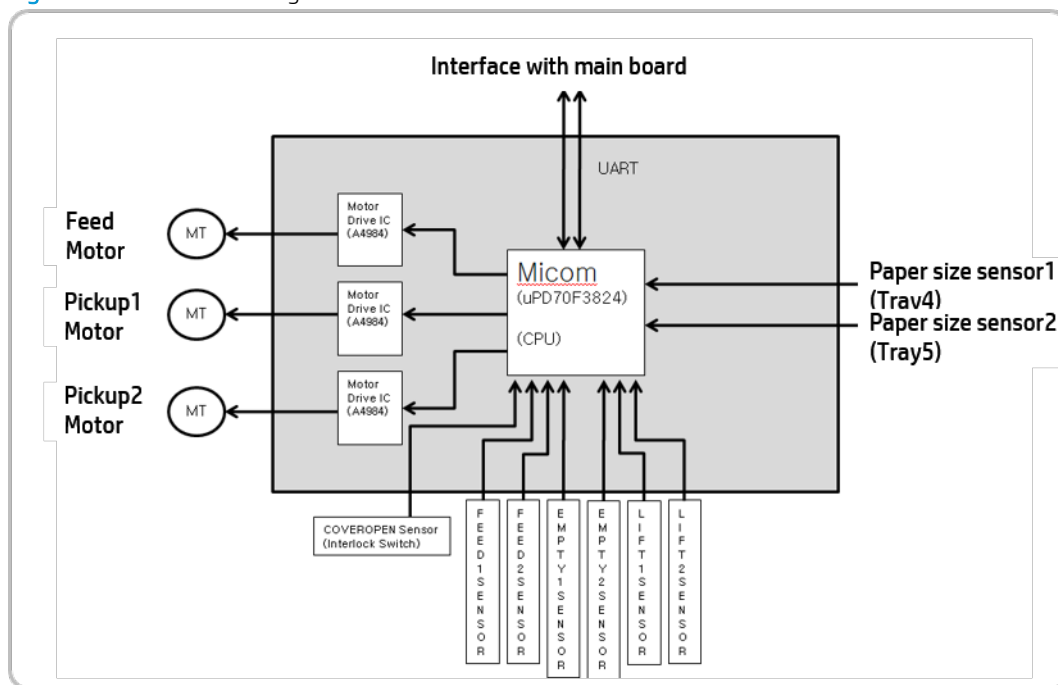

Dual cassette feeder (DCF) components

The dual cassette feeder (DCF) is an optional accessory containing two additional paper trays.

Figure 1-72 DCF components

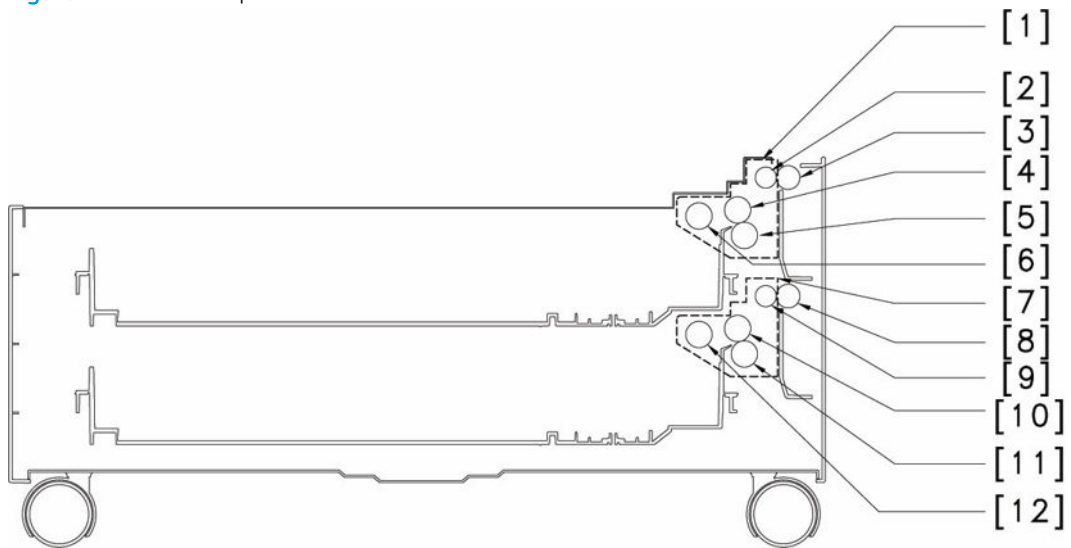

Table 1-40 DCF components

Callout	Description
1	Tray 4 pickup assembly
2	Feed roller (Tray 4)
3	Idle roller (Tray 4)
4	Forward roller (Tray 4)
5	Separation roller (Tray 4)
6	Pickup roller (Tray 4)
7	Tray 5 pickup assembly
8	Feed roller (Tray 5)
9	Idle roller (Tray 5)
10	Forward roller (Tray 5)
11	Separation roller (Tray 5)
12	Pickup roller (Tray 5)

Dual cassette feeder (DCF) paper path

Figure 1-73 DCF paper path

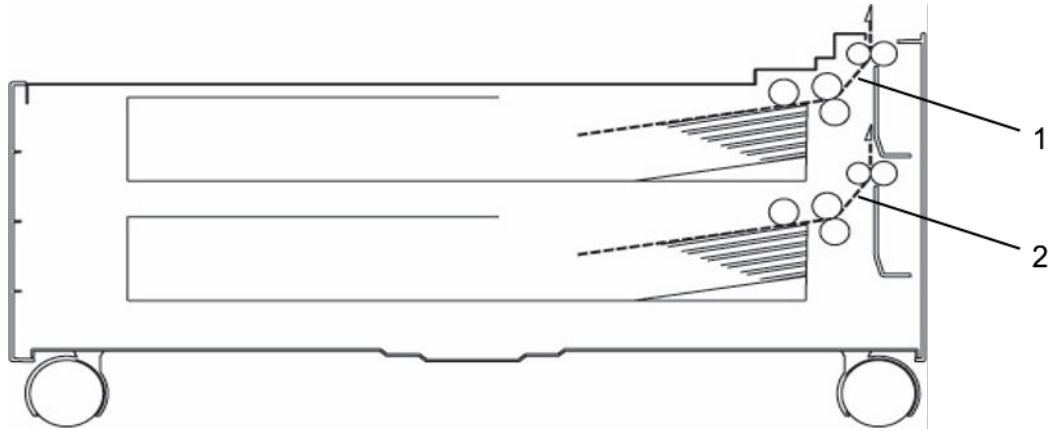

Table 1-41 DCF paper path

Callout	Description
1	Tray 4 paper path
2	Tray 5 paper path

Dual cassette feeder (DCF) electrical parts location

Figure 1-74 DCF electrical parts location

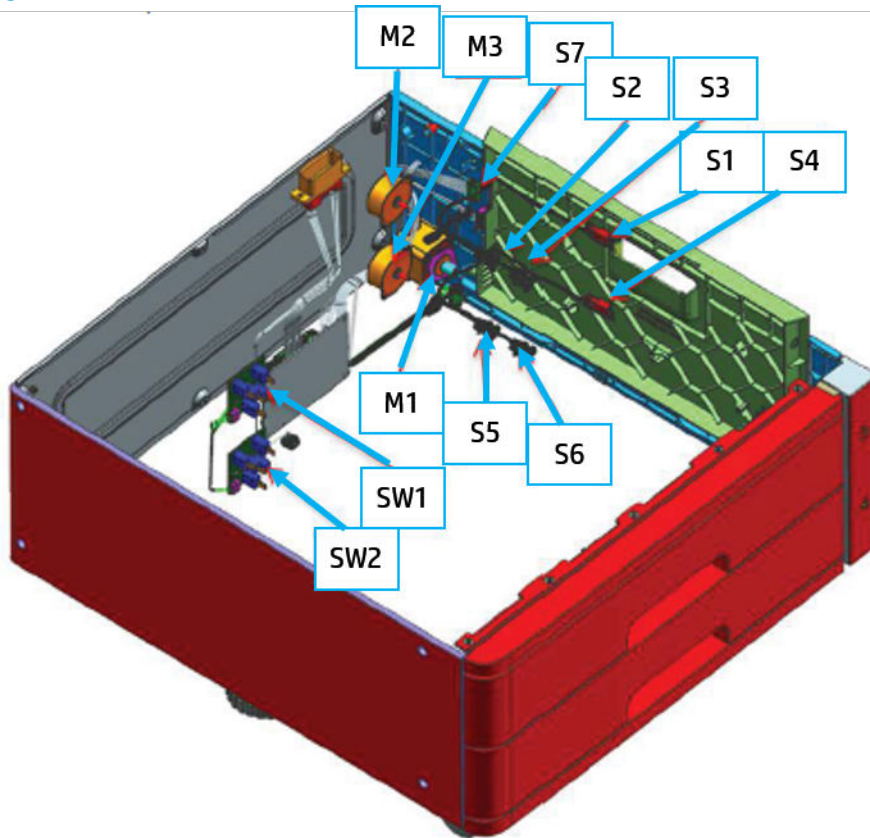

Table 1-42 DCF electrical parts location

Callout	Description	Part number	DC controller PCB
M1	Feed motor	JC31-00033B	CN5 3 to 6
M2	Tray 4 pickup motor	JC31-00149A	CN5 9 to 12
M3	Tray 5 pickup motor	JC31-00149A	CN5 13 to 16
SW1	Tray 4 auto-size switch	JC32-00013A	CN9 1 to 4
SW2	Tray 5 auto-size switch	JC32-00013A	CN9 5 to 8
S1	Tray 4 feed sensor	0604-001381	CN6 7 to 9
S2	Tray 4 limit sensor	0604-001393	CN6 4 to 6
S3	Tray 4 paper empty sensor	0604-001393	CN6 1 to 3
S4	Tray 5 feed sensor	0604-001381	CN6 16 to 18
S5	Tray 5 limit sensor	0604-001393	CN6 13 to 15
S6	Tray 5 paper empty sensor	0604-001393	CN6 10 to 12
S7	Door open sensor	JC39-01696A	CN3 1 to 2

Dual cassette feeder (DCF) sensors and signals

Figure 1-75 Dual cassette feeder (DCF) sensors and signals

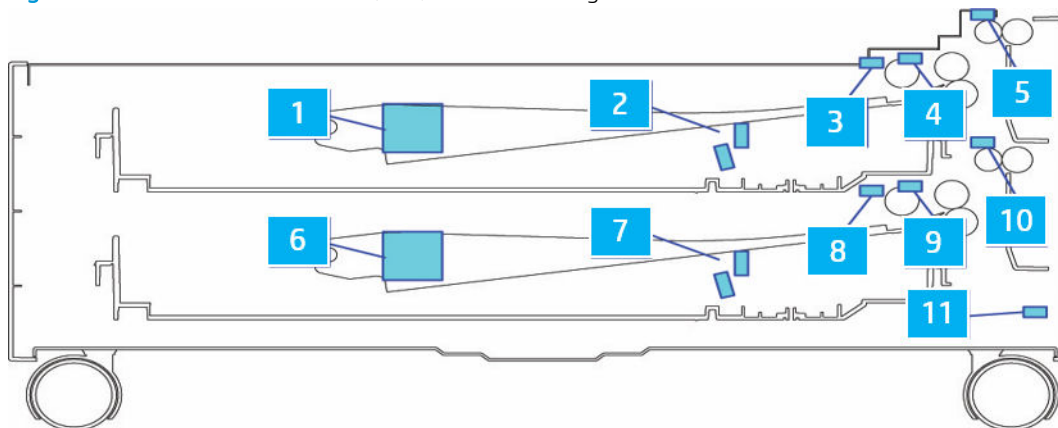

Table 1-43 Dual cassette feeder (DCF) sensors and signals

Callout	Sensor	Signal
1	P_Size_DCF1	Tray 4 paper size analog signal
3	np_Empty_DCF1_IHCF	Tray 4 paper empty signal
4	Limit_DCF1_IHCF	Tray 4 paper limit signal
5	Feed_DCF1_IHCF	Tray 4 feed signal
6	P_Size_DCF2	Tray 5 paper size analog signal
8	np_Empty_DCF2	Tray 5 paper empty signal
9	Limit_DCF2	Tray 5 paper limit signal

Table 1-43 Dual cassette feeder (DCF) sensors and signals (continued)

Callout	Sensor	Signal
10	Feed_DCF2	Tray 5 feed signal
11	ndoor_open	Door open signal

Dual cassette feeder (DCF) paper feeding system

Figure 1-76 Dual cassette feeder (DCF) paper feeding system

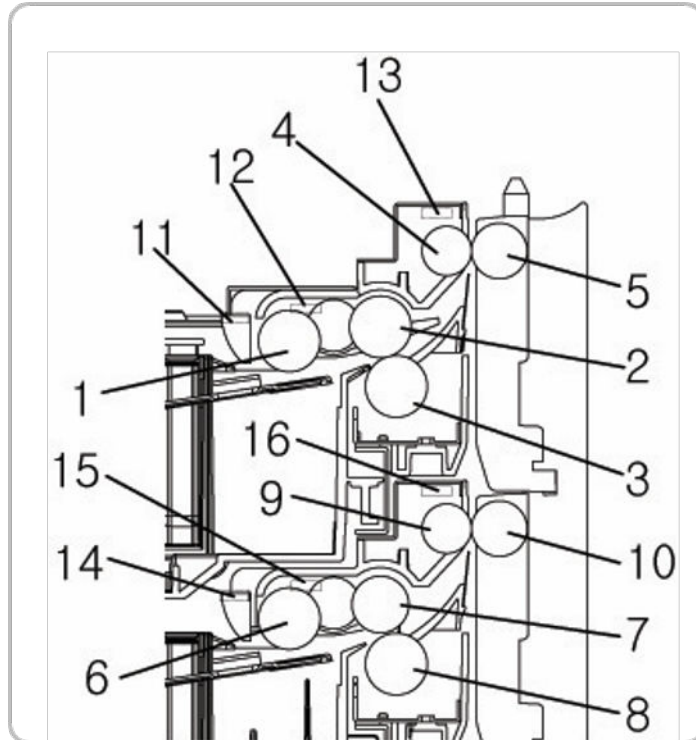

Table 1-44 Dual cassette feeder (DCF) paper feeding system

Callout	Description	Part number
1	Pickup roller (Tray 4)	This roller transports the paper from Trays 4 or 5.
6	Pickup roller (Tray 5)	
2	Forward roller (Tray 4)	This roller transports the paper from the pickup roller to the feed roller.
7	Forward roller (Tray 5)	
3	Separation roller (Tray 4)	When two sheets of paper or more are transported from the pickup roller, the torque limit load is greater than the resistance between the sheets. As a result, the separation roller is stopped and the lower paper is not advanced any further. When the last sheet is transported from the pickup roller, the separation roller rotates following the feed roller.
8	Separation roller (Tray 5)	
4	Feed roller (Tray 4)	This roller transports the paper from the forward roller to the printer.
9	Feed roller (Tray 5)	

Table 1-44 Dual cassette feeder (DCF) paper feeding system (continued)

Callout	Description	Part number
5	Idle roller (Tray 4)	When paper is passed through the feed roller, the idle roller helps make the paper transport smooth.
10	Idle roller (Tray 5)	
11	nP_Empty_DCF1	This sensor detects paper in Trays 4 or 5.
14	nP_Empty_DCF2	
12	Limit_DCF1_IDCF	This sensor detects whether or not the paper is at the pickup position.
15	Limit_DCF2_IDCF	
13	Feed_DCF1_IDCF	This sensor detects when the leading edge of the paper passes over the feed roller.
16	Feed_DCF2_IDCF	

Dual cassette feeder (DCF) plug and jack locations

Figure 1-77 Dual cassette feeder (DCF) plug and jack locations

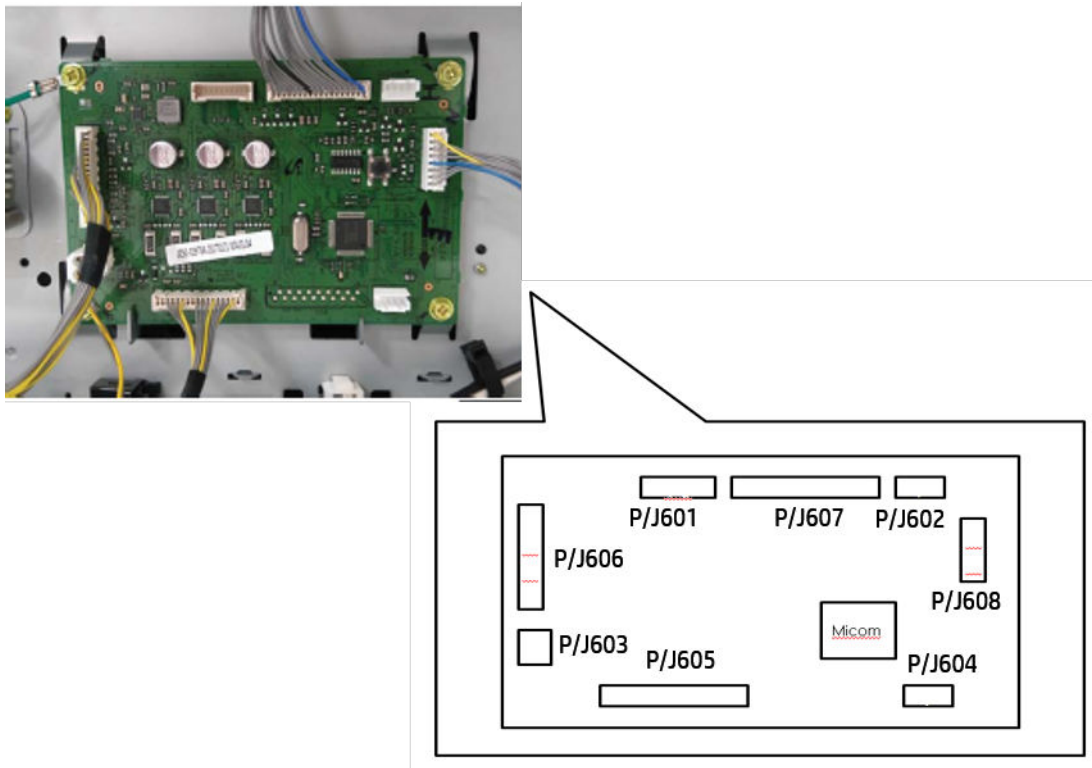

Table 1-45 Dual cassette feeder (DCF) plug and jack locations

Connector number	Connection
P/J601	Download tool I/F (minicube)
P/J602	Debug I/F
P/J603	Cover open switch (24V interlock switch)
P/J604	USB I/F

Table 1-45 Dual cassette feeder (DCF) plug and jack locations (continued)

Connector number	Connection
P/J605	EMPTY/LIFT/FEED (Tray 4, 5) sensor
P/J606	FEED / PICKUP 4, 5 motor
P/J607	Interface with main
P/J608	Paper size sensor (Tray 4, 5)

2 Parts, diagrams, removal and replacement

HP service and support

Learn about HP access to additional service and support information.

Additional service and support for channel partners

Channel partners go to partner.hp.com, and then use the steps below to access the HP Web-based Interactive Search Engine (WISE).

Access WISE for Channel partners

1. Select [Services & Support](#) (near the top of the screen).
2. Under [Services Delivery](#), select [Technical Support](#).
3. Select [Technical Documentation](#).

Find information about the following topics

- Service manuals
- Service advisories
- Up-to-date control panel message (CPMD) troubleshooting
- Solutions for printer issues and emerging issues
- Remove and replace part instructions and videos
- Install and configure
- Printer specifications
- Warranty and regulatory information

Additional service and support for HP internal personnel

HP internal personnel, go to one of the following Web-based Interactive Search Engine (WISE) sites:

Americas (AMS)

- [WISE - English](#)
- [WISE - Spanish](#)
- [WISE - Portuguese](#)
- [WISE - French](#)

Asia Pacific / Japan (APJ)

- [WISE - English](#)
- [WISE - Japanese](#)
- [WISE - Korean](#)
- [WISE - Chinese \(simplified\)](#)
- [WISE - Chinese \(traditional\)](#)
- [WISE - Thai](#)

Europe / Middle East / Africa (EMEA)

- [WISE - English](#)

Order parts by authorized service providers

Ordering

Table 2-1 Ordering

Item	Description
Order supplies and paper	http://www.hp.com/go/suresupply
Order genuine HP parts or accessories	https://parts.hp.com
Order through service or support providers	Contact an HP-authorized service or support provider.
Order using the HP Embedded Web Server (EWS)	To access, in a supported web browser on your computer, enter the printer IP address or host name in the address/URL field. The EWS contains a link to the HP SureSupply web site, which provides options for purchasing Original HP supplies.

Orderable parts

Not all parts can be ordered. Refer to the parts table following the exploded diagram in the parts chapter to determine if a part is orderable.

Related documentation and software

HP service personnel, go to one of the following Web-based Interactive Search Engines (WISE) sites:

AMS

- <https://support.hp.com/wise/home/ams-en>
- <https://support.hp.com/wise/home/ams-es>
- <https://support.hp.com/wise/home/ams-pt>

APJ

- <https://support.hp.com/wise/home/apj-en>
- <https://support.hp.com/wise/home/apj-ja>
- <https://support.hp.com/wise/home/apj-ko>
- <https://support.hp.com/wise/home/apj-zh-Hans>
- <https://support.hp.com/wise/home/apj-zh-Hant>

EMEA

- <https://support.hp.com/wise/home/emea-en>

Channel partners, go to HP Channel Services Network (CSN) at <http://www.hp.com/partners/csn>.

Channel partners, access training materials in the HP University and Partner Learning Center at <https://content.ext.hp.com/sites/LMS/HPU.page>.

How to use the parts lists and diagrams



The figures in this chapter show the major sub-assemblies in the printer and their component parts. A parts list table follows each exploded view assembly diagram. Each table lists the item number, the associated part number, and the description of each part. If there is (*) at the end of the part number in the table, then it is service available.

 **CAUTION:** Be sure to order the correct part. When looking for part numbers for electrical components, pay careful attention to the voltage that is listed in the description column. Doing so will ensure that the part number selected is for the correct model.

 **NOTE:** In this manual, the abbreviation “PCA” stands for “printed circuit-board assembly.” Components described as a PCA might consist of a single circuit board or a circuit board plus other parts, such as cables and sensors.

Electrostatic discharge

Learn how to protect sensitive parts against damage from electrostatic discharge.

 **CAUTION:**  Some parts are sensitive to electrostatic discharge (ESD). Look for the ESD reminder when removing printer parts. Always perform service work at an ESD-protected workstation or mat. If an ESD workstation or mat is not available, touch the sheet-metal chassis to provide a static ground before touching an ESD-sensitive assembly.

Protect the ESD-sensitive assemblies by placing them in ESD pouches when they are out of the printer.

Service approach

Before performing service

- Remove all paper from the product.
- Turn off the power using the power button.
- Unplug the power cable and interface cable or cables.
- Remove the output bin.
- Place the product on an ESD workstation or mat, or use an ESD strap (if one is available). If an ESD workstation, mat, or strap is not available, ground yourself by touching the sheet-metal chassis before touching an ESD-sensitive part.
- Remove the toner cartridges.
- Remove the Tray 2 cassette.

Releasing plastic latches:

Many of the parts are held in place with plastic latches. The latches break easily; release them carefully. To remove, press the hook end of the latch away from the part to which it is latched.

After performing service

Complete the following after service is performed.

- Plug in the power cable.
- Reinstall the output bin.
- Reinstall the toner cartridges.
- Reinstall the Tray 2 cassette.
- Load paper in the product.

Post-service test

Perform the following tests to verify that the repair or replacement was successful:

Maintenance

Clean the printer

Check the scanner glass for dirt and smudges (MFP)

Over time, specks of debris might collect on the scanner glass and white plastic backing, which can affect performance. Use the following procedure to clean the scanner if the printed pages have streaks, unwanted lines, black dots, poor print quality, or unclear text.

1. Press the power button to turn the printer off, and then disconnect the power cable from the electrical outlet.
2. Open the scanner lid.

Figure 2-1 Open the scanner lid

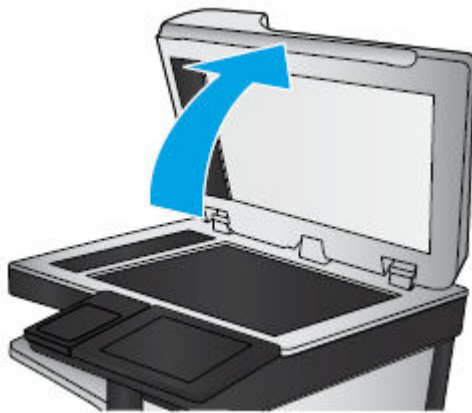

3. Clean the scanner glass, the document feeder strips, and the white plastic backing with a soft cloth or sponge that has been moistened with nonabrasive glass cleaner.

⚠ CAUTION: Do not use abrasives, acetone, benzene, ammonia, ethyl alcohol, or carbon tetrachloride on any part of the printer; these can damage the printer. Do not place liquids directly on the glass or platen. They might seep and damage the printer.

📝 NOTE: If you are having trouble with streaks on copies when you are using the document feeder, be sure to clean the small strip of glass on the left side of the scanner.

Figure 2-2 Clean the scanner glass

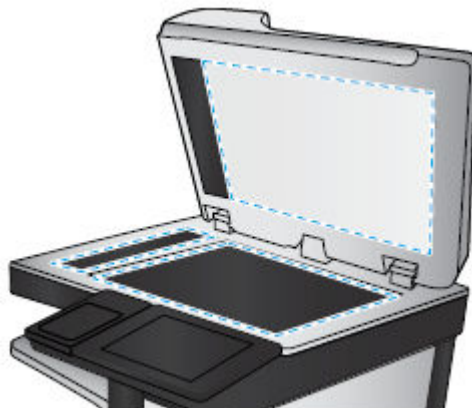

4. Dry the glass and white plastic parts with a chamois or a cellulose sponge to prevent spotting.
5. Connect the power cable to an outlet, and then press the power button to turn the printer on.

Cleaning the laser scanner assembly window

1. Open the front cover. Remove the toner collection unit.

Figure 2-3 Remove toner collection unit



2. Remove the laser scanner assembly window cleaning tool located on the front cover.

Figure 2-4 Remove laser scanner assembly window cleaning tool

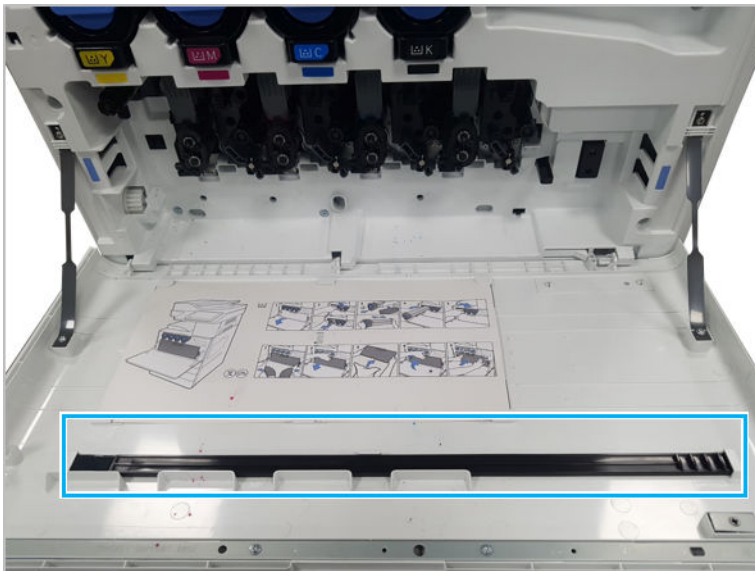

3. Insert the laser scanner assembly window cleaning tool into each color entrance.
Slowly remove and reinsert the cleaning tool.

Figure 2-5 Laser scanner assembly color entrances



4. Repeat the previous step at least five times for each laser scanner assembly window.

Main parts

Learn about the printer main parts.

Main assembly 1 (Right side and rear side)

View Main assembly 1 exploded view, parts list, and repair procedures.

Main assembly 1 (Right side and rear side)

Figure 2-6 Main assembly 1 (Right side and rear side)

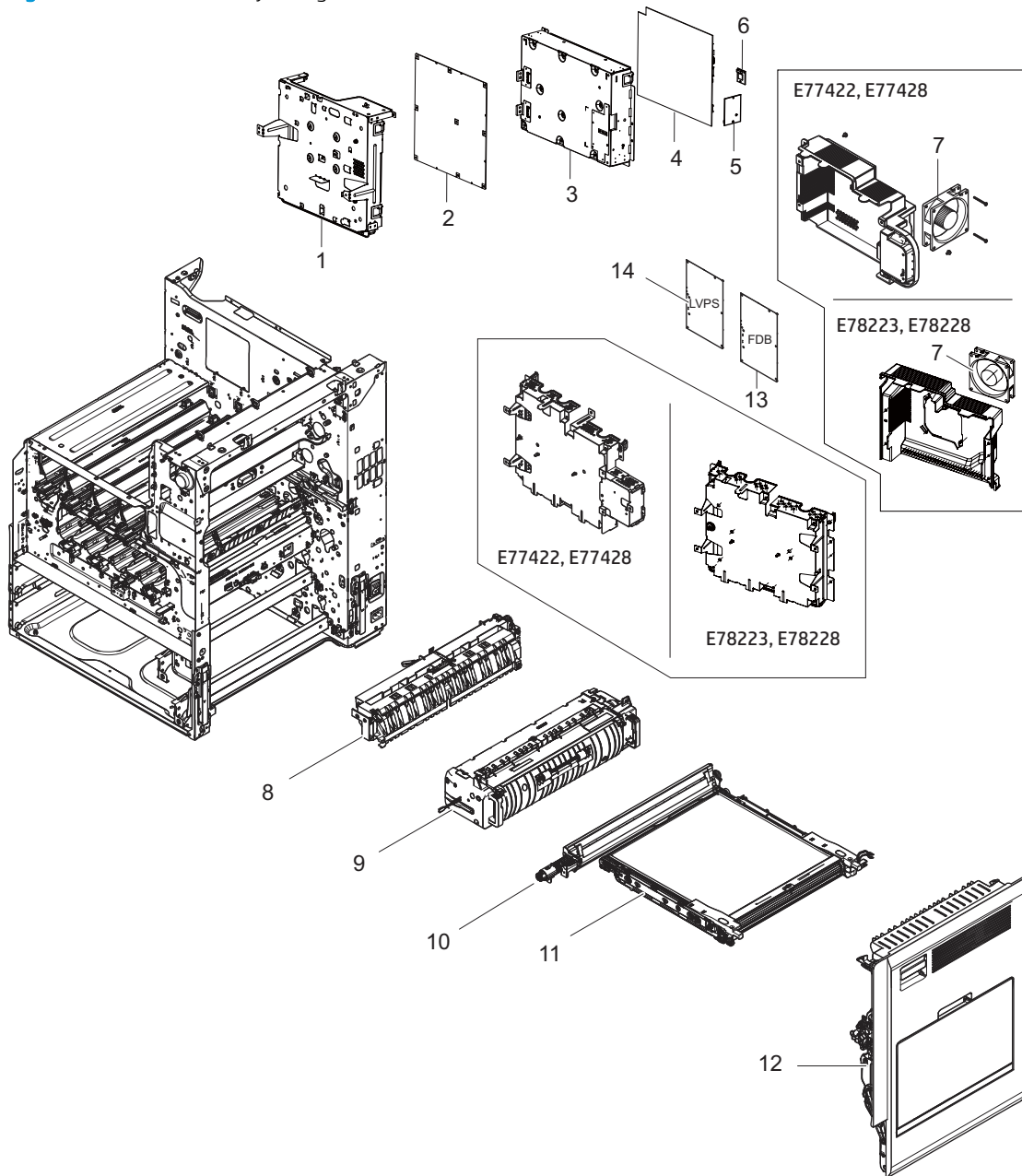

Table 2-2 Main assembly 1 (Right side and rear side)

Ref	Description	Part Number (*)	Qty
1	Main PCA shield	JC93-01389A (*)	1

Table 2-2 Main assembly 1 (Right side and rear side) (continued)

Ref	Description	Part Number (*)	Qty
2	Main board PCA (ECB) kit (For E77422, E77428)	3BE77-67001 (*)	1
2	Main board PCA (ECB) kit (For E78223, E78228)	8GS44-60001 (*)	1
3	Formatter PCA shield	JC93-01538A	1
4	Formatter PCA (For E77422, E77428)	JC92-03036A (*)	1
4	Formatter PCA (For E78223, E78228)	X3A92-60007 (*)	1
5	STMS PCA (SDS)	JC92-02976A (*)	1
6	eMMC card (For E77422, E77428)	JC98-05747A(*)	1
6	eMMC card (For E78223, E78228)	B5L32-60002 (*)	1
7	Fan-type 8 LVPS	JC31-00162A (*)	1
8	1st exit assembly	JC90-01118B (*)	1
9	Fuser, 220V	Z9M03-67002 (*)	1
9	Fuser, 110V	Z7Y77-67002 (*)	1
10	SVC LJ Image Transfer Blade Kit (For E77422, E77428)	JC96-06246A (*)	1
10	SVC LJ Image Transfer Blade Kit (For E78223, E78228)	5PN64-67001 (*)	1
11	SVC LJ Image Transfer Kit (For E77422, E77428)	JC98-00980D (*)	1
11	SVC LJ Image Transfer Kit (For E78223, E78228)	5PN63-67001 (*)	1
12	MP right door (For E77422, E77428)	JC95-02241A (*)	1
12	MP right door (For E78223, E78228)	8GR88-60101 (*)	1
13	Fuser drive board (FDB), 220V (For E77422, E77428)	JC44-00211E (*)	1
13	Fuser drive board (FDB), 220V (For E78223, E78228)	8GR94-60002 (*)	1
13	Fuser drive board (FDB), 110V (For E77422, E77428)	JC44-00210E (*)	1
13	Fuser drive board (FDB), 110V (For E78223, E78228)	8GR94-60001 (*)	1
14	LVPS (SMPS), type 5H, 110V	JC44-00249A (*)	1
14	LVPS (SMPS), type 5H, 220V	JC44-00250A (*)	1
Not shown	Memory PCA (IOD)	X3A92-60002 (*)	1
Not shown	Harness, engine side for DCF	JC39-02112A (*)	1
Not shown	Harness, finisher	JC39-02072A (*)	1
Not shown	Harness, heater	JC39-01583A (*)	1

Table 2-2 Main assembly 1 (Right side and rear side) (continued)

Ref	Description	Part Number (*)	Qty
Not shown	Harness, FDB interface (For E77422, E77428)	JC39-02564A (*)	1
Not shown	Harness, FDB / SMPS Fan / DEVE Fan (For E78223, E78228)	8GR94-50002 (*)	1
Not shown	Harness, FDB type 5	JC39-01585A	1
Not shown	Wiring harness (output device)	JC39-02072A	1

* This part is in ordering system. If the ordering system has this part in stock, it can be ordered.

HP Color LaserJet Managed MFP E77422, E77428, E78223, and E78228 - Removal and replacement: Formatter PCA

Follow these steps to remove the formatter PCA.

To view a short video of this procedure, click the link below.



[View a video of how to remove and replace the formatter PCA.](#)

Mean time to repair: 3 minutes

Service level: Intermediate



IMPORTANT: When applicable, special installation instructions are provided for an assembly at the end of the removal procedure. Always completely read the removal instructions and follow all special installation instructions.

Before performing service

- Disconnect the power cable.



WARNING! To avoid damage to the printer, turn the printer off, wait 30 seconds, and then remove the power cable before attempting to service the printer.

Use the table below to identify the correct part number for your printer. To order the part, go to <https://parts.hp.com>

Table 2-3 Part information

Part number	Part description
JC92-03036A	Formatter PCA (For E77422, E77428)
X3A92-60007	Formatter PCA (For E78223, E78228)

Required tools

- #2 JIS screwdriver with a magnetic tip

After performing service

Complete the following after service is performed.

- Connect the power cable.
- Use the power switch to turn the power on.

Post service test

Verify that the document was copied, scanned, or printed correctly.

1. Remove the formatter covers.

- ▲ Unscrew two captive thumbscrews on the formatter cover. Slide the formatter cover to the left, and then to the right to remove.

Figure 2-7 Remove the formatter cover

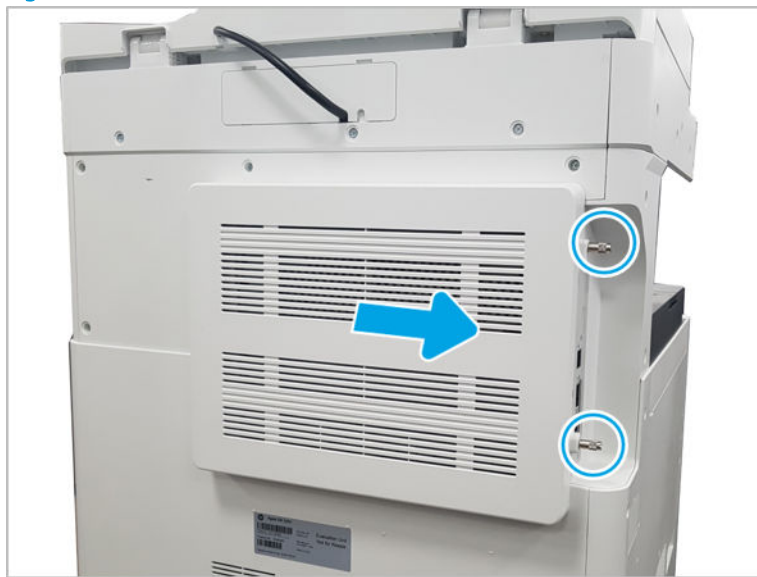

2. Remove the HDD if it is installed.

- ▲ Release one retainer, and then remove the HDD.

 **NOTE:** The HDD for the formatter is optional.

 **IMPORTANT:** The HDD and the memory PCA cannot be replaced at the same time.

3. Remove the formater PCA.

- ▲ Disconnect all connectors and eight screws, and then remove the formatter PCA.

Figure 2-8 Remove the formatter connectors and screws

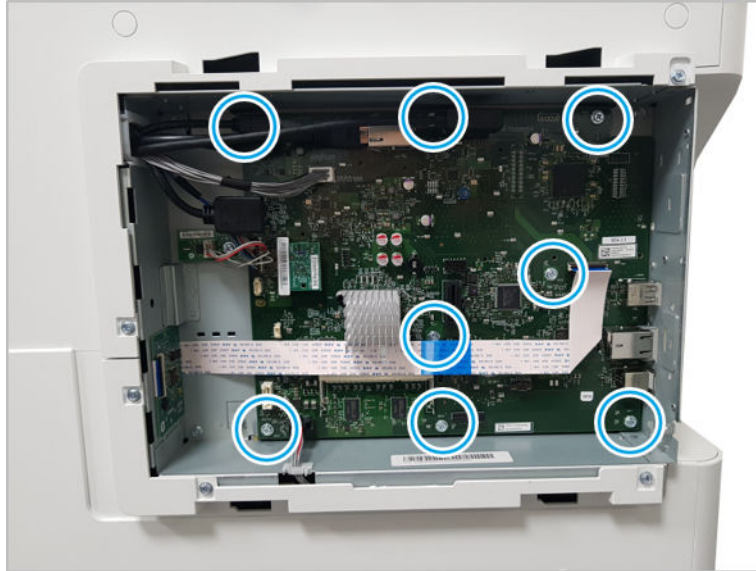

4. Unpack the replacement assembly.

- a. Dispose of the defective part.



NOTE: HP recommends responsible disposal of the defective part.

<http://www8.hp.com/us/en/hp-information/environment/product-recycling.html>

- b. Unpack the replacement part from the packaging.



CAUTION:



Some parts are sensitive to electrostatic discharge (ESD). Always perform service work at an ESD-protected workstation or mat. If an ESD workstation or mat is not available, touch the sheet-metal chassis to provide a static ground before touching an ESD-sensitive assembly. Protect the ESD-sensitive assemblies by placing them in ESD pouches when they are out of the printer.

If the replacement part is a roller or pad, avoid touching the spongy part of it. Skin oils on the roller or pad can cause paper pickup and/or print-quality problems. HP recommends using disposable gloves when handling rollers or pads or washing your hands before touching rollers or pads.



IMPORTANT: Make sure that all of the shipping materials (for example shipping tape) are removed from the replacement part prior to installation.

- c. To install an assembly, reverse the removal steps.



NOTE: When applicable, special installation instructions are provided for an assembly at the end of the removal procedure. Always completely read the removal instructions and follow all special installation instructions.

HP Color LaserJet Managed MFP E77422, E77428, E78223, and E78228 - Removal and replacement: Engine controller board (ECB)

Follow these steps to remove the engine controller board (ECB).

To view a short video of this procedure, click the link below.

 [View a video of how to remove and replace the engine controller board \(ECB\).](#)

Mean time to repair: 15 minutes

Service level: Intermediate

 **IMPORTANT:** When applicable, special installation instructions are provided for an assembly at the end of the removal procedure. Always completely read the removal instructions and follow all special installation instructions.

Before performing service

- Disconnect the power cable.

 **WARNING!** To avoid damage to the printer, turn the printer off, wait 30 seconds, and then remove the power cable before attempting to service the printer.

Use the table below to identify the correct part number for your printer. To order the part, go to <https://parts.hp.com>

Table 2-4 Part information

Part number	Part description
3BE77-67001	Main board PCA (ECB) kit (For E77422, E77428)
8GS44-60001	Main board PCA (ECB) kit (For E78223, E78228)

Required tools

- #2 JIS screwdriver with a magnetic tip

After performing service

Turn the printer power on

- Connect the power cable.
- Use the power switch to turn the power on.

Post service test

Verify that the document was copied, scanned, or printed correctly.

1. Remove the rear covers.
 - a. Unscrew two captive thumbscrews on the formatter cover. Slide the formatter cover to the left, and then to the right to remove.

Figure 2-9 Remove the formatter cover

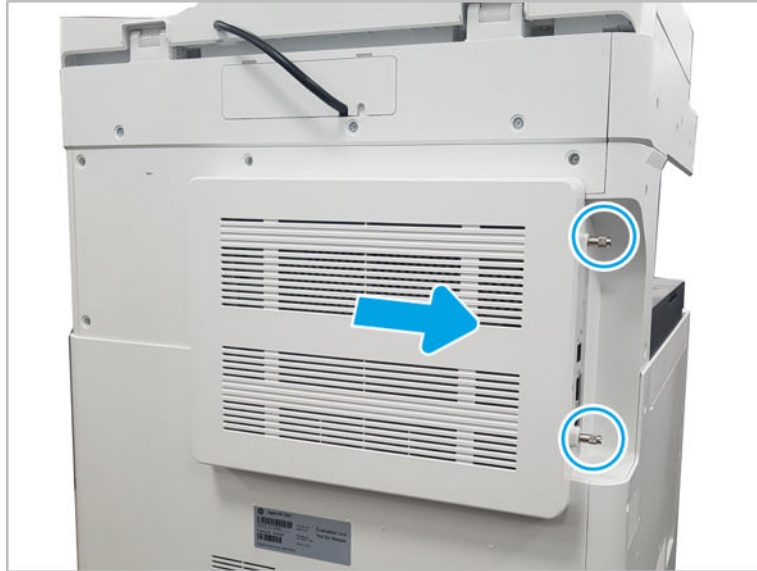

- b. Remove thirteen screws, and then remove the rear-bottom cover and rear-top cover.

Figure 2-10 Remove the rear-bottom cover and rear-top cover



- 2. Remove the formatter cage.
 - a. Remove three screws, and then remove the left-upper cover.

Figure 2-11 Remove the left-upper cover

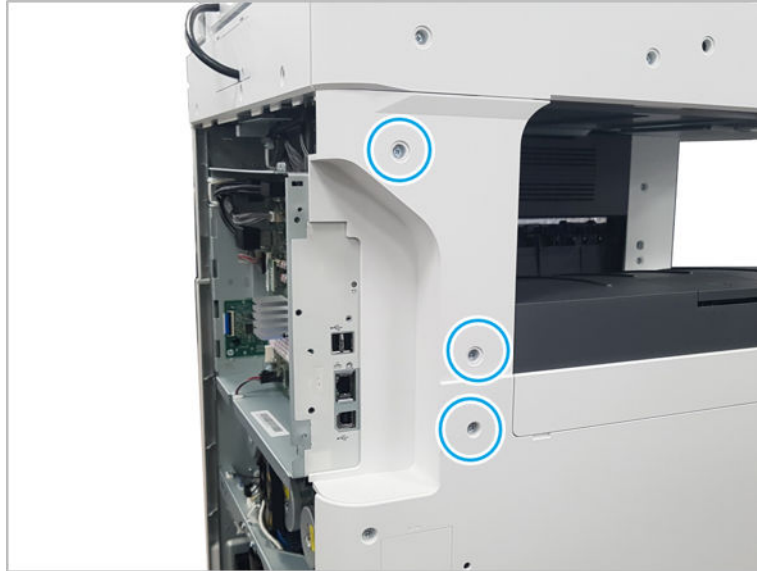

- b. Remove one screw from the side of the formatter cage (beneath the left-upper cover location).

Figure 2-12 Remove the formatter cage side screw



- c. Disconnect all connectors on the formatter PCA and two cable restraints.

- d. Remove three screws from the formatter cage face, and then release one tab to remove the formatter cage.

Figure 2-13 Remove three screws to remove the formatter cage

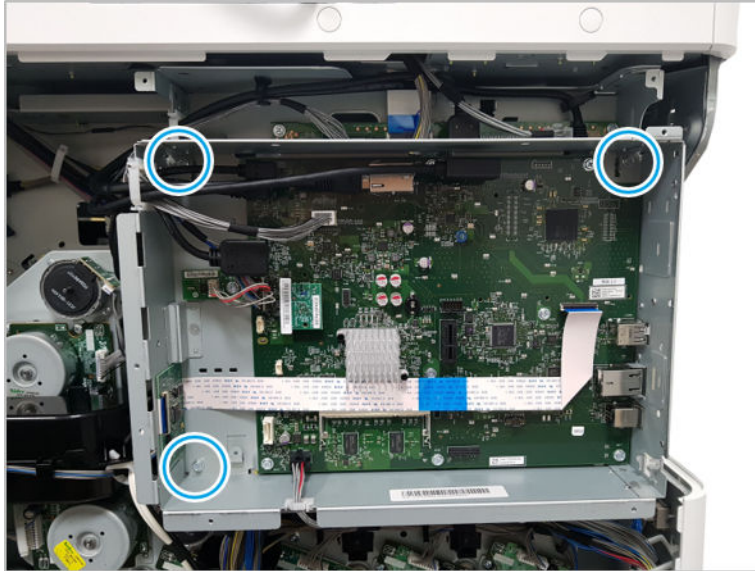

3. Remove the engine controller board (ECB).
 - a. Disconnect all connectors and the FFCs on the engine controller board (ECB). Remove nine screws, and then remove the engine controller board (ECB).

Figure 2-14 Remove the engine controller board (ECB) connectors and screws

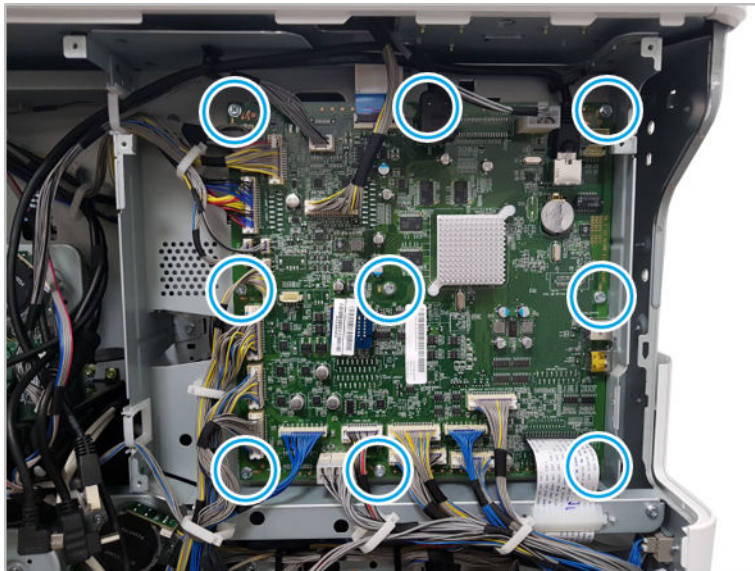

- b. Disconnect the master system operation key (MSOK) from the removed main board, noting its orientation. Transfer the MSOK to the replacement main board and install it using the same orientation.

 **TIP:** The main board is marked to show the correct orientation of the MSOK when installed.

Figure 2-15 MSOK installation orientation



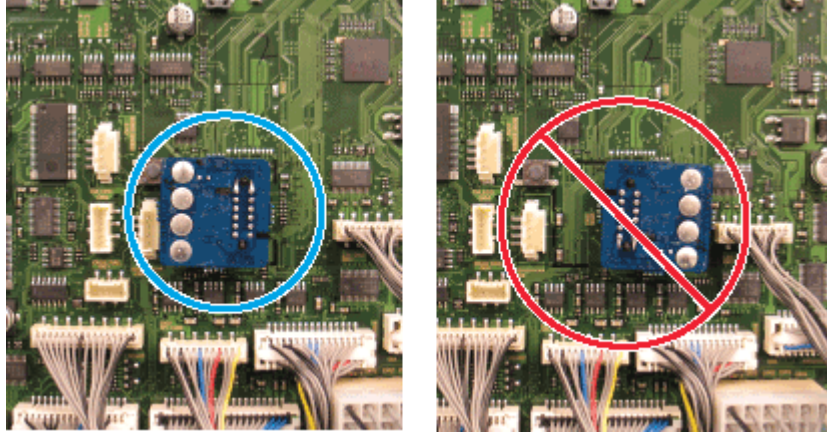

4. Unpack the replacement assembly.
 - a. Dispose of the defective part.

 **NOTE:** HP recommends responsible disposal of the defective part.

<http://www8.hp.com/us/en/hp-information/environment/product-recycling.html>

- b. Unpack the replacement part from the packaging.

 **CAUTION:**  Some parts are sensitive to electrostatic discharge (ESD). Always perform service work at an ESD-protected workstation or mat. If an ESD workstation or mat is not available, touch the sheet-metal chassis to provide a static ground before touching an ESD-sensitive assembly. Protect the ESD-sensitive assemblies by placing them in ESD pouches when they are out of the printer.

If the replacement part is a roller or pad, avoid touching the spongy part of it. Skin oils on the roller or pad can cause paper pickup and/or print-quality problems. HP recommends using disposable gloves when handling rollers or pads or washing your hands before touching rollers or pads.

 **IMPORTANT:** Make sure that all of the shipping materials (for example shipping tape) are removed from the replacement part prior to installation.

- c. To install an assembly, reverse the removal steps.

 **NOTE:** When applicable, special installation instructions are provided for an assembly at the end of the removal procedure. Always completely read the removal instructions and follow all special installation instructions.

1st Exit assembly

View 1st exit assembly exploded view, parts list, and repair procedures.

1st Exit assembly

Figure 2-16 1st Exit assembly

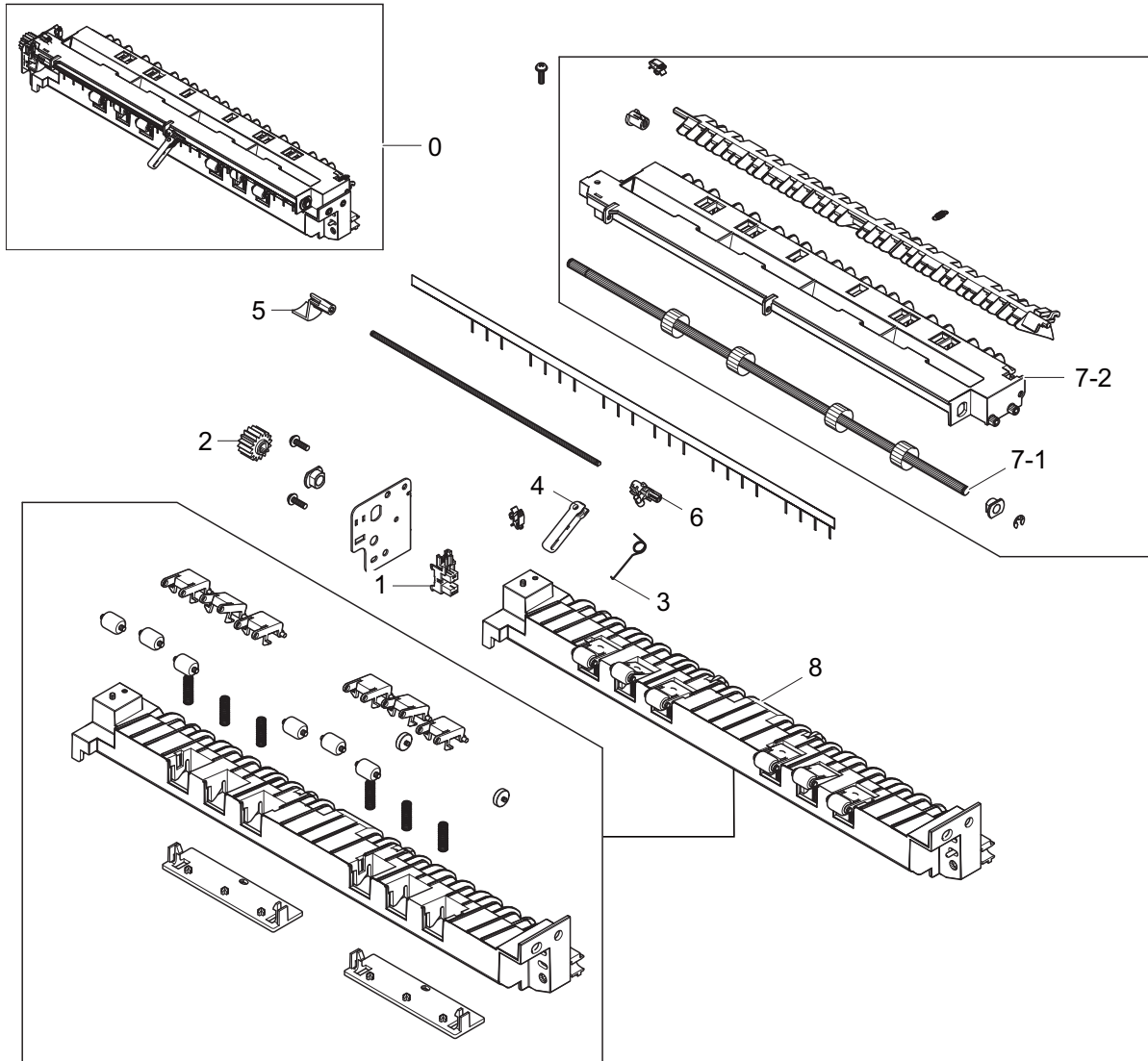

Table 2-5 1st Exit assembly

Ref	Description	Part Number (*)	Qty
0	Exit assembly	JC90-01118B (*)	1
1	Photo interrupter	0604-001393 (*)	1
2	Gear, exit	JC66-02163A	1
3	Spring, ts	JC61-07185A (*)	1
4	Actuator, Exit Bin Full	JC66-04339A (*)	1

Table 2-5 1st Exit assembly (continued)

Ref	Description	Part Number (*)	Qty
5	Actuator, Full Exit	JC66-02218A (*)	1
6	Actuator, Full Exit	JC66-02278A (*)	1
7-1	Roller, face down exit	JC66-03183A (*)	1
7-2	Upper exit guide	JC61-04799A (*)	1
8	Lower exit guide	JC90-01133A (*)	1
Not shown	Harness, exit color	JC39-02075A (*)	1

* This part is in ordering system. If the ordering system has this part in stock, it can be ordered.

HP Color LaserJet Managed MFP E77422, E77428, E78223, and E78228 - Removal and replacement: 1st exit assembly

Follow these steps to remove the 1st exit assembly.

To view a short video of this procedure, click the link below.



[View a video of how to remove and replace the 1st exit assembly.](#)

Mean time to repair: 1 minutes

Service level: Intermediate



IMPORTANT: When applicable, special installation instructions are provided for an assembly at the end of the removal procedure. Always completely read the removal instructions and follow all special installation instructions.

Before performing service

- Disconnect the power cable.

Use the table below to identify the correct part number for your printer. To order the part, go to <https://parts.hp.com>

Table 2-6 Part information

Part number	Part description
JC90-01118B	1st Exit assembly

Required tools

- #2 JIS screwdriver with a magnetic tip

After performing service

Turn the printer power on

- Connect the power cable.
- Use the power switch to turn the power on.

Post service test

Verify that the document was copied, scanned, or printed correctly.

1. Remove the exit assembly.

 **NOTE:** Remove second exit drive if installed.

- a. Open the right door. Open two cable restraints. And then, disconnect the exit assembly connector.

Figure 2-17 Disconnect exit unit connector and cable restraints

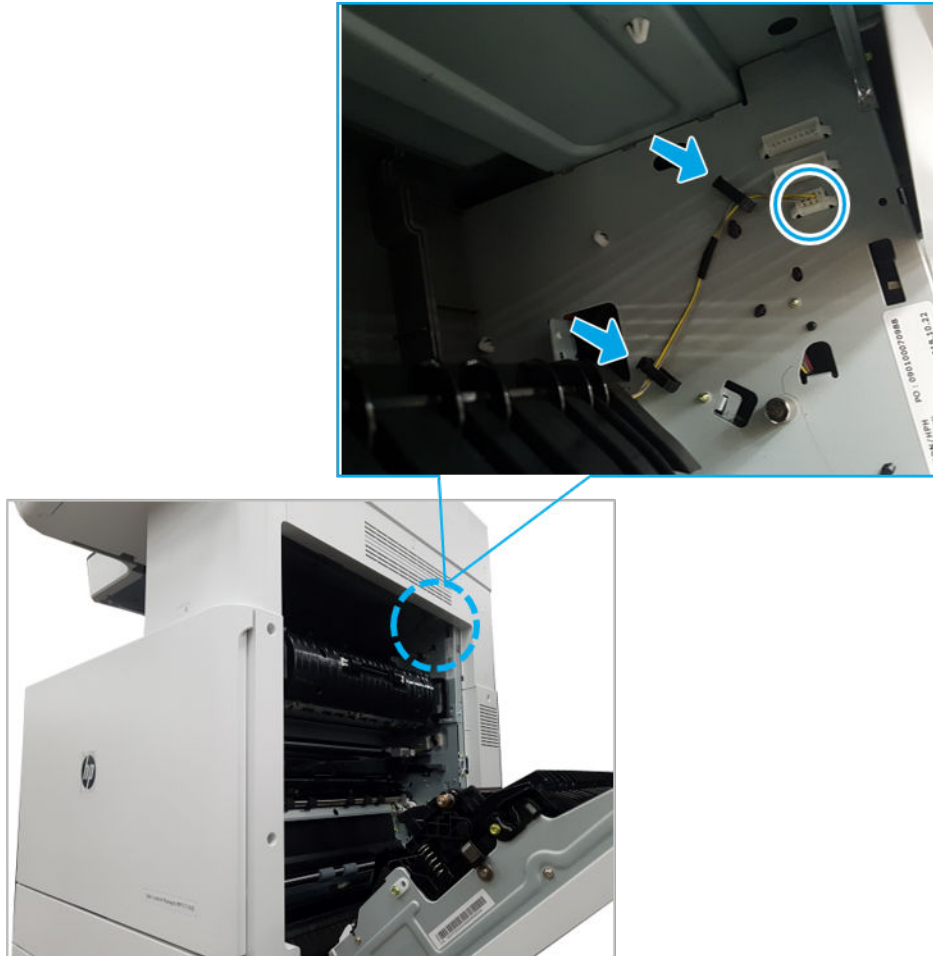

- b. Remove three screws, and then remove the exit assembly.

Figure 2-18 Remove screws and exit assembly



- 2. Unpack the replacement assembly.

- a. Dispose of the defective part.



NOTE: HP recommends responsible disposal of the defective part.

<http://www8.hp.com/us/en/hp-information/environment/product-recycling.html>

- b. Unpack the replacement part from the packaging.



CAUTION:



Some parts are sensitive to electrostatic discharge (ESD). Always perform service work at an ESD-protected workstation or mat. If an ESD workstation or mat is not available, touch the sheet-metal chassis to provide a static ground before touching an ESD-sensitive assembly. Protect the ESD-sensitive assemblies by placing them in ESD pouches when they are out of the printer.

If the replacement part is a roller or pad, avoid touching the spongy part of it. Skin oils on the roller or pad can cause paper pickup and/or print-quality problems. HP recommends using disposable gloves when handling rollers or pads or washing your hands before touching rollers or pads.



IMPORTANT: Make sure that all of the shipping materials (for example shipping tape) are removed from the replacement part prior to installation.

- c. To install an assembly, reverse the removal steps.



NOTE: When applicable, special installation instructions are provided for an assembly at the end of the removal procedure. Always completely read the removal instructions and follow all special installation instructions.

HP Color LaserJet Managed MFP E77422, E77428, E78223, and E78228 - Removal and replacement: Fuser unit

Follow these steps to remove the fuser unit.

To view a short video of this procedure, click the link below.

 [View a video of how to remove and replace the fuser unit.](#)

Mean time to repair: 1 minutes

Service level: Basic

 **IMPORTANT:** When applicable, special installation instructions are provided for an assembly at the end of the removal procedure. Always completely read the removal instructions and follow all special installation instructions.

Before performing service

- Disconnect the power cable.

Use the table below to identify the correct part number for your printer. To order the part, go to <https://parts.hp.com>

Table 2-7 Part information

Part number	Part description
Z7Y77-67002	Kit-HP LaserJet 110V Fuser
Z9M03-67002	Kit-HP LaserJet 220V Fuser

Required tools

- #2 JIS screwdriver with a magnetic tip

After performing service

Turn the printer power on

- Connect the power cable.
- Use the power switch to turn the power on.

Post service test

Verify that the document was copied, scanned, or printed correctly.

1. Remove the fuser unit.
 - a. Open the right door.

- b. Remove the one screw, and then remove the bracket.

Figure 2-19 Remove the bracket

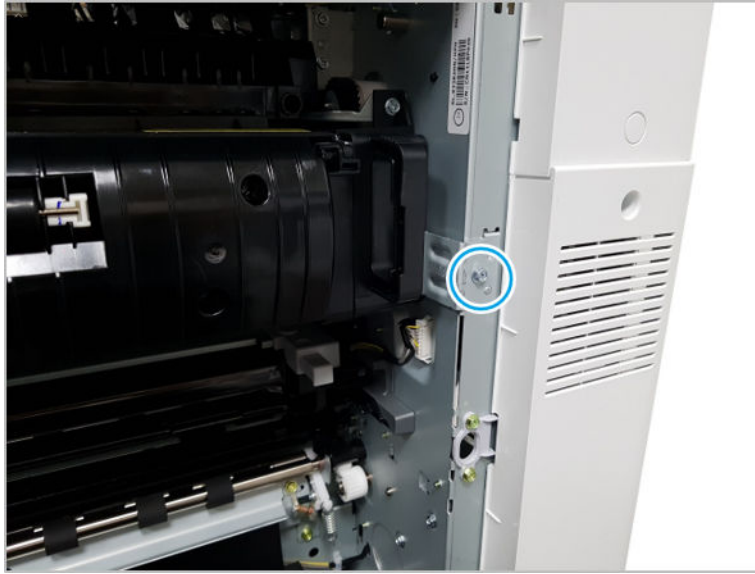

- c. Remove two screws, and then remove the fuser unit while holding both fuser handles (callout 1).

Figure 2-20 Remove the fuser unit

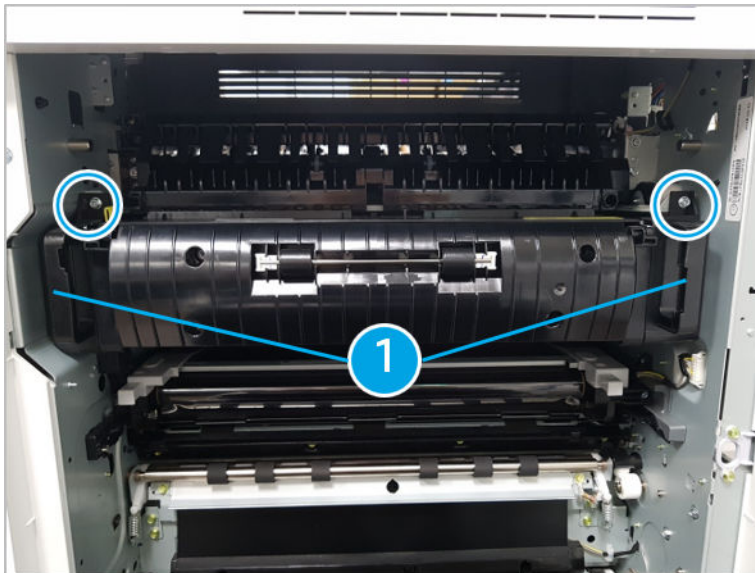



- 2. Unpack the replacement assembly.
 - a. Dispose of the defective part.

 **NOTE:** HP recommends responsible disposal of the defective part.

<http://www8.hp.com/us/en/hp-information/environment/product-recycling.html>

b. Unpack the replacement part from the packaging.

 **CAUTION:**  Some parts are sensitive to electrostatic discharge (ESD). Always perform service work at an ESD-protected workstation or mat. If an ESD workstation or mat is not available, touch the sheet-metal chassis to provide a static ground before touching an ESD-sensitive assembly. Protect the ESD-sensitive assemblies by placing them in ESD pouches when they are out of the printer.

If the replacement part is a roller or pad, avoid touching the spongy part of it. Skin oils on the roller or pad can cause paper pickup and/or print-quality problems. HP recommends using disposable gloves when handling rollers or pads or washing your hands before touching rollers or pads.

 **IMPORTANT:** Make sure that all of the shipping materials (for example shipping tape) are removed from the replacement part prior to installation.

c. To install an assembly, reverse the removal steps.

 **NOTE:** When applicable, special installation instructions are provided for an assembly at the end of the removal procedure. Always completely read the removal instructions and follow all special installation instructions.

HP Color LaserJet Managed MFP E77422, E77428, E78223, and E78228 - Removal and replacement: Intermediate transfer belt (ITB) cleaner

Follow these steps to remove the intermediate transfer belt (ITB) cleaner.

To view a short video of this procedure, click the link below.

 [View a video of how to remove and replace the ITB cleaner.](#)

Mean time to repair: 1 minutes

Service level: Basic

 **IMPORTANT:** When applicable, special installation instructions are provided for an assembly at the end of the removal procedure. Always completely read the removal instructions and follow all special installation instructions.

Before performing service

- Disconnect the power cable.

Use the table below to identify the correct part number for your printer. To order the part, go to <https://parts.hp.com>

Table 2-8 Part information

Part number	Part description
JC96-06246A	SVC LJ Image Transfer Blade Kit (For E77422, E77428)
5PN64-67001	SVC LJ Image Transfer Blade Kit (For E78223, E78228)

Required tools

- #2 JIS screwdriver with a magnetic tip

After performing service

Turn the printer power on

- Connect the power cable.
- Use the power switch to turn the power on.

Post service test

Verify that the document was copied, scanned, or printed correctly.

1. Remove the ITB cleaner.
 - a. Open the front cover.
 - b. Open the front cover, and then remove the toner collection unit(TCU).

Figure 2-21 Remove TCU



- c. Remove one screw.

Figure 2-22 Remove one screw

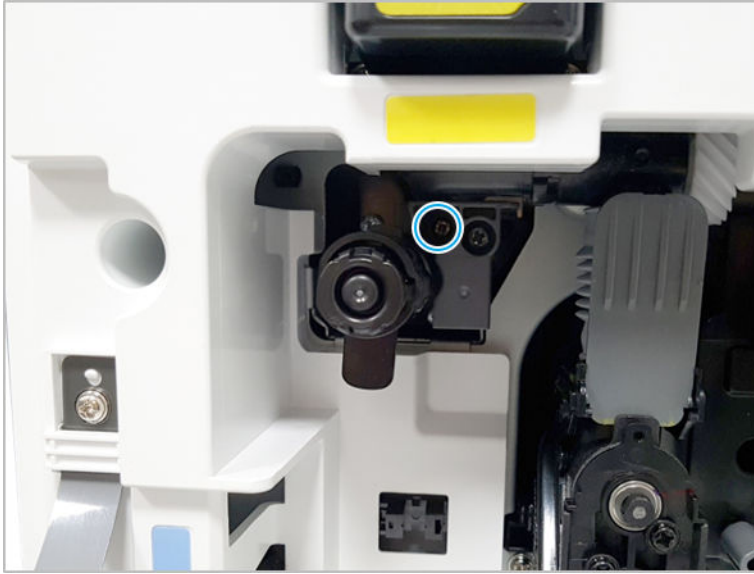

- d. Release the ITB cleaner.

Figure 2-23 Release ITB cleaner

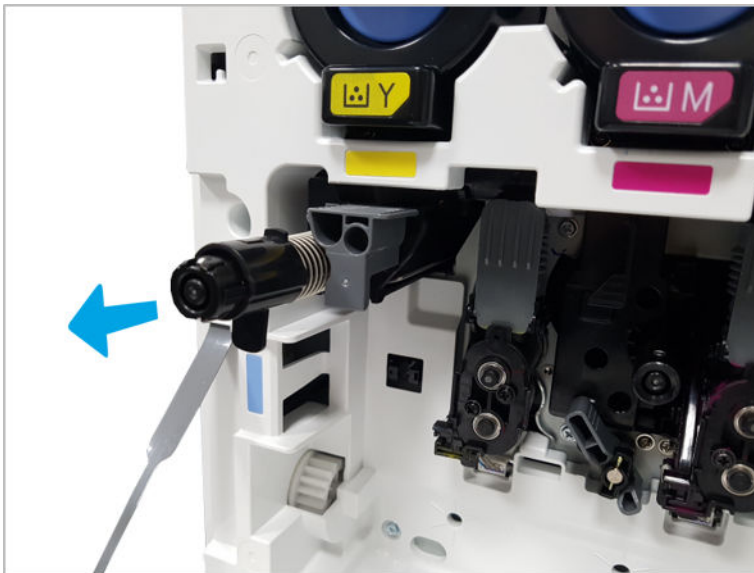



- 2. Unpack the replacement assembly.
 - a. Dispose of the defective part.

 **NOTE:** HP recommends responsible disposal of the defective part.

<http://www8.hp.com/us/en/hp-information/environment/product-recycling.html>

- b. Unpack the replacement part from the packaging.

 **CAUTION:**  Some parts are sensitive to electrostatic discharge (ESD). Always perform service work at an ESD-protected workstation or mat. If an ESD workstation or mat is not available, touch the sheet-metal chassis to provide a static ground before touching an ESD-sensitive assembly. Protect the ESD-sensitive assemblies by placing them in ESD pouches when they are out of the printer.

If the replacement part is a roller or pad, avoid touching the spongy part of it. Skin oils on the roller or pad can cause paper pickup and/or print-quality problems. HP recommends using disposable gloves when handling rollers or pads or washing your hands before touching rollers or pads.

 **IMPORTANT:** Make sure that all of the shipping materials (for example shipping tape) are removed from the replacement part prior to installation.

- c. To install an assembly, reverse the removal steps.

 **NOTE:** When applicable, special installation instructions are provided for an assembly at the end of the removal procedure. Always completely read the removal instructions and follow all special installation instructions.

HP Color LaserJet Managed MFP E77422, E77428, E78223, and E78228 - Removal and replacement: Intermediate transfer belt (ITB) unit

Follow these steps to remove the intermediate transfer belt (ITB).

To view a short video of this procedure, click the link below.

 [View a video of how to remove and replace the ITB.](#)

Mean time to repair: 2 minutes

Service level: Intermediate

 **IMPORTANT:** When applicable, special installation instructions are provided for an assembly at the end of the removal procedure. Always completely read the removal instructions and follow all special installation instructions.

Before performing service

- Disconnect the power cable.

Use the table below to identify the correct part number for your printer. To order the part, go to <https://parts.hp.com>

Table 2-9 Part information

Part number	Part description
JC96-06246A	SVC LJ Image Transfer Kit (For E77422, E77428)
5PN63-67001	SVC LJ Image Transfer Kit (For E78223, E78228)

Required tools

- #2 JIS screwdriver with a magnetic tip

After performing service

Turn the printer power on

- Connect the power cable.
- Use the power switch to turn the power on.

Post service test

Verify that the document was copied, scanned, or printed correctly.

1. Remove the ITB cleaner.
 - a. Open the front cover.
 - b. Open the front cover, and then remove the toner collection unit(TCU).

Figure 2-24 Remove TCU



- c. Remove one screw.

Figure 2-25 Remove one screw

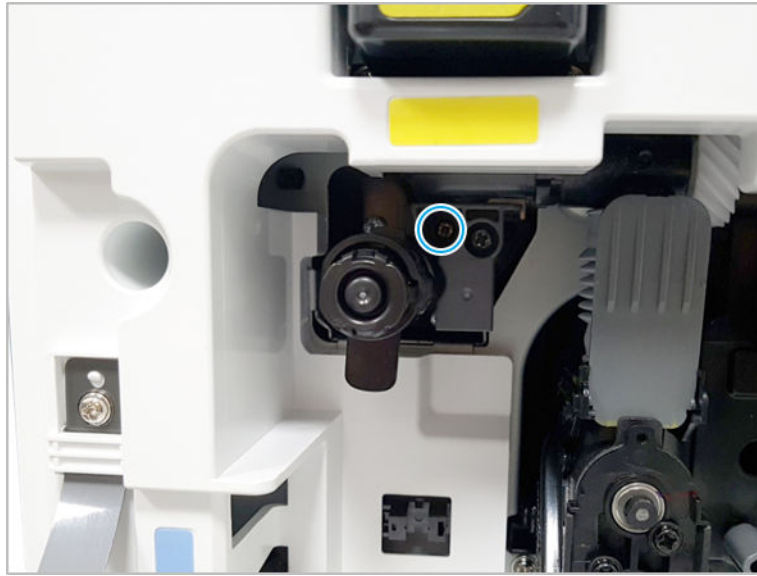

- d. Release the ITB cleaner.

Figure 2-26 Release ITB cleaner

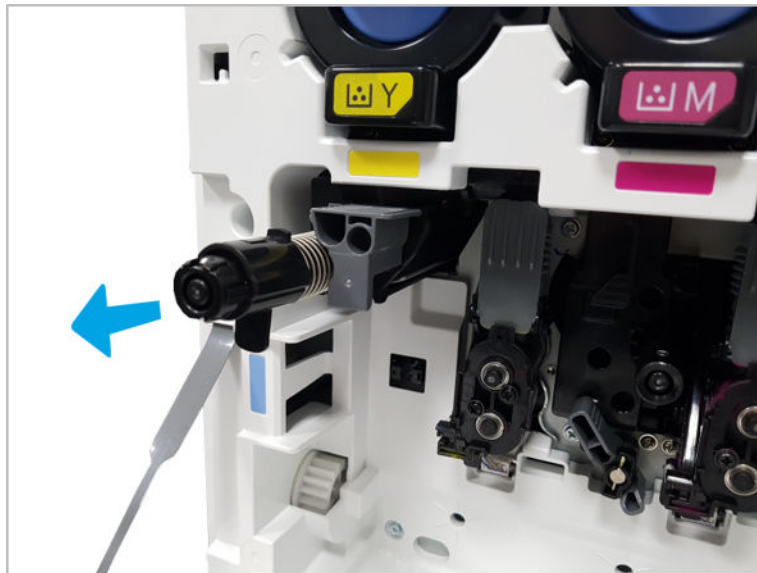

- 2. Remove the right door.

 **NOTE:** Remove second exit drive if installed.

- a. Remove three screws, and then remove the right-rear cover.

Figure 2-27 Remove the right-rear cover



- b. Disconnect the right door connector.

Figure 2-28 Disconnect right door connector



- c. Open the right door.

- d. Release the right hinge (callout 1).

⚠ CAUTION: The right hinge spring tension can be dangerous. Use caution when releasing the right hinge to avoid injury.

Figure 2-29 Release right hinge

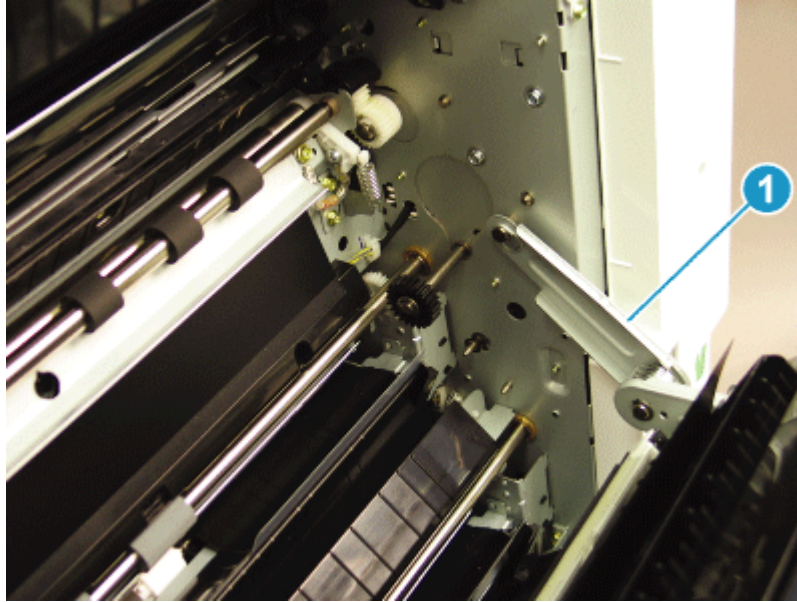

- e. Release the left dampener (callout 1).

Figure 2-30 Release left dampener

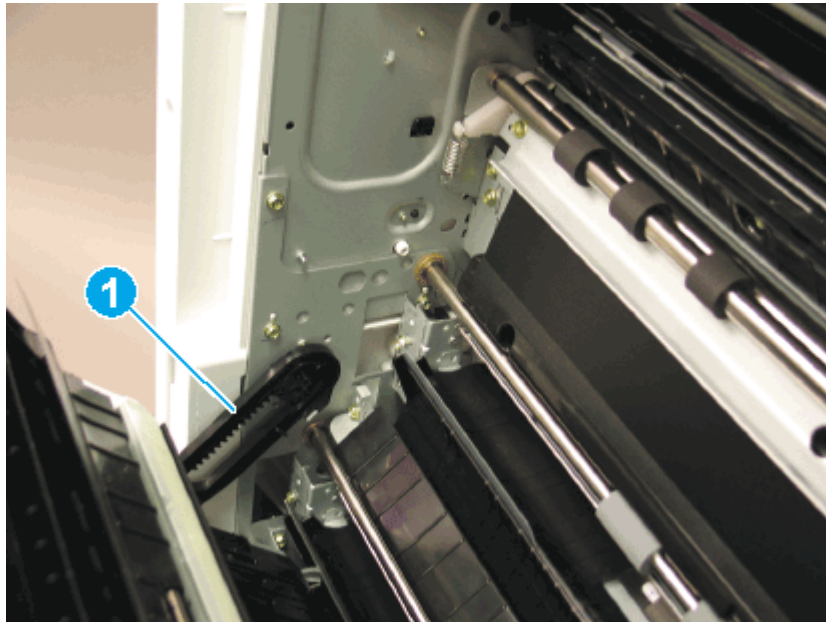

- f. Remove the right door.

 **NOTE:** Open the lower access door. If there is an high-capacity input (HCI) or 2x520 input device, release the dampener to clear the lower right door. Remove clockwise.

Figure 2-31 Remove right door



3. Remove the ITB unit.
 - a. Disconnect the ITB connector from the right. Pull the holder to the front.

Figure 2-32 Disconnect ITB connector

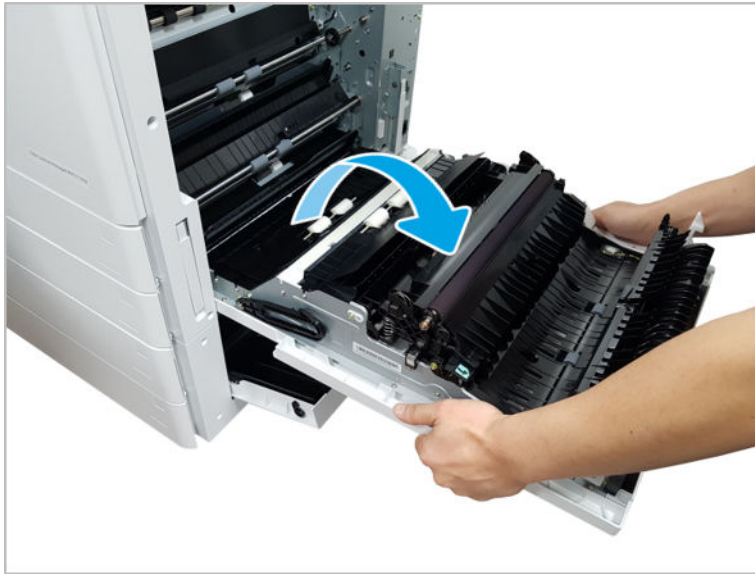
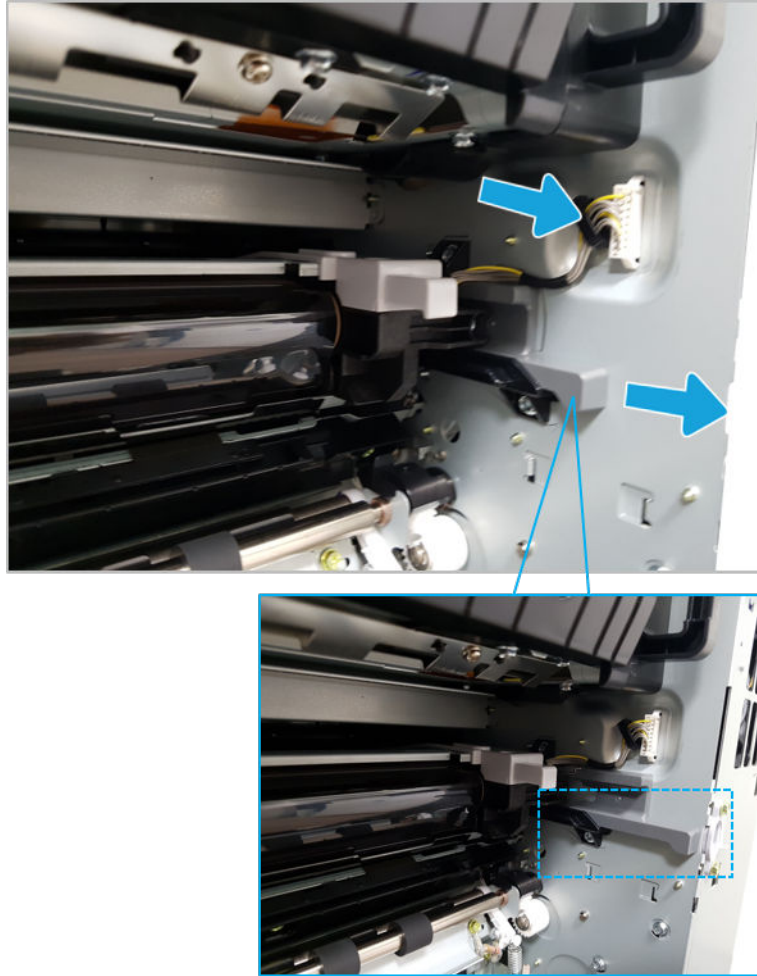

- b. Remove two screws.

Figure 2-33 Remove two screws

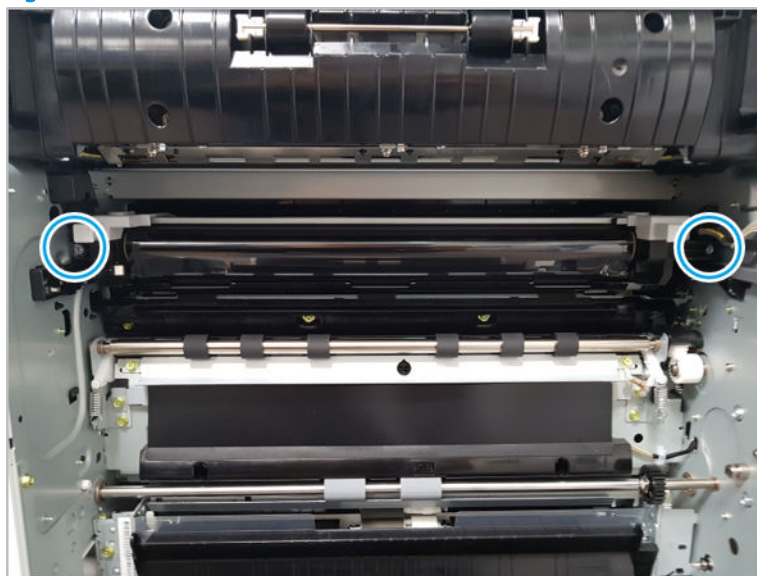

- c. Remove the ITB unit until the handles are fully visible. Release the ITB unit smoothly.

⚠ CAUTION: Make sure not to touch the belt surface of the ITB.

Figure 2-34 Release ITB unit



- d. Before installing the new ITB unit, align the CAM position with the two arrows shown.

Figure 2-35 Align CAM

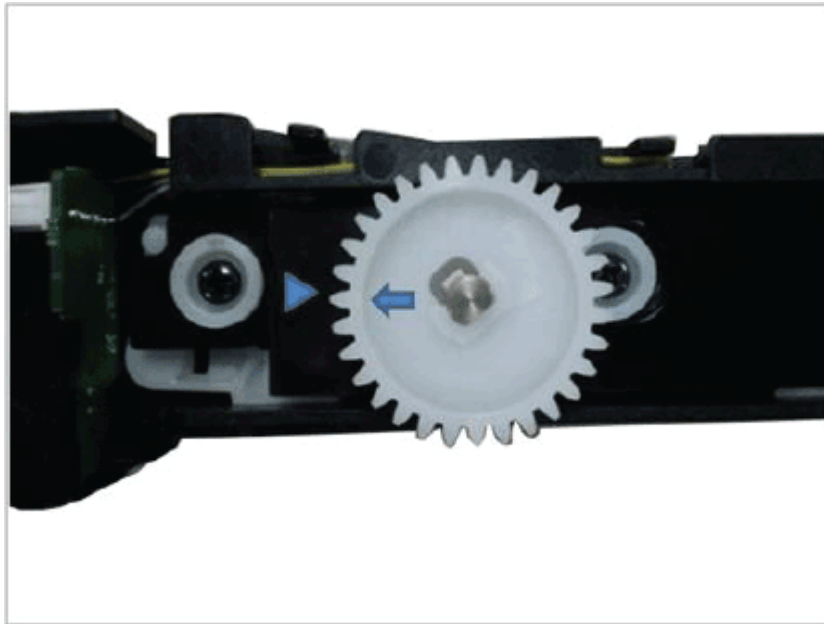

- e. Install the new ITB unit, and then install the ITB cleaner.
4. Unpack the replacement assembly.
 - a. Dispose of the defective part.



NOTE: HP recommends responsible disposal of the defective part.

<http://www8.hp.com/us/en/hp-information/environment/product-recycling.html>

- b. Unpack the replacement part from the packaging.



CAUTION:  Some parts are sensitive to electrostatic discharge (ESD). Always perform service work at an ESD-protected workstation or mat. If an ESD workstation or mat is not available, touch the sheet-metal chassis to provide a static ground before touching an ESD-sensitive assembly. Protect the ESD-sensitive assemblies by placing them in ESD pouches when they are out of the printer.

If the replacement part is a roller or pad, avoid touching the spongy part of it. Skin oils on the roller or pad can cause paper pickup and/or print-quality problems. HP recommends using disposable gloves when handling rollers or pads or washing your hands before touching rollers or pads.



IMPORTANT: Make sure that all of the shipping materials (for example shipping tape) are removed from the replacement part prior to installation.

- c. To install an assembly, reverse the removal steps.



NOTE: When applicable, special installation instructions are provided for an assembly at the end of the removal procedure. Always completely read the removal instructions and follow all special installation instructions.

HP Color LaserJet Managed MFP E77422, E77428, E78223, and E78228 - Removal and replacement: LVPS fan

Follow these steps to remove the LVPS fan assembly.

To view a short video of this procedure, click the link below.



[View a video of how to remove and replace the LVPS fan.](#)

Mean time to repair: 3~4 minutes

Service level: Basic



IMPORTANT: When applicable, special installation instructions are provided for an assembly at the end of the removal procedure. Always completely read the removal instructions and follow all special installation instructions.

Before performing service

- Disconnect the power cable.



WARNING! To avoid damage to the printer, turn the printer off, wait 30 seconds, and then remove the power cable before attempting to service the printer.

Use the table below to identify the correct part number for your printer. To order the part, go to <https://parts.hp.com>

Table 2-10 Part information

Part number	Part description
JC31-00162A	LVPS fan (type 8)

Required tools

- #2 JIS screwdriver with a magnetic tip

After performing service

Turn the printer power on

- Connect the power cable.
- Use the power switch to turn the power on.

Post service test

Verify that the document was copied, scanned, or printed correctly.

1. Remove the rear covers.
 - a. Unscrew two captive thumbscrews on the formatter cover. Slide the formatter cover to the left, and then to the right to remove.

Figure 2-36 Remove the formatter cover

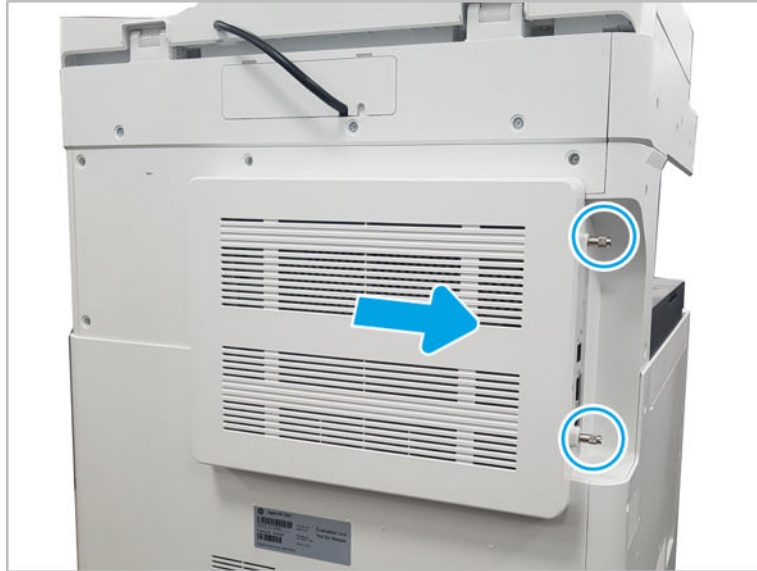

- b. Remove seven screws, and then remove the rear-bottom cover.

Figure 2-37 Remove the rear-bottom cover



- 2. Remove the LVPS cover.
 - ▲ Open three cable restraints and disconnect the connector. Remove four screws. And then remove the LVPS cover.

Figure 2-38 Remove the LVPS cover



3. Remove the LVPS fan.
 - ▲ Release the fan holder hooks, and then remove the LVPS fan.

Figure 2-39 Remove the LVPS fan

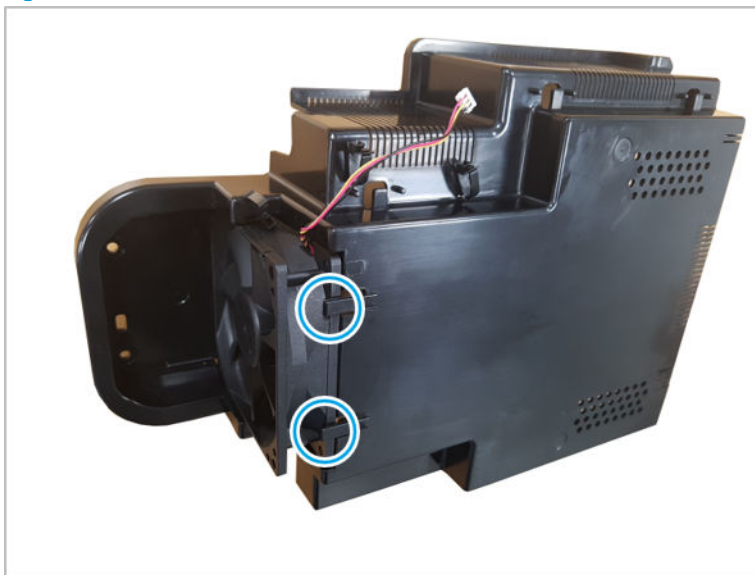



 **TIP:** When reinstalling, verify that the fan is oriented as indicated by the arrows on the fan housing.

4. Unpack the replacement assembly.
 - a. Dispose of the defective part.

 **NOTE:** HP recommends responsible disposal of the defective part.

<http://www8.hp.com/us/en/hp-information/environment/product-recycling.html>

- b. Unpack the replacement part from the packaging.

 **CAUTION:**  Some parts are sensitive to electrostatic discharge (ESD). Always perform service work at an ESD-protected workstation or mat. If an ESD workstation or mat is not available, touch the sheet-metal chassis to provide a static ground before touching an ESD-sensitive assembly. Protect the ESD-sensitive assemblies by placing them in ESD pouches when they are out of the printer.

If the replacement part is a roller or pad, avoid touching the spongy part of it. Skin oils on the roller or pad can cause paper pickup and/or print-quality problems. HP recommends using disposable gloves when handling rollers or pads or washing your hands before touching rollers or pads.

 **IMPORTANT:** Make sure that all of the shipping materials (for example shipping tape) are removed from the replacement part prior to installation.

- c. To install an assembly, reverse the removal steps.

 **NOTE:** When applicable, special installation instructions are provided for an assembly at the end of the removal procedure. Always completely read the removal instructions and follow all special installation instructions.

HP Color LaserJet Managed MFP E77422, E77428, E78223, and E78228 - Removal and replacement: LVPS board

Follow these steps to remove the scanner LVPS board.

To view a short video of this procedure, click the link below.

 [View a video of how to remove and replace the LVPS board.](#)

Mean time to repair: 5 minutes

Service level: Basic

 **IMPORTANT:** When applicable, special installation instructions are provided for an assembly at the end of the removal procedure. Always completely read the removal instructions and follow all special installation instructions.

Before performing service

- Disconnect the power cable.

 **CAUTION:** Wait five minutes after disconnecting the power cable before replacing the LVPS board. Not waiting long enough after disconnecting the power cable can cause electric shock.

Use the table below to identify the correct part number for your printer. To order the part, go to <https://parts.hp.com>

Table 2-11 Part information

Part number	Part description
JC44-00249A	LVPS 110V type 5H (SMPS V1)
JC44-00250A	LVPS 220V Type 5H (SMPS V2)

Required tools

- #2 JIS screwdriver with a magnetic tip

After performing service

Turn the printer power on

- Connect the power cable.
- Use the power switch to turn the power on.

Post service test

Verify that the document was copied, scanned, or printed correctly.

1. Remove the rear covers.
 - a. Unscrew two captive thumbscrews on the formatter cover. Slide the formatter cover to the left, and then to the right to remove.

Figure 2-40 Remove the formatter cover

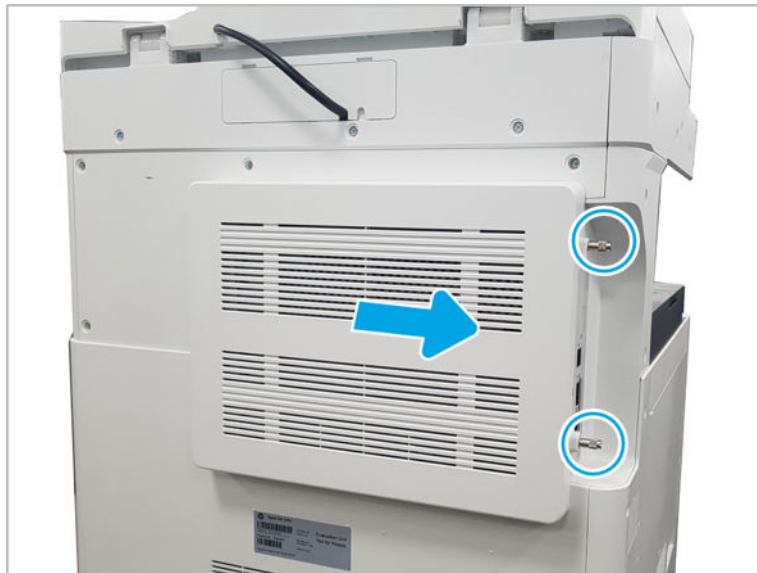

- b. Remove seven screws, and then remove the rear-bottom cover.

Figure 2-41 Remove the rear-bottom cover

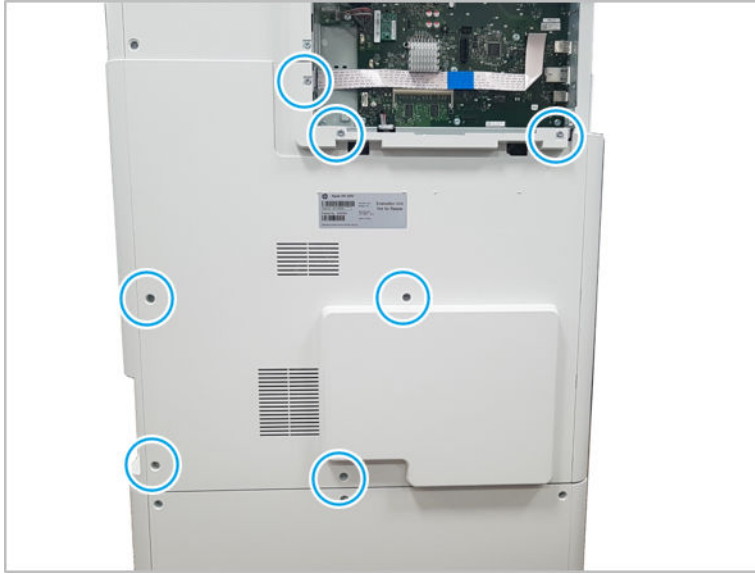

2. Remove the LVPS cover.

- ▲ Disconnect the LVPS fan connector, remove four screws, and then remove the LVPS cover.

Figure 2-42 Remove the LVPS cover



3. Remove the LVPS board.

- a. Disconnect all connectors on the LVPS board.

- b. Remove four screws, and then remove the LVPS board.

Figure 2-43 Remove the LVPS board

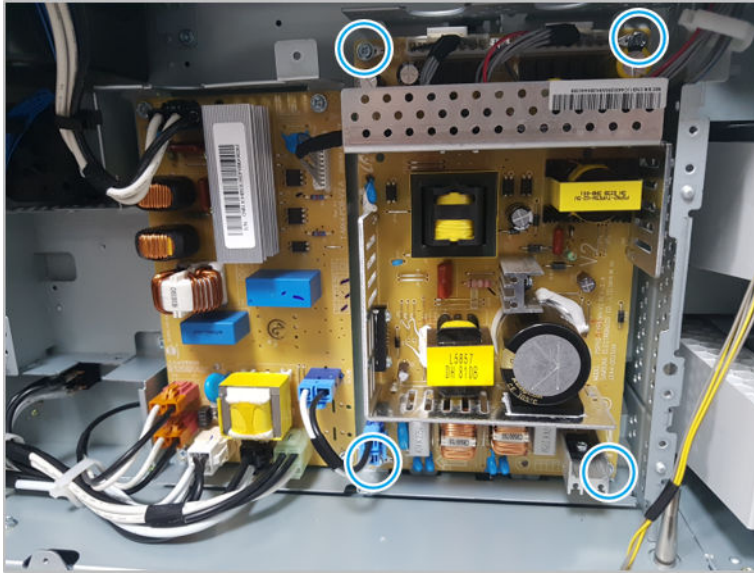

4. Unpack the replacement assembly.
 - a. Dispose of the defective part.



NOTE: HP recommends responsible disposal of the defective part.

<http://www8.hp.com/us/en/hp-information/environment/product-recycling.html>

- b. Unpack the replacement part from the packaging.



CAUTION:  Some parts are sensitive to electrostatic discharge (ESD). Always perform service work at an ESD-protected workstation or mat. If an ESD workstation or mat is not available, touch the sheet-metal chassis to provide a static ground before touching an ESD-sensitive assembly. Protect the ESD-sensitive assemblies by placing them in ESD pouches when they are out of the printer.

If the replacement part is a roller or pad, avoid touching the spongy part of it. Skin oils on the roller or pad can cause paper pickup and/or print-quality problems. HP recommends using disposable gloves when handling rollers or pads or washing your hands before touching rollers or pads.



IMPORTANT: Make sure that all of the shipping materials (for example shipping tape) are removed from the replacement part prior to installation.

- c. To install an assembly, reverse the removal steps.



NOTE: When applicable, special installation instructions are provided for an assembly at the end of the removal procedure. Always completely read the removal instructions and follow all special installation instructions.

HP Color LaserJet Managed MFP E77422, E77428, E78223, and E78228 - Removal and replacement: Fuser drive board (FDB)

Follow these steps to remove the fuser drive board (FDB).

To view a short video of this procedure, click the link below.

 [View a video of how to remove and replace the FDB.](#)

Mean time to repair: 5 minutes

Service level: Basic

 **IMPORTANT:** When applicable, special installation instructions are provided for an assembly at the end of the removal procedure. Always completely read the removal instructions and follow all special installation instructions.

Before performing service

- Disconnect the power cable.

 **CAUTION:** Wait five minutes after disconnecting the power cable before replacing the fuser drive board. Not waiting long enough after disconnecting the power cable can cause electric shock.

Use the table below to identify the correct part number for your printer. To order the part, go to <https://parts.hp.com>

Table 2-12 Part information

Part number	Part description
JC44-00210E	Fuser drive board, 110V, For E77422, E77428
JC44-00211E	Fuser drive board, 220V, For E77422, E77428
8GR94-60001	Fuser drive board, 110V, For E78223, E78228
8GR94-60002	Fuser drive board, 220V, For E78223, E78228

Required tools

- #2 JIS screwdriver with a magnetic tip

After performing service

Turn the printer power on

- Connect the power cable.
- Use the power switch to turn the power on.

Post service test

Verify that the document was copied, scanned, or printed correctly.

1. Remove the rear covers.
 - a. Unscrew two captive thumbscrews on the formatter cover. Slide the formatter cover to the left, and then to the right to remove.

Figure 2-44 Remove the formatter cover

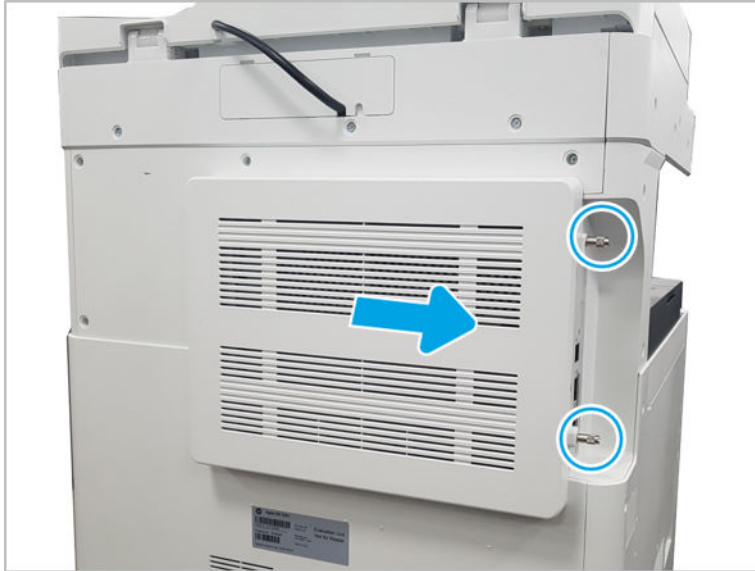

- b. Remove seven screws, and then remove the rear-bottom cover.

Figure 2-45 Remove the rear-bottom cover



- 2. Remove the LVPS cover.
 - ▲ Open three cable restraints and disconnect the connector. Remove four screws. And then remove the LVPS cover.

Figure 2-46 Remove the LVPS cover



3. Remove the fuser drive board.

- ▲ Disconnect all connectors on fuser drive board. Remove four screws, and then remove the fuser drive board.

Figure 2-47 Remove the fuser drive board

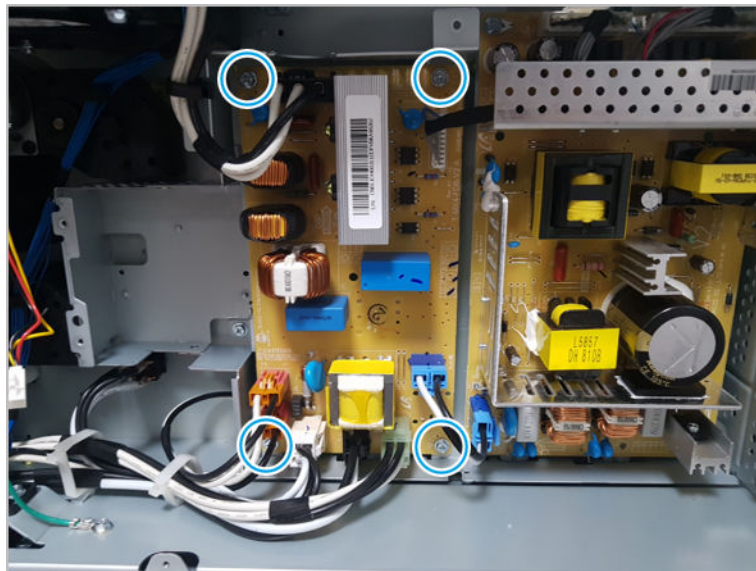

4. Unpack the replacement assembly.

- a. Dispose of the defective part.

 **NOTE:** HP recommends responsible disposal of the defective part.

<http://www8.hp.com/us/en/hp-information/environment/product-recycling.html>

- b. Unpack the replacement part from the packaging.



CAUTION:  Some parts are sensitive to electrostatic discharge (ESD). Always perform service work at an ESD-protected workstation or mat. If an ESD workstation or mat is not available, touch the sheet-metal chassis to provide a static ground before touching an ESD-sensitive assembly. Protect the ESD-sensitive assemblies by placing them in ESD pouches when they are out of the printer.

If the replacement part is a roller or pad, avoid touching the spongy part of it. Skin oils on the roller or pad can cause paper pickup and/or print-quality problems. HP recommends using disposable gloves when handling rollers or pads or washing your hands before touching rollers or pads.



IMPORTANT: Make sure that all of the shipping materials (for example shipping tape) are removed from the replacement part prior to installation.

- c. To install an assembly, reverse the removal steps.



NOTE: When applicable, special installation instructions are provided for an assembly at the end of the removal procedure. Always completely read the removal instructions and follow all special installation instructions.

Main assembly 2 (Front side and left side)

View Main assembly 2 exploded view, parts list, and repair procedures.

Main assembly 2 (Front side and left side)

Figure 2-48 Main assembly 2 (Front side and left side)

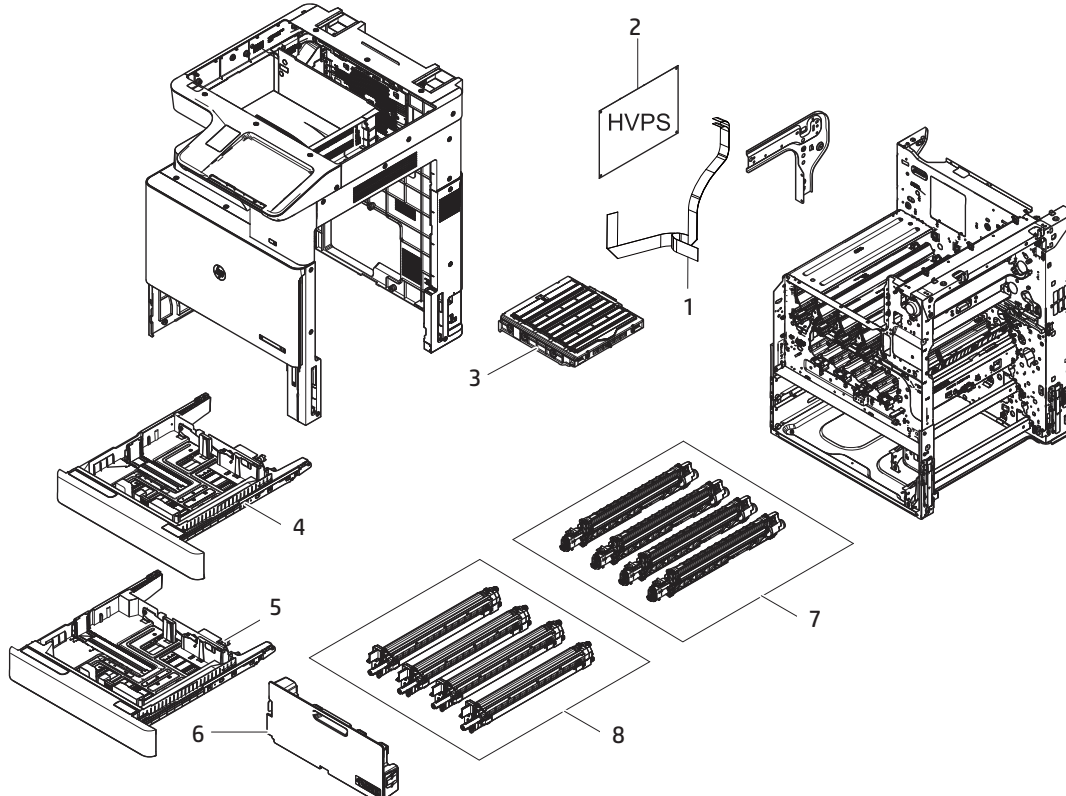

Table 2-13 Main assembly 2 (Front side and left side)

Ref	Description	Part Number (*)	Qty
1	Laser scanner unit and HVPS interface cable	JC39-02114A (*)	1
2	HVPS (For E77422, E77428)	JC44-00212C (*)	1
2	HVPS (For E78223, E78228)	JC44-00212D (*)	1
3	Laser scanner unit (LSU)	JC97-04010A (*)	1
4	Cassette Tray 2	JC90-01773A (*)	1
5	Cassette Tray 3	5QJ98-60101 (*)	1
6	Toner Collection Unit (TCU)	X3A83-67923 (*)	1
7	Imaging drum CMYK (For E77422, E77428)	X3A83-67905 (*)	4
7	Imaging drum CMYK (For E78223, E78228)	W9215-67901 (*)	4
8	Developer unit, Y (For E77422, E77428)	JC96-11663A (*)	1
8	Developer unit, Y (For E78223, E78228)	8JM72-67001 (*)	1

Table 2-13 Main assembly 2 (Front side and left side) (continued)

Ref	Description	Part Number (*)	Qty
8	Developer unit, M (For E77422, E77428)	JC96-11664A (*)	1
8	Developer unit, M (For E78223, E78228)	8JM73-67001 (*)	1
8	Developer unit, C (For E77422, E77428)	JC96-11665A (*)	1
8	Developer unit, C (For E78223, E78228)	8JM71-67001 (*)	1
8	Developer unit, K (For E77422, E77428)	JC96-11666A (*)	1
8	Developer unit, K (For E78223, E78228)	8JM70-67001 (*)	1

* This part is in ordering system. If the ordering system has this part in stock, it can be ordered.

Remove and replace the toner collection unit

Follow these steps to replace the toner collection unit (TCU).

1. Open the front door.

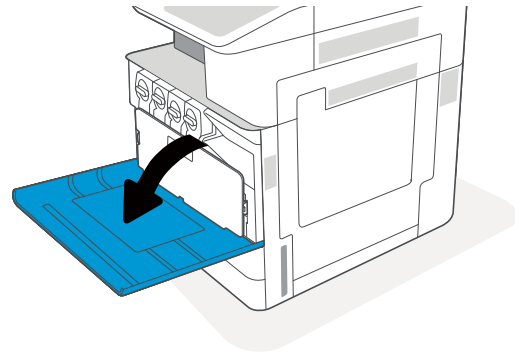

2. Pull on each tab on the sides of the toner collection unit to release the TCU, and then pull it straight out of the printer.

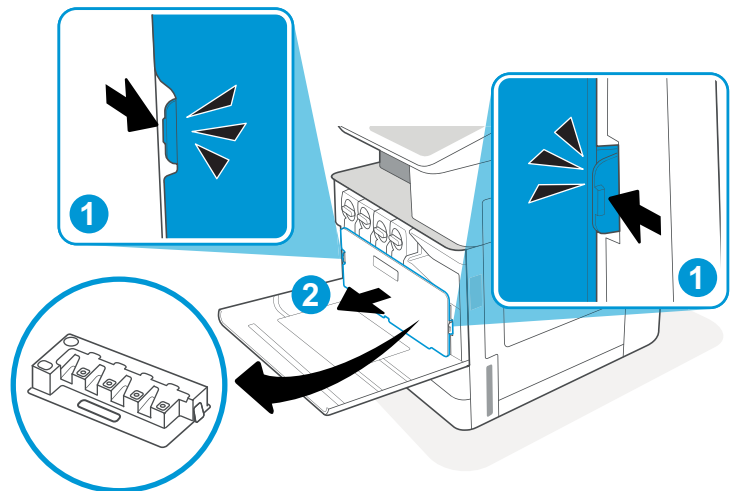

NOTE: Maintain the position of the TCU as you pull it out from the printer. This will ensure that you do not spill any waste toner in the printer. Once the TCU is fully removed, do not place it on its side with holes facing down. Place the unit into the clear plastic bag the new TCU was packaged in. Seal plastic bag.

3. Remove the new toner collection unit (TCU) from its package. Save all packaging for recycling the used toner collection unit (TCU).

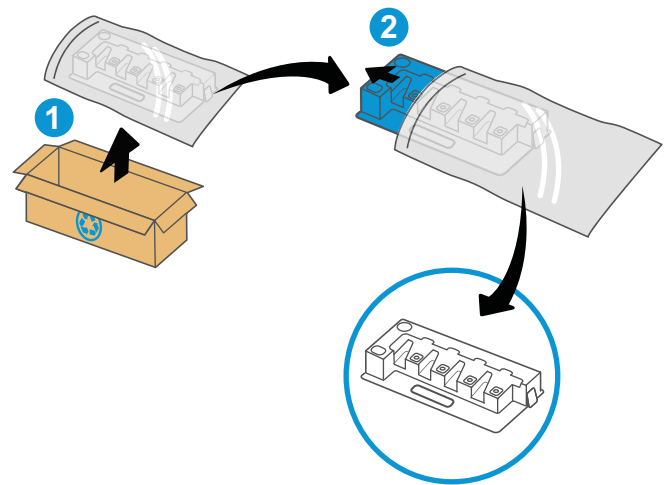

4. Install the new TCU by pushing in on both sides until the tabs snap into place.

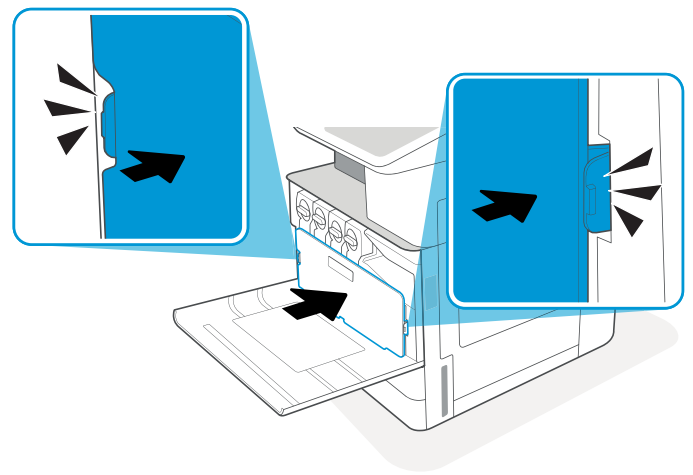

5. Close the front door.

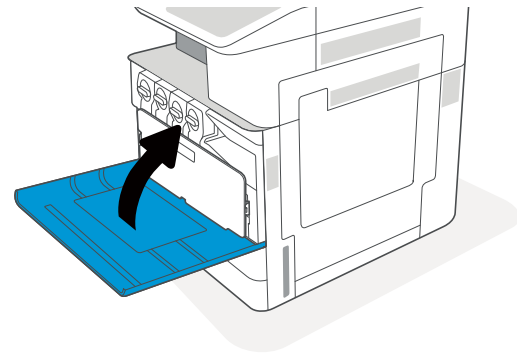

6. Pack the used toner collection unit (TCU) into the box that the new toner collection unit (TCU) came in. See the enclosed recycling guide for information about recycling.

In the U.S. and Canada, a pre-paid shipping label is included in the box. In other countries/regions, go to www.hp.com/recycle to print a pre-paid shipping label.

Adhere the pre-paid shipping label to the box, and return the used toner collection unit (TCU) to HP for recycling.

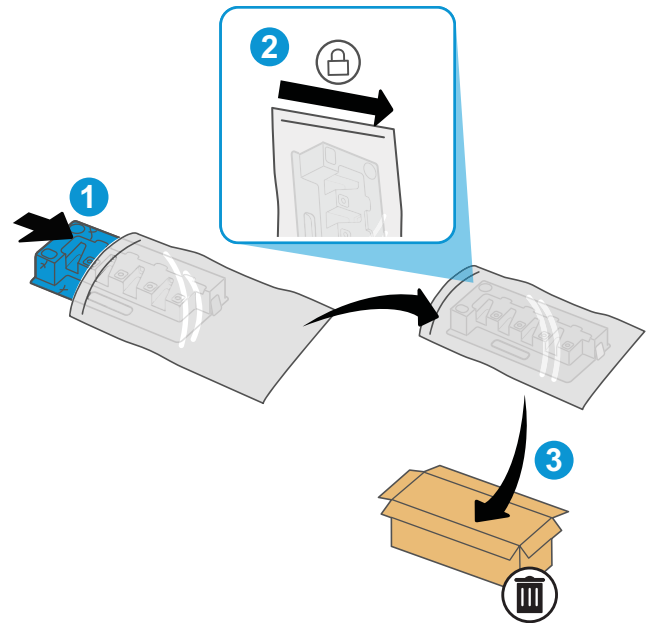

Remove and replace the toner cartridge

Follow these steps to replace the toner cartridge.

 [View a video of how to remove and replace the toner cartridge](#)

1. Open the front door.

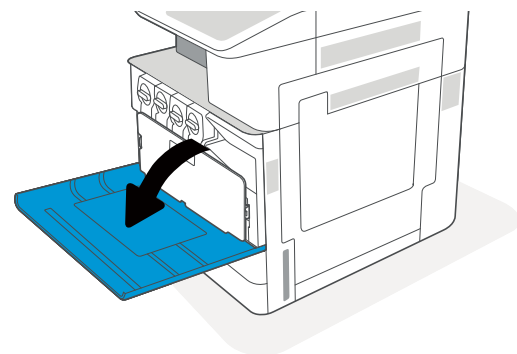

2. Release the toner cartridge latch and pull the cartridge straight out of the printer.

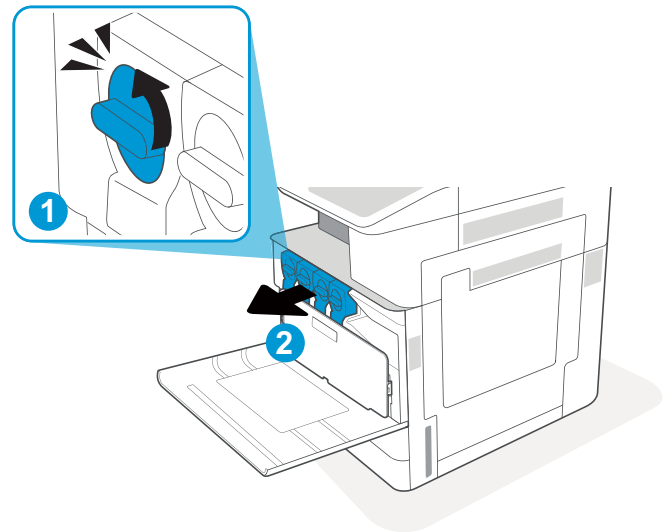

3. Remove the new toner cartridge from its package. Save all packaging for recycling the used toner cartridge.

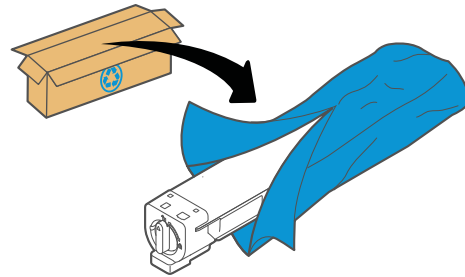

4. Hold both ends of the toner cartridge and rock it to evenly distribute the toner that is inside. And then, remove the seal.

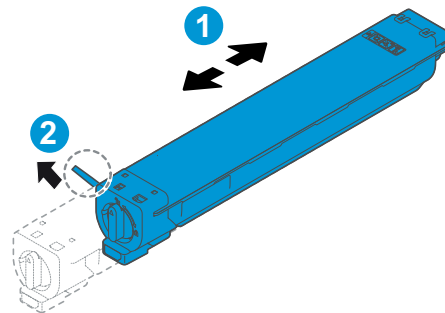

5. Align the toner cartridge with its slot, insert the toner cartridge into the printer, and secure the latch.

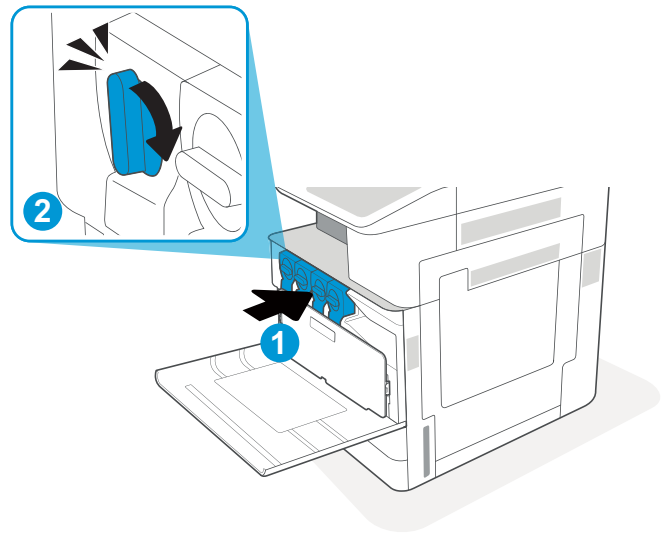

6. Close the front door.

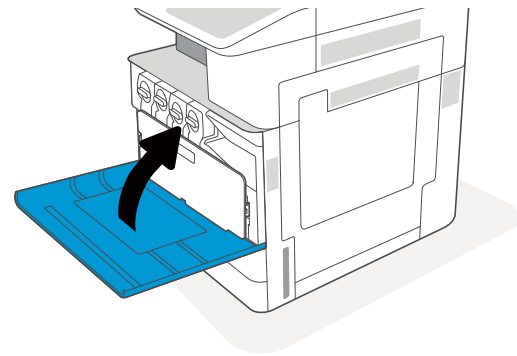

7. Pack the used toner cartridge into the box that the new toner cartridge came in. See the enclosed recycling guide for information about recycling.

In the U.S. and Canada, a pre-paid shipping label is included in the box. In other countries/regions, go to www.hp.com/recycle to print a pre-paid shipping label.

Adhere the pre-paid shipping label to the box, and return the used cartridge to HP for recycling.

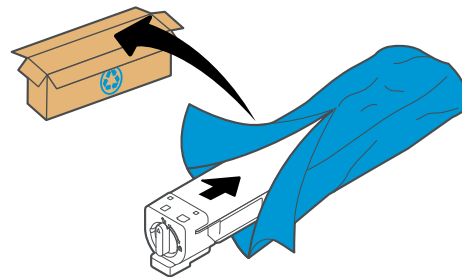

HP Color LaserJet Managed MFP E77422, E77428, E78223, and E78228 - Removal and replacement: Laser scanning unit assembly (LSU)

Follow these steps to remove the laser scanner assembly.

To view a short video of this procedure, click the link below.

 [View a video of how to remove and replace the laser scanner assembly.](#)

Mean time to repair: 5 minutes

Service level: Basic

 **IMPORTANT:** When applicable, special installation instructions are provided for an assembly at the end of the removal procedure. Always completely read the removal instructions and follow all special installation instructions.

Before performing service

- Disconnect the power cable.

 **WARNING!** To avoid damage to the printer, turn the printer off, wait 30 seconds, and then remove the power cable before attempting to service the printer.

Use the table below to identify the correct part number for your printer. To order the part, go to <https://parts.hp.com>

Table 2-14 Part information

Part number	Part description
JC97-04010A	Laser scanner assembly

Required tools

- #2 JIS screwdriver with a magnetic tip

After performing service

Turn the printer power on

- Connect the power cable.
- Use the power switch to turn the power on.

Post service test

Verify that the document was copied, scanned, or printed correctly.

1. Remove the left cover.
 - a. Release the lock with tweezers at the releasing point, and then remove the left trim cover

Figure 2-49 Remove the left trim cover

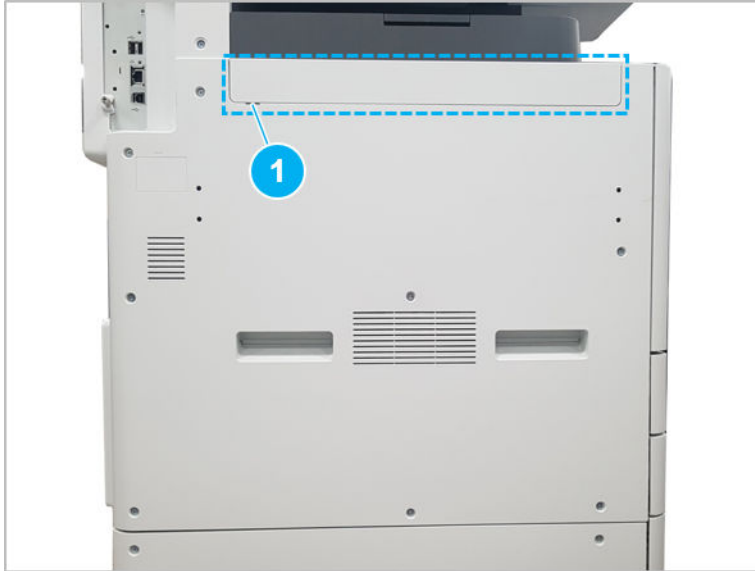

- b. Remove ten screws, and then remove the left cover.

Figure 2-50 Remove the left cover



- 2. Remove the high-voltage power supply (HVPS).
 - a. Remove seven screws, and then release the middle hook.

Figure 2-51 Remove the HVPS

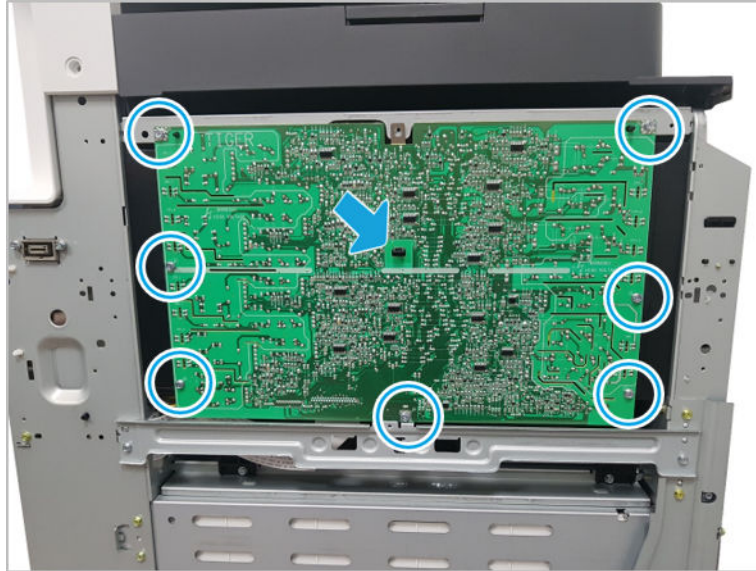

- b. Disconnect one connector and one FFC. And then, remove the HVPS board.

 **TIP:** To easily disconnect the connectors, remove the Laser scanner unit (LSU) assembly.

Figure 2-52 Remove the HVPS board



3. Remove the laser scanner assembly.
 - a. Remove two screws, and then release the bracket.

Figure 2-53 Release the bracket

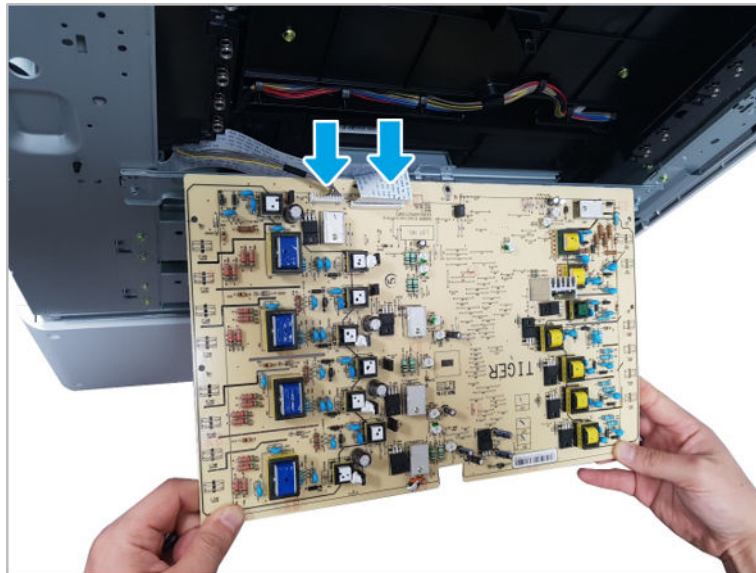

- b. Remove two screws.

Figure 2-54 Remove the laser scanner assembly

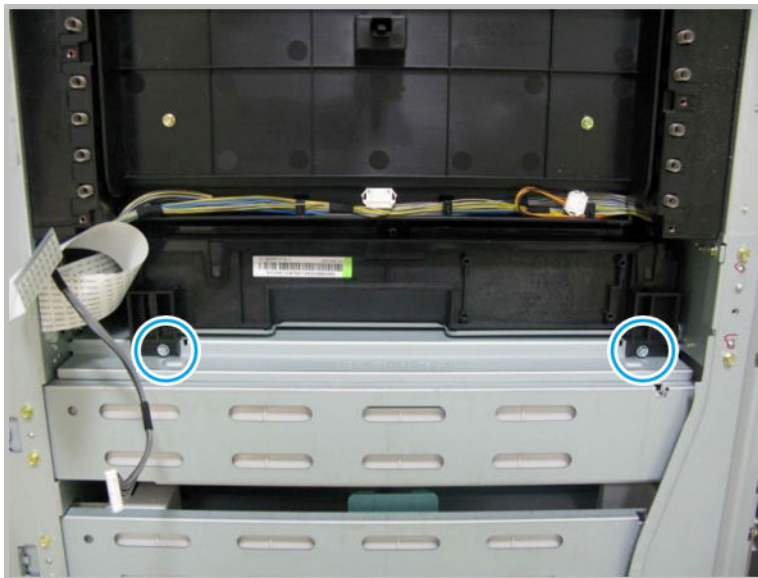

- c. Disconnect the laser scanner assembly harness at the left, and then partially remove the assembly from the chassis. Open the FFC lock, and then release the FFC. And then, remove the laser scanner assembly completely.

CAUTION: If the laser scanner assembly is removed too rough or fast, the harness can be damaged.

Figure 2-55 Disconnect the laser scanner assembly harness and FFC

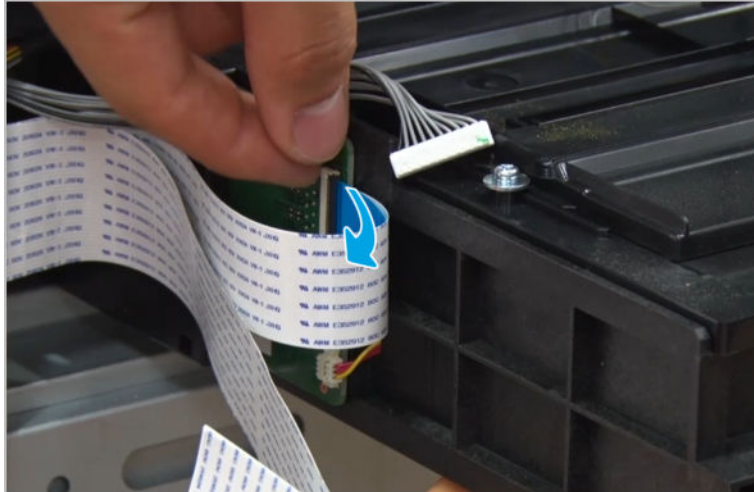

- d. Complete a laser scanner assembly adjustment after a new laser scanner assembly has been installed.
4. Unpack the replacement assembly.
 - a. Dispose of the defective part.

NOTE: HP recommends responsible disposal of the defective part.

<http://www8.hp.com/us/en/hp-information/environment/product-recycling.html>

- b. Unpack the replacement part from the packaging.

CAUTION:  Some parts are sensitive to electrostatic discharge (ESD). Always perform service work at an ESD-protected workstation or mat. If an ESD workstation or mat is not available, touch the sheet-metal chassis to provide a static ground before touching an ESD-sensitive assembly. Protect the ESD-sensitive assemblies by placing them in ESD pouches when they are out of the printer.

If the replacement part is a roller or pad, avoid touching the spongy part of it. Skin oils on the roller or pad can cause paper pickup and/or print-quality problems. HP recommends using disposable gloves when handling rollers or pads or washing your hands before touching rollers or pads.

IMPORTANT: Make sure that all of the shipping materials (for example shipping tape) are removed from the replacement part prior to installation.

- c. To install an assembly, reverse the removal steps.

NOTE: When applicable, special installation instructions are provided for an assembly at the end of the removal procedure. Always completely read the removal instructions and follow all special installation instructions.

HP Color LaserJet Managed MFP E77422, E77428, E78223, and E78228 - Removal and replacement: High-voltage power supply (HVPS) board

Follow these steps to remove the high-voltage power supply (HVPS) board.

To view a short video of this procedure, click the link below.

 [View a video of how to remove and replace the HVPS board.](#)

Mean time to repair: 1 minutes

Service level: Intermediate

 **IMPORTANT:** When applicable, special installation instructions are provided for an assembly at the end of the removal procedure. Always completely read the removal instructions and follow all special installation instructions.

Before performing service

- Disconnect the power cable.

 **WARNING!** To avoid damage to the printer, turn the printer off, wait 30 seconds, and then remove the power cable before attempting to service the printer.

Use the table below to identify the correct part number for your printer. To order the part, go to <https://parts.hp.com>

Table 2-15 Part information

Part number	Part description
JC44-00212C	HVPS (For E77422, E77428)
JC44-00212D	HVPS (For E78223, E78228)
JC39-02114A	Laser scanner unit and HVPS interface cable

Required tools

- #2 JIS screwdriver with a magnetic tip

After performing service

Turn the printer power on

- Connect the power cable.
- Use the power switch to turn the power on.

Post service test

Verify that the document was copied, scanned, or printed correctly.

1. Remove the left cover.
 - a. Release the lock with tweezers at the releasing point, and then remove the left trim cover

Figure 2-56 Remove the left trim cover

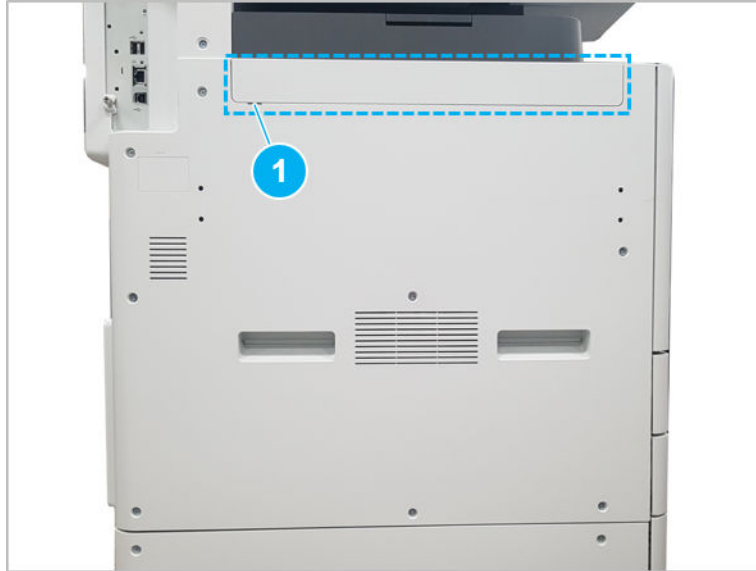

- b. Remove ten screws, and then remove the left cover.

Figure 2-57 Remove the left cover



- 2. Remove the high-voltage power supply (HVPS).
 - a. Remove seven screws, and then release the middle hook.

Figure 2-58 Remove the HVPS

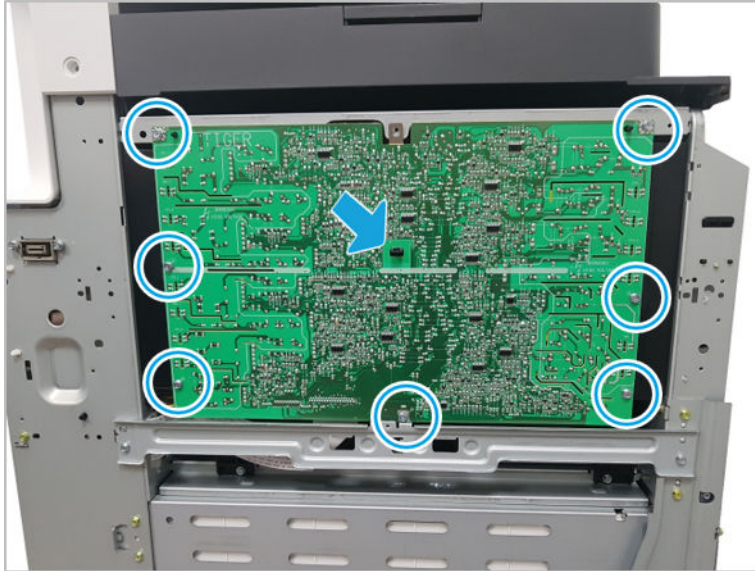

- b. Disconnect one connector and one FFC. And then, remove the HVPS board.

 **TIP:** To easily disconnect the connectors, remove the LSU.

Figure 2-59 Remove the HVPS board

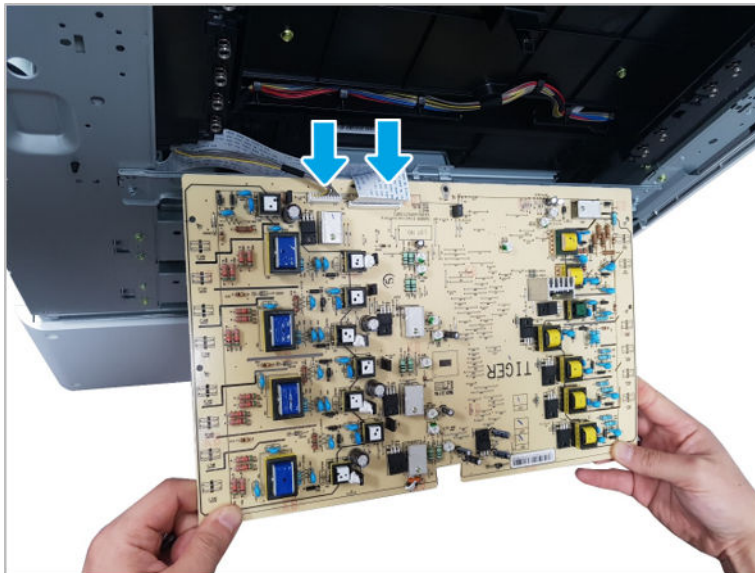



3. Unpack the replacement assembly.
 - a. Dispose of the defective part.

 **NOTE:** HP recommends responsible disposal of the defective part.

<http://www8.hp.com/us/en/hp-information/environment/product-recycling.html>

- b. Unpack the replacement part from the packaging.

 **CAUTION:**  Some parts are sensitive to electrostatic discharge (ESD). Always perform service work at an ESD-protected workstation or mat. If an ESD workstation or mat is not available, touch the sheet-metal chassis to provide a static ground before touching an ESD-sensitive assembly. Protect the ESD-sensitive assemblies by placing them in ESD pouches when they are out of the printer.

If the replacement part is a roller or pad, avoid touching the spongy part of it. Skin oils on the roller or pad can cause paper pickup and/or print-quality problems. HP recommends using disposable gloves when handling rollers or pads or washing your hands before touching rollers or pads.

 **IMPORTANT:** Make sure that all of the shipping materials (for example shipping tape) are removed from the replacement part prior to installation.

- c. To install an assembly, reverse the removal steps.

 **NOTE:** When applicable, special installation instructions are provided for an assembly at the end of the removal procedure. Always completely read the removal instructions and follow all special installation instructions.

HP Color LaserJet Managed MFP E77422, E77428, E78223, and E78228 - Removal and replacement: Imaging drum unit

Follow these steps to remove the imaging drum unit.

To view a short video of this procedure, click the link below.

 [View a video of how to remove and replace the imaging drum unit.](#)

Mean time to repair: 3 minutes

Service level: Basic

 **IMPORTANT:** When applicable, special installation instructions are provided for an assembly at the end of the removal procedure. Always completely read the removal instructions and follow all special installation instructions.

Before performing service

- Disconnect the power cable.

Use the table below to identify the correct part number for your printer. To order the part, go to <https://parts.hp.com>

Table 2-16 Part information

Part number	Part description
X3A83-67905	Imaging drum CMYK (For E77422, E77428)
W9215-67901	Imaging drum CMYK (For E78223, E78228)

Required tools

- #2 JIS screwdriver with a magnetic tip

After performing service

Turn the printer power on

- Connect the power cable.
- Use the power switch to turn the power on.

Post service test

Verify that the document was copied, scanned, or printed correctly.

1. Remove the imaging drum.
 - a. Open the front cover.

Figure 2-60 Open the front cover



- b. Open the right door and make sure the latch releases.

- c. Remove the toner collection unit (TCU).

Figure 2-61 Remove TCU



- d. Turn the locking lever counterclockwise.

Figure 2-62 Turn the locking lever

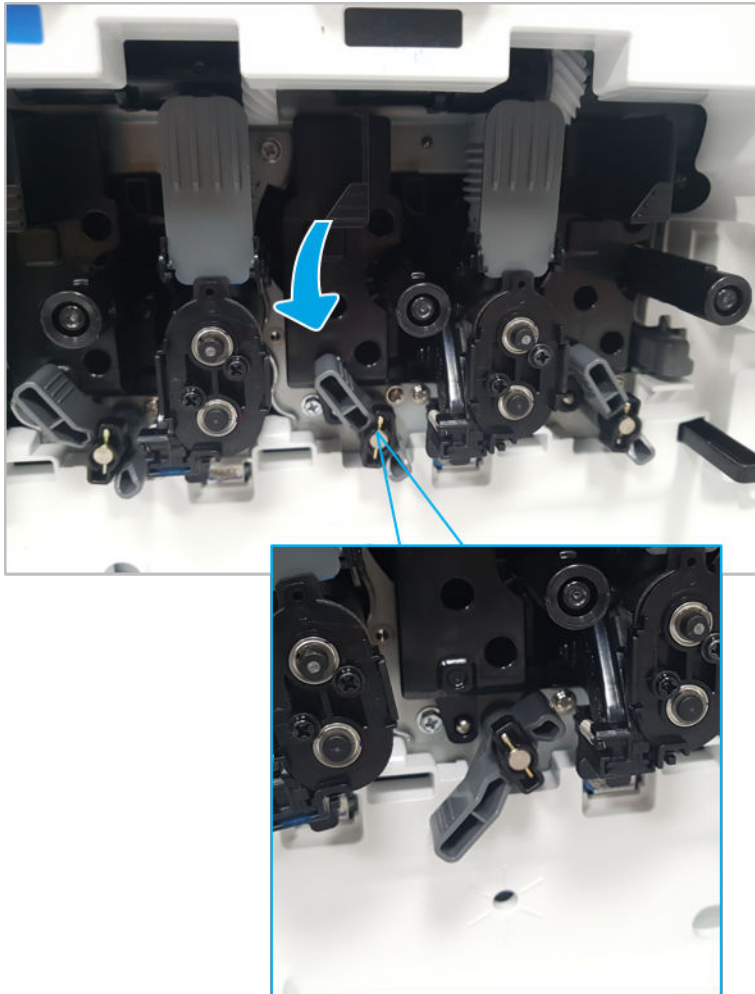

- e. Remove the imaging drum.

Figure 2-63 Remove the imaging drum.



- f. If installing a new imaging drum, remove the imaging drum from its packaging, and then rotate the locking lever clockwise until it makes a solid “click”.

 **NOTE:** If you intend to reuse an imaging drum, make sure the imaging drum surface is covered and not exposed to direct light or sunlight. Cover the imaging drum with a few sheets of paper or keep it in the original packaging until ready to install. When handling any imaging drum, do not touch the drum surface.



2. Unpack the replacement assembly.

- a. Dispose of the defective part.

 **NOTE:** HP recommends responsible disposal of the defective part.

<http://www8.hp.com/us/en/hp-information/environment/product-recycling.html>

- b. Unpack the replacement part from the packaging.

 **CAUTION:**  Some parts are sensitive to electrostatic discharge (ESD). Always perform service work at an ESD-protected workstation or mat. If an ESD workstation or mat is not available, touch the sheet-metal chassis to provide a static ground before touching an ESD-sensitive assembly. Protect the ESD-sensitive assemblies by placing them in ESD pouches when they are out of the printer.

If the replacement part is a roller or pad, avoid touching the spongy part of it. Skin oils on the roller or pad can cause paper pickup and/or print-quality problems. HP recommends using disposable gloves when handling rollers or pads or washing your hands before touching rollers or pads.

 **IMPORTANT:** Make sure that all of the shipping materials (for example shipping tape) are removed from the replacement part prior to installation.

- c. To install an assembly, reverse the removal steps.

 **NOTE:** When applicable, special installation instructions are provided for an assembly at the end of the removal procedure. Always completely read the removal instructions and follow all special installation instructions.

HP Color LaserJet Managed MFP E77422, E77428, E78223, and E78228 - Removal and replacement: Developer unit

Follow these steps to remove the developer unit(s).

To view a short video of this procedure, click the link below.

 [View a video of how to remove and replace the developer unit\(s\).](#)

Mean time to repair: 11 minutes

Service level: Basic

 **IMPORTANT:** When applicable, special installation instructions are provided for an assembly at the end of the removal procedure. Always completely read the removal instructions and follow all special installation instructions.

Before performing service

- Disconnect the power cable.

Use the table below to identify the correct part number for your printer. To order the part, go to <https://parts.hp.com>

Table 2-17 part information

Part number	Part description
JC96-11663A	Developer unit, Y (For E77422, E77428)
8JM72-67001	Developer unit, Y (For E78223, E78228)
JC96-11664A	Developer unit, M (For E77422, E77428)
8JM73-67001	Developer unit, M (For E78223, E78228)
JC96-11665A	Developer unit, C (For E77422, E77428)
8JM71-67001	Developer unit, C (For E78223, E78228)
JC96-11666A	Developer unit, K (For E77422, E77428)
8JM70-67001	Developer unit, K (For E78223, E78228)

Required tools

- #2 JIS screwdriver with a magnetic tip

After performing service

Turn the printer power on

- Connect the power cable.
- Use the power switch to turn the power on.

Post service test

Verify that the document was copied, scanned, or printed correctly.

1. Remove the toner collection unit (TCU).
 - ▲ Turn off the printer. Open the front door and remove the TCU.

Figure 2-64 Remove TCU



2. Remove the imaging drum that corresponds with the developer unit being replaced.
 - a. Turn the locking lever counterclockwise.

Figure 2-65 Turn the locking lever

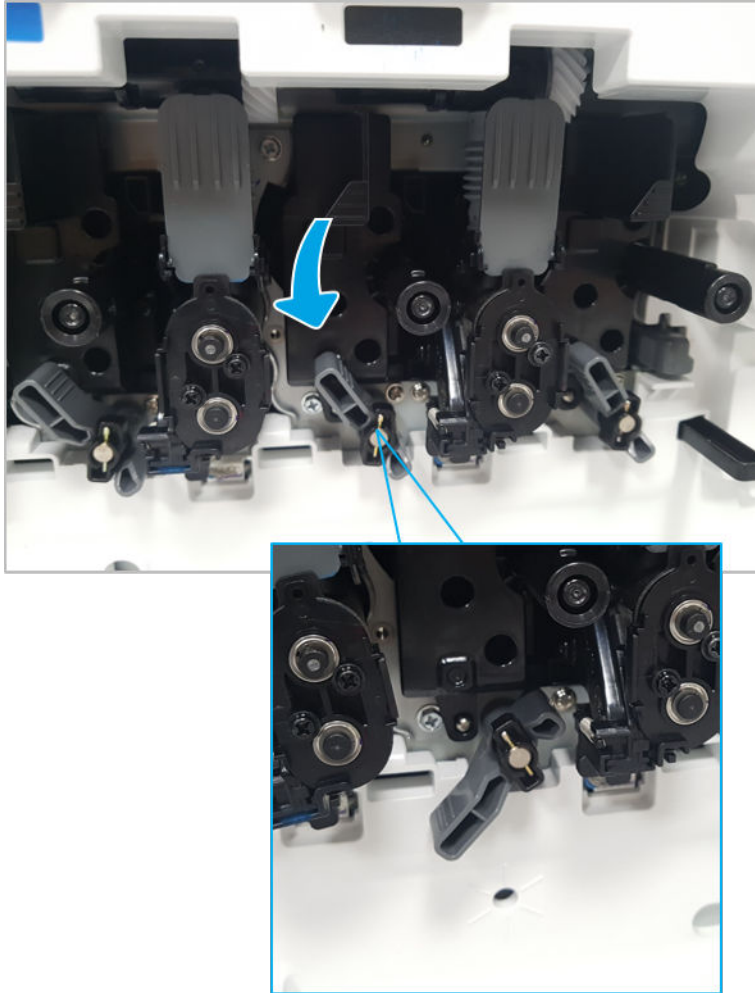

- b. Remove the imaging drum.

Figure 2-66 Remove the imaging drum



3. Remove the developer unit.
 - a. Fold down the toner supply shutter.

⚠ CAUTION: The toner supply cap contains toner. Use caution to avoid spilling toner during removal.

Figure 2-67 Fold down the toner supply shutter



- b. Push the shutter in to close the toner supply.

Figure 2-68 Close the shutter



- c. Grasp the toner supply connection on the black plastic and wiggle and pull out to disengage the connection from the developing unit. Rotate the toner supply up.

⚠ CAUTION: Do not compress or squeeze the gray supply pipe. This supply pipe is filled with toner and will leak if squeezed.

Figure 2-69 Rotate swivel

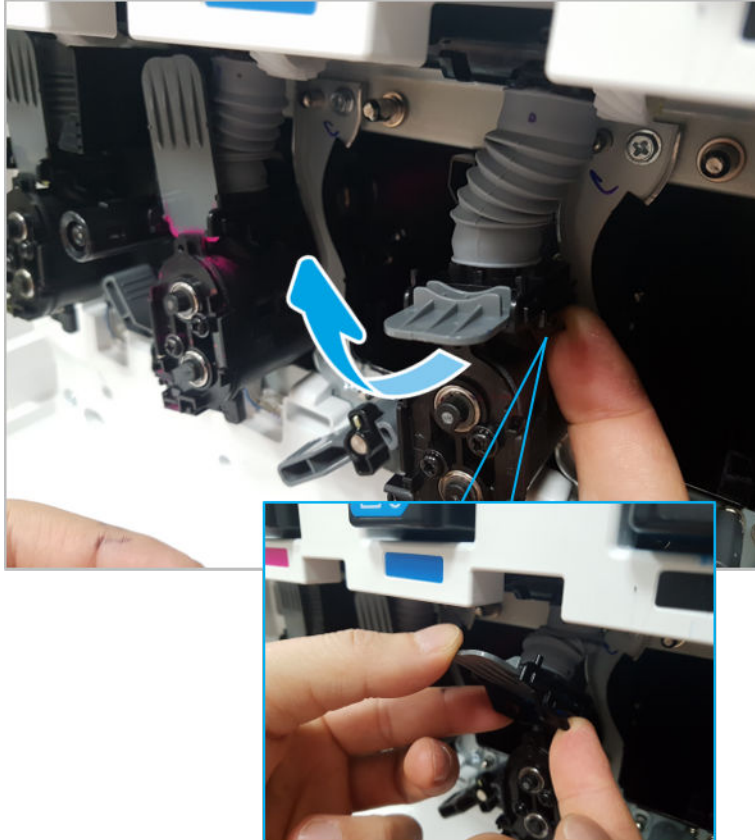

- d. Remove two screws and then remove the bracket.

Figure 2-70 Remove bracket



- e. Disconnect the connector.

Figure 2-71 Disconnect the connector

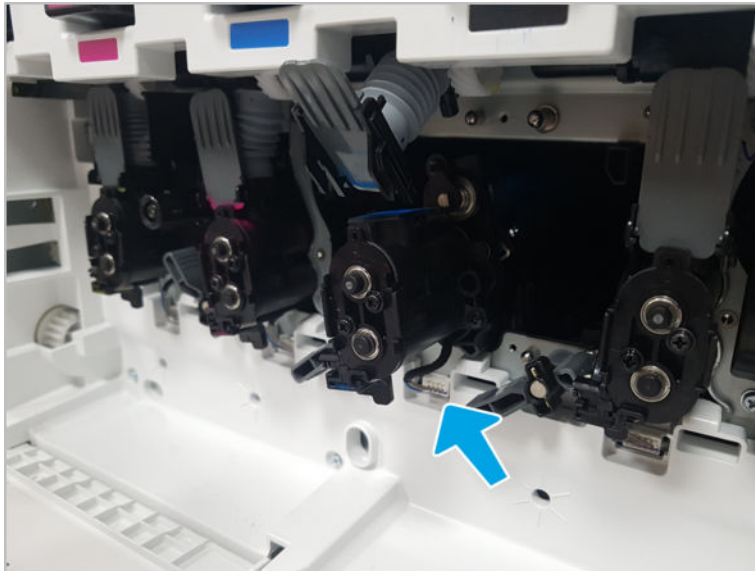

- f. Remove the developer unit.

Figure 2-72 Remove developer unit



 **NOTE:** The carrier in this printer series developer unit cannot be changed. The entire developer unit must be replaced.

- g. Remove the new developer unit from its package. Place it on the plastic bag with supplied with the kit. And then, open the developer unit cover.

Figure 2-73 Open the developer unit cover

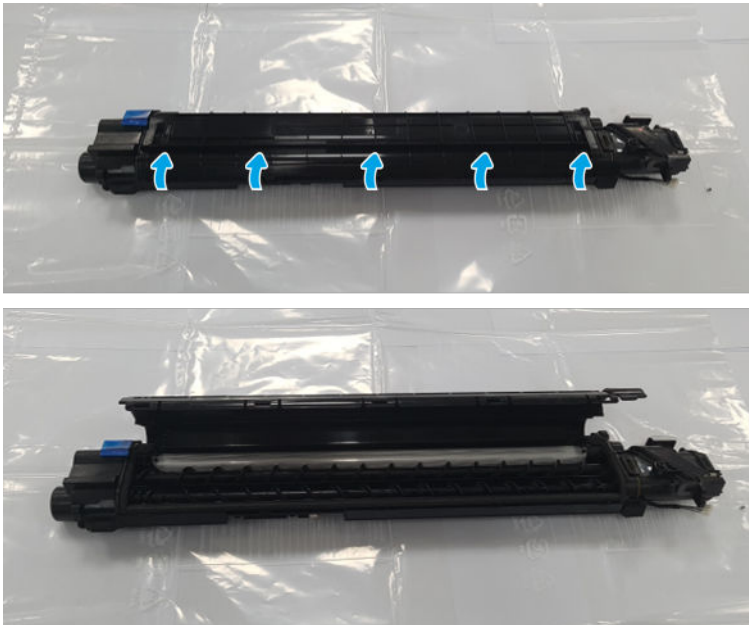

- h. Flip the carrier bag up and down several times.

Figure 2-74 Flip the carrier bag up and down



- i. Open the carrier bag, and then pour the carrier into the developer unit.

Figure 2-75 Pour the carrier



- j. Close the developer unit cover.

Figure 2-76 Close the developer unit cover



- k. Remove the red and blue tapes.

Figure 2-77 Remove the tape

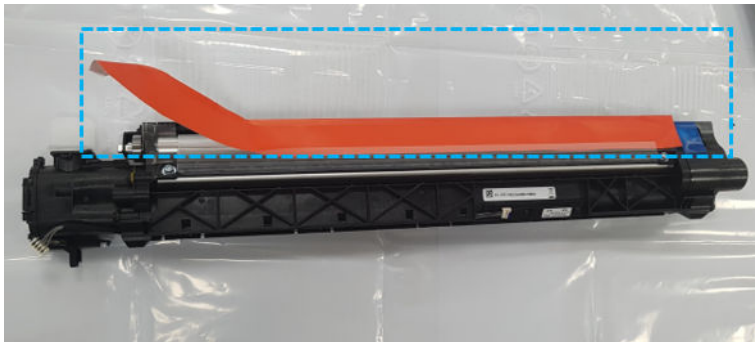

- l. Remove the cap.

Figure 2-78 Remove the cap

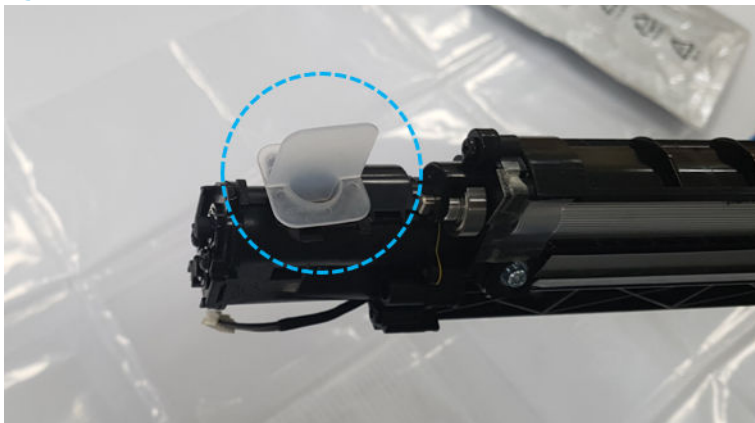

- m. Install the new developer unit. Make sure that the bracket is seated correctly and that the bracket screws are installed. Install the toner supply by swiveling down to the normal position, and make sure the toner supply shutter is pulled up to the “open” position.
- n. Reinstall the imaging drum, and then reinstall the toner collection unit.
- o. **Turn on the printer while the front cover is open.**



NOTE:

- Execute a "Life Count Update" and "TC calibration" when replacing the developer unit.
- If the printer is turned on after closing the front cover, the toner will be supplied without TC calibration and might affect the image quality.

- p. When the control panel is activated, select the **Developer Unit** menu.
Information > Supply Status > Field Replacement Unit > Developer Unit
- q. Select the **Developer Unit** for all colors that were replaced.
- r. Select the **OK** button.
- s. Close the front cover.



NOTE: TC calibration starts after the front cover is closed. Wait for the warm-up operation to complete.

4. Unpack the replacement assembly.

- a. Dispose of the defective part.



NOTE: HP recommends responsible disposal of the defective part.

<http://www8.hp.com/us/en/hp-information/environment/product-recycling.html>

- b. Unpack the replacement part from the packaging.



CAUTION:  Some parts are sensitive to electrostatic discharge (ESD). Always perform service

work at an ESD-protected workstation or mat. If an ESD workstation or mat is not available, touch the sheet-metal chassis to provide a static ground before touching an ESD-sensitive assembly. Protect the ESD-sensitive assemblies by placing them in ESD pouches when they are out of the printer.

If the replacement part is a roller or pad, avoid touching the spongy part of it. Skin oils on the roller or pad can cause paper pickup and/or print-quality problems. HP recommends using disposable gloves when handling rollers or pads or washing your hands before touching rollers or pads.



IMPORTANT: Make sure that all of the shipping materials (for example shipping tape) are removed from the replacement part prior to installation.

- c. To install an assembly, reverse the removal steps.



NOTE: When applicable, special installation instructions are provided for an assembly at the end of the removal procedure. Always completely read the removal instructions and follow all special installation instructions.

Frame assembly

View frame assembly exploded view, parts list, and repair procedures.

Main engine frame 1

View main engine frame 1 exploded view, parts list, and repair procedures.

Main engine frame (1/2)

Figure 2-79 Main engine frame (1/2)

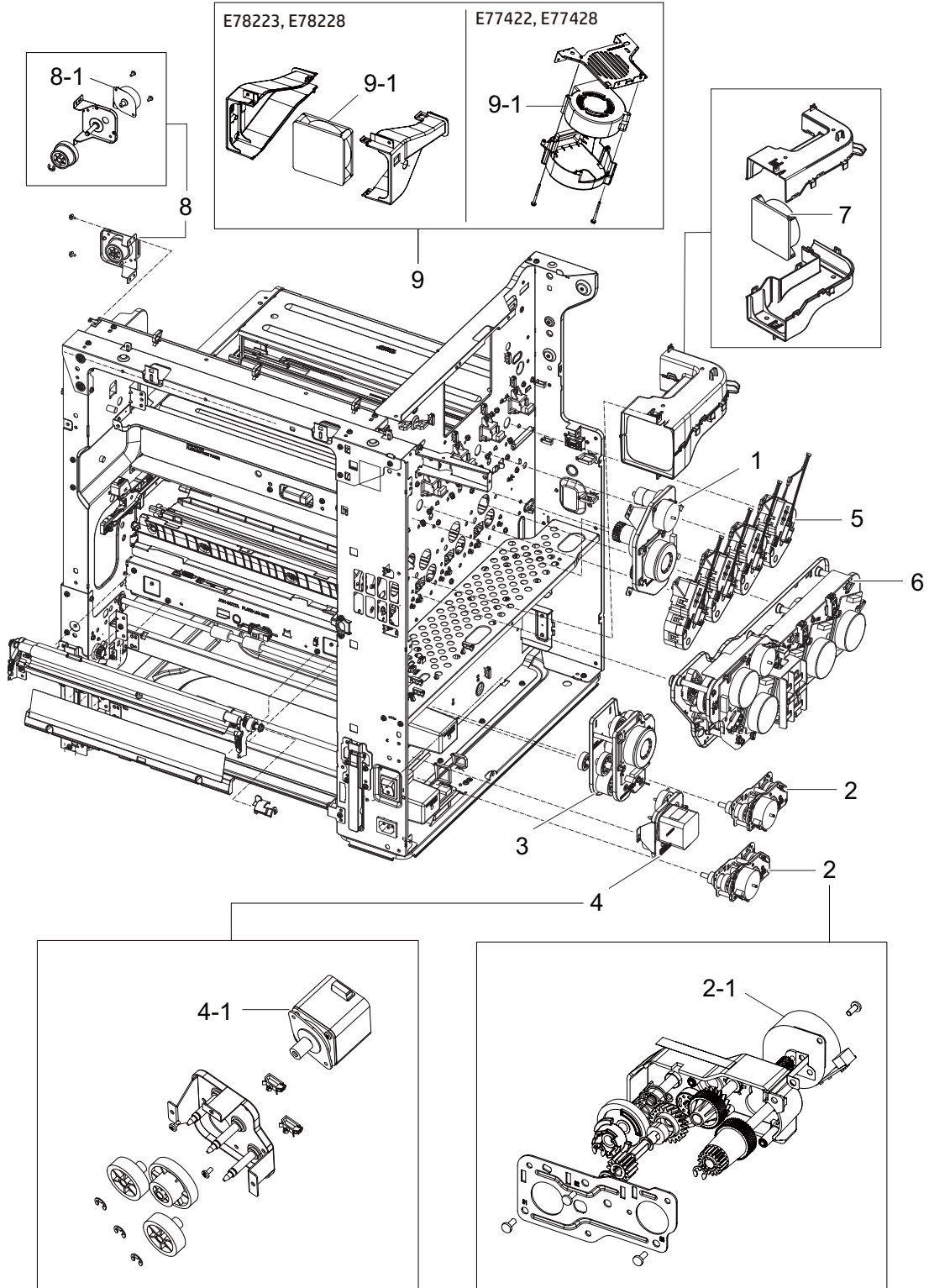

Table 2-18 Main engine frame (1/2)

Ref	Description	Part Number (*)	Qty
1	Fuser & Exit drive assembly	JC93-00441A (*)	1

Table 2-18 Main engine frame (1/2) (continued)

Ref	Description	Part Number (*)	Qty
2	Pickup drive assembly (For E77422, E77428)	JC93-00442C (*)	2
2	Pickup drive assembly (For E78223, E78228)	5QJ90-64001 (*)	2
2-1	Pickup drive motor	JC93-00452A (*)	1
3	Registration & MP Tray drive assembly	JC93-00443A (*)	1
4	Feed drive assembly	JC93-00444A (*)	1
4-1	Feed drive motor	JC31-00033B (*)	1
5	Toner supply drive assembly (For E77422, E77428)	JC93-00446B (*)	4
5	Toner supply drive assembly (For E78223, E78228)	5QJ83-64002 (*)	4
6	Main drive	JC93-00915B (*)	1
7	Fan, type 7 fuser	JC31-00161A (*)	1
8	TCU drive assembly	JC93-00445A (*)	1
8-1	TCU drive motor	JC31-00166A (*)	1
9	Fan assembly (For E77422, E77428)	JC93-01400A (*)	1
9	Fan assembly (For E78223, E78228)	JC93-01785A (*)	1
9-1	Fan, type7 developer (For E77422, E77428)	JC31-00130A (*)	1
9-1	Fan, type7 developer (For E78223, E78228)	JC31-00161A (*)	1

* This part is in ordering system. If the ordering system has this part in stock, it can be ordered.

Fuser & Exit drive assembly

View fuser & exit drive assembly exploded view, parts list, and repair procedures.

Fuser & Exit drive assembly

Figure 2-80 Fuser & Exit drive assembly

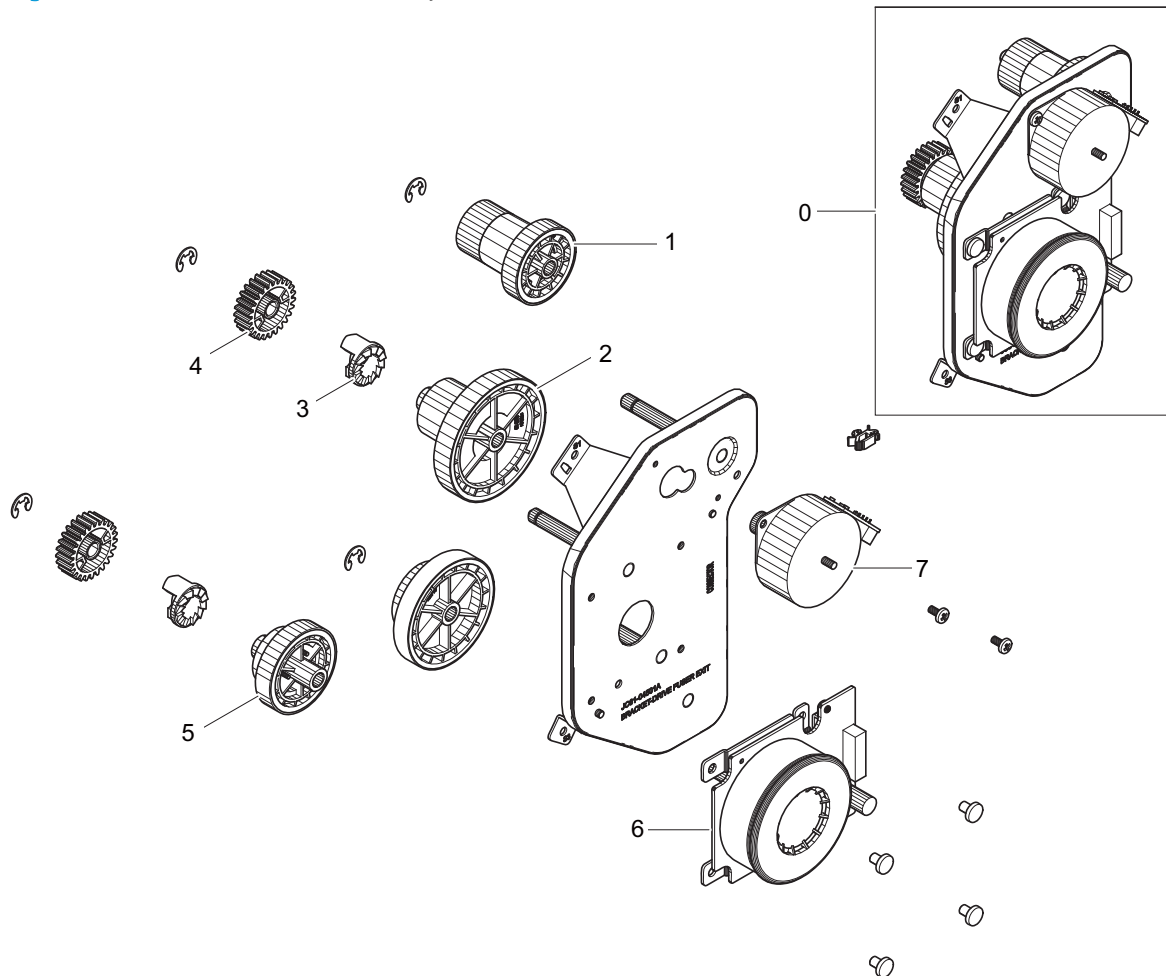

Table 2-19 Fuser & Exit drive assembly

Ref	Description	Part Number (*)	Qty
0	Fuser & Exit drive assembly	JC93-00441A (*)	1
1	Gear, rdcn exit	JC66-03108A (*)	1
2	Gear, fuser one way	JC66-03105A (*)	1
3	Gear, hub clutch	JC66-00340A (*)	2
4	Gear, rdcn fuser out	JC66-00417A (*)	2
5	Gear, fuser release	JC66-03107A (*)	1
6	Fuser Motor, BLDC	JC31-00123B (*)	1
7	Exit motor, Step	JC93-00452A (*)	1

* This part is in ordering system. If the ordering system has this part in stock, it can be ordered.

HP Color LaserJet Managed MFP E77422, E77428, E78223, and E78228 - Removal and replacement: Fuser and exit drive assembly

Follow these steps to remove the fuser and exit drive assembly.

To view a short video of this procedure, click the link below.

 [View a video of how to remove and replace the fuser and exit drive assembly.](#)

Mean time to repair: 15 minutes

Service level: Intermediate

 **IMPORTANT:** When applicable, special installation instructions are provided for an assembly at the end of the removal procedure. Always completely read the removal instructions and follow all special installation instructions.

Before performing service

- Disconnect the power cable.

Use the table below to identify the correct part number for your printer. To order the part, go to <https://parts.hp.com>

Table 2-20 Part information

Part number	Part description
JC93-00441A	Fuser and exit drive assembly

Required tools

- #2 JIS screwdriver with a magnetic tip

After performing service

Turn the printer power on

- Connect the power cable.
- Use the power switch to turn the power on.

Post service test

Verify that the document was copied, scanned, or printed correctly.

1. Remove the rear covers.
 - a. Unscrew two captive thumbscrews on the formatter cover. Slide the formatter cover to the left, and then to the right to remove.

Figure 2-81 Remove the formatter cover

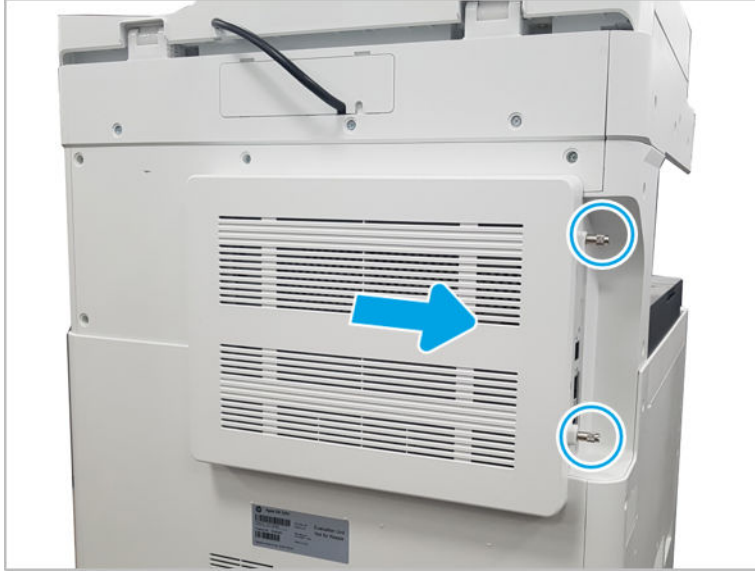

- b. Remove thirteen screws, and then remove the rear-bottom cover and rear-top cover.

Figure 2-82 Remove the rear-bottom cover and rear-top cover



- 2. Remove the fuser output drive assembly.
 - a. Disconnect the connector and remove the cable from the cable restraint. Remove the cable from the guides on the duct housing. Remove three screws, and then remove the Fuser-Duct.

Figure 2-83 Remove the fuser-duct

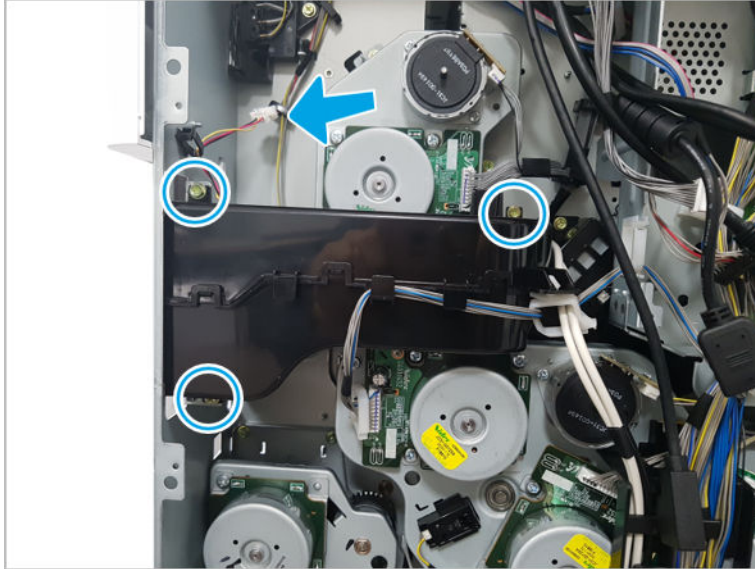

- b. Disconnect two motor connectors, remove three screws, and then remove the fuser output drive assembly.

Figure 2-84 Remove screws and the fuser output drive assembly

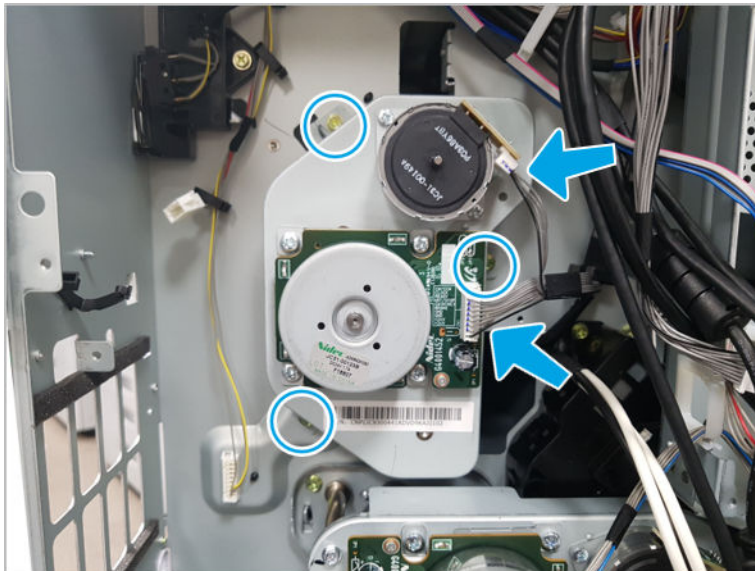



3. Unpack the replacement assembly.
 - a. Dispose of the defective part.

 **NOTE:** HP recommends responsible disposal of the defective part.

<http://www8.hp.com/us/en/hp-information/environment/product-recycling.html>

- b. Unpack the replacement part from the packaging.

 **CAUTION:**  Some parts are sensitive to electrostatic discharge (ESD). Always perform service work at an ESD-protected workstation or mat. If an ESD workstation or mat is not available, touch the sheet-metal chassis to provide a static ground before touching an ESD-sensitive assembly. Protect the ESD-sensitive assemblies by placing them in ESD pouches when they are out of the printer.

If the replacement part is a roller or pad, avoid touching the spongy part of it. Skin oils on the roller or pad can cause paper pickup and/or print-quality problems. HP recommends using disposable gloves when handling rollers or pads or washing your hands before touching rollers or pads.

 **IMPORTANT:** Make sure that all of the shipping materials (for example shipping tape) are removed from the replacement part prior to installation.

- c. To install an assembly, reverse the removal steps.

 **NOTE:** When applicable, special installation instructions are provided for an assembly at the end of the removal procedure. Always completely read the removal instructions and follow all special installation instructions.

HP Color LaserJet Managed MFP E77422, E77428, E78223, and E78228 - Removal and replacement: Pickup drive units

Follow these steps to remove the pickup drive assembly.

To view a short video of this procedure, click the link below.

 [View a video of how to remove and replace the pickup drive unit 1.](#)

 [View a video of how to remove and replace the pickup drive unit 2.](#)

Mean time to repair: 6 minutes

Service level: Intermediate

 **IMPORTANT:** When applicable, special installation instructions are provided for an assembly at the end of the removal procedure. Always completely read the removal instructions and follow all special installation instructions.

Before performing service

- Disconnect the power cable.

Use the table below to identify the correct part number for your printer. To order the part, go to <https://parts.hp.com>

Table 2-21 Part information

Part number	Part description
JC93-00442C	Pickup drive assembly (For E77422, E77428)

Table 2-21 Part information (continued)

Part number	Part description
5QJ90-64001	Pickup drive assembly (For E78223, E78228)
JC93-00452A	Pickup motor

Required tools

- #2 JIS screwdriver with a magnetic tip

After performing service

Turn the printer power on

- Connect the power cable.
- Use the power switch to turn the power on.

Post service test

Verify that the document was copied, scanned, or printed correctly.

1. Remove the rear covers.
 - a. Unscrew two captive thumbscrews on the formatter cover. Slide the formatter cover to the left, and then to the right to remove.

Figure 2-85 Remove the formatter cover

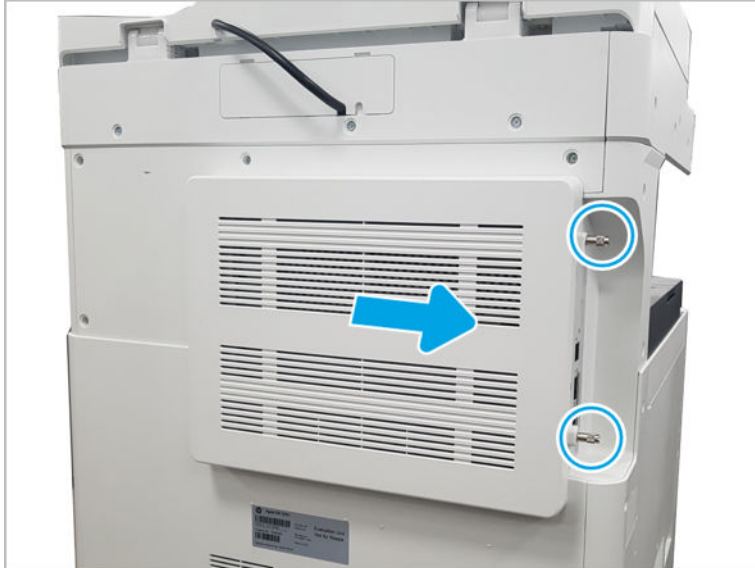

- b. Remove seven screws, and then remove the rear-bottom cover.

Figure 2-86 Remove the rear-bottom cover



2. Remove the pickup drive unit.

- a. Release the cable from the cable restraint and disconnect the connector. Remove three yellow screws, and then remove the pickup drive unit 1.

Figure 2-87 Remove screws and pickup drive unit 1

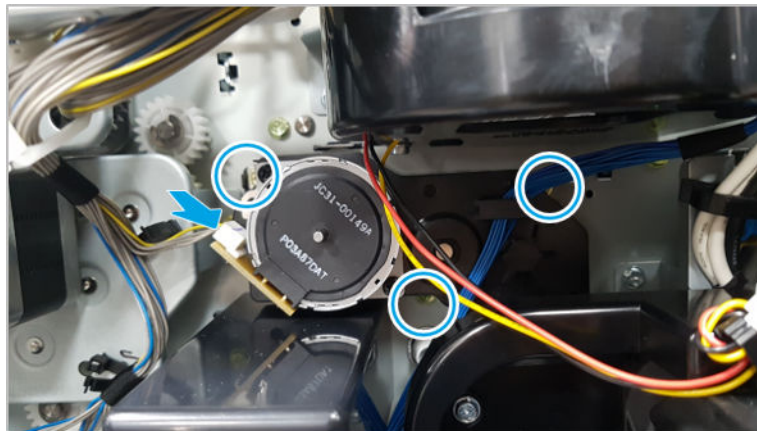

- b. Release the cable from the cable restraint and disconnect the connector. Remove three yellow screws, and then remove the pickup drive unit 2.

Figure 2-88 Remove screws and pickup drive unit 2

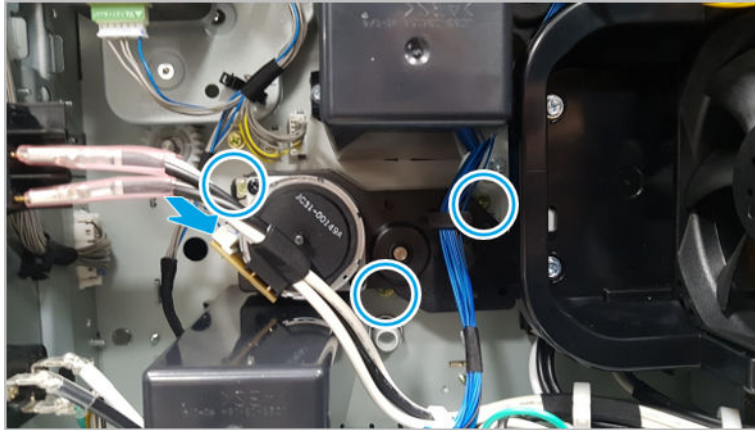



3. Unpack the replacement assembly.

- a. Dispose of the defective part.

 **NOTE:** HP recommends responsible disposal of the defective part.

<http://www8.hp.com/us/en/hp-information/environment/product-recycling.html>

- b. Unpack the replacement part from the packaging.

 **CAUTION:**  Some parts are sensitive to electrostatic discharge (ESD). Always perform service work at an ESD-protected workstation or mat. If an ESD workstation or mat is not available, touch the sheet-metal chassis to provide a static ground before touching an ESD-sensitive assembly. Protect the ESD-sensitive assemblies by placing them in ESD pouches when they are out of the printer.

If the replacement part is a roller or pad, avoid touching the spongy part of it. Skin oils on the roller or pad can cause paper pickup and/or print-quality problems. HP recommends using disposable gloves when handling rollers or pads or washing your hands before touching rollers or pads.

 **IMPORTANT:** Make sure that all of the shipping materials (for example shipping tape) are removed from the replacement part prior to installation.

- c. To install an assembly, reverse the removal steps.

 **NOTE:** When applicable, special installation instructions are provided for an assembly at the end of the removal procedure. Always completely read the removal instructions and follow all special installation instructions.

Registration & MP tray drive assembly

View registration & MP tray drive assembly exploded view, parts list, and repair procedures.

Registration & MP tray drive assembly

Figure 2-89 Registration & MP tray drive assembly

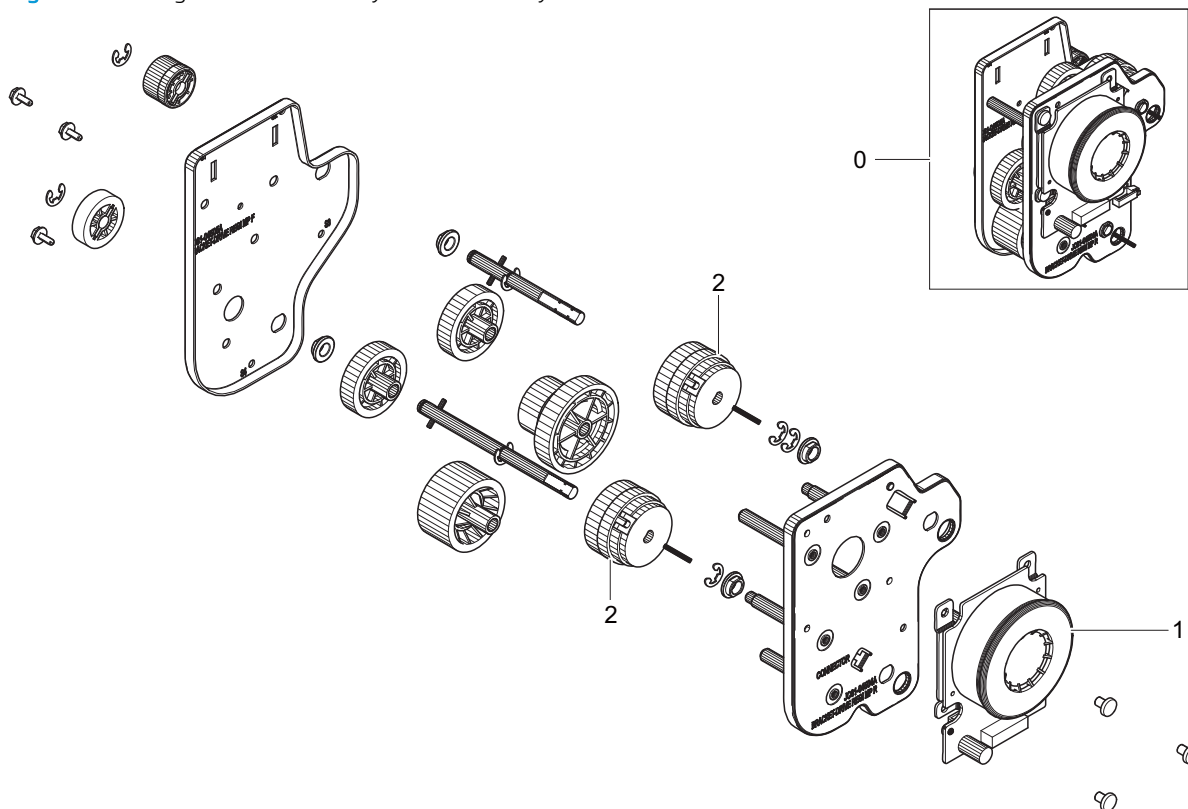

Table 2-22 Registration + MP Tray Motor drive

Ref	Description	Part Number (*)	Qty
0	Registration drive	JC93-00443A (*)	1
1	Motor, BLDC	JC31-00123B (*)	1
2	Electric clutch	JC47-00037A (*)	2

* This part is in ordering system. If the ordering system has this part in stock, it can be ordered.

HP Color LaserJet Managed MFP E77422, E77428, E78223, and E78228 - Removal and replacement: Registration and Tray 1 (MP) drive assembly

Follow these steps to remove the registration and MP tray drive assembly.

To view a short video of this procedure, click the link below.

 [View a video of how to remove and replace the registration and MP tray drive assembly.](#)

Mean time to repair: 5 minutes

Service level: Intermediate



IMPORTANT: When applicable, special installation instructions are provided for an assembly at the end of the removal procedure. Always completely read the removal instructions and follow all special installation instructions.

Before performing service

- Disconnect the power cable.

Use the table below to identify the correct part number for your printer. To order the part, go to <https://parts.hp.com>

Table 2-23 Part information

Part number	Part description
JC93-00443A	Registration and MP tray drive assembly

Required tools

- #2 JIS screwdriver with a magnetic tip

After performing service

Turn the printer power on

- Connect the power cable.
- Use the power switch to turn the power on.

Post service test

Verify that the document was copied, scanned, or printed correctly.

1. Remove the rear covers.
 - a. Unscrew two captive thumbscrews on the formatter cover. Slide the formatter cover to the left, and then to the right to remove.

Figure 2-90 Remove the formatter cover

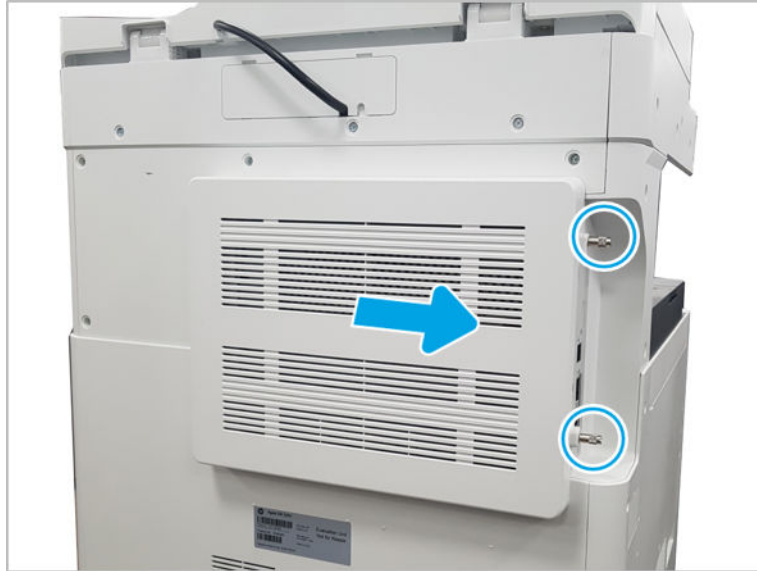

- b. Remove thirteen screws, and then remove the rear-bottom cover and rear-top cover.

Figure 2-91 Remove the rear-bottom cover and rear-top cover



- 2. Remove the registration and MP drive assembly.
 - a. Disconnect three connectors, one at the motor and two at the frame.
 - b. Release the cables from the cable guides.

- c. Remove four screws, and then remove the registration and MP drive assembly by lifting up and out at the top. Clear the white gear and the cable guide while removing.

 **IMPORTANT:** Remove and replace the screws in the order indicated on the chassis.

Figure 2-92 Remove the registration and MP drive unit

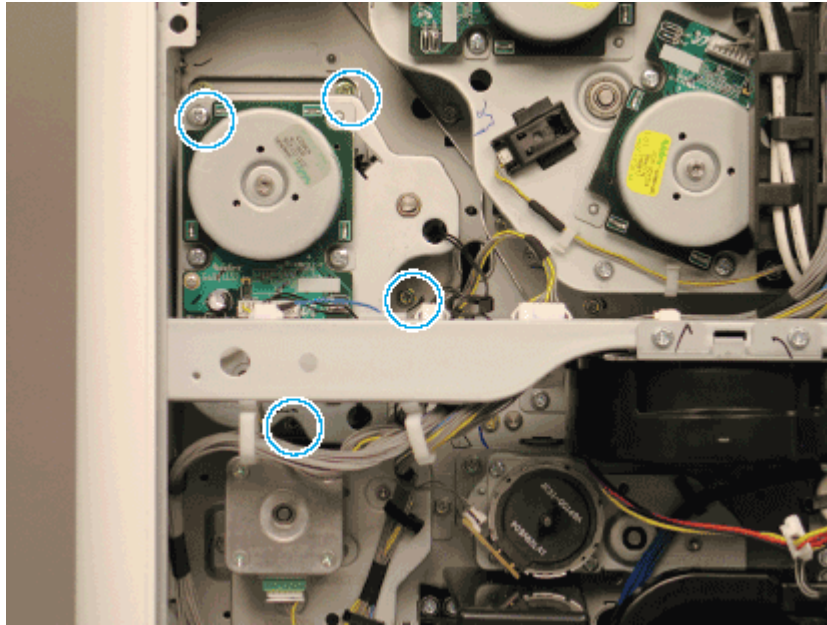

 **NOTE:** Reinstall the bottom of the unit first while clearing the white gear.



3. Unpack the replacement assembly.

- a. Dispose of the defective part.

 **NOTE:** HP recommends responsible disposal of the defective part.

<http://www8.hp.com/us/en/hp-information/environment/product-recycling.html>

- b. Unpack the replacement part from the packaging.

 **CAUTION:**  Some parts are sensitive to electrostatic discharge (ESD). Always perform service work at an ESD-protected workstation or mat. If an ESD workstation or mat is not available, touch the sheet-metal chassis to provide a static ground before touching an ESD-sensitive assembly. Protect the ESD-sensitive assemblies by placing them in ESD pouches when they are out of the printer.

If the replacement part is a roller or pad, avoid touching the spongy part of it. Skin oils on the roller or pad can cause paper pickup and/or print-quality problems. HP recommends using disposable gloves when handling rollers or pads or washing your hands before touching rollers or pads.

 **IMPORTANT:** Make sure that all of the shipping materials (for example shipping tape) are removed from the replacement part prior to installation.

- c. To install an assembly, reverse the removal steps.

 **NOTE:** When applicable, special installation instructions are provided for an assembly at the end of the removal procedure. Always completely read the removal instructions and follow all special installation instructions.

HP Color LaserJet Managed MFP E77422, E77428, E78223, and E78228 - Removal and replacement: Paper feed drive assembly

Follow these steps to remove the paper feed drive assembly.

To view a short video of this procedure, click the link below.

 [View a video of how to remove and replace the paper feed drive assembly.](#)

Mean time to repair: 5 minutes

Service level: Intermediate

 **IMPORTANT:** When applicable, special installation instructions are provided for an assembly at the end of the removal procedure. Always completely read the removal instructions and follow all special installation instructions.

Before performing service

- Disconnect the power cable.

Use the table below to identify the correct part number for your printer. To order the part, go to <https://parts.hp.com>

Table 2-24 Part information

Part number	Part description
JC93-00444A	Paper feed drive assembly

Required tools

- #2 JIS screwdriver with a magnetic tip

After performing service

Turn the printer power on

- Connect the power cable.
- Use the power switch to turn the power on.

Post service test

Verify that the document was copied, scanned, or printed correctly.

1. Remove the rear covers.
 - a. Unscrew two captive thumbscrews on the formatter cover. Slide the formatter cover to the left, and then to the right to remove.

Figure 2-93 Remove the formatter cover

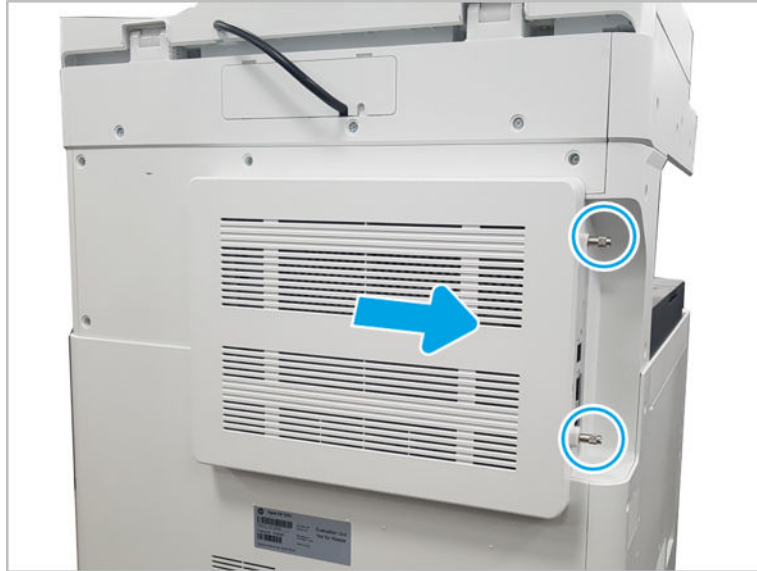

- b. Remove seven screws, and then remove the rear-bottom cover.

Figure 2-94 Remove the rear-bottom cover



- 2. Remove the paper feed drive unit.
 - ▲ Release the cable from two cable restraints and disconnect the connector. Remove three yellow screws, and then remove the paper feed drive unit.

Figure 2-95 Remove screws and paper feed drive unit

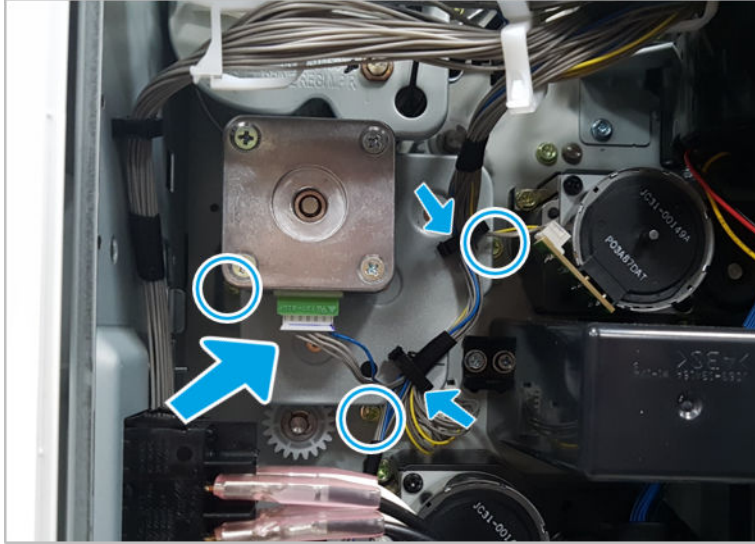



3. Unpack the replacement assembly.
 - a. Dispose of the defective part.

 **NOTE:** HP recommends responsible disposal of the defective part.

<http://www8.hp.com/us/en/hp-information/environment/product-recycling.html>

- b. Unpack the replacement part from the packaging.

 **CAUTION:**  Some parts are sensitive to electrostatic discharge (ESD). Always perform service work at an ESD-protected workstation or mat. If an ESD workstation or mat is not available, touch the sheet-metal chassis to provide a static ground before touching an ESD-sensitive assembly. Protect the ESD-sensitive assemblies by placing them in ESD pouches when they are out of the printer.

If the replacement part is a roller or pad, avoid touching the spongy part of it. Skin oils on the roller or pad can cause paper pickup and/or print-quality problems. HP recommends using disposable gloves when handling rollers or pads or washing your hands before touching rollers or pads.

 **IMPORTANT:** Make sure that all of the shipping materials (for example shipping tape) are removed from the replacement part prior to installation.

- c. To install an assembly, reverse the removal steps.

 **NOTE:** When applicable, special installation instructions are provided for an assembly at the end of the removal procedure. Always completely read the removal instructions and follow all special installation instructions.

HP Color LaserJet Managed MFP E77422, E77428, E78223, and E78228 - Removal and replacement: Toner supply drive assembly

Follow these steps to remove the toner supply drive assembly.

To view a short video of this procedure, click the link below.

 [View a video of how to remove and replace the toner supply drive assembly \(K\).](#)

 [View a video of how to remove and replace the toner supply drive assembly \(C,M,Y\).](#)

Mean time to repair: 16 minutes

Service level: Intermediate

 **IMPORTANT:** When applicable, special installation instructions are provided for an assembly at the end of the removal procedure. Always completely read the removal instructions and follow all special installation instructions.

Before performing service

- Disconnect the power cable.

Use the table below to identify the correct part number for your printer. To order the part, go to <https://parts.hp.com>

Table 2-25 Part information

Part number	Part description
JC93-00446B	Toner supply drive assembly (For E77422, E77428)
5QJ83-64002	Toner supply drive assembly (For E78223, E78228)

Required tools

- #2 JIS screwdriver with a magnetic tip

After performing service

Turn the printer power on

- Connect the power cable.
- Use the power switch to turn the power on.

Post service test

Verify that the document was copied, scanned, or printed correctly.

1. Remove the rear covers.
 - a. Unscrew two captive thumbscrews on the formatter cover. Slide the formatter cover to the left, and then to the right, to remove.

Figure 2-96 Remove the formatter cover

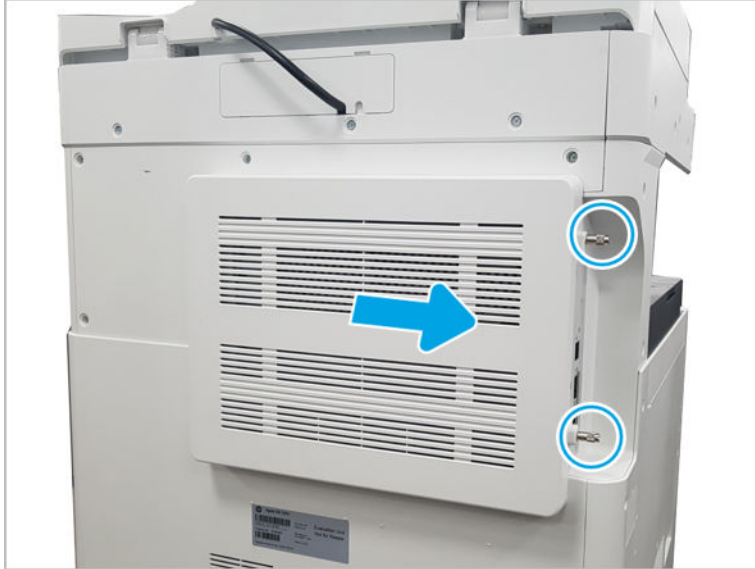

- b. Remove thirteen screws, and then remove the rear-bottom cover and rear-top cover.

Figure 2-97 Remove the rear-bottom cover and rear-top cover



- 2. Remove the formatter cage.
 - a. Remove two screw-caps and three screws, and then remove the left-upper cover.

Figure 2-98 Remove the left-upper cover

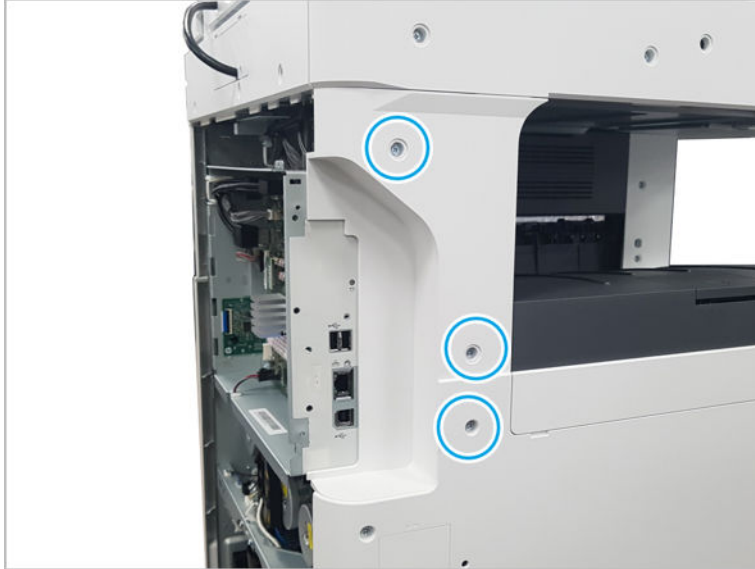

- b. Remove one screw from the side of the formatter cage (beneath the left-upper cover location).

Figure 2-99 Remove the formatter cage side screw



- c. Disconnect all connectors on the formatter PCA and two cable restraints.

- d. Remove three screws from the formatter cage face, and then release one tab to remove the formatter cage.

Figure 2-100 Remove three screws to remove the formatter cage

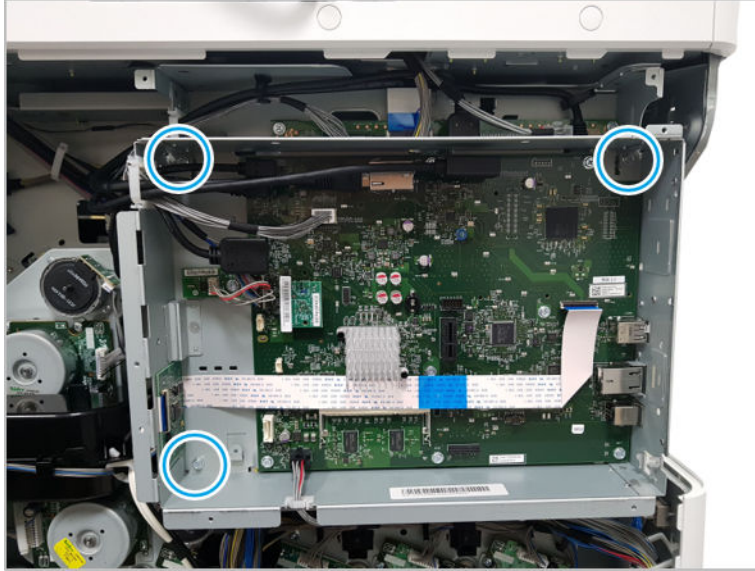

3. Remove the left cover.
 - a. Release the lock with tweezers at the releasing point, and then remove the left trim cover

Figure 2-101 Remove the left trim cover



- b. Remove ten screws, and then remove the left cover.

Figure 2-102 Remove the left cover

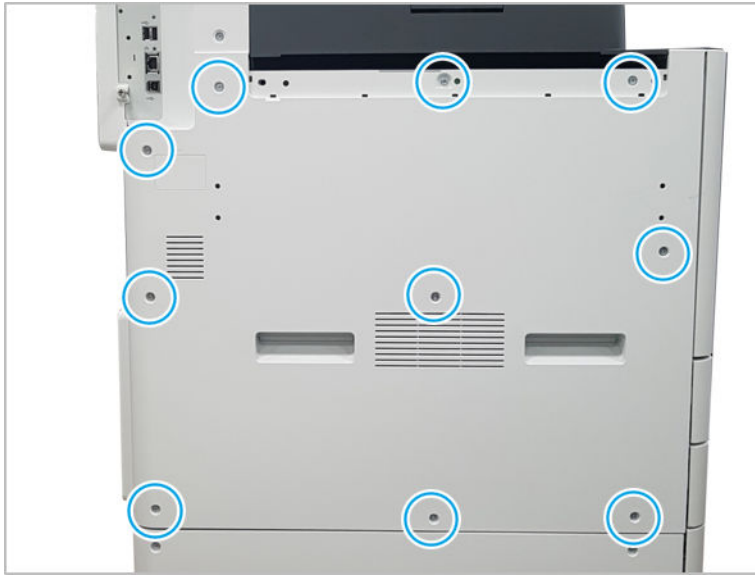

- 4. Remove the main board cage.
 - a. Remove the FFC retainer at the bottom-right.
 - b. Open seven cable retainers.
 - c. Disconnect all connectors on main board.
 - d. Remove four screws.

Figure 2-103 Remove the main board cage screws

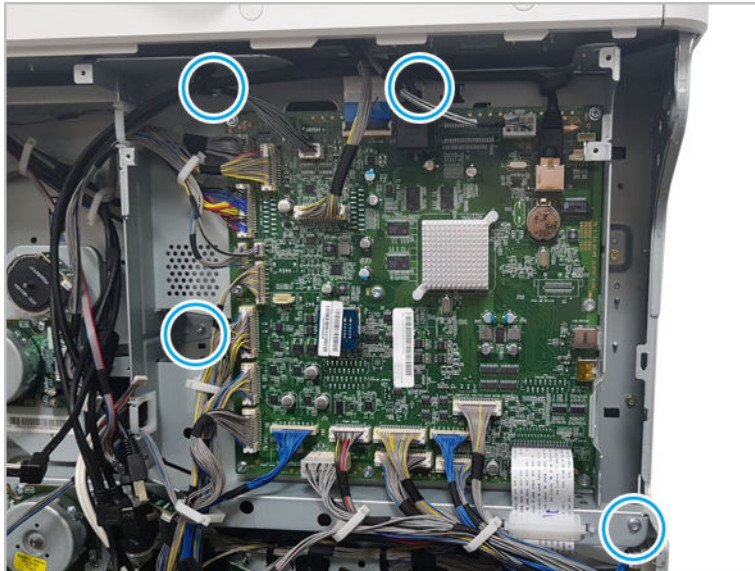

- e. Lift the main board cage up slightly to release one bracket, and then pull out to remove.
- 5. Remove the toner supply drive unit.

- ▲ Disconnect two connectors, one on the body and one inline. Remove three screws, release one cable harness, and then remove the toner supply drive unit by carefully releasing the snaps.

Figure 2-104 Remove the toner supply drive

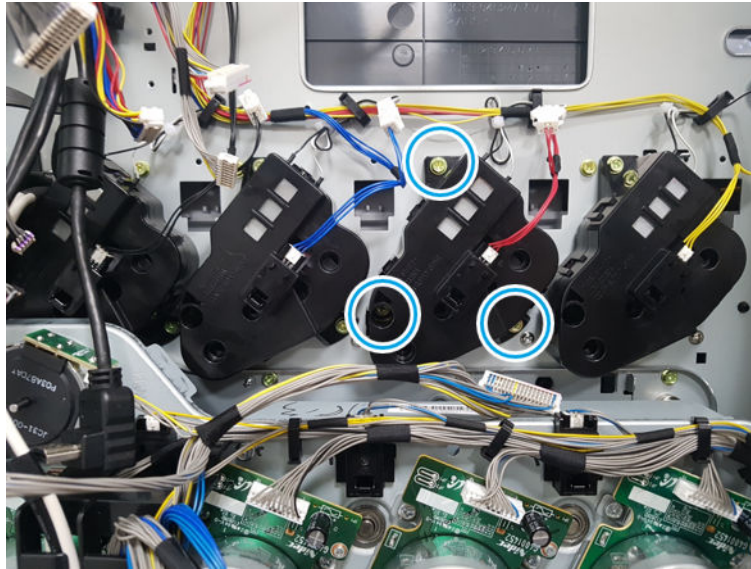

 **NOTE:**

- To remove the K toner supply drive unit, first remove the main drive unit.
- The toner supply drive units are interchangeable.

6. Unpack the replacement assembly.

- a. Dispose of the defective part.



NOTE: HP recommends responsible disposal of the defective part.

<http://www8.hp.com/us/en/hp-information/environment/product-recycling.html>

- b. Unpack the replacement part from the packaging.



CAUTION:  Some parts are sensitive to electrostatic discharge (ESD). Always perform service work at an ESD-protected workstation or mat. If an ESD workstation or mat is not available, touch the sheet-metal chassis to provide a static ground before touching an ESD-sensitive assembly. Protect the ESD-sensitive assemblies by placing them in ESD pouches when they are out of the printer.

If the replacement part is a roller or pad, avoid touching the spongy part of it. Skin oils on the roller or pad can cause paper pickup and/or print-quality problems. HP recommends using disposable gloves when handling rollers or pads or washing your hands before touching rollers or pads.



IMPORTANT: Make sure that all of the shipping materials (for example shipping tape) are removed from the replacement part prior to installation.

- c. To install an assembly, reverse the removal steps.



NOTE: When applicable, special installation instructions are provided for an assembly at the end of the removal procedure. Always completely read the removal instructions and follow all special installation instructions.

Main drive assembly

View main drive assembly exploded view, parts list, and repair procedures.

Main drive assembly

Figure 2-105 Main drive assembly

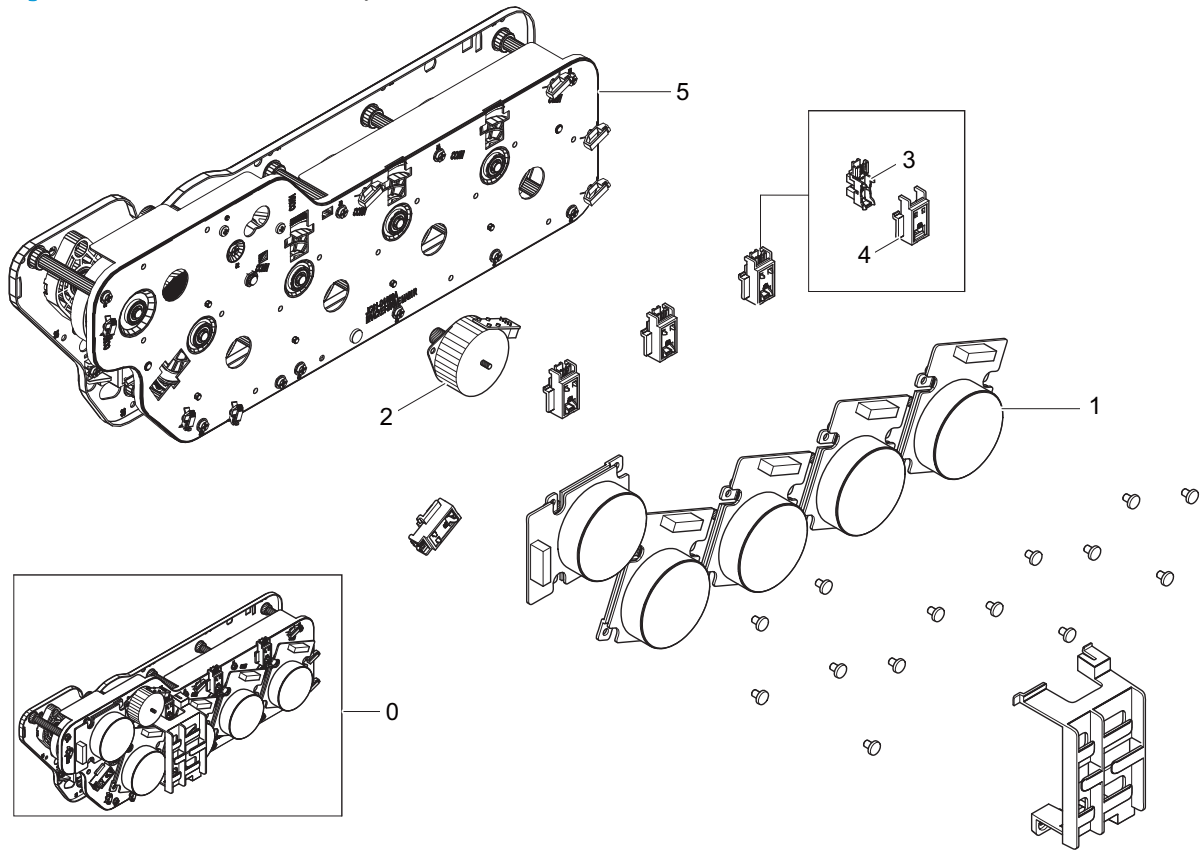

Table 2-26 Main drive assembly

Ref	Description	Part Number (*)	Qty
0	Main drive	JC93-00915B (*)	1
1	Motor, bldc	JC31-00123A (*)	5
2	ITB Engage/Disengage drive assembly	JC93-00452A (*)	1
3	Photo interrupter	0604-001393 (*)	4
4	OPC sensor holder	JC61-04538A (*)	4
5	Main sub drive	JC93-00914B (*)	1

* This part is in ordering system. If the ordering system has this part in stock, it can be ordered.

HP Color LaserJet Managed MFP E77422, E77428, E78223, and E78228 - Removal and replacement: Main drive assembly

Follow these steps to remove the main drive assembly.

To view a short video of this procedure, click the link below.

 [View a video of how to remove and replace the main drive assembly.](#)

Mean time to repair: 9 minutes

Service level: Intermediate

 **IMPORTANT:** When applicable, special installation instructions are provided for an assembly at the end of the removal procedure. Always completely read the removal instructions and follow all special installation instructions.

Before performing service

- Disconnect the power cable.

Use the table below to identify the correct part number for your printer. To order the part, go to <https://parts.hp.com>

Table 2-27 part information

Part number	Part description
JC93-00915B	Main drive unit assembly

Required tools

- #2 JIS screwdriver with a magnetic tip

After performing service

Turn the printer power on

- Connect the power cable.
- Use the power switch to turn the power on.

Post service test

Verify that the document was copied, scanned, or printed correctly.

1. Remove the TCU.
 - ▲ Open the front door and remove the toner collection unit (TCU).

Figure 2-106 Remove TCU



2. Remove the imaging drum units.
3. Remove the rear covers.
 - a. Unscrew two captive thumbscrews on the formatter cover. Slide the formatter cover to the left, and then to the right to remove.

Figure 2-107 Remove the formatter cover



- b. Remove thirteen screws, and then remove the rear-bottom cover and rear-top cover.

Figure 2-108 Remove the rear-bottom cover and rear-top cover



- 4. Remove the main drive unit.
 - a. Disconnect the OPC/Deve motor connector and OPC sensor connector from the engine controller board(ECB).

- b. Release the all obstructive cables from the restraints and harness holder. Remove eight screws. And then, remove the main drive unit.

 **IMPORTANT:** Remove and replace the screws in the order indicated on the chassis.

Figure 2-109 Remove screws and the main drive unit



- c. Remove the connector(s) for the motor(s) to be replaced.

 **NOTE:** The following graphics show *all* the connectors associated with the main motors for reference purposes.

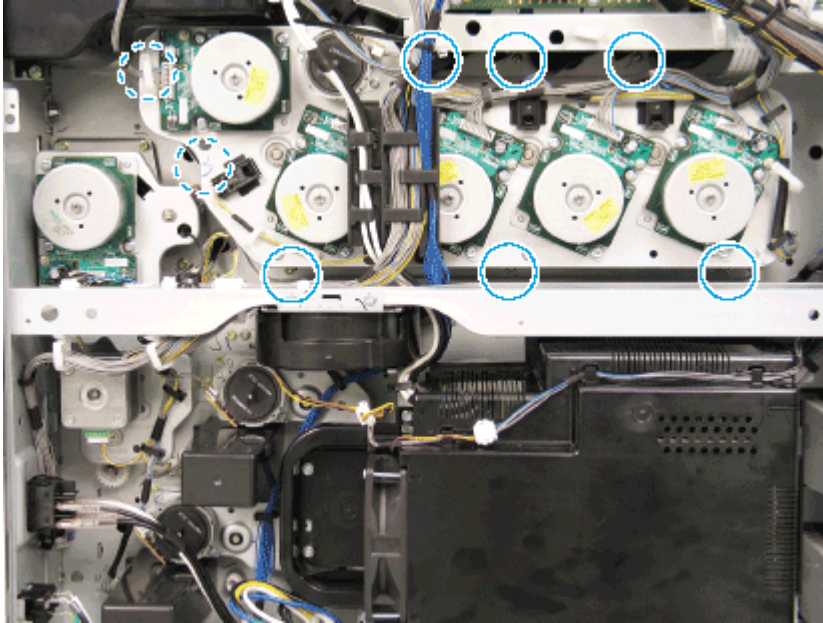
Figure 2-110 Main drive motor electrical connectors – top view

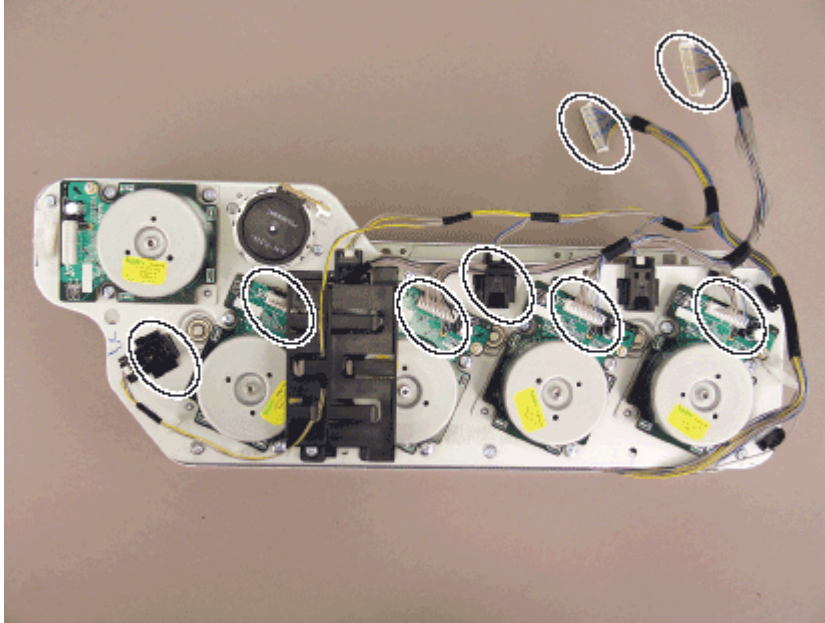
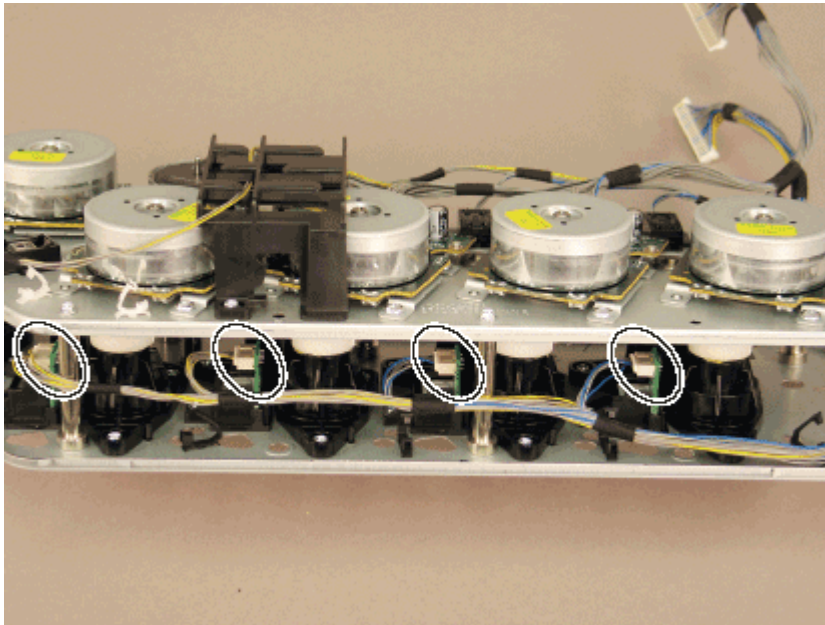



Figure 2-111 Main drive motor electrical connectors – photo interrupters





 **NOTE:** To remove the photo interrupters, release the tabs on the back side. Use caution not to damage the plastic hooks.

- 5. Unpack the replacement assembly.
 - a. Dispose of the defective part.

 **NOTE:** HP recommends responsible disposal of the defective part.

<http://www8.hp.com/us/en/hp-information/environment/product-recycling.html>

b. Unpack the replacement part from the packaging.

 **CAUTION:**  Some parts are sensitive to electrostatic discharge (ESD). Always perform service work at an ESD-protected workstation or mat. If an ESD workstation or mat is not available, touch the sheet-metal chassis to provide a static ground before touching an ESD-sensitive assembly. Protect the ESD-sensitive assemblies by placing them in ESD pouches when they are out of the printer.

If the replacement part is a roller or pad, avoid touching the spongy part of it. Skin oils on the roller or pad can cause paper pickup and/or print-quality problems. HP recommends using disposable gloves when handling rollers or pads or washing your hands before touching rollers or pads.

 **IMPORTANT:** Make sure that all of the shipping materials (for example shipping tape) are removed from the replacement part prior to installation.

c. To install an assembly, reverse the removal steps.

 **NOTE:** When applicable, special installation instructions are provided for an assembly at the end of the removal procedure. Always completely read the removal instructions and follow all special installation instructions.

HP Color LaserJet Managed MFP E77422, E77428, E78223, and E78228 - Removal and replacement: Toner collection unit drive assembly

Follow these steps to remove the toner collection unit (TCU) drive assembly.

To view a short video of this procedure, click the link below.

 [View a video of how to remove and replace the TCU drive assembly.](#)

Mean time to repair: 6 minutes

Service level: Intermediate

 **IMPORTANT:** When applicable, special installation instructions are provided for an assembly at the end of the removal procedure. Always completely read the removal instructions and follow all special installation instructions.

Before performing service

- Disconnect the power cable.

Use the table below to identify the correct part number for your printer. To order the part, go to <https://parts.hp.com>

Table 2-28 Part information

Part number	Part description
JC93-00445A	Toner collection unit drive assembly

Required tools

- #2 JIS screwdriver with a magnetic tip

After performing service

Turn the printer power on

- Connect the power cable.
- Use the power switch to turn the power on.

Post service test

Verify that the document was copied, scanned, or printed correctly.

1. Remove the toner cartridges.
 - ▲ Open the front door and remove the toner collection unit (TCU) and toner cartridges.

Figure 2-112 Remove TCU



2. Remove the front inner cover.
 - a. Open the right door, and then remove one screw.

Figure 2-113 Remove one screw



- b. Remove two screws.

Figure 2-114 Remove two screws

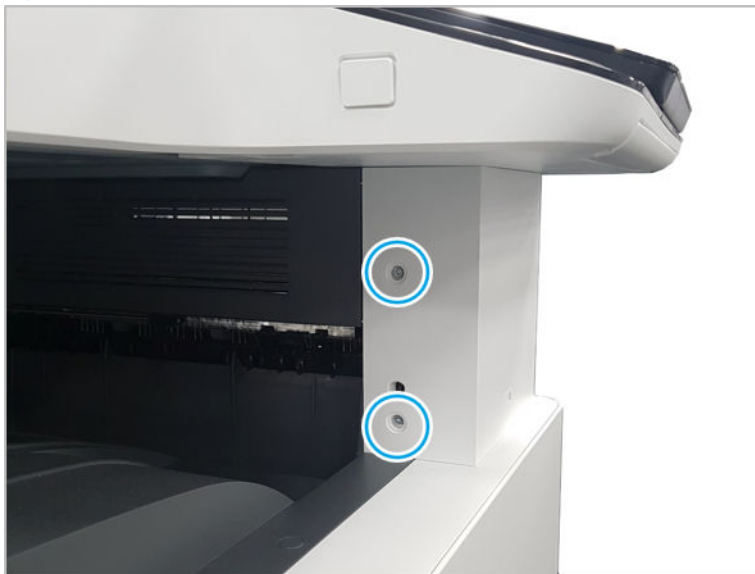

- c. Disconnect the connector, and then remove the middle right cover.

Figure 2-115 Remove the middle right cover



- d. Disconnect the connector connecting the front inner cover.

Figure 2-116 Disconnect the connector

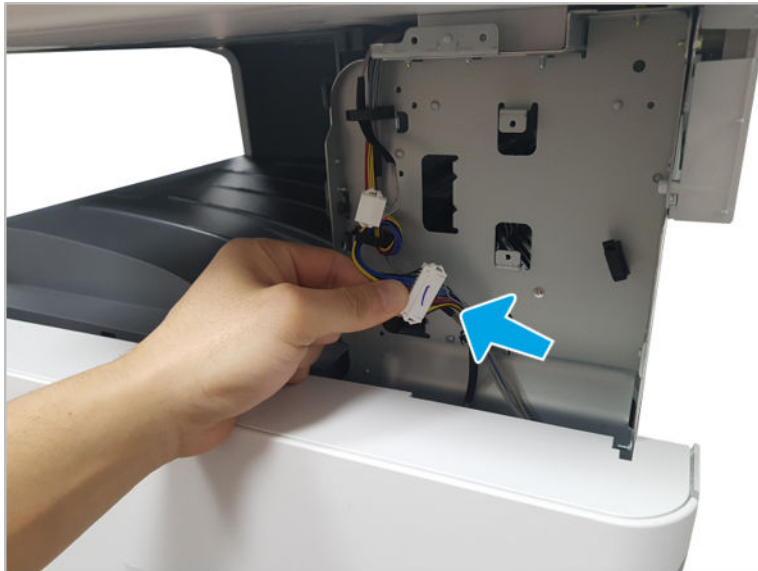

- e. Remove eight screws, and then remove the front inner cover.

 **NOTE:** The TCU cleaning blade must be removed to remove the front inner cover.

Figure 2-117 Remove the front inner cover



- 3. Remove the toner collection drive unit.

- ▲ Disconnect one connector. Remove two screws, and then remove the toner collection unit drive unit.

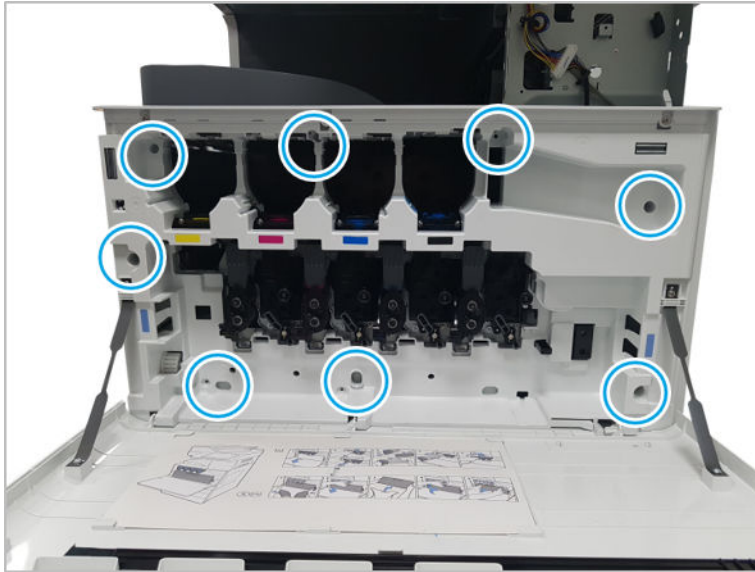
Figure 2-118 Remove screws and toner collection unit drive unit

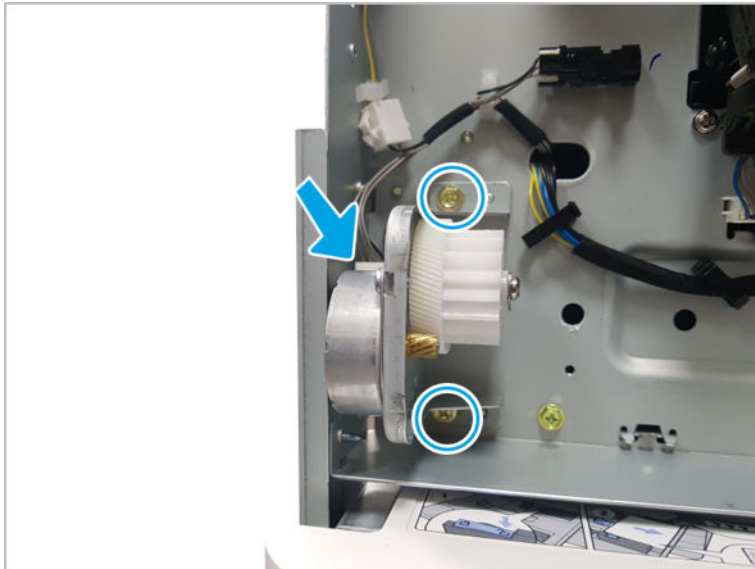



- 4. Unpack the replacement assembly.

- a. Dispose of the defective part.

 **NOTE:** HP recommends responsible disposal of the defective part.

<http://www8.hp.com/us/en/hp-information/environment/product-recycling.html>

b. Unpack the replacement part from the packaging.

 **CAUTION:**  Some parts are sensitive to electrostatic discharge (ESD). Always perform service work at an ESD-protected workstation or mat. If an ESD workstation or mat is not available, touch the sheet-metal chassis to provide a static ground before touching an ESD-sensitive assembly. Protect the ESD-sensitive assemblies by placing them in ESD pouches when they are out of the printer.

If the replacement part is a roller or pad, avoid touching the spongy part of it. Skin oils on the roller or pad can cause paper pickup and/or print-quality problems. HP recommends using disposable gloves when handling rollers or pads or washing your hands before touching rollers or pads.

 **IMPORTANT:** Make sure that all of the shipping materials (for example shipping tape) are removed from the replacement part prior to installation.

c. To install an assembly, reverse the removal steps.

 **NOTE:** When applicable, special installation instructions are provided for an assembly at the end of the removal procedure. Always completely read the removal instructions and follow all special installation instructions.

HP Color LaserJet Managed MFP E77422, E77428, E78223, and E78228 - Removal and replacement: Fan, type7 fuser

Follow these steps to remove the fan, type7 fuser.

To view a short video of this procedure, click the link below.

 [View a video of how to remove and replace the fan, type7 fuser.](#)

Mean time to repair: 5 minutes

Service level: Intermediate

 **IMPORTANT:** When applicable, special installation instructions are provided for an assembly at the end of the removal procedure. Always completely read the removal instructions and follow all special installation instructions.

Before performing service

- Disconnect the power cable.

Use the table below to identify the correct part number for your printer. To order the part, go to <https://parts.hp.com>

Table 2-29 Part information

Part number	Part description
JC31-00161A	Fan, type7 fuser

Required tools

- #2 JIS screwdriver with a magnetic tip

After performing service

Turn the printer power on

- Connect the power cable.
- Use the power switch to turn the power on.

Post service test

Verify that the document was copied, scanned, or printed correctly.

1. Remove the rear covers.
 - a. Unscrew two captive thumbscrews on the formatter cover. Slide the formatter cover to the left, and then to the right, to remove.

Figure 2-119 Remove the formatter cover

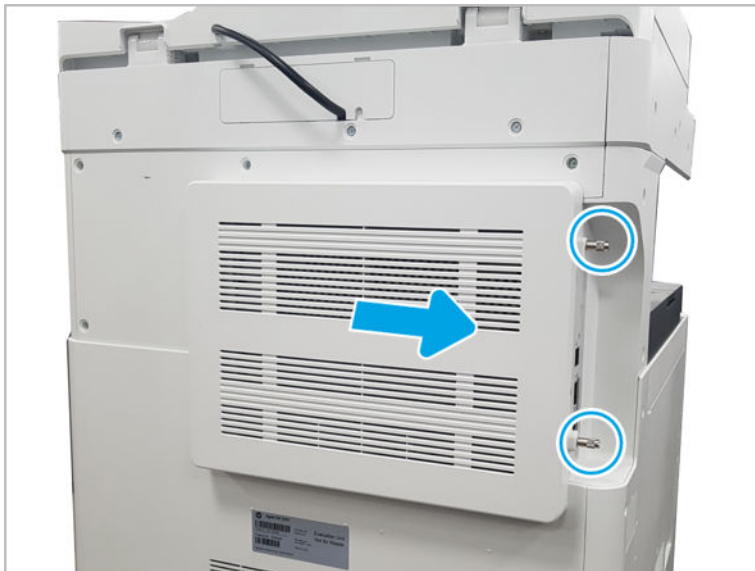

- b. Remove thirteen screws, and then remove the rear-bottom cover and rear-top cover.

Figure 2-120 Remove the rear-bottom cover and rear-top cover



- 2. Remove the fuser duct.
 - a. Disconnect the connector and remove the cable from the cable restraint. Remove the cable from the guides on the duct housing. Remove three yellow screws, and then remove the fuser-duct.

Figure 2-121 Remove the fuser-duct

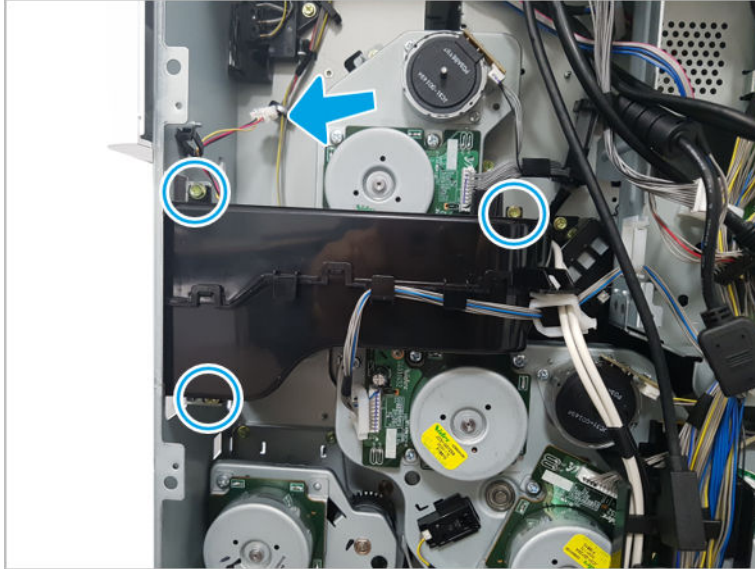

- b. Release the fan by separating the fuser-duct.

Figure 2-122 Separate the fuser-duct

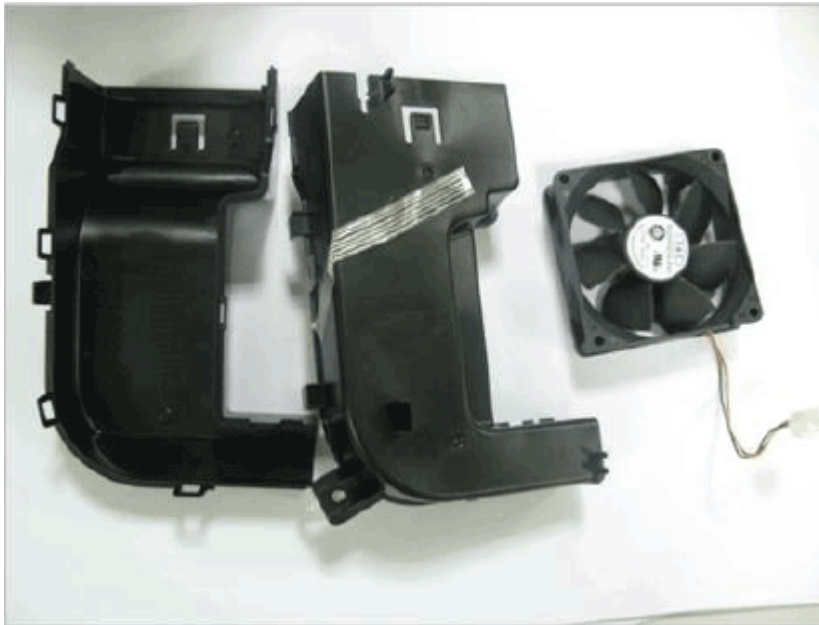

3. Unpack the replacement assembly.
 - a. Dispose of the defective part.

 **NOTE:** HP recommends responsible disposal of the defective part.

<http://www8.hp.com/us/en/hp-information/environment/product-recycling.html>

- b. Unpack the replacement part from the packaging.



CAUTION:  Some parts are sensitive to electrostatic discharge (ESD). Always perform service work at an ESD-protected workstation or mat. If an ESD workstation or mat is not available, touch the sheet-metal chassis to provide a static ground before touching an ESD-sensitive assembly. Protect the ESD-sensitive assemblies by placing them in ESD pouches when they are out of the printer.

If the replacement part is a roller or pad, avoid touching the spongy part of it. Skin oils on the roller or pad can cause paper pickup and/or print-quality problems. HP recommends using disposable gloves when handling rollers or pads or washing your hands before touching rollers or pads.

 **IMPORTANT:** Make sure that all of the shipping materials (for example shipping tape) are removed from the replacement part prior to installation.

- c. To install an assembly, reverse the removal steps.

 **NOTE:** When applicable, special installation instructions are provided for an assembly at the end of the removal procedure. Always completely read the removal instructions and follow all special installation instructions.

Main engine frame 2

View main engine frame 2 exploded view, parts list, and repair procedures.

Main engine frame (2/2)

Figure 2-123 Main engine frame (2/2)

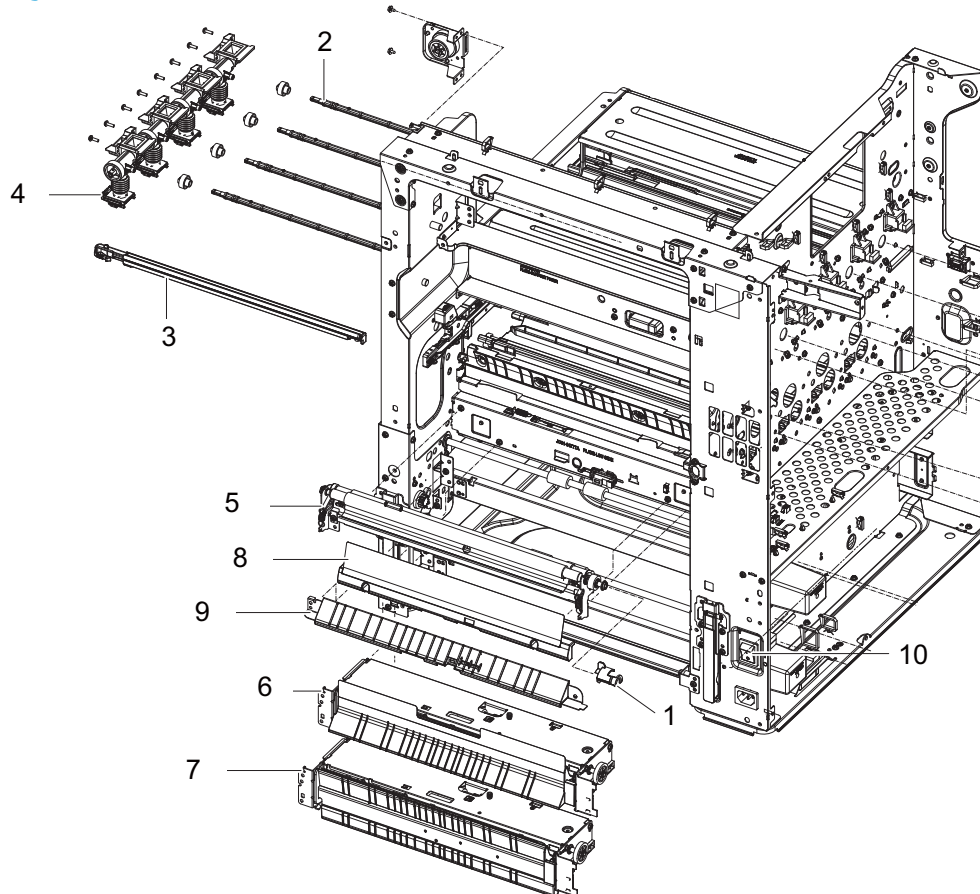

Table 2-30 Main engine frame (2/2)

Ref	Description	Part Number (*)	Qty
1	Registration stopper	JC61-04900A (*)	1
2	Feeding Duct Shaft	JC66-03164A (*)	4
3	Registration Cleaner	JC93-00078C (*)	1
4	Toner Supply Duct (For E77422, E77428)	JC93-00483B (*)	4
4	Toner Supply Duct (For E78223, E78228)	5QJ94-40001 (*)	4
5	Registration assembly (For E77422, E77428)	JC93-01371A (*)	1
5	Registration assembly (For E78223, E78228)	8G505-60130 (*)	1
6	Main frame first pickup	JC93-00511A (*)	1
7	Main frame second pickup	JC93-01441A (*)	1

Table 2-30 Main engine frame (2/2) (continued)

Ref	Description	Part Number (*)	Qty
8	Main feed first color	JC93-00536A (*)	1
9	Main feed second	JC93-00537D (*)	1
10	Main switch	JC39-01582A	1

* This part is in ordering system. If the ordering system has this part in stock, it can be ordered.

HP Color LaserJet Managed MFP E77422, E77428, E78223, and E78228 - Removal and replacement: Toner duct assembly

Follow these steps to remove the toner duct assembly.

To view a short video of this procedure, click the link below.

 [View a video of how to remove and replace the toner duct assembly.](#)

Mean time to repair: 6 minutes

Service level: Intermediate

 **IMPORTANT:** When applicable, special installation instructions are provided for an assembly at the end of the removal procedure. Always completely read the removal instructions and follow all special installation instructions.

Before performing service

- Disconnect the power cable.

Use the table below to identify the correct part number for your printer. To order the part, go to <https://parts.hp.com>

Table 2-31 Part information

Part number	Part description
JC93-00483B	Toner Supply Duct (For E77422, E77428)
5QJ94-40001	Toner Supply Duct (For E78223, E78228)

Required tools

- #2 JIS screwdriver with a magnetic tip

After performing service

Turn the printer power on

- Connect the power cable.
- Use the power switch to turn the power on.

Post service test

Verify that the document was copied, scanned, or printed correctly.

1. Remove the toner cartridges.
 - ▲ Open the front door and remove the toner collection unit (TCU) and toner cartridges.

Figure 2-124 Remove TCU



2. Remove the front inner cover.
 - a. Open the right door, and then remove one screw.

Figure 2-125 Remove one screw



- b. Remove two screws.

Figure 2-126 Remove two screws

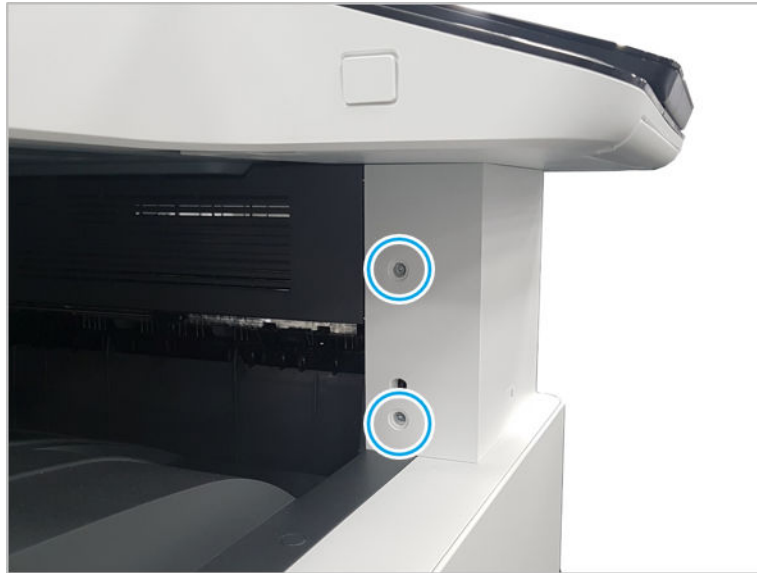

- c. Disconnect the connector, and then remove the middle right cover.

Figure 2-127 Remove the middle right cover



- d. Disconnect the connector connecting the front inner cover.

Figure 2-128 Disconnect the connector

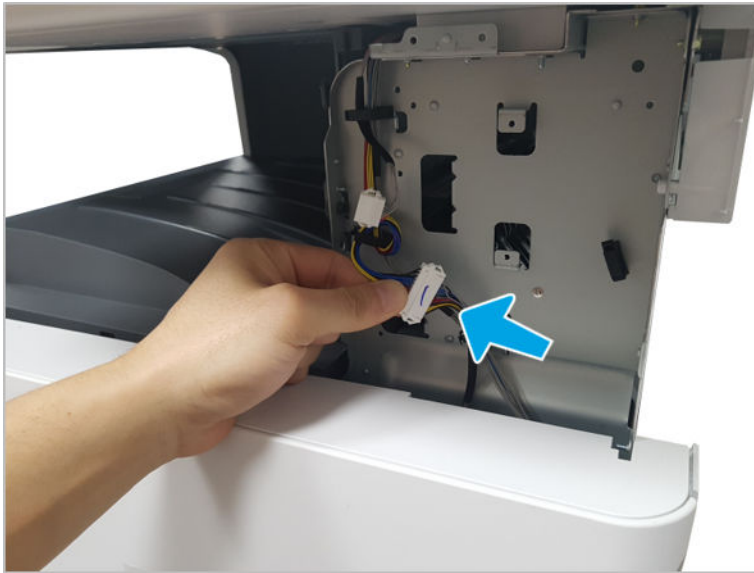

- e. Remove eight screws, and then remove the front inner cover.

 **NOTE:** The TCU cleaning blade must be removed to remove the front inner cover.

Figure 2-129 Remove the front inner cover



- 3. Remove the toner duct assembly.
 - a. Close the shutter duct on the developer unit.

Figure 2-130 Close the developer unit shutter duct for the station being replaced

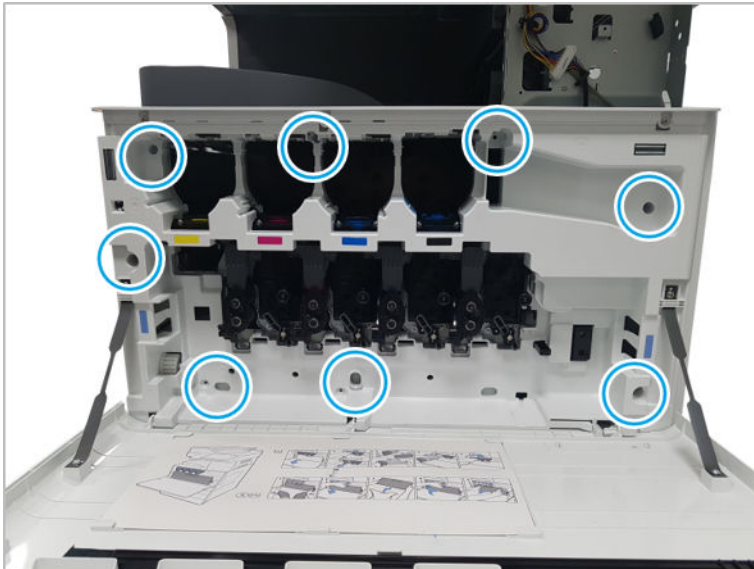
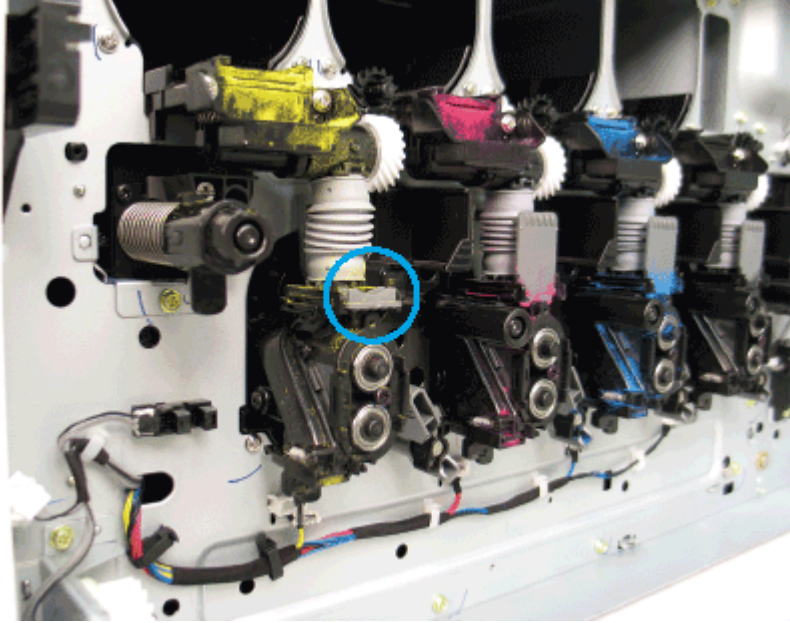

- b. Remove the shutter from the top of the developer unit.

Figure 2-131 Remove the developer unit shutter duct



- c. Remove two screws, and then remove the cover at the front of the duct assembly.

⚠ CAUTION: Be careful not to spill toner while removing the toner duct assembly.

Figure 2-132 Remove the toner duct cover

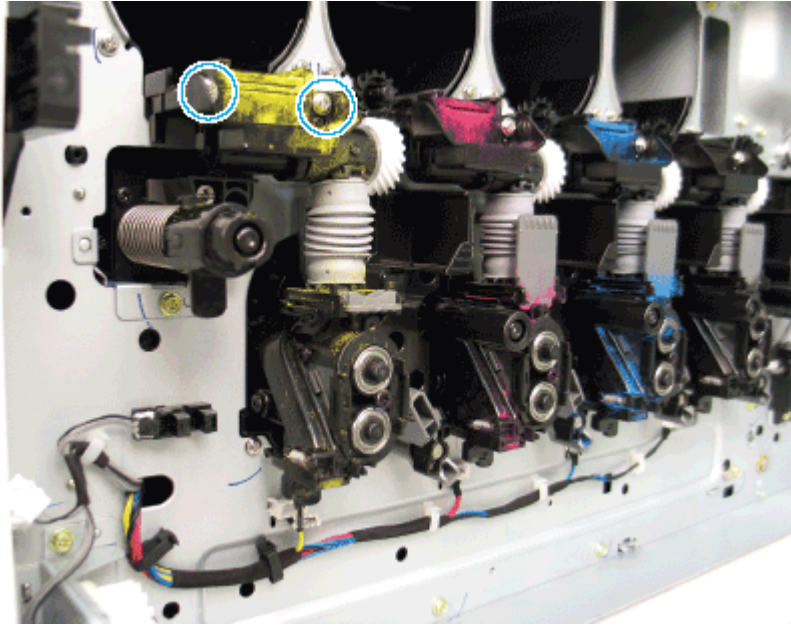

- d. Remove the toner duct assembly.

Figure 2-133 Remove the toner duct assembly

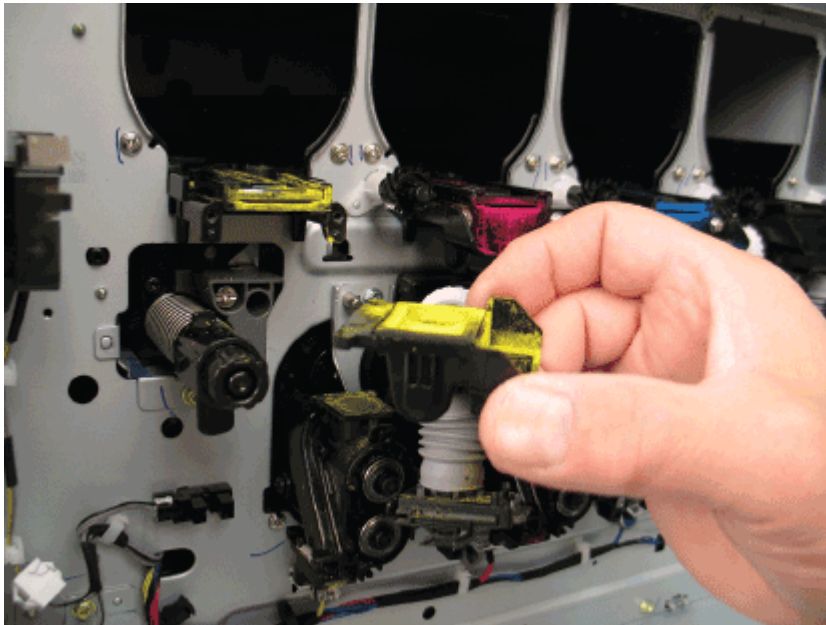



📌 IMPORTANT: The toner supply shutters must be in the open (up) position whenever performing service in this area of the printer.

4. Unpack the replacement assembly.
 - a. Dispose of the defective part.

 **NOTE:** HP recommends responsible disposal of the defective part.

<http://www8.hp.com/us/en/hp-information/environment/product-recycling.html>

- b. Unpack the replacement part from the packaging.

 **CAUTION:**  Some parts are sensitive to electrostatic discharge (ESD). Always perform service work at an ESD-protected workstation or mat. If an ESD workstation or mat is not available, touch the sheet-metal chassis to provide a static ground before touching an ESD-sensitive assembly. Protect the ESD-sensitive assemblies by placing them in ESD pouches when they are out of the printer.

If the replacement part is a roller or pad, avoid touching the spongy part of it. Skin oils on the roller or pad can cause paper pickup and/or print-quality problems. HP recommends using disposable gloves when handling rollers or pads or washing your hands before touching rollers or pads.

 **IMPORTANT:** Make sure that all of the shipping materials (for example shipping tape) are removed from the replacement part prior to installation.

- c. To install an assembly, reverse the removal steps.

 **NOTE:** When applicable, special installation instructions are provided for an assembly at the end of the removal procedure. Always completely read the removal instructions and follow all special installation instructions.

Registration assembly

View registration assembly exploded view, parts list, and repair procedures.

Registration assembly

Figure 2-134 Registration assembly

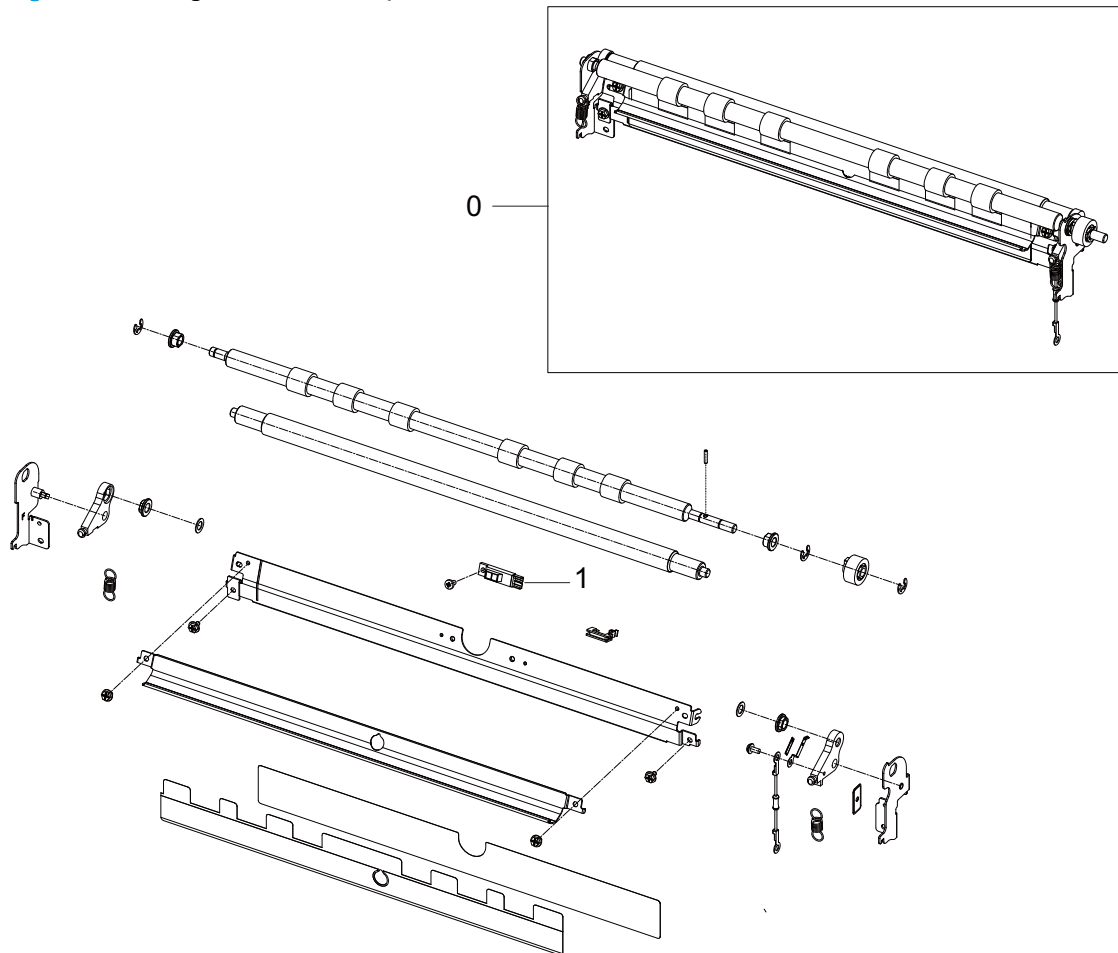

Table 2-32 Registration assembly

Ref	Description	Part Number (*)	Qty
0	Registration assembly (For E77422, E77428)	JC93-01371A (*)	1
0	Registration assembly (For E78223, E78228)	8G505-60130 (*)	1
1	Photo interrupter	0604-001502 (*)	1

* This part is in ordering system. If the ordering system has this part in stock, it can be ordered.

HP Color LaserJet Managed MFP E77422, E77428, E78223, and E78228 - Removal and replacement: Registration assembly

Follow these steps to remove the registration assembly.

To view a short video of this procedure, click the link below.



[View a video of how to remove and replace the registration assembly.](#)

Mean time to repair: 15 minutes

Service level: Intermediate



IMPORTANT: When applicable, special installation instructions are provided for an assembly at the end of the removal procedure. Always completely read the removal instructions and follow all special installation instructions.

Before performing service

- Disconnect the power cable.

Use the table below to identify the correct part number for your printer. To order the part, go to <https://parts.hp.com>

Table 2-33 Part information

Part number	Part description
JC93-01371A	Registration assembly (For E77422, E77428)
GS805-60130	Registration assembly (For E78223, E78228)

Required tools

- #2 JIS screwdriver with a magnetic tip

After performing service

Turn the printer power on

- Connect the power cable.
- Use the power switch to turn the power on.

Post service test

Verify that the document was copied, scanned, or printed correctly.

1. Remove the right door.



NOTE: Remove second exit drive if installed.

- a. Remove three screws, and then remove the right-rear cover.

Figure 2-135 Remove the right-rear cover



- b. Disconnect the right door connector.

Figure 2-136 Disconnect right door connector



- c. Open the right door.

- d. Release the right hinge (callout 1).

⚠ CAUTION: The right hinge spring tension can be dangerous. Use caution when releasing the right hinge to avoid injury.

Figure 2-137 Release right hinge

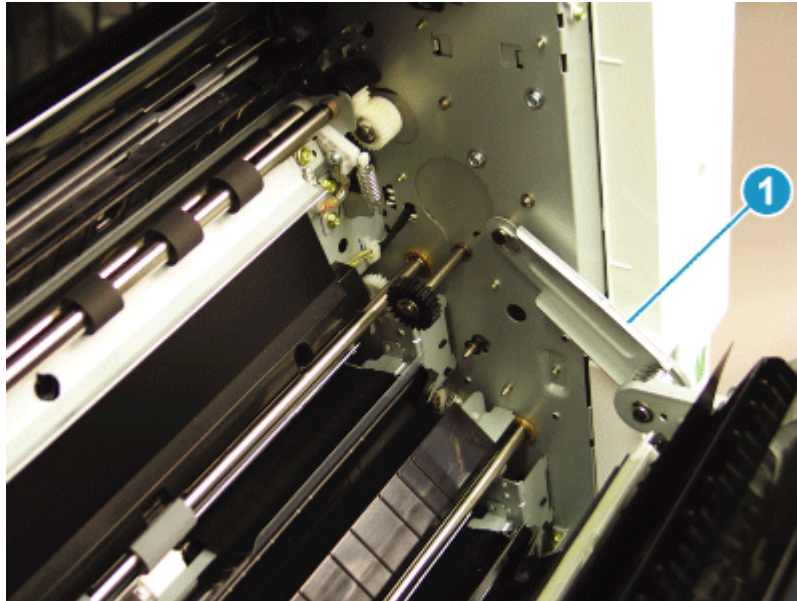

- e. Release the left dampener (callout 1).

Figure 2-138 Release left dampener

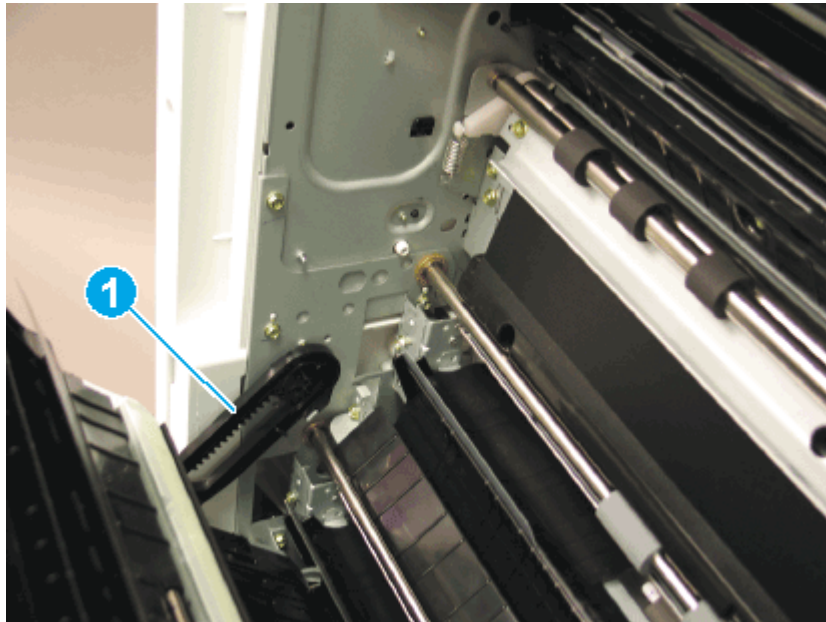

- f. Remove the right door.

 **NOTE:** Open the lower access door. If there is an HCI or 2x520 input device, release the dampener to clear the lower right door. Remove clockwise.

Figure 2-139 Remove right door



- 2. Remove the registration assembly.
 - a. Remove two screws, and then remove the feed sensor cover.

Figure 2-140 Remove the feed sensor cover

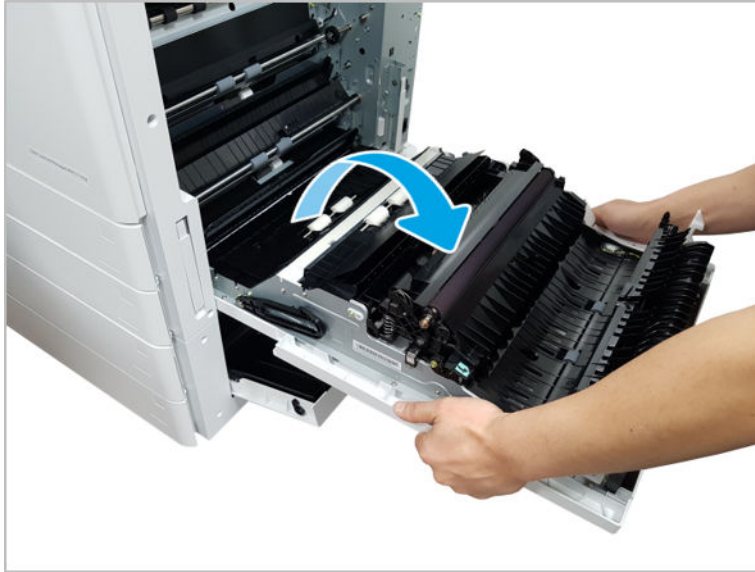
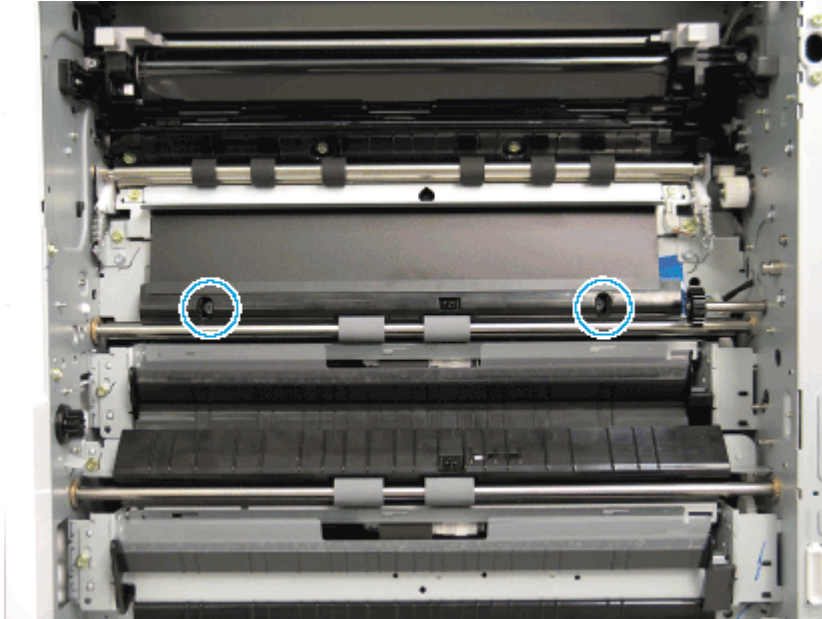

- b. Remove the black plastic bushing retainer at the rear of the registration assembly, disconnect one connector, and then remove two screws at the front and rear of the registration assembly.

Figure 2-141 Remove the registration assembly

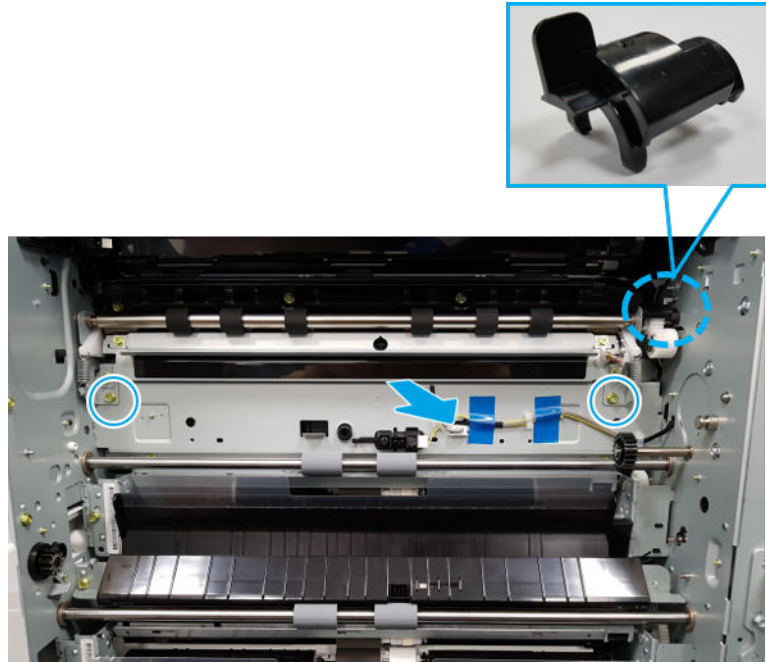

- c. Release the front side of the registration assembly first, and then release the back side to remove.

 **IMPORTANT:** Note the bushings on the registration assembly - they are not retained and can fall from the assembly during removal.



3. Unpack the replacement assembly.

- a. Dispose of the defective part.

 **NOTE:** HP recommends responsible disposal of the defective part.

<http://www8.hp.com/us/en/hp-information/environment/product-recycling.html>

- b. Unpack the replacement part from the packaging.

 **CAUTION:**  Some parts are sensitive to electrostatic discharge (ESD). Always perform service work at an ESD-protected workstation or mat. If an ESD workstation or mat is not available, touch the sheet-metal chassis to provide a static ground before touching an ESD-sensitive assembly. Protect the ESD-sensitive assemblies by placing them in ESD pouches when they are out of the printer.

If the replacement part is a roller or pad, avoid touching the spongy part of it. Skin oils on the roller or pad can cause paper pickup and/or print-quality problems. HP recommends using disposable gloves when handling rollers or pads or washing your hands before touching rollers or pads.

 **IMPORTANT:** Make sure that all of the shipping materials (for example shipping tape) are removed from the replacement part prior to installation.

- c. To install an assembly, reverse the removal steps.

 **NOTE:** When applicable, special installation instructions are provided for an assembly at the end of the removal procedure. Always completely read the removal instructions and follow all special installation instructions.

HP Color LaserJet Managed MFP E77422, E77428, E78223, and E78228 - Removal and replacement: Feed sensor 1

Follow these steps to remove the feed sensor 1.

To view a short video of this procedure, click the link below.

 [View a video of how to remove and replace the feed sensor 1.](#)

Mean time to repair: 10 minutes

Service level: Basic

 **IMPORTANT:** When applicable, special installation instructions are provided for an assembly at the end of the removal procedure. Always completely read the removal instructions and follow all special installation instructions.

Before performing service

- Disconnect the power cable.

Use the table below to identify the correct part number for your printer. To order the part, go to <https://parts.hp.com>

Table 2-34 Part information

Part number	Part description
0604-001393	Feed sensor 1

Required tools

- #2 JIS screwdriver with a magnetic tip

After performing service

Turn the printer power on

- Connect the power cable.
- Use the power switch to turn the power on.

Post service test

Verify that the document was copied, scanned, or printed correctly.

1. Remove the right door.

 **NOTE:** Remove second exit drive if installed.

- a. Remove three screws, and then remove the right-rear cover.

Figure 2-142 Remove the right-rear cover



- b. Disconnect the right door connector.

Figure 2-143 Disconnect right door connector



- c. Release the right hinge (callout 1).

⚠ CAUTION: The right hinge spring tension can be dangerous. Use caution when releasing the right hinge to avoid injury.

Figure 2-144 Release right hinge

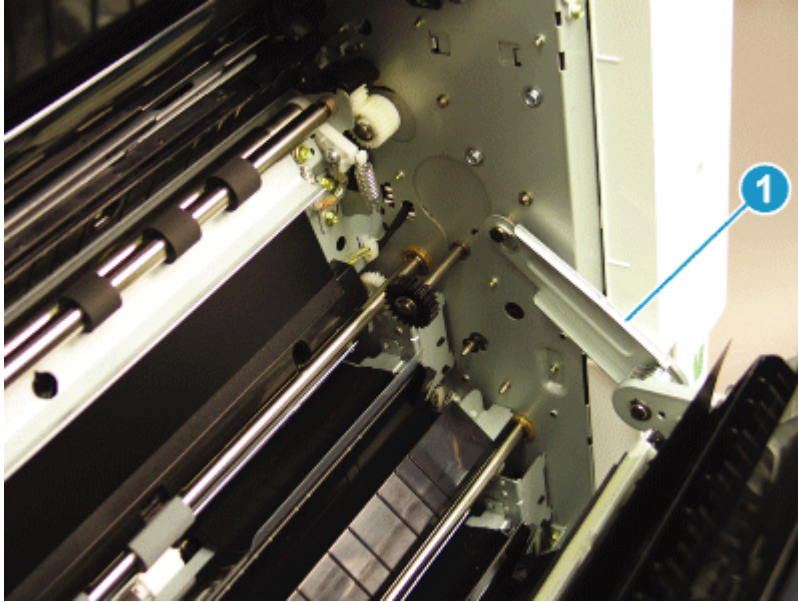

- d. Release the left dampener (callout 1).

Figure 2-145 Release left dampener

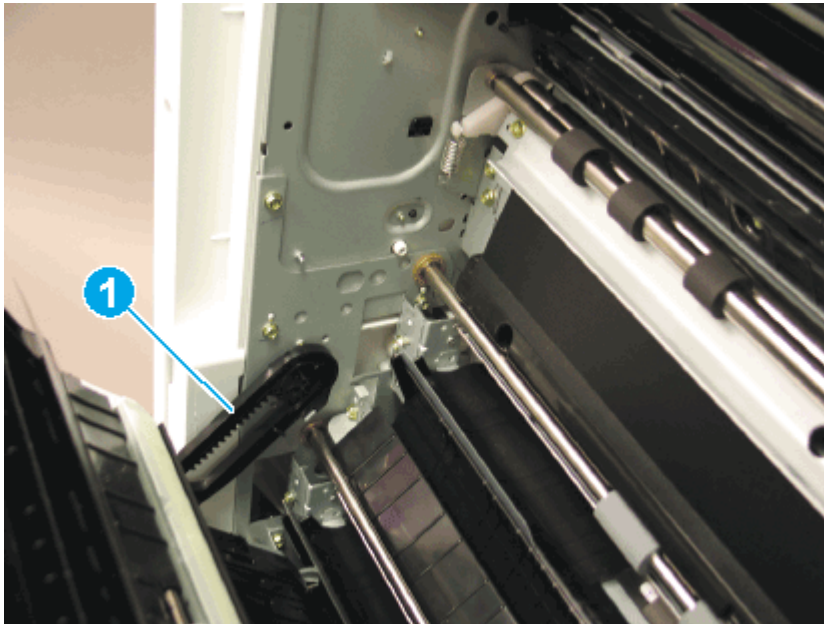

- e. Remove the right door.

 **NOTE:** Open the lower access door. If there is an HCI or 2x520 input device, release the dampener to clear the lower right door. Remove clockwise.

Figure 2-146 Remove right door

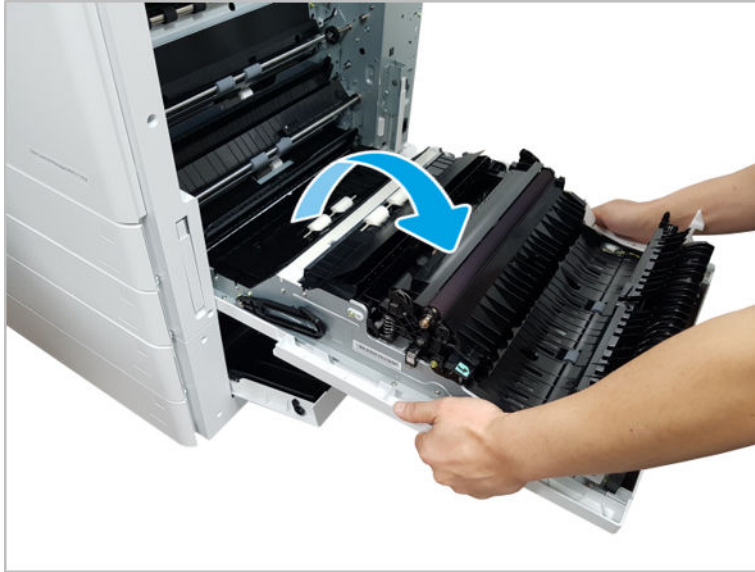

- 2. Remove feed sensor 1.

- a. Remove two screws, and then remove the sensor cover.

Figure 2-147 Remove screws and sensor cover

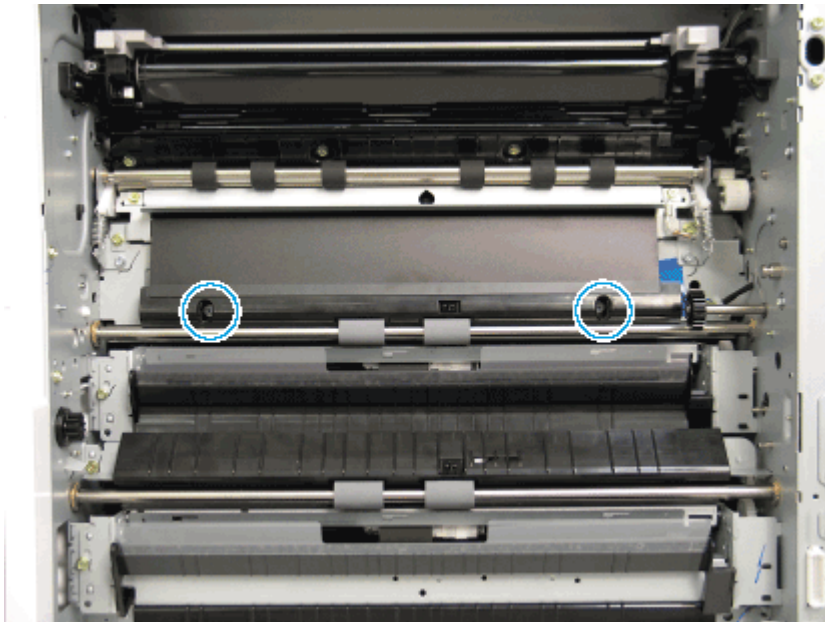

- b. Disconnect the connector, remove one screw, and then remove the feed sensor 1.

Figure 2-148 Remove feed sensor

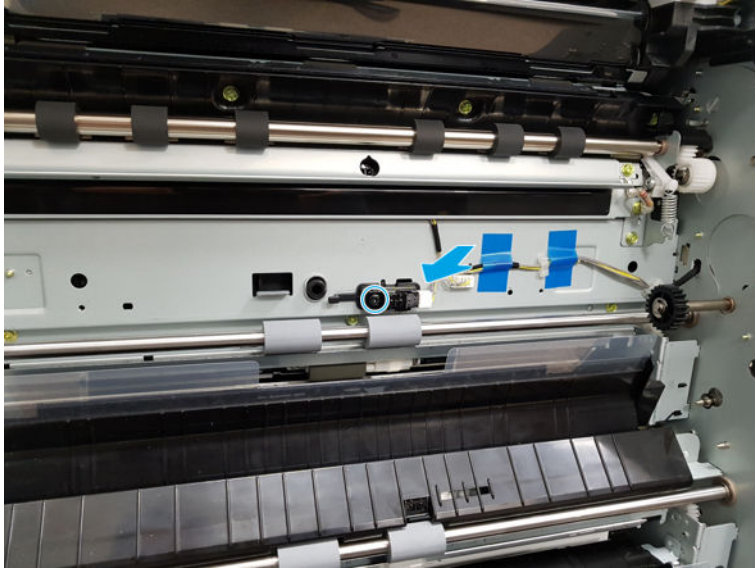

3. Unpack the replacement assembly.

- a. Dispose of the defective part.



NOTE: HP recommends responsible disposal of the defective part.

<http://www8.hp.com/us/en/hp-information/environment/product-recycling.html>

- b. Unpack the replacement part from the packaging.



CAUTION:  Some parts are sensitive to electrostatic discharge (ESD). Always perform service work at an ESD-protected workstation or mat. If an ESD workstation or mat is not available, touch the sheet-metal chassis to provide a static ground before touching an ESD-sensitive assembly. Protect the ESD-sensitive assemblies by placing them in ESD pouches when they are out of the printer.

If the replacement part is a roller or pad, avoid touching the spongy part of it. Skin oils on the roller or pad can cause paper pickup and/or print-quality problems. HP recommends using disposable gloves when handling rollers or pads or washing your hands before touching rollers or pads.



IMPORTANT: Make sure that all of the shipping materials (for example shipping tape) are removed from the replacement part prior to installation.

- c. To install an assembly, reverse the removal steps.



NOTE: When applicable, special installation instructions are provided for an assembly at the end of the removal procedure. Always completely read the removal instructions and follow all special installation instructions.

HP LaserJet Managed MFP E72425, E72430, E77422, E77428, E78223, E78228 - Removal and replacement: Feed sensor 2

Follow these steps to remove the feed unit and feed sensor 2.

To view a short video of this procedure, click the link below.



[View a video of how to remove and replace the feed sensor 2.](#)

Mean time to repair: 15 minutes

Service level: Intermediate



IMPORTANT: When applicable, special installation instructions are provided for an assembly at the end of the removal procedure. Always completely read the removal instructions and follow all special installation instructions.

Before performing service

- Disconnect the power cable.

Use the table below to identify the correct part number for your printer. To order the part, go to <https://parts.hp.com>

Table 2-35 Part information

Part number	Part description
0604-001381	Feed sensor 2

Required tools

- #2 JIS screwdriver with a magnetic tip

After performing service

Turn the printer power on

- Connect the power cable.
- Use the power switch to turn the power on.

Post service test

Verify that the document was copied, scanned, or printed correctly.

1. Remove the right door.
 - a. Remove three screws, and then remove the right-rear cover.

Figure 2-149 Remove the right-rear cover.



- b. Disconnect the right door connector.

Figure 2-150 Disconnect right door connector



- c. Release the right hinge (callout 1).

⚠ CAUTION: The right hinge spring tension can be dangerous. Use caution when releasing the right hinge to avoid injury.

Figure 2-151 Release right hinge

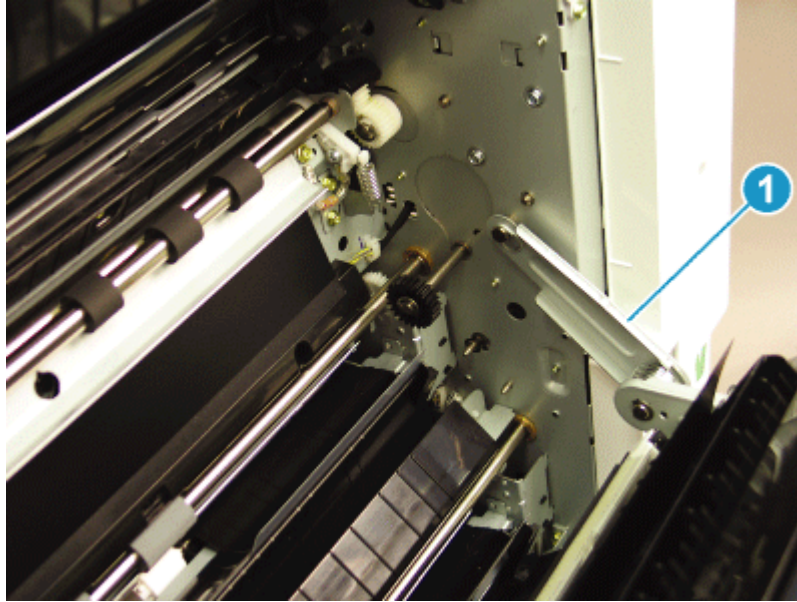

- d. Release the left dampener (callout 1).

Figure 2-152 Release left dampener

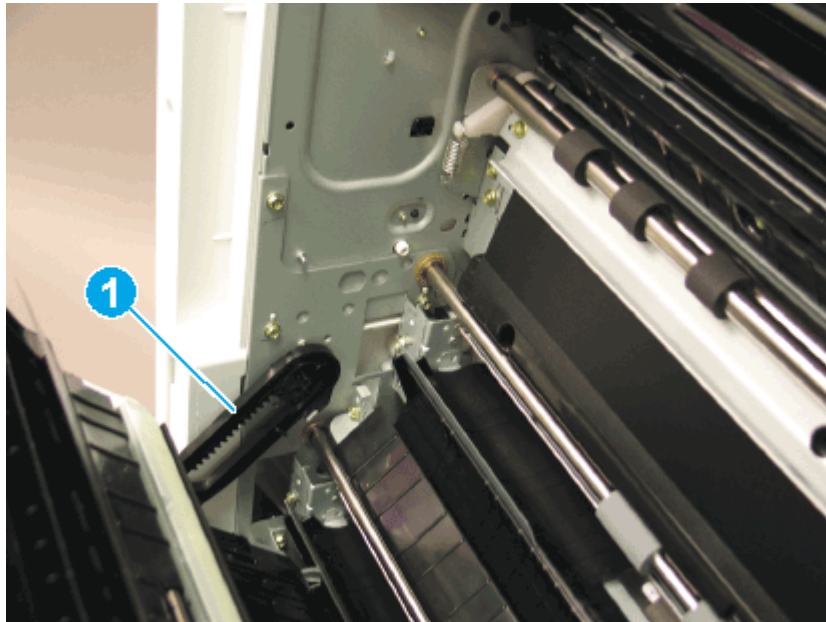

- e. Remove the right door.

 **NOTE:** Open the lower access door. If there is an HCI or 2x520 input device, release the dampener to clear the lower right door. Remove clockwise.

Figure 2-153 Remove right door



- 2. Remove feed unit and feed sensor 2.
 - a. Remove one screw, disconnect one connector, and then remove the feed unit (callout A).

Figure 2-154 Remove screw and feed unit

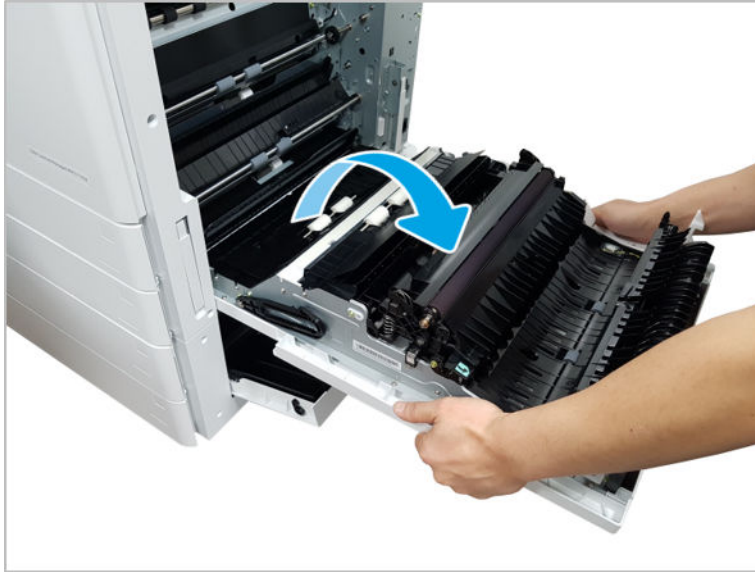
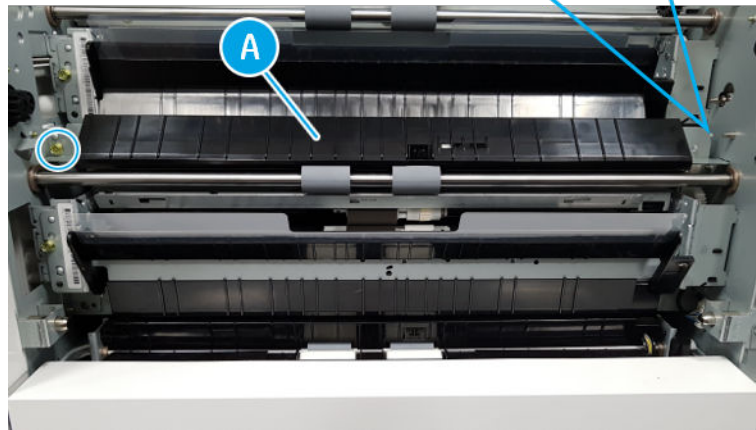
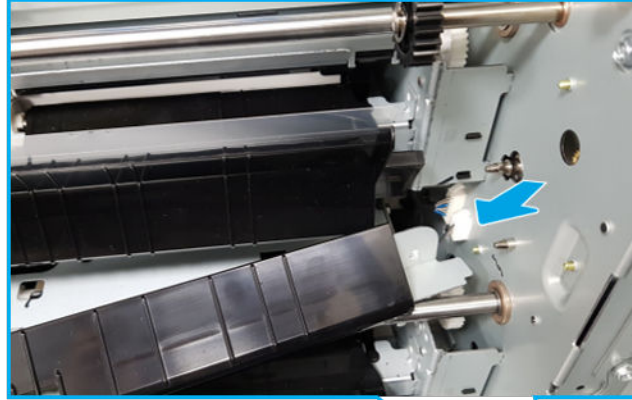

- b. Remove three screws, and then remove the bracket (callout B).

Figure 2-155 Remove screws and bracket



- c. Disconnect the connector, and then remove the feed sensor 2.

Figure 2-156 Remove feed sensor

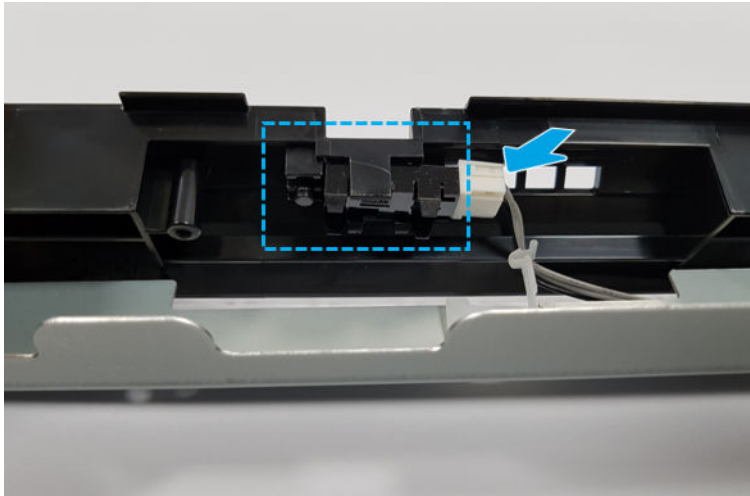



3. Unpack the replacement assembly.

- a. Dispose of the defective part.

 **NOTE:** HP recommends responsible disposal of the defective part.

<http://www8.hp.com/us/en/hp-information/environment/product-recycling.html>

- b. Unpack the replacement part from the packaging.

 **CAUTION:**  Some parts are sensitive to electrostatic discharge (ESD). Always perform service work at an ESD-protected workstation or mat. If an ESD workstation or mat is not available, touch the sheet-metal chassis to provide a static ground before touching an ESD-sensitive assembly. Protect the ESD-sensitive assemblies by placing them in ESD pouches when they are out of the printer.

If the replacement part is a roller or pad, avoid touching the spongy part of it. Skin oils on the roller or pad can cause paper pickup and/or print-quality problems. HP recommends using disposable gloves when handling rollers or pads or washing your hands before touching rollers or pads.

 **IMPORTANT:** Make sure that all of the shipping materials (for example shipping tape) are removed from the replacement part prior to installation.

- c. To install an assembly, reverse the removal steps.

 **NOTE:** When applicable, special installation instructions are provided for an assembly at the end of the removal procedure. Always completely read the removal instructions and follow all special installation instructions.

Main frame pickup assembly

View main frame pickup assembly exploded view, parts list, and repair procedures.

Main frame pickup

Figure 2-157 Main frame pickup

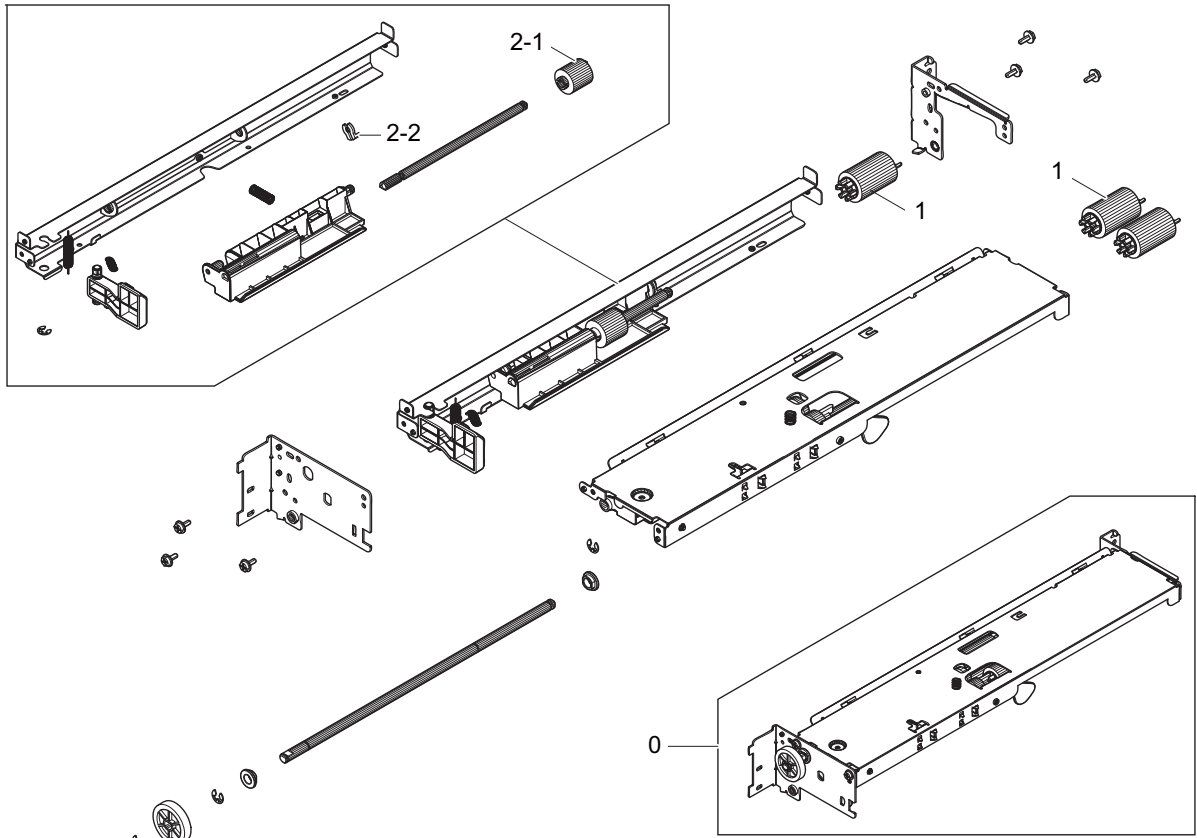

Table 2-36 Main frame pickup

Ref	Description	Part Number (*)	Qty
0	Main frame pickup	JC93-00510A (*)	1
1	Pick, reverse and feed roller Tray 2-5	JC93-00540A (*)	3
2-1	Coupler, torque limiter	JC67-00455A (*)	1
2-2	Fixer, E-ring 4pi	JC61-01367A (*)	1

* This part is in ordering system. If the ordering system has this part in stock, it can be ordered.

Main frame pickup, upper

Figure 2-158 Main frame pickup, upper

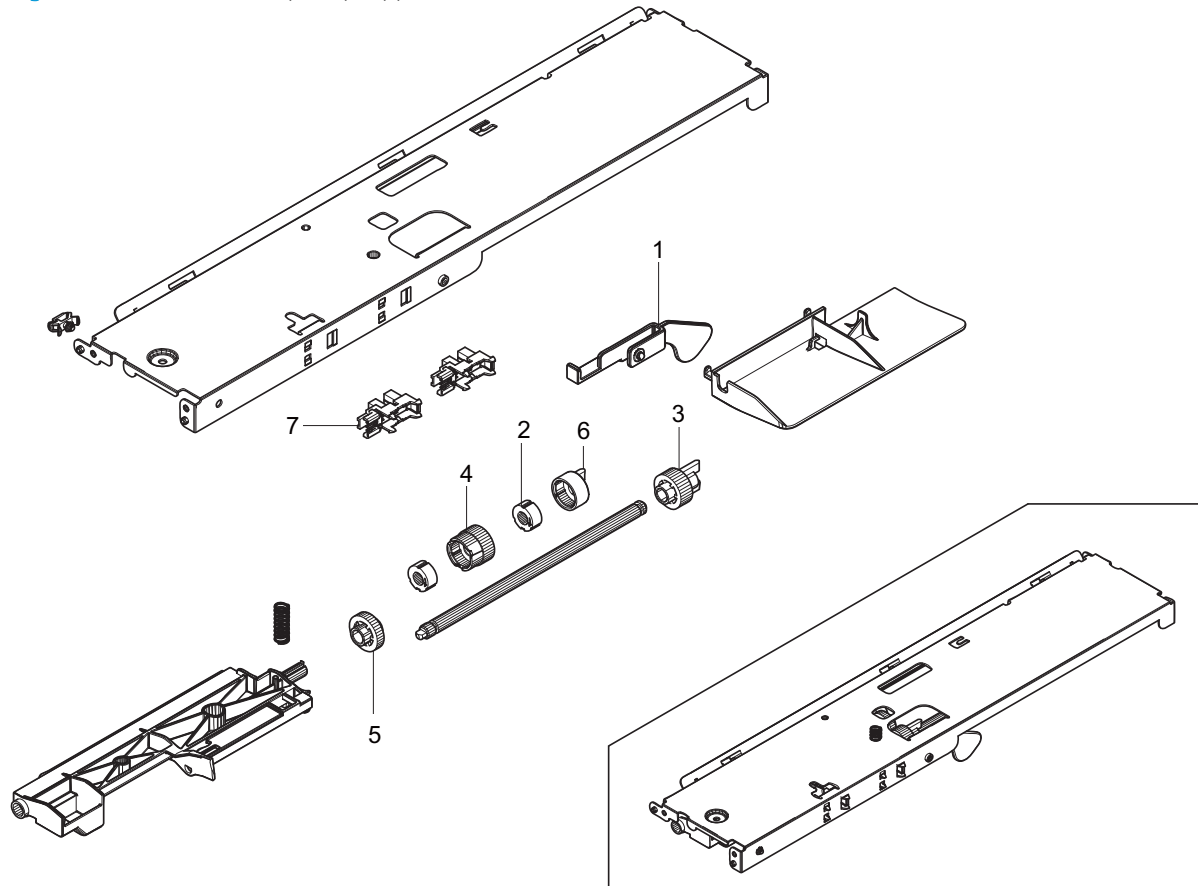

Table 2-37 Main frame pickup, upper

Ref	Description	Part Number (*)	Qty
1	Actuator, empty pickup	JC66-03199A (*)	1
2	Clutch one way	JC66-00977A (*)	1
3	Gear-m, joint	JC66-00943A (*)	1
4	Gear-m, one way	JC66-00941A (*)	1
5	Gear-m, idle	JC66-00940A (*)	1
6	Holder-m, idle one way	JC61-01288A (*)	1
7	Photo interrupter	0604-001393 (*)	2

* This part is in ordering system. If the ordering system has this part in stock, it can be ordered.

HP LaserJet Managed MFP E72425, E72430, E77422, E77428, E78223, E78228 - Removal and replacement: Pickup/reverse/feed roller

Follow these steps to remove the pickup/reverse/feed roller.

To view a short video of this procedure, click the link below.

 [View a video of how to remove and replace the tray 2 pickup/reverse/feed roller.](#)

 [View a video of how to remove and replace the tray 3 pickup/reverse/feed roller.](#)

Mean time to repair: 2 minutes

Service level: Basic

 **IMPORTANT:** When applicable, special installation instructions are provided for an assembly at the end of the removal procedure. Always completely read the removal instructions and follow all special installation instructions.

Before performing service

- Disconnect the power cable.

Use the table below to identify the correct part number for your printer. To order the part, go to <https://parts.hp.com>

Table 2-38 Part information

Part number	Part description
JC93-00540A	Pickup/reverse/feed roller assembly

Required tools

- #2 JIS screwdriver with a magnetic tip

After performing service

Turn the printer power on

- Connect the power cable.
- Use the power switch to turn the power on.

Post service test



Verify that the document was copied, scanned, or printed correctly.

1. Remove all trays to access the inside of the printer.
2. Remove the pickup/feed/reverse roller.
 - a. Remove one screw, disconnect one connector, and then remove the pickup assembly.

 **NOTE:** HP recommends responsible disposal of the defective part.

<http://www8.hp.com/us/en/hp-information/environment/product-recycling.html>

- b. Unpack the replacement part from the packaging.

 **CAUTION:**  Some parts are sensitive to electrostatic discharge (ESD). Always perform service work at an ESD-protected workstation or mat. If an ESD workstation or mat is not available, touch the sheet-metal chassis to provide a static ground before touching an ESD-sensitive assembly. Protect the ESD-sensitive assemblies by placing them in ESD pouches when they are out of the printer.

If the replacement part is a roller or pad, avoid touching the spongy part of it. Skin oils on the roller or pad can cause paper pickup and/or print-quality problems. HP recommends using disposable gloves when handling rollers or pads or washing your hands before touching rollers or pads.

 **IMPORTANT:** Make sure that all of the shipping materials (for example shipping tape) are removed from the replacement part prior to installation.

- c. To install an assembly, reverse the removal steps.

 **NOTE:** When applicable, special installation instructions are provided for an assembly at the end of the removal procedure. Always completely read the removal instructions and follow all special installation instructions.

HP LaserJet Managed MFP E72425, E72430, E77422, E77428, E78223, E78228 - Removal and replacement: Paper pickup assemblies and empty/level sensor

Follow these steps to remove the paper pickup assemblies and empty/level sensor .

To view a short video of this procedure, click the link below.

 [View a video of how to remove and replace the tray 2 paper pickup assembly and empty/level sensor.](#)

 [View a video of how to remove and replace the tray 3 paper pickup assembly and empty/level sensor.](#)

Mean time to repair: 15 minutes

Service level: Intermediate

 **IMPORTANT:** When applicable, special installation instructions are provided for an assembly at the end of the removal procedure. Always completely read the removal instructions and follow all special installation instructions.

Before performing service

- Disconnect the power cable.

Use the table below to identify the correct part number for your printer. To order the part, go to <https://parts.hp.com>

Table 2-39 Part information

Part numbers	Part description
JC93-00511A	Main frame first pickup

Table 2-39 Part information (continued)

Part numbers	Part description
JC93-01441A	Main frame second pickup
0604-001393	Photo interrupter

Required tools

- #2 JIS screwdriver with a magnetic tip

After performing service

Turn the printer power on

- Connect the power cable.
- Use the power switch to turn the power on.

Post service test

Verify that the document was copied, scanned, or printed correctly.

1. Remove the right door.

 **NOTE:** Remove second exit drive if installed.

- a. Remove three screws, and then remove the right-rear cover.

Figure 2-160 Remove the right-rear cover.



- b. Disconnect the right door connector.

Figure 2-161 Disconnect right door connector



- c. Release the right hinge (callout 1).

⚠ CAUTION: The right hinge spring tension can be dangerous. Use caution when releasing the right hinge to avoid injury.

Figure 2-162 Release right hinge

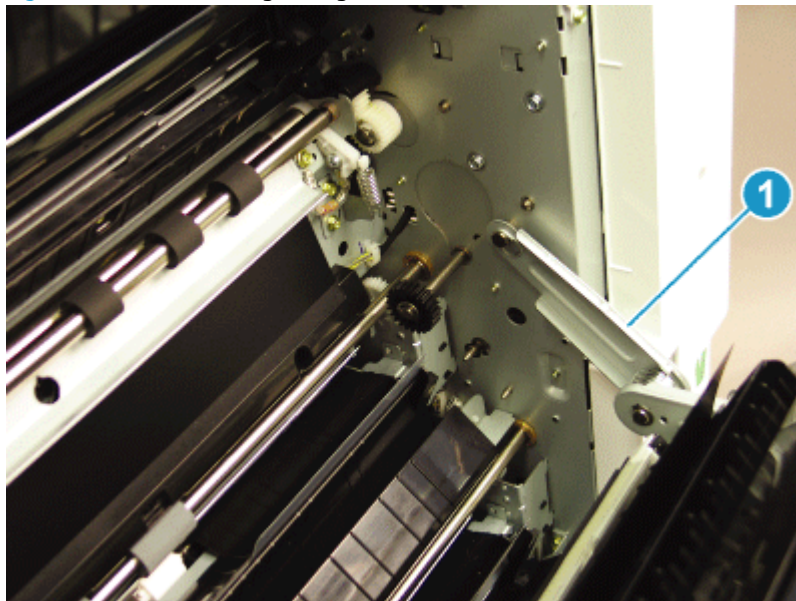

- d. Release the left dampener (callout 1).

Figure 2-163 Release left dampener

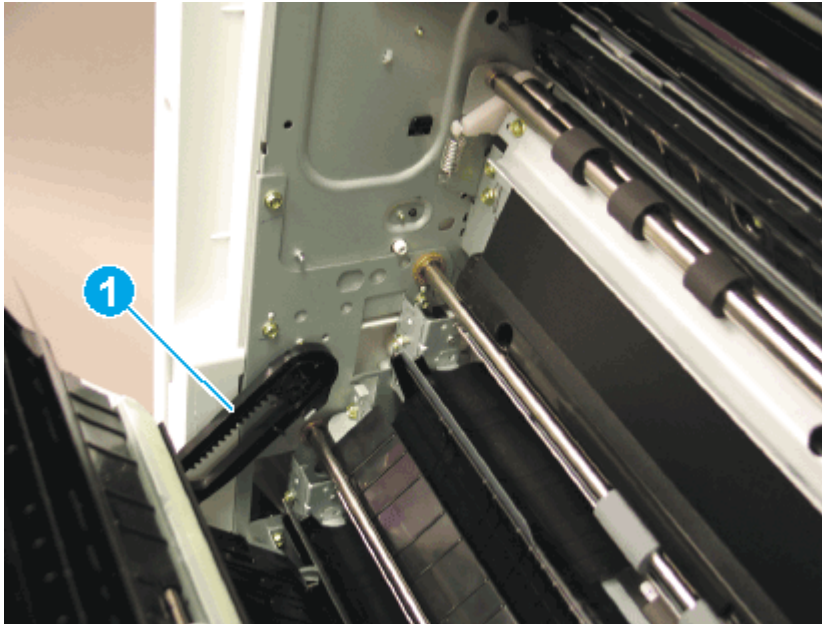

- e. Remove the right door.

 **NOTE:** Open the lower access door. If there is an HCl or 2x520 input device, release the dampener to clear the lower right door. Remove clockwise.

Figure 2-164 Remove right door



- 2. Remove the paper trays.
- 3. Remove the paper pickup unit.
 - a. Remove one screw.

Figure 2-165 Remove one screw



- b. Release the feed unit and disconnect one connector.

Figure 2-166 Disconnect one connector



- c. For each pickup unit, disconnect one connector (callout 1), remove one screw (callout 2), and then remove the pickup unit.

Figure 2-167 Disconnect one connector and remove one screw

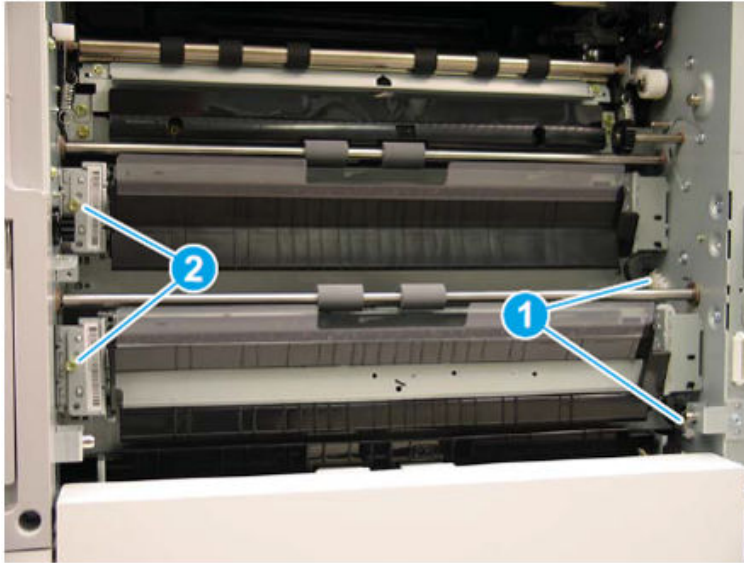

4. Remove the empty and level sensors.

- a. Release the sensor after disconnecting the connector. (Empty sensor [callout A], level sensor [callout B]).

Figure 2-168 Release the empty and level sensor

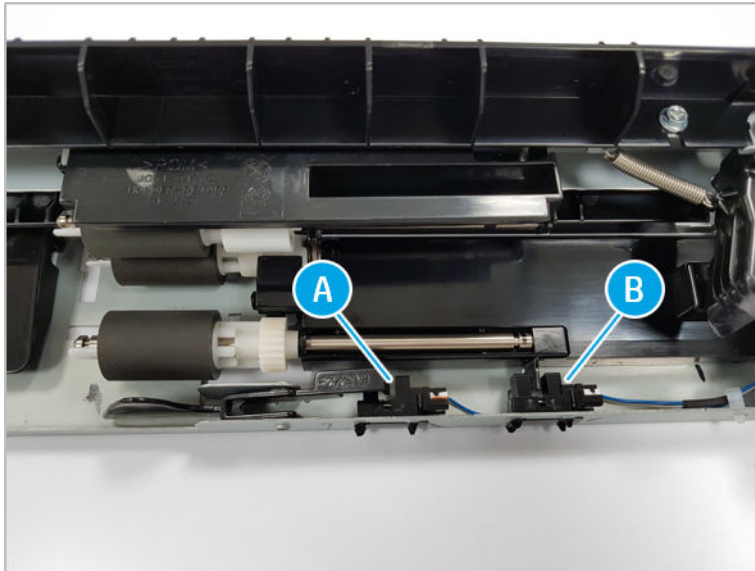

5. Unpack the replacement assembly.
 - a. Dispose of the defective part.

 **NOTE:** HP recommends responsible disposal of the defective part.

<http://www8.hp.com/us/en/hp-information/environment/product-recycling.html>

- b. Unpack the replacement part from the packaging.



CAUTION:  Some parts are sensitive to electrostatic discharge (ESD). Always perform service work at an ESD-protected workstation or mat. If an ESD workstation or mat is not available, touch the sheet-metal chassis to provide a static ground before touching an ESD-sensitive assembly. Protect the ESD-sensitive assemblies by placing them in ESD pouches when they are out of the printer.

If the replacement part is a roller or pad, avoid touching the spongy part of it. Skin oils on the roller or pad can cause paper pickup and/or print-quality problems. HP recommends using disposable gloves when handling rollers or pads or washing your hands before touching rollers or pads.

 **IMPORTANT:** Make sure that all of the shipping materials (for example shipping tape) are removed from the replacement part prior to installation.

- c. To install an assembly, reverse the removal steps.



NOTE: When applicable, special installation instructions are provided for an assembly at the end of the removal procedure. Always completely read the removal instructions and follow all special installation instructions.

Main frame

View main frame exploded view, parts list, and repair procedures.

Main frame parts

Figure 2-169 Main frame parts

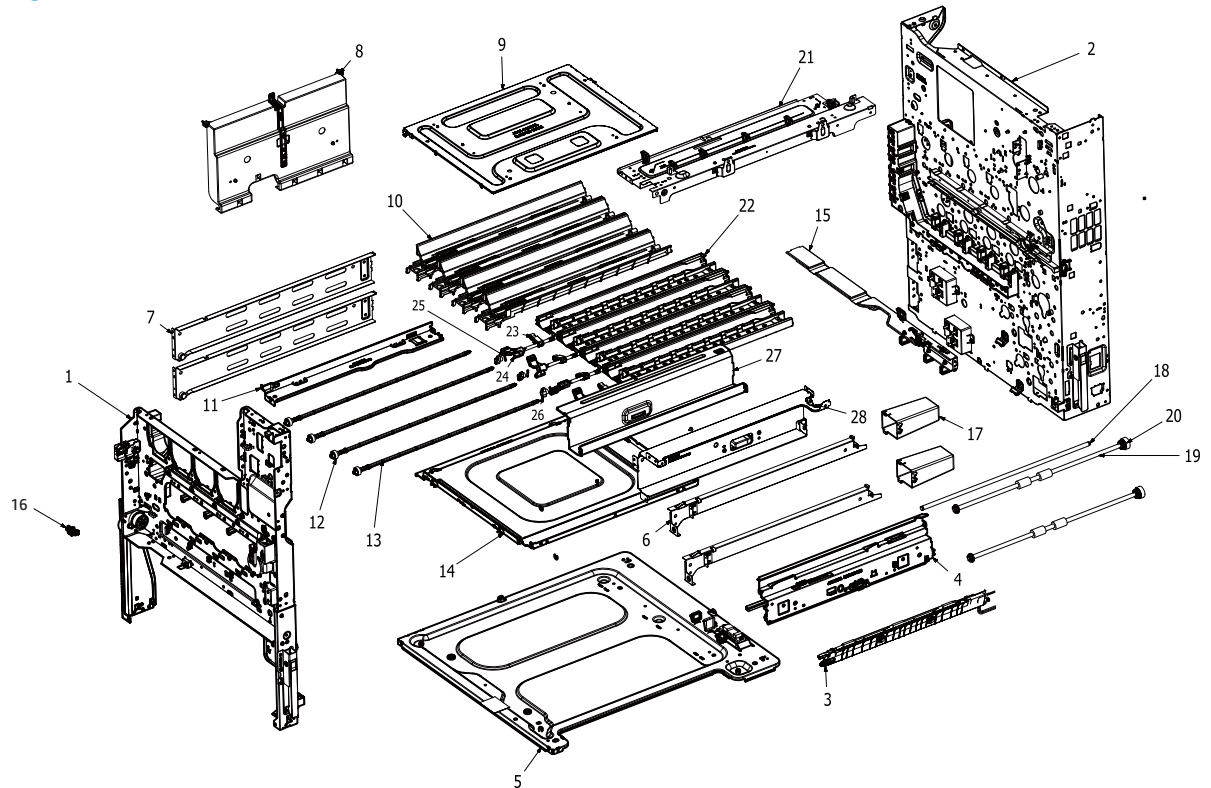

Table 2-40 Main frame parts

Ref	Description	Part Number (*)	Qty
1	Front frame parts	JC93-01397A	1
2	Rear frame parts (For E77422, E77428)	JC93-01644A	1
2	Rear frame parts (For E78223, E78228)	8GS50-40017	1
3	Automatic Color Registration (ACR) assembly	JC93-01803A	1
4	Frame main middle plate LSU	JC93-00859A	1
5	Base bottom frame	JC93-00926A	1
6	Right cassette rail	JC93-00478A	2
7	Left cassette rail	JC93-00477A	2
8	HVPS shield	JC95-02243A	1
9	Top plate	JC61-06621A	1
10	Toner guide frame (For E77422, E77428)	JC93-00618A (*)	4

Table 2-40 Main frame parts (continued)

Ref	Description	Part Number (*)	Qty
10	Toner guide frame (For E78223, E78228)	5QJ83-40030 (*)	4
11	ITB cleaner guide	JC61-04774A	1
12	Idle gear feeding duct	JC66-03166A	4
13	Link feeding duct	JC66-03164A	4
14	LSU plate	JC61-04775A	1
15	Rear frame support	JC93-01399A	1
16	Photo interrupter	0604-001393 (*)	1
17	Right cassette rail cover	JC63-03416A	2
18	LSU align shaft	JC66-03231A	1
19	Idle feed roller	JC66-03203A	2
20	Gear clutch	JC93-01186A	2
21	Scan right frame	JC93-01648A	1
22	OPC developer guide	JC61-04785A	4
23	Swing lever frame	JC93-00485A	4
24	Developer swing handle	JC64-00708B	4
25	Pin, parallel	6043-001115	4
26	Developer swing link	JC66-03229A	4
27	Exit top plate	JC61-04773A	1
28	Fuser support	JC93-00481B	1

* This part is in ordering system. If the ordering system has this part in stock, it can be ordered.

Front frame

View front frame exploded view, parts list, and repair procedures.

Front frame parts

Figure 2-170 Front frame parts

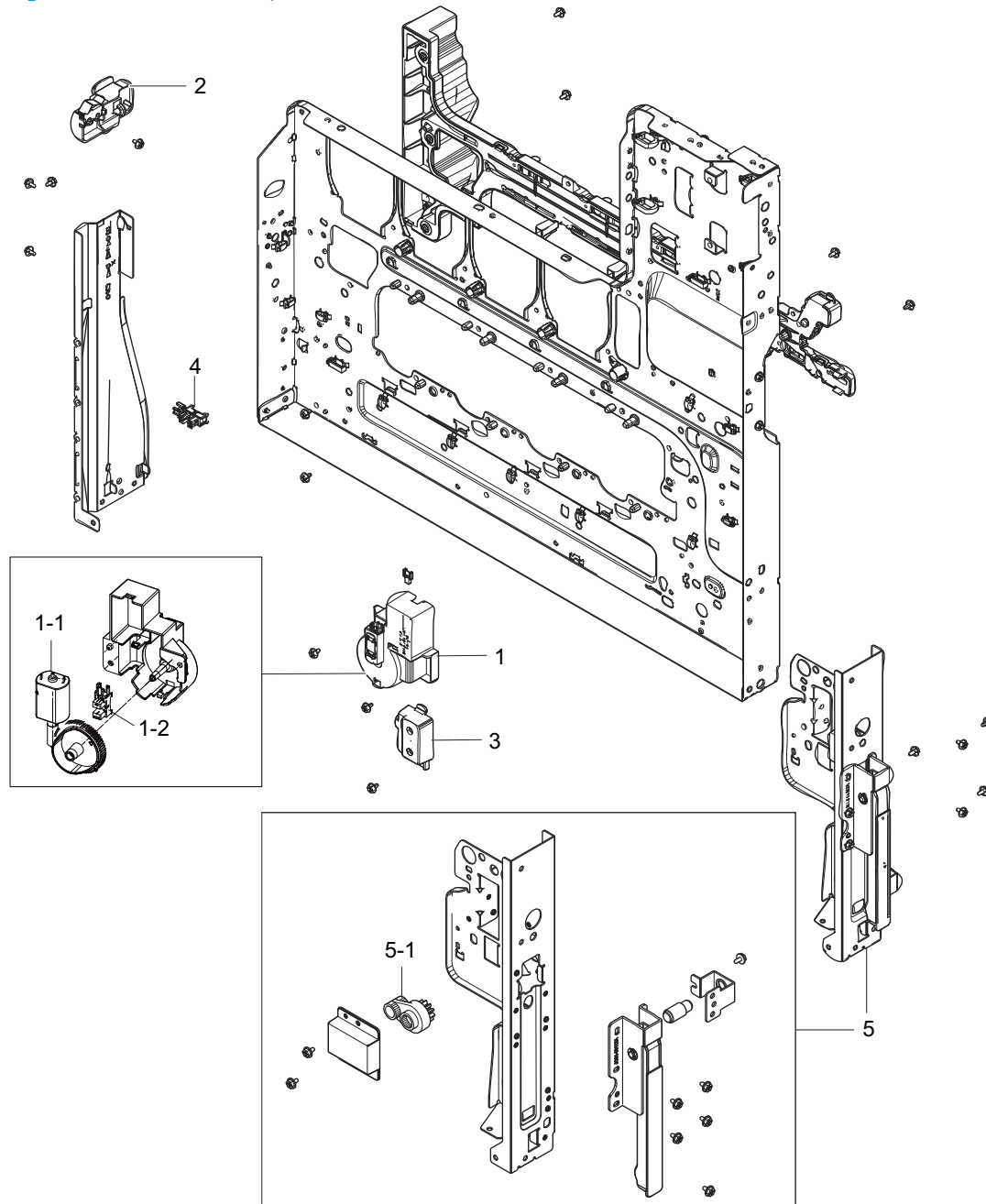

Table 2-41 Front frame parts

Ref	Description	Part Number (*)	Qty
1	ACR shutter drive assembly	JC93-00894A	1

Table 2-41 Front frame parts (continued)

Ref	Description	Part Number (*)	Qty
1-1	Motor DC	JC31-00078A (*)	1
1-2	ACR shutter sensor	0604-001393	1
2	Front Door Switch assembly	JC93-00466A (*)	1
3	Main TCU sensor	JC93-00492A (*)	1
4	Installation TCU sensor	0604-001393 (*)	1
5	Right lower frame	JC93-01418A	1
5-1	Damper hinge	JC66-01425A (*)	1

* This part is in ordering system. If the ordering system has this part in stock, it can be ordered.

HP Color LaserJet Managed MFP E77422, E77428, E78223, and E78228 - Removal and replacement: Front cover open switch

Follow these steps to remove the front cover open switch.

To view a short video of this procedure, click the link below.



[View a video of how to remove and replace the front cover open switch.](#)

Mean time to repair: 6 minutes

Service level: Intermediate



IMPORTANT: When applicable, special installation instructions are provided for an assembly at the end of the removal procedure. Always completely read the removal instructions and follow all special installation instructions.

Before performing service

- Disconnect the power cable.

Use the table below to identify the correct part number for your printer. To order the part, go to <https://parts.hp.com>

Table 2-42 Part information

Part number	Part description
JC93-00466A	Front cover open switch

Required tools

- #2 JIS screwdriver with a magnetic tip

After performing service

Turn the printer power on

- Connect the power cable.
- Use the power switch to turn the power on.

Post service test

Verify that the document was copied, scanned, or printed correctly.

1. Remove the toner cartridges and toner collection unit (TCU).
 - ▲ Open the front door and remove the toner collection unit and toner cartridges.

Figure 2-171 Remove TCU



2. Remove the front inner cover.
 - a. Open the right door, and then remove one screw.

Figure 2-172 Remove one screw



- b. Remove two screws.

Figure 2-173 Remove two screws

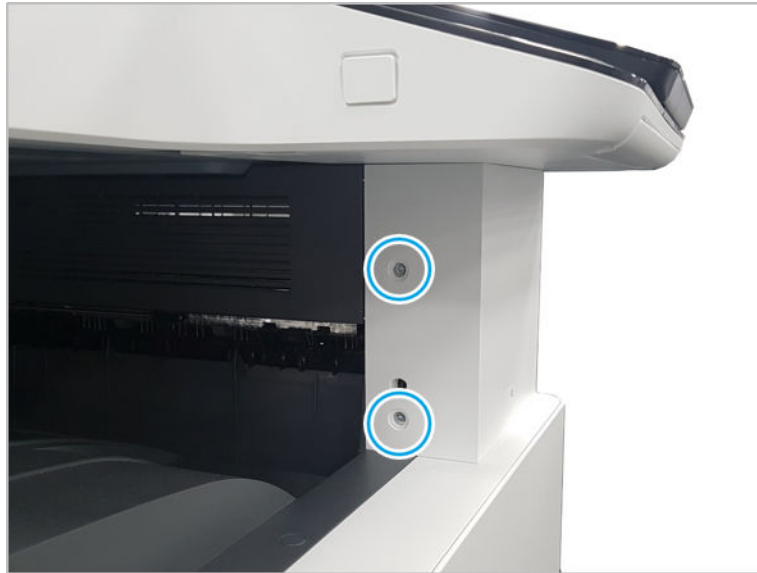

- c. Disconnect the connector, and then remove the middle right cover.

Figure 2-174 Remove the middle right cover



- d. Disconnect the connector connecting the front inner cover.

Figure 2-175 Disconnect the connector

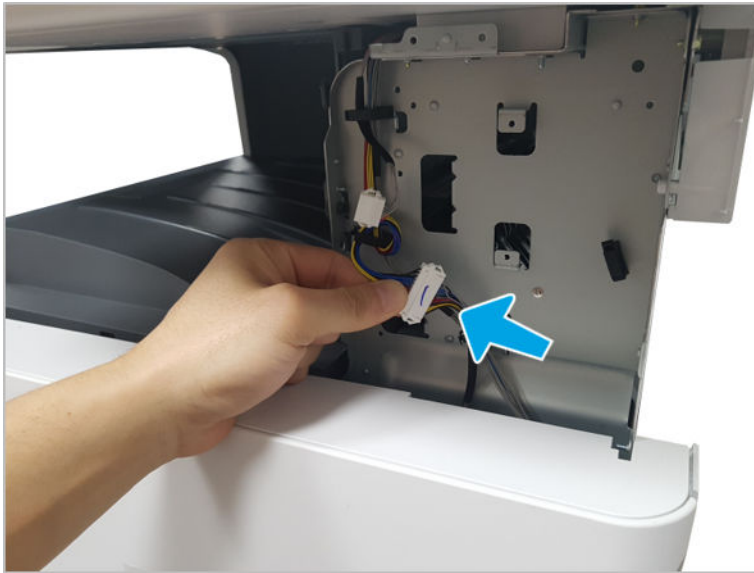

- e. Remove eight screws, and then remove the front inner cover.

 **NOTE:** The TCU cleaning blade must be removed to remove the front inner cover.

Figure 2-176 Remove the front inner cover



3. Remove the front cover open switch.
 - ▲ Remove one screw, and then remove the front cover open switch.

Figure 2-177 Remove screw and front cover open switch

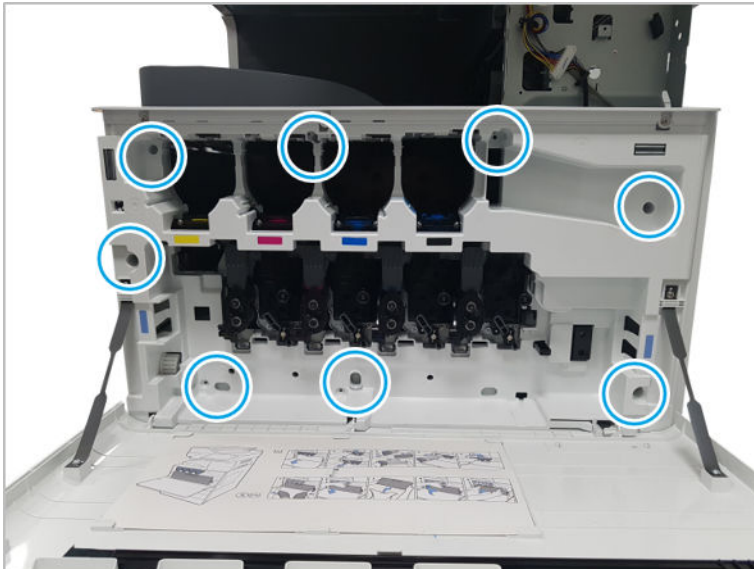
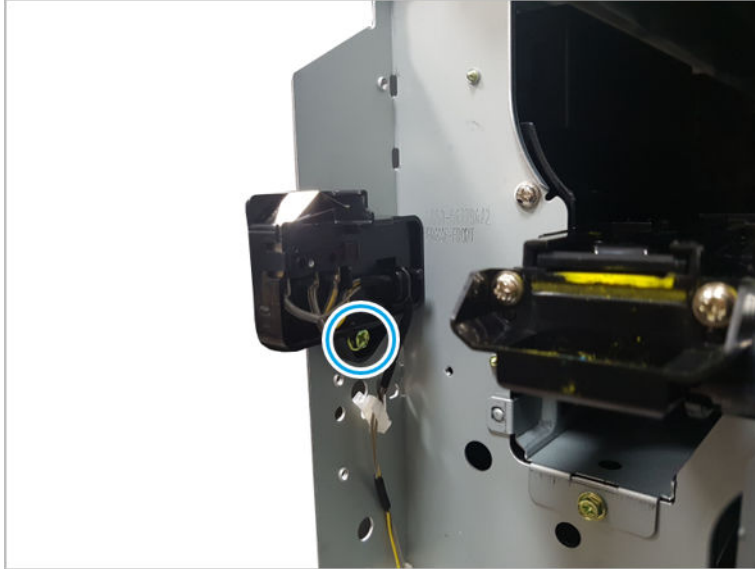

4. Unpack the replacement assembly.

- a. Dispose of the defective part.



NOTE: HP recommends responsible disposal of the defective part.

<http://www8.hp.com/us/en/hp-information/environment/product-recycling.html>

- b. Unpack the replacement part from the packaging.



CAUTION:



Some parts are sensitive to electrostatic discharge (ESD). Always perform service work at an ESD-protected workstation or mat. If an ESD workstation or mat is not available, touch the sheet-metal chassis to provide a static ground before touching an ESD-sensitive assembly. Protect the ESD-sensitive assemblies by placing them in ESD pouches when they are out of the printer.

If the replacement part is a roller or pad, avoid touching the spongy part of it. Skin oils on the roller or pad can cause paper pickup and/or print-quality problems. HP recommends using disposable gloves when handling rollers or pads or washing your hands before touching rollers or pads.



IMPORTANT: Make sure that all of the shipping materials (for example shipping tape) are removed from the replacement part prior to installation.

- c. To install an assembly, reverse the removal steps.



NOTE: When applicable, special installation instructions are provided for an assembly at the end of the removal procedure. Always completely read the removal instructions and follow all special installation instructions.

HP Color LaserJet Managed MFP E77422, E77428, E78223, and E78228 - Removal and replacement: Automatic color registration (ACR) shutter motor

Follow these steps to remove the ACR shutter motor.

To view a short video of this procedure, click the link below.



[View a video of how to remove and replace the ACR shutter motor.](#)

Mean time to repair: 6 minutes

Service level: Intermediate



IMPORTANT: When applicable, special installation instructions are provided for an assembly at the end of the removal procedure. Always completely read the removal instructions and follow all special installation instructions.

Before performing service

- Disconnect the power cable.

Use the table below to identify the correct part number for your printer. To order the part, go to <https://parts.hp.com>

Table 2-43 Part information

Part number	Part description
JC93-00894A	ACR shutter motor

Required tools

- #2 JIS screwdriver with a magnetic tip

After performing service

Turn the printer power on

- Connect the power cable.
- Use the power switch to turn the power on.

Post service test

Verify that the document was copied, scanned, or printed correctly.

1. Remove the toner cartridges and toner collection unit (TCU).
 - ▲ Open the front door and remove the toner collection unit and toner cartridges.

Figure 2-178 Remove TCU



2. Remove the front inner cover.
 - a. Open the right door, and then remove one screw.

Figure 2-179 Remove one screw



- b. Remove two screw-caps and two screws.

Figure 2-180 Remove two screws

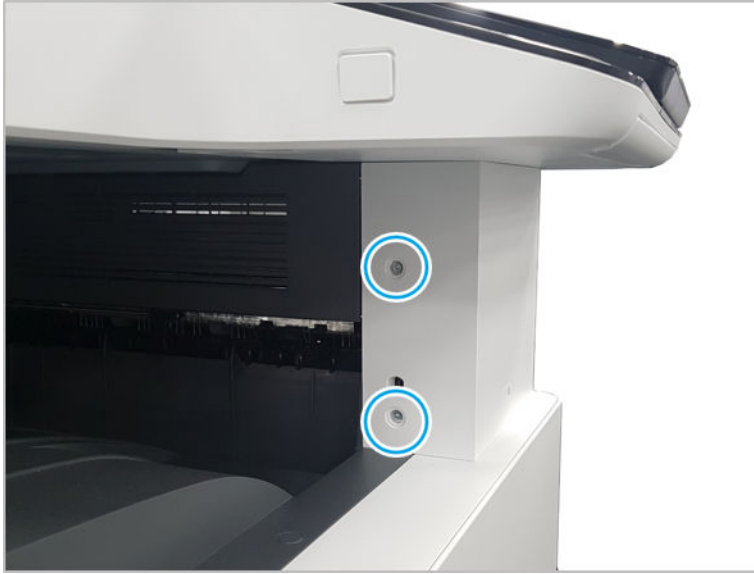

- c. Disconnect the connector, and then remove the middle right cover.

Figure 2-181 Remove the middle right cover



- d. Disconnect the connector connecting the front inner cover.

Figure 2-182 Disconnect the connector

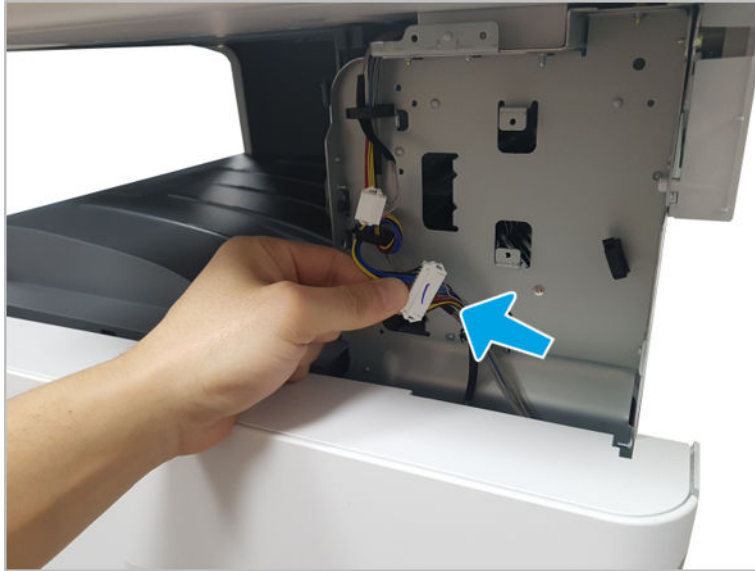

- e. Remove eight screws, and then remove the front inner cover.

 **NOTE:** The TCU cleaning blade must be removed to remove the front inner cover.

Figure 2-183 Remove the front inner cover



- 3. Remove the ACR shutter motor.
 - ▲ Disconnect one inline connector and remove two screws, and then remove the motor.

Figure 2-184 Remove the ACR shutter motor

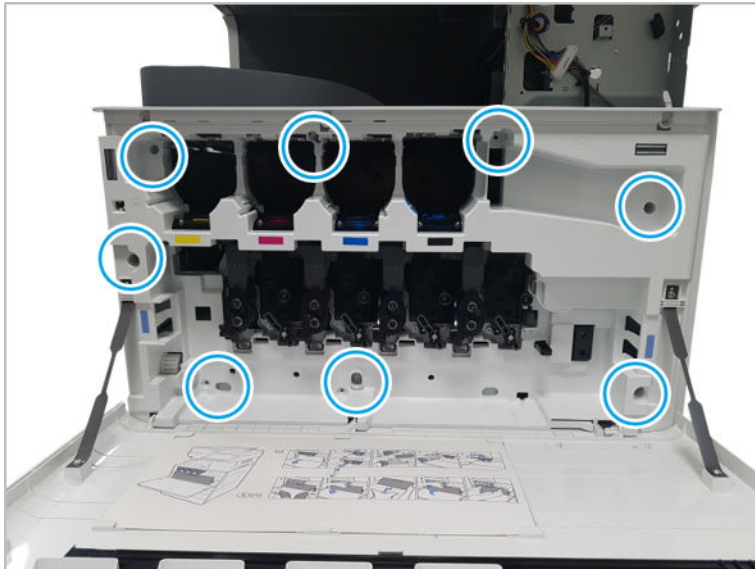
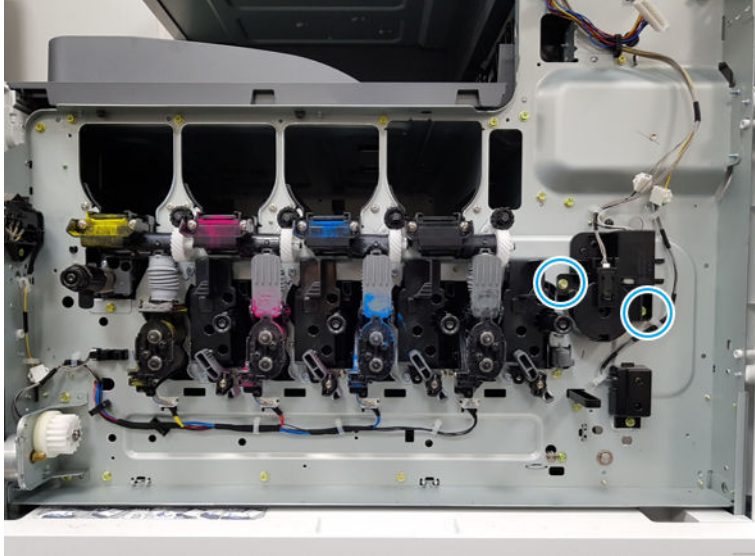

4. Unpack the replacement assembly.
 - a. Dispose of the defective part.



NOTE: HP recommends responsible disposal of the defective part.

<http://www8.hp.com/us/en/hp-information/environment/product-recycling.html>

- b. Unpack the replacement part from the packaging.



CAUTION:  Some parts are sensitive to electrostatic discharge (ESD). Always perform service work at an ESD-protected workstation or mat. If an ESD workstation or mat is not available, touch the sheet-metal chassis to provide a static ground before touching an ESD-sensitive assembly. Protect the ESD-sensitive assemblies by placing them in ESD pouches when they are out of the printer.

If the replacement part is a roller or pad, avoid touching the spongy part of it. Skin oils on the roller or pad can cause paper pickup and/or print-quality problems. HP recommends using disposable gloves when handling rollers or pads or washing your hands before touching rollers or pads.



IMPORTANT: Make sure that all of the shipping materials (for example shipping tape) are removed from the replacement part prior to installation.

- c. To install an assembly, reverse the removal steps.



NOTE: When applicable, special installation instructions are provided for an assembly at the end of the removal procedure. Always completely read the removal instructions and follow all special installation instructions.

HP Color LaserJet Managed MFP E77422, E77428, E78223, and E78228 - Removal and replacement: Toner collection full sensor

Follow these steps to remove the toner collection full sensor.

To view a short video of this procedure, click the link below.



[View a video of how to remove and replace the toner collection full sensor.](#)

Mean time to repair: 6 minutes

Service level: Intermediate

 **IMPORTANT:** When applicable, special installation instructions are provided for an assembly at the end of the removal procedure. Always completely read the removal instructions and follow all special installation instructions.

Before performing service

- Disconnect the power cable.

Use the table below to identify the correct part number for your printer. To order the part, go to <https://parts.hp.com>

Table 2-44 Part information

Part number	Part description
JC93-00492A	Toner collection full sensor

Required tools

- #2 JIS screwdriver with a magnetic tip

After performing service

Turn the printer power on

- Connect the power cable.
- Use the power switch to turn the power on.

Post service test

Verify that the document was copied, scanned, or printed correctly.

1. Remove the toner cartridges and toner collection unit (TCU).
 - ▲ Open the front door and remove the toner collection unit and toner cartridges.

Figure 2-185 Remove TCU



2. Remove the front inner cover.
 - a. Open the right door, and then remove one screw.

Figure 2-186 Remove one screw



- b. Remove two screws.

Figure 2-187 Remove two screws

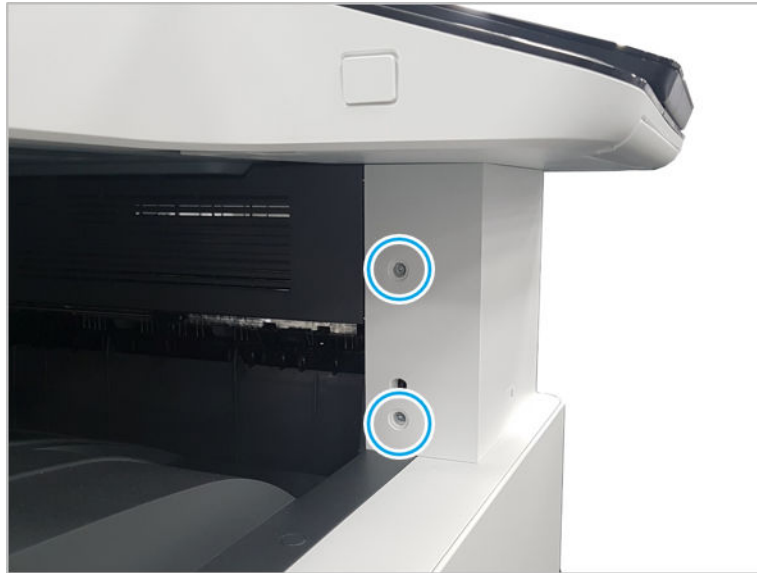

- c. Disconnect the connector, and then remove the middle right cover.

Figure 2-188 Remove the middle right cover



- d. Disconnect the connector connecting the front inner cover.

Figure 2-189 Disconnect the connector

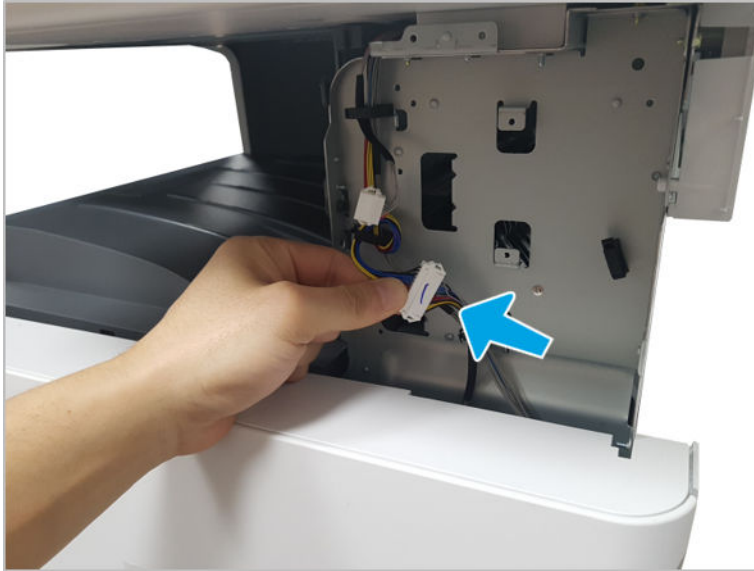

- e. Remove eight screws, and then remove the front inner cover.

 **NOTE:** The TCU cleaning blade must be removed to remove the front inner cover.

Figure 2-190 Remove the front inner cover



3. Remove the toner collection full sensor.
 - a. Release the cable from three restraints.
 - b. Disconnect one inline connector.

- c. Remove one screw, and then remove the sensor.

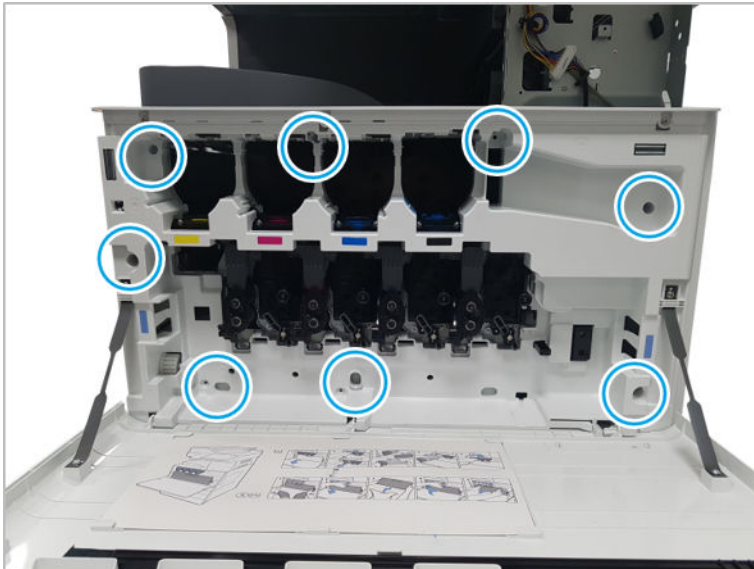
Figure 2-191 Remove the TCU full sensor

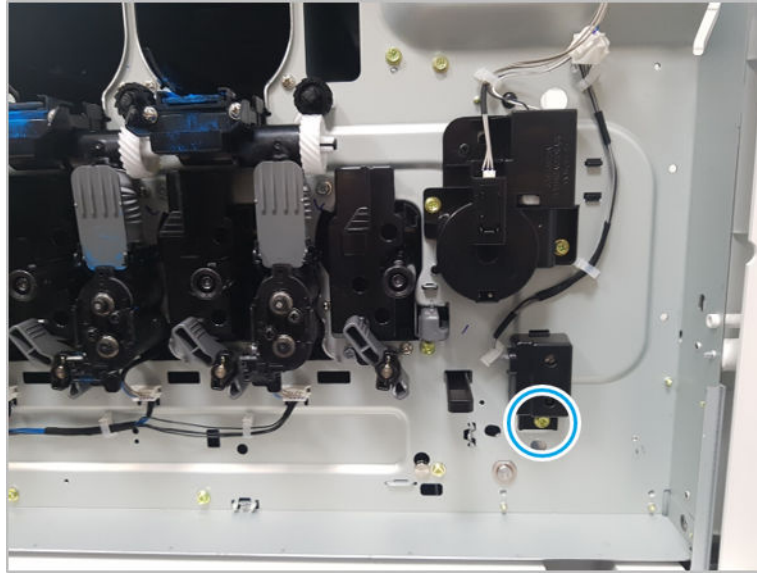

4. Unpack the replacement assembly.
 - a. Dispose of the defective part.



NOTE: HP recommends responsible disposal of the defective part.

<http://www8.hp.com/us/en/hp-information/environment/product-recycling.html>

- b. Unpack the replacement part from the packaging.



CAUTION:  Some parts are sensitive to electrostatic discharge (ESD). Always perform service work at an ESD-protected workstation or mat. If an ESD workstation or mat is not available, touch the sheet-metal chassis to provide a static ground before touching an ESD-sensitive assembly. Protect the ESD-sensitive assemblies by placing them in ESD pouches when they are out of the printer.

If the replacement part is a roller or pad, avoid touching the spongy part of it. Skin oils on the roller or pad can cause paper pickup and/or print-quality problems. HP recommends using disposable gloves when handling rollers or pads or washing your hands before touching rollers or pads.



IMPORTANT: Make sure that all of the shipping materials (for example shipping tape) are removed from the replacement part prior to installation.

- c. To install an assembly, reverse the removal steps.



NOTE: When applicable, special installation instructions are provided for an assembly at the end of the removal procedure. Always completely read the removal instructions and follow all special installation instructions.

HP Color LaserJet Managed MFP E77422, E77428, E78223, and E78228 - Removal and replacement: TCU presence photo sensor

Follow these steps to remove the TCU presence photo sensor.

To view a short video of this procedure, click the link below.

 [View a video of how to remove and replace the TCU presence photo sensor.](#)

Mean time to repair: 6 minutes

Service level: Intermediate

 **IMPORTANT:** When applicable, special installation instructions are provided for an assembly at the end of the removal procedure. Always completely read the removal instructions and follow all special installation instructions.

Before performing service

- Disconnect the power cable.

Use the table below to identify the correct part number for your printer. To order the part, go to <https://parts.hp.com>

Table 2-45 Part information

Part number	Part description
JC93-00492A	TCU presence photo sensor

Required tools

- #2 JIS screwdriver with a magnetic tip

After performing service

Turn the printer power on

- Connect the power cable.
- Use the power switch to turn the power on.

Post service test

Verify that the document was copied, scanned, or printed correctly.

1. Remove the toner cartridges and toner collection unit (TCU).
 - ▲ Open the front door and remove the toner collection unit and toner cartridges.

Figure 2-192 Remove TCU



2. Remove the front inner cover.
 - a. Open the right door, and then remove one screw.

Figure 2-193 Remove one screw



- b. Remove two screws.

Figure 2-194 Remove two screws

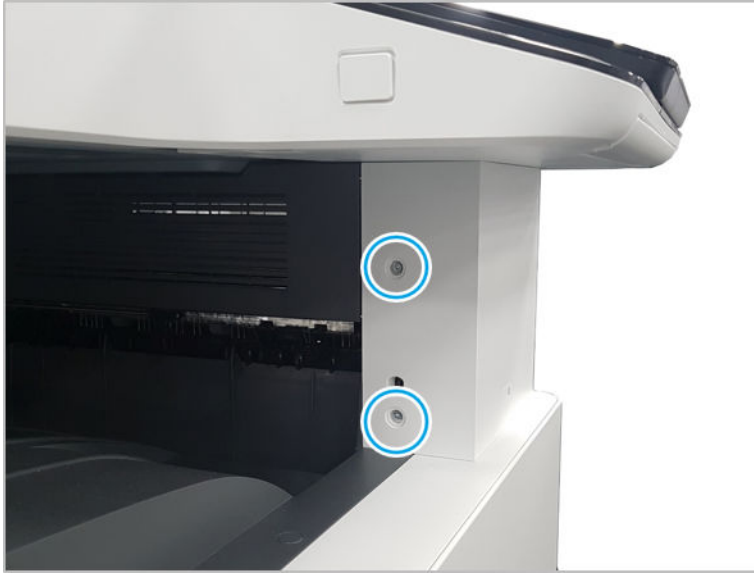

- c. Disconnect the connector, and then remove the middle right cover.

Figure 2-195 Remove the middle right cover



- d. Disconnect the connector connecting the front inner cover.

Figure 2-196 Disconnect the connector

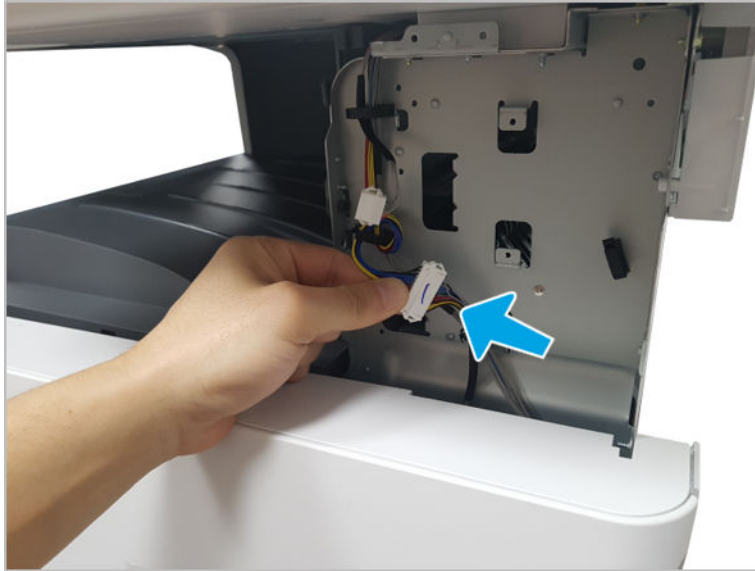

- e. Remove eight screws, and then remove the front inner cover.

 **NOTE:** The TCU cleaning blade must be removed to remove the front inner cover.

Figure 2-197 Remove the front inner cover



- 3. Remove the TCU presence photo sensor.
 - a. Remove the yellow imaging and developer units.

- b. Disconnect one connector. Reach inside the chassis and squeeze two tabs on the connector side of the sensor, and then release the hook on the right side of the sensor assembly.

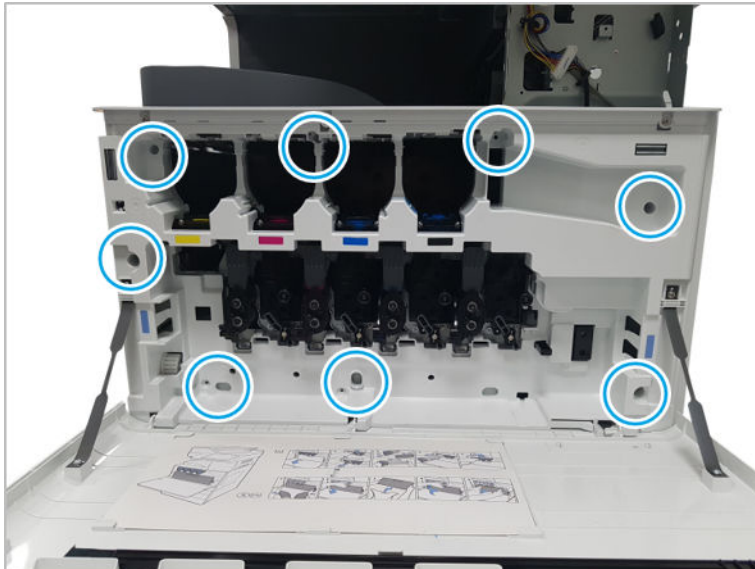
Figure 2-198 Remove the TCU presence sensor

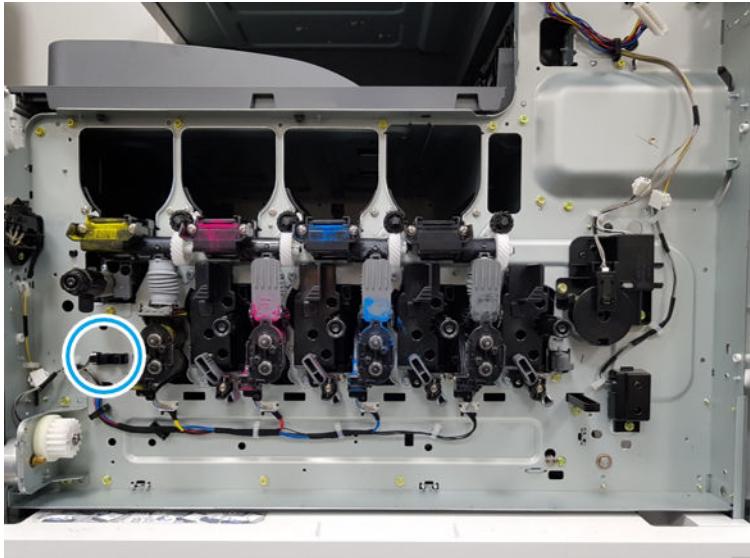



4. Unpack the replacement assembly.
 - a. Dispose of the defective part.

 **NOTE:** HP recommends responsible disposal of the defective part.

<http://www8.hp.com/us/en/hp-information/environment/product-recycling.html>

- b. Unpack the replacement part from the packaging.

 **CAUTION:**  Some parts are sensitive to electrostatic discharge (ESD). Always perform service work at an ESD-protected workstation or mat. If an ESD workstation or mat is not available, touch the sheet-metal chassis to provide a static ground before touching an ESD-sensitive assembly. Protect the ESD-sensitive assemblies by placing them in ESD pouches when they are out of the printer.

If the replacement part is a roller or pad, avoid touching the spongy part of it. Skin oils on the roller or pad can cause paper pickup and/or print-quality problems. HP recommends using disposable gloves when handling rollers or pads or washing your hands before touching rollers or pads.

 **IMPORTANT:** Make sure that all of the shipping materials (for example shipping tape) are removed from the replacement part prior to installation.

- c. To install an assembly, reverse the removal steps.

 **NOTE:** When applicable, special installation instructions are provided for an assembly at the end of the removal procedure. Always completely read the removal instructions and follow all special installation instructions.

Rear frame

View rear frame exploded view, parts list, and repair procedures.

Rear frame parts

Figure 2-199 Rear frame parts

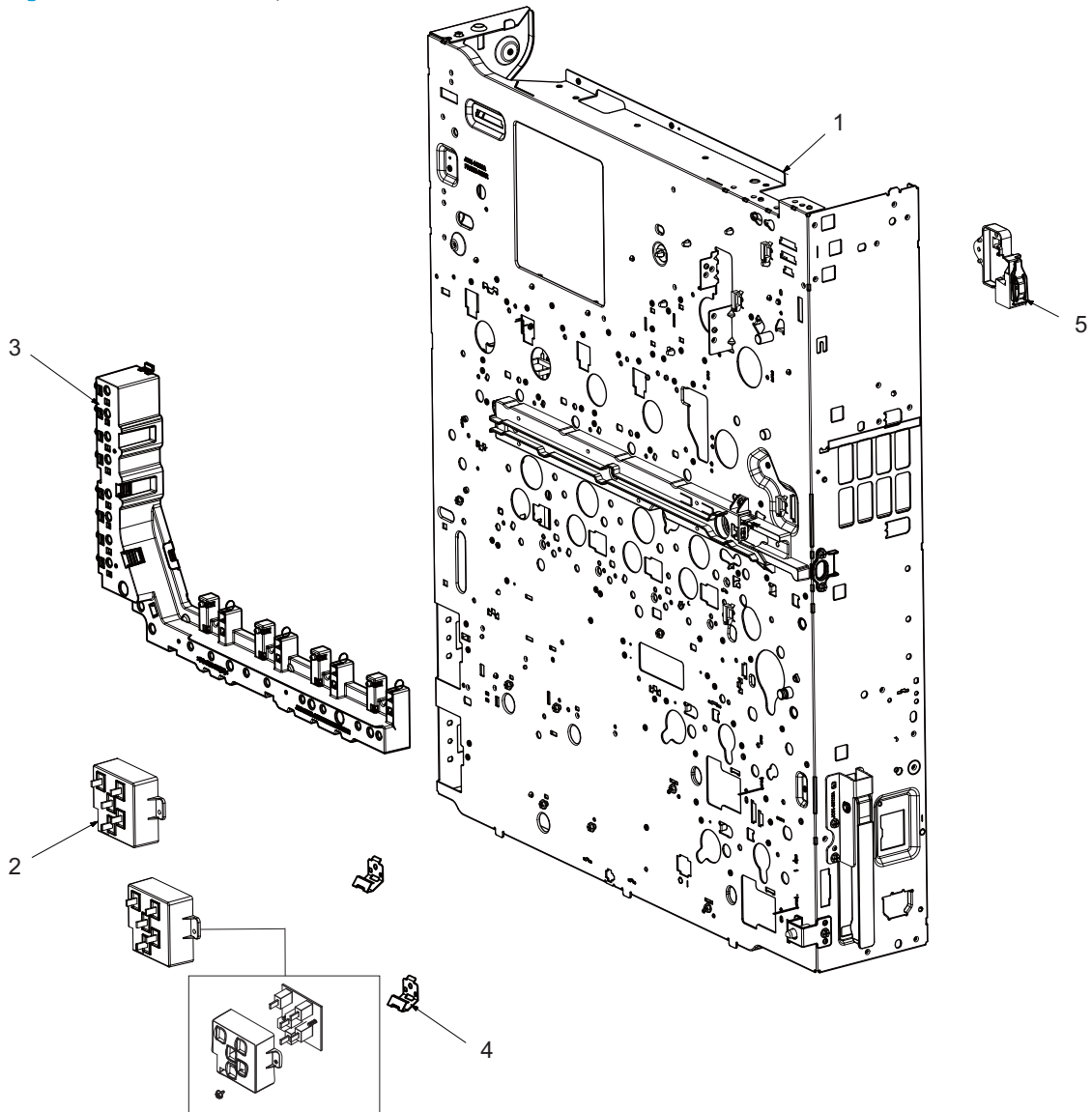

Table 2-46 Rear frame parts

Ref	Description	Part Number (*)	Qty
1	Rear frame	JC93-01396A	1
2	Autosize sensor	JC93-00018B (*)	2
3	Rear frame, HV package (For E77422, E77428)	JC93-00489A	1
3	Rear frame, HV package (For E78223, E78228)	JC93-01806A	1

Table 2-46 Rear frame parts (continued)

Ref	Description	Part Number (*)	Qty
4	Ground plate	JC61-03002A	2
5	Right door switch assembly	JC93-01467A (*)	1

* This part is in ordering system. If the ordering system has this part in stock, it can be ordered.

HP LaserJet Managed MFP E72425, E72430, E77422, E77428, E78223, E78228, E78223, E78228 - Removal and replacement: Paper size sensor PCA

Follow these steps to remove the paper size sensor PCA.

To view a short video of this procedure, click the link below.

 [View a video of how to remove and replace the paper size sensor PCA.](#)

Mean time to repair: 2 minutes

Service level: Intermediate

 **IMPORTANT:** When applicable, special installation instructions are provided for an assembly at the end of the removal procedure. Always completely read the removal instructions and follow all special installation instructions.

Before performing service

- Disconnect the power cable.

Use the table below to identify the correct part number for your printer. To order the part, go to <https://parts.hp.com>

Table 2-47 Part information

Part number	Part description
JC93-00018B	Paper size sensor PCA

Required tools

- #2 JIS screwdriver with a magnetic tip

After performing service

Turn the printer power on

- Connect the power cable.
- Use the power switch to turn the power on.

Post service test

Verify that the document was copied, scanned, or printed correctly.

1. Remove the paper size sensor.

- a. Remove all trays to access the inside of the printer. Disconnect the connector and remove two screws. And then, remove the sensor assembly.

Figure 2-200 Remove paper size sensor

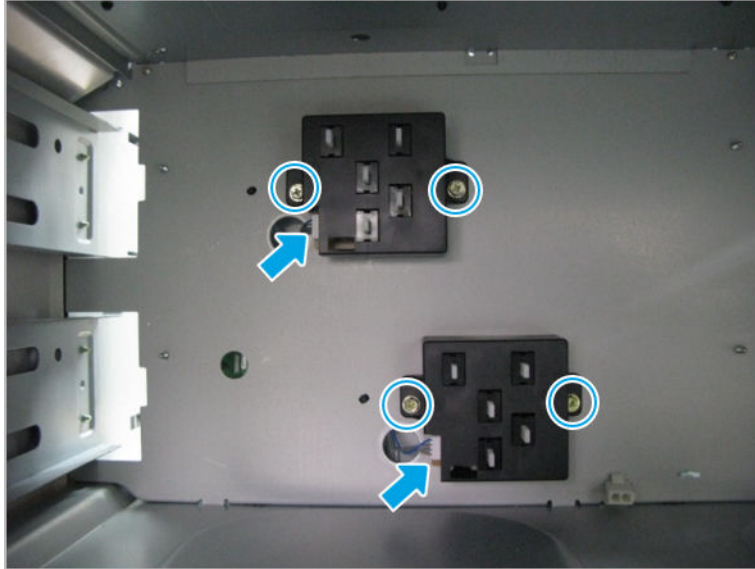

- b. Remove two screws. And then, remove the paper size sensor PCA from the holder.

Figure 2-201 Remove the paper size sensor PCA

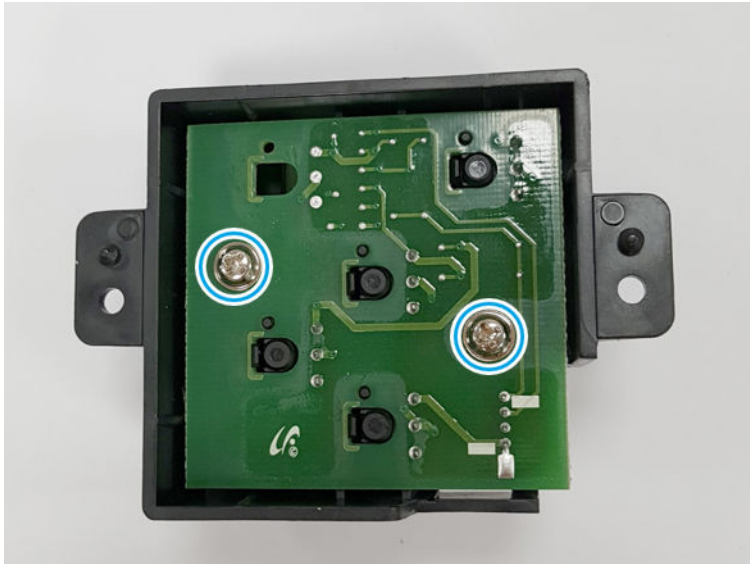



2. Unpack the replacement assembly.
 - a. Dispose of the defective part.

 **NOTE:** HP recommends responsible disposal of the defective part.

<http://www8.hp.com/us/en/hp-information/environment/product-recycling.html>

b. Unpack the replacement part from the packaging.

 **CAUTION:**  Some parts are sensitive to electrostatic discharge (ESD). Always perform service work at an ESD-protected workstation or mat. If an ESD workstation or mat is not available, touch the sheet-metal chassis to provide a static ground before touching an ESD-sensitive assembly. Protect the ESD-sensitive assemblies by placing them in ESD pouches when they are out of the printer.

If the replacement part is a roller or pad, avoid touching the spongy part of it. Skin oils on the roller or pad can cause paper pickup and/or print-quality problems. HP recommends using disposable gloves when handling rollers or pads or washing your hands before touching rollers or pads.

 **IMPORTANT:** Make sure that all of the shipping materials (for example shipping tape) are removed from the replacement part prior to installation.

c. To install an assembly, reverse the removal steps.

 **NOTE:** When applicable, special installation instructions are provided for an assembly at the end of the removal procedure. Always completely read the removal instructions and follow all special installation instructions.

HP Color LaserJet Managed MFP E77422, E77428, E78223, and E78228 - Removal and replacement: Right door open switch

Follow these steps to remove the right door open switch.

To view a short video of this procedure, click the link below.

 [View a video of how to remove and replace the right door open switch.](#)

Mean time to repair: 5 minutes

Service level: Intermediate

 **IMPORTANT:** When applicable, special installation instructions are provided for an assembly at the end of the removal procedure. Always completely read the removal instructions and follow all special installation instructions.

Before performing service

- Disconnect the power cable.

Use the table below to identify the correct part number for your printer. To order the part, go to <https://parts.hp.com>

Table 2-48 Part information

Part number	Part description
JC93-01467A	Right door open switch

Required tools

- #2 JIS screwdriver with a magnetic tip

After performing service

Turn the printer power on

- Connect the power cable.
- Use the power switch to turn the power on.

Post service test

Verify that the document was copied, scanned, or printed correctly.

1. Remove the rear covers.
 - a. Unscrew two captive thumbscrews on the formatter cover. Slide the formatter cover to the left, and then to the right to remove.

Figure 2-202 Remove the formatter cover

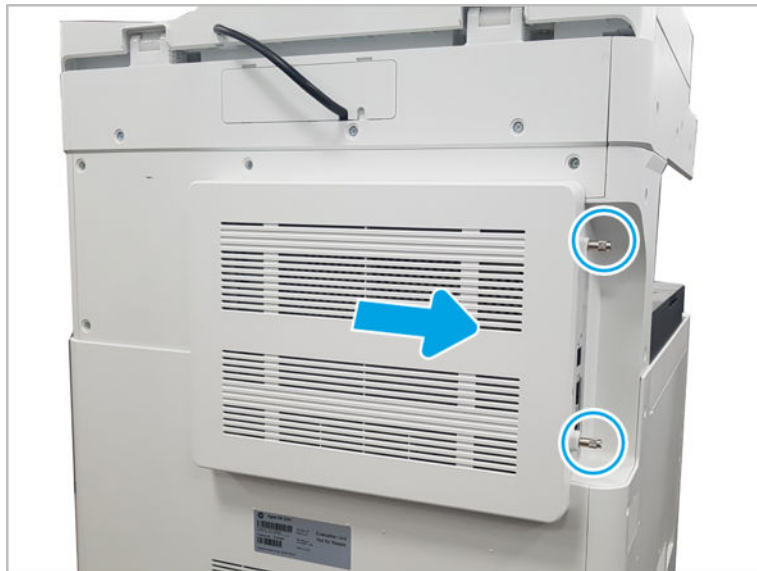

- b. Remove thirteen screws, and then remove the rear-bottom cover and rear-top cover.

Figure 2-203 Remove the rear-bottom cover and rear-top cover



2. Remove the right door open switch.

- ▲ Disconnect one connector. Open two cable restraints. And then, remove the right door open switch from its holder.

Figure 2-204 Remove the right door open switch

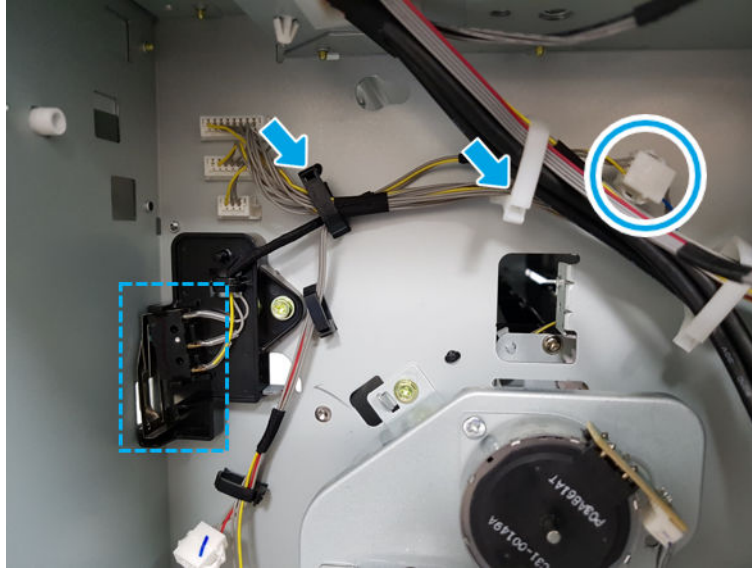

3. Unpack the replacement assembly.

- a. Dispose of the defective part.



NOTE: HP recommends responsible disposal of the defective part.

<http://www8.hp.com/us/en/hp-information/environment/product-recycling.html>

- b. Unpack the replacement part from the packaging.



CAUTION:



Some parts are sensitive to electrostatic discharge (ESD). Always perform service work at an ESD-protected workstation or mat. If an ESD workstation or mat is not available, touch the sheet-metal chassis to provide a static ground before touching an ESD-sensitive assembly. Protect the ESD-sensitive assemblies by placing them in ESD pouches when they are out of the printer.

If the replacement part is a roller or pad, avoid touching the spongy part of it. Skin oils on the roller or pad can cause paper pickup and/or print-quality problems. HP recommends using disposable gloves when handling rollers or pads or washing your hands before touching rollers or pads.



IMPORTANT: Make sure that all of the shipping materials (for example shipping tape) are removed from the replacement part prior to installation.

- c. To install an assembly, reverse the removal steps.



NOTE: When applicable, special installation instructions are provided for an assembly at the end of the removal procedure. Always completely read the removal instructions and follow all special installation instructions.

Color plane registration (CPR) assembly

View color plane registration (CPR) assembly exploded view, parts list, and repair procedures.

Color plane registration (CPR) assembly

Figure 2-205 CPR assembly

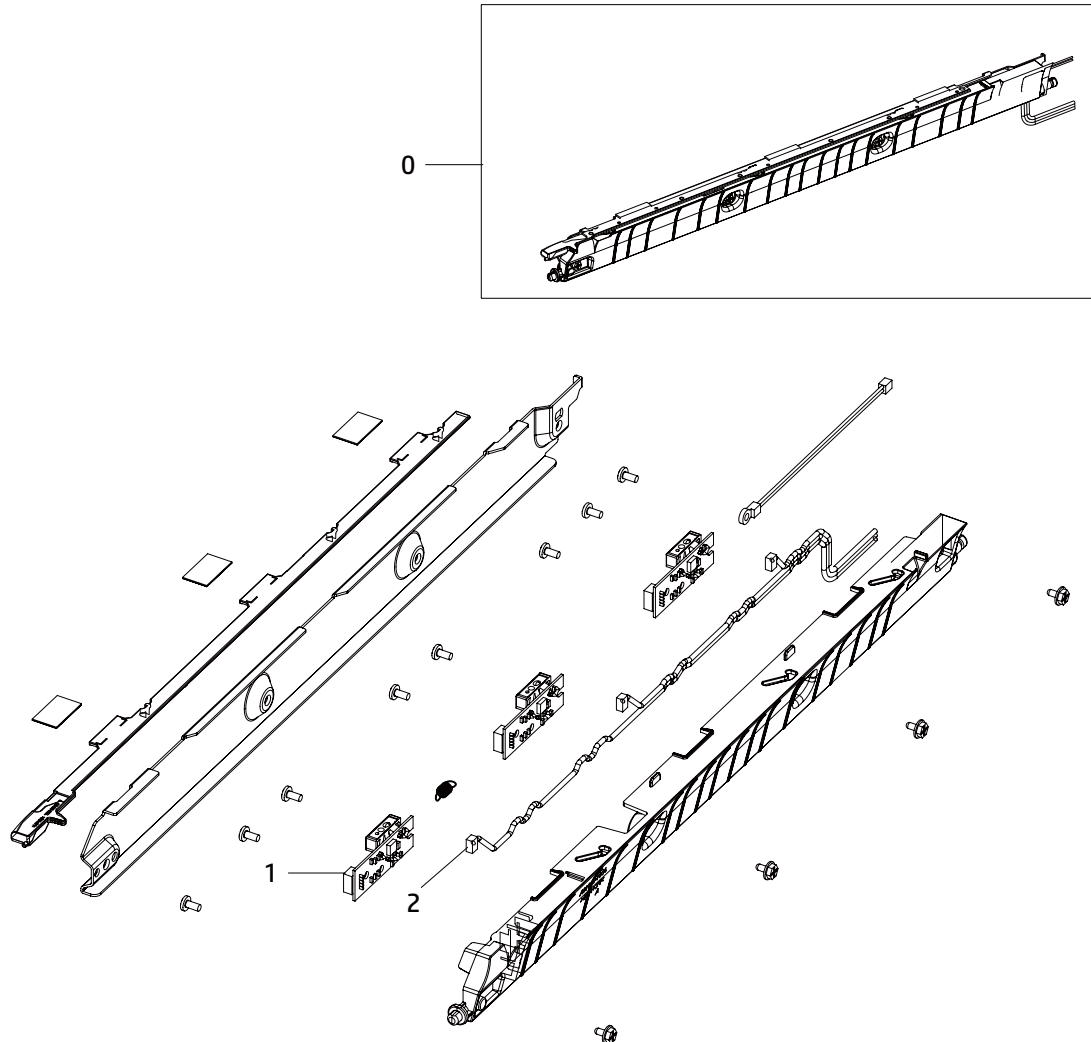

Table 2-49 CPR assembly

Ref	Description	Part Number (*)	Qty
0	Color plane registration (CPR) assembly	JC93-01803A (*)	1
1	CTD sensor	JC32-00014A (*)	3
2	Harness, ID Sensor	JC39-02763A (*)	1

* This part is in ordering system.

HP Color LaserJet Managed MFP E77422, E77428, E78223, and E78228 - Removal and replacement: Color plane registration (CPR) assembly

Follow these steps to remove the color plane registration (CPR) assembly.

To view a short video of this procedure, click the link below.

 [View a video of how to remove and replace the CPR assembly.](#)

Mean time to repair: 15 minutes

Service level: Intermediate

 **IMPORTANT:** When applicable, special installation instructions are provided for an assembly at the end of the removal procedure. Always completely read the removal instructions and follow all special installation instructions.

Before performing service

- Disconnect the power cable.

Use the table below to identify the correct part number for your printer. To order the part, go to <https://parts.hp.com>

Table 2-50 Part information

Part number	Part description
JC93-01803A	Color plane registration (CPR) assembly

Required tools

- #2 JIS screwdriver with a magnetic tip

After performing service

Turn the printer power on

- Connect the power cable.
- Use the power switch to turn the power on.

Post service test

Verify that the document was copied, scanned, or printed correctly.

1. Remove the right door.

 **NOTE:** Remove second exit drive if installed.

- a. Remove three screws, and then remove the right-rear cover.

Figure 2-206 Remove the right-rear cover



- b. Disconnect the right door connector.

Figure 2-207 Disconnect right door connector



- c. Release the right hinge (callout 1).

⚠ CAUTION: The right hinge spring tension can be dangerous. Use caution when releasing the right hinge to avoid injury.

Figure 2-208 Release right hinge

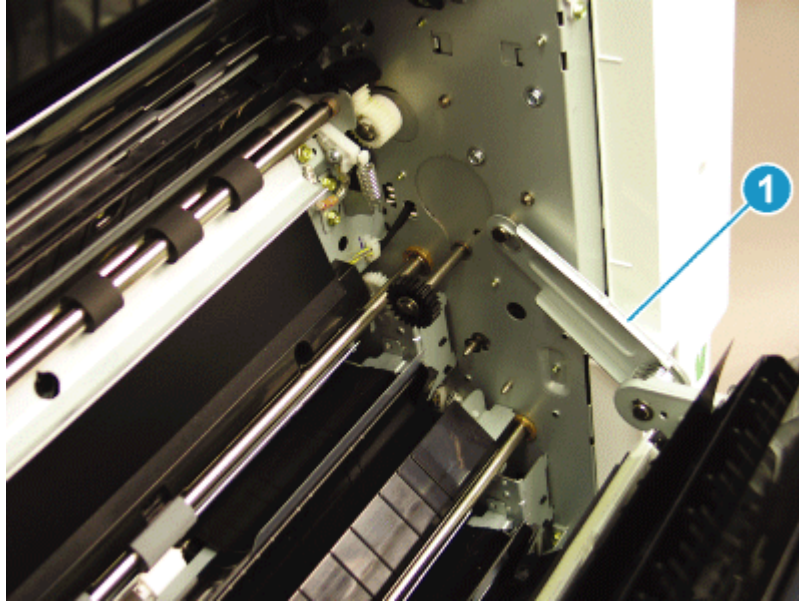

- d. Release the left dampener (callout 1).

Figure 2-209 Release left dampener

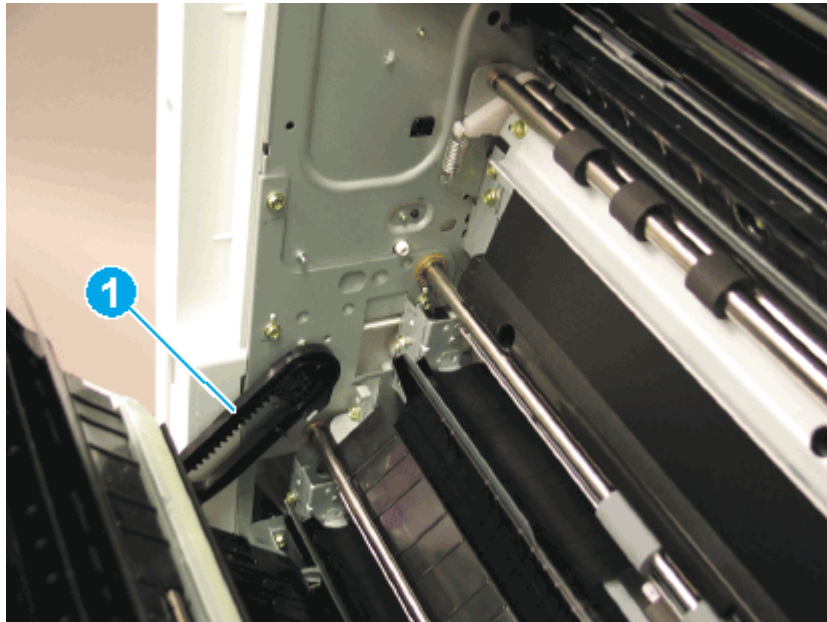

- e. Remove the right door.

 **NOTE:** Open the lower access door. If there is an HCI or 2x520 input device, release the dampener to clear the lower right door. Remove clockwise.

Figure 2-210 Remove right door



- 2. Remove the color plane registration assembly.
 - a. Remove two screws, and then remove the feed sensor cover.

Figure 2-211 Remove the feed sensor cover

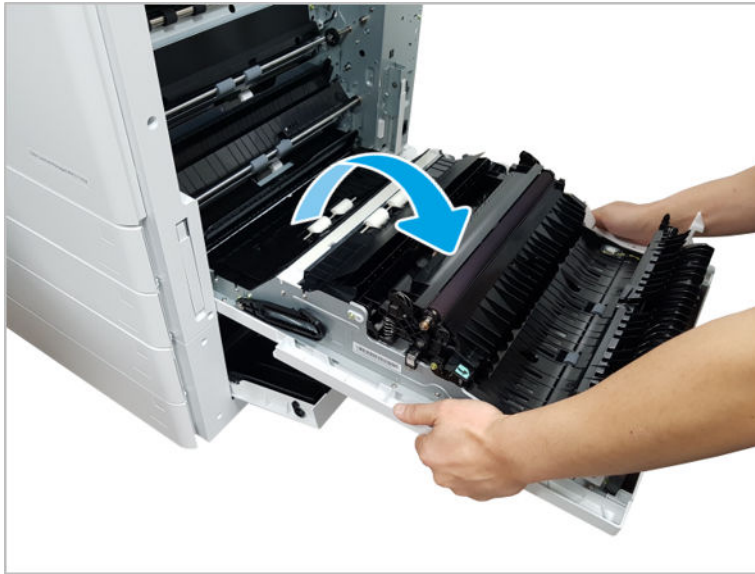
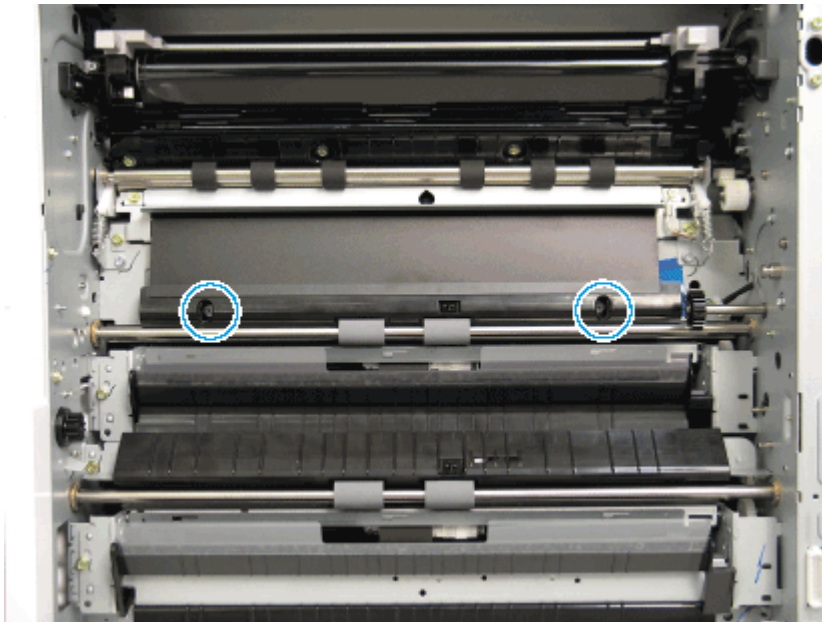

- b. Remove the black plastic bushing retainer at the rear of the registration assembly, disconnect one connector, and then remove two screws at the front and rear of the registration assembly.

Figure 2-212 Remove the registration assembly

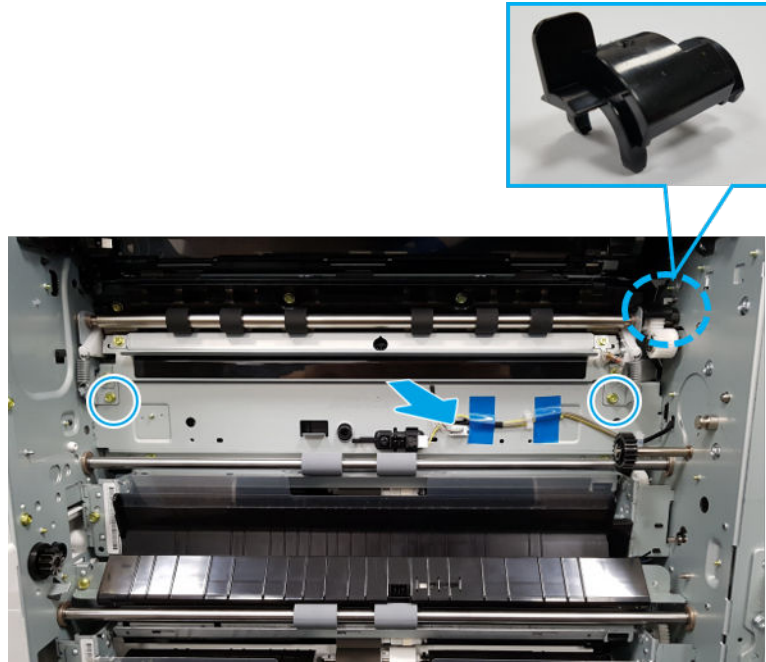

- c. Release the front side of the registration assembly first, and then release the back side to remove.

 **IMPORTANT:** The bushings on the registration assembly are not retained and can fall from the assembly during removal.

- d. Locate and remove the clip at the rear (make note of the orientation of the spring and the clip before removal).

- e. Release the spring from the hook at the rear.

Figure 2-213 Release the spring

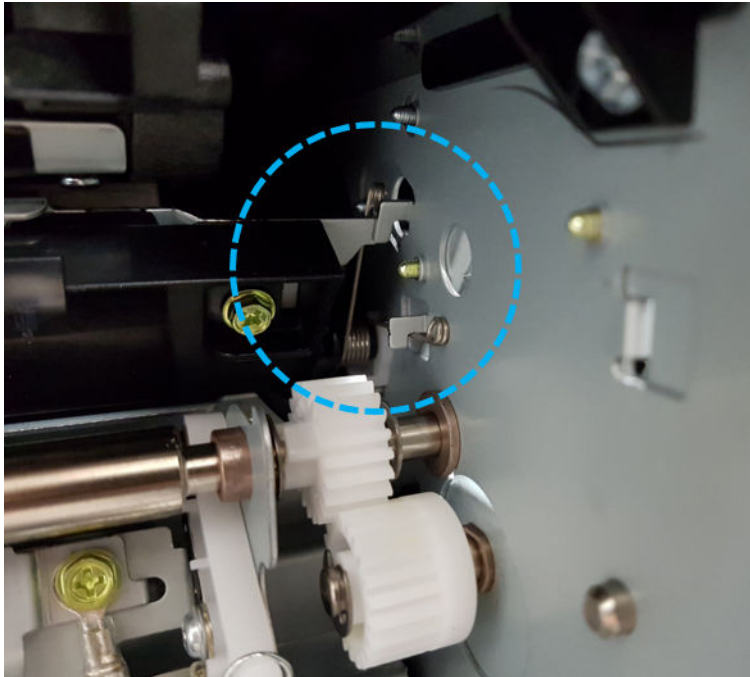

- f. Slide the shutter toward rear.
- g. Remove the spring (make note of the orientation of the spring before removal).
- h. Remove four screws in the cover.
- i. Release the left cover at the front and slide off at the rear of the assembly.
- j. Replace the sensor (remove two screws and one connector) or thermistor (remove one screw and one connector).

Figure 2-214 Replace the sensor or thermistor

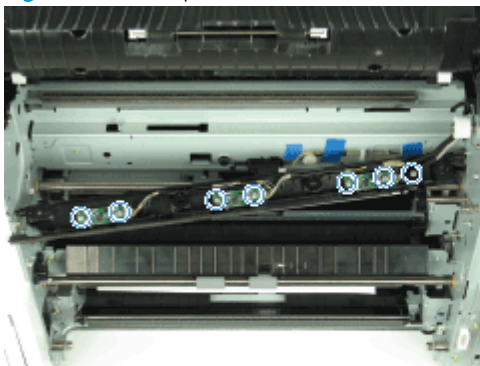

- k. Disconnect the thermistor cable and three connectors at the sensor PCA.

 **NOTE:** After replacing the CPR sensor assembly, make sure the assembly rests forward, but moves backward freely.

- l. A [Color Plane Registration](#) must be performed from the [Diagnostics](#) menu whenever a sensor is replaced.
3. Unpack the replacement assembly.
- a. Dispose of the defective part.

 **NOTE:** HP recommends responsible disposal of the defective part.

<http://www8.hp.com/us/en/hp-information/environment/product-recycling.html>

- b. Unpack the replacement part from the packaging.



CAUTION:  Some parts are sensitive to electrostatic discharge (ESD). Always perform service work at an ESD-protected workstation or mat. If an ESD workstation or mat is not available, touch the sheet-metal chassis to provide a static ground before touching an ESD-sensitive assembly. Protect the ESD-sensitive assemblies by placing them in ESD pouches when they are out of the printer.

If the replacement part is a roller or pad, avoid touching the spongy part of it. Skin oils on the roller or pad can cause paper pickup and/or print-quality problems. HP recommends using disposable gloves when handling rollers or pads or washing your hands before touching rollers or pads.

 **IMPORTANT:** Make sure that all of the shipping materials (for example shipping tape) are removed from the replacement part prior to installation.

- c. To install an assembly, reverse the removal steps.

 **NOTE:** When applicable, special installation instructions are provided for an assembly at the end of the removal procedure. Always completely read the removal instructions and follow all special installation instructions.

Frame main middle plate LSU

Figure 2-215 Frame main middle plate LSU

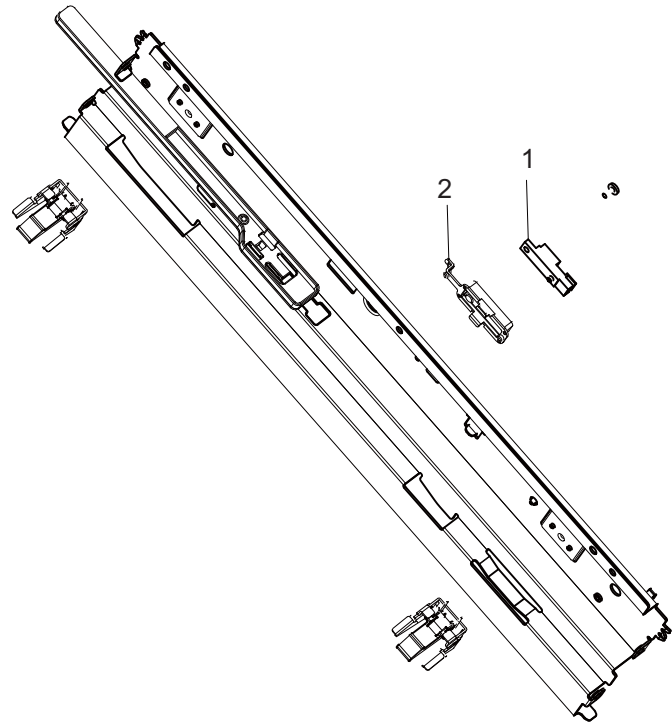
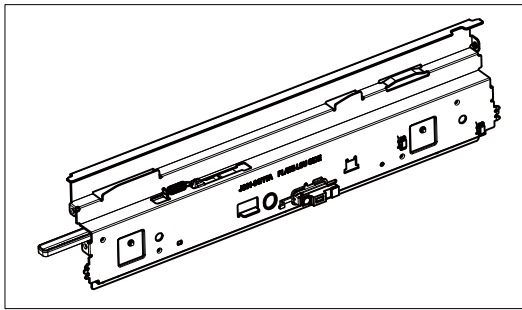

Table 2-51 Frame main middle plate LSU

Ref	Description	Part Number (*)	Qty
1	Photo interrupter	0604-001502 (*)	1
2	Feed sensor holder	JC61-04857A	1
Not shown	Harness, feed and registration sensor	JC39-02113A (*)	1

* This part is in ordering system. If the ordering system has this part in stock, it can be ordered.

Covers

Figure 2-216 Covers

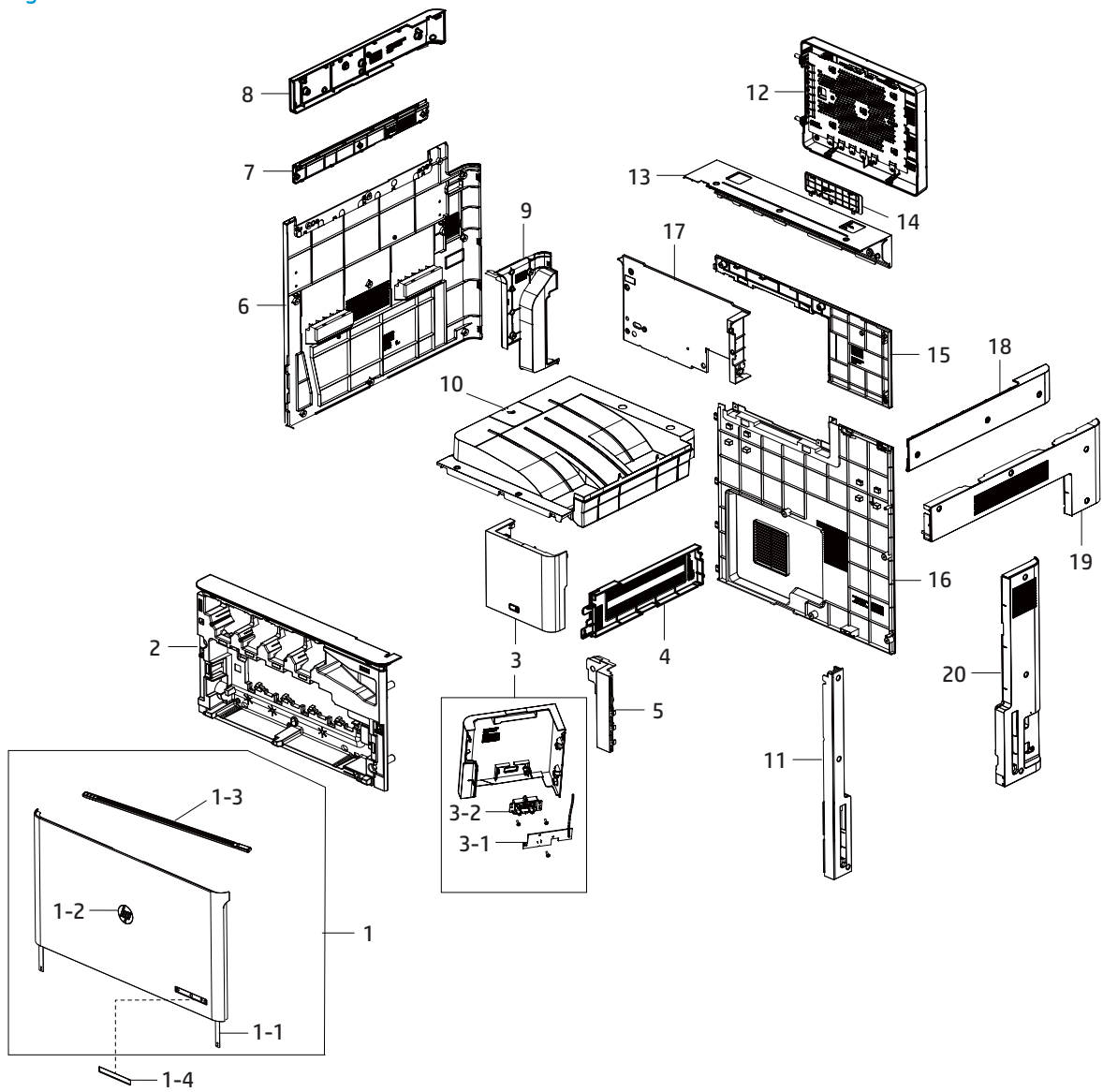

Table 2-52 Covers

Ref	Description	Part Number (*)	Qty
1	Cover, front	JC95-02234A (*)	1
1-1	Front cover strap	JC61-04626A (*)	1
1-2	HP badge logo	JC64-01027A (*)	1
1-3	LSU cleaner lever	JC66-02258A (*)	1
1-4	Front Label Kit for E78223	8G543-40001 (*)	1
1-4	Front Label Kit for E78228	8G544-40001 (*)	1
1-4	Front Label Kit for E782xx	8G550-60104 (*)	1

Table 2-52 Covers (continued)

Ref	Description	Part Number (*)	Qty
2	Cover, inner color	JC95-02235A (*)	1
3	Cover, middle right assembly	JC95-02082A (*)	1
3-1	PCA switch	JC92-02969A (*)	1
3-2	Power key	JC64-01034A (*)	1
4	Cover, exit dummy	JC63-04526B (*)	1
5	Cover, front lower	JC63-04536B	1
6	Cover, left color	JC95-02085A (*)	1
7	Cover, left top	JC63-04534B	1
8	Cover, scan left	JC63-05576A (*)	1
9	Cover, left upper	JC63-05623A (*)	1
10	Cover, exit staker	JC95-02208A	1
11	Cover, right front color	JC63-04531B (*)	1
12	Cover, formatter	JC95-02099A (*)	1
13	Cover, scan-rear	JC63-06054A (*)	1
14	Cover, rear dummy	JC63-04567B	1
15	Cover, rear upper	JC63-05618A	1
16	Cover, rear lower	8GR98-40016 (*)	1
17	Cover, exit rear	JC63-04524B	1
18	Cover, scan right	JC63-05575A	1
19	Cover, right upper	JC63-04520B (*)	1
20	Cover, right rear color	JC63-04532B (*)	1

* This part is in ordering system. If the ordering system has this part in stock, it can be ordered.

Control panel assembly

View control panel assembly exploded view, parts list, and repair procedures.

Control panel assembly (a,dv models only)

Figure 2-217 Control panel assembly

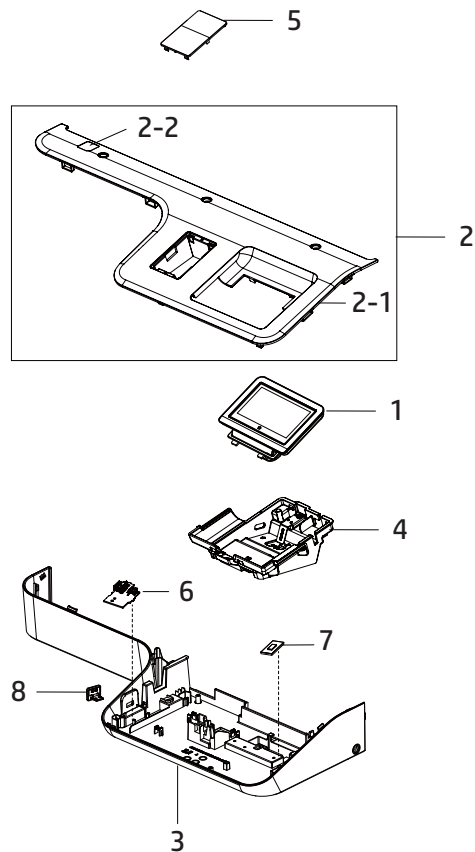

Table 2-53 Control panel assembly

Ref	Description	Part Number (*)	Qty
1	Control panel (CP) assembly (a,dv models only)	Y3Z60-60108 (*)	1
2	Cover, control panel upper (a,dv models only)	JC95-02232A (*)	1
2-1	Cover only, control panel upper (a,dv models only)	JC63-06055A (*)	1
2-2	Sheet, scan cleaning	JC63-03495B	1
3	Cover, control panel lower (a,dv models only)	JC63-06056A (*)	1
4	OPE holder	JC61-08591A	1
5	Cover, HIP	JC63-05670A(*)	1

Table 2-53 Control panel assembly (continued)

Ref	Description	Part Number (*)	Qty
6	PCA - USB host	JC92-02951A (*)	1
7	Humidity encoder/sensor	JC32-00015A (*)	1
8	USB cap	JC67-00867A(*)	1
Not shown	CP interface cable bundle to formatter	JC39-02554A (*)	1
Not shown	Harness CP side band (a,dv models only)	JC39-02705A (*)	1
Not shown	Harness CP GND	JC39-02729A (*)	1

* This part is in ordering system. If the ordering system has this part in stock, it can be ordered.

HP LaserJet Managed MFP E72425, E72430, E77422, E77428, E78223, E78228 - Control panel assembly (a,dv models only) , USB host PCA, and humidity & encoder sensor

Follow these steps to remove the control panel assembly.

To view a short video of this procedure, click the link below.

 [View a video of how to remove and replace the control panel assembly.](#)

 [View a video of how to remove and replace the USB host PCA.](#)

 [View a video of how to remove and replace the humidity & encoder sensor.](#)

Mean time to repair: 3 minutes

Service level: Intermediate

 **IMPORTANT:** When applicable, special installation instructions are provided for an assembly at the end of the removal procedure. Always completely read the removal instructions and follow all special installation instructions.

Before performing service

- Disconnect the power cable.

 **WARNING!** To avoid damage to the printer, turn the printer off, wait 30 seconds, and then remove the power cable before attempting to service the printer.

Use the table below to identify the correct part number for your printer. To order the part, go to <https://parts.hp.com>

Table 2-54 Part information

Part numbers	Part description
Y3Z60-60108	Control panel assembly
JC92-02951A	PCA USB host
JC32-00015A	Humidity & Encoder sensor

Required tools

- #2 JIS screwdriver with a magnetic tip

After performing service

Turn the printer power on

- Connect the power cable.
- Use the power switch to turn the power on.

Post service test

Verify that the document was copied, scanned, or printed correctly.

1. Remove the control panel bezel.
 - a. Open the ADF. Remove the wireless LAN cover and three screw caps. And then, remove four screws.

Figure 2-218 Remove four screws



- b. Place the control panel in the upright position.
- c. Gently pry the control panel bezel from the center screw hole, and then pry from the center of the control panel bezel to the edges to release.

CAUTION: Do not pry against the scanner glass when removing the control panel bezel.

2. Remove the control panel assembly.
 - a. Remove one screw.

Figure 2-219 Remove one screw.



- b. Push up the control panel assembly to release it from its holder.

Figure 2-220 Release the control panel assembly



- c. Disconnect one connector and one cable(callout 1).

Figure 2-221 Disconnect connectors

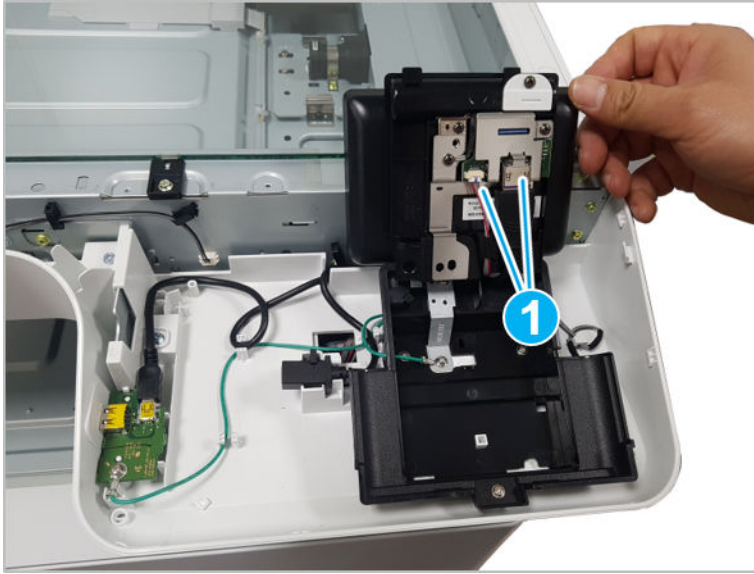

- 3. Remove the USB host PCA.
 - a. Remove the USB cover cap.

Figure 2-222 Remove the USB cover cap



- b. Disconnect one cable, Remove one screw, and then remove the USB host PCA.

Figure 2-223 Remove the USB host PCA



- 4. Remove the Humidity & Encoder sensor.
 - a. Release the latch to remove the Humidity & Encoder sensor.

Figure 2-224 Release the latch



- b. Disconnect one connector, and then remove the Humidity & Encoder sensor.

Figure 2-225 Remove the Humidity & Encoder sensor





5. Unpack the replacement assembly.
 - a. Dispose of the defective part.

 **NOTE:** HP recommends responsible disposal of the defective part.

<http://www8.hp.com/us/en/hp-information/environment/product-recycling.html>

- b. Unpack the replacement part from the packaging.

 **CAUTION:**  Some parts are sensitive to electrostatic discharge (ESD). Always perform service work at an ESD-protected workstation or mat. If an ESD workstation or mat is not available, touch the sheet-metal chassis to provide a static ground before touching an ESD-sensitive assembly. Protect the ESD-sensitive assemblies by placing them in ESD pouches when they are out of the printer.

If the replacement part is a roller or pad, avoid touching the spongy part of it. Skin oils on the roller or pad can cause paper pickup and/or print-quality problems. HP recommends using disposable gloves when handling rollers or pads or washing your hands before touching rollers or pads.

 **IMPORTANT:** Make sure that all of the shipping materials (for example shipping tape) are removed from the replacement part prior to installation.

- c. To install an assembly, reverse the removal steps.

 **NOTE:** When applicable, special installation instructions are provided for an assembly at the end of the removal procedure. Always completely read the removal instructions and follow all special installation instructions.

Control panel assembly (dn models only)

Figure 2-226 Control panel assembly

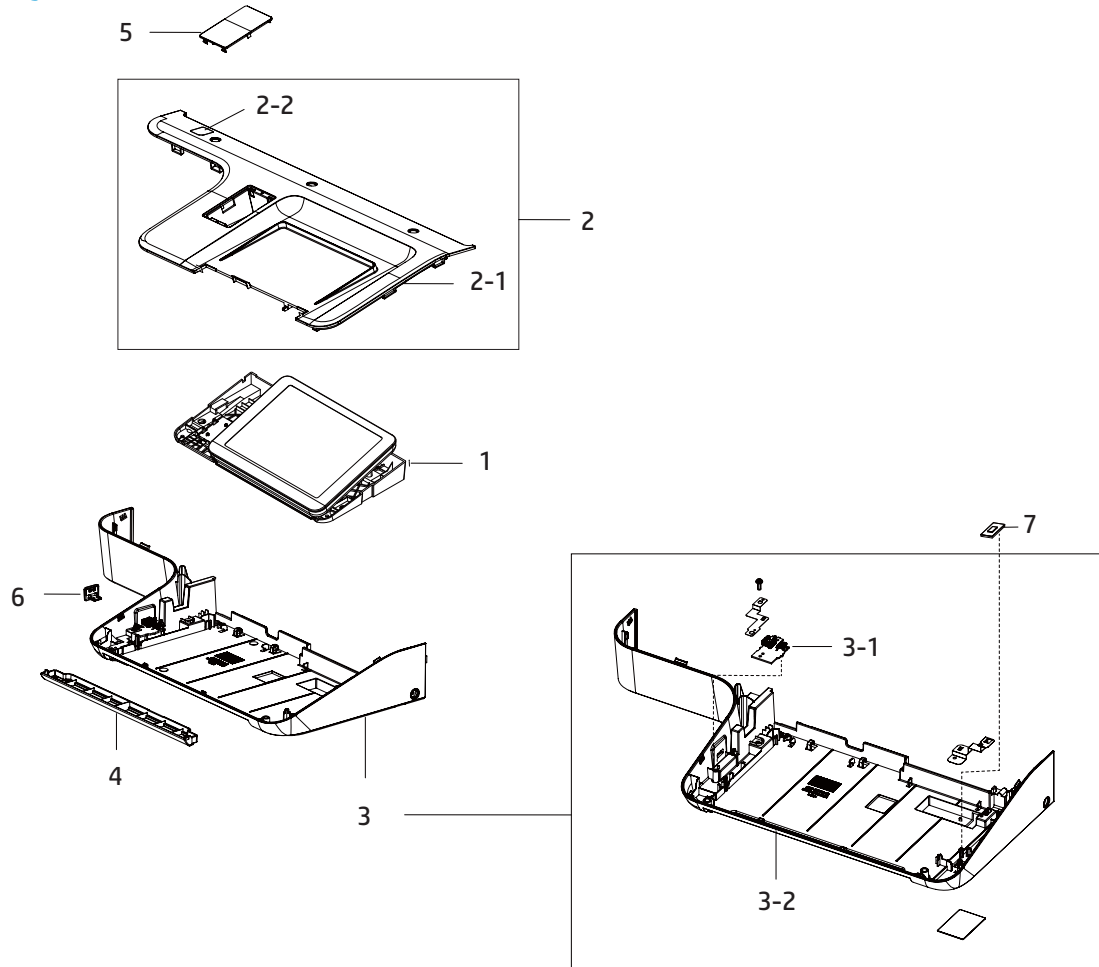

Table 2-55 Control panel assembly

Ref	Description	Part Number (*)	Qty
1	Control panel (CP) assembly (dn models only)	B5L47-60101 (*)	1
2	Cover, control panel upper (dn models only)	JC95-02086A (*)	1
2-1	Cover only, control panel upper (dn models only)	JC63-05647A (*)	1
2-2	Sheet, scan cleaning	JC63-03495B	1
3	Cover, control panel lower (dn models only)	JC95-02083A (*)	1
3-1	PCA - USB host	JC92-02951A (*)	1
3-2	Cover only, control panel lower (dn models only)	JC63-05648A (*)	1
4	Cover, CP dummy	JC63-05675A (*)	1
5	Cover, HIP	JC63-05670A(*)	1
6	USB cap	JC67-00867A(*)	1

Table 2-55 Control panel assembly (continued)

Ref	Description	Part Number (*)	Qty
7	Humidity encoder/sensor	JC32-00015A (*)	1
Not shown	CP interface cable bundle to formatter	JC39-02554A (*)	1
Not shown	Harness CP side band (dn models only)	JC39-02557A (*)	1
Not shown	Harness CP GND	JC39-02729A (*)	1

* This part is in ordering system. If the ordering system has this part in stock, it can be ordered.

HP LaserJet Managed MFP E72425, E72430, E77422, E77428, E78223, E78228 - Control panel assembly (dn models only), USB host PCA, and humidity & encoder sensor

Follow these steps to remove the control panel assembly.

To view a short video of this procedure, click the link below.



[View a video of how to remove and replace the control panel assembly.](#)



[View a video of how to remove and replace the USB host PCA.](#)



[View a video of how to remove and replace the humidity & encoder sensor.](#)

Mean time to repair: 4 minutes

Service level: Intermediate



IMPORTANT: When applicable, special installation instructions are provided for an assembly at the end of the removal procedure. Always completely read the removal instructions and follow all special installation instructions.

Before performing service

- Disconnect the power cable.



WARNING! To avoid damage to the printer, turn the printer off, wait 30 seconds, and then remove the power cable before attempting to service the printer.

Use the table below to identify the correct part number for your printer. To order the part, go to <https://parts.hp.com>

Table 2-56 Part information

Part numbers	Part description
B5L47-60101	Control panel assembly
JC92-02951A	PCA USB host
JC32-00015A	Humidity & Encoder sensor

Required tools

- #2 JIS screwdriver with a magnetic tip

After performing service

Turn the printer power on

- Connect the power cable.
- Use the power switch to turn the power on.

Post service test

Verify that the document was copied, scanned, or printed correctly.

1. Remove the control-panel bezel.
 - a. Open the document feeder, and then remove three screws.

Figure 2-227 Remove three screws



- b. Place the control panel in the upright position.
- c. Gently pry the control panel bezel from the center screw hole, and then pry from the center of the control-panel bezel to the edges to release.

⚠ CAUTION: Do not pry against the scanner glass when removing the control-panel bezel.

2. Remove the control panel assembly.
 - a. Place the control panel in the upright position.

- b. Disconnect one USB interconnect cable, one connector, and one HDMI connector (callout 1), and then remove two screws on the control panel frame.

Figure 2-228 Remove the control panel screws and disconnect connectors

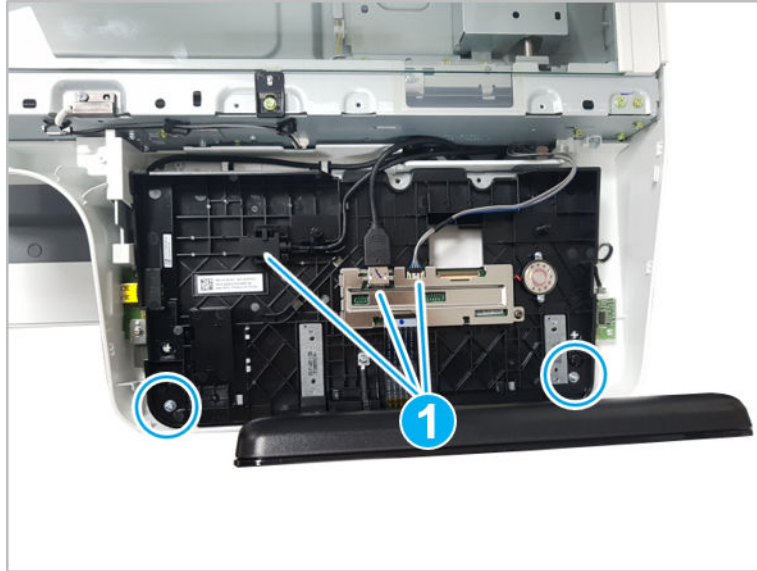

- c. Lift the control panel up from the front to release the tabs at the rear, and then remove the control panel.

 **TIP:** Align the four tabs at the rear of the control panel, and then snap in the control panel.

3. Remove the USB host PCA.

- a. Remove the USB cover cap.

Figure 2-229 Remove the USB cover cap



- b. Disconnect one cable, remove one screw, and then remove the USB host PCA.

Figure 2-230 Remove the USB host PCA

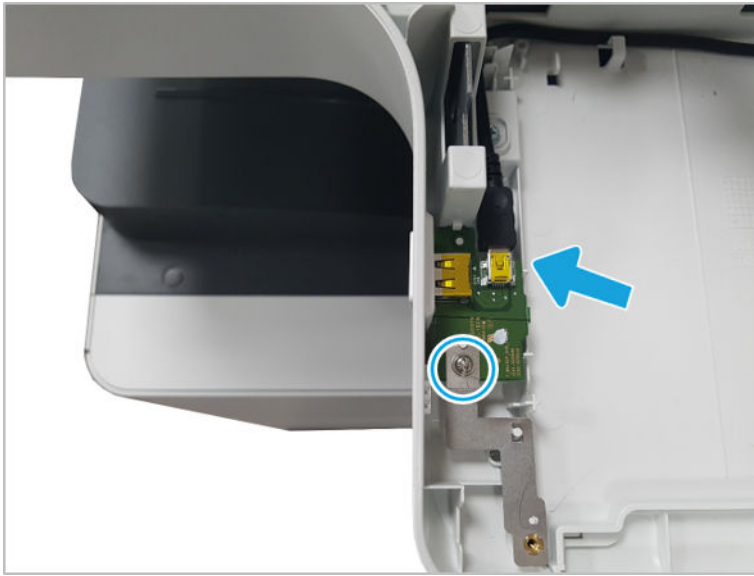

4. Remove the humidity & encoder sensor.
 - a. Release the latch to remove the humidity & encoder sensor.

Figure 2-231 Release the latch



- b. Disconnect one connector, and then remove the humidity & encoder sensor.

Figure 2-232 Remove the humidity & encoder sensor

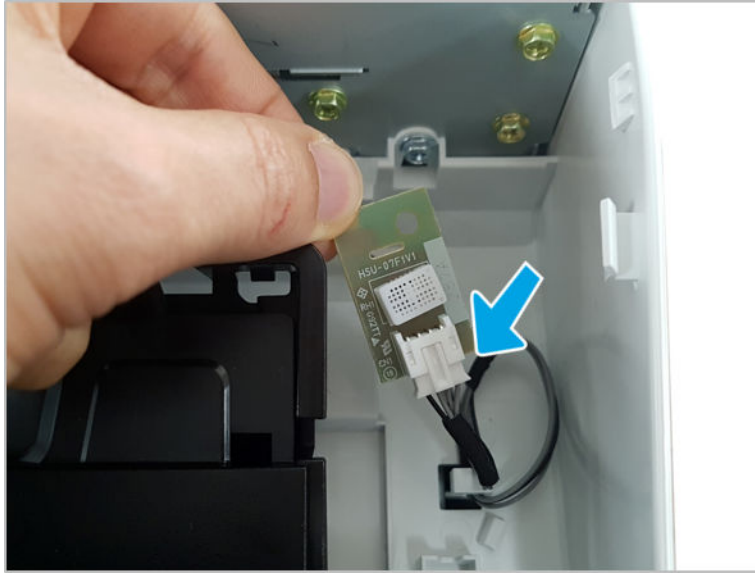

5. Unpack the replacement assembly.

- a. Dispose of the defective part.



NOTE: HP recommends responsible disposal of the defective part.

<http://www8.hp.com/us/en/hp-information/environment/product-recycling.html>

- b. Unpack the replacement part from the packaging.



CAUTION:  Some parts are sensitive to electrostatic discharge (ESD). Always perform service work at an ESD-protected workstation or mat. If an ESD workstation or mat is not available, touch the sheet-metal chassis to provide a static ground before touching an ESD-sensitive assembly. Protect the ESD-sensitive assemblies by placing them in ESD pouches when they are out of the printer.

If the replacement part is a roller or pad, avoid touching the spongy part of it. Skin oils on the roller or pad can cause paper pickup and/or print-quality problems. HP recommends using disposable gloves when handling rollers or pads or washing your hands before touching rollers or pads.



IMPORTANT: Make sure that all of the shipping materials (for example shipping tape) are removed from the replacement part prior to installation.

- c. To install an assembly, reverse the removal steps.



NOTE: When applicable, special installation instructions are provided for an assembly at the end of the removal procedure. Always completely read the removal instructions and follow all special installation instructions.

Tray 1 (MP) right door assembly

View Tray 1 (MP) right door assembly exploded view, parts list, and repair procedures.

Tray 1 (MP) right door parts

Figure 2-233 Tray 1 (MP) right door parts

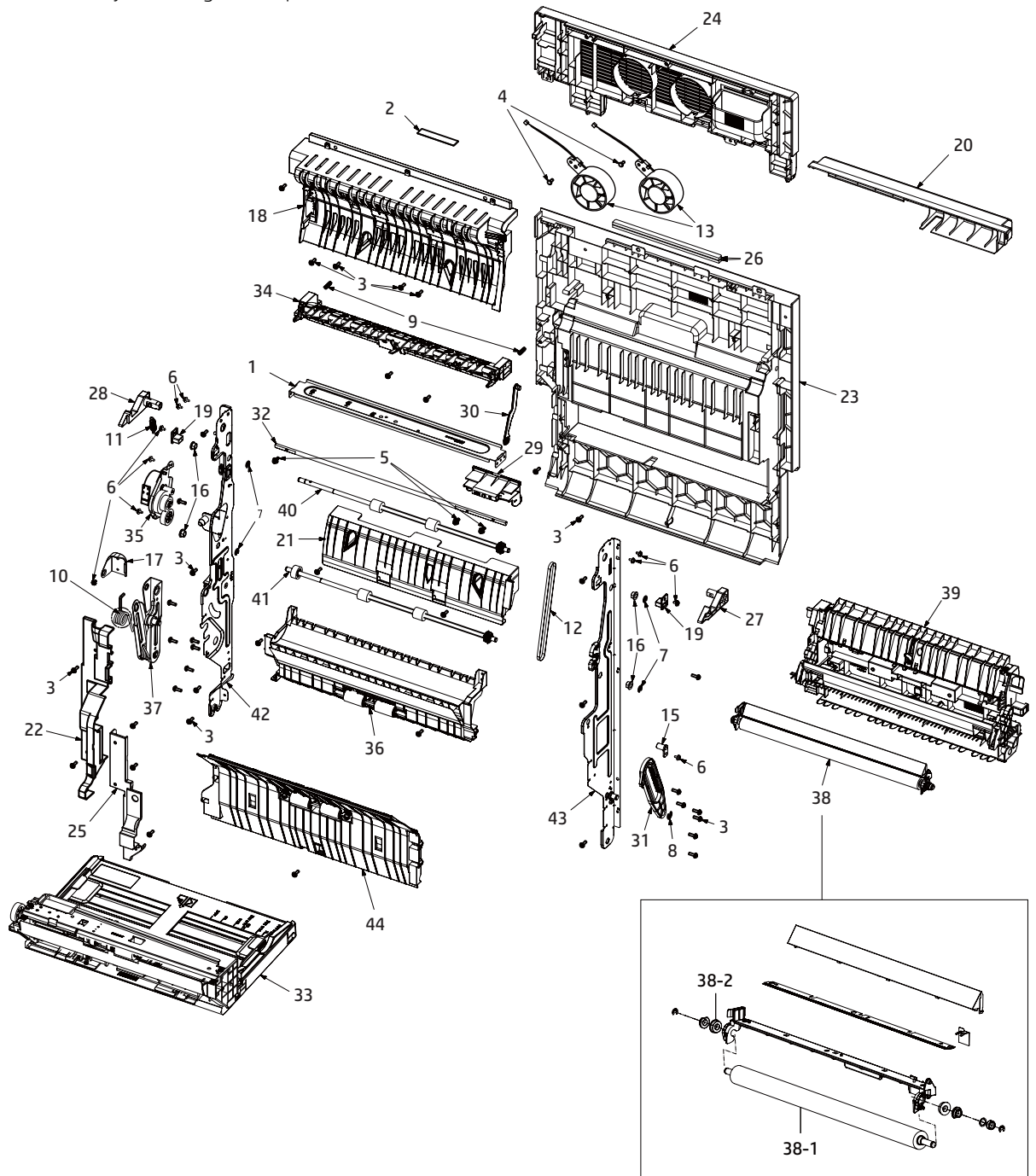

Table 2-57 Tray 1 (MP) right door parts

Ref	Description	Part Number (*)	Qty
1	Side cover, exit	JC95-02160A	1
2	Bar code label	JF68-10532B	1
3	Screw	6003-000196	40
4	Screw	6003-000282	2
5	Screw	6006-001193	3
6	Screw	6009-001665	10
7	E-ring	6044-000125	4
8	E-ring	6044-000231	1
9	Spring, cs	6107-001731	2
10	Spring, ts	6107-003052 (*)	1
11	Spring, es	6107-003056	1
12	Belt gear	6602-003299	1
13	Fan, Fuser type 6	JC31-00160C (*)	2
14	Wire harness	JC39-02704A	1
15	Duplex guide stopper	JC61-03115A	1
16	Bush	JC61-03527A	4
17	Link support bracket	JC61-04684A	1
18	Upper duplex guide (For E77422, E77428)	JC61-04795A (*)	1
18	Upper duplex guide (For E78223, E78228)	5QJ90-40013 (*)	1
19	Gate stopper	JC61-04899A	2
20	MP front cover	JC63-03356C (*)	1
21	Side cover, middle	JC63-03377A	1
22	Harness cover	JC63-03378C	1
23	Side cover	JC63-04570B (*)	1
24	Side cover, upper (For E77422, E77428)	JC63-04573B (*)	1
24	Side cover, upper (For E78223, E78228)	5QJ90-40014 (*)	1
25	Harness lower cover	JC63-04574B	1
26	Sponge	JC63-05075A	2
27	Side locker	JC64-00710A	1
28	Rear side locker	JC64-00711A (*)	1
29	Side handle	JC64-00948B	1
30	Side link	JC66-03220B	1
31	Link, front	JC66-03235A (*)	1

Table 2-57 Tray 1 (MP) right door parts (continued)

Ref	Description	Part Number (*)	Qty
32	Handle shaft	JC66-03301A	1
33	Tray 1 (MP) parts	JC90-01777A	1
34	Side cover, exit (For E77422, E77428)	JC95-01509C	1
34	Side cover, exit (For E78223, E78228)	JC90-01877A	1
35	Side cover, duplex motor	JC95-01510A (*)	1
36	Side cover, duplex feed	JC95-01517A (*)	1
37	Link rear	JC95-01518A (*)	1
37	Link rear	JC95-02256A (*)	1
38	T2 Transfer roller assembly (For E77422, E77428)	JC95-01942A (*)	1
38	T2 Transfer roller assembly (For E78223, E78228)	5QJ90-61041 (*)	1
38-1	Transfer roller (For E77422, E77428)	JC66-04204A	1
38-1	Transfer roller (For E78223, E78228)	JC66-05561A	1
38-2	Bearing ball	6601-001389 (*)	1
39	Side cover, feed (For E77422, E77428)	JC95-02081A (*)	1
39	Side cover, feed (For E78223, E78228)	JC95-02292A (*)	1
40	Side cover, rear roller	JC95-02126A	1
41	Side cover, rear roller	JC95-02127A	1
42	Side cover, rear	JC95-02128A	1
43	Side cover, right	JC95-02129A	1
44	Side cover, guide	JC95-02130A (*)	1

* This part is in ordering system. If the ordering system has this part in stock, it can be ordered.

HP Color LaserJet Managed MFP E77422, E77428, E78223, and E78228 - Removal and replacement: Tray 1 (MP) right door assembly

Follow these steps to remove the Tray 1 (MP) right door assembly.

To view a short video of this procedure, click the link below.

 [View a video of how to remove and replace the Tray 1 \(MP\) right door assembly.](#)

Mean time to repair: 2 minutes

Service level: Basic

 **IMPORTANT:** When applicable, special installation instructions are provided for an assembly at the end of the removal procedure. Always completely read the removal instructions and follow all special installation instructions.

Before performing service

- Disconnect the power cable.

Use the table below to identify the correct part number for your printer. To order the part, go to <https://parts.hp.com>

Table 2-58 Part information

Part number	Part description
JC95-02241A	Tray 1 (MP) right door (For E77422, E77428)
8GR88-60101	Tray 1 (MP) right door (For E78223, E78228)

Required tools

- #2 JIS screwdriver with a magnetic tip

After performing service

Turn the printer power on

- Connect the power cable.
- Use the power switch to turn the power on.

Post service test

Verify that the document was copied, scanned, or printed correctly.

1. Remove the right door.

 **NOTE:** Remove second exit drive if installed.

- a. Remove three screws, and then remove the right-rear cover.

Figure 2-234 Remove the right-rear cover



- b. Disconnect the right door connector.

Figure 2-235 Disconnect right door connector



- c. Release the right hinge (1).

⚠ CAUTION: The right hinge spring tension can be dangerous. Use caution when releasing the right hinge to avoid injury.

Figure 2-236 Release right hinge

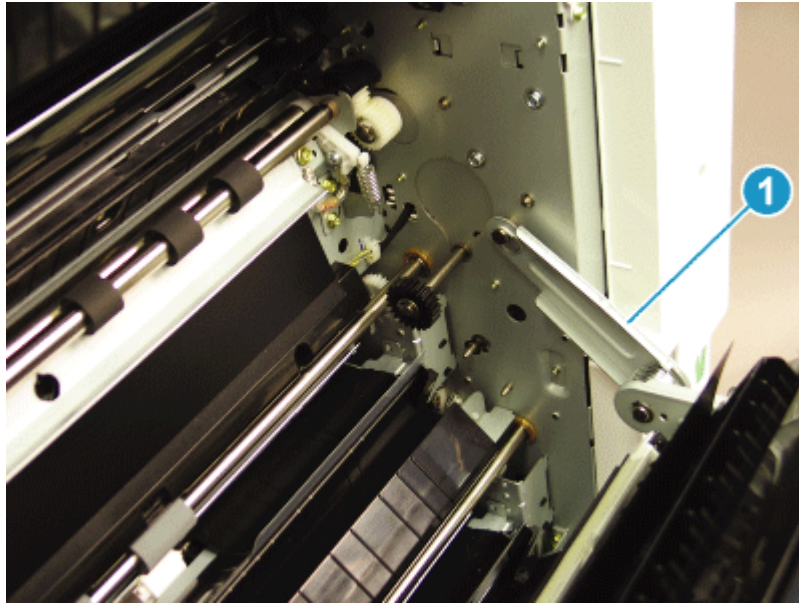

- d. Release the left dampener (1).

Figure 2-237 Release left dampener

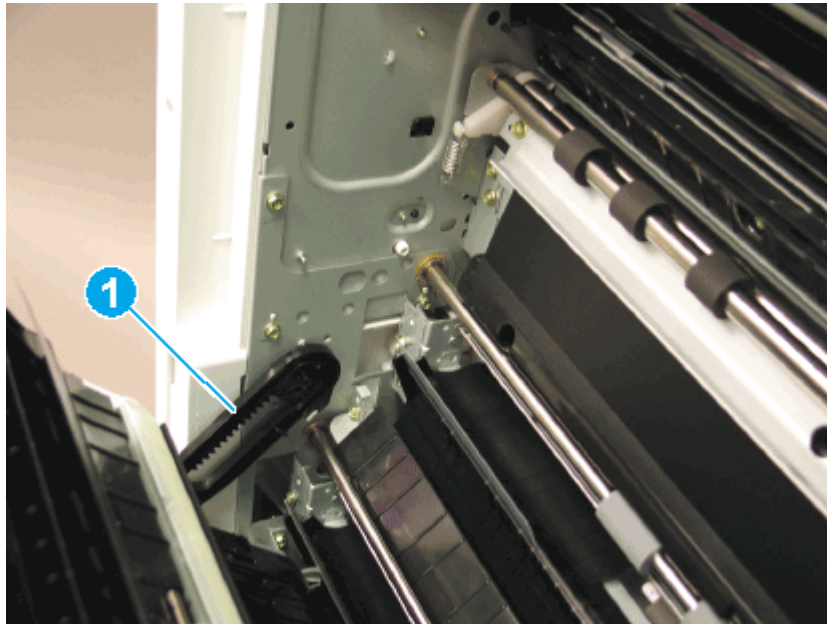

- e. Remove the Tray 1 (MP) right door.

 **NOTE:** Open the lower access door. If there is an HCI or 2x520 input device, release the dampener to clear the lower right door. Remove clockwise.

Figure 2-238 Remove Tray 1 (MP) right door



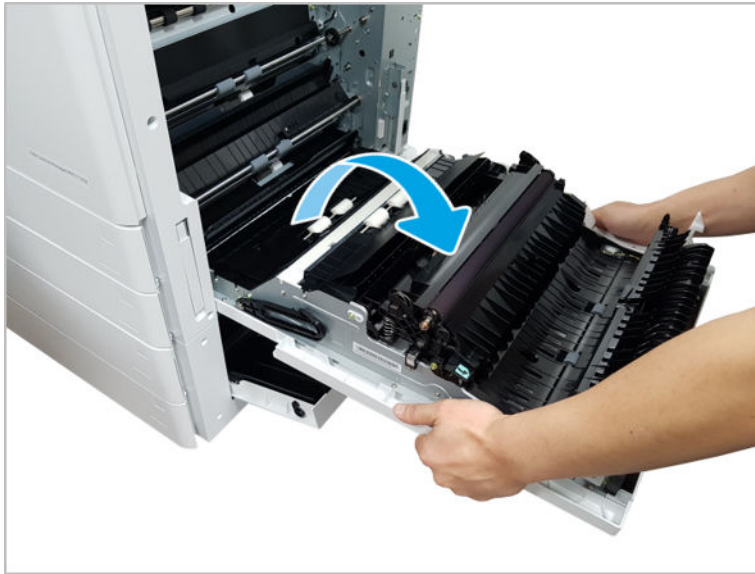

2. Unpack the replacement assembly.

- a. Dispose of the defective part.

 **NOTE:** HP recommends responsible disposal of the defective part.

<http://www8.hp.com/us/en/hp-information/environment/product-recycling.html>

- b. Unpack the replacement part from the packaging.

 **CAUTION:**  Some parts are sensitive to electrostatic discharge (ESD). Always perform service work at an ESD-protected workstation or mat. If an ESD workstation or mat is not available, touch the sheet-metal chassis to provide a static ground before touching an ESD-sensitive assembly. Protect the ESD-sensitive assemblies by placing them in ESD pouches when they are out of the printer.

If the replacement part is a roller or pad, avoid touching the spongy part of it. Skin oils on the roller or pad can cause paper pickup and/or print-quality problems. HP recommends using disposable gloves when handling rollers or pads or washing your hands before touching rollers or pads.

 **IMPORTANT:** Make sure that all of the shipping materials (for example shipping tape) are removed from the replacement part prior to installation.

- c. To install an assembly, reverse the removal steps.

 **NOTE:** When applicable, special installation instructions are provided for an assembly at the end of the removal procedure. Always completely read the removal instructions and follow all special installation instructions.

Tray 1 (MP) parts

Figure 2-239 Tray 1 (MP) parts

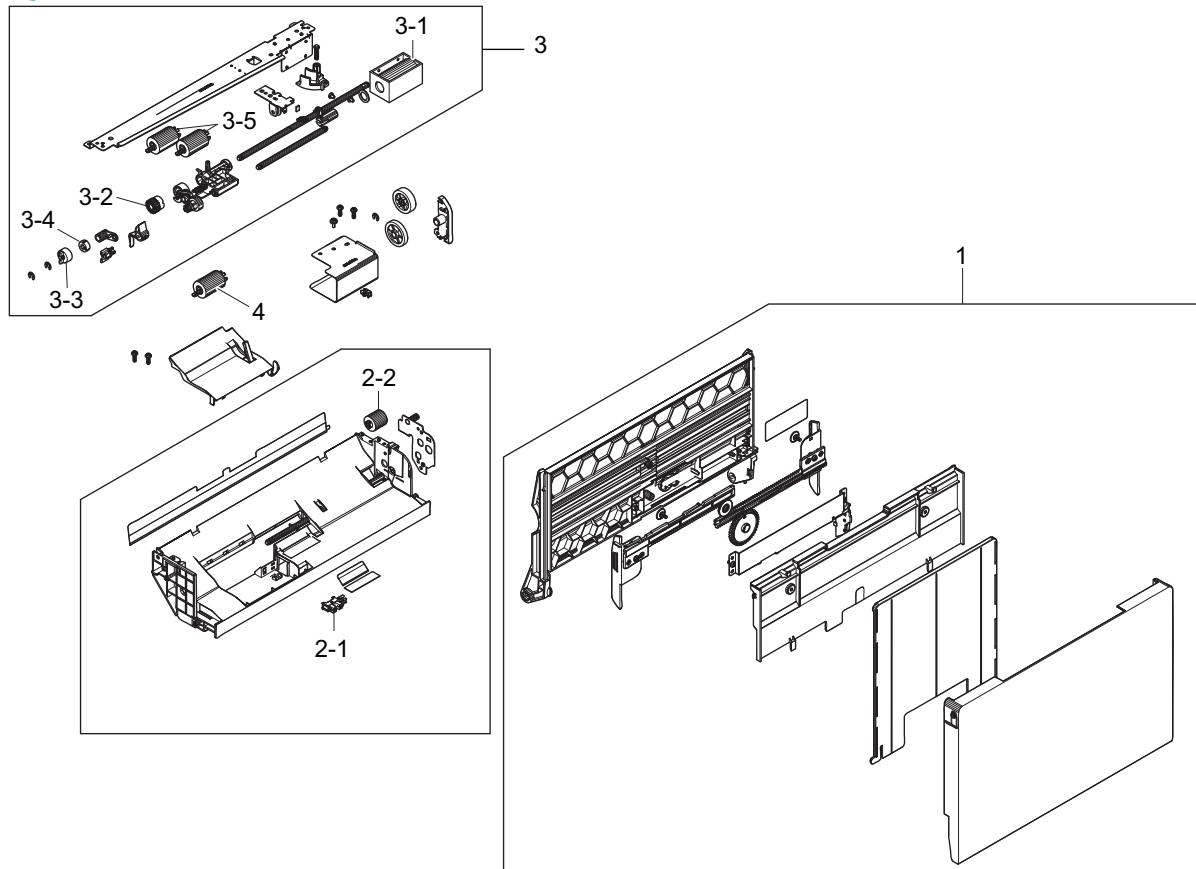

Table 2-59 Tray 1 (MP) parts

Ref	Description	Part Number (*)	Qty
1	Tray 1 door	JC90-01778A	1
2-1	Photo interrupter	0604-001393 (*)	1
2-2	Coupler, torque limiter	JC67-00455A (*)	1
3	MP pickup bracket assembly	JC90-01125B (*)	1
3-1	Solenoid Tray 1	JC33-00029B (*)	1
3-2	Tray 1 (MP) One way	JC90-00918A (*)	1
3-3	Holder, idel one way	JC61-01288A	1
3-4	Clutch, one way	JC66-00977A (*)	1
3-5	Pick, reverse and feed roller Tray 1	JC93-00540B (*)	2
4	Pick, reverse and feed roller Tray 1	JC93-00540B (*)	1

* This part is in ordering system. If the ordering system has this part in stock, it can be ordered.

HP LaserJet Managed MFP E72425, E72430, E77422, E77428, E78223, E78228 - Removal and replacement: Tray 1 main rollers

This document provides the procedures to remove the Tray 1 (MP) main rollers.

To view a short video of this procedure, click the link below.



[View a video of how to remove and replace the tray 1 \(MP\) main rollers.](#)

Mean time to repair: 3 minutes

Service level: Basic



IMPORTANT: When applicable, special installation instructions are provided for an assembly at the end of the removal procedure. Always completely read the removal instructions and follow all special installation instructions.

Before performing service

- Disconnect the power cable.

Use the table below to identify the correct part number for your printer. To order the part, go to <https://parts.hp.com>

Table 2-60 Part information

Part number	Part description
JC93-00540B	Pick, reverse and feed roller Tray 1

Required tools

- #2 JIS screwdriver with a magnetic tip
- Small flat-blade screwdriver

After performing service

Turn the printer power on

- Connect the power cable.
- Use the power switch to turn the power on.

Post service test

Copy, scan, or print a document. Verify the document copies, scans, or prints correctly.

1. Remove the Tray 1 rollers.
 - a. Open Tray 1. Use a small flat blade screwdriver to release the tab on the right side of the MP roller cover.



NOTE: The plastic tabs on the edges of the cover might require extra pressure to remove.

Figure 2-240 Remove the MP roller cover

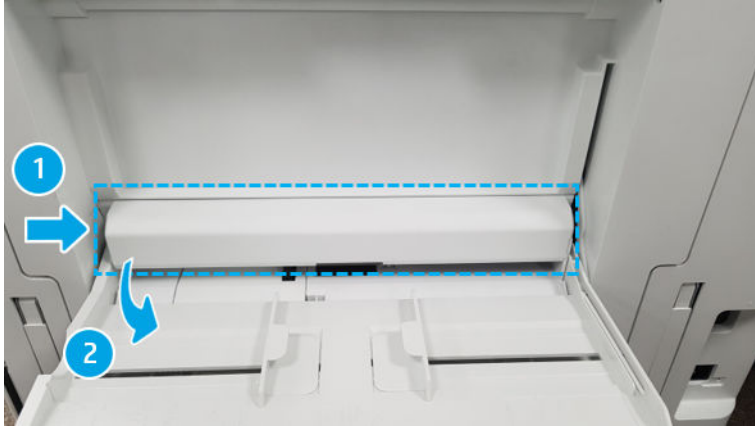

- b. Remove the cover shown using a small flat blade screwdriver to release the tab on the right side of the MP sensor cover.

 **NOTE:** The flag needs to be moved out of the way to remove the MP sensor cover.

Figure 2-241 Remove the MP sensor cover



- c. Release the small tab and remove the Tray 1 pick/reverse/feed roller (2). The flag (1) needs to be moved out of the way to release the rollers. Use caution and remove slowly to avoid loosening the parts behind the rollers. If these parts come loose, they might fall into the printer and will be difficult to retrieve. Note the location of all components.

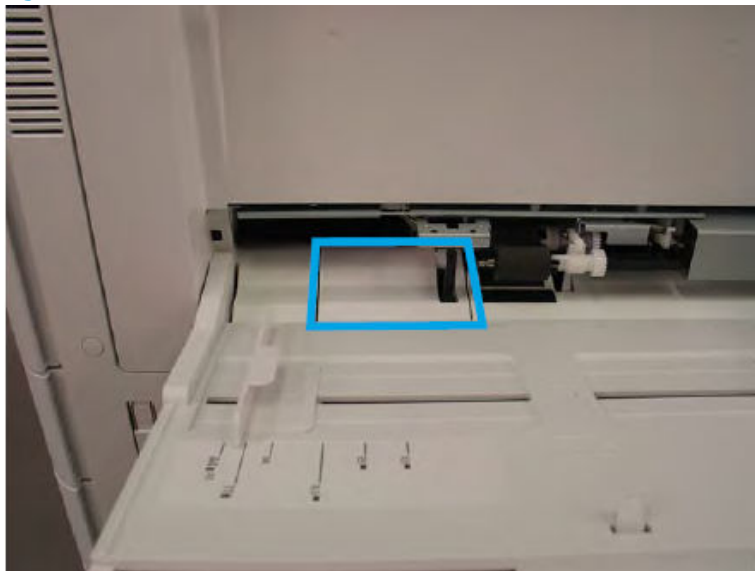

NOTE: It is recommended that all three rollers be replaced at the same time.

Figure 2-242 Remove the Tray 1 pick/reverse/feed roller

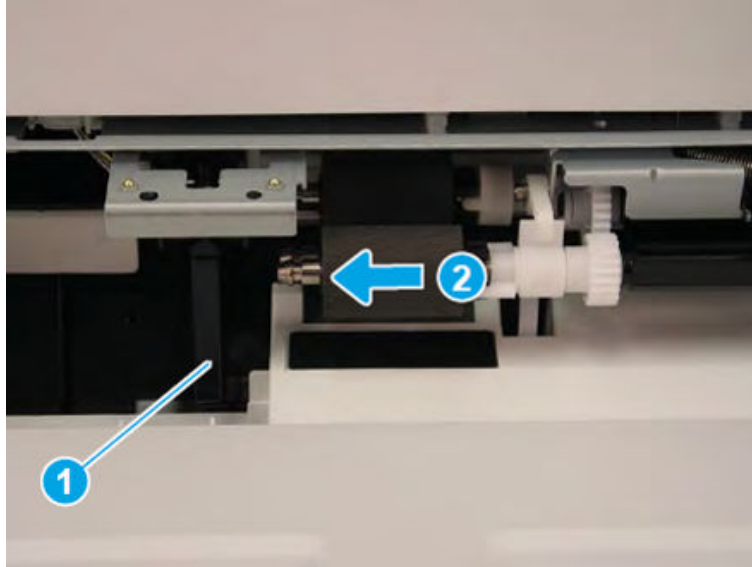



- d. Reverse the removal steps to install the assembly.
 1. After the replacement rollers are installed, follow these instructions to reset the firmware counter:
 2. From the Home screen on the printer control panel, select the [Support Tools](#) menu.
 3. Select the [Service](#) menu.
 4. Make sure that [Service Access Code](#) is selected in the drop-down menu, and then enter the service access code.
 5. Select the [Service Tools](#) menu.
 6. Select the [Supply Status](#) menu.
 7. Select [Field Replacement Unit](#).
 8. Select [Tray X Rollers](#).
 9. Select [Tray 1 Roller Kit](#).
 10. Select [Reset](#).
2. Unpack the replacement assembly.
 - a. Dispose of the defective part.

 **NOTE:** HP recommends responsible disposal of the defective part.

<http://www8.hp.com/us/en/hp-information/environment/product-recycling.html>

b. Unpack the replacement part from the packaging.

 **CAUTION:**  Some parts are sensitive to electrostatic discharge (ESD). Always perform service work at an ESD-protected workstation or mat. If an ESD workstation or mat is not available, touch the sheet-metal chassis to provide a static ground before touching an ESD-sensitive assembly. Protect the ESD-sensitive assemblies by placing them in ESD pouches when they are out of the printer.

If the replacement part is a roller or pad, avoid touching the spongy part of it. Skin oils on the roller or pad can cause paper pickup and/or print-quality problems. HP recommends using disposable gloves when handling rollers or pads or washing your hands before touching rollers or pads.

 **IMPORTANT:** Make sure that all of the shipping materials (for example shipping tape) are removed from the replacement part prior to installation.

c. To install an assembly, reverse the removal steps.

 **NOTE:** When applicable, special installation instructions are provided for an assembly at the end of the removal procedure. Always completely read the removal instructions and follow all special installation instructions.

HP LaserJet Managed MFP E72425, E72430, E77422, E77428, E78223, E78228 - Removal and replacement: Tray 1 (MP) unit and Tray 1 (MP) solenoid

Follow these steps to remove the multipurpose (MP) assembly.

To view a short video of this procedure, click the link below.

 [View a video of how to remove and replace the multipurpose \(MP\) assembly.](#)

Mean time to repair: 15 minutes

Service level: Intermediate

 **IMPORTANT:** When applicable, special installation instructions are provided for an assembly at the end of the removal procedure. Always completely read the removal instructions and follow all special installation instructions.

Before performing service

- Disconnect the power cable.

Use the table below to identify the correct part number for your printer. To order the part, go to <https://parts.hp.com>

Table 2-61 Part information

Part numbers	Part description
JC90-01777A	MP (Tray 1) unit
JC33-00029B	Solenoid Tray 1

Required tools

- #2 JIS screwdriver with a magnetic tip
- Small flat-blade screwdriver

After performing service

Turn the printer power on

- Connect the power cable.
- Use the power switch to turn the power on.

Post service test

Verify that the document was copied, scanned, or printed correctly.

1. Remove the right door.



NOTE: Remove second exit drive if installed.

- a. Remove three screws, and then remove the right-rear cover.

Figure 2-243 Remove the right-rear cover.



- b. Disconnect the right door connector.

Figure 2-244 Disconnect right door connector



- c. Open the right door.
- d. Release the right hinge (1).

⚠ CAUTION: The right hinge spring tension can be dangerous. Use caution when releasing the right hinge to avoid injury.

Figure 2-245 Release right hinge

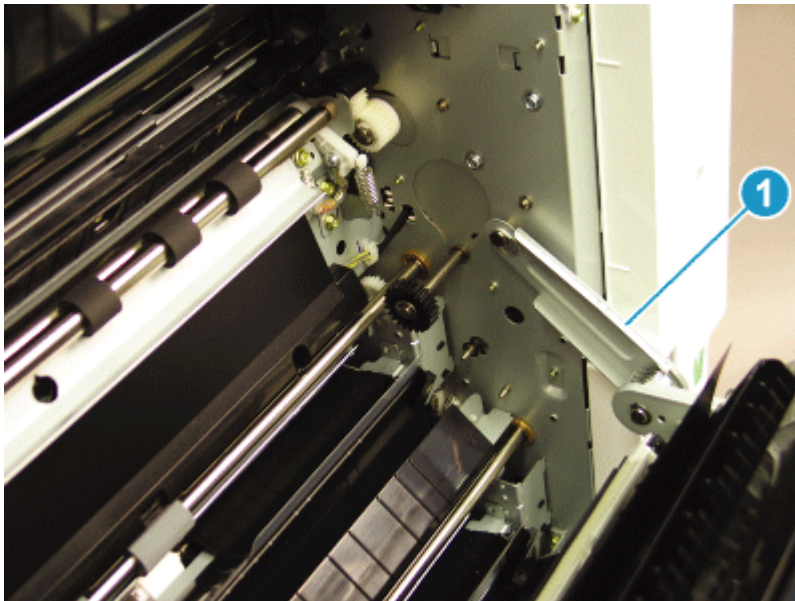

- e. Release the left dampener (1).

Figure 2-246 Release left dampener

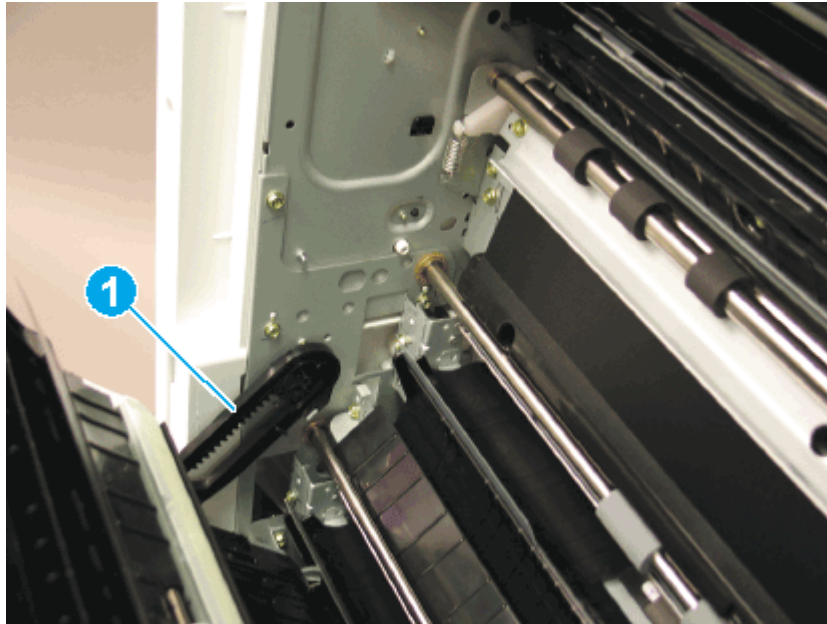

- f. Remove the right door.

 **NOTE:** Open the lower access door. If there is an HCI or 2x520 input device, release the dampener to clear the lower right door. Remove clockwise.

Figure 2-247 Remove right door



- 2. Remove the multipurpose unit.
 - a. Open the MP tray and remove the MP roller cover. Release tabs at back of the roller cover and rotate to release.

Figure 2-248 Remove the MP roller cover

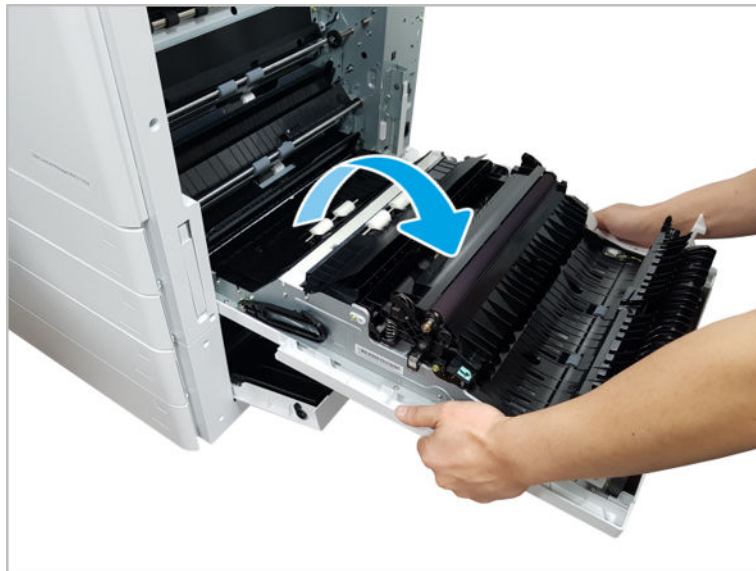
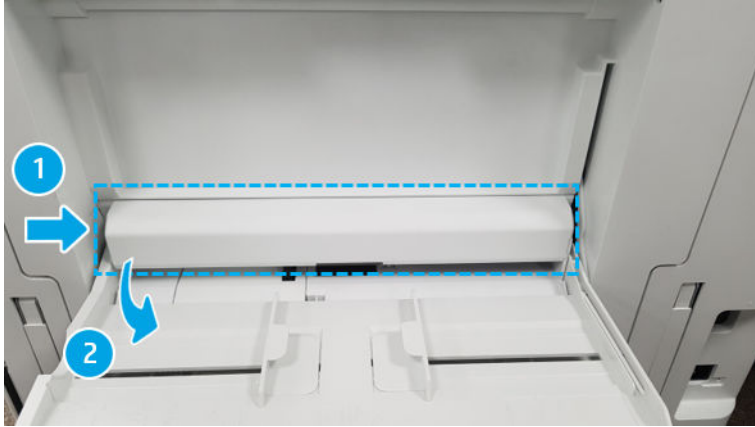

- b. Open the MP tray and release the hinge from the right, flexing the linker to remove.

Figure 2-249 Open MP tray and release link



- c. Remove two screws and then remove the cable cover.

Figure 2-250 Remove screws and cable cover

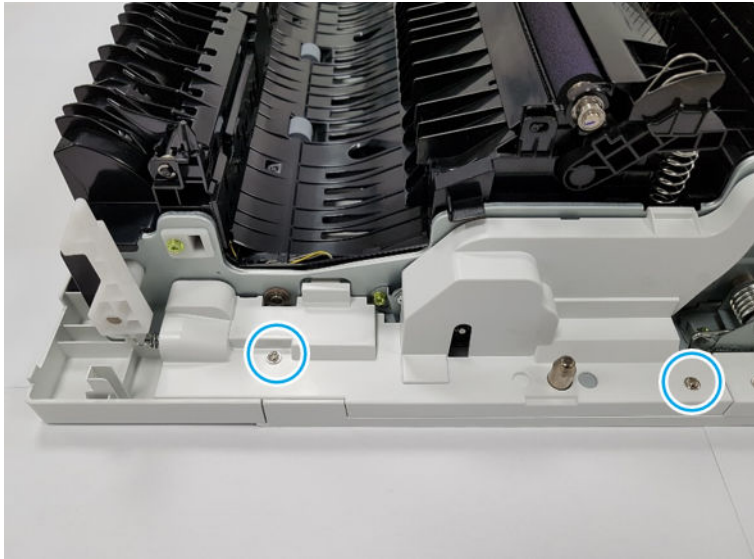

- d. Remove three screws and then remove the lower cable cover.

Figure 2-251 Remove screws and the lower cable cover

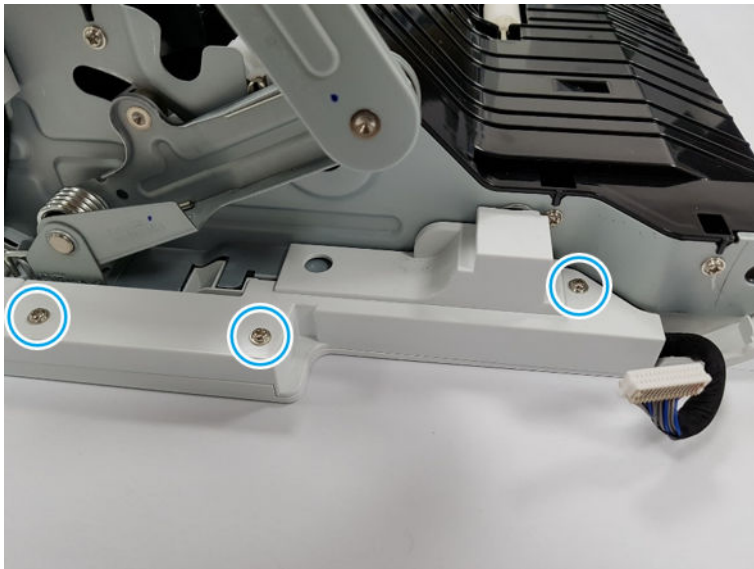

- e. Remove five screws.

Figure 2-252 Remove screws

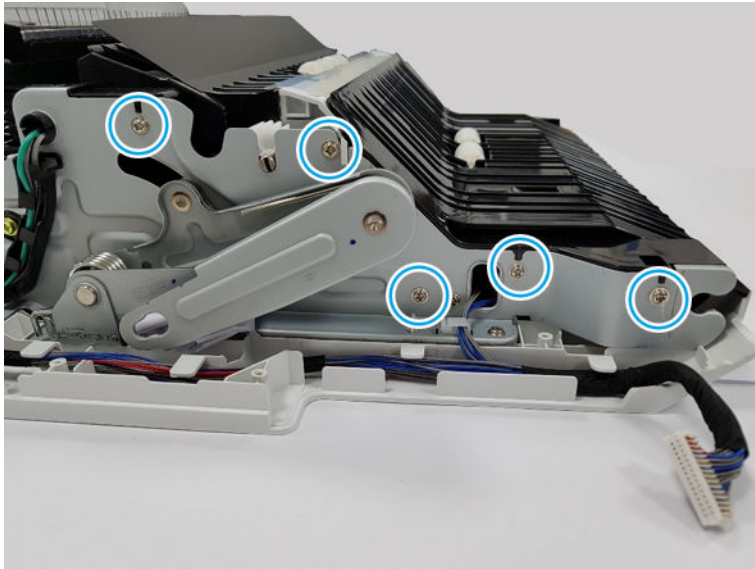

- f. Remove six screws and one holder from the other side of the door.

Figure 2-253 Remove screws

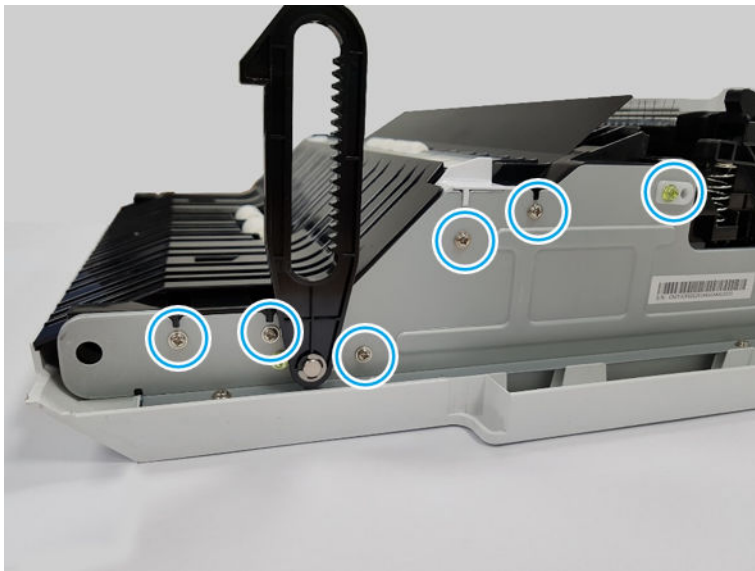

- g. Remove one screw and then remove the right door duplex lower.

Figure 2-254 Remove the right door duplex lower

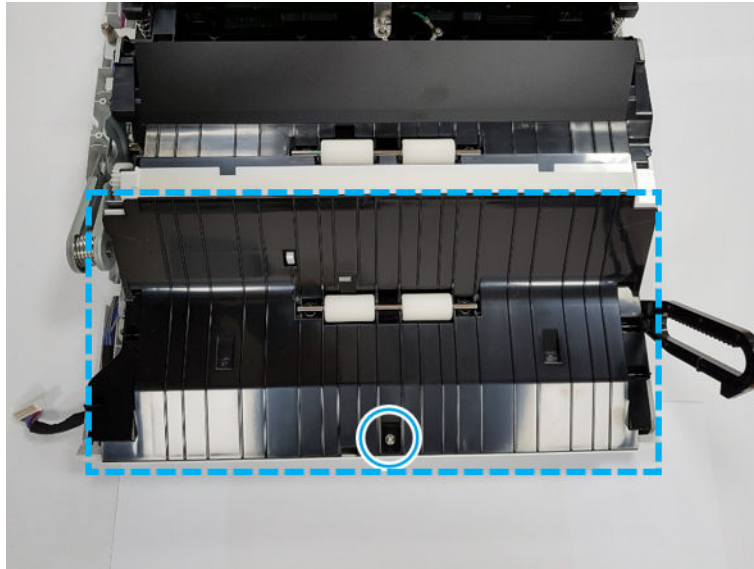

- h. Remove one screw. Disconnect one connector. And then, release the wires from the wire guide.

Figure 2-255 Release the wires

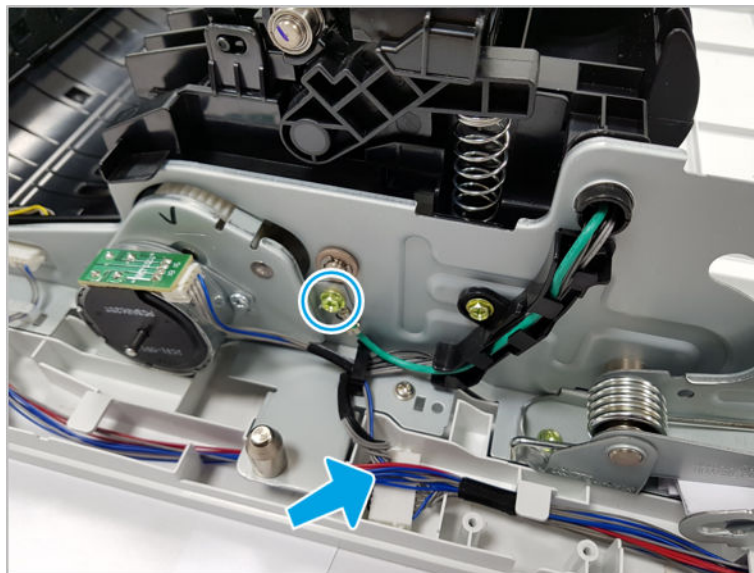

- i. Remove the duplex side cover.

Figure 2-256 Remove the duplex side cover

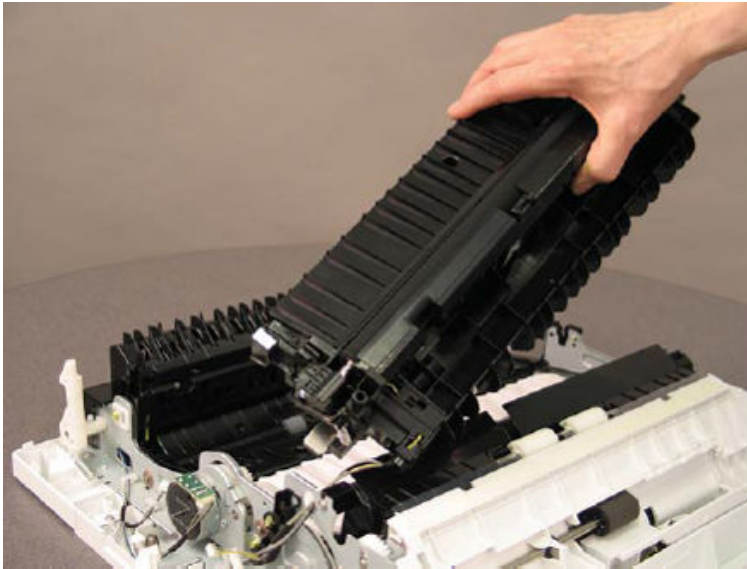

- j. Remove two screws.

Figure 2-257 Remove screws

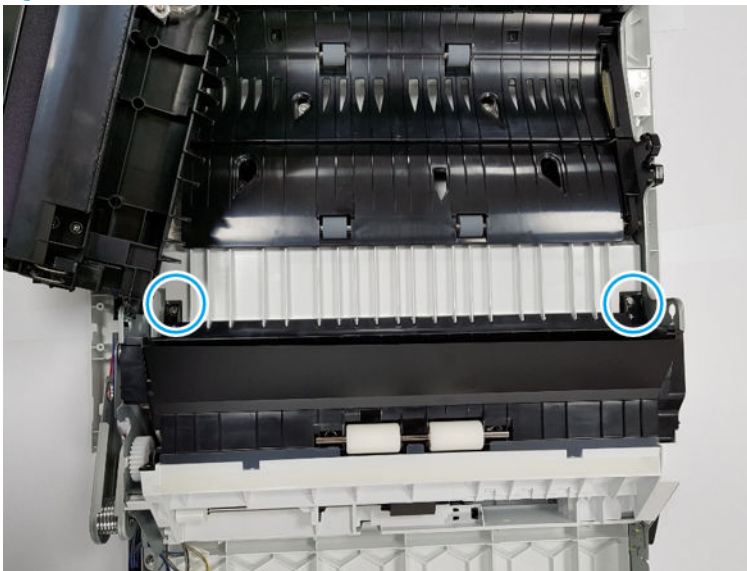

- k. Disconnect two connectors.

Figure 2-258 Disconnect connectors

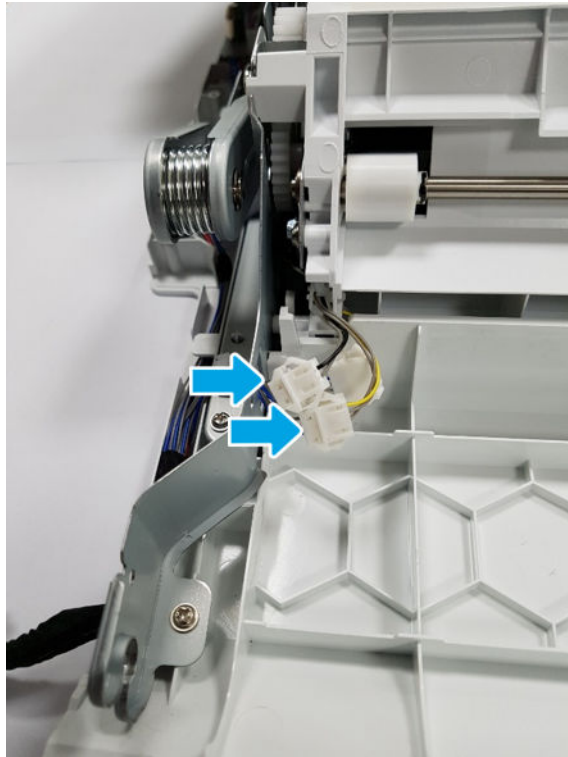

- l. Remove the MP unit.

Figure 2-259 Remove the MP unit

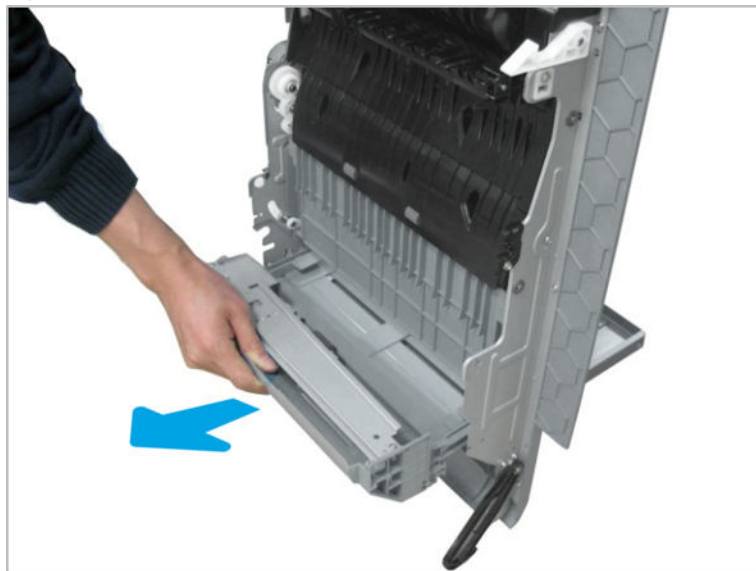

- 3. Remove the MP solenoid.
 - a. Remove the MP base cover.

Figure 2-260 Remove the MP base cover

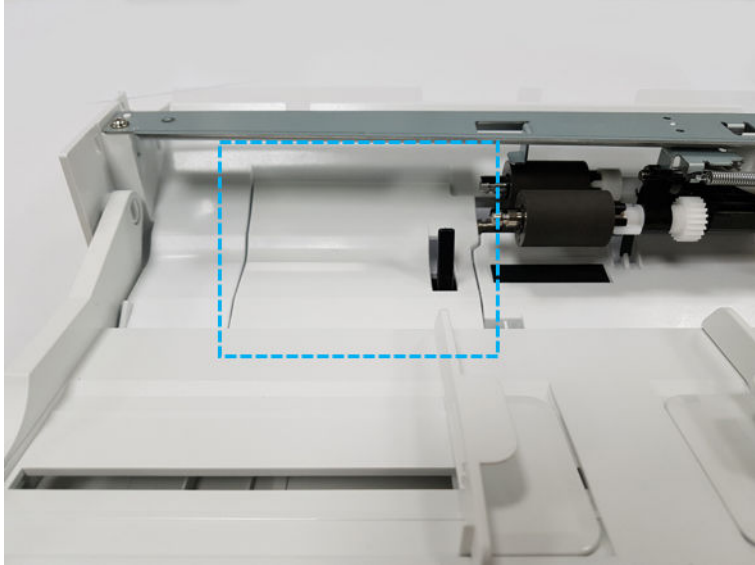

- b. Remove the e-ring (callout 1), and then remove the gear (callout 2).

Figure 2-261 Remove the e-ring and gear

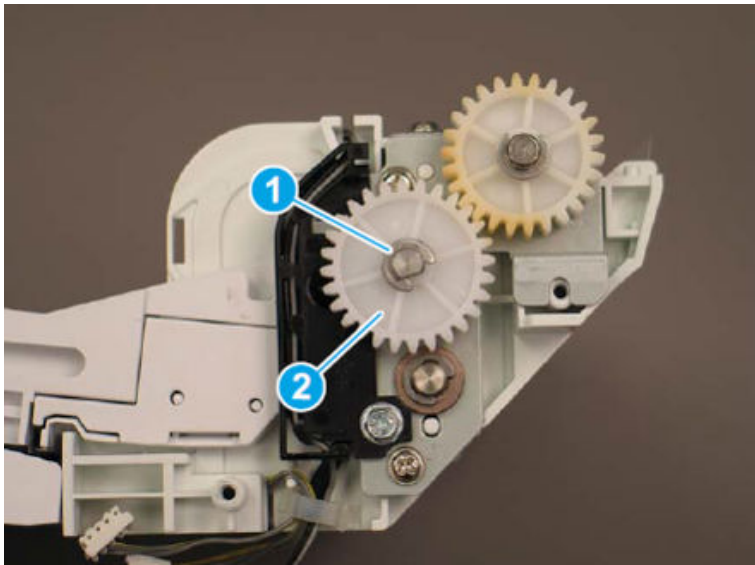

- c. Remove the bushing (callout 1), release the retainer (callout 2), and then release the wires from the guide (callout 3).

Figure 2-262 Remove the bushing and release the wires

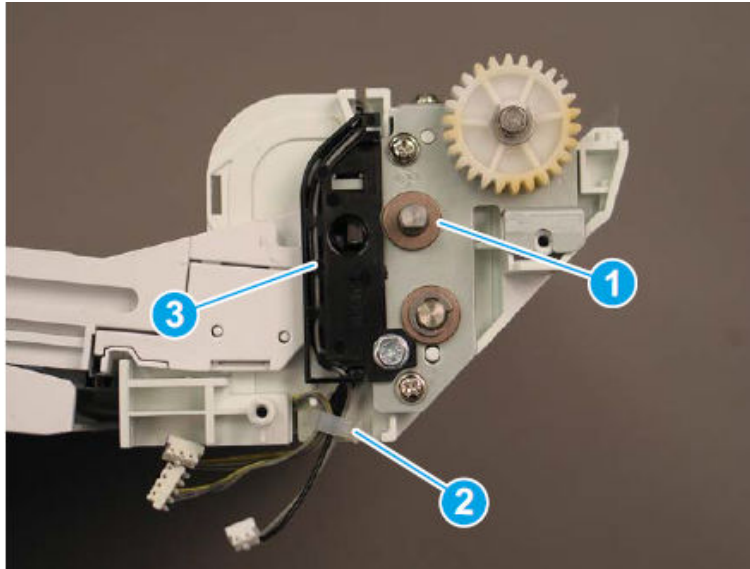

- d. Remove four screws (callout 1), and then remove the MP pickup bracket (callout 2).

Figure 2-263 Remove four screws and the bracket

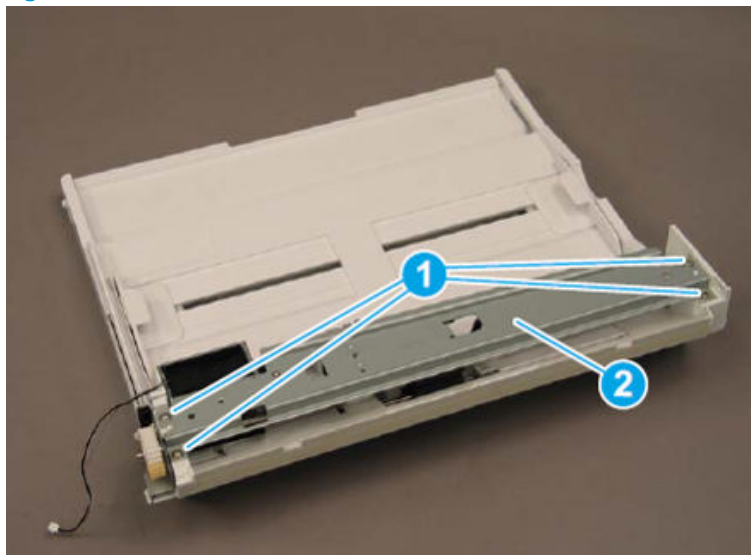

- e. Remove two screws, and then remove the MP solenoid.

Figure 2-264 Remove two screws and the solenoid

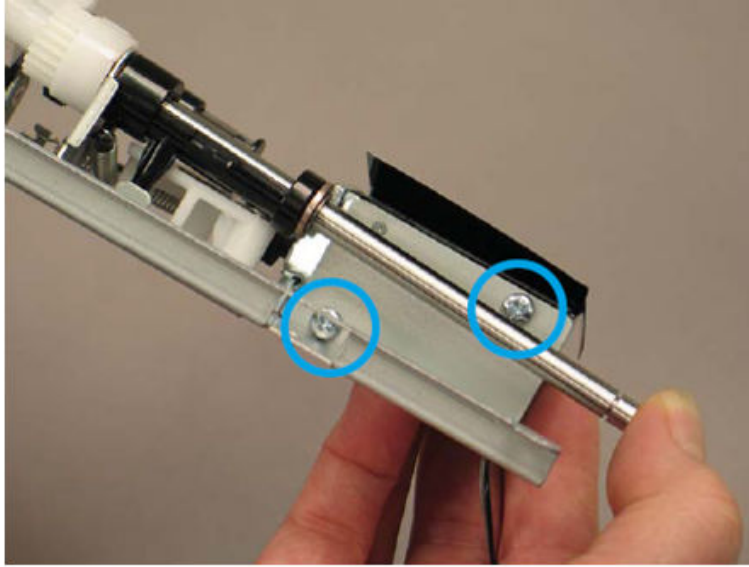



4. Unpack the replacement assembly.
 - a. Dispose of the defective part.

 **NOTE:** HP recommends responsible disposal of the defective part.

<http://www8.hp.com/us/en/hp-information/environment/product-recycling.html>

- b. Unpack the replacement part from the packaging.

 **CAUTION:**  Some parts are sensitive to electrostatic discharge (ESD). Always perform service work at an ESD-protected workstation or mat. If an ESD workstation or mat is not available, touch the sheet-metal chassis to provide a static ground before touching an ESD-sensitive assembly. Protect the ESD-sensitive assemblies by placing them in ESD pouches when they are out of the printer.

If the replacement part is a roller or pad, avoid touching the spongy part of it. Skin oils on the roller or pad can cause paper pickup and/or print-quality problems. HP recommends using disposable gloves when handling rollers or pads or washing your hands before touching rollers or pads.

 **IMPORTANT:** Make sure that all of the shipping materials (for example shipping tape) are removed from the replacement part prior to installation.

- c. To install an assembly, reverse the removal steps.

 **NOTE:** When applicable, special installation instructions are provided for an assembly at the end of the removal procedure. Always completely read the removal instructions and follow all special installation instructions.

Right door output

Figure 2-265 Right door output

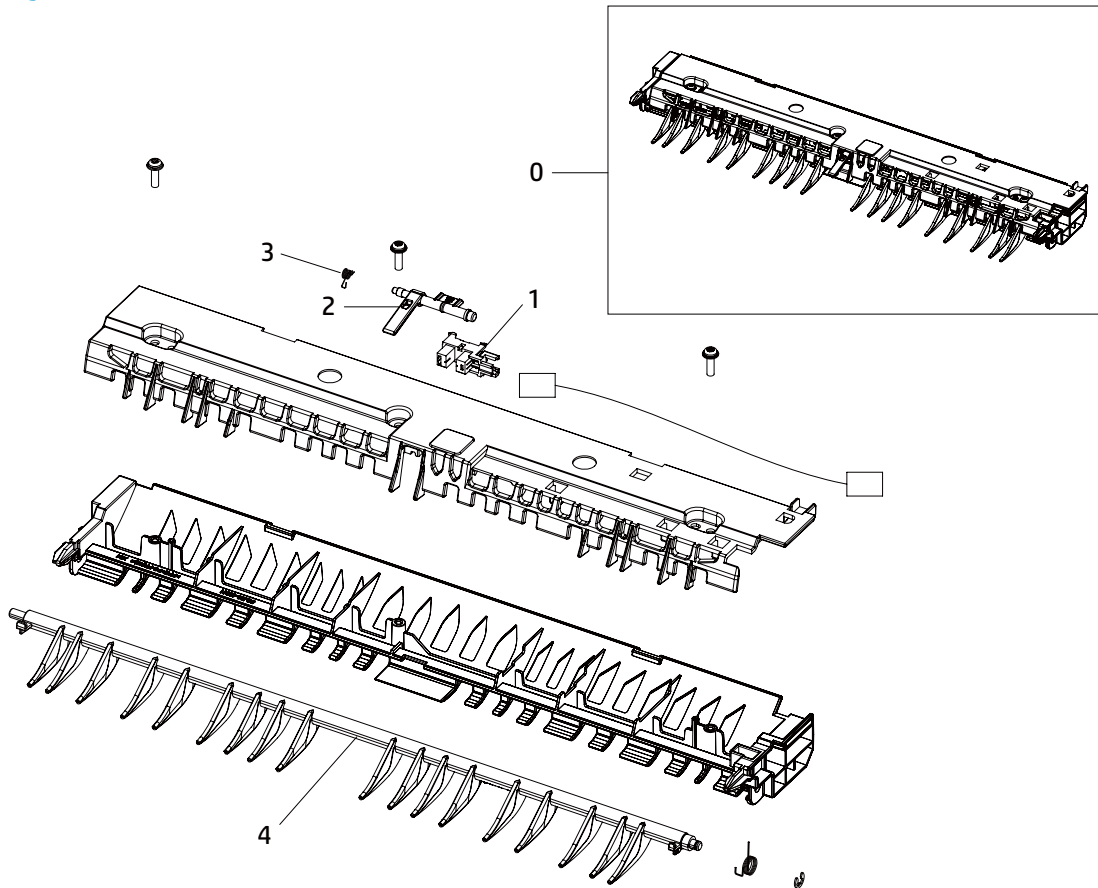

Table 2-62 Right door output

Ref	Description	Part Number (*)	Qty
0	Right door output	JC95-01509C (*)	1
1	Photo interrupter	0604-001393 (*)	1
2	Actuator, fuser out	JC66-03307A (*)	1
3	Spring, ts	6107-001737 (*)	1
4	Guide, gate	JC61-04792A (*)	1

* This part is in ordering system.

HP LaserJet Managed MFP E72425, E72430, E77422, E77428, E78223, E78228 - Removal and replacement: Fuser out sensor

Follow these steps to remove the fuser out sensor.

To view a short video of this procedure, click the link below.

 [View a video of how to remove and replace the fuser out sensor.](#)

Mean time to repair: 10 minutes

Service level: Intermediate



IMPORTANT: When applicable, special installation instructions are provided for an assembly at the end of the removal procedure. Always completely read the removal instructions and follow all special installation instructions.

Before performing service

- Disconnect the power cable.

Use the table below to identify the correct part number for your printer. To order the part, go to <https://parts.hp.com>

Table 2-63 Part information

Part number	Part description
0604-001393	Fuser-out sensor

Required tools

- #2 JIS screwdriver with a magnetic tip

After performing service

Turn the printer power on

- Connect the power cable.
- Use the power switch to turn the power on.

Post service test

Verify that the document was copied, scanned, or printed correctly.

1. Remove the right door.



NOTE: Remove second exit drive if installed.

- a. Remove three screws, and then remove the right-rear cover.

Figure 2-266 Remove the right-rear cover.



- b. Disconnect the right door connector.

Figure 2-267 Disconnect right door connector



- c. Release the right hinge (1).

⚠ CAUTION: The right hinge spring tension can be dangerous. Use caution when releasing the right hinge to avoid injury.

Figure 2-268 Release right hinge

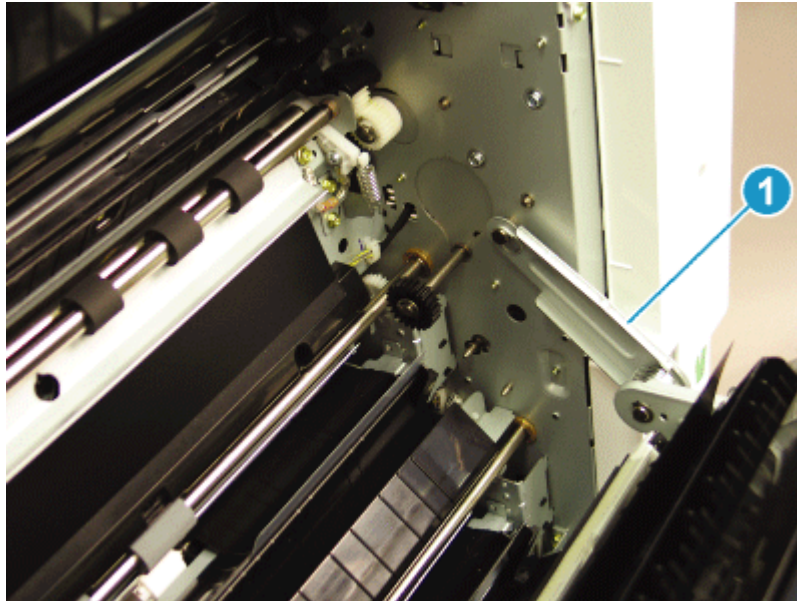

- d. Release the left dampener (1).

Figure 2-269 Release left dampener

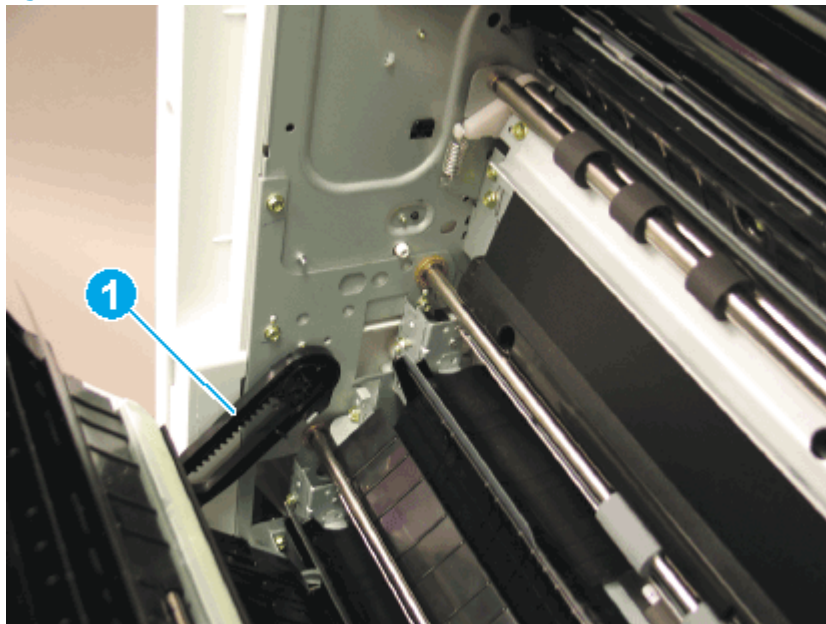

- e. Remove the right door.

 **NOTE:** Open the lower access door. If there is an HCI or 2x520 input device, release the dampener to clear the lower right door. Remove clockwise.

Figure 2-270 Remove right door



- 2. Remove the fuser out sensor.

 **NOTE:** Remove second exit drive if installed.

- a. Remove two screws and two plastic guides. Lift up the right-door exit.

Figure 2-271 Lift right-door exit

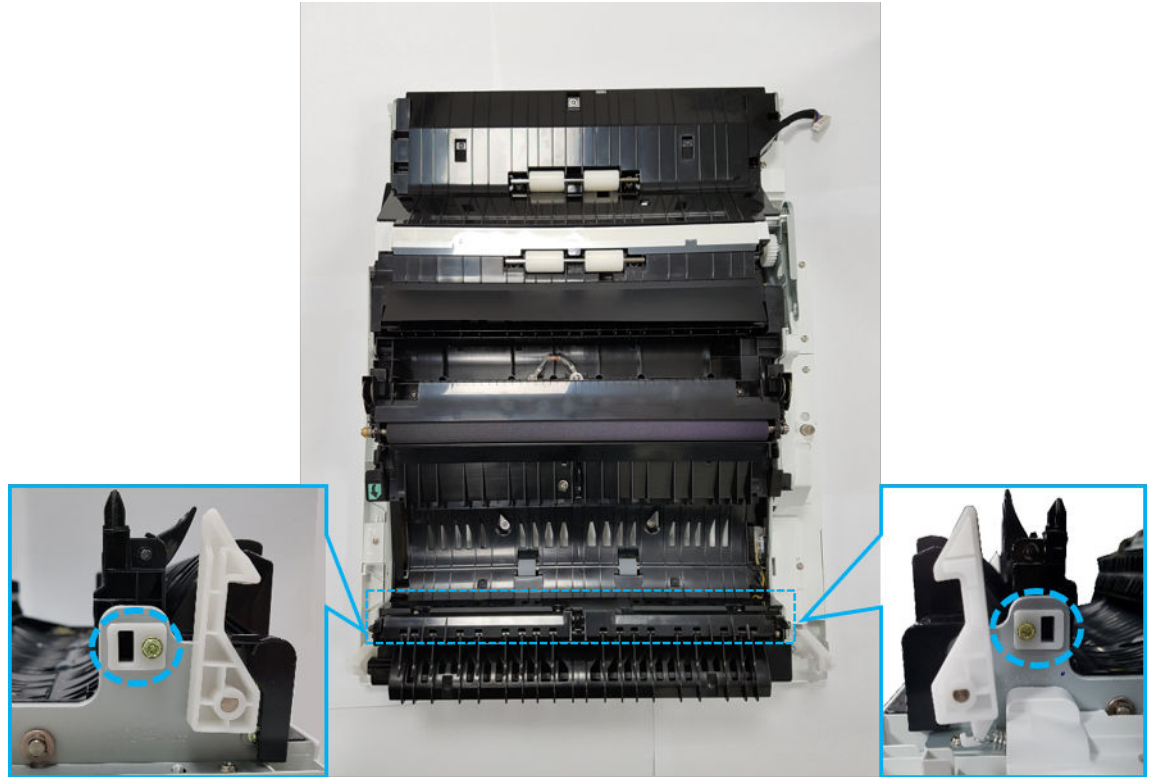

- b. Disconnect one connector. Remove the right-door exit. Use caution as the springs are not retained.

Figure 2-272 Remove right-door exit

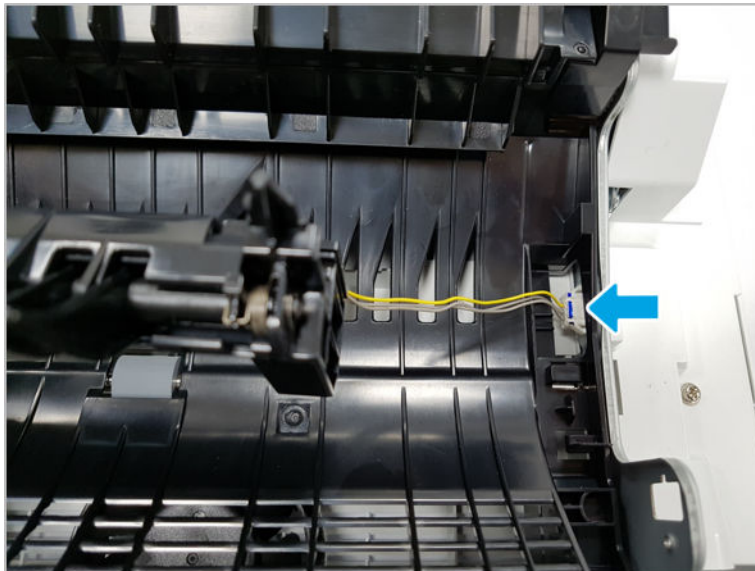

- c. Separate the right-door exit after removing three screws.

Figure 2-273 Remove screws and separate right-door exit

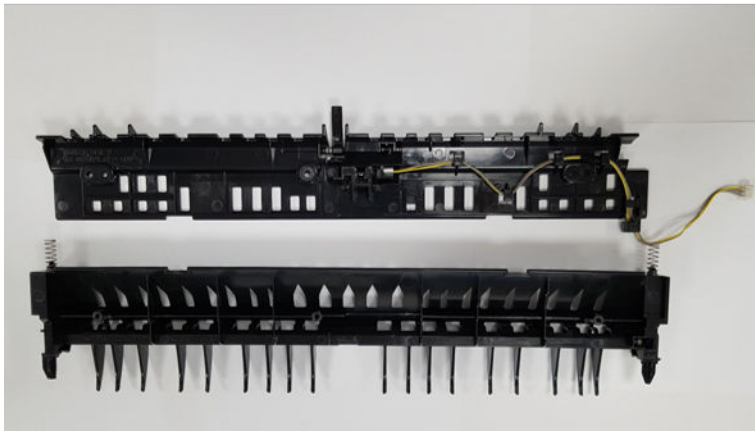
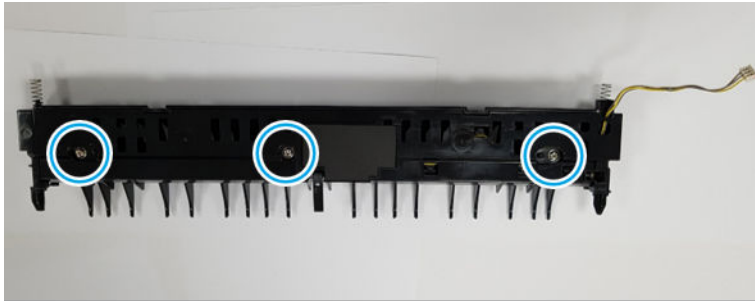

- d. Remove the black sheet. Disconnect the connector and remove the fuser out sensor.



 **TIP:** When removing the sensor, lift the flag, compress the bottom tabs and push from the hole, and then rotate and release the top tabs.

Figure 2-274 Disconnect connector and remove fuser out sensor



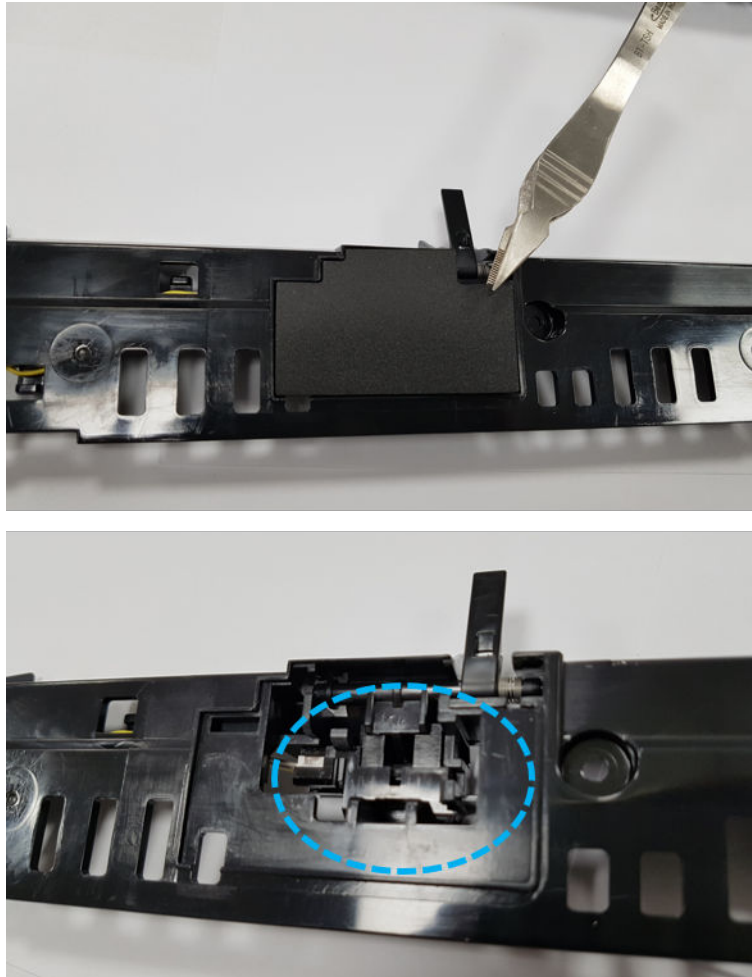

- 3. Unpack the replacement assembly.
 - a. Dispose of the defective part.

 **NOTE:** HP recommends responsible disposal of the defective part.

<http://www8.hp.com/us/en/hp-information/environment/product-recycling.html>

- b. Unpack the replacement part from the packaging.

 **CAUTION:**  Some parts are sensitive to electrostatic discharge (ESD). Always perform service work at an ESD-protected workstation or mat. If an ESD workstation or mat is not available, touch the sheet-metal chassis to provide a static ground before touching an ESD-sensitive assembly. Protect the ESD-sensitive assemblies by placing them in ESD pouches when they are out of the printer.

If the replacement part is a roller or pad, avoid touching the spongy part of it. Skin oils on the roller or pad can cause paper pickup and/or print-quality problems. HP recommends using disposable gloves when handling rollers or pads or washing your hands before touching rollers or pads.

 **IMPORTANT:** Make sure that all of the shipping materials (for example shipping tape) are removed from the replacement part prior to installation.

- c. To install an assembly, reverse the removal steps.

 **NOTE:** When applicable, special installation instructions are provided for an assembly at the end of the removal procedure. Always completely read the removal instructions and follow all special installation instructions.

Right door feed guide parts

Figure 2-275 Right door feed guide parts

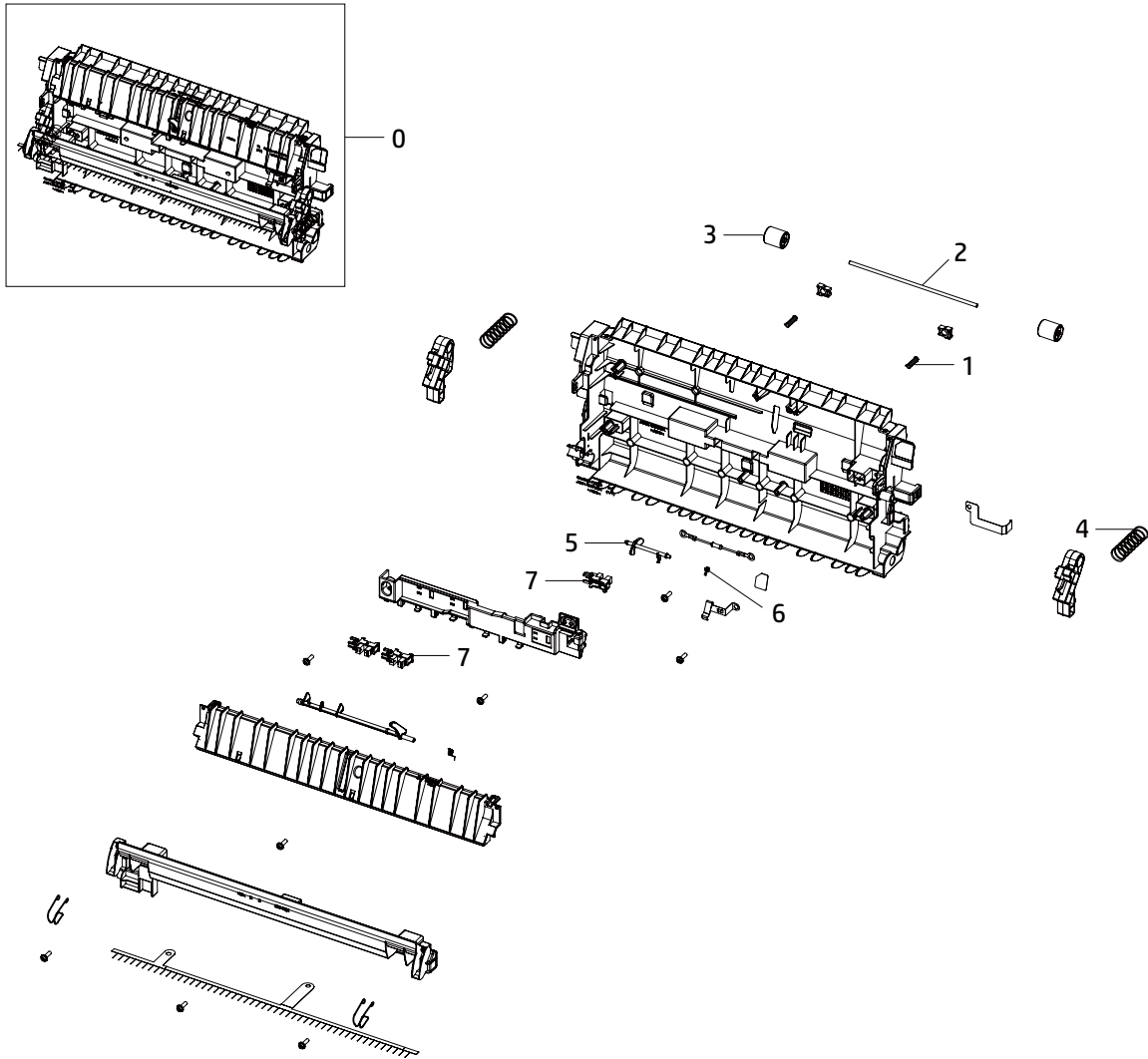

Table 2-64 Right door feed guide parts

Ref	Description	Part Number (*)	Qty
0	Right door feed guide (For E77422, E77428)	JC95-02081A (*)	1
0	Right door feed guide (For E78223, E78228)	JC95-02292A (*)	1
1	Spring, cs	6107-001731 (*)	2
2	Roller shaft	JC66-02354A (*)	1
3	Idle roller	JC66-02289B (*)	2
4	Spring, cs	6107-003048 (*)	2
5	Acutuator, duplex2	JC66-02180A (*)	1
6	Spring, ts	6107-001731 (*)	1

Table 2-64 Right door feed guide parts (continued)

Ref	Description	Part Number (*)	Qty
7	Photo interrupter	0604-001393 (*)	3
8	Transfer roller assembly (For E77422, E77428)	JC95-01942A (*)	1
8	Transfer roller assembly (For E78223, E78228)	5QJ90-61041 (*)	1
8-1	Transfer roller (For E77422, E77428)	JC66-04204A	1
8-1	Transfer roller (For E78223, E78228)	JC66-05561A	1
8-2	Bearing ball	6601-001389 (*)	2

* This part is in ordering system. If the ordering system has this part in stock, it can be ordered.

HP Color LaserJet Managed MFP E77422, E77428, E78223, and E78228 - Removal and replacement: Transfer roller assembly

Follow these steps to remove the transfer roller assembly.

To view a short video of this procedure, click the link below.



[View a video of how to remove and replace the transfer roller assembly.](#)

Mean time to repair: 1 minutes

Service level: Intermediate



IMPORTANT: When applicable, special installation instructions are provided for an assembly at the end of the removal procedure. Always completely read the removal instructions and follow all special installation instructions.

Before performing service

- Disconnect the power cable.

Use the table below to identify the correct part number for your printer. To order the part, go to <https://parts.hp.com>

Table 2-65 Part information

Part number	Part description
JC95-01942A	Transfer roller assembly (For E77422, E77428)
5QJ90-61041	Transfer roller assembly (For E78223, E78228)

Required tools

- #2 JIS screwdriver with a magnetic tip

After performing service

Turn the printer power on

- Connect the power cable.
- Use the power switch to turn the power on.

Post service test

Verify that the document was copied, scanned, or printed correctly.

1. Remove the transfer roller.
 - a. Open the right door.
 - b. Lift up and release both sides of the transfer roller while pushing the right holder to unlock.

Figure 2-276 Remove transfer roller assembly

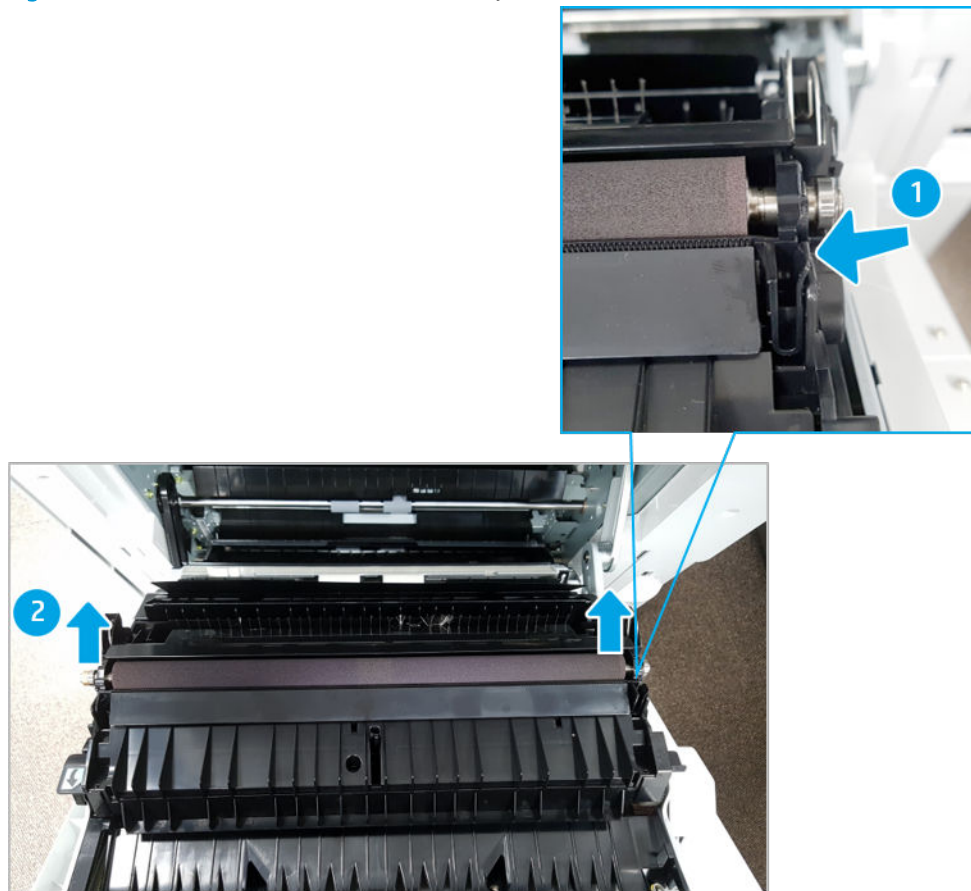



2. Unpack the replacement assembly.
 - a. Dispose of the defective part.

 **NOTE:** HP recommends responsible disposal of the defective part.

<http://www8.hp.com/us/en/hp-information/environment/product-recycling.html>

- b. Unpack the replacement part from the packaging.

 **CAUTION:**  Some parts are sensitive to electrostatic discharge (ESD). Always perform service work at an ESD-protected workstation or mat. If an ESD workstation or mat is not available, touch the sheet-metal chassis to provide a static ground before touching an ESD-sensitive assembly. Protect the ESD-sensitive assemblies by placing them in ESD pouches when they are out of the printer.

If the replacement part is a roller or pad, avoid touching the spongy part of it. Skin oils on the roller or pad can cause paper pickup and/or print-quality problems. HP recommends using disposable gloves when handling rollers or pads or washing your hands before touching rollers or pads.

 **IMPORTANT:** Make sure that all of the shipping materials (for example shipping tape) are removed from the replacement part prior to installation.

- c. To install an assembly, reverse the removal steps.

 **NOTE:** When applicable, special installation instructions are provided for an assembly at the end of the removal procedure. Always completely read the removal instructions and follow all special installation instructions.

HP Color LaserJet Managed MFP E77422, E77428, E78223, and E78228 - Removal and replacement: Duplex sensor and loop sensor

Follow these steps to remove the duplex sensor and loop sensor.

To view a short video of this procedure, click the link below.

 [View a video of how to remove and replace the duplex sensor and loop sensor.](#)

Mean time to repair: 10 minutes

Service level: Intermediate

 **IMPORTANT:** When applicable, special installation instructions are provided for an assembly at the end of the removal procedure. Always completely read the removal instructions and follow all special installation instructions.

Before performing service

- Disconnect the power cable.

Use the table below to identify the correct part number for your printer. To order the part, go to <https://parts.hp.com>

Table 2-66 Part information

Part number	Part description
0604-001393	Duplex sensor and loop sensor

Required tools

- #2 JIS screwdriver with a magnetic tip

After performing service

Turn the printer power on

- Connect the power cable.
- Use the power switch to turn the power on.

Post service test

Verify that the document was copied, scanned, or printed correctly.

1. Remove the right door.

 **NOTE:** Remove second exit drive if installed.

- a. Remove three screws, and then remove the right-rear cover.

Figure 2-277 Remove the right-rear cover



- b. Disconnect the right door connector.

Figure 2-278 Disconnect right door connector



- c. Release the right hinge (1).

⚠ CAUTION: The right hinge spring tension can be dangerous. Use caution when releasing the right hinge to avoid injury.

Figure 2-279 Release right hinge

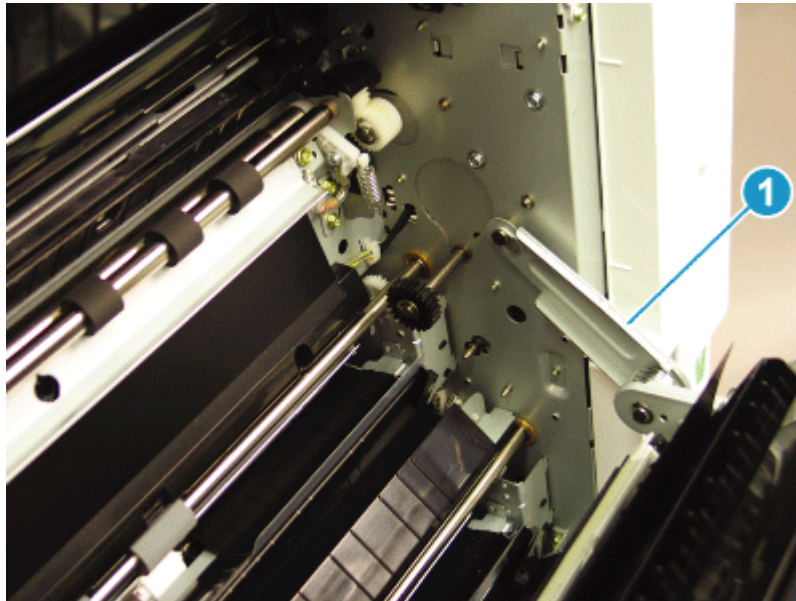

- d. Release the left dampener (1).

Figure 2-280 Release left dampener

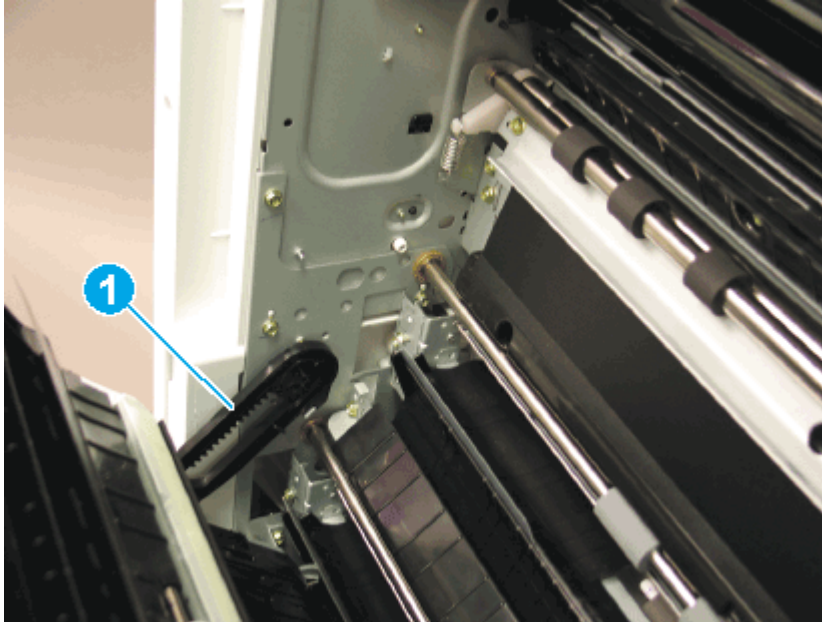

- e. Remove the right door.

 **NOTE:** Open the lower access door. If there is an HCI or 2x520 input device, release the dampener to clear the lower right door. Remove clockwise.

Figure 2-281 Remove right door



2. Remove the duplex sensor and loop sensor.
 - a. Push down on the transfer roller assembly at the front to release one tab. Move the transfer roller assembly slightly toward the back, and then release one tab. Rotate the transfer roller assembly outward to remove it.

Figure 2-282 Remove transfer roller assembly

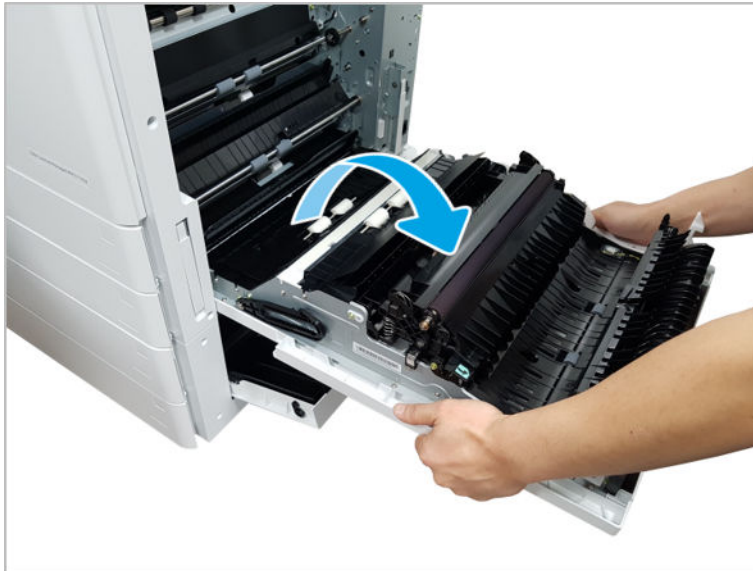
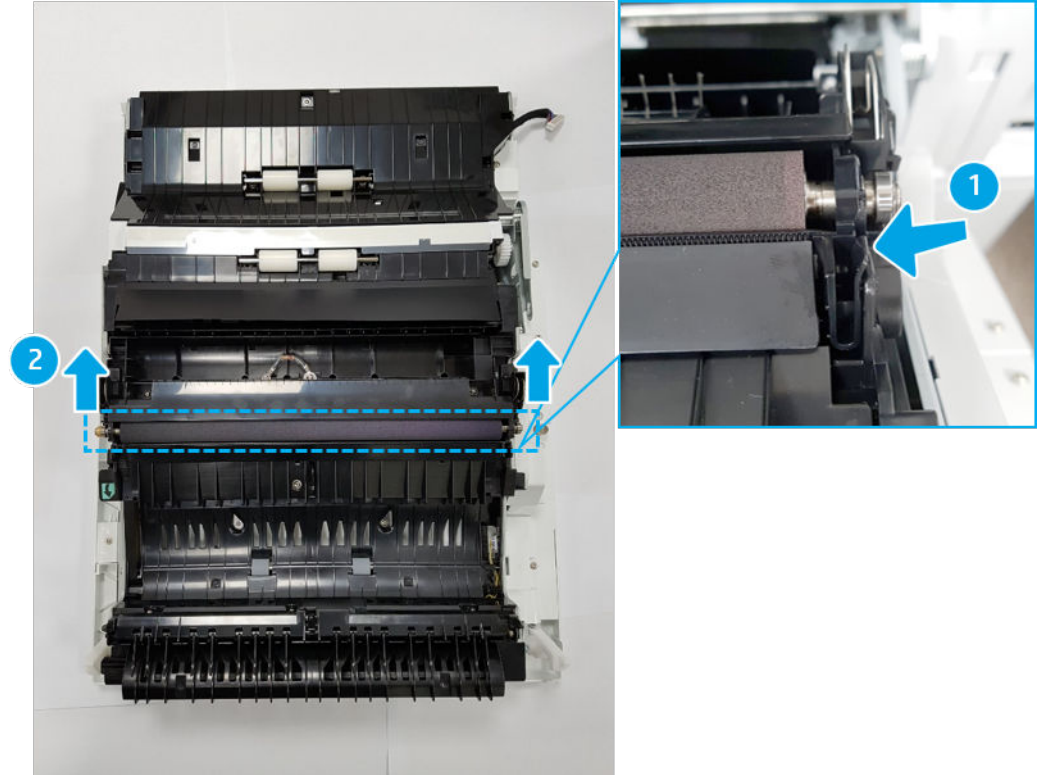

- b. Remove one screw. Unlock both sides cover lock. Turn over the guide-transfer roller upper.

Figure 2-283 Remove screw and turn over guide-transfer roller upper

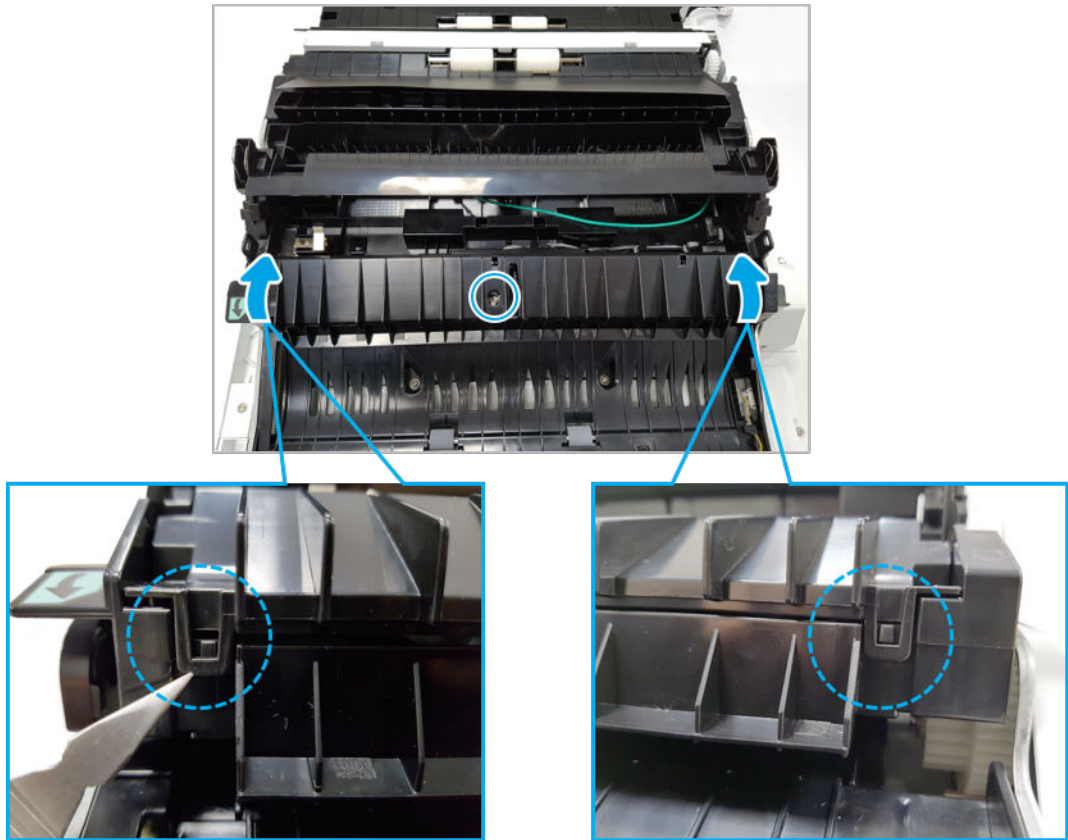

- c. Remove two screws, and then remove the sensor holder.

Figure 2-284 Remove the sensor holder

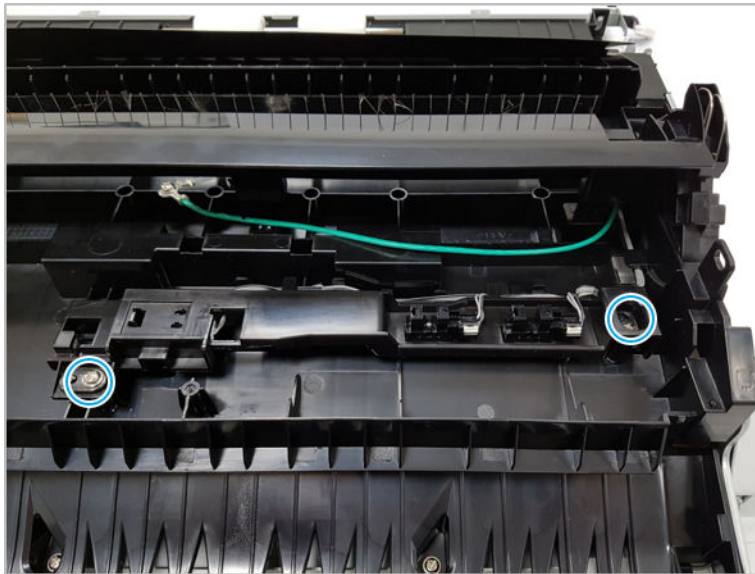

- d. Remove the duplex sensor (A) and loop sensor (B). To remove the sensors, pinch the tabs and push to release the sensors. Use caution while handling the plastic snaps as they can become damaged when handled with force.

Figure 2-285 Remove duplex and loop sensors

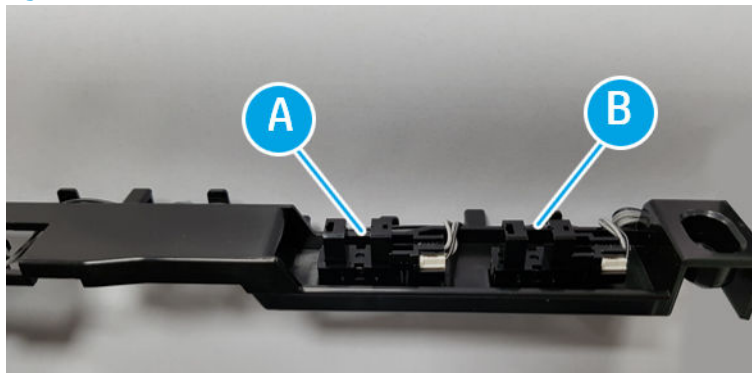

3. Unpack the replacement assembly.

- a. Dispose of the defective part.



NOTE: HP recommends responsible disposal of the defective part.

<http://www8.hp.com/us/en/hp-information/environment/product-recycling.html>

- b. Unpack the replacement part from the packaging.



CAUTION:  Some parts are sensitive to electrostatic discharge (ESD). Always perform service work at an ESD-protected workstation or mat. If an ESD workstation or mat is not available, touch the sheet-metal chassis to provide a static ground before touching an ESD-sensitive assembly. Protect the ESD-sensitive assemblies by placing them in ESD pouches when they are out of the printer.

If the replacement part is a roller or pad, avoid touching the spongy part of it. Skin oils on the roller or pad can cause paper pickup and/or print-quality problems. HP recommends using disposable gloves when handling rollers or pads or washing your hands before touching rollers or pads.



IMPORTANT: Make sure that all of the shipping materials (for example shipping tape) are removed from the replacement part prior to installation.

- c. To install an assembly, reverse the removal steps.



NOTE: When applicable, special installation instructions are provided for an assembly at the end of the removal procedure. Always completely read the removal instructions and follow all special installation instructions.

Scanner assembly

View scanner assembly exploded view, parts list, and repair procedures.

Scanner assembly

Figure 2-286 Scanner assembly

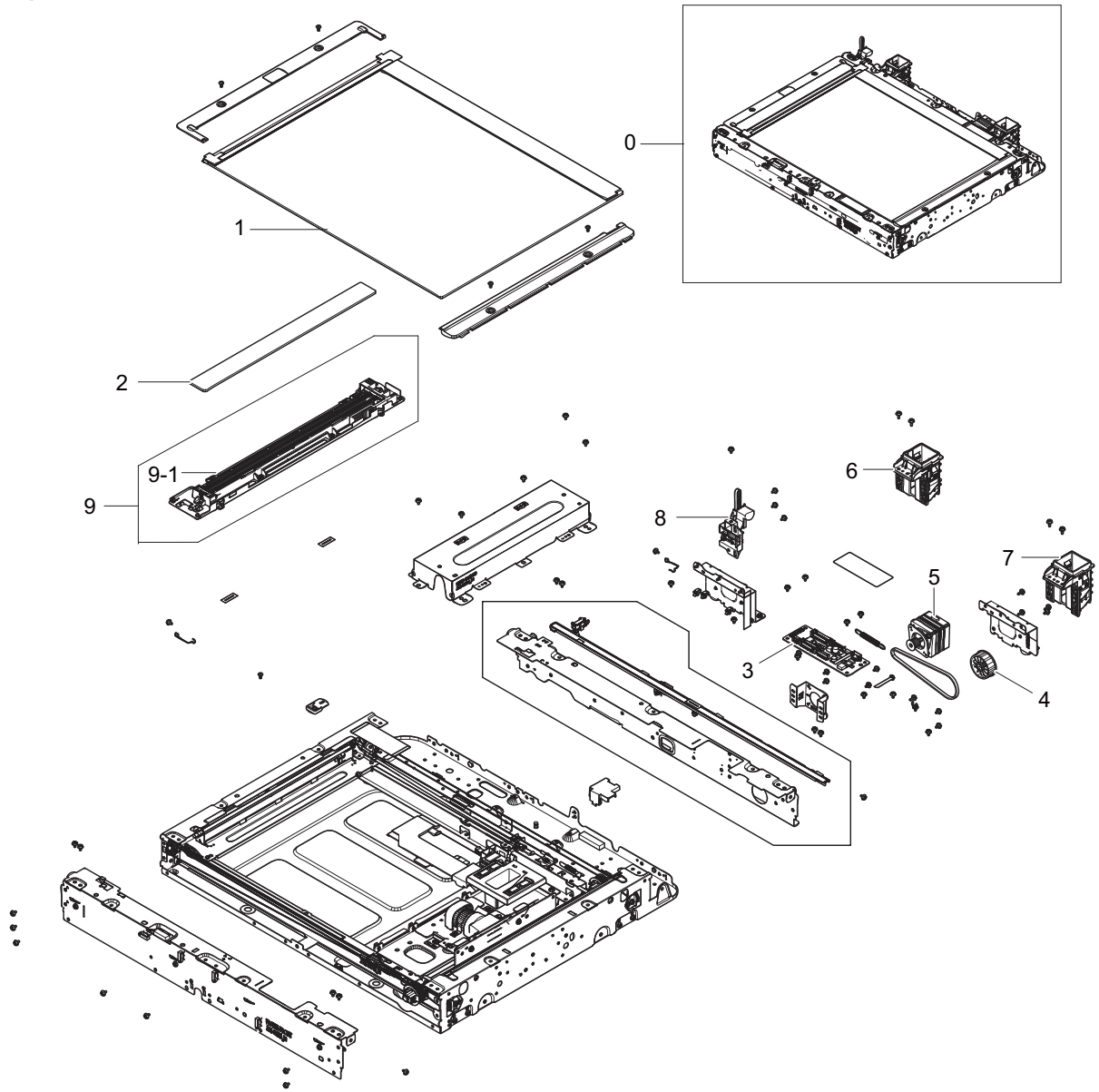

Table 2-67 Scanner assembly

Ref	Description	Part Number (*)	Qty
0	Scanner assembly	JC97-05115A (*)	1
1	Scanner glass, large	JC97-05126A (*)	1
2	ADF tempered glass, small	JC01-00101A (*)	1

Table 2-67 Scanner assembly (continued)

Ref	Description	Part Number (*)	Qty
3	PCA, scanner joint	JC92-02781A (*)	1
4	Belt pulley	JC66-02257A	1
5	Motor, scanner	JC31-00158A (*)	1
6	Hinge, scanner left	JC97-04736A	1
7	Hinge, scanner right	JC97-04737A	1
8	Scanner open sensor	JC97-04516A (*)	1
9	FR carriage assembly	JC97-04510A (*)	1
9-1	Lamp, scanner	JC97-04521A (*)	1
Not shown	Auto adjustment chart A3 Ver1.0	JC81-09891A (*)	1

* This part is in ordering system. If the ordering system has this part in stock, it can be ordered.

HP Color LaserJet Managed MFP E77422, E77428, E78223, and E78228 - Removal and replacement: Scanner whole unit for control panel assembly (dn models only)

This document provides the procedures to remove the scanner whole unit.

To view a short video of this procedure, click the link below.



[View a video of how to remove and replace the scanner whole unit.](#)

Mean time to repair: 20 minutes

Service level: Advanced



IMPORTANT: When applicable, special installation instructions are provided for an assembly at the end of the removal procedure. Always completely read the removal instructions and follow all special installation instructions.

Before performing service

- Disconnect the power cable.

Use the table below to identify the correct part number for your printer. To order the part, go to <https://parts.hp.com>

Table 2-68 Part information

Part number	Part description
JC97-05115A	Scanner whole unit

Required tools

- #2 JIS screwdriver with a magnetic tip

After performing service

Turn the printer power on

- Connect the power cable.
- Use the power switch to turn the power on.

Post service test

Copy, scan, or print a document. Verify the document copies, scans, or prints correctly.

1. Remove the rear covers.
 - a. Unscrew two captive thumbscrews on the formatter cover. Slide the formatter cover to the left, and then to the right to remove.

Figure 2-287 Remove the formatter cover

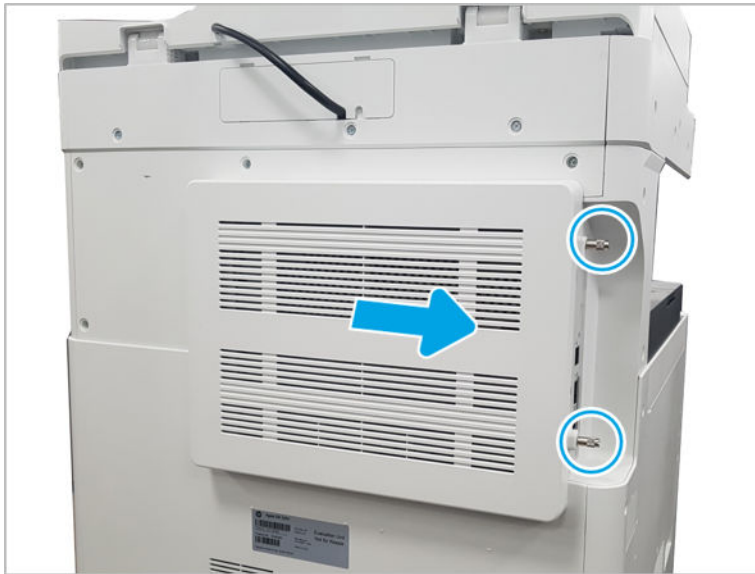

- b. Remove thirteen screws, and then remove the rear-bottom cover and rear-top cover.

Figure 2-288 Remove the rear-bottom cover and rear-top cover



- 2. Disconnect the scanner cables.
 - a. Remove two screw-caps and three screws, and then remove the left-upper cover.

Figure 2-289 Remove the left-upper cover

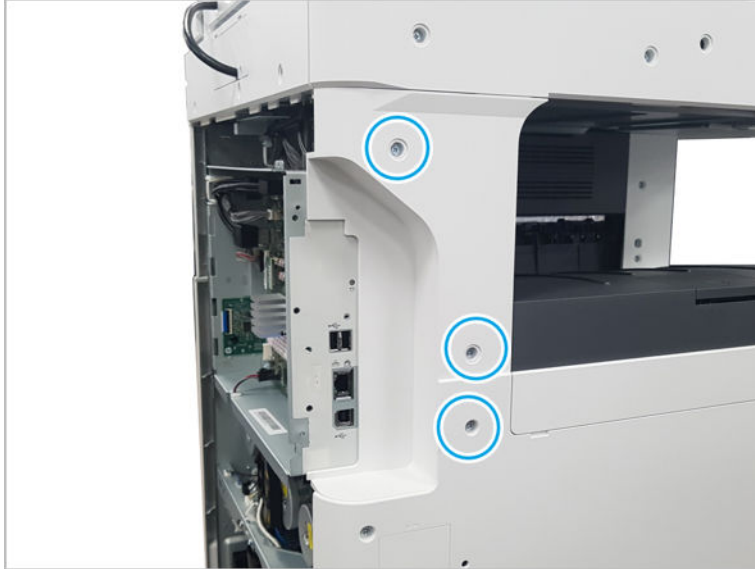

- b. Remove one screw from the side of the formatter cage (beneath the left-upper cover location).

Figure 2-290 Remove the formatter cage side screw



- c. Disconnect all connectors on the formatter PCA and two cable restraints.

- d. Remove three screws from the formatter cage face, and then release one tab to remove the formatter cage.

Figure 2-291 Remove three screws to remove the formatter cage

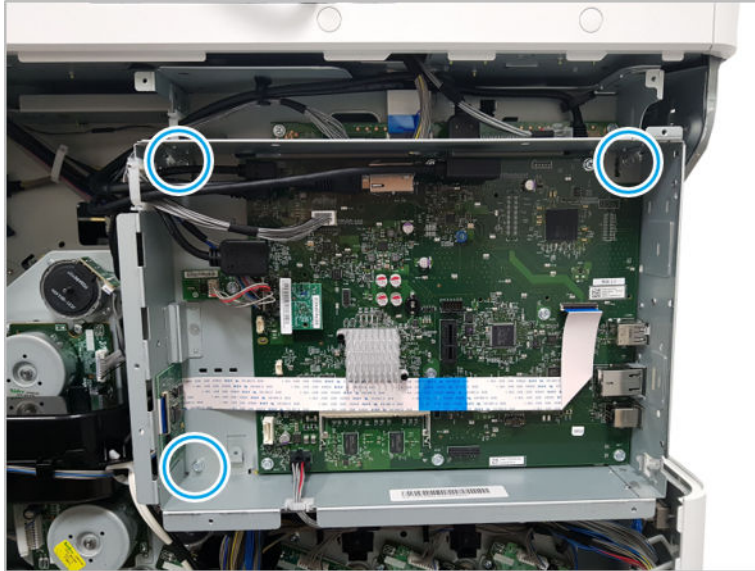

3. Disconnect two connectors and one flexible flat cable.

Figure 2-292 Disconnect scanner connectors

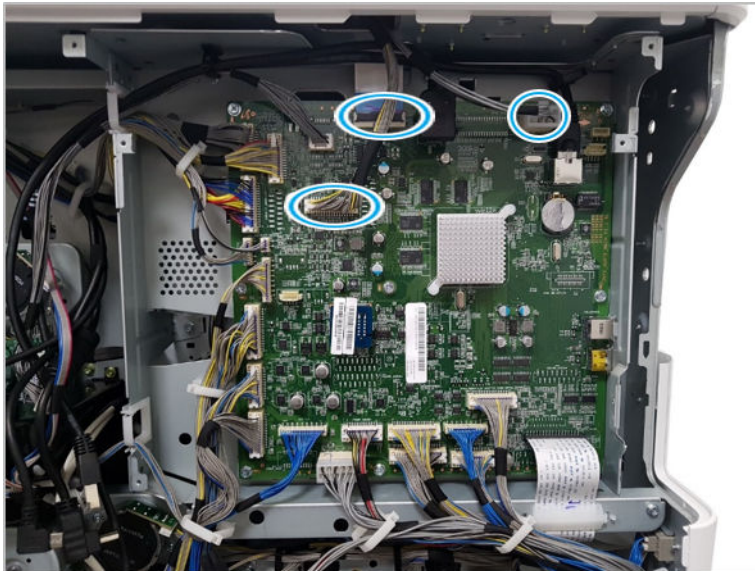

4. Remove the ADF unit.
 - a. Remove the ADF connector cover.

Figure 2-293 Remove ADF connector cover



- b. Disconnect the ADF harness from the scan joint board. Remove one connector and one grounding wire.

Figure 2-294 Disconnect ADF harness

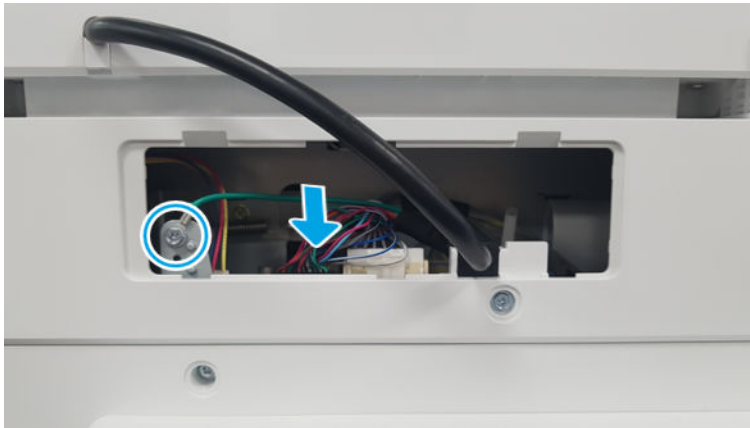

- c. Pull back and then lift up to release the ADF unit.

Figure 2-295 Release the ADF



5. Remove the control panel bezel.
 - a. Open the ADF. Remove the wireless LAN cover. And then, remove four screws.

Figure 2-296 Remove the ADF bezel



- b. Place the control panel in the upright position.
 - c. Gently pry the control panel bezel from the center screw hole, and then pry from the center of the control panel bezel to the edges to release.

CAUTION: Do not pry against the scanner glass when removing the control panel bezel.

6. Remove the control panel bottom cover.
 - a. Remove one screw.

Figure 2-297 Remove one screw



- b. Push up the control panel assembly to release it from its holder.

Figure 2-298 Release the control panel assembly



- c. Disconnect one connector and one cable(1).

Figure 2-299 Disconnect connectors

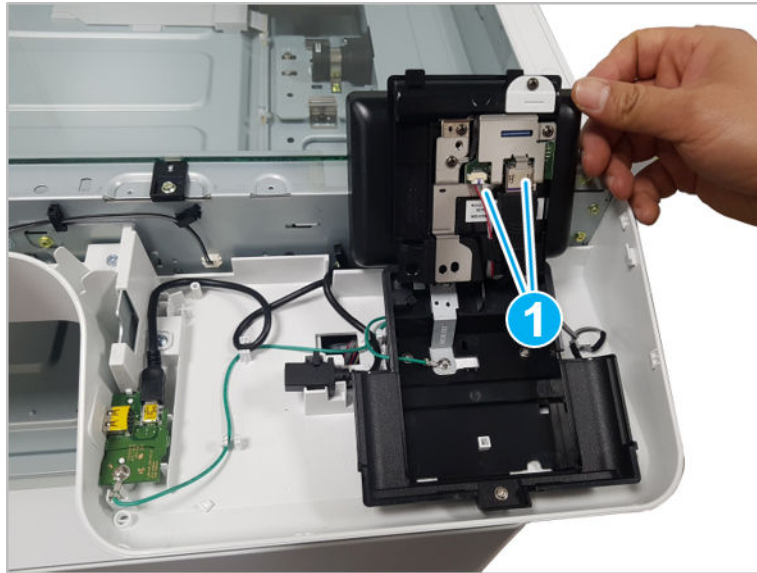

- d. Remove four screws, and then remove the control panel assembly holder.

Figure 2-300 Remove the control panel assembly holder

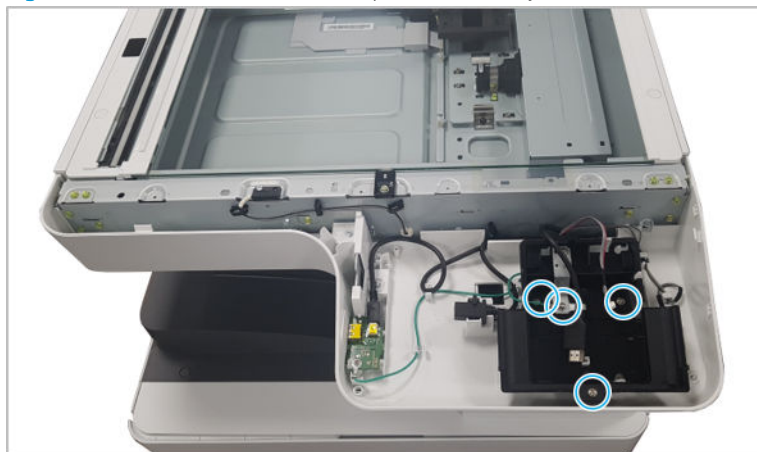

- e. Remove the humidity sensor. Disconnect one cable and release all wires. Remove six screws. And, remove the control panel bottom cover.

Figure 2-301 Remove the control panel assembly holder



- 7. Remove the scanner whole unit.
 - a. Remove four screws, and then remove the bracket.

 **NOTE:** Install this on the replacement scanner whole unit.

Figure 2-302 Remove the bracket



- b. Remove three screw-caps and six screws. Release the rear scanner cover.

Figure 2-303 Release the rear scanner cover

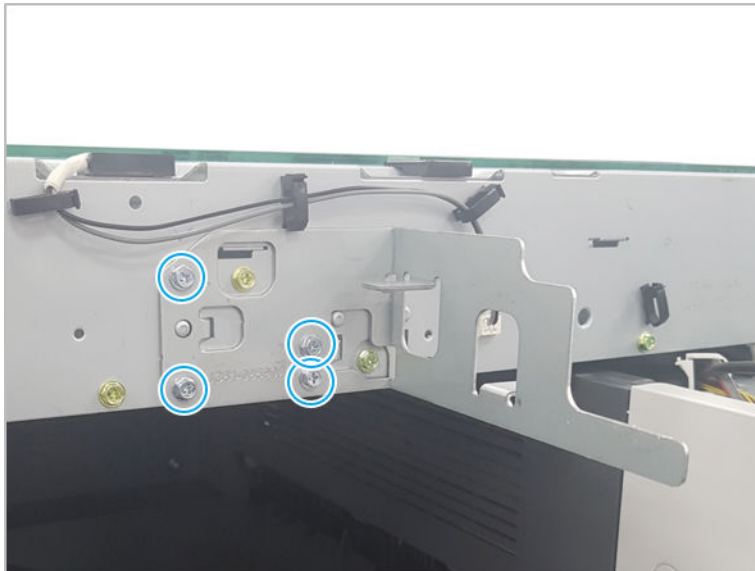
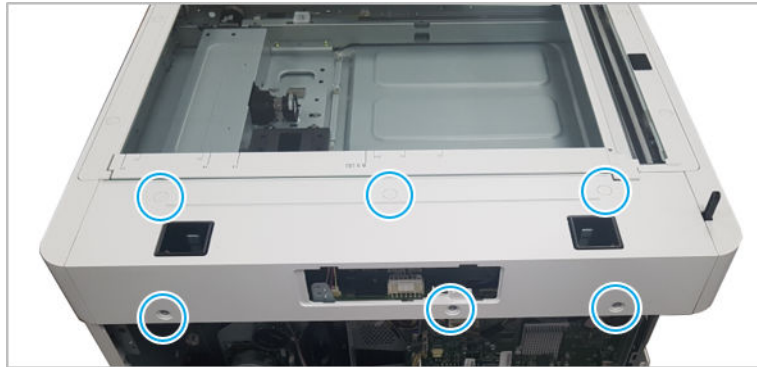

- c. Remove three screws. Release the left scanner cover.

Figure 2-304 Release the left scanner cover



- d. Remove three screws. Release the right scanner cover.

Figure 2-305 Release the right scanner cover

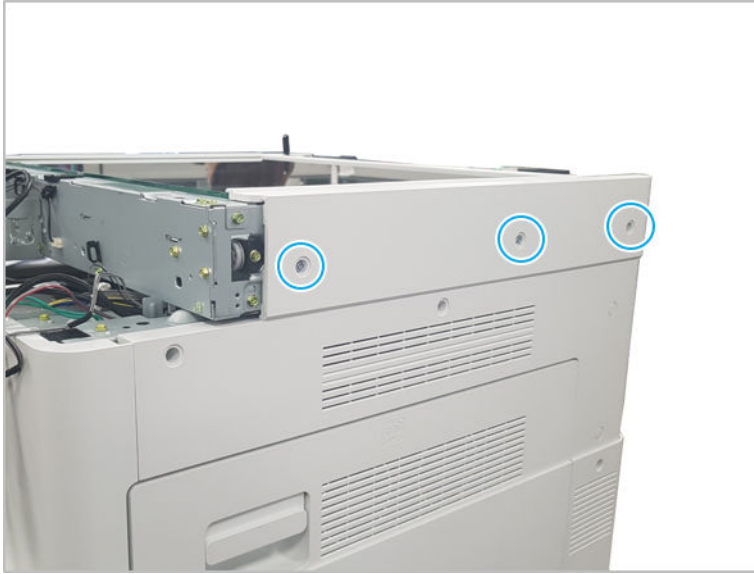

- e. Remove two screws.

Figure 2-306 Remove two screws



- f. Remove three screws.

Figure 2-307 Remove three screws

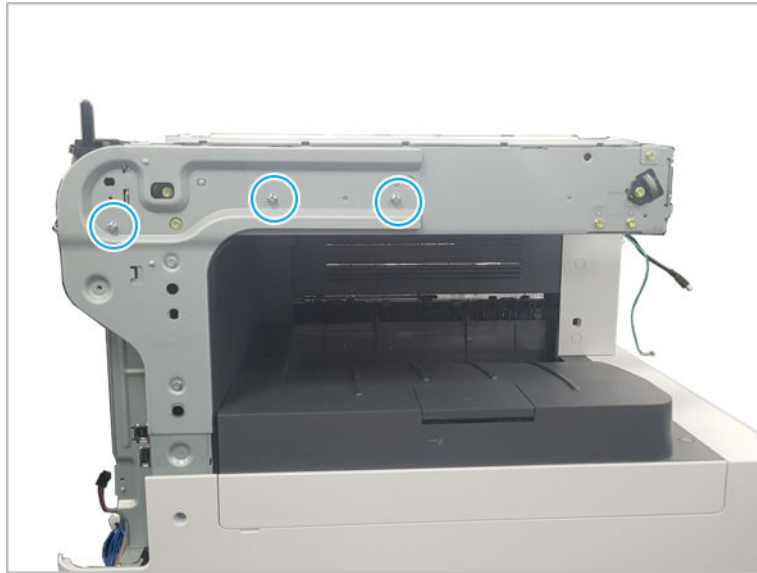

- g. Lift the scanner whole unit straight up and off of the printer to remove it.

Figure 2-308 Remove the scanner whole unit

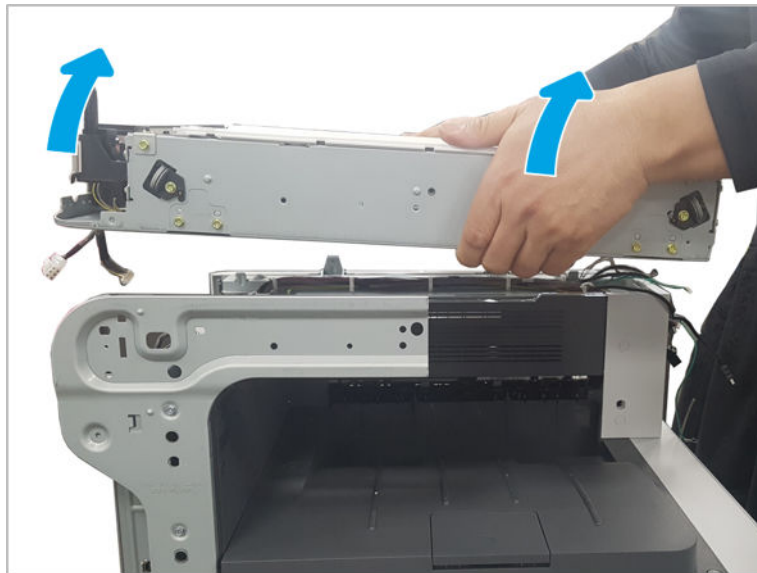



- 8. Unpack the replacement assembly.
 - a. Dispose of the defective part.

 **NOTE:** HP recommends responsible disposal of the defective part.

<http://www8.hp.com/us/en/hp-information/environment/product-recycling.html>

b. Unpack the replacement part from the packaging.

 **CAUTION:**  Some parts are sensitive to electrostatic discharge (ESD). Always perform service work at an ESD-protected workstation or mat. If an ESD workstation or mat is not available, touch the sheet-metal chassis to provide a static ground before touching an ESD-sensitive assembly. Protect the ESD-sensitive assemblies by placing them in ESD pouches when they are out of the printer.

If the replacement part is a roller or pad, avoid touching the spongy part of it. Skin oils on the roller or pad can cause paper pickup and/or print-quality problems. HP recommends using disposable gloves when handling rollers or pads or washing your hands before touching rollers or pads.

 **IMPORTANT:** Make sure that all of the shipping materials (for example shipping tape) are removed from the replacement part prior to installation.

c. To install an assembly, reverse the removal steps.

 **NOTE:** When applicable, special installation instructions are provided for an assembly at the end of the removal procedure. Always completely read the removal instructions and follow all special installation instructions.

HP Color LaserJet Managed MFP E77422, E77428, E78223, and E78228 - Removal and replacement: Scanner whole unit for control panel assembly (a,dv models only)

Follow these steps to remove the scanner whole unit.

Mean time to repair: 20 minutes

Service level: Advanced

 **IMPORTANT:** When applicable, special installation instructions are provided for an assembly at the end of the removal procedure. Always completely read the removal instructions and follow all special installation instructions.

Before performing service

- Disconnect the power cable.

Use the table below to identify the correct part number for your printer. To order the part, go to <https://parts.hp.com>

Table 2-69 Part information

Part number	Part description
JC97-05115A	Scanner whole unit

Required tools

- #2 JIS screwdriver with a magnetic tip

After performing service

Turn the printer power on

- Connect the power cable.
- Use the power switch to turn the power on.

Post service test

Verify that the document was copied, scanned, or printed correctly.

1. Remove the rear covers.
 - a. Unscrew two captive thumbscrews on the formatter cover. Slide the formatter cover to the left, and then to the right to remove.

Figure 2-309 Remove the formatter cover

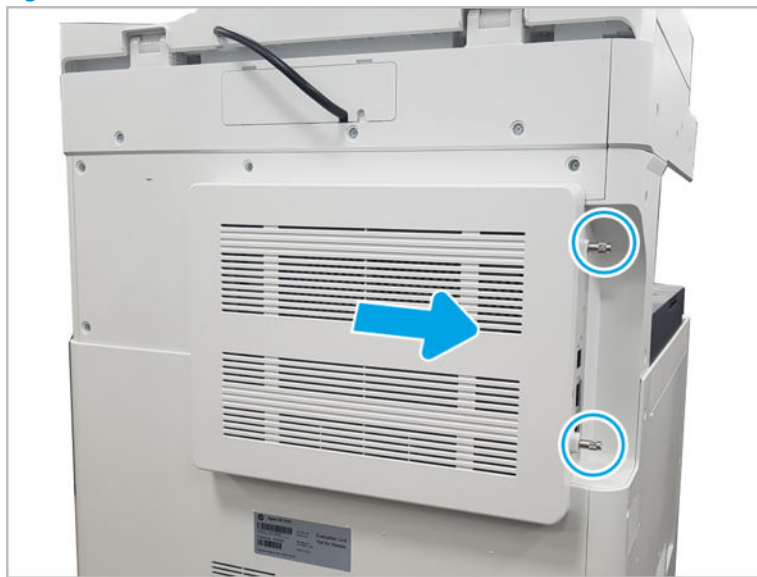
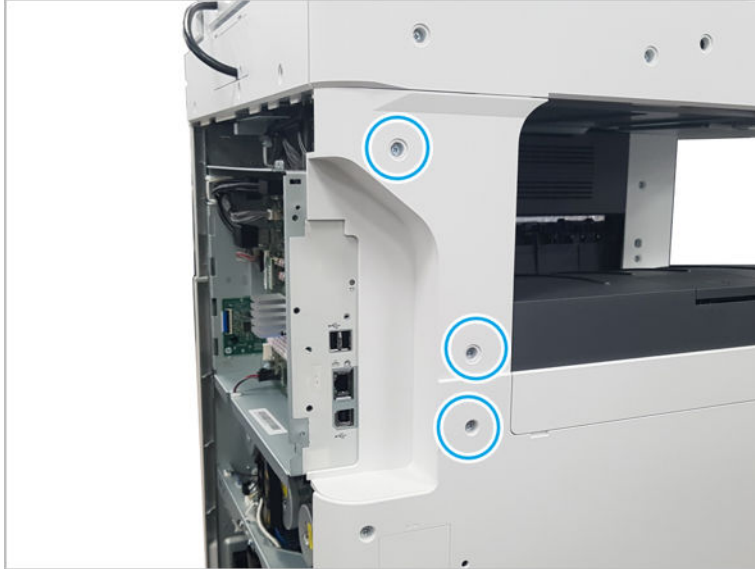

Figure 2-311 Remove the left-upper cover



- b. Remove one screw from the side of the formatter cage (beneath the left-upper cover location).

Figure 2-312 Remove the formatter cage side screw



- c. Disconnect all connectors on the formatter PCA and two cable restraints.

- d. Remove three screws from the formatter cage face, and then release one tab to remove the formatter cage.

Figure 2-313 Remove three screws to remove the formatter cage

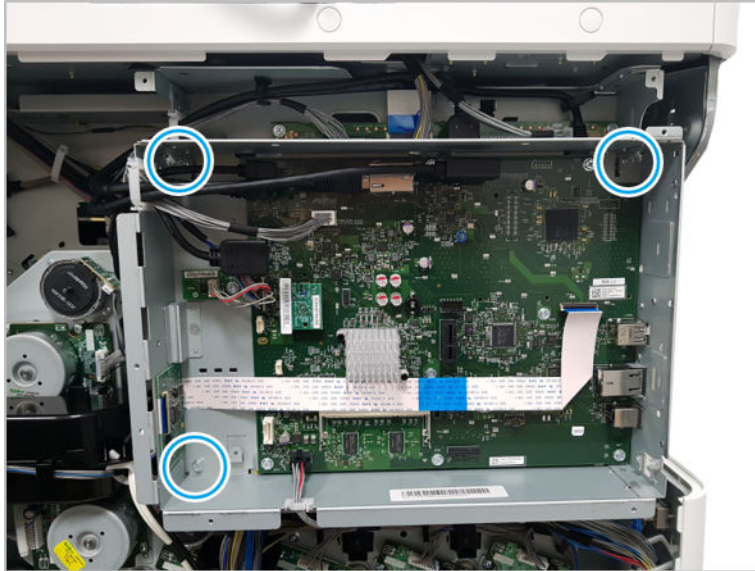

3. Disconnect two connectors and one FFC.

Figure 2-314 Disconnect scanner connectors

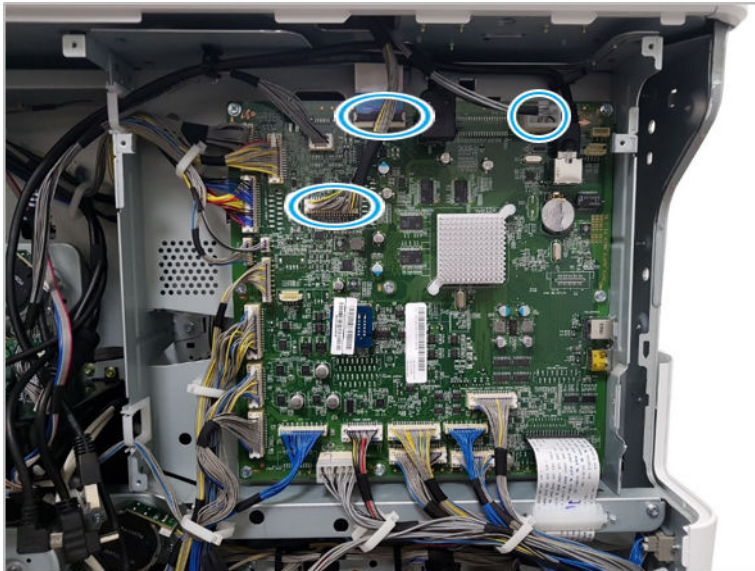

4. Remove the ADF unit.
 - a. Remove the ADF connector cover.

Figure 2-315 Remove ADF connector cover

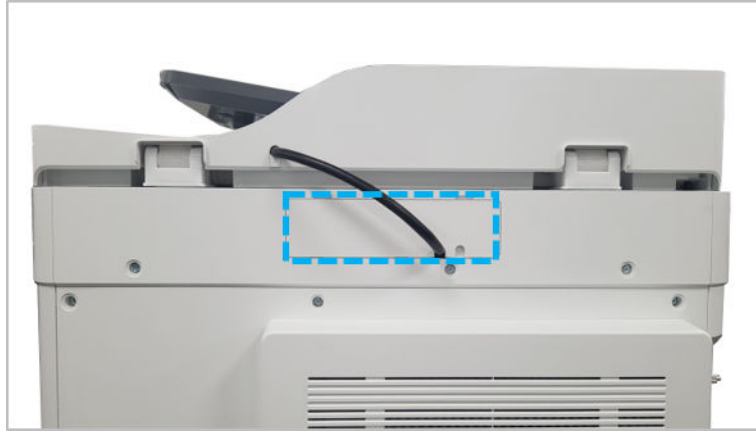

- b. Disconnect the document feeder harness from the scan joint board. Remove one connector and one grounding wire.

Figure 2-316 Disconnect ADF harness

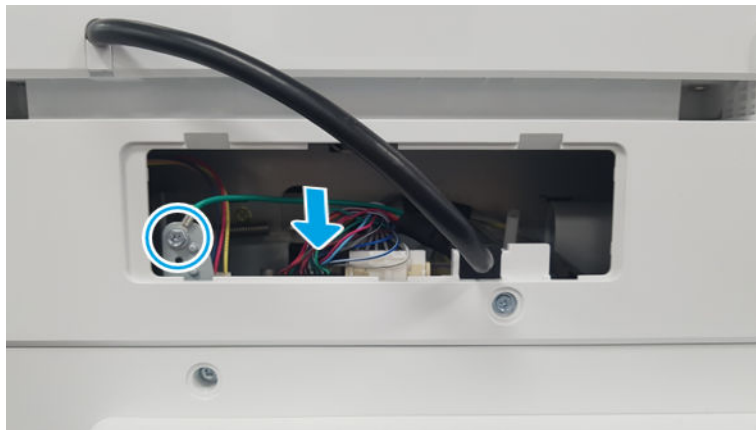

- c. Pull back and then lift up to release the ADF unit.

Figure 2-317 Release the document feeder



5. Remove the control-panel bezel.
 - a. Open the ADF, and then remove three screws.

Figure 2-318 Remove the ADF bezel



- b. Place the control panel in the upright position.
 - c. Gently pry the control panel bezel from the center screw hole, and then pry from the center of the control panel bezel to the edges to release.

⚠ CAUTION: Do not pry against the scanner glass when removing the control panel bezel.

6. Remove the control panel assembly.
 - a. Place the control panel in the upright position.

- b. Disconnect one USB interconnect cable, one connector, and one HDMI connector (1), and then remove two screws on the control panel frame.

Figure 2-319 Remove the control panel screws and disconnect connectors

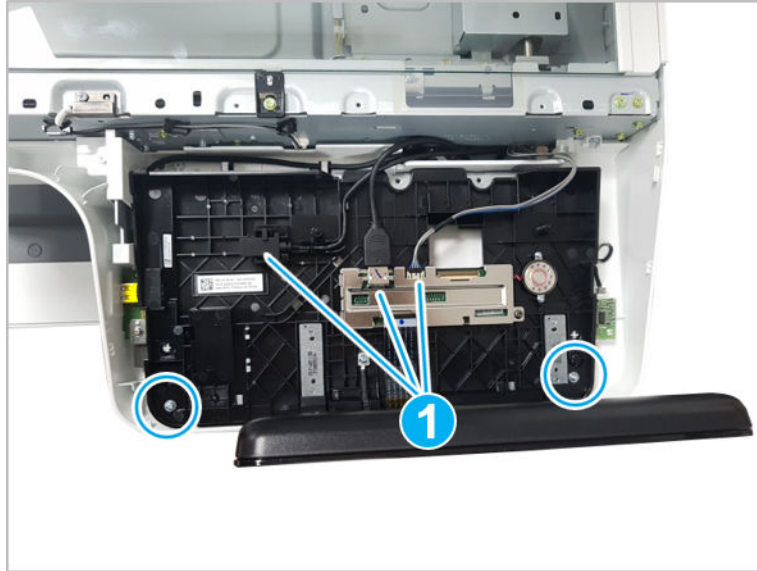

- c. Lift the control panel up from the front to release the tabs at the rear, and then remove the control panel.

 **TIP:** Align the four tabs at the rear of control panel, and then snap in the control panel.

- d. Remove the humidity sensor. Disconnect one cable. Remove six screws. And, remove the control panel bottom cover.

Figure 2-320 Remove the control panel bottom cover screws and disconnect connectors

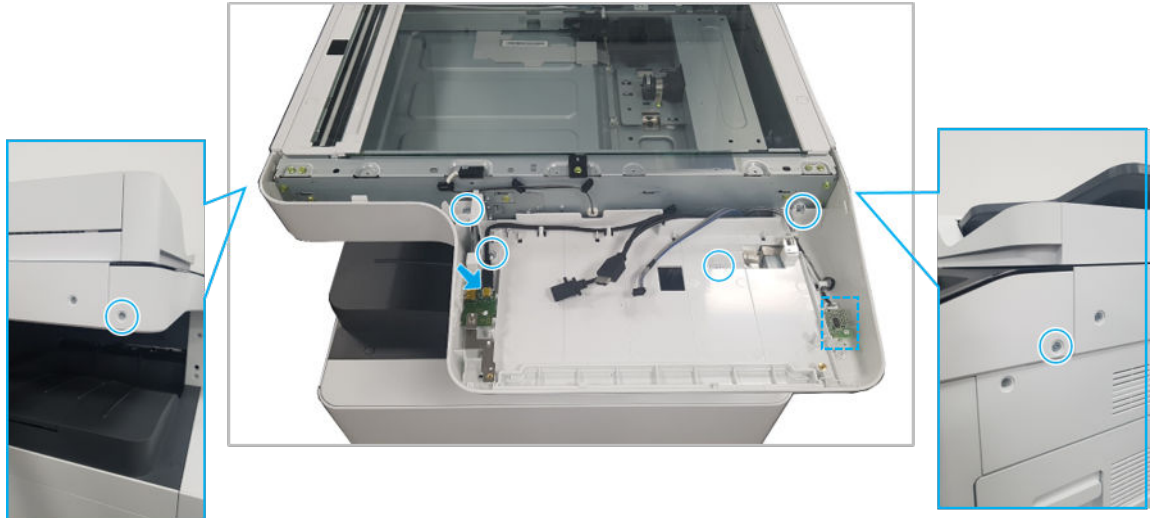

- 7. Remove the scanner whole unit.

- a. Remove four screws, and then remove the bracket.

 **NOTE:** Install this on the replacement scanner whole unit.

Figure 2-321 Remove the bracket



- b. Remove three screw-caps and six screws. Release the rear scanner cover.

Figure 2-322 Release the rear scanner cover

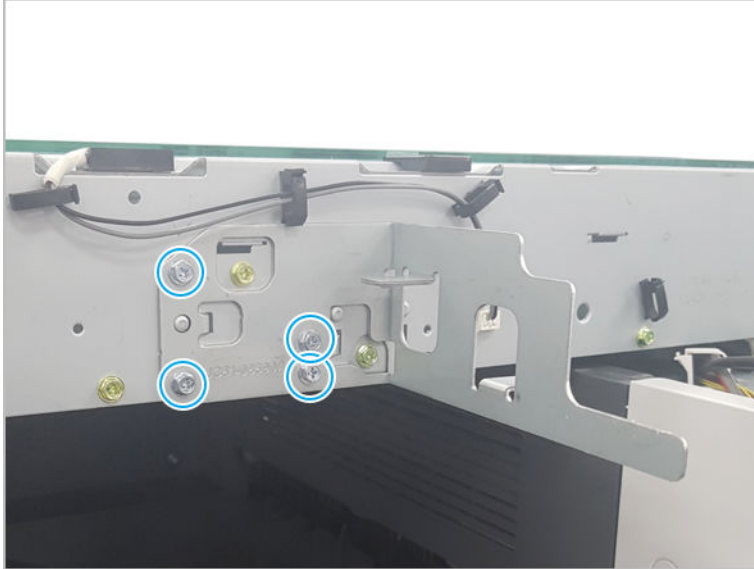
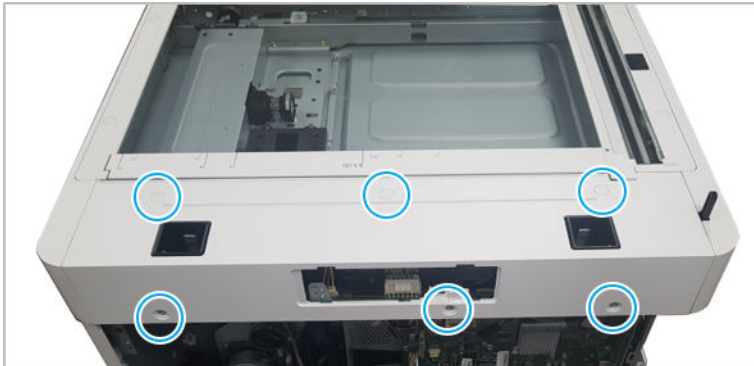

- c. Remove three screws. Release the left scanner cover.

Figure 2-323 Release the left scanner cover



- d. Remove three screws. Release the right scanner cover.

Figure 2-324 Release the right scanner cover



- e. Remove two screws.

Figure 2-325 Remove two screws

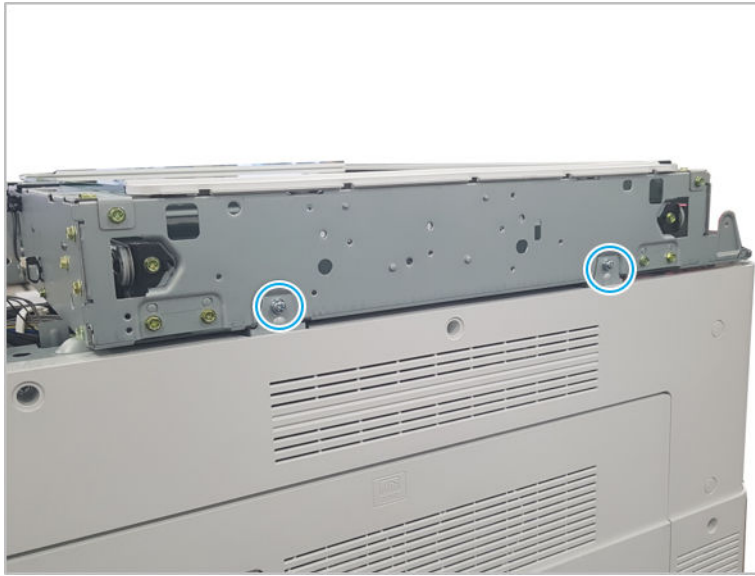

- f. Remove three screws.

Figure 2-326 Remove three screws

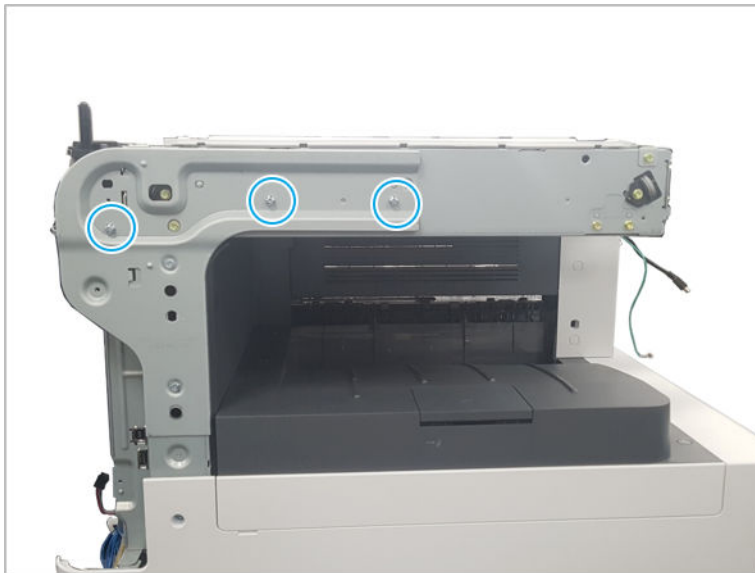

- g. Lift the scanner whole unit straight up and off of the printer to remove it.

Figure 2-327 Remove the scanner whole unit

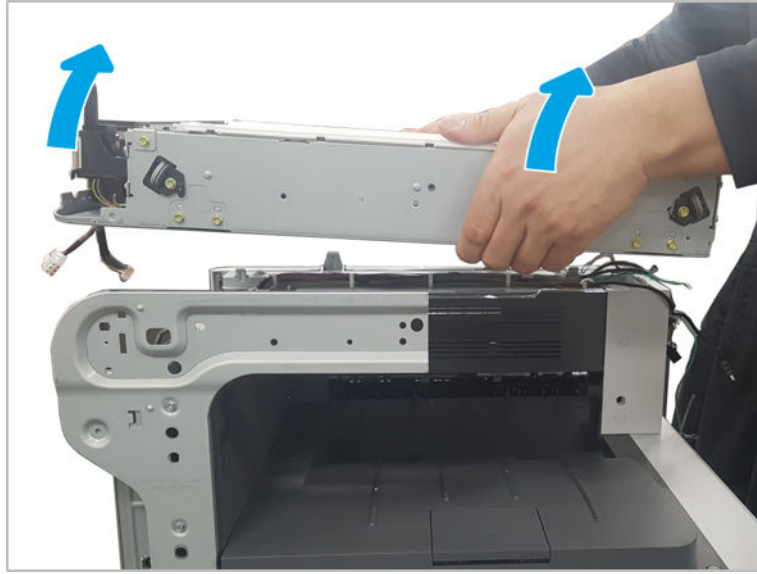

- 8. Unpack the replacement assembly.

- a. Dispose of the defective part.



NOTE: HP recommends responsible disposal of the defective part.

<http://www8.hp.com/us/en/hp-information/environment/product-recycling.html>

- b. Unpack the replacement part from the packaging.



CAUTION:



Some parts are sensitive to electrostatic discharge (ESD). Always perform service work at an ESD-protected workstation or mat. If an ESD workstation or mat is not available, touch the sheet-metal chassis to provide a static ground before touching an ESD-sensitive assembly. Protect the ESD-sensitive assemblies by placing them in ESD pouches when they are out of the printer.

If the replacement part is a roller or pad, avoid touching the spongy part of it. Skin oils on the roller or pad can cause paper pickup and/or print-quality problems. HP recommends using disposable gloves when handling rollers or pads or washing your hands before touching rollers or pads.



IMPORTANT: Make sure that all of the shipping materials (for example shipping tape) are removed from the replacement part prior to installation.

- c. To install an assembly, reverse the removal steps.



NOTE: When applicable, special installation instructions are provided for an assembly at the end of the removal procedure. Always completely read the removal instructions and follow all special installation instructions.

HP LaserJet Managed MFP E72425, E72430, E77422, E77428, E78223, E78228 - Removal and replacement: Scanner Glass

Follow these steps to remove the scanner glass.

To view a short video of this procedure, click the link below.

 [View a video of how to remove and replace the scanner glass.](#)

Mean time to repair: 1 minutes

Service level: Advanced

 **IMPORTANT:** When applicable, special installation instructions are provided for an assembly at the end of the removal procedure. Always completely read the removal instructions and follow all special installation instructions.

Before performing service

- Disconnect the power cable.

Use the table below to identify the correct part number for your printer. To order the part, go to <https://parts.hp.com>

Table 2-70 Part information

Part number	Part description
JC97-05126A	Scanner glass, large

Required tools

- #2 JIS screwdriver with a magnetic tip

After performing service

Turn the printer power on

- Connect the power cable.
- Use the power switch to turn the power on.

Post service test

Verify that the document was copied, scanned, or printed correctly.

1. Remove the scanner glass.
 - a. Open the ADF, and then remove two screws.

Figure 2-328 Remove scanner glass

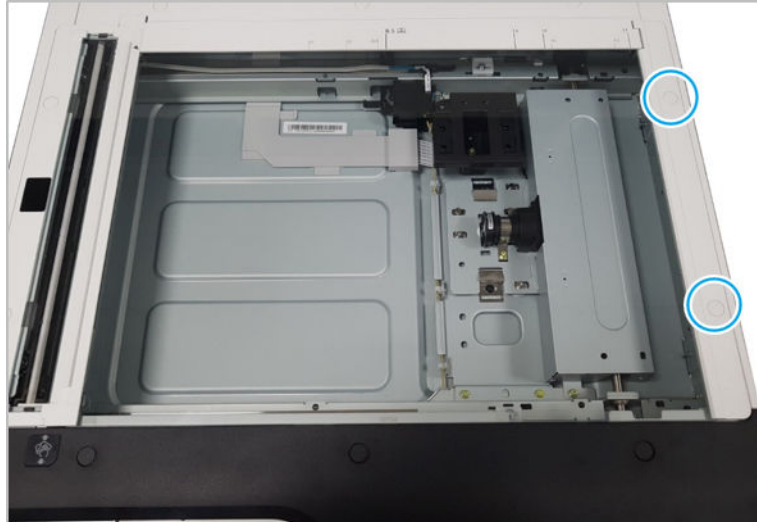

- b. Slide the scanner glass to the right to remove it.

Figure 2-329 Remove scanner glass

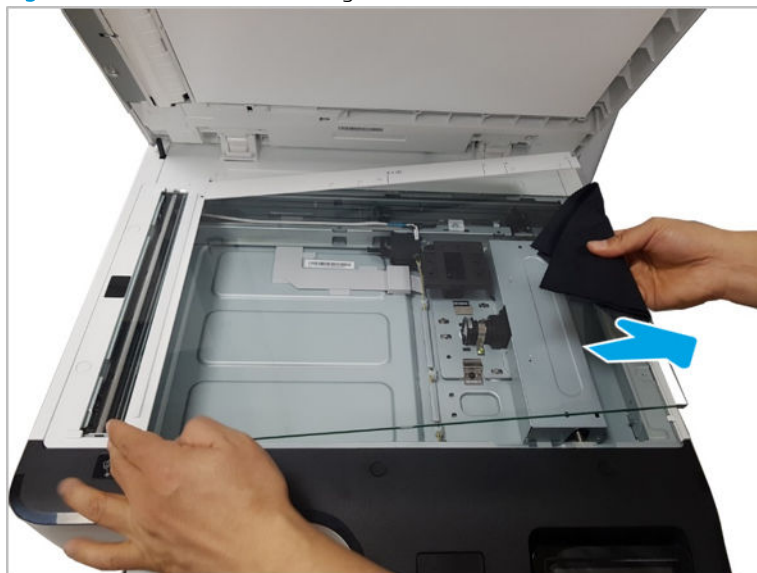



- 2. Unpack the replacement assembly.
 - a. Dispose of the defective part.

 **NOTE:** HP recommends responsible disposal of the defective part.

<http://www8.hp.com/us/en/hp-information/environment/product-recycling.html>

- b. Unpack the replacement part from the packaging.

 **CAUTION:**  Some parts are sensitive to electrostatic discharge (ESD). Always perform service work at an ESD-protected workstation or mat. If an ESD workstation or mat is not available, touch the sheet-metal chassis to provide a static ground before touching an ESD-sensitive assembly. Protect the ESD-sensitive assemblies by placing them in ESD pouches when they are out of the printer.

If the replacement part is a roller or pad, avoid touching the spongy part of it. Skin oils on the roller or pad can cause paper pickup and/or print-quality problems. HP recommends using disposable gloves when handling rollers or pads or washing your hands before touching rollers or pads.

 **IMPORTANT:** Make sure that all of the shipping materials (for example shipping tape) are removed from the replacement part prior to installation.

- c. To install an assembly, reverse the removal steps.

 **NOTE:** When applicable, special installation instructions are provided for an assembly at the end of the removal procedure. Always completely read the removal instructions and follow all special installation instructions.

Scanner lower parts

Figure 2-330 Scanner lower parts

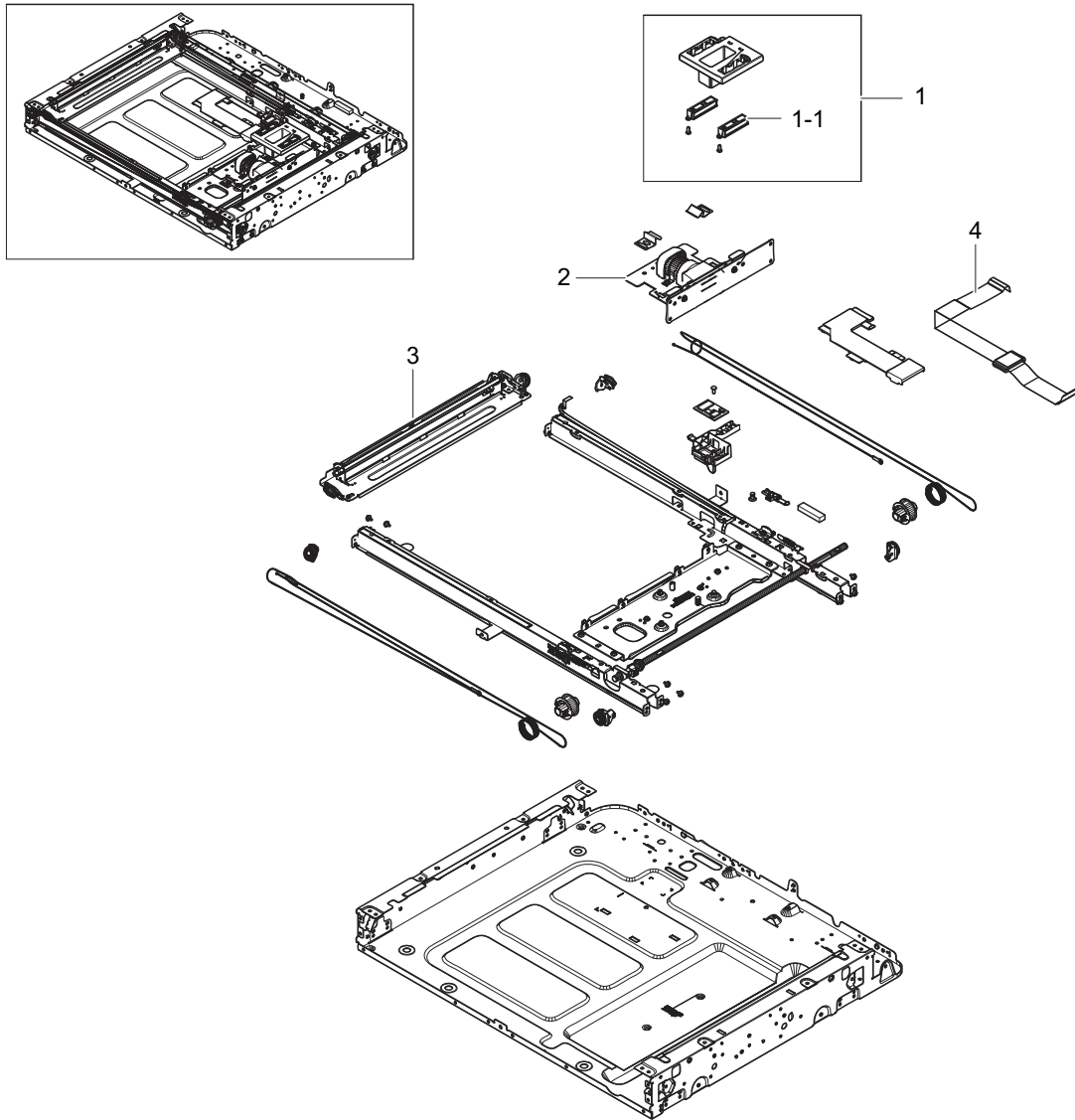

Table 2-71 Scanner lower parts

Ref	Description	Part Number (*)	Qty
1	Scanner APS sensor	JC97-04507A	1
1-1	Sensor, photo interrupter	0604-001453 (*)	2
2	Lens, scanner	JC97-04523B (*)	1
3	Scanner, HR carriage	JC97-04514A	1
4	Scanner, FFC	JC39-02119A	1

* This part is in ordering system. If the ordering system has this part in stock, it can be ordered.

HP LaserJet Managed MFP E72425, E72430, E77422, E77428, E78223, E78228 - Removal and replacement: Scanner imaging unit

Follow these steps to remove the scanner imaging unit.

To view a short video of this procedure, click the link below.



[View a video of how to remove and replace the scanner imaging unit.](#)

Mean time to repair: 3 minutes

Service level: Advanced



IMPORTANT: When applicable, special installation instructions are provided for an assembly at the end of the removal procedure. Always completely read the removal instructions and follow all special installation instructions.

Before performing service

- Disconnect the power cable.

Use the table below to identify the correct part number for your printer. To order the part, go to <https://parts.hp.com>

Table 2-72 Part information

Part number	Part description
JC97-04523B	Scanner imaging unit assembly

Required tools

- #2 JIS screwdriver with a magnetic tip

After performing service

Turn the printer power on

- Connect the power cable.
- Use the power switch to turn the power on.

Post service test

Verify that the document was copied, scanned, or printed correctly.

1. Remove the scanner glass.
 - a. Open the ADF. Remove two screws. And then, scan glass right cover.

Figure 2-331 Remove scan glass



- b. Slide the scanner glass to the right to remove it.

Figure 2-332 Remove scanner glass

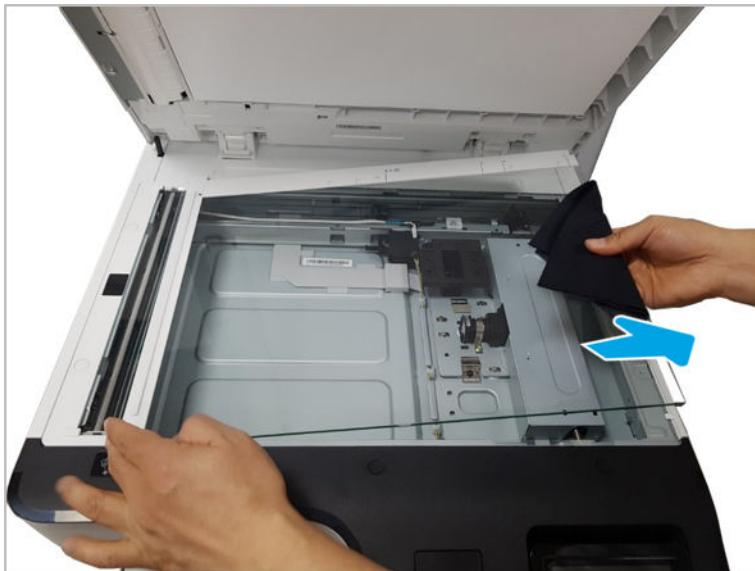

- 2. Remove the scanner imaging unit.
 - a. Remove five screws, and then release the imaging unit cover.

Figure 2-333 Remove screws and release imaging unit cover

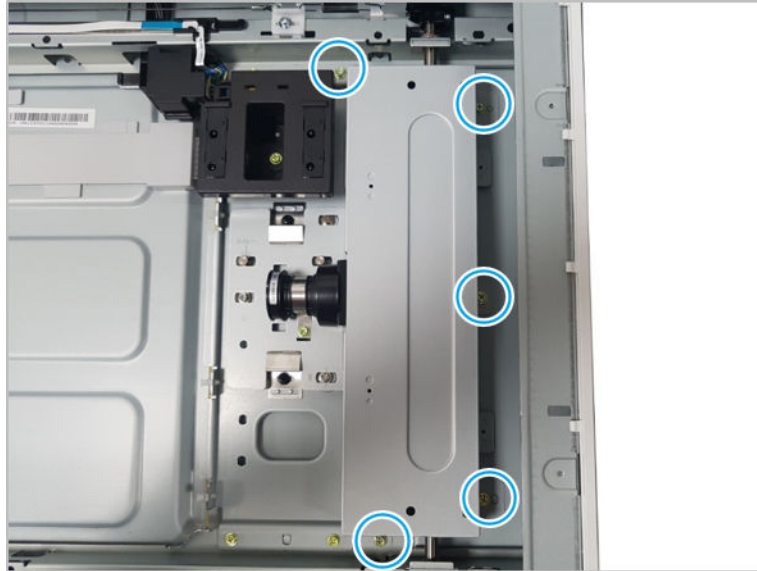

- b. Disconnect the FCC.

Figure 2-334 Disconnect FCC

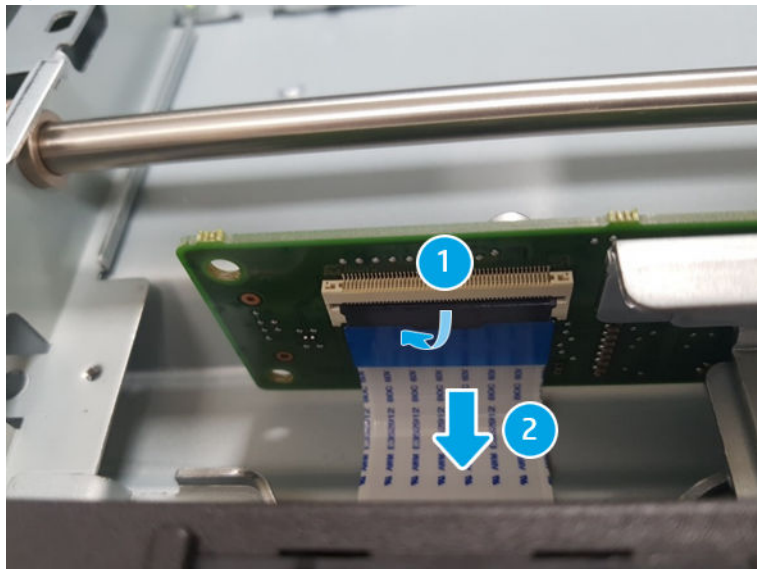

- c. Remove two screws and release the scanner imaging unit.

CAUTION: Do not remove or adjust the other two screws shown as they require factory setting only.

Figure 2-335 Remove screws and release scanner imaging unit



3. Unpack the replacement assembly.

- a. Dispose of the defective part.

NOTE: HP recommends responsible disposal of the defective part.

<http://www8.hp.com/us/en/hp-information/environment/product-recycling.html>

- b. Unpack the replacement part from the packaging.

CAUTION:  Some parts are sensitive to electrostatic discharge (ESD). Always perform service work at an ESD-protected workstation or mat. If an ESD workstation or mat is not available, touch the sheet-metal chassis to provide a static ground before touching an ESD-sensitive assembly. Protect the ESD-sensitive assemblies by placing them in ESD pouches when they are out of the printer.

If the replacement part is a roller or pad, avoid touching the spongy part of it. Skin oils on the roller or pad can cause paper pickup and/or print-quality problems. HP recommends using disposable gloves when handling rollers or pads or washing your hands before touching rollers or pads.

IMPORTANT:  Make sure that all of the shipping materials (for example shipping tape) are removed from the replacement part prior to installation.

- c. To install an assembly, reverse the removal steps.

NOTE:  When applicable, special installation instructions are provided for an assembly at the end of the removal procedure. Always completely read the removal instructions and follow all special installation instructions.

HP LaserJet Managed MFP E72425, E72430, E77422, E77428, E78223, E78228 - Removal and replacement: Scanner APS sensor

Follow these steps to remove the scanner APS sensor.

To view a short video of this procedure, click the link below.



[View a video of how to remove and replace the scanner APS sensor.](#)

Mean time to repair: 3 minutes

Service level: Advanced



IMPORTANT: When applicable, special installation instructions are provided for an assembly at the end of the removal procedure. Always completely read the removal instructions and follow all special installation instructions.

Before performing service

- Disconnect the power cable.

Use the table below to identify the correct part number for your printer. To order the part, go to <https://parts.hp.com>

Table 2-73 Part information

Part number	Part description
0604-001453	APS sensor

Required tools

- #2 JIS screwdriver with a magnetic tip

After performing service

Turn the printer power on

- Connect the power cable.
- Use the power switch to turn the power on.

Post service test

Verify that the document was copied, scanned, or printed correctly.

1. Remove the scanner glass.
 - a. Open the ADF. Remove two screws. And then, remove the scanner glass right cover.

Figure 2-336 Remove screws and scanner glass right cover



- b. Slide the scanner glass to the right to remove it.

Figure 2-337 Remove scanner glass

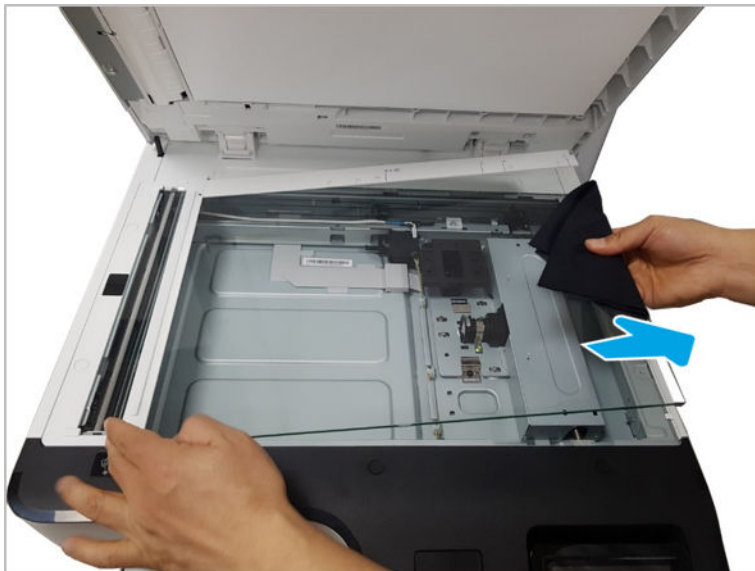

- 2. Remove the scanner APS sensor.
 - a. Remove the joint board cover.

Figure 2-338 Remove joint board cover



- b. Disconnect the harness.

Figure 2-339 Disconnect harness

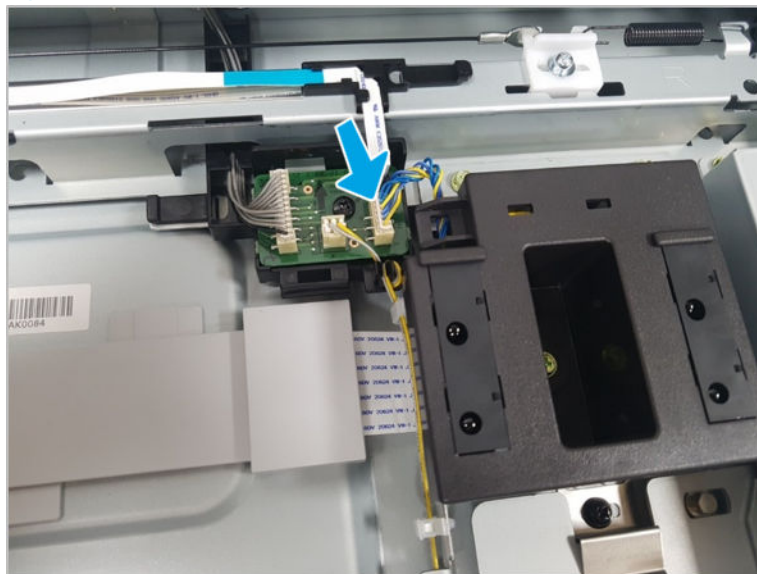

- c. Remove one screw. And then, remove the APS sensor assembly.

Figure 2-340 Remove screw

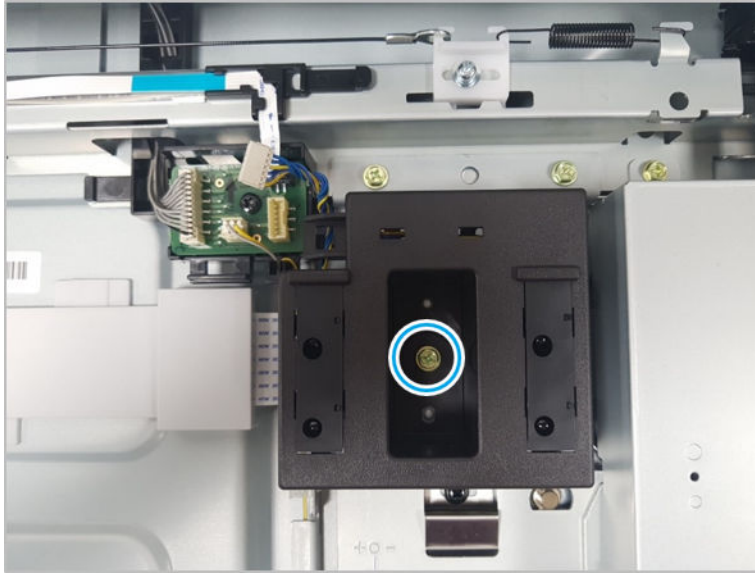

- d. Remove two screws. And then, remove two APS sensors from the sensor holder.

Figure 2-341 Remove APS sensor

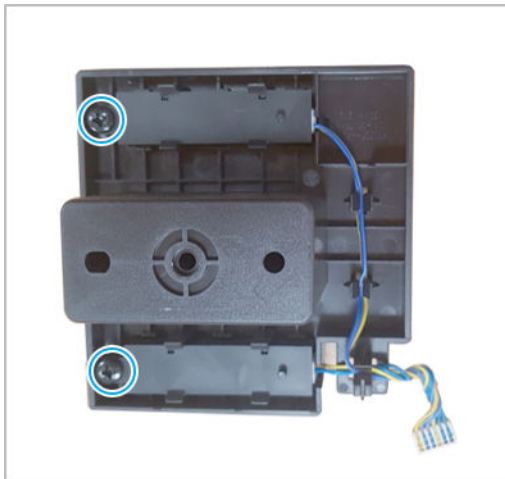

- 3. Unpack the replacement part.
 - a. Dispose of the defective part.

 **NOTE:** HP recommends responsible disposal of the defective part.

<http://www8.hp.com/us/en/hp-information/environment/product-recycling.html>

- b. Unpack the replacement part from the packaging.



CAUTION:  Some parts are sensitive to electrostatic discharge (ESD). Always perform service work at an ESD-protected workstation or mat. If an ESD workstation or mat is not available, touch the sheet-metal chassis to provide a static ground before touching an ESD-sensitive assembly. Protect the ESD-sensitive assemblies by placing them in ESD pouches when they are out of the printer.

If the replacement part is a roller or pad, avoid touching the spongy part of it. Skin oils on the roller or pad can cause paper pickup and/or print-quality problems. HP recommends using disposable gloves when handling rollers or pads or washing your hands before touching rollers or pads.

 **IMPORTANT:** Make sure that all of the shipping materials (for example shipping tape) are removed from the replacement part prior to installation.

- c. To install an assembly, reverse the removal steps.

 **NOTE:** When applicable, special installation instructions are provided for an assembly at the end of the removal procedure. Always completely read the removal instructions and follow all special installation instructions.

Automatic document feeder (ADF) assembly

View automatic document feeder (ADF) assembly exploded view, parts list, and repair procedures.

Automatic Document Feeder (ADF) upper parts

Figure 2-342 ADF upper parts

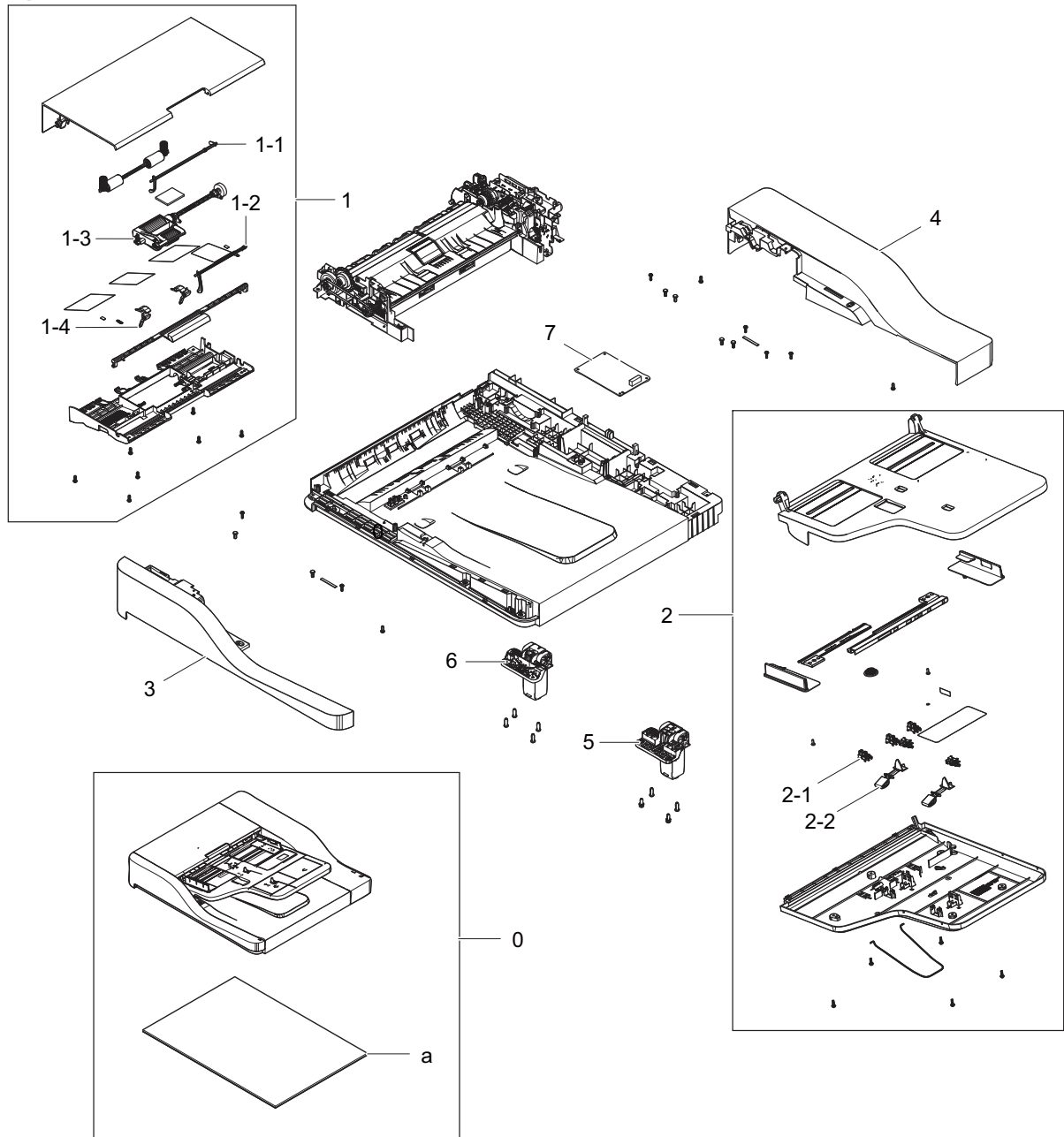

Table 2-74 ADF upper parts

Ref	Description	Part Number(*)	Qty
0	Automatic document feeder kit	JC97-04942B (*)	1
a	Sponge RADF	JC63-05343A (*)	1

Table 2-74 ADF upper parts (continued)

Ref	Description	Part Number(*)	Qty
1	Cover, ADF open	JC97-04789A	1
1-1	Actuator, registration	JC66-03148A	1
1-2	Actuator, detect paper	JC66-03147A	1
1-3	Pickup assembly, ADF	JC97-04009A(*)	1
1-4	Guide, paper stop	JC61-04647A	1
2	ADF stacker	JC97-05029A(*)	1
2-1	ADF paper length and width sensors	0604-001393(*)	5
2-2	Actuator, paper length	JC66-03209D	2
3	Cover, ADF side front	JC63-05426A(*)	1
4	Cover, ADF side rear	JC63-05427A(*)	1
5	Hinge, ADF right	JC97-04555B(*)	1
6	Hinge, ADF left	JC97-04757B(*)	1
7	PCA, ADF	JC92-03002B(*)	1
8	Sponge RADF	JC63-05343A(*)	1
9	Harness RADF	JC39-02451A(*)	1

* This part is in ordering system. If the ordering system has this part in stock, it can be ordered.

HP LaserJet Managed MFP E72425, E72430, E77422, E77428, E78223, E78228 - Removal and replacement: ADF whole unit

Follow these steps to remove the automatic document feeder (ADF) whole unit.

To view a short video of this procedure, click the link below.

 [View a video of how to remove and replace the ADF whole unit.](#)

Mean time to repair: 1 minutes

Service level: Basic

 **IMPORTANT:** When applicable, special installation instructions are provided for an assembly at the end of the removal procedure. Always completely read the removal instructions and follow all special installation instructions.

Before performing service

- Disconnect the power cable.

Use the table below to identify the correct part number for your printer. To order the part, go to <https://parts.hp.com>

Table 2-75 Part information

Part number	Part description
JC97-04942B	Automatic document feeder kit

Required tools

- #2 JIS screwdriver with a magnetic tip

After performing service

- Connect the power cable.
- Turn on the power switch next to the power cable, and then press the power button on the front of the printer.
- Verify that the most recent firmware is installed on the printer.
- Verify that all parts are correctly reinstalled and are properly working.
- Verify that the printer is in better condition than when you arrived, cosmetically and electrically.

Post service test

Print any pages necessary to verify that the repair resolved the issue and did not create any new issues.

1. Remove the ADF whole unit.
 - a. Remove the document feeder connector cover.

Figure 2-343 Remove document feeder connector cover



- b. Disconnect the document feeder harness from the scan joint board. Remove one connector and one grounding wire.

Figure 2-344 Disconnect document feeder harness

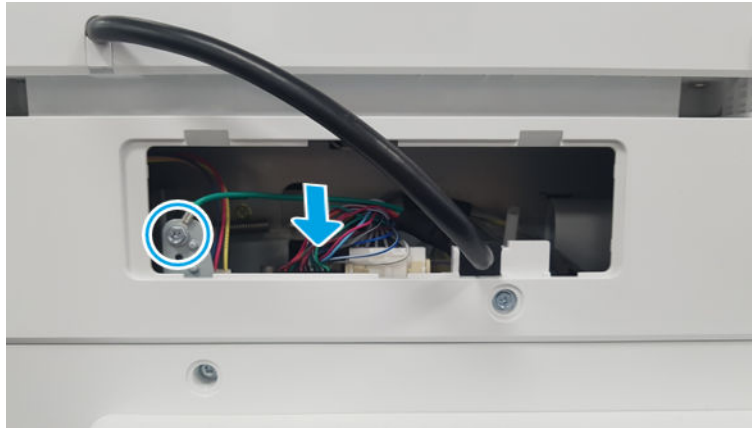

- c. Pull back and then lift up to release the document feeder unit.

Figure 2-345 Release the document feeder





 **NOTE:** Complete a shading test and a skew alignment after replacing the document feeder unit.

- 2. Unpack the replacement assembly.
 - a. Dispose of the defective part.

 **NOTE:** HP recommends responsible disposal of the defective part.

<http://www8.hp.com/us/en/hp-information/environment/product-recycling.html>

b. Unpack the replacement part from the packaging.

 **CAUTION:**  Some parts are sensitive to electrostatic discharge (ESD). Always perform service work at an ESD-protected workstation or mat. If an ESD workstation or mat is not available, touch the sheet-metal chassis to provide a static ground before touching an ESD-sensitive assembly. Protect the ESD-sensitive assemblies by placing them in ESD pouches when they are out of the printer.

If the replacement part is a roller or pad, avoid touching the spongy part of it. Skin oils on the roller or pad can cause paper pickup and/or print-quality problems. HP recommends using disposable gloves when handling rollers or pads or washing your hands before touching rollers or pads.

 **IMPORTANT:** Make sure that all of the shipping materials (for example shipping tape) are removed from the replacement part prior to installation.

c. To install an assembly, reverse the removal steps.

 **NOTE:** When applicable, special installation instructions are provided for an assembly at the end of the removal procedure. Always completely read the removal instructions and follow all special installation instructions.

HP LaserJet Managed MFP E72425, E72430, E77422, E77428, E78223, E78228 - Removal and replacement: ADF open cover

Follow these steps to remove the ADF open cover.

To view a short video of this procedure, click the link below.

 [View a video of how to remove and replace the ADF open cover.](#)

Mean time to repair: 1 minutes

Service level: Basic

 **IMPORTANT:** When applicable, special installation instructions are provided for an assembly at the end of the removal procedure. Always completely read the removal instructions and follow all special installation instructions.

Before performing service

- Disconnect the power cable.

 **WARNING!** To avoid damage to the printer, turn the printer off, wait 30 seconds, and then remove the power cable before attempting to service the printer.

Use the table below to identify the correct part number for your printer. To order the part, go to <https://parts.hp.com>

Table 2-76 Part information

Part numbers	
JC97-04789A	ADF open cover

Required tools

- #2 JIS screwdriver with a magnetic tip

After performing service

Turn the printer power on

- Connect the power cable.
- Use the power switch to turn the power on.

Post service test

When the power is turned on, listen for normal startup sounds.

Check the control panel display for error messages.

Make sure that the printer initializes to a Ready state.

Verify that the document was copied, scanned, or printed correctly.

1. Remove the ADF open cover.
 - ▲ Remove the ADF open cover by first sliding it in the direction shown in the figure below, and then rotating it away from the document feeder to release the hinge pins.

Figure 2-346 Remove the ADF open cover





2. Unpack the replacement assembly.
 - a. Dispose of the defective part.

 **NOTE:** HP recommends responsible disposal of the defective part.

<http://www8.hp.com/us/en/hp-information/environment/product-recycling.html>

b. Unpack the replacement part from the packaging.

 **CAUTION:**  Some parts are sensitive to electrostatic discharge (ESD). Always perform service work at an ESD-protected workstation or mat. If an ESD workstation or mat is not available, touch the sheet-metal chassis to provide a static ground before touching an ESD-sensitive assembly. Protect the ESD-sensitive assemblies by placing them in ESD pouches when they are out of the printer.

If the replacement part is a roller or pad, avoid touching the spongy part of it. Skin oils on the roller or pad can cause paper pickup and/or print-quality problems. HP recommends using disposable gloves when handling rollers or pads or washing your hands before touching rollers or pads.

 **IMPORTANT:** Make sure that all of the shipping materials (for example shipping tape) are removed from the replacement part prior to installation.

c. To install an assembly, reverse the removal steps.

 **NOTE:** When applicable, special installation instructions are provided for an assembly at the end of the removal procedure. Always completely read the removal instructions and follow all special installation instructions.

HP LaserJet Managed MFP E72425, E72430, E77422, E77428, E78223, E78228 - Removal and replacement: ADF stacker

Follow these steps to remove the ADF stacker.

To view a short video of this procedure, click the link below.

 [View a video of how to remove and replace the ADF stacker.](#)

Mean time to repair: 4 minutes

Service level: Advanced

 **IMPORTANT:** When applicable, special installation instructions are provided for an assembly at the end of the removal procedure. Always completely read the removal instructions and follow all special installation instructions.

Before performing service

- Disconnect the power cable.

 **WARNING!** To avoid damage to the printer, turn the printer off, wait 30 seconds, and then remove the power cable before attempting to service the printer.

Use the table below to identify the correct part number for your printer. To order the part, go to <https://parts.hp.com>

Table 2-77 Part information

Part numbers	Part description
JC97-05029A	ADF stacker

Required tools

- #2 JIS screwdriver with a magnetic tip

After performing service

Turn the printer power on

- Connect the power cable.
- Use the power switch to turn the power on.

Post service test

When the power is turned on, listen for normal startup sounds.

Check the control panel display for error messages.

Make sure that the printer initializes to a Ready state.

Verify that the document was copied, scanned, or printed correctly.

1. Remove the ADF rear cover.
 - a. Remove the whole ADF unit.
 - b. Remove two screws on the bottom of the document feeder, and then release the hooks.

Figure 2-347 Remove two screws and release the hooks



- c. Open the ADF door, and then remove two screws.

Figure 2-348 Remove two screws

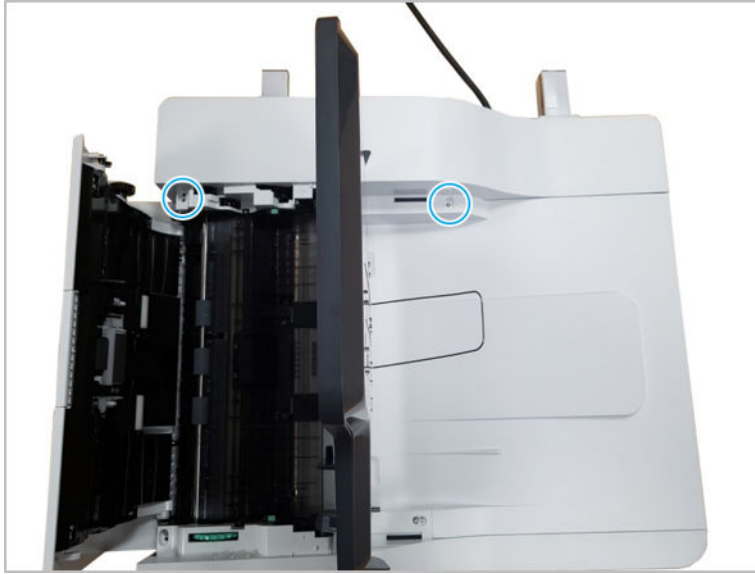

- d. Remove the ADF rear cover.

Figure 2-349 Remove the ADF rear cover

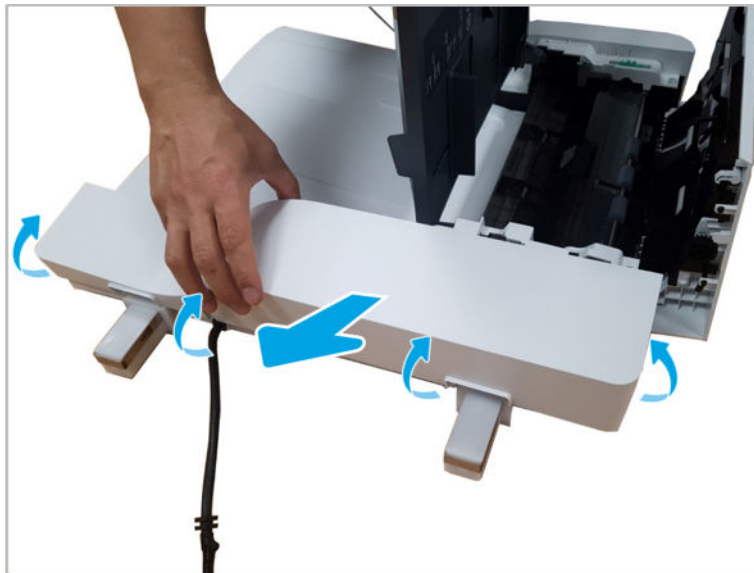

- 2. Remove the ADF stacker.
 - a. Disconnect the stacker connector from the ADF PCA.

Figure 2-350 Disconnect the stacker connector

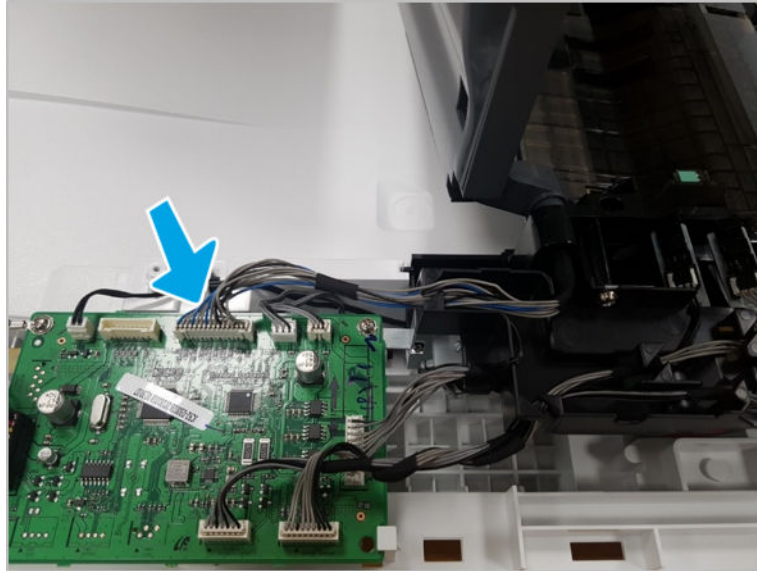

- b. Push and release the stacker tray hinge, and the lift up to remove the stacker unit.

Figure 2-351 Remove the stacker unit

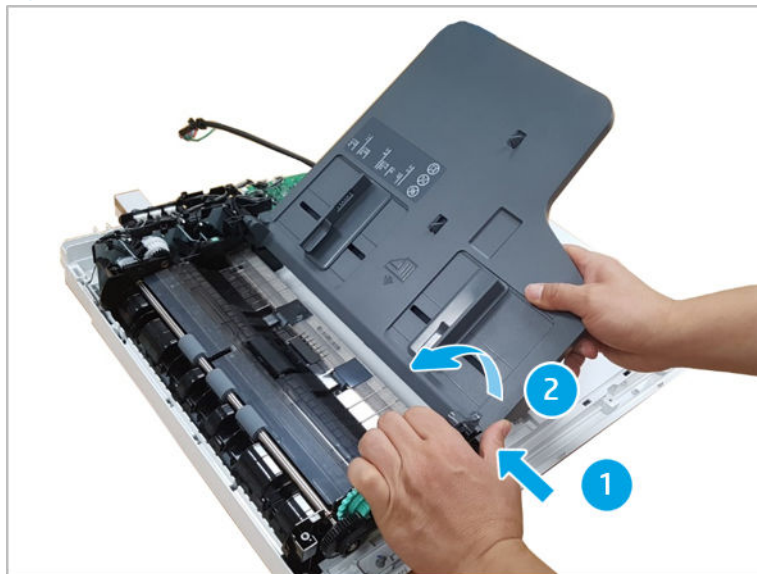



- 3. Unpack the replacement assembly.
 - a. Dispose of the defective part.

 **NOTE:** HP recommends responsible disposal of the defective part.

<http://www8.hp.com/us/en/hp-information/environment/product-recycling.html>

b. Unpack the replacement part from the packaging.

 **CAUTION:**  Some parts are sensitive to electrostatic discharge (ESD). Always perform service work at an ESD-protected workstation or mat. If an ESD workstation or mat is not available, touch the sheet-metal chassis to provide a static ground before touching an ESD-sensitive assembly. Protect the ESD-sensitive assemblies by placing them in ESD pouches when they are out of the printer.

If the replacement part is a roller or pad, avoid touching the spongy part of it. Skin oils on the roller or pad can cause paper pickup and/or print-quality problems. HP recommends using disposable gloves when handling rollers or pads or washing your hands before touching rollers or pads.

 **IMPORTANT:** Make sure that all of the shipping materials (for example shipping tape) are removed from the replacement part prior to installation.

c. To install an assembly, reverse the removal steps.

 **NOTE:** When applicable, special installation instructions are provided for an assembly at the end of the removal procedure. Always completely read the removal instructions and follow all special installation instructions.

HP LaserJet Managed MFP E72425, E72430, E77422, E77428, E78223, E78228 - Removal and replacement: ADF PCA

Follow these steps to remove the ADF PCA.

To view a short video of this procedure, click the link below.

 [View a video of how to remove and replace the ADF PCA.](#)

Mean time to repair: 3 minutes

Service level: Advanced

 **IMPORTANT:** When applicable, special installation instructions are provided for an assembly at the end of the removal procedure. Always completely read the removal instructions and follow all special installation instructions.

Before performing service

- Disconnect the power cable.

 **WARNING!** To avoid damage to the printer, turn the printer off, wait 30 seconds, and then remove the power cable before attempting to service the printer.

Use the table below to identify the correct part number for your printer. To order the part, go to <https://parts.hp.com>

Table 2-78 Part information

Part numbers	Part description
JC92-03002B	PCA, ADF

Required tools

- #2 JIS screwdriver with a magnetic tip

After performing service

Turn the printer power on

- Connect the power cable.
- Use the power switch to turn the power on.

Post service test

When the power is turned on, listen for normal startup sounds.

Check the control panel display for error messages.

Make sure that the printer initializes to a ready state.

Verify that the document was copied, scanned, or printed correctly.

1. Remove the ADF rear cover.
 - a. Remove the ADF whole unit.
 - b. Remove two screws on the bottom of the document feeder, and then release the hooks.

Figure 2-352 Remove two screws and release the hooks



- c. Open the ADF door, and then remove two screws.

Figure 2-353 Remove two screws

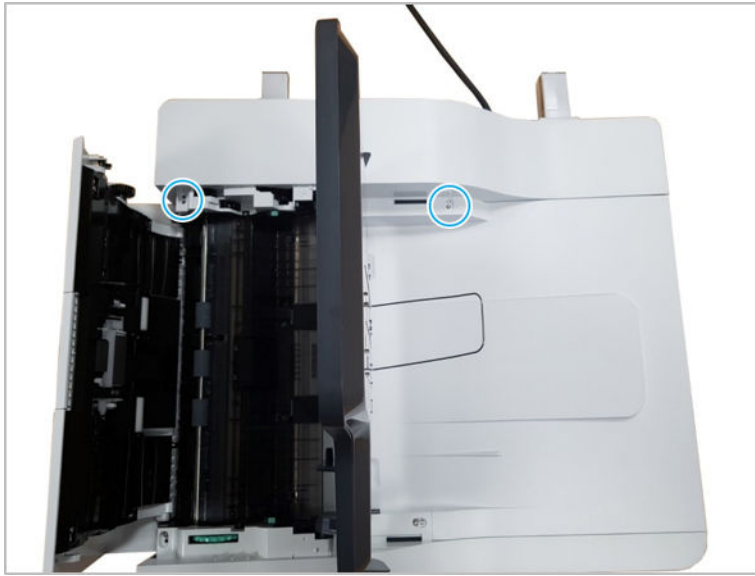

- d. Remove the ADF rear cover.

Figure 2-354 Remove the ADF rear cover

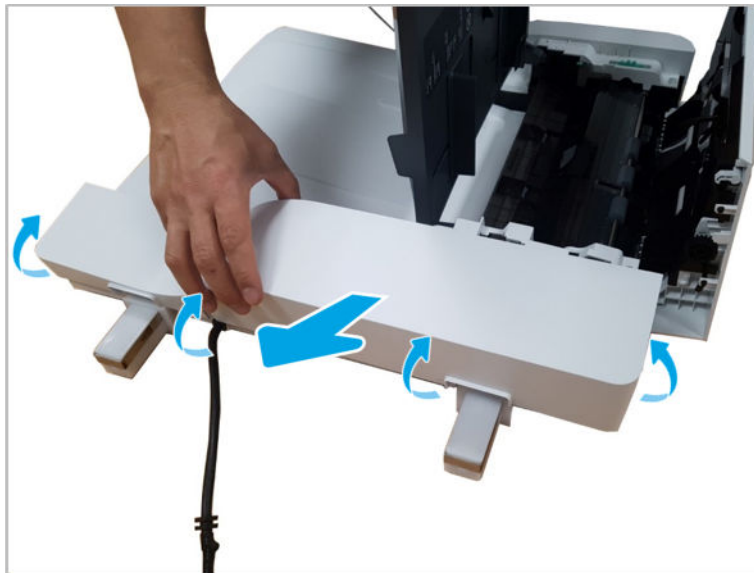

- 2. Remove the ADF PCA.

- ▲ Disconnect all of the connectors on the ADF PCA, and then remove two screws. Remove the ADF PCA.

Figure 2-355 Remove the ADF PCA

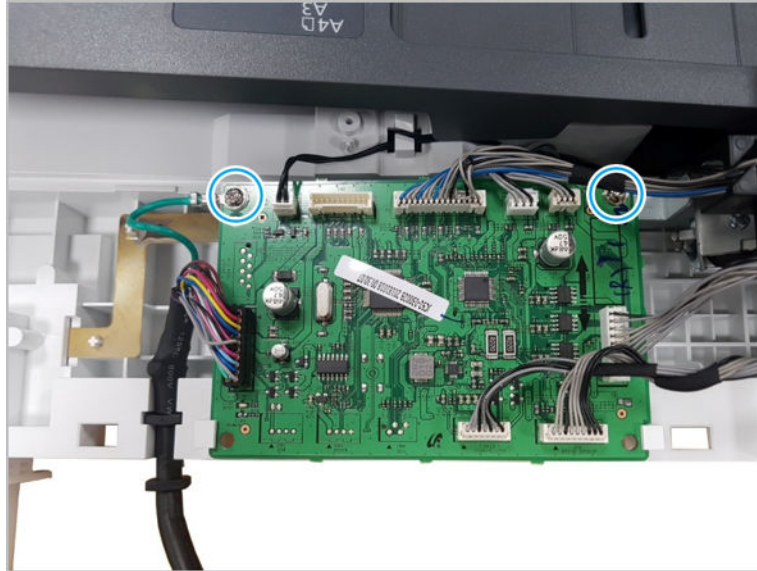



3. Unpack the replacement assembly.

- a. Dispose of the defective part.

 **NOTE:** HP recommends responsible disposal of the defective part.

<http://www8.hp.com/us/en/hp-information/environment/product-recycling.html>

- b. Unpack the replacement part from the packaging.

 **CAUTION:**  Some parts are sensitive to electrostatic discharge (ESD). Always perform service work at an ESD-protected workstation or mat. If an ESD workstation or mat is not available, touch the sheet-metal chassis to provide a static ground before touching an ESD-sensitive assembly. Protect the ESD-sensitive assemblies by placing them in ESD pouches when they are out of the printer.

If the replacement part is a roller or pad, avoid touching the spongy part of it. Skin oils on the roller or pad can cause paper pickup and/or print-quality problems. HP recommends using disposable gloves when handling rollers or pads or washing your hands before touching rollers or pads.

 **IMPORTANT:** Make sure that all of the shipping materials (for example shipping tape) are removed from the replacement part prior to installation.

- c. To install an assembly, reverse the removal steps.

 **NOTE:** When applicable, special installation instructions are provided for an assembly at the end of the removal procedure. Always completely read the removal instructions and follow all special installation instructions.

Automatic Document Feeder (ADF) main frame parts

Figure 2-356 Automatic Document Feeder (ADF) main frame parts

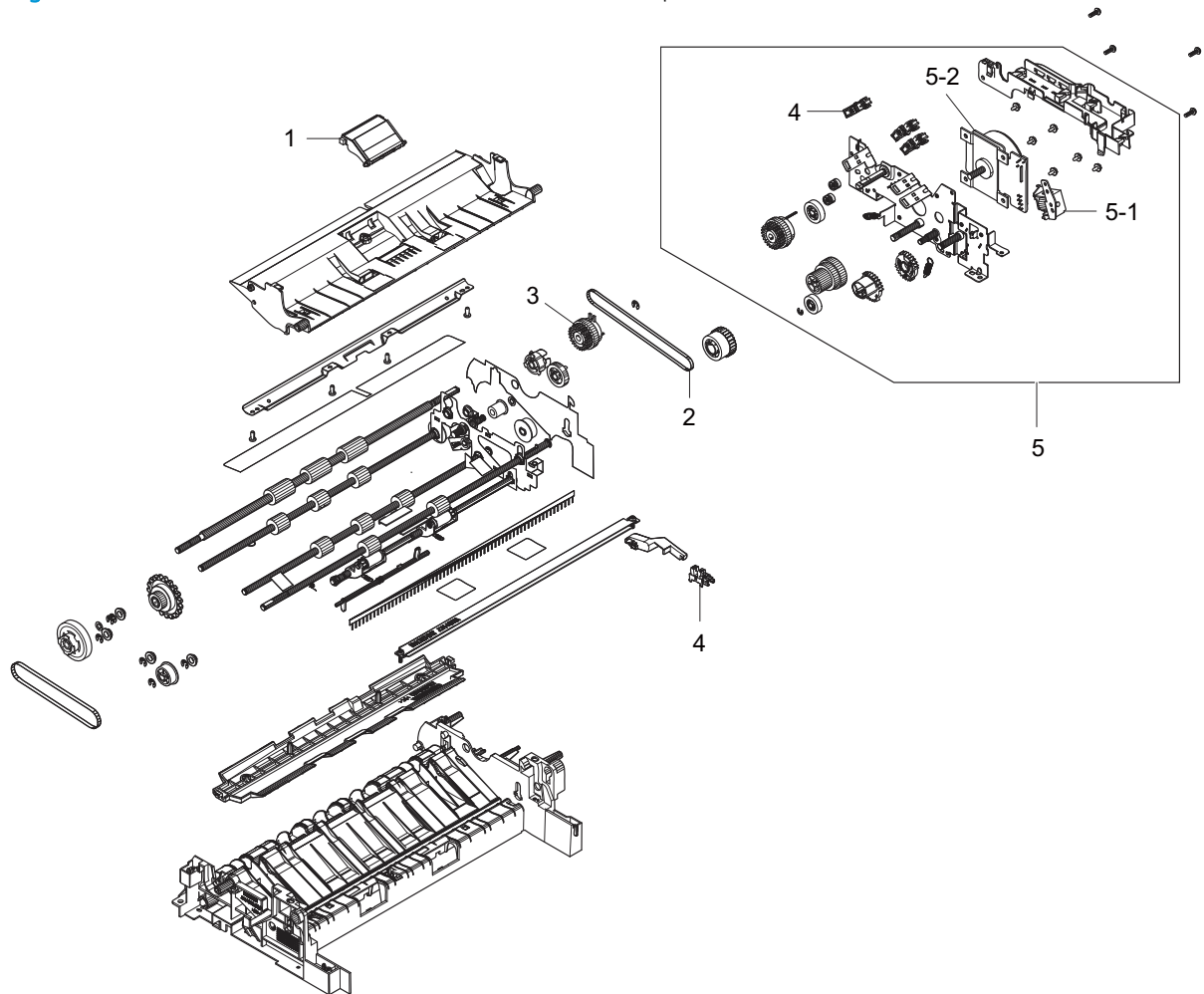

Table 2-79 Automatic Document Feeder (ADF) main frame parts

Ref	Description	Part Number (*)	Qty
1	ADF friction pad	JC97-04733A (*)	1
2	Belt, ADF timing gear	6602-003186	1
3	Clutch, ADF	JC47-00033G	1
4	ADF exit, feeder registration, cover, and detect sensors	0604-001393 (*)	4
5	Motor, ADF assembly	JC97-03993A (*)	1
5-1	Solenoid, pickup assembly	JC33-00007A	1
5-2	Motor, bldc	JC31-00156C (*)	1

* This part is in ordering system. If the ordering system has this part in stock, it can be ordered.

HP LaserJet Managed MFP E72425, E72430, E77422, E77428, E78223, E78228 - Removal and replacement: ADF registration, cover, and detect sensors

Follow these steps to remove the ADF registration, cover, and detect sensors.

To view a short video of this procedure, click the link below.



[View a video of how to remove and replace the ADF registration, cover, and detect sensors.](#)

Mean time to repair: 3 minutes

Service level: Advanced



IMPORTANT: When applicable, special installation instructions are provided for an assembly at the end of the removal procedure. Always completely read the removal instructions and follow all special installation instructions.

Before performing service

- Disconnect the power cable.



WARNING! To avoid damage to the printer, turn the printer off, wait 30 seconds, and then remove the power cable before attempting to service the printer.

Use the table below to identify the correct part number for your printer. To order the part, go to <https://parts.hp.com>

Table 2-80 Part information

Part numbers	Part description
0604-001393	ADF registration, cover, and detect sensors

Required tools

- #2 JIS screwdriver with a magnetic tip

After performing service

Turn the printer power on

- Connect the power cable.
- Use the power switch to turn the power on.

Post service test

When the power is turned on, listen for normal startup sounds.

Check the control panel display for error messages.

Make sure that the printer initializes to a ready state.

Verify that the document was copied, scanned, or printed correctly.

1. Remove the ADF rear cover.
 - a. Remove the whole ADF unit.

- b. Remove two screws on the bottom of the document feeder, and then release the hooks.

Figure 2-357 Remove two screws and release the hooks



- c. Open the ADF door, and then remove two screws.

Figure 2-358 Remove two screws

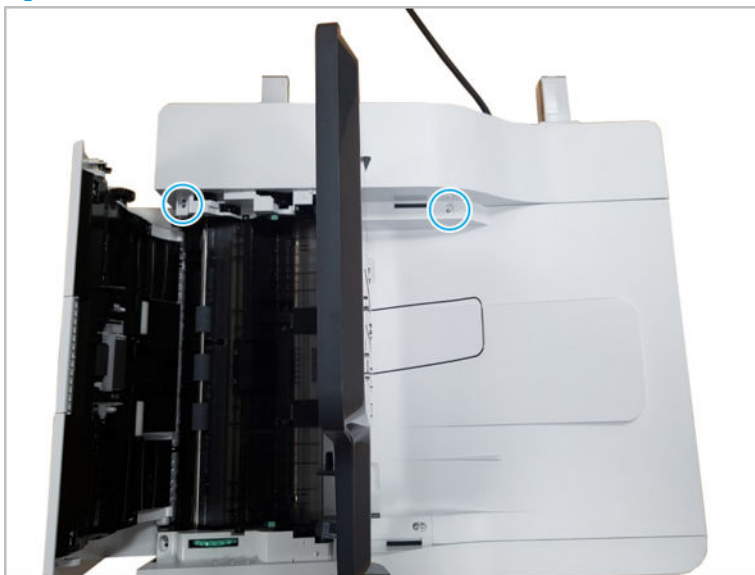

- d. Remove the ADF rear cover.

Figure 2-359 Remove the ADF rear cover

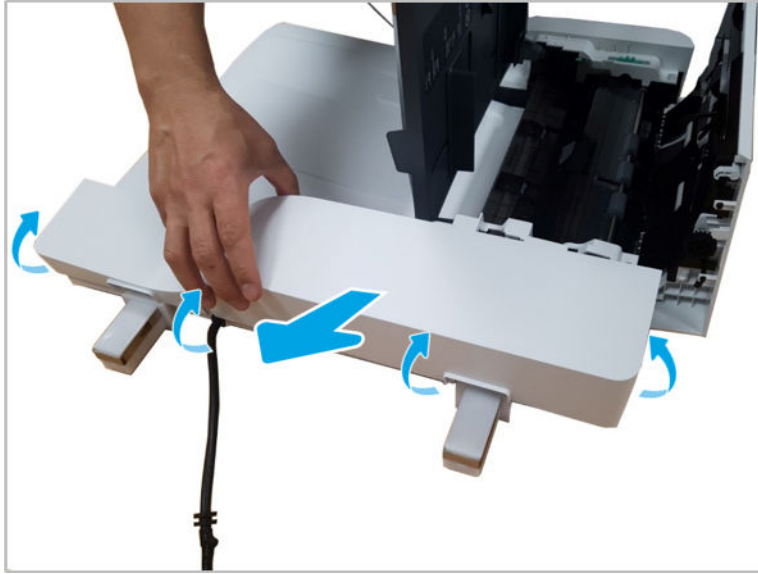

2. Remove the ADF registration, cover, and detect sensors.

- ▲ Disconnect the connector, and then remove one or more of the following sensors: detect sensor (A), cover sensor (B), or registration sensor (C)

Figure 2-360 Remove the ADF registration, cover, and detect sensors

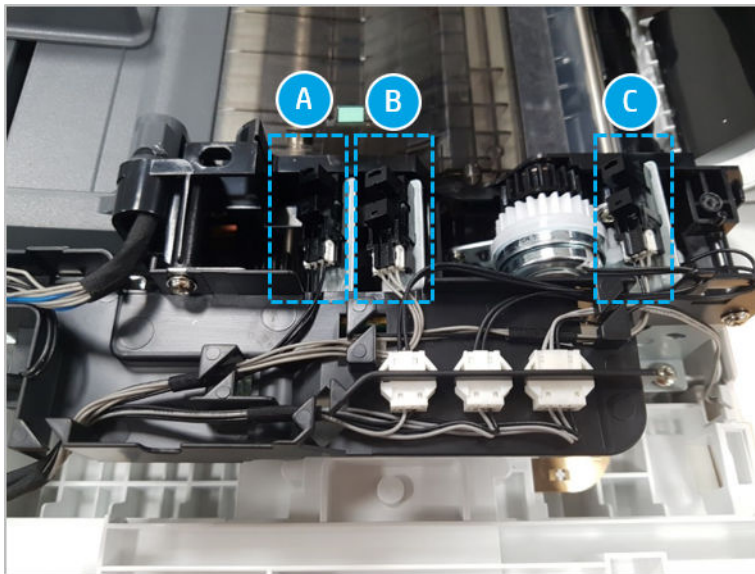



3. Unpack the replacement assembly.
 - a. Dispose of the defective part.

 **NOTE:** HP recommends responsible disposal of the defective part.

<http://www8.hp.com/us/en/hp-information/environment/product-recycling.html>

b. Unpack the replacement part from the packaging.

 **CAUTION:**  Some parts are sensitive to electrostatic discharge (ESD). Always perform service work at an ESD-protected workstation or mat. If an ESD workstation or mat is not available, touch the sheet-metal chassis to provide a static ground before touching an ESD-sensitive assembly. Protect the ESD-sensitive assemblies by placing them in ESD pouches when they are out of the printer.

If the replacement part is a roller or pad, avoid touching the spongy part of it. Skin oils on the roller or pad can cause paper pickup and/or print-quality problems. HP recommends using disposable gloves when handling rollers or pads or washing your hands before touching rollers or pads.

 **IMPORTANT:** Make sure that all of the shipping materials (for example shipping tape) are removed from the replacement part prior to installation.

c. To install an assembly, reverse the removal steps.

 **NOTE:** When applicable, special installation instructions are provided for an assembly at the end of the removal procedure. Always completely read the removal instructions and follow all special installation instructions.

HP LaserJet Managed MFP E72425, E72430, E77422, E77428, E78223, E78228 - Removal and replacement: ADF motor

Follow these steps to remove the ADF motor.

To view a short video of this procedure, click the link below.

 [View a video of how to remove and replace the ADF motor.](#)

Mean time to repair: 8 minutes

Service level: Advanced

 **IMPORTANT:** When applicable, special installation instructions are provided for an assembly at the end of the removal procedure. Always completely read the removal instructions and follow all special installation instructions.

Before performing service

- Disconnect the power cable.

 **WARNING!** To avoid damage to the printer, turn the printer off, wait 30 seconds, and then remove the power cable before attempting to service the printer.

Use the table below to identify the correct part number for your printer. To order the part, go to <https://parts.hp.com>

Table 2-81 Part information

Part numbers	Part description
JC31-00156C	ADF motor

Required tools

- #2 JIS screwdriver with a magnetic tip

After performing service

Turn the printer power on

- Connect the power cable.
- Use the power switch to turn the power on.

Post service test

When the power is turned on, listen for normal startup sounds.

Check the control-panel display for error messages.

Make sure that the printer initializes to a ready state.

Verify that the document was copied, scanned, or printed correctly.

1. Remove the ADF covers.
 - a. Remove the whole ADF unit.
 - b. Remove four screws on the bottom of the ADF, and then release the hooks.

Figure 2-361 Remove four screws and release the hooks



- c. Open the ADF door, and then remove four screws.

Figure 2-362 Remove four screws

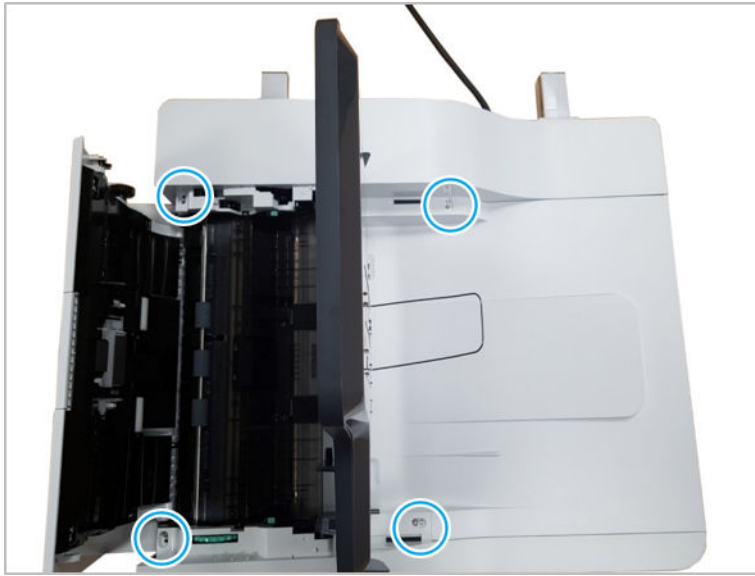

- d. Remove the ADF rear cover.

Figure 2-363 Remove the ADF rear cover

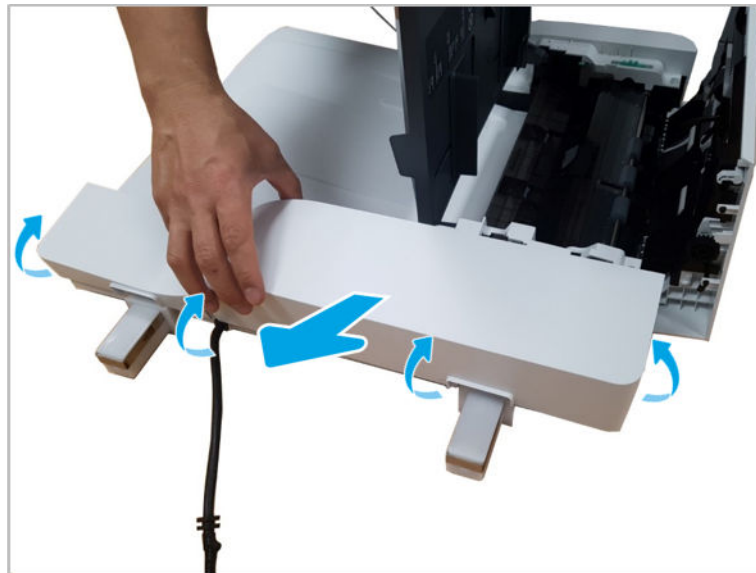

- e. Remove the ADF open cover by first sliding it in the direction shown in the figure below, and then rotating it away from the document feeder to release the hinge pins.

Figure 2-364 Remove the ADF open cover



- f. Remove the ADF front cover.

Figure 2-365 Remove the ADF front cover

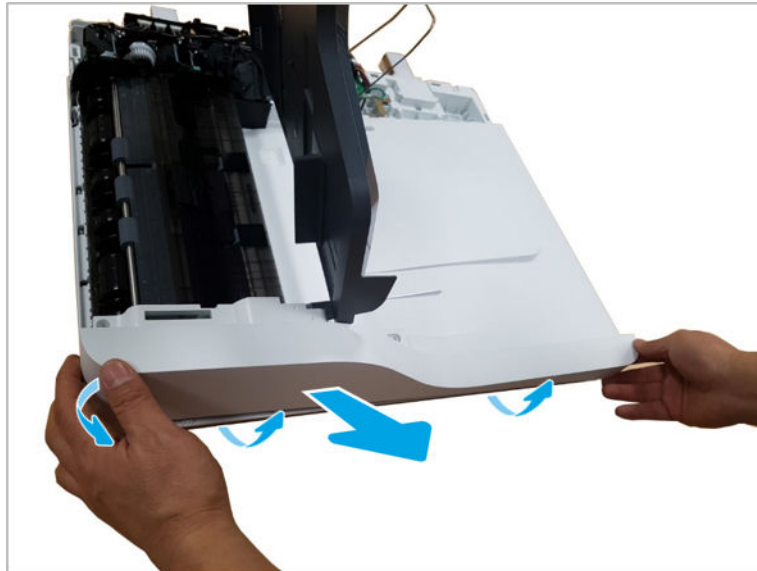

- 2. Remove the ADF stacker.
 - a. Disconnect the stacker connector from the ADF PCA.

Figure 2-366 Disconnect the stacker connector

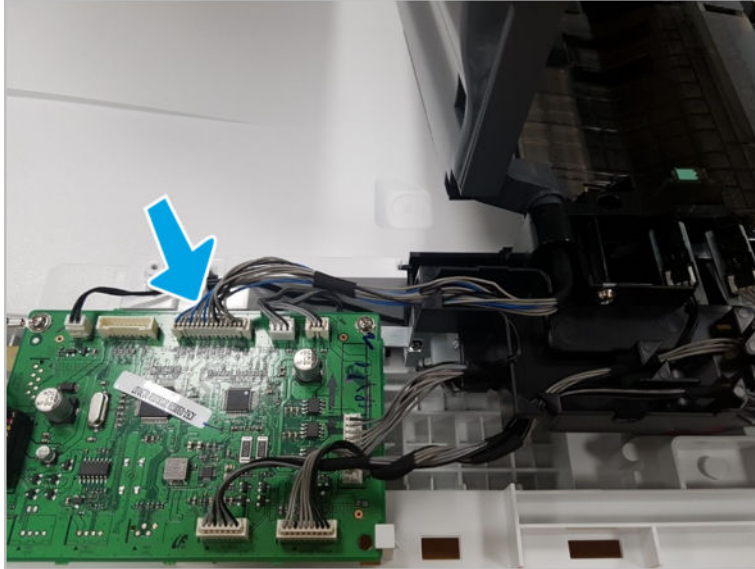

- b. Push and release the stacker tray hinge, and the lift up to remove the stacker unit.

Figure 2-367 Remove the ADF stacker

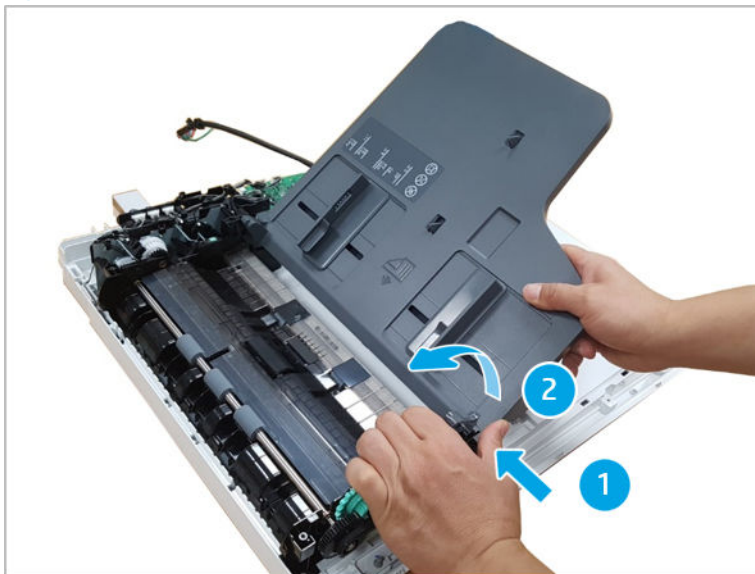

3. Remove the ADF PCA.
 - ▲ Disconnect all of the connectors on the ADF PCA, and then remove two screws. Remove the ADF PCA.

Figure 2-368 Remove the ADF PCA

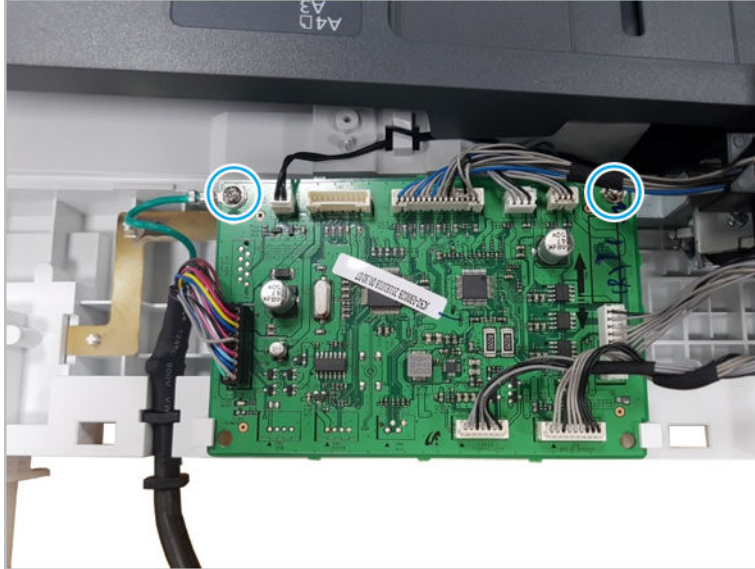

4. Remove the ADF motor
 - a. Remove three screws.

Figure 2-369 Remove three screws

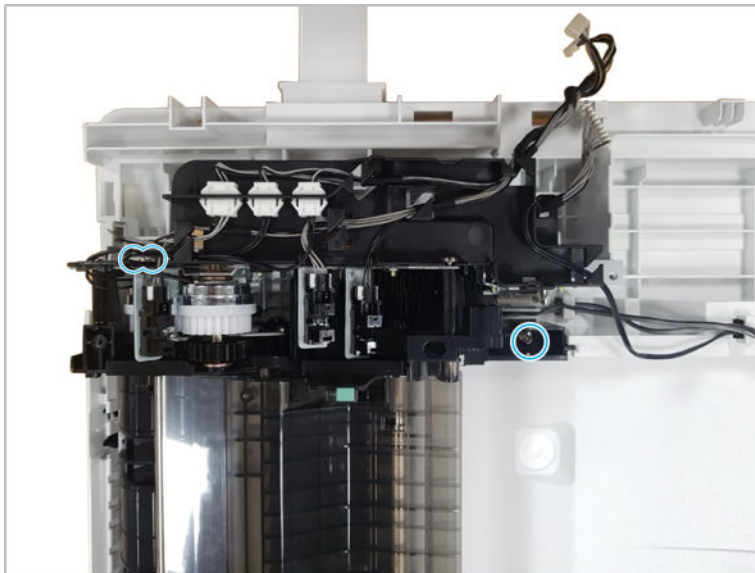

- b. Remove two screws.

Figure 2-370 Remove two screws



- c. Lift up and release the ADF main frame.

Figure 2-371 Release the main frame

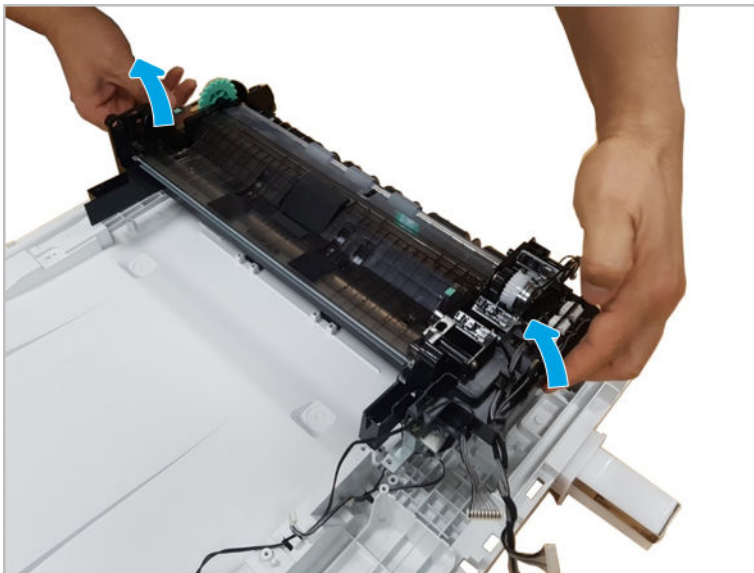

- d. Disconnect one connector, remove four screws, and then remove the ADF motor.

Figure 2-372 Remove the motor

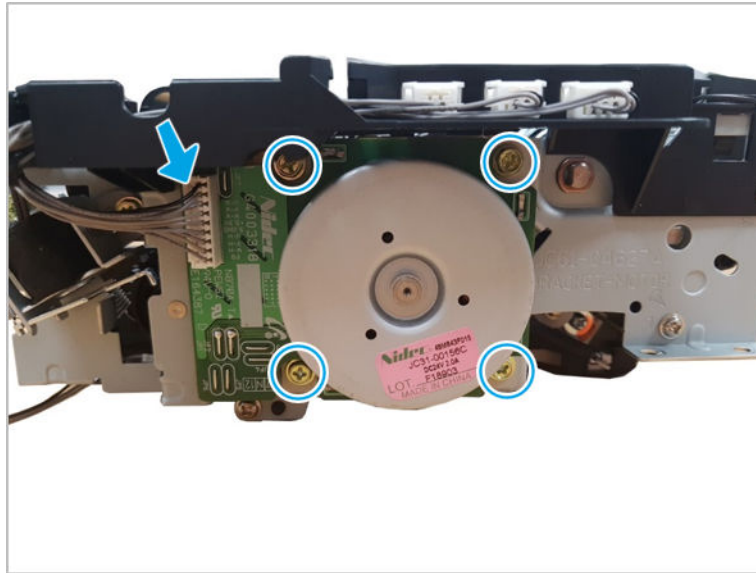

5. Unpack the replacement assembly.

- a. Dispose of the defective part.



NOTE: HP recommends responsible disposal of the defective part.

<http://www8.hp.com/us/en/hp-information/environment/product-recycling.html>

- b. Unpack the replacement part from the packaging.



CAUTION:



Some parts are sensitive to electrostatic discharge (ESD). Always perform service work at an ESD-protected workstation or mat. If an ESD workstation or mat is not available, touch the sheet-metal chassis to provide a static ground before touching an ESD-sensitive assembly. Protect the ESD-sensitive assemblies by placing them in ESD pouches when they are out of the printer.

If the replacement part is a roller or pad, avoid touching the spongy part of it. Skin oils on the roller or pad can cause paper pickup and/or print-quality problems. HP recommends using disposable gloves when handling rollers or pads or washing your hands before touching rollers or pads.



IMPORTANT: Make sure that all of the shipping materials (for example shipping tape) are removed from the replacement part prior to installation.

- c. To install an assembly, reverse the removal steps.



NOTE: When applicable, special installation instructions are provided for an assembly at the end of the removal procedure. Always completely read the removal instructions and follow all special installation instructions.

Document lid assembly

View document lid assembly exploded view, parts list, and repair procedures.

Document lid assembly

Figure 2-373 Document lid assembly

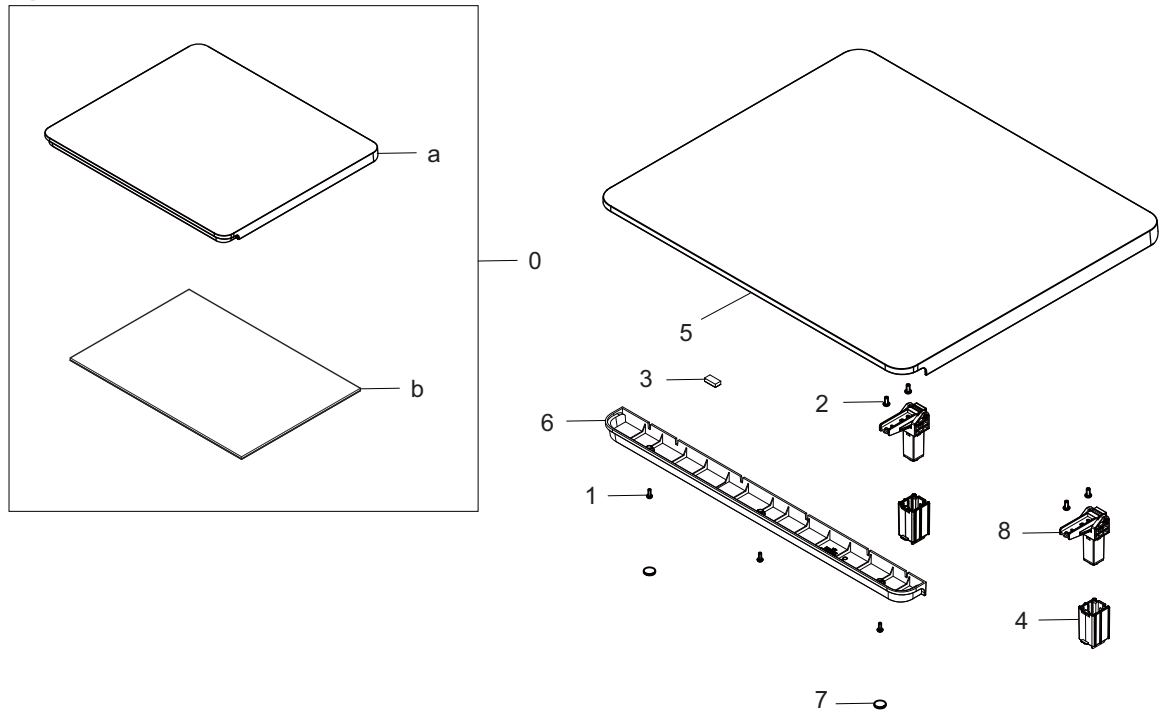

Table 2-82 Document lid assembly

Ref	Description	Part Number (*)	Qty
0	Document lid cover kit	3BE77-67003	1
a	Document lid cover	JC97-05065A	1
b	Sponge document lid	JC63-06114A (*)	1
1	Screw	6003-000196	3
2	Screw	6003-001256	4
3	Magnet switch	JC61-06349A (*)	1
4	Hinge holder	JC61-08587A (*)	2
5	Flatbed cover, top	JC63-06047A (*)	1
6	Open handle	JC64-01061A (*)	1
7	Flatbed damper	JC69-01663A (*)	2
8	Hinge	JC97-04309C (*)	2

* This part is in ordering system. If the ordering system has this part in stock, it can be ordered.

HP LaserJet Managed MFP E72425, E72430, E77422, E77428, E78223, E78228 - Removal and replacement: Document lid assembly

This document provides the procedures to remove the document lid assembly.

Mean time to repair: 1 minutes

Service level: Intermediate



IMPORTANT: When applicable, special installation instructions are provided for an assembly at the end of the removal procedure. Always completely read the removal instructions and follow all special installation instructions.

Before performing service

- Turn the power off.

Use the table below to identify the correct part number for your printer. To order the part, go to <https://parts.hp.com>

Table 2-83 Part information

Part number	Part description
3BE77-67003	Document lid cover kit
JC64-01061A	Open handle
JC97-04309C	Hinge

Required tools

- #2 JIS screwdriver with a magnetic tip

After performing service

Turn the printer power on

- Connect the power cable.
- Use the power switch to turn the power on.

Post service test

No post service test is available for this assembly.

1. Remove the document lid assembly.
 - ▲ Pull back and then lift up to release the document lid assembly.

Figure 2-374 Remove the document lid assembly

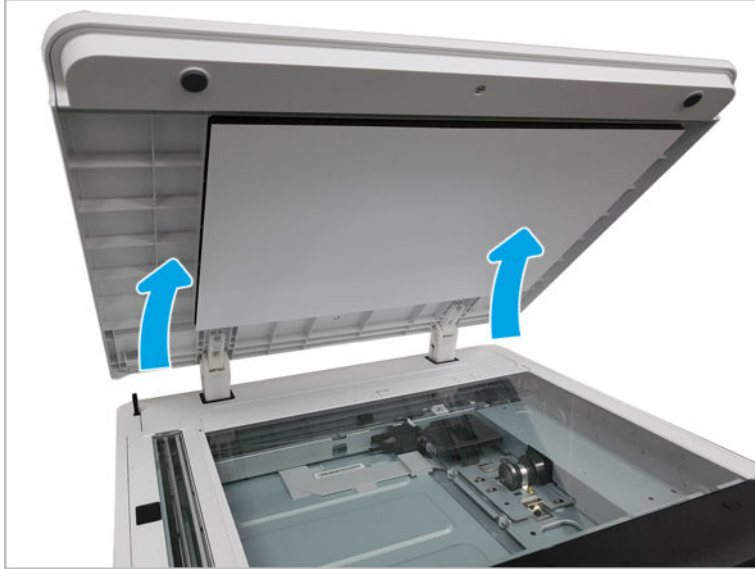

2. Remove the open handle.
 - ▲ Remove two screw caps. Remove three screws. And then, remove the open handle.

Figure 2-375 Remove the open handle

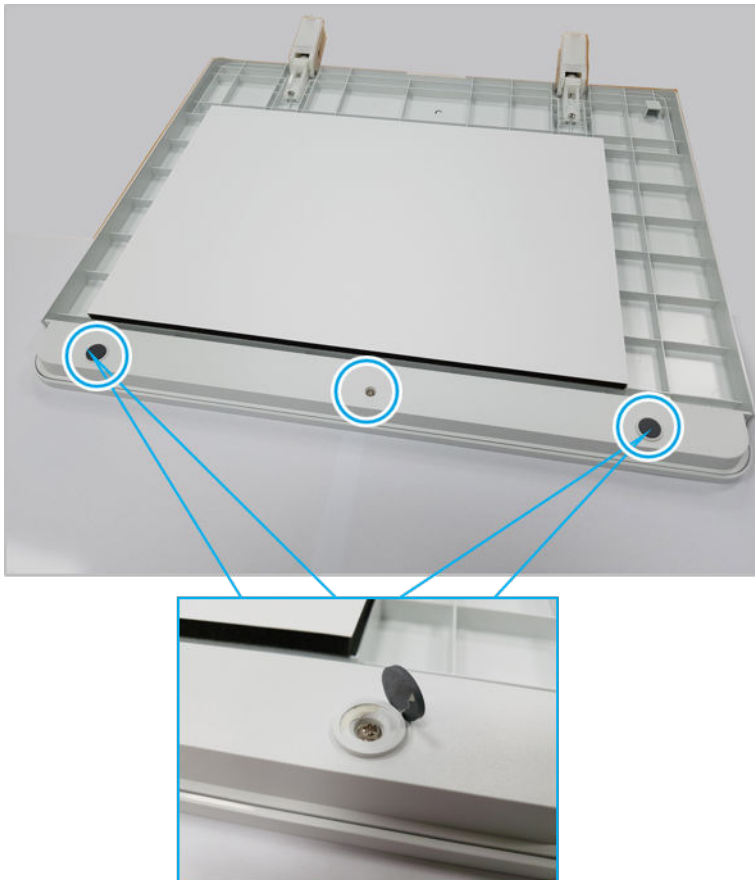

3. Remove the hinge unit.

- ▲ Remove four screws from both hinge units, and then remove two hinge units.

Figure 2-376 Remove the hinge unit

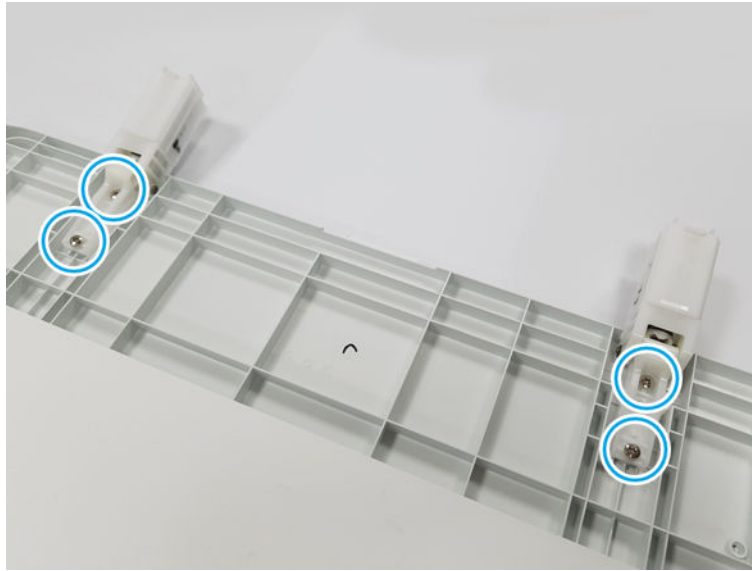

4. Unpack the replacement assembly.

- a. Dispose of the defective part.



NOTE: HP recommends responsible disposal of the defective part.

<http://www8.hp.com/us/en/hp-information/environment/product-recycling.html>

- b. Unpack the replacement part from the packaging.



CAUTION:



Some parts are sensitive to electrostatic discharge (ESD). Always perform service work at an ESD-protected workstation or mat. If an ESD workstation or mat is not available, touch the sheet-metal chassis to provide a static ground before touching an ESD-sensitive assembly. Protect the ESD-sensitive assemblies by placing them in ESD pouches when they are out of the printer.

If the replacement part is a roller or pad, avoid touching the spongy part of it. Skin oils on the roller or pad can cause paper pickup and/or print-quality problems. HP recommends using disposable gloves when handling rollers or pads or washing your hands before touching rollers or pads.



IMPORTANT: Make sure that all of the shipping materials (for example shipping tape) are removed from the replacement part prior to installation.

- c. To install an assembly, reverse the removal steps.



NOTE: When applicable, special installation instructions are provided for an assembly at the end of the removal procedure. Always completely read the removal instructions and follow all special installation instructions.

Removal and replacement: Optional Hard Disk Drive

Follow these steps to remove the Hard Disk Drive.

Mean time to repair: 5 minutes

Service level: Basic

 **IMPORTANT:** When applicable, special installation instructions are provided for an assembly at the end of the removal procedure. Always completely read the removal instructions and follow all special installation instructions.

Before performing service

- Update the firmware to the latest version. (This item is supported from FutureSmart 4.8 version)
- Press the power button on the front of the printer. A shutting-down message appears on the control panel display.
- Turn off the power switch next to the power cable.
- Disconnect the printer power cable after the printer has completely shut down. (The control-panel display is blank.)

 **WARNING!** To avoid damage to the printer, turn the printer off, wait for 30 seconds, and then remove the power cable before attempting to service the printer.

Use the table below to identify the correct part number for your printer. To order the part, go to <https://parts.hp.com>

Table 2-84 Part information

Part number	Part description
5YP34A	Hard Disk Drive

Required tools

- #2 JIS screwdriver with a magnetic tip

Post service test

- Verify the value of Reports > Configuration Page > Installed Personalities and Options > Engine Disk (Capacity, Hard Disk Encryption Status)
- The expected values are following;
 - Engine Disk Hard Disk: Enabled
 - Capacity 512000MB
 - Hard Disk Encryption Status Encrypted

 **NOTE:** If you don't follow the guide in the correct order, the drive may not be encrypted.

In this case, Hard Disk Encryption Status displays "Drive is not yet encrypted".

- Copy, scan, or print a document. Verify the document copies, scan, or prints correctly.
1. Unscrew two captive thumbscrews on the formatter cover. Slide the formatter cover to the left, and then to the right to remove.

Figure 2-377 Remove the formatter cover

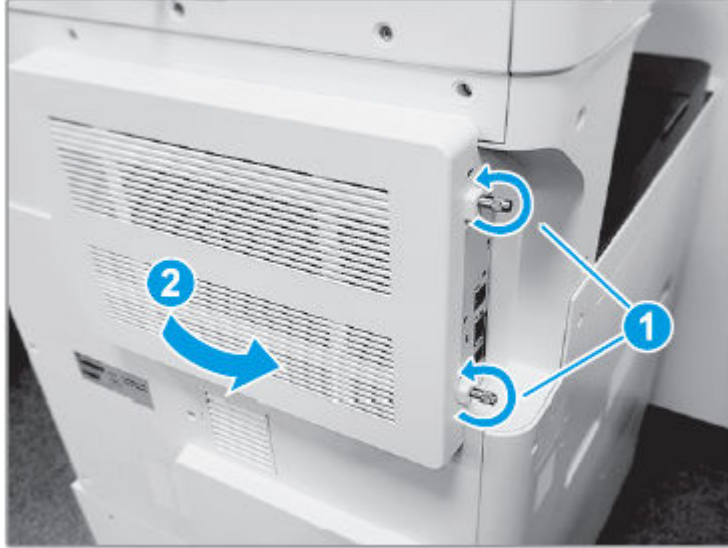

2. Remove thirteen screws, and then remove the rear-bottom cover and rear-top cover.

Figure 2-378 Remove the rear-bottom cover and rear-top cover

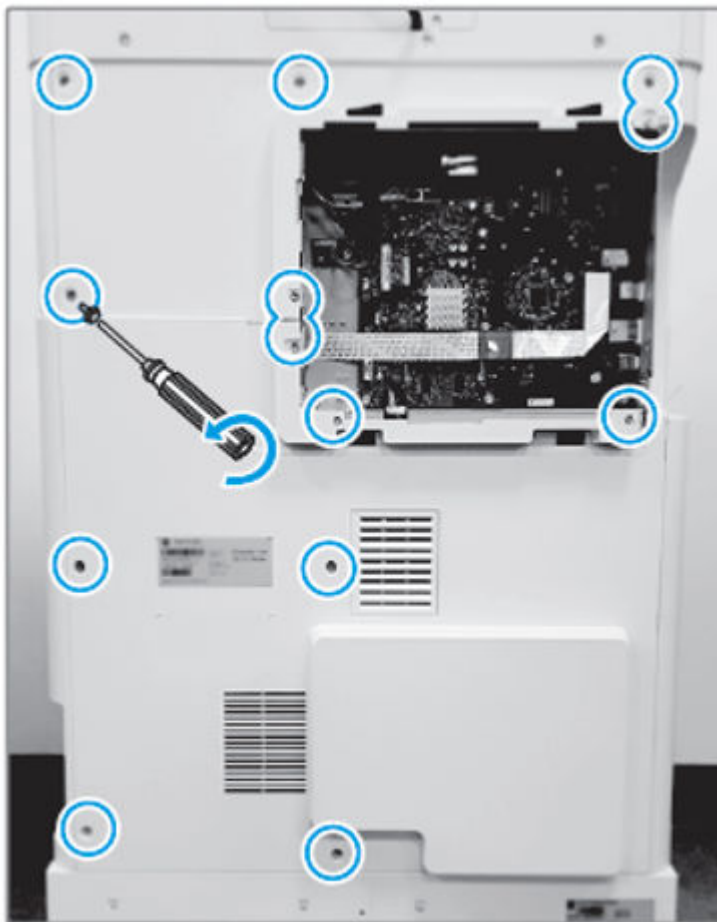

3. Remove three screws, and then remove the left-upper cover.

Figure 2-379 Remove the left-upper cover

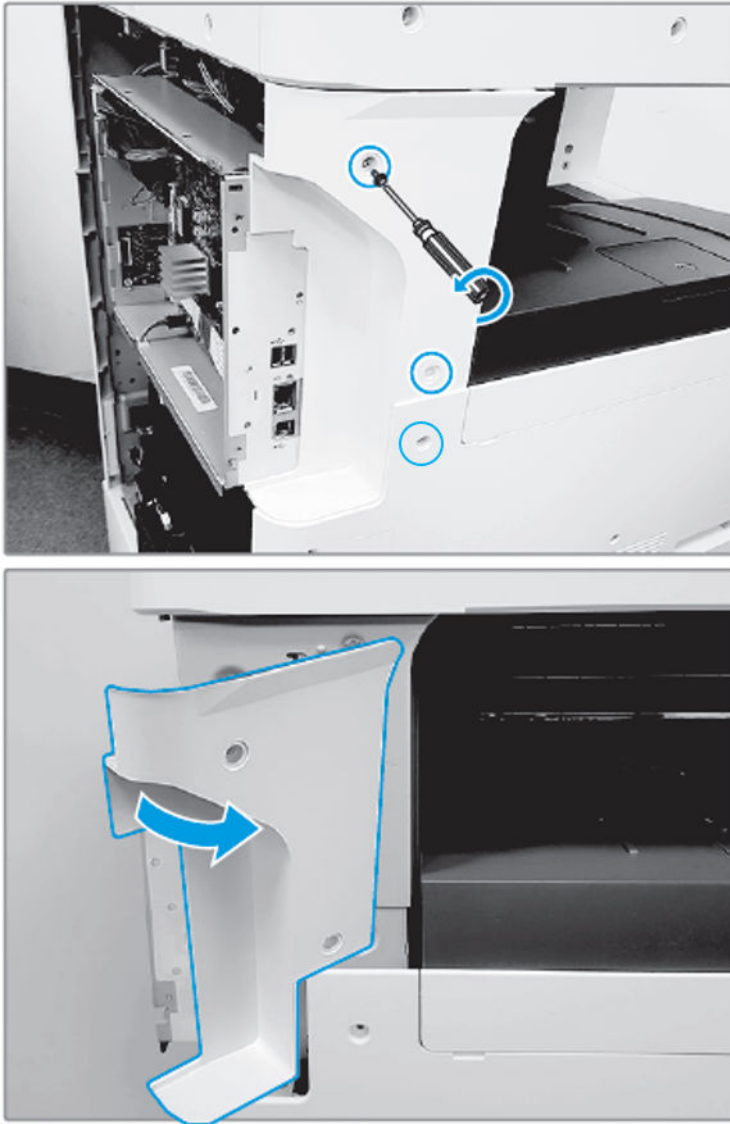

4. Remove one screw from the side of the formatter cage (beneath the left-upper cover location).

Figure 2-380 Remove one screw

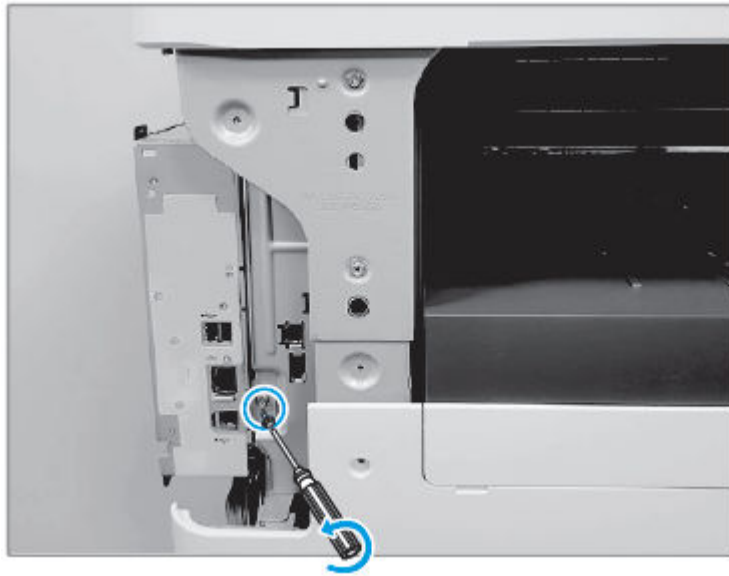

5. Remove three screws from the formatter cage face.

Figure 2-381 Remove one screw

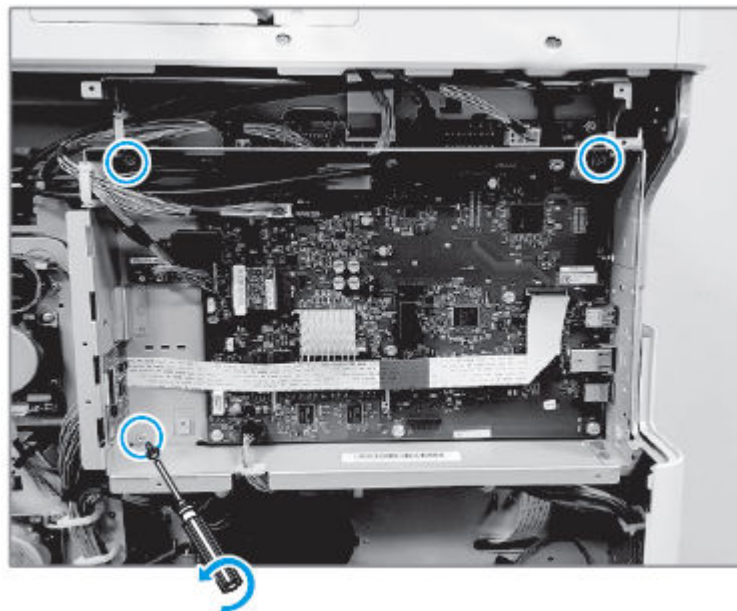

6. Disconnect all connectors on the formatter PCA and two cable restraints.

Figure 2-382 Disconnect all connectors

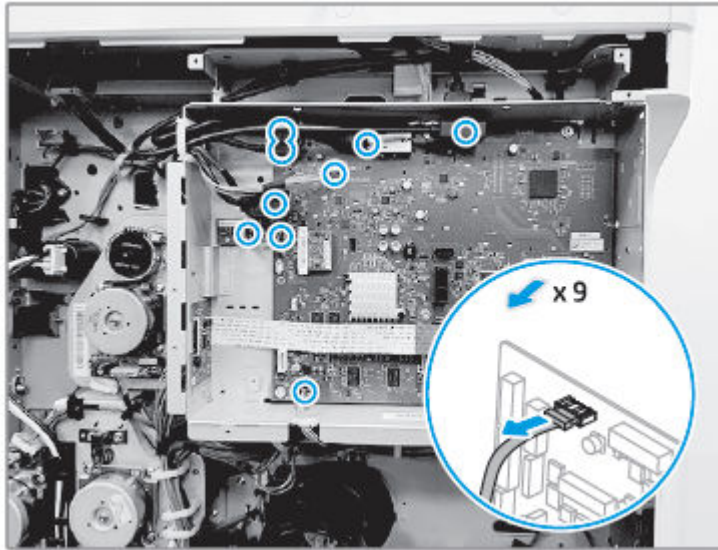

7. Remove the formatter cage.

Figure 2-383 Remove the formatter cage

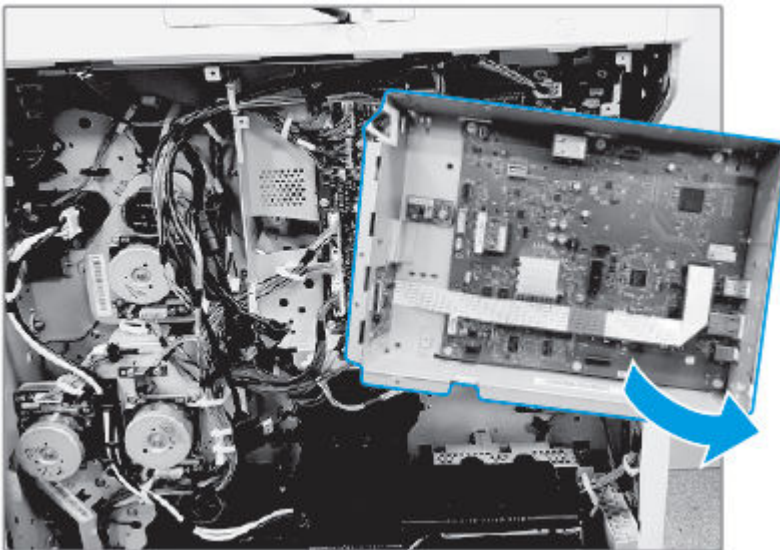

8. Remove two screws.

Figure 2-384 Remove two screws



9. Open the right door, and then remove one screw.

Figure 2-385 Remove two screws

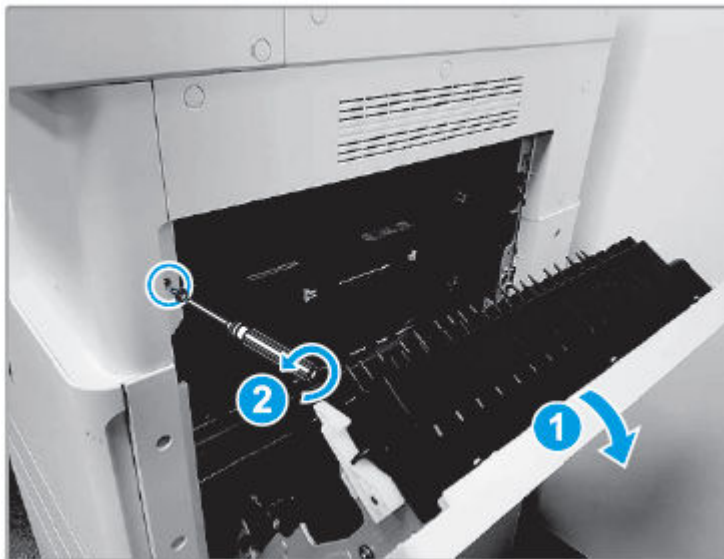

10. Pull out the middle right cover, and then disconnect the connector.

Figure 2-386 Disconnect the connector

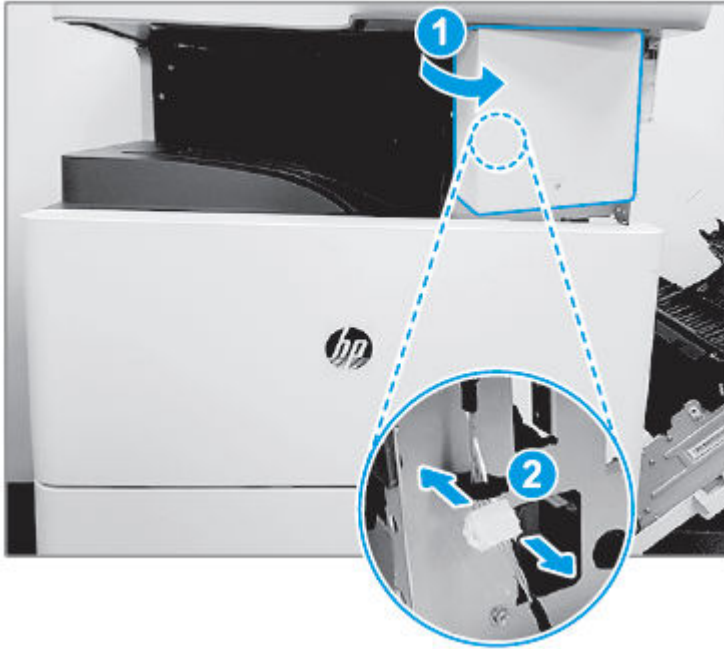

11. Remove the middle right cover.

Figure 2-387 Remove the middle right cover



12. Remove two screws.

Figure 2-388 Remove two screws

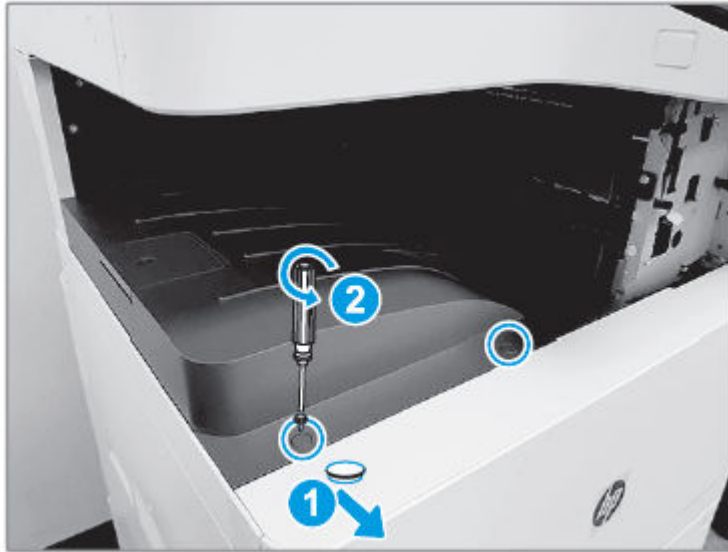

13. Remove the exit stacker.

Figure 2-389 Remove the exit stacker

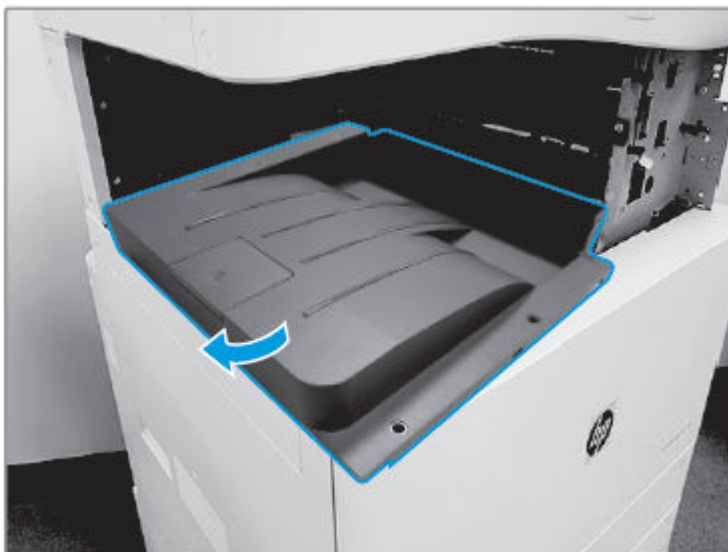

14. Remove one screw.

Figure 2-390 Remove one screw

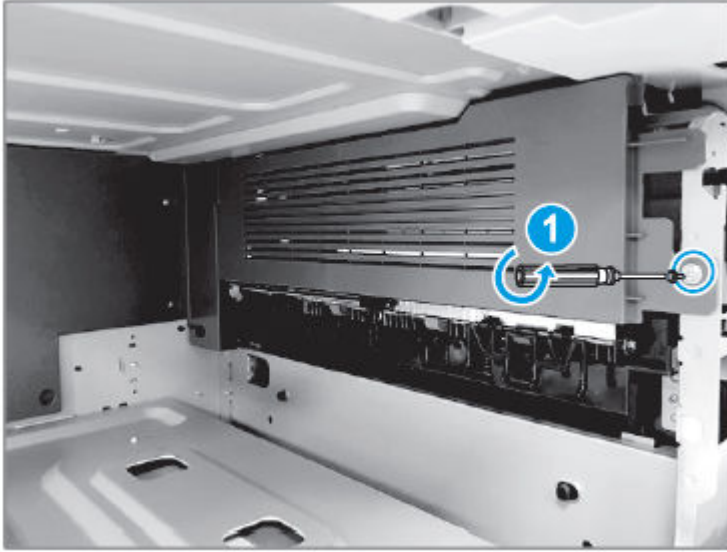

15. Remove four screws.

Figure 2-391 Remove four screws

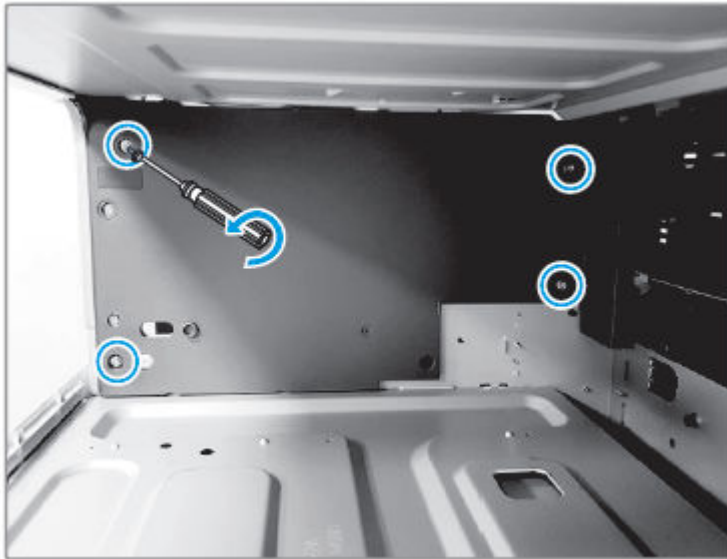

16. Remove the exit rear cover and exit dummy cover.

Figure 2-392 Remove two covers

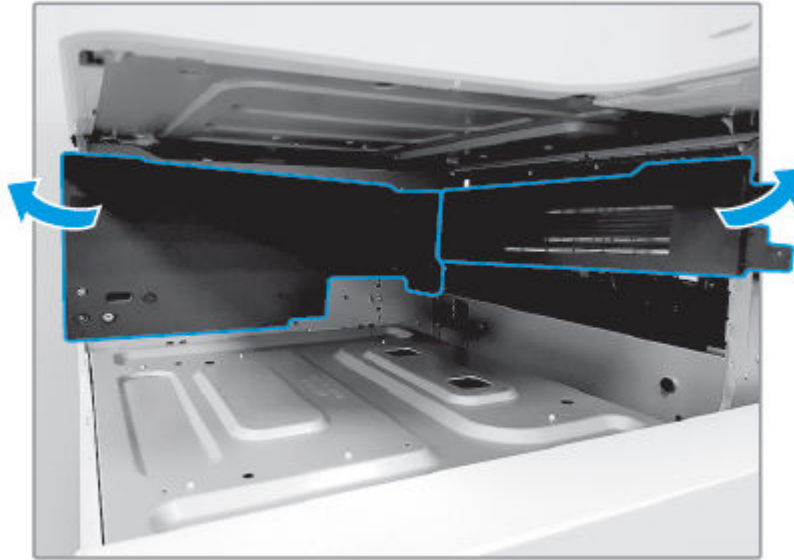

17. Disconnect two HDD cables from the engine controller board.

Figure 2-393 Disconnect cables

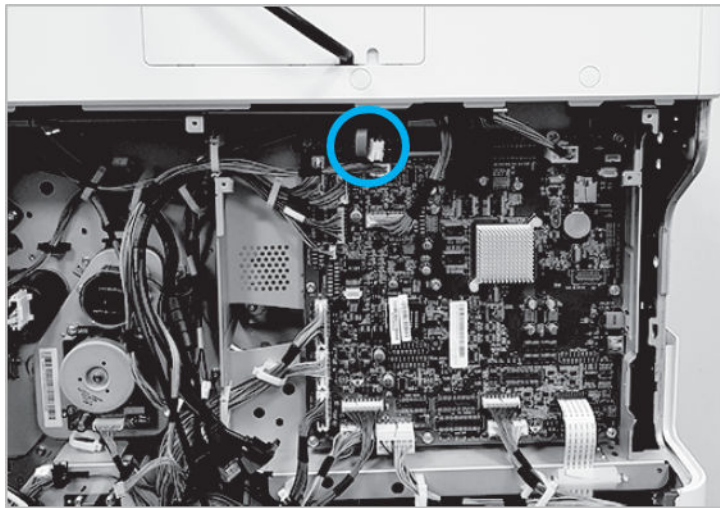

18. Remove four screws, and then remove the HDD with the holder.

Figure 2-394 Remove the HDD

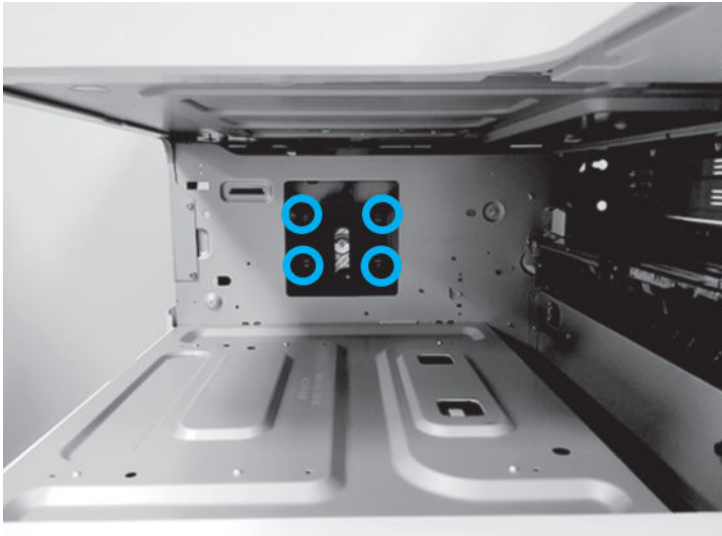



19. Unpack the replacement assembly.

- a. Dispose of the defective part.

 **NOTE:** HP recommends responsible disposal of the defective part.

<http://www8.hp.com/us/en/hp-information/environment/product-recycling.html>

- b. Unpack the replacement part from the packaging.

 **CAUTION:**  Some parts are sensitive to electrostatic discharge (ESD). Always perform service work at an ESD-protected workstation or mat. If an ESD workstation or mat is not available, touch the sheet-metal chassis to provide a static ground before touching an ESD-sensitive assembly. Protect the ESD-sensitive assemblies by placing them in ESD pouches when they are out of the printer.

If the replacement part is a roller or pad, avoid touching the spongy part of it. Skin oils on the roller or pad can cause paper pickup and/or print-quality problems. HP recommends using disposable gloves when handling rollers or pads or washing your hands before touching rollers or pads.

 **IMPORTANT:** Make sure that all of the shipping materials (for example shipping tape) are removed from the replacement part prior to installation.

- c. To install an assembly, reverse the removal steps.

 **NOTE:** When applicable, special installation instructions are provided for an assembly at the end of the removal procedure. Always completely read the removal instructions and follow all special installation instructions.

20. Turn the printer on.

21. Perform the partial clean on the Pre-boot menu.

- a. The HP logo displays on the printer control panel. When a "1/8" with an underscore display, touch the middle of the screen to open the Pre-boot menu.
- b. Use the arrow buttons on the touchscreen to scroll down and highlight the +3:Administrator item, and then touch the OK button to select it.
- c. Use the arrow buttons on the touchscreen to scroll down and highlight the +3:Partial Clean item, and then touch the OK button to select it.



- d. Touch the OK button to proceed with Partial clean.

⚠ WARNING! To avoid damage to the printer, do not turn the printer off while partial clean is in operation. If you turn off the device, then the device could be not working anymore.

- e. If the Partial clean is done, then use the back buttons on the touchscreen and highlight the 1.Continue item, and touch the OK button to select it.

Optional dual-cassette feeder (DCF)

Removal and replacement processes for the HP Laserjet dual-cassette feeder (DCF).

Removal and replacement: Dual-cassette feeder (DCF) rear cover

This document provides the procedures to remove the rear cover assembly.

Mean time to repair: 5 minutes

Service level: Basic

 **IMPORTANT:** When applicable, special installation instructions are provided for an assembly at the end of the removal procedure. Always completely read the removal instructions and follow all special installation instructions.

Before performing service

- Disconnect the power cable.

 **WARNING!** To avoid damage to the printer, turn the printer off, wait 30 seconds, and then remove the power cable before attempting to service the printer.

Use the table below to identify the correct part number for your printer. To order the part, go to <https://parts.hp.com>

Table 2-85 Part information

Dual cassette feeder (DCF) rear cover assembly part number	
JC63-04604B	Dual cassette feeder (DCF) rear cover assembly

Required tools

- #2 JIS screwdriver with a magnetic tip

After performing service

Turn the printer power on

- Connect the power cable.
- Use the power switch to turn the power on.

Post service test

Copy, scan, or print a document. Verify the document copies, scans, or prints correctly.

- ▲ Remove the rear cover.
 - ▲ Remove four screw caps and four screws, and then remove the rear cover.

Figure 2-395 Remove the DCF rear cover



Removal and replacement: Dual-cassette feeder (DCF) right door

This document provides the procedures to remove the right door assembly.

Meant time to repair: 5 minutes

Service level: Basic

 **IMPORTANT:** When applicable, special installation instructions are provided for an assembly at the end of the removal procedure. Always completely read the removal instructions and follow all special installation instructions.

Before performing service

- Disconnect the power cable.

 **WARNING!** To avoid damage to the printer, turn the printer off, wait 30 seconds, and then remove the power cable before attempting to service the printer.

Use the table below to identify the correct part number for your printer. To order the part, go to <https://parts.hp.com>

Table 2-86 Part information

DCF right door part number	
JC90-01285A	DCF right door

Required tools

- #2 JIS screwdriver with a magnetic tip

After performing service

Turn the printer power on

- Connect the power cable.
- Use the power switch to turn the power on.

Post service test

Copy, scan, or print a document. Verify the document copies, scans, or prints correctly.

- ▲ Remove the DCF right door.
 - a. Remove four screw caps and four screws, and then remove the lower right cover.

Figure 2-396 Remove the lower right cover



- b. Open the DCF right door and slide the hinge pin to the left. Make sure that the pin slides under the tab (1).

Figure 2-397 Slide the hinge pin

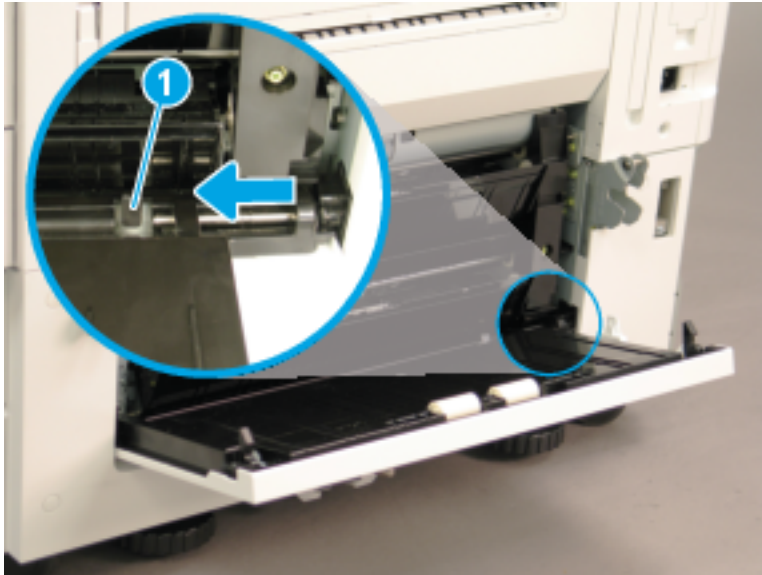

- c. Rotate the right edge of the door away from the feeder (1), and then slide the door to the right to remove it (2).

Figure 2-398 Remove the DCF right door

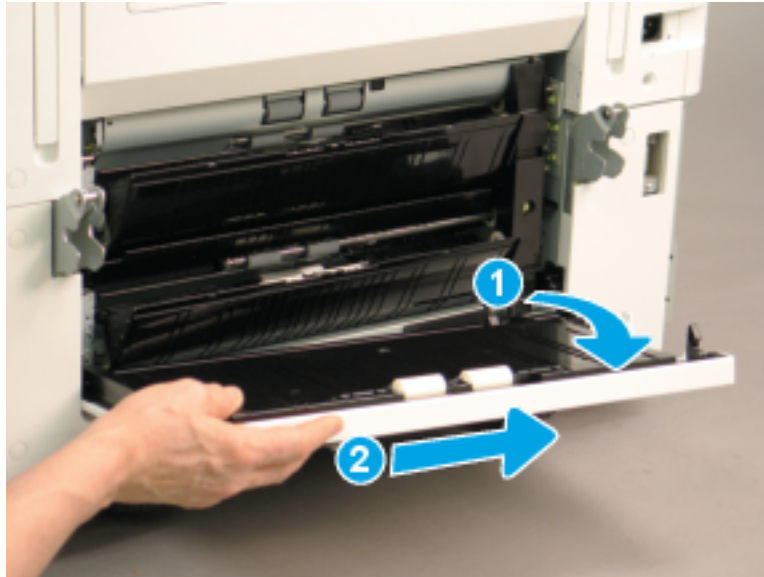

Removal and replacement: Dual-cassette feeder (DCF) PCA

This document provides the procedures to remove the PCA assembly.

Mean time to repair: 15 minutes

Service level: Intermediate

 **IMPORTANT:** When applicable, special installation instructions are provided for an assembly at the end of the removal procedure. Always completely read the removal instructions and follow all special installation instructions.

Before performing service

- Disconnect the power cable.

 **WARNING!** To avoid damage to the printer, turn the printer off, wait 30 seconds, and then remove the power cable before attempting to service the printer.

Use the table below to identify the correct part number for your printer. To order the part, go to <https://parts.hp.com>

Table 2-87 Part information

Dual cassette feeder (DCF) PCA assembly part number	
JC92-02978A	Dual cassette feeder (DCF) PCA assembly

Required tools

- #2 JIS screwdriver with a magnetic tip

After performing service

Turn the printer power on

- Connect the power cable.
- Use the power switch to turn the power on.

Post service test

Copy, scan, or print a document. Verify the document copies, scans, or prints correctly.

1. Remove the rear cover.
 - ▲ Remove four screw caps and four screws, and then remove the rear cover.

Figure 2-399 Remove the DCF rear cover



2. Remove the DCF PCA.
 - ▲ Disconnect eight connectors, remove three screws, and then remove the DCF PCA.

Figure 2-400 Remove the DCF PCA

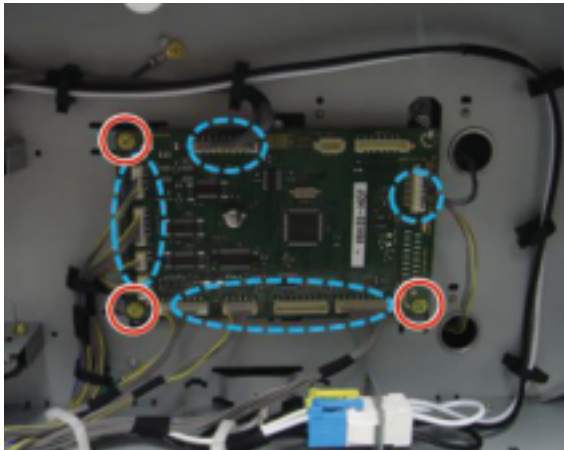

Removal and replacement: Dual-cassette feeder (DCF) motor

This document provides the procedures to remove the DCF motor assembly.

Mean time to repair: 10 minutes

Service level: Basic

 **IMPORTANT:** When applicable, special installation instructions are provided for an assembly at the end of the removal procedure. Always completely read the removal instructions and follow all special installation instructions.

Before performing service

- Disconnect the power cable.

⚠ WARNING! To avoid damage to the printer, turn the printer off, wait 30 seconds, and then remove the power cable before attempting to service the printer.

Use the table below to identify the correct part number for your printer. To order the part, go to <https://parts.hp.com>

Table 2-88 Part information

DCF motor assembly part number	
JC93-00442B	DCF motor

Required tools

- #2 Phillips screwdriver with a magnetic tip

After performing service

Turn the printer power on

- Connect the power cable.
- Use the power switch to turn the power on.

Post service test

Copy, scan, or print a document. Verify the document copies, scans, or prints correctly.

1. Remove the rear cover.
 - ▲ Remove four screw caps and four screws, and then remove the rear cover.

Figure 2-401 Remove the DCF rear cover



2. Remove the DCF motor.
 - a. Disconnect two connectors, and then open one retainer.

Figure 2-402 Disconnect two connectors and open one retainer

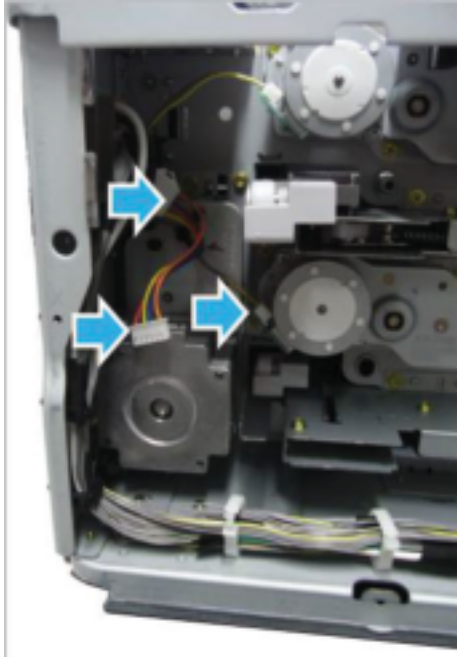

- b. Remove three screws, and then remove the feed drive unit.

Figure 2-403 Remove the feed drive unit

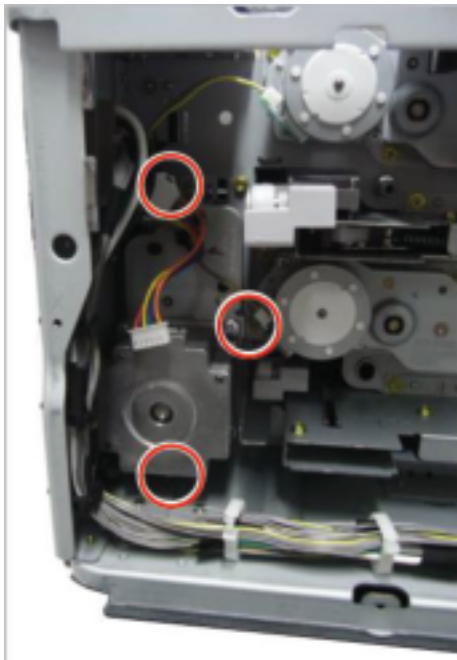

- c. Remove two screws, and then remove the feed motor.

Figure 2-404 Remove the feed motor



Removal and replacement: Dual-cassette feeder (DCF) motor

This document provides the procedures to remove the DCF pickup motor assembly.

Mean time to repair: 10 minutes

Service level: Basic

 **IMPORTANT:** When applicable, special installation instructions are provided for an assembly at the end of the removal procedure. Always completely read the removal instructions and follow all special installation instructions.

Before performing service

- Disconnect the power cable.

 **WARNING!** To avoid damage to the printer, turn the printer off, wait 30 seconds, and then remove the power cable before attempting to service the printer.

Use the table below to identify the correct part number for your printer. To order the part, go to www.hp.com/buy/parts

Table 2-89 Part information

DCF pickup motor assembly part number	DCF pickup motor assembly part number
JC93-00447A	DCF pickup motor assembly part number

Required tools

- #2 Phillips screwdriver with a magnetic tip

After performing service

Turn the printer power on

- Connect the power cable.
- Use the power switch to turn the power on.

Post service test

Copy, scan, or print a document. Verify the document copies, scans, or prints correctly.

1. Remove the rear cover.

- ▲ Remove four screw caps and four screws, and then remove the rear cover.

Figure 2-405 Remove the DCF rear cover



2. Remove the DCF pickup motor.

- ▲ Disconnect the motor connector, remove two screws, and then remove the DCF pickup motor.

Figure 2-406 Remove the DCF pickup motor

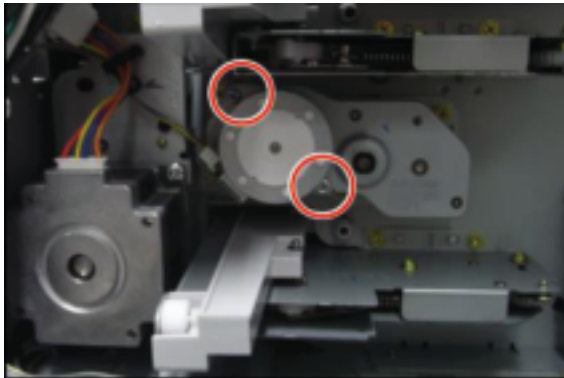

Removal and replacement: Dual-cassette feeder (DCF) motor

This document provides the procedures to remove the Dual cassette feeder (DCF) pickup units assembly.

Mean time to repair: 15 minutes

Service level: Intermediate

 **IMPORTANT:** When applicable, special installation instructions are provided for an assembly at the end of the removal procedure. Always completely read the removal instructions and follow all special installation instructions.

Before performing service

- Disconnect the power cable.

⚠ WARNING! To avoid damage to the printer, turn the printer off, wait 30 seconds, and then remove the power cable before attempting to service the printer.

Use the table below to identify the correct part number for your printer. To order the part, go to <https://parts.hp.com>

Table 2-90 Part information

Dual cassette feeder (DCF) pickup units assembly part number	
JC93-00510A	Dual cassette feeder (DCF) pickup units assembly

Required tools

- #2 JIS screwdriver with a magnetic tip

After performing service

Turn the printer power on

- Connect the power cable.
- Use the power switch to turn the power on.

Post service test

Copy, scan, or print a document. Verify the document copies, scans, or prints correctly.

- ▲ Remove the pickup units.
 - a. Remove the DCF right door.
 - b. Remove two screws, and then remove the cable cover.

Figure 2-407 Remove two screws and the cable cover

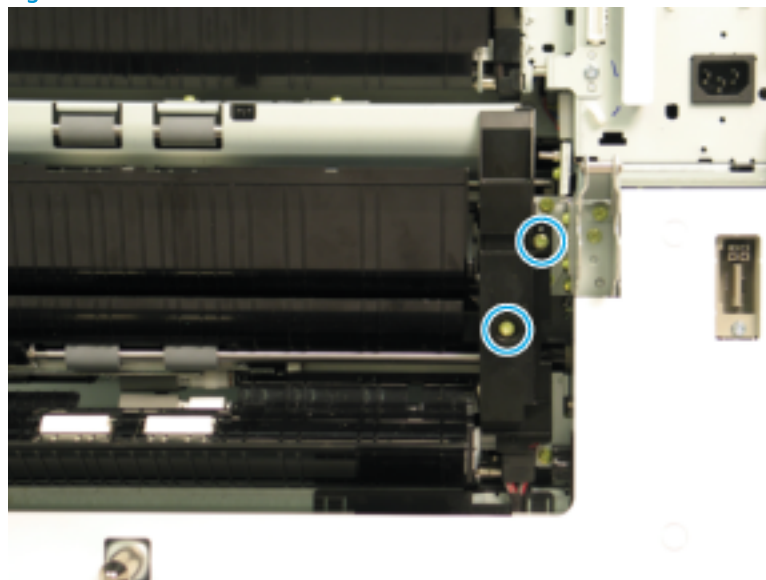

- c. At the front of the printer, remove five screws, and then remove two brackets.

Figure 2-408 Remove five screws and two brackets

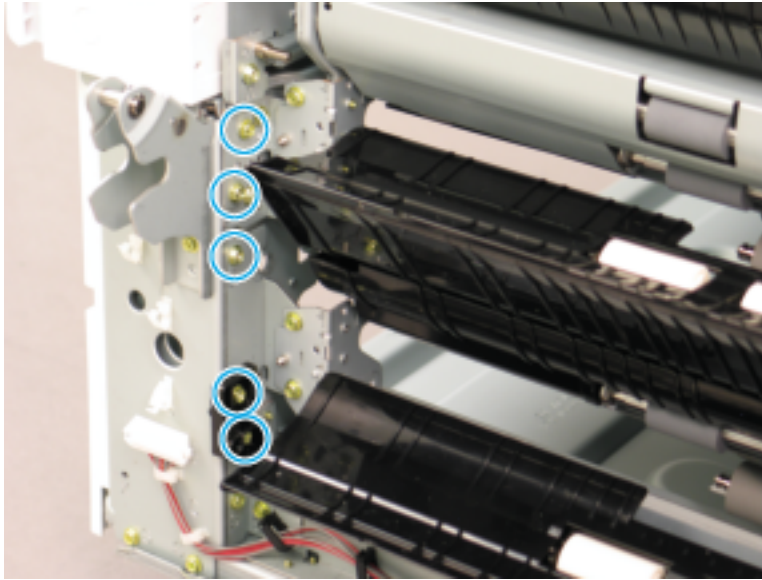

- d. Disconnect two connectors (1), and then remove the wire harness from the cable guide (2). Remove eight screws (3).

Figure 2-409 Disconnect two connectors and remove eight screws

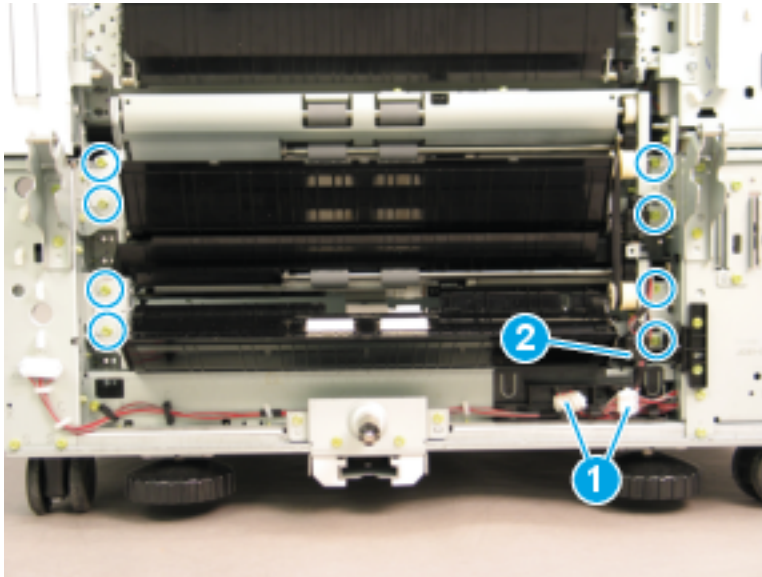

- e. Rotate both pickup units away from the feeder on the left (callout 1). Release the belt (callout 2) that connects the two units. Slide the pickup units to the left (callout 3) to remove them.

Figure 2-410 Remove the pickup units

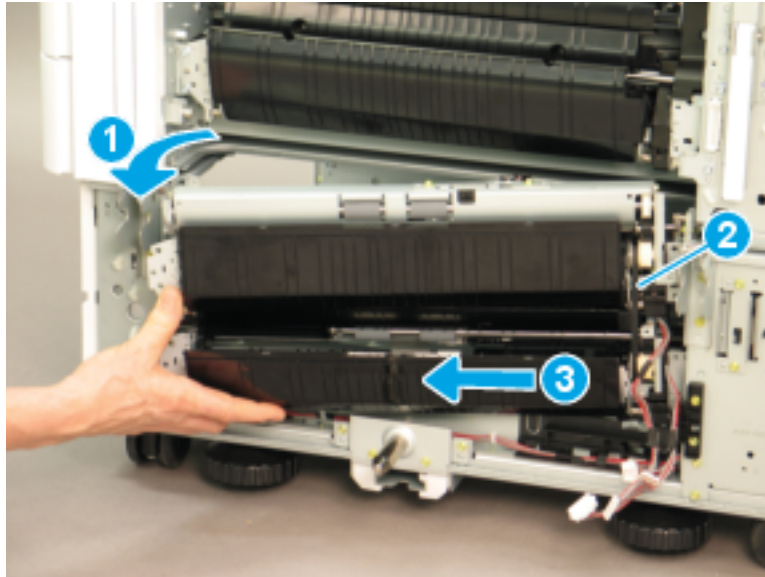

3 Problem solving

Error code and control panel message troubleshooting overview

Error codes and control-panel messages display on the printer control panel to indicate the current printer status or situations that might require action.

Error codes

Error codes indicate the current printer status or situations that might require action.

Error codes are numerical, or alphanumeric, and have a set structure with six characters (example: 13.WX.YZ).

- The first two characters are numeric and represent the system component that is causing the error. For example, in error code 10.22.15, **10 = Supplies** for HP LaserJets.
- The remaining four characters (WX, Y, and Z values) further define the error.

HP LaserJet and HP PageWide Enterprise error codes are documented in the control panel message document (CPMD) for each printer

The CPMD is a comprehensive list of error codes, diagnostic and troubleshooting steps to clear or resolve the error, and other helpful information such as service mode pins and part numbers.

The CPMD is continually updated and republished with the latest information for the following error codes.

Table 3-1 Error codes: The first two characters

Error code	System component	System error description
10.WX.YZ	Supplies (LaserJet)	Supply error or supply memory error
11.WX.YZ	Real-time clock	Internal error with the clock on the formatter.
13.WX.YZ	Jam (LaserJet)	Paper jam or open door jam error.
15.WX.YZ	Jam (PageWide)	Paper jam or open door jam error.
17.WX.YZ	Supplies (PageWide)	Supply error or supply memory error.
20.WX.YZ	Printer memory	Insufficient memory or buffering error.
21.WX.YZ	Page	Page complexity causing a decompression error when trying to process job.
30.WX.YZ	Scanner	Flatbed scanner error occurring inside the unit.
31.WX.YZ	Document feeder	Document feeder, scanner, or jam error.
32.WX.YZ	Backup, restore, or reset	Backup, restore, or reset notification or error.
33.WX.YZ	Security	Backup, Disk, EFI BIOS, Firmware integrity (SureStart), or error.
40.WX.YZ	Input/Output (I/O)	Partition manager, secure erase, or USB accessory error.
41.WX.YZ	Fuser, Laser scanner, or Paper path	Miscellaneous error including general and misprint or mismatch errors typically involving (but not limited to) the fuser, the laser scanner, or the paper path.

Table 3-1 Error codes: The first two characters (continued)

Error code	System component	System error description
42.WX.YZ	Firmware	Firmware failure involving the Event Log, Shell, System Manager, or other component.
44.WX.YZ	Firmware	Firmware failure involving a digital sending component.
45.WX.YZ	OXPd/Web Kit (PageWide)	Informational notifications involving the OXPd Web Kit (communications log).
46.WX.YZ	Engine (LaserJet)	Engine communication error.
47.WX.YZ	Firmware	Job parser or printer calibration error.
48.WX.YZ	Firmware	PJA job accounting, job management, or job pipeline error.
49.WX.YZ	Firmware	Firmware communication error.
50.WX.YZ	Fuser (LaserJet)	Fuser error.
51.WX.YZ	Laser scanner (LaserJet)	Laser scanner beam error.
52.WX.YZ	Laser scanner (LaserJet)	Laser scanner startup error.
54.WX.YZ	Sensor	Sensor error (not jam related).
55.WX.YZ	DC controller (LaserJet)	DC controller communication error.
56.WX.YZ	Paper handling (LaserJet)	Paper input/output or accessory error.
57.WX.YZ	Fan	Fan error.
58.WX.YZ	Sensor	Engine sensor failure.
59.WX.YZ	Motor (LaserJet)	Motor error.
60.WX.YZ	Tray motor error (LaserJet)	Tray lifting or pick up error.
61.WX.YZ	Engine (PageWide and Laser Jet)	Print engine error with the 8-bit data package.
62.WX.YZ	System (LaserJet) Print bar (PageWide)	LaserJet internal system error. PageWide print system error.
63.WX.YZ	Engine (LaserJet)	General engine error (electrical, communication, etc.).
65.WX.YZ	Connector	Output accessory connection error.
66.WX.YZ	Output accessory	Output accessory error.
67.WX.YZ	Input accessory	Input accessory connection error.
69.WX.YZ	Duplexer	Duplexer error.
70.WX.YZ	DC controller (LaserJet)	DC controller firmware error.
80.WX.YZ	Managed device	Embedded Jetdirect error.
81.WX.YZ	Near Field Communication (NFC)	Wireless, Bluetooth or internal EIO error.
82.WX.YZ	Memory (hard disk, EMMC, etc.)	Disk hardware error.

Table 3-1 Error codes: The first two characters (continued)

Error code	System component	System error description
90.WX.YZ	Internal diagnostics	Internal test of systems (i.e. disk, CPB, display) or interconnection error.
98.WX.YZ	Hard disk	Hard disk partition error.
99.WX.YZ	Firmware installer	Remote Firmware Upgrade (RFU), firmware install (engine or accessory), or disk error

How to search for printer documentation

Find printer documentation using the internal HP portals.

The CPMD, error codes, and other support documentation for each printer is found on the internal HP portals [GCSN](#) and [WISE](#) (formerly SAW). GCSN is available to HP channel partners and WISE is available to call agents, service technicians, and other HP internal users. The level of detail available will depend on your access credentials.

How to search WISE for printer documentation

These instructions are for HP internal use by call agents, service technicians, and other internal users. [View a video of how to find support content in WISE.](#)

To view a list of control panel message documents per printer in WISE, enter document ID **c05048451**, to locate CPMD list.

Go to WISE and enter this document ID **c05791539** for written instructions.

How to search GCSN for printer documentation

These instructions are for internal use by HP Channel Partners. [View a video of how find support content in GCSN](#), or follow the steps below.

1. On the Home screen in GCSN, open **Technical information** using one of the following two methods:
 - Type **TINF** in the **Speedcode** field found in the upper right corner and press **Enter**, or
 - On the Home page, click **Technical information** in the left pane.

Figure 3-1 GCSN home page

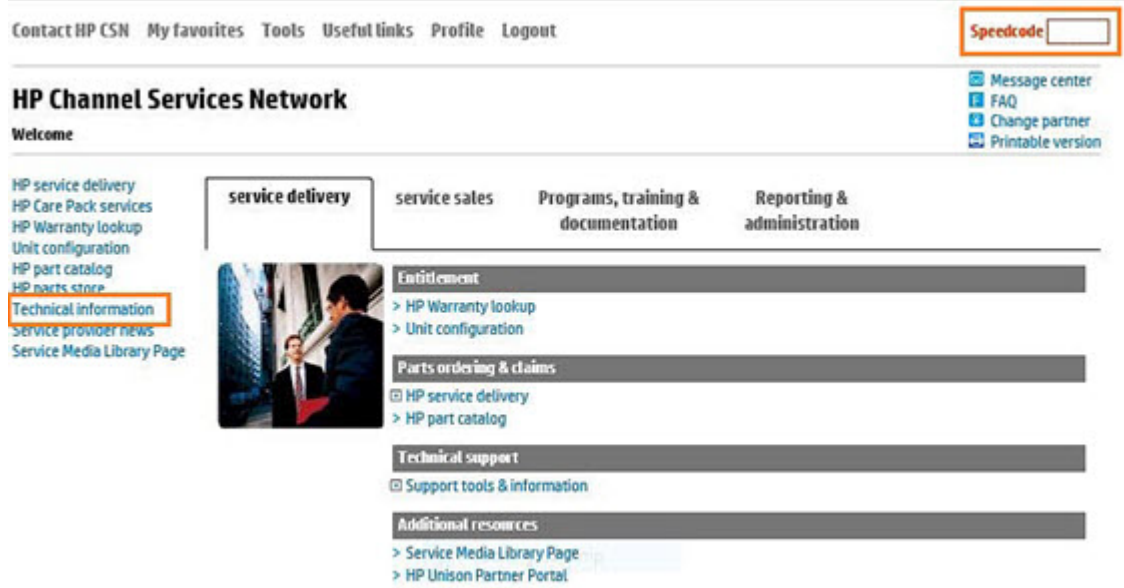

2. Under **Product Search**, select the **Type**, **Category**, **Family**, and **Series** that match your product model (leave the **Model** field as blank or the default).

 **NOTE:** Make sure to login to GCSN using your service-qualified credentials to access the most comprehensive content list available. To find out how to become service-qualified, contact your HP representative.

Figure 3-2 Sample product search criteria (GCSN)

Product Search [Add Favorites](#)

Type
Printers and Multifunction

Category
Multifunction and All-in-One

Family
HP LaserJet MFP and All-in-One Products

Series
HP Color LaserJet Enterprise MFP M682 series

Model
Select a Model

- Click **Add Favorites** and then click **Add** to add the printer to your Favorites list and allow you to bypass the **Product Search** fields next time for that particular model (optional).

Figure 3-3 Add favorites (GCSN)

The screenshot shows a section titled 'Product Search' with a blue 'Add Favorites' button. Below the button are three dropdown menus: 'Type' set to 'Printers and Multifunction', 'Category' set to 'Multifunction and All-in-One', and 'Family' set to 'HP LaserJet MFP and All-in-One Products'.

- Clear all of the high-level check boxes.

Figure 3-4 Clear search criteria (GCSN)

The screenshot shows a list of search criteria checkboxes under the heading 'Select the appropriate check boxes for the document types you wish to review.' The high-level categories 'Support Communications', 'Manuals and Guides', and 'Support Information' are highlighted with orange boxes. All individual checkboxes under these categories are unchecked.

- Select the check boxes for the document types for which you want to search.

NOTE: Select only the high-level **Manuals and Guides** search option if you are not sure in which type of manual or guide the content might be listed.

Figure 3-5 Select search criteria (GCSN)

The screenshot shows the same search criteria checkboxes as Figure 3-4. In this view, several checkboxes are selected (checked) and highlighted with orange boxes: 'Maintenance/Service Guide', 'Service Guide/Manual', 'User Guide', 'CPMMap', and 'Support Information'.

- Select **Submit**.
- If needed, click **Back To selection Criteria** and narrow your search (the maximum allowed search result is 100 documents).



NOTE: Do not select the **Top Issue** option unless you only want to view top issues for that model. All other available content is filtered out.

Table 3-2 Information type selections

Technical information type	Select this checkbox
Control panel message document (CPMD)	CPMD-Map
List of all CPMDs per product	Support Information
Installation Guide or Hardware Install Guide	Maintenance/Service Guide or Install Guide
Service cost document	Install Guide or Service Guide/Manual
Service guide or Service manual	Service Guide/Manual
Self-solve or troubleshooting document	Support Information
User manual or User guide	User Guide
Warranty and Legal Guide	Warranty Statement

Troubleshooting process

Determine the problem source

When the printer malfunctions or encounters an unexpected situation, the printer control panel alerts you to the situation. This section contains a pre-troubleshooting checklist to filter out many possible causes of the problem. A troubleshooting flowchart helps you diagnose the root cause of the problem. The remainder of this chapter provides steps for correcting problems.

- Use the troubleshooting flowchart to pinpoint the root cause of hardware malfunctions. The flowchart guides you to the section of this chapter that contains steps for correcting the malfunction.

Before beginning any troubleshooting procedure, check the following issues:

- Are supply items within their rated life?
- Are supply items genuine HP supplies?
- Does the configuration page reveal any configuration errors?



NOTE: The customer or service provider is responsible for checking supplies and for using supplies that are in good condition.

Power subsystem

Power-on checks

The basic printer functions should start up when the printer is connected to an electrical outlet and the power switch is pushed to the on position. If the printer does not start, use the information in this section to isolate and solve the problem.

If the control panel display remains blank, random patterns display, or asterisks remain on the control-panel display, perform power-on checks to find the cause of the problem.

Power-on troubleshooting overview

During normal operation, a cooling fan begins to spin briefly after the printer power is turned on. Place your hand over the vents at the rear of the printer, next to the formatter, or on the rear of the scanner. If the fan is operating, you will feel air passing out of the printer. You can lean close to the printer and hear the fan operating.

A fan begins to blow on the right door (fuser), and then the control panel goes through a series of set up functions. The main motor turns on (unless the left door or cartridge access door is open, a jam condition is sensed, or the paper-path sensors are damaged). You might be able to visually and audibly determine if the main motor is turned on.

If the fan and main motor are operating correctly, the next troubleshooting step is to isolate print engine, formatter, and control panel problems.

If the control panel is blank one minute after turning on the printer, check the following items:

1. Make sure that the printer is connected directly into an active electrical outlet (not a power strip) that delivers the correct voltage.
2. Make sure that the power switch is in the on position, and then verify that the LED is on.
3. Make sure that the fan runs briefly, which indicates that the power supply is operational.
4. Depress the button on the back of the control panel to test the control panel functionality.
5. Make sure that the control panel display wire harness is connected.
6. Remove any external solutions, and then try to turn the printer on again.

Troubleshooting a blank display, black display, no display, or no power situation

Customers usually report that the control panel display is not showing anything. It is very important to collect as much information as possible from the customer about the issue to help resolve it.

Following are some printer behaviors the customer might encounter:

- The control panel is completely blank (no LEDs or back light).
- The control panel is blank, but there might be LEDs illuminated.
- The control panel is blank (LEDs are on or flashing), and the back light is on (but no text is visible).

Following are some possible causes of a blank control panel display:

- No power to the printer.
- The control panel contrast setting is not correctly adjusted.
- The formatter connector(s) are not fully seated into the connector(s) on the DC controller, or the connectors are not fully seated on the formatter.
- A faulty component is installed on the formatter (for example a memory DIMM, fax PCA, network PCA, USB device, or other component).
- The formatter is defective.
- The control panel connector is not fully seated, or the control panel is defective.
- The DC controller is defective.

Following are some questions to ask the customer:

- Was the printer newly install or has the printer been properly functioning?
 - For a new install, investigate to see if there was any shipping damage to the printer.
 - Did the customer notice any damage to the shipping box or any visible damage to the printer?
- What happened just prior to the control panel going blank?
 - Was the printer serviced recently, a power outage occurred?
 - Has a lightning storm recently occurred?
 - Did the customer recently add a memory DIMM or install a third-party component?
- Make sure to get a complete description of the failure.
 - Is the control panel display completely blank (might be faint text and no back light)?
 - Is the control panel display back light on?
 - Has a print job been sent to the printer? The customer might report that their print jobs seemed to print but when they go to the printer the control panel display is blank.

Recommended actions

If the control panel display is completely blank (no LEDs illuminated or no back light) check to see if the printer is getting power. Listen for fans or any printer initialization sounds when the power is turned on.

If there are no signs of power, then perform the following:

1. Make sure that the printer is plugged directly into an active electrical outlet (not a power strip or interruptible power supply) that delivers the correct voltage.

 **TIP:** Try using a different power cable if possible.

2. Turn the printer power on, and make sure that the fan(s) run briefly (this indicates that the power supply is operational).
3. Check if the yellow LED on the formatter is flashing. If so, there is a communication issue between the formatter and the control panel.
4. Turn the printer power off.
5. Make sure that the control panel display wire harness (and/or flat cable) is properly connected (and fully seated), and then turn the printer power on again.
6. Check control panel diagnostics by pressing the button on the back of the control panel to run different diagnostic tests.
7. Verify the status LEDs are illuminated, but the control panel display is blank. If applicable, check if the contrast setting is adjusted to very low. If so, try turning the contrast knob to see if the control panel display becomes visible.
8. From a host computer, send a print job to the printer.

 **NOTE:** If the print job correctly prints, then the problem is most likely a defective control panel.

9. Turn the printer power off, and then make sure that the memory DIMM is installed in the correct slot and is fully seated.

 **NOTE:** For some printers, there may be more than one memory DIMM installed. Some printers have third party solutions/applications or fonts that use memory.

10. Remove all of the components/accessories installed on the formatter (for example, hard drive, solid-state drive, memory DIMM(s), fax PCA, network PCA, USB devices, or other devices).

- Make sure that the formatter is fully seated.

 **IMPORTANT:** This is important because the formatter or a component on the formatter might be defective or shorted, which causes the printer to lose power.

11. Reinstall the formatter. Make sure that it makes a good connection and is fully seated.

Make sure that all of the connectors on the formatter are correctly connected and fully seated.

12. Turn the printer power on, and then check the control panel display.

13. If the printer control panel is properly working, replace each removed component (one at a time) to determine which one is causing the problem.

 **CAUTION:** Turn the printer power off, and then on again, after replacing a component on the formatter.

14. If the control panel display is still blank after performing the above troubleshooting steps, and the control panel diagnostics do not function, replace the control panel. If the control panel diagnostics are functioning, then replace the formatter.

Control panel checks

Control panel diagnostic flowcharts

Use the flowcharts in this section to troubleshoot the following control panel problems.

Touchscreen black, white, or dim (no image)

 **NOTE:** To open the diagnostic function, press the button on the back of the control panel.

Figure 3-6 Touchscreen blank, white, or dim (no image)

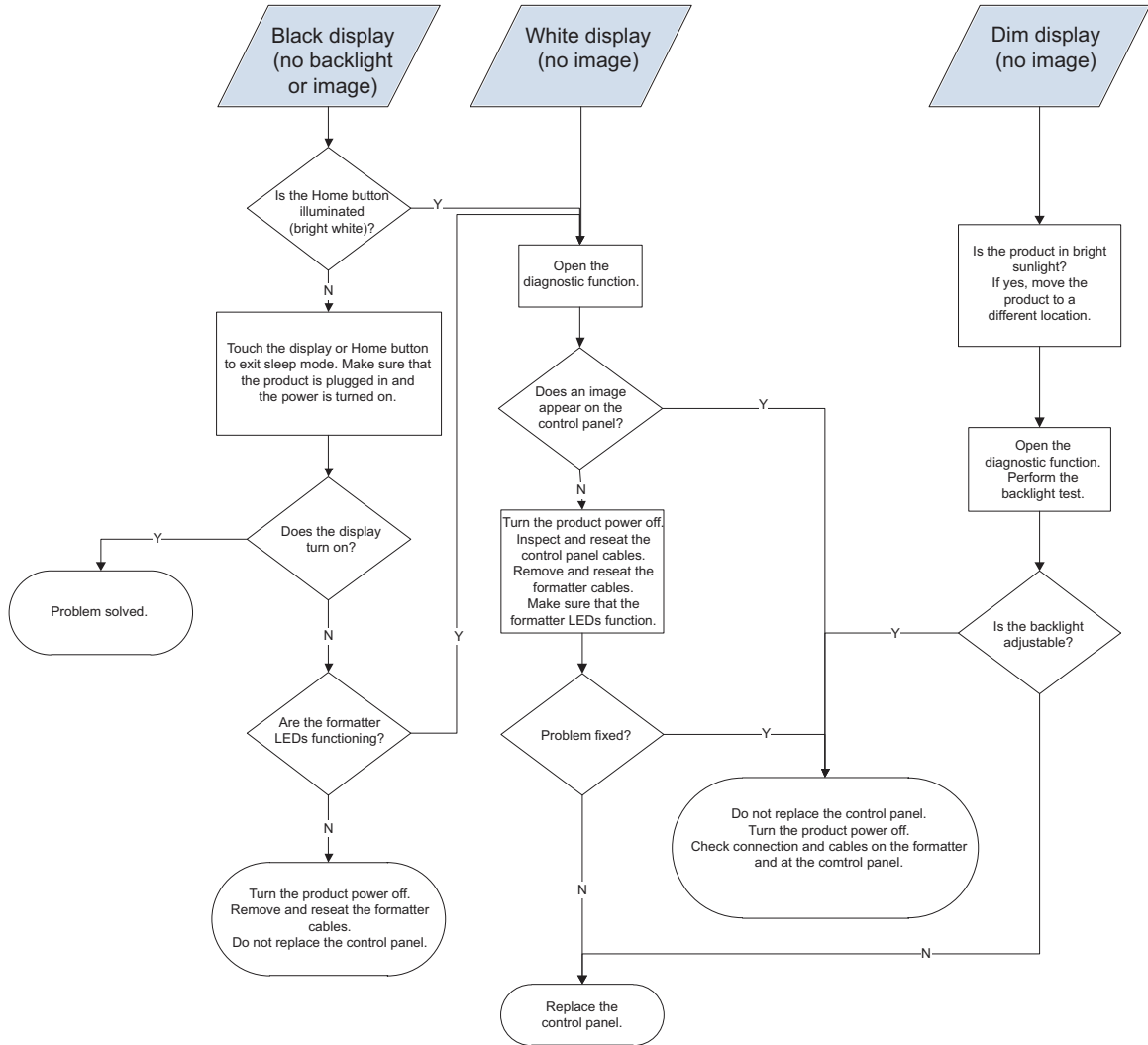

Touchscreen has an unresponsive zone

 **NOTE:** To open the diagnostic function, press the button on the back of the control panel.

Figure 3-7 Touchscreen has an unresponsive zone

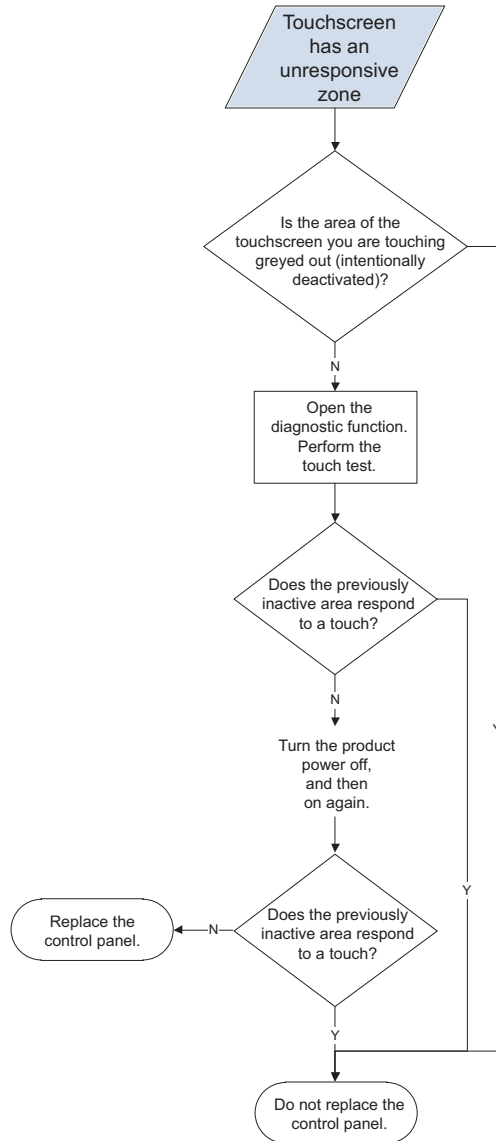

No control panel sound

 **NOTE:** To open the diagnostic function, press the button on the back of the control panel.

Figure 3-8 No control panel sound

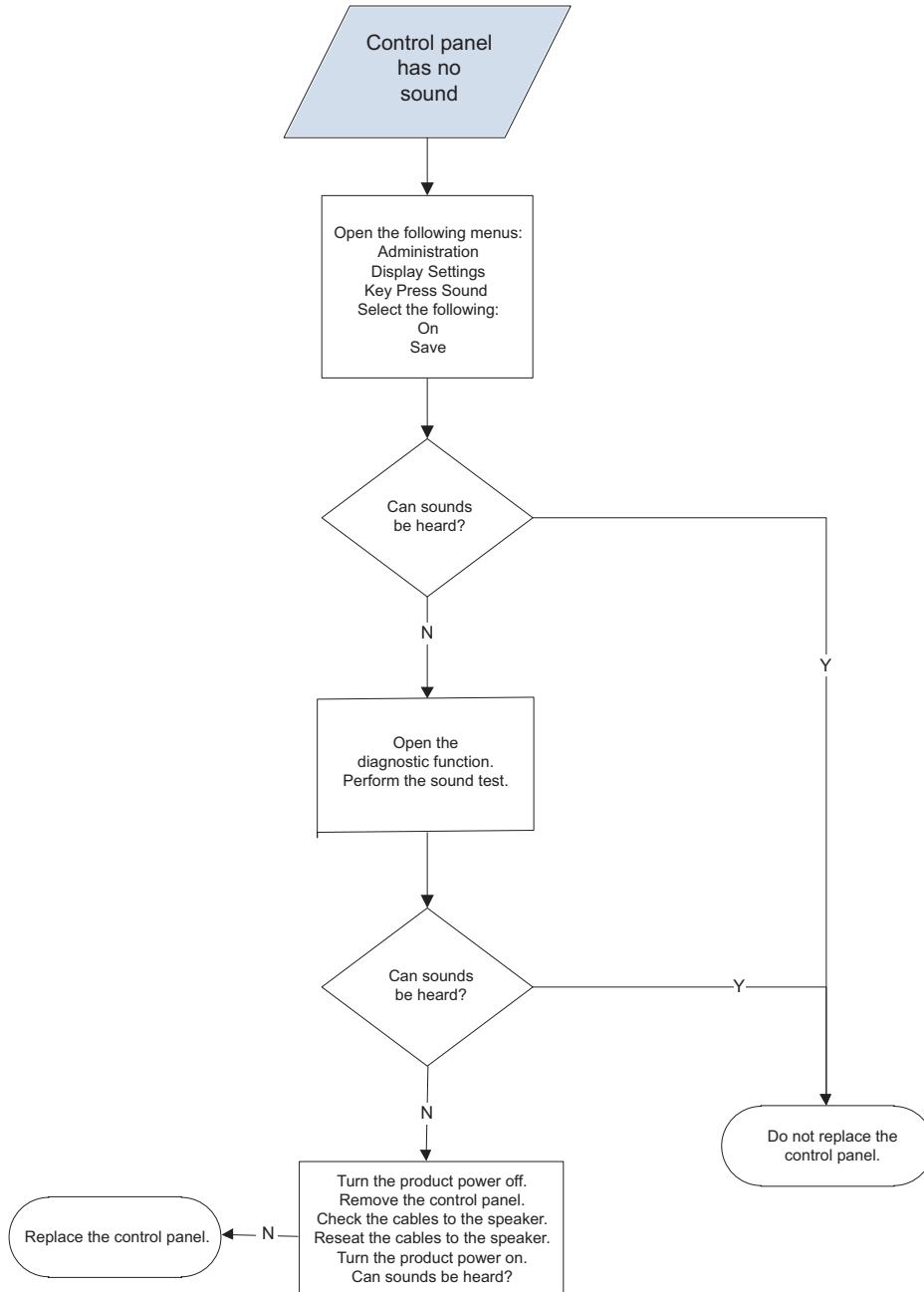

Home button is unresponsive



NOTE: To open the diagnostic function, press the button on the back of the control panel.

Figure 3-9 Home button is unresponsive

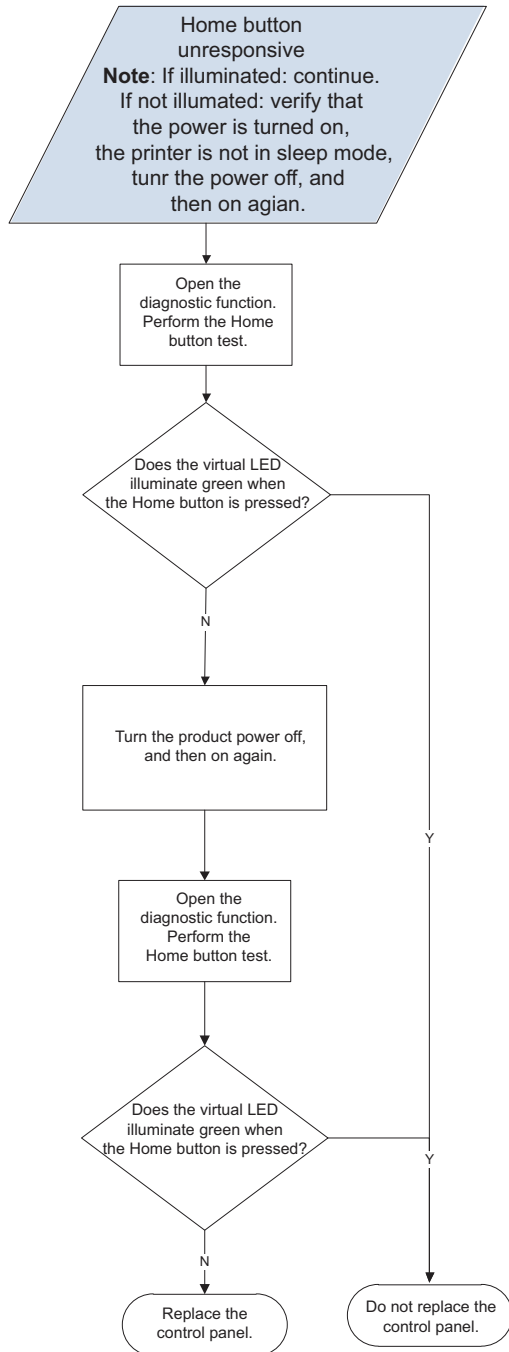

Hardware integration pocket (HIP) is not functioning (control panel functional)

Figure 3-10 Hardware integration pocket (HIP) is not functioning (control panel functional)

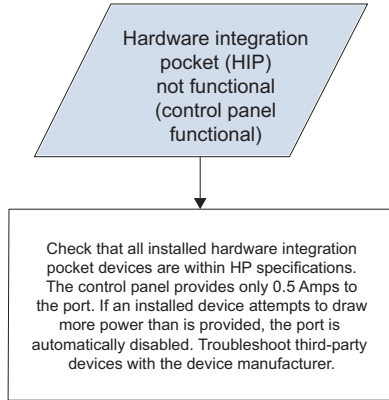

Individual component diagnostics

Tools for troubleshooting: LED diagnostics

LED, engine, and individual diagnostics can identify and troubleshoot printer problems.

Understand lights on the formatter

Three LEDs on the formatter indicate that the printer is functioning correctly.

Figure 3-11 LEDs

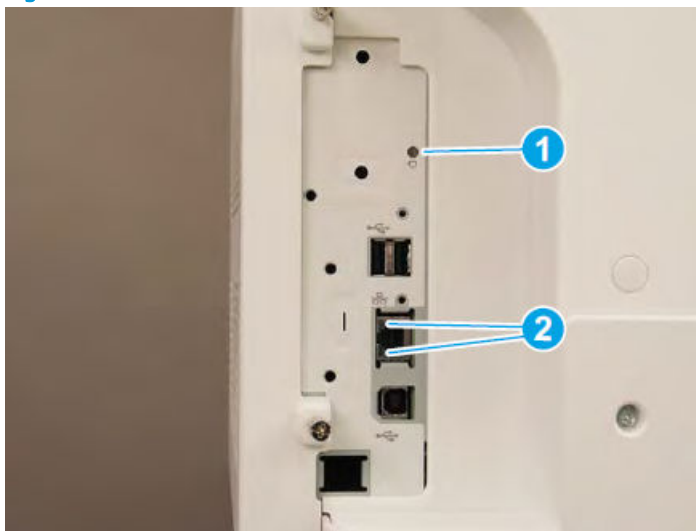

Table 3-3 LEDs

No.	Description
1	Heartbeat LED
2	HP Jetdirect LEDs

HP Jetdirect LEDs

The embedded HP Jetdirect print server has two LEDs. The yellow LED indicates network activity, and the green LED indicates the link status. A blinking yellow LED indicates network traffic. If the green LED is off, a link has failed.

For link failures, check all the network cable connections. In addition, try to manually configure the link settings on the embedded print server by using the printer control-panel menus.

1. From the Home screen on the printer control panel, select **Settings**.
2. Open the following menus:
 - **Networking**
 - **Ethernet**
 - **Link Speed**
3. Select the appropriate link speed, and then select **OK**.

Tools for troubleshooting: Engine diagnostics

The printer contains extensive internal engine diagnostics that help in troubleshooting print quality, paper path, noise, assembly, and timing issues.

Defeating interlocks

Different tests can be used to isolate different types of issues. For assembly or noise isolation, run the diagnostic test when the toner cartridge door or right door is open.

Defeating the door interlocks allows observation of the paper pick operation (and view the page enter registration).

⚠ WARNING! Be careful when performing printer diagnostics to avoid risk of injury. Only trained service personnel should open and run the diagnostics with a door open. Never touch any of the power supplies when the printer is turned on.

Defeat the toner cartridge door interlock

1. Open the toner cartridge door.
2. Insert a folded piece of paper into the slot.

💡 TIP: Fold a stiff piece of paper, for example a business card or index card, into two 10 mm (.375 in) strips, and insert the strips into the slot for the cartridge door logic switches.

Figure 3-12 Defeat the toner cartridge door interlock



Defeat the front door interlock

1. Open the right door.
2. Insert a folded piece of paper into the slot.

📝 NOTE: Fold a stiff piece of paper, for example a business card or index card, into two 10 mm (.375 in) strips, and insert the strips into the slot for the front door logic switches.

Figure 3-13 Defeat the front door interlock



Tools for troubleshooting

Individual component diagnostics (special-mode test)

This test activates individual parts independently to isolate problems.

Each component test can be performed once or repeatedly.



NOTE: The cartridge door interlocks must be defeated to run the component tests.

Access the individual component diagnostics from a touchscreen control panel

1. From the Home screen on the printer control panel, scroll to and touch the **Support Tools** button.
2. Select one of the following tests:
 - **Continuous Scan**
 - **Run Fax Test**
3. Select the component test options for the test.

Tools for troubleshooting

Problem-solving checklist

Follow these steps when trying to solve a problem with the printer.

Step 1: Check that the printer power is on

1. Make sure that the printer is plugged in and turned on. The power button should be lit with a white light. If it is not, press the power button. If the power button does not light up, check the following conditions.
 - Make sure that the power cable is connected to the printer and the outlet.
 - Check the power source by connecting the power cable to a different outlet.
2. If the printer motors do not rotate, make sure that the toner cartridges are installed and that the doors are all closed. The control panel displays messages to indicate problems.

Step 2: Check the control panel for error messages

The control panel should indicate ready status. If an error message appears, resolve the error.

Print a supplies status page to ensure that the supplies are not at or over end of life.

 **NOTE:** HP long-life consumable and maintenance kit life specifications are estimations. Actual individual life or yield during normal use will vary depending on usage, environment, media, and other factors. Estimated life is not an implied warranty.

Step 3: Test print functionality

1. From the control panel Home screen, touch the **Reports** button.
2. Open the **Reports** menu, touch the **Configuration/Status Pages** menu, select the **Configuration Page** item, and then touch the **Print** button to print the report.
3. If the report does not print, make sure that paper is loaded in the tray, and check the control panel to see if paper is jammed inside the printer.

 **NOTE:** Make sure that the paper in the tray meets specifications for this printer.

Step 4: Test copy functionality

1. Place the configuration page in the ADF and make a copy. If paper does not feed smoothly through the ADF, you might need to clean the ADF rollers and separation pad. Make sure that the paper meets specifications for this printer.
2. Place the configuration page onto the scanner glass and make a copy.
3. If the print quality on the copied pages is not acceptable, clean the scanner glass and the small glass strip.

Step 5: Test the fax sending functionality

1. From the control panel Home screen, touch the **Support Tools** button.
2. Open the **Troubleshooting** menu, and then open the **Diagnostics Tools** menu. Touch the **Run Fax Test** button to test the fax functionality.
3. Touch the **Fax** on the printer control panel, and then touch the **Start Fax** button.

Step 6: Test the fax receiving functionality

1. From the control panel Home screen, touch the **Support Tools** button.
2. Touch the **Troubleshooting** menu, and then open the **Diagnostics Tests** menu. Touch the **Run Fax Test** button to test the fax functionality.
3. Use another fax machine to send a fax to the printer.
4. Review and reset the printer fax settings.

Step 7: Try sending a print job from a computer

1. Use a word processor program to send a print job to the printer.
2. If the job does not print, make sure that you selected the correct printer driver.
3. Uninstall and then reinstall the printer software.

Step 8: Test the plug and print USB drive printing functionality

1. Load a .PDF document or .JPEG photo onto a USB flash drive, and insert it in the USB port near the control panel.
2. The **USB flash drive** menu opens. Try printing the document or photo.
3. If no documents are listed, try a different type of USB flash drive.

Factors that affect printer performance

Several factors affect the time it takes to print a job:

- The software program that you are using and its settings
- The use of special paper (such as heavy paper or custom-size paper)
- Printer processing and download time
- The complexity and size of graphics
- The speed of the computer you are using
- The USB or network connection
- Whether the printer is printing in color or in monochrome
- The type of USB drive, if you are using one
- Environmental factors, such as low temperature or high humidity

Print menu map

To more easily navigate individual settings, print a report of the complete the **Reports** menu.

Print the menu map from a touchscreen control panel

1. From the **Home screen** on the printer control panel, scroll to and touch the **Reports** button.
2. Open the **Configuration/Status pages** menu.
3. Select the **Settings menu map** option.
4. Touch the **Print** button to print the report.

 **TIP:** Multiple report pages can be selected, and then printed together.

Print current settings pages

Printing the current settings page provides a map of the user configurable settings that might be helpful in the troubleshooting process.

Print the current settings page from the touchscreen control panel

1. From the **Home screen** on the printer control panel, scroll to and touch the **Reports** button.
2. Open the **Configuration/Status pages** menu.
3. Select the **Current settings page** option.
4. Touch the **Print** button to print the report.

 **TIP:** Multiple report pages can be selected, and then printed together.

Print event log

Printing the event log might be helpful in the troubleshooting process.

Print the event log from the Reports menu from a touchscreen control panel

1. From the Home screen on the printer control panel, scroll to and touch the Support Tools button.
2. Open the following menus:
 - Troubleshooting
 - Event Log
3. The event log displays on the screen. To print it, touch the Print button.

Print the event log from the Service menu from a touchscreen control panel

1. From the Home screen on the printer control panel, scroll to and touch the Support Tools button.
2. Open the Service menu.
3. Enter the following service access code for the printer:

– 04077419

4. Touch the Event Log item.

Clear the event log from a touchscreen control panel

1. From the Home screen on the printer control panel, scroll to and touch the Support Tools button
2. Open the Service menu.
3. On the sign-in screen, select the Service Access Code option from the drop-down list.
4. Enter the following service access code for the printer:
 - 04077419
5. Select the trash icon to clear the event log.

Pre-boot menu options

The Pre-boot menus are available prior to the printer initializing.

⚠ CAUTION: The Format Disk option (printers with a hard-disk drive only) performs a disk initialization for the entire disk. The operating system, firmware files, and third party files (among other files) will be completely lost. HP does not recommend this action.

💡 TIP: The Pre-boot menu can be remotely accessed by using a telnet network protocol to establish an administration connection to the printer.

Open the Pre-boot menu from a touchscreen control panel

Learn how to open the Pre-boot menu from a touchscreen control panel.

1. Touch the middle of the control-panel display when you see the 1/8 under the logo.

Figure 3-14 Open the Pre-boot menu



2. On the **Pre-boot** menu screen, use the following buttons to navigate the tests.

Figure 3-15 Pre-boot menu



Use this button to see more information about a selected item.



Use this button to scroll up through menu items.



Use this button to select a highlighted menu item.



Use this button to scroll down through menu items.



Use this button to go back to the previous menu.



Not used.



Use this button to exit a diagnostic test.

3. Use the arrow buttons on the touchscreen to navigate the [Pre-boot](#) menu.
4. Touch the [OK](#) button to select a menu item.

Cold reset using the Pre-boot menu from a touchscreen control panel

Learn how to cold reset using the Pre-boot menu from a touchscreen control panel.

CAUTION: This procedure resets all printer configurations and settings to factory defaults (customer configurations and settings are lost).

1. Touch the middle of the control-panel display when you see the [1/8](#) under the logo.

Figure 3-16 Open the Pre-boot menu

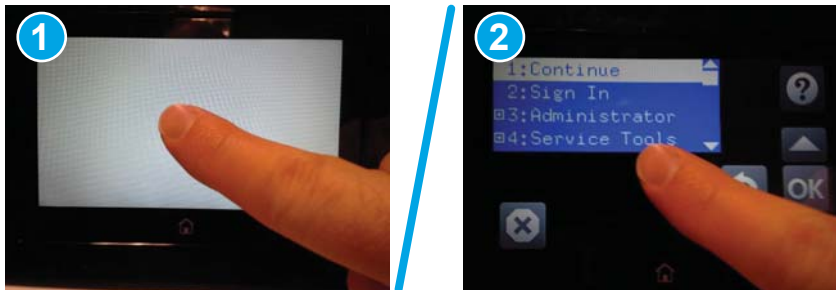

2. Use the ▼ button to highlight the [+3:Administrator](#) item, and then touch the [OK](#) button.
3. Use the ▼ button to highlight the [+8:Startup Options](#) item, and then touch the [OK](#) button.
4. Use the ▼ button to highlight the [2 Cold Reset](#) item, and then touch the [OK](#) button to select it.
5. Touch the Home button to return to the main [Pre-boot](#) menu and highlight the [1:Continue](#) item, and then touch the [OK](#) button.

NOTE: The printer will initialize.

NOTE: Some of the pre-boot options in the following tables are not supported by the current version of the printer firmware and are included for information only. Future versions of firmware will support these options.

Table 3-4 Pre-boot menu options (1 of 7)

Menu option	First level	Second level	Third level	Description
Continue				<p>Selecting the Continue item exits the Pre-boot menu and continues the normal boot process.</p> <p>If a selection is not made in the initial menu within 30 seconds, the printer returns to a normal boot (the same as selecting Continue).</p> <p>If the user navigates to another menu, the timeout does not apply.</p>
Sign In				Enter the administrator PIN or service PIN if one is required to open the Pre-boot menu.
Administrator				<p>This item navigates to the Administrator submenus.</p> <p>If authentication is required (and the user is not already signed in) the Sign In prompt displays. The user is required to sign in.</p>

Table 3-4 Pre-boot menu options (1 of 7) (continued)

Menu option	First level	Second level	Third level	Description
	Download	Network USB USB Thumbdrive		This item initiates a Pre-boot firmware download process. A USB Thumbdrive option will work on all FutureSmart printers. USB or Network connections are not currently supported.
	Format Disk			This item reinitializes the disk and cleans all disk partitions. CAUTION: Selecting the Format Disk item removes all data. A delete confirmation prompt is not provided. The system is not bootable after this action and a 99.09.67 error displays on the control panel. A firmware download must be performed to return the system to a bootable state.
	Partial Clean			This item reinitializes the disk (removing all data except the firmware repository where the master firmware bundle is downloaded and saved). CAUTION: Selecting the Partial Clean item removes all data except the firmware repository. A delete confirmation prompt is not provided. CAUTION: This procedure resets all printer configurations and settings to factory defaults (customer configurations and settings are lost). This allows a user to reformat the disk by removing the firmware image from the active directory without having to download new firmware code (printer remains bootable).
	Change Password			Select this item to set or change the administrator password.
	Clear Password			Select the Clear Password item to remove a password from the Administrator menu. Before the password is actually cleared, a message will be shown asking to confirm that the password should be cleared. Press the OK button to confirm the action. When the confirmation prompt displays, press the OK button to clear the password.

Table 3-5 Pre-boot menu options (2 of 7)

Menu option	First level	Second level	Third level	Description
Administrator (continued)	Manage Disk	Clear disk		Select the Clear disk item to enable using an external device for job storage. Job storage is normally enabled only for the Boot device. This will be grayed out unless the 99.09.68 error is displayed.

Table 3-5 Pre-boot menu options (2 of 7) (continued)

Menu option	First level	Second level	Third level	Description
		Lock Disk		<p>Select the Lock Disk item to lock (mate) a new secure disk to this printer.</p> <p>The secure disk already locked to this printer will remain accessible to this printer. Use this function to have more than one encrypted disk accessible by the printer when using them interchangeably.</p> <p>The data stored on the secure disk locked to this printer always remains accessible to this printer.</p>
		Leave Unlocked		<p>Select the Leave Unlocked item to use a new secure disk in an unlocked mode for a single service event. The secure disk that is already locked to this printer will remain accessible to this printer and uses the old disk's encryption password with the new disk.</p> <p>The secure disk that is already locked to this printer remains accessible to this printer.</p>
		Clear Disk Pwd		<p>Select the Clear Disk Pwd item to continue using the non-secure disk and clear the password associated with the yet-to-be installed secure disk.</p> <p>CAUTION: Data on the missing secure disk will be permanently inaccessible.</p>
		Retain Password		<p>Select the Retain Password item to use the non-secure disk for this session only, and then search for the missing secure disk in future sessions.</p>
	Boot Device		Secure Erase	<p>Select the Secure Erase item to erase all of the data on the disk and unlock it if required.</p> <p>This might take a long time.</p> <p>NOTE: The system will be unusable until the system files are reinstalled. The ATA secure-erase command is a one-pass overwrite, which erases the entire disk including firmware. The disk remains an encrypted disk.</p>
			Erase/Unlock	<p>Select the Erase/Unlock item to cryptographically erase all data on the disk and unlock the disk to allow a user to gain access to it from any printer.</p> <p>NOTE: The system will be unusable until the system files are reinstalled. It erases the encryption key. The encryption key is erased, so the disk becomes a non-encrypted disk.</p>
			Get Status	<p>This item provides disk status information if any is available.</p>

Table 3-6 Pre-boot menu options (3 of 7)

Menu option	First level	Second level	Third level	Description
Administrator	Manage Disk	Internal Device		Select the Internal Device item to erase the internal device or get a status about the internal device.
(continued)	(continued)			

Table 3-6 Pre-boot menu options (3 of 7) (continued)

Menu option	First level	Second level	Third level	Description
			Secure Erase	Select the Secure Erase item to erase all of the data on the disk and unlock it if required. This might take a long time. NOTE: The system will be unusable until the system files are reinstalled. The ATA secure-erase command erases the entire disk, including firmware. The disk remains an encrypted disk.
			Erase/Unlock	Select the Erase/Unlock item to cryptographically erase all of the data on disk and unlock the disk to allow the user to gain access to it from any printer. NOTE: The system will be unusable until the system files are reinstalled. The HP High Performance Secure Hard Disk is erased.
			Get Status	This item provides disk status information if any is available.
		External Device		Select the External Device item to erase the external device or get status about the external device.
			Secure Erase	Select the Secure Erase item to erase all of the data on the disk and unlock it if required. This might take a long time. NOTE: The system will be unusable until the system files are reinstalled. The ATA secure-erase command erases the entire disk, including firmware. The disk remains an encrypted disk.
			Erase/Unlock	Select the Erase/Unlock item to cryptographically erase all of the data on disk and unlock the disk to allow a user to gain access to it from any printer. NOTE: The system will be unusable until the system files are reinstalled. The encryption key is erased, so the disk becomes a non-encrypted disk.
			Get Status	This item provides disk status information if any is available.

Table 3-7 Pre-boot menu options (4 of 7)

Menu option	First level	Second level	Third level	Description
Administrator	Configure LAN	IP Mode [DHCP]		The network can be configured to obtain the network settings from a DHCP server or as static. Use this item for automatic IP address acquisition from the DHCP server.
(continued)	NOTE: This configuration is only active when the Pre-boot menu is open.	IP Mode [STATIC]		Use this item to manually assign the network addresses.
			IP Address	Use this item to manually enter the IP addresses.
			Subnet Mask	Use this item to manually enter the subnet mask.
			Default Gateway	Use this item to manually enter the default gateway.
			Save	Select the Save item to save the manual settings.

Table 3-8 Pre-boot menu options (5 of 7)

Menu option	First level	Second level	Third level	Description
Administrator (continued)	Startup Options			Select the Startup Options item to specify options that can be set for the next time the printer is turned on and initializes to the Ready state.
		Show Revision		Not currently functional: Select the Show Revision item to allow the printer to initialize and show the firmware version when the printer reaches the Ready state. Once the printer power is turned on the next time, the Show Revision item is unchecked so that the firmware revision is not shown.
		Cold Reset		Select the Cold Reset item to clear the IP address and all customer settings. (This item also returns all settings to factory defaults.) NOTE: Items in the Service menu are not reset.
		Skip Disk Load		Select the Skip Disk Load item to disable installed third-party applications.
		Skip Cal		Select the Skip Cal item to skip the printer calibration for the very next power-initialization cycle only.
		Lock Service		CAUTION: Select the Lock Service item to lock the Service menu access (both in the Pre-boot menu and the Device Maintenance menu). Service personnel must have the administrator remove the Lock Service setting before they can open the Service menu.
		Skip FSCK		Select the Skip FSCK item to disable Chkdisk/ScanVolume during startup.
Administrator (continued)	Startup Options (continued)	First Power		Not currently functional: This item allows the printer to initialize as if it is the first time it has been turned on. For example, the user is prompted to configure first-time settings like date/time, language, and other settings. Select this item so that it is enabled for the next time the printer power is turned on. When the printer power is turned on the next time, this item is unchecked so that the pre-configured settings are used during configuration, and the first-time setting prompt is not used.
		Embedded Jetdirect Off		Select the Embedded Jetdirect Off item to disable the embedded HP Jetdirect. By default this item is unchecked so that HP Jetdirect is always enabled.
		WiFi Accessory		Select the WiFi Accessory item to enable the wireless accessory.

Table 3-9 Pre-boot menu options (6 of 7)

Menu option	First level	Second level	Third level	Description
Administrator (continued)	Diagnostics			Diagnostic items are useful to diagnose hardware components and their interface connections. Use these items to troubleshoot specific hardware components, and the interface between them and other components.
		Memory	Do Not Run	Use the Do Not Run item to exclude the Memory diagnostic when executing multiple diagnostics.
			Short	Use the Short item to select a brief memory test. NOTE: This test requires about four minutes to execute.
			Long	Use the Long item to select an extended memory test. NOTE: This test requires about twenty minutes to execute.
		Disk	Do Not Run	Use the Do Not Run item to exclude the Disk diagnostic when executing multiple diagnostics.
			Short	Use the Short item to select a brief firmware self-test. NOTE: This test requires about two or three minutes to execute.
			Long	Use the Long item to select an extended firmware self-test. NOTE: This test requires about sixty minutes to execute.
			Optimized	Use the Optimized item to select a test that checks the active sectors on the disk. NOTE: This test requires about thirty minutes to execute.
			Raw	Use the Raw item to select a test that checks every sector on the disk. NOTE: This test requires about fifty minutes to execute.
			Smart	Use the Smart item to select a very brief test that checks the drive self-monitoring analysis and reporting technology (SMART) status—the drive detects and reports reliability indicators to help anticipate disk failures (SMART status).
			CPB	Use the CPB item to verify the integrity of the copy processor board (CPB) and the formatter PCA connections.

Table 3-9 Pre-boot menu options (6 of 7) (continued)

Menu option	First level	Second level	Third level	Description
		Interconnect		Use the Interconnect item to verify the integrity of the interconnect PCA (ICB) and its connections.
		Run Selected		Select the Run Selected item to execute a selected test. NOTE: If more than one test is selected, they are executed in sequence.

Table 3-10 Pre-boot menu options (7 of 7)

Menu option	First level	Second level	Third level	Description
Administrator (continued)	Remote Admin	Start Telnet		The Remote Admin item allows a service technician to access to the printer Pre-boot menu remotely, and to navigate the menu selections from a remote location. IMPORTANT: A Remote Admin connection must be initiated by a person that is physically present at the printer. This person will also need to provide a randomly generated PIN to the remote service technician.
		Stop Telnet		
		Refresh IP		
	System Triage	Copy Logs		If the device will not boot to the Ready state, or the diagnostic log feature found in the Troubleshooting menu is not accessible, then use the System Triage item to copy the diagnostic logs to a USB flash drive at the next printer start up. The files can then be sent to HP to help diagnose the problem.
		Change Svc PWD		Use this item to change the Service menu personal identification number (PIN).
		Reset Svc PWD		If the Service menu personal identification number (PIN) has been changed. Use this item to reset it to the original PIN.
Service Tools	Reset Password			Use this item to reset the Pre-boot administrator password.
	Subsystems			For manufacturing use only. Do not change these values.
Developer Tools	Netexec			

Remote Admin

The Remote Admin feature allows remote access the printer Pre-boot menu (BIOS environment). The printer functions as a telnet server which uses the telnet networking protocol to transmit text data. Any computer (with telnet installed and enabled) can function as the telnet client to remotely display and interact with the Pre-boot menu.



IMPORTANT: While the Remote Admin function allows remote access the Pre-boot menu, for security reasons the Remote Admin connection must be initiated by a person that is physically present at the printer.

This section describes the following Remote Admin items.

Required software and network connection

Before using the Remote Admin feature, make sure that the telnet network protocol is installed, and enabled, on the remote telnet client computer.

 **NOTE:** This section describes enabling and configuring the telnet feature for computers using a Windows® operating system.

HP recommends that the telnet client computer be a Windows based system, however, there are other operating systems that support the telnet network protocol. For information about enabling and configuring the telnet network protocol for other operating systems, see the owner's manual for that operating system.

Telnet client

All computers using the Windows operating system have the telnet client installed, however, the telnet client function might not be enabled by default.

 **NOTE:** The figures and menus in this section are for the Windows 7 Enterprise® operating system. Screens and menu selections might vary slightly for other operating systems.

1. Use the **Start** menu to open the **Control Panel**, and then click the **Programs** item to select it.

Figure 3-17 Open the Control Panel

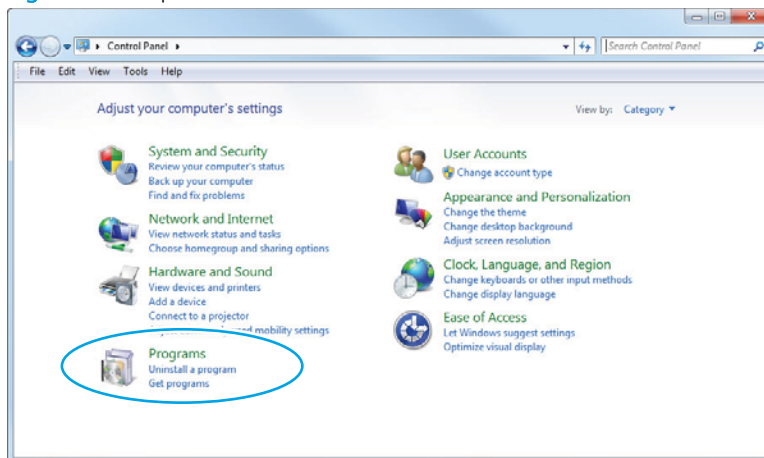

2. Click the **Turn Windows features on or off** item to select it.

Figure 3-18 Turn Windows features on or off

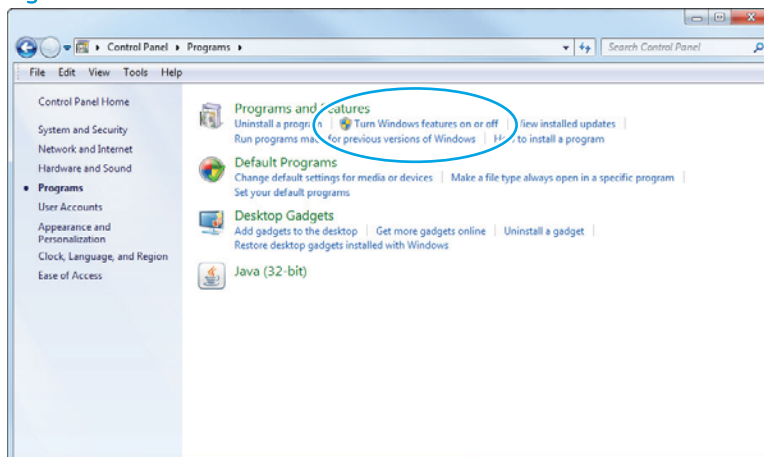

3. In the **Windows Features** box, scroll down to **Telnet Client**. If the check box is not checked, click the box to select it, and then click the **OK** button.

 **TIP:** If the check box is already checked then the telnet client function is already enabled. Click the **Cancel** button.

Figure 3-19 Enable the telnet client feature



Network connection

The remote telnet client computer must have direct network access to the printer for the Remote Admin function to operate. This means that the telnet client computer must be on the same network as the printer. The Remote Admin function cannot be accessed through a network firewall or other remote access network security programs.

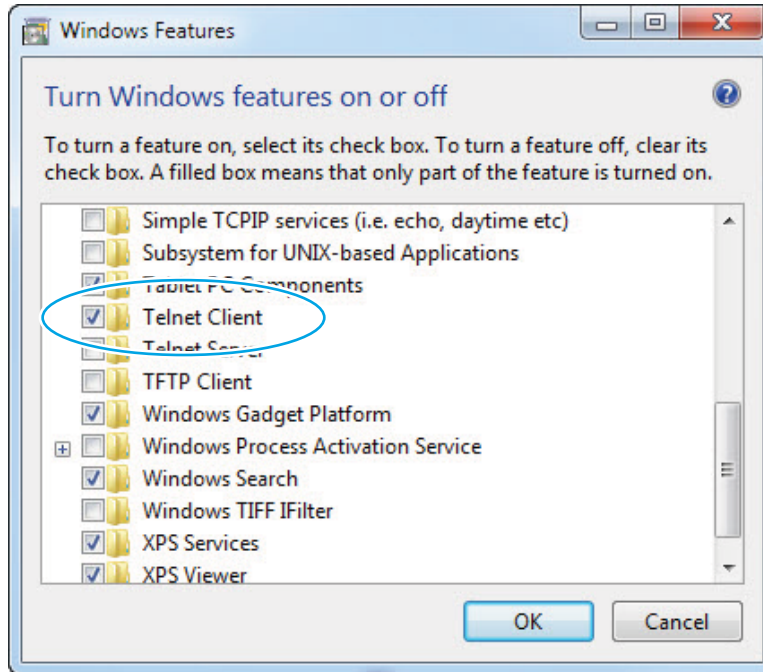
If a private network is not accessible, ask the network administrator to set up a virtual private network (VPN) connection to the network.

Connect a remote connection

Learn how to connect a remote connection using telnet.

Start the telnet server function at the printer

For security reasons the Remote Admin feature must be initiated by a person that is physically present at the printer. The following steps must be performed by a person that is physically present at the printer.

 **NOTE:** This person might need to sign in with an administrator or service password depending on how the printer is configured.

1. Turn the printer on.
2. The HP logo displays on the printer control panel. When a "1/8" with an underscore displays, touch the middle of the screen to open the [Pre-boot](#) menu.
3. Use the arrow buttons on the touchscreen to scroll down and highlight the **+3:Administrator** item, and then touch the **OK** button to select it.

Figure 3-20 Select the +3:Administrator item

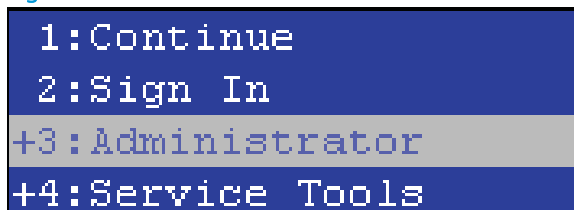

4. Use the arrow buttons on the touchscreen to scroll down and highlight the **+A:Remote Admin** item, and then touch the **OK** button to select it.

Figure 3-21 Select the +A:Remote Admin item

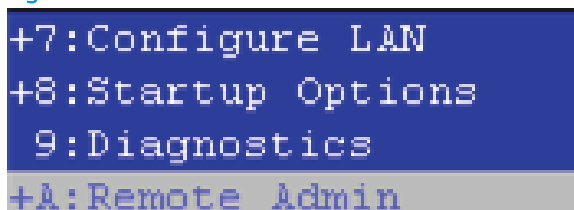

5. Use the arrow buttons on the touchscreen to scroll down and highlight the **1:Start Telnet** item, and then touch the **OK** button to select it.

Figure 3-22 Select the 1:Start Telnet item

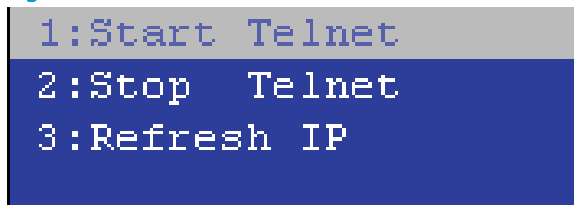

6. Do one of the following
 - If a connecting message displays briefly, go to step 7.

Figure 3-23 Telnet connecting message

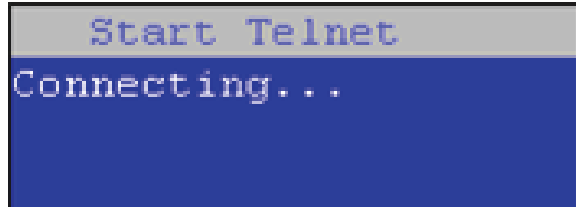

- If an error message displays, use the steps below to identify the problem.

Figure 3-24 Telnet error message



- a. The printer network cable is not correctly connected.
 - b. The BIOS LAN settings are incorrect.
 - The printer should be configured to use a static IP address, but is configured to use DHCP instead.
 - The printer is configured to use a static IP address, but the IP address is incorrect.
 - c. The printer is correctly configured to use DHCP, but the DHCP server is not turned on or is malfunctioning.
7. When the printer telnet server function is initialized, the following screen appears. Use the information on this screen to connect the remote telnet client computer to the printer.

 **NOTE:** The printer is now ready to receive remote telnet client commands.

- **IP:** The static or dynamically allocated IP address for the printer.
- **Port:** The standard telnet port (23).
- **Pin:** A randomly generated 4-digit personal identification number (PIN).

Figure 3-25 Telnet server function initialized

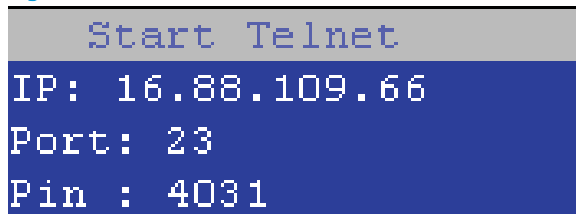

Start the telnet client function at the remote computer

The following steps establish a Remote Admin connection from a remote computer to the printer.

1. From the **Start** menu click **Run** to open a dialog box, type `cmd` in the **Open** field, and then click the **OK** button to open a Windows command window.

Figure 3-26 Open a command window

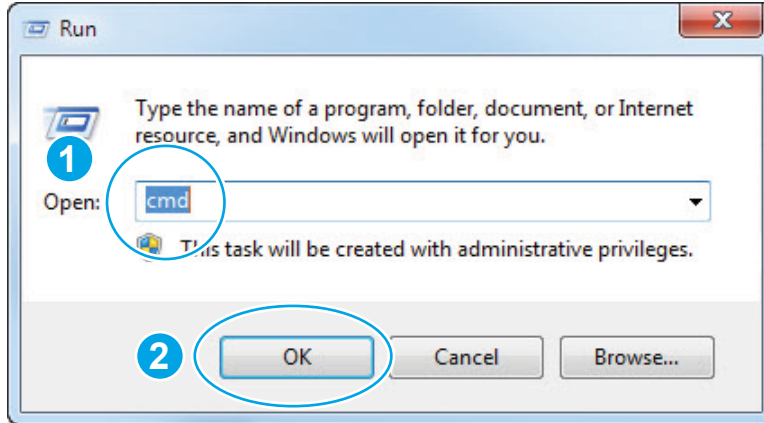

2. From any displayed directory, type `telnet` at the prompt, and then press the **Enter** key.

Figure 3-27 Start a telnet session

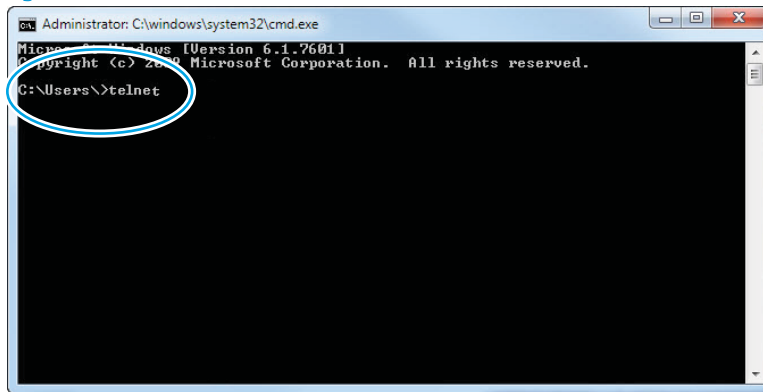

3. Type `<IP ADDRESS>` at the telnet prompt, and then press the **Enter** key.

 **NOTE:** For `<IP ADDRESS>`, substitute the IP address that was displayed in step 7 in [Start the telnet server function at the printer on page 494](#).

 **TIP:** If the telnet connection fails to establish a connection, the printer is probably behind a firewall or on a different network than the remote telnet client computer. See [Network connection on page 493](#).

Figure 3-28 Establish a telnet connection



4. Type the PIN that was displayed in step 7 in [Start the telnet server function at the printer on page 494](#) at the prompt, and then press the **Enter** key.

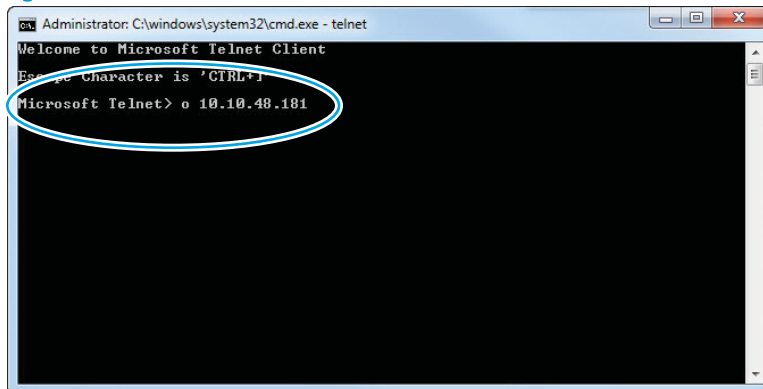

 **IMPORTANT:** Make sure to type the PIN correctly. After five incorrect PIN entries, the printer terminates the Remote Admin connection. The Remote Admin feature must be re-initiated at the printer. See [Start the telnet server function at the printer on page 494](#).

Figure 3-29 Enter the PIN

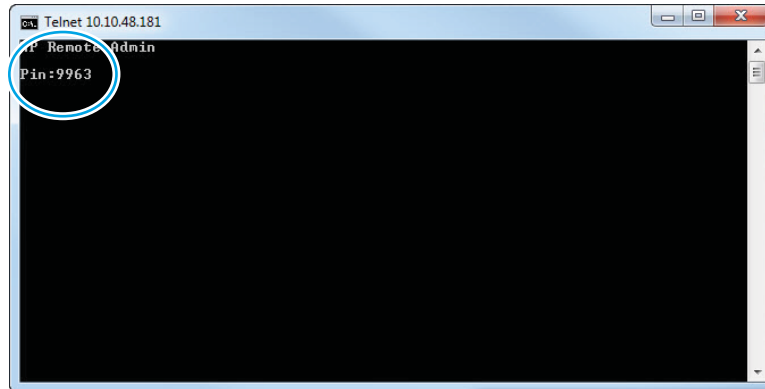

5. The following screen displays when the correct PIN is entered and the Remote Admin connection is successful.

 **NOTE:** Because a Remote Admin connection is an unsecure telnet network protocol connection, the following Pre-boot menu items are disabled for the remote telnet client computer.

- The +3:Administrator menu 4:Change Password item.
- The +3:Administrator menu 5:Clear Password item.
- The +3:Administrator menu 6:Disk Manage item.

Figure 3-30 Remote Admin window

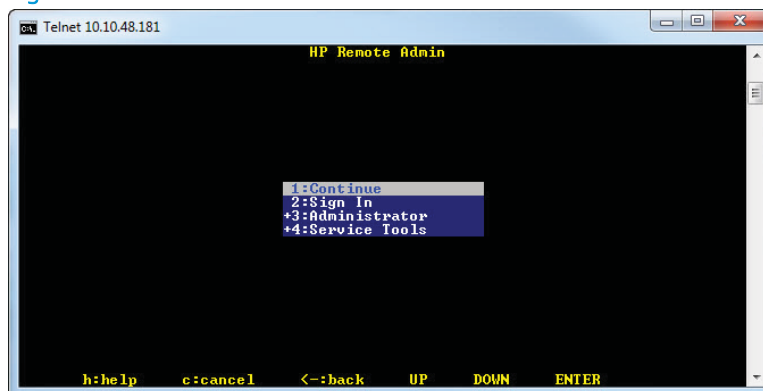

Disconnect a remote connection

Learn how to disconnect a remote connection.

The Remote Admin connection can be terminated from the printer control panel or the remote telnet client computer.



NOTE: The following procedure describes terminating a Remote Admin connection from the remote telnet client computer.

1. From the Pre-boot main menu, use the arrow buttons on the keyboard to scroll down to the **+3:Administrator** item, and then press the **Enter** key.

Figure 3-31 Access the administrator menu

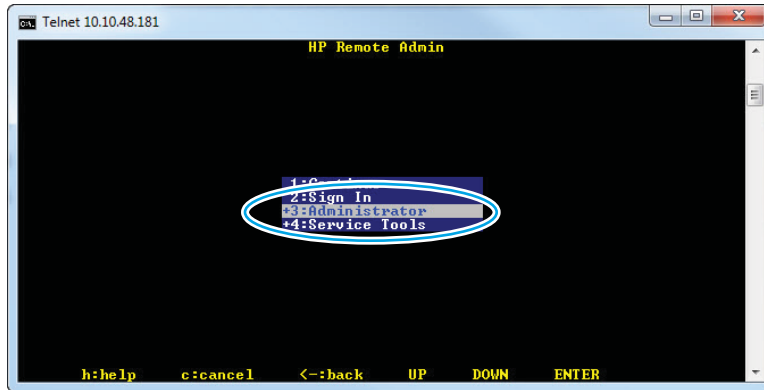

2. Use the arrow buttons on the keyboard to scroll down to the **+A:Remote Admin** item, and then press the **Enter** key.

Figure 3-32 Access the remote admin menu

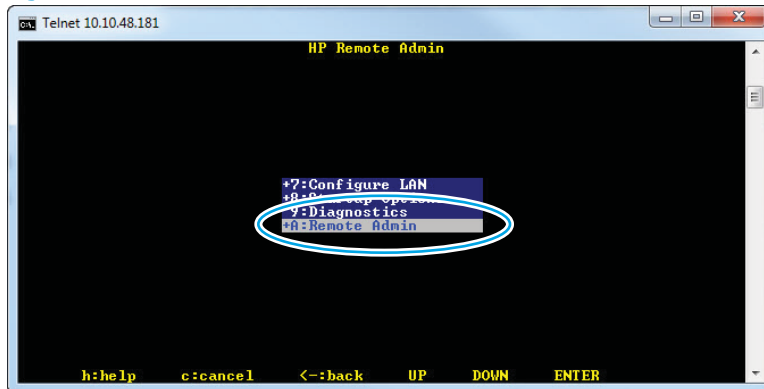

3. Use the arrow buttons on the keyboard to scroll down to the **2:Stop Telnet** item, and then press the **Enter** key. The Remote Admin connection between the printer and the remote telnet client computer terminates.



IMPORTANT: The printer remains in the Pre-boot menu. Have the person that is physically present at the printer do the following:

- Touch the **Home** button to return to the main Pre-boot menu and highlight the **1:Continue** item, and then touch the **OK** button. The printer will continue to initialize.

Figure 3-33 Terminate the telnet connection

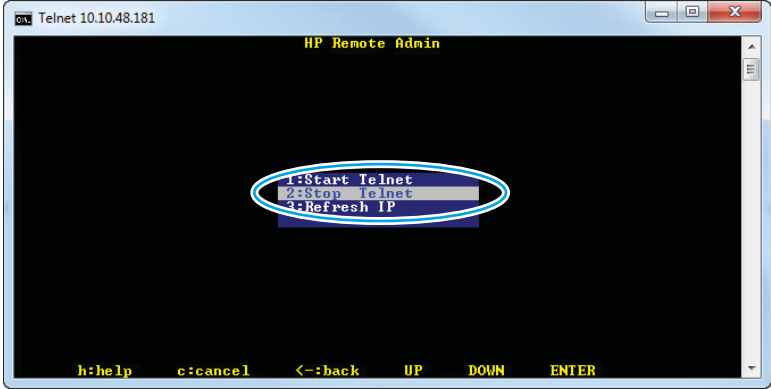

Control panel menus

You can perform basic printer setup by using the [Settings](#) menu. Use the HP Embedded Web Server for more advanced printer setup. To open the HP Embedded Web Server, enter the printer IP address or host name in the address bar of a web browser.

Reports menu

To display: At the printer control panel, select [Reports](#).

In the following table, asterisks (*) indicate the factory default setting.

Table 3-11 Reports menu

First level	Second level	Values	Description
Configuration/Status Pages	Settings Menu Map	Print	Shows a map of the entire control panel system and the selected values for each setting.
		View	
	Current Settings Page	Print	Shows a summary of the current settings for the printer. This might be helpful if you plan to make changes and need a record of the present configuration.
		View	
	Configuration Page	Print	Shows the printer settings and installed accessories.
		View	
	How to Connect Page	Print	Shows the network information typically needed to connect the printer to a network.
		View	
	Supplies Status Page	Print	Shows the approximate remaining life for the supplies; reports statistics on total number of pages and jobs processed, serial number, page counts, and maintenance information.
		View	
Usage Page	Print	Shows a count of all paper sizes that have passed through the printer; lists whether they were simplex, duplex, monochrome, or color; and reports the page count.	
	View		
File Directory	Print	Shows the file name and folder name for files that are stored in the printer memory.	
	View		
Web Services Status Page	Print	Shows the detected Web Services for the printer.	
	View		
Color Usage Job Log	Print	Shows color jobs completed by the printer.	
	View		

Table 3-11 Reports menu (continued)

First level	Second level	Values	Description
Fax Reports (MFP fax models only)	Fax Activity Log	Print	Contains a list of the faxes that have been sent from or received by this printer.
		View	
	Billing Codes Report	Print	Provides a list of billing codes that have been used for outgoing faxes. This report shows how many sent faxes were billed to each code.
		View	
	Blocked Fax List	Print	A list of phone numbers that are blocked from sending faxes to this printer.
View			
Speed Dial List	Print	Shows the speed dials that have been set up for this printer.	
	View		
Fax Call Report	Print	A detailed report of the last fax operation, either sent or received.	
	View		
Other Pages	Demonstration Page	Print	Prints a demonstration page.
	RGB samples	Print	Prints color samples for different RGB values. Use the samples as a guide for matching printed colors.
	CMYK samples	Print	Prints color samples for different CMYK values. Use the samples as a guide for matching printed colors.
	PCL Font List	Print	Prints the available PCL fonts.
	PS Font List	Print	Prints the available PS fonts.

Settings menu

To display: At the printer control panel, select the [Settings](#) menu.

In the following table, asterisks (*) indicate the factory default setting.

Table 3-12 Settings menu

First level	Second level	Third level	Fourth level	Fifth level	Values	Description
General	Date/Time Settings	Date/Time Format	Date Format		DD/MMM/YYYY	Use the Date/Time Settings menu to specify the date and time and to configure date/time settings.
					MMM/DD/YYYY	
					YYYY/MMM/DD	
			Time Format	12 hour (AM/PM)	Select the format that the printer uses to show the date and time, for example 12-hour format or 24-hour format.	
		24 hours				

Table 3-12 Settings menu (continued)

First level	Second level	Third level	Fourth level	Fifth level	Values	Description
		Date/Time	Date		Select the time zone from a list.	Select the time zone, date, and time that the printer uses.
			Time		Select the date from a pop-up calendar.	
			Time Zone		Select the time from a pop-up keypad.	
	Energy Settings	Sleep Schedule	A list of scheduled events displays.		+ (Add) Edit Delete	Use to configure the printer to automatically wake up or go to sleep at specific times on specific days. Using this feature saves energy. NOTE: You must configure the date and time settings before you can use this feature.
			New event	Event Type		Select whether to add or edit a Wake event or a Sleep event, and then select the time and the days for the wake or sleep event.
				Time		Set the wake or sleep event time parameters.
				Event Days	Select days of the week from a list.	Set the wake or sleep event day parameters.
		Sleep Settings	Auto Off After Sleep		Range: 1 to 110 minutes	Set the number of minutes after which the printer enters Sleep or Auto Off mode. Touch the existing number to open the virtual keypad, and then increase or decrease the number of minutes.
			Sleep After Inactivity		Default = 0 minutes	
			HP Auto Off/Auto On			
			Shut Down			
			Wake/Auto On to These Events		All Events* Network port Power button only	

Table 3-12 Settings menu (continued)

First level	Second level	Third level	Fourth level	Fifth level	Values	Description
	Display Settings	Display Brightness	Automatic* Manual		The Manual setting uses a slider to manually control the display brightness.	Use to specify the intensity of the LCD control panel display.
		System Sound			On* Off	Use to specify whether you hear a sound when you touch the screen or press buttons on the control panel.
		Language Settings	Language		Select from a list of languages that the printer supports.	Use to select a different language for control panel messages and specify the default keyboard layout. When you select a new language, the keyboard layout automatically changes to match the factory default for the selected language.
			Keyboard Layout M681z/M682z only		Each language has a default keyboard layout. To change it, select from a list of layouts.	Select the default keyboard layout that matches the language you want to use.
		Information Screen			Show connection information* Hide connection information	Use this menu item to display or hide connection information on the Home screen.
		DisplayDate and Time M681/M682 only			Show Date and Time* Hide Date and Time	Select whether to display or hide the date and time on the control panel Home screen.
		Inactivity Timeout			Range: 10-300 seconds Default = 60 seconds	Specifies the amount of time that elapses between any activity on the control panel and when the printer resets to the default settings. When the timeout expires, the control panel display returns to the Home menu, and any user signed in to the printer is signed out.

Table 3-12 Settings menu (continued)

First level	Second level	Third level	Fourth level	Fifth level	Values	Description
		Clearable Warnings			On Job*	Use this feature to set the period that a clearable warning displays on the control panel. If the On setting is selected, clearable warnings appear until the Clearable Warnings button is pressed. If the Job setting is selected, clearable warnings stay on the display during the job that generated the warning and disappear from the display when the next job starts.
		Continuable Events			Auto-continue (10 seconds)* Touch OK to continue	Use this option to configure the printer behavior when the printer encounters certain errors. If the Auto-continue (10 seconds) option is selected, the job will continue after 10 seconds. If the Touch OK to continue option is selected, the job will stop and require the user to touch the OK button before continuing.

Table 3-12 Settings menu (continued)

First level	Second level	Third level	Fourth level	Fifth level	Values	Description
	Jam Recovery				Auto* Off On	<p>This printer provides a jam recovery feature that reprints jammed pages. Select one of the following options:</p> <p>Auto: The printer attempts to reprint jammed pages when sufficient memory is available. This is the default setting.</p> <p>Off: The printer does not attempt to reprint jammed pages. Because no memory is used to store the most recent pages, performance is optimal.</p> <p>NOTE: When using this option, if the printer runs out of paper and the job is being printed on both sides, some pages can be lost.</p> <p>On: The printer always reprints jammed pages. Additional memory is allocated to store the last few pages printed. This might cause a decrease in overall performance.</p>
	Auto Recovery				Enabled Disabled*	<p>The printer attempts to reprint jammed pages when sufficient memory is available. This is the default setting.</p>

Table 3-12 Settings menu (continued)

First level	Second level	Third level	Fourth level	Fifth level	Values	Description
	Hold Off Print Job				Enabled* Disabled	Enable this feature if you want to prevent print jobs from starting while a user is initiating a copy job from the control panel. Held print jobs start printing after the copy job is finished, provided that no other copy job is in the print queue.
	Restore Factory Settings				Restore Cancel	Use to restore all printer settings to their factory defaults.
Copy/Print	Copy Settings	Image Preview				Display a preview of the image before printing it.
	Enable Device USB				Enabled Disabled*	Enables the printer to open a file from a USB drive.
	Manage Stored Jobs	Job Sort Order			Job Name* Date	This option allows you list the jobs either alphabetically or chronologically.
		Retain Temporary Jobs After Reboot			Do not retain Personal jobs only All temporary jobs	Sets which temporary jobs will be retained in the event of a printer reboot.
		Temporary Job Storage Limit			1-300 Default = 32	Configure global settings for jobs that are stored in the printer memory. The Temporary Job Storage Limit feature specifies the number of temporary jobs that can be stored on the printer. The maximum allowed value is 300.

Table 3-12 Settings menu (continued)

First level	Second level	Third level	Fourth level	Fifth level	Values	Description
		Temporary Stored Job Retention			1-300 Default = 32	Configure global settings for jobs that are stored in the printer memory. The Temporary Stored Job Retention feature specifies the number of temporary jobs that can be stored on the printer. The maximum allowed value is 300.
		Standard Stored Job Retention			1-300 Default = 32	Configure global settings for jobs that are stored in the printer memory. The Temporary Stored Job Retention feature specifies the number of standard jobs that can be stored on the printer. The maximum allowed value is 300.
Default Print Options		Number of Copies			Range: 1-32000 Default = 1	Sets the default number of copies for a copy job. This default applies when the Copy function or the Quick Copy function is initiated from the printer Home screen.
		Paper Selection			Select from a list of sizes that the printer supports.	Configures the default paper size used for print jobs.
	Default Custom Paper Size	X Dimension			Range: 3-8.5 inches Default = 8.5 inches	Configures the default paper size that is used when the user selects Custom as the paper size for a print job.
		Y Dimension			Range: 5-14 inches Default = 14 inches	
		Use Inches			Enabled* Disabled	

Table 3-12 Settings menu (continued)

First level	Second level	Third level	Fourth level	Fifth level	Values	Description
		Output Sides		1-sided* 2-sided		Use to indicate whether the original document is printed on one or both sides, and whether the copies should be printed on one or both sides. For example, select the 1-sided original, 2-sided output option when the original is printed on one side, but you want to make two-sided copies.
		Staple			None Top left Top right Top left or right	Sets the position of the staple on the page.
		Output Bin			Automatically select Standard bin Upper bin Middle bin	
		Resolution			FastRes1200 1200x1200dpi	Sets the resolution for sent documents. Higher resolution images have more dots per inch (dpi), so they show more detail. Lower resolution images have fewer dots per inch and show less detail, but the file size is smaller. Some file types, for example a file that will be processed with OCR, require a specific resolution. When these file types are selected, the Resolution setting might automatically change to a valid value.

Table 3-12 Settings menu (continued)

First level	Second level	Third level	Fourth level	Fifth level	Values	Description
	PCL and PostScript Settings	Courier Font			Regular* Dark	Select which version of the Courier font you want to use. The factory default setting is Regular , which uses an average stroke width. The Dark setting can be used if a heavier Courier font is needed.
		Wide A4			Enabled Disabled*	Changes the printable area of A4-size paper. If you enable this option, eighty 10-pitch characters can be printed on a single line of A4 paper.
		Print PS Errors			Enabled Disabled*	Use this feature to select whether a PostScript (PS) error page is printed when the printer encounters a PS error.
		Print PDF Errors			Enabled Disabled*	Selects whether a PDF error page is printed when the printer encounters a PDF error.
		Personality			Auto* PCL PS PDF	Configures the default print language or personality for the printer. Normally you should not change the printer language. If you change the setting to a specific printer language, the printer does not automatically switch from one language to another unless specific software commands are sent to it.

Table 3-12 Settings menu (continued)

First level	Second level	Third level	Fourth level	Fifth level	Values	Description
		PCL	Font Settings	Font Source	Internal Disk resident	Selects the font source for the user-soft default font. The list of available options varies depending on the installed printer options.
				Font Number	Range: 0-110 Default = 0	Specifies the font number for the user-soft default font using the source that is specified in the Font Source menu. The printer assigns a number to each font and lists it on the PCL font list. The font number displays in the Font # column of the printout.
				Font Pitch	Range: 0.44-99.99 Default = 10	If the Font Source option and the Font Number setting indicate a contour font, then use this feature to select a default pitch (for a fixed-spaced font).
			PCL Settings	Form Length	Range: 5-128 Default = 60	Controls the PCL print-command options. PCL is a set of printer commands that HP developed to provide access to printer features. Use the Form Length feature to select the user-soft default vertical form length.
				Orientation	Portrait* Landscape	Select the orientation that is most often used for copy or scan originals. Select the Portrait option if the short edge is at the top or select the Landscape option if the long edge is at the top.

Table 3-12 Settings menu (continued)

First level	Second level	Third level	Fourth level	Fifth level	Values	Description
				Symbol Set	Select from a list of symbol sets.	Select any one of several available symbol sets from the control panel. A symbol set is a unique grouping of all the characters in a font. The factory default value for this option is PC-8. Either PC-8 or PC-850 are recommended for line-draw characters.
				Append CR to LF	No* Yes	Configure whether a carriage return (CR) is appended to each line feed (LF) encountered in backwards-compatible PCL jobs (pure text, no job control). Select Yes to append the carriage return. The default setting is No. Some environments, such as UNIX, indicate a new line by using only the line-feed control code. This option allows the user to append the required carriage return to each line feed.
				Suppress Blank Pages	No* Yes	This option is for users who are generating their own PCL, which could include extra form feeds that would cause blank pages to be printed. When the Yes option is selected, form feeds are ignored if the page is blank.

Table 3-12 Settings menu (continued)

First level	Second level	Third level	Fourth level	Fifth level	Values	Description
				Media Source Mapping	Standard* Classic	Use to select and maintain input trays by number when you are not using the printer driver, or when the software program has no option for tray selection. The following options are available: Standard: Tray numbering is based on newer HP LaserJet models. Classic: Tray numbering is based on HP LaserJet 4 and older models.
	Print Quality	Adjust Color	Tonal Range	Highlights Midtones Shadows		
			Cyan Magenta Yellow Black			
		Image Registration	Tray	Tray 1 Tray 2 Tray 3 Tray 4 Tray 5 Depends upon number of trays installed		Specify tray to be adjusted

Table 3-12 Settings menu (continued)

First level	Second level	Third level	Fourth level	Fifth level	Values	Description
			Front-side Horizontal Shift		-5.00 mm to 5.00 mm	Shift the margin alignment to center the image on the page from top to bottom and from left to right. You can also align the image on the front with the image printed on the back.
			Front-side Vertical Shift			The direction that is perpendicular to the way the paper passes through the printer is referred to as X. This is also known as the scan direction. X1 is the scan direction for a single-sided page or for the second side of a two-sided page. X2 is the scan direction for the first side of a two-sided page.
			Back-side Horizontal Shift			The direction that the paper feeds through the printer is referred to as Y. Y1 is the feed direction for a single-sided page or for the second side of a two-sided page. Y2 is the feed direction for the first side of a two-sided page.
			Back-side Vertical Shift			Use the Adjust Tray <X> menu to adjust the registration settings for each tray. Before adjusting these values, print a registration test page. It provides alignment guides in the X and Y directions so you can determine which adjustments are necessary. You can adjust values for X1 Shift, X2 Shift, Y1 Shift, and Y2 Shift.

Table 3-12 Settings menu (continued)

First level	Second level	Third level	Fourth level	Fifth level	Values	Description
				Print Test Page		Use the Print Test Page option to print a page to test the image registration. It provides alignment guides in the X and Y directions so you can determine which adjustments are necessary.
		Auto Sense Behavior	Tray 1		Sense every page Sense first page Sense transparency only	
			All Other Trays		Sense first page Sense transparency only	
		Adjust paper types			Select from a list of paper types Reset Paper Types	
		Optimize			Normal Paper Heavy paper Envelope control Tray 1 Background Background 1 Uniformity Control Tracking Control Registration Transfer Control Moisture Control Reset Optimize	
		Edge Control			Off Light Normal Maximum	

Table 3-12 Settings menu (continued)

First level	Second level	Third level	Fourth level	Fifth level	Values	Description
	Manage Trays	Use Requested Tray			Exclusively* First	<p>Controls how the printer handles jobs that have specified a specific input tray. Two options are available:</p> <p>Exclusively: The printer never selects a different tray when the user has indicated that a specific tray should be used, even if that tray is empty.</p> <p>First: The printer pulls from another tray if the specified tray is empty, even though the user specifically indicated a tray for the job.</p>
		Manually Feed Prompt			Always* Unless loaded	<p>Indicate whether a prompt should appear when the type or size for a job does not match the specified tray and the printer pulls from the multipurpose tray instead. Two options are available:</p> <p>Always: A prompt always displays before using the multipurpose tray.</p> <p>Unless loaded: A message displays only if the multipurpose tray is empty.</p>

Table 3-12 Settings menu (continued)

First level	Second level	Third level	Fourth level	Fifth level	Values	Description
		Size/Type Prompt			Display* Do not display	<p>Controls whether the tray configuration message displays whenever a tray is closed. Two options are available:</p> <p>Display: Shows the tray configuration message when a tray is closed. The user is able to configure the tray settings directly from this message.</p> <p>Do not display: Prevents the tray configuration message from automatically appearing.</p>
		Use Another Tray			Enabled* Disabled	<p>Use to turn on or off the control panel prompt to select another tray when the specified tray is empty. Two options are available:</p> <p>Enabled: When this option is selected, the user is prompted either to add paper to the selected tray or to choose a different tray.</p> <p>Disabled: When this option is selected, the user is not given the option of selecting a different tray. The printer prompts the user to add paper to the tray that was initially selected.</p>

Table 3-12 Settings menu (continued)

First level	Second level	Third level	Fourth level	Fifth level	Values	Description
		Alternative Letterhead Mode			Disabled* Enabled	Use to load letterhead or preprinted paper into the tray the same way for all print jobs, whether you are printing to one side of the sheet or to both sides of the sheet. When this option is selected, load the paper as you would for printing on both sides. See the user documentation that came with the printer for instructions about loading letterhead for printing on both sides. When this option is selected, the printer speed slows to the speed required for printing on both sides.
		Duplex Blank Pages			Auto* Yes	Controls how the printer handles two-sided jobs (duplexing). Two options are available: Auto: Enables Smart Duplexing, which instructs the printer not to process blank pages. Yes: Disables Smart Duplexing and forces the duplexer to flip the sheet of paper even if it is printed on only one side. This might be preferable for certain jobs that use paper types such as letterhead or prepunched paper.

Table 3-12 Settings menu (continued)

First level	Second level	Third level	Fourth level	Fifth level	Values	Description
		Override A4/Letter			Yes* No	Prints on letter-size paper when an A4 job is sent but no A4-size paper is loaded in the printer (or to print on A4 paper when a letter-size job is sent but no letter-size paper is loaded). This option will also override A3 with ledger-size paper and ledger with A3-size paper.
Scan/Digital Send	E-mail Settings Network Folder Settings SharePoint Settings Scan to USB Drive Settings	E-mail Setup NOTE: Email Settings only				Use to configure settings that apply to sending documents through email or saving documents to a folder on the network or on a USB multi-drive. The E-mail Setup Wizard feature configures the printer to send scanned images as email attachments. To open the printer HP Embedded Web Server and set up the email notification server, enter the printer IP address into a Web browser.
	NOTE: The same options are available for each of these features, except where noted.					

Table 3-12 Settings menu (continued)

First level	Second level	Third level	Fourth level	Fifth level	Values	Description
		Image Preview			Make optional* Require preview Disable preview	<p>Defines the default job options for each function. If you do not specify the job options when creating the job, the default options are used. For complete setup, go to the HP Embedded Web Server by typing the IP address of the printer into a Web browser.</p> <p>Use the Image Preview feature to scan a document and display a preview before completing the job. Select whether this feature is available on the printer.</p> <p>Make optional: The feature is optional, depending on the user who is signed in.</p> <p>Require preview: Previews are required for all users.</p> <p>Disable preview: Previews are disabled for all users.</p>

Table 3-12 Settings menu (continued)

First level	Second level	Third level	Fourth level	Fifth level	Values	Description
		Default File Name				The printer is shipped with a factory default file name of [Untitled] for any scanned files that are sent or saved. Use this feature to specify a different default file name. If you are saving a file to a network folder or USB storage printer and a file with the default file name already exists, a number is appended to the file name, for example, [Untitled]001.

Table 3-12 Settings menu (continued)

First level	Second level	Third level	Fourth level	Fifth level	Values	Description
		Document File Type			Select from a list of file types.	<p>PDF provides the best overall image and text quality.</p> <p>JPEG is a good choice for most graphics. Most computers have a browser that can view .JPEG files. This file type produces one file per page.</p> <p>TIFF is a standard file format that many graphics programs support. This file type produces one file per page.</p> <p>MTIFF: stands for multi-page TIFF. This file type saves multiple scanned pages in a single file.</p> <p>XPS (XML Paper Specification) creates an XML file that preserves the original formatting of the document and supports color graphics and embedded fonts.</p> <p>NOTE: OCR file types are not supported on this printer unless attached to DSS.</p>

Table 3-12 Settings menu (continued)

First level	Second level	Third level	Fourth level	Fifth level	Values	Description
		Optimize Text/ Picture			Manually Adjust* Text Printed picture Photograph	<p>Use to optimize the output for a particular type of content. You can optimize the output for text, printed pictures, or a mixture.</p> <p>Manually Adjust: Use to manually optimize the setting for text or for pictures.</p> <p>Text: Use to optimize the text portion of the copy when text and/or pictures are on the original.</p> <p>Printed picture: Use for line drawings and preprinted images, such as magazine clippings or pages from books.</p> <p>Photograph: Best suited for making copies of printed pictures.</p>
		Output Quality			High (large file) Medium* Low (small file)	<p>Use to select the quality for the output. Higher-quality images require a larger file size than lower-quality images. Larger files take more time to send, and some recipients might have trouble receiving larger files.</p>

Table 3-12 Settings menu (continued)

First level	Second level	Third level	Fourth level	Fifth level	Values	Description
		Original Sides			1-sided 2-sided	Use to describe the layout for each side of the original document. First select whether the original document is printed on one side or both sides. Then touch the Orientation setting to indicate whether the original has portrait or landscape orientation. If it is printed on both sides, also select the 2-sided format that matches the original document.
			Orientation		Automatically detect Portrait* Landscape	For some features to work correctly, you must specify the way the content of the original document is placed on the page. Portrait orientation means the short edge of the page is along the top. Landscape orientation means the long edge of the page is along the top. In the Orientation area, select whether the original document has a portrait or landscape orientation.

Table 3-12 Settings menu (continued)

First level	Second level	Third level	Fourth level	Fifth level	Values	Description
			2-Sided Format		Book-style Flip-style	<p>Book-style: The back side of the original is printed right-side-up, and the back side of the copy is printed the same way. Use this option for originals and copies that are bound along the left edge.</p> <p>Flip-style: The back side of the original is printed upside-down, and the back side of the copy is printed the same way. Use this option for originals and copies that are to be bound along the top edge.</p>
		Resolution			400 dpi 300 dpi 200 dpi 150 dpi* 75 dpi	<p>Sets the resolution for sent documents. Higher resolution images have more dots per inch (dpi), so they show more detail. Lower resolution images have fewer dots per inch and show less detail, but the file size is smaller. Some file types, for example a file that will be processed with OCR, require a specific resolution. When these file types are selected, the Resolution setting might automatically change to a valid value.</p>

Table 3-12 Settings menu (continued)

First level	Second level	Third level	Fourth level	Fifth level	Values	Description
		Content Orientation	Orientation		Auto Detect Portrait* Landscape	For some features to work correctly, you must specify the way the content of the original document is placed on the page. Portrait orientation means the short edge of the page is along the top. Landscape orientation means the long edge of the page is along the top. In the Orientation area, select whether the original document has a portrait or landscape orientation.
			2-Sided Format		Book-style* Flip-style	Use to configure the default style for 2-sided print jobs. If the Book-style option is selected, the back side of the page is printed the right way up. This option is for print jobs that are bound along the left edge. If the Flip-style option is selected, the back side of the page is printed upside-down. This option is for print jobs that are bound along the top edge.

Table 3-12 Settings menu (continued)

First level	Second level	Third level	Fourth level	Fifth level	Values	Description
		Color/Black			Automatically detect*	Use to enable or disable color scanning.
					Color	
					Black/Gray	Automatically detect:
					Black	Automatically scans documents in color if at least one page has color.
						Color: Scans documents in color.
						Black/Gray: Scans documents in grayscale.
						Black: Scans documents in black and white with a compressed file size.
		Original Size			Select from a list of supported sizes.	Use to describe the page size of the original document.
		Notification			Do not notify*	Configure to receive notification about the status of a sent document.
					Notify when job completes	
					Notify only if job fails	Do not notify: Turns off this feature.
					Print	
					E-mail	Notify when job completes: Select to receive notification for this job only.
						Notify only if job fails: Select to receive notification only if the job is not sent successfully.
						Print: Select to print the notification at this printer.
						E-mail: Select to receive the notification to an email account.

Table 3-12 Settings menu (continued)

First level	Second level	Third level	Fourth level	Fifth level	Values	Description
			Include Thumbnail			NOTE: When sending an analog fax, select Include Thumbnail to receive a thumbnail image of the first page of the fax in your notification.
			Notification E-mail address			E-mail: Select to receive the notification in an email. Touch the text box following Email Address , and then type the email address for the notification.
		Image Adjustment		Darkness		Use to improve the overall quality of the copy. Adjust the Darkness setting to increase or decrease the amount of white and black in the colors.
				Contrast		Adjust the Contrast setting to increase or decrease the difference between the lightest and darkest color on the page.
				Background Cleanup		Adjust the Background Cleanup setting if you are having trouble copying a faint image.
				Sharpness		Adjust the Sharpness setting to clarify or soften the image. For example, increasing the sharpness could make text appear crisper, but decreasing it could make photographs appear smoother.

Table 3-12 Settings menu (continued)

First level	Second level	Third level	Fourth level	Fifth level	Values	Description
				Automatic Tone		The printer automatically adjusts the Darkness , Contrast , and Background Cleanup settings to the most appropriate for the scanned document.
				Default		Select this to make the selected Image Adjustment setting the default value.
		Job Build			Job Build off* Job Build on	Use to combine several original documents into one job. Also use to scan an original document that has more pages than the document feeder can accommodate at one time. The printer temporarily saves all the scanned images. After you have scanned all the pages for the job, touch Finish to finish the job.
		Cropping Options			Do not crop* Crop to content Crop to paper	Use this menu item to automatically crop the scan for digital sending. Use the Crop to content option to scan the smallest possible area that has detectable content.
		Erase Edges			Use inches Back side erase Front side erase	Use this menu item to remove blemishes, such as dark borders or staple marks, by cleaning the specified edges of the scanned image. In each of the text boxes enter the measurements, in millimeters or inches, for how much of the top edge, bottom edge, left edge, and right edge to clean.

Table 3-12 Settings menu (continued)

First level	Second level	Third level	Fourth level	Fifth level	Values	Description
		Multi-feed Detection			Disabled Enabled*	This setting stops the scanning process if it detects multiple-page feeds through the document feeder.
		Blank Page Suppression			Disabled* Enabled	Use to prevent blank pages in the original document from being included in the output document.
		Create Multiple Files			Disabled* Enabled	Enable this item to scan pages into separate files based on a specified page limit. A page is one side of an original document. JPEG and TIFF have a limit of one page per file.
	Digital Sending Software Setup	Allow Use of a DSS Server			Disabled Enabled*	Configure how the printer interacts with the HP Digital Sending Software (DSS) server. HP DSS handles digital sending tasks, such as faxing, emailing, and sending scanned documents to a network folder or USB storage device. Use the Allow Use of a DSS Server and Allow Transfer to New DSS server options to configure the printer to use HP DSS.
		Allow Transfer to New DSS server				
Fax	Internal Fax Modem Setup					
	Fax Send Settings	Image Preview				

Table 3-12 Settings menu (continued)

First level	Second level	Third level	Fourth level	Fifth level	Values	Description
		Fax Dialing Settings	Fax Dial Volume		Off Low* High	These settings control how the fax modem dials the outgoing fax number when faxes are sent.
			Dialing Mode		Tone* Pulse	
			Redial Interval		1-5 Minutes Default = 5 minutes	
			Fax Send Speed		Fast* Medium Slow	
			Dialing Prefix			
			Detect Dial Tone			
			Redial on Error		Range: 0-9 Default = 2	
			Redial on No Answer		Range: 0-2 Default = 0	
			Redial on Busy		Range: 0-9 Default = 3	
		General Fax Send Settings	Fax Number Confirmation		Enabled Disabled*	If this feature is enabled, you must enter the fax number twice.
			PC Fax Send		Enabled* Disabled	Enables users who have the correct driver installed to send faxes through the printer from their computers.

Table 3-12 Settings menu (continued)

First level	Second level	Third level	Fourth level	Fifth level	Values	Description
			JBIG Compression		Enabled*	The JBIG compression reduces fax-transmission time, which can result in lower phone charges. However, using JBIG compression sometimes causes compatibility problems with older fax machines. If this occurs, turn off the JBIG compression.
					Disabled	
			Error Correction Mode		Enabled*	When error-correction mode is enabled and an error occurs during fax transmission, the printer sends or receives the error portion again.
					Disabled	
			Fax Header		Prepend*	Use to prepend or overlay the fax header page.
					Overlay	
			Fax Number Speed Dial Matching		Enabled	Use this item to match the fax number that you type to numbers that are saved as a speed dial.
					Disabled*	

Table 3-12 Settings menu (continued)

First level	Second level	Third level	Fourth level	Fifth level	Values	Description
		Billing Code Settings	Enable Billing Codes		Off* On	When billing codes are enabled, a prompt displays that asks the user to enter the billing code for an outgoing fax. This prompt does not appear if the Allow users to edit billing codes check box is not checked. You can also use the billing codes report in the Reports menu to view the list of the billing codes that have been used for faxes that have been sent from the printer. The list is grouped by billing code and also shows fax details. This feature can be used for billing or usage tracking.
			Default Billing Code			Specify a default billing code for faxing. If you specify a default billing code, this code displays in the Billing Code field when the user sends an outgoing fax. If this field is blank, no default billing code is provided for the user.
			Minimum Length		Range: 1-16 Default = 1	Specify the required length of the billing code. Billing codes can be between 1 and 16 characters long.
			Allow users to edit billing codes		Off On*	
Fax Receive Settings	Fax Receive Setup	Ringer Volume			Off Low* High	Use to configure settings for receiving faxes.

Table 3-12 Settings menu (continued)

First level	Second level	Third level	Fourth level	Fifth level	Values	Description
			Rings To Answer		Range: 1-6 Default = 1	
			Fax Receive Speed		Fast* Medium Slow	
			Ring Interval		Range: 220-600 ms Default = 600 ms	
			Ring Frequency		Range: 1-200 Default = 68hz	
		Fax Printing Schedule			Always store faxes Always print faxes* Use Fax Printing Schedule	If you have concerns about the security of private faxes, use this feature to store faxes rather than having them automatically print. Open the Fax Printing Schedule sub-menu, and then you can choose to always store faxes, always print them, or you can set up a schedule for each day of the week.
			Schedule	+ (Add) Edit Delete (trash can)	Print incoming faxes Store incoming faxes Time Event Days	If you are using a fax printing schedule, use this menu to configure when to print faxes.
				Touch this to set up a fax printing schedule if you selected the Use Fax Printing Schedule option.		

Table 3-12 Settings menu (continued)

First level	Second level	Third level	Fourth level	Fifth level	Values	Description
		Blocked Fax Numbers	Fax Number to Block			<p>The blocked fax list can contain up to 30 numbers. When the printer receives a call from one of the blocked fax numbers, it deletes the incoming fax. It also logs the blocked fax in the activity log along with job-accounting information.</p> <p>Add blocked numbers: Enter a fax number into the Fax Number to Block field, and then touch the arrow button to add a new number to the blocked fax list.</p> <p>To remove blocked numbers: Select a number and touch the Delete button to delete it from the blocked fax list.</p> <p>To clear all blocked numbers: Touch the Delete All button to clear all of the numbers from the blocked fax list.</p> <p>You also can use the Blocked Fax List report in the Information menu to view the list of the fax numbers that have been blocked on this printer.</p>

Table 3-12 Settings menu (continued)

First level	Second level	Third level	Fourth level	Fifth level	Values	Description
		Default Job Options	Notification		Do not notify* Notify when job completes Notify only if job fails	Configure to receive notification about the status of a sent document. Do not notify: Turns off this feature. Notify when job completes: Select to receive notification for this job only. Notify only if job fails: Select to receive notification only if the job is not sent successfully.
					Print E-mail*	E-mail: Select to receive the notification in an email. Touch the text box following Email Address, and then enter the email address for the notification.
				Include Thumbnail		NOTE: When sending an analog fax, select Include Thumbnail to receive a thumbnail image of the first page of the fax in your notification.
				Notification E-mail address		Touch this text field, provide the email address to which you want notifications sent, and then touch the OK button.
			Stamp Received Faxes		Enabled Disabled*	Use this option to add the date, time, sender's phone number, and page number to each page of the faxes that this printer receives.

Table 3-12 Settings menu (continued)

First level	Second level	Third level	Fourth level	Fifth level	Values	Description
			Fit to Page		Enabled* Disabled	Use to shrink faxes that are larger than Letter-size or A4-size so that they can fit onto a Letter-size or A4-size page. If this feature set to Disabled, faxes larger than Letter or A4 will flow across multiple pages.
			Paper Tray		Automatic* Select from a list of the trays.	
			Output Bin		Automatically select Standard bin Upper bin Middle bin	
			Out Sides		1-sided* 2-sided	Use to describe the layout for each side of the original document. First select whether the original document is printed on one side or both sides.
	Fax Forwarding	Enable Fax Forwarding			Disabled* Enabled	Use to forward received faxes to another fax machine.
			Type of Fax Job to Forward		All faxes Sent faxes Received faxes	Use to select the type of fax jobs that you want forwarded.
			Fax Forwarding Number			Provide the forwarding phone number, and then touch the OK button.
	Clear Fax Activity Log					Clears all events from the fax activity log.

Table 3-12 Settings menu (continued)

First level	Second level	Third level	Fourth level	Fifth level	Values	Description	
Manage Supplies	Low Warning Thresholds			Black Cartridge	1-100%	Set the estimated percentage at which the printer notifies you when a toner cartridge is very low.	
				Cyan Cartridge	Default = 5%		
				Magenta Cartridge			
				Yellow Cartridge			
		Low Warning Threshold Message				On	Displays a message on the control panel when a cartridge is very low.
						Off	
		Very Low Behavior	Black Cartridge				Stop
			Color Cartridges				Continue
			Transfer Kit				Prompt to continue
			Fuser Kit				
	Document Feeder Kit						
		Staples				Stop	
						Prompt to continue	
	Restrict Color Use				Enable	Use this feature to enable, restrict, or disable color printing or copying.	
				Disable Color			
				Color if allowed*			

Table 3-12 Settings menu (continued)

First level	Second level	Third level	Fourth level	Fifth level	Values	Description
	Color/Black Mix				Auto Mostly Color Pages Mostly Black Pages	<p>Instructs the printer when to switch between color and monochrome printing modes for the best overall performance.</p> <p>Auto: Uses the mode that is appropriate for the first page of the job. If necessary, the printer switches modes during the middle of a job and then stays in that mode until the job is finished.</p> <p>Mostly Color Pages: The printer uses color mode for all jobs, even if the job contains no color pages.</p> <p>Mostly Black Pages: The printer uses monochrome mode until it detects a color page. The printer switches back to monochrome mode when it detects a sequence of several monochrome pages.</p>

Table 3-12 Settings menu (continued)

First level	Second level	Third level	Fourth level	Fifth level	Values	Description
	Store Usage Data				On supplies Not on supplies	The Store Usage Data provides a way to suppress the toner cartridges from storing most of the information gathered exclusively for the purpose of understanding the usage of the printer. Select the On supplies setting to store the data on the toner cartridge memory chip. Select the Not on supplies setting to suppress the information from being stored on the memory chip.
	Cartridge Protection				Off* Protect Cartridges	Select to permanently protect cartridges so that they can be used only in this product or fleet of products.
	Cartridge Policy				Off* Authorized HP	Set Authorized HP to allow only genuine HP cartridges to be used in this product.
Manage Stapler/ Stacker	Operation Mode				Mailbox Stacker Function Separator	
	Job Offset				On Off	
Networking	Ethernet	Information	Print Security Report		Yes No*	Yes : Prints a page that contains the current security settings on the HP Jetdirect print server. No : A security settings page is not printed.

Table 3-12 Settings menu (continued)

First level	Second level	Third level	Fourth level	Fifth level	Values	Description
		TCP/IP	Host Name		Use the arrow buttons to edit the host name. NPIXXXXXX*	An alphanumeric string, up to 32 characters, used to identify the printer. This name is listed on the HP Jetdirect configuration page. The default host name is NPIxxxxxx, where xxxxxx is the last six digits of the LAN hardware (MAC) address.
			IPv4 Settings	Config Method	Bootp DHCP* Auto IP Manual	Specifies the method that TCP/IPv4 parameters will be configured on the HP Jetdirect print server. <p>Bootp (Bootstrap Protocol): Use for automatic configuration from a BootP server.</p> <p>DHCP (Dynamic Host Configuration Protocol): Use for automatic configuration from a DHCPv4 server. If selected and a DHCP lease exists, the DHCP Release menu and the DHCP Renew menu are available to set DHCP lease options.</p> <p>Auto IP: Use for automatic link-local IPv4 addressing. An address in the form 169.254.x.x is assigned automatically.</p> <p>If you set this option to the Manual setting, use the Manual Settings menu to configure TCP/IPv4 parameters.</p>

Table 3-12 Settings menu (continued)

First level	Second level	Third level	Fourth level	Fifth level	Values	Description
				Default IP	Auto IP* Legacy	Specify the IP address to default to when the print server is unable to obtain an IP address from the network during a forced TCP/IP reconfiguration (for example, when manually configured to use BootP or DHCP). NOTE: This feature assigns a static IP address that might interfere with a managed network. Auto IP: A link-local IP address 169.254.x.x is set. Legacy: The address 192.0.0.192 is set, consistent with older HP Jetdirect printers.
				Primary DNS	Range: 0-255 Default = xxx.xxx.xx.xx	Specify the IP address (n.n.n.n) of a Primary Domain Name System (DNS) Server.
				Secondary DNS	Range: 0-255 Default = 0.0.0.0	Specify the IP address (n.n.n.n) of a Secondary DNS Server.
		IPv6 Settings		Enable	Off On*	Use this item to enable or disable IPv6 operation on the print server. Off: IPv6 is disabled. On: IPv6 is enabled.
				Address	Manual Settings Enable Address	Use this item to enable and manually configure a TCP/IPv6 address.

Table 3-12 Settings menu (continued)

First level	Second level	Third level	Fourth level	Fifth level	Values	Description
				DHCPv6 Policy	Router Specified Router Unavailable* Always	<p>Router Specified: The stateful auto-configuration method to be used by the print server is determined by a router. The router specifies whether the print server obtains its address, its configuration information, or both from a DHCPv6 server.</p> <p>Router Unavailable: If a router is not available, the print server should attempt to obtain its stateful configuration from a DHCPv6 server.</p> <p>Always: Whether a router is available, the print server always attempts to obtain its stateful configuration from a DHCPv6 server.</p>
				Primary DNS	Range: 0-255 Default = xxx.xxx.xx.xx	Specify the IP address (n.n.n.n) of a Primary Domain Name System (DNS) Server.
				Secondary DNS	Range: 0-255 Default = 0.0.0.0	Specify the IP address (n.n.n.n) of a Secondary DNS Server.

Table 3-12 Settings menu (continued)

First level	Second level	Third level	Fourth level	Fifth level	Values	Description
			Proxy Server		Select from a provided list.	<p>Specifies the proxy server to be used by embedded applications in the printer. A proxy server is typically used by network clients for Internet access. It caches Web pages, and provides a degree of Internet security for those clients.</p> <p>To specify a proxy server, enter its IPv4 address or fully-qualified domain name. The name can be up to 255 octets.</p> <p>For some networks, you might need to contact your Internet Service Provider (ISP) for the proxy server address.</p>
			Proxy Port		Default = 0080	<p>Enter the port number used by the proxy server for client support. The port number identifies the port reserved for proxy activity on your network, and can be a value from 0 to 65535.</p>
			Idle Timeout		Default = 0270	<p>The time period, in seconds, after which an idle TCP print data connection is closed (default is 270 seconds, 0 disables the timeout).</p>

Copy menu (MFP only)

To display: At the printer control panel, select the [Copy](#) menu.

In the following table, asterisks (*) indicate the factory default setting.

Table 3-13 Copy menu (MFP only)

First level	Second level	Third level	Values	Description	
Sides	Original Sides		1-sided*	Use to indicate whether the original document is printed on one or both sides.	
			2-sided		
	Output Sides		1-sided	Use to indicate whether the copies should be printed on one or both sides.	
			2-sided		
Color/Black			Automatically detect*	Select how the copy should be printed.	
			Color	Automatically detect: Prints color documents in color, and black and white documents in black and white. For mixed documents, the printer will determine whether to print in color or black and white. Color: Prints documents in color. Black: Prints documents in black and white or grayscale.	
			Black/Gray		
Quick Sets and Defaults			Load		
			Save		
Options	Sides	Original Sides	1-sided	Select how the copy should be printed. Automatically detect: Prints color documents in color, and black and white documents in black and white. For mixed documents, the printer will determine whether to print in color or black and white. Color: Prints documents in color. Black: Prints documents in black and white or grayscale.	
			2-sided		
	Output Sides	1-sided			
		2-sided			
	Color/Black		Automatically detect*		
			Color		
			Black/Gray		
	Staple				None
					Top left angled
					Top right angled

Table 3-13 Copy menu (MFP only) (continued)

First level	Second level	Third level	Values	Description
	Scan mode		Standard Document Book Mode 2-sided ID	Book Mode allows the user to scan pages from a book. 2-sided ID allows the user to scan both sides of an identification card onto one sheet.
	Reduce/Enlarge		Automatic* Manual	Use to scale the size of the document up or down. Select one of the predefined percentages, or select the Scaling field and type a percentage between 25 and 400. The Auto option automatically scales the image to fit the paper size in the tray. NOTE: To reduce the image, select a scaling percentage that is less than 100. To enlarge the image, select a scaling percentage that is greater than 100.
	Original Size		Select from a list of sizes that the printer supports.	Describes the page size of the original document.
	Paper Selection		Paper Size Paper Type Paper Tray	For the best color and image quality, select the appropriate paper type from the control panel menu or from the print driver.
	Booklet	Booklet Format	(Checkbox)	Use to copy two or more pages onto one sheet of paper so you can fold the sheets in the center to form a booklet. The printer arranges the pages in the correct order. For example, if the original document has eight pages, the printer prints pages 1 and 8 on the same sheet.
	Content Orientation		Auto Detect Portrait* Landscape	For some features to work correctly, you must specify the way the content of the original document is placed on the page. Portrait orientation means the short edge of the page is along the top. Landscape orientation means the long edge of the page is along the top. In the Orientation area, select whether the original document has a portrait or landscape orientation.

Table 3-13 Copy menu (MFP only) (continued)

First level	Second level	Third level	Values	Description
	Pages per Sheet		One (1) Two (2) Four (4)	Copies multiple pages onto one sheet of paper. NOTE: Before using this screen, use the Content Orientation screen to describe the original document orientation.
	Image Adjustment	Sharpness		Adjust the Sharpness setting to clarify or soften the image. For example, increasing the sharpness could make text appear crisper, but decreasing it could make photographs appear smoother.
		Darkness		Use to improve the overall quality of the copy. Adjust the Darkness setting to increase or decrease the amount of white and black in the colors.
		Contrast		Adjust the Contrast setting to increase or decrease the difference between the lightest and darkest color on the page.
		Background Cleanup		Adjust the Background Cleanup setting if you are having trouble copying a faint image.
	Optimize Text/Picture	Manually Adjust*	Optimize For: Text Mixed Printed picture Photograph	Optimizes the output for a particular type of content. You can optimize the output for text, printed pictures, or a mixture. Manually Adjust: Use to manually optimize the setting for text or for pictures. Text: Use to optimize the text portion of the copy where text and/or pictures are on the original. Printed picture: Use for line drawings and preprinted images, such as magazine clippings or pages from books. Photograph: Best suited for making copies of printed pictures.

Table 3-13 Copy menu (MFP only) (continued)

First level	Second level	Third level	Values	Description
	Erase Edges	Front Side	Use inches Apply same width to all edges Top edge Bottom edge Left edge Right edge	Use this menu item to remove blemishes, such as dark borders or staple marks, by cleaning the specified edges of the scanned image. In each of the text boxes enter the measurements, in millimeters or inches, for how much of the top edge, bottom edge, left edge, and right edge to clean.
		Back Side	Use inches Mirror front side Top edge Bottom edge Left edge Right edge	
	Collate		Collate on (Sets in page order)* Collate off (Pages grouped)	If you are making more than one copy, select the Collate on (Sets in page order) option to assemble the pages in the correct order in each set of copies. Select the Collate off (Pages grouped) option to group the same pages together. For example, if you are making five copies of an original document that has two pages, all five first pages would be grouped together and all five second pages would be grouped together.
	Multi-feed Detection		Enabled* Disabled	This setting stops the scanning process if it detects multiple-page feeds through the document feeder.
	Output Bin		Automatically select Standard bin Upper bin Middle bin	

Scan menu (MFP only)

To display: At the printer control panel, select the [Scan](#) menu.

In the following table, asterisks (*) indicate the factory default setting.

Table 3-14 Scan menu (MFP)

First level	Second level	Third level	Fourth level	Values	Description
Scan to Email					
Scan to Network Folder	Folder Paths				
	File Name				
	Quick Sets and Defaults				
	Options	File Type and Resolution			
		Original sides		1-sided 2-sided	Use to describe the layout for each side of the original document. First select whether the original document is printed on one side or both sides. Then touch the Orientation setting to indicate whether the original has portrait or landscape orientation. If it is printed on both sides, also select the 2-sided format that matches the original document.
		Color/Black		Automatically detect* Color Black/Gray Black	Use to enable or disable color scanning. Automatically detect: Automatically scans documents in color if at least one page has color. Color: Scans documents in color. Black/Gray: Scans documents in grayscale. Black: Scans documents in black and white with a compressed file size.
		Original Size		Select from a list of supported sizes.	Use to describe the page size of the original document.

Table 3-14 Scan menu (MFP) (continued)

First level	Second level	Third level	Fourth level	Values	Description
		Content Orientation	Orientation	Automatically Detect Portrait* Landscape	For some features to work correctly, you must specify the way the content of the original document is placed on the page. Portrait orientation means the short edge of the page is along the top. Landscape orientation means the long edge of the page is along the top. In the Orientation area, select whether the original document has a portrait or landscape orientation.
		Image Adjustment	Darkness		Use to improve the overall quality of the copy. Adjust the Darkness setting to increase or decrease the amount of white and black in the colors.
			Contrast		Adjust the Contrast setting to increase or decrease the difference between the lightest and darkest color on the page.
			Background Cleanup		Adjust the Background Cleanup setting if you are having trouble copying a faint image.
			Sharpness		Adjust the Sharpness setting to clarify or soften the image. For example, increasing the sharpness could make text appear crisper, but decreasing it could make photographs appear smoother.
			Automatic Tone		The printer automatically adjusts the Darkness , Contrast , and Background Cleanup settings to the most appropriate for the scanned document.

Table 3-14 Scan menu (MFP) (continued)

First level	Second level	Third level	Fourth level	Values	Description
			Default		Select this to make the selected Image Adjustment setting the default value.
		Optimize Text/Picture			
		Erase Edges		Use inches Back side erase Front side erase	Use this menu item to remove blemishes, such as dark borders or staple marks, by cleaning the specified edges of the scanned image. In each of the text boxes enter the measurements, in millimeters or inches, for how much of the top edge, bottom edge, left edge, and right edge to clean.
		Cropping Options		Do not crop Crop to content Crop to paper	Use this menu item to automatically crop the scan for digital sending. Use the Crop to content option to scan the smallest possible area that has detectable content.
		Automatically Straighten			
		Blank Page Suppression		Disabled Enabled	Use to prevent blank pages in the original document from being included in the output document.
		Multi-feed Detection		Disabled Enabled*	This setting stops the scanning process if it detects multiple-page feeds through the document feeder.
		Create Multiple Files		Disabled Enabled	Enable this item to scan pages into separate files based on a specified page limit. A page is one side of an original document. JPEG and TIFF have a limit of one page per file.

Table 3-14 Scan menu (MFP) (continued)

First level	Second level	Third level	Fourth level	Values	Description
		Notification		Do not notify Notify when job completes Notify only if job fails Print E-mail	Configure to receive notification about the status of a sent document. Do not notify: Turns off this feature. Notify when job completes: Select to receive notification for this job only. Notify only if job fails: Select to receive notification only if the job is not sent successfully. Print: Select to print the notification at this printer. E-mail: Select to receive the notification to an email account.
			Include Thumbnail		Select Include Thumbnail to receive a thumbnail image of the first page of the job in your notification.
			Notification Email		E-mail: Select to receive the notification in an email. Touch the text box following Email Address, and then type the email address for the notification.
Scan to USB Drive	Destination				
	Job Name				
	Options	File Type and Resolution			

Table 3-14 Scan menu (MFP) (continued)

First level	Second level	Third level	Fourth level	Values	Description
		Original sides		1-sided 2-sided	Use to describe the layout for each side of the original document. First select whether the original document is printed on one side or both sides. Then touch the Orientation setting to indicate whether the original has portrait or landscape orientation. If it is printed on both sides, also select the 2-sided format that matches the original document.
		Color/Black		Automatically detect* Color Black/Gray Black	Use to enable or disable color scanning. Automatically detect : Automatically scans documents in color if at least one page has color. Color : Scans documents in color. Black/Gray : Scans documents in grayscale. Black : Scans documents in black and white with a compressed file size.
		Original Size		Select from a list of supported sizes.	Use to describe the page size of the original document.
		Content Orientation		Automatically detect Portrait* Landscape	For some features to work correctly, you must specify the way the content of the original document is placed on the page. Portrait orientation means the short edge of the page is along the top. Landscape orientation means the long edge of the page is along the top. In the Orientation area, select whether the original document has a portrait or landscape orientation.

Table 3-14 Scan menu (MFP) (continued)

First level	Second level	Third level	Fourth level	Values	Description
		Image Adjustment	Darkness		Use to improve the overall quality of the copy. Adjust the Darkness setting to increase or decrease the amount of white and black in the colors.
			Contrast		Adjust the Contrast setting to increase or decrease the difference between the lightest and darkest color on the page.
			Background Cleanup		Adjust the Background Cleanup setting if you are having trouble copying a faint image.
			Sharpness		Adjust the Sharpness setting to clarify or soften the image. For example, increasing the sharpness could make text appear crisper, but decreasing it could make photographs appear smoother.
			Automatic Tone		The printer automatically adjusts the Darkness , Contrast , and Background Cleanup settings to the most appropriate for the scanned document.
			Default		Select this to make the selected Image Adjustment setting the default value.

Table 3-14 Scan menu (MFP) (continued)

First level	Second level	Third level	Fourth level	Values	Description
		Optimize Text/Picture		Manually Adjust* Text Printed picture Photograph	<p>Use to optimize the output for a particular type of content. You can optimize the output for text, printed pictures, or a mixture.</p> <p>Manually Adjust: Use to manually optimize the setting for text or for pictures.</p> <p>Text: Use to optimize the text portion of the copy when text and/or pictures are on the original.</p> <p>Printed picture: Use for line drawings and preprinted images, such as magazine clippings or pages from books.</p> <p>Photograph: Best suited for making copies of printed pictures.</p>
		Erase Edges		Use inches Back side erase Front side erase	<p>Use this menu item to remove blemishes, such as dark borders or staple marks, by cleaning the specified edges of the scanned image. In each of the text boxes enter the measurements, in millimeters or inches, for how much of the top edge, bottom edge, left edge, and right edge to clean.</p>
		Cropping Options		Do not crop Crop to content Crop to paper	<p>Use this menu item to automatically crop the scan for digital sending. Use the Crop to content option to scan the smallest possible area that has detectable content.</p>
		Automatically Straighten			
		Blank Page Suppression		Disabled Enabled	<p>Use to prevent blank pages in the original document from being included in the output document.</p>

Table 3-14 Scan menu (MFP) (continued)

First level	Second level	Third level	Fourth level	Values	Description
		Multi-feed Detection		Disabled Enabled*	This setting stops the scanning process if it detects multiple-page feeds through the document feeder.
		Create Multiple Files		Disabled Enabled	Enable this item to scan pages into separate files based on a specified page limit. A page is one side of an original document. JPEG and TIFF have a limit of one page per file.
		Notification		Do not notify Notify when job completes Notify only if job fails Print E-mail	Configure to receive notification about the status of a sent document. Do not notify: Turns off this feature. Notify when job completes: Select to receive notification for this job only. Notify only if job fails: Select to receive notification only if the job is not sent successfully. Print: Select to print the notification at this printer. E-mail: Select to receive the notification to an email account.
			Include Thumbnail		Select Include Thumbnail to receive a thumbnail image of the first page of the job in your notification.
			Notification Email		E-mail: Select to receive the notification in an email. Touch the text box following Email Address , and then type the email address for the notification.
Scan to Job Storage				Folder Job Name	

Fax menu (fax models only)

To display: At the printer control panel, select the [Fax](#) menu.

In the following table, asterisks (*) indicate the factory default setting.

Table 3-15 Fax menu (fax models only)

First level	Second level	Third level	Values	Description
Dialing Prefix				
Fax Recipients				
Quick Sets and Defaults				
Options	Original Sides		1-sided* 2-sided	Use to describe the layout for each side of the original document. First select whether the original document is printed on one side or both sides. Then touch the Orientation setting to indicate whether the original has portrait or landscape orientation. If it is printed on both sides, also select the 2-sided format that matches the original document.
	Resolution		Standard (100 x 200dpi)* Fine (200 x 200dpi) Superfine (300 x 300dpi)	Select the resolution for outgoing faxes. If you increase the resolution, faxes might be clearer but they could transmit more slowly. Some file types, for example a file that will be processed with OCR, require a specific resolution. When these file types are selected, the Resolution setting might be automatically changed to a valid value.
	Original Size		Select from a list of sizes that the printer supports.	Use to describe the page size of the original document.
	Content Orientation	Orientation	Portrait* Landscape	For some features to work correctly, you must specify the way the content of the original document is placed on the page. Portrait : This setting means the short edge of the page is along the top. Landscape : This setting means the long edge of the page is along the top.

Table 3-15 Fax menu (fax models only) (continued)

First level	Second level	Third level	Values	Description
	Image Adjustment	Darkness		Use to improve the overall quality of the copy. Adjust the Darkness setting to increase or decrease the amount of white and black in the colors.
		Contrast		Adjust the Contrast setting to increase or decrease the difference between the lightest and darkest color on the page.
		Background Cleanup		Adjust the Background Cleanup setting if you are having trouble copying a faint image.
		Sharpness		Adjust the Sharpness setting to clarify or soften the image. For example, increasing the sharpness could make text appear crisper, but decreasing it could make photographs appear smoother.
		Automatic Tone		The printer automatically adjusts the Darkness , Contrast , and Background Cleanup settings to the most appropriate for the scanned document.
		Default		Select this to make the selected Image Adjustment setting the default value.

Table 3-15 Fax menu (fax models only) (continued)

First level	Second level	Third level	Values	Description
	Optimize Text/Picture	Manually Adjust*	Optimize For: Text Printed picture Photograph	Optimizes the output for a particular type of content. You can optimize the output for text, printed pictures, or a mixture. Manually Adjust: Use to manually optimize the setting for text or for pictures. Text: Use to optimize the text portion of the copy where text and/or pictures are on the original. Printed picture: Use for line drawings and preprinted images, such as magazine clippings or pages from books. Photograph: Best suited for making copies of printed pictures.
	Blank Page Suppression		Disabled* Enabled	Prevents blank pages in the original document from being included in the output document.
	Multi-feed Detection		Disabled Enabled*	Use this feature to prevent multiple pages being fed through the document feeder during document scans.
	Notification		Do not notify* Notify when job completes Notify only if job fails Print E-mail	Use to receive notification about the status of a sent document. Do not notify: Turns off this feature. Notify when job completes: Select to receive notification for this job only. Notify only if job fails: Select to receive notification only if the job is not sent successfully. Print: Select to print the notification at this printer. E-mail: Select to receive the notification in an email. Touch the text box following Email Address , and then enter the email address for the notification.

Table 3-15 Fax menu (fax models only) (continued)

First level	Second level	Third level	Values	Description
		Include Thumbnail		When sending an analog fax, select Include Thumbnail to receive a thumbnail image of the first page of the fax in your notification.
		Notification E-mail address		Provide the email address that will receive notifications.
		2-Sided Format	Book-style* Flip-style	Use to configure the default style for 2-sided print jobs. If the Book-style option is selected, the back side of the page is printed the right way up. This option is for print jobs that are bound along the left edge. If the Flip-style option is selected, the back side of the page is printed upside-down. This option is for print jobs that are bound along the top edge.

Print menu

To display: At the printer control panel, select the [Print](#) menu.

In the following table, asterisks (*) indicate the factory default setting.

Table 3-16 Print Options menu

First level	Second level	Values	Description
Print from Job Storage	Stored Job to Print	Untitled Stored Faxes	Print a job stored on the printer.
Print from USB Drive	Stored Job to Print	Choose file to print on USB drive.	Print a job stored on a USB drive.
Fax Polling	Fax Polling Number		

Supplies menu

To display: At the printer control panel, select the [Supplies](#) menu.

In the following table, asterisks (*) indicate the factory default setting.

Table 3-17 Supplies menu

First level	Values	Description
Supplies Summary		

Table 3-17 Supplies menu (continued)

First level	Values	Description
Black Cartridge	Status	
Cyan Cartridge	Order HP Part	
Magenta Cartridge	Pages Printed	
Yellow Cartridge	Approximate Pages Remaining	
Toner Collection Unit	Status	
Transfer Kit	Order HP Part	
Fuser Kit		
Document Feeder Kit		
Stapler 1		

Trays menu

To display: At the printer control panel, select the [Trays](#) menu.

In the following table, asterisks (*) indicate the factory default setting.

Table 3-18 Trays menu

First level	Second level	Values	Description
Tray 1	Size	Select paper size from a list of supported sizes.	Choose the paper size for the tray
Tray 2-x	Type	Select paper type from a list of supported types.	Choose the paper type for the tray.

Troubleshooting menu

To display: At the product control panel, select the [Support Tools](#) menu, and then select the [Troubleshooting](#) menu.

In the following table, asterisks (*) indicate the factory default setting.

Table 3-19 Troubleshooting

First level	Second level	Third level	Fourth level	Values	Description
Configuration/Status Pages	<ul style="list-style-type: none"> • Settings Menu Map • Current Settings Page • Configuration Page • How to Connect Page • Supplies Status Page • sage Page • File Directory Page • Web Services Status Page • Color Usage Job Log 				Select the configuration/Status reports to review, and then touch the Print or View button.
Reports					
Other Pages	<ul style="list-style-type: none"> • Demonstration Page • RGB Samples • CMYK Samples • PCL Font List • PS Font List 				
Event Log				Print	Prints the 50 most recent events in the Event Log. For each event, the printed log shows the error number, page count, error code, and description or personality.
Paper Path Page				View Print	Shows how many pages were printed from each tray.
Fax (Fax is optional)	Fax T.30 Trace	Print T.30 Report		Print	Use to print or configure the fax T.30 trace report. T.30 is the standard that specifies handshaking, protocols, and error correction between fax machines.

Table 3-19 Troubleshooting (continued)

First level	Second level	Third level	Fourth level	Values	Description
		When to Print Report		Never automatically print* Print after every fax Print only after fax send jobs Print after any fax error Print only after fax send errors Print only after fax receive errors	Configure the T.30 report to print after certain events. You can choose to print the report after every fax job, every fax job sent, every fax job received, every send error, or every receive error.
	Fax V.34			Normal* Off	Use to disable V.34 modulations if several fax failures have occurred or if phone line conditions require it.
	Fax Speaker Mode			Normal* Diagnostic	Used by a technician to evaluate and diagnose fax issues by listening to the sounds of fax modulations
	Fax Log Entries			On Off*	The standard fax log includes basic information such as the time and whether the fax was successful. The detailed fax log shows the intermediate results of the redial process not shown in the standard fax log.
Print Quality Pages	Print Fuser Test Page			Print	Use to print pages that help you resolve problems with print quality.
Diagnostic Tests					
	Continuous Scan			2-sided	
	Run Fax Test			Start	Use this menu to perform a test on specific components within the product to determine whether the components are functioning correctly.

Table 3-19 Troubleshooting (continued)

First level	Second level	Third level	Fourth level	Values	Description
Retrieve Diagnostic Data				Insert a US drive into the USB port. The exported data might contain personally identifiable information.	Create files that contain information about the product that can help identify the cause of problems.
Generate Debug Data				Start	

Maintenance menu

Learn about the Maintenance menu.

Backup/Restore menu

To display: At the product control panel, select [Support Tools](#) and then [Maintenance](#), and then select the [Backup/Restore](#) menu.

In the following table, asterisks (*) indicate the factory default setting.

Table 3-20 Backup/Restore menu

First level	Second level	Third level	Values	Description
Backup Data	Enable Scheduled Backups	Backup Time	Enter a time	
		Days Between Backups	Enter the number of days	
	Backup Now			
	Export Last Backup			
Restore Data			Insert a USB drive that contains the backup file.	

Calibration/Cleaning menu

To display: At the product control panel, select the [Maintenance](#) menu, and then select the [Calibrate/Cleaning](#) menu.

In the following table, asterisks (*) indicate the factory default setting.

Table 3-21 Calibrate/Cleaning menu

First level	Second level	Values	Description
Calibration/Cleaning Page		Print	Use to process the cleaning page that was created by using the Create Cleaning Page menu. The process takes up to 1.5 minutes.

Table 3-21 Calibrate/Cleaning menu (continued)

First level	Second level	Values	Description
Calibration		Start	<p>The product automatically calibrates itself at various times. However, you can calibrate the product immediately if you see problems with print quality. Use this feature to perform a full calibration, which can take up to three minutes. Use this calibration if the color layers seem to be shifted on the page.</p> <p>Before calibrating the product, make sure that the Ready indicator displays on the control-panel display. If a job is in progress, the calibration occurs when that job is complete.</p>
Delay Calibration at Wake/Power On		<p>No Delay</p> <p>Delay 15 minutes</p>	<p>Controls the timing of power-on calibration when the product wakes up or is turned on.</p> <p>Wake: Select if you are not using the feature and want to print jobs immediately when the product wakes up or is turned on, before calibration begins.</p> <p>No: The product will calibrate immediately when it wakes up or is turned on. The product will not print any jobs until it finishes calibrating.</p> <p>Yes: Enables the product that is asleep to accept print jobs before it calibrates. It might start calibrating before it has printed all the jobs it has received. This option allows quicker printing when coming out of sleep mode or when you turn the product on, but print quality might be reduced.</p> <p>NOTE: For the best results, allow the product to calibrate before printing. Print jobs performed before calibration might not be of the highest quality.</p>

USB Firmware Upgrade menu

To display: At the product control panel, select the **Maintenance** menu, and then select the **USB Firmware Upgrade** menu.

Insert a USB storage device with a firmware upgrade bundle into the USB port, and follow the on-screen instructions.

Solve paper handling problems

Printer feeds incorrect page size

Table 3-22 Printer feeds incorrect page size

Cause	Solution
The correct size paper is not loaded in the tray.	Load the correct size paper in the tray.
The correct size paper is not selected in the software program or printer driver.	Confirm that the settings in the software program and printer driver are correct, because the software program settings override the printer driver and control panel settings, and the printer driver settings override the control panel settings.
The correct size paper for the tray is not selected in the printer control panel.	From the control panel, select the correct size paper for the tray.
The paper size is not configured correctly for the tray.	Print a configuration page to determine the paper size for which the tray is configured.
The guides in the tray are not against the paper.	Verify that the paper guides are touching the paper.

Printer pulls from incorrect tray

Table 3-23 Printer pulls from incorrect tray

Cause	Solution
A driver for a different printer is in use.	Use a driver for this printer.
The specified tray is empty.	Load paper in the specified tray.
The paper size is not configured correctly for the input tray.	Print a configuration page or use the control panel to determine the paper size for which the tray is configured.
The guides in the tray are not against the paper.	Verify that the guides are touching the paper.

Printer will not duplex or duplexes incorrectly

Table 3-24 Printer will not duplex (print 2-sided jobs) or duplexes incorrectly

Cause	Solution
The duplex job is trying to use unsupported paper.	Verify that the paper is supported for duplex printing.
The printer driver is not set up for duplex printing.	Set up the printer driver to enable duplex printing.
The first page is printing on the back of preprinted forms or letterhead.	Load preprinted forms and letterhead in Tray 1 with the letterhead or printed side down, with the top of the page leading into the printer. For Tray 2-X, load the paper printed side up with the top of the page toward the right of the printer.
The printer model does not support automatic 2-sided printing.	The printer model does not support automatic 2-sided printing.

Paper does not feed from Tray 2-X

Table 3-25 Paper does not feed from Tray 2-X

Cause	Solution
The correct size paper is not loaded.	Load the correct size paper.
The input tray is empty.	Load paper in the input tray.
The correct paper type for the input tray is not selected in the printer control panel.	From the printer control panel, select the correct paper type for the input tray. Trays configured for a paper type with a specific weight range will not match a print job that specifies an exact weight, even if the specified weight is within the weight range.
Paper from a previous jam has not been completely removed.	Open the printer and remove any paper in the paper path. Closely inspect the fuser area for jams.
None of the optional trays appear as input tray options.	The optional trays only display as available if they are installed. Verify that any optional trays are correctly installed. Verify that the printer driver has been configured to recognize the optional trays.
An optional tray is incorrectly installed.	Print a configuration page to confirm that the optional tray is installed. If not, verify that the tray is correctly attached to the printer.
The paper size is not configured correctly for the input tray.	Print a configuration page or use the control panel to determine the paper size for which the tray is configured.
The guides in the tray are not against the paper.	Verify that the guides are touching the paper.

Output is curled or wrinkled

Table 3-26 Output is curled or wrinkled

Cause	Solution
Paper does not meet the specifications for this printer.	Use only paper that meets the HP paper specifications for this printer.
The correct paper type for the input tray is not selected in the printer control panel.	From the printer control panel, select the correct paper type for the input tray. Trays configured for a paper type with a specific weight range will not match a print job that specifies an exact weight, even if the specified weight is within the weight range.
Paper is damaged or in poor condition.	Remove paper from the input tray and load paper that is in good condition.
The printer is operating in an excessively humid environment.	Verify that the printing environment is within humidity specifications.
The print job consist of large, solid-filled areas.	Large, solid-filled areas can cause excessive curl. Try using a different pattern.
Paper used was not stored correctly and might have absorbed moisture.	Remove paper and replace it with paper from a fresh, unopened package.
Paper has poorly cut edges.	Remove paper, flex it, rotate it 180 degrees or turn it over, and then reload it into the input tray. Do not fan paper. If the problem persists, replace the paper.

Table 3-26 Output is curled or wrinkled (continued)

Cause	Solution
The specific paper type was not configured for the tray or selected in the software.	Configure the software for the paper (see the software documentation). Configure the tray for the paper.
The paper has previously been used for a print job.	Do not re-use paper.

Printer does not pick up paper or misfeeds

Use the following procedures if the printer will not pick or misfeeds paper.

The printer does not pick up paper

If the printer does not pick up paper from the tray, try these solutions.



NOTE: Tray 1 and Tray 2 are optimal for paper pickup when using special paper or media other than 20lb plain paper. For Tray 1 and Tray 2 the printer increases the number of attempts to pick up a page, which increases the reliability of successfully picking the page from the tray and decreases the possibility of a mispick jam.

HP recommends using Tray 1 or Tray 2 if the printer is experiencing excessive or reoccurring jams from trays other than Tray 1 and Tray 2, or for print jobs that require media other than 20lb plain paper.

1. Open the printer and remove any jammed sheets of paper.
2. Load the tray with the correct size of paper for the job.
3. Make sure the paper size and type are set correctly on the printer control panel.
4. Make sure the paper guides in the tray are adjusted correctly for the size of paper. Adjust the guides to the appropriate indentation in the tray.
5. Check the printer control panel to see if the printer is waiting for an acknowledgment to the feed the paper manually prompt. Load paper, and continue.
6. The rollers above the tray might be contaminated. Clean the rollers with a lint-free cloth dampened with warm water.

The printer picks up multiple sheets of paper

If the printer picks up multiple sheets of paper from the tray, try these solutions.

1. Remove the stack of paper from the tray and flex it, rotate it 180 degrees, and flip it over. Do not fan the paper. Return the stack of paper to the tray.
2. Use only paper that meets HP specifications for this printer.
3. Use paper that is not wrinkled, folded, or damaged. If necessary, use paper from a different package.
4. Make sure the tray is not overfilled. If it is, remove the entire stack of paper from the tray, straighten the stack, and then return some of the paper to the tray.
5. Make sure the paper guides in the tray are adjusted correctly for the size of paper. Adjust the guides to the appropriate indentation in the tray.
6. Make sure the printing environment is within recommended specifications.

The ADF jams, skews, or picks up multiple sheets of paper (MFP)

- Check to see if there are areas on the page that might have had staples removed. This can cause jams and/or mispicks.
- The original might have something on it, such as staples or self-adhesive notes that must be removed.
- Check that all rollers are in place and correctly installed.
- Make sure that the ADF cover is closed.
- The pages might not be placed correctly. Straighten the pages and adjust the paper guides to center the stack.
- The paper guides must be touching the sides of the paper stack to work correctly. Make sure that the paper stack is straight and the guides are against the paper stack.
- The document feeder input tray or output bin might contain more than the maximum number of pages. Make sure the paper stack fits below the guides in the input tray, and remove pages from the output bin.
- Verify that there are no pieces of paper, staples, paper clips, or other debris in the paper path.
- Clean the document-feeder rollers and the separation pad. Use compressed air or a clean, lint-free cloth moistened with warm water. If misfeeds still occur, replace the rollers.

Paper does not feed automatically

Table 3-27 Paper does not feed automatically

Cause	Solution
Manual feed is selected in the software program.	Load Tray 1 with paper, or, if the paper is loaded, press the OK button.
The correct size paper is not loaded.	Load the correct size paper.
The input tray is empty.	Load paper into the input tray.
Paper from a previous jam has not been completely removed.	Open the printer and remove any paper in the paper path.
The paper size is not configured correctly for the input tray.	Print a configuration page or use the control panel to determine the paper size for which the tray is configured.
The guides in the tray are not against the paper.	Verify that the rear and width paper guides are touching the paper.

Clear paper jams

When an original jams while passing through the reverse automatic document feeder(RADF), a warning message appears on the display screen.

⚠ CAUTION: To avoid tearing the document, remove the jammed document slowly and gently.

📄 NOTE: To prevent document jams, use the scanner glass for thick, thin, or mixed paper-type originals.

Paper jam locations

Jams can occur in these locations.

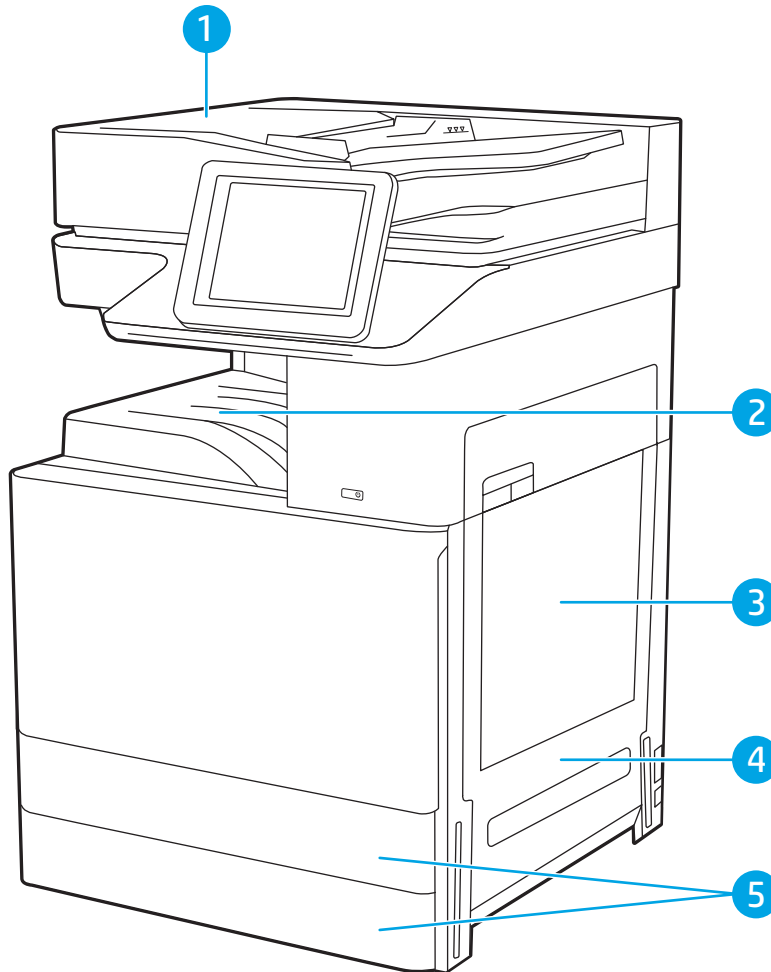

Item	Description
1	Document feeder
2	Output bin
3	Tray 1 (multipurpose tray)
4	Right door and fuser area
5	Tray 2 and Tray 3

Clear paper jams in the document feeder - 31.13.yz

The following information describes how to clear paper jams in the document feeder. When a jam occurs, the control panel displays an animation that assists in clearing the jam.

[HP LaserJet Managed MFP E82540, E82550, E82560: View a video of how to clear paper jams in the document feeder](#)

[HP Color LaserJet Managed MFP E87640, E87650, E87660: View a video of how to clear paper jams in the document feeder](#)

1. Open the document-feeder cover.

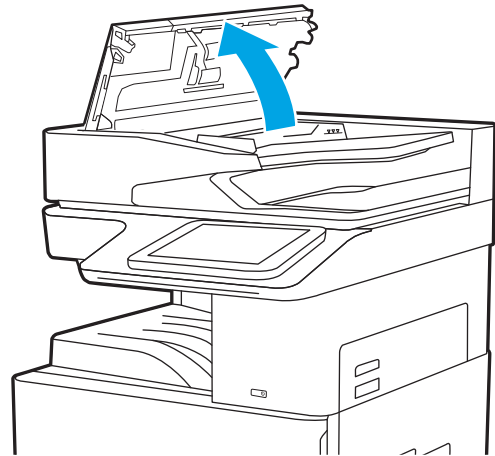

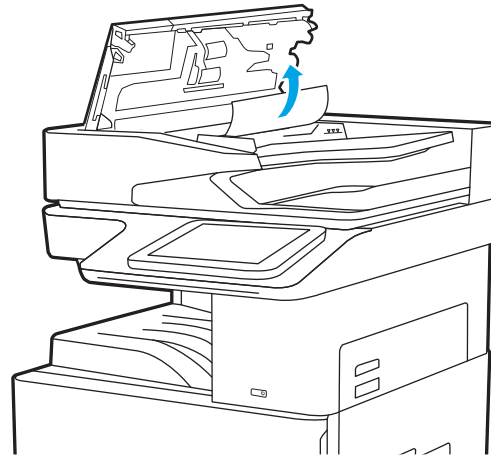

2. Remove any jammed paper.

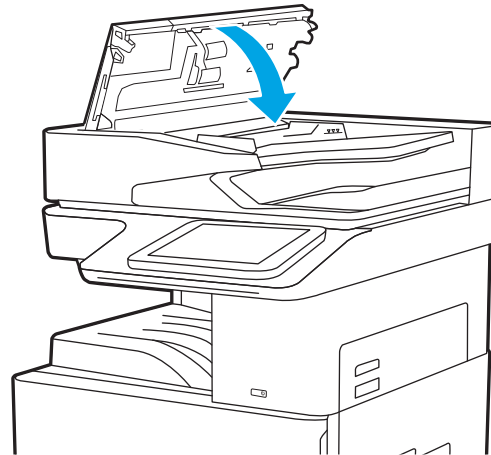

3. Close the document-feeder cover.



 **NOTE:** To avoid jams, make sure the guides in the document-feeder input tray are adjusted against the document, without bending the document. To copy narrow documents, use the flatbed scanner. Remove all staples and paper clips from original documents.

 **NOTE:** Original documents that are printed on heavy, glossy paper can jam more frequently than originals that are printed on plain paper.

Clear paper jams in Tray 1 (multipurpose tray)—13.A1

Use the following procedure to clear paper jams in Tray 1 (multipurpose tray). When a jam occurs, the control panel displays an animation that assists in clearing the jam.

1. Gently remove the jammed paper.

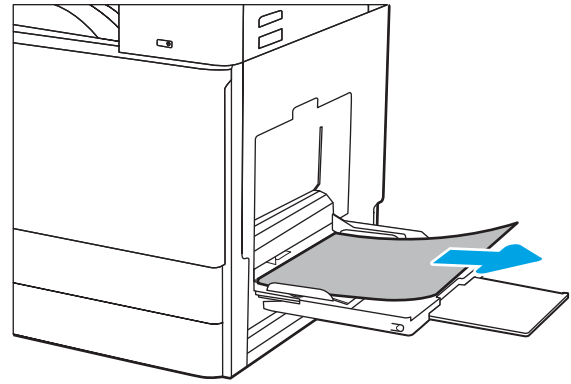

2. Open and then close the front door to resume printing.

Clear paper jams in Tray 2, Tray 3, and the optional 2 x 520-sheet trays – 13.A2, 13.A3, 13.A4

Use the following procedure to check for paper in all possible jam locations related to Tray 2, Tray 3, or the optional 2 x 520-sheet trays. When a jam occurs, the control panel might display a message and an animation that assists in clearing the jam.

CAUTION: The fuser can be hot while the printer is in use. Wait for the fuser to cool before handling it.

NOTE: The procedure to clear a paper jam in Tray 3, or the optional 2 x 520-sheet trays, is the same as for Tray 2. Only Tray 2 is shown here.

 [View a video of how to clear a paper jam in Tray 2, Tray 3, or the optional 2 x 520-sheet trays](#)

1. Open the right door.

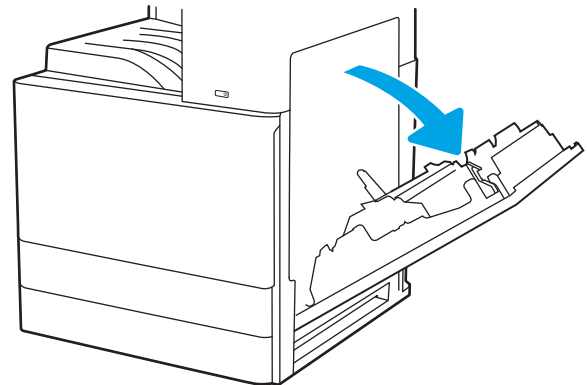

2. Gently remove any jammed paper.

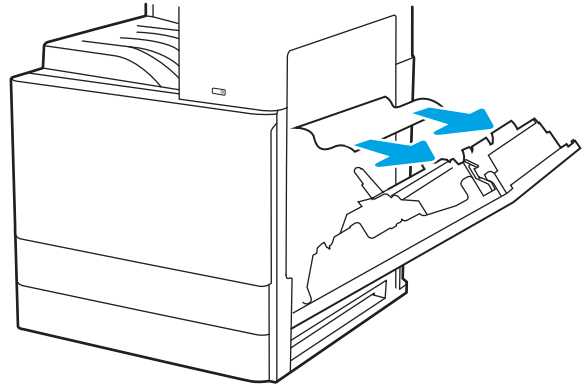

3. Close the right door.

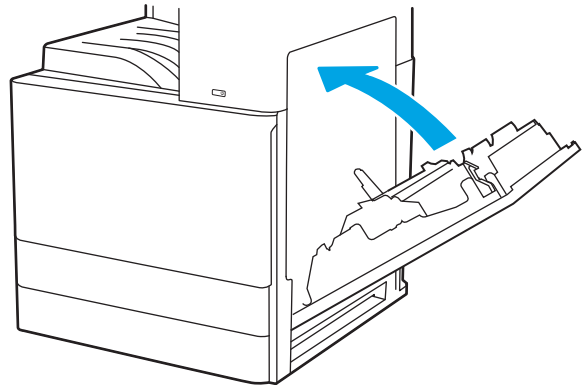

4. Open the tray.

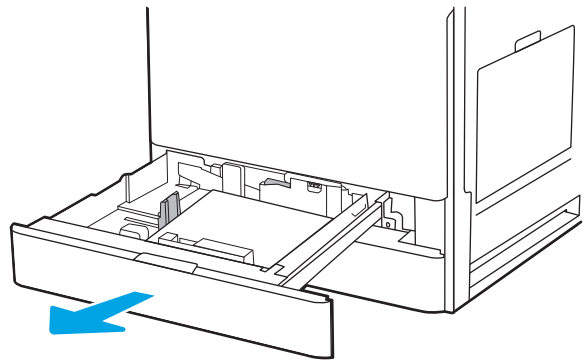

5. Gently remove any jammed paper.

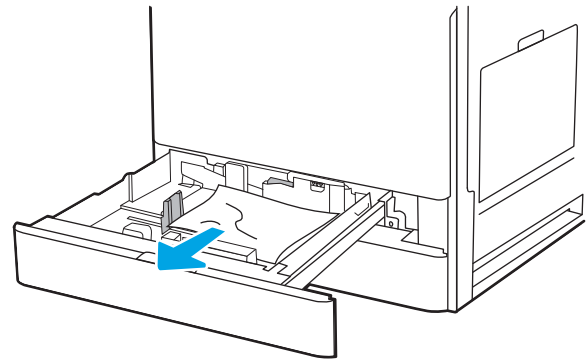

6. Close the tray. Printing automatically resumes.

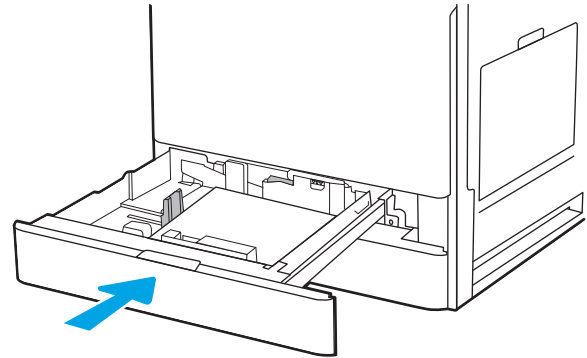

Clear paper jams in the output bin - 13.E1

Use the following procedure to check for paper in all possible jam locations in the output bin. When a jam occurs, the control panel displays an animation that assists in clearing the jam.

1. If paper is visible in the output bin, grasp the leading edge and remove it.

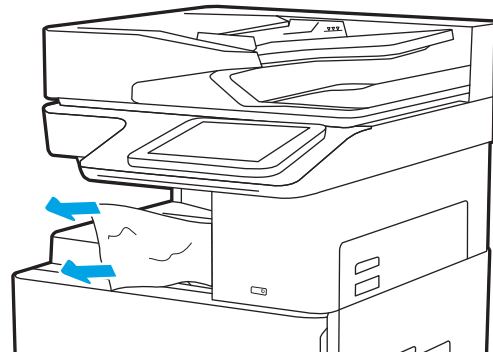

Clear paper jams in the right door and fuser area—13.B9, 13.B2, 13.FF

Use the following procedure to clear paper jams in the right door and fuser area. When a jam occurs, the control panel displays an animation that assists in clearing the jam.

 **NOTE:** The fuser is hot while the printer is in use. Wait for the fuser to cool before clearing jams.

1. Open the right door.

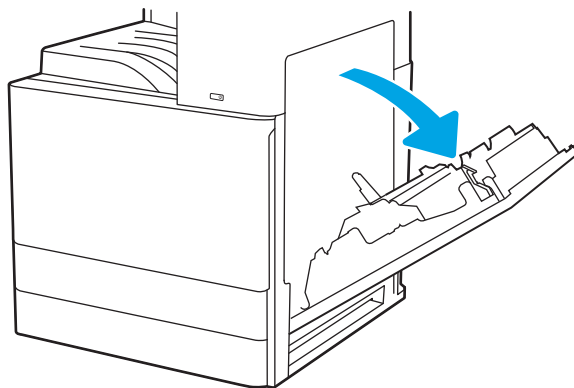

2. Gently remove any jammed paper.

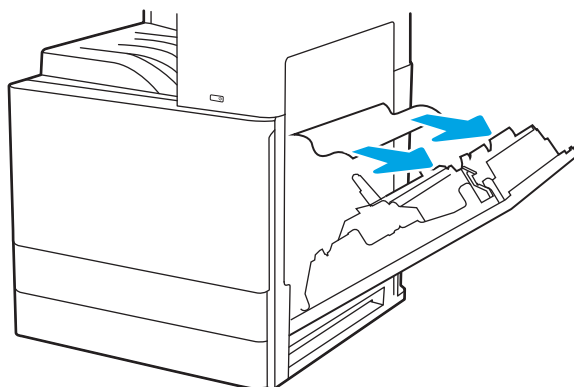

3. Close the right door.

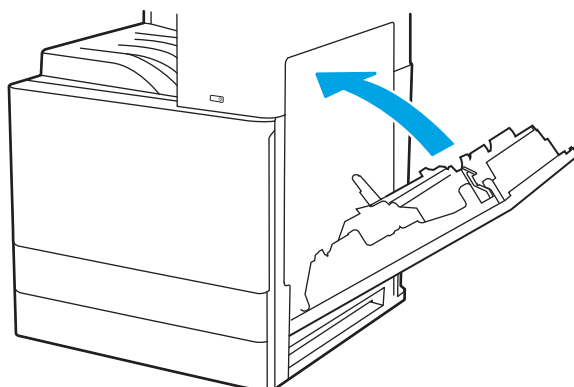

Service mode (tech mode)

Entering service mode

1. From the control panel, select **Support Tools**, and then select **Service**.
2. Enter the Service PIN ID.
 - 04077419
3. Select **Service Tools**.

Service mode menu tree

The tables below provide descriptions of the menus within the printer service mode.

Figure 3-34 Service mode Information tab

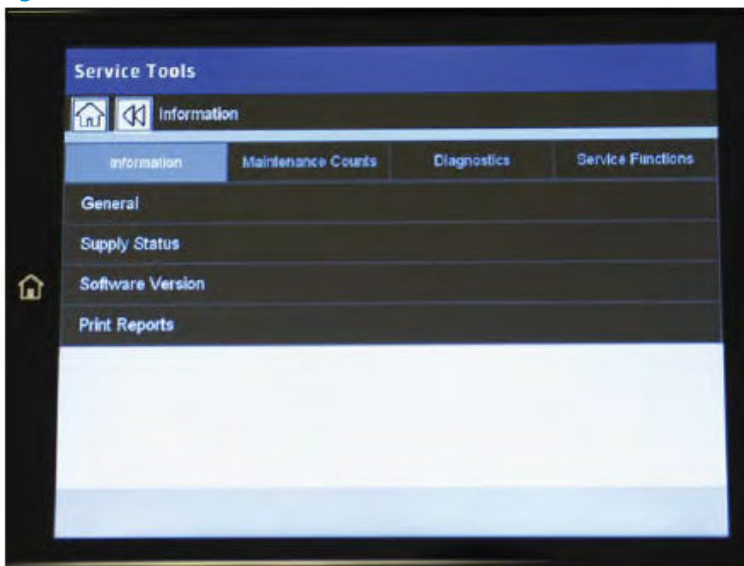

Table 3-28 Service mode Information tab

Level 1	Level 2	Level 3	Level 4	
Information	General	Engine Board Serial Number		
		Customer Replacement Unit	Toner Cartridge (YMCK)	
	Supply Status	Field Replacement Unit		Imaging Unit (Drum) (YMCK)
				Development Unit (Developer) (YMCK)
				ITB (Image Transfer Belt)
				ITB Cleaner
				Fuser
				Tray X Rollers
				ADF Pickup Roller

Table 3-28 Service mode Information tab (continued)

Level 1	Level 2	Level 3	Level 4
			ADF Separation (Reverse) Roller
	Software Version		
		Supplies Information	
		Auto Color Registration	
		Full Auto Color Registration	
		Auto Toning History	
	Print Reports	Fax Diagnostics	
		Auto Color Registration	
		Job Duty	
		Auto Toning History	
		Full Auto Color Registration	

Figure 3-35 Service mode Maintenance Counts tab

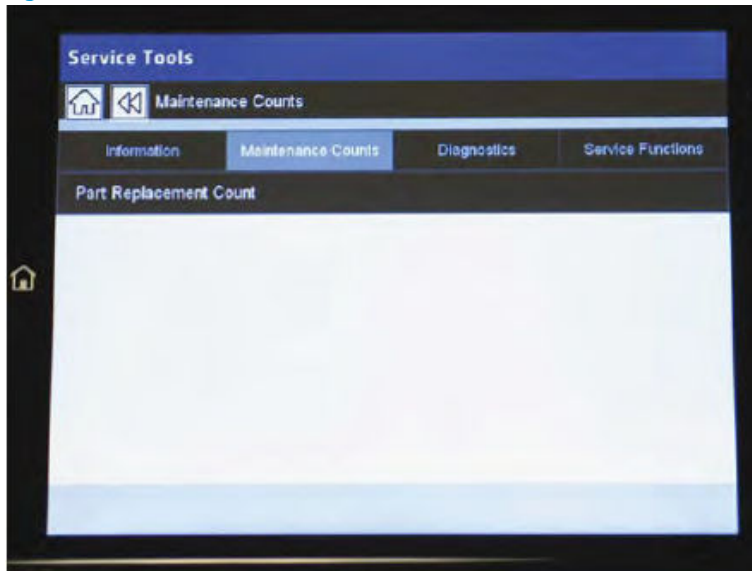

Table 3-29 Service mode Maintenance Counts tab

Level 1	Level 2	Level 3	Level 4
		Toner Cartridge (YMCK)	
		Imaging Unit (Drum) (YMCK)	
Maintenance Counts	Part Replacement Count	Development Unit (Developer) (YMCK)	
		ITB (Image Transfer Belt)	
		ITB Cleaner	
		Transfer Roller / T2 Roller	

Table 3-29 Service mode Maintenance Counts tab (continued)

Level 1	Level 2	Level 3	Level 4
		Fuser	
		Tray X Rollers	
		ADF Pickup Roller	
		ADF Separation (Reverse) Roller	

Figure 3-36 Service mode Diagnostics tab

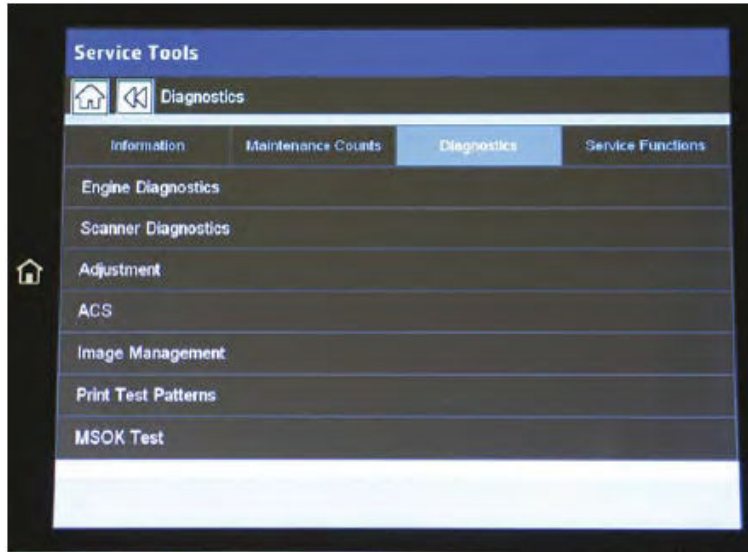

Table 3-30 Service mode Diagnostics tab

Level 1	Level 2	Level 3	Level 4
		Engine NVM Initialization	
	Engine Diagnostics	Engine NVM Read/Write	
		Engine Test Routines	
	Scanner Diagnostics	Shading Test	
		Scanner/ADF NVM Read/Write	
		Scanner/ADF Test Routines	
Diagnostics		Print Adjustment	Image Position
			Print Margin Test
		Copy Adjustment	Image Position
	Adjustment	Scan Area Adjustment	Automatic Adjustment
			Manual Adjustment
		ADF Adjustment	Automatic Adjustment
			Manual Adjustment
		Buckle Adjustment	

Table 3-30 Service mode Diagnostics tab (continued)

Level 1	Level 2	Level 3	Level 4
	ACS	ACS Page Adjustment	[1–5]: 5*
		ACR Reference Adjustment	Full
		Cancel ACR Reference Adjustment	
		Auto Color Registration	
		Full Auto Color Registration	
		Customer Color	
	Image Management	Auto Tone Adjustment Activation	
		Auto Tone Adjustment	
		Setting Standard Tone	
		Cancel Setting Standard Tone	
		Auto Color Balance	
		Cancel Auto Color Balance	
		Manual Tone Adjustment	
	Print Test Patterns		
	MSOK Test	EEPROM Test	

Figure 3-37 Service mode Service Functions tab

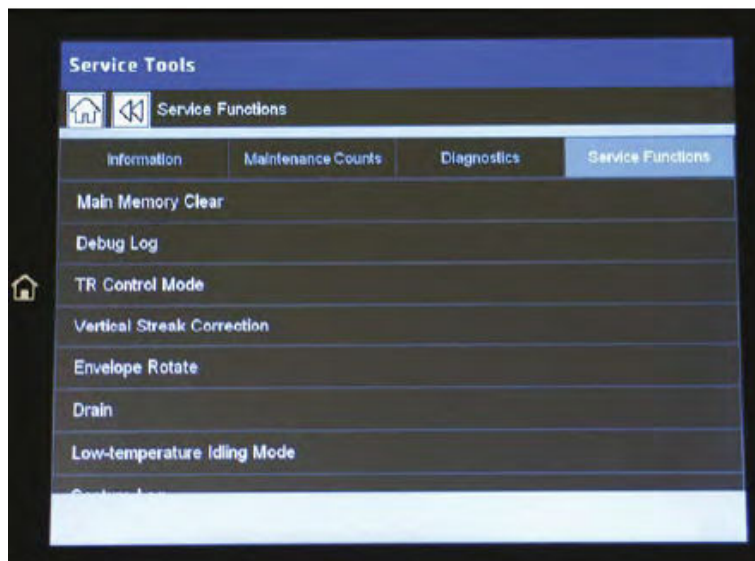

Table 3-31 Service mode Service Functions tab

Level 1	Level 2	Level 3	Level 4
Service Functions	Main Memory Clear		
	Debug Log	Info	

Table 3-31 Service mode Service Functions tab (continued)

Level 1	Level 2	Level 3	Level 4
		Job Status	
	TR Control Mode	T2 Control Mode	Paper Group/Paper Side/Paper Direction/T2 PWM
	Vertical Streak Correction		
	Envelope Rotate	Off / 90 degrees / 180 degrees	
	Drain	On	
		Off	
	Clean Fuser	Off / On / Auto	
	Capture Log		
		IP address (manual entry)	
	IP Setting	Subnet Mask (manual entry)	
		Default Gateway (manual entry)	
	Footer		
	Firmware Upgrade		
		Enable Dump	
	File Dump Mode	Retrieve Dump Image	
		Delete Dump Image	
		Disable Dump	
	Copy Original Thickness		
	Scan Original Thickness		
	Altitude Adjustment		
	Humidity		
	Vapor Mode		
	Event Logging		
	Scan Minimize Skew		

Information tab

This section provides detailed information about the service mode Information tab.

General

Information > General

This menu displays the printer information like a serial number.

Supply Status

Information > Supply Status > Customer Replacement Unit

This menu displays the printer's customer replacement unit status. Users can select one item in the list to check the information of the selected unit. This menu allows users to reset the counter if new supply has been replaced and a reset is required.

Information > Supply Status > Field Replacement Unit

This menu displays the printer's field replacement unit status. Users can select one item in the list to check the information of the selected unit. This menu allows users to reset a counter if a supply has been replaced, if a reset is required.

In this menu, there are five columns: Item, Threshold, Status, and Count. Some items have the Maximum Life option.

- Status: This column shows the current status of the selected item.
 - OK: The current count is smaller than the default warning value.
 - Check: The current count is bigger than the default warning value.
 - OFF: The current count exceeds the maximum life.
- Count: This column shows the current count of the selected item.
- Maximum Life: This column shows the maximum capacity of the selected item.

The technician can edit the default warning value within the given threshold.

Selecting some items will enable the reset button to reset the current count to zero after replacing the unit.

Software Version

Information > Software Version

This menu allow the user to see firmware and software versions across the entire printer.

Fault Log

Information > Fault Log

This menu displays faults that have occurred while the system was operating.

Pressing the **Clear** button will clear all the saved fault logs.

Print Reports

Information > Print Reports

This menu displays reports that can be printed from the system. The following reports are available to print:

- Supplies Information
- Auto Color Registration
- Full Auto Color Registration
- Auto Toning History

Information > Print Reports > Auto Color Registration

- This report lists the last ten color plane registration (CPR) results.

If there is a color registration problem, and executing a auto color registration does not solve the problem, service engineers can print out this report and check the “Succeeded or Failed for CPR” field.

Table 3-32 Color Plane Registration (CPR) report

Result	Meaning
0	Success
256	Pattern sensing sensor LED calibration failure
1152	Machine is unable to read the pattern and cannot execute the calibration.

Information > Print Reports > Auto Toning History

This report shows a history of execution of the tone reproduction curve (TRC) control. The TRC control preserves color consistency against changes in supplies resulting from long-time use and environmental change. The purpose of the history report is to check if the TRC control is working normally.

- If the TRC control performs normally, “Pass” count must be a non-zero value and “Fail” count must be zero.
- If “Fail” count is not zero, check the image density sensor.

Maintenance Counts tab

This section provides detailed information about the service mode Maintenance Counts tab.

Fault Count

Maintenance Counts > Fault Count

This menu displays fault counts. The technician can select one fault group and press **OK** to see detailed fault descriptions. The detailed fault description window displays engine diagnostic codes, descriptions of the fault, and the number of occurrences.

The following table shows the fault groups defined for the system:

Table 3-33 Fault count groups

A1 Motor	H2 Output (Bins) System	S3 Scan System
A2 Fan	M1 Input (Trays) System	S5 UI System
A3 Sensor	M2 Media Path System	S6 Network System
C1 Toner Cartridge Unit	M3 Output (Bins) System	S7 HDD System
C3 Imaging Unit	M4 ADF System	U1 Fusing Unit
C7 Fusing Unit	S1 Video System	U2 Laser Scanner Assembly Unit
H1 Input (Trays) System	S2 Engine System	

Part Replacement Count

Maintenance Counts > Part Replacement Count

This menu displays the replacement counts for the system parts. Users can select one group and press **“OK”** to see the exact name of the part and the occurrence of the replacement.

The following table shows replaceable parts groups of the system:

Table 3-34 Part Replacement Count

Unit	Item	Sensing Method
Toner Cartridge	Toner	Auto Sensing
Imaging Unit	Imaging Unit	Auto Sensing
Fuser	Fuser	Auto Sensing
ITB	ITB	
ITB Cleaner	ITB cleaner	
Transfer Roller	Transfer roller	Count Clear
Roller	Tray 2 Roller	Count Clear
	Tray 3 Roller	Count Clear

Table 3-34 Part Replacement Count (continued)

Unit	Item	Sensing Method
	Tray 4 Roller	Count Clear
	Tray 5 Roller	Count Clear
ADF Roller	ADF Pickup Roller	
	ADF Separation Roller	
Filter	Ozone filter	

Diagnostics tab

This section provides detailed information about the service mode Diagnostics tab.

Engine diagnostics

Diagnostics > Engine Diagnostics > Engine NVM Initialization

This menu initializes all engine NVM values to the default.

Diagnostics > Engine Diagnostics > Engine NVM Read/Write

- Purpose : To change a configuration value for the engine firmware
- Operation Procedure :

When the main “NVM Read/Write” window displays, users can navigate through the list of codes with descriptions and saved values.

Users can also input a code through the text box to find a configuration value directly.

After selecting one value, press the **Edit** button to open an interface for user input.

Table 3-35 Engine NVM Read/Write

Code	Display	Meaning	Default	Max/Min
109-0200	StandBy Center	Temperature offset	10	15 / 5
109-0201	StandBy Side	Temperature offset	10	15 / 5
109-0205	Warmup Center	Temperature offset	10	15 / 5
109-0206	Warmup Side	Temperature offset	10	15 / 5
109-0255	Thin Center	Temperature offset	10	15 / 5
109-0256	Thin Side	Temperature offset	10	15 / 5
109-0265	Plain Center	Temperature offset	10	15 / 5
109-0266	Plain Side	Temperature offset	10	15 / 5
109-0275	Heavy Center	Temperature offset	10	15 / 5
109-0276	Heavy Side	Temperature offset	10	15 / 5
109-0280	Extra Heavy Center	Temperature offset	10	15 / 5
109-0281	Extra Heavy Side	Temperature offset	10	15 / 5
109-0300	Envelopes Center	Temperature offset	10	15 / 5
109-0301	Envelopes Side	Temperature offset	10	15 / 5
109-0305	Labels Center	Temperature offset	10	15 / 5
109-0306	Labels Side	Temperature offset	10	15 / 5
109-0310	Thick Center	Temperature offset	10	15 / 5
109-0311	Thick Side	Temperature offset	10	15 / 5

Table 3-35 Engine NVM Read/Write (continued)

Code	Display	Meaning	Default	Max/Min
109-0315	Recycled Center	Temperature offset	10	15 / 5
109-0316	Recycled Side	Temperature offset	10	15 / 5
109-0320	Special Center	Temperature offset	10	15 / 5
109-0321	Special Side	Temperature offset	10	15 / 5
109-0325	1200 dpi_thin Center	Temperature offset	10	15 / 5
109-0326	1200 dpi_thin Side	Temperature offset	10	15 / 5
109-0330	1200 dpi_plain Center	Temperature offset	10	15 / 5
109-0331	1200 dpi_plain Side	Temperature offset	10	15 / 5
109-0335	1200 dpi_thick Center	Temperature offset	10	15 / 5
109-0336	1200 dpi_thick Side	Temperature offset	10	15 / 5
112-0120	Manual Color Registration X-Offset Yellow	Distance from hsync to lsync (multi-hsync) for yellow	100	200/0
112-0130	Manual Color Registration X-Offset Magenta	Distance from hsync to lsync (multi-hsync) for magenta	100	200/0
112-0140	Manual Color Registration X-Offset Cyan	Distance from hsync to lsync (multi-hsync) for cyan	100	200/0
112-0150	Manual Color Registration X-Offset Black	Distance from hsync to lsync (multi-hsync) for black	100	200/0
112-0160	Manual Color Registration Y-Offset Yellow	Distance from psync to image area for yellow	100	200/0
112-0170	Manual Color Registration Y-Offset Magenta	Distance from psync to image area for magenta	100	200/0
112-0180	Manual Color Registration Y-Offset Cyan	Distance from psync to image area for cyan	100	200/0
112-0190	Manual Color Registration Y-Offset Black	Distance from psync to image area for black	100	200/0

Diagnosics > Engine Diagnostics > Engine Test Routines

- Purpose : To perform test routines for the engine
- Operation Procedure :

When the main Engine Test Routines window displays, users can navigate through the list of routines and descriptions that display. Users can directly input an EDC code through the text box to search for a routine. A maximum of three routines can be selected at the same time.

After selecting one or more routines, press the “OK” button to open the test window. The selected routines are displayed and users can start/stop the selected test routine.

Code	Displayed Name	Meaning
100-0000	Main BLDC Motor	Main BLDC Motor is On/Off
100-0001	Main BLDC Motor Slow	Main BLDC Motor Slow On/Off

Code	Displayed Name	Meaning
100-0010	Main BLDC Motor Ready	Detect if Main BLDC Motor runs at normal speed
100-0044	OPC Motor K	Black Opc BLDC Motor is On/Off
100-0049	K OPC Motor Ready	Detect if Black OPC BLDC Motor runs at normal speed
100-0076	Ozone Suction Fan Run	Start/Stop Ozone Suction Fan run
100-0077	Ozone Suction Fan Ready	Detects if Ozone Suction Fan runs at normal speed.
100-0120	Exit Motor Forward Fast	Exit Motor Forward Fast On/Off
100-0130	Exit Motor Forward Slow	Exit Motor Forward Slow On/Off
100-0131	Exit Motor Backward	Exit Motor Forward Backward On/Off
100-0132	Exit Motor Backward Slow	Exit Motor Forward Backward Slow On/Off
100-0140	Duplex Motor Forward	Duplex Motor Forward On/Off
100-0141	Duplex Motor Forward Slow	Duplex Motor Forward Slow On/Off
100-0160	Duplex Fan1 Run	Start/Stop Duplex Fan1 run
100-0180	Duplex Fan1 Run Ready	Detects if Duplex Fan1 runs at normal speed.
100-0200	T1 Elevating Motor	T1 Elevate Motor On/Off
100-0210	T2 Elevating Motor	T2 Elevate Motor On/Off (Optional)
100-0220	T3 Elevating Motor	T3 Elevate Motor On/Off (Optional)
100-0230	T4 Elevating Motor	T4 Elevate Motor On/Off (Optional)
100-0241	Waste Toner Led	Waste Toner Led On/Off
100-0250	Waste Toner Full Sensor	Detect if the waste toner is full or not.
100-0260	SMPS Fan Run	Start/Stop SMPS Fan run
100-0270	SMPS Fan Run Ready	Detects if SMPS Fan runs at normal speed.
100-0370	Tray 1 Pickup Motor	Tray 1 Motor is On/Off
100-0371	Tray 1 Pickup Motor Slow	Tray 1 Motor Slow On/Off
100-0380	Tray 2 Pickup Motor	Tray 2 Motor is On/Off
100-0381	Tray 2 Pickup Motor Slow	Tray 2 Motor Slow On/Off
100-0390	Tray 3 Pickup Motor	Tray 3 Motor is On/Off
100-0391	Tray 3 Pickup Motor Slow	Tray 3 Motor Slow On/Off
100-0400	Tray 4 Pickup Motor	Tray 4 Motor is On/Off
100-0401	Tray 4 Pickup Motor Slow	Tray 4 Motor Slow On/Off
100-0411	Registration Motor Slow	Registration Motor Slow On/Off
100-0412	Registration Motor Slowest	Registration Motor Slowest On/Off
100-0430	Exit2 Motor Forward	Exit2 Motor is On/Off
100-0431	Exit2 Motor Forward Slow	Exit2 Motor Slow On/Off
100-0440	Exit2 Motor Backward	Exit2 Motor is On/Off

Code	Displayed Name	Meaning
100-0441	Exit2 Motor Backward Slow	Exit2 Motor Slow Backward On/Off
100-0470	DCF Feed Motor	DCF Feed Motor is On/Off
100-0471	DCF Feed Motor Slow	DCF Feed Motor Slow On/Off
100-0480	Duct Motor	Duct Motor On/Off.
100-0481	Duct Motor Sensor	Duct Motor Rib Sensing.
101-0000	Bypass Feed Clutch	Engages drive to pick up a paper from bypass Tray(MP Tray).
101-0050	Registration Clutch	Engages drive to registartion rolls.
101-0080	T1 Feed Clutch	T1 Feed Clutch On/Off
101-0141	T3 Feed Motor Slow	T3 Feed Motor Slow On/Off
101-0151	T4 Feed Motor Slow	T4 Feed Motor Slow On/Off
101-0190	Out-Bin Full Sensor	Detect when a paper is at Out-Bin Full Sensor
101-0191	Out-Bin2 Full Sensor	Detect when a paper is at Out-Bin2 Full Sensor
101-0270	MP Clutch	MP Clutch On/Off
101-0271	MP Solenoid	MP Solenoid On/Off
101-0280	Return Gate Solenoid	Return Gate Solenoid On/Off
102-0000	Tray 1 Home Position	Detect when Tray 1 is closed.
102-0010	T1 Paper Empty Sensor	Detect when paper is in Tray 1.
102-0041	T1 Paper Size Read	Detects Paper Tray 1 size.
102-0050	T1 Stack Height Sensor	Detects if paper in Tray 1 is elevated to the sensor.
102-0070	Tray 2 Home Position	Detect when Tray 2 is closed.
102-0080	T2 Paper Empty Sensor	Detect when paper is in Tray 2.
102-0111	T2 Paper Size Read	Detects Paper Tray 2 size.
102-0120	T2 Stack Height Sensor	Detects if paper in Tray 2 is elevated to the sensor.
102-0140	Tray 3 Home Position	Detect when Tray 3 is closed.
102-0150	T3 Paper Empty Sensor	Detect when paper is in Tray 3.
102-0181	T3 Paper Size Read	Detects Paper Tray 3 size.
102-0190	T3 Stack Height Sensor	Detects if paper in Tray 3 is elevated to the sensor.
102-0210	Tray 4 Home Position	Detect when Tray 4 is closed.
102-0220	T4 Paper Empty Sensor	Detect when paper is in Tray 4.
102-0251	T4 Paper Size Read	Detects Paper Tray 4 size.
102-0260	T4 Stack Height Sensor	Detects if paper in Tray 4 is elevated to the sensor.
102-0280	Bypass Paper Empty Sensor	Detects when paper is in Bypass Tray (MP Tray).
102-0290	Feed Sensor	Detect when paper is at the feed sensor.
102-0300	T2 Feed Sensor (or Door Open)	Detect when paper is at T2 Feed sensor. (optional)

Code	Displayed Name	Meaning
102-0320	T3 Feed Sensor (or Door Open)	Detect when paper is at T3 Feed sensor. (optional)
102-0340	T4 Feed Sensor (or Door Open)	Detect when paper is at T4 Feed sensor. (optional)
102-0352	DCF Feed Cover Open	Detect that the DCF cover is closed
102-0360	Registration Sensor	Detect when a paper is at registration sensor.
102-0361	FuserOut Sensor	Detect when a paper is at FuserOut sensor.
102-0371	Exit2 Sensor	Detect when a paper is at Exit2 sensor.
102-0380	Duplex Jam1 Sensor	Detect when a paper is at Duplex Jam1 sensor.
102-0435	Front Cover Sensor	Detect status of front cover.
102-0436	Side Cover Sensor	Detect status of front cover.
104-0000	Toner collection unit (TCU) Install Sensor	Detect if the TCU is installed.
106-0200	HVPS Installed	Detect HVPS unit
107-0165	K Eraser On	K eraser lamp On/Off
107-0169	K Eraser Detect	Detect K eraser status
109-0030	Fuser Motor Forward	Fuser Motor Forward On/Off
109-0031	Fuser Motor Backward	Fuser Motor Backward On/Off
109-0034	Fuser Motor Ready	Detect if Fuser Motor runs at each speed
109-0140	Fuser Gap Home Sensor	Detect if the fuser press is located Home position.
109-0200	Detect Fuser Relay	Detect Fuser Relay Status
109-0210	Detect ZeroCross Period	Detect ZeroCross Period
109-0300	Fuser Installed	Detect Fuser Unit
110-0000	LSU Motor1 Run Ready	Detects if LSU motor1 runs at normal speed.
110-0060	LSU Motor1 Run	LSU Motor1 On/Off
110-0170	LSU HSync4	Detect LSU HSync4 (Black)
110-0200	LSU Installed	Detect LSU Unit
111-0030	Toner Dispense Motor Black	Toner Dispense(Supply) Motor On/Off
111-0070	Toner Sensor Black	TC sensor in developer tank.
111-0140	Toner Control Voltage K	K Toner Voltage On/Off

Scanner Diagnostics

Diagnostics > Scanner Diagnostics > Shading Test

- Purpose:

- To check the quality of scanned images, especially if there might be defects in optical devices such as the lens, mirror, or lamp.
- Check the quality problem as shown below:

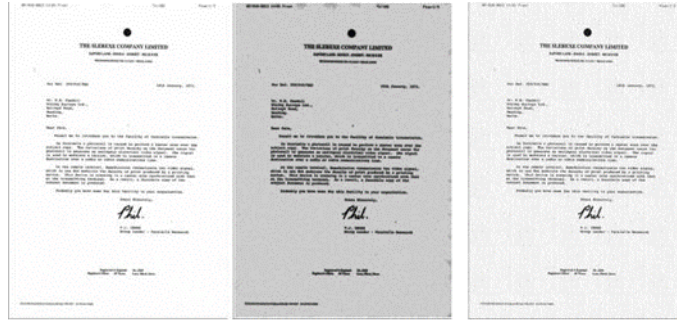

Normal Image

Defected Image

Defected Image

- Operation procedure:

1. For Image Scanner Unit :

Press **“Shade and Print report”** to see if the current shading value is correct. Mono, red, green, and blue gray shading values will be shown on the printed report. When the previous shading value is needed, press **“Print Last Shade Report”**.

2. For ADF Unit

1. Load the shading sheet in the ADF tray.

2. Enter SCV mode. Select the following menu items:

Diagnostics > Scanner Diagnostics > Shading Test > Shade and Print Report (ADF)

Press **“Print last shade report (ADF)”** for the previous shading value report.

3. Check if the printed results are correct.

 **NOTE:**

- When executing ADF shading, use only the shading sheet.
- A shading test for the ADF unit must be completed after replacing the ADF unit or main board.

• Verification:

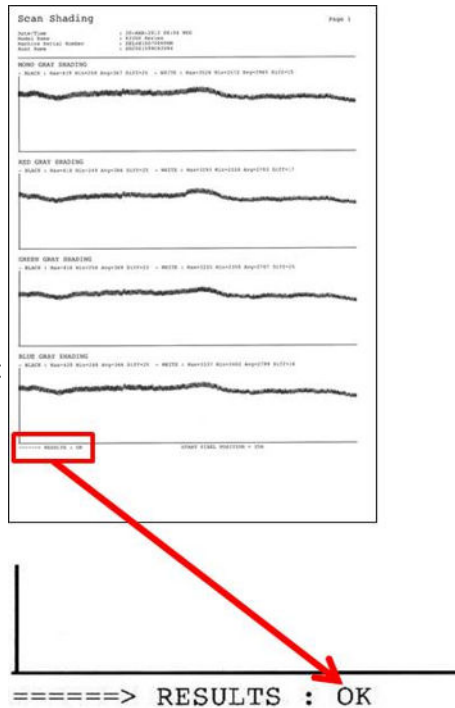

Diagnostics > Scanner Diagnostics > Scanner/ADF NVM Read/Write

- Purpose: To read and/or write values in the scanner and ADF memory.
- Operation Procedure:

When the main “NVM read/write” window displays, users can navigate through the list of codes with descriptions and saved values. Users can also directly input a code through the text box to search for an NVM.

After selecting a code, the “Edit” button will be enabled only if the code is writable.

If the selected code is writable, and the “Edit” button is enabled, press the button to configure the desired value for the code.

Code	NVM Description	Default
05-0000	Pick Up Count	0
05-0001	Retard Roller Count	0
05-0030	Simplex Regi Value(Regi1)	0
05-0040	Duplex Regi Value(Regi2)	0
05-0050	Width Guide Max Value	Depends on ADF
05-0060	Width Guide Min Value	Depends on ADF

Diagnosics > Scanner Diagnostics > Scanner/ADF Test Routines

- Purpose: To perform test routines for the scanner and ADF.
- Operation Procedure:

When the main scanner/ADF test routines window displays, users can navigate through the list of routines that display along with description.

Users can also input a code to the text box to find a routine directly.

After selecting one routine, pressing “OK” button, the test window that lists the selected routine opens. Users can start/stop a desired test routine.

- Reference: Table below

Code	Name	Value
06-0000	Scanner Original Size Detecting Sensor 1	High/Low
06-0001	Scanner Original Size Detecting Sensor 2	High/Low
06-0010	Scanner Cover Open/Close Sensor 1	High/Low
06-0011	Scanner Cover Open/Close Sensor 2	High/Low
06-0020	Scanner Platen Motor Forward	Start/Stop
06-0030	Scanner Platen Motor Backward	Start/Stop
06-0040	Scanner Platen Home Position Sensor	High/Low
05-0000	Document Length .1 Sensor	High/Low
05-0001	Document Length .2 Sensor	High/Low
05-0020	Document Cover Open Sensor	High/Low
05-0040	Document Detect Sensor	High/Low
05-0060	Document Simplex Registration Sensor	High/Low
05-0061	Document Duplex Registration Sensor	High/Low
05-0070	Document Scan Read Sensor1	High/Low
05-0080	Document Exit Sensor	High/Low
05-0081	Document Exit IDLE Sensor	High/Low
05-0090	Document Pick up Clutch	Start/Stop
05-0100	Document Regi Clutch	Start/Stop
05-0101	Document Exit Solenoid	High/Low
05-0110	Document Motor Forward	Start/Stop
05-0111	Document Motor Backward	Start/Stop
05-0140	Document Pickup Roller Detect Sensor	High/Low
05-0190	Document Width Guide ADC Sensor	10Bit (0~1023)
05-0210	Document Jig Test Low Speed Simplex	Start/Stop
05-0220	Document Jig Test Low Speed Duplex	Start/Stop

Code	Name	Value
05-0230	Document Jig Test High Speed Simplex	Start/Stop
05-0240	Document Jig Test High Speed Duplex	Start/Stop

Adjustment

Diagnostics > Adjustment > Print Adjustment > Image Position

- Purpose: Manually adjust the position of the printed image on the paper in the print engine.
- Operation procedure:
 1. Select a tray to adjust.
 2. Change the adjustment value using the **+** or **-** buttons, then press the **OK** button to save the changes.
 - Simplex leading edge
 - Simplex side edge
 - Duplex leading edge
 - Duplex side edge



NOTE:

- Adjustment must be done for each tray (Tray 2, 2, 3, 4, and MP).
 - Do not choose **"ALL"** for the tray selection.
 - Adjust for the tray with each new tray selection.
3. Print out the test pattern and check if the image is adjusted. If not, repeat step 2.

Diagnostics > Adjustment > Print Adjustment > Print Margin Test

This menu is used to print out the test pattern manually.

Diagnostics > Adjustment > Copy Adjustment > Image Position

- Purpose: Manually adjust the position of the copied image on the paper in the copy engine.
- Operation procedure:



NOTE: Before copy adjustment:

- Make sure that the initial values of margin adjustment are the same as the values of the print adjustment.
- Perform an adjustment for each tray. Do not choose **"All"** for tray selection, as this can change the adjustment.

 **NOTE:**

- Complete adjustment for each tray (Tray 2, 3, 4, and MP).
 - Do not choose "**All**" for tray selection.
 - Adjust the tray with each new tray selection.
-

1. Place the Scanner A/S Chart on the scanner glass.
2. Change the adjustment value using the + or - button, and then press "**OK**" to save the changes.
 - o Simplex leading edge
 - o Simplex side edge
 - o Duplex leading edge
 - o Duplex side edge
3. Print out the test pattern and check if the image has moved. If not, repeat step 2.

Diagnostics > Adjustment > Scan Area Adjustment > Automatic Adjustment

- Purpose: To correct the image position and magnification of scanned images automatically.
- Operation procedure:
 1. Place the Scanner A/S chart on the scanner glass.

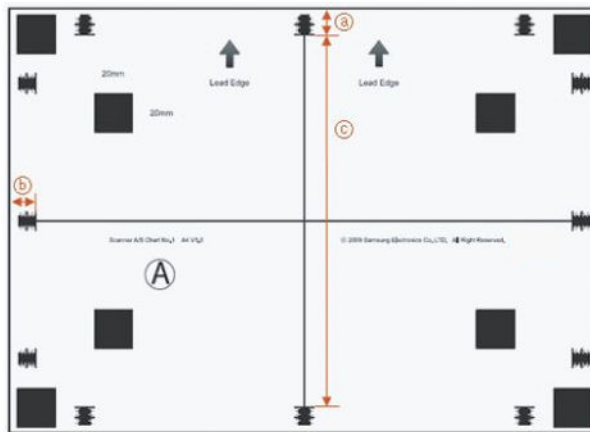

Note that the "Lead Edge" arrows point to the left side of the scanner glass and are placed face down. The Scanner A/S Chart comes in two sizes, A4 and Letter.

2. Press the **OK** button. A scan begins and the system will automatically calculate the proper value based on the scanning result of the chart.
3. The new value saves to the system.
4. Scan the Scanner A/S Chart and send it to a PC. The chart must be scanned from the scanner glass.
5. To check the image position, compare the position of the scale marks (a, b) from the chart to the scanned image.
6. To check the magnification, compare the length of line "c" from the chart to the scanned image.



NOTE: Specifications:

- a, b: 10, ± 1.5 mm
- c: 190, ± 1.5 mm

Diagnostics > Adjustment > Scan Area Adjustment > Manual Adjustment

- Purpose: To correct the position and magnification of scanned images manually.
- Operation procedure:
 1. Choose one item from the table:
 - Image position : Leading edge (Unit: mm, Scale: 0.1, Min/Max: -6/+6)
 - Image position : Side edge (Unit: mm, Scale: 0.1, Min/Max: -6/+6)
 - Magnification : Vertical direction (Unit: %, Min/Max: 98.5/101.5)
 2. Select one item and press the **Edit** button.
 3. Change the adjustment value using the arrow button.
 4. Image position (a, b): If the current value is smaller than the specification, press "+", otherwise press "-".
 5. Magnification (c): If the current value is smaller than the specification, press "-", otherwise, press "+".
 6. Press the **OK** button to apply the new value to the system.
 7. Scan the Scanner A/S chart and send it to a PC. The chart must be scanned from the scanner glass.
 8. To check the image position, compare the position of the scale marks (a, b) from the chart to the scanned image.
 9. To check the magnification, compare the length of line "c" from the chart to the scanned image.
 - a, b: 10, ± 1.5 mm
 - c: 190, ± 1.5 mm

Diagnostics > Adjustment > ADF Adjustment > Automatic Adjustment

- Purpose: To correct the image position and magnification of images scanned with the Flow ADF/ADF automatically.
- Operation procedure:
 1. Place the scanner A/S chart in the ADF tray.

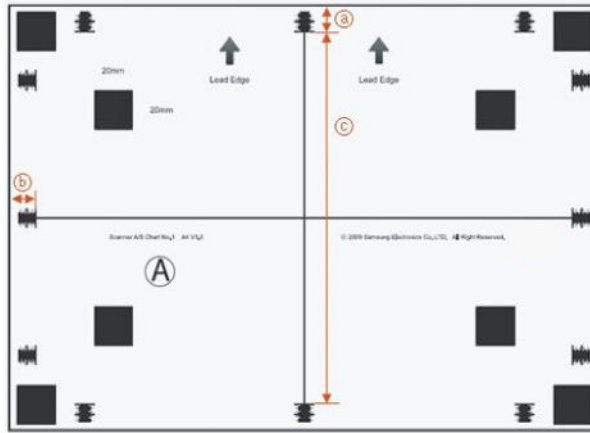

2. Press the **OK** button. A scan begins and the system will automatically calculate the proper value based on the scanning result of the chart.
3. The new value saves to the system.
4. Scan the scanner A/S chart and send it to a PC. The chart must be scanned from the ADF.
5. To check the image position, compare the position of the scale marks (a, b) from the chart to the scanned image.
6. To check the magnification, compare the length of line "c" from the chart to the scanned image.

 **NOTE:** Specifications:

- a, b: 10, ± 1.5 mm
- c: 190, ± 1.5 mm

 **NOTE:** After executing the ADF adjustment, perform a shading test.

Diagnostics > Adjustment > ADF Adjustment > Manual Adjustment

- Purpose: To correct the position and magnification of scanned images manually.
- Operation procedure:
 1. Choose one item from the table:
 - Image position : Leading edge (Unit: mm, Scale: 0.1, Min/Max: -6/+6)
 - Image position : Side edge (Unit: mm, Scale: 0.1, Min/Max: -6/+6)
 - Magnification : Vertical direction (Unit: %, Min/Max: 98.5/101.5)
 2. Select one item and press the **Edit** button.
 3. Change the adjustment value using the arrow button.
 4. Image position (a, b): If the current value is smaller than the specification, press "+", otherwise press -.
 5. Magnification (c): If the current value is smaller than the specification, press "-", otherwise, press "+".
 6. Press the **OK** button to apply the new value to the system.

7. Scan the scanner A/S chart and send it to a PC. The chart must be scanned from the ADF.
8. To check the image position, compare the position of the scale marks (a, b) from the chart to the scanned image.
9. To check the magnification, compare the length of line “c” from the chart to the scanned image.

Specifications

 - a, b: 10, ± 1.5 mm
 - c: 190, ± 1.5 mm

After executing the ADF adjustment, perform a shading test.

Diagnostics > Auto Color Sensing (ACS)

- Purpose:

To set the color coverage ratio of auto color mode in the copy function.

 - Color coverage ratio: The ratio of color contents in the original document.
- Operation procedure:

Change the level from 1 to 5.

 - Classifies a document as color, if color coverage of the document is higher than a predefined level.
 - Level 1 has a higher probability of classifying documents to color, while level 5 has lower probability.
- Verification: Copy a “mono copied” original with auto color mode and check if the print out is monochrome.
- Specification:

Color coverage

 - Level 1: 0.01%
 - Level 2: 0.05%
 - Level 3: 0.1%
 - Level 4: 0.25%
 - Level 5: 0.5%

Image management

Diagnostics > Image Management > Auto Tone Adjustment Activation > Normal

- Purpose: To correct image quality when density of the image is poor. Normal TRC Control is recommended after changing a unit, such as a toner cartridge, imaging unit, or ITB, or after restarting the printer.
- Operation procedure:
 1. Select “on” or “off” for Normal TRC Control execution.

- Off: Normal TRC Control will not execute.
- On: Normal TRC Control will execute during the determined conditions,
- 2. Change the execution condition(s) of Normal TRC Control.
 - Page Count: The system executes Normal TRC Control based on the count of printed pages since the last execution.
 - Time Left Alone: The system executes Normal TRC Control when the system returns from a power save mode and the rest time exceeds the configured value.
- Verification: Print a test job and make sure the image quality has improved.

Auto Tone Adjustment Activation (full)

- Purpose: To correct image quality when an OPC drum is replaced, the life of an OPC drum is changed, the density of an image is poor, or the temperature and/or humidity in the room changes suddenly.
- Operation procedure:
 1. Select **“on”** or **“off”** for Full TRC Control execution.
 - Off: Full TRC Control will not execute.
 - On: Full TRC Control will execute during the determined conditions,
 2. Change the execution condition(s) of Full TRC Control.
 - Page Count: The system executes Full TRC Control based on the count of printed pages since the last execution.
 - Time Left Alone: The system executes Full TRC Control when the system returns from a power save mode and the rest time exceeds the configured value.
- Verification: Print a test job and make sure the image quality has improved.

Diagnostics > Image Management > Auto Tone Adjustment > Normal

- Purpose: To correct image quality when image density is poor. Normal TRC Control is recommended after changing a unit, such as toner cartridge, imaging unit, or ITB, or after restarting the printer.
- Operation procedure: Select **“OK”** to execute Normal TRC.
- Verification: Print a test job and make sure the image quality has improved.
- Diagnostics > Image Management > Auto Tone Adjustment > Full

Diagnostics > Image Management > Auto Tone Adjustment > Full

- Purpose: To correct image quality when an OPC drum is changed, the life of an OPC drum is changed, the image density is poor, or the temperature and/or humidity in the room changes suddenly.
- Operation procedure: Select **“OK”** to execute Full TRC.
- Verification: Print a test job and make sure the image quality has improved.

[Diagnostics > Image Management > Auto Tone Adjustment > CTD Sensor Cleaning](#)

- Purpose: To solve the “CTD Sensor Failure” error.
- Operation procedure: After cleaning the CTD/CPR sensor, execute this function.

[Print Test Patterns](#)

[Diagnostics > Print Test Patterns > Skew Pattern](#)

- The skew pattern stored in the machine is printed as the selected size.

Service Functions tab

This section provides detailed information about the service mode Service Functions tab.

Main Memory Clear

Service Functions > Main Memory Clear

This function resets the main memory of the system to the factory default setting. This function can be used to reset the system to the initial value when the product is functioning abnormally. User configured values return to the default values.

To clear the main memory, select the country/region where the system is located, and restart the printer.

Debug Log

Service Functions > Debug Log

This function sets the system log message level. Users can select from three options:

- Off: This disables the logging option.
- Job Status: This only enables the logging of user created jobs.
- Details: This enables all the logging options of the running tasks of the system. This option might effect the performance of certain system operations. Use this option when the system performs abnormally and engineers need to investigate the problem.

Capture Log

Service Functions > Capture Log

This function copies all the saved logs in the system to a USB flash drive as a .zip file. The size of the system log could reach up to 1GB. If the system log size becomes very large, it takes longer to copy to the USB flash drive.

1. Connect the USB flash drive to the printer.
2. Tap the **Service Mode** app.
3. Go to **Service Functions > Debug Log** and change the debug log level to **INFO**.
4. Go to **Service Functions > Capture Log**.
5. Select **All** or **Period**. If selecting **Period**, enter the start and end date.
6. Press the **Capture Log** button.
7. Once the log is completed, a completion message will display. Restore the debug log level to **JOB STATUS**.







NOTE: If the system log size becomes very large, it takes longer to copy to the USB flash drive.

8. Check that the log file has been saved to the USB flash drive.

TR Control Mode

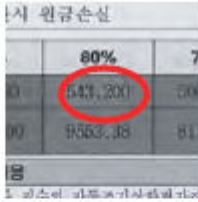
Service Functions > TR Control Mode

Table 3-36 TR control mode

Purpose	To correct transfer related problems. This function can be used to change the transfer value to optimize image quality to a certain type of paper.
Operation procedure	<ul style="list-style-type: none"> • T1 Control Problems <ul style="list-style-type: none"> – Choose the process speed (Full, Half, Lower) based on the type of paper being used. – Adjust T1 PWM value based on the problem type: <ul style="list-style-type: none"> ○ Gray spot: Increase T1 PWM value of the issued color ○ Non cyclic White Line: Decrease T1 PWM value of the issued color ○ OPC cyclic Ghost: Decrease T1 PWM value of the issued color • T2 Control Problems <ul style="list-style-type: none"> – Choose the paper group, paper side, and paper direction. – Adjust T1 PWM value based on the problem type: <ul style="list-style-type: none"> ○ Blur: Increase T1 PWM value ○ Poor transfer: Increase T1 PWM value ○ Re-transfer: Decrease T1 PWM value ○ White spot: Decrease T1 PWM value <p>TR control mode</p> <div style="display: flex; justify-content: space-around; align-items: flex-end;"> <div style="text-align: center;">  <p>Blur</p> </div> <div style="text-align: center;">  <p>Poor Transfer</p> </div> <div style="text-align: center;">  <p>Retransfer</p> </div> </div> <div style="display: flex; justify-content: space-around; align-items: flex-end; margin-top: 20px;"> <div style="text-align: center;">  <p>White Spot</p> </div> <div style="text-align: center;">  <p>OPC Cyclic Ghost</p> </div> </div>
Verification	Print a test job and make sure the transfer problem has been resolved.

Part Replacement Alert

Service Functions > Part Replacement Alert

This function enables/disables the alert message of the consumable's life time.

- ON: Alert message on (Level: Low, Empty, Exhaust, Worn)
- OFF: Alert message off

Envelope Rotate

Service Functions > Envelope Rotate

This menu enables rotation when printing on an envelope. The machine usually guides loaded envelopes with SEF direction. If this function is enabled, the user can load an envelope with LEF direction and the machine will rotate the image for printing on the envelope.

This function provides the following setting options:

- Off (default): Load envelope SEF direction
- 90 degrees: Load envelope LEF direction
- 180 degrees: Load envelope SEF direction with flap on bottom side.

Figure 3-38 Envelope rotate



Drain

Service Functions > Drain

This menu recovers toner density. The printer prints grayed images after operating over 500 low coverage images. This menu supports 10 level.

This function provides the following setting options:

- Off (default)
- On
- Yellow [1~10]
- Cyan [1~10]
- Magenta [1~10]
- Black [1~10]

Print quality troubleshooting guide

Image quality problems and solutions

Print-quality defects may be caused by printer components, supplies, media, internal software, external software applications, and environmental conditions.

To successfully troubleshoot print-quality problems, as many variables as possible must be eliminated. The first step is to prints using pages embedded in the printer on laser paper. The paper should be from an unopened ream that has been acclimated to room temperature, and you should ensure that genuine HP toner is installed in the printer.

Figure 3-39 A/S chart

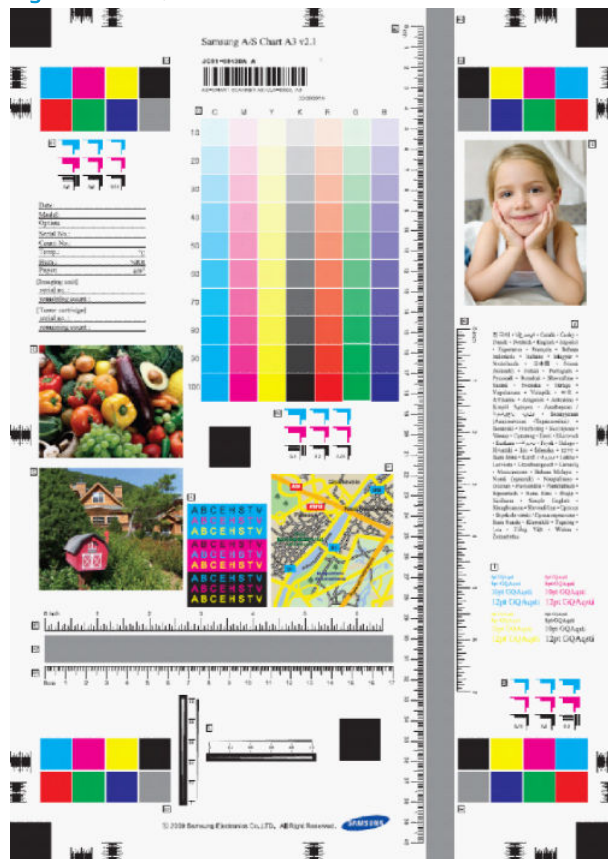

Figure 3-40 A/S chart components

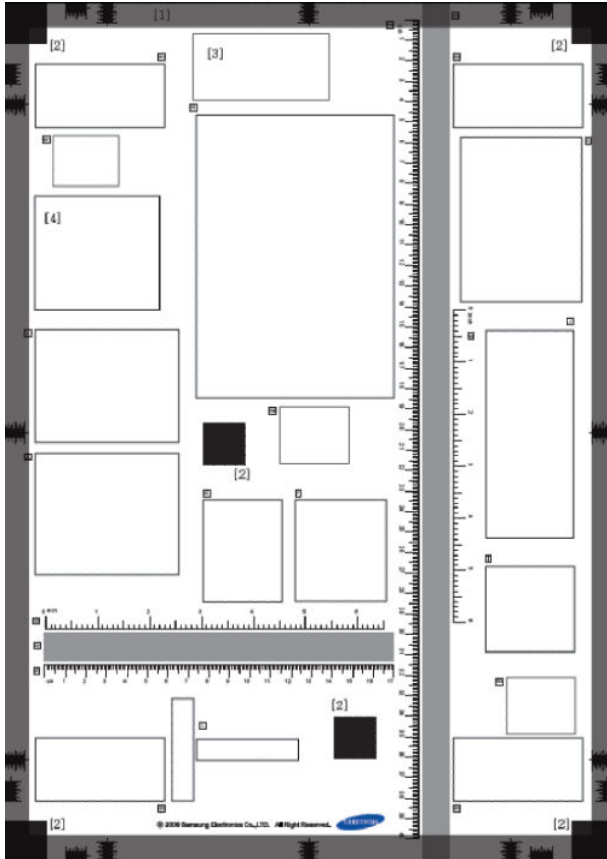

Table 3-37 A/S chart components

Symbol	Item	Description
[1]	Grid pattern	For adjusting margin and magnification
[2]	Black patches	For adjusting skew error
[3]	Barcode	For checking the reproduction of barcodes
[4]	Note area	For recording the date, conditions, etc.
[A]	Halftone band	For checking banding and jitter (K 50%)
[B, L]	Resolution patterns	For checking resolution
[C, D, E]	Images	For checking color reproduction
[F]	Map image	For checking fine line reproduction
[G]	Color patches	For checking color reproduction and uniformity
[H]	Gradation pattern	For checking tone reproduction of 7 colors (C, M, Y, K, R, G, B/ 10~100%)
[I]	Color/Mono text	For checking the reproduction of color, mono text
[J]	Multilingual Feature	For checking the reproduction of small text
[K]	White Gap pattern	For checking color to color, color to mono white gap
[M]	Rulers	For checking the magnification error (unit : cm)
[N]	Rulers	For checking the magnification error (unit : inch)

Defect analysis flowchart

Refer to the following flowchart as a guide for analyzing print defects.

TIP: Depending on the remaining life of the part, the cause of the defect can vary. Check the remaining life of the part.

Check for defects even if the defect is not repeated.

Figure 3-41 Defect analysis flowchart

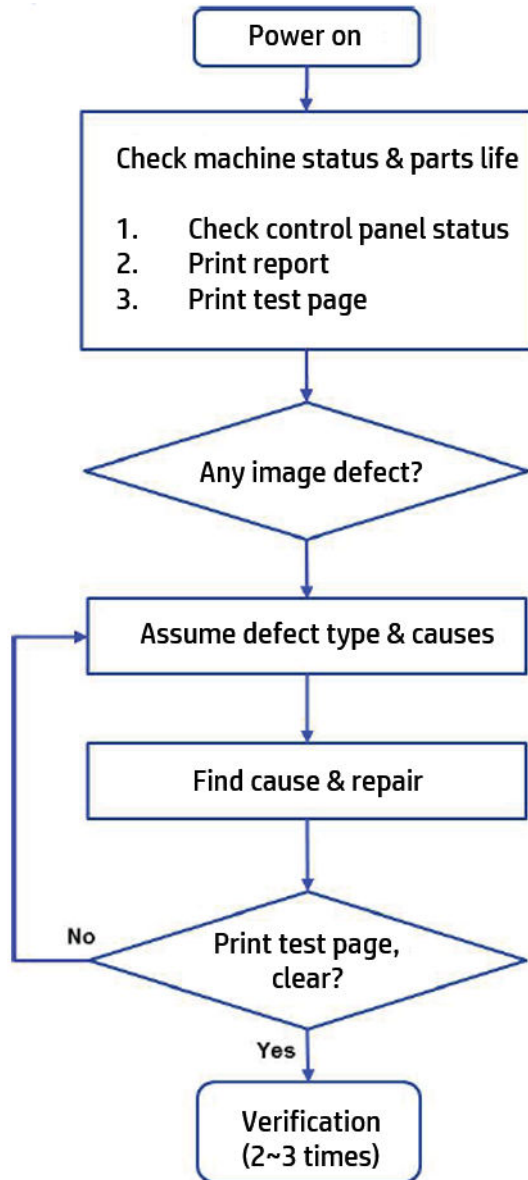

Vertical black band

Figure 3-42 Typical faulty images



Table 3-38 Troubleshooting procedure: vertical black band

Step	Cause	Action
1	Charge roller (CR) is contaminated.	Check if the CR is contaminated. Replace the drum unit if there are additional problems.
2	ITB belt is contaminated. <ul style="list-style-type: none"> • ITB cleaning is poor. • ITB cleaning blade is partially broken. 	Check if the ITB belt is contaminated. Replace the ITB cleaner if there are additional problems.
3	The scanner unit is contaminated. <ul style="list-style-type: none"> • Scan glass contamination • Mirror contamination • CCD sensor contamination 	Wipe the contaminated part of the surface with a soft cloth. CAUTION: The scanner unit contains fragile parts. Use caution while cleaning.

Vertical white band, light band

Figure 3-43 Typical faulty images



Table 3-39 Troubleshooting procedure: vertical white band, light band

Step	Cause	Action
1	<p>A foreign substance is between the developing roller (DR) and blade.</p> <ul style="list-style-type: none"> The toner on the magnetic roller is partially empty. 	<p>Remove the foreign substance.</p> <ul style="list-style-type: none"> Make a hook shape using a sheet (transparency sheet is recommended). Place the hook into the gap between the DR and the blade. Pull out the foreign substance.  <p>Replace the Drum unit if there are additional problems.</p>
2	<p>The Developer unit carrier is insufficient.</p>	<p>Replace the developer unit.</p> <ul style="list-style-type: none"> Check the remaining toner. Make sure the toner layer is uniform on the magnetic roller in the developer unit. 

Table 3-39 Troubleshooting procedure: vertical white band, light band (continued)



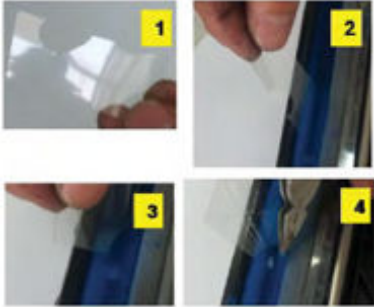
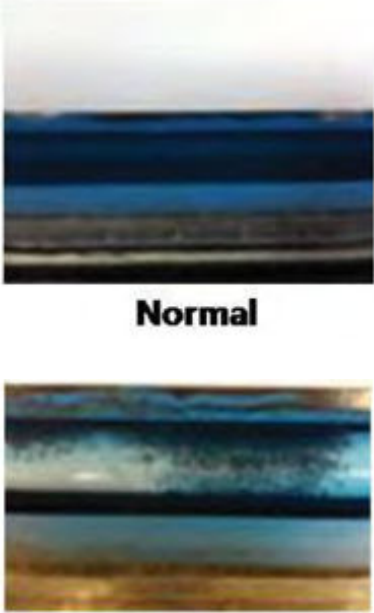

Step	Cause	Action
3	<p>The laser beam path is blocked.</p> <p>A foreign substance is on the laser scanner assembly window.</p>	<p>Clean the laser scanner assembly window.</p>
4	<p>OPC is scratched.</p> 	<p>Replace the drum unit.</p>
5	<p>Transfer unit is contaminated due to paper dust stuck.</p> <ul style="list-style-type: none"> • ITB cleaner contamination 	<p>Clean the paper dust stick regular basis.</p>  <p>NOTE: The paper dust stick(Callout 1) may vary depending on the product.</p> <p>NOTE: Clean the paper dust stick regular basis in order to prevent horizontal light band. Frequent cleaning can help maintain product quality, hp recommends to clean at least when replacing TCU.</p>

Table 3-39 Troubleshooting procedure: vertical white band, light band (continued)

Step	Cause	Action
	 <ul style="list-style-type: none"> <li data-bbox="387 974 815 999">• T2 contamination (Callout 1) & Image defect 	

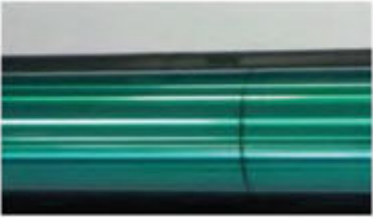
Horizontal periodic black band or dot

Figure 3-44 Typical faulty images

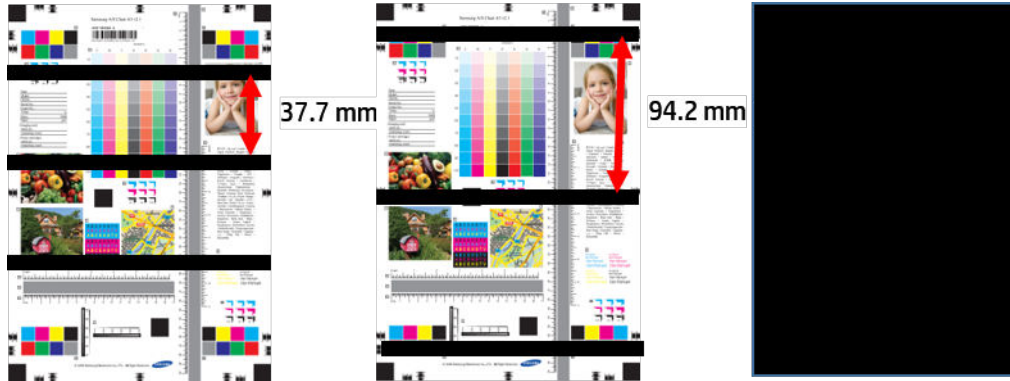

Table 3-40 Troubleshooting procedure: horizontal periodic black band or dot

Step	Cause	Action
1	Horizontal periodic dot (CR, 37.7 mm) <ul style="list-style-type: none"> The surface of the charge roller (CR) is contaminated. CR is scratched. 	Wipe the surface of the contaminated part with a soft cloth and alcohol. Replace the drum unit.
2	Horizontal periodic black band (CR, 37.7 mm) <ul style="list-style-type: none"> CR in poor condition. 	Replace the drum unit.
3	OPC is damaged.	Replace the drum unit.

Horizontal periodic light/dark band or dot

Figure 3-45 Typical faulty images

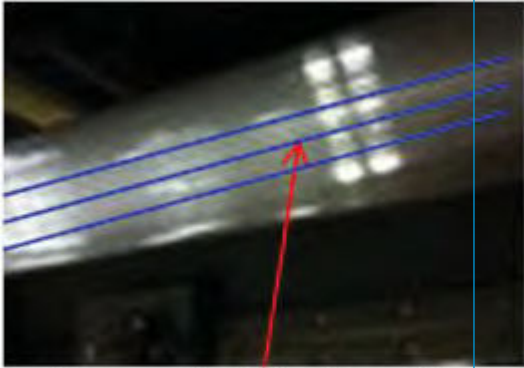

Table 3-41 Troubleshooting procedure: horizontal periodic light/dark band or dot

Step	Cause	Action
1	Horizontal periodic band (CR, 94.2 mm) <ul style="list-style-type: none"> • OPC was left exposed for too long. • OPC is damaged by a high voltage in a short amount of time. 	This problem will resolve itself over time. If the problem is not resolved, replace the drum unit.
2	Horizontal periodic light/dark band (Magnetic roller, 31.4 mm). <ul style="list-style-type: none"> • The Magnetic Roller is in poor condition. • V-groove of the Magnetic Roller surface is not uniform. 	Replace the developer unit.

Foggy image

Figure 3-46 Typical faulty images



Table 3-42 Troubleshooting procedure: foggy image

Step	Cause	Action
1	Voltage of OPC is abnormally low.	Replace the Drum unit.
2	HVPS operates abnormally. <ul style="list-style-type: none"> • HVPS is damaged or broken. 	Replace the HVPS board.

Table 3-42 Troubleshooting procedure: foggy image (continued)

Step	Cause	Action
3	Toner is over supplied. <ul style="list-style-type: none"> TC sensor operates abnormally. 	Replace the toner cartridge.
4	Voltage of OPC is abnormally low. <ul style="list-style-type: none"> T1 voltage is abnormally high. 	Check the T1 connection in the HVPS. Check if the T1 roller spring in the ITB is connected correctly. Replace the HVPS board.

Light image

Figure 3-47 Typical faulty images



Table 3-43 Troubleshooting procedure: light image

Step	Cause	Action
1	Toner cartridge is not installed correctly.	Check if the toner cartridge is installed completely. Make sure that the latching mechanism is correctly engaged. 
2	Toner not distributed in the toner cartridge.	Hold the toner cartridge horizontally and shake it side to side several times to evenly distribute the toner. 

Table 3-43 Troubleshooting procedure: light image (continued)

Step	Cause	Action
4	Output voltage of the HVPS is abnormally low. <ul style="list-style-type: none"> • Color density decreases. 	Replace the HVPS board.
5	TC down and toner spills.	Replace the developer unit.
6	Toner spills by eraser.	Check if the eraser is contaminated. Replace the drum unit or developer unit.

Blurred image

Figure 3-48 Typical faulty images

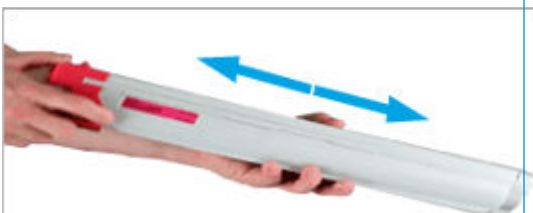

Table 3-44 Troubleshooting procedure: blurred image

Step	Cause	Action
1	High humidity and/or the quality of the paper.	Use new, higher quality paper.
2	T2 transfer voltage is low.	Turn up the T2 transfer voltage.

Table 3-44 Troubleshooting procedure: blurred image (continued)

Step	Cause	Action
3	Connection between HVPS and THV is incorrect.	<p>Check if the connection between T2 high voltage terminal and HVPS THV terminal is correct.</p> <p>Check if the connection between the HVPS and ITB is correct.</p> 
4	HVPS operates abnormally.	Replace the HVPS.

Incorrect color registration

Figure 3-49 Typical faulty images



Table 3-45 Troubleshooting procedure: incorrect color registration

Step	Cause	Action
1	CPR execution is needed.	Execute CPR manually.
2	CPR sensor is contaminated.	Clean the CPR sensor.

Table 3-45 Troubleshooting procedure: incorrect color registration (continued)

Step	Cause	Action
3	Environmental circumstances - such as temperature or humidity - have changed.	To recognize the environment change, execute CPR after a enough time has passed for the printer to become acclimated.
4	Check if the skew occurs at the trays or feeding rollers.	Adjust the skew manually.
5	Belt surface is contaminated.	Remove the ITB. If the surface of the belt is contaminated, clean with a soft cloth.

Uneven pitch and jitter image

Figure 3-50 Typical faulty images



Table 3-46 Troubleshooting procedure: uneven pitch and jitter image

Step	Cause	Action
1	Under 3 mm periodic jitters or horizontal bands have occurred.	<p>Check for foreign substance in the drive gears.</p> <p>Grease the drive gears.</p> <ul style="list-style-type: none"> • Developer unit gears • Drum unit gears • Main drive unit gears <p>If the problem persists, replace the abnormal units.</p> <ul style="list-style-type: none"> • Developer unit • Drum unit • Main drive unit
2	Under 1 mm periodic jitters or horizontal bands have occurred.	<p>Check if the laser scanner assembly is installed correctly. If not, remove and tighten the screws.</p> <p>If the problem persists, replace the laser scanner assembly.</p>

Skewed image

Figure 3-51 Typical faulty images

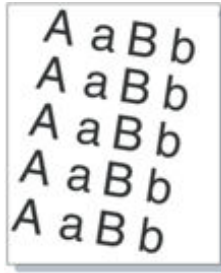

Table 3-47 Troubleshooting procedure: skewed image

Step	Cause	Action
1	<ul style="list-style-type: none"> • Tray is not installed properly. • Too much paper is loaded in the tray. • The tray guide is not set properly. 	Reinstall the tray properly.
2	The surface of the pickup/reverse/ feed roller is contaminated or worn out.	Clean or replace the contaminated roller.
3	If the skewed image occurs during a copy job, check the ADF installation.	Reinstall the ADF (flow ADF or ADF) unit. Adjust the ADF skew.



Blank copy

Figure 3-52 Typical faulty images

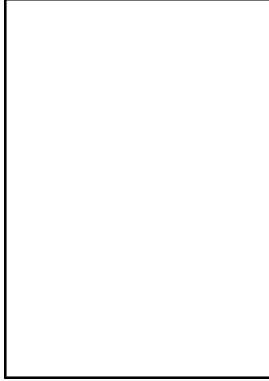

Table 3-48 Troubleshooting procedure: blank copy

Step	Cause	Action
1	Laser scanner assembly operation error	Check laser scanner assembly connections
2	All connections on the HVPS board are connected correctly	Reconnect all connections
3	Check if the related parts are damaged or broken	Replace the HVPS board, engine controller board, or laser scanner assembly
4	Check the connection between the scan joint board and the engine controller board	Reconnect the harness If the connection is correct, replace the engine controller board

Poor fusing performance

Figure 3-53 Typical faulty images

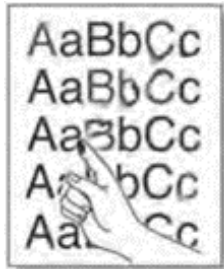

Table 3-49 Troubleshooting procedure: poor fusing performance

Step	Cause	Action
1	<p>Check the paper type.</p> <p>Depending on what type of paper is used, print speed varies.</p> <ul style="list-style-type: none"> • Plain (71~90g/), Thick (91~105g/): Full Speed • Heavy weight (106~175g/): Half speed • Envelope (75~90 g/), Label (120~150 g/): Half speed 	Check that the paper type displayed on the control panel is the same type of paper being used for the print job.
2	The fuser unit is worn out.	Replace the fuser unit.

Table 3-49 Troubleshooting procedure: poor fusing performance (continued)

Step	Cause	Action
3	Check the surface of the fuser belt and pressure roller for scratches.	Replace the fuser unit.
4	Check the temperature control system for problems. <ul style="list-style-type: none"> • Thermistor is broken or operates abnormally • Halogen lamp is broken or operates abnormally 	Check the non-contact thermistor sensor. Check the halogen lamp. If parts are broken, replace the broken parts or the Fuser unit.
5	Check if the pressure control system operates properly.	Check the pressure control system. If the problem persists, replace the fuser unit.
6	Paper is wrapped on the heating roller.	Remove the wrapped paper and print a test page. If the problem persists, replace the Fuser unit.

Stain on back of paper

Figure 3-54 Typical faulty images

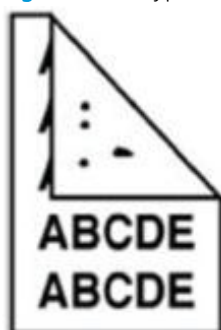
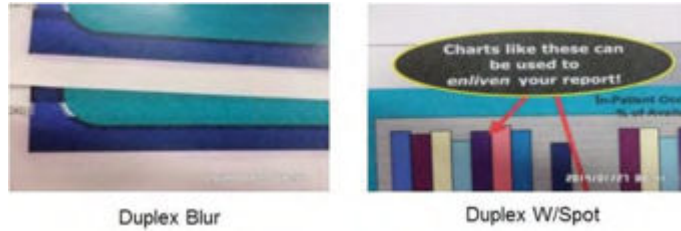

Table 3-50 Troubleshooting procedure: stain on back of paper

Step	Cause	Action
1	The transfer roller is dirty or worn out.	Clean or replace the transfer roller assembly.
2	There is any stain caused by poor cleaning on the ITB unit.	Clean the ITB. If the problem persists, replace the ITB unit.
3	The ITB cleaning blade is not in proper contact with the ITB.	Take off the ITB and check that the ITB cleaning blade pressure spring and the pressure hook are installed correctly.
4	The fuser belt and pressure roller are dirty.	Clean the fuser belt and pressure roller.
5	Pressure roller surface is damaged.	Replace the fuser unit.

Duplex blur, white spot blur on color print-out

Figure 3-55 Typical faulty images table



Troubleshooting procedure

1. Enter SVC Mode → **Service Functions** → **TR Control Mode**.
2. Select [**T2 Control Mode**].
3. Select the paper setting based on the site. (Paper Group, Paper Side, Paper Direction)
4. Increase value for T2 PWM and check if the blur problem is resolved.
5. If the problem persists after changing the [**T2 Control Mode**] values, change the [**T1 Control Mode**] values.
6. Decrease the value for each color and see whether the symptom disappears.
In this case, [-4] was applied and solved the blur.
7. As there can be variation for each device, change T1, and T2 observe the results.

Setting standard tone

Setting Standard Tone

Purpose

- To adjust the color tone to the standard set by the manufacturer.

 **NOTE:** Complete this procedure after replacing the ITB unit or cleaning the color toner density (CTD) sensor.

Procedure

1. Load A4 or Letter with Short Edge Feeding (SEF) direction on tray.
2. Select [**Setting**] on the control panel.
3. Log in as Admin.
4. Select [**Adjustment**] > [**Tone Adjustment**] > [**Setting Standard Tone**].
5. Select "OK" on confirmation window.
6. The scan ID chart prints.
7. Load the chart on the scanner glass. (Horizontal direction)
8. Start the scan.
9. When the scan complete window appears, select "OK".
10. Execute "FullTRC" : [**Adjustment**] > [**Tone Adjustment**] > [**Auto Tone Adjustment**] > *Full + Execute Now

Cancel Setting Standard Tone

Purpose

- Cancel the setting standard tone
- Return to the customized tone set by the user after setting the standard tone

Procedure

1. Select [Adjustment] > [Tone Adjustment] > [Cancel Setting Standard Tone].
2. When the cancellation is complete, select "OK".
3. Execute "FullTRC" : [Adjustment] > [Tone Adjustment] > [Auto Tone Adjustment] > *Full + Execute Now

Scan Image Fail

- When a problem occurs on the scanned ID chart, an error message will display.

Check items

- Check the scanned ID chart for correct placement.
- Make sure the chart direction is horizontal.
- Retry the setting standard tone procedure.

When to perform Setting Standard Tone procedure

- When installing the machine for the first time
- When the brightness has changed in comparison to the previous image.



- When there is a difference in the color between the same models.

 **NOTE:** If the problem persists after executing the setting standard tone procedure, look for other causes.

Red/Magenta hue printouts

Symptom

Figure 3-56 Typical faulty images

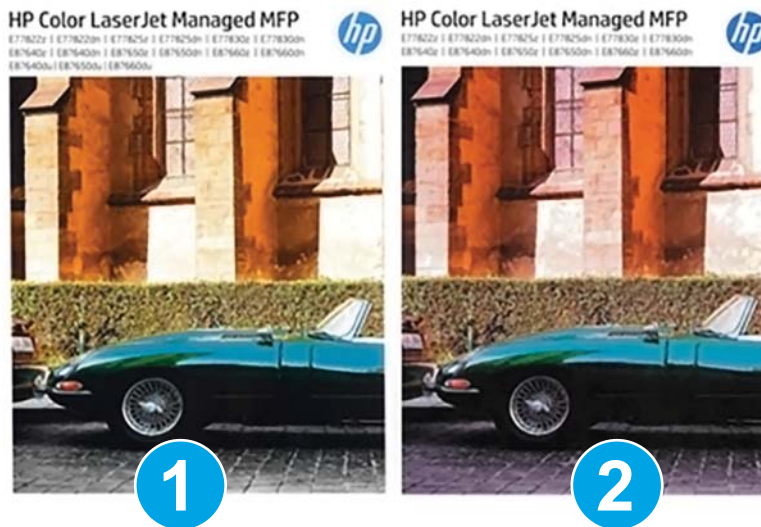

Pages prints out with a red/magenta hue.

The printouts show a red or magenta tone on them in areas where magenta is not supposed to be present

Troubleshooting procedure

1. Print the Demo page from the printer to ensure that the issue is not occurring in the print application on the PC.
2. If the Demo page has the red/magenta hue, perform a color calibration.
 1. Go to the following menus : Support Tools > Maintenance > Calibration/Cleaning
 2. Run Color Calibration.
3. If the issue persists, check to ensure that no customized colors have been set.
 1. Go to the following menus : Settings > Copy/Print > Print Quality
 2. Check the "Customize Colors".

 **NOTE:** If this is locked, see your printer administrator.

4. If the problem persists, replace the laser scanner unit.

Solve connectivity problems

Solve wired network problems

Introduction

Certain types of problems can indicate there is a network communication problem. These problems include the following issues:

- The periodic loss of ability to communicate with the printer
- The printer cannot be found during driver installation
- A periodic failure to print



NOTE: If you have been experiencing intermittent loss of network connectivity, first update the printer firmware. For instructions on how to update the printer firmware, go to <http://support.hp.com>, search for your printer, and then search on “update the firmware.”

Poor physical connection

1. Verify that the printer is attached to the correct network port using a cable of the correct length.
2. Verify that cable connections are secure.
3. Look at the network port connection on the back of the printer, and verify that the amber activity light flashes indicating network traffic, and the green link-status light is continuously lit indicating a network link.
4. If the problem continues, try a different cable or port on the hub.

The computer is unable to communicate with the printer

1. Test network communication by pinging the network.
 1. Open a command-line prompt on your computer.
 - For Windows, click **Start**, click **Run**, type `cmd`, and then press Enter.
 - For OS X, go to **Applications**, then **Utilities**, and open **Terminal**.
 2. Type “ping” followed by the IP address for your printer.
 3. If the window displays round-trip times, the network is working.
2. If the ping command failed, verify that the network hubs are on, and then verify that the network settings, the printer, and the computer are all configured for the same network (also known as subnet).
3. Open the printer properties and click the **Ports** tab. Verify that the current IP address for the printer is selected. The printer IP address is listed on the printer configuration page.
4. If you installed the printer using the HP standard TCP/IP port, select the box labeled **Always print to this printer, even if its IP address changes**.
5. If you installed the printer using a Microsoft standard TCP/IP port, use the printer’s hostname instead of the IP address.
6. If the IP address is correct, delete the printer and then add it again.

The printer is using incorrect link and duplex settings for the network

HP recommends leaving these settings in automatic mode (the default setting). If you change these settings, you must also change them for your network.

New software programs might be causing compatibility problems

Verify that any new software programs are correctly installed and that they use the correct print driver.

The computer or workstation might be set up incorrectly

1. Check the network drivers, print drivers, and the network redirection settings.
2. Verify that the operating system is configured correctly.

The printer is disabled, or other network settings are incorrect

1. Review the printer's configuration/networking pages to check the status of the network settings and protocols.
2. Reconfigure the network settings if necessary.

Other Errors

Image system problem

Table 3-51 Image system problem

No	Problem Description
1	TCU noise problem
2	The cleaning blade is overturned
3	Toner supply error and toner leakage problem
4	Toner cartridge detection error
5	94 mm periodic jitter occurs in printed document
6	Image registration problem occurs after color plane registration (CPR)
7	How to handle TRC error and CPR
8	Removing debris from the developer unit

TCU noise problem

- Symptom: When printing, a blunt noise occurs at the front of the printer.
- Cause: Defective toner collection unit (TCU).
- Troubleshooting: Replace the toner collection unit (TCU).

The cleaning blade is overturned

- Symptom
 - A toner leakage has occurred (for example, on the surface of the drum or on printed paper).
 - The printed page is blank.
 - The coupler (OPC unit) is difficult to rotate (coupler locking).
 - The blade is overturned.
- Cause
 - CR electrification part transformation happens due to overturned blade.
 - OPC rotation torque increases due to overturned blade.
- Troubleshooting
 - Replace the toner collection unit (TCU).

Toner supply error and toner leakage problem

- Symptom : Toner supply error and toner leakage has occurred.
- Cause : Toner supply duct assembly does not reach the designated position.
- Troubleshooting : Reassemble or replace the toner duct assembly.

Toner cartridge detection error

- Symptom : Toner cartridge is installed, but a “Not Installed” message displays.
- Cause :
 - Toner cartridge is not properly installed.
 - Toner cartridge CRUM harness is defective.
 - CRUM PCA or CRUM chip is defective.
 - CRUM connection (modular connector) is defective.
 - CRUM joint PCA is defective.
 - Bad connection between the Engine Controller Board(ECB) and the CRUM joint PCA.
- Troubleshooting :
 - Toner cartridge installation problem
 - Check if the toner cartridge is properly installed.
 - If the cartridge comes out automatically, check the cartridge fixing hook.
 - If the cartridge fixing hook is damaged, replace the cartridge cap or cartridge.
 - CRUM harness problem
 - Make sure the CRUM harness is correctly connected.
Check the modular jack for damage or abnormal assembly.
 - If the modular jack harness is defective, replace it with a new one.
If the modular jack has moved into the toner cartridge, remove it.
 - CRUM PCA problem or CRUM data problem:
 - Replace the toner cartridge.
 - CRUM connection (modular connector) installation problem
 - Open the front cover. Remove the toner cartridge.
 - Make sure that the CRUM connection (modular connector) is correctly installed.
 - If the modular connector is not installed correctly, open the rear cover and reinstall.
 - CRUM Joint PCA problem
 - If the CRUM Joint PCA, modular jack pin, or Engine Controller Board(ECB) interface connector are damaged, replace the PCA.

- Bad connection between the Engine Controller Board(ECB) and the CRUM Joint PCA
 - Check the connection between the Engine Controller Board(ECB) and the CRUM Joint PCA. If the connection is bad, replace the harness, the CRUM Joint PCA, or the Engine Controller Board(ECB).

94 mm periodic jitter occurs in printed document

- Symptom: 94 mm periodic jitter occurs in a printed document.
- Cause: Defective OPC drum
- Troubleshooting :
 1. Perform a printout for each color with the “Check Drum Prn” file.
 2. Check the period of the jitter with a ruler to determine the type of fault.
 3. Switch the organic photo conductor(OPC) drum with another OPC drum of a different color. If this resolves the problem, replace only the OPC drum.
 4. Check the gear of the main drive for damage or a foreign substance. If the gear is damaged, replace the main drive. Remove any foreign substance found.
 5. Replace the imaging unit.

Image registration problem occurs after color plane registration (CPR)

- Symptom : Image registration problem occurs after CPR.
- Cause :
 - Laser scanner assembly
- Troubleshooting :
 1. Perform CPR
Home > Machine Setup > General Settings > Image Management > Color Plane Registration
 2. Print CPR Report
Service Mode > Information > Print Reports > Color Plane Registration
Succeed or Failed for CPR: [1152] → Registration cannot be adjusted by CPR.
 - Check if the skew data from the CPR Report is changed.
 - Check if OPC surface of Y/M/C is damaged, scratched, or torn.
 - Print and check separated Y/M/C color for damage.
 - Find “Succeeded or Failed for CPR” from the CPR report.
 - If the value is 1152 like the above report, CPR cannot be performed. Replace the laser scanner assembly.
 - Succeeded or Failed for CPR: [0] → CPR was performed OK [OK]
 - Succeeded or Failed for CPR: [1] → CPR was not performed OK [Fail]

How to handle TRC error and CPR

- Symptom: Abnormal color density (thick, thin) and/or color registration is wrong.
- Cause: Toner supply is abnormal or transfer roller is not installed correctly.
- Troubleshooting :
 - If the color density is wrong, perform TRC and print a TRC report.
 - Check for a TRC error on the TRC report.
 - Mode column format
 - F = Full TRC
 - S = Normal TRC
 - Error column format: 1X0 where the last digit indicates the color that is out of range.
 - 1X0: Sensed value from Y is abnormal.
 - 1X1: Sensed value from M is abnormal.
 - 1X2: Sensed value from C is abnormal.
 - 1X3: Sensed value from K is abnormal.
 - Check the following for the corresponding color
 - Make sure that the toner motor is working normally.
 - Enter "Service mode"
Diagnostics > Engine > Diagnostics > Engine Test Routines > Toner Dispense Motor On/Off
111–0000 (Y), 111–0010 (M), 111–0020 (C), 111–0030 (K)
 - Check if the toner supply is blocked.
 - Check if the toner seal has been removed.
 - Check if the transfer roller is correctly installed.
 - Print the CPR report. Check if the CPR was successful.

Removing debris from the Developer unit

- Symptom: Line occurs on the paper in the direction the paper moves.
- Cause: Debris on developer unit causes a line on the printed page.
- Troubleshooting :
 1. Remove the developer unit.
 2. Disassemble the developer unit cover (make sure not to damage or destroy the lock). Empty developer out onto clean paper.
 3. Remove lumps with the jig from the magnetic roller.
 4. Carefully clean the area where oil can cause build-up in the fuser.

Fuser problem

Acoustic noise in Fuser unit

- Symptom: Acoustic noise from the fuser assembly in the early stages of printing.
- Cause: Fuser sleeve edges are damaged.
- Troubleshooting: Replace the fuser unit.

Scanner and ADF problems

Table 3-52 Scanner and ADF problems

No	Problem Description
1	How to resolve CCD lock due to spring-wire
2	Noise of ADF hinge/Crack of ADF hinge/ADF will not stay open
3	ADF paper jam (multi-feed)
4	Scanner locked error
5	How to adjust image distortion
6	Line skew occurs due to scanner internal module
7	Paper jam occurs due to registration ROLLER-IDLE of ADF

How to resolve CCD lock because of spring wire

- Symptom: The control panel displays a CCD lock message when turning on the printer. The FR carriage cannot move on the rail.
- Cause:
 - The printer is tilted more than 20 degrees.
 - Completing a scan with the FR pushed.
- Troubleshooting:
 - Open the top cover, showing the scanner glass.
 - Bend the spring.

Noise of ADF hinge/Crack of ADF/ADF does not stay open

- Symptom:
 - A noise comes from the ADF hinges when it is opened or closed.
 - When the ADF is opened to access the scanner glass, the unit should remain at a 50° angle ($\pm 10^\circ$). The ADF does not remain open as expected.
- Cause:

- The ADF hinge is cracked.
- Troubleshooting:
 1. Remove the ADF connector cover.
 2. Remove the connector and one screw.
 3. Remove two screws. Slide the assembly back, and then lift the ADF to remove it.
 4. Reinstall the ADF.

ADF paper jam (multi-feed)

- Symptom: Paper stops between the ADF roller and the registration roller causing a paper jam.
- Troubleshooting: When a registration out jam occurs during multi-feeding, the guide pickup must be replaced. This also stabilizes the paper path.



NOTE: The friction pad must be replaced at the time that the guide pickup is replaced.

Scanner locked error

- Symptom: Paper stops between the ADF roller and the registration roller causes a paper jam.
- Cause: All 24V channels output voltage is off (24V output voltage is nearly 0V) and 5V channels output is normal.
- Troubleshooting
 1. Check all 24V output channels (24VS1, 24VS2, 24VS3, 24VS4), whether or not 24V voltage occurs.
 2. If 24V voltage does not occur, check the “24V on/off signal pin” on the engine controller board(ECB).
 The voltage at “24V on/off signal pin” is 0V: Engine controller board(ECB) and signal is normal.
 The voltage at signal pin 4~5.3V: Engine controller board(ECB) and signal is abnormal.
 3. If the engine controller board(ECB) and signal is normal, and all 24V output channels are nearly 0V, check out parts (such as the fuser motor, scanner harness, etc.) driven by 24V voltage before replacing the LVPS.
 4. If the engine controller board(ECB) and signal is normal, and only 1-3 24V output channels are nearly 0V, inspect the harness from the abnormal 24V output channel(s) before replacing the LVPS.
 5. If the engine controller board(ECB) and signal is abnormal and all 24V output channels are nearly 0V, inspect the harness, connector, and engine controller board(ECB).

How to adjust image distortion

- Symptom: Image distortion occurs when paper is fed from the ADF.
- Cause: ADF hinge is not installed correctly.
- Troubleshooting:

1. Loosen the four screws on the left hinge, and then loosen the four screws on the right hinge. Adjust the ADF.
2. Perform a copy job from the ADF and check if image distortion occurs. Repeat steps 1 and 2 if there is distortion.
3. If the problem is resolved, tighten the screws on the hinges.

Line Skew occurs due to internal module of scanner

- Symptom: Line skew occurs when a copy is performed from the scanner glass.
- Troubleshooting:
 1. Open the ADF. Remove the scanner glass.
 2. Use vernier calipers to check and record the difference between the front and rear of the FR module from scan left exterior.
 3. Use vernier calipers to check and record the difference between the front and rear of the HR module from scan left exterior.
 4. Results
 - If the difference of the FR module is +4 mm and HR is +2 mm, (or -4/-2)
 - Remove the pulley screw slightly with a size 2 mm Allen wrench.
 - Measure the length from the left-right exterior of the FR module with vernier calipers. Adjust the FR module so that the distance is equal and then lock it.
 - Adjust the distance of the left-right exterior so that it is smaller than 0.5 mm.
It is alright if the difference is less than 1 mm after locking the screw. (Check the HR module).

⚠ CAUTION: Four screws (two front pulleys and two rear pulleys) need to be tightly locked with 7 kgf*cm torque. If the torque is too strong the pulley can break. If the torque is too weak the pulley can be unlocked.

 - If the difference of the FR Module is +4 mm and HR is -1 mm to +1 mm
 - The front screw is located where it can be seen from the front of the printer/the rear screw is located where it can be seen from the rear of the printer.
 - The distance between the head of the screw and the heat sink is usually about 1 mm.

Paper jam occurs due to registration idle roller of ADF

- Symptom:
 - Paper jam occurs due to registration idle roller of ADF.

When a paper jam occurs during original document scanning, the registration sensor and spring tension need to be checked. Otherwise, the registration idle roller needs to be checked.
- Cause:

- A screw was tightened too much during ADF cover assembly. The cover presses the registration idle roller and it cannot rotate smoothly, causing a paper jam.
- Troubleshooting:
 1. Open the ADF cover.
 2. Rotate the registration idle roller by hand. If the registration idle roller is too close to a screw, it will not rotate smoothly.
 3. If the roller does not rotate smoothly, loosen the screw until the roller does rotate smoothly.
 4. If loosening the screw does not resolve the problem, remove the ADF cover and scrape the contact point with a knife or sharp edge until the roller rotates smoothly. Install the ADF and adjust the screw.

Drive unit problem

Machine makes noise during print job

- Symptom: Machine makes noise during a print job.
- Cause:
 - The gear train needs to be greased.
 - An old type gear is installed.
- Troubleshooting:
 1. Enter service mode.
 2. Execute a fuser motor test.
Service Mode > Diagnostics > Engine Diagnostics > Engine Test Routines > Fuser Motor Forward
 3. Remove the fuser unit and execute the fuser motor test again.
 4. If the printer still makes a noise during a print job, replace the drive-fuser exit assembly.
 5. If the problem is not resolved, replace the fuser unit.

Feeding system problem

Table 3-53 Feeding system problem

No	Problem Description
1	How to resolve tray locking
2	Tray 1, Tray 2, and Tray 3 cannot pick up paper
3	Printer cannot feed paper
4	Envelope wrinkle

How to resolve tray locking

- Symptom: Tray does not open or does not open easily.
- Cause: Tray operation is not smooth because toner powder is attached on the tray locker.
- Troubleshooting:
 1. Wipe the toner powder that is attached to the tray locker.
 2. Apply a small amount of grease to the tray locker.
 3. HANARL grease
 - Product name: HANARL SN-250
 - Manufacturer: KANTO KASEI, Inc.
 - Appearance: Orange
 - Directions: Soak the object in HANARL, or apply HANARL to the object using a brush.
 - After the object has dried for 30 minutes, apply HANARL to the assembly.

Tray 1, Tray 2, and Tray 3 cannot pick up paper

- Symptom: Tray 1, Tray 2, and Tray 3 cannot pick up paper.
- Cause:
 - Bad harness connection on the engine controller board(ECB).
 - Connector defect of the engine controller board(ECB).
- Troubleshooting:
 1. Check the harness connection. Reconnect the harness if it is not connected correctly.
 2. Check the pickup connector on the engine controller board(ECB).
 - If the connector has a problem with the soldering, replace the engine controller board(ECB).

Printer cannot feed paper

- Symptom: The printer cannot feed paper from Tray 2 or Tray 3.
- Cause:
 - Feed motor problem
 - Feed motor connection problem
 - Engine controller board(ECB) defect
- Troubleshooting:
 - Check the feed motor operation
 - Open the right door and forcibly push the cover switch.
 - Enter service mode.

- Select the following menu items
EDC Mode > Diagnostics > Engine Diagnostics > Engine Test Routine > Feed motor > On/Off
Check the operating status of the two feed rollers.
- If the feed rollers cannot rotate, open the rear cover and check the motor and gears.
- Check the connection between the engine controller board(ECB) (CN27) and the feed motor.
- If the problem persists, replace the engine controller board(ECB).

Envelope wrinkle

- Symptom: Envelope is wrinkled when printed from Tray 1.
- Troubleshooting:
 1. Enter service mode.
 2. Select **“Envelope Rotate”** (Service Functions > Envelope Rotate)
 3. Select a menu item: Off, 90 degrees, or 180 degrees.

Laser scanning unit assembly (LSU) problem

CPR failure

- Symptom: The control panel indicates a CPR failure message.
- Cause: The reflection mirror in the LSU is broken or damaged.
- Troubleshooting: Replace the LSU.

Laser scanning unit assembly (LSU) motor makes a loud noise

- Symptom: The LSU motor makes a loud noise while in printing mode.
- Cause: The LSU motor is defective.
- Troubleshooting:
 1. Enter service mode and execute the LSU motor test.
 2. If the LSU motor running sound is loud, replace the LSU.

Electrical circuit problem

Right door recognition error

- Symptom: The right door is closed but the right door open message displays on the control panel.
- Cause: The right door open sensor spring plate is damaged by the right door stopper.
- Troubleshooting: Replace the right door open sensor assembly, or manually reshape the spring plate.

LVPS output voltage drop error

- Symptom: LVPS output voltage is low.
- Cause: 24V channel output voltage drops to under 21.6V and 5V channel output is normal.
- Troubleshooting
 - ▲ Check all 24V output channels (24VS1, 24VS2, 24VS3, 24VS4) for 24V voltage.
 1. Check all 24V output channels (24VS1, 24VS2, 24VS3, 24VS4) whether or not 24V voltage occurs.
 2. If 24V voltage does not occur, check the “24V on/off signal pin” on the engine controller board(ECB).

The voltage at “24V on/off signal pin” is 0V: Engine controller board(ECB) and signal is normal.

The voltage at signal pin 4~5.3V: Engine controller board(ECB) and signal is abnormal.
 3. If the engine controller board(ECB) and signal is normal, and all 24V output channels are nearly 0V, check out parts (such as the Fuser motor, scanner harness, etc.) driven by 24V voltage before replacing the LVPS.
 4. If the engine controller board(ECB) and signal is normal, and only 1–3 24V output channels are nearly 0V, inspect the harness from the abnormal 24V output channel(s) before replacing the LVPS.
 5. If the engine controller board(ECB) and signal is abnormal and all 24V output channels are nearly 0V, inspect the harness, connector, and engine controller board(ECB).

Hard disk drive (HDD) makes a loud noise

- Symptom: The hard disk drive (HDD) makes a loud noise.
- Cause: The HDD has defects.
- Troubleshooting: Replace the HDD.

Networking not working

- Symptom: Network is not functioning.
- Cause
 - Network line itself is not working properly.
 - Network configuration is wrong.
 - Some related electronic components on the engine controller board(ECB) have defects.
- Troubleshooting
 1. Connect a network line to the PC and complete a ping test.
 2. Complete a ping test after connecting the network line. If the connection is working, check the network configuration, which might have been set incorrectly.

3. If the ping test does not have a result, open the rear cover and check the engine controller board(ECB) for visible defects on the network related components such as the connector, capacitor, and other close components. Surge voltage from the outside can cause defects.
4. If any of the components have visible defects, then replace the engine controller board(ECB).

Firmware upgrades

To download the most recent firmware upgrade for the product, go to:

- In the US, go to <http://www.hp.com/support>.
 1. Select **Get drivers, Software, and Firmware**, and then select the appropriate product by name.

 **NOTE:** More than one product model might be listed. Make sure to select the correct model so that the upgraded firmware supports all of the product functions.
 2. Select the driver language and operating system.
 3. Locate the firmware download, and then select **Download**.
- Outside the U.S., go to <http://www.hp.com/support>.
 1. Select your country/region.
 2. Select **Drivers & Downloads**.
 3. Enter the product name in the **Find my product** dialogue box, and then select **Go**.

 **TIP:** Click on the **How do I find my product name/number?** link to see a short video on identifying the printer name and number.
 4. Select the appropriate product by name.

 **NOTE:** More than one product model might be listed. Make sure to select the correct model so that the upgraded firmware supports all of the product functions.
 5. Select the driver language and operating system.
 6. Locate the firmware download, and then select **Download**.

Perform a firmware upgrade

The firmware bundle is a .bdl file. This file requires an interactive upgrade method. The traditional FTP, LPR or Port 9100 methods of upgrading are not available. Use the following method to upgrade the firmware for this product through the HP Embedded Web Server.

 **NOTE:** The product should be at the Ready state.

The firmware update might take 10 minutes or longer based on the input/output (I/O) transfer rates and the time it takes for the product to reinitialize.

1. Open an Internet browser window.
2. Enter the product IP address in the URL line.
3. Sign in using the admin user name and password: admin/admin.

 **NOTE:** The admin password is set the first time the printer initializes.

4. Select the **Maintenance** tab.
5. Click **Upgrade Wizard**.
6. Click **Browse** and browse to the location where the firmware upgrade file was downloaded to, and then select the firmware file—the file has an .hd file extension. Click the **Next** button to verify the firmware file. Click the **Next** button to perform the upgrade.

 **NOTE:** Do not close the browser window OR interrupt communication until the HP Embedded Web Server (EWS) displays the confirmation page.

7. After the product reinitializes, return to the **Maintenance** tab to verify the updated firmware version or print a configuration page and verify that the latest firmware version has been installed.

Adjusting the laser scanning unit assembly (LSU) skew error

Learn about adjusting the laser scanning unit assembly (LSU) skew error.

1. Check the skew error.
 - a. Execute the CPR.
Machine Setup > General Settings > Image Management > Auto Color Registration
 - b. Print the CPR report.
SVC (Tech) Mode > Information > Print Reports > Auto Color Registration
 - c. Check [Y] [M] [C] Skew Data in CPR report.
2. Adjust the skew error.
 - a. Open the front cover. Remove the toner collection unit.
 - b. There are three skew holes for YMC color. Insert the Phillips screw driver and adjust CW, CCW referred to adjustment amount.

Figure 3-57 YMC skew holes

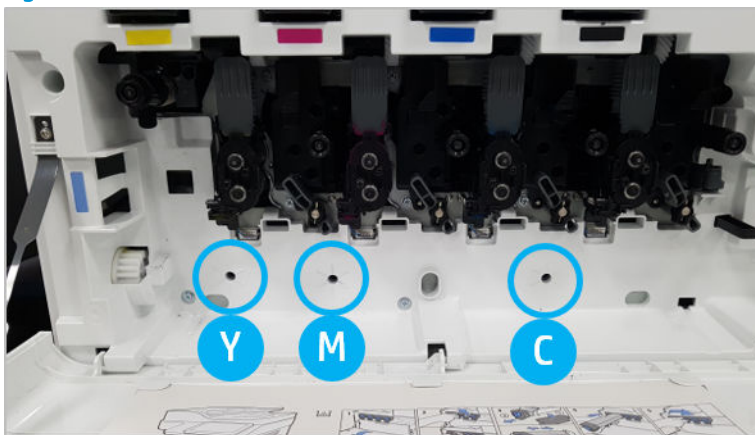

- i. The standard skew value is 200. If the skew data in the CPR report is 200, skew adjustment is unnecessary.

ii. Adjustment method:

- Skew Data < 200: Rotate the driver in a counterclockwise direction. Example: Skew Data is 192: $200 - 192 = 8$. Click CCW rotation.
- Skew Data = 200: No adjustment needed.
- Skew Data > 200: Rotate the driver in a clockwise direction. Example: Skew Data is 213: $213 - 200 = 13$. Click CW rotation.

 **NOTE:** One click is equal to 1/7 dot.

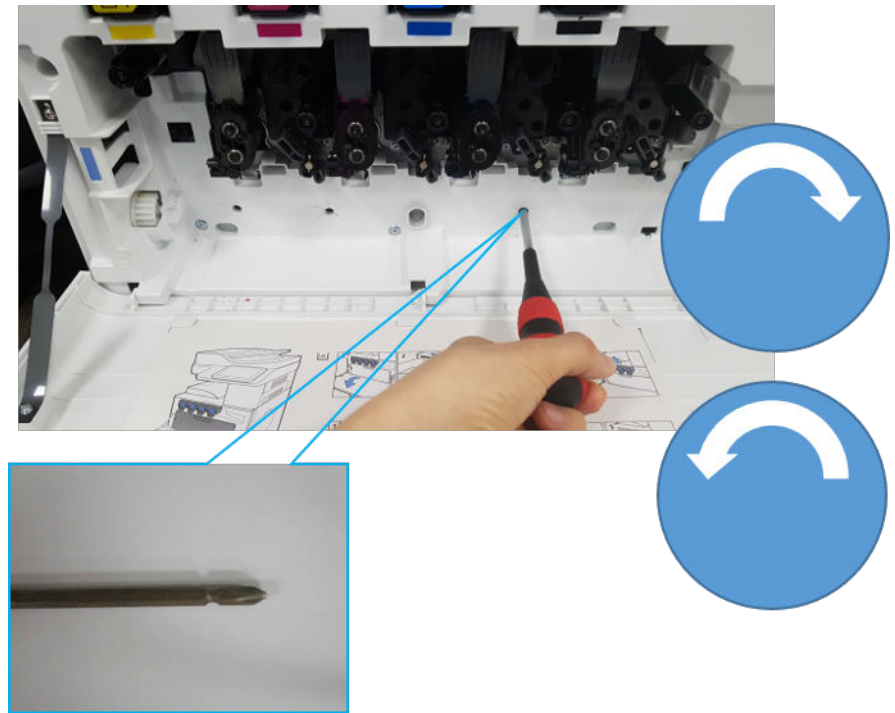

3. Check the skew error again.
 - a. Execute the CPR after the skew adjustment.
 - b. Print the CPR report.
 - c. Check the [Y] [M] [C] skew error.
 - d. If the value for YMC is 200 ± 7 , complete the skew adjustment.

 **NOTE:** If the value does not meet the target, repeat steps 1-3.

Adjusting the ADF skew

Learn about adjusting the ADF skew.

1. Open the ADF. Slightly loosen four screws securing the right hinge unit.

 **NOTE:** The left hinge is not adjustable.

Figure 3-58 Open ADF and loosen screws



2. Adjust the position of the ADF hinge as the skew status. (1 scale => 0.9 mm (0.04 in))

Figure 3-59 Adjust ADF hinge

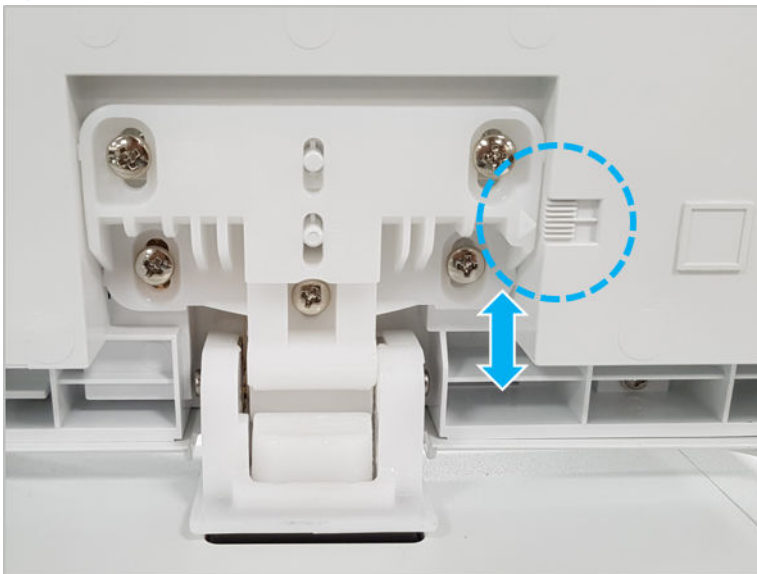

3. Detach the ADF sponge sheet after adjusting the skew. Place the ADF sponge sheet on the scanner glass. And then, close the ADF unit to attach the sponge sheet.

Figure 3-60 Detach and attach the sponge sheet



4 Electrical Mechanical Diagrams

PCAs, Boards, and Laser Scanning Unit(LSU)

Formatter

Figure 4-1 Formatter

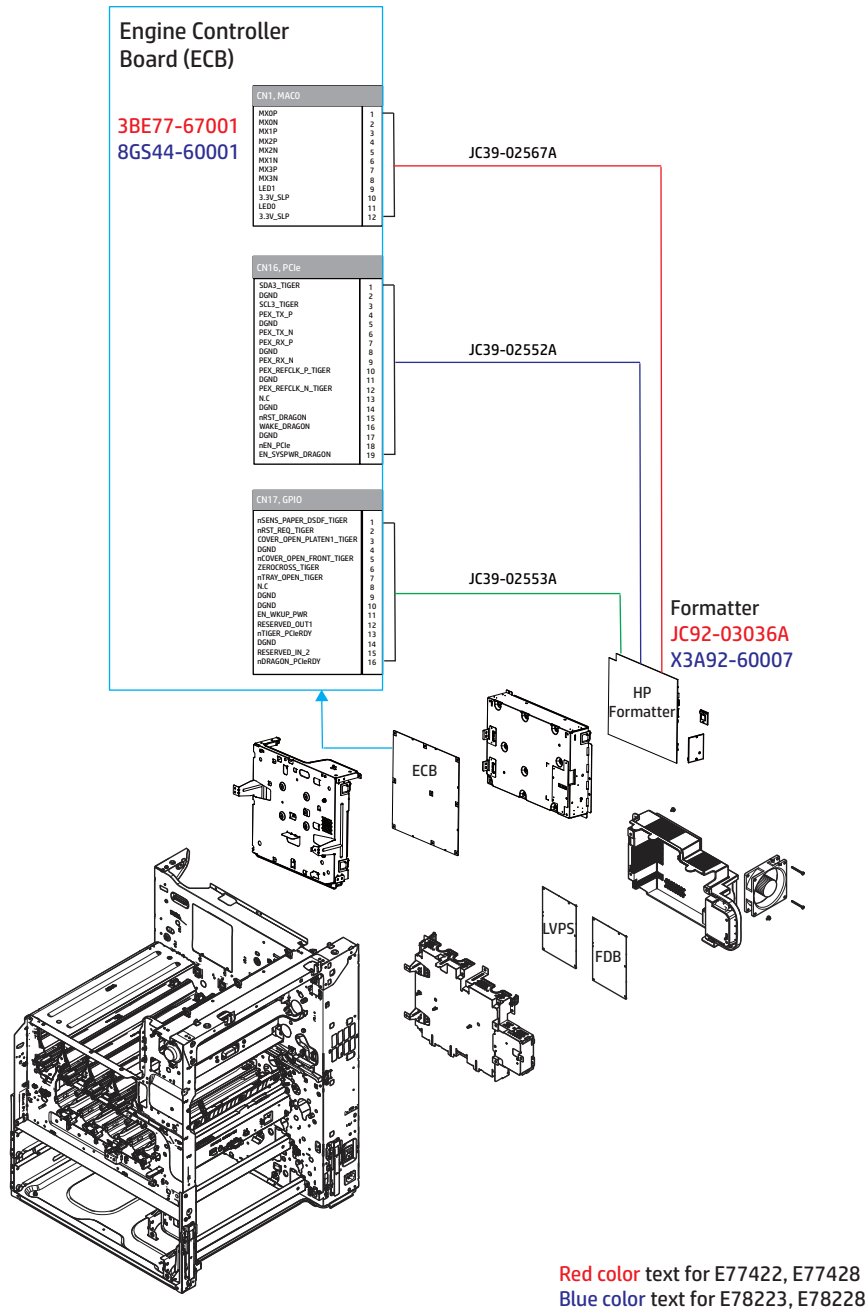

High Voltage Power Supply (HVPS) and Laser Scanning Unit Assembly (LSU)

Figure 4-3 High Voltage Power Supply (HVPS) and Laser Scanning Unit Assembly (LSU)

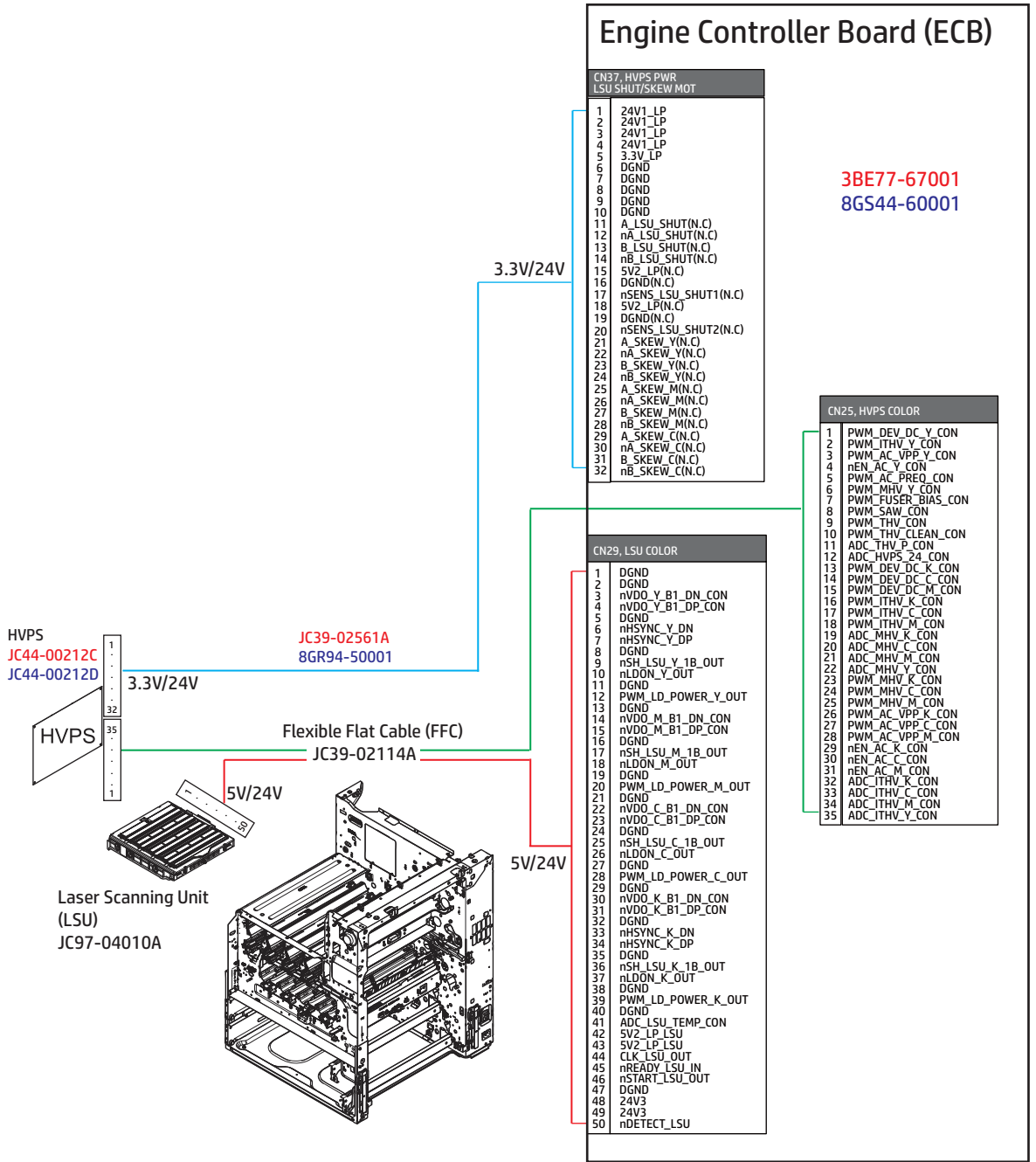

Red color text for E77422, E77428
Blue color text for E78223, E78228

Temp/Humidity sensor (a,dv models only)

Figure 4-4 Temp/Humidity sensor (a,dv models only)

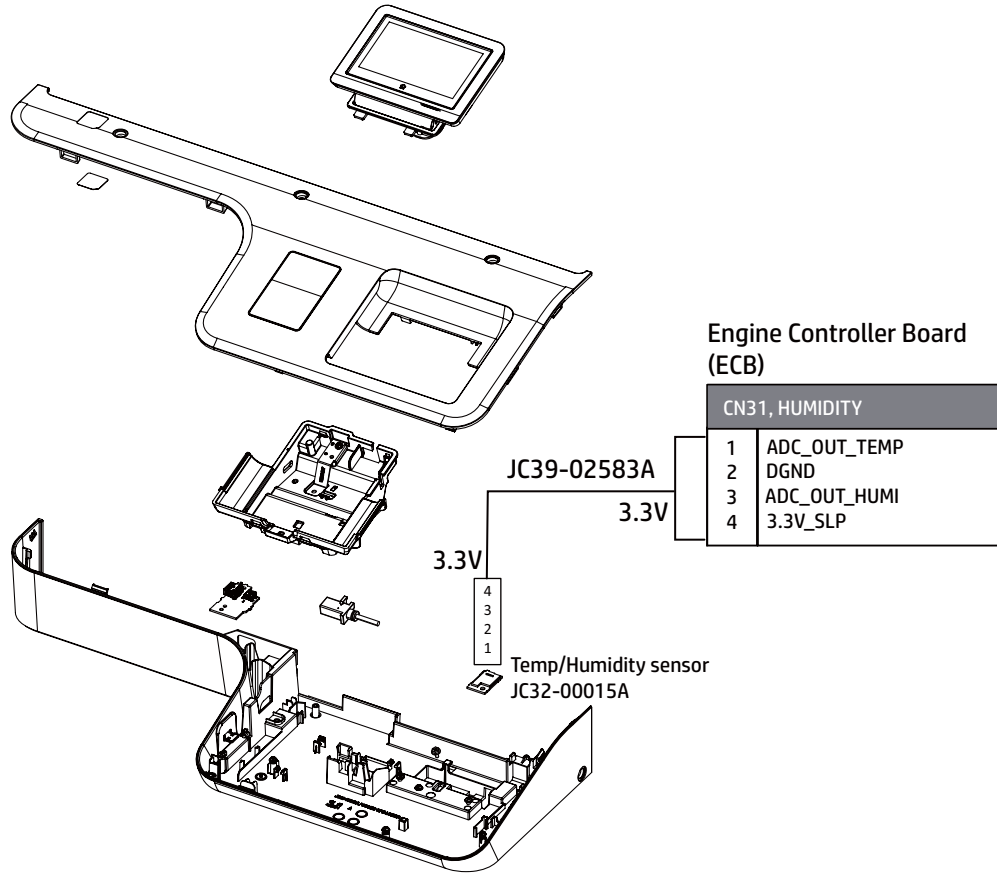

Temp/Humidity sensor (dn models only)

Figure 4-5 Temp/Humidity sensor (dn models only)

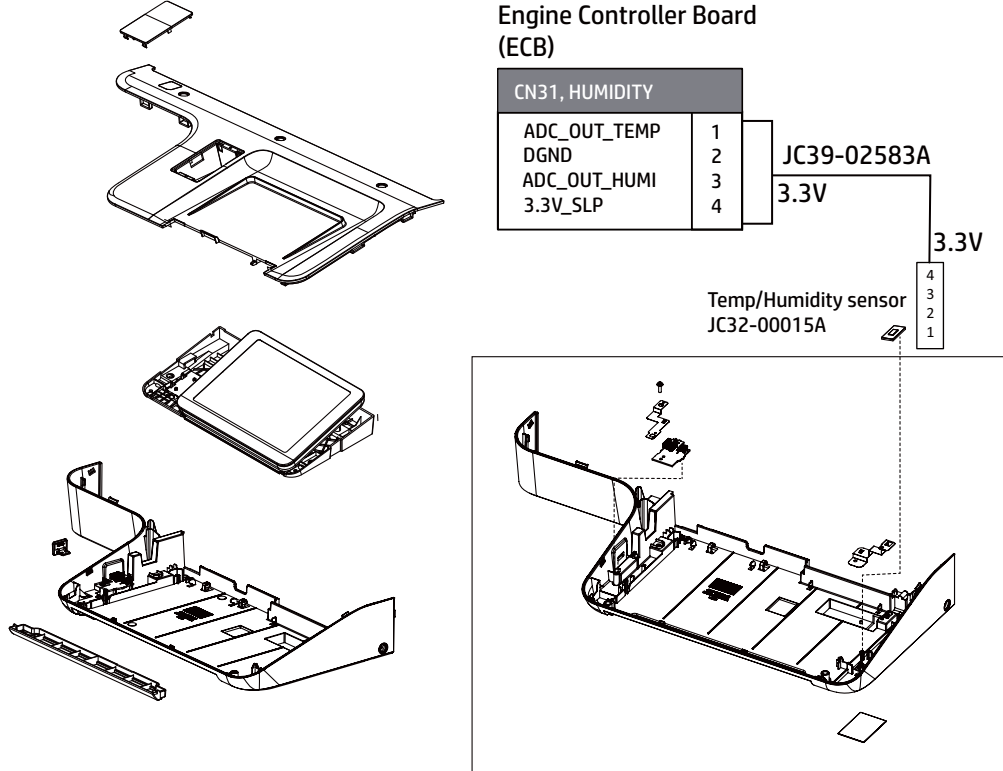

Exit section

Exit assembly

Figure 4-6 Exit assembly

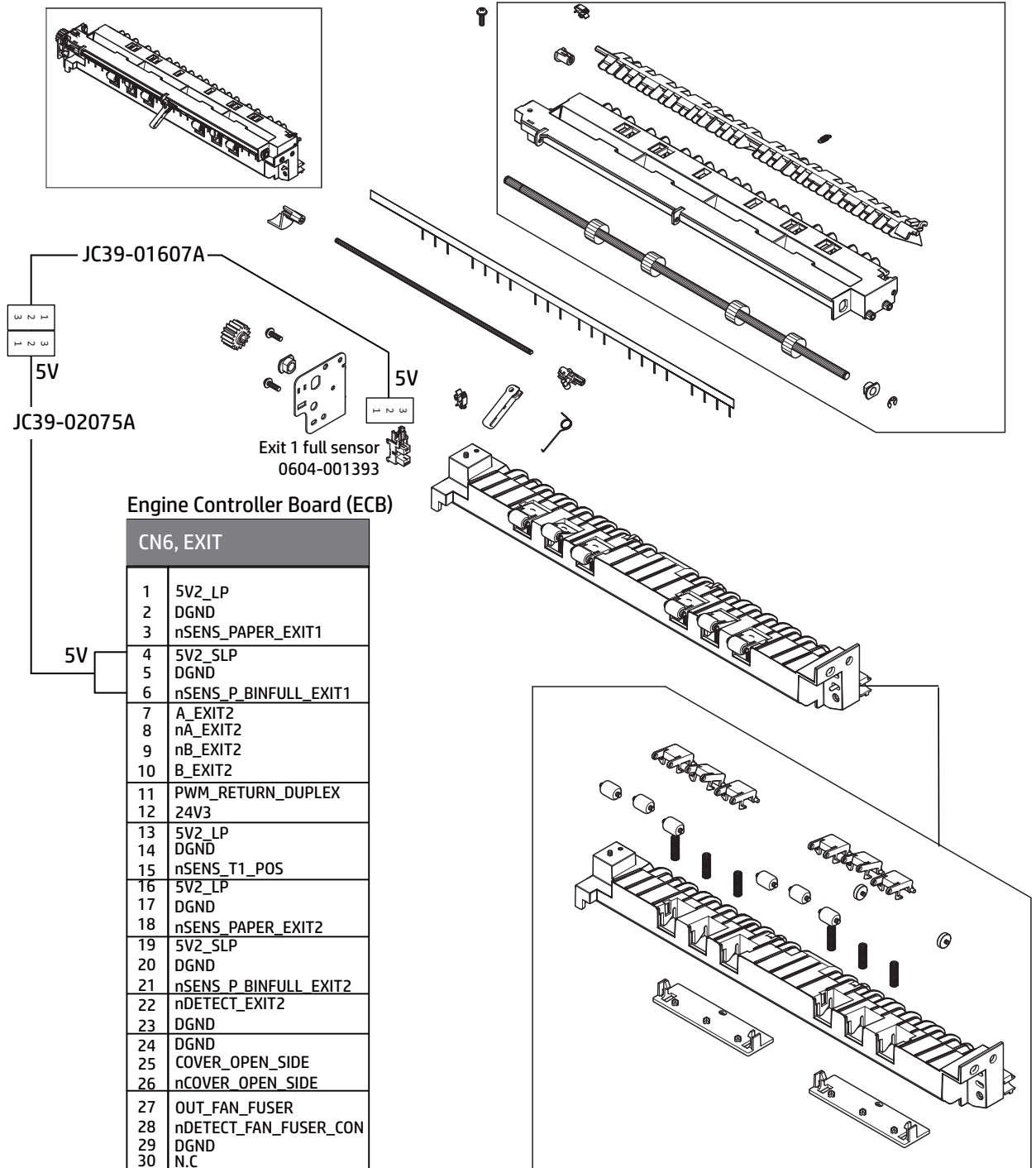

Drive section

Main drive assembly

Figure 4-7 Main drive assembly

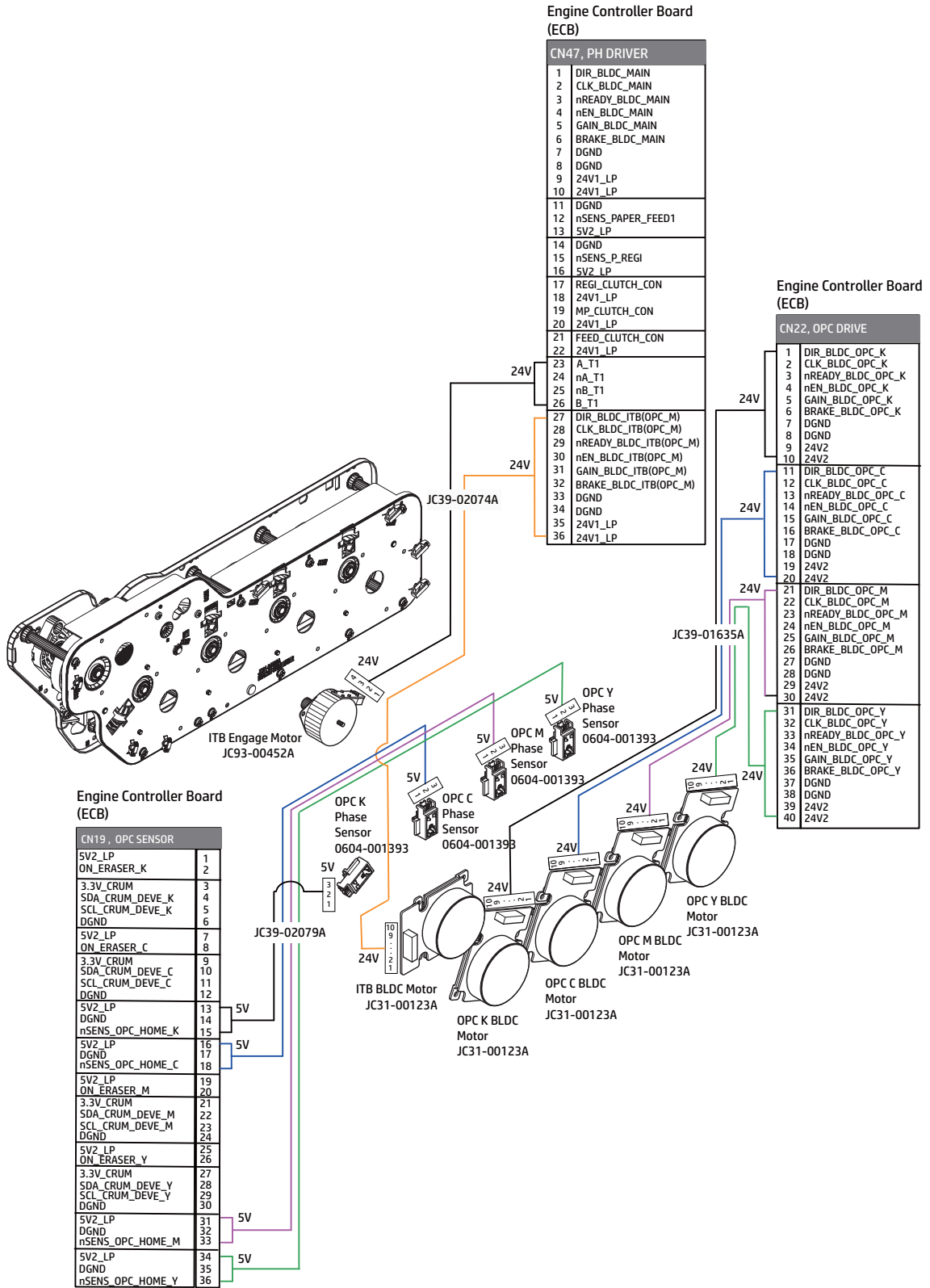

Registration & Tray 1 (MP) drive assembly

Figure 4-8 Registration & Tray 1 (MP) drive assembly

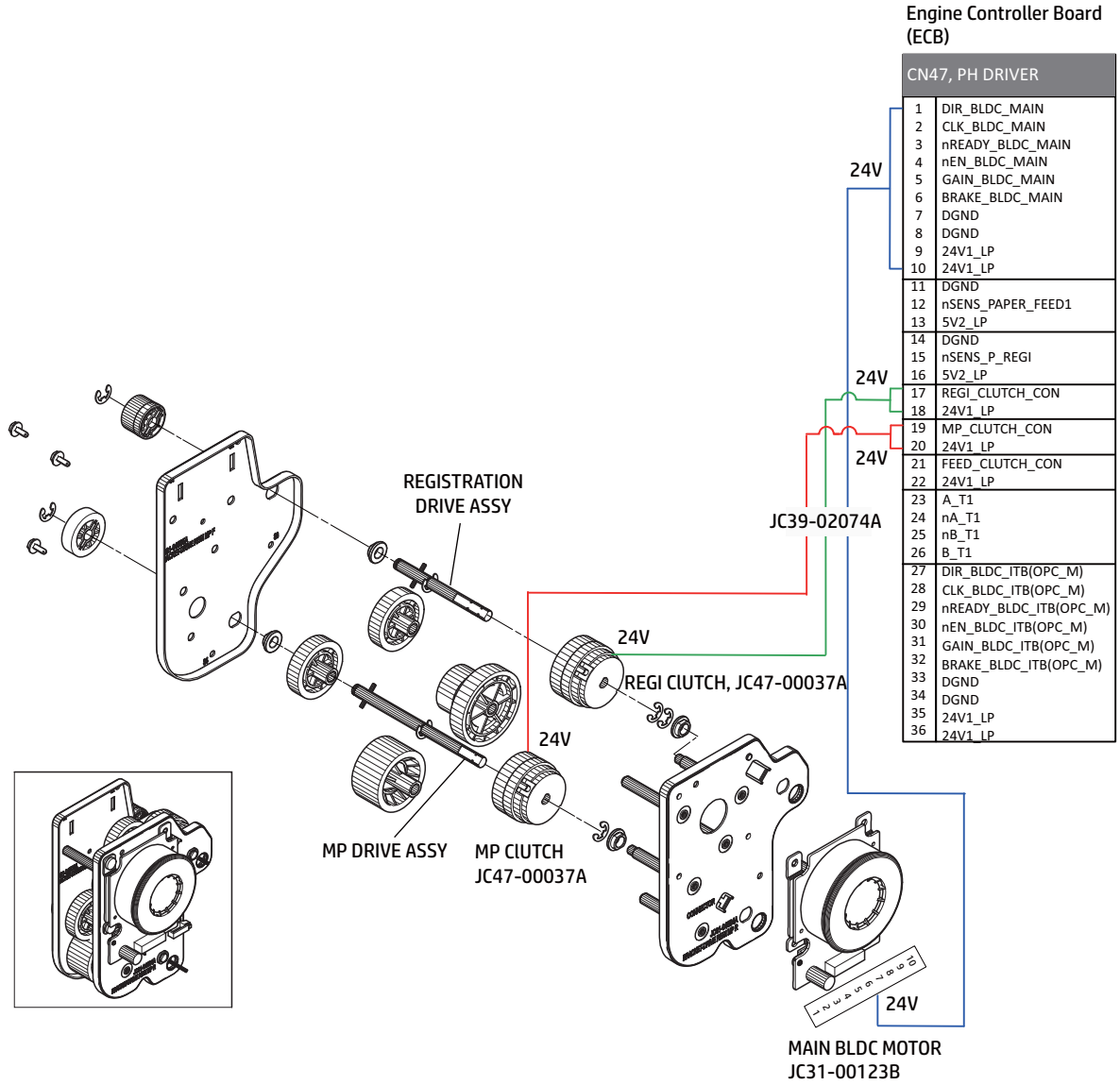

Fuser & Exit drive assembly

Figure 4-9 Fuser & Exit drive assembly

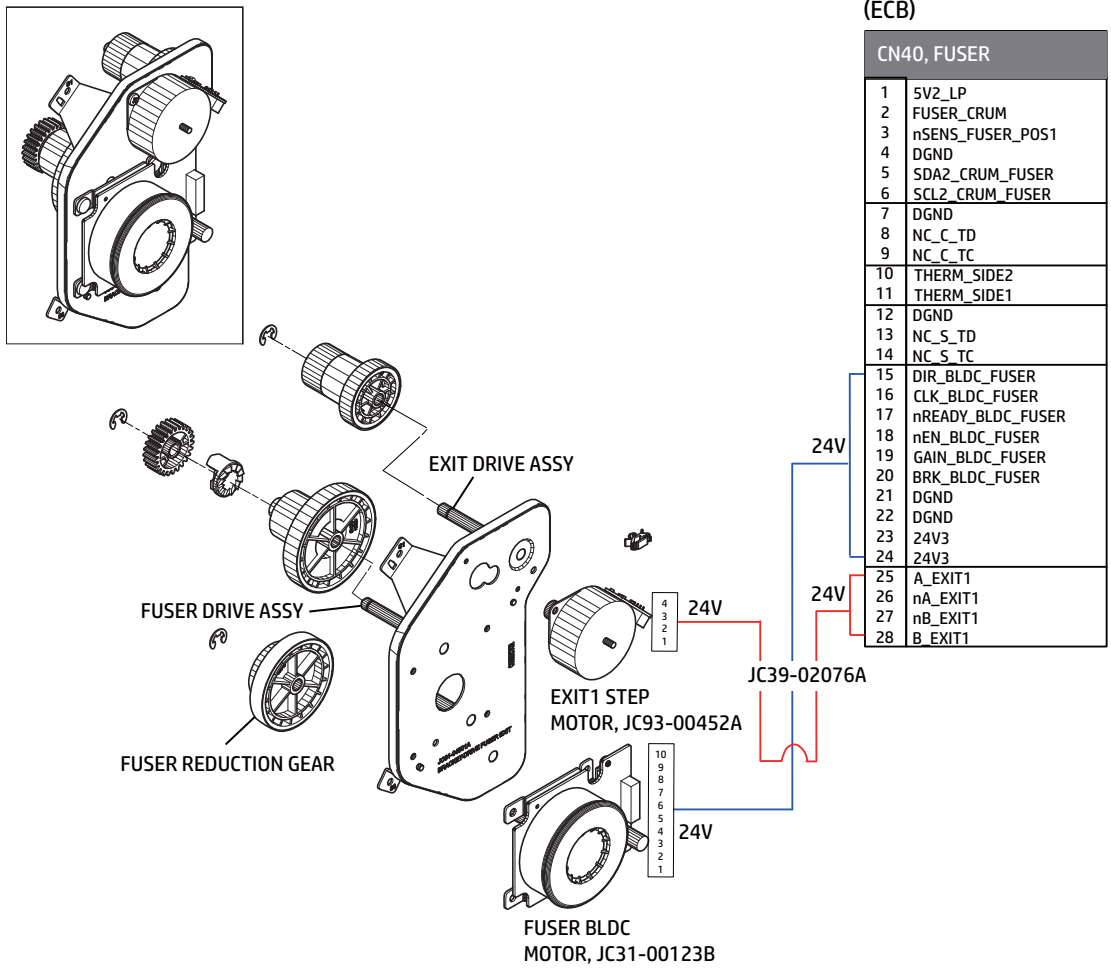

Paper feed drive assembly

Figure 4-10 Paper feed drive assembly

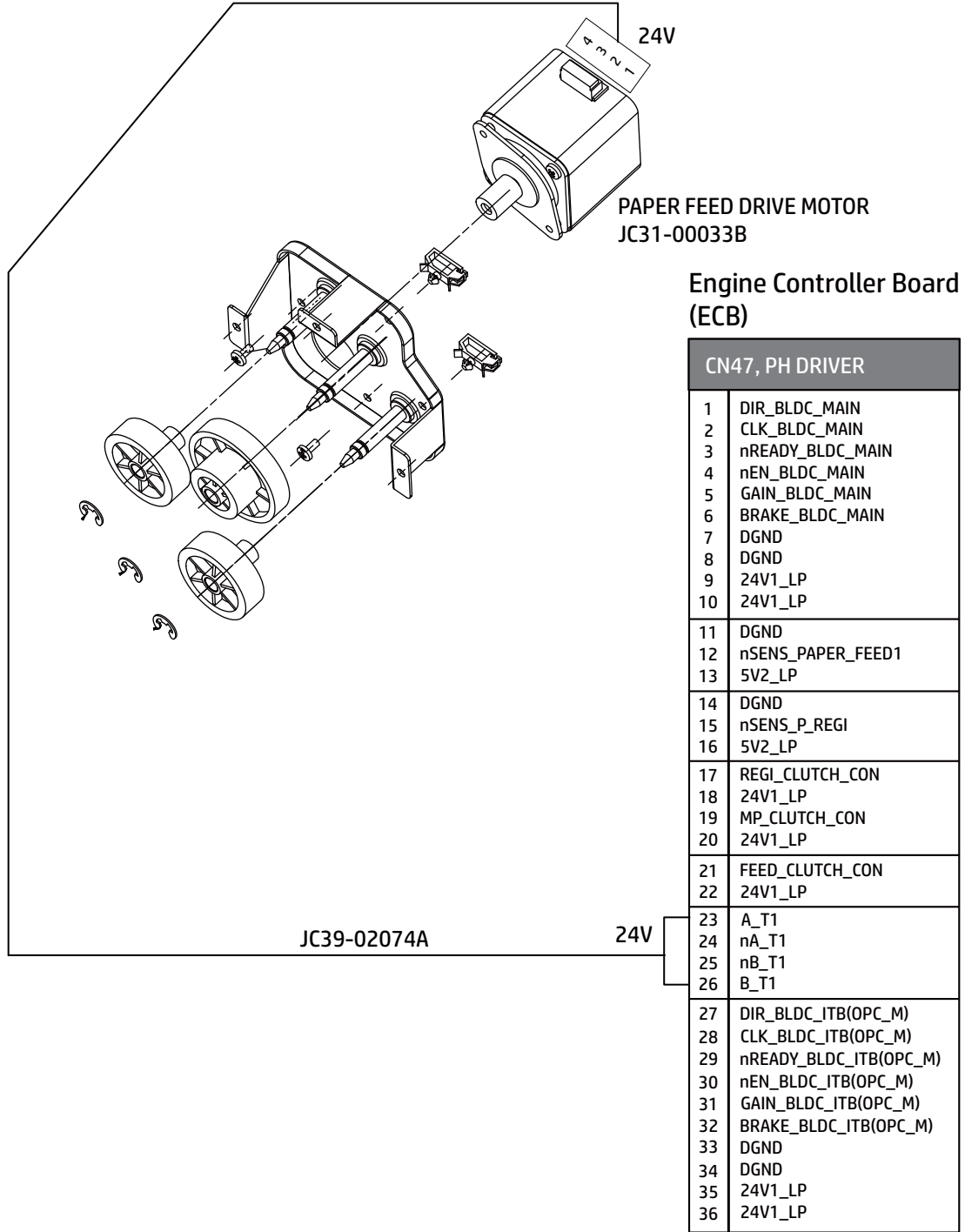

Toner supply drive assembly

Figure 4-11 Toner supply drive assembly

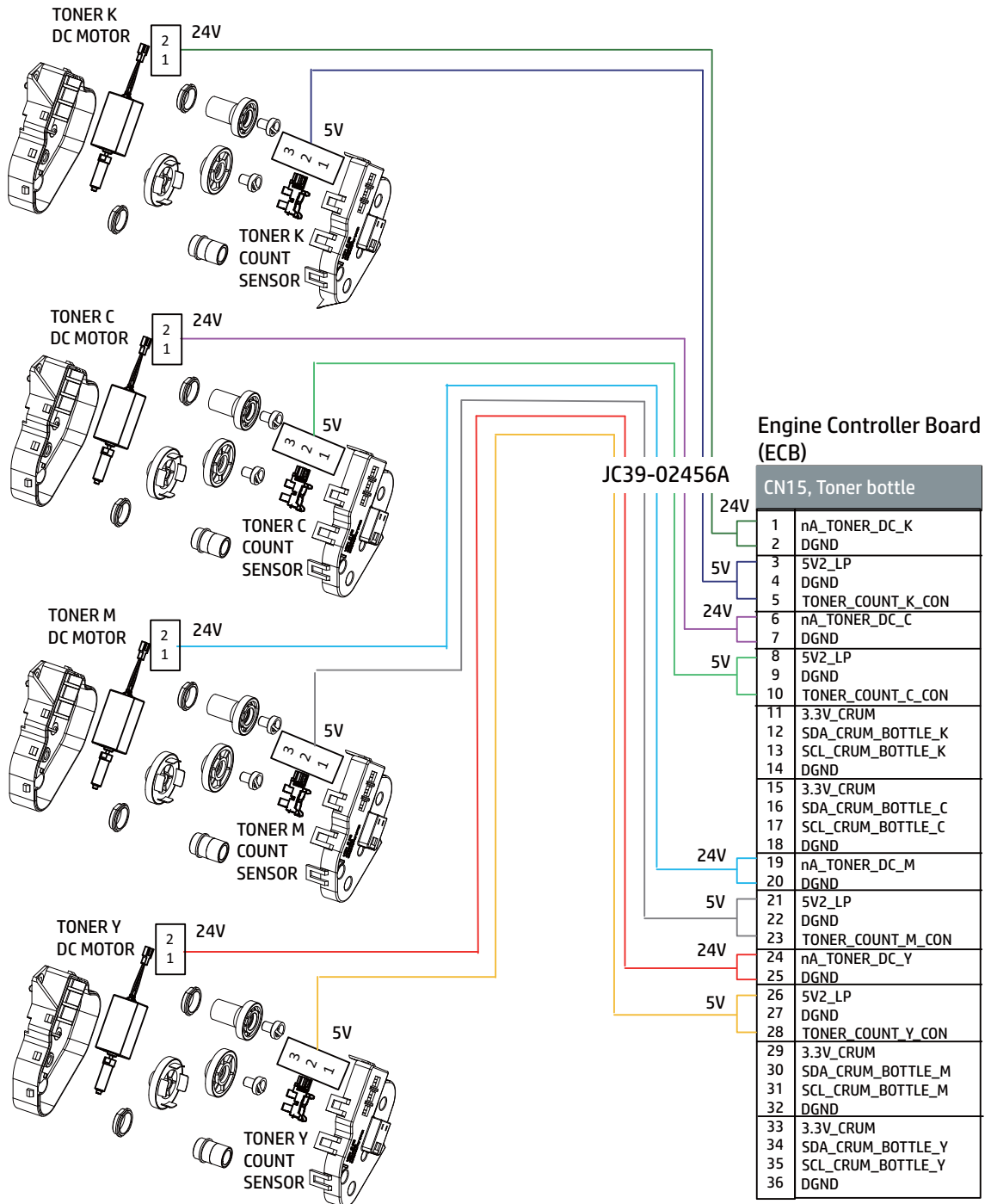

Paper pickup drive assembly

Figure 4-12 Paper pickup drive assembly

Pickup drive 1
JC93-00442C

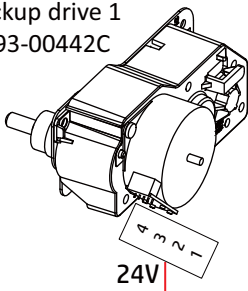

Pickup drive 2
JC93-00442C

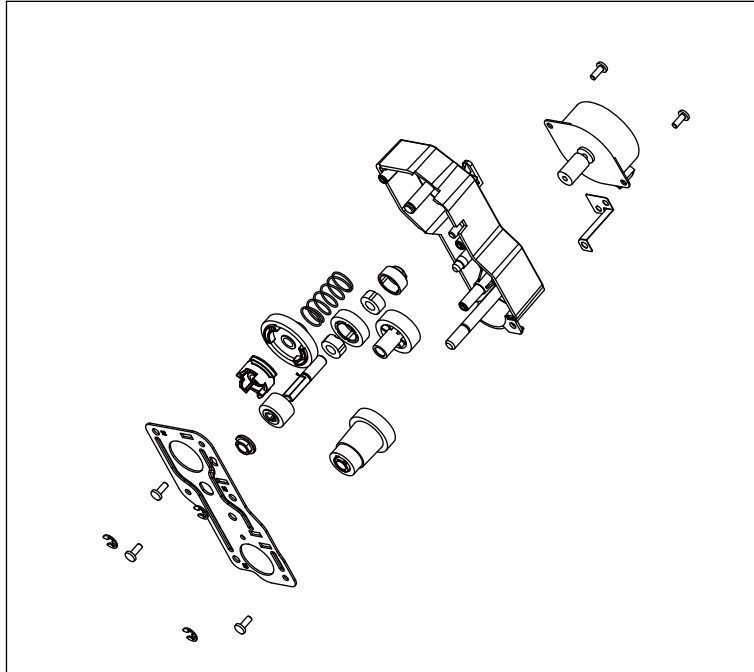
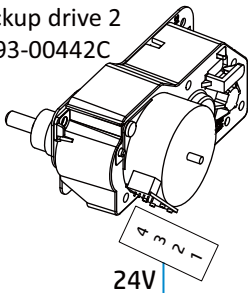

Engine Controller Board
(ECB)

CN46, PICKUP	
1	5V2_LP
2	DGND
3	PAPER_EMPTY1
4	5V2_LP
5	DGND
6	nSENS_PAPER_LIFT1
7	A_PICKUP1
8	nA_PICKUP1
9	nB_PICKUP1
10	B_PICKUP1
11	A_FEED
12	nA_FEED
13	nB_FEED
14	B_FEED
15	5V2_LP
16	DGND
17	PAPER_EMPTY2
18	5V2_LP
19	DGND
20	nSENS_PAPER_LIFT2
21	DGND
22	nSENS_PAPER_FEED2
23	5V2_LP
24	A_PICKUP2
25	nA_PICKUP2
26	nB_PICKUP2
27	B_PICKUP2
28	N.C

JC39-02078A

24V

24V

Paper handling section

First & Second pickup assembly

Figure 4-13 First & Second pickup assembly

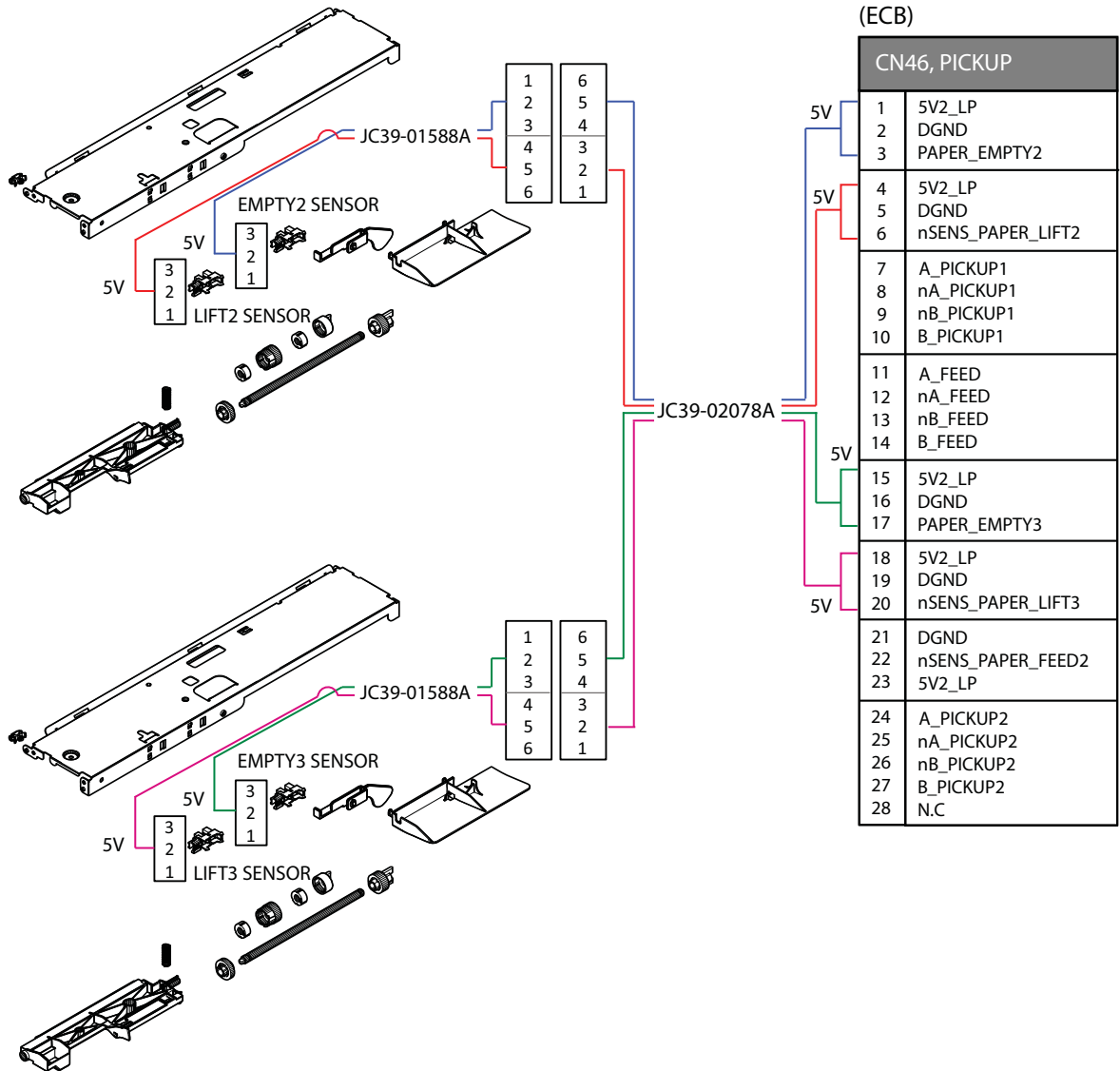

Registration assembly

Figure 4-14 Registration assembly

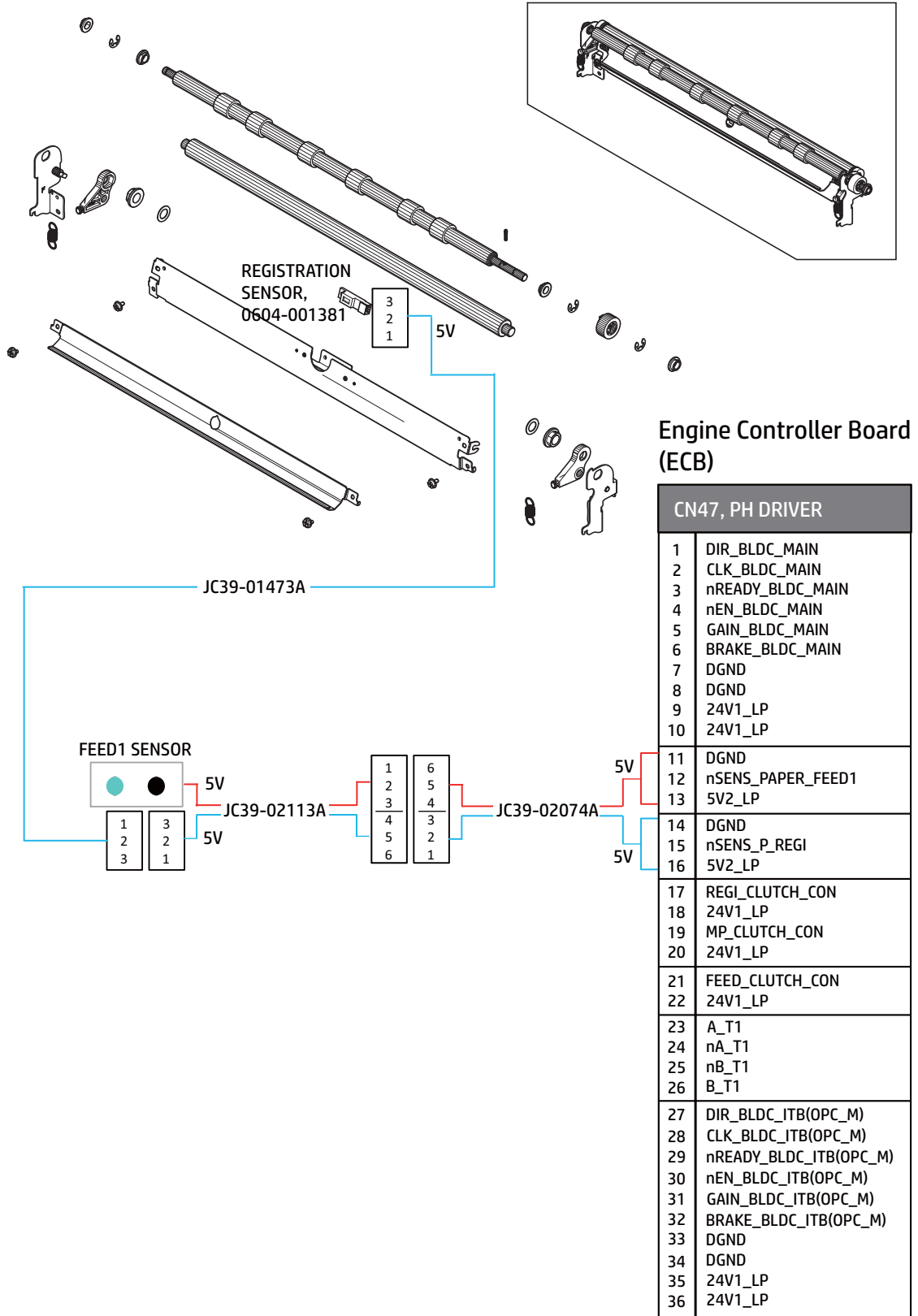

Frame section

Front frame

Figure 4-15 Front frame

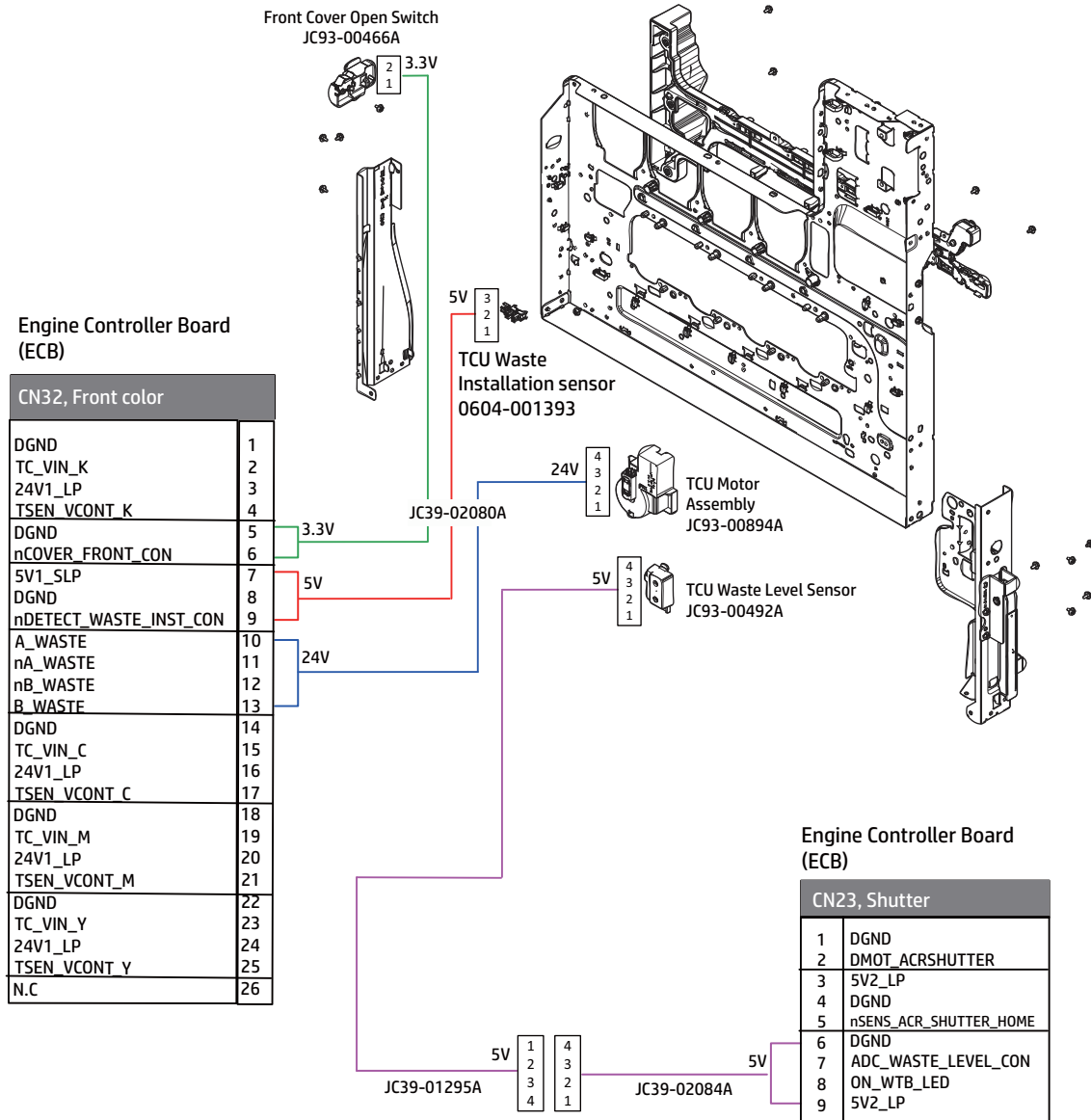

Rear frame

Figure 4-16 Rear frame

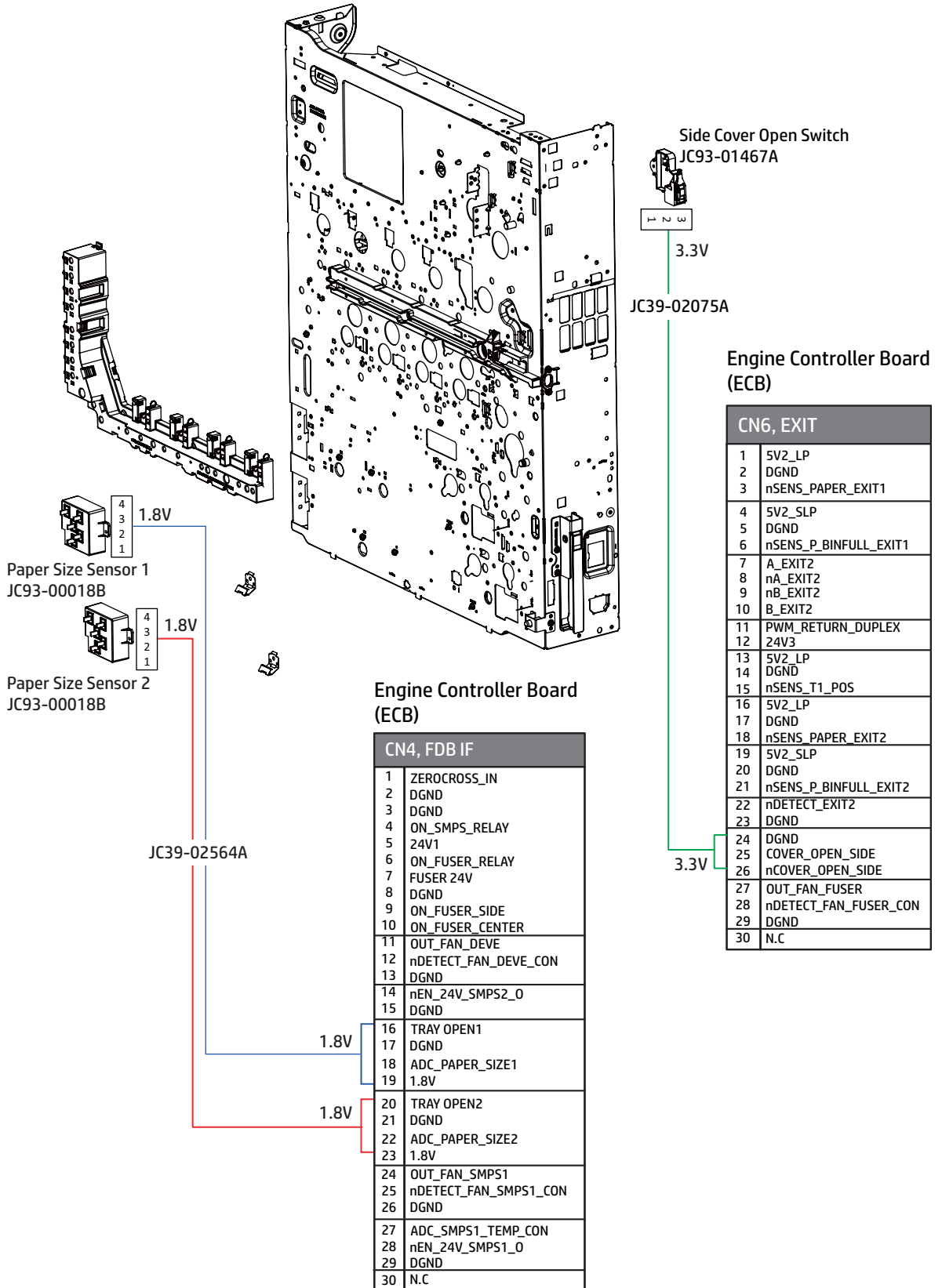

Color Plane Registration (CPR) assembly

Figure 4-17 Color Plane Registration (CPR) assembly

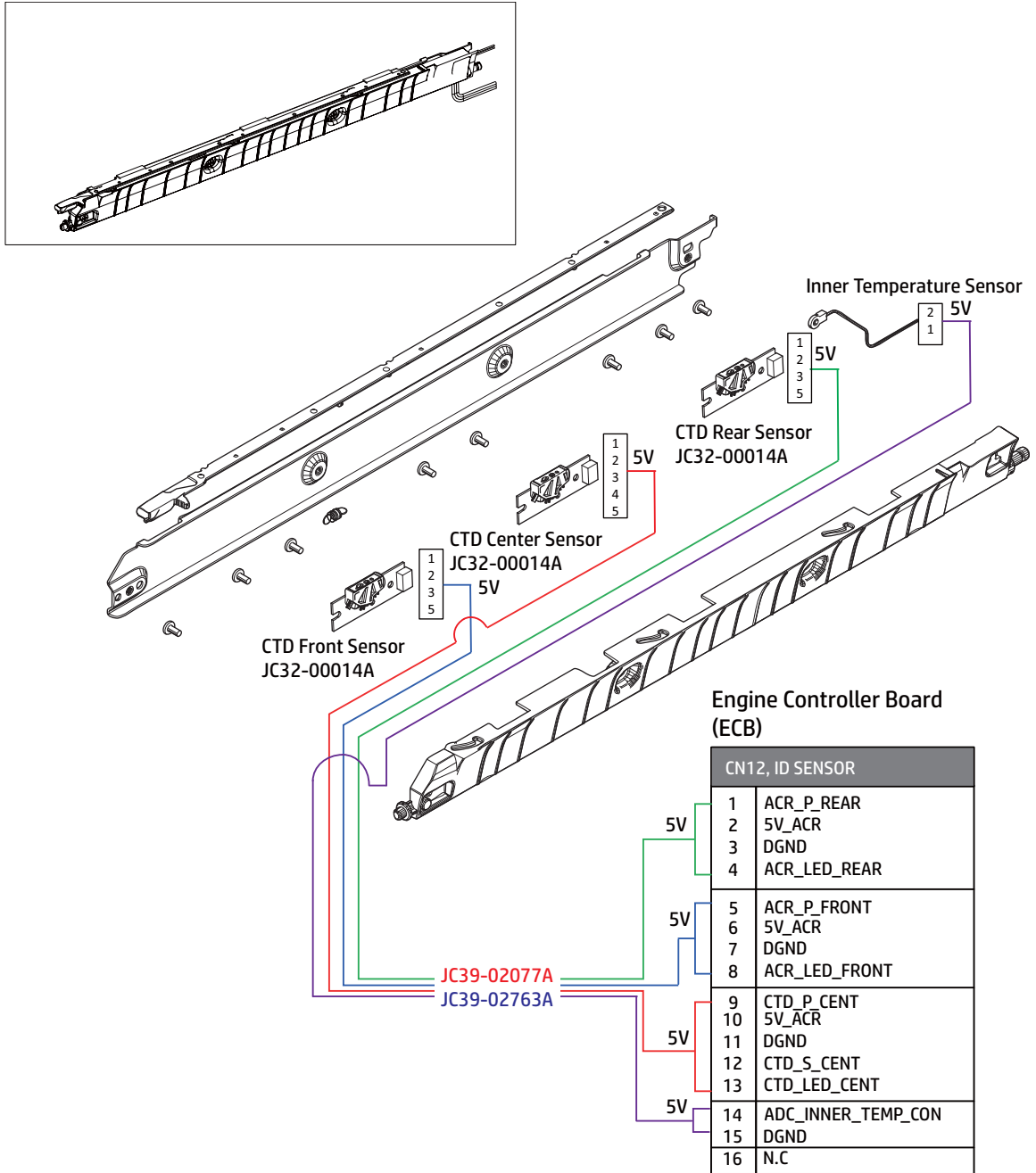

Red color text for E77422, E77428
Blue color text for E78223, E78228

Feed sensor

Figure 4-18 Feed sensor
< MAIN FRAME >

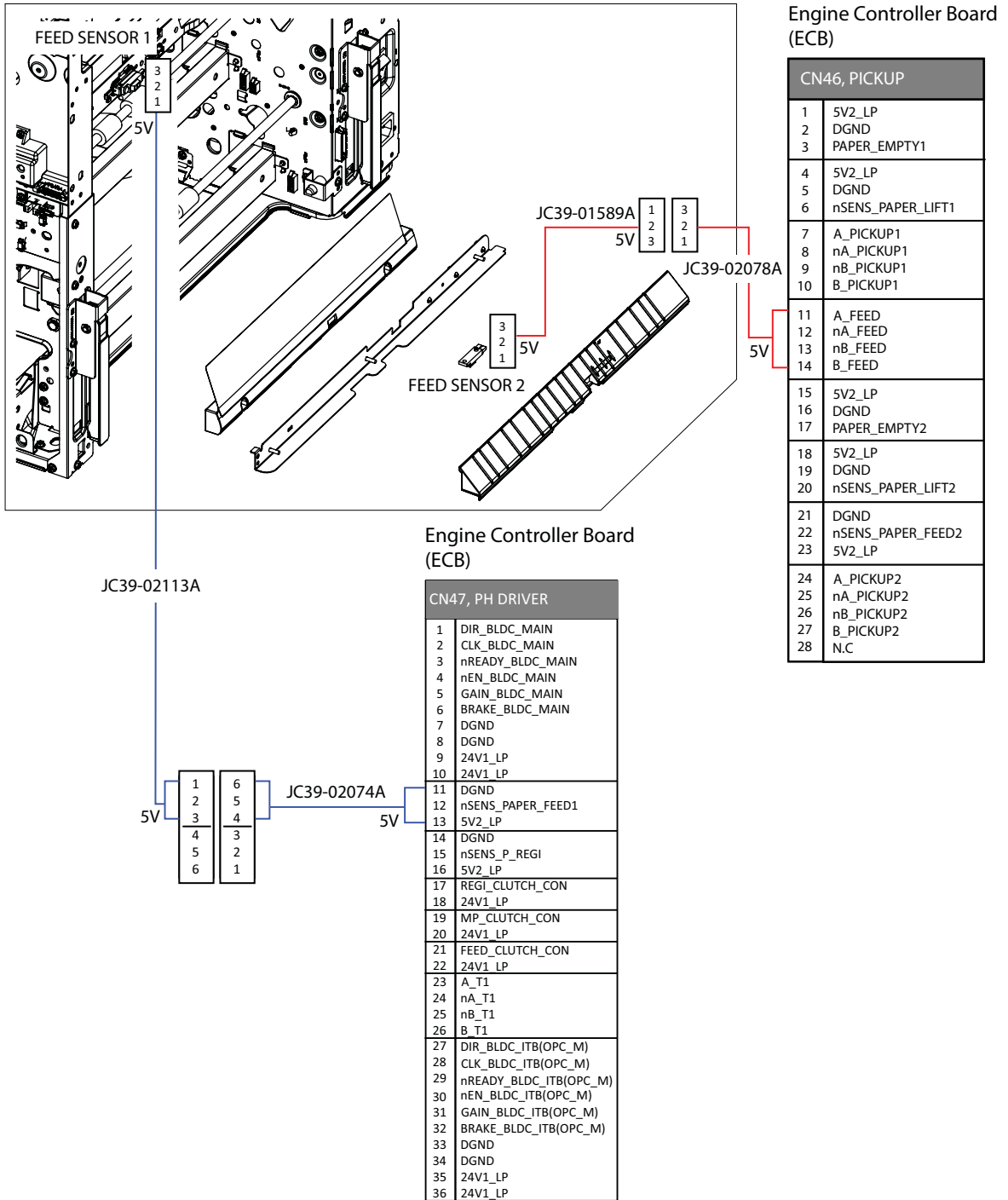

Fuser section

Fuser assembly

Figure 4-19 Fuser assembly

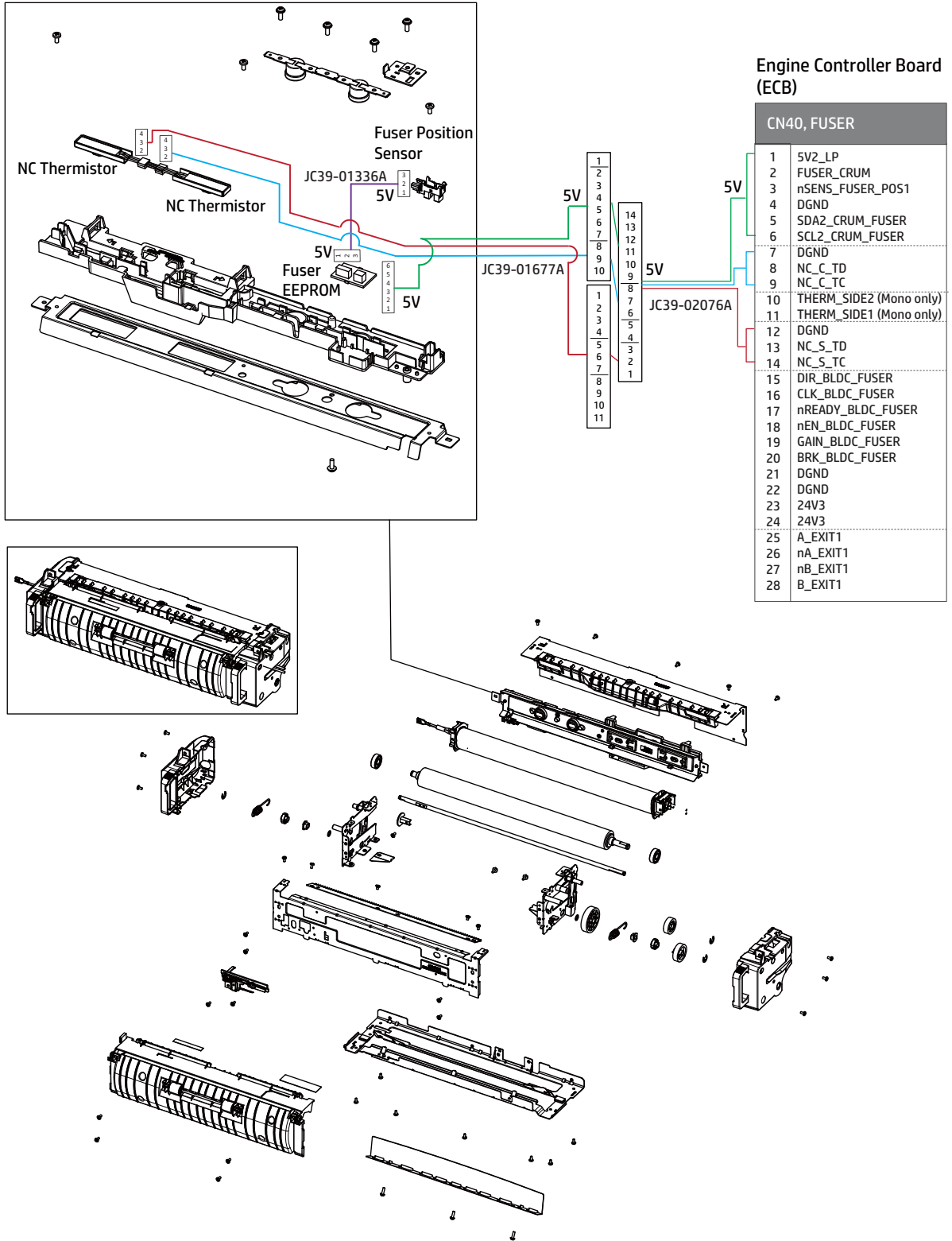

Engine Controller Board (ECB)

CN40, FUSER	
1	5V2_LP
2	FUSER_CRUM
3	nSENS_FUSER_POS1
4	DGND
5	SDA2_CRUM_FUSER
6	SCL2_CRUM_FUSER
7	DGND
8	NC_C_TD
9	NC_C_TC
10	THERM_SIDE2 (Mono only)
11	THERM_SIDE1 (Mono only)
12	DGND
13	NC_S_TD
14	NC_S_TC
15	DIR_BLDC_FUSER
16	CLK_BLDC_FUSER
17	nREADY_BLDC_FUSER
18	nEN_BLDC_FUSER
19	GAIN_BLDC_FUSER
20	BRK_BLDC_FUSER
21	DGND
22	DGND
23	24V3
24	24V3
25	A_EXIT1
26	nA_EXIT1
27	nB_EXIT1
28	B_EXIT1

MP right door section

Right door assembly

Figure 4-20 Right door assembly

Engine Controller Board (ECB)

CN36, SIDE	
5V2_SLP	1
DGND	2
nSENS_P_MP_EMPTY	3
MP_SOL_CON	4
24V3	5
A_DUP	6
nA_DUP	7
nB_DUP	8
B_DUP	9
5V2_LP	10
DGND	11
nSENS_P_FUSER_OUT	12
OUT_FAN_DUPLEX2	13
nDETECT_FAN_DUPLEX2_CON	14
DGND	15
(N.C)	16
(N.C)	17
(N.C)	18
5V2_LP	19
DGND	20
nSENS_CURL2	21
5V2_LP	22
DGND	23
nSENS_JAM_DUPLEX	24
OUT_FAN_DUPLEX1	25
nDETECT_FAN_DUPLEX1_CON	26
DGND	27
1.8V	28
ADC_MP_SIZE	29
DGND	30

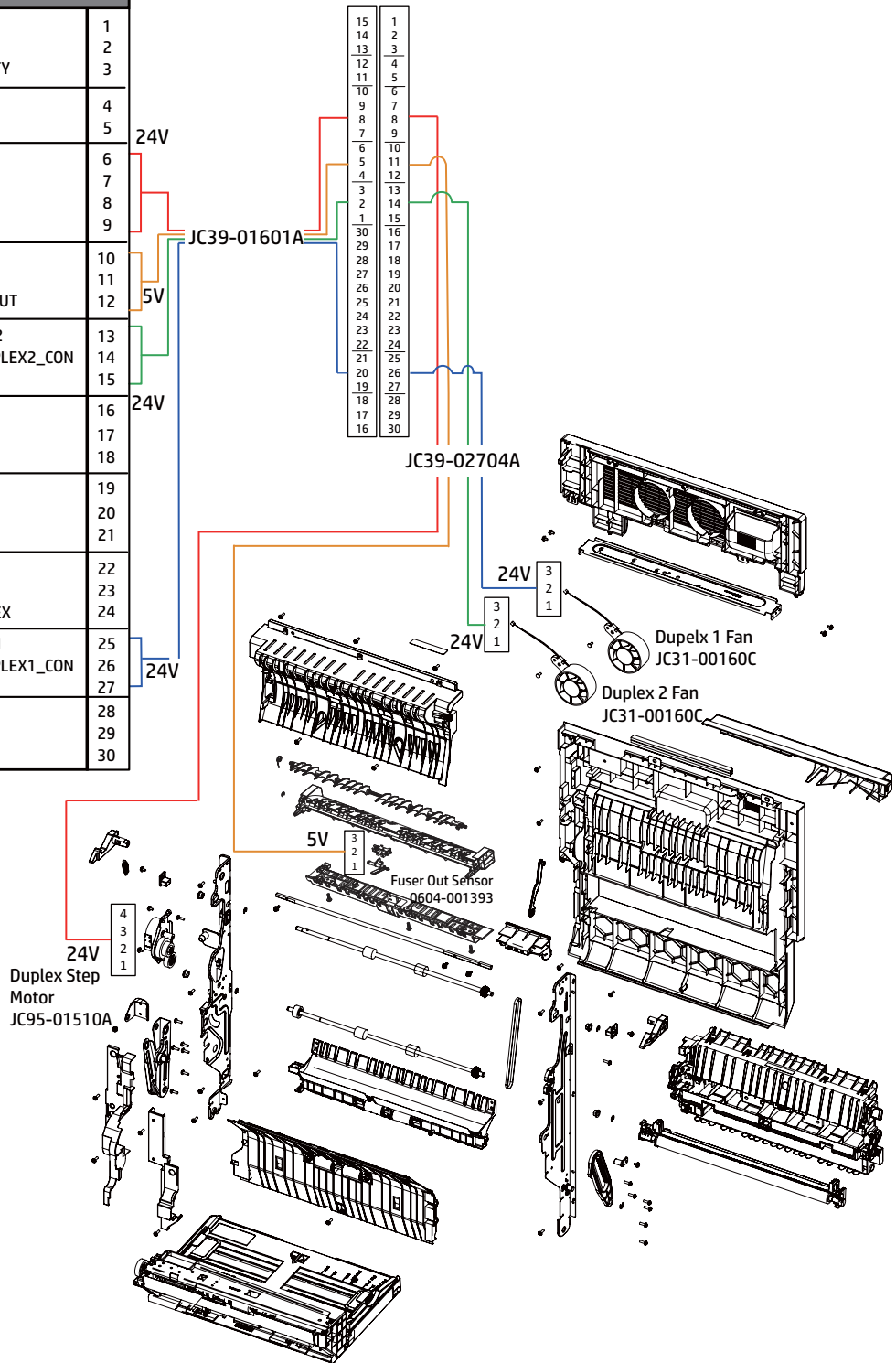

Tray 1 (MP) assembly

Figure 4-21 Tray 1 (MP) assembly

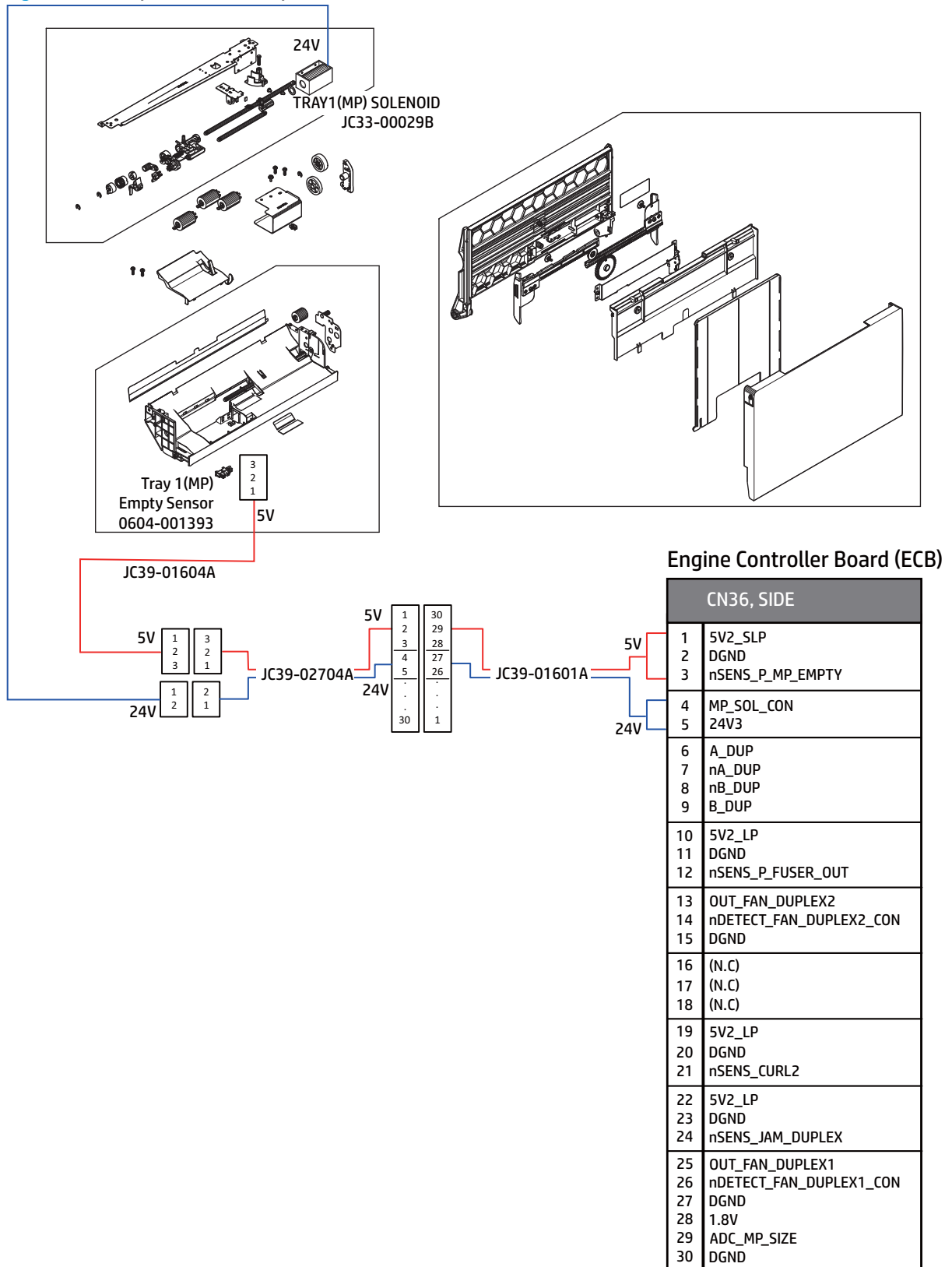

Right door feed guide

Figure 4-22 Right door feed guide

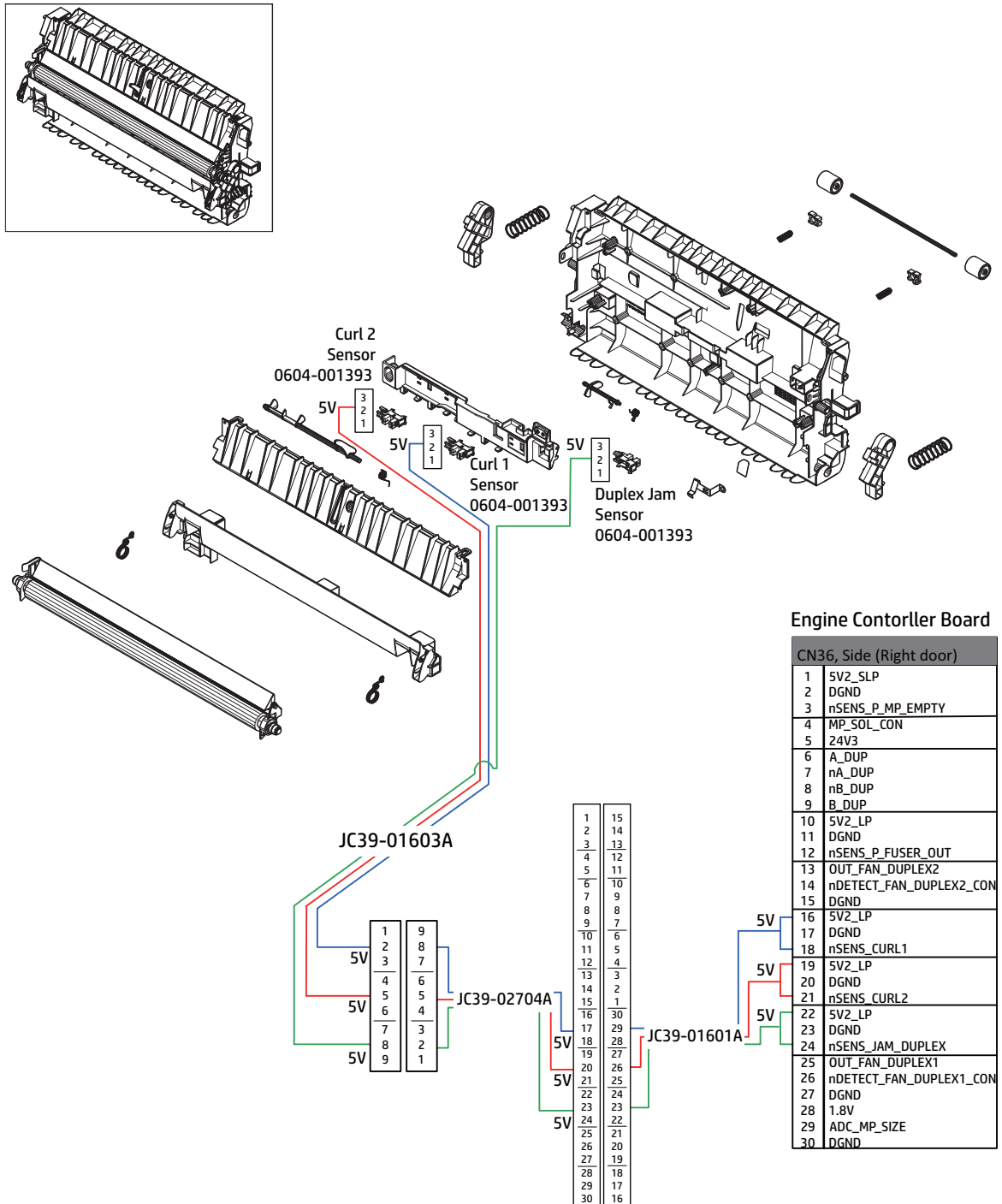

Right door output

Figure 4-23 Right door output

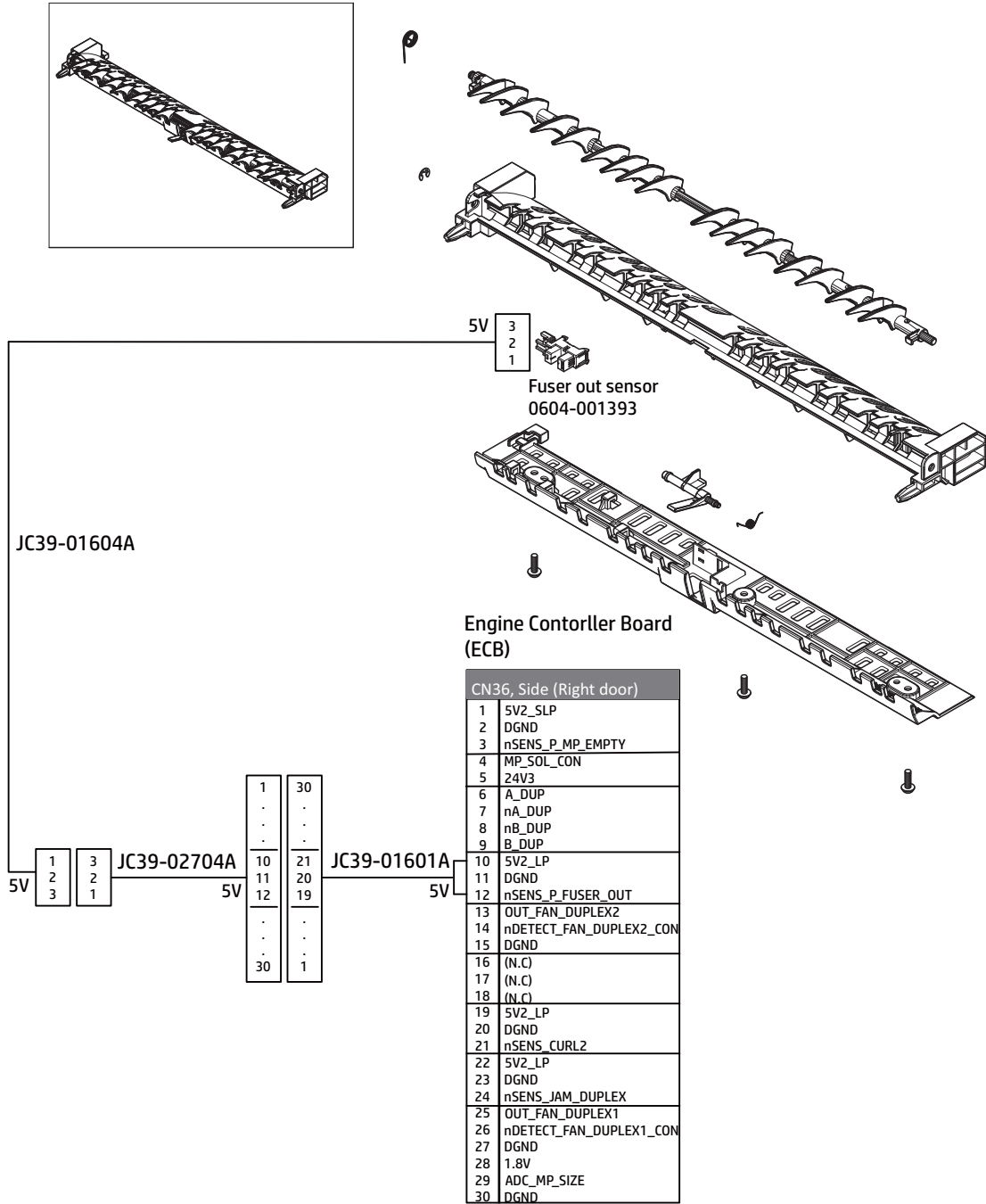

Scanner section

Scanner assembly (1/2)

Figure 4-24 Scanner assembly (1/2)

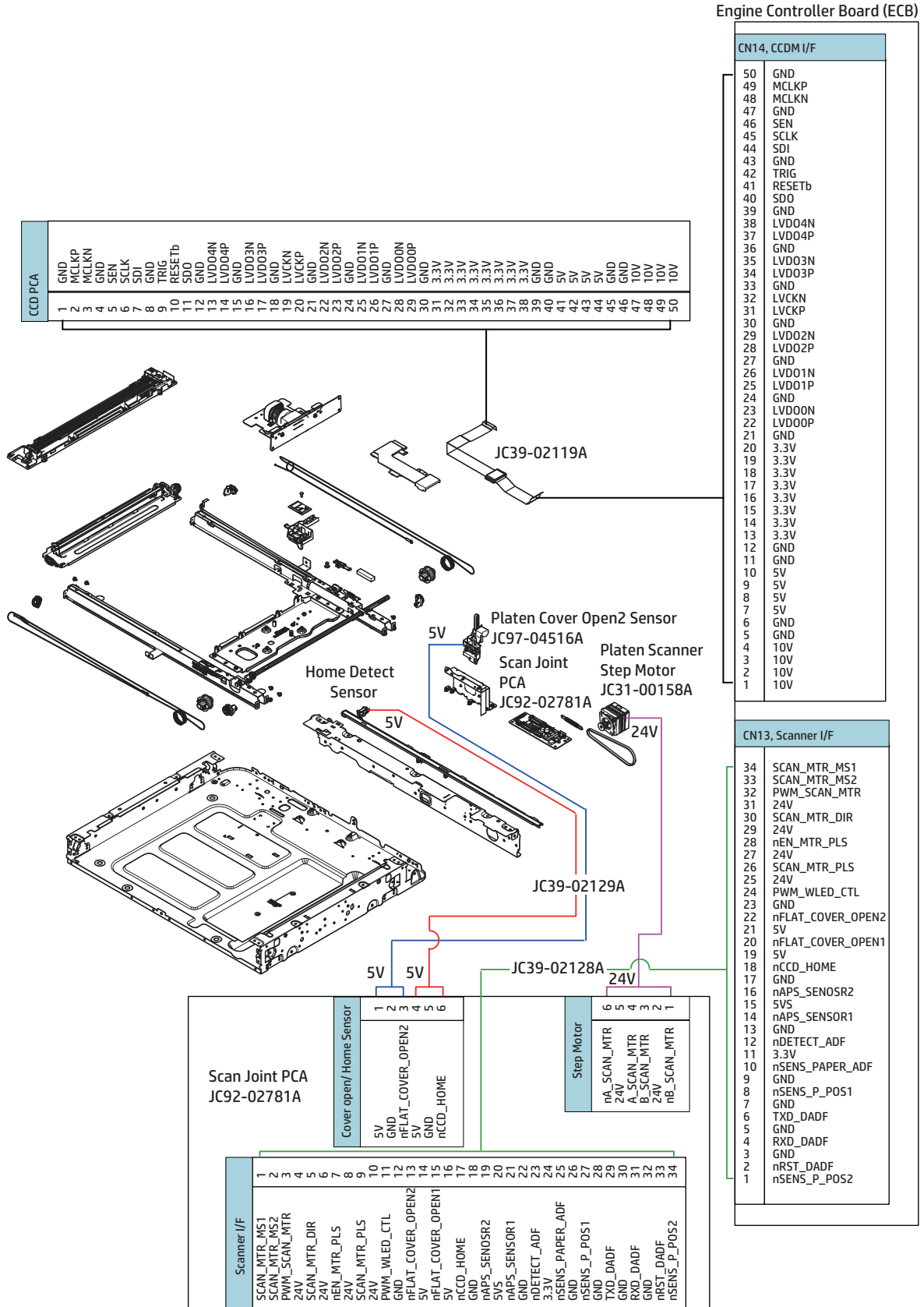

Scanner assembly (2/2)

Figure 4-25 Scanner assembly (2/2)

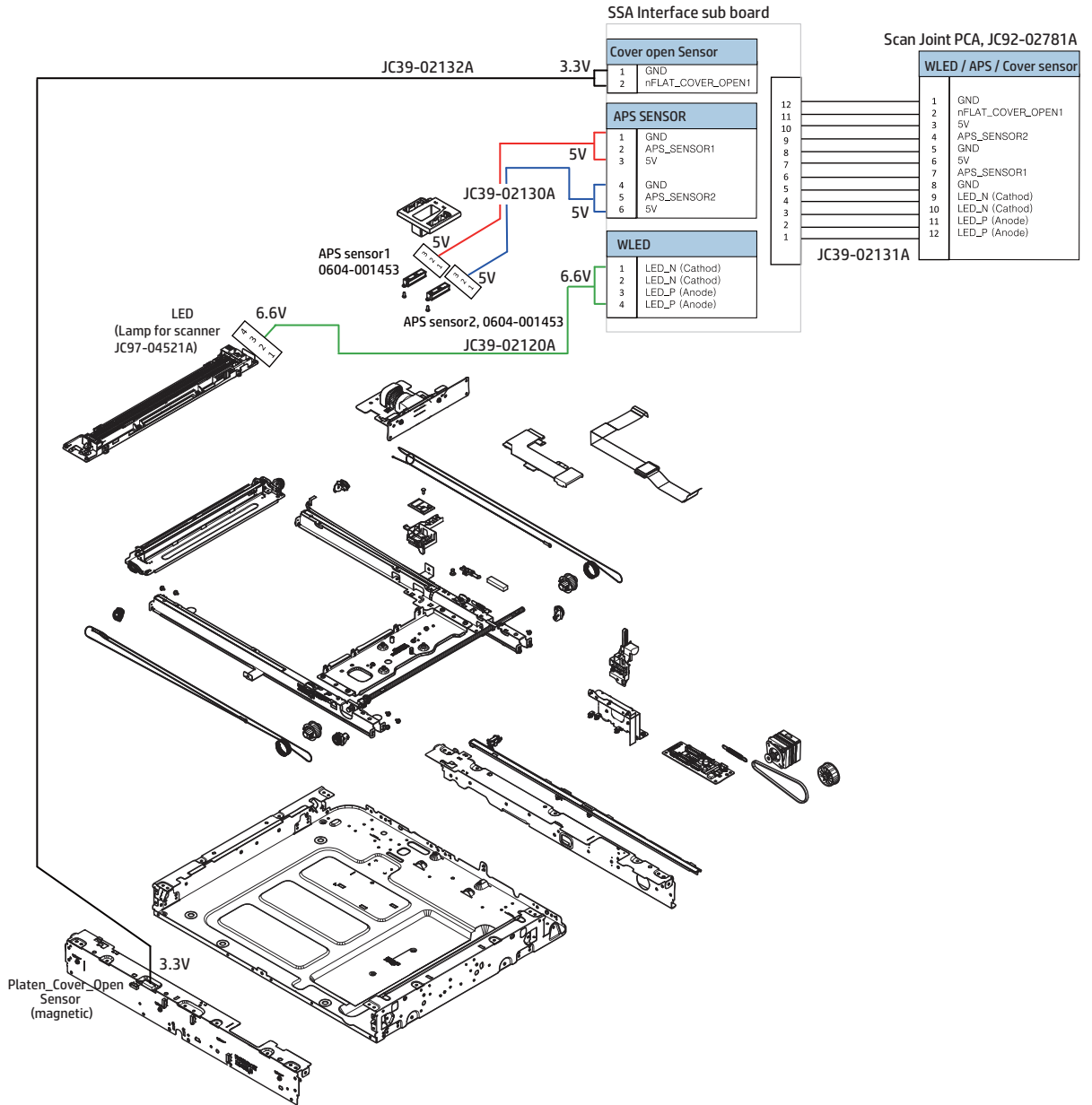

Automatic Document Feeder (ADF) section

Automatic Document Feeder (ADF) assembly (1/2)

Figure 4-26 Automatic Document Feeder (ADF) assembly (1/2)

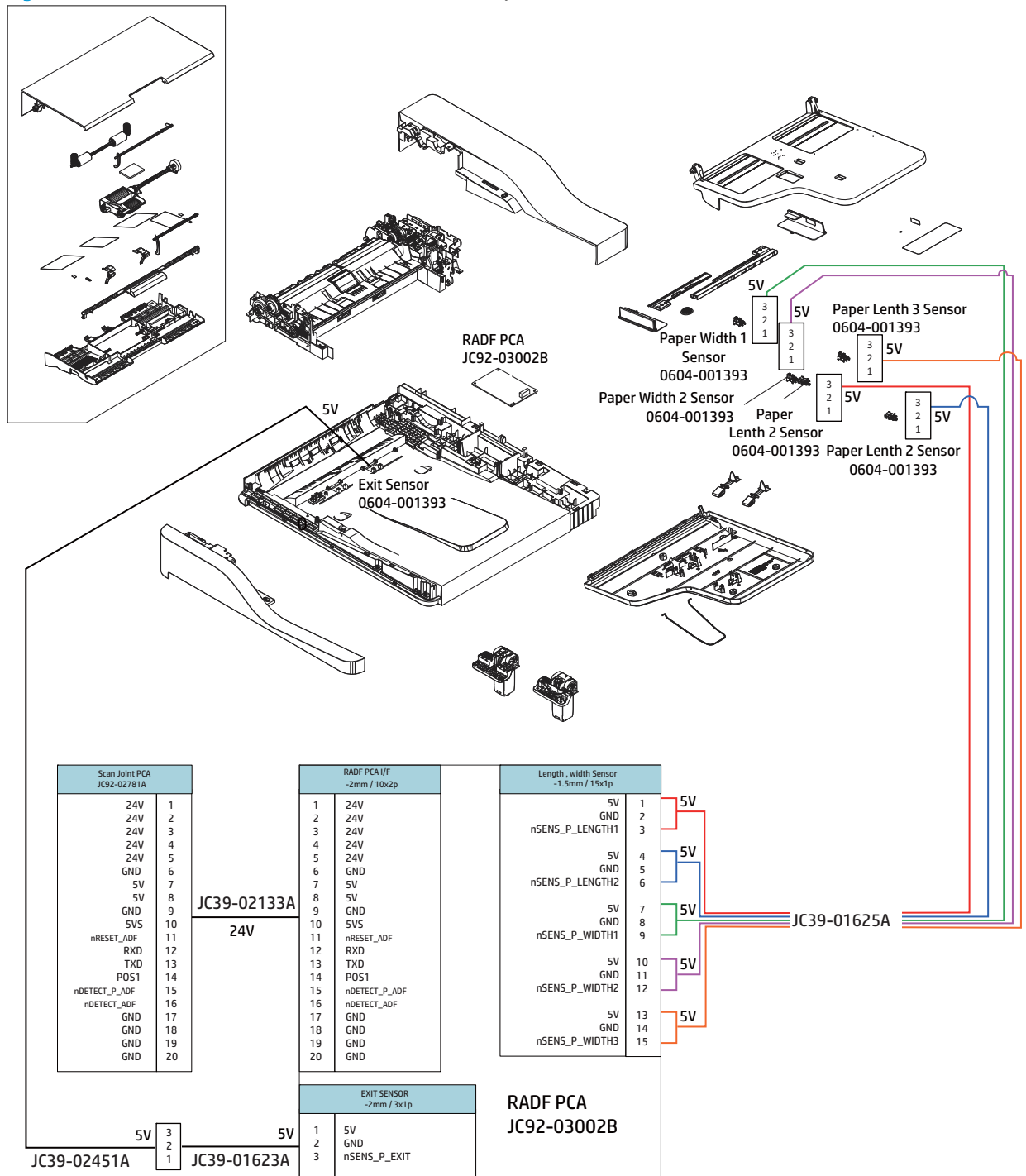

Automatic Document Feeder (ADF) assembly (2/2)

Figure 4-27 Automatic Document Feeder (ADF) assembly (2/2)

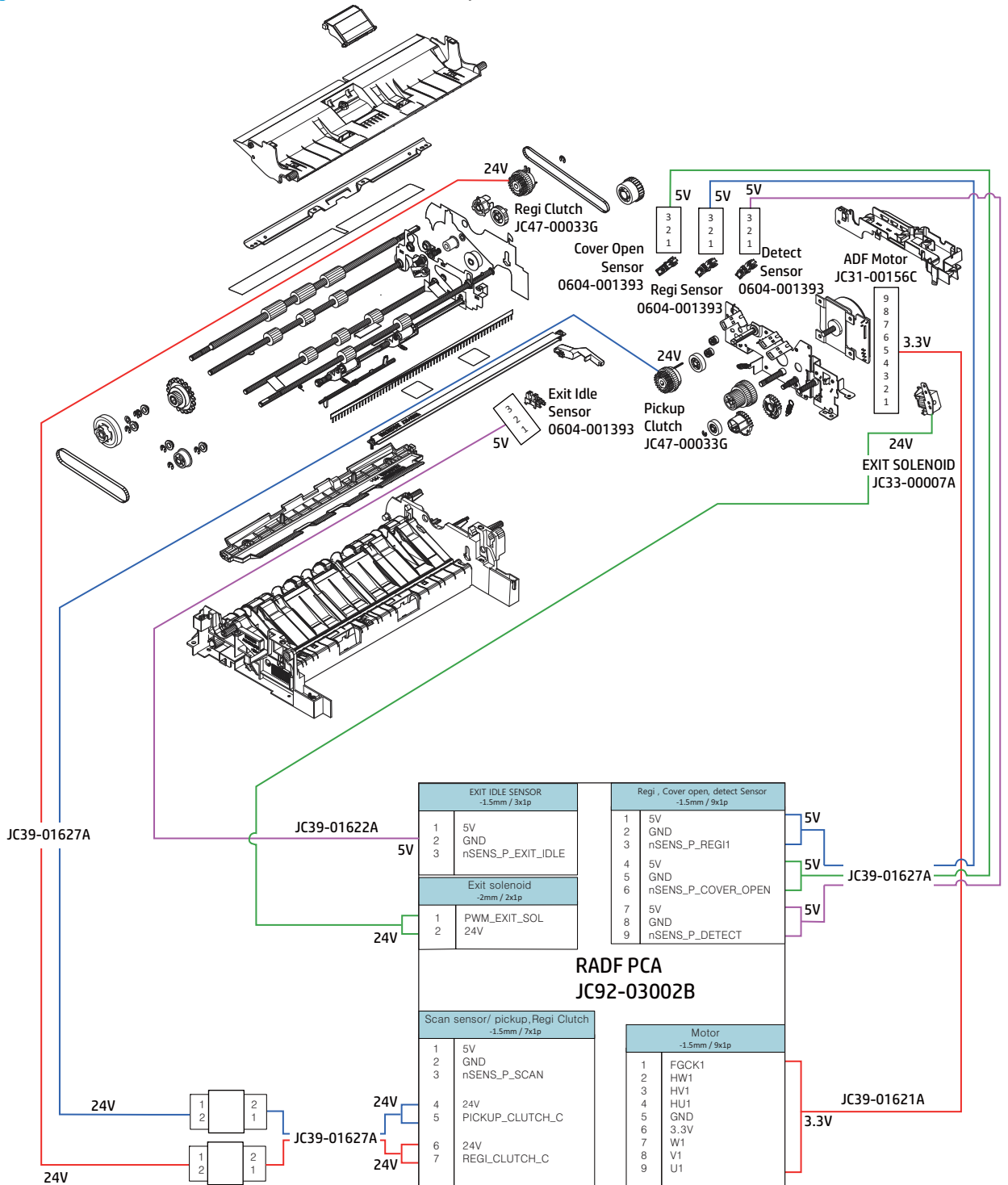
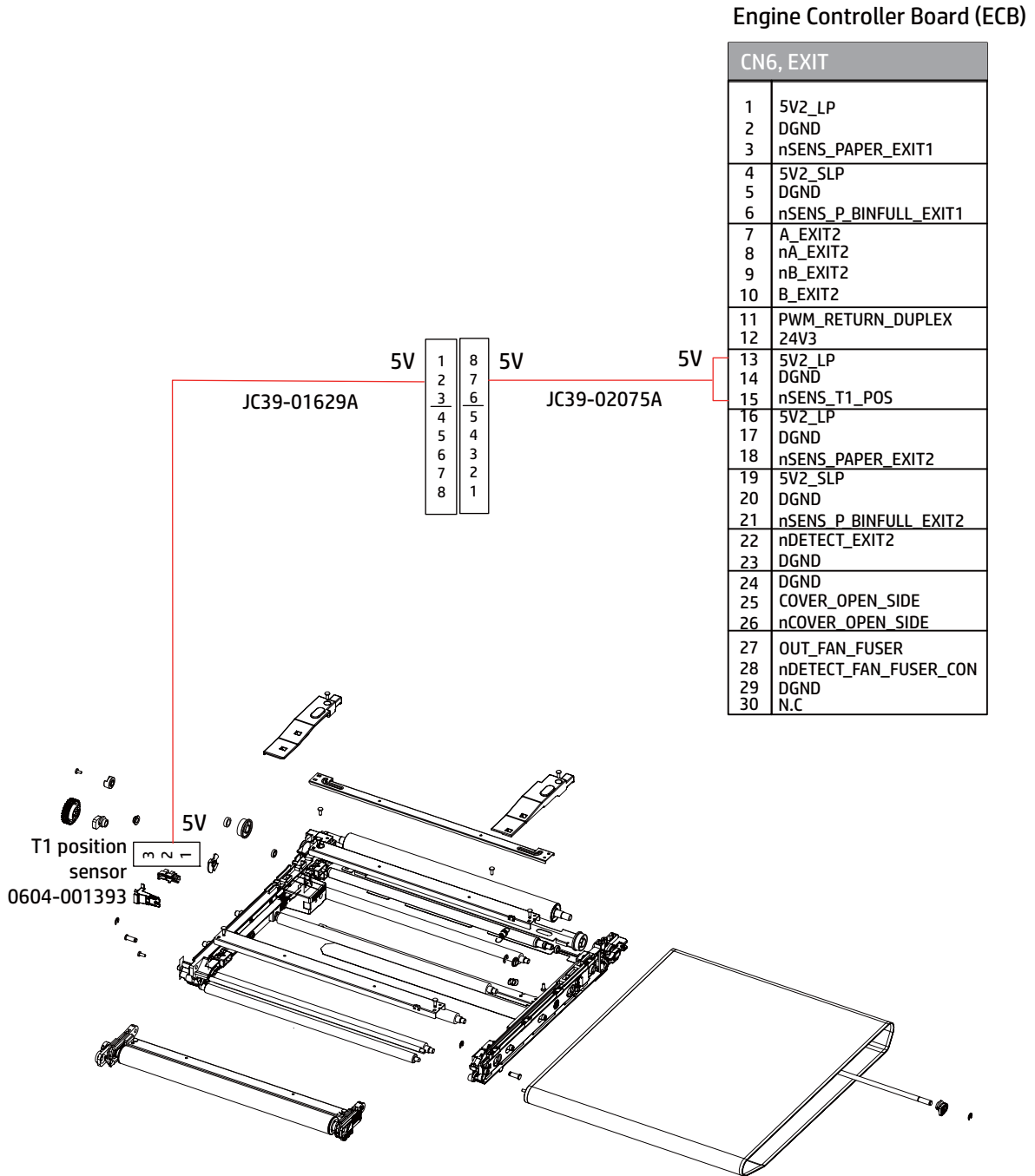

Image formation section

Image transfer belt (ITB) assembly

Figure 4-28 Image transfer belt (ITB) assembly



Toner cartridges

Figure 4-29 Toner cartridges

Engine Controller Board
(ECB)

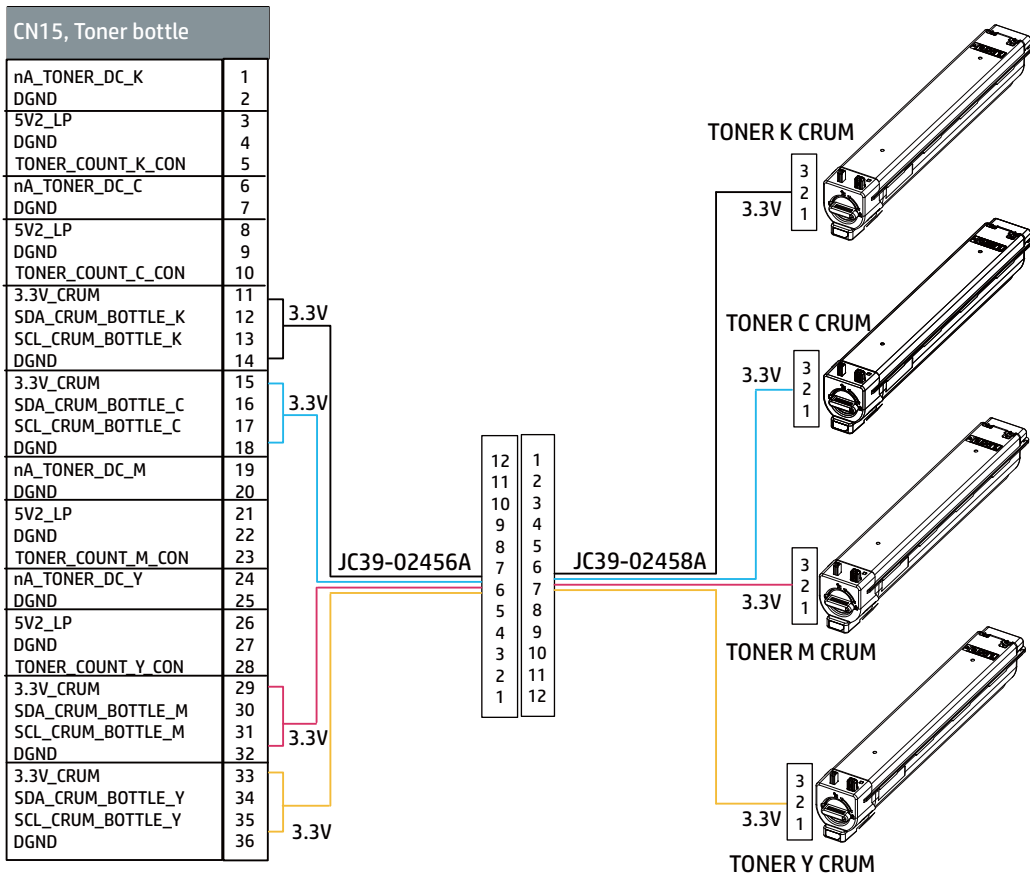

TC Sensor

Figure 4-30 TC Sensor

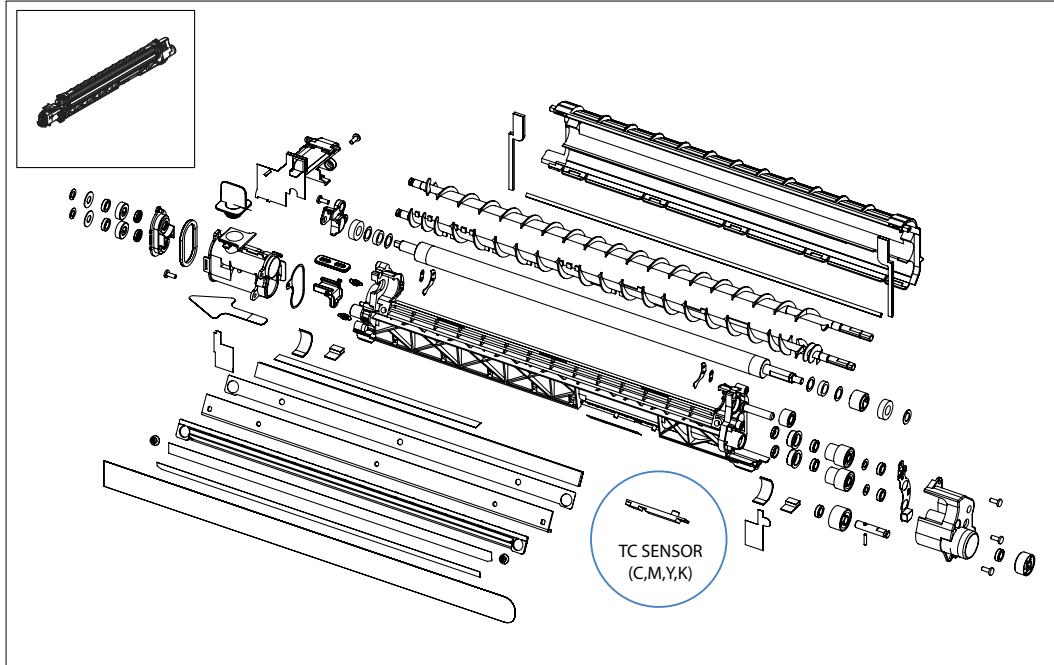

Engine Controller Board (ECB)

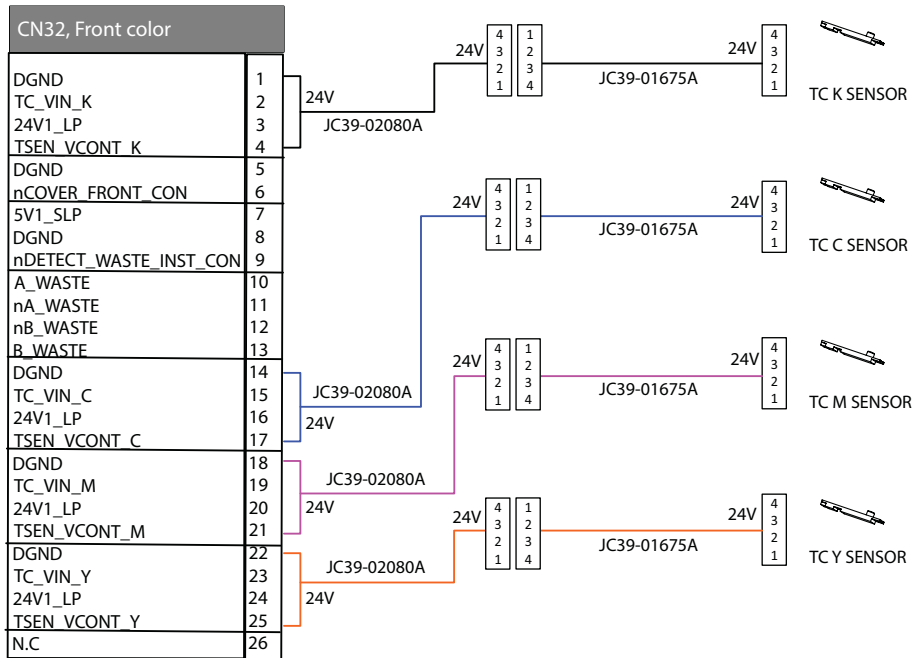

Toner crum & Eraser sensor

Figure 4-31 Toner crum & Eraser sensor

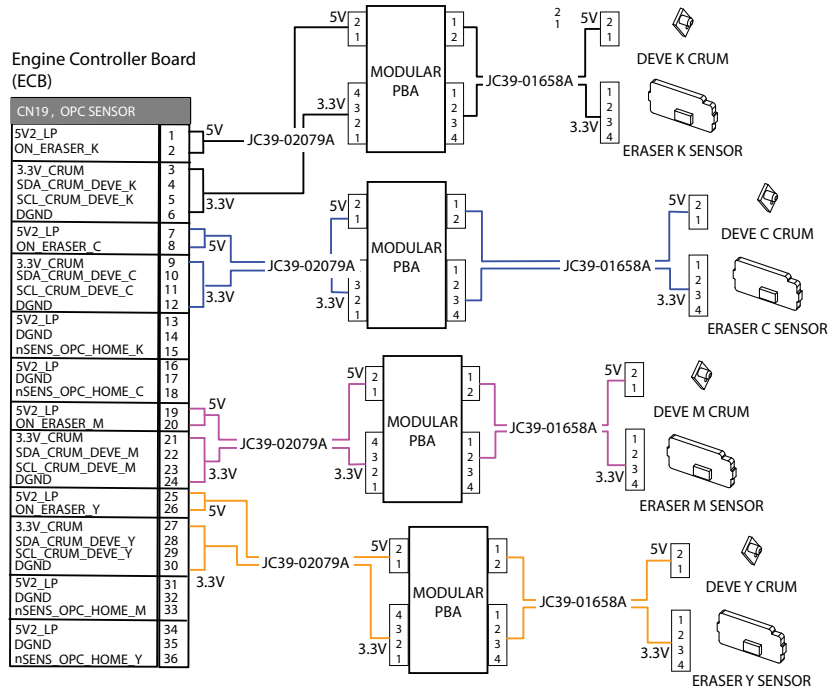
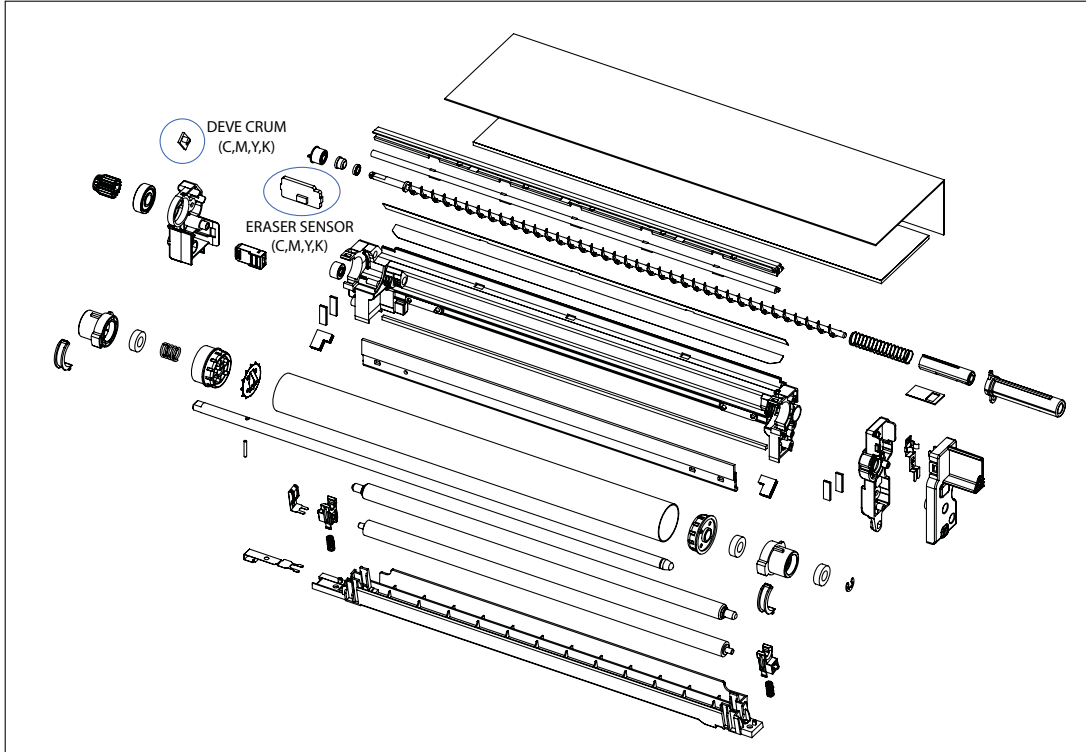

Optional dual-cassette feeder (DCF)

Pickup motor 1/2, feed motor, paper size sensor 1/2 and cover open sensor (DCF)

Figure 4-32 Pickup motor 1/2, feed motor, paper size sensor 1/2 and cover open sensor (DCF)

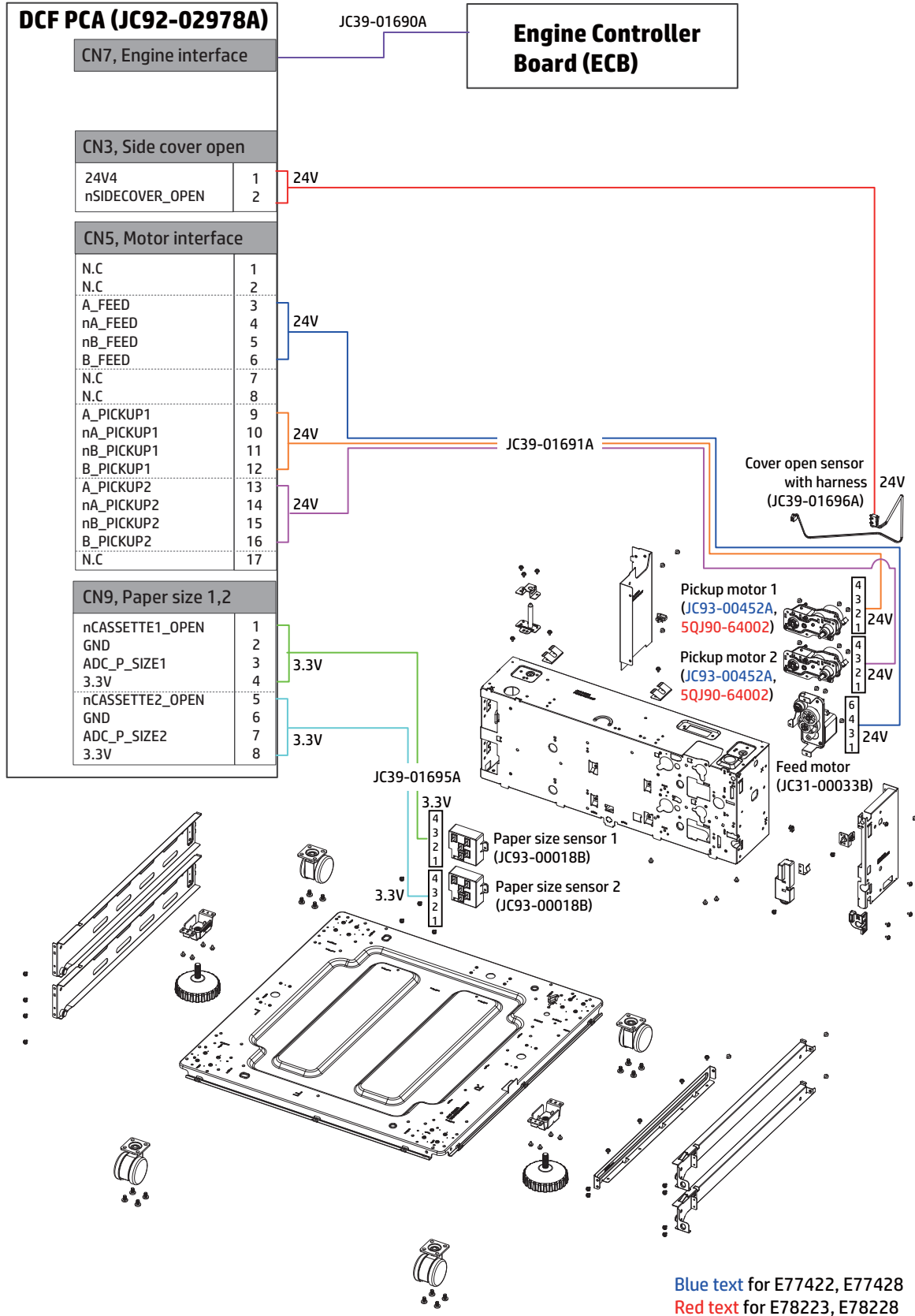

Feed sensor 1, empty sensor 1, and lift sensor 1 for tray 4 (DCF)

Figure 4-33 Feed sensor 1, empty sensor 1, and lift sensor 1 for tray 4 (DCF)

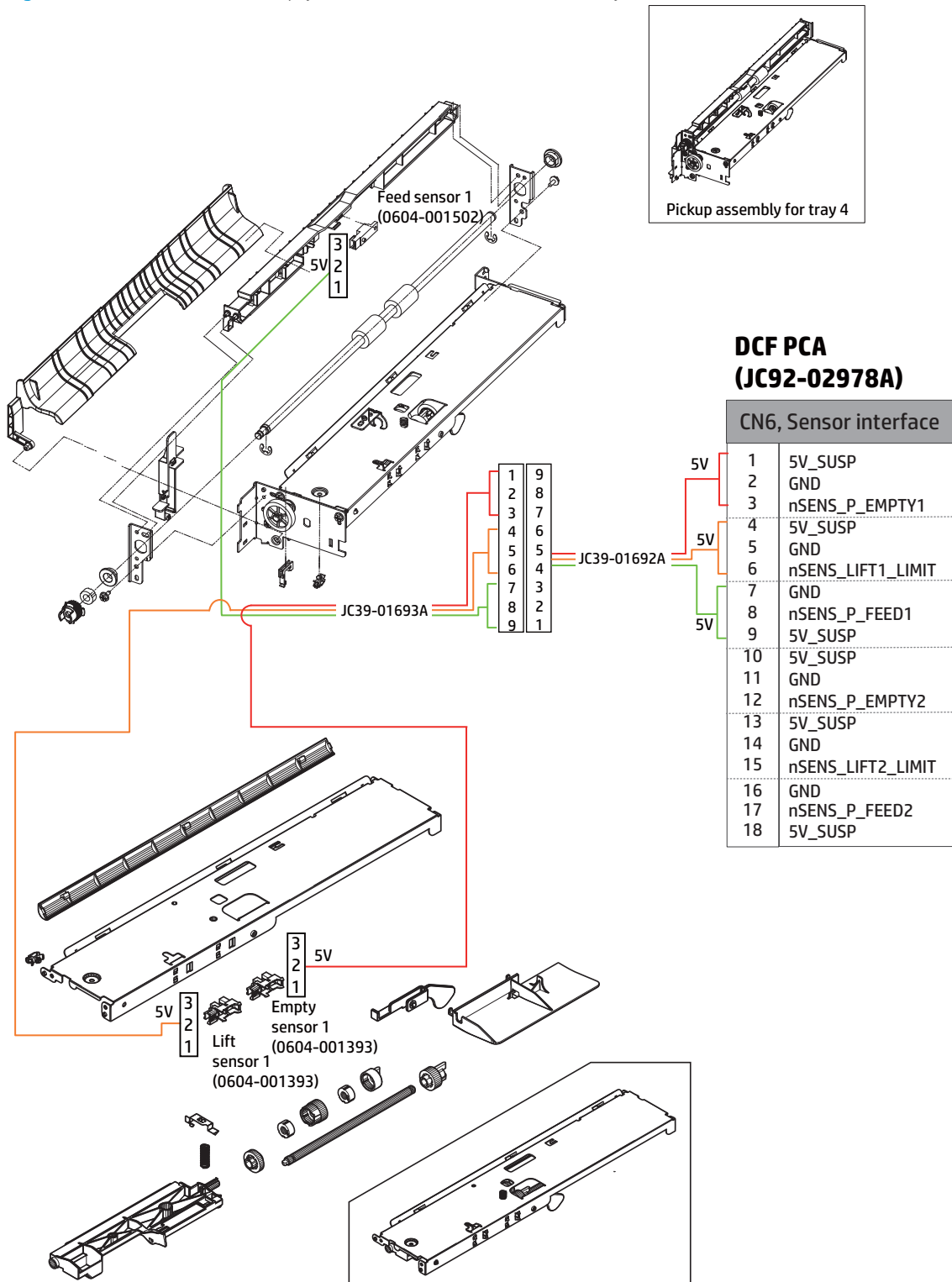

Feed sensor 2, empty sensor 2, and lift sensor 2 for tray 5 (DCF)

Figure 4-34 Feed sensor 2, empty sensor 2, and lift sensor 2 for tray 5 (DCF)

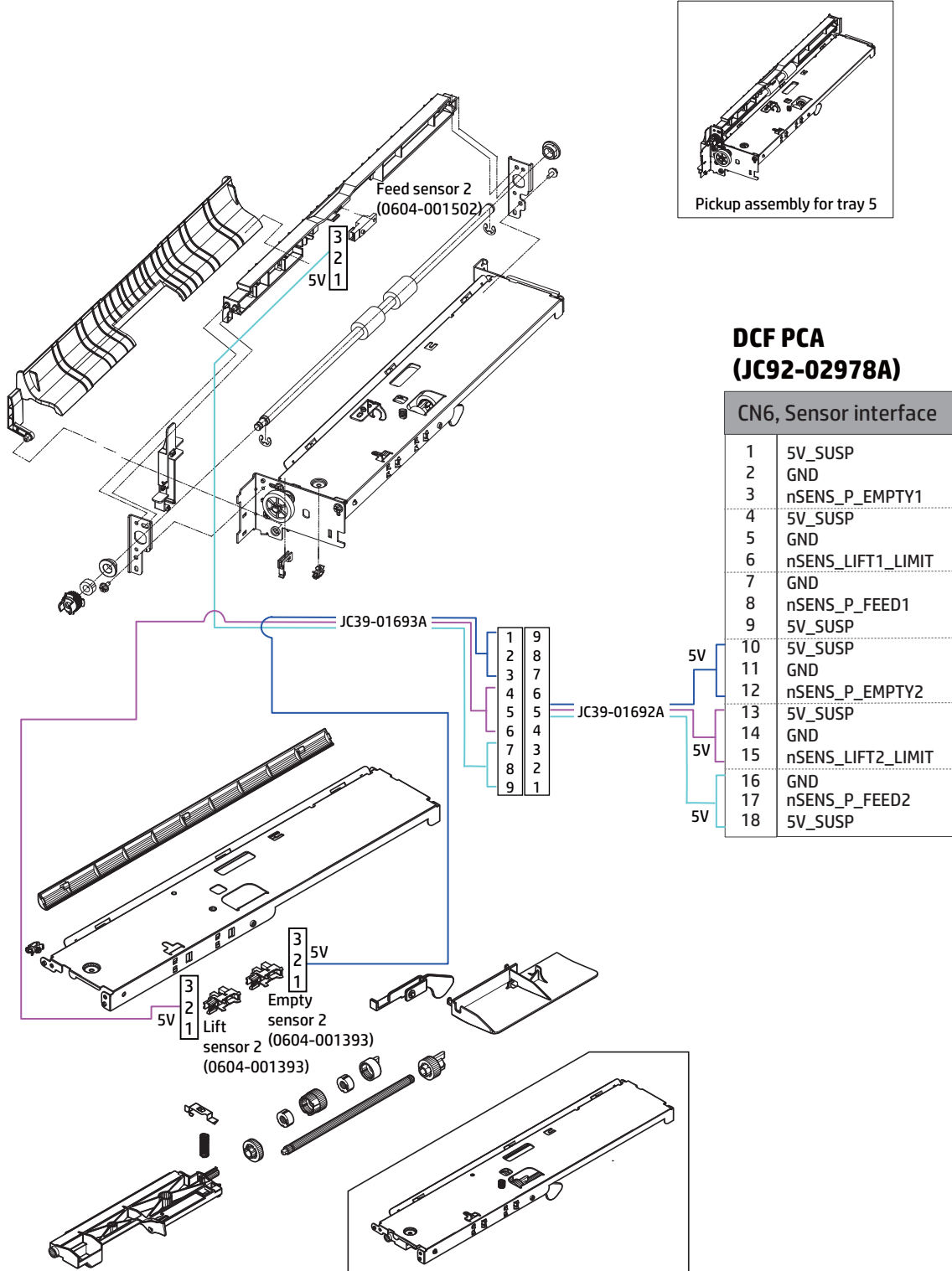

5 Inner finisher

Learn more about the inner finisher.

Product Specification and Description

Learn about the product specifications and descriptions of the inner finisher.

Inner finisher view

Learn about the front view and rear view of the inner finisher.

Front & rear view

Figure 5-1 Inner finisher system - front view

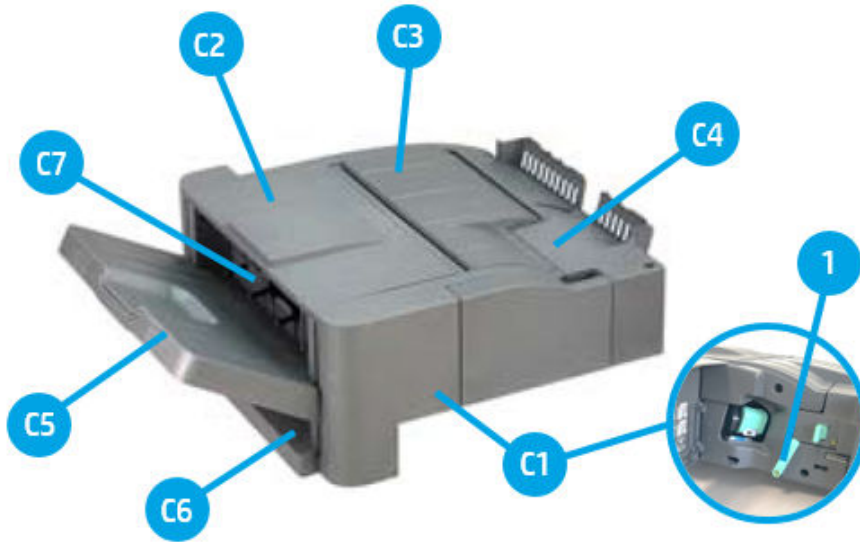

Figure 5-2 Inner finisher system - rear view

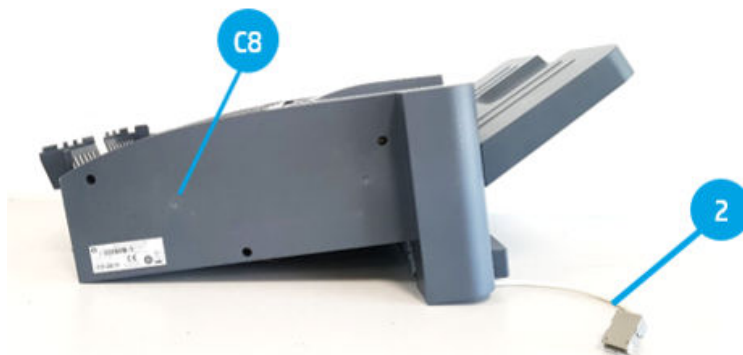

Table 5-1 Inner finisher system - entrance unit parts information

Item	Part name	Part number	Orderable ^(*)
C1	Front cover	JC90-01321B	(*)
C2	Top cover	JC90-01323B	(*)
C3	Middle cover	JC90-01322B	(*)
C4	Punch cover	JC90-01343B	(*)

Table 5-1 Inner finisher system - entrance unit parts information (continued)

Item	Part name	Part number	Orderable ^(*)
C5	Output tray	JC90-01337B	(*)
C6	PCA cover	JC63-04792B	(*)
C7	Left cover	JC90-01324B	(*)
C8	Rear cover	JC63-04750B	(*)
1	Lock release handle	JC66-04233A	(*)
2	Main interface harness	JC39-02169A	(*)

(*) This part is in ordering system.

Specification

Learn about the specifications of the inner finisher.

Item	Description
Capacity	550 Sheets (Main 500, Top 50) @ 80gsm
Sensing	Paper Jam/Tray Sensing/Stapler/Cover Open
Media Sizes	<ul style="list-style-type: none"> Main: 148 - 320 mm x 140-457.2 mm (58.3-126 inch x 55.1-180 inch) Top: 98 - 297 mm x 140-432 mm (38.6-116.9 inch x 55.1-170.1 inch)
Media types	Plain/Thick/Heavy weight/Thin/Cotton/Colored/Recycled/Bond/Archive/Pre-Punched/Cardstock/Glossy/Envelope
Media Weight	<ul style="list-style-type: none"> Main: 52-256 gsm (13.9-68.3 lb.) Top: 52-325 gsm (13.9-86.7 lb.)
Number of Bin	2 (Main/Top)
Dimension (W X D X H)	458 x 491 x 173 mm (18.0 X 19.3 X 6.8 inch)
Weight	15 kg (33 lb.)
Tray1 Finishing Capacity	50 Sheets @ 80gsm
Tray1 Finishing Mode	Stapling (Left, Right, Center)/Punch (2/3, 2/4, Swedish)
Tray2 Finishing Capacity	500 Sheets @ 80 gsm

Table 5-2 Paper Size Specification

Name	Paper size		Orientation	Output			Staple position			
	mm	Inches		Direction	Main tray		Top tray	Corner		DUAL
					52-256 g	Offset	52-325 g	45°	Flat	
A5	210 x 148	8.3 x 5.8	LEF	0	0	0	X	F/R ¹	0	
Statement	216 x 140	8.5 x 5.5	LEF	0	0	0	X	F/R ¹	0	

Table 5-2 Paper Size Specification (continued)

Name	Paper size		Orientation	Output			Staple position			
	mm	Inches		Direction	Main tray		Top tray	Corner		DUAL
					52-256 g	Offset	52-325 g	45°	Flat	
Lt	279 x 216	11 x 8.5	LEF	0	0	0	F/R ¹	X	0	
A4	297 x 210	8.3 x 11.7	LEF	0	0	0	F/R ¹	X	0	
B5(JIS)	257 x 182	10.1 x 7.2	LEF	0	0	0	F/R ¹	X	0	
B5(ISO)	250 x 176	9.8 x 6.9	LEF	0	0	0	F/R ¹	X	0	
Executive	267 x 184	10.5 x 7.3	LEF	0	0	0	F/R ¹	X	0	
No 9 Env	98 x 225	3.9 x 8.9	SEF	X	X	0	X	X	X	
Monarch Env	98.4 x 190.5	3.9 x 7.5	SEF	X	X	0	X	X	X	
PostCard 4X6	101.6 x 152.4	4.0 x 6.0	SEF	X	X	0	X	X	X	
A6	105 x 148	4.1 x 5.8	SEF	X	X	0	X	X	X	
No 10 Env	105 x 241	4.1 x 9.5	SEF	X	X	0	X	X	X	
DL Env	110 x 220	4.3 x 8.7	SEF	X	X	0	X	X	X	
C6 Env	114 x 162	4.5 x 6.4	SEF	X	X	0	X	X	X	
B6	128 x 182	5.0 x 7.2	SEF	X	X	0	X	X	X	
Statement	140 x 216	5.5 x 8.5	SEF	X	X	0	X	X	X	
A5	148 x 210	5.8 x 8.3	SEF	0	X	0	X	X	X	
C5 Env	162 x 229	6.4 x 9.0	SEF	X	X	0	X	X	X	
B5(ISO)	176 x 250	6.9 x 9.8	SEF	0	0	0	X	F/R ¹	X	
B5(JIS)	182 x 257	6.9 x 9.8	SEF	0	0	0	X	F/R ¹	X	
Executive	184 x 267	7.3 x 10.5	SEF	0	0	0	X	F/R ¹	X	
16k	195 x 270	7.7 x 10.6	SEF	0	0	0	X	F/R ¹	0	
A4	210 x 297	8.3 x 11.7	SEF	0	0	0	X	F/R ¹	0	
Legal	216 x 356	8.5 x 14	SEF	0	0	0	X	F/R ¹	0	
Letter	216 x 279	8.5 x 11	SEF	0	0	0	X	F/R ¹	0	
Folio	216 x 330	8.5 x 13	SEF	0	0	0	X	F/R ¹	0	
Oficio	215.9 x 342.9	8.5 x 13.5	SEF	0	0	0	X	F/R ¹	0	
C4	229 x 324	9.1 x 12.8	SEF	X	X	0	X	X	X	
Tabloid	254 x 374	10 x 14.7	SEF	0	0	0	F/R ¹	X	0	
B4	257 x 364	10 x 14.3	SEF	0	0	0	F/R ¹	X	0	
8K	270 x 390	10.6 x 15.4	SEF	0	0	0	F/R ¹	X	0	

Table 5-2 Paper Size Specification (continued)

Name	Paper size		Orientation	Output			Staple position			
	mm	Inches		Direction	Main tray		Top tray	Corner		DUAL
					52-256 g	Offset	52-325 g	45°	Flat	
Ledger	279 x 432	11 x 17	SEF	0	0	0	F/R ¹	X	0	
A3	297 x 420	11.7 x 16.5	SEF	0	0	0	F/R ¹	X	0	
Tabloid Extra	304.8 x 457.2	12 x 18	SEF	0	X	X	X	X	X	
SRA3	320 x 450	12.6 x 17.7	SEF	0	0	X	X	X	X	
Custom	W 98-320 ~ L 140-1200	W 3.9-12.6 ~ L 5.5-47	—	W 148-320 - L 140-1200	X	W 98-297 - L 140-1200	X	X	X	

¹ "F/R" means front side and rear side can be supported.

Name	Paper size		Orientation	Punch						
	mm	Inches			Direction	NA 2/3		EU 2/4H		Swedish
						2H	3H	2H	4H	4H
A5	210 x 148	8.3 x 5.8	LEF	0	X	0	X	0		
Statement	216 x 140	8.5 x 5.5	LEF	0	X	0	X	0		
Lt	279 x 216	11 x 8.5	LEF	0	0	0	0	0		
A4	297 x 210	8.3 x 11.7	LEF	0	0	0	0	0		
B5 (JIS)	257 x 182	10.1 x 7.2	LEF	0	0	0	X	0		
B5 (ISO)	250 x 176	9.8 x 6.9	LEF	0	0	0	X	0		
Executive	267 x 184	10.5 x 7.3	LEF	0	0	0	0	0		
No 9 Env	98 x 225	3.9 x 8.9	SEF	X	X	X	X	X		
Monarch Env	98.4 x 190.5	3.9 x 7.5	SEF	X	X	X	X	X		
PostCard 4X6	101.6 x 152.4	4.0 x 6.0	SEF	X	X	X	X	X		
A6	105 x 148	4.1 x 5.8	SEF	X	X	X	X	X		
No 10 Env	105 x 241	4.1 x 9.5	SEF	X	X	X	X	X		
DL Env	110 x 220	4.3 x 8.7	SEF	X	X	X	X	X		
C6 Env	114 x 162	4.5 x 6.4	SEF	X	X	X	X	X		
B6	128 x 182	5.0 x 7.2	SEF	X	X	X	X	X		
Statement	140 x 216	5.5 x 8.5	SEF	X	X	X	X	X		
A5	148 x 210	5.8 x 8.3	SEF	0	X	0	X	0		

Name	Paper size		Orientation	Punch				
	mm	Inches		Direction	NA 2/3		EU 2/4H	
			2H		3H	2H	4H	4H
C5 Env	162 x 229	6.4 x 9.0	SEF	X	X	X	X	X
B5(ISO)	176 x 250	6.9 x 9.8	SEF	0	X	0	X	0
B5(JIS)	182 x 257	6.9 x 9.8	SEF	0	X	0	X	0
Executive	184 x 267	7.3 x 10.5	SEF	0	X	0	X	0
16k	195 x 270	7.7 x 10.6	SEF	0	X	0	X	0
A4	210 x 297	8.3 x 11.7	SEF	0	X	0	X	0
Legal	216 x 356	8.5 x 14	SEF	0	X	0	X	0
Letter	216 x 279	8.5 x 11	SEF	0	X	0	X	0
Folio	216 x 330	8.5 x 13	SEF	0	X	0	X	0
Oficio	215.9 x 342.9	8.5 x 13.5	SEF	0	X	0	X	0
C4	229 x 324	9.1 x 12.8	SEF	X	X	X	X	X
Tabloid	254 x 374	10 x 14.7	SEF	0	0	0	X	0
B4	257 x 364	10 x 14.3	SEF	0	0	0	X	0
8K	270 x 390	10.6 x 15.4	SEF	0		0	0	0
Ledger	279 x 432	11 x 17	SEF	0	0	0	0	0
A3	297 x 420	11.7 x 16.5	SEF	0	0	0	0	0
Tabloid Extra	304.8 x 457.2	12 x 18	SEF	X	X	X	X	X
SRA3	320 x 450	12.6 x 17.7	SEF	X	X	X	X	X
Custom	W 98-320 ~ L 140-1200	W3.9-12.6 ~ L 5.5-47	-	X	X	X	X	X

Table 5-3 Media performance

Paper Type	Function			
	Main Tray	Top Tray	Staple	Punch
Plain (71-90 g/m ²)	0	0	0	0
Thick (91-105 g/m ²)	0	0	0	0
Heavy weight (106-175 g/m ²)	0	0	0	0
Extra Heavy weight 1 (176-216 g/m ²)	0	0	0	0
Extra Heavy weight 2 (217-256 g/m ²)	0	0	0	0
Extra Heavy weight 3 (257-300 g/m ²)	X	0	X	X
Extra Heavy weight 4 (301-325 g/m ²)	X	0	X	X

Table 5-3 Media performance (continued)

Paper Type	Function			
	Main Tray	Top Tray	Staple	Punch
Thin (60-70 g/m ²)	0	0	0	0
Cotton (75-90 g/m ²)	0	0	0	0
Colored (75-90 g/m ²)	0	0	0	0
Pre-Printed (75-90 g/m ²)	0	0	0	0
Recycled (60-90 g/m ²)	0	0	0	0
Bond	0	0	0	0
Archive (75-105 g/m ²)	0	0	0	0
LetterHead	0	0	0	0
Pre-Punched	0	0	0	X
Thin Cardstock (105-163 g/m ²)	0	0	0	0
Thick Cardstock (170-216 g/m ²)	0	0	0	X
Heavy Cardstock (217-256 g/m ²)	0	0	0	X
Extra Heavy Cardstock 1(257-300 g/m ²)	X	0	X	X
Extra Heavy Cardstock 2(301-325 g/m ²)	X	0	X	X
Thin Glossy (106-169 g/m ²)	0	0	0	0
Thick Glossy (170-216 g/m ²)	0	0	0	X
Heavy Glossy (217-256 g/m ²)	0	X	X	X
Envelope (75-90 g/m ²)	X	0	X	X
Thick Envelope (217-256 g/m ²)	0	X	X	X
Tab	0	X	X	0
Perforated Paper (75-90 g/m ²)	X	0	X	X

Inner finisher system

Learn about the inner finisher system.

Overview

Learn about the overview of the inner finisher.

Work flow

Figure 5-3 Inner finisher system - work flow overview

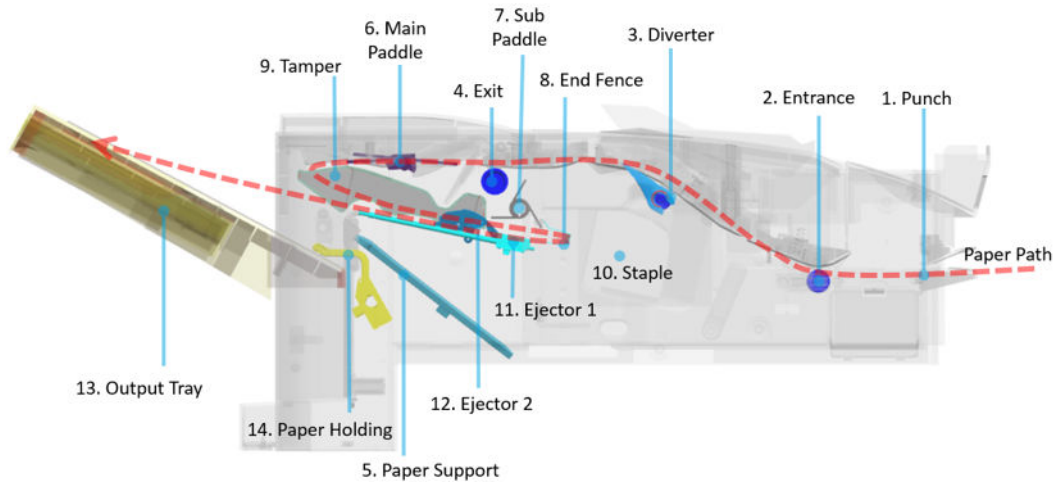

Table 5-4 Inner finisher system - work flow overview

Item	Unit	Description
1	Punch unit	holes in a specific location on a sheet of paper
2	Entrance unit	allows paper to move into the finisher
3	Diverter unit	holds paper so that the newly printed paper can stay out for seconds while the stapled bundle of paper moves to the output tray
4	Exit unit	moves paper from the diverter unit to the ejector unit
5	Paper support unit	prevents paper from being fallen down or bent when the long length paper such as A3 is ejected from the exit unit
6	Main paddle unit	moves paper to the sub paddle
7	Sub paddle unit	moves paper to the end fence
8	End fence unit	sets the standard position of the paper to be aligned towards top and bottom of the paper
9	Tamper unit	aligns the paper on the right and left side of the paper
10	Stapler unit	performs stapling to a bundle of aligned documents
11	Ejector 1 unit	transfers a stapled paper loaded at the end fence unit to the ejector2 unit
12	Ejector 2 unit	grips a stack of paper up and ejects it onto the output tray
13	Output tray unit	stacks the job ended paper
14	Paper holding unit	controls the output tray movement

Figure 5-4 Inner finisher system - sensor

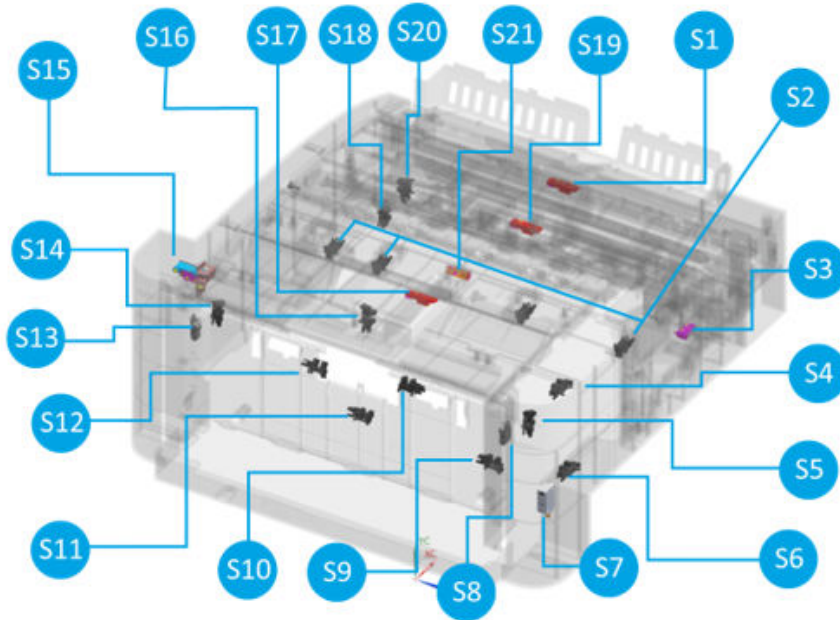

Table 5-5 Inner finisher system - sensor

No	Name	Part number	Orderable ^(*)	Diagnostics	Type	Description
S1	Entrance sensor	0604-001381	(*)	113-0350	Photo emitter, detector	Checks paper comes into the entrance unit
S2	Stapler position sensor	0604-001393		113-0491 113-0492	Photo interrupter	Makes the stapler be positioned in the exact stapling position
S3	Front cover switch	JC39-01610A		113-0410	Cover open switch	Checks whether the front cover is closed or opened
S4	Main paddle home sensor	0604-001393		113-0370	Photo interrupter	Checks the main paddle locates at the home position
S5	Front tamper home sensor	0604-001393		113-0390	Photo interrupter	Checks the front tamper locates at the home position
S6	Output tray motor sensor	0604-001393		113-0473	Photo interrupter	Checks the output tray motor is operational
S7	Output tray lower limit switch	JC90-01320A	(*)	113-0472	Lower limit switch assembly	Checks the lower limit (=Output tray is full) of the output tray
S8	Output tray top of stack sensor (receiver)	0603-001309	(*)	113-0471	Photo TR	Checks the upper limit of output tray
S9	Paper holding sensor	0604-001393		113-0470	Photo interrupter	Checks the location of the paper holding actuator
S10	Ejector 2 home sensor	0604-001393		113-0462	Photo interrupter	Checks the ejector 2 locates at the home position.
S11	Ejector 2 motor sensor	0604-001393		113-0463	Photo interrupter	Checks the ejector 2 motor is operational

Table 5-5 Inner finisher system - sensor (continued)

No	Name	Part number	Orderable ^(*)	Diagnostics	Type	Description
S12	Paper support home sensor	0604-001393		113-0481	Photo interrupter	Checks the paper support locates at the home position
S13	Output tray top of stack sensor (led)	0601-003440		113-0471	LED IR	Checks the upper limit of output tray
S14	Rear tamper home sensor	0604-001393		113-0380	Photo interrupter	Checks the rear tamper locates at the home position
S15	Top cover switch	JC39-01610A	(*)	113-0420	Cover open switch	Checks whether the top cover is closed or opened
S16	Ejector 1 home sensor	0604-001393		113-0461	Photo interrupter	Checks the ejector 1 locates at the home position
S17	End fence sensor	0604-001381	(*)	113-0361	Photo emitter, detector	Check paper comes into the end fence unit
S18	Punch waste box sensor	0604-001393		113-0620	Photo interrupter	Detects the punch waste box is installed
S19	Punch waste full sensor	0604-001381	(*)	113-0621	Photo emitter, detector	Checks the punch waste box is full
S20	Finisher docking sensor	0604-001393		113-0000	Photo interrupter	Checks the finisher is installed
S21	Exit sensor	0604-001415	(*)	113-0360	Photo interrupter	Checks paper comes into the exit unit

^(*) This part is in ordering system.

Figure 5-5 Inner finisher system - Photo interrupter (0604-001393)

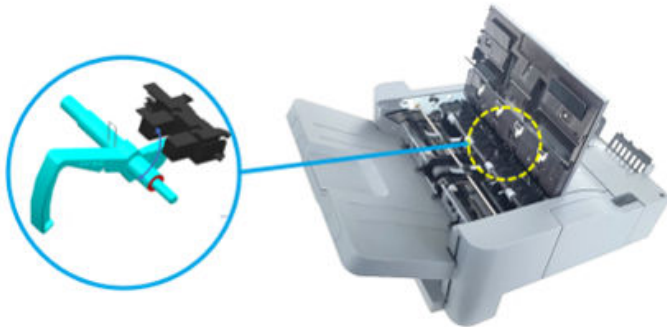
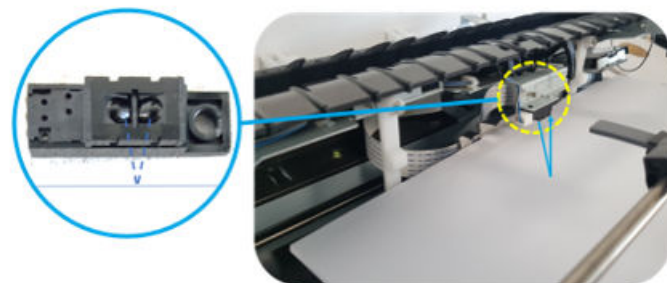

Figure 5-6 Inner finisher system - Photo emitter, detector (0604-001381)



Motor and solenoid

Figure 5-7 Inner finisher system - motor, solenoid

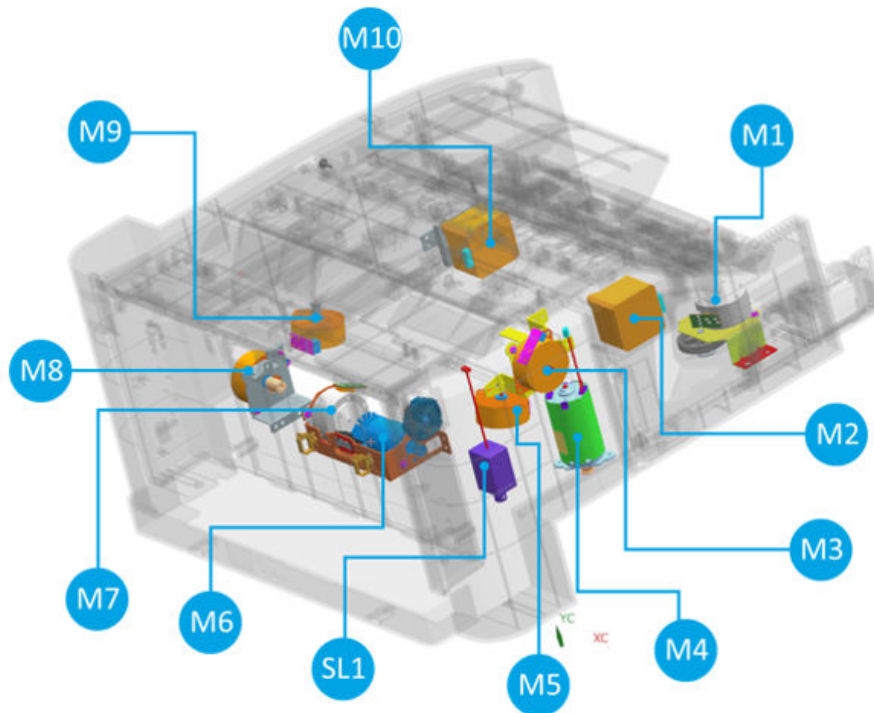

Table 5-6 Inner finisher system - motor, solenoid

No	Name	Part number	Orderable ^(*)	Diagnostics	Type	Motor sensor	Description
M1	Stapler position motor	JC93-00999A	(*)	113-0581	Step motor		Drives the stapler unit
M2	Exit motor	JC31-00169B	(*)	113-0502	Step motor		Drives the exit roller and the sub paddle unit
M3	Main paddle motor assembly	JC93-01001A	(*)	113-0510	Step motor	Home	Drives the main paddle unit
M4	Output tray motor assembly	JC90-01334B	(*)	113-0570	DC Motor	Encoder	Drives the output tray unit
M5	Rear tamper motor assembly	JC93-01001A	(*)	113-0520	Step motor	Home	Drives the rear tamper unit
M6	Ejector2 motor assembly	JC93-01168A		113-0562	DC Motor	Home, encoder	Drives the ejector 2 unit
M7	Ejector1 motor assembly	JC93-00998A		113-0561	Step Motor	Home	Drives the ejector 1 unit
M8	Paper support motor assembly	JC93-00802B		113-0571	Step Motor	Home	Drives paper support unit

Table 5-6 Inner finisher system - motor, solenoid (continued)

No	Name	Part number	Orderable ^(*)	Diagnostics	Type	Motor sensor	Description
M9	Front tamper motor assembly	JC93-01001A	(*)	113-0530	Step Motor	Home	Drives the front tamper unit
M10	Entrance motor assembly	JC90-01344A	(*)	113-0501	Step Motor		Drives the entrance roller and the middle roller
SL1	Paper holding solenoid	JC33-00037A	(*)	113-0591	Solenoid		Drives paper holding unit

^(*) This part is in ordering system.

The sensor mounted at the driving motor detects motor operation. If a motor doesn't work properly, an event code only for the motor will pop up.

Figure 5-8 Inner finisher system - motor sensor

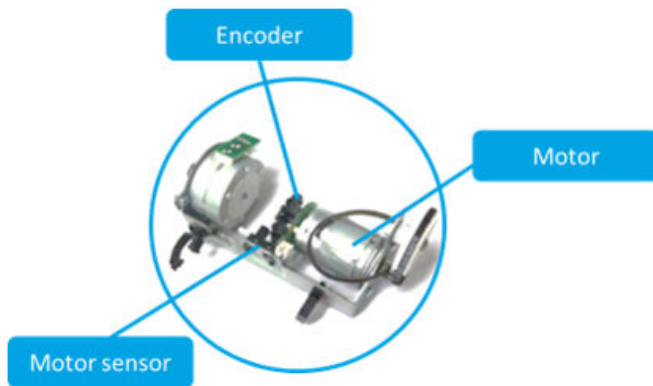

The home position sensor is installed for the purpose of checking the reference point when the specific unit is operating.

Figure 5-9 Inner finisher system - home sensor

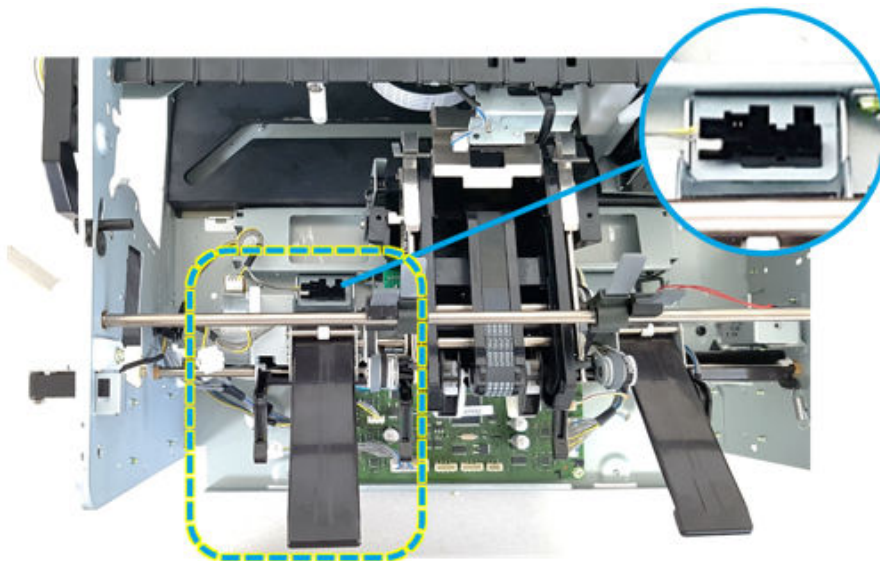

Roller

Figure 5-10 Inner finisher system - roller

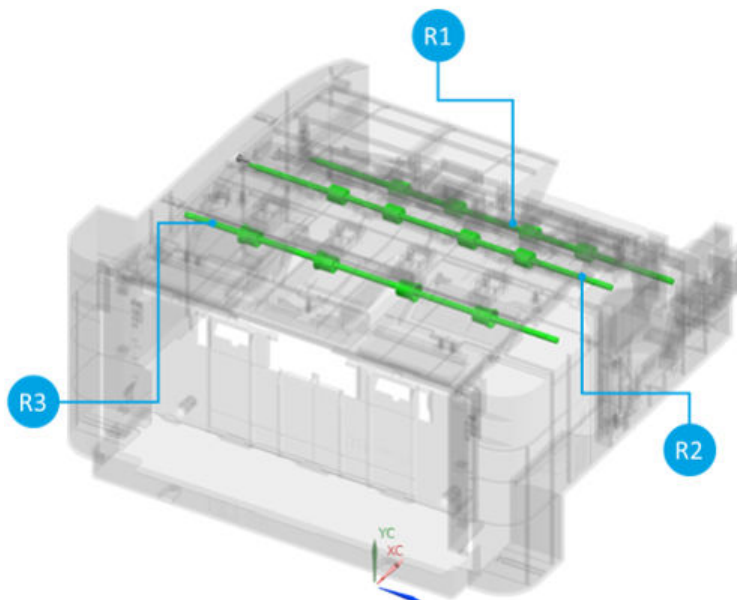

Table 5-7 Inner finisher system - roller

No	Name	Part number	Orderable ^(*)	Diagnostics	Type	Description
R1	Entrance roller	JC66-04243A	(*)		Roller	Moves paper forward
R2	Middle roller	JC66-04243A	(*)		Roller	Moves paper forward
R3	Exit roller	JC66-04244A	(*)		Roller	Moves paper forward

^(*) This part is in ordering system.

Figure 5-11 Inner finisher system - PCA

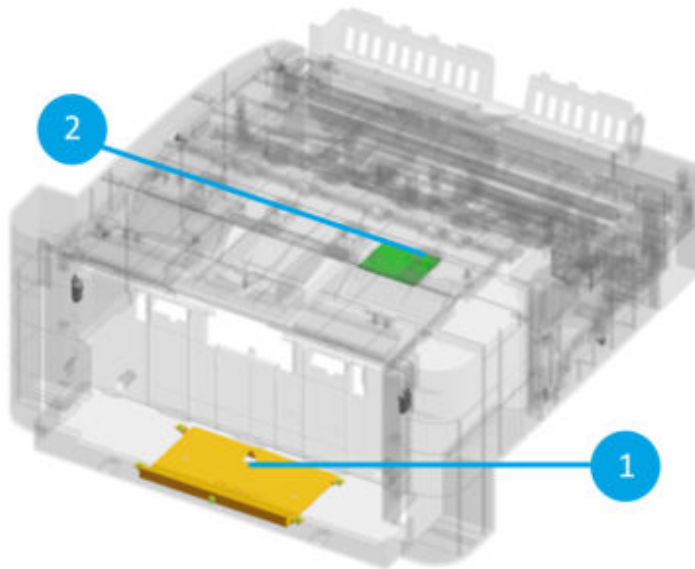

Table 5-8 Inner finisher system - roller

No	Name	Part number	Orderable ^(*)	Diagnostics	Type	Description
1	Main PCA	JC92-02774B	(*)			
2	Rear joint PCA	JC92-02780A	(*)			Joint PCA between main PCA and several parts punch, stapler, entrance, and front door

(*) This part is in ordering system.

Punch unit (optional)

Learn about the punch unit of the inner finisher.

The punch unit is a device that punches holes in a specific location on a sheet of paper. The punch unit is located immediately before the entrance unit and punches holes onto a paper.

- HP LaserJet Inner Finisher Hole2/3 Punch : Y1G02-67901
- HP LaserJet Inner Finisher Hole2/4 Punch : Y1G03-67901
- HP LaserJet Inner Finisher Swedish Punch : Y1G04-67901

 **NOTE:** Puncher types vary depending on the country/region.

In case of 2/3 hole punch, the 5 hole-punches are mounted in the punch unit. As the punch motor rotates clockwise, the inner gear moves to the right and the 3 hole-punches are moved downward to make holes. When making 2 holes, the motor rotates in the counterclockwise direction and the inner gear rotates to the left to drill two holes. The travel distance and position of the motor are detected and controlled by the hole punch home sensor and the hole punch motor sensor.

Figure 5-12 Inner finisher system - punched hole location and pair

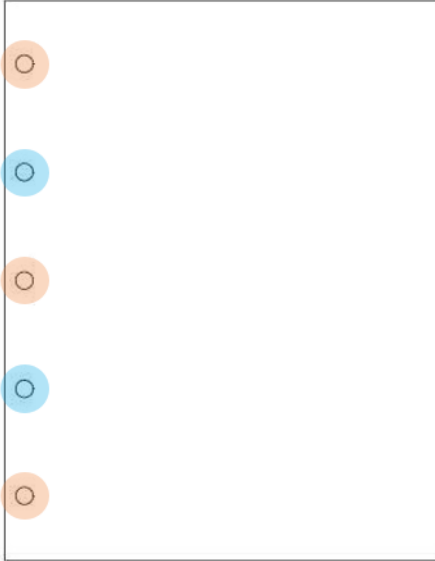

For more information, go to the HP WISE support portal and search for *HP LaserJet Managed MFP - How to use the hole punch* (c05450959).

Figure 5-13 Inner finisher system - punch unit overview

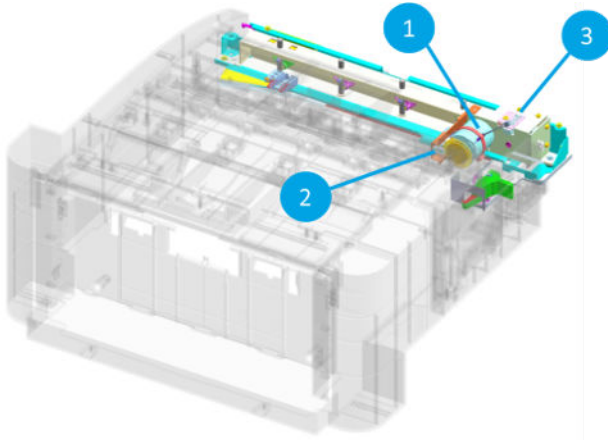

Figure 5-14 Inner finisher system - punch unit detail view

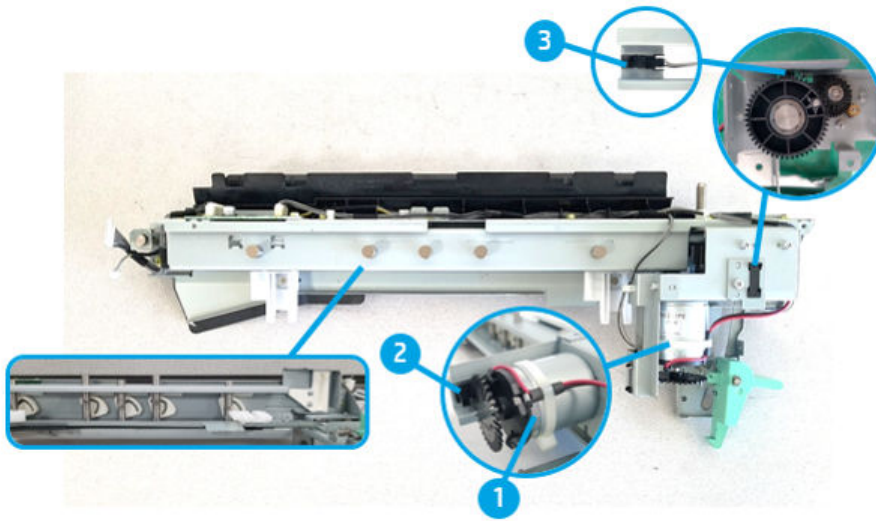

Table 5-9 Inner finisher system - punch unit parts information

Item	Part name	Part number	Orderable ^(*)	Diagnostics	Description
-	Hole 2/3 Punch	Y1G02-67901	(*)		Punch unit assembly for hole 2/3
	Hole 2/4 Punch	Y1G03-67901			Punch unit assembly for hole 2/4
	Swedish Punch	Y1G04-67901			Punch unit assembly for swedish
	Punch cover	JC90-01343B			Punch cover (for the finisher punch is not installed)
1	Punch motor	-		113-0610	Drives the entrance roller connected by a belt
2	Punch motor sensor	-		113-0600	Detects punch motor operation
3	Punch home sensor	-		113-0612	Detects punchers' home position
Not shown	SVC AS-PBA-HOLE PUNCH 2-4 HOLE	SS465-67001	(*)		
Not shown	SVC AS-PBA-HOLE PUNCH SWEDISH	SS466-67001	(*)		
Not shown	SVC AS-PBA-HOLE PUNCH 2-3	SS467-67001	(*)		

(*) This part is in system.

Figure 5-15 Inner finisher system - punch unit operation (3 holes)

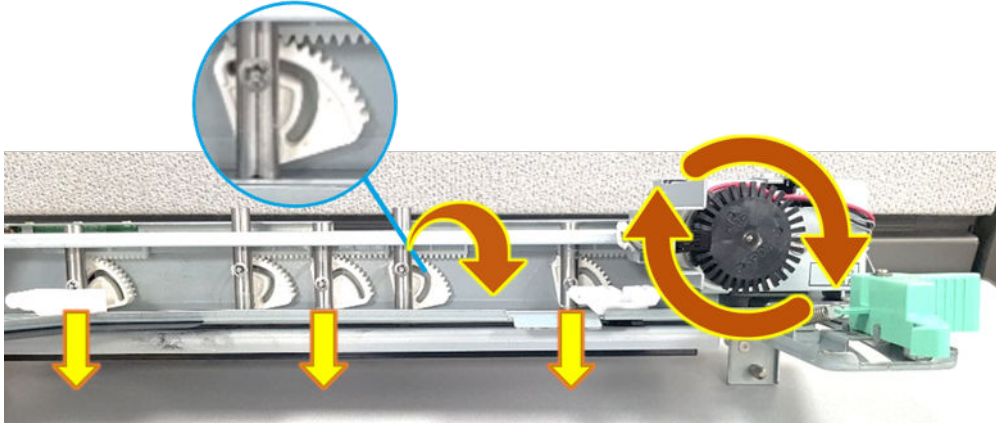
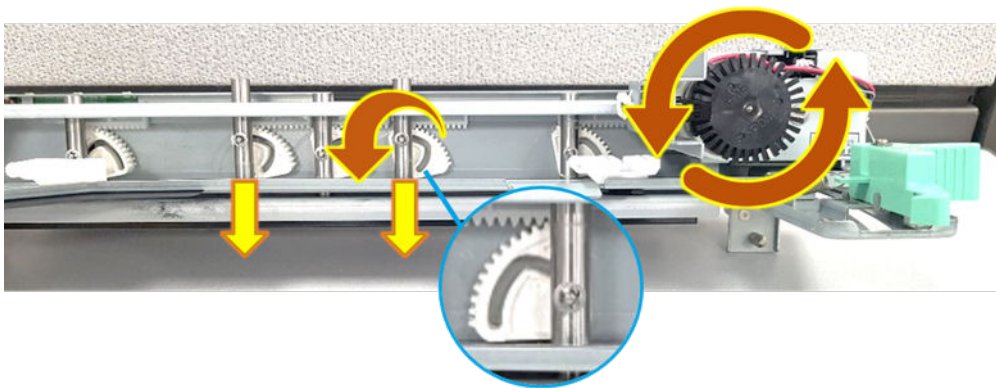

Figure 5-16 Inner finisher system - punch unit operation (2 holes)



Entrance unit

Learn about the entrance unit of the inner finisher.

The entrance unit is located right after the punch unit. This unit is driven by entrance motor which is installed on the rear of the finisher. This motor is connected to the entrance roller by a belt, which transfers driving force to move paper from the printer to the finisher inside. If an error such as paper jam occurs in the entrance unit, the entrance sensor detects the error and generates an event code (13.60.xx).

Figure 5-17 Inner finisher system - entrance unit overview

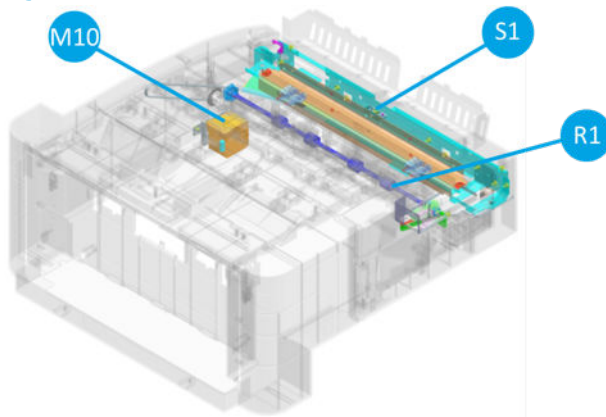

Figure 5-18 Inner finisher system - entrance unit detail view

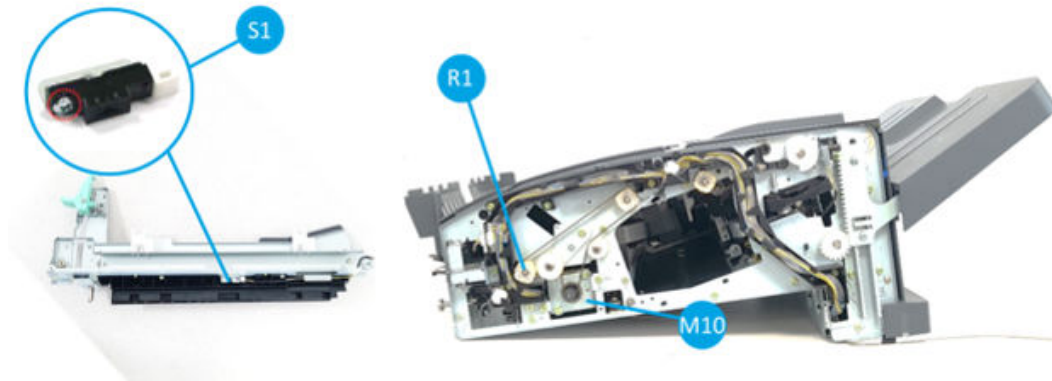

Table 5-10 Inner finisher system - entrance unit parts information

Item	Part name	Part number	Orderable ^(*)	Diagnostics	Description
S1	Entrance sensor	0604-001381	(*)	113-0350	Detects paper if it comes into the entrance unit
M10	Entrance motor assembly	JC90-01344A	(*)	113-0501	Drives the entrance roller connected by a belt
-	Entrance motor	JC31-00169B	(*)		
R1	Entrance roller	JC66-04243A	(*)		Moves paper forward

(*) This part is in ordering system.

Diverter unit

Learn about the diverter unit of the inner finisher.

The diverter unit holds paper so that the newly printed paper can wait for a few seconds until the stapled bundle moves to the output tray. The diverter unit is used to change paper path, which is done by a spring mounted on the diverter unit. When paper exit from the unit, it goes through the upper path of the diverter. When the paper rolls back, it passes the lower paper path created by the diverter. Here, the paper sits for a while until the next paper is ready to come out together.

Figure 5-19 Inner finisher system - diverter unit overview

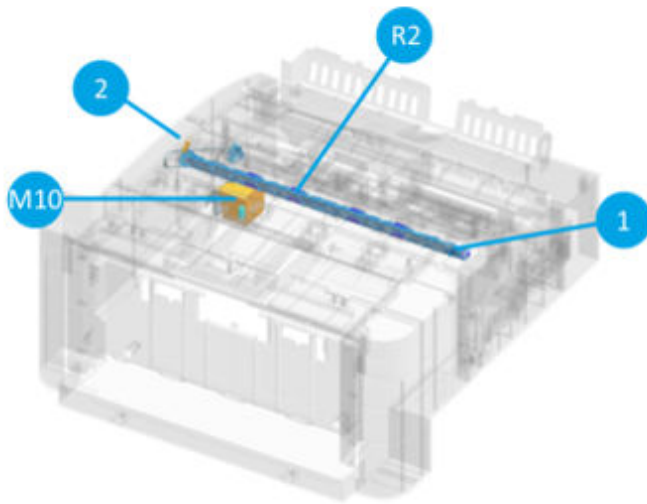

Figure 5-20 Inner finisher system - diverter unit detail view

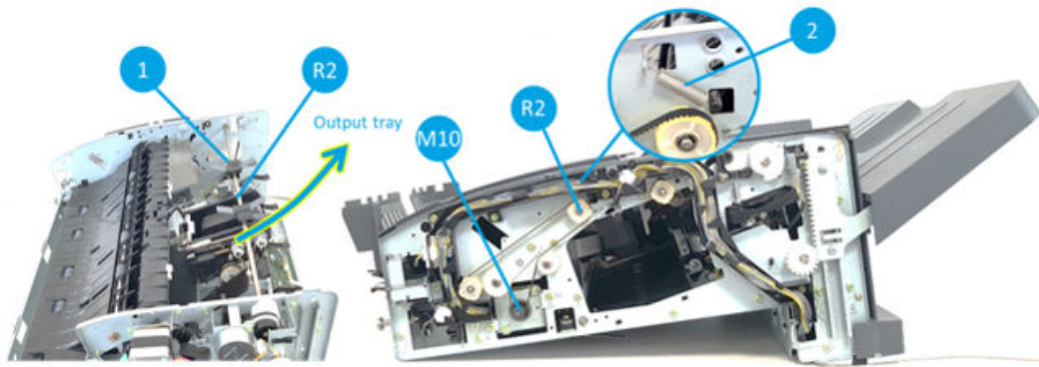

Table 5-11 Inner finisher system - diverter unit parts information

Item	Part name	Part number	Orderable ^(*)	Diagnostics	Description
M10	Entrance motor assembly	JC90-01344A	(*)	113-501	Drives the feed roller connected by a belt
	Entrance motor	JC31-00169B	(*)		
R2	Middle roller	JC66-04243A	(*)		Drives paper forward installed in front of the diverter
1	Diverter	JC61-06392A			Changes paper path when paper goes backward
2	Diverter spring	JC61-07269A			Pulls the diverter to upward so that it makes paper path to the lower of the diverter

(*) This part is in ordering system.

Diverter unit operation

1. Paper goes forward to the output tray.

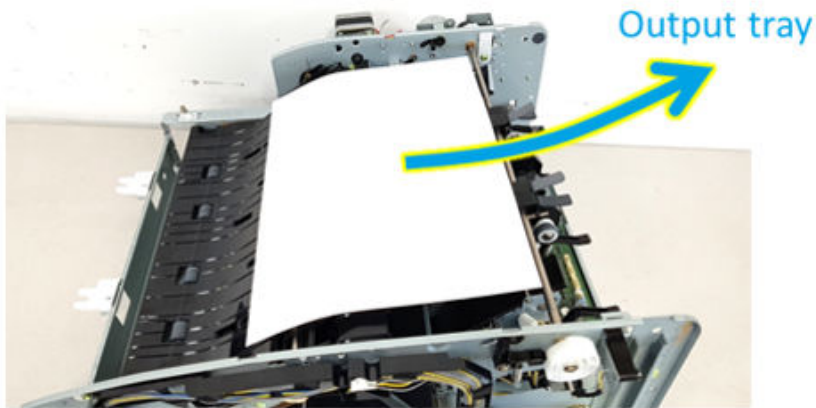

2. Exit roller stops after paper passes by the diverter unit.

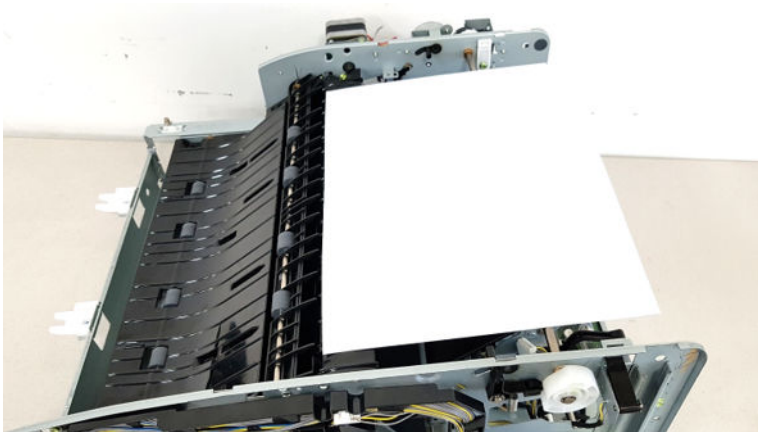

3. Paper goes backward under the diverter unit.

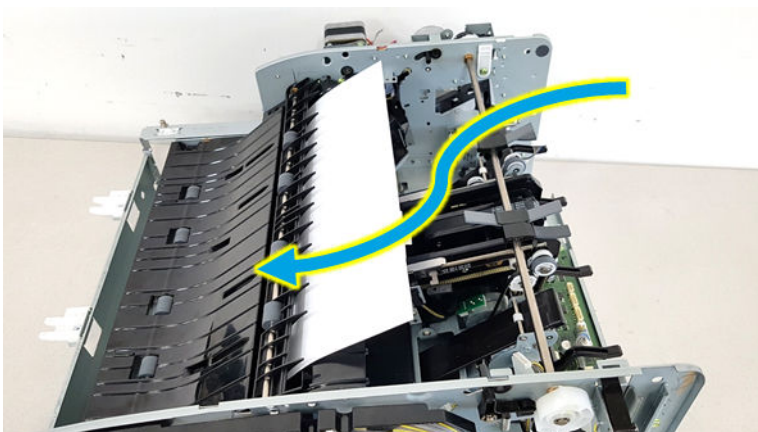

Exit unit

Learn about the exit unit of the inner finisher.

The exit unit is the part that moves paper from the diverter unit to the ejector unit. The exit unit is powered by an exit motor installed on the front of the finisher. The motor and the exit roller are connected by a single belt. The exit motor rotates in both the forward and reverse directions, since it serves to return paper to a new paper path

created by the diverter unit. The exit sensor is installed right in front of exit roller. It generates an event code when a paper jam occurred.

Figure 5-21 Inner finisher system - exit unit overview

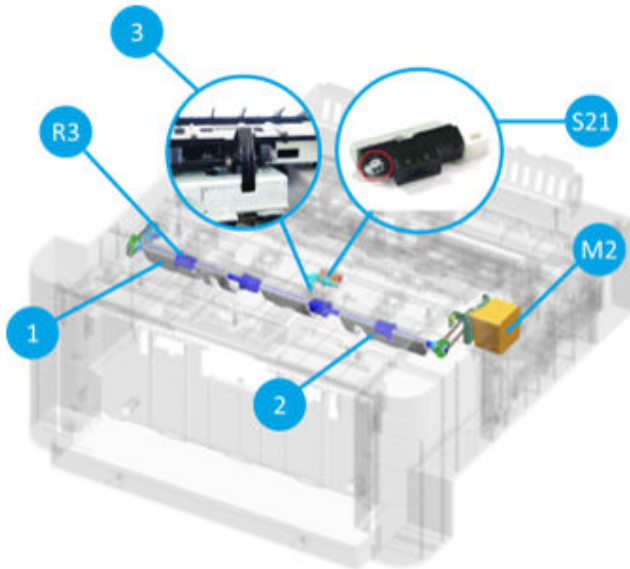

Figure 5-22 Inner finisher system - exit unit detail view

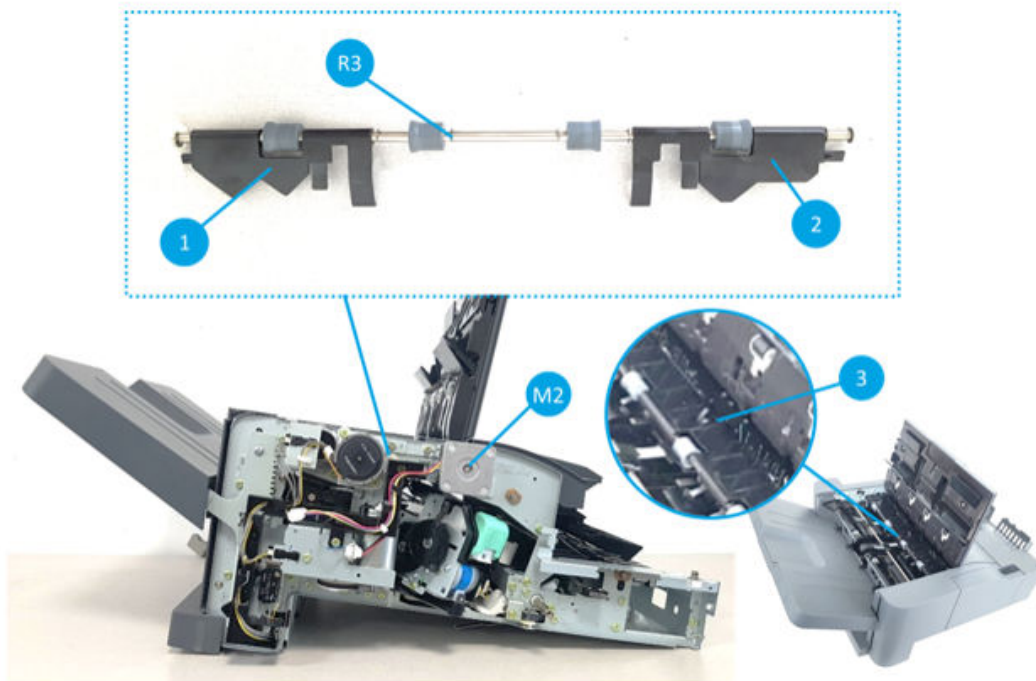

Table 5-12 Inner finisher system - exit unit parts information

Item	Part name	Part number	Orderable ^(*)	Diagnostics	Description
1	Rear compile guide	JC61-07450A	(*)		Guides to help paper move through the paper path
2	Front compile guide	JC61-07449A	(*)		Guides to help paper move through the paper path

Table 5-12 Inner finisher system - exit unit parts information (continued)

Item	Part name	Part number	Orderable ^(*)	Diagnostics	Description
3	Exit sensor actuator	JC66-04199A	(*)	113-0360	Makes the sensor on and off by checking paper
S21	Exit sensor	0604-001415	(*)	113-0360	Detects paper if it passes through the exit unit
M2	Exit motor assembly	JC90-01331A		113-0502	Drives the exit roller connected by a belt
	Exit motor	JC31-00169B	(*)		
R3	Exit roller	JC66-04244A	(*)		Moves paper to the ejector unit

^(*) This part is in ordering system.

Exit unit operation

1. When rotating the exit motor counter clockwise, paper goes forward to the output tray.

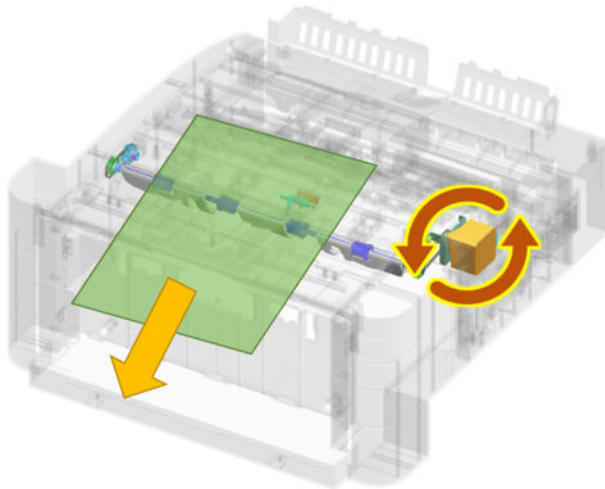

2. When rotating the exit motor clockwise, paper goes backward to the end fence unit.

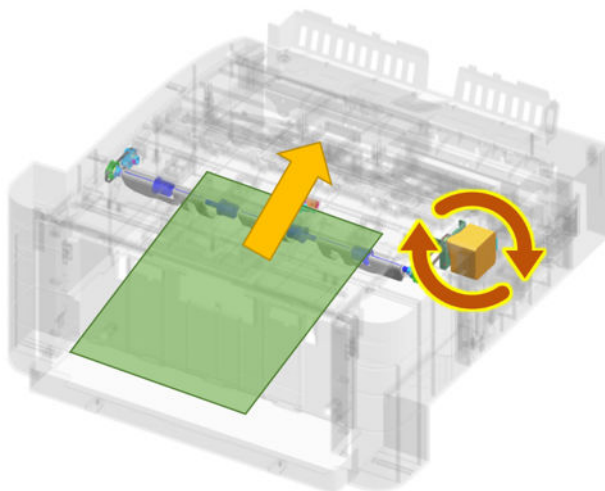

Paper support unit

Learn about the paper support unit of the inner finisher.

Paper support unit works to prevent the paper from falling out or being folded. Also, the newly printed paper will not scatter papers already sitting on the output tray. Paper guides are installed on each front and rear side of the finisher, these guides move towards the output tray when the paper exits, then the guides return to the original position after the support operation is completed. The paper support home sensor confirms the original position of the guide.

Figure 5-23 Inner finisher system - paper support unit overview

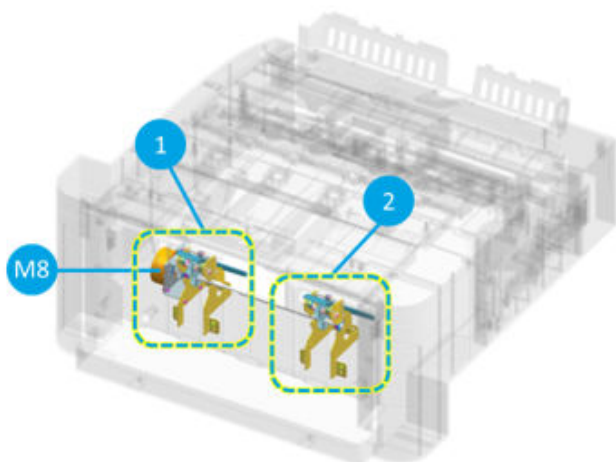

Figure 5-24 Inner finisher system - paper support unit detail view

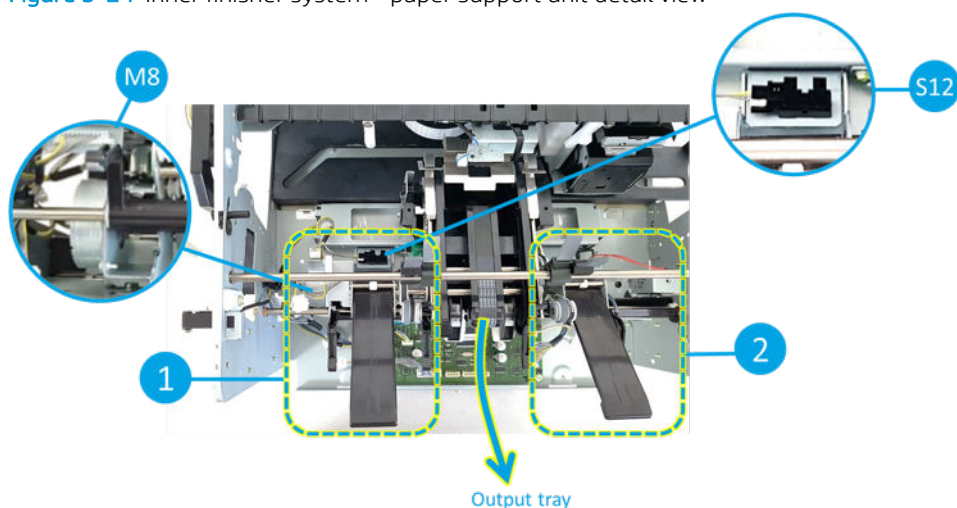

Table 5-13 Inner finisher system - paper support unit parts information

Item	Part name	Part number	Orderable ^(*)	Diagnostics	Description
1	Rear paper support	JC90-01311A	(*)		Supports paper not to be bended
2	Front paper support	JC90-01310A	(*)		Supports paper not to be bended
S12	Paper support home sensor	0604-001393		113-0481	Detects the paper support guides locate at the home position

Table 5-13 Inner finisher system - paper support unit parts information (continued)

Item	Part name	Part number	Orderable ^(*)	Diagnostics	Description
M8	Paper support motor assembly	JC93-00802B		113-0571	Drives paper support guides from the home position to the forward direction
	Paper support motor	JC31-00149A			

(*) This part is in ordering system.

Paper support unit operation

Paper support unit is extended to the arrow direction to help paper is bent of fallen to the output tray.

Figure 5-25 Inner finisher system - paper support unit operation



Paddle unit

Learn about the paddle unit of the inner finisher.

The paddle unit consists of two paddle systems, a main paddle and a sub paddle. First, when paper is discharged from the exit unit, the main paddle unit moves paper to the sub paddle. Then the sub paddle unit moves paper to the end fence unit so that it can be ready to be stapled.

The main paddle unit is operated by the main paddle motor. The main paddle sensor detects the main paddle position. The sub paddle unit rotates by the exit motor.

Figure 5-26 Inner finisher system - paddle unit driving system overview (main paddle unit)

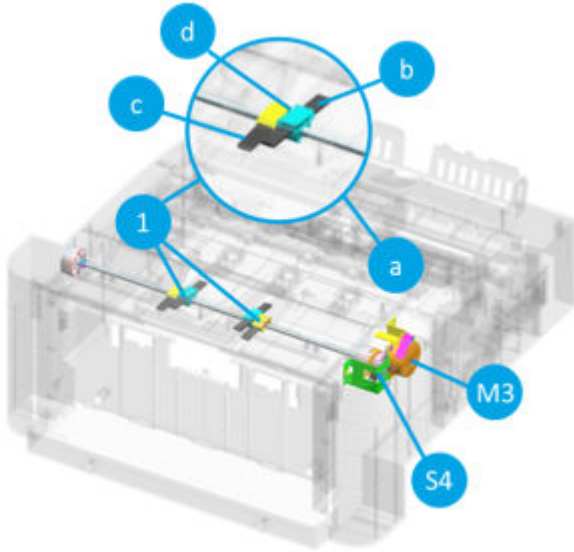

Figure 5-27 Inner finisher system - paddle unit driving system overview (sub paddle unit)

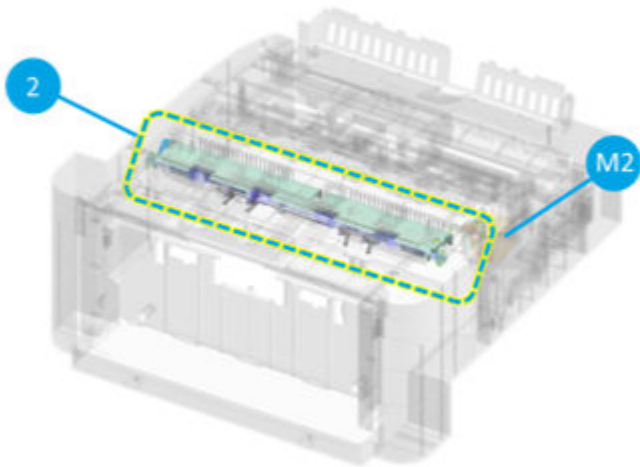

Figure 5-28 Inner finisher system - paddle unit driving system detail view (1/2)

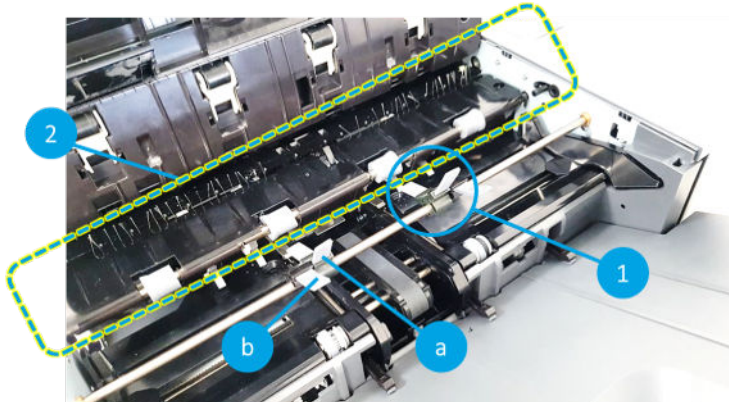

Figure 5-29 Inner finisher system - paddle unit driving system detail view (2/2)

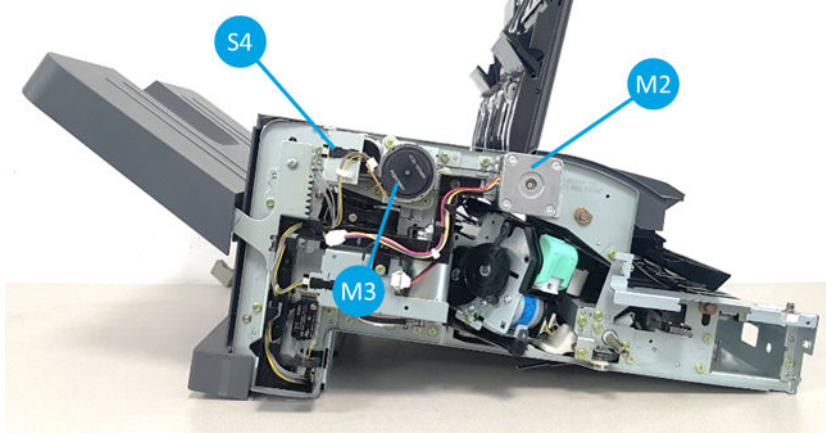

Table 5-14 Inner finisher system - paddle unit parts information

Item	Part name	Part number	Orderable ^(*)	Diagnostics	Description
1	Main paddle	JC90-01327A	(*)		Moves paper to the sub paddle unit
1-a	Main paddle kit	JC82-01038A	(*)		
1-b	Main paddle A	JC63-04957A	(*)		
1-c	Main paddle B	JC63-04958A	(*)		
1-d	Main paddle holder	JC81-07560A	(*)		
2	Sub paddle	JC90-01336A	(*)		Gets paper move to the end fence and arrange them to be stapled correctly
S4	Main paddle home sensor	0604-001393		113-0370	Detects the home position of the main paddle
M3	Main paddle motor assembly	JC90-01331A	(*)	113-0510	Drives the main paddle unit connected by a belt
	Main paddle motor	JC31-00149A			
M2	Exit motor	JC31-00169B	(*)	113-0502	Drives the sub paddle unit connected by a belt

^(*) This part is in ordering system.

Paddle unit operation

1. Main paddles get paper moves to the sub paddle unit.



2. Sub paddle unit gets paper goes to the end fence unit.

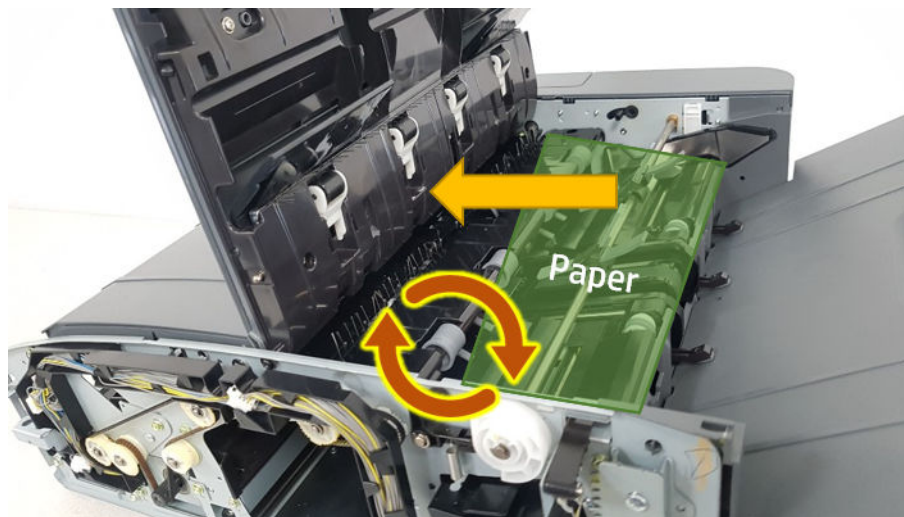

Tamper unit

Learn about the tamper unit of the inner finisher.

The tamper unit functions to align the left and right sides of a bundle of paper in order to staple it to the correct position. When a certain amount of paper for stapling is collected after printing, the tamper unit hits the left and right ends of the paper to align the paper correctly.

Each temper has a motor on the back side that delivers driving force to move. The temper unit sensors are mounted on the back side of the unit, to check the position of the temper unit.

Figure 5-30 Inner finisher system - tamper unit overview

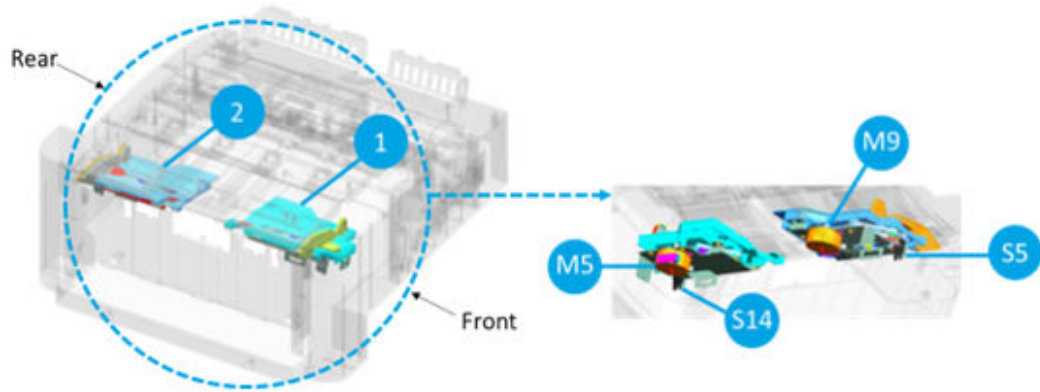

Figure 5-31 Inner finisher system - tamper unit detail view (1/3)

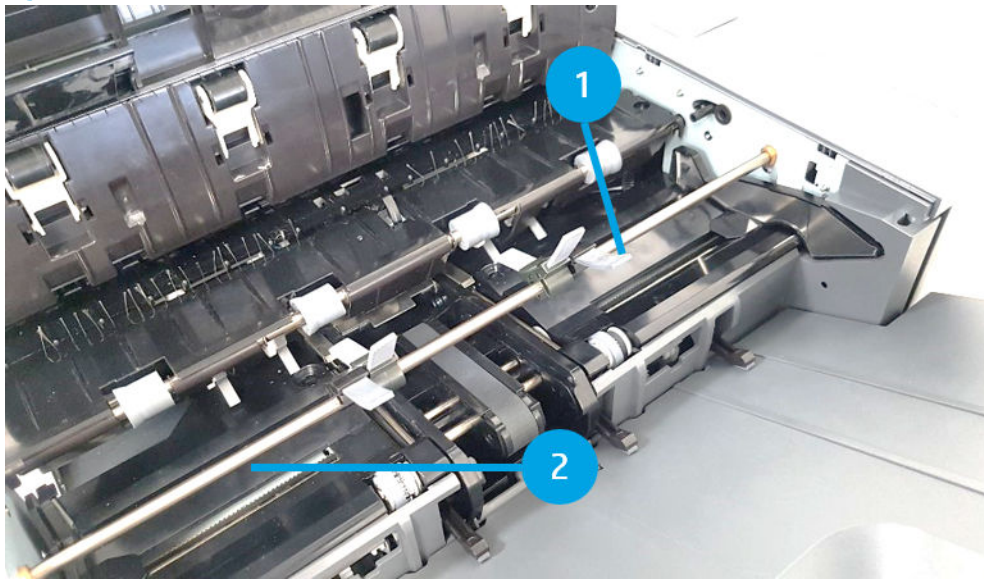

Figure 5-32 Inner finisher system - tamper unit detail view (rear) (2/3)

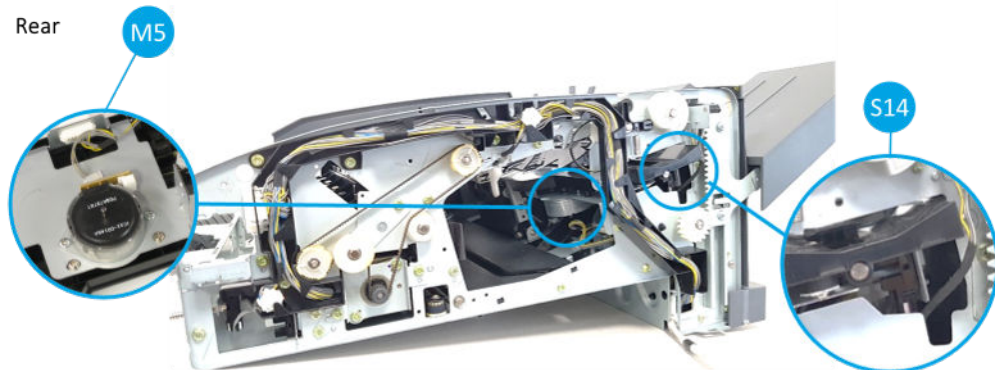

Figure 5-33 Inner finisher system - tamper unit detail view (front) (3/3)

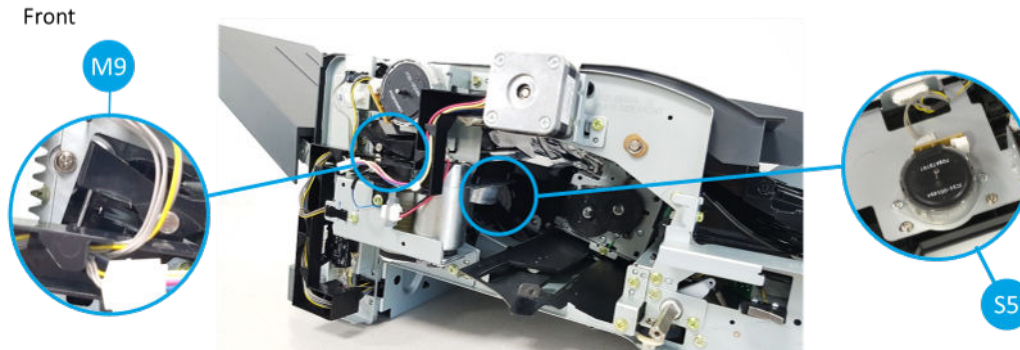

Table 5-15 Inner finisher system - tamper unit parts information

Item	Part name	Part number	Orderable ^(*)	Diagnostics	Description
1	Front tamper	JC82-00899A	(*)		Aligns left and right side of paper
2	Rear tamper	JC82-00900A	(*)		Aligns left and right side of paper
M5	Rear tamper motor assembly	JC93-01001A	(*)	113-0520	Drives the rear tamper unit
	Rear tamper motor	JC31-00149A			
S14	Rear tamper home sensor	0604-001393		113-0380	Detects the reference position of the tamper unit
M9	Front tamper motor assembly	JC93-01001A	(*)	113-0530	Drives the front tamper unit
	Front tamper motor	JC31-00149A			
S5	Front tamper home sensor	0604-001393		113-0390	Detects the reference position of the tamper unit

(*) This part is in ordering system.

Tamper unit operation

1. Paper is arranged at the end of the end fence unit.



2. The left and right tampers arrange a stack of paper.

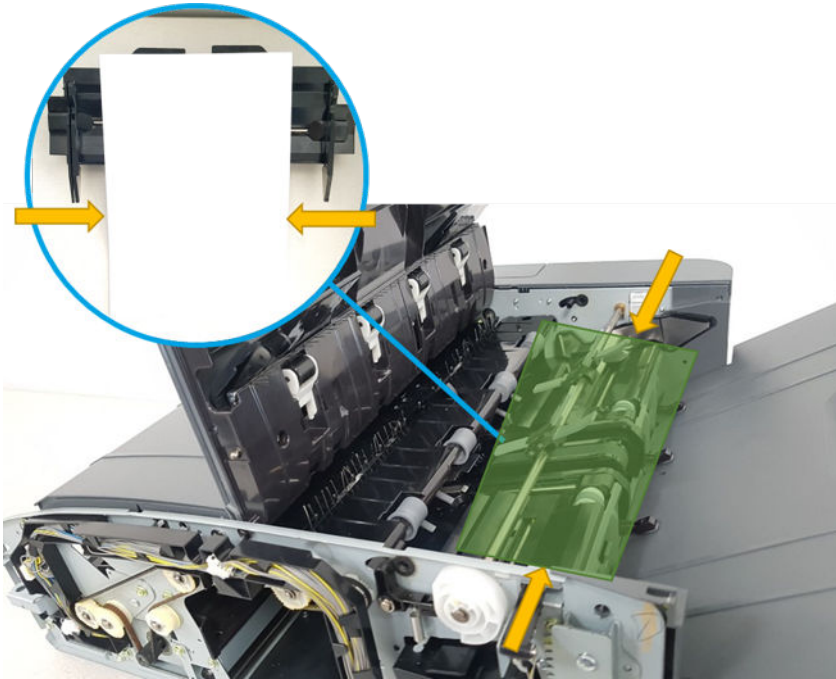

End fence unit

Learn about the end fence unit of the inner finisher.

The paddle unit moves paper to the end fence unit. The end fence unit sets the standard position of the paper to be aligned towards top and bottom of the paper. The end fence is fixed onto the finisher, and the end fence sensor can sense any paper entering the end fence unit.

Figure 5-34 Inner finisher system - end fence unit overview

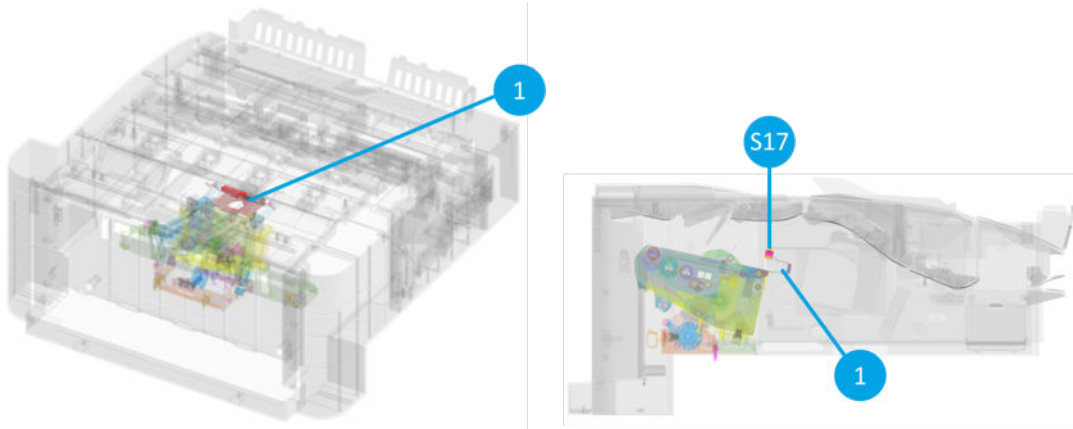

Figure 5-35 Inner finisher system - end fence unit detail view

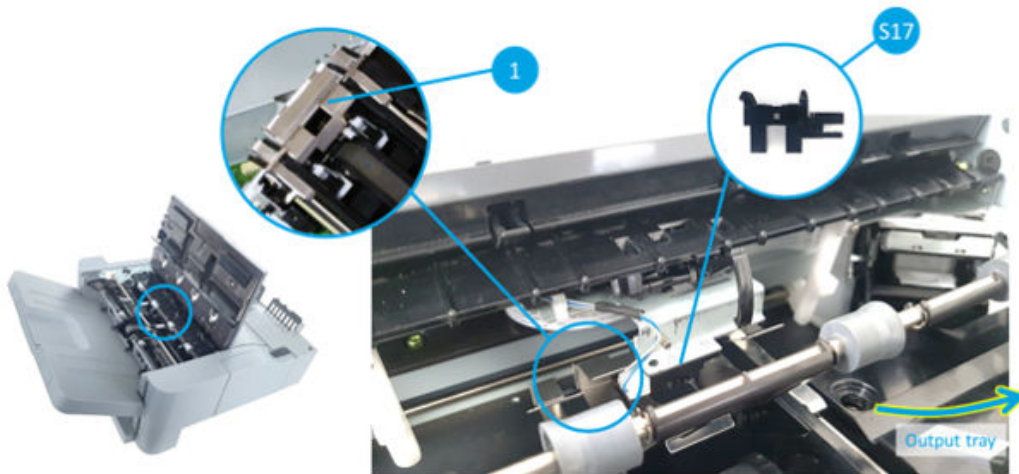

Table 5-16 Inner finisher system - end fence unit parts information

Item	Part name	Part number	Orderable ^(*)	Diagnostics	Description
1	End fence	JC61-06428A			Aligns paper toward top and bottom direction
2	End fence sensor	0604-001381	(*)	113-0361	Detects paper whether paper exists in the end fence unit

(*) This part is in ordering system.

End fence unit operation

1. Paper goes into the end fence unit through the main paddle unit and sub paddle unit. At the same time the end fence unit is aligned paper to the direction of yellow line.



2. The end fence sensor is checking whether paper goes into the end fence sensor.

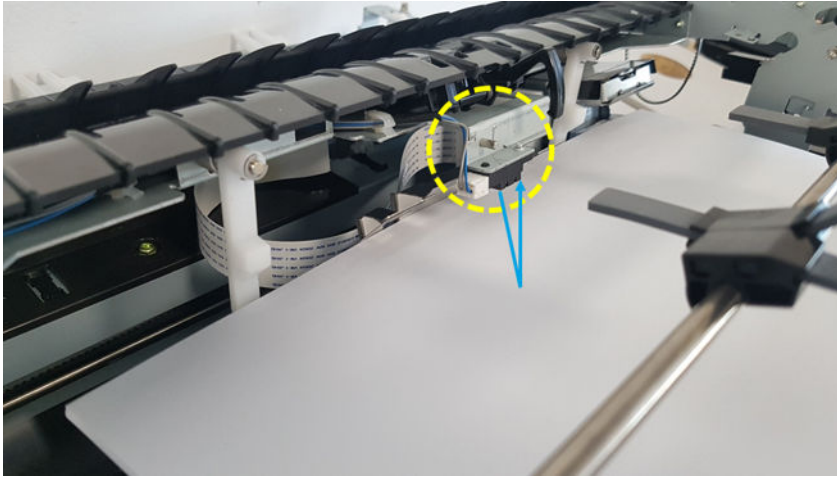

Stapler unit

Learn about the stapler unit of the inner finisher.

Stapler unit is a device installed inside the finisher that staples a bundle of aligned documents. Documents are collected as a bundle by the tamper unit and the end fence unit for stapling, then stapler assembly staples the bundle. There are 6 options to make a bundle.

Figure 5-36 Inner finisher system - stapling options



The stapler unit moves using the stapler motor installed inside. The four stapler position sensors are mounted so that the stapler can be positioned in the exact stapling position whether it is stapled on the left, the right, or at the center of the document. Stapling is done by the motor inside the stapler assembly.

Figure 5-37 Inner finisher system - stapler unit overview

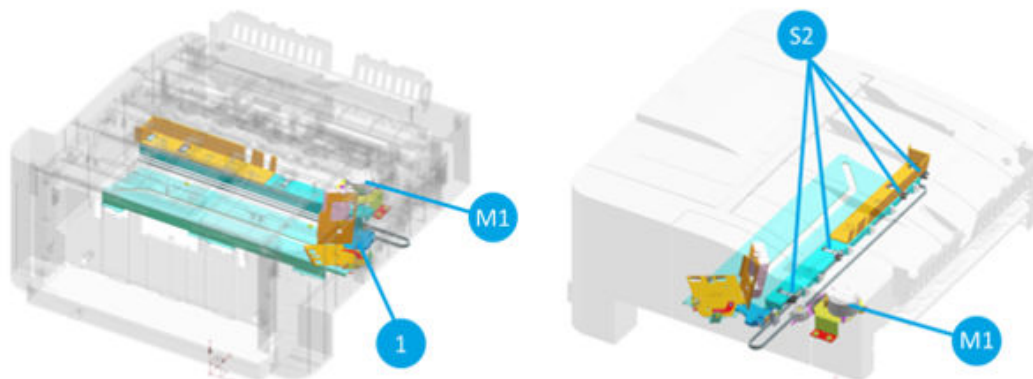

Figure 5-38 Inner finisher system - stapler unit detail view (1/2)

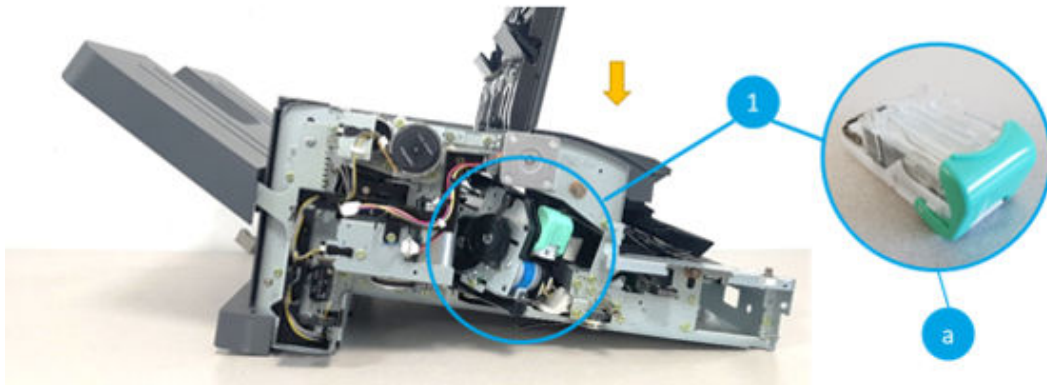

Figure 5-39 Inner finisher system - stapler unit detail view (2/2)

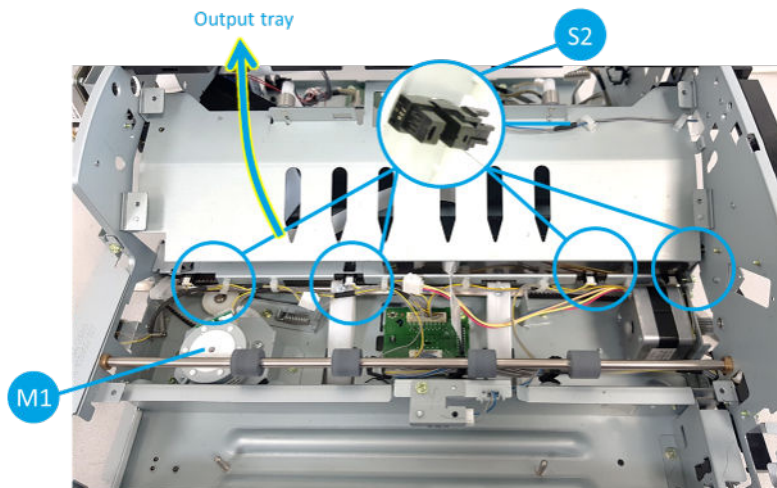

Table 5-17 Inner finisher system - stapler unit parts information

Item	Part name	Part number	Orderable ^(*)	Diagnostics	Description
1	Stapler assembly	JC59-00040A	(*)		Staples a bundle of paper
1-a	Staple cartridge	JC81-07408B	(*)		Staple cartridge
S2	Stapler position sensor	0604-001393	(*)	113-0491 113-0492	Detects and moves the staple assembly position to make a bundle of paper at the exact location
M1	Stapler position motor	JC93-00999A	(*)	113-0581	Gets the staple assembly move toward top and down direction of paper

(*) This part is in ordering system.

Stapler unit operation

1. The stapler position motor delivers the stapler assembly to the horizontal direction (yellow line).

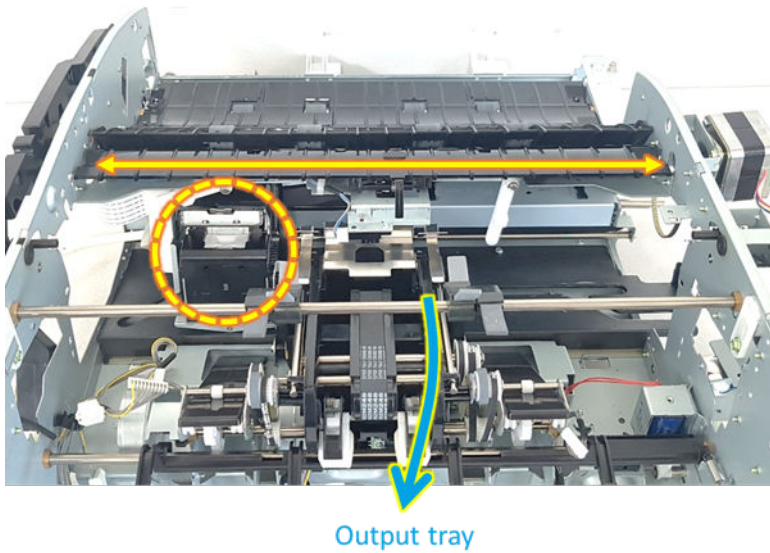

2. The stapler assembly checks front and rear home position and moves where the stapler position sensors are located depending on stapling types.

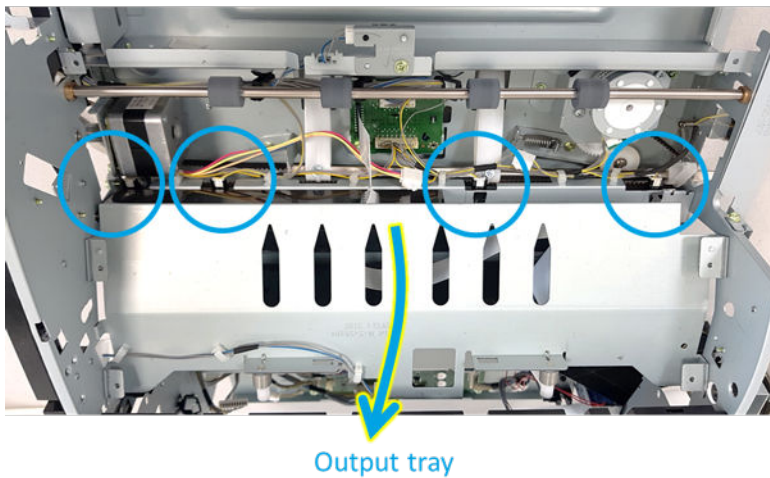

Ejector unit

Learn about the ejector unit of the inner finisher.

The ejector unit moves a bundle of stapled paper out. The ejector unit consists of ejector1 and ejector2. The Ejector1 transfers a stapled paper loaded at the end fence unit to the ejector2 unit. During this process, the ejector1 motor transmits the driving force to the ejector1 unit. And the ejector1 home position sensor controls the movement of the ejector1. When the paper arrives at the ejector2 unit, the ejector2 grabs a stack of paper and ejects it onto the output tray. The ejector2 motor is responsible for this process, and the ejector2 motor sensor helps it to be controlled correctly. In addition, the ejector2 home position sensor is mounted to check the location of the ejector2.

Figure 5-40 Inner finisher system - ejector unit overview

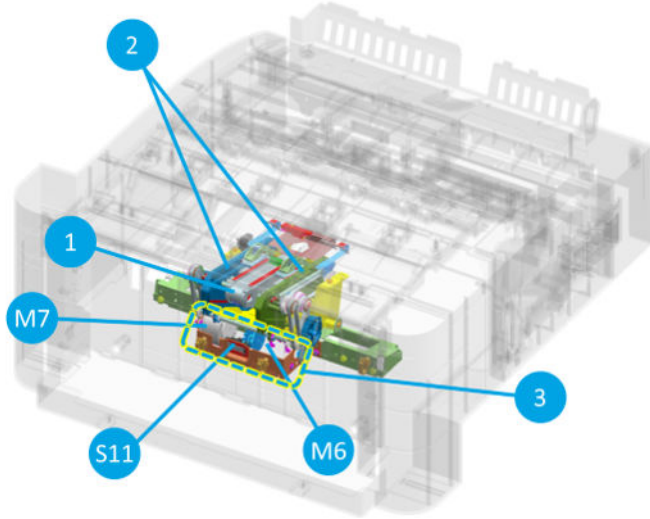

Figure 5-41 Inner finisher system - ejector unit detail view (1/3)

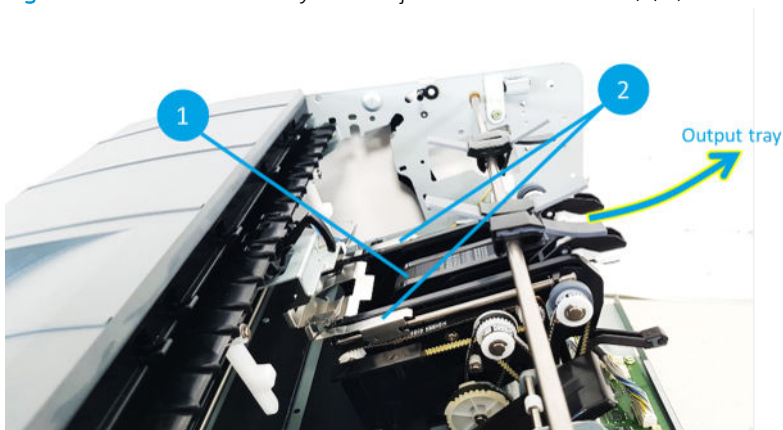

Figure 5-42 Inner finisher system - ejector unit detail view (2/3)

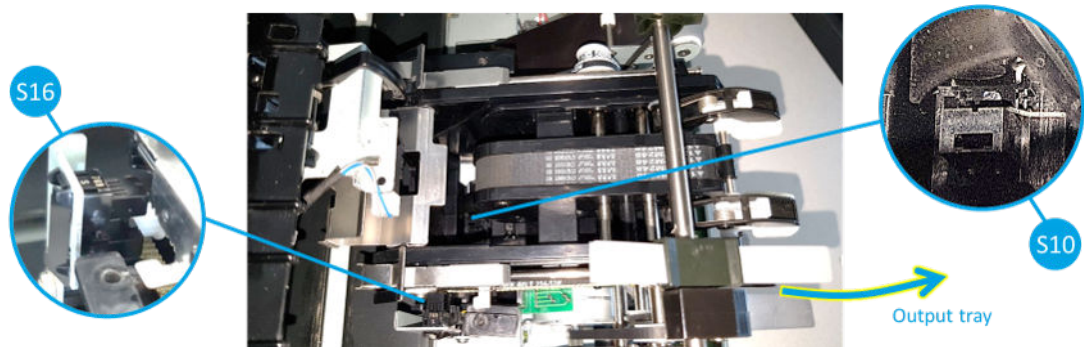

Figure 5-43 Inner finisher system - ejector unit detail view (3/3)

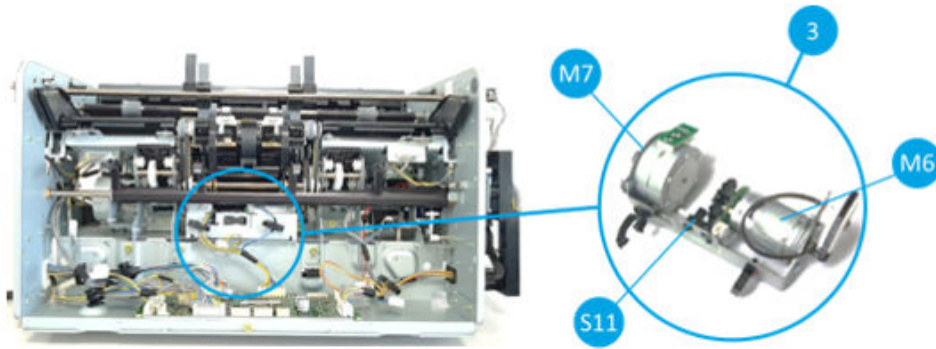

Table 5-18 Inner finisher system – ejector unit parts information

Item	Part name	Part number	Orderable ^(*)	Diagnostics	Description
	Ejector	SS456-61001	(*)		
1	Ejector2				Moves paper from the ejector 1 to the output tray
2	Ejector1	Y1G14-67901			Moves the stack of paper from the end fence to the ejector2
S10	Ejector2 home sensor	0604-001393		113-0462	Detects the home position of the ejector2
S16	Ejector1 home sensor	0604-001393		113-0461	Detects the home position of the ejector1
3	Ejector motor assembly	JC90-01309A			Moves the ejector1 and ejector2
M6	Ejector2 motor assembly	JC93-01168A		113-0562	Moves the ejector2 forward and backward
	Ejector2 motor	JC31-00175A			Detects the ejector2 motor rotation
S11	Ejector2 motor sensor	0604-001393		113-0463	
M7	Ejector1 motor assembly	JC93-00998A		113-0561	Grabs a stack of paper, then move it to the output tray
	Ejector1 motor	JC31-00009C			

^(*) This part is in ordering system.

Ejector unit operation

1. Ejector 1 pushes aligned paper at the end fence unit to ejector 2 unit.



2. Ejector 2 grabs paper, then moves forward to the output tray unit direction.

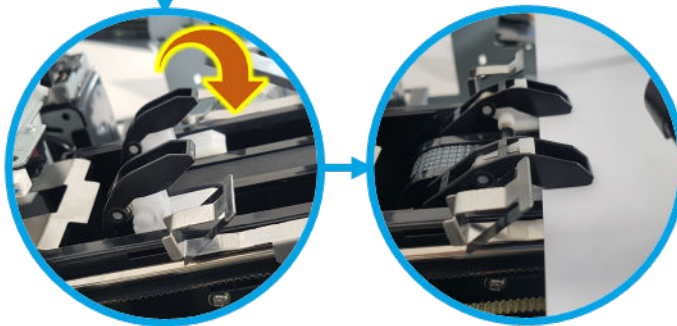

3. Ejector2 draws off paper on the output tray.



Output tray & paper holding unit

Learn about the output tray & paper holding unit of the inner finisher.

The output tray moves up and down along the rails inside the finisher, and the output tray motor controls those movement according to the signals sent from the paper holding sensor. As paper stacks up on the output tray, the paper holding unit is lifted by papers. When the paper holding sensor is touched, the output tray moves downward.

The machine detects when the output tray is full as the output tray hits the lower limit switch. The output tray top of stack sensor is mounted on both left and right sides for the case that the paper holding sensor breaks down.

The paper holding solenoid lifts the paper holding actuator up when a new bundle of paper come to the output tray.

Figure 5-44 Inner finisher system - output tray unit overview

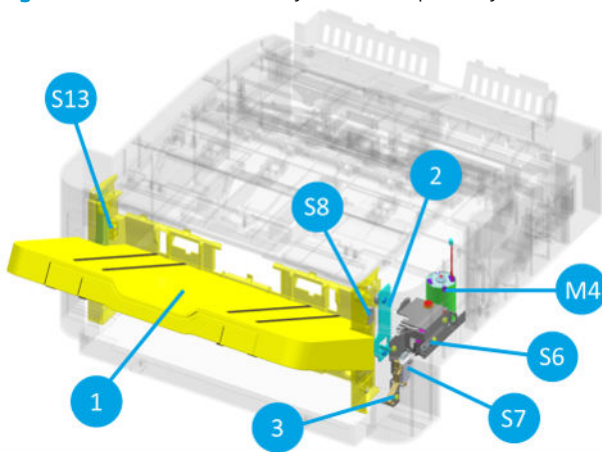

Figure 5-45 Inner finisher system - output tray unit detail view (1/2)

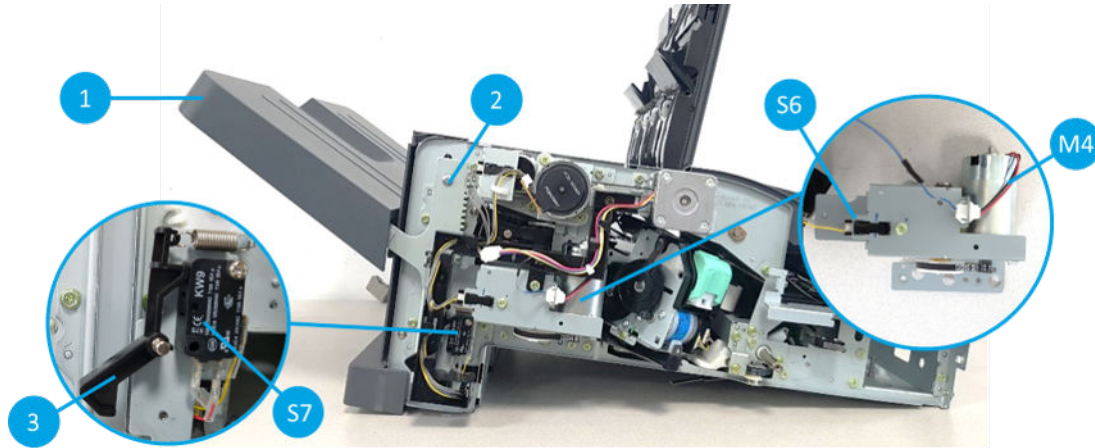

Figure 5-46 Inner finisher system - output tray unit detail view (2/2)

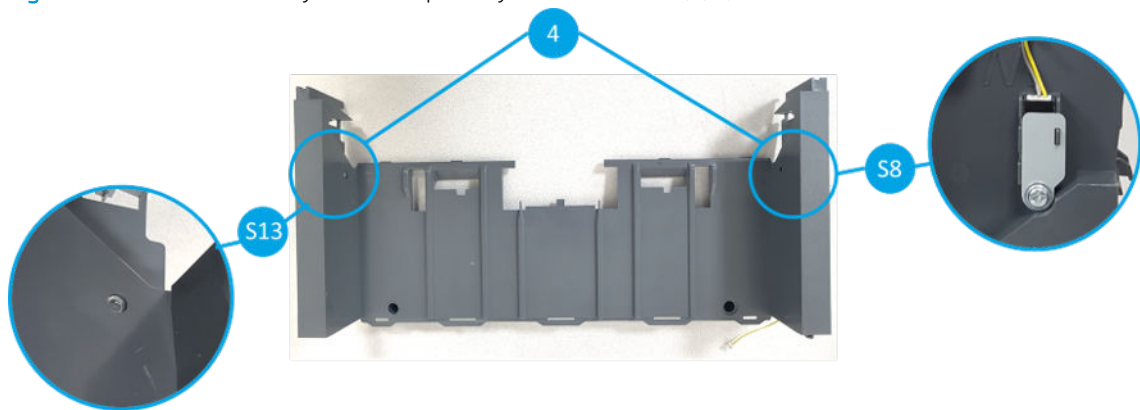

Table 5-19 Inner finisher system - output tray unit parts information

Item	Part name	Part number	Orderable ^(*)	Diagnostics	Description
1	Output tray	JC90-01337B	(*)		Stacking plate for ejected paper
M4	Output tray motor assembly	JC90-01334B	(*)	113-0570	Moves the output tray up and down
	Output tray motor	JC31-00178B	(*)		
S6	Output tray motor sensor	0604-001393		113-0473	Detects if the output tray motor is operational
2	Output tray frame	JC90-01319A	(*)		
S7	Output tray lower limit switch	JC90-01320A	(*)	113-0472	Detects the lowest position of the output tray
3	Output tray lower actuator	JC66-04200A	(*)	113-0472	Detects the lowest position of the output tray
4	Output tray top of stack sensor kit	JC82-01039A	(*)	113-0471	Detects abnormal movement of output tray (Output tray top of stack sensor receiver + led)
S8	Output tray top of stack sensor (receiver)	0603-001309	(*)		

Table 5-19 Inner finisher system - output tray unit parts information (continued)

Item	Part name	Part number	Orderable ^(*)	Diagnostics	Description
S13	Output tray top of stack sensor (led)	0601-003440			

^(*) This part is in ordering system.

Figure 5-47 Inner finisher system - paper holding unit overview

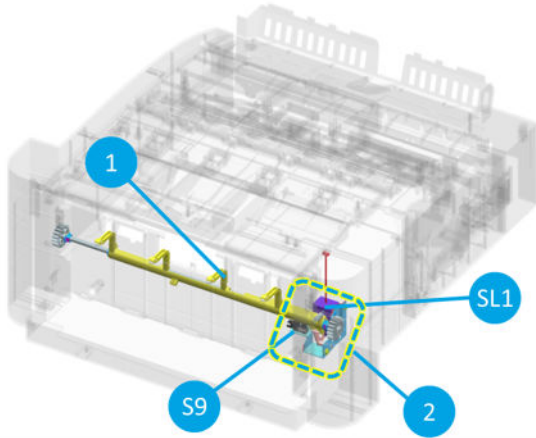

Figure 5-48 Inner finisher system - paper holding unit detail view

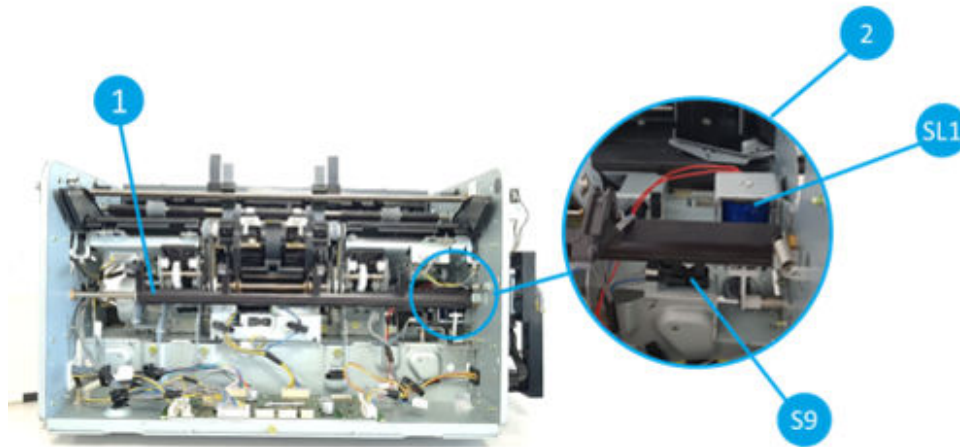

Table 5-20 Inner finisher system - output tray unit parts information

Item	Part name	Part number	Orderable ^(*)	Diagnostics	Description
1	Paper holding actuator	JC90-01313A	(*)		Controls the output tray height, and grabs stacked paper not to be scattered
2	Paper holding kit	JC90-01314A	(*)		Paper holding solenoid + Paper holding sensor
SL1	Paper holding solenoid	JC33-00037A	(*)	113-0591	Moves paper holding actuator up when paper goes out to the output tray

Table 5-20 Inner finisher system - output tray unit parts information (continued)

Item	Part name	Part number	Orderable ^(*)	Diagnostics	Description
S9	Paper holding sensor	0604-001393		113-0470	Detects stacked paper position

^(*) This part is in ordering system.

Inner finisher system - output tray & paper holding unit operation

1. Paper holding unit helps paper stores stable on the output tray. Besides it detects amount of stacked paper and get the output tray moves downward.

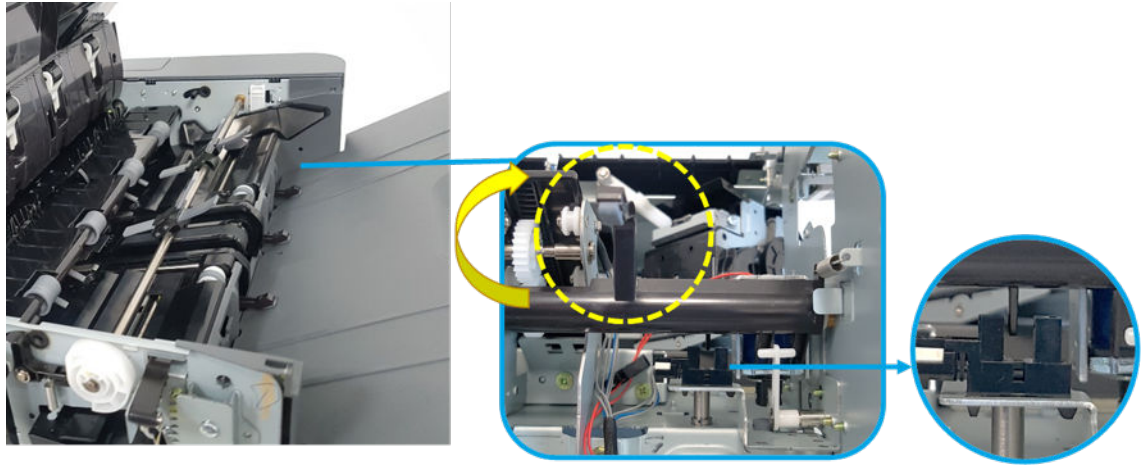

2. When paper goes out to the output tray, paper holding solenoid forcibly make paper holding actuator goes upward to create the paper passage not to be jammed by the paper holding actuator.

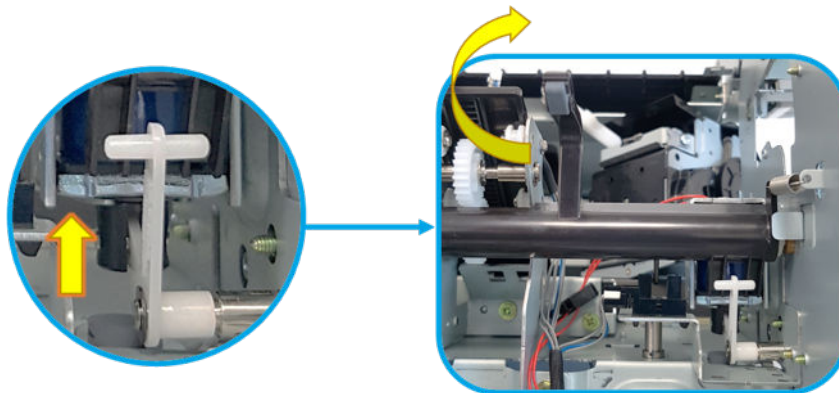

3. As the paper accumulates, output tray moves downward. When it reaches at the end of the moving range, output tray lower limit switch is pressed. The switch detects paper stacks full on the output tray.

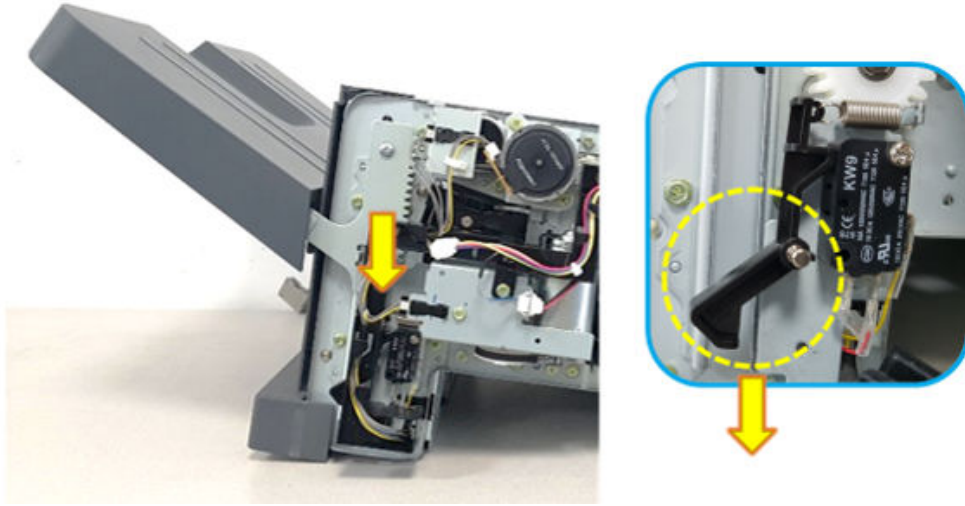

4. In case of fatal error in the output tray unit and paper holding unit, output tray top of stack sensor makes the machine emergency stop so that output tray unit does not move upward.

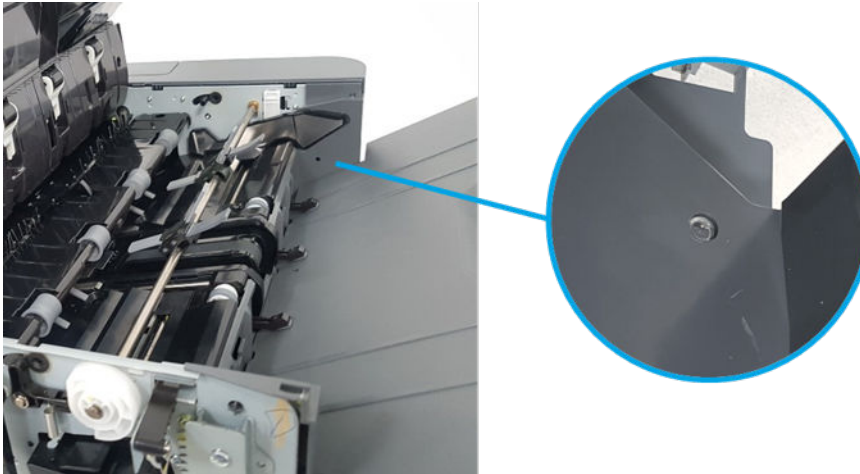

PCA connection information

Learn about the PCA connection information.

Figure 5-49 Inner finisher system - PCA connection information

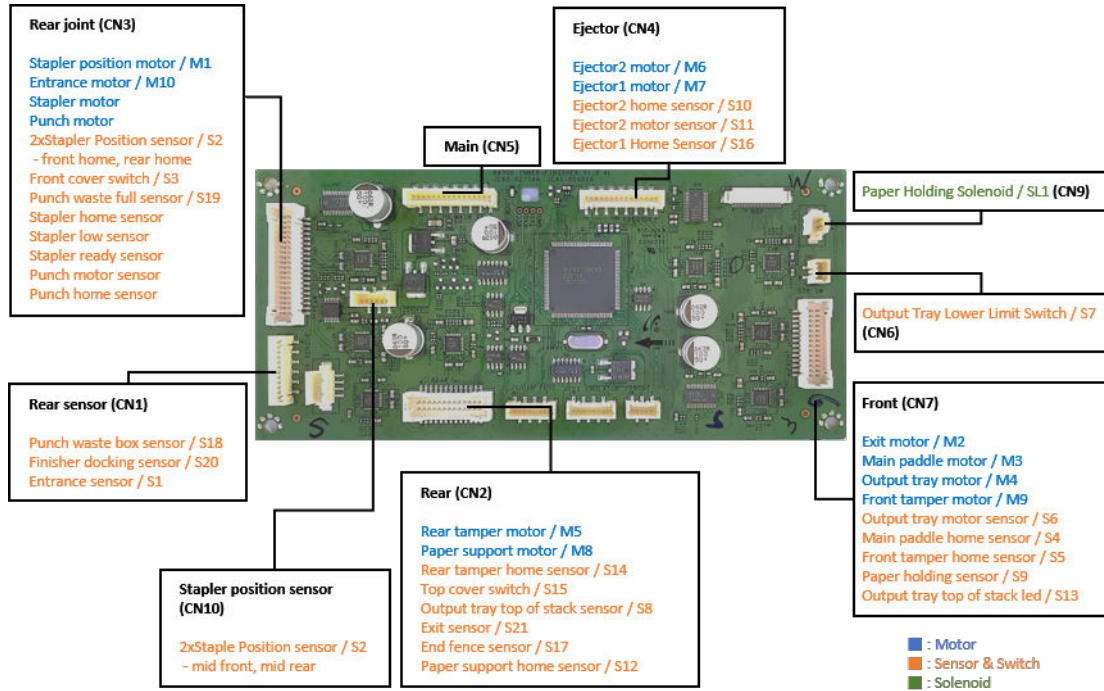

Table 5-21 Inner finisher system - PCA connectors, parts, and diagnostics information

CN No.	Connector name	Motor (Diagnostics)	Sensor (Diagnostics)	Switch & Solenoid (Diagnostics)
CN1	Rear sensor		<ul style="list-style-type: none"> Punch waste box sensor (113-0620) Finisher docking sensor (113-0000) Entrance sensor (113-0350) 	
CN2	Rear	<ul style="list-style-type: none"> Rear tamper motor (113-0520) Paper support motor (113-0571) 	<ul style="list-style-type: none"> Rear tamper home sensor (113-0380) Output tray top of stack sensor (113-0471) Exit sensor (113-0360) End fence sensor (113-0361) Paper support home sensor (113-0481) 	<ul style="list-style-type: none"> Top cover switch (113-0420)

Table 5-21 Inner finisher system - PCA connectors, parts, and diagnostics information (continued)

CN No.	Connector name	Motor (Diagnostics)	Sensor (Diagnostics)	Switch & Solenoid (Diagnostics)
CN3	Rear joint	<ul style="list-style-type: none"> • Stapler motor (113-0550) • Stapler position motor (113-0581) • Entrance motor (113-0501) • Punch motor (113-0610) 	<ul style="list-style-type: none"> • Stapler low sensor(113-0440) • Stapler ready sensor (113-0451) • Stapler home sensor(113-0430) • Stapler position sensor (front home) (113-0491) • Stapler position sensor (rear home) (113-0492) • Punch waste full sensor (113-0621) • Punch motor sensor(113-0600) • Punch home sensor (113-0612) 	<ul style="list-style-type: none"> • Front cover switch (113-0420)
CN4	Ejector	<ul style="list-style-type: none"> • Ejector2 motor (113-0562) • Ejector1 motor (113-0561) 	<ul style="list-style-type: none"> • Ejector2 motor sensor (113-0463) • Ejector2 home sensor (113-0462) • Ejector1 home sensor (113-0461) 	
CN5	Main (to the main PBA)			
CN6	Output tray lower limit switch			<ul style="list-style-type: none"> • Output tray lower limit switch (113-0472)
CN7	Front	<ul style="list-style-type: none"> • Exit motor (113-0502) • Main paddle motor (113-0510) • Output tray motor (113-0570) • Front tamper motor (113-0530) 	<ul style="list-style-type: none"> • Output tray motor sensor (113-0473) • Main paddle home sensor (113-0370) • Front tamper home sensor (113-0390) • Paper holding sensor (113-0470) • Output tray top of stack sensor (113-0471) 	

Table 5-21 Inner finisher system - PCA connectors, parts, and diagnostics information (continued)

CN No.	Connector name	Motor (Diagnostics)	Sensor (Diagnostics)	Switch & Solenoid (Diagnostics)
CN9	Paper holding solenoid			<ul style="list-style-type: none"> • Paper holding solenoid (113-0591)
CN10	Stapler position sensor		<ul style="list-style-type: none"> • Stapler position sensor (mid front) (-) • Stapler position sensor (mid rear) (-) 	

Service approach

Learn about the service approach of the inner finisher.

 **CAUTION:** When working on the product, do not pick up the unit by the output tray, which will detach under the weight of the product.



Before performing service

Learn what to do before performing service.

- Remove all paper from the product.
- Turn off the power using the power button.
- Unplug the power cable and interface cable or cables.
- Place the product on an ESD workstation or mat, or use an ESD strap (if one is available). If an ESD workstation, mat, or strap is not available, ground yourself by touching the sheet-metal chassis *before* touching an ESD-sensitive part.
- Remove the toner cartridges.
- Remove the Tray 2 cassette.

ESD precautions

Learn the importance of electrostatic discharge and necessary precautions.

 **CAUTION:**  Some parts are sensitive to electrostatic discharge (ESD). Always perform service work at an ESD-protected workstation or mat. If an ESD workstation or mat is not available, touch the sheet-metal chassis to provide a static ground before touching an ESD-sensitive assembly. Protect the ESD-sensitive assemblies by placing them in ESD pouches when they are out of the printer.

After performing service

Learn what to do after performing service.

- Plug in the power cable.
- Verify the functions of the printer that might have been impacted by service procedures. Make sure the printer is in complete working order.
- Replace any accessories removed for service.

Post-service test

Perform the following tests to verify that the repair or replacement was successful:

Print-quality test

Learn about the print-quality test.

1. Verify that you have completed the necessary reassembly steps.
2. Make sure that the tray contains clean, unmarked paper.
3. Attach the power cord and interface cable or interface cables, and then turn on the product.
4. Print a configuration page.
5. Print a print quality page, and then verify that there are no lines, streaks, banding, or other print quality defects.
6. Send a print job from the host computer, and then verify that the output meets expectations.

Order parts, accessories, and supplies

Learn how to order parts, accessories and supplies.

Ordering

Learn how to order supplies, paper, and genuine HP parts or accessories.

Order supplies and paper	HP SureSupply
Order genuine HP parts or accessories	HP Parts Store
	or
	HP Part Surfer
Order through service or support providers	Contact an HP-authorized service or support provider.
Order using the HP Embedded Web Server (EWS)	To access, in a supported Web browser on your computer, enter the printer IP address or host name in the address/URL field. The EWS contains a link to the HP SureSupply Web site, which provides options for purchasing Original HP supplies.

Orderable parts

Not all of the parts shown in the diagrams in this chapter can be ordered. Refer to the table following the diagram or the parts lists at the end of this chapter to determine if a part is orderable.

Parts, diagrams, removal and replacement (inner finisher)

Learn about parts, diagrams, removal and replacement (inner finisher)



NOTE:  Some parts are sensitive to electrostatic discharge (ESD). Always perform service work at an ESD-protected workstation or mat. If an ESD workstation or mat is not available, touch the sheet-metal chassis to provide a static ground before touching an ESD-sensitive assembly. Protect the ESD-sensitive assemblies by placing them in ESD pouches when they are out of the printer.

Parts and diagrams (inner finisher)

View inner finisher exploded diagrams and parts lists.

Inner finisher (main)

Parts diagram and parts list for the inner finisher (main).

Figure 5-50 Inner finisher (main)

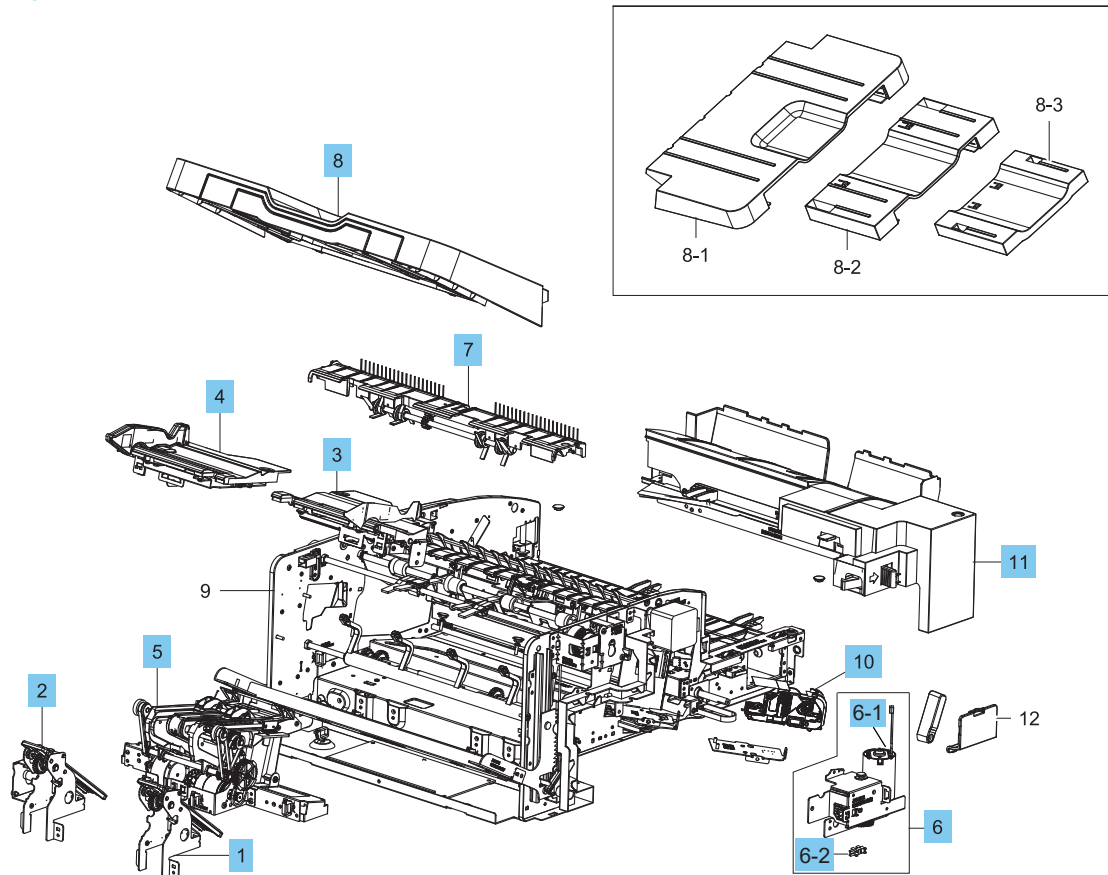

Table 5-22 Inner finisher (main)

Ref	Part number	Description	Qty
Complete	Y1G00-67902	Inner finisher whole unit	1
1	JC90-01310A	Front paper support	1
2	JC90-01311A	Rear paper support	1
3	JC82-00899A	Front tamper unit assembly	1
4	JC82-00900A	Rear tamper unit assembly	1
5	SS456-61001	Ejector	1
6	JC90-01334B	Output tray motor assembly	1
6-1	JC31-00178B	Output tray motor	1
6-2	0604-001393	Output tray motor sensor	1
7	JC90-01336A	Sub paddle unit	1
8	JC90-01337B	Output tray	1
10	JC81-07408B	Staple cartridge	1
11	JC90-01343B	Punch cover	1
Not shown	JC39-02169A	Main interface harness	1

Inner finisher (covers)

Parts diagram and parts list for the inner finisher (covers)

Figure 5-51 Inner finisher (covers)

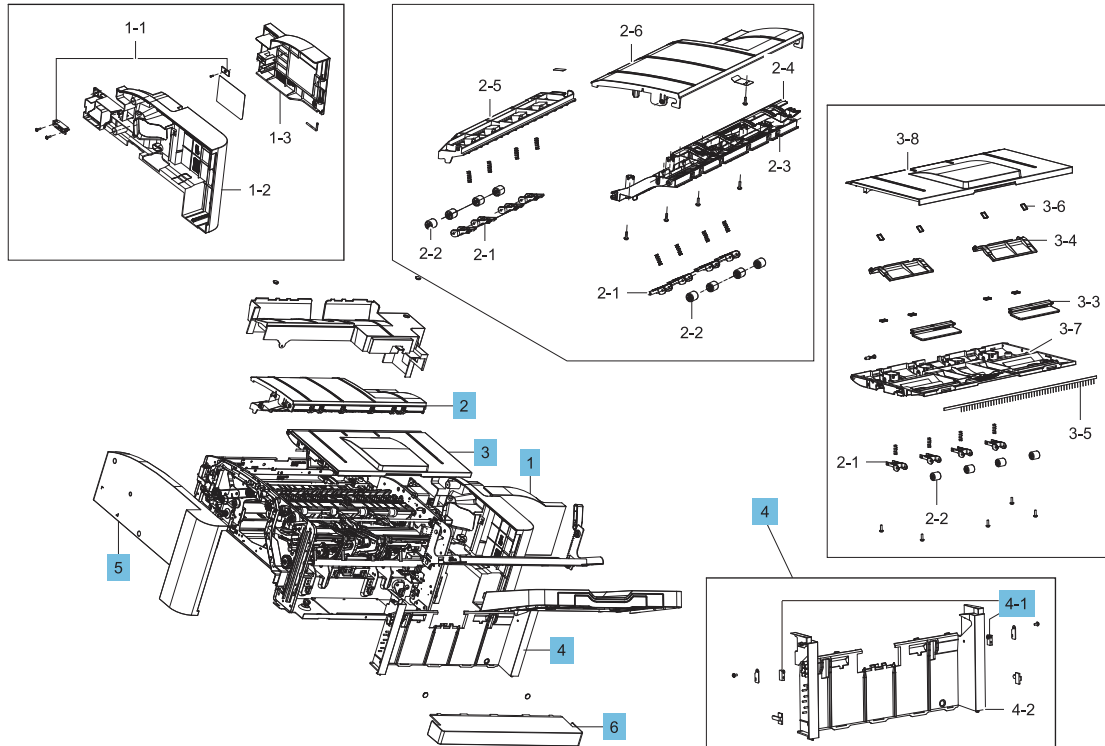

Table 5-23 Inner finisher (covers)

Ref	Part number	Description	Qty
1	JC90-01321B	Front cover	1
2	JC90-01322B	Middle cover	1
3	JC90-01323B	Top cover	1
4	JC90-01324B	Left cover	1
4-1	JC82-01039A	Output tray top of stack sensor kit	1
5	JC63-04750B	Rear cover	1
6	JC63-04792B	PCA cover	1

Inner finisher (main paddle unit, entrance unit, exit unit, paper holding unit, and output tray unit)

Parts diagram and parts list for the inner finisher (main paddle unit, entrance unit, exit unit, paper holding unit, and output tray unit).

Figure 5-52 Inner finisher (main paddle unit, entrance unit, exit unit, paper holding unit, and output tray unit)

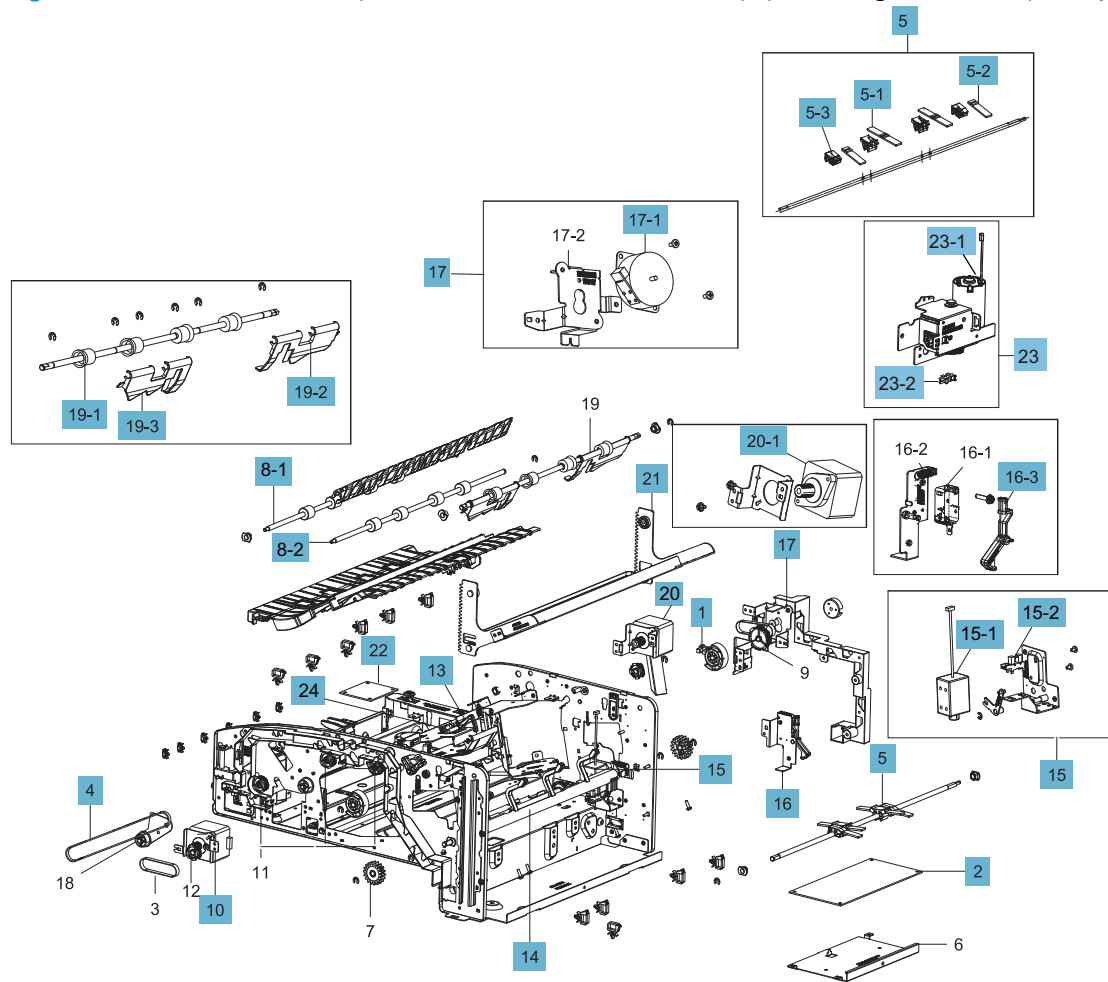

Table 5-24 Inner finisher (main paddle unit, entrance unit, exit unit, paper holding unit, and output tray unit)

Ref	Part number	Description	Qty
1	0604-001393	Main paddle home sensor	2
2	JC92-02774B	Main PCA	1
4	6602-003644	Entrance motor timing belt	1
5	JC82-01038A	Paddle kit	1
5-1	JC63-04957A	Paddle A	2
5-2	JC63-04958A	Paddle B	2
5-3	JC81-07560A	Paddle holder	4
8-1	JC66-04243A	Entrance roller	1
8-2	JC66-04243A	Middle roller	1
10	JC90-01344A	Entrance motor assembly	1
13	JC66-04199A	Exit sensor actuator	1
14	JC90-01313A	Paper holding actuator	1
15	JC90-01314A	Paper holding kit	1
15-1	JC33-00037A	Paper holding solenoid	1
15-2	0604-001393	Paper holding sensor	1
16	JC90-01320A	Output tray lower limit switch	1
16-3	JC66-04200A	Output tray lower limit switch actuator	1
17	JC93-01001A	Main paddle motor assembly	1
17-1	JC31-00149A	Main paddle motor	1
19-1	JC66-04244A	Exit roller	1
19-2	JC61-07449A	Front compile guide	1
19-3	JC61-07450A	Rear compile guide	1
20	JC90-01331A	Exit motor assembly	1
20-1	JC31-00169B	Exit motor	1
21	JC90-01319A	Output tray frame	1
22	JC92-02780A	Rear joint PCA	1
23 shown	JC90-01334B	Output tray motor assembly	1
23-1	JC31-00178B	Output tray motor	1
23-2	0604-001393	Output tray motor sensor	1
24	0604-001415	Exit sensor	1

Inner finisher (paper support unit)

Parts diagram and parts list for the inner finisher (paper support unit).

Figure 5-53 Inner finisher (paper support unit)

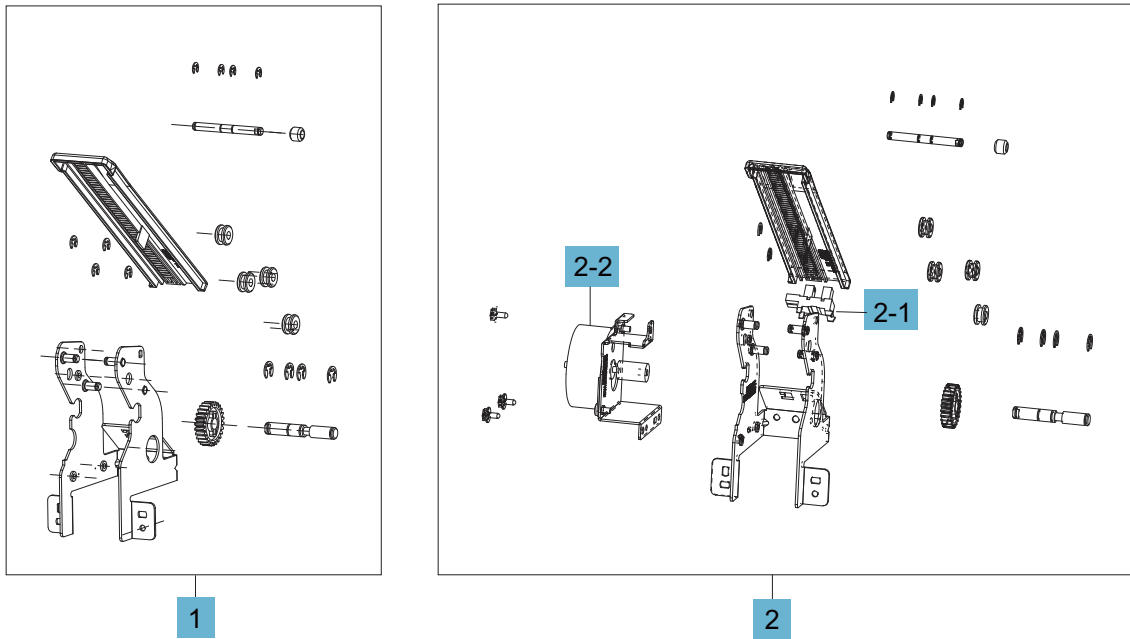

Table 5-25 Inner finisher (paper support unit)

Ref	Part number	Description	Qty
1	JC90-01310A	Front paper support	1
2	JC90-01311A	Rear paper support	1
2-1	0604-001393	Paper support home sensor	1
2-2	JC93-00802B	Paper suport motor assembly	1

Inner finisher (tamper unit)

Parts diagram and parts list for the inner finisher (tamper unit).

Figure 5-54 Inner finisher (tamper unit)

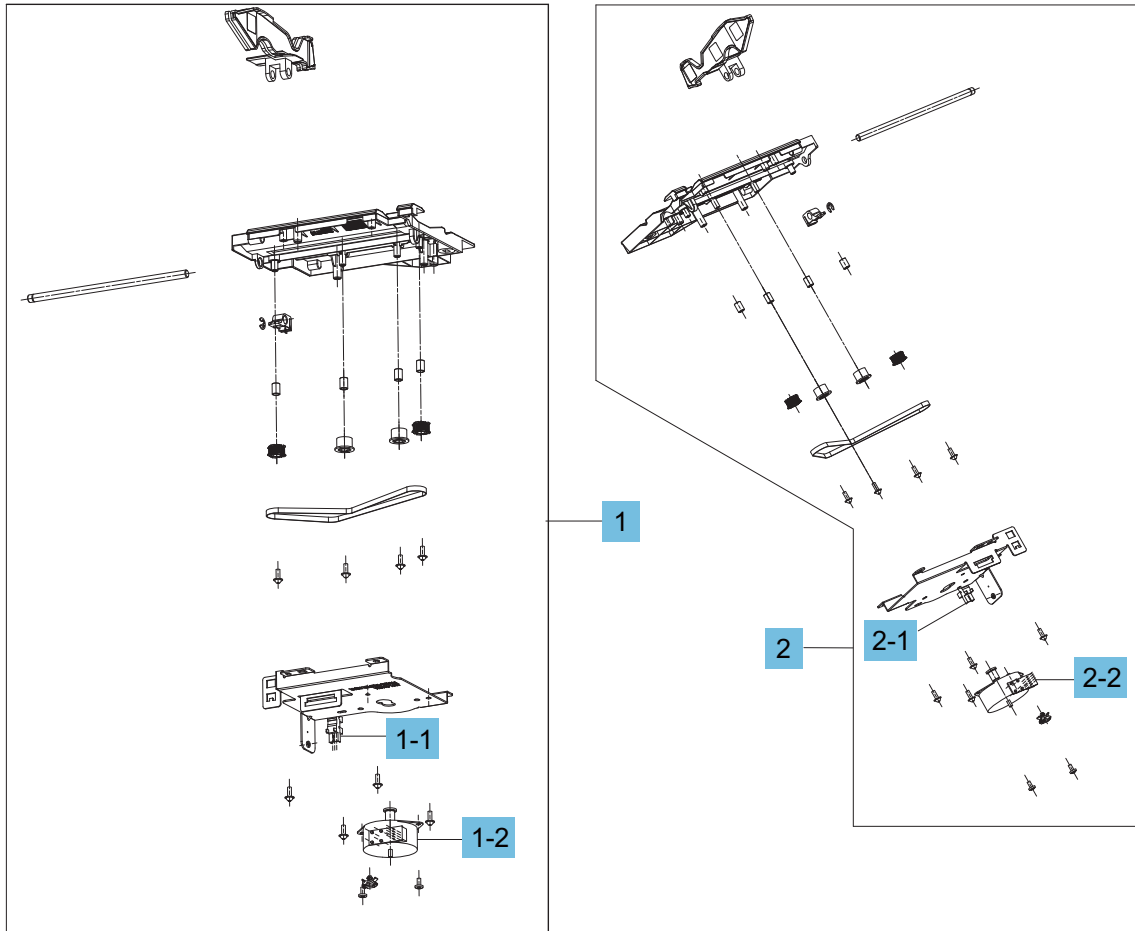

Table 5-26 Inner finisher (tamper unit)

Ref	Part number	Description	Qty
1	JC82-00900A	Rear tamper unit	1
1-1	0604-001393	Rear tamper home sensor	1
1-2	JC93-01001A	Rear tamper motor assembly	1
2	JC82-00899A	Front tamper unit	1
2-1	0604-001393	Front tamper home sensor	1
2-2	JC93-01001A	Front tamper motor assembly	1

Inner finisher (stapler unit, end fence unit)

Parts diagram and parts list for the inner finisher (stapler unit, end fence unit).

Figure 5-55 Inner finisher (stapler unit, end fence unit)

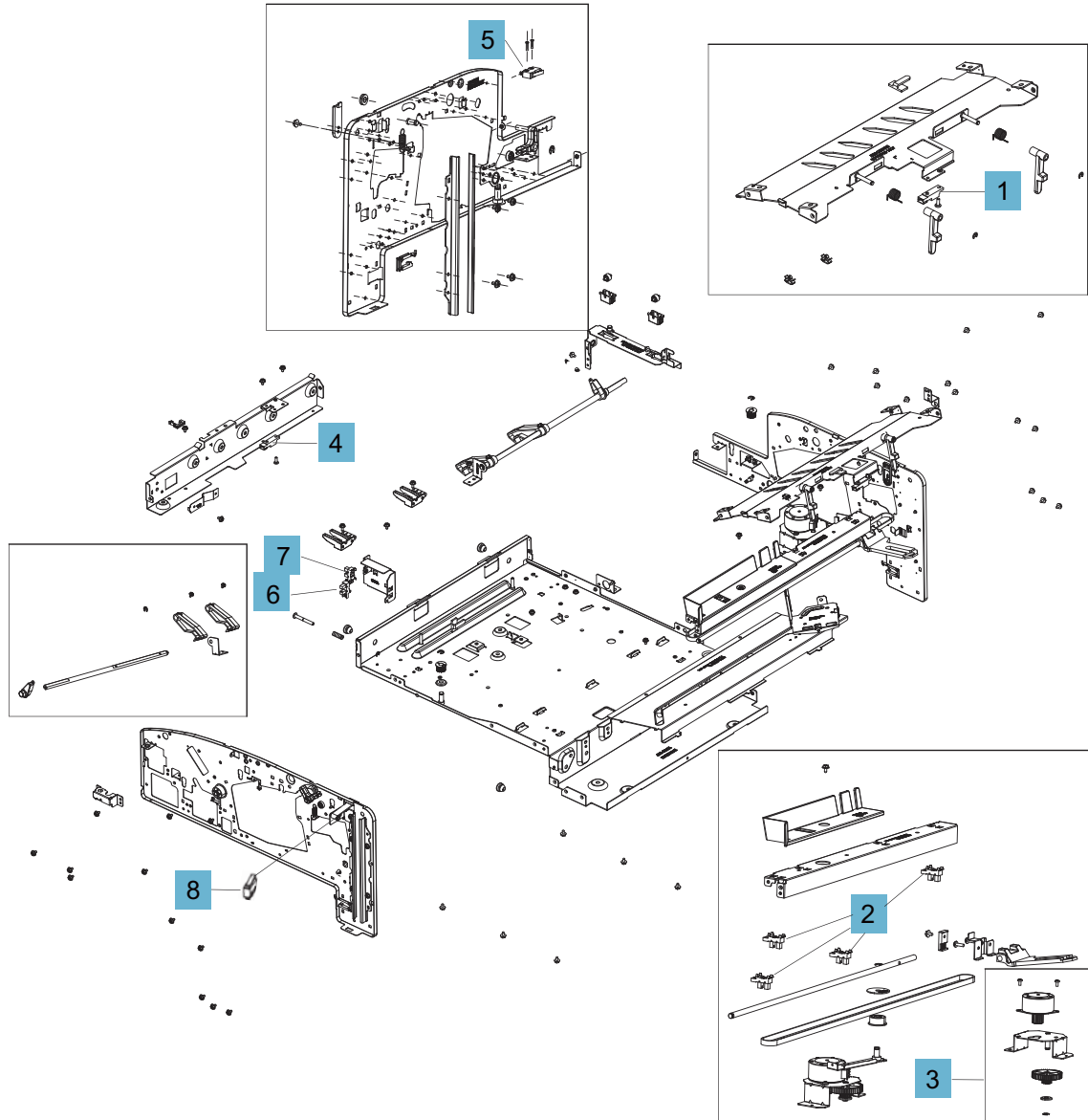

Table 5-27 Inner finisher (stapler unit, end fence unit)

Ref	Part number	Description	Qty
1	0604-001381	End fence sensor	1
2	0604-001393	Stapler position sensor	1
3	JC93-00999A	Stapler position motor	1
4	0604-001381	Punch waste full sensor	1
5	JC39-01610A	Top cover switch	1
6	0604-001393	Finisher docking sensor	1
7	0604-001393	Punch waste box sensor	1
8	JC39-01610A	Compile cover switch	1

Inner finisher (stapler assembly, entrance unit)

Parts diagram and parts list for the inner finisher (stapler assembly, entrance unit).

Figure 5-56 Inner finisher (stapler assembly, entrance unit)

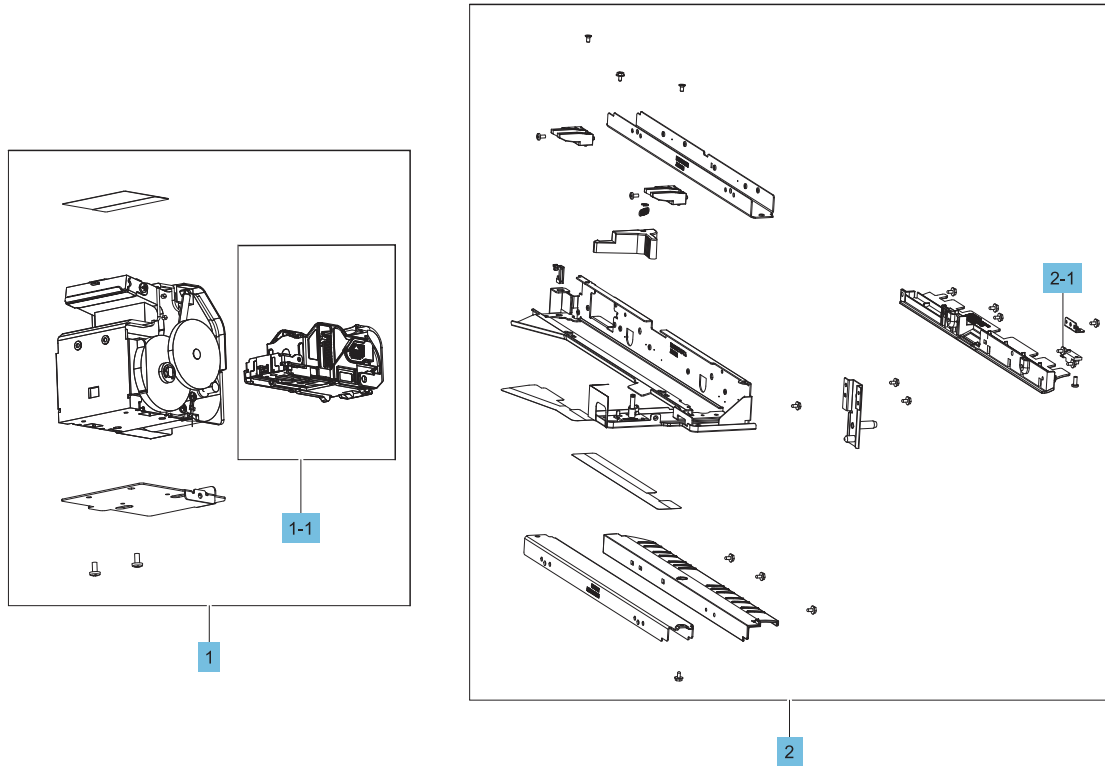

Table 5-28 Inner finisher (stapler assembly, entrance unit)

Ref	Part number	Description	Qty
1	JC59-00040A	Stapler assembly	1
1-1	JC81-07408B	Staple cartridge	1
2	JC90-01343B	Punch cover	1
2-1	0604-001381	Entrance sensor	1
Not shown	SS465-67001	SVC AS-PBA-HOLE PUNCH 2-4 HOLE	1
Not shown	SS466-67001	SVC AS-PBA-HOLE PUNCH SWEDISH	1
Not shown	SS467-67001	SVC AS-PBA-HOLE PUNCH 2-3	1

Inner finisher (ejector unit)

Parts diagram and parts list for the inner finisher (ejector unit).

Figure 5-57 Inner finisher (ejector unit)

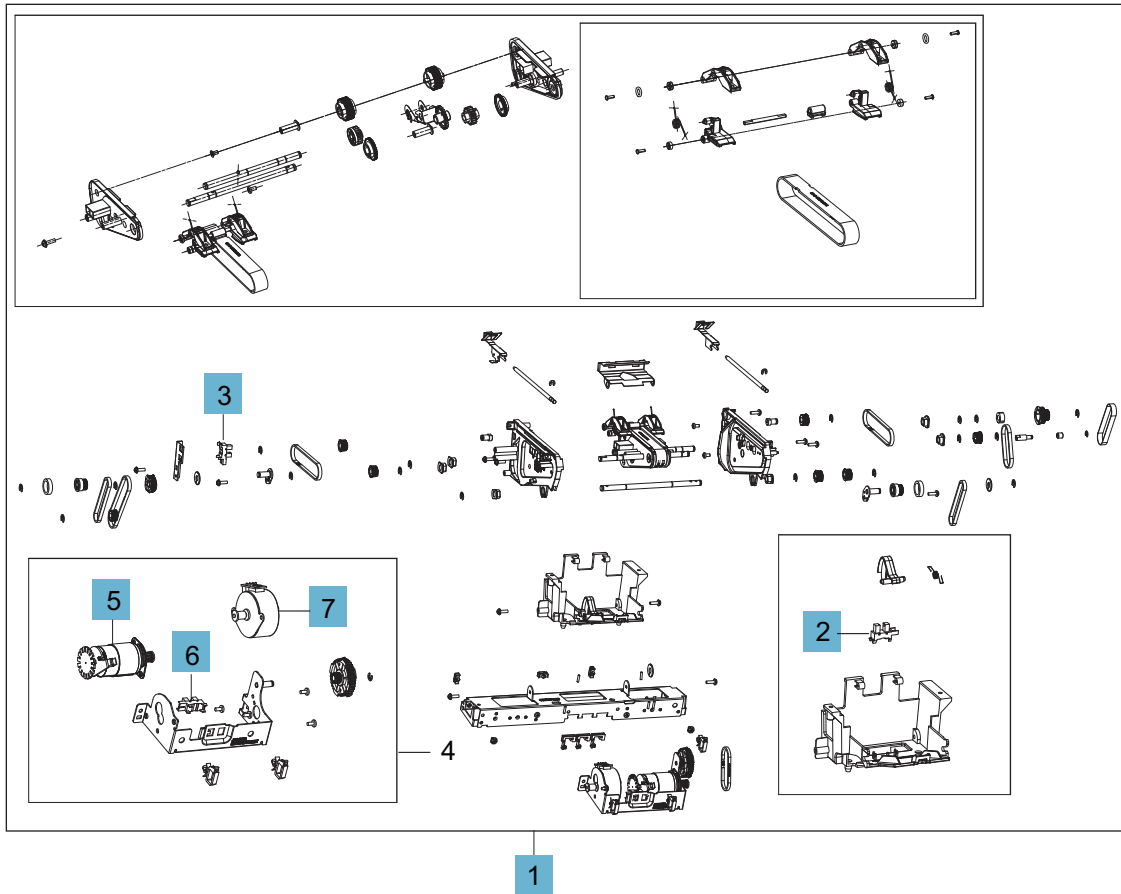

Table 5-29 Inner finisher (ejector unit)

Ref	Part number	Description	Qty
1	SS456-61001	Ejector	1
2	0604-001393	Ejector2 home sensor	1
3	0604-001393	Ejector1 home sensor	1
4	JC90-01309A	Ejector motor assembly	1
5	JC93-01168A	Ejector2 motor assembly	1
6	0604-001393	Ejector2 motor sensor	1
7	JC93-00998A	Ejector1 motor assembly	1

Covers

Removal and replacement: Front cover (C1)

Learn how to remove and replace the front cover.

To view teardown&reassembling video of the inner finisher, click the link below.

 [View a teardown video of the inner finisher .](#)

 [View a reassembling video of the inner finisher .](#)

 **IMPORTANT:** When applicable, special installation instructions are provided for an assembly at the end of the removal procedure. Always completely read the removal instructions and follow all special installation instructions.

Mean time to repair:

Service level:

Before performing service

Turn the printer power off

- Press the power button on the front of the printer, and then turn off the power switch next to the power cable.
- A shutting-down message appears on the control-panel display.

 **WARNING!** To avoid damage to the printer, turn the power off and wait until the printer shuts down before removing the power cable.

- Disconnect the printer power cable after the printer has completely shut down (the control-panel display is blank).

Use the table below to identify the correct part number for your printer. To order the part, go to <https://parts.hp.com>.

Table 5-30 Part information

Part number	Part description
JC90-01321B	Front cover

Required tools

- #2 JIS screwdriver with a magnetic tip

After performing service

Turn the printer power on

- Connect the power cable.
- Use the power switch to turn the power on.

Post service test

Print any pages necessary to verify that the repair resolved the issue and did not create any new issues.

1. Remove the front cover.
 - a. Open the front door and open the punch cover.
 - b. Remove three screws in the front.
 - c. Remove the lever.
 - d. Open the top cover.
 - e. From the right side of the front cover, carefully lift and pry toward the top-left corner to remove the front cover.

Figure 5-58 Remove the front cover

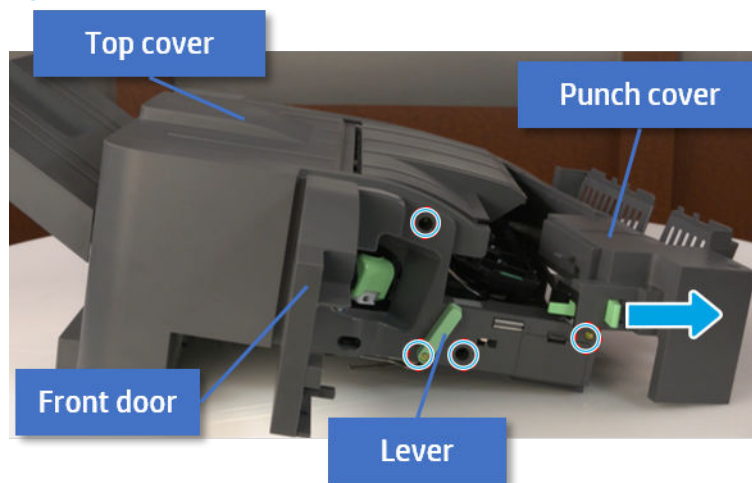



2. Unpack the replacement assembly.
 - a. Dispose of the defective part.

 **NOTE:** HP recommends responsible disposal of the defective part.

<http://www8.hp.com/us/en/hp-information/environment/product-recycling.html>

b. Unpack the replacement part from the packaging.

 **CAUTION:**  Some parts are sensitive to electrostatic discharge (ESD). Always perform service work at an ESD-protected workstation or mat. If an ESD workstation or mat is not available, touch the sheet-metal chassis to provide a static ground before touching an ESD-sensitive assembly. Protect the ESD-sensitive assemblies by placing them in ESD pouches when they are out of the printer.

If the replacement part is a roller or pad, avoid touching the spongy part of it. Skin oils on the roller or pad can cause paper pickup and/or print-quality problems. HP recommends using disposable gloves when handling rollers or pads or washing your hands before touching rollers or pads.

 **IMPORTANT:** Make sure that all of the shipping materials (for example shipping tape) are removed from the replacement part prior to installation.

c. To install an assembly, reverse the removal steps.

When applicable, special installation instructions are provided for an assembly at the end of the removal procedure. Always completely read the removal instructions and follow all special installation instructions.

Removal and replacement: Rear cover (C8)

Learn how to remove and replace the rear cover.

To view teardown&reassembling video of the inner finisher, click the link below.

 [View a teardown video of the inner finisher .](#)

 [View a reassembling video of the inner finisher .](#)

 **IMPORTANT:** When applicable, special installation instructions are provided for an assembly at the end of the removal procedure. Always completely read the removal instructions and follow all special installation instructions.

Mean time to repair:

Service level:

Before performing service

Turn the printer power off

- Press the power button on the front of the printer, and then turn off the power switch next to the power cable.
- A shutting-down message appears on the control-panel display.

 **WARNING!** To avoid damage to the printer, turn the power off and wait until the printer shuts down before removing the power cable.

- Disconnect the printer power cable after the printer has completely shut down (the control-panel display is blank).

Use the table below to identify the correct part number for your printer. To order the part, go to <https://parts.hp.com>.

Table 5-31 Part information

Part number	Part description
JC63-04750B	Rear cover

Required tools

- #2 JIS screwdriver with a magnetic tip

After performing service

Turn the printer power on

- Connect the power cable.
- Use the power switch to turn the power on.

Post service test

Print any pages necessary to verify that the repair resolved the issue and did not create any new issues.

1. Remove the rear cover.
 - a. Open the top cover.

Figure 5-59 Open the top cover

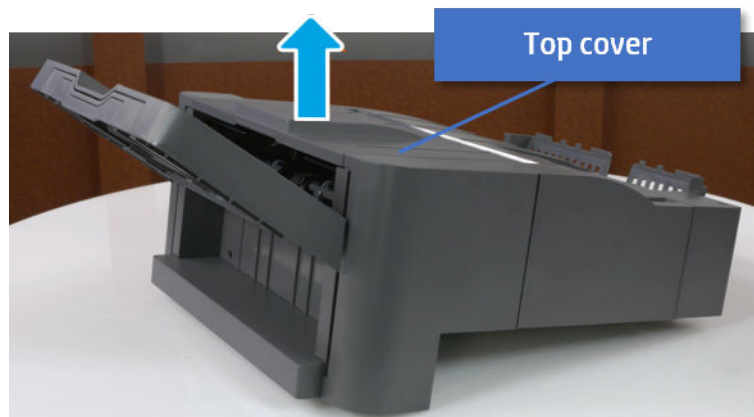

- b. Remove three screws.

- c. Release hooks carefully and remove the rear cover.

Figure 5-60 Remove the rear cover

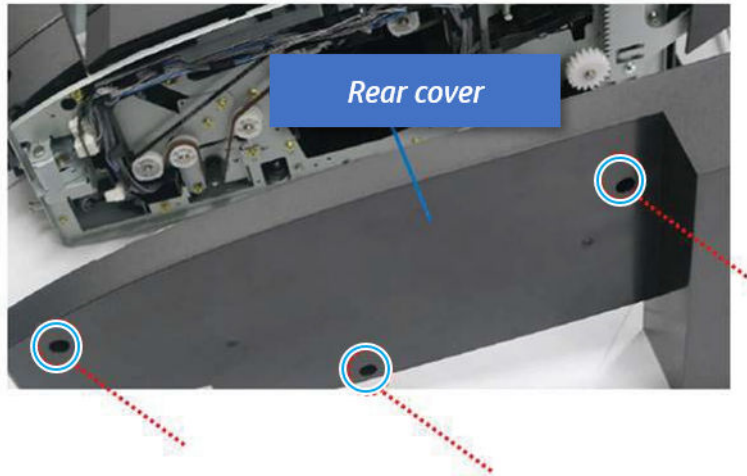

2. Unpack the replacement assembly.

- a. Dispose of the defective part.



NOTE: HP recommends responsible disposal of the defective part.

<http://www8.hp.com/us/en/hp-information/environment/product-recycling.html>

- b. Unpack the replacement part from the packaging.



CAUTION:  Some parts are sensitive to electrostatic discharge (ESD). Always perform service work at an ESD-protected workstation or mat. If an ESD workstation or mat is not available, touch the sheet-metal chassis to provide a static ground before touching an ESD-sensitive assembly. Protect the ESD-sensitive assemblies by placing them in ESD pouches when they are out of the printer.

If the replacement part is a roller or pad, avoid touching the spongy part of it. Skin oils on the roller or pad can cause paper pickup and/or print-quality problems. HP recommends using disposable gloves when handling rollers or pads or washing your hands before touching rollers or pads.



IMPORTANT: Make sure that all of the shipping materials (for example shipping tape) are removed from the replacement part prior to installation.

- c. To install an assembly, reverse the removal steps.

When applicable, special installation instructions are provided for an assembly at the end of the removal procedure. Always completely read the removal instructions and follow all special installation instructions.

Removal and replacement: Middle cover (C3)

Learn how to remove and replace the middle cover.

To view teardown&reassembling video of the inner finisher, click the link below.



[View a teardown video of the inner finisher .](#)

 [View a reassembling video of the inner finisher .](#)

 **IMPORTANT:** When applicable, special installation instructions are provided for an assembly at the end of the removal procedure. Always completely read the removal instructions and follow all special installation instructions.

Mean time to repair:

Service level:

Before performing service

Turn the printer power off

- Press the power button on the front of the printer, and then turn off the power switch next to the power cable.
- A shutting-down message appears on the control-panel display.

 **WARNING!** To avoid damage to the printer, turn the power off and wait until the printer shuts down before removing the power cable.

- Disconnect the printer power cable after the printer has completely shut down (the control-panel display is blank).

Use the table below to identify the correct part number for your printer. To order the part, go to <https://parts.hp.com>.

Table 5-32 Part information

Part number	Part description
JC90-01322B	Middle cover

Required tools

- #2 JIS screwdriver with a magnetic tip

After performing service

Turn the printer power on

- Connect the power cable.
- Use the power switch to turn the power on.

Post service test

Print any pages necessary to verify that the repair resolved the issue and did not create any new issues.

1. Remove the rear cover.
 - a. Open the top cover.

Figure 5-61 Open the top cover

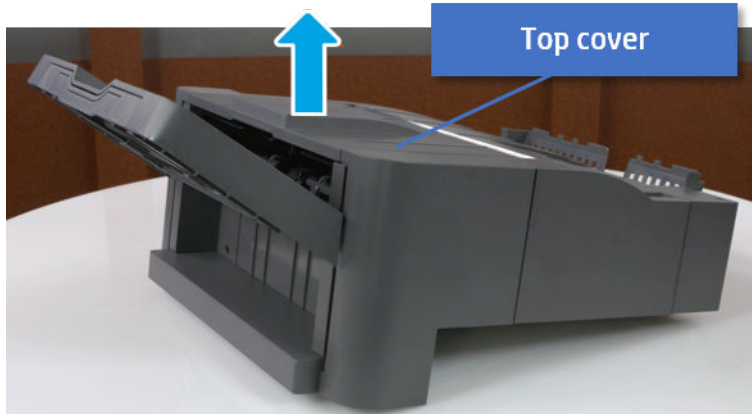

- b. Remove three screws.
- c. Release hooks carefully and remove the rear cover.

Figure 5-62 Remove the rear cover

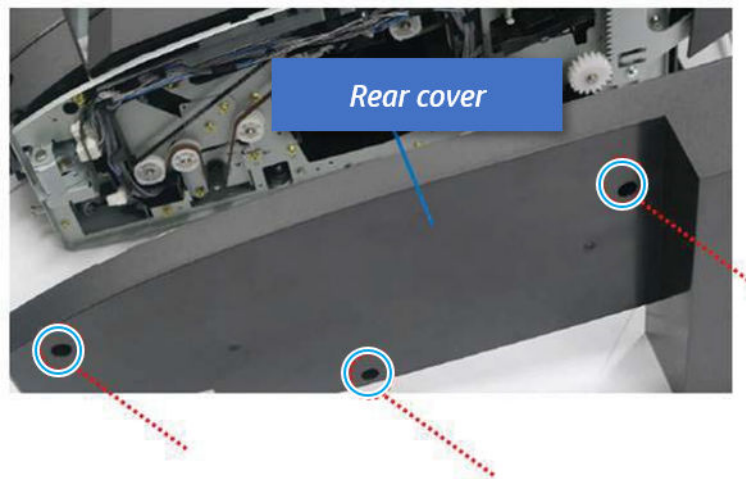

- 2. Remove the middle cover.
 - a. Open the front door and then open the punch cover.

Figure 5-63 Open the front door and punch cover.

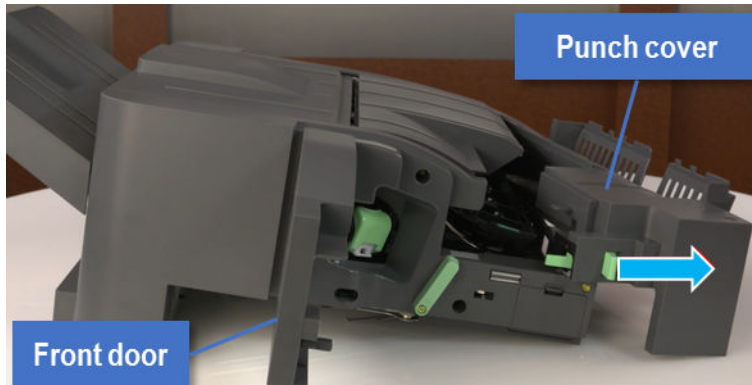

- b. Remove left-side one screw at the rear of the inner finisher, and then remove the middle cover by lifting off the hinge pins at the front.

Figure 5-64 Remove the middle cover

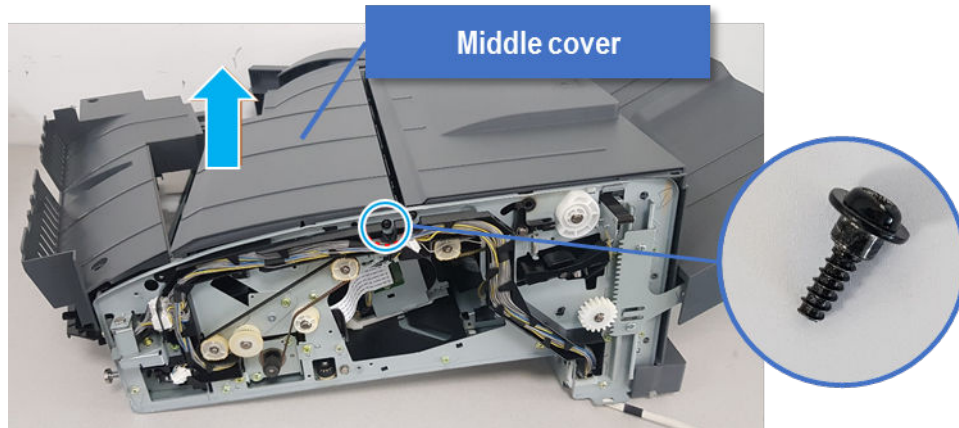

3. Unpack the replacement assembly.

- a. Dispose of the defective part.



NOTE: HP recommends responsible disposal of the defective part.

<http://www8.hp.com/us/en/hp-information/environment/product-recycling.html>

- b. Unpack the replacement part from the packaging.



CAUTION:



Some parts are sensitive to electrostatic discharge (ESD). Always perform service work at an ESD-protected workstation or mat. If an ESD workstation or mat is not available, touch the sheet-metal chassis to provide a static ground before touching an ESD-sensitive assembly. Protect the ESD-sensitive assemblies by placing them in ESD pouches when they are out of the printer.

If the replacement part is a roller or pad, avoid touching the spongy part of it. Skin oils on the roller or pad can cause paper pickup and/or print-quality problems. HP recommends using disposable gloves when handling rollers or pads or washing your hands before touching rollers or pads.



IMPORTANT: Make sure that all of the shipping materials (for example shipping tape) are removed from the replacement part prior to installation.

- c. To install an assembly, reverse the removal steps.

When applicable, special installation instructions are provided for an assembly at the end of the removal procedure. Always completely read the removal instructions and follow all special installation instructions.

Removal and replacement: Top cover (C2)

Learn how to remove and replace the top cover.

To view teardown&reassembling video of the inner finisher, click the link below.



[View a teardown video of the inner finisher .](#)

 [View a reassembling video of the inner finisher .](#)

 **IMPORTANT:** When applicable, special installation instructions are provided for an assembly at the end of the removal procedure. Always completely read the removal instructions and follow all special installation instructions.

Mean time to repair:

Service level:

Before performing service

Turn the printer power off

- Press the power button on the front of the printer, and then turn off the power switch next to the power cable.
- A shutting-down message appears on the control-panel display.

 **WARNING!** To avoid damage to the printer, turn the power off and wait until the printer shuts down before removing the power cable.

- Disconnect the printer power cable after the printer has completely shut down (the control-panel display is blank).

Use the table below to identify the correct part number for your printer. To order the part, go to <https://parts.hp.com>.

Table 5-33 Part information

Part number	Part description
JC90-01323B	Top cover

Required tools

- #2 JIS screwdriver with a magnetic tip

After performing service

Turn the printer power on

- Connect the power cable.
- Use the power switch to turn the power on.

Post service test

Print any pages necessary to verify that the repair resolved the issue and did not create any new issues.

1. Remove the rear cover.
 - a. Open the top cover.

Figure 5-65 Open the top cover

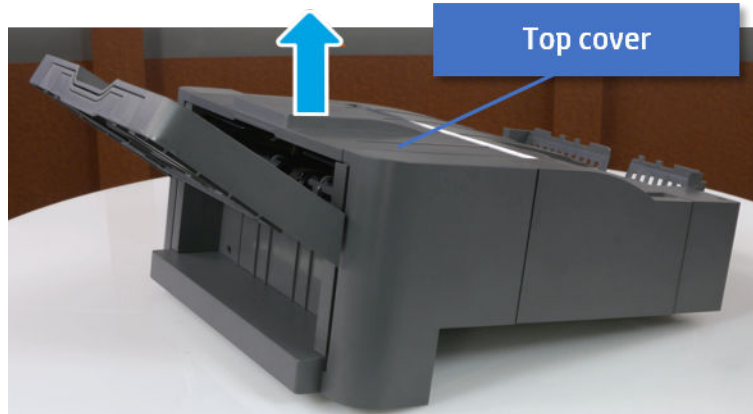

- b. Remove three screws.
- c. Release hooks carefully and remove the rear cover.

Figure 5-66 Remove the rear cover

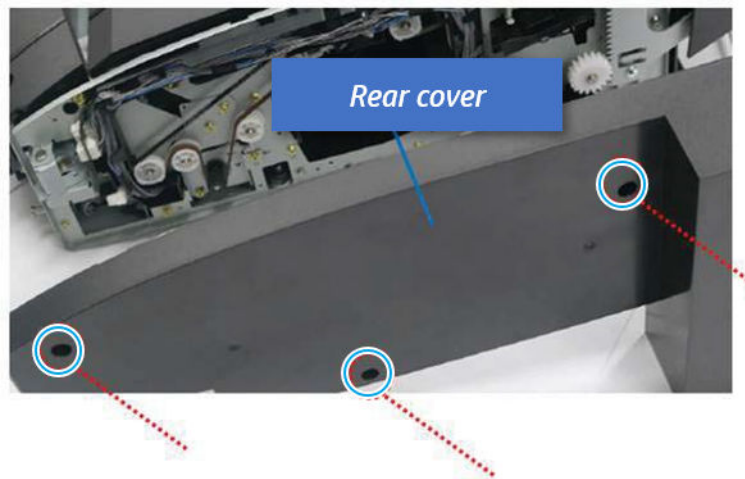

- 2. Remove the top cover.
 - ▲ Remove one screw at the rear of the inner finisher, and then remove the top cover by lifting off the hinge pins at the front.

Figure 5-67 Remove the top cover

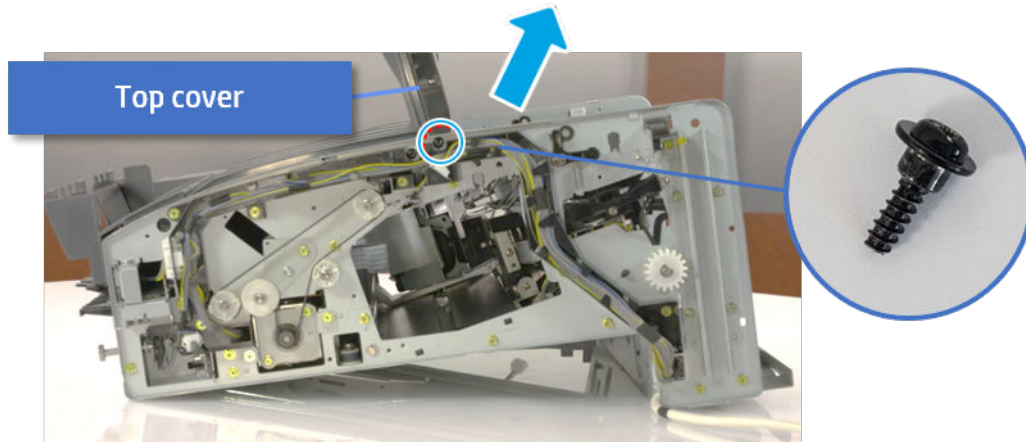



3. Unpack the replacement assembly.

- a. Dispose of the defective part.

 **NOTE:** HP recommends responsible disposal of the defective part.

<http://www8.hp.com/us/en/hp-information/environment/product-recycling.html>

- b. Unpack the replacement part from the packaging.

 **CAUTION:**  Some parts are sensitive to electrostatic discharge (ESD). Always perform service work at an ESD-protected workstation or mat. If an ESD workstation or mat is not available, touch the sheet-metal chassis to provide a static ground before touching an ESD-sensitive assembly. Protect the ESD-sensitive assemblies by placing them in ESD pouches when they are out of the printer.

If the replacement part is a roller or pad, avoid touching the spongy part of it. Skin oils on the roller or pad can cause paper pickup and/or print-quality problems. HP recommends using disposable gloves when handling rollers or pads or washing your hands before touching rollers or pads.

 **IMPORTANT:** Make sure that all of the shipping materials (for example shipping tape) are removed from the replacement part prior to installation.

- c. To install an assembly, reverse the removal steps.

When applicable, special installation instructions are provided for an assembly at the end of the removal procedure. Always completely read the removal instructions and follow all special installation instructions.

Removal and replacement: PCA cover (C6)

Learn how to remove and replace the PCA cover.

To view teardown&reassembling video of the inner finisher, click the link below.

 [View a teardown video of the inner finisher .](#)

 [View a reassembling video of the inner finisher .](#)

 **IMPORTANT:** When applicable, special installation instructions are provided for an assembly at the end of the removal procedure. Always completely read the removal instructions and follow all special installation instructions.

Mean time to repair:

Service level:

Before performing service

Turn the printer power off

- Press the power button on the front of the printer, and then turn off the power switch next to the power cable.
- A shutting-down message appears on the control-panel display.

 **WARNING!** To avoid damage to the printer, turn the power off and wait until the printer shuts down before removing the power cable.

- Disconnect the printer power cable after the printer has completely shut down (the control-panel display is blank).

Use the table below to identify the correct part number for your printer. To order the part, go to <https://parts.hp.com>.

Table 5-34 Part information

Part number	Part description
JC63-04792B	PCA cover

Required tools

- #2 JIS screwdriver with a magnetic tip

After performing service

Turn the printer power on

- Connect the power cable.
- Use the power switch to turn the power on.

Post service test

Print any pages necessary to verify that the repair resolved the issue and did not create any new issues.

1. Remove the PCA cover.
 - ▲ Remove two screws, and then remove the PCA cover.

Figure 5-68 Remove the PCA cover

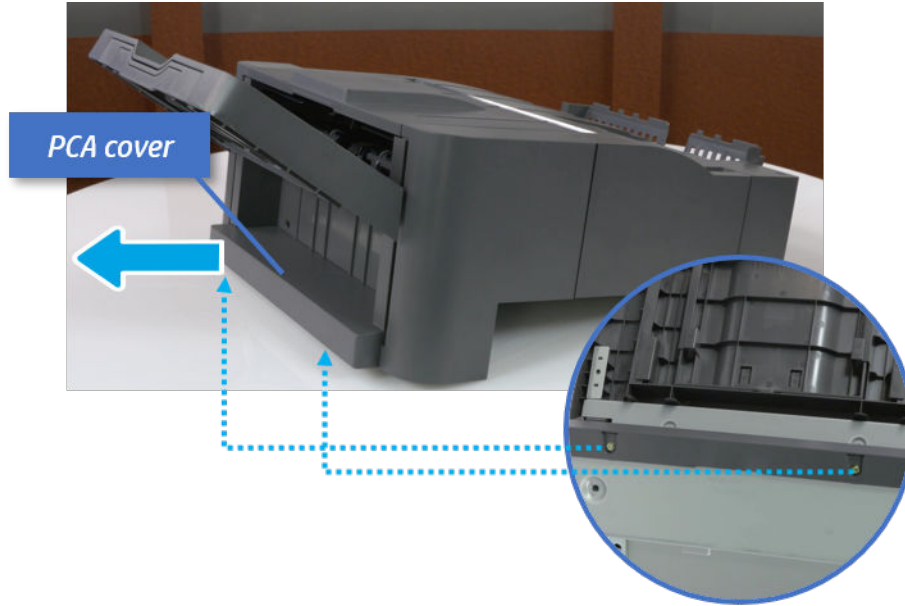

2. Unpack the replacement assembly.
 - a. Dispose of the defective part.



NOTE: HP recommends responsible disposal of the defective part.

<http://www8.hp.com/us/en/hp-information/environment/product-recycling.html>

- b. Unpack the replacement part from the packaging.



CAUTION:  Some parts are sensitive to electrostatic discharge (ESD). Always perform service work at an ESD-protected workstation or mat. If an ESD workstation or mat is not available, touch the sheet-metal chassis to provide a static ground before touching an ESD-sensitive assembly. Protect the ESD-sensitive assemblies by placing them in ESD pouches when they are out of the printer.

If the replacement part is a roller or pad, avoid touching the spongy part of it. Skin oils on the roller or pad can cause paper pickup and/or print-quality problems. HP recommends using disposable gloves when handling rollers or pads or washing your hands before touching rollers or pads.



IMPORTANT: Make sure that all of the shipping materials (for example shipping tape) are removed from the replacement part prior to installation.

- c. To install an assembly, reverse the removal steps.

When applicable, special installation instructions are provided for an assembly at the end of the removal procedure. Always completely read the removal instructions and follow all special installation instructions.

Removal and replacement: Left cover (C7)

Learn how to remove and replace the left cover.

To view teardown&reassembling video of the inner finisher, click the link below.

 [View a teardown video of the inner finisher .](#)

 [View a reassembling video of the inner finisher .](#)

 **IMPORTANT:** When applicable, special installation instructions are provided for an assembly at the end of the removal procedure. Always completely read the removal instructions and follow all special installation instructions.

Mean time to repair:

Service level:

Before performing service

Turn the printer power off

- Press the power button on the front of the printer, and then turn off the power switch next to the power cable.
- A shutting-down message appears on the control-panel display.

 **WARNING!** To avoid damage to the printer, turn the power off and wait until the printer shuts down before removing the power cable.

- Disconnect the printer power cable after the printer has completely shut down (the control-panel display is blank).

Use the table below to identify the correct part number for your printer. To order the part, go to <https://parts.hp.com>.

Table 5-35 Part information

Part number	Part description
JC90-01324B	Left cover

Required tools

- #2 JIS screwdriver with a magnetic tip

After performing service

Turn the printer power on

- Connect the power cable.
- Use the power switch to turn the power on.

Post service test

Print any pages necessary to verify that the repair resolved the issue and did not create any new issues.

1. Remove the front cover.
 - a. Open the front door and open the punch cover.
 - b. Remove three screws in the front.

- c. Remove the lever.
- d. Open the top cover.
- e. From the right side of the front cover, carefully lift and pry toward the top-left corner to remove the front cover.

Figure 5-69 Remove the front cover

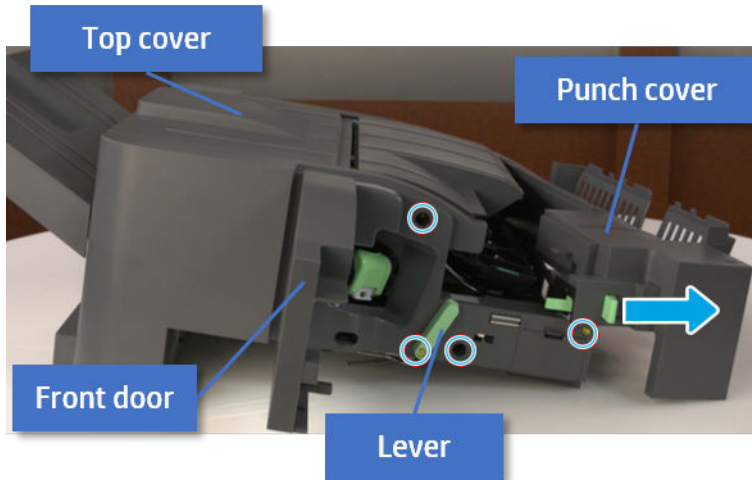

- 2. Remove the rear cover.
 - a. Open the top cover.

Figure 5-70 Open the top cover

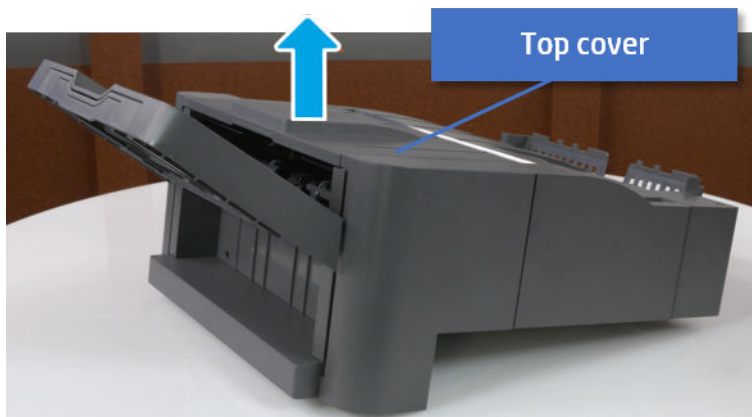

- b. Remove three screws.

- c. Release hooks carefully and remove the rear cover.

Figure 5-71 Remove the rear cover

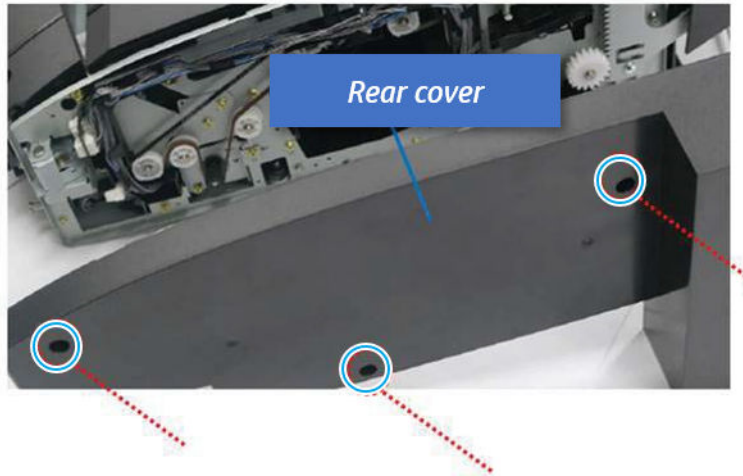

- 3. Remove the output tray.

- a. Remove four screws.

Figure 5-72 Remove four screws

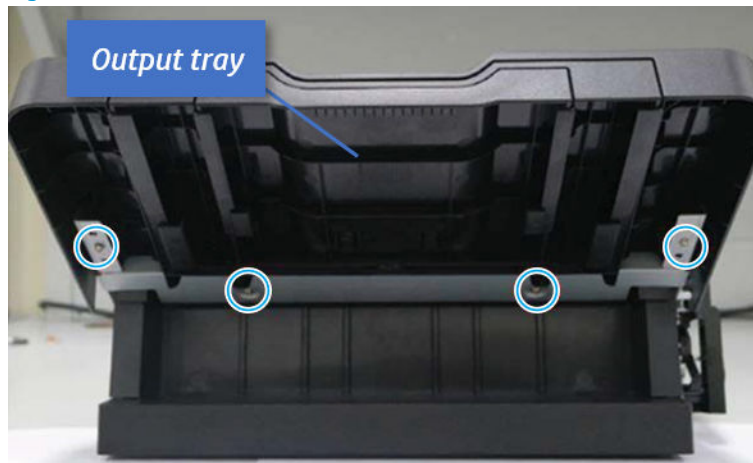

- b. Push the paper holding actuator into the inner finisher, and then remove the output tray.

Figure 5-73 Remove the output tray.



- 4. Remove the output tray frame.
 - a. Rotate the pulley until the output tray frame depart from the gear.

Figure 5-74 Remove the pulley

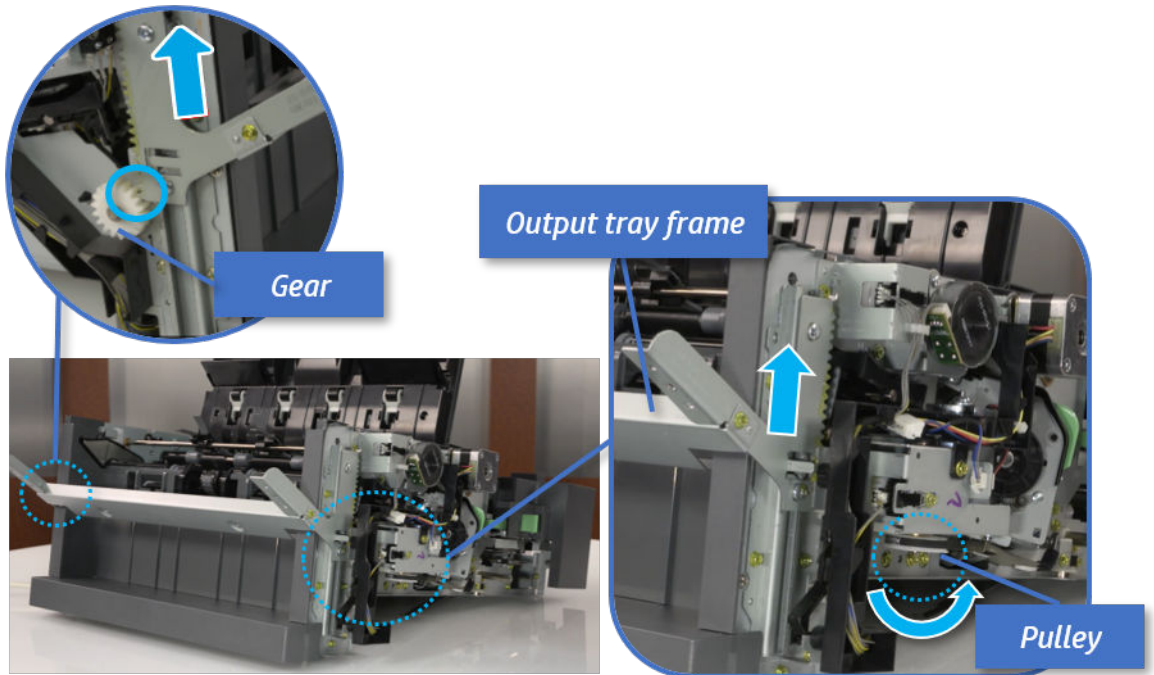

- b. Push the paper holding actuator into the inner finisher, and then remove the output tray frame.

Figure 5-75 Remove the output tray frame

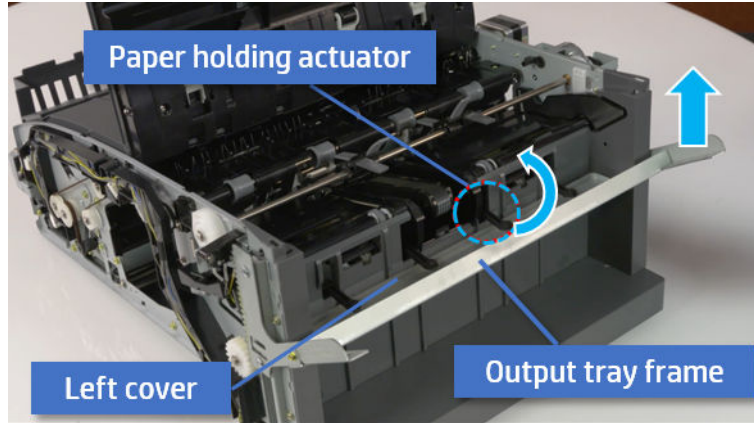

TIP: Push the paper holding actuator into the inner finisher when reassembling. Be sure to level the output tray.

1. Position the first wheel into the channel on both sides while pushing the paper holding actuator.

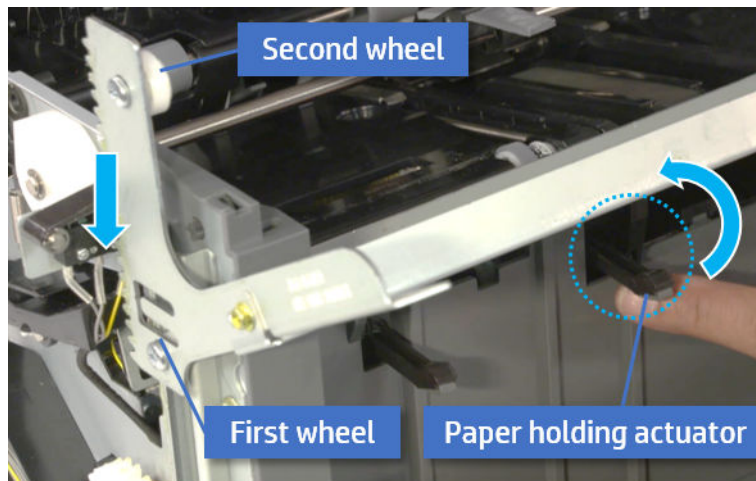

2. Let the second wheel rest on the channel on both sides simultaneously.
3. Gently squeeze the wheels into channel until the output tray frame meet the gear.

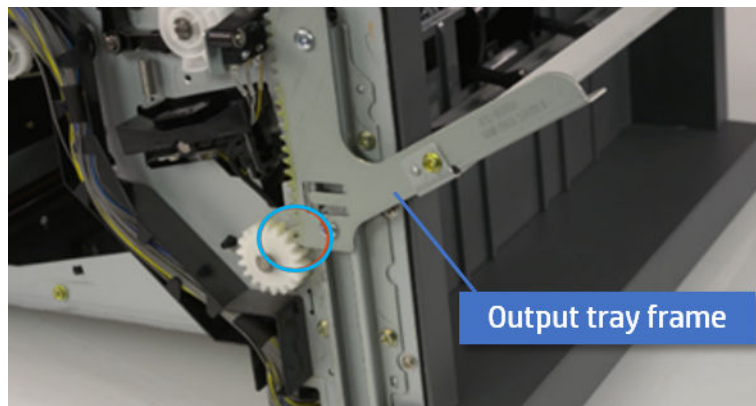

4. Rotate the pulley until the output tray frame is no longer lifted. It can make to level the output tray frame.

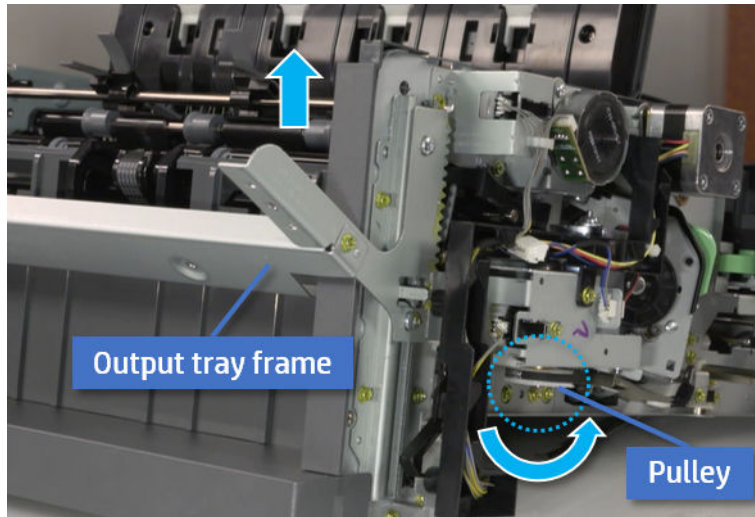

5. Rotate the pulley in the opposite direction.

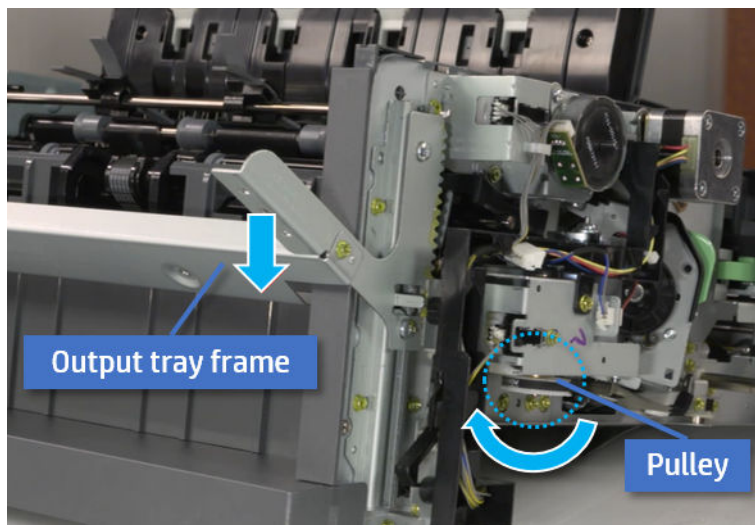

5. Remove the PCA cover.
 - ▲ Remove two screws, and then remove the PCA cover.

Figure 5-76 Remove the PCA cover

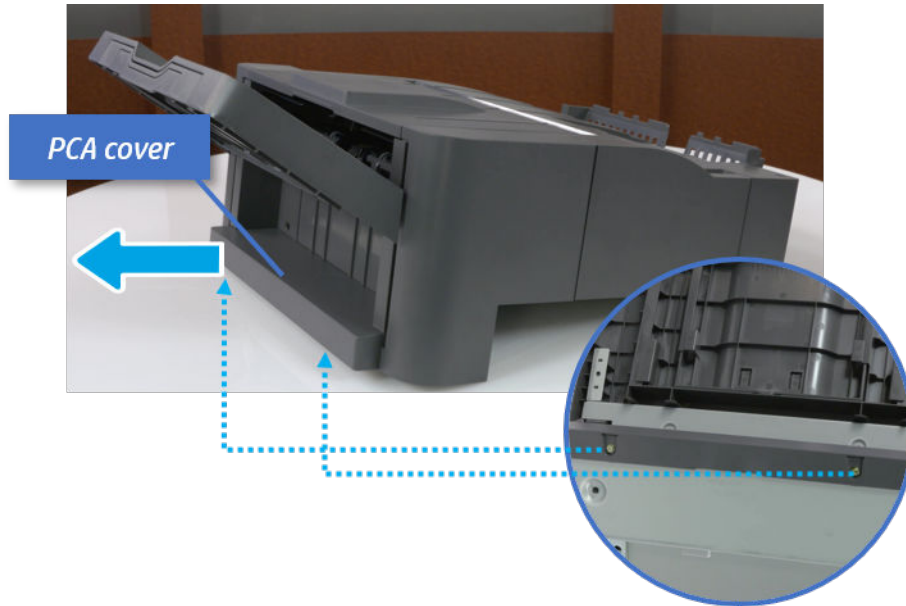

6. Remove the left cover.
 - a. Remove two screws.

Figure 5-77 Remove two screws

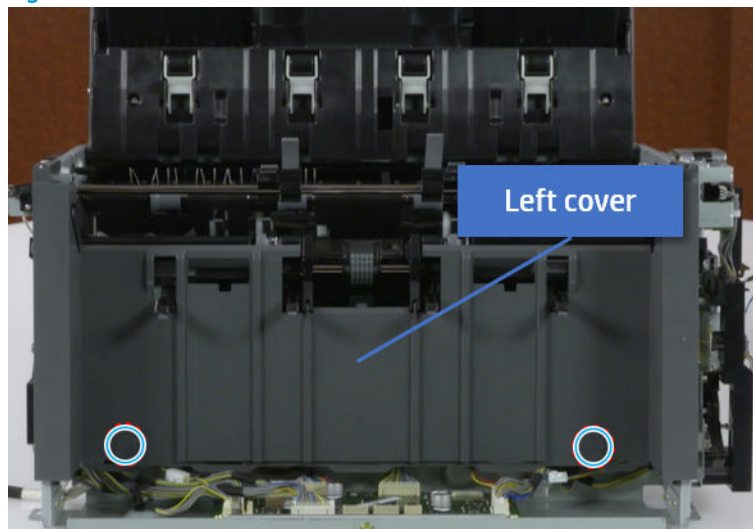

- b. Remove four screws from both front and rear sides.

Figure 5-78 Remove four screws

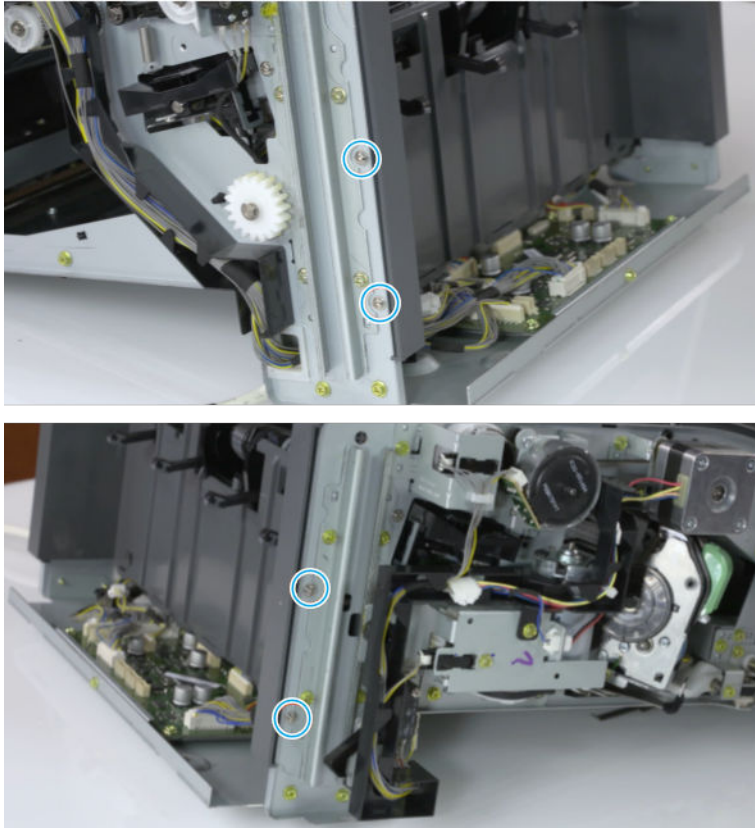

- c. Unplug two inline connectors, and then remove the left cover.

Figure 5-79 Unplug two connectors

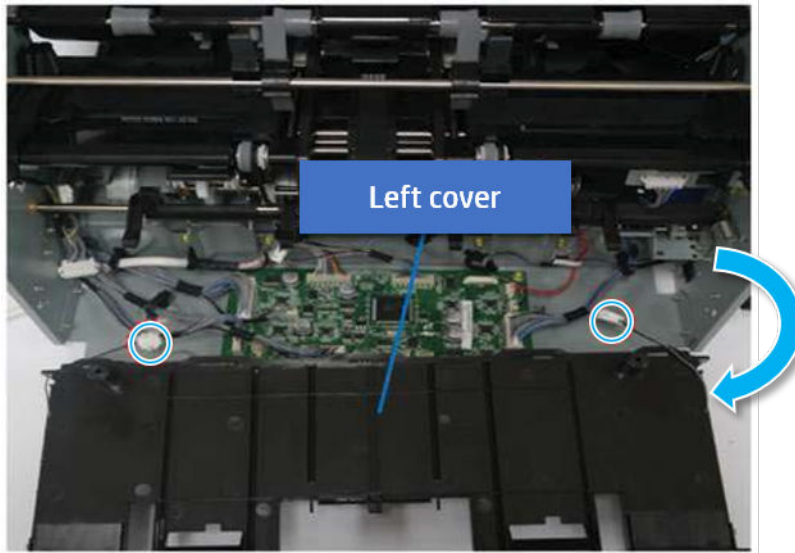

 **TIP:** Be sure to check the hook when reassembling.

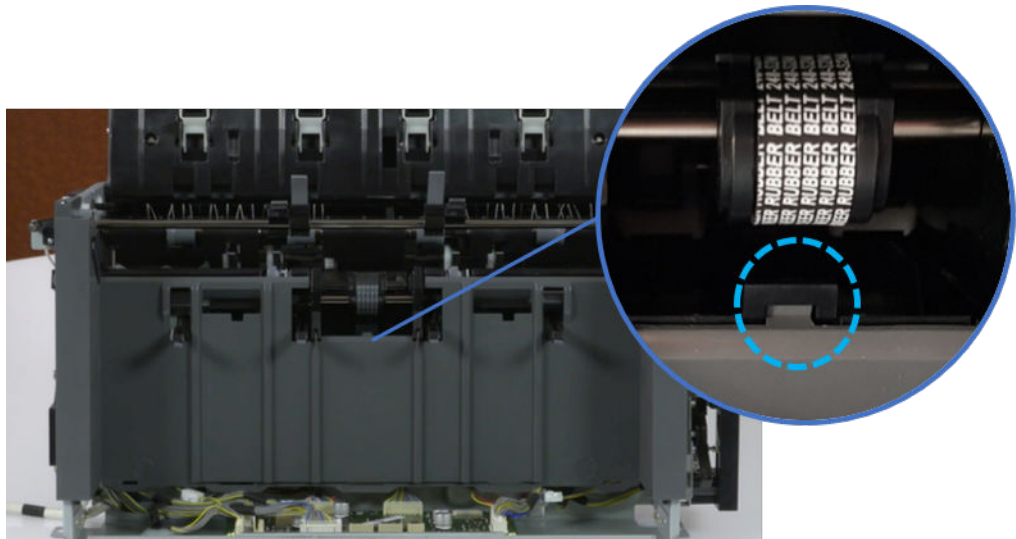



- 7. Unpack the replacement assembly.
 - a. Dispose of the defective part.

 **NOTE:** HP recommends responsible disposal of the defective part.

<http://www8.hp.com/us/en/hp-information/environment/product-recycling.html>

- b. Unpack the replacement part from the packaging.

 **CAUTION:**  Some parts are sensitive to electrostatic discharge (ESD). Always perform service work at an ESD-protected workstation or mat. If an ESD workstation or mat is not available, touch the sheet-metal chassis to provide a static ground before touching an ESD-sensitive assembly. Protect the ESD-sensitive assemblies by placing them in ESD pouches when they are out of the printer.

If the replacement part is a roller or pad, avoid touching the spongy part of it. Skin oils on the roller or pad can cause paper pickup and/or print-quality problems. HP recommends using disposable gloves when handling rollers or pads or washing your hands before touching rollers or pads.

 **IMPORTANT:** Make sure that all of the shipping materials (for example shipping tape) are removed from the replacement part prior to installation.

- c. To install an assembly, reverse the removal steps.

When applicable, special installation instructions are provided for an assembly at the end of the removal procedure. Always completely read the removal instructions and follow all special installation instructions.

Entrance unit

Removal and replacement: Entrance sensor (S1)

Learn how to remove and replace the entrance sensor.

To view teardown&reassembling video of the inner finisher, click the link below.

 [View a teardown video of the inner finisher .](#)

 [View a reassembling video of the inner finisher .](#)

 **IMPORTANT:** When applicable, special installation instructions are provided for an assembly at the end of the removal procedure. Always completely read the removal instructions and follow all special installation instructions.

Mean time to repair:

Service level:

Before performing service

Turn the printer power off

- Press the power button on the front of the printer, and then turn off the power switch next to the power cable.
- A shutting-down message appears on the control-panel display.

 **WARNING!** To avoid damage to the printer, turn the power off and wait until the printer shuts down before removing the power cable.

- Disconnect the printer power cable after the printer has completely shut down (the control-panel display is blank).

Use the table below to identify the correct part number for your printer. To order the part, go to <https://parts.hp.com>.

Table 5-36 Part information

Part number	Part description
0604-001381	Entrance sensor

Required tools

- #2 JIS screwdriver with a magnetic tip

After performing service

Turn the printer power on

- Connect the power cable.
- Use the power switch to turn the power on.

Post service test

Print any pages necessary to verify that the repair resolved the issue and did not create any new issues.

1. Remove the rear cover.
 - a. Open the top cover.

Figure 5-80 Open the top cover

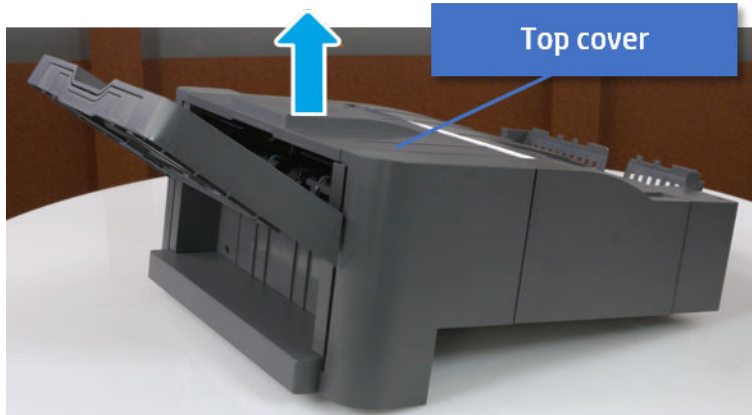

- b. Remove three screws.
 - c. Release hooks carefully and remove the rear cover.

Figure 5-81 Remove the rear cover

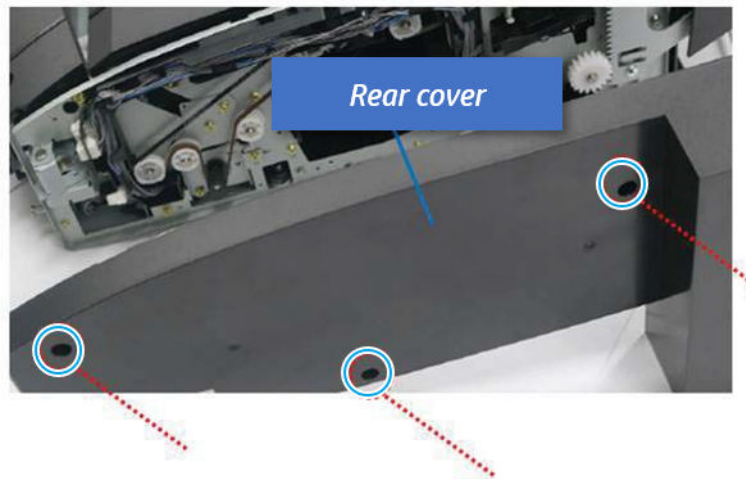

2. Remove the punch cover.
 - a. Unplug the connector. Remove the e-ring, and then remove the slide shaft at the rear of the inner finisher.

Figure 5-82 Remove the slide shaft

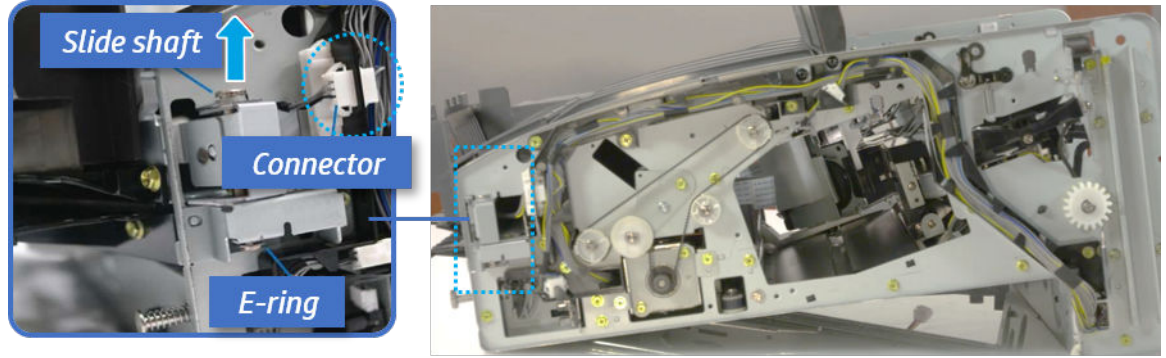

- b. Open the punch cover.

Figure 5-83 Open the punch cover

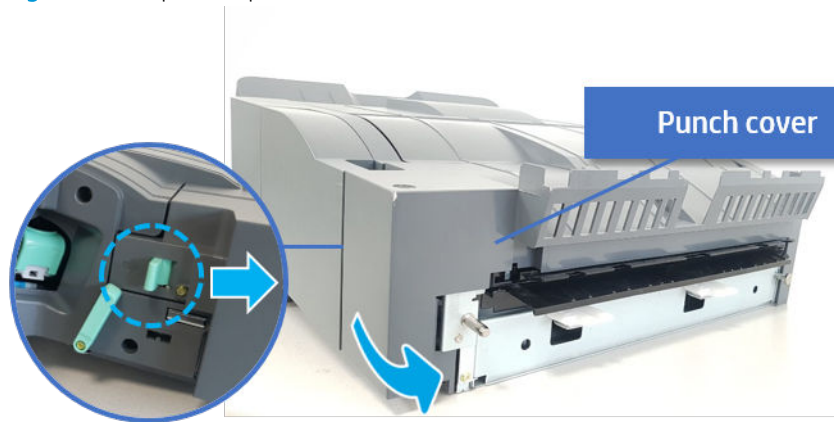

- c. Remove the front punch sheet, and then remove the e-ring and the washer. And then remove the punch cover.

Figure 5-84 Remove the punch cover

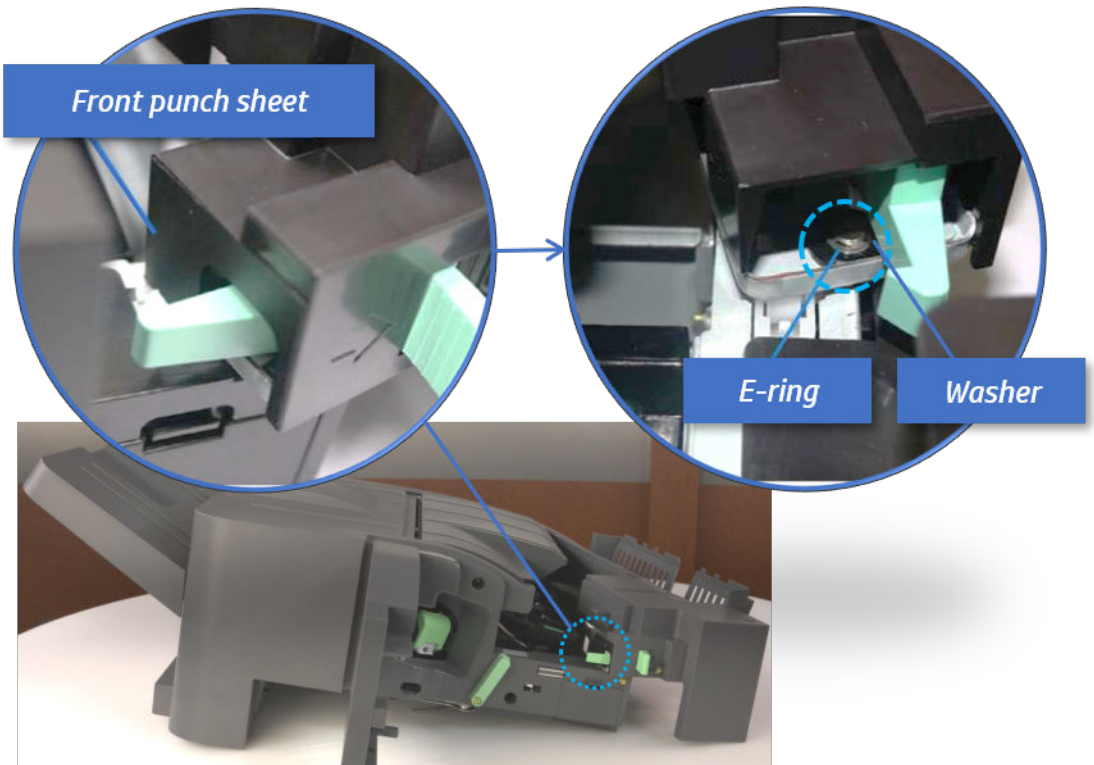

3. Remove the entrance sensor.
 - a. Loosen the adhesive tape around, and then remove four screws. And then remove the punch cover.

Figure 5-85 Remove the punch cover

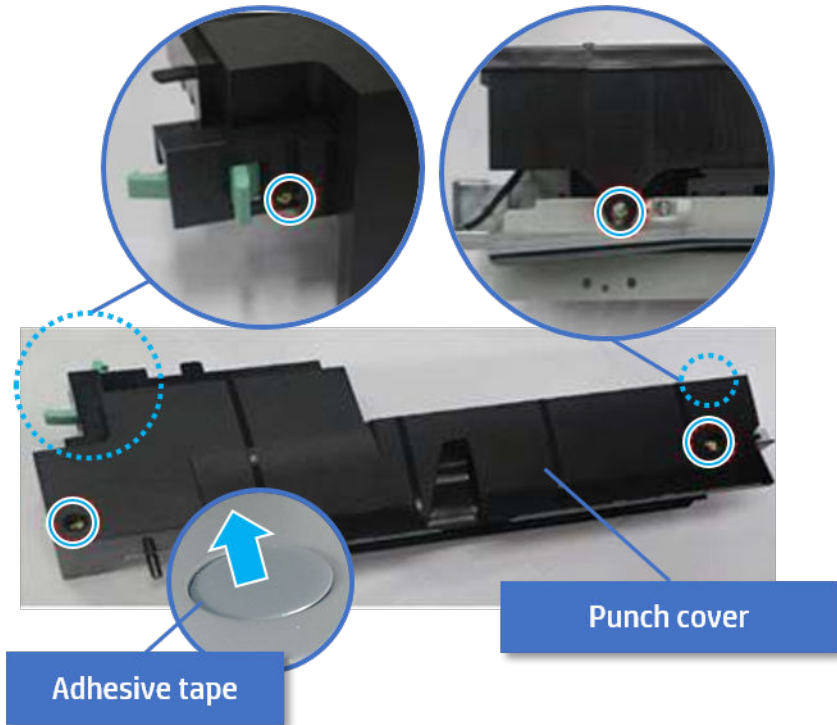

- b. Remove one screw, unplug the connector, and then remove the entrance sensor bracket.

Figure 5-86 Remove the entrance sensor bracket

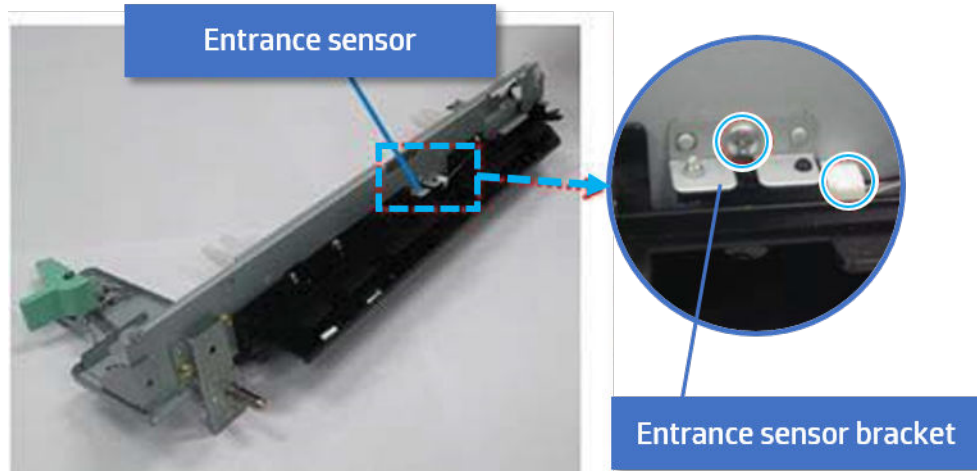

- c. Remove one screw, and then remove the sensor.

Figure 5-87 Remove the entrance sensor

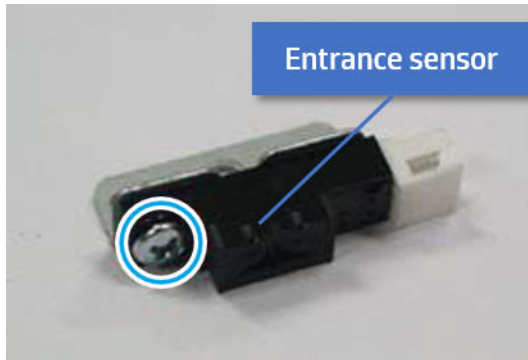

4. Unpack the replacement assembly.
 - a. Dispose of the defective part.



NOTE: HP recommends responsible disposal of the defective part.

<http://www8.hp.com/us/en/hp-information/environment/product-recycling.html>

- b. Unpack the replacement part from the packaging.



CAUTION:  Some parts are sensitive to electrostatic discharge (ESD). Always perform service work at an ESD-protected workstation or mat. If an ESD workstation or mat is not available, touch the sheet-metal chassis to provide a static ground before touching an ESD-sensitive assembly. Protect the ESD-sensitive assemblies by placing them in ESD pouches when they are out of the printer.

If the replacement part is a roller or pad, avoid touching the spongy part of it. Skin oils on the roller or pad can cause paper pickup and/or print-quality problems. HP recommends using disposable gloves when handling rollers or pads or washing your hands before touching rollers or pads.



IMPORTANT: Make sure that all of the shipping materials (for example shipping tape) are removed from the replacement part prior to installation.

- c. To install an assembly, reverse the removal steps.

When applicable, special installation instructions are provided for an assembly at the end of the removal procedure. Always completely read the removal instructions and follow all special installation instructions.

Removal and replacement: Entrance motor (M10)

Learn how to remove and replace the entrance motor.

To view teardown&reassembling video of the inner finisher, click the link below.



[View a teardown video of the inner finisher .](#)



[View a reassembling video of the inner finisher .](#)



IMPORTANT: When applicable, special installation instructions are provided for an assembly at the end of the removal procedure. Always completely read the removal instructions and follow all special installation instructions.

Mean time to repair:

Service level:

Before performing service

Turn the printer power off

- Press the power button on the front of the printer, and then turn off the power switch next to the power cable.
- A shutting-down message appears on the control-panel display.

⚠ WARNING! To avoid damage to the printer, turn the power off and wait until the printer shuts down before removing the power cable.

- Disconnect the printer power cable after the printer has completely shut down (the control-panel display is blank).

Use the table below to identify the correct part number for your printer. To order the part, go to <https://parts.hp.com>.

Table 5-37 Part information

Part number	Part description
JC90-01344A	Entrance motor assembly

Required tools

- #2 JIS screwdriver with a magnetic tip

After performing service

Turn the printer power on

- Connect the power cable.
- Use the power switch to turn the power on.

Post service test

Print any pages necessary to verify that the repair resolved the issue and did not create any new issues.

1. Remove the front cover.
 - a. Open the front door and open the punch cover.
 - b. Remove three screws in the front.
 - c. Remove the lever.
 - d. Open the top cover.

- e. From the right side of the front cover, carefully lift and pry toward the top-left corner to remove the front cover.

Figure 5-88 Remove the front cover

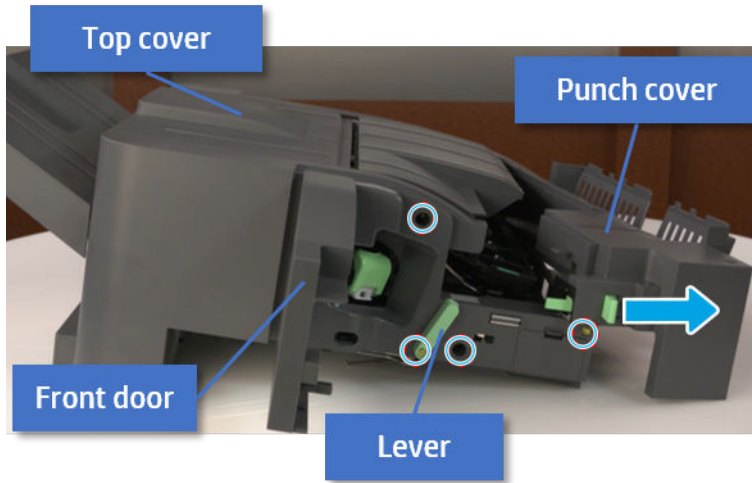

2. Remove the rear cover.
 - a. Open the top cover.

Figure 5-89 Open the top cover

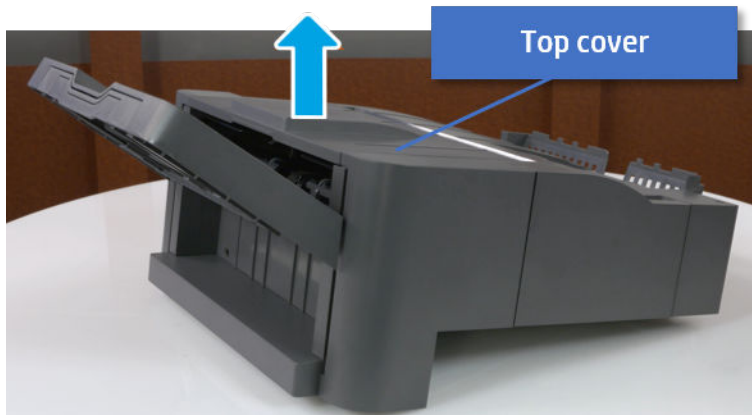

- b. Remove three screws.

- c. Release hooks carefully and remove the rear cover.

Figure 5-90 Remove the rear cover

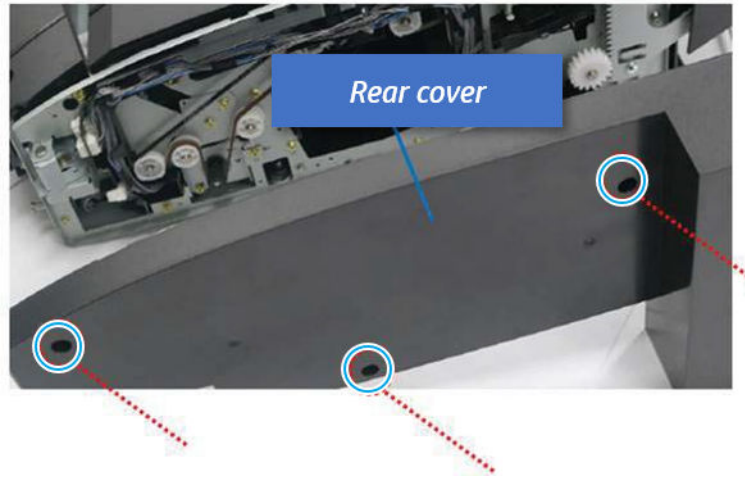

- 3. Remove the middle cover.

- a. Open the front door and then open the punch cover.

Figure 5-91 Open the front door and punch cover.

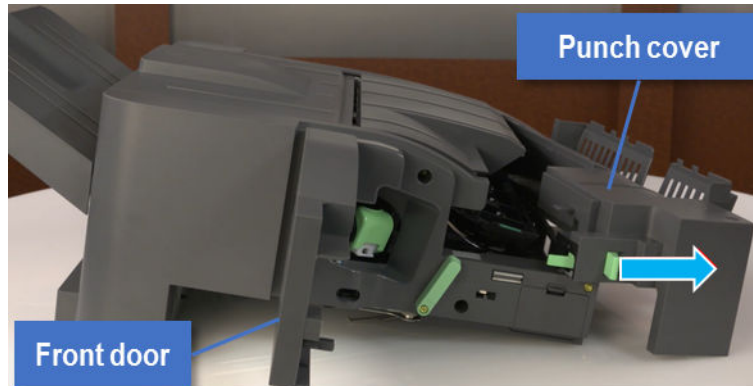

- b. Remove left-side one screw at the rear of the inner finisher, and then remove the middle cover by lifting off the hinge pins at the front.

Figure 5-92 Remove the middle cover

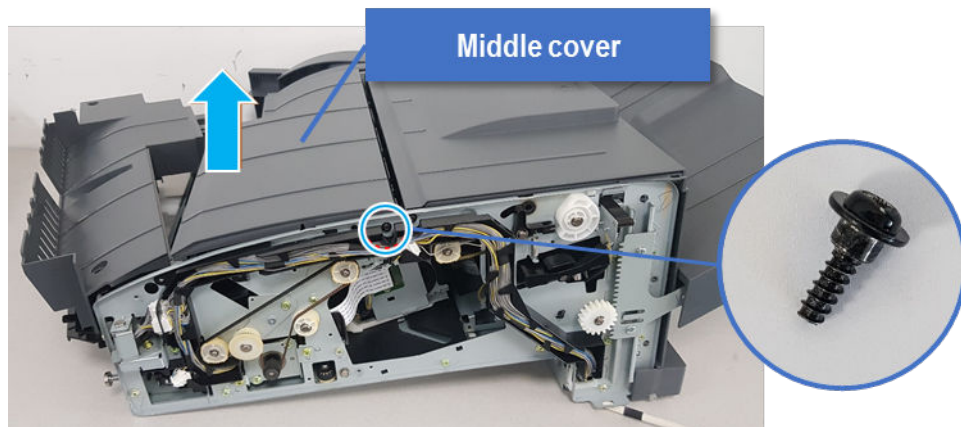

4. Remove the punch cover.
 - a. Unplug the connector. Remove the e-ring, and then remove the slide shaft at the rear of the inner finisher.

Figure 5-93 Remove the slide shaft

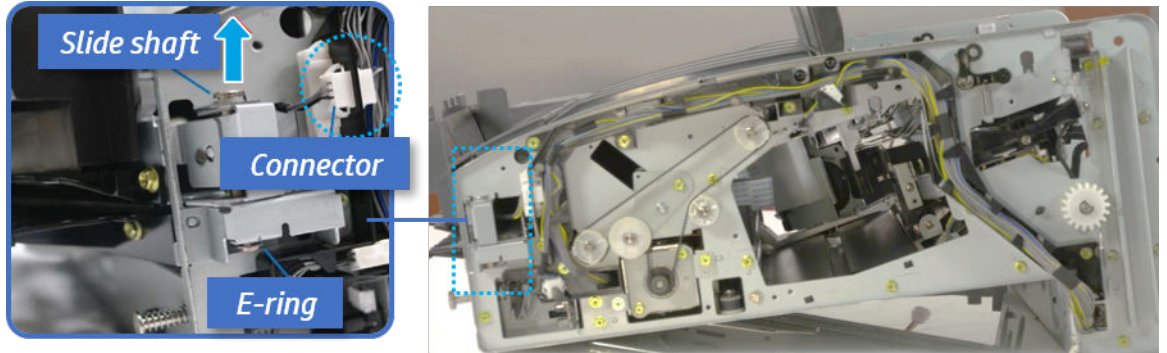

- b. Open the punch cover.

Figure 5-94 Open the punch cover

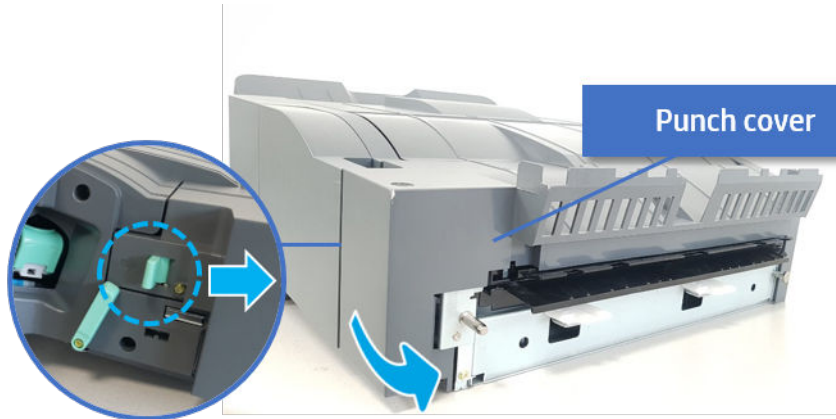

- c. Remove the front punch sheet, and then remove the e-ring and the washer. And then remove the punch cover.

Figure 5-95 Remove the punch cover

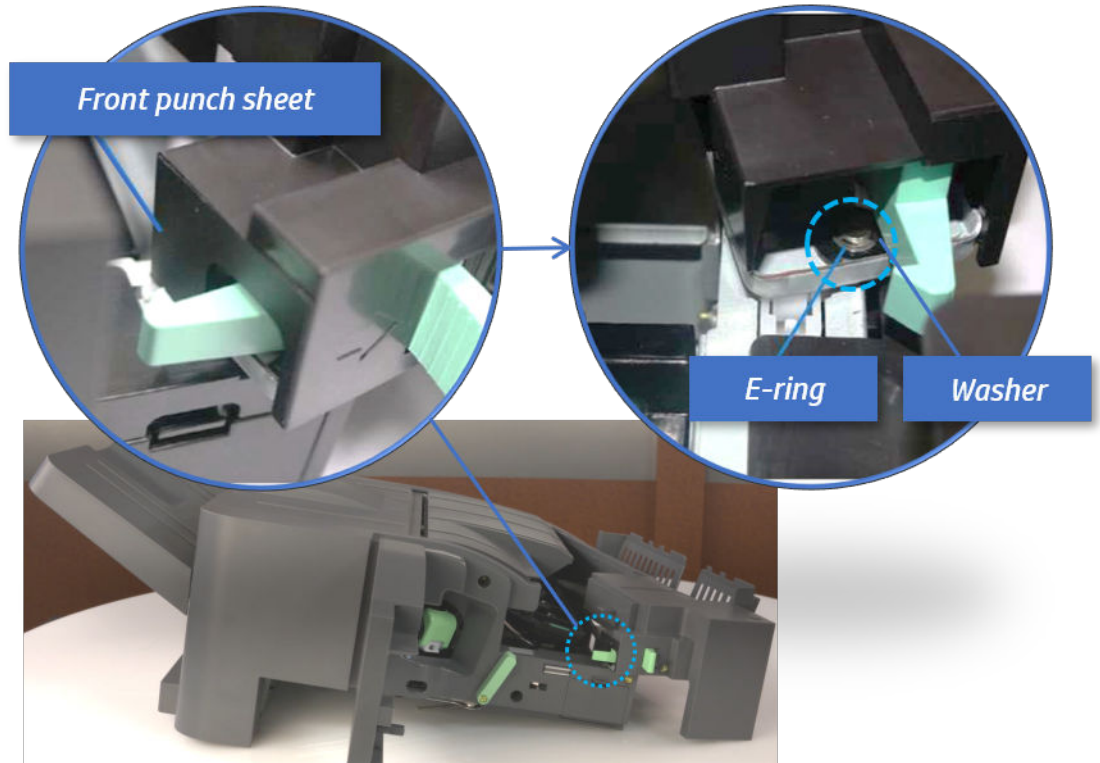

- 5. Remove the diverter guide and the middle roller
 - a. On the front of the inner finisher, remove the e-ring and bushing.

Figure 5-96 Remove the e-ring and bushing

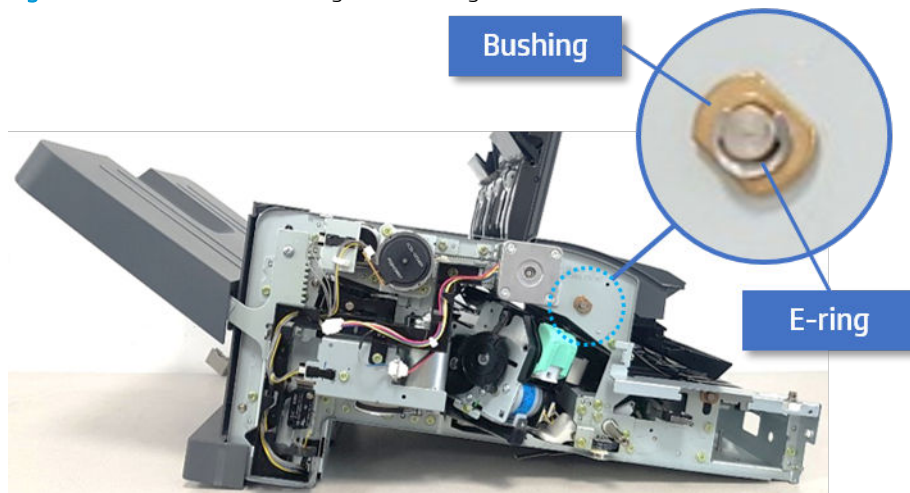

- b. On the rear of the inner finisher, remove the e-ring, pulley, bushing, belt, and spring (slightly hidden from view).

Figure 5-97 Remove the e-ring, pulley, bushing, belt, and spring

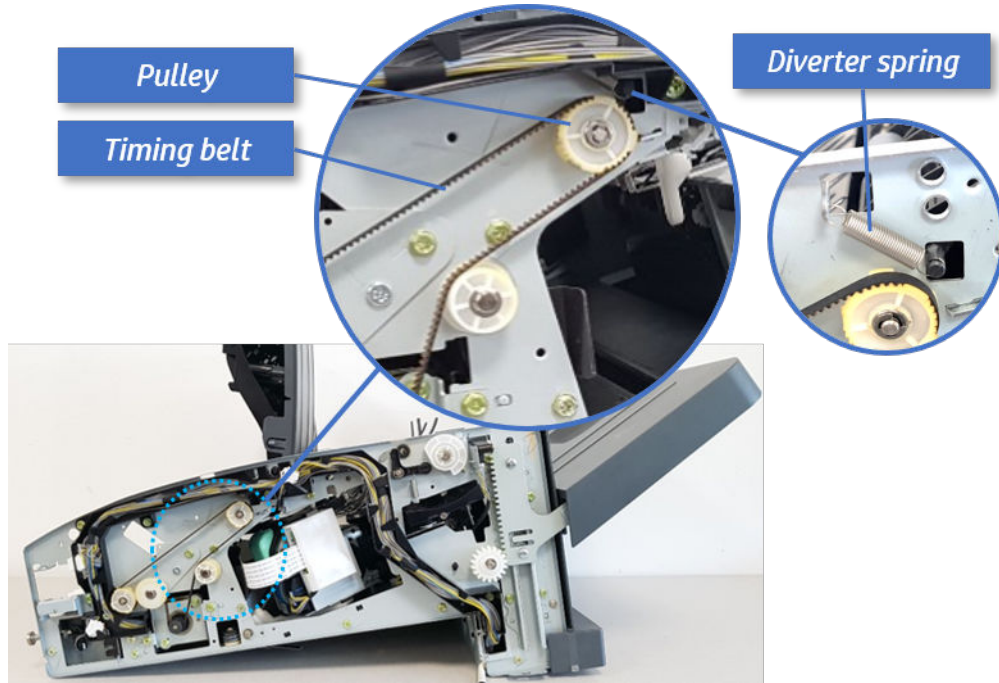

- c. Remove the diverter guide and the middle roller.

Figure 5-98 Remove the diverter guide and the middle roller

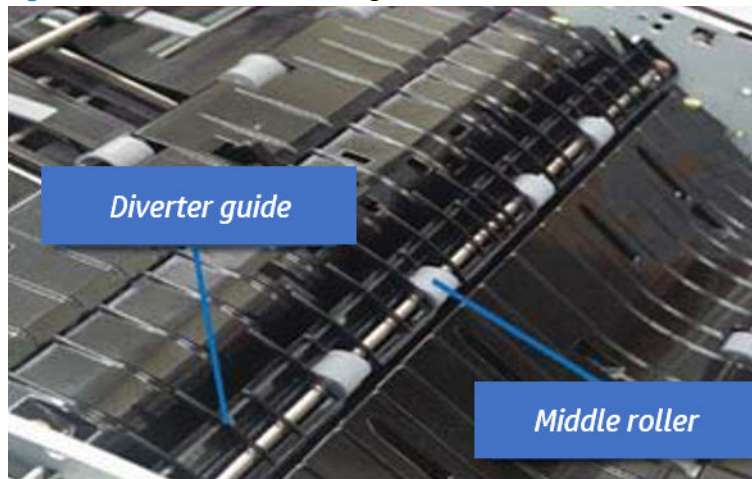

6. Remove the middle paper guide.
 - a. Remove six screws, and then open the middle paper guide in the direction of the arrow.

Figure 5-99 Open the middle paper guide

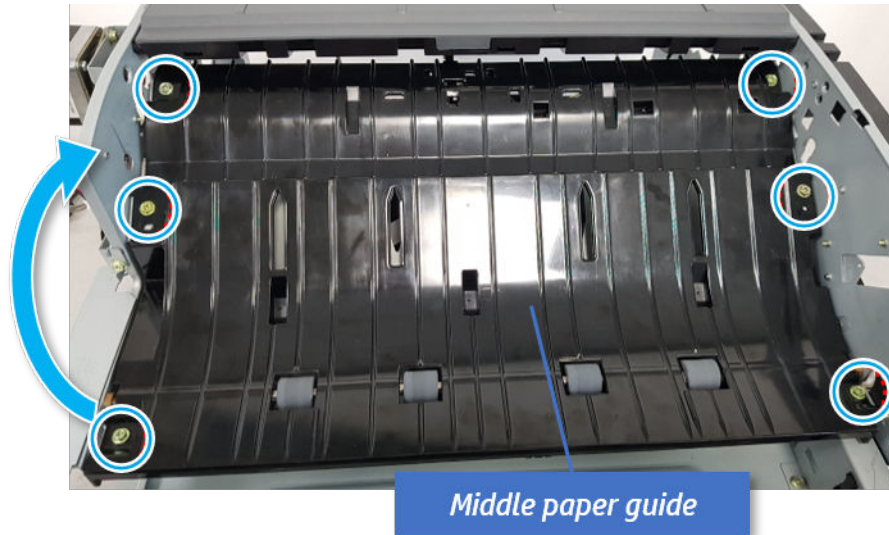

 **NOTE:** Be careful not to damage the sensor connector.

- b. Unplug the connector under the middle paper guide. And then, remove the middle paper guide.

Figure 5-100 Remove the middle paper guide

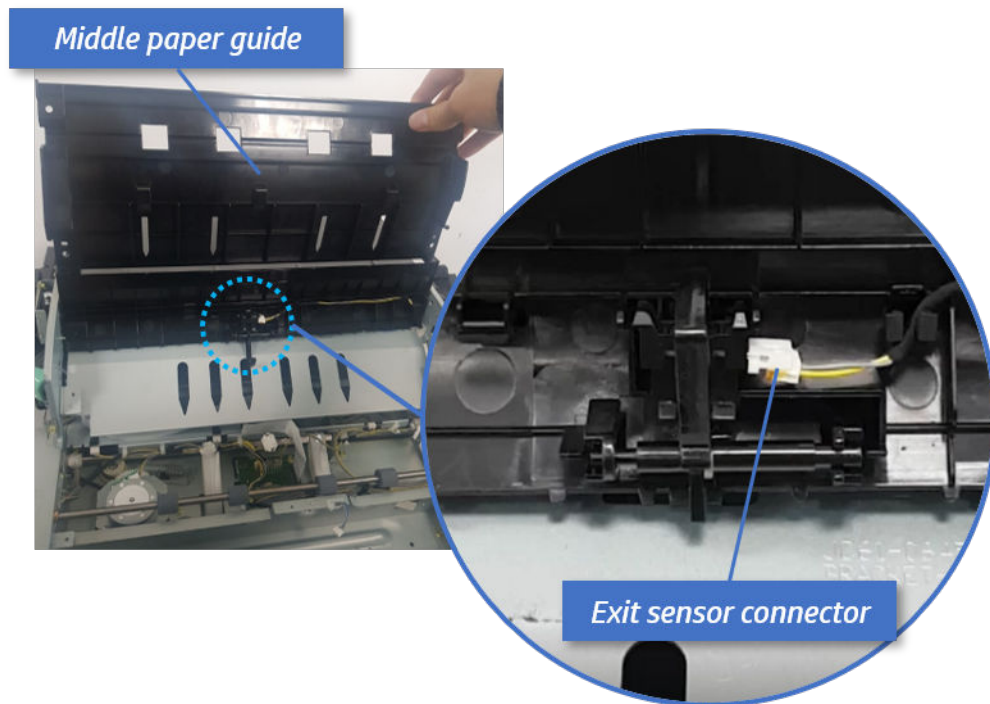

7. Remove the entrance motor.
 - a. Remove two screws.

Figure 5-101 Remove two screws

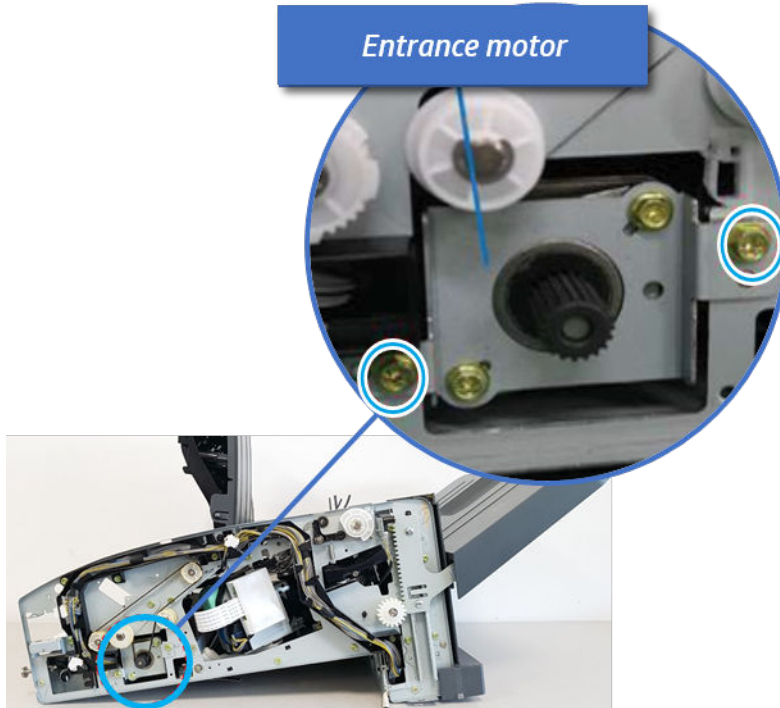

- b. Open the clamps, and then unplug the connector.

Figure 5-102 Unplug the connector

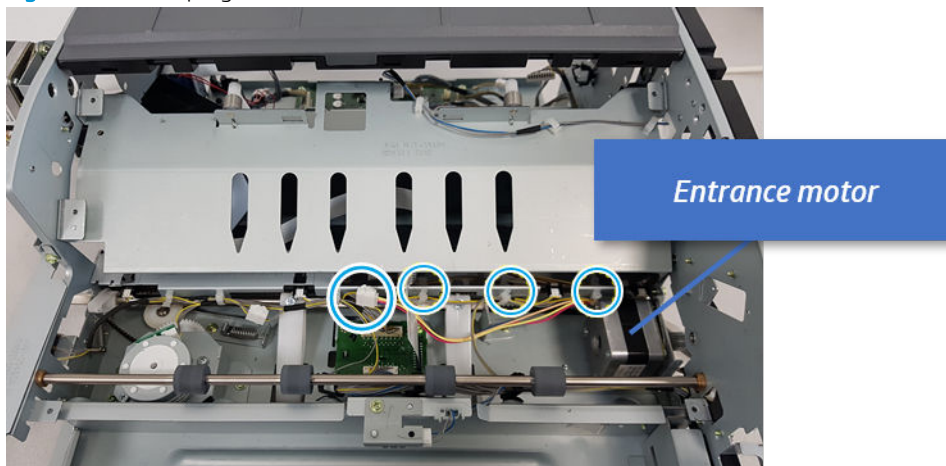

- c. Remove two screws, and then remove the motor.

Figure 5-103 Remove the entrance motor

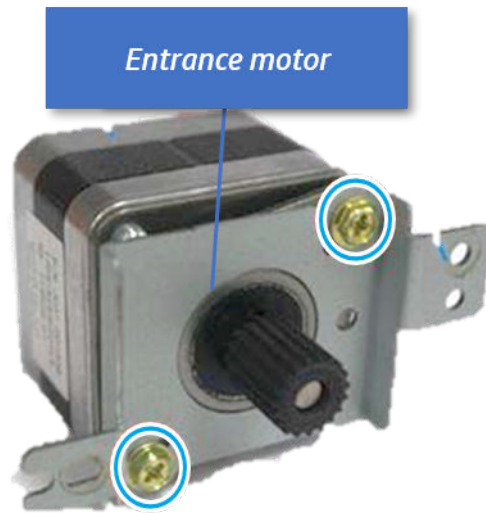

8. Unpack the replacement assembly.

- a. Dispose of the defective part.



NOTE: HP recommends responsible disposal of the defective part.

<http://www8.hp.com/us/en/hp-information/environment/product-recycling.html>

- b. Unpack the replacement part from the packaging.



CAUTION:  Some parts are sensitive to electrostatic discharge (ESD). Always perform service

work at an ESD-protected workstation or mat. If an ESD workstation or mat is not available, touch the sheet-metal chassis to provide a static ground before touching an ESD-sensitive assembly. Protect the ESD-sensitive assemblies by placing them in ESD pouches when they are out of the printer.

If the replacement part is a roller or pad, avoid touching the spongy part of it. Skin oils on the roller or pad can cause paper pickup and/or print-quality problems. HP recommends using disposable gloves when handling rollers or pads or washing your hands before touching rollers or pads.



IMPORTANT: Make sure that all of the shipping materials (for example shipping tape) are removed from the replacement part prior to installation.

- c. To install an assembly, reverse the removal steps.

When applicable, special installation instructions are provided for an assembly at the end of the removal procedure. Always completely read the removal instructions and follow all special installation instructions.

Exit unit

Removal and replacement: Exit sensor (S21)

Learn how to remove and replace the exit sensor.

To view teardown&reassembling video of the inner finisher, click the link below.

 [View a teardown video of the inner finisher .](#)

 [View a reassembling video of the inner finisher .](#)

 **IMPORTANT:** When applicable, special installation instructions are provided for an assembly at the end of the removal procedure. Always completely read the removal instructions and follow all special installation instructions.

Mean time to repair:

Service level:

Before performing service

Turn the printer power off

- Press the power button on the front of the printer, and then turn off the power switch next to the power cable.
- A shutting-down message appears on the control-panel display.

 **WARNING!** To avoid damage to the printer, turn the power off and wait until the printer shuts down before removing the power cable.

- Disconnect the printer power cable after the printer has completely shut down (the control-panel display is blank).

Use the table below to identify the correct part number for your printer. To order the part, go to <https://parts.hp.com>.

Table 5-38 Part information

Part number	Part description
0604-001415	Exit sensor

Required tools

- #2 JIS screwdriver with a magnetic tip

After performing service

Turn the printer power on

- Connect the power cable.
- Use the power switch to turn the power on.

Post service test

Print any pages necessary to verify that the repair resolved the issue and did not create any new issues.

1. Remove the front cover.
 - a. Open the front door and open the punch cover.
 - b. Remove three screws in the front.
 - c. Remove the lever.
 - d. Open the top cover.
 - e. From the right side of the front cover, carefully lift and pry toward the top-left corner to remove the front cover.

Figure 5-104 Remove the front cover

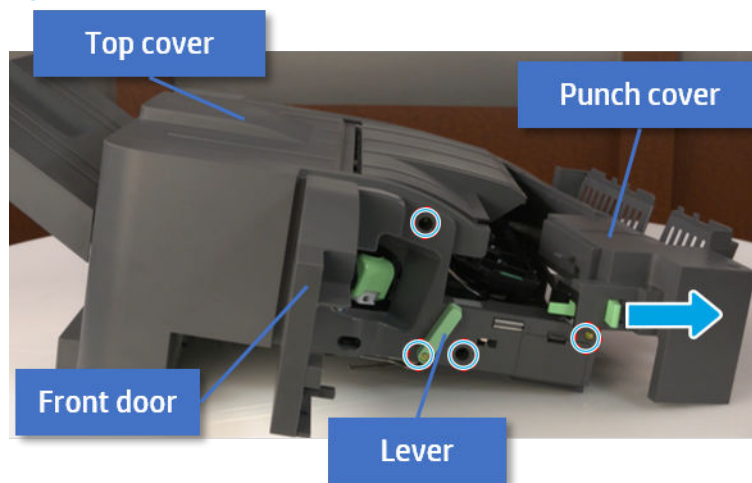

2. Remove the rear cover.
 - a. Open the top cover.

Figure 5-105 Open the top cover

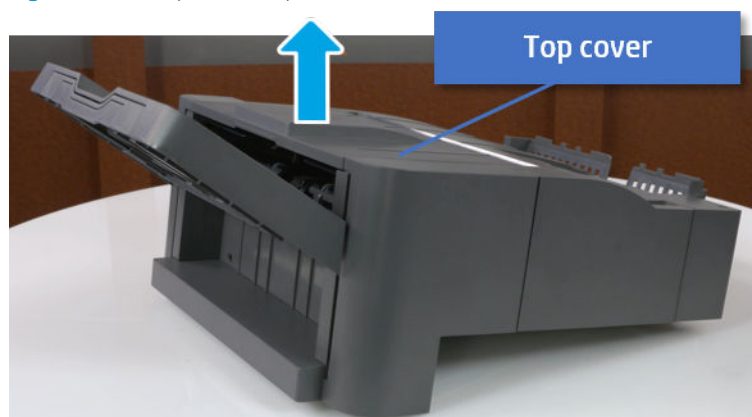

- b. Remove three screws.

- c. Release hooks carefully and remove the rear cover.

Figure 5-106 Remove the rear cover

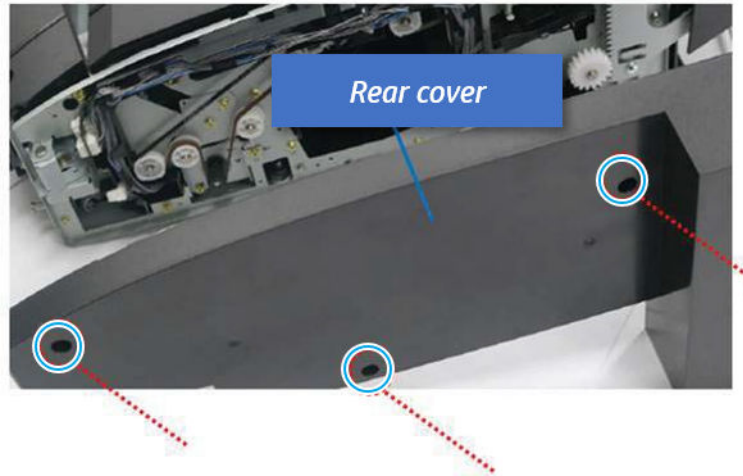

- 3. Remove the middle cover.

- a. Open the front door and then open the punch cover.

Figure 5-107 Open the front door and punch cover.



- b. Remove left-side one screw at the rear of the inner finisher, and then remove the middle cover by lifting off the hinge pins at the front.

Figure 5-108 Remove the middle cover

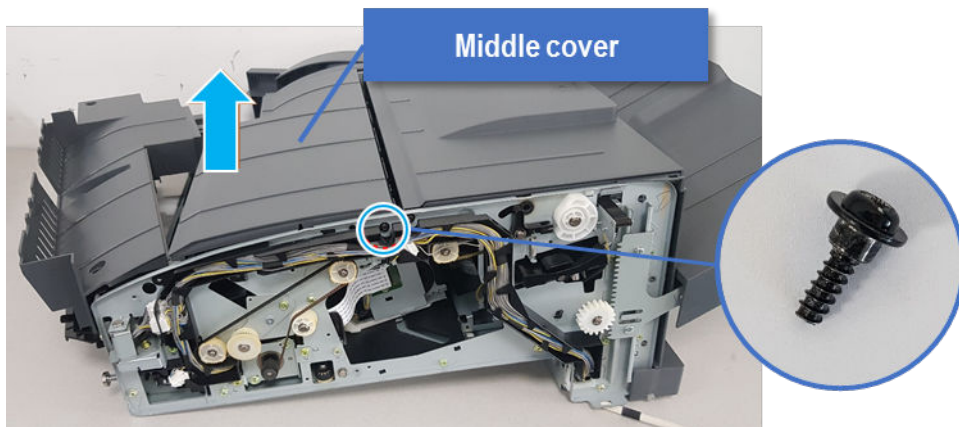

4. Remove the punch cover.
 - a. Unplug the connector. Remove the e-ring, and then remove the slide shaft at the rear of the inner finisher.

Figure 5-109 Remove the slide shaft

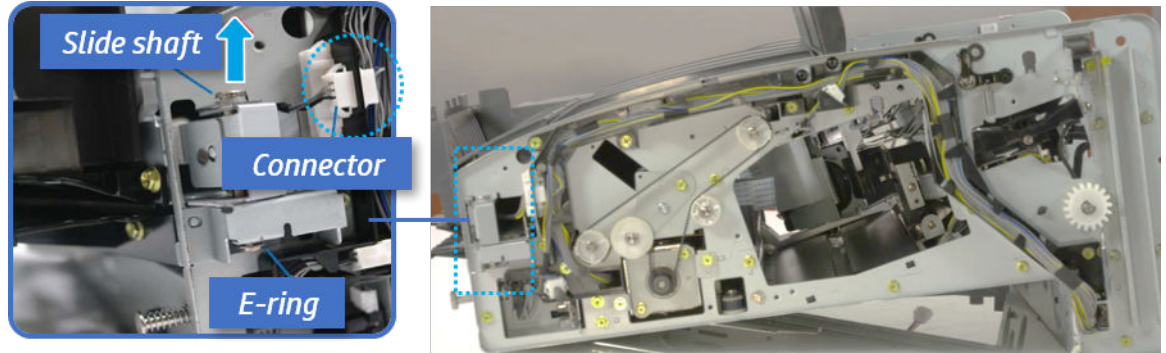

- b. Open the punch cover.

Figure 5-110 Open the punch cover

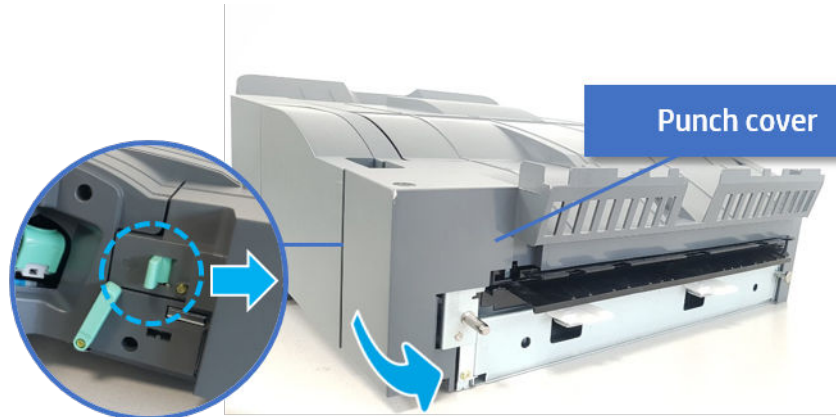

- c. Remove the front punch sheet, and then remove the e-ring and the washer. And then remove the punch cover.

Figure 5-111 Remove the punch cover

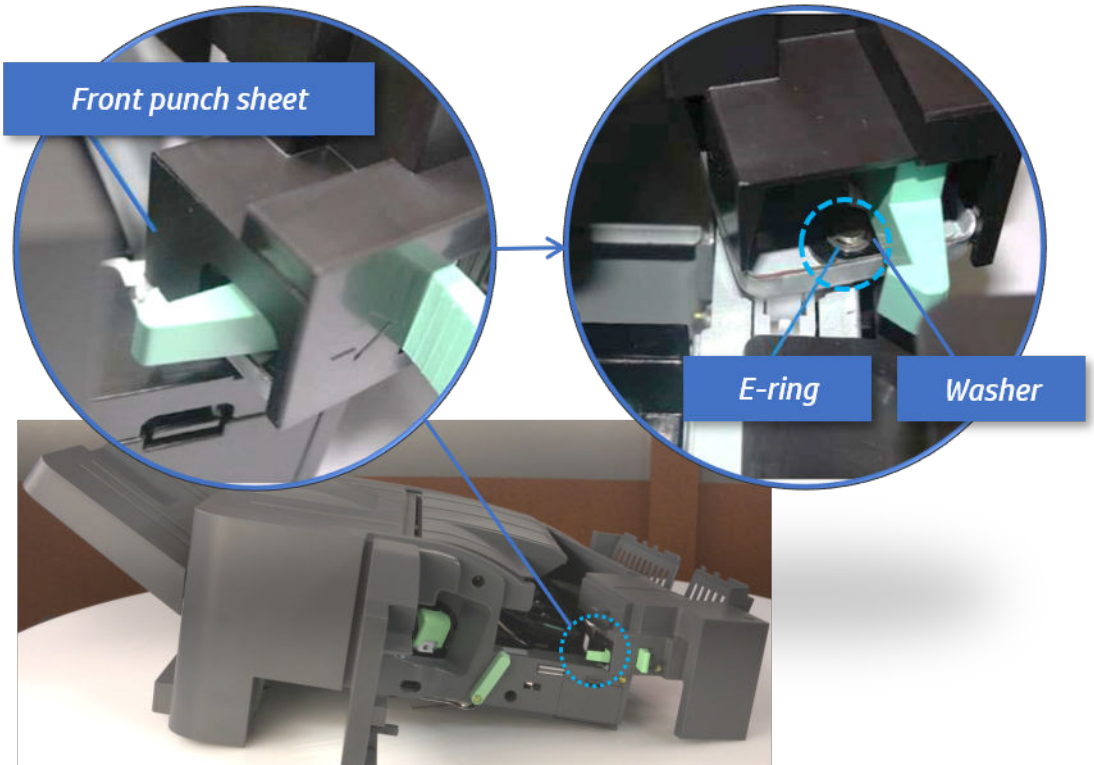

- 5. Remove the diverter guide and the middle roller
 - a. On the front of the inner finisher, remove the e-ring and bushing.

Figure 5-112 Remove the e-ring and bushing

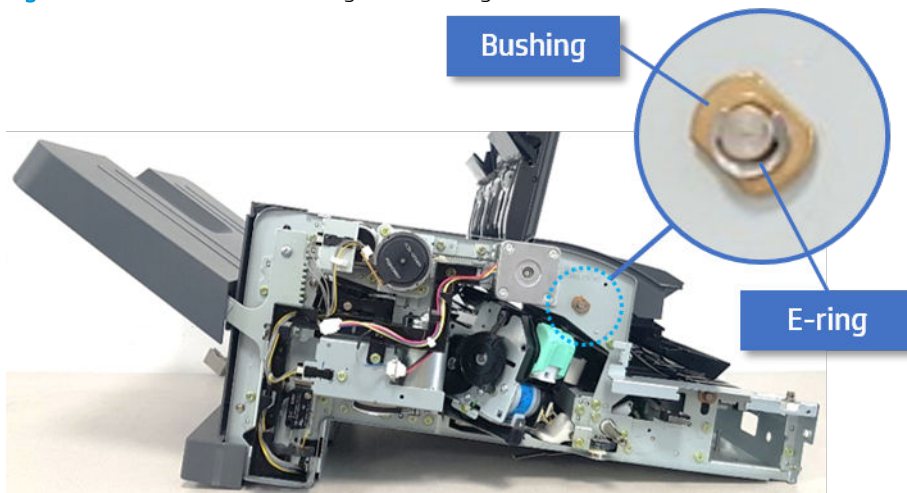

- b. On the rear of the inner finisher, remove the e-ring, pulley, bushing, belt, and spring (slightly hidden from view).

Figure 5-113 Remove the e-ring, pulley, bushing, belt, and spring

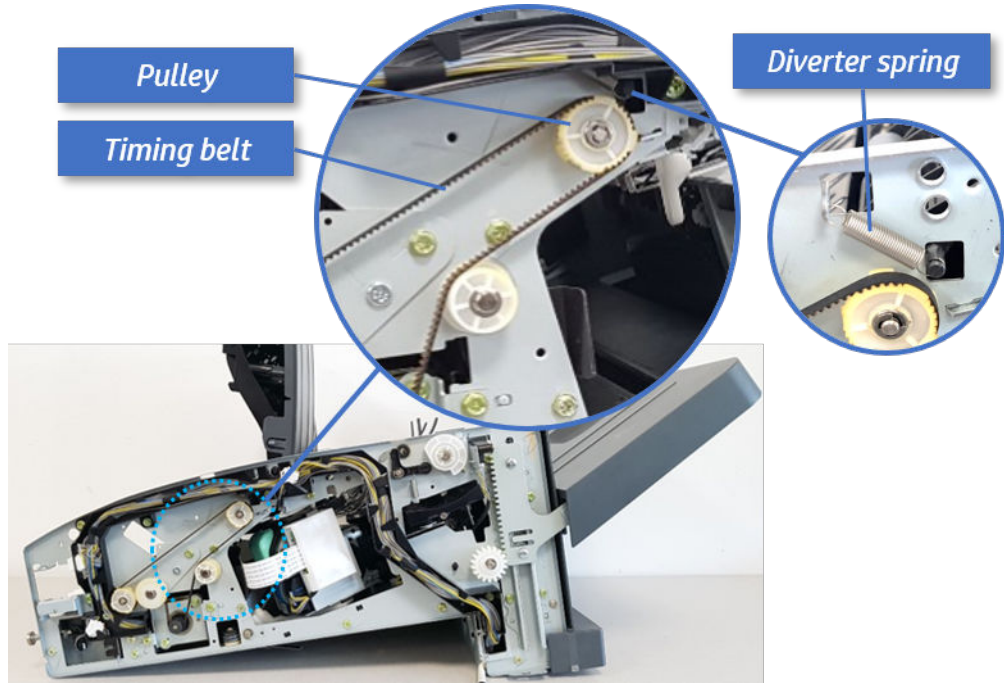

- c. Remove the diverter guide and the middler roller.

Figure 5-114 Remove the diverter guide and the middler roller

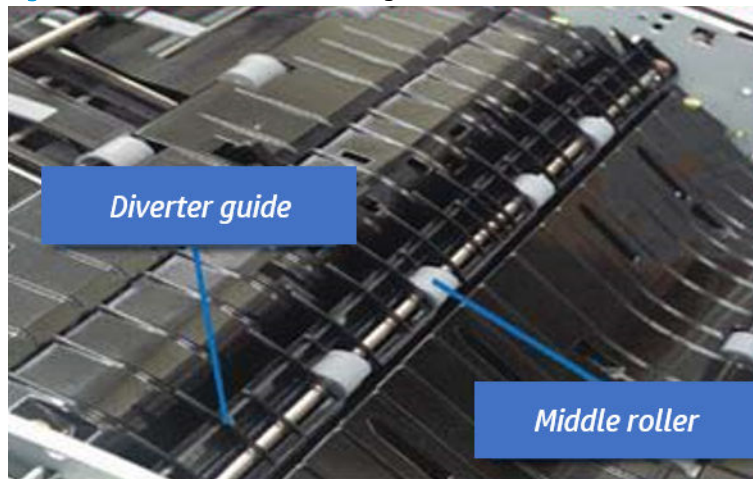

- 6. Remove the middle paper guide.
 - a. Remove six screws, and then open the middle paper guide in the direction of the arrow.

Figure 5-115 Open the middle paper guide

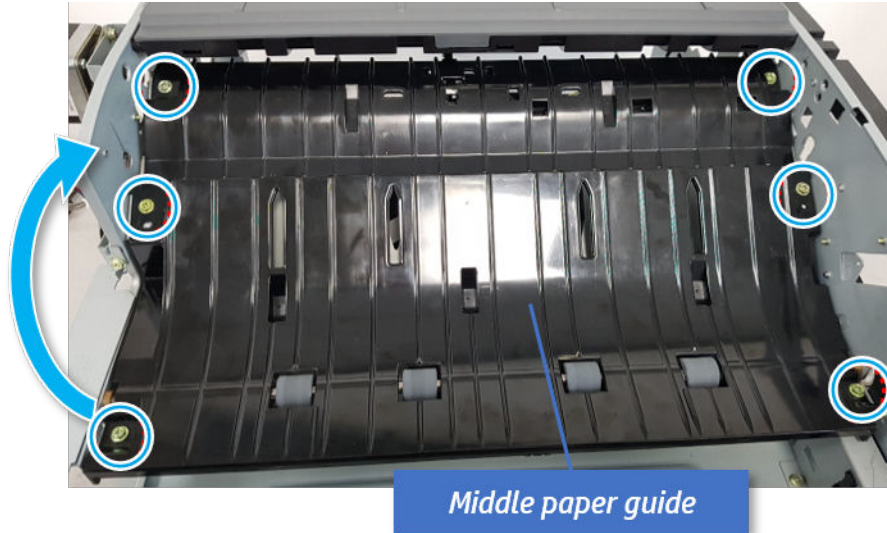

 **NOTE:** Be careful not to damage the sensor connector.

- b. Unplug the connector under the middle paper guide. And then, remove the middle paper guide.

Figure 5-116 Remove the middle paper guide

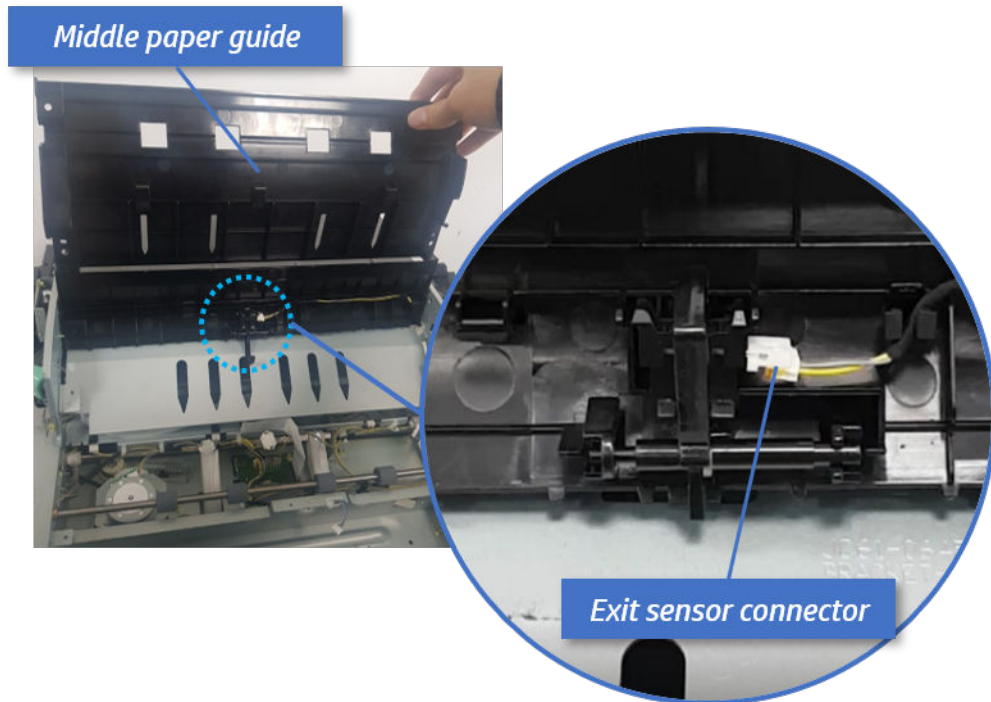

7. Remove the exit sensor.
 - ▲ Remove the exit sensor from the middle paper guide.

Figure 5-117 Remove the exit sensor

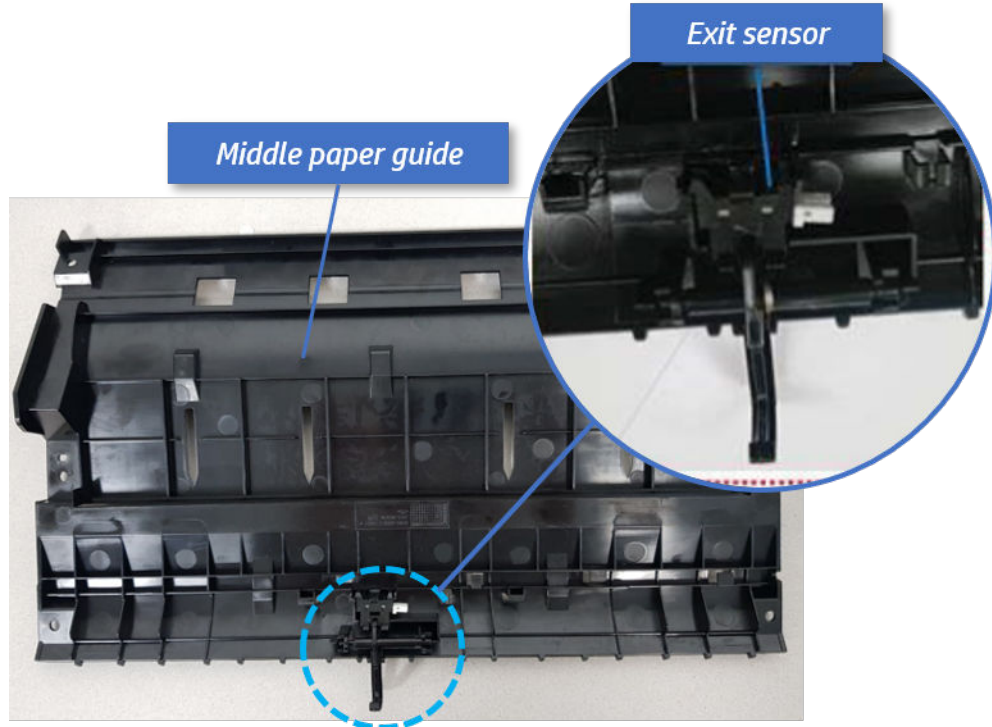

8. Unpack the replacement assembly.

- a. Dispose of the defective part.



NOTE: HP recommends responsible disposal of the defective part.

<http://www8.hp.com/us/en/hp-information/environment/product-recycling.html>

- b. Unpack the replacement part from the packaging.



CAUTION:  Some parts are sensitive to electrostatic discharge (ESD). Always perform service work at an ESD-protected workstation or mat. If an ESD workstation or mat is not available, touch the sheet-metal chassis to provide a static ground before touching an ESD-sensitive assembly. Protect the ESD-sensitive assemblies by placing them in ESD pouches when they are out of the printer.

If the replacement part is a roller or pad, avoid touching the spongy part of it. Skin oils on the roller or pad can cause paper pickup and/or print-quality problems. HP recommends using disposable gloves when handling rollers or pads or washing your hands before touching rollers or pads.



IMPORTANT: Make sure that all of the shipping materials (for example shipping tape) are removed from the replacement part prior to installation.

- c. To install an assembly, reverse the removal steps.

When applicable, special installation instructions are provided for an assembly at the end of the removal procedure. Always completely read the removal instructions and follow all special installation instructions.

Removal and replacement: Exit motor (M2)

Learn how to remove and replace the exit motor.

To view teardown&reassembling video of the inner finisher, click the link below.

 [View a teardown video of the inner finisher .](#)

 [View a reassembling video of the inner finisher .](#)

 **IMPORTANT:** When applicable, special installation instructions are provided for an assembly at the end of the removal procedure. Always completely read the removal instructions and follow all special installation instructions.

Mean time to repair:

Service level:

Before performing service

Turn the printer power off

- Press the power button on the front of the printer, and then turn off the power switch next to the power cable.
- A shutting-down message appears on the control-panel display.

 **WARNING!** To avoid damage to the printer, turn the power off and wait until the printer shuts down before removing the power cable.

- Disconnect the printer power cable after the printer has completely shut down (the control-panel display is blank).

Use the table below to identify the correct part number for your printer. To order the part, go to <https://parts.hp.com>.

Table 5-39 Part information

Part number	Part description
JC31-00169B	Exit motor

Required tools

- #2 JIS screwdriver with a magnetic tip

After performing service

Turn the printer power on

- Connect the power cable.
- Use the power switch to turn the power on.

Post service test

Print any pages necessary to verify that the repair resolved the issue and did not create any new issues.

1. Remove the front cover.
 - a. Open the front door and open the punch cover.
 - b. Remove three screws in the front.
 - c. Remove the lever.
 - d. Open the top cover.
 - e. From the right side of the front cover, carefully lift and pry toward the top-left corner to remove the front cover.

Figure 5-118 Remove the front cover

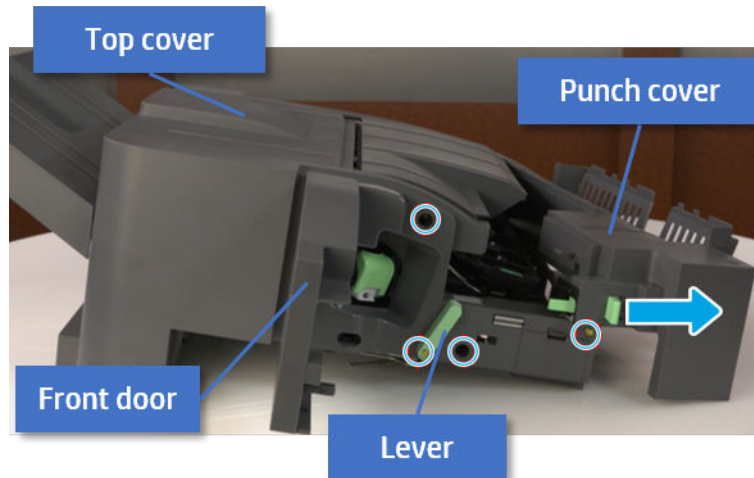

2. Remove the exit motor bracket.
 - ▲ Remove two screws, unplug the motor connector. And then remove exit motor bracket.

Figure 5-119 Remove the exit motor bracket

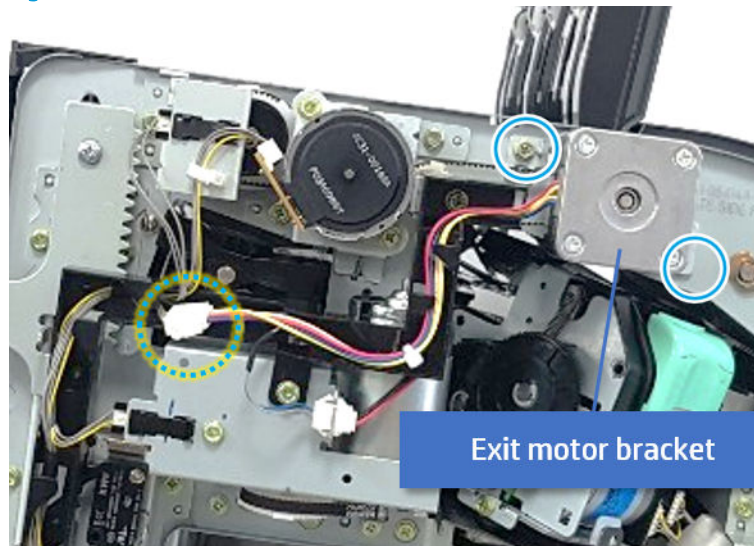

3. Remove the exit motor.
 - ▲ Remove two screws, and then remove the exit motor from the bracket.

Figure 5-120 Remove the exit motor

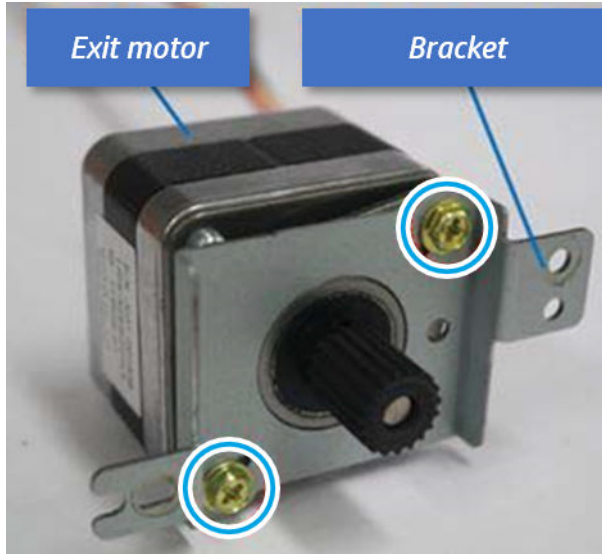

4. Unpack the replacement assembly.

- a. Dispose of the defective part.



NOTE: HP recommends responsible disposal of the defective part.

<http://www8.hp.com/us/en/hp-information/environment/product-recycling.html>

- b. Unpack the replacement part from the packaging.



CAUTION:  Some parts are sensitive to electrostatic discharge (ESD). Always perform service work at an ESD-protected workstation or mat. If an ESD workstation or mat is not available, touch the sheet-metal chassis to provide a static ground before touching an ESD-sensitive assembly. Protect the ESD-sensitive assemblies by placing them in ESD pouches when they are out of the printer.

If the replacement part is a roller or pad, avoid touching the spongy part of it. Skin oils on the roller or pad can cause paper pickup and/or print-quality problems. HP recommends using disposable gloves when handling rollers or pads or washing your hands before touching rollers or pads.



IMPORTANT: Make sure that all of the shipping materials (for example shipping tape) are removed from the replacement part prior to installation.

- c. To install an assembly, reverse the removal steps.

When applicable, special installation instructions are provided for an assembly at the end of the removal procedure. Always completely read the removal instructions and follow all special installation instructions.

Removal and replacement: Exit roller (R3)

Learn how to remove and replace the exit roller.

To view teardown&reassembling video of the inner finisher, click the link below.



[View a teardown video of the inner finisher .](#)

 [View a reassembling video of the inner finisher .](#)

 **IMPORTANT:** When applicable, special installation instructions are provided for an assembly at the end of the removal procedure. Always completely read the removal instructions and follow all special installation instructions.

Mean time to repair:

Service level:

Before performing service

Turn the printer power off

- Press the power button on the front of the printer, and then turn off the power switch next to the power cable.
- A shutting-down message appears on the control-panel display.

 **WARNING!** To avoid damage to the printer, turn the power off and wait until the printer shuts down before removing the power cable.

- Disconnect the printer power cable after the printer has completely shut down (the control-panel display is blank).

Use the table below to identify the correct part number for your printer. To order the part, go to <https://parts.hp.com>.

Table 5-40 Part information

Part number	Part description
JC66-04244A	Exit roller
JC61-07449A	Front compile guide
JC61-07450A	Rear compile guide

Required tools

- #2 JIS screwdriver with a magnetic tip

After performing service

Turn the printer power on

- Connect the power cable.
- Use the power switch to turn the power on.

Post service test

Print any pages necessary to verify that the repair resolved the issue and did not create any new issues.

1. Remove the front cover.

- a. Open the front door and open the punch cover.
- b. Remove three screws in the front.
- c. Remove the lever.
- d. Open the top cover.
- e. From the right side of the front cover, carefully lift and pry toward the top-left corner to remove the front cover.

Figure 5-121 Remove the front cover

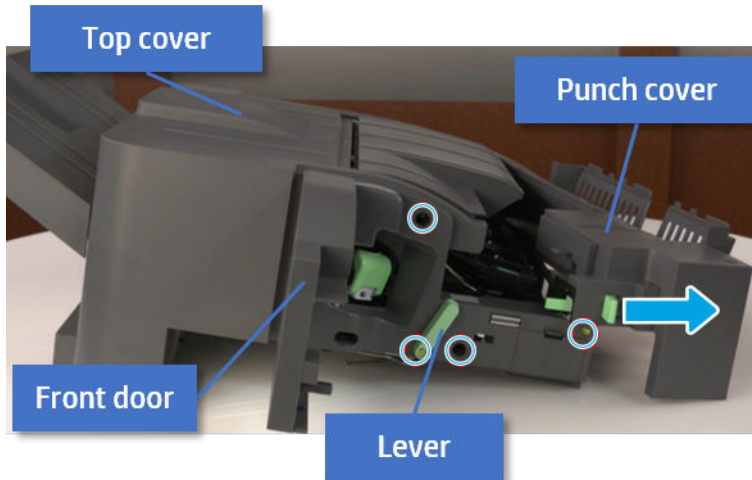

2. Remove the rear cover.
 - a. Open the top cover.

Figure 5-122 Open the top cover

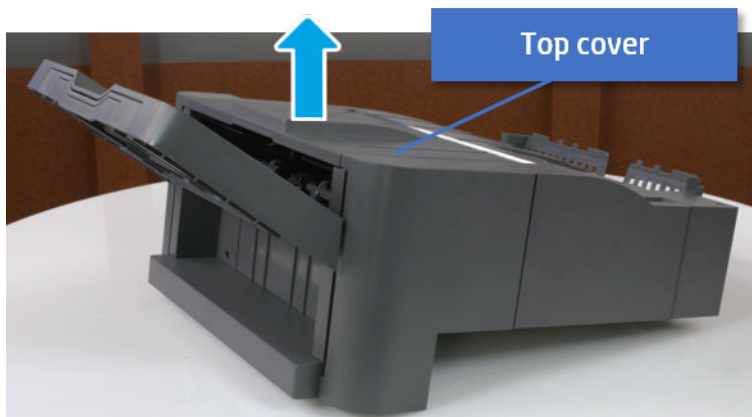

- b. Remove three screws.

- c. Release hooks carefully and remove the rear cover.

Figure 5-123 Remove the rear cover

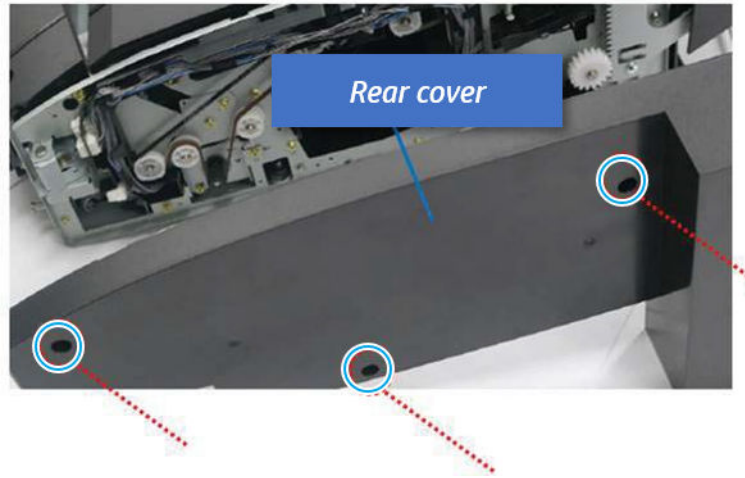

- 3. Remove the sub paddle unit.
 - a. Open the top cover, and then remove one screw securing the sub paddle unit.

Figure 5-124 Remove one screw

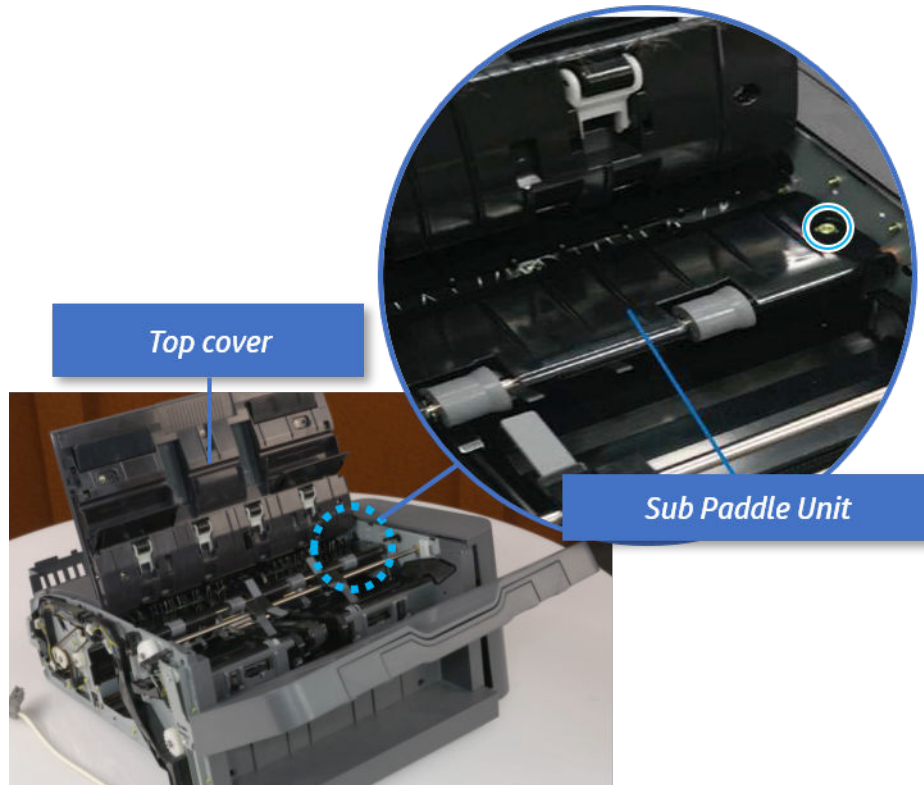

- b. Remove the e-ring, and then remove the pulley and timing belt. And then remove the e-ring and the bushing.

Figure 5-125 Remove the e-ring, pulley, timing belt, and bushing

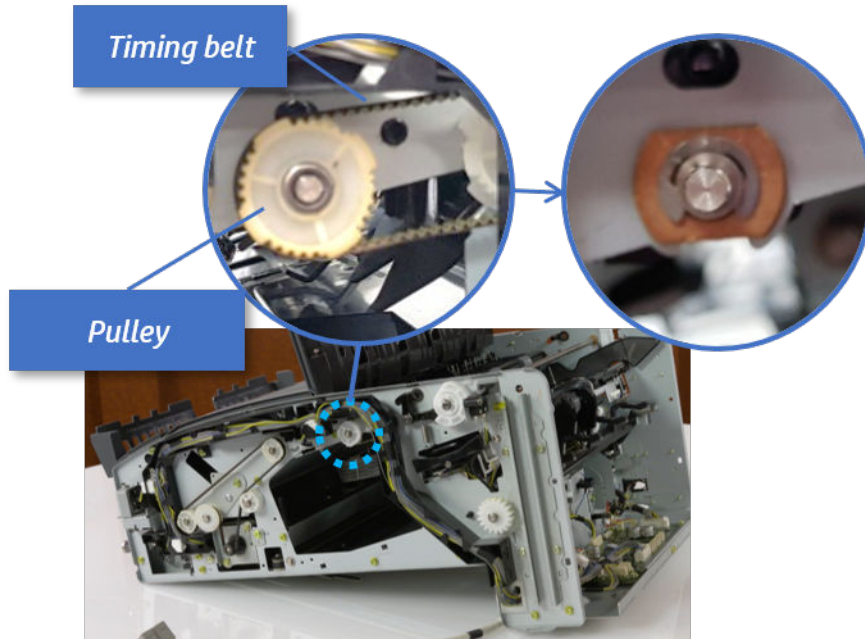

- c. Lift up and remove the sub paddle unit.

Figure 5-126 Remove the sub paddle unit

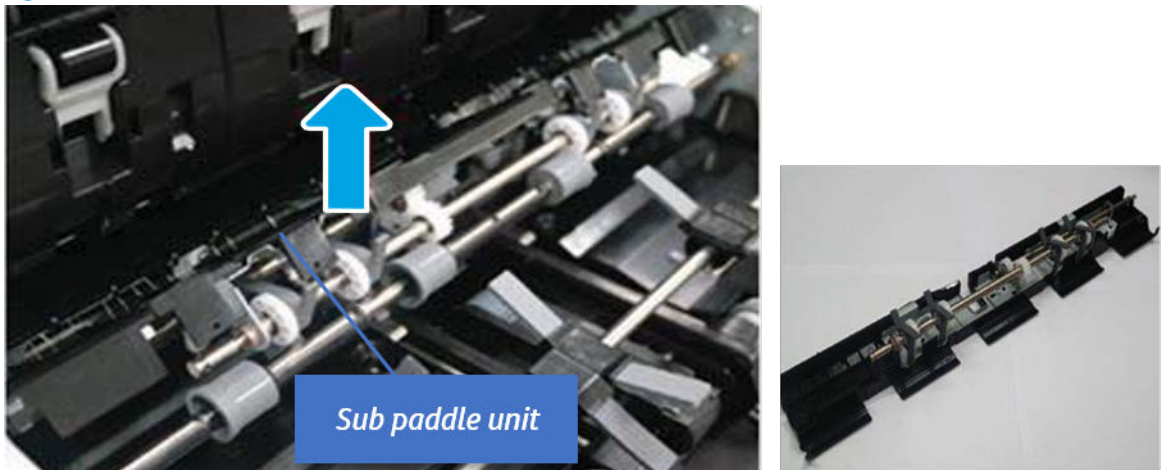

4. Remove the exit roller.
 - a. Remove the guide on the center of the exit roller.

Figure 5-127 Remove the guide

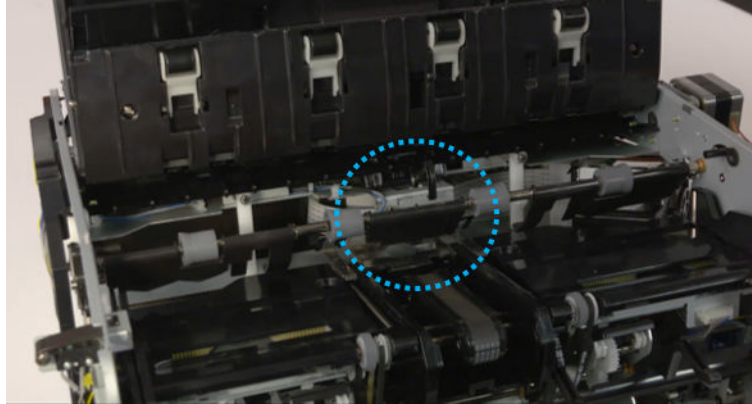

- b. On the front of the inner finisher, release the timing belt connected to the exit motor.

Figure 5-128 Release the timing belt

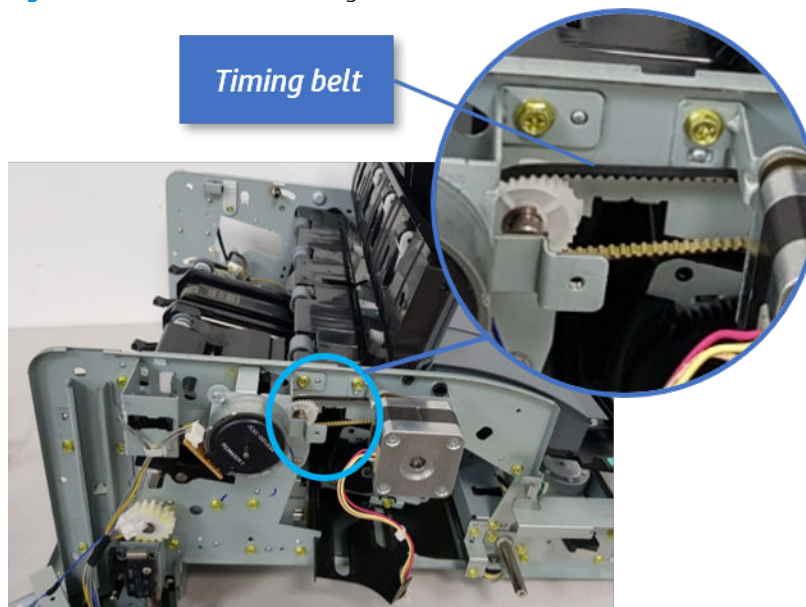

- c. Remove five screws securing the rear harness guide.

Figure 5-129 Remove five screws

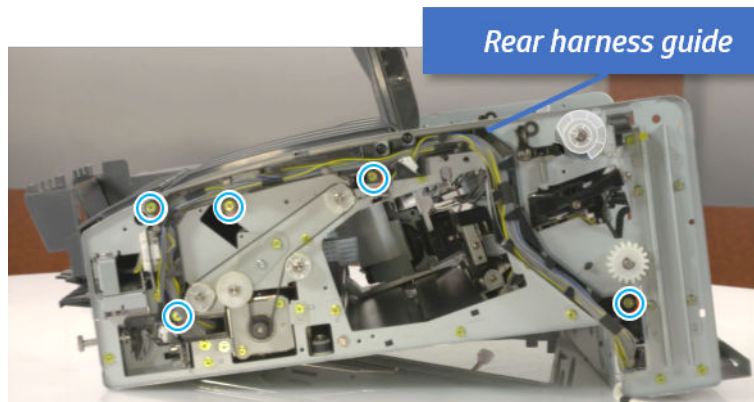

- d. On the rear of the inner finisher, remove the e-ring and the pulley and then remove the e-ring and the bushing.

Figure 5-130 Remove e-ring, pulley, and bushing

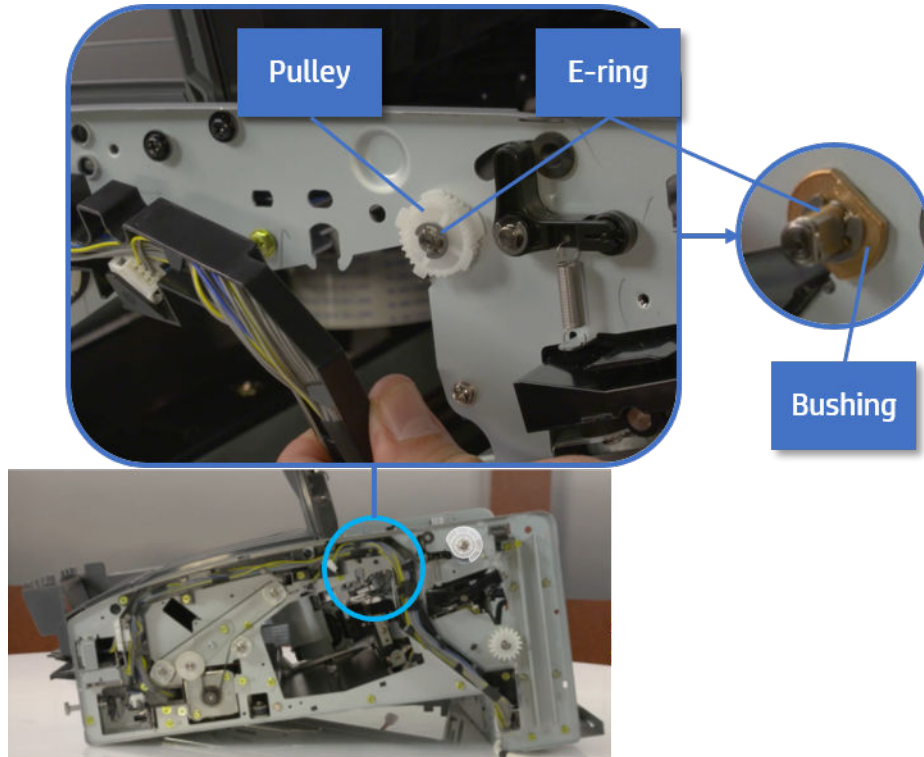

- e. Push the bushing to detach it, and then remove the exit roller.

Figure 5-131 Remove the exit roller

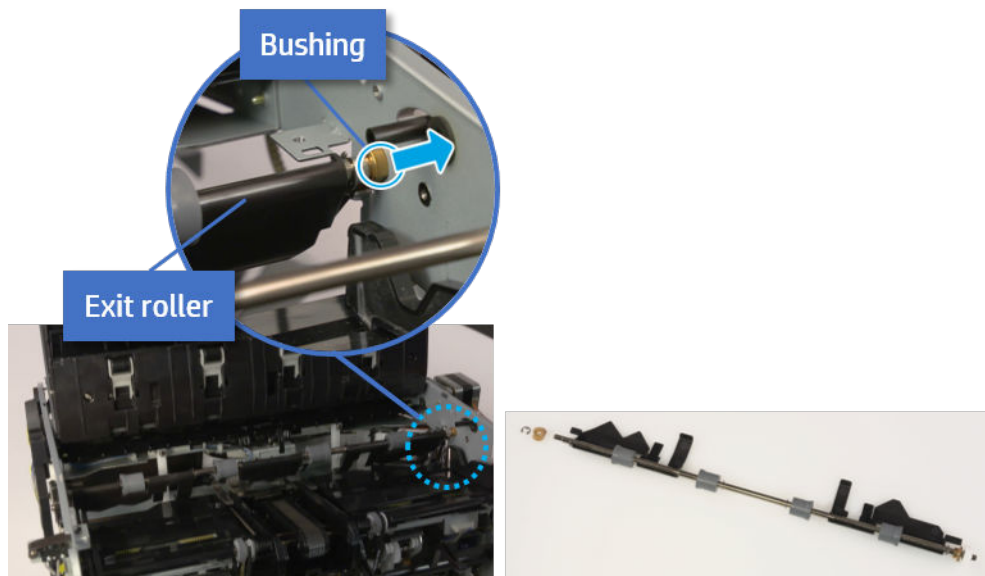

- 5. Unpack the replacement assembly.
 - a. Dispose of the defective part.

 **NOTE:** HP recommends responsible disposal of the defective part.

<http://www8.hp.com/us/en/hp-information/environment/product-recycling.html>

- b. Unpack the replacement part from the packaging.



CAUTION:  Some parts are sensitive to electrostatic discharge (ESD). Always perform service work at an ESD-protected workstation or mat. If an ESD workstation or mat is not available, touch the sheet-metal chassis to provide a static ground before touching an ESD-sensitive assembly. Protect the ESD-sensitive assemblies by placing them in ESD pouches when they are out of the printer.

If the replacement part is a roller or pad, avoid touching the spongy part of it. Skin oils on the roller or pad can cause paper pickup and/or print-quality problems. HP recommends using disposable gloves when handling rollers or pads or washing your hands before touching rollers or pads.



IMPORTANT: Make sure that all of the shipping materials (for example shipping tape) are removed from the replacement part prior to installation.

- c. To install an assembly, reverse the removal steps.

When applicable, special installation instructions are provided for an assembly at the end of the removal procedure. Always completely read the removal instructions and follow all special installation instructions.

Paper support unit

Removal and replacement: Front paper support

Learn how to remove and replace the front paper support.

To view teardown&reassembling video of the inner finisher, click the link below.

 [View a teardown video of the inner finisher .](#)

 [View a reassembling video of the inner finisher .](#)

 **IMPORTANT:** When applicable, special installation instructions are provided for an assembly at the end of the removal procedure. Always completely read the removal instructions and follow all special installation instructions.

Mean time to repair:

Service level:

Before performing service

Turn the printer power off

- Press the power button on the front of the printer, and then turn off the power switch next to the power cable.
- A shutting-down message appears on the control-panel display.

 **WARNING!** To avoid damage to the printer, turn the power off and wait until the printer shuts down before removing the power cable.

- Disconnect the printer power cable after the printer has completely shut down (the control-panel display is blank).

Use the table below to identify the correct part number for your printer. To order the part, go to <https://parts.hp.com>.

Table 5-41 Part information

Part number	Part description
JC90-01310A	Front paper support

Required tools

- #2 JIS screwdriver with a magnetic tip

After performing service

Turn the printer power on

- Connect the power cable.
- Use the power switch to turn the power on.

Post service test

Print any pages necessary to verify that the repair resolved the issue and did not create any new issues.

1. Remove the front cover.
 - a. Open the front door and open the punch cover.
 - b. Remove three screws in the front.
 - c. Remove the lever.
 - d. Open the top cover.
 - e. From the right side of the front cover, carefully lift and pry toward the top-left corner to remove the front cover.

Figure 5-132 Remove the front cover

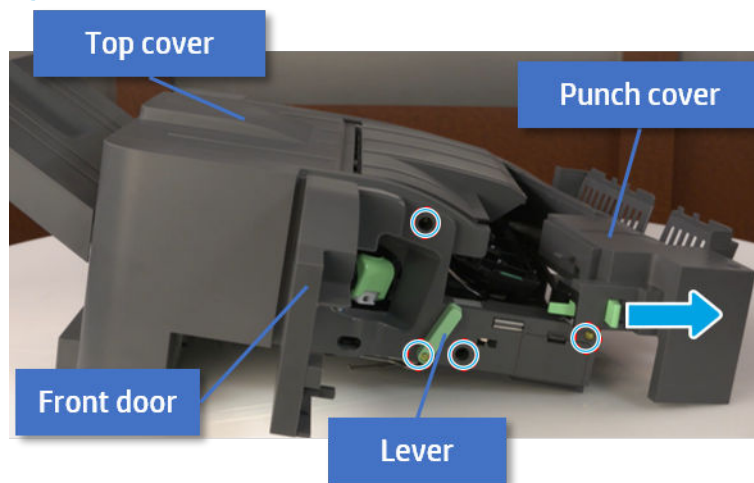

2. Remove the rear cover.
 - a. Open the top cover.

Figure 5-133 Open the top cover

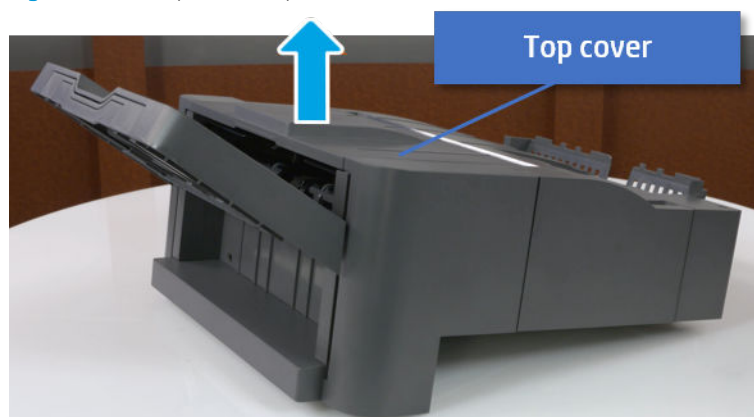

- b. Remove three screws.

- c. Release hooks carefully and remove the rear cover.

Figure 5-134 Remove the rear cover

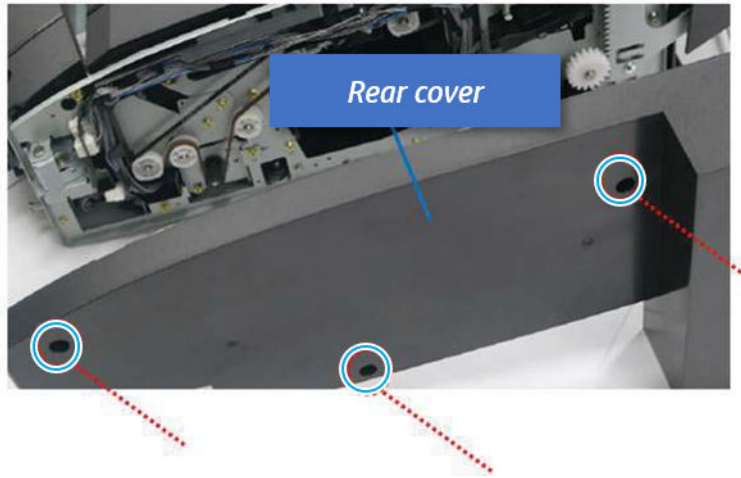

- 3. Remove the output tray.

- a. Remove four screws.

Figure 5-135 Remove four screws

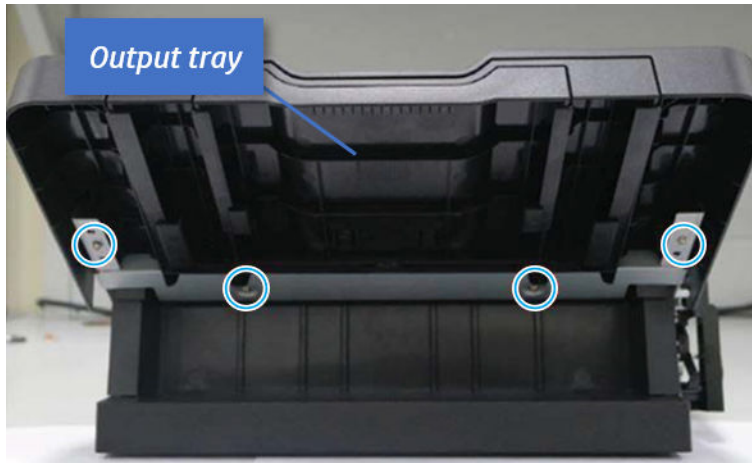

- b. Push the paper holding actuator into the inner finisher, and then remove the output tray.

Figure 5-136 Remove the output tray.



- 4. Remove the output tray frame.
 - a. Rotate the pulley until the output tray frame depart from the gear.

Figure 5-137 Remove the pulley

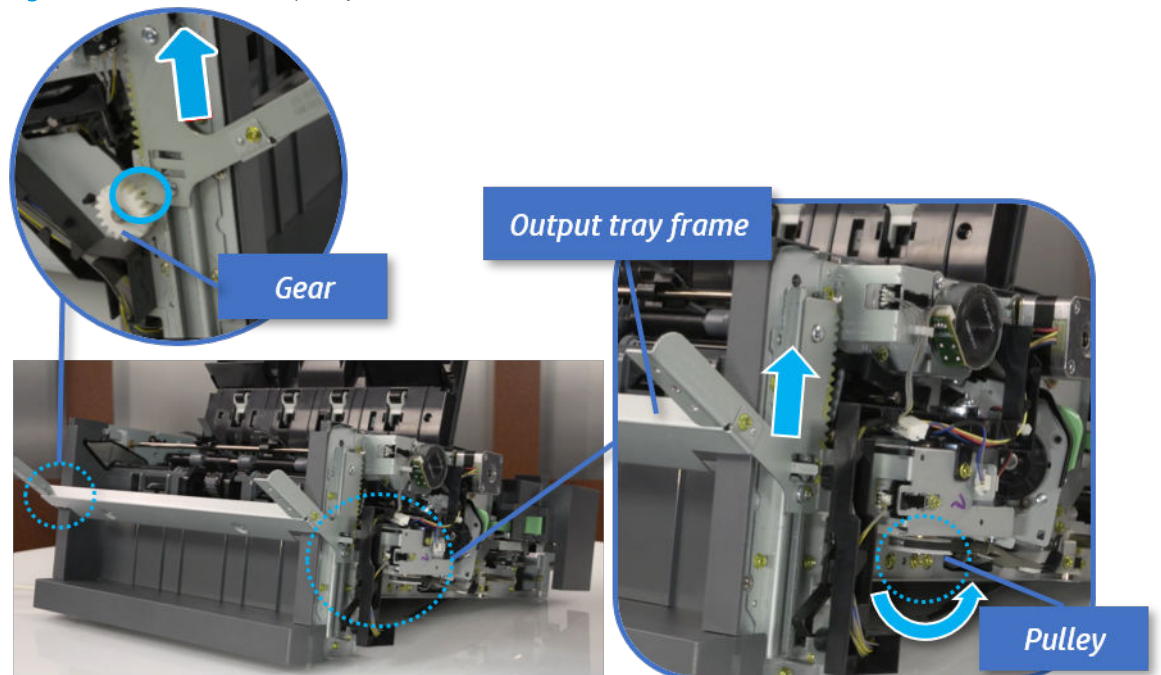

- b. Push the paper holding actuator into the inner finisher, and then remove the output tray frame.

Figure 5-138 Remove the output tray frame

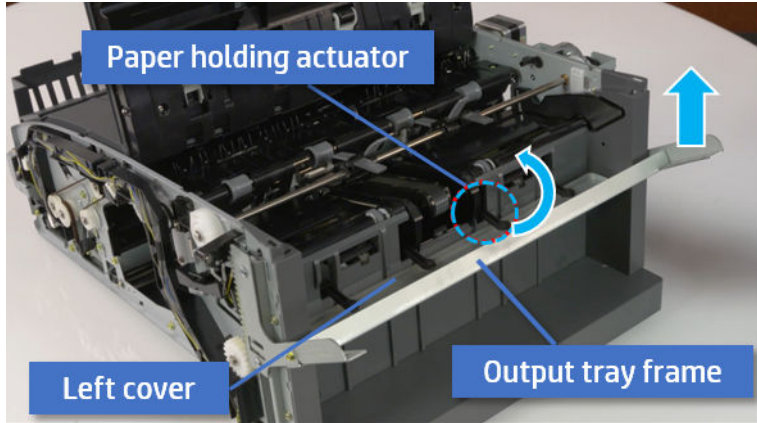

 **TIP:** Push the paper holding actuator into the inner finisher when reassembling. Be sure to level the output tray.

1. Position the first wheel into the channel on both sides while pushing the paper holding actuator.

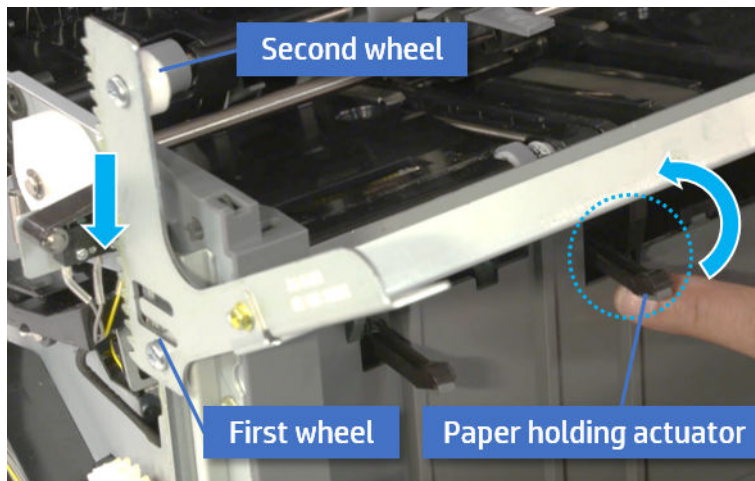

2. Let the second wheel rest on the channel on both sides simultaneously.
3. Gently squeeze the wheels into channel until the output tray frame meet the gear.

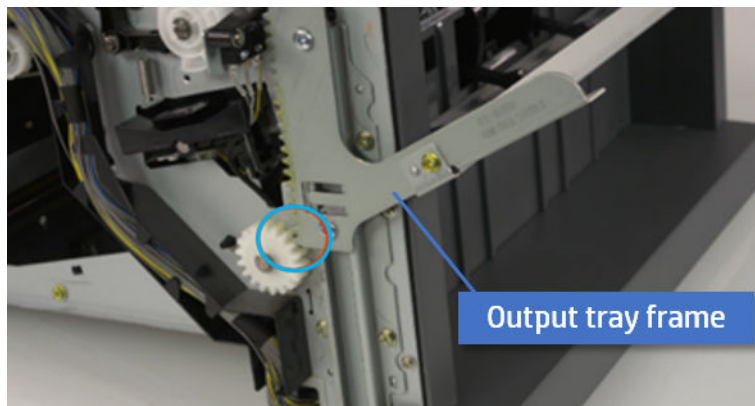

4. Rotate the pulley until the output tray frame is no longer lifted. It can make to level the output tray frame.

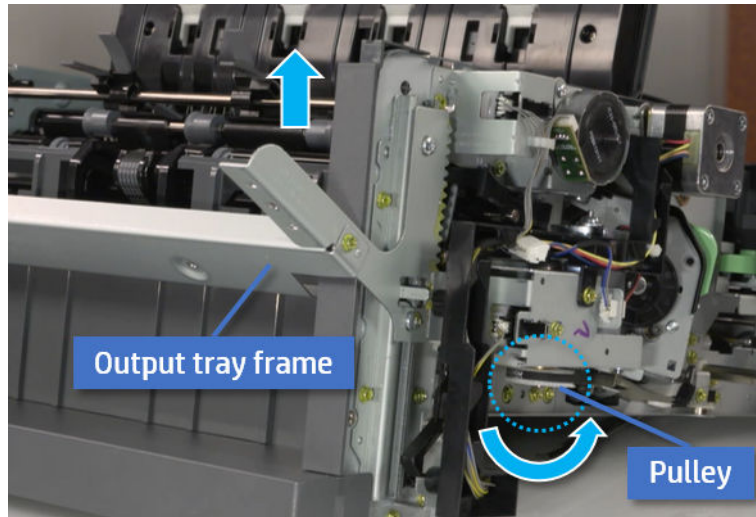

5. Rotate the pulley in the opposite direction.

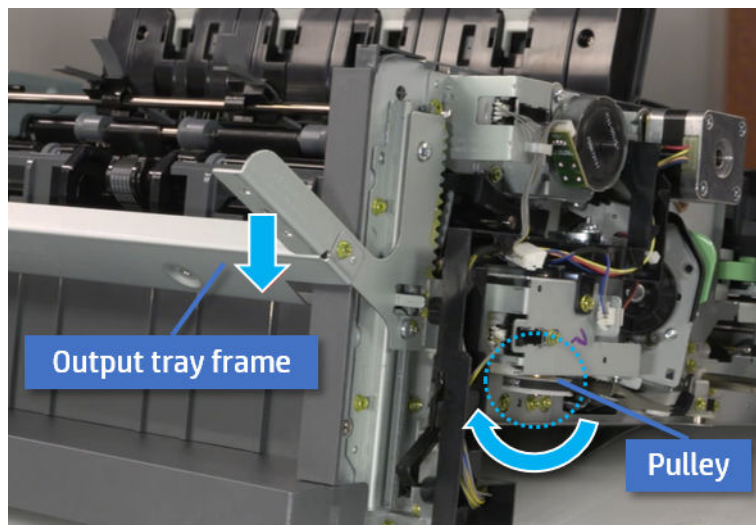

5. Remove the PCA cover.

- ▲ Remove two screws, and then remove the PCA cover.

Figure 5-139 Remove the PCA cover

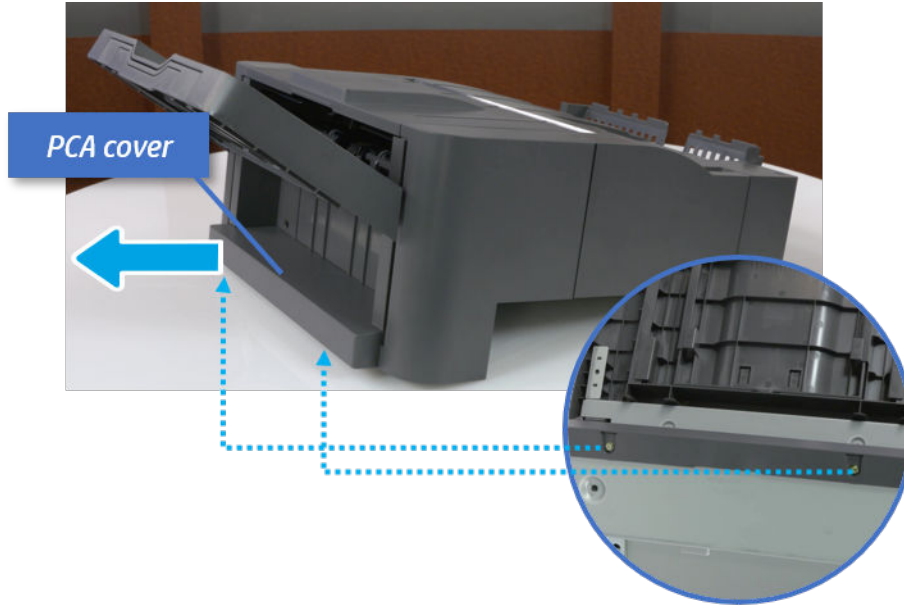

- 6. Remove the left cover.
 - a. Remove two screws.

Figure 5-140 Remove two screws

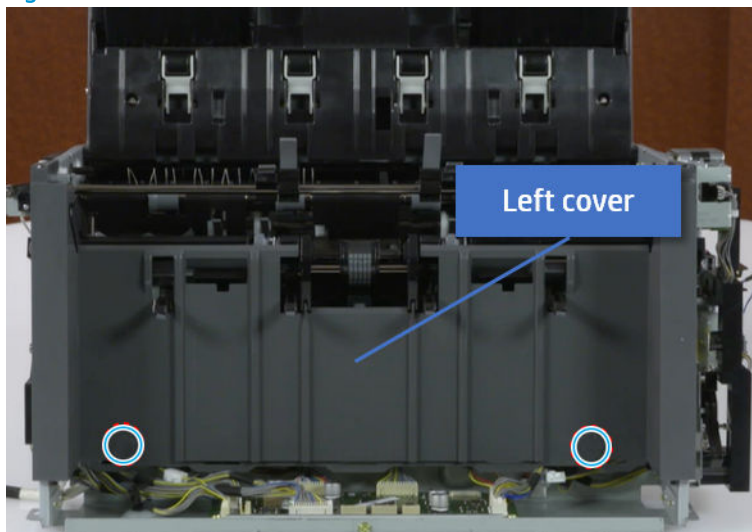

- b. Remove four screws from both front and rear sides.

Figure 5-141 Remove four screws

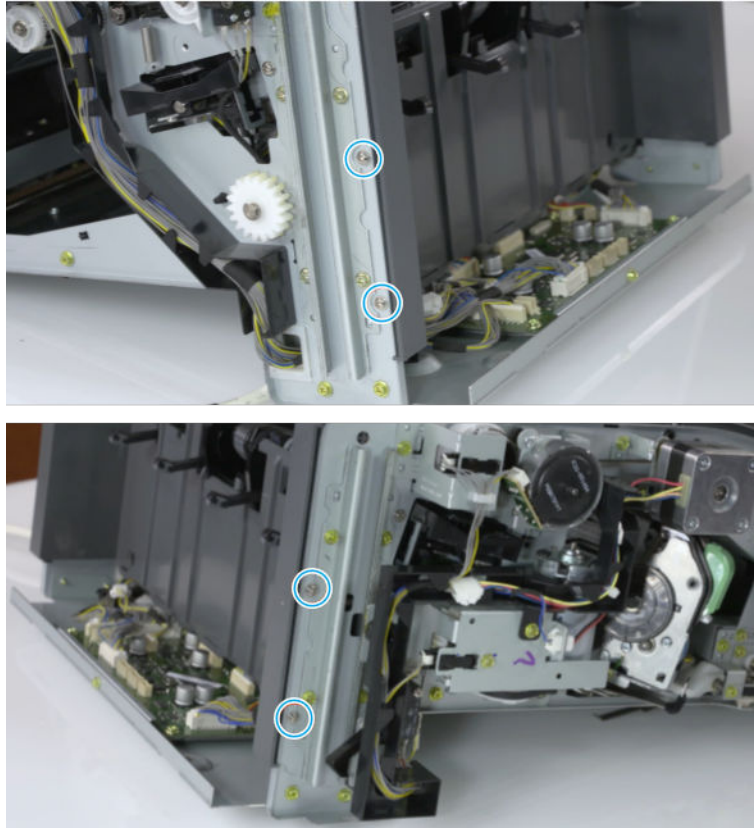

- c. Unplug two inline connectors, and then remove the left cover.

Figure 5-142 Unplug two connectors

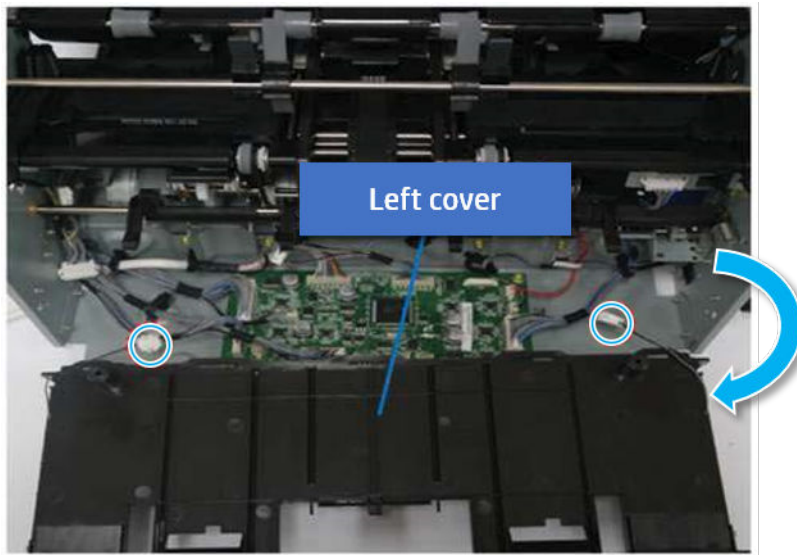

 **TIP:** Be sure to check the hook when reassembling.

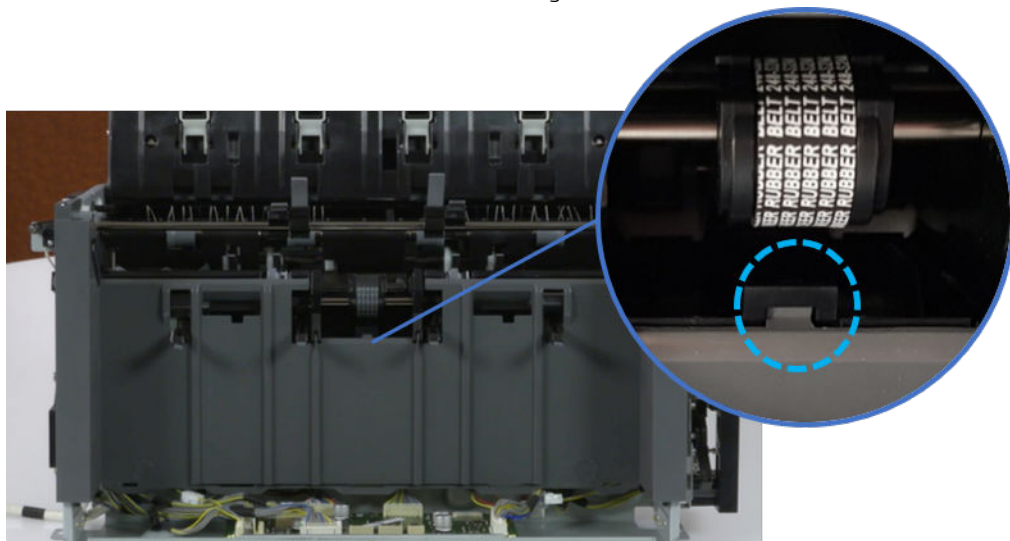

- 7. Remove the front harness guide.
 - a. Open one clamp and unplug five connectors, and then remove the wire harness from the front harness guide.

- b. Remove four screws, and then remove the front harness guide.

Figure 5-143 Remove the front harness guide

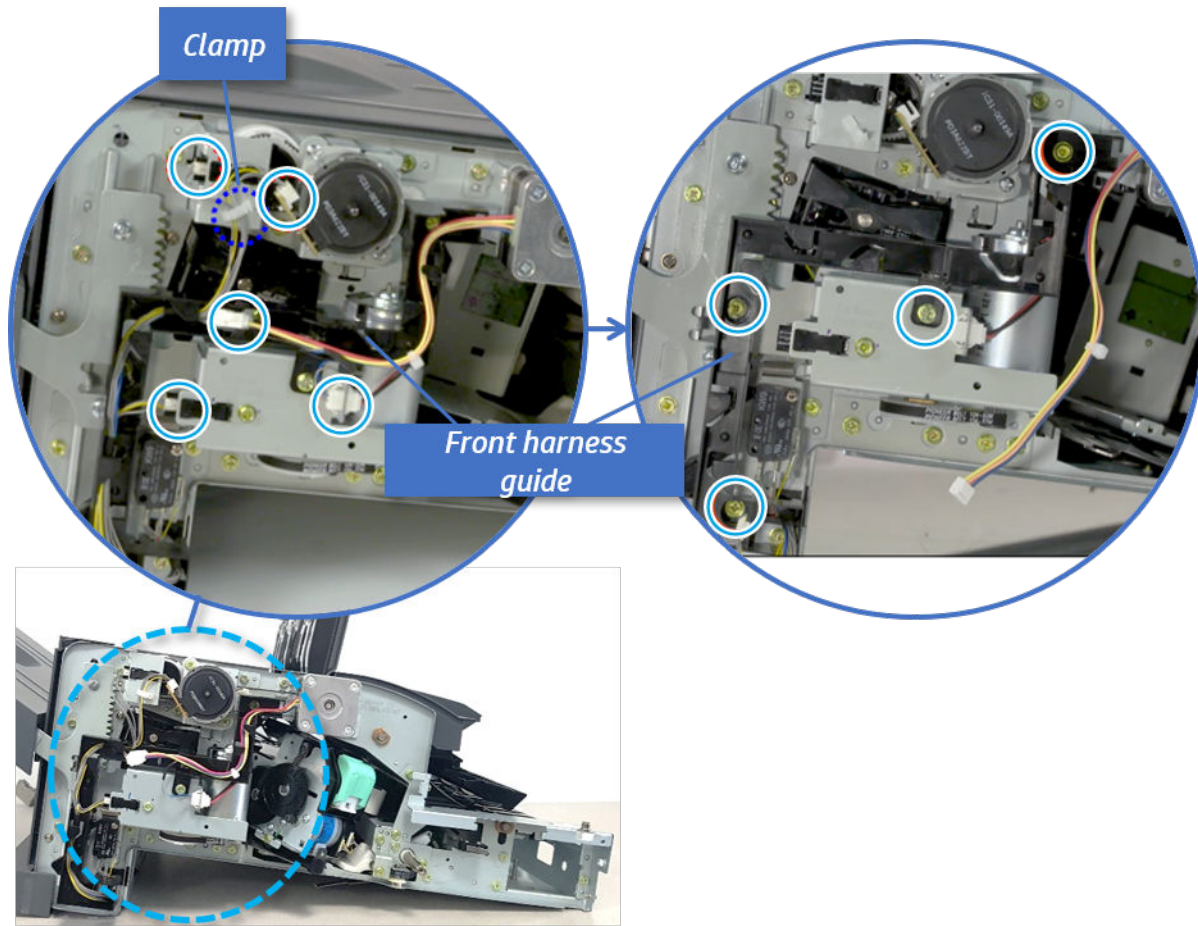

8. Remove the output tray motor assembly.
- ▲ Remove three screws, and then remove the output tray motor assembly.

Figure 5-144 Remove the output tray motor assembly

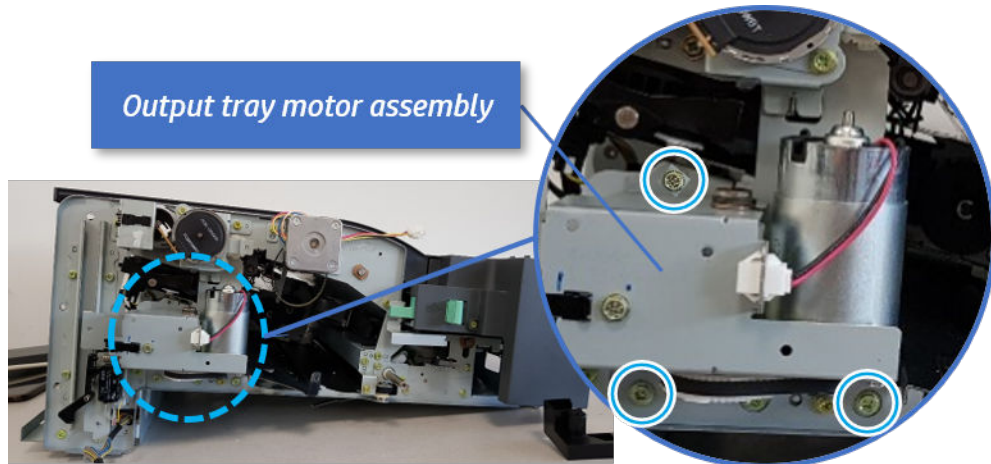

9. Remove the output tray lower limit switch.

- ▲ Remove one screw, and then remove the output tray lower limit switch.

Figure 5-145 Remove the output tray lower limit switch

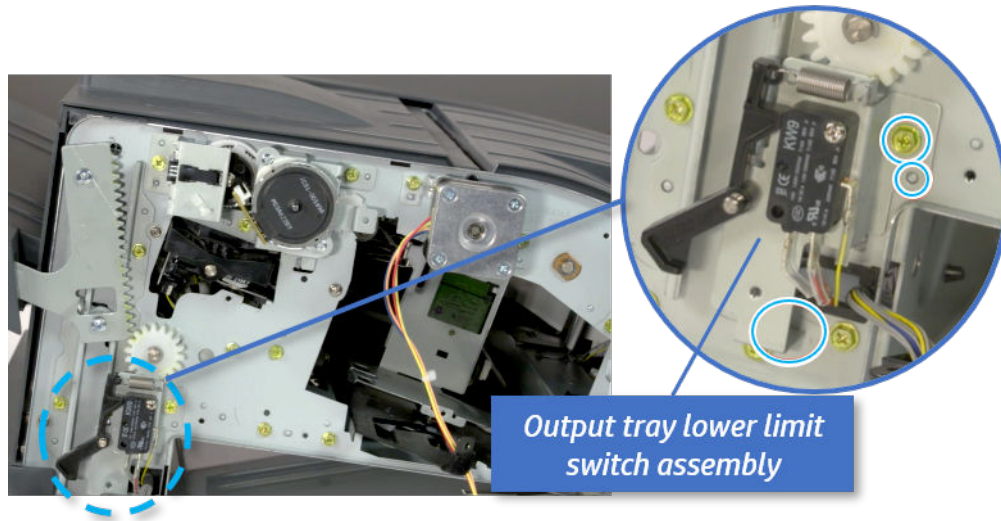

- 10. Remove the paper holding.
 - a. Remove the paper holding actuator spring.

Figure 5-146 Remove the paper holding actuator spring

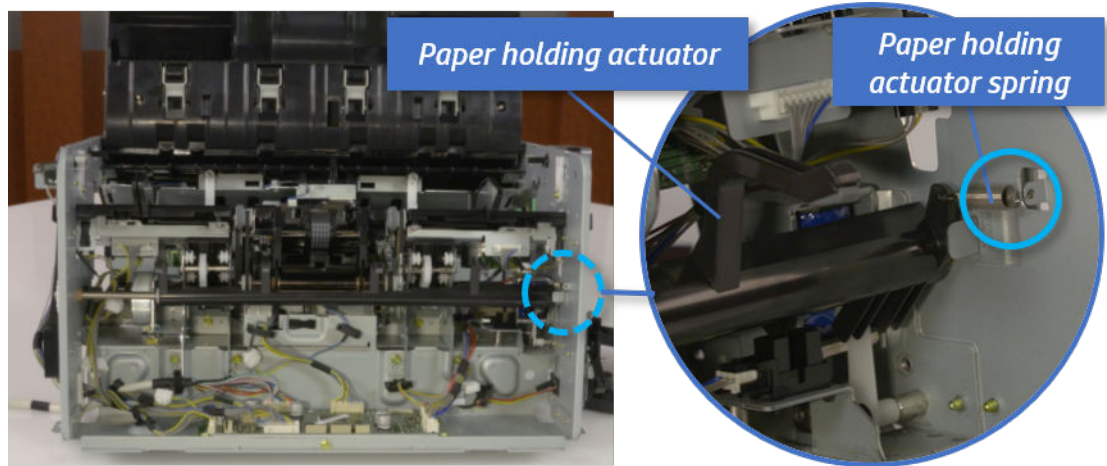

- b. Remove the e-ring and the rack pinion gear. And then remove the pin and the e-ring, and then remove the bushing.

Figure 5-147 Remove e-ring, rack pinion gear, pin, and bushing

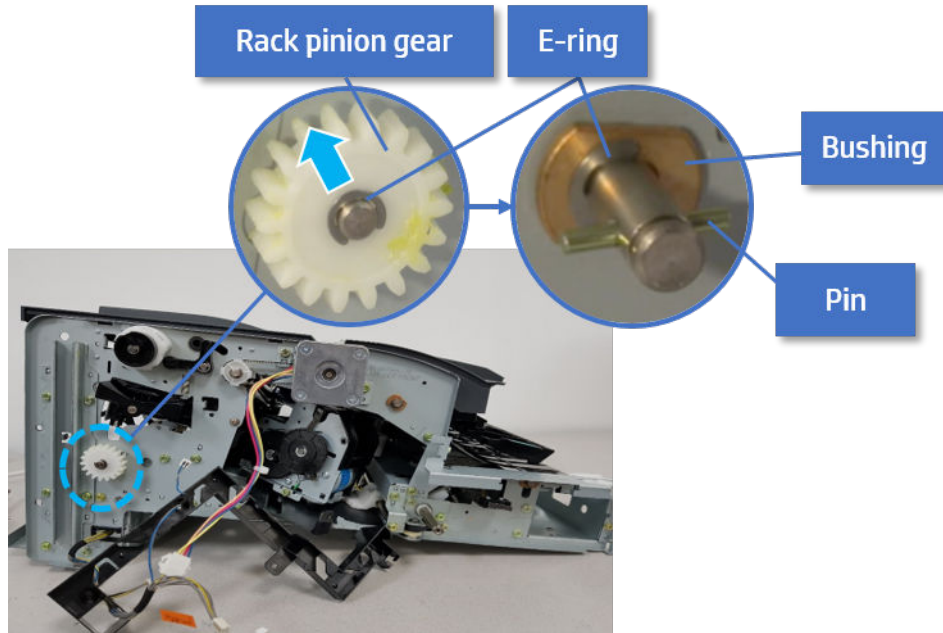

 **NOTE:** Be sure not to lose the pin.

- c. Carefully remove the paper holding shaft and the actuator.

Figure 5-148 Remove the paper holding shaft and the actuator

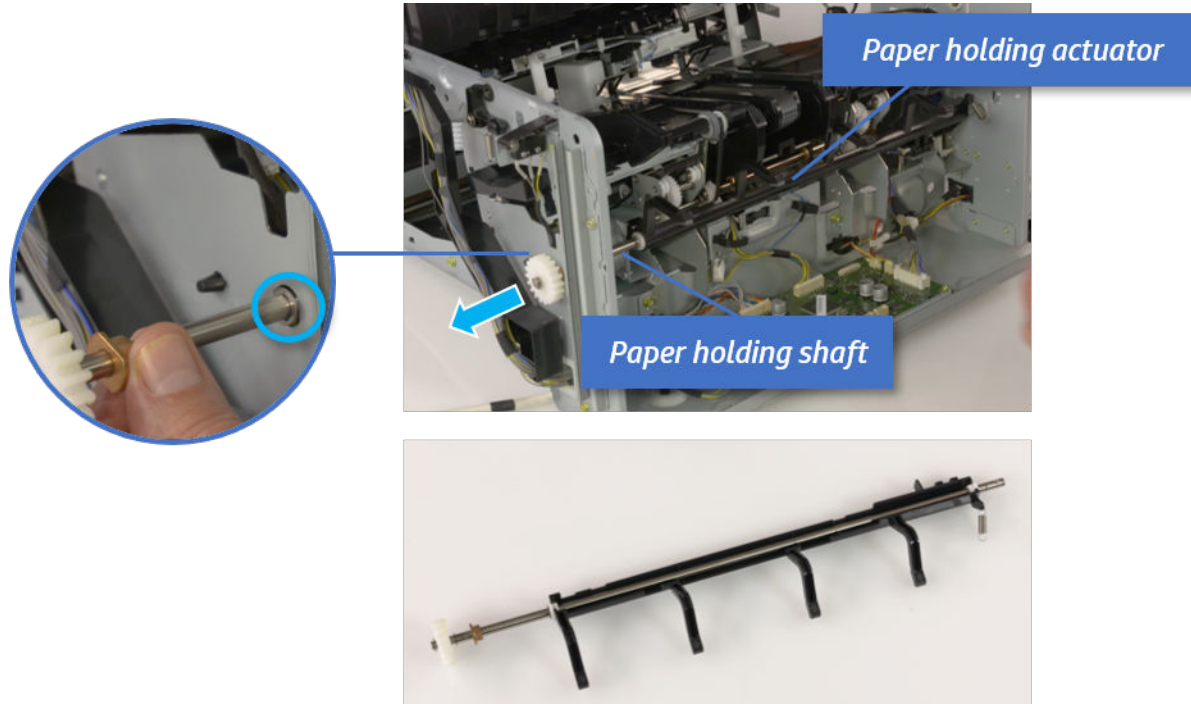

- 11. Remove the sub paddle unit.

- a. Open the top cover, and then remove one screw securing the sub paddle unit.

Figure 5-149 Remove one screw

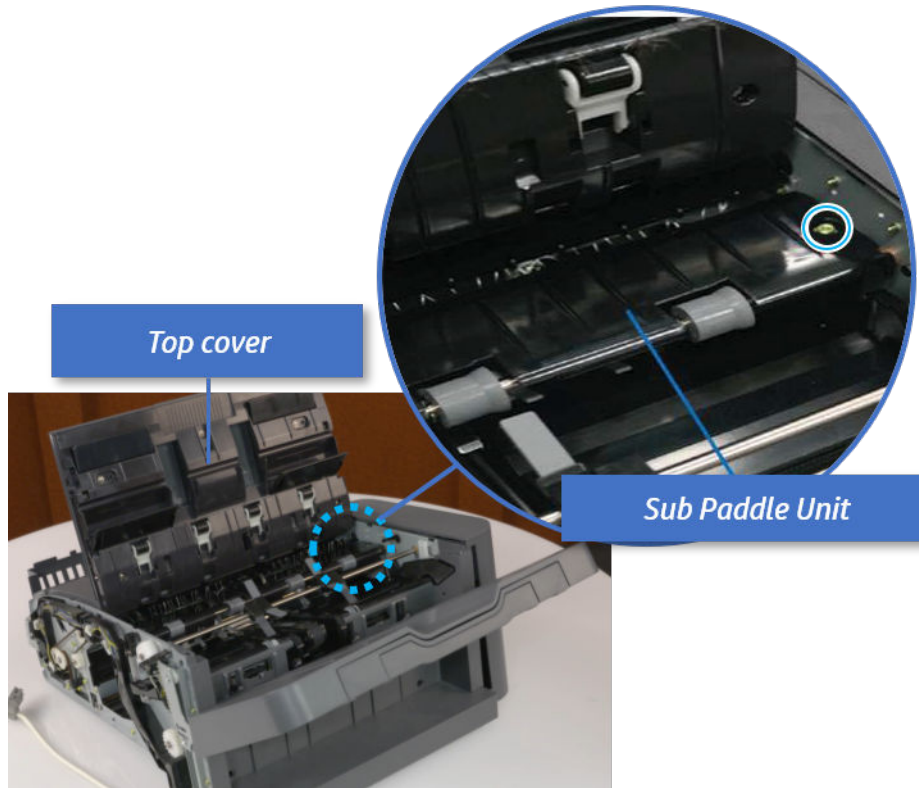

- b. Remove the e-ring, and then remove the pulley and timing belt. And then remove the e-ring and the bushing.

Figure 5-150 Remove the e-ring, pulley, timing belt, and bushing

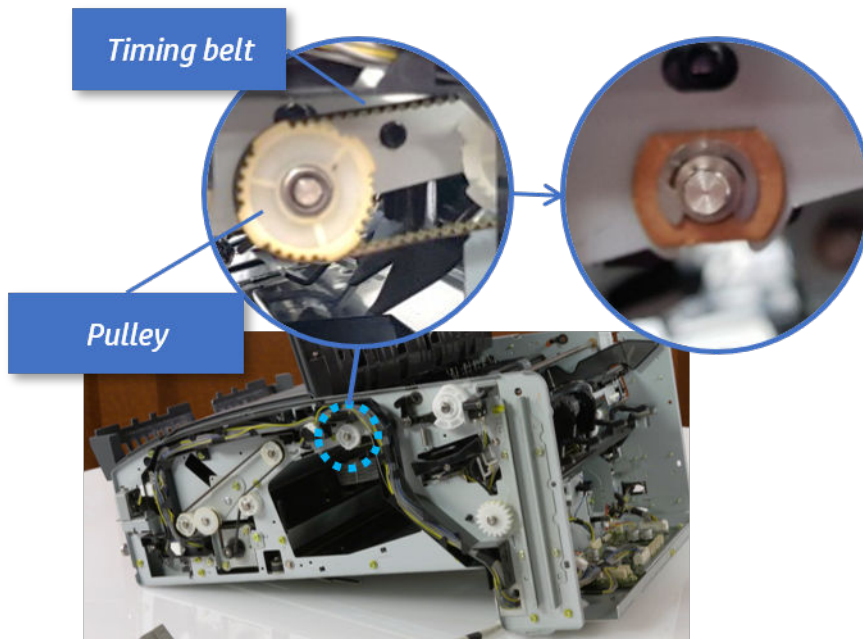

- c. Lift up and remove the sub paddle unit.

Figure 5-151 Remove the sub paddle unit

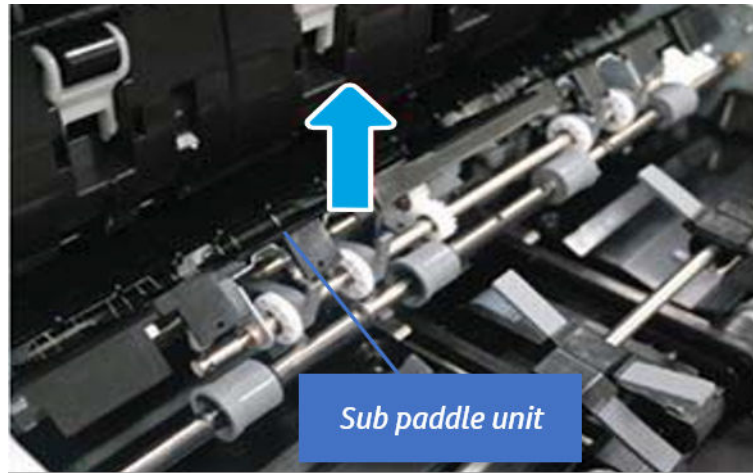

- 12. Remove the exit roller.

- a. Remove the guide on the center of the exit roller.

Figure 5-152 Remove the guide

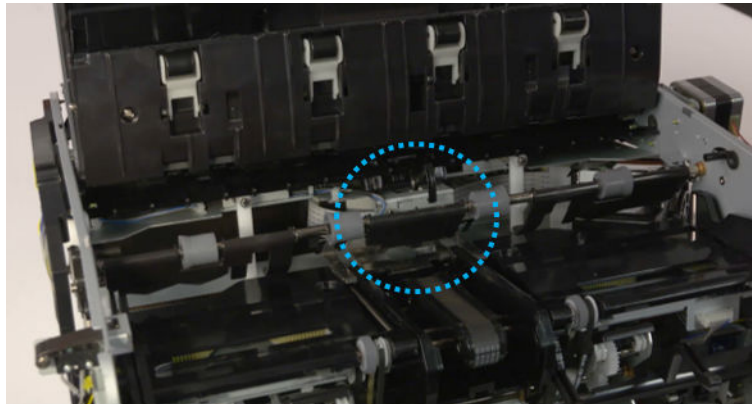

- b. On the front of the inner finisher, release the timing belt connected to the exit motor.

Figure 5-153 Release the timing belt

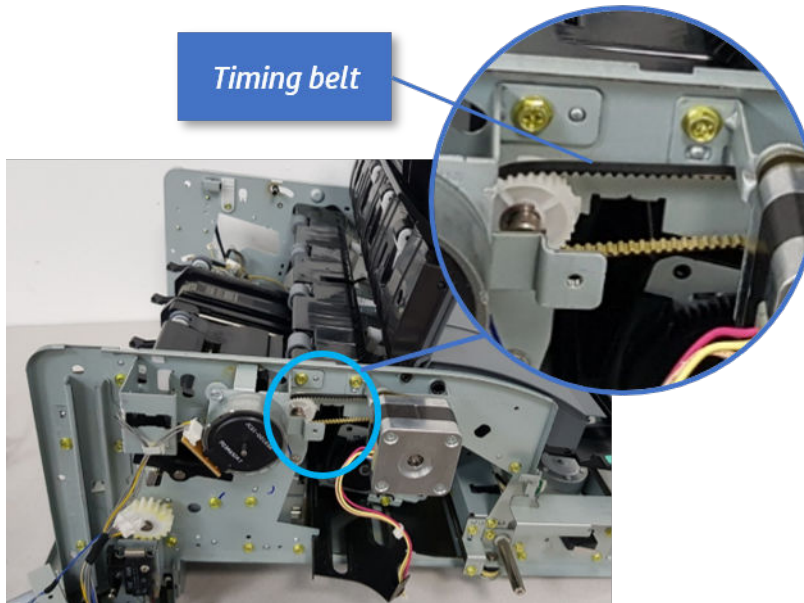

- c. Remove five screws securing the rear harness guide.

Figure 5-154 Remove five screws

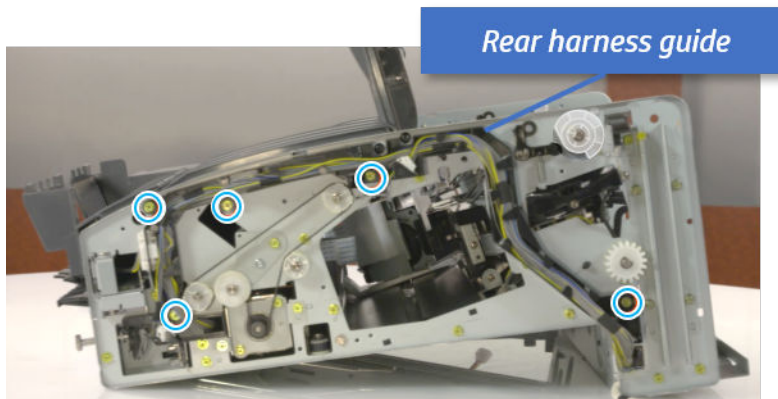

- d. On the rear of the inner finisher, remove the e-ring and the pulley and then remove the e-ring and the bushing.

Figure 5-155 Remove e-ring, pulley, and bushing

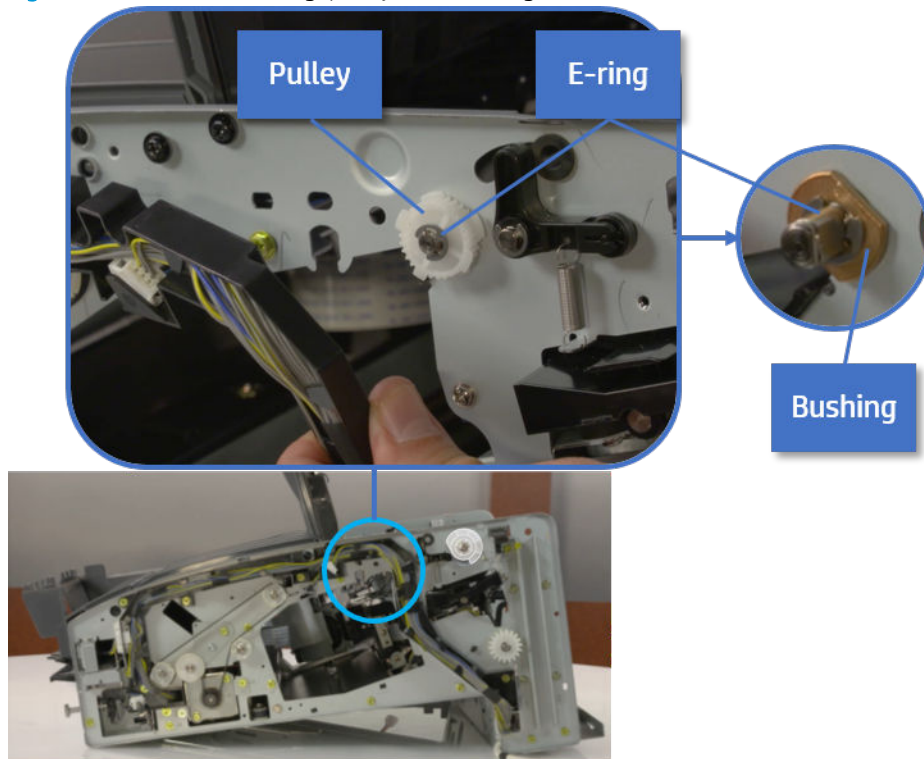

- e. Push the bushing to detach it, and then remove the exit roller.

Figure 5-156 Remove the exit roller

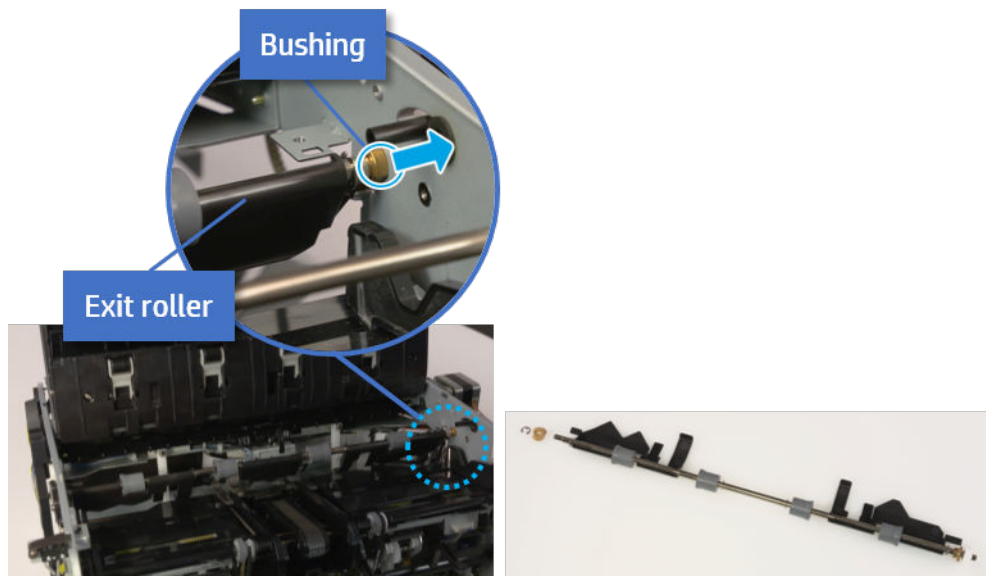

- 13. Remove the front tamper.
 - a. Remove four screws.

Figure 5-157 Remove four screws

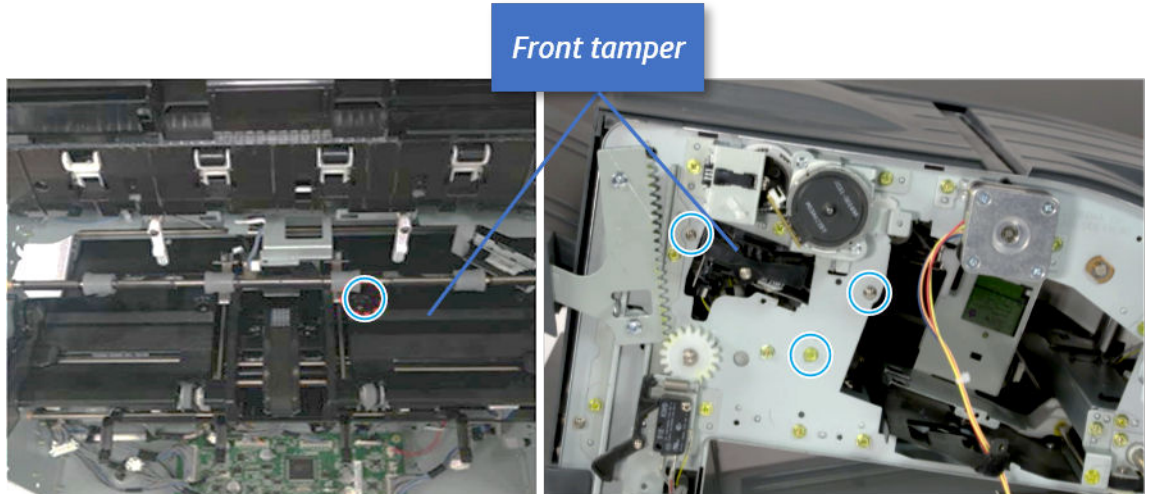

- b. Unplug the connector and release the hook, and then pull the front tamper up to remove.

Figure 5-158 Remove the front tamper

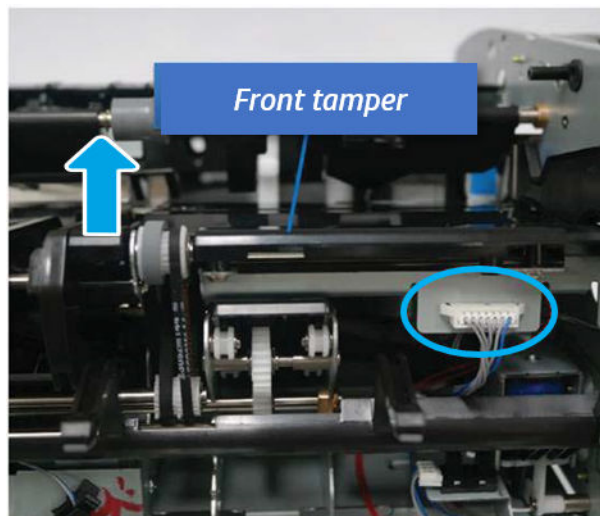

14. Remove the rear tamper.
 - a. Remove four screws.

 **NOTE:** Move cable guide out of position to access the screws.

Figure 5-159 Remove four screws



- b. Unplug two connectors and release the hook, and then remove the rear tamper.

Figure 5-160 Remove the rear tamper

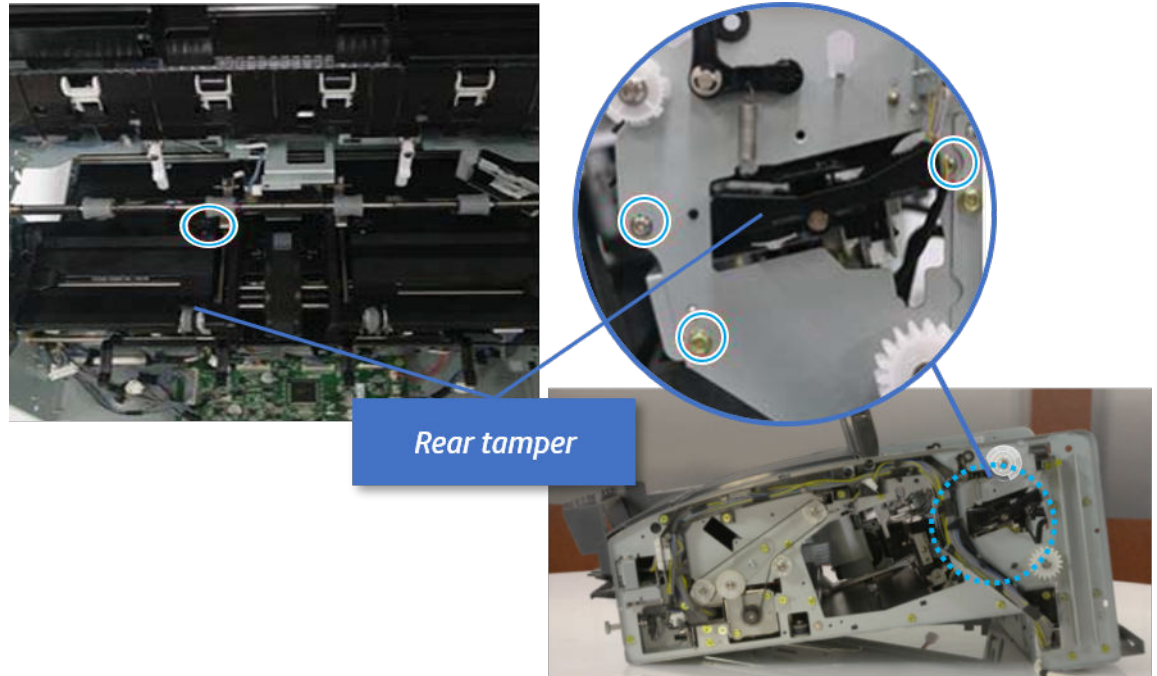
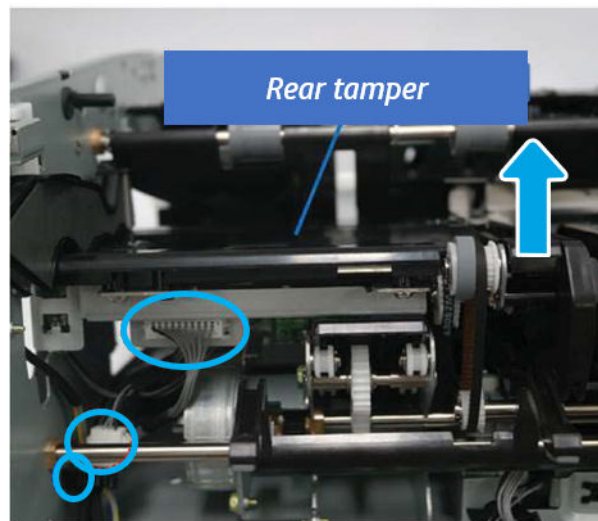

- 15. Remove the ejector & paper support assembly.
 - a. Open one clamp, disconnect one connector.

Figure 5-161 Disconnect one connector

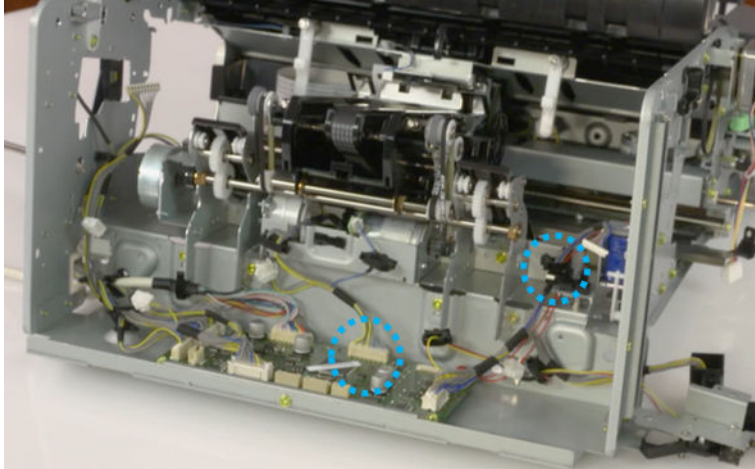

- b. Pull the rear paper support up, and then release one clamp and disconnect two connectors.

Figure 5-162 Disconnect two connector

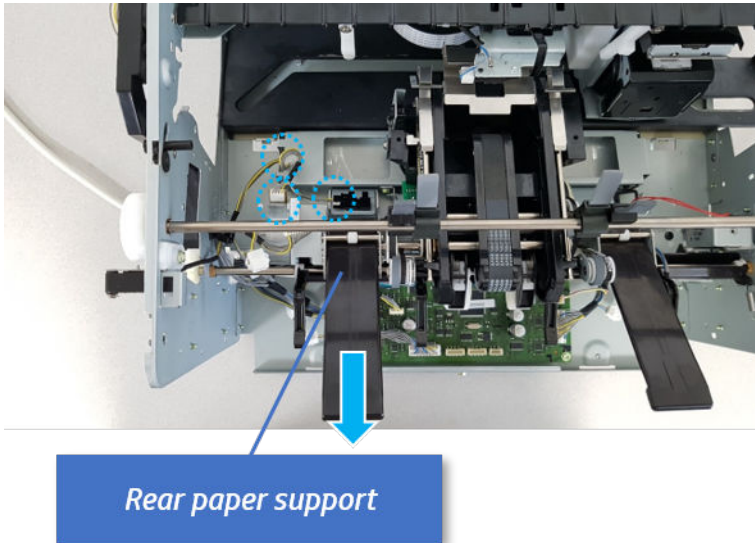

- c. Remove four screws, and then remove the ejector & paper support assembly.

Figure 5-163 Remove the ejector & paper support assembly

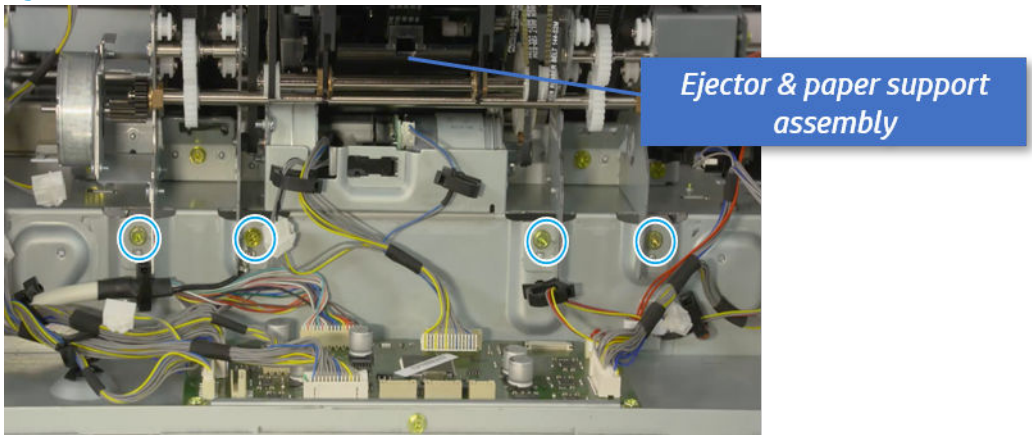

16. Remove the front paper support.
 - a. Remove the e-ring and the bushing, and then pull and remove the drive shaft.

Figure 5-164 Remove the drive shaft

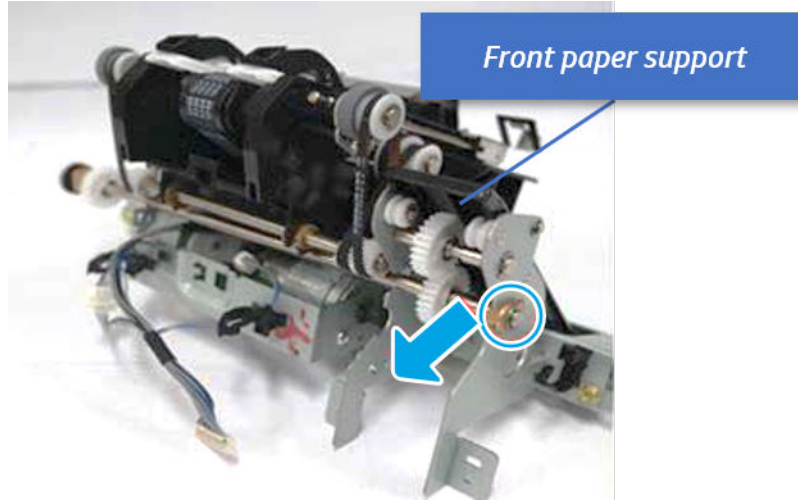

TIP: When reassembling the drive shaft, ensure the paper supports are in the full down position (against the stops).

- b. Remove one screw, and then remove the front paper support.

Figure 5-165 Remove the front paper support

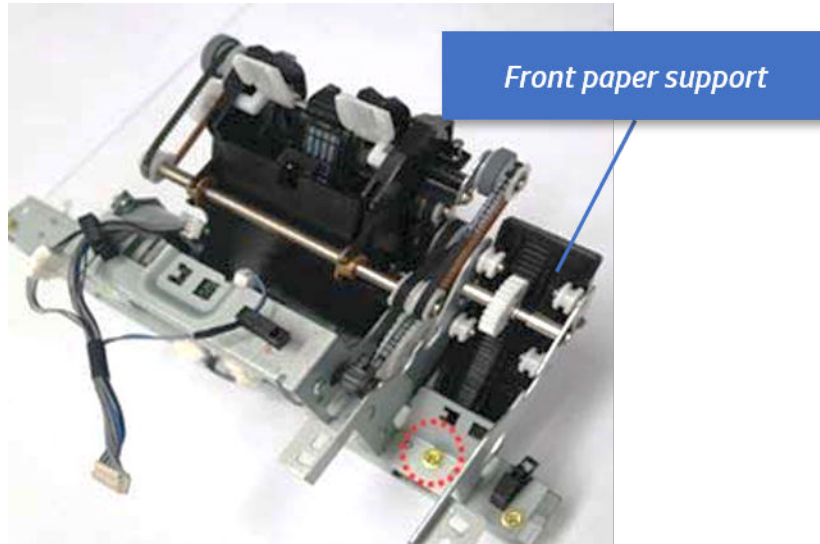



17. Unpack the replacement assembly.
 - a. Dispose of the defective part.

 **NOTE:** HP recommends responsible disposal of the defective part.

<http://www8.hp.com/us/en/hp-information/environment/product-recycling.html>

- b. Unpack the replacement part from the packaging.

 **CAUTION:**  Some parts are sensitive to electrostatic discharge (ESD). Always perform service work at an ESD-protected workstation or mat. If an ESD workstation or mat is not available, touch the sheet-metal chassis to provide a static ground before touching an ESD-sensitive assembly. Protect the ESD-sensitive assemblies by placing them in ESD pouches when they are out of the printer.

If the replacement part is a roller or pad, avoid touching the spongy part of it. Skin oils on the roller or pad can cause paper pickup and/or print-quality problems. HP recommends using disposable gloves when handling rollers or pads or washing your hands before touching rollers or pads.

 **IMPORTANT:** Make sure that all of the shipping materials (for example shipping tape) are removed from the replacement part prior to installation.

- c. To install an assembly, reverse the removal steps.

When applicable, special installation instructions are provided for an assembly at the end of the removal procedure. Always completely read the removal instructions and follow all special installation instructions.

Rear paper support

Removal and replacement: Rear paper support

Learn how to remove and replace the rear paper support.

To view teardown&reassembling video of the inner finisher, click the link below.

 [View a teardown video of the inner finisher .](#)

 [View a reassembling video of the inner finisher .](#)

 **IMPORTANT:** When applicable, special installation instructions are provided for an assembly at the end of the removal procedure. Always completely read the removal instructions and follow all special installation instructions.

Mean time to repair:

Service level:

Before performing service

Turn the printer power off

- Press the power button on the front of the printer, and then turn off the power switch next to the power cable.
- A shutting-down message appears on the control-panel display.

 **WARNING!** To avoid damage to the printer, turn the power off and wait until the printer shuts down before removing the power cable.

- Disconnect the printer power cable after the printer has completely shut down (the control-panel display is blank).

Use the table below to identify the correct part number for your printer. To order the part, go to <https://parts.hp.com>.

Table 5-42 Part information

Part number	Part description
JC90-01311A	Rear paper support

Required tools

- #2 JIS screwdriver with a magnetic tip

After performing service

Turn the printer power on

- Connect the power cable.
- Use the power switch to turn the power on.

Post service test

Print any pages necessary to verify that the repair resolved the issue and did not create any new issues.

1. Remove the front cover.
 - a. Open the front door and open the punch cover.
 - b. Remove three screws in the front.
 - c. Remove the lever.
 - d. Open the top cover.
 - e. From the right side of the front cover, carefully lift and pry toward the top-left corner to remove the front cover.

Figure 5-166 Remove the front cover

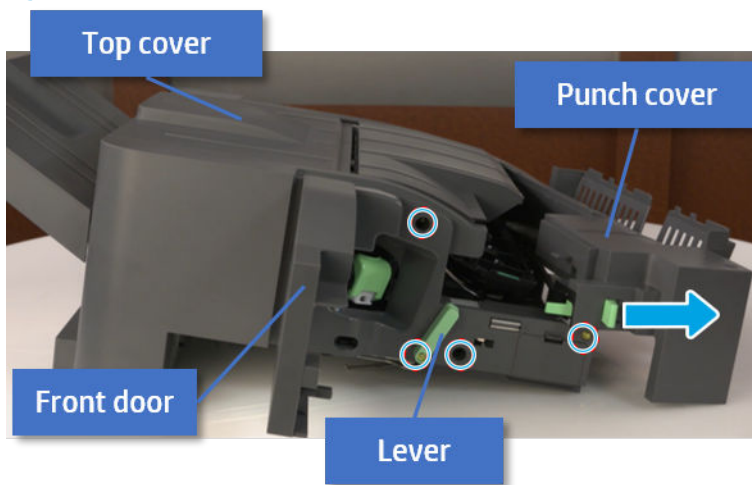

2. Remove the rear cover.
 - a. Open the top cover.

Figure 5-167 Open the top cover

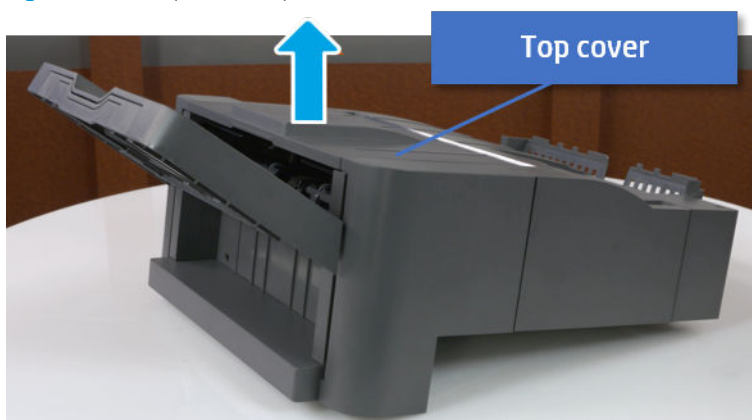

- b. Remove three screws.

- c. Release hooks carefully and remove the rear cover.

Figure 5-168 Remove the rear cover

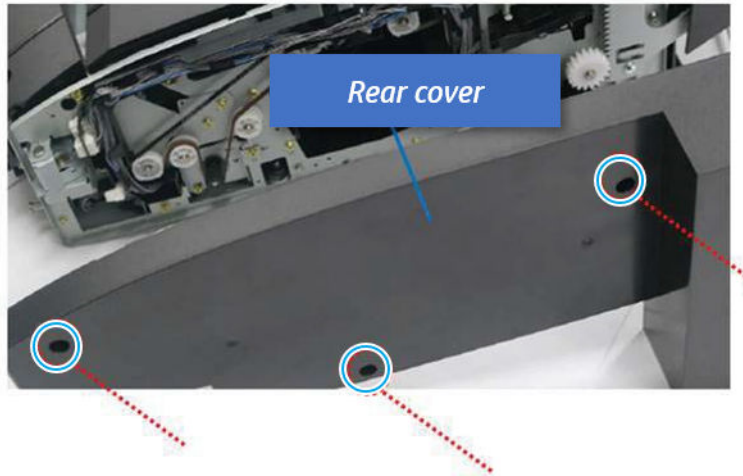

- 3. Remove the output tray.

- a. Remove four screws.

Figure 5-169 Remove four screws

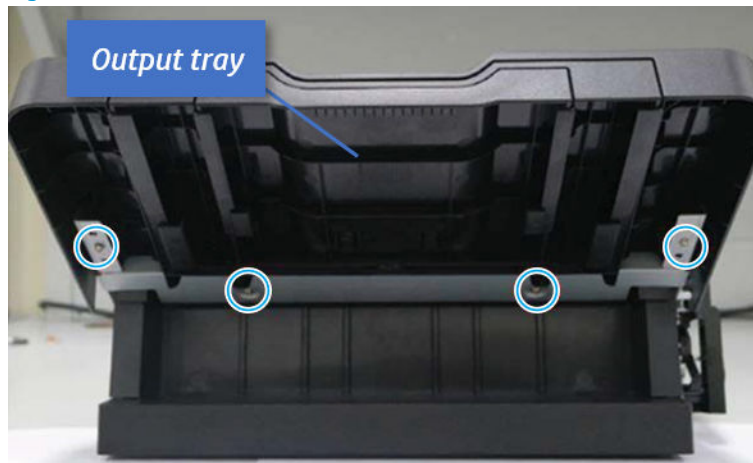

- b. Push the paper holding actuator into the inner finisher, and then remove the output tray.

Figure 5-170 Remove the output tray.



- 4. Remove the output tray frame.
 - a. Rotate the pulley until the output tray frame depart from the gear.

Figure 5-171 Remove the pulley

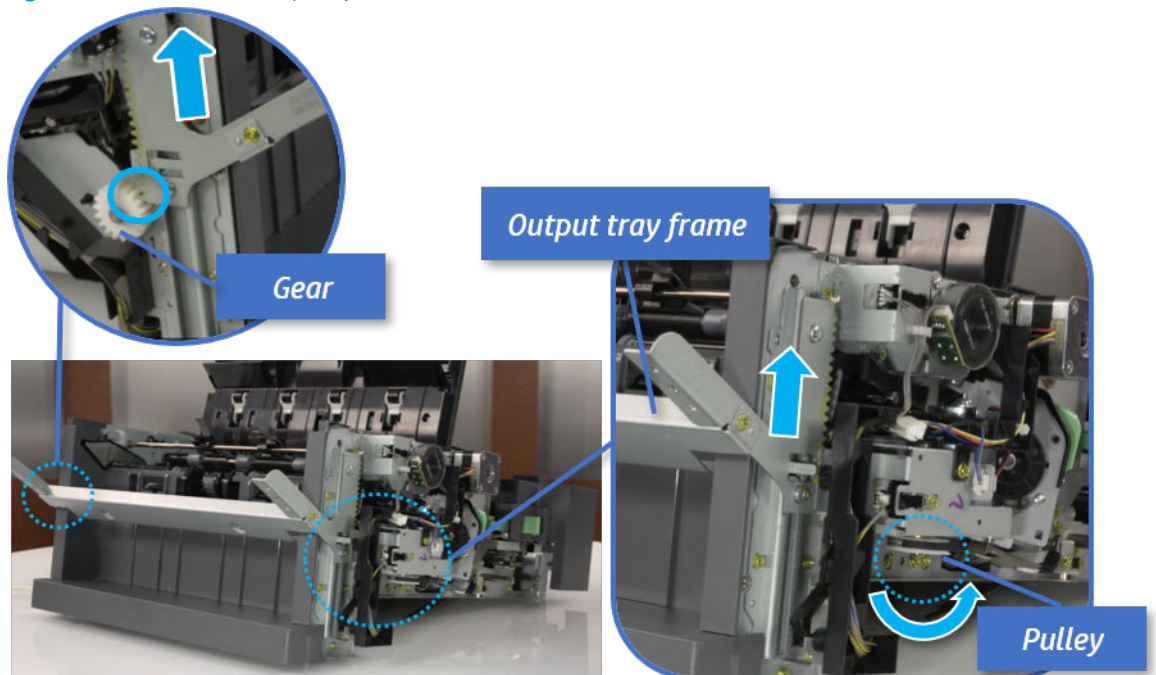

- b. Push the paper holding actuator into the inner finisher, and then remove the output tray frame.

Figure 5-172 Remove the output tray frame

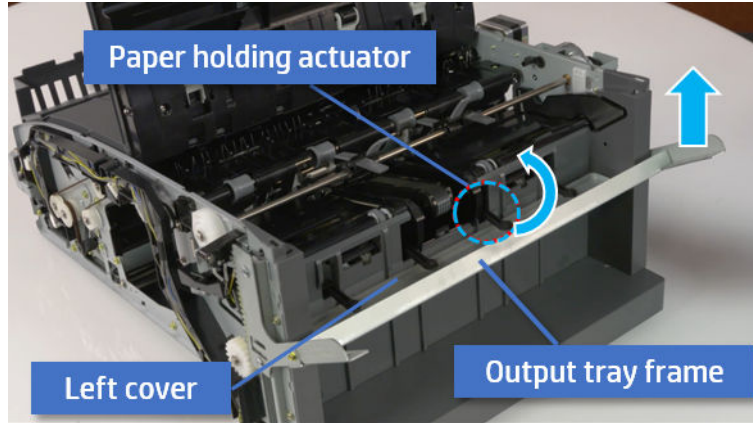

TIP: Push the paper holding actuator into the inner finisher when reassembling. Be sure to level the output tray.

1. Position the first wheel into the channel on both sides while pushing the paper holding actuator.

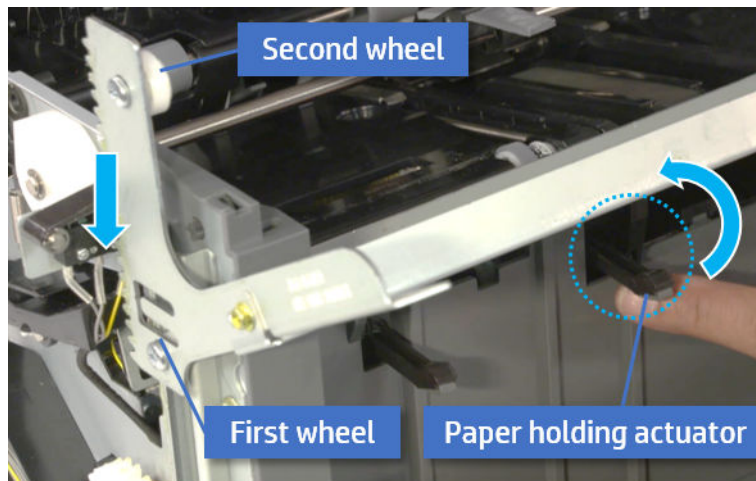

2. Let the second wheel rest on the channel on both sides simultaneously.
3. Gently squeeze the wheels into channel until the output tray frame meet the gear.

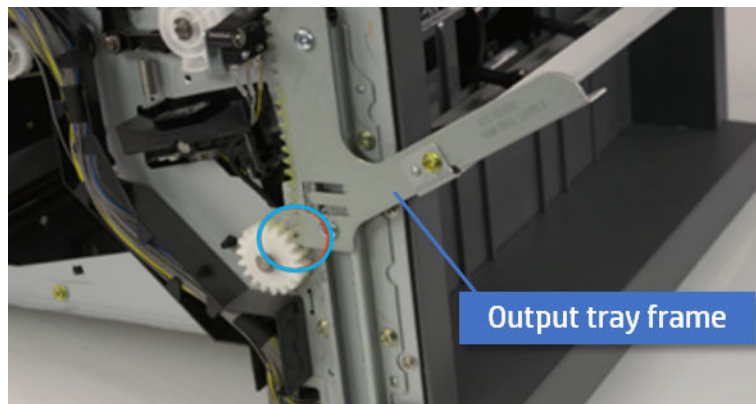

4. Rotate the pulley until the output tray frame is no longer lifted. It can make to level the output tray frame.

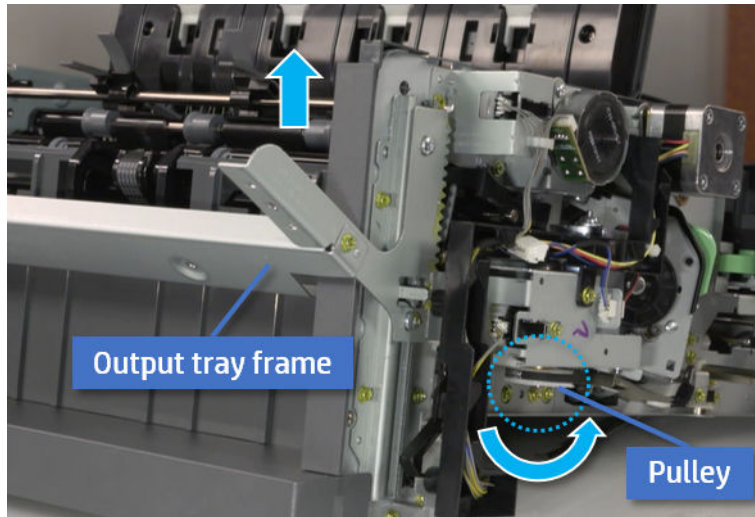

5. Rotate the pulley in the opposite direction.

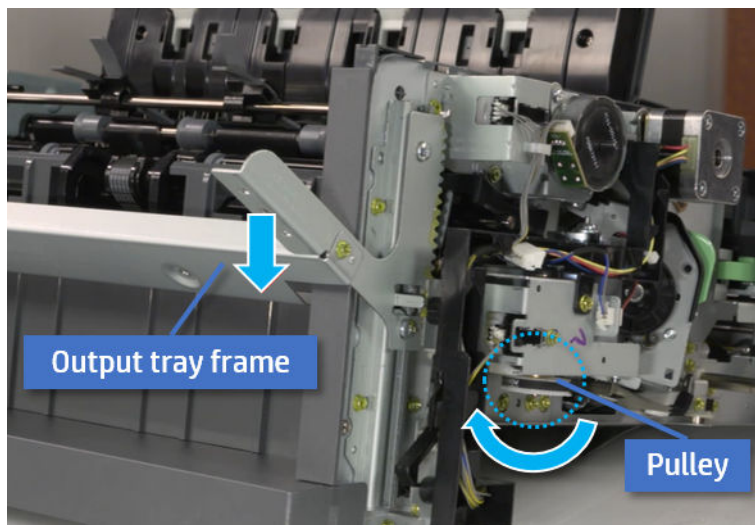

5. Remove the PCA cover.
 - ▲ Remove two screws, and then remove the PCA cover.

Figure 5-173 Remove the PCA cover

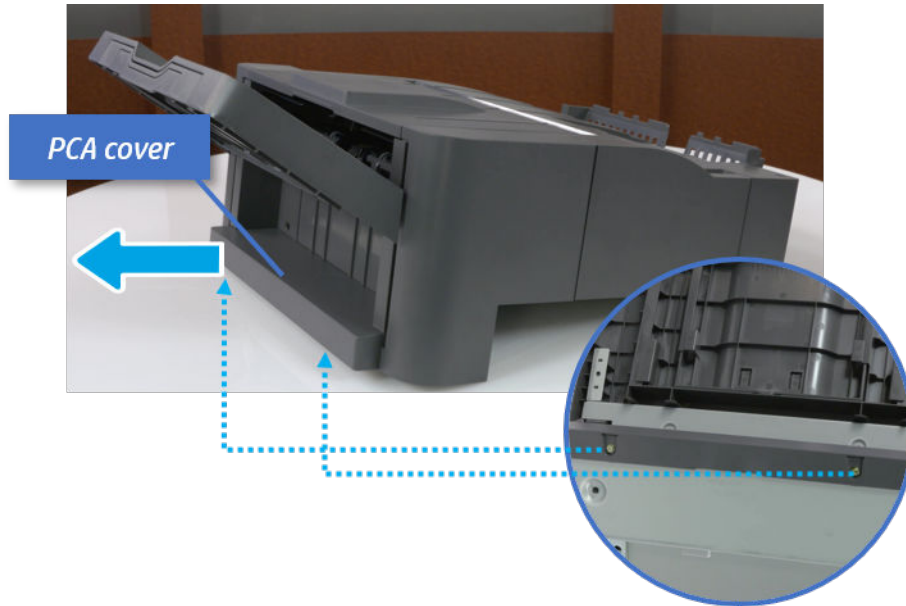

6. Remove the left cover.
 - a. Remove two screws.

Figure 5-174 Remove two screws

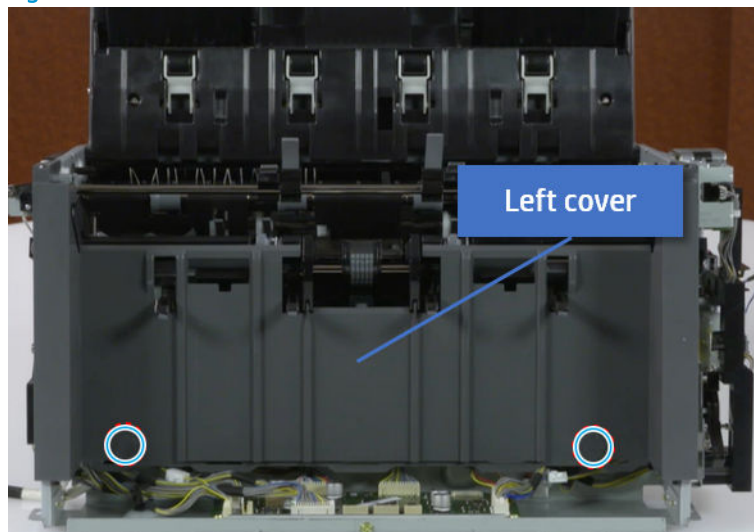

- b. Remove four screws from both front and rear sides.

Figure 5-175 Remove four screws

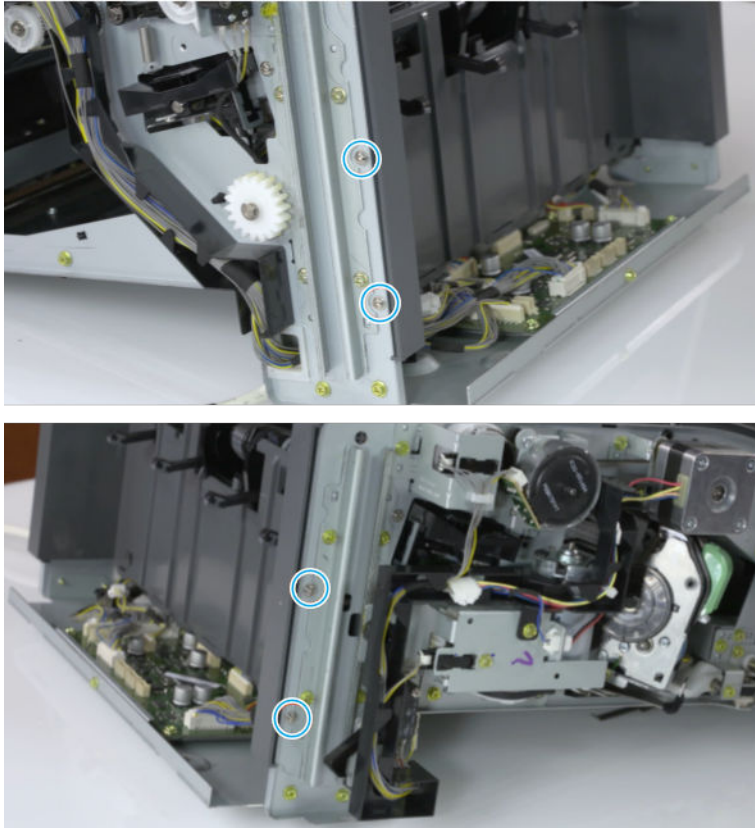

- c. Unplug two inline connectors, and then remove the left cover.

Figure 5-176 Unplug two connectors

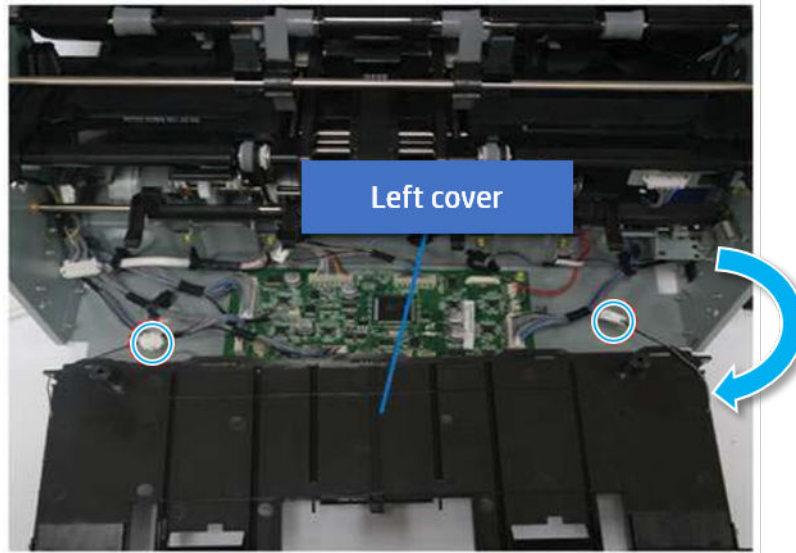

 **TIP:** Be sure to check the hook when reassembling.

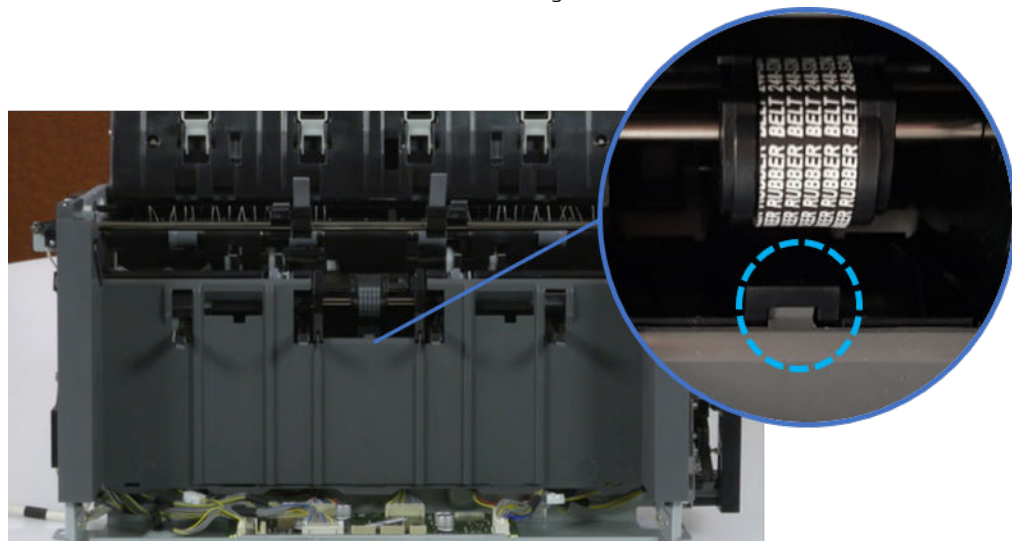

- 7. Remove the front harness guide.
 - a. Open one clamp and unplug five connectors, and then remove the wire harness from the front harness guide.

- b. Remove four screws, and then remove the front harness guide.

Figure 5-177 Remove the front harness guide

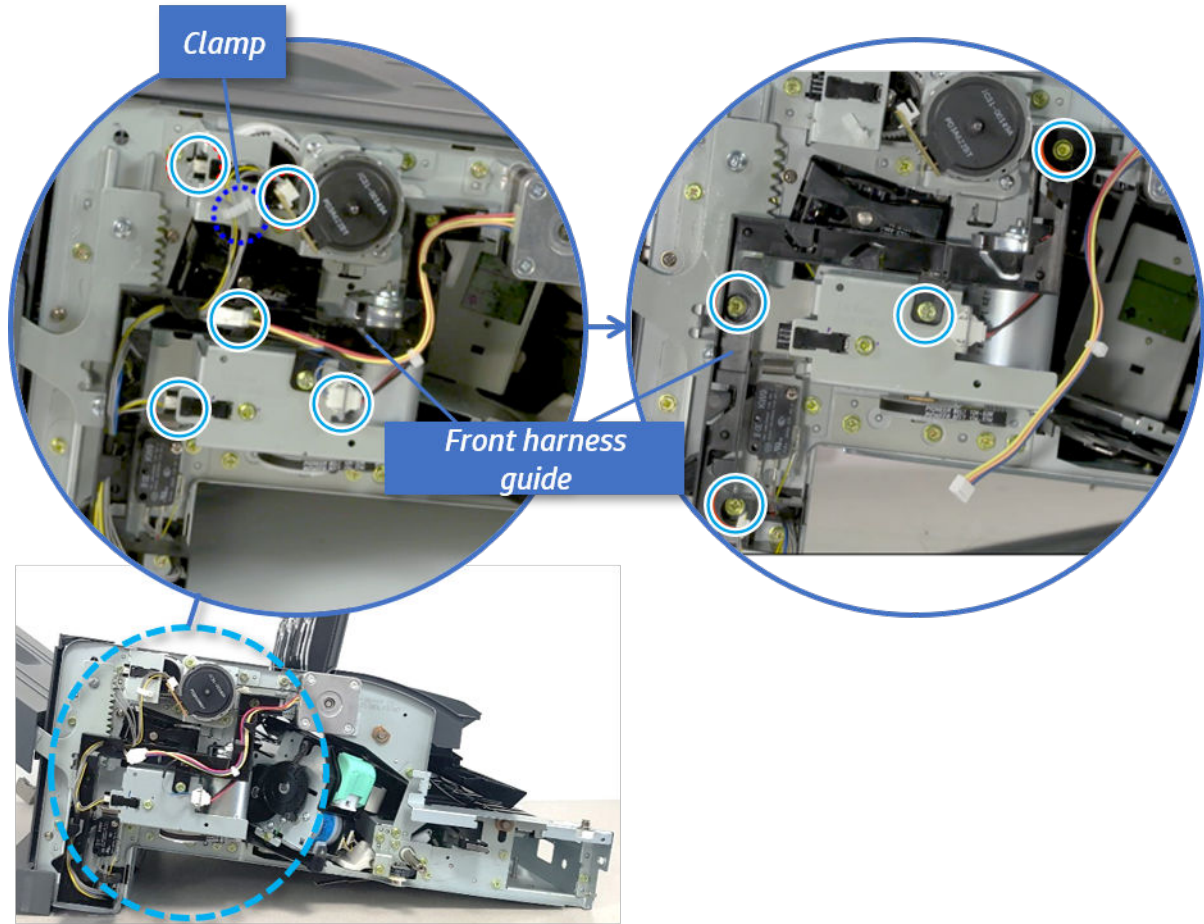

8. Remove the output tray motor assembly.

- ▲ Remove three screws, and then remove the output tray motor assembly.

Figure 5-178 Remove the output tray motor assembly

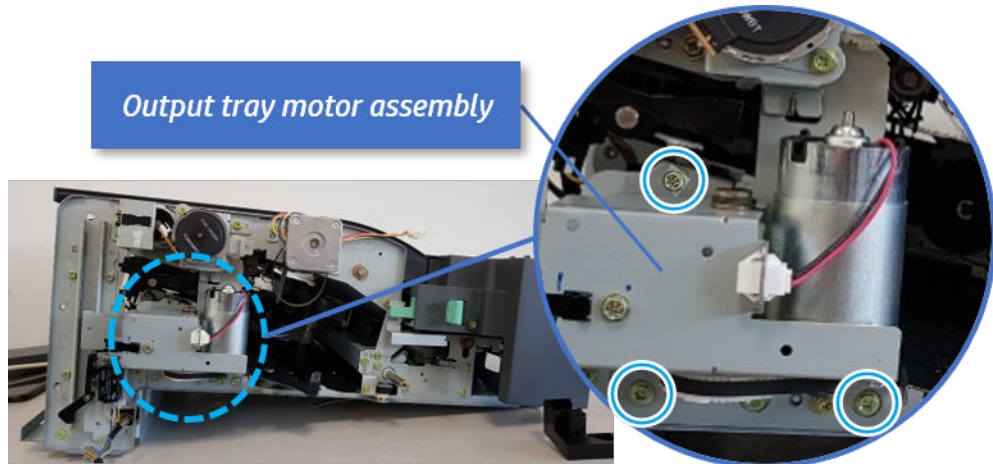

9. Remove the output tray lower limit switch.

- ▲ Remove one screw, and then remove the output tray lower limit switch.

Figure 5-179 Remove the output tray lower limit switch

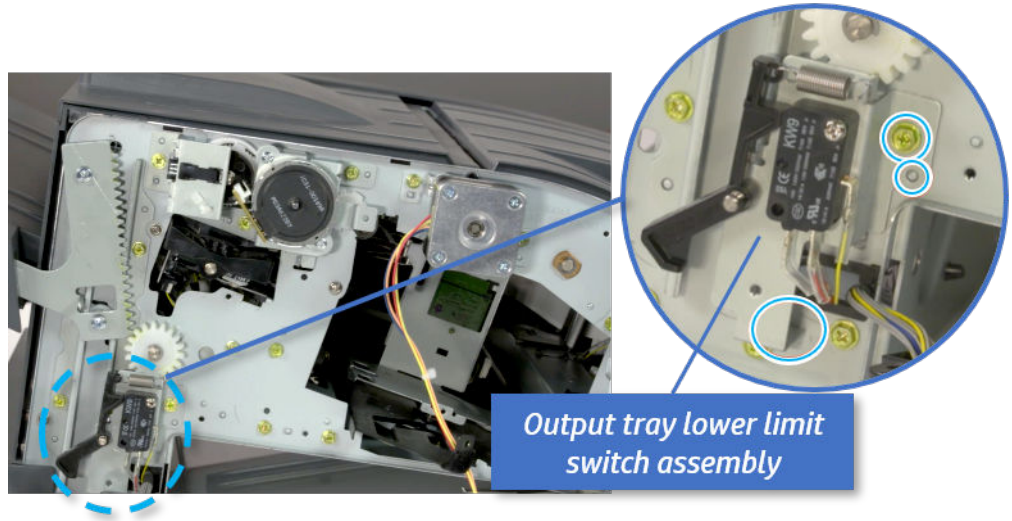

- 10. Remove the paper holding.
 - a. Remove the paper holding actuator spring.

Figure 5-180 Remove the paper holding actuator spring

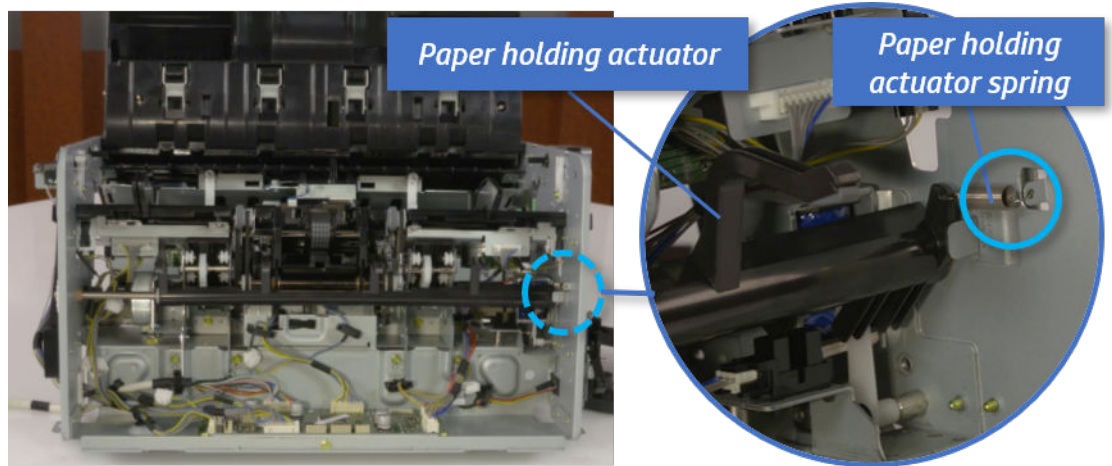

- b. Remove the e-ring and the rack pinion gear. And then remove the pin and the e-ring, and then remove the bushing.

Figure 5-181 Remove e-ring, rack pinion gear, pin, and bushing

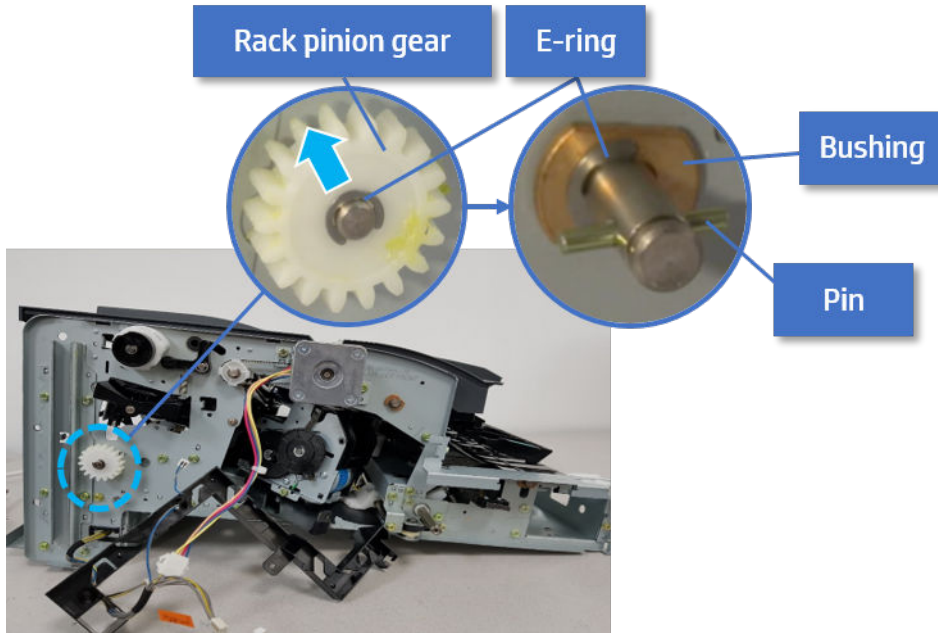

 **NOTE:** Be sure not to lose the pin.

- c. Carefully remove the paper holding shaft and the actuator.

Figure 5-182 Remove the paper holding shaft and the actuator

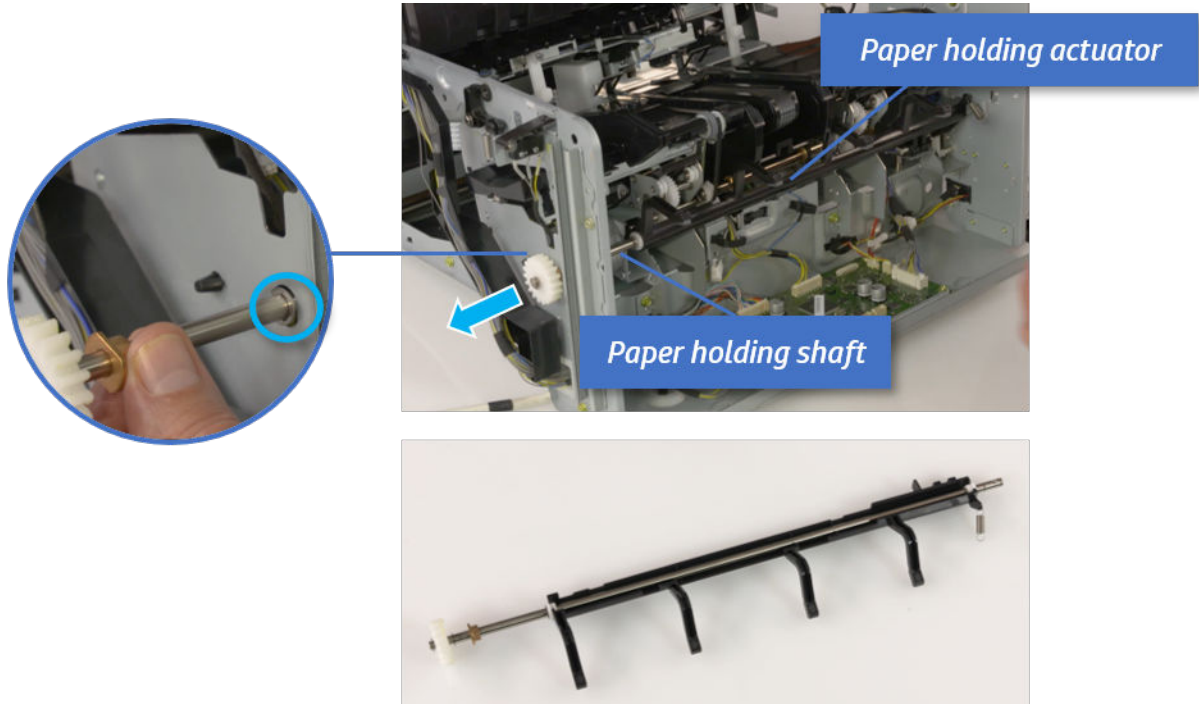

11. Remove the sub paddle unit.

- a. Open the top cover, and then remove one screw securing the sub paddle unit.

Figure 5-183 Remove one screw

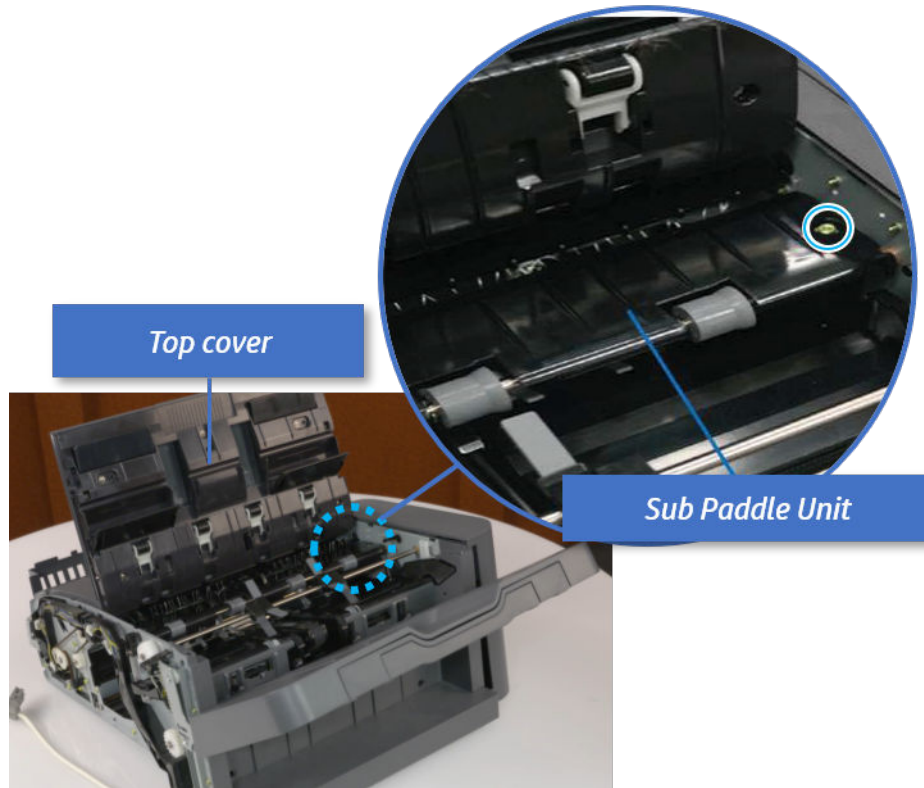

- b. Remove the e-ring, and then remove the pulley and timing belt. And then remove the e-ring and the bushing.

Figure 5-184 Remove the e-ring, pulley, timing belt, and bushing

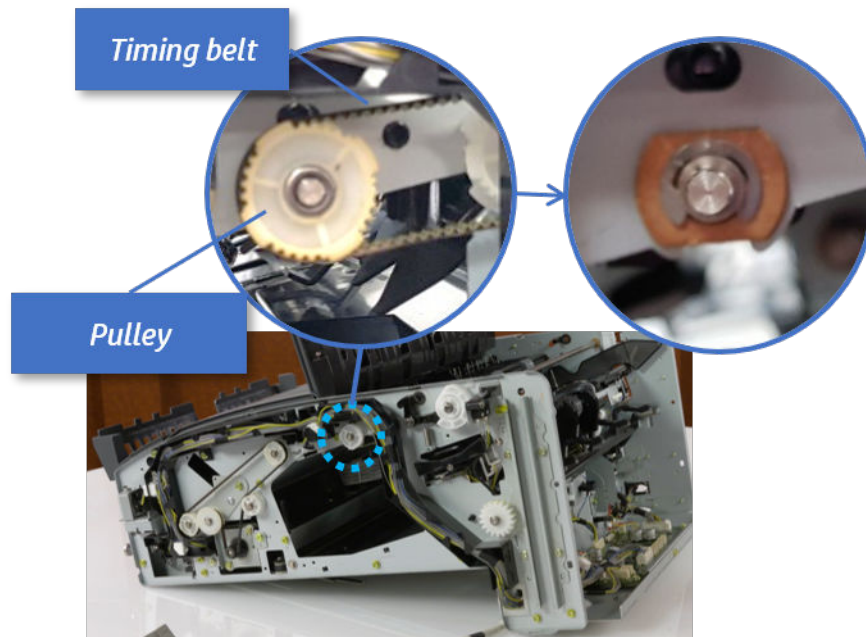

- c. Lift up and remove the sub paddle unit.

Figure 5-185 Remove the sub paddle unit

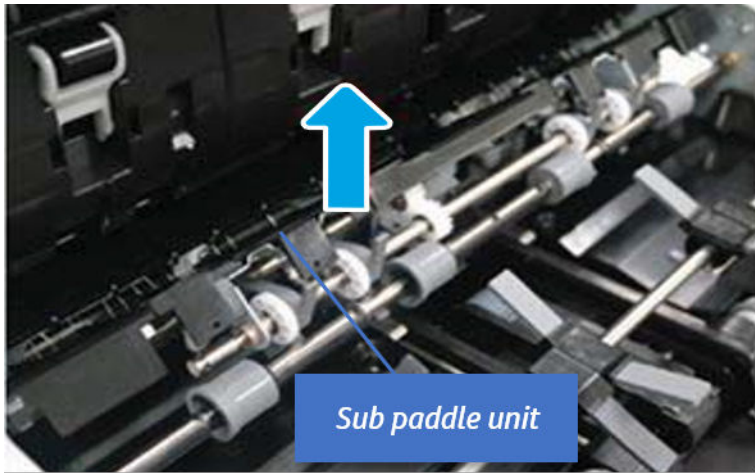

- 12. Remove the exit roller.

- a. Remove the guide on the center of the exit roller.

Figure 5-186 Remove the guide

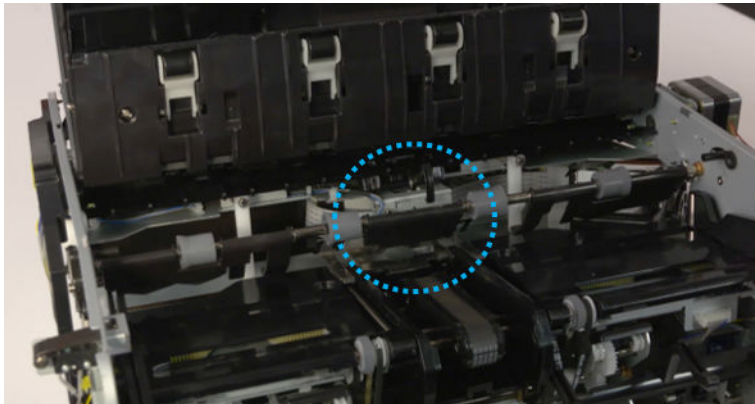

- b. On the front of the inner finisher, release the timing belt connected to the exit motor.

Figure 5-187 Release the timing belt

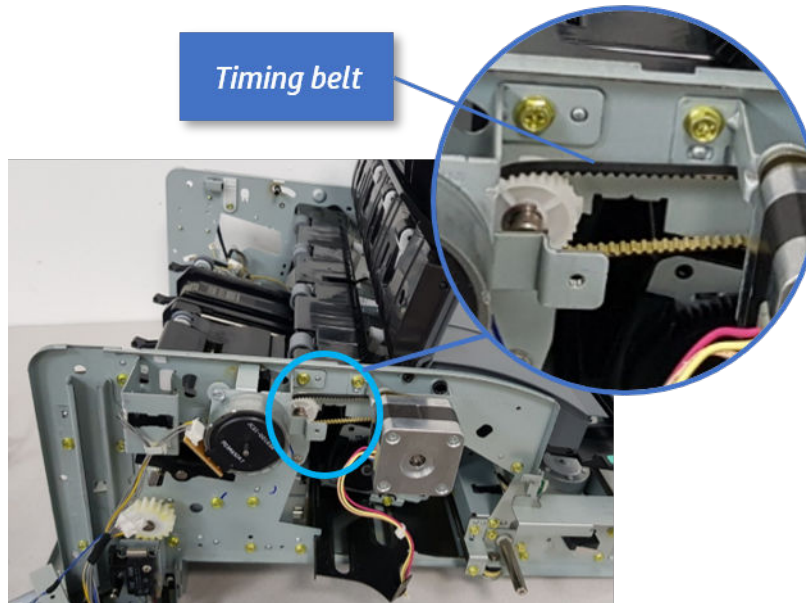

- c. Remove five screws securing the rear harness guide.

Figure 5-188 Remove five screws

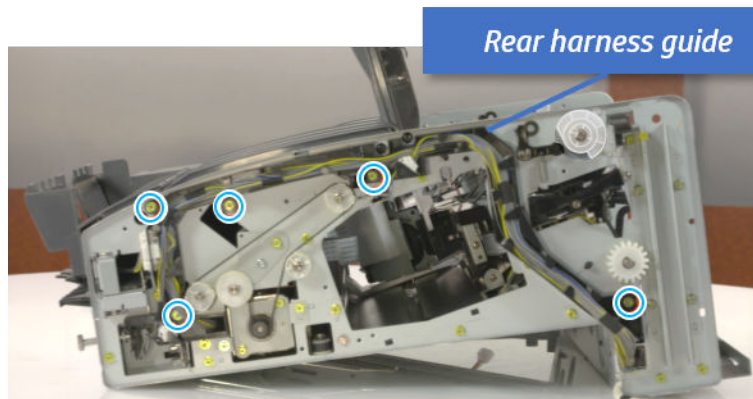

- d. On the rear of the inner finisher, remove the e-ring and the pulley and then remove the e-ring and the bushing.

Figure 5-189 Remove e-ring, pulley, and bushing

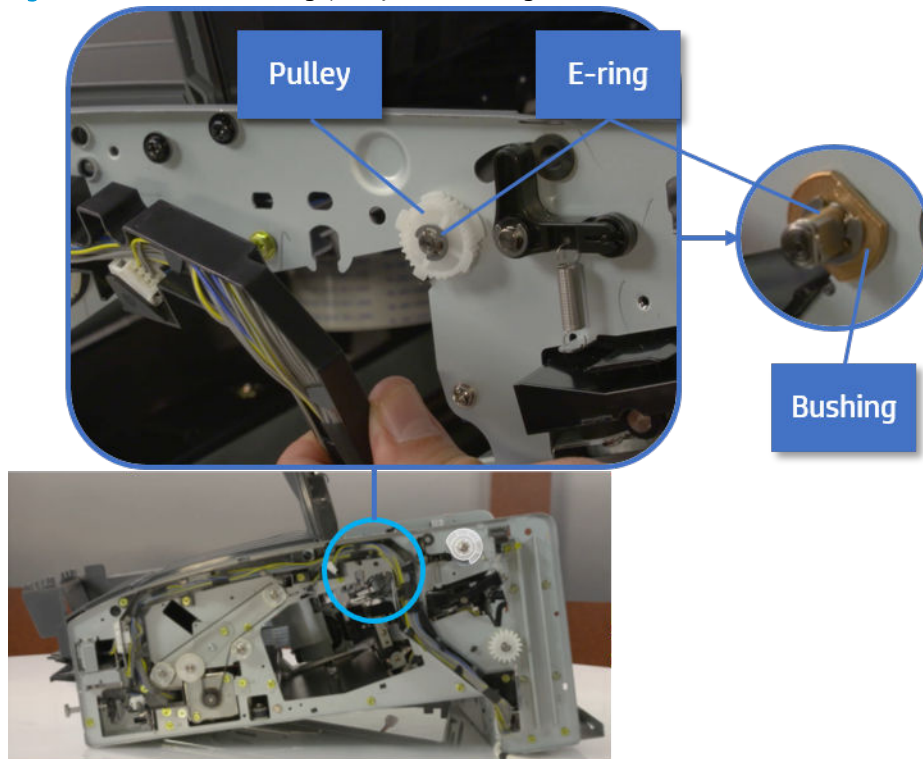

- e. Push the bushing to detach it, and then remove the exit roller.

Figure 5-190 Remove the exit roller

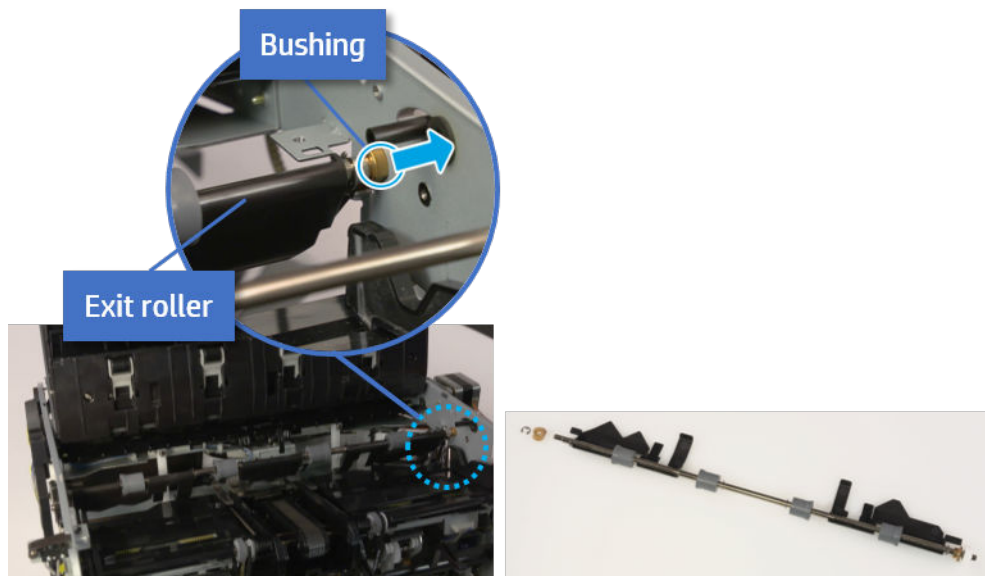

- 13. Remove the front tamper.
 - a. Remove four screws.

Figure 5-191 Remove four screws

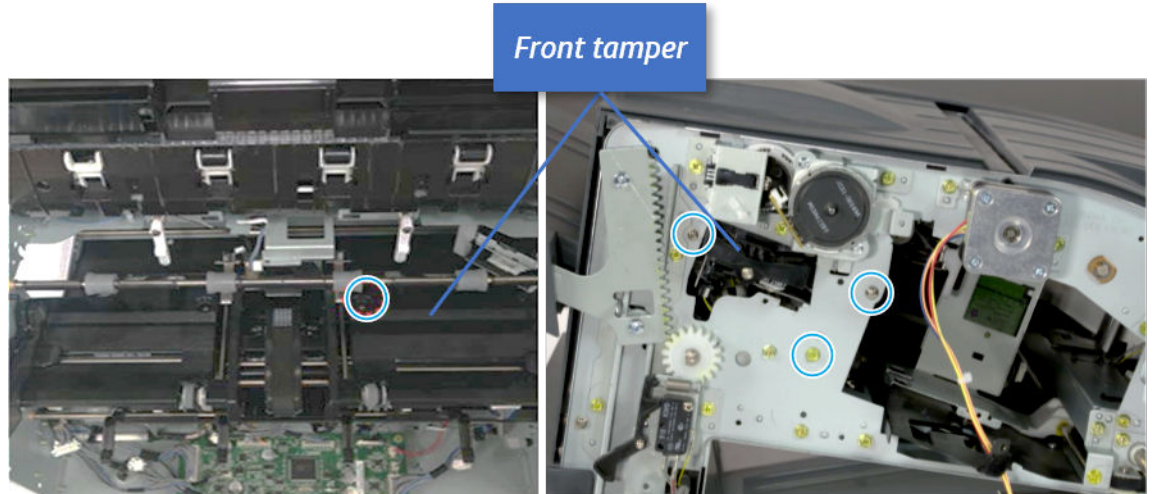

- b. Unplug the connector and release the hook, and then pull the front tamper up to remove.

Figure 5-192 Remove the front tamper

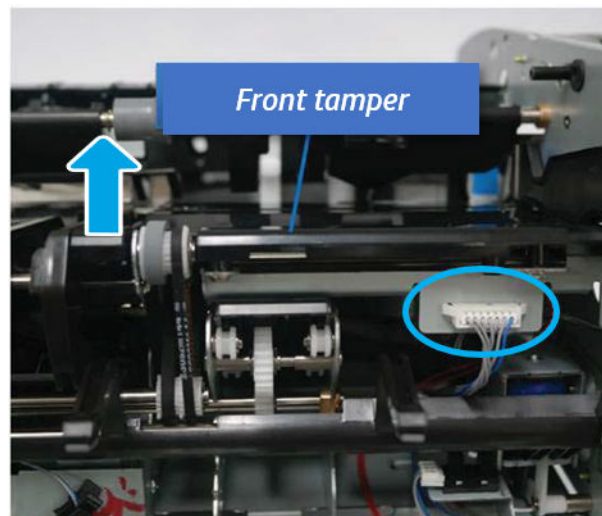

- 14. Remove the rear tamper.

- a. Remove four screws.

 **NOTE:** Move cable guideout of position to access the screws.

Figure 5-193 Remove four screws



- b. Unplug two connectors and release the hook, and then remove the rear tamper.

Figure 5-194 Remove the rear tamper

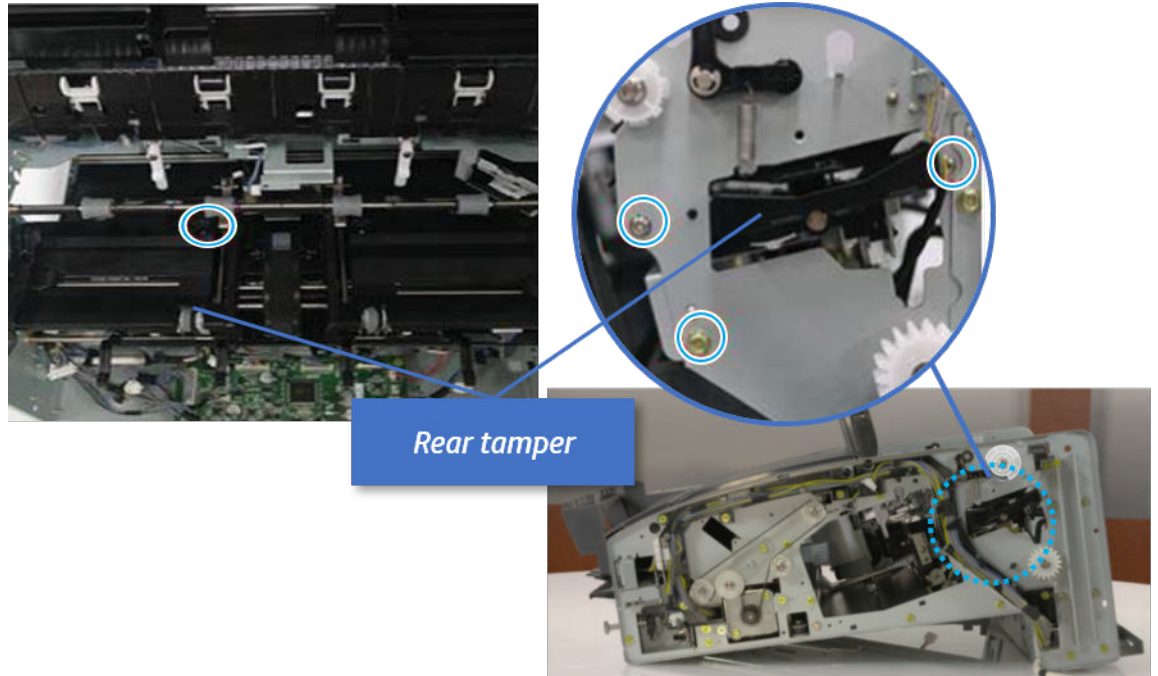
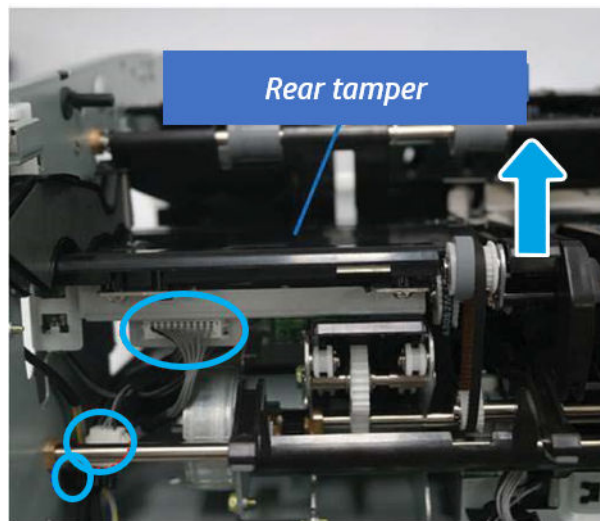

- 15. Remove the ejector & paper support assembly.
 - a. Open one clamp, disconnect one connector.

Figure 5-195 Disconnect one connector

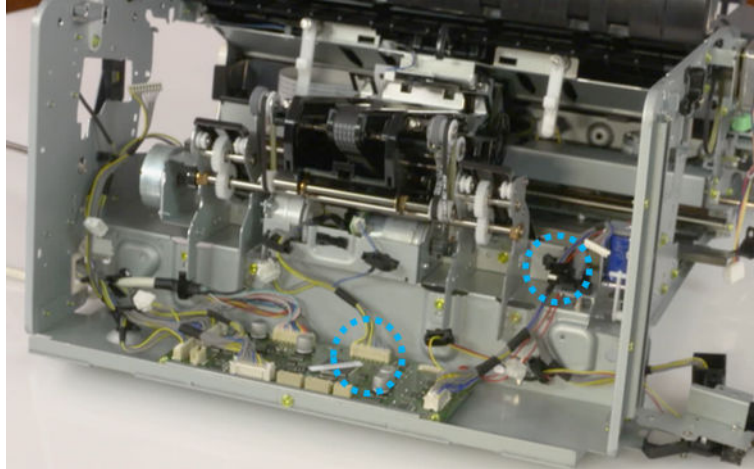

- b. Pull the rear paper support up, and then release one clamp and disconnect two connectors.

Figure 5-196 Disconnect two connector

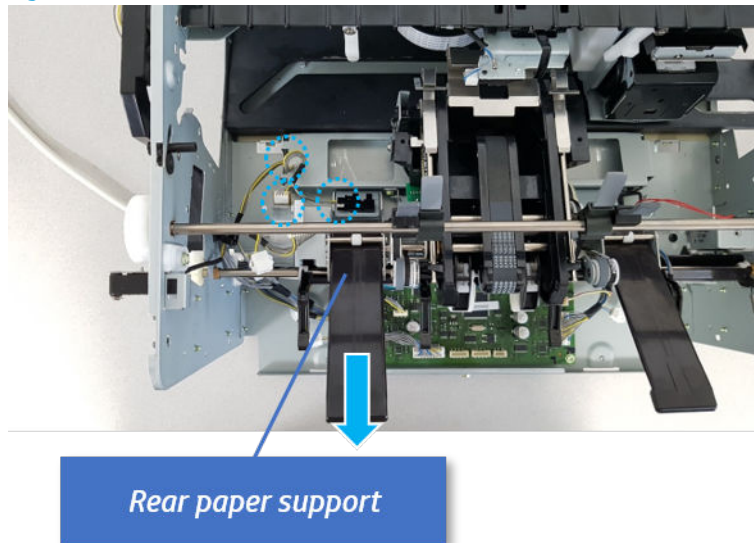

- c. Remove four screws, and then remove the ejector & paper support assembly.

Figure 5-197 Remove the ejector & paper support assembly

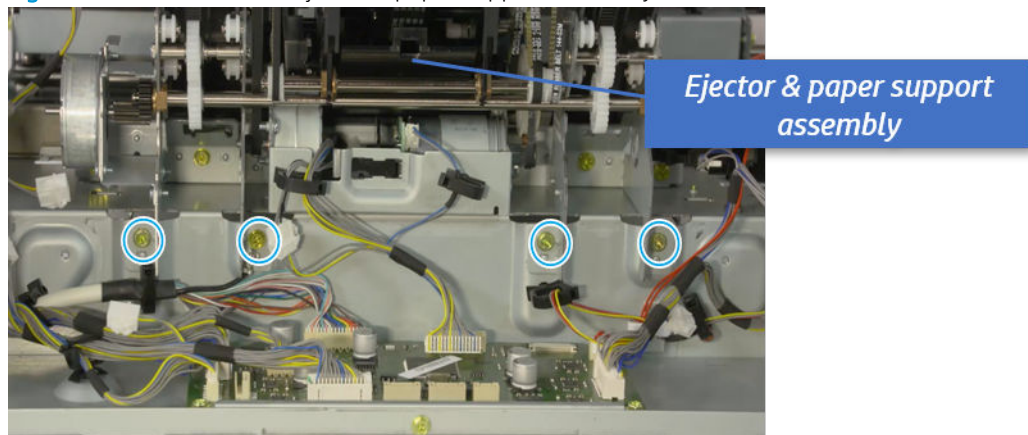

16. Remove the rear paper support.

a. Remove one screw.

Figure 5-198 Remove one screw

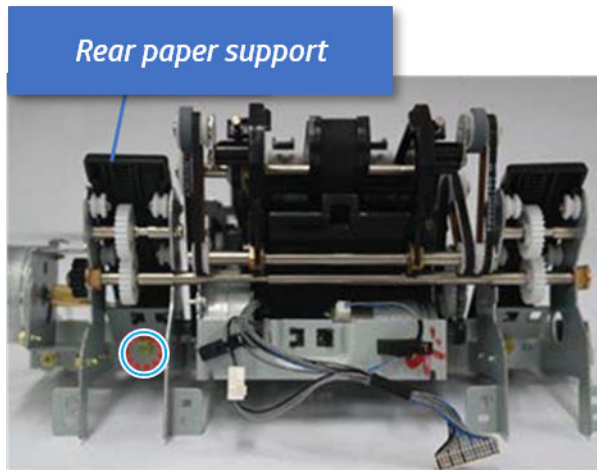

b. Remove the shaft while pulling the bushing in the direction of the arrow.

Figure 5-199 Remove the shaft

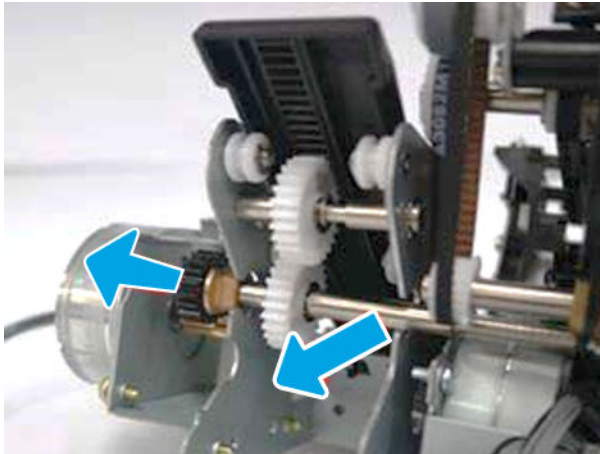

- c. Remove the rear paper support with attention for pinion.

Figure 5-200 Remove the rear paper support

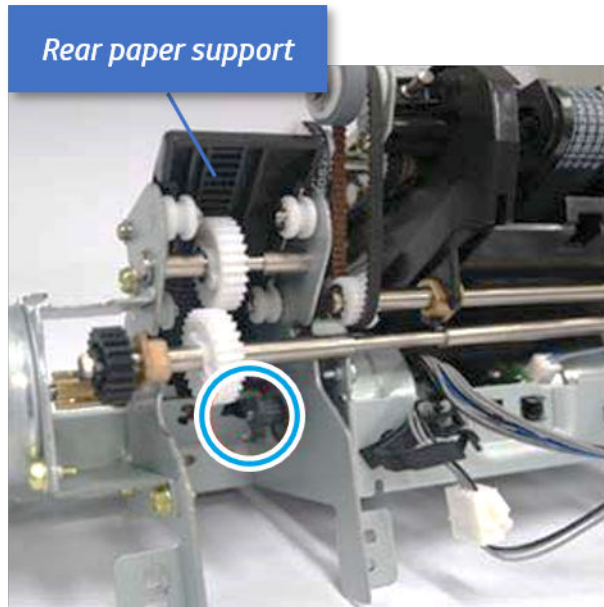

17. Unpack the replacement assembly.

- a. Dispose of the defective part.



NOTE: HP recommends responsible disposal of the defective part.

<http://www8.hp.com/us/en/hp-information/environment/product-recycling.html>

- b. Unpack the replacement part from the packaging.



CAUTION:  Some parts are sensitive to electrostatic discharge (ESD). Always perform service work at an ESD-protected workstation or mat. If an ESD workstation or mat is not available, touch the sheet-metal chassis to provide a static ground before touching an ESD-sensitive assembly. Protect the ESD-sensitive assemblies by placing them in ESD pouches when they are out of the printer.

If the replacement part is a roller or pad, avoid touching the spongy part of it. Skin oils on the roller or pad can cause paper pickup and/or print-quality problems. HP recommends using disposable gloves when handling rollers or pads or washing your hands before touching rollers or pads.



IMPORTANT: Make sure that all of the shipping materials (for example shipping tape) are removed from the replacement part prior to installation.

- c. To install an assembly, reverse the removal steps.

When applicable, special installation instructions are provided for an assembly at the end of the removal procedure. Always completely read the removal instructions and follow all special installation instructions.

Removal and replacement: Paper support home sensor (S12)

Learn how to remove and replace the paper support home sensor.

To view teardown&reassembling video of the inner finisher, click the link below.

 [View a teardown video of the inner finisher .](#)

 [View a reassembling video of the inner finisher .](#)

 **IMPORTANT:** When applicable, special installation instructions are provided for an assembly at the end of the removal procedure. Always completely read the removal instructions and follow all special installation instructions.

Mean time to repair:

Service level:

Before performing service

Turn the printer power off

- Press the power button on the front of the printer, and then turn off the power switch next to the power cable.
- A shutting-down message appears on the control-panel display.

 **WARNING!** To avoid damage to the printer, turn the power off and wait until the printer shuts down before removing the power cable.

- Disconnect the printer power cable after the printer has completely shut down (the control-panel display is blank).

Use the table below to identify the correct part number for your printer. To order the part, go to <https://parts.hp.com>.

Table 5-43 Part information

Part number	Part description
0604-001393	Paper support home sensor

Required tools

- #2 JIS screwdriver with a magnetic tip

After performing service

Turn the printer power on

- Connect the power cable.
- Use the power switch to turn the power on.

Post service test

Print any pages necessary to verify that the repair resolved the issue and did not create any new issues.

1. Remove the front cover.
 - a. Open the front door and open the punch cover.
 - b. Remove three screws in the front.

- c. Remove the lever.
- d. Open the top cover.
- e. From the right side of the front cover, carefully lift and pry toward the top-left corner to remove the front cover.

Figure 5-201 Remove the front cover

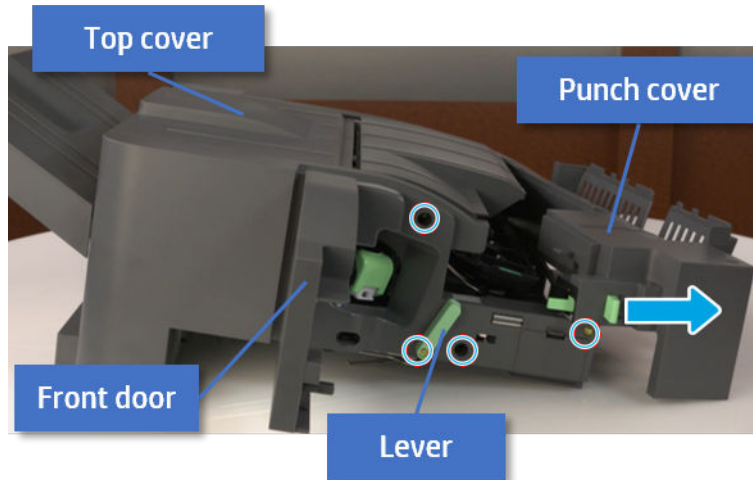

- 2. Remove the rear cover.
 - a. Open the top cover.

Figure 5-202 Open the top cover

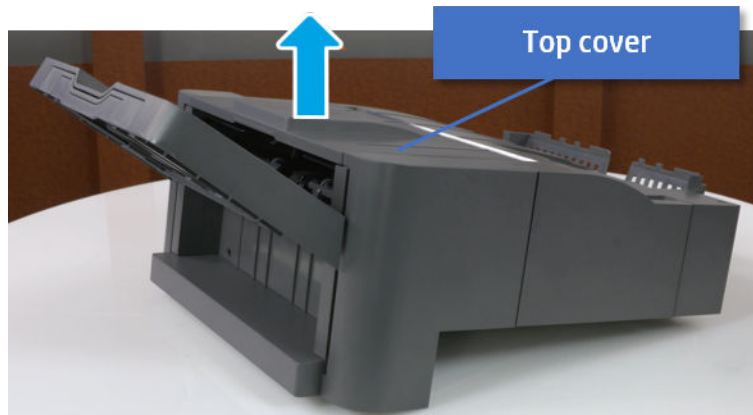

- b. Remove three screws.

- c. Release hooks carefully and remove the rear cover.

Figure 5-203 Remove the rear cover

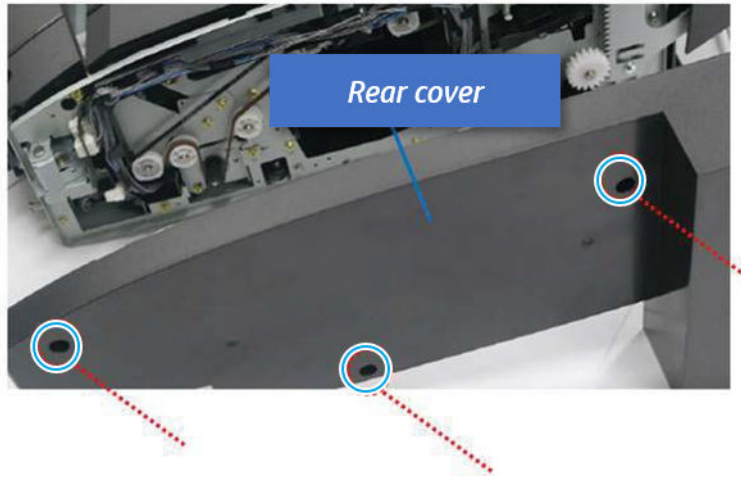

- 3. Remove the output tray.

- a. Remove four screws.

Figure 5-204 Remove four screws

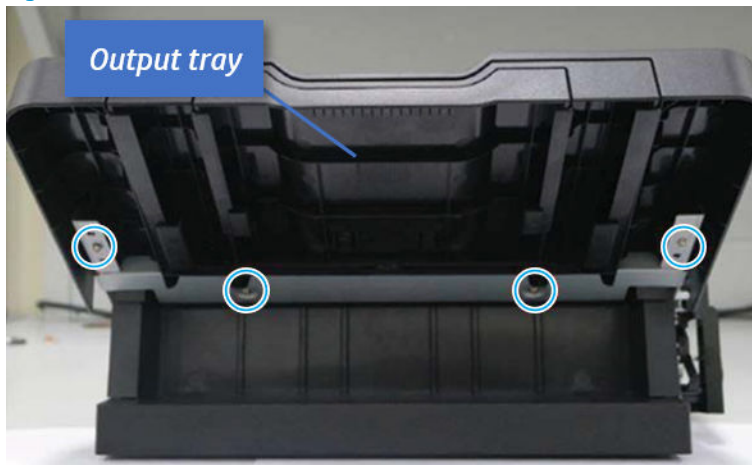

- b. Push the paper holding actuator into the inner finisher, and then remove the output tray.

Figure 5-205 Remove the output tray.



- 4. Remove the output tray frame.
 - a. Rotate the pulley until the output tray frame depart from the gear.

Figure 5-206 Remove the pulley

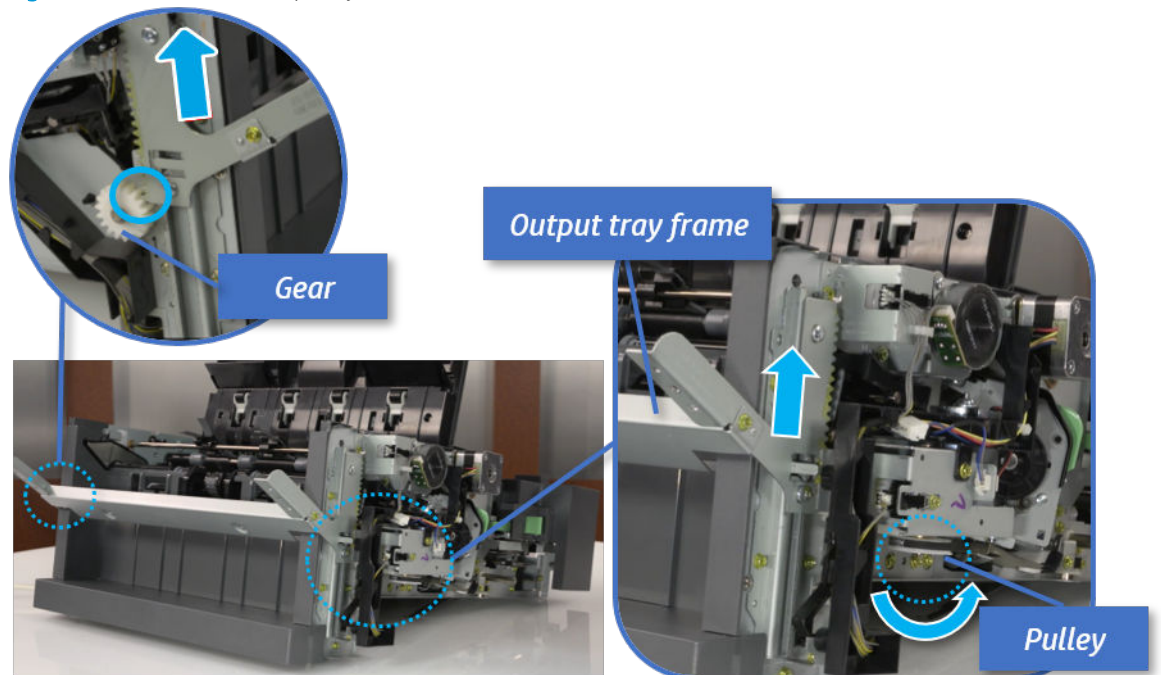

- b. Push the paper holding actuator into the inner finisher, and then remove the output tray frame.

Figure 5-207 Remove the output tray frame

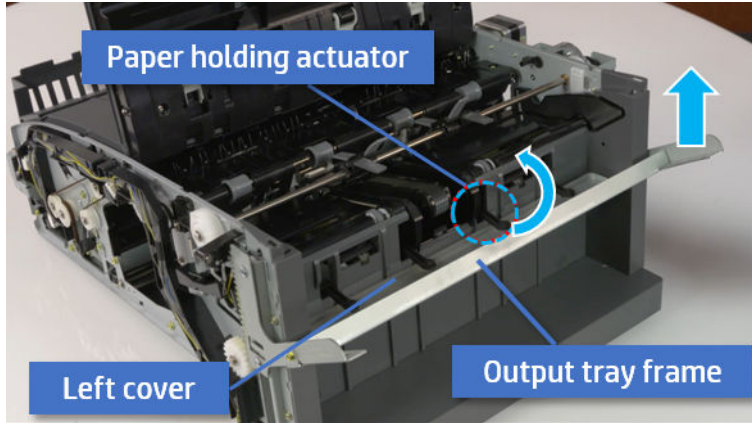

TIP: Push the paper holding actuator into the inner finisher when reassembling. Be sure to level the output tray.

1. Position the first wheel into the channel on both sides while pushing the paper holding actuator.

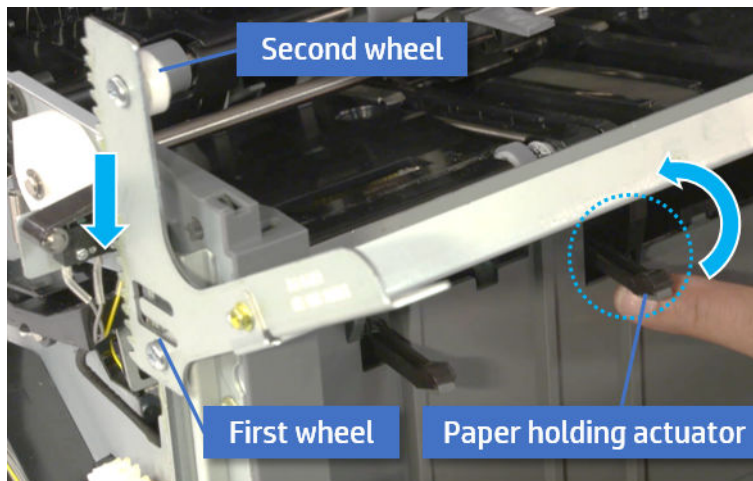

2. Let the second wheel rest on the channel on both sides simultaneously.
3. Gently squeeze the wheels into channel until the output tray frame meet the gear.

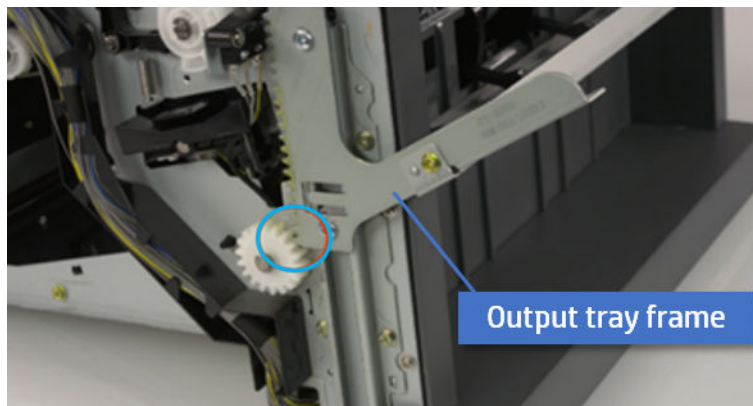

4. Rotate the pulley until the output tray frame is no longer lifted. It can make to level the output tray frame.

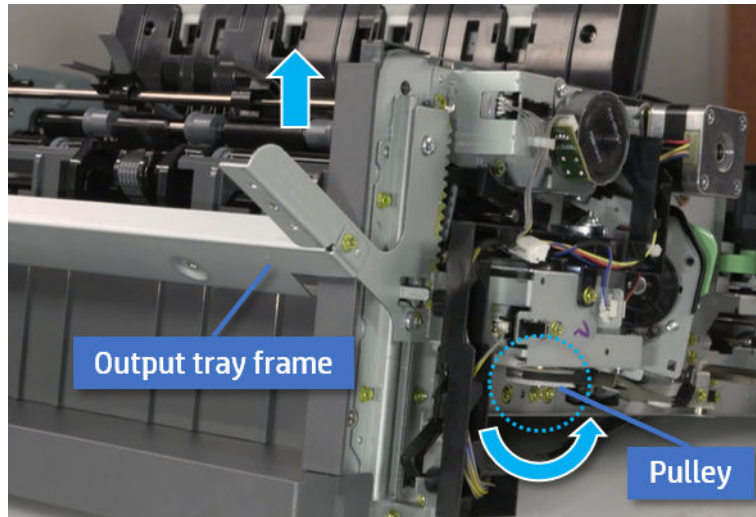

5. Rotate the pulley in the opposite direction.

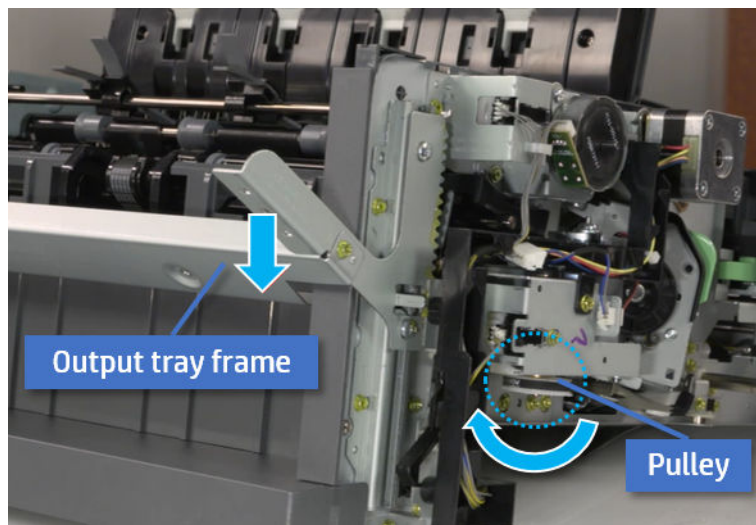

5. Remove the PCA cover.

- ▲ Remove two screws, and then remove the PCA cover.

Figure 5-208 Remove the PCA cover

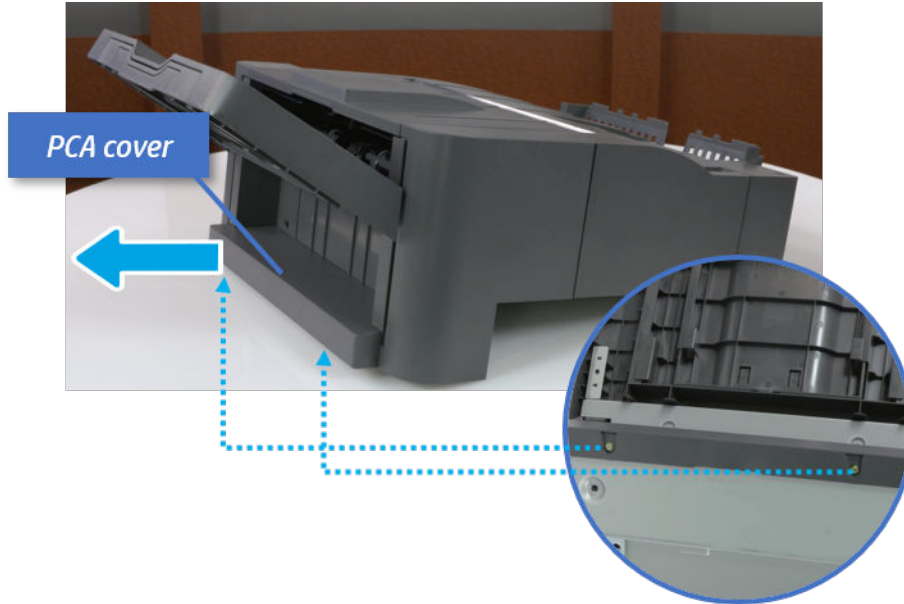

- 6. Remove the left cover.
 - a. Remove two screws.

Figure 5-209 Remove two screws

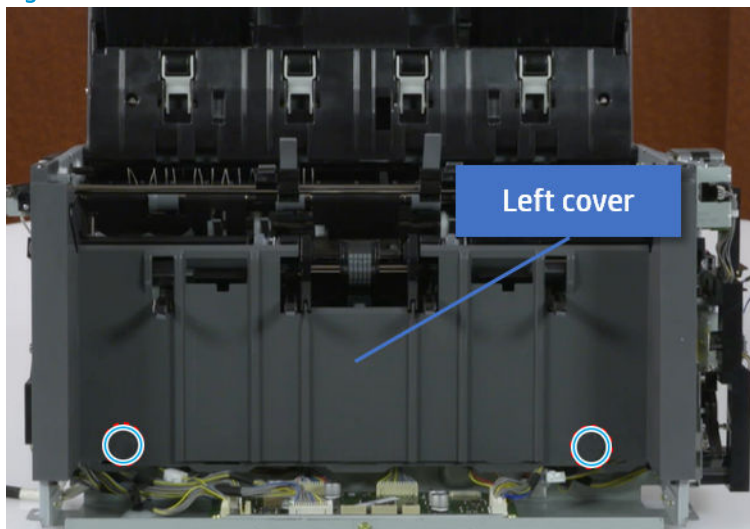

- b. Remove four screws from both front and rear sides.

Figure 5-210 Remove four screws

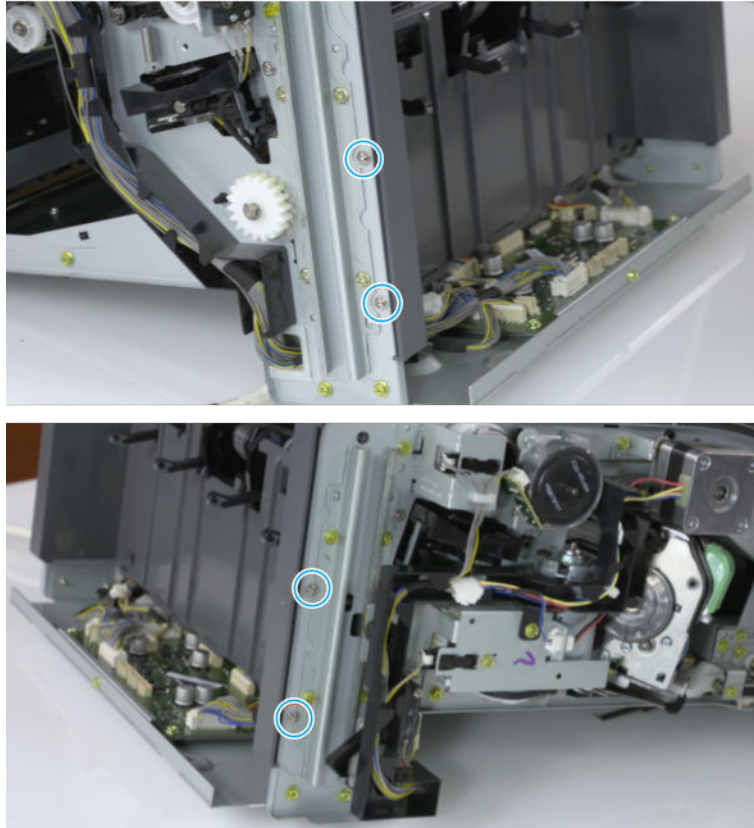

- c. Unplug two inline connectors, and then remove the left cover.

Figure 5-211 Unplug two connectors

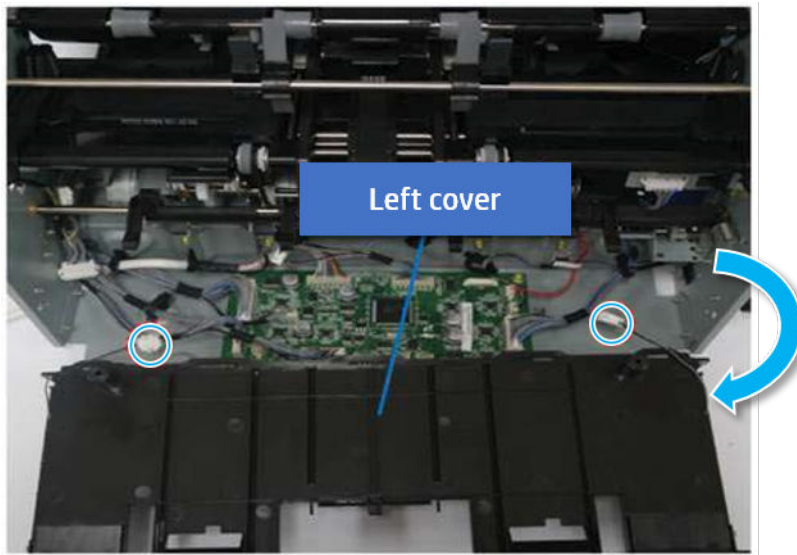

 **TIP:** Be sure to check the hook when reassembling.

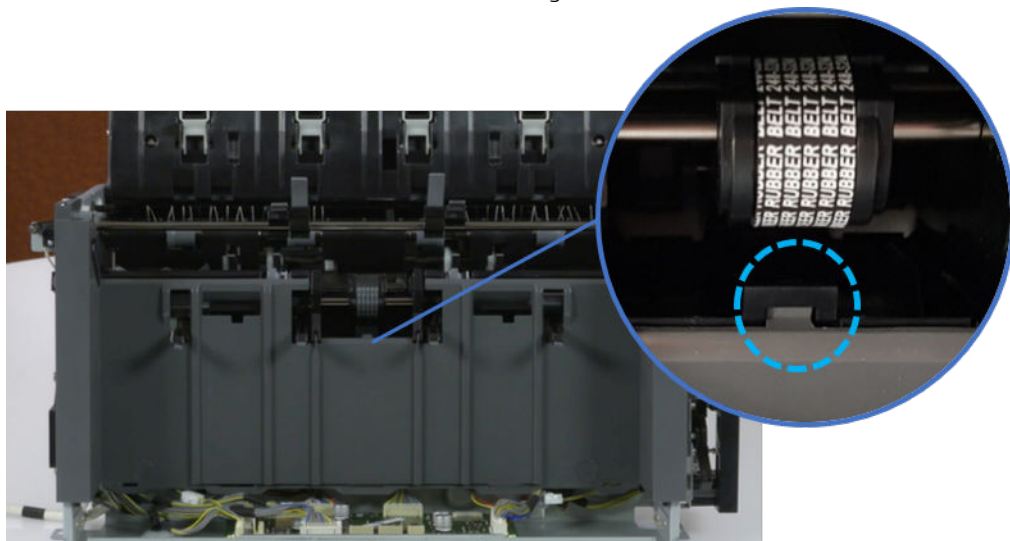

- 7. Remove the front harness guide.
 - a. Open one clamp and unplug five connectors, and then remove the wire harness from the front harness guide.

- b. Remove four screws, and then remove the front harness guide.

Figure 5-212 Remove the front harness guide

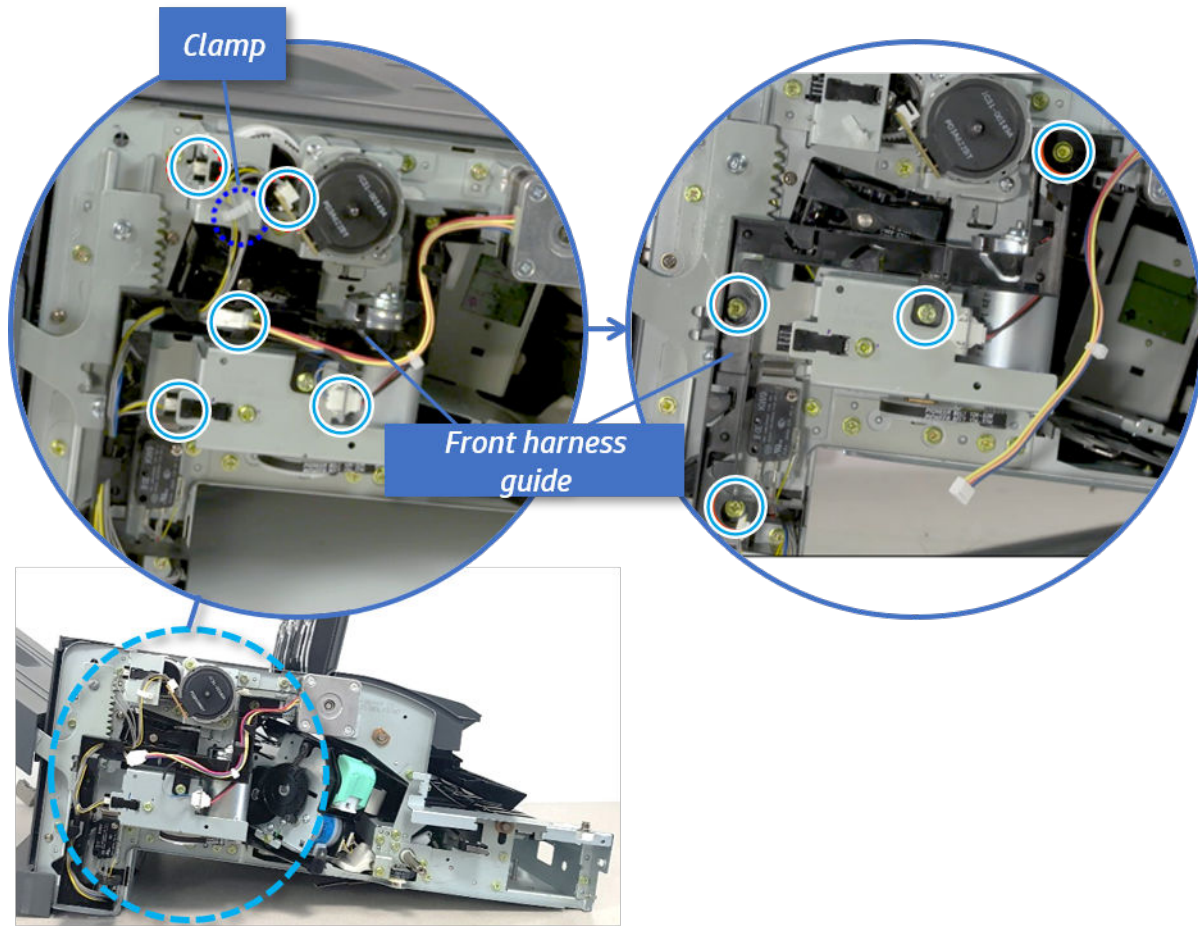

- 8. Remove the output tray motor assembly.
 - ▲ Remove three screws, and then remove the output tray motor assembly.

Figure 5-213 Remove the output tray motor assembly

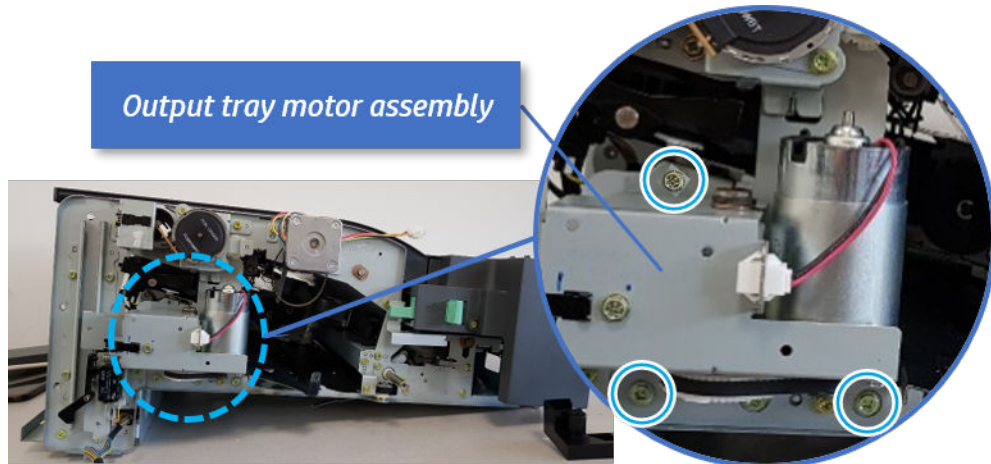

- 9. Remove the output tray lower limit switch.

- ▲ Remove one screw, and then remove the output tray lower limit switch.

Figure 5-214 Remove the output tray lower limit switch

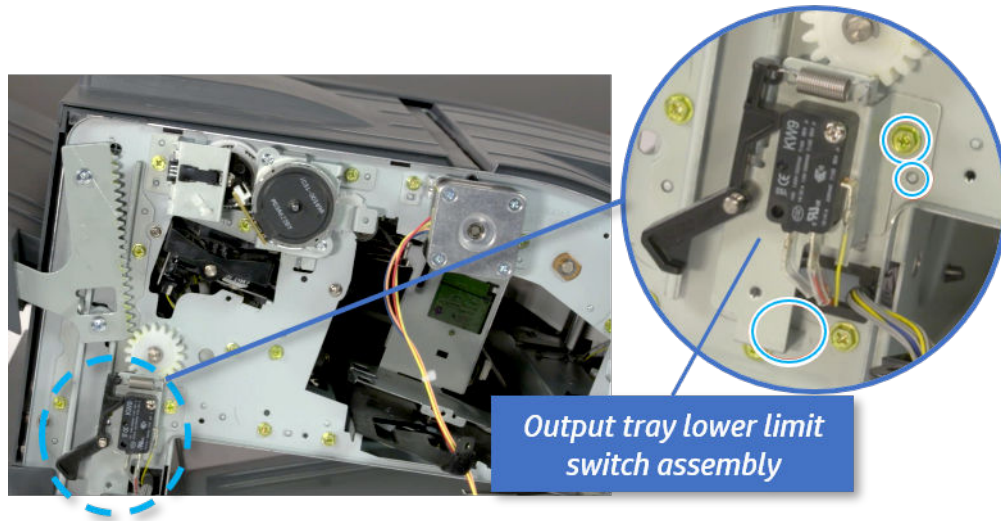

- 10. Remove the paper holding.
 - a. Remove the paper holding actuator spring.

Figure 5-215 Remove the paper holding actuator spring

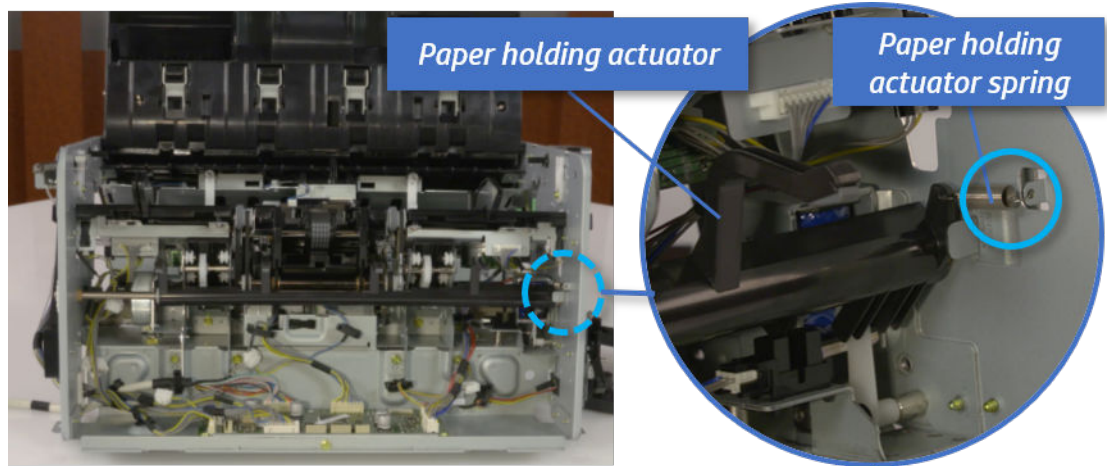

- b. Remove the e-ring and the rack pinion gear. And then remove the pin and the e-ring, and then remove the bushing.

Figure 5-216 Remove e-ring, rack pinion gear, pin, and bushing

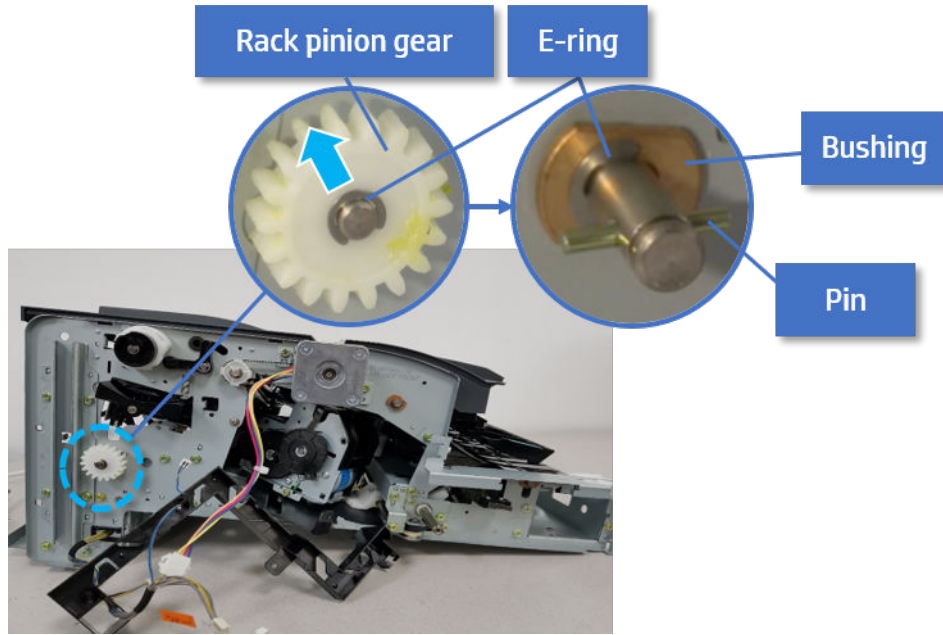

 **NOTE:** Be sure not to lose the pin.

- c. Carefully remove the paper holding shaft and the actuator.

Figure 5-217 Remove the paper holding shaft and the actuator

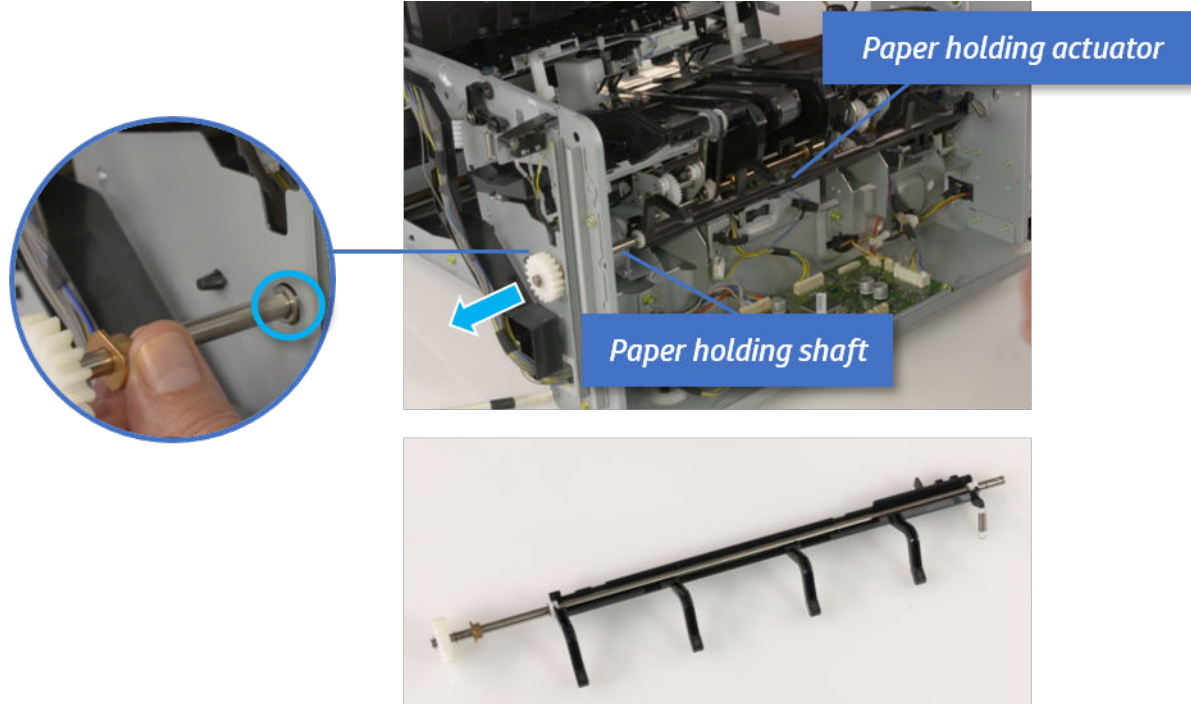

11. Remove the sub paddle unit.

- a. Open the top cover, and then remove one screw securing the sub paddle unit.

Figure 5-218 Remove one screw

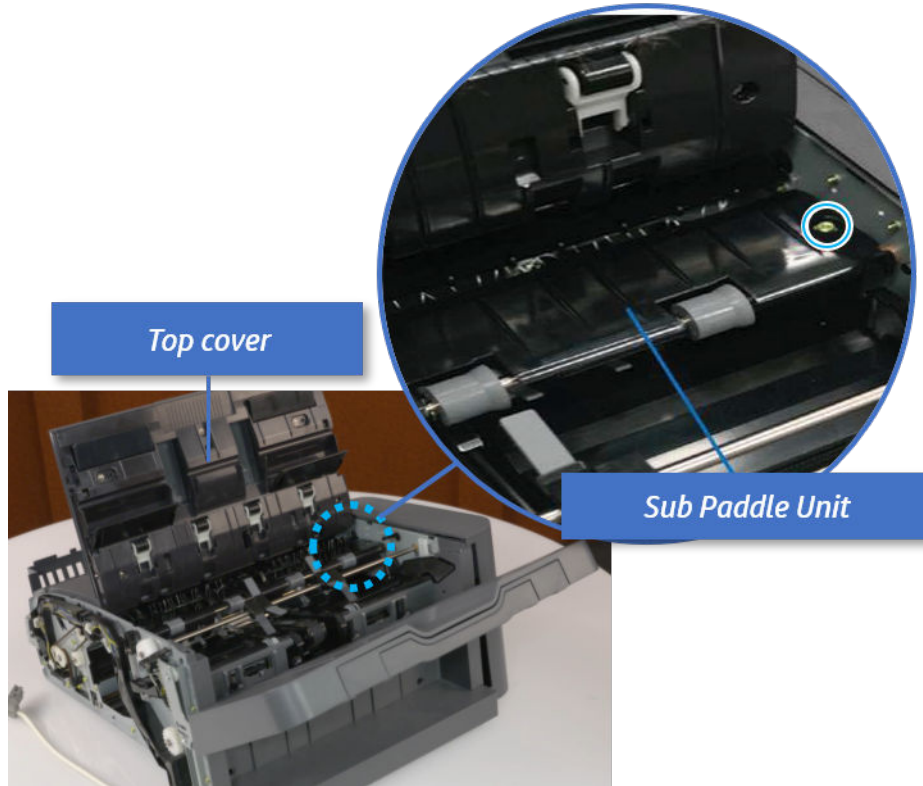

- b. Remove the e-ring, and then remove the pulley and timing belt. And then remove the e-ring and the bushing.

Figure 5-219 Remove the e-ring, pulley, timing belt, and bushing

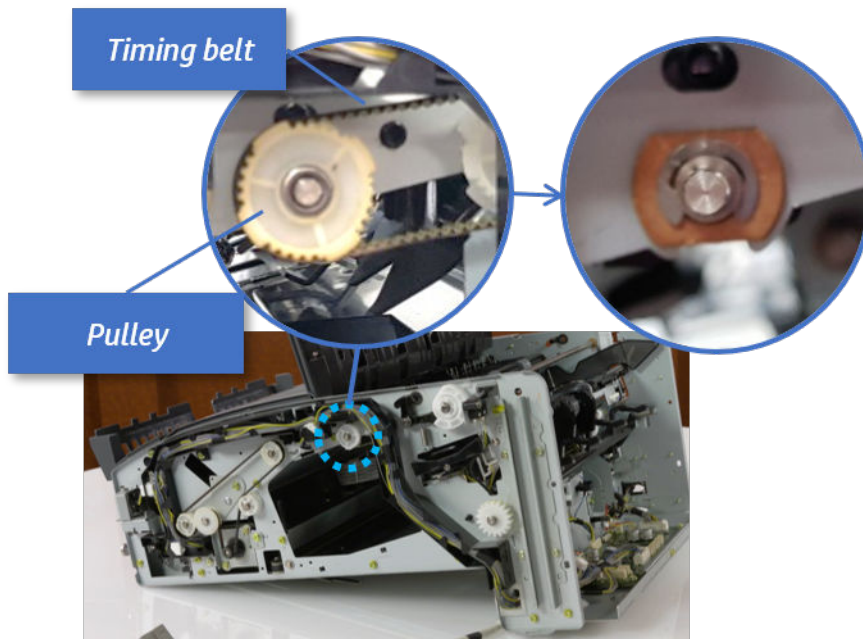

- c. Lift up and remove the sub paddle unit.

Figure 5-220 Remove the sub paddle unit

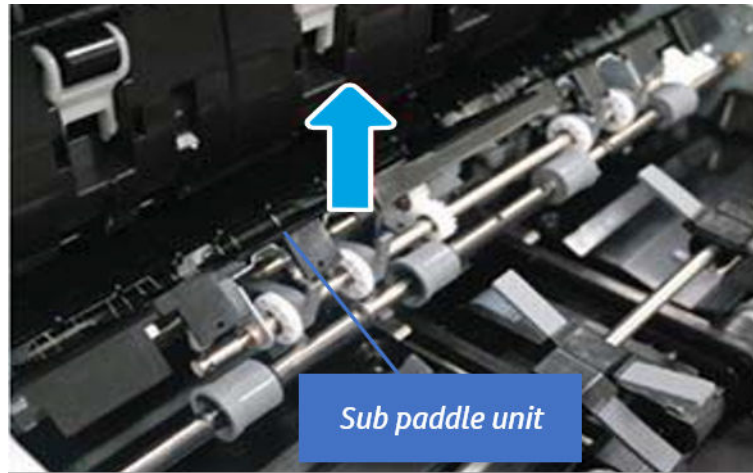

- 12. Remove the exit roller.

- a. Remove the guide on the center of the exit roller.

Figure 5-221 Remove the guide

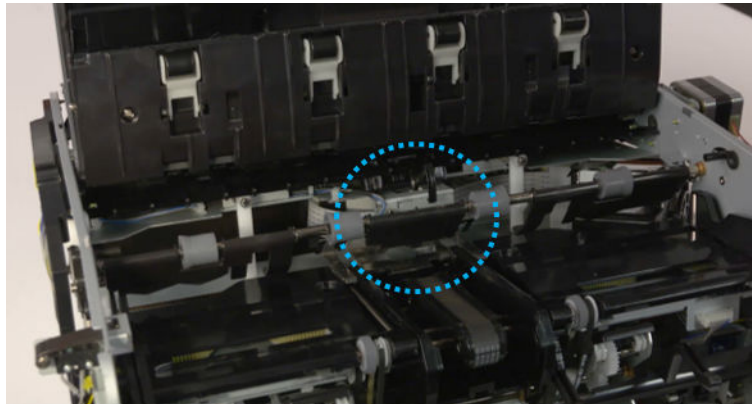

- b. On the front of the inner finisher, release the timing belt connected to the exit motor.

Figure 5-222 Release the timing belt

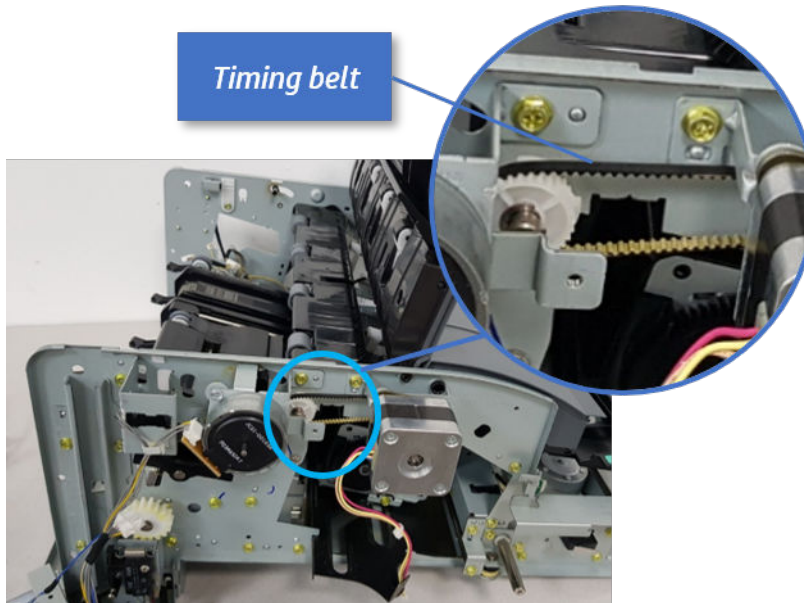

- c. Remove five screws securing the rear harness guide.

Figure 5-223 Remove five screws

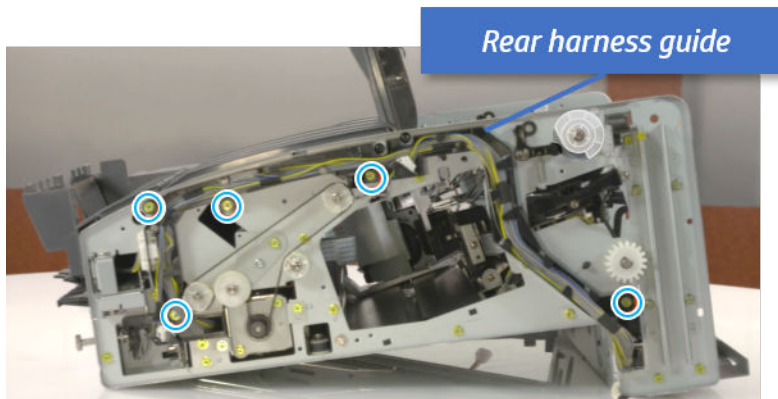

- d. On the rear of the inner finisher, remove the e-ring and the pulley and then remove the e-ring and the bushing.

Figure 5-224 Remove e-ring, pulley, and bushing

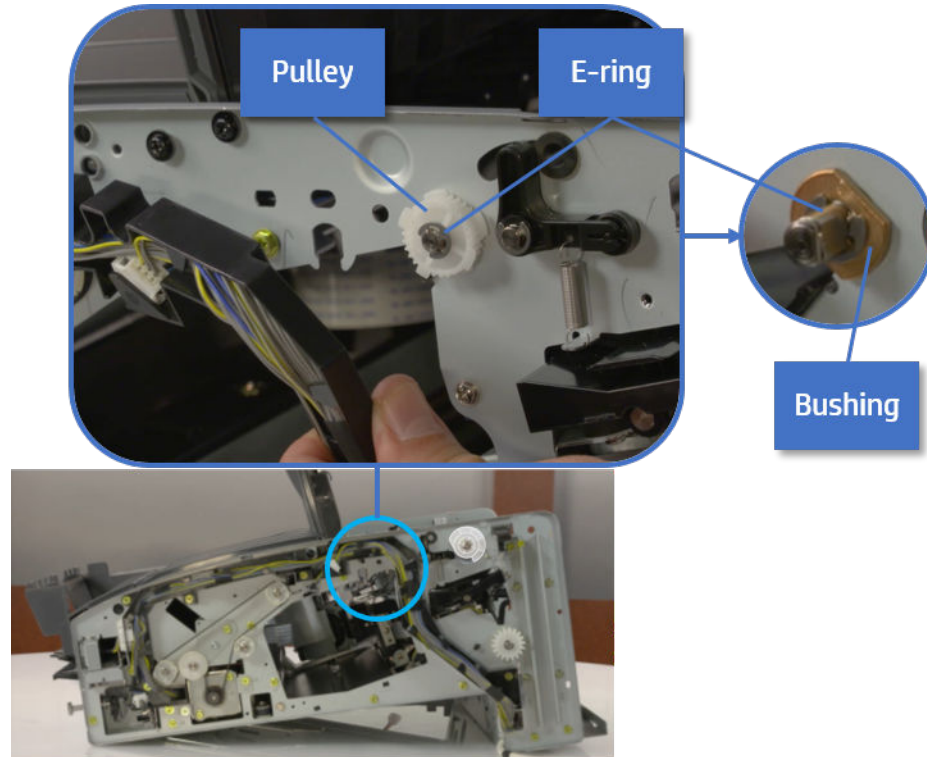

- e. Push the bushing to detach it, and then remove the exit roller.

Figure 5-225 Remove the exit roller

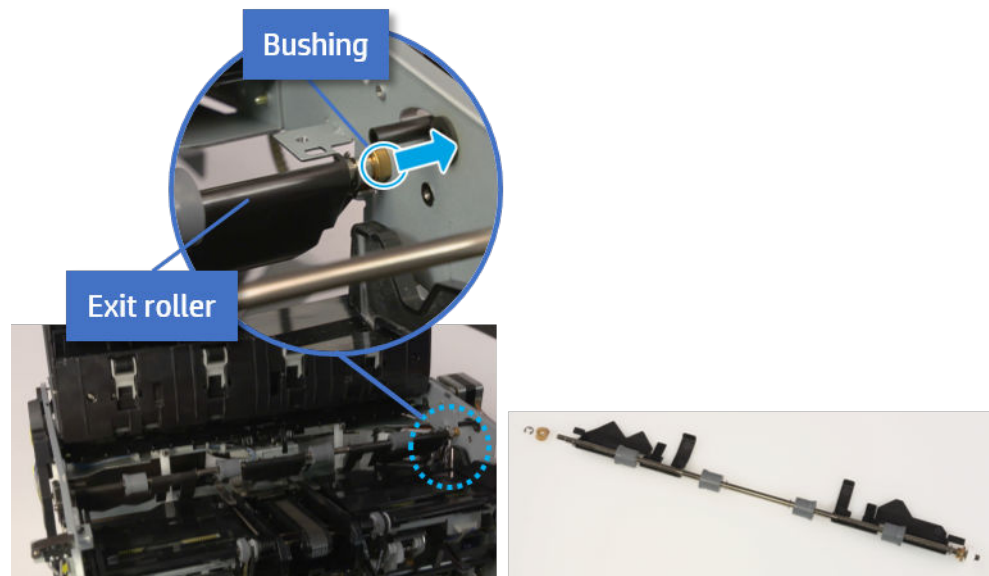

- 13. Remove the front tamper.
 - a. Remove four screws.

Figure 5-226 Remove four screws

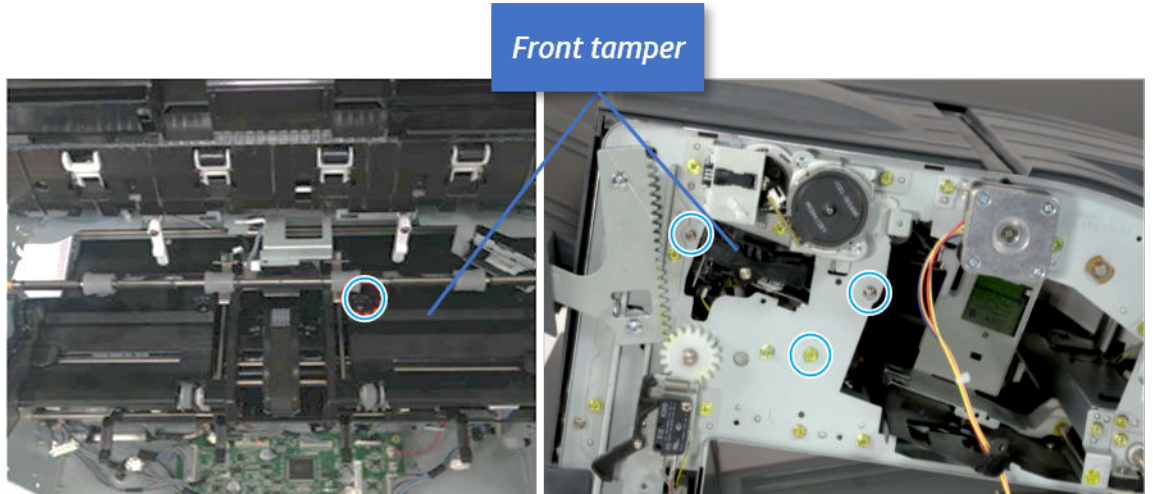

- b. Unplug the connector and release the hook, and then pull the front tamper up to remove.

Figure 5-227 Remove the front tamper

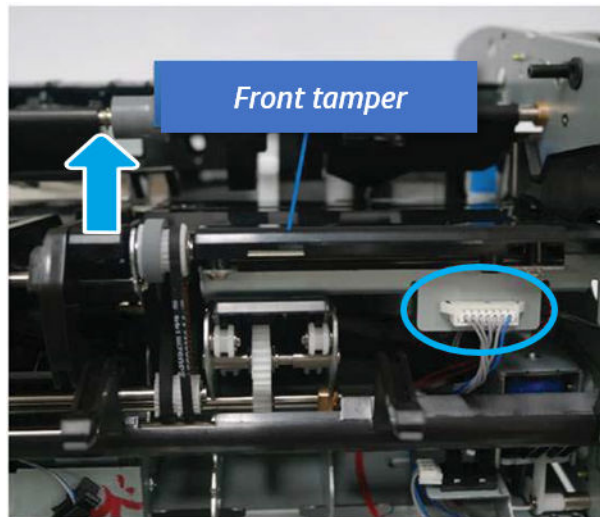

14. Remove the rear tamper.
 - a. Remove four screws.

 **NOTE:** Move cable guide out of position to access the screws.

Figure 5-228 Remove four screws



- b. Unplug two connectors and release the hook, and then remove the rear tamper.

Figure 5-229 Remove the rear tamper

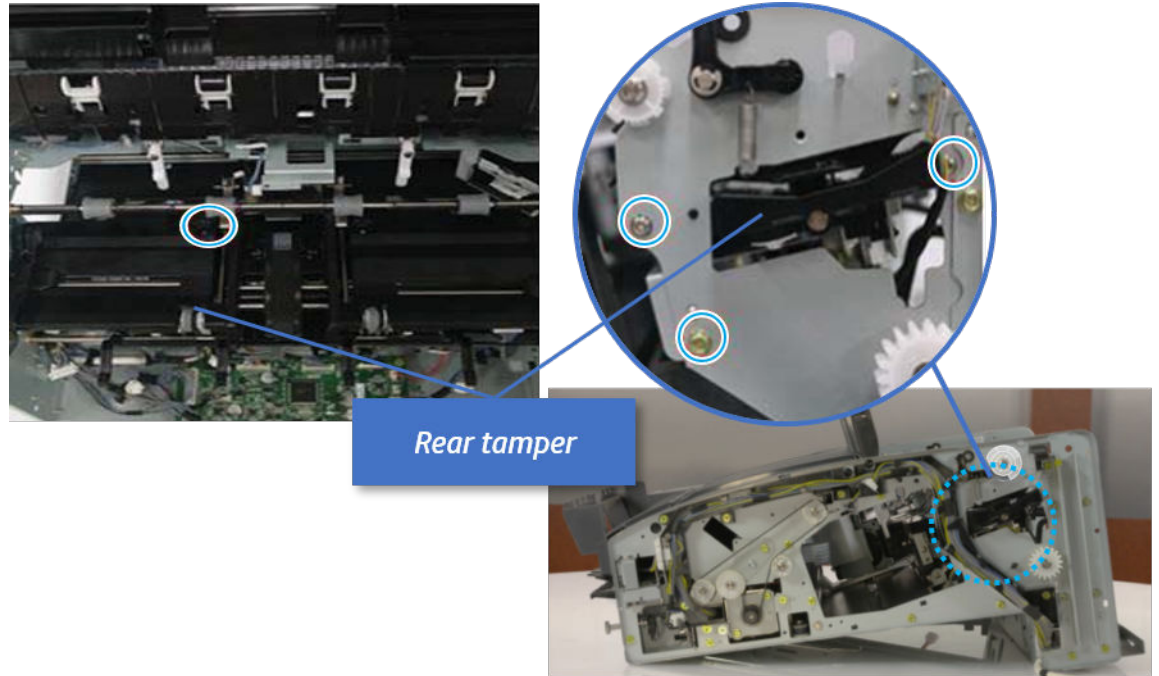
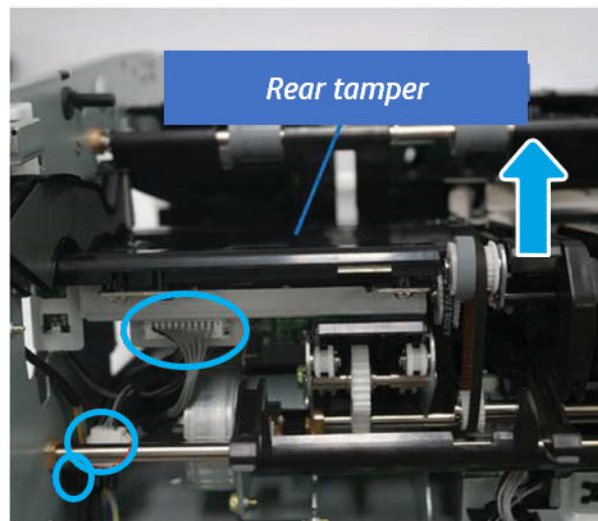

15. Remove the ejector & paper support assembly.
 - a. Open one clamp, disconnect one connector.

Figure 5-230 Disconnect one connector

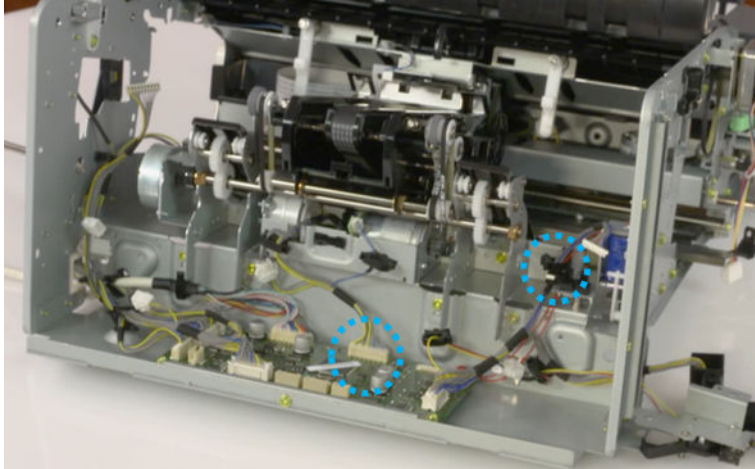

- b. Pull the rear paper support up, and then release one clamp and disconnect two connectors.

Figure 5-231 Disconnect two connector

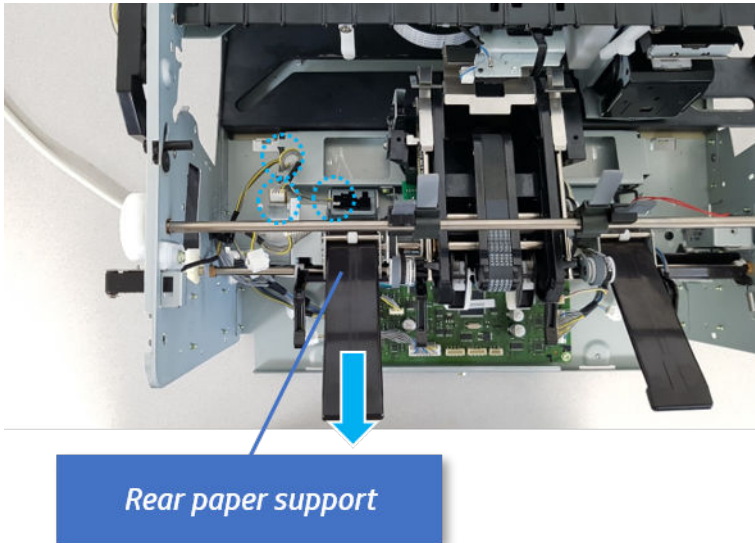

- c. Remove four screws, and then remove the ejector & paper support assembly.

Figure 5-232 Remove the ejector & paper support assembly

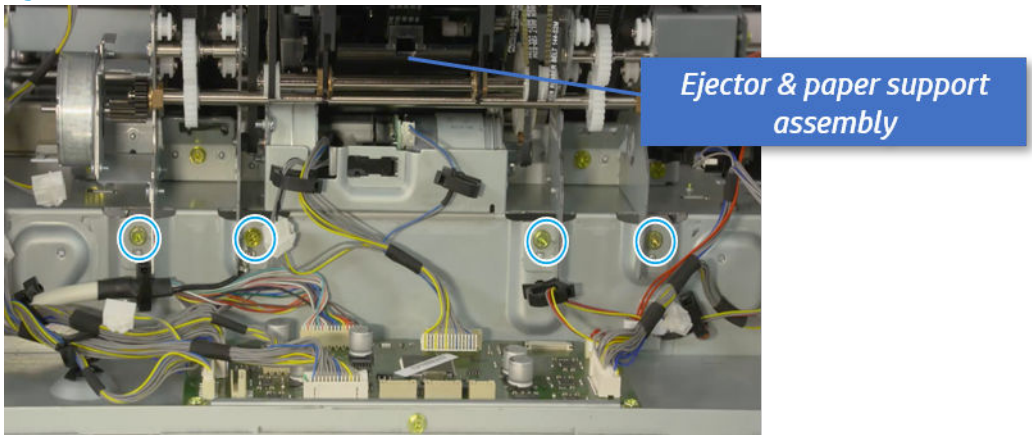

16. Remove the rear paper support.

a. Remove one screw.

Figure 5-233 Remove one screw

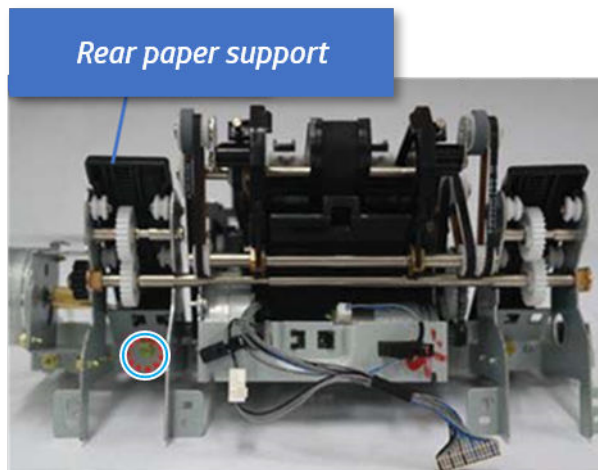

b. Remove the shaft while pulling the bushing in the direction of the arrow.

Figure 5-234 Remove the shaft

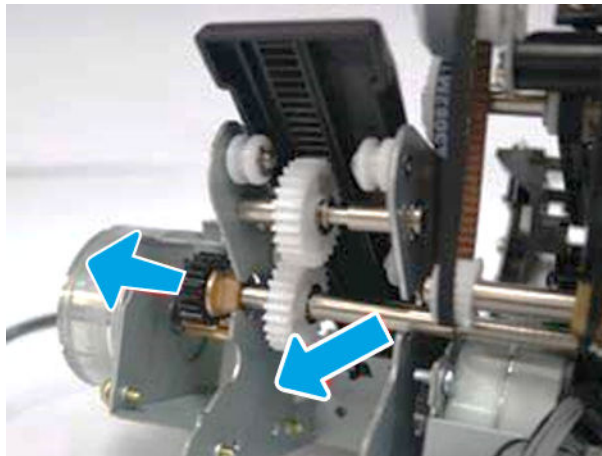

- c. Remove the rear paper support with attention for pinion.

Figure 5-235 Remove the rear paper support

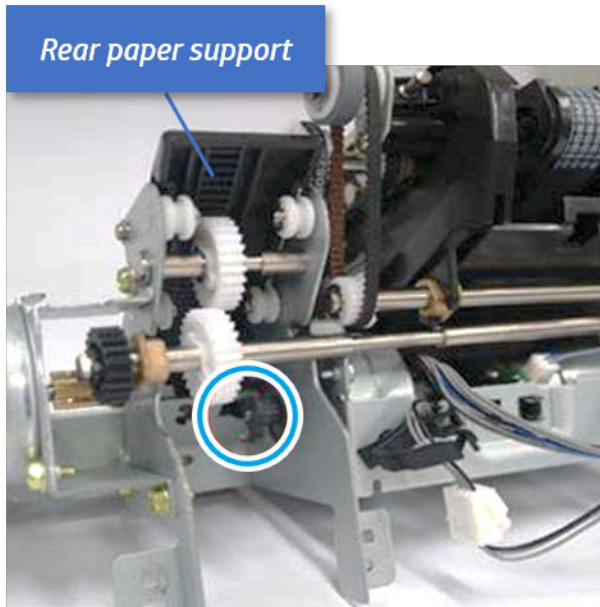

- 17. Remove the paper support home sensor.

- ▲ Remove the sensor from the rear paper support.

Figure 5-236 Remove the paper support home sensor





- 18. Unpack the replacement assembly.
 - a. Dispose of the defective part.

 **NOTE:** HP recommends responsible disposal of the defective part.

<http://www8.hp.com/us/en/hp-information/environment/product-recycling.html>

- b. Unpack the replacement part from the packaging.

 **CAUTION:**  Some parts are sensitive to electrostatic discharge (ESD). Always perform service work at an ESD-protected workstation or mat. If an ESD workstation or mat is not available, touch the sheet-metal chassis to provide a static ground before touching an ESD-sensitive assembly. Protect the ESD-sensitive assemblies by placing them in ESD pouches when they are out of the printer.

If the replacement part is a roller or pad, avoid touching the spongy part of it. Skin oils on the roller or pad can cause paper pickup and/or print-quality problems. HP recommends using disposable gloves when handling rollers or pads or washing your hands before touching rollers or pads.

 **IMPORTANT:** Make sure that all of the shipping materials (for example shipping tape) are removed from the replacement part prior to installation.

- c. To install an assembly, reverse the removal steps.

When applicable, special installation instructions are provided for an assembly at the end of the removal procedure. Always completely read the removal instructions and follow all special installation instructions.

Removal and replacement: Paper support motor (M8)

Learn how to remove and replace the paper support motor.

To view teardown&reassembling video of the inner finisher, click the link below.

 [View a teardown video of the inner finisher .](#)

 [View a reassembling video of the inner finisher .](#)

 **IMPORTANT:** When applicable, special installation instructions are provided for an assembly at the end of the removal procedure. Always completely read the removal instructions and follow all special installation instructions.

Mean time to repair:

Service level:

Before performing service

Turn the printer power off

- Press the power button on the front of the printer, and then turn off the power switch next to the power cable.
- A shutting-down message appears on the control-panel display.

 **WARNING!** To avoid damage to the printer, turn the power off and wait until the printer shuts down before removing the power cable.

- Disconnect the printer power cable after the printer has completely shut down (the control-panel display is blank).

Use the table below to identify the correct part number for your printer. To order the part, go to <https://parts.hp.com>.

Table 5-44 Part information

Part number	Part description
JC93-00802B (not orderable)	Paper support motor assembly
JC31-00149A (not orderable)	Paper support motor

Required tools

- #2 JIS screwdriver with a magnetic tip

After performing service

Turn the printer power on

- Connect the power cable.
- Use the power switch to turn the power on.

Post service test

Print any pages necessary to verify that the repair resolved the issue and did not create any new issues.

1. Remove the front cover.
 - a. Open the front door and open the punch cover.
 - b. Remove three screws in the front.
 - c. Remove the lever.
 - d. Open the top cover.
 - e. From the right side of the front cover, carefully lift and pry toward the top-left corner to remove the front cover.

Figure 5-237 Remove the front cover

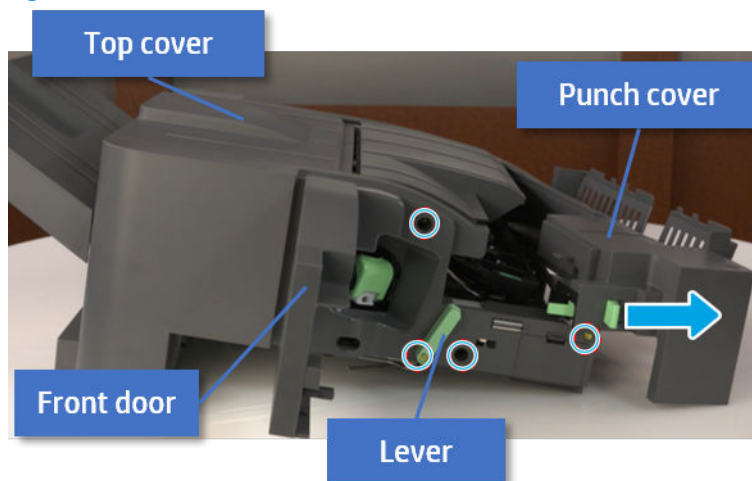

2. Remove the rear cover.
 - a. Open the top cover.

Figure 5-238 Open the top cover

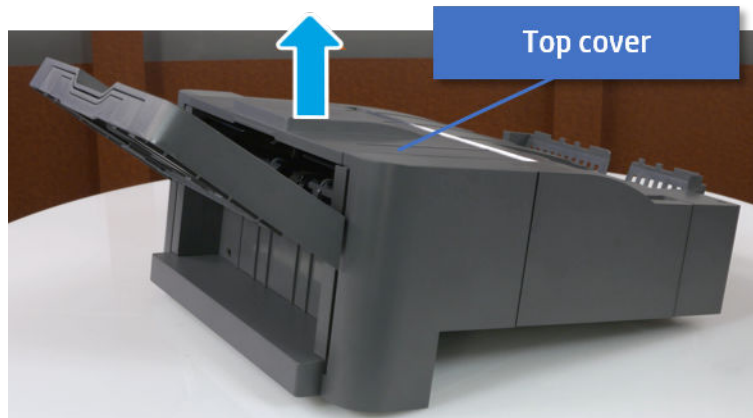

- b. Remove three screws.
 - c. Release hooks carefully and remove the rear cover.

Figure 5-239 Remove the rear cover

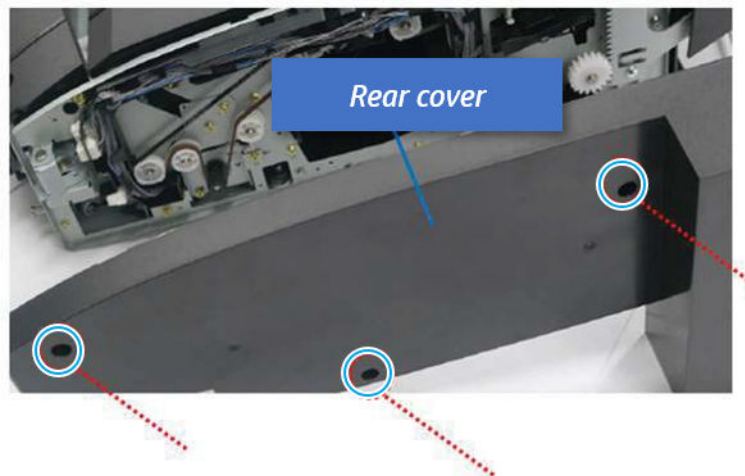

3. Remove the output tray.
 - a. Remove four screws.

Figure 5-240 Remove four screws

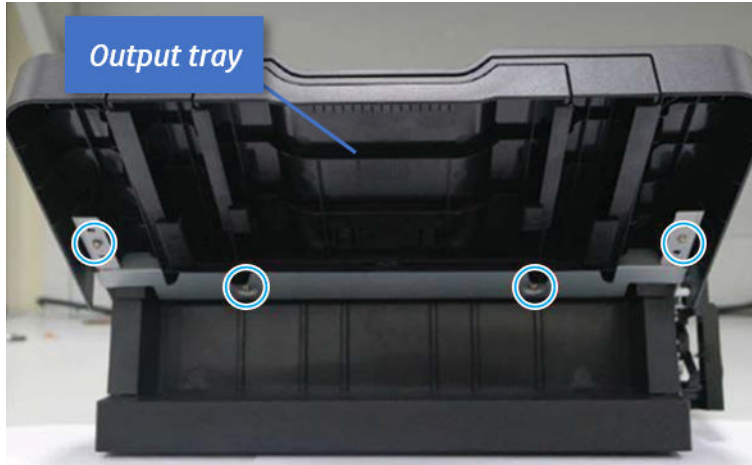

- b. Push the paper holding actuator into the inner finisher, and then remove the output tray.

Figure 5-241 Remove the output tray.



4. Remove the output tray frame.
 - a. Rotate the pulley until the output tray frame depart from the gear.

Figure 5-242 Remove the pulley

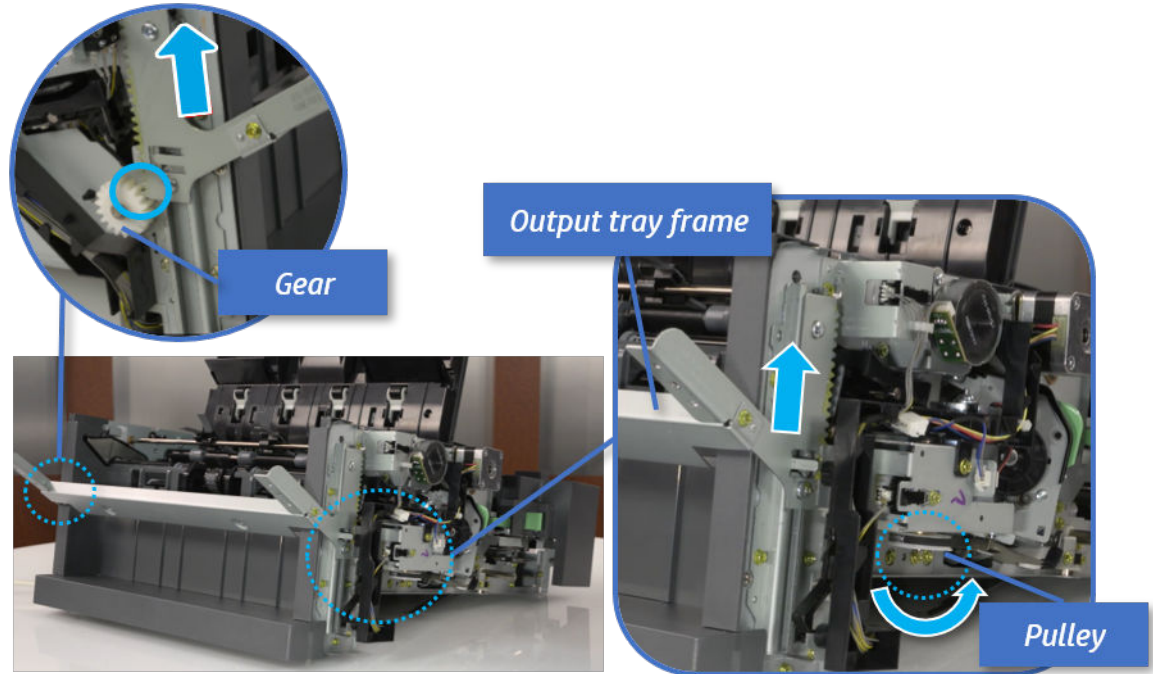

- b. Push the paper holding actuator into the inner finisher, and then remove the output tray frame.

Figure 5-243 Remove the output tray frame

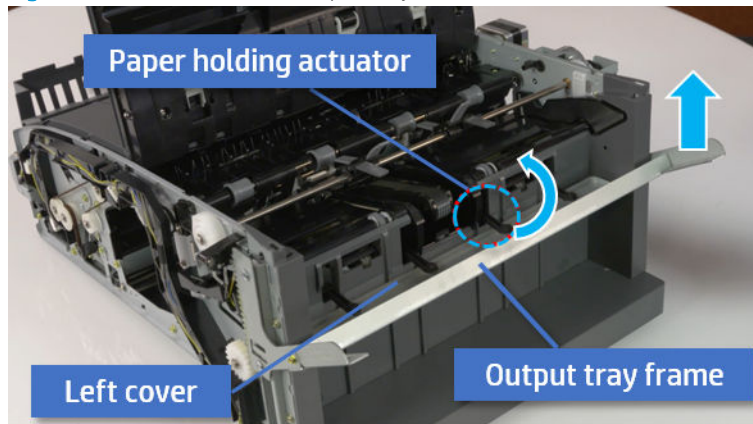

TIP: Push the paper holding actuator into the inner finisher when reassembling. Be sure to level the output tray.

1. Position the first wheel into the channel on both sides while pushing the paper holding actuator.

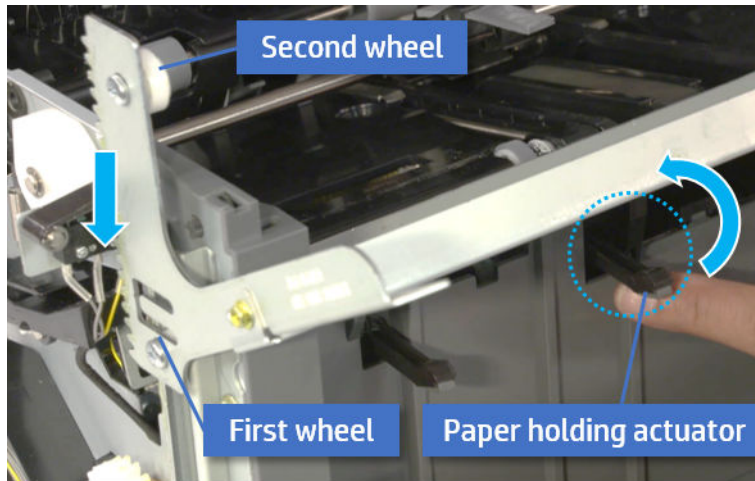

2. Let the second wheel rest on the channel on both sides simultaneously.
3. Gently squeeze the wheels into channel until the output tray frame meet the gear.

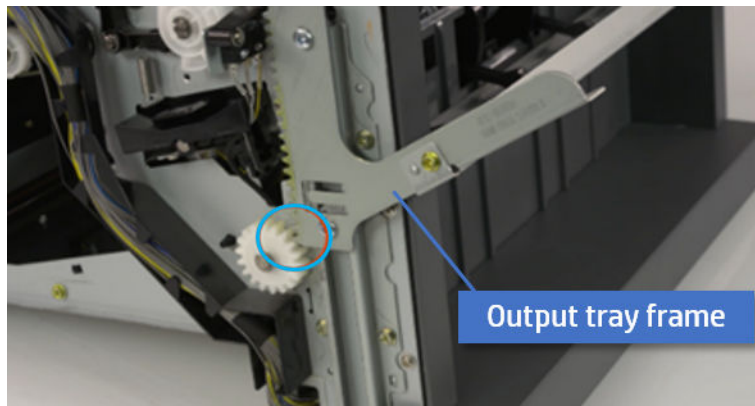

4. Rotate the pulley until the output tray frame is no longer lifted. It can make to level the output tray frame.

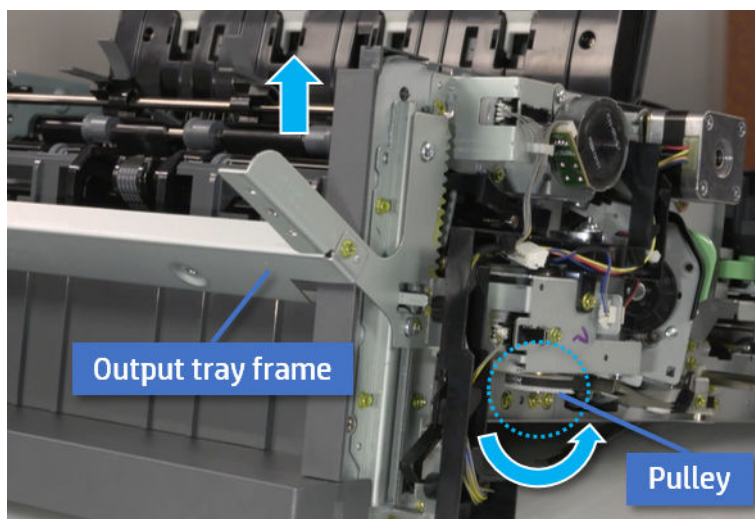

5. Rotate the pulley in the opposite direction.

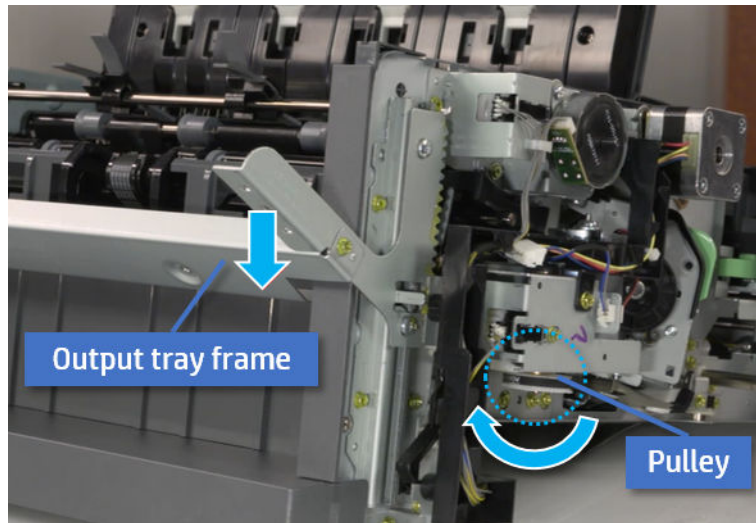

5. Remove the PCA cover.

- ▲ Remove two screws, and then remove the PCA cover.

Figure 5-244 Remove the PCA cover

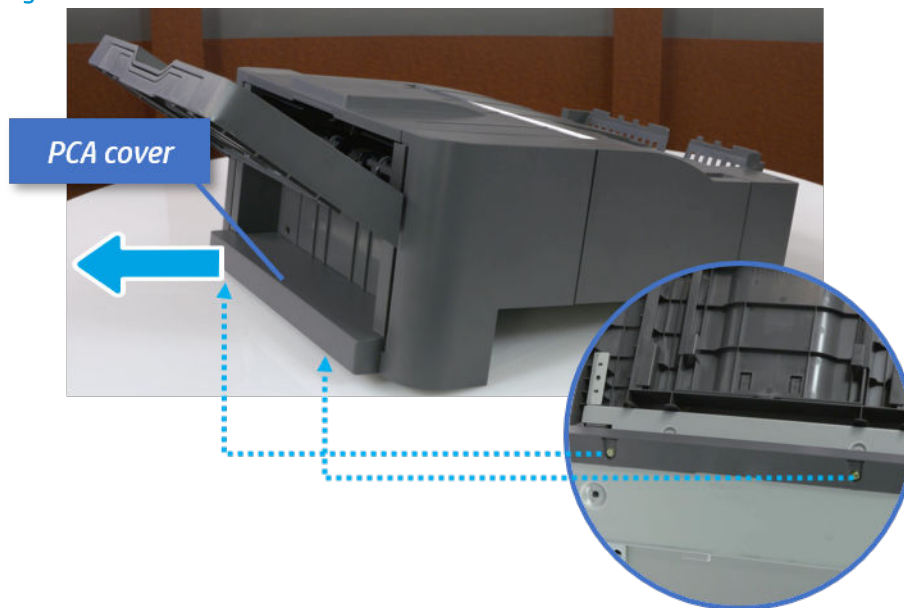

6. Remove the left cover.

- a. Remove two screws.

Figure 5-245 Remove two screws

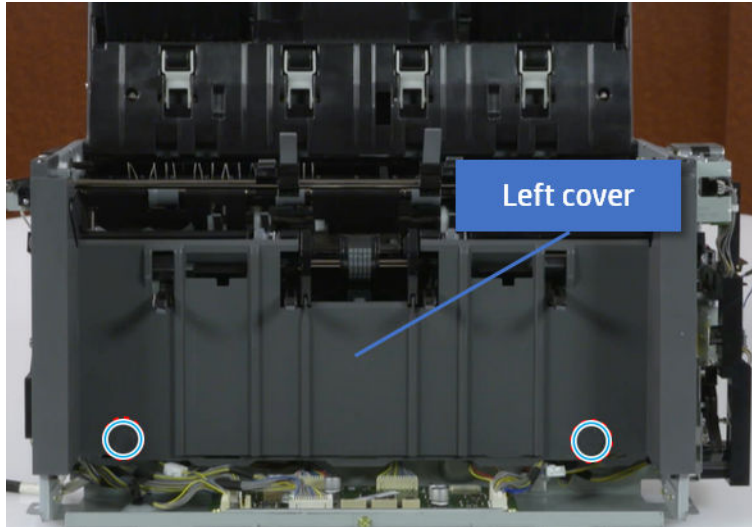

- b. Remove four screws from both front and rear sides.

Figure 5-246 Remove four screws

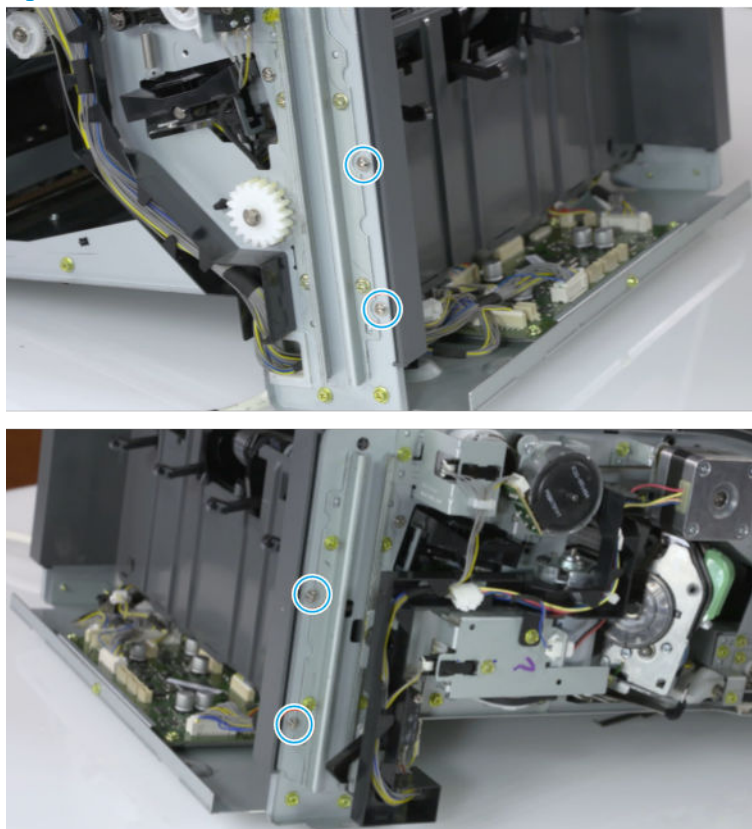

- c. Unplug two inline connectors, and then remove the left cover.

Figure 5-247 Unplug two connectors

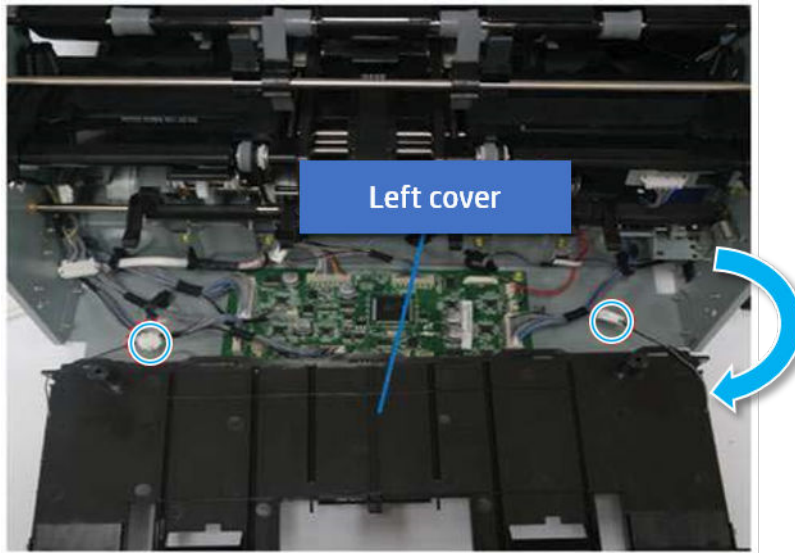

 **TIP:** Be sure to check the hook when reassembling.

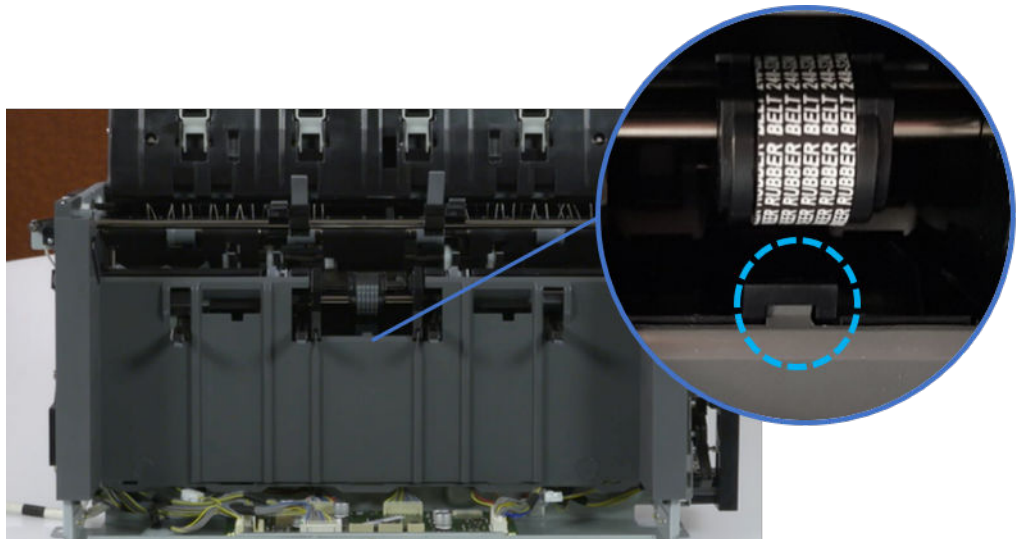

- 7. Remove the front harness guide.
 - a. Open one clamp and unplug five connectors, and then remove the wire harness from the front harness guide.

- b. Remove four screws, and then remove the front harness guide.

Figure 5-248 Remove the front harness guide

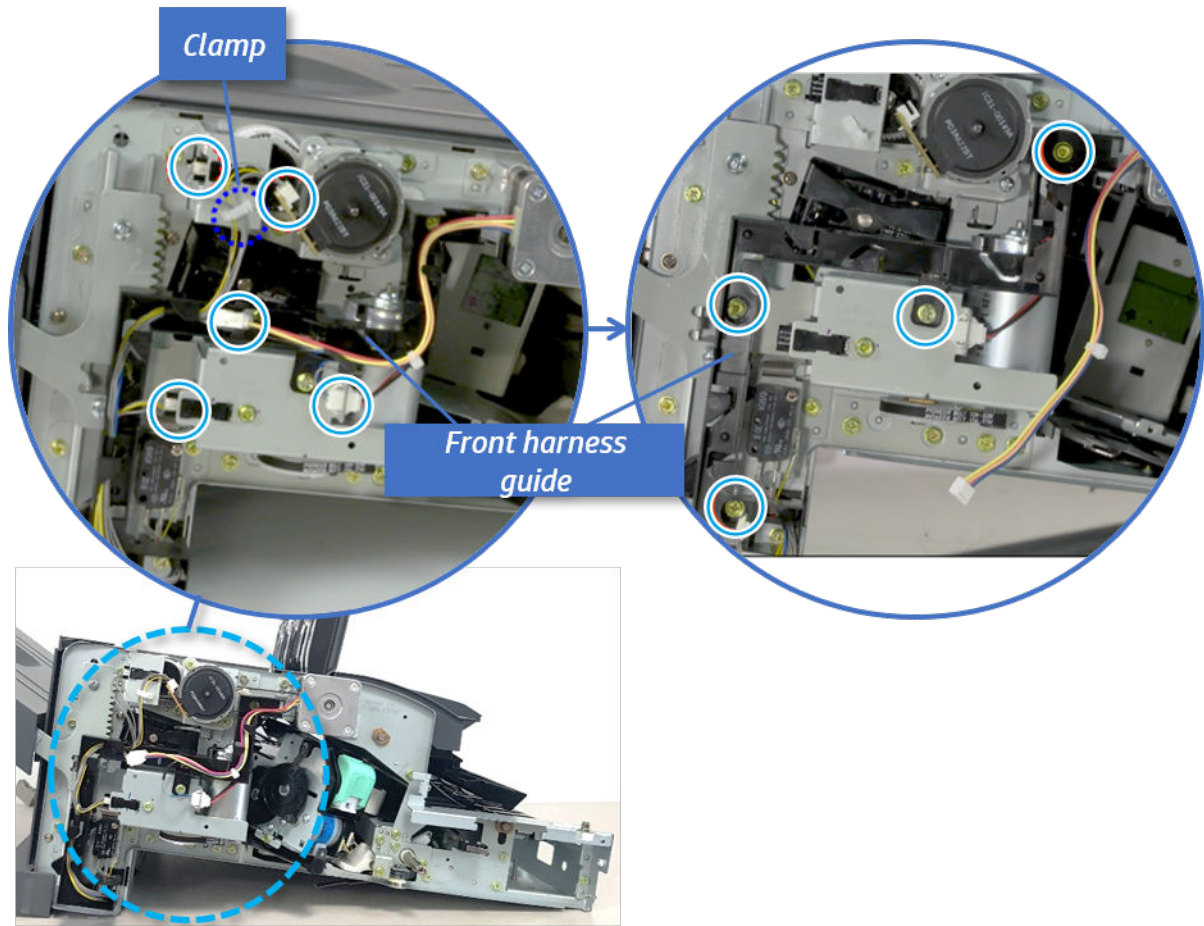

8. Remove the output tray motor assembly.
- ▲ Remove three screws, and then remove the output tray motor assembly.

Figure 5-249 Remove the output tray motor assembly

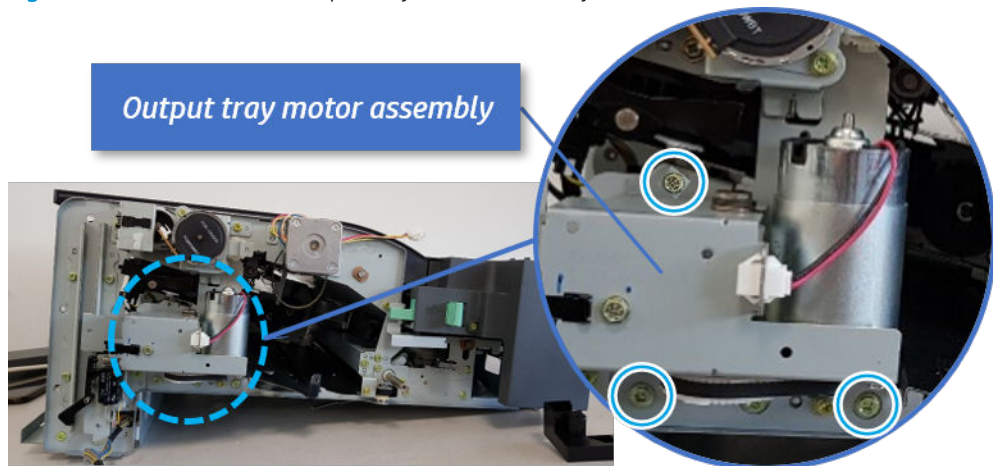

9. Remove the output tray lower limit switch.

- ▲ Remove one screw, and then remove the output tray lower limit switch.

Figure 5-250 Remove the output tray lower limit switch

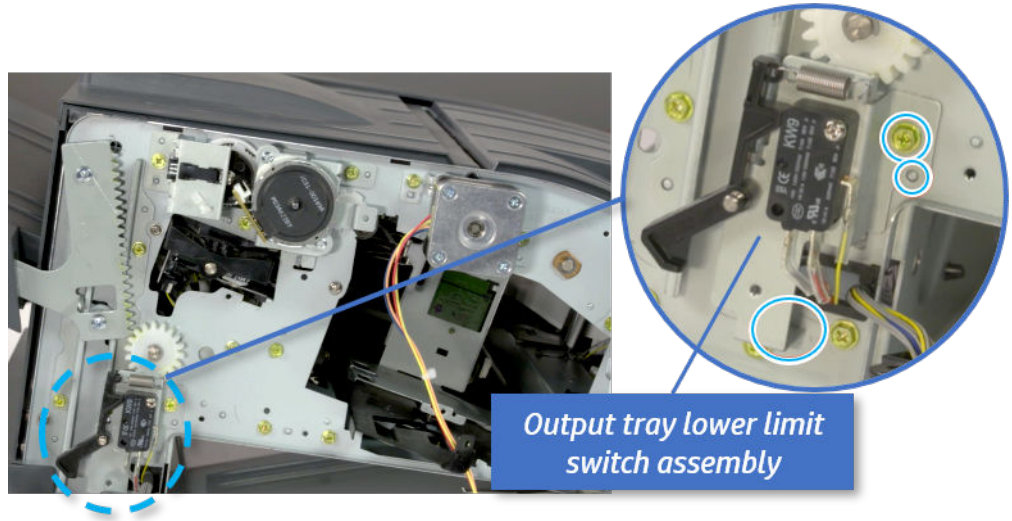

- 10. Remove the paper holding.
 - a. Remove the paper holding actuator spring.

Figure 5-251 Remove the paper holding actuator spring

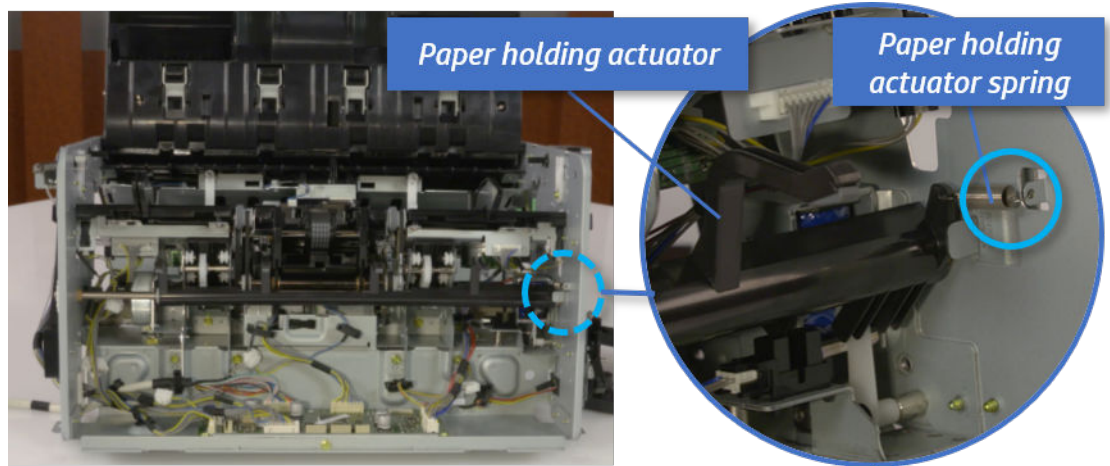

- b. Remove the e-ring and the rack pinion gear. And then remove the pin and the e-ring, and then remove the bushing.

Figure 5-252 Remove e-ring, rack pinion gear, pin, and bushing

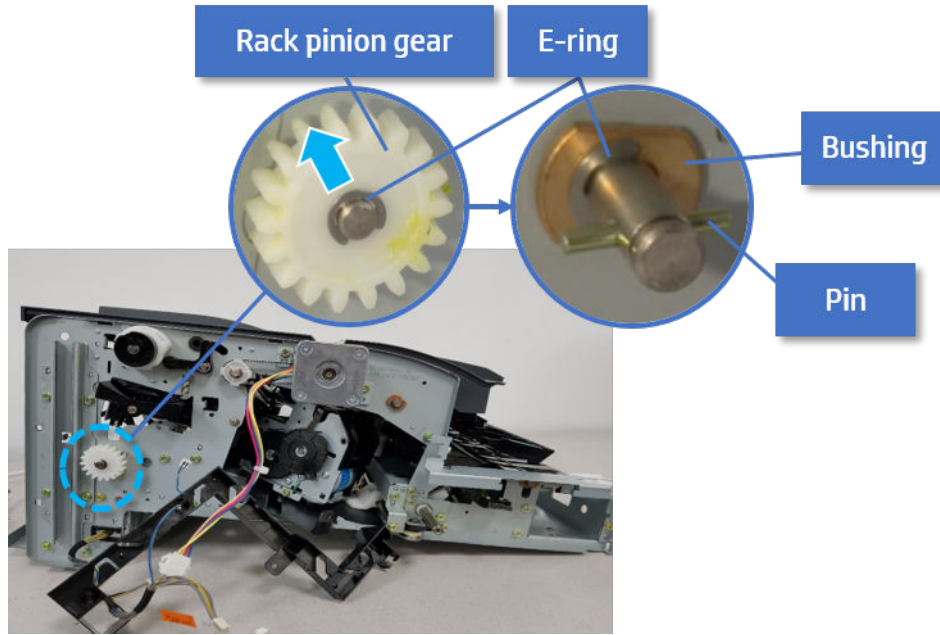

 **NOTE:** Be sure not to lose the pin.

- c. Carefully remove the paper holding shaft and the actuator.

Figure 5-253 Remove the paper holding shaft and the actuator

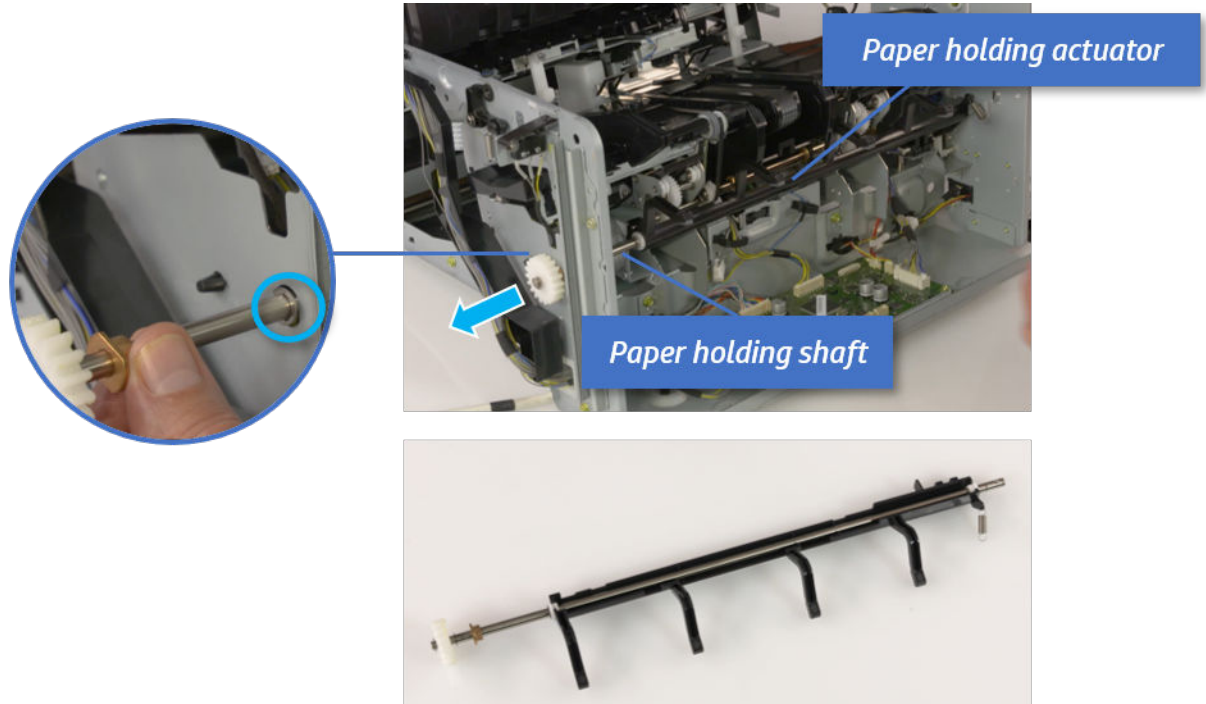

- 11. Remove the sub paddle unit.

- a. Open the top cover, and then remove one screw securing the sub paddle unit.

Figure 5-254 Remove one screw

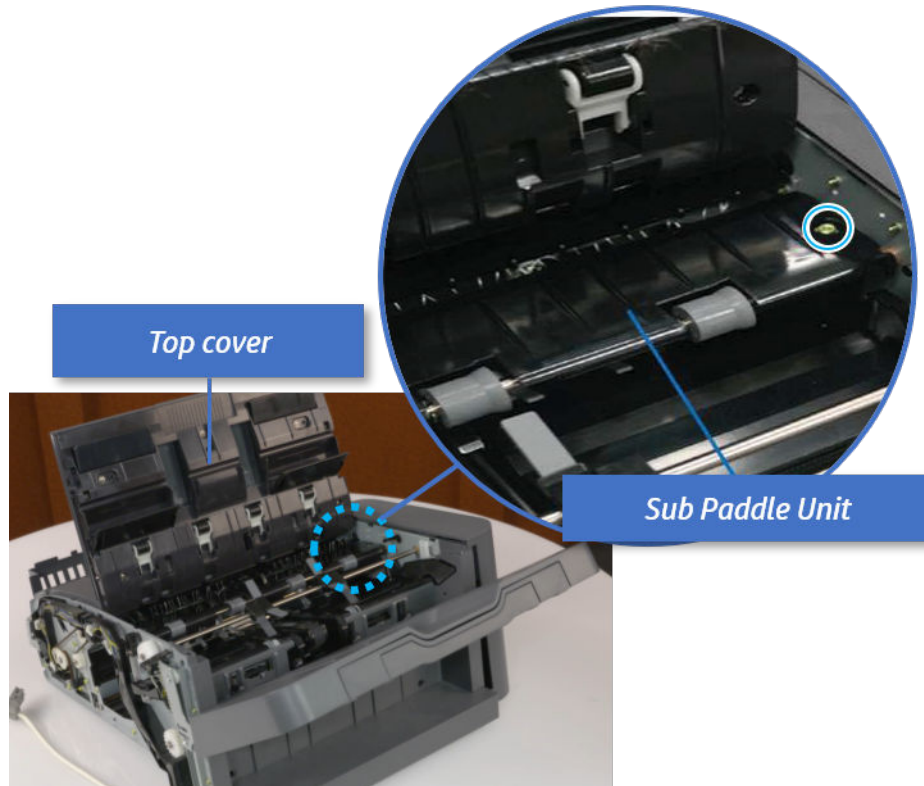

- b. Remove the e-ring, and then remove the pulley and timing belt. And then remove the e-ring and the bushing.

Figure 5-255 Remove the e-ring, pulley, timing belt, and bushing

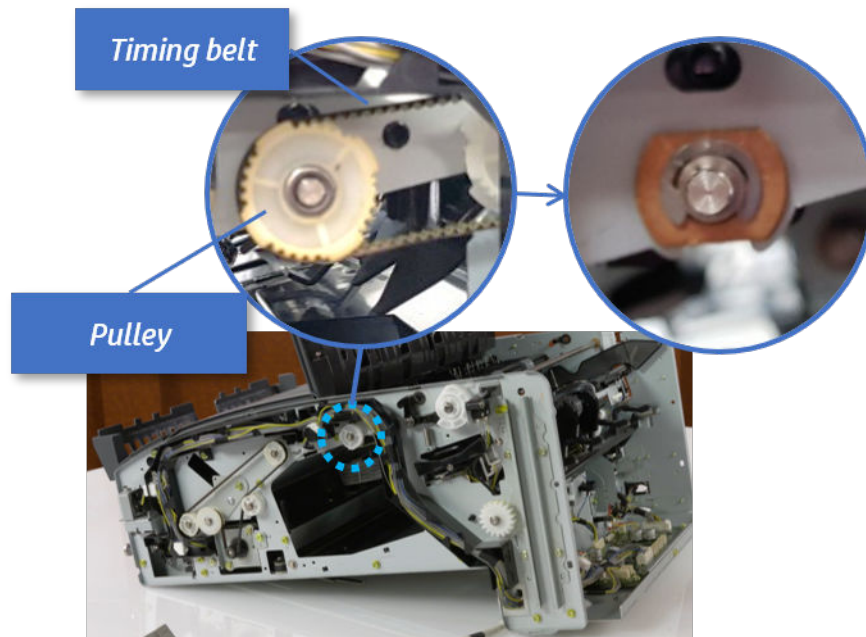

- c. Lift up and remove the sub paddle unit.

Figure 5-256 Remove the sub paddle unit

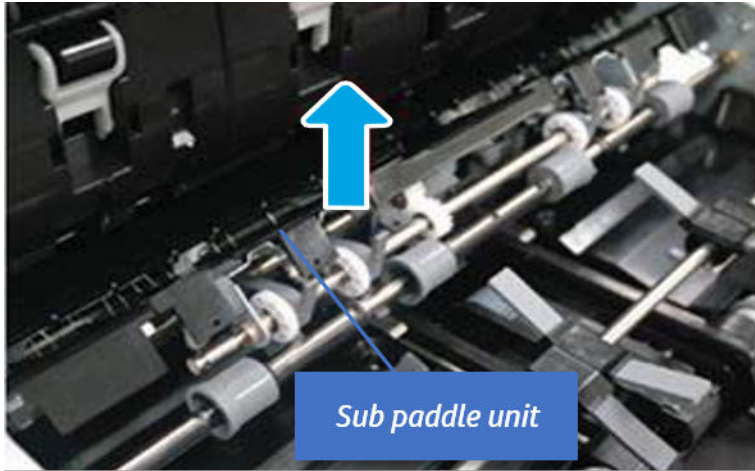

- 12. Remove the exit roller.

- a. Remove the guide on the center of the exit roller.

Figure 5-257 Remove the guide

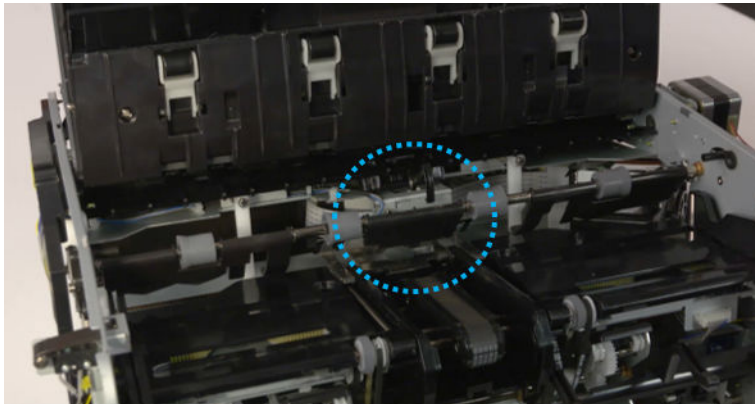

- b. On the front of the inner finisher, release the timing belt connected to the exit motor.

Figure 5-258 Release the timing belt

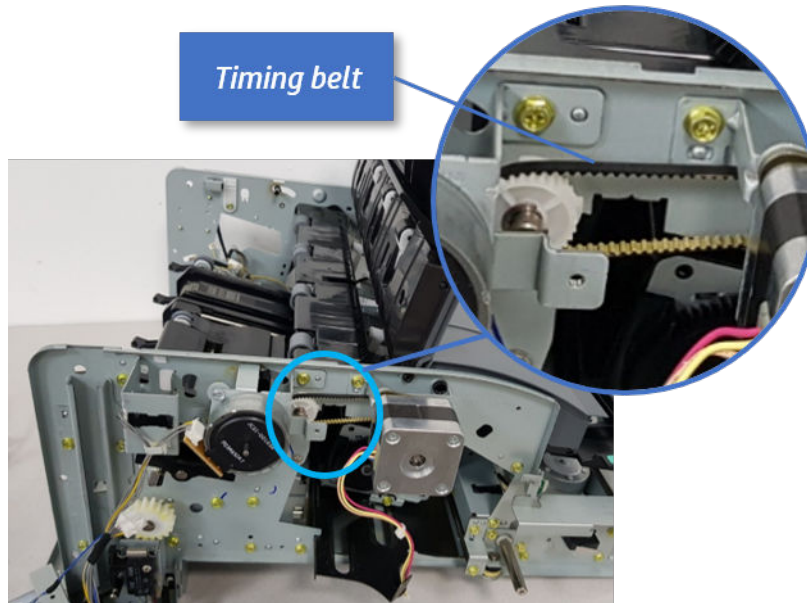

- c. Remove five screws securing the rear harness guide.

Figure 5-259 Remove five screws

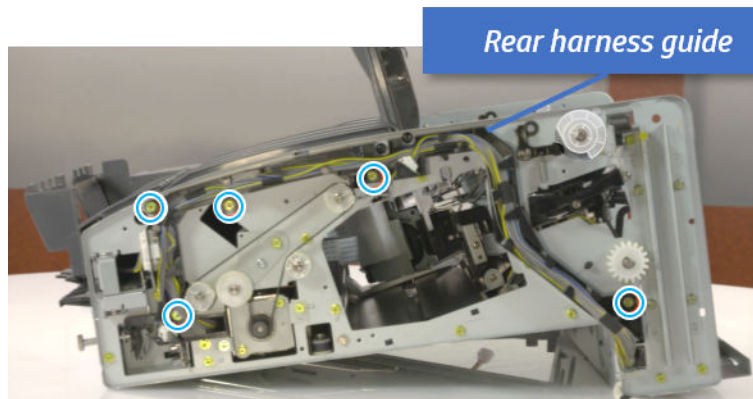

- d. On the rear of the inner finisher, remove the e-ring and the pulley and then remove the e-ring and the bushing.

Figure 5-260 Remove e-ring, pulley, and bushing

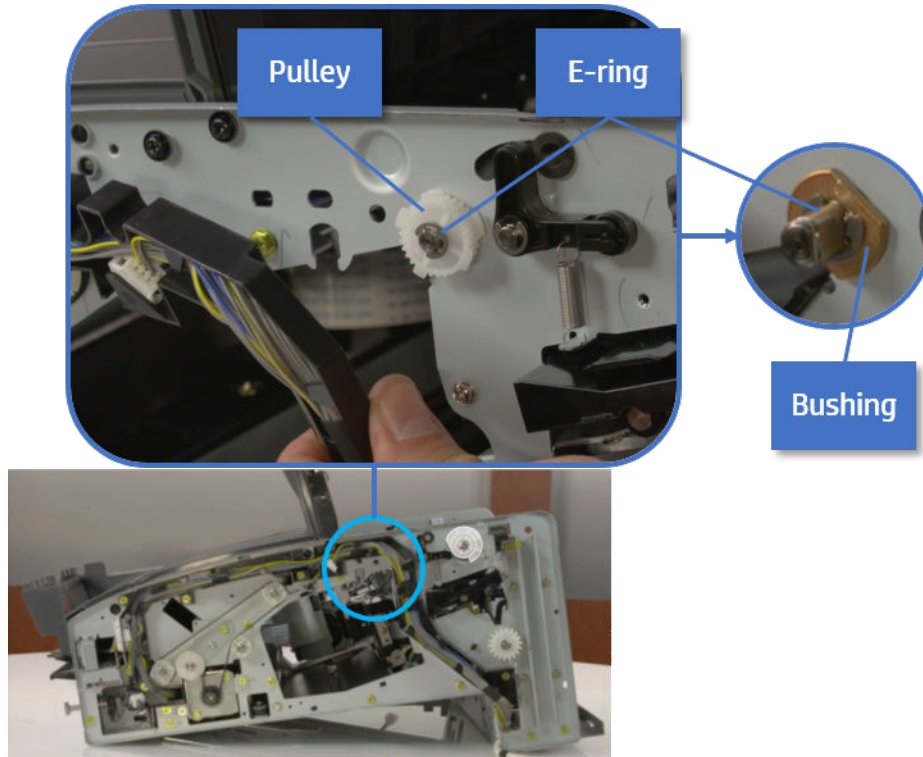

- e. Push the bushing to detach it, and then remove the exit roller.

Figure 5-261 Remove the exit roller

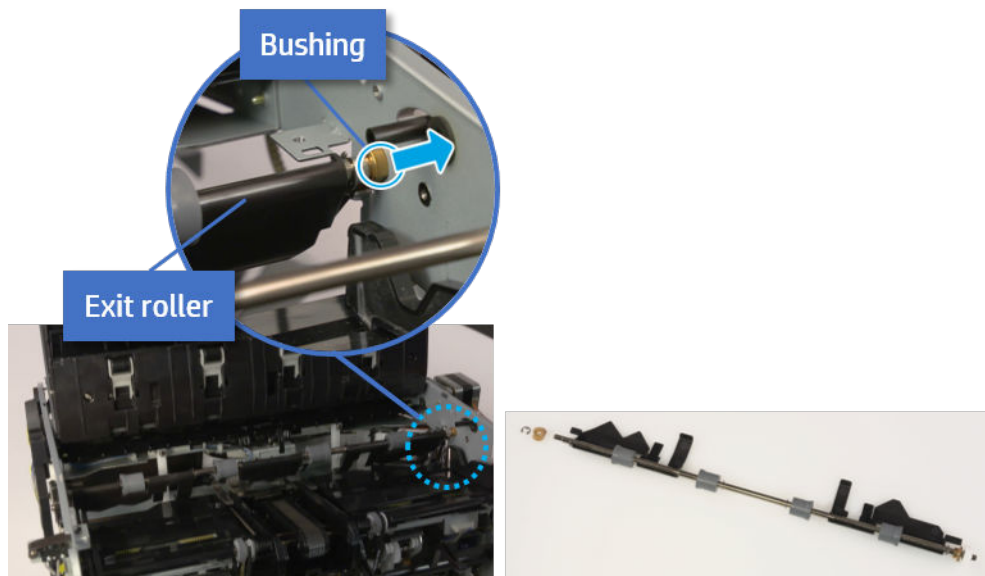

- 13. Remove the front tamper.
 - a. Remove four screws.

Figure 5-262 Remove four screws

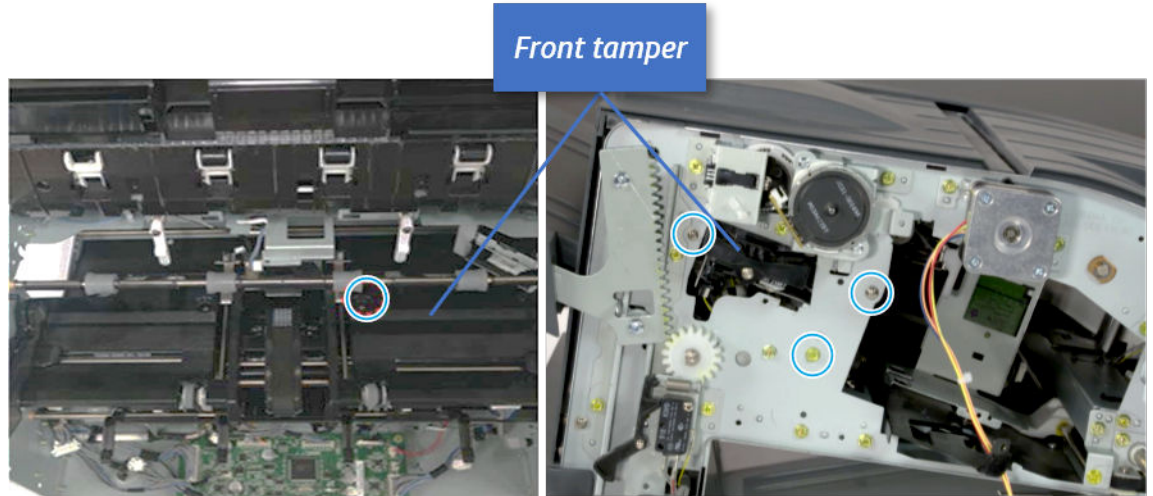

- b. Unplug the connector and release the hook, and then pull the front tamper up to remove.

Figure 5-263 Remove the front tamper

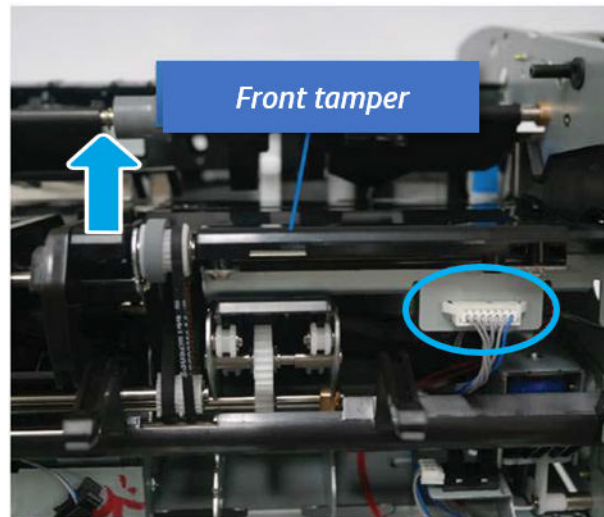

- 14. Remove the rear tamper.

- a. Remove four screws.

 **NOTE:** Move cable guideout of position to access the screws.

Figure 5-264 Remove four screws



- b. Unplug two connectors and release the hook, and then remove the rear tamper.

Figure 5-265 Remove the rear tamper

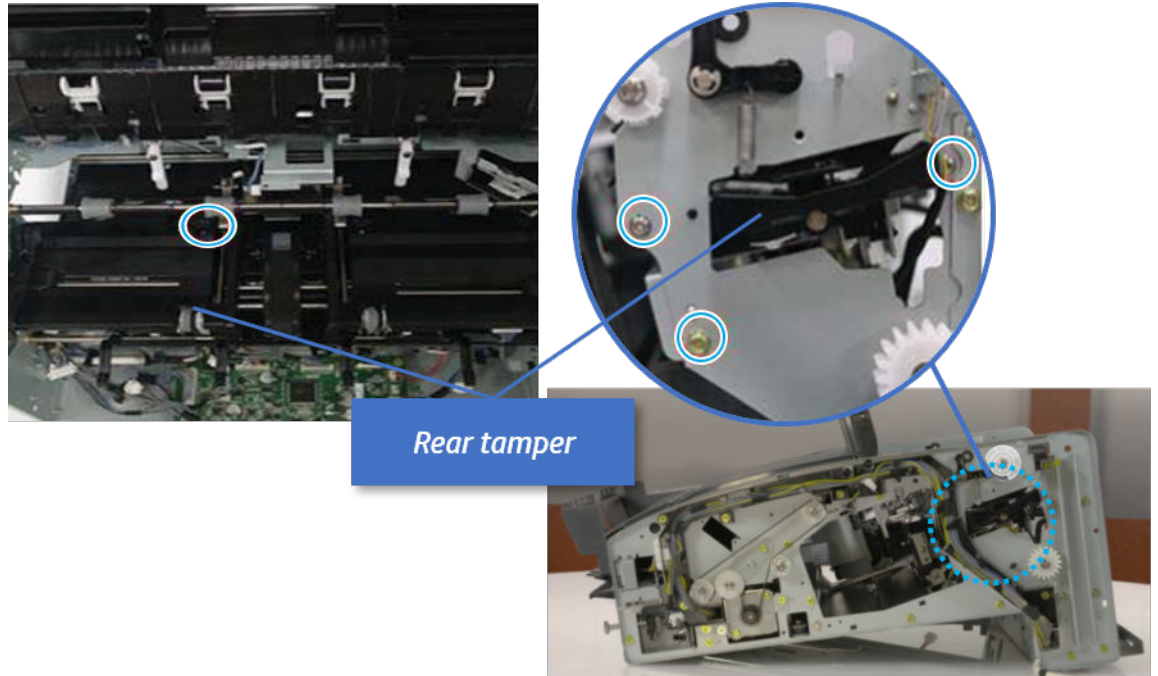
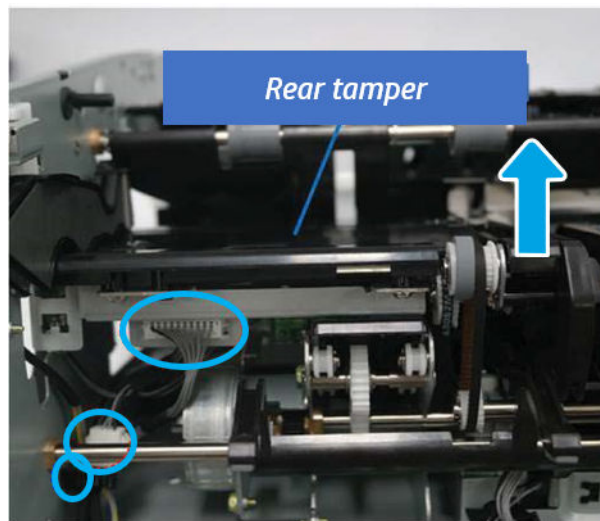

- 15. Remove the ejector & paper support assembly.
 - a. Open one clamp, disconnect one connector.

Figure 5-266 Disconnect one connector

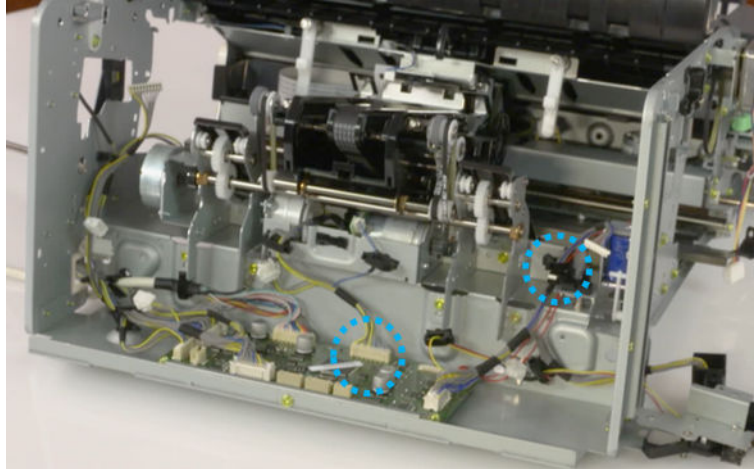

- b. Pull the rear paper support up, and then release one clamp and disconnect two connectors.

Figure 5-267 Disconnect two connector

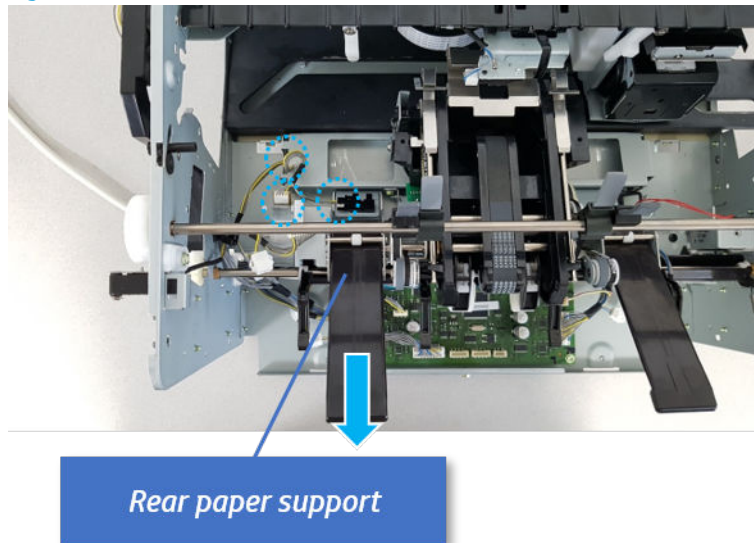

- c. Remove four screws, and then remove the ejector & paper support assembly.

Figure 5-268 Remove the ejector & paper support assembly

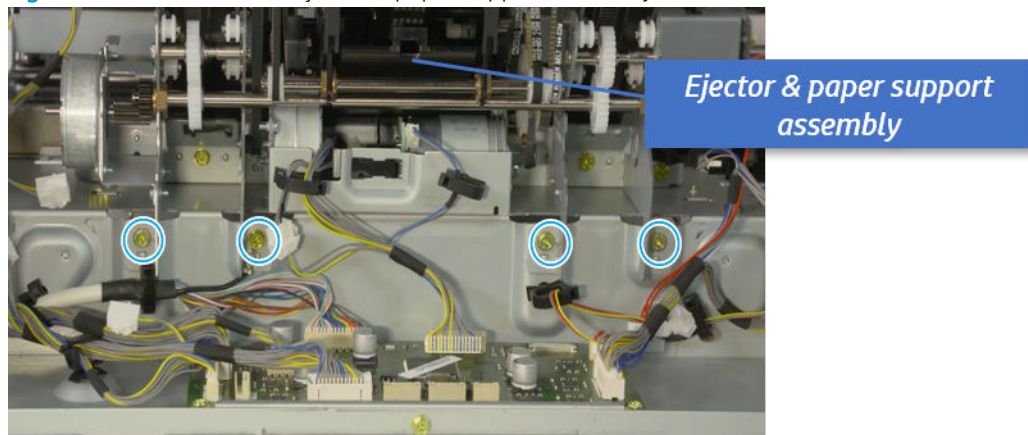

16. Remove the paper support motor.

- ▲ Remove two screws, disconnect one connect, and then remove the paper support motor.

Figure 5-269 Remove the paper support motor

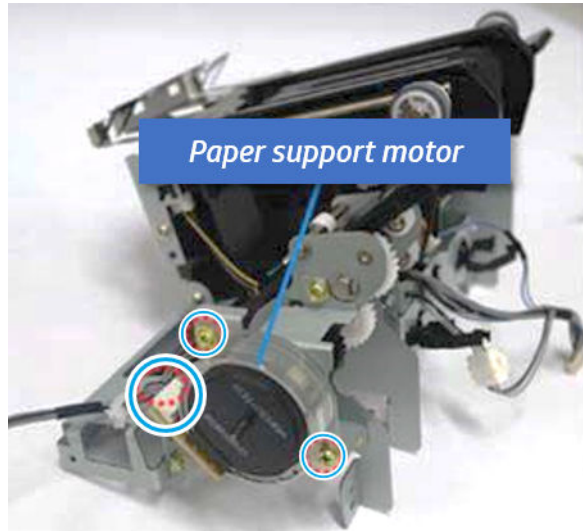



17. Unpack the replacement assembly.

- a. Dispose of the defective part.

 **NOTE:** HP recommends responsible disposal of the defective part.

<http://www8.hp.com/us/en/hp-information/environment/product-recycling.html>

- b. Unpack the replacement part from the packaging.

 **CAUTION:**  Some parts are sensitive to electrostatic discharge (ESD). Always perform service work at an ESD-protected workstation or mat. If an ESD workstation or mat is not available, touch the sheet-metal chassis to provide a static ground before touching an ESD-sensitive assembly. Protect the ESD-sensitive assemblies by placing them in ESD pouches when they are out of the printer.

If the replacement part is a roller or pad, avoid touching the spongy part of it. Skin oils on the roller or pad can cause paper pickup and/or print-quality problems. HP recommends using disposable gloves when handling rollers or pads or washing your hands before touching rollers or pads.

 **IMPORTANT:** Make sure that all of the shipping materials (for example shipping tape) are removed from the replacement part prior to installation.

- c. To install an assembly, reverse the removal steps.

When applicable, special installation instructions are provided for an assembly at the end of the removal procedure. Always completely read the removal instructions and follow all special installation instructions.

Paddle unit

Removal and replacement: Main paddle

Learn how to remove and replace the main paddle.

To view teardown&reassembling video of the inner finisher, click the link below.

 [View a teardown video of the inner finisher .](#)

 [View a reassembling video of the inner finisher .](#)

 **IMPORTANT:** When applicable, special installation instructions are provided for an assembly at the end of the removal procedure. Always completely read the removal instructions and follow all special installation instructions.

Mean time to repair:

Service level:

Before performing service

Turn the printer power off

- Press the power button on the front of the printer, and then turn off the power switch next to the power cable.
- A shutting-down message appears on the control-panel display.

 **WARNING!** To avoid damage to the printer, turn the power off and wait until the printer shuts down before removing the power cable.

- Disconnect the printer power cable after the printer has completely shut down (the control-panel display is blank).

Use the table below to identify the correct part number for your printer. To order the part, go to <https://parts.hp.com>.

Table 5-45 Part information

Part number	Part description
JC90-01327A	Main paddle
JC82-01038A	Main paddle kit
JC63-04957A	Main paddle A
JC63-04958A	Main paddle B
JC81-07560A	Main paddle holder

Required tools

- #2 JIS screwdriver with a magnetic tip

After performing service

Turn the printer power on

- Connect the power cable.
- Use the power switch to turn the power on.

Post service test

Print any pages necessary to verify that the repair resolved the issue and did not create any new issues.

1. Remove the main paddle.
 - a. Open the top cover.
 - b. Rotate the main paddle shaft to see the lower side of the main paddle.

Figure 5-270 Rotate the main paddle shaft

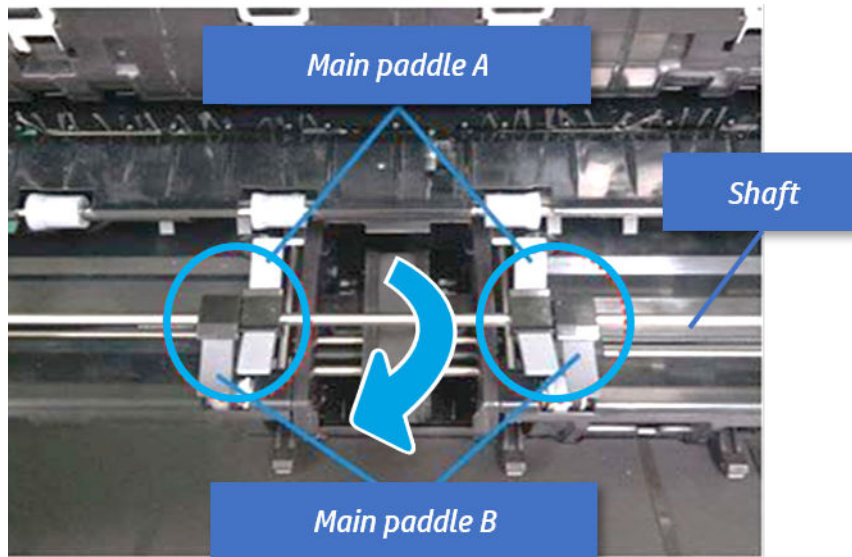

- c. Remove the main paddle by pushing both sides.

Figure 5-271 Remove the main paddle

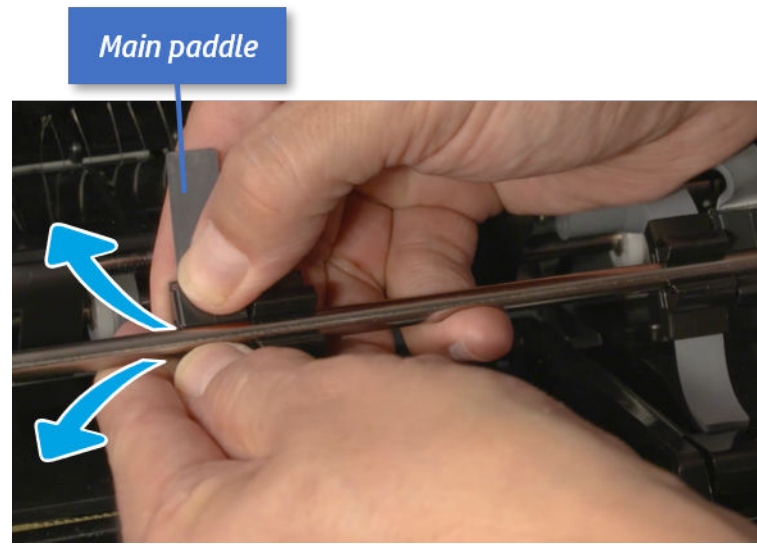

 **TIP:** When reassembling the main paddle, check the pin position of the paddle and the hole position of the shaft, and then assemble them.

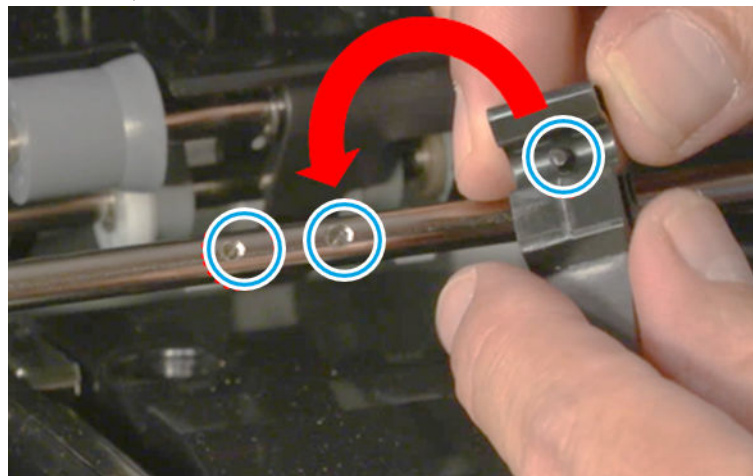



- 2. Unpack the replacement assembly.
 - a. Dispose of the defective part.

 **NOTE:** HP recommends responsible disposal of the defective part.

<http://www8.hp.com/us/en/hp-information/environment/product-recycling.html>

- b. Unpack the replacement part from the packaging.

 **CAUTION:**  Some parts are sensitive to electrostatic discharge (ESD). Always perform service work at an ESD-protected workstation or mat. If an ESD workstation or mat is not available, touch the sheet-metal chassis to provide a static ground before touching an ESD-sensitive assembly. Protect the ESD-sensitive assemblies by placing them in ESD pouches when they are out of the printer.

If the replacement part is a roller or pad, avoid touching the spongy part of it. Skin oils on the roller or pad can cause paper pickup and/or print-quality problems. HP recommends using disposable gloves when handling rollers or pads or washing your hands before touching rollers or pads.

 **IMPORTANT:** Make sure that all of the shipping materials (for example shipping tape) are removed from the replacement part prior to installation.

- c. To install an assembly, reverse the removal steps.

When applicable, special installation instructions are provided for an assembly at the end of the removal procedure. Always completely read the removal instructions and follow all special installation instructions.

Removal and replacement: Main paddle home sensor (S4)

Learn how to remove and replace the main paddle home sensor.

To view teardown&reassembling video of the inner finisher, click the link below.

 [View a teardown video of the inner finisher .](#)

 [View a reassembling video of the inner finisher .](#)

 **IMPORTANT:** When applicable, special installation instructions are provided for an assembly at the end of the removal procedure. Always completely read the removal instructions and follow all special installation instructions.

Mean time to repair:

Service level:

Before performing service

Turn the printer power off

- Press the power button on the front of the printer, and then turn off the power switch next to the power cable.
- A shutting-down message appears on the control-panel display.

 **WARNING!** To avoid damage to the printer, turn the power off and wait until the printer shuts down before removing the power cable.

- Disconnect the printer power cable after the printer has completely shut down (the control-panel display is blank).

Use the table below to identify the correct part number for your printer. To order the part, go to <https://parts.hp.com>.

Table 5-46 Part information

Part number	Part description
0604-001393	Main paddle home sensor

Required tools

- #2 JIS screwdriver with a magnetic tip

After performing service

Turn the printer power on

- Connect the power cable.
- Use the power switch to turn the power on.

Post service test

Print any pages necessary to verify that the repair resolved the issue and did not create any new issues.

1. Remove the front cover.
 - a. Open the front door and open the punch cover.
 - b. Remove three screws in the front.
 - c. Remove the lever.
 - d. Open the top cover.
 - e. From the right side of the front cover, carefully lift and pry toward the top-left corner to remove the front cover.

Figure 5-272 Remove the front cover

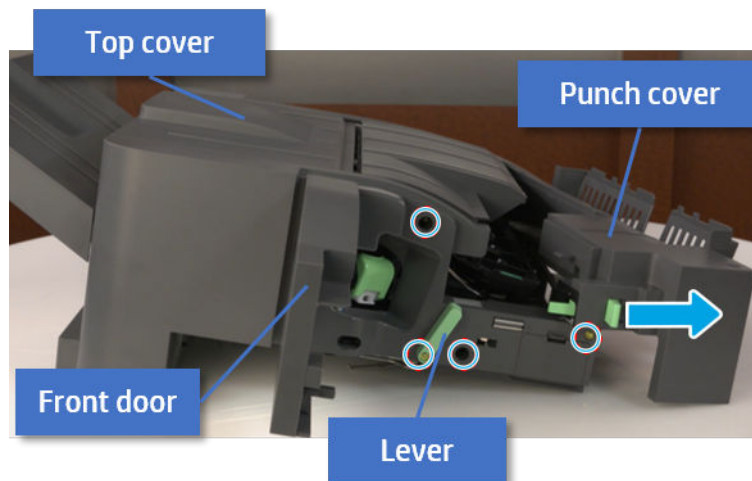

2. Remove the main paddle home sensor.

- a. Remove one screw. Open the clamp and unplug one connector, and then remove the main paddle home sensor bracket.

Figure 5-273 Remove the main paddle home sensor bracket

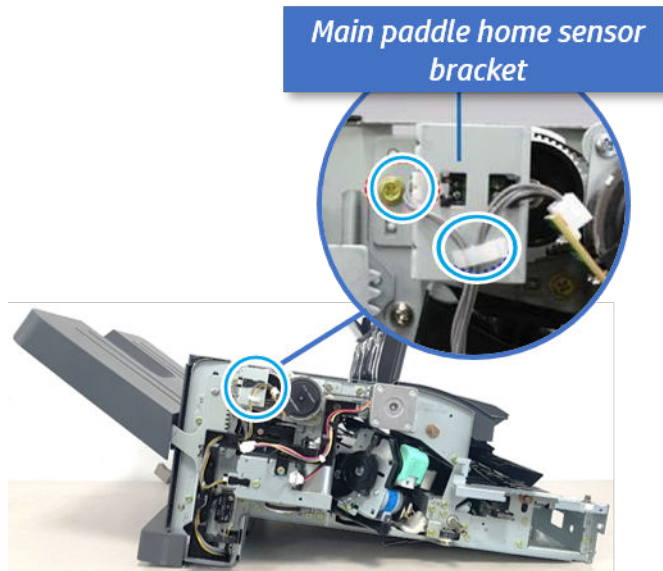

- b. Remove the main paddle home sensor from the bracket.

Figure 5-274 Remove the main paddle home sensor

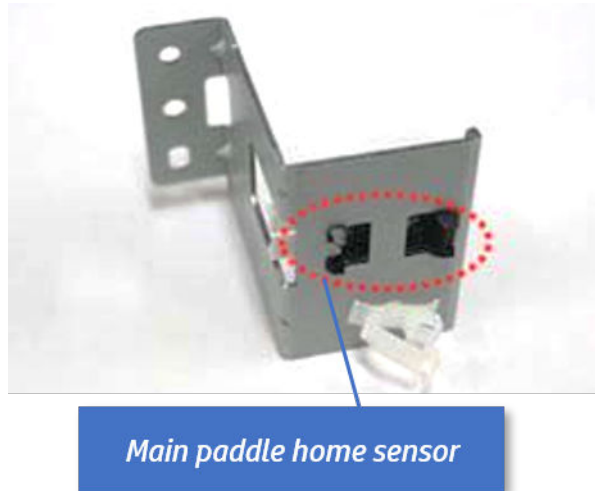



3. Unpack the replacement assembly.
 - a. Dispose of the defective part.

 **NOTE:** HP recommends responsible disposal of the defective part.

<http://www8.hp.com/us/en/hp-information/environment/product-recycling.html>

- b. Unpack the replacement part from the packaging.

 **CAUTION:**  Some parts are sensitive to electrostatic discharge (ESD). Always perform service work at an ESD-protected workstation or mat. If an ESD workstation or mat is not available, touch the sheet-metal chassis to provide a static ground before touching an ESD-sensitive assembly. Protect the ESD-sensitive assemblies by placing them in ESD pouches when they are out of the printer.

If the replacement part is a roller or pad, avoid touching the spongy part of it. Skin oils on the roller or pad can cause paper pickup and/or print-quality problems. HP recommends using disposable gloves when handling rollers or pads or washing your hands before touching rollers or pads.

 **IMPORTANT:** Make sure that all of the shipping materials (for example shipping tape) are removed from the replacement part prior to installation.

- c. To install an assembly, reverse the removal steps.

When applicable, special installation instructions are provided for an assembly at the end of the removal procedure. Always completely read the removal instructions and follow all special installation instructions.

Removal and replacement: Main paddle motor (M3)

Learn how to remove and replace the main paddle motor.

To view teardown&reassembling video of the inner finisher, click the link below.

 [View a teardown video of the inner finisher .](#)

 [View a reassembling video of the inner finisher .](#)

 **IMPORTANT:** When applicable, special installation instructions are provided for an assembly at the end of the removal procedure. Always completely read the removal instructions and follow all special installation instructions.

Mean time to repair:

Service level:

Before performing service

Turn the printer power off

- Press the power button on the front of the printer, and then turn off the power switch next to the power cable.
- A shutting-down message appears on the control-panel display.

 **WARNING!** To avoid damage to the printer, turn the power off and wait until the printer shuts down before removing the power cable.

- Disconnect the printer power cable after the printer has completely shut down (the control-panel display is blank).

Use the table below to identify the correct part number for your printer. To order the part, go to <https://parts.hp.com>.

Table 5-47 Part information

Part number	Part description
JC93-01001A	Main paddle motor assembly

Required tools

- #2 JIS screwdriver with a magnetic tip

After performing service

Turn the printer power on

- Connect the power cable.
- Use the power switch to turn the power on.

Post service test

Print any pages necessary to verify that the repair resolved the issue and did not create any new issues.

1. Remove the front cover.
 - a. Open the front door and open the punch cover.
 - b. Remove three screws in the front.
 - c. Remove the lever.
 - d. Open the top cover.
 - e. From the right side of the front cover, carefully lift and pry toward the top-left corner to remove the front cover.

Figure 5-275 Remove the front cover

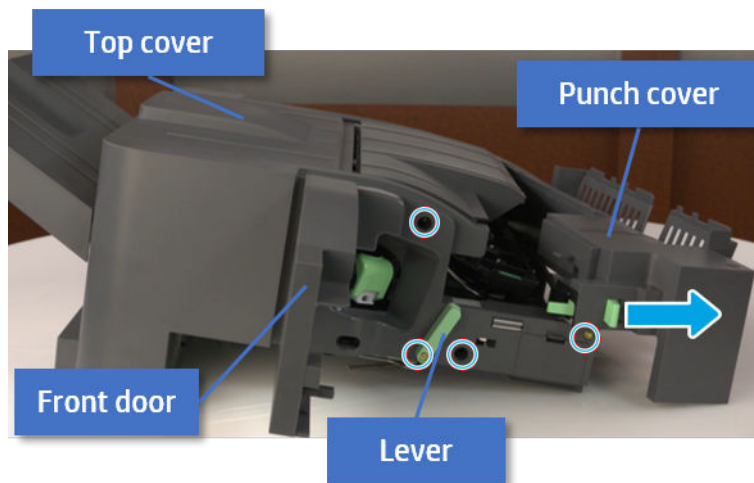

2. Remove the main paddle motor.

- a. Remove three screws, unplug the connector, and then remove the main paddle motor bracket.

Figure 5-276 Remove the main paddle motor bracket

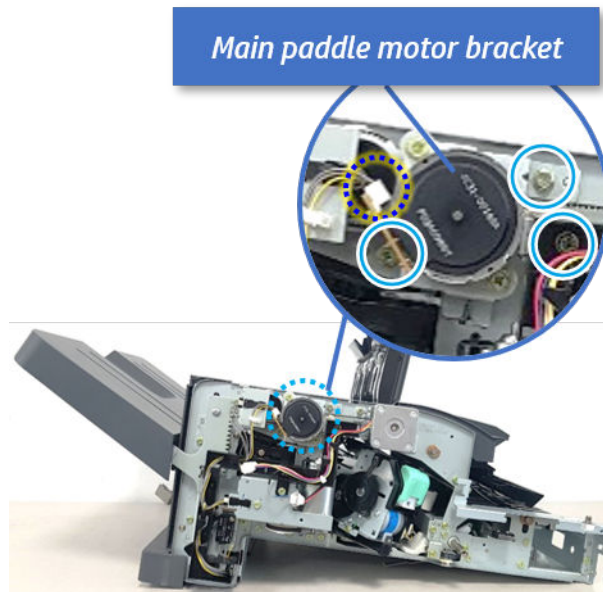

- b. Remove two screws, and then remove the motor from the bracket.

Figure 5-277 Remove the main paddle motor





3. Unpack the replacement assembly.
 - a. Dispose of the defective part.

 **NOTE:** HP recommends responsible disposal of the defective part.

<http://www8.hp.com/us/en/hp-information/environment/product-recycling.html>

b. Unpack the replacement part from the packaging.

 **CAUTION:**  Some parts are sensitive to electrostatic discharge (ESD). Always perform service work at an ESD-protected workstation or mat. If an ESD workstation or mat is not available, touch the sheet-metal chassis to provide a static ground before touching an ESD-sensitive assembly. Protect the ESD-sensitive assemblies by placing them in ESD pouches when they are out of the printer.

If the replacement part is a roller or pad, avoid touching the spongy part of it. Skin oils on the roller or pad can cause paper pickup and/or print-quality problems. HP recommends using disposable gloves when handling rollers or pads or washing your hands before touching rollers or pads.

 **IMPORTANT:** Make sure that all of the shipping materials (for example shipping tape) are removed from the replacement part prior to installation.

c. To install an assembly, reverse the removal steps.

When applicable, special installation instructions are provided for an assembly at the end of the removal procedure. Always completely read the removal instructions and follow all special installation instructions.

Removal and replacement: Main paddle assembly

Learn how to remove and replace the main paddle assembly.

To view teardown&reassembling video of the inner finisher, click the link below.

 [View a teardown video of the inner finisher .](#)

 [View a reassembling video of the inner finisher .](#)

 **IMPORTANT:** When applicable, special installation instructions are provided for an assembly at the end of the removal procedure. Always completely read the removal instructions and follow all special installation instructions.

Mean time to repair:

Service level:

Before performing service

Turn the printer power off

- Press the power button on the front of the printer, and then turn off the power switch next to the power cable.
- A shutting-down message appears on the control-panel display.

 **WARNING!** To avoid damage to the printer, turn the power off and wait until the printer shuts down before removing the power cable.

- Disconnect the printer power cable after the printer has completely shut down (the control-panel display is blank).

Use the table below to identify the correct part number for your printer. To order the part, go to <https://parts.hp.com>.

Table 5-48 Part information

Part number	Part description
JC90-01327A (not orderable)	Main paddle assembly

Required tools

- #2 JIS screwdriver with a magnetic tip

After performing service

Turn the printer power on

- Connect the power cable.
- Use the power switch to turn the power on.

Post service test

Print any pages necessary to verify that the repair resolved the issue and did not create any new issues.

1. Remove the front cover.
 - a. Open the front door and open the punch cover.
 - b. Remove three screws in the front.
 - c. Remove the lever.
 - d. Open the top cover.
 - e. From the right side of the front cover, carefully lift and pry toward the top-left corner to remove the front cover.

Figure 5-278 Remove the front cover

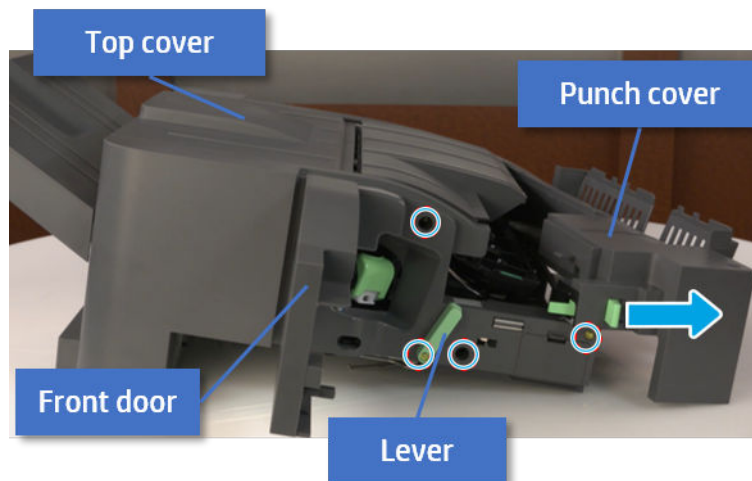

2. Remove the rear cover.

- a. Open the top cover.

Figure 5-279 Open the top cover

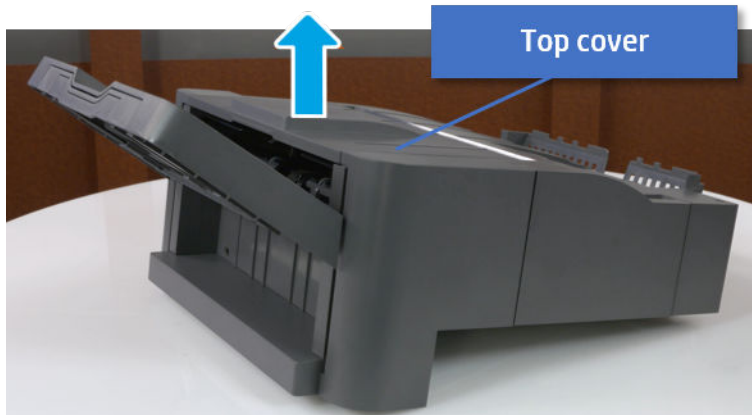

- b. Remove three screws.
- c. Release hooks carefully and remove the rear cover.

Figure 5-280 Remove the rear cover

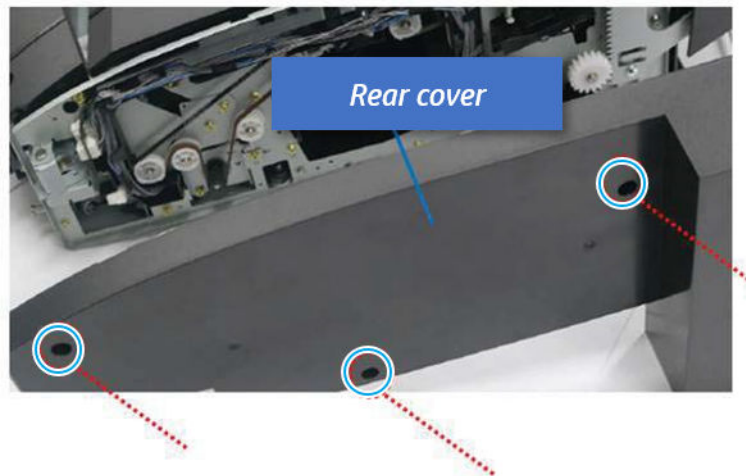

3. Remove the main paddle home sensor bracket.
 - ▲ Remove one screw. Open the clamp and unplug one connector, and then remove the main paddle home sensor bracket.

Figure 5-281 Remove the main paddle home sensor bracket

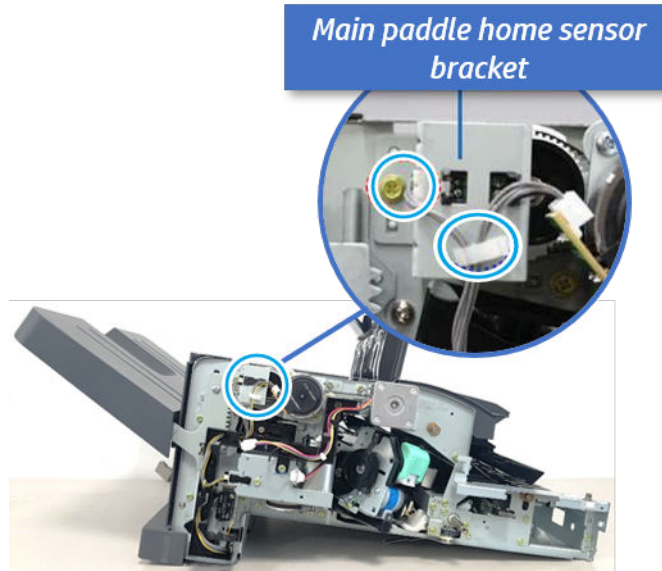

4. Remove the main paddle motor bracket.
 - ▲ Remove three screws, unplug the connector, and then remove the main paddle motor bracket.

Figure 5-282 Remove the main paddle motor bracket

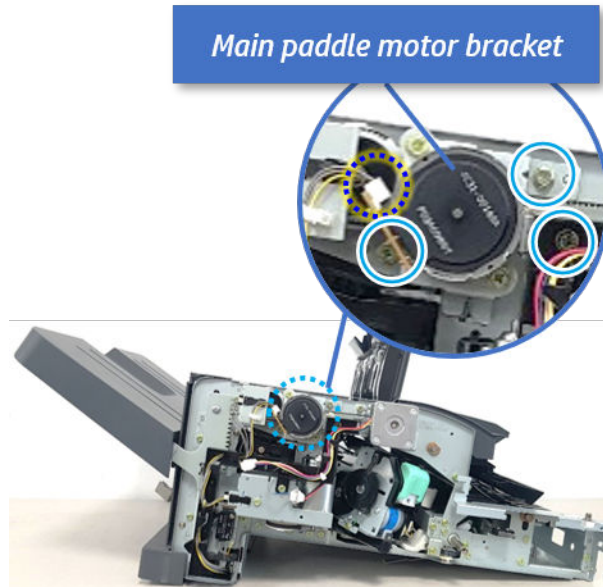

5. Remove the main paddle.
 - a. Open the top cover.

- b. Rotate the main paddle shaft to see the lower side of the main paddle.

Figure 5-283 Rotate the main paddle shaft

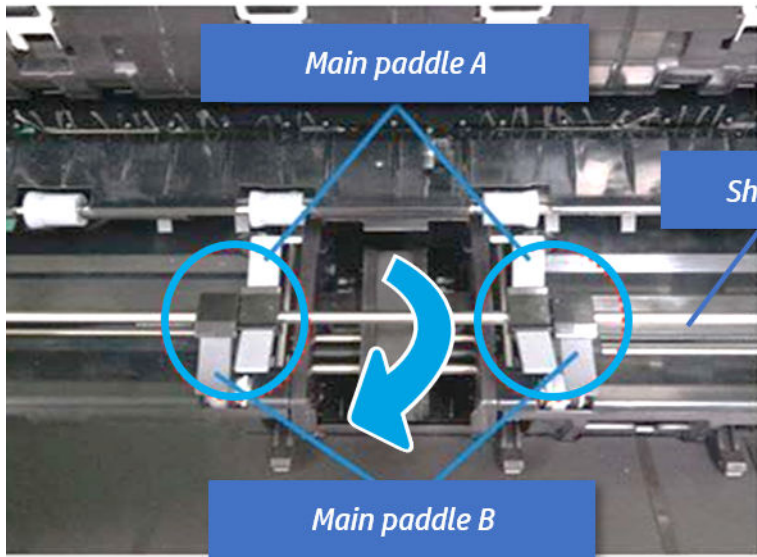

- c. Remove the main paddle by pushing both sides.

Figure 5-284 Remove the main paddle

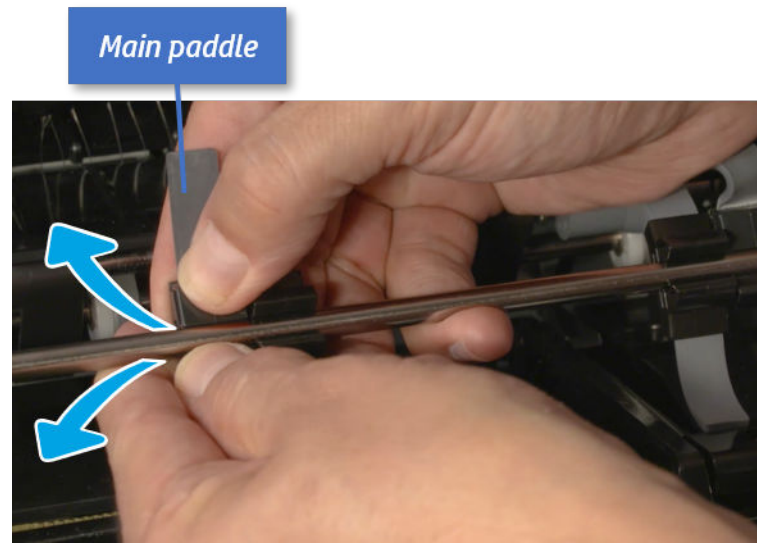

 **TIP:** When reassembling the main paddle, check the pin position of the paddle and the hole position of the shaft, and then assemble them.

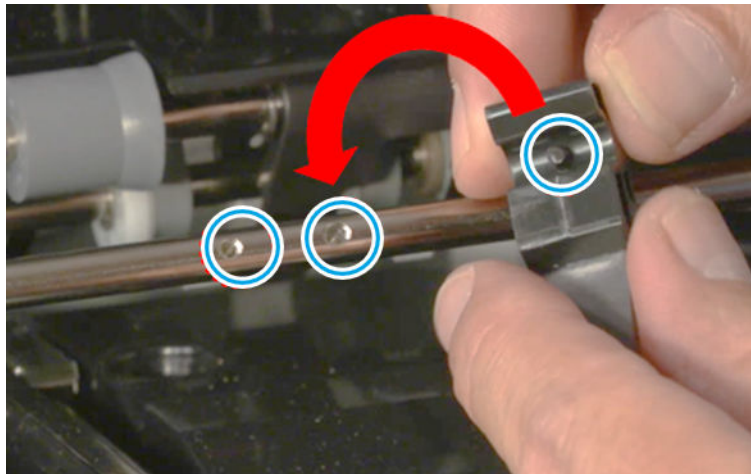

- 6. Remove the main paddle assembly.
 - a. Remove the belt in the front.

Figure 5-285 Remove the belt

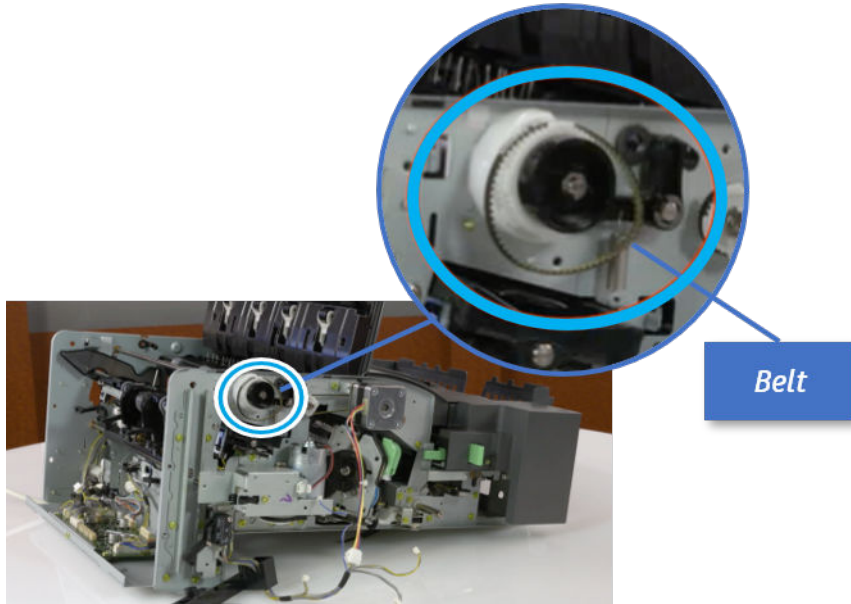

- b. Remove the e-ring and the main paddle CAM in the rear. And then remove the e-ring and the bushing.

Figure 5-286 Remove the e-ring, cam, and bushing

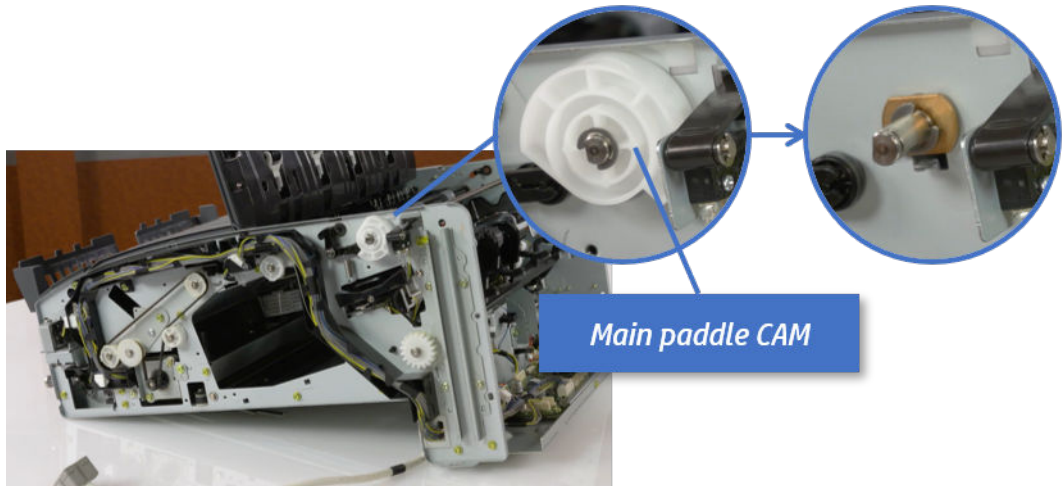

- c. Push the shaft to remove the main paddle shaft.

Figure 5-287 Remove the main paddle shaft

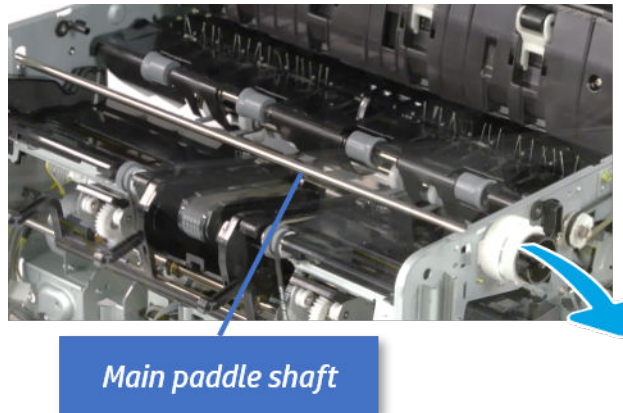

7. Unpack the replacement assembly.

- a. Dispose of the defective part.



NOTE: HP recommends responsible disposal of the defective part.

<http://www8.hp.com/us/en/hp-information/environment/product-recycling.html>

- b. Unpack the replacement part from the packaging.



CAUTION:  Some parts are sensitive to electrostatic discharge (ESD). Always perform service

work at an ESD-protected workstation or mat. If an ESD workstation or mat is not available, touch the sheet-metal chassis to provide a static ground before touching an ESD-sensitive assembly. Protect the ESD-sensitive assemblies by placing them in ESD pouches when they are out of the printer.

If the replacement part is a roller or pad, avoid touching the spongy part of it. Skin oils on the roller or pad can cause paper pickup and/or print-quality problems. HP recommends using disposable gloves when handling rollers or pads or washing your hands before touching rollers or pads.



IMPORTANT: Make sure that all of the shipping materials (for example shipping tape) are removed from the replacement part prior to installation.

- c. To install an assembly, reverse the removal steps.

When applicable, special installation instructions are provided for an assembly at the end of the removal procedure. Always completely read the removal instructions and follow all special installation instructions.

Removal and replacement: Sub paddle unit

Learn how to remove and replace the sub paddle unit.

To view teardown&reassembling video of the inner finisher, click the link below.



[View a teardown video of the inner finisher .](#)



[View a reassembling video of the inner finisher .](#)



IMPORTANT: When applicable, special installation instructions are provided for an assembly at the end of the removal procedure. Always completely read the removal instructions and follow all special installation instructions.

Mean time to repair:

Service level:

Before performing service

Turn the printer power off

- Press the power button on the front of the printer, and then turn off the power switch next to the power cable.
- A shutting-down message appears on the control-panel display.

⚠ WARNING! To avoid damage to the printer, turn the power off and wait until the printer shuts down before removing the power cable.

- Disconnect the printer power cable after the printer has completely shut down (the control-panel display is blank).

Use the table below to identify the correct part number for your printer. To order the part, go to <https://parts.hp.com>.

Table 5-49 Part information

Part number	Part description
JC90-01336A	Sub paddle unit

Required tools

- #2 JIS screwdriver with a magnetic tip

After performing service

Turn the printer power on

- Connect the power cable.
- Use the power switch to turn the power on.

Post service test

Print any pages necessary to verify that the repair resolved the issue and did not create any new issues.

1. Remove the rear cover.
 - a. Open the top cover.

Figure 5-288 Open the top cover

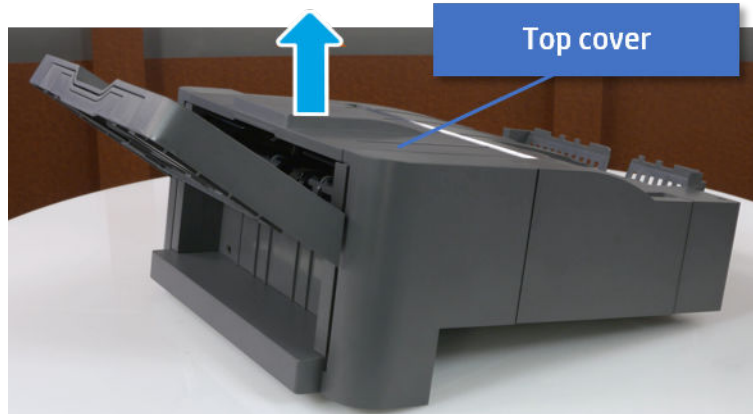

- b. Remove three screws.
- c. Release hooks carefully and remove the rear cover.

Figure 5-289 Remove the rear cover

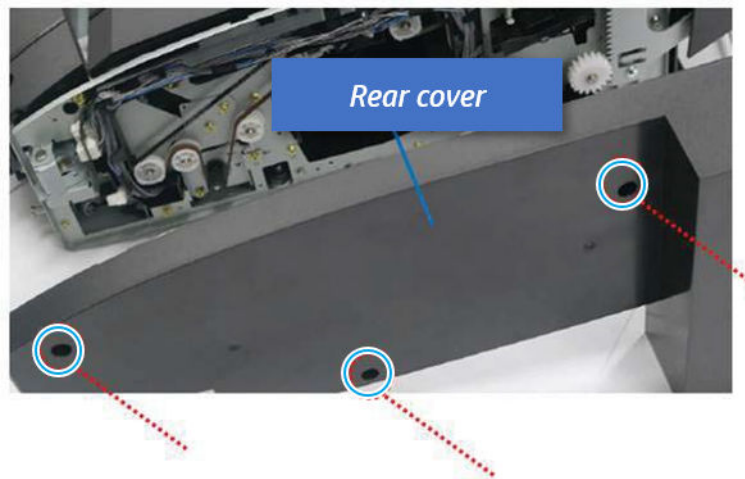

- 2. Remove the sub paddle unit.
 - a. Open the top cover, and then remove one screw securing the sub paddle unit.

Figure 5-290 Remove one screw

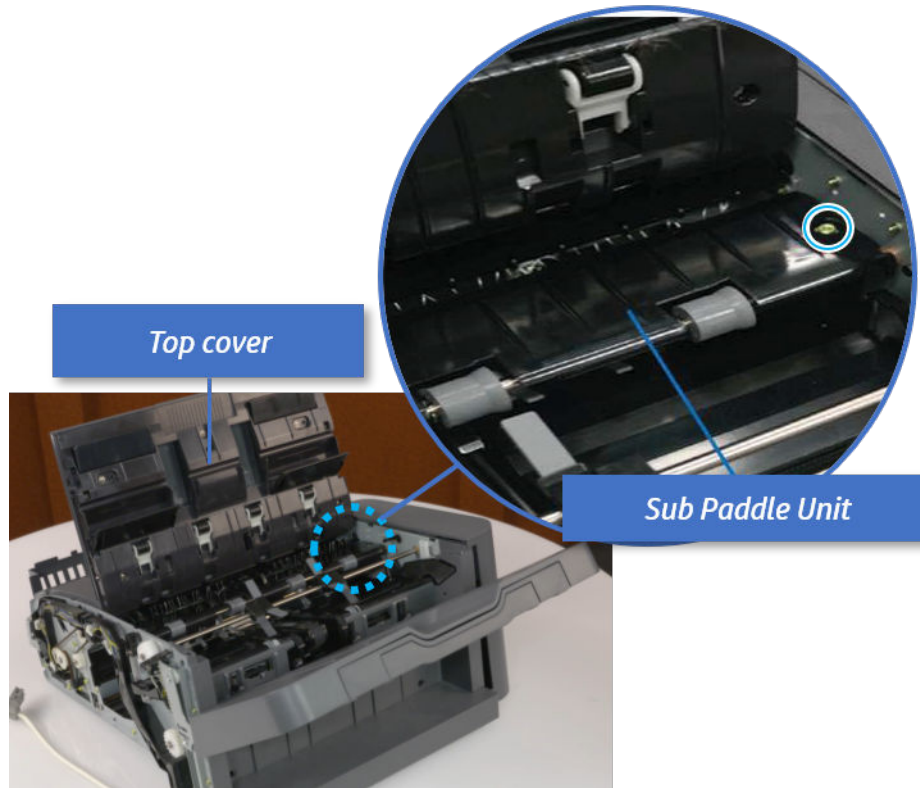

- b. Remove the e-ring, and then remove the pulley and timing belt. And then remove the e-ring and the bushing.

Figure 5-291 Remove the e-ring, pulley, timing belt, and bushing

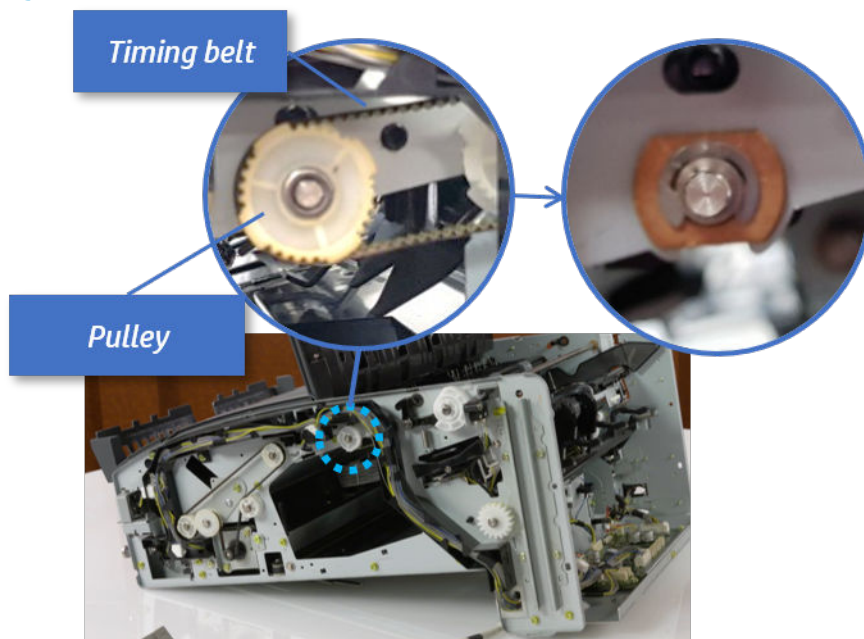

- c. Lift up and remove the sub paddle unit.

Figure 5-292 Remove the sub paddle unit

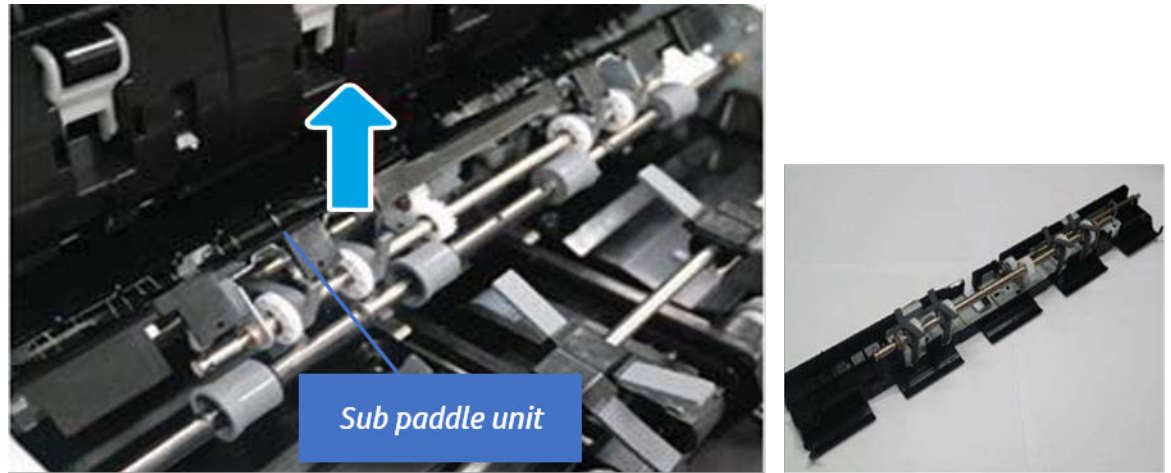

3. Unpack the replacement assembly.

- a. Dispose of the defective part.



NOTE: HP recommends responsible disposal of the defective part.

<http://www8.hp.com/us/en/hp-information/environment/product-recycling.html>

- b. Unpack the replacement part from the packaging.



CAUTION:  Some parts are sensitive to electrostatic discharge (ESD). Always perform service work at an ESD-protected workstation or mat. If an ESD workstation or mat is not available, touch the sheet-metal chassis to provide a static ground before touching an ESD-sensitive assembly. Protect the ESD-sensitive assemblies by placing them in ESD pouches when they are out of the printer.

If the replacement part is a roller or pad, avoid touching the spongy part of it. Skin oils on the roller or pad can cause paper pickup and/or print-quality problems. HP recommends using disposable gloves when handling rollers or pads or washing your hands before touching rollers or pads.



IMPORTANT: Make sure that all of the shipping materials (for example shipping tape) are removed from the replacement part prior to installation.

- c. To install an assembly, reverse the removal steps.

When applicable, special installation instructions are provided for an assembly at the end of the removal procedure. Always completely read the removal instructions and follow all special installation instructions.

Tamper unit

Front tamper

Removal and replacement: Front tamper

Learn how to remove and replace the front tamper.

To view teardown&reassembling video of the inner finisher, click the link below.

 [View a teardown video of the inner finisher .](#)

 [View a reassembling video of the inner finisher .](#)

 **IMPORTANT:** When applicable, special installation instructions are provided for an assembly at the end of the removal procedure. Always completely read the removal instructions and follow all special installation instructions.

Mean time to repair:

Service level:

Before performing service

Turn the printer power off

- Press the power button on the front of the printer, and then turn off the power switch next to the power cable.
- A shutting-down message appears on the control-panel display.

 **WARNING!** To avoid damage to the printer, turn the power off and wait until the printer shuts down before removing the power cable.

- Disconnect the printer power cable after the printer has completely shut down (the control-panel display is blank).

Use the table below to identify the correct part number for your printer. To order the part, go to <https://parts.hp.com>.

Table 5-50 Part information

Part number	Part description
JC82-00899A	Front tamper

Required tools

- #2 JIS screwdriver with a magnetic tip

After performing service

Turn the printer power on

- Connect the power cable.
- Use the power switch to turn the power on.

Post service test

Print any pages necessary to verify that the repair resolved the issue and did not create any new issues.

1. Remove the front cover.
 - a. Open the front door and open the punch cover.
 - b. Remove three screws in the front.
 - c. Remove the lever.
 - d. Open the top cover.
 - e. From the right side of the front cover, carefully lift and pry toward the top-left corner to remove the front cover.

Figure 5-293 Remove the front cover

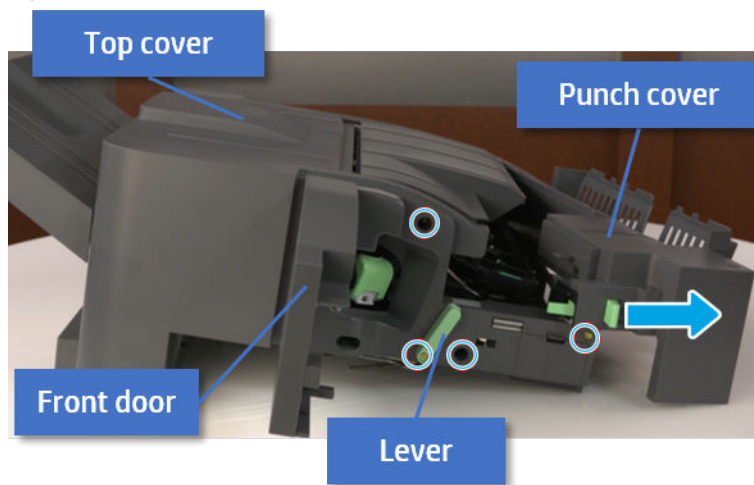

2. Remove the rear cover.
 - a. Open the top cover.

Figure 5-294 Open the top cover

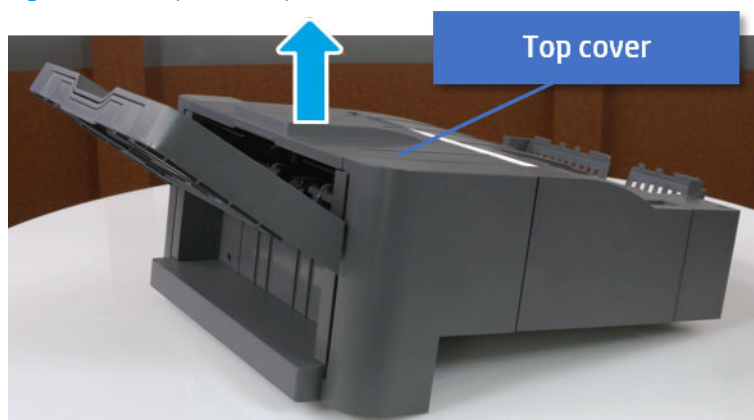

- b. Remove three screws.

- c. Release hooks carefully and remove the rear cover.

Figure 5-295 Remove the rear cover

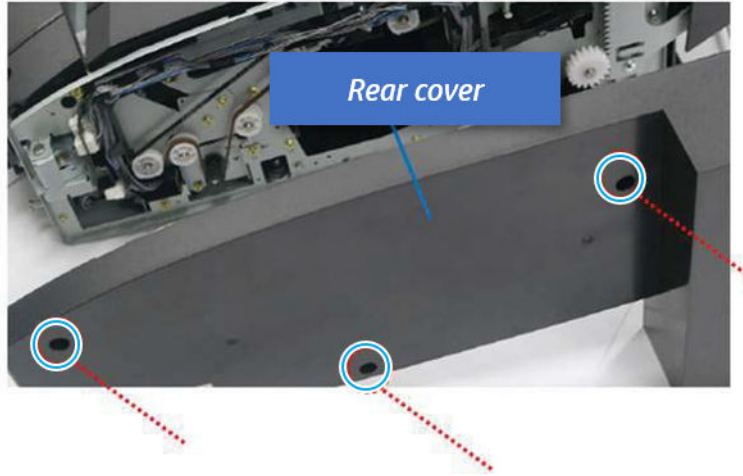

- 3. Remove the output tray.

- a. Remove four screws.

Figure 5-296 Remove four screws

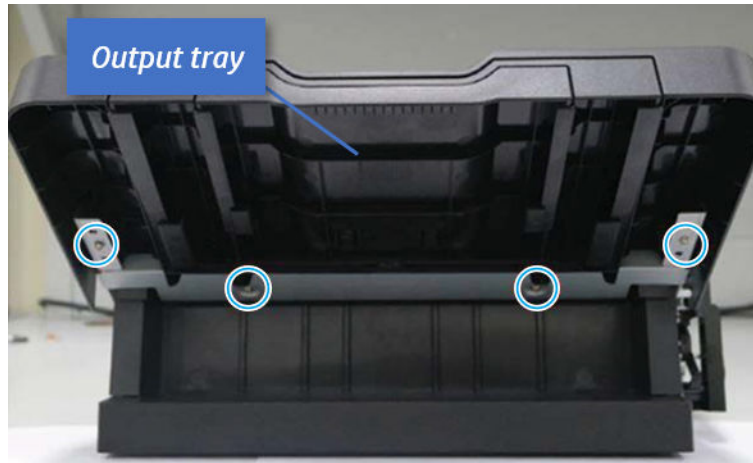

- b. Push the paper holding actuator into the inner finisher, and then remove the output tray.

Figure 5-297 Remove the output tray.



- 4. Remove the output tray frame.
 - a. Rotate the pulley until the output tray frame depart from the gear.

Figure 5-298 Remove the pulley

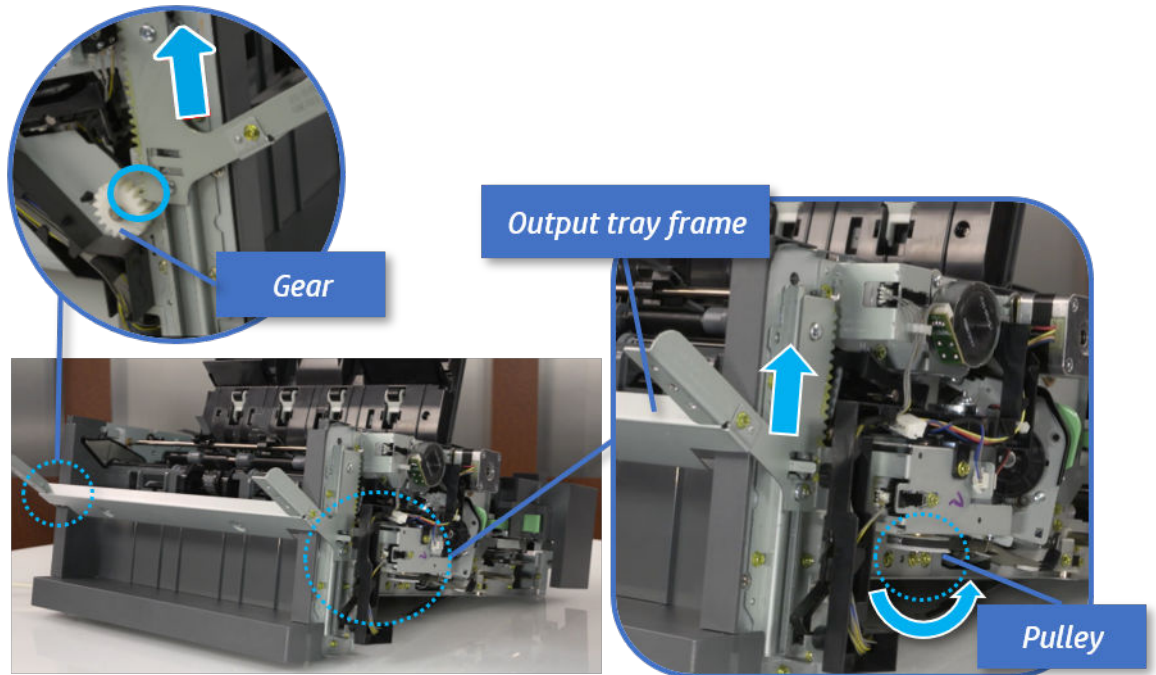

- b. Push the paper holding actuator into the inner finisher, and then remove the output tray frame.

Figure 5-299 Remove the output tray frame

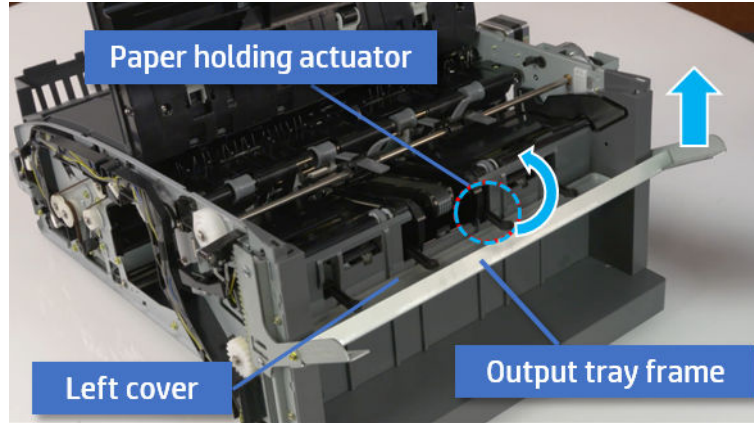

TIP: Push the paper holding actuator into the inner finisher when reassembling. Be sure to level the output tray.

1. Position the first wheel into the channel on both sides while pushing the paper holding actuator.

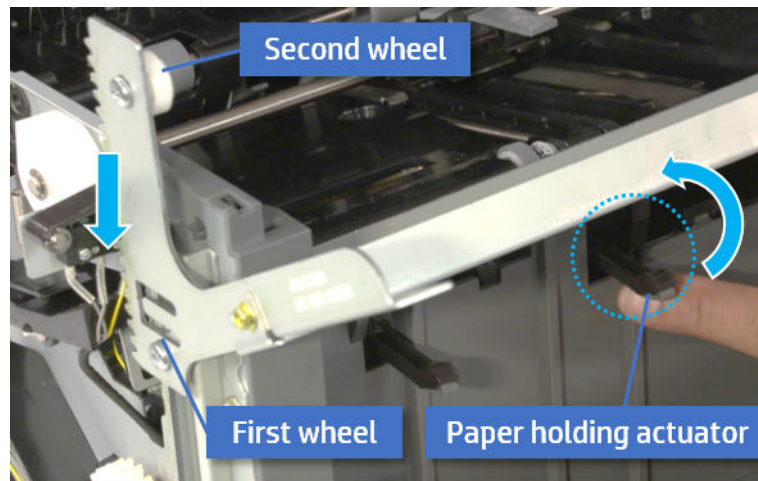

2. Let the second wheel rest on the channel on both sides simultaneously.
3. Gently squeeze the wheels into channel until the output tray frame meet the gear.

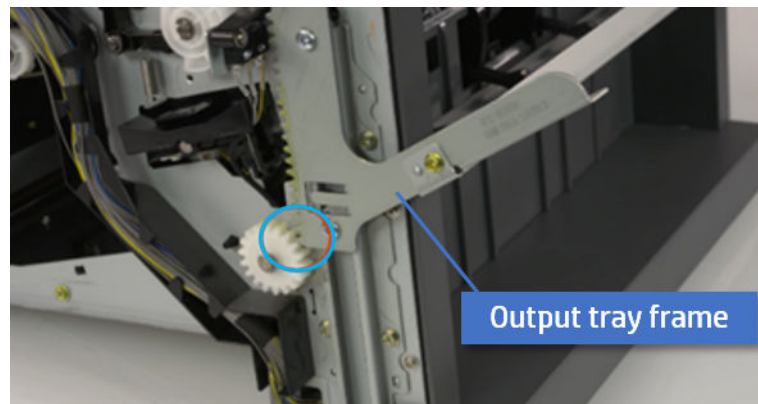

4. Rotate the pulley until the output tray frame is no longer lifted. It can make to level the output tray frame.

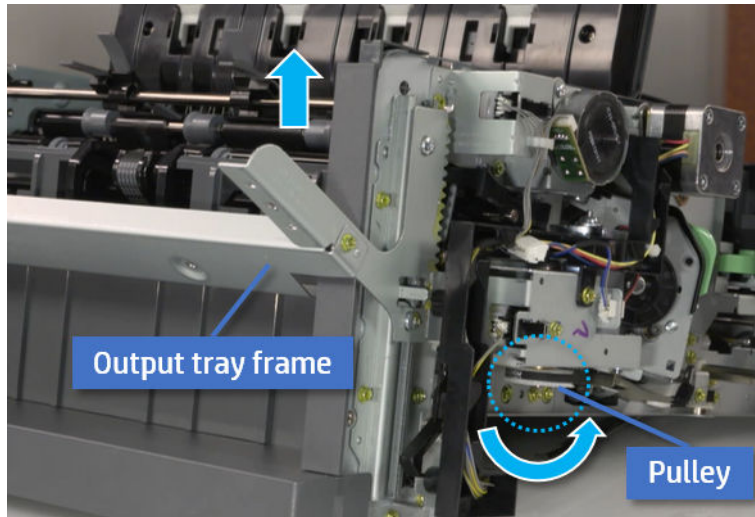

5. Rotate the pulley in the opposite direction.

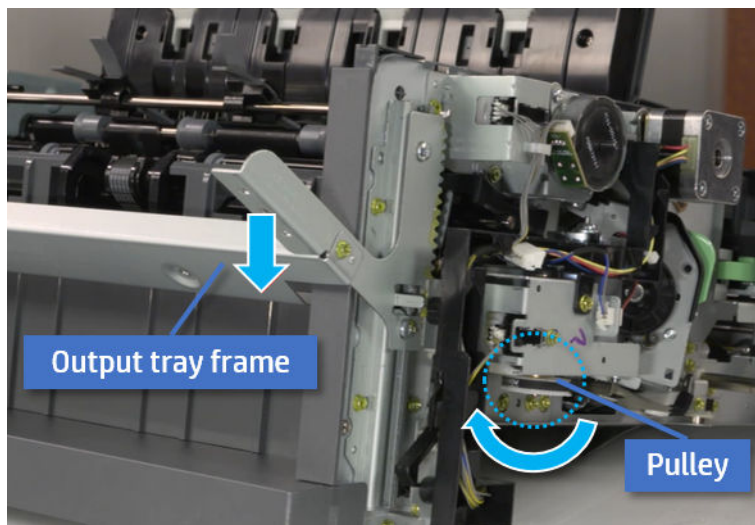

5. Remove the PCA cover.
 - ▲ Remove two screws, and then remove the PCA cover.

Figure 5-300 Remove the PCA cover

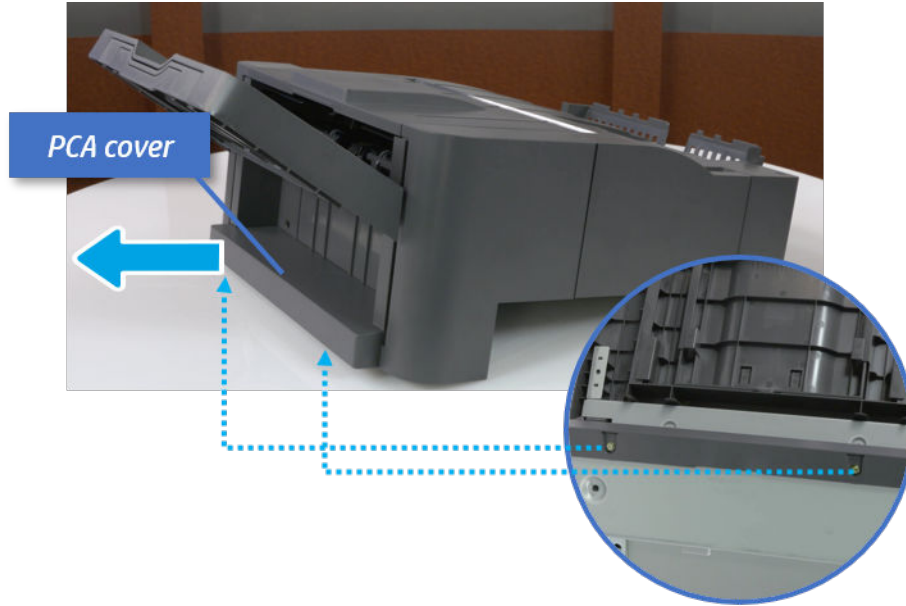

6. Remove the left cover.
 - a. Remove two screws.

Figure 5-301 Remove two screws

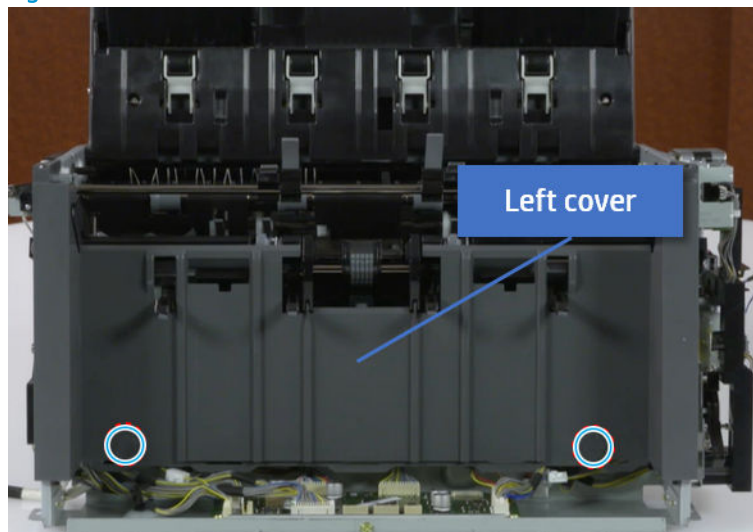

- b. Remove four screws from both front and rear sides.

Figure 5-302 Remove four screws

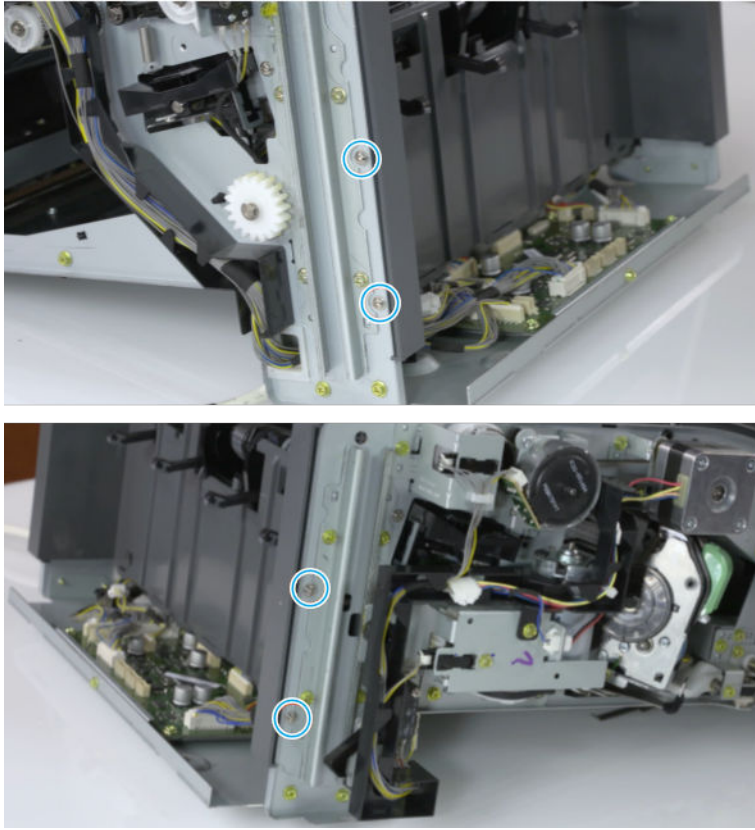

- c. Unplug two inline connectors, and then remove the left cover.

Figure 5-303 Unplug two connectors

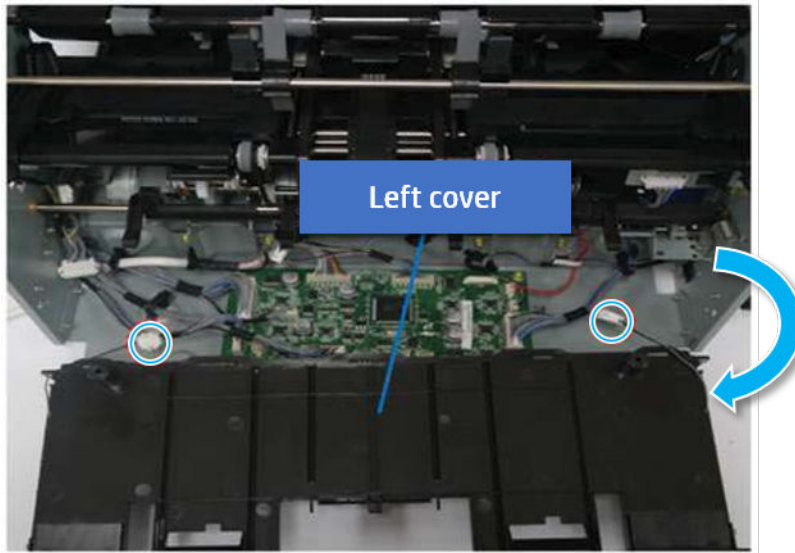

 **TIP:** Be sure to check the hook when reassembling.

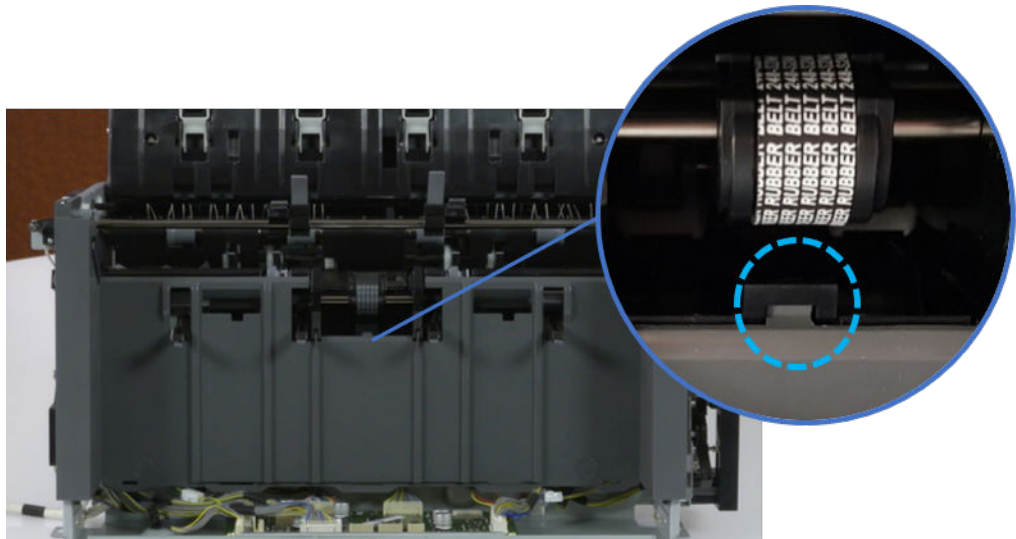

- 7. Remove the front harness guide.
 - a. Open one clamp and unplug five connectors, and then remove the wire harness from the front harness guide.

- b. Remove four screws, and then remove the front harness guide.

Figure 5-304 Remove the front harness guide

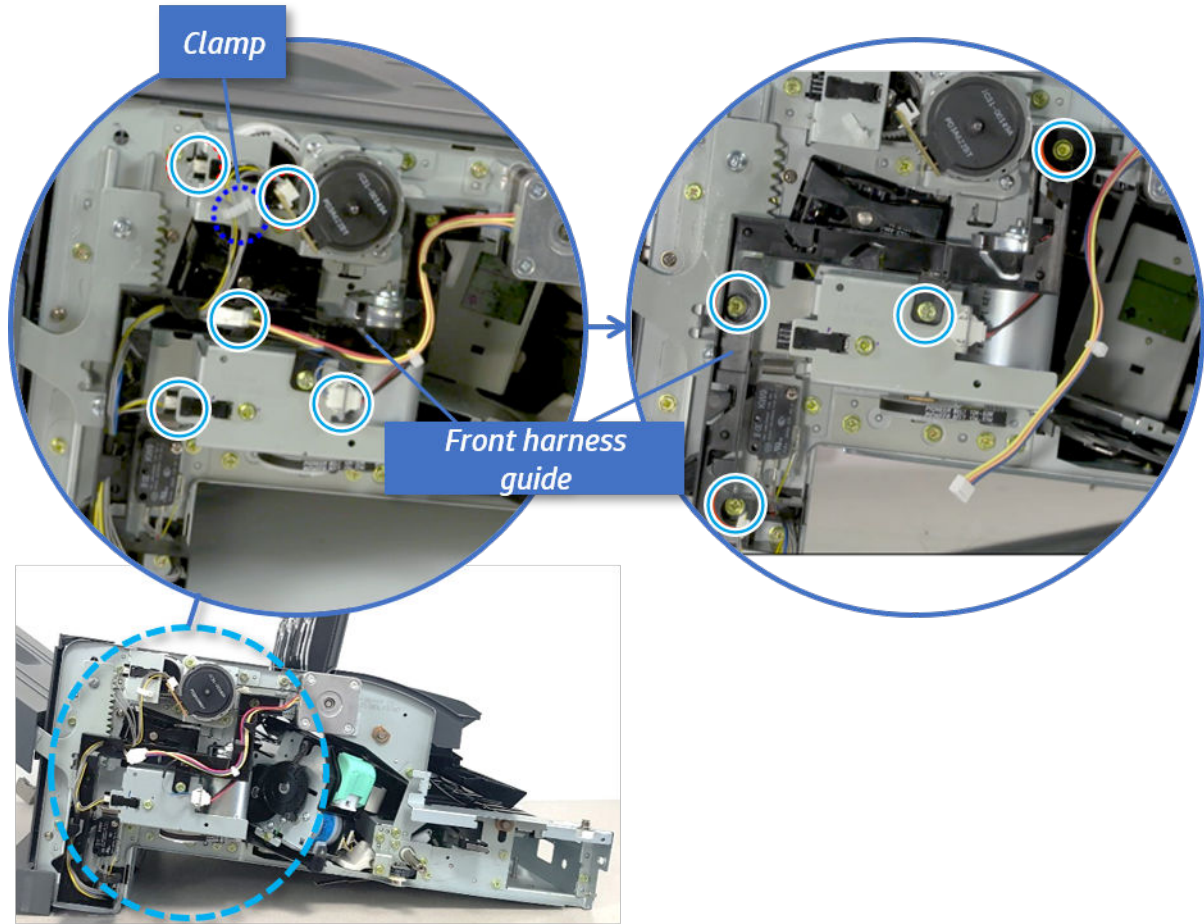

8. Remove the output tray motor assembly.
- ▲ Remove three screws, and then remove the output tray motor assembly.

Figure 5-305 Remove the output tray motor assembly

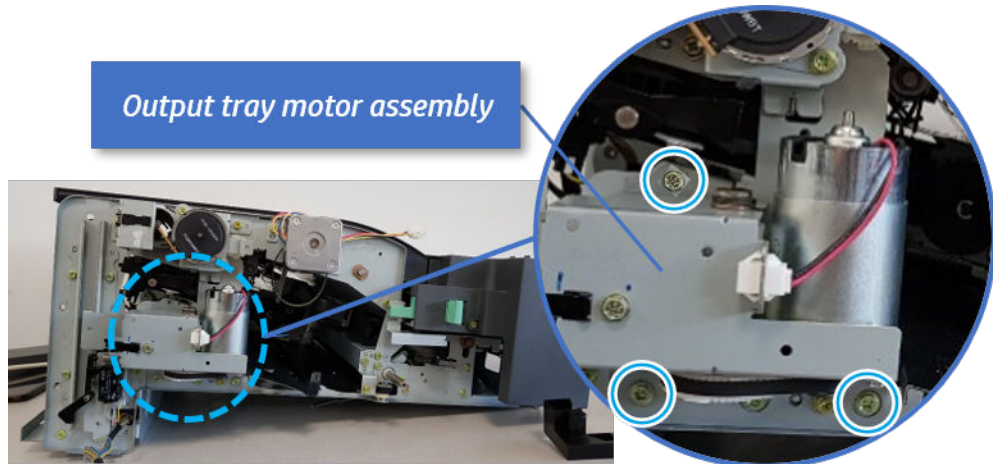

9. Remove the output tray lower limit switch.

- ▲ Remove one screw, and then remove the output tray lower limit switch.

Figure 5-306 Remove the output tray lower limit switch

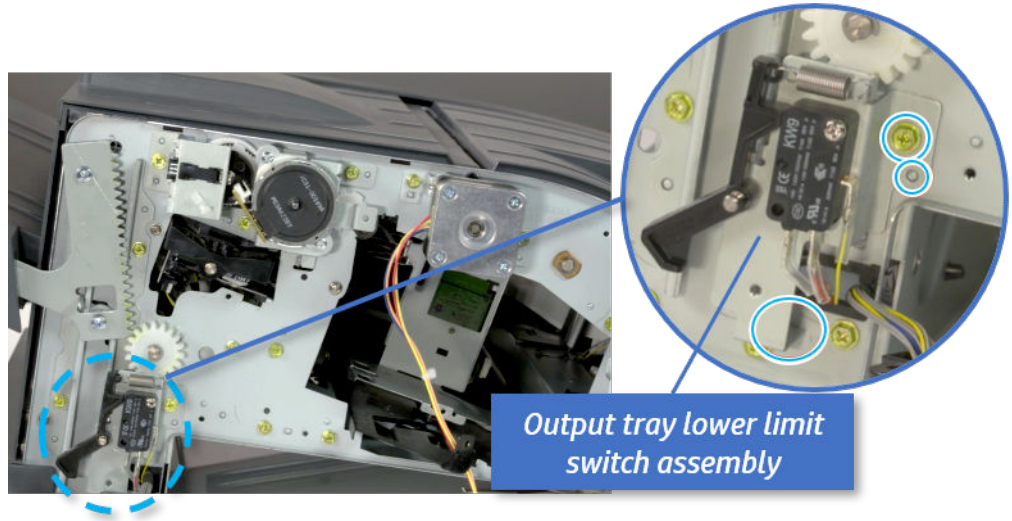

10. Remove the paper holding.

- a. Remove the paper holding actuator spring.

Figure 5-307 Remove the paper holding actuator spring

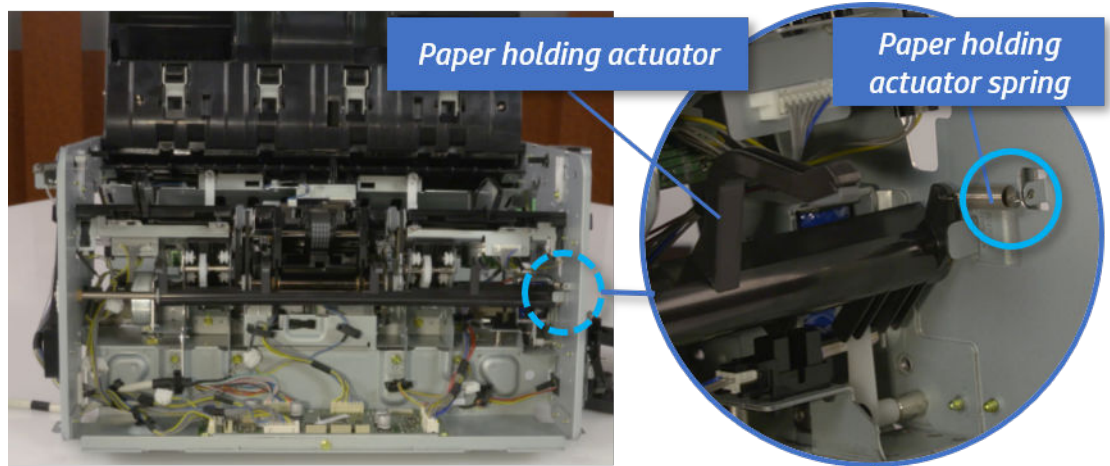

- b. Remove the e-ring and the rack pinion gear. And then remove the pin and the e-ring, and then remove the bushing.

Figure 5-308 Remove e-ring, rack pinion gear, pin, and bushing

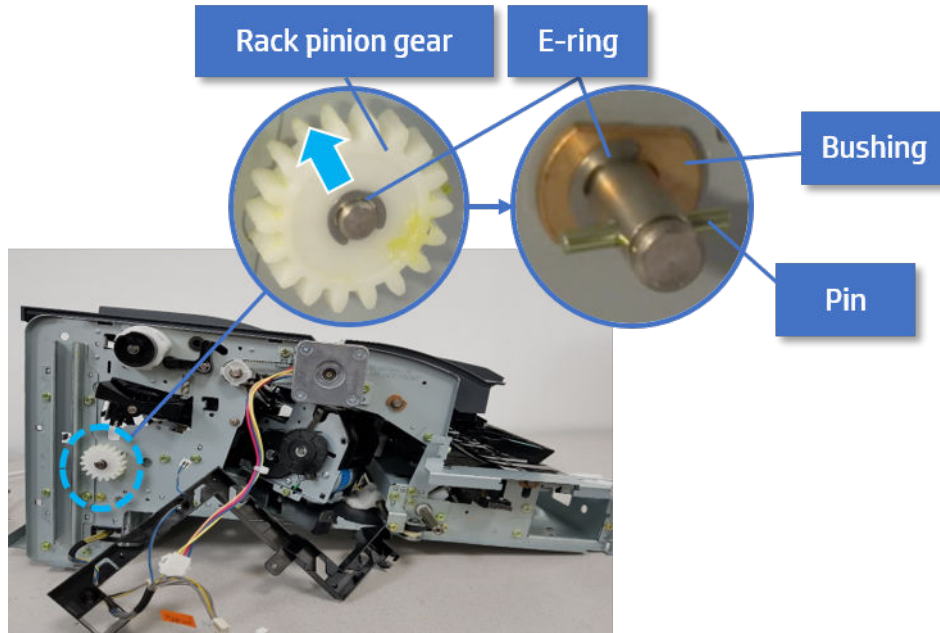

 **NOTE:** Be sure not to lose the pin.

- c. Carefully remove the paper holding shaft and the actuator.

Figure 5-309 Remove the paper holding shaft and the actuator

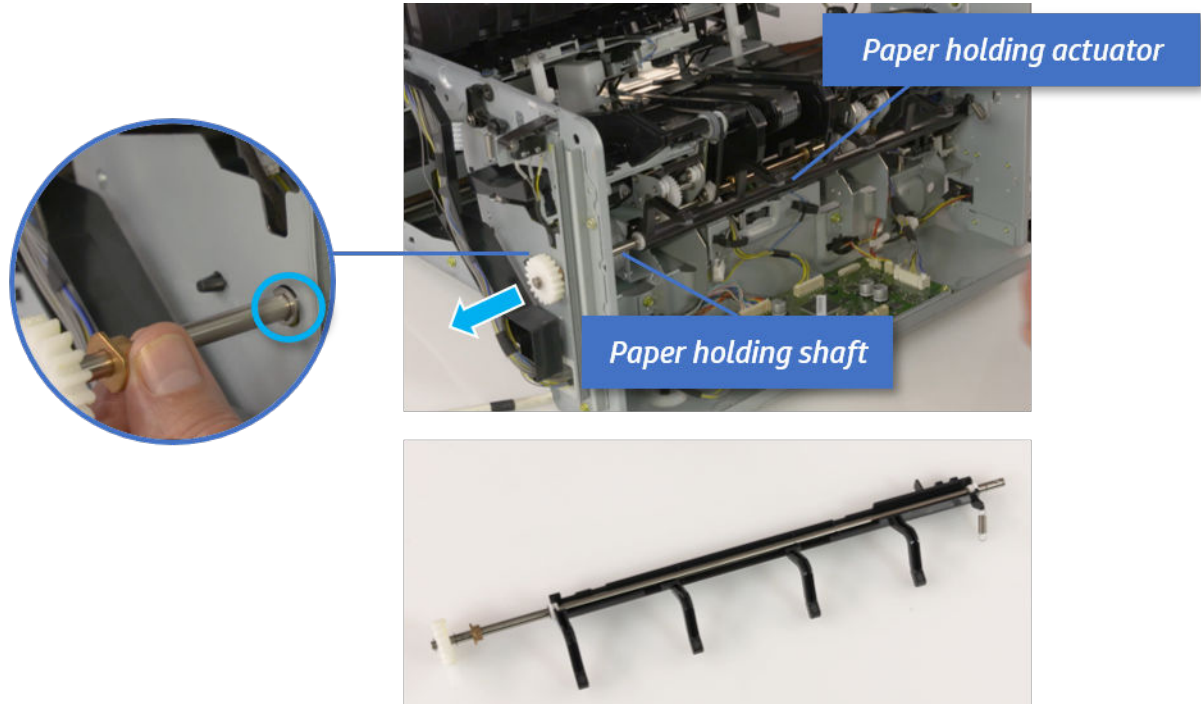

11. Remove the sub paddle unit.

- a. Open the top cover, and then remove one screw securing the sub paddle unit.

Figure 5-310 Remove one screw

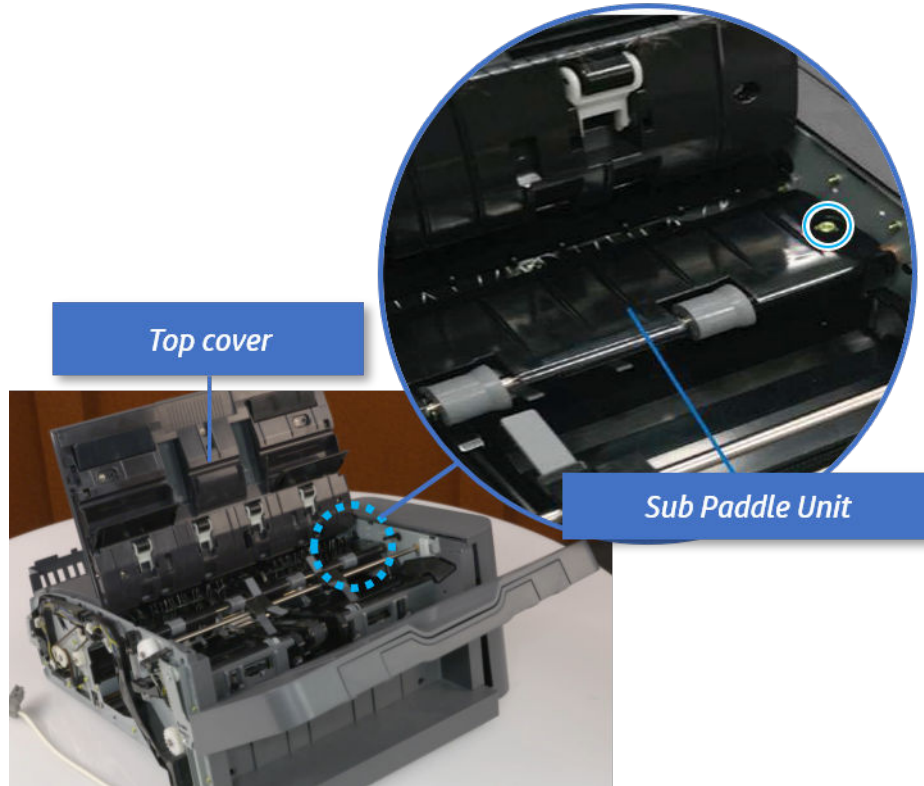

- b. Remove the e-ring, and then remove the pulley and timing belt. And then remove the e-ring and the bushing.

Figure 5-311 Remove the e-ring, pulley, timing belt, and bushing

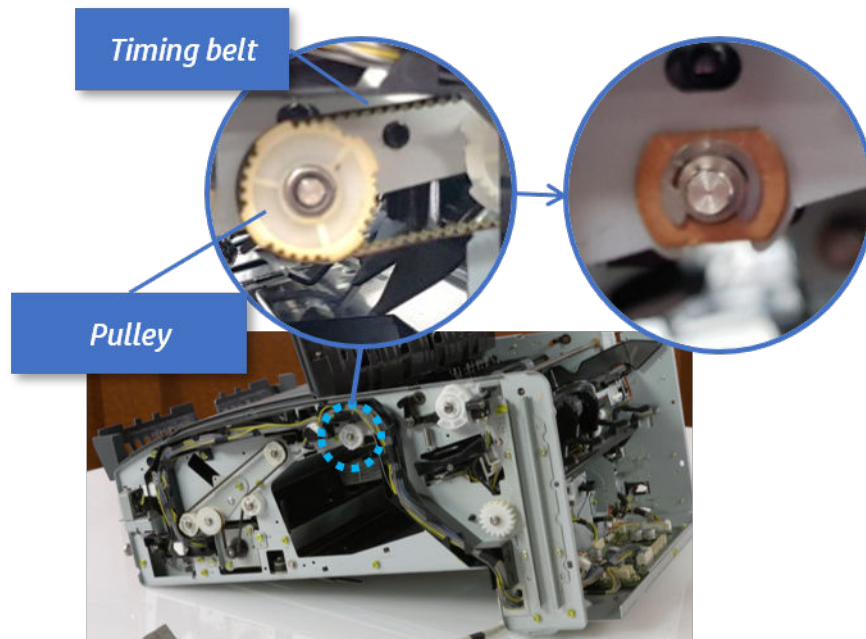

- c. Lift up and remove the sub paddle unit.

Figure 5-312 Remove the sub paddle unit

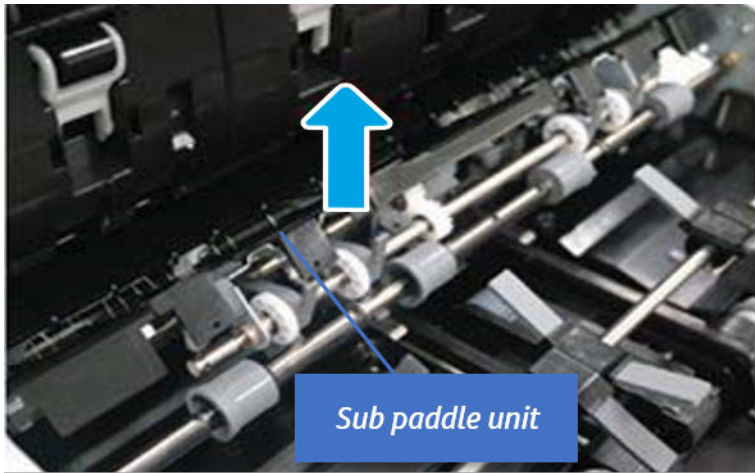

- 12. Remove the exit roller.

- a. Remove the guide on the center of the exit roller.

Figure 5-313 Remove the guide

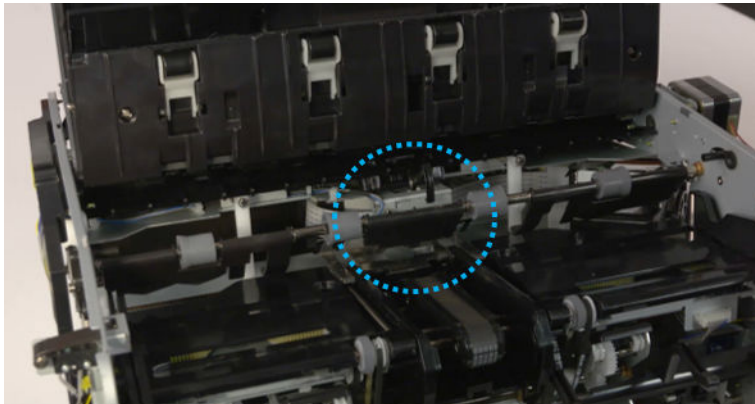

- b. On the front of the inner finisher, release the timing belt connected to the exit motor.

Figure 5-314 Release the timing belt

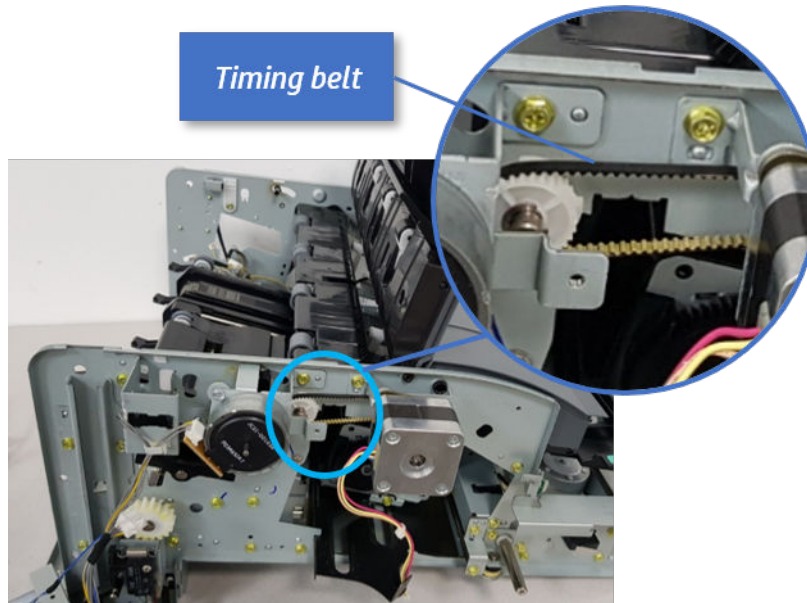

- c. Remove five screws securing the rear harness guide.

Figure 5-315 Remove five screws

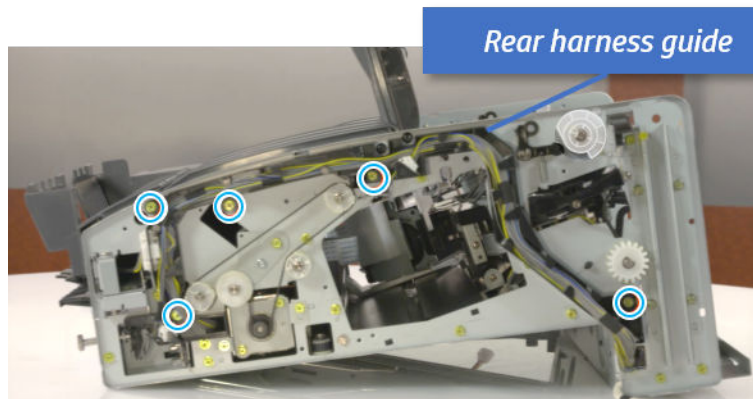

- d. On the rear of the inner finisher, remove the e-ring and the pulley and then remove the e-ring and the bushing.

Figure 5-316 Remove e-ring, pulley, and bushing

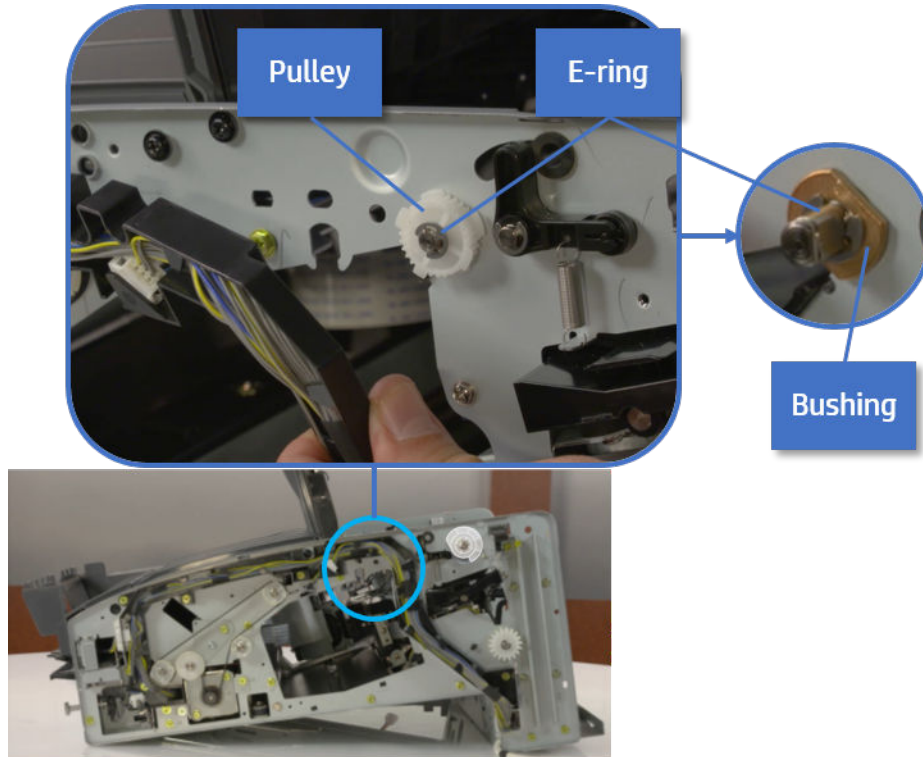

- e. Push the bushing to detach it, and then remove the exit roller.

Figure 5-317 Remove the exit roller

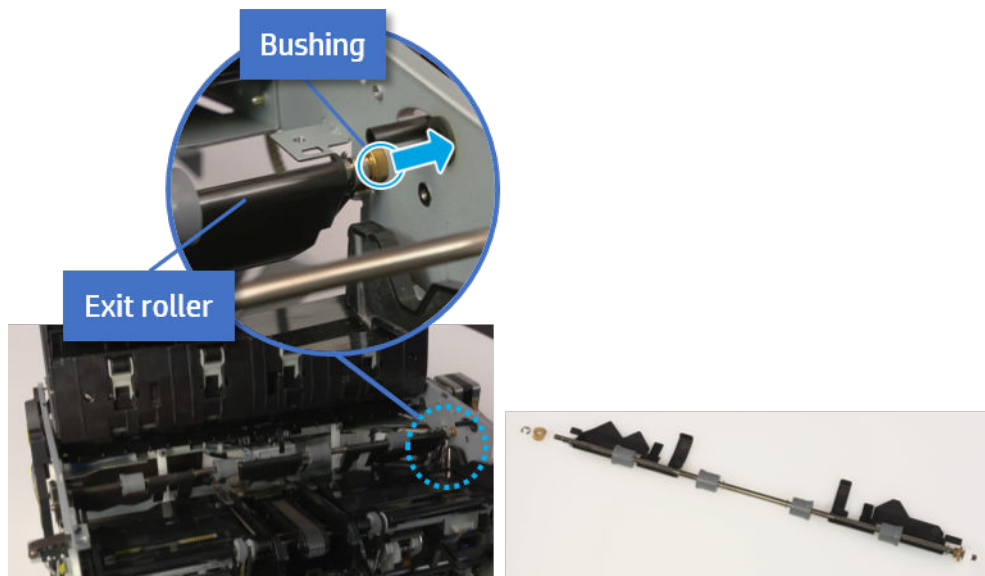

- 13. Remove the front tamper.
 - a. Remove four screws.

Figure 5-318 Remove four screws

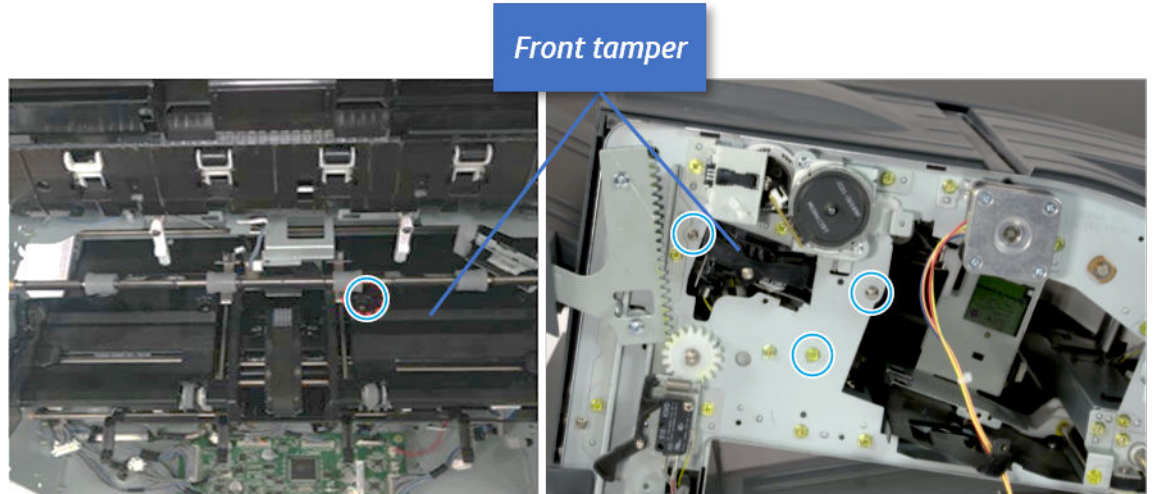

- b. Unplug the connector and release the hook, and then pull the front tamper up to remove.

Figure 5-319 Remove the front tamper

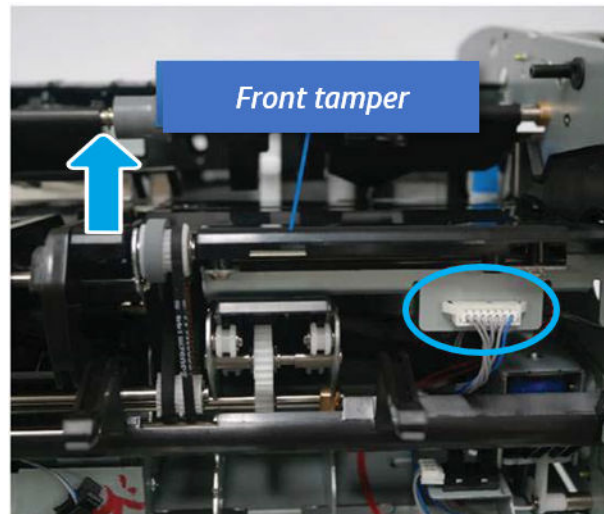



- 14. Unpack the replacement assembly.
 - a. Dispose of the defective part.

 **NOTE:** HP recommends responsible disposal of the defective part.

<http://www8.hp.com/us/en/hp-information/environment/product-recycling.html>

b. Unpack the replacement part from the packaging.

 **CAUTION:**  Some parts are sensitive to electrostatic discharge (ESD). Always perform service work at an ESD-protected workstation or mat. If an ESD workstation or mat is not available, touch the sheet-metal chassis to provide a static ground before touching an ESD-sensitive assembly. Protect the ESD-sensitive assemblies by placing them in ESD pouches when they are out of the printer.

If the replacement part is a roller or pad, avoid touching the spongy part of it. Skin oils on the roller or pad can cause paper pickup and/or print-quality problems. HP recommends using disposable gloves when handling rollers or pads or washing your hands before touching rollers or pads.

 **IMPORTANT:** Make sure that all of the shipping materials (for example shipping tape) are removed from the replacement part prior to installation.

c. To install an assembly, reverse the removal steps.

When applicable, special installation instructions are provided for an assembly at the end of the removal procedure. Always completely read the removal instructions and follow all special installation instructions.

Removal and replacement: Front tamper home sensor (S5)

Learn how to remove and replace the front tamper home sensor.

To view teardown&reassembling video of the inner finisher, click the link below.

 [View a teardown video of the inner finisher .](#)

 [View a reassembling video of the inner finisher .](#)

 **IMPORTANT:** When applicable, special installation instructions are provided for an assembly at the end of the removal procedure. Always completely read the removal instructions and follow all special installation instructions.

Mean time to repair:

Service level:

Before performing service

Turn the printer power off

- Press the power button on the front of the printer, and then turn off the power switch next to the power cable.
- A shutting-down message appears on the control-panel display.

 **WARNING!** To avoid damage to the printer, turn the power off and wait until the printer shuts down before removing the power cable.

- Disconnect the printer power cable after the printer has completely shut down (the control-panel display is blank).

Use the table below to identify the correct part number for your printer. To order the part, go to <https://parts.hp.com>.

Table 5-51 Part information

Part number	Part description
0604-001393	Front tamper home sensor

Required tools

- #2 JIS screwdriver with a magnetic tip

After performing service

Turn the printer power on

- Connect the power cable.
- Use the power switch to turn the power on.

Post service test

Print any pages necessary to verify that the repair resolved the issue and did not create any new issues.

1. Remove the front cover.
 - a. Open the front door and open the punch cover.
 - b. Remove three screws in the front.
 - c. Remove the lever.
 - d. Open the top cover.
 - e. From the right side of the front cover, carefully lift and pry toward the top-left corner to remove the front cover.

Figure 5-320 Remove the front cover

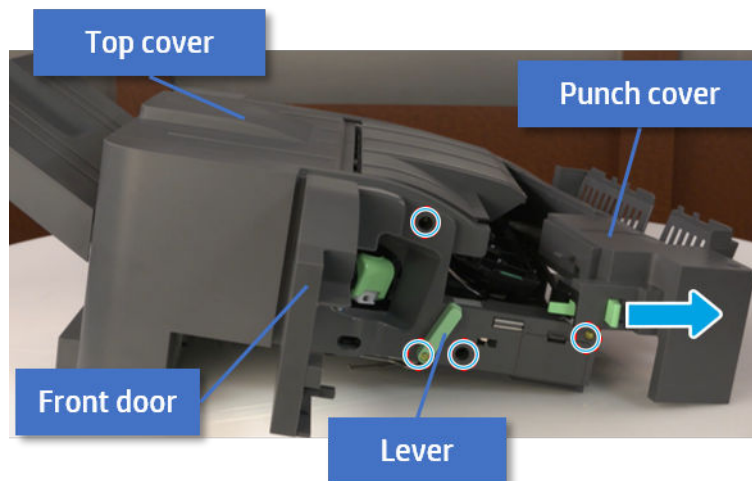

2. Remove the rear cover.

- a. Open the top cover.

Figure 5-321 Open the top cover

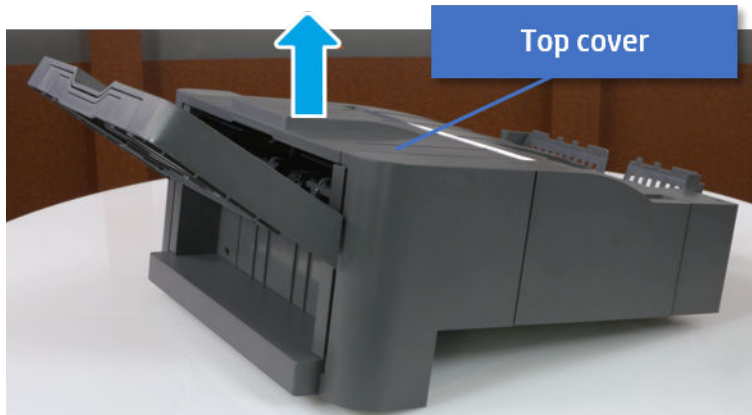

- b. Remove three screws.
- c. Release hooks carefully and remove the rear cover.

Figure 5-322 Remove the rear cover

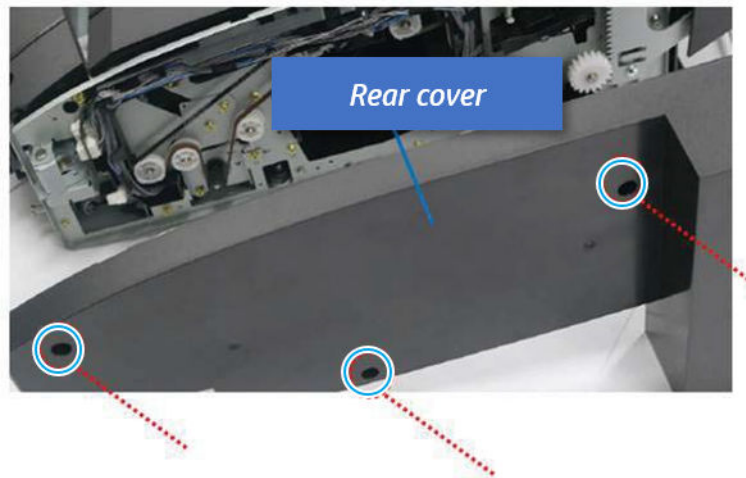

3. Remove the output tray.
 - a. Remove four screws.

Figure 5-323 Remove four screws

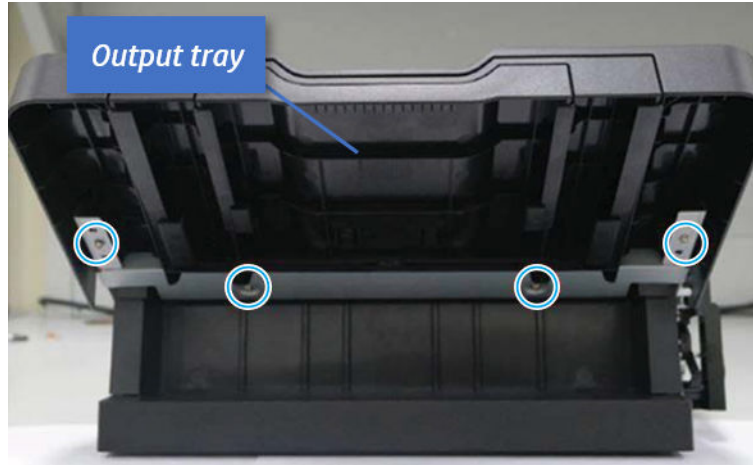

- b. Push the paper holding actuator into the inner finisher, and then remove the output tray.

Figure 5-324 Remove the output tray.



4. Remove the output tray frame.
 - a. Rotate the pulley until the output tray frame depart from the gear.

Figure 5-325 Remove the pulley

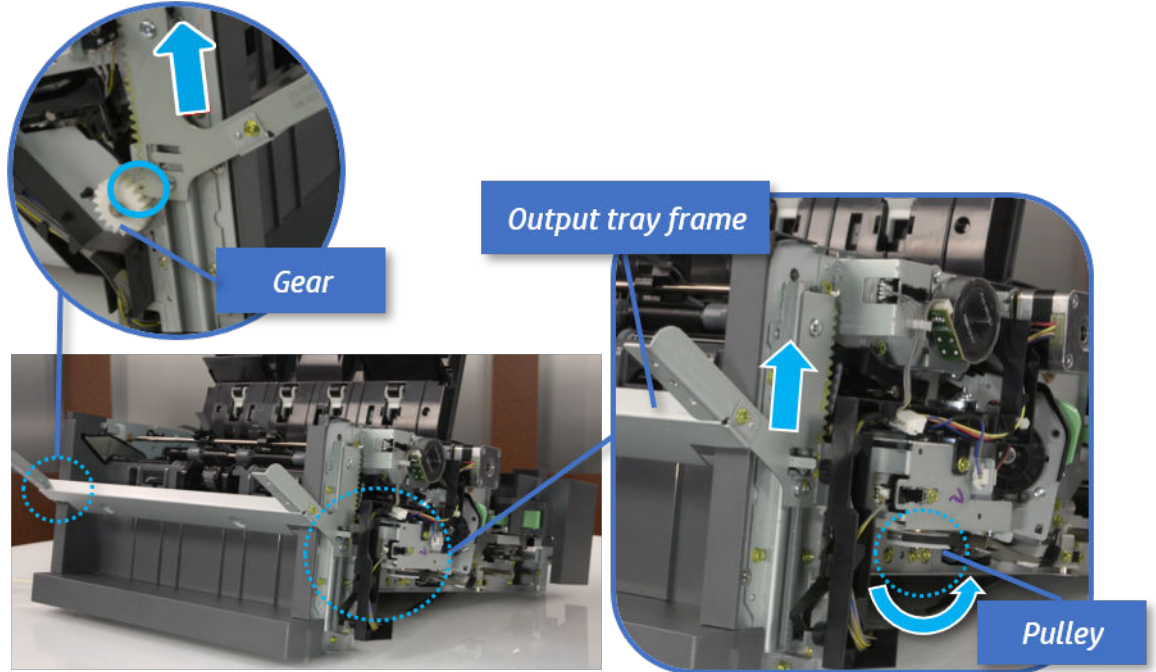

- b. Push the paper holding actuator into the inner finisher, and then remove the output tray frame.

Figure 5-326 Remove the output tray frame

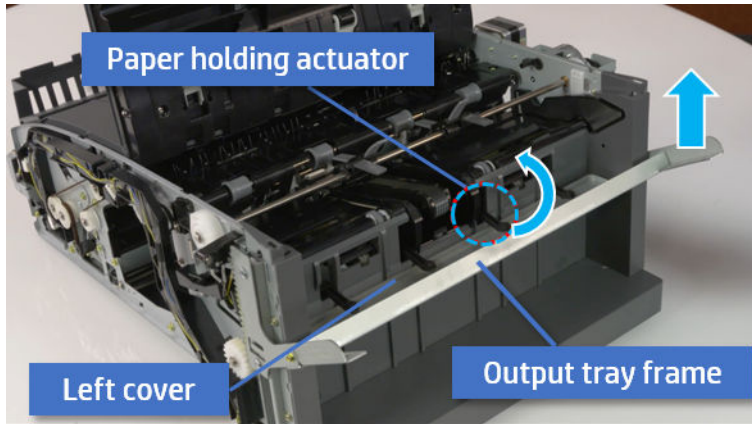

TIP: Push the paper holding actuator into the inner finisher when reassembling. Be sure to level the output tray.

1. Position the first wheel into the channel on both sides while pushing the paper holding actuator.

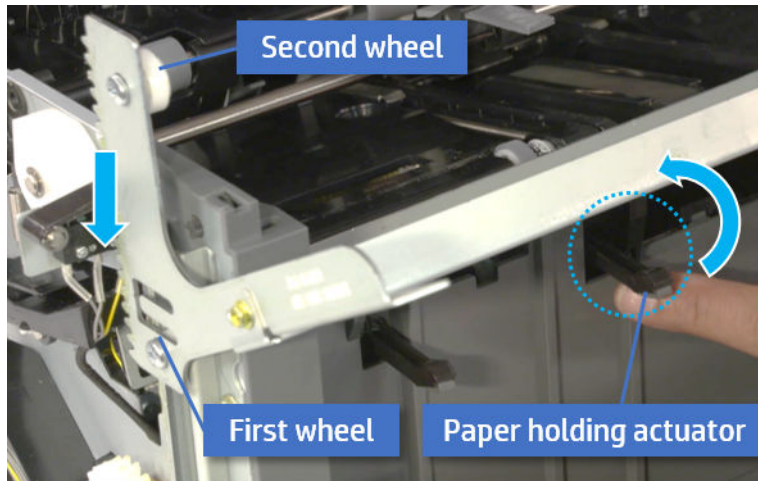

2. Let the second wheel rest on the channel on both sides simultaneously.
3. Gently squeeze the wheels into channel until the output tray frame meet the gear.

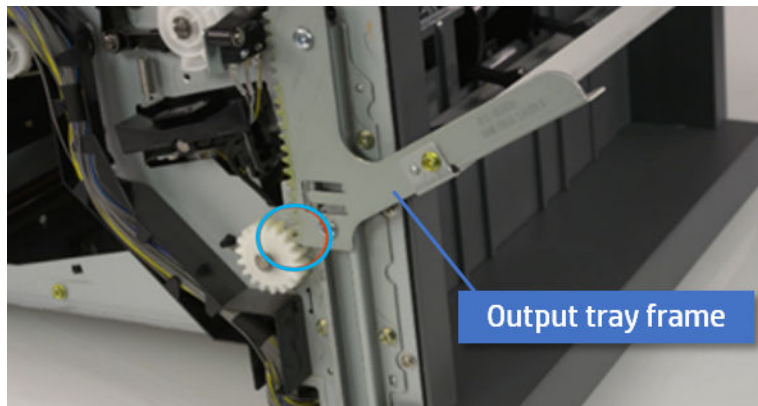

4. Rotate the pulley until the output tray frame is no longer lifted. It can make to level the output tray frame.

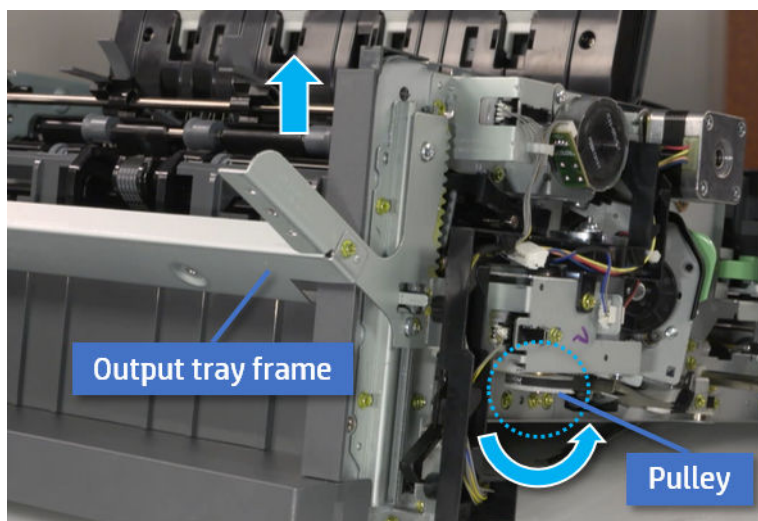

5. Rotate the pulley in the opposite direction.

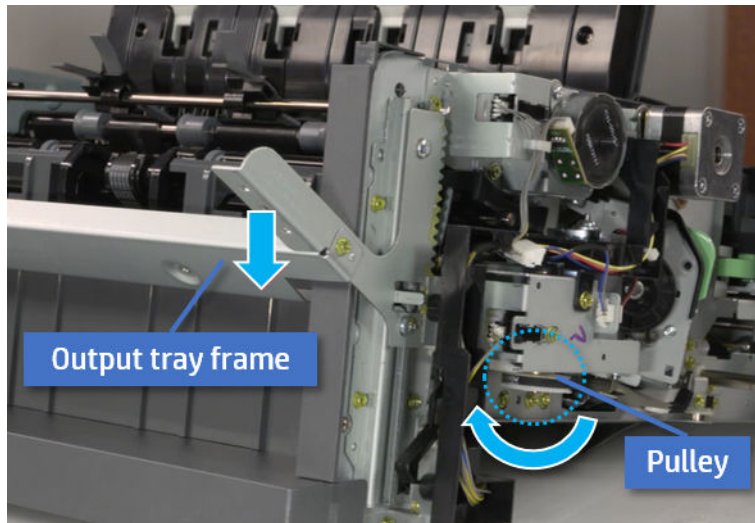

5. Remove the PCA cover.
 - ▲ Remove two screws, and then remove the PCA cover.

Figure 5-327 Remove the PCA cover

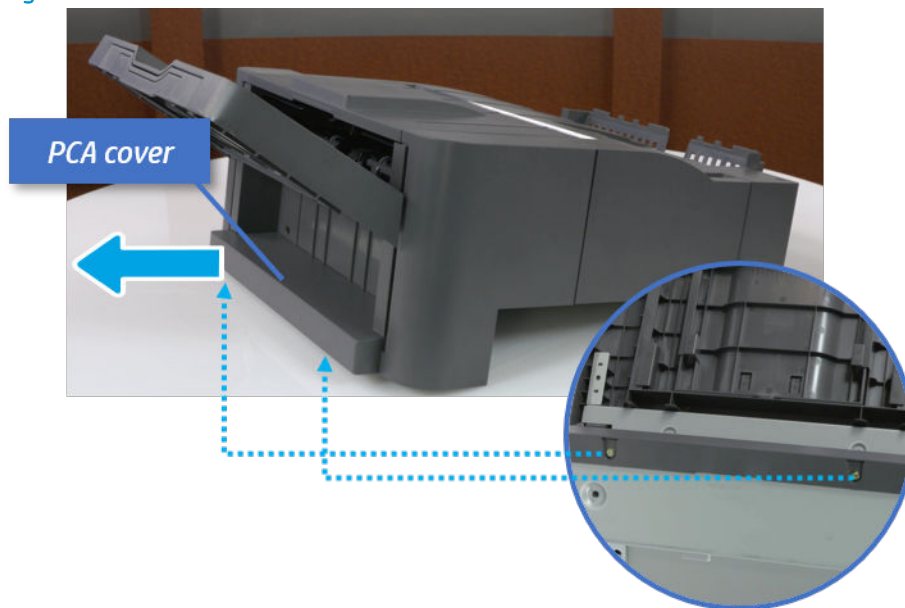

6. Remove the left cover.
 - a. Remove two screws.

Figure 5-328 Remove two screws

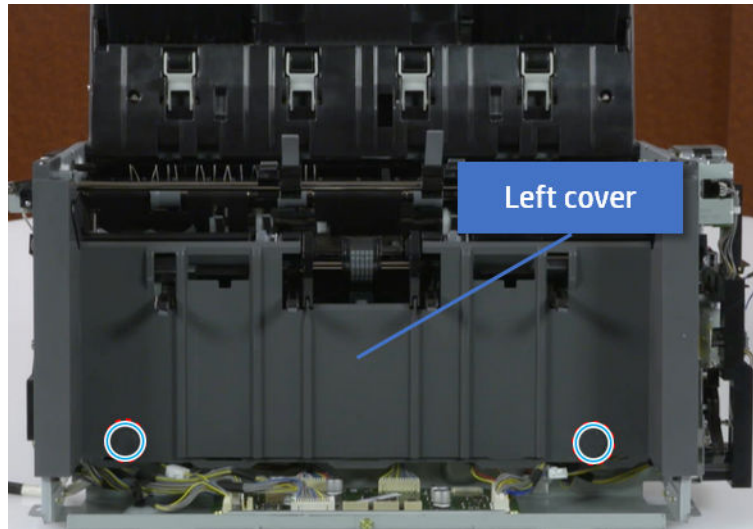

- b. Remove four screws from both front and rear sides.

Figure 5-329 Remove four screws

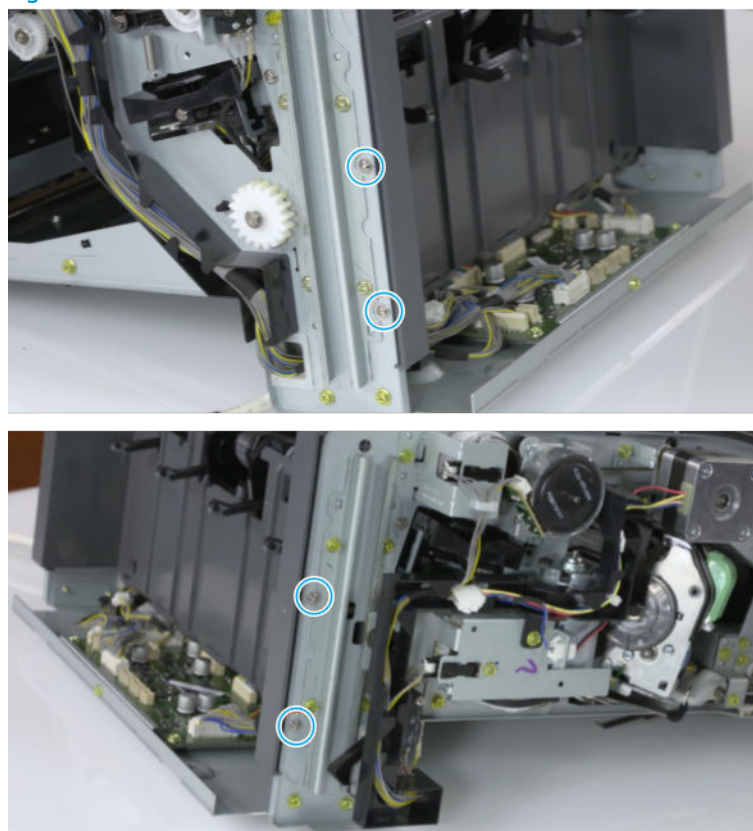

- c. Unplug two inline connectors, and then remove the left cover.

Figure 5-330 Unplug two connectors

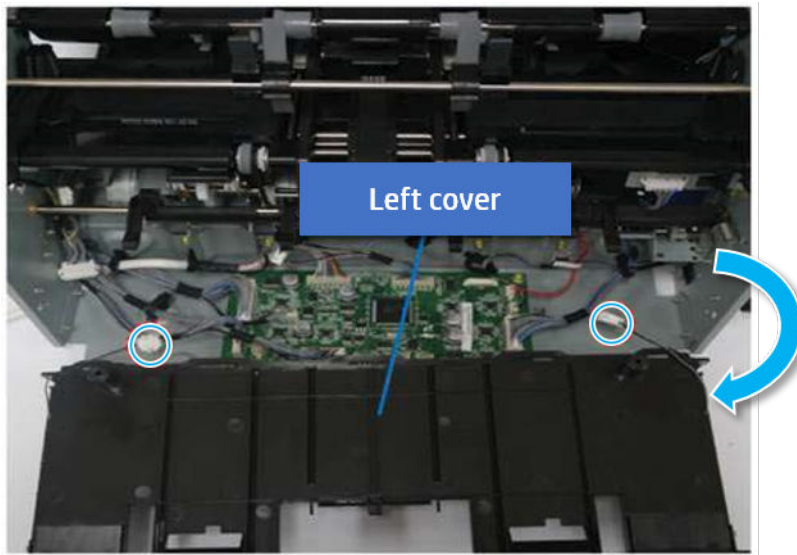

 **TIP:** Be sure to check the hook when reassembling.

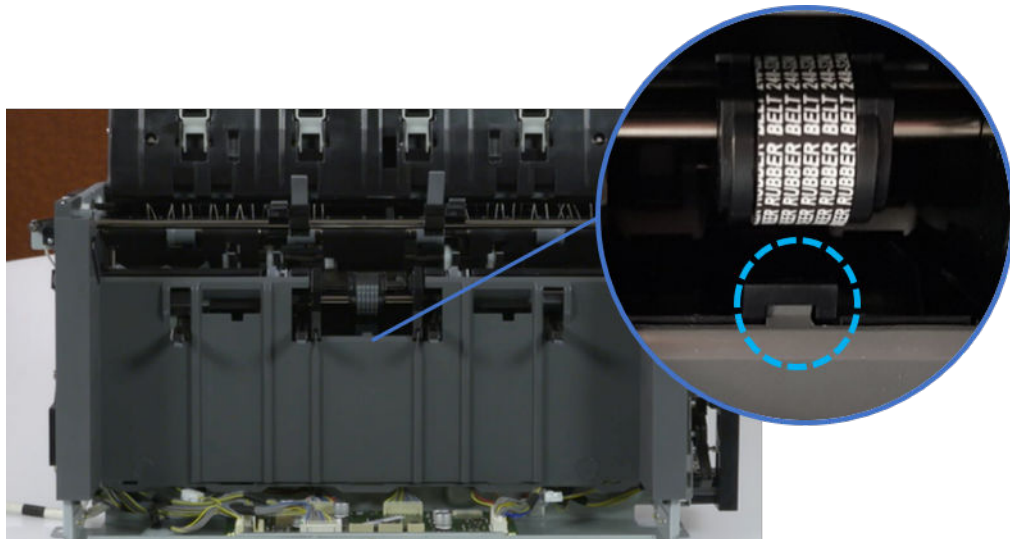

- 7. Remove the front harness guide.
 - a. Open one clamp and unplug five connectors, and then remove the wire harness from the front harness guide.

- b. Remove four screws, and then remove the front harness guide.

Figure 5-331 Remove the front harness guide

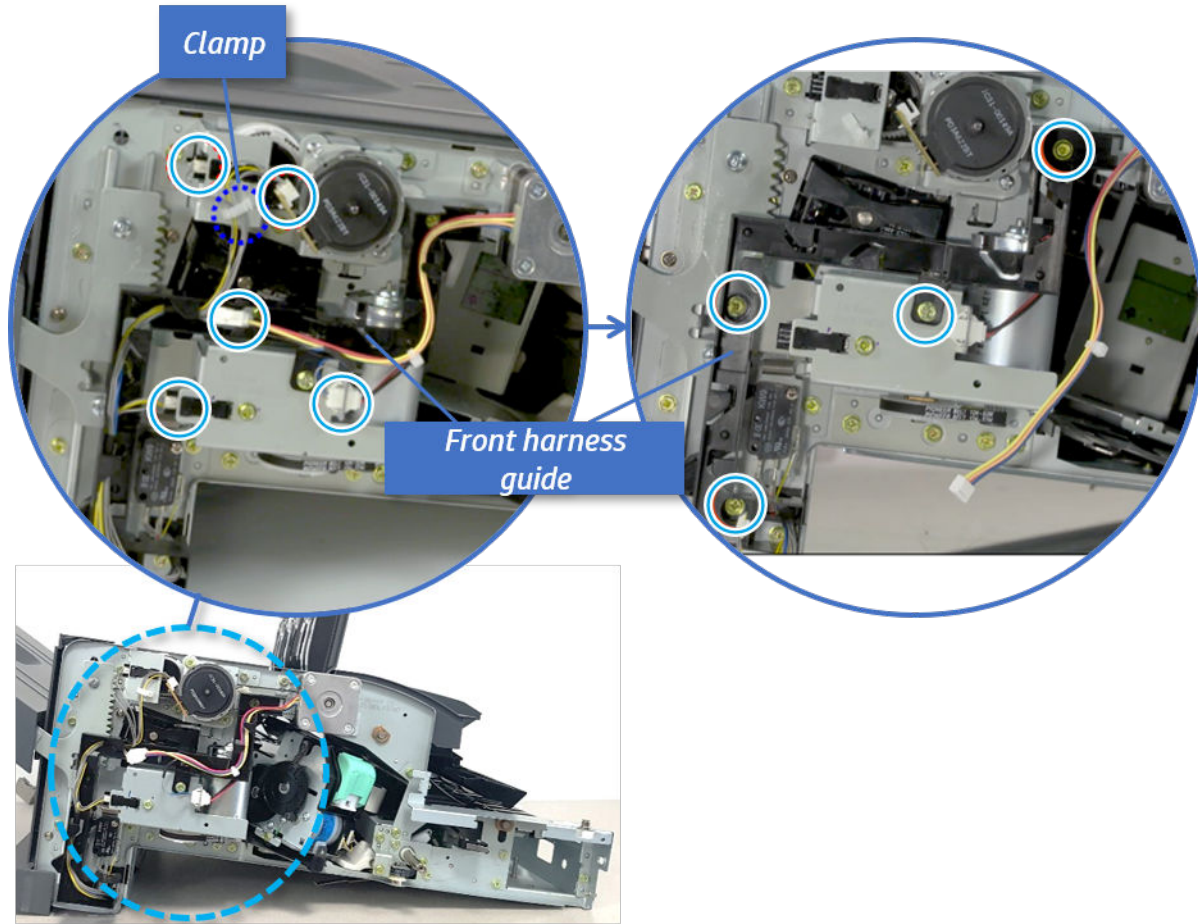

- 8. Remove the output tray motor assembly.
 - ▲ Remove three screws, and then remove the output tray motor assembly.

Figure 5-332 Remove the output tray motor assembly

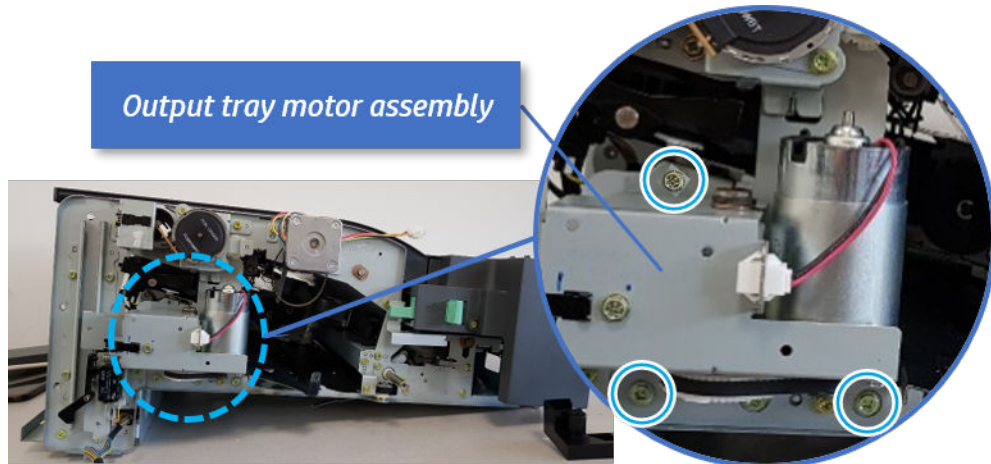

- 9. Remove the output tray lower limit switch.

- ▲ Remove one screw, and then remove the output tray lower limit switch.

Figure 5-333 Remove the output tray lower limit switch

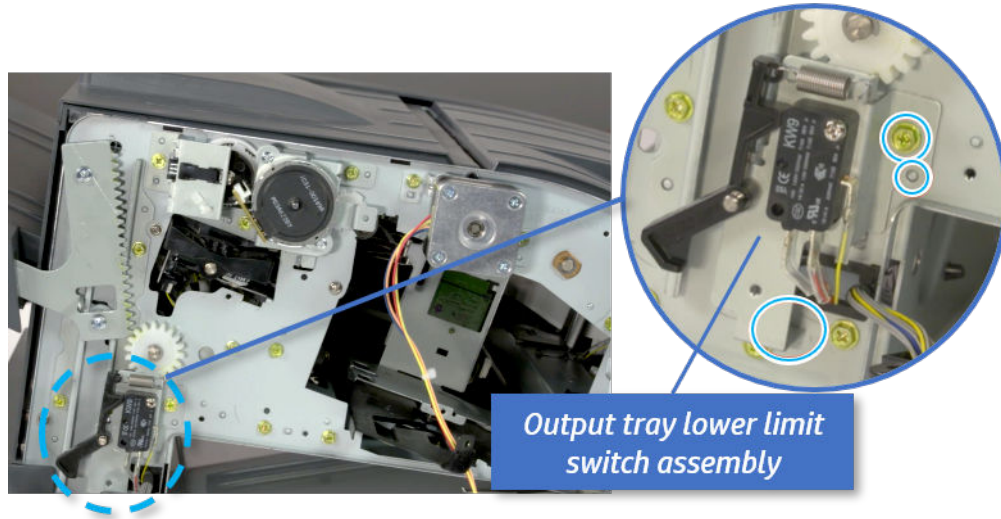

- 10. Remove the paper holding.
 - a. Remove the paper holding actuator spring.

Figure 5-334 Remove the paper holding actuator spring

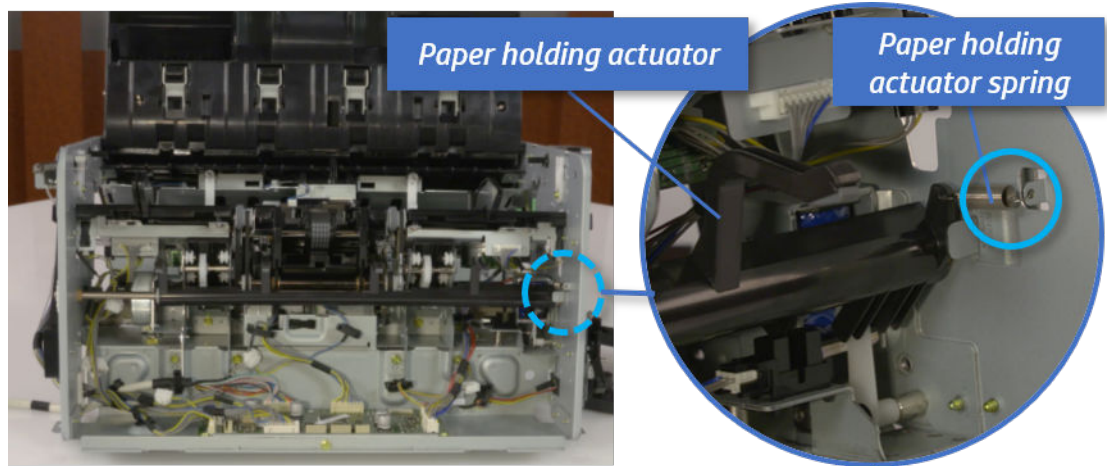

- b. Remove the e-ring and the rack pinion gear. And then remove the pin and the e-ring, and then remove the bushing.

Figure 5-335 Remove e-ring, rack pinion gear, pin, and bushing

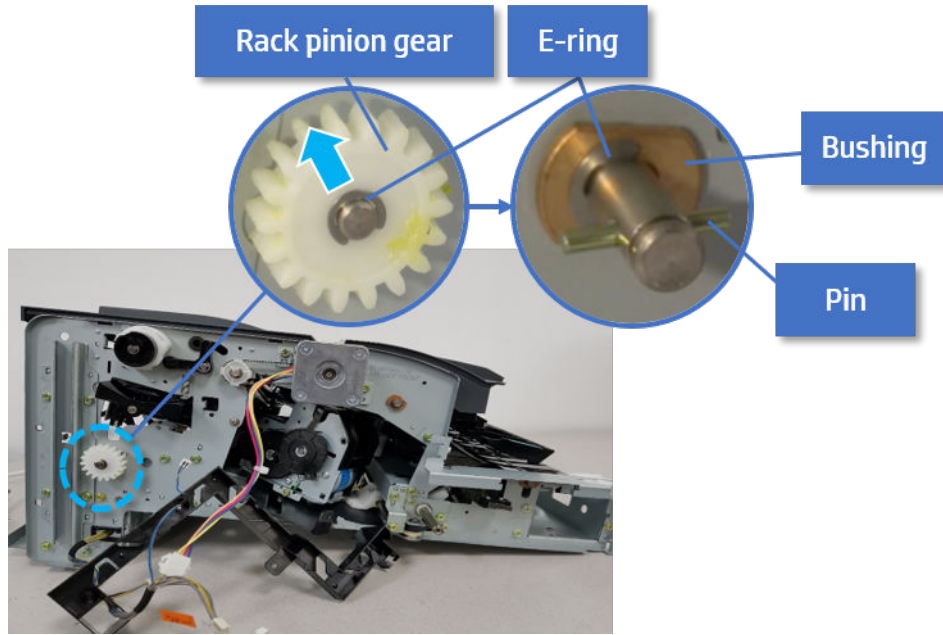

 **NOTE:** Be sure not to lose the pin.

- c. Carefully remove the paper holding shaft and the actuator.

Figure 5-336 Remove the paper holding shaft and the actuator

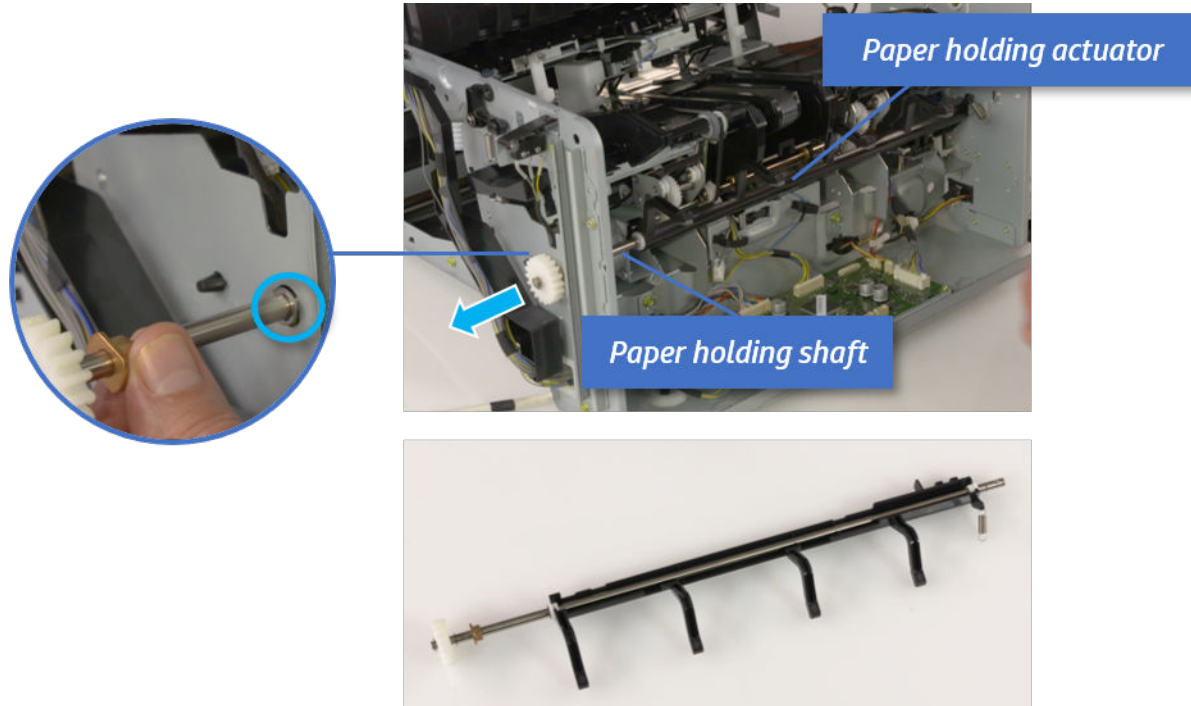

- 11. Remove the sub paddle unit.

- a. Open the top cover, and then remove one screw securing the sub paddle unit.

Figure 5-337 Remove one screw

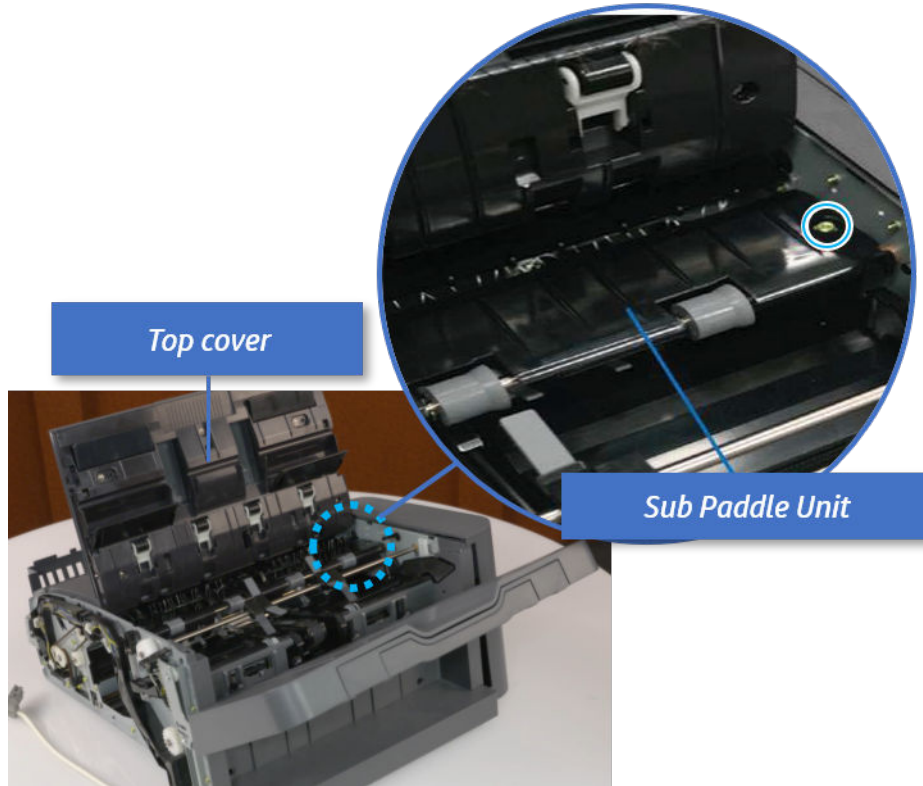

- b. Remove the e-ring, and then remove the pulley and timing belt. And then remove the e-ring and the bushing.

Figure 5-338 Remove the e-ring, pulley, timing belt, and bushing

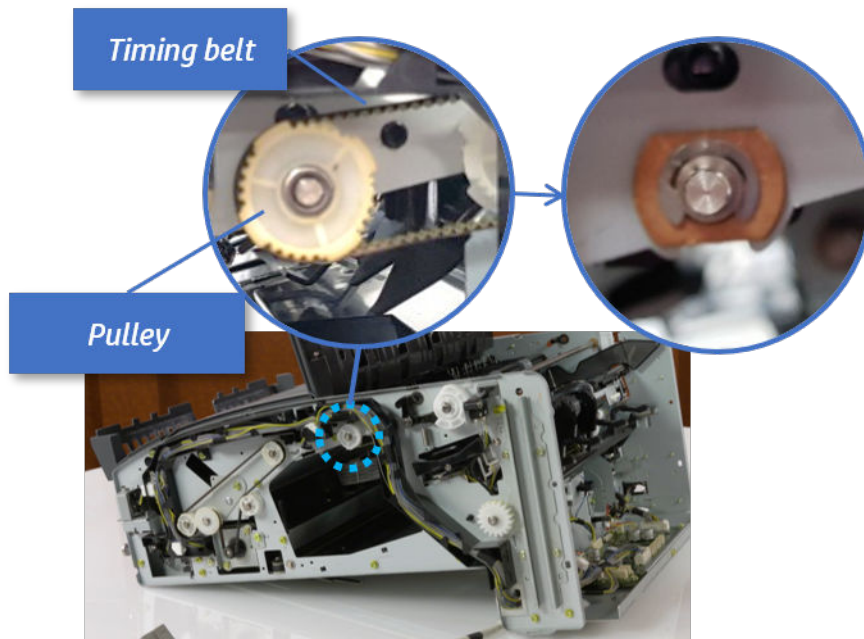

- c. Lift up and remove the sub paddle unit.

Figure 5-339 Remove the sub paddle unit

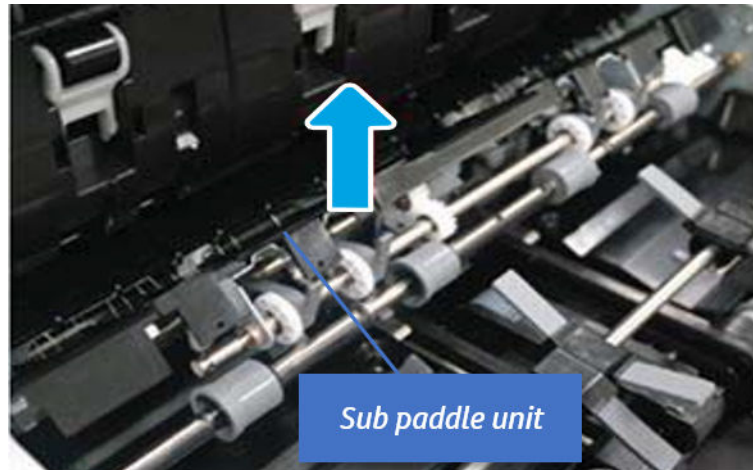

- 12. Remove the exit roller.

- a. Remove the guide on the center of the exit roller.

Figure 5-340 Remove the guide

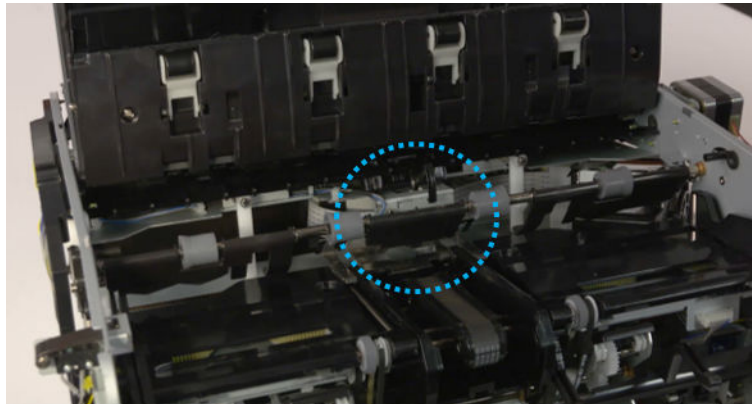

- b. On the front of the inner finisher, release the timing belt connected to the exit motor.

Figure 5-341 Release the timing belt

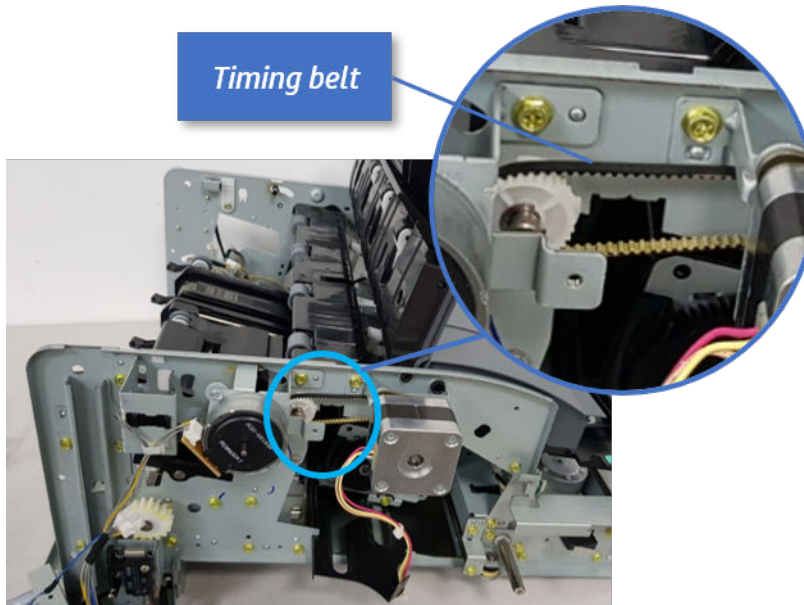

- c. Remove five screws securing the rear harness guide.

Figure 5-342 Remove five screws

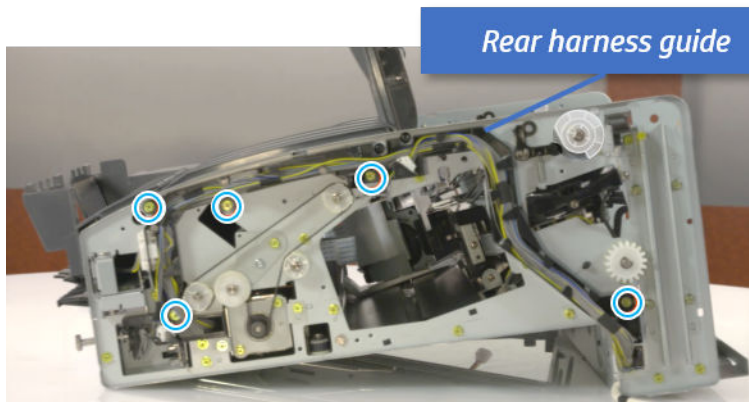

- d. On the rear of the inner finisher, remove the e-ring and the pulley and then remove the e-ring and the bushing.

Figure 5-343 Remove e-ring, pulley, and bushing

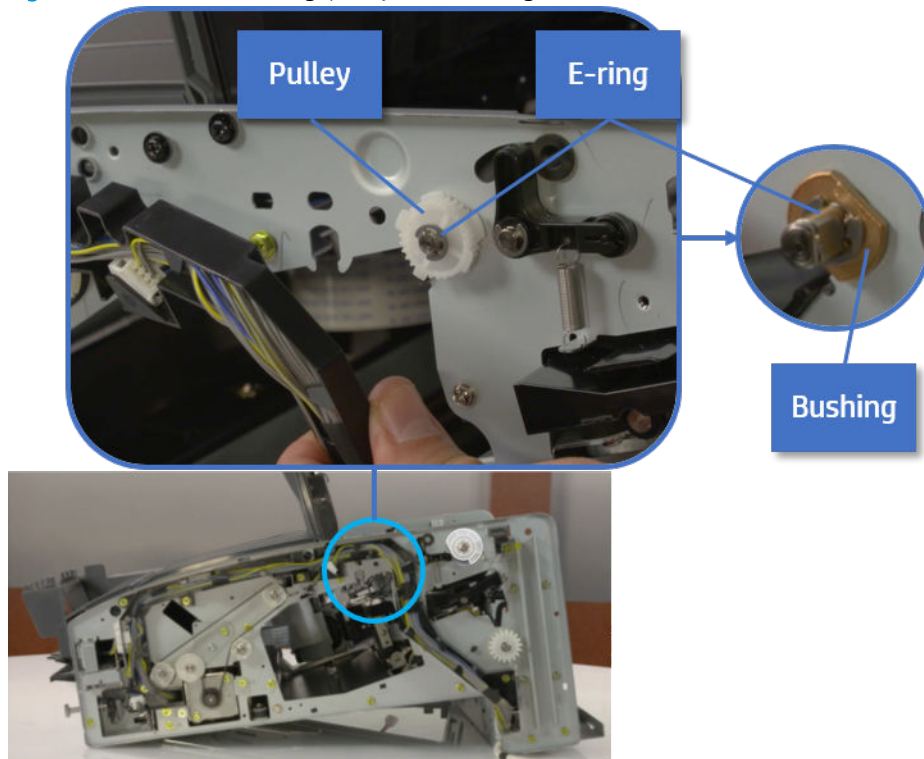

- e. Push the bushing to detach it, and then remove the exit roller.

Figure 5-344 Remove the exit roller

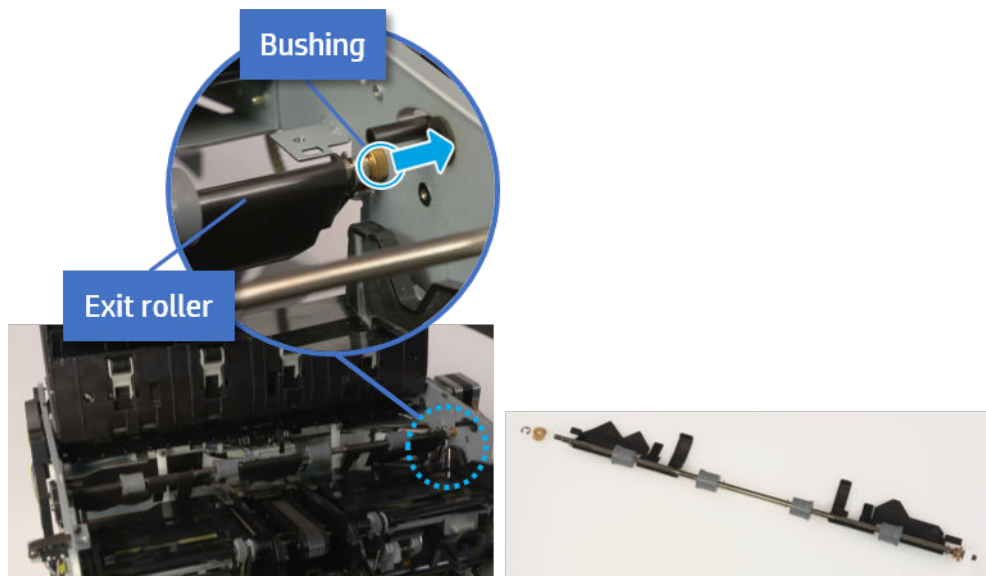

- 13. Remove the front tamper.
 - a. Remove four screws.

Figure 5-345 Remove four screws

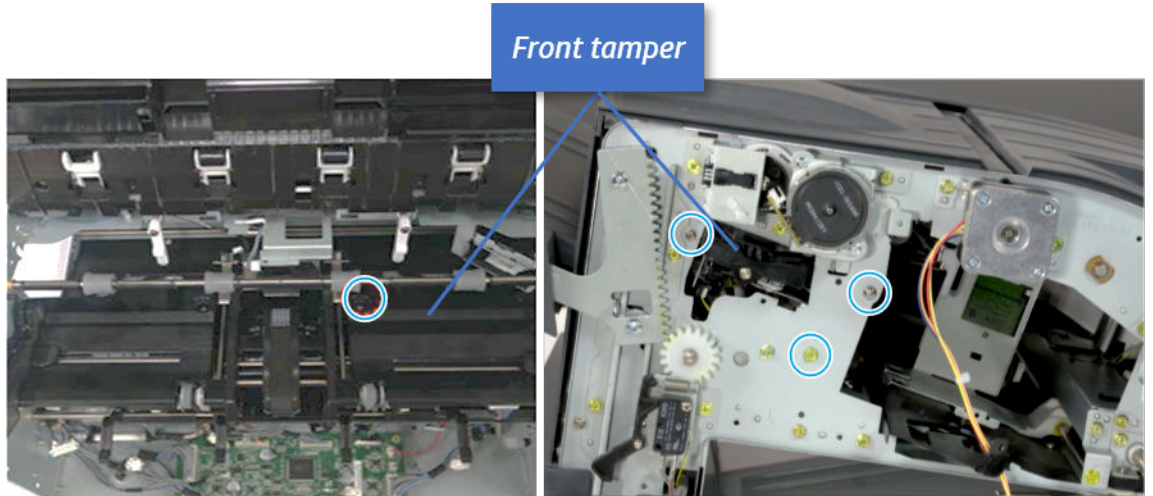

- b. Unplug the connector and release the hook, and then pull the front tamper up to remove.

Figure 5-346 Remove the front tamper

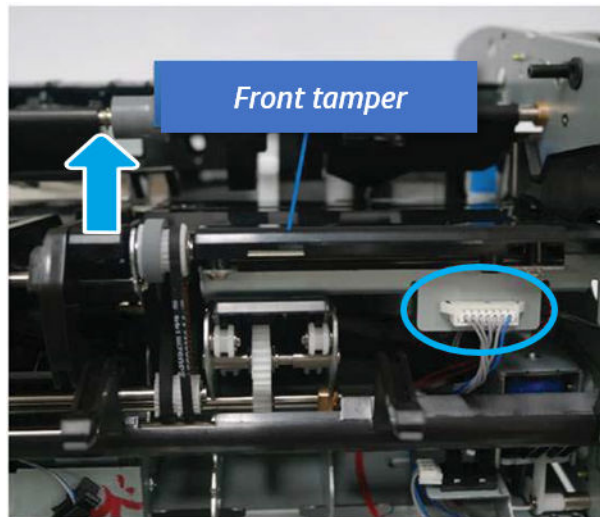

- 14. Remove the front tamper home sensor.
 - ▲ Unplug the connector, and then remove the front tamper home sensor.

Figure 5-347 Remove the front tamper home sensor

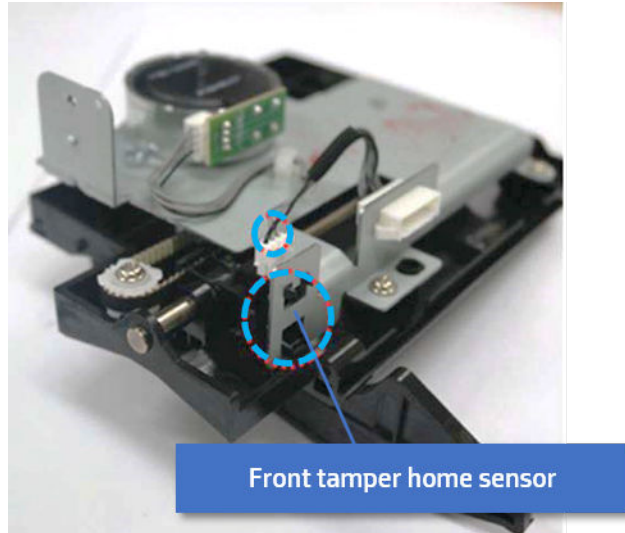

15. Unpack the replacement assembly.

a. Dispose of the defective part.



NOTE: HP recommends responsible disposal of the defective part.

<http://www8.hp.com/us/en/hp-information/environment/product-recycling.html>

b. Unpack the replacement part from the packaging.



CAUTION:  Some parts are sensitive to electrostatic discharge (ESD). Always perform service work at an ESD-protected workstation or mat. If an ESD workstation or mat is not available, touch the sheet-metal chassis to provide a static ground before touching an ESD-sensitive assembly. Protect the ESD-sensitive assemblies by placing them in ESD pouches when they are out of the printer.

If the replacement part is a roller or pad, avoid touching the spongy part of it. Skin oils on the roller or pad can cause paper pickup and/or print-quality problems. HP recommends using disposable gloves when handling rollers or pads or washing your hands before touching rollers or pads.



IMPORTANT: Make sure that all of the shipping materials (for example shipping tape) are removed from the replacement part prior to installation.

c. To install an assembly, reverse the removal steps.

When applicable, special installation instructions are provided for an assembly at the end of the removal procedure. Always completely read the removal instructions and follow all special installation instructions.

Removal and replacement: Front tamper motor (M9)

Learn how to remove and replace the front tamper motor.

To view teardown&reassembling video of the inner finisher, click the link below.



[View a teardown video of the inner finisher .](#)

 [View a reassembling video of the inner finisher .](#)

 **IMPORTANT:** When applicable, special installation instructions are provided for an assembly at the end of the removal procedure. Always completely read the removal instructions and follow all special installation instructions.

Mean time to repair:

Service level:

Before performing service

Turn the printer power off

- Press the power button on the front of the printer, and then turn off the power switch next to the power cable.
- A shutting-down message appears on the control-panel display.

 **WARNING!** To avoid damage to the printer, turn the power off and wait until the printer shuts down before removing the power cable.

- Disconnect the printer power cable after the printer has completely shut down (the control-panel display is blank).

Use the table below to identify the correct part number for your printer. To order the part, go to <https://parts.hp.com>.

Table 5-52 Part information

Part number	Part description
JC93-01001A	Front tamper motor assembly

Required tools

- #2 JIS screwdriver with a magnetic tip

After performing service

Turn the printer power on

- Connect the power cable.
- Use the power switch to turn the power on.

Post service test

Print any pages necessary to verify that the repair resolved the issue and did not create any new issues.

1. Remove the front cover.
 - a. Open the front door and open the punch cover.
 - b. Remove three screws in the front.
 - c. Remove the lever.

- d. Open the top cover.
- e. From the right side of the front cover, carefully lift and pry toward the top-left corner to remove the front cover.

Figure 5-348 Remove the front cover

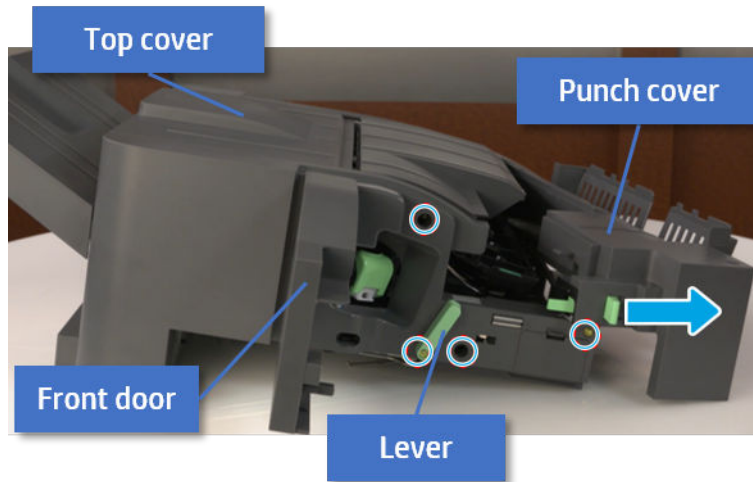

- 2. Remove the rear cover.
 - a. Open the top cover.

Figure 5-349 Open the top cover

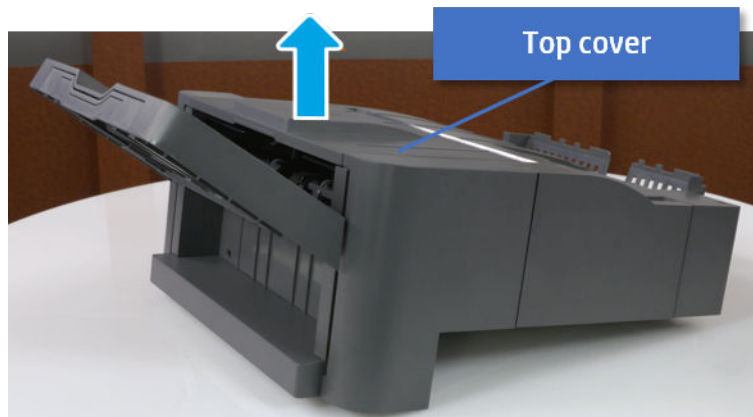

- b. Remove three screws.

- c. Release hooks carefully and remove the rear cover.

Figure 5-350 Remove the rear cover

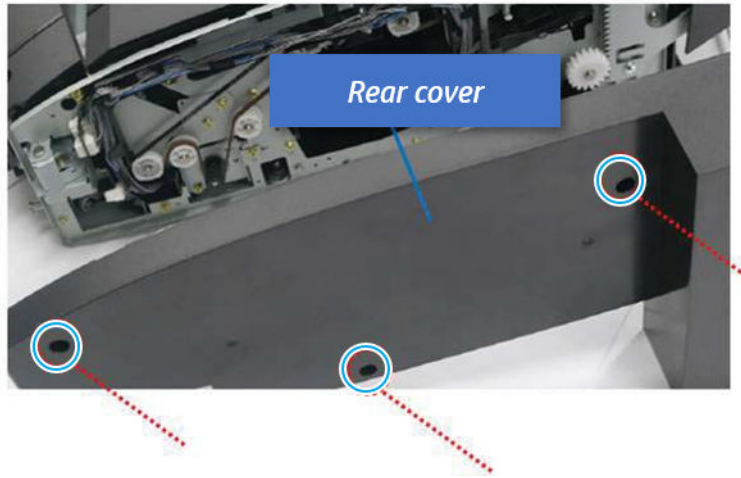

- 3. Remove the output tray.

- a. Remove four screws.

Figure 5-351 Remove four screws

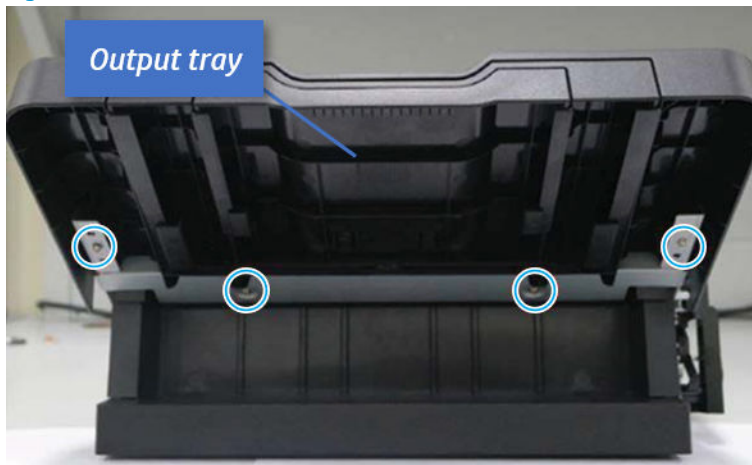

- b. Push the paper holding actuator into the inner finisher, and then remove the output tray.

Figure 5-352 Remove the output tray.



- 4. Remove the output tray frame.
 - a. Rotate the pulley until the output tray frame depart from the gear.

Figure 5-353 Remove the pulley

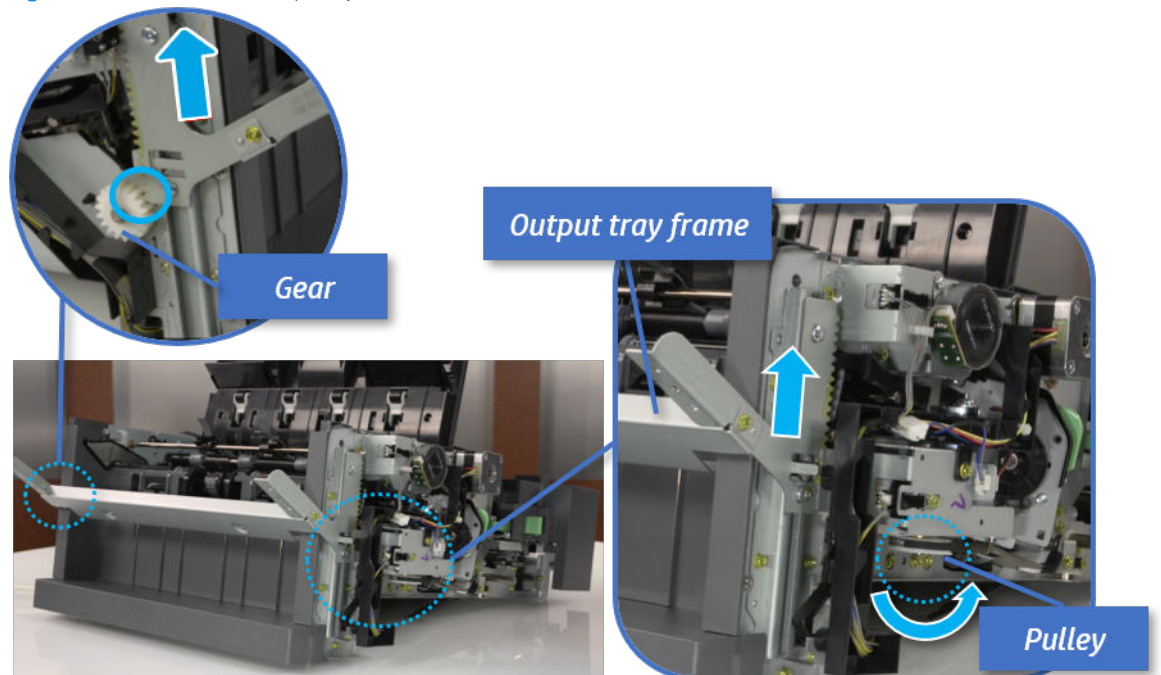

- b. Push the paper holding actuator into the inner finisher, and then remove the output tray frame.

Figure 5-354 Remove the output tray frame

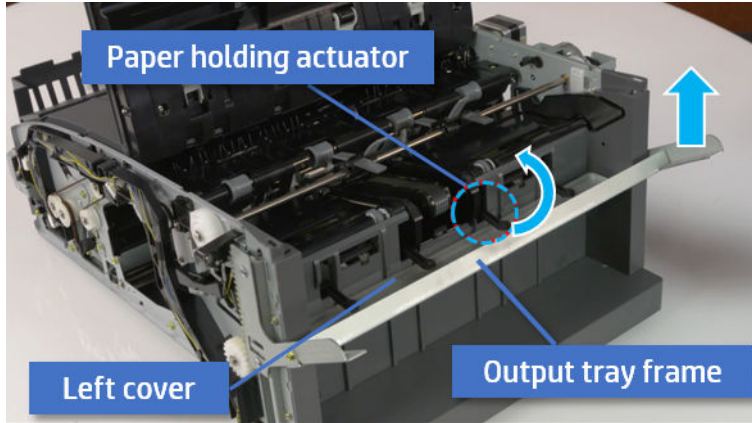

TIP: Push the paper holding actuator into the inner finisher when reassembling. Be sure to level the output tray.

1. Position the first wheel into the channel on both sides while pushing the paper holding actuator.

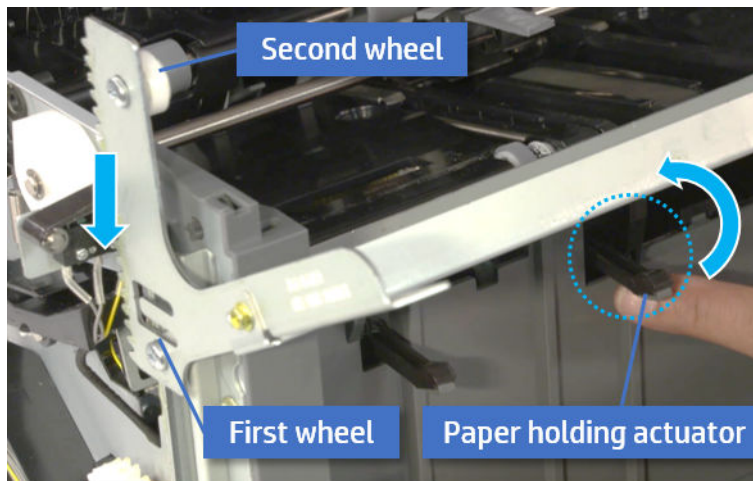

2. Let the second wheel rest on the channel on both sides simultaneously.
3. Gently squeeze the wheels into channel until the output tray frame meet the gear.

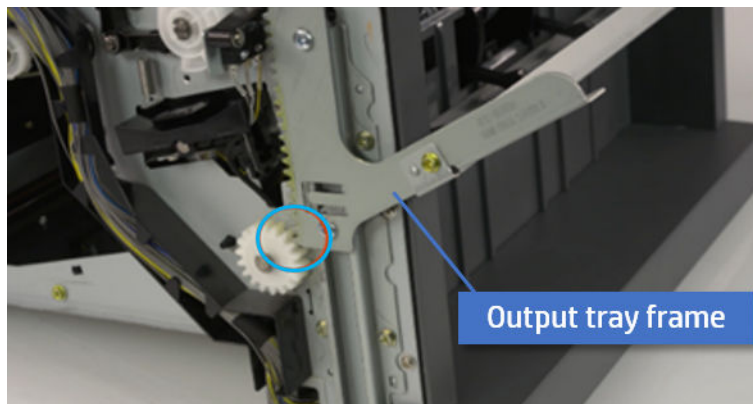

4. Rotate the pulley until the output tray frame is no longer lifted. It can make to level the output tray frame.

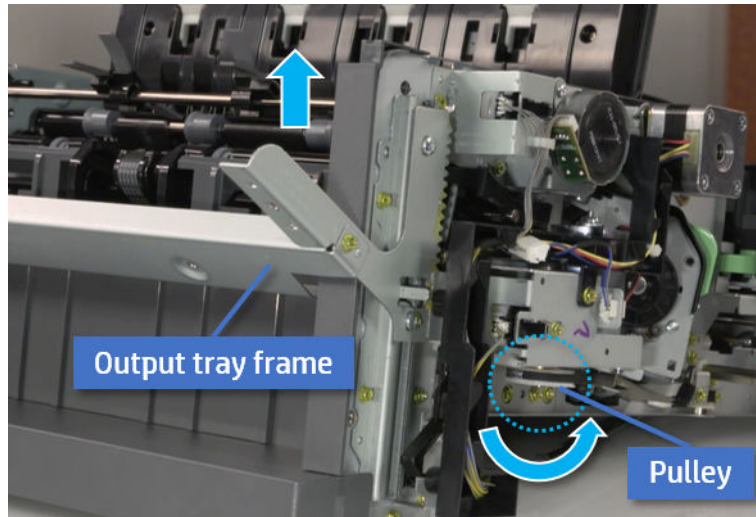

5. Rotate the pulley in the opposite direction.

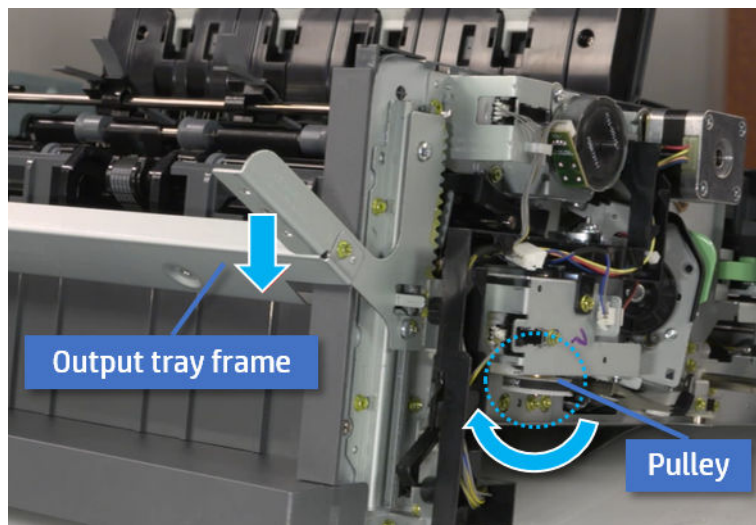

5. Remove the PCA cover.

- ▲ Remove two screws, and then remove the PCA cover.

Figure 5-355 Remove the PCA cover

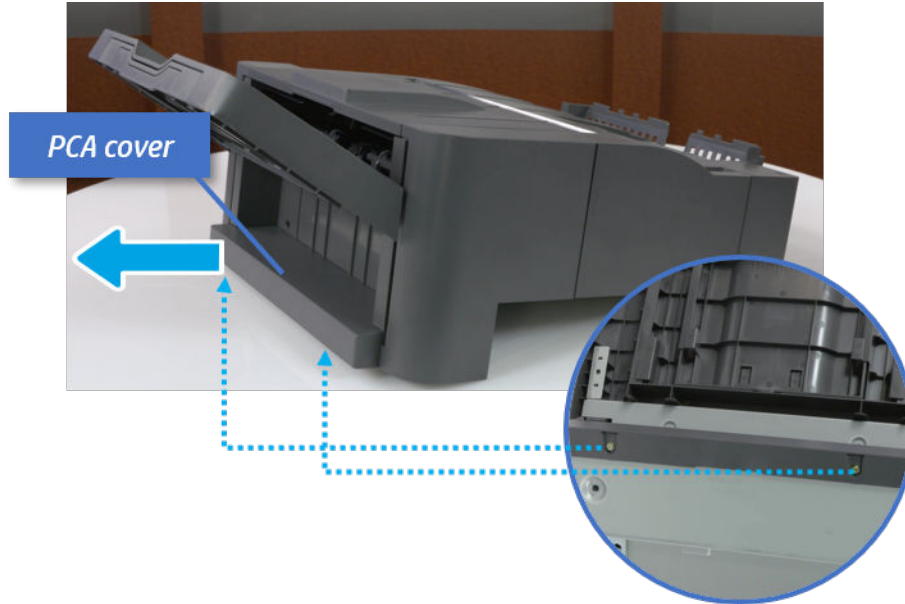

6. Remove the left cover.
 - a. Remove two screws.

Figure 5-356 Remove two screws

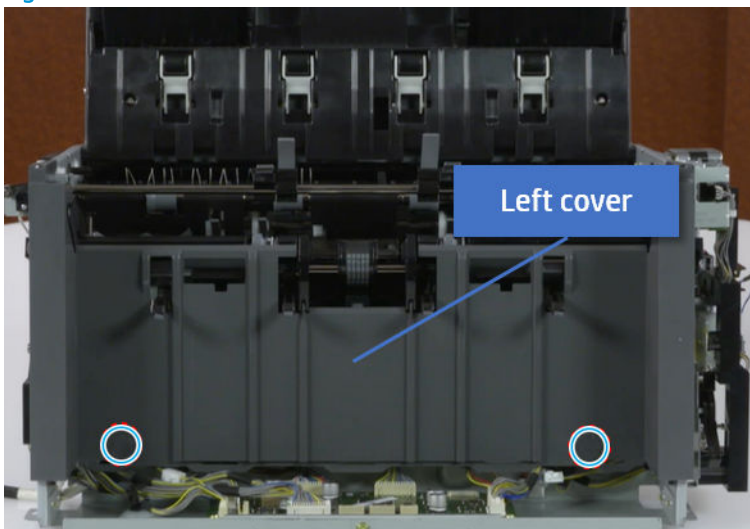

- b. Remove four screws from both front and rear sides.

Figure 5-357 Remove four screws

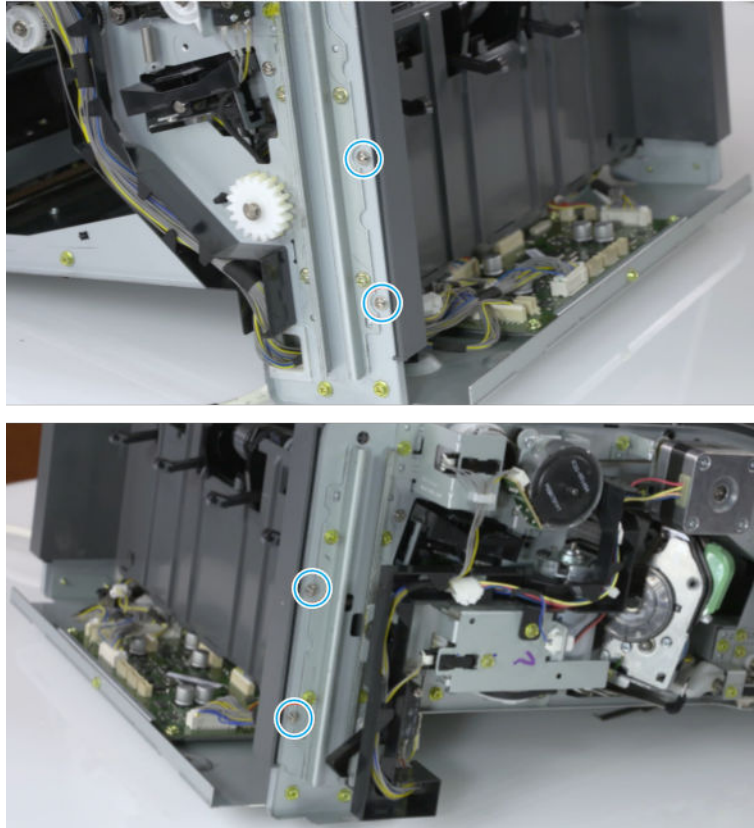

- c. Unplug two inline connectors, and then remove the left cover.

Figure 5-358 Unplug two connectors

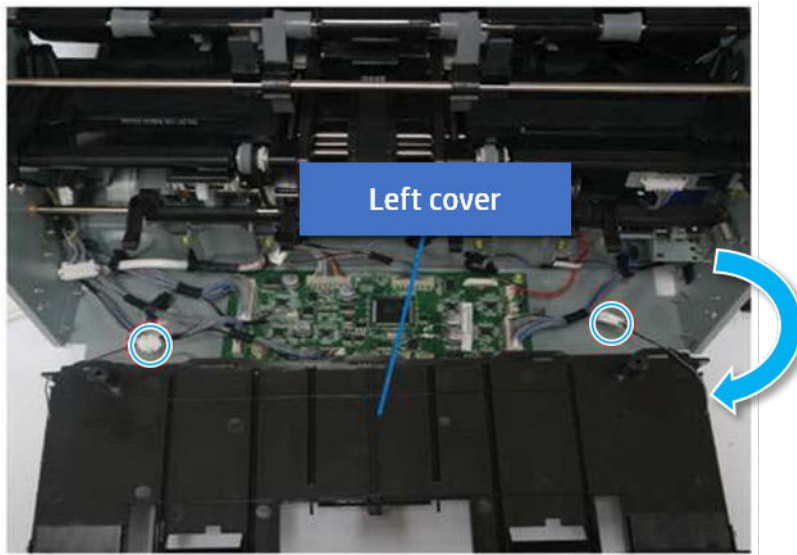

 **TIP:** Be sure to check the hook when reassembling.

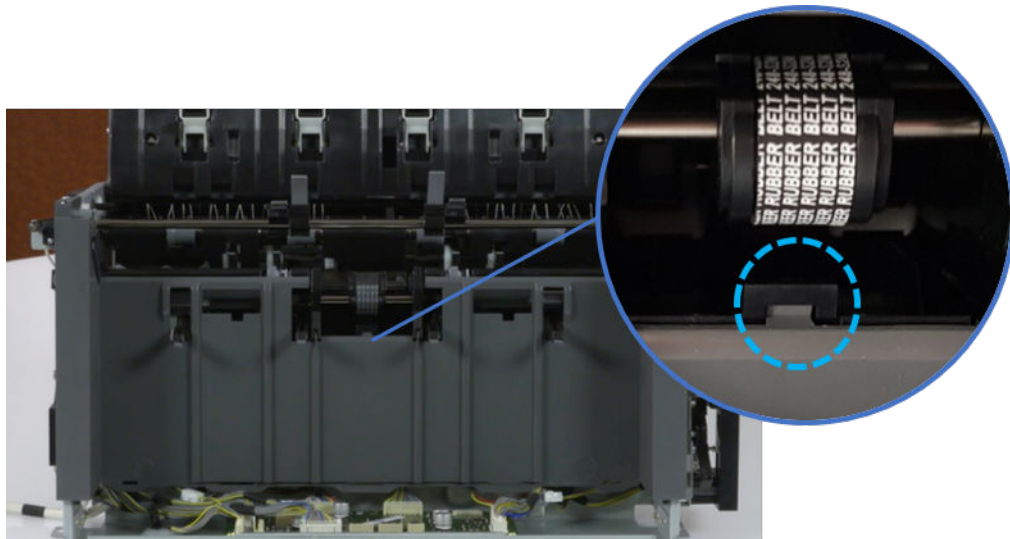

- 7. Remove the front harness guide.
 - a. Open one clamp and unplug five connectors, and then remove the wire harness from the front harness guide.

- b. Remove four screws, and then remove the front harness guide.

Figure 5-359 Remove the front harness guide

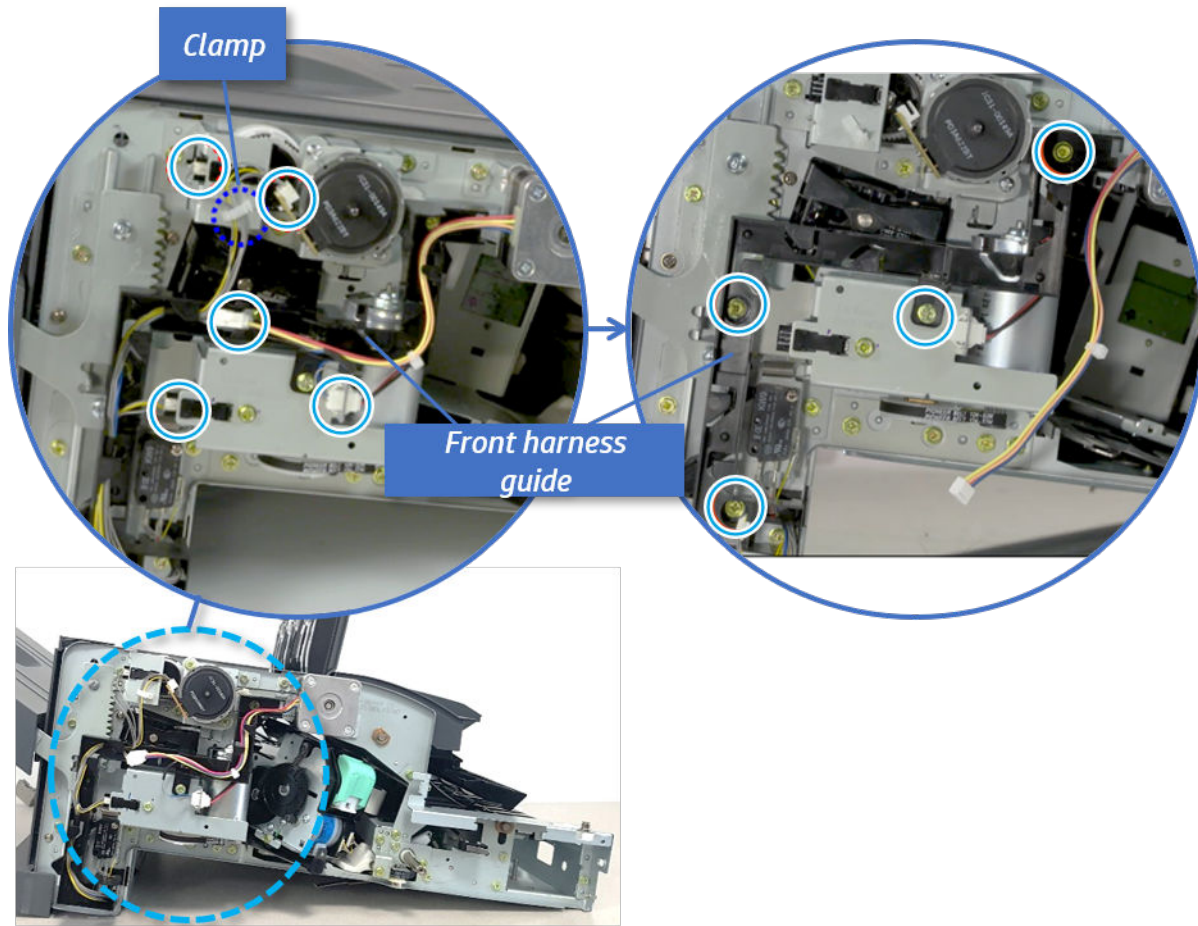

8. Remove the output tray motor assembly.
- ▲ Remove three screws, and then remove the output tray motor assembly.

Figure 5-360 Remove the output tray motor assembly

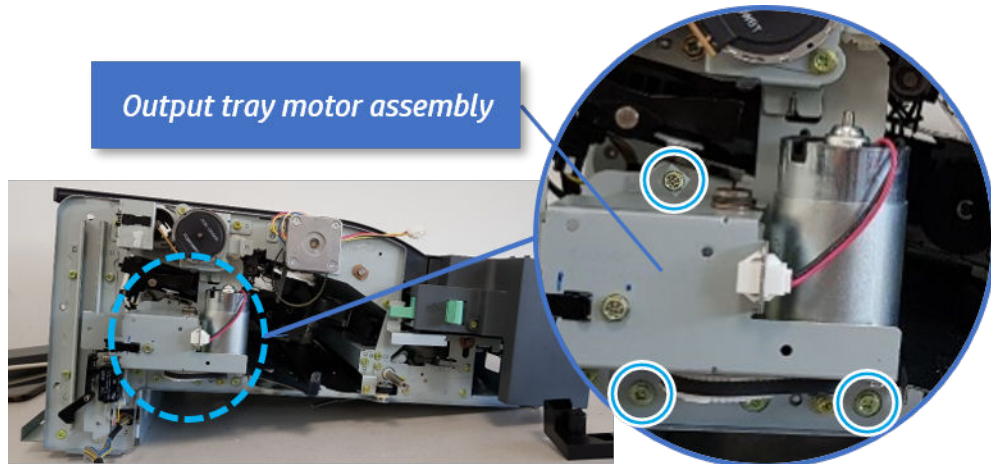

9. Remove the output tray lower limit switch.

- ▲ Remove one screw, and then remove the output tray lower limit switch.

Figure 5-361 Remove the output tray lower limit switch

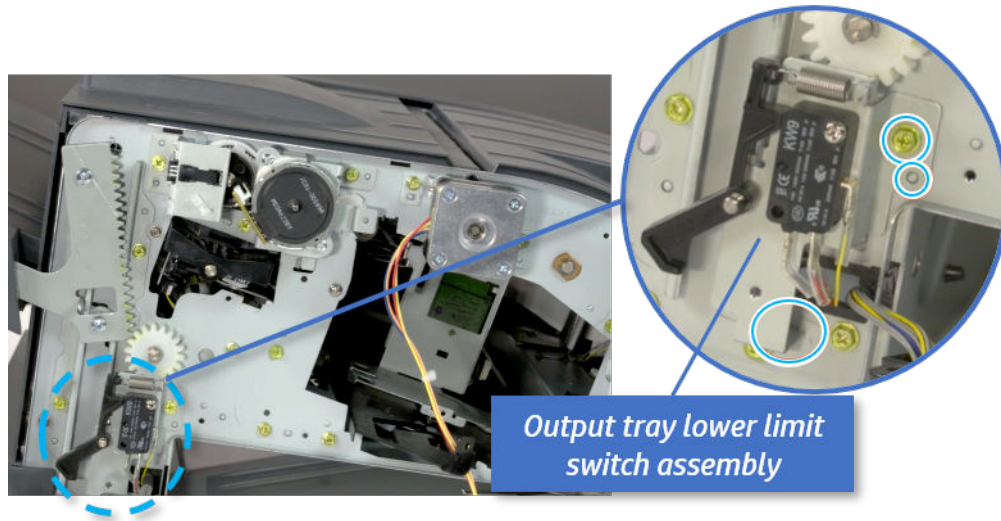

- 10. Remove the paper holding.
 - a. Remove the paper holding actuator spring.

Figure 5-362 Remove the paper holding actuator spring

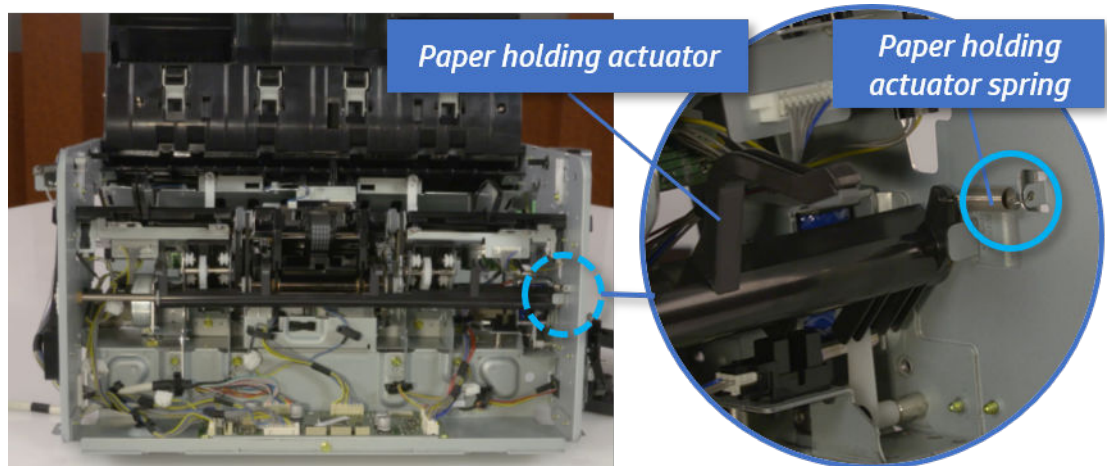

- b. Remove the e-ring and the rack pinion gear. And then remove the pin and the e-ring, and then remove the bushing.

Figure 5-363 Remove e-ring, rack pinion gear, pin, and bushing

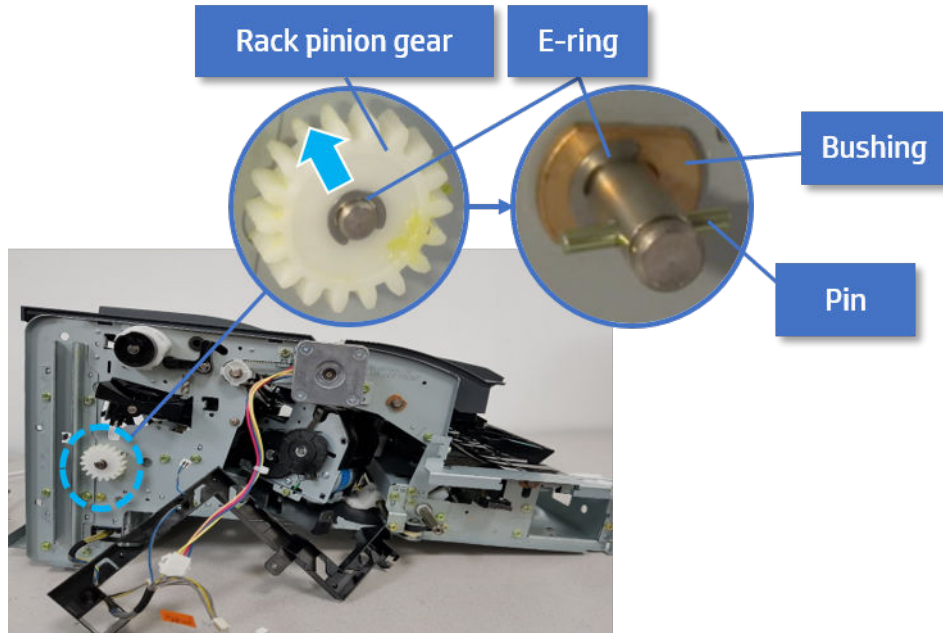

 **NOTE:** Be sure not to lose the pin.

- c. Carefully remove the paper holding shaft and the actuator.

Figure 5-364 Remove the paper holding shaft and the actuator

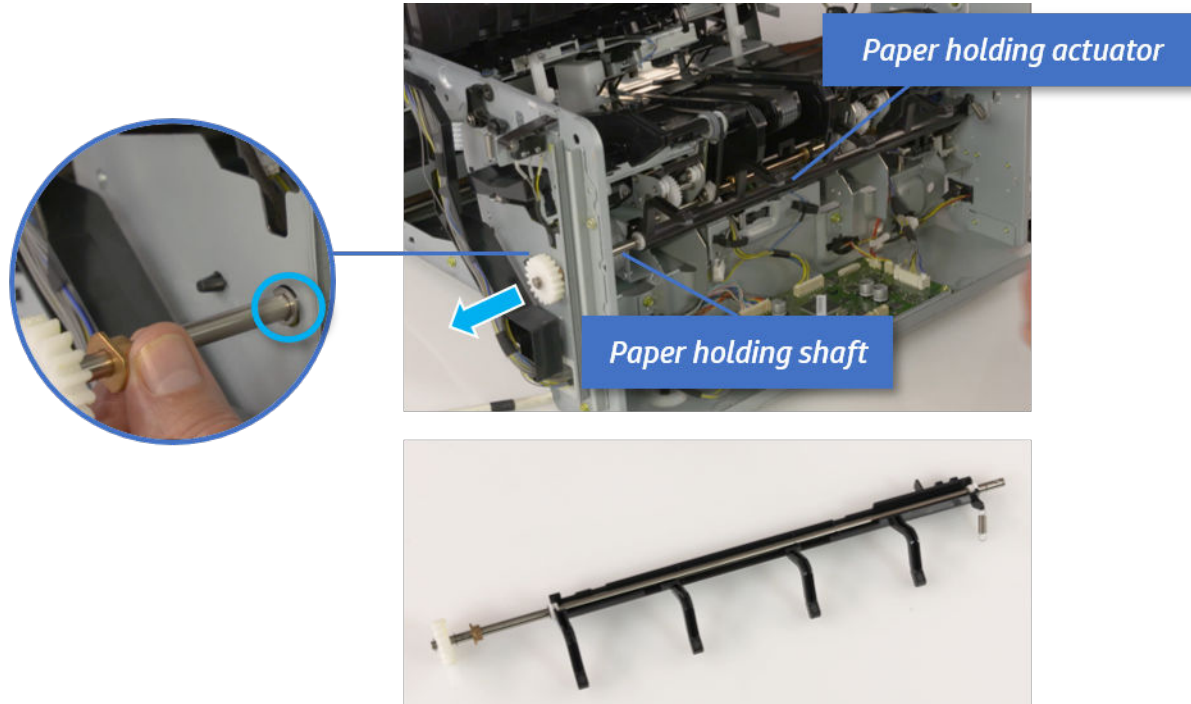

11. Remove the sub paddle unit.

- a. Open the top cover, and then remove one screw securing the sub paddle unit.

Figure 5-365 Remove one screw

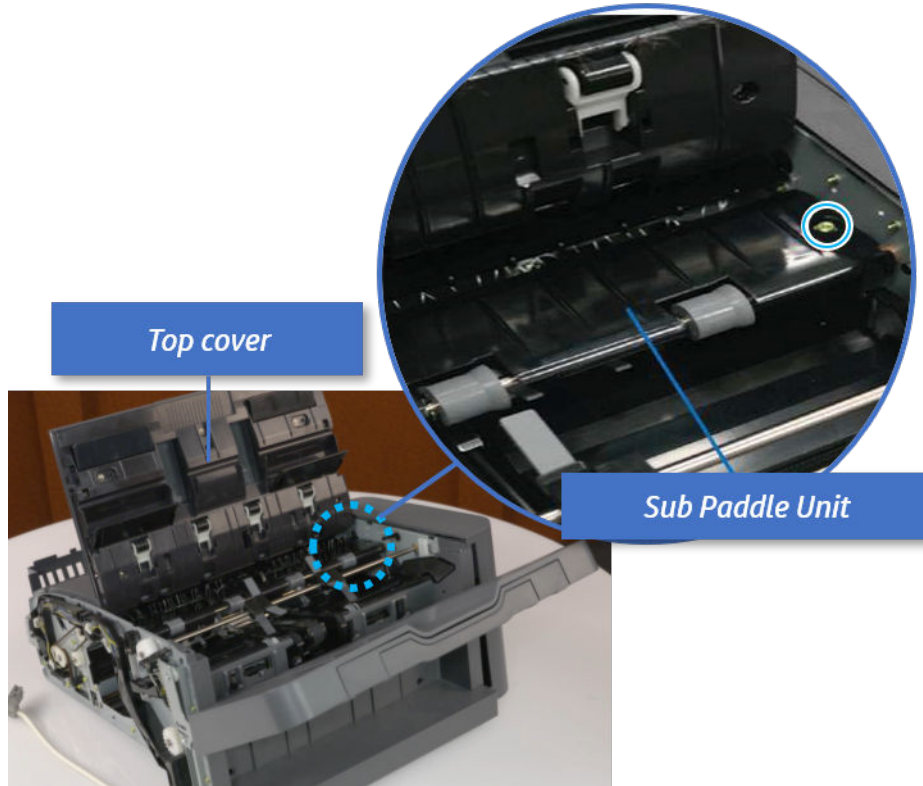

- b. Remove the e-ring, and then remove the pulley and timing belt. And then remove the e-ring and the bushing.

Figure 5-366 Remove the e-ring, pulley, timing belt, and bushing

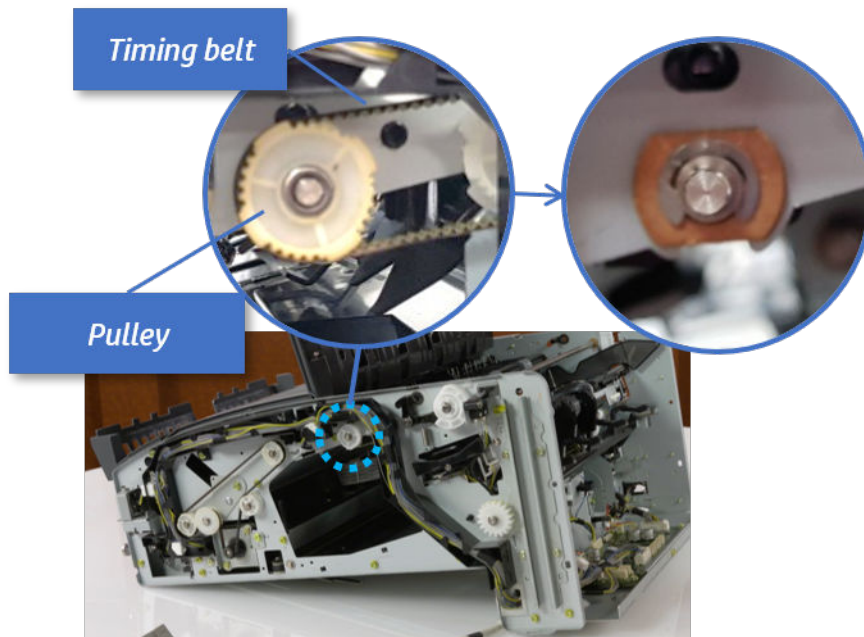

- c. Lift up and remove the sub paddle unit.

Figure 5-367 Remove the sub paddle unit

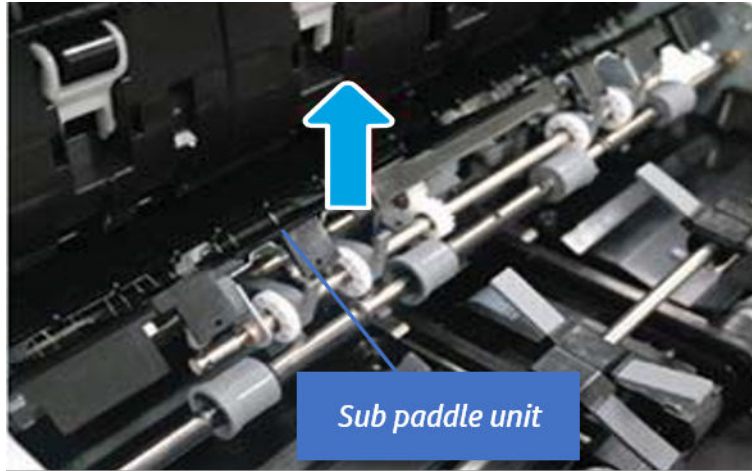

- 12. Remove the exit roller.

- a. Remove the guide on the center of the exit roller.

Figure 5-368 Remove the guide

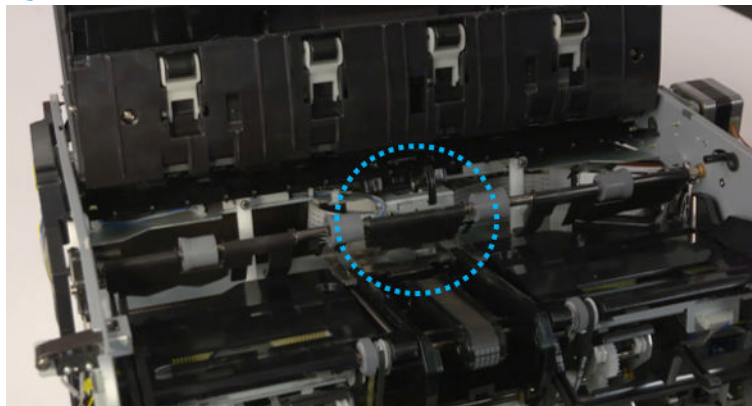

- b. On the front of the inner finisher, release the timing belt connected to the exit motor.

Figure 5-369 Release the timing belt

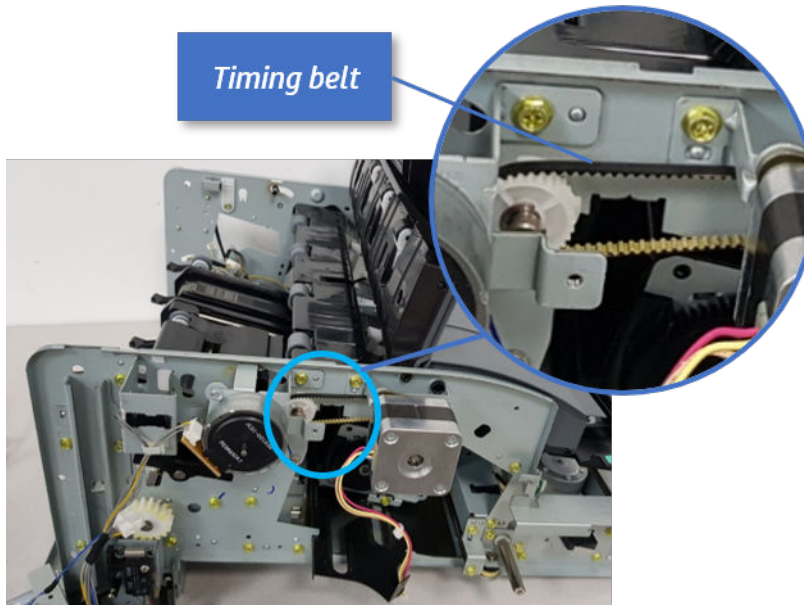

- c. Remove five screws securing the rear harness guide.

Figure 5-370 Remove five screws

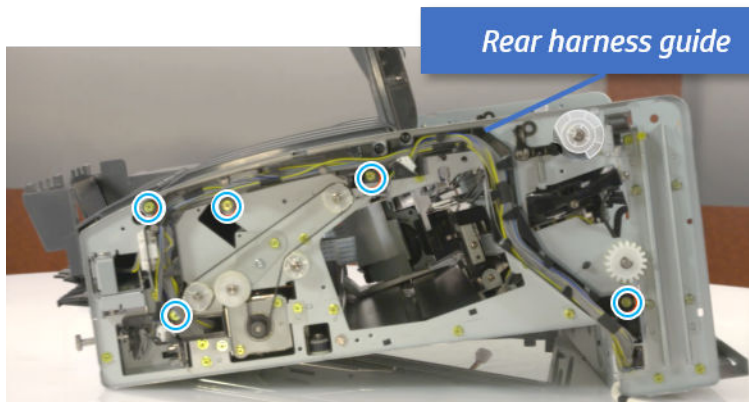

- d. On the rear of the inner finisher, remove the e-ring and the pulley and then remove the e-ring and the bushing.

Figure 5-371 Remove e-ring, pulley, and bushing

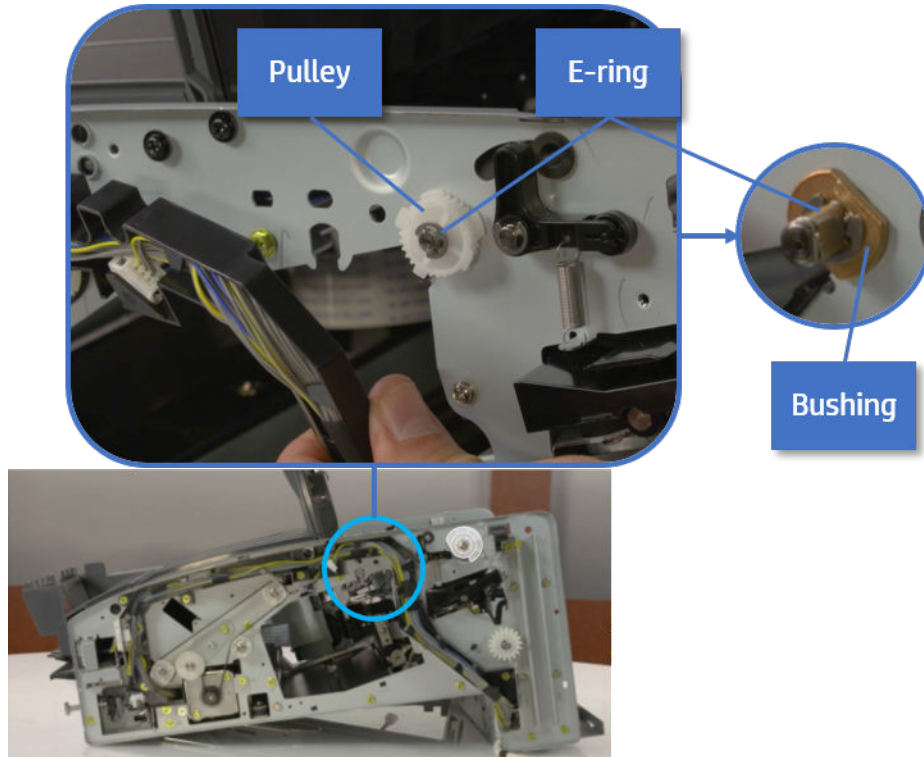

- e. Push the bushing to detach it, and then remove the exit roller.

Figure 5-372 Remove the exit roller

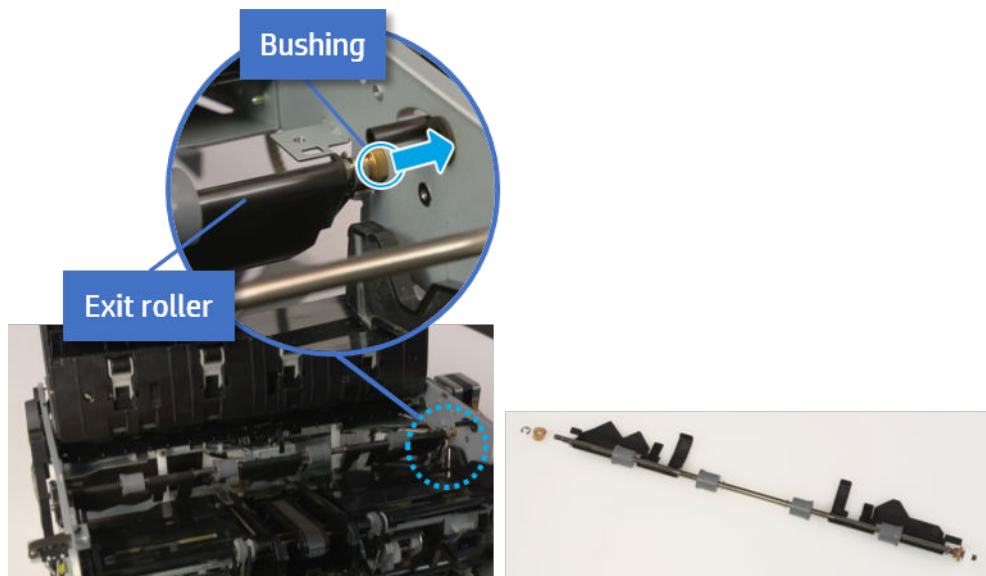

- 13. Remove the front tamper.
 - a. Remove four screws.

Figure 5-373 Remove four screws

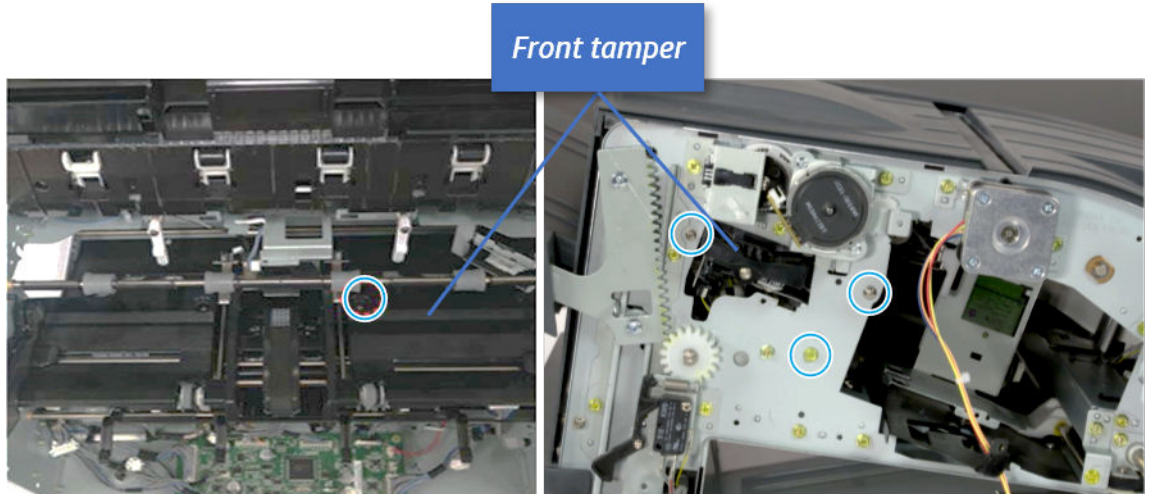

- b. Unplug the connector and release the hook, and then pull the front tamper up to remove.

Figure 5-374 Remove the front tamper

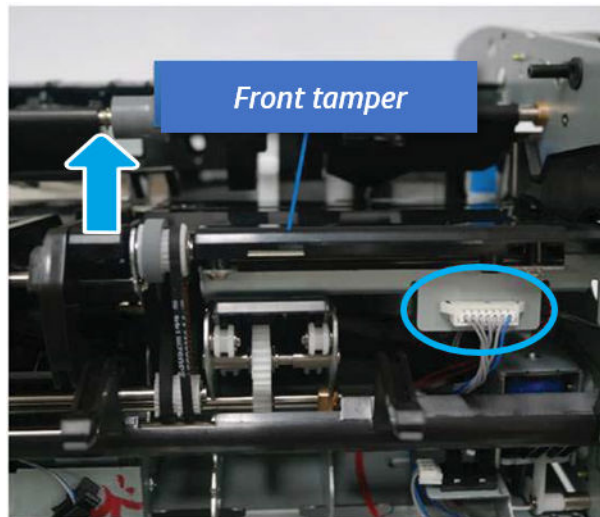

- 14. Remove the front tamper motor.
 - ▲ Remove two screws, unplug the connector, and then remove the motor.

Figure 5-375 Remove the front tamper motor

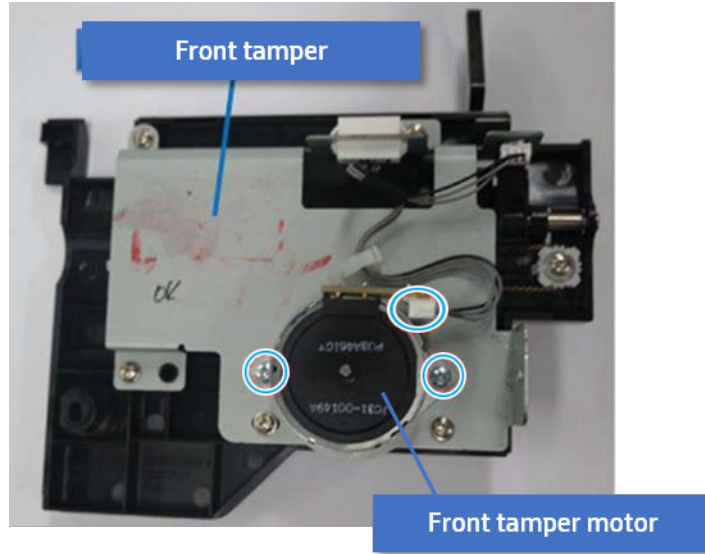

15. Unpack the replacement assembly.

- a. Dispose of the defective part.



NOTE: HP recommends responsible disposal of the defective part.

<http://www8.hp.com/us/en/hp-information/environment/product-recycling.html>

- b. Unpack the replacement part from the packaging.



CAUTION: 

Some parts are sensitive to electrostatic discharge (ESD). Always perform service work at an ESD-protected workstation or mat. If an ESD workstation or mat is not available, touch the sheet-metal chassis to provide a static ground before touching an ESD-sensitive assembly. Protect the ESD-sensitive assemblies by placing them in ESD pouches when they are out of the printer.

If the replacement part is a roller or pad, avoid touching the spongy part of it. Skin oils on the roller or pad can cause paper pickup and/or print-quality problems. HP recommends using disposable gloves when handling rollers or pads or washing your hands before touching rollers or pads.



IMPORTANT: Make sure that all of the shipping materials (for example shipping tape) are removed from the replacement part prior to installation.

- c. To install an assembly, reverse the removal steps.

When applicable, special installation instructions are provided for an assembly at the end of the removal procedure. Always completely read the removal instructions and follow all special installation instructions.

Rear tamper

Removal and replacement: Rear tamper

Learn how to remove and replace the rear tamper.

To view teardown&reassembling video of the inner finisher, click the link below.

 [View a teardown video of the inner finisher .](#)

 [View a reassembling video of the inner finisher .](#)

 **IMPORTANT:** When applicable, special installation instructions are provided for an assembly at the end of the removal procedure. Always completely read the removal instructions and follow all special installation instructions.

Mean time to repair:

Service level:

Before performing service

Turn the printer power off

- Press the power button on the front of the printer, and then turn off the power switch next to the power cable.
- A shutting-down message appears on the control-panel display.

 **WARNING!** To avoid damage to the printer, turn the power off and wait until the printer shuts down before removing the power cable.

- Disconnect the printer power cable after the printer has completely shut down (the control-panel display is blank).

Use the table below to identify the correct part number for your printer. To order the part, go to <https://parts.hp.com>.

Table 5-53 Part information

Part number	Part description
JC82-00900A	Rear tamper

Required tools

- #2 JIS screwdriver with a magnetic tip

After performing service

Turn the printer power on

- Connect the power cable.
- Use the power switch to turn the power on.

Post service test

Print any pages necessary to verify that the repair resolved the issue and did not create any new issues.

1. Remove the front cover.
 - a. Open the front door and open the punch cover.
 - b. Remove three screws in the front.
 - c. Remove the lever.
 - d. Open the top cover.
 - e. From the right side of the front cover, carefully lift and pry toward the top-left corner to remove the front cover.

Figure 5-376 Remove the front cover

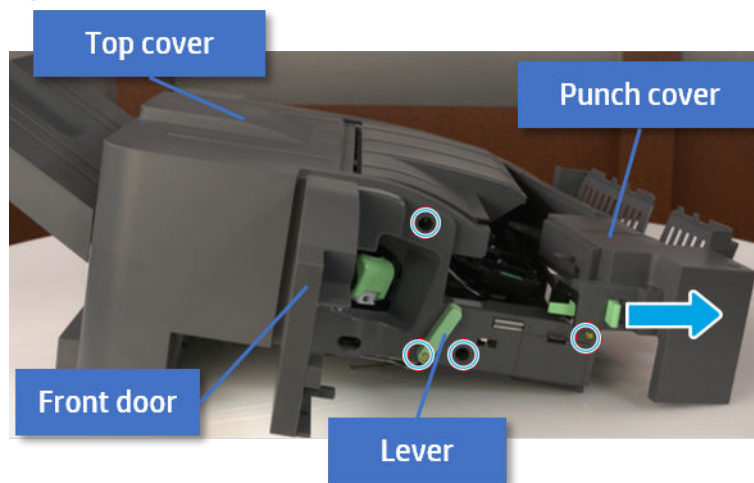

2. Remove the rear cover.
 - a. Open the top cover.

Figure 5-377 Open the top cover

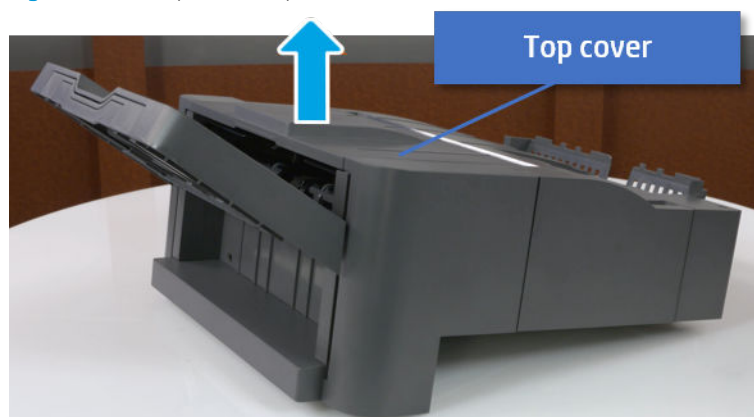

- b. Remove three screws.

- c. Release hooks carefully and remove the rear cover.

Figure 5-378 Remove the rear cover

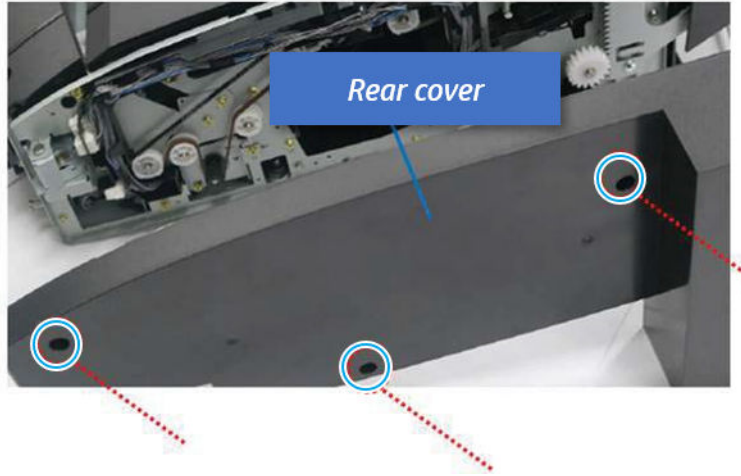

- 3. Remove the output tray.

- a. Remove four screws.

Figure 5-379 Remove four screws

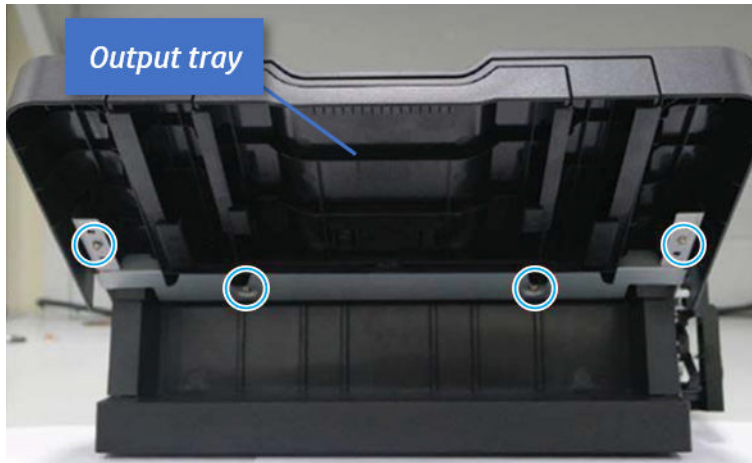

- b. Push the paper holding actuator into the inner finisher, and then remove the output tray.

Figure 5-380 Remove the output tray.



- 4. Remove the output tray frame.
 - a. Rotate the pulley until the output tray frame depart from the gear.

Figure 5-381 Remove the pulley

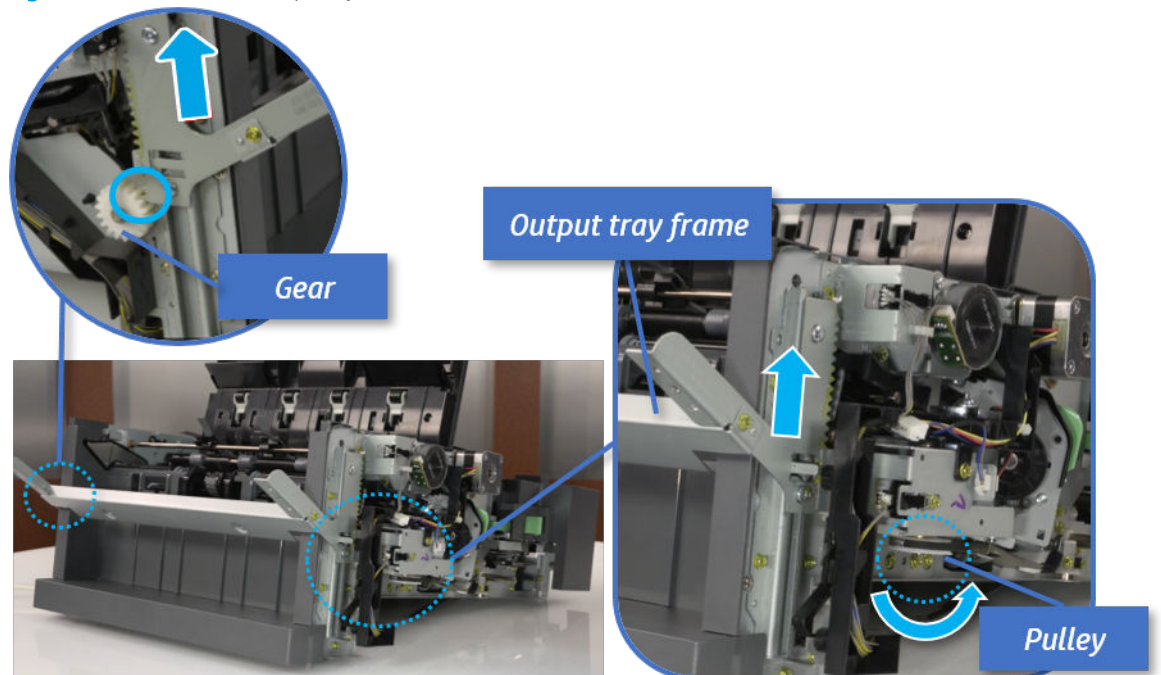

- b. Push the paper holding actuator into the inner finisher, and then remove the output tray frame.

Figure 5-382 Remove the output tray frame

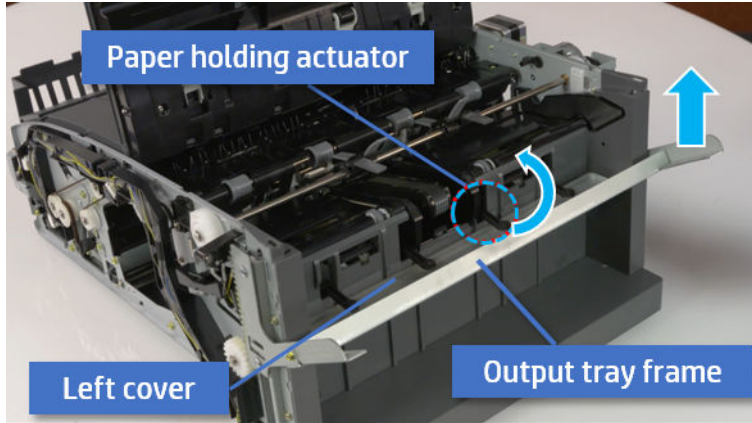

TIP: Push the paper holding actuator into the inner finisher when reassembling. Be sure to level the output tray.

1. Position the first wheel into the channel on both sides while pushing the paper holding actuator.

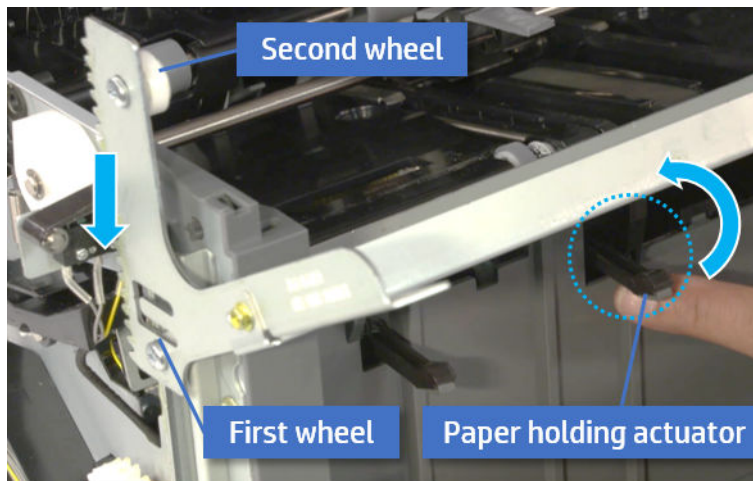

2. Let the second wheel rest on the channel on both sides simultaneously.
3. Gently squeeze the wheels into channel until the output tray frame meet the gear.

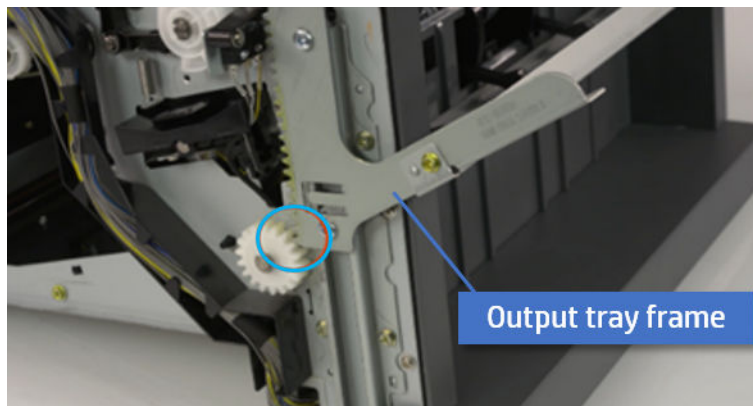

4. Rotate the pulley until the output tray frame is no longer lifted. It can make to level the output tray frame.

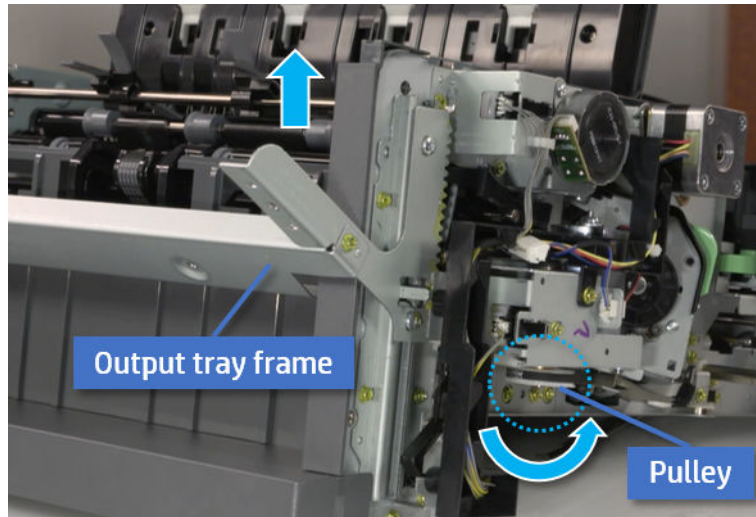

5. Rotate the pulley in the opposite direction.

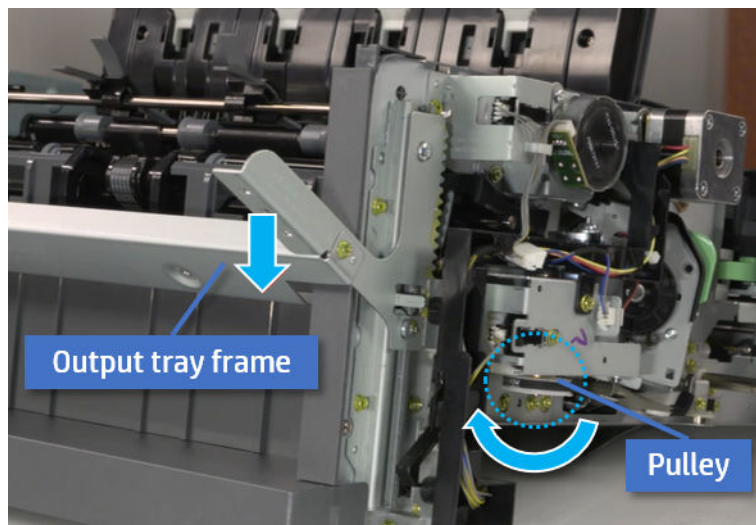

5. Remove the PCA cover.

- ▲ Remove two screws, and then remove the PCA cover.

Figure 5-383 Remove the PCA cover

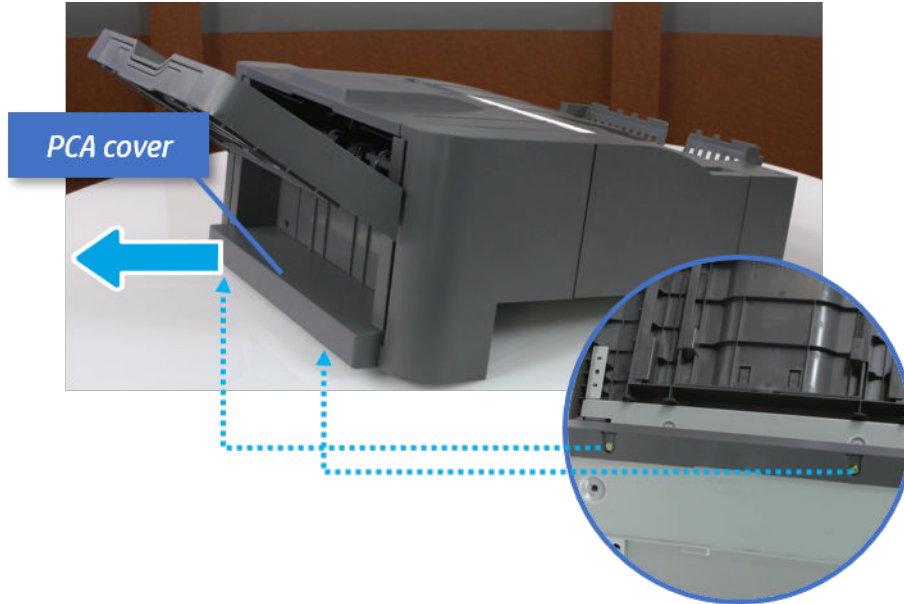

6. Remove the left cover.
 - a. Remove two screws.

Figure 5-384 Remove two screws

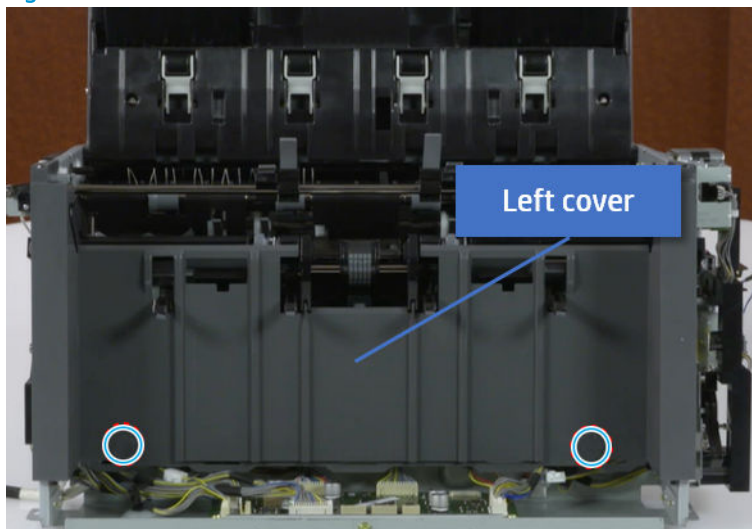

- b. Remove four screws from both front and rear sides.

Figure 5-385 Remove four screws

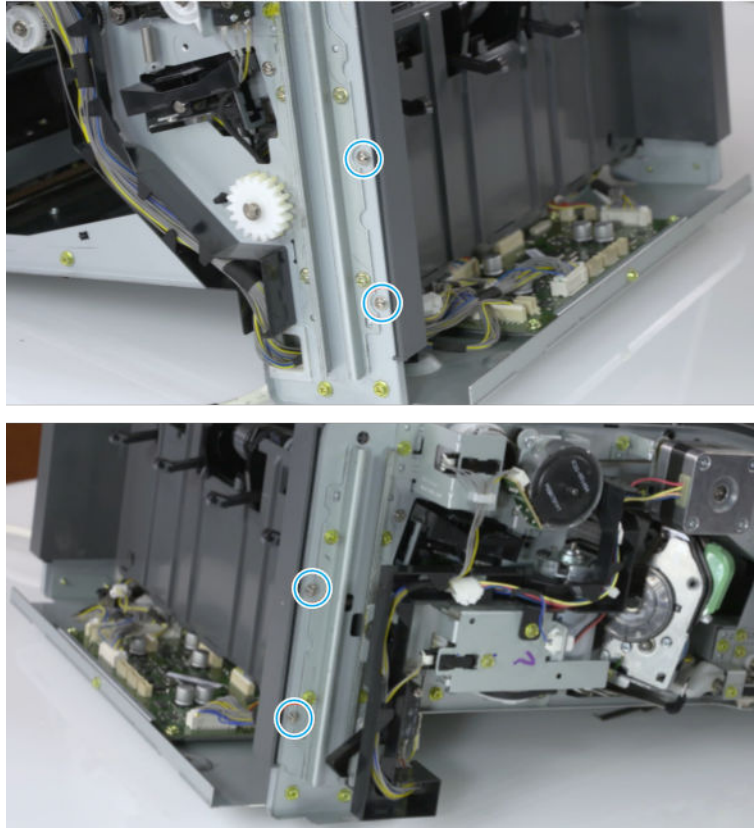

- c. Unplug two inline connectors, and then remove the left cover.

Figure 5-386 Unplug two connectors

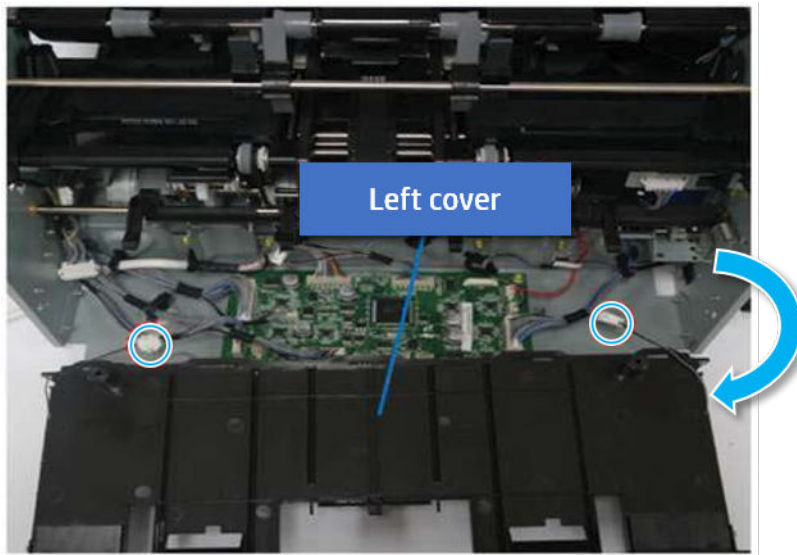

 **TIP:** Be sure to check the hook when reassembling.

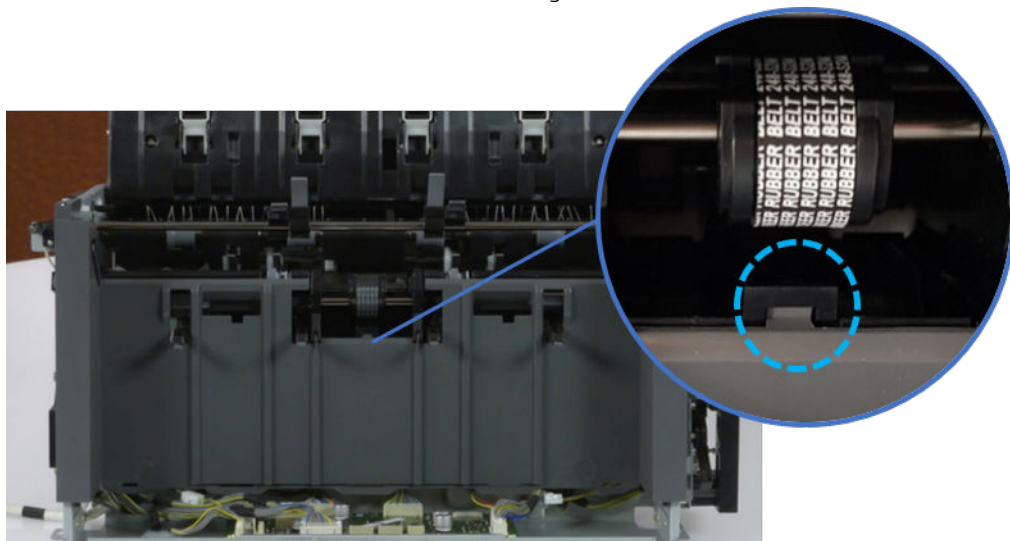

7. Remove the front harness guide.
 - a. Open one clamp and unplug five connectors, and then remove the wire harness from the front harness guide.

- b. Remove four screws, and then remove the front harness guide.

Figure 5-387 Remove the front harness guide

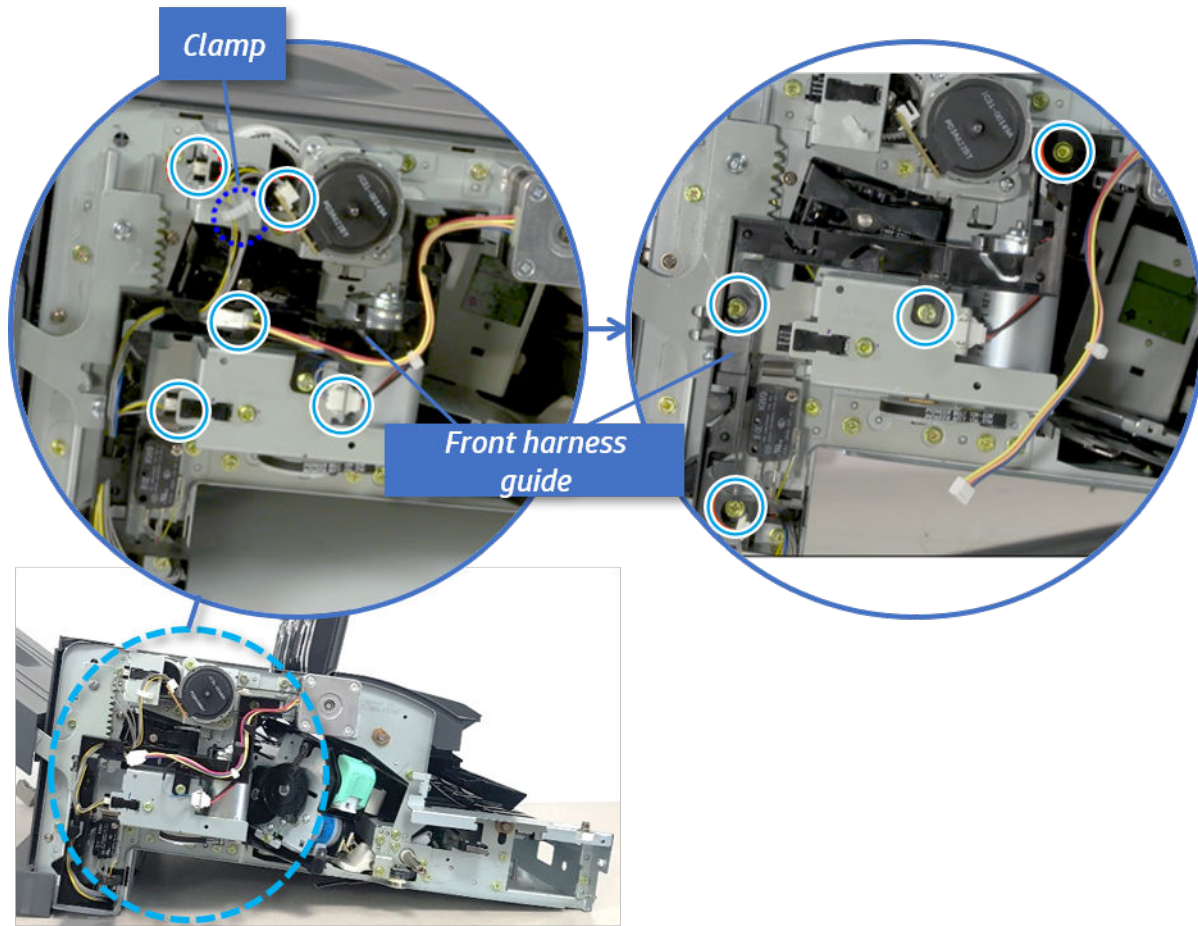

- 8. Remove the output tray motor assembly.
 - ▲ Remove three screws, and then remove the output tray motor assembly.

Figure 5-388 Remove the output tray motor assembly

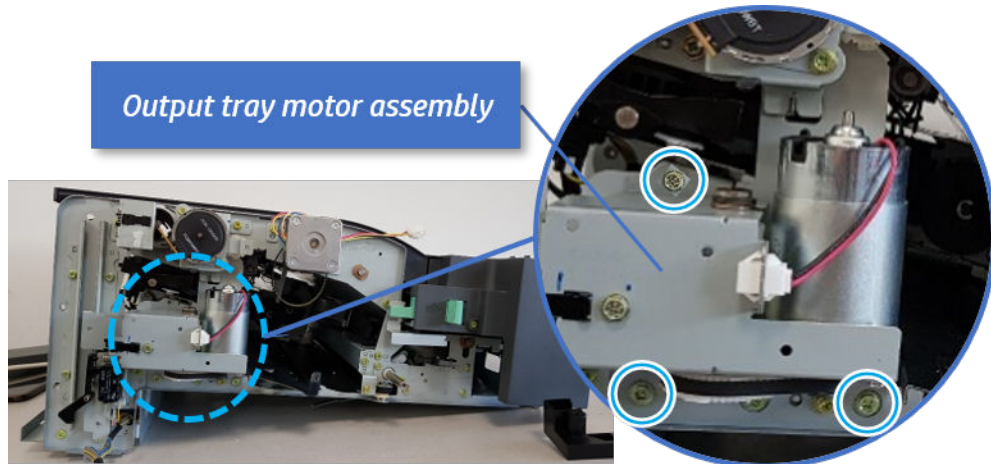

- 9. Remove the output tray lower limit switch.

- ▲ Remove one screw, and then remove the output tray lower limit switch.

Figure 5-389 Remove the output tray lower limit switch

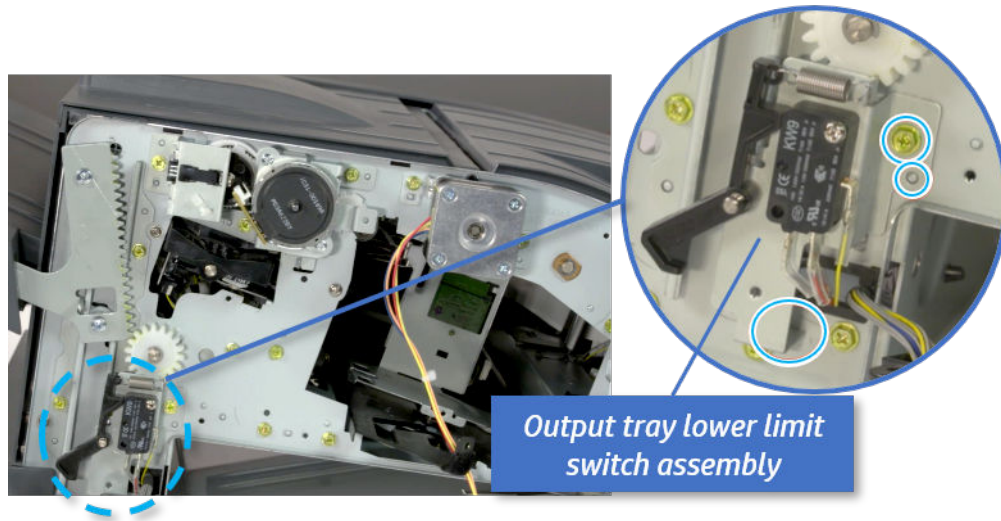

- 10. Remove the paper holding.
 - a. Remove the paper holding actuator spring.

Figure 5-390 Remove the paper holding actuator spring

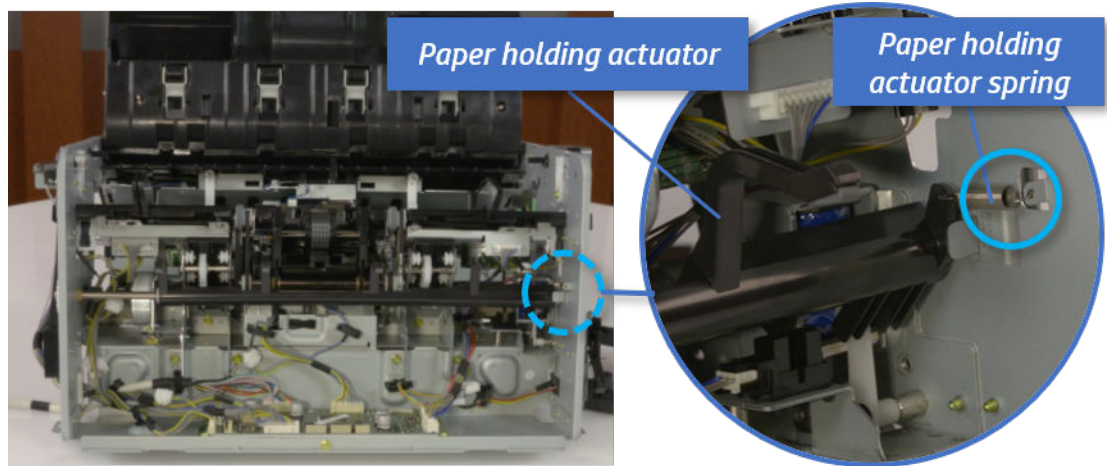

- b. Remove the e-ring and the rack pinion gear. And then remove the pin and the e-ring, and then remove the bushing.

Figure 5-391 Remove e-ring, rack pinion gear, pin, and bushing

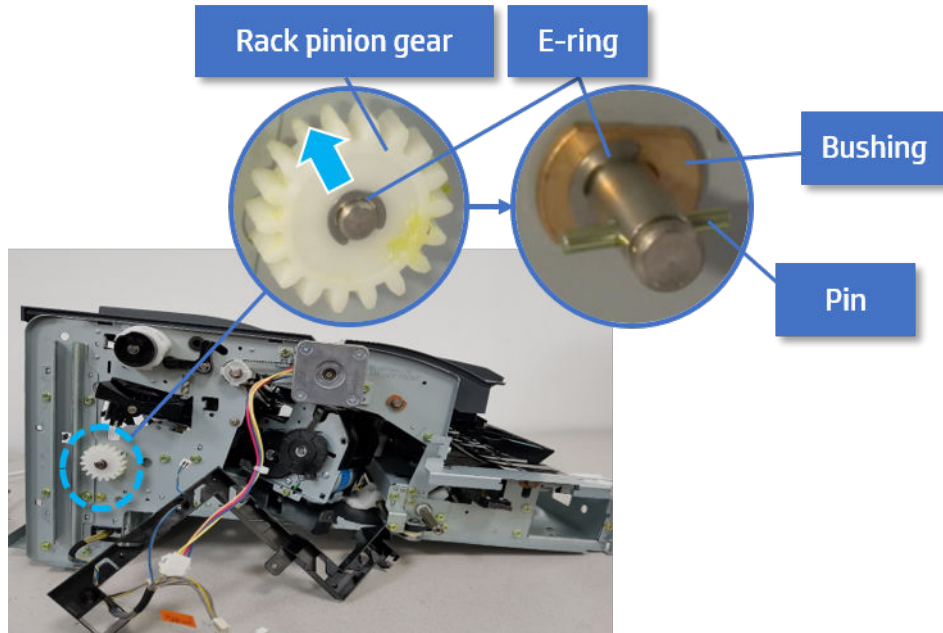

 **NOTE:** Be sure not to lose the pin.

- c. Carefully remove the paper holding shaft and the actuator.

Figure 5-392 Remove the paper holding shaft and the actuator

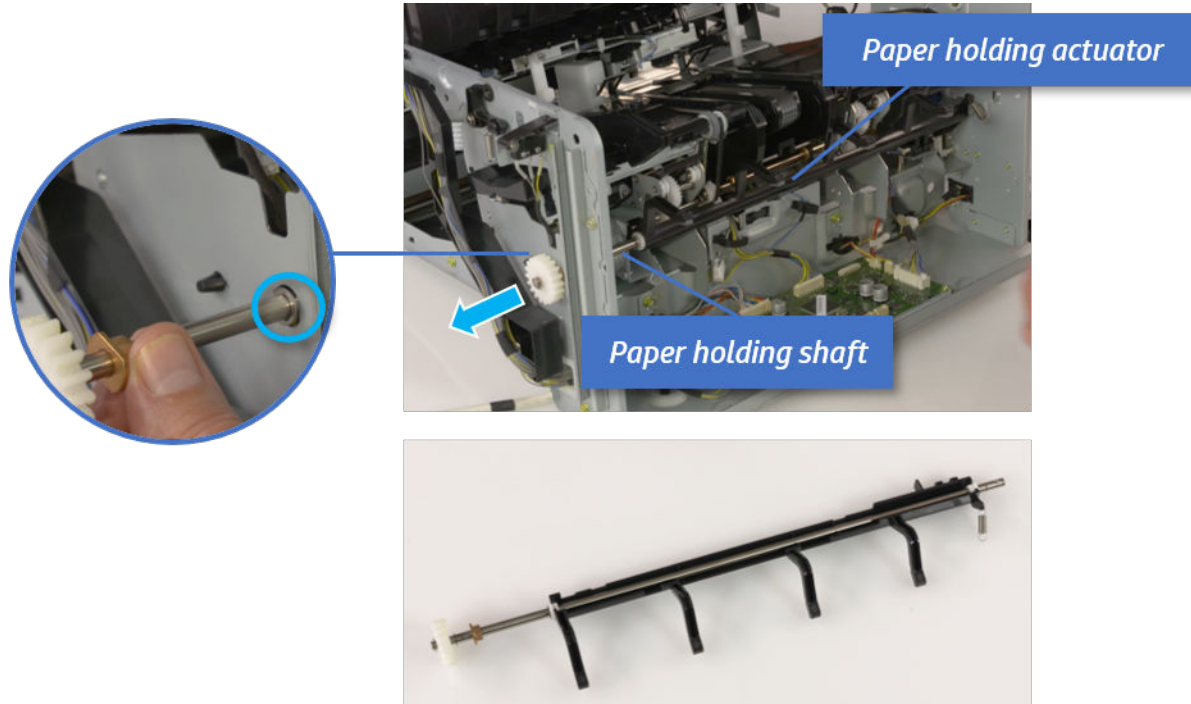

- 11. Remove the sub paddle unit.

- a. Open the top cover, and then remove one screw securing the sub paddle unit.

Figure 5-393 Remove one screw

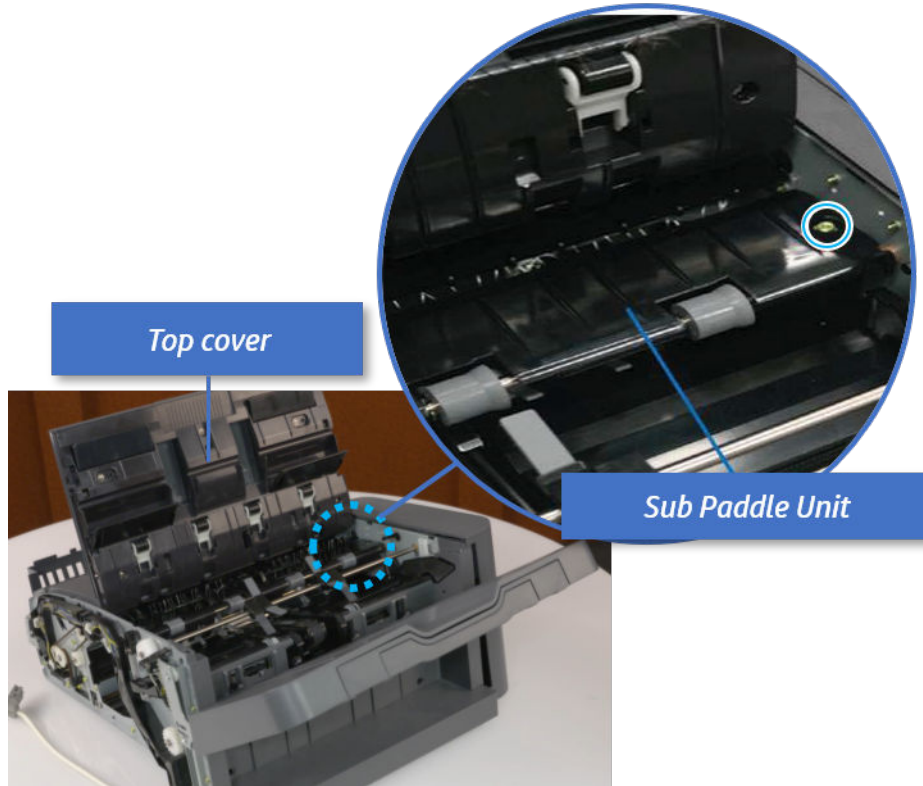

- b. Remove the e-ring, and then remove the pulley and timing belt. And then remove the e-ring and the bushing.

Figure 5-394 Remove the e-ring, pulley, timing belt, and bushing

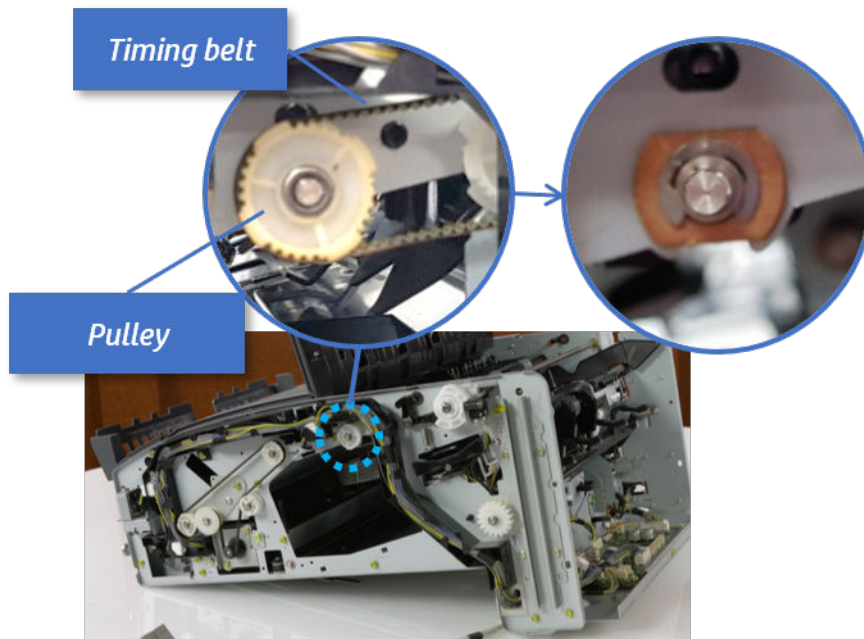

- c. Lift up and remove the sub paddle unit.

Figure 5-395 Remove the sub paddle unit

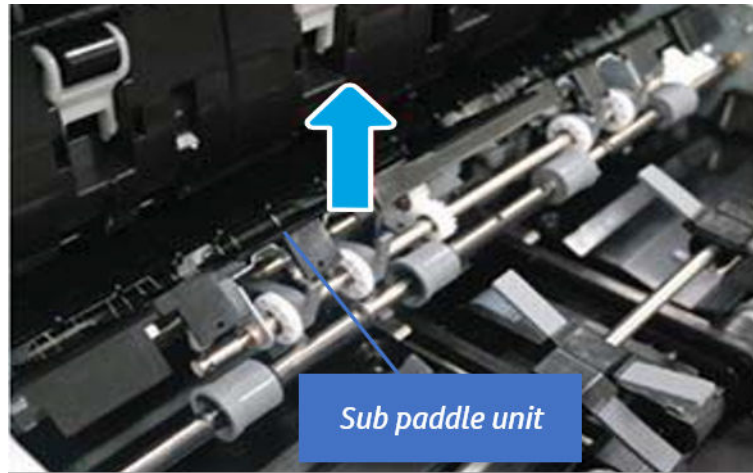

- 12. Remove the exit roller.

- a. Remove the guide on the center of the exit roller.

Figure 5-396 Remove the guide

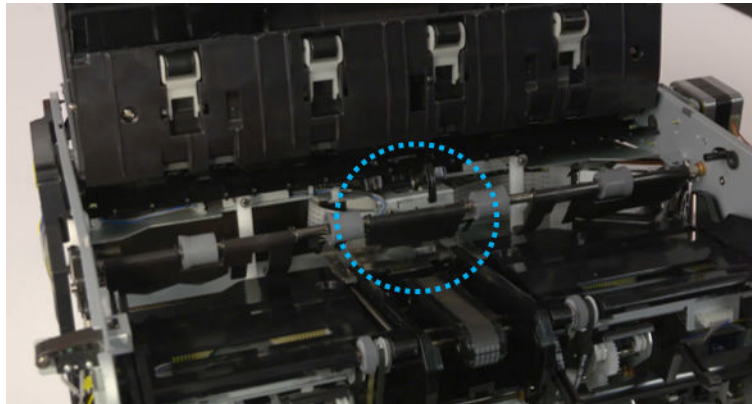

- b. On the front of the inner finisher, release the timing belt connected to the exit motor.

Figure 5-397 Release the timing belt

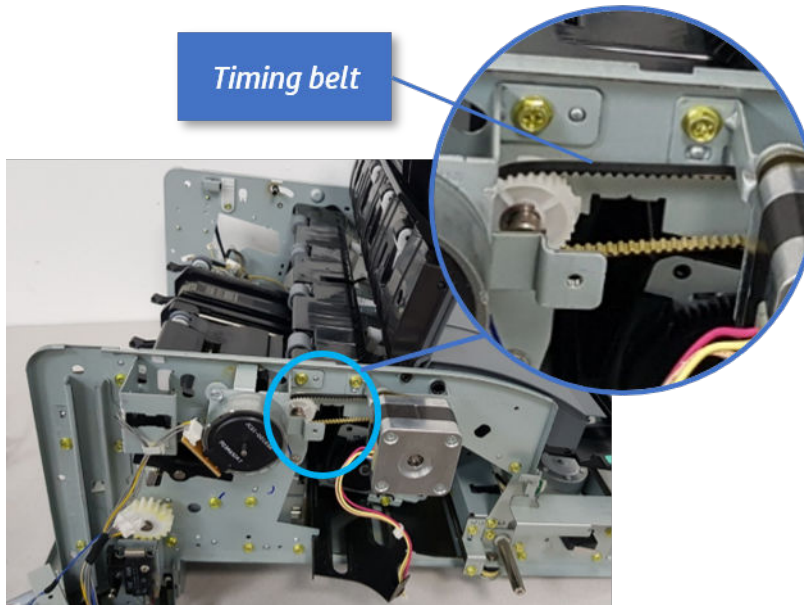

- c. Remove five screws securing the rear harness guide.

Figure 5-398 Remove five screws

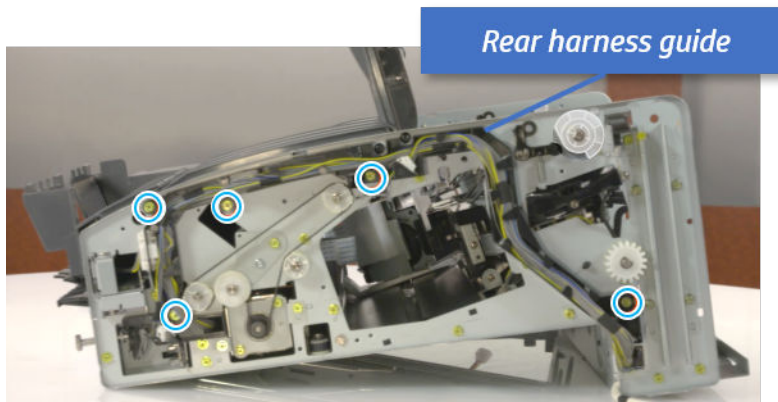

- d. On the rear of the inner finisher, remove the e-ring and the pulley and then remove the e-ring and the bushing.

Figure 5-399 Remove e-ring, pulley, and bushing

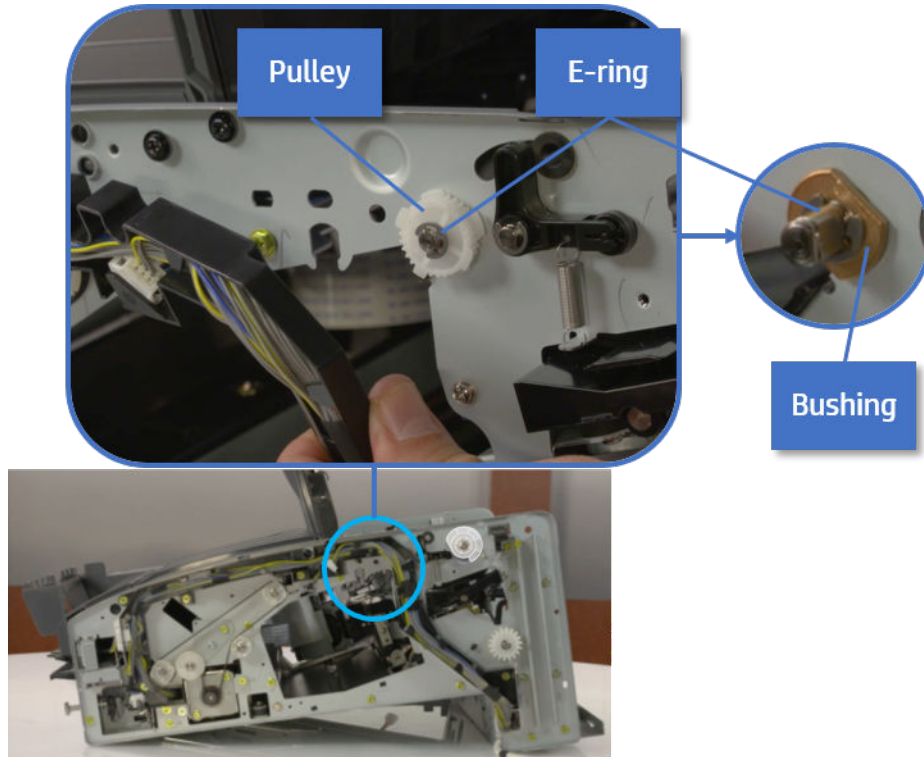

- e. Push the bushing to detach it, and then remove the exit roller.

Figure 5-400 Remove the exit roller

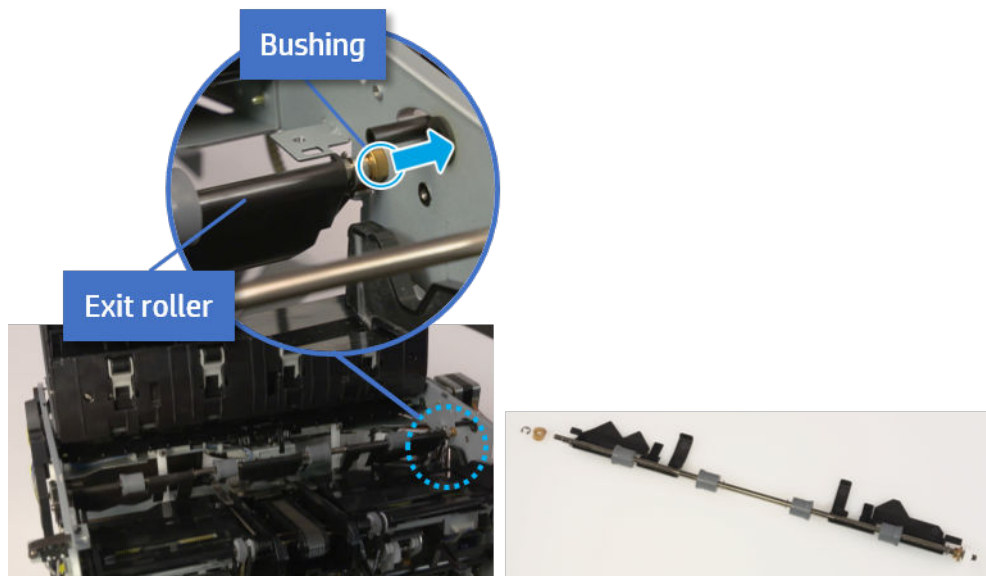

- 13. Remove the rear tamper.
 - a. Remove four screws.

 **NOTE:** Move cable guideout of position to access the screws.

Figure 5-401 Remove four screws



- b. Unplug two connectors and release the hook, and then remove the rear tamper.

Figure 5-402 Remove the rear tamper

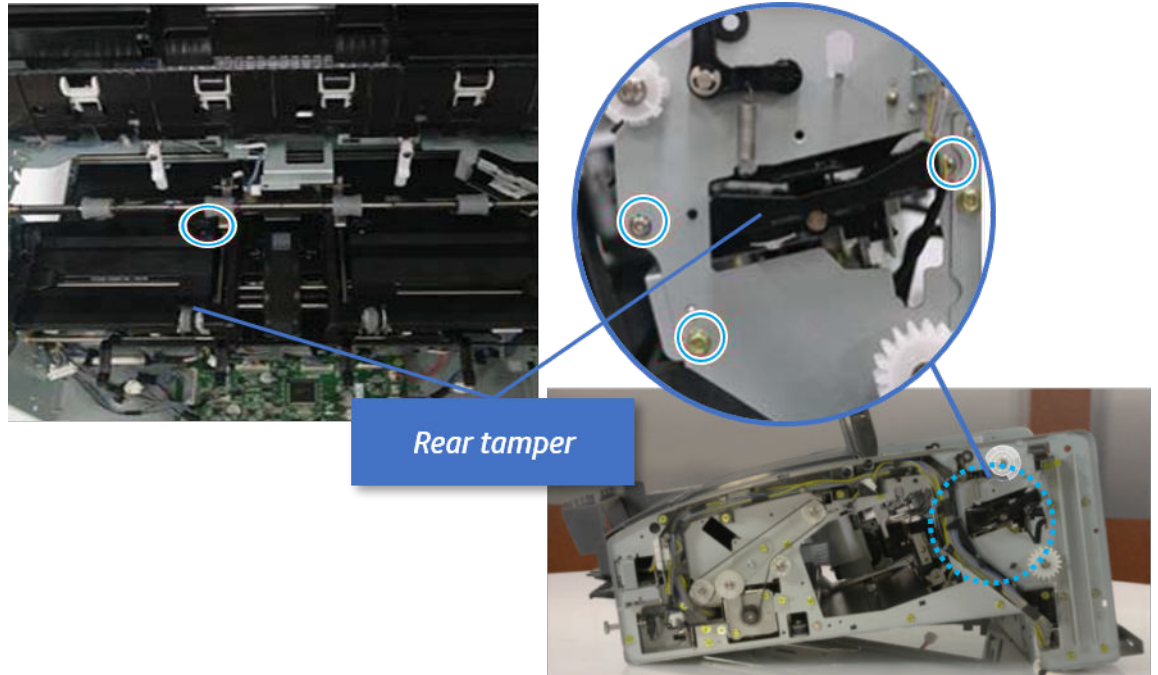
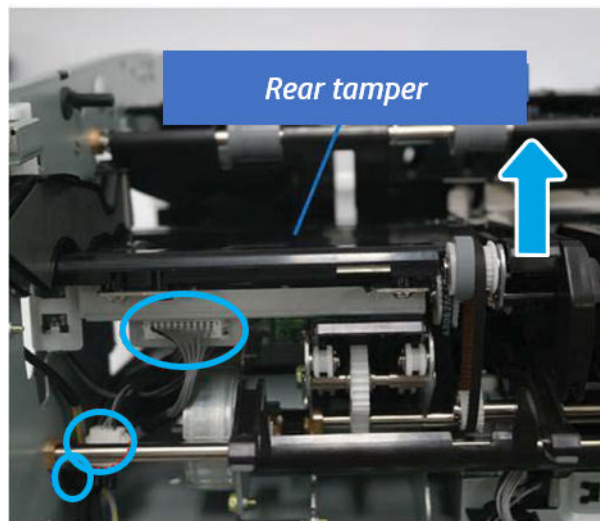



14. Unpack the replacement assembly.
 - a. Dispose of the defective part.

 **NOTE:** HP recommends responsible disposal of the defective part.

<http://www8.hp.com/us/en/hp-information/environment/product-recycling.html>

- b. Unpack the replacement part from the packaging.

 **CAUTION:**  Some parts are sensitive to electrostatic discharge (ESD). Always perform service work at an ESD-protected workstation or mat. If an ESD workstation or mat is not available, touch the sheet-metal chassis to provide a static ground before touching an ESD-sensitive assembly. Protect the ESD-sensitive assemblies by placing them in ESD pouches when they are out of the printer.

If the replacement part is a roller or pad, avoid touching the spongy part of it. Skin oils on the roller or pad can cause paper pickup and/or print-quality problems. HP recommends using disposable gloves when handling rollers or pads or washing your hands before touching rollers or pads.

 **IMPORTANT:** Make sure that all of the shipping materials (for example shipping tape) are removed from the replacement part prior to installation.

- c. To install an assembly, reverse the removal steps.

When applicable, special installation instructions are provided for an assembly at the end of the removal procedure. Always completely read the removal instructions and follow all special installation instructions.

Removal and replacement: Rear tamper home sensor (S14)

Learn how to remove and replace the rear tamper home sensor.

To view teardown&reassembling video of the inner finisher, click the link below.

 [View a teardown video of the inner finisher .](#)

 [View a reassembling video of the inner finisher .](#)

 **IMPORTANT:** When applicable, special installation instructions are provided for an assembly at the end of the removal procedure. Always completely read the removal instructions and follow all special installation instructions.

Mean time to repair:

Service level:

Before performing service

Turn the printer power off

- Press the power button on the front of the printer, and then turn off the power switch next to the power cable.
- A shutting-down message appears on the control-panel display.

 **WARNING!** To avoid damage to the printer, turn the power off and wait until the printer shuts down before removing the power cable.

- Disconnect the printer power cable after the printer has completely shut down (the control-panel display is blank).

Use the table below to identify the correct part number for your printer. To order the part, go to <https://parts.hp.com>.

Table 5-54 Part information

Part number	Part description
0604-001393	Rear tamper home sensor

Required tools

- #2 JIS screwdriver with a magnetic tip

After performing service

Turn the printer power on

- Connect the power cable.
- Use the power switch to turn the power on.

Post service test

Print any pages necessary to verify that the repair resolved the issue and did not create any new issues.

1. Remove the front cover.
 - a. Open the front door and open the punch cover.
 - b. Remove three screws in the front.
 - c. Remove the lever.
 - d. Open the top cover.
 - e. From the right side of the front cover, carefully lift and pry toward the top-left corner to remove the front cover.

Figure 5-403 Remove the front cover

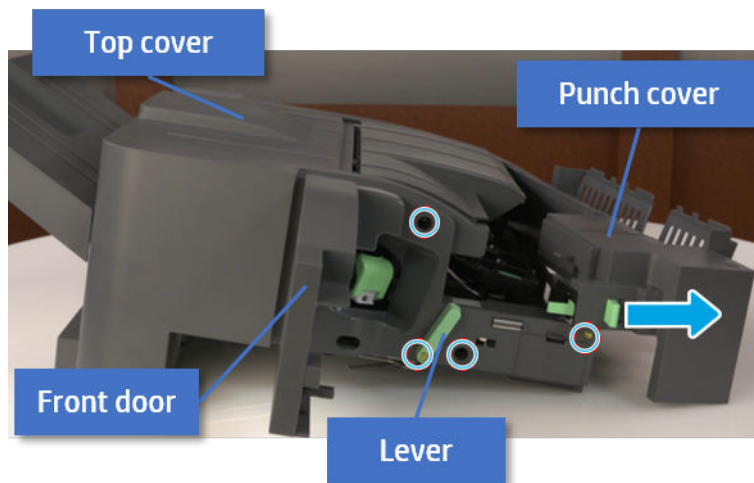

2. Remove the rear cover.

- a. Open the top cover.

Figure 5-404 Open the top cover

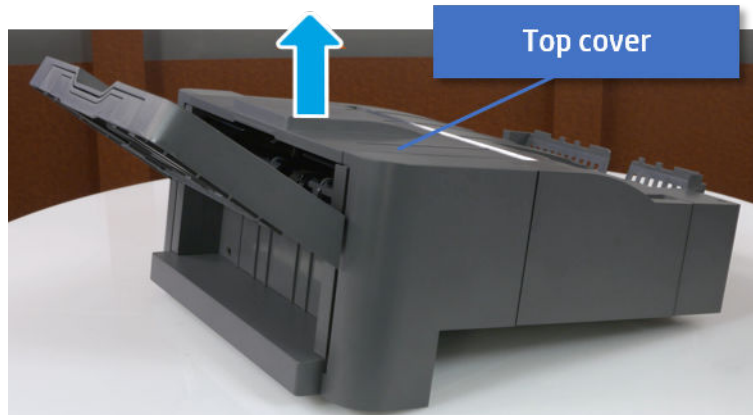

- b. Remove three screws.
- c. Release hooks carefully and remove the rear cover.

Figure 5-405 Remove the rear cover

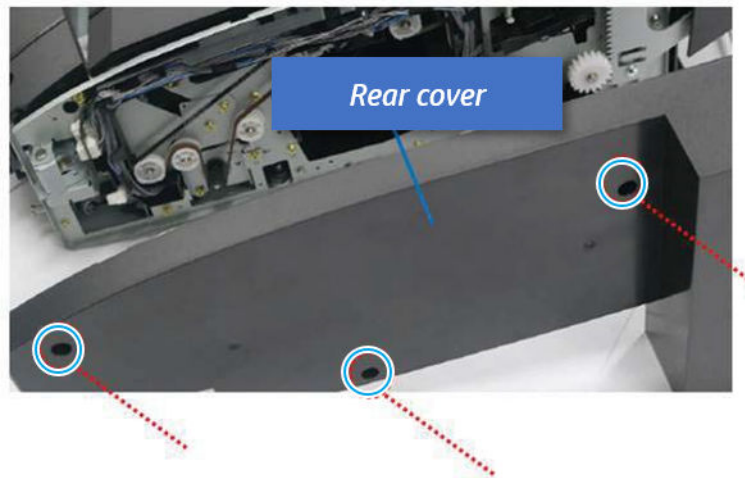

3. Remove the output tray.
 - a. Remove four screws.

Figure 5-406 Remove four screws

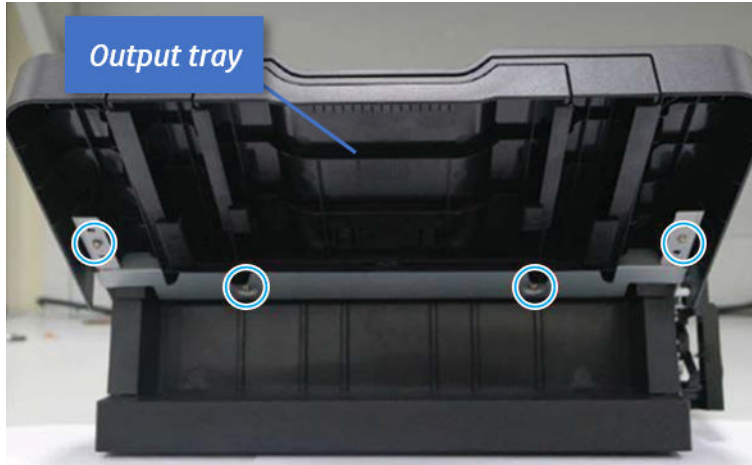

- b. Push the paper holding actuator into the inner finisher, and then remove the output tray.

Figure 5-407 Remove the output tray.



4. Remove the output tray frame.
 - a. Rotate the pulley until the output tray frame depart from the gear.

Figure 5-408 Remove the pulley

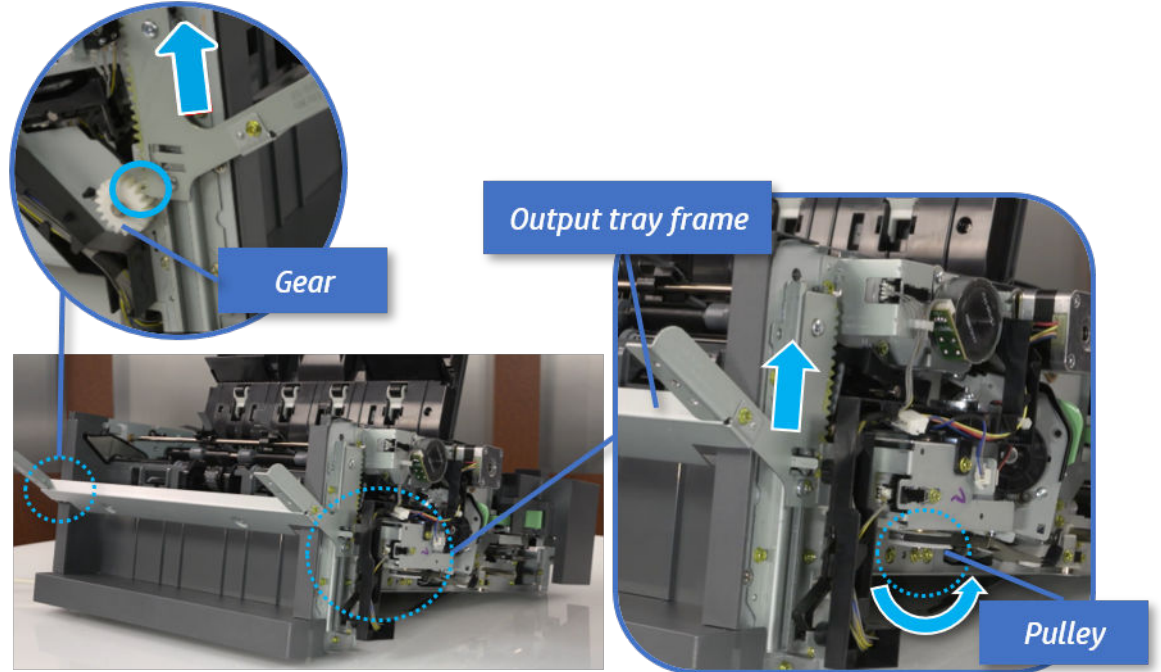

- b. Push the paper holding actuator into the inner finisher, and then remove the output tray frame.

Figure 5-409 Remove the output tray frame

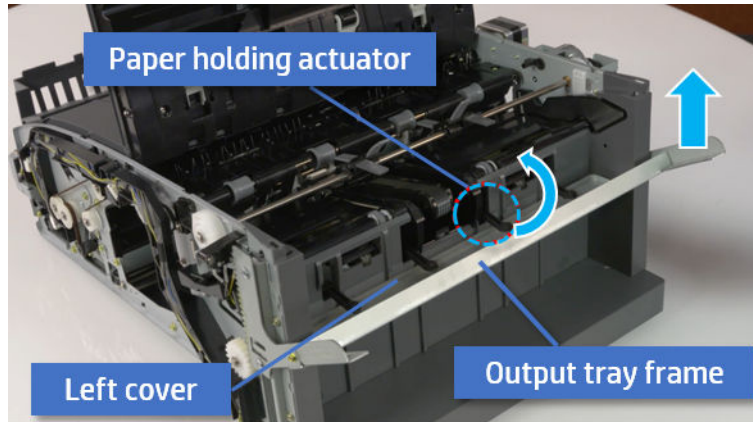

TIP: Push the paper holding actuator into the inner finisher when reassembling. Be sure to level the output tray.

1. Position the first wheel into the channel on both sides while pushing the paper holding actuator.

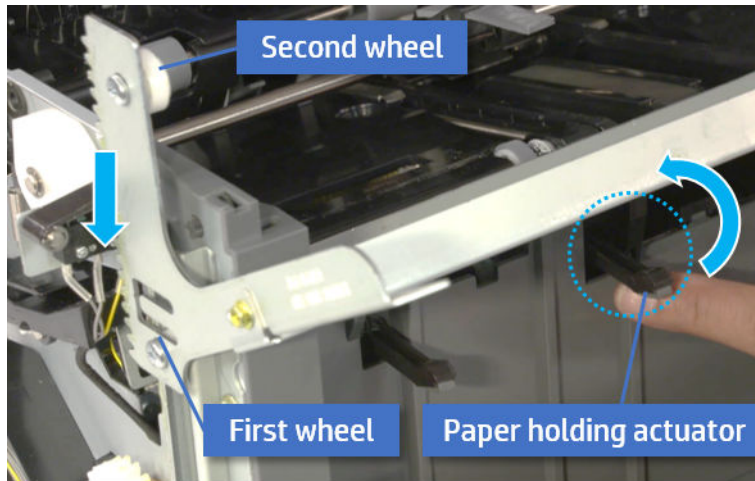

2. Let the second wheel rest on the channel on both sides simultaneously.
3. Gently squeeze the wheels into channel until the output tray frame meet the gear.

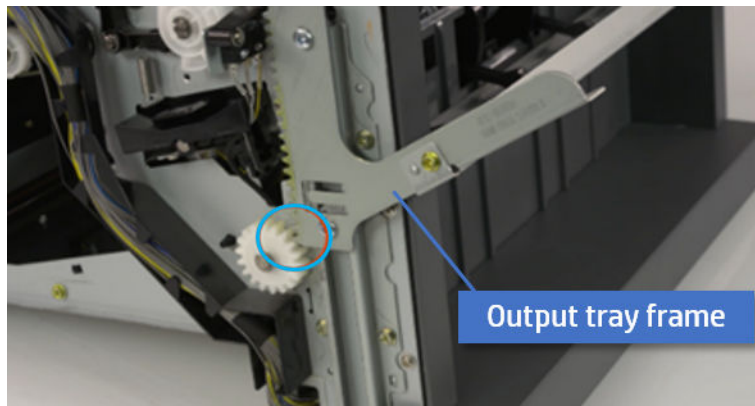

4. Rotate the pulley until the output tray frame is no longer lifted. It can make to level the output tray frame.

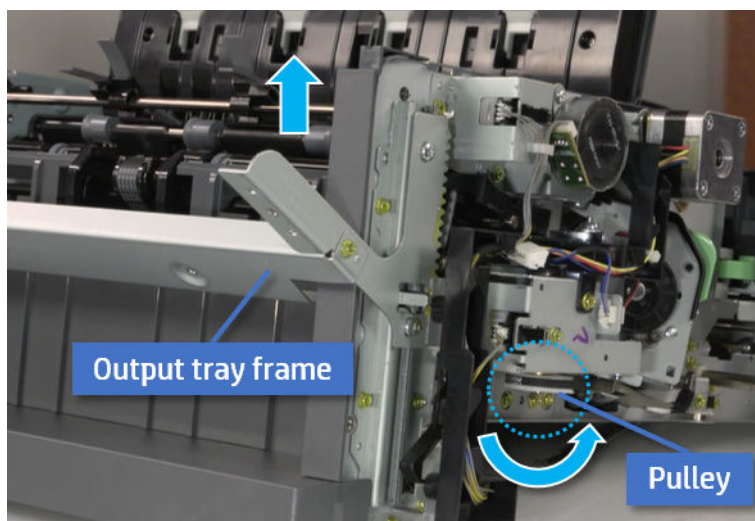

5. Rotate the pulley in the opposite direction.

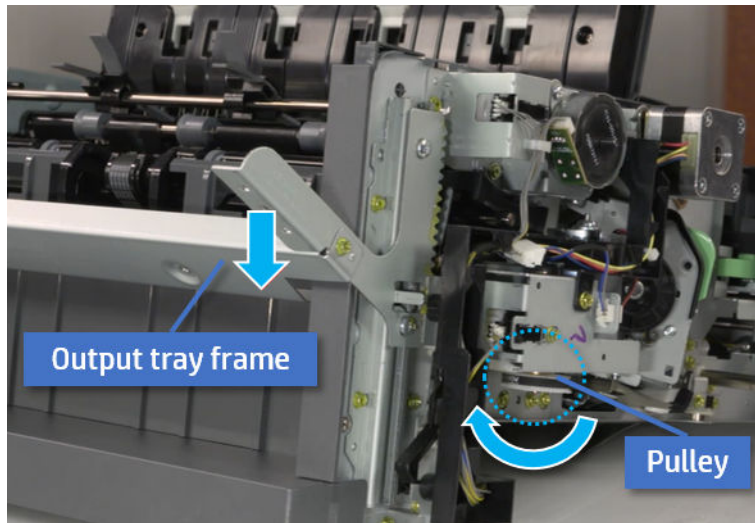

5. Remove the PCA cover.

- ▲ Remove two screws, and then remove the PCA cover.

Figure 5-410 Remove the PCA cover

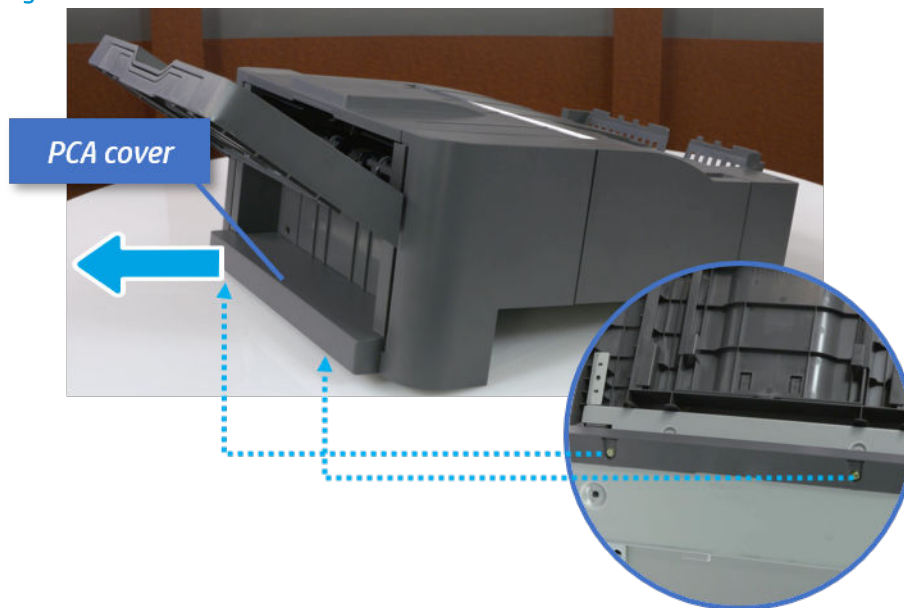

6. Remove the left cover.

- a. Remove two screws.

Figure 5-411 Remove two screws

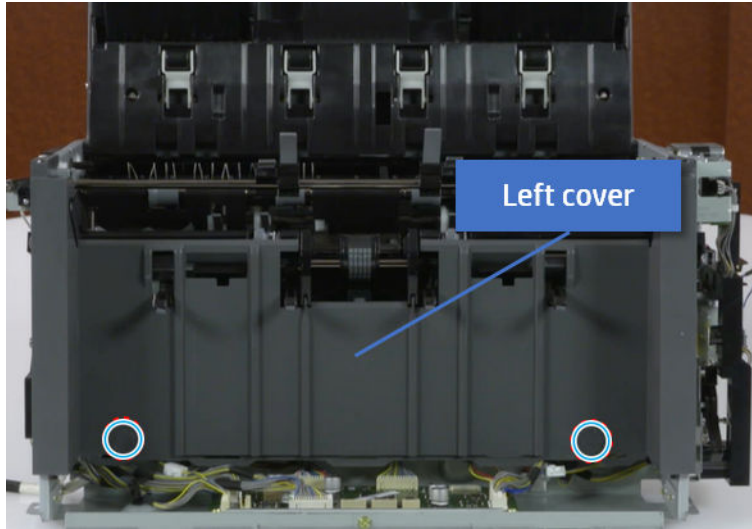

- b. Remove four screws from both front and rear sides.

Figure 5-412 Remove four screws

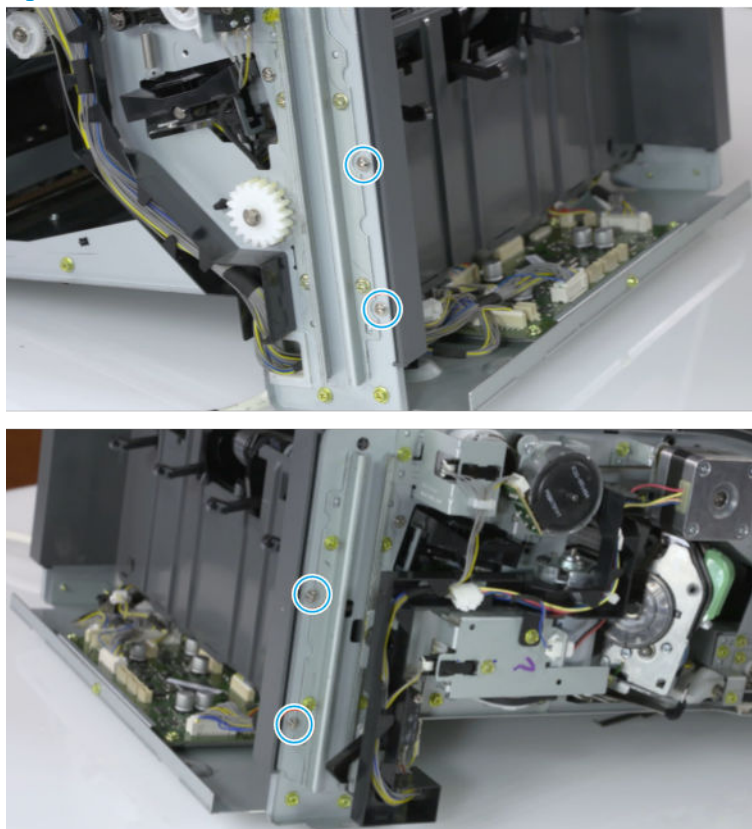

- c. Unplug two inline connectors, and then remove the left cover.

Figure 5-413 Unplug two connectors

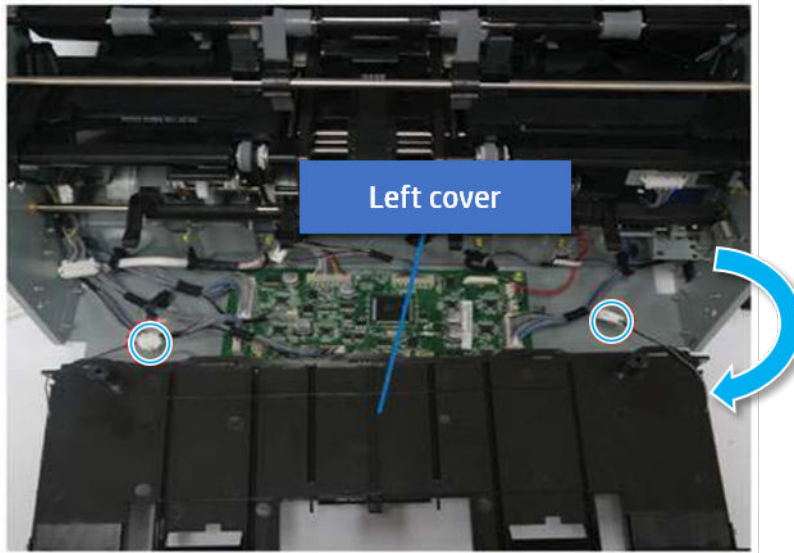

 **TIP:** Be sure to check the hook when reassembling.

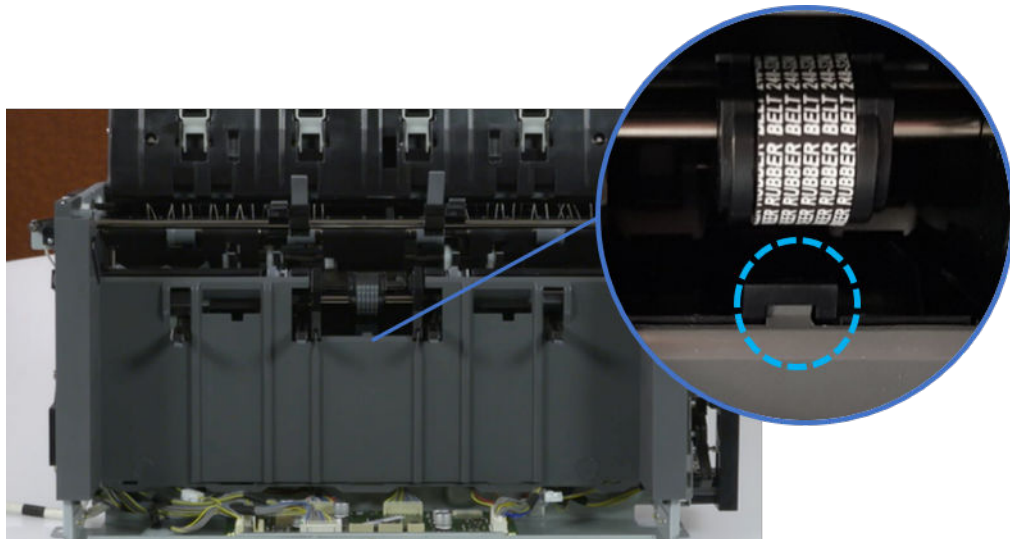

- 7. Remove the front harness guide.
 - a. Open one clamp and unplug five connectors, and then remove the wire harness from the front harness guide.

- b. Remove four screws, and then remove the front harness guide.

Figure 5-414 Remove the front harness guide

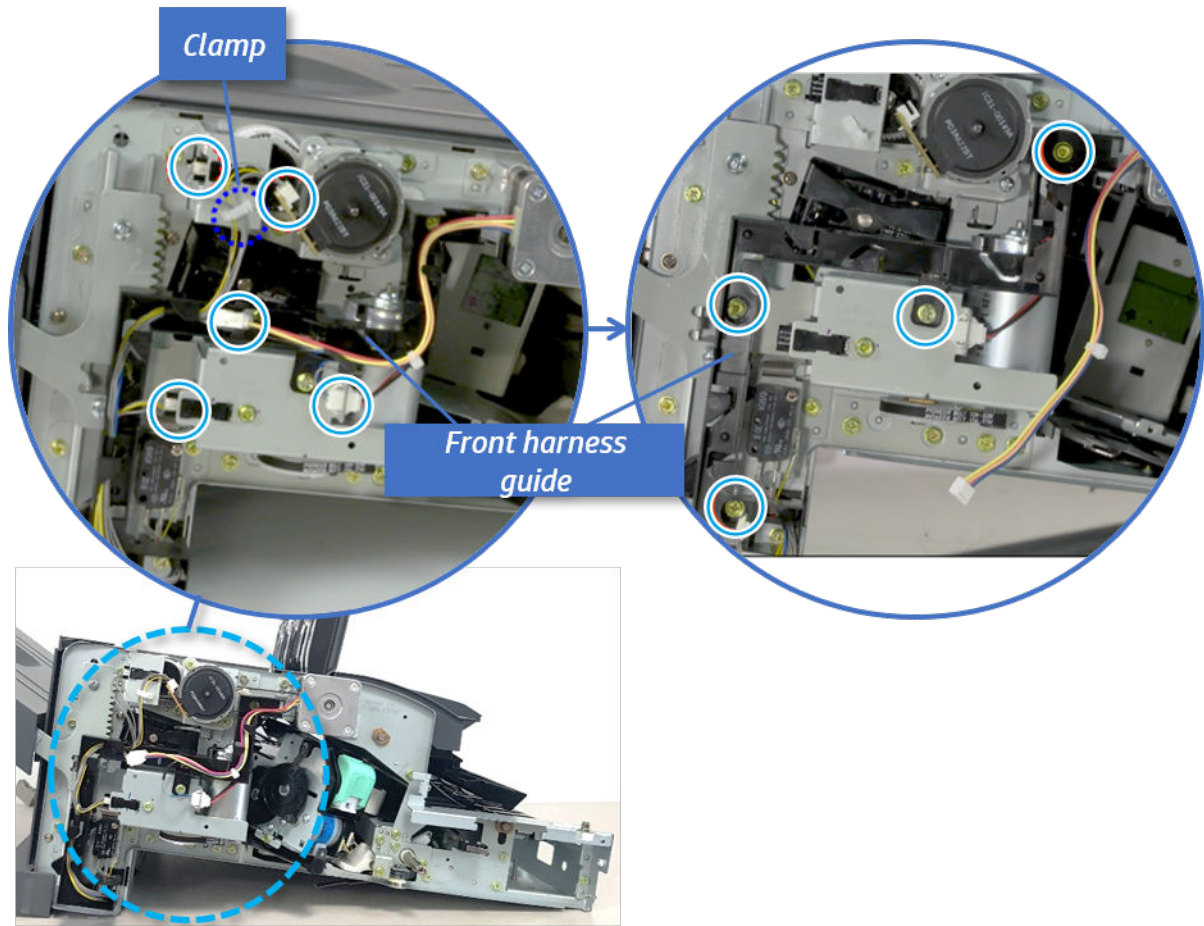

8. Remove the output tray motor assembly.

- ▲ Remove three screws, and then remove the output tray motor assembly.

Figure 5-415 Remove the output tray motor assembly

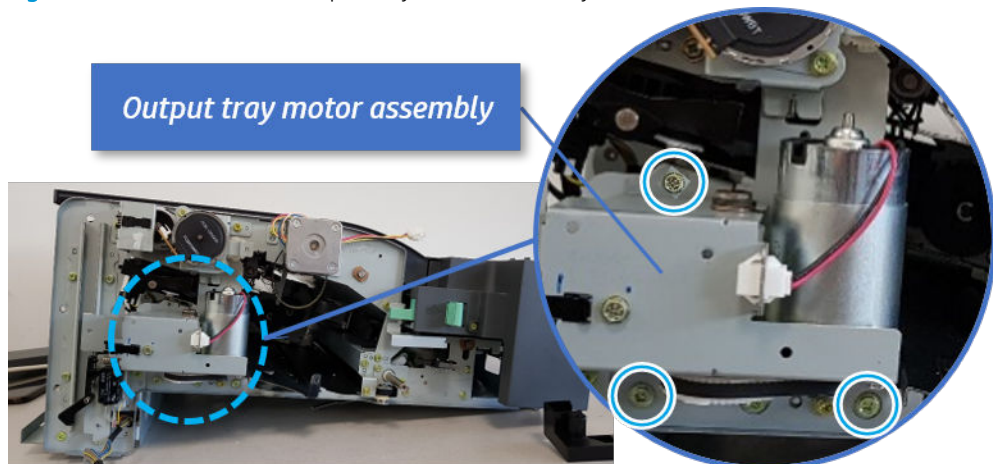

9. Remove the output tray lower limit switch.

- ▲ Remove one screw, and then remove the output tray lower limit switch.

Figure 5-416 Remove the output tray lower limit switch

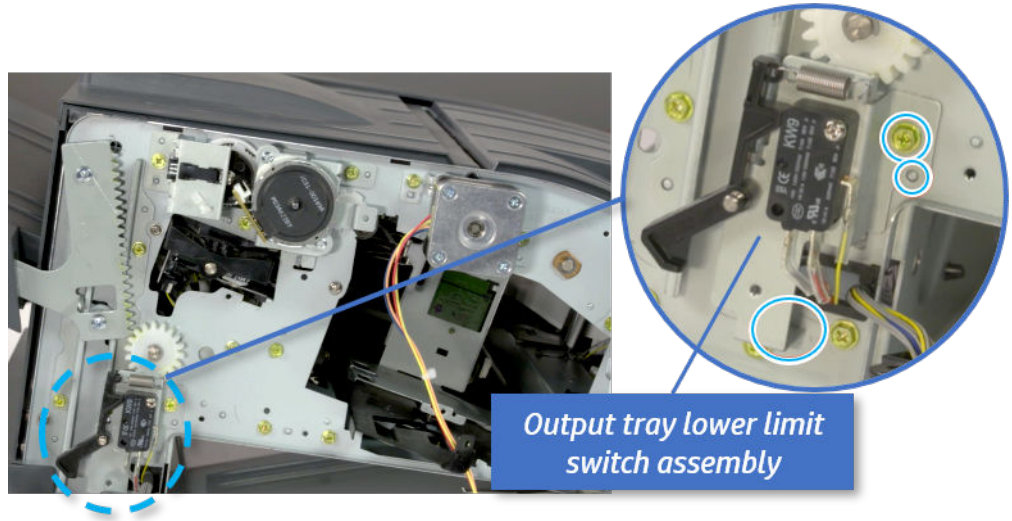

- 10. Remove the paper holding.
 - a. Remove the paper holding actuator spring.

Figure 5-417 Remove the paper holding actuator spring

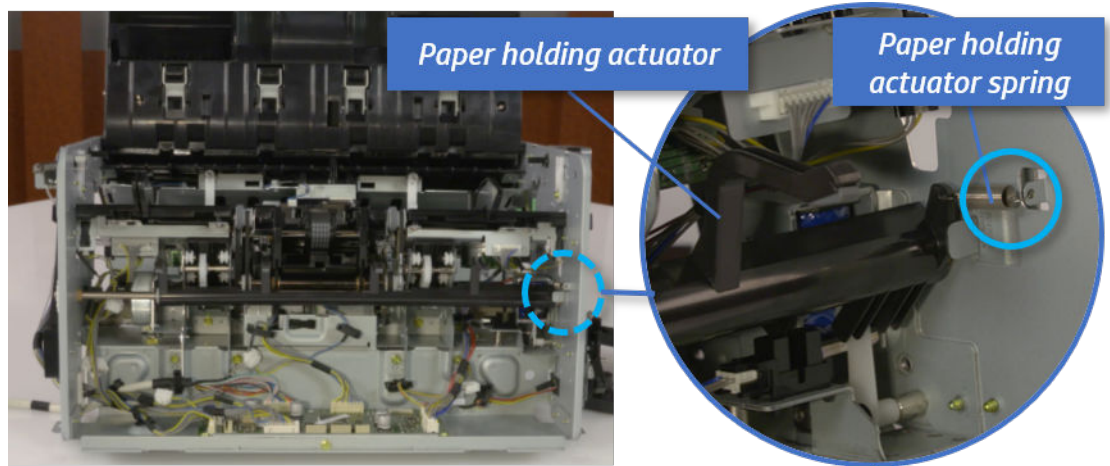

- b. Remove the e-ring and the rack pinion gear. And then remove the pin and the e-ring, and then remove the bushing.

Figure 5-418 Remove e-ring, rack pinion gear, pin, and bushing

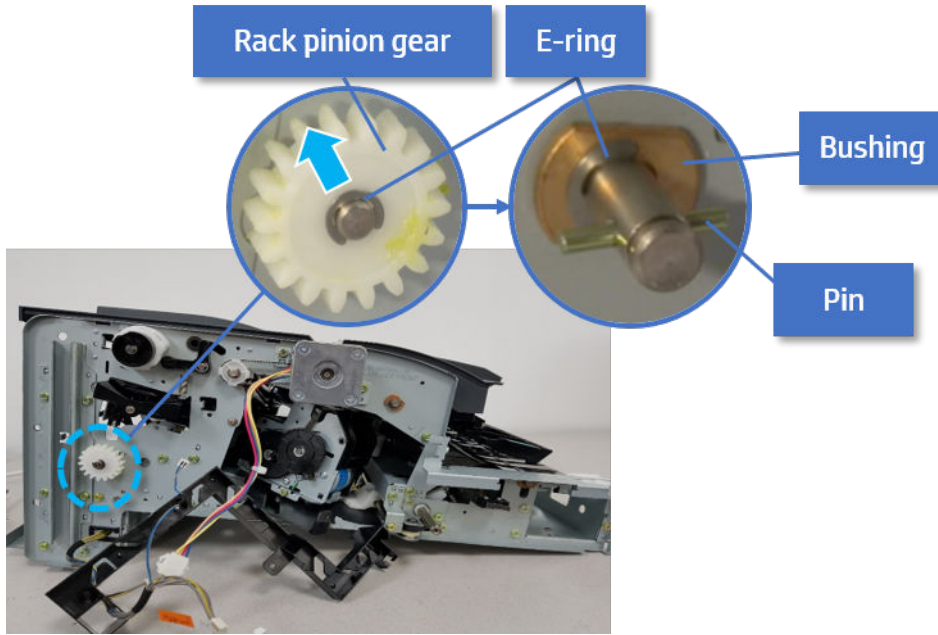

 **NOTE:** Be sure not to lose the pin.

- c. Carefully remove the paper holding shaft and the actuator.

Figure 5-419 Remove the paper holding shaft and the actuator

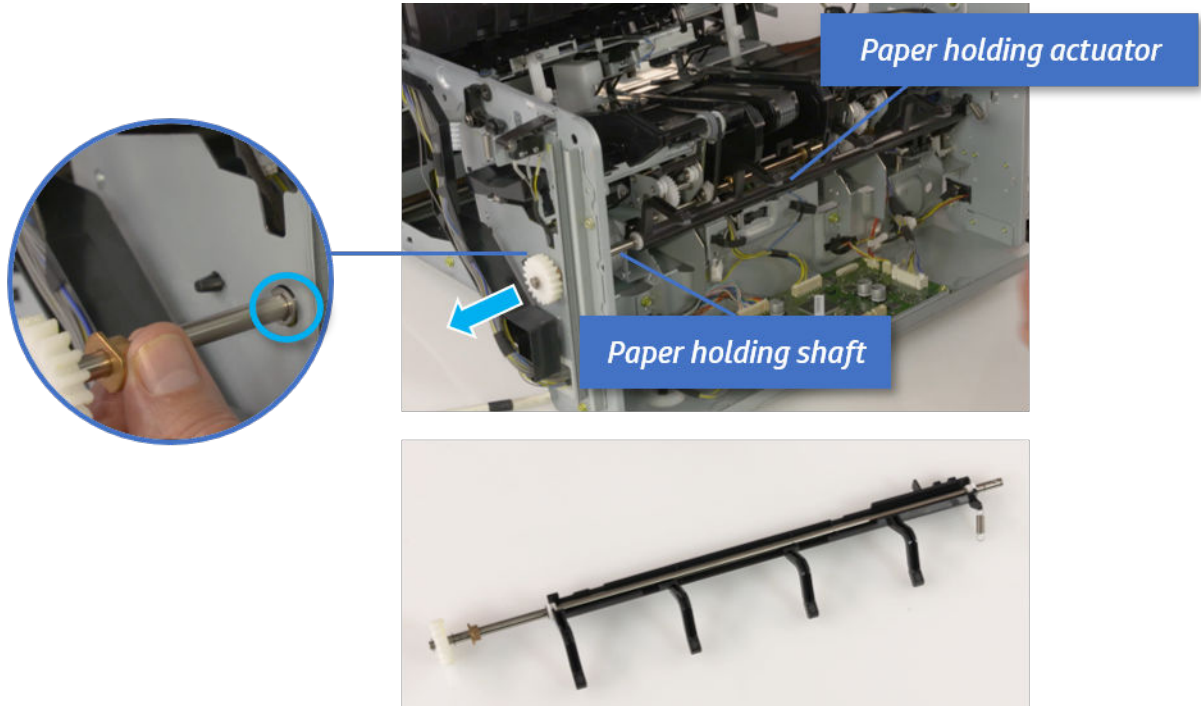

- 11. Remove the sub paddle unit.

- a. Open the top cover, and then remove one screw securing the sub paddle unit.

Figure 5-420 Remove one screw

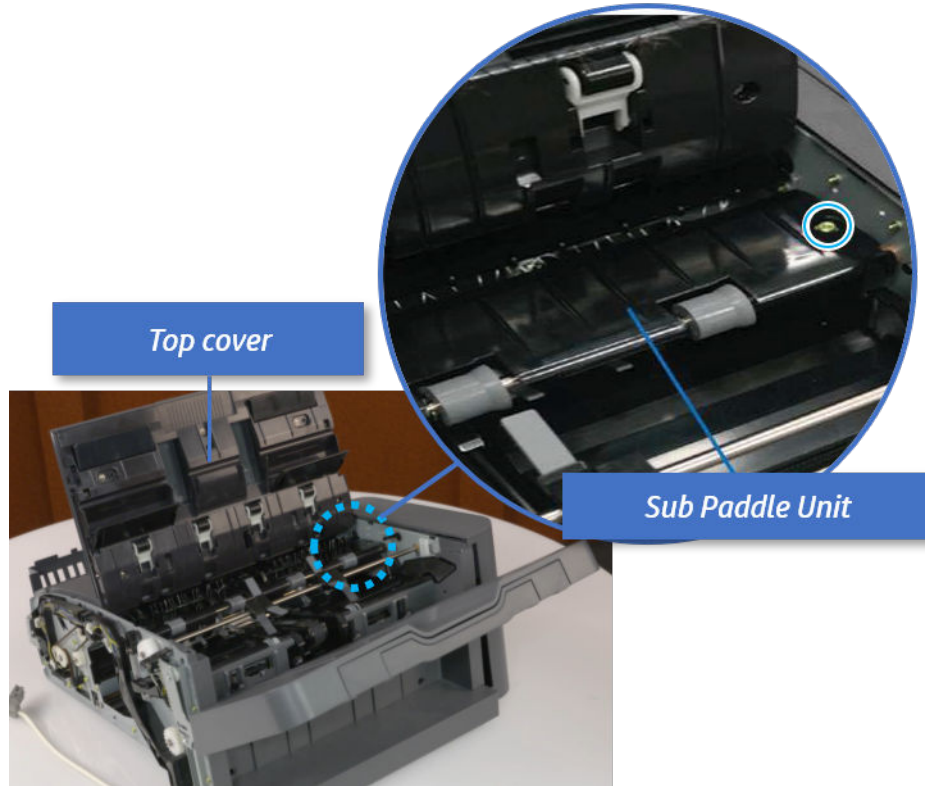

- b. Remove the e-ring, and then remove the pulley and timing belt. And then remove the e-ring and the bushing.

Figure 5-421 Remove the e-ring, pulley, timing belt, and bushing

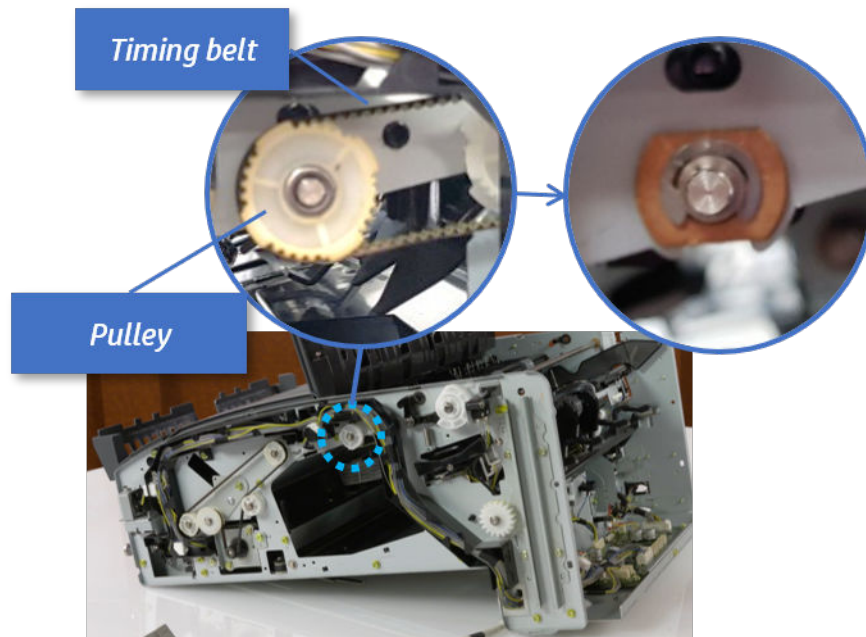

- c. Lift up and remove the sub paddle unit.

Figure 5-422 Remove the sub paddle unit

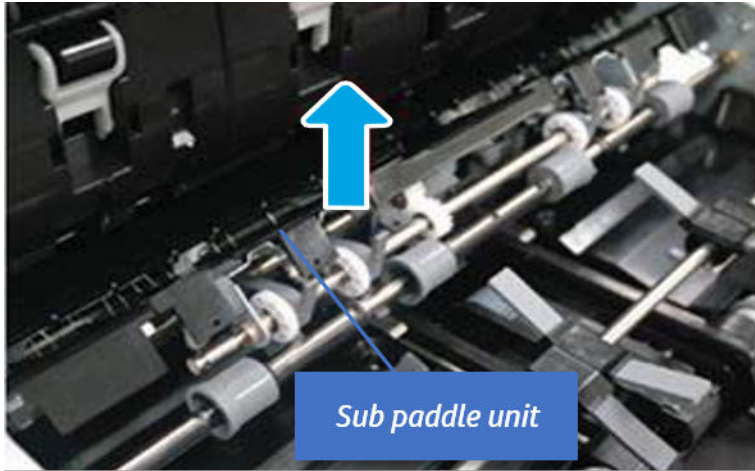

- 12. Remove the exit roller.

- a. Remove the guide on the center of the exit roller.

Figure 5-423 Remove the guide

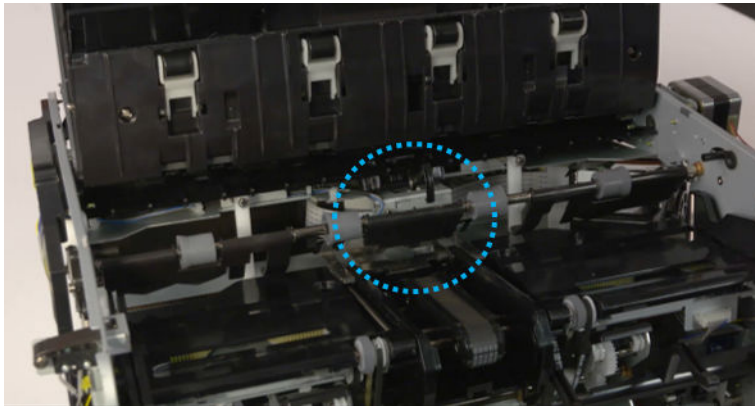

- b. On the front of the inner finisher, release the timing belt connected to the exit motor.

Figure 5-424 Release the timing belt

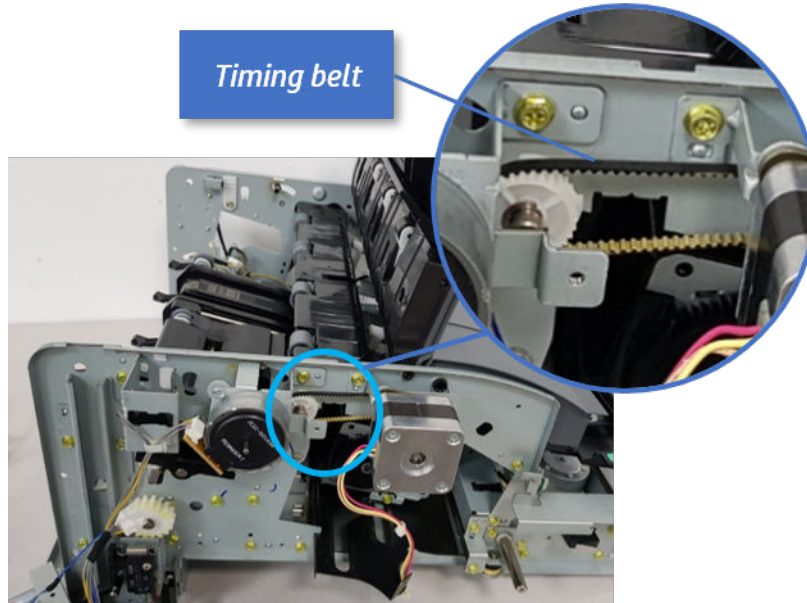

- c. Remove five screws securing the rear harness guide.

Figure 5-425 Remove five screws

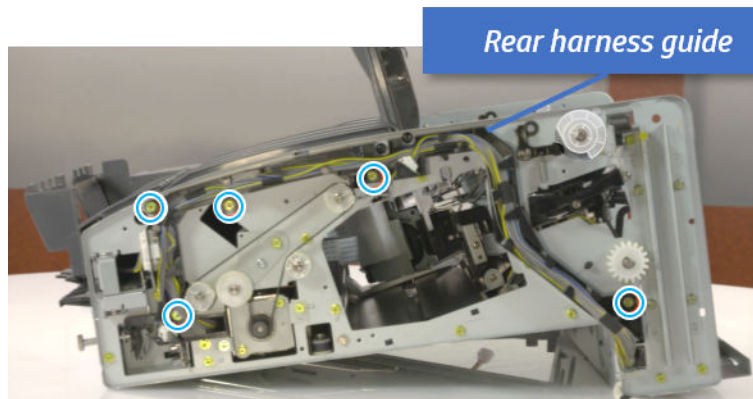

- d. On the rear of the inner finisher, remove the e-ring and the pulley and then remove the e-ring and the bushing.

Figure 5-426 Remove e-ring, pulley, and bushing

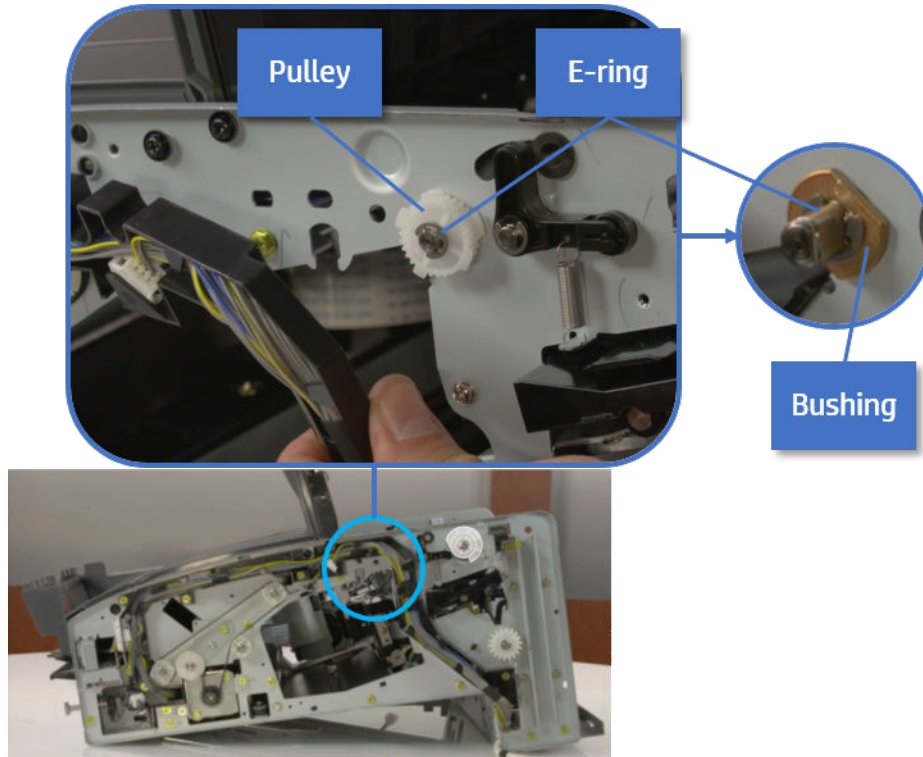

- e. Push the bushing to detach it, and then remove the exit roller.

Figure 5-427 Remove the exit roller

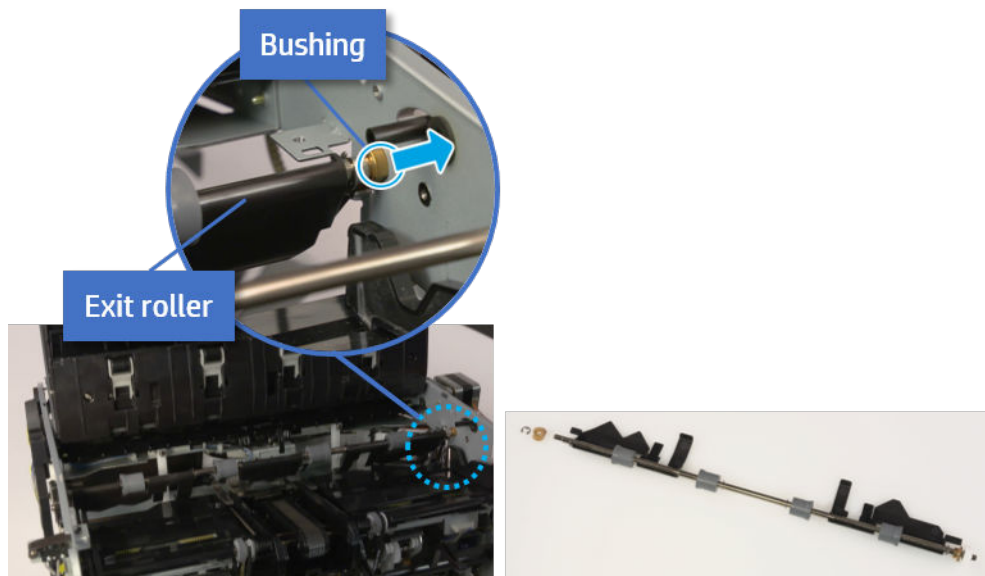

- 13. Remove the rear tamper.
 - a. Remove four screws.

 **NOTE:** Move cable guideout of position to access the screws.

Figure 5-428 Remove four screws



- b. Unplug two connectors and release the hook, and then remove the rear tamper.

Figure 5-429 Remove the rear tamper

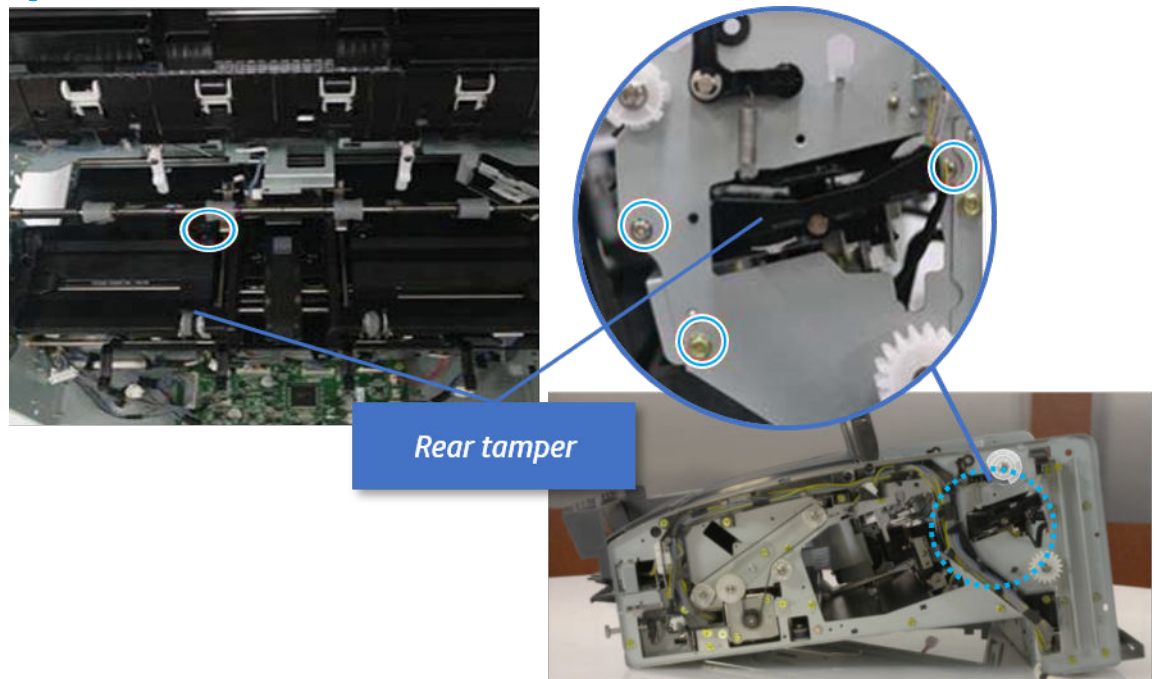
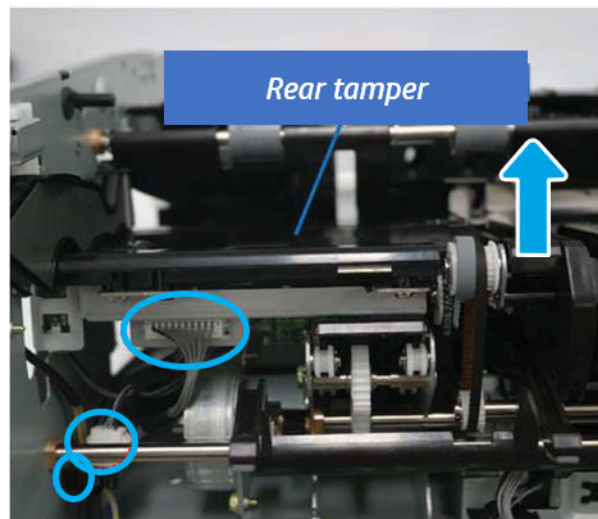

14. Remove the rear tamper home sensor.

- ▲ Unplug the connector, and then remove the rear tamper home sensor.

Figure 5-430 Remove the rear tamper home sensor

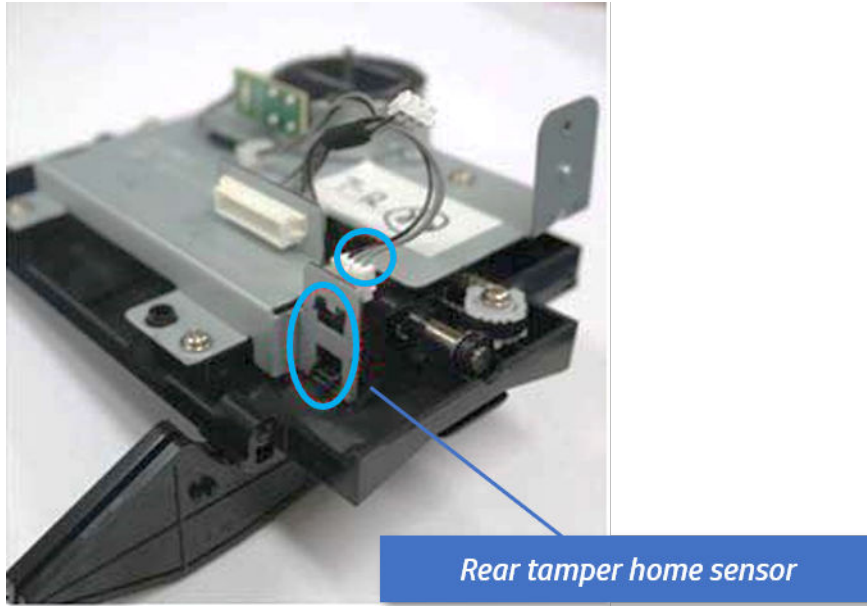

15. Unpack the replacement assembly.

- a. Dispose of the defective part.



NOTE: HP recommends responsible disposal of the defective part.

<http://www8.hp.com/us/en/hp-information/environment/product-recycling.html>

- b. Unpack the replacement part from the packaging.



CAUTION:  Some parts are sensitive to electrostatic discharge (ESD). Always perform service work at an ESD-protected workstation or mat. If an ESD workstation or mat is not available, touch the sheet-metal chassis to provide a static ground before touching an ESD-sensitive assembly. Protect the ESD-sensitive assemblies by placing them in ESD pouches when they are out of the printer.

If the replacement part is a roller or pad, avoid touching the spongy part of it. Skin oils on the roller or pad can cause paper pickup and/or print-quality problems. HP recommends using disposable gloves when handling rollers or pads or washing your hands before touching rollers or pads.



IMPORTANT: Make sure that all of the shipping materials (for example shipping tape) are removed from the replacement part prior to installation.

- c. To install an assembly, reverse the removal steps.

When applicable, special installation instructions are provided for an assembly at the end of the removal procedure. Always completely read the removal instructions and follow all special installation instructions.

Removal and replacement: Rear tamper motor (M5)

Learn how to remove and replace the rear tamper motor.

To view teardown&reassembling video of the inner finisher, click the link below.

 [View a teardown video of the inner finisher .](#)

 [View a reassembling video of the inner finisher .](#)

 **IMPORTANT:** When applicable, special installation instructions are provided for an assembly at the end of the removal procedure. Always completely read the removal instructions and follow all special installation instructions.

Mean time to repair:

Service level:

Before performing service

Turn the printer power off

- Press the power button on the front of the printer, and then turn off the power switch next to the power cable.
- A shutting-down message appears on the control-panel display.

 **WARNING!** To avoid damage to the printer, turn the power off and wait until the printer shuts down before removing the power cable.

- Disconnect the printer power cable after the printer has completely shut down (the control-panel display is blank).

Use the table below to identify the correct part number for your printer. To order the part, go to <https://parts.hp.com>.

Table 5-55 Part information

Part number	Part description
JC93-01001A	Rear tamper motor assembly

Required tools

- #2 JIS screwdriver with a magnetic tip

After performing service

Turn the printer power on

- Connect the power cable.
- Use the power switch to turn the power on.

Post service test

Print any pages necessary to verify that the repair resolved the issue and did not create any new issues.

1. Remove the front cover.
 - a. Open the front door and open the punch cover.
 - b. Remove three screws in the front.

- c. Remove the lever.
- d. Open the top cover.
- e. From the right side of the front cover, carefully lift and pry toward the top-left corner to remove the front cover.

Figure 5-431 Remove the front cover

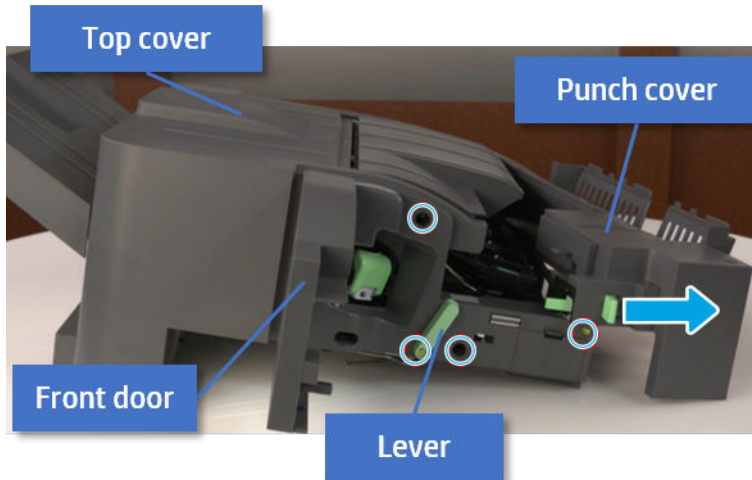

- 2. Remove the rear cover.
 - a. Open the top cover.

Figure 5-432 Open the top cover

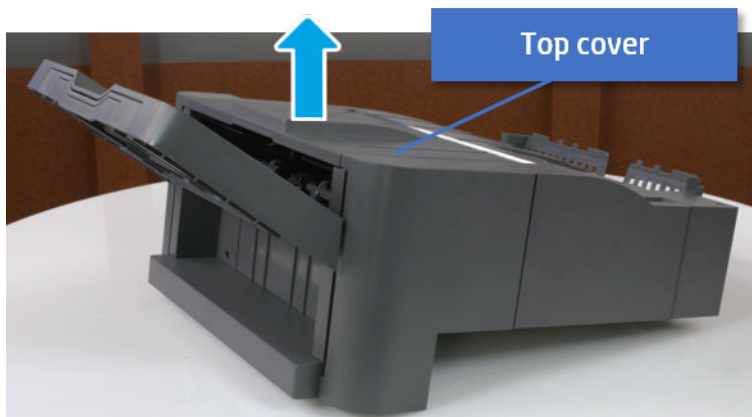

- b. Remove three screws.

- c. Release hooks carefully and remove the rear cover.

Figure 5-433 Remove the rear cover

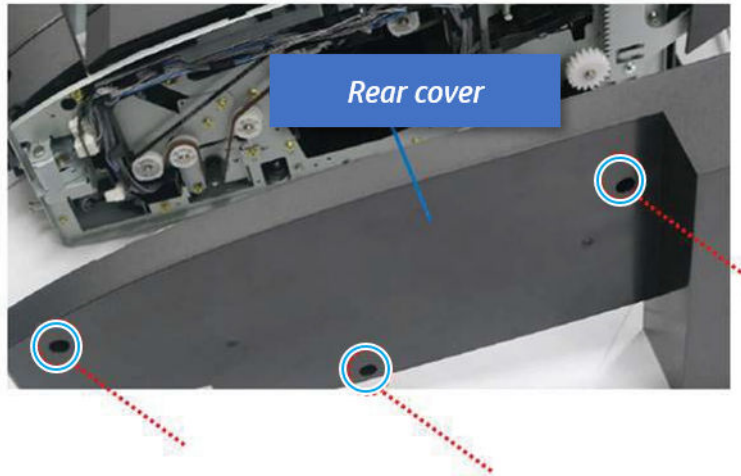

- 3. Remove the output tray.

- a. Remove four screws.

Figure 5-434 Remove four screws

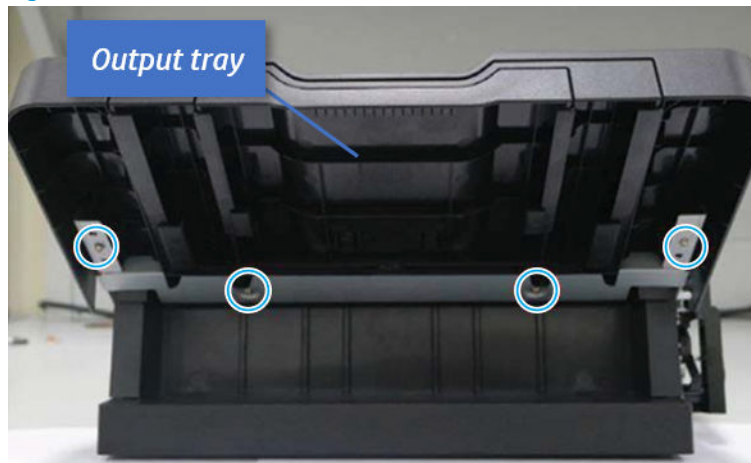

- b. Push the paper holding actuator into the inner finisher, and then remove the output tray.

Figure 5-435 Remove the output tray.



- 4. Remove the output tray frame.
 - a. Rotate the pulley until the output tray frame depart from the gear.

Figure 5-436 Remove the pulley

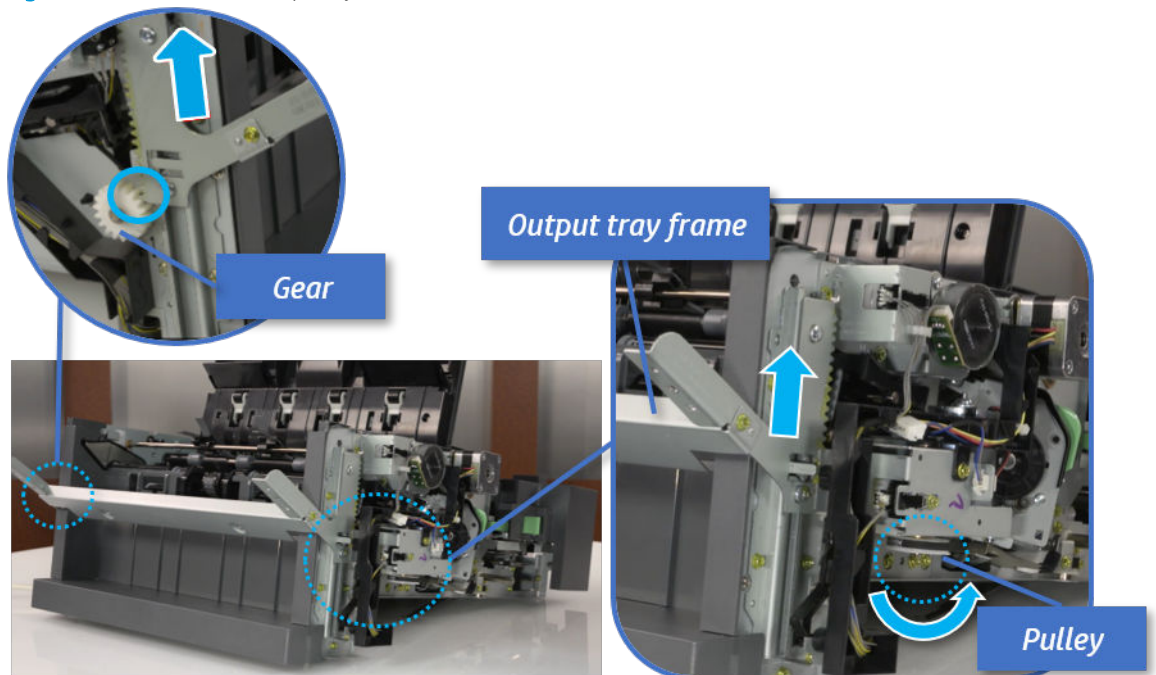

- b. Push the paper holding actuator into the inner finisher, and then remove the output tray frame.

Figure 5-437 Remove the output tray frame

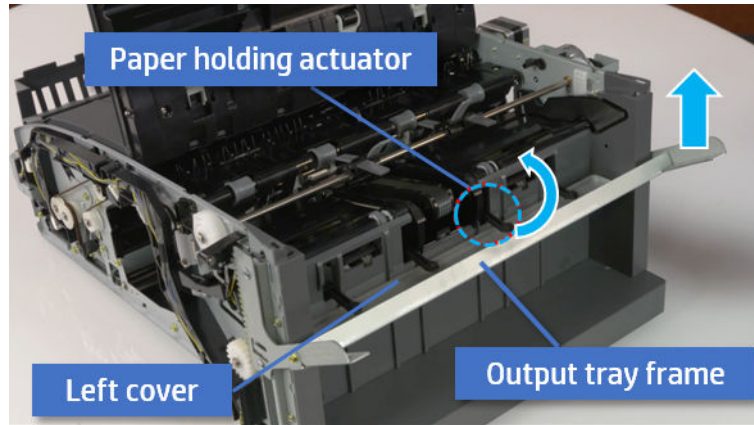

TIP: Push the paper holding actuator into the inner finisher when reassembling. Be sure to level the output tray.

1. Position the first wheel into the channel on both sides while pushing the paper holding actuator.

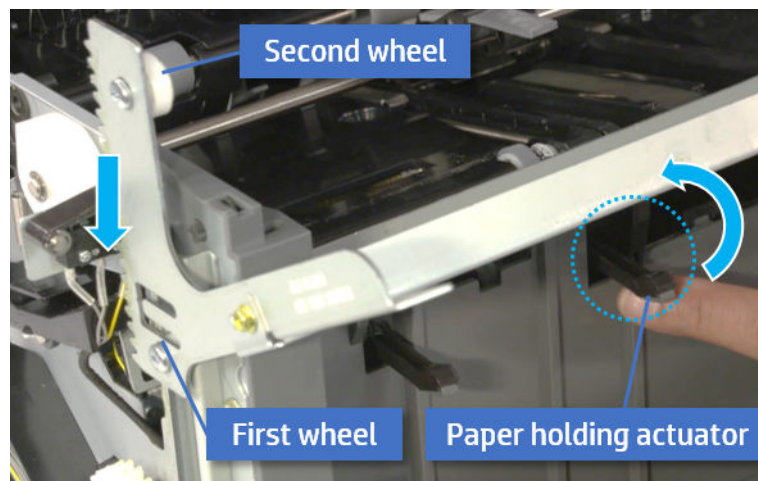

2. Let the second wheel rest on the channel on both sides simultaneously.
3. Gently squeeze the wheels into channel until the output tray frame meet the gear.

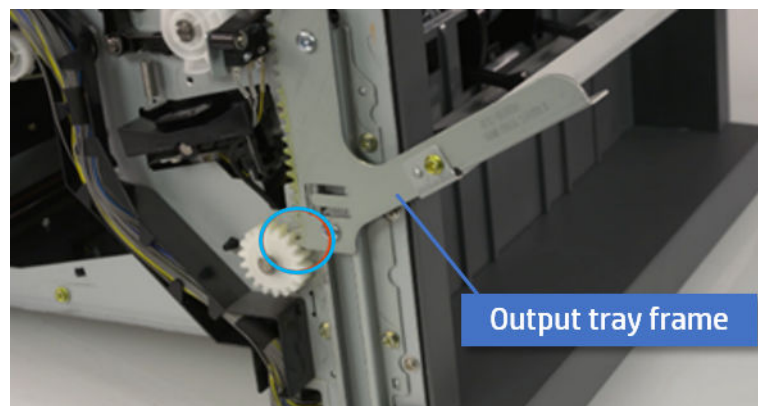

4. Rotate the pulley until the output tray frame is no longer lifted. It can make to level the output tray frame.

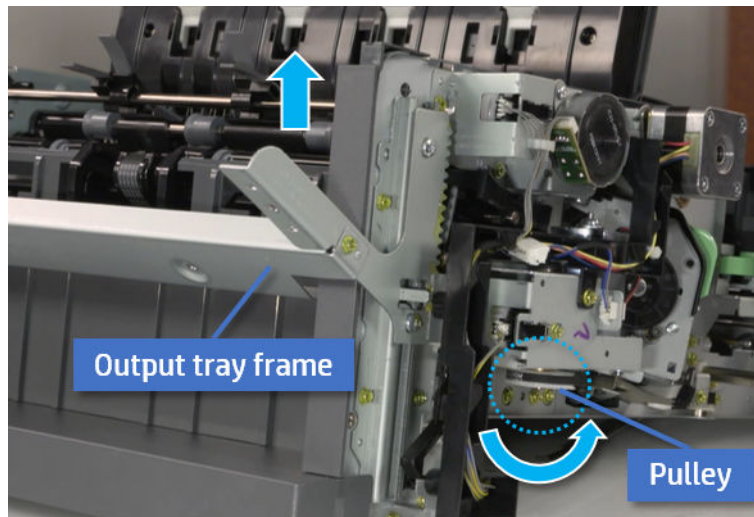

5. Rotate the pulley in the opposite direction.

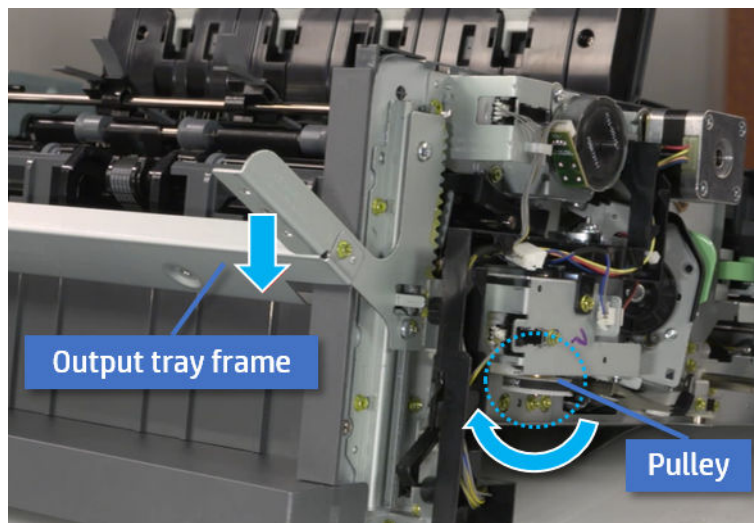

5. Remove the PCA cover.
 - ▲ Remove two screws, and then remove the PCA cover.

Figure 5-438 Remove the PCA cover

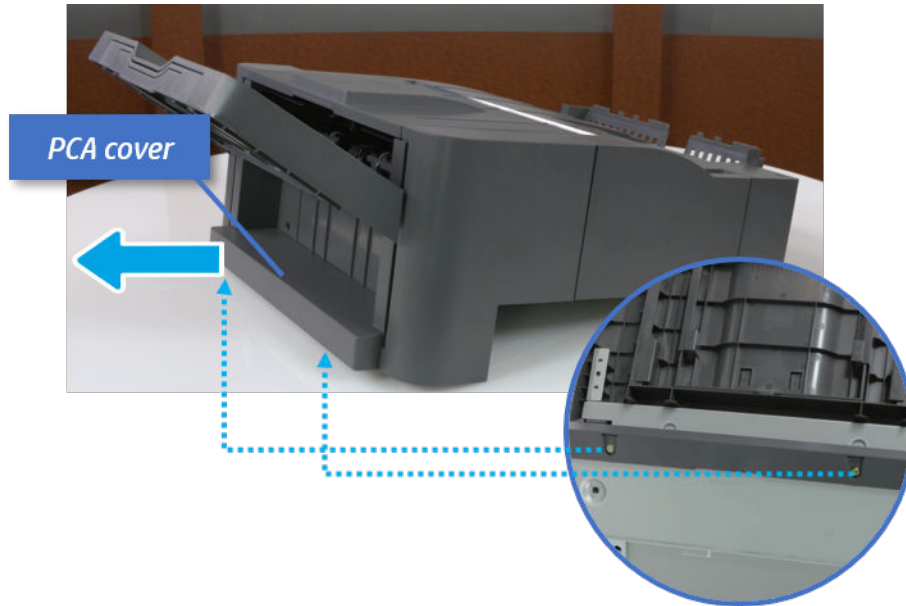

6. Remove the left cover.
 - a. Remove two screws.

Figure 5-439 Remove two screws

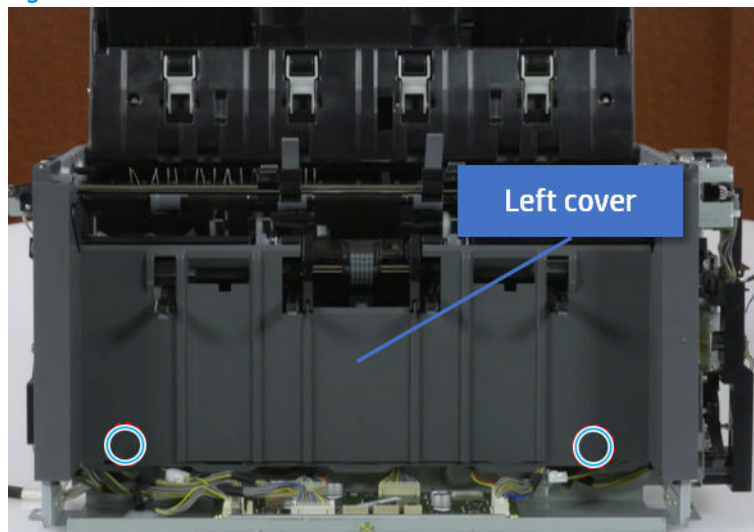

- b. Remove four screws from both front and rear sides.

Figure 5-440 Remove four screws

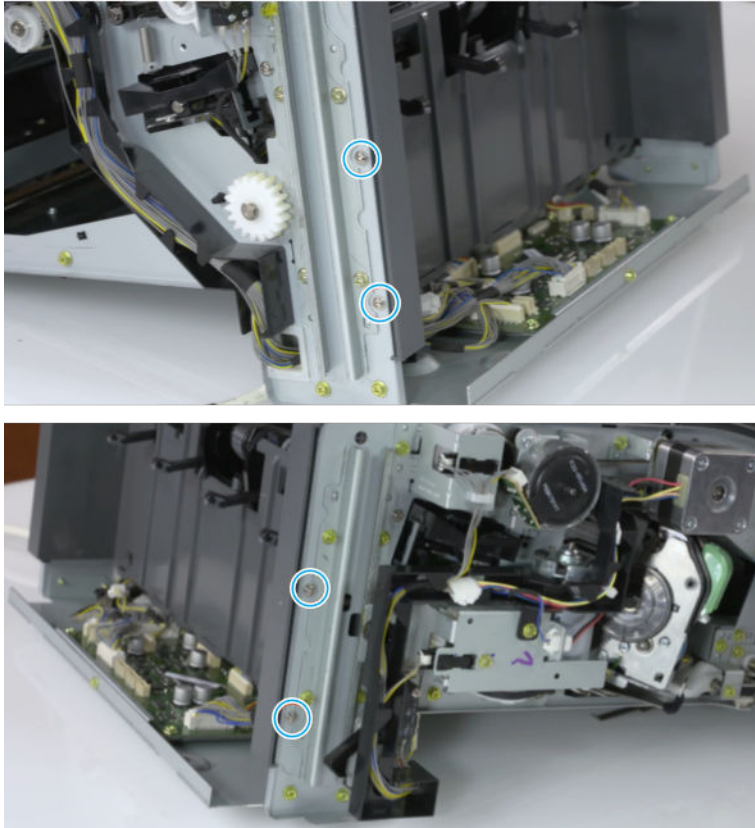

- c. Unplug two inline connectors, and then remove the left cover.

Figure 5-441 Unplug two connectors

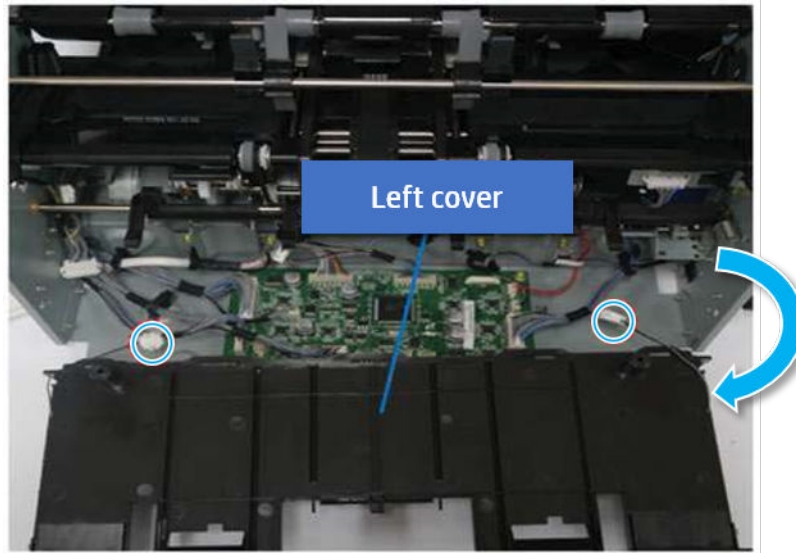

 **TIP:** Be sure to check the hook when reassembling.

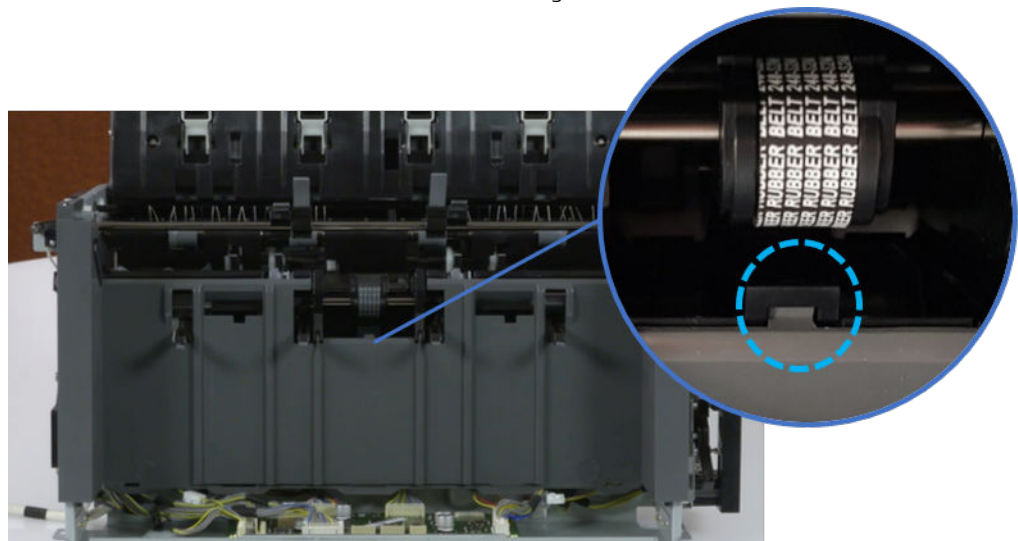

- 7. Remove the front harness guide.
 - a. Open one clamp and unplug five connectors, and then remove the wire harness from the front harness guide.

- b. Remove four screws, and then remove the front harness guide.

Figure 5-442 Remove the front harness guide

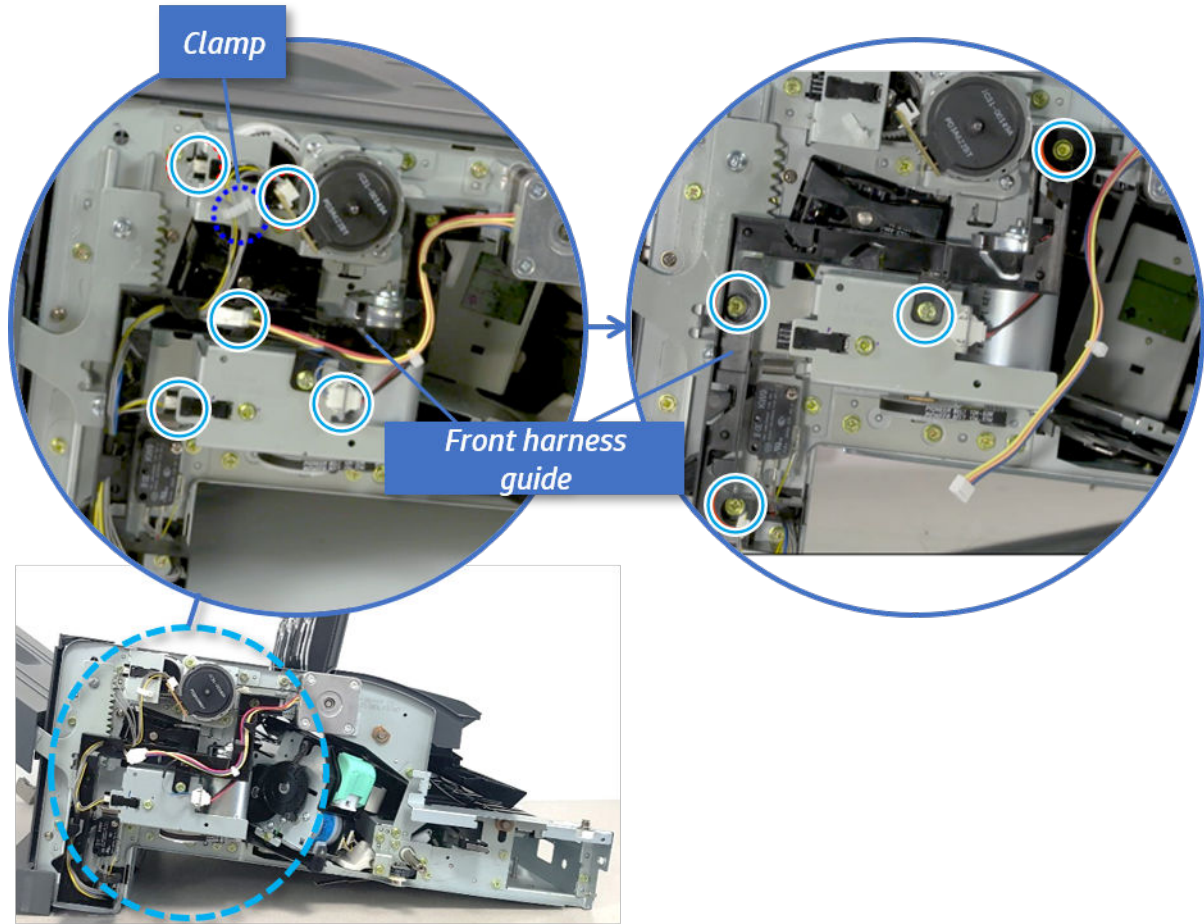

8. Remove the output tray motor assembly.

- ▲ Remove three screws, and then remove the output tray motor assembly.

Figure 5-443 Remove the output tray motor assembly

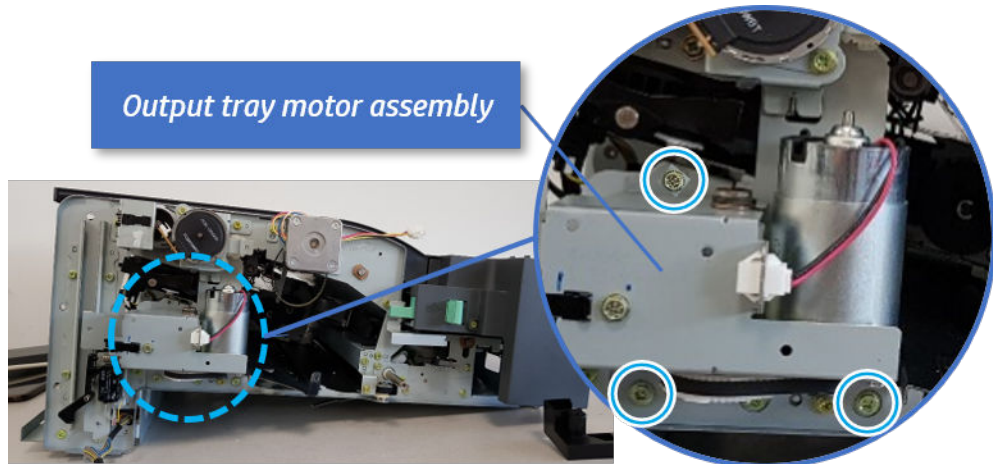

9. Remove the output tray lower limit switch.

- ▲ Remove one screw, and then remove the output tray lower limit switch.

Figure 5-444 Remove the output tray lower limit switch

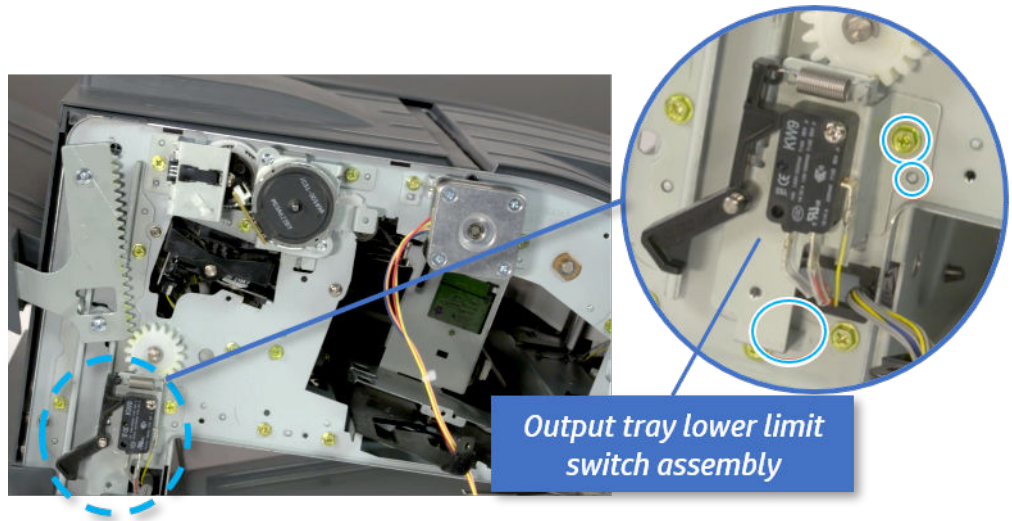

- 10. Remove the paper holding.
 - a. Remove the paper holding actuator spring.

Figure 5-445 Remove the paper holding actuator spring

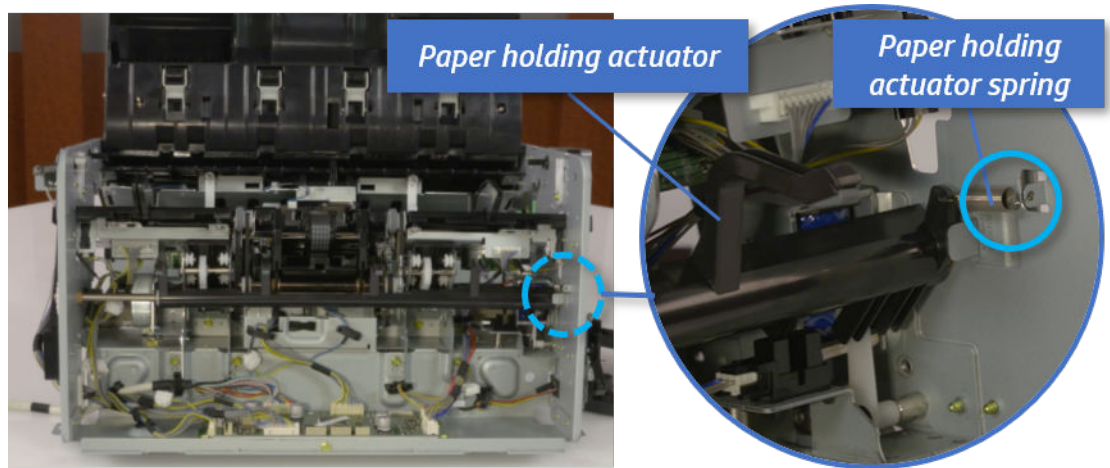

- b. Remove the e-ring and the rack pinion gear. And then remove the pin and the e-ring, and then remove the bushing.

Figure 5-446 Remove e-ring, rack pinion gear, pin, and bushing

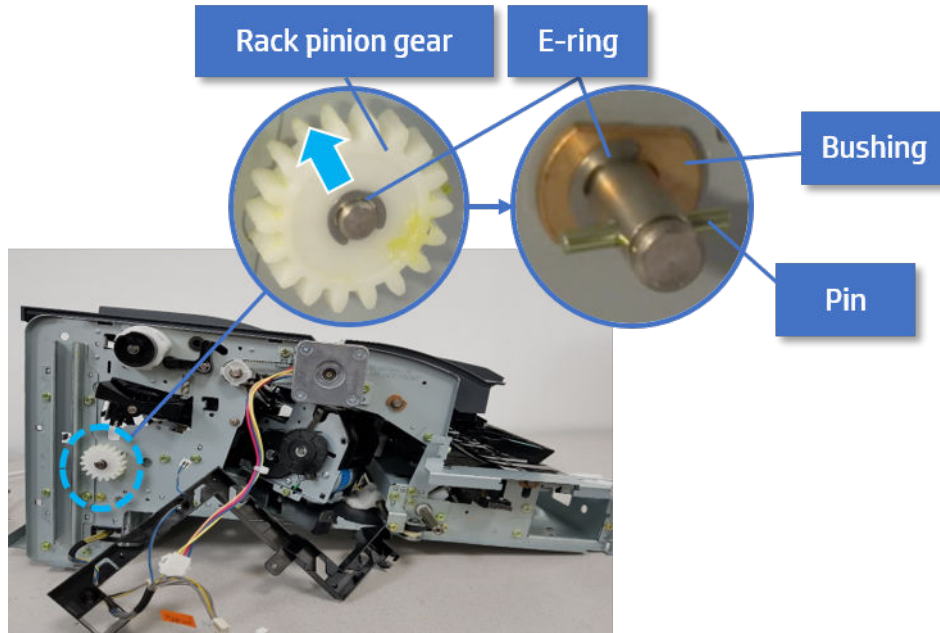

 **NOTE:** Be sure not to lose the pin.

- c. Carefully remove the paper holding shaft and the actuator.

Figure 5-447 Remove the paper holding shaft and the actuator

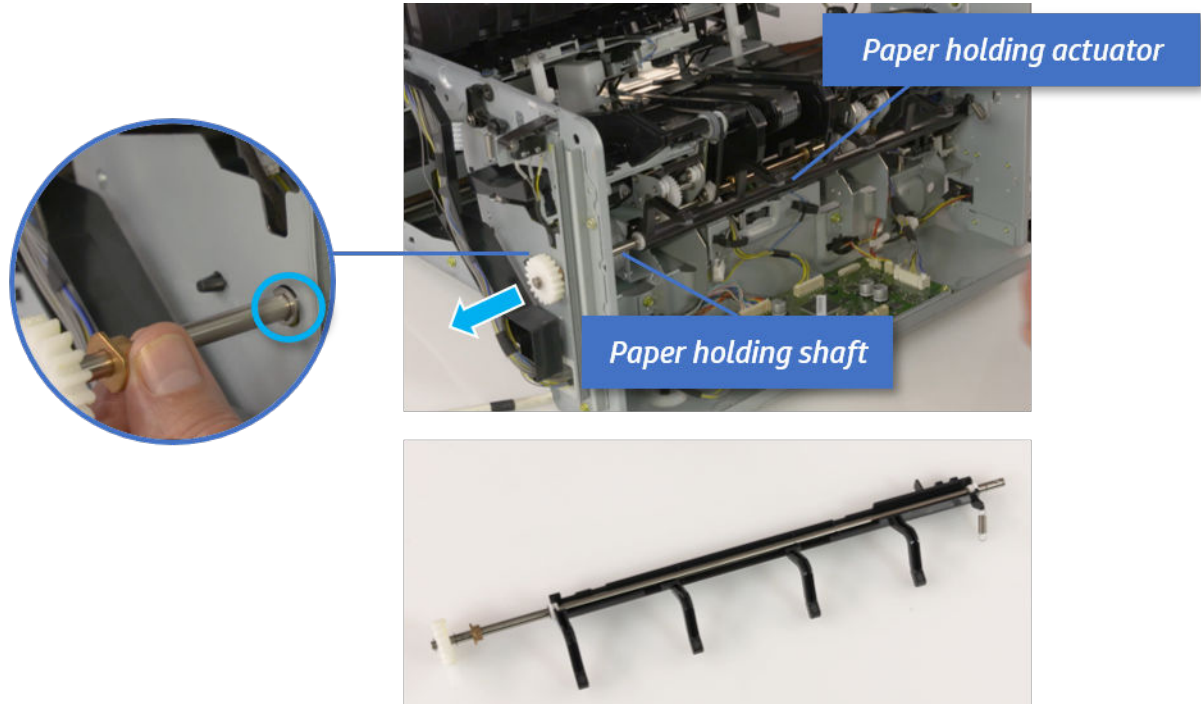

- 11. Remove the sub paddle unit.

- a. Open the top cover, and then remove one screw securing the sub paddle unit.

Figure 5-448 Remove one screw

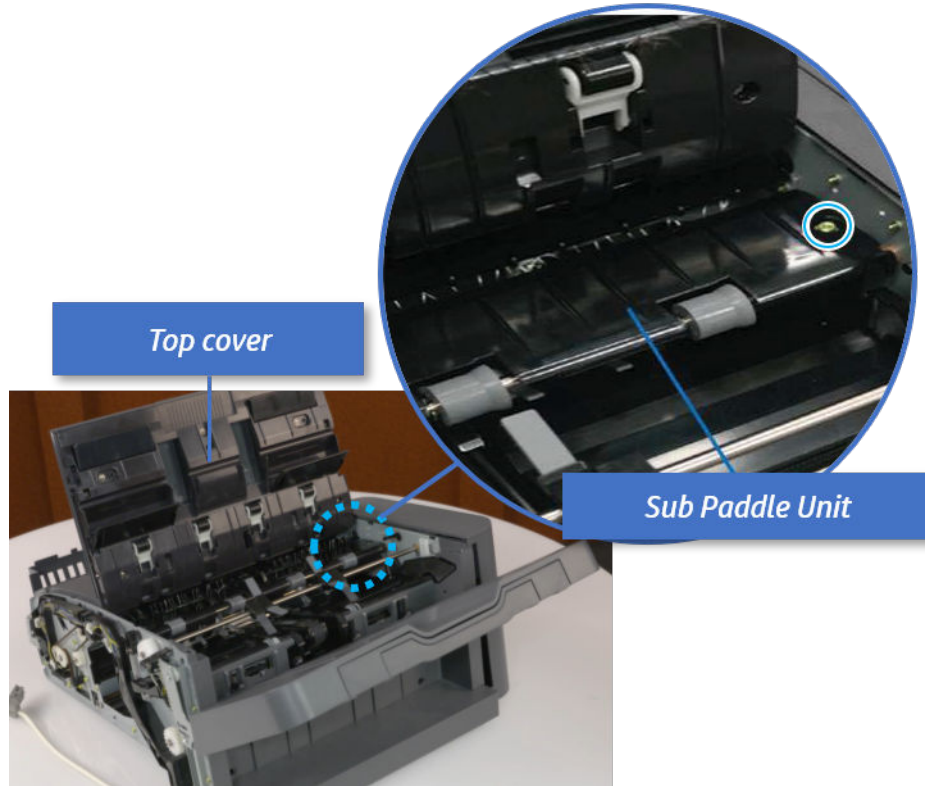

- b. Remove the e-ring, and then remove the pulley and timing belt. And then remove the e-ring and the bushing.

Figure 5-449 Remove the e-ring, pulley, timing belt, and bushing

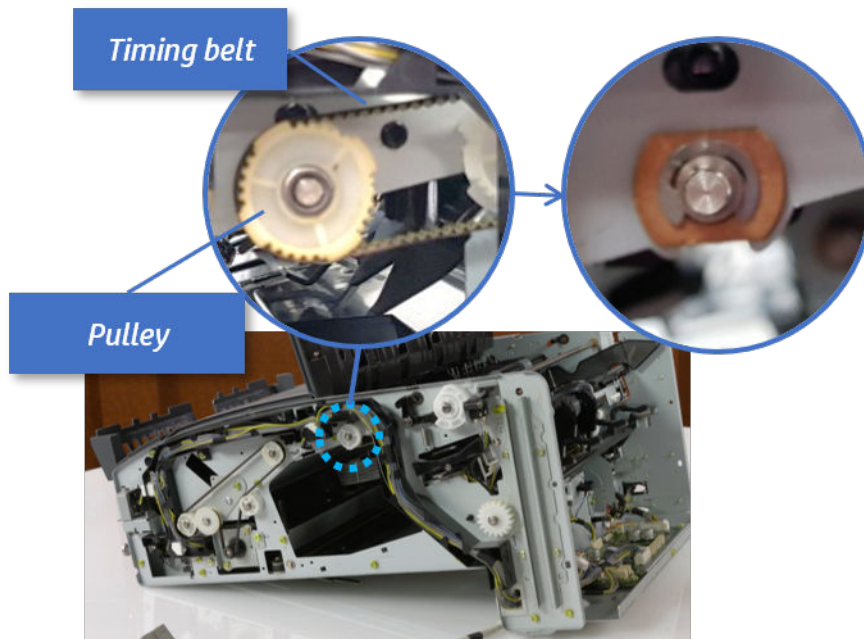

- c. Lift up and remove the sub paddle unit.

Figure 5-450 Remove the sub paddle unit

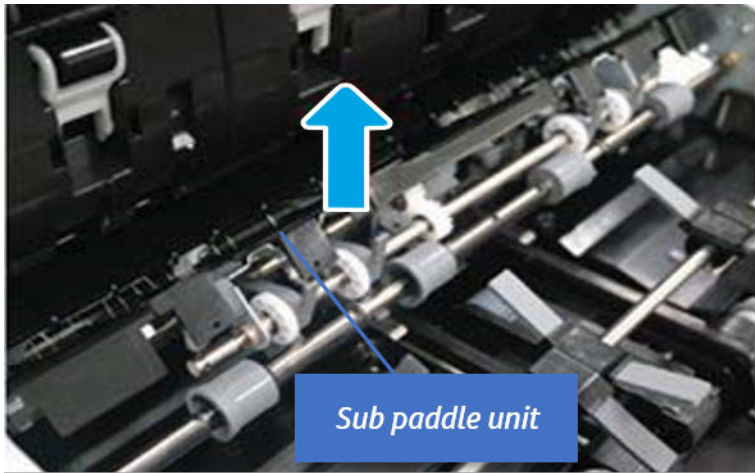

- 12. Remove the exit roller.

- a. Remove the guide on the center of the exit roller.

Figure 5-451 Remove the guide

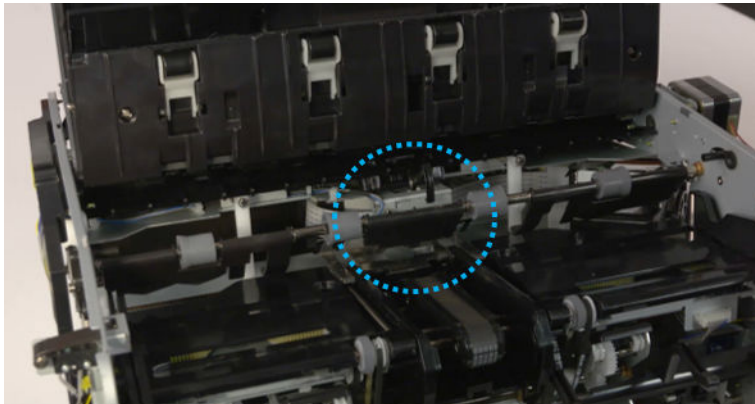

- b. On the front of the inner finisher, release the timing belt connected to the exit motor.

Figure 5-452 Release the timing belt

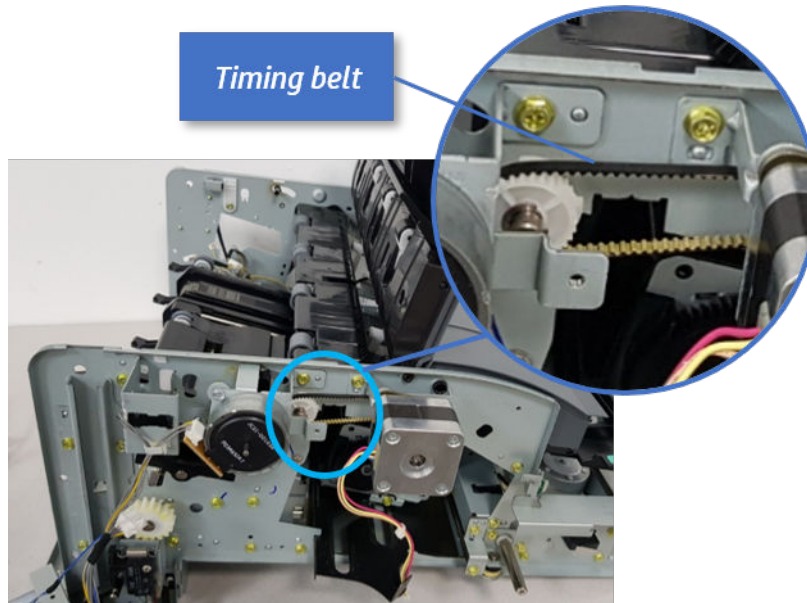

- c. Remove five screws securing the rear harness guide.

Figure 5-453 Remove five screws

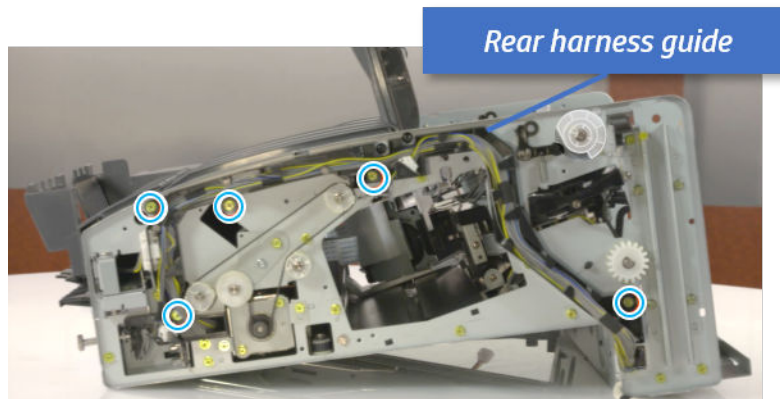

- d. On the rear of the inner finisher, remove the e-ring and the pulley and then remove the e-ring and the bushing.

Figure 5-454 Remove e-ring, pulley, and bushing

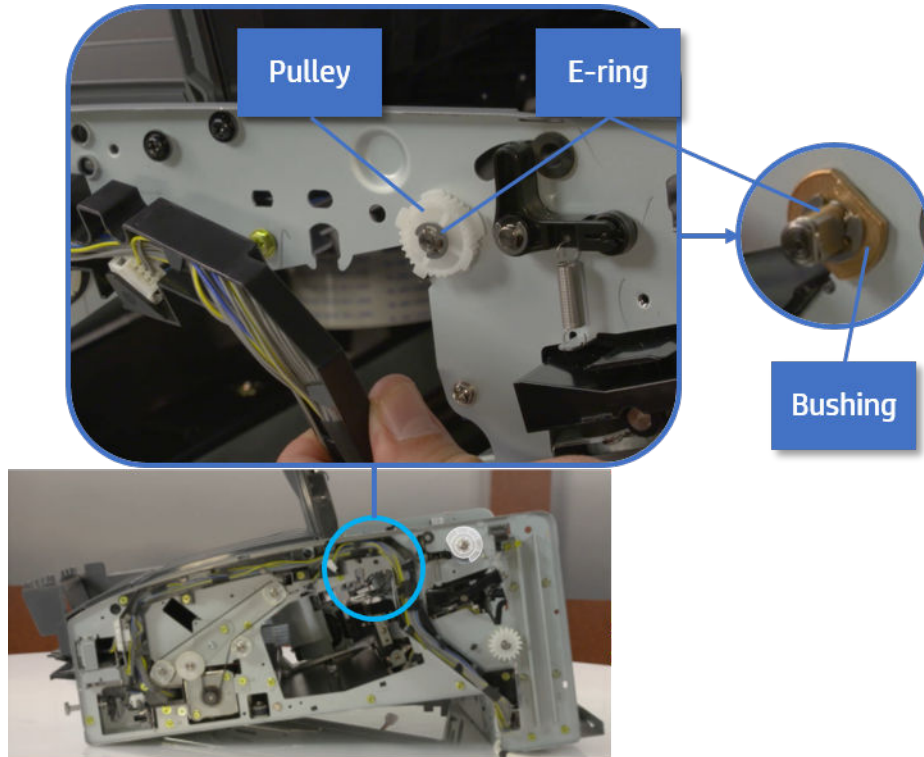

- e. Push the bushing to detach it, and then remove the exit roller.

Figure 5-455 Remove the exit roller

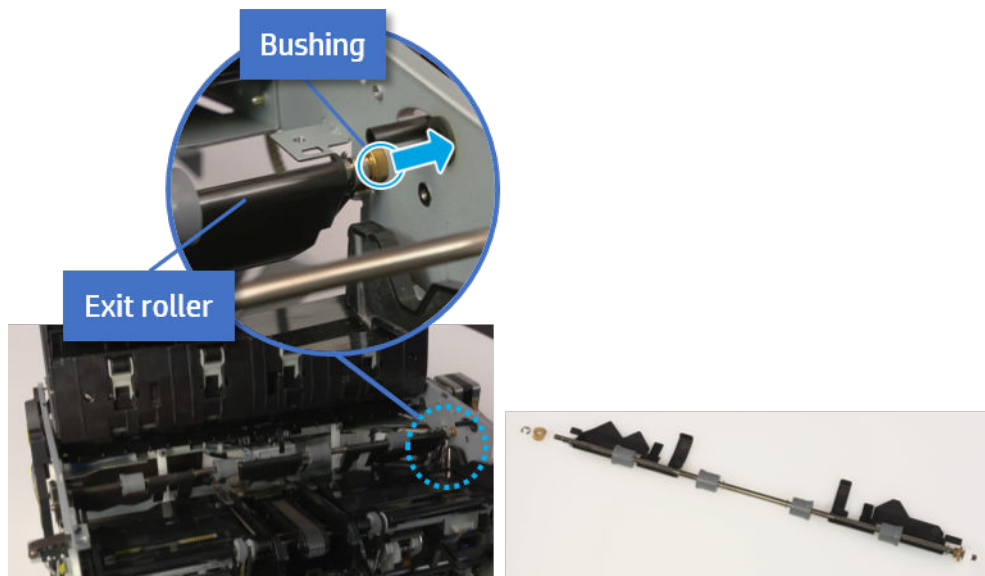

- 13. Remove the rear tamper.
 - a. Remove four screws.

 **NOTE:** Move cable guideout of position to access the screws.

Figure 5-456 Remove four screws



- b. Unplug two connectors and release the hook, and then remove the rear tamper.

Figure 5-457 Remove the rear tamper

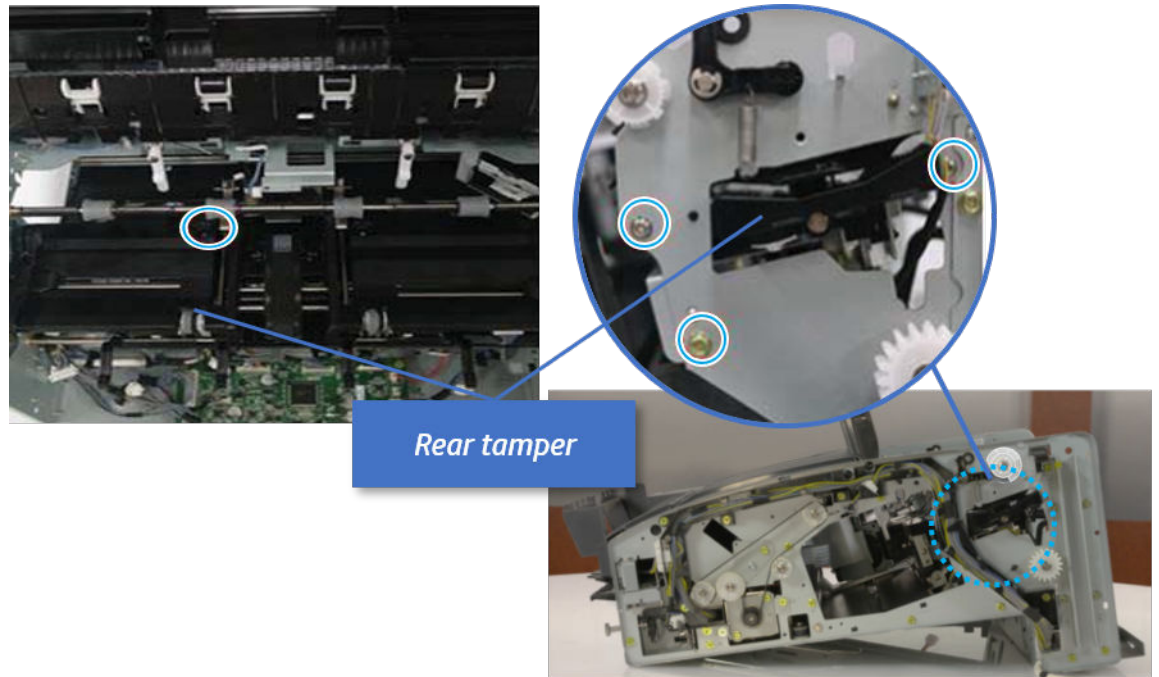
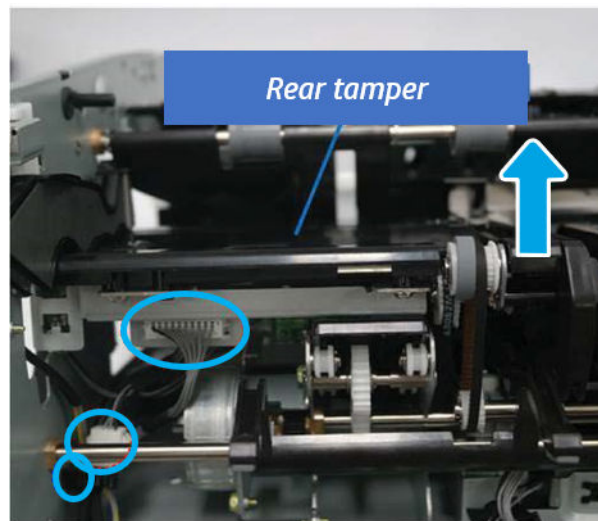

14. Remove the rear tamper motor.
- ▲ Remove two screws, unplug the connector, and then remove the motor.

Figure 5-458 Remove the rear tamper motor

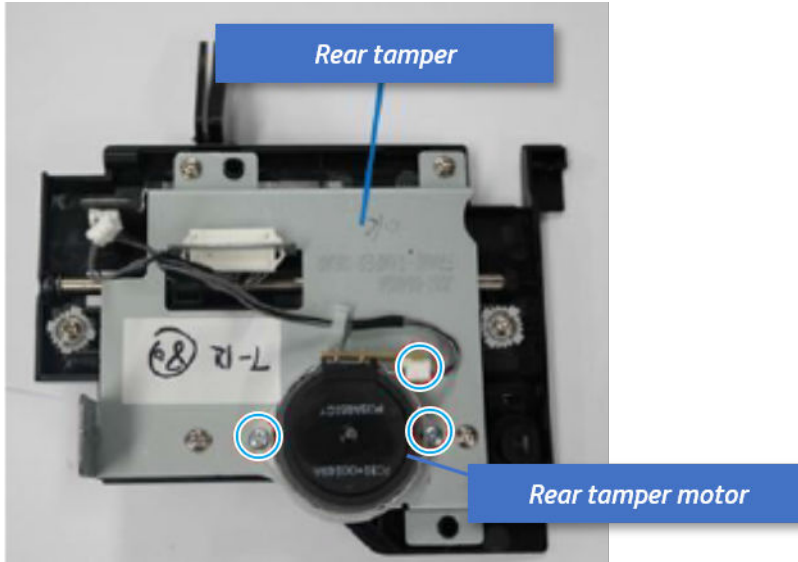

15. Unpack the replacement assembly.

- a. Dispose of the defective part.



NOTE: HP recommends responsible disposal of the defective part.

<http://www8.hp.com/us/en/hp-information/environment/product-recycling.html>

- b. Unpack the replacement part from the packaging.



CAUTION:  Some parts are sensitive to electrostatic discharge (ESD). Always perform service work at an ESD-protected workstation or mat. If an ESD workstation or mat is not available, touch the sheet-metal chassis to provide a static ground before touching an ESD-sensitive assembly. Protect the ESD-sensitive assemblies by placing them in ESD pouches when they are out of the printer.

If the replacement part is a roller or pad, avoid touching the spongy part of it. Skin oils on the roller or pad can cause paper pickup and/or print-quality problems. HP recommends using disposable gloves when handling rollers or pads or washing your hands before touching rollers or pads.



IMPORTANT: Make sure that all of the shipping materials (for example shipping tape) are removed from the replacement part prior to installation.

- c. To install an assembly, reverse the removal steps.

When applicable, special installation instructions are provided for an assembly at the end of the removal procedure. Always completely read the removal instructions and follow all special installation instructions.

Stapler unit

Removal and replacement: Stapler

Learn how to remove and replace the stapler.

To view teardown&reassembling video of the inner finisher, click the link below.

 [View a teardown video of the inner finisher .](#)

 [View a reassembling video of the inner finisher .](#)

 **IMPORTANT:** When applicable, special installation instructions are provided for an assembly at the end of the removal procedure. Always completely read the removal instructions and follow all special installation instructions.

Mean time to repair:

Service level:

Before performing service

Turn the printer power off

- Press the power button on the front of the printer, and then turn off the power switch next to the power cable.
- A shutting-down message appears on the control-panel display.

 **WARNING!** To avoid damage to the printer, turn the power off and wait until the printer shuts down before removing the power cable.

- Disconnect the printer power cable after the printer has completely shut down (the control-panel display is blank).

Use the table below to identify the correct part number for your printer. To order the part, go to <https://parts.hp.com>.

Table 5-56 Part information

Part number	Part description
C59-00040A	Stapler assembly

Required tools

- #2 JIS screwdriver with a magnetic tip

After performing service

Turn the printer power on

- Connect the power cable.
- Use the power switch to turn the power on.

Post service test

Print any pages necessary to verify that the repair resolved the issue and did not create any new issues.

1. Remove the front cover.
 - a. Open the front door and open the punch cover.
 - b. Remove three screws in the front.
 - c. Remove the lever.
 - d. Open the top cover.
 - e. From the right side of the front cover, carefully lift and pry toward the top-left corner to remove the front cover.

Figure 5-459 Remove the front cover

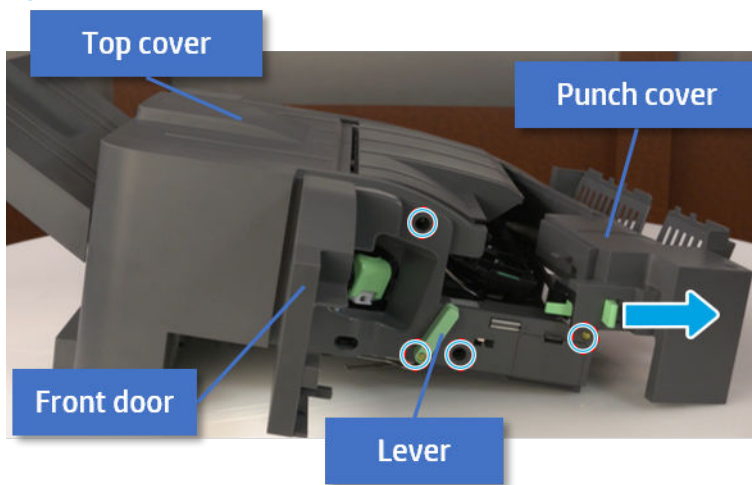

2. Remove the rear cover.
 - a. Open the top cover.

Figure 5-460 Open the top cover

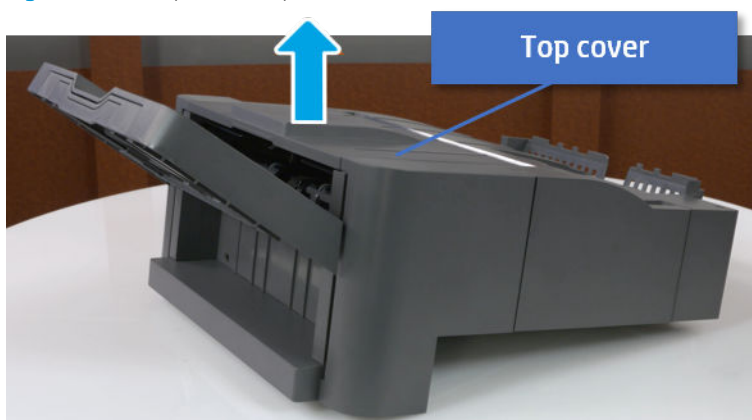

- b. Remove three screws.

- c. Release hooks carefully and remove the rear cover.

Figure 5-461 Remove the rear cover

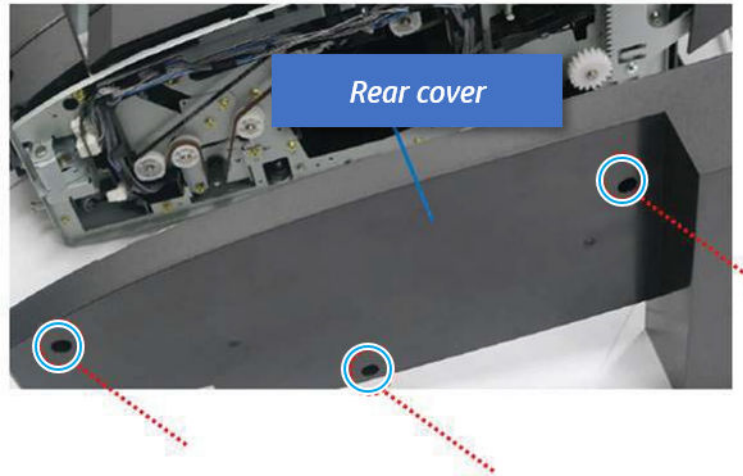

3. Remove the exit motor bracket.

- ▲ Remove two screws, unplug the motor connector. And then remove exit motor bracket.

Figure 5-462 Remove the exit motor bracket

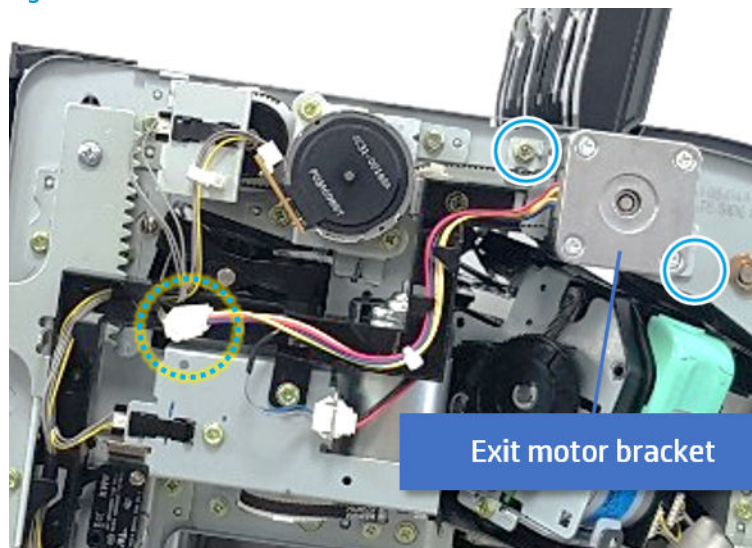

4. Remove the stapler.

- a. Push the stapler from the rear-side to the front-side.

Figure 5-463 Push the stapler

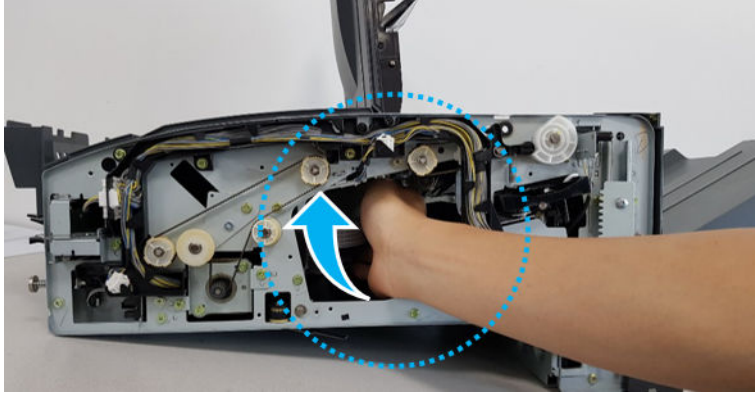

- b. Remove one screw, unplug two connectors, and then remove the stapler assembly.

Figure 5-464 Remove the stapler assembly

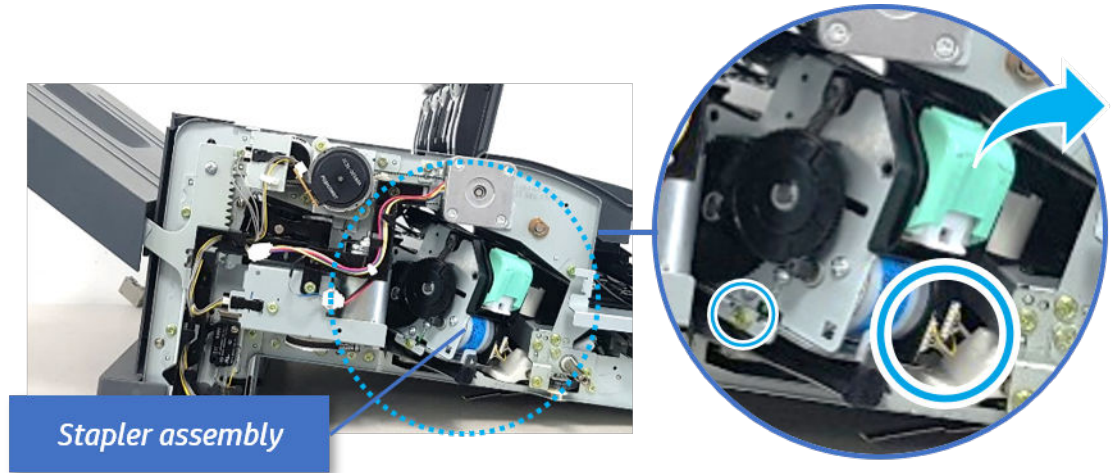

- c. Remove two screws, and then remove the stapler.

Figure 5-465 Remove the stapler

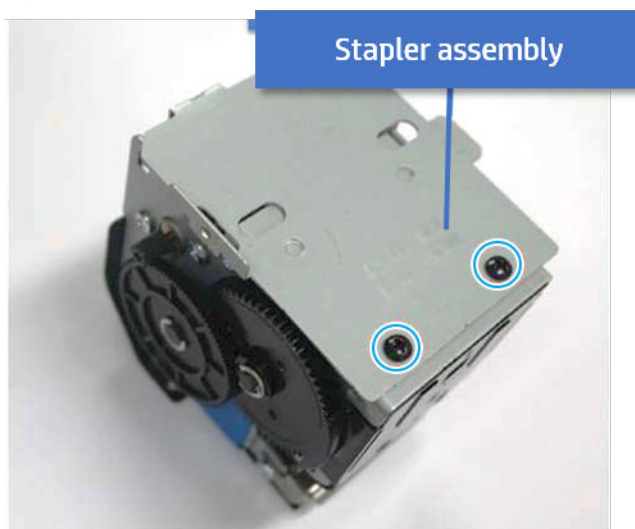

- 5. Unpack the replacement assembly.

- a. Dispose of the defective part.



NOTE: HP recommends responsible disposal of the defective part.

<http://www8.hp.com/us/en/hp-information/environment/product-recycling.html>

- b. Unpack the replacement part from the packaging.



CAUTION:  Some parts are sensitive to electrostatic discharge (ESD). Always perform service

work at an ESD-protected workstation or mat. If an ESD workstation or mat is not available, touch the sheet-metal chassis to provide a static ground before touching an ESD-sensitive assembly. Protect the ESD-sensitive assemblies by placing them in ESD pouches when they are out of the printer.

If the replacement part is a roller or pad, avoid touching the spongy part of it. Skin oils on the roller or pad can cause paper pickup and/or print-quality problems. HP recommends using disposable gloves when handling rollers or pads or washing your hands before touching rollers or pads.



IMPORTANT: Make sure that all of the shipping materials (for example shipping tape) are removed from the replacement part prior to installation.

- c. To install an assembly, reverse the removal steps.

When applicable, special installation instructions are provided for an assembly at the end of the removal procedure. Always completely read the removal instructions and follow all special installation instructions.

Removal and replacement: Stapler position sensor (S2)

Learn how to remove and replace the stapler position sensor.

To view teardown&reassembling video of the inner finisher, click the link below.



[View a teardown video of the inner finisher .](#)



[View a reassembling video of the inner finisher .](#)



IMPORTANT: When applicable, special installation instructions are provided for an assembly at the end of the removal procedure. Always completely read the removal instructions and follow all special installation instructions.

Mean time to repair:

Service level:

Before performing service

Turn the printer power off

- Press the power button on the front of the printer, and then turn off the power switch next to the power cable.
- A shutting-down message appears on the control-panel display.

 **WARNING!** To avoid damage to the printer, turn the power off and wait until the printer shuts down before removing the power cable.

- Disconnect the printer power cable after the printer has completely shut down (the control-panel display is blank).

Use the table below to identify the correct part number for your printer. To order the part, go to <https://parts.hp.com>.

Table 5-57 Part information

Part number	Part description
0604-001393	Stapler position sensor

Required tools

- #2 JIS screwdriver with a magnetic tip

After performing service

Turn the printer power on

- Connect the power cable.
- Use the power switch to turn the power on.

Post service test

Print any pages necessary to verify that the repair resolved the issue and did not create any new issues.

1. Remove the front cover.
 - a. Open the front door and open the punch cover.
 - b. Remove three screws in the front.
 - c. Remove the lever.
 - d. Open the top cover.

- e. From the right side of the front cover, carefully lift and pry toward the top-left corner to remove the front cover.

Figure 5-466 Remove the front cover

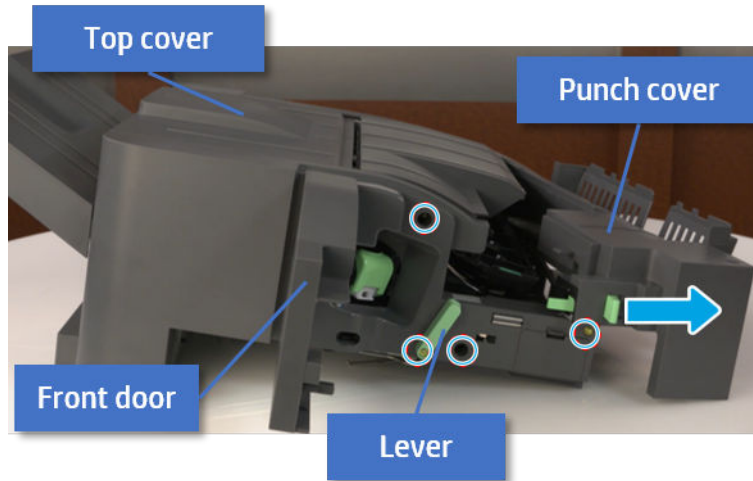

- 2. Remove the rear cover.

- a. Open the top cover.

Figure 5-467 Open the top cover

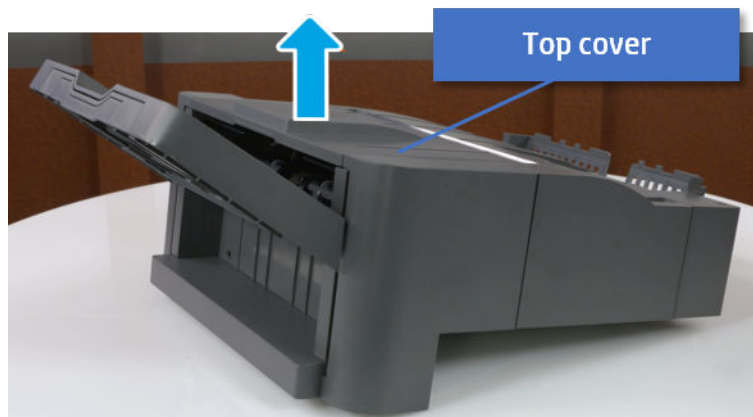

- b. Remove three screws.

- c. Release hooks carefully and remove the rear cover.

Figure 5-468 Remove the rear cover

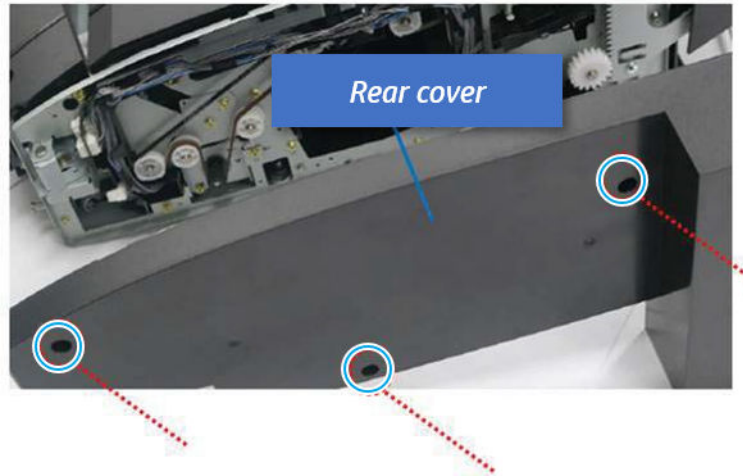

- 3. Remove the middle cover.

- a. Open the front door and then open the punch cover.

Figure 5-469 Open the front door and punch cover.

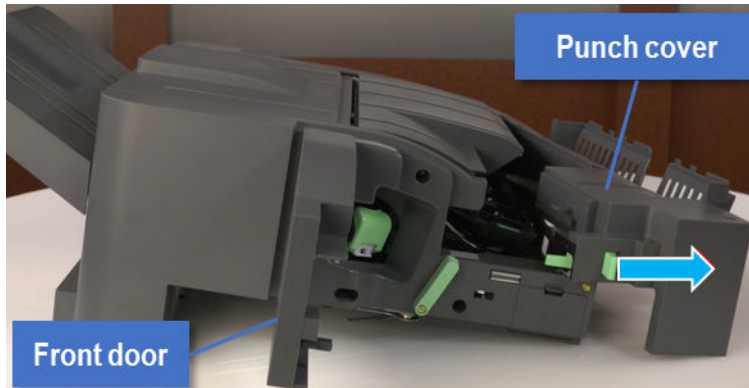

- b. Remove left-side one screw at the rear of the inner finisher, and then remove the middle cover by lifting off the hinge pins at the front.

Figure 5-470 Remove the middle cover

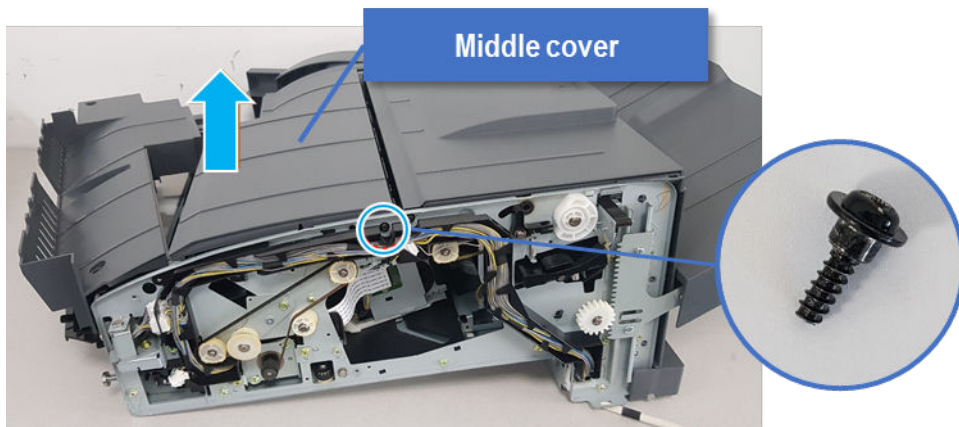

4. Remove the punch cover.
 - a. Unplug the connector. Remove the e-ring, and then remove the slide shaft at the rear of the inner finisher.

Figure 5-471 Remove the slide shaft

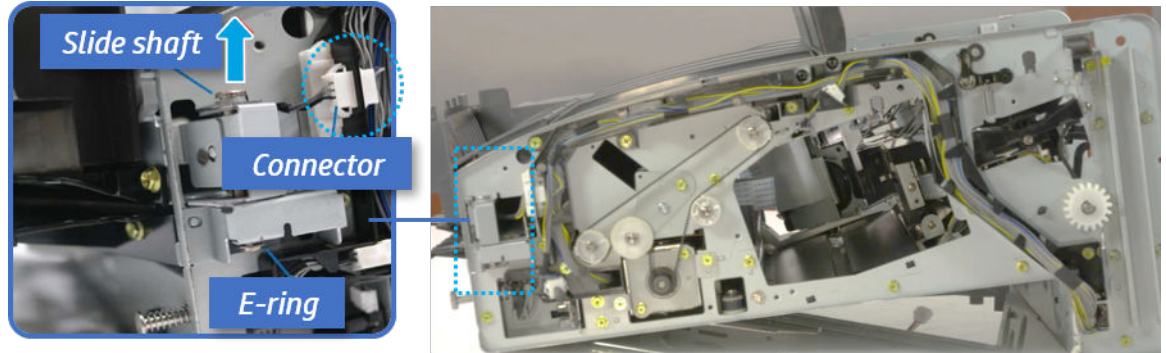

- b. Open the punch cover.

Figure 5-472 Open the punch cover

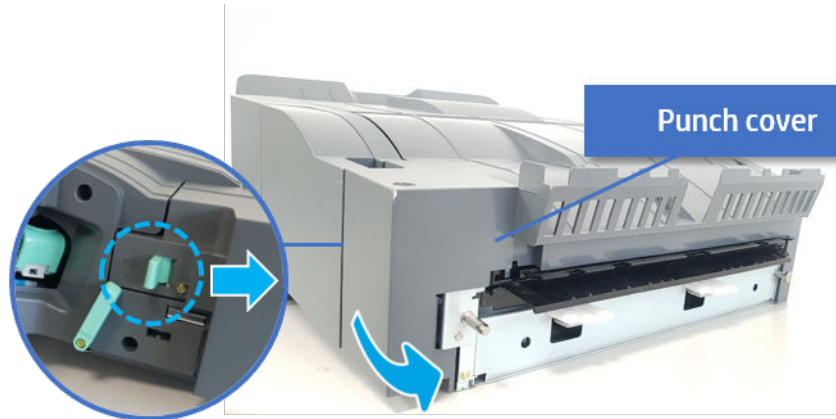

- c. Remove the front punch sheet, and then remove the e-ring and the washer. And then remove the punch cover.

Figure 5-473 Remove the punch cover

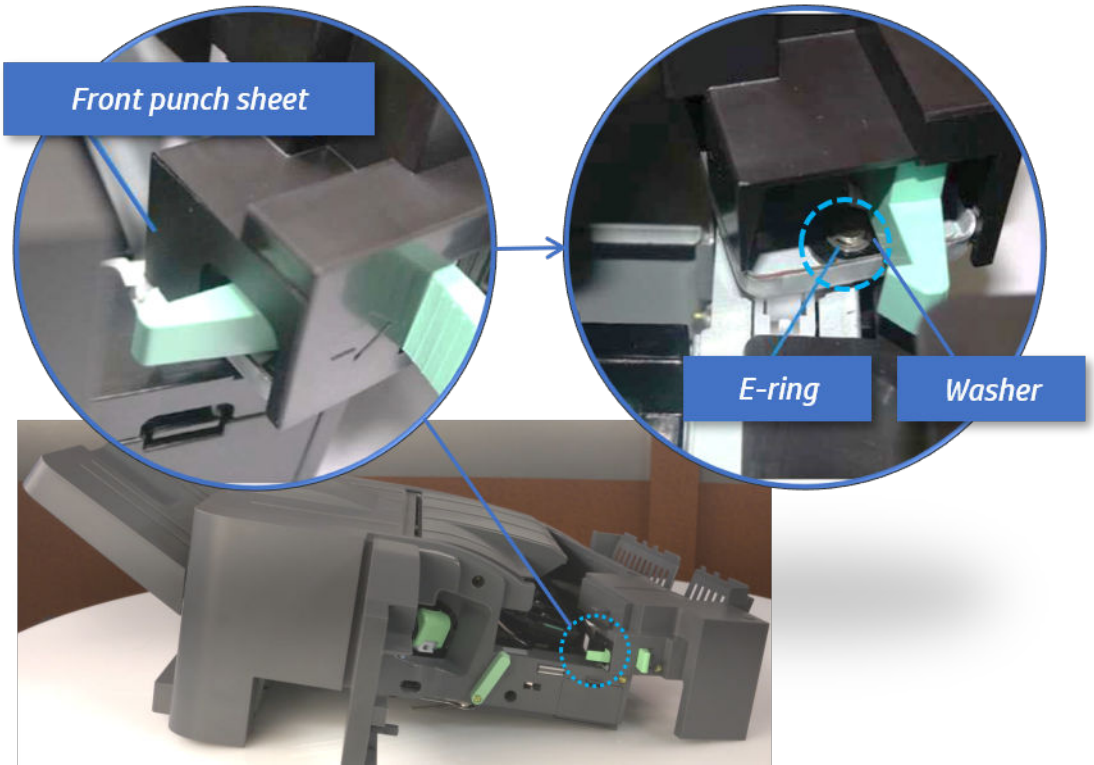

- 5. Remove the diverter guide and the middle roller
 - a. On the front of the inner finisher, remove the e-ring and bushing.

Figure 5-474 Remove the e-ring and bushing

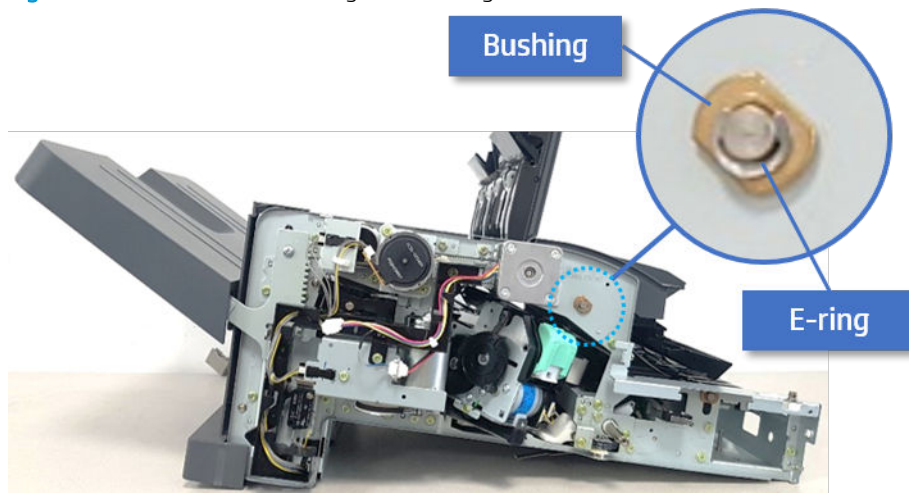

- b. On the rear of the inner finisher, remove the e-ring, pulley, bushing, belt, and spring (slightly hidden from view).

Figure 5-475 Remove the e-ring, pulley, bushing, belt, and spring

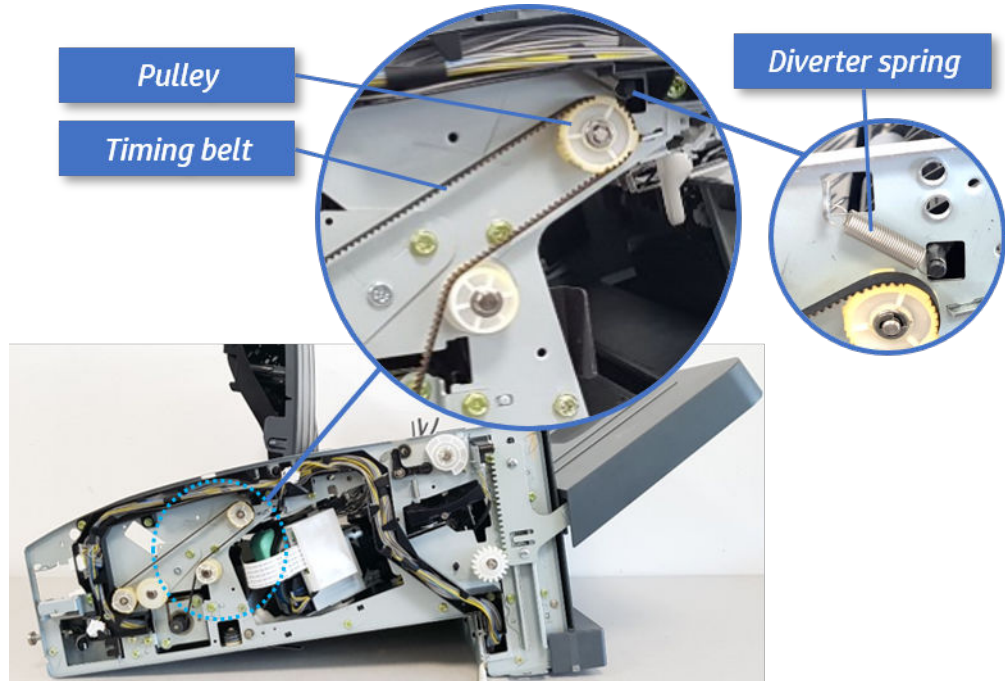

- c. Remove the diverter guide and the middle roller.

Figure 5-476 Remove the diverter guide and the middle roller

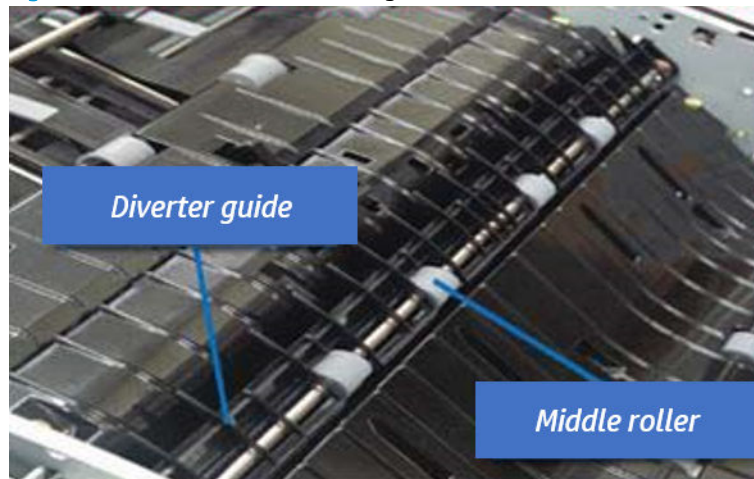

- 6. Remove the middle paper guide.
 - a. Remove six screws, and then open the middle paper guide in the direction of the arrow.

Figure 5-477 Open the middle paper guide

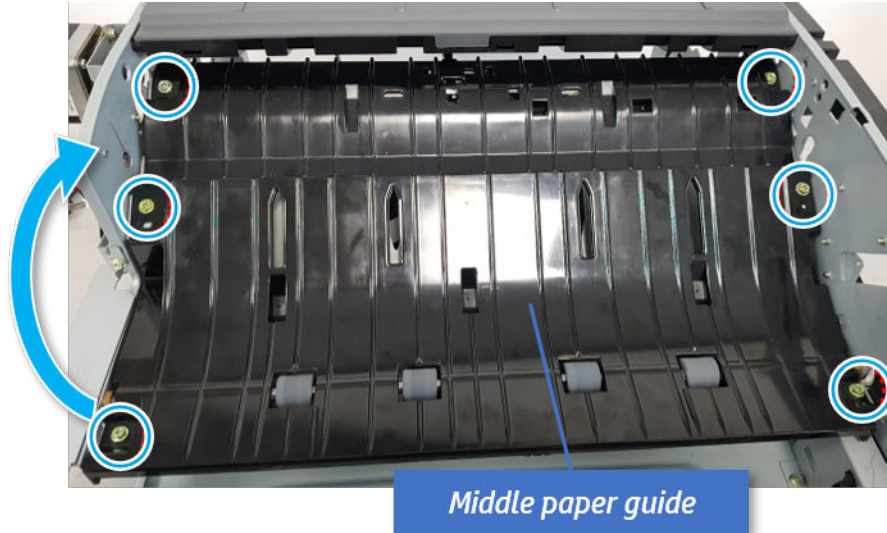

 **NOTE:** Be careful not to damage the sensor connector.

- b. Unplug the connector under the middle paper guide. And then, remove the middle paper guide.

Figure 5-478 Remove the middle paper guide

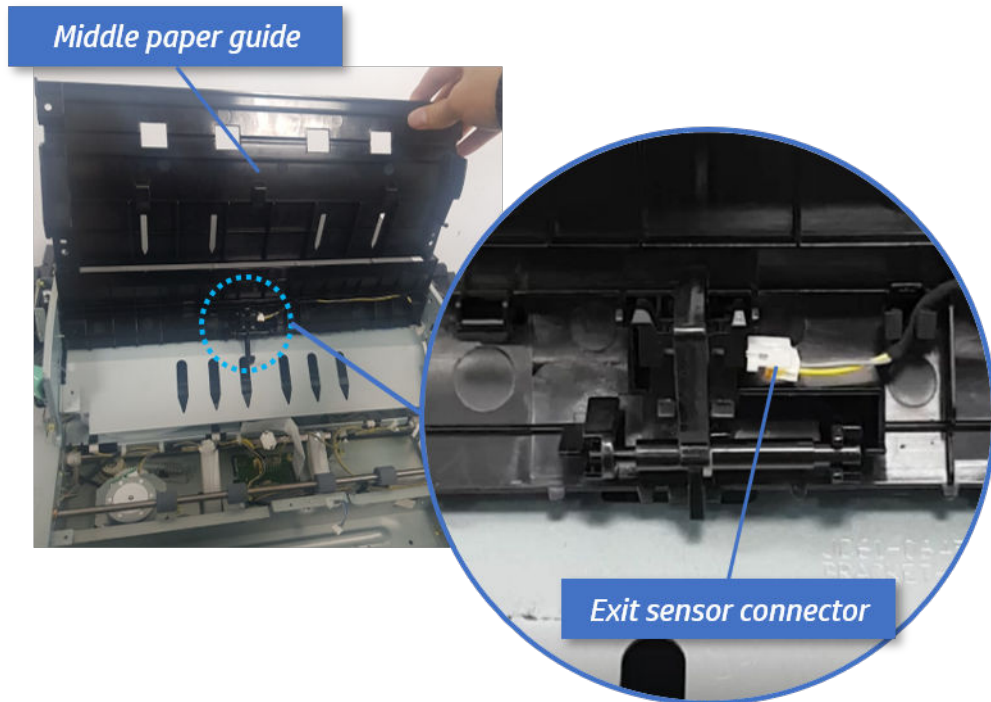

7. Remove the exit motor bracket.
 - ▲ Remove two screws, unplug the motor connector. And then remove exit motor bracket.

Figure 5-479 Remove the exit motor bracket

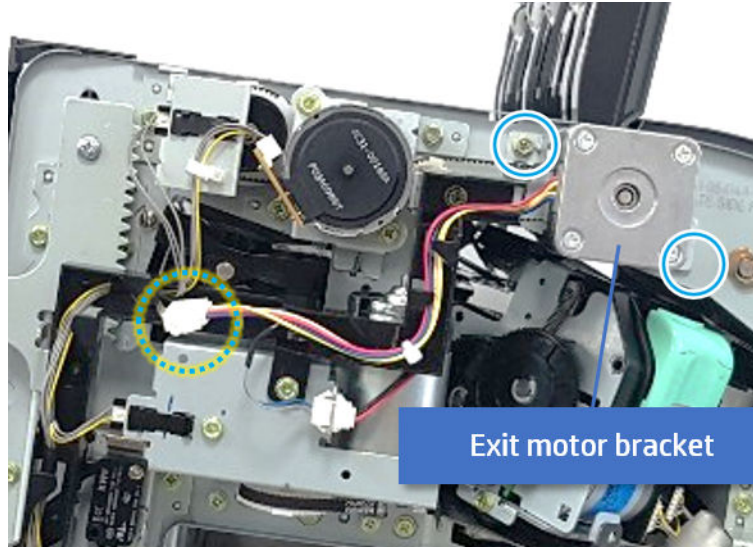

8. Remove the end fence sensor bracket.
 - a. Remove three screws at the front of the inner finisher, and then remove the bracket.

Figure 5-480 Remove the bracket

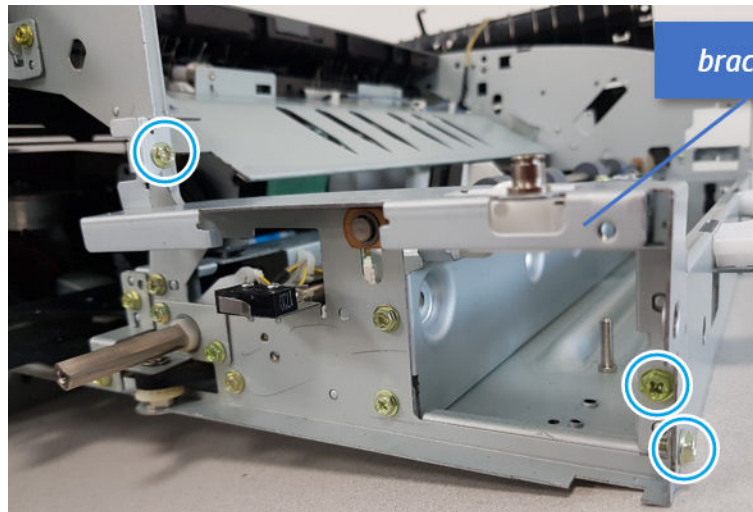

- b. Remove two screws at the front of the inner finisher.

Figure 5-481 Remove two screws

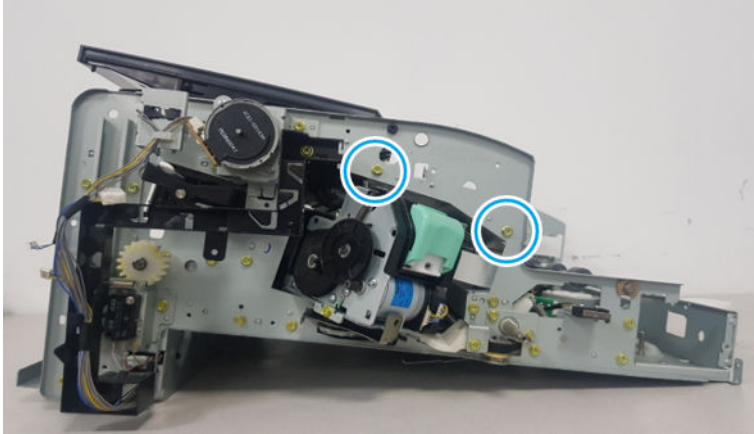

- c. Remove two screws at the rear of the inner finisher.

Figure 5-482 Remove two screws

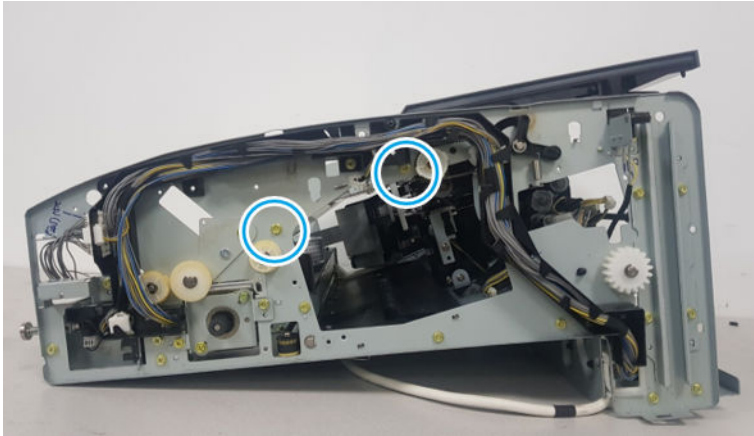

- d. Loosen three cable clamps. Unplug the connector at the sensor, and then remove the end fence sensor bracket.

Figure 5-483 Remove the end fence sensor bracket

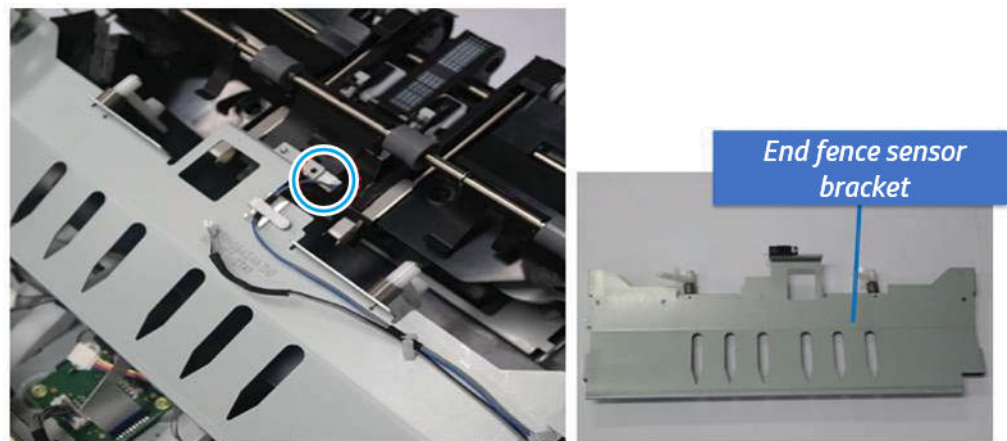

- 9. Remove the stapler position sensor.

- a. Remove one screw from the front of the inner finisher.

Figure 5-484 Remove one screw

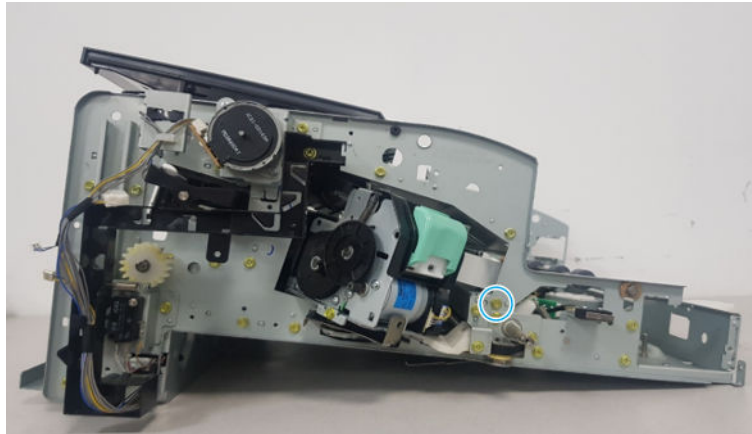

- b. Remove one screw from the rear of the inner finisher.

Figure 5-485 Remove one screw

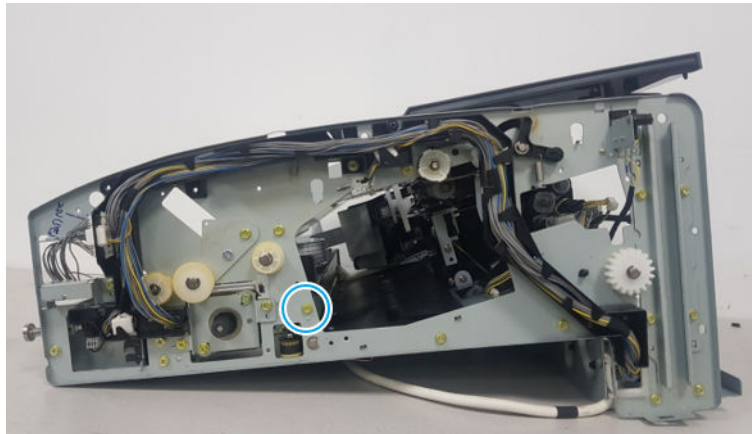

- c. Unplug four photo-sensor connectors. Open the six cable clamps.

Figure 5-486 Unplug connectors

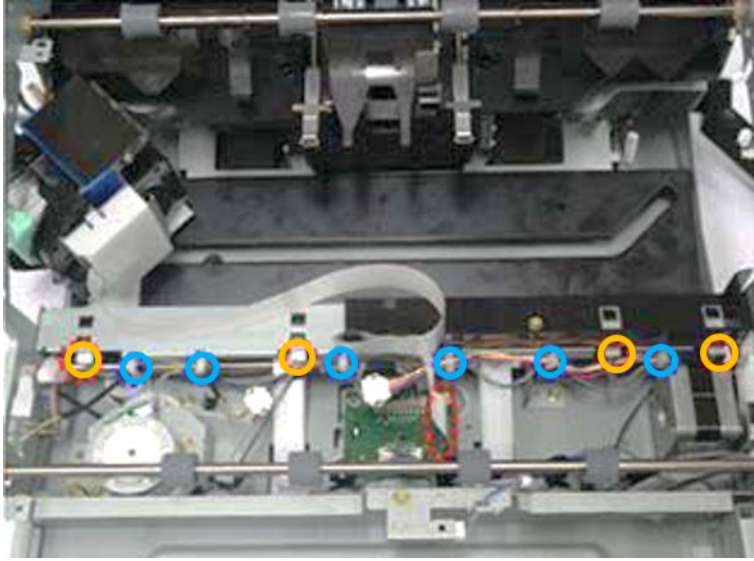

- d. Remove the assembly, and then remove the sensor.

Figure 5-487 Remove the stapler position sensor

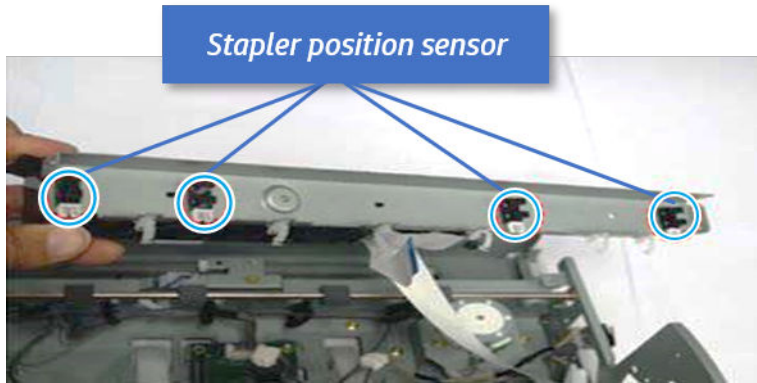



- 10. Unpack the replacement assembly.
 - a. Dispose of the defective part.

 **NOTE:** HP recommends responsible disposal of the defective part.

<http://www8.hp.com/us/en/hp-information/environment/product-recycling.html>

b. Unpack the replacement part from the packaging.

 **CAUTION:**  Some parts are sensitive to electrostatic discharge (ESD). Always perform service work at an ESD-protected workstation or mat. If an ESD workstation or mat is not available, touch the sheet-metal chassis to provide a static ground before touching an ESD-sensitive assembly. Protect the ESD-sensitive assemblies by placing them in ESD pouches when they are out of the printer.

If the replacement part is a roller or pad, avoid touching the spongy part of it. Skin oils on the roller or pad can cause paper pickup and/or print-quality problems. HP recommends using disposable gloves when handling rollers or pads or washing your hands before touching rollers or pads.

 **IMPORTANT:** Make sure that all of the shipping materials (for example shipping tape) are removed from the replacement part prior to installation.

c. To install an assembly, reverse the removal steps.

When applicable, special installation instructions are provided for an assembly at the end of the removal procedure. Always completely read the removal instructions and follow all special installation instructions.

Removal and replacement: Stapler position motor (M1)

Learn how to remove and replace the stapler position motor.

To view teardown&reassembling video of the inner finisher, click the link below.

 [View a teardown video of the inner finisher .](#)

 [View a reassembling video of the inner finisher .](#)

 **IMPORTANT:** When applicable, special installation instructions are provided for an assembly at the end of the removal procedure. Always completely read the removal instructions and follow all special installation instructions.

Mean time to repair:

Service level:

Before performing service

Turn the printer power off

- Press the power button on the front of the printer, and then turn off the power switch next to the power cable.
- A shutting-down message appears on the control-panel display.

 **WARNING!** To avoid damage to the printer, turn the power off and wait until the printer shuts down before removing the power cable.

- Disconnect the printer power cable after the printer has completely shut down (the control-panel display is blank).

Use the table below to identify the correct part number for your printer. To order the part, go to <https://parts.hp.com>.

Table 5-58 Part information

Part number	Part description
JC93-00999A	Stapler position motor

Required tools

- #2 JIS screwdriver with a magnetic tip

After performing service

Turn the printer power on

- Connect the power cable.
- Use the power switch to turn the power on.

Post service test

Print any pages necessary to verify that the repair resolved the issue and did not create any new issues.

1. Remove the front cover.
 - a. Open the front door and open the punch cover.
 - b. Remove three screws in the front.
 - c. Remove the lever.
 - d. Open the top cover.
 - e. From the right side of the front cover, carefully lift and pry toward the top-left corner to remove the front cover.

Figure 5-488 Remove the front cover

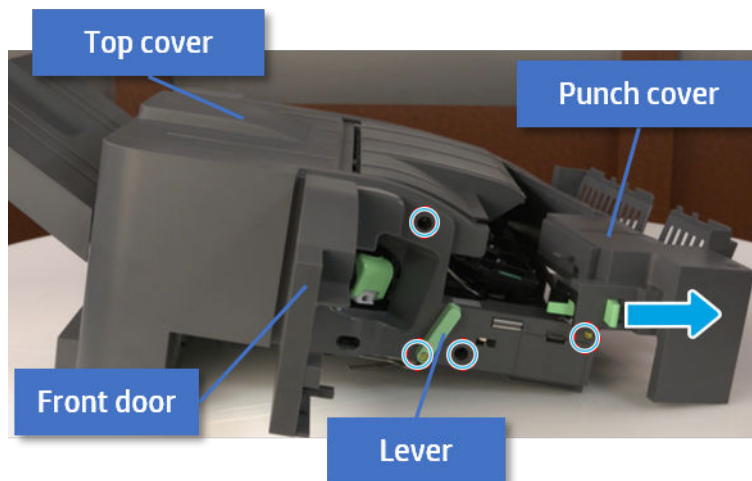

2. Remove the rear cover.

- a. Open the top cover.

Figure 5-489 Open the top cover

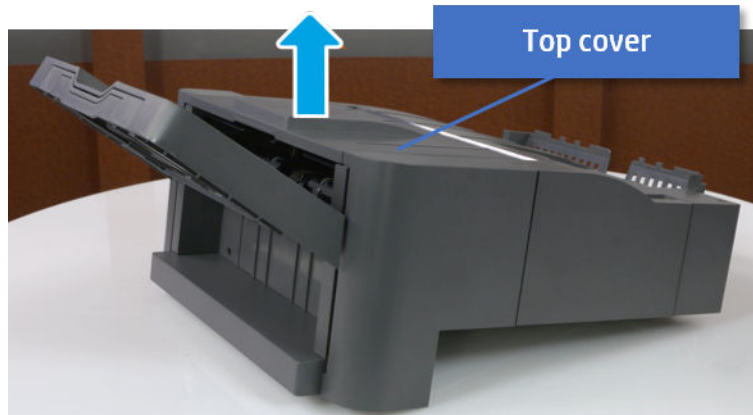

- b. Remove three screws.
- c. Release hooks carefully and remove the rear cover.

Figure 5-490 Remove the rear cover

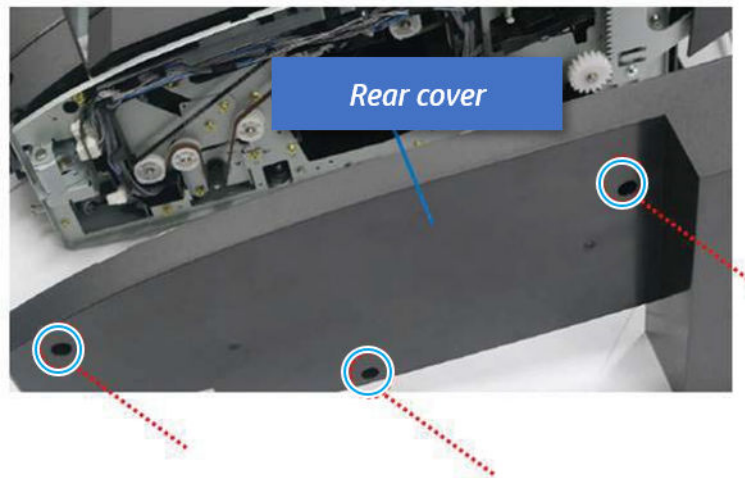

3. Remove the middle cover.
 - a. Open the front door and then open the punch cover.

Figure 5-491 Open the front door and punch cover.



- b. Remove left-side one screw at the rear of the inner finisher, and then remove the middle cover by lifting off the hinge pins at the front.

Figure 5-492 Remove the middle cover

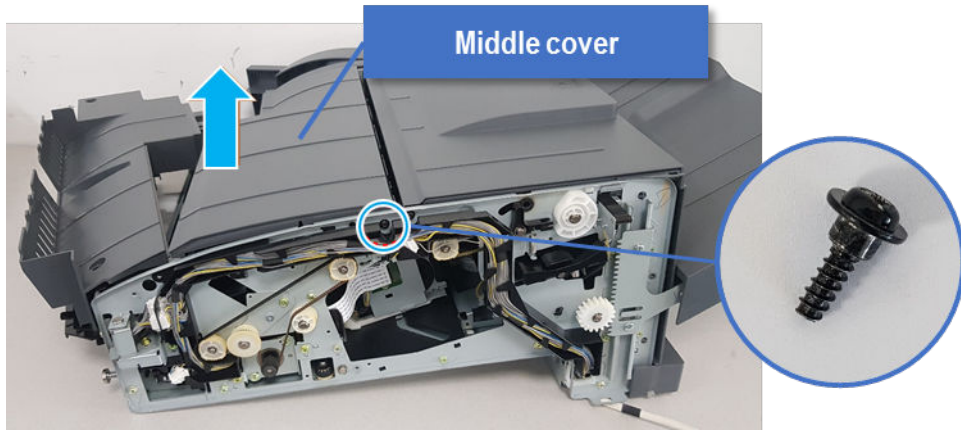

- 4. Remove the punch cover.
 - a. Unplug the connector. Remove the e-ring, and then remove the slide shaft at the rear of the inner finisher.

Figure 5-493 Remove the slide shaft

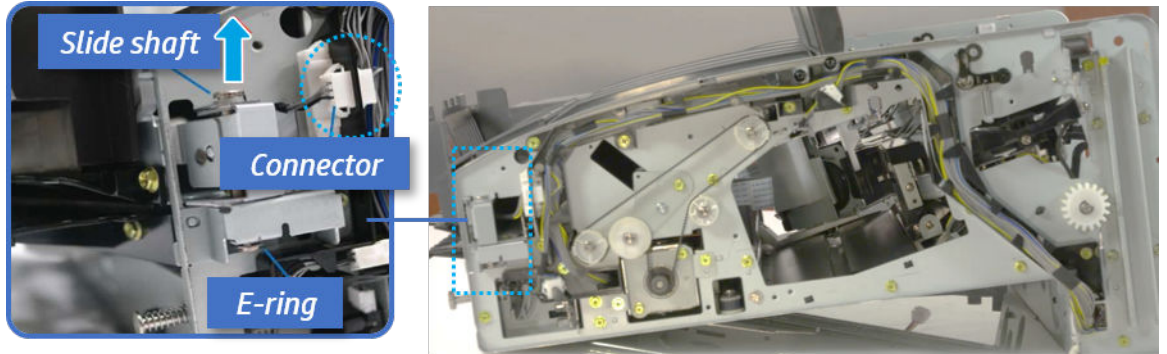

- b. Open the punch cover.

Figure 5-494 Open the punch cover

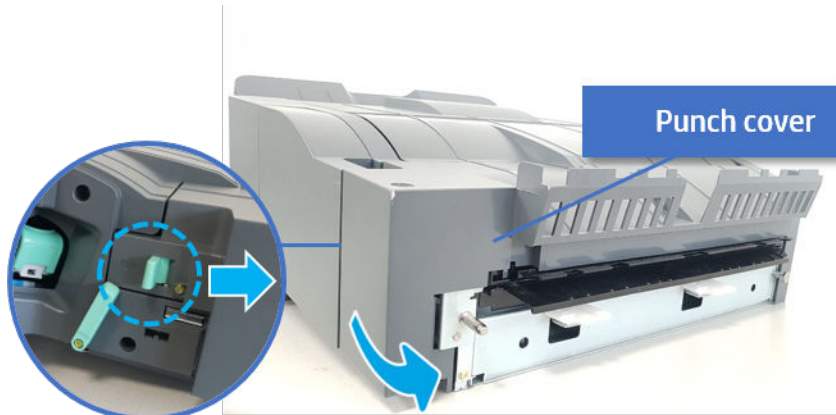

- c. Remove the front punch sheet, and then remove the e-ring and the washer. And then remove the punch cover.

Figure 5-495 Remove the punch cover

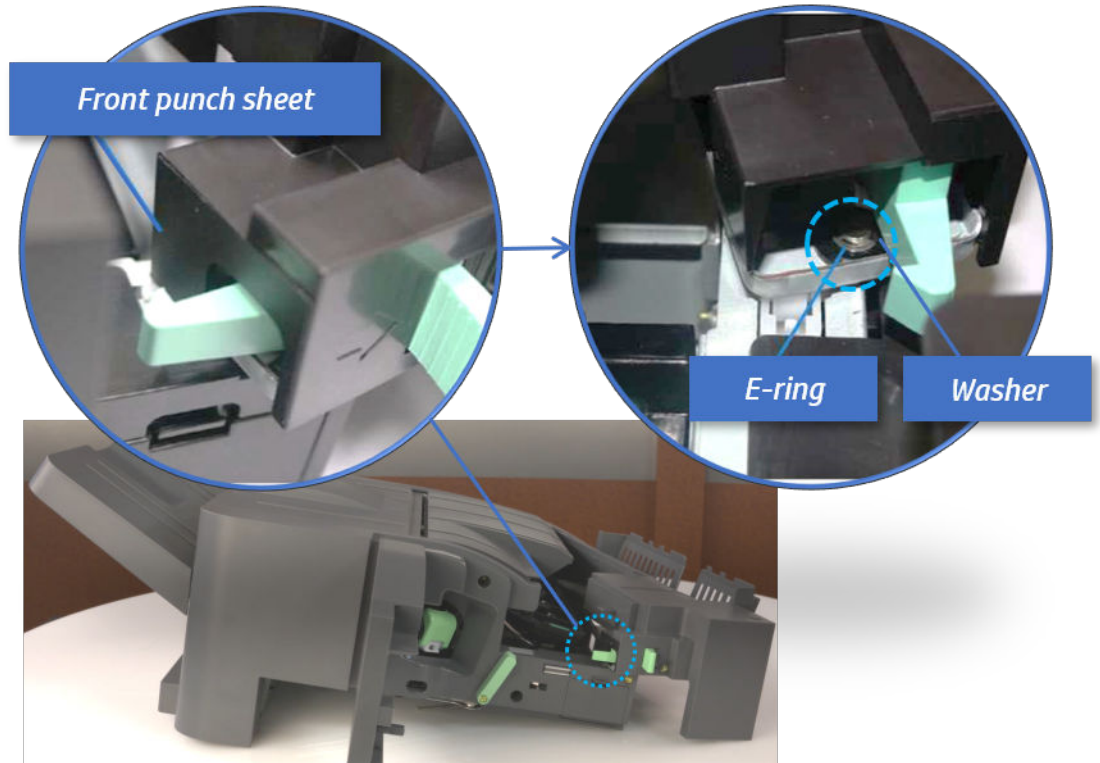

- 5. Remove the diverter guide and the middle roller
 - a. On the front of the inner finisher, remove the e-ring and bushing.

Figure 5-496 Remove the e-ring and bushing

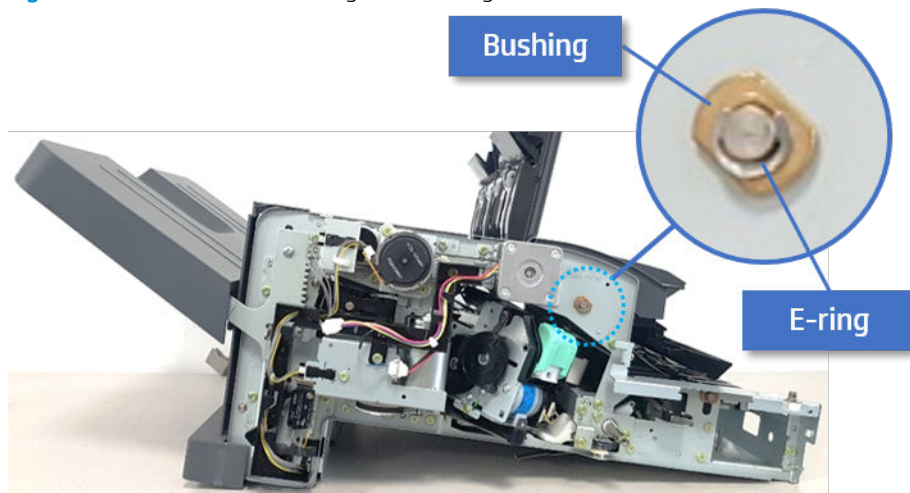

- b. On the rear of the inner finisher, remove the e-ring, pulley, bushing, belt, and spring (slightly hidden from view).

Figure 5-497 Remove the e-ring, pulley, bushing, belt, and spring

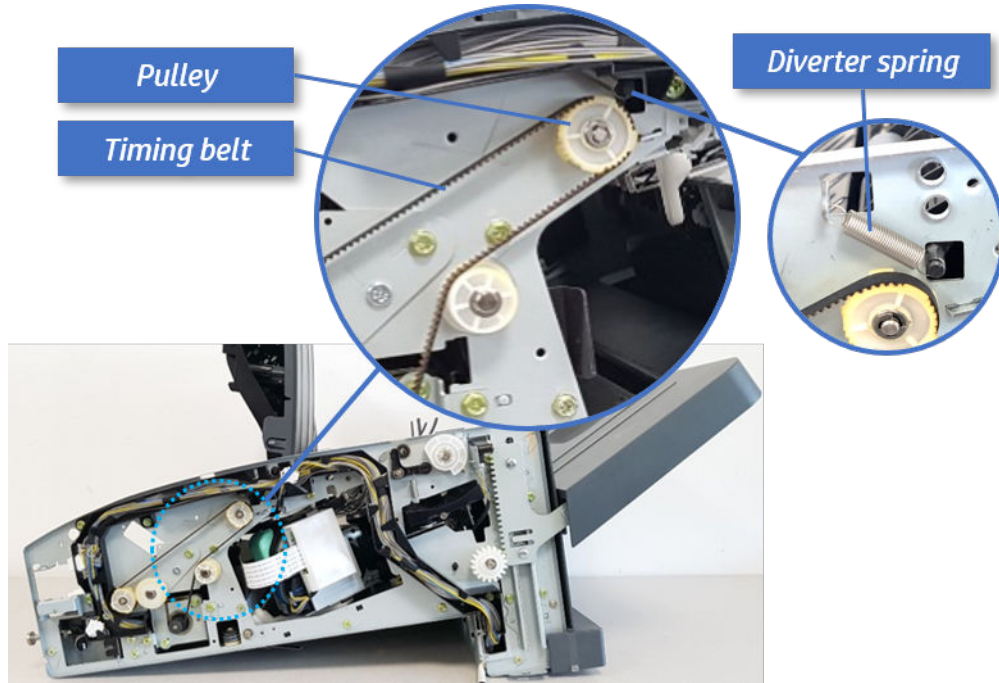

- c. Remove the diverter guide and the middle roller.

Figure 5-498 Remove the diverter guide and the middle roller

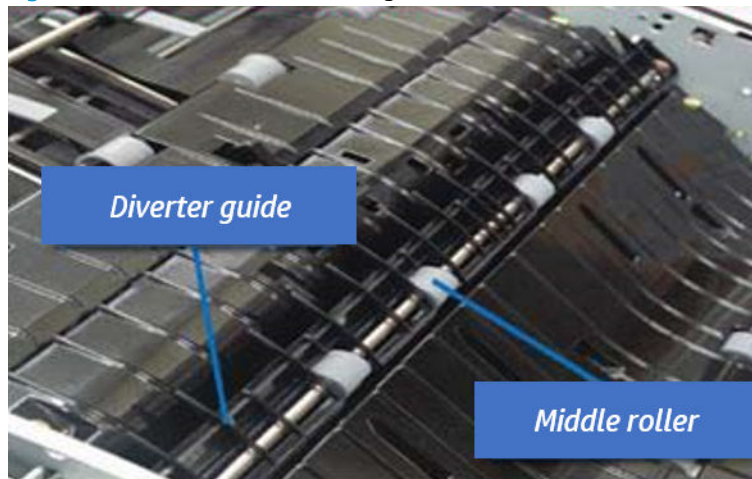

6. Remove the middle paper guide.
 - a. Remove six screws, and then open the middle paper guide in the direction of the arrow.

Figure 5-499 Open the middle paper guide

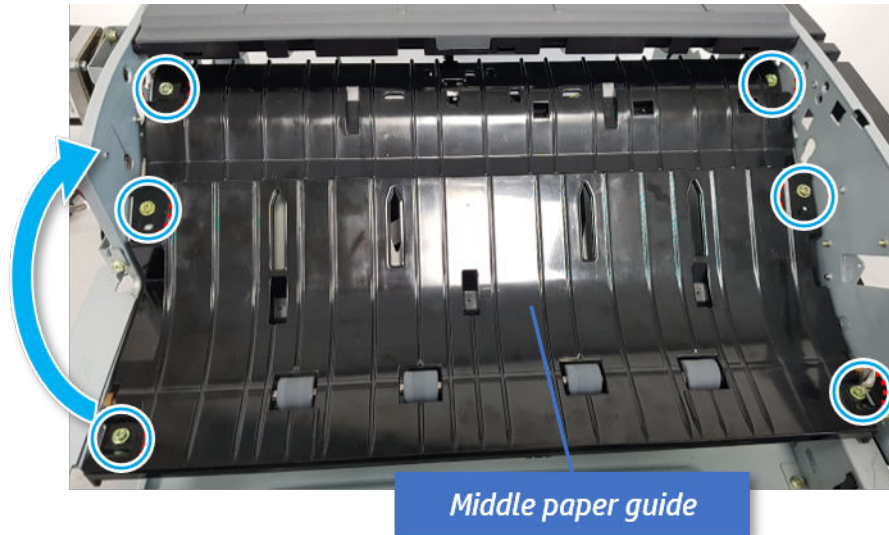

 **NOTE:** Be careful not to damage the sensor connector.

- b. Unplug the connector under the middle paper guide. And then, remove the middle paper guide.

Figure 5-500 Remove the middle paper guide

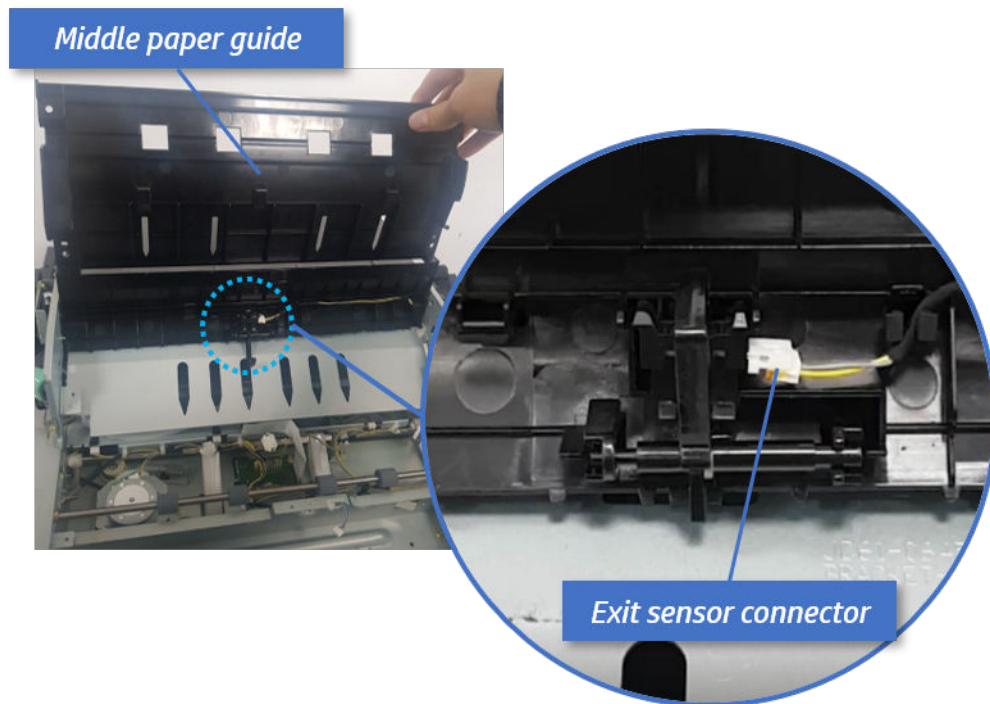

7. Remove the stapler position motor.
 - a. Remove three screws, unplug the motor connector, and then remove the stapler position motor bracket.

Figure 5-501 Remove the stapler position motor bracket

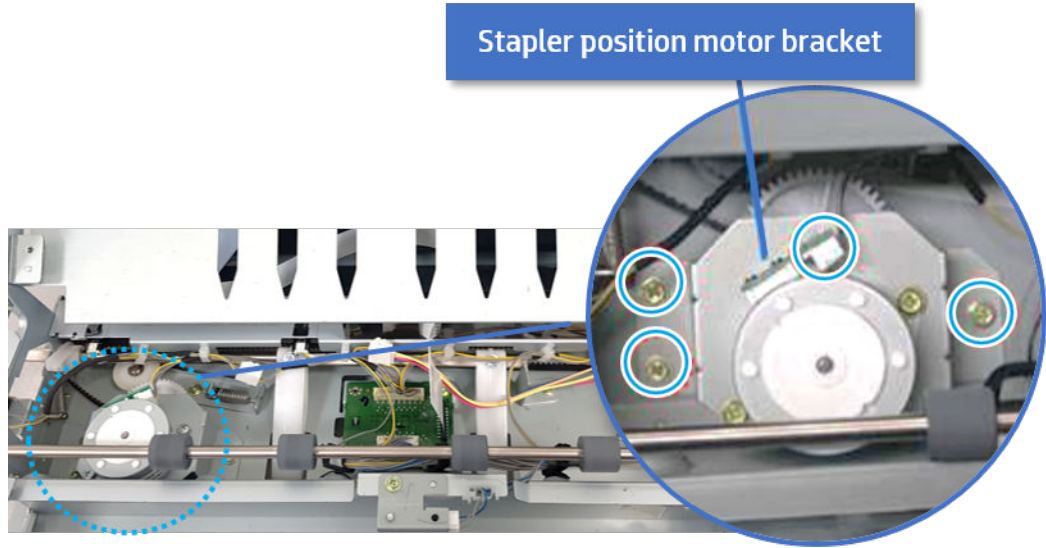

- b. Remove two screws, and then remove the motor from the bracket.

Figure 5-502 Remove the stapler position motor

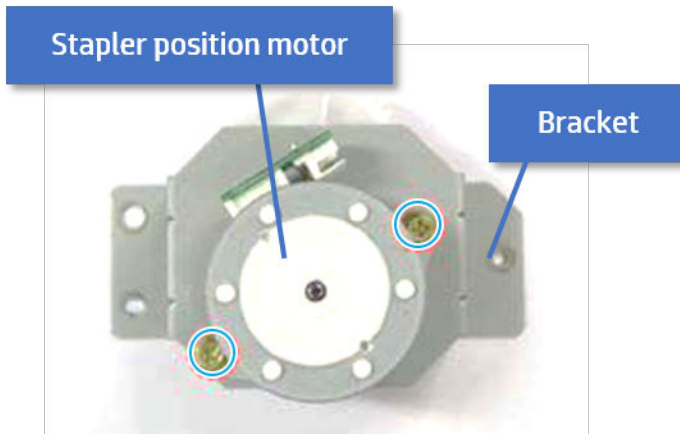

-
- TIP:** Use the following steps when reinstalling the stapler position motor.
- i. Release the spring tension screw.

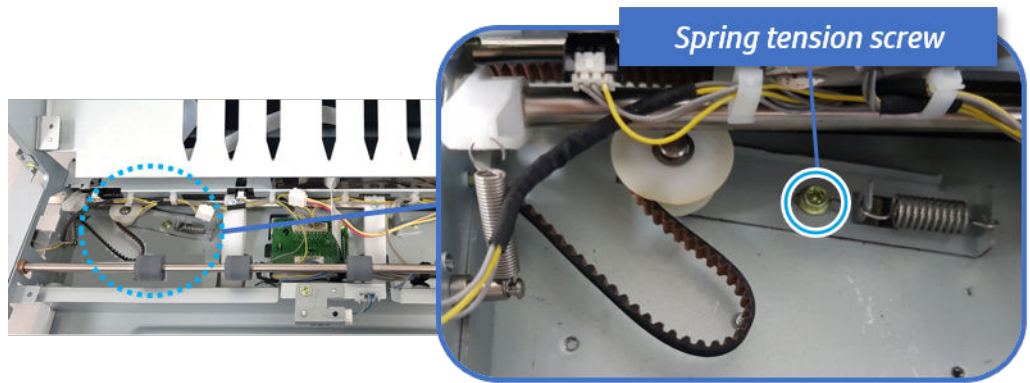

- ii. Apply tension to the spring by pulling the belt, and then tighten the spring tension screw. Tightening the screw puts maximum slack in the belt.

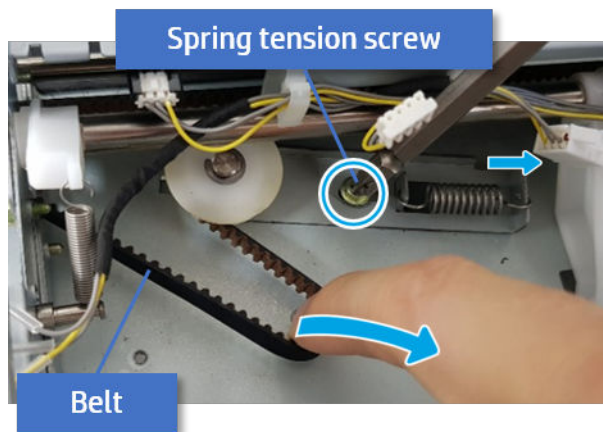



- iii. Lower the stapler position motor while placing the belt on the motor pulley, and then secure the bracket with three screws.
- iv. Release the spring tension screw to allow the spring to apply tension to the belt, and then tighten it again

-
8. Unpack the replacement assembly.
 - a. Dispose of the defective part.

 **NOTE:** HP recommends responsible disposal of the defective part.

<http://www8.hp.com/us/en/hp-information/environment/product-recycling.html>

- b. Unpack the replacement part from the packaging.

 **CAUTION:**  Some parts are sensitive to electrostatic discharge (ESD). Always perform service work at an ESD-protected workstation or mat. If an ESD workstation or mat is not available, touch the sheet-metal chassis to provide a static ground before touching an ESD-sensitive assembly. Protect the ESD-sensitive assemblies by placing them in ESD pouches when they are out of the printer.

If the replacement part is a roller or pad, avoid touching the spongy part of it. Skin oils on the roller or pad can cause paper pickup and/or print-quality problems. HP recommends using disposable gloves when handling rollers or pads or washing your hands before touching rollers or pads.

 **IMPORTANT:** Make sure that all of the shipping materials (for example shipping tape) are removed from the replacement part prior to installation.

- c. To install an assembly, reverse the removal steps.

When applicable, special installation instructions are provided for an assembly at the end of the removal procedure. Always completely read the removal instructions and follow all special installation instructions.

Ejector unit

Removal and replacement: Ejector & paper support assembly

Learn how to remove and replace the ejector & paper support assembly.

To view teardown&reassembling video of the inner finisher, click the link below.

 [View a teardown video of the inner finisher .](#)

 [View a reassembling video of the inner finisher .](#)

 **IMPORTANT:** When applicable, special installation instructions are provided for an assembly at the end of the removal procedure. Always completely read the removal instructions and follow all special installation instructions.

Mean time to repair:

Service level:

Before performing service

Turn the printer power off

- Press the power button on the front of the printer, and then turn off the power switch next to the power cable.
- A shutting-down message appears on the control-panel display.

 **WARNING!** To avoid damage to the printer, turn the power off and wait until the printer shuts down before removing the power cable.

- Disconnect the printer power cable after the printer has completely shut down (the control-panel display is blank).

Use the table below to identify the correct part number for your printer. To order the part, go to <https://parts.hp.com>.

Table 5-59 Part information

Part number	Part description
SS456-61001	Ejector
JC90-01310A	Front paper support
JC90-01311A	Rear paper support

Required tools

- #2 JIS screwdriver with a magnetic tip

After performing service

Turn the printer power on

- Connect the power cable.
- Use the power switch to turn the power on.

Post service test

Print any pages necessary to verify that the repair resolved the issue and did not create any new issues.

1. Remove the front cover.
 - a. Open the front door and open the punch cover.
 - b. Remove three screws in the front.
 - c. Remove the lever.
 - d. Open the top cover.
 - e. From the right side of the front cover, carefully lift and pry toward the top-left corner to remove the front cover.

Figure 5-503 Remove the front cover

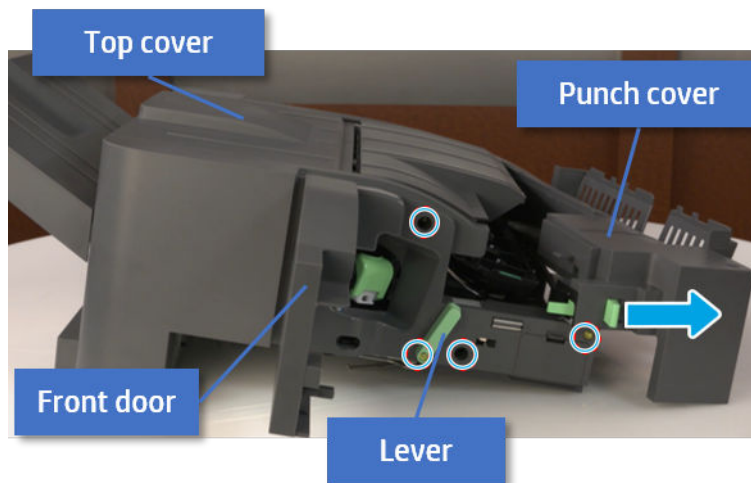

2. Remove the rear cover.
 - a. Open the top cover.

Figure 5-504 Open the top cover

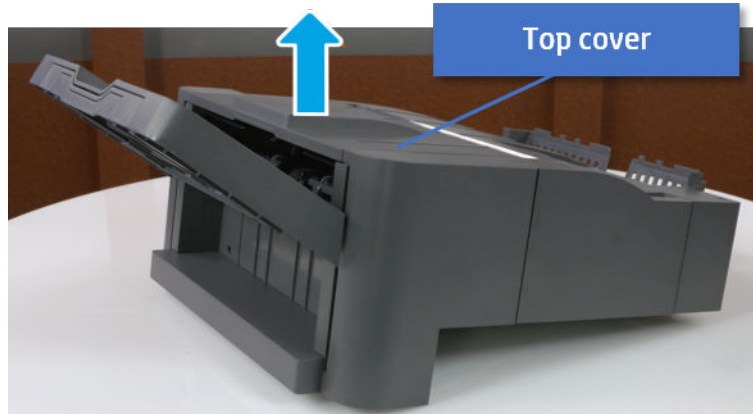

- b. Remove three screws.
- c. Release hooks carefully and remove the rear cover.

Figure 5-505 Remove the rear cover

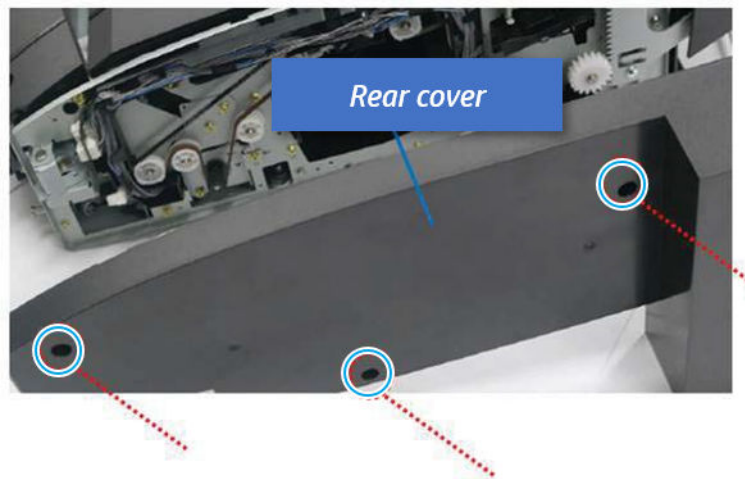

- 3. Remove the output tray.
 - a. Remove four screws.

Figure 5-506 Remove four screws

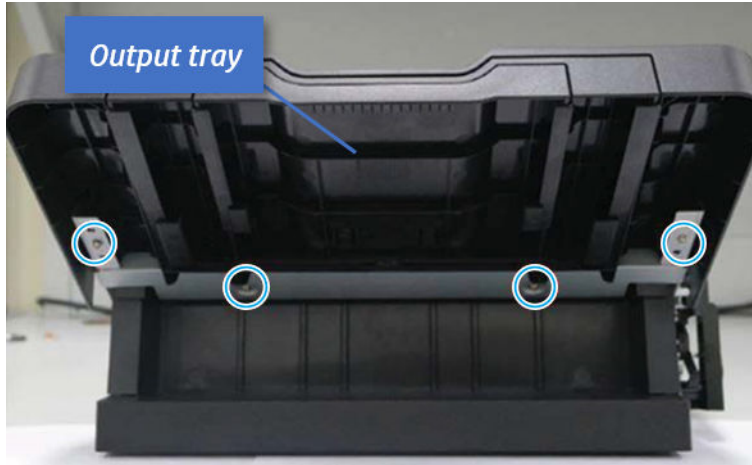

- b. Push the paper holding actuator into the inner finisher, and then remove the output tray.

Figure 5-507 Remove the output tray.



4. Remove the output tray frame.
 - a. Rotate the pulley until the output tray frame depart from the gear.

Figure 5-508 Remove the pulley

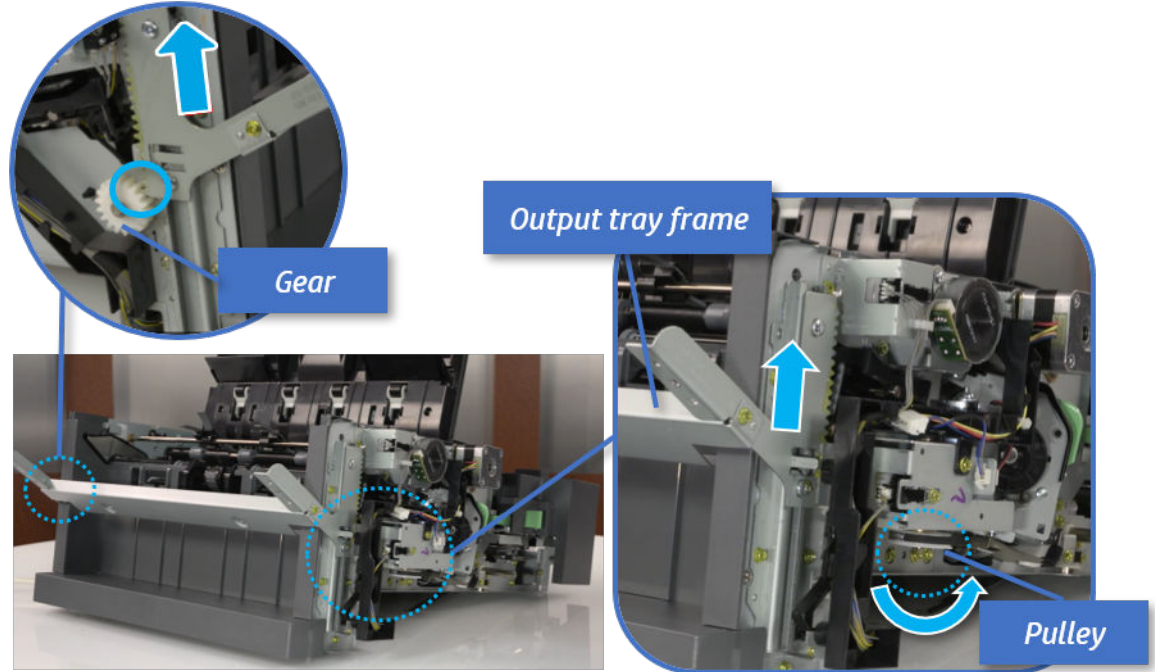

- b. Push the paper holding actuator into the inner finisher, and then remove the output tray frame.

Figure 5-509 Remove the output tray frame

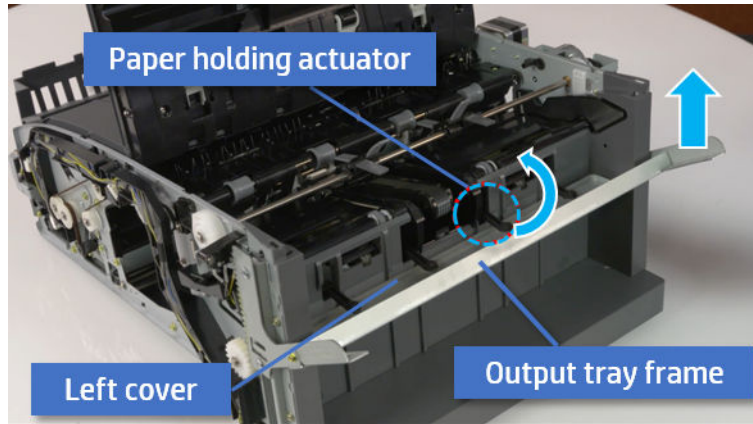

TIP: Push the paper holding actuator into the inner finisher when reassembling. Be sure to level the output tray.

1. Position the first wheel into the channel on both sides while pushing the paper holding actuator.

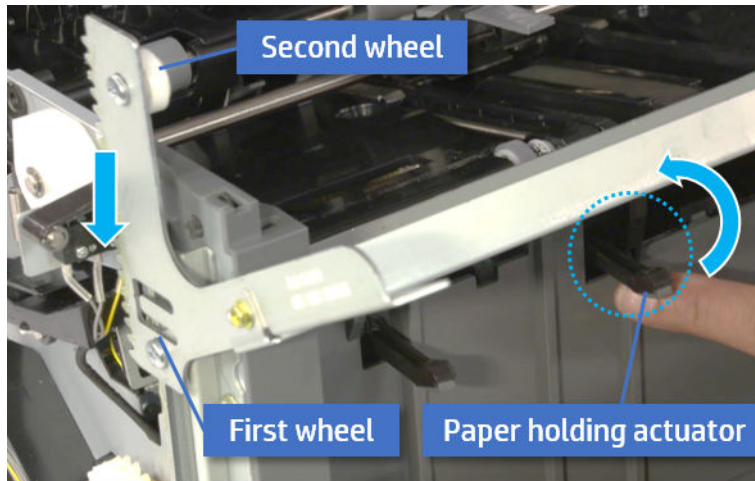

2. Let the second wheel rest on the channel on both sides simultaneously.
3. Gently squeeze the wheels into channel until the output tray frame meet the gear.

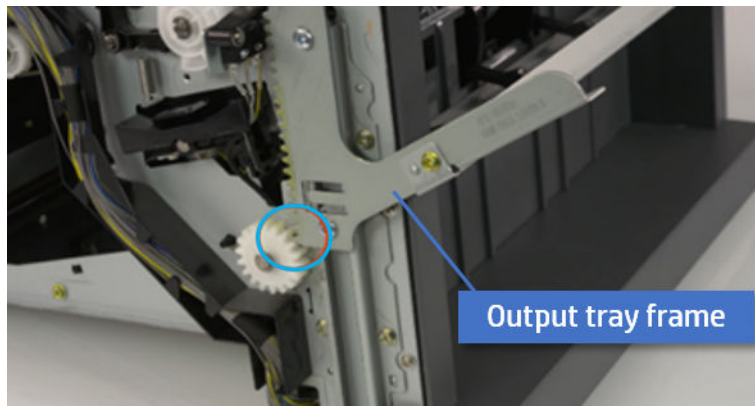

4. Rotate the pulley until the output tray frame is no longer lifted. It can make to level the output tray frame.

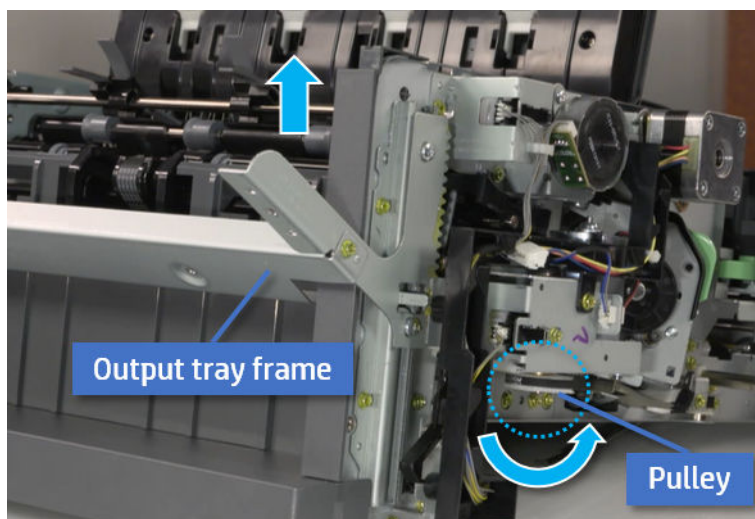

5. Rotate the pulley in the opposite direction.

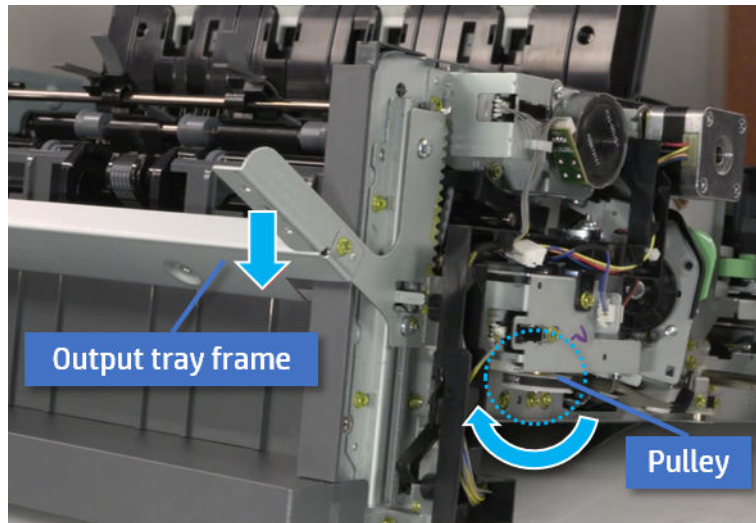

5. Remove the PCA cover.

- ▲ Remove two screws, and then remove the PCA cover.

Figure 5-510 Remove the PCA cover

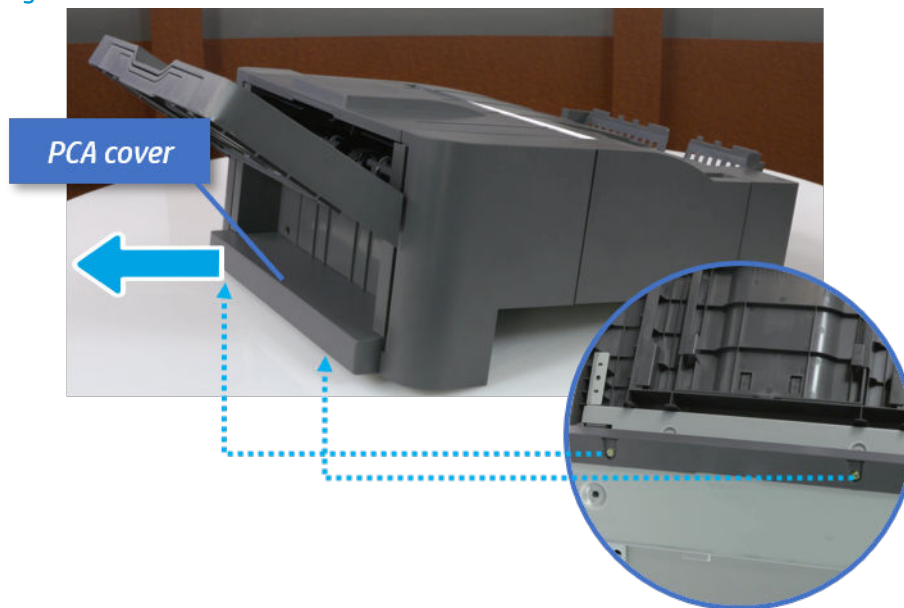

6. Remove the left cover.

- a. Remove two screws.

Figure 5-511 Remove two screws

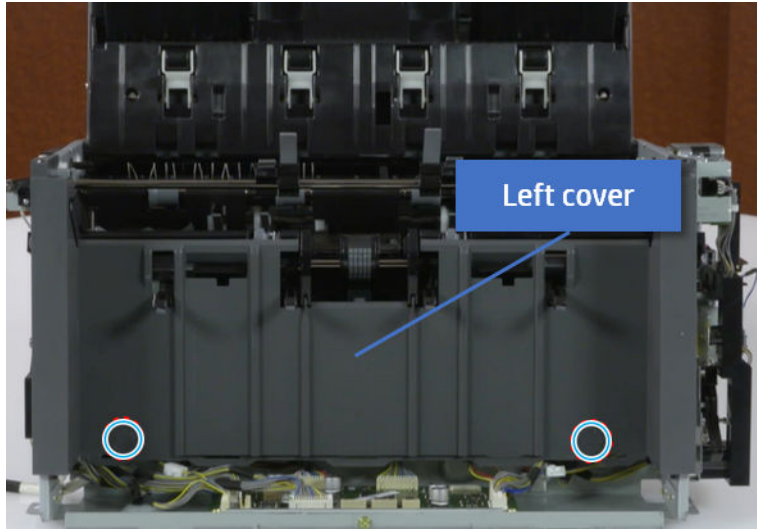

- b. Remove four screws from both front and rear sides.

Figure 5-512 Remove four screws

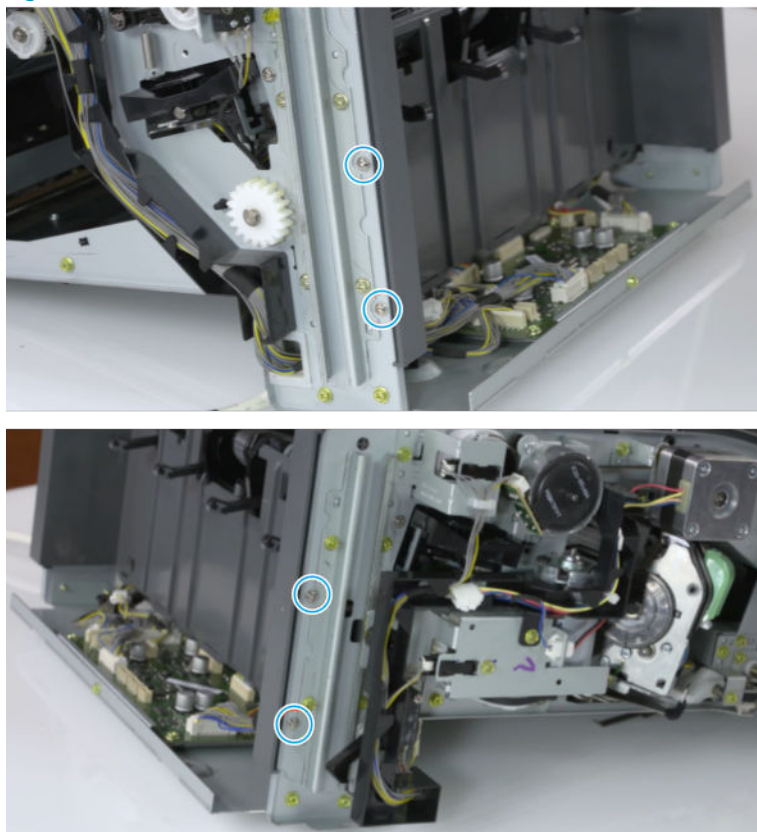

- c. Unplug two inline connectors, and then remove the left cover.

Figure 5-513 Unplug two connectors

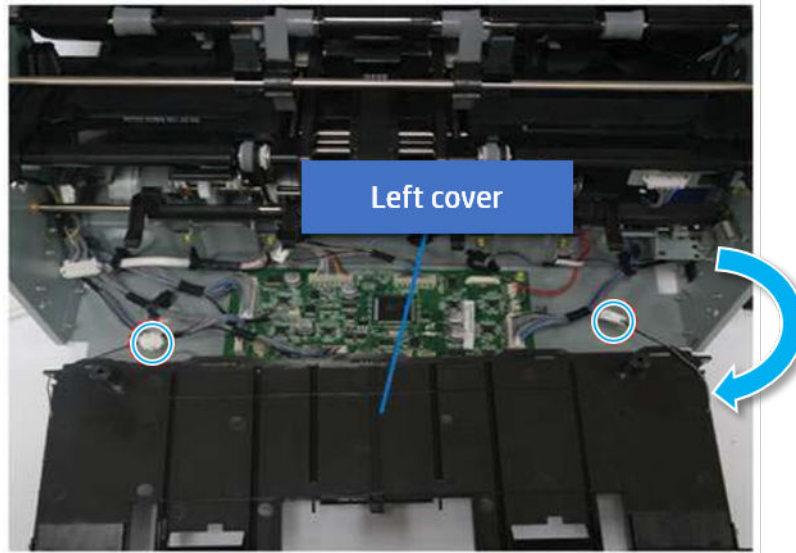

 **TIP:** Be sure to check the hook when reassembling.

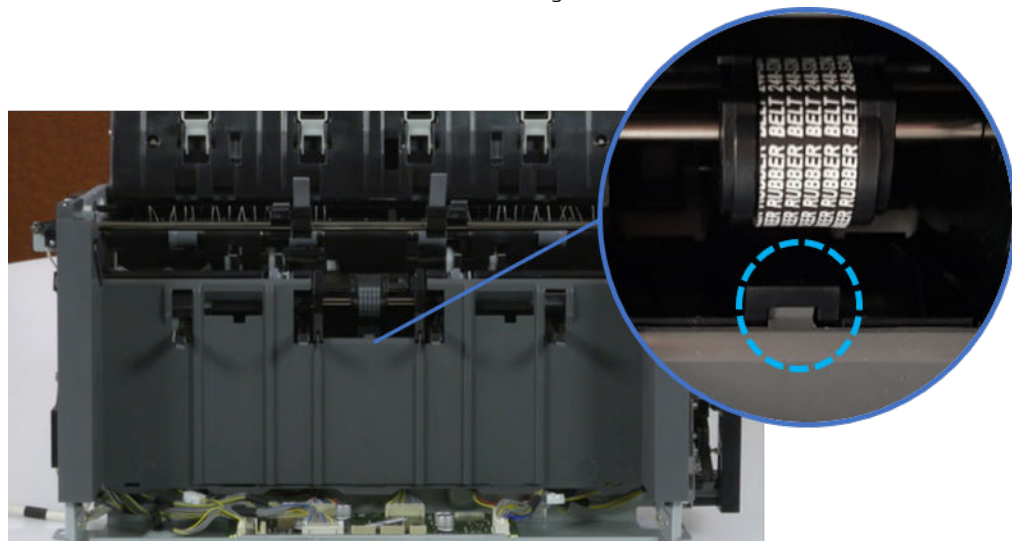

- 7. Remove the front harness guide.
 - a. Open one clamp and unplug five connectors, and then remove the wire harness from the front harness guide.

- b. Remove four screws, and then remove the front harness guide.

Figure 5-514 Remove the front harness guide

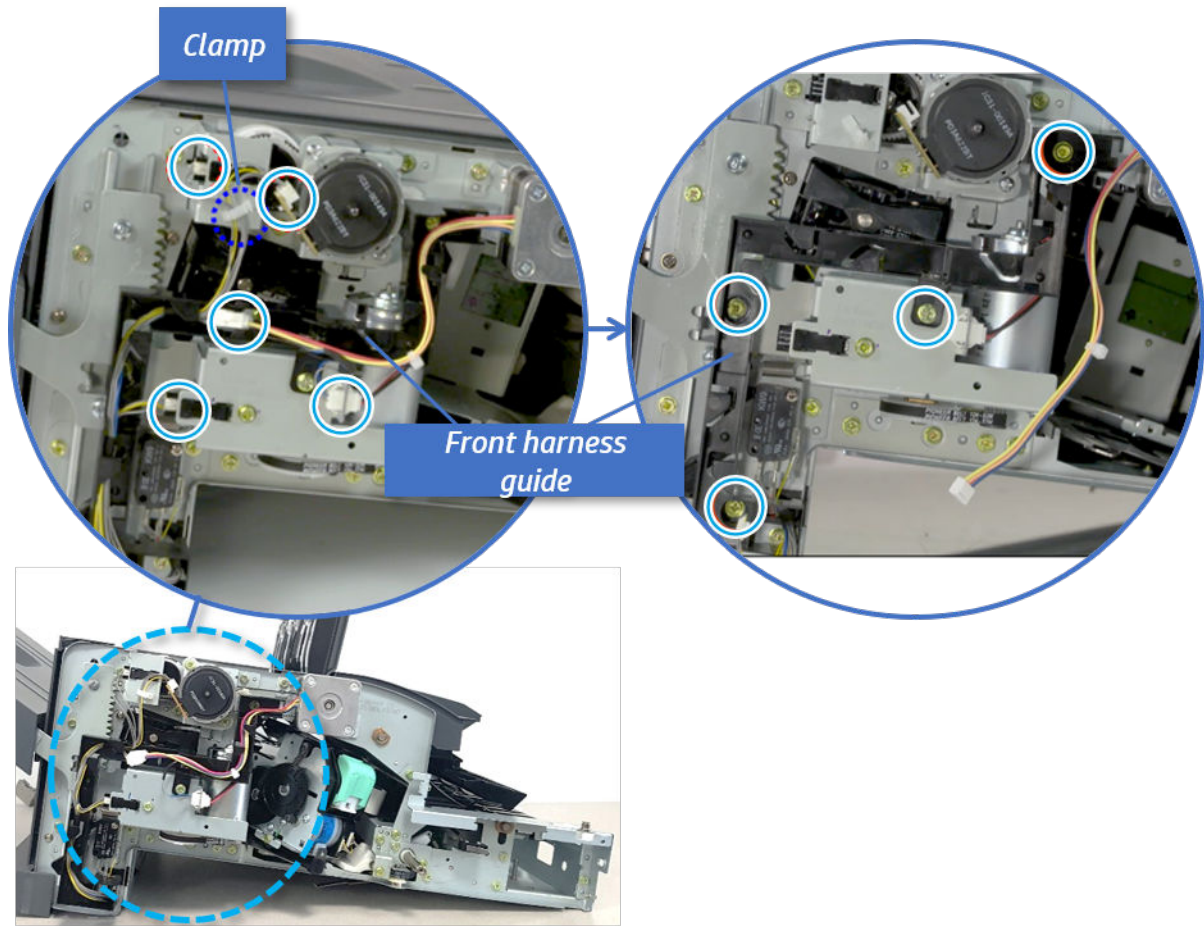

8. Remove the output tray motor assembly.

- ▲ Remove three screws, and then remove the output tray motor assembly.

Figure 5-515 Remove the output tray motor assembly

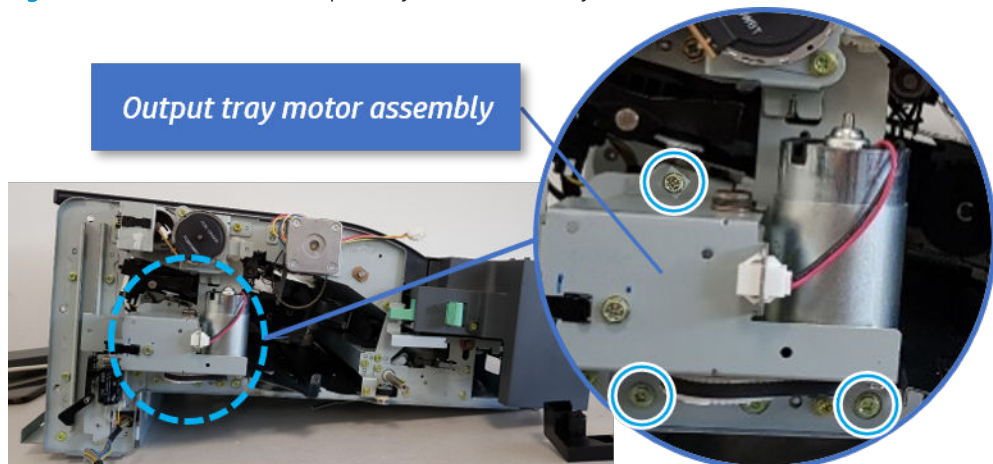

9. Remove the output tray lower limit switch.

- ▲ Remove one screw, and then remove the output tray lower limit switch.

Figure 5-516 Remove the output tray lower limit switch

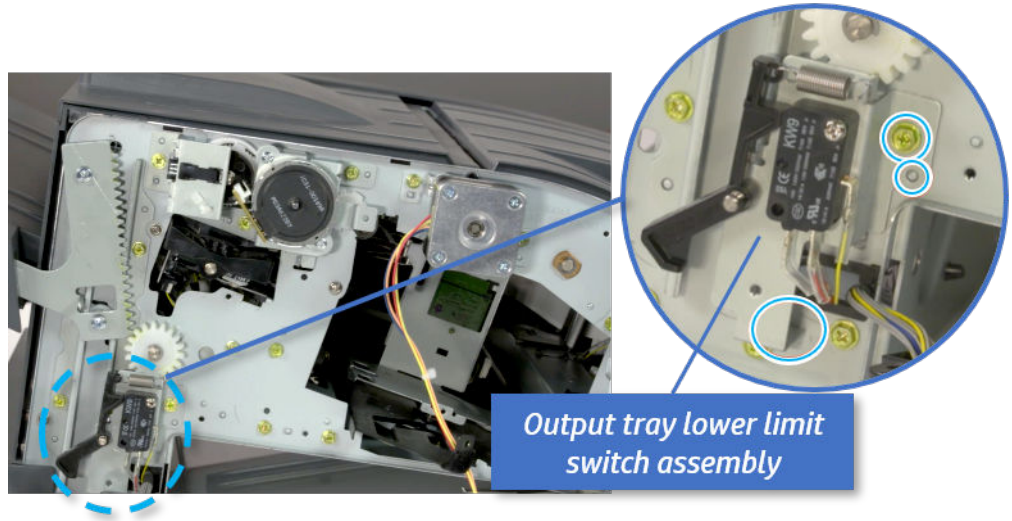

- 10. Remove the paper holding.

- a. Remove the paper holding actuator spring.

Figure 5-517 Remove the paper holding actuator spring

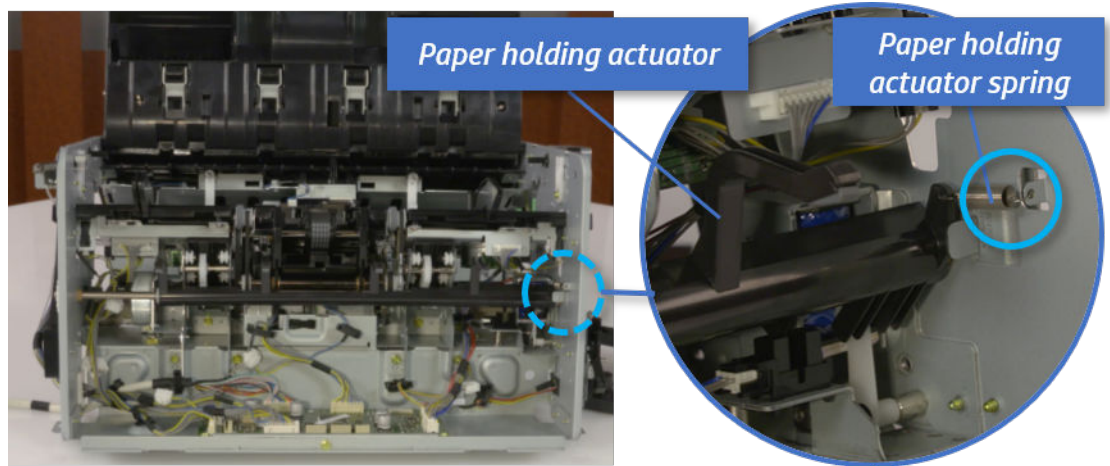

- b. Remove the e-ring and the rack pinion gear. And then remove the pin and the e-ring, and then remove the bushing.

Figure 5-518 Remove e-ring, rack pinion gear, pin, and bushing

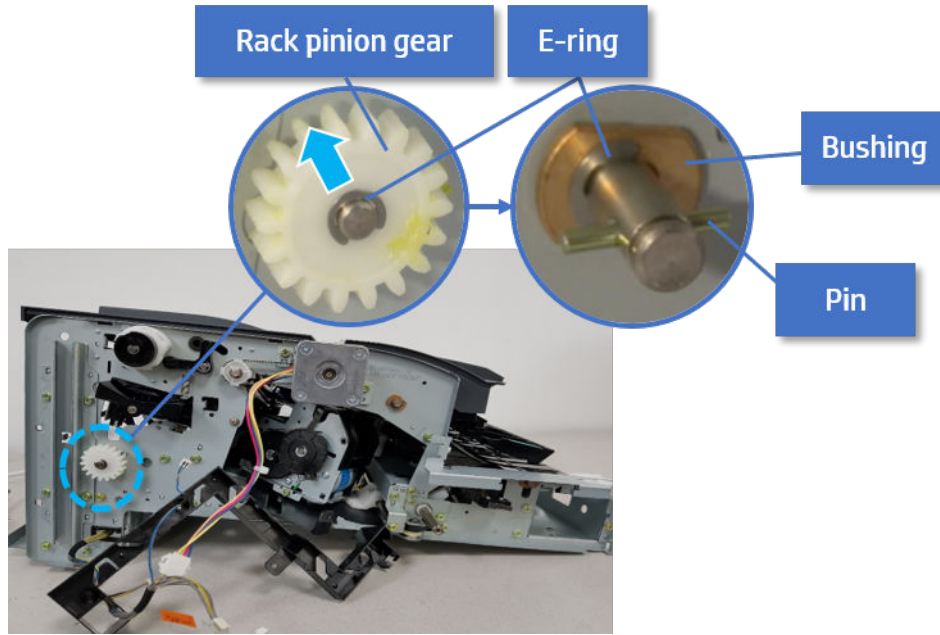

 **NOTE:** Be sure not to lose the pin.

- c. Carefully remove the paper holding shaft and the actuator.

Figure 5-519 Remove the paper holding shaft and the actuator

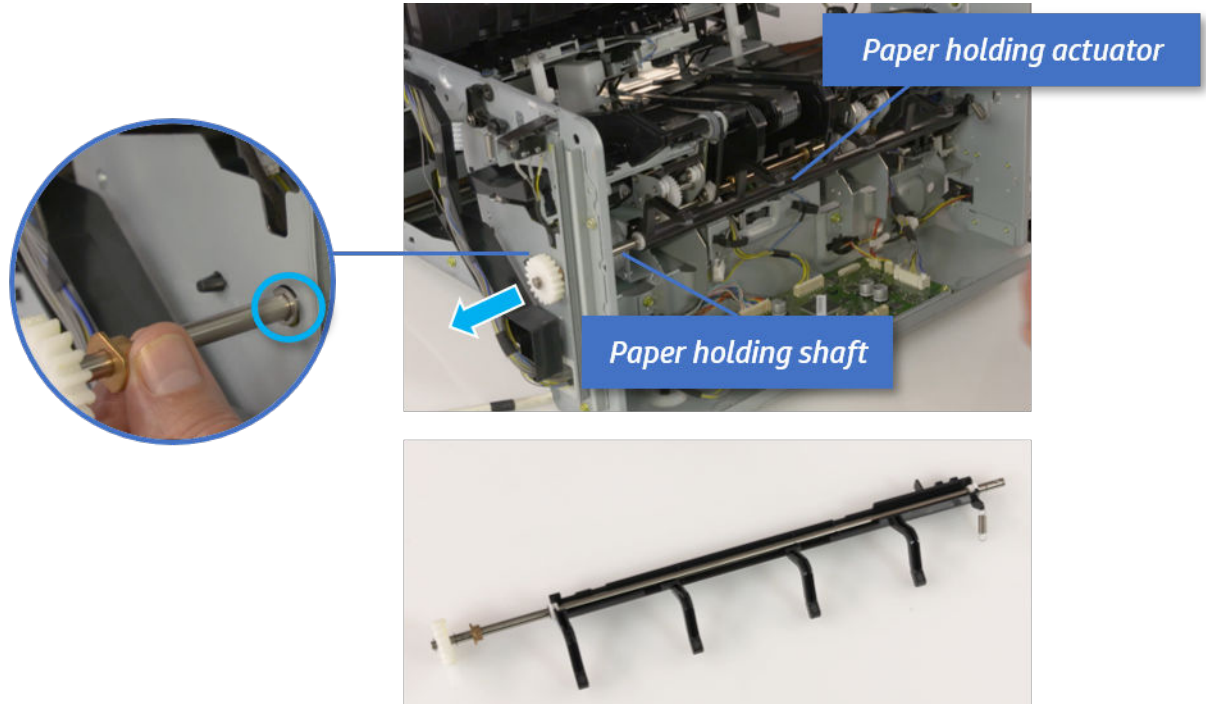

- 11. Remove the sub paddle unit.

- a. Open the top cover, and then remove one screw securing the sub paddle unit.

Figure 5-520 Remove one screw

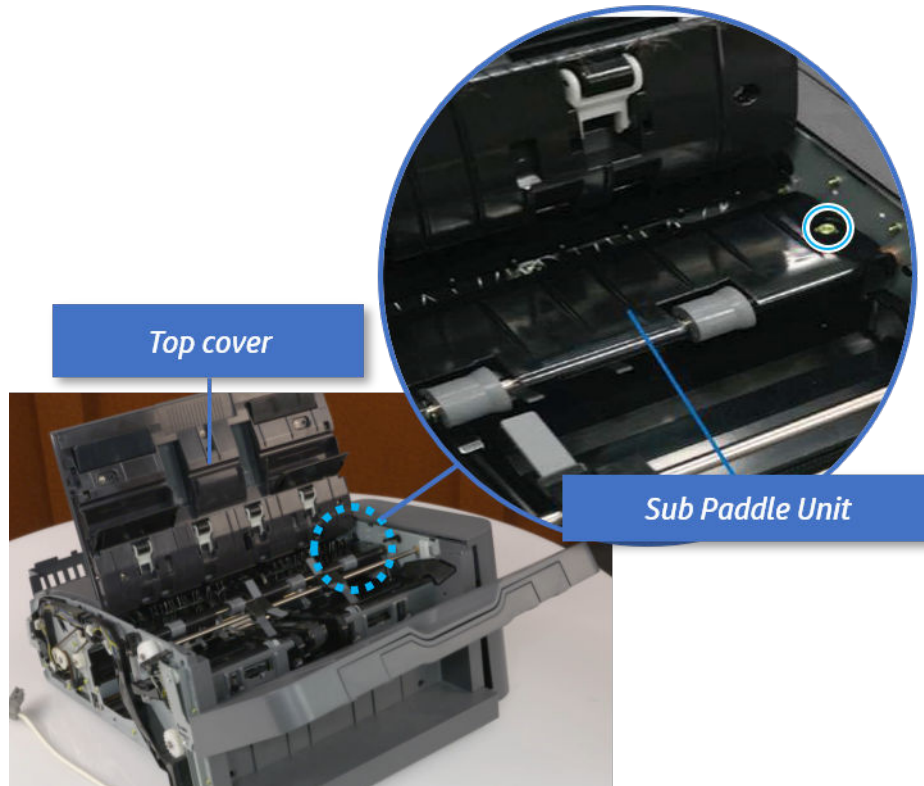

- b. Remove the e-ring, and then remove the pulley and timing belt. And then remove the e-ring and the bushing.

Figure 5-521 Remove the e-ring, pulley, timing belt, and bushing

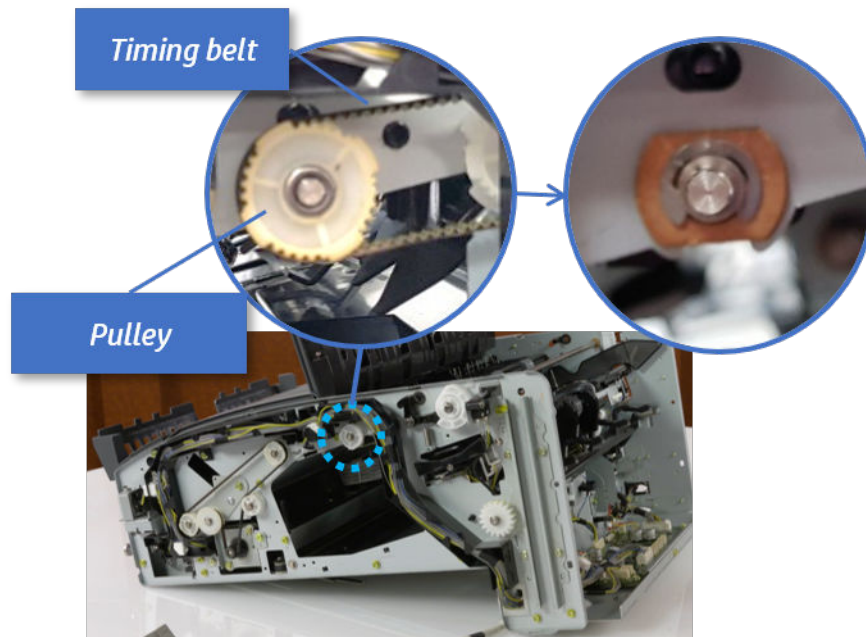

- c. Lift up and remove the sub paddle unit.

Figure 5-522 Remove the sub paddle unit

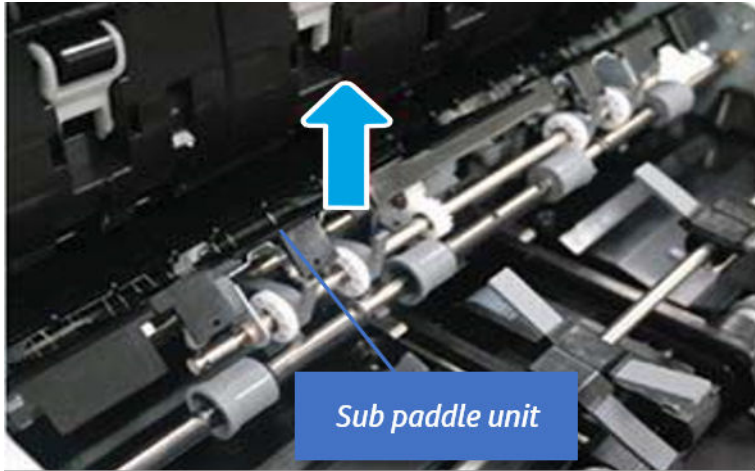

- 12. Remove the exit roller.

- a. Remove the guide on the center of the exit roller.

Figure 5-523 Remove the guide

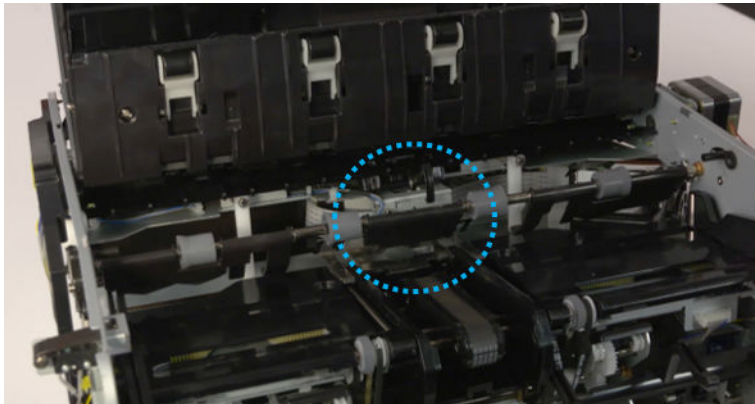

- b. On the front of the inner finisher, release the timing belt connected to the exit motor.

Figure 5-524 Release the timing belt

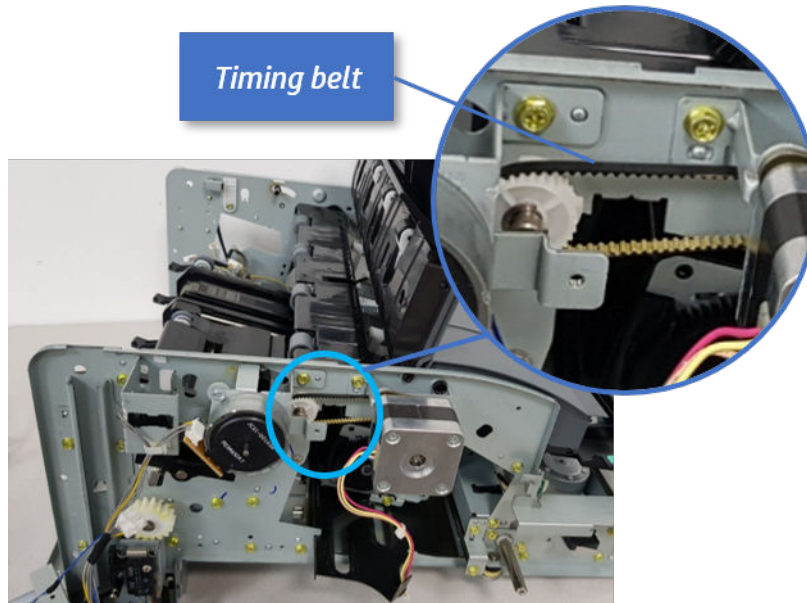

- c. Remove five screws securing the rear harness guide.

Figure 5-525 Remove five screws

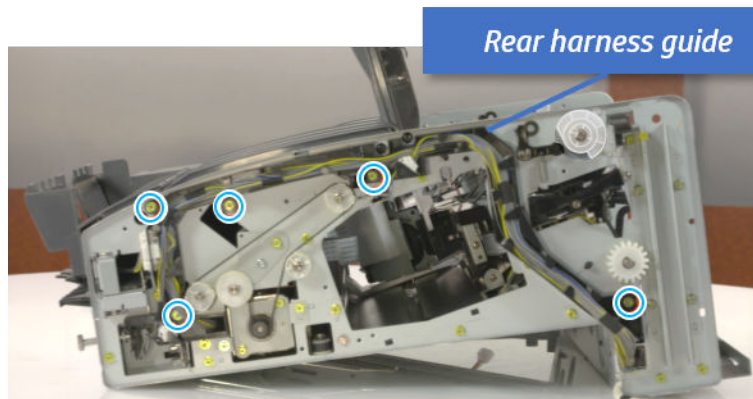

- d. On the rear of the inner finisher, remove the e-ring and the pulley and then remove the e-ring and the bushing.

Figure 5-526 Remove e-ring, pulley, and bushing

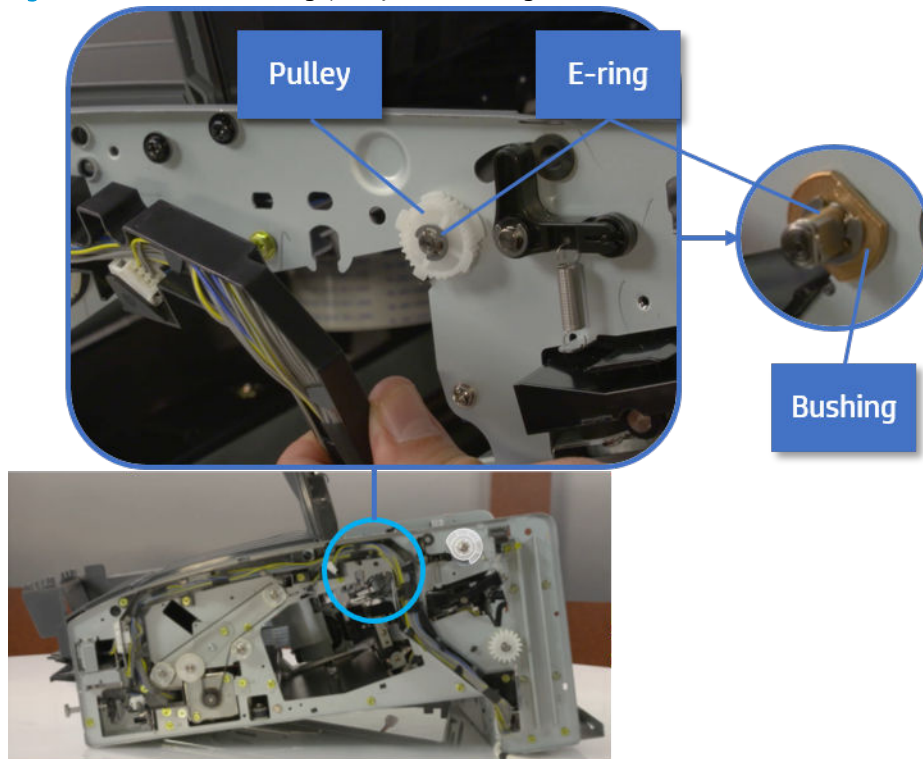

- e. Push the bushing to detach it, and then remove the exit roller.

Figure 5-527 Remove the exit roller

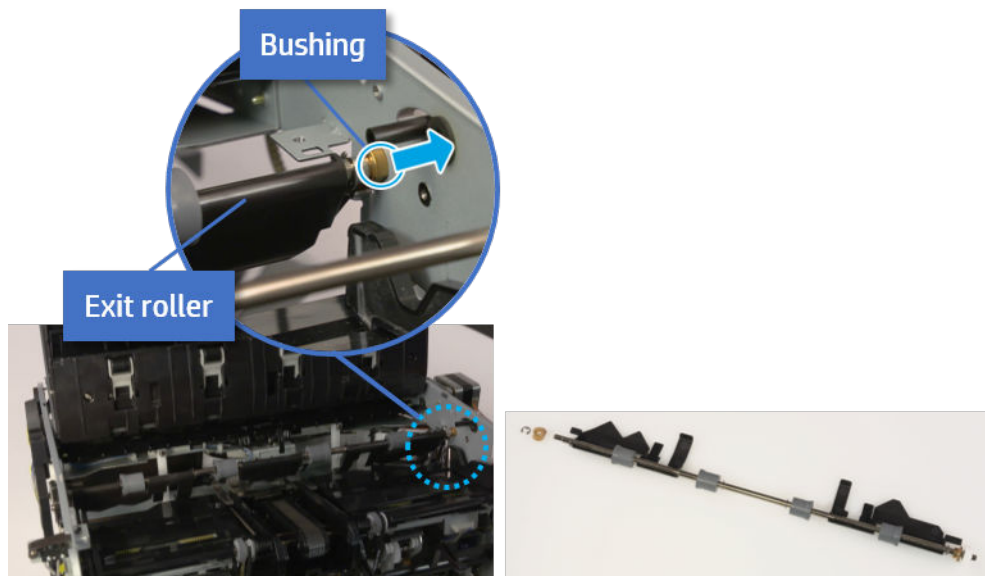

- 13. Remove the front tamper.
 - a. Remove four screws.

Figure 5-528 Remove four screws

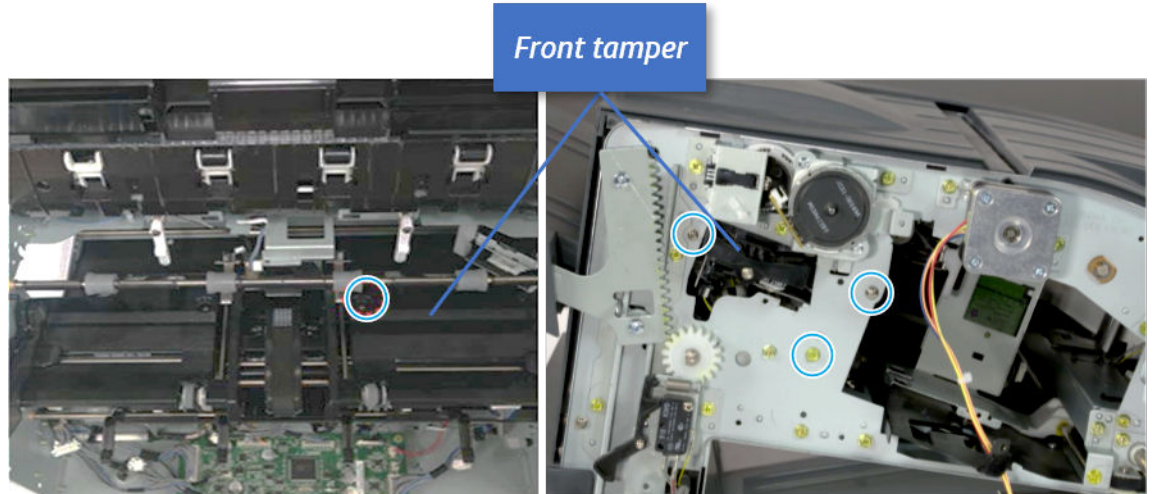

- b. Unplug the connector and release the hook, and then pull the front tamper up to remove.

Figure 5-529 Remove the front tamper

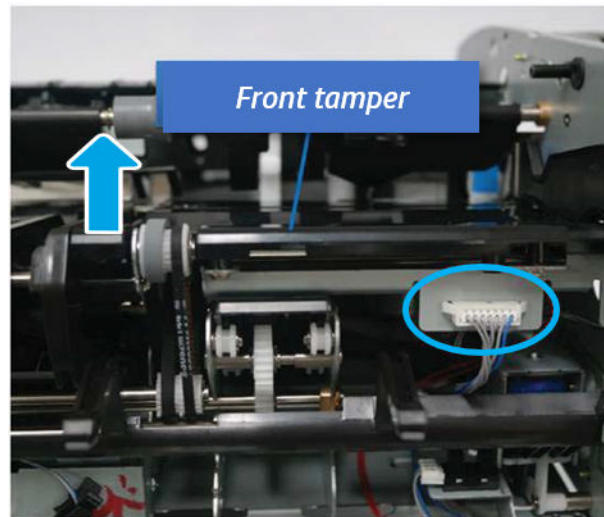

14. Remove the rear tamper.

- a. Remove four screws.

 **NOTE:** Move cable guideout of position to access the screws.

Figure 5-530 Remove four screws



- b. Unplug two connectors and release the hook, and then remove the rear tamper.

Figure 5-531 Remove the rear tamper

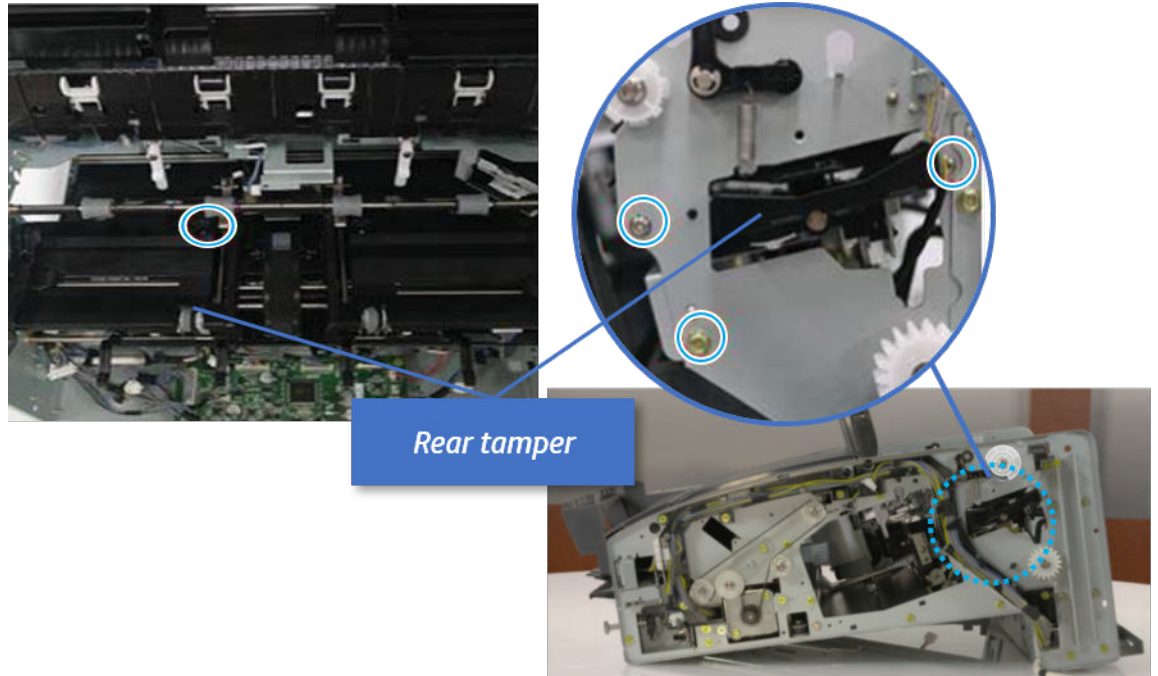
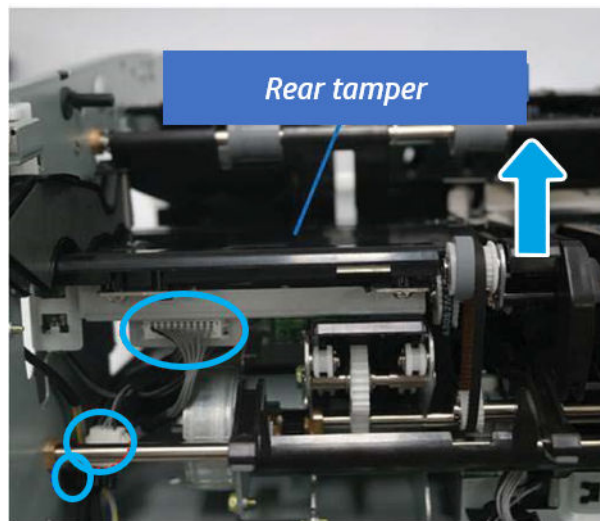

- 15. Remove the ejector & paper support assembly.
 - a. Open one clamp, disconnect one connector.

Figure 5-532 Disconnect one connector

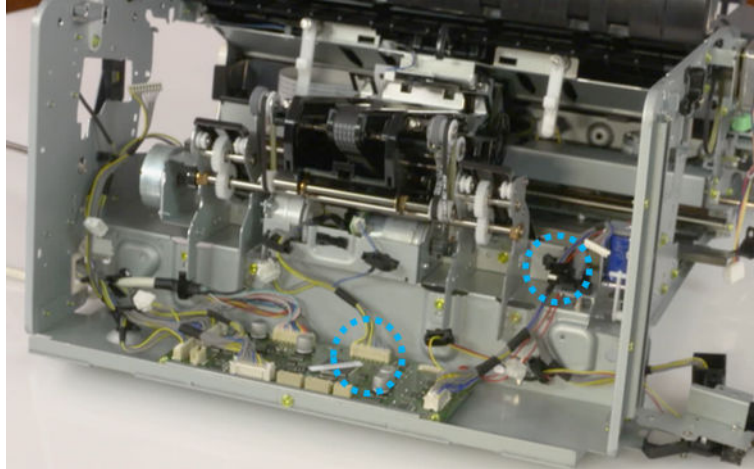

- b. Pull the rear paper support up, and then release one clamp and disconnect two connectors.

Figure 5-533 Disconnect two connector

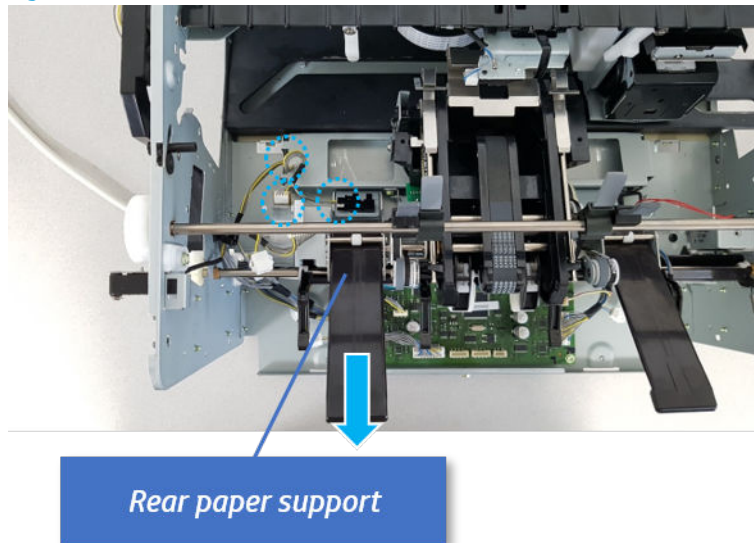

- c. Remove four screws, and then remove the ejector & paper support assembly.

Figure 5-534 Remove the ejector & paper support assembly

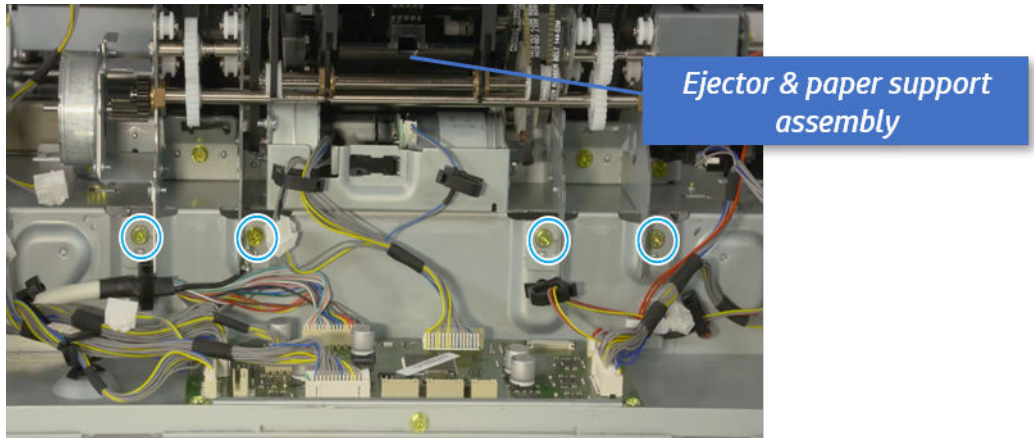

16. Unpack the replacement assembly.

- a. Dispose of the defective part.



NOTE: HP recommends responsible disposal of the defective part.

<http://www8.hp.com/us/en/hp-information/environment/product-recycling.html>

- b. Unpack the replacement part from the packaging.



CAUTION:  Some parts are sensitive to electrostatic discharge (ESD). Always perform service work at an ESD-protected workstation or mat. If an ESD workstation or mat is not available, touch the sheet-metal chassis to provide a static ground before touching an ESD-sensitive assembly. Protect the ESD-sensitive assemblies by placing them in ESD pouches when they are out of the printer.

If the replacement part is a roller or pad, avoid touching the spongy part of it. Skin oils on the roller or pad can cause paper pickup and/or print-quality problems. HP recommends using disposable gloves when handling rollers or pads or washing your hands before touching rollers or pads.



IMPORTANT: Make sure that all of the shipping materials (for example shipping tape) are removed from the replacement part prior to installation.

- c. To install an assembly, reverse the removal steps.

When applicable, special installation instructions are provided for an assembly at the end of the removal procedure. Always completely read the removal instructions and follow all special installation instructions.

Removal and replacement: Ejector motor assembly (S11/ M6/ M7)

Learn how to remove and replace the ejector motor assembly.

To view teardown&reassembling video of the inner finisher, click the link below.



[View a teardown video of the inner finisher .](#)



[View a reassembling video of the inner finisher .](#)

 **IMPORTANT:** When applicable, special installation instructions are provided for an assembly at the end of the removal procedure. Always completely read the removal instructions and follow all special installation instructions.

Mean time to repair:

Service level:

Before performing service

Turn the printer power off

- Press the power button on the front of the printer, and then turn off the power switch next to the power cable.
- A shutting-down message appears on the control-panel display.

 **WARNING!** To avoid damage to the printer, turn the power off and wait until the printer shuts down before removing the power cable.

- Disconnect the printer power cable after the printer has completely shut down (the control-panel display is blank).

Use the table below to identify the correct part number for your printer. To order the part, go to <https://parts.hp.com>.

Table 5-60 Part information

Part number	Part description
JC90-01309A (not orderable)	Ejector motor assembly

Required tools

- #2 JIS screwdriver with a magnetic tip

After performing service

Turn the printer power on

- Connect the power cable.
- Use the power switch to turn the power on.

Post service test

Print any pages necessary to verify that the repair resolved the issue and did not create any new issues.

1. Remove the front cover.
 - a. Open the front door and open the punch cover.
 - b. Remove three screws in the front.
 - c. Remove the lever.
 - d. Open the top cover.

- e. From the right side of the front cover, carefully lift and pry toward the top-left corner to remove the front cover.

Figure 5-535 Remove the front cover

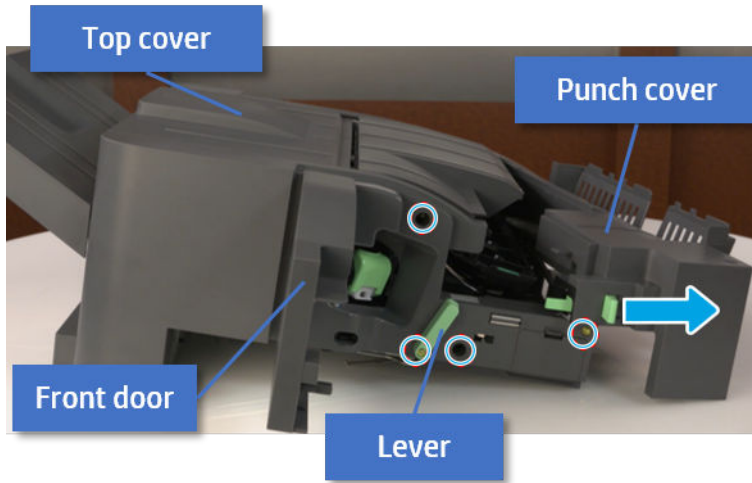

- 2. Remove the rear cover.
 - a. Open the top cover.

Figure 5-536 Open the top cover

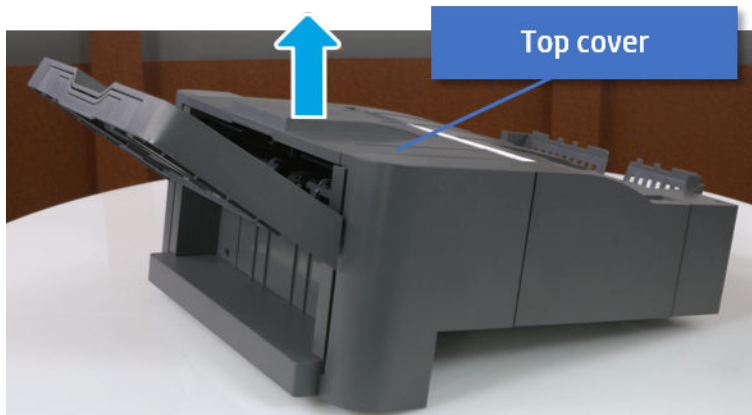

- b. Remove three screws.

- c. Release hooks carefully and remove the rear cover.

Figure 5-537 Remove the rear cover

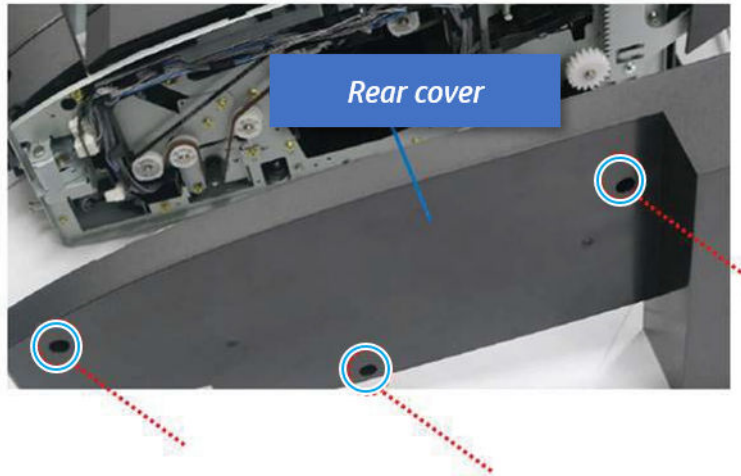

3. Remove the output tray.

- a. Remove four screws.

Figure 5-538 Remove four screws

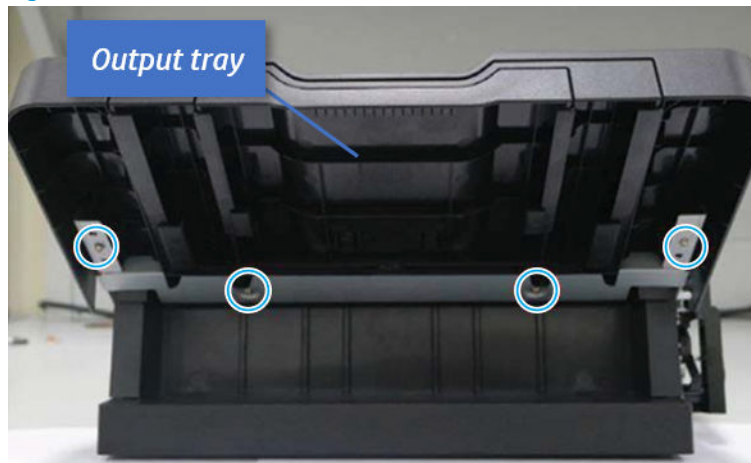

- b. Push the paper holding actuator into the inner finisher, and then remove the output tray.

Figure 5-539 Remove the output tray.



- 4. Remove the output tray frame.
 - a. Rotate the pulley until the output tray frame depart from the gear.

Figure 5-540 Remove the pulley

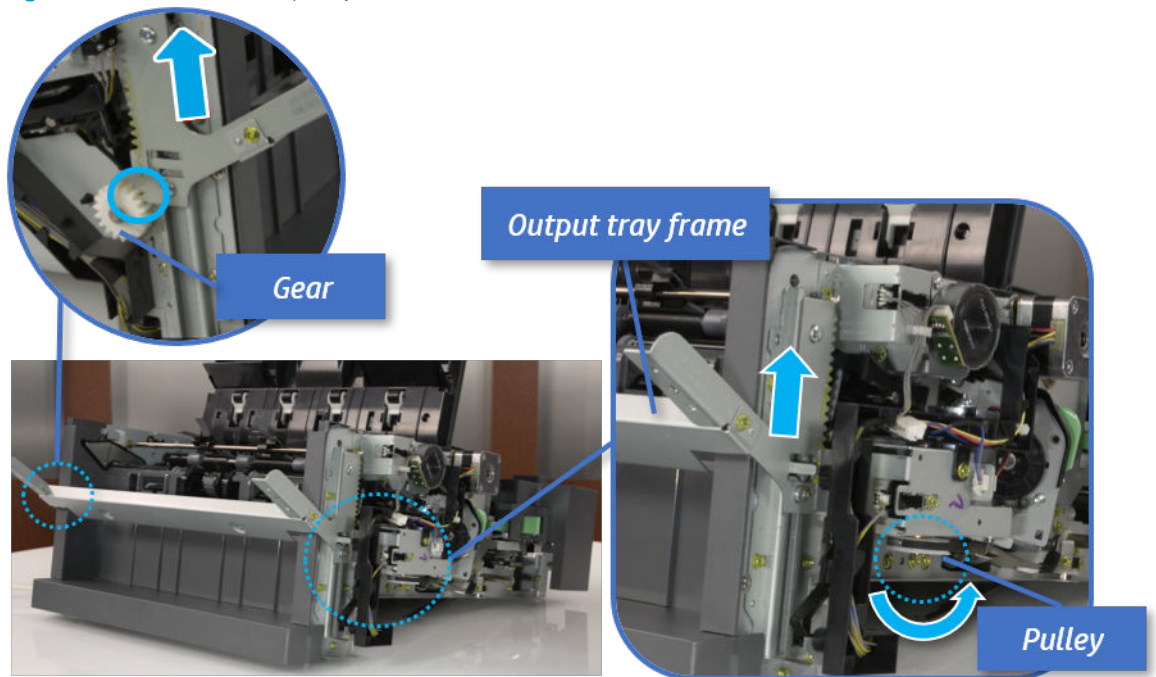

- b. Push the paper holding actuator into the inner finisher, and then remove the output tray frame.

Figure 5-541 Remove the output tray frame

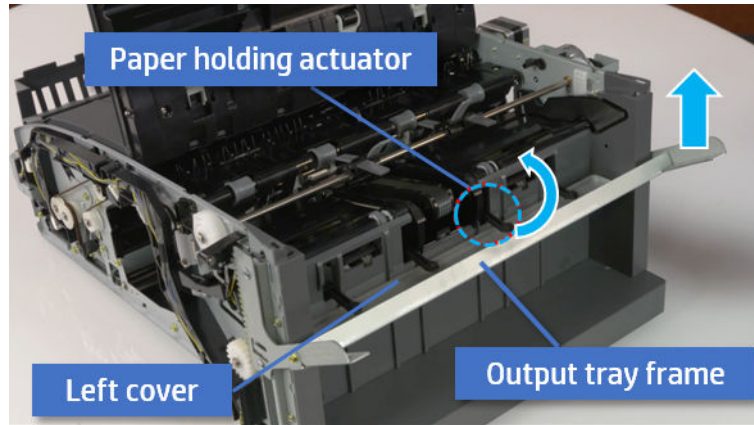

TIP: Push the paper holding actuator into the inner finisher when reassembling. Be sure to level the output tray.

1. Position the first wheel into the channel on both sides while pushing the paper holding actuator.

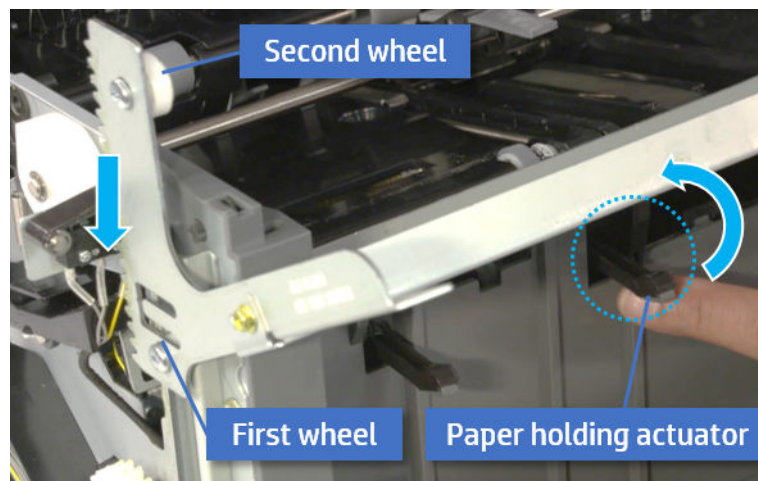

2. Let the second wheel rest on the channel on both sides simultaneously.
3. Gently squeeze the wheels into channel until the output tray frame meet the gear.

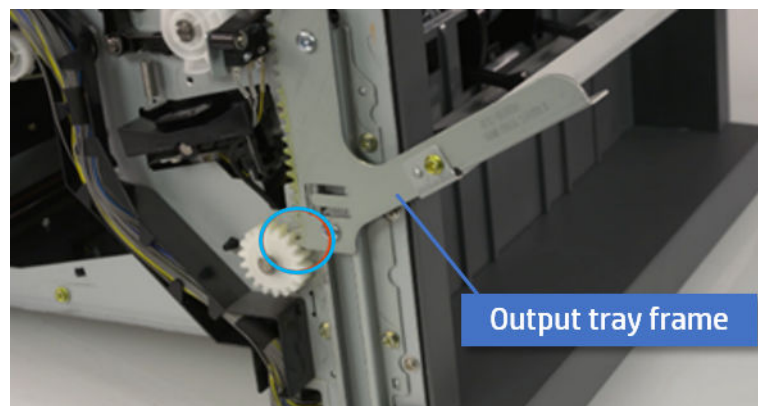

4. Rotate the pulley until the output tray frame is no longer lifted. It can make to level the output tray frame.

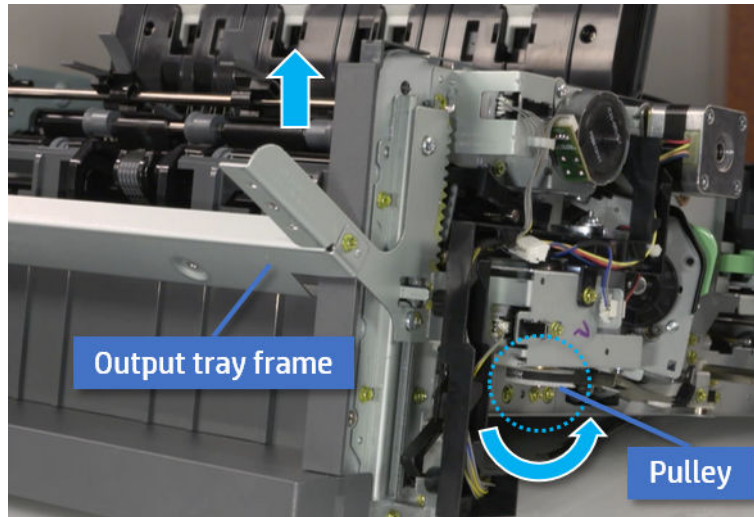

5. Rotate the pulley in the opposite direction.

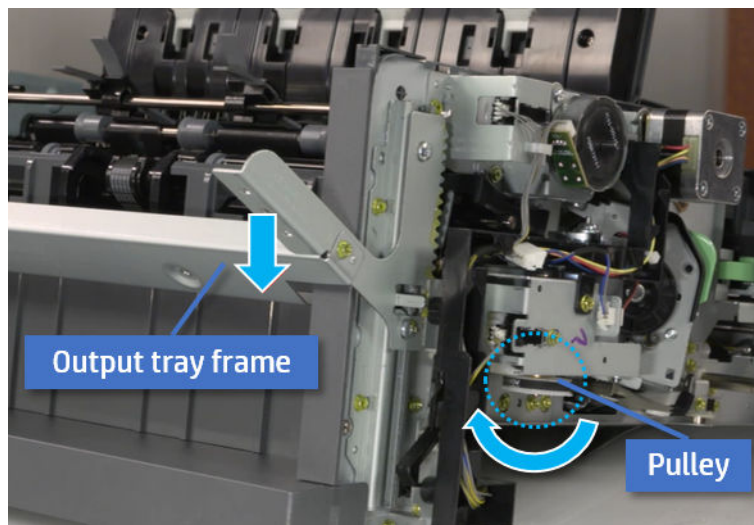

5. Remove the PCA cover.
 - ▲ Remove two screws, and then remove the PCA cover.

Figure 5-542 Remove the PCA cover

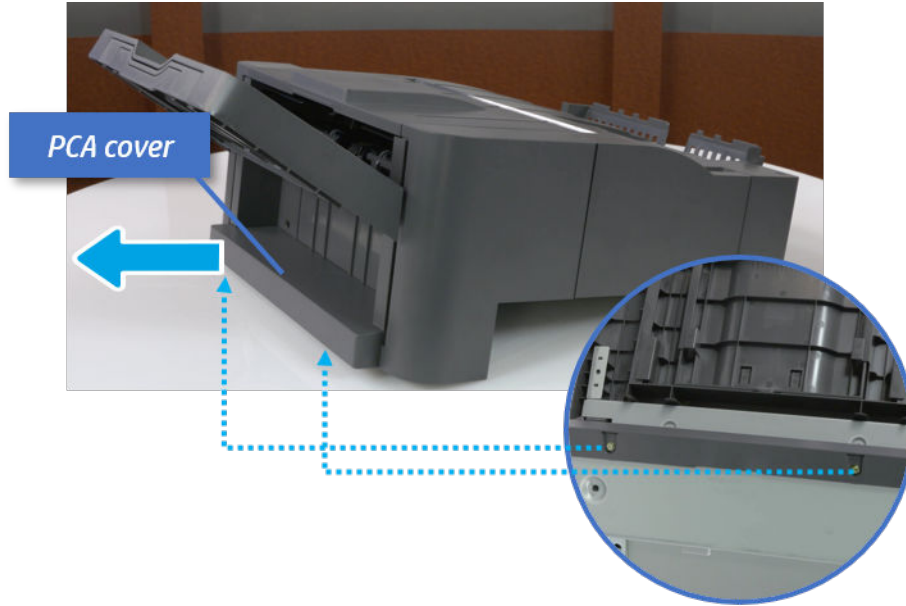

- 6. Remove the left cover.
 - a. Remove two screws.

Figure 5-543 Remove two screws

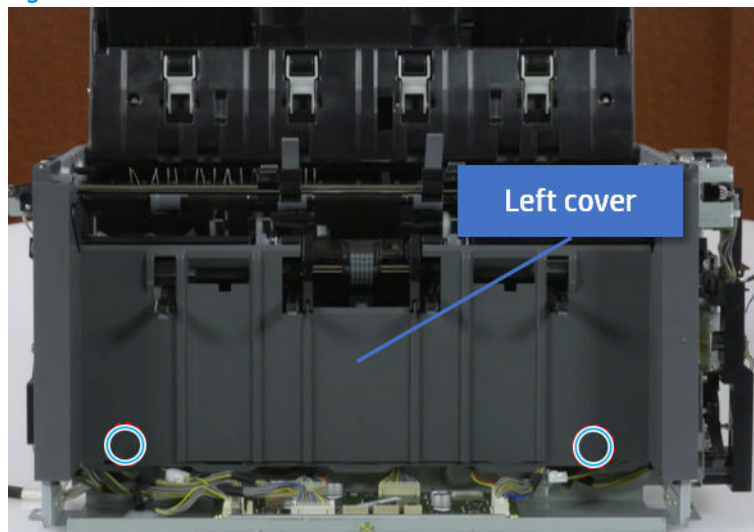

- b. Remove four screws from both front and rear sides.

Figure 5-544 Remove four screws

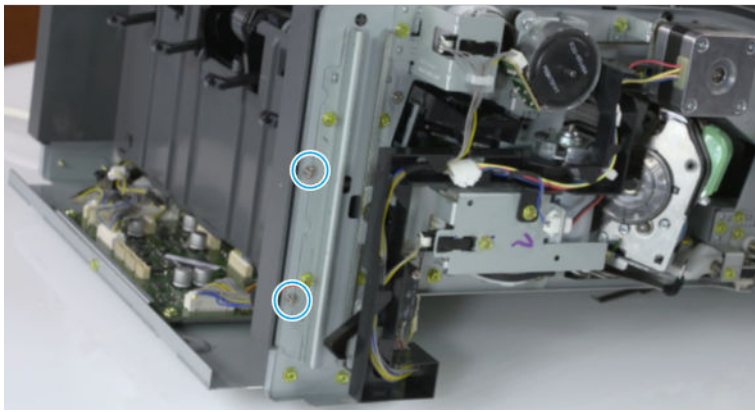
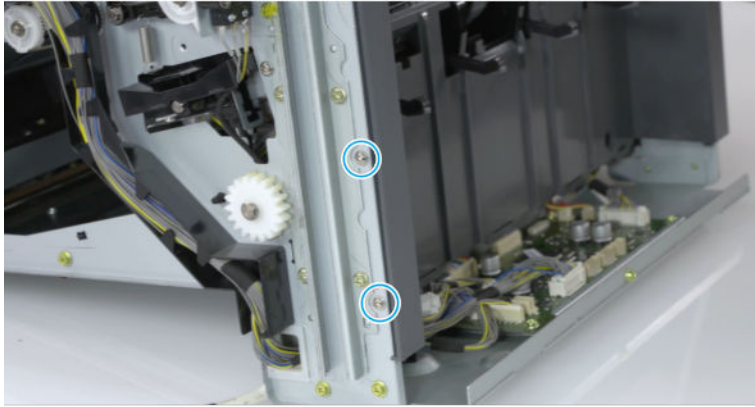

- c. Unplug two inline connectors, and then remove the left cover.

Figure 5-545 Unplug two connectors

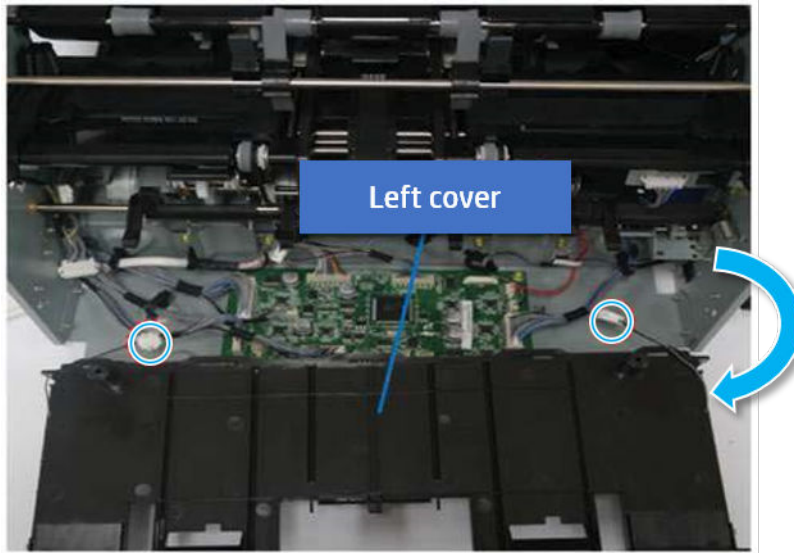

 **TIP:** Be sure to check the hook when reassembling.

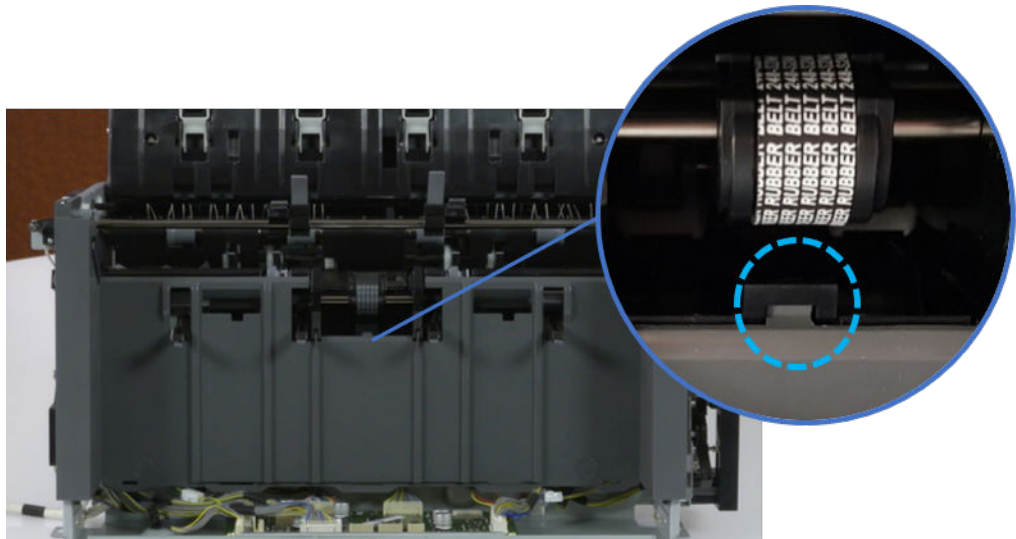

- 7. Remove the front harness guide.
 - a. Open one clamp and unplug five connectors, and then remove the wire harness from the front harness guide.

- b. Remove four screws, and then remove the front harness guide.

Figure 5-546 Remove the front harness guide

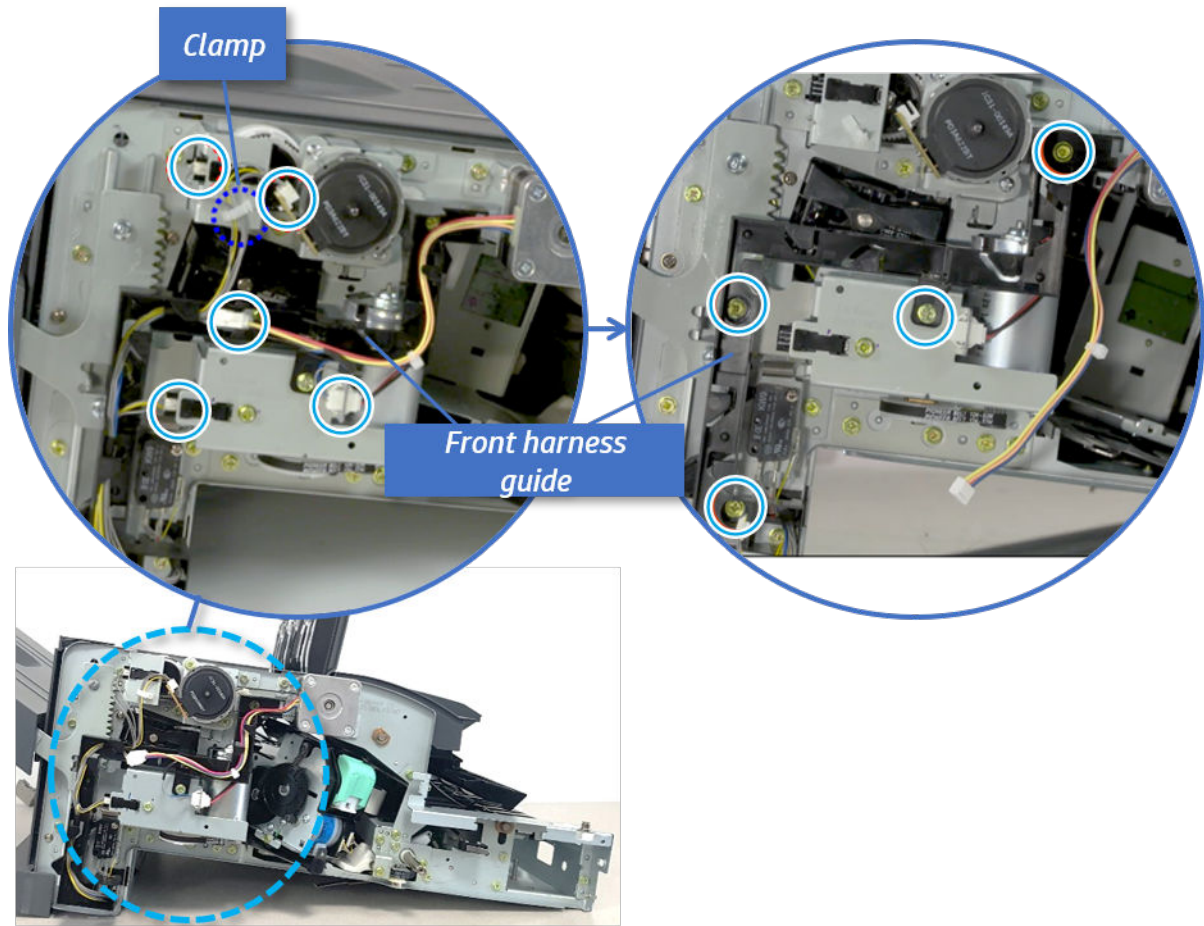

8. Remove the output tray motor assembly.

- ▲ Remove three screws, and then remove the output tray motor assembly.

Figure 5-547 Remove the output tray motor assembly

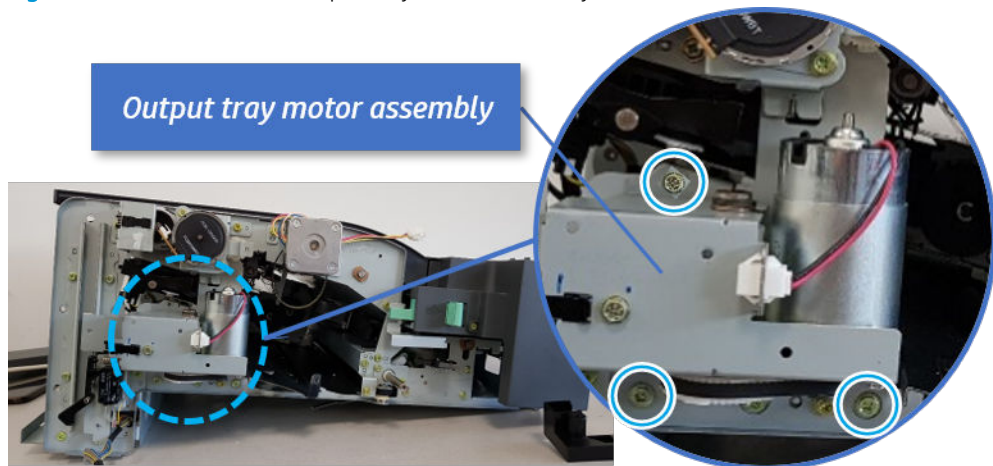

9. Remove the output tray lower limit switch.

- ▲ Remove one screw, and then remove the output tray lower limit switch.

Figure 5-548 Remove the output tray lower limit switch

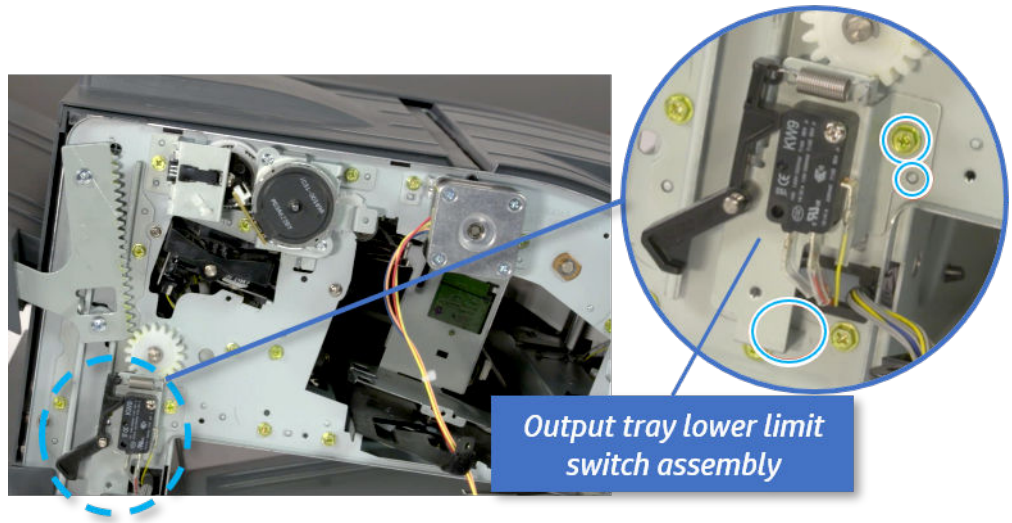

- 10. Remove the paper holding.
 - a. Remove the paper holding actuator spring.

Figure 5-549 Remove the paper holding actuator spring

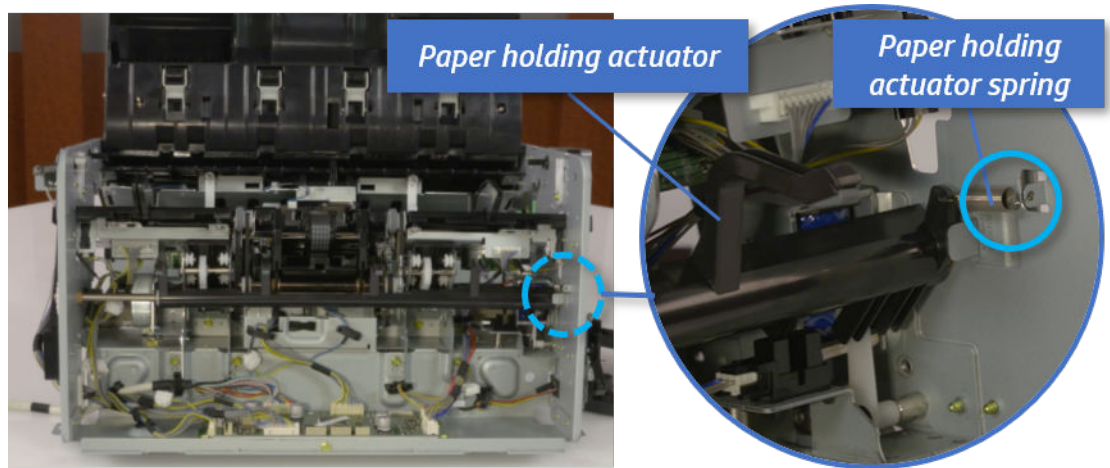

- b. Remove the e-ring and the rack pinion gear. And then remove the pin and the e-ring, and then remove the bushing.

Figure 5-550 Remove e-ring, rack pinion gear, pin, and bushing

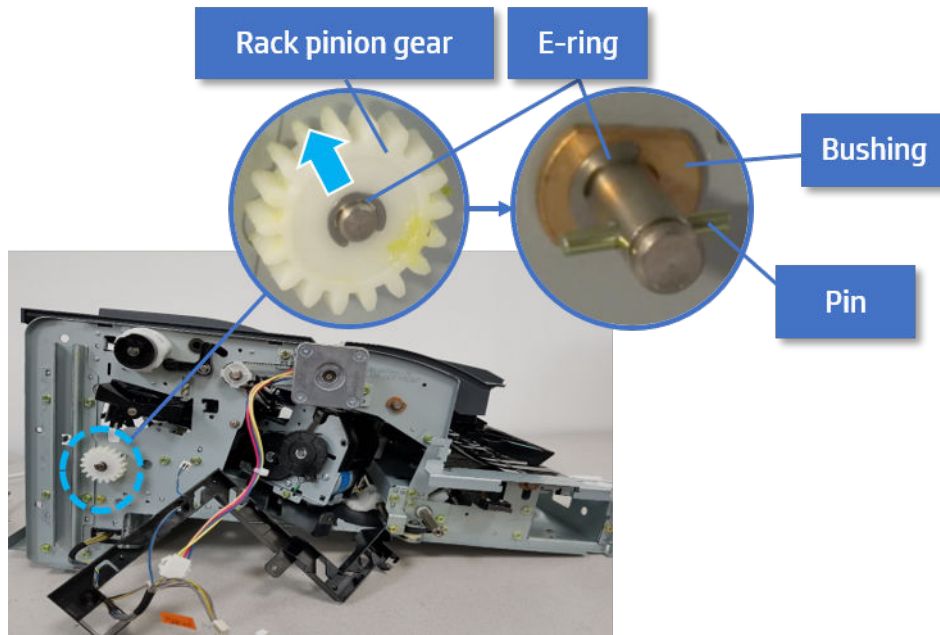

 **NOTE:** Be sure not to lose the pin.

- c. Carefully remove the paper holding shaft and the actuator.

Figure 5-551 Remove the paper holding shaft and the actuator

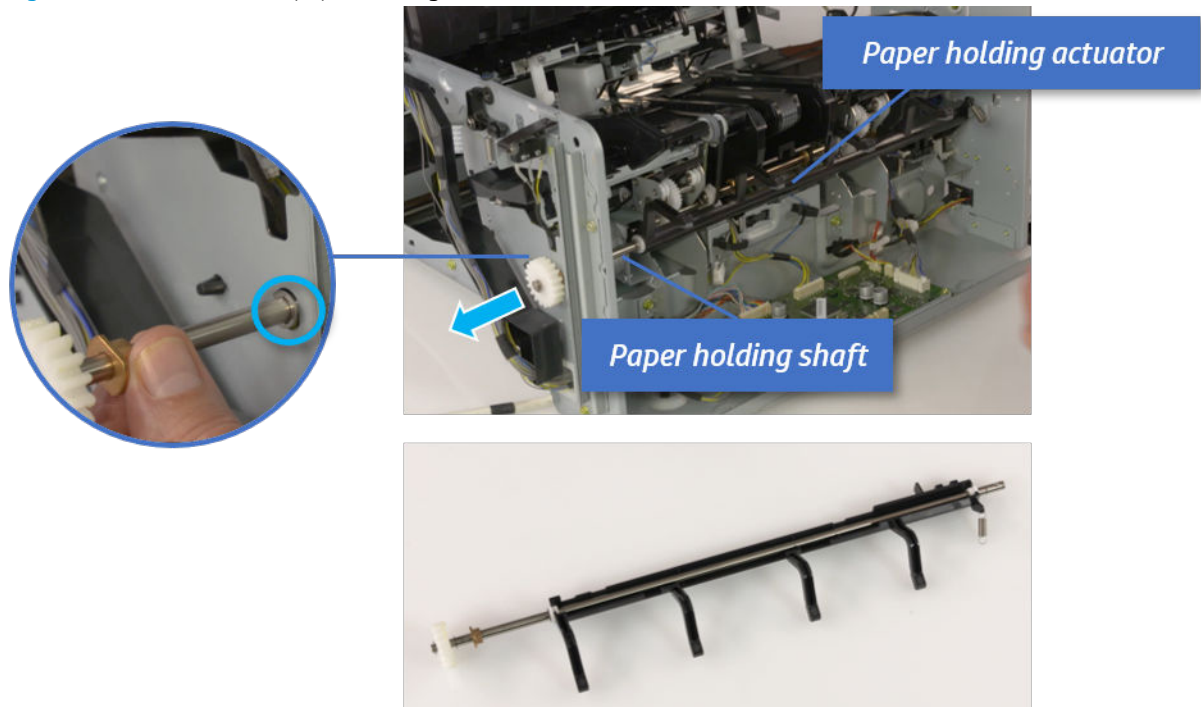

11. Remove the sub paddle unit.

- a. Open the top cover, and then remove one screw securing the sub paddle unit.

Figure 5-552 Remove one screw

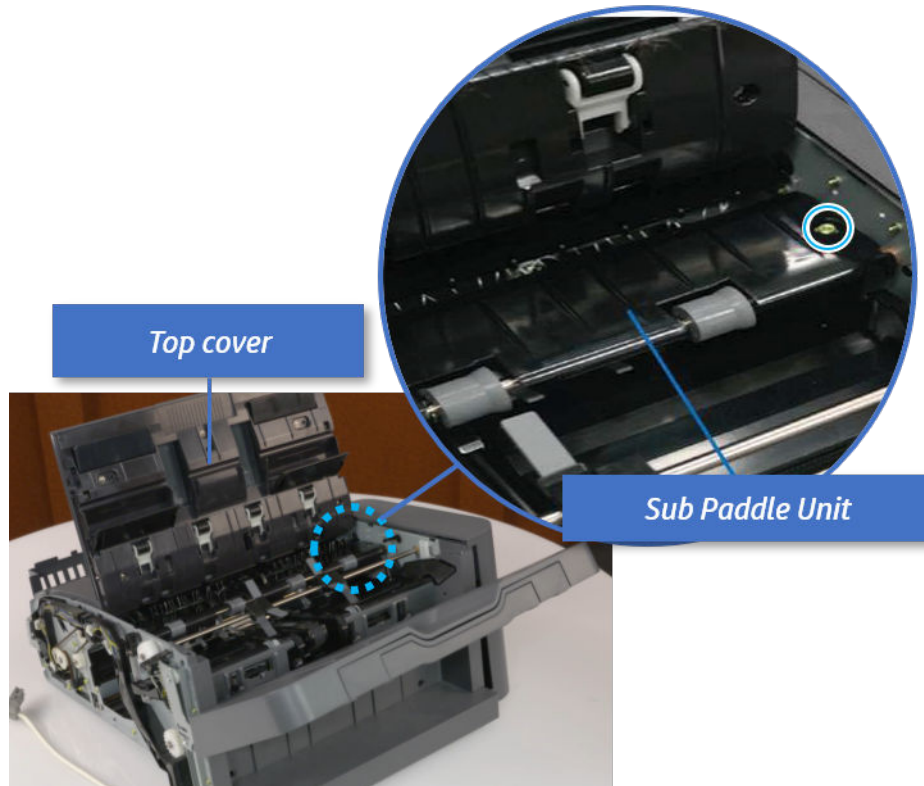

- b. Remove the e-ring, and then remove the pulley and timing belt. And then remove the e-ring and the bushing.

Figure 5-553 Remove the e-ring, pulley, timing belt, and bushing

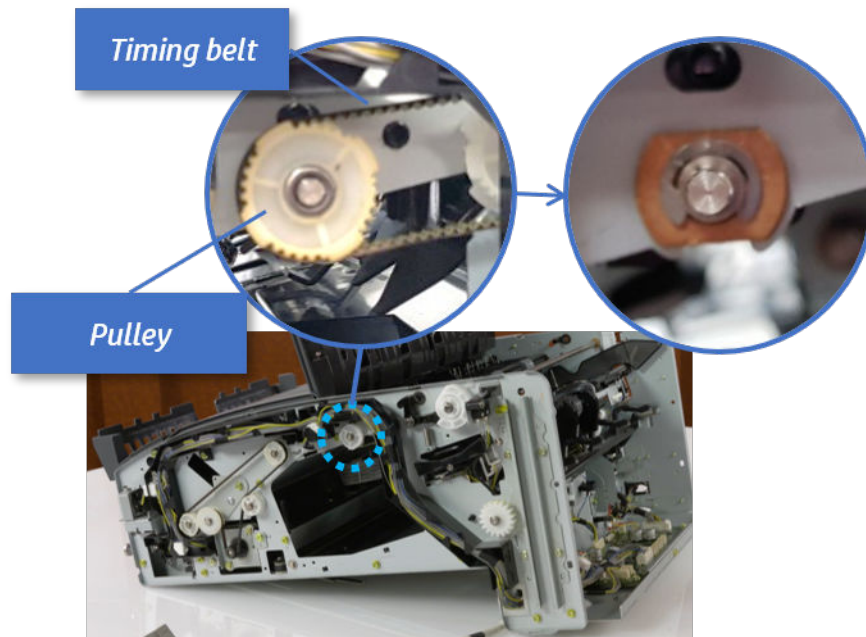

- c. Lift up and remove the sub paddle unit.

Figure 5-554 Remove the sub paddle unit

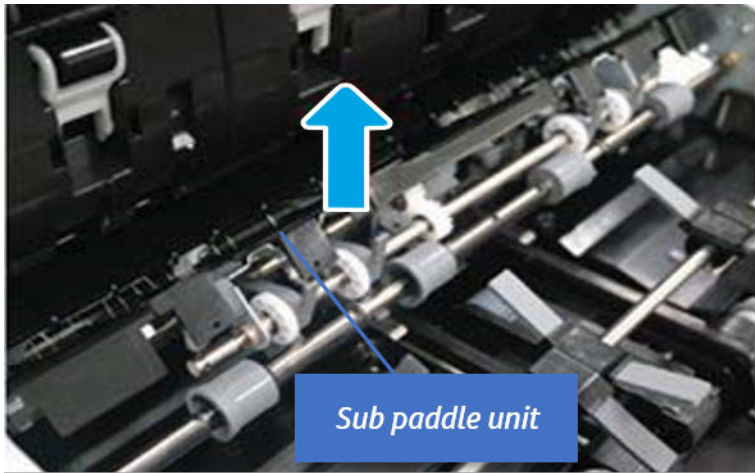

- 12. Remove the exit roller.

- a. Remove the guide on the center of the exit roller.

Figure 5-555 Remove the guide

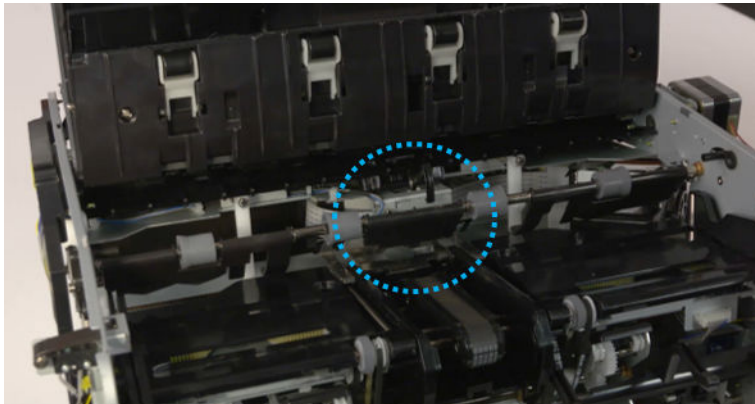

- b. On the front of the inner finisher, release the timing belt connected to the exit motor.

Figure 5-556 Release the timing belt

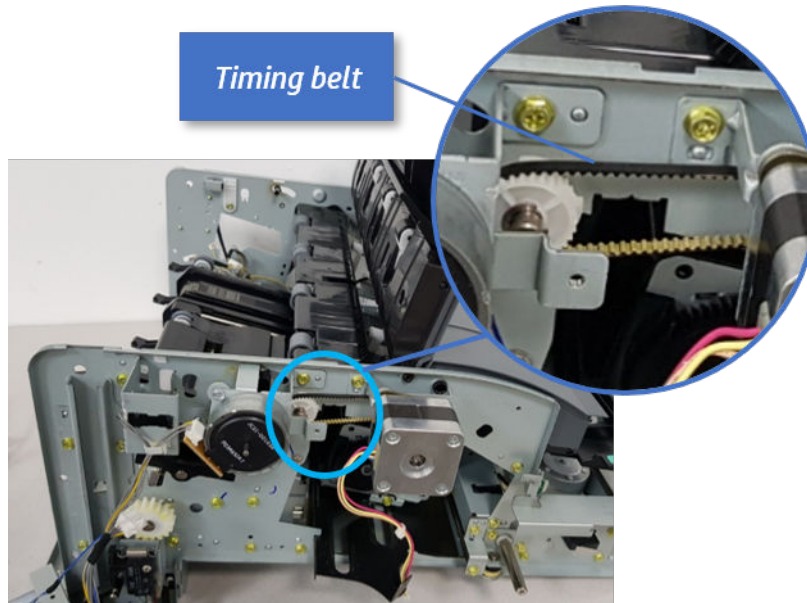

- c. Remove five screws securing the rear harness guide.

Figure 5-557 Remove five screws

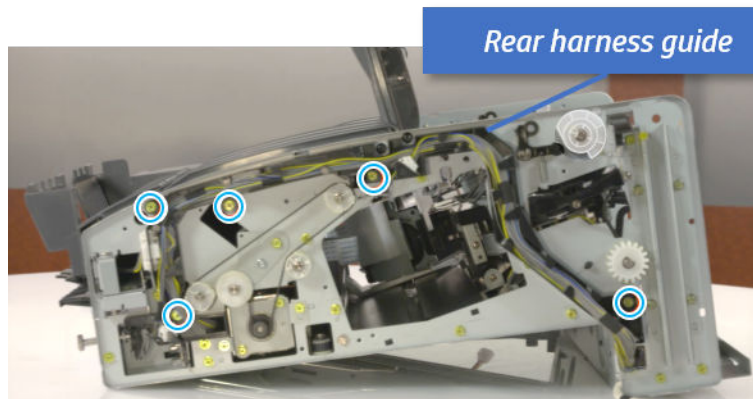

- d. On the rear of the inner finisher, remove the e-ring and the pulley and then remove the e-ring and the bushing.

Figure 5-558 Remove e-ring, pulley, and bushing

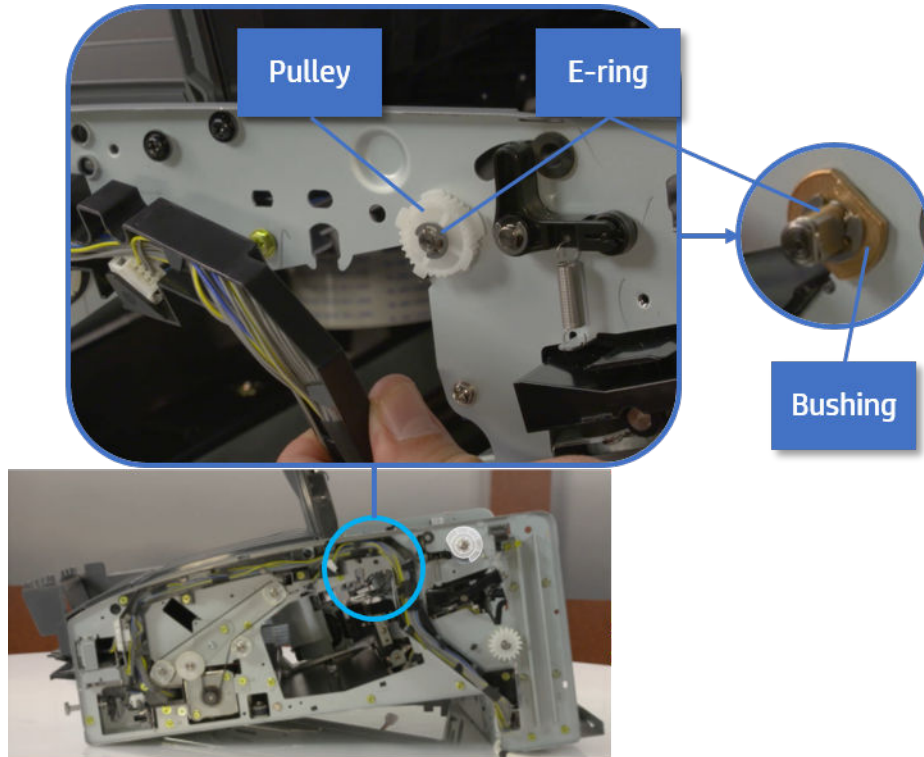

- e. Push the bushing to detach it, and then remove the exit roller.

Figure 5-559 Remove the exit roller

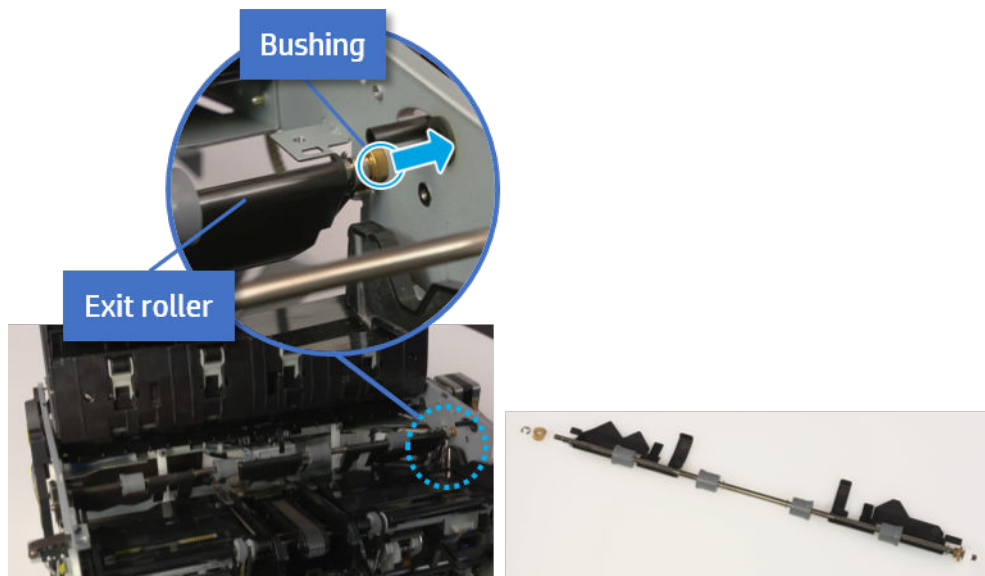

- 13. Remove the front tamper.
 - a. Remove four screws.

Figure 5-560 Remove four screws

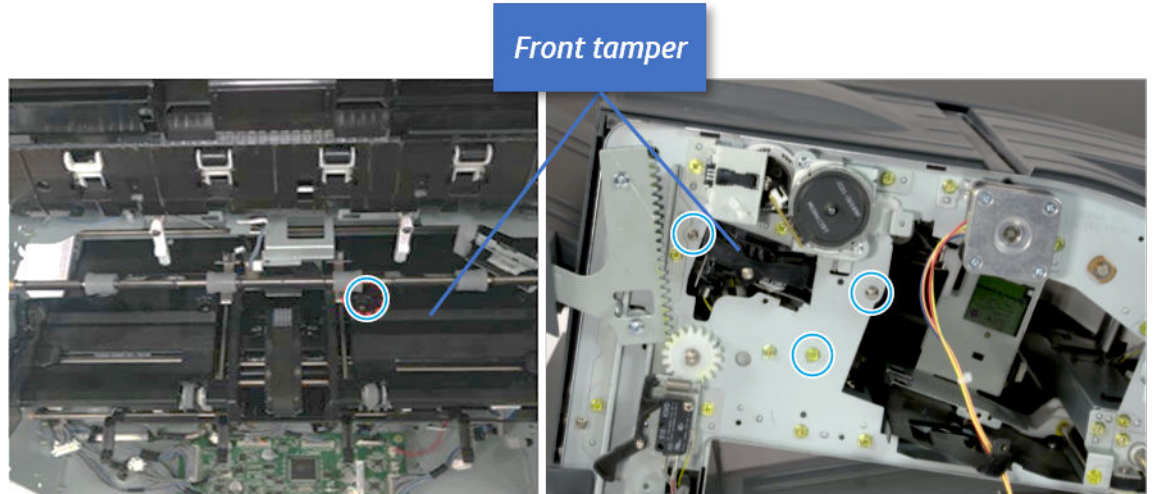

- b. Unplug the connector and release the hook, and then pull the front tamper up to remove.

Figure 5-561 Remove the front tamper

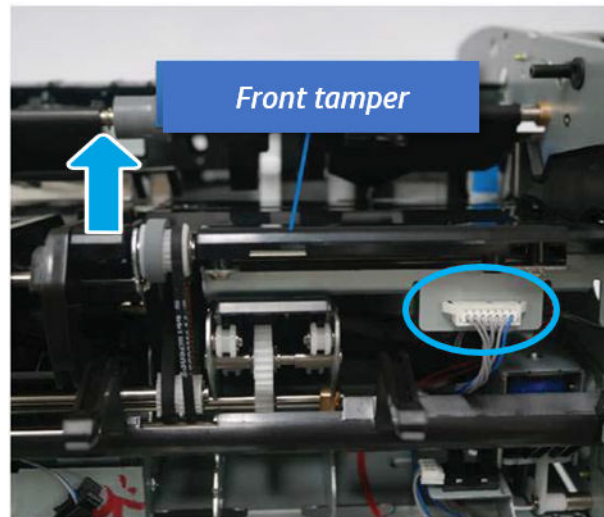

14. Remove the rear tamper.

- a. Remove four screws.

 **NOTE:** Move cable guideout of position to access the screws.

Figure 5-562 Remove four screws



- b. Unplug two connectors and release the hook, and then remove the rear tamper.

Figure 5-563 Remove the rear tamper

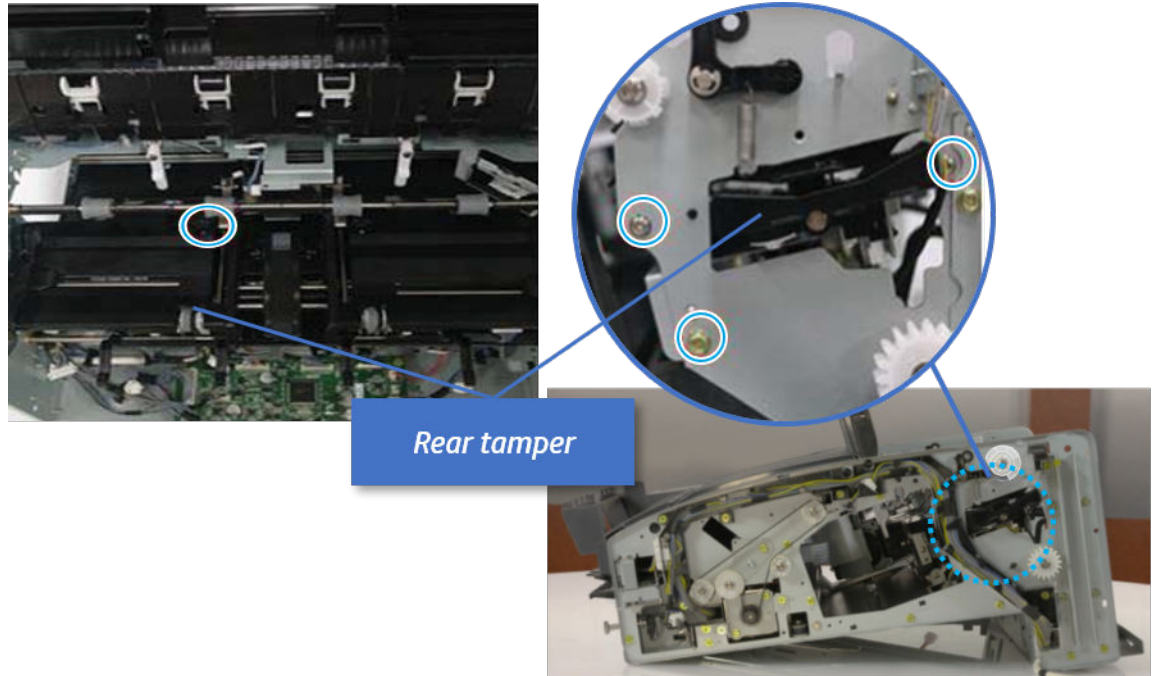
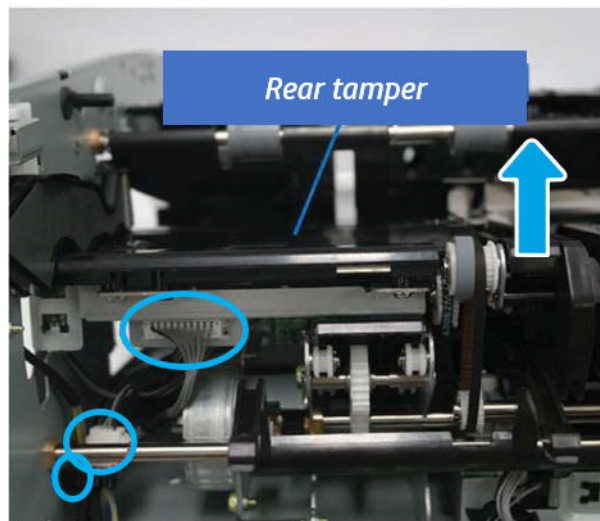

- 15. Remove the ejector & paper support assembly.
 - a. Open one clamp, disconnect one connector.

Figure 5-564 Disconnect one connector

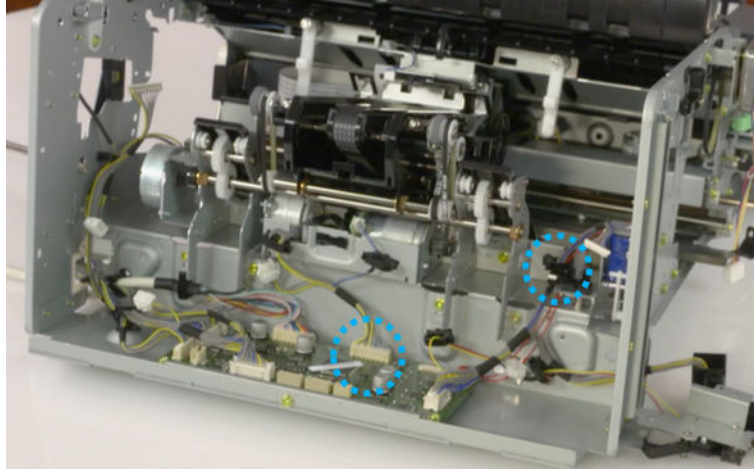

- b. Pull the rear paper support up, and then release one clamp and disconnect two connectors.

Figure 5-565 Disconnect two connector

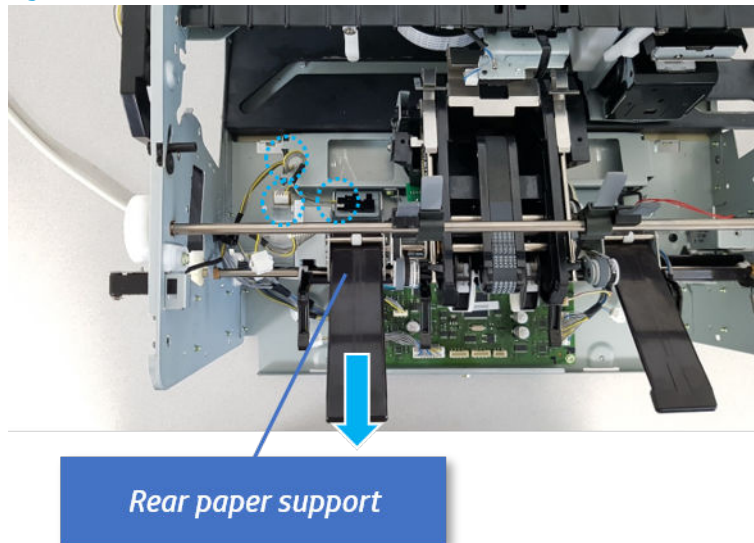

- c. Remove four screws, and then remove the ejector & paper support assembly.

Figure 5-566 Remove the ejector & paper support assembly

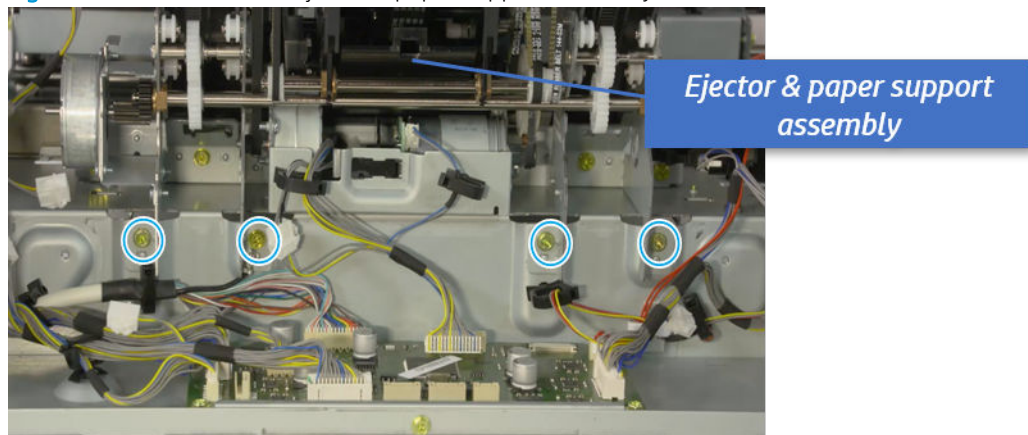

16. Remove the front paper support and the rear paper support.
 - ▲ Remove two screws, and then pull the paper support assembly out of ejector assembly.

Figure 5-567 Remove paper support assembly

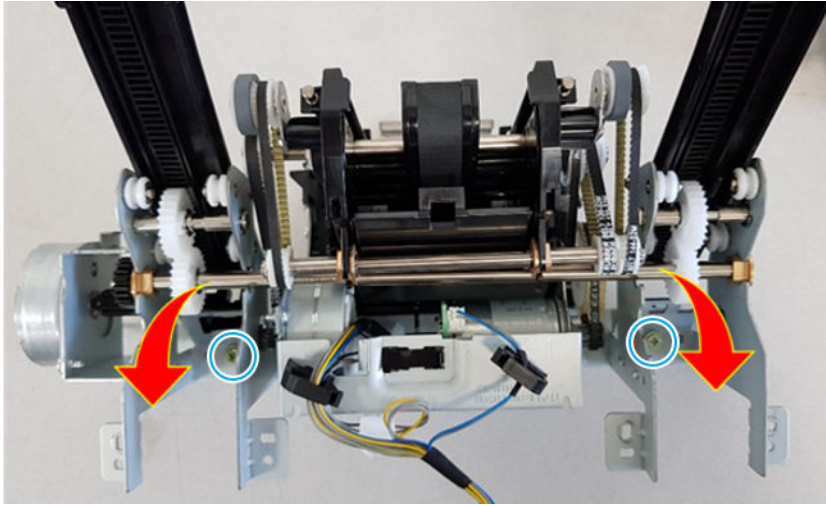

17. Remove the ejector motor assembly.
 - a. Remove the e-ring and washer. Remove two timing belts, and then remove one screw.

Figure 5-568 Remove e-ring, washer, belt, and screw

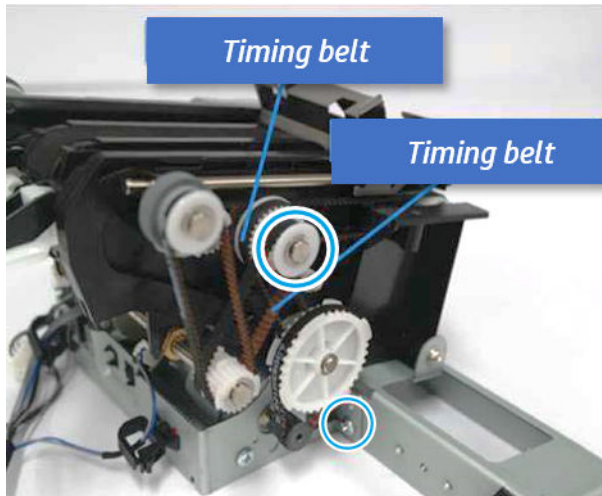

- b. Remove the timing belt, and then remove one screw.

Figure 5-569 Remove the belt, screw

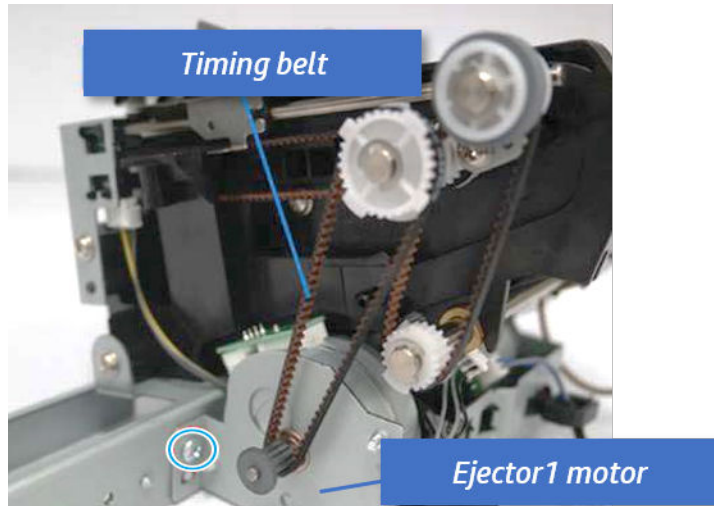

- c. Remove the cable from clamp, and then disconnect two motor connectors and the sensor connector.

Figure 5-570 Disconnect the motor and sensor connectors

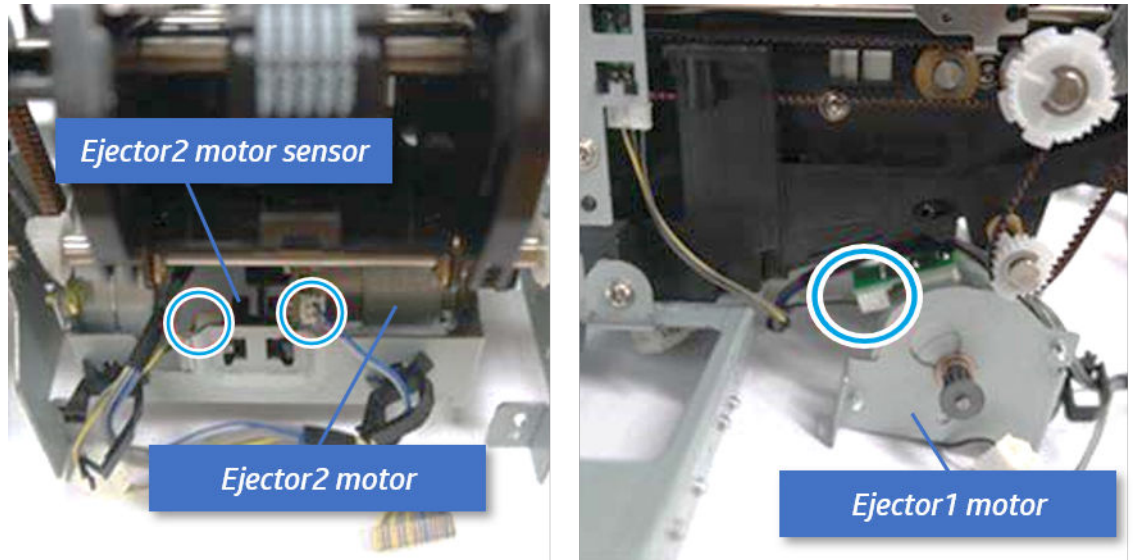

- d. Remove the ejector motor assembly.

Figure 5-571 Remove the ejector motor assembly

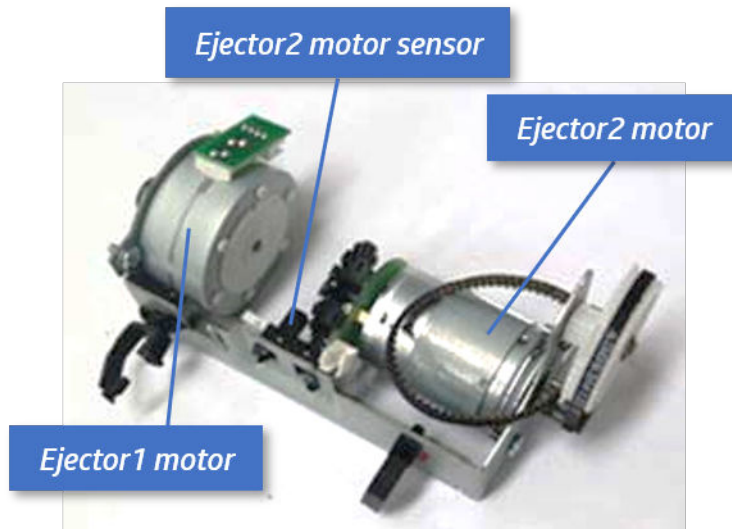

18. Unpack the replacement assembly.
 - a. Dispose of the defective part.



NOTE: HP recommends responsible disposal of the defective part.

<http://www8.hp.com/us/en/hp-information/environment/product-recycling.html>

- b. Unpack the replacement part from the packaging.



CAUTION:  Some parts are sensitive to electrostatic discharge (ESD). Always perform service

work at an ESD-protected workstation or mat. If an ESD workstation or mat is not available, touch the sheet-metal chassis to provide a static ground before touching an ESD-sensitive assembly. Protect the ESD-sensitive assemblies by placing them in ESD pouches when they are out of the printer.

If the replacement part is a roller or pad, avoid touching the spongy part of it. Skin oils on the roller or pad can cause paper pickup and/or print-quality problems. HP recommends using disposable gloves when handling rollers or pads or washing your hands before touching rollers or pads.



IMPORTANT: Make sure that all of the shipping materials (for example shipping tape) are removed from the replacement part prior to installation.

- c. To install an assembly, reverse the removal steps.

When applicable, special installation instructions are provided for an assembly at the end of the removal procedure. Always completely read the removal instructions and follow all special installation instructions.

Removal and replacement: Ejector assembly (include end fence, S10/ S16)

Learn how to remove and replace the ejector assembly.

View videos on how to remove and reassemble the inner finisher below:



[View a teardown video of the inner finisher .](#)

 [View a reassembling video of the inner finisher .](#)

 **IMPORTANT:** When applicable, special installation instructions are provided for an assembly at the end of the removal procedure. Always completely read the removal instructions and follow all special installation instructions.

Mean time to repair:

Service level:

Before performing service

Turn the printer power off

- Press the power button on the front of the printer, and then turn off the power switch next to the power cable.
- A shutting-down message appears on the control-panel display.

 **WARNING!** To avoid damage to the printer, turn the power off and wait until the printer shuts down before removing the power cable.

- Disconnect the printer power cable after the printer has completely shut down (the control-panel display is blank).

Use the table below to identify the correct part number for your printer. To order the part, go to <https://parts.hp.com>.

Table 5-61 Part information

Part number	Part description
SS456-61001	Ejector

Required tools

- #2 JIS screwdriver with a magnetic tip

After performing service

Turn the printer power on

- Connect the power cable.
- Use the power switch to turn the power on.

Post service test

Print any pages necessary to verify that the repair resolved the issue and did not create any new issues.

1. Remove the front cover.
 - a. Open the front door and open the punch cover.
 - b. Remove three screws in the front.
 - c. Remove the lever.

- d. Open the top cover.
- e. From the right side of the front cover, carefully lift and pry toward the top-left corner to remove the front cover.

Figure 5-572 Remove the front cover

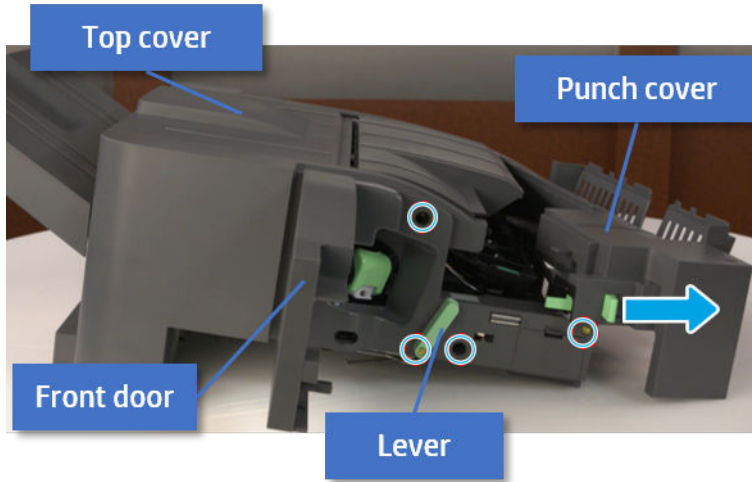

- 2. Remove the rear cover.
 - a. Open the top cover.

Figure 5-573 Open the top cover

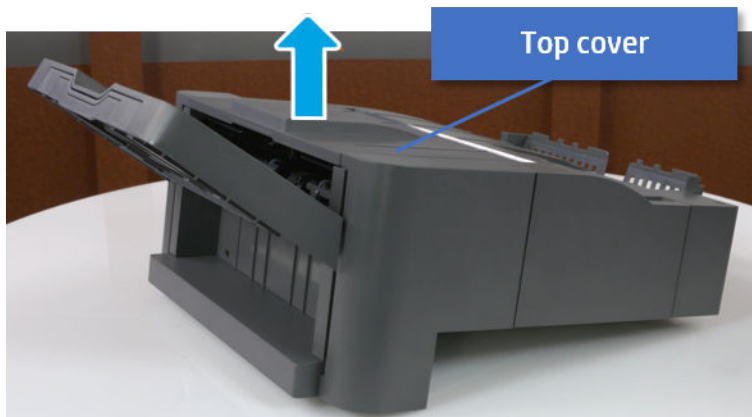

- b. Remove three screws.

- c. Release hooks carefully and remove the rear cover.

Figure 5-574 Remove the rear cover

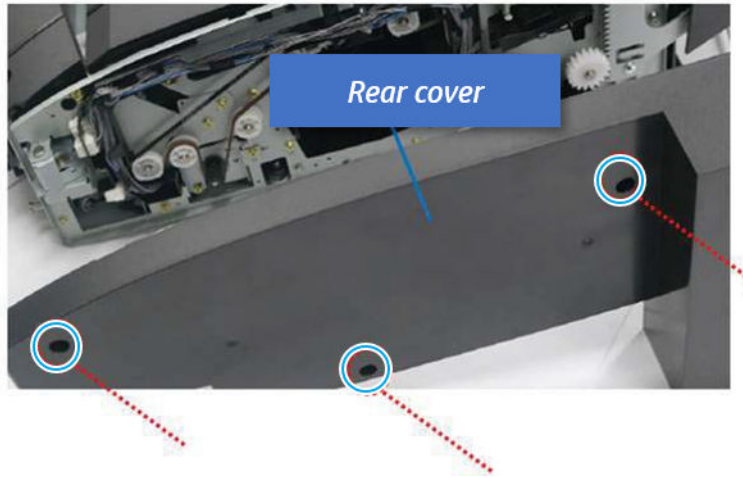

- 3. Remove the output tray.

- a. Remove four screws.

Figure 5-575 Remove four screws

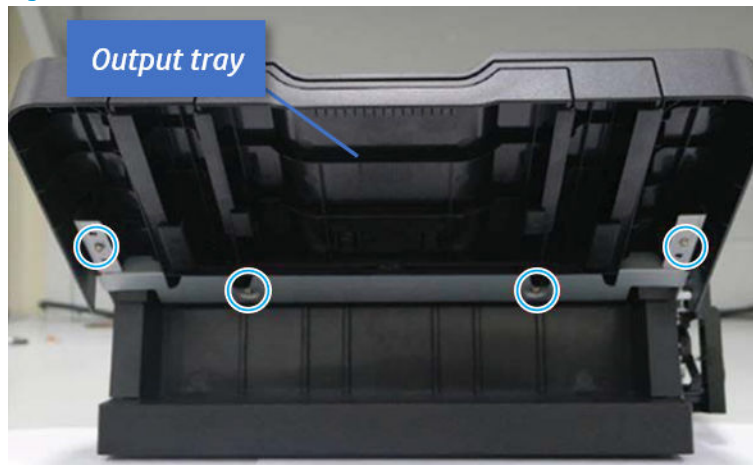

- b. Push the paper holding actuator into the inner finisher, and then remove the output tray.

Figure 5-576 Remove the output tray.



- 4. Remove the output tray frame.
 - a. Rotate the pulley until the output tray frame depart from the gear.

Figure 5-577 Remove the pulley

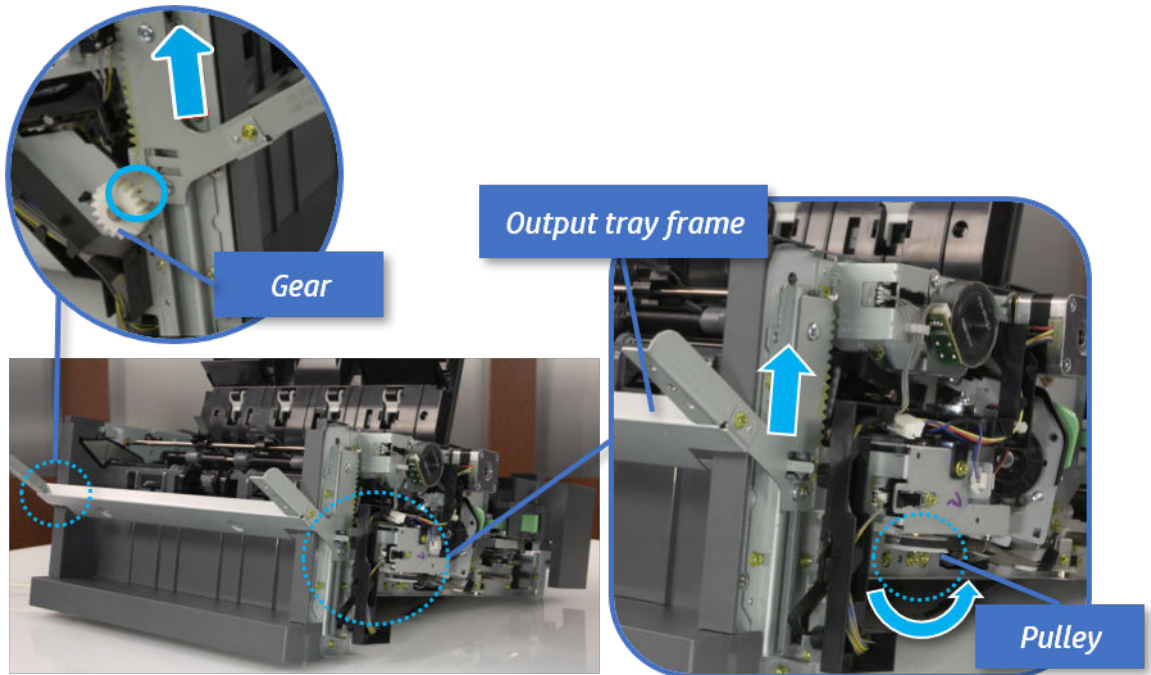

- b. Push the paper holding actuator into the inner finisher, and then remove the output tray frame.

Figure 5-578 Remove the output tray frame

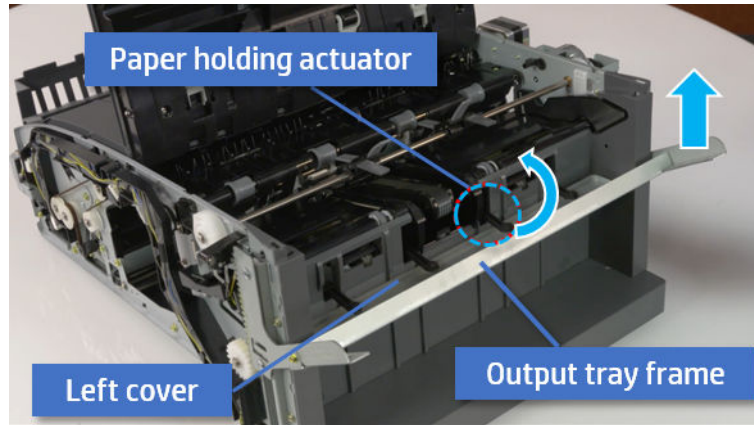

 **TIP:** Push the paper holding actuator into the inner finisher when reassembling. Be sure to level the output tray.

1. Position the first wheel into the channel on both sides while pushing the paper holding actuator.

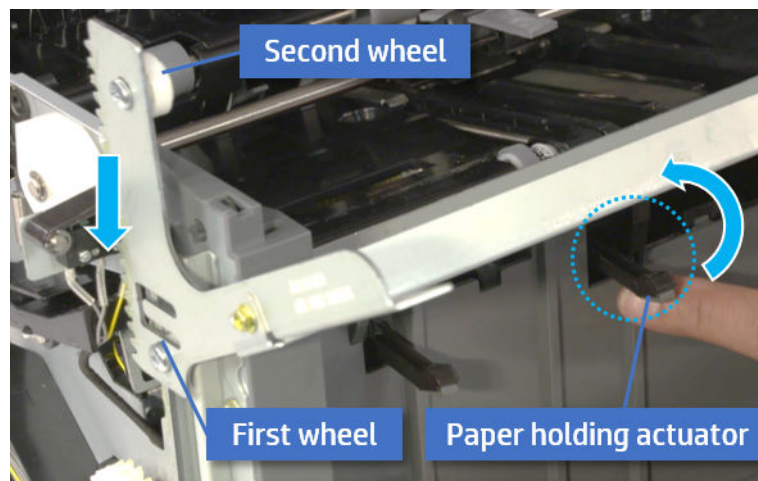

2. Let the second wheel rest on the channel on both sides simultaneously.
3. Gently squeeze the wheels into channel until the output tray frame meet the gear.

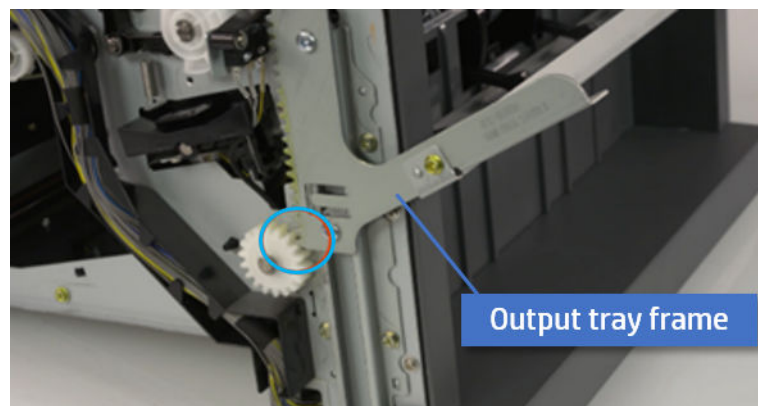

4. Rotate the pulley until the output tray frame is no longer lifted. It can make to level the output tray frame.

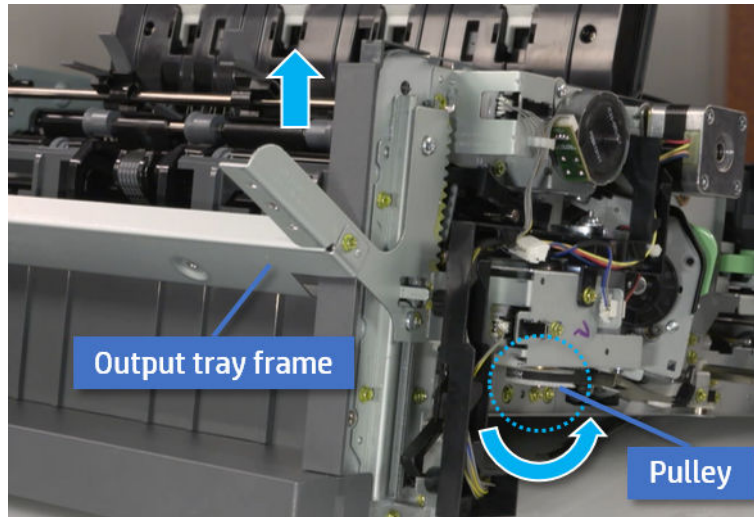

5. Rotate the pulley in the opposite direction.

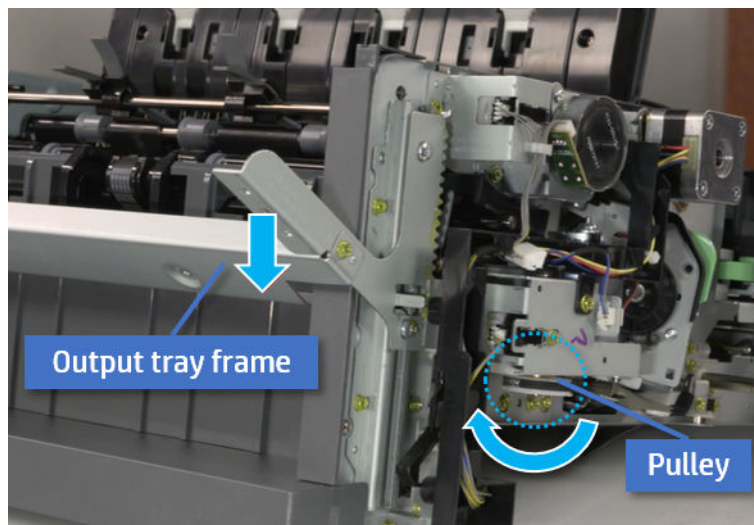

5. Remove the PCA cover.
 - ▲ Remove two screws, and then remove the PCA cover.

Figure 5-579 Remove the PCA cover

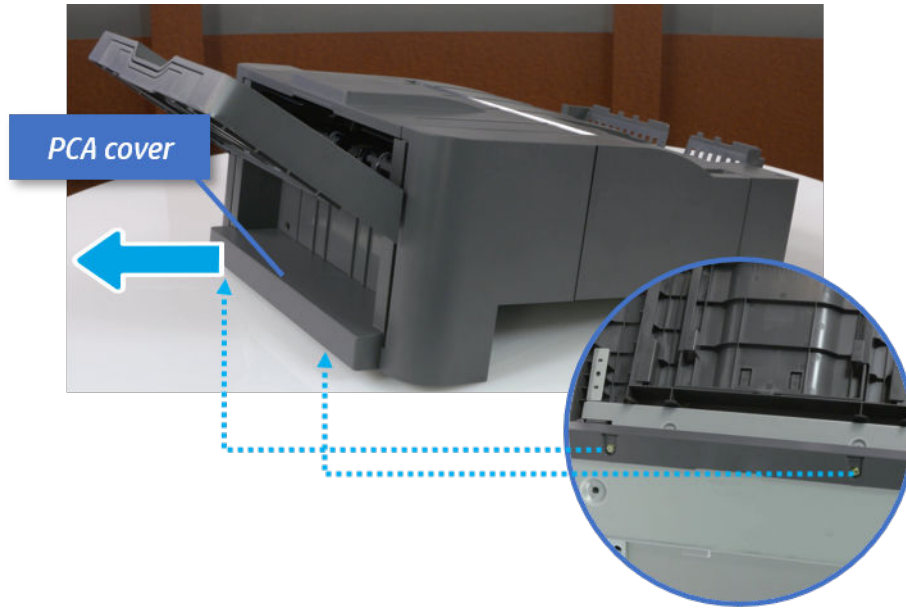

- 6. Remove the left cover.
 - a. Remove two screws.

Figure 5-580 Remove two screws

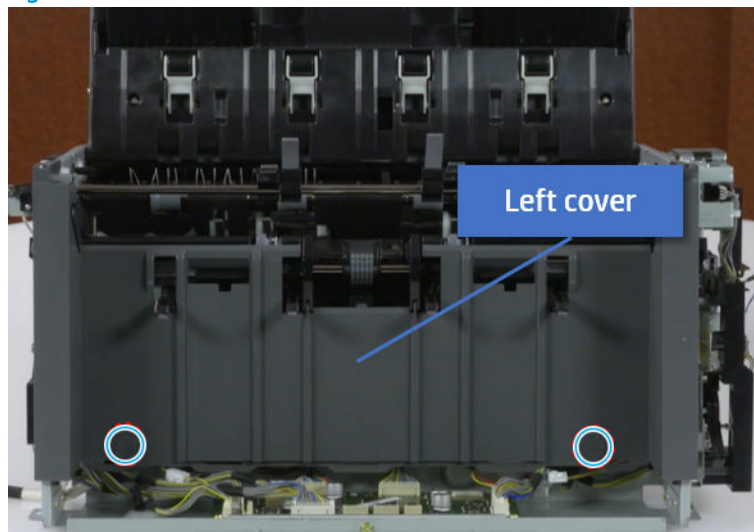

- b. Remove four screws from both front and rear sides.

Figure 5-581 Remove four screws

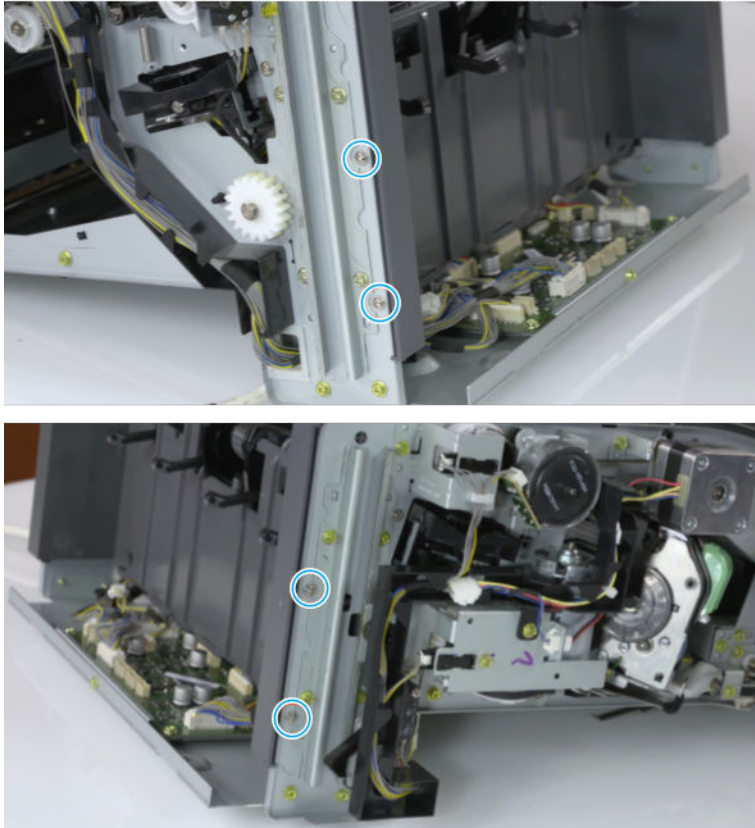

- c. Unplug two inline connectors, and then remove the left cover.

Figure 5-582 Unplug two connectors

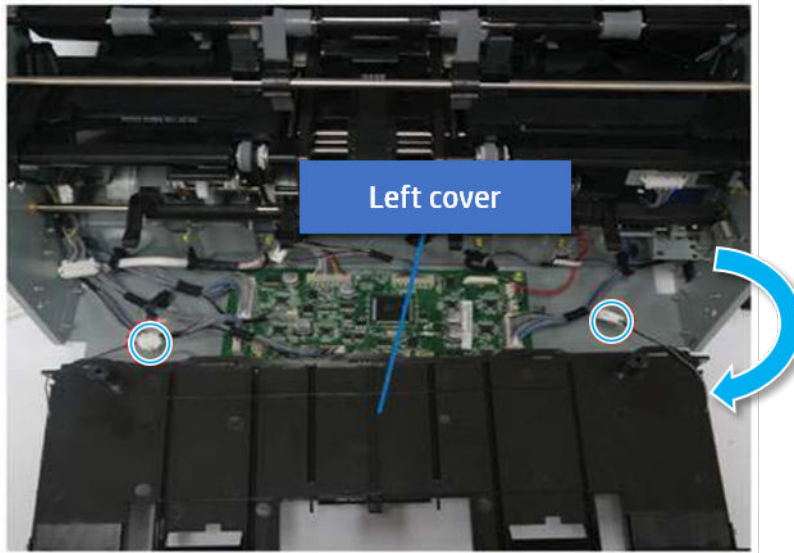

 **TIP:** Be sure to check the hook when reassembling.

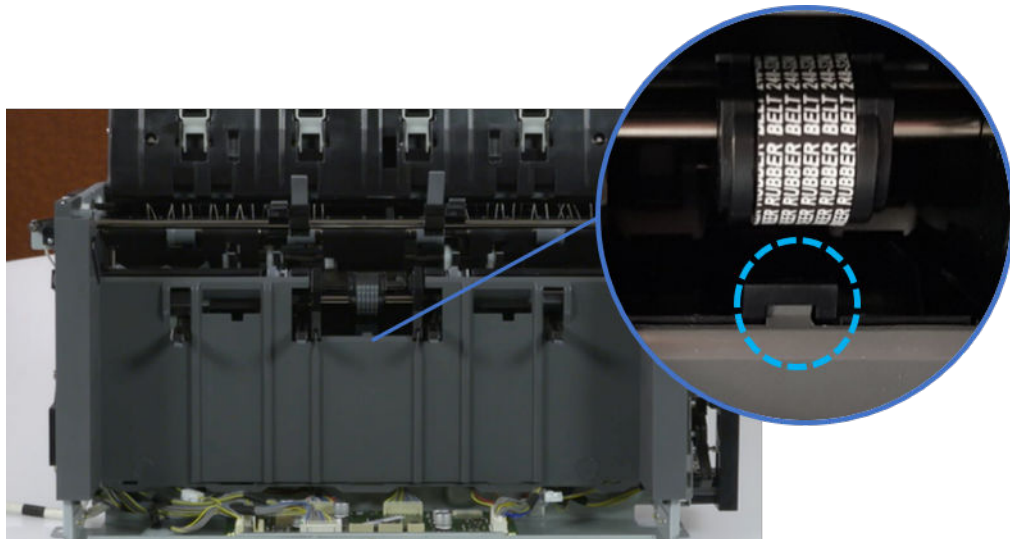

- 7. Remove the front harness guide.
 - a. Open one clamp and unplug five connectors, and then remove the wire harness from the front harness guide.

- b. Remove four screws, and then remove the front harness guide.

Figure 5-583 Remove the front harness guide

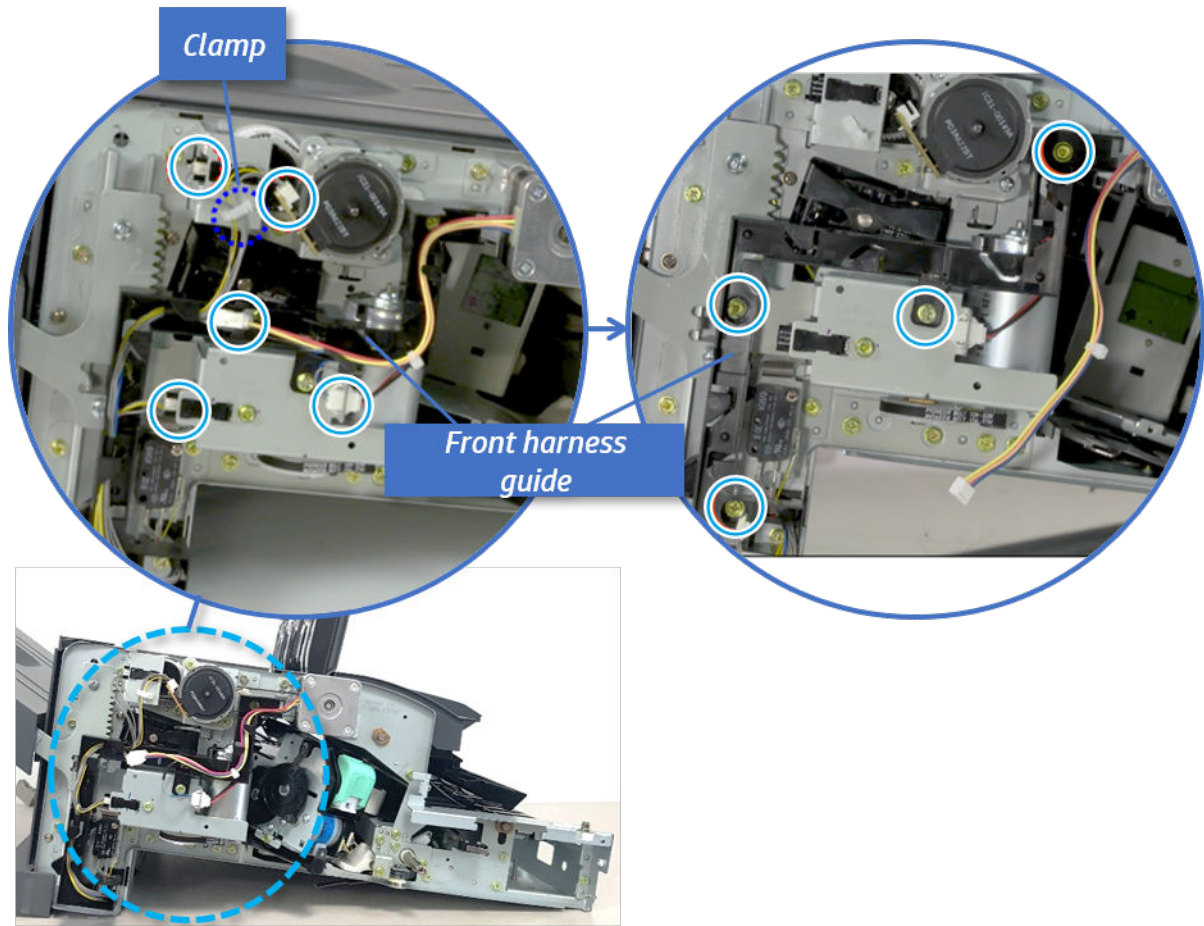

8. Remove the output tray motor assembly.

- ▲ Remove three screws, and then remove the output tray motor assembly.

Figure 5-584 Remove the output tray motor assembly

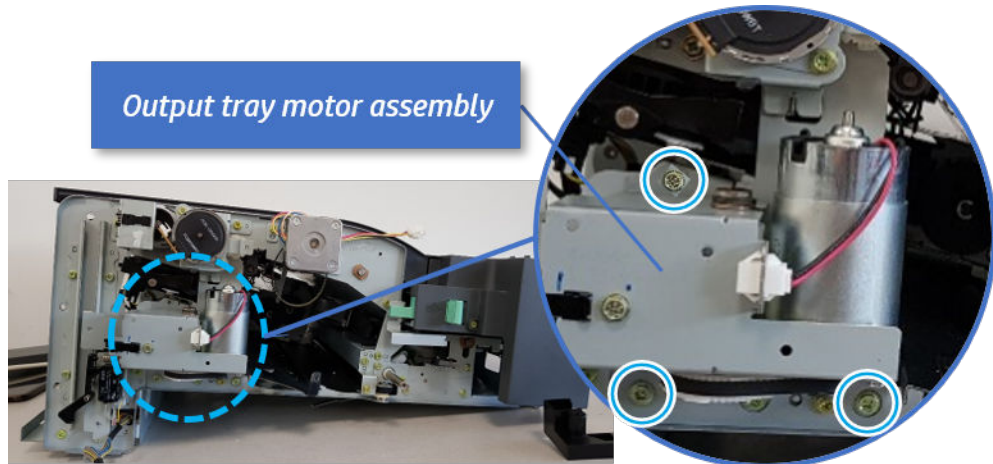

9. Remove the output tray lower limit switch.

- ▲ Remove one screw, and then remove the output tray lower limit switch.

Figure 5-585 Remove the output tray lower limit switch

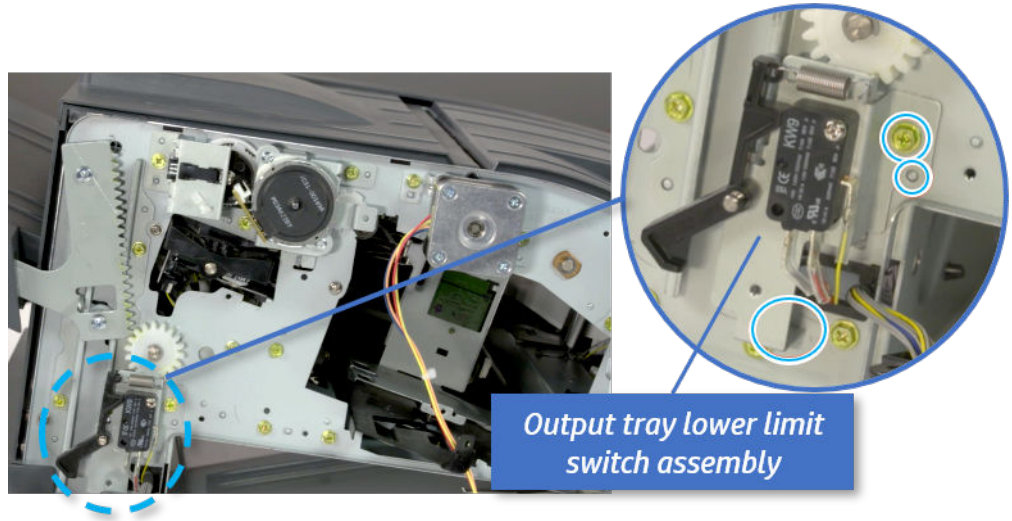

- 10. Remove the paper holding.
 - a. Remove the paper holding actuator spring.

Figure 5-586 Remove the paper holding actuator spring

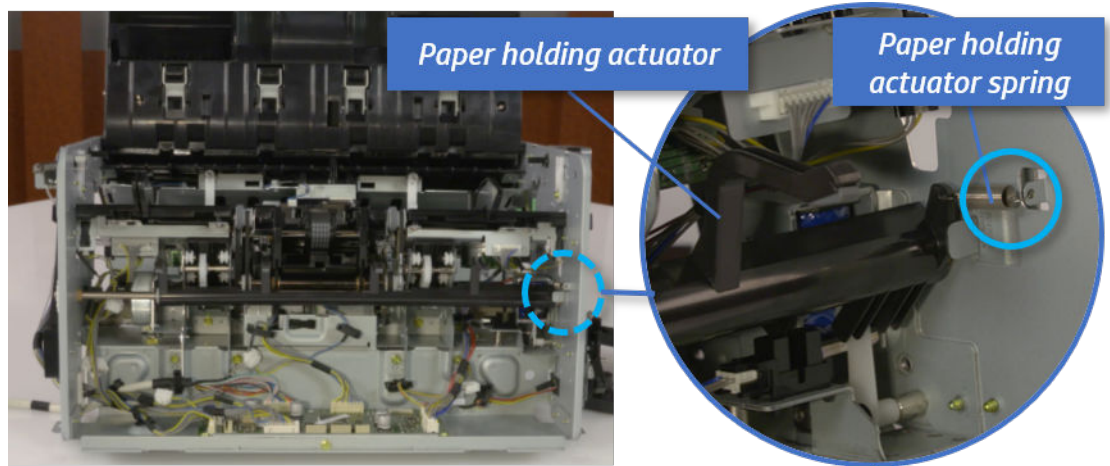

- b. Remove the e-ring and the rack pinion gear. And then remove the pin and the e-ring, and then remove the bushing.

Figure 5-587 Remove e-ring, rack pinion gear, pin, and bushing

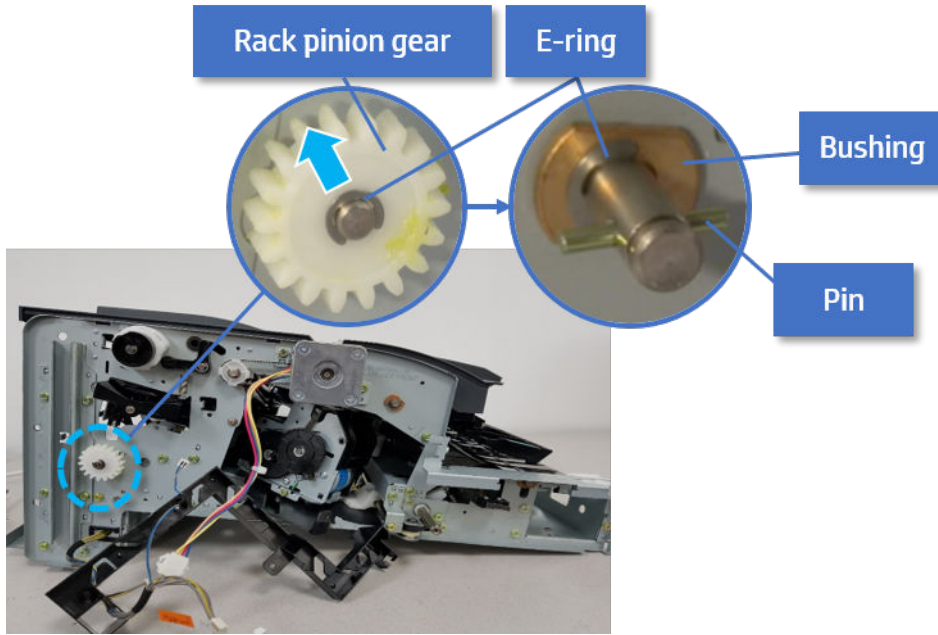

 **NOTE:** Be sure not to lose the pin.

- c. Carefully remove the paper holding shaft and the actuator.

Figure 5-588 Remove the paper holding shaft and the actuator

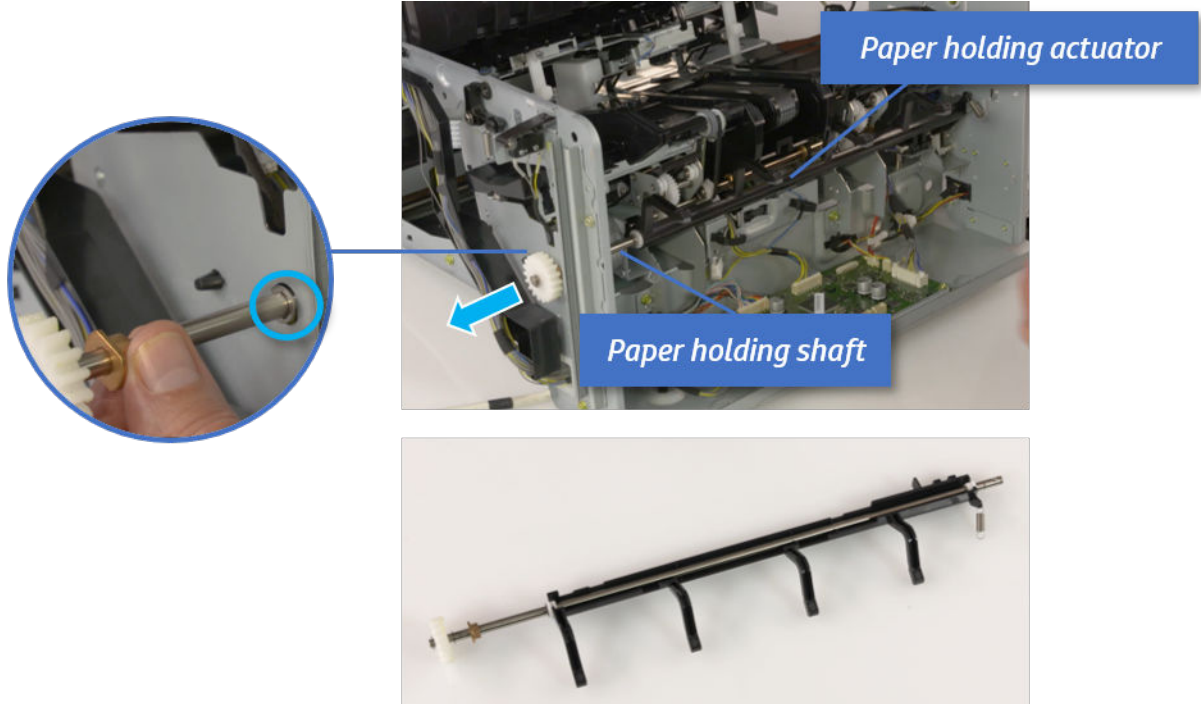

- 11. Remove the sub paddle unit.

- a. Open the top cover, and then remove one screw securing the sub paddle unit.

Figure 5-589 Remove one screw

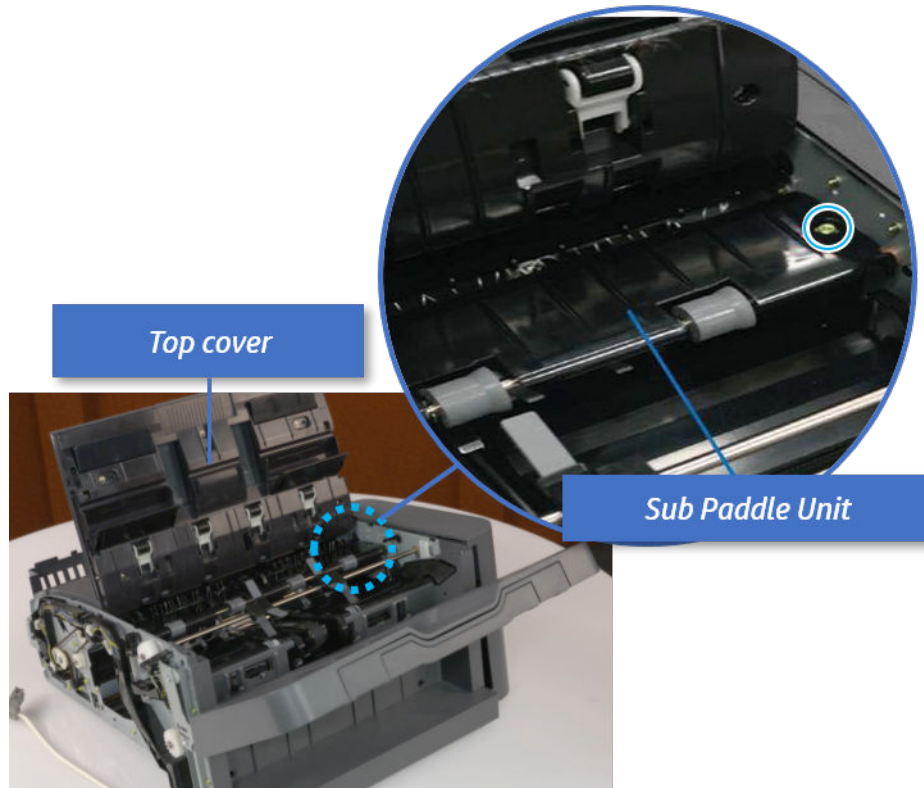

- b. Remove the e-ring, and then remove the pulley and timing belt. And then remove the e-ring and the bushing.

Figure 5-590 Remove the e-ring, pulley, timing belt, and bushing

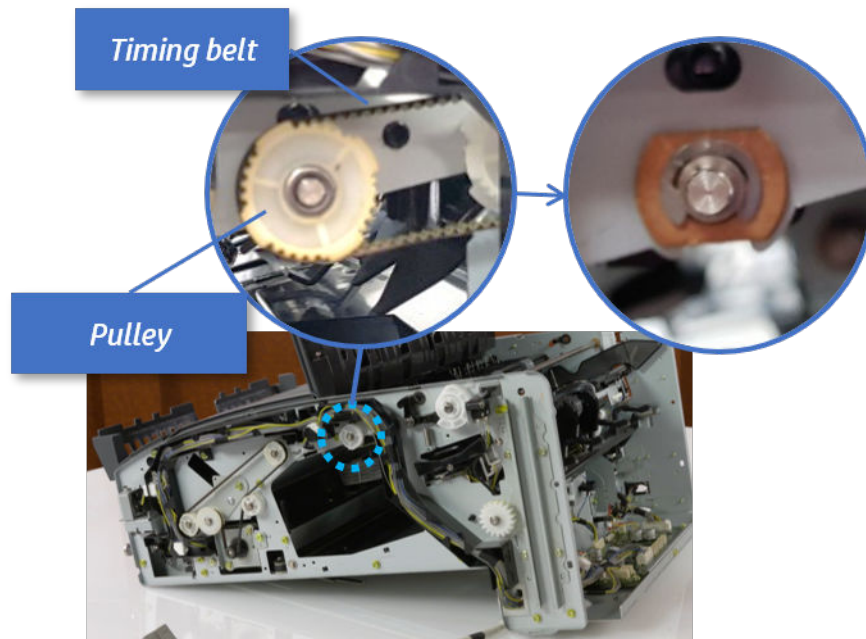

- c. Lift up and remove the sub paddle unit.

Figure 5-591 Remove the sub paddle unit

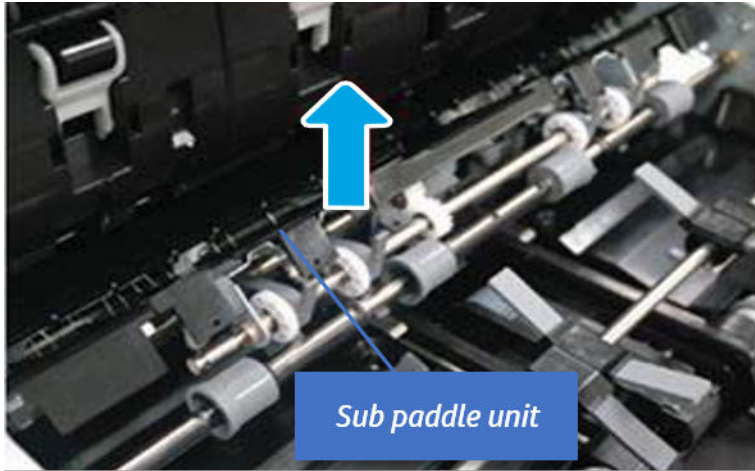

- 12. Remove the exit roller.

- a. Remove the guide on the center of the exit roller.

Figure 5-592 Remove the guide

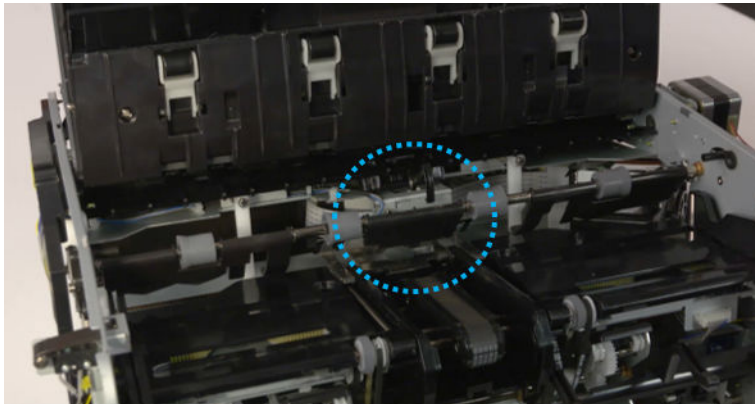

- b. On the front of the inner finisher, release the timing belt connected to the exit motor.

Figure 5-593 Release the timing belt

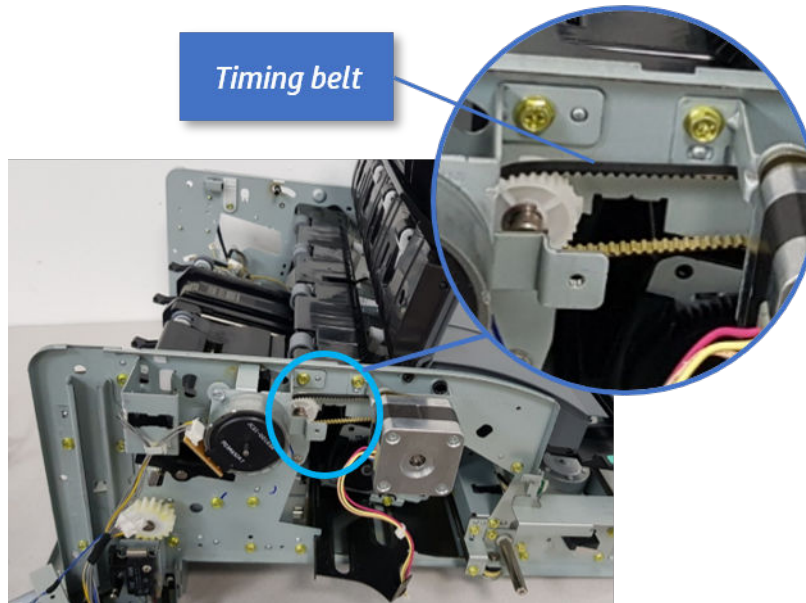

- c. Remove five screws securing the rear harness guide.

Figure 5-594 Remove five screws

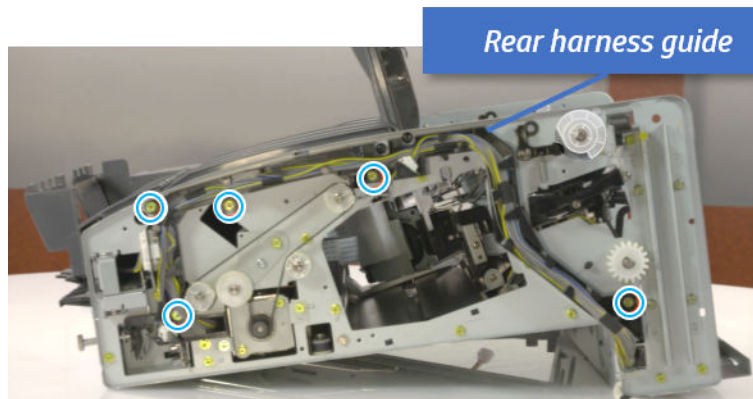

- d. On the rear of the inner finisher, remove the e-ring and the pulley and then remove the e-ring and the bushing.

Figure 5-595 Remove e-ring, pulley, and bushing

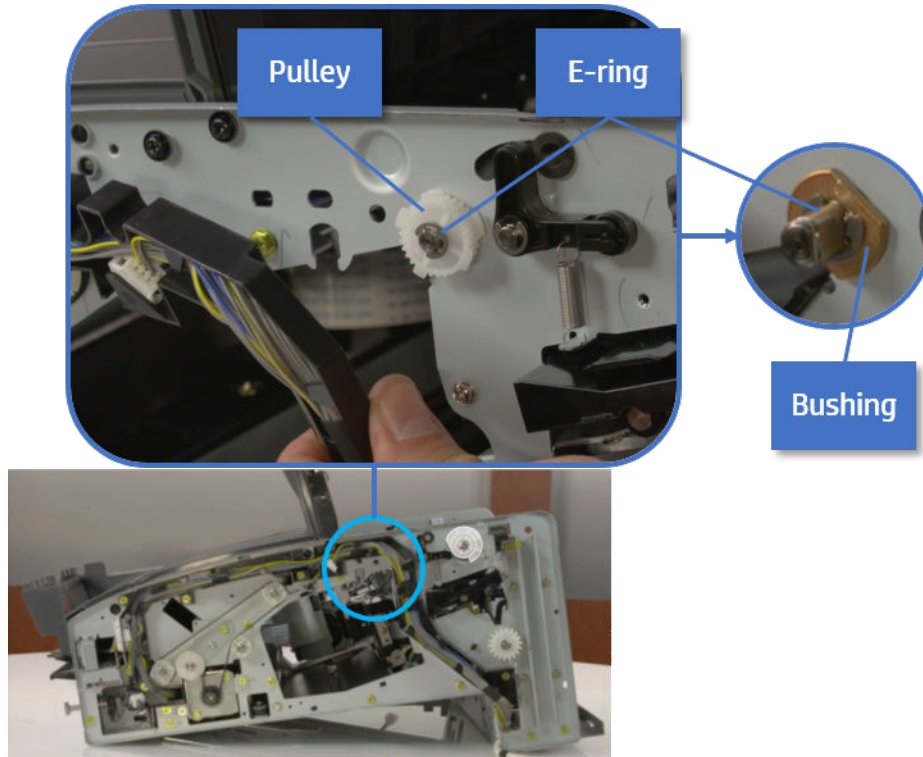

- e. Push the bushing to detach it, and then remove the exit roller.

Figure 5-596 Remove the exit roller

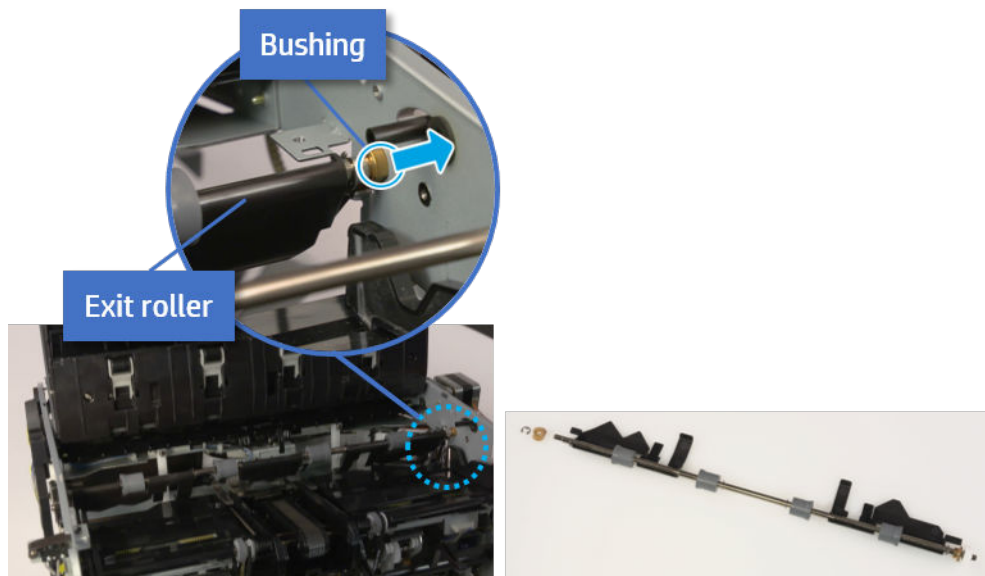

- 13. Remove the front tamper.
 - a. Remove four screws.

Figure 5-597 Remove four screws

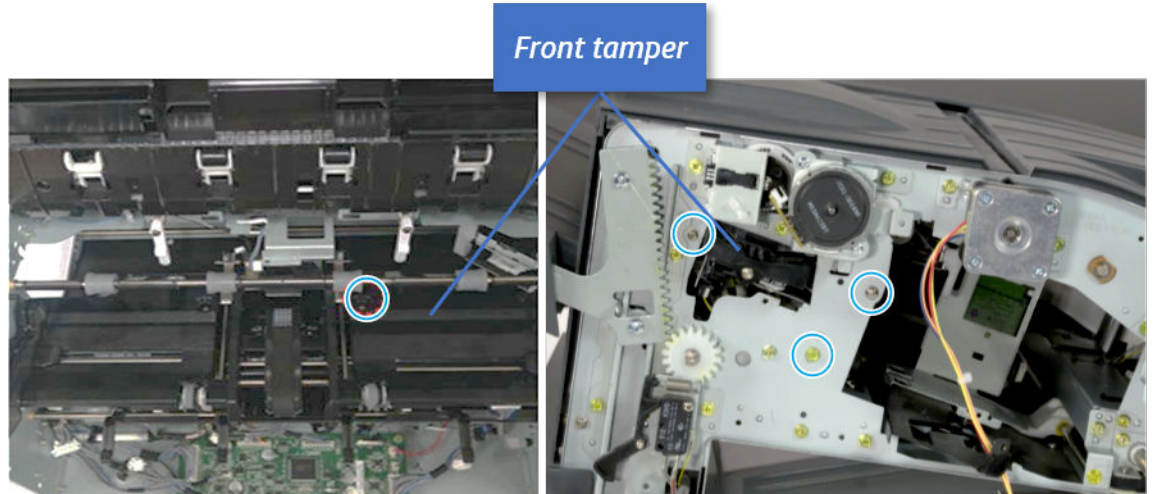

- b. Unplug the connector and release the hook, and then pull the front tamper up to remove.

Figure 5-598 Remove the front tamper

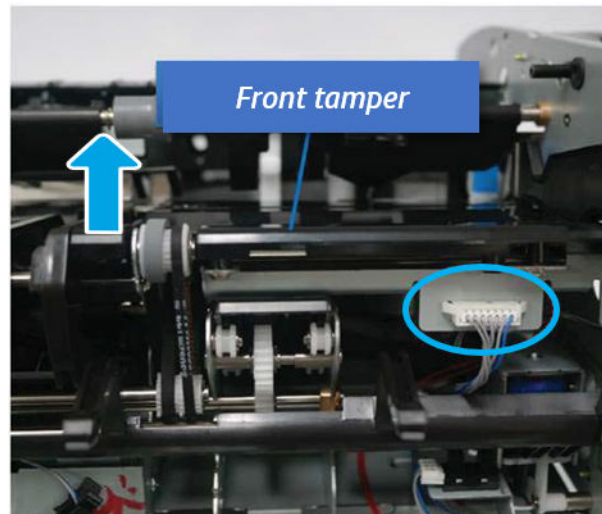

14. Remove the rear tamper.

- a. Remove four screws.

 **NOTE:** Move cable guideout of position to access the screws.

Figure 5-599 Remove four screws



- b. Unplug two connectors and release the hook, and then remove the rear tamper.

Figure 5-600 Remove the rear tamper

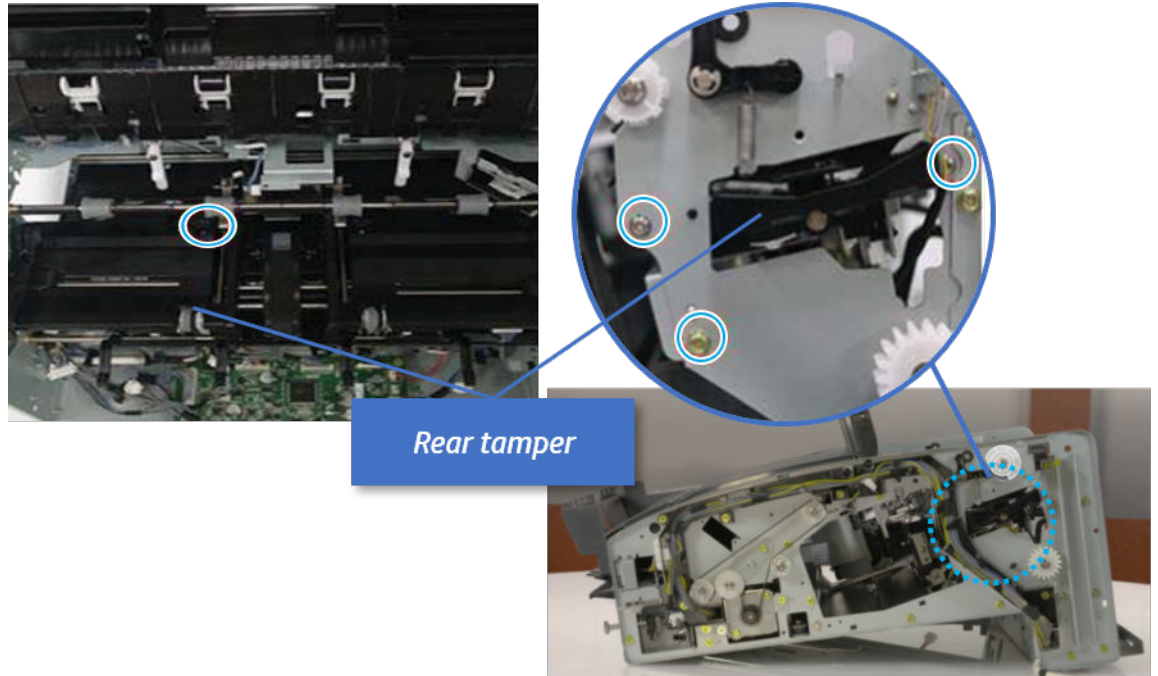
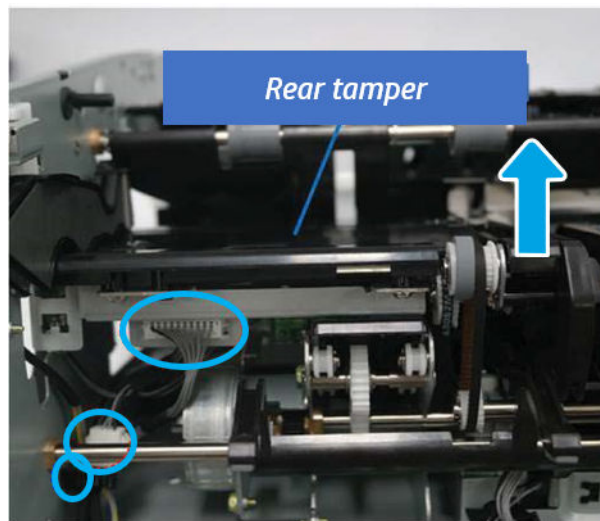

- 15. Remove the ejector & paper support assembly.
 - a. Open one clamp, disconnect one connector.

Figure 5-601 Disconnect one connector

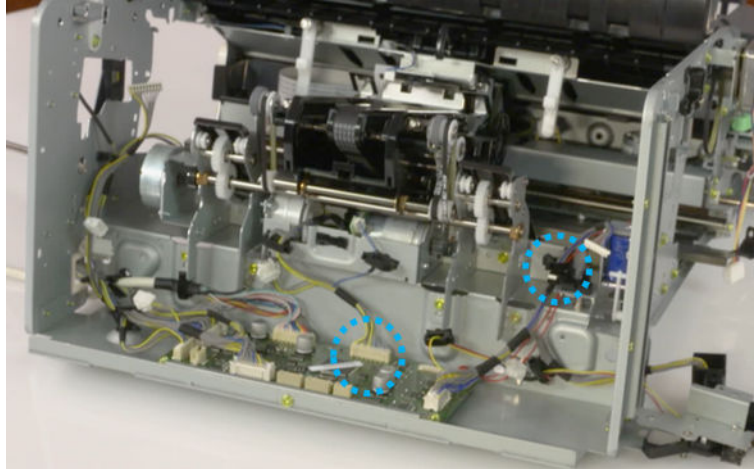

- b. Pull the rear paper support up, and then release one clamp and disconnect two connectors.

Figure 5-602 Disconnect two connector

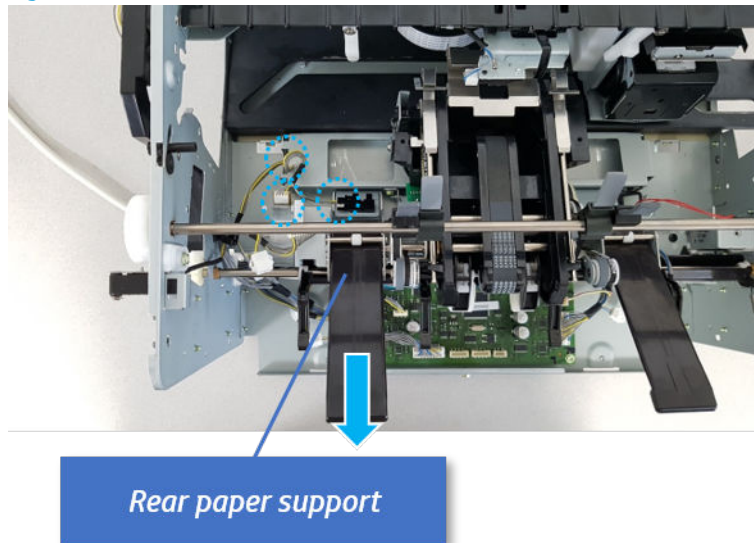

- c. Remove four screws, and then remove the ejector & paper support assembly.

Figure 5-603 Remove the ejector & paper support assembly

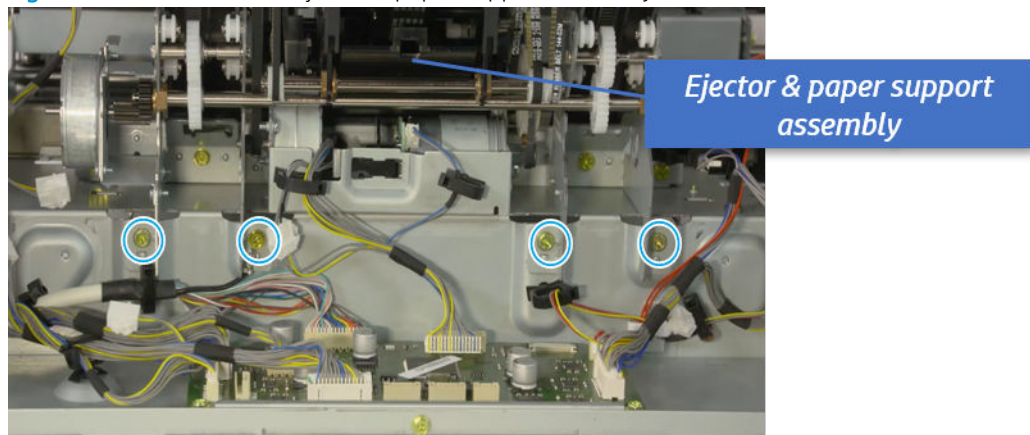

16. Remove the front paper support and the rear paper support.
 - ▲ Remove two screws, and then pull the paper support assembly out of ejector assembly.

Figure 5-604 Remove paper support assembly

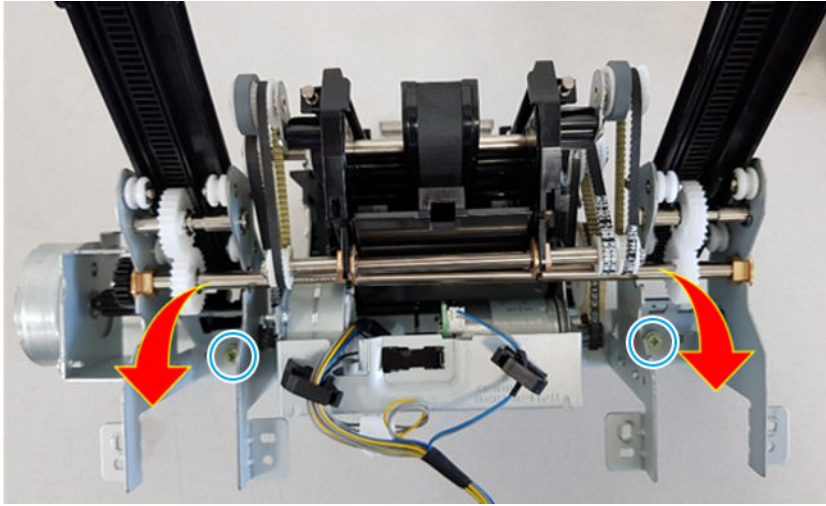

17. Remove the ejector motor assembly.
 - a. Remove the e-ring and washer. Remove two timing belts, and then remove one screw.

Figure 5-605 Remove e-ring, washer, belt, and screw

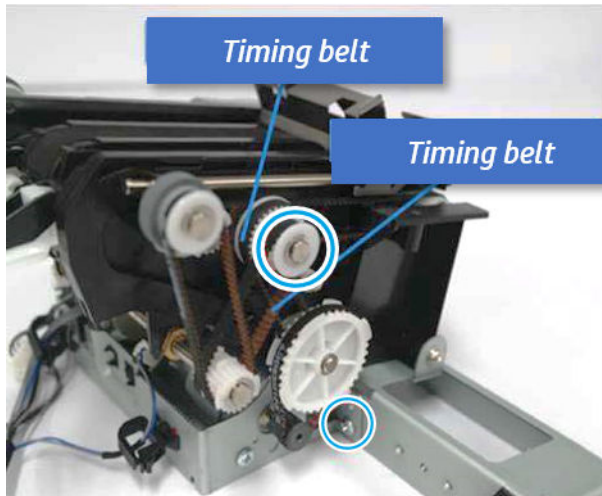

- b. Remove the timing belt, and then remove one screw.

Figure 5-606 Remove the belt, screw

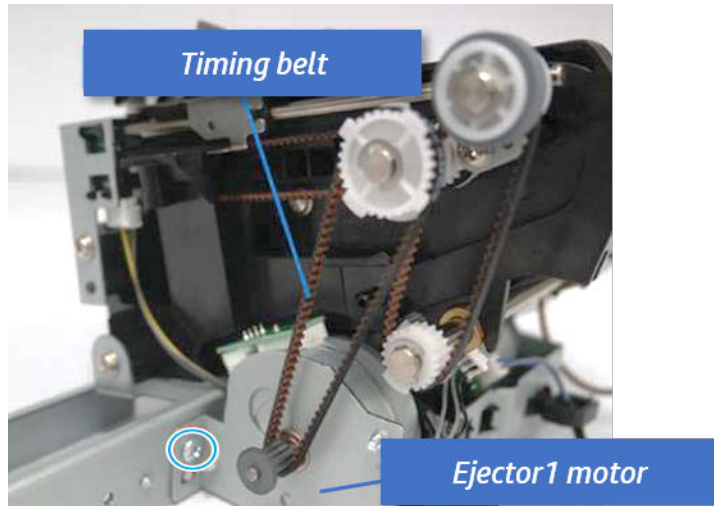

- c. Remove the cable from clamp, and then disconnect two motor connectors and the sensor connector.

Figure 5-607 Disconnect the motor and sensor connectors

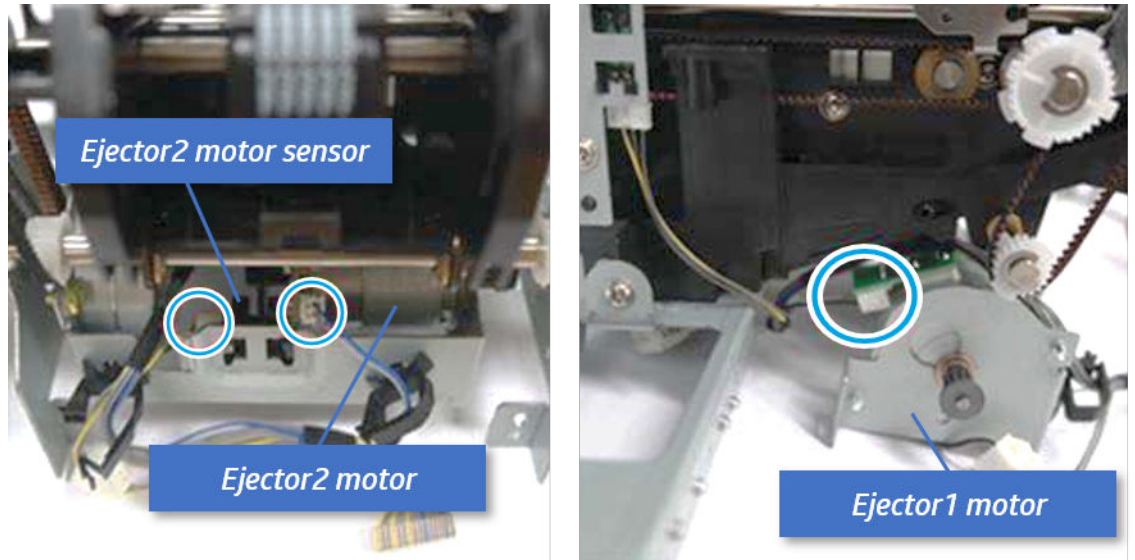

- d. Remove the ejector motor assembly.

Figure 5-608 Remove the ejector motor assembly

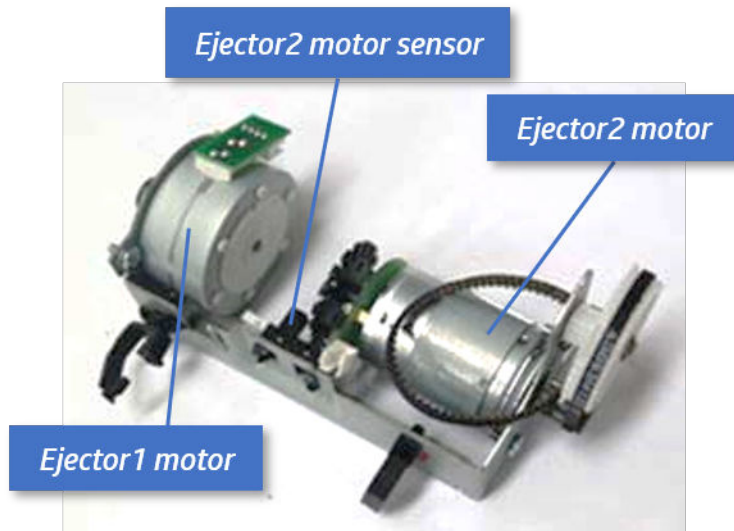

- 18. Remove the ejector assembly.

- a. Remove two screws.

Figure 5-609 Remove two screws

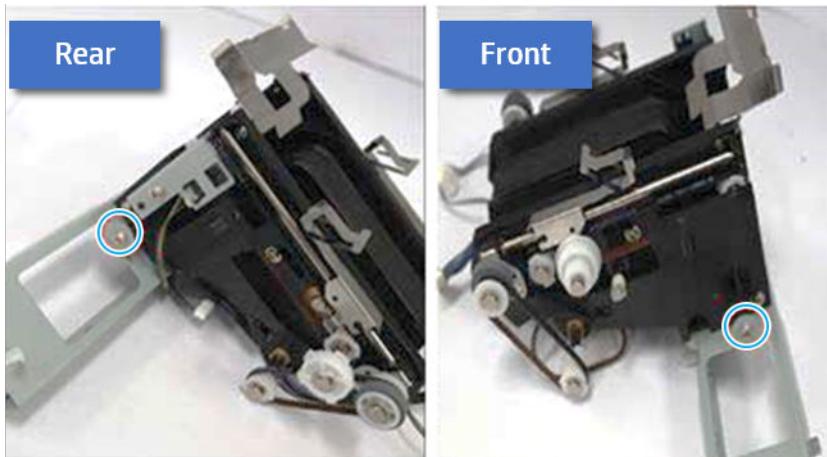

- b. Unplug two connectors, and then remove the ejector assembly.

Figure 5-610 Remove the ejector assembly

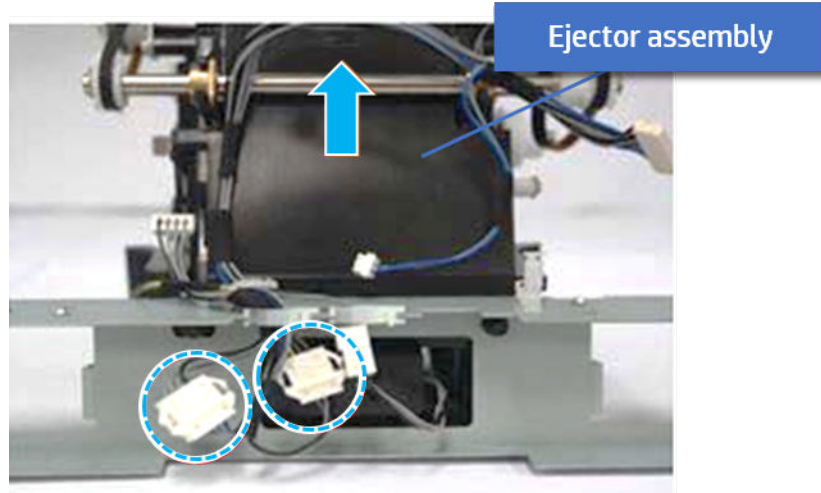

19. Unpack the replacement assembly.

- a. Dispose of the defective part.



NOTE: HP recommends responsible disposal of the defective part.

<http://www8.hp.com/us/en/hp-information/environment/product-recycling.html>

- b. Unpack the replacement part from the packaging.



CAUTION:  Some parts are sensitive to electrostatic discharge (ESD). Always perform service work at an ESD-protected workstation or mat. If an ESD workstation or mat is not available, touch the sheet-metal chassis to provide a static ground before touching an ESD-sensitive assembly. Protect the ESD-sensitive assemblies by placing them in ESD pouches when they are out of the printer.

If the replacement part is a roller or pad, avoid touching the spongy part of it. Skin oils on the roller or pad can cause paper pickup and/or print-quality problems. HP recommends using disposable gloves when handling rollers or pads or washing your hands before touching rollers or pads.



IMPORTANT: Make sure that all of the shipping materials (for example shipping tape) are removed from the replacement part prior to installation.

- c. To install an assembly, reverse the removal steps.

When applicable, special installation instructions are provided for an assembly at the end of the removal procedure. Always completely read the removal instructions and follow all special installation instructions.

End fence unit

Removal and replacement: End fence sensor (S17)

Learn how to remove and replace the end fence sensor.

To view teardown&reassembling video of the inner finisher, click the link below.

 [View a teardown video of the inner finisher .](#)

 [View a reassembling video of the inner finisher .](#)

 **IMPORTANT:** When applicable, special installation instructions are provided for an assembly at the end of the removal procedure. Always completely read the removal instructions and follow all special installation instructions.

Mean time to repair:

Service level:

Before performing service

Turn the printer power off

- Press the power button on the front of the printer, and then turn off the power switch next to the power cable.
- A shutting-down message appears on the control-panel display.

 **WARNING!** To avoid damage to the printer, turn the power off and wait until the printer shuts down before removing the power cable.

- Disconnect the printer power cable after the printer has completely shut down (the control-panel display is blank).

Use the table below to identify the correct part number for your printer. To order the part, go to <https://parts.hp.com>.

Table 5-62 Part information

Part number	Part description
0604-001381	End fence sensor

Required tools

- #2 JIS screwdriver with a magnetic tip

After performing service

Turn the printer power on

- Connect the power cable.
- Use the power switch to turn the power on.

Post service test

Print any pages necessary to verify that the repair resolved the issue and did not create any new issues.

1. Remove the front cover.
 - a. Open the front door and open the punch cover.
 - b. Remove three screws in the front.
 - c. Remove the lever.
 - d. Open the top cover.
 - e. From the right side of the front cover, carefully lift and pry toward the top-left corner to remove the front cover.

Figure 5-611 Remove the front cover

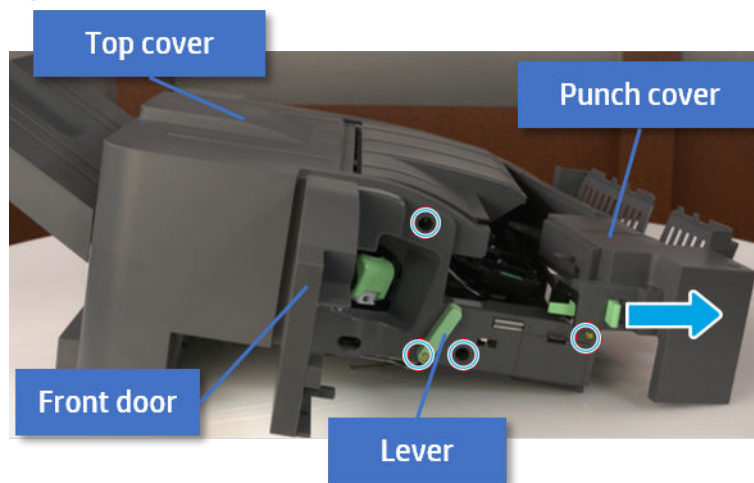

2. Remove the rear cover.
 - a. Open the top cover.

Figure 5-612 Open the top cover

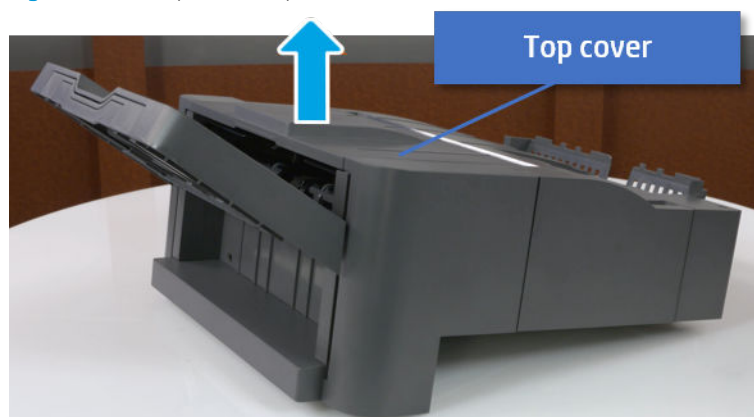

- b. Remove three screws.

- c. Release hooks carefully and remove the rear cover.

Figure 5-613 Remove the rear cover

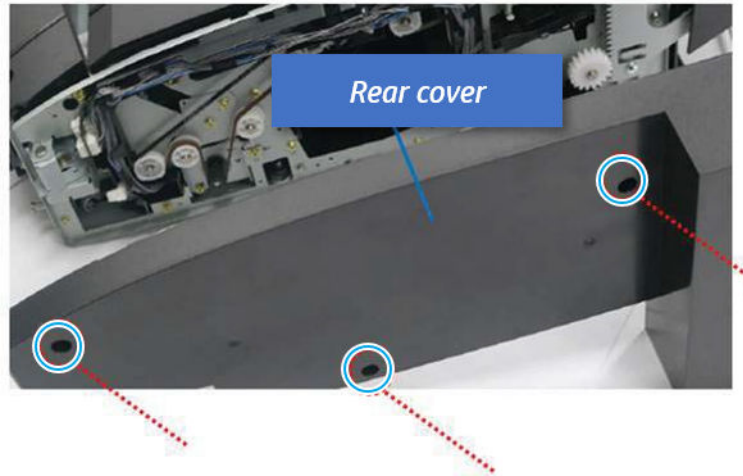

- 3. Remove the middle cover.

- a. Open the front door and then open the punch cover.

Figure 5-614 Open the front door and punch cover.



- b. Remove left-side one screw at the rear of the inner finisher, and then remove the middle cover by lifting off the hinge pins at the front.

Figure 5-615 Remove the middle cover

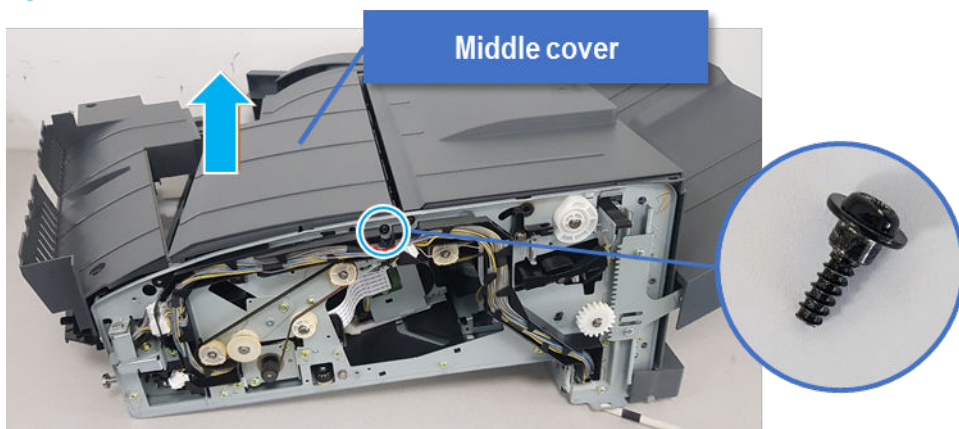

4. Remove the punch cover.
 - a. Unplug the connector. Remove the e-ring, and then remove the slide shaft at the rear of the inner finisher.

Figure 5-616 Remove the slide shaft

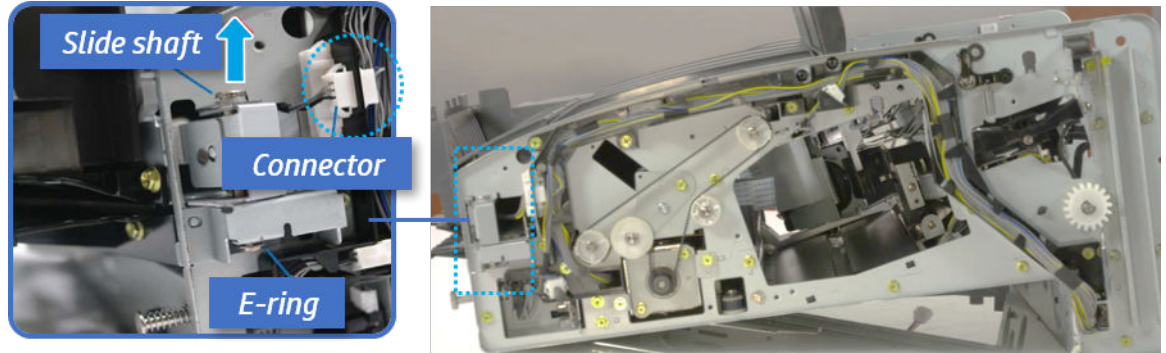

- b. Open the punch cover.

Figure 5-617 Open the punch cover

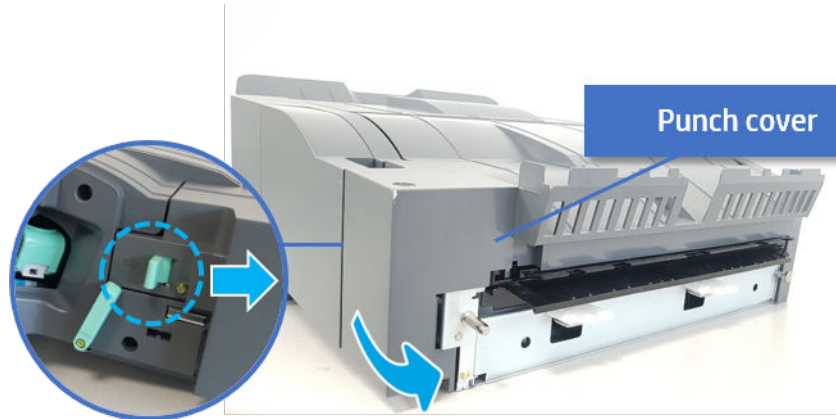

- c. Remove the front punch sheet, and then remove the e-ring and the washer. And then remove the punch cover.

Figure 5-618 Remove the punch cover

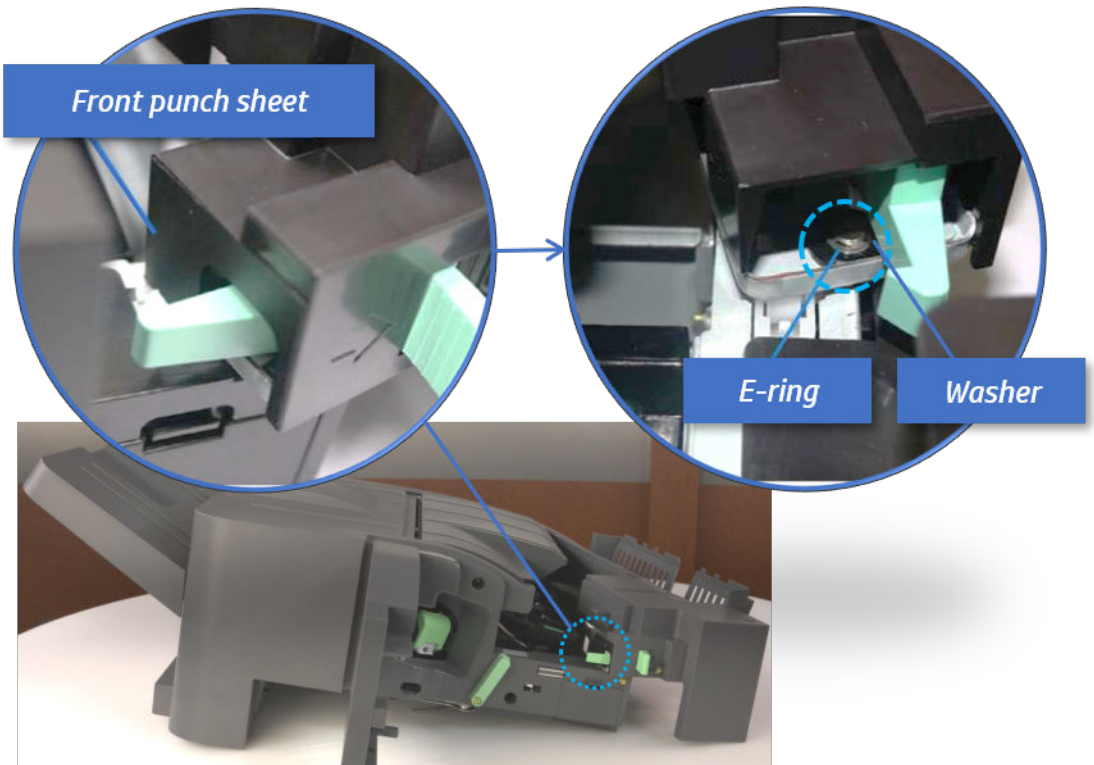

- 5. Remove the diverter guide and the middle roller
 - a. On the front of the inner finisher, remove the e-ring and bushing.

Figure 5-619 Remove the e-ring and bushing

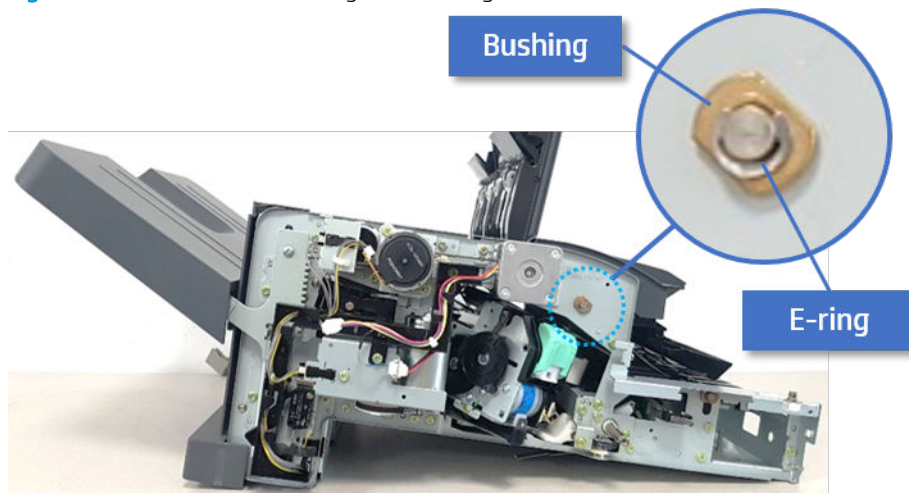

- b. On the rear of the inner finisher, remove the e-ring, pulley, bushing, belt, and spring (slightly hidden from view).

Figure 5-620 Remove the e-ring, pulley, bushing, belt, and spring

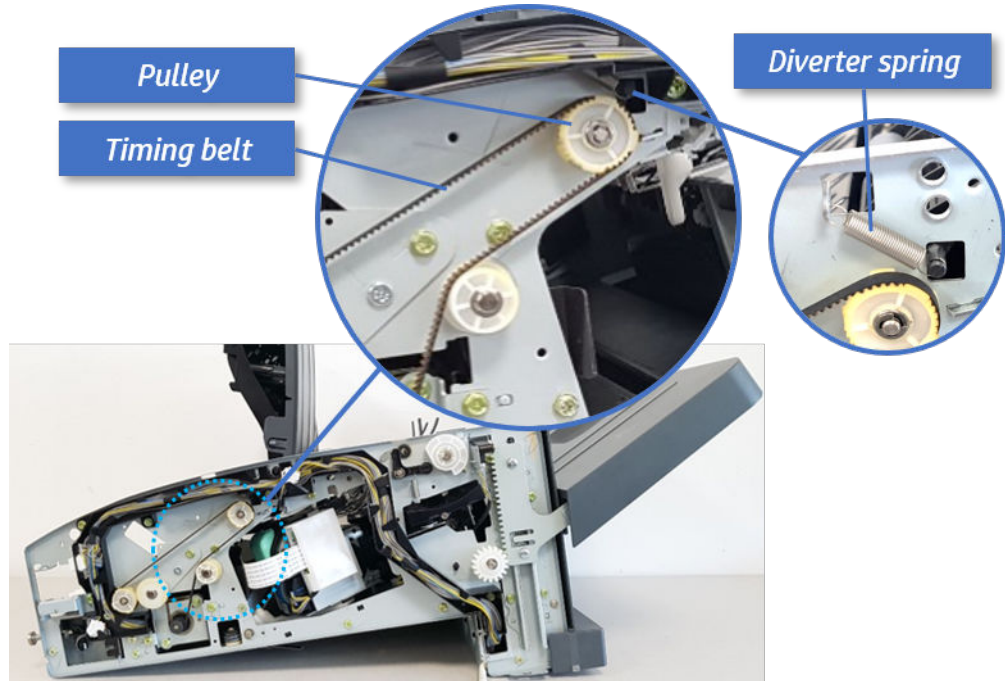

- c. Remove the diverter guide and the middler roller.

Figure 5-621 Remove the diverter guide and the middler roller

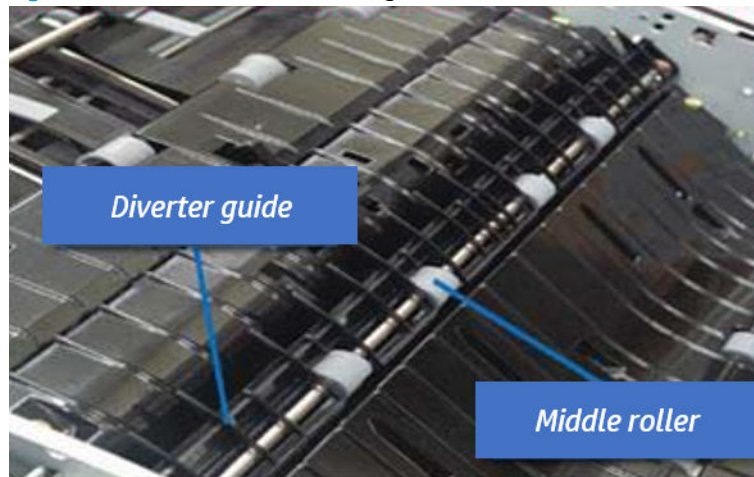

6. Remove the middle paper guide.
 - a. Remove six screws, and then open the middle paper guide in the direction of the arrow.

Figure 5-622 Open the middle paper guide

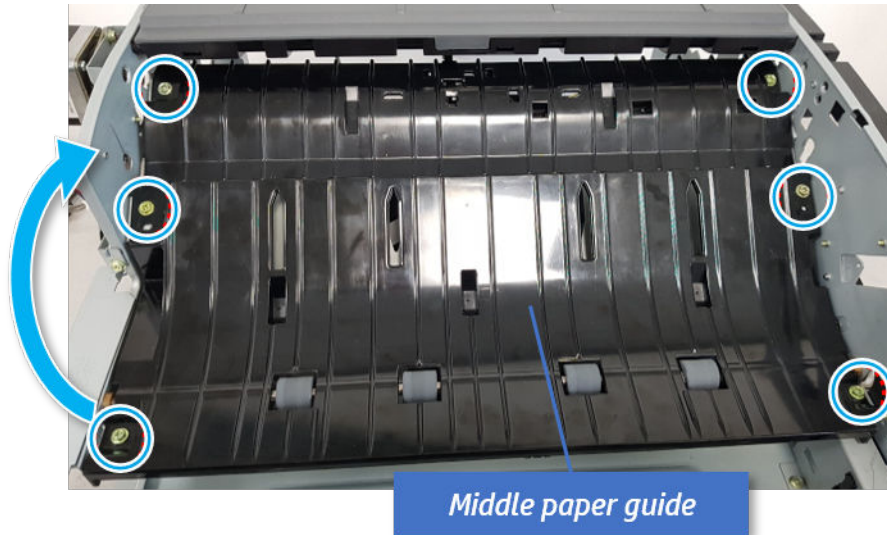

 **NOTE:** Be careful not to damage the sensor connector.

- b. Unplug the connector under the middle paper guide. And then, remove the middle paper guide.

Figure 5-623 Remove the middle paper guide

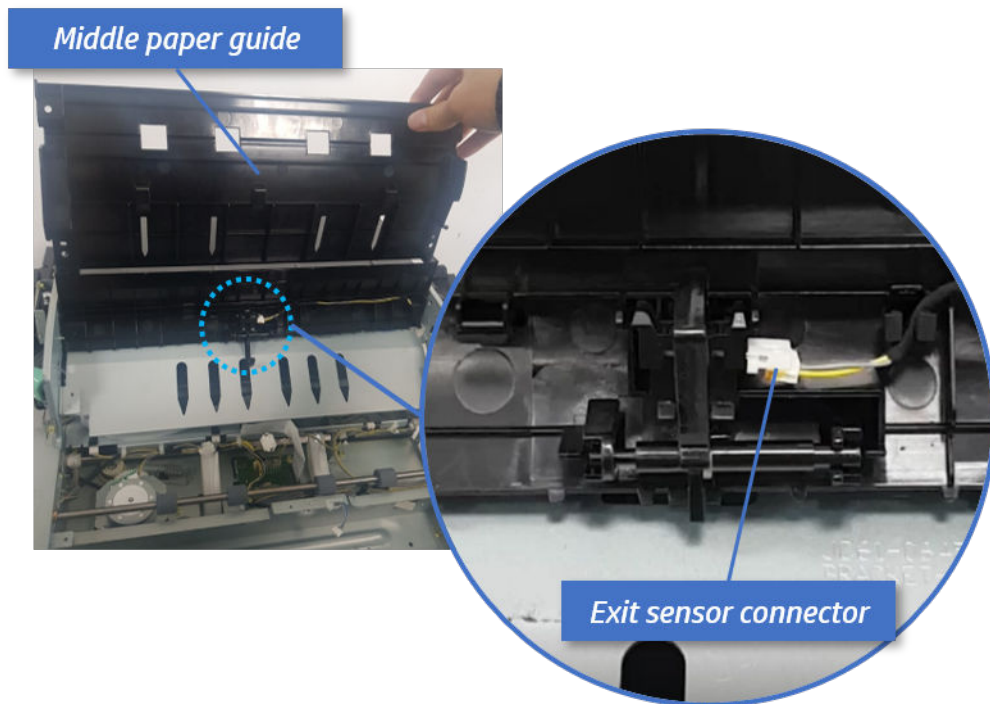

7. Remove the exit motor bracket.
 - ▲ Remove two screws, unplug the motor connector. And then remove exit motor bracket.

Figure 5-624 Remove the exit motor bracket

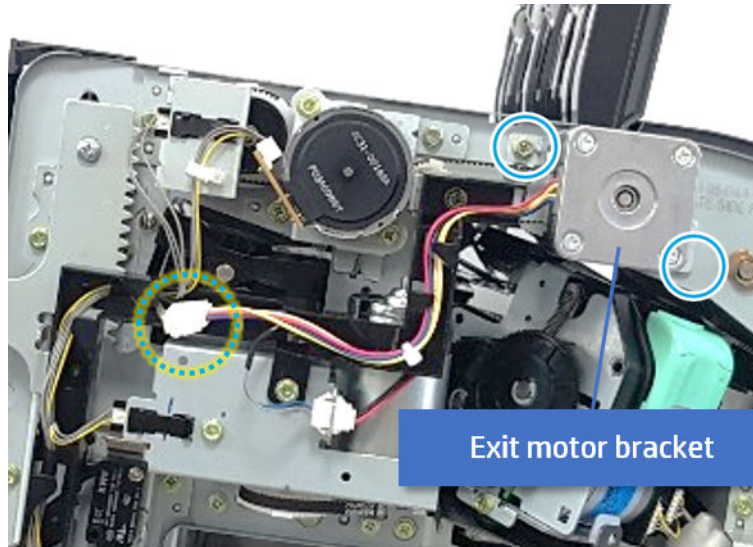

8. Remove the end fence sensor bracket.
 - a. Remove three screws at the front of the inner finisher, and then remove the bracket.

Figure 5-625 Remove the bracket

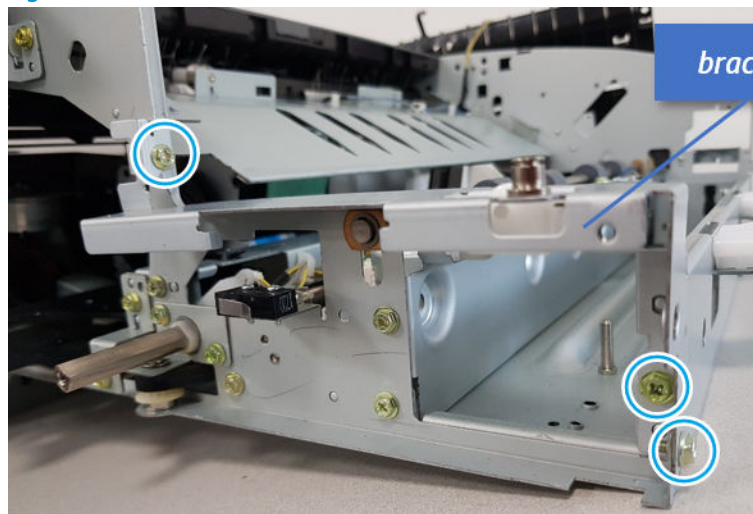

- b. Remove two screws at the front of the inner finisher.

Figure 5-626 Remove two screws

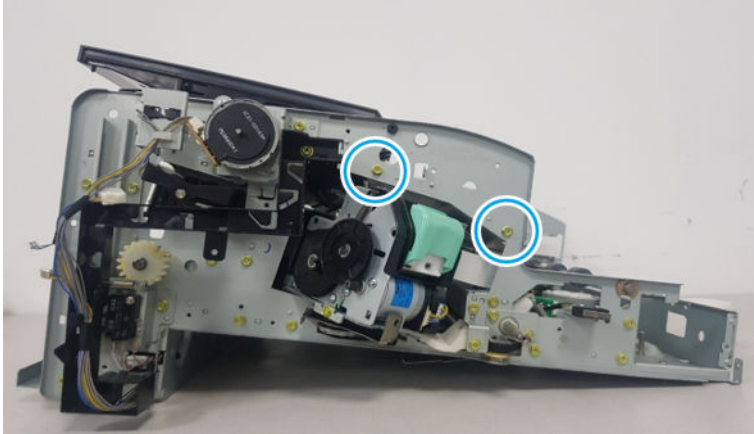

- c. Remove two screws at the rear of the inner finisher.

Figure 5-627 Remove two screws

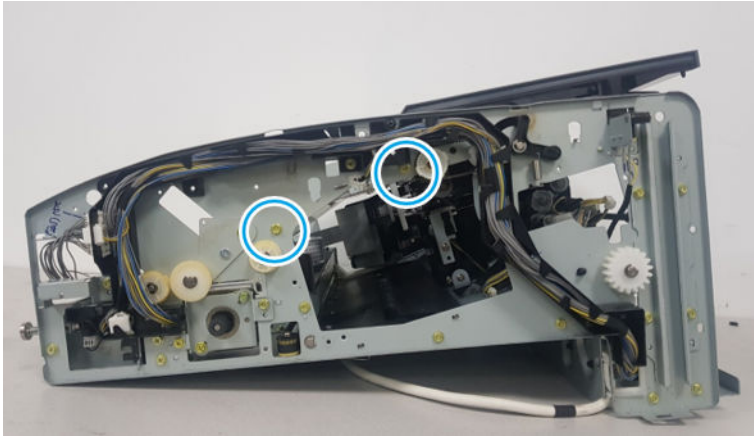

- d. Loosen three cable clamps. Unplug the connector at the sensor, and then remove the end fence sensor bracket.

Figure 5-628 Remove the end fence sensor bracket

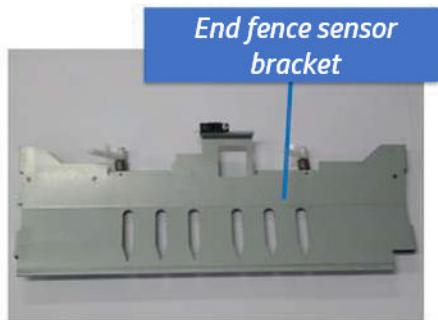
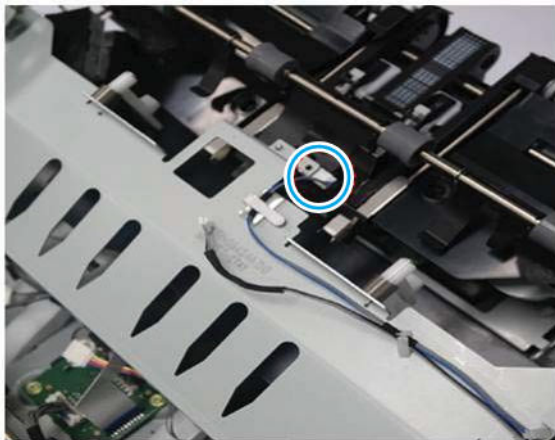

- 9. Remove the end fence sensor.

- ▲ Remove one screw, and then remove the end fence sensor.

Figure 5-629 Remove the end fence sensor

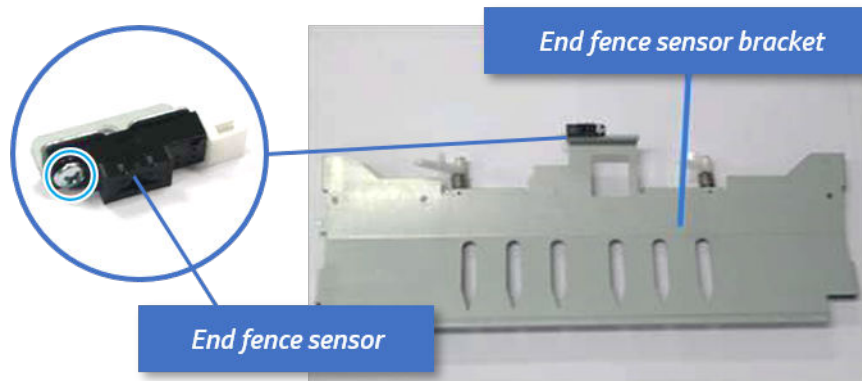

10. Unpack the replacement assembly.

- a. Dispose of the defective part.



NOTE: HP recommends responsible disposal of the defective part.

<http://www8.hp.com/us/en/hp-information/environment/product-recycling.html>

- b. Unpack the replacement part from the packaging.



CAUTION:  Some parts are sensitive to electrostatic discharge (ESD). Always perform service work at an ESD-protected workstation or mat. If an ESD workstation or mat is not available, touch the sheet-metal chassis to provide a static ground before touching an ESD-sensitive assembly. Protect the ESD-sensitive assemblies by placing them in ESD pouches when they are out of the printer.

If the replacement part is a roller or pad, avoid touching the spongy part of it. Skin oils on the roller or pad can cause paper pickup and/or print-quality problems. HP recommends using disposable gloves when handling rollers or pads or washing your hands before touching rollers or pads.



IMPORTANT: Make sure that all of the shipping materials (for example shipping tape) are removed from the replacement part prior to installation.

- c. To install an assembly, reverse the removal steps.

When applicable, special installation instructions are provided for an assembly at the end of the removal procedure. Always completely read the removal instructions and follow all special installation instructions.

Output tray unit

Removal and replacement: Output tray

Learn how to remove and replace the output tray.

To view teardown&reassembling video of the inner finisher, click the link below.

 [View a teardown video of the inner finisher .](#)

 [View a reassembling video of the inner finisher .](#)

 **IMPORTANT:** When applicable, special installation instructions are provided for an assembly at the end of the removal procedure. Always completely read the removal instructions and follow all special installation instructions.

Mean time to repair:

Service level:

Before performing service

Turn the printer power off

- Press the power button on the front of the printer, and then turn off the power switch next to the power cable.
- A shutting-down message appears on the control-panel display.

 **WARNING!** To avoid damage to the printer, turn the power off and wait until the printer shuts down before removing the power cable.

- Disconnect the printer power cable after the printer has completely shut down (the control-panel display is blank).

Use the table below to identify the correct part number for your printer. To order the part, go to <https://parts.hp.com>.

Table 5-63 Part information

Part number	Part description
JC90-01337B	Output tray

Required tools

- #2 JIS screwdriver with a magnetic tip

After performing service

Turn the printer power on

- Connect the power cable.
- Use the power switch to turn the power on.

Post service test

Print any pages necessary to verify that the repair resolved the issue and did not create any new issues.

1. Remove the front cover.
 - a. Open the front door and open the punch cover.
 - b. Remove three screws in the front.
 - c. Remove the lever.
 - d. Open the top cover.
 - e. From the right side of the front cover, carefully lift and pry toward the top-left corner to remove the front cover.

Figure 5-630 Remove the front cover

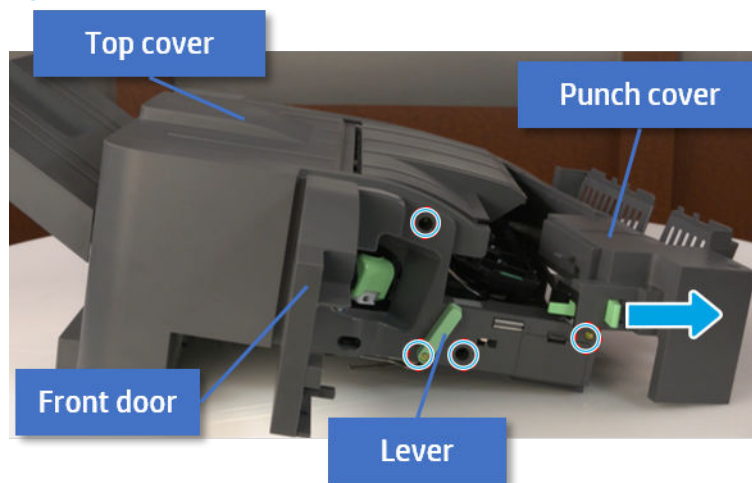

2. Remove the rear cover.
 - a. Open the top cover.

Figure 5-631 Open the top cover

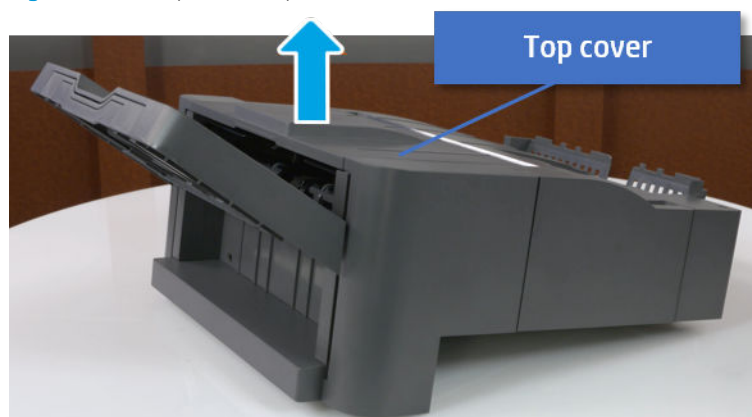

- b. Remove three screws.

- c. Release hooks carefully and remove the rear cover.

Figure 5-632 Remove the rear cover

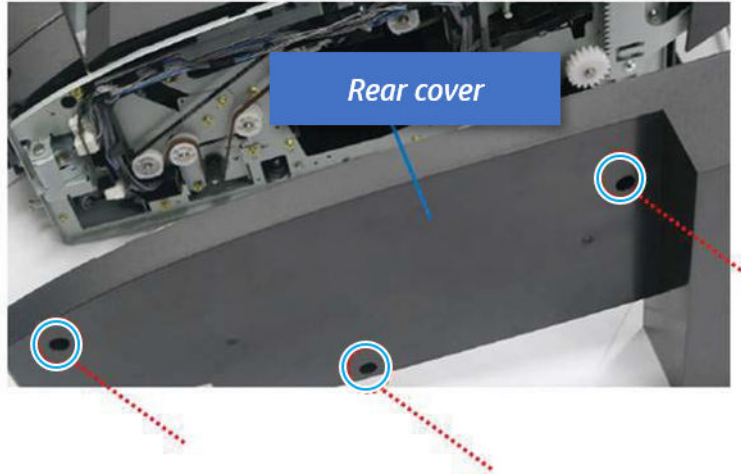

- 3. Remove the output tray.

- a. Remove four screws.

Figure 5-633 Remove four screws

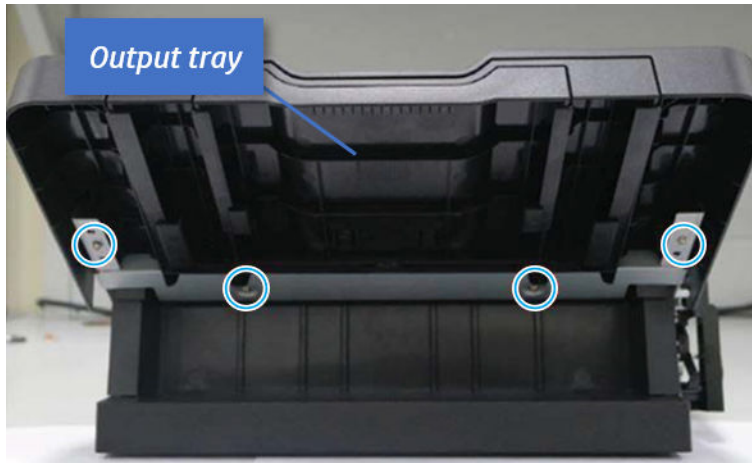

- b. Push the paper holding actuator into the inner finisher, and then remove the output tray.

Figure 5-634 Remove the output tray.



- 4. Remove the output tray frame.
 - a. Rotate the pulley until the output tray frame depart from the gear.

Figure 5-635 Remove the pulley

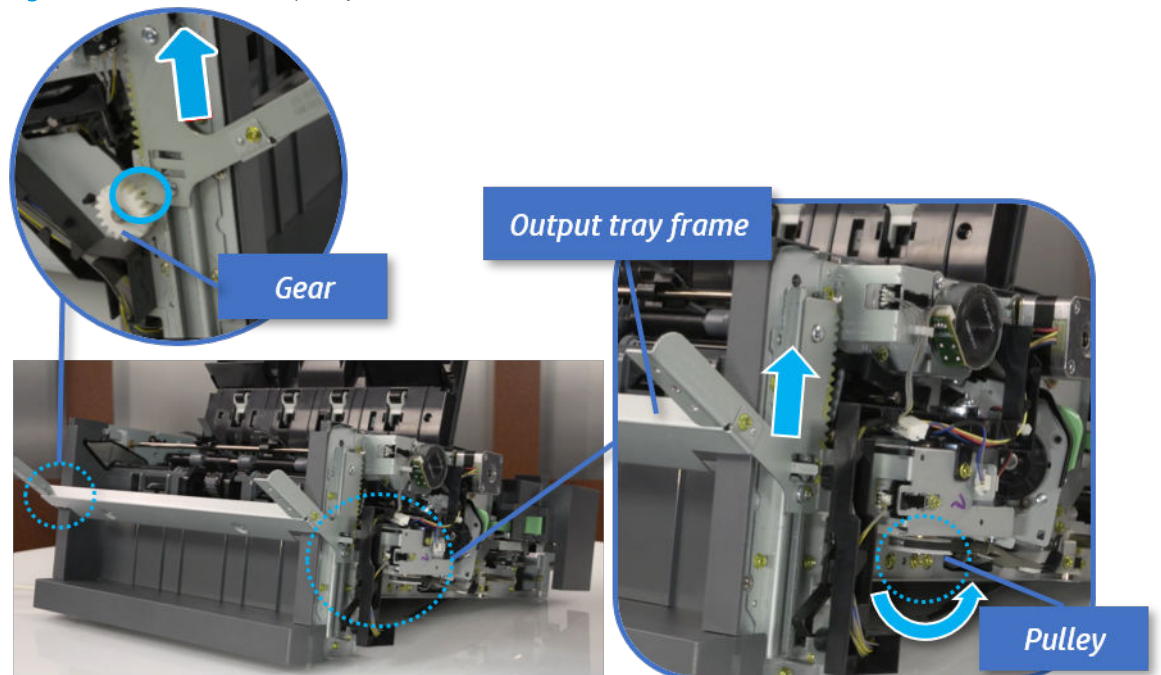

- b. Push the paper holding actuator into the inner finisher, and then remove the output tray frame.

Figure 5-636 Remove the output tray frame

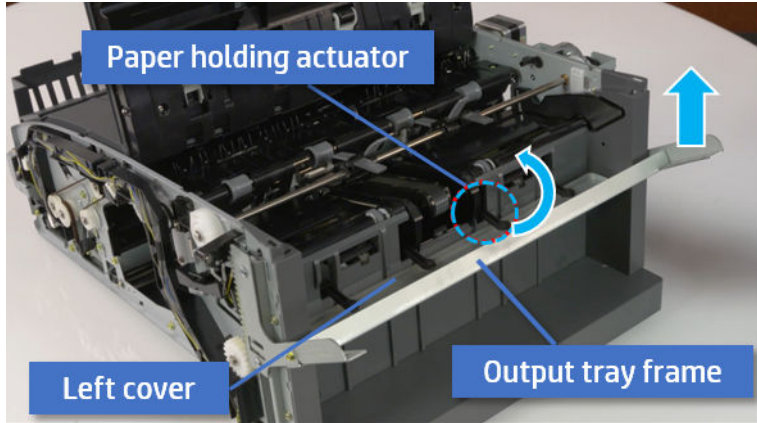

 **TIP:** Push the paper holding actuator into the inner finisher when reassembling. Be sure to level the output tray.

1. Position the first wheel into the channel on both sides while pushing the paper holding actuator.

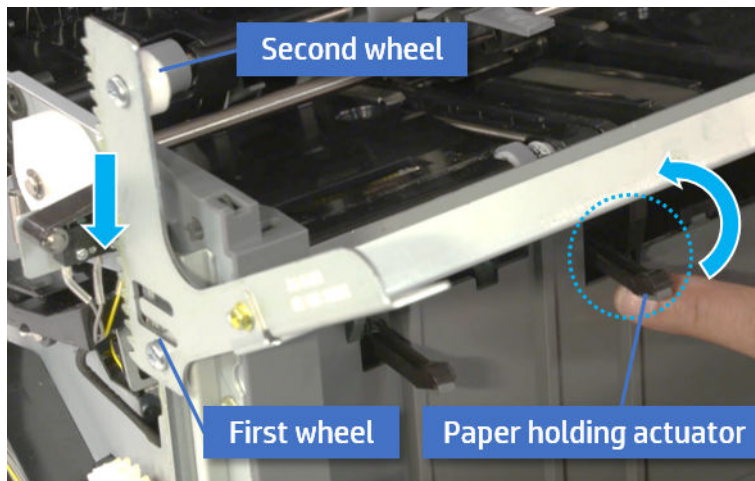

2. Let the second wheel rest on the channel on both sides simultaneously.
3. Gently squeeze the wheels into channel until the output tray frame meet the gear.

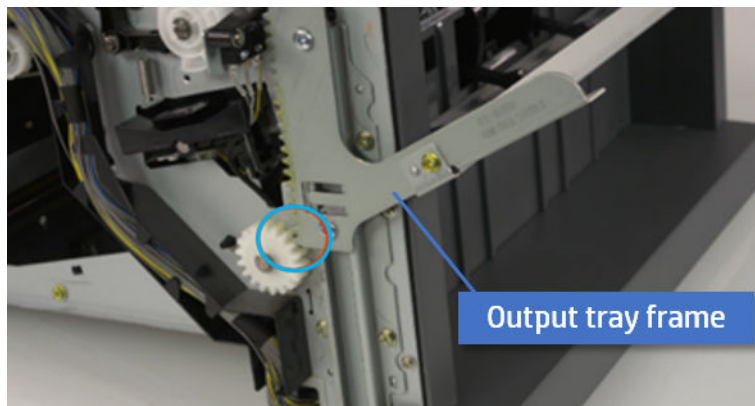

4. Rotate the pulley until the output tray frame is no longer lifted. It can make to level the output tray frame.

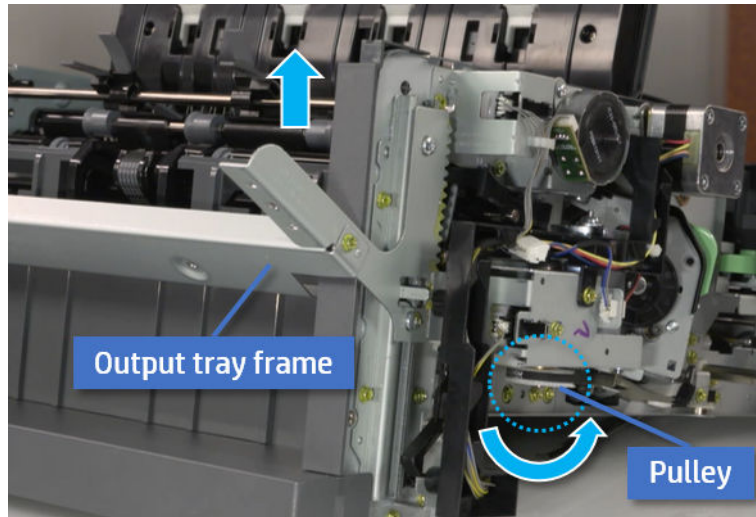

5. Rotate the pulley in the opposite direction.

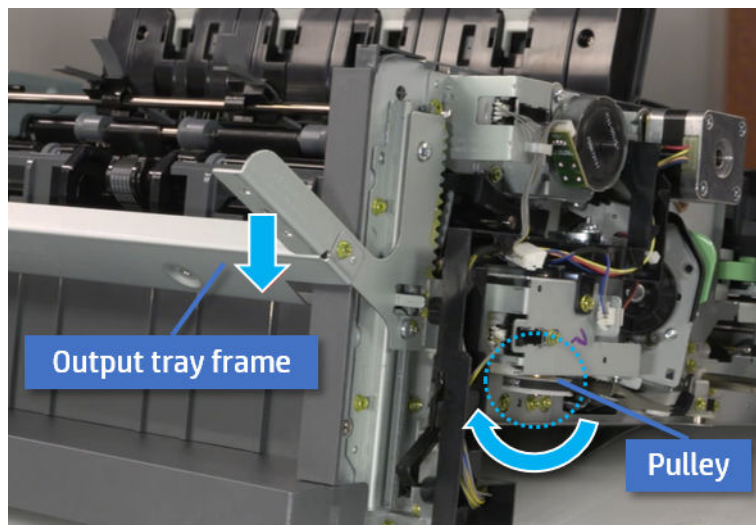



5. Unpack the replacement assembly.
 - a. Dispose of the defective part.

 **NOTE:** HP recommends responsible disposal of the defective part.

<http://www8.hp.com/us/en/hp-information/environment/product-recycling.html>

b. Unpack the replacement part from the packaging.

 **CAUTION:**  Some parts are sensitive to electrostatic discharge (ESD). Always perform service work at an ESD-protected workstation or mat. If an ESD workstation or mat is not available, touch the sheet-metal chassis to provide a static ground before touching an ESD-sensitive assembly. Protect the ESD-sensitive assemblies by placing them in ESD pouches when they are out of the printer.

If the replacement part is a roller or pad, avoid touching the spongy part of it. Skin oils on the roller or pad can cause paper pickup and/or print-quality problems. HP recommends using disposable gloves when handling rollers or pads or washing your hands before touching rollers or pads.

 **IMPORTANT:** Make sure that all of the shipping materials (for example shipping tape) are removed from the replacement part prior to installation.

c. To install an assembly, reverse the removal steps.

When applicable, special installation instructions are provided for an assembly at the end of the removal procedure. Always completely read the removal instructions and follow all special installation instructions.

Removal and replacement: Output tray top of stack sensor (S8)

Learn how to remove and replace the output tray top of stack sensor.

To view teardown&reassembling video of the inner finisher, click the link below.

 [View a teardown video of the inner finisher .](#)

 [View a reassembling video of the inner finisher .](#)

 **IMPORTANT:** When applicable, special installation instructions are provided for an assembly at the end of the removal procedure. Always completely read the removal instructions and follow all special installation instructions.

Mean time to repair:

Service level:

Before performing service

Turn the printer power off

- Press the power button on the front of the printer, and then turn off the power switch next to the power cable.
- A shutting-down message appears on the control-panel display.

 **WARNING!** To avoid damage to the printer, turn the power off and wait until the printer shuts down before removing the power cable.

- Disconnect the printer power cable after the printer has completely shut down (the control-panel display is blank).

Use the table below to identify the correct part number for your printer. To order the part, go to <https://parts.hp.com>.

Table 5-64 Part information

Part number	Part description
JC82-01039A	output tray top of stack sensor

Required tools

- #2 JIS screwdriver with a magnetic tip

After performing service

Turn the printer power on

- Connect the power cable.
- Use the power switch to turn the power on.

Post service test

Print any pages necessary to verify that the repair resolved the issue and did not create any new issues.

1. Remove the front cover.
 - a. Open the front door and open the punch cover.
 - b. Remove three screws in the front.
 - c. Remove the lever.
 - d. Open the top cover.
 - e. From the right side of the front cover, carefully lift and pry toward the top-left corner to remove the front cover.

Figure 5-637 Remove the front cover

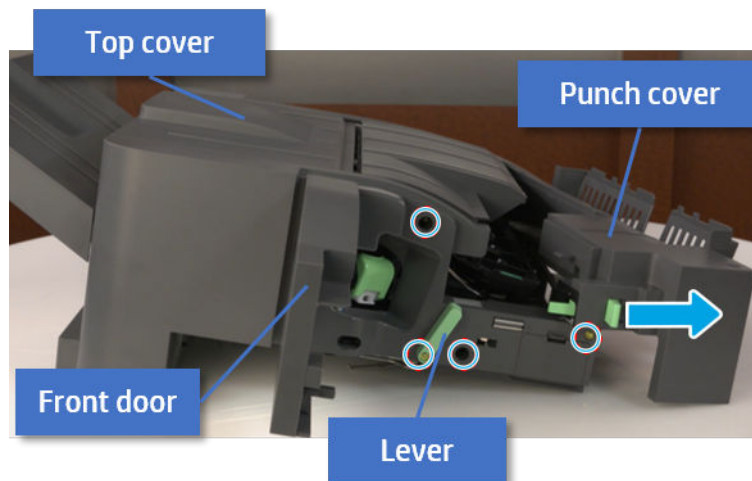

2. Remove the rear cover.

- a. Open the top cover.

Figure 5-638 Open the top cover

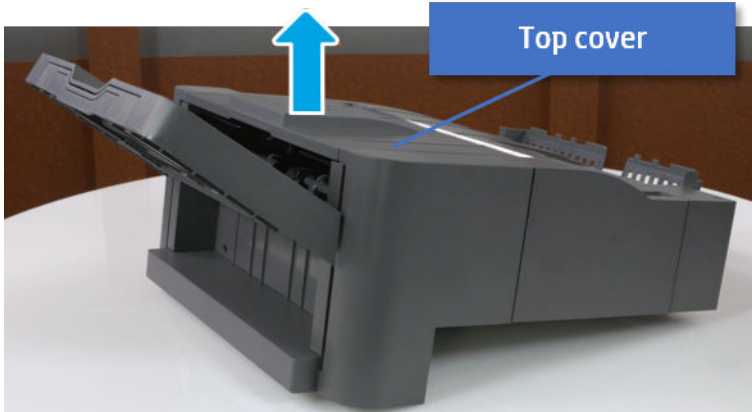

- b. Remove three screws.
- c. Release hooks carefully and remove the rear cover.

Figure 5-639 Remove the rear cover

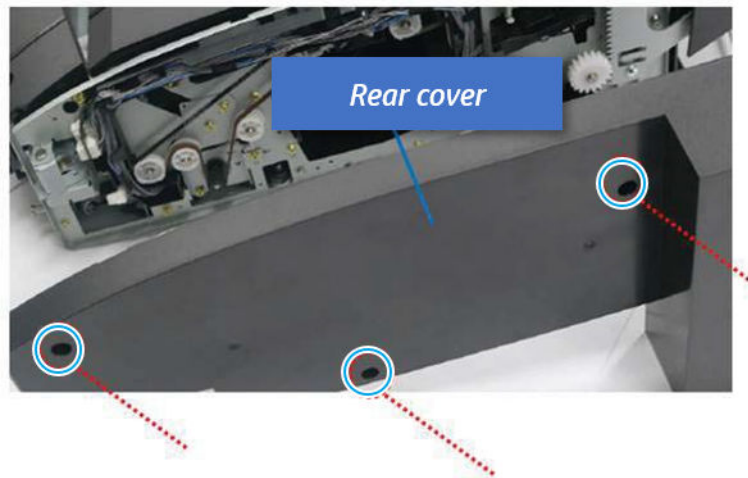

3. Remove the output tray.
 - a. Remove four screws.

Figure 5-640 Remove four screws

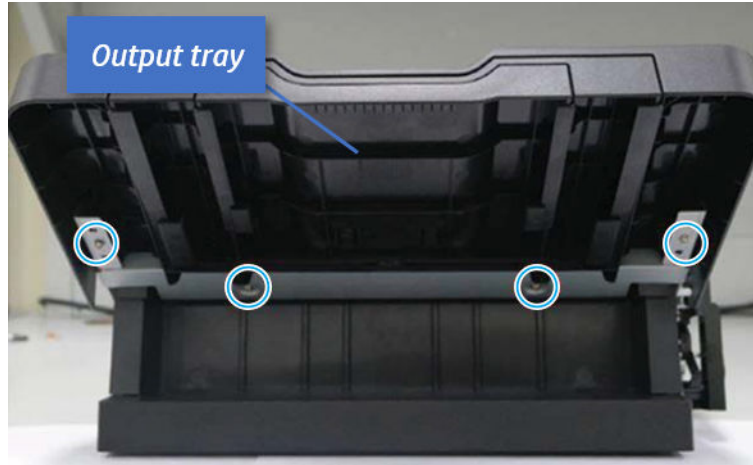

- b. Push the paper holding actuator into the inner finisher, and then remove the output tray.

Figure 5-641 Remove the output tray.



4. Remove the output tray frame.
 - a. Rotate the pulley until the output tray frame depart from the gear.

Figure 5-642 Remove the pulley

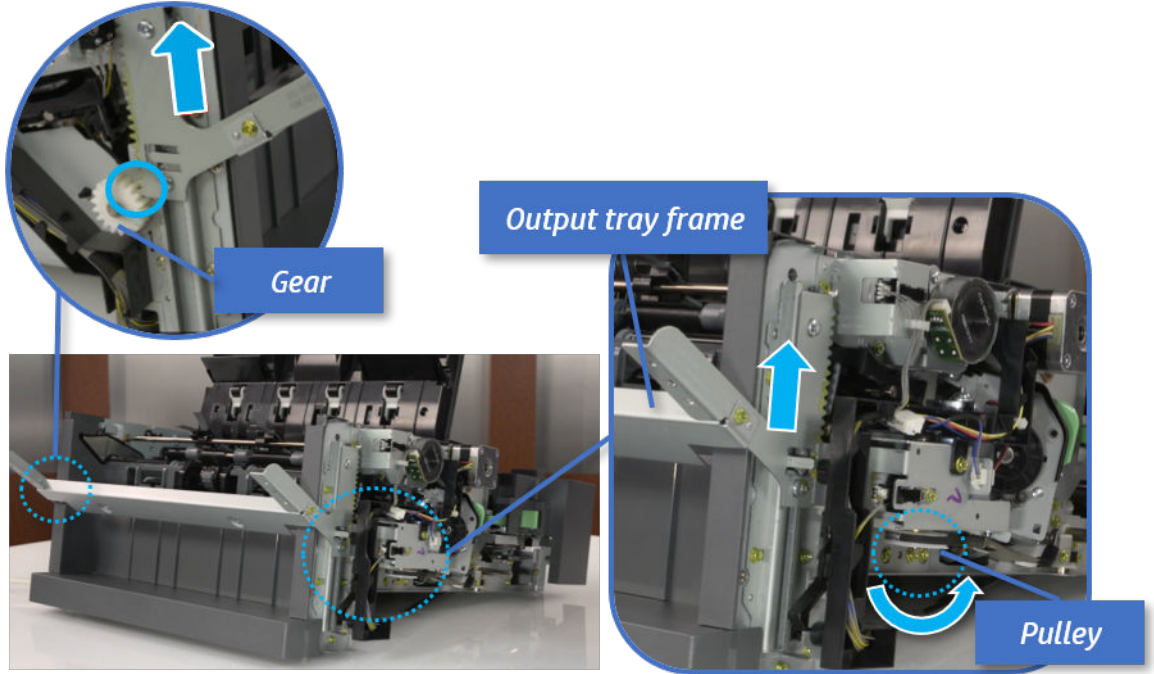

- b. Push the paper holding actuator into the inner finisher, and then remove the output tray frame.

Figure 5-643 Remove the output tray frame

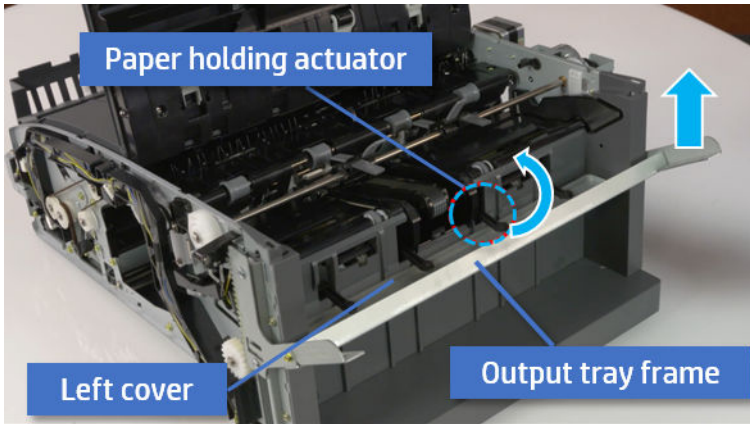

TIP: Push the paper holding actuator into the inner finisher when reassembling. Be sure to level the output tray.

1. Position the first wheel into the channel on both sides while pushing the paper holding actuator.

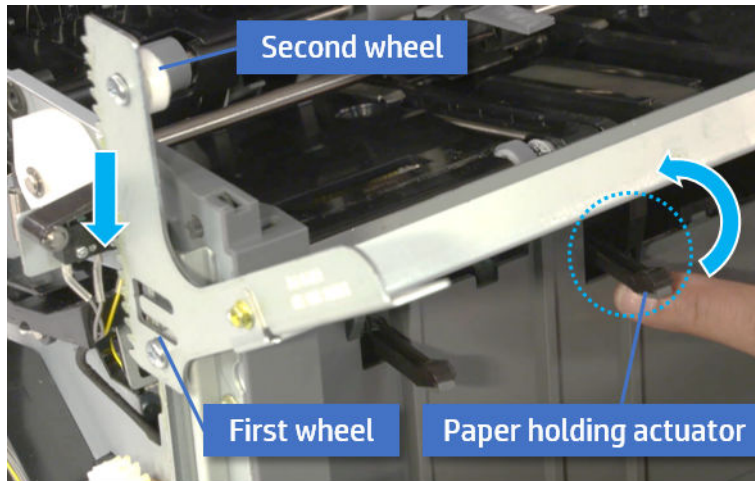

2. Let the second wheel rest on the channel on both sides simultaneously.
3. Gently squeeze the wheels into channel until the output tray frame meet the gear.

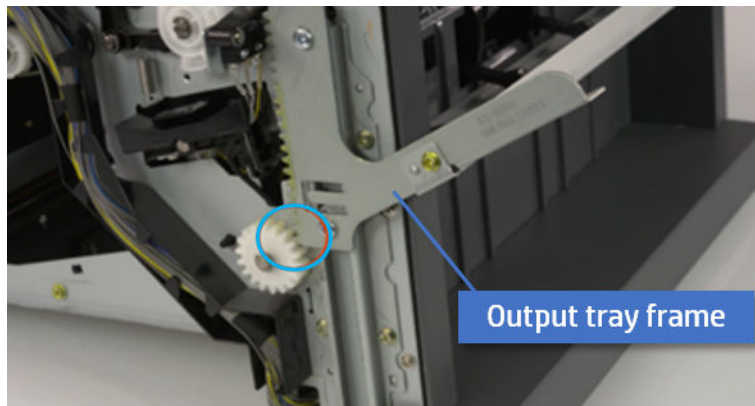

4. Rotate the pulley until the output tray frame is no longer lifted. It can make to level the output tray frame.

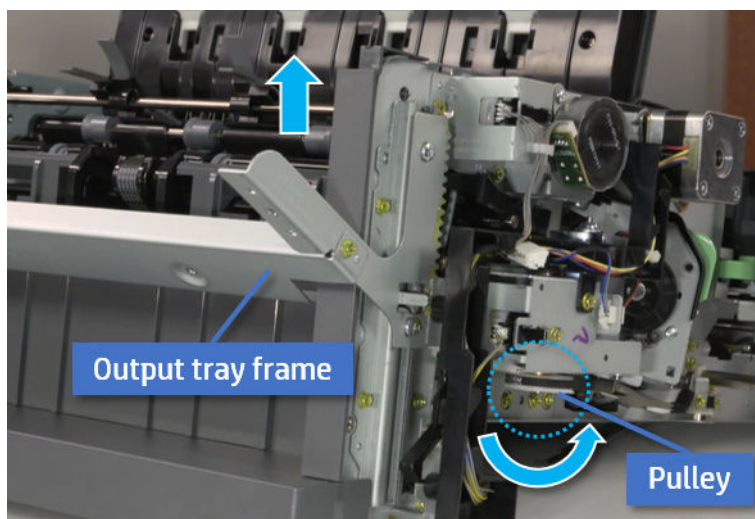

5. Rotate the pulley in the opposite direction.

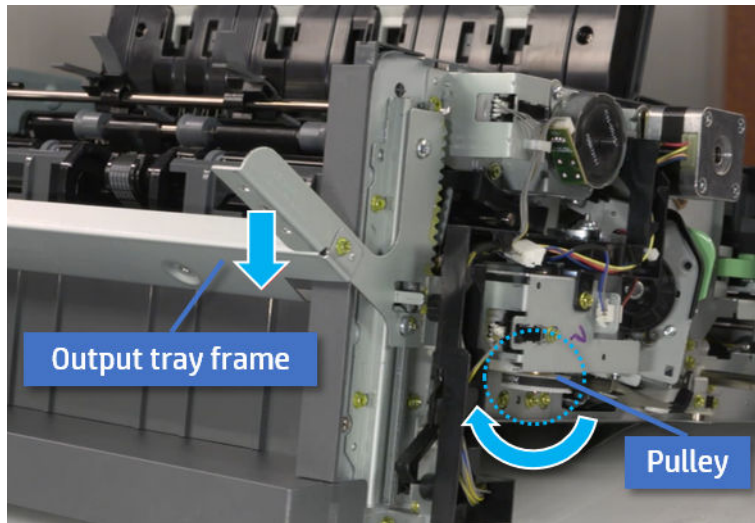

5. Remove the PCA cover.
 - ▲ Remove two screws, and then remove the PCA cover.

Figure 5-644 Remove the PCA cover

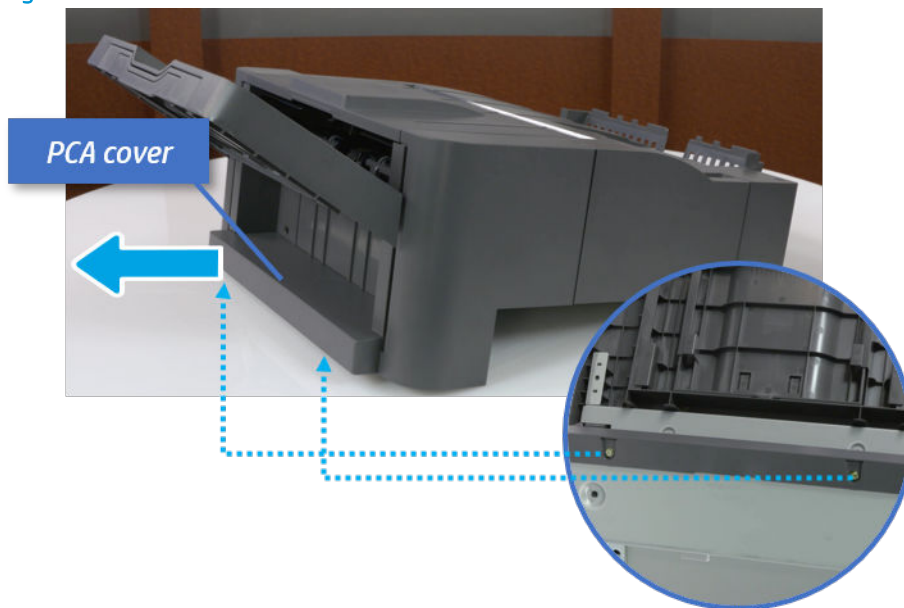

6. Remove the left cover.
 - a. Remove two screws.

Figure 5-645 Remove two screws

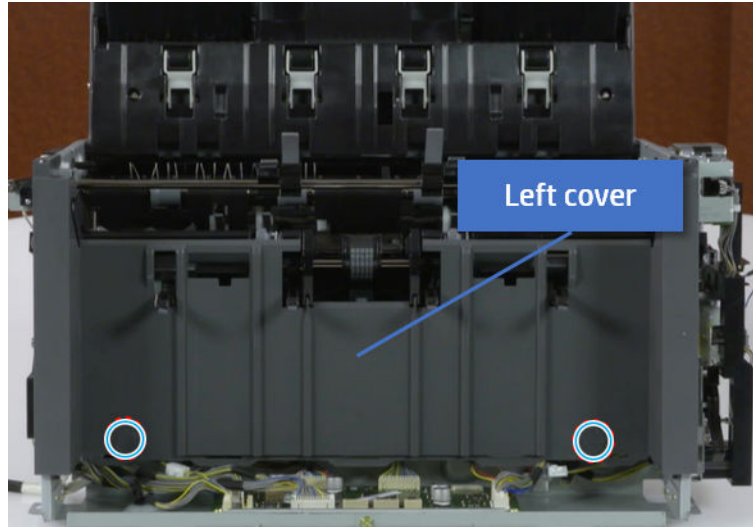

- b. Remove four screws from both front and rear sides.

Figure 5-646 Remove four screws

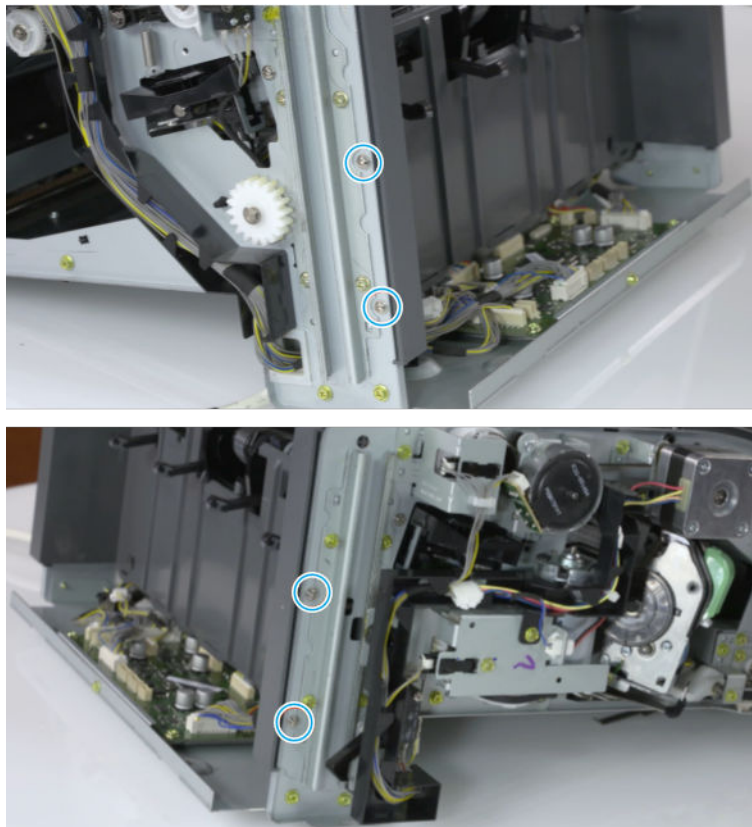

- c. Unplug two inline connectors, and then remove the left cover.

Figure 5-647 Unplug two connectors

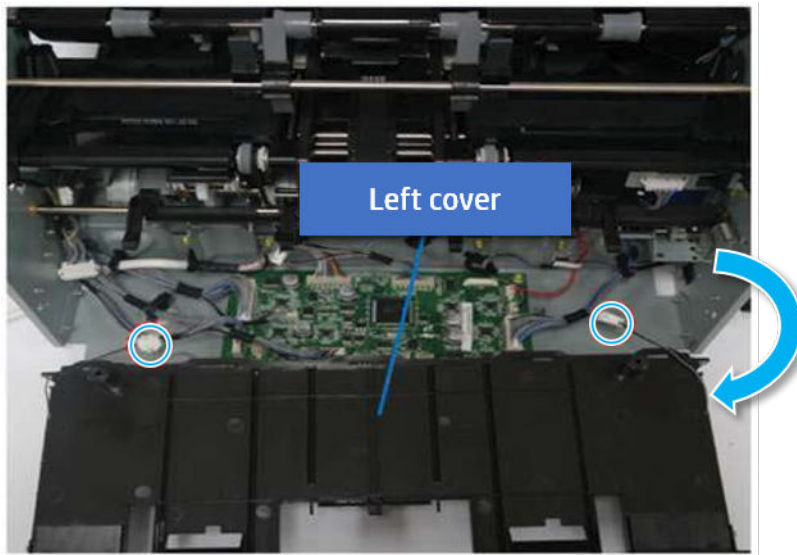

 **TIP:** Be sure to check the hook when reassembling.

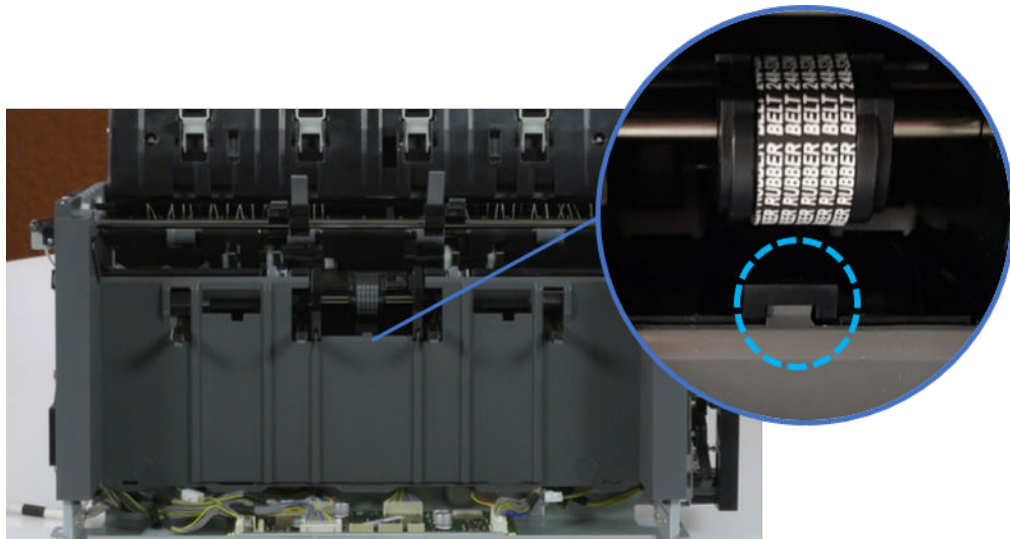

7. Remove the output tray top of stack sensor.

- ▲ Remove two screws from both sides of the left cover. Remove the bracket, and then remove the sensor.

Figure 5-648 Remove the output tray top of stack sensor



8. Unpack the replacement assembly.

- a. Dispose of the defective part.



NOTE: HP recommends responsible disposal of the defective part.

<http://www8.hp.com/us/en/hp-information/environment/product-recycling.html>

- b. Unpack the replacement part from the packaging.



CAUTION:



Some parts are sensitive to electrostatic discharge (ESD). Always perform service work at an ESD-protected workstation or mat. If an ESD workstation or mat is not available, touch the sheet-metal chassis to provide a static ground before touching an ESD-sensitive assembly. Protect the ESD-sensitive assemblies by placing them in ESD pouches when they are out of the printer.

If the replacement part is a roller or pad, avoid touching the spongy part of it. Skin oils on the roller or pad can cause paper pickup and/or print-quality problems. HP recommends using disposable gloves when handling rollers or pads or washing your hands before touching rollers or pads.



IMPORTANT: Make sure that all of the shipping materials (for example shipping tape) are removed from the replacement part prior to installation.

- c. To install an assembly, reverse the removal steps.

When applicable, special installation instructions are provided for an assembly at the end of the removal procedure. Always completely read the removal instructions and follow all special installation instructions.

Removal and replacement: Output tray lower limit switch (S7)

Learn how to remove and replace the output tray lower limit switch.

To view teardown&reassembling video of the inner finisher, click the link below.



[View a teardown video of the inner finisher .](#)



[View a reassembling video of the inner finisher .](#)



IMPORTANT: When applicable, special installation instructions are provided for an assembly at the end of the removal procedure. Always completely read the removal instructions and follow all special installation instructions.

Mean time to repair:

Service level:

Before performing service

Turn the printer power off

- Press the power button on the front of the printer, and then turn off the power switch next to the power cable.
- A shutting-down message appears on the control-panel display.

 **WARNING!** To avoid damage to the printer, turn the power off and wait until the printer shuts down before removing the power cable.

- Disconnect the printer power cable after the printer has completely shut down (the control-panel display is blank).

Use the table below to identify the correct part number for your printer. To order the part, go to <https://parts.hp.com>.

Table 5-65 Part information

Part number	Part description
JC90-01320A	Output tray lower limit switch

Required tools

- #2 JIS screwdriver with a magnetic tip

After performing service

Turn the printer power on

- Connect the power cable.
- Use the power switch to turn the power on.

Post service test

Print any pages necessary to verify that the repair resolved the issue and did not create any new issues.

1. Remove the front cover.
 - a. Open the front door and open the punch cover.
 - b. Remove three screws in the front.
 - c. Remove the lever.
 - d. Open the top cover.

- e. From the right side of the front cover, carefully lift and pry toward the top-left corner to remove the front cover.

Figure 5-649 Remove the front cover

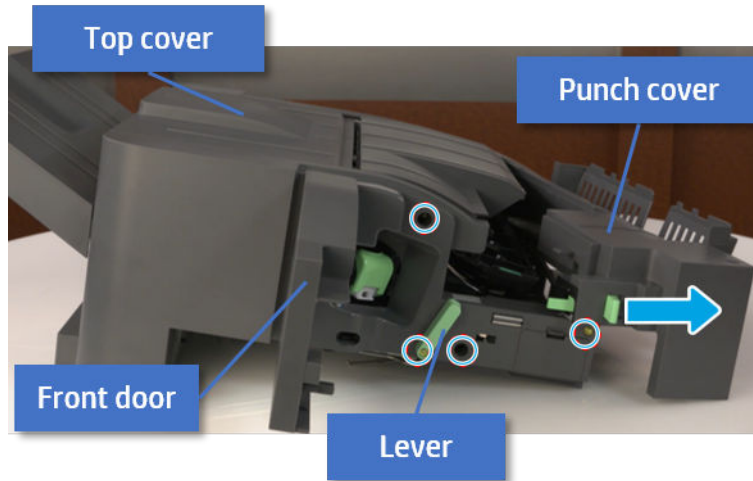

- 2. Remove the rear cover.
 - a. Open the top cover.

Figure 5-650 Open the top cover

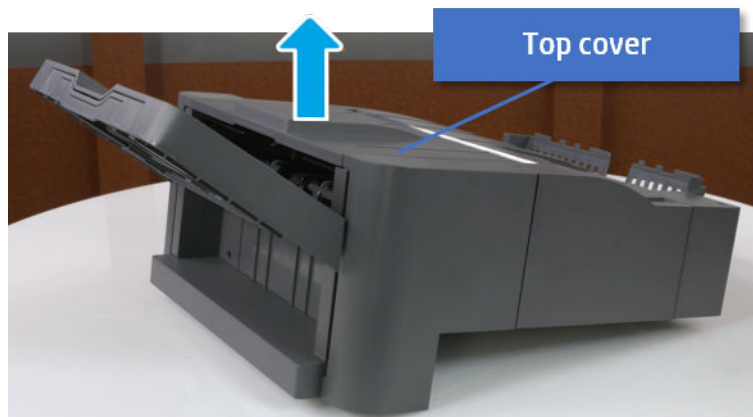

- b. Remove three screws.

- c. Release hooks carefully and remove the rear cover.

Figure 5-651 Remove the rear cover

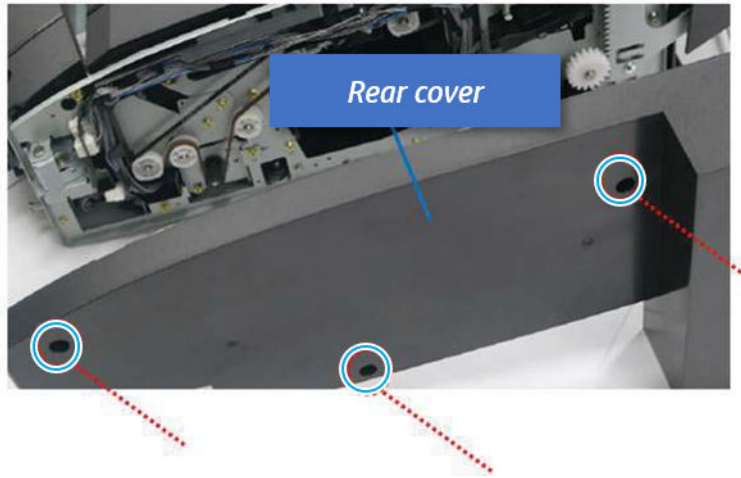

- 3. Remove the output tray.

- a. Remove four screws.

Figure 5-652 Remove four screws

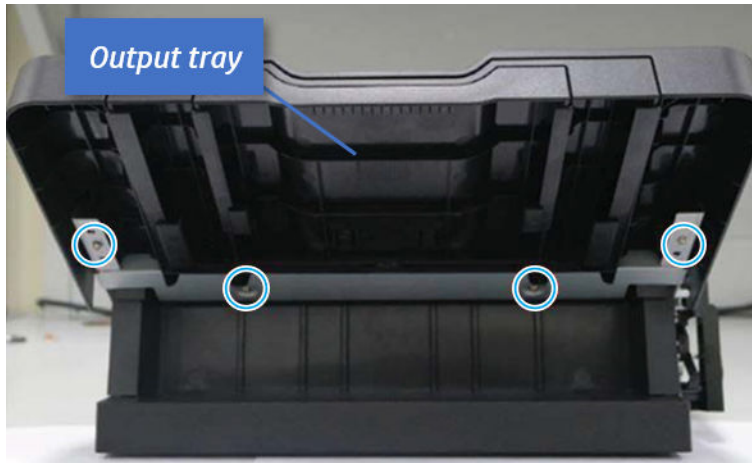

- b. Push the paper holding actuator into the inner finisher, and then remove the output tray.

Figure 5-653 Remove the output tray.



- 4. Remove the output tray frame.
 - a. Rotate the pulley until the output tray frame depart from the gear.

Figure 5-654 Remove the pulley

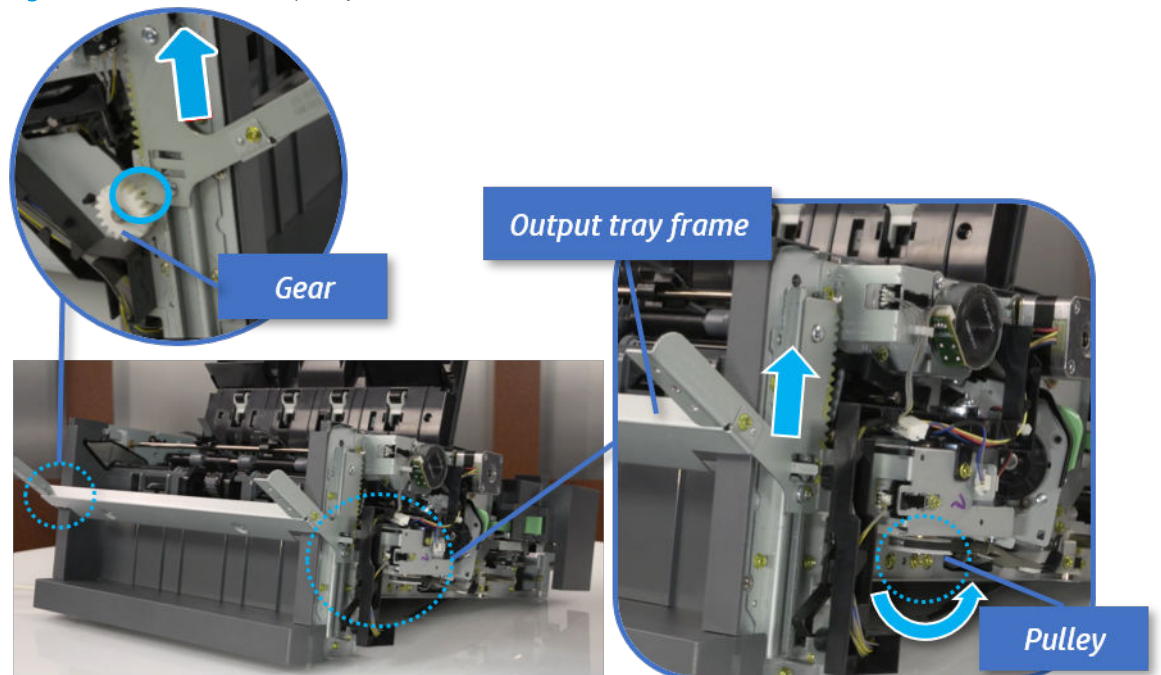

- b. Push the paper holding actuator into the inner finisher, and then remove the output tray frame.

Figure 5-655 Remove the output tray frame

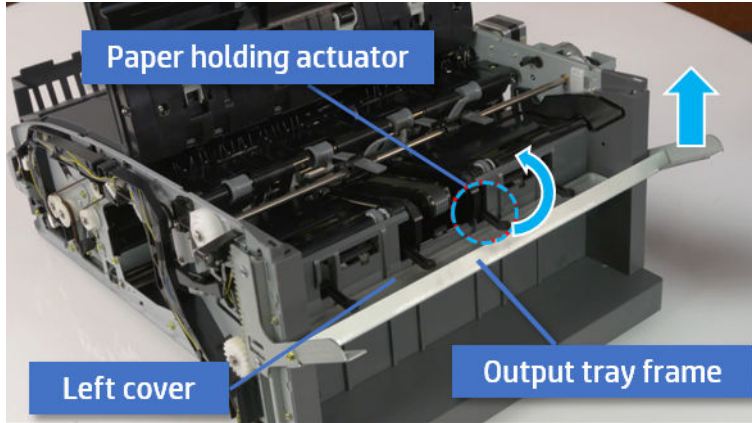

TIP: Push the paper holding actuator into the inner finisher when reassembling. Be sure to level the output tray.

1. Position the first wheel into the channel on both sides while pushing the paper holding actuator.

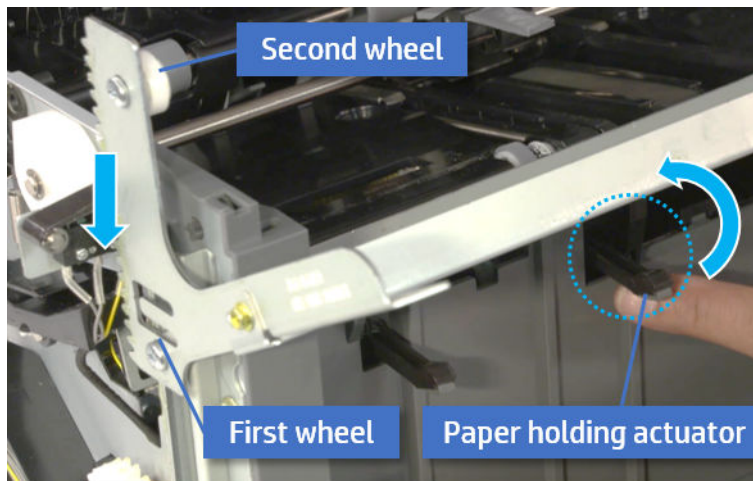

2. Let the second wheel rest on the channel on both sides simultaneously.
3. Gently squeeze the wheels into channel until the output tray frame meet the gear.

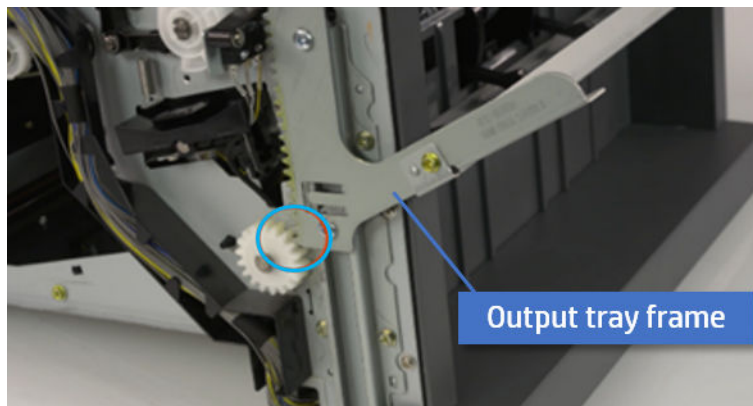

4. Rotate the pulley until the output tray frame is no longer lifted. It can make to level the output tray frame.

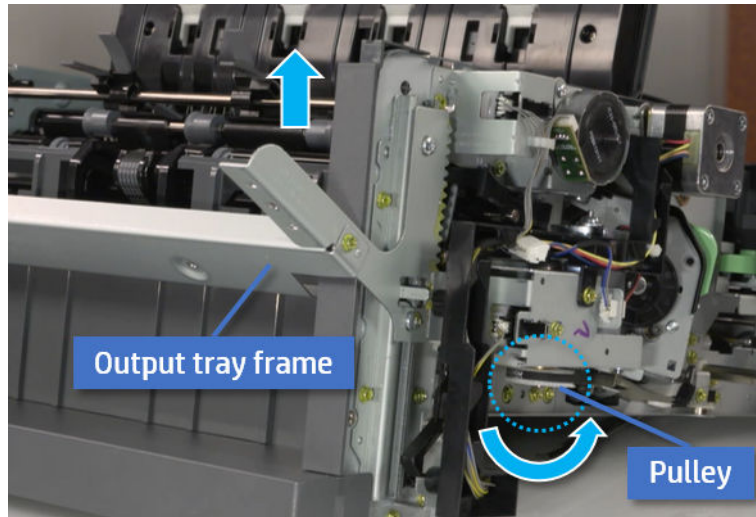

5. Rotate the pulley in the opposite direction.

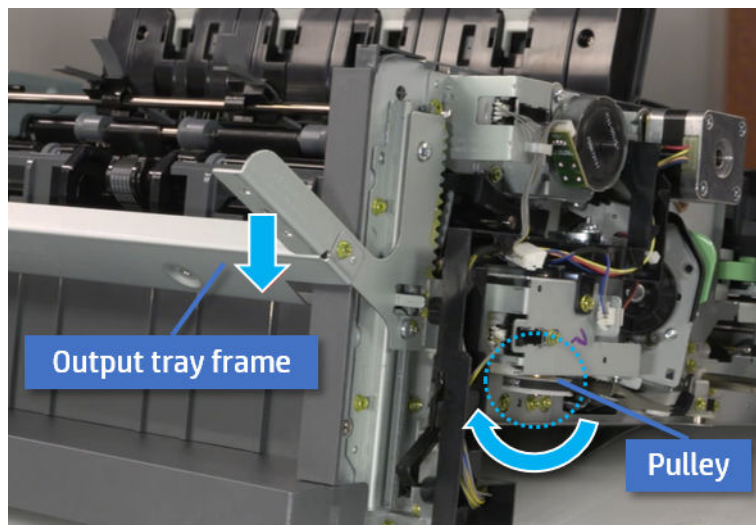

5. Remove the PCA cover.

- ▲ Remove two screws, and then remove the PCA cover.

Figure 5-656 Remove the PCA cover

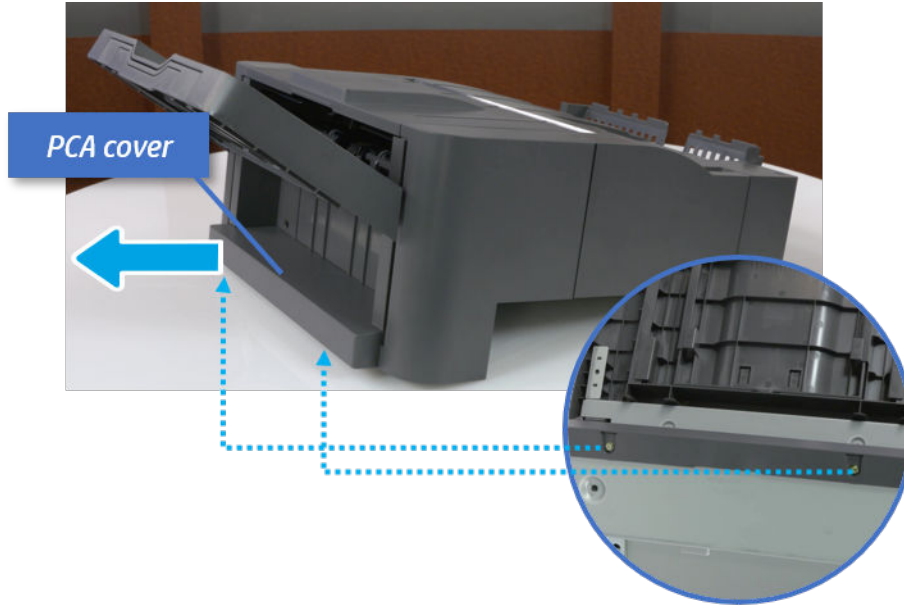

6. Remove the left cover.
 - a. Remove two screws.

Figure 5-657 Remove two screws

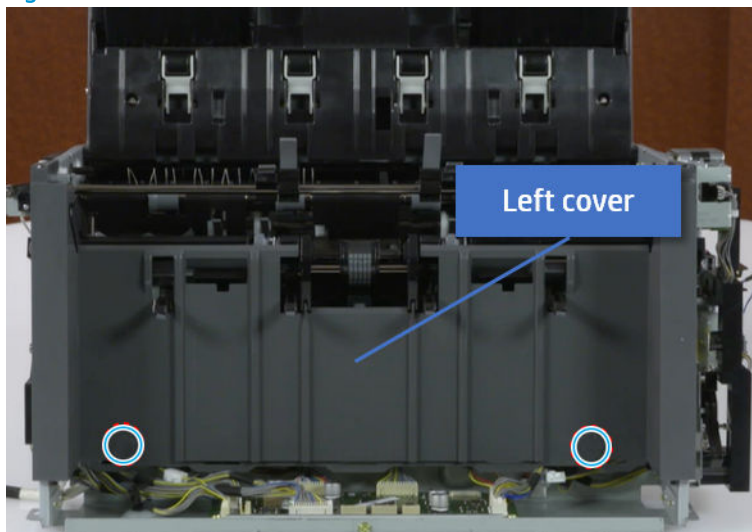

- b. Remove four screws from both front and rear sides.

Figure 5-658 Remove four screws

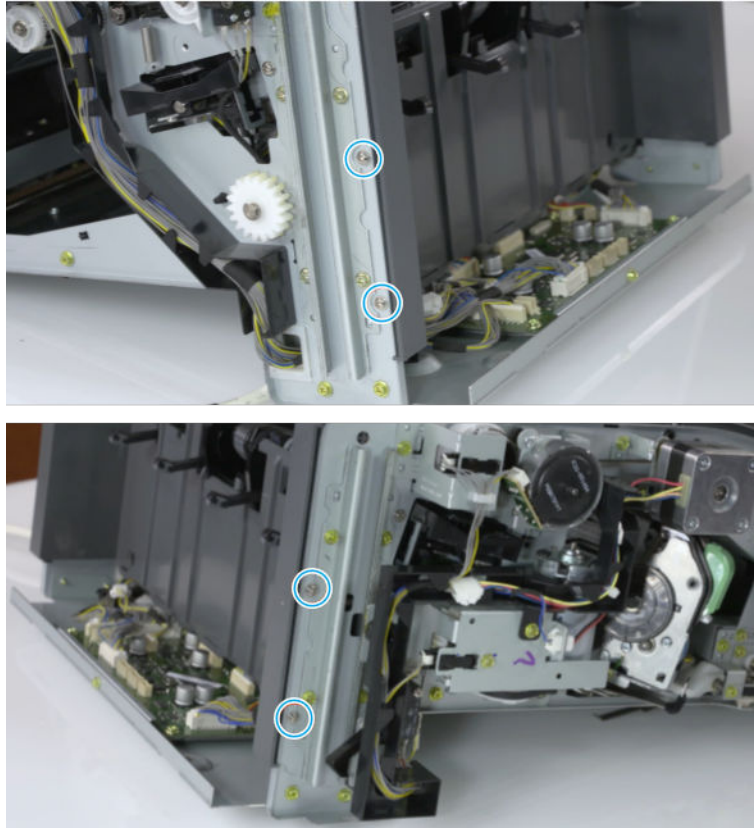

- c. Unplug two inline connectors, and then remove the left cover.

Figure 5-659 Unplug two connectors

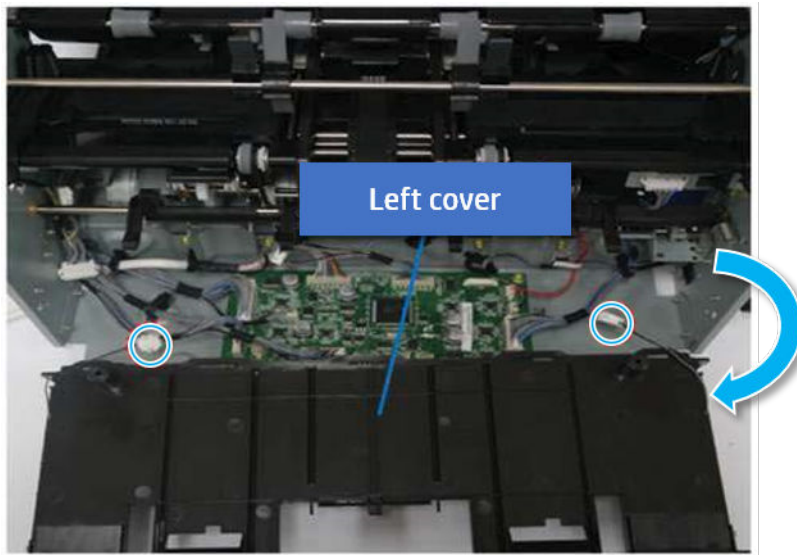

 **TIP:** Be sure to check the hook when reassembling.

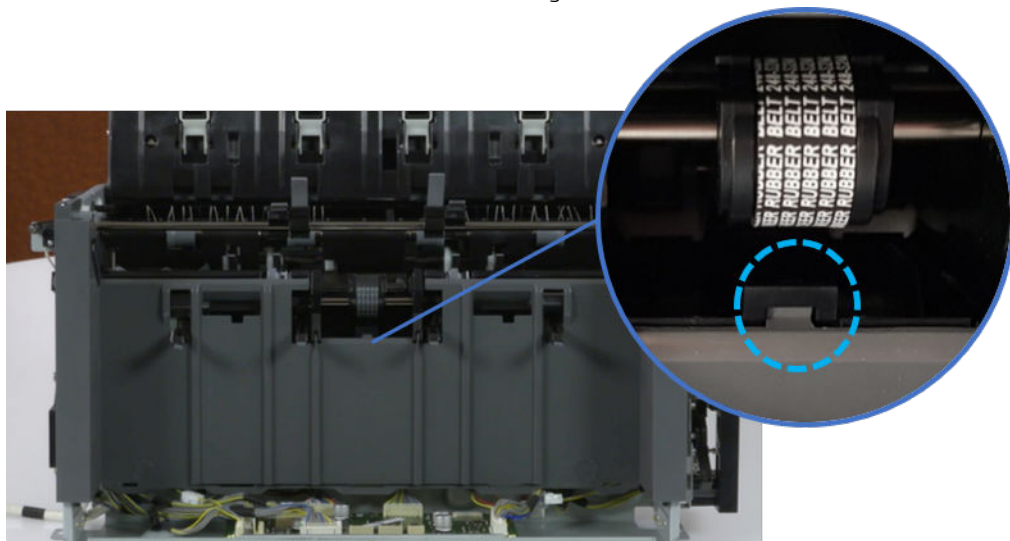

- 7. Remove the front harness guide.
 - a. Open one clamp and unplug five connectors, and then remove the wire harness from the front harness guide.

- b. Remove four screws, and then remove the front harness guide.

Figure 5-660 Remove the front harness guide

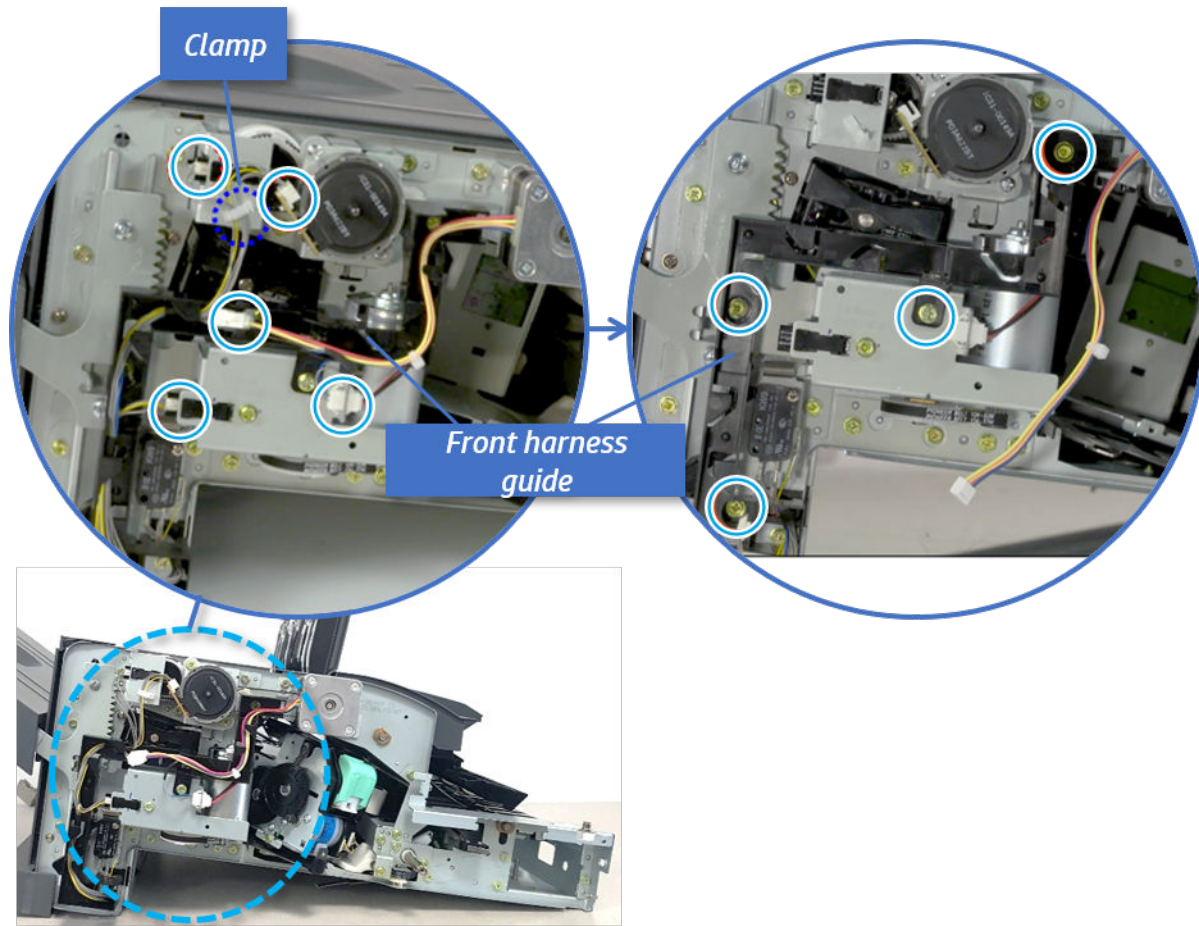

- 8. Remove the output tray lower limit switch.
 - ▲ Remove one screw, and then remove the output tray lower limit switch.

Figure 5-661 Remove the output tray lower limit switch

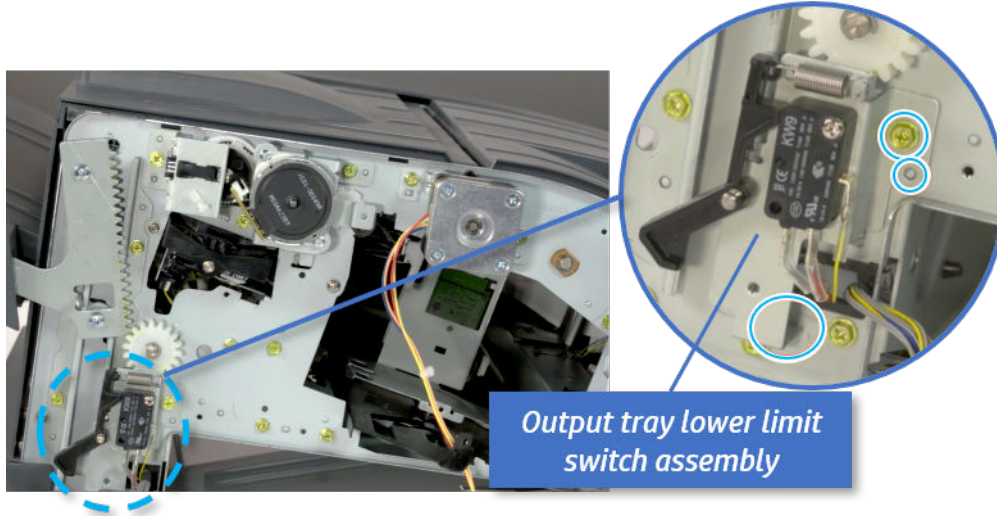



9. Unpack the replacement assembly.

a. Dispose of the defective part.

 **NOTE:** HP recommends responsible disposal of the defective part.

<http://www8.hp.com/us/en/hp-information/environment/product-recycling.html>

b. Unpack the replacement part from the packaging.

 **CAUTION:**  Some parts are sensitive to electrostatic discharge (ESD). Always perform service work at an ESD-protected workstation or mat. If an ESD workstation or mat is not available, touch the sheet-metal chassis to provide a static ground before touching an ESD-sensitive assembly. Protect the ESD-sensitive assemblies by placing them in ESD pouches when they are out of the printer.

If the replacement part is a roller or pad, avoid touching the spongy part of it. Skin oils on the roller or pad can cause paper pickup and/or print-quality problems. HP recommends using disposable gloves when handling rollers or pads or washing your hands before touching rollers or pads.

 **IMPORTANT:** Make sure that all of the shipping materials (for example shipping tape) are removed from the replacement part prior to installation.

c. To install an assembly, reverse the removal steps.

When applicable, special installation instructions are provided for an assembly at the end of the removal procedure. Always completely read the removal instructions and follow all special installation instructions.

Output tray motor assembly

Removal and replacement: Output tray motor assembly (M4)

Learn how to remove and replace the output tray motor assembly.

To view teardown&reassembling video of the inner finisher, click the link below.

 [View a teardown video of the inner finisher .](#)

 [View a reassembling video of the inner finisher .](#)

 **IMPORTANT:** When applicable, special installation instructions are provided for an assembly at the end of the removal procedure. Always completely read the removal instructions and follow all special installation instructions.

Mean time to repair:

Service level:

Before performing service

Turn the printer power off

- Press the power button on the front of the printer, and then turn off the power switch next to the power cable.
- A shutting-down message appears on the control-panel display.

 **WARNING!** To avoid damage to the printer, turn the power off and wait until the printer shuts down before removing the power cable.

- Disconnect the printer power cable after the printer has completely shut down (the control-panel display is blank).

Use the table below to identify the correct part number for your printer. To order the part, go to <https://parts.hp.com>.

Table 5-66 Part information

Part number	Part description
JC90-01334B	Output tray motor assembly

Required tools

- #2 JIS screwdriver with a magnetic tip

After performing service

Turn the printer power on

- Connect the power cable.
- Use the power switch to turn the power on.

Post service test

Print any pages necessary to verify that the repair resolved the issue and did not create any new issues.

1. Remove the front cover.
 - a. Open the front door and open the punch cover.
 - b. Remove three screws in the front.
 - c. Remove the lever.
 - d. Open the top cover.
 - e. From the right side of the front cover, carefully lift and pry toward the top-left corner to remove the front cover.

Figure 5-662 Remove the front cover

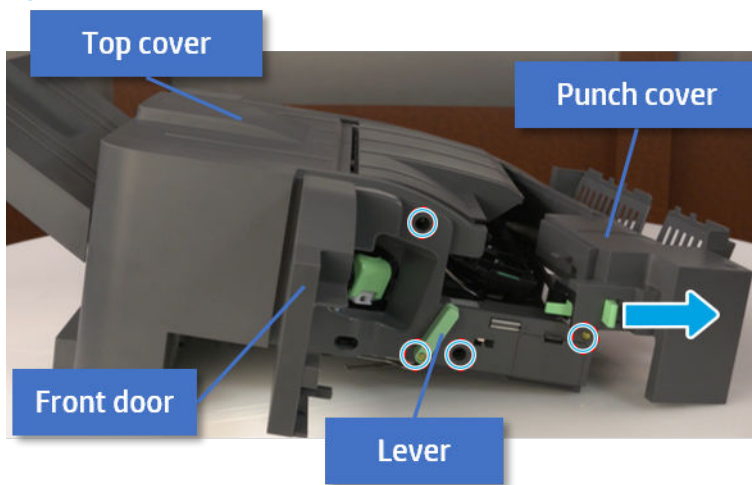

2. Remove the rear cover.
 - a. Open the top cover.

Figure 5-663 Open the top cover

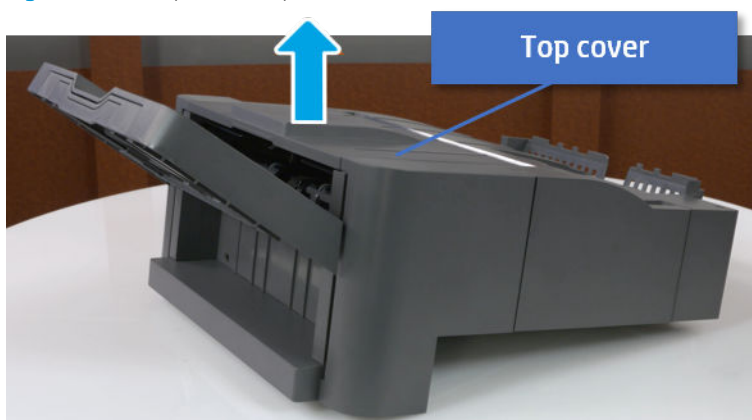

- b. Remove three screws.

- c. Release hooks carefully and remove the rear cover.

Figure 5-664 Remove the rear cover

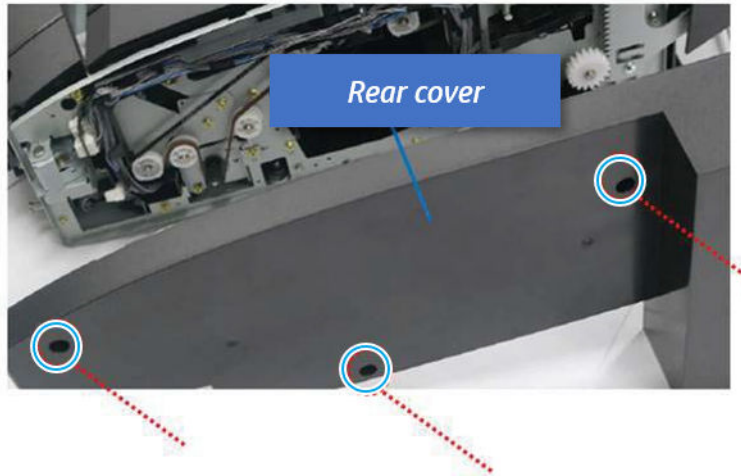

- 3. Remove the output tray.

- a. Remove four screws.

Figure 5-665 Remove four screws

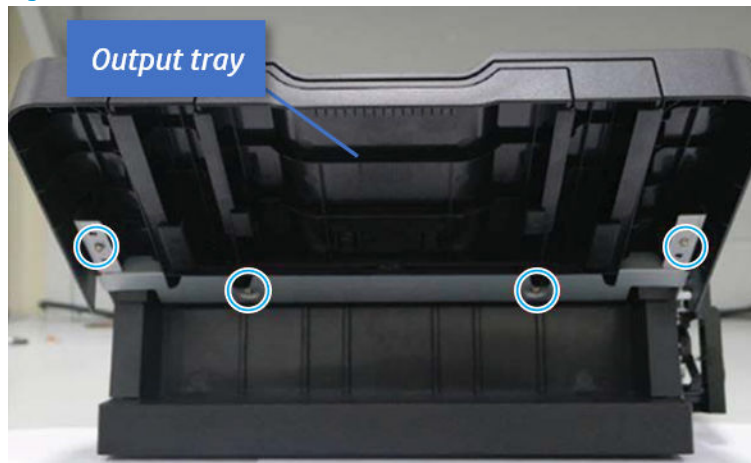

- b. Push the paper holding actuator into the inner finisher, and then remove the output tray.

Figure 5-666 Remove the output tray.



- 4. Remove the output tray frame.
 - a. Rotate the pulley until the output tray frame depart from the gear.

Figure 5-667 Remove the pulley

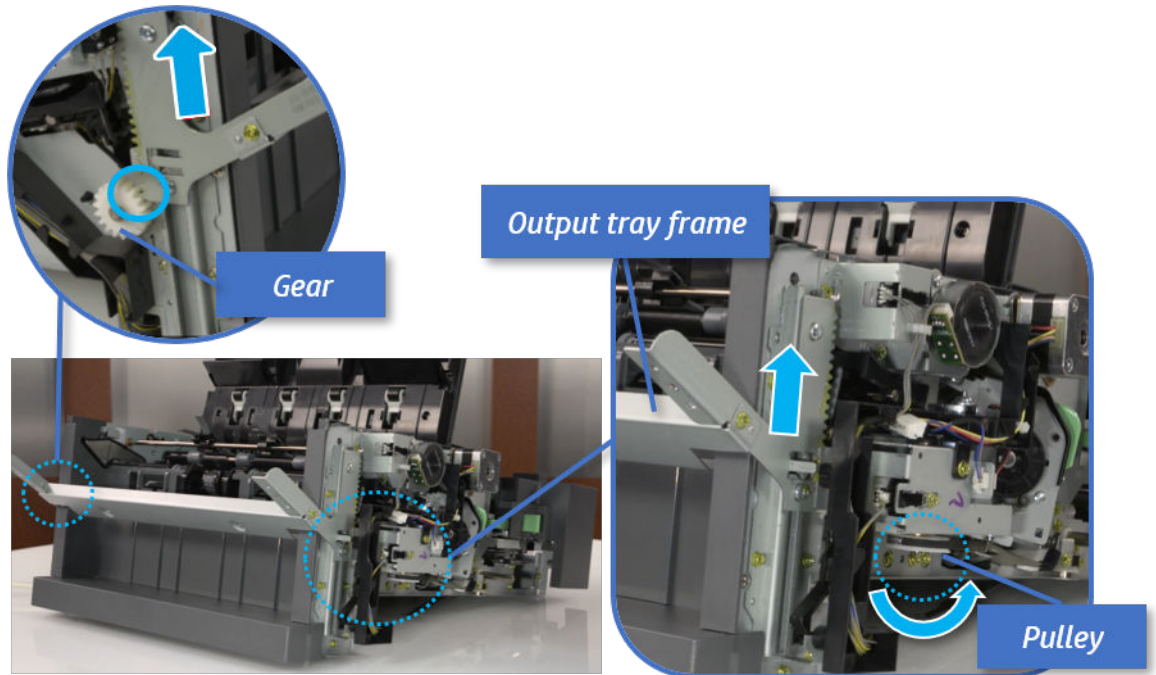

- b. Push the paper holding actuator into the inner finisher, and then remove the output tray frame.

Figure 5-668 Remove the output tray frame

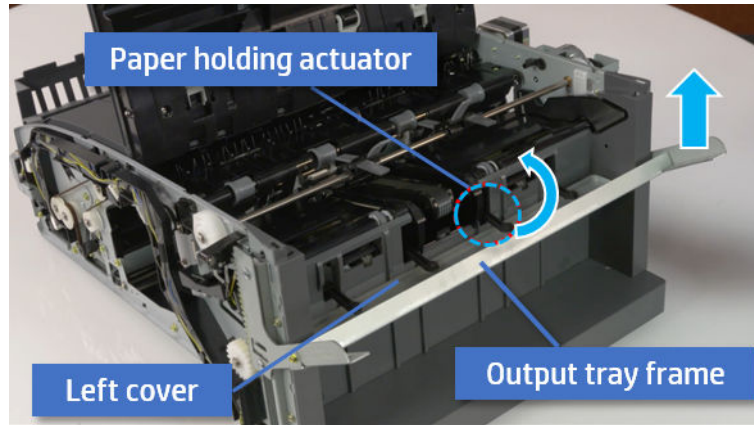

TIP: Push the paper holding actuator into the inner finisher when reassembling. Be sure to level the output tray.

1. Position the first wheel into the channel on both sides while pushing the paper holding actuator.

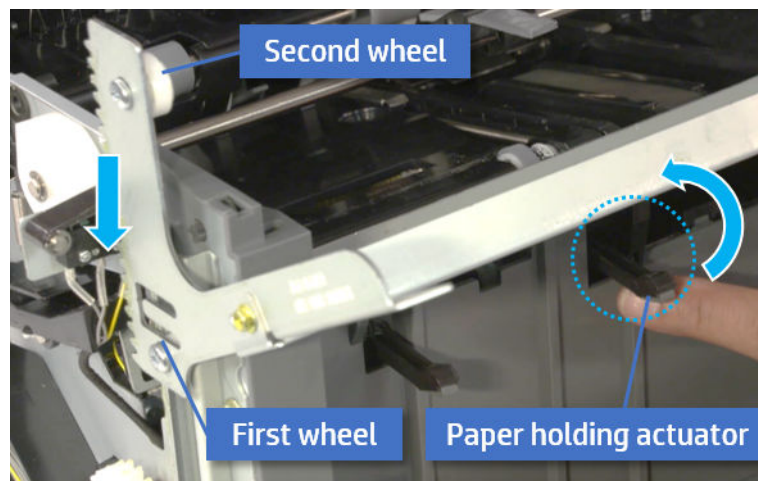

2. Let the second wheel rest on the channel on both sides simultaneously.
3. Gently squeeze the wheels into channel until the output tray frame meet the gear.

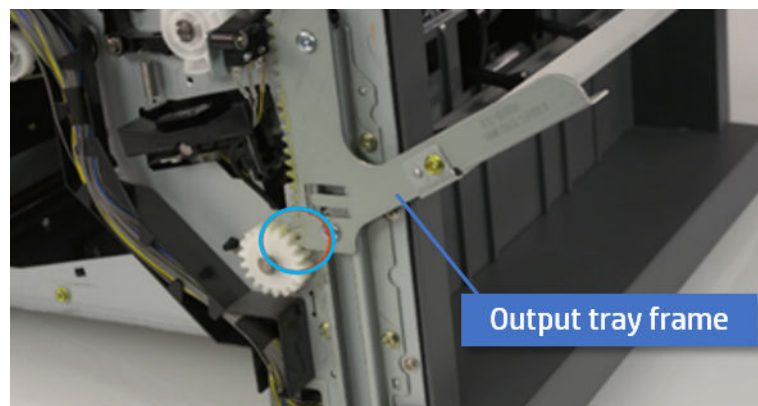

4. Rotate the pulley until the output tray frame is no longer lifted. It can make to level the output tray frame.

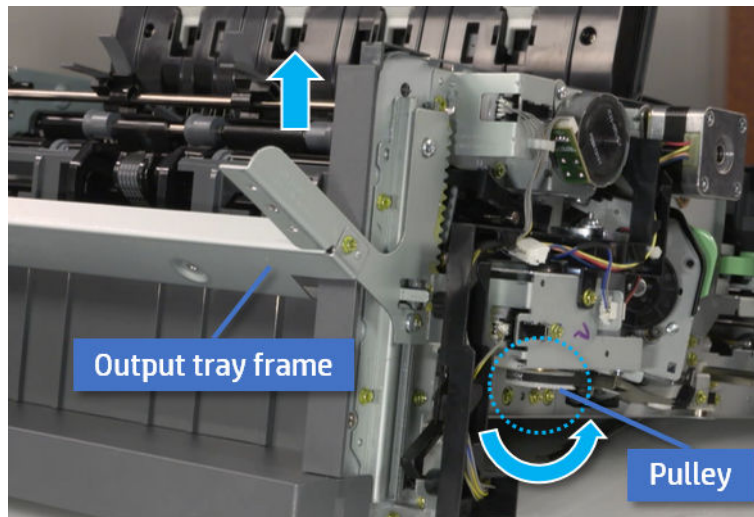

5. Rotate the pulley in the opposite direction.

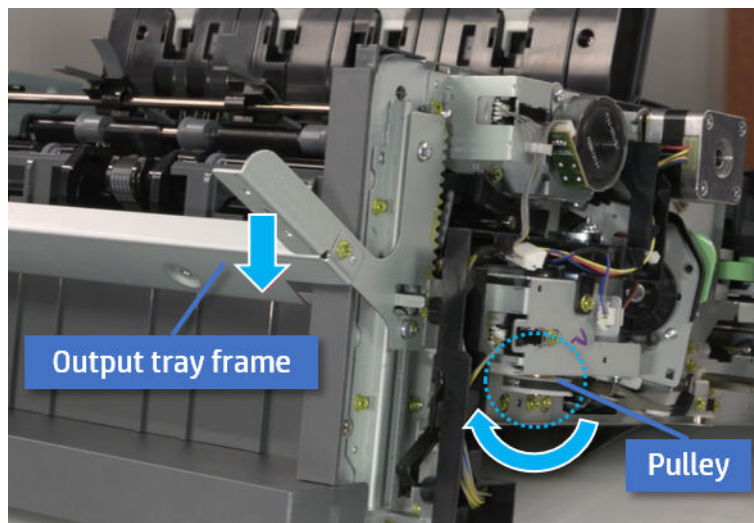

5. Remove the PCA cover.
 - ▲ Remove two screws, and then remove the PCA cover.

Figure 5-669 Remove the PCA cover

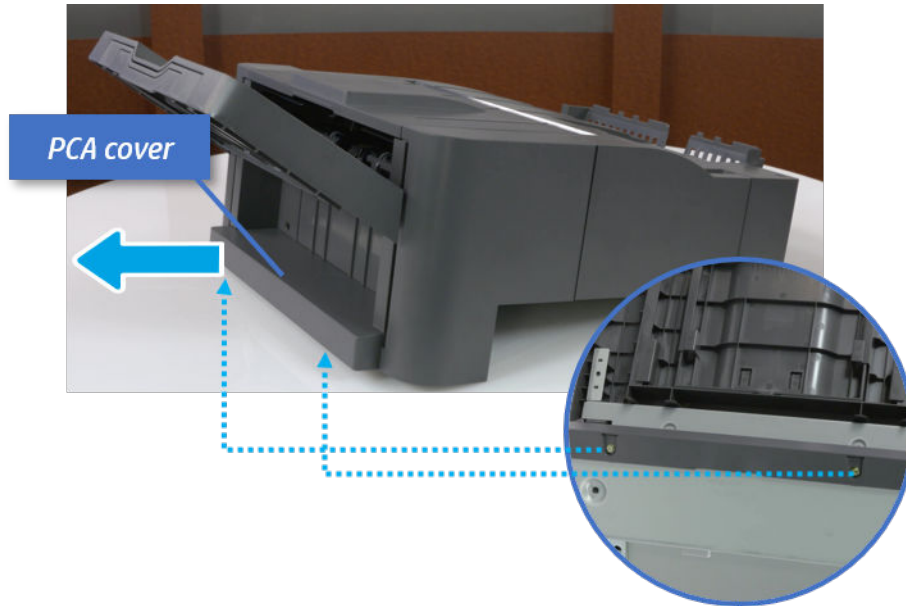

6. Remove the left cover.
 - a. Remove two screws.

Figure 5-670 Remove two screws

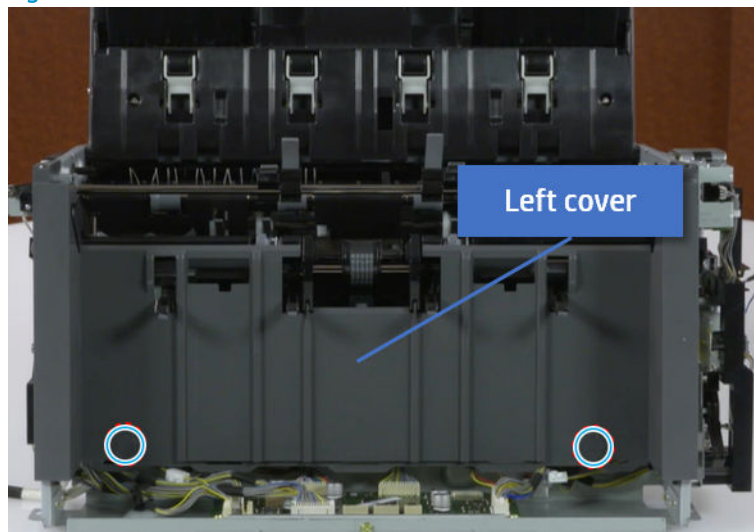

- b. Remove four screws from both front and rear sides.

Figure 5-671 Remove four screws

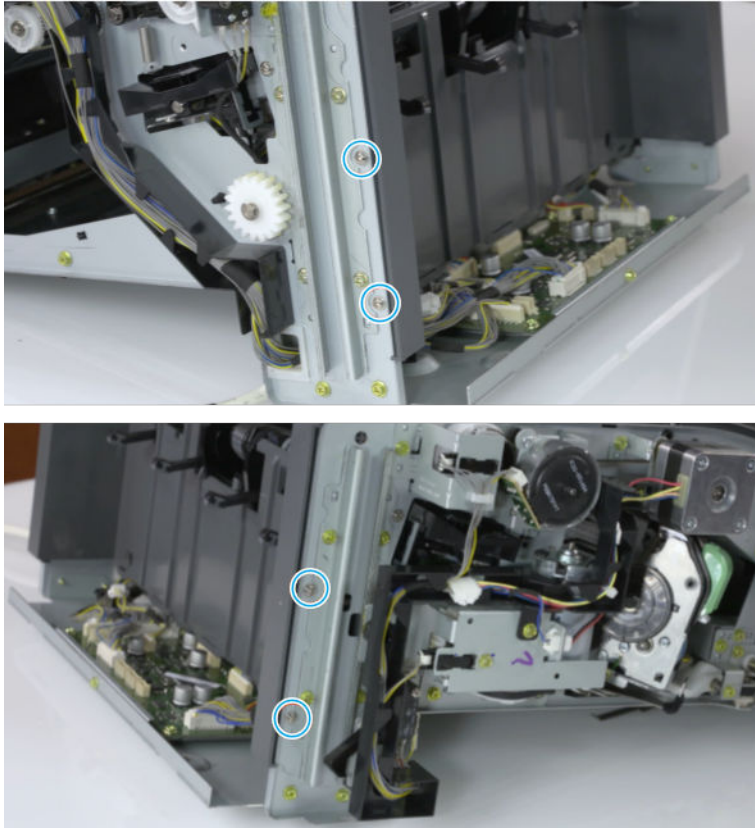

- c. Unplug two inline connectors, and then remove the left cover.

Figure 5-672 Unplug two connectors

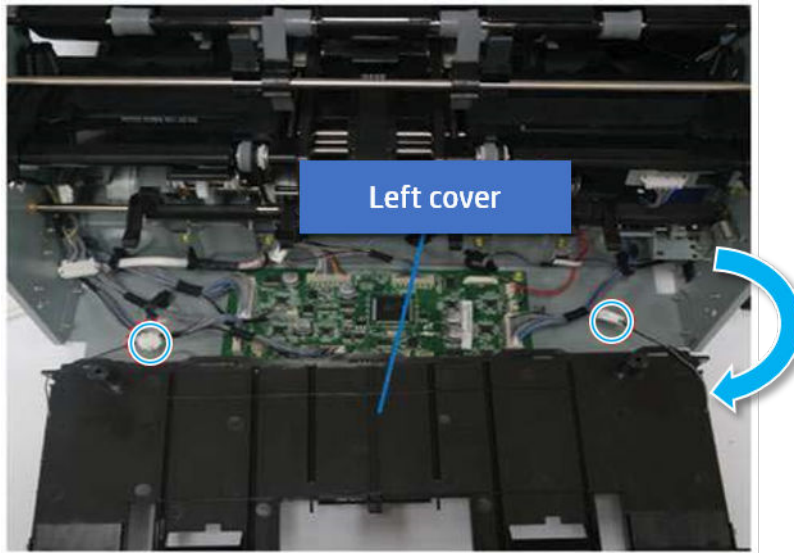

 **TIP:** Be sure to check the hook when reassembling.

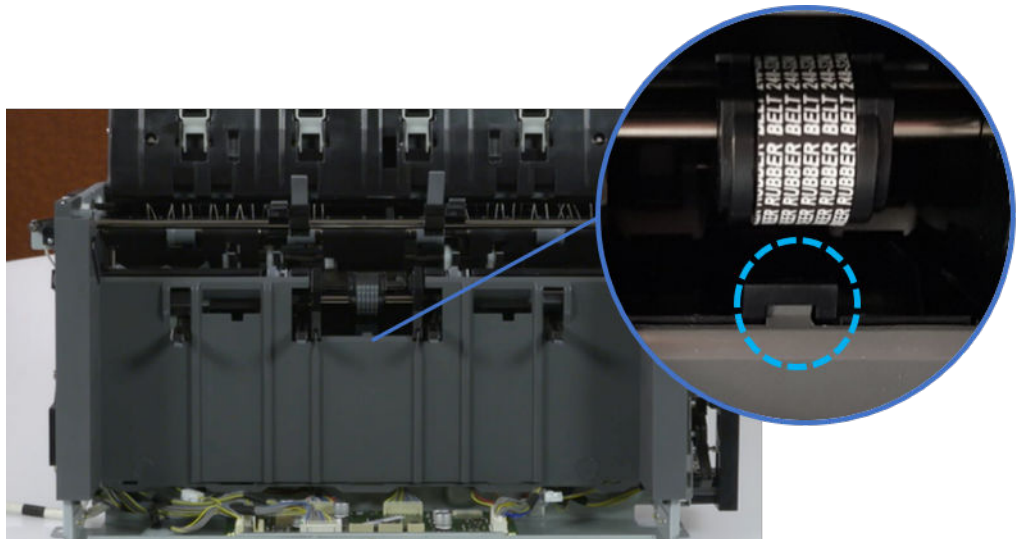

- 7. Remove the front harness guide.
 - a. Open one clamp and unplug five connectors, and then remove the wire harness from the front harness guide.

- b. Remove four screws, and then remove the front harness guide.

Figure 5-673 Remove the front harness guide

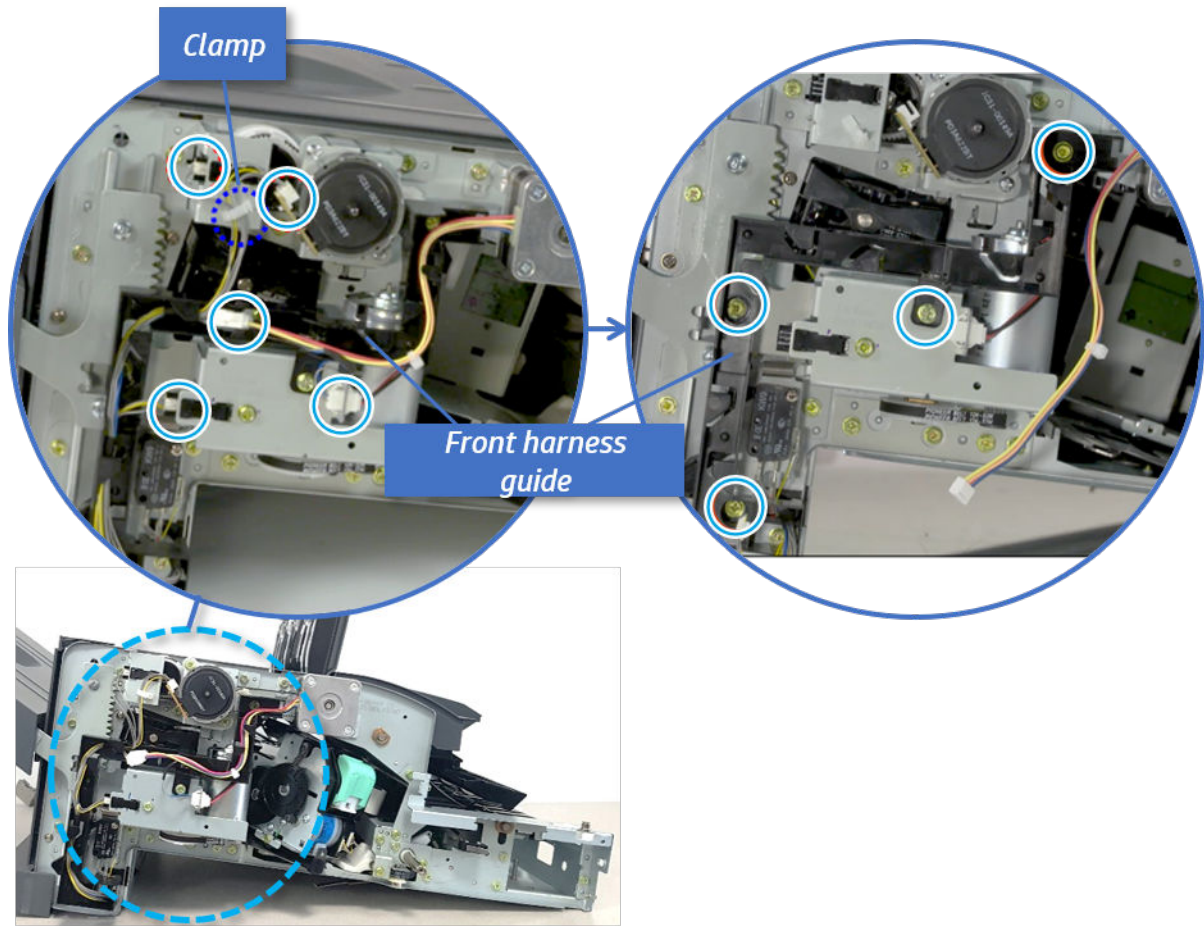

8. Remove the output tray motor assembly.
- ▲ Remove three screws, and then remove the output tray motor assembly.

Figure 5-674 Remove the output tray motor assembly

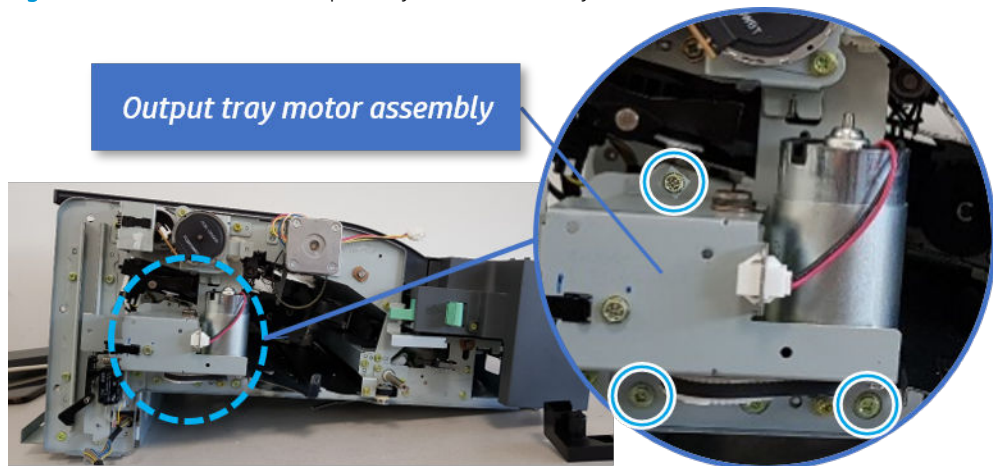

9. Unpack the replacement assembly.

- a. Dispose of the defective part.



NOTE: HP recommends responsible disposal of the defective part.

<http://www8.hp.com/us/en/hp-information/environment/product-recycling.html>

- b. Unpack the replacement part from the packaging.



CAUTION:



Some parts are sensitive to electrostatic discharge (ESD). Always perform service

work at an ESD-protected workstation or mat. If an ESD workstation or mat is not available, touch the sheet-metal chassis to provide a static ground before touching an ESD-sensitive assembly. Protect the ESD-sensitive assemblies by placing them in ESD pouches when they are out of the printer.

If the replacement part is a roller or pad, avoid touching the spongy part of it. Skin oils on the roller or pad can cause paper pickup and/or print-quality problems. HP recommends using disposable gloves when handling rollers or pads or washing your hands before touching rollers or pads.



IMPORTANT: Make sure that all of the shipping materials (for example shipping tape) are removed from the replacement part prior to installation.

- c. To install an assembly, reverse the removal steps.

When applicable, special installation instructions are provided for an assembly at the end of the removal procedure. Always completely read the removal instructions and follow all special installation instructions.

Removal and replacement: Output tray motor sensor (S6)

Learn how to remove and replace the output tray motor sensor.

To view teardown&reassembling video of the inner finisher, click the link below.



[View a teardown video of the inner finisher .](#)



[View a reassembling video of the inner finisher .](#)



IMPORTANT: When applicable, special installation instructions are provided for an assembly at the end of the removal procedure. Always completely read the removal instructions and follow all special installation instructions.

Mean time to repair:

Service level:

Before performing service

Turn the printer power off

- Press the power button on the front of the printer, and then turn off the power switch next to the power cable.
- A shutting-down message appears on the control-panel display.

 **WARNING!** To avoid damage to the printer, turn the power off and wait until the printer shuts down before removing the power cable.

- Disconnect the printer power cable after the printer has completely shut down (the control-panel display is blank).

Use the table below to identify the correct part number for your printer. To order the part, go to <https://parts.hp.com>.

Table 5-67 Part information

Part number	Part description
0604-001393	Output tray motor sensor

Required tools

- #2 JIS screwdriver with a magnetic tip

After performing service

Turn the printer power on

- Connect the power cable.
- Use the power switch to turn the power on.

Post service test

Print any pages necessary to verify that the repair resolved the issue and did not create any new issues.

1. Remove the front cover.
 - a. Open the front door and open the punch cover.
 - b. Remove three screws in the front.
 - c. Remove the lever.
 - d. Open the top cover.

- e. From the right side of the front cover, carefully lift and pry toward the top-left corner to remove the front cover.

Figure 5-675 Remove the front cover

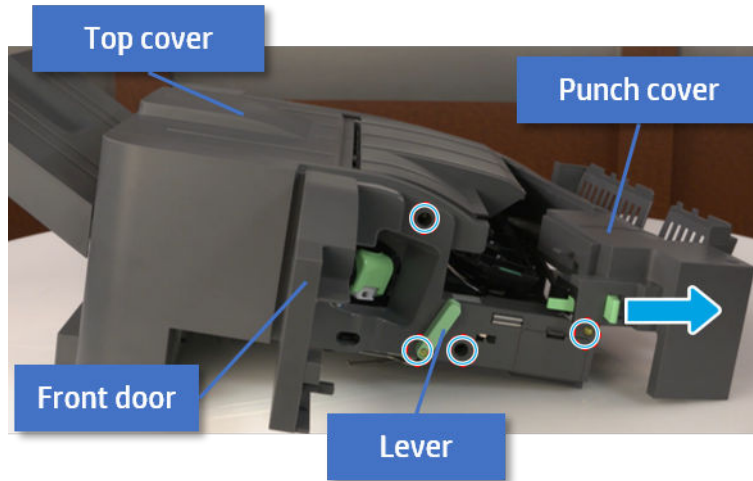

- 2. Remove the rear cover.
 - a. Open the top cover.

Figure 5-676 Open the top cover

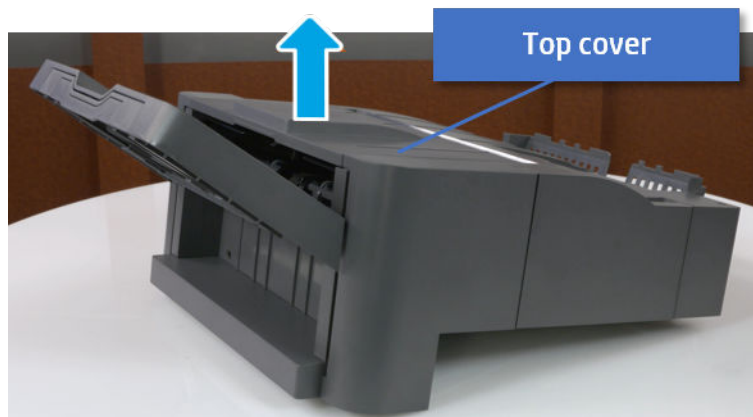

- b. Remove three screws.

- c. Release hooks carefully and remove the rear cover.

Figure 5-677 Remove the rear cover

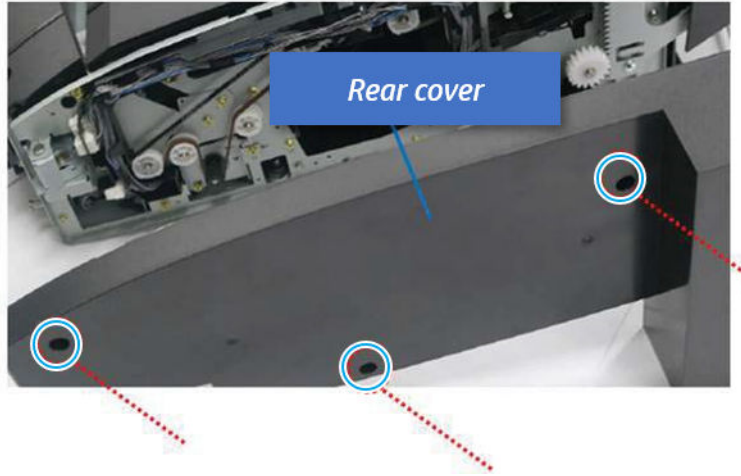

- 3. Remove the output tray.

- a. Remove four screws.

Figure 5-678 Remove four screws

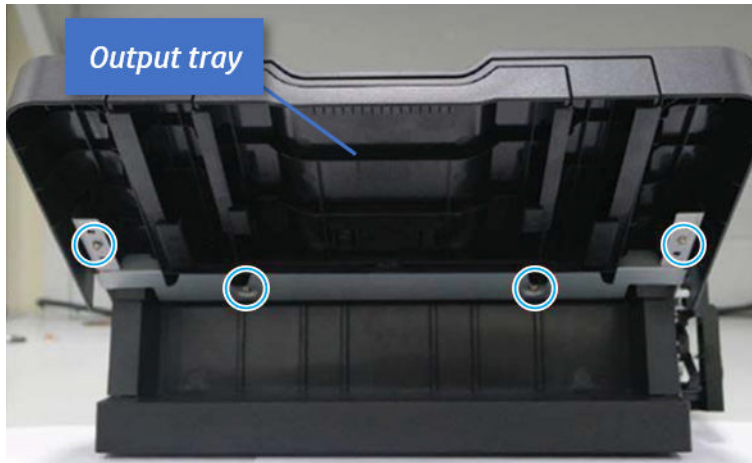

- b. Push the paper holding actuator into the inner finisher, and then remove the output tray.

Figure 5-679 Remove the output tray.



- 4. Remove the output tray frame.
 - a. Rotate the pulley until the output tray frame depart from the gear.

Figure 5-680 Remove the pulley

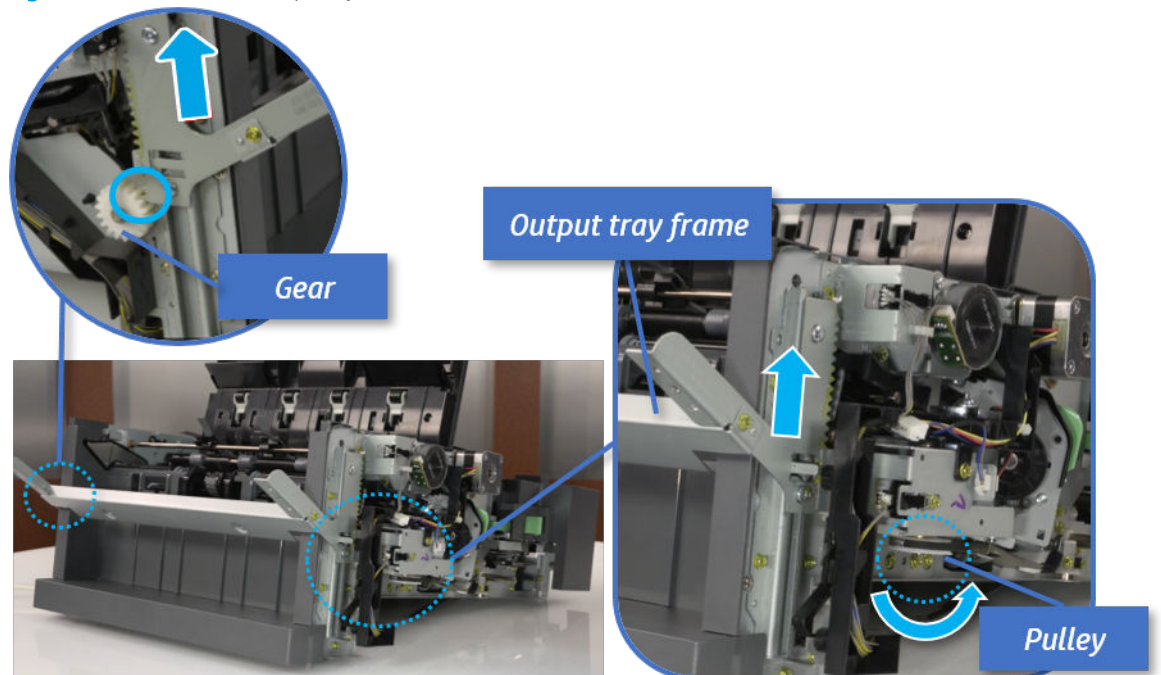

- b. Push the paper holding actuator into the inner finisher, and then remove the output tray frame.

Figure 5-681 Remove the output tray frame

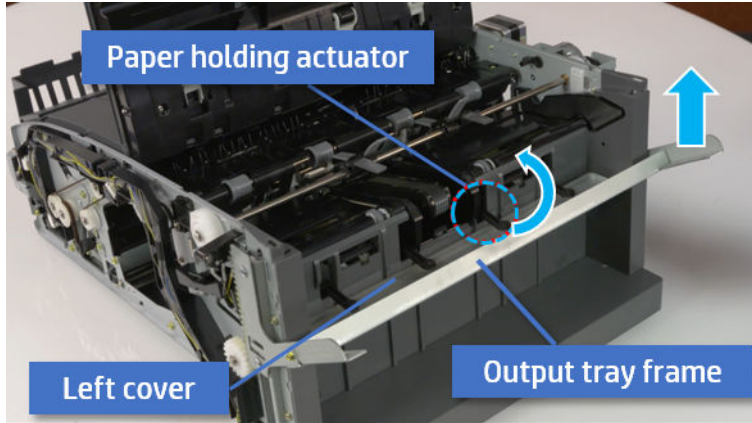

 **TIP:** Push the paper holding actuator into the inner finisher when reassembling. Be sure to level the output tray.

1. Position the first wheel into the channel on both sides while pushing the paper holding actuator.

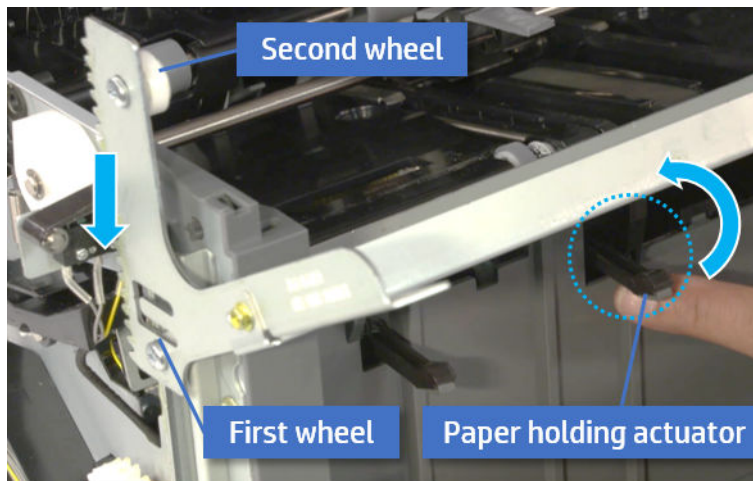

2. Let the second wheel rest on the channel on both sides simultaneously.
3. Gently squeeze the wheels into channel until the output tray frame meet the gear.

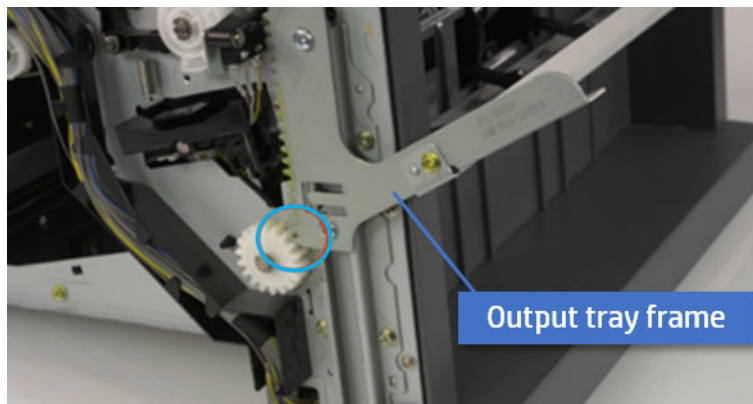

4. Rotate the pulley until the output tray frame is no longer lifted. It can make to level the output tray frame.

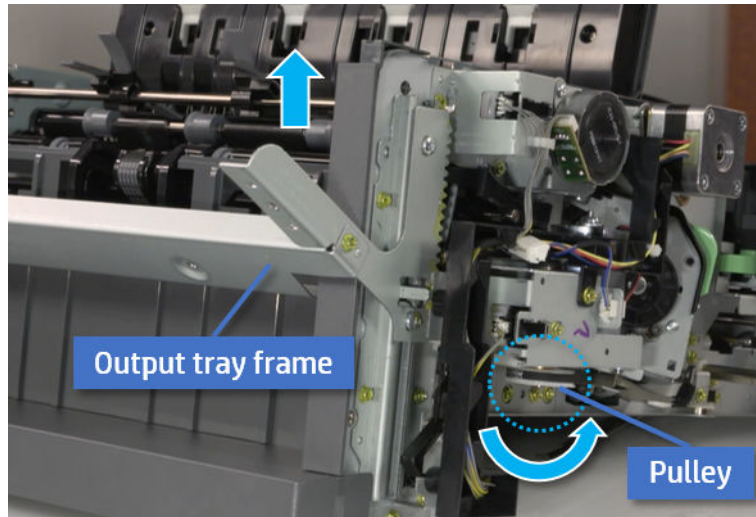

5. Rotate the pulley in the opposite direction.

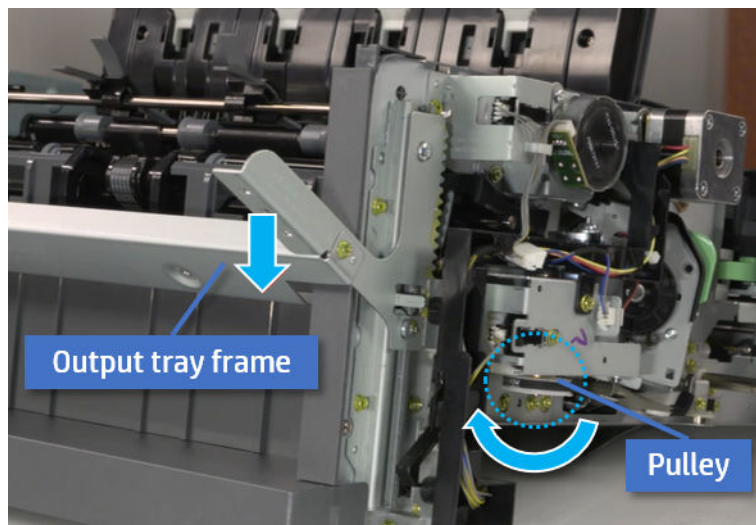

5. Remove the PCA cover.

- ▲ Remove two screws, and then remove the PCA cover.

Figure 5-682 Remove the PCA cover

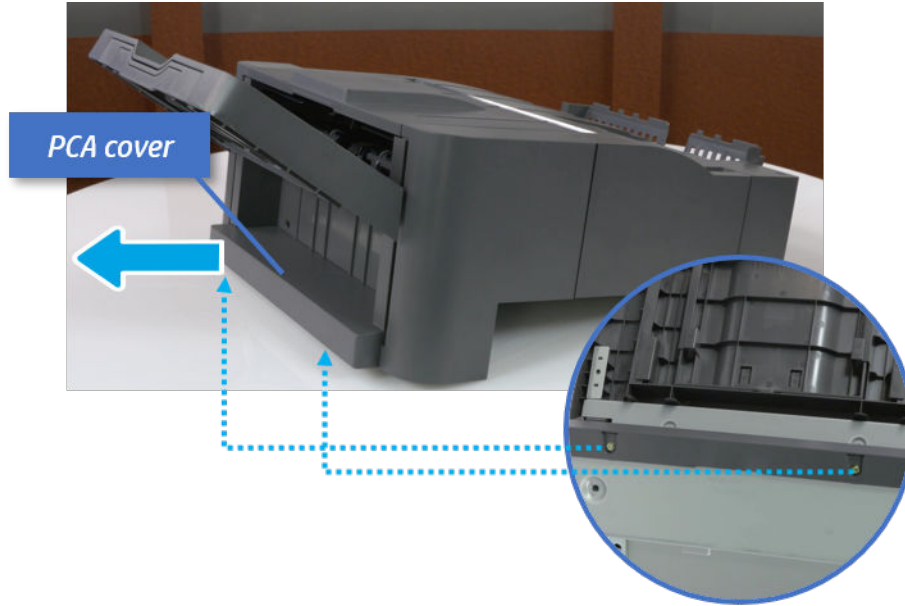

6. Remove the left cover.
 - a. Remove two screws.

Figure 5-683 Remove two screws

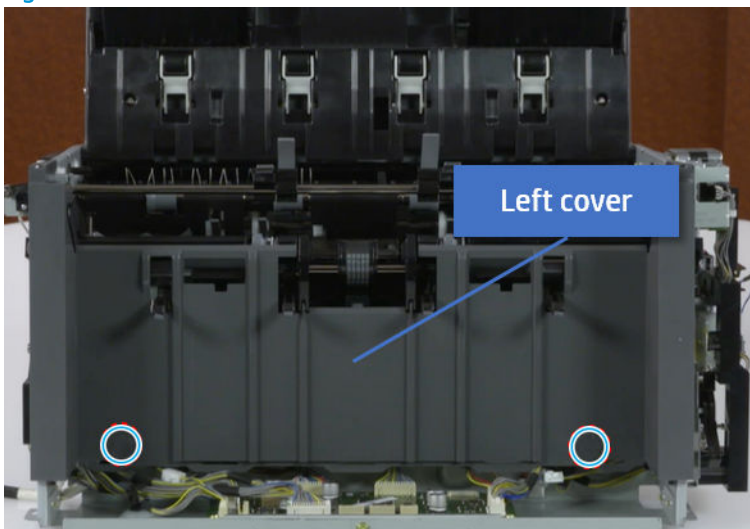

- b. Remove four screws from both front and rear sides.

Figure 5-684 Remove four screws

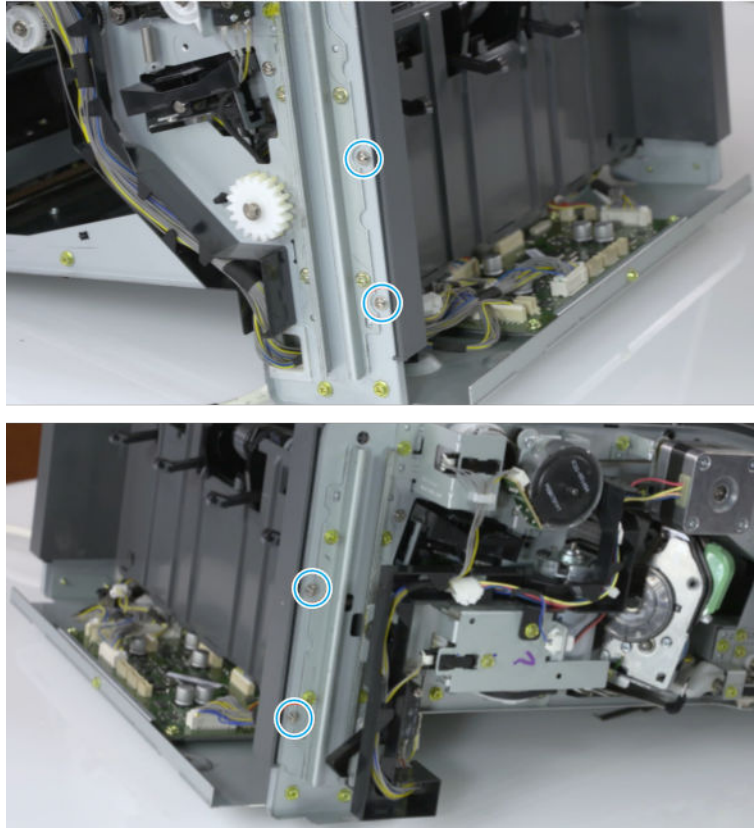

- c. Unplug two inline connectors, and then remove the left cover.

Figure 5-685 Unplug two connectors

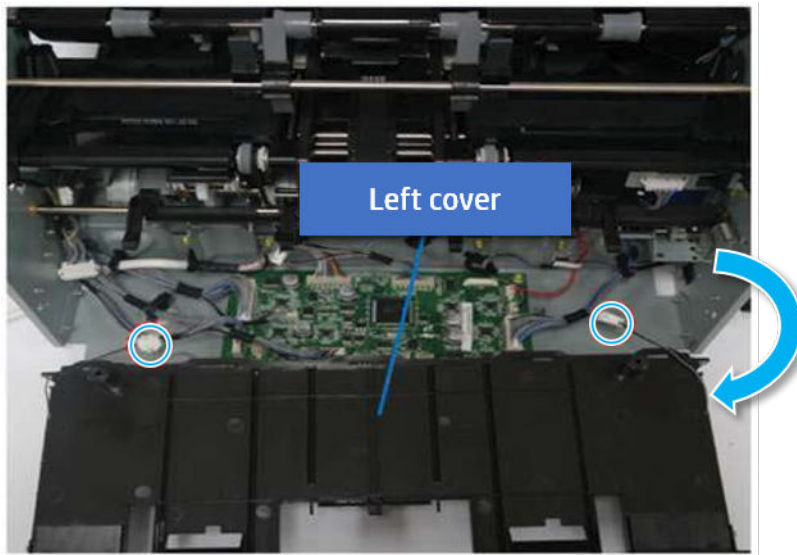

 **TIP:** Be sure to check the hook when reassembling.

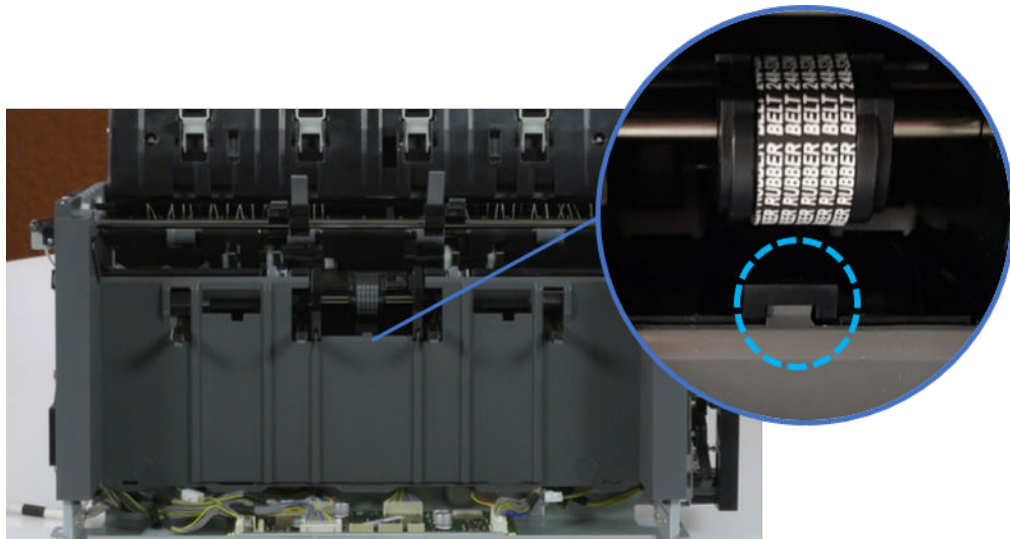

- 7. Remove the front harness guide.
 - a. Open one clamp and unplug five connectors, and then remove the wire harness from the front harness guide.

- b. Remove four screws, and then remove the front harness guide.

Figure 5-686 Remove the front harness guide

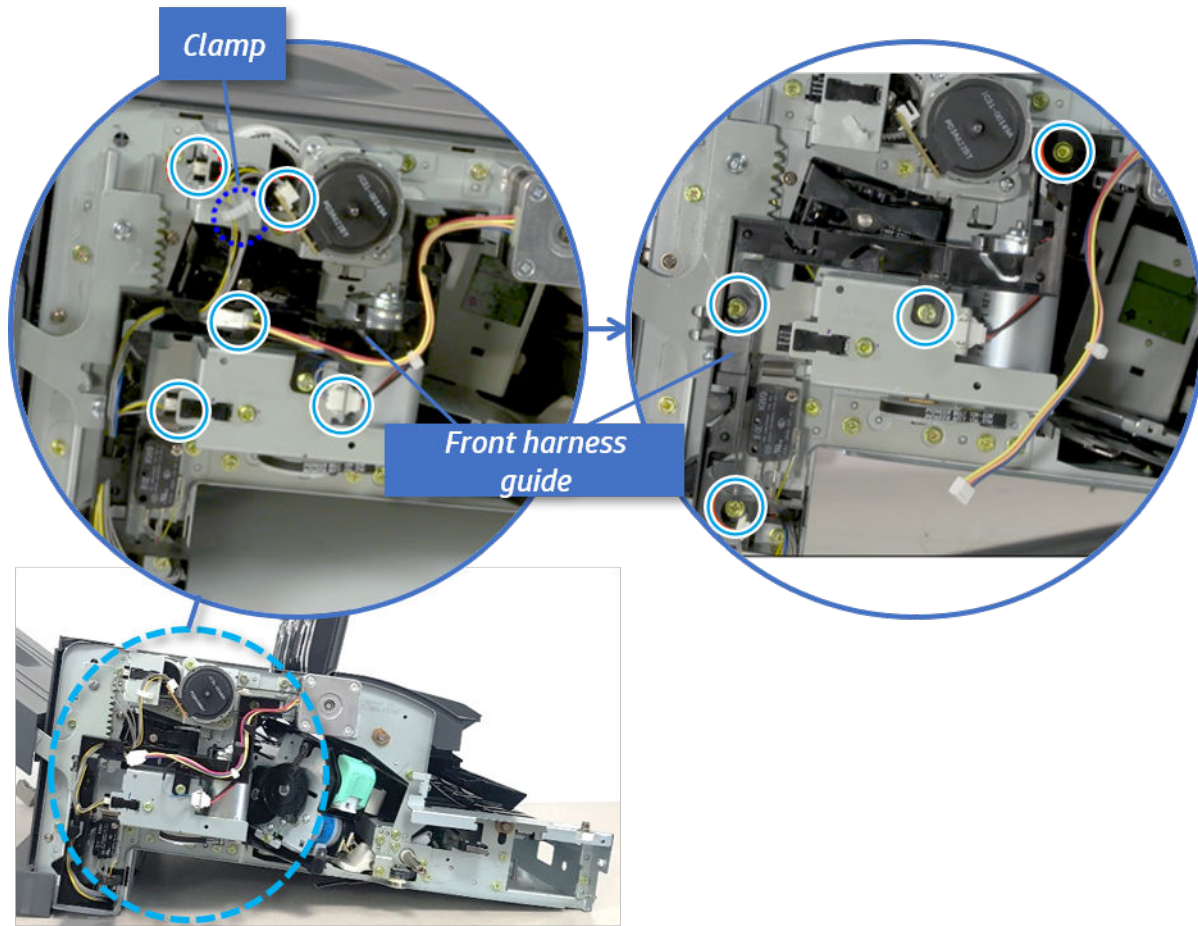

8. Remove the output tray motor assembly.

- ▲ Remove three screws, and then remove the output tray motor assembly.

Figure 5-687 Remove the output tray motor assembly

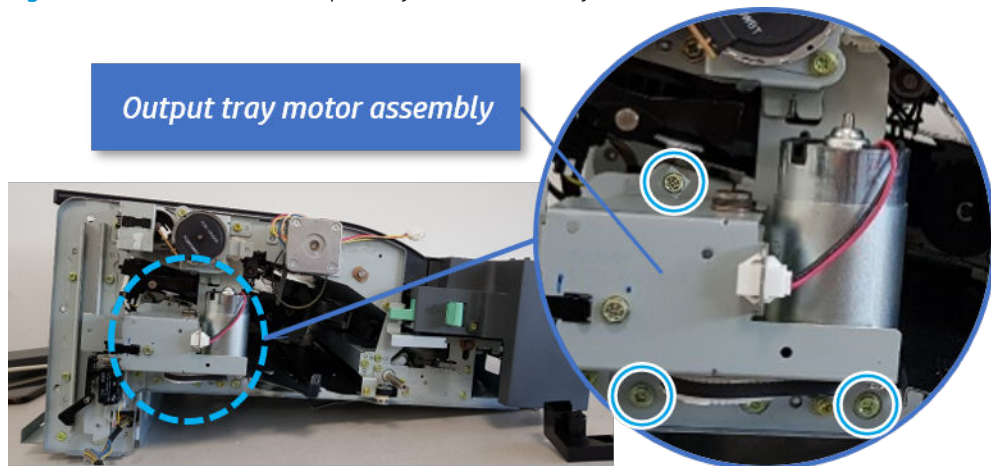

9. Remove the output tray motor sensor.

- ▲ Remove one screw, remove the shaft, and then remove the sensor.

Figure 5-688 Remove the output tray motor sensor

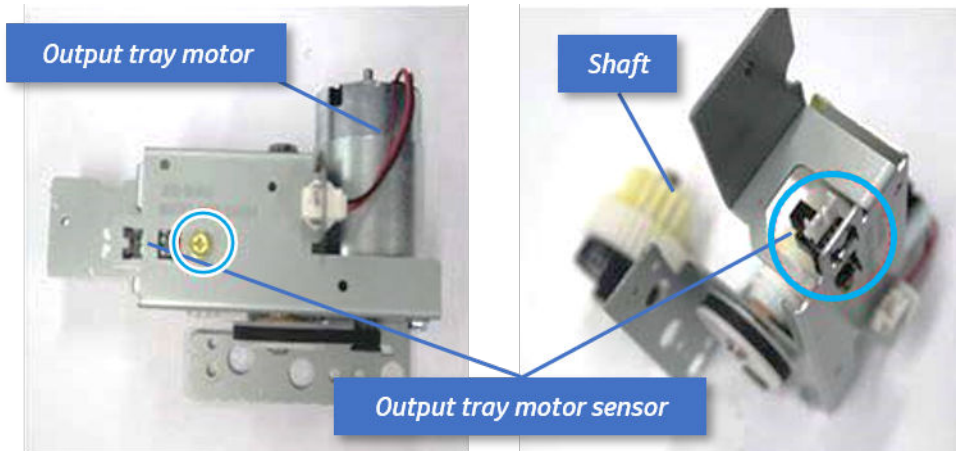

10. Unpack the replacement assembly.

- a. Dispose of the defective part.



NOTE: HP recommends responsible disposal of the defective part.

<http://www8.hp.com/us/en/hp-information/environment/product-recycling.html>

- b. Unpack the replacement part from the packaging.



CAUTION:  Some parts are sensitive to electrostatic discharge (ESD). Always perform service work at an ESD-protected workstation or mat. If an ESD workstation or mat is not available, touch the sheet-metal chassis to provide a static ground before touching an ESD-sensitive assembly. Protect the ESD-sensitive assemblies by placing them in ESD pouches when they are out of the printer.

If the replacement part is a roller or pad, avoid touching the spongy part of it. Skin oils on the roller or pad can cause paper pickup and/or print-quality problems. HP recommends using disposable gloves when handling rollers or pads or washing your hands before touching rollers or pads.



IMPORTANT: Make sure that all of the shipping materials (for example shipping tape) are removed from the replacement part prior to installation.

- c. To install an assembly, reverse the removal steps.

When applicable, special installation instructions are provided for an assembly at the end of the removal procedure. Always completely read the removal instructions and follow all special installation instructions.

Removal and replacement: Output tray motor

Learn how to remove and replace the output tray motor.

To view teardown&reassembling video of the inner finisher, click the link below.



[View a teardown video of the inner finisher .](#)



[View a reassembling video of the inner finisher .](#)



IMPORTANT: When applicable, special installation instructions are provided for an assembly at the end of the removal procedure. Always completely read the removal instructions and follow all special installation instructions.

Mean time to repair:

Service level:

Before performing service

Turn the printer power off

- Press the power button on the front of the printer, and then turn off the power switch next to the power cable.
- A shutting-down message appears on the control-panel display.

⚠ WARNING! To avoid damage to the printer, turn the power off and wait until the printer shuts down before removing the power cable.

- Disconnect the printer power cable after the printer has completely shut down (the control-panel display is blank).

Use the table below to identify the correct part number for your printer. To order the part, go to <https://parts.hp.com>.

Table 5-68 Part information

Part number	Part description
JC31-00178B	Output tray motor

Required tools

- #2 JIS screwdriver with a magnetic tip

After performing service

Turn the printer power on

- Connect the power cable.
- Use the power switch to turn the power on.

Post service test

Print any pages necessary to verify that the repair resolved the issue and did not create any new issues.

1. Remove the front cover.
 - a. Open the front door and open the punch cover.
 - b. Remove three screws in the front.
 - c. Remove the lever.
 - d. Open the top cover.

- e. From the right side of the front cover, carefully lift and pry toward the top-left corner to remove the front cover.

Figure 5-689 Remove the front cover

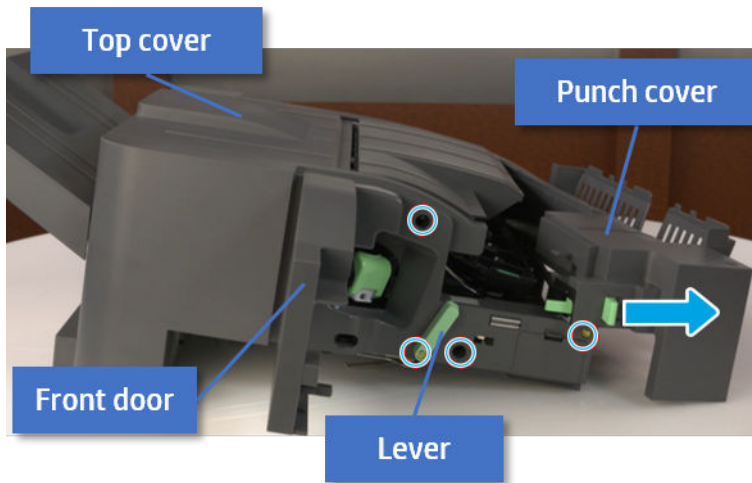

2. Remove the rear cover.
 - a. Open the top cover.

Figure 5-690 Open the top cover

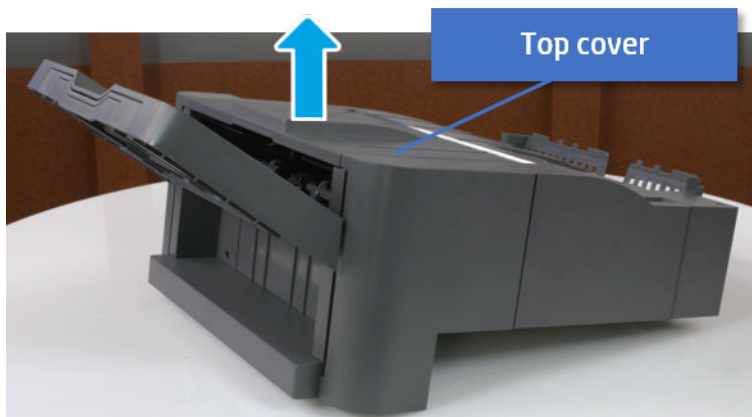

- b. Remove three screws.

- c. Release hooks carefully and remove the rear cover.

Figure 5-691 Remove the rear cover

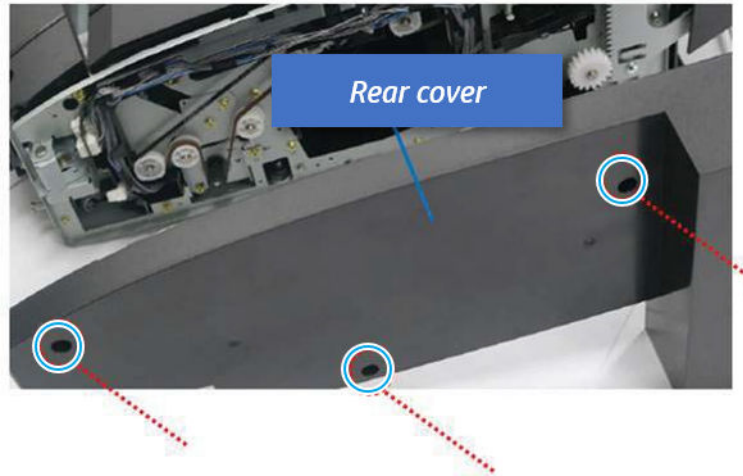

- 3. Remove the output tray.

- a. Remove four screws.

Figure 5-692 Remove four screws

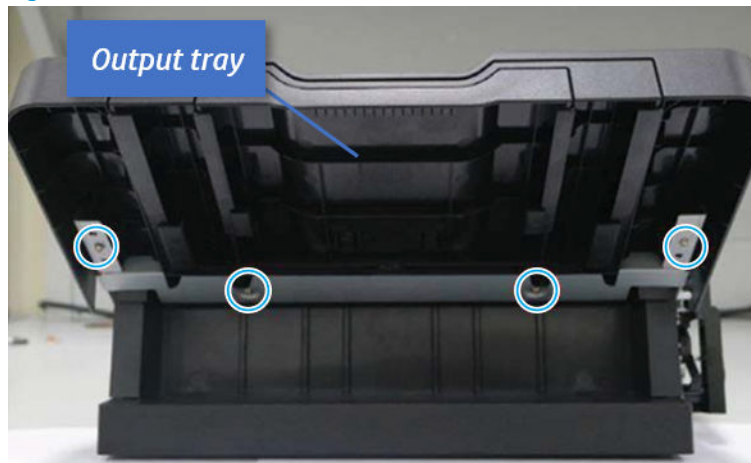

- b. Push the paper holding actuator into the inner finisher, and then remove the output tray.

Figure 5-693 Remove the output tray.



- 4. Remove the output tray frame.
 - a. Rotate the pulley until the output tray frame depart from the gear.

Figure 5-694 Remove the pulley

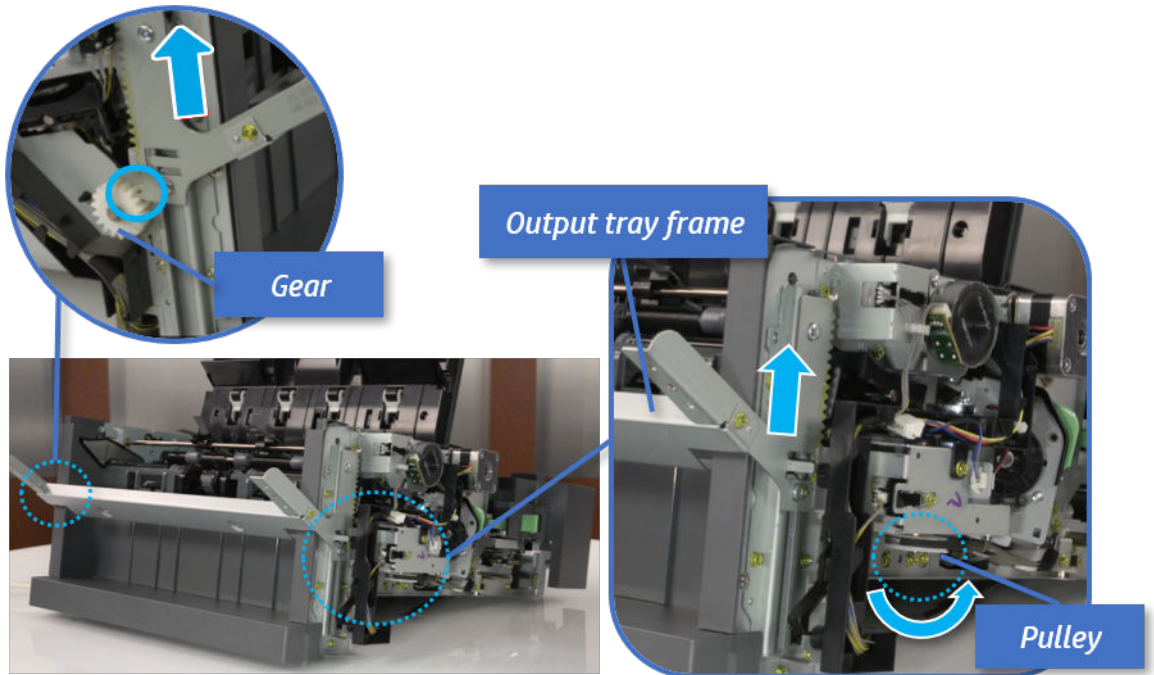

- b. Push the paper holding actuator into the inner finisher, and then remove the output tray frame.

Figure 5-695 Remove the output tray frame

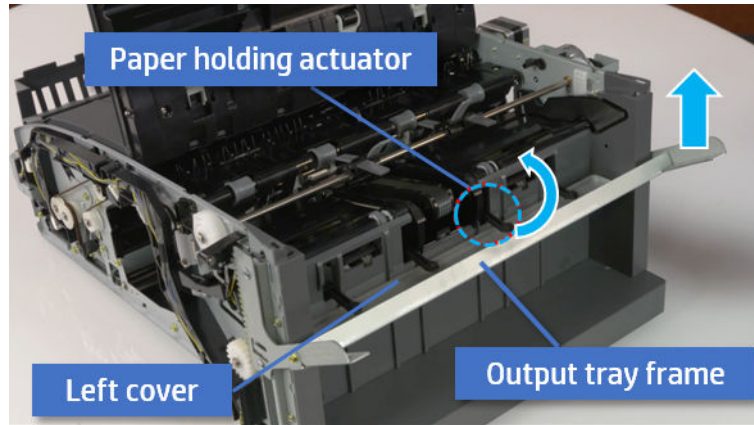

TIP: Push the paper holding actuator into the inner finisher when reassembling. Be sure to level the output tray.

1. Position the first wheel into the channel on both sides while pushing the paper holding actuator.

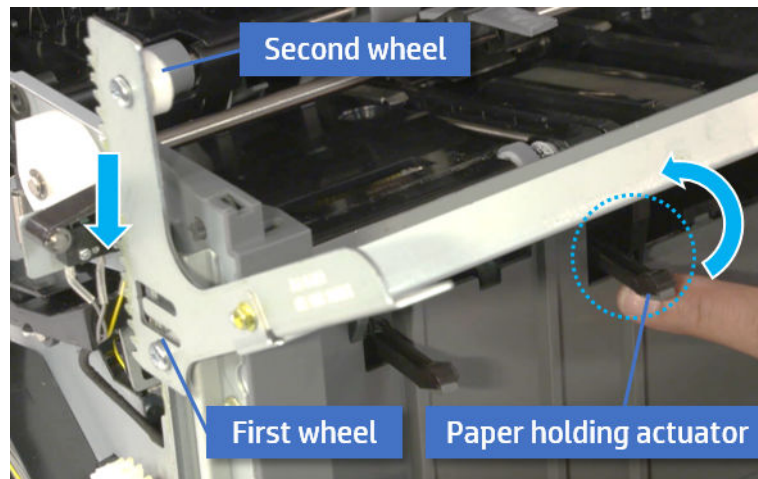

2. Let the second wheel rest on the channel on both sides simultaneously.
3. Gently squeeze the wheels into channel until the output tray frame meet the gear.

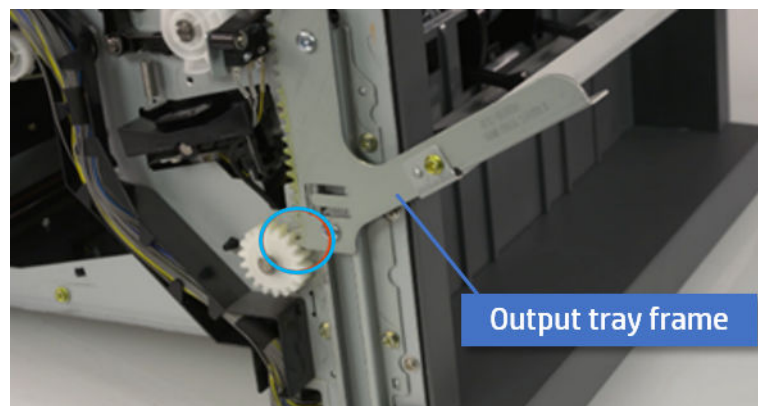

4. Rotate the pulley until the output tray frame is no longer lifted. It can make to level the output tray frame.

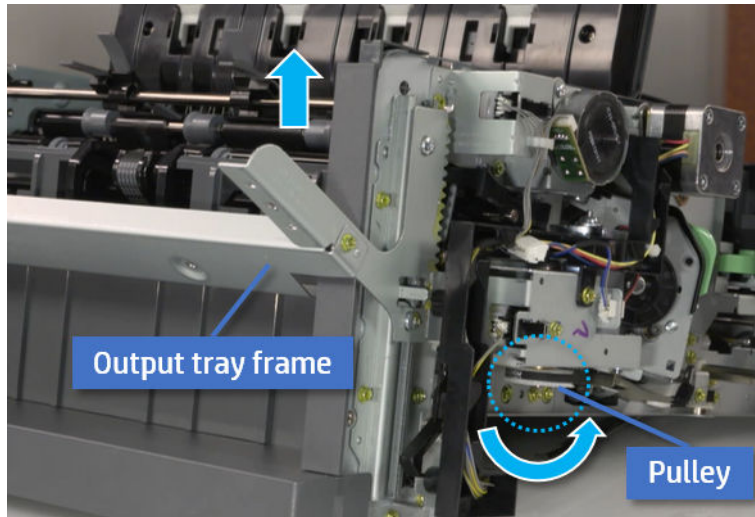

5. Rotate the pulley in the opposite direction.

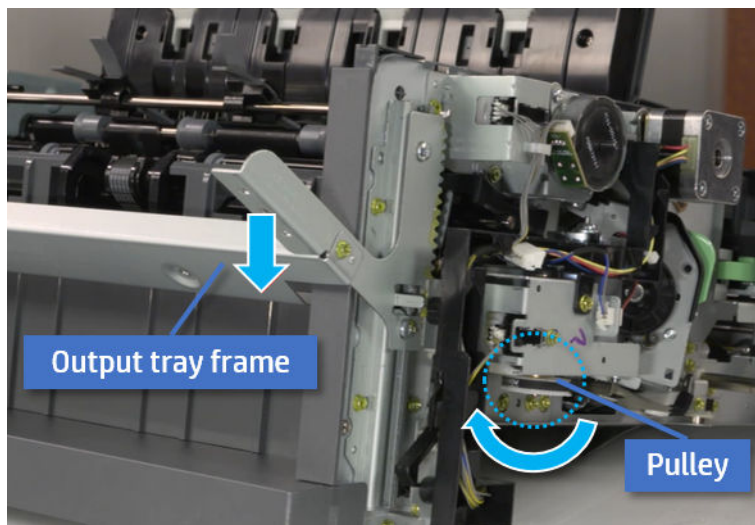

5. Remove the PCA cover.
 - ▲ Remove two screws, and then remove the PCA cover.

Figure 5-696 Remove the PCA cover

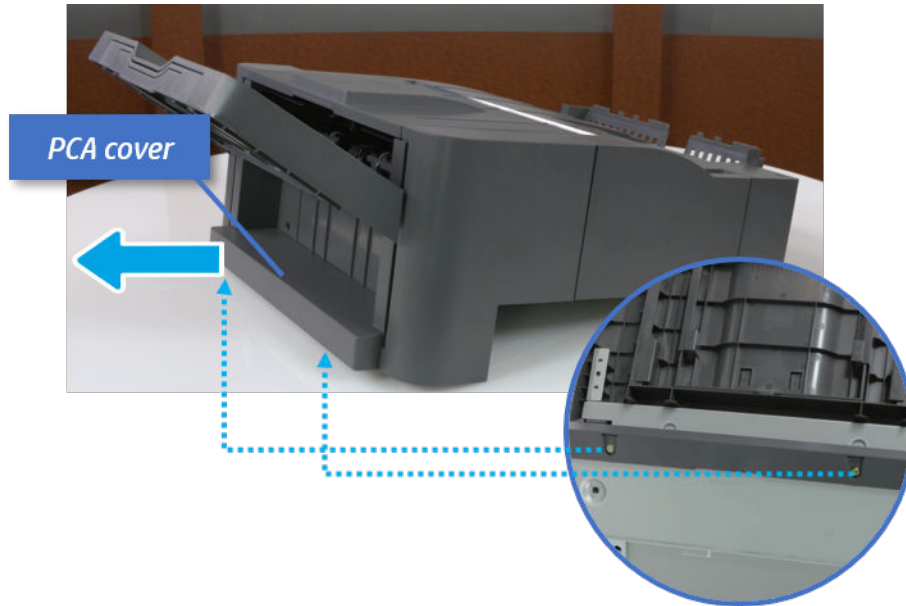

6. Remove the left cover.
 - a. Remove two screws.

Figure 5-697 Remove two screws

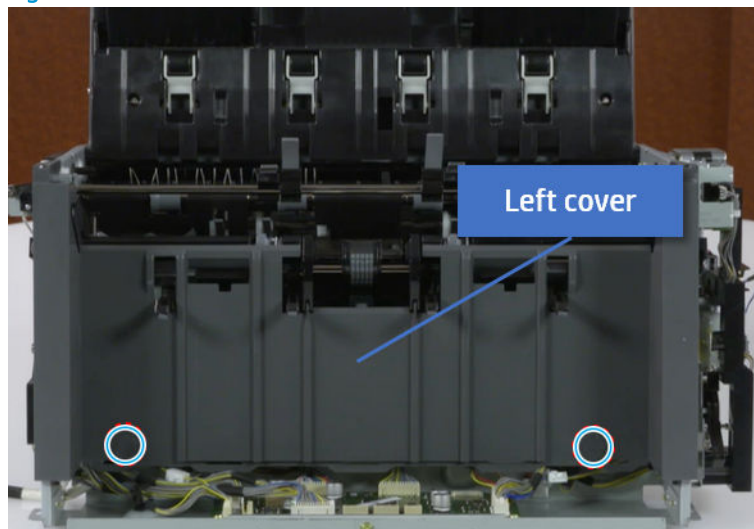

- b. Remove four screws from both front and rear sides.

Figure 5-698 Remove four screws

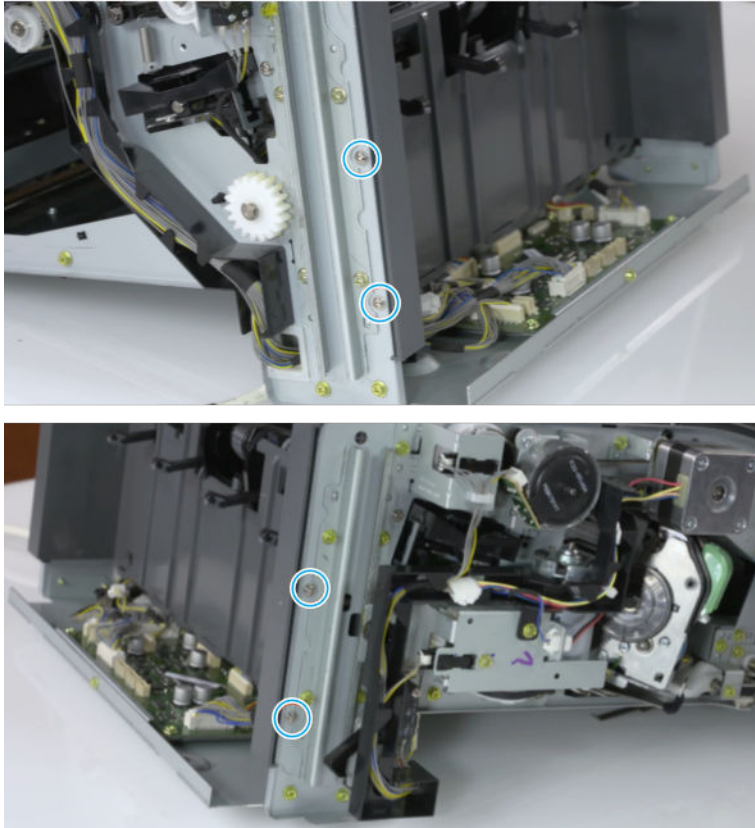

- c. Unplug two inline connectors, and then remove the left cover.

Figure 5-699 Unplug two connectors

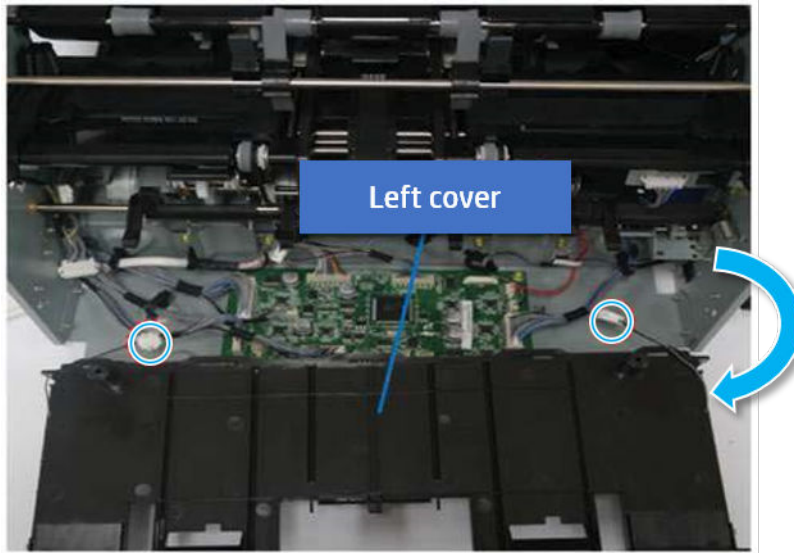

 **TIP:** Be sure to check the hook when reassembling.

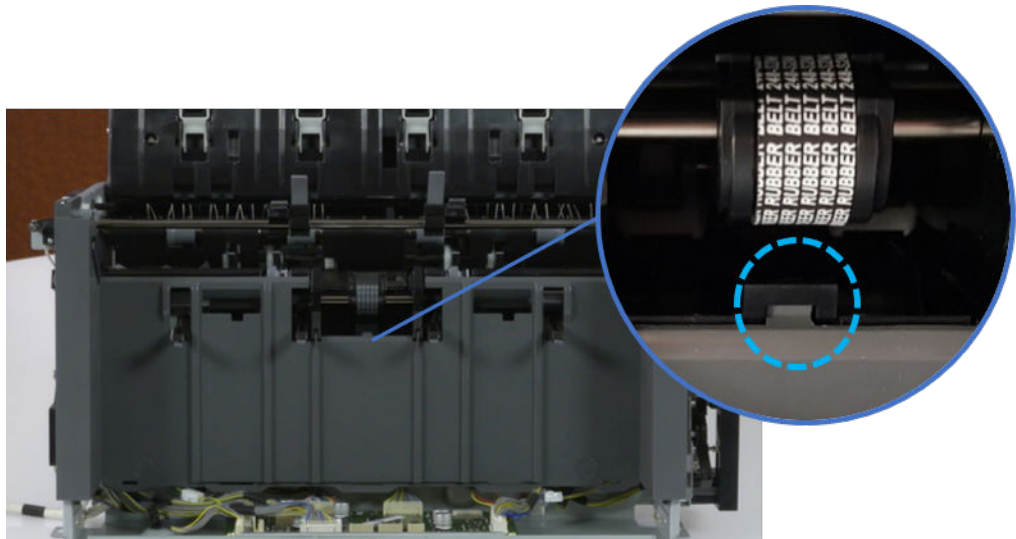

- 7. Remove the front harness guide.
 - a. Open one clamp and unplug five connectors, and then remove the wire harness from the front harness guide.

- b. Remove four screws, and then remove the front harness guide.

Figure 5-700 Remove the front harness guide

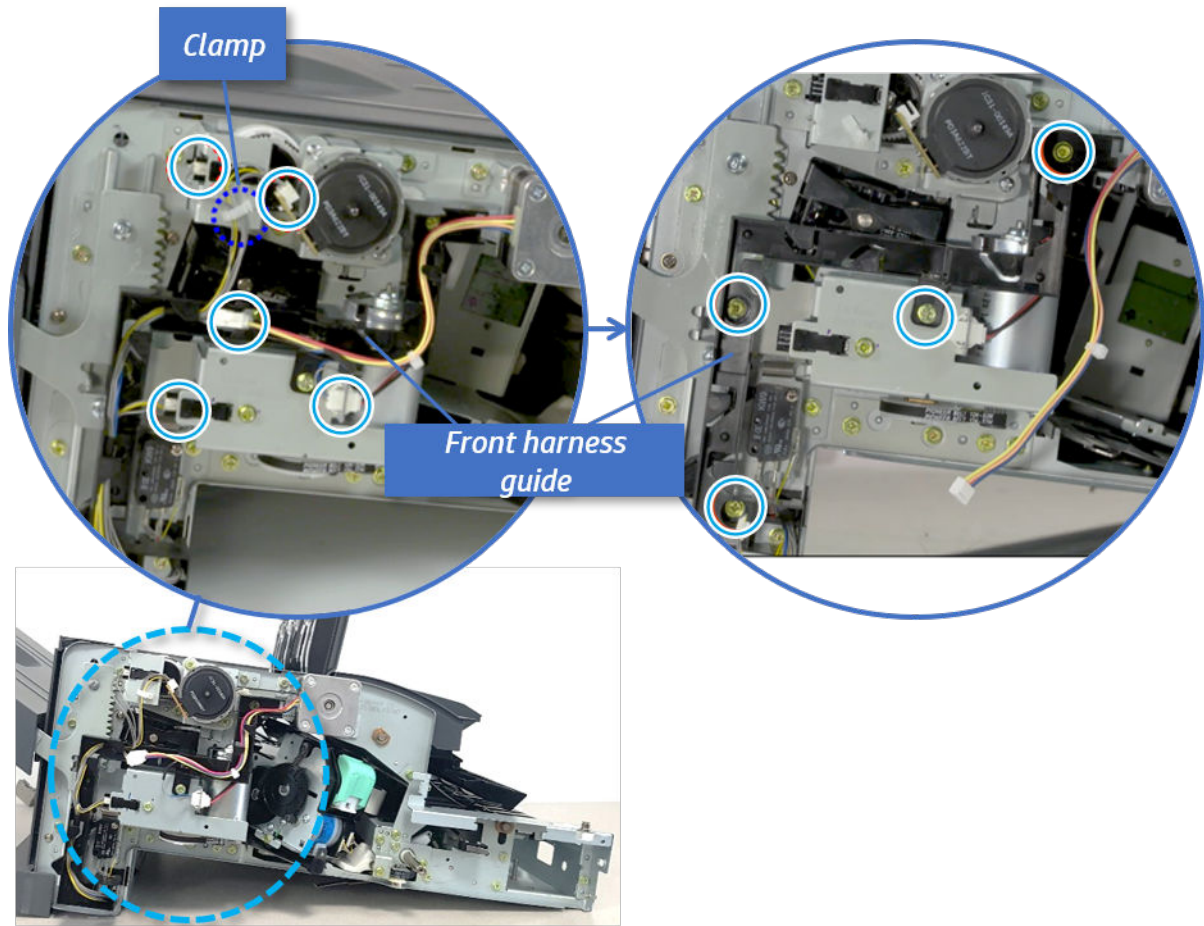

8. Remove the output tray motor assembly.

- ▲ Remove three screws, and then remove the output tray motor assembly.

Figure 5-701 Remove the output tray motor assembly

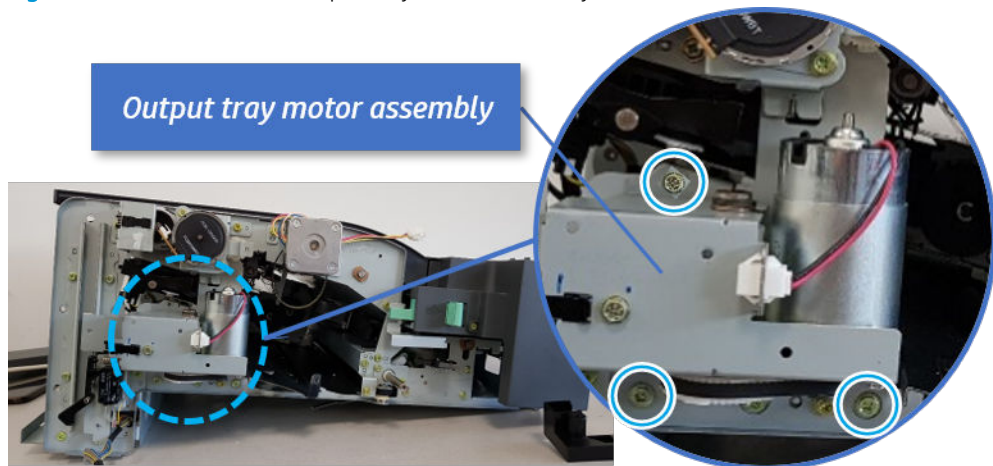

9. Remove the output tray motor.

- ▲ Remove two screws, unplug the connector, and then remove the output tray motor.

Figure 5-702 Remove the output tray motor

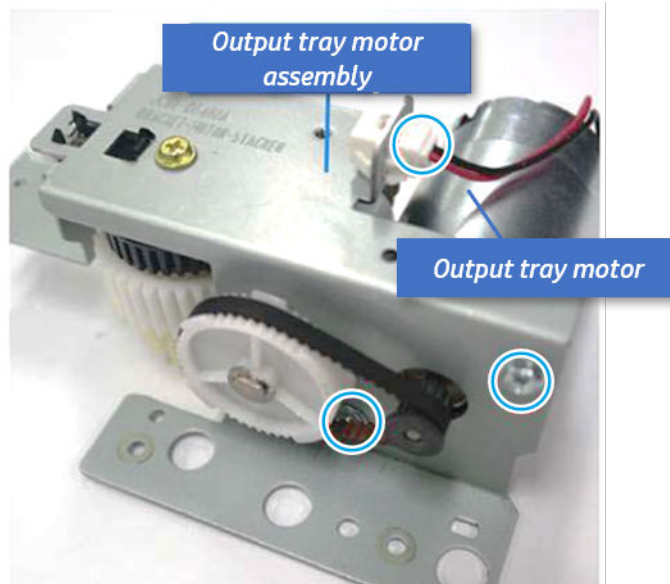

10. Unpack the replacement assembly.

- a. Dispose of the defective part.



NOTE: HP recommends responsible disposal of the defective part.

<http://www8.hp.com/us/en/hp-information/environment/product-recycling.html>

- b. Unpack the replacement part from the packaging.



CAUTION:  Some parts are sensitive to electrostatic discharge (ESD). Always perform service work at an ESD-protected workstation or mat. If an ESD workstation or mat is not available, touch the sheet-metal chassis to provide a static ground before touching an ESD-sensitive assembly. Protect the ESD-sensitive assemblies by placing them in ESD pouches when they are out of the printer.

If the replacement part is a roller or pad, avoid touching the spongy part of it. Skin oils on the roller or pad can cause paper pickup and/or print-quality problems. HP recommends using disposable gloves when handling rollers or pads or washing your hands before touching rollers or pads.



IMPORTANT: Make sure that all of the shipping materials (for example shipping tape) are removed from the replacement part prior to installation.

- c. To install an assembly, reverse the removal steps.

When applicable, special installation instructions are provided for an assembly at the end of the removal procedure. Always completely read the removal instructions and follow all special installation instructions.

Paper holding unit

Removal and replacement: Paper holding

Learn how to remove and replace the paper holding.

To view teardown&reassembling video of the inner finisher, click the link below.

 [View a teardown video of the inner finisher .](#)

 [View a reassembling video of the inner finisher .](#)

 **IMPORTANT:** When applicable, special installation instructions are provided for an assembly at the end of the removal procedure. Always completely read the removal instructions and follow all special installation instructions.

Mean time to repair:

Service level:

Before performing service

Turn the printer power off

- Press the power button on the front of the printer, and then turn off the power switch next to the power cable.
- A shutting-down message appears on the control-panel display.

 **WARNING!** To avoid damage to the printer, turn the power off and wait until the printer shuts down before removing the power cable.

- Disconnect the printer power cable after the printer has completely shut down (the control-panel display is blank).

Use the table below to identify the correct part number for your printer. To order the part, go to <https://parts.hp.com>.

Table 5-69 Part information

Part number	Part description
JC90-01313A	Paper holding actuator

Required tools

- #2 JIS screwdriver with a magnetic tip

After performing service

Turn the printer power on

- Connect the power cable.
- Use the power switch to turn the power on.

Post service test

Print any pages necessary to verify that the repair resolved the issue and did not create any new issues.

1. Remove the front cover.
 - a. Open the front door and open the punch cover.
 - b. Remove three screws in the front.
 - c. Remove the lever.
 - d. Open the top cover.
 - e. From the right side of the front cover, carefully lift and pry toward the top-left corner to remove the front cover.

Figure 5-703 Remove the front cover

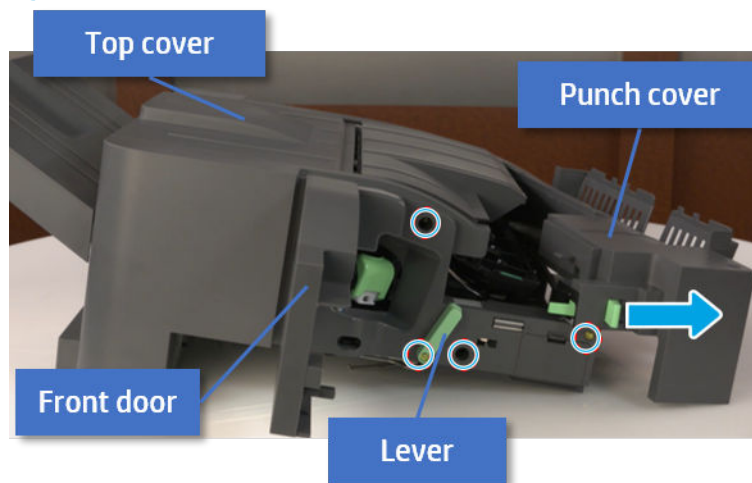

2. Remove the rear cover.
 - a. Open the top cover.

Figure 5-704 Open the top cover

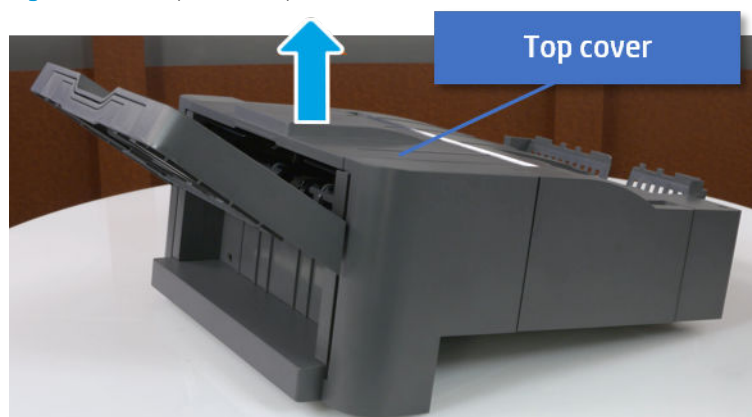

- b. Remove three screws.

- c. Release hooks carefully and remove the rear cover.

Figure 5-705 Remove the rear cover

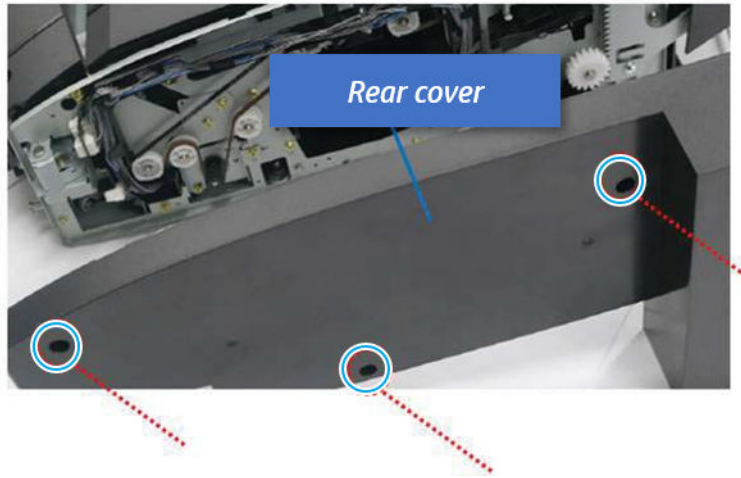

- 3. Remove the output tray.

- a. Remove four screws.

Figure 5-706 Remove four screws

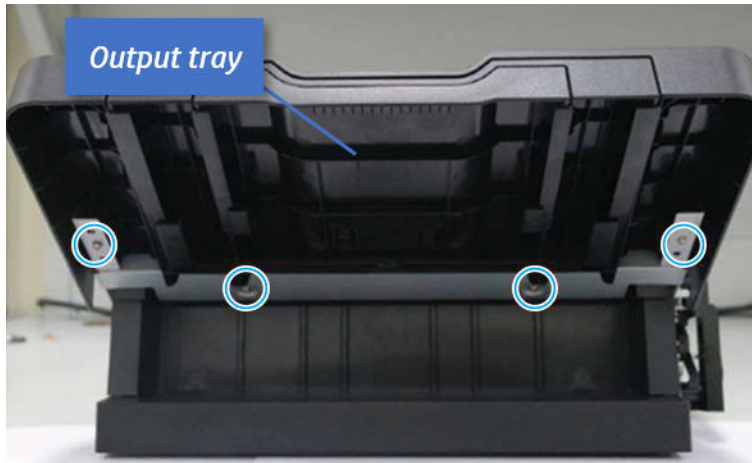

- b. Push the paper holding actuator into the inner finisher, and then remove the output tray.

Figure 5-707 Remove the output tray.



- 4. Remove the output tray frame.
 - a. Rotate the pulley until the output tray frame depart from the gear.

Figure 5-708 Remove the pulley

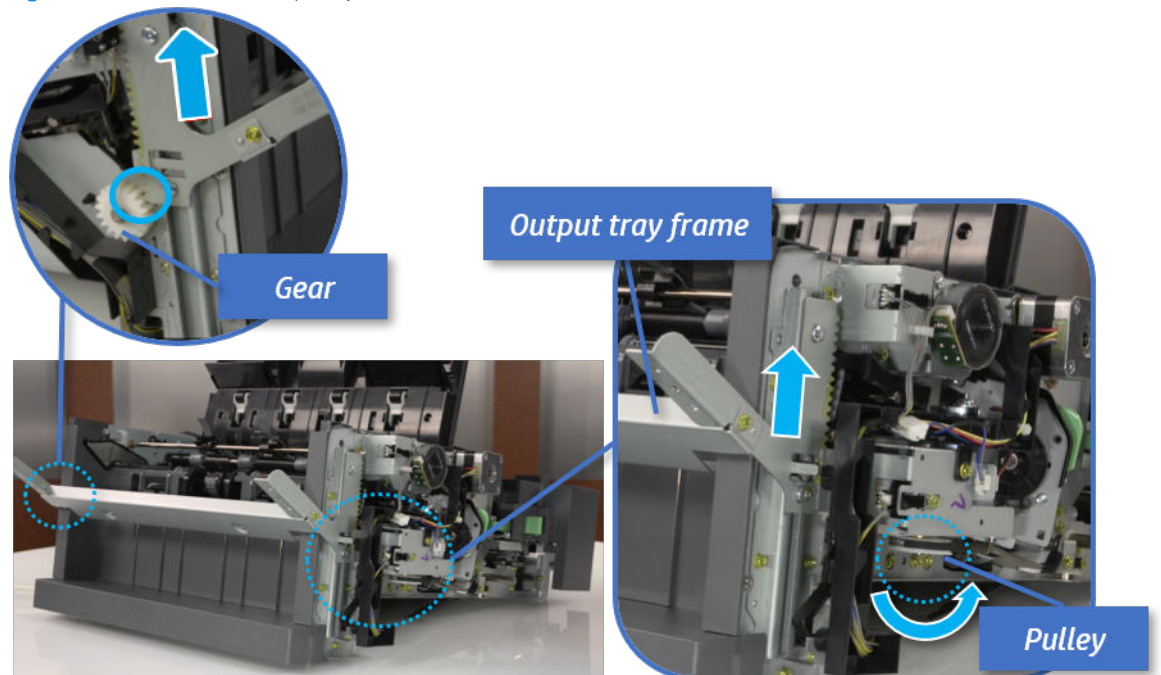

- b. Push the paper holding actuator into the inner finisher, and then remove the output tray frame.

Figure 5-709 Remove the output tray frame

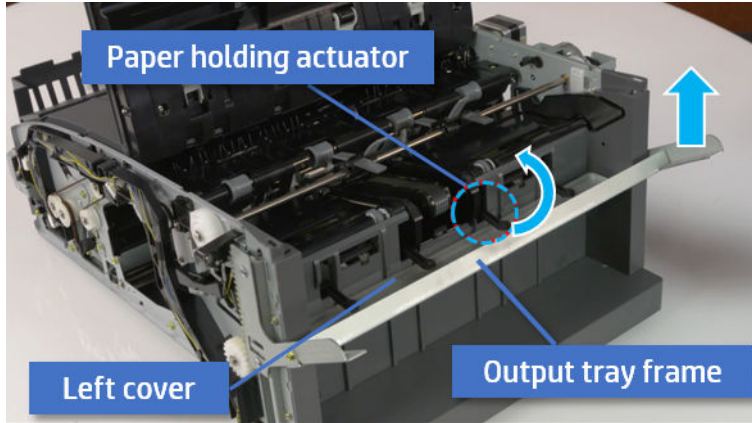

 **TIP:** Push the paper holding actuator into the inner finisher when reassembling. Be sure to level the output tray.

1. Position the first wheel into the channel on both sides while pushing the paper holding actuator.

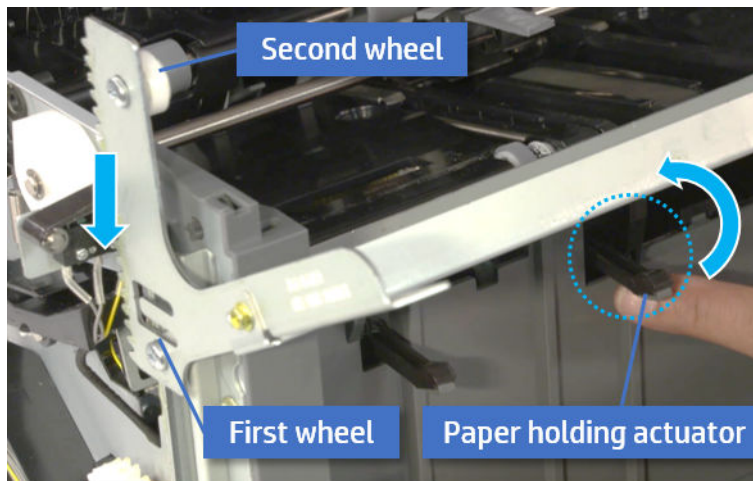

2. Let the second wheel rest on the channel on both sides simultaneously.
3. Gently squeeze the wheels into channel until the output tray frame meet the gear.

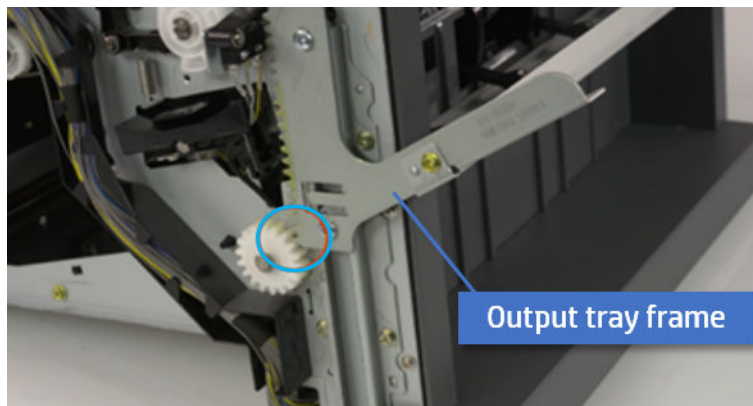

4. Rotate the pulley until the output tray frame is no longer lifted. It can make to level the output tray frame.

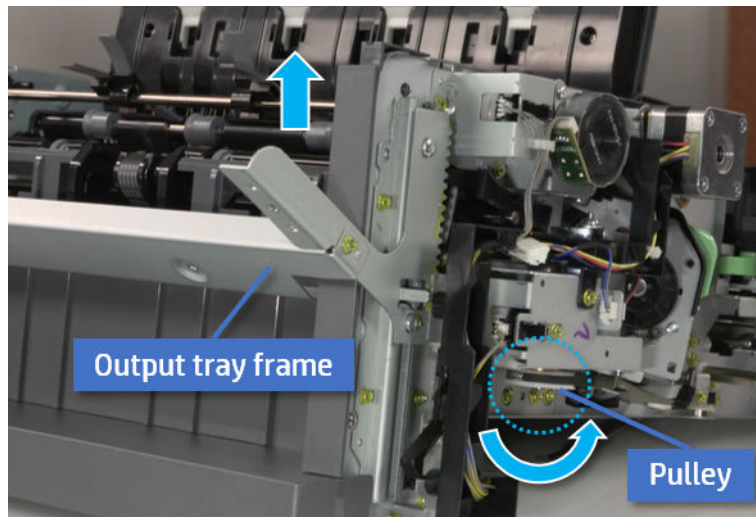

5. Rotate the pulley in the opposite direction.

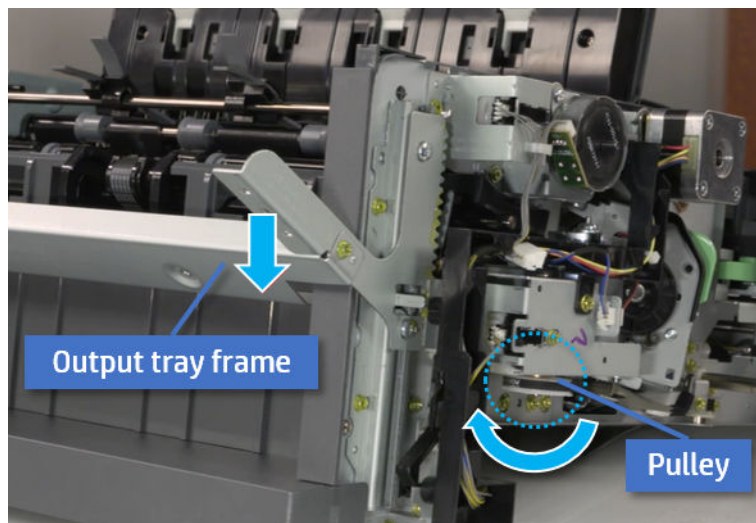

5. Remove the PCA cover.

- ▲ Remove two screws, and then remove the PCA cover.

Figure 5-710 Remove the PCA cover

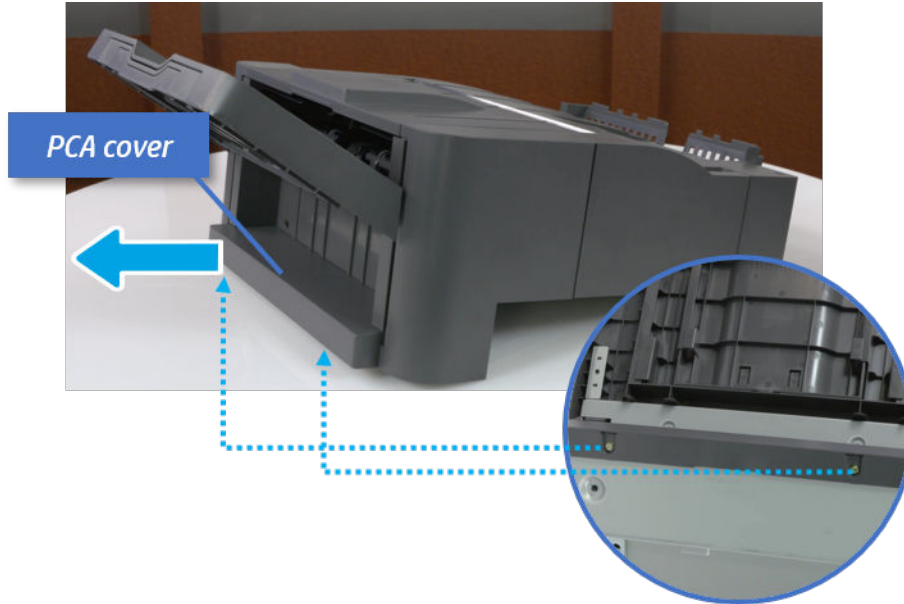

6. Remove the left cover.
 - a. Remove two screws.

Figure 5-711 Remove two screws

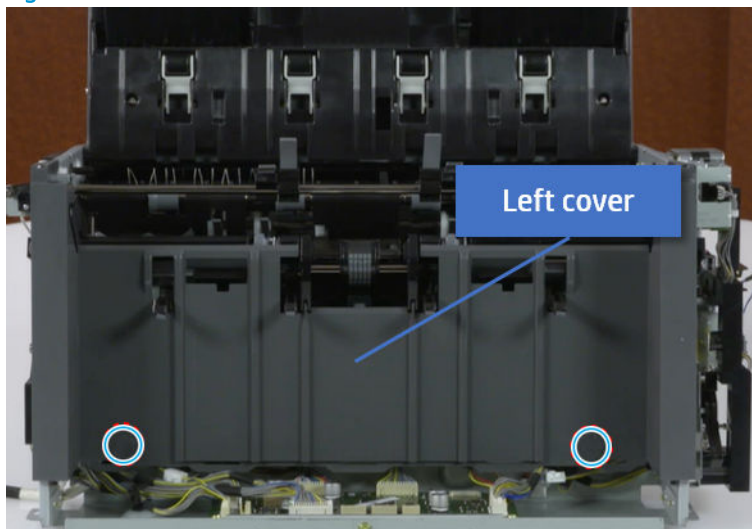

- b. Remove four screws from both front and rear sides.

Figure 5-712 Remove four screws

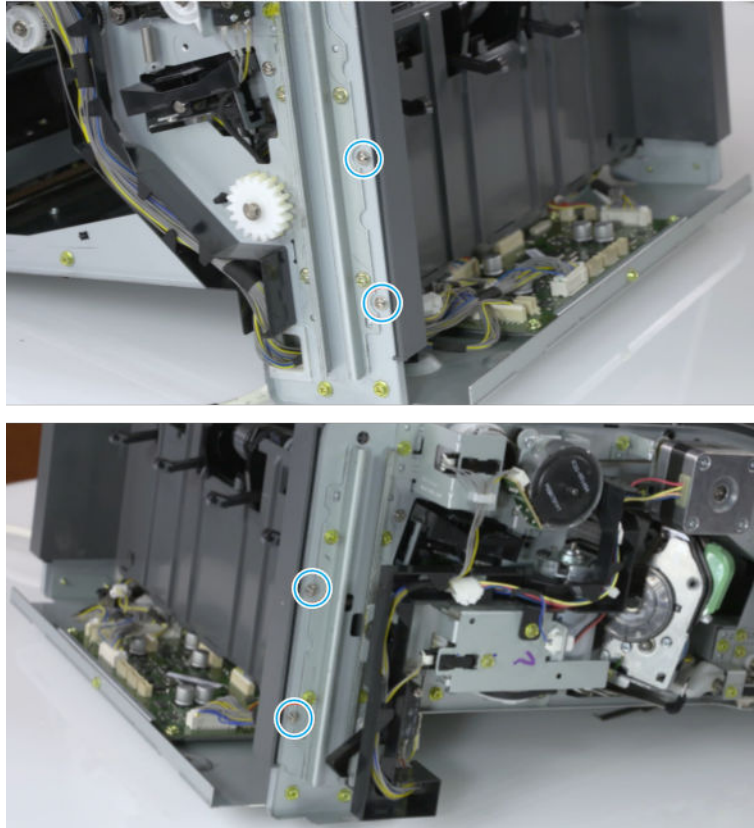

- c. Unplug two inline connectors, and then remove the left cover.

Figure 5-713 Unplug two connectors

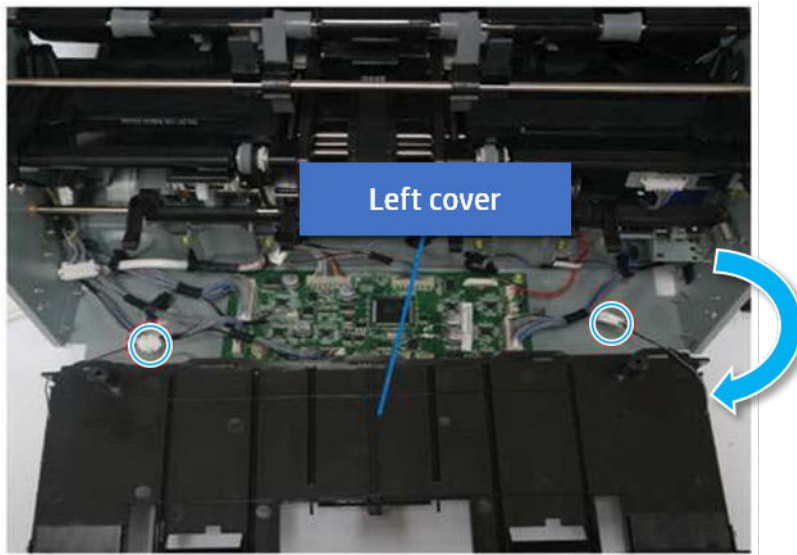

 **TIP:** Be sure to check the hook when reassembling.

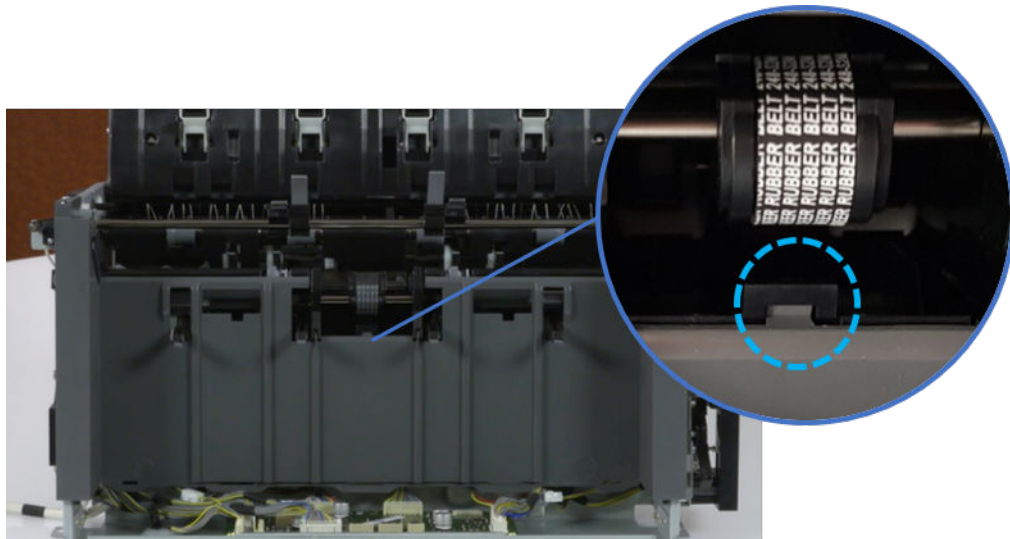

- 7. Remove the front harness guide.
 - a. Open one clamp and unplug five connectors, and then remove the wire harness from the front harness guide.

- b. Remove four screws, and then remove the front harness guide.

Figure 5-714 Remove the front harness guide

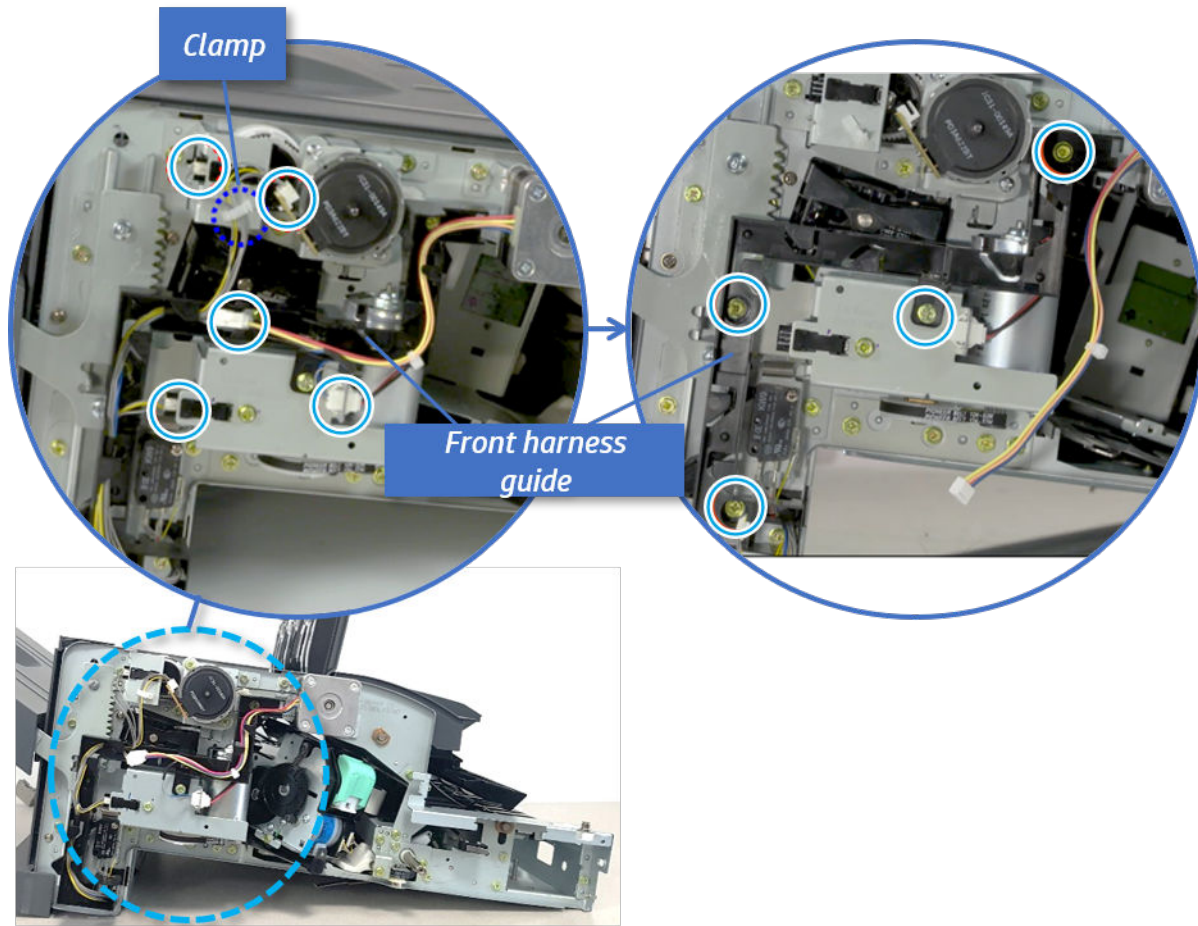

8. Remove the output tray motor assembly.

- ▲ Remove three screws, and then remove the output tray motor assembly.

Figure 5-715 Remove the output tray motor assembly

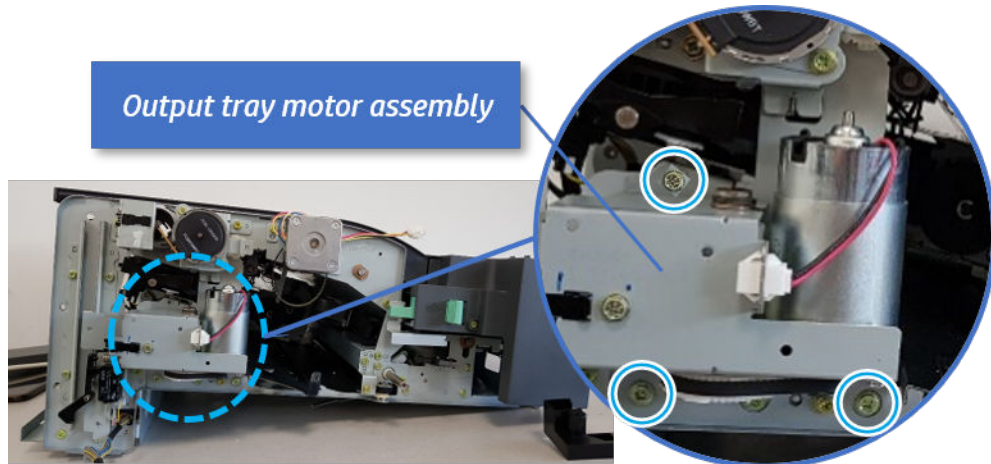

9. Remove the output tray lower limit switch.

- ▲ Remove one screw, and then remove the output tray lower limit switch.

Figure 5-716 Remove the output tray lower limit switch

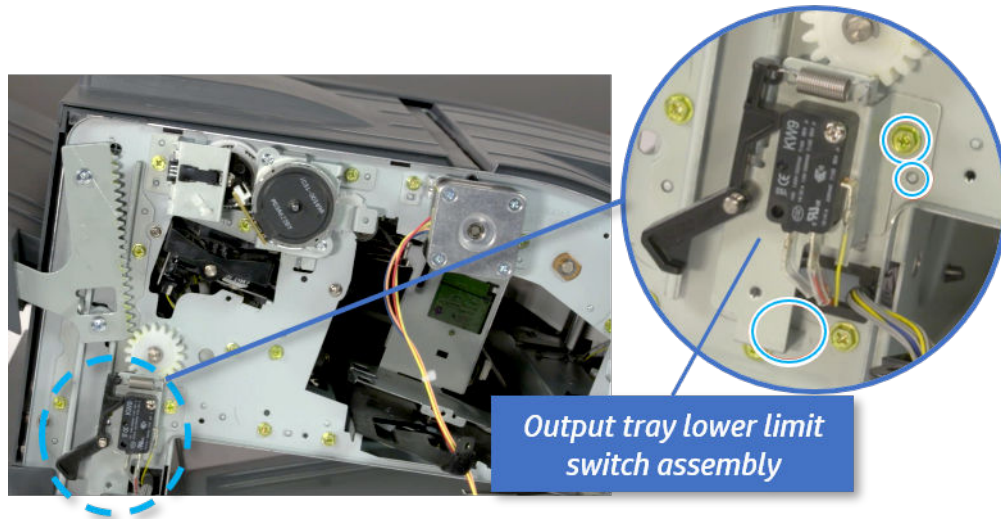

- 10. Remove the paper holding.
 - a. Remove the paper holding actuator spring.

Figure 5-717 Remove the paper holding actuator spring

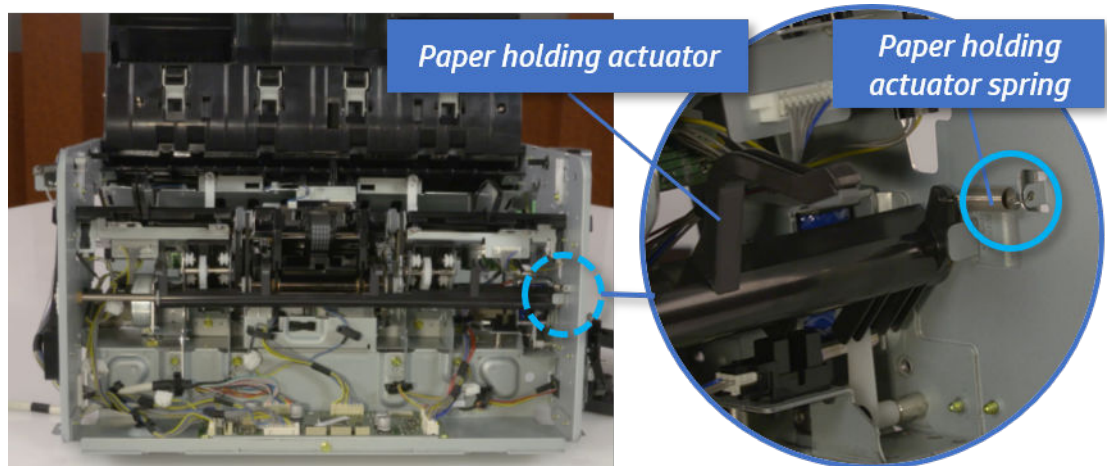

- b. Remove the e-ring and the rack pinion gear. And then remove the pin and the e-ring, and then remove the bushing.

Figure 5-718 Remove e-ring, rack pinion gear, pin, and bushing

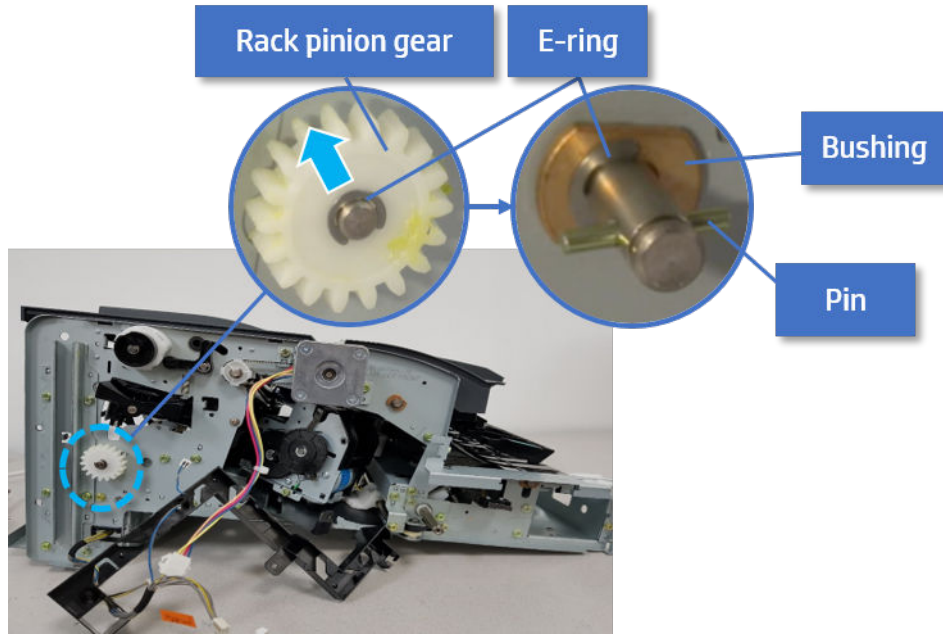

 **NOTE:** Be sure not to lose the pin.

- c. Carefully remove the paper holding shaft and the actuator.

Figure 5-719 Remove the paper holding shaft and the actuator

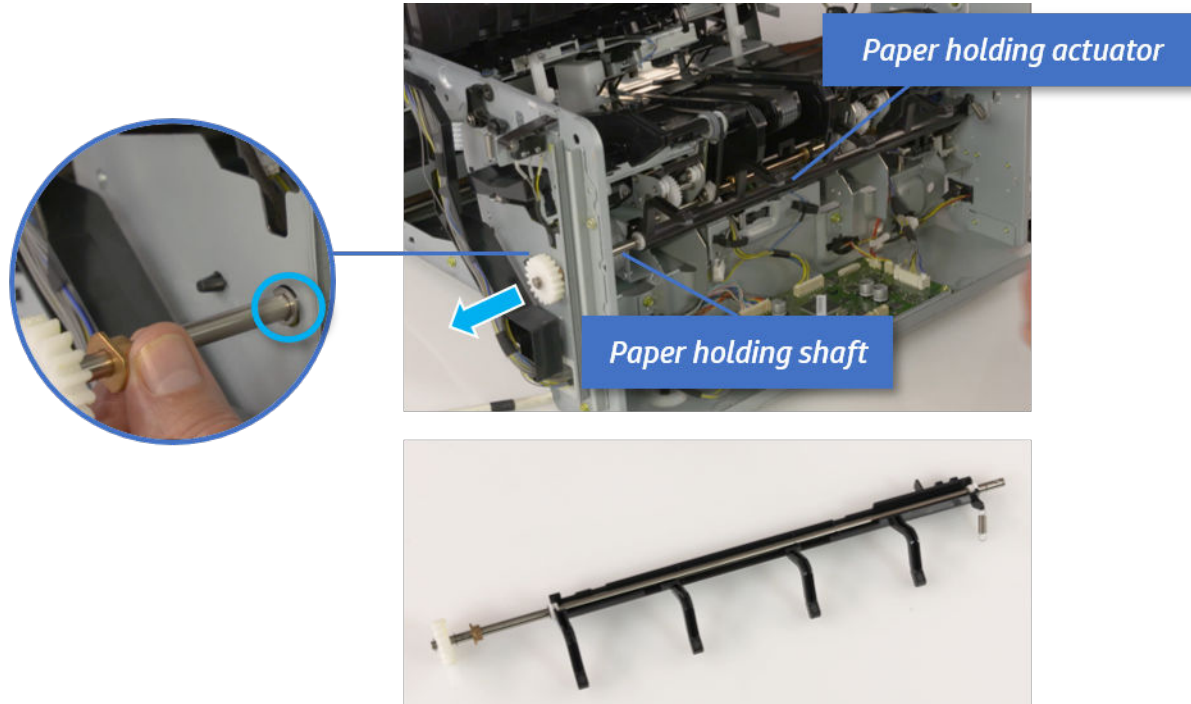



- 11. Unpack the replacement assembly.

- a. Dispose of the defective part.

 **NOTE:** HP recommends responsible disposal of the defective part.

<http://www8.hp.com/us/en/hp-information/environment/product-recycling.html>

b. Unpack the replacement part from the packaging.

 **CAUTION:**  Some parts are sensitive to electrostatic discharge (ESD). Always perform service work at an ESD-protected workstation or mat. If an ESD workstation or mat is not available, touch the sheet-metal chassis to provide a static ground before touching an ESD-sensitive assembly. Protect the ESD-sensitive assemblies by placing them in ESD pouches when they are out of the printer.

If the replacement part is a roller or pad, avoid touching the spongy part of it. Skin oils on the roller or pad can cause paper pickup and/or print-quality problems. HP recommends using disposable gloves when handling rollers or pads or washing your hands before touching rollers or pads.

 **IMPORTANT:** Make sure that all of the shipping materials (for example shipping tape) are removed from the replacement part prior to installation.

c. To install an assembly, reverse the removal steps.

When applicable, special installation instructions are provided for an assembly at the end of the removal procedure. Always completely read the removal instructions and follow all special installation instructions.

Removal and replacement: Paper holding sensor (S9)

Learn how to remove and replace the paper holding sensor.

To view teardown&reassembling video of the inner finisher, click the link below.

 [View a teardown video of the inner finisher .](#)

 [View a reassembling video of the inner finisher .](#)

 **IMPORTANT:** When applicable, special installation instructions are provided for an assembly at the end of the removal procedure. Always completely read the removal instructions and follow all special installation instructions.

Mean time to repair:

Service level:

Before performing service

Turn the printer power off

- Press the power button on the front of the printer, and then turn off the power switch next to the power cable.
- A shutting-down message appears on the control-panel display.

 **WARNING!** To avoid damage to the printer, turn the power off and wait until the printer shuts down before removing the power cable.

- Disconnect the printer power cable after the printer has completely shut down (the control-panel display is blank).

Use the table below to identify the correct part number for your printer. To order the part, go to <https://parts.hp.com>.

Table 5-70 Part information

Part number	Part description
0604-001393	Paper holding sensor

Required tools

- #2 JIS screwdriver with a magnetic tip

After performing service

Turn the printer power on

- Connect the power cable.
- Use the power switch to turn the power on.

Post service test

Print any pages necessary to verify that the repair resolved the issue and did not create any new issues.

1. Remove the front cover.
 - a. Open the front door and open the punch cover.
 - b. Remove three screws in the front.
 - c. Remove the lever.
 - d. Open the top cover.
 - e. From the right side of the front cover, carefully lift and pry toward the top-left corner to remove the front cover.

Figure 5-720 Remove the front cover

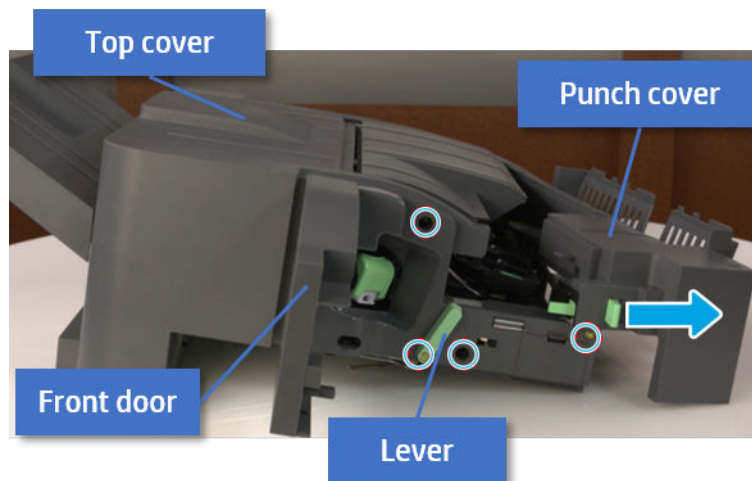

2. Remove the rear cover.

- a. Open the top cover.

Figure 5-721 Open the top cover

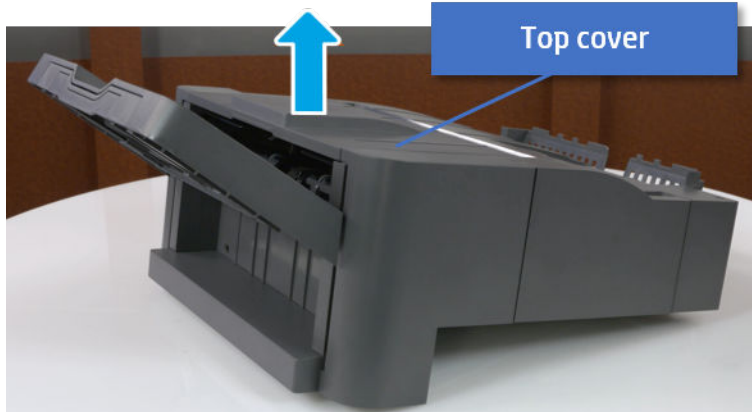

- b. Remove three screws.
- c. Release hooks carefully and remove the rear cover.

Figure 5-722 Remove the rear cover

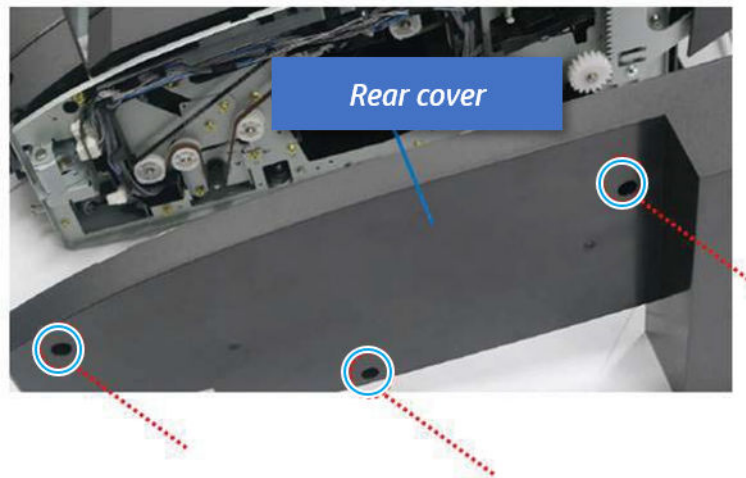

3. Remove the output tray.
 - a. Remove four screws.

Figure 5-723 Remove four screws

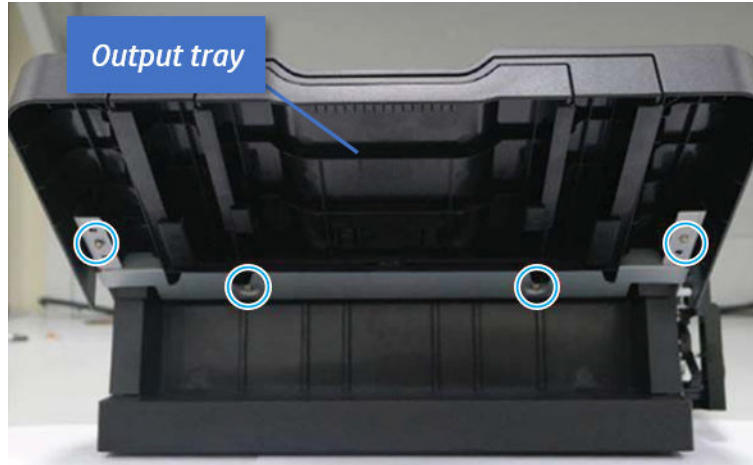

- b. Push the paper holding actuator into the inner finisher, and then remove the output tray.

Figure 5-724 Remove the output tray.



- 4. Remove the output tray frame.
 - a. Rotate the pulley until the output tray frame depart from the gear.

Figure 5-725 Remove the pulley

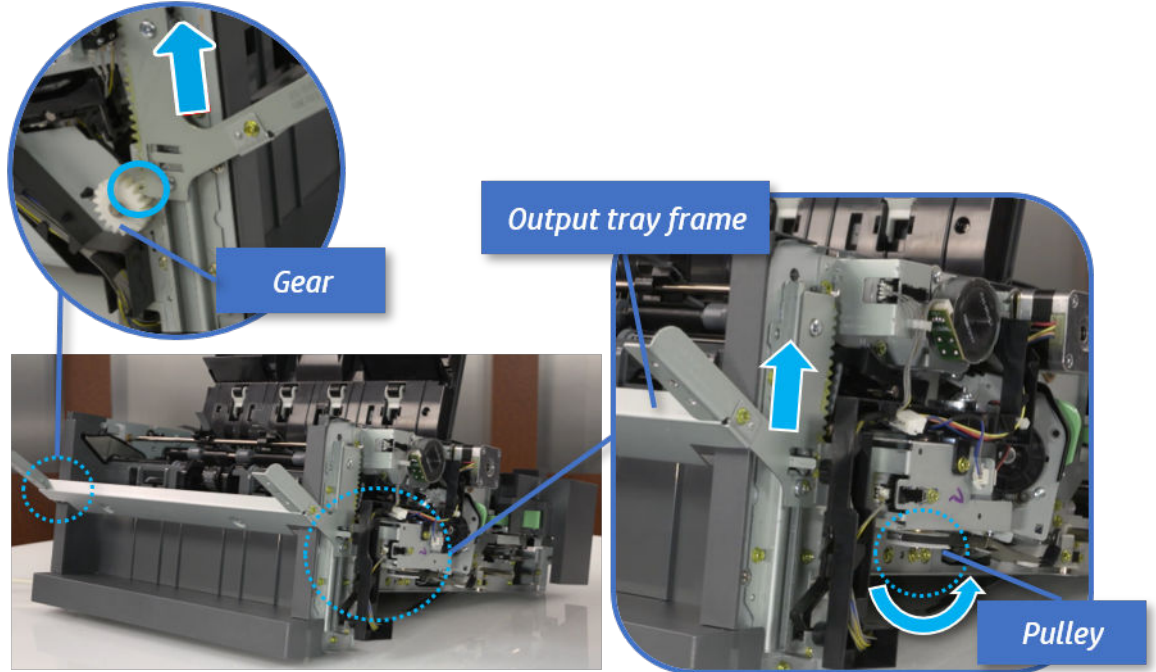

- b. Push the paper holding actuator into the inner finisher, and then remove the output tray frame.

Figure 5-726 Remove the output tray frame

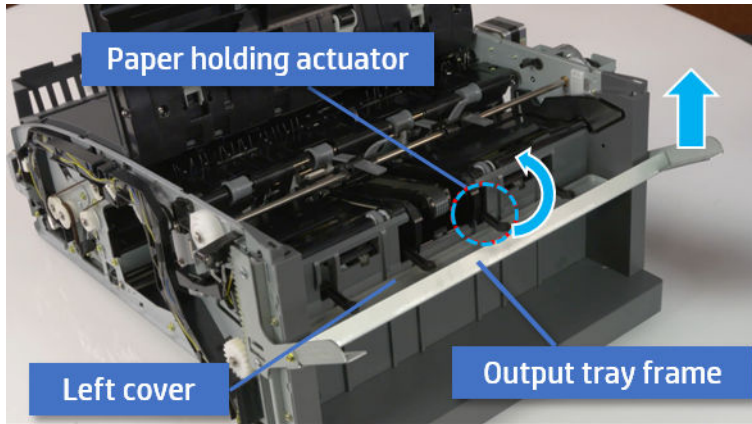

TIP: Push the paper holding actuator into the inner finisher when reassembling. Be sure to level the output tray.

1. Position the first wheel into the channel on both sides while pushing the paper holding actuator.

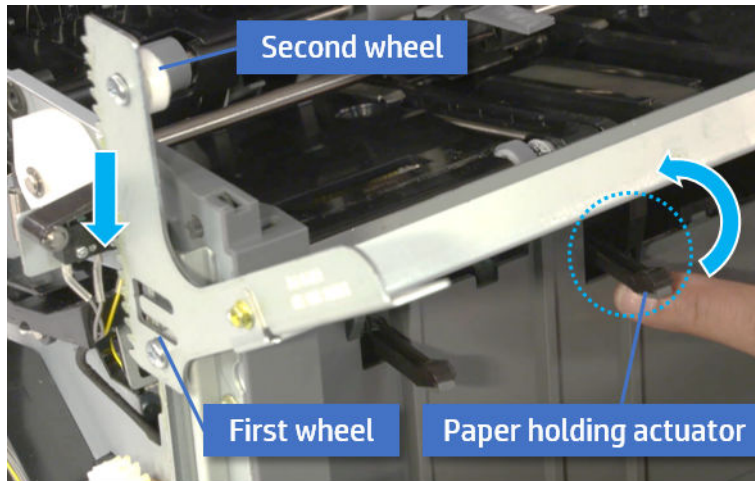

2. Let the second wheel rest on the channel on both sides simultaneously.
3. Gently squeeze the wheels into channel until the output tray frame meet the gear.

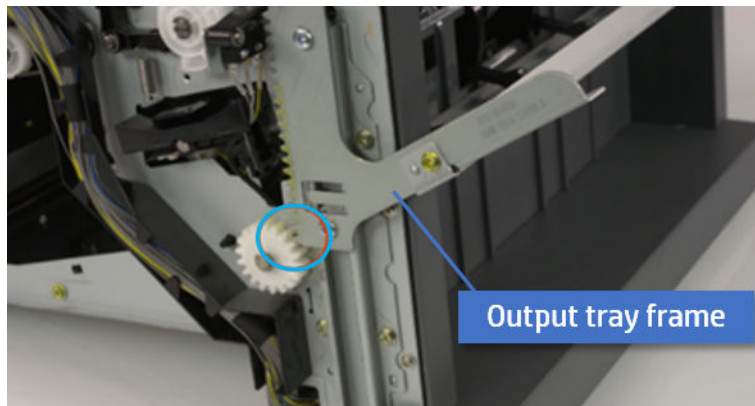

4. Rotate the pulley until the output tray frame is no longer lifted. It can make to level the output tray frame.

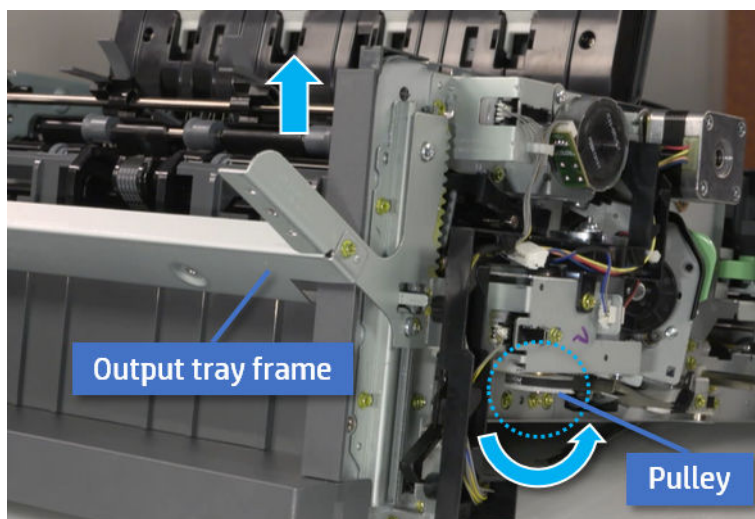

5. Rotate the pulley in the opposite direction.

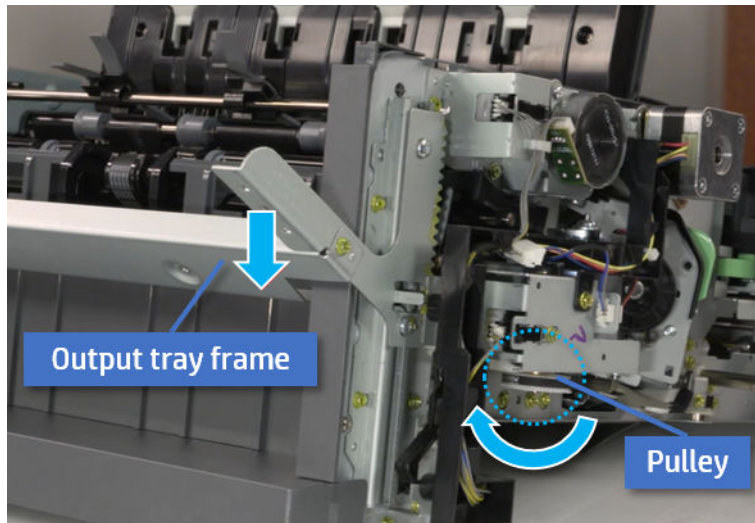

5. Remove the PCA cover.
 - ▲ Remove two screws, and then remove the PCA cover.

Figure 5-727 Remove the PCA cover

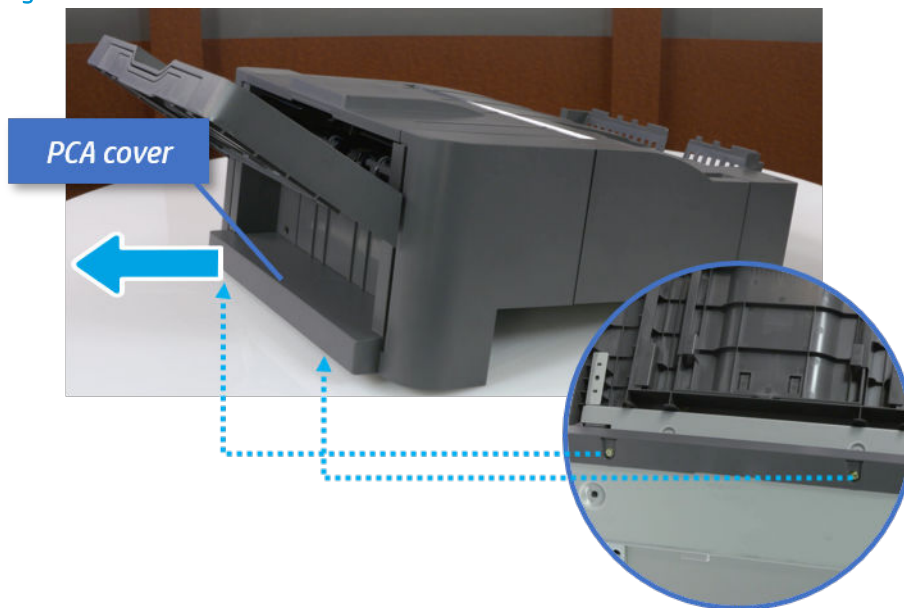

6. Remove the left cover.
 - a. Remove two screws.

Figure 5-728 Remove two screws

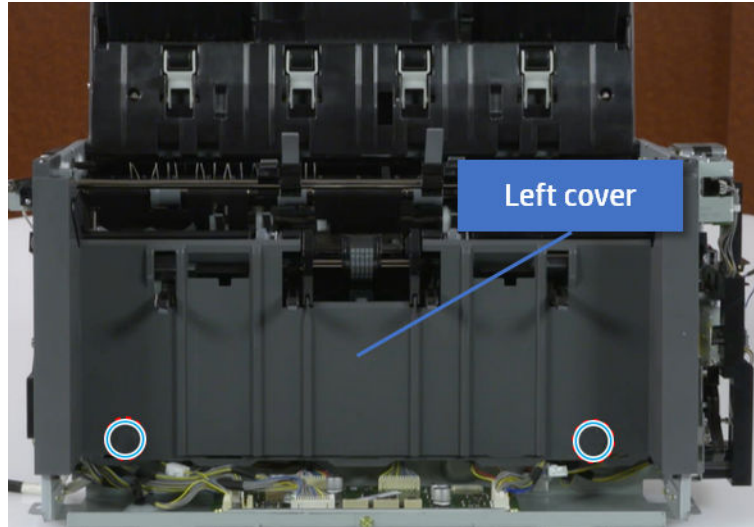

- b. Remove four screws from both front and rear sides.

Figure 5-729 Remove four screws

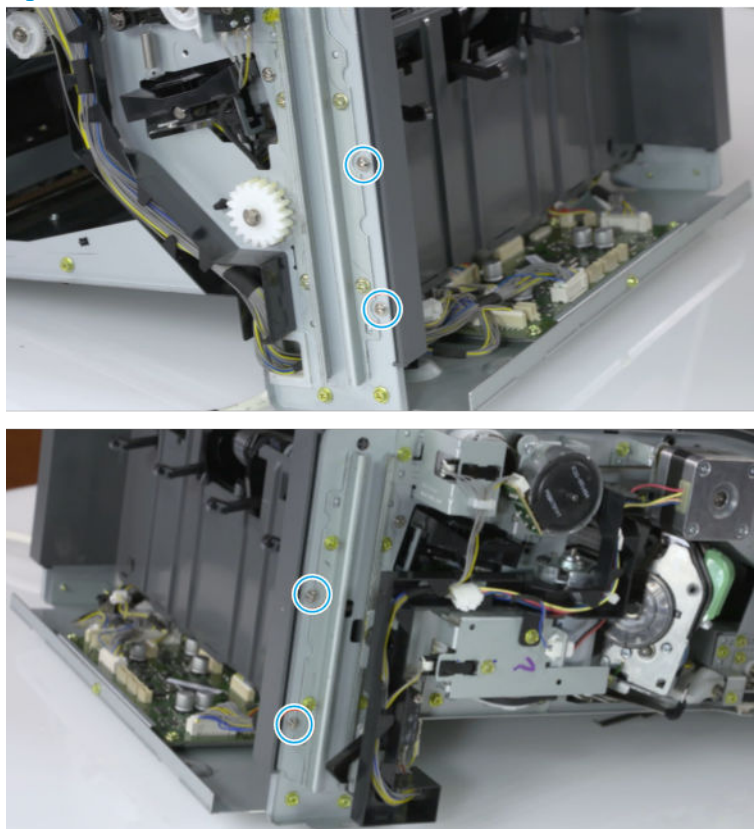

- c. Unplug two inline connectors, and then remove the left cover.

Figure 5-730 Unplug two connectors

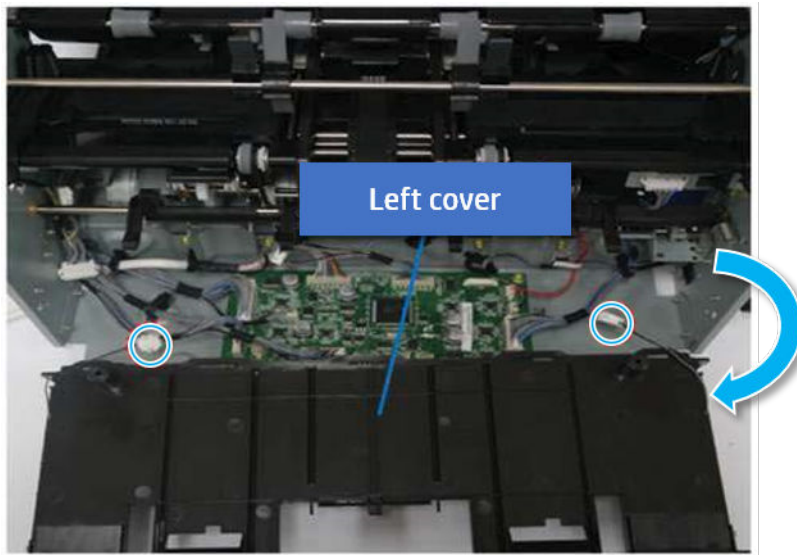

 **TIP:** Be sure to check the hook when reassembling.

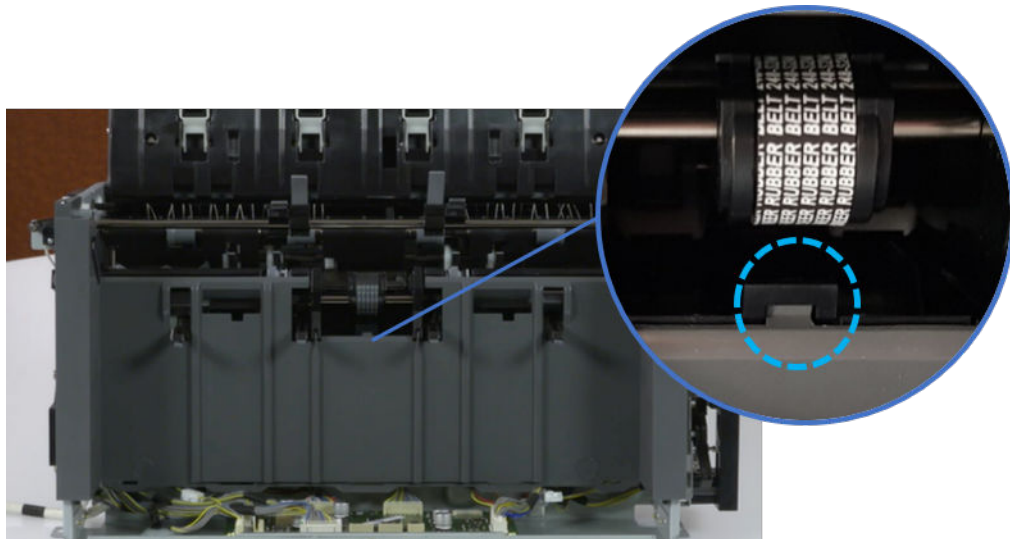

- 7. Remove the front harness guide.
 - a. Open one clamp and unplug five connectors, and then remove the wire harness from the front harness guide.

- b. Remove four screws, and then remove the front harness guide.

Figure 5-731 Remove the front harness guide

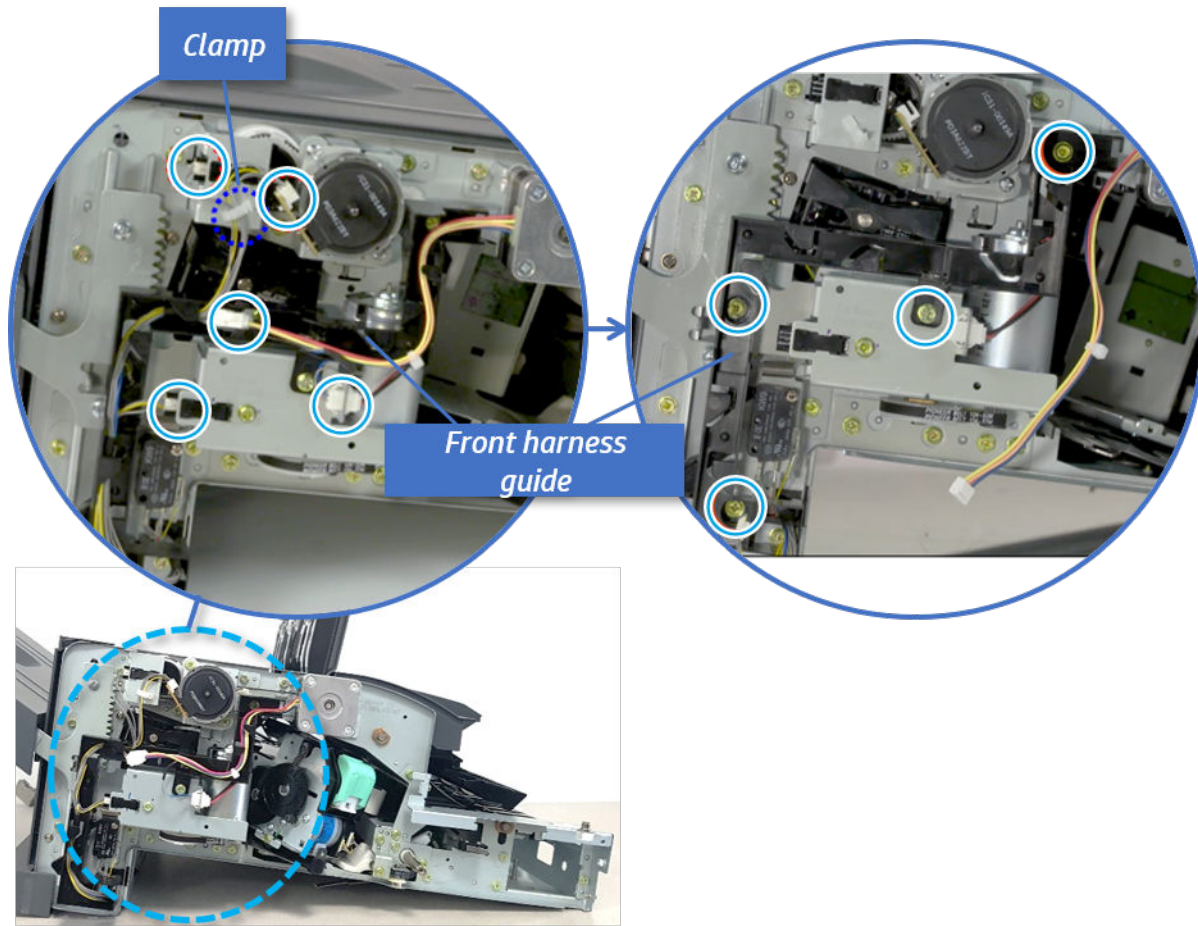

- 8. Remove the output tray motor assembly.
 - ▲ Remove three screws, and then remove the output tray motor assembly.

Figure 5-732 Remove the output tray motor assembly

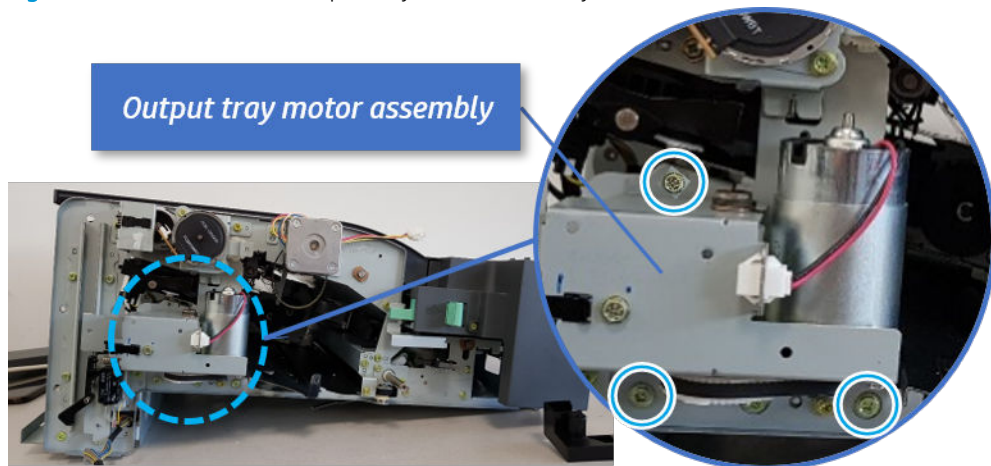

- 9. Remove the output tray lower limit switch.

- ▲ Remove one screw, and then remove the output tray lower limit switch.

Figure 5-733 Remove the output tray lower limit switch

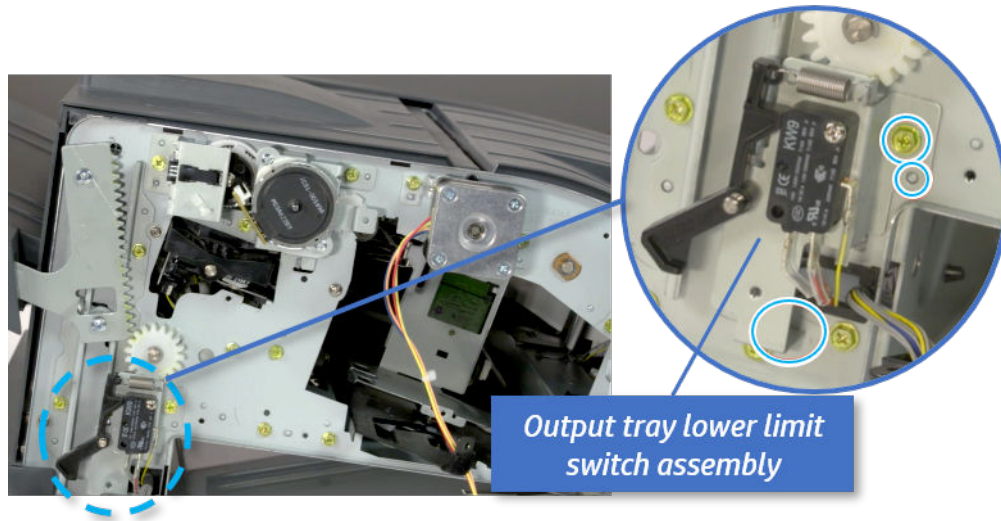

- 10. Remove the paper holding.
 - a. Remove the paper holding actuator spring.

Figure 5-734 Remove the paper holding actuator spring

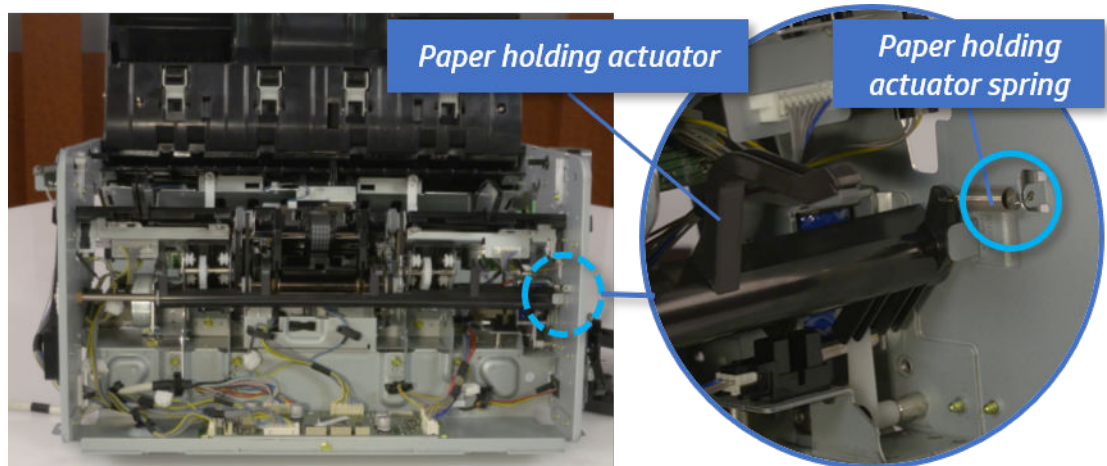

- b. Remove the e-ring and the rack pinion gear. And then remove the pin and the e-ring, and then remove the bushing.

Figure 5-735 Remove e-ring, rack pinion gear, pin, and bushing

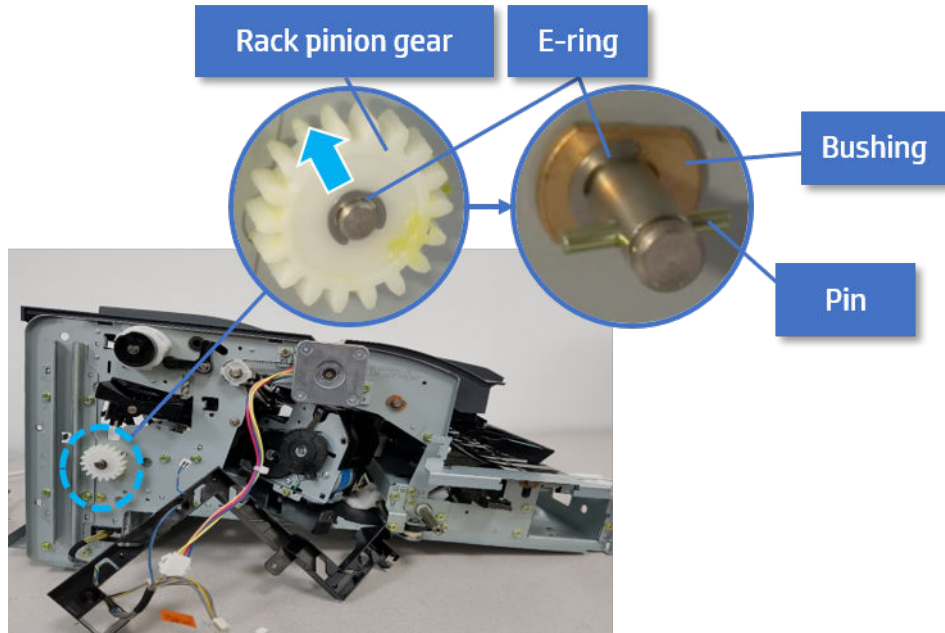

 **NOTE:** Be sure not to lose the pin.

- c. Carefully remove the paper holding shaft and the actuator.

Figure 5-736 Remove the paper holding shaft and the actuator

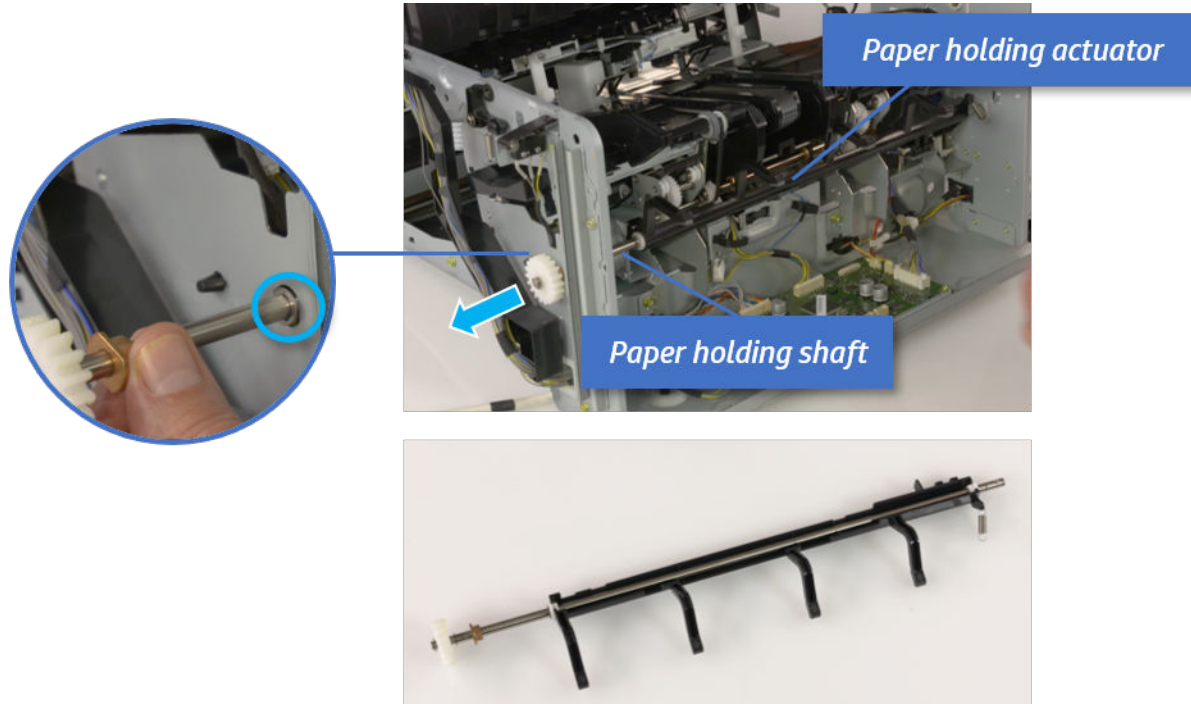

- 11. Remove the paper holding sensor.

- a. Unplug the connector.
- b. Remove the adhesive strip from below the sensor.
- c. Remove the paper holding sensor.

Figure 5-737 Remove the paper holding sensor

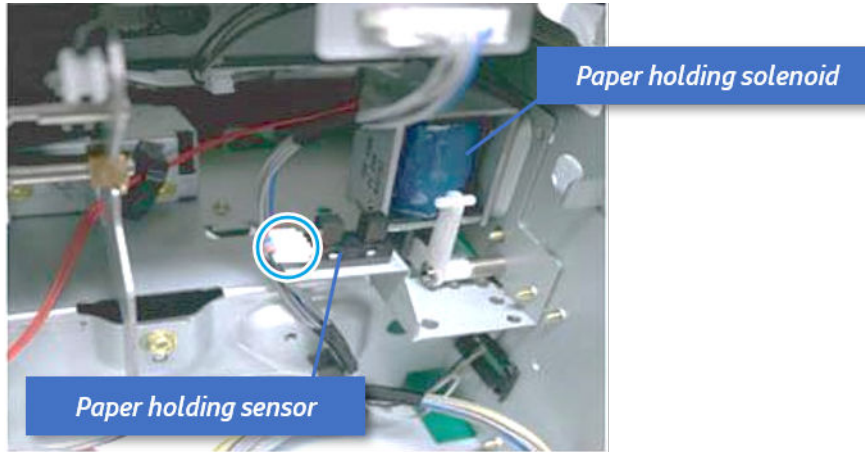

12. Unpack the replacement assembly.

- a. Dispose of the defective part.



NOTE: HP recommends responsible disposal of the defective part.

<http://www8.hp.com/us/en/hp-information/environment/product-recycling.html>

- b. Unpack the replacement part from the packaging.



CAUTION:  Some parts are sensitive to electrostatic discharge (ESD). Always perform service

work at an ESD-protected workstation or mat. If an ESD workstation or mat is not available, touch the sheet-metal chassis to provide a static ground before touching an ESD-sensitive assembly. Protect the ESD-sensitive assemblies by placing them in ESD pouches when they are out of the printer.

If the replacement part is a roller or pad, avoid touching the spongy part of it. Skin oils on the roller or pad can cause paper pickup and/or print-quality problems. HP recommends using disposable gloves when handling rollers or pads or washing your hands before touching rollers or pads.



IMPORTANT: Make sure that all of the shipping materials (for example shipping tape) are removed from the replacement part prior to installation.

- c. To install an assembly, reverse the removal steps.

When applicable, special installation instructions are provided for an assembly at the end of the removal procedure. Always completely read the removal instructions and follow all special installation instructions.

Removal and replacement: Paper holding solenoid (SL1)

Learn how to remove and replace the paper holding solenoid.

To view teardown&reassembling video of the inner finisher, click the link below.

 [View a teardown video of the inner finisher .](#)

 [View a reassembling video of the inner finisher .](#)

 **IMPORTANT:** When applicable, special installation instructions are provided for an assembly at the end of the removal procedure. Always completely read the removal instructions and follow all special installation instructions.

Mean time to repair:

Service level:

Before performing service

Turn the printer power off

- Press the power button on the front of the printer, and then turn off the power switch next to the power cable.
- A shutting-down message appears on the control-panel display.

 **WARNING!** To avoid damage to the printer, turn the power off and wait until the printer shuts down before removing the power cable.

- Disconnect the printer power cable after the printer has completely shut down (the control-panel display is blank).

Use the table below to identify the correct part number for your printer. To order the part, go to <https://parts.hp.com>.

Table 5-71 Part information

Part number	Part description
JC33-00037A	Paper holding solenoid

Required tools

- #2 JIS screwdriver with a magnetic tip

After performing service

Turn the printer power on

- Connect the power cable.
- Use the power switch to turn the power on.

Post service test

Print any pages necessary to verify that the repair resolved the issue and did not create any new issues.

1. Remove the front cover.
 - a. Open the front door and open the punch cover.
 - b. Remove three screws in the front.

- c. Remove the lever.
- d. Open the top cover.
- e. From the right side of the front cover, carefully lift and pry toward the top-left corner to remove the front cover.

Figure 5-738 Remove the front cover

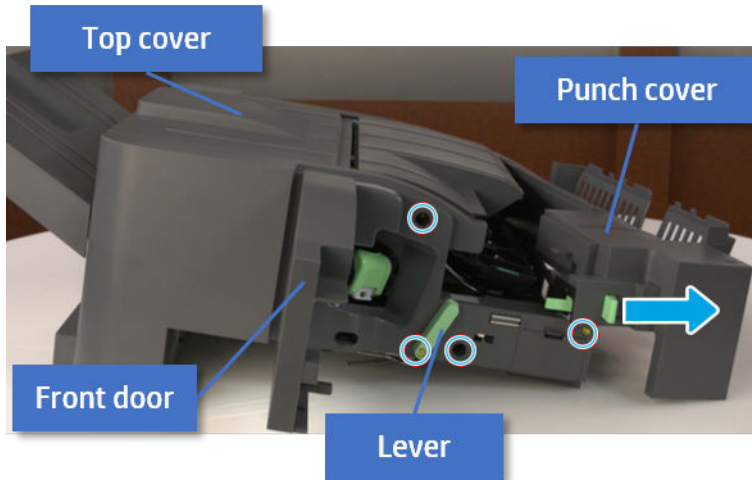

- 2. Remove the rear cover.
 - a. Open the top cover.

Figure 5-739 Open the top cover

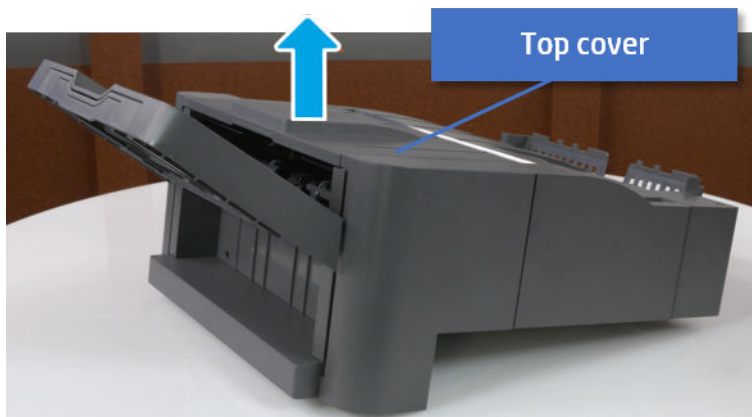

- b. Remove three screws.

- c. Release hooks carefully and remove the rear cover.

Figure 5-740 Remove the rear cover

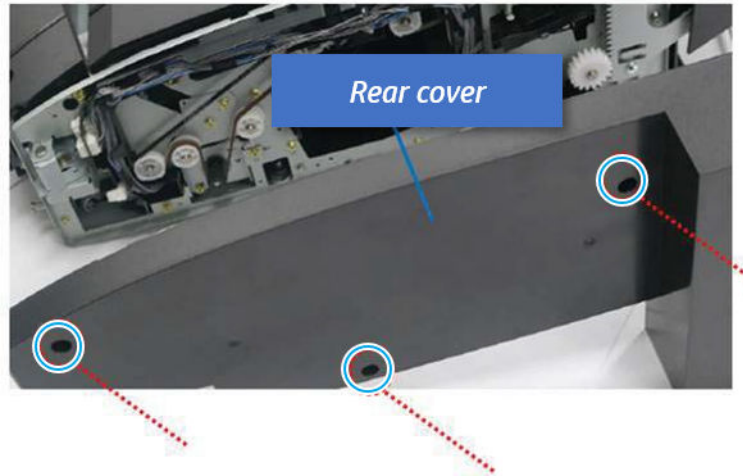

- 3. Remove the output tray.

- a. Remove four screws.

Figure 5-741 Remove four screws

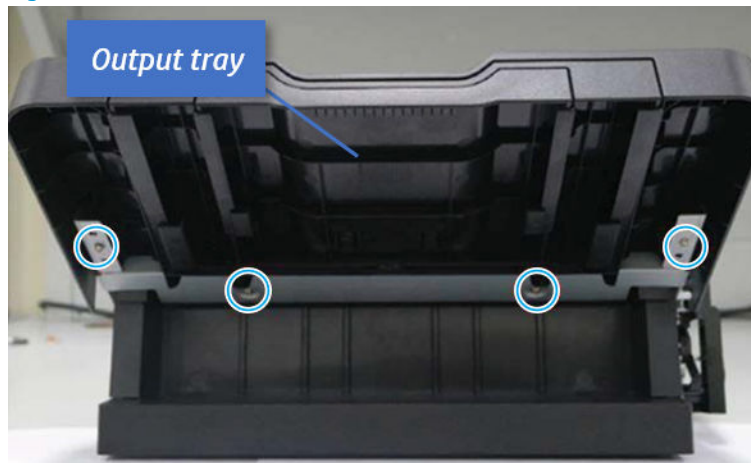

- b. Push the paper holding actuator into the inner finisher, and then remove the output tray.

Figure 5-742 Remove the output tray.



- 4. Remove the output tray frame.
 - a. Rotate the pulley until the output tray frame depart from the gear.

Figure 5-743 Remove the pulley

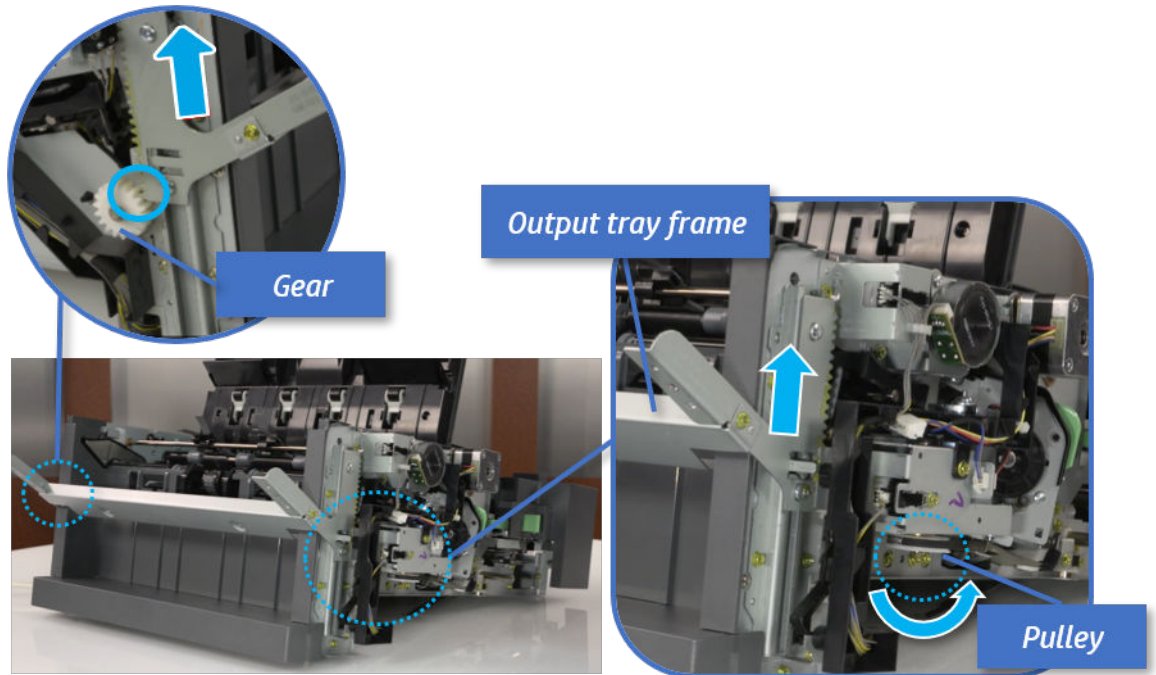

- b. Push the paper holding actuator into the inner finisher, and then remove the output tray frame.

Figure 5-744 Remove the output tray frame

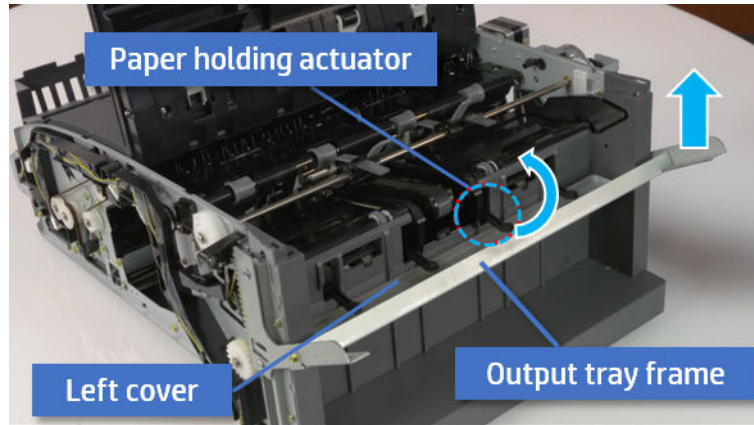

TIP: Push the paper holding actuator into the inner finisher when reassembling. Be sure to level the output tray.

1. Position the first wheel into the channel on both sides while pushing the paper holding actuator.

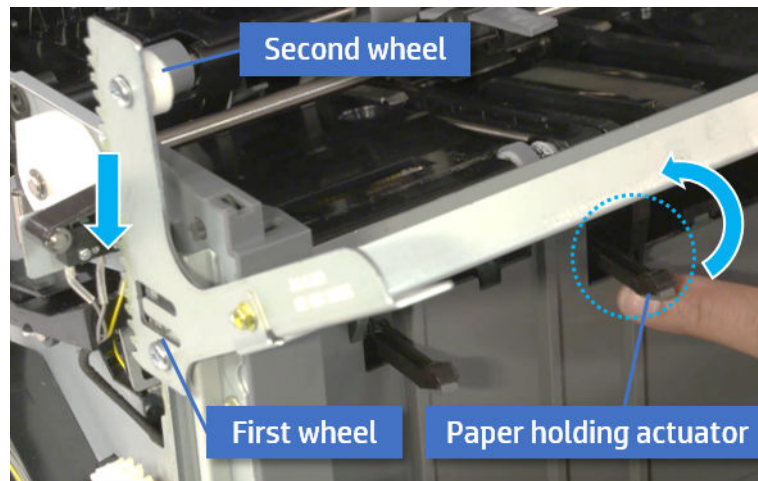

2. Let the second wheel rest on the channel on both sides simultaneously.
3. Gently squeeze the wheels into channel until the output tray frame meet the gear.

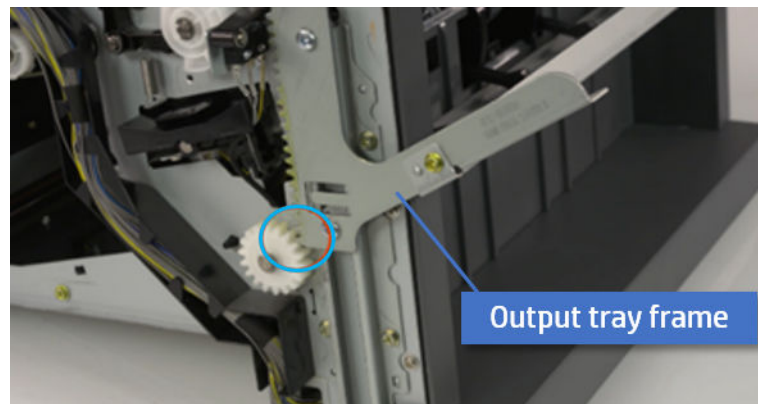

4. Rotate the pulley until the output tray frame is no longer lifted. It can make to level the output tray frame.

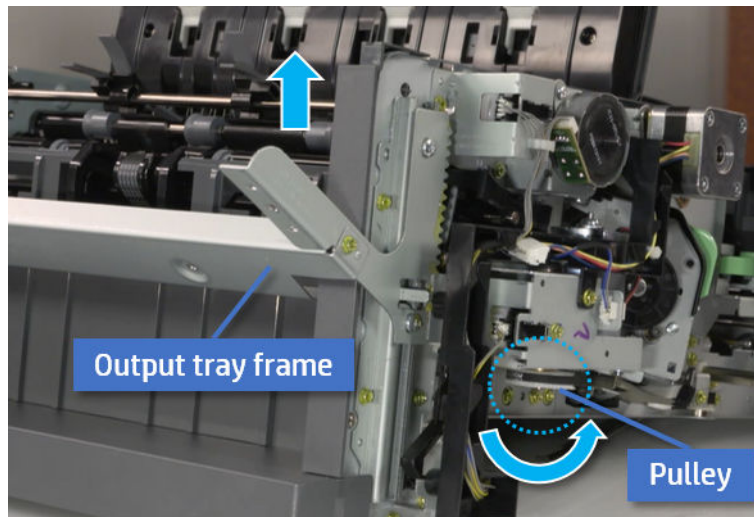

5. Rotate the pulley in the opposite direction.

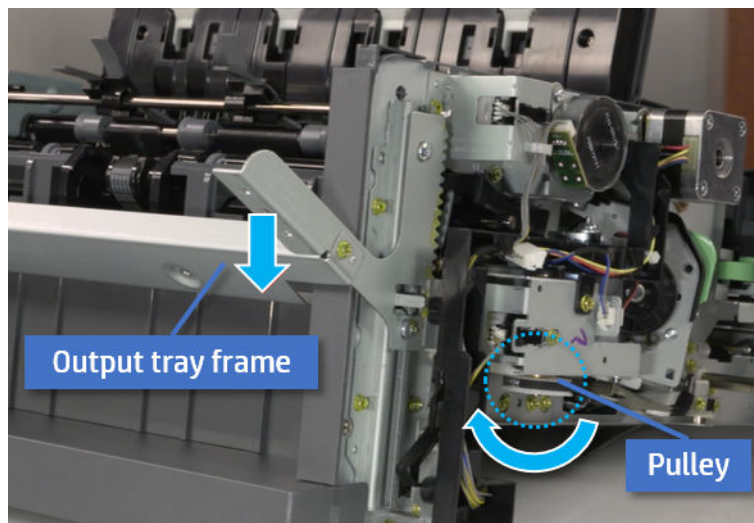

5. Remove the PCA cover.
 - ▲ Remove two screws, and then remove the PCA cover.

Figure 5-745 Remove the PCA cover

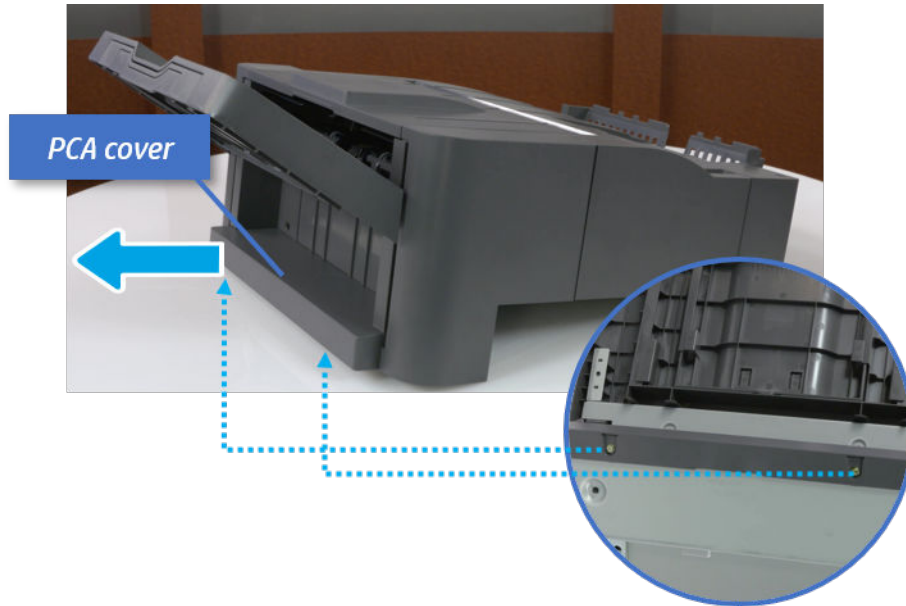

6. Remove the left cover.
 - a. Remove two screws.

Figure 5-746 Remove two screws

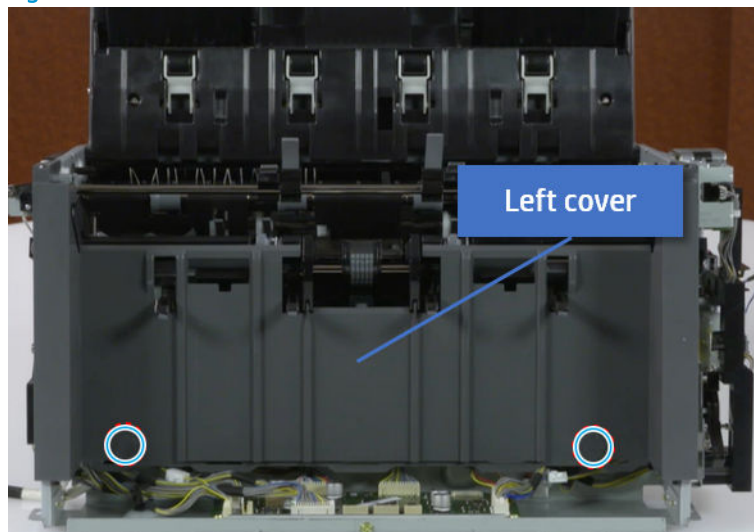

- b. Remove four screws from both front and rear sides.

Figure 5-747 Remove four screws

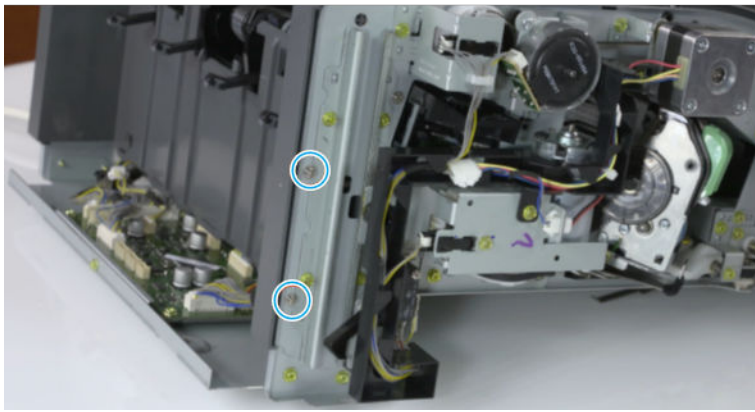
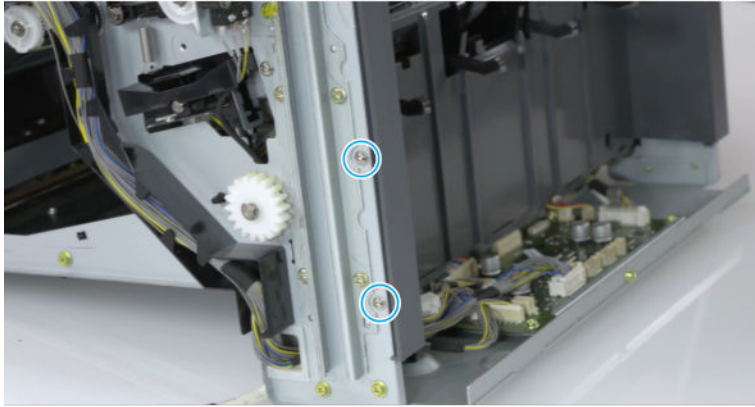

- c. Unplug two inline connectors, and then remove the left cover.

Figure 5-748 Unplug two connectors

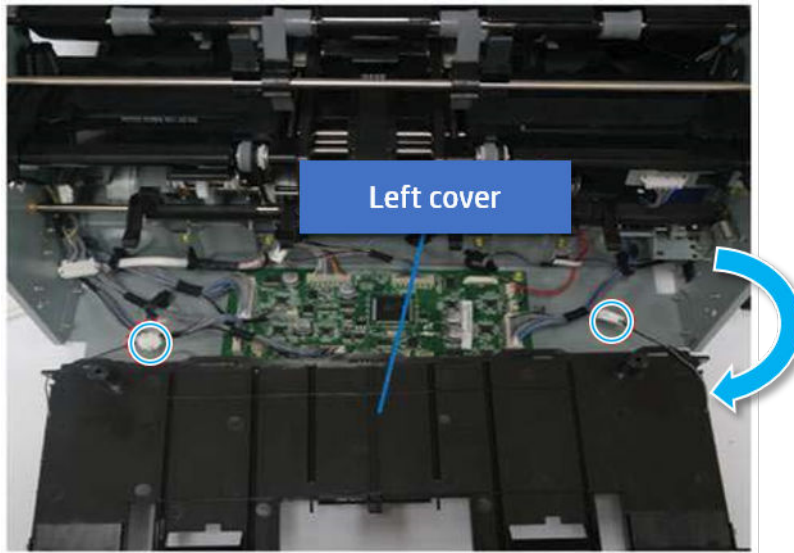

 **TIP:** Be sure to check the hook when reassembling.

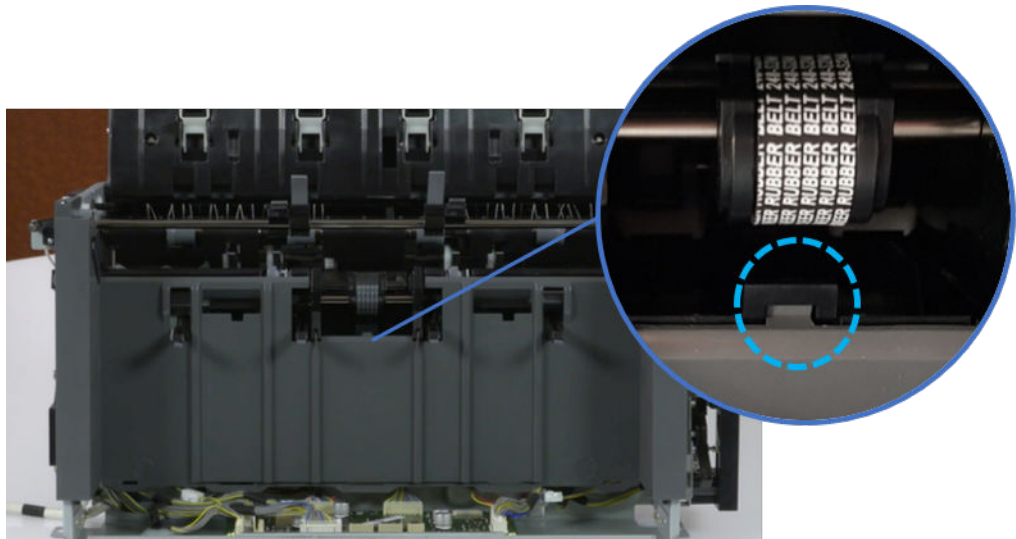

- 7. Remove the front harness guide.
 - a. Open one clamp and unplug five connectors, and then remove the wire harness from the front harness guide.

- b. Remove four screws, and then remove the front harness guide.

Figure 5-749 Remove the front harness guide

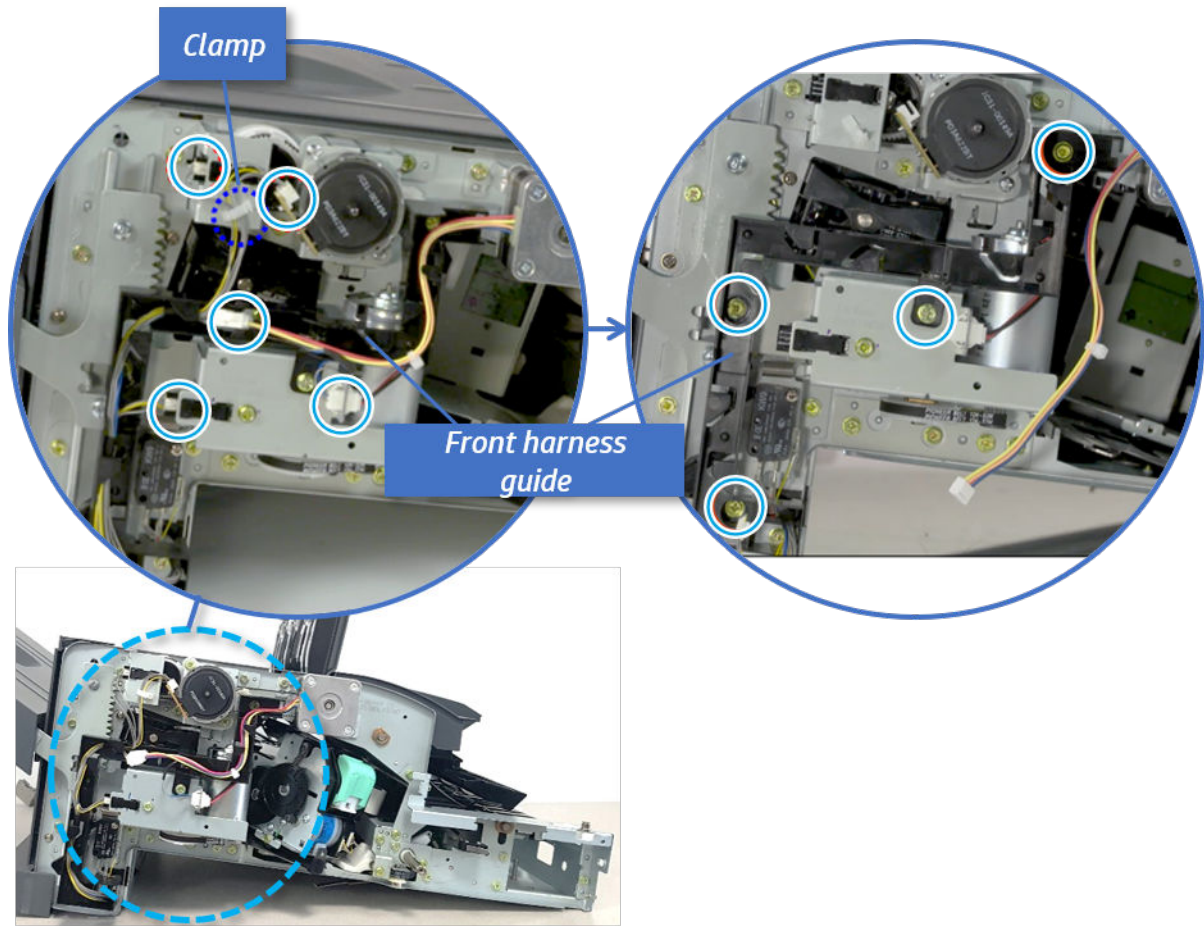

8. Remove the output tray motor assembly.
- ▲ Remove three screws, and then remove the output tray motor assembly.

Figure 5-750 Remove the output tray motor assembly

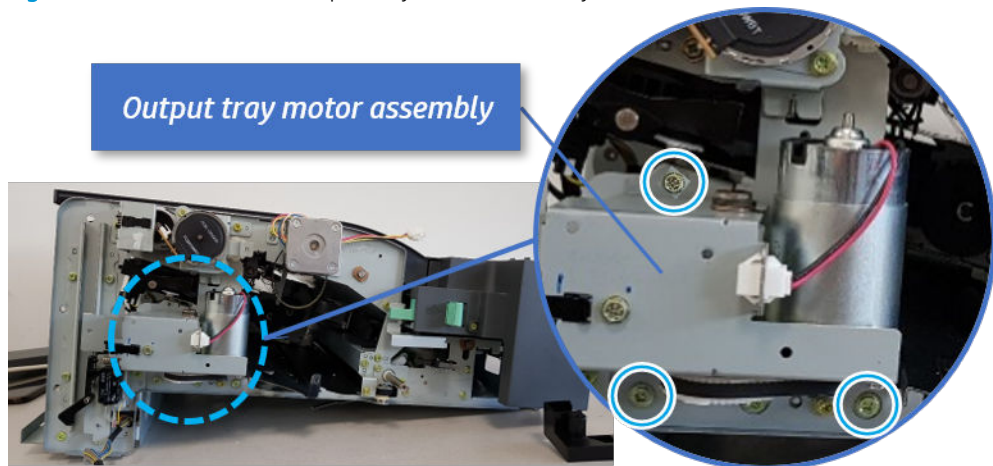

9. Remove the output tray lower limit switch.

- ▲ Remove one screw, and then remove the output tray lower limit switch.

Figure 5-751 Remove the output tray lower limit switch

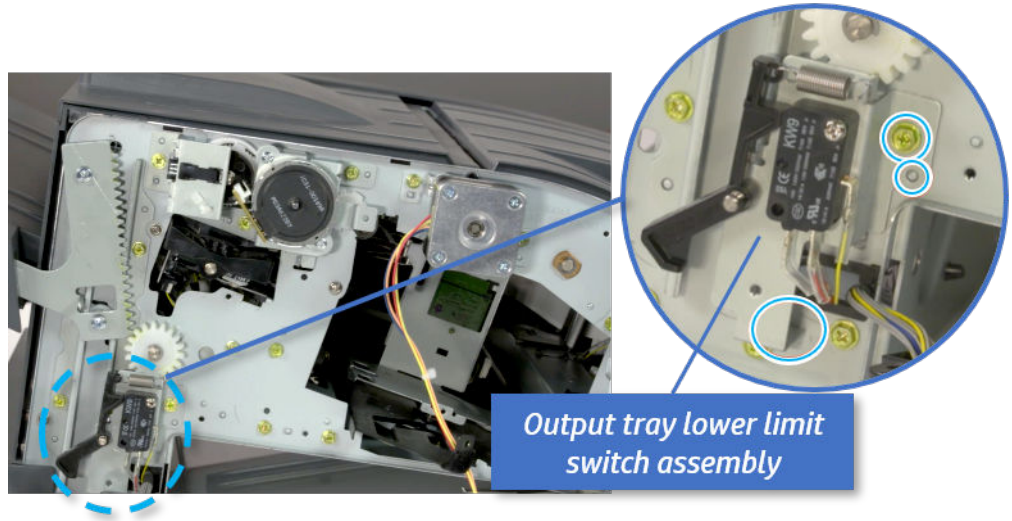

- 10. Remove the paper holding.
 - a. Remove the paper holding actuator spring.

Figure 5-752 Remove the paper holding actuator spring

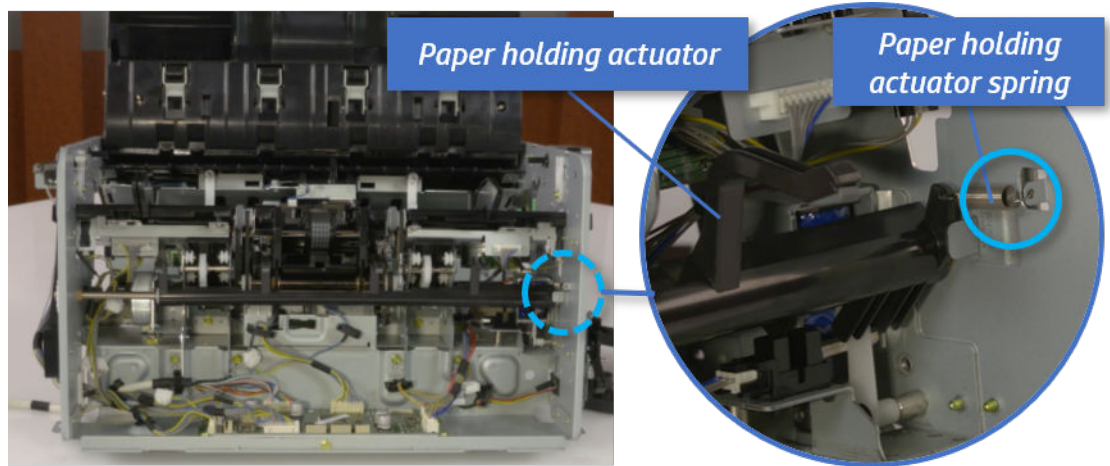

- b. Remove the e-ring and the rack pinion gear. And then remove the pin and the e-ring, and then remove the bushing.

Figure 5-753 Remove e-ring, rack pinion gear, pin, and bushing

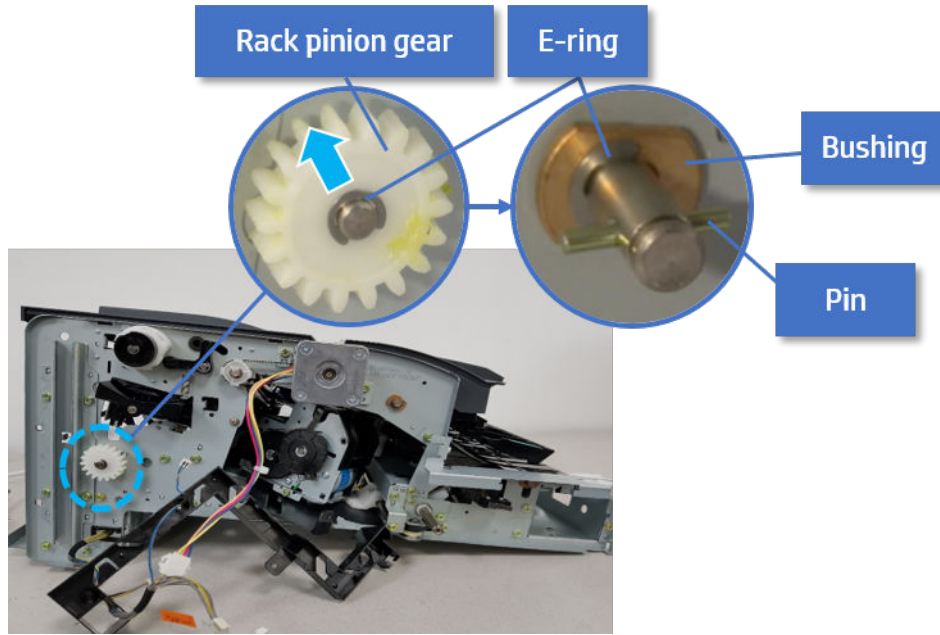

 **NOTE:** Be sure not to lose the pin.

- c. Carefully remove the paper holding shaft and the actuator.

Figure 5-754 Remove the paper holding shaft and the actuator

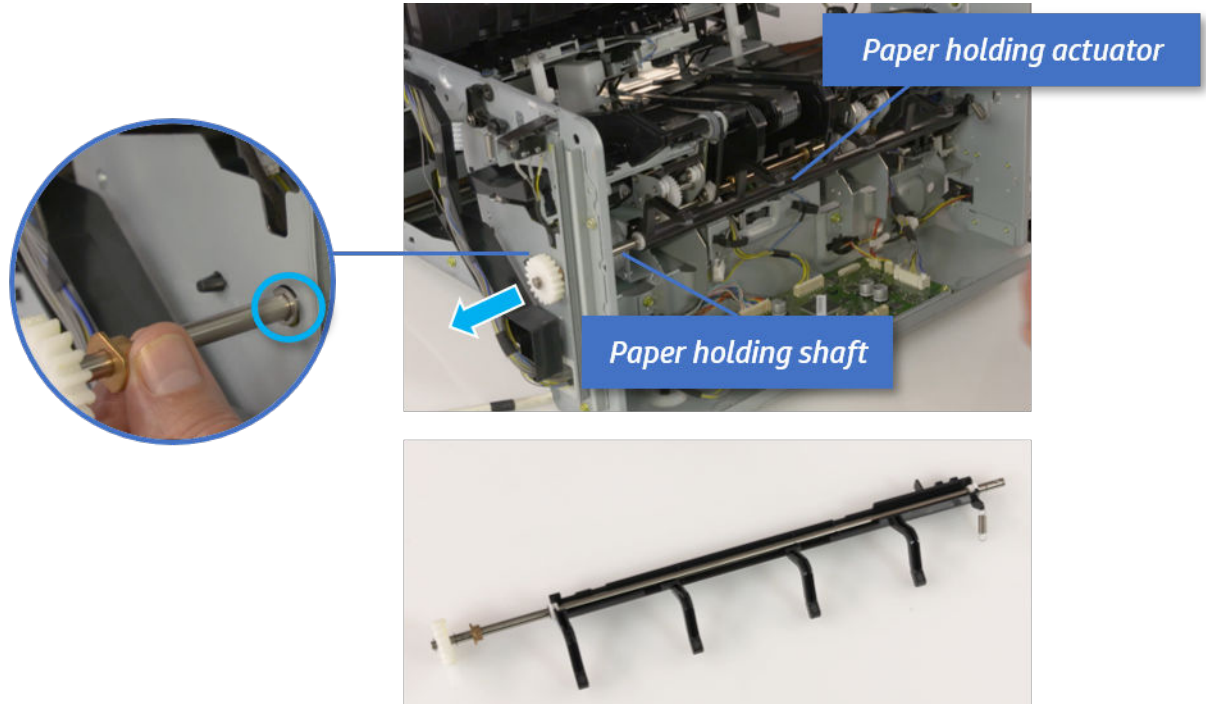

- 11. Remove the sub paddle unit.

- a. Open the top cover, and then remove one screw securing the sub paddle unit.

Figure 5-755 Remove one screw

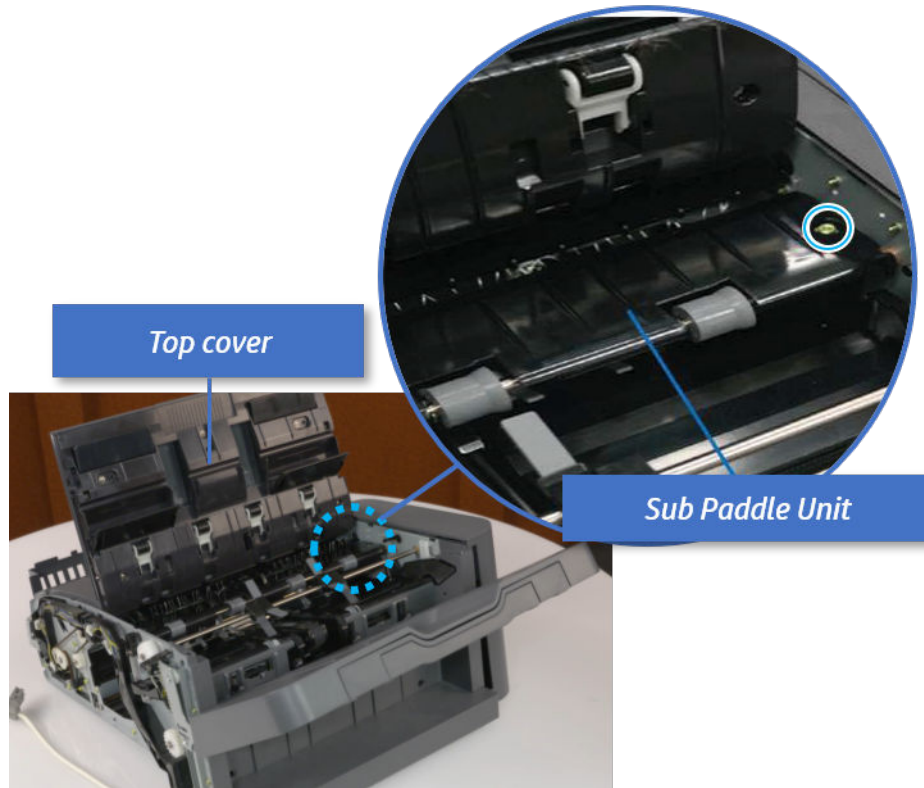

- b. Remove the e-ring, and then remove the pulley and timing belt. And then remove the e-ring and the bushing.

Figure 5-756 Remove the e-ring, pulley, timing belt, and bushing

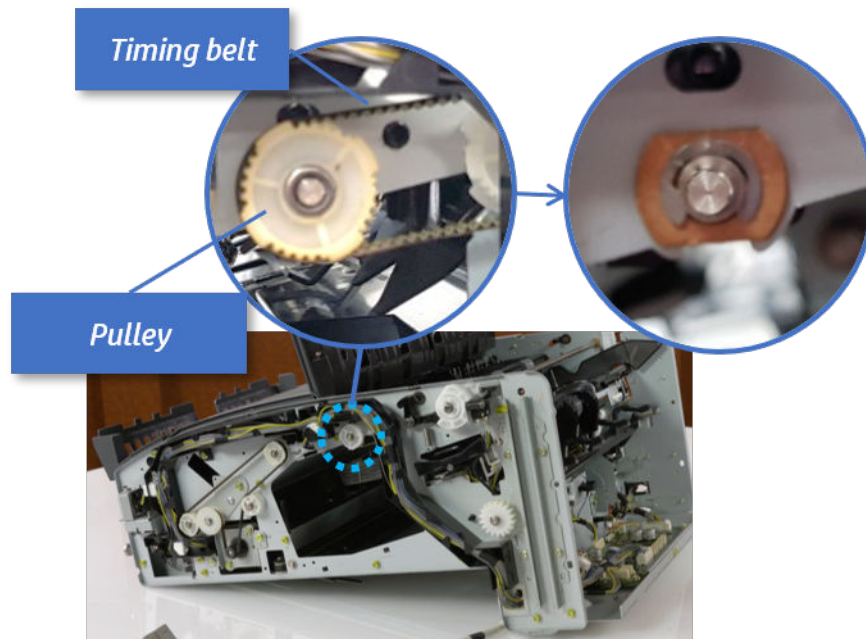

- c. Lift up and remove the sub paddle unit.

Figure 5-757 Remove the sub paddle unit

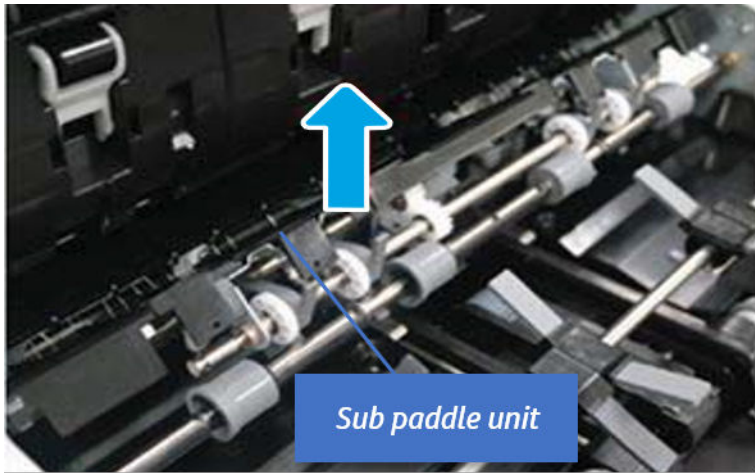

- 12. Remove the exit roller.

- a. Remove the guide on the center of the exit roller.

Figure 5-758 Remove the guide

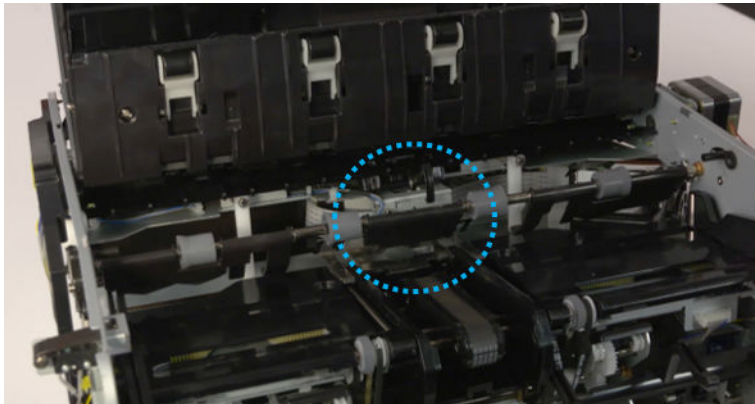

- b. On the front of the inner finisher, release the timing belt connected to the exit motor.

Figure 5-759 Release the timing belt

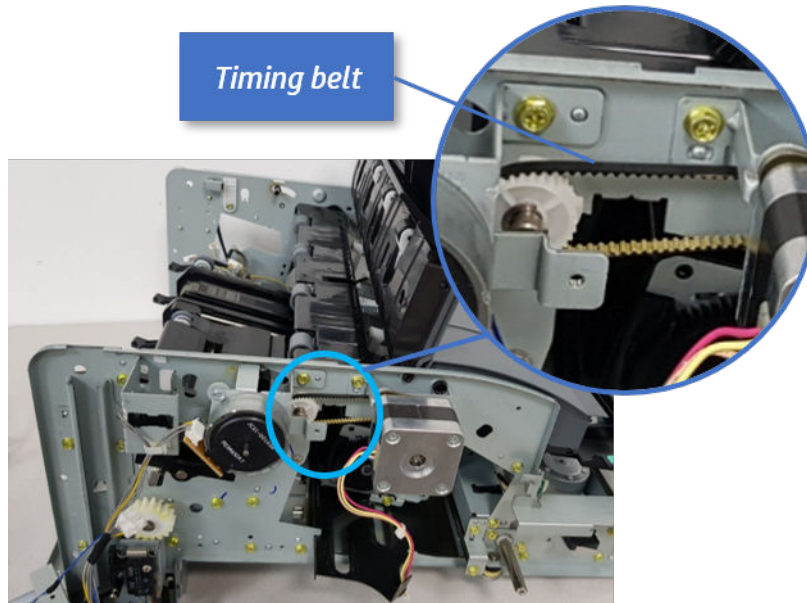

- c. Remove five screws securing the rear harness guide.

Figure 5-760 Remove five screws

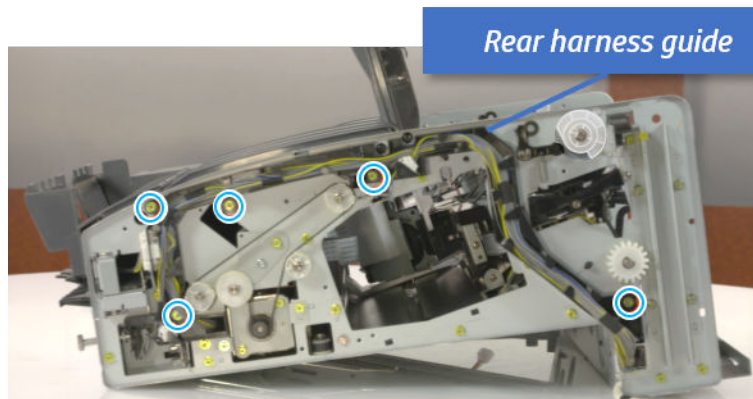

- d. On the rear of the inner finisher, remove the e-ring and the pulley and then remove the e-ring and the bushing.

Figure 5-761 Remove e-ring, pulley, and bushing

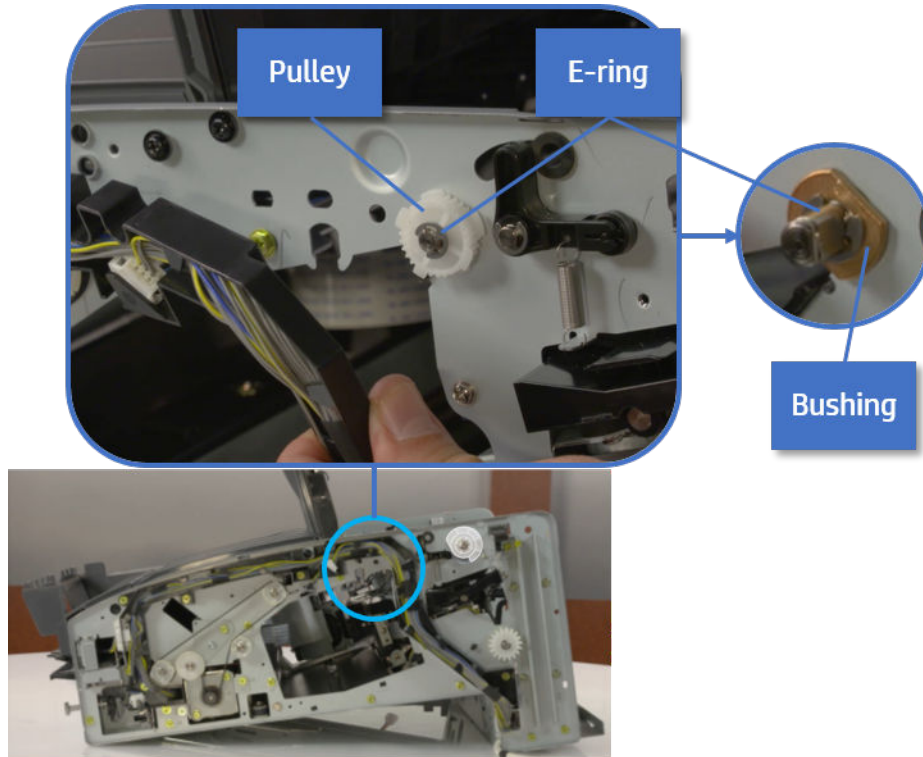

- e. Push the bushing to detach it, and then remove the exit roller.

Figure 5-762 Remove the exit roller

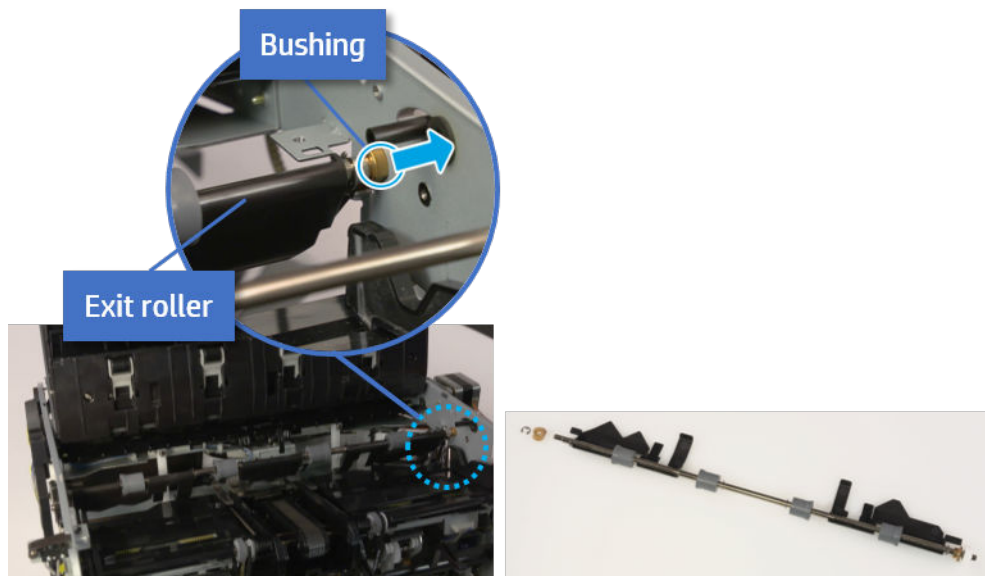

- 13. Remove the front tamper.
 - a. Remove four screws.

Figure 5-763 Remove four screws

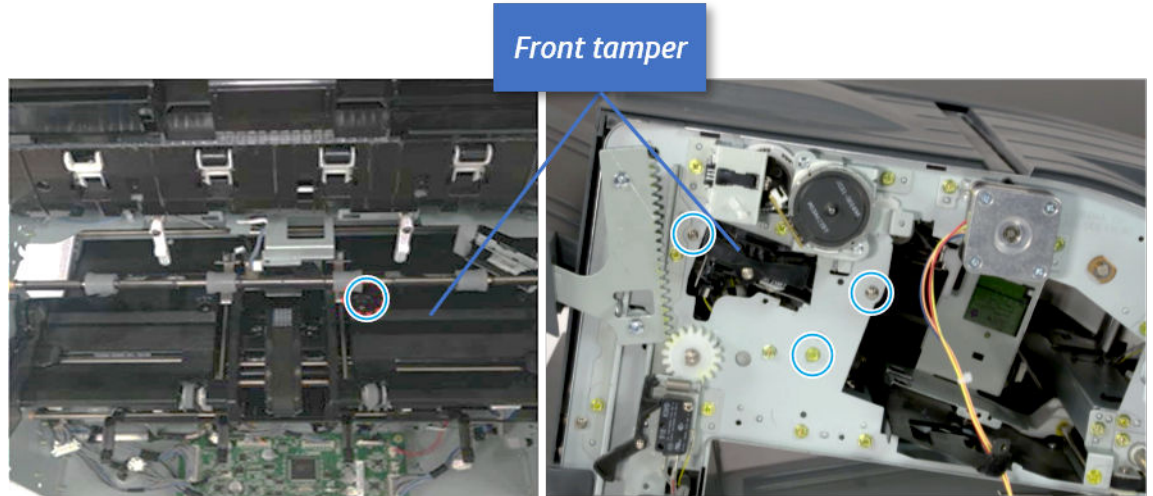

- b. Unplug the connector and release the hook, and then pull the front tamper up to remove.

Figure 5-764 Remove the front tamper

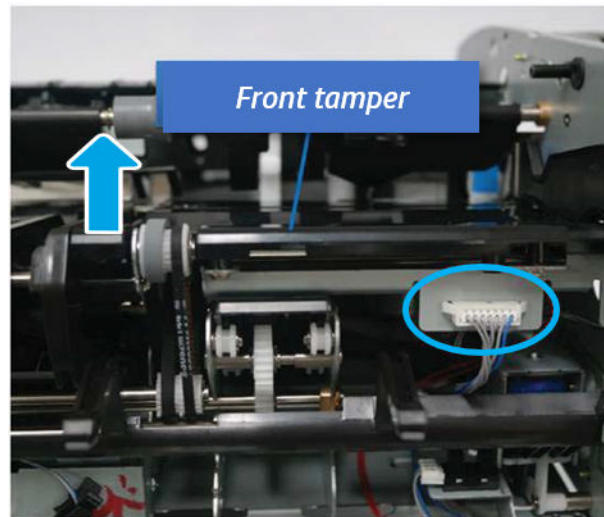

14. Remove the paper holding solenoid

- a. Remove two screws at the front of the inner finisher.

Figure 5-765 Remove two screws

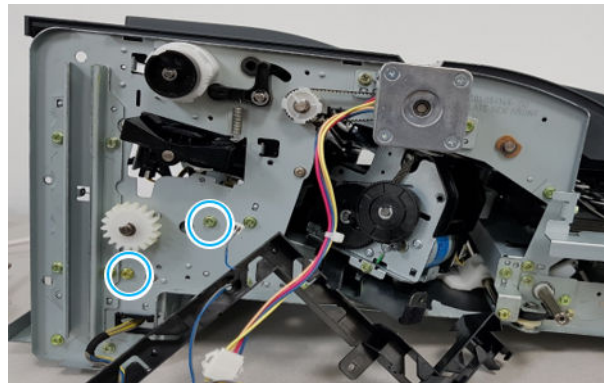

- b. Remove one screw.

Figure 5-766 Remove one screw

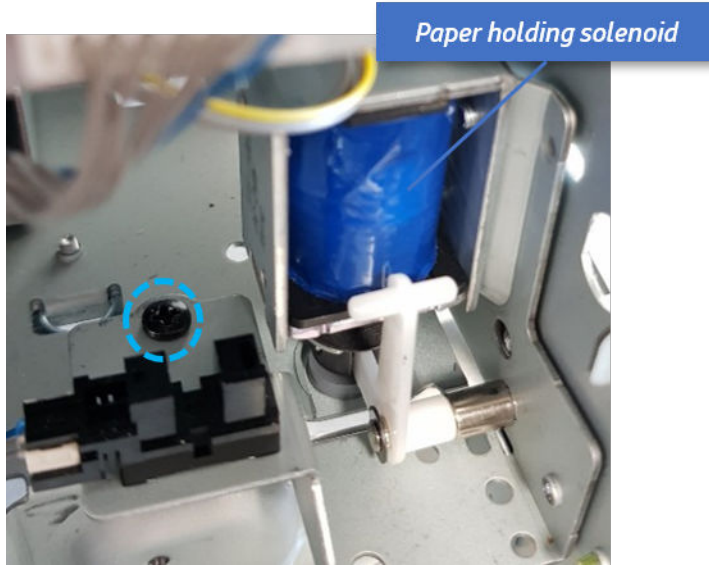

- c. Disconnect two connectors and remove the solenoid assembly.

Figure 5-767 Remove the solenoid assembly

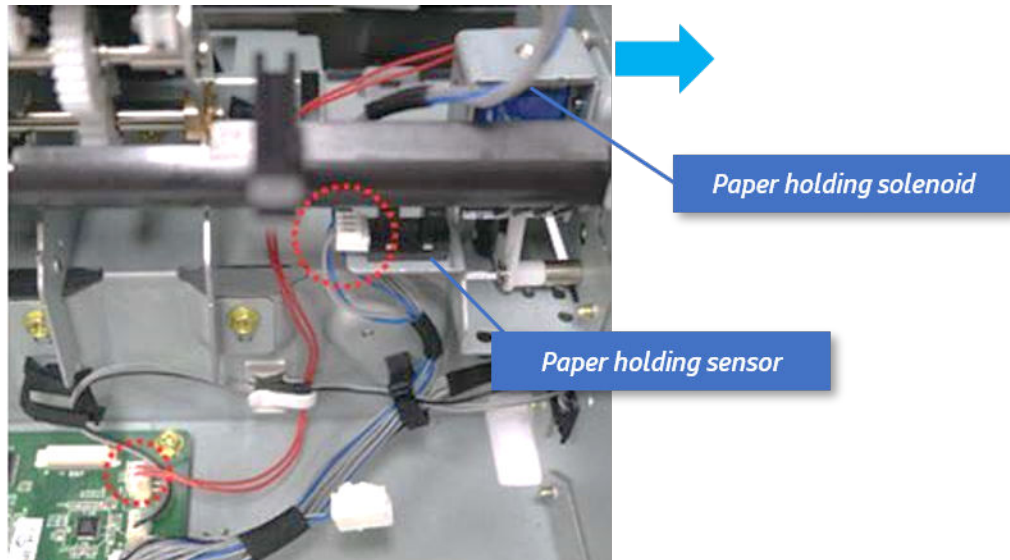

- d. Remove two screws, and then release the solenoid from the bracket.

Figure 5-768 Remove the paper holding solenoid

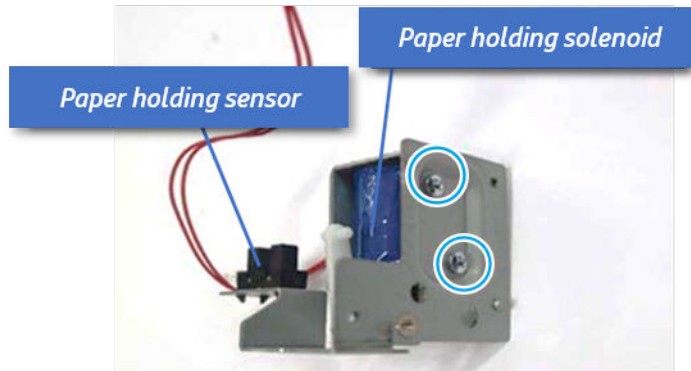

15. Unpack the replacement assembly.

- a. Dispose of the defective part.



NOTE: HP recommends responsible disposal of the defective part.

<http://www8.hp.com/us/en/hp-information/environment/product-recycling.html>

- b. Unpack the replacement part from the packaging.



CAUTION:



Some parts are sensitive to electrostatic discharge (ESD). Always perform service work at an ESD-protected workstation or mat. If an ESD workstation or mat is not available, touch the sheet-metal chassis to provide a static ground before touching an ESD-sensitive assembly. Protect the ESD-sensitive assemblies by placing them in ESD pouches when they are out of the printer.

If the replacement part is a roller or pad, avoid touching the spongy part of it. Skin oils on the roller or pad can cause paper pickup and/or print-quality problems. HP recommends using disposable gloves when handling rollers or pads or washing your hands before touching rollers or pads.



IMPORTANT: Make sure that all of the shipping materials (for example shipping tape) are removed from the replacement part prior to installation.

- c. To install an assembly, reverse the removal steps.

When applicable, special installation instructions are provided for an assembly at the end of the removal procedure. Always completely read the removal instructions and follow all special installation instructions.

Punch unit

Removal and replacement: Punch cover

Learn how to remove and replace the punch cover.

To view teardown&reassembling video of the inner finisher, click the link below.

 [View a teardown video of the inner finisher .](#)

 [View a reassembling video of the inner finisher .](#)

 **IMPORTANT:** When applicable, special installation instructions are provided for an assembly at the end of the removal procedure. Always completely read the removal instructions and follow all special installation instructions.

Mean time to repair:

Service level:

Before performing service

Turn the printer power off

- Press the power button on the front of the printer, and then turn off the power switch next to the power cable.
- A shutting-down message appears on the control-panel display.

 **WARNING!** To avoid damage to the printer, turn the power off and wait until the printer shuts down before removing the power cable.

- Disconnect the printer power cable after the printer has completely shut down (the control-panel display is blank).

Use the table below to identify the correct part number for your printer. To order the part, go to <https://parts.hp.com>.

Table 5-72 Part information

Part number	Part description
JC90-01343B	Punch cover

Required tools

- #2 JIS screwdriver with a magnetic tip

After performing service

Turn the printer power on

- Connect the power cable.
- Use the power switch to turn the power on.

Post service test

Print any pages necessary to verify that the repair resolved the issue and did not create any new issues.

1. Remove the rear cover.
 - a. Open the top cover.

Figure 5-769 Open the top cover

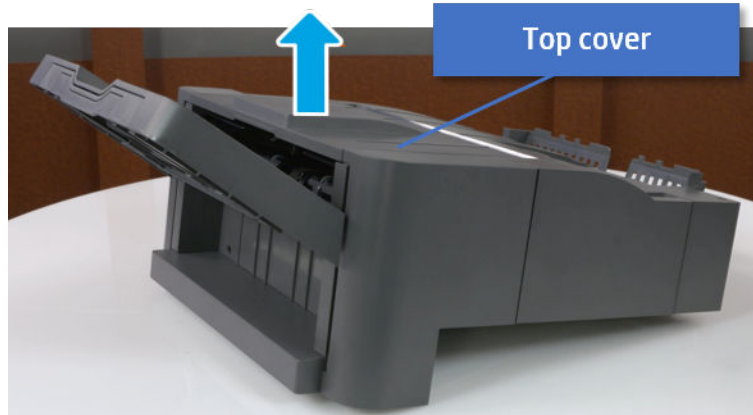

- b. Remove three screws.
 - c. Release hooks carefully and remove the rear cover.

Figure 5-770 Remove the rear cover

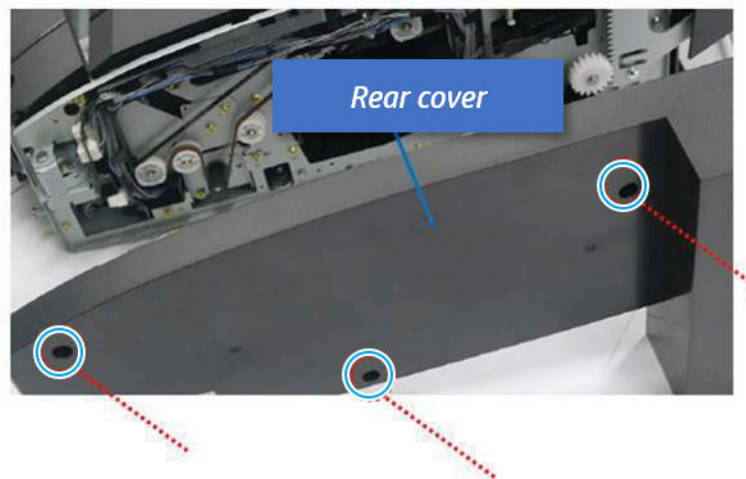

2. Remove the punch cover.
 - a. Unplug the connector. Remove the e-ring, and then remove the slide shaft at the rear of the inner finisher.

Figure 5-771 Remove the slide shaft

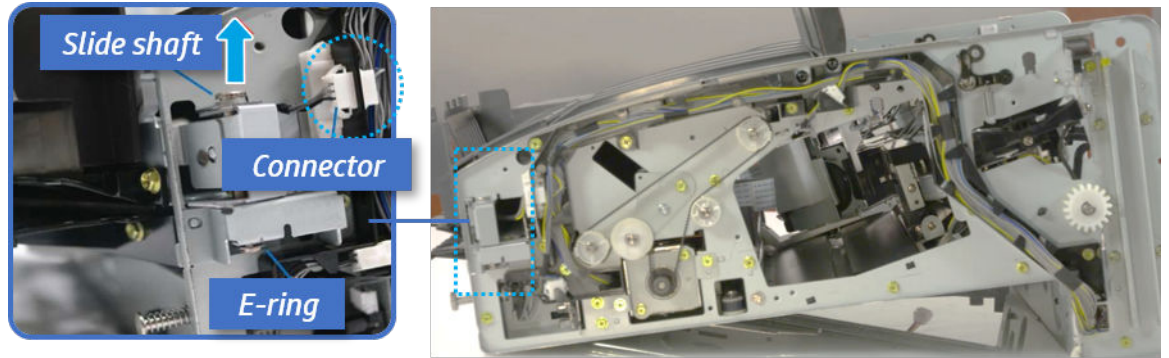

- b. Open the punch cover.

Figure 5-772 Open the punch cover

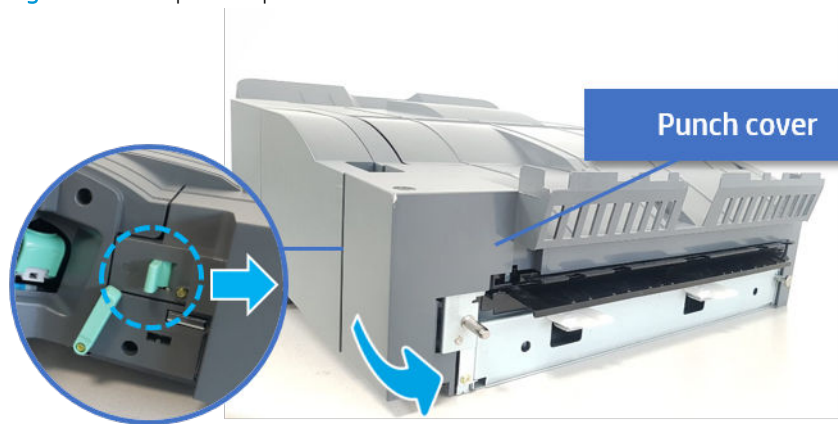

- c. Remove the front punch sheet, and then remove the e-ring and the washer. And then remove the punch cover.

Figure 5-773 Remove the punch cover

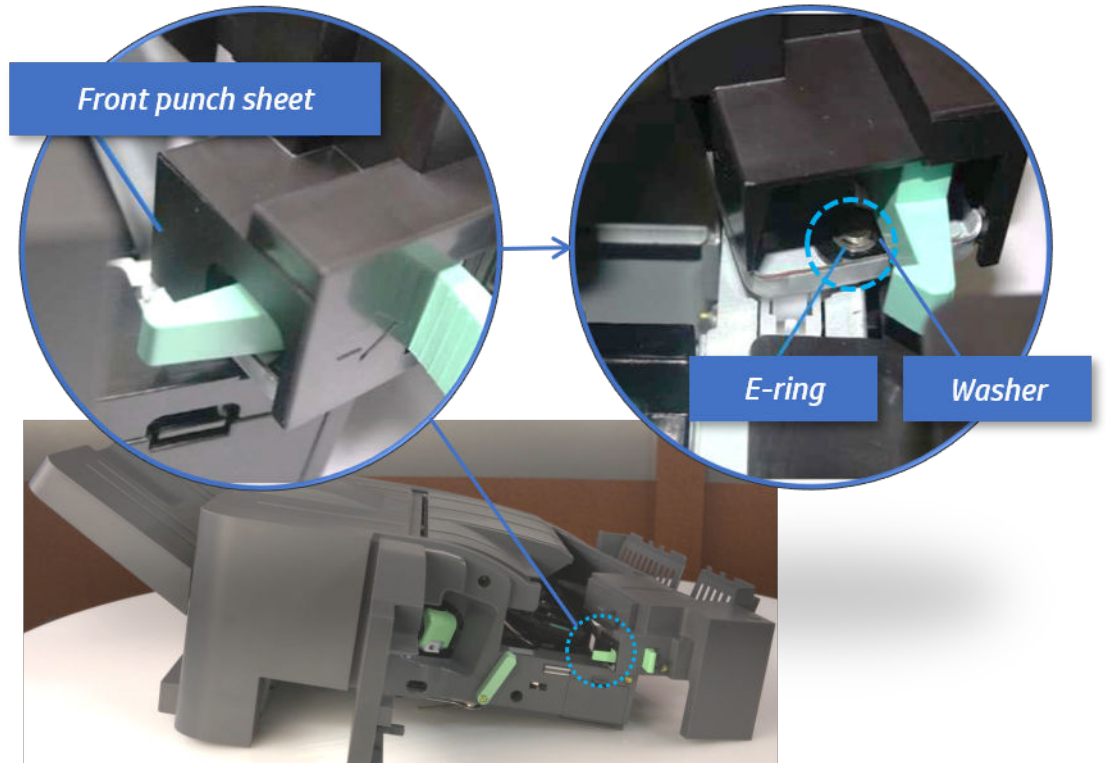



3. Unpack the replacement assembly.
 - a. Dispose of the defective part.

 **NOTE:** HP recommends responsible disposal of the defective part.

<http://www8.hp.com/us/en/hp-information/environment/product-recycling.html>

- b. Unpack the replacement part from the packaging.

 **CAUTION:**  Some parts are sensitive to electrostatic discharge (ESD). Always perform service work at an ESD-protected workstation or mat. If an ESD workstation or mat is not available, touch the sheet-metal chassis to provide a static ground before touching an ESD-sensitive assembly. Protect the ESD-sensitive assemblies by placing them in ESD pouches when they are out of the printer.

If the replacement part is a roller or pad, avoid touching the spongy part of it. Skin oils on the roller or pad can cause paper pickup and/or print-quality problems. HP recommends using disposable gloves when handling rollers or pads or washing your hands before touching rollers or pads.

 **IMPORTANT:** Make sure that all of the shipping materials (for example shipping tape) are removed from the replacement part prior to installation.

- c. To install an assembly, reverse the removal steps.

When applicable, special installation instructions are provided for an assembly at the end of the removal procedure. Always completely read the removal instructions and follow all special installation instructions.

Removal and replacement: Punch waste full sensor (S19)

Learn how to remove and replace the punch waste full sensor.

To view teardown&reassembling video of the inner finisher, click the link below.

 [View a teardown video of the inner finisher .](#)

 [View a reassembling video of the inner finisher .](#)

 **IMPORTANT:** When applicable, special installation instructions are provided for an assembly at the end of the removal procedure. Always completely read the removal instructions and follow all special installation instructions.

Mean time to repair:

Service level:

Before performing service

Turn the printer power off

- Press the power button on the front of the printer, and then turn off the power switch next to the power cable.
- A shutting-down message appears on the control-panel display.

 **WARNING!** To avoid damage to the printer, turn the power off and wait until the printer shuts down before removing the power cable.

- Disconnect the printer power cable after the printer has completely shut down (the control-panel display is blank).

Use the table below to identify the correct part number for your printer. To order the part, go to <https://parts.hp.com>.

Table 5-73 Part information

Part number	Part description
0604-001381	Punch waste full sensor

Required tools

- #2 JIS screwdriver with a magnetic tip

After performing service

Turn the printer power on

- Connect the power cable.
- Use the power switch to turn the power on.

Post service test

Print any pages necessary to verify that the repair resolved the issue and did not create any new issues.

1. Remove the front cover.
 - a. Open the front door and open the punch cover.
 - b. Remove three screws in the front.
 - c. Remove the lever.
 - d. Open the top cover.
 - e. From the right side of the front cover, carefully lift and pry toward the top-left corner to remove the front cover.

Figure 5-774 Remove the front cover

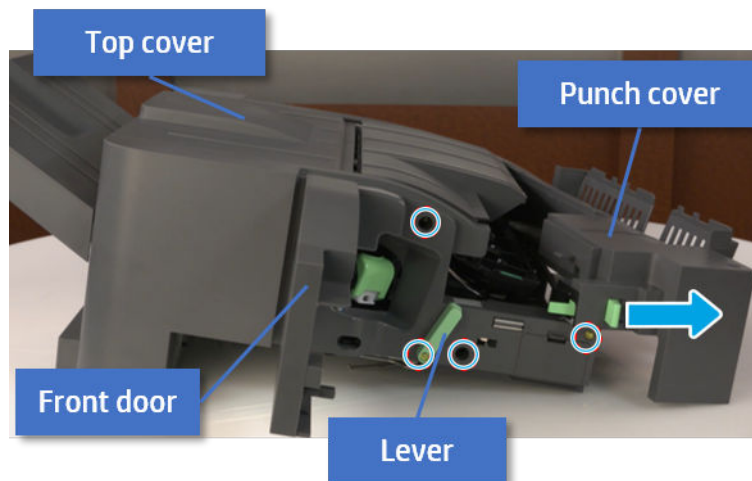

2. Remove the rear cover.

- a. Open the top cover.

Figure 5-775 Open the top cover

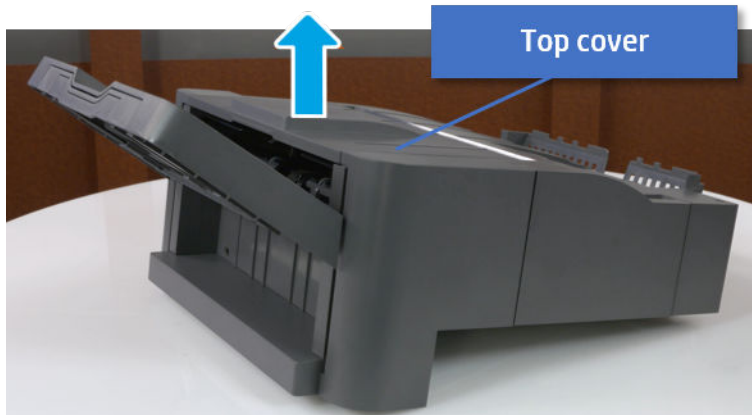

- b. Remove three screws.
- c. Release hooks carefully and remove the rear cover.

Figure 5-776 Remove the rear cover

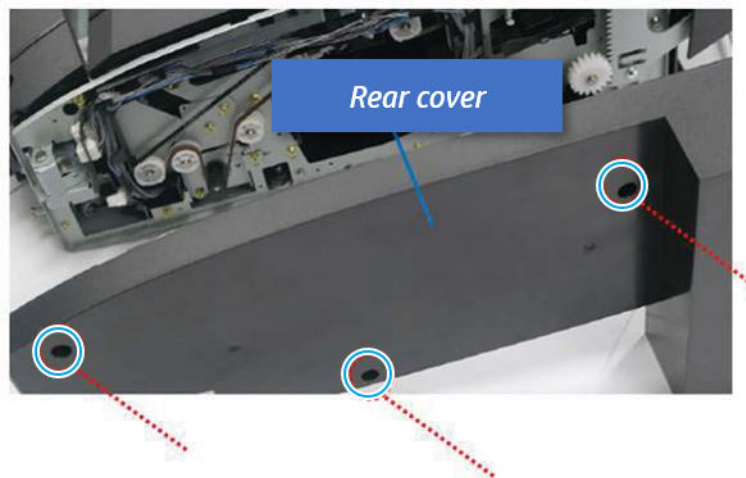

3. Remove the middle cover.
 - a. Open the front door and then open the punch cover.

Figure 5-777 Open the front door and punch cover.



- b. Remove left-side one screw at the rear of the inner finisher, and then remove the middle cover by lifting off the hinge pins at the front.

Figure 5-778 Remove the middle cover



- 4. Remove the punch cover.

- a. Unplug the connector. Remove the e-ring, and then remove the slide shaft at the rear of the inner finisher.

Figure 5-779 Remove the slide shaft

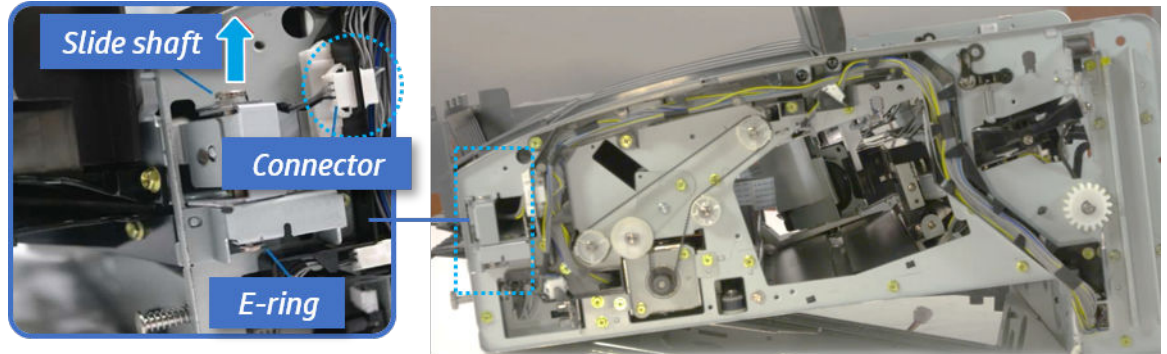

- b. Open the punch cover.

Figure 5-780 Open the punch cover

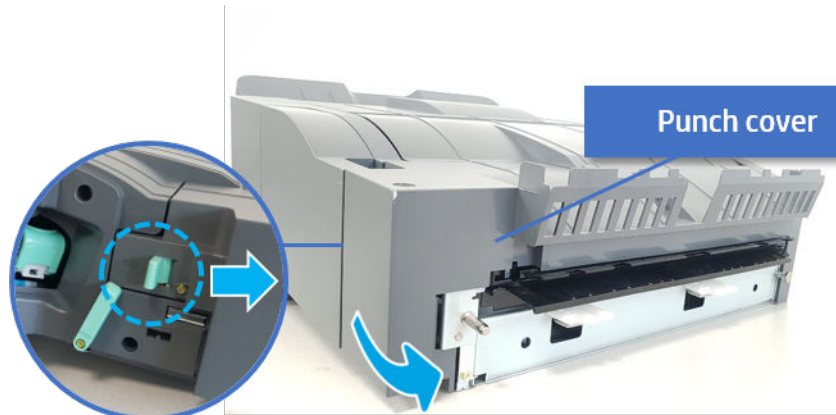

- c. Remove the front punch sheet, and then remove the e-ring and the washer. And then remove the punch cover.

Figure 5-781 Remove the punch cover

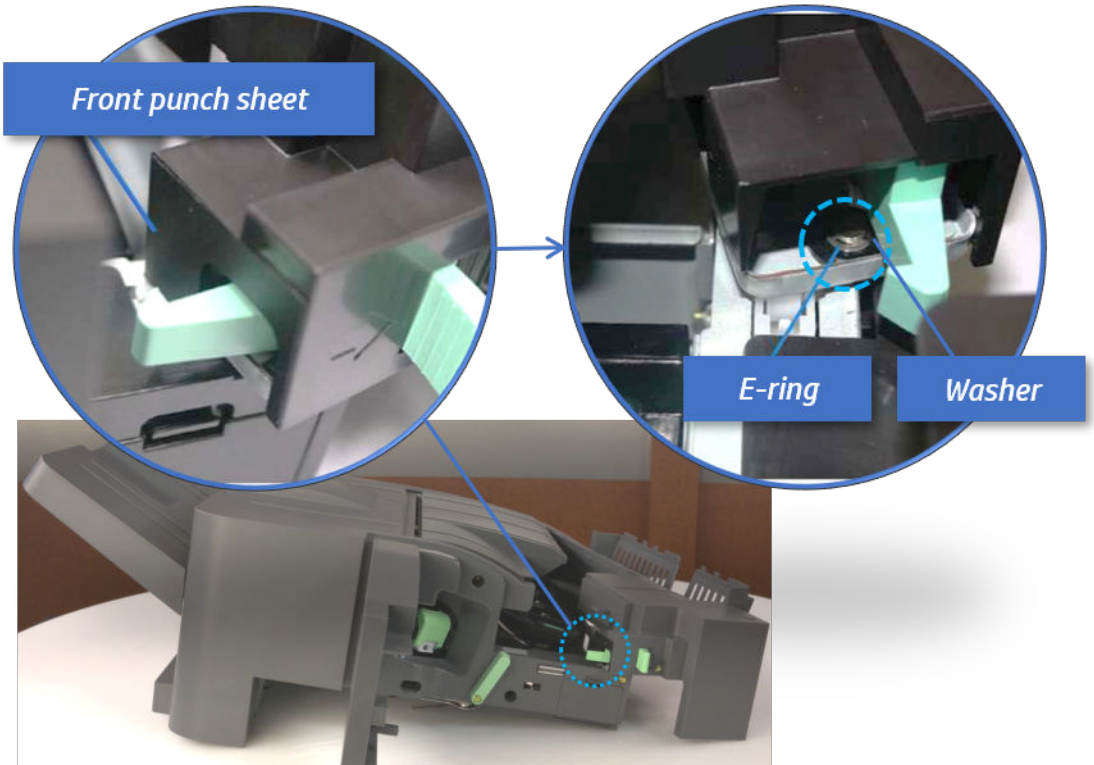

- 5. Remove the diverter guide and the middle roller
 - a. On the front of the inner finisher, remove the e-ring and bushing.

Figure 5-782 Remove the e-ring and bushing

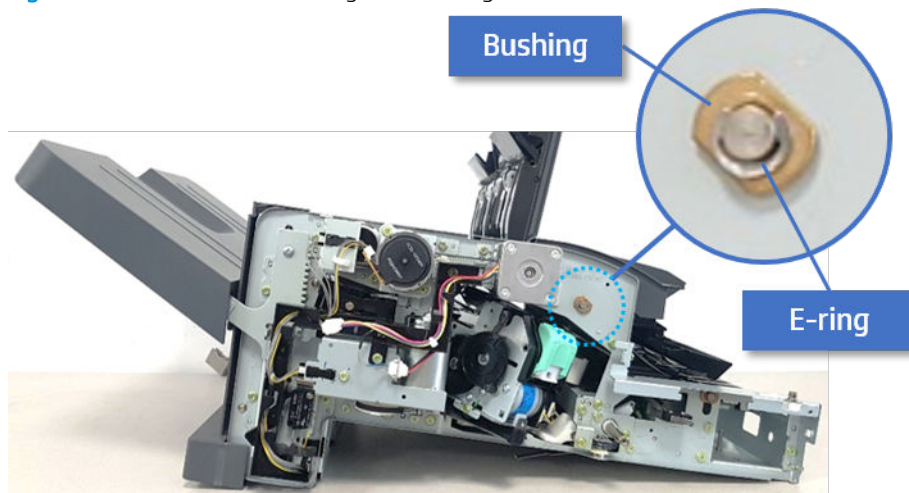

- b. On the rear of the inner finisher, remove the e-ring, pulley, bushing, belt, and spring (slightly hidden from view).

Figure 5-783 Remove the e-ring, pulley, bushing, belt, and spring

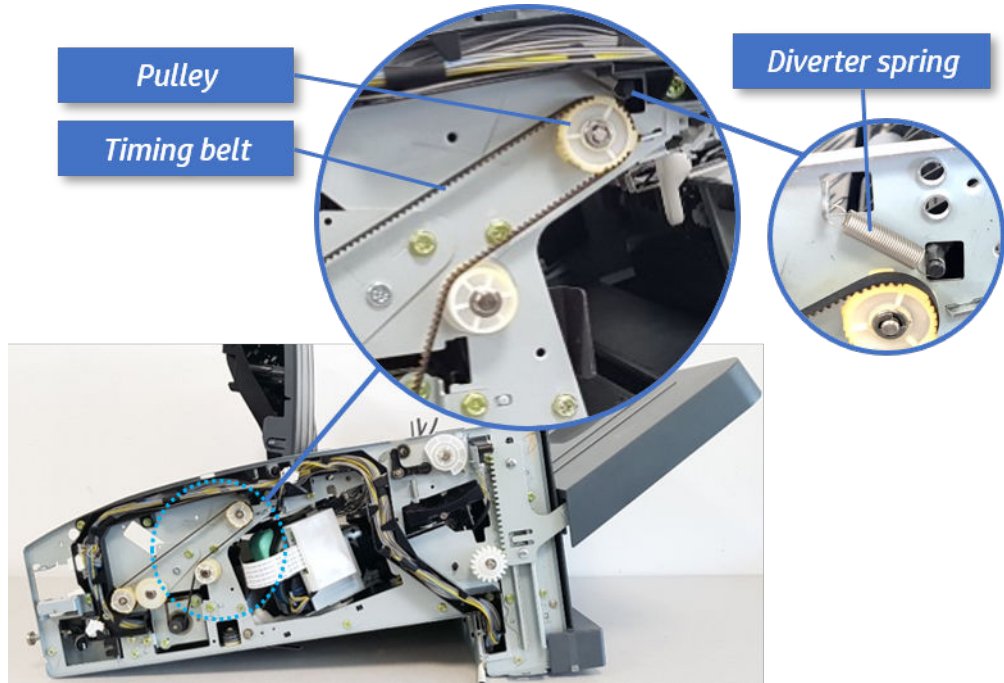

- c. Remove the diverter guide and the middler roller.

Figure 5-784 Remove the diverter guide and the middler roller

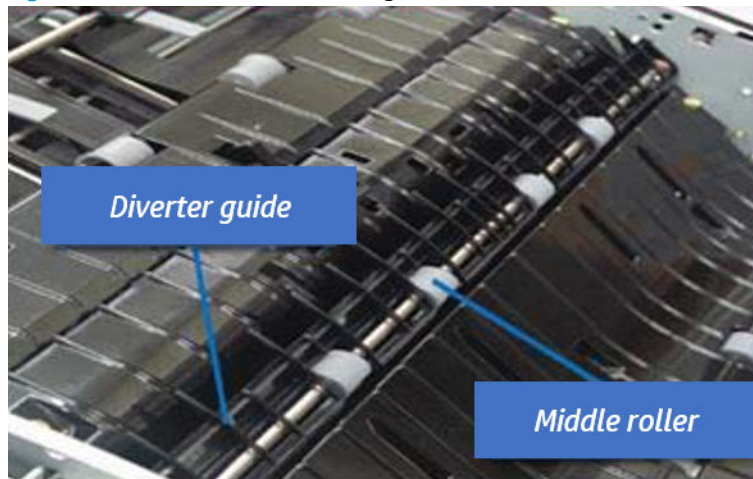

- 6. Remove the middle paper guide.
 - a. Remove six screws, and then open the middle paper guide in the direction of the arrow.

Figure 5-785 Open the middle paper guide

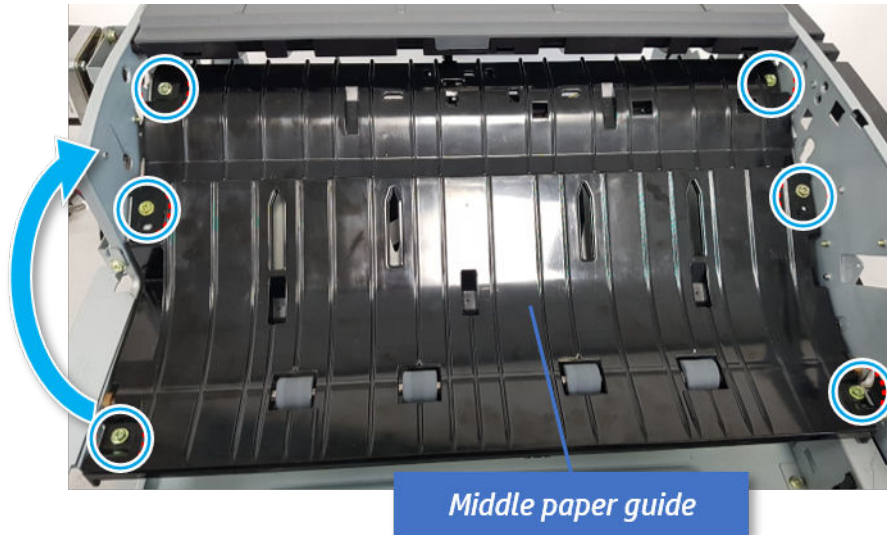

 **NOTE:** Be careful not to damage the sensor connector.

- b. Unplug the connector under the middle paper guide. And then, remove the middle paper guide.

Figure 5-786 Remove the middle paper guide

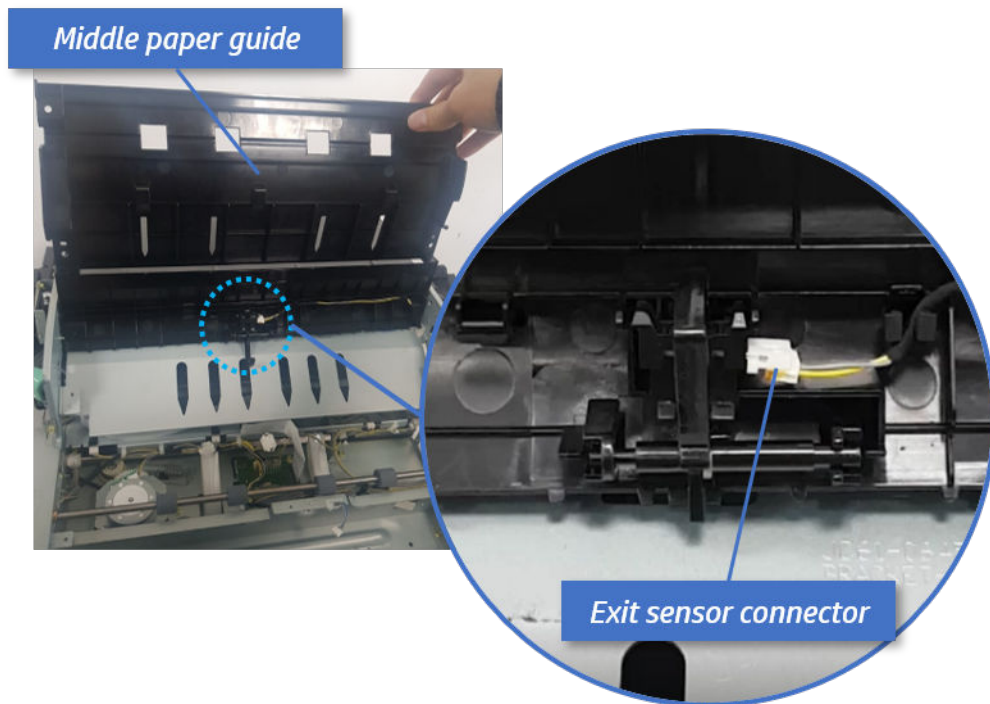

7. Remove the punch waste full sensor.
 - a. Remove one screw, unplug the connector, and then remove the punch waste full sensor bracket.

Figure 5-787 Remove the punch waste full sensor bracket

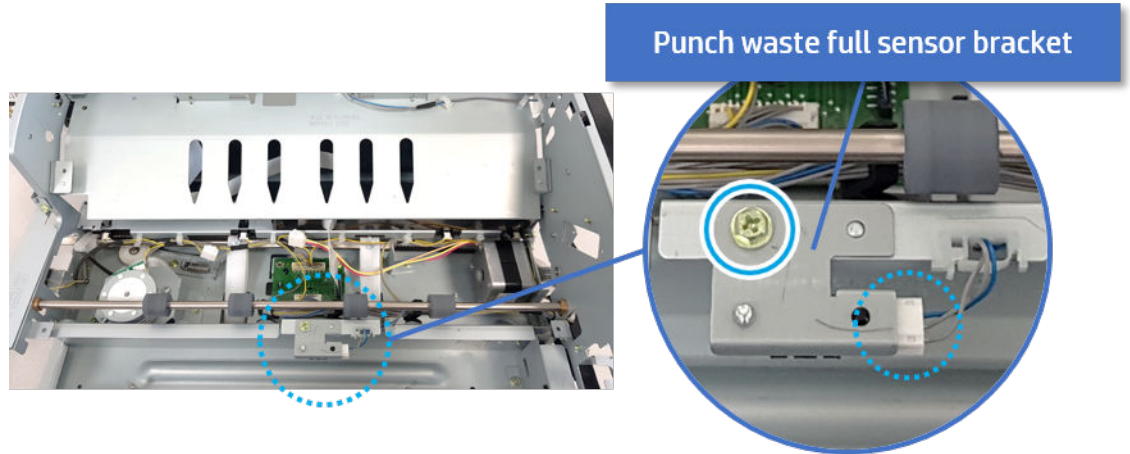

- b. Remove one screw, and then remove the punch waste full sensor from the bracket.

Figure 5-788 Remove the punch waste full sensor





8. Unpack the replacement assembly.
 - a. Dispose of the defective part.

 **NOTE:** HP recommends responsible disposal of the defective part.

<http://www8.hp.com/us/en/hp-information/environment/product-recycling.html>

- b. Unpack the replacement part from the packaging.

 **CAUTION:**  Some parts are sensitive to electrostatic discharge (ESD). Always perform service work at an ESD-protected workstation or mat. If an ESD workstation or mat is not available, touch the sheet-metal chassis to provide a static ground before touching an ESD-sensitive assembly. Protect the ESD-sensitive assemblies by placing them in ESD pouches when they are out of the printer.

If the replacement part is a roller or pad, avoid touching the spongy part of it. Skin oils on the roller or pad can cause paper pickup and/or print-quality problems. HP recommends using disposable gloves when handling rollers or pads or washing your hands before touching rollers or pads.

 **IMPORTANT:** Make sure that all of the shipping materials (for example shipping tape) are removed from the replacement part prior to installation.

- c. To install an assembly, reverse the removal steps.

When applicable, special installation instructions are provided for an assembly at the end of the removal procedure. Always completely read the removal instructions and follow all special installation instructions.

Problem solving

Learn about problem solving.

Control panel message document (CPMD)

Refer to CPMD document for more details.

Electrical Mechanical Diagrams (Inner finisher)

Inner finisher PCA

Figure 5-789 Inner finisher PCA

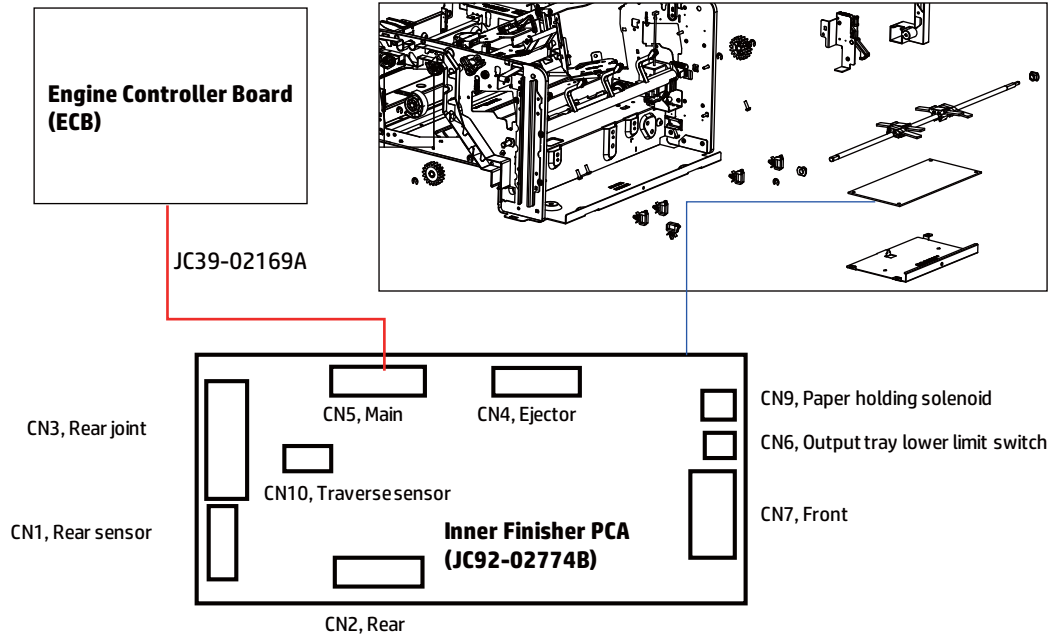

Punch waste full sensor

Figure 5-790 Punch waste full sensor

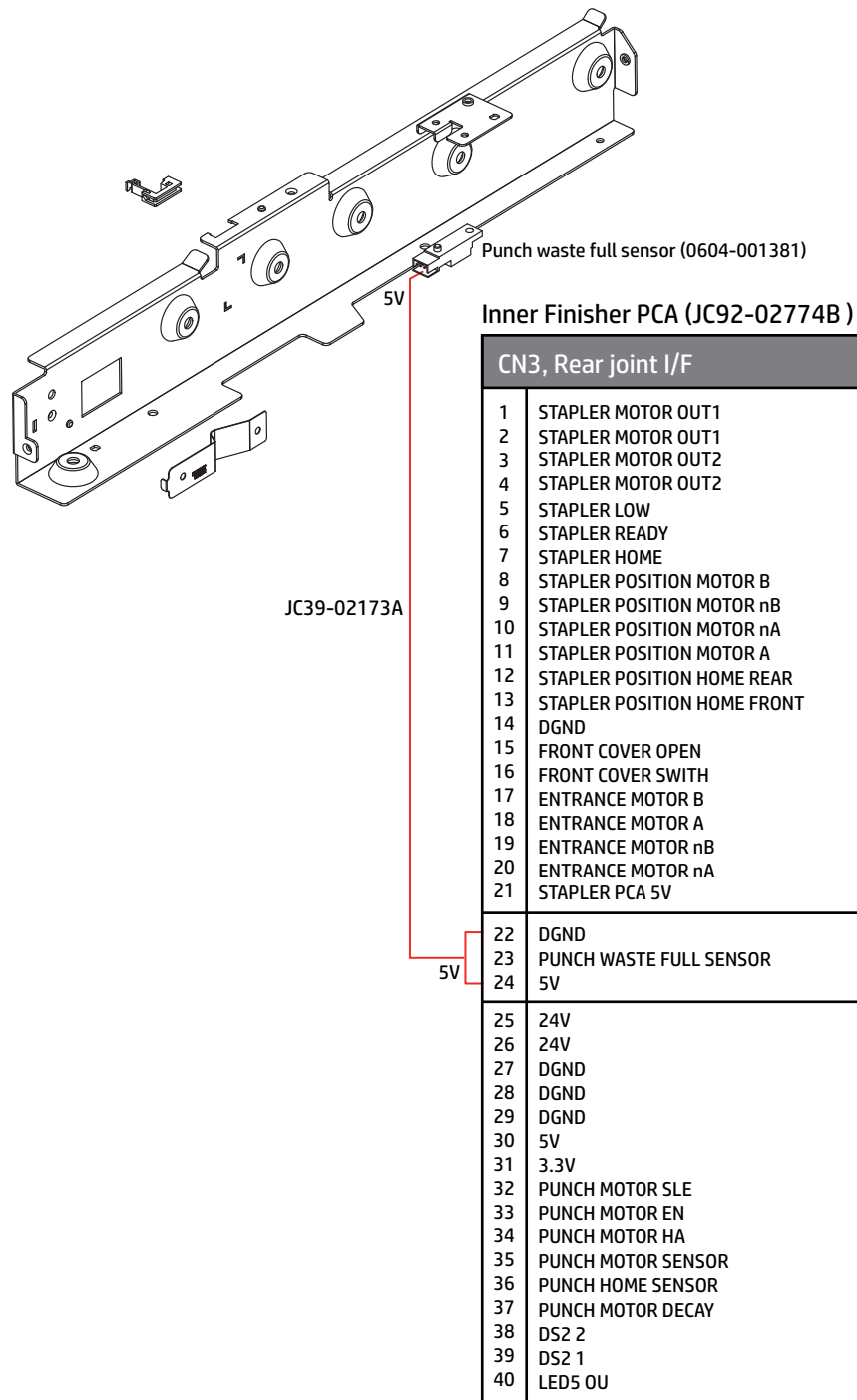

Punch waste box sensor and finisher docking sensor

Figure 5-792 Entrance motor

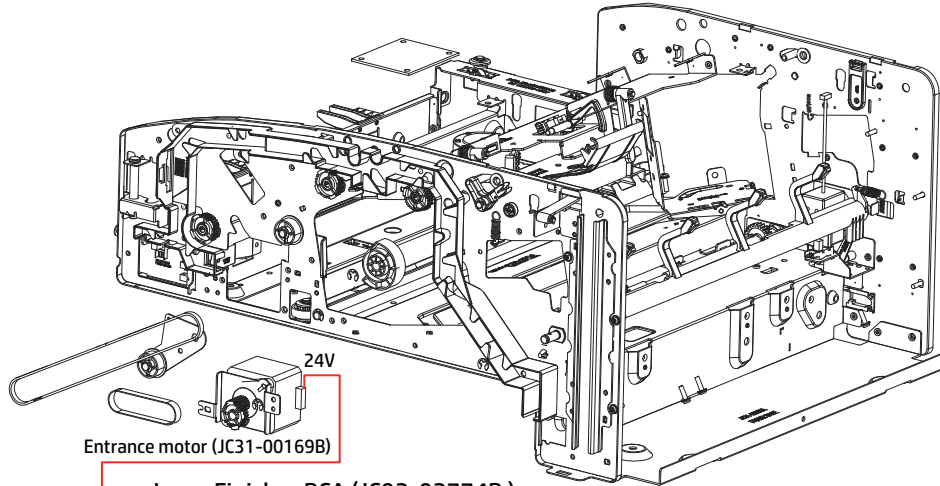

Entrance motor (JC31-00169B)

Inner Finisher PCA (JC92-02774B)

CN3, Rear joint I/F	
1	STAPLER MOTOR OUT1
2	STAPLER MOTOR OUT1
3	STAPLER MOTOR OUT2
4	STAPLER MOTOR OUT2
5	STAPLER LOW
6	STAPLER READY
7	STAPLER HOME
8	STAPLER POSITION MOTOR B
9	STAPLER POSITION MOTOR nB
10	STAPLER POSITION MOTOR nA
11	STAPLER POSITION MOTOR A
12	STAPLER POSITION HOME REAR
13	STAPLER POSITION HOME FRONT
14	DGND
15	FRONT COVER OPEN
16	FRONT COVER SWITH
17	ENTRANCE MOTOR B
18	ENTRANCE MOTOR A
19	ENTRANCE MOTOR nB
20	ENTRANCE MOTOR nA
21	STAPLER PCA 5V
22	DGND
23	PUNCH WASTE FULL SENSOR
24	5V
25	24V
26	24V
27	DGND
28	DGND
29	DGND
30	5V
31	3.3V
32	PUNCH MOTOR SLE
33	PUNCH MOTOR EN
34	PUNCH MOTOR HA
35	PUNCH MOTOR SENSOR
36	PUNCH HOME SENSOR
37	PUNCH MOTOR DECAY
38	DS2 2
39	DS2 1
40	LED5 OU

JC39-02173A

24V

Entrance sensor

Figure 5-793 Entrance sensor

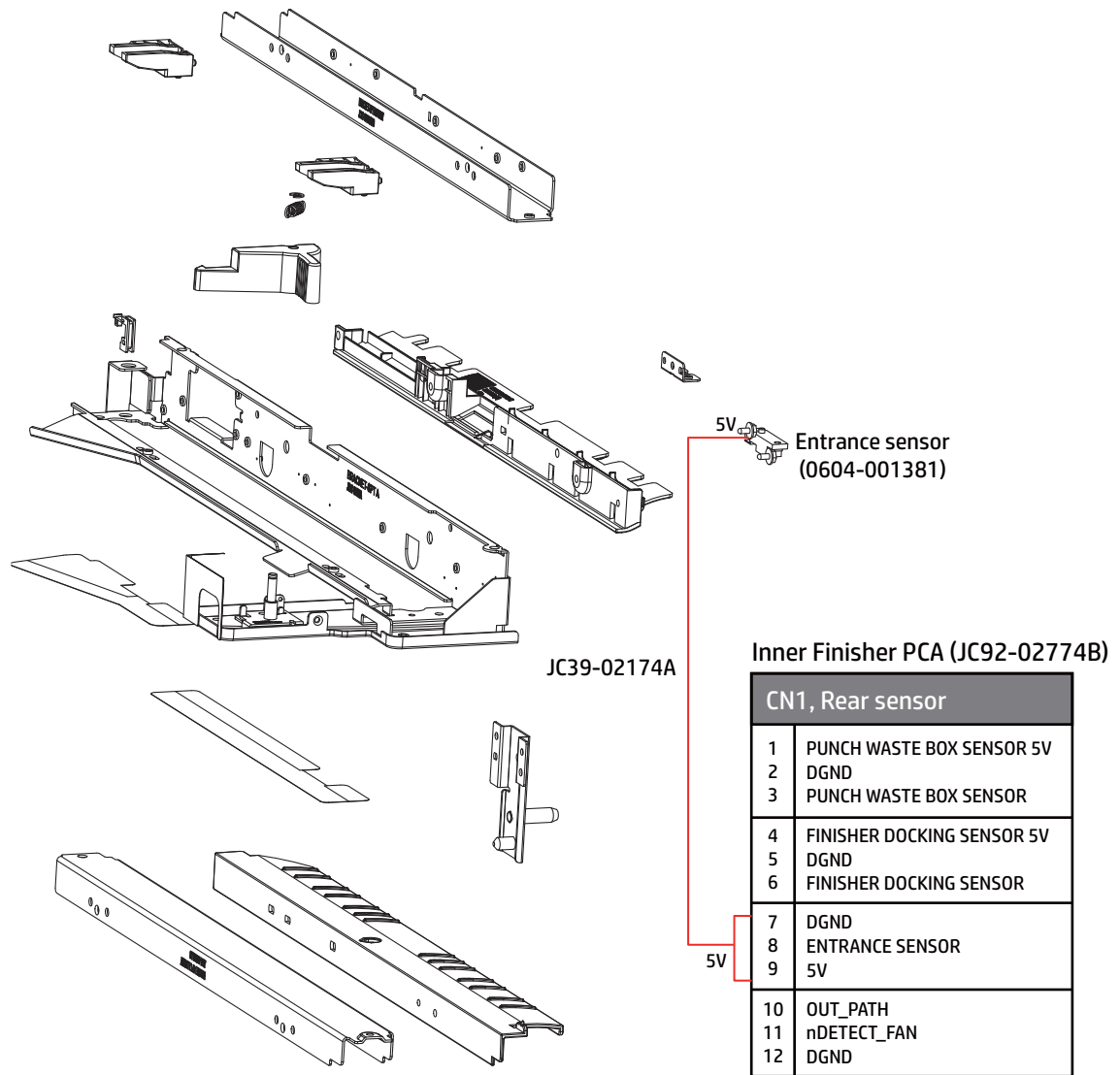

Exit sensor

Figure 5-794 Exit sensor

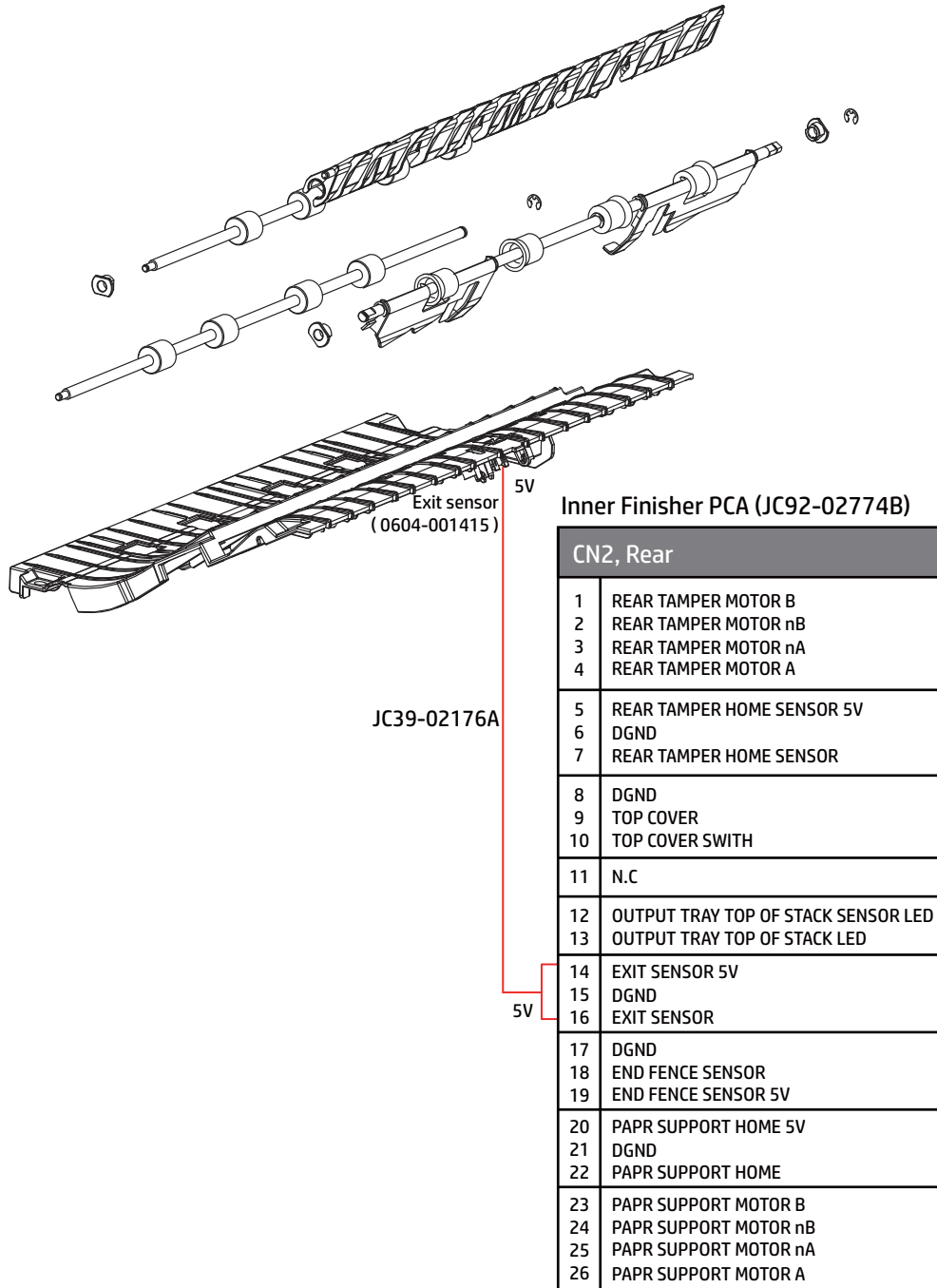

Exit motor, main paddle motor & home sensor, output tray lower limit switch, and paper holding solenoid

Figure 5-795 Exit motor, paddle motor&sensor, output tray lower limit sensor, and paper holding solenoid

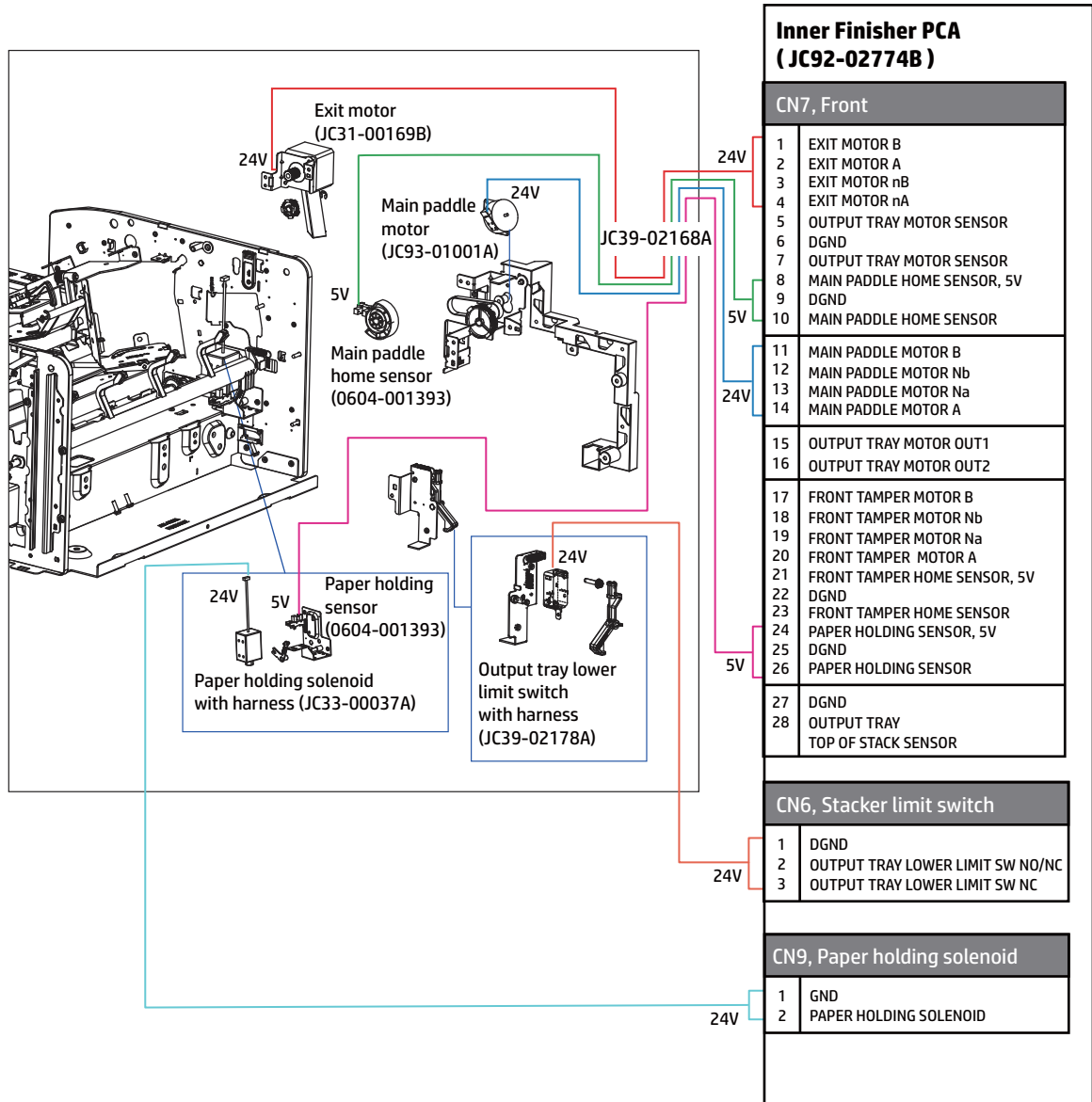

Paper support motor & home sensor

Figure 5-796 Paper support sensor and motor

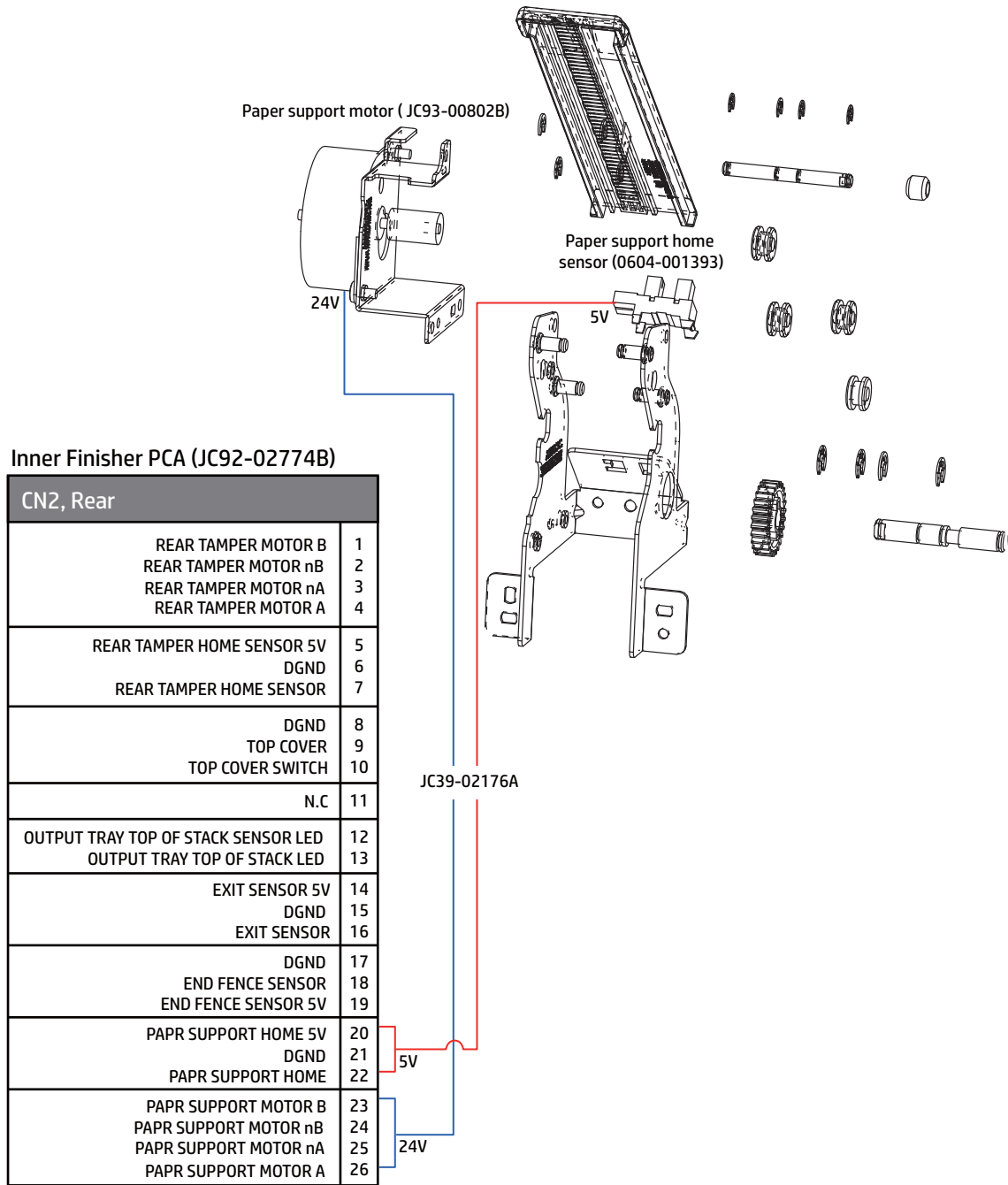

Front tamper motor and home sensor

Figure 5-797 Front tamper sensor and motor

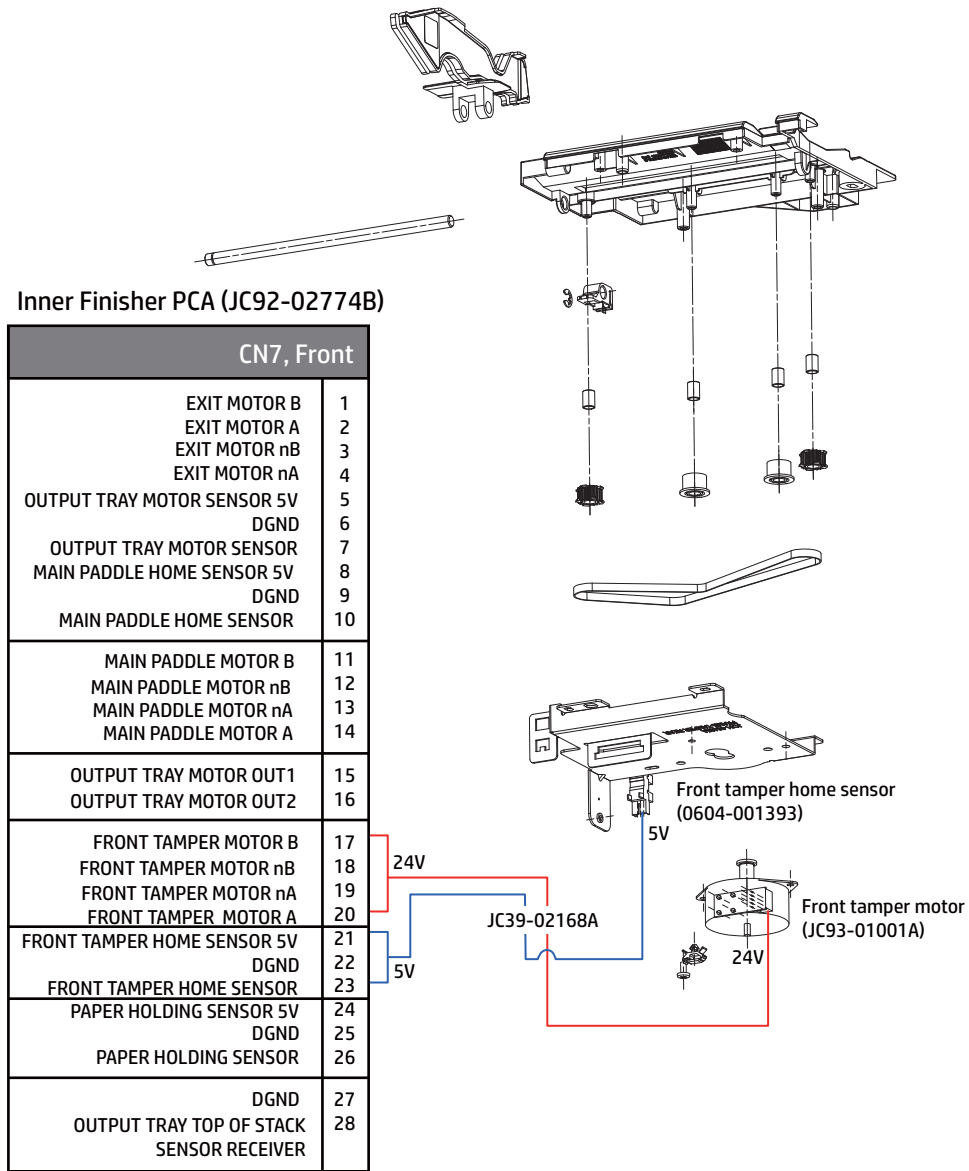

Rear tamper motor and home sensor

Figure 5-798 Rear tamper sensor and motor

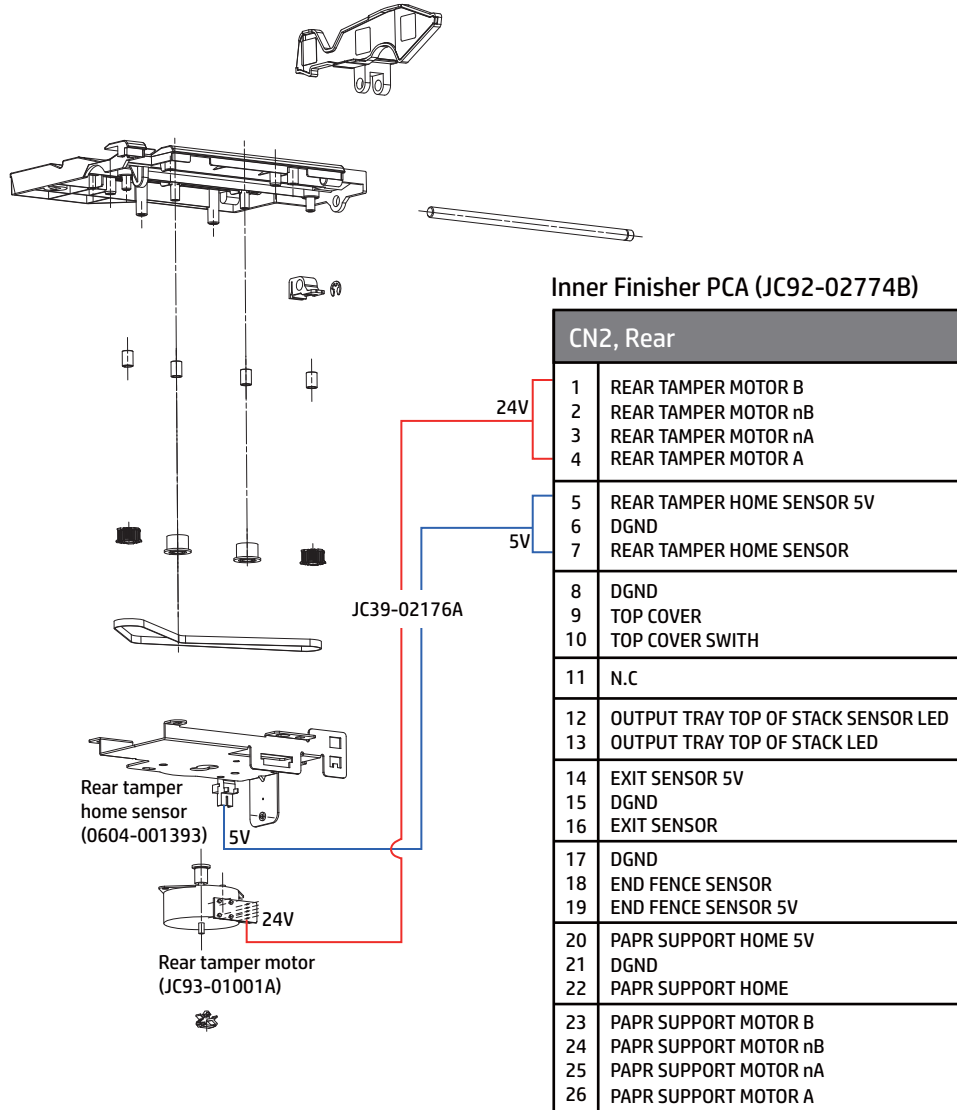

End fence sensor

Figure 5-799 End fence sensor

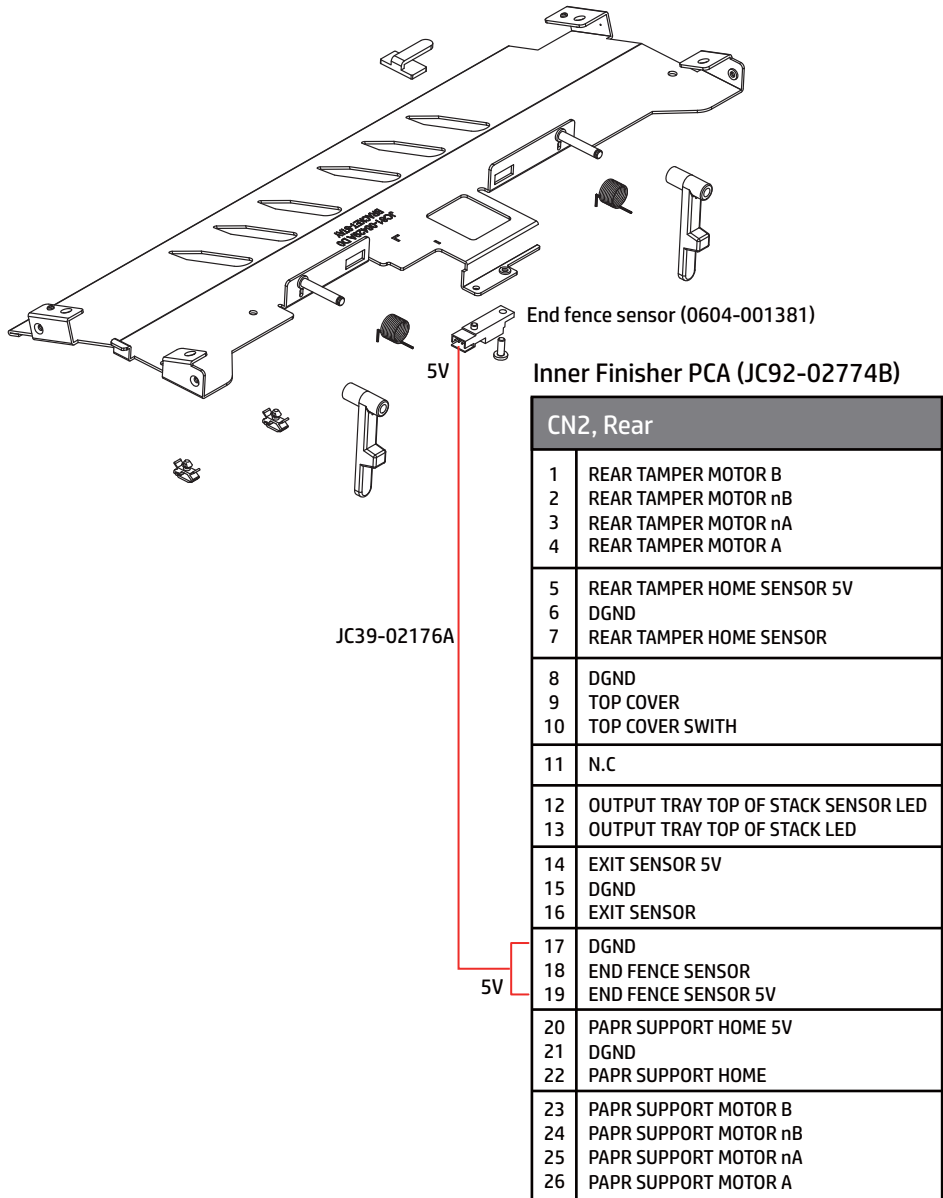

Stapler position motor and sensor

Figure 5-800 Stapler position sensor and motor

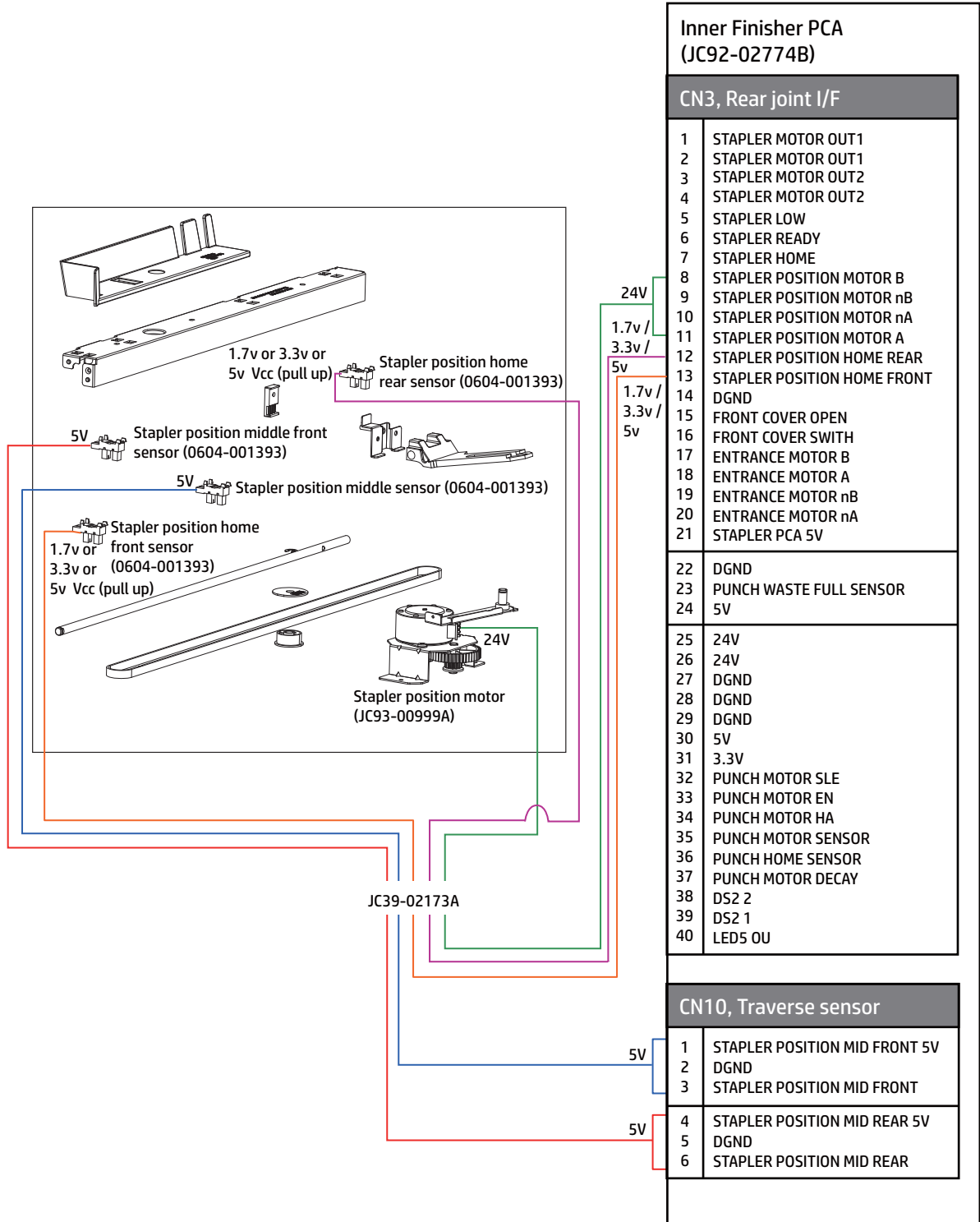

Inner Finisher PCA (JC92-02774B)	
CN3, Rear joint I/F	
1	STAPLER MOTOR OUT1
2	STAPLER MOTOR OUT1
3	STAPLER MOTOR OUT2
4	STAPLER MOTOR OUT2
5	STAPLER LOW
6	STAPLER READY
7	STAPLER HOME
8	STAPLER POSITION MOTOR B
9	STAPLER POSITION MOTOR nB
10	STAPLER POSITION MOTOR nA
11	STAPLER POSITION MOTOR A
12	STAPLER POSITION HOME REAR
13	STAPLER POSITION HOME FRONT
14	DGND
15	FRONT COVER OPEN
16	FRONT COVER SWITCH
17	ENTRANCE MOTOR B
18	ENTRANCE MOTOR A
19	ENTRANCE MOTOR nB
20	ENTRANCE MOTOR nA
21	STAPLER PCA 5V
22	DGND
23	PUNCH WASTE FULL SENSOR
24	5V
25	24V
26	24V
27	DGND
28	DGND
29	DGND
30	5V
31	3.3V
32	PUNCH MOTOR SLE
33	PUNCH MOTOR EN
34	PUNCH MOTOR HA
35	PUNCH MOTOR SENSOR
36	PUNCH HOME SENSOR
37	PUNCH MOTOR DECAY
38	DS2 2
39	DS2 1
40	LED5 OU
CN10, Traverse sensor	
1	STAPLER POSITION MID FRONT 5V
2	DGND
3	STAPLER POSITION MID FRONT
4	STAPLER POSITION MID REAR 5V
5	DGND
6	STAPLER POSITION MID REAR

Ejector 1 motor and home sensor, ejector 2 motor, motor sensor, and home sensor

Figure 5-801 Ejector 1 motor and home sensor, ejector 2 motor, motor sensor, and home sensor

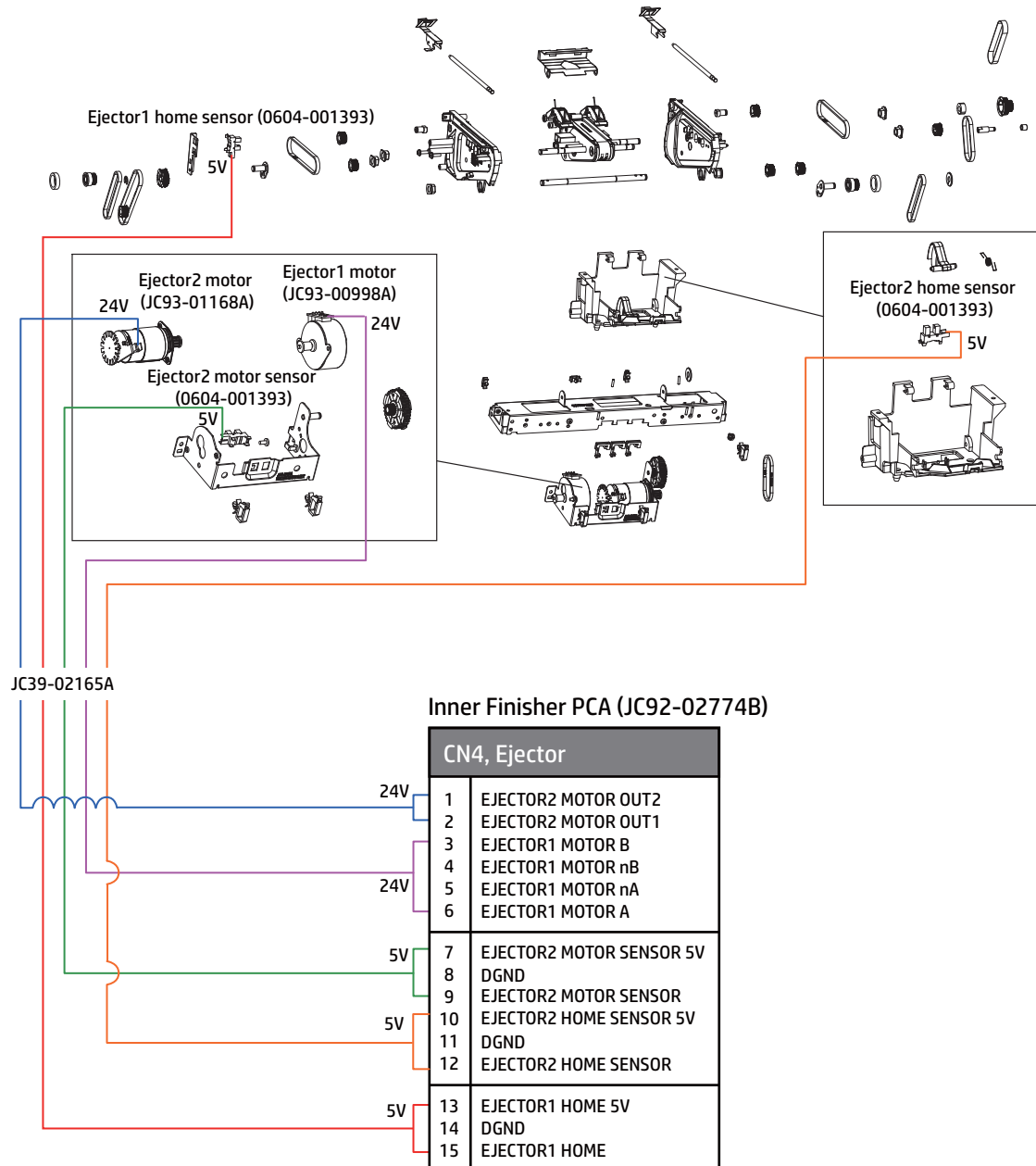

Output tray motor and sensor

Figure 5-802 Output tray motor and sensor

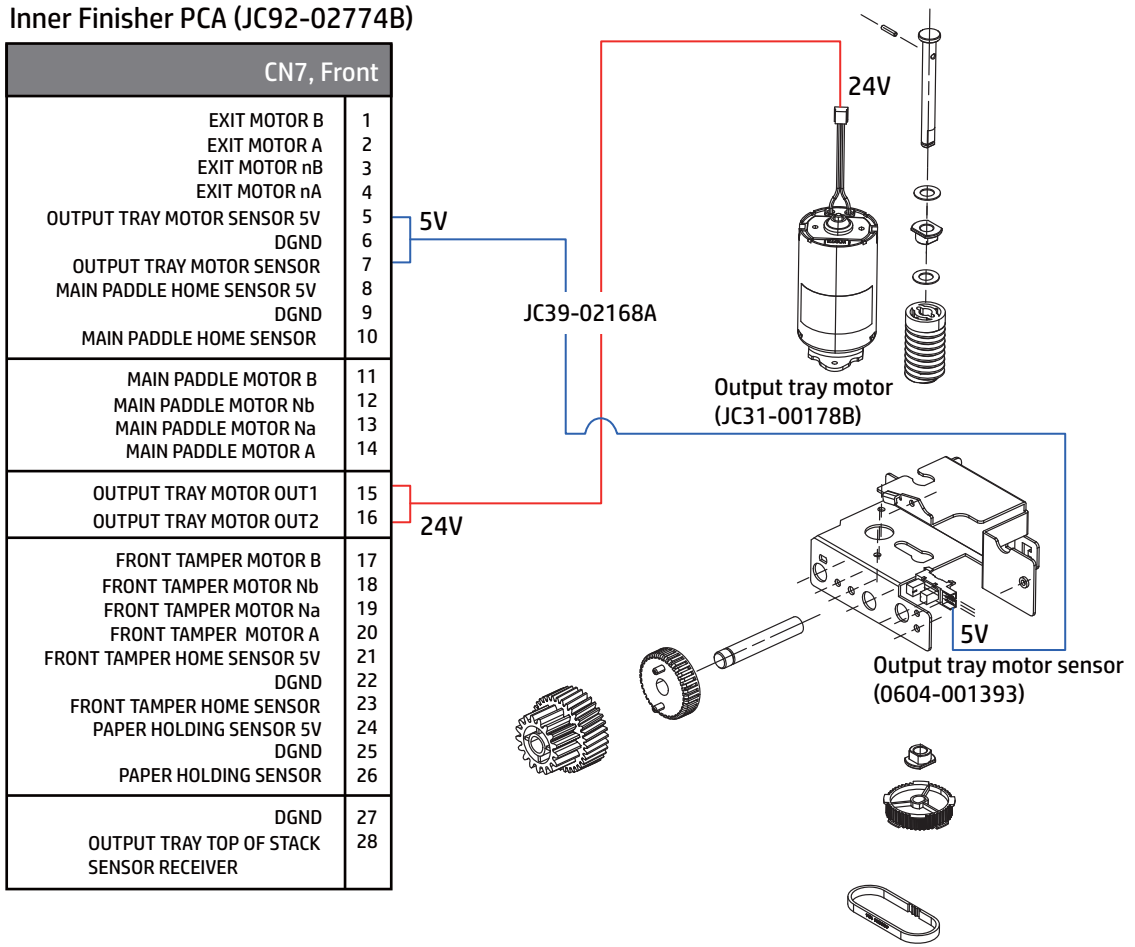

Output tray top of stack sensor

Figure 5-803 Output tray top of stack sensor

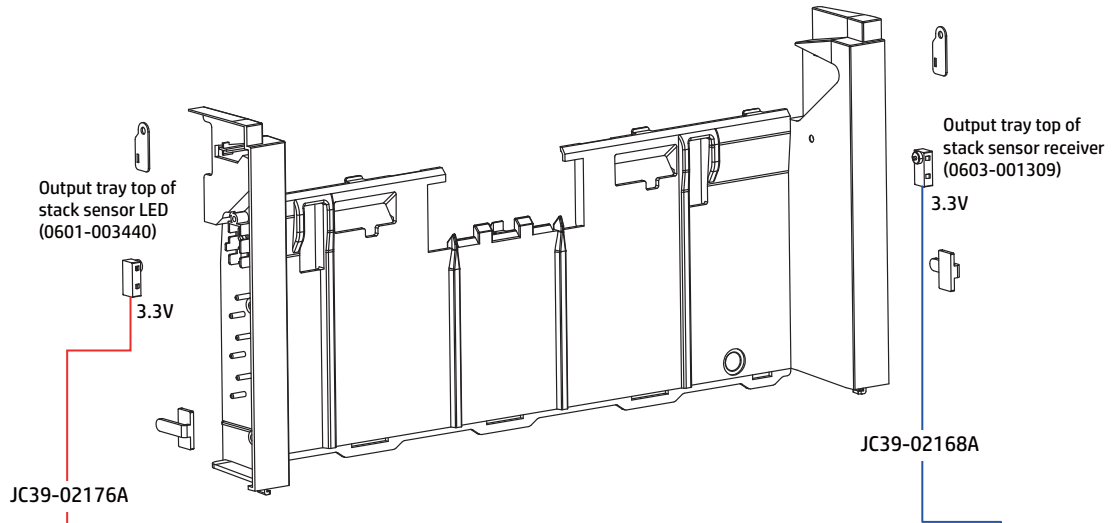

Inner Finisher PCA (JC92-02774B)	
CN2, Rear	
1	REAR TAMPER MOTOR B
2	REAR TAMPER MOTOR nB
3	REAR TAMPER MOTOR nA
4	REAR TAMPER MOTOR A
5	REAR TAMPER HOME SENSOR 5V
6	DGND
7	REAR TAMPER HOME SENSOR
8	DGND
9	TOP COVER 24V
10	TOP COVER SWITCH
11	N.C
12	OUTPUT TRAY TOP OF STACK SENSOR LED 3.3V
13	OUTPUT TRAY TOP OF STACK LED
14	EXIT SENSOR 5V
15	DGND
16	EXIT SENSOR
17	DGND
18	END FENCE SENSOR
19	END FENCE SENSOR 5V
20	PAPR SUPPORT HOME 5V
21	DGND
22	PAPR SUPPORT HOME
23	PAPR SUPPORT MOTOR B
24	PAPR SUPPORT MOTOR nB
25	PAPR SUPPORT MOTOR nA
26	PAPR SUPPORT MOTOR A
CN7, Front	
	EXIT MOTOR B
	EXIT MOTOR A
	EXIT MOTOR nB
	EXIT MOTOR nA
	OUTPUT TRAY MOTOR SENSOR 5V
	DGND
	OUTPUT TRAY MOTOR SENSOR
	MAIN PADDLE HOME SENSOR 5V
	DGND
	MAIN PADDLE HOME SENSOR
	MAIN PADDLE MOTOR B
	MAIN PADDLE MOTOR nB
	MAIN PADDLE MOTOR nA
	MAIN PADDLE MOTOR A
	OUTPUT TRAY MOTOR OUT1
	OUTPUT TRAY MOTOR OUT2
	FRONT TAMPER MOTOR B
	FRONT TAMPER MOTOR nB
	FRONT TAMPER MOTOR nA
	FRONT TAMPER MOTOR A
	FRONT TAMPER HOME SENSOR 5V
	DGND
	FRONT TAMPER HOME SENSOR
	PAPER HOLDING SENSOR 5V
	DGND
	PAPER HOLDING SENSOR
	DGND
	OUTPUT TRAY TOP OF STACK SENSOR RECEIVER 3.3V

Top cover switch

Figure 5-804 Top cover switch

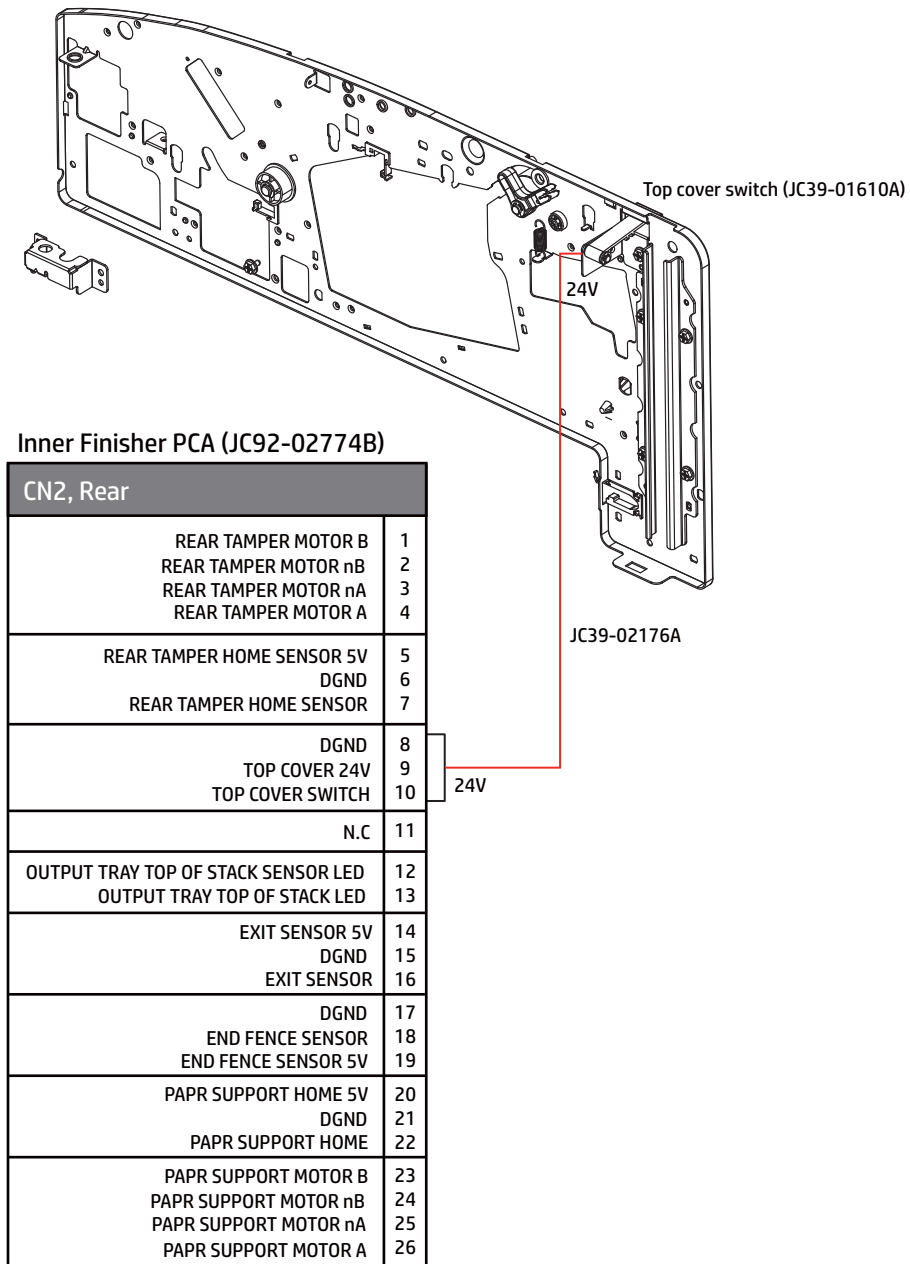

Front cover switch

Figure 5-805 Frame front

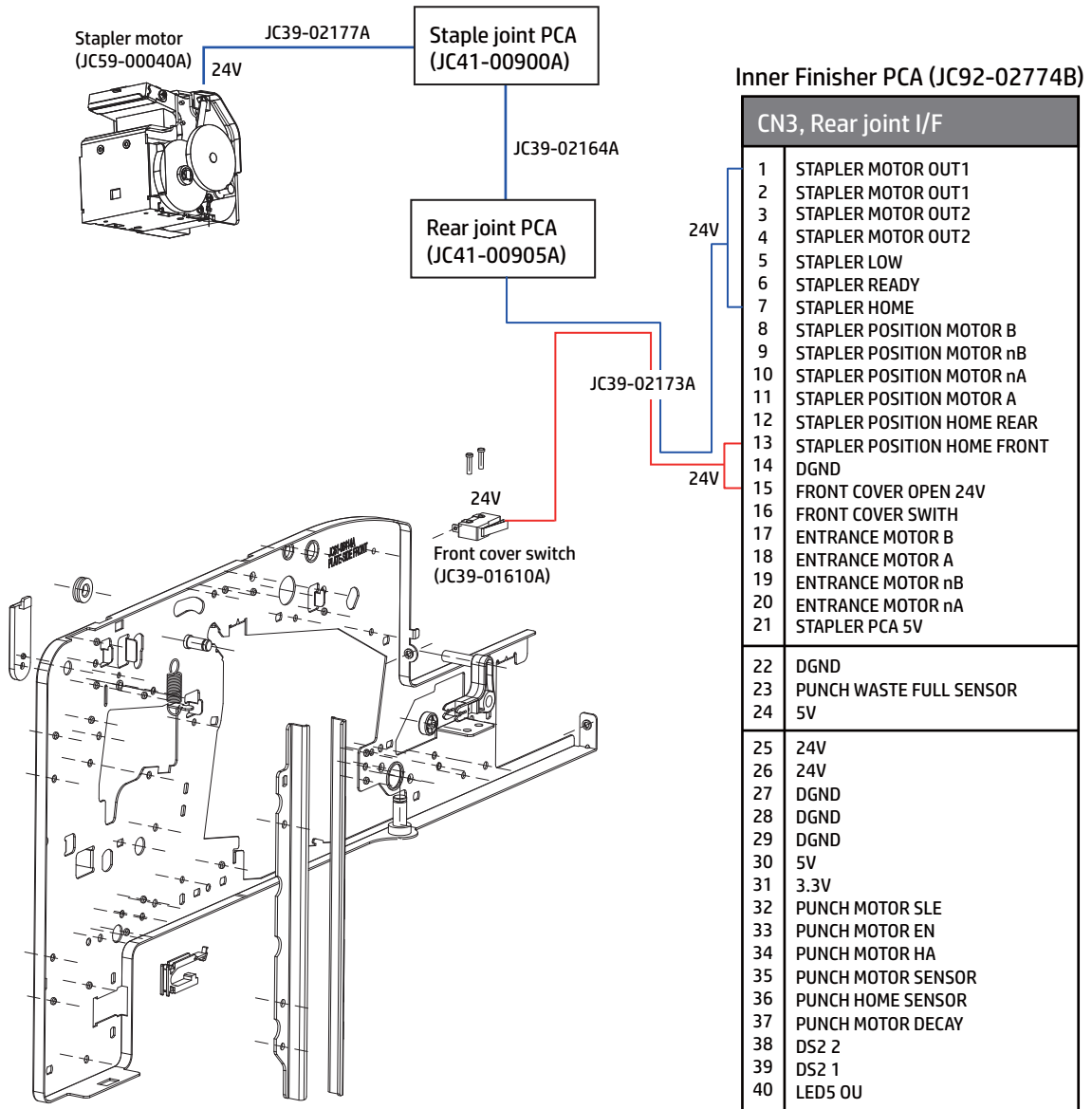

A Glossary

Learn about terms in the glossary.

Glossary of terms

The following glossary includes terminology commonly used with printing, as well as terminology used in this service manual.

Table A-1 Glossary

Term	Definition
802.11	802.11 is a set of standards for wireless local area network (WLAN) communication, developed by the IEEE LAN/MAN Standards Committee (IEEE 802).
802.11b/g/n	802.11b/g/n can share the same hardware and use the 2.4 GHz band. 802.11b supports bandwidth up to 11 Mbps, 802.11n supports bandwidth up to 150 Mbps. 802.11b/g/n devices might occasionally suffer interferences from microwave ovens, cordless telephones, and Bluetooth devices.
ADF	An Automatic Document Feeder (ADF) is a scanning unit that will automatically feed an original sheet of paper for scanning.
BOOTP	Bootstrap Protocol. A network protocol used by a network client to obtain its IP address automatically. This is usually done in the bootstrap process of computers or operating systems running on them. The BOOTP servers assigns an IP address from a pool of addresses to each client. BOOTP enables "diskless workstation" computers to obtain an IP address prior to loading any advanced operating system.
CCD	Charged Coupled Device (CCD) is a hardware which enables the scan job. The CCD locking mechanism is also used to hold the CCD module to prevent any damage when the printer is moved.
Collation	Collation is a process of printing a multiple-copy job in sets. When collation is selected, the device prints an entire set before printing additional copies.
Control Panel	The control panel is a flat, typically vertical panel or screen where control or monitoring instruments are displayed. The control panel is found on the front of the printer.
Coverage	Coverage is the printing term used for a toner usage measurement on printing. For example, 5% coverage means that an A4 sided paper has about 5% image or text on it. If the paper or original has complicated images or a large amount of text, the coverage will be higher and at the same time, a toner usage will be as much as the coverage.
Default	The value or setting that is in effect when a printer is unboxed, reset, or initialized.
DHCP	A Dynamic Host Configuration Protocol (DHCP) is a client-server networking protocol. A DHCP server provides configuration parameters specific to the DHCP client host requesting, generally, information required by the client host to participate on an IP network. The DHCP also provides a mechanism for allocation of IP addresses to client hosts.
DIMM	Dual Inline Memory Module (DIMM) is a small circuit board that holds memory. The DIMM stores all data within the machine, such as printing data and received fax data.

Table A-1 Glossary (continued)

Term	Definition
DPI	Dots Per Inch (DPI) is a measurement of resolution that is used for scanning and printing. Generally, higher DPI results in a higher resolution, more visible detail in the image, and a larger file size.
Duplex	A mechanism that will automatically turn over a sheet of paper so that the printer can print (or scan) on both sides of the paper. A printer equipped with a duplex unit can print on both sides of the paper during one print cycle.
Duty Cycle	Duty cycle is the page quantity which does not affect printer performance for a month. Generally, the printer has the lifespan limitation such as pages per year. The lifespan means the average capacity of print-outs, usually within the warranty period. For example, if the duty cycle is 48,000 pages per month assuming 20 working days, a printer limits 2,400 pages a day.
Emulation	Emulation is a technique of one machine obtaining the same results as another. An emulator duplicates the functions of one system with a different system, so that the second system behaves like the first system. Emulation focuses on exact reproduction of external behavior. This is different from simulation, which concerns an abstract model of the system being simulated, often considering its internal state.
ESD	An electrostatic discharge (ESD) is a sudden flow of electricity between two electrically charged objects caused by contact, an electrical short, or dielectric breakdown. Discharge of built up static electricity.
Ethernet	Ethernet is a frame-based computer networking technology for local area networks (LANs). It defines wiring and signaling for the physical layer, and frame formats and protocols for the media access control (MAC)/data link layer of the OSI model. Ethernet is mostly standardized as IEEE 802.3. Ethernet has become the most widespread LAN technology in use during the 1990s to present.
FIH	A Foreign Interface Harness (FIH) is a port that enables HP multifunction printers (MFPs) to use third-party devices to extend the capabilities of the MFP.
Flow document feeder	A flow document feeder is a scanning unit that will automatically feed and turn over an original sheet of paper so that the machine can scan both sides of the paper.
FTP	A File Transfer Protocol (FTP) is a commonly used protocol for exchanging files over any network that supports the TCP/IP protocol (such as the internet or an intranet).
Fuser Unit	The fuser unit is part of a laser printer that fuses the toner onto the print media. It consists of a heat roller and a pressure roller. After toner is transferred onto the paper, the fuser unit applies heat and pressure to make sure that the toner stays on the paper permanently, which is why paper is warm when it comes out of a laser printer.
Gateway	A connection between computer networks, or between a computer network and a telephone line. It is very popular, as it is a computer or a network that allows access to another computer or network.
Grayscale	Shades of gray that represent light and dark portions of an image when color images are converted to grayscale. Colors are represented by various shades of gray.
Halftone	An image type that simulates grayscale by varying the number of dots. Highly colored areas consist of a large number of dots, while lighter areas consist of a smaller number of dots.
HDD	Hard Disk Drive (HDD), commonly referred to as a hard drive or hard disk, is a non-volatile storage device which stores digitally-encoded data on rapidly rotating platters with magnetic surfaces.
IEEE	The Institute of Electrical and Electronics Engineers (IEEE) is an international non-profit, professional organization for the advancement of technology related to electricity.
IP address	An Internet Protocol (IP) address is a unique number that a device uses in order to identify and communicate with other devices on a network utilizing the Internet Protocol standard.
IPM	The Images Per Minute (IPM) is a method of measuring the speed of a printer. An IPM rate indicates the number of single-sided sheets a printer can complete in one minute.
IPP	The Internet Printing Protocol (IPP) defines a standard protocol for printing and managing print jobs, media size, resolution, etc. IPP can be used locally, or over the internet to reach hundreds of printers. IPP also supports access control, authentication, and encryption, making it a capable and secure printing solution.

Table A-1 Glossary (continued)

Term	Definition
ISO	The International Organization for Standardization (ISO) is an international standard-setting body composed of representatives from national standards bodies. It produces world-wide industrial and commercial standards.
JBIG	Joint Bi-level Image Experts Group (JBIG) is an image compression standard with no loss of accuracy or quality. It was designed for compression of binary images, particularly for faxes, but can also be used for other images.
JPEG	Joint Photographic Experts Group (JPEG) is a commonly used standard method of loss compression for photographic images. It is the format used for storing and transmitting photographs on the World Wide Web.
LDAP	The Lightweight Directory Access Protocol (LDAP) is a networking protocol for querying and modifying directory services running over TCP/IP.
LED	A Light-Emitting Diode (LED) is a semiconductor device that indicates the status of a machine.
LVPS - SMPS	Low Voltage Power Supply (LVPS) / Switching Mode Power Supply (SMPS)
MAC address	Media Access Control (MAC) address is a unique identifier associated with a network adapter. MAC address is a unique 48-bit identifier usually written as 12 hexadecimal characters grouped in pairs (e.g., 00-00-0c-34-11-4e). This address is usually hard-coded into a Network Interface Card (NIC) by the manufacturer, and used as an aid for routers trying to locate machines on a large network.
MFP	Multi Function Printer (MFP) is an office printer that includes multiple functionality in one physical body, such as a printer, copier, fax, scanner, etc.
MHV	Miniature High Voltage (MHV) is designed for high voltage applications of BNC connectors (DC voltage between 500 V and 5 kV).
Modem	A device that modulates a carrier signal to encode digital information, and also demodulates such a carrier signal to decode transmitted information.
OPC	Organic Photo Conductor (OPC) is a mechanism that makes a virtual image for print using a laser beam emitted from a laser printer. It is usually green or rust colored and has a cylinder shape. An imaging unit containing a drum slowly wears the drum surface during its usage in the printer, and it should be replaced appropriately due to wear from contact with the cartridge development brush, cleaning mechanism, and paper.
Originals	The first example of something, such as a document, photograph, or text which is copied, reproduced, or translated to produce additional copies. The original itself is not copied or derived from something else.
PCA	Printed Circuit Assembly (PCA). Once the printed circuit board (PCB) is complete, electronic components must be assembled to form a functional printed circuit assembly or PCA.
PCL	Printer Command Language (PCL) is a Page Description Language (PDL) developed by HP as a printer protocol. PCL has become an industry standard. Originally developed for early Inkjet printers, PCL has been released in varying levels for thermal, dot matrix printers and laser printers.
PDF	Portable Document Format (PDF) is a proprietary file format developed by Adobe Systems. A PDF represents two dimension documents in a device independent and resolution independent format.
PostScript (PS)	PostScript (PS) is a page description language and programming language used primarily in electronic and desktop publishing. PostScript is run in an interpreter to generate an image.
Printer Driver	A program used to send commands and transfer data from the computer to the printer.
Print Media	Media like paper, envelopes, labels, and transparencies which can be used in a printer, scanner, fax, or copier.
PPM	Pages Per Minute (PPM) is a method of measurement for determining how fast a printer works, meaning the number of pages a printer can produce in one minute.
Protocol	A convention or standard that controls or enables the connection, communication, and data transfer between two computing endpoints.

Table A-1 Glossary (continued)

Term	Definition
Resolution	The sharpness of an image, measured in Dots Per Inch (DPI). The higher the DPI, the greater the resolution.
SMB	Server Message Block (SMB) is a network protocol mainly applied to share files, printers, serial ports, and miscellaneous communications between nodes on a network. SMB also provides an authenticated Interprocess communication mechanism.
SMTP	Simple Mail Transfer Protocol (SMTP) is the standard for email transmissions across the internet. SMTP is a relatively simple, text-based protocol, where one or more recipient of a message are specified and the message text is transferred. It is a client server protocol where the client transmits an email message to the server.
Subnet Mask	The subnet mask is used in conjunction with the network address to determine which part of the address is the network address and which part is the host address.
TCP/IP	The Transmission Control Protocol (TCP) and the Internet Protocol (IP) are the set of communications protocols that implement the protocol stack on which the internet and most commercial networks run.
TIFF	Tagged Image File Format (TIFF) is a variable-resolution bitmapped image format. TIFF describes image data that typically come from scanners. TIFF images use tags, keywords defining the characteristics of the image that is included in the file. This flexible and platform-independent format can be used for pictures that have been made by various image processing applications.
Toner Cartridge	A bottle or container that holds toner, which is used in a machine like a printer. Toner is a powder used in laser printers and photocopiers. The toner forms the text and images on printed paper. Toner can be fused by a combination of heat/pressure from the fuser, causing it to bind the fibers in the paper.
TWAIN	An industry standard for scanners and software. By using a TWAIN compliant scanner with TWAIN-compliant software, a scan can be initiated from the program. TWAIN is an image capture API for Microsoft Windows and Apple Macintosh operating systems.
URL	Uniform Resource Locator (URL) is the global address of documents and resources on the internet. The first part of the address indicates what protocol to use. The second part specifies the IP address or the domain name where the resource is located.
USB	Universal Serial Bus (USB) is a standard that was developed by the USB Implementers Forum, Inc., to connect computers and peripherals. Unlike the parallel port, USB is designed to concurrently connect a single computer USB port to multiple peripherals.
Watermark	A watermark is a recognizable image or pattern in paper that appears lighter when viewed by transmitted light. Watermarks were first introduced in Bologna, Italy in 1282. Watermarks have been used by paper makers to identify their product, and also on postage stamps, currency, and other government documents to discourage counterfeiting.
XPS	XML Paper Specification (XPS) is a specification for a Page Description Language (PDL) and a new document format developed by Microsoft. This has benefits for portable document and electronic documents. It is an XML-based specification based on a new print path and vector-based, device-independent document format.

B Certificate of Volatility

Certificate of Volatility (for E77422, E77428)

Figure B-1 Certificate of Volatility (1 of 3)

Hewlett-Packard Certificate of Volatility				
Model: HP Color LaserJet Managed MFP E774xxa HP Color LaserJet Managed MFP E774xxdv HP Color LaserJet Managed MFP E774xxdn		Part Number: 5CM76A=E77422a 5CM77A=E77422dv 5CM78A= E77422dn 5CM79A=E77428dn		Address: Hewlett Packard Company 11311 Chinden Blvd Boise, ID 83714
Volatile Memory				
Does the device contain volatile memory (Memory whose contents are lost when power is removed)? <input checked="" type="checkbox"/> Yes <input type="checkbox"/> No If Yes please describe the type, size, function, and steps to clear the memory below				
Type (SRAM, DRAM, etc): DDR3-DRAM	Size: HP Formatter (Obsidian II) – 1.25GB ECB – 3GB	User Modifiable: <input type="checkbox"/> Yes <input checked="" type="checkbox"/> No	Function: Operation system and print/scan buffer	Steps to clear memory: When the printer is powered off the memory is erased
Type (SRAM, DRAM, etc): DIMM (Optional)	Size: 2GB	User Modifiable: <input type="checkbox"/> Yes <input checked="" type="checkbox"/> No	Function: For JA link (supported only for dn bundle)	Steps to clear memory: When the printer is powered off the memory is erased
Non-Volatile Memory				
Does the device contain non-volatile memory (Memory whose contents are retained when power is removed)? <input checked="" type="checkbox"/> Yes <input type="checkbox"/> No If Yes please describe the type, size, function, and steps to clear the memory below				
Type (Flash, EEPROM, etc): IOD EEPROM	Size: 64KB	User Modifiable: <input type="checkbox"/> Yes <input checked="" type="checkbox"/> No	Function: Store customer setting data for backup/restore	Steps to clear memory: There are no steps to clear this data.
Type (Flash, EEPROM, etc): HP side: SPI Flash	Size: 4MB	User Modifiable: <input checked="" type="checkbox"/> Yes <input type="checkbox"/> No	Function: Contains the boot code and factory product configuration data required for the device to function. User modifications are limited to downloading digitally signed HP firmware images.	Steps to clear memory: There are no steps to clear this data
Type (Flash, EEPROM, etc): MSOK : MSOK – TPM NVRAM MSOK – EEPROM MSOK – CRUM	Size: 256 KB 32 KB 120 KB	User Modifiable: <input type="checkbox"/> Yes <input checked="" type="checkbox"/> No	Function: TPM NVRAM - stores HP-signed immutable ID certificate and associated RSA key pair in locked memory. EEPROM - stores device lifecycle data (e.g. device page counts), copy of device speed license, and SED (self-encrypting drive) drive lock password. CRUM - stores device page counts, consumables information, device speed information, and product serial number.	Steps to clear memory: Drive lock password can be changed through the device embedded web server interface. No other data stored on the MSOK can be cleared.

Figure B-2 Certificate of Volatility (2 of 3)

Mass Storage				
Does the device contain mass storage memory (Hard Disk Drive, Tape Backup)? <input checked="" type="checkbox"/> Yes <input type="checkbox"/> No If Yes please describe the type, size, function, and steps to clear the memory below				
Type (HDD, Tape, etc.): 1 – EMMC card	Size: HP Formatter (Obsidian II) – 16GB (Card) ECB – 16GB	User Modifiable: <input checked="" type="checkbox"/> Yes <input type="checkbox"/> No	Function: Stores customer data, OS, applications, digitally signed firmware images, persistent data, and temporary data used for processing and system functions.	Steps to clear memory: 1. Secure Fast Erase – Changes the encryption keys rendering all data in the customer partition unreadable. 2. Power Cycle of the printer – Deletes all customer data stored in the customer partition.
Type (HDD, Tape, etc.):	Size:	User Modifiable: <input type="checkbox"/> Yes <input type="checkbox"/> No	Function:	Steps to clear memory:

Optional Mass Storage				
Does the device contain mass storage memory (Hard Disk Drive, Tape Backup)? <input checked="" type="checkbox"/> Yes <input type="checkbox"/> No If Yes please describe the type, size, function, and steps to clear the memory below				
Type (HDD, Tape, etc.): 2 - optional Hard drives 1- Optional ECB HDD 500 GB SED Encrypted HDD 2- Optional HP Formatter HDD 500 GB SED Encrypted HDD	Size: 500 GB 500 GB	User Modifiable: <input checked="" type="checkbox"/> Yes <input type="checkbox"/> No	Function: Stores customer data, OS, applications, digitally signed firmware images, persistent data, and temporary data used for processing and system functions.	Steps to clear memory: 1. Secure Storage Erase – Areas temporary files and job data by overwriting information overwriting information one or three times. 2. Secure Disk Erase – Erases files when jobs finish processing by overwriting them one or three times. 3. Secure File Erase – Erases files when jobs finish processing by overwriting them one or three times.

Optional Mass Storage				
Does the device contain mass storage memory (Hard Disk Drive, Tape Backup)? <input checked="" type="checkbox"/> Yes <input type="checkbox"/> No If Yes please describe the type, size, function, and steps to clear the memory below				
Type (HDD, Tape, etc.): Optional Formatter HDD 500 GB FIPS Encrypted HDD	Size: 500GB	User Modifiable: <input checked="" type="checkbox"/> Yes <input type="checkbox"/> No	Function: Stores customer data, OS, applications, digitally signed firmware images, persistent data, and temporary data used for processing and system functions.	Steps to clear memory: 1. Erase and Unlock Encrypted Disk – This changes the Encryption keys rendering all data unreadable. 2. Secure Storage Erase – Areas temporary files and job data by overwriting information overwriting information one or three times. 3. Secure Disk Erase – Erases files when jobs finish processing 4. Secure File Erase – Erases files when jobs finish processing by overwriting them one or three times.

Figure B-3 Certificate of Volatility (3 of 3)

USB			
Does the item accept USB input and if so, for what purpose (i.e Print Jobs, device firmware updates, scan upload)? <input checked="" type="checkbox"/> Yes <input type="checkbox"/> No If Yes please describe below			
Print jobs, HP digitally signed firmware upgrades, 3rd party application loading. USB ports can be disabled.			
Can any data other than scan upload be sent to the USB device? <input checked="" type="checkbox"/> Yes <input type="checkbox"/> No If Yes please describe below			
Diagnostic service logs can be uploaded. Print files can be printed via a USB thumb drive.			
RF/RFID			
Does the item use RF or RFID for receive or transmit of any data including remote diagnostics. (e.g. Cellular phone, Bluetooth) <input type="checkbox"/> Yes <input checked="" type="checkbox"/> No If Yes please describe below			
Purpose:			
Frequency:		Bandwidth:	
Modulation:		Effective Radiate Power (ERP):	
Specifications:			
Other Transmission Capabilities			
Does the device employ any other methods of non-wired access to transmit or receive any data whatsoever (e.g. anything other than standard hard wired TCP/IP, direct USB, or parallel connections)? <input checked="" type="checkbox"/> Yes <input type="checkbox"/> No If Yes please describe below:			
Purpose: WiFi Direct Print			
Frequency: 2.4 GHz, 5GHz		Bandwidth: 2401 - 2495 MHz; depending on selected channel in 2.4GHz band. 5180 - 5825 MHz; depending on selected channel in 5GHz band.	
Modulation:		Effective Radiate Power (ERP):	
Specifications: 802.11 b/g/n			
Other Transmission Capabilities			
Does the device employ any other methods of non-wired access to transmit or receive any data whatsoever (e.g. anything other than standard hard wired TCP/IP, direct USB, or parallel connections)? <input type="checkbox"/> Yes <input type="checkbox"/> No If Yes please describe below:			
Purpose:			
Frequency:		Bandwidth:	
Modulation:		Effective Radiate Power (ERP):	
Specifications:			
Other Capabilities			
Does the device employ any other method of communications such as a Modem to transmit or receive any data whatsoever? <input type="checkbox"/> Yes <input checked="" type="checkbox"/> No If Yes please describe below:			
Purpose:			
Specifications:			
Author Information			
Name	Title	Email	Business Unit
Mast John	Technical Marketing Engineer	john.mast@hp.com	IPG
Jaeseung Jang	Technical Marketing Engineer	jaeseung.jang@hp.com	IPG
Date Prepared: 1/30/2019			

Certificate of Volatility (for E78223, E78228)

Figure B-4 Certificate of Volatility (1 of 3)

Hewlett-Packard Certificate of Volatility				
Model: HP Color LaserJet Managed MFP E782xxdv HP Color LaserJet Managed MFP E782xxdn		Part Number: 8GS13A= E78223dv 8GS14A=E78223dn 8GS15A=E78228dn		Address: Hewlett Packard Company 11311 Chinden Blvd Boise, ID 83714
Volatile Memory				
Does the device contain volatile memory (Memory whose contents are lost when power is removed)? <input checked="" type="checkbox"/> Yes <input type="checkbox"/> No If Yes please describe the type, size, function, and steps to clear the memory below				
Type (SRAM, DRAM, etc): DDR3-DRAM	Size: HP Fornatter (Obsidian II) – 1.25GB ECB – 3GB	User Modifiable: <input type="checkbox"/> Yes <input checked="" type="checkbox"/> No	Function: Operation system and print/scan buffer	Steps to clear memory: When the printer is powered off the memory is erased
Type (SRAM, DRAM, etc): DIMM (Optional)	Size: 2GB	User Modifiable: <input type="checkbox"/> Yes <input checked="" type="checkbox"/> No	Function: For JA link (supported only for dn bundle)	Steps to clear memory:
Non-Volatile Memory				
Does the device contain non-volatile memory (Memory whose contents are retained when power is removed)? <input checked="" type="checkbox"/> Yes <input type="checkbox"/> No If Yes please describe the type, size, function, and steps to clear the memory below				
Type (Flash, EEPROM, etc): IOD EEPROM	Size:	User Modifiable: <input type="checkbox"/> Yes <input checked="" type="checkbox"/> No	Function:	Steps to clear memory:
Type (Flash, EEPROM, etc): HP side: SPI Flash	Size: 4MB	User Modifiable: <input checked="" type="checkbox"/> Yes <input type="checkbox"/> No	Function: Contains the boot code and factory product configuration data required for the device to function. User modifications are limited to downloading digitally signed HP firmware images.	Steps to clear memory: There are no steps to clear this data
Type (Flash, EEPROM, etc): MSOK : MSOK – TPM NVRAM MSOK – EEPROM MSOK – CRUM	Size: 256 KB 32 KB 120 KB	User Modifiable: <input type="checkbox"/> Yes <input checked="" type="checkbox"/> No	Function: signed immutable ID certificate and associated RSA key pair in locked memory. EEProm - stores device lifecycle data (e.g. device page counts), copy of device speed license, and SED (self-encrypting drive) drive lock password. CRUM - stores device page counts, consumables information, device speed information, and product	Steps to clear memory: changed through the device embedded web server interface. No other data stored on

Figure B-5 Certificate of Volatility (2 of 3)

Mass Storage				
Does the device contain mass storage memory (Hard Disk Drive, Tape Backup)? <input checked="" type="checkbox"/> Yes <input type="checkbox"/> No If Yes please describe the type, size, function, and steps to clear the memory below				
Type (HDD, Tape, etc.): 1 – EMMC card	Size: HP Formatter (Obsidian II) – 16GB (Card) ECB – 16GB	User Modifiable: <input checked="" type="checkbox"/> Yes <input type="checkbox"/> No	Function: Stores customer data, OS, applications, digitally signed firmware images, persistent data, and temporary data used for processing and system functions.	Steps to clear memory: 1. Secure Fast Erase – Changes the encryption keys rendering all data in the customer partition unreadable. 2. Power Cycle of the printer – Deletes all customer data stored in the customer partition.
Type (HDD, Tape, etc.):	Size:	User Modifiable: <input type="checkbox"/> Yes <input type="checkbox"/> No	Function:	Steps to clear memory:

Optional Mass Storage				
Does the device contain mass storage memory (Hard Disk Drive, Tape Backup)? <input checked="" type="checkbox"/> Yes <input type="checkbox"/> No If Yes please describe the type, size, function, and steps to clear the memory below				
Type (HDD, Tape, etc.): Optional ECB HDD SED Encrypted HDD	Size: 500 GB	User Modifiable: <input checked="" type="checkbox"/> Yes <input type="checkbox"/> No	Function: Stores customer data, OS, applications, digitally signed firmware images, persistent data, and temporary data used for processing and system functions.	Steps to clear memory: 1. Secure Storage Erase – Areas temporary files and job data by overwriting information overwriting information one or three times. 2. Secure Disk Erase – Erases files when jobs finish processing by overwriting them one or three times. 3. Secure File Erase – Erases files when jobs finish processing by overwriting them one or three times.

Optional Mass Storage				
Does the device contain mass storage memory (Hard Disk Drive, Tape Backup)? <input checked="" type="checkbox"/> Yes <input type="checkbox"/> No If Yes please describe the type, size, function, and steps to clear the memory below				
Type (HDD, Tape, etc.): Optional Formatter HDD FIPS Encrypted HDD	Size: 500GB	User Modifiable: <input checked="" type="checkbox"/> Yes <input type="checkbox"/> No	Function: Stores customer data, OS, applications, digitally signed firmware images, persistent data, and temporary data used for processing and system functions.	Steps to clear memory: 1. Erase and Unlock Encrypted Disk – This changes the Encryption keys rendering all data unreadable. 2. Secure Storage Erase – Areas temporary files and job data by overwriting information overwriting information one or three times. 3. Secure Disk Erase – Erases files when jobs finish processing 4. Secure File Erase – Erases files when jobs finish processing by overwriting them one or three times.
Optional Formatter HDD TAA Secure Encrypted HDD (Available AMS only)	500GB			

Figure B-6 Certificate of Volatility (3 of 3)

USB			
Does the item accept USB input and if so, for what purpose (i.e Print Jobs, device firmware updates, scan upload)? <input checked="" type="checkbox"/> Yes <input type="checkbox"/> No If Yes please describe below			
Print jobs, HP digitally signed firmware upgrades, 3rd party application loading. USB ports can be disabled.			
Can any data other than scan upload be sent to the USB device? <input checked="" type="checkbox"/> Yes <input type="checkbox"/> No If Yes please describe below			
Diagnostic service logs can be uploaded. Print files can be printed via a USB thumb drive.			
RF/RFID			
Does the item use RF or RFID for receive or transmit of any data including remote diagnostics. (e.g. Cellular phone, Bluetooth) <input type="checkbox"/> Yes <input checked="" type="checkbox"/> No If Yes please describe below			
Purpose:			
Frequency:		Bandwidth:	
Modulation:		Effective Radiate Power (ERP):	
Specifications:			
Other Transmission Capabilities			
Does the device employ any other methods of non-wired access to transmit or receive any data whatsoever (e.g. anything other than standard hard wired TCP/IP, direct USB, or parallel connections)? <input checked="" type="checkbox"/> Yes <input type="checkbox"/> No If Yes please describe below:			
Purpose: WiFi Direct Print			
Frequency: 2.4 GHz, 5GHz		Bandwidth: 2401 - 2495 MHz; depending on selected channel in 2.4GHz band. 5180 - 5825 MHz; depending on selected channel in 5GHz band.	
Modulation:		Effective Radiate Power (ERP):	
Specifications: 802.11 b/g/n			
Other Transmission Capabilities			
Does the device employ any other methods of non-wired access to transmit or receive any data whatsoever (e.g. anything other than standard hard wired TCP/IP, direct USB, or parallel connections)? <input type="checkbox"/> Yes <input type="checkbox"/> No If Yes please describe below:			
Purpose:			
Frequency:		Bandwidth:	
Modulation:		Effective Radiate Power (ERP):	
Specifications:			
Other Capabilities			
Does the device employ any other method of communications such as a Modem to transmit or receive any data whatsoever? <input type="checkbox"/> Yes <input checked="" type="checkbox"/> No If Yes please describe below:			
Purpose:			
Specifications:			
Author Information			
Name	Title	Email	Business Unit
Jaeseung Jang	Technical Marketing Engineer	jaeseung.jang@hp.com	IPG
LEE, JAESUNG	HW Asset Engineer	jaesung.lee@hp.com	IPG
Date Prepared: 3/30/2020			

C Service parts changes For Environmental Protection Agency 3.0 Compliant Products

Learn about service part changes for EPA compliance.

HP is introducing A3 Laser Jet MFPs to meet the new Environmental Protection Agency (EPA) 3.0 Compliance standards. A few service parts are changing even though their appearance and ways of replacing them are almost the same as before. These new regulations are primarily concerned with lower power consumption which the parts affected contribute to. All Items listed in this document are service parts being changed for these EPA 3.0 Compliant products.

These EPA 3.0 compliant devices will begin manufacturing in Spring 2020 and will not have new product numbers. Identification of these products will be accomplished by a specific character in their serial numbers.

Printer service parts affected

- Formatter
- FDB (Fuser Drive Board)
- Fuser unit

Printer service parts affected

- HP Color LaserJet Managed MFP **E77822dn / E77825dn** / E77830dn
- HP Color LaserJet Managed Flow MFP **E77822z / E77825z** / E77830z
- HP Color LaserJet Managed MFP **E77422a / E77422dv / E77422dn** / E77428dn
- HP LaserJet Managed MFP **E72525dn / E72530dn** / E72535dn
- HP LaserJet Managed Flow MFP **E72525z / E72530z** / E72535z
- HP LaserJet Managed MFP **E72425a / E72425dv / E72425dn** / E72430dn

* Parts referenced in this doc are also compatible with the SKU's above. However, installation of these parts in the SKU's in **BOLD** will not make them EPA 3.0 compliant. Only SKU's identified by a specific character in their serial number are EPA 3.0 compliant.

Table C-1 E77822z/E77825z/E77830z (color printers)

Item	Description
1	Formatter Rock

Table C-1 E77822z/E77825z/E77830z (color printers) (continued)

Item	Description
2	FDB V1
3	FDB V2

Table C-2 E77822dn/E77825dn/E77830dn (color printers)

Item	Description
1	Formatter Obisidian1
2	FDB V1
3	FDB V2

Table C-3 E77422a/E77428dv/E77422dn/E77428dn (color printers)

Item	Description
1	Formatter Obisidian2
2	FDB V1
3	FDB V2

Table C-4 E72525z/E72530z/E72535z (mono printers)

Item	Description
1	Formatter Rock
2	FDB V1
3	FDB V2
4	Fuser V1
5	Fuser V2

Table C-5 E72525dn/E72530dn/E72535dn (mono printers)

Item	Description
1	Formatter Obisidian1
2	FDB V1
3	FDB V2
4	Fuser V1
5	Fuser V2

Table C-6 E72425a/E72425dv/E72425dnE72430dn (mono printers)

Item	Description
1	Formatter Obisidian2
2	FDB V1
3	FDB V2
4	Fuser V1
5	Fuser V2

Table C-7 Foramtter type 1/2/3

No	Legacy part number	EPA 3.0 compliant product	Common	Part name	Description	Remark
1	JC92-03070A	Y3K99-60005	New	Formatter	Rock PCA	Formatter_Rock
1	JC92-03005A	X3A92-60006	New	Formatter	Obsidian PCA	Formatter_Obisidian1
1	JC92-03036A	X3A92-60007	New	Formatter	Obsidian PCA	Formatter_Obisidian2

Table C-8 FDB V1/V2

No	Legacy part number	EPA 3.0 compliant product	Common	Part name	Description	Remark
2	JC44-00210E	8GR94-60001	New	FDB	110V(V1)	FDB V1
3	JC44-00211E	8GR94-60002	New	FDB	220V(V2)	FDB V1

Table C-9 Fuser V1/V2

No	Legacy part number	EPA 3.0 compliant product	Common	Part name	Description	Remark
4	JC82-00479A	X3A65-61001	New	Fuser	110V(V1)	Fuser V1
5	JC82-00481A	X3A65-61002	New	Fuser	220V(V2)	Fuser V1

Notes

- Service parts referenced above for legacy products (Gemstone 1.0/1.1) and EPA 3.0 Compliant products are forward and backward compatible. **However, Hp does not recommend installing old service parts which do not meet EPA 3.0 Compliance in EPA 3.0 Compliant products.** This is to ensure these products remain EPA 3.0 compliant after field service.
- If an EPA 3.0 Compliant FUSER is installed in any printer, **that unit needs to have firmware upgraded to the latest level to function properly, especially those with a B or C in 3rd digit of serial number (SN).**

- EPA 3.0 Compliant products will be identified as indicated below : 3rd digit will be shown as “D” from “B” or “C”.



Index

A

Accessories part numbers 24
acoustic specifications 16
ADF 674
 whole unit 397
ADF glass 66
after-service checklist 685, 730
APS sensor 390
Automatic document feed drive
 assembly 73
Automatic Document Feeder 674,
 675
Automatic document feeder (ADF)
 69
Automatic document feeder exit drive
 assembly 73
Automatic document feeder
 registration drive assembly 72

B

bin, output
 locating 2

C

Calibrate/Cleaning menu, control
 panel 500, 564
Cassette 31
cautions v
Certificate of Volatility 1257, 1260
Channel partners
 WISE 95
Charge coupled device (CCD) 59
checklists
 after-service 685, 730
 preservice 685, 730
cleaning page 500, 564
Color Plane Registration (CPR)
 assembly 662

Color plane registration assembly
 frame main 285
consumable life 20
control panel 297, 305
 Backup/Restore menu 500, 564
 Calibrate/Cleaning menu 500,
 564
 Copy menu (MFP only) 500, 543
 Fax menu (fax models only) 500,
 556
 locating 2
 locating features 2, 7
 Print menu 500, 559
 Reports menu 500
 Scan menu (MFP only) 500, 547
 Settings menu 500, 501
 Supplies menu 500, 559
 Trays menu 500, 560
 troubleshooting menu 500, 560
 USB Firmware Upgrade menu
 500, 564, 565
control panel menus 500
control panel message document
 WISE, search 452
conventions, document v
Copy menu (MFP only), control
 panel 500, 543
Cover open sensor #1 66
Cover open sensor #2 66
Covers 750
CPMD
 error codes 452
CPMP
 WISE 454
CPR 285

D

DCF 680

definitions
 glossary 1253
Delivery system 27
Developer unit 38
developer unit
 remove 164
 replace 164
diagrams
 covers-inner finisher 736
 ejector unit-inner finisher 748
 inner finisher 734
 paper support unit-inner finisher
 740
 sensor, motor, and roller-inner
 finisher 738
 stapler unit-inner finisher 746
 tamper unit-inner finisher 742,
 744
diverter unit 702
document conventions v
document feeder
 jams 571
 locating 2
Document lid assembly 423
documentation, printer error codes
 and messages
 WISE 454
Drive motor 65
Drive motors 52
Drive system 52
drum 159
Drum drive 37
Dual cassette feeder 88, 680
dual cassette feeder (DCF) 438
 motor 442
 PCA 441
 pickup motor 445
 pickup units 446

- rear cover 438
- right door 439
- duplex sensor 349

E

- easy-access USB port
 - locating 2
- ECB 76
- ejector home sensor 1247
- ejector motor 1247
- Ejector unit 1043
- ejector unit 718
- electrical specifications 16
- electrostatic discharge 98
- electrostatic discharge (ESD) 685, 730
- empty level sensor 247
- end fence sensor 1245
- End fence unit 1108
- end fence unit 714
- Engine controller board 76
- entrance motor 1238, 1239
- Entrance unit 773
- entrance unit 701
- Eraser PCA 85
- error codes 452
 - CPMD 452
- ESD electrostatic discharge (ESD) 685, 730
- Ethernet (RJ-45)
 - locating 2, 5
- event log
 - error codes 452
- Exit assembly 649
- Exit drive 56
- exit drive unit 179
- exit sensor 1240
- Exit unit 788
- exit unit 704

F

- Fax menu (fax models only), control panel 500, 556
- fax port
 - locating 2
- FDB 140, 645
- Feed drive 55
- feed roller 244
 - MP 319
 - multipurpose 319

- Feed sensor 662
- feed sensor 1 232
- Feed sensor 1, empty sensor 1, and lift sensor 1 (DCF) 682
- Feed sensor 2, empty sensor 2, and lift sensor 2 for tray 5 (DCF) 682
- Feed system 27
- feed unit
 - feed sensor 2 236
- finisher docking sensor 1237
- finisher system 692
- finisher system diagram 692
- finisher system electrical parts 692
- finisher system paper path 692
- finisher system PBA connection 692
- finisher system sectional view 692
- Firmware upgrades 637
- Flatbed glass 65
- Flatbed scanner system 59
- Formatter 80, 644
- formatter 107
 - locating 2, 5
- front cover
 - open switch 257
- front cover open switch 257
- front cover switch 1251
- front door
 - locating 2
- Front frame 660
- Front tamper 911
- front tamper motor 1243
- front tamper sensor 1243
- front view 686
- Full rate (FR) carriage 59
- Fuser 43
- fuser 119
 - duct fan 213
 - jams 575
 - out sensor 336
- Fuser & Exit drive assembly 179, 652
- Fuser assembly 664
- Fuser drive 56
- Fuser Drive Board 645
- Fuser drive board 140
- Fuser drive board (FDB) 83
- fuser drive unit 179
- fuser duct fan 213
- fuser out sensor 336
- fuser unit 119

- Fuser unit drive 44
- Fuser unit temperature control 44

G

- General Settings menu, control panel 500, 501
- glossary
 - terms and definitions 1253

H

- Half rate (HR) carriage 59
- Half rate (HR) carriage (mirror unit) 63
- Hard Disk Drive 425
- hardware integration pocket (HIP)
 - locating 2
- HDD 425
- Help button
 - locating 2, 7
- Hi-Speed USB 2.0 printing port
 - locating 2, 5
- High Voltage Power Supply 646
- high voltage power supply 156
- High-voltage power supply (HVPS) PCA 84
- Home button
 - locating 2, 7
- Home sensor 66
- HP internal users
 - WISE 95
- Humidity & Encoder sensor 297, 305
- HVPS 156, 646

I

- Image transfer belt (ITB) assembly 676
- Image transfer belt (ITB) drive 41
- Image Transfer Belt (ITB) Unit 40
- Image transfer belt (ITB) Unit 40
- imaging drum
 - remove 159
 - replace 159
- Imaging unit 37, 64
- inner finisher
 - block diagram 685
 - ejector & paper support assembly 1043
 - ejector assembly 733, 1084
 - ejector motor 733
 - ejector motor assembly 1062
 - end fence home 733

- end fence sensor 1108
- entrance motor 733, 778
- entrance sensor 733, 773
- exir roller 733
- exit motor 733, 796
- exit roller 798
- exit sensor 733, 788
- front cover 750
- front paper support 733, 806
- front tamper 911
- front tamper home sensor 928
- front tamper motor 945
- left cover 762
- main paddle 733, 889
- main paddle assembly 898
- main paddle home sensor 892
- main paddle motor 895
- middle cover 754
- motor 733
- output tray 1118
- output tray lower limit switch 1133
- output tray motor 1166
- output tray motor assembly 1145
- output tray motor sensor 1155
- output tray top of stack sensor 1124
- paper holding 1178
- paper holding sensor 1190
- paper holding solenoid 733, 1202
- paper support 733
- paper support home sensor 733, 847
- paper support motor 869
- parts and diagrams 734
- parts and diagrams - covers 736
- parts and diagrams - ejector unit 748
- parts and diagrams - paper support unit 740
- parts and diagrams - sensor, motor, and roller 738
- parts and diagrams - stapler unit 746
- parts and diagrams - tamper unit 742, 744
- PCA cover 760
- punch cover 1222

- punch waste full 733
- punch waste full sensor 1226
- rear cover 752
- rear paper support 733, 827
- rear tamper 964, 981
- rear tamper motor 998
- sensor 733
- stacker lower limit switch 733
- stacker motor 733
- stapler 733, 1017
- stapler position motor 1033
- stapler position sensor 733, 1021
- sub paddle unit 905
- switch 733
- top cover 757
- inner finisher diagrams 733
- inner finisher parts 733
- Inner finisher PCA 1236
- inner finisher PCA 726
- inner finisher remove and replace 733
- inner finisher specification 687
- interface ports
 - locating 2, 5
- intermediate transfer belt 125
 - cleaner 122
- interpret control-panel messages and event log entries 685, 1235
- ITB 125
 - cleaner 122

J

- jams
 - document feeder 571
 - fuser 575
 - locations 570
 - output bin 575
 - right door 575
 - Tray 1 572

L

- LAN port
 - locating 2, 5
- Laser scanning optical path 47
- Laser Scanning Unit 646
- Laser scanning unit 46
- Laser scanning unit assembly 635
- laser scanning unit assembly (LSU) 46

- Laser synchronizing detectors 47, 48
- local area network (LAN)
 - locating 2, 5
- loop sensor 349
- Low Voltage Power Supply 645
- Low voltage power supply 81
- LSU 46, 646
- LVPS 81, 645
 - board 137
 - fan 134
- LVPS board 137

M

- Main board 76
- Main controller 76
- Main drive 53
- main drive 202
- Main drive assembly 202, 650
- maintenance life 20
- menus, control panel
 - Calibrate/Cleaning 500, 564
 - Copy (MFP only) 500, 543
 - Fax (fax models only) 500, 556
 - General Settings 500, 501
 - Manage Trays 500, 560
 - Print 500, 559
 - Reports 500
 - Scan (MFP only) 500, 547
 - Supplies 500, 559
- MP drive 187
- MP drive unit 187
- MP unit 322
- multipurpose drive unit 187
- multipurpose unit 322

N

- notes v

O

- on/off button
 - locating 2
- operating systems, supported 13
- ordering 685, 730, 732
- Original return drive 74
- output bin
 - clear jams 575
 - locating 2
- output tray 722
- output tray motor 1248
- Output tray motor assembly 1145
- output tray motor sensor 1248

Output tray top of stack sensor 1249
Output tray unit 1118

P

Paddle unit 889
paddle unit 708
paper feed drive 192
Paper feed drive assembly 653
paper feed drive unit 192
Paper handling system 27
Paper holding unit 1178
paper holding unit 722
paper jams
 document feeder 571
 fuser 575
 locations 570
 output bin 575
 right door 575
 Tray 1 572
Paper pickup drive assembly 656
Paper size sensor 66
paper size sensor 278
Paper size sensor PCA 86, 278
paper support motor 1242
paper support sensor 1242
Paper support unit 806
paper support unit 707
Parts
 covers-inner finisher 736
 ejector unit-inner finisher 748
 inner finisher 734
 paper support unit-inner finisher 740
 ssensor, motor, and roller-inner finisher 738
 stapler unit-inner finisher 746
 tamper unit-inner finisher 742, 744
parts and accessories 685, 730, 732
Pick up system 27
pickup 244
Pickup assembly 658
Pickup drive 54
pickup drive 183
pickup drive unit 183
Pickup motor 1/2, feed motor, paper size sensor 1/2 and cover open sensor (DCF) 680
pickup roller 244
 MP 319
 multipurpose 319
Pickup unit 31
pickup unit 247
ports
 locating 2, 5
post-service test 99
post-service tests 685, 730, 731
power
 consumption 16
power connection
 locating 2
Power key PCA 86
power switch
 locating 2
pre-boot menu options 482
preservice checklist 685, 730
Print menu, control panel 500, 559
print quality
 test 685, 730, 731
Print Test Page 500, 501
Process Cleaning Page 500, 564
product number
 location 2, 5
Punch unit 1222
punch unit 698
punch waste box sensor 1237
Punch waste full sensor 1236

R

Rear frame 660
Rear paper support 827
Rear tamper 964
rear tamper motor 1244
rear tamper sensor 1244
rear view 686
Registration & Tray 1 (MP) drive assembly 651
Registration (regi) unit 32
Registration assembly 658
Registration drive 55
registration drive 187
registration drive unit 187
registration unit 226
removal and replacement inner finisher 733
removing parts
 checklists 685, 730
Reports menu, control panel 500
reverse roller 244
 MP 319
 multipurpose 319
right door 312
 jams 575
 locating 2
 open switch 280
Right door assembly 666
Right door feed guide 669
right door open switch 280
Right door output 669
RJ-45 port
 locating 2, 5

S

scan glass 381
Scan menu (MFP only), control panel 500, 547
scanner
 imaging unit 387
 scan glass 381
Scanner assembly 671, 673
scanner imaging unit 387
Scanner lower parts 674
serial number
 locating 2, 5
service and support
 WISE 95
service approach 99, 685, 730
Service mode 577
Shading sheet 67
Sign In button
 locating 2, 7
Sign Out button
 locating 2, 7
SMPS 81
specifications
 electrical and acoustic 16
stapler position motor 1246
stapler position sensor 1246
Stapler unit 1017
stapler unit 716
Start Copy button
 locating 2
static, precautions for 685, 730
supplies 685, 730, 732
Supplies menu, control panel 500, 559
supported operating systems 13

T

Tamper unit 910
tamper unit 711
TC Sensor 677
Temp/Humidity sensor 646, 647
terms
 glossary 1253
test
 post-service 99
tests
 post-service 685, 730, 731
 print-quality 685, 730, 731
Timing belt 66
tips v
toner
 collection unit drive 208
Toner cartridge 676
Toner collection unit drive 57
toner collection unit drive 208
Toner crum & Eraser sensor 678
Toner CRUM joint PCA 85
toner supply 194
Toner supply drive 58
toner supply drive 194
Toner supply drive assembly 654
toner supply drive unit 194
toner-collection unit
 locating 2
top cover switch 1250
touchscreen
 locating features 2, 7
transfer belt 125
 cleaner 122
transfer roller 347
Tray 1
 jams 572
 locating 2
Tray 1 (MP) assembly 668
Tray 1 feed assembly 33
Tray 2
 locating 2
Tray 3
 locating 2
tray selection - use requested tray
 500, 501
Tray1 drive 55
trays
 locating 2
Trays menu, control panel 500, 560

U

USB host PCA 297, 305
USB port
 locating 2, 5
Use Requested Tray 500, 501

W

Walkup USB PCA 86
warnings v
Waste sensor PCA 85
Web-based Interactive Search Engine
(WISE)
 HP internal users and Channel
 partners 95
Wire driving 64, 67
WISE
 CPMD 454
 HP internal users and Channel
 partners 95
Wise
 control panel message
 document 452

