

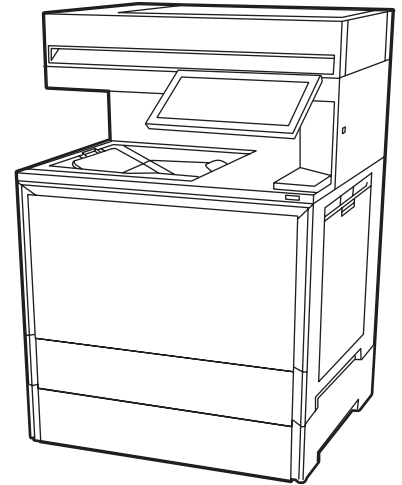

HP Color LaserJet Enterprise 5700
HP Color LaserJet Enterprise X557, X55745
HP Color LaserJet Enterprise MFP 5800
HP Color LaserJet Enterprise MFP X57945

Service Manual

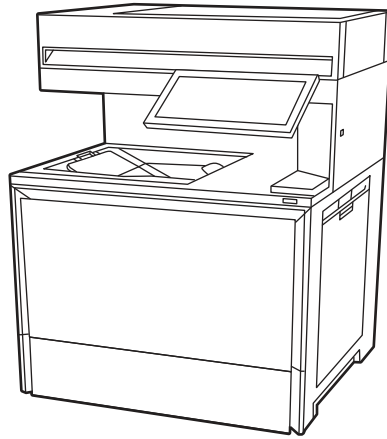
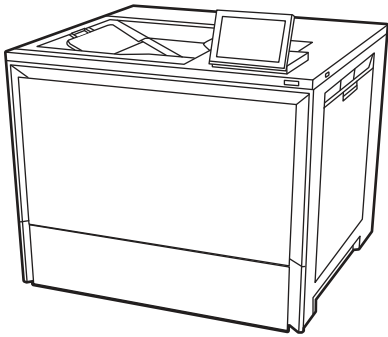

www.hp.com/support/colorlj5700
www.hp.com/support/colorljX557

www.hp.com/support/colorlj5800MFP
www.hp.com/support/colorljX57945MFP



HP Color LaserJet 5700, X557, X55745, MFP 5800, X57945 - Service Manual

SUMMARY

This guide provides theory of operation, troubleshooting, and repair information.

Legal information

Copyright and License

© Copyright 2023 HP Development Company, L.P.

Reproduction, adaptation, or translation without prior written permission is prohibited, except as allowed under the copyright laws.

The information contained herein is subject to change without notice.

The only warranties for HP products and services are set forth in the express warranty statements accompanying such products and services. Nothing herein should be construed as constituting an additional warranty. HP shall not be liable for technical or editorial errors or omissions contained herein.

Edition 1, 3/2023

Revision history

View a list of document revisions.

The information contained herein is subject to change without notice. The only warranties for HP products and services are set forth in the express warranty statements accompanying such products and services. Nothing herein should be construed as constituting an additional warranty. HP shall not be liable for technical or editorial errors or omissions contained herein.

Table Revision history

Revision number	Revision date	Revision notes
1.1	04/2023	Service manual updates include, but not limited to: <ul style="list-style-type: none">• Updated wast toner duct remove/replace (unseat ITB)• Additional reinstall content to main drive assembly remove/replace• Updated HCl lifter drive remove/replace Added managed toner cartridges manual unlock procedure. See Removal and replacement: Toner cartridges (manual unlock) (X57945 models) on page 624.
1	03/2023	Service manual initial release.

Conventions used in this guide

Learn about the conventions used in this publication.



TIP: Tips provide helpful hints or shortcuts.



NOTE: Notes provide important information to explain a concept or to complete a task.



CAUTION: Cautions indicate procedures that you should follow to avoid losing data or damaging the product.



WARNING! Warnings alert you to specific procedures that you should follow to avoid personal injury, catastrophic loss of data, or extensive damage to the product.

HP service and support

Learn about access to additional service and support information.

Additional service and support for channel partners

Channel partners can use the HP Partner Portal or the Channel Services Delivery Platform (CSDP) to access the HP Web-based Interactive Search Engine (WISE).

Find information about the following topics.

- Service manuals, service cost data, and service advisories
- The latest control panel message (CPMD) troubleshooting information
- Remove and replace part instructions and videos
- Solutions for printer issues and emerging issues
- Printer specifications, warranty, and regulatory information
- Install, configure, and how to information



[View a video of how to use the HP Partner First Portal to access WISE.](#)

Access WISE for Channel partners (HP Partner Portal)

1. Sign-in to the HP Partner Portal (click <https://partner.hp.com> to access the sign-in page).
2. Select the **Services & Support** item (near the top of the screen).
3. Select the **Technical Support (WISE)** item.
4. Select the **Technical Documentation** item.
5. Use the WISE portal to search for printer information.

Access WISE for Channel partners (CSDP)

1. Sign-in to the CSDP portal (click csdp.hp.com to access the sign-in page).
2. Select the **Knowledge and Training** item.
3. Select the **HP Technical Documentation** item.
4. Use the WISE portal to search for printer information.

Additional service and support for HP internal personnel

HP internal personnel, go to one of the following Web-based Interactive Search Engine (WISE) sites:

 [View a video of how to access WISE for internal HP users.](#)

Americas (AMS)

- [WISE - English](#)
- [WISE - Spanish](#)
- [WISE - Portuguese](#)
- [WISE - French](#)

Asia Pacific / Japan (APJ)

- [WISE - English](#)
- [WISE - Japanese](#)
- [WISE - Korean](#)
- [WISE - Chinese \(simplified\)](#)
- [WISE - Chinese \(traditional\)](#)
- [WISE - Thai](#)

Europe / Middle East / Africa (EMEA)

- [WISE - English](#)

Additional technical support WISE videos

The videos below provide additional ways to access printer information using WISE.

 [View a video of how to use WISE to find technical support videos \(model number search\).](#)

 [View a video of ow to use WISE to find technical support videos \(Product detail page \[PDP\] search\).](#)

Table of contents

1 Printer information, configurations, and specifications	1
Document feeder / scanner	1
Information (document feeder and scanner).....	1
Document feeder and scanner front view.....	1
Technical specifications.....	1
Information (base printer).....	2
Printer front view (5700 models).....	2
Printer front view (X557 models).....	3
Printer back view (5700/X557 models).....	3
Printer front view (5800/X57945 models).....	4
Printer back view (5800/X57945 models).....	6
Configuration (base printer).....	7
Configuration (base printer SFP).....	7
Configuration (base printer MFP).....	8
Specifications (base printer).....	9
Technical specifications (5700).....	9
Technical specifications (X55745).....	11
Technical specifications (5800).....	12
Technical specifications (X57945).....	14
Printer dimensions (5700/X557 models).....	15
Printer dimensions.....	16
Printer dimensions (X57945 models).....	18
Printer space requirements.....	21
Power consumption, electrical specifications, and acoustic emissions.....	21
Operating-environment range.....	22
Information (input devices).....	22
550-sheet paper feeder front view.....	22
High capacity input (HCI) paper feeder front view.....	23
Information (output devices).....	24
3-bin stapler-stacker front view.....	24
2 Printer installation and maintenance	26
Document feeder / scanner	26
Clean the pickup rollers and separation pad in the document feeder (MFP).....	26
Check the scanner glass for dirt and smudges.....	27

Base printer	28
Remove and replace the toner cartridges (5700/X557/5800 models).....	29
Remove and replace the toner cartridges (X57945 models).....	30
Remove and replace the imaging drums (X57945 models)	32
Clean the Tray 1 pickup and separation rollers	35
Clean the Tray 2 pickup and separation rollers	38

3 Theory of operation..... 41

Document feeder / scanner	41
Document feeder simplex operation	41
Scanning and image capture system.....	42
Base printer	42
Basic operation.....	43
Sequence of operation	43
Formatter-control system.....	45
Power management	45
Set the sleep timer and configure the printer to use 1 watt or less of power	46
Set the sleep schedule	46
Printer job language (PJL).....	47
Control panel	47
Walk-up USB	47
Low end data model (LEDm) overview.....	48
CPU	48
Input/output (I/O)	48
Memory.....	48
Engine-control unit.....	49
DC controller	50
Motors	54
Fans.....	56
Low-voltage power supply.....	56
Low-voltage power supply voltages description.....	57
Over-current/over-voltage protection	58
Low-voltage power supply safety	58
Low-voltage power supply functions	58
High-voltage power supply	59
Fuser control.....	60
Fuser heater protection.....	65
Fuser control functions.....	66
Engine laser/scanner system	66
Laser scanner failure detection.....	67
Laser scanner safety.....	67
Image-formation process	68
Step 1: Pre-exposure (X57945 models only).....	70
Step 2: Primary charging.....	71
Step 3: Laser-beam exposure.....	71
Step 4: Development.....	72
Step 5: Primary transfer	72
Step 6: Secondary transfer.....	73
Step 7: Separation.....	73

Step 8: Fusing.....	74
Step 9: ITB cleaning	74
Toner cartridges.....	75
Design.....	75
Toner cartridge functions	77
Intermediate transfer belt assembly.....	77
Intermediate transfer belt (ITB) functions.....	78
Secondary transfer roller assembly.....	79
Secondary transfer roller functions.....	79
Calibration	79
Calibration functions.....	79
Engine pickup, feed, and delivery system	80
Sensors and switches	82
Motors, clutches, and solenoids.....	84
Feed speed control.....	86
Pickup and feed delivery features	86
Media detection.....	87
Jam detection/prevention.....	88
Input devices.....	91
550-sheet paper feeder.....	91
550-sheet paper feeder paper path.....	91
Paper feeder controller.....	92
550-sheet paper feeder electrical components.....	92
550-sheet paper feeder motor control	93
550-sheet paper feeder other functions	94
550-sheet feeder jam detection.....	94
High capacity input (HCI) paper feeder.....	94
HCI paper path.....	94
HCI controller	95
HCI electrical components	96
HCI motor control.....	97
HCI other functions.....	97
HCI jam detection.....	98
Output devices	98
3-bin stapler-stacker.....	98
3-bin stapler-stacker paper path.....	98
3-bin stapler-stacker controller.....	99
3-bin stapler-stacker electrical components.....	100
3-bin stapler-stacker motor control.....	102
3-bin stapler-stacker fan control.....	102
3-bin stapler-stacker other functions	102
3-bin stapler-stacker jam detection.....	103
4 Solve problems.....	104
How to search for printer documentation.....	104
How to search WISE for printer information and documentation.....	104
Accessing WISE for HP channel partners (CSDP).....	110
Accessing WISE for HP channel partners (HP Partner Portal).....	111

Determine the problem source	113
Pre-troubleshooting checklist	114
Troubleshooting flowchart	115
Firmware upgrades	117
Determine the installed revision of firmware	117
HP Embedded Web Server	118
USB flash drive firmware (Pre-boot menu)	119
USB flash drive firmware (control panel menu)	119
Comprehensive list of troubleshooting tools	120
Engine test	120
Control panel checks	121
Touchscreen diagnostic mode	121
Open the control panel system diagnostic tests	122
Screen test	124
Touch test	128
SoftKey test	129
Backlight test	131
Sound test	132
Keyboard test (flow models only)	132
Version	133
Control panel diagnostic flowcharts	134
Touchscreen black, white, or dim (no image)	134
Touchscreen has an unresponsive zone	135
No control panel sound	136
Home button is unresponsive	137
Hardware integration pocket (HIP) is not functioning (control panel functional)	138
Print menu (SFP) and Copy/Print menu (MFP)	139
Defeating interlocks	161
LED diagnostics (formatter)	162
Scanner tests (MFP)	163
Disable cartridge check	164
Print/stop test	164
Individual component diagnostics	165
Paper path test	165
Paper path sensors test	166
Individual component test	166
Manual sensor test	166
Tray/bin manual sensor test	167
Diagrams: Block diagrams	167
Diagrams: External plug and port locations	167
Sensors and switches	168
Diagrams: Major component locations	172
Printed circuit assembly (PCA) connector locations	188
Diagrams: General timing chart	194
Diagrams: General circuit diagrams	195
Internal test and information pages	206
Reports menu	210
Settings menu	211

General menu.....	212
Scan/Digital Send Settings menu (MFP).....	218
Fax menu (MFP).....	229
Manage Supplies menu.....	240
Networking menu.....	243
Support Tools menu.....	249
Maintenance menu.....	249
Backup/Restore menu.....	249
Calibration/Cleaning menu.....	250
USB Firmware Upgrade menu.....	251
Service menu.....	251
Troubleshooting menu.....	252
Service menu.....	256
Printer resets.....	260
Format Disk and Partial Clean functions.....	262
Power on troubleshooting.....	266
Power-on checks.....	266
Power on troubleshooting overview.....	266
Troubleshooting power-on or blank control panel problems.....	266
Engine diagnostics.....	268
Engine test.....	268
Defeating interlocks.....	269
Disable cartridge check.....	270
LED diagnostics (formatter).....	271
Use the solve problems checklist.....	271
Control panel troubleshooting.....	274
Control panel system diagnostics.....	274
Open the control panel system diagnostic tests.....	274
Screen test.....	276
Touch test.....	280
SoftKey test.....	281
Backlight test.....	283
Sound test.....	284
Version.....	284
Control panel messages document (CPMD).....	285
Print the supplies status page.....	285
Pre-boot menu options.....	285
Open the Pre-boot menu from a touchscreen control panel.....	286
Cold reset using the Pre-boot menu from a touchscreen control panel.....	287
Remote Admin.....	288
Required software and network connection.....	288
Connect a remote connection.....	290
Disconnect a remote connection.....	293
Print the event log.....	295
How to search for printer documentation.....	295
How to search WISE for printer information and documentation.....	295
Accessing WISE for HP channel partners (CSDP).....	301
Accessing WISE for HP channel partners (HP Partner Portal).....	302

Error-code and control-panel-message troubleshooting overview	304
Error codes (types and structure).....	304
Solve paper handling problems	306
Clear paper jams (SFP models).....	306
Paper jam locations.....	307
Auto-navigation for clearing paper jams.....	307
Experiencing frequent or recurring paper jams?.....	307
13.B2.D1 jam error in Tray 1 (multipurpose tray).....	308
13.B2.D2 jam error in Tray 2.....	311
13.A3 jam error in Tray 3.....	316
13.A4 jam error in Tray 4.....	322
13.A4 jam error in Tray 4 (2,100 sheet feeder HCI).....	329
13.B2 jam error in right door.....	336
13.B4 jam errors in the right door	339
13.B9 jam errors in the fuser.....	341
13.D3 jam errors in the duplexer.....	345
13.E1 jam error in the output bin	347
Clear paper jams (MFP models).....	348
Paper jam locations.....	348
Auto-navigation for clearing paper jams.....	349
Experiencing frequent or recurring paper jams?.....	349
31.13.yz jam error in the document feeder	350
13.B2.D1 jam error in Tray 1 (multipurpose tray).....	354
13.B2.D2 jam error in Tray 2.....	358
13.A3 jam error in Tray 3.....	363
13.A4 jam error in Tray 4.....	369
13.A4 jam error in Tray 4 (2,100 sheet feeder HCI).....	376
13.B2 jam error in right door.....	383
13.B4 jam errors in the right door	386
13.B9 jam errors in the fuser.....	388
13.D3 jam errors in the duplexer.....	392
13.E1 jam error in the output bin	394
13.E2 jam error in top cover	395
13.60 jam errors in the fuser exit area when printing to a stapler/stacker or floor-standing finisher ..	397
13.80, 13.83, or 13.84 jam errors in the 3 Bin Stapler/Stacker	399
Printer feeds incorrect page size	403
Printer pulls from incorrect tray.....	404
Printer will not duplex or duplexes incorrectly (duplex models).....	404
Paper does not feed from Tray 2-X.....	404
Output is curled or wrinkled.....	405
The printer does not pick up paper	406
The printer picks up multiple sheets of paper	406
The document feeder jams, skews, or picks up multiple sheets of paper (MFP).....	407
Paper does not feed automatically	407
Image-quality troubleshooting.....	408
Print-quality troubleshooting.....	409
Repetitive image defect ruler	409
Use a ruler to measure between repetitive defects	409

Print from a different software program	412
Check the paper-type setting for the print job.....	412
Check the paper type setting on the control panel.....	412
Check the paper type setting (Windows).....	413
Check the paper type setting (macOS)	413
Check toner-cartridge status.....	413
Step one: Print the Supplies Status Page.....	413
Step two: Check supplies status.....	414
Print a cleaning page	414
Check paper and the printing environment	414
Step one: Use paper that meets HP specifications.....	414
Step two: Check the environment.....	415
Step three: Set the individual tray alignment.....	415
Try a different print driver	415
Troubleshoot image defects.....	416
Copy-quality troubleshooting	423
Check the scanner glass for dirt and smudges	424
Vertical lines, bands, or streaks	425
Modify printer settings to improve scan or copy quality.....	429
Light or faint copies (color models).....	430
Performance and connectivity troubleshooting.....	432
Solve fax or email problems	432
Solve performance problems	433
Factors affecting print performance.....	433
Print speeds	434
The printer does not print.....	435
The printer prints slowly	436
Solve connectivity problems.....	436
Solve USB connection problems	436
Solve wired network problems	436
Introduction	436
Poor physical connection.....	437
The computer is using the incorrect IP address for the printer	437
The computer is unable to communicate with the printer	437
The printer is using incorrect link and duplex settings for the network.....	437
New software programs might be causing compatibility problems.....	438
The computer or workstation might be set up incorrectly.....	438
The printer is disabled, or other network settings are incorrect.....	438
5 Removal and replacement.....	439
Customer self-repair (CSR) A parts and accessories	439
Customer-replaceable units.....	439
Internal parts and assemblies.....	439
Removal and replacement: Toner cartridges (5700/X557/5800 models).....	439
Removal and replacement: Toner cartridges (X57945 models).....	442
Removal and replacement: Imaging drums (X57945 models).....	447
Removal and replacement: Toner collection unit (TCU).....	451
Removal and replacement: 3-bin stapler-stacker staple cartridge (3-bin stapler-stacker).....	455
Removal and replacement: Convenience staple cartridge (convenience stapler models)	457

Removal and replacement: Fuser	459
Removal and replacement: Image transfer belt (ITB).....	462
Removal and replacement: Secondary transfer roller	464
Removal and replacement: Document feeder rollers (MFP models).....	467
Installation: Keyboard overlay (MFP models).....	469
Removal and replacement: Tray 1 pickup and separation roller assemblies.....	473
Removal and replacement: Tray 2 pickup and separation roller assemblies.....	478
Customer self-repair (CSR) B parts and accessories	481
Customer-replaceable units.....	481
Internal parts and assemblies.....	481
Removal and replacement: Keyboard (MFP models).....	481
Removal and replacement: Hard-disk drive (HDD).....	486
Removal and replacement: Dual in-line memory module (DIMM) (SFP models).....	490
Removal and replacement: Fax PCA (fax models).....	494
Removal and replacement: Workflow accelerator	497
Removal and replacement: USB expansion kit.....	501
Removal and replacement: Solid state drive (SSD).....	505
Removal and replacement: Near field communication (NFC) PCA (MFP models).....	523
Removal and replacement: embedded MultiMedia Card (eMMC) (SFP models).....	526
Document feeder / scanner	530
Field-replaceable units (FRUs)	530
Internal parts and assemblies.....	530
Removal and replacement: Scanner control board (SCB) (MFP models).....	530
Removal and replacement: White backing (MFP models)	535
Whole-unit replacement (WUR).....	537
Automatic document feeder (WUR).....	537
Removal and replacement: Document feeder (MFP models).....	537
Integrated scanner assembly (WUR).....	541
Removal and replacement: Flatbed scanner assembly (MFP models)	541
Removal and replacement: Internal parts and assemblies (base printer).....	547
Field-replaceable units (FRUs)	547
Covers, panels, and doors.....	547
Removal and replacement: Formatter cover	547
Removal and replacement: Front door	549
Removal and replacement: Toner cartridge access door (X557/X57945 models).....	552
Removal and replacement: Rear cover	555
Removal and replacement: Rear upper cover (MFP models).....	558
Removal and replacement: Left upper cover (MFP models).....	561
Removal and replacement: Left cover	563
Removal and replacement: Left handle	567
Removal and replacement: Front left cover.....	571
Removal and replacement: Front right cover.....	573
Removal and replacement: Right door	575
Removal and replacement: Right lower door (X57945 models).....	580
Removal and replacement: Rear lower cover (X57945 models).....	583
Removal and replacement: Left lower cover (X57945 models).....	586
Removal and replacement: Output bin.....	591
Removal and replacement: Right handle	595

Removal and replacement: Top cover (SFP models).....	600
Removal and replacement: Top cover (MFP models).....	607
Removal and replacement: Top front cover (MFP models).....	611
Removal and replacement: Hardware Integration Pocket (HIP) cover.....	617
Removal and replacement: Control panel (SFP models).....	619
Removal and replacement: Control panel (MFP models).....	622
Internal parts and assemblies.....	624
Removal and replacement: Toner cartridges (manual unlock) (X57945 models).....	624
Removal and replacement: Secondary transfer assembly.....	627
Removal and replacement: Registration density sensor assembly.....	631
Removal and replacement: Registration assembly.....	637
Removal and replacement: Paper pickup assembly (5700/X557/5800 models).....	643
Removal and replacement: Paper pickup assembly (X57945 models).....	648
Removal and replacement: Delivery assembly.....	652
Removal and replacement: Laser scanner assembly.....	656
Removal and replacement: DC controller (DCC).....	661
Removal and replacement: Formatter.....	664
Removal and replacement: Formatter cage assembly (SFP models).....	667
Removal and replacement: Formatter cage assembly (MFP models).....	672
Removal and replacement: Feed drive assembly (X57945 models).....	676
Removal and replacement: Pickup drive assembly (5700/X557/5800 models).....	681
Removal and replacement: Pickup drive assembly (X57945 models).....	687
Removal and replacement: Toner supply motor assembly (X57945 models).....	693
Removal and replacement: Lifter drive assembly (5700/X557/5800 models).....	697
Removal and replacement: Lifter drive assembly (X57945 models).....	702
Removal and replacement: Auto close assembly (5700/X557/5800 models).....	707
Removal and replacement: Auto close assembly (X57945 models).....	712
Removal and replacement: Tray 2 media size detect assembly (X557 models).....	717
Removal and replacement: Tray 2 media size detect assembly (X57945 models).....	723
Removal and replacement: Fuser drive assembly.....	728
Removal and replacement: Main-drive assembly.....	737
Removal and replacement: Interlock assembly.....	754
Removal and replacement: Waste toner duct assembly (X57945 models).....	773
Removal and replacement: Waste toner duct assembly (5700/X557/5800 models).....	792
Removal and replacement: Pre-exposure PCA holder assembly (5700/X557/5800 models).....	800
Removal and replacement: Pre-exposure PCA holder assembly (X57945 models).....	814
Removal and replacement: Toner supply drive assembly (X57945 models).....	828
Removal and replacement: Toner supply assembly (X57945 models).....	833
Removal and replacement: Toner supply buffer assembly/intermediate pipe (X57945 models).....	836
Removal and replacement: Feed assembly (X57945 models).....	843
Removal and replacement: Low-voltage power supply (LVPS).....	849
Removal and replacement: High-voltage power supply (HVPS).....	854
Removal and replacement: Drive PCA.....	861
Removal and replacement: Feed/toner supply controller PCA (X57945 models).....	867
Removal and replacement: Right PCA.....	871
Removal and replacement: Rear PCA.....	875
Removal and replacement: Environmental sensor PCA.....	881
Removal and replacement: Drum home position PCA.....	884

Removal and replacement: Drum motor	889
Removal and replacement: Developer motor	894
Removal and replacement: Image transfer belt (ITB) motor	899
Removal and replacement: Developer alienation motor.....	905
Removal and replacement: Fuser motor.....	913
Removal and replacement: Duplex motor.....	918
Removal and replacement: Power-supply fan	924
Removal and replacement: Cartridge fan.....	930
Removal and replacement: Fuser fan	935
Input device - 550-sheet paper feeder.....	942
Field-replaceable units (FRUs)	943
Covers, panels, and doors.....	943
Removal and replacement: Front left cover (550-sheet paper feeder)	943
Removal and replacement: Front right cover (550-sheet paper feeder).....	945
Removal and replacement: Right door (550-sheet paper feeder).....	946
Removal and replacement: Rear cover (550-sheet paper feeder).....	949
Removal and replacement: Left cover (550-sheet paper feeder).....	953
Internal parts and assemblies.....	957
Removal and replacement: Pickup assembly (550-sheet paper feeder)	957
Removal and replacement: Lifter drive assembly (550-sheet paper feeder)	962
Removal and replacement: Pickup drive assembly (550-sheet paper feeder).....	966
Removal and replacement: Auto close assembly (550-sheet paper feeder).....	973
Removal and replacement: Media size detection assembly (550-sheet paper feeder).....	978
Removal and replacement: Controller PCA (550-sheet paper feeder).....	983
Removal and replacement: Separation roller assembly (550-sheet paper feeder).....	988
Removal and replacement: Pickup roller assembly (550-sheet paper feeder).....	989
Removal and replacement: 2,100-sheet paper deck.....	992
Field-replaceable units (FRUs)	992
Covers, panels, and doors.....	992
Removal and replacement: Right door (HCI)	992
Removal and replacement: Front left cover/left cover (HCI).....	993
Removal and replacement: Rear cover (HCI).....	997
Removal and replacement: Rear lower cover (HCI).....	999
Internal parts and assemblies.....	1002
Removal and replacement: Cassette assembly (HCI)	1002
Removal and replacement: Pickup assembly (HCI).....	1004
Removal and replacement: Auto close assembly (HCI).....	1007
Removal and replacement: Lifter drive assembly (HCI).....	1010
Removal and replacement: Pickup alienation assembly (HCI).....	1014
Removal and replacement: Pickup drive assembly (HCI).....	1018
Removal and replacement: Controller PCA (HCI).....	1022
Removal and replacement: Separation roller assembly (HCI).....	1026
Removal and replacement: Pickup roller assembly (HCI).....	1028
Output device - 3-bin staple stacker multi-bin mailbox	1031
Field-replaceable units (FRUs)	1031
Covers, panels, and doors.....	1031
Removal and replacement: Rear cover (3-bin stapler-stacker).....	1031
Removal and replacement: Staple cover and staple door (3-bin stapler-stacker).....	1033

Removal and replacement: Right upper cover (3-bin stapler-stacker).....	1036
Removal and replacement: Right corner cover (3-bin stapler-stacker).....	1037
Removal and replacement: Right lower cover (3-bin stapler-stacker).....	1040
Removal and replacement: Rear inner cover (3-bin stapler-stacker).....	1045
Removal and replacement: Stapler-stacker door assembly (3-bin stapler-stacker).....	1048
Removal and replacement: Stacking wall assembly (3-bin stapler-stacker).....	1055
Internal parts and assemblies.....	1067
Removal and replacement: Stapler assembly (3-bin stapler-stacker).....	1067
Removal and replacement: Jogger assembly (3-bin stapler-stacker).....	1071
Removal and replacement: Output bin 1 (3-bin stapler-stacker).....	1075
Removal and replacement: Upper feed assembly (3-bin stapler-stacker).....	1077
Removal and replacement: Lower feed assembly (3-bin stapler-stacker).....	1086
Removal and replacement: Solenoid assembly (3-bin stapler-stacker).....	1101
Removal and replacement: MBM fan (3-bin stapler-stacker).....	1108
Removal and replacement: Stapler-stacker feed motor (3-bin stapler-stacker).....	1111
Removal and replacement: Controller PCA (3-bin stapler-stacker).....	1114

6 Parts and diagrams..... 1118

Document feeder / scanner	1118
Integrated scanner assembly	1118
Base printer	1120
Control panels.....	1120
Control panels	1120
Covers, panels, and doors.....	1122
Parts and diagrams: Covers 5700/X557 models.....	1122
Parts and diagrams: Covers 5800 models.....	1124
Parts and diagrams: Covers X57945 models.....	1126
Internal parts and assemblies.....	1128
Parts and diagrams: Internal assemblies (1 of 9) X57945 models.....	1128
Parts and diagrams: Internal assemblies (2 of 9) X57945 models.....	1130
Parts and diagrams: Internal assemblies (3 of 9) X57945 models.....	1132
Parts and diagrams: Internal assemblies (4 of 9) X57945 models.....	1134
Parts and diagrams: Internal assemblies (5 of 9) X57945 models.....	1136
Parts and diagrams: Internal assemblies (6 of 9) X57945 models.....	1137
Parts and diagrams: Internal assemblies (7 of 9) X57945 models.....	1139
Parts and diagrams: Internal assemblies (8 of 9) X57945 models.....	1140
Parts and diagrams: Internal assemblies (9 of 9)X57945 models.....	1142
Parts and diagrams: Internal assemblies (1 of 7) 5700/X557/5800 models.....	1143
Parts and diagrams: Internal assemblies (2 of 7)5700/X557/5800 models.....	1145
Parts and diagrams: Internal assemblies (3 of 7)5700/X557/5800 models.....	1147
Parts and diagrams: Internal assemblies (4 of 7) 5700/X557/5800 models.....	1149
Parts and diagrams: Internal assemblies (5 of 7) 5700/X557/5800 models.....	1151
Parts and diagrams: Internal assemblies (6 of 7) 5700/X557/5800 models.....	1152
Parts and diagrams: Internal assemblies (7 of 7)5700/X557/5800 models	1154
Input devices.....	1154
Input device - 550-sheet paper feeder	1155
Covers, panels, and doors.....	1155
Covers, panels, and doors (550-sheet paper feeder).....	1155

Internal parts and assemblies.....	1156
Internal parts and assemblies (550-sheet paper feeder)	1156
Output devices	1157
Output device - 3-bin staple stacker	1157
Covers, panels, and doors.....	1157
Parts and diagrams: 3 bin staple stacker covers 5800/X57945 models.....	1157
Internal parts and assemblies.....	1158
Parts and diagrams: 3 bin staple stacker main body 5800/X57945 models	1158
Alphabetical parts list.....	1161
Document feeder / scanner	1118
Integrated scanner assembly	1118
Base printer	1120
Control panels	1120
Control panels	1120
Covers, panels, and doors.....	1122
Parts and diagrams: Covers 5700/X557 models.....	1122
Parts and diagrams: Covers 5800 models.....	1124
Parts and diagrams: Covers X57945 models	1126
Internal parts and assemblies.....	1128
Parts and diagrams: Internal assemblies (1 of 9) X57945 models	1128
Parts and diagrams: Internal assemblies (2 of 9) X57945 models.....	1130
Parts and diagrams: Internal assemblies (3 of 9) X57945 models	1132
Parts and diagrams: Internal assemblies (4 of 9) X57945 models	1134
Parts and diagrams: Internal assemblies (5 of 9) X57945 models	1136
Parts and diagrams: Internal assemblies (6 of 9) X57945 models	1137
Parts and diagrams: Internal assemblies (7 of 9) X57945 models.....	1139
Parts and diagrams: Internal assemblies (8 of 9) X57945 models	1140
Parts and diagrams: Internal assemblies (9 of 9)X57945 models	1142
Parts and diagrams: Internal assemblies (1 of 7) 5700/X557/5800 models.....	1143
Parts and diagrams: Internal assemblies (2 of 7)5700/X557/5800 models.....	1145
Parts and diagrams: Internal assemblies (3 of 7)5700/X557/5800 models.....	1147
Parts and diagrams: Internal assemblies (4 of 7) 5700/X557/5800 models.....	1149
Parts and diagrams: Internal assemblies (5 of 7) 5700/X557/5800 models.....	1151
Parts and diagrams: Internal assemblies (6 of 7) 5700/X557/5800 models.....	1152
Parts and diagrams: Internal assemblies (7 of 7)5700/X557/5800 models	1154
Input devices.....	1154
Input device - 550-sheet paper feeder	1155
Covers, panels, and doors	1155
Covers, panels, and doors (550-sheet paper feeder).....	1155
Internal parts and assemblies.....	1156
Internal parts and assemblies (550-sheet paper feeder)	1156
Output devices.....	1157
Output device - 3-bin staple stacker	1157
Covers, panels, and doors	1157
Parts and diagrams: 3 bin staple stacker covers 5800/X57945 models.....	1157
Internal parts and assemblies.....	1158
Parts and diagrams: 3 bin staple stacker main body 5800/X57945 models.....	1158

Numerical parts list.....	1175
Document feeder / scanner	1118
Integrated scanner assembly.....	1118
Base printer	1120
Control panels	1120
Control panels	1120
Covers, panels, and doors.....	1122
Parts and diagrams: Covers 5700/X557 models.....	1122
Parts and diagrams: Covers 5800 models.....	1124
Parts and diagrams: Covers X57945 models	1126
Internal parts and assemblies.....	1128
Parts and diagrams: Internal assemblies (1 of 9) X57945 models	1128
Parts and diagrams: Internal assemblies (2 of 9) X57945 models.....	1130
Parts and diagrams: Internal assemblies (3 of 9) X57945 models	1132
Parts and diagrams: Internal assemblies (4 of 9) X57945 models	1134
Parts and diagrams: Internal assemblies (5 of 9) X57945 models	1136
Parts and diagrams: Internal assemblies (6 of 9) X57945 models	1137
Parts and diagrams: Internal assemblies (7 of 9) X57945 models.....	1139
Parts and diagrams: Internal assemblies (8 of 9) X57945 models	1140
Parts and diagrams: Internal assemblies (9 of 9)X57945 models	1142
Parts and diagrams: Internal assemblies (1 of 7) 5700/X557/5800 models.....	1143
Parts and diagrams: Internal assemblies (2 of 7)5700/X557/5800 models.....	1145
Parts and diagrams: Internal assemblies (3 of 7)5700/X557/5800 models.....	1147
Parts and diagrams: Internal assemblies (4 of 7) 5700/X557/5800 models.....	1149
Parts and diagrams: Internal assemblies (5 of 7) 5700/X557/5800 models.....	1151
Parts and diagrams: Internal assemblies (6 of 7) 5700/X557/5800 models.....	1152
Parts and diagrams: Internal assemblies (7 of 7)5700/X557/5800 models	1154
Input devices.....	1154
Input device - 550-sheet paper feeder	1155
Covers, panels, and doors	1155
Covers, panels, and doors (550-sheet paper feeder).....	1155
Internal parts and assemblies.....	1156
Internal parts and assemblies (550-sheet paper feeder).....	1156
Output devices	1157
Output device - 3-bin staple stacker.....	1157
Covers, panels, and doors	1157
Parts and diagrams: 3 bin staple stacker covers 5800/X57945 models.....	1157
Internal parts and assemblies.....	1158
Parts and diagrams: 3 bin staple stacker main body 5800/X57945 models	1158
Appendix A Certificate of Volatility.....	1189
Certificate of Volatility	1189
Appendix B Glossary of terms	1193
Index.....	1203

List of videos

View a video of how to use the HP Partner First Portal to access WISE.....	v
View a video of how to access WISE for internal HP users.....	vi
View a video of how to use WISE to find technical support videos (model number search).....	vi
View a video of ow to use WISE to find technical support videos (Product detail page [PDP] search).....	vi
View a video of cleaning the document feeder glass and flatbed glass.....	27
View a video of how to replace the toner cartridges.....	29
View a video of how to replace the toner cartridges.....	30
View a video of how to replace the imaging drums.....	32
View a video of how to access WISE for HP channel partners.....	111
View a video of how to access WISE for HP channel partners.....	302
View a video that demonstrates how to load paper in a way that reduces the number of paper jams.....	307
View a video of how to clear a jam in Tray 1.....	308
View a video of how to clear a jam in Tray 2.....	311
View a video of how to clear a jam in Tray 3, and the optional trays.....	317
View a video of how to clear a jam in Tray 4.....	323
View a video of how to clear a jam in the high-capacity input Tray 4.....	329
View a video of how to clear a jam in the right door and fuser area.....	336
View a video of how to clear a jam in the right door and fuser area.....	339
View a video of how to clear a jam in the right door and fuser area.....	341
View a video of how to clear a jam in the right door and fuser area.....	345
View a video of how to clear a jam in the output bin.....	347
View a video that demonstrates how to load paper in a way that reduces the number of paper jams.....	349
View a video of how to clear a jam in the document feeder.....	350
View a video of how to clear a jam in Tray 1.....	354
View a video of how to clear a jam in Tray 2.....	358

View a video of how to clear a jam in Tray 3, and the optional trays.....	364
View a video of how to clear a jam in Tray 4.....	370
View a video of how to clear a jam in the high-capacity input Tray 4.....	376
View a video of how to clear a jam in the right door and fuser area.....	383
View a video of how to clear a jam in the right door and fuser area.....	386
View a video of how to clear a jam in the right door and fuser area.....	388
View a video of how to clear a jam in the right door and fuser area.....	392
View a video of how to clear a jam in the output bin.....	394
View a video of how to clear a jam in the output bin.....	395
View a video of how to clear a jam in the output bin.....	397
View a video of how to clear a jam in the output bin.....	399
View a video of cleaning the document feeder glass and flatbed glass.....	424
View a video of removing and replacing the toner cartridges.....	439
View a video of removing and replacing the toner cartridges.....	442
View a video of removing and replacing the image drums.....	447
View a video of removing and replacing the TCU.....	451
View a video of removing and replacing the staple cartridge.....	455
View a video of removing and replacing the staple cartridge.....	457
View a video to remove and replace the fuser.....	459
View a video demonstration of removing and replacing the image transfer belt.....	462
View a video of removing and replacing the T2 roller.....	464
View a video of removing and replacing the document feeder rollers.....	467
View a video of how to install the keyboard overlay.....	469
View a video of removing and replacing the Tray 1 rollers.....	473
View a video of removing and replacing the Tray 2 rollers.....	478
View a video of how to remove and replace the keyboard.....	481
View a video demonstration of removing and replacing the hard-disk drive.....	486
View a video demonstration of removing and replacing the DIMM.....	490
View a video demonstration of removing and replacing the fax PCA.....	494
View a video demonstration of removing and replacing the workflow accelerator.....	497
View a video demonstration of removing and replacing the USB expansion kit.....	501
View a video demonstration of removing and replacing the SSD.....	505

View a video demonstration of removing and replacing the NFC PCA.....	523
View a video demonstration of removing and replacing the eMMC.....	526
View a video demonstration of removing and replacing the control panel.....	622
View a video of removing and replacing the toner cartridges (manual unlock).....	624
View a video demonstration of removing and replacing the paper pickup assembly.....	643
View a video demonstration of removing and replacing the lifter drive assembly.....	697
View a video demonstration of removing and replacing the fuser drive assembly.....	728
View a video demonstration of removing and replacing the main drive assembly.....	737
View a video demonstration of removing and replacing the HVPS.....	854
View a video demonstration of removing and replacing the drive PCA.....	861
View a video demonstration of removing and replacing the rear PCA.....	875
View a video demonstration of removing and replacing the fuser fan.....	935
View a video demonstration of removing and replacing the lifter drive assembly.....	962
View a video demonstration of removing and replacing the pickup drive assembly.....	966
View a video demonstration of removing and replacing the auto close assembly.....	973
View a video demonstration of removing and replacing the media size detection assembly.....	978
View a video demonstration of removing and replacing the pickup drive assembly.....	1018
View a video demonstration of removing and replacing the upper feed assembly.....	1077
View a video demonstration of removing and replacing the lower feed assembly.....	1086
View a video demonstration of removing and replacing the solenoid assembly.....	1101

1 Printer information, configurations, and specifications

Learn about printer configuration and specifications.

Document feeder / scanner

Learn about the printer document feeder and scanner configuration and specifications.

 **NOTE:** This section is for MFP printers only.

Information (document feeder and scanner)

Learn about the document feeder and scanner.

Document feeder and scanner front view

Learn about the document feeder and scanner components.

Figure 1-1 Document feeder and scanner front view

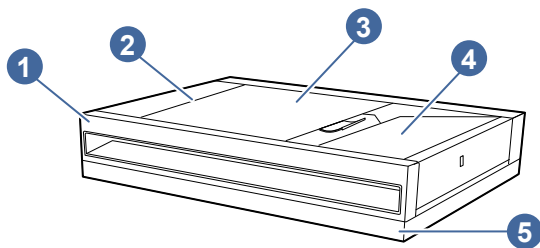

Item	Description
1	Document feeder
2	Output bin
3	Jam access
4	Input tray
5	Flatbed scanner

Technical specifications

Learn about the document feeder and scanner specifications.

Review the technical specifications for the document feeder and scanner.

See <http://www.hp.com/support/colorlj5800MFP> for current information.

Table 1-1 Copy and scan specifications (document feeder and scanner)

Copy and scan features	5800dn	5800f	5800zf	5800 Configurable	X57945dn	X57945z	X579 Configurable
ADF copy/scan speed 100 images-per-minute (ipm) single-sided, and 50 ipm double-sided	✓	✓	Not available	Available option	✓	Not available	Available option
ADF copy/scan speed 120 ipm single-sided, and 60 ipm double-sided	Not available	Not available	✓	Available option	Not available	✓	Available option
100-page document feeder with dual-head scanning for single-pass duplex copying and scanning	✓	✓	✓	✓	✓	✓	✓

Information (base printer)

Learn about the base printer.

Printer front view (5700 models)

Identify the parts on the front of the printer (5700 models).

Figure 1-2 Printer front view (5700 models)

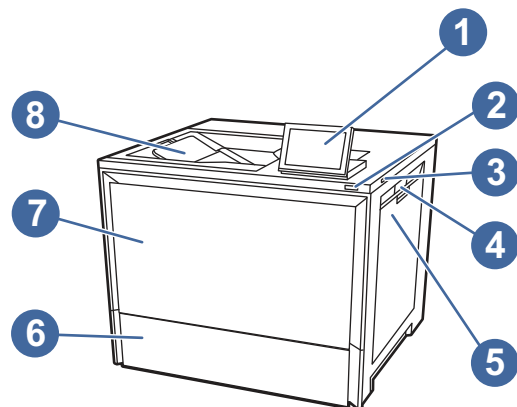

Item	Description
1	Control panel with color touchscreen display (tilts up for easier viewing)
2	On/off button
3	Easy-access USB port Insert a USB flash drive for printing without a computer or to update the printer firmware. NOTE: An administrator must enable this port before use.

Item	Description
4	Right door, access for clearing jams
5	Tray 1 (multipurpose tray) and right door (access for clearing jams)
6	Tray 2
7	Front door, for access to the toner cartridges
8	Output bin

Printer front view (X557 models)

Locate features on the front of the printer.

Figure 1-3 Printer front view

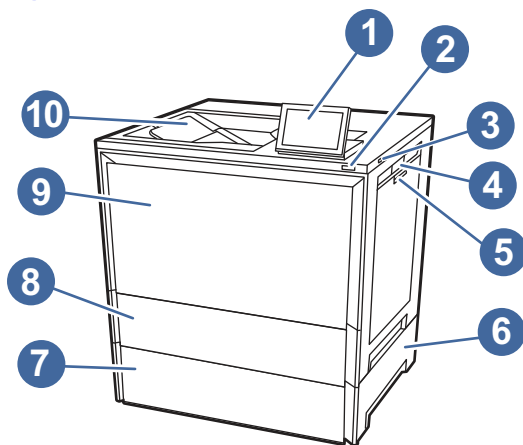

Item	Description
1	Control panel with color touchscreen display (tilts up for easier viewing)
2	On/off button
3	Easy-access USB port Insert a USB flash drive for printing or scanning without a computer or to update the printer firmware. NOTE: An administrator must enable this port before use.
4	Right door, for access for clearing jams
5	Tray 1 (multipurpose tray)
6	Tray 2 jam access door
7	Tray 2
8	Toner cartridge access door
9	Front door, for access to the imaging drums and toner collection unit
10	Output bin

Printer back view (5700/X557 models)

Identify the parts on the back of the printer (SFP).

Figure 1-4 Printer rear view, 5700/X557 models

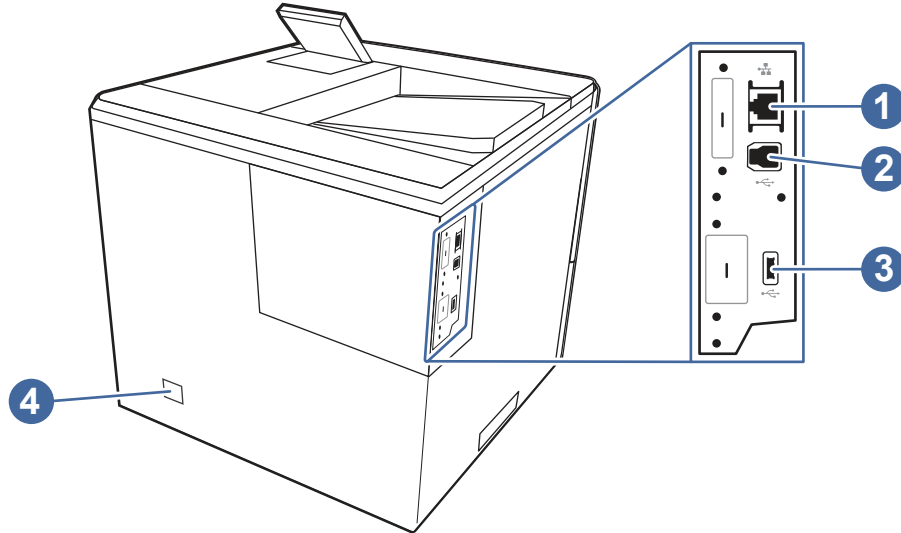

Item	Description
1	Local area network (LAN) Ethernet (RJ-45) network port
2	SuperSpeed USB 3.0 interface port
3	SuperSpeed USB 3.0 host port (for job storage and private printing)
	NOTE: This port should remain covered when not in use.
4	Power connection

Printer front view (5800/X57945 models)

Identify the parts on the front of the printer (MFP).

Figure 1-5 Printer front view, 5800 models

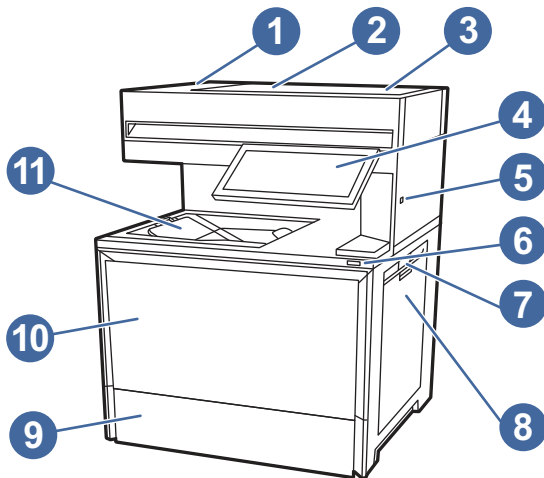

Item	Description
1	Automatic document feeder output tray
2	Automatic document feeder cover, for access for clearing jams

Item	Description
3	Automatic document feeder input tray
4	Control panel with color touchscreen display (tilts up for easier viewing)
5	Easy-access USB port Insert a USB flash drive for printing or scanning without a computer or to update the printer firmware. NOTE: An administrator must enable this port before use.
6	On/off button
7	Right door, for access for clearing jams
8	Tray 1 (multipurpose tray)
9	Tray 2
10	Front door, for access to the toner cartridges
11	Output bin

Figure 1-6 Printer front view, X57945 models

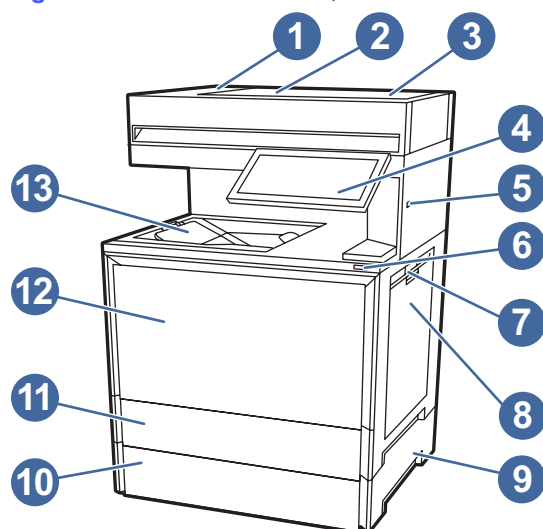

Item	Description
1	Automatic document feeder output tray
2	Automatic document feeder cover, for access for clearing jams
3	Automatic document feeder input tray
4	Control panel with color touchscreen display (tilts up for easier viewing)
5	Easy-access USB port Insert a USB flash drive for printing or scanning without a computer or to update the printer firmware. NOTE: An administrator must enable this port before use.
6	On/off button
7	Right door, for access for clearing jams
8	Tray 1 (multipurpose tray)

Item	Description
9	Tray 2 jam access door
10	Tray 2
11	Toner cartridge access door
12	Front door, for access to the imaging drums and toner collection unit
13	Output bin

Printer back view (5800/X57945 models)

Identify the parts on the back of the printer (MFP).

Figure 1-7 Printer back view, 5800/X57945 models

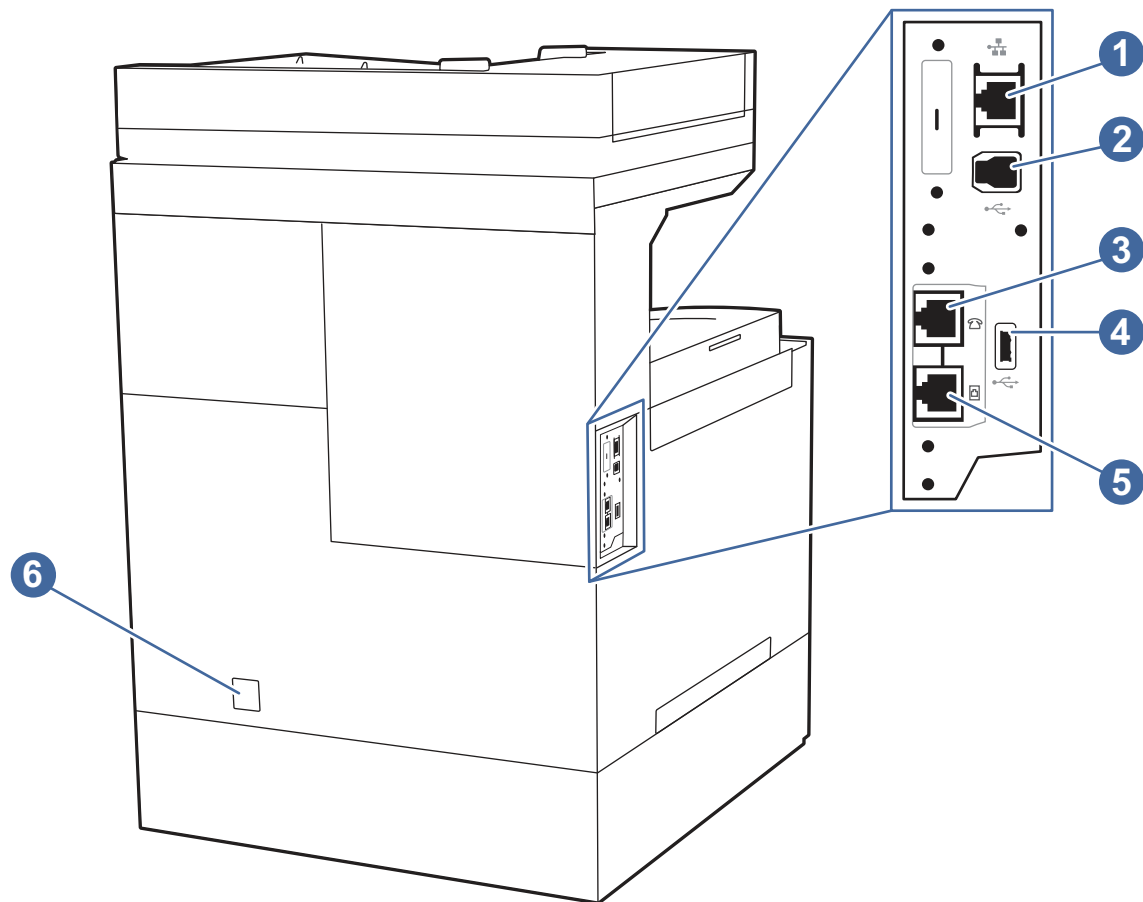

Item	Description
1	Local area network (LAN) Ethernet (RJ-45) network port
2	SuperSpeed USB 3.0 interface port
3	Fax models only: Telephone "line out" port (for attaching an extension phone, answering machine, or other device)
	NOTE: This port should remain covered when not in use.

Item	Description
4	SuperSpeed USB 3.0 host port (for job storage and private printing) NOTE: This port should remain covered when not in use.
5	Fax models only. Fax "line in" port (for attaching the fax phone line to the printer)
6	Power connection

Configuration (base printer)

Learn about the base printer configurations.

Configuration (base printer SFP)

Learn about the base printer SFP configurations.

Figure 1-8 HP Color LaserJet Enterprise 5700/X55745 printer

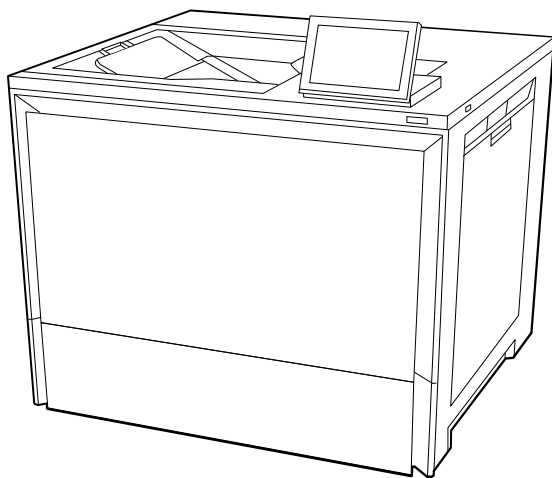

HP Color LaserJet Enterprise 5700

- 45/43 pages per minute (letter/A4)
- FutureSmart 5 firmware
- Trusted platform module 2.0 (security)
- HP Web JetAdmin
- Automatic duplex printing
- 650-sheet standard capacity
- 2,300-sheet maximum capacity
- 109.2 mm (4.3 in) color non-touchscreen control panel
- 1.5 GB RAM memory
- 16 GB eMMC mass storage

- 550-sheet paper feeder (optional)

HP Color LaserJet Managed X55745

- Same features as the HP LaserJet Enterprise 5700
- Locking tray guides
- Smart device services (SDS) firmware features

Configuration (base printer MFP)

Learn about the base printer MFP configurations.

Figure 1-9 HP Color LaserJet Enterprise MFP 5800 printer

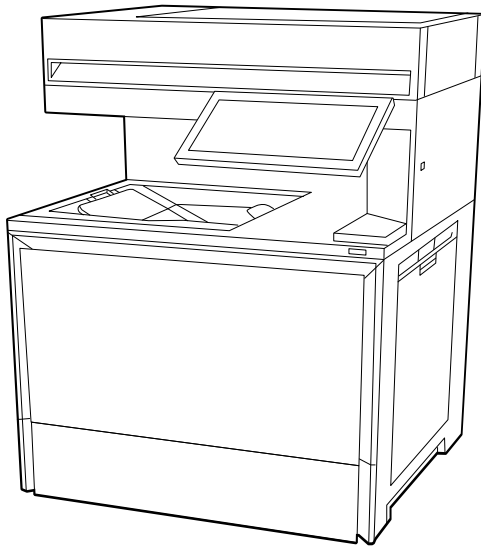

HP Color LaserJet Enterprise MFP 5800

- 45/43 pages per minute (letter/A4)
- FutureSmart 5 firmware
- Trusted platform module 2.0 (security)
- HP Web JetAdmin
- Automatic duplex printing
- 100-sheet document feeder (duplex scanning)
- Single pass double-sided scan/copy
- Fax (optional on 5800dn models; standard on 5800f and 5800zf models)
- 650-sheet standard capacity
- 2,300-sheet maximum capacity
- **5800dn/5800f**: 203 mm (8 in) color touchscreen control panel
- **5800zf**: 256.5 mm (10.1 in) color touchscreen control panel

- 6 GB RAM memory
- 32 GB eMMC mass storage

Figure 1-10 HP Color LaserJet Enterprise MFP X57945

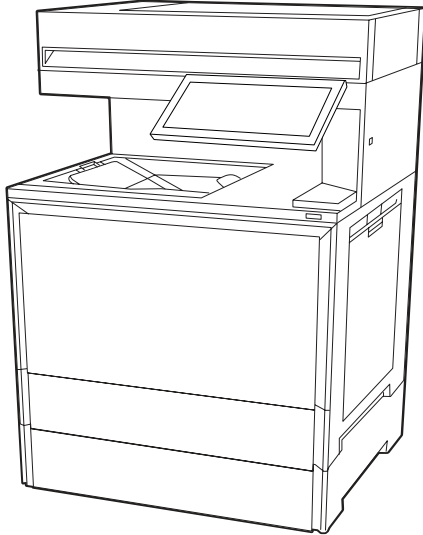

HP Color LaserJet Managed MFP X57945

- Same features as the HP Color LaserJet Enterprise MFP 5800
- **X57945dn**: 203 mm (8 in) color touchscreen control panel
- **X57945z**: 256.5 mm (10.1 in) color touchscreen control panel
- Fax is optional on all X57945 models
- Locking tray guides
- Smart device services (SDS) firmware features

Specifications (base printer)

Learn about the base printer specifications.

Technical specifications (5700)

Review the technical specifications for the printer.

See <http://www.hp.com/support/colorlj5700> or <http://www.hp.com/support/colorljX557> or <http://www.hp.com/support/colorlj5800MFP> or <http://www.hp.com/support/colorljX57945MFP> for current information.

Product numbers for each model

- 5700dn - #6QN28A
- 5700 Configurable (can be custom-configured when ordered)

Table 1-2 Paper handling specifications

Paper handling features	5700dn	5700 Configurable
Tray 1 (100-sheet capacity)	✓	✓
Tray 2 (550-sheet capacity)	✓	✓
Optional 550-sheet accessory tray	Optional	Available option
Printer stand	Optional	Available option
Printer stand with storage compartment	Optional	Available option
Automatic duplex printing	✓	✓

Table 1-3 Connectivity specifications

Connectivity features	5700dn	5700 Configurable
10/100/1000 Ethernet LAN connection with IPv4 and IPv6	✓	✓
Dual-band Wireless	Optional	Available option
Wifi-Direct and BLE	Optional	Available option
SuperSpeed USB 3.0 rear ports and Hi-Speed USB 2.0 front port for walk-up USB printing	✓	✓
Hardware integration pocket (HIP) for connecting accessory and third-party devices	✓	✓

Table 1-4 Print specifications

Print features	5700dn	5700 Configurable
Prints 43 pages per minute (ppm) on A4 and 45 ppm on letter-size paper	✓	✓
Job storage and private printing	✓	✓

Table 1-5 Other specifications

Other features	5700dn	5700 Configurable
1.5 GB base memory, expandable to 3.5 GB	✓	✓
16 GB embedded Multi-Media Controller (eMMC)	✓	Available option
32 GB embedded Multi-Media Controller (eMMC)	Not available	Available option
256 GB Solid-state drive	Optional	Available option
512 GB FIPS Hard Disk Drive	Optional	Available option
512 GB Hard Disk Drive	Optional	Available option
Color touchscreen control panel	✓	✓
HP Trusted Platform Module for encrypting all data that passes through the printer	✓	✓

Technical specifications (X55745)

Review the technical specifications for the X55745 printer.

See <http://www.hp.com/support/colorlj5700> or <http://www.hp.com/support/colorljX557> or <http://www.hp.com/support/colorlj5800MFP> or <http://www.hp.com/support/colorljX57945MFP> for current information.

Product numbers for each model

- X55745dn - #6QP97A
- X557 Configurable (can be custom-configured when ordered)

Table 1-6 Paper handling specifications

Paper handling features	X55745dn	X557 Configurable
Tray 1 (100-sheet capacity)	✓	✓
Tray 2 (550-sheet capacity)	✓	✓
Optional 550-sheet accessory tray	Optional	Available option
Printer stand	Optional	Available option
Printer stand with storage compartment	Optional	Available option
Automatic duplex printing	✓	✓

Table 1-7 Connectivity specifications

Connectivity features	X55745dn	X557 Configurable
10/100/1000 Ethernet LAN connection with IPv4 and IPv6	✓	✓
Dual-band Wireless	Optional	Available option
Wifi-Direct and BLE	Optional	Available option
SuperSpeed USB 3.0 rear ports and Hi-Speed USB 2.0 front port for walk-up USB printing	✓	✓
Hardware integration pocket (HIP) for connecting accessory and third-party devices	✓	✓

Table 1-8 Print specifications

Print features	X55745dn	X557 Configurable
Prints 43 pages per minute (ppm) on A4 and 45 ppm on letter-size paper	✓	✓
Job storage and private printing	✓	✓

Table 1-9 Other specifications

Other features	X55745dn	X557 Configurable
1.5 GB base memory, expandable to 3.5 GB	✓	✓

Table 1-9 Other specifications (continued)

Other features	X55745dn	X557 Configurable
16 GB embedded Multi-Media Controller (eMMC)	✓	Available option
32 GB embedded Multi-Media Controller (eMMC)	Not available	Available option
256 GB Solid-state drive	Optional	Available option
512 GB FIPS Hard Disk Drive	Optional	Available option
512 GB Hard Disk Drive	Optional	Available option
Color touchscreen control panel	✓	✓
HP Trusted Platform Module for encrypting all data that passes through the printer	✓	✓
Custom color printer skins	Not available	Available option

Technical specifications (5800)

Review the technical specifications for the 5800 printer.

See <http://www.hp.com/support/colorlj5700> or <http://www.hp.com/support/colorljX557> or <http://www.hp.com/support/colorlj5800MFP> or <http://www.hp.com/support/colorljX57945MFP> for current information.

Product numbers for each model

- 5800dn - #6QN29A
- 5800f - #6QN30A
- 5800zf - #58R10A
- 5800 Configurable (can be custom-configured when ordered)

Table 1-10 Paper handling specifications

Paper handling features	5800dn	5800f	5800zf	5800 Configurable
Tray 1 (50-sheet capacity)	✓	✓	✓	✓
Tray 2 (250-sheet capacity)	✓	✓	✓	✓
Optional 550-sheet accessory tray	Optional	Optional	Optional	Available option
Printer stand	Optional	Optional	Optional	Available option
Printer stand with storage compartment	Optional	Optional	Optional	Available option
Convenience stapler	Not available	✓	✓	Available option
3-bin Stapler/stacker	Not available	Not available	Not available	Available option
Automatic duplex printing	✓	✓	✓	Available option

Table 1-11 Connectivity specifications

Connectivity features	5800dn	5800f	5800zf	5800 Configurable
10/100/1000 Ethernet LAN connection with IPv4 and IPv6	✓	✓	✓	✓
Dual-band wireless	Optional	Optional	Optional	Available option
Wifi-Direct and BLE	Optional	Optional	Optional	Available option
SuperSpeed USB 3.0 rear ports and Hi-Speed USB 2.0 front port for walk-up USB printing	✓	✓	✓	✓
Hardware integration pocket (HIP) for connecting accessory and third-party devices	✓	✓	✓	✓

Table 1-12 Print specifications

Print features	5800dn	5800f	5800zf	5800 Configurable
Prints up to 43 pages per minute (ppm) on A4 and 45 ppm on letter-sized paper	✓	✓	✓	✓
Job storage and private printing	✓	✓	✓	✓

Table 1-13 Copy and scan specifications

Copy and scan features	5800dn	5800f	5800zf	5800 Configurable
ADF copy/scan speed 100 images-per-minute (ipm) single-sided, and 50 ipm double-sided	✓	✓	Not included	Available option
ADF copy/scan speed 120 ipm single-sided, and 60 ipm double-sided	Not included	Not included	✓	Available option
100-page document feeder with dual-head scanning for single-pass duplex copying and scanning	✓	✓	✓	✓
Scan to E-mail, Scan to USB, and Scan to Network Folder options	✓	✓	✓	✓

Table 1-14 Other specifications

Other features	5800dn	5800f	5800zf	5800 Configurable
6 GB base memory	✓	✓	✓	✓
32 GB embedded Multi-Media Controller (eMMC)	✓	✓	Not included	Available option
500 GB hard disk drive	Optional	Optional	✓	Available option
256 GB solid-state drive	Optional	Optional	Optional	Available option
512 GB FIPS hard disk drive	Optional	Optional	Optional	Available option
Small color touchscreen control panel	✓	✓	Not included	Available option

Table 1-14 Other specifications (continued)

Other features	5800dn	5800f	5800zf	5800 Configurable
Large color touchscreen control panel	Not included	Not included	✓	Available option
Fax features	Optional	✓	✓	Available option
HP Trusted Platform Module for encrypting all data that passes through the printer	✓	✓	✓	✓

Technical specifications (X57945)

Review the technical specifications for the X57945 printer.

See <http://www.hp.com/support/colorlj5700> or <http://www.hp.com/support/colorljX557> or <http://www.hp.com/support/colorlj5800MFP> or <http://www.hp.com/support/colorljX57945MFP> for current information.

Product numbers for each model

- X57945dn - #6QP98A
- X57945z - #6QP99A
- X579 Configurable (can be custom-configured when ordered)

Table 1-15 Paper handling specifications

Paper handling features	X57945dn	X57945z	X579 Configurable
Tray 1 (100-sheet capacity)	✓	✓	✓
Tray 2 (550-sheet capacity)	✓	✓	✓
Optional 550-sheet accessory tray	Optional	Optional	Available option
Printer stand	Optional	Optional	Available option
Printer stand with storage compartment	Optional	Optional	Available option
Convenience stapler	Not available	✓	Available option
3-bin Stapler/stacker	Not available	Not available	Available option
Automatic duplex printing	✓	✓	✓

Table 1-16 Connectivity specifications

Connectivity features	X57945dn	X57945z	X579 Configurable
10/100/1000 Ethernet LAN connection with IPv4 and IPv6	✓	✓	✓
Dual-band wireless	Optional	Optional	Available option
Wifi-Direct and BLE	Optional	Optional	Available option
SuperSpeed USB 3.0 rear ports and Hi-Speed USB 2.0 front port for walk-up USB printing	✓	✓	✓

Table 1-16 Connectivity specifications (continued)

Connectivity features	X57945dn	X57945z	X579 Configurable
Hardware integration pocket (HIP) for connecting accessory and third-party devices	✓	✓	✓

Table 1-17 Print specifications

Print features	X57945dn	X57945z	X579 Configurable
Prints up to 43 pages per minute (ppm) on A4 and 45 ppm on letter-sized paper	✓	✓	✓
Job storage and private printing	✓	✓	✓

Table 1-18 Copy and scan specifications

Copy and scan features	X57945dn	X57945z	X579 Configurable
ADF copy/scan speed 100 images-per-minute (ipm) single-sided, and 50 ipm double-sided	✓	Not included	Available option
ADF copy/scan speed 120 ipm single-sided, and 60 ipm double-sided	Not included	✓	Available option
100-page document feeder with dual-head scanning for single-pass duplex copying and scanning	✓	✓	✓
Scan to E-mail, Scan to USB, and Scan to Network Folder options	✓	✓	✓

Table 1-19 Other specifications

Other features	X57945dn	X57945z	X579 Configurable
6 GB base memory	✓	✓	✓
32 GB embedded Multi-Media Controller (eMMC)	✓	Not included	Available option
500 GB Hard Disk Drive	Optional	✓	Available option
256 GB Solid-state drive	Optional	Optional	Available option
512 GB FIPS Hard Disk Drive	Optional	Optional	Available option
Small color touchscreen control panel	✓	Not included	Available option
Large color touchscreen control panel	Not included	✓	Available option
Fax features	Optional	Optional	Available option
HP Trusted Platform Module for encrypting all data that passes through the printer	✓	✓	✓
Custom color printer skins	Not available	Not available	Available option

Printer dimensions (5700/X557 models)

Make sure your printer environment is large enough to accommodate the printer.

Figure 1-11 Printer dimensions, 5700/X557 models

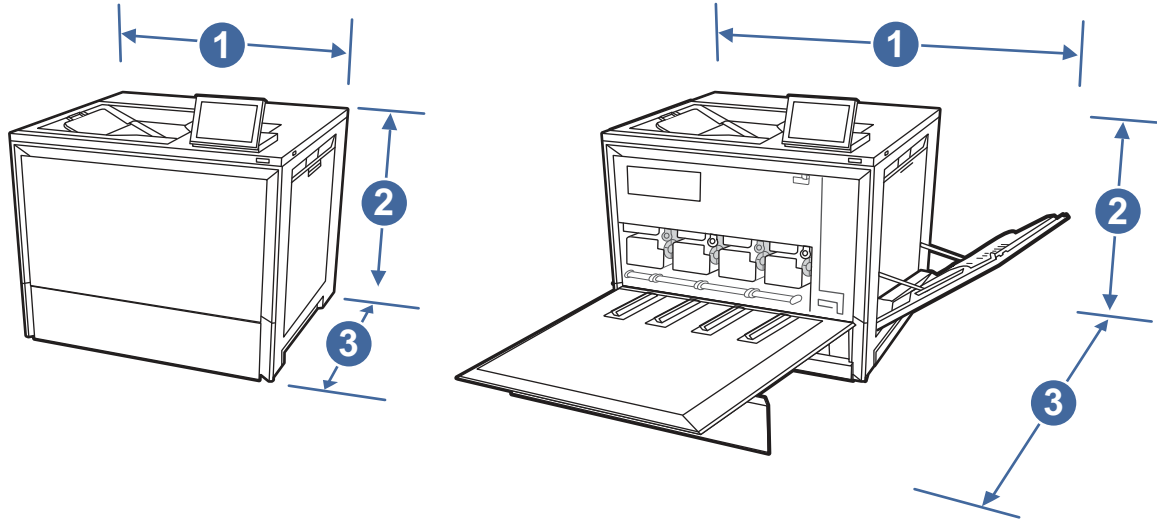

Table 1-20 Dimensions for the printer

Measurement	Printer fully closed	Printer fully opened
1. Width	500 mm (19.7 in)	860 mm (33.8 in)
2. Height	417 mm (16.4 in)	417 mm (16.4 in)
3. Depth	460 mm (18.1 in)	770 mm (30.3 in)
Weight (with cartridges)	28.6 kg (63 lb)	28.6 kg (63 lb)

Printer dimensions

Make sure your printer environment is large enough to accommodate the printer.

Figure 1-12 Printer dimensions (5800dn model)

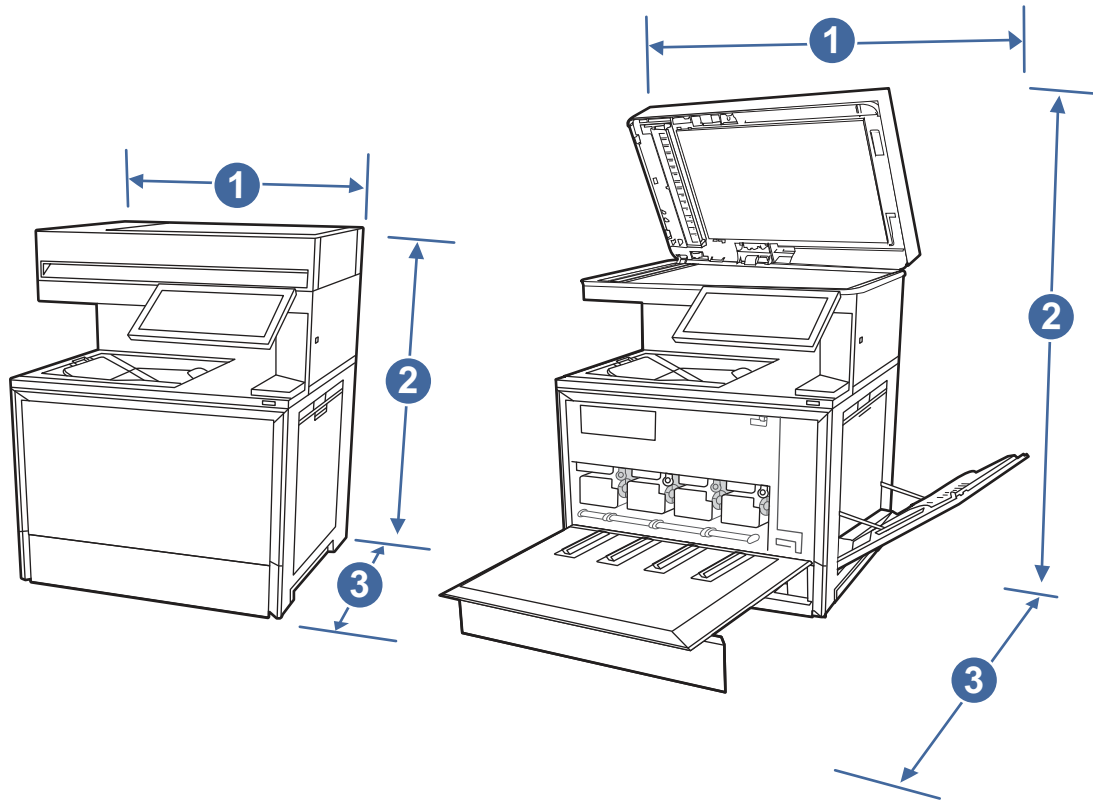

Table 1-21 Dimensions for the printer (5800dn model)

Measurement	Printer fully closed	Printer fully opened
1. Width	500 mm (19.6 in)	860 mm (33.8 in)
2. Height	583 mm (23 in)	853 mm (33.6 in)
3. Depth	460 mm (18.1 in)	770 mm (30.3 in)
Weight (with cartridges)	39 kg (86 lb)	39 kg (86 lb)

Figure 1-13 Printer dimensions (5800f and 5800zf models)

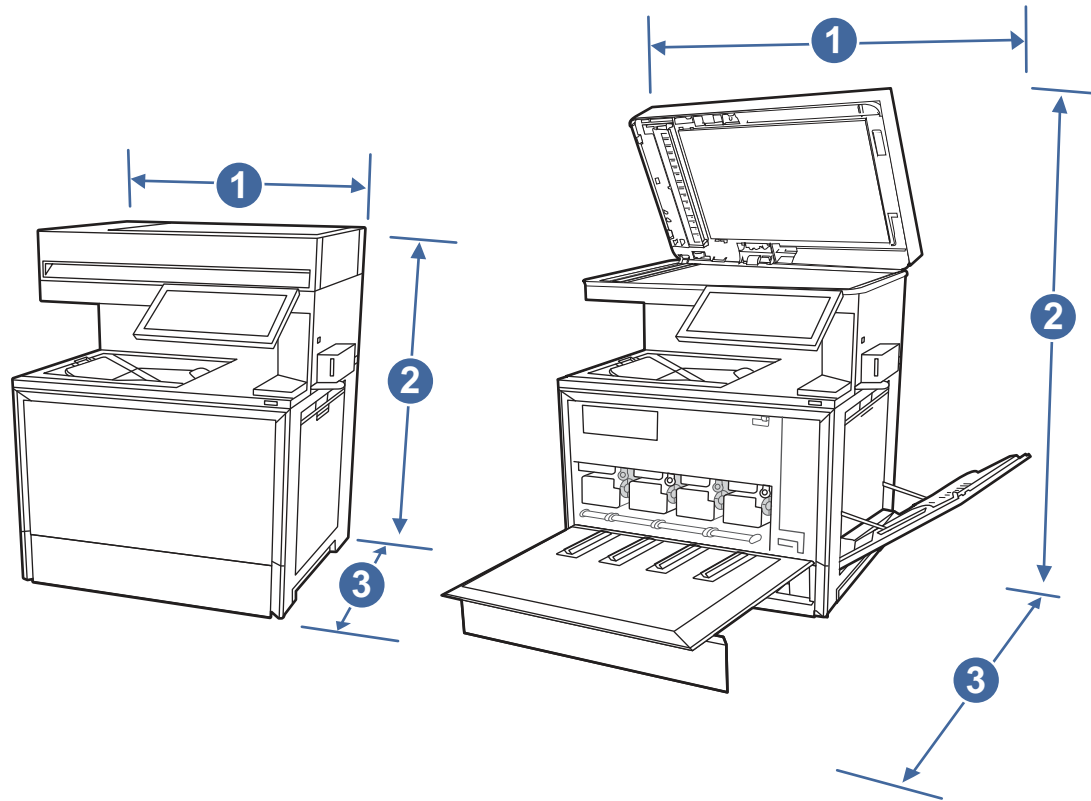

Table 1-22 Dimensions for the printer (5800f and 5800zf models)

Measurement	Printer fully closed	Printer fully opened
1. Width	542 mm (21.3 in)	860 mm (33.8 in)
2. Height	583 mm (23 in)	853 mm (33.6 in)
3. Depth	460 mm (18.1 in)	770 mm (30.3 in)
Weight (with cartridges)	f model: 38.9 kg (85.76 lb)	f model: 38.9 kg (85.76 lb)
	zf model: 39.1 kg (86.2 lb)	zf model: 39.1 kg (86.2 lb)

Printer dimensions (X57945 models)

Make sure your printer environment is large enough to accommodate the printer.

Figure 1-14 Printer dimensions (X57945dn model)

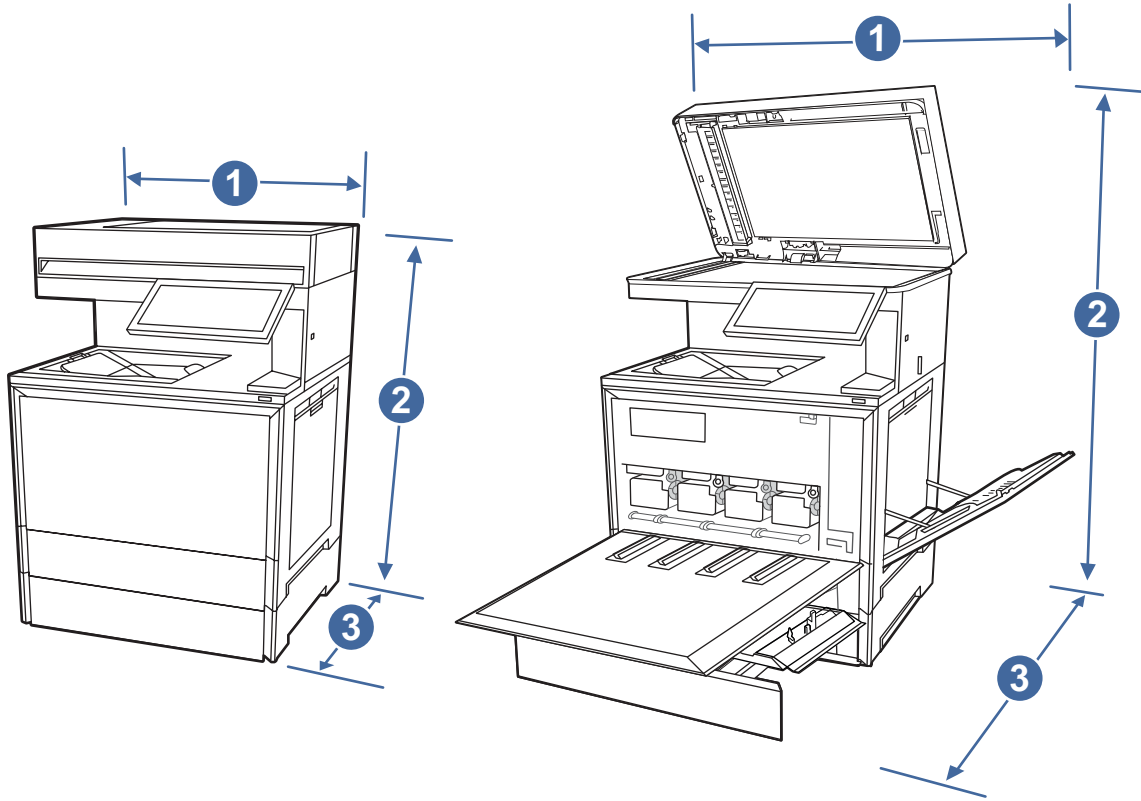

Table 1-23 Dimensions for the printer (X57945dn model)

Measurement	Printer fully closed	Printer fully opened
1. Width	500 mm (19.6 in)	860 mm (33.8 in)
2. Height	703 mm (27.7 in)	973 mm (38.3 in)
3. Depth	460 mm (18.1 in)	770 mm (30.3 in)
Weight (with cartridges)	46.3 kg (102 lb)	46.3 kg (102 lb)

Figure 1-15 Printer dimensions (X57945z model)

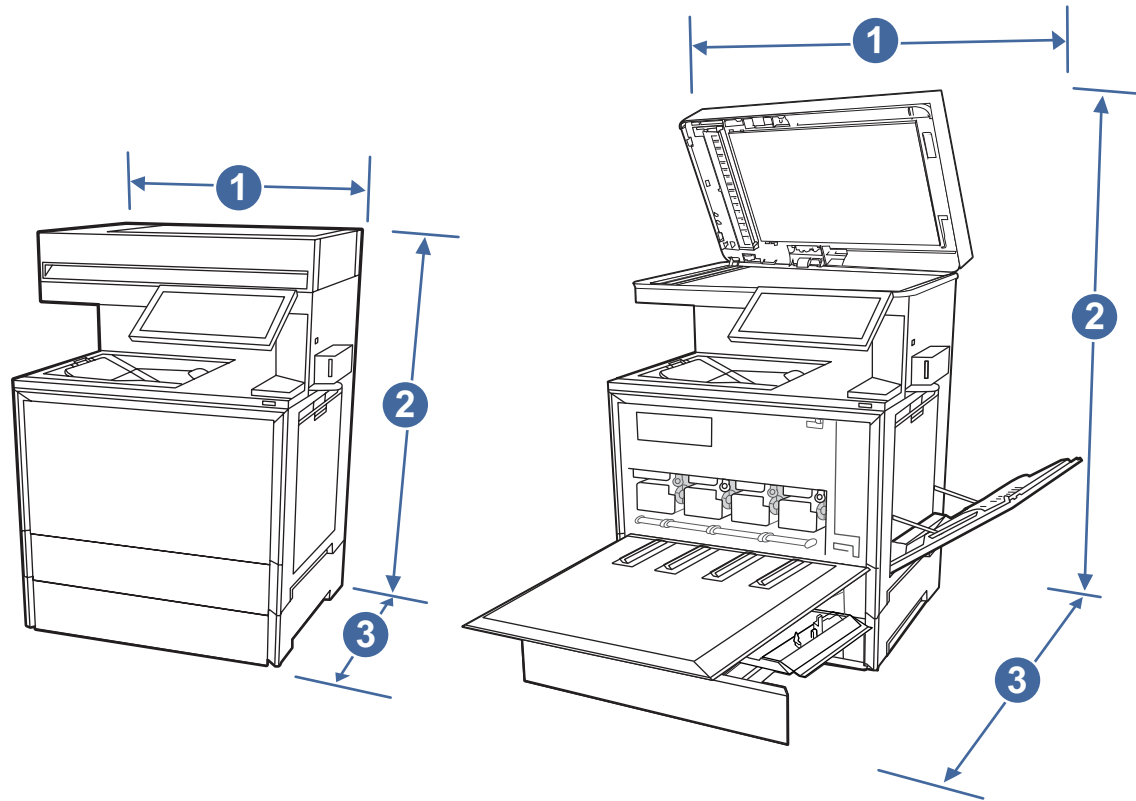

Table 1-24 Dimensions for the printer (X57945z model)

Measurement	Printer fully closed	Printer fully opened
1. Width	542 mm (21.3 in)	860 mm (33.8 in)
2. Height	703 mm (27.7 in)	973 mm (38.3 in)
3. Depth	460 mm (18.1 in)	770 mm (30.3 in)
Weight (with cartridges)	47.2 kg (104 lb)	47.2 kg (104 lb)

Figure 1-16 Printer dimensions (X57945zs model)

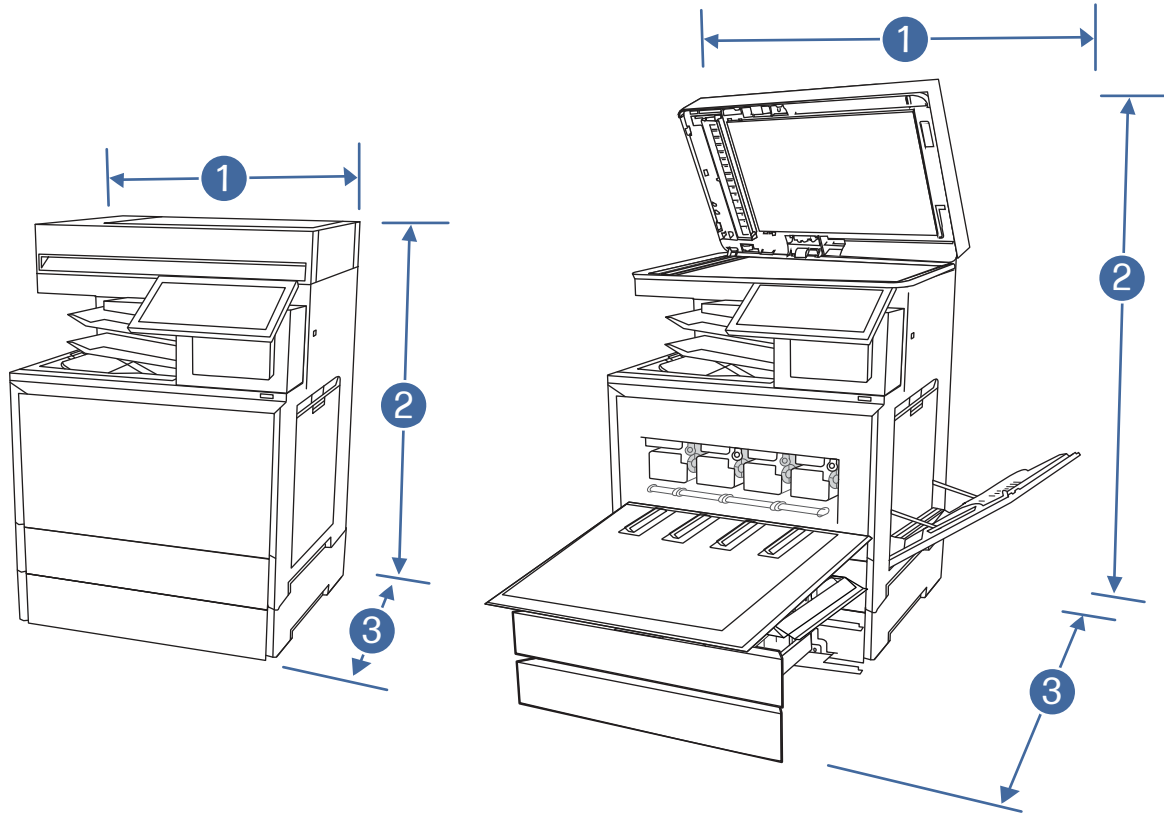

Table 1-25 Dimensions for the printer (X57945zs model)

Measurement	Printer fully closed	Printer fully opened
1. Width	500 mm (19.6 in)	860 mm (33.8 in)
2. Height	777 mm (30.6 in)	1032 mm (40.6 in)
3. Depth	460 mm (18.1 in)	770 mm (30.3 in)
Weight (with cartridges)	60.1 kg (132.5 lb)	60.1 kg (132.5 lb)

Printer space requirements

Learn about the printer space requirements

HP recommends that 30 mm (1.81 in) be added to the printer dimensions to make sure there is sufficient space to open doors and covers, and to provide proper ventilation. See the printer dimensions sections in this manual.

Power consumption, electrical specifications, and acoustic emissions

In order to operate properly, the printer must be in an environment that meets certain power specifications.

See <http://www.hp.com/support/colorlj5700> or <http://www.hp.com/support/colorljX557> or <http://www.hp.com/support/colorlj5800MFP> or <http://www.hp.com/support/colorljX57945MFP> for current information.

CAUTION: Power requirements are based on the country/region where the printer is sold. Do not convert operating voltages. This will damage the printer and void the printer warranty.

Operating-environment range

In order to operate properly, the printer must be in an environment that meets certain specifications.

Table 1-26 Operating-environment specifications

Environment	Recommended	Storage
Temperature	15° to 27°C (59° to 80.6°F)	10° to 32.5°C (50° to 90.5°F)
Relative humidity	30% to 70% relative humidity (RH)	10% to 80% RH

Information (input devices)

Learn about the printer input devices.

550-sheet paper feeder front view

Identify the parts on the 550-sheet paper feeder.

Figure 1-17 550-sheet paper feeder front view

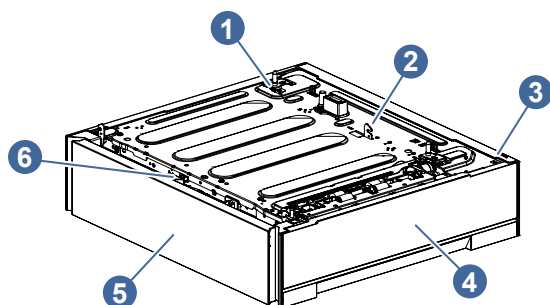

Number	Description
1	Connector
2	Lock
3	Right door (for access to tray rollers and jams)
4	Tray cassette
5	Left cover
6	Lock lever

Technical specifications

Table 1-27 550-sheet paper feeder technical specifications

Feature	Specification
Media types	Plain paper, recycled paper, heavy paper, bond paper, glossy paper, label, and index card
Media sizes	Standard: A5-R, B5, A4, Letter, and Legal Custom minimum: 101.6 mm (4 in) (W) x 148 mm (5.8 in) (L) Custom maximum: 215.9 mm (8.5 in) (W) x 355.6 mm (14 in) (L)
Media weights	Non-glossy paper: 60 g/m ² (16 lb) to 163 g/m ² (43 lb) Glossy paper: 120 g/m ² (32 lb) to 200 g/m ² (53 lb)
Capacity	55 mm (2.2 in) stack (approximately 550 sheets of 75g/m ² (20 lb) paper)
Dimensions	Width: 500 mm (19.7 in) Depth: 460 mm (18.1 in) Height: 120 mm (4.7 in)
Weight	Approximately 6.2 kg (13.7 lb)
Power requirements	DC24V, DC3.3V (supplied from the printer engine)

High capacity input (HCI) paper feeder front view

Identify the parts on the HCI paper feeder.

Figure 1-18 HCI paper feeder front view

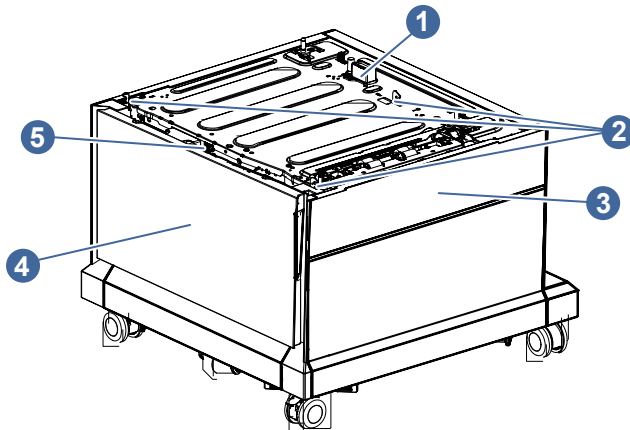

Number	Description
1	Connector
2	Lock
3	Right door
4	HCI cassette
5	Lock lever

Technical specifications

Table 1-28 HCL paper feeder technical specifications

Feature	Specification
Media types	Plain paper, recycled paper, heavy paper, and bond paper
Media sizes	A4, Letter, and Legal
Media weights	60 g/m ² (16 lb) to 163 g/m ² (43 lb)
Capacity	210 mm (8.3 in) stack (approximately 2,100 sheets of 75g/m ² (20 lb) paper)
Dimensions	Width: 520 mm (20.5 in) Depth: 520 mm (20.5 in) Height: 364 mm (14.3 in)
Weight	Approximately 21.7 kg (47.8 lb)
Power requirements	DC24V, DC3.3V (supplied from the printer engine)

Information (output devices)

Learn about the printer output devices.

3-bin stapler-stacker front view

Identify the parts on the 3-bin stapler-stacker output device.



NOTE: This section is for MFP printers only.

Figure 1-19 3-bin stapler-stacker front view

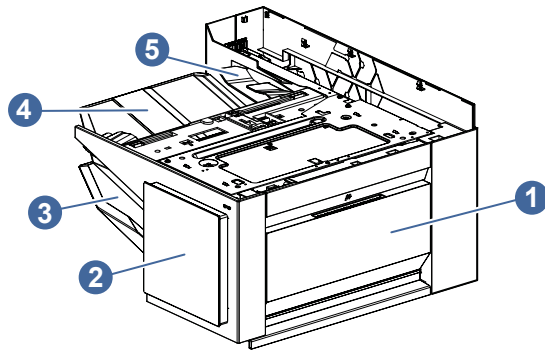

Number	Description
1	Stapler-stacker door
2	Staple door
3	Output bin 2
4	Output bin 1
5	Jogger guide

Technical specifications

Table 1-29 3-bin stapler-stacker technical specifications

Feature	Specification
Media types	Plain paper, recycled paper, heavy paper, bond paper, and glossy paper
Media sizes, output bin 1	Stack mode: 148 mm (5.8 in) (W) x 210 mm (8.3 in) (L) to 216 mm (8.5 in) (W) x 355 mm (14 in) (L) Staple mode/job offset mode: A4, Letter, and Legal
Media sizes, output bin 2	Stack mode: 148 mm (5.8 in) (W) x 210 mm (8.3 in) (L) to 216 mm (8.5 in) (W) x 355 mm (14 in) (L)
Media weights, output bin 1	Stack mode/job offset mode, non-glossy paper: 60 g/m ² (16 lb) to 163 g/m ² (43 lb) Stack mode/job offset mode, glossy paper: 120 g/m ² (32 lb) to 200 g/m ² (53 lb) Staple mode, non-glossy paper: 60 g/m ² (16 lb) to 120 g/m ² (32 lb) Staple mode, glossy paper: 120 g/m ² (32 lb)
Media weights, output bin 2	Stack mode, non-glossy paper: 60 g/m ² (16 lb) to 163 g/m ² (43 lb) Stack mode, glossy paper: 120 g/m ² (32 lb) to 200 g/m ² (53 lb)
Capacity, output bin 1	Stack mode/job offset mode: 48 mm (1.9 in) stack (approximately 400 sheets of 75 g/m ² (20 lb) paper) Staple mode: 48 mm (1.9 in) stack (approximately 6 sets of 50 sheets of 75 g/m ² (20 lb) paper)
Capacity, output bin 2	Stack mode: 19 mm (0.75 in) stack (approximately 100 sheets of 75 g/m ² (20 lb) paper)
Capacity, staple cartridge	5,000 staples/cartridge
Capacity, stapler	Up to 50 sheets (60 g/m ² (16 lb) to 120 g/m ² (32 lb) paper)
Stapling position	Upper left corner at one point
Dimensions	Width: 510 mm (20.1 in) Depth: 475 mm (18.7 in) Height: 280 mm (11 in)
Weight	Approximately 8.7 kg (19.2 lb)
Power requirements	DC24V, DC3.3V (supplied from the printer engine)

2 Printer installation and maintenance

Learn about printer installation and maintenance.

Document feeder / scanner

Learn about the printer document feeder and scanner installation and maintenance.

Clean the pickup rollers and separation pad in the document feeder (MFP)

Learn about cleaning the document feeder rollers and pads.

Over time, specks of debris might collect on the document feeder rollers and pads which can affect performance.

 **NOTE:** The figures in this topic show a typical MFP printer. However, the procedure is correct for all MFP printers.

1. Open the document-feeder cover.

Figure 2-1 Open the document-feeder cover

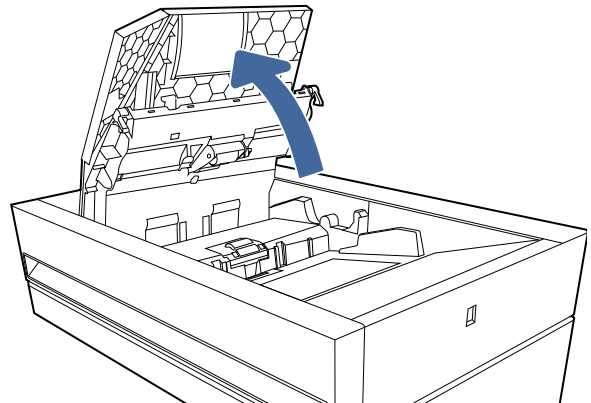

2. Remove any visible lint or dust from each of the feed rollers and the separation pad using compressed air or a clean lint-free cloth moistened with warm water. Carefully rotate the roller as you clean it.

Figure 2-2 Clean the document feeder rollers

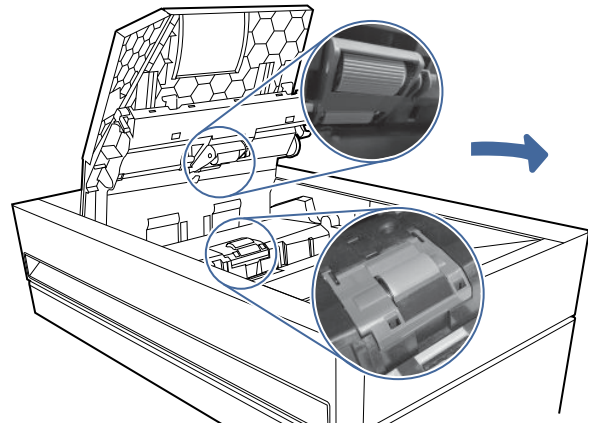

3. Close the document-feeder cover.

Check the scanner glass for dirt and smudges

Learn about solving copy-quality debris problems.

Over time, specks of debris might collect on the scanner glass and document feeder white plastic backing, which might cause print defects. Use the following procedure to clean the scanner if the printed pages have streaks, unwanted lines, black dots, poor print quality, or unclear text.

 [View a video of cleaning the document feeder glass and flatbed glass.](#)

1. Press the power button to turn the printer off, and then disconnect the power cable from the electrical outlet.

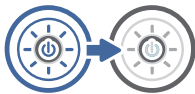

2. Open the scanner lid.

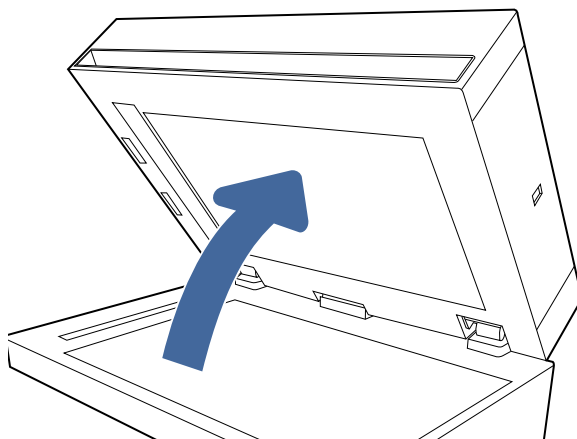

3. Clean the scanner glass (callout 1) and the document feeder strips (callout 2, callout 3) with a soft cloth or sponge that has been moistened with nonabrasive glass cleaner.

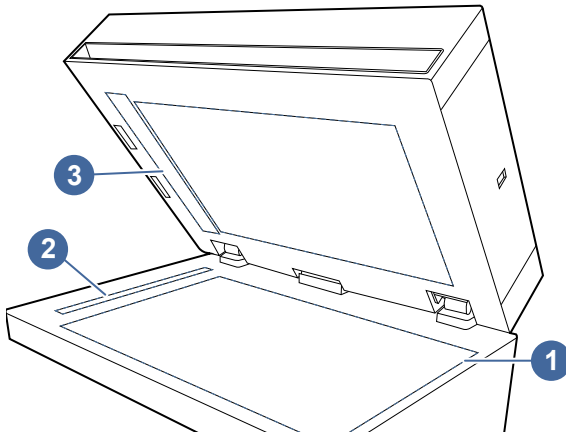

CAUTION: Do not use abrasives, acetone, benzene, ammonia, ethyl alcohol, or carbon tetrachloride on any part of the printer; these can damage the printer. Do not place liquids directly on the glass or platen. They might seep and damage the printer.

NOTE: If you are having trouble with streaks on copies when you are using the document feeder, be sure to clean the small strips of glass on the left side of the scanner (callout 2, callout 3).

4. Dry the glass and white plastic parts with a chamois or a cellulose sponge to prevent spotting.
5. Close the scanner lid.

Figure 2-3 Close the scanner lid

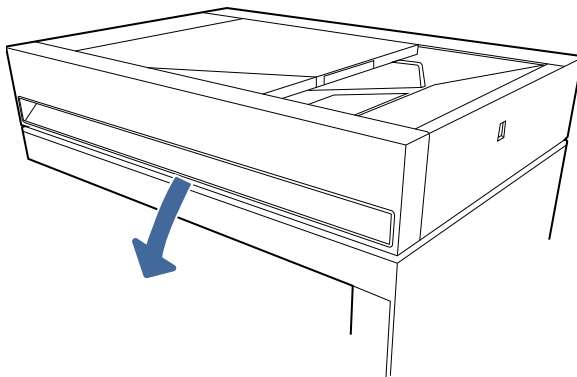

6. Connect the power cable to an outlet, and then press the power button to turn the printer on.



Base printer

Learn about the base printer installation and maintenance.

Remove and replace the toner cartridges (5700/X557/5800 models)

Follow these steps to replace the toner cartridge.

 [View a video of how to replace the toner cartridges](#)

1. Open the front door.

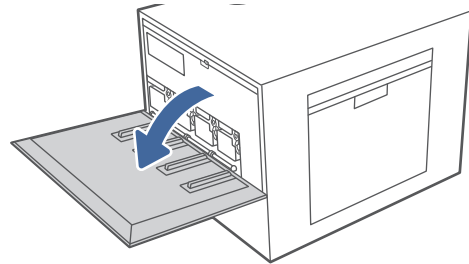

2. Grasp the end of the toner cartridge and pull it straight out of the printer.

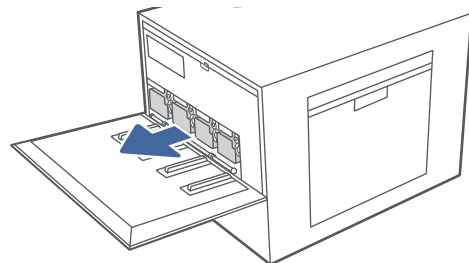

3. Remove the new toner cartridge from its package. Save all packaging for recycling the used toner cartridge.

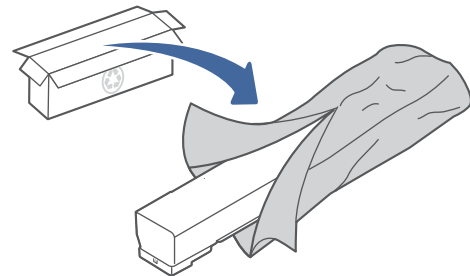

4. Hold both ends of the toner cartridge and rock it back and forth end to end to evenly distribute the toner that is inside.

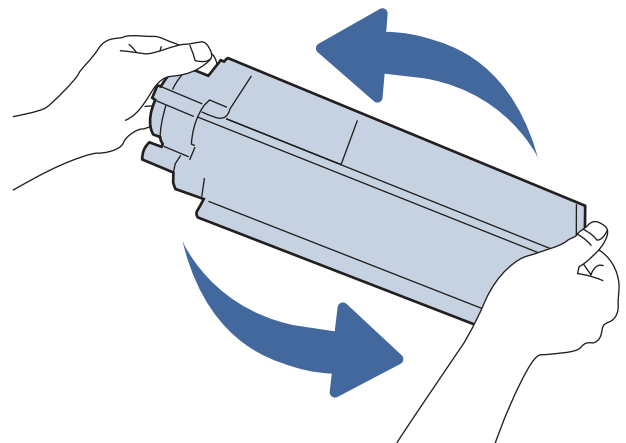

5. Align the toner cartridge with its slot and insert it into the printer.

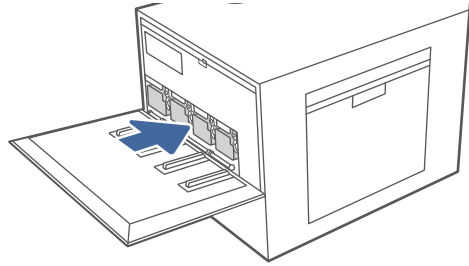

6. Close the front door.

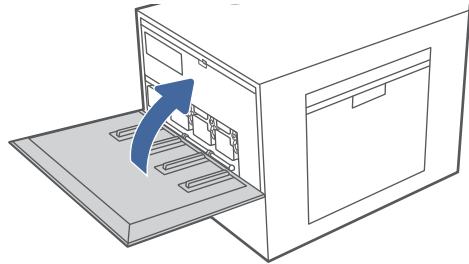

7. Pack the used toner cartridge into the box that the new toner cartridge came in. See the enclosed recycling guide for information about recycling.

In the U.S. and Canada, a pre-paid shipping label is included in the box. In other countries/regions, go to www.hp.com/recycle to print a pre-paid shipping label.

Adhere the pre-paid shipping label to the box, and return the used cartridge to HP for recycling.

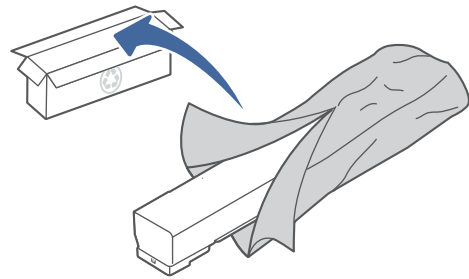

Remove and replace the toner cartridges (X57945 models)

Follow these steps to replace the toner cartridge.

 [View a video of how to replace the toner cartridges](#)

1. Release the toner cartridge by following the instructions on the control panel.
2. Open the toner cartridge door on the front of the printer.

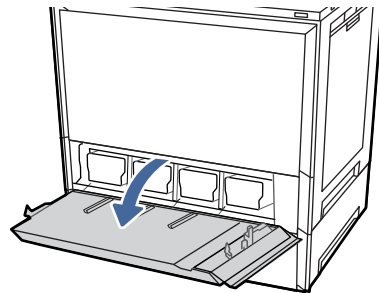

3. Grasp the end of the toner cartridge and pull it straight out of the printer.

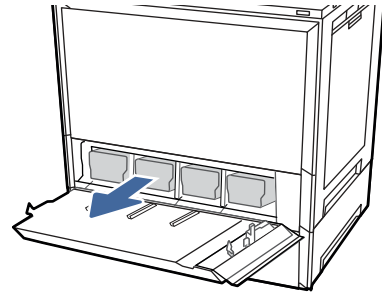

4. Remove the new toner cartridge from its package. Save all packaging for recycling the used toner cartridge.

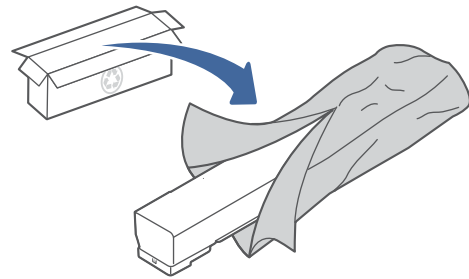

5. Hold both ends of the toner cartridge and rock it to evenly distribute the toner that is inside.

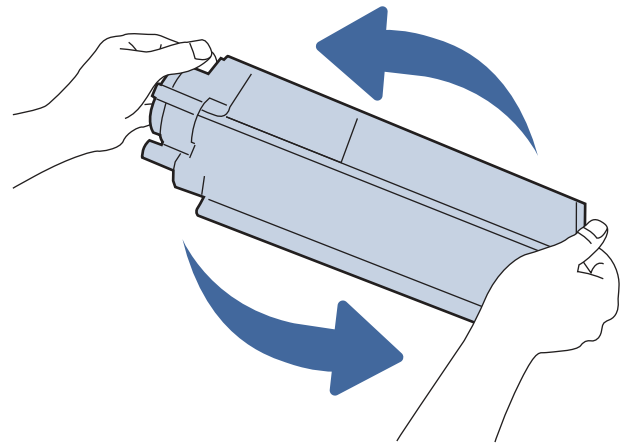

6. Align the toner cartridge with its slot and insert it into the printer.

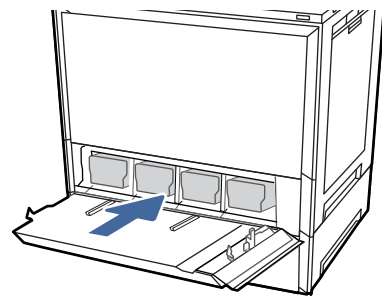

7. Close the toner cartridge door.

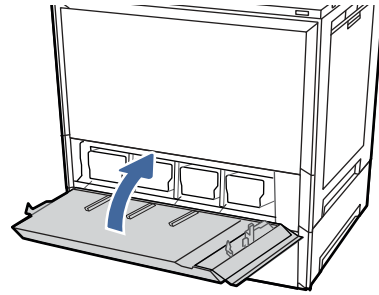

8. Pack the used toner cartridge into the box that the new toner cartridge came in. See the enclosed recycling guide for information about recycling.

In the U.S. and Canada, a pre-paid shipping label is included in the box. In other countries/regions, go to www.hp.com/recycle to print a pre-paid shipping label.

Adhere the pre-paid shipping label to the box, and return the used cartridge to HP for recycling.

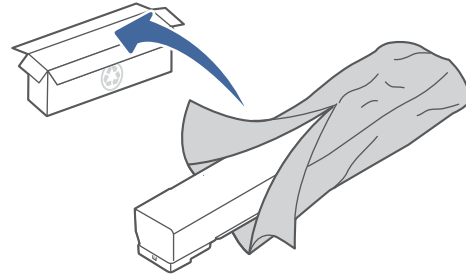

Remove and replace the imaging drums (X57945 models)

Follow these steps to replace the imaging drums.



[View a video of how to replace the imaging drums](#)

1. Open the front door.

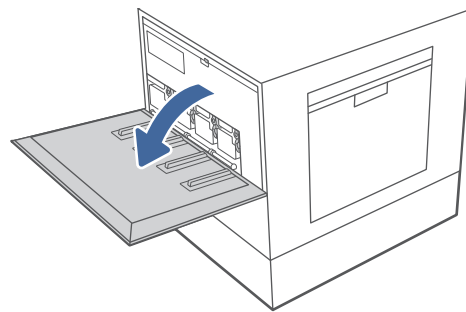

NOTE: If necessary, remove two screws holding the imaging drum access cover in place, and then lower the cover to access the imaging drums. See the figure below.

Figure 2-4 Remove two screws, open the cover

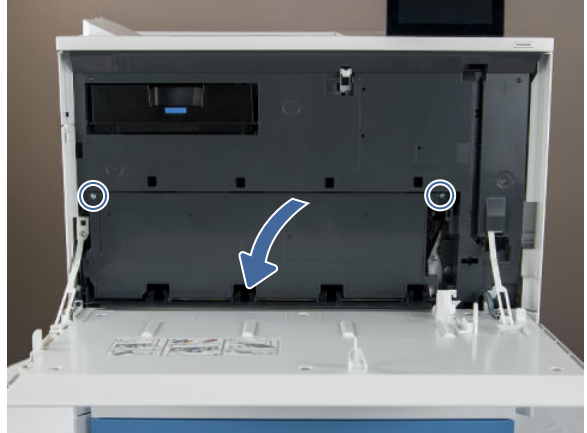

2. Grasp the end of the imaging drum and pull it straight out of the printer.

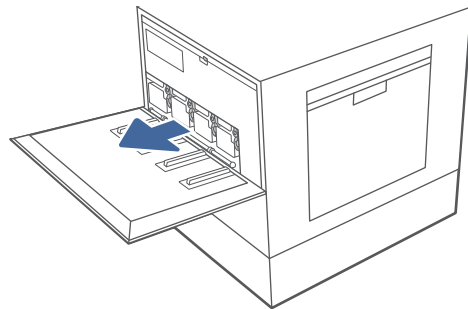

3. Remove the new imaging drum from its package. Save all packaging for recycling the used imaging drum.

CAUTION: To prevent damage to the imaging drum, do not expose it to light for more than a few minutes. Cover the imaging drum if it must be removed from the printer for an extended period of time. Do not touch the blue imaging drum.

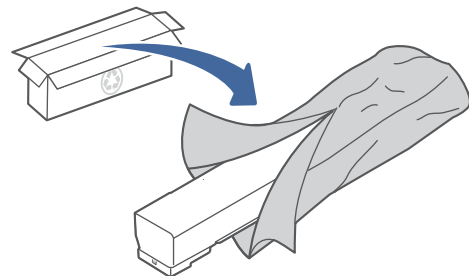

4. Hold both ends of the imaging drum and rock it back and forth end to end to evenly distribute the toner that is inside.

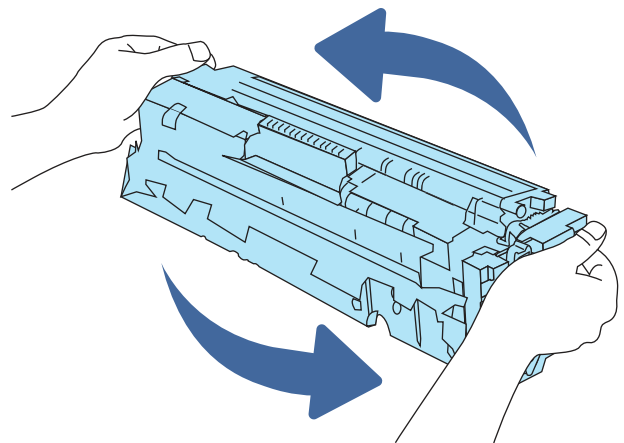

5. Align the imaging drum with its slot and insert it into the printer.

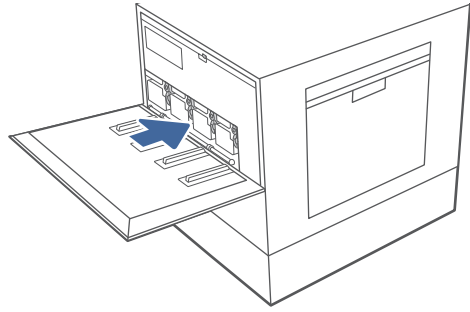

NOTE: If necessary, close the imaging drum access cover, and then install the two screws to secure the cover. See the figure below.

Figure 2-5 Close the cover, install two screws



6. Close the front door.

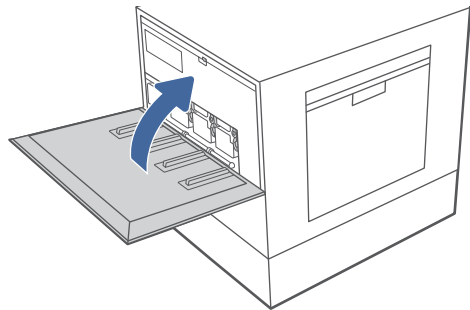

7. Pack the used imaging drum into the box that the new imaging drum came in. See the enclosed recycling guide for information about recycling.

In the U.S. and Canada, a pre-paid shipping label is included in the box. In other countries/regions, go to www.hp.com/recycle to print a pre-paid shipping label.

Adhere the pre-paid shipping label to the box, and return the used imaging drum to HP for recycling.

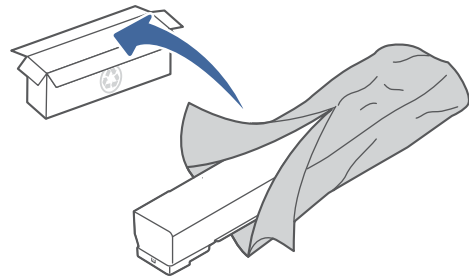

Clean the Tray 1 pickup and separation rollers

Learn about cleaning the Tray 1 pickup and separation rollers.

1. Open Tray 1.

Figure 2-6 Open Tray 1

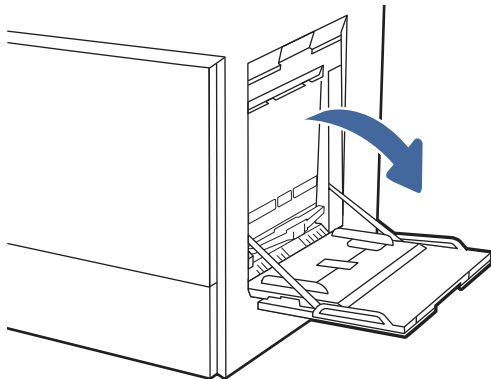

2. Locate and release the blue pickup roller assembly release tab (callout 1).

Figure 2-7 Locate the pickup roller assembly tab

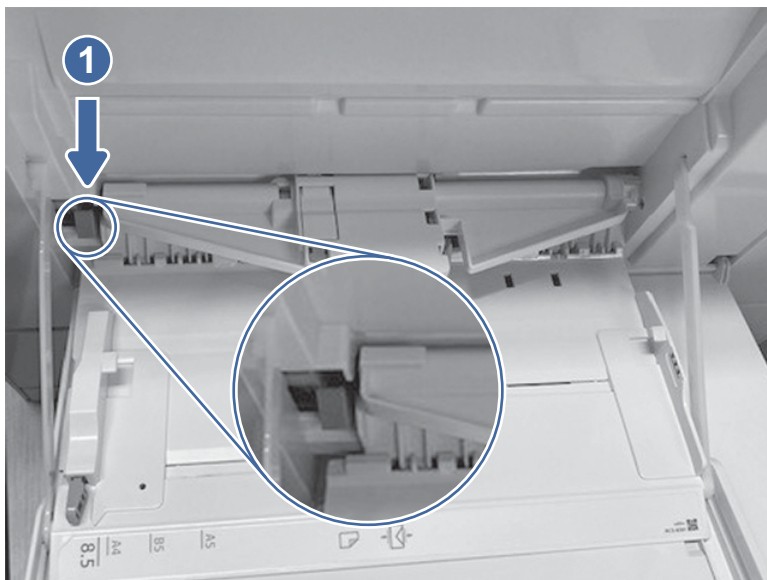

3. Push the pickup roller assembly to the right and then away from the printer.

Figure 2-8 Remove the pickup roller assembly

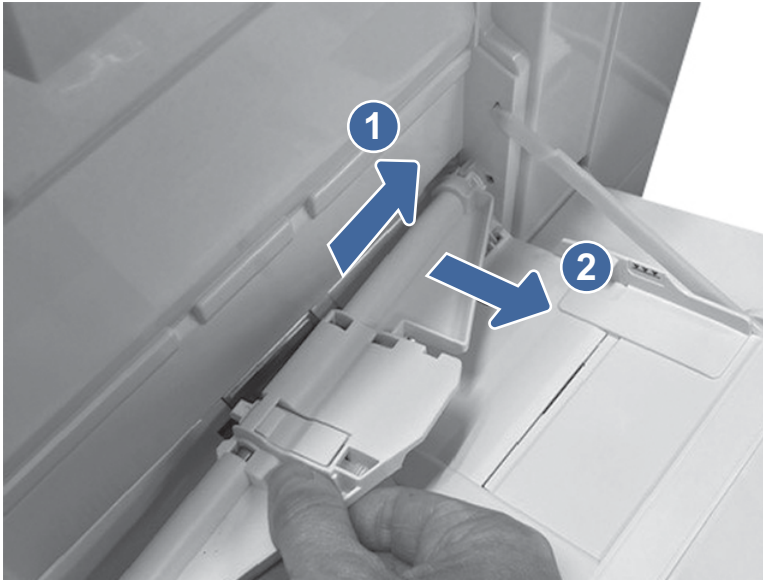

4. Grasp the left- and right-side of the separation roller assembly, and then lift the assembly up.

Figure 2-9 Lift the separation roller assembly

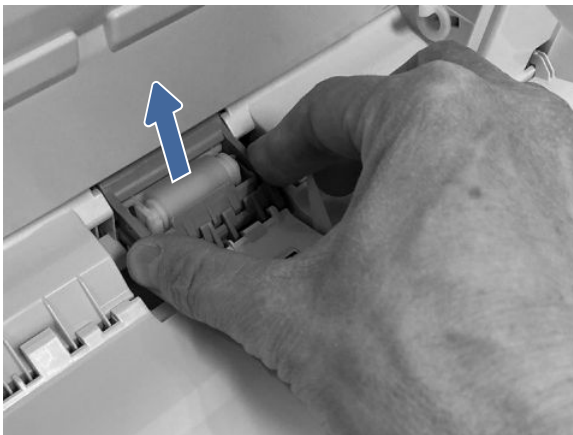

5. Pull the separation roller assembly straight out to remove it.

Figure 2-10 Remove the separation roller assembly

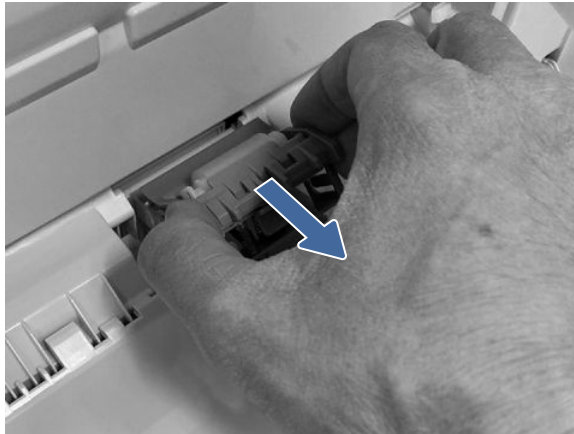

6. Clean the Tray 1 pickup and separation rollers. Use a damp, lint-free cloth to gently clean the rollers.

⚠ CAUTION: Do not touch the spongy portion of the roller. Skin oils on the roller can cause paper-handling and print-quality problems. HP recommends using disposable gloves or thoroughly washing your hands before handling the assembly.

7. Insert the separation roller assembly into the printer.

Figure 2-11 Insert the separation roller assembly

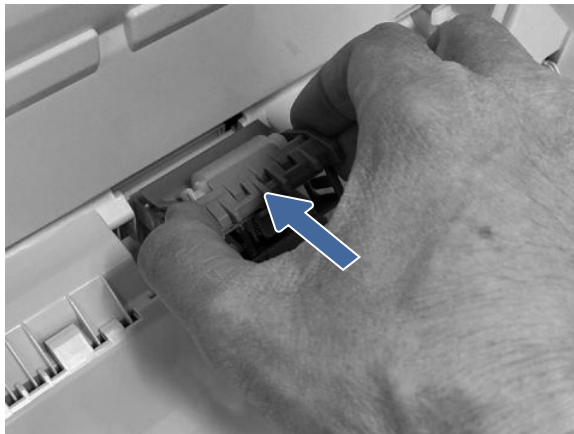

8. Push down on the Tray 1 separation roller until it snaps into place.

Figure 2-12 Secure the separation roller assembly

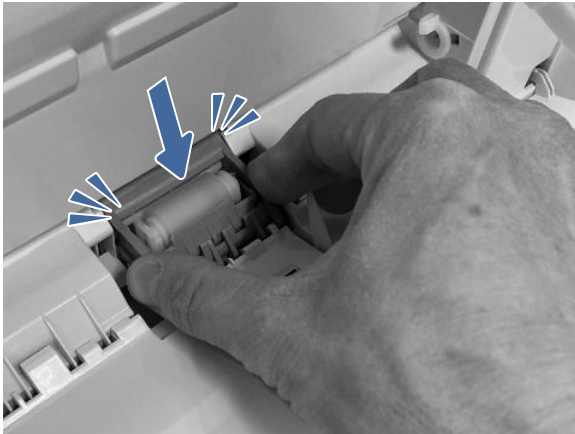

9. Insert the keyed right end of the pickup roller assembly into the provided slot, and then rotate the left end into place to install it.

Figure 2-13 Install the pickup roller assembly

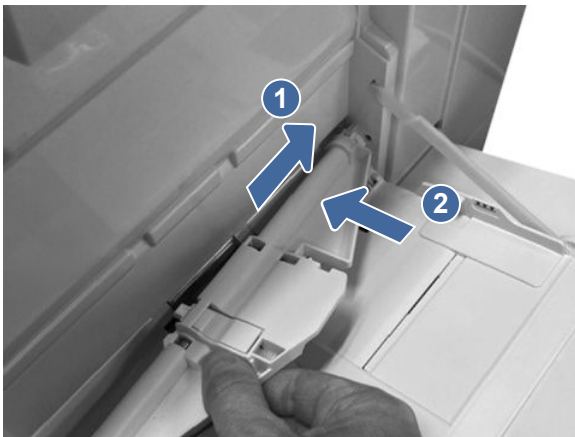

Clean the Tray 2 pickup and separation rollers

Learn about cleaning the Tray 2 rollers.

1. Depending on the printer model, perform one of the following steps.
 - 5700/X557/5800 models: Open the right door.
 - X57945 models: Open the lower right door.

2. Slide the blue lever (callout 1) to the right, and then remove the separation roller assembly (callout 2) by pulling it out from the printer.

Figure 2-14 Remove the separation roller assembly

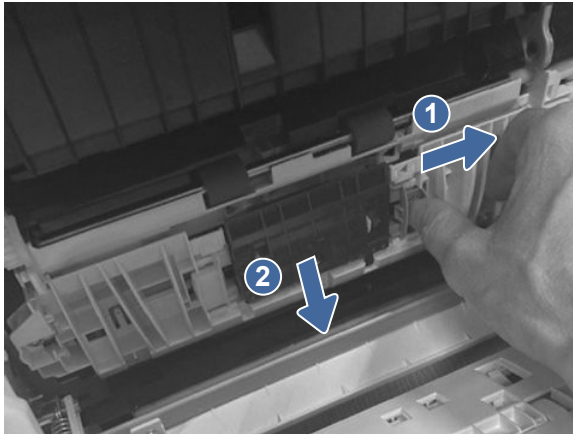

3. Locate the pickup roller assembly, and then pull it away from the printer to remove it.

Figure 2-15 Remove the pickup roller assembly

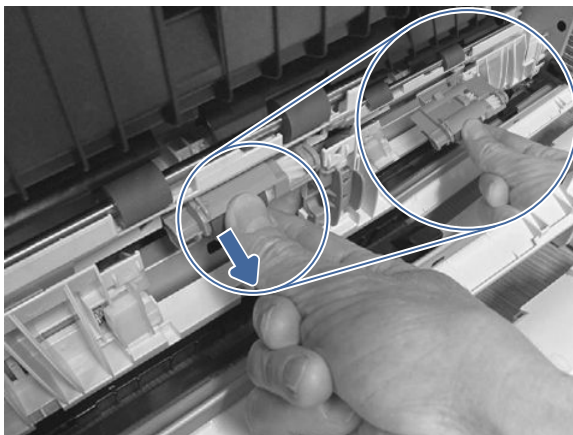

 **NOTE:** As the roller assembly can be hard to grip, you might need to reach under and behind the rollers to securely grip it.

 **CAUTION:** Skin oils on the roller can cause paper-handling and print-quality problems. HP recommends using disposable gloves or thoroughly washing your hands before handling the assembly.

4. Clean the Tray 2 pickup and separation rollers. Use a damp, lint-free cloth to gently clean the rollers.

5. Position the pickup roller assembly in the printer in the correct orientation, and then press the assembly into place.

Figure 2-16 Install the pickup roller assembly

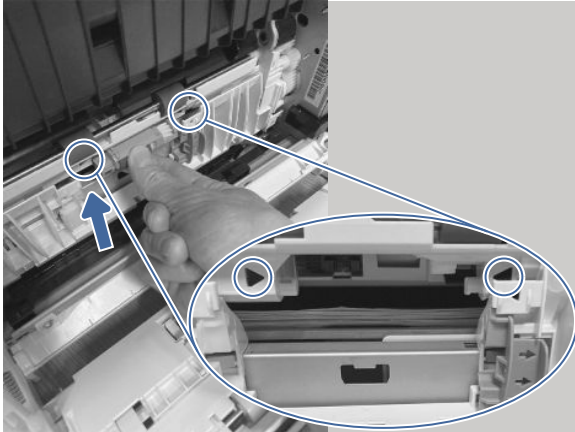

6. Insert the separation roller assembly into the printer to install it.

Figure 2-17 Install the separation roller assembly



3 Theory of operation

Learn about the printer theory of operation.

Document feeder / scanner

Learn about the printer document feeder and scanner components.

 **NOTE:** This section is for MFP printers only.

Document feeder simplex operation

Learn about document feeder operation.

The document feeder will not function when the document feeder cover is open. The paper path is incomplete if the document feeder cover is lifted from the glass.

When the printer duplex scans from the document feeder, the paper moves through one time, because the document feeder has a contact image sensor (CIS) scanner for side two which is scanned simultaneously with side one.

 **NOTE:** Duplex scanning is model specific. Some printer models might not support duplex scanning and printing.

The standard operation of the document feeder consists of the standby (paper loading) mode, pick, feed, and lift steps:

- **Standby (paper-loading) mode**

In standby mode, the lift plate is in the down position. When a document is loaded into the input tray, the paper-present sensor detects its presence.

When a copy/scan is initiated, the document feeder motor engages the gear train and raises the lift plate until the document makes contact with the pick roller. The document feeder then begins the pick, feed, and lower sequence.

- **Pick**

The pick roller rotates and moves one or more sheets forward into the document feeder where the sheets engage with the separation roller. The separation roller contacts the document feeder separation pad, which separates multiple sheets into a single sheet.

- **Feed**

The single sheet continues through the document feeder paper path (aided by the pre-scan rollers) until the leading edge of the page activates the top-of-form sensor. Activation of this sensor initiates the scan process, and the scanner acquires the image as the document moves over the document feeder glass. The post-scan rollers then eject the sheet into the output area. The pick and feed steps are repeated as long as paper is detected by the paper-present sensor.

- **Home**

When the top-of-form sensor detects the trailing edge of the last page, the last sheet is ejected and the motor turns on a sequence that rests the separation floor back down in standby mode, which allows it to detect when more media is loaded.

Scanning and image capture system

Learn about the scanning and image capture system.



NOTE: This section is for MFP printers only.

The flatbed image scanner captures an electronic image of the document on the glass. The scanner does this by illuminating the document with LEDs (red, green, and blue) and capturing the image in the image sensor to create an electronic format of the document. The flatbed scanner consists of three main elements.

- **CIS scanner**

The CIS (contact image sensor) scanner captures an image using the printer's optical path. Red, green, and blue LEDs sequentially illuminate a small strip of the document (often called a raster line), and the optical system captures each color in a single row of CCD sensors that cover the entire page width. Because only one color is captured for each line per exposure, the three colors are recombined electronically to create the full color image. For monochromatic scans or copies, all three LEDs are illuminated to create a white light for the scan so the raster line can be captured in one exposure.

- **Mechanical drive system**

The drive system moves the CIS scanner along the document length to create the image. In this printer, the drive system consists of a small DC motor with an optical encoder, a drive belt, and a guide rod. The speed of the drive system is proportional to the scan resolution (300 ppi is much faster than 1200 ppi) and also proportional to the type of scan (color scans are slower than monochromatic scans).

- **Image processing system (formatter)**

The formatter processes the scanner data into either a copy or a scan to the computer. For copies, the image data is sent directly to the printer without being transmitted to the computer. Depending on user selections for the copy settings, the formatter enhances the scanner data significantly before sending it to the printer. Image data is captured at 300 ppi for copies and is user selectable for scans to the computer. Each pixel is represented by 8 bits for each of the three colors (256 levels for each color), for a total of 24 bits per pixel (24-bit color).

Base printer

Learn about the base printer components.

Basic operation

Learn about the basic operation of the printer.

The printer routes all high-level processes through the formatter, which stores font information, processes the print image, and communicates with the host computer.

The basic printer operation comprises the following systems:

- Engine-control system
- Laser/scanner system
- Image-formation system
- Pickup, feed and delivery system
- Accessory (optional paper feeders)
- Integrated scanner assembly (document feeder and sub-scanner assembly) (not shown)

Figure 3-1 Relationship between the main printer systems

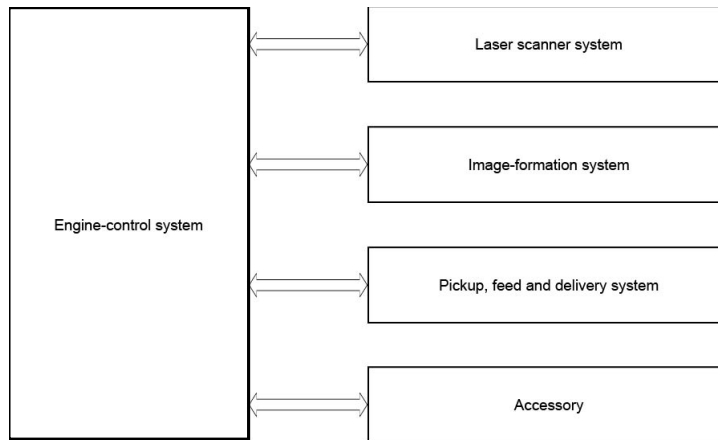

Sequence of operation

Learn about the printer sequence of operation.

The DC controller PCA controls the operating sequence, as described in the following table.

Table 3-1 Sequence of operation

Period	Duration	Description
Waiting	From the time the power is turned on, the door is closed, or when the printer exits sleep mode until the printer is ready for printing.	<ul style="list-style-type: none"> • Heats the fuser roller in the fuser • Pressurizes the fuser film • Detects the toner cartridges • Separates all of the developing rollers from the photosensitive drums in the toner cartridges • Rotates and stops each motor • Cleans the intermediate transfer belt (ITB) and secondary transfer roller • Detects cable breakage on the thermistor • Rotates and stops each fan • Detects any residual paper in the engine
Standby	From the end of the waiting sequence, the last rotation until the formatter receives a print command, or until the printer is turned off.	<ul style="list-style-type: none"> • Is in the Ready state • Enters Sleep mode if the formatter sends the sleep command • The printer calibrates if it is time for an automatic calibration
Initial rotation	From the time the formatter receives a print command until the paper enters the paper path.	<ul style="list-style-type: none"> • Rotates each motor • Rotates each fan • Activates the high-voltage power supply • Prepares the laser/scanner unit • Warms the fuser to the correct temperature
Printing	From the time the first sheet of paper enters the paper path until the last sheet has passed through the fuser.	<ul style="list-style-type: none"> • Forms the image on the photosensitive drums • Transfers the toner to the paper • Fuses the toner image onto the paper
Last rotation	From the time the last sheet of paper exits the fuser until the motors stop rotating.	<ul style="list-style-type: none"> • Moves the last printed sheet into the output bin • Stops each motor • Stops the high-voltage power supply • Stops the laser/scanner unit • Turns the fuser heater off • Cleans the ITB and secondary transfer roller • If another print command is received, the printer enters the initial rotation period when the last rotation is complete.

Formatter-control system

Learn about how the formatter operates.

-
-  **CAUTION:** Under **NO** circumstances should a formatter from a different printer be installed during the repair or troubleshooting processes. The formatter stores important data specific to the model of printer it is installed in and is not designed to be swapped or repurposed in any way. Return a used formatter to HP.

Issues that can occur from swapping a formatter include:

- Serial number, product number, product name, page count, and supported cartridges information change and might make a product unusable
- 33.02.01 Used board/Disk installed errors

If a used formatter is installed and causes this issue, the **partner** must cover the costs of the repair in the form of a product replacement. **There is no method in the field to recover a printer where a used formatter is installed.**

-  **IMPORTANT:** When a formatter PCA or DC controller is replaced a pairing operation must be completed to make the printer functional.
-

The formatter performs the following functions:

- Controls the sleep delay function
- Receives and processes print data from the various printer inputs
- Monitors control panel functions and relaying printer status information through the control panel and the network or bi-directional interface
- Develops and coordinates data placement and timing with the DC controller PCA
- Stores customer configuration settings and paper types.
- Stores font information
- Communicates with the host computer through the network or the bidirectional interface

The formatter receives a print job from the network or bidirectional interface and separates it into image information and instructions that control the printing process. The DC controller PCA synchronizes the image formation system with the paper input and output systems, and then signals the formatter to send the print image data.

Power management

Learn about printer power management.

Power management conserves power after the printer has been idle for an adjustable length of time. When the printer is in sleep mode, the control-panel back-light is turned off, but the printer retains all printer settings, downloaded fonts, and macros. Power management can be modified or turned off from the control-panel menus.

The printer exits sleep mode and enters the warm-up cycle when any of the following occurs.

- A print job, valid data, or a PML or PJJL command is received at the serial port.
- A print job or fax (fax models) is received.

- The control panel is touched (button press or touchscreen touch depending on model).
- A document is loaded in the document feeder (MFP only).
- Opening the scanner lid (model dependent).
- The power button is pressed for 3 seconds or less.
- Connecting an operational live network Ethernet cable or fax line (fax models).
- Inserting a USB drive in either the front USB port or the USB port on the back of the device.
- Connecting a USB cable to an operating computer.
- Opening the cartridge, front, or rear door (model dependent).



NOTE: Opening a paper tray does not wake up the printer.



TIP: Error messages override the sleep delay message. The printer enters sleep mode at the selected time, but the error message continues to appear.

Set the sleep timer and configure the printer to use 1 watt or less of power

The sleep settings affect how much power the printer uses, the wake/sleep time, how quickly the printer enters sleep mode, and how quickly the printer wakes up from sleep mode.

To configure the printer to use 1 watt or less of power while in sleep mode, enter the time for the [Sleep after Inactivity](#) setting.

1. From the Home screen on the printer control panel, select [Settings](#).
2. Open the following menus:
 - [General](#)
 - [Energy Settings](#)
 - [Sleep Settings](#)
3. Select [Sleep after Inactivity](#) to specify the number of minutes the printer is inactive before it enters sleep mode. Enter the appropriate time period.
4. Select [Done](#) to save the settings.

Set the sleep schedule

Use the [Sleep Schedule](#) feature to configure the printer to automatically wake or go into Sleep mode at specific times on specific days of the week.

1. From the Home screen on the printer control panel, navigate to the [Settings](#) application, and then select the [Settings](#) icon.
2. Open the following menus:
 - a. [General](#)
 - b. [Energy Settings](#)
 - c. [Sleep Schedule](#)

3. Select the [New Event](#) button, and then select the type of event to schedule: [Wake Event](#) or [Sleep Event](#).
4. For a wake or sleep event, configure the time and the days of the week for the event. Select [Save](#) to save the setting.

Printer job language (PJL)

Learn about printer job language (PJL).

PJL is an integral part of printer configuration, in addition to the standard PCL and PostScript (PS). With standard cabling, the printer can use PJL to perform a variety of functions.

- **Dynamic I/O switching:** The printer can be configured with a host on each I/O by using dynamic I/O switching. Even when the printer is offline, it can receive data from more than one I/O simultaneously, until the I/O buffer is full.
- **Context-sensitive switching:** The printer can automatically recognize the personality (PS or PCL) of each job and configure itself to serve that personality.
- **Isolation of print environment settings from one print job to the next:** For example, if a print job is sent to the printer in landscape mode, the subsequent print jobs print in landscape only if they are formatted for landscape printing.

Control panel

Learn about the control panel.

The formatter sends and receives printer status and command data to and from the control panel.

Walk-up USB

Learn about the walk-up USB function.

 **NOTE:** Touchscreen models only.

This printer features printing from a USB flash drive. This printer supports printing the following types of files from the USB flash drive.

- .pdf
- .jpg
- .prn and .PRN
- .pcl and .PCL
- ps and .PS
- doc and .docx
- .ppt and .pptx

When a USB flash drive is inserted into the front of the printer, the control panel will display the [USB Flash Drive menu](#). The files present on the USB flash drive can be accessed from the control panel.

 **NOTE:** The USB flash drive must be formatted using the FAT32 format. Drives formatted with NTFS will not work.

Any files in a supported format on the USB flash drive can be printed directly from the printer control panel. Pages also can be scanned and saved to the USB flash drive from the control panel.

Low end data model (LEDM) overview

Learn about the low-end data model (LEDM).

The low-end data model (LEDM) provides one consistent data representation method and defines the dynamic and capabilities tickets shared between clients and devices, as well as the access protocol, event, security, and discovery methods.

CPU

Learn about the printer microprocessor.

The formatter incorporates a 1200 MHz processor.

Input/output (I/O)

Learn about printer I/O functionality.



NOTE: Some of the following printer I/O functions are model specific. For example, not all printer models have a fax function.

Walk-up USB

The printer includes a Hi-Speed USB 2.0 front port for walkup USB printing.

Universal serial bus (USB) hosts

The printer includes SuperSpeed USB 3.0 rear hosts for USB flash drive and job storage.

10/100/1000 networking

The printer includes a 10/100/1000 network (Ethernet) connection.

Fax

The printer includes a fax phone line connection.



NOTE: Fax models only. For some fax model printers, the telephone extension port is plugged and not operational.

Wireless

Wireless products contain a wireless card to enable 802.11b/g/n wireless communication with dual band support for 2.4Ghz and 5 Ghz.



NOTE: Wireless models only.

Memory

Learn about printer memory functionality.



NOTE: Some of the following printer memory functions are model specific. For example, not all printer models have Flash memory.

Firmware

The formatter stores the printer firmware. A firmware upgrade process is used to overwrite and upgrade the firmware.

 **NOTE:** For more information about a specific printer model, see the *Printer information, configurations, and specifications* section in the service manual.

Nonvolatile random access memory (NVRAM)

The printer uses nonvolatile memory (NVRAM) to store I/O and information about the print environment configuration. The contents of NVRAM are retained when the printer is turned off or disconnected.

Flash memory

NAND: Stores fax memory.

Random access memory

The printer uses the following RAM:

- SFP: 1.5 GB
- MFP: 6 GB

HP Memory Enhancement technology (MEt)

The HP Memory Enhancement technology (MEt) effectively doubles the standard memory through a variety of font- and data-compression methods.

 **NOTE:** MEt is available only in PCL mode; it is not functional when printing in PS mode.

Engine-control unit

Learn about the engine control unit.

The engine-control unit includes the following:

- DC controller
- High-voltage power supply
- Low-voltage power supply
- Fuser control

Figure 3-2 Engine-control unit

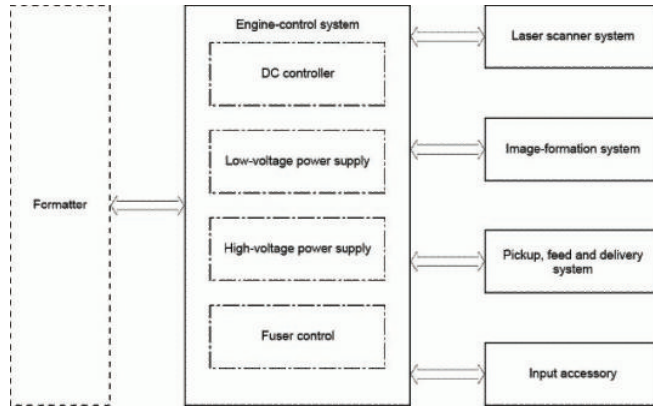

DC controller

Learn about the DC controller.

The DC controller controls the operation of the printer and its components. The DC controller starts the printer operation when the printer power is turned on and the power supply sends DC voltage to the DC controller. After the printer enters the standby period, the DC controller sends out various signals to operate motors, solenoids, and other printer components based on the print command and image data that the host computer sends.

Figure 3-3 DC controller diagram

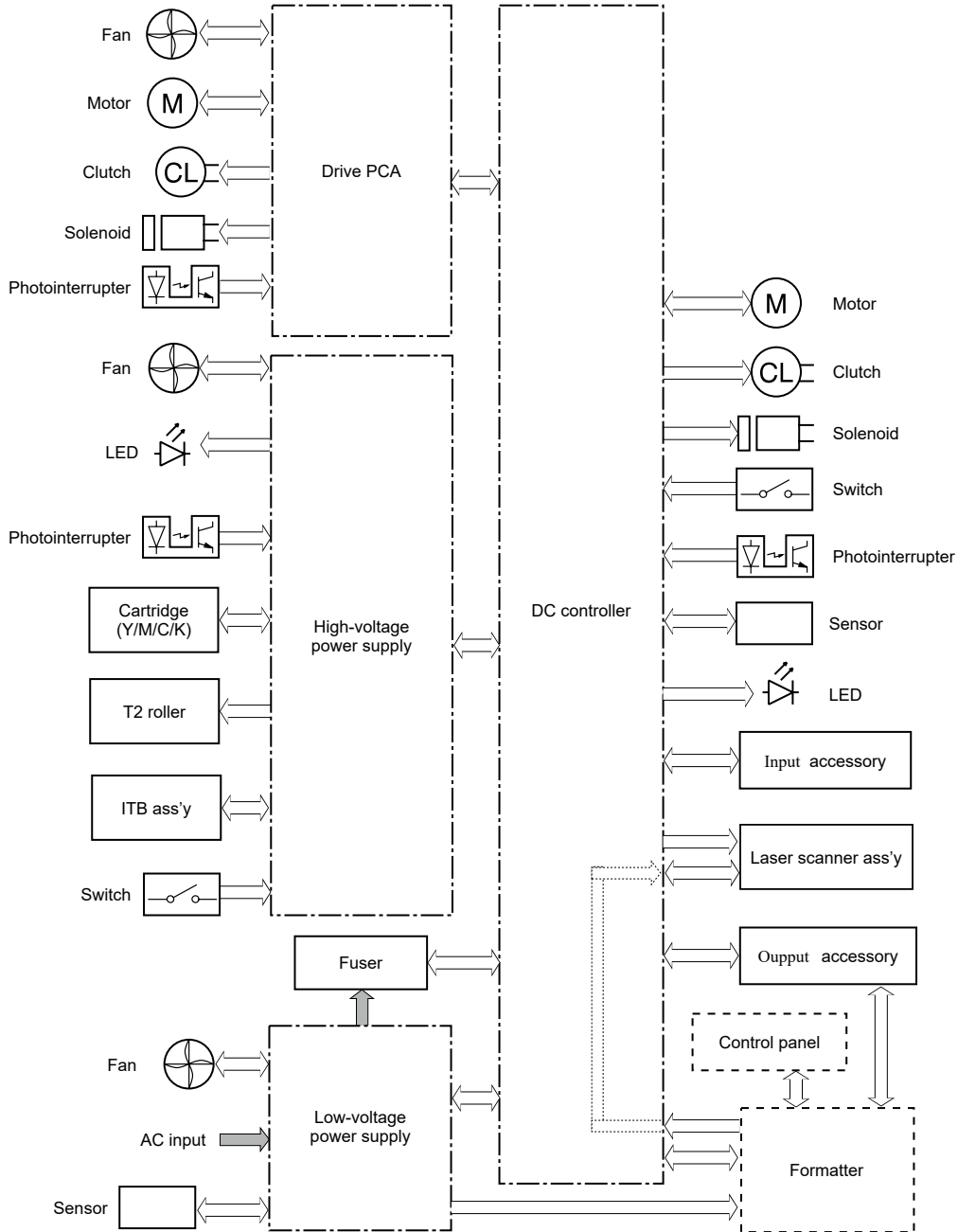

Table 3-2 Printer electrical components

Component type	Abbreviation	Component name
Motor	SCN_MTR_12st	Scanner motor
Motor	SCN_MTR_34st	Scanner motor
Motor	LIFT_MTR	Lifter motor
Motor	FEED_MTR	Pickup motor
Motor	FEED_MTR (X57945 only)	Feed motor
Motor	FSR_MTR	Fuser motor

Table 3-2 Printer electrical components (continued)

Component type	Abbreviation	Component name
Motor	ITB_BK_MTR	ITB motor
Motor	3DRM_MTR	Drum motor
Motor	4DEV_MTR	Developer motor
Motor	DEV_MTR	Developer alienation motor
Motor	DUP_MTR	Duplex motor
Motor	CAC_MTR (X55745 only)	Cartridge access release motor
Motor	TS_MOTOR (X57945 only)	Toner-supply motor
Fan	FSR_FAN	Fuser fan
Fan	CRG_FAN	Cartridge fan
Fan	PS_FAN	Power supply fan
Solenoid	T1_SL	Tray 1 (MP) alienation solenoid
Solenoid	DUP_SL	Duplex flapper solenoid
Solenoid	MP_SL	Tray 1 (MP) pickup solenoid
Clutch	FEED_CL	Tray 2 pickup clutch
Clutch	REFEED_CL	Duplex re-pickup clutch
Clutch	U_CL1 (X57945 only)	Toner-supply upper feed clutch 1
Clutch	T_CL1 (X57945 only)	Toner-supply clutch 1
Clutch	U_CL2 (X57945 only)	Toner-supply upper feed clutch 2
Clutch	T_CL2 (X57945 only)	Toner-supply clutch 2
Clutch	U_CL3 (X57945 only)	Toner-supply upper feed clutch 3
Clutch	T_CL3 (X57945 only)	Toner-supply clutch 3
Clutch	U_CL4 (X57945 only)	Toner-supply upper feed clutch 4
Clutch	T_CL4 (X57945 only)	Toner-supply clutch 4
Switch	24V_ILK_SW	24V interlock switch
Switch	FR_DOOR_SW	Front door switch
Switch	FDOOR_SW (X57945 only)	Toner-supply door switch
Switch	R_DOOR_SW	Right door switch
Switch	R_DOOR_SW (X57945 only)	Right door switch 2
Switch	POWER_SW	Power supply switch
Switch	CST_SIZE 1 (X55745/ X57945 only)	Tray 2 media size switch 1
Switch	CST_SIZE 2 (X55745/ X57945 only)	Tray 2 media size switch 2
Switch	CST_SIZE 3 (X55745/ X57945 only)	Tray 2 media size switch 3

Table 3-2 Printer electrical components (continued)

Component type	Abbreviation	Component name
Switch	CST_SIZE 4 (X55745/ X57945 only)	Tray 2 media size switch 4
Switch	CST	Tray 2 cassette presence switch
Photo interrupter	LIFT_SNS	Tray 2 lifter motor rotation sensor
Photo interrupter	DRM_HP123_SNS	Drum home position sensor YMC
Photo interrupter	DRM_HP4_SNS	Drum home position sensor K
Photo interrupter	DEV_HP_SNS	Developer alienation sensor
Photo interrupter	DUP_FL_SNS	Duplex flapper position sensor
Photo interrupter	OUT_FULL_SNS	FD1 media full sensor, fuser output sensor
Photo interrupter	CST_PAP_SNS	Tray 2 media out sensor
Photo interrupter	CST_FACE_SNS	Tray 2 media surface sensor
Photo interrupter	LOOP_SNS	Fuser loop sensor
Photo interrupter	REFEED_SNS (X55745/ X57945 only)	Duplex feed sensor
Photo interrupter	ENC_SNS	Registration roller rotation sensor
Photo interrupter	REG_SNS	Registration sensor
Photo interrupter	MP_PAP_SNS	Tray 1 media out sensor
Photo interrupter	TCU_FULL_SNS	ITB toner collection unit near full sensor
Photo interrupter	T1_HP_SNS	ITB alienation sensor
Photo interrupter	TCU_VSCW_SNS	Toner collection unit screw rotation sensor
Photo interrupter	FSR_PRS_SNS	Fuser pressure release sensor
Photo interrupter	PAPOUT-M_SNS	Fuser output sensor 2
Photo interrupter	CAC_SNS (X55745 only)	Cartridge access home position sensor
Photo interrupter	ENCORDER-SNS	Pressure roller rotation sensor
Photo interrupter	TRANS_SNS (X57945 only)	Tray 2 feed sensor
Photo interrupter	CAC_SNS (1st) (X57945 only)	Cartridge release unit home position sensor Y
Photo interrupter	CAC_SNS (2nd) (X57945 only)	Cartridge release unit home position sensor M
Photo interrupter	CAC_SNS (5rd) (X57945 only)	Cartridge release unit home position sensor C
Photo interrupter	CAC_SNS (4th) (X57945 only)	Cartridge release unit home position sensor K
Sensor	-(media sensor PCA)	Media sensor
Sensor	-(RD sensor PCA)	Registration density sensor 1
Sensor	-(RD sensor PCA)	Registration density sensor 2
Sensor	PAPOUT-L_SNS	Fuser output sensor 1

Table 3-2 Printer electrical components (continued)

Component type	Abbreviation	Component name
Sensor	ENV SNS	Environment sensor
Sensor	BUFF_PTR_PCA (1st) (X57945 only)	Toner supply sensor Y
Sensor	BUFF_PTR_PCA (2nd) (X57945 only)	Toner supply sensor M
Sensor	BUFF_PTR_PCA (3rd) (X57945 only)	Toner supply sensor C
Sensor	BUFF_PTR_PCA (4th) (X57945 only)	Toner supply sensor K
LED	3rd (X57945 only)	Pre-exposure LED 3
LED	4th (X57945 only)	Pre-exposure LED 4
LED	LED6	Power supply switch LED

Motors

Learn about the printer motors.

The printer uses several motors for the paper-feed and image-formation processes.



NOTE: The DC controller determines the following motor failures.

- Developer motor ([color] developer motor startup failure)
- Developer motor ([color] developer motor rotation failure)
- Drum motor ([color] drum motor startup failure)
- Drum motor ([color] drum motor rotation failure)
- ITB motor (ITB motor start-up failure)
- ITB motor (ITB motor rotation failure)
- Fuser motor (fuser motor start-up failure)
- Fuser motor (fuser motor rotation failure)
- Developer alienation motor (developer alienation motor failure)
- Scanner motor (scanner motor startup failure)
- Scanner motor (scanner motor rotation failure)
- Toner-supply motor ([color] toner replenish motor failure)

Table 3-3 Motors

Component name		Components driven
4DEV_MTR	Developer motor	<ul style="list-style-type: none"> • Yellow developer • Magenta developer • Cyan developer • Black developer • Waste toner feed screw
3DRM_MTR	Drum motor	<ul style="list-style-type: none"> • Yellow photosensitive drum • Magenta photosensitive drum • Cyan photosensitive drum
ITB_BK_MTR	ITB motor	<ul style="list-style-type: none"> • Intermediate transfer belt (ITB) • Black photosensitive drum • Toner feed screw
FSR_MTR	Fuser motor	<ul style="list-style-type: none"> • Pressure roller and output roller • Pressurizes/releases the pressure roller • Engages/disengages the T1 roller • Engages/disengages the T2 roller
FEED_MTR	Pickup motor	<ul style="list-style-type: none"> • Tray 1 pickup roller (5700/X557/5800 models only) • Tray 1 feed roller (5700/X557/5800 models only) • Tray 2 pickup roller • Tray 2 feed roller • Feed roller (X57945 models only) • Registration roller (5700/X557/5800 models only) • Intermediate feed roller (5700/X557/5800 models only) • Duplex re-pickup roller (5700/X557/5800 models only)
FEED_MTR	Feed motor (X57945 models only)	<ul style="list-style-type: none"> • Tray 1 pickup roller • Tray 1 feed roller • Registration roller • Intermediate feed roller • Duplex re-pickup roller
DEV_MTR	Developer alienation motor	Engages/disengages the developer rollers
SCN_MTR_12st	Scanner motor	Scanner mirror
SCN_MTR_34st		
LIFT_MTR	Lifter motor	<ul style="list-style-type: none"> • Lifts up the Tray 2 lifting plate • Engages/disengages the Tray 2 pickup roller

Table 3-3 Motors (continued)

Component name		Components driven
DUP_MTR	Duplex motor	<ul style="list-style-type: none">• Duplex switchback roller• Duplex feed roller
CAC_MTR	Cartridge access release motor (X55745 models only)	Cartridge lock door lever
TS_MOTOR	Toner-supply motor (X57945 models only)	Toner feed screw

Fans

Learn about the printer fans.

The printer has three fans for preventing the temperature from rising in the printer and for cooling the printed pages.



NOTE: The DC controller determines the following fan failures.

- Cartridge fan (fan motor 1 failure)
- Power supply fan (fan motor 2 failure)
- Fuser fan (fan motor 3 failure)

Table 3-4 Fans

Component name	Description	Cooling area	Type	Speed
FSR_FAN	Fuser fan	Around the fuser	Intake	Full
CRG_FAN	Cartridge fan	Around the toner cartridges	Intake	Variable (full/95%)
PS_FAN	Power supply fan	Around the low-voltage power supply unit	Intake	Variable (full/half)

Low-voltage power supply

Learn about the low-voltage power supply (LVPS).

The low-voltage power supply converts the AC power into the DC voltage that the printer components use.

Figure 3-4 Low-voltage power supply

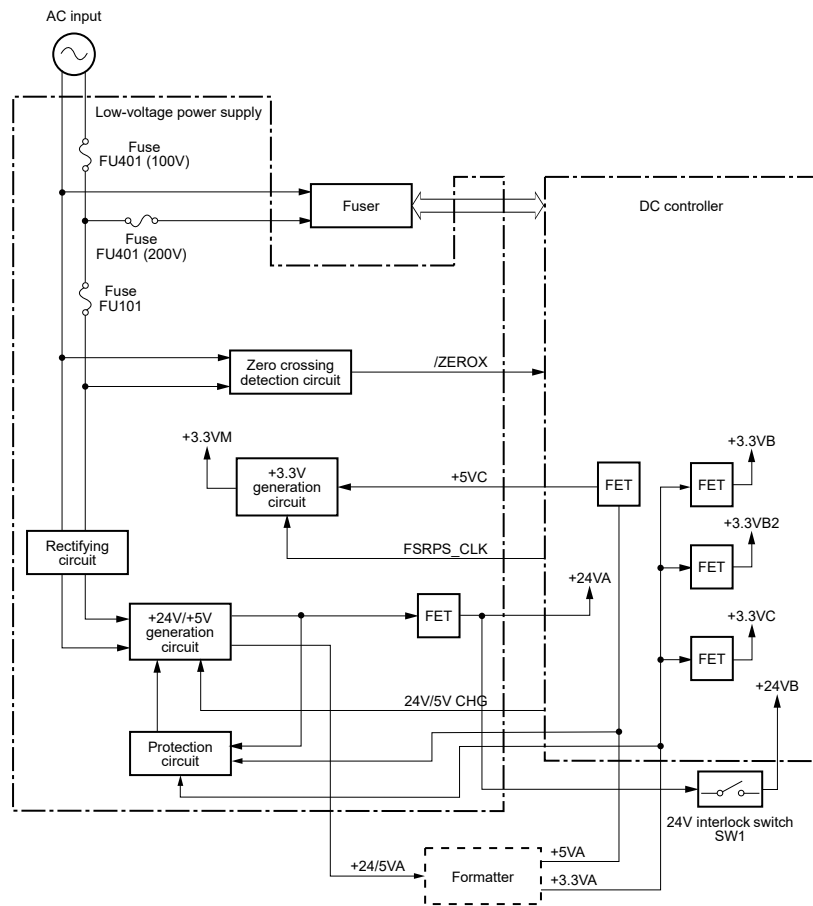

Low-voltage power supply voltages description

Learn about LVPS voltages.

The low-voltage power supply converts the AC power into three DC voltages, which it then subdivides, as described in the following table.

Table 3-5 LVPS voltages

DC power supply	Reference Item	Inactive OFF	Active OFF	Print/Standby
+24V	+24VA	OFF	OFF	ON
+24V	+24VB	OFF	OFF	ON
+5V	+5VA	OFF	ON	ON
+5V	+5VC	OFF	OFF	ON

Table 3-5 LVPS voltages (continued)

DC power supply	Reference Item	Inactive OFF	Active OFF	Print/Standby
+3.3V	+3.3VA	ON	ON	ON
+3.3V	+3.3VB	OFF	ON	ON
+3.3V	+3.3VB2	OFF	Intermittent	ON
+3.3V	+3.3VC	OFF	OFF	ON
+3.3V	+3.3VM	OFF	OFF	ON

Over-current/over-voltage protection

Learn about LVPS protections.

The low-voltage power supply automatically stops supplying the DC voltage to the printer components whenever it detects excessive current or abnormal voltage. The low-voltage power supply has a protective circuit against over-current and over-voltage to prevent failures in the power supply circuit.

⚠ CAUTION: If DC voltage is not being supplied from the low-voltage power supply, the protective function might be running. In this case, turn the power switch off and unplug the power cord.

Do not turn the power switch on until the root cause is found and corrected.

If the protective function is active, the DC controller notifies the formatter of a low-voltage power supply failure. In addition, the low-voltage power supply has two fuses to protect against over-current. If over-current flows into the AC line, the fuse stops the AC power.

Low-voltage power supply safety

Learn about LVPS safety.

For the customer and service technician safety, the printer has a function to stop +24VB power when the 24V interlock switch is turned off. This stops the DC power supply to the following loads.

- High-voltage power supply
- Fuser motor
- Pickup motor
- Developer alienation motor
- Duplex switchback motor

The remote switch control circuit turns on or off the printer power so that the AC power flows even if the power switch is turned off. Unplug the printer power cord before disassembling the printer.

Low-voltage power supply functions

Learn about LVPS functions.

The printer has the following low-voltage power supply functions.

Table 3-6 Low-voltage power supply functions

Function	Description
Active OFF	Inactive OFF is a state that the power supply is OFF.
Inactive OFF	Active OFF is a state of sleep. The low-voltage power supply is output only to formatter and DC controller.
Low-voltage power supply failure detection	When +24V is supplied from the low-voltage power supply, the DC controller always monitors output status of 24VA. The DC controller determines it as low-voltage power supply malfunction if 24VA would not become the specified value at the specified timing. When the DC controller monitors AC voltage input from inlet, it also determines it as low-voltage power supply malfunction if AC voltage input from inlet would not reach the specified voltage.

High-voltage power supply

Learn about the high-voltage power supply.

The DC controller controls the high-voltage power supply to generate high-voltage biases. The high-voltage power supply generates the high-voltage biases that are applied to the following components:

- Primary charging roller (in the toner cartridges)
- RS roller (in the toner cartridges)
- Developer blade (in the toner cartridges)
- Developer roller (in the toner cartridges)
- Primary transfer roller
- Secondary transfer roller
- Static charge eliminator

Figure 3-5 High-voltage power supply

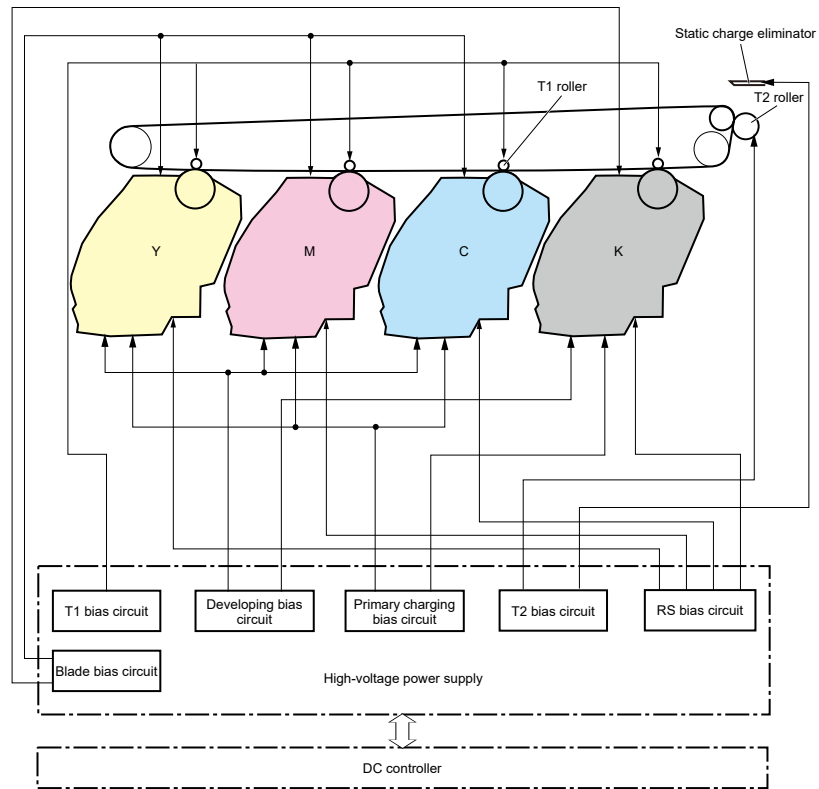

Fuser control

Learn about the fuser control process.

The fuser heater control circuit and the fuser safety circuit control the fuser temperature based on the commands from the DC controller. The printer uses an on-demand fusing method. There are two types of fusers, a conventional ODF fuser and a zone-heated A2ODF fuser in which a heater is divided into seven zones.

Figure 3-6 ODF fuser control

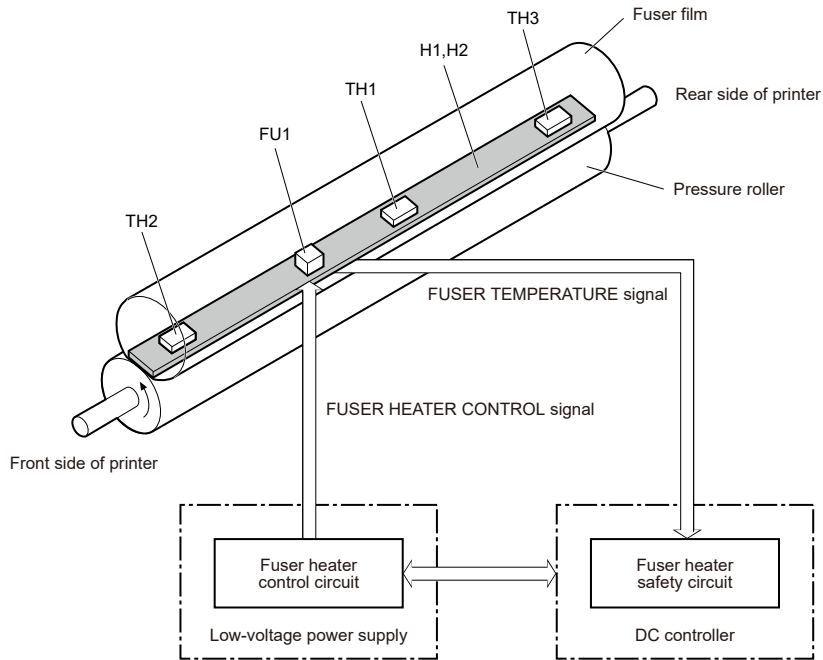
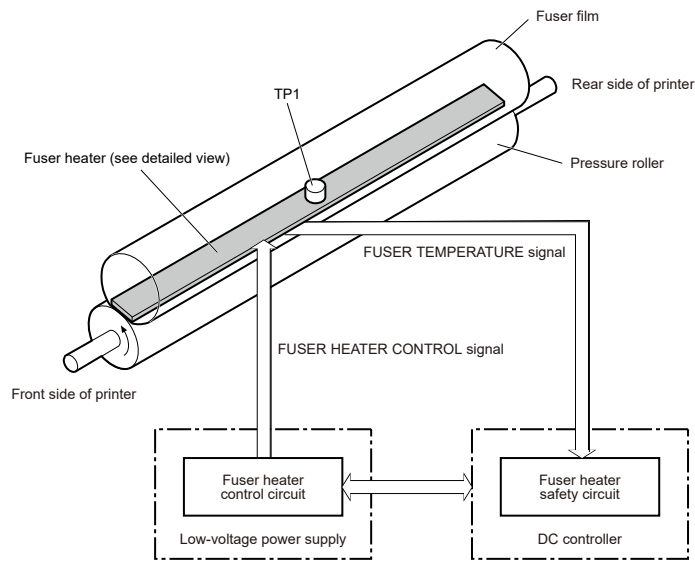

Table 3-7 ODF fuser components

Abbreviation	Component name	Function
H1	Fuser main heater	Heats the fuser film (Letter width compatible)
H2	Fuser sub heater	Heats the fuser film (A4 width compatible)
TH1	Main thermistor	Detects the center temperature of the fuser film (contact type)
TH2	Sub thermistor 1	Detects the temperature at one end of the fuser heater (contact type)
TH3	Sub thermistor 2	Detects the temperature at one end of the fuser heater (contact type)
FU1	Thermal fuse	Prevents an abnormal temperature rise of fuser heater (non-contact type)

Figure 3-7 A²ODF fuser control



Detailed view of fuser heater

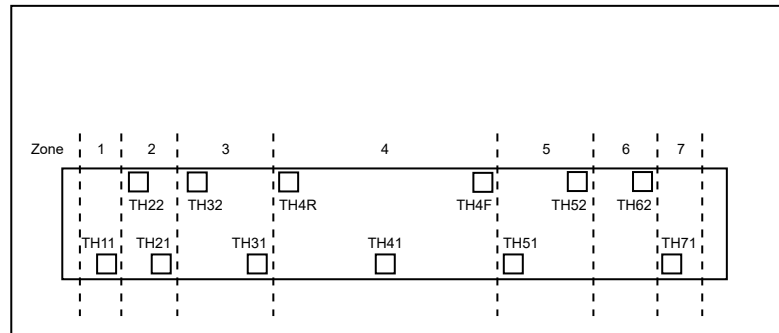

Table 3-8

Abbreviation	Component name	Function
H1	Fuser heater 1	Heats the fuser film (zone 1)
H2	Fuser heater 2	Heats the fuser film (zone 2)
H3	Fuser heater 3	Heats the fuser film (zone 3)
H4	Fuser heater 4	Heats the fuser film (zone 4)
H5	Fuser heater 5	Heats the fuser film (zone 5)
H6	Fuser heater 6	Heats the fuser film (zone 6)
H7	Fuser heater 7	Heats the fuser film (zone 7)

Table 3-8 (continued)

Abbreviation	Component name	Function
TH11	Main thermistor	Detects the temperature of the fuser zone 1 (built-in type)
TH21	Main thermistor	Detects the temperature of the fuser zone 2 (built-in type)
TH41	Main thermistor	Detects the temperature of the fuser zone 4 (built-in type)
TH51	Main thermistor	Detects the temperature of the fuser zone 5 (built-in type)
TH71	Main thermistor	Detects the temperature of the fuser zone 7 (built-in type)
TH22	Sub thermistor	Detects the temperature of the fuser zone 2 (built-in type)
TH32	Sub thermistor	Detects the temperature of the fuser zone 3 (built-in type)
TH4R	Sub thermistor	Detects the temperature of the fuser zone 4 (built-in type)
TH4F	Sub thermistor	Detects the temperature of the fuser zone 4 (built-in type)
TH52	Sub thermistor	Detects the temperature of the fuser zone 5 (built-in type)
TH62	Sub thermistor	Detects the temperature of the fuser zone 6 (built-in type)
TH31	Sub thermistor	Detects the excursion of the fuser heater (built-in type)
TP1	Thermoswitch	Prevents an abnormal temperature rise of fuser heater (non-contact type)

Figure 3-8 ODF fuser control block diagram

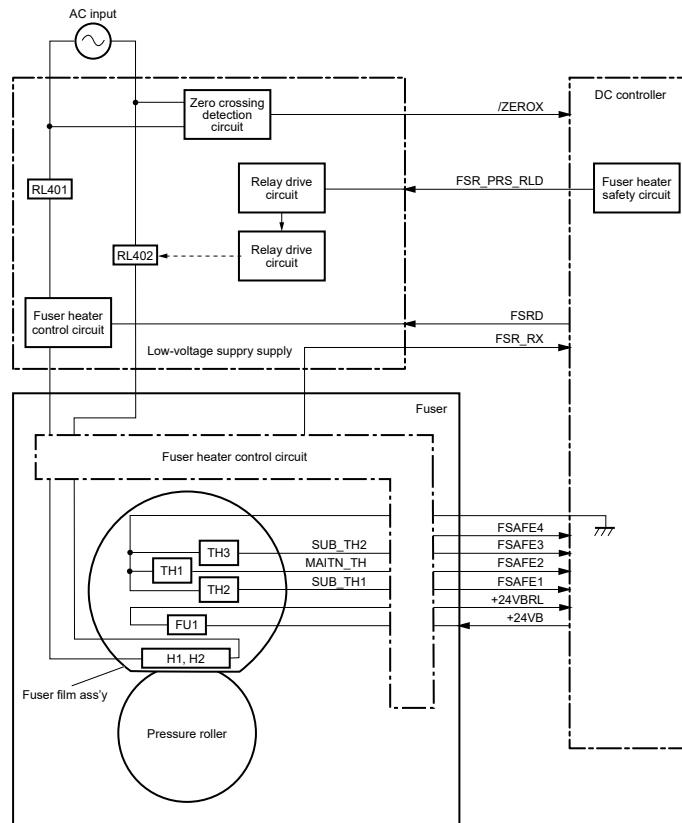
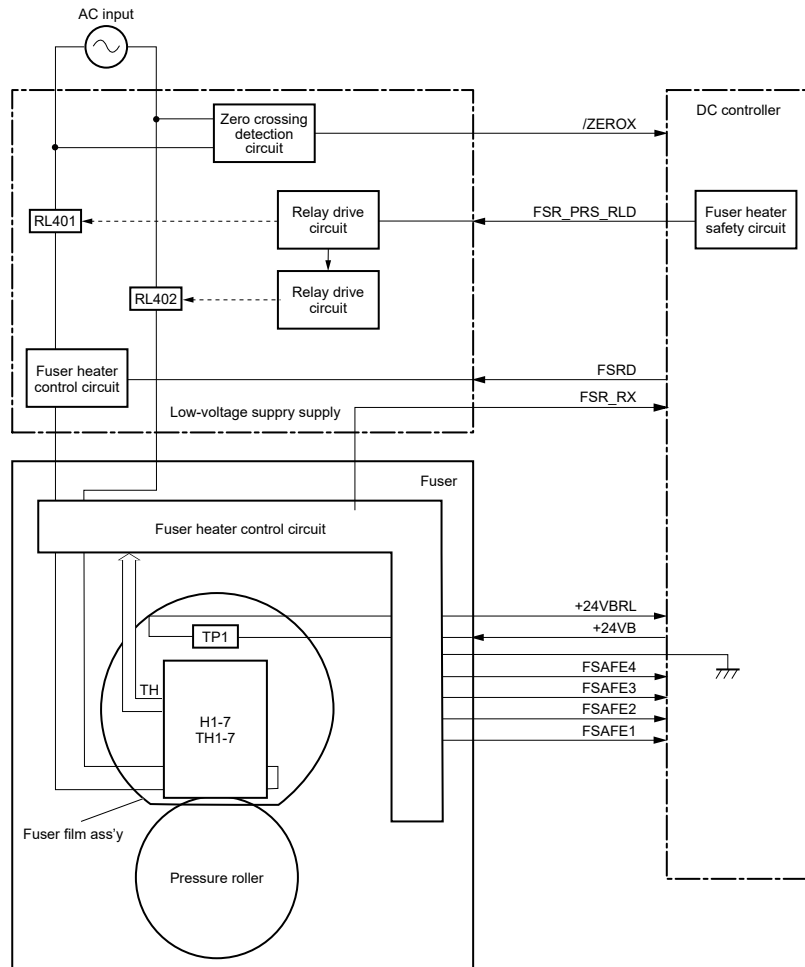

Figure 3-9 A²ODF fuser control block diagram



Fuser heater protection

Learn about fuser heater protection.

The fuser heater protective function detects an excessive temperature rise of the fuser and interrupts power supply to the fuser heater. The printer has the following protective functions to prevent the fuser heater from excessive rising temperature.

- DC controller:** The DC controller constantly monitors the temperature of the thermistor. The DC controller stops the FUSER HEATER CONTROL signal output and turns off the relays (RL401/RL402) to interrupt power supply to the fuser heater when it detects an excessive temperature.

- **Fuser heater safety circuit:** The fuser heater safety circuit constantly monitors the temperature of the thermistor. The fuser heater safety circuit turns off the relays (RL401/RL402) or the triacs (Q409/Q410/Q411) and the fuser heater control circuit to interrupt power supply to the fuser heater when it detects an excessive temperature. Triac (Q409) corresponds only to the A²ODF fuser.
- **Thermal fuse (ODF fuser):** Contact of the thermal fuse opens and it interrupts power supply to the fuser heater when the temperature of the fuser heater is abnormally high.
- **Thermoswitch (A²ODF fuser):** The contact of the thermoswitch breaks to interrupt power supply to the fuser heater when the temperature of the fuser heater is abnormally high.

Fuser control functions

Learn about fuser control functions.

The printer has the following fuser control functions.

Table 3-9 Fuser control functions

Function	Supported feature
Fuser temperature control	Yes
Fuser failure detection	Yes
Frequency detection circuit failure detection	Yes
Fuser pressure release mechanism failure detection	Yes
Fuser type discrepancy detection	Yes
Fuser type identification detection	No
Fuser presence detection	Yes
Fuser life detection	Yes
Relay failure detection	No
Pressure roller cleaning	Yes

Engine laser/scanner system

Learn about the engine laser/scanner system.

The DC controller controls the laser scanner system by following the instruction from the formatter. The DC controller formats the latent electrostatic image on the surface of photosensitive drum by controlling the components of the laser scanner system as dictated by the VIDEO signals.

The main components of the image-formation system are as follows:

- Laser assembly
- Scanner motor assembly
- Beam detect (BD) sensor
- Scanner mirror



NOTE: The printer has one laser scanner assembly each for yellow, magenta, cyan, and black.

Figure 3-10 Laser scanner system

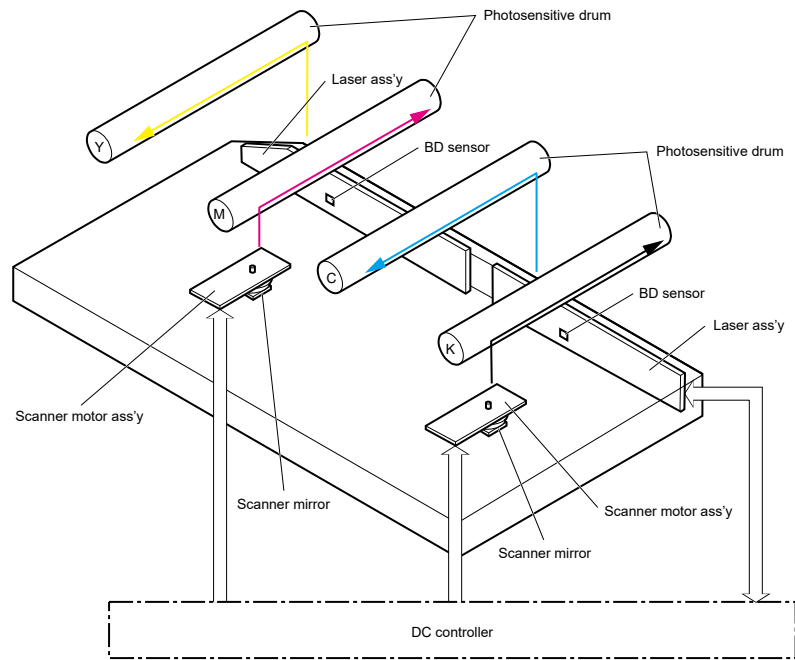

Laser scanner failure detection

Learn about laser scanner failure detection functions.

The DC controller detects the following laser scanner failures.

Table 3-10 Laser scanner failure detection

Function	Supported feature
BD failure detection	No
Scanner motor start-up failure detection	Yes
Scanner motor rotational failure detection	Yes
Laser scanner failure detection	No

Laser scanner safety

Learn about laser scanner safety.

The printer has door interlock switches. In the case that one of the following doors opens, the interlock switches stop output to the laser for the user or service technician's safety.

- Front door

- Right door

Image-formation process

Learn about the image-formation process.

The DC controller controls the image-formation system according to commands from the formatter. The DC controller controls the internal components of the image-formation system to form the toner image on the photosensitive drum surface. The toner image is then transferred to the print media and fused. The system consists of the following components:

- Toner cartridges
- Intermediate Transfer Belt (ITB)
- Primary transfer (T1) roller
- Secondary transfer (T2) roller
- Fuser
- Laser scanner assembly
- High-voltage power supply

Figure 3-11 Image-formation system

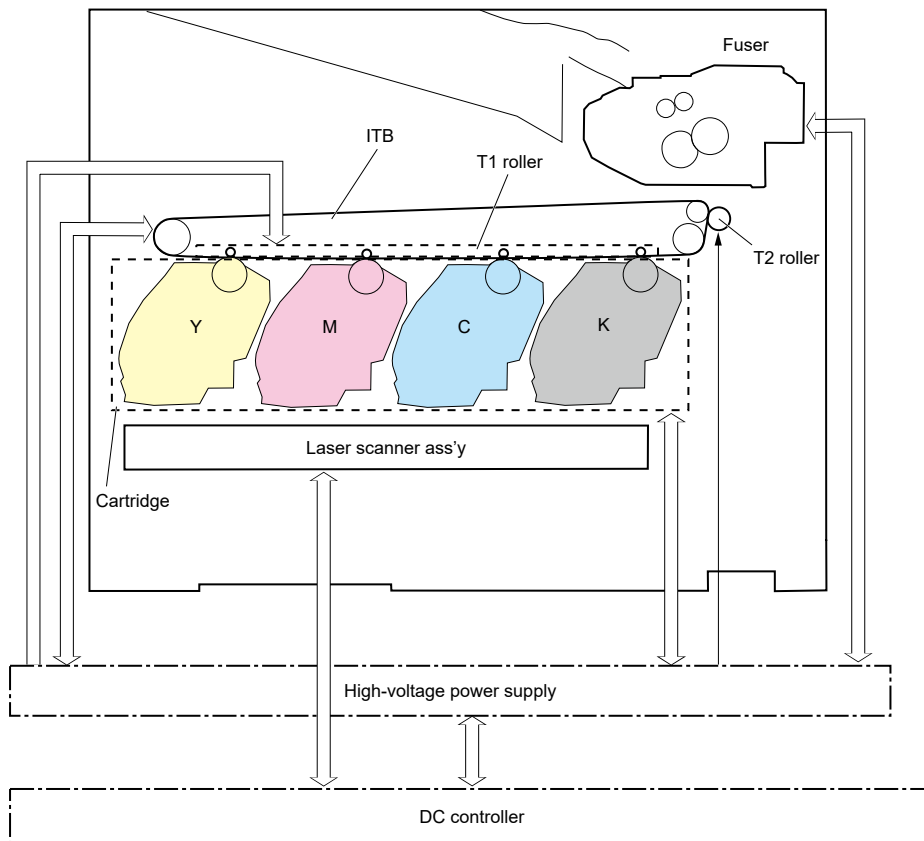

Image-formation system motors

The following figure shows the motors for the image-formation system.

Figure 3-12 Image-formation system motors

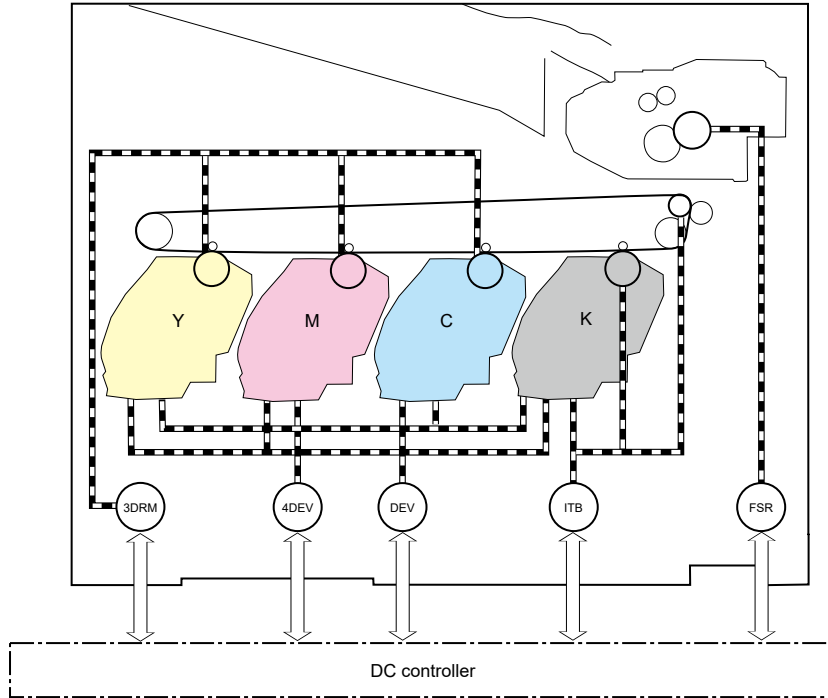

Table 3-11 Image-formation system motors

Item	Abbreviation	Component
4DEV	4DEV_MTR	Developer motor
3DRM	3DRM_MTR	Drum motor
ITB	ITB_MTR	ITB motor
FSR	FSR_MTR	Fuser motor
DEV	DEV_MTR	Developer alienation motor

Image-formation system sensors

The following figure shows the sensors for the image-formation system.

Figure 3-13 Image-formation system sensors

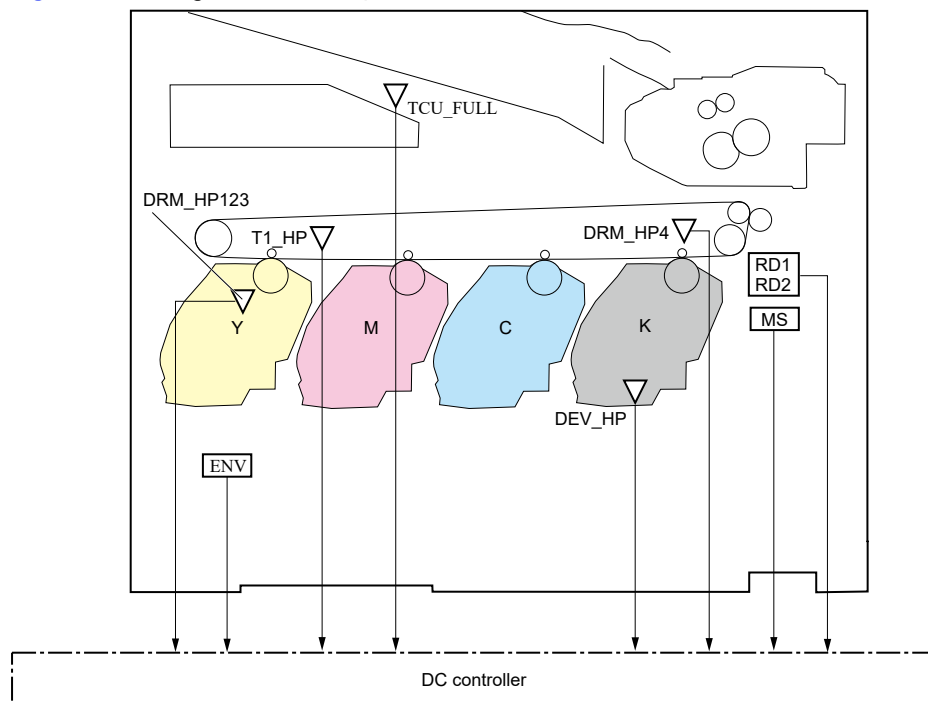

Table 3-12 Image-formation system sensors

Item	Abbreviation	Name
DRM_HP123	DRM_HP123_SNS	Drum home position sensor YMC
DRM_HP4	DRM_HP4_SNS	Drum home position sensor K
DEV_HP	DEV_HP_SNS	Developer alienation sensor
TCU_FULL	TCU_FULL_SNS	ITB toner collection near full sensor
T1_HP	T1_HP_SNS	ITB alienation sensor
MS	- (Media sensor PCA)	Media sensor
RD1	- (RD sensor PCA)	Registration density sensor 1
RD2	- (RD sensor PCA)	Registration density sensor 2
ENV	ENV_SNS	Environment sensor

Step 1: Pre-exposure (X57945 models only)

Learn about the image formation pre-exposure step.

 **NOTE:** This step applies to the X57945 models only.

Light from the pre-exposure LED strikes the surface of the photosensitive drum to remove any residual electrical charges from the drum surface.

Figure 3-14 Pre-exposure

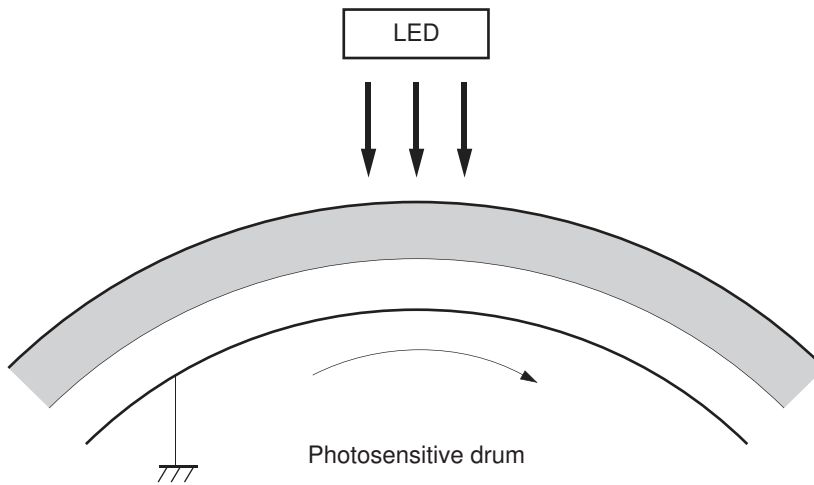

Step 2: Primary charging

Learn about the image formation primary charging step.

To prepare for latent image formation, the surface of the photosensitive drum is charged with a uniform negative charge. The primary charging roller receives the primary charging bias, and then the roller charges the drum by direct contact.

Figure 3-15 Primary charging

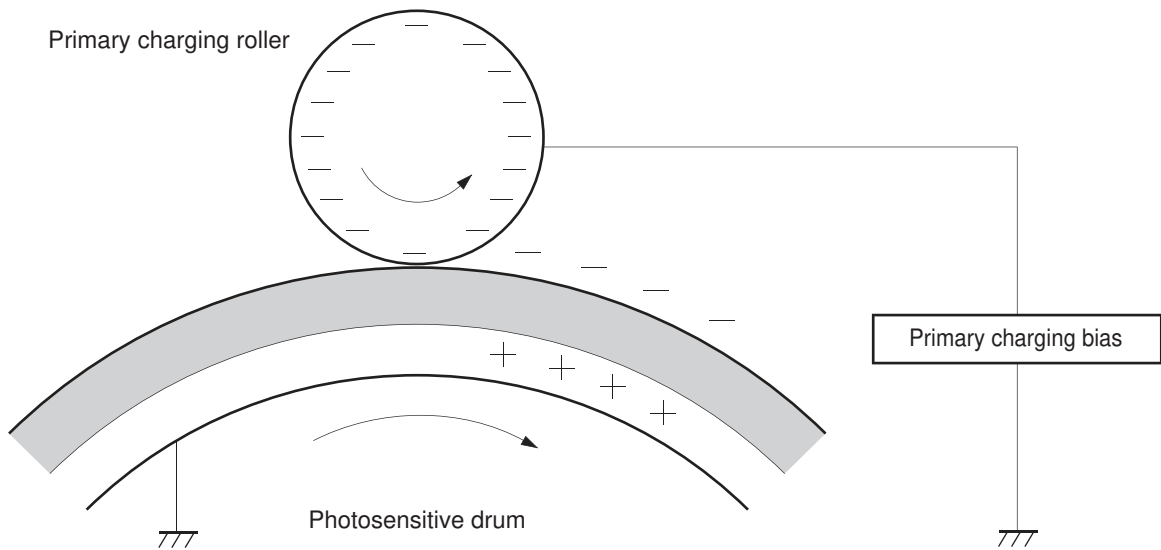

Step 3: Laser-beam exposure

Learn about the image formation laser-beam exposure step.

The laser beam strikes the photosensitive drum to neutralize the negative charge on the portions of the drum surface where the image will form. An electrostatic latent image forms where the negative charge was neutralized. The neutralized areas on the drum are ready to accept toner.

Figure 3-16 Laser-beam exposure

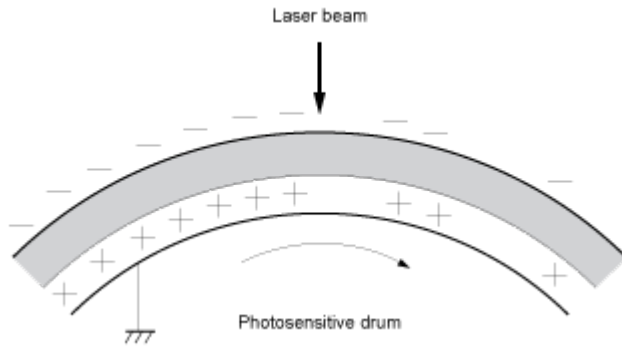

Step 4: Development

Learn about the image formation development step.

A developing bias is applied to the developing roller. The toner acquires a negative charge as a result of the friction from the developing roller rotating against the developing blade. Because the negatively charged surface of the photosensitive drums were neutralized where they have been struck by the laser beam, the toner adheres to those areas on the drums. The latent image becomes visible on the surface of the drum.

Figure 3-17 Development

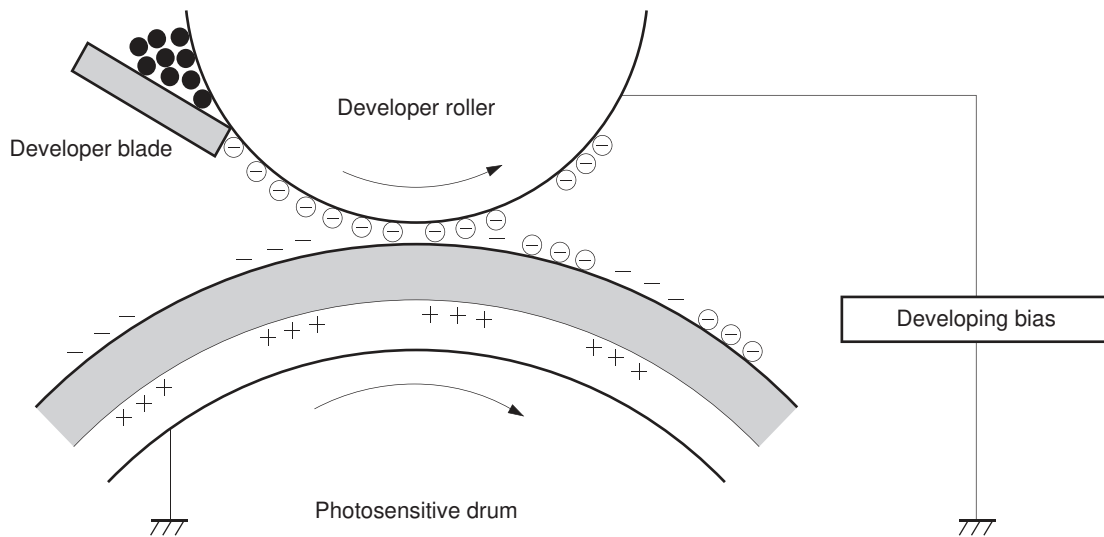

Step 5: Primary transfer

Learn about the image formation primary transfer step.

The toner on the photosensitive drum is transferred to the ITB. T1 bias is applied to the T1 roller to charge the ITB positive. The ITB attracts the negatively charged toner from the surface of each photosensitive drum. The complete toner image forms on the ITB.

Figure 3-18 Primary transfer

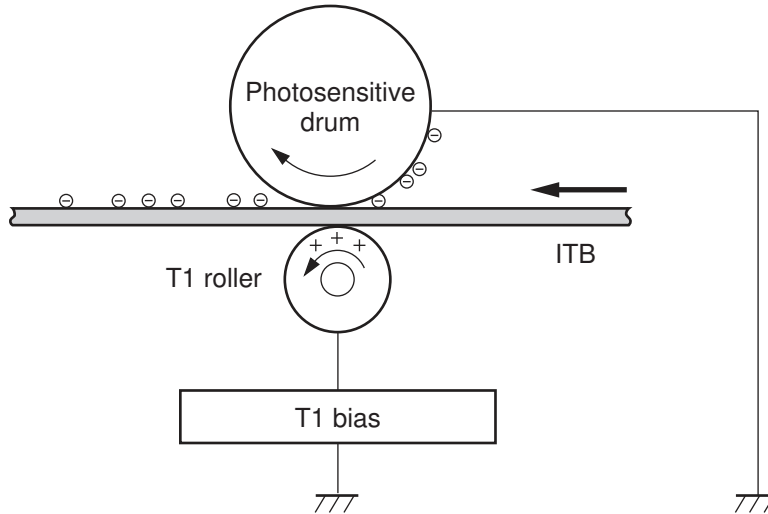

Step 6: Secondary transfer

Learn about the image formation secondary transfer step.

The paper acquires a positive charge from the secondary-transfer roller, and attracts the negatively charged toner from the surface of the ITB. The complete toner image transfers onto the paper.

Figure 3-19 Secondary transfer

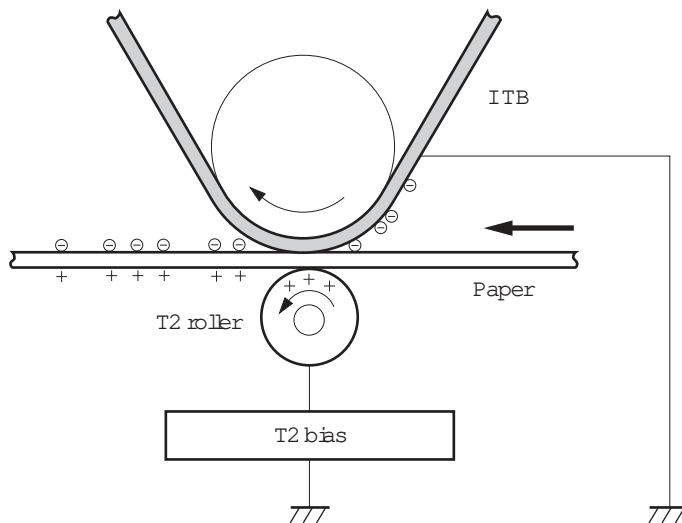

Step 7: Separation

Learn about the image formation separation step.

The stiffness of the paper causes it to separate from the ITB as the ITB bends. The static-charge eliminator removes excess charge from the paper for stable paper feeding and print quality.

Figure 3-20 Separation

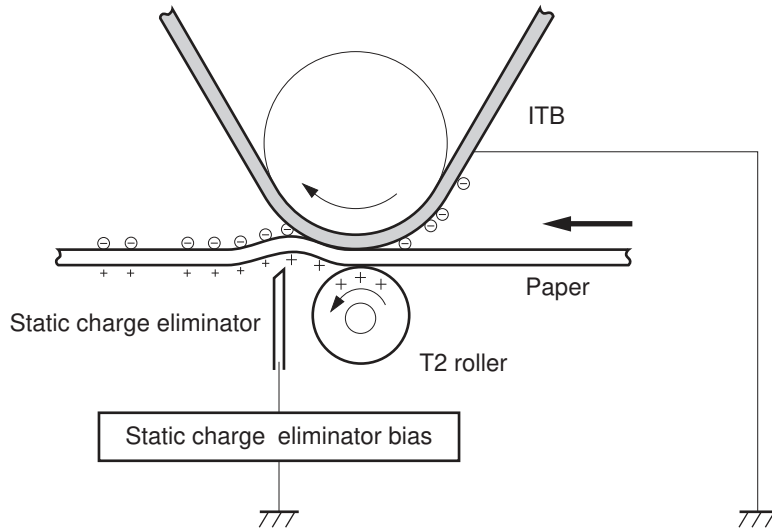

Step 8: Fusing

Learn about the image formation fusing step.

The printer uses an on-demand fusing method to adhere the toner image onto the page. As the page passes through the heated and pressurized rollers in the fuser the toner melts onto the page. The toner image is now permanently fused to the page. A fusing bias applied to the pressure roller improves image quality.

Figure 3-21 Fusing

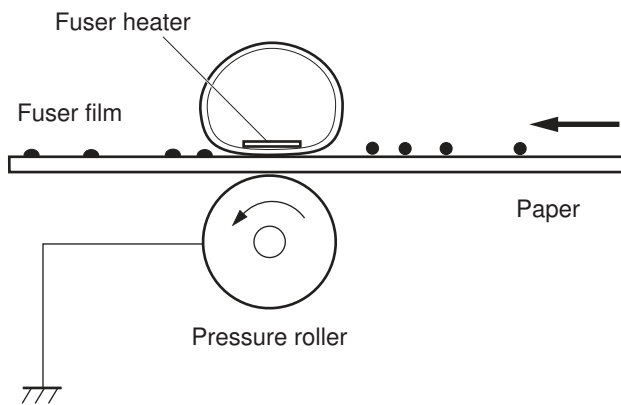

Step 9: ITB cleaning

Learn about the image formation ITB cleaning step.

ITB cleaning process is to remove the residual toner on the ITB surface.

The residual toner is scraped off by the cleaning blade and then collected into the toner collection box ass'y by the toner feed screw.

Figure 3-22 ITB cleaning

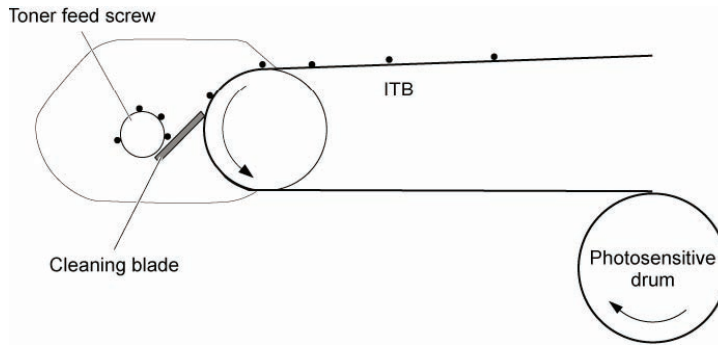

Toner cartridges

Learn about the toner cartridges.

The following sections discuss the printer toner cartridges. The printer has four toner cartridges, one for each color: cyan, magenta, yellow, and black.

Design

Learn about toner cartridge design.

Each toner cartridge is filled with toner and consists of the following components:

- Photosensitive drum
- Developer
- Primary-charging roller
- Memory chip

The printer has four cartridges, one for each color: yellow, magenta, cyan and black. Each of them has the same structure

The X57945 models have two cartridge types: four (YMCK) toner cartridges and four imaging drums (YMCK).

Figure 3-23 Standard toner cartridge block diagram

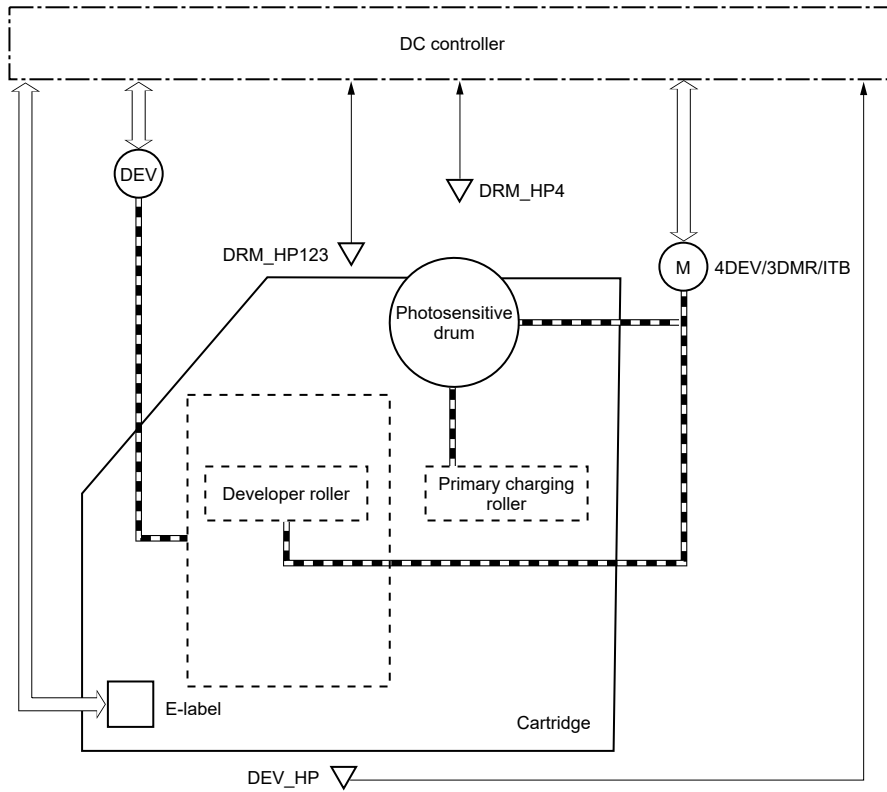
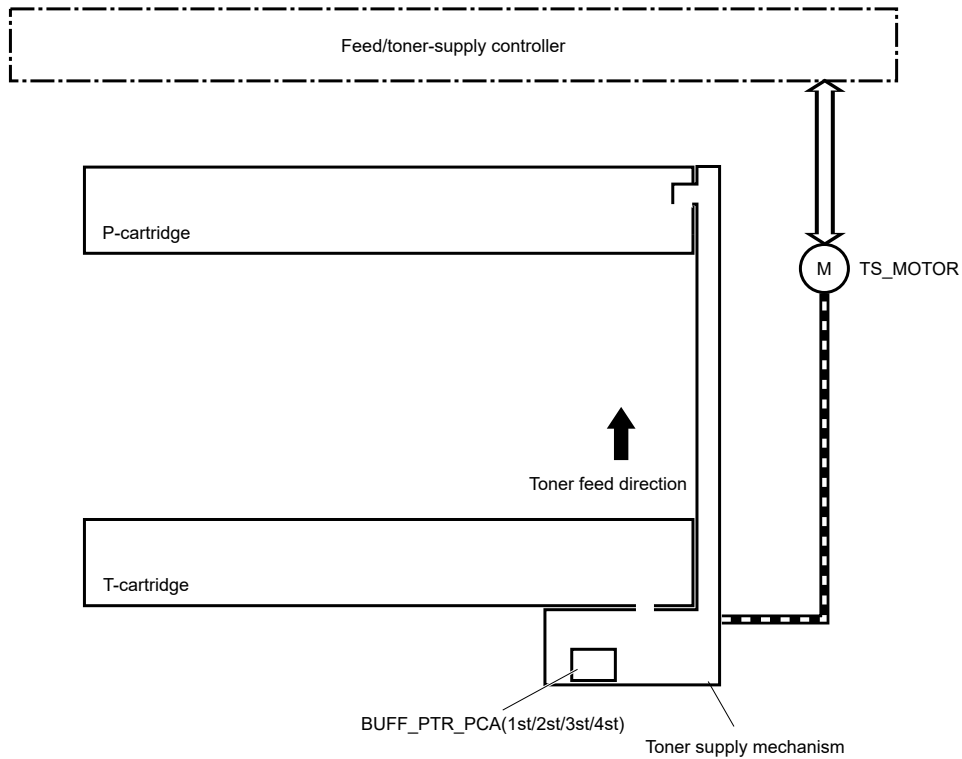

Figure 3-24 Toner cartridge and imaging drum block diagram



Toner cartridge functions

Learn about toner cartridge functions.

The printer has the following cartridge functions.

Table 3-13 Cartridge functions

Function	Supported feature
Cartridge presence detection (not applicable to T-cartridges)	Yes
Toner level detection	Yes
Cartridge life detection	Yes
Cartridge misinstallation detection	Yes
Developer alienation control	Yes
Developer alienation motor failure detection	Yes
Drum discharge mechanism	No

Intermediate transfer belt assembly

Learn about the intermediate transfer belt (ITB) assembly.

The ITB unit accepts the toner images from the photosensitive drums and transfers the completed image to the paper. The ITB unit has the following main components:

- Intermediate transfer belt (ITB)
- ITB-drive roller
- Primary-transfer roller
- ITB cleaner

Figure 3-25 ITB unit

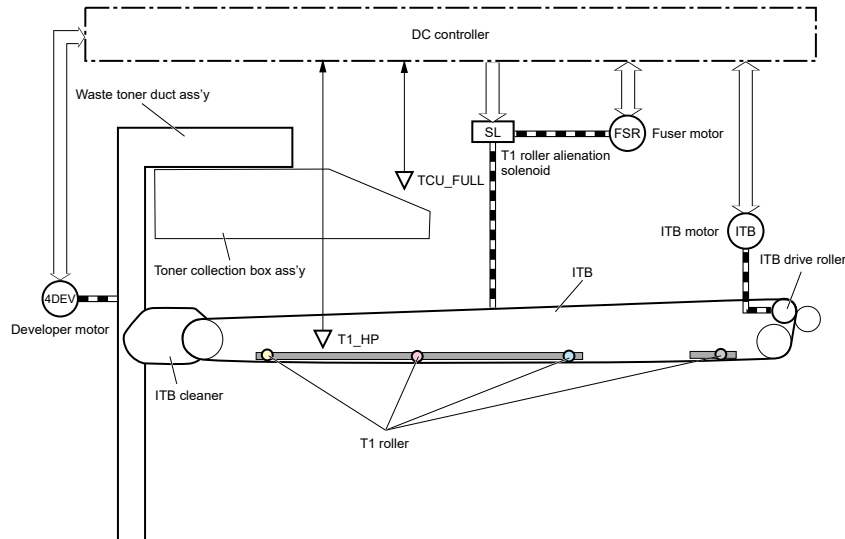

Intermediate transfer belt (ITB) functions

Learn about intermediate transfer belt functions.

The printer has the following ITB assembly functions.

Table 3-14 Intermediate transfer belt functions

Function	Supported feature
T1 roller alienation control	Yes
T1 roller alienation mechanism failure detection	Yes
ITB assembly life detection	Yes
ITB assembly presence detection	No
Blade cleaning mechanism	Yes
Electrostatic cleaning mechanism	No
ITB toner collection box full detection	No
ITB toner collection box presence detection	No
ITB perimeter detection	Yes
ITB seal detection sensor failure detection	No
New ITB detection	Yes
ITB cleaning mechanism	No

Table 3-14 Intermediate transfer belt functions (continued)

Function	Supported feature
Toner collection box full detection	Yes
Toner collection box presence detection	No

Secondary transfer roller assembly

Learn about the secondary transfer roller assembly.

The secondary transfer roller assembly transfers the toner image on the ITB to the paper.

Secondary transfer roller functions

Learn about secondary transfer roller functions.

The printer has the following secondary transfer roller functions.

Table 3-15 Secondary transfer roller functions

Function	Supported feature
Secondary transfer roller cleaning mechanism	Yes
Secondary transfer roller presence detection	No
Secondary transfer roller life detection	Yes
Secondary transfer roller alienation control	Yes

Calibration

Learn about the printer calibration process.

The printer calibrates itself to maintain proper print-quality. The calibration corrects color-misregistration and color-density variation due to environmental changes or internal variation in the printer.

Calibration functions

Learn about color calibration functions.

The printer has the following calibration functions.

Table 3-16 Calibration functions

Function	Supported feature
Color-plane registration correction control	Yes
Environment correction control	Yes
Image density control (DMAX)	Yes
Image halftone control (DHALF)	Yes
Registration density sensor failure detection	Yes
Color sensor control	No

Table 3-16 Calibration functions (continued)

Function	Supported feature
Gray axis control (GAS)	No
Environment sensor failure detection	Yes

Engine pickup, feed, and delivery system

Learn about the printer pickup, feed, and delivery system.

The DC controller controls the pickup, feed, and delivery system according to commands from the formatter. The pickup, feed, and delivery system uses a series of rollers to move the paper through the printer.

The pickup, feed, and delivery system consists of the following three functional blocks.

- **Pickup-and-feed-block:** Controls the movement of the paper from each pickup source to the fuser inlet
- **Fuser-and-delivery-block:** Controls the movement of the paper from the fuser to the delivery destination
- **Duplex block:** Controls the movement of the paper from the duplex switchback unit to the duplex re-pickup unit

Figure 3-26 Engine pickup, feed, and delivery system (5700/X557/5800 models)

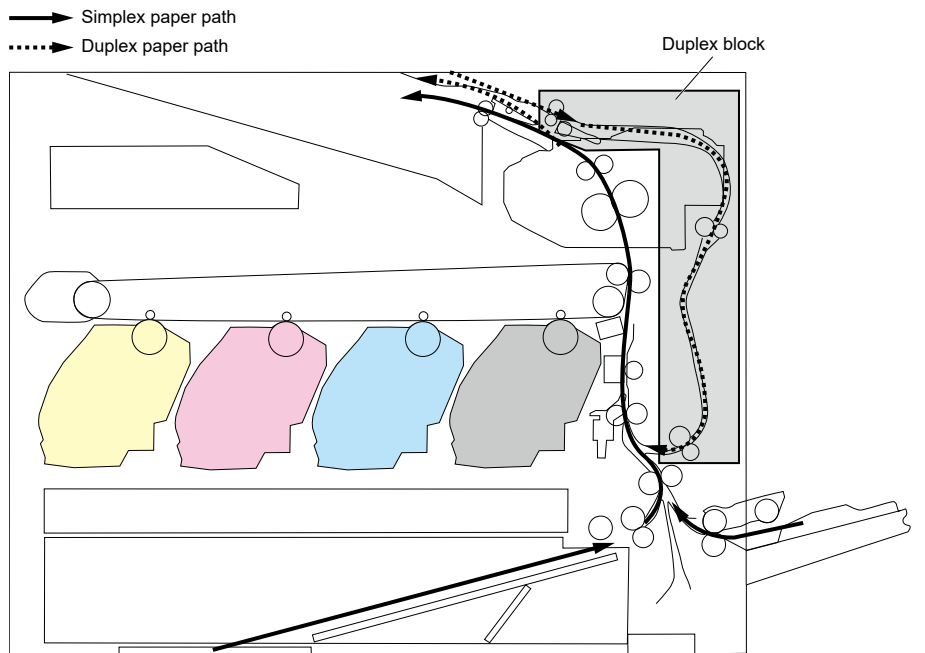
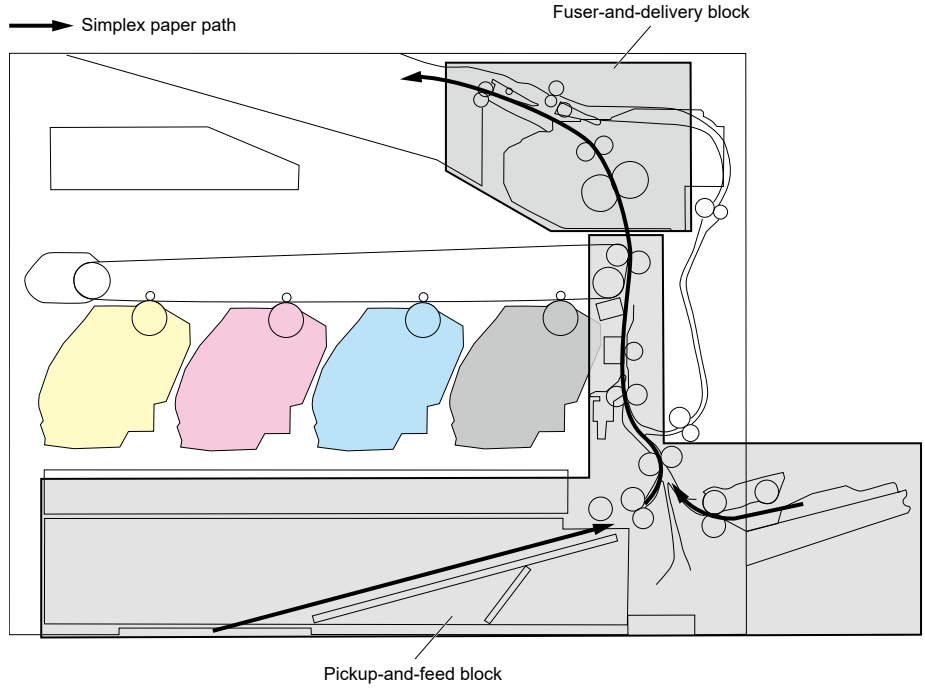
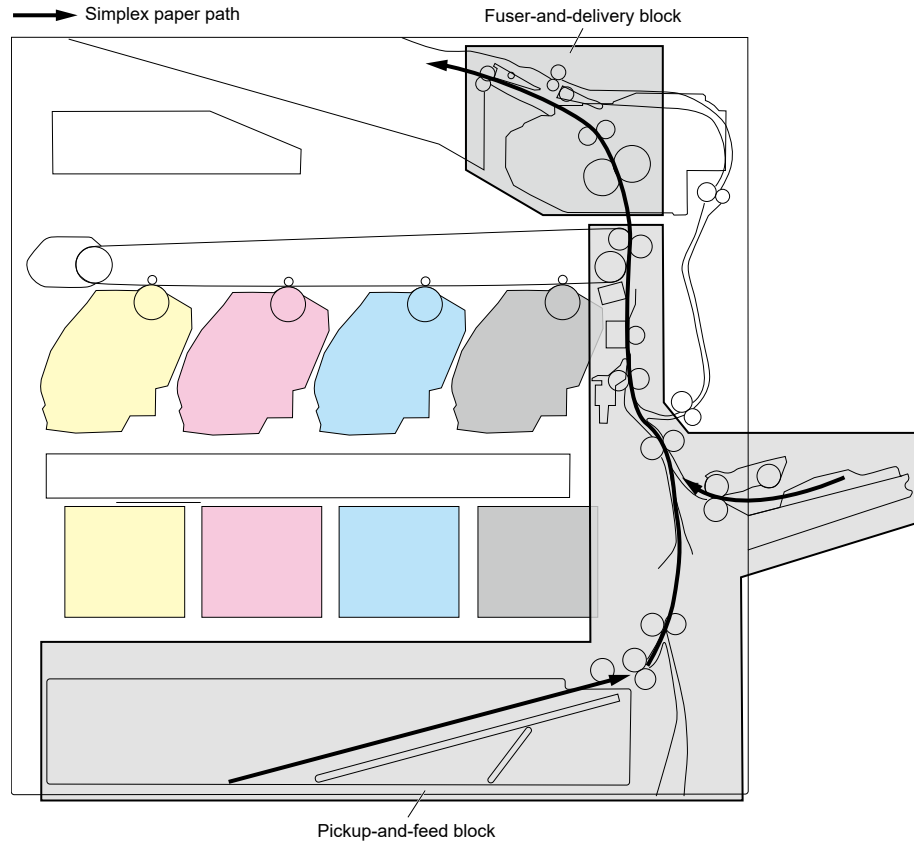

Figure 3-27 Engine pickup, feed, and delivery system (X57945 models)



Sensors and switches

Learn about the pickup, feed, and delivery sensors and switches.

The following figure shows the sensors and switches for the pickup, feed, and delivery system.

Figure 3-28 Photo sensors and switches

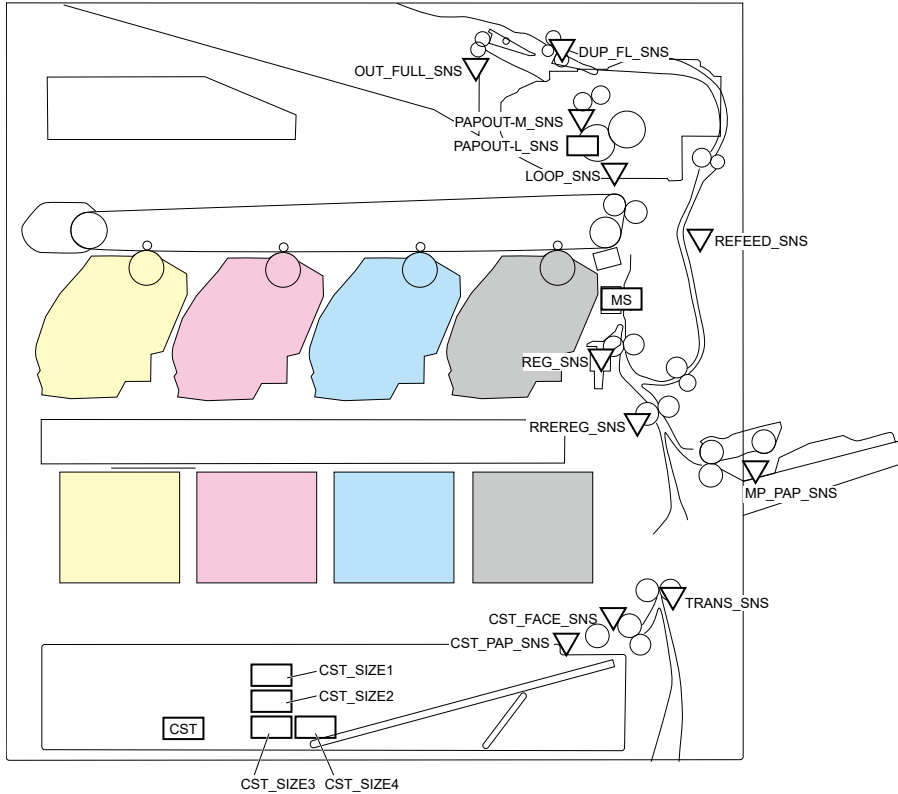

Table 3-17 Photo sensors and switches

Abbreviation	Component
CST_SIZE1	Tray 2 media size switch 1 (X557/X579 models only)
CST_SIZE2	Tray 2 media size switch 2 (X557/X579 models only)
CST_SIZE3	Tray 2 media size switch 3 (X557/X579 models only)
CST_SIZE4	Tray 2 media size switch 4 (X557/X579 models only)
CST	Tray 2 cassette presence switch
DUP_FL_SNS	Duplex flapper position sensor
OUT_FULL_SNS	FD1 media full sensor
CST_PAP_SNS	Tray 2 media out sensor
CST_FACE_SNS	Tray 2 media surface sensor
LOOP_SNS	Fuser loop sensor
REFEED_SNS	Duplex feed sensor (X557/X579 models only)
REG_SNS	Registration sensor
MP_PAP_SNS	Tray 1 media out sensor
PAPOUT-M_SNS	Fuser output sensor 2
TRANS_SNS	Tray 2 feed sensor (X57945 models only)
MS (Media sensor PCA)	Media sensor

Table 3-17 Photo sensors and switches (continued)

Abbreviation	Component
PAPOUT-L_SNS	Fuser output sensor 1

Motors, clutches, and solenoids

Learn about the pickup, feed, and delivery motors, clutches, and solenoids.

The following figure shows the motors, clutches, and solenoids for the pickup, feed, and delivery system.

Figure 3-29 Motors, clutches, and solenoids (5700/X557/5800 models)

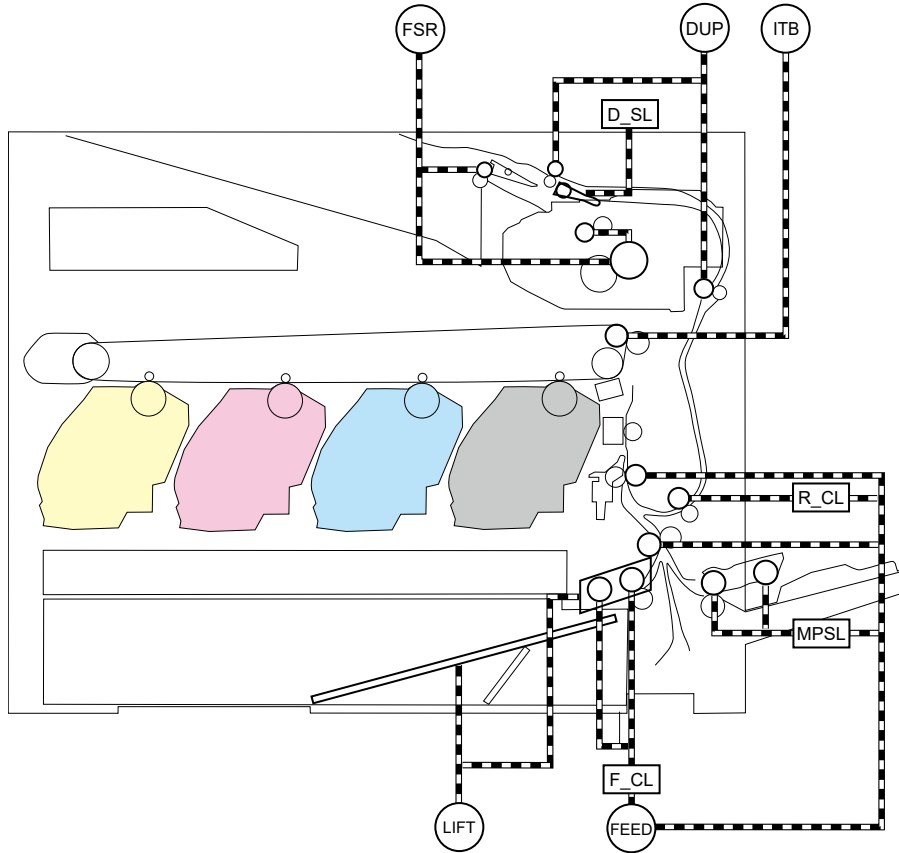

Abbreviation 1	Abbreviation 2	Component
ITB	ITB_BK_MTR	ITB motor
FSR	FSR_MTR	Fuser motor
FEED	FEED_MTR	Pickup motor
LEFT	LIFT_MTR	Lifter motor
DUP	DUP_MTR	Duplex motor
MPSL	MP-SL	Tray 1 pickup solenoid
D_SL	DUP_SL	Duplex flapper solenoid
F_CL	FEED_CL	Tray 2 pickup clutch

Abbreviation 1	Abbreviation 2	Component
R_CL	REFEED_CL	Duplex re-pickup clutch

Figure 3-30 Motors, clutches, and solenoids (X57945 models)

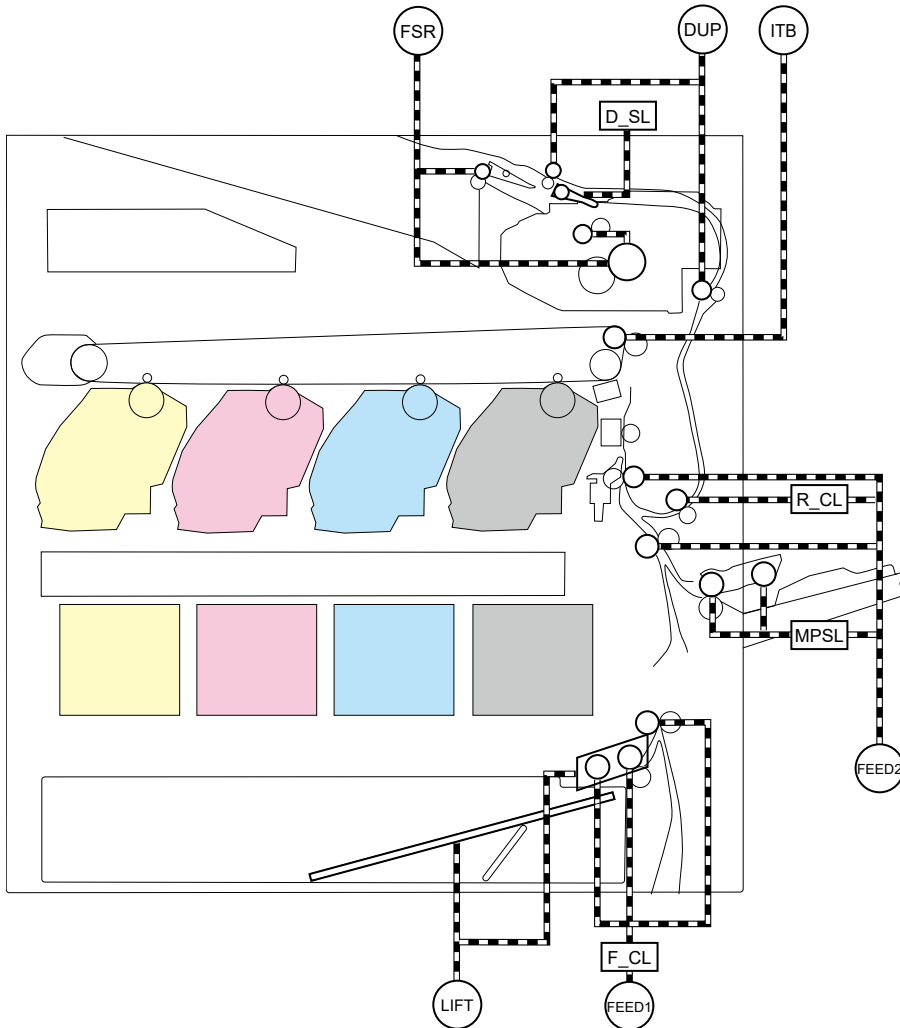

Abbreviation 1	Abbreviation 2	Component
ITB	ITB_BK_MTR	ITB motor
FSR	FSR_MTR	Fuser motor
FEED1	FEED_MTR	Pickup motor
FEED2	FEED_MTR	Feed motor
LEFT	LIFT_MTR	Lifter motor
DUP	DUP_MTR	Duplex motor
MPSL	MP-SL	Tray 1 pickup solenoid
D_SL	DUP_SL	Duplex flapper solenoid

Abbreviation 1	Abbreviation 2	Component
F_CL	FEED_CL	Tray 2 pickup clutch
R_CL	REFEED_CL	Duplex re-pickup clutch

Feed speed control

Learn about pickup, feed, and delivery feed speed control.

The DC controller adjusts the feed speed to improve the print quality depending on the paper type. The paper is fed at a specified speed according to the print mode designated by the formatter.

Table 3-18 Print mode and feed speed

Print mode	Feed speed, monochrome	Feed speed, full color
Auto	3/4/5	3/4/5
Normal media 1	3/4	3/4
Normal media 2	3/4	3/4
Heavy media 1	3/4	3/4
Heavy media 2	3/5	3/5
Heavy media 3	4/5	4/5
Light media 1	3	3
Light media 2	3	3
Light media 3	3	3
Glossy media 1	5	5
Glossy media 2	5	5
Glossy media 3	5	5
Glossy film	5	5
Photo media 1	Not applicable	Not applicable
Photo media 2	Not applicable	Not applicable
Photo media 3	Not applicable	Not applicable
Envelope	3/4	3/4
OHT	5	5
Extra light media	3	3
Label	3/4	3/4
Designated media 1	3/4	3/4
Designated media 2	4/5	4/5
Designated media 3	3	3

Pickup and feed delivery features

Learn about pickup, feed, and delivery print mode and feed speed features.

The printer has the following pickup, feed and delivery functions.

Table 3-19 Print mode and feed speed

Function	Supported feature
Cassette (Tray 2) media size detection	Yes (X557/X57945 models only)
Cassette (Tray 2) presence detection	Yes
Cassette (Tray 2) media surface detection	Yes
Cassette (Tray 2) media presence detection	Yes
Cassette (Tray 2) media level detection	Yes
Cassette (Tray 2) lift-up control	Yes
Cassette (Tray 2) lift-down control	Yes
Cassette (Tray 2) multiple-feed prevention mechanism	No
Cassette (Tray 2) pickup roller presence detection	Yes
Cassette (Tray 2) pickup roller alienation detection	Yes
Tray 1 (MP) tray media presence detection	Yes
Tray 1 (MP) tray media width detection	No
Tray 1 (MP) tray last-media detection	No
Skew-feed prevention mechanism	Yes
Feed speed control	Yes
Loop control	Yes
Media detection	Yes
OHT detection	Yes
Image leading edge positioning	Yes
Media length detection	No
Media width detection	Yes
Pressure roller pressure release control	Yes
Output bin media-full detection	Yes
Automatic delivery	Yes
Duplex switchback control	Yes
Duplex feed control	Yes

Media detection

Learn about pickup, feed, and delivery media detection.

The printer is equipped with media sensor on paper path, and can detect media type fed. The media sensor consists of an optical sensor which detects surface roughness and ultrasonic sensor which detects paper weight, and the distance between the optical sensor and the print media is kept constant by roller.

The DC controller detects media type using the media sensor and switches to an optimized print mode for the media, if Auto mode is designated from the formatter and media type for the specified input source is not designated from the formatter.

The followings are print modes that can be switched for media detection.

- Normal
- Heavy media 1
- Heavy media 2
- Heavy media 3
- Light media
- Glossy media 1
- Glossy media 2
- Glossy media 3
- Rough media
- OHT
- Glossy film

Jam detection/prevention

Learn about pickup, feed, and delivery jam detection.

The printer uses the following sensors to detect the presence of paper and to check whether paper is being fed correctly or has jammed.

- Registration sensor (REG_SNS)
- Fuser output sensor 1 (PAPOUT-L_SNS)
- Fuser output sensor 2 (PAPOUT-M_SNS)
- Fuser loop sensor (LOOP_SNS)
- FD1 media full sensor (OUT_FULL_SNS)
- Duplex feed sensor (REFEED_SNS) (X557/X57945 models only)
- Tray 2 feed sensor (TRANS_SNS) (X57945 models only)
- PF feed sensor (PS23) (550-sheet paper feeder only)
- HCI feed sensor (SR4) (HCI only)

Figure 3-31 Jam detection sensors (X57945 models models)

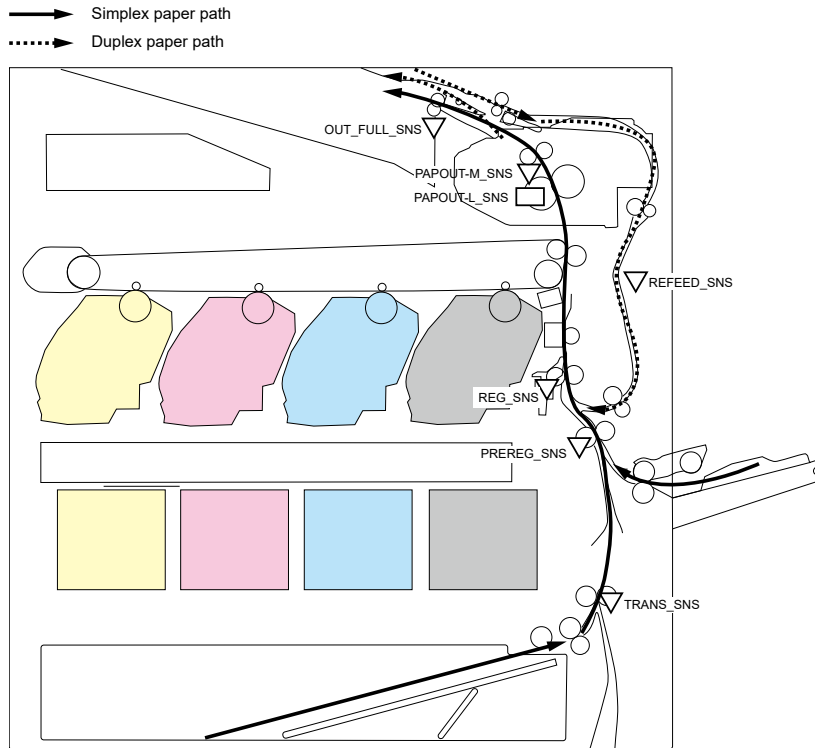

Figure 3-32 Jam detection sensors (5700/X557/5800 models and 550-sheet paper feeder)

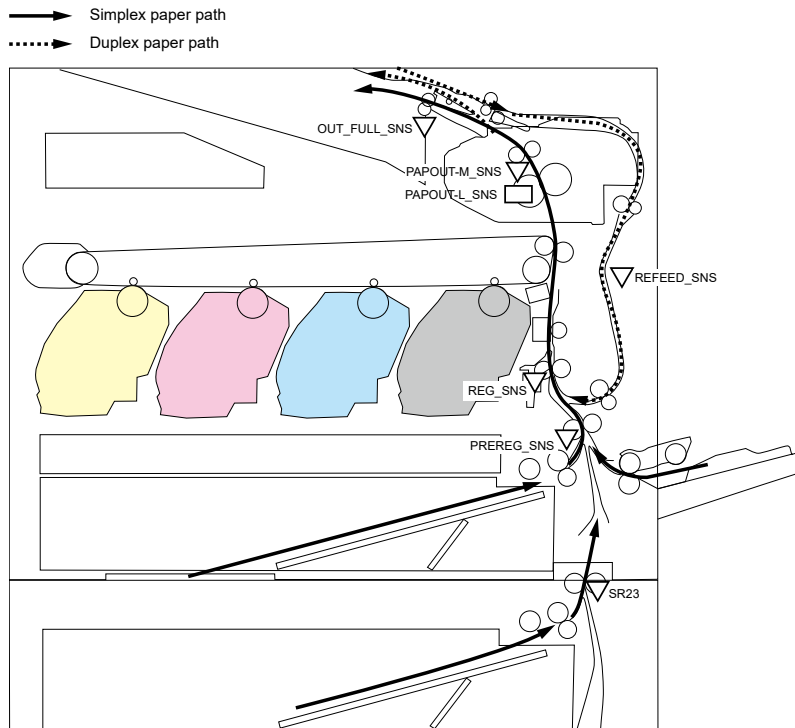
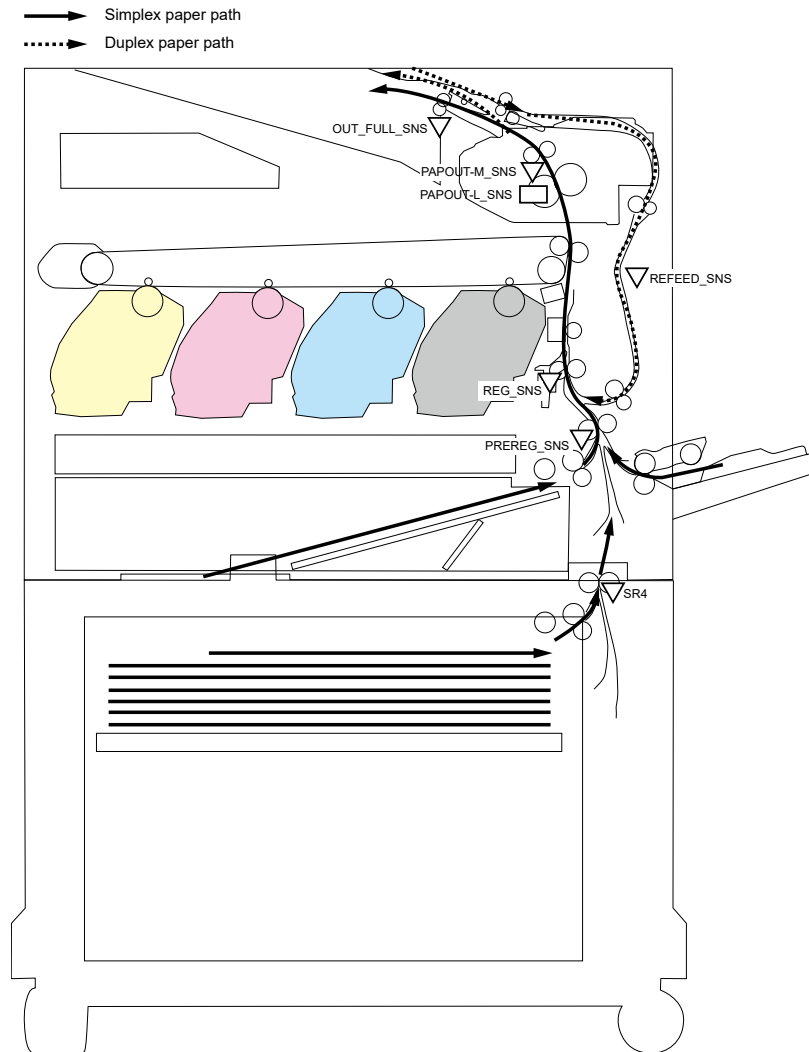

Figure 3-33 Jam detection sensors (5700/X557/5800 models and HCI)



The printer determines that a jam has occurred if one of these sensors detects paper at an inappropriate time. The DC controller stops the print operation and notifies the formatter.

The printer detects the following jams:

- No pick jam 1
- No pick jam 2
- No pick jam 3
- Pickup stay jam 1
- Fuser delivery delay jam 1
- Fuser delivery delay jam 2
- Fuser delivery stay jam 1
- Fuser delivery stay jam 2
- Residual paper jam 1

- Door open jam 1
- Fuser wrap jam 1
- Fuser wrap jam 2
- Duplex feed delay jam
- Duplex re-pickup delay jam
- Delivery delay jam 1
- Inappropriate to the delivery path jam 2
- Transfer area wrapping jam

Input devices

Learn about the input devices.

550-sheet paper feeder

Learn about the 550-sheet paper feeder (Tray 3).

The 550-sheet paper feeder is installed at bottom of the printer. It picks up the print media and feeds it to the printer. The paper feeder controller controls the operational sequence of the paper feeder.

550-sheet paper feeder paper path

Learn about the 550-sheet paper feeder paper path.

The figure below shows the 550-sheet paper feeder paper path.

Figure 3-34 550-sheet paper feeder paper path

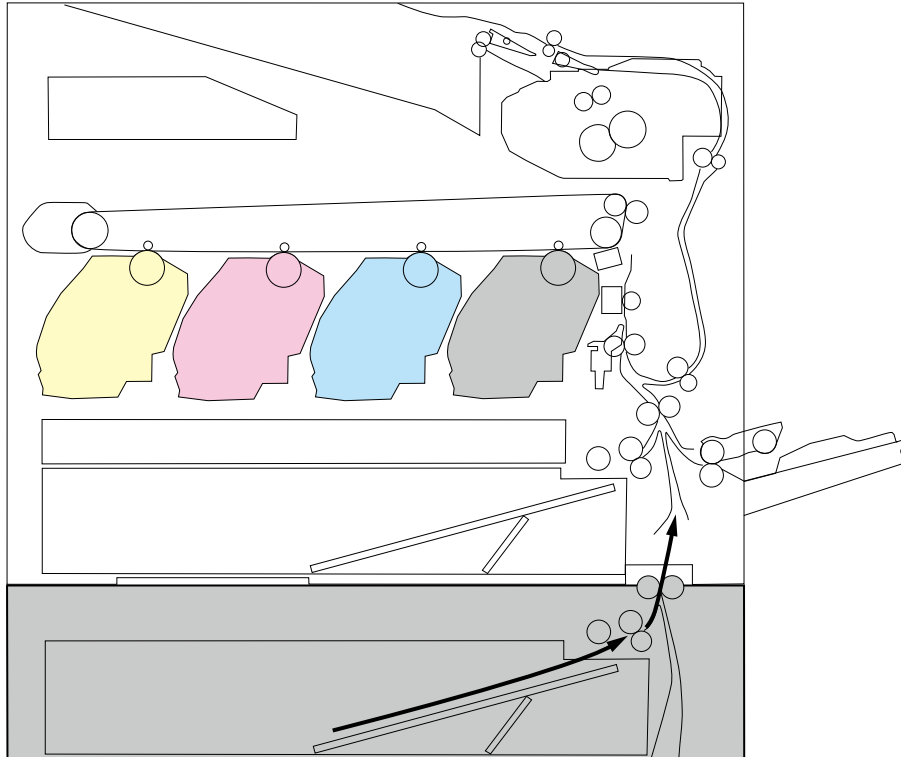

Paper feeder controller

Learn about the paper feeder controller.

The figure below shows the paper feeder controller block diagram.

Figure 3-35 Paper feeder controller

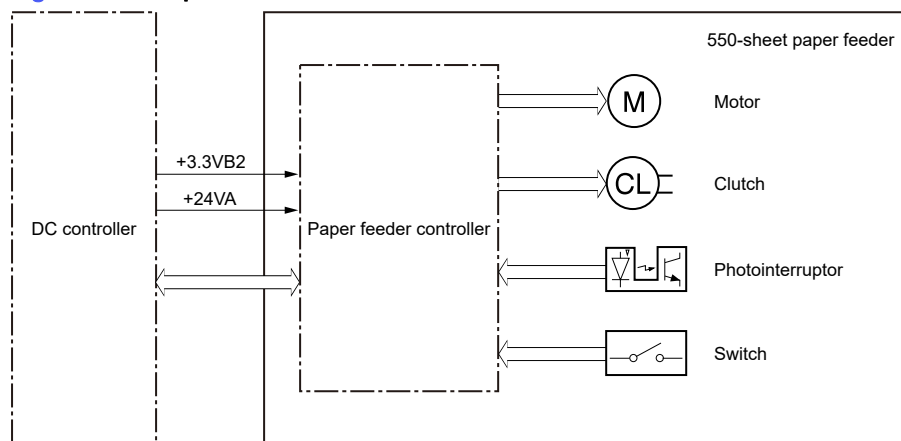

550-sheet paper feeder electrical components

Learn about the 550-sheet paper feeder electrical components.

The figure below shows the paper feeder electrical components. The table in this section describes the paper feeder electrical components.

Figure 3-36 Paper feeder electrical components

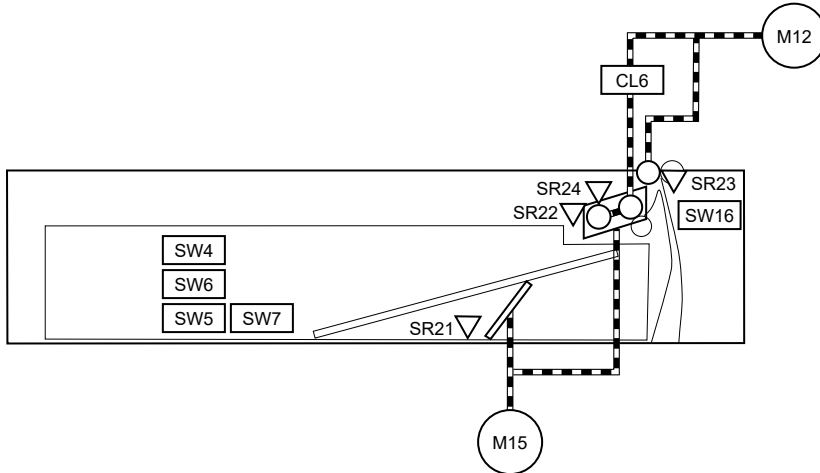

Table 3-20 Electrical component list, paper feeder

Component type	Abbreviation	Component name
Motor	M12	Paper feeder feed motor
Motor	M15	Paper feeder lifter motor
Clutch	CL6	Paper feeder pickup clutch
Switch	SW4	Paper feeder media size switch 1
Switch	SW5	Paper feeder media size switch 2
Switch	SW6	Paper feeder media size switch 3
Switch	SW7	Paper feeder media size switch 4
Switch	SW16	Paper feeder door switch
Photo interrupter	SR21	Paper feeder lifter motor rotation sensor
Photo interrupter	SR22	Paper feeder media out sensor
Photo interrupter	SR23	Paper feeder feed sensor
Photo interrupter	SR24	Paper feeder media surface sensor

550-sheet paper feeder motor control

The 550-sheet paper feeder has two motors for the paper-feed and cassette lift-up.

The table below describes which components the paper feeder motors drive.

Table 3-21 Paper feeder motors

Abbreviation	Component	Drives	Failure detection
M12	Paper feeder feed motor	Paper feeder cassette pickup roller Paper feeder cassette feed roller Paper feeder feed roller	No

Table 3-21 Paper feeder motors (continued)

Abbreviation	Component	Drives	Failure detection
M15	Paper feeder lifter motor	Paper feeder cassette lifter drive assembly	No

550-sheet paper feeder other functions

Learn about the other paper feeder pickup and feed functions.

The paper feeder has the following pickup and feed functions.

- Cassette lift-up control
- Cassette presence detection
- Cassette media size detection
- Cassette media stack surface detection
- Cassette media out detection
- Cassette media level detection
- Multiple-feed prevention
- Automatic delivery

550-sheet feeder jam detection

Learn about the 550-sheet feeder jam detection function.

The paper feeder uses the following sensor to detect the presence of paper and to check whether paper is being fed correctly or has jammed.

- Paper feeder feed sensor (SR23)

The printer determines that a jam has occurred if the sensor detects paper at an inappropriate time.

High capacity input (HCI) paper feeder

Learn about the HCI.

The HCI is optionally installed at bottom of the printer. It picks up the print media and feeds it to the printer. The HCI controller controls the operational sequence of the HCI.

HCI paper path

Learn about the HCI paper path.

The figure below shows the HCI paper path.

Figure 3-37 HCl paper path

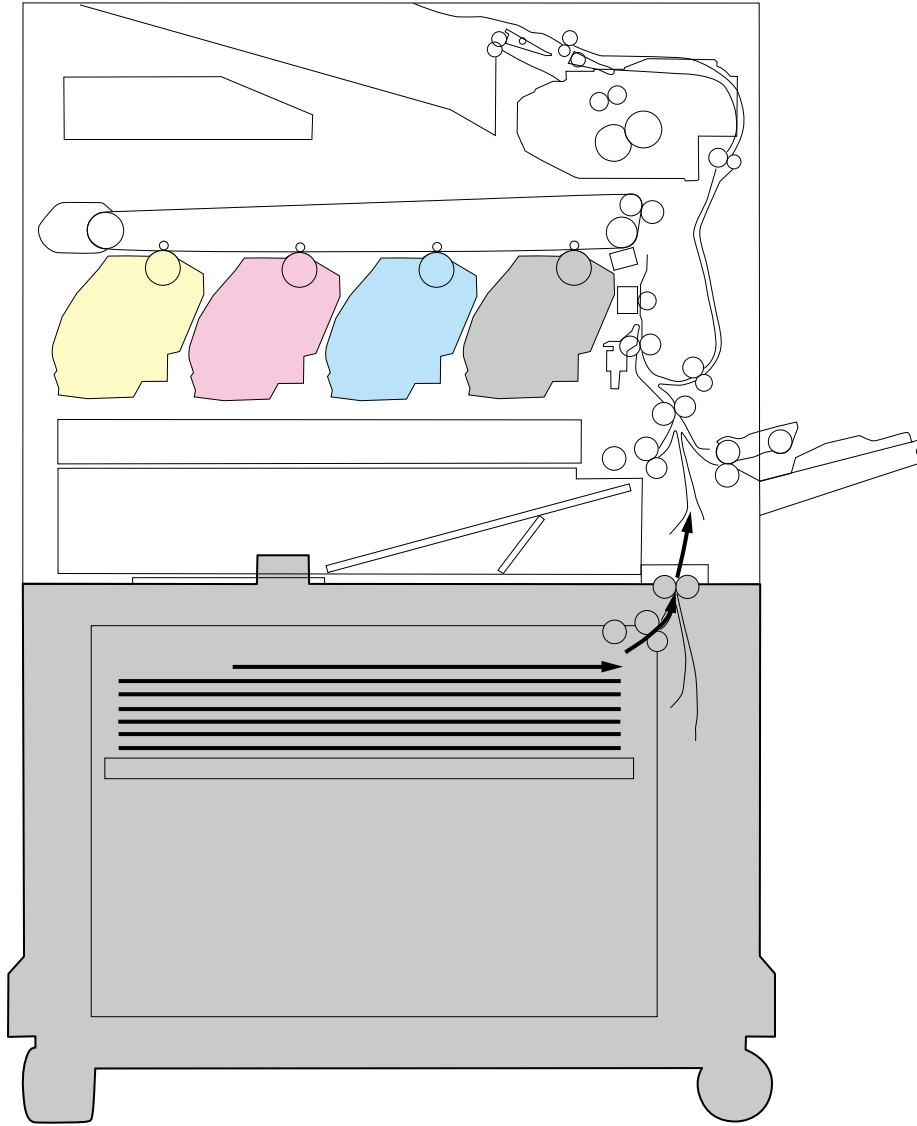

HCl controller

Learn about the HCl controller.

The figure below shows the HCl controller block diagram.

Figure 3-38 HCl controller

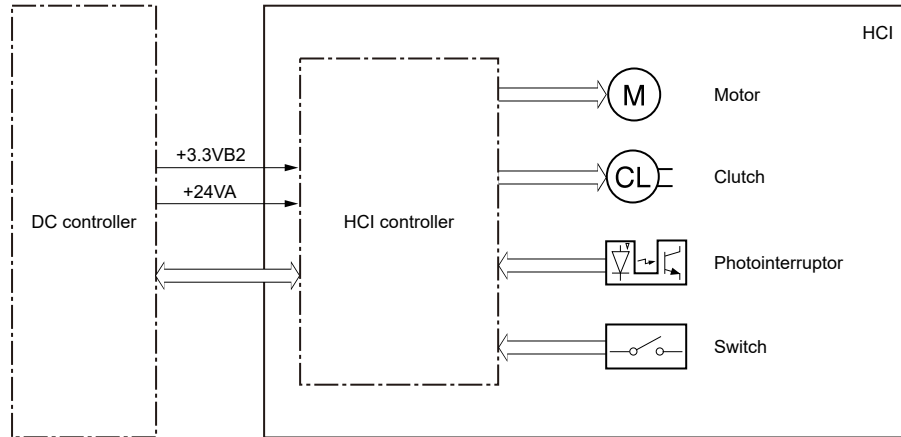

HCl electrical components

Learn about the HCl electrical components.

The figure below shows the HCl electrical components. The table in this section describes the HCl electrical components.

Figure 3-39 HCl electrical components

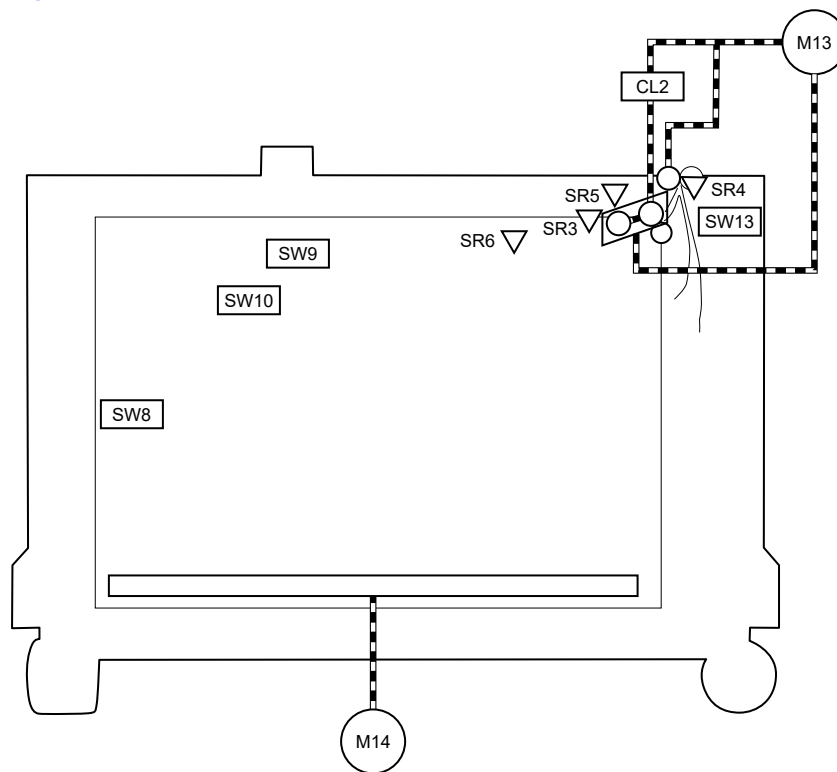

Table 3-22 Electrical component list, HCl

Component type	Abbreviation	Component name
Motor	M13	HCl feed motor
Motor	M14	HCl lifter motor

Table 3-22 Electrical component list, HCI (continued)

Component type	Abbreviation	Component name
Clutch	CL2	HCI pickup clutch
Switch	SW8	HCI cassette lifting plate position switch
Switch	SW9	HCI cassette media size switch 1
Switch	SW10	HCI cassette media size switch 2
Switch	SW13	HCI door switch
Photo interrupter	SR3	HCI cassette media out sensor
Photo interrupter	SR4	HCI feed sensor
Photo interrupter	SR5	HCI cassette media surface sensor
Photo interrupter	SR6	HCI cassette pickup rotation sensor

HCI motor control

The HCI has two motors for the paper-feed and cassette lift-up.

The table below describes which components the HCI motors drive.

Table 3-23 Paper feeder motors

Abbreviation	Component	Drives	Failure detection
M13	HCI feed motor	HCI cassette pickup roller HCI cassette feed roller HCI feed roller	No
M14	HCI lifter motor	HCI cassette lifter drive assembly	No

HCI other functions

Learn about the other HCI pickup and feed functions.

The HCI has the following pickup and feed functions.

- Cassette lift-up control
- Cassette presence detection
- Cassette media size detection
- Cassette media stack surface detection
- Cassette media out detection
- Cassette multiple-feed prevention
- Automatic delivery

HCI jam detection

Learn about the HCI jam detection function.

The HCI uses the following sensor to detect the presence of paper and to check whether paper is being fed correctly or has jammed.

- HCI feed sensor (SR4)

The printer determines that a jam has occurred if the sensor detects paper at an inappropriate time.

Output devices

Learn about the output devices.

3-bin stapler-stacker

Learn about the 3-bin stapler-stacker.

The 3-bin stapler-stacker is installed on the upper side of the printer. It delivers the print media to the output bin after the staple process. The unit's controller controls the operational sequence of the paper feeder.

3-bin stapler-stacker paper path

Learn about the 3-bin stapler-stacker paper path.

The figure below shows the 3-bin stapler-stacker paper path.

Figure 3-40 3-bin stapler-stacker paper path

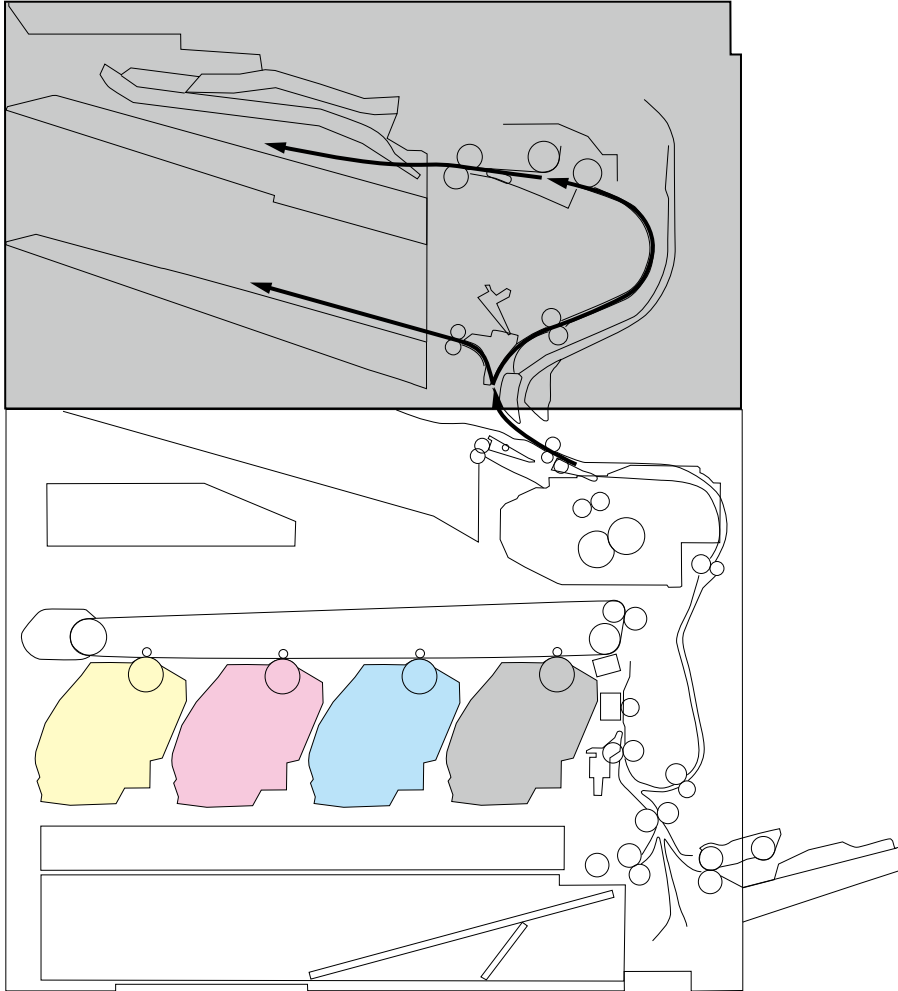

3-bin stapler-stacker controller

Learn about the 3-bin stapler-stacker controller.

The figure below shows the 3-bin stapler-stacker controller block diagram.

Figure 3-41 3-bin stapler-stacker controller

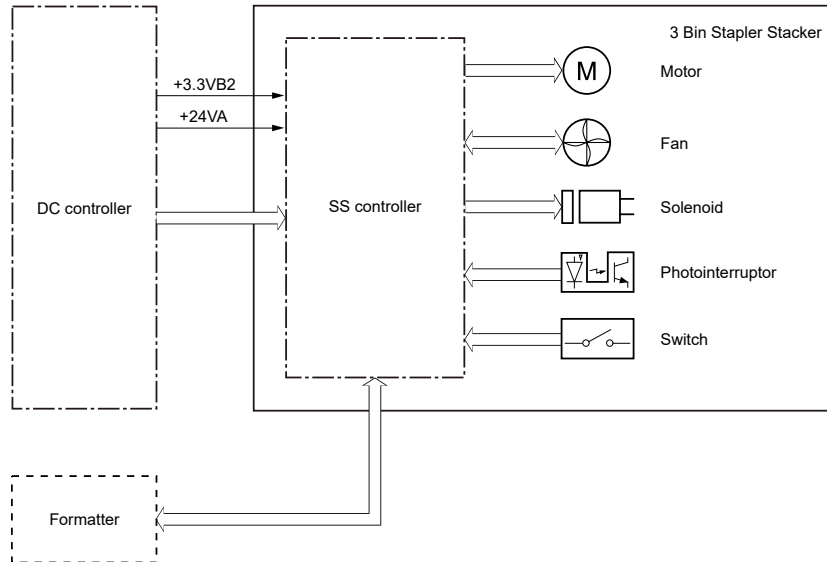

3-bin stapler-stacker electrical components

Learn about the 3-bin stapler-stacker electrical components.

The figures below show the 3-bin stapler-stacker electrical components. The table in this section describes the 3-bin stapler-stacker electrical components.

Figure 3-42 3-bin stapler-stacker motors and solenoids

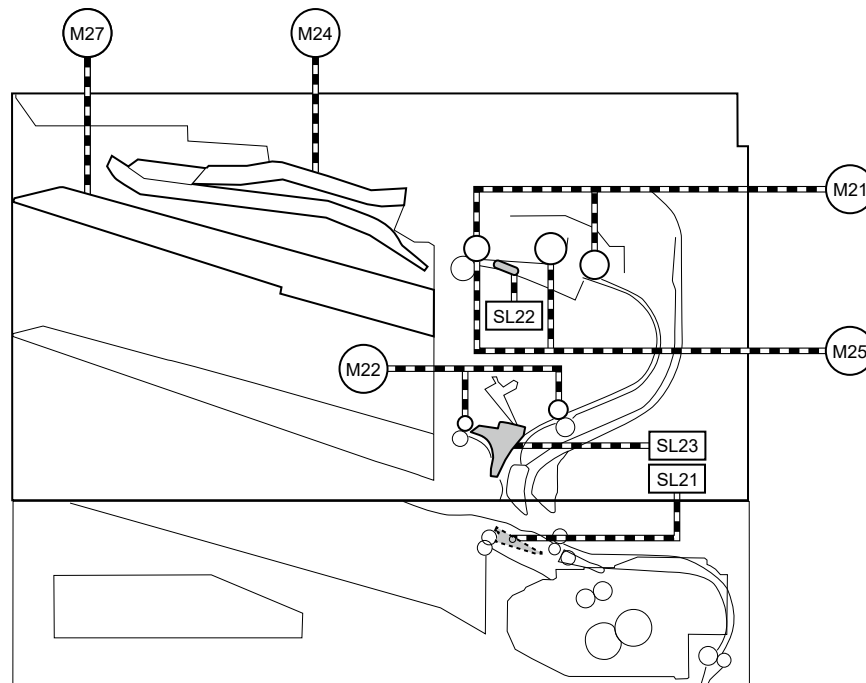

Figure 3-43 3-bin stapler-stacker sensors and switches

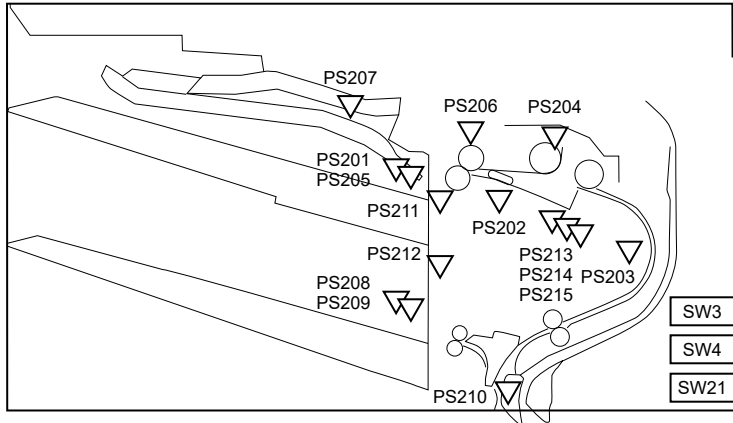

Table 3-24 Electrical component list, 3-bin stapler-stacker

Component type	Abbreviation	Component name
Motor	M21	Stapler-stacker output motor
Motor	M22	Stapler-stacker feed motor
Motor	M24	Jogger motor
Motor	M25	Y alignment motor
Motor	M26	Stapler motor
Motor	M27	Lifter motor
Fan	FAN21	Stapler-stacker fan
Solenoid	SL21	Inlet flapper solenoid
Solenoid	SL22	Stamp solenoid
Solenoid	SL23	Output bin 2 flapper solenoid
Photo interrupter	PS201	Bin 1 media presence sensor
Photo interrupter	PS202	Stapler-stacker exit sensor
Photo interrupter	PS203	Staple inlet sensor
Photo interrupter	PS204	Y alignment home position sensor
Photo interrupter	PS205	Bin 1 media full sensor 1
Photo interrupter	PS206	Alienation home position sensor
Photo interrupter	PS207	Jogger home position sensor
Photo interrupter	PS208	Bin 2 media presence sensor
Photo interrupter	PS209	Bin 2 media full sensor
Photo interrupter	PS210	Stapler-stacker inlet sensor
Photo interrupter	PS211	Bin 1 upper limit sensor
Photo interrupter	PS212	Bin 1 lower limit sensor
Photo interrupter	PS213	Staple low sensor
Photo interrupter	PS214	Staple ready sensor

Table 3-24 Electrical component list, 3-bin stapler-stacker (continued)

Component type	Abbreviation	Component name
Photo interrupter	PS215	Staple home position sensor
Switch	SW3	Stapler-stacker door switch
Switch	SW4	Staple door switch
Switch	SW21	Interlock switch

3-bin stapler-stacker motor control

The 3-bin stapler-stacker has six motors for paper feed, paper alignment, output bin lift up/down, and staple functions.

The table below describes which components the 3-bin stapler-stacker motors drive.

Table 3-25 Paper feeder motors

Abbreviation	Component	Drives	Failure detection
M21	Stapler-stacker output motor	Output bin 1 delivery roller Output bin 1 exit feed roller	No
M22	Stapler-stacker feed motor	Output bin 2 delivery roller Output bin 2 inlet feed roller	No
M24	Jogger motor	Jogger guide	Yes
M25	Y alignment motor	Alignment roller Engages/disengages the output bin 1 delivery roller	Yes
M26	Staple motor	Staple	Yes
M27	Lifter motor	Output bin 1 lifter	No

3-bin stapler-stacker fan control

The 3-bin stapler-stacker has one fan.

The table below describes the stapler-stacker fan functions.

Table 3-26 3-bin stapler-stacker fan

Abbreviation	Component	Cooling area	Type	Speed	Failure detection
FAN21	Stapler-stacker fan	Stapler-stacker interior	Intake	Full/low	Yes

3-bin stapler-stacker other functions

Learn about the other 3-bin stapler-stacker delivery functions.

The 3-bin stapler-stacker has the following delivery functions.

- Mailbox mode
- Staple control
- Automatic delivery

3-bin stapler-stacker jam detection

Learn about the 3-bin stapler-stacker jam detection function.

The 3-bin stapler-stacker uses the following sensors to detect the presence of paper and to check whether paper is being fed correctly or has jammed.

- Stapler-stacker inlet sensor (PS210)
- Staple inlet sensor (PS203)
- Stapler-stacker exit sensor (PS202)

The printer determines that a jam has occurred if the sensors detect paper at an inappropriate time. The stapler-stacker detects the following jams.

- Residual paper jam
- Feed delay jam
- Feed stay jam

4 Solve problems

Learn about solving printer problems.

How to search for printer documentation

The CPMD, error codes, and other support documentation for each printer is available on the HP portals.

For HP internal access to WISE, go to [WISE](#).

For HP channel partners access WISE, see [Accessing WISE for HP channel partners \(HP Partner Portal\) on page 111](#) or [Accessing WISE for HP channel partners \(CSDP\) on page 110](#).

WISE is available to call agents, service technicians, and HP internal users. The level of detail available depends on your access credentials. To learn how to find support content in WISE, [watch the video here](#).

How to search WISE for printer information and documentation

These instructions are for HP internal use by call agents, service technicians, and other internal users.

To learn how to find support content in WISE, watch the video here: [Finding Error Code and Control Panel Message Document in WISE](#).

 **TIP:** The Product Detail Page (PDP) is available from the WISE home page. Enter, and then select a product name or number in the **Go to a Product Detail Page** area (callout 1), or select the **...or select your product from a list** item (callout 2) on the WISE home page.

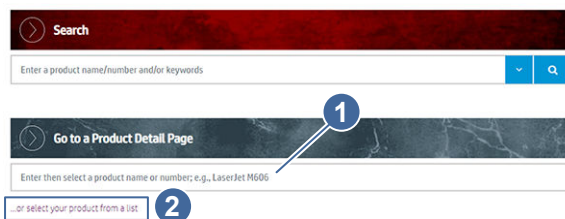

The screenshot shows two search input fields. The first field is titled "Search" and contains the placeholder text "Enter a product name/number and/or keywords". The second field is titled "Go to a Product Detail Page" and contains the placeholder text "Enter then select a product name or number; e.g., LaserJet M606". Below the second field is a link that says "...or select your product from a list". Callout 1 points to the second field, and callout 2 points to the link below it.

Many types of printer documentation and information are available on WISE. This section details methods for finding error code descriptions and solutions.

 **TIP:** To view a list of control panel message documents (CPMD) per printer, search for the following topic in **WISE**: HP LaserJet, OfficeJet, PageWide, ScanJet Enterprise - Control panel message document (CPMD) list or click the link below.

- [HP LaserJet, HP OfficeJet, HP PageWide, HP ScanJet - Control panel messages document \(CPMD\), Service manual, and Service cost data list](#)

Use one of the following methods to search for CPMD error code information.

- [Method 1: Use the WISE home page Error Code Lookup tool on page 105](#)
- [Method 2: Search for error codes using the WISE search function on page 106](#)
- [Method 3: Search for error codes using the Product Detail Page on page 108](#)

Method 1: Use the WISE home page Error Code Lookup tool

Use the WISE Error Code Lookup tool to find error code troubleshooting procedures using the following steps.

1. On the WISE home page, click the **Error Code Lookup tool** icon.

Figure 4-1 WISE Error Code Lookup tool icon

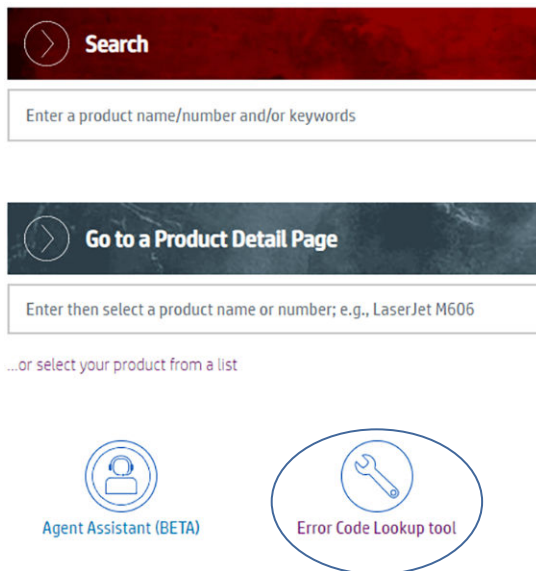

2. Enter a printer model number (for example, M606) in the **Error Code Lookup** dialog box.

Figure 4-2 WISE Error Code Lookup tool dialog box

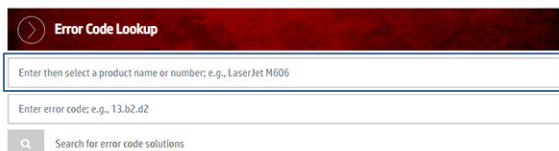

3. A drop-down list appears. Click on the full printer series name (for example, HP LaserJet Enterprise M606 series) in the list.



NOTE: Selecting the **series** item from the drop-down list is recommended for the most accurate search return.

Figure 4-3 WISE Error Code Lookup tool drop-down list

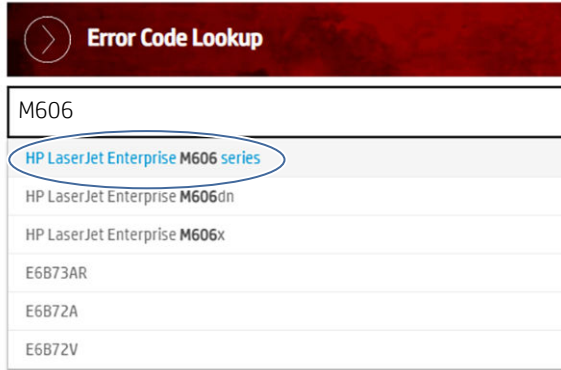

4. Type the error code (for example, 13.b2.d2) in the **Error Code Lookup** keyword field, and then select the search icon.

Figure 4-4 WISE Error Code Lookup tool search



5. The error code troubleshooting content displays in the **All Search Results** area.

Figure 4-5 WISE Search results

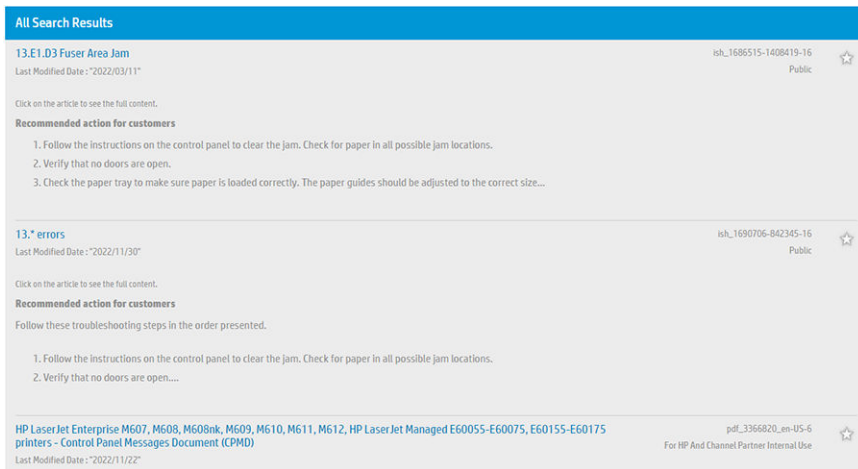

Method 2: Search for error codes using the WISE search function

Use the WISE search function to find error code troubleshooting procedures using the following steps.

1. On the WISE home page, enter a printer model number (for example, M606) in the **Search** dialog box.

Figure 4-6 WISE Search dialog box

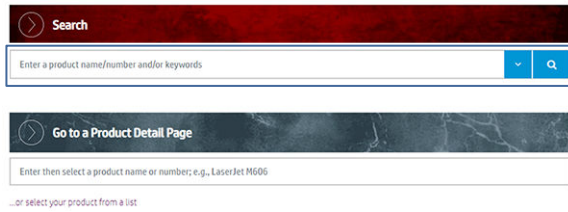

2. A drop-down list appears. Click on the full printer series name (for example, HP LaserJet Enterprise M606 series) in the list.

 **NOTE:** Selecting the **series** item from the drop-down list is recommended for the most accurate search return.

Figure 4-7 WISE Search drop-down list



3. Type the error code (for example, 13.E1.D3) in the **Search** keyword field, and then select the search icon.

Figure 4-8 WISE Search

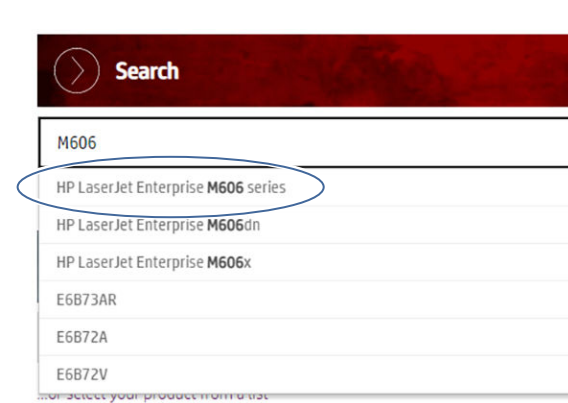

4. The error code troubleshooting content displays in the **All Search Results** area.

Figure 4-9 WISE Search results

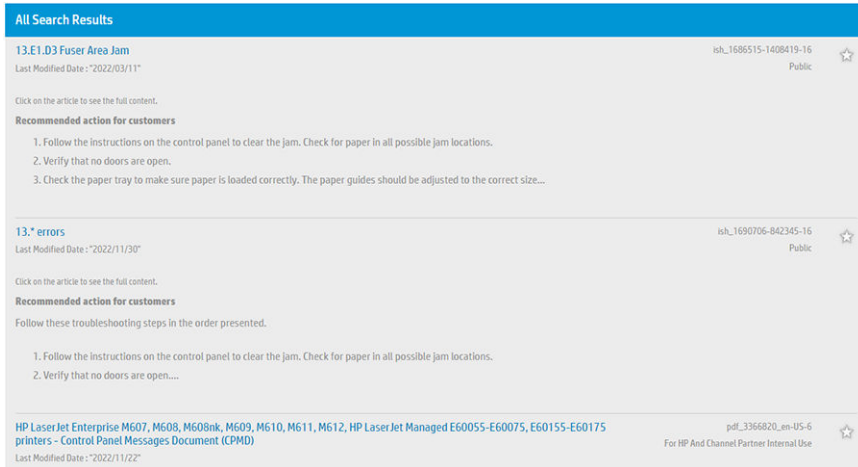

Method 3: Search for error codes using the Product Detail Page

Use the WISE Product Detail Page (PDP) to find error code troubleshooting procedures using the following steps.

1. On the WISE home page, enter a printer model number (for example, M606) in the **Go to a Product Detail page** dialog box.



TIP: To find a PDP from a list of products by product type, select the **...or select your product from a list** item just below the dialog box.

Figure 4-10 WISE PDP dialog box

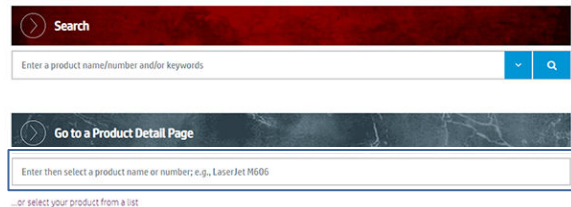

2. A drop-down list appears. Click on the full printer series name (for example, HP LaserJet Enterprise M606 series) in the list.



NOTE: Selecting the **series** item from the drop-down list is recommended for the most accurate search return.

Figure 4-11 WISE PDP drop-down list

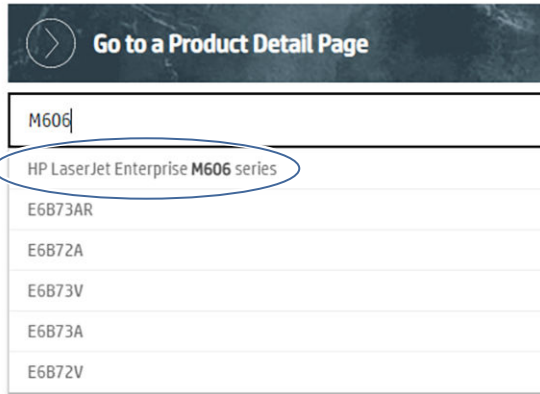

3. Type the error code (for example, 13.E1.D3) in the **Error Code Lookup** field, and then select the search icon.

Figure 4-12 WISE PDP search

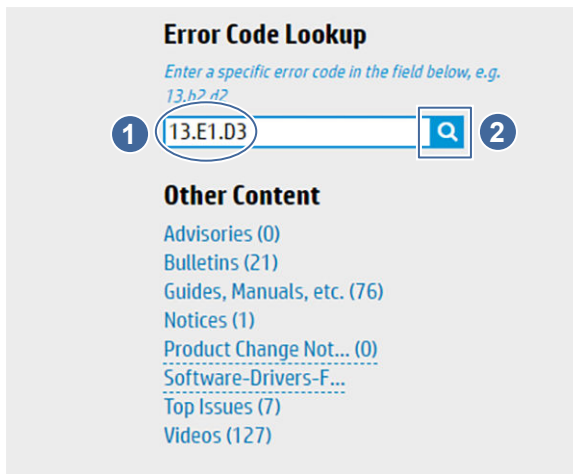

4. The error code troubleshooting content displays in the **All Search Results** area.

Figure 4-13 WISE PDP search results

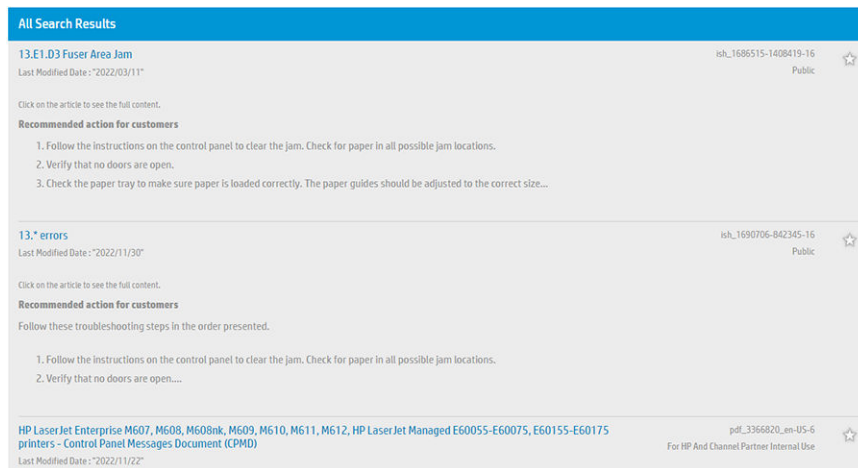

Accessing WISE for HP channel partners (CSDP)

Learn how to access WISE by accessing the HP Channel Services Delivery Platform (CSDP) if you are an HP Channel Partner.

 **IMPORTANT:** A Partner Admin must request access, via the CSDP portal, to create a new user before you can sign into the CSDP portal.

1. Sign-in to the CSDP portal (click csdp.hp.com to access the sign-in page).

Figure 4-14 CSDP sign-in page

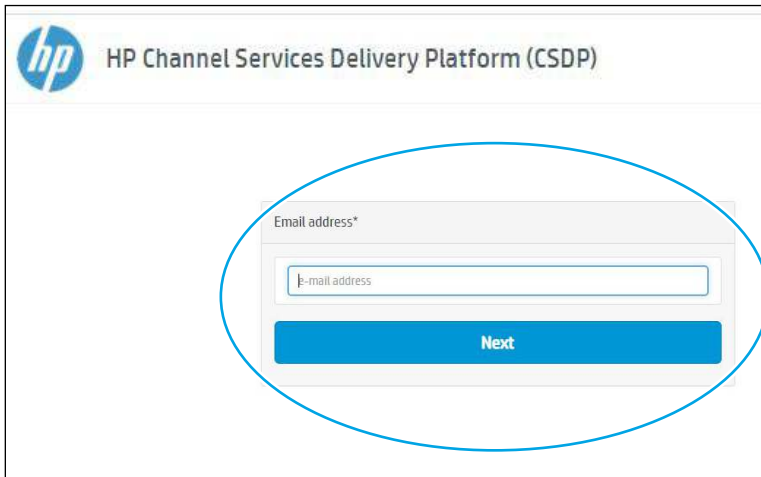

2. On the CSDP home page, click the **Knowledge and Training** item.

 **TIP:** Use the **Knowledge and Training** item at the top of the CSDP home page (callout 1), or the **Knowledge and Training** action icon (callout 2).

Figure 4-15 CSDP portal home page



3. Select **HP Technical Documentation** on the **Knowledge and Training** page to open the WISE portal home page.

Figure 4-16 CSDP portal HP Knowledge and Training page

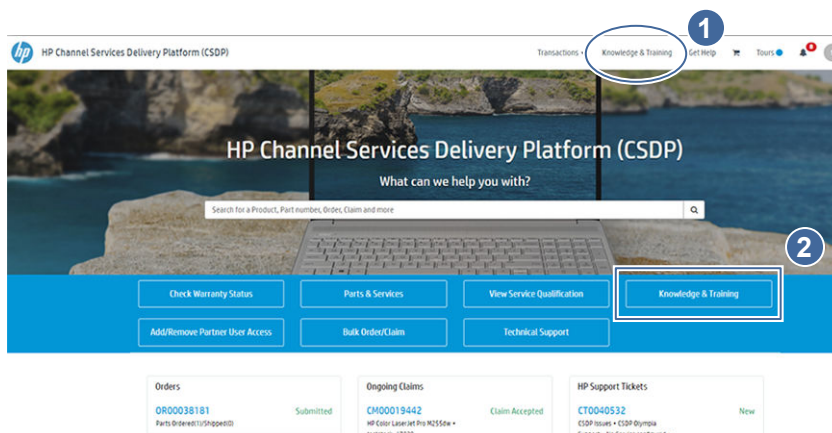
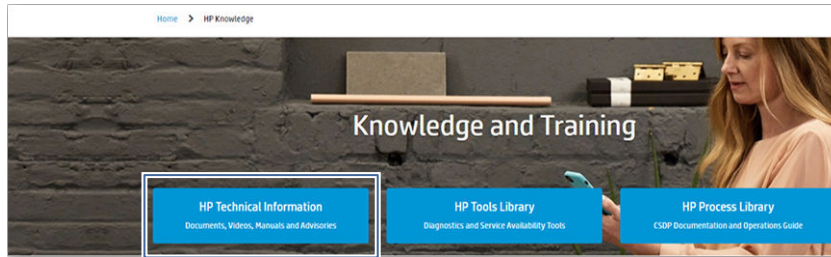

4. Use the WISE portal to search for printer information.

Figure 4-17 WISE portal home page

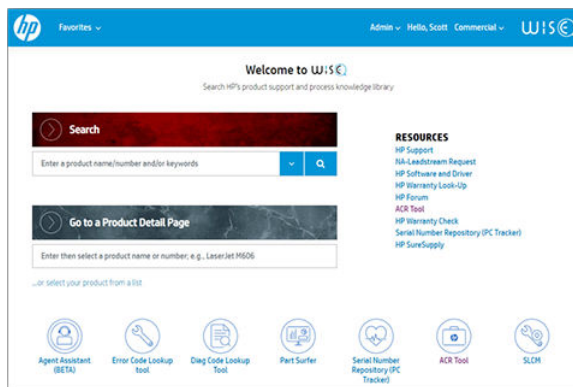

Accessing WISE for HP channel partners (HP Partner Portal)

Learn how to access WISE by accessing the HP Partner Portal if you are an HP Channel Partner.

NOTE: If this is your first visit to the HP Partner Portal, you will be asked to create an account. Follow the setup directions using your HP Partner credentials.

 [View a video of how to access WISE for HP channel partners](#)

1. Sign-in to the HP Partner Portal (click <https://partner.hp.com> to access the sign-in page).

Figure 4-18 HP Partner Portal sign-in page

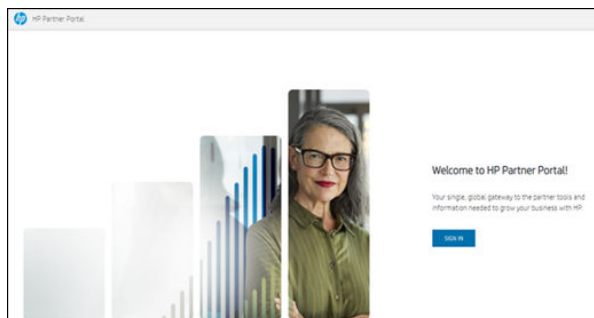

2. On the HP Partner Portal home page, click the **Services & Support** item.

Figure 4-19 HP Partner Portal home page

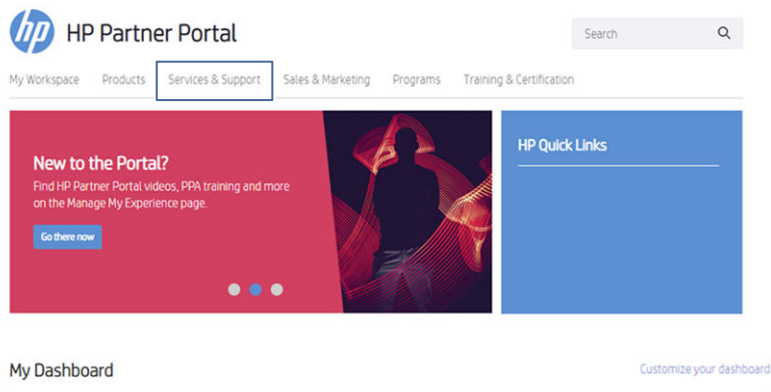

3. Select the **Technical Support (WISE)** item.

Figure 4-20 HP Partner Portal Service & Support page

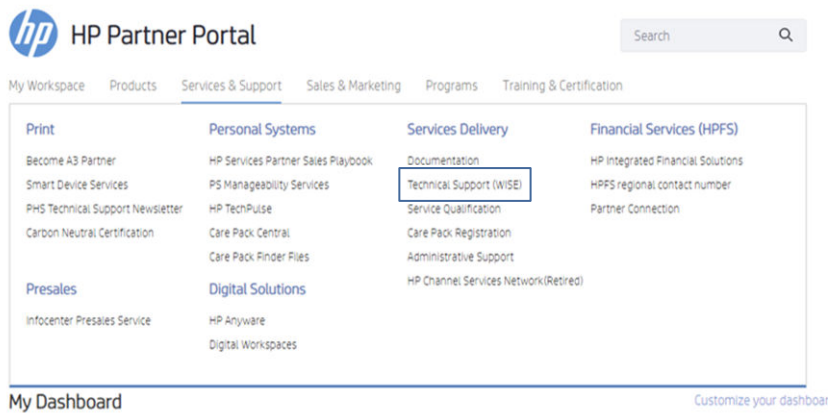

4. Select the **Technical Documentation** item.

Figure 4-21 HP Partner Portal Technical Support (WISE)page

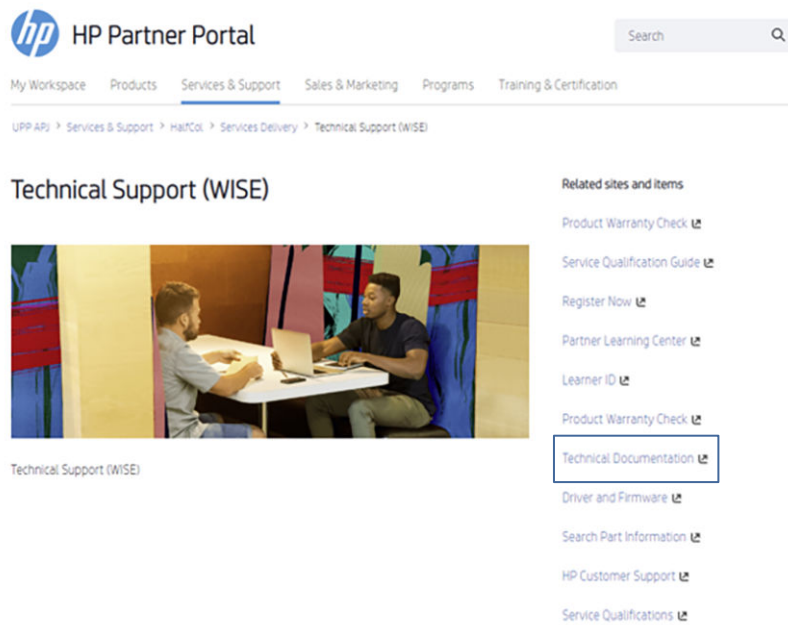

5. Use the WISE portal to search for printer information.

Figure 4-22 WISE portal home page

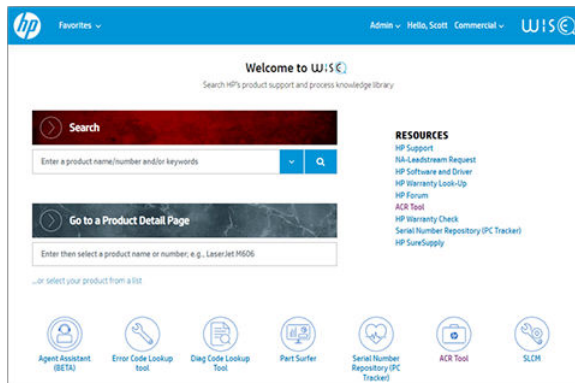

Determine the problem source

When the printer malfunctions or encounters an unexpected situation, the printer control panel alerts the user to the situation.

This section contains a pre-troubleshooting checklist and a troubleshooting flow chart to filter out many possible causes of the problem.

- Use the pre-troubleshooting check list to gather information about the problem from the customer.
- Use the troubleshooting flowchart to pinpoint the root cause of hardware malfunctions. The flowchart guides you to the section of this chapter that contains steps for correcting the malfunction.

Before beginning any troubleshooting procedure, check the following issues:

- Are supply items within their rated life?
- Does the configuration page reveal any configuration errors?



NOTE: The customer is responsible for checking supplies and for using supplies that are in good condition.

Pre-troubleshooting checklist

The following table includes basic questions to ask the customer to quickly help define the problem(s).

Table 4-1 Pre-troubleshooting checklist

General topic	Questions
Environment	<ul style="list-style-type: none">• Is the printer installed on a solid, level surface (+/- 1°)?• Is the power-supply voltage within ± 10 volts of the specified power source?• Is the power-supply plug inserted in the printer and the wall outlet (not a surge protector)?• Is the operating environment within the specified parameters?• Is the printer exposed to ammonia gas, such as that produced by diazo copiers or office cleaning materials? <p>NOTE: Diazo copiers produce ammonia gas as part of the copying processes. Ammonia gas (from cleaning supplies or a diazo copier) can have an adverse effect on some printer components (for example, the toner cartridge or cartridges OPC).</p> <ul style="list-style-type: none">• Is the printer exposed to direct sunlight?• Is the printer exposed to an air conditioning or heating vent that can cause temperature fluctuations?
Media	<ul style="list-style-type: none">• Does the customer use only supported media?• Is the media in good condition (no curls, folds, or distortion)?• Is the media stored correctly and within environmental limits?
Input trays	<ul style="list-style-type: none">• Is the amount of media in the tray within specifications?• Is the media correctly placed in the tray?• Are the paper guides aligned with the stack (no gaps in the stack or excessive pressure causing the stack to bow)?• Is the tray (or trays) correctly installed in the printer?
Toner cartridge	<ul style="list-style-type: none">• Is the toner cartridge (or cartridges) installed correctly? <p>NOTE: If country/region specific toner cartridges are available for the printer, make sure the correct cartridge is installed.</p>
Transfer unit and fuser	<ul style="list-style-type: none">• Are the transfer unit and fuser installed correctly? <p>NOTE: For printers with an intermediate transfer belt (ITB), is the ITB installed correctly and fully seated. If a replacement ITB was installed, was all of the packing materials removed?</p>
Covers	<ul style="list-style-type: none">• Is the toner cartridge door closed?

Table 4-1 Pre-troubleshooting checklist (continued)

General topic	Questions
Condensation	<ul style="list-style-type: none"> Does condensation occur following a temperature change (particularly in winter following cold storage)? If so, wipe affected parts dry or leave the printer on for 10 to 20 minutes. Was a toner cartridge (or cartridges) opened soon after being moved from a cold to a warm room? If so, allow the toner cartridge (or cartridges) to sit at room temperature for 1 to 2 hours.
Miscellaneous	<ul style="list-style-type: none"> Check for and remove any non-HP components (toner cartridges, memory modules, and EIO cards) from the printer. Remove the printer from the network and ensure that the failure is associated with the printer before beginning troubleshooting. For any color print-quality issues (color printers only), calibrate the printer, and then print a diagnostics page to verify print quality.

Troubleshooting flowchart

This flowchart highlights the general processes to follow to quickly isolate and solve printer hardware problems.

Each row depicts a major troubleshooting step. Follow a “yes” answer to a question to proceed to the next major step. A “no” answer indicates that more testing is needed. Go to the appropriate section in this chapter and follow the instructions there. After completing the instructions, go to the next major step in this troubleshooting flowchart.

Table 4-2 Troubleshooting flowchart

Step	Question	Action
1 Power on	Is the printer on and does a readable message display?	<p>Basic printer functions should start up when the printer is connected into an electrical outlet and the power switch is pushed to the on position.</p> <p>During normal operation cooling fans and/or motors should be operating. Place a hand over fan intake or exhaust vents to determine if the fan or fans are spinning. Lean close to the printer to hear motors rotating.</p> <p>If fans and/or motors are operating, the dc side of the power supply is functioning.</p> <p>Always make sure that the printer is plugged into a known-functioning wall receptacle. Remove power strips and plug the printer directly into a wall receptacle.</p> <p>After the control panel display is functional, see step 2.</p>
	Yes ↓	
2 Control panel messages	Does the message Ready display on the control panel?	

Table 4-2 Troubleshooting flowchart (continued)

Step	Question	Action
	Yes ↓ No →	After the errors have been corrected, go to step 3. Use the control panel message document (CPMD) section in this manual to correct any displayed error messages.
3 Event log	Open the Troubleshooting menu and print an event log to see the history of errors with this printer. Does the event log print?	
	Yes ↓ No →	If the event log does not print, check for error messages. If paper jams inside the printer, see the jams section of the printer service manual. If error messages display on the control panel when trying to print an event log, see the control panel message document (CPMD) section of this manual. After successfully printing and evaluating the event log, see step 4.
4 Information pages	Open the Reports menu and print the configuration pages to verify that all the accessories are installed. Are all the accessories installed?	
	Yes ↓ No →	If accessories that are installed are not listed on the configuration page, remove the accessory and reinstall it. Make sure that the most recent firmware is installed. See the firmware upgrade section of this manual for more information. After evaluating the configuration pages, see step 5.
5 Print quality	Does the print quality meet the customer's requirements?	
	Yes ↓ No →	Compare the images with the sample defects in the Image-quality troubleshooting section of this manual. Solve print-quality and copy-quality issues as needed. After the print quality is acceptable, see step 6.
6 Interface	Can the customer print successfully from the host computer?	

Table 4-2 Troubleshooting flowchart (continued)

Step	Question	Action
	<p>Yes. This is the end of the troubleshooting process.</p> <p>No →</p>	<p>Verify that all I/O cables are connected correctly and that a valid IP address is listed on the HP Jetdirect configuration page.</p> <p>If error messages display on the control panel or appear in the event log, see the control-panel message document (CPMD) section of this manual.</p> <p>When the customer can print from the host computer, this is the end of the troubleshooting process.</p>

Firmware upgrades

Learn about printer firmware upgrades.

To download the most recent firmware upgrade for the printer, go to:

- In the US, go to <http://www.hp.com/support/colorlj5700> or <http://www.hp.com/support/colorljX557> or <http://www.hp.com/support/colorlj5800MFP> or <http://www.hp.com/support/colorljX57945MFP>.

- a. Select **Get drivers, Software, and Firmware**, and then select the appropriate product by name.



NOTE: More than one printer model might be listed. Make sure to select the correct model so that the upgraded firmware supports all of the printer functions.

- b. Select the driver language and operating system.
- c. Locate the firmware download, and then select **Download**.

- Outside the U.S., go to www.hp.com/support.

- Select your country/region.
- Select **Drivers & Downloads**.
- Enter the product name in the **Find my product** dialogue box, and then select **Go**.



TIP: Click on the **How do I find my product name/number?** link to see a short video on identifying the printer's name and number.

- Select the appropriate product by name.



NOTE: More than one printer model might be listed. Make sure to select the correct model so that the upgraded firmware supports all of the printer functions.

- Select the driver language and operating system.
- Locate the firmware download, and then select **Download**.

Determine the installed revision of firmware

Learn about how to determine the version of installed printer firmware.

Print a configuration page to determine the installed revision of firmware.



1. From the **Home** screen on the printer control panel, scroll to and touch the **Reports** button.
2. Open the **Configuration/Status pages** menu.
3. Touch **Configuration Page** to select it.
4. Touch the print icon  to print the pages.
5. Find the firmware revision on the configuration page.

Figure 4-23 Configuration page firmware version

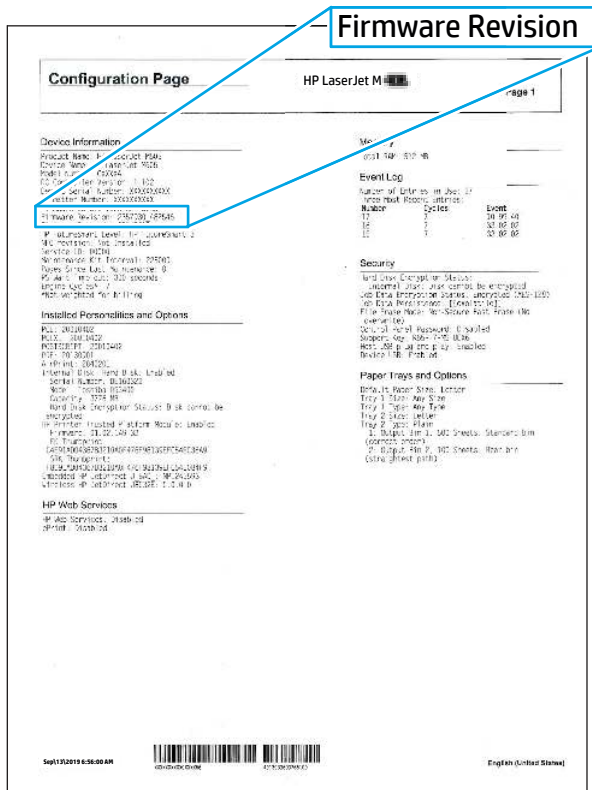

HP Embedded Web Server

Learn how to perform a firmware upgrade using the HP Embedded Web Server.

 **NOTE:** The printer should be at the **Ready** state.

The firmware update might take 10 minutes or longer based on the input/output (I/O) transfer rates and the time it takes for the printer to reinitialize.

1. Open an Internet browser window.
2. Enter the printer IP address in the URL line.
3. Select the **Firmware Upgrade** link from the **General** tab or from the **Troubleshooting** tab.

4. Browse to the location that the firmware upgrade file was downloaded to, and then select the firmware file. The file has a .bdl file extension. Select the **Install** button to perform the upgrade.

 **NOTE:** Do not close the browser window OR interrupt communication until the HP Embedded Web Server (EWS) displays the confirmation page.

5. After the printer reinitializes, print a configuration page and verify that the latest firmware version has been installed.

USB flash drive firmware (Pre-boot menu)

Learn how to perform a USB flash drive firmware (Pre-boot menu) update from the control panel.

1. Copy the .bdl file to a portable USB flash drive.
2. Touch the middle of the control panel display when you see the **1/8** under the logo.

Figure 4-24 Open the Pre-boot menu

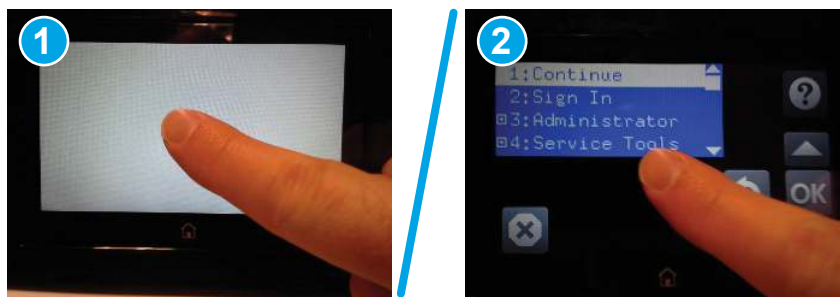

3. Use the arrow buttons to highlight **+3 Administrator**, and then touch the **OK** button.
4. Use the arrow buttons to highlight **+1 Download**, and then touch the **OK** button.
5. Insert the USB flash drive with the .bdl file on it into the USB port on the printer.

 **NOTE:** If the error message **No USB Thumbdrive Files Found** displays on the control panel display, try using a different portable storage device.

6. Use the arrow buttons to highlight **USB Thumbdrive**, and then touch the **OK** button.
7. Use the arrow buttons to highlight the .bdl file, and then touch the **OK** button.

 **NOTE:** The upgrade process can take 10 minutes or longer to complete.

 **TIP:** If there is more than one .bdl file on the storage device, make sure to select the correct file for this printer.

8. When the message **Complete** displays on the control panel display, touch the down arrow ▼ button several times until the message **Continue** displays.
9. Touch the **OK** button to begin the upgrade. When the upgrade is complete, the printer will initialize to the **Ready** state.
10. When the upgrade process is complete, print a configuration page and verify that the upgrade firmware version was installed.

USB flash drive firmware (control panel menu)

Learn how to perform a USB flash drive firmware (control panel menu) update from the control panel.

1. Copy the .bdl file to a portable USB flash drive.
2. Turn the printer on, and then wait until it reaches the **Ready** state.
3. From the [Home](#) screen on the printer control panel, scroll to and touch the [Support Tools](#) button.
4. Open the [Maintenance](#) menu.
5. Touch the [USB Firmware Upgrade](#) button.
6. Insert the USB flash drive with the .bdl file on it into the USB port on the printer.
7. Touch the .bdl file, and then touch the [Upgrade](#) button.



TIP: If there is more than one .bdl file on the storage device, make sure to select the correct file for this printer.

8. Select one of the following options:

- [Upgrade](#)



NOTE: The upgrade process can take 10 minutes or longer to complete.

- [Re-install](#)
- [Downgrade](#)

9. When the upgrade is complete, the printer will initialize to the **Ready** state.
10. When the upgrade process is complete, print a configuration page and verify that the upgrade firmware version was installed.

Comprehensive list of troubleshooting tools

Learn about the printer troubleshooting tools.

Engine test

Learn about troubleshooting the printer using the engine test diagnostic.

When the engine test is performed, a test page with lines prints if the engine is functioning correctly.



NOTE: Depending on printer models, either a simplex engine test page, a duplex engine test page, or both simplex and duplex engine test pages might be available.

Use a small pointed object to depress and hold the engine test button (location varies depending on the printer model). An engine test page prints. The test page can use only Tray 2 as the paper source, so make sure that paper is loaded in Tray 2.

Possible engine test pages (printer dependent)

- A series of lines parallel to the **short** end of the page.
- A series of lines parallel to the **long** end of the page.

Figure 4-25 Engine test button

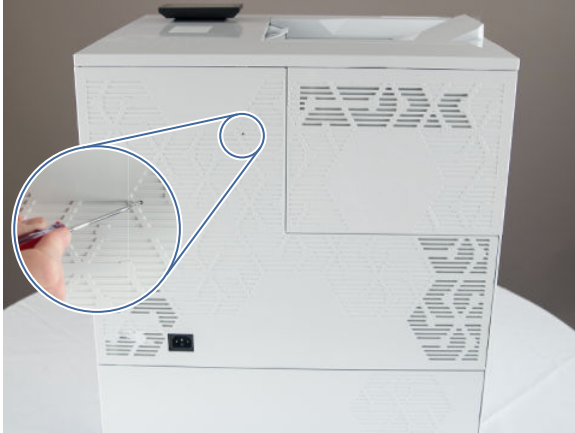

Control panel checks

Learn about control panel troubleshooting.

The printer includes a diagnostic test mode for the touchscreen control panels.

Touchscreen diagnostic mode

Learn about touchscreen diagnostic mode.

Use the diagnostics in this section to test the control-panel hardware and embedded firmware. These tests are useful for checking control-panel functionality independent of the printer control-panel system diagnostics.

1. Locate the diagnostic-tests access button on the back of the control panel, and then press the button.

Figure 4-26 Diagnostic-tests access button – 8-inch control panel



Figure 4-27 Diagnostic-tests access button – 10-inch control panel



2. Observe the control panel screen as it cycles through the following colors:
 - Red
 - Green
 - Blue
 - Black
 - White

Open the control panel system diagnostic tests

Learn about accessing the control panel system diagnostics tests from a touchscreen control panel.

Use the following procedure to open the control panel system diagnostics tests.

1. Turn the printer power off, and then on again.
2. Touch the middle of the control panel display when you see the 1/8 under the logo.

Figure 4-28 Open the Pre-boot menu

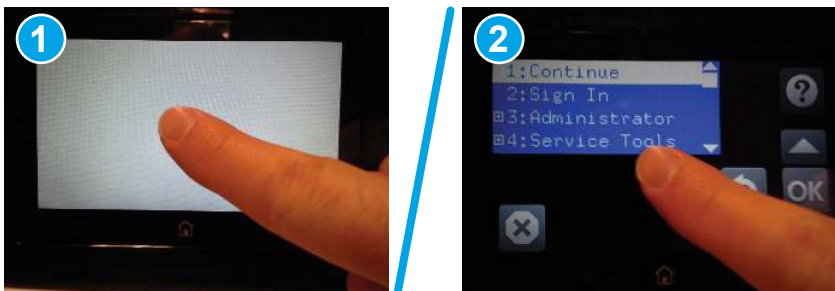

- On the **Pre-boot** menu screen, use the following buttons to navigate the tests.

Figure 4-29 Pre-boot menu

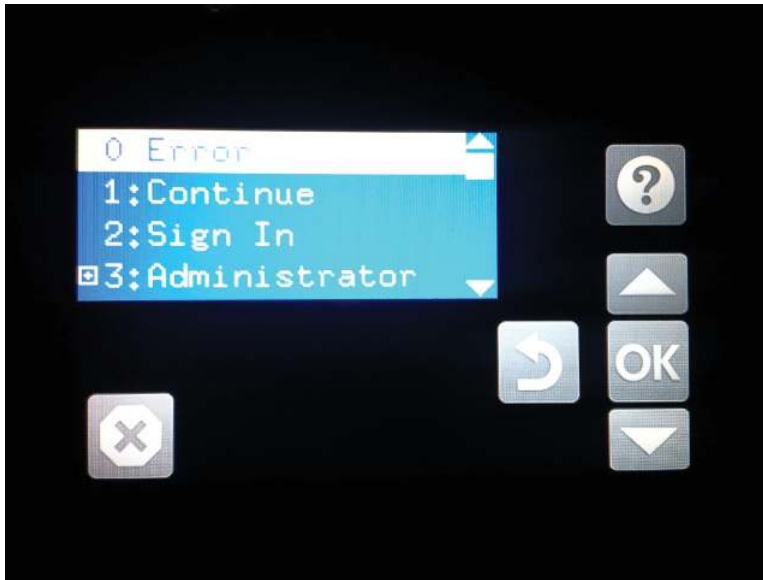
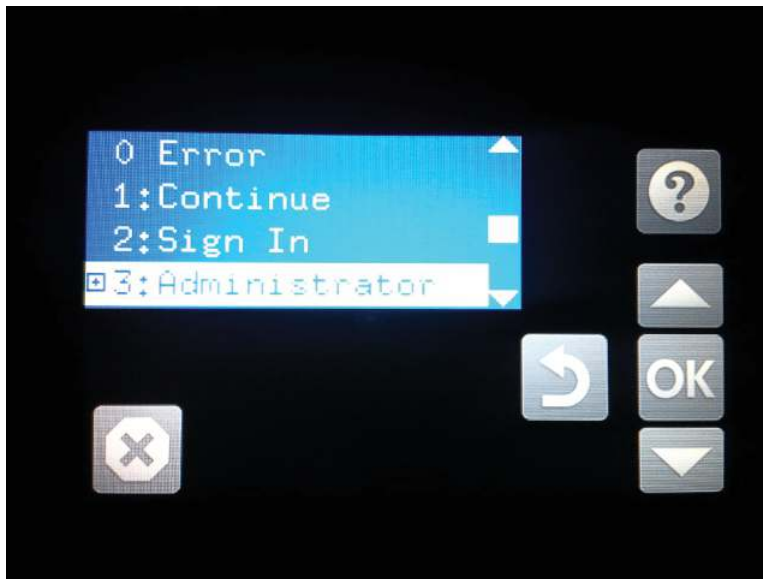

Table 4-3 Pre-boot menu button descriptions

Button	Description
	Use this button to see more information about a selected item.
	Use this button to scroll up through menu items.
	Use this button to select a highlighted menu item.
	Use this button to scroll down through menu items.
	Use this button to go back to the previous menu.
	Not used.

4. Use the **down arrow ▼** button to scroll to **+3 Administration**, and then press the **OK** button to select it.

Figure 4-30 Access the administration menu



5. Use the **down arrow ▼** button to scroll to **+E CP Diagnostics**, and then press the **OK** button to select it.

 **NOTE:** An administrator password might be required to continue.

Figure 4-31 Access the diagnostics menu



Screen test

Learn about the control panel system diagnostic screen test.

1. Open the control panel system diagnostic tests.

- With **1 Screen Test** highlighted, press the **OK** button to select it.

Figure 4-32 Open the screen test

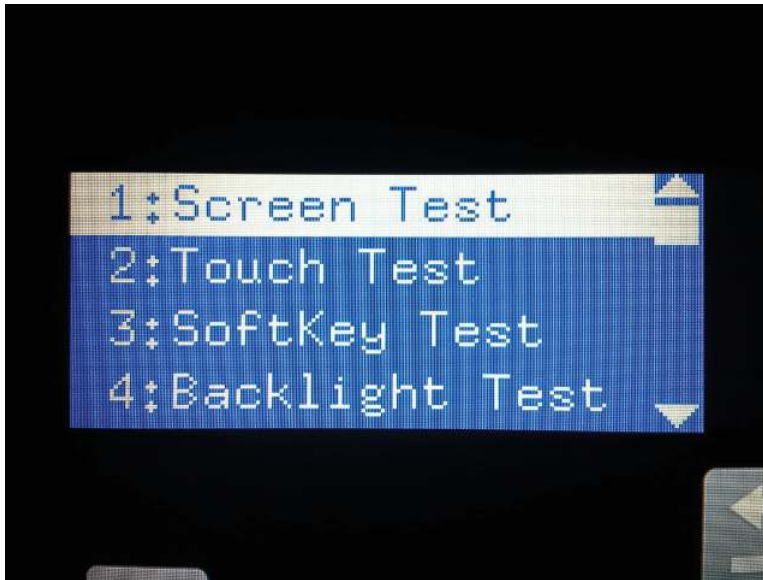

The blue horizontal gradient screen appears.

Figure 4-33 Blue horizontal gradient screen

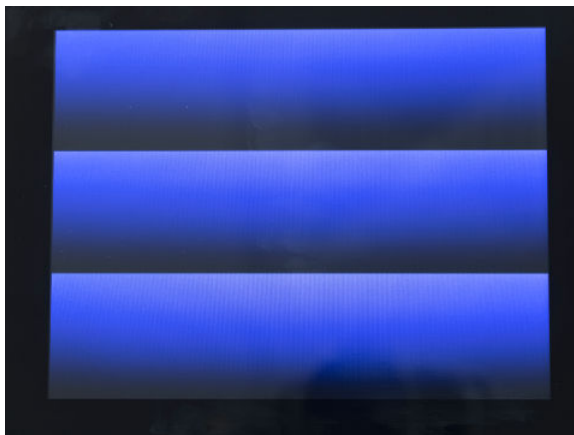

- Touch the touchscreen to scroll through the remaining touchscreen test screens.

 **NOTE:** Touch the **Home** button to exit the test.

Table 4-4 Touchscreen test screens

Screen	Description
	Green horizontal gradient

Table 4-4 Touchscreen test screens (continued)





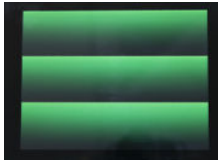

Screen	Description
	Red horizontal gradient
	Blue vertical gradient
	Green vertical gradient
	Red vertical gradient
	Blue with horizontal interlaced
	Green with horizontal interlaced
	Red with horizontal interlaced

Table 4-4 Touchscreen test screens (continued)

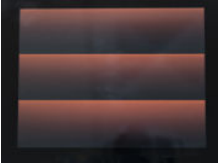

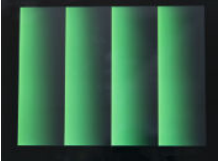
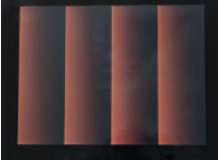

Screen	Description
	Blue with vertical interlaced
	Green with vertical interlaced
	Red with vertical interlaced
	Black with white center
	White with black center
	Checkerboard

Table 4-4 Touchscreen test screens (continued)

Screen	Description
	Multicolor stripes
	Blue green grid meshing

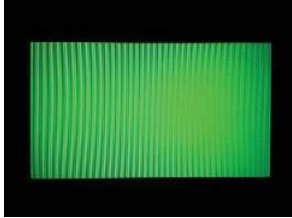
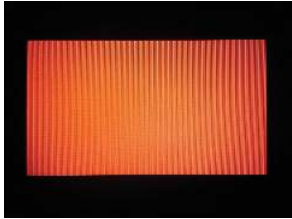
Touch test

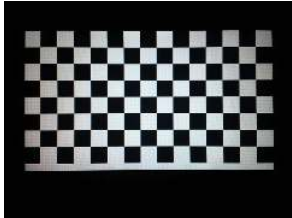
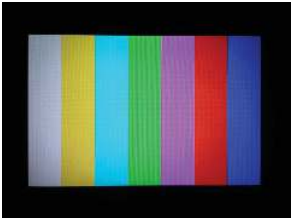
Learn about the control panel system diagnostic touch test.

1. Open the control panel system diagnostic tests.
2. Use the **down arrow ▼** button to scroll to **2 Touch Test**, and then press the **OK** button to select it.

Figure 4-34 Open the touch test

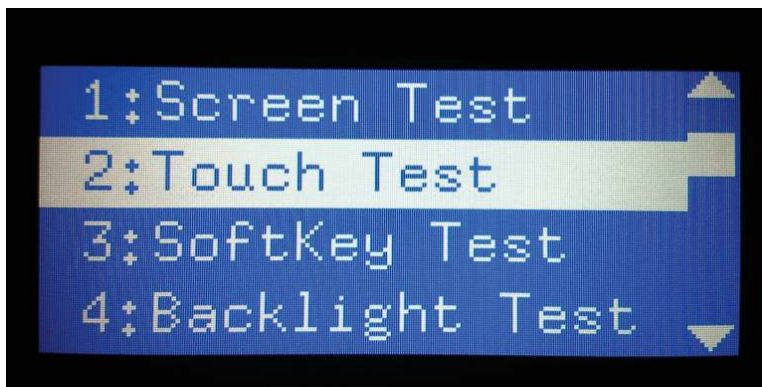

3. Use your finger to touch the white grid on the display.

Figure 4-35 Touch the white grid

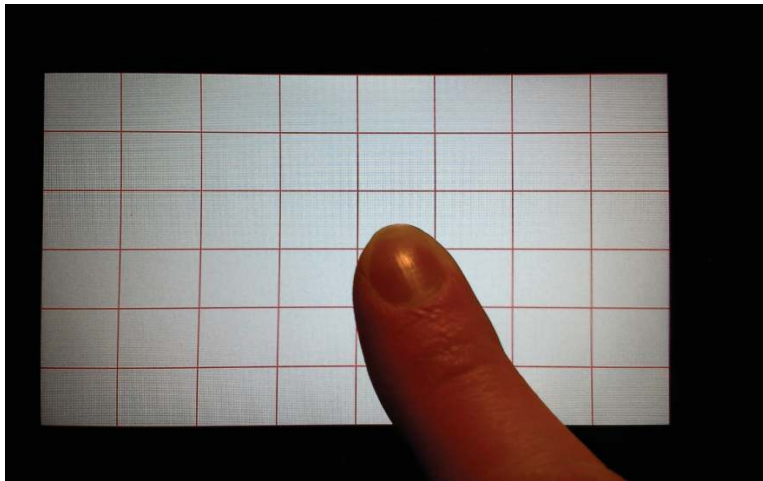

A mark appears on the grid where it was touched.

 **NOTE:** Touch the [Home](#) button to exit the test.

Figure 4-36 Verify the mark

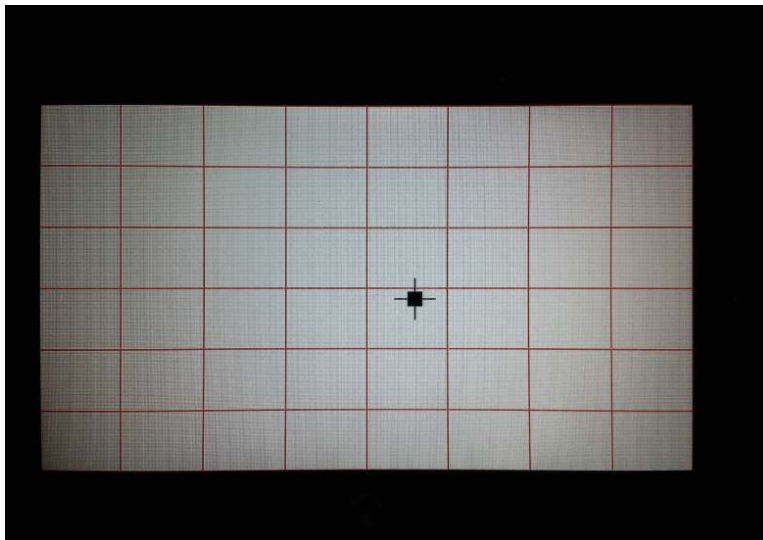

SoftKey test

Learn about the control panel system diagnostic SoftKey test.

1. Open the control panel system diagnostic tests.

- Use the [down arrow ▼](#) button to scroll to [3 SoftKey Test](#), and then press the [OK](#) button to select it.

Figure 4-37 Open the softkey test



- When prompted, touch the [Home](#) button.

Figure 4-38 Touch the [Home](#) button

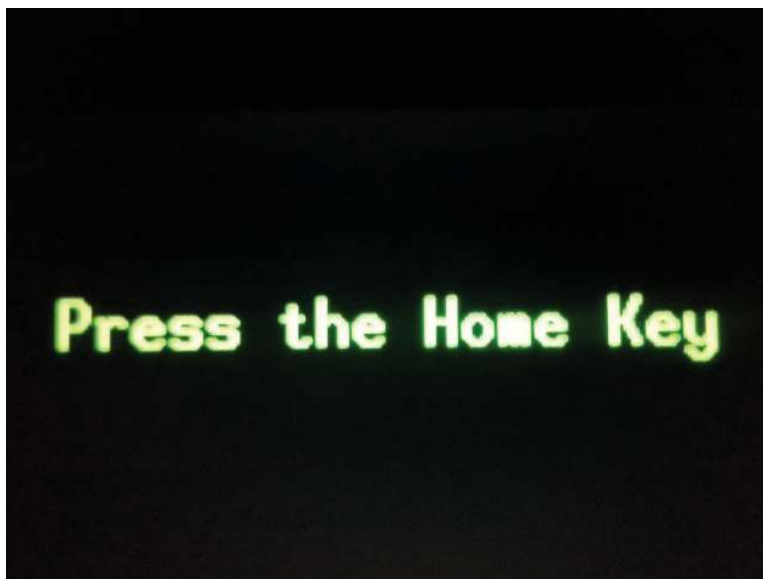

If the test is successful, the following screen appears on the display.

 **NOTE:** Touch the screen to exit the test.

Figure 4-39 Successful test



Backlight test

Learn about the control panel system diagnostic backlight test.

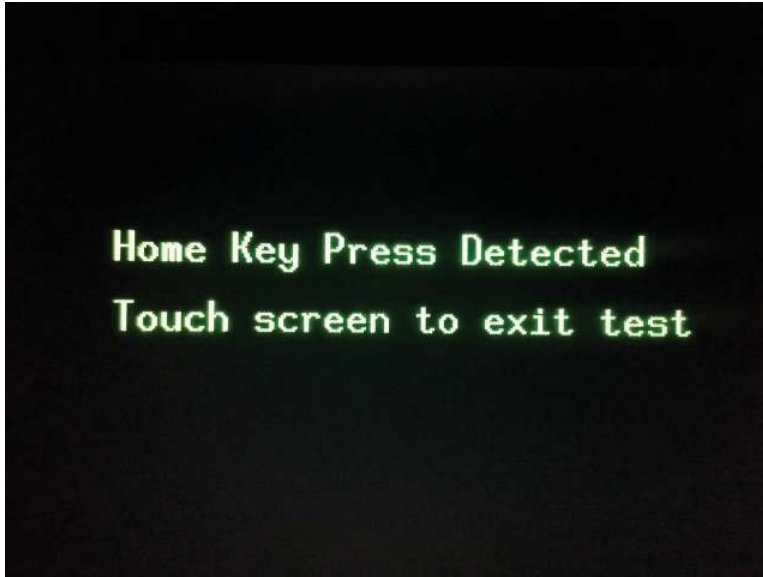
1. Open the control panel system diagnostic tests.
2. Use the [down arrow ▼](#) button to scroll to [4 Backlight Test](#), and then press the [OK](#) button to select it.

After selecting the [4 Backlight Test](#), the screen automatically dims, and then returns to full brightness.



NOTE: Touch any key to exit the test.

Figure 4-40 Open the backlight test

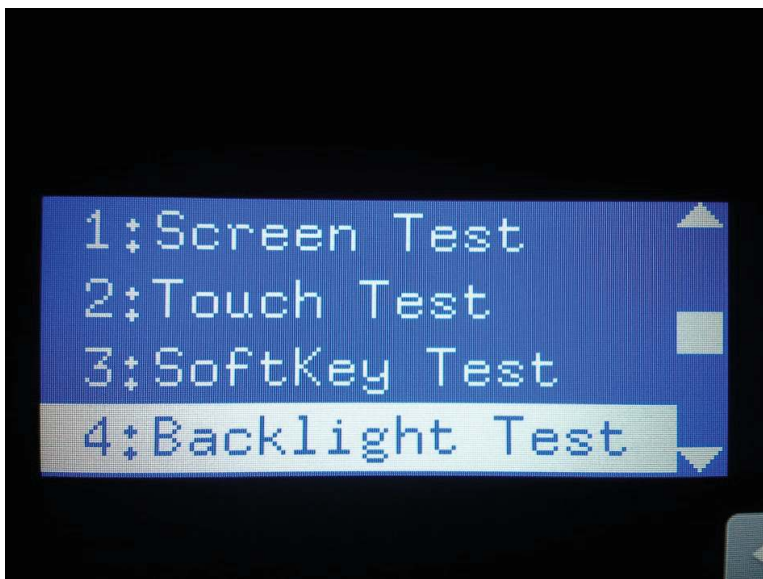

Sound test

Learn about the control panel system diagnostic sound test.

1. Open the control panel system diagnostic tests.
2. Use the **down arrow ▼** button to scroll to **5 Sound Test**, and then press the **OK** button to select it.

After selecting the **5 Sound Test**, the printer emits a series of audible tones.



 **NOTE:** Touch any key to exit the test.

Figure 4-41 Open the sound test

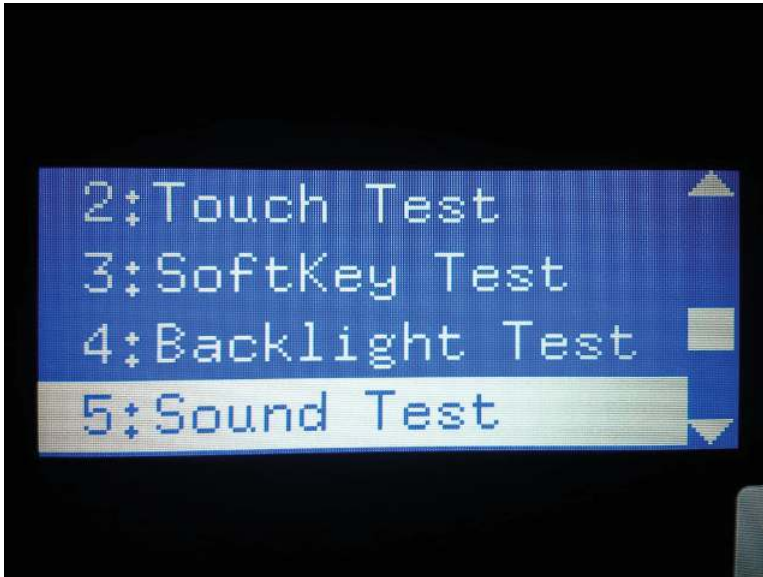

Keyboard test (flow models only)

Learn about the control panel system diagnostic keyboard test.

 **IMPORTANT:** The control-panel system diagnostic tests include a **6 Keyboard Test** item. This test is not valid for printers that do **not** have a pull out keyboard installed, even though this option is present in the control-panel system diagnostic tests menu.

If the **6 Keyboard Test** is opened on a non-flow printer, the printer power must be turned off to exit the test.

HP **does not recommend** turning the printer power off during the control-panel system diagnostic tests.

1. Open the control panel system diagnostic tests.

2. Use the [down arrow ▼](#) button to scroll to [6 Keyboard Test](#), and then press the [OK](#) button to select it.

Figure 4-42 Open the keyboard test

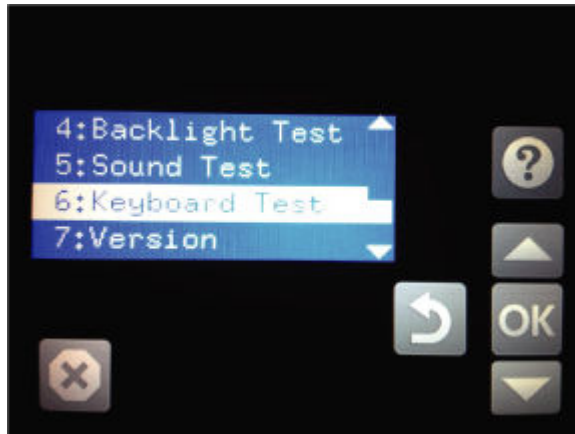

3. When prompted, touch the H key on the keyboard or the Home button to exit the test.

Version

Learn about the control panel system diagnostic version information.

1. Open the control panel system diagnostic tests.
2. Use the [down arrow ▼](#) button to scroll to [7 Version](#), and then press the [OK](#) button to select it.

 **NOTE:** Touch any key to exit the test.

Select [7 Version](#) to view the following types of information:

 **NOTE:** The following types of information are for the control panel only, not the printer.

- Panel ID
- Hardware (version)
- Firmware (version)
- KB Hw (version)
- KB Firm (version)
- LCD Vendor
- Touch Controller Version

Figure 4-43 Open the version information

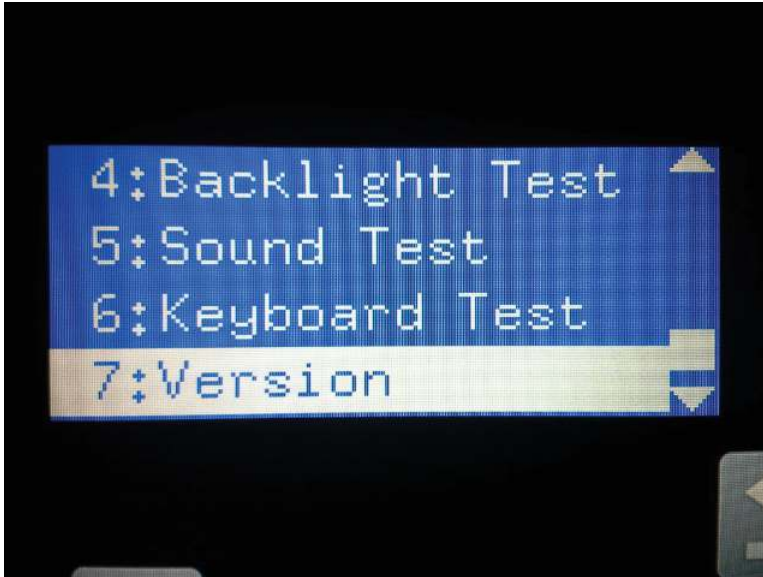

Control panel diagnostic flowcharts

Use the flowcharts in this section to troubleshoot the following control panel problems.

- Touchscreen is blank, white, or dim (no image).
- Touchscreen is slow to respond or requires multiple presses to respond.
- Touchscreen has an unresponsive zone.
- No control panel sound.
- Home button is unresponsive.
- Hardware integration pocket (HIP) is not functioning (control panel functional).

Touchscreen black, white, or dim (no image)

To open the diagnostic function, press the button on the back of the control panel.

Figure 4-44 Touchscreen blank, white, or dim (no image)

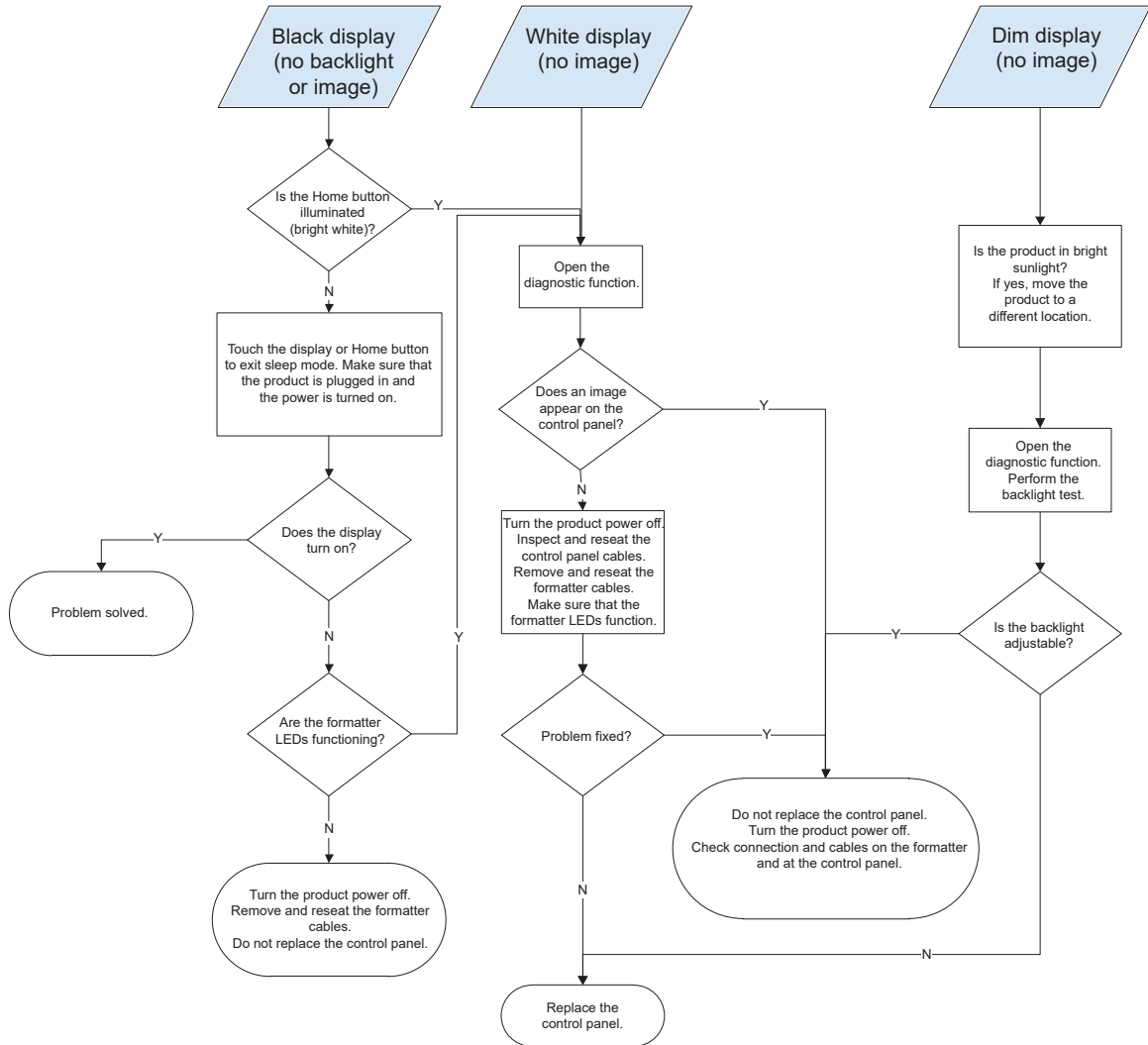

Touchscreen has an unresponsive zone

To open the diagnostic function, press the button on the back of the control panel.

Figure 4-45 Touchscreen has an unresponsive zone

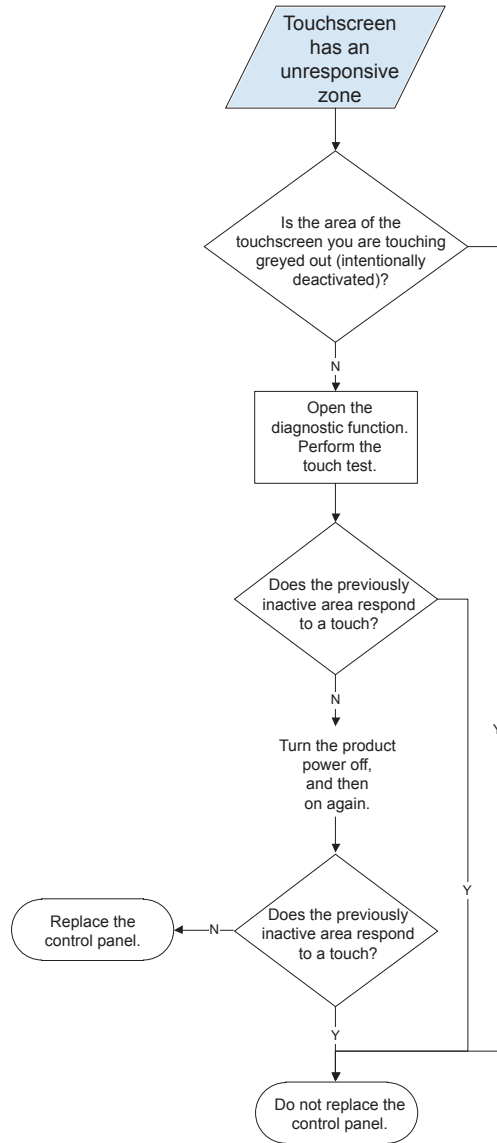

No control panel sound

To open the diagnostic function, press the button on the back of the control panel.

Figure 4-46 No control panel sound

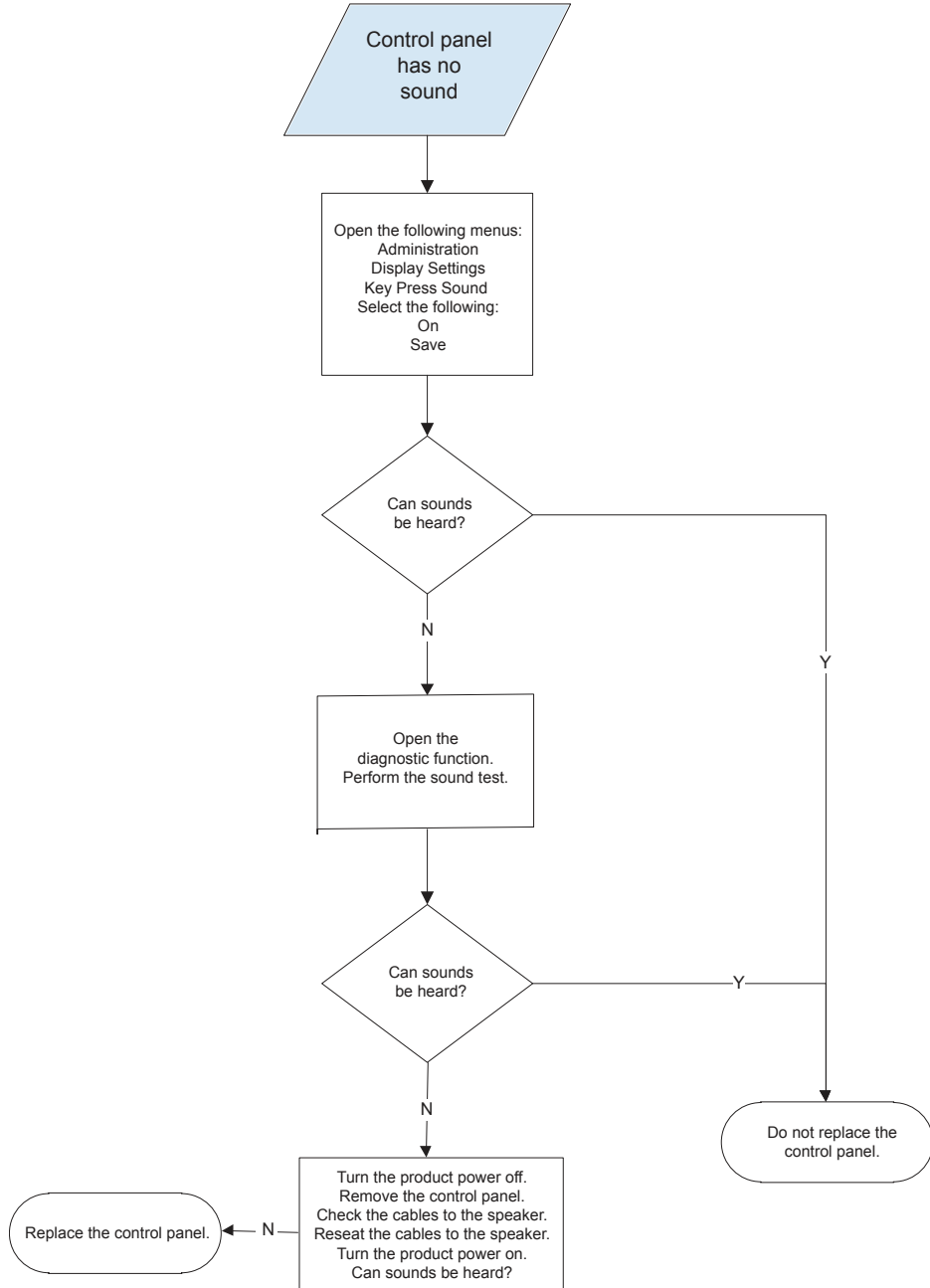

Home button is unresponsive

To open the diagnostic function, press the button on the back of the control panel.

Figure 4-47 Home button is unresponsive

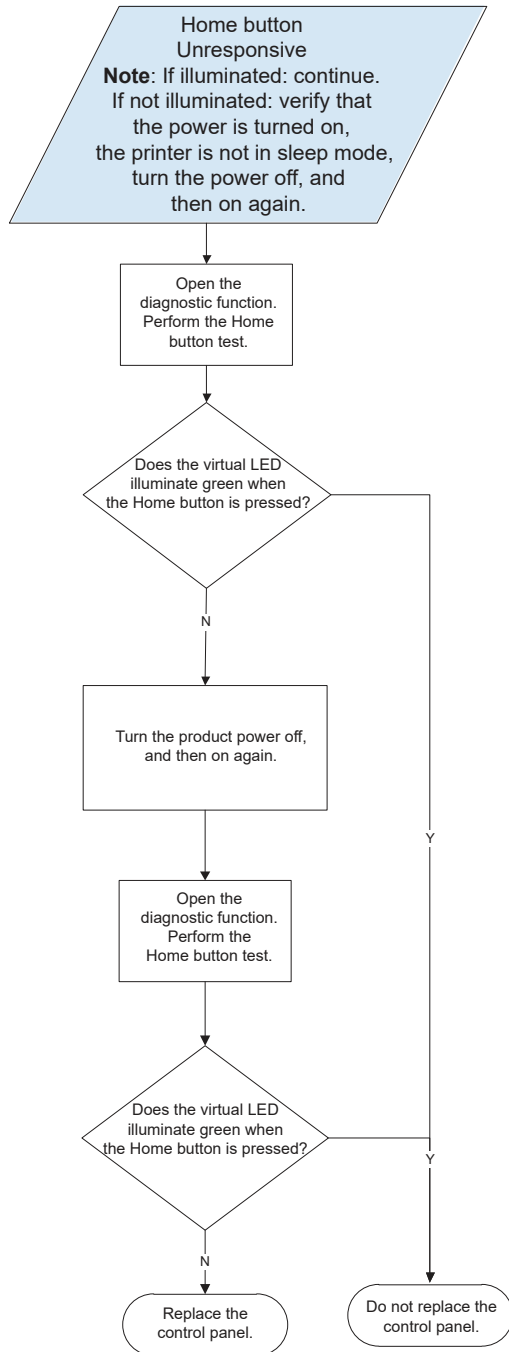

Hardware integration pocket (HIP) is not functioning (control panel functional)

Review the following information when the HIP is not functioning, but the control panel is functional.

Figure 4-48 Hardware integration pocket (HIP) is not functioning (control panel functional)

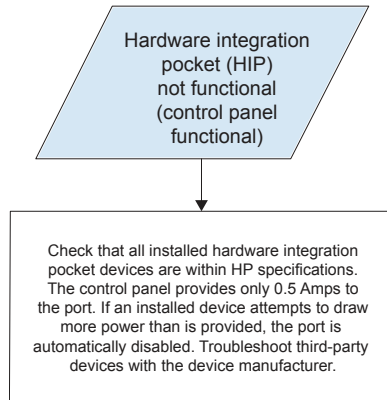

Print menu (SFP) and Copy/Print menu (MFP)

Learn about the control-panel [Print](#) menu (SFP) and the [Copy/Print](#) menu (MFP).

To display: At the printer control panel, select the [Settings](#) menu, and then select the [Print](#) menu (SFP) or the [Copy/Print](#) menu (MFP).

To print: At the printer control panel, touch the printer icon .

In the following table, asterisks (*) indicate the factory default setting.

Table 4-5 Print menu (SFP) or Copy/Print menu (MFP)

First level	Second level	Third level	Fourth Level	Values	Description
Copy Settings MFP	Image preview			Make optional	Use this menu to configure how Copy behaves.
				Require preview	
				Disable preview	
Copy Settings MFP	Copies			1-9999	Configure the default options for copy jobs. If the user does not specify the job options when creating the job, the default options are used.
				Default = 1	

Table 4-5 Print menu (SFP) or Copy/Print menu (MFP) (continued)

First level	Second level	Third level	Fourth Level	Values	Description
Copy Settings MFP	Sides	Original Sides		1-sided	Use to indicate whether the original document is printed on one or both sides. For example, select Original Sides 1-sided and Output Sides 2-sided when the original is printed on one side, but you want to make two-sided copies. Select Flip pages up to print the pages with long edge of the in the landscape orientation.
				2-sided	
				Flip pages up	
Copy Settings MFP	Sides	Output Sides		1-sided	Use to indicate whether the copies should be printed on one or both sides. For example, select Original Sides 1-sided and Output Sides 2-sided when the original is printed on one side, but you want to make two-sided copies. Select Flip pages up to print the pages with long edge of the in the landscape orientation.
				2-sided	
				Flip pages up	
Copy Settings MFP	Watermark	Watermark Type		None*	Use to set a text watermark.
				Text	
Copy Settings MFP	Watermark	Watermark Text		Draft	Select a predefined text watermark.
				Confidential	
				Secret	
				Top Secret	
Copy Settings MFP	Watermark	Text Font		Letter Gothic*	Select the font of the text watermark.
				Antique Olive	
				New Century Schoolbook Roman	
				Garamond Antiqua	

Table 4-5 Print menu (SFP) or Copy/Print menu (MFP) (continued)

First level	Second level	Third level	Fourth Level	Values	Description
Copy Settings MFP	Watermark	Text Size		30 point	Select the font point size of the text watermark.
				40 point*	
				60 point	
Copy Settings MFP	Watermark	Darkness		1- (Lighter)	Select the darkness of the text watermark.
				2	
				3*	
				4	
				5 - (Darker)	
Copy Settings MFP	Stamps	Stamp Content		User-defined value	Use to set a stamp in any or all the following locations in the document:
				None*	
				IP address	
				User name	
				Product information	
				Page number	
				Date and time	
	<ul style="list-style-type: none"> • Top Left • Top Center • Top Right • Bottom Left • Bottom Center • Bottom Right 				
Copy Settings MFP	Stamps	Text Font		Letter Gothic*	Select the font of the stamp.
				Antique Olive	
				New Century Schoolbook Roman	
				Garamond Antiqua	
Copy Settings MFP	Stamps	Text Size		8 point	Select the font point size of the stamp.
				12 point*	
				20 point	
Copy Settings MFP	Stamps	White background		Disabled*	Select the check box to enable a white background for the stamp.
				Enabled	

Table 4-5 Print menu (SFP) or Copy/Print menu (MFP) (continued)

First level	Second level	Third level	Fourth Level	Values	Description
Copy Settings	Scan Mode			Standard document*	Use to indicate the type of original document to be scanned.
MFP				Prompt for additional pages	
				Book	Select Prompt for additional pages to copy or scan an original document that has more pages than the document feeder can accommodate at one time, or to scan originals of different sizes that cannot be scanned together, and then combine these separate scan jobs into a single job.
				2-sided ID	
Copy Settings	Reduce/Enlarge			Automatic*	Scale the size of the document up or down.
MFP				Include margins	
				Manual	To reduce the image, select a scaling percentage that is less than 100. To enlarge the image, select a scaling percentage that is greater than 100.
				Default=100	
					When Include margins is enabled, the printer reduces the image slightly to fit the entire scanned image within the printable area on the page.

Table 4-5 Print menu (SFP) or Copy/Print menu (MFP) (continued)

First level	Second level	Third level	Fourth Level	Values	Description
Copy Settings	Original Size			Automatically detect*	Specify the size of the original document.
MFP				Letter (8.5x11)	
				Mixed Letter/Legal	
				Legal (8.5x14)	
				Executive (7.25x10.5)	
				Statement (5.5x8.5)	
				Oficio (8.5x13)	
				4x6	
				5x7	
				5x8	
				A4 (210x297 mm)	
				A5 (148x210 mm)	
				A6 (105x148 mm)	
				RA4 (215x305 mm)	
				B5 (182x257 mm)	
				B6 (128x182 mm)	
				10x15cm	
				16K (195x270 mm)	
				16K (184x260 mm)	
				16K (197x273 mm)	
				DPostcard JIS (148x200 mm)	
				Oficio (216x340 mm)	

Table 4-5 Print menu (SFP) or Copy/Print menu (MFP) (continued)

First level	Second level	Third level	Fourth Level	Values	Description
Copy Settings	Paper Selection		Paper Size	Match original size*	Select the size of paper to use when printing or making copies.
MFP				Letter (8.5x11)	
				Legal (8.5x14)	
				Executive (7.25x10.5)	
				Statement (5.5x8.5)	
				Oficio (8.5x13)	
				3x5	
				4x6	
				5x7	
				5x8	
				A4 (210x297 mm)	
				A5 (148x210 mm)	
				A6 (105x148 mm)	
				RA4 (215x305 mm)	
				B5 (182x257 mm)	
				B6 (128x182 mm)	
				10x15cm	
				16K (195x270 mm)	
				16K (184x260 mm)	
				16K (197x273 mm)	
				Postcard JIS (100x148 mm)	
				DPostcard JIS (148x200 mm)	
				Envelope #9	
				Envelope #10	
				Envelope Monarch	
				Envelope #10	
				Envelope B5	
				Envelope C5	
				Envelope C6	
				Envelope DL	
				Custom	
				Oficio (216x340 mm)	

Table 4-5 Print menu (SFP) or Copy/Print menu (MFP) (continued)

First level	Second level	Third level	Fourth Level	Values	Description
Copy Settings MFP	Paper Selection		Paper Type	Any Type	Select the type of paper to use when printing or making copies.
				Plain*	
				Light 60-74g	
				Intermediate 85-95g	
				Mid-Weight 96-110g	
				Heavy 111-130g	
				Extra Heavy 131-175g	
				Cardstock 176-220g	
				Mono Transparency	
				Labels	
				Letterhead	
				Envelope	
				Preprinted	
				Prepunched	
				Colored	
Bond					
Recycled					
Rough					
HP EcoFFICIENT					
Light Bond					
Copy Settings MFP	Paper Selection		Paper Tray	Automatically detect*	Select which tray to use when printing or making copies.
				Manually Feed	
				Tray 1	
				Tray 2	
Copy Settings MFP	Booklet	Booklet Format		Enabled	Select to have Booklet Format off or on.
				Disabled*	
Copy Settings MFP	Booklet	Booklet Format	Borders on each page	Enabled	Select to have borders printed on the page.
				Disabled*	
Copy Settings MFP	Content Orientation			Portrait*	Specify the way the content of the original document is placed on the page.
				Landscape	

Table 4-5 Print menu (SFP) or Copy/Print menu (MFP) (continued)

First level	Second level	Third level	Fourth Level	Values	Description
Copy Settings MFP	Pages per Sheet			One*	Select how many pages to print on one sheet.
				Two	
				Four	
Copy Settings MFP	Page Order			Right, then down	Select to print the pages in rows or columns.
				Down, then right	
Copy Settings MFP	Add page borders			Enabled	Select the Add page borders checkbox to add borders to the pages.
				Disabled*	
Copy Settings MFP	Image Adjustment	Darkness		1 - (Lighter)	Adjust to increase or decrease the amount of white and black in the colors.
				2	
				3	
				4	
				5*	
				6	
				7	
				8	
				9 - (Darker)	
Copy Settings MFP	Image Adjustment	Contrast		1 - (Less)	Adjust to increase or decrease the difference between the lightest and darkest color on the page.
				2	
				3	
				4	
				5*	
				6	
				7	
				8	
				9 - (More)	

Table 4-5 Print menu (SFP) or Copy/Print menu (MFP) (continued)

First level	Second level	Third level	Fourth Level	Values	Description
Copy Settings MFP	Image Adjustment	Background Cleanup		1 - (Normal)	Adjust if you are having trouble copying a faint image.
				2	
				3*	
				4	
				5*	
				6	
				7	
				8	
				9 - (Cleaner)	
Copy Settings MFP	Image Adjustment	Sharpness		1 - (Less)	Adjust to sharpen or soften the image.
				2	
				3*	
				4	
				5 - (More)	
Copy Settings MFP	Optimize Text/ Picture		Text	Select to optimize for the output of a particular type of content.	
			Mixed*		
			Printed picture		
			Photograph		
Copy Settings MFP	Edge-to-Edge		Normal (recommended)	When the Edge-to-Edge feature is enabled, the product minimizes margins and prints as close to the edge of the paper as possible.	
			Edge-to-Edge output		
Copy Settings MFP	Erase Edges	Use inches		Enabled*	Use the Erase Edges feature to remove blemishes, such as dark borders or staple marks, by cleaning the edges of the scanned image.
				Disabled	
					Disabling Use inches changes the measurements to millimeters.

Table 4-5 Print menu (SFP) or Copy/Print menu (MFP) (continued)

First level	Second level	Third level	Fourth Level	Values	Description
Copy Settings MFP	Erase Edges	Front Side		Specify a different width for each edge	Sets the width of the edge to clean.
				Apply same width to all edges*	
				All edges value	
				Default = 0.00	
Copy Settings MFP	Erase Edges	Back Side		Specify a different width for each edge	Sets the width of the edge to clean.
				Apply same width to all edges	
				Mirror front side*	
Copy Settings MFP	Collate			Collate on*	When Collate on is selected, each set of copied pages are assembled in the same order as the original document.
				Collate off	
Copy Settings MFP	Multi-feed Detection			Disabled	Use this feature to detect when multiple pages are fed simultaneously into the ADF (automatic document feeder) or sheet-feed scanner.
				Enabled*	
Copy Settings MFP					
				Enabled	Enables the printer to open a file from a USB drive.
				Disabled*	
Manage Stored Jobs	Job Sort Order			Job Name*	This option allows you list the jobs either alphabetically or chronologically.
				Date*	
Manage Stored Jobs	Retain Temporary Jobs			Do not retain	Sets which temporary jobs will be retained in the event of a printer reboot.
				Personal jobs only	
				All temporary jobs	

Table 4-5 Print menu (SFP) or Copy/Print menu (MFP) (continued)

First level	Second level	Third level	Fourth Level	Values	Description
Manage Stored Jobs	Temporary Job Storage Limit			1-300	Configure global settings for jobs that are stored in the printer memory. The Temporary Job Storage Limit feature specifies the number of temporary jobs that can be stored on the printer. The maximum allowed value is 300.
				Default = 32	
Manage Stored Jobs	Temporary Job Storage Retention			Off	Configure global settings for temporary jobs that are stored in the printer memory. The Temporary Stored Job Retention feature specifies the amount of time temporary jobs can be stored on the printer.
				30 minutes	
				1 hour	
				4 hours	
				1 day	
				1 week	
				4 weeks	
				3 days	
Manage Stored Jobs	Standard Stored Job Retention			Off	Configure global settings for jobs that are stored in the printer memory.
				30 minutes	
				1 hour	
				4 hours	The Standard Stored Job Retention feature specifies the amount of time jobs can be stored on the printer.
				1 day	
				1 week	
				4 weeks	
		3 days			
Default Print Options	Number of Copies			Range: 1-32000	Sets the default number of copies for a copy job. This default applies when the Copy function or the Quick Copy function is initiated from the printer Home screen.
				Default = 1	
Default Print Options	Paper Selection	Paper size		Select from a list of sizes that the printer supports.	Configures the default paper size, type and tray used for print jobs.
		Paper type			
		Paper tray			

Table 4-5 Print menu (SFP) or Copy/Print menu (MFP) (continued)

First level	Second level	Third level	Fourth Level	Values	Description
Default Print Options	Default Custom Paper Size	X Dimension		Range: 3.00-8.50 inches Default = 8.5 inches	Configures the default paper size that is used when the user selects Custom as the paper size for a print job.
Default Print Options	Default Custom Paper Size	Y Dimension		Range: 5.00-14.00 inches Default = 14 inches	Configures the default paper size that is used when the user selects Custom as the paper size for a print job.
Default Print Options	Default Custom Paper Size	Use Inches		Enabled* Disabled	
Default Print Options	Output Sides			1-sided* 2-sided	Use to indicate whether the original document is printed on one or both sides.
Default Print Options	Edge-to-Edge			Normal (recommended)* Edge-to-Edge output	Use to avoid shadows that can appear along the edges of copies when the original document is printed close to the edges.
Default Print Options	Resolution			FastRes 1200* ProRes 1200	Use to select the level of desired print quality.
Default Print Options	Resolution	Economode		Enabled Disabled*	Text is printed using less toner. This setting is useful when you are printing drafts. You can turn on this option independently of other print quality settings.
PCL and Postscript Settings	Courier Font			Regular* Dark	Select which version of the Courier font you want to use. The factory default setting is Regular , which uses an average stroke width. The Dark setting can be used if a heavier Courier font is needed.

Table 4-5 Print menu (SFP) or Copy/Print menu (MFP) (continued)

First level	Second level	Third level	Fourth Level	Values	Description
PCL and Postscript Settings	Wide A4			Enabled	Changes the printable area of A4-size paper. If you enable this option, eighty 10-pitch characters can be printed on a single line of A4 paper.
				Disabled*	
PCL and Postscript Settings	Print PS Errors			Enabled	Use this feature to select whether a PostScript (PS) error page is printed when the printer encounters a PS error.
				Disabled*	
PCL and Postscript Settings	Print PDF Errors			Enabled	Selects whether a PDF error page is printed when the printer encounters a PDF error.
				Disabled*	
PCL and Postscript Settings	Personality			Automatic*	Configures the default print language or personality for the printer. Normally you should not change the printer language. If you change the setting to a specific printer language, the printer does not automatically switch from one language to another unless specific software commands are sent to it.
				PCL	
				PS	
				PDF	
PCL and Postscript Settings	PCL	Font Settings	Font Source	Internal	Selects the font source for the user-soft default font. The list of available options varies depending on the installed printer options.
				Disk resident*	

Table 4-5 Print menu (SFP) or Copy/Print menu (MFP) (continued)

First level	Second level	Third level	Fourth Level	Values	Description
PCL and Postscript Settings	PCL	Font Settings	Font Number	Range: 0-110 Default = 0	Specifies the font number for the user-soft default font using the source that is specified in the Font Source menu. The printer assigns a number to each font and lists it on the PCL font list. The font number displays in the Font # column of the printout.
PCL and Postscript Settings	PCL	Font Settings	Font Pitch	Range: 0.44-99.99 Default = 10	If the Font Source option and the Font Number setting indicate a contour font, then use this feature to select a default pitch (for a fixed-spaced font).
PCL and Postscript Settings	PCL	PCL Settings	Form Length	Range: 5-128 lines Default = 60	Controls the PCL print-command options. PCL is a set of printer commands that HP developed to provide access to printer features. Use the Form Length feature to select the user soft -default vertical form length.
PCL and Postscript Settings	PCL	PCL Settings	Orientation	Portrait* Landscape	Select the orientation that is most often used for copy or scan originals. Select the Portrait option if the short edge is at the top or select the Landscape option if the long edge is at the top.

Table 4-5 Print menu (SFP) or Copy/Print menu (MFP) (continued)

First level	Second level	Third level	Fourth Level	Values	Description
PCL and Postscript Settings	PCL	PCL Settings	Symbol Set	Select from a list of symbol sets.	Select any one of several available symbol sets from the control panel. A symbol set is a unique grouping of all the characters in a font. The factory default value for this option is PC-8. Either PC-8 or PC-850 are recommended for line-draw characters.
PCL and Postscript Settings	PCL	PCL Settings	Append CR to LF	Enabled Disabled*	When enabled, this option appends a carriage return to each line feed encountered in backwards-compatible PCL jobs.
PCL and Postscript Settings	PCL	PCL Settings	Suppress Blank Pages	Enabled Disabled*	This option is for users who are generating their own PCL, which could include extra form feeds that would cause blank pages to be printed. When the On option is selected, form feeds are ignored if the page is blank.
PCL and Postscript Settings	PCL	PCL Settings	Media Source Mapping	Standard* Classic	Use to select and maintain input trays by number when you are not using the printer driver, or when the software program has no option for tray selection. The following options are available: Standard: Tray numbering is based on newer HP LaserJet models. Classic: Tray numbering is based on HP LaserJet 4 and older models.

Table 4-5 Print menu (SFP) or Copy/Print menu (MFP) (continued)

First level	Second level	Third level	Fourth Level	Values	Description
Print Quality	General	Toner Density		A sliding bar appears with the indicator set in the middle between Less and More .	Lighten or darken the print on the page by changing the toner density setting.
Print Quality	General	REt		Disabled Enabled*	Use this setting to enable or disable Resolution Enhancement technology (REt), which produces smoother angles, curves, and edges.
Print Quality	Image Registration	Tray	Tray 1 Tray 2 Tray 3 Tray 4 Tray 5 Depends upon the number of trays installed		Specify tray to be adjusted

Table 4-5 Print menu (SFP) or Copy/Print menu (MFP) (continued)

First level	Second level	Third level	Fourth Level	Values	Description
Print Quality	Image Registration	Front-side Horizontal Shift		-5.00 mm to 5.00 mm	Shift the margin alignment to center the image on the page from top to bottom and from left to right. You can also align the image on the front with the image printed on the back.
		Front-side Vertical Shift			The direction that is perpendicular to the way the paper passes through the printer is referred to as X. This is also known as the scan direction. X1 is the scan direction for a single-sided page or for the second side of a two-sided page. X2 is the scan direction for the first side of a two-sided page.
		Back-side Horizontal Shift			The direction that the paper feeds through the printer is referred to as Y. Y1 is the feed direction for a single-sided page or for the second side of a two-sided page. Y2 is the feed direction for the first side of a two-sided page.
		Back-side Vertical Shift			Use the Adjust Tray <X> menu to adjust the registration settings for each tray. Before adjusting these values, print a registration test page. It provides alignment guides in the X and Y directions so you can determine which adjustments are necessary. You can adjust values for X1 Shift, X2 Shift, Y1 Shift, and Y2 Shift.

Table 4-5 Print menu (SFP) or Copy/Print menu (MFP) (continued)

First level	Second level	Third level	Fourth Level	Values	Description
Print Quality	Image Registration	Print Test Page			Use the Print Test Page option to print a page to test the image registration. It provides alignment guides in the X and Y directions so you can determine which adjustments are necessary.
Print Quality	Auto Sense Behavior	Tray 1		Sense every page Sense first page Sense transparency only	
Print Quality	Auto Sense Behavior	All Other Trays		Sense first page Sense transparency only	
Print Quality	Adjust Paper types	Select from a list of paper types that the printer supports. The available options are the same for each paper type.	Print mode	Select from a list of paper types Reset Paper Types	Changing the Print mode setting is usually the first thing to try to resolve print-quality problems. Problems can include toner not sticking well to the page, a faint image of the page repeated on the same or following page, incorrect gloss level, and so on.
Print Quality	Adjust Paper types	Select from a list of paper types that the printer supports. The available options are the same for each paper type.	Resistance mode	Normal* Up 1 Up 2	<p>Use this setting to correct print quality problems in low-humidity environments and highly resistive paper.</p> <p>Use the Up options to solve print quality problems that are related to faded images or scattered toner on certain paper types.</p> <p>The Up options raise the secondary transfer bias.</p>

Table 4-5 Print menu (SFP) or Copy/Print menu (MFP) (continued)

First level	Second level	Third level	Fourth Level	Values	Description
Print Quality	Adjust Paper types	Select from a list of paper types that the printer supports. The available options are the same for each paper type.	Paper curl mode	Normal* Reduced	Use this setting to reduce paper curl in print jobs.
Print Quality	Optimize	Line Detail		Normal* Off Alternate	Use this setting if you have scattered lines in printed pages.
Print Quality	Optimize	Moisture Control		Normal* Alternate	
Print Quality	Optimize	Envelope control		Normal Reduced Temp	
Print Quality	Optimize	Tray 1		Normal Alternate	
Print Quality	Optimize	Background		Normal Alternate	
Print Quality	Optimize	Uniformity Control		Normal Alternate 1 Alternate 2 Alternate 3	
Print Quality	Optimize	Cac03		Off On	
Print Quality	Optimize	Best Normal		Off On	
Print Quality	Optimize	Tracking Control		Off On	
Print Quality	Optimize	Registration		Normal Alternate	
Print Quality	Optimize	Transfer Control		Normal Alternate 1	
Print Quality	Optimize	Moisture Control		Normal Alternate	
Print Quality	Optimize	Reset Optimize		Reset	

Table 4-5 Print menu (SFP) or Copy/Print menu (MFP) (continued)

First level	Second level	Third level	Fourth Level	Values	Description
Print Quality	Edge Control			Off Light Normal* Maximum	
Manage Trays	Use Requested Tray			Exclusively* When available	<p>Controls how the printer handles jobs that have specified a specific input tray. Two options are available:</p> <p>Exclusively: The printer never selects a different tray when the user has indicated that a specific tray should be used, even if that tray is empty.</p> <p>When available: The printer pulls from another tray if the specified tray is empty, even though the specific tray was indicated for the job.</p>
Manage Trays	Manually Feed Prompt			Always prompt* Prompt on mismatch	<p>Indicate whether a prompt should appear when the type or size for a job does not match the specified tray and the printer pulls from the multipurpose tray instead. Two options are available:</p> <p>Always: A prompt always displays before using the multipurpose tray.</p> <p>Prompt on mismatch: A prompt displays only if the size or type do not match or the tray is empty.</p>

Table 4-5 Print menu (SFP) or Copy/Print menu (MFP) (continued)

First level	Second level	Third level	Fourth Level	Values	Description
Manage Trays	Size/Type Prompt			<p>Display*</p> <p>Do not display</p>	<p>Controls whether the tray configuration message displays whenever a tray is closed. Two options are available:</p> <p>Display: Shows the tray configuration message when a tray is closed. The user is able to configure the tray settings directly from this message.</p> <p>Do not display: Prevents the tray configuration message from automatically appearing.</p>
Manage Trays	Use Another Tray			<p>Allow*</p> <p>Do not allow</p>	<p>Use to turn on or off the control panel prompt to select another tray when the specified tray is empty. Two options are available:</p> <p>Allow: When this option is selected the user is prompted to either add paper to the selected tray or to choose a different tray. This is the factory default.</p> <p>Do not allow: When this option is selected, the user is not given the option of selecting a different tray. The printer prompts the user to add paper to the tray that was initially selected.</p>

Table 4-5 Print menu (SFP) or Copy/Print menu (MFP) (continued)

First level	Second level	Third level	Fourth Level	Values	Description
Manage Trays	Alternative Letterhead Mode			Off* On	Use to load letterhead or preprinted paper into the tray the same way for all print jobs, whether you are printing to one side of the sheet or to both sides of the sheet. When this option is selected, load the paper as you would for printing on both sides. See the user documentation that came with the printer for instructions about loading letterhead for printing on both sides. When this option is selected, the printer speed slows to the speed required for printing on both sides.
Manage Trays	Duplex Blank Pages			Automatic* Always	Controls how the printer handles two-sided jobs (duplexing). Two options are available: Automatic: Choose this option to skip printing blank sides during a two-sided print job. The printer can print jobs faster when blank sides are skipped. Always: Choose this option to print all sides of a two-sided job, even if one side is blank. This might be preferable for certain jobs that use paper types such as letterhead or prepunched paper.

Table 4-5 Print menu (SFP) or Copy/Print menu (MFP) (continued)

First level	Second level	Third level	Fourth Level	Values	Description
Manage Trays	Override A4/ Letter			Yes* No	Prints on letter-size paper when an A4 job is sent but no A4-size paper is loaded in the printer (or to print on A4 paper when a letter-size job is sent but no letter-size paper is loaded). This option will also override A3 with ledger-size paper and ledger with A3-size paper.

Defeating interlocks

Learn about defeating printer interlocks.

Different tests can be used to isolate different types of issues. For assembly or noise isolation, run the diagnostic test when the front, right or toner supply (model specific) door is open.

Defeating the door interlocks allows observation of the paper pick operation.

Defeat the front door interlock

1. Open the front door.
2. Insert a folded piece of paper into the slot.

 **TIP:** Fold a stiff piece of paper, for example a business card or index card, into a strip, and insert the strip into the slot for the door interlock logic switch.

It might be easier to use a small flat-blade screwdriver to defeat the door interlock.

Figure 4-49 Defeat the front door interlock



Defeat the right door interlock

1. Open the right door.

2. Insert a folded piece of paper into the slot.

 **TIP:** Fold a stiff piece of paper, for example a business card or index card, into a strip, and insert the strip into the slot for the door interlock logic switch.

It might be easier to use a small flat-blade screwdriver to defeat the door interlock.

Figure 4-50 Defeat the right door interlock

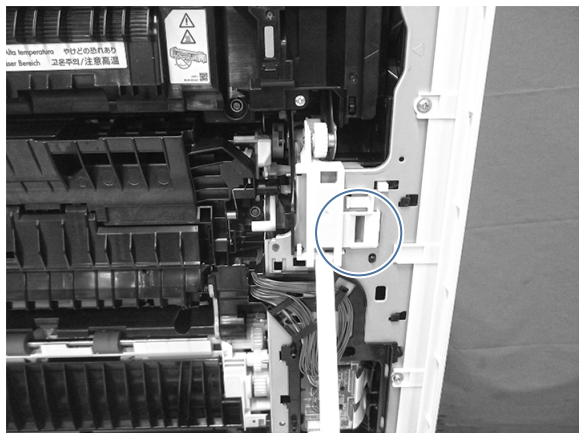

Defeat the toner supply door interlock (X57945 models)

1. Open the toner supply door.
2. Insert a folded piece of paper into the slot.

 **TIP:** Fold a stiff piece of paper, for example a business card or index card, into a strip, and insert the strip into the slot for the door interlock logic switch.

It might be easier to use a small flat-blade screwdriver to defeat the door interlock.

Figure 4-51 Defeat the toner supply door interlock (X57945 models)

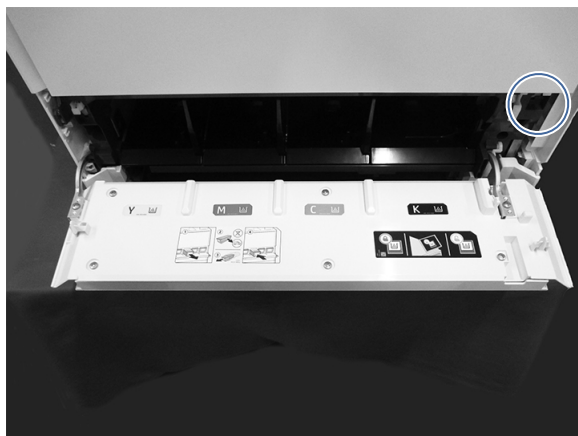

LED diagnostics (formatter)

Learn about troubleshooting the printer using formatter LEDs.

The formatter has two network port LEDs. When the printer is connected to a properly working network through a network cable, the amber LED indicates network activity, and the green LED indicates the link status.

A blinking amber LED indicates network traffic. If the green LED is off, a link has failed. For link failures, check all of the network cable connections.

In addition, try to manually configure the network card link speed setting by using the printer control panel. To change the link speed, complete the following steps.

1. From the [Home](#) screen on the printer control panel, scroll to and touch the [Settings](#) button.
2. Open the following menus:
 - [Networking](#)
 - [Ethernet](#)
 - [Link Speed](#)
3. Touch the desired link speed setting, and then touch the [Done](#) button.

Scanner tests (MFP)

Learn about troubleshooting the MFP scanner tests.

Use the scanner tests

The [Scanner Tests](#) screen shows the sensor name, sensor state (active or inactive), and the number of times the sensor has been toggled (activated).

1. From the Home screen on the product control panel, scroll to and select the [Support Tools](#) item.
2. Open the following menus:
 - [Troubleshooting](#)
 - [Diagnostic Tests](#)
 - [Scanner Tests](#)
 - – [Sensors](#)
3. Touch the sensor name on the [Scanner Tests](#) screen to display a sensor location graphic on the control panel display.
4. Activate the desired sensor, and then check the control-panel display to verify the sensor state (active or inactive).
 - The [State](#) virtual LED next to the sensor number and sensor name illuminates green when the sensor is active.
 - The [Toggle](#) virtual LED next to the sensor number and sensor name illuminates green after the sensor is activated and increments by one each time the sensor is interrupted (activated or deactivated).

For example, opening the flatbed cover increments the [Flatbed cover Toggle](#) item count two times—once when the door is opened, and once when the door is closed.
5. Select the [Reset sensors](#) item to reset the [Toggle](#) count item.

-or-

Touch the [Cancel](#) button to exit the [Scanner Tests](#) screen, and then touch the [Cancel](#) button again to return the [Diagnostic Tests](#) menu.

Scanner test sensors

- [ADF paper present](#)
- [ADF Y \(length\)](#)
- [ADF jam cover](#)
- [ADF paper path deskew](#)
- [ADF paper path pick success](#)
- [Paper path sensor 1 \(unreachable\)](#)
- [Flatbed Y \(length\)](#)
- [Flatbed cover](#)

Disable cartridge check

Learn about the disable cartridge check troubleshooting diagnostic.

 **CAUTION:** Do not perform a disable cartridge check on color printers that use a two-part cartridge design. Doing so might result in toner cross contamination in the supply lines.

Use this diagnostic test to print internal pages or send an external job to the printer when a toner cartridge is removed or exchanged. Supply errors are ignored while the printer is in this mode.

When the printer is in this mode, access the troubleshooting menus and print internal pages (the print quality pages will be the most useful). This test can be used to isolate problems, such as noise, and to isolate print-quality problems that are related to a toner cartridge.

 **NOTE:** Do not remove or exchange the toner cartridge until after beginning the disable cartridge check diagnostic.

1. From the Home screen on the printer control panel, scroll to and touch the [Support Tools](#) button.
2. Open the following menus:
 - [Troubleshooting](#)
 - [Diagnostic Tests](#)
 - [Disable Cartridge Check](#)

Print/stop test

Learn about the print/stop test troubleshooting diagnostic.

Use this diagnostic test to isolate the cause of problems such as image-formation defects and jams within the engine.

During this test, stop the paper anywhere along the printer paper path. The test can be programmed to stop printing internal pages or an external print job when the paper reaches a certain position. The test

can also be programmed to stop from 0 to 60,000 ms. If the timer is set to a value that is greater than the job-print time, the printer can recover in one of two ways.

Printer recovery (print/stop test)

- After the print job is completed press the **OK** button to return to the **Troubleshooting** menu before the timer times out.
- After the timer times out, touch the **Stop** button. Activate the door switch to restart the engine and return it to a normal state.

Common print/stop test timing millisecond (ms) stops

- **600 ms:** The page has passed the registration area and the leading edge is just short of entering the fuser. The image can be seen on the paper but has not fused. If the defect is visible then the cause might be the drum, transfer roller, or a roller prior to, or in, the registration area.
 - **1200 ms:** The leading edge is about 18mm (0.71 in) into the top output bin. The image has gone through the fuser. If the defect was not visible prior to the fuser, and is visible after the fuser, then the fuser is the likely cause of the print quality defect. Inspect the fuser for damage, debris, or labels stuck to the fuser. Replace the fuser. Discuss media specifications and proper care of the fuser with the customer.
1. From the **Home** screen on the printer control panel, scroll to and touch the **Support Tools** button.
 2. Open the following menus:
 - **Troubleshooting**
 - **Diagnostic Tests**
 - **Print/Stop Test**
 3. Enter a range, and then touch the **OK** button.

Individual component diagnostics

Learn about printer individual component diagnostics.

Paper path test

Learn about the paper path test troubleshooting diagnostic.

This diagnostic test generates one or more test pages. Use these pages to isolate the cause of jams.

To isolate a problem, specify which input tray to use, and specify the number of copies to print. Print multiple copies to help isolate intermittent problems. The following options become available after beginning the diagnostic feature:

- **Print Test Page:** Run the paper-path test from the default settings: Tray 2, no duplex, and one copy. To specify other settings, scroll down the menu, and select the setting, and then scroll back up and select **Print Test Page** to start the test.
 - **Source Tray:** Select Tray 1, Tray 2, or the optional tray.
 - **Number of Copies:** Set the numbers of copies to be printed; the choices are 1, 10, 50, 100, or 500.
1. From the **Home** screen on the printer control panel, scroll to and touch the **Support Tools** button.

2. Open the following menus:
 - [Troubleshooting](#)
 - [Diagnostic Tests](#)
 - [Paper Path Test](#)
3. Select the paper path test options for the test.

Paper path sensors test

Learn about the paper path sensors test troubleshooting diagnostic.

This test displays the status of each paper path sensor and allows viewing of sensor status while printing internal pages.

1. From the [Home](#) screen on the printer control panel, scroll to and touch the [Support Tools](#) button.
2. Open the following menus:
 - [Troubleshooting](#)
 - [Diagnostic Tests](#)
 - [Paper Path Sensors](#)
3. Touch the [Start](#) button to run the test.

Individual component test

Learn about the individual component test troubleshooting diagnostic.

This test activates individual parts independently to isolate problems.

Each component test can be performed once or repeatedly. If the [Repeat](#) option is enabled from the drop-down menu, the test cycles the component on and off. This process continues for two minutes, and then the test terminates.



NOTE: The cartridge door interlocks must be defeated to run the component tests. A control panel display prompt appears to indicate removing the toner cartridge, during certain tests.

1. From the [Home](#) screen on the printer control panel, scroll to and touch the [Support Tools](#) button.
2. Open the following menus:
 - [Troubleshooting](#)
 - [Diagnostic Tests](#)
 - [Component Test](#)
3. Select the component test options for the test.

Manual sensor test

Learn about the manual sensor test troubleshooting diagnostic.

The [Manual Sensor Test](#) screen shows the sensor number, sensor name (model specific), sensor state (active or inactive), and the number of times the sensor has been toggled (activated).

1. From the [Home](#) screen on the printer control panel, scroll to and touch the [Support Tools](#) button.
2. Open the following menus:
 - [Troubleshooting](#)
 - [Diagnostic Tests](#)
 - [Manual Sensor Test](#)
3. Activate the desired sensor, and then check the control panel display to verify the sensor state (active or inactive).
 - The [State](#) virtual LED next to the sensor number and sensor name illuminates green when the sensor is active.
 - The [Toggle](#) virtual LED next to the sensor number and sensor name illuminates green after the sensor is activated and increments by one each time the sensor is interrupted (activated or deactivated).

For example, opening a door increments the appropriate sensor item count two times—once when the door is opened, and once when the door is closed.

Tray/bin manual sensor test

Learn about the tray/bin manual sensor test troubleshooting diagnostic.

The [Tray/Bin Manual Sensor Test](#) screen shows the sensor number, sensor name (model specific), sensor state (active or inactive), and the number of times the sensor has been toggled (activated).

1. From the [Home](#) screen on the printer control panel, scroll to and touch the [Support Tools](#) button.
2. Open the following menus:
 - [Troubleshooting](#)
 - [Diagnostic Tests](#)
 - [Tray/Bin Manual Sensor Test](#)
3. Activate the desired sensor, and then check the control panel display to verify the sensor state (active or inactive).
 - The [State](#) virtual LED next to the sensor number and sensor name illuminates green when the sensor is active.
 - The [Toggle](#) virtual LED next to the sensor number and sensor name illuminates green after the sensor is activated and increments by one each time the sensor is interrupted (activated or deactivated).

For example, opening a door increments the appropriate sensor item count two times—once when the door is opened, and once when the door is closed.

Diagrams: Block diagrams

View block diagrams for the printer.

Diagrams: External plug and port locations

View printer external plugs and ports diagrams.

Figure 4-52 External plug and port locations

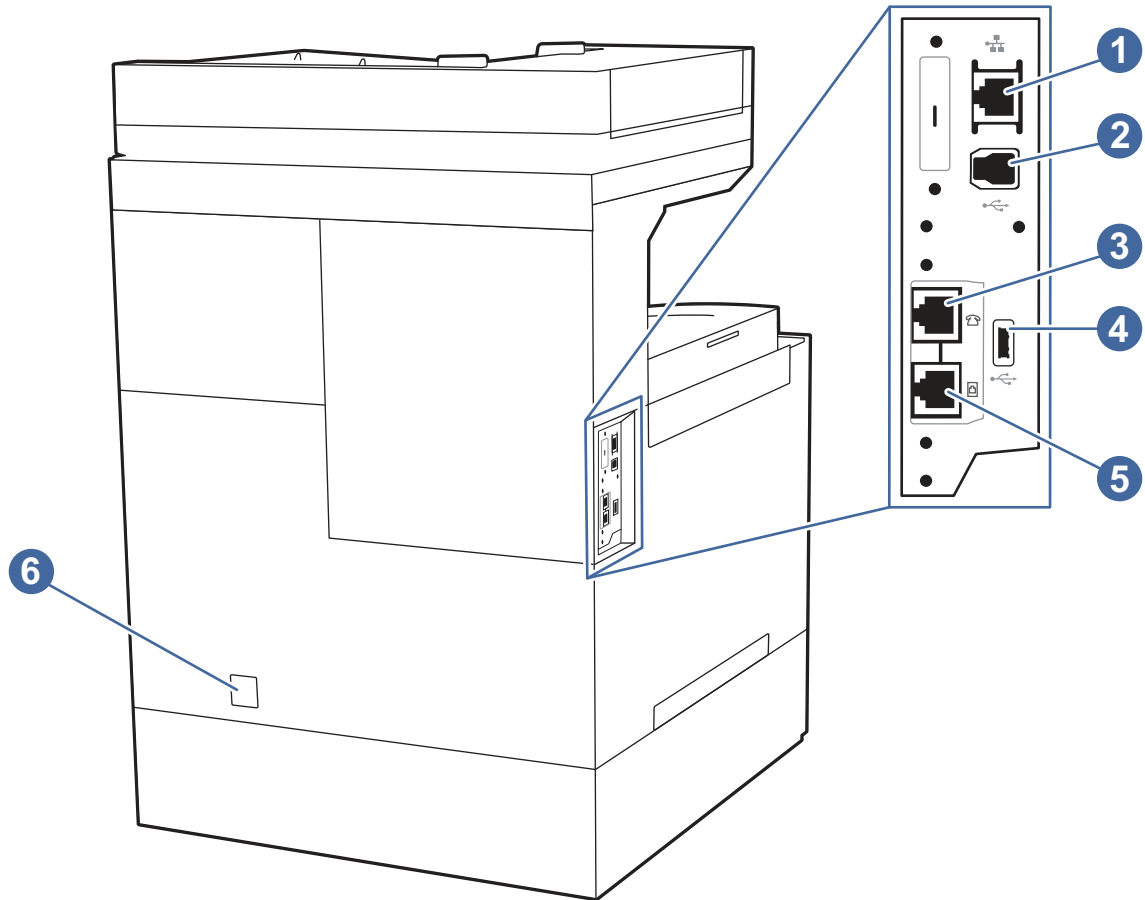

Item	Description
1	Local area network (LAN) Ethernet (RJ-45) network port
2	SuperSpeed USB 3.0 interface port
3	Fax MFP models only: Telephone "line out" port (for attaching an extension phone, answering machine, or other device) NOTE: This port should remain covered when not in use.
4	SuperSpeed USB 3.0 host port (for job storage and private printing) NOTE: This port should remain covered when not in use.
5	Fax MFP models only: Fax "line in" port (for attaching the fax phone line to the printer)
6	Power connection

Sensors and switches

View printer and paper feeder sensor and switch diagrams.

Sensors and switches, printer base

Figure 4-53 Sensors and switches, printer base

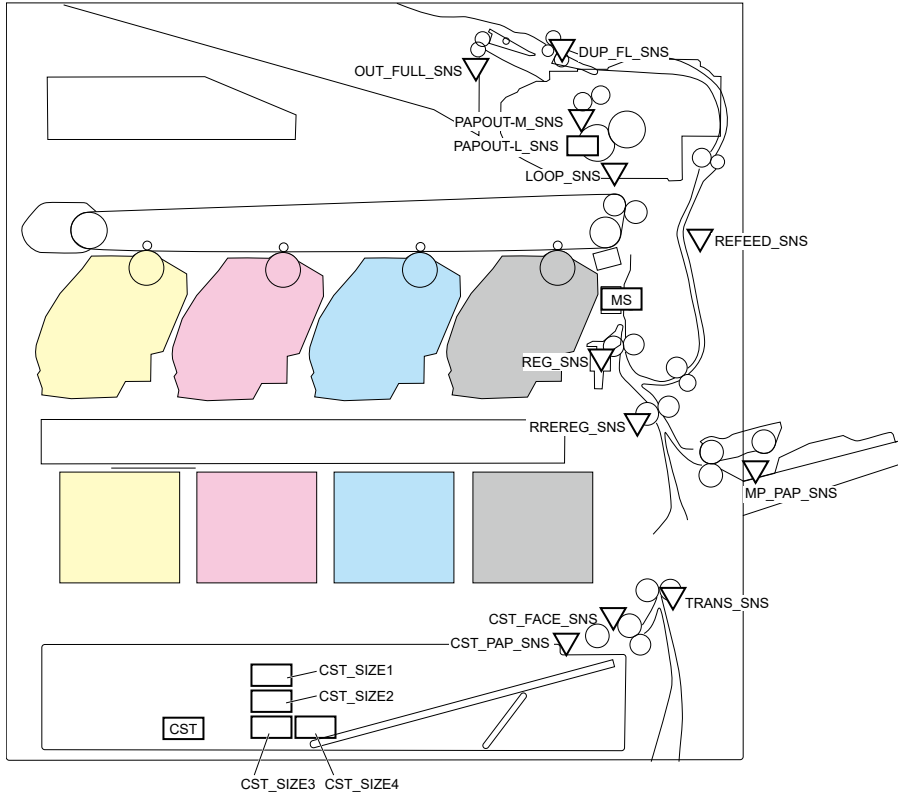

Table 4-6 Sensors and switches, printer base

Abbreviation	Component
CST_SIZE1 (X557/X57945 models only)	Tray 2 media size switch 1
CST_SIZE2 (X557/X57945 models only)	Tray 2 media size switch 2
CST_SIZE3 (X557/X57945 models only)	Tray 2 media size switch 3
CST_SIZE4 (X557/X57945 models only)	Tray 2 media size switch 4
CST (5700/5800 models only)	Tray 2 cassette presence switch
DUP_FL_SNS	Duplex flapper position sensor
OUT_FULL_SNS	FD1 media full sensor
CST_PAP_SNS	Tray 2 media out sensor
CST_FACE_SNS	Tray 2 media surface sensor
LOOP_SNS	Fuser loop sensor
REFEED_SNS (X557/X57945 models only)	Duplex feed sensor
REG_SNS	Registration sensor
MP_PAP_SNS	Tray 1 media out sensor
PAYOUT-M_SNS	Fuser output sensor 2
TRANS_SNS (X57945 models only)	Tray 2 feed sensor
MS (Media sensor PCA)	Media sensor

Table 4-6 Sensors and switches, printer base (continued)

Abbreviation	Component
PAYOUT-L_SNS	Fuser output sensor 1

Sensors and switches, 550-sheet paper feeder

Figure 4-54 Sensors and switches, 550-sheet paper feeder

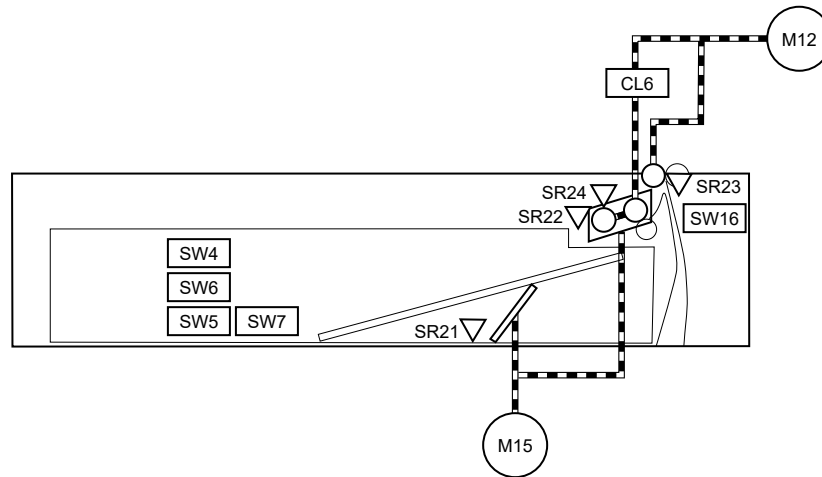

Table 4-7 Sensors and switches, 550-sheet paper feeder

Abbreviation	Component name
SW4	Paper feeder media size switch 1
SW5	Paper feeder media size switch 2
SW6	Paper feeder media size switch 3
SW7	Paper feeder media size switch 4
SW16	Paper feeder door switch
SR21	Paper feeder lifter motor rotation sensor
SR22	Paper feeder media out sensor
SR23	Paper feeder feed sensor
SR24	Paper feeder media surface sensor

Sensors and switches, HCI

Figure 4-55 Sensors and switches, HCI

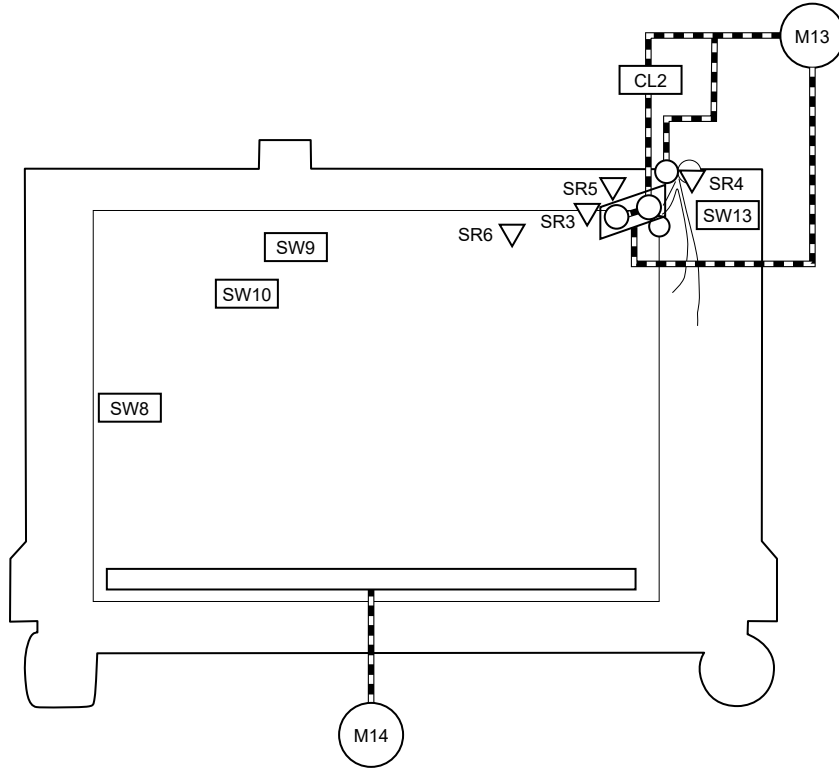

Table 4-8 Sensors and switches, HCI

Abbreviation	Component name
SW8	HCI cassette lifting plate position switch
SW9	HCI cassette media size switch 1
SW10	HCI cassette media size switch 2
SW13	HCI door switch
SR3	HCI cassette media out sensor
SR4	HCI feed sensor
SR5	HCI cassette media surface sensor
SR6	HCI cassette pickup rotation sensor

Sensors and switches, 3-bin stapler-stacker

Figure 4-56 Sensors and switches, 3-bin stapler-stacker

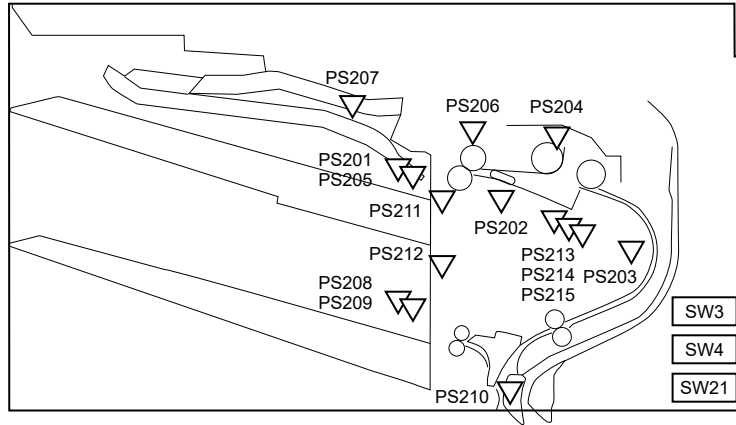

Table 4-9 Sensors and switches, 3-bin stapler-stacker

Abbreviation	Component name
PS201	Bin 1 media presence sensor
PS202	Stapler-stacker exit sensor
PS203	Staple inlet sensor
PS204	Y alignment home position sensor
PS205	Bin 1 media full sensor 1
PS206	Alienation home position sensor
PS207	Jogger home position sensor
PS208	Bin 2 media presence sensor
PS209	Bin 2 media full sensor
PS210	Stapler-stacker inlet sensor
PS211	Bin 1 upper limit sensor
PS212	Bin 1 lower limit sensor
PS213	Staple low sensor
PS214	Staple ready sensor
PS215	Staple home position sensor
SW3	Stapler-stacker door switch
SW4	Staple door switch
SW21	Interlock switch

Diagrams: Major component locations

View printer major component locations diagrams.

Major components, printer base

Figure 4-57 Major components, printer base (1 of 5)

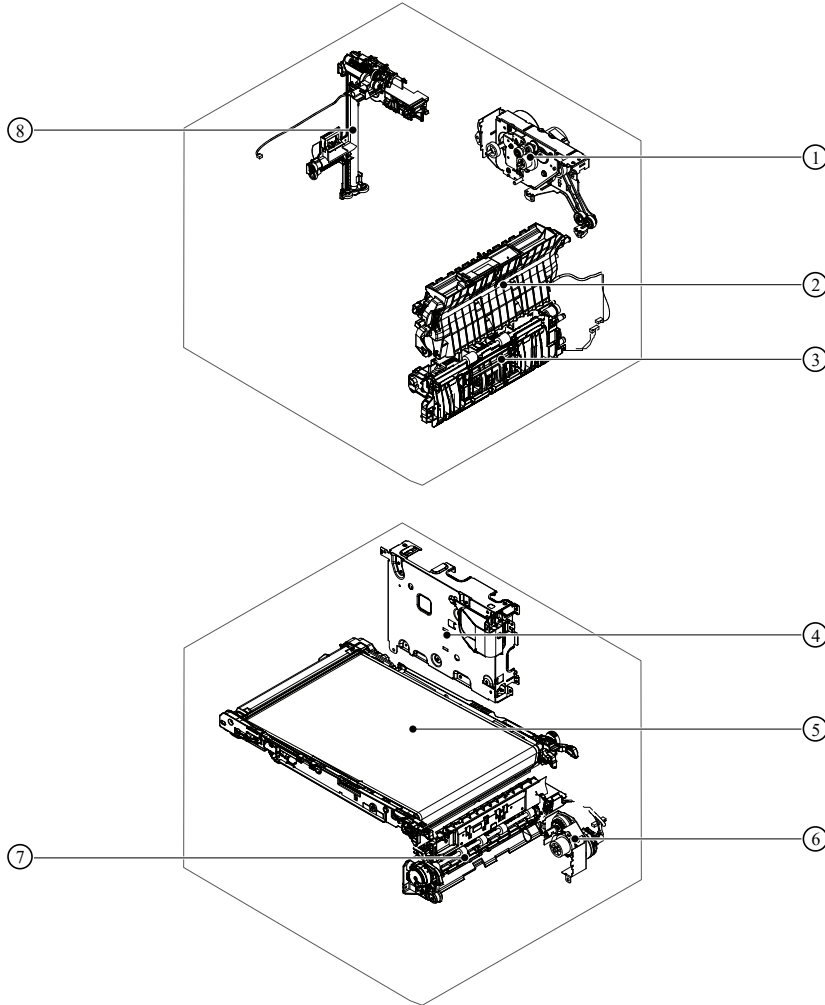

Item	Description	Item	Description
1	Fuser drive assembly	5	Intermediate transfer belt (ITB) assembly
2	Secondary transfer (T2) assembly	6	Pickup drive assembly
3	Pickup assembly	7	Registration assembly
4	Formatter cage assembly	8	Waste toner duct assembly

Figure 4-58 Major components, printer base (2 of 5)

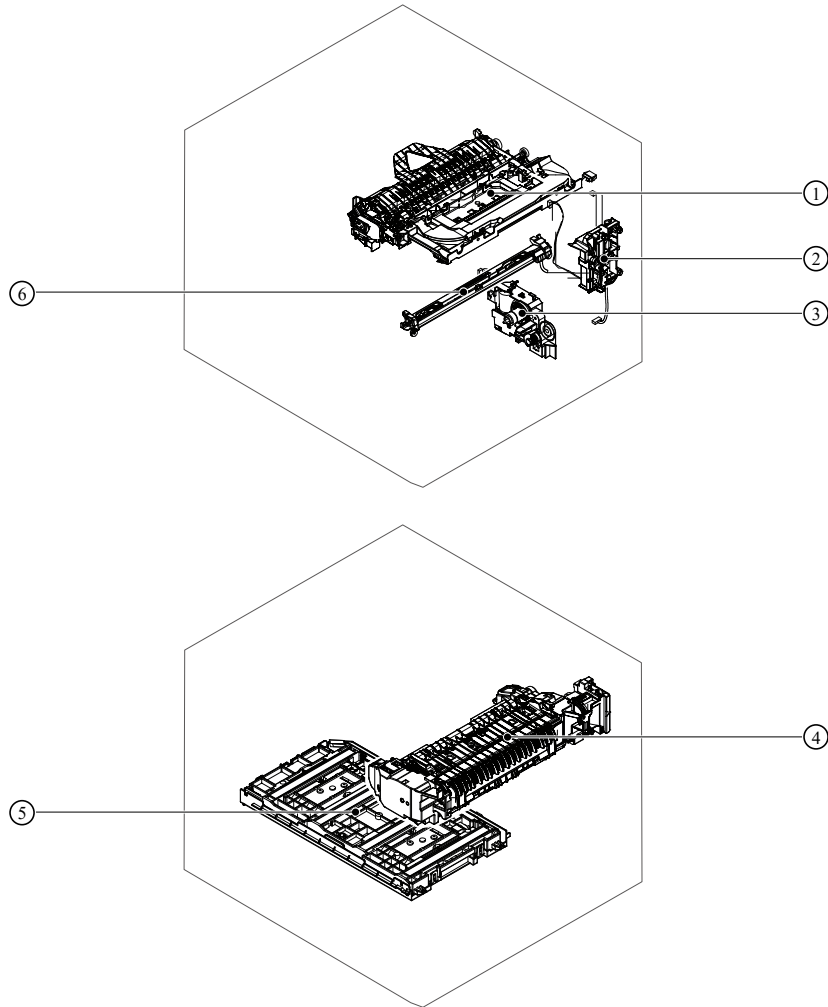

Item	Description	Item	Description
1	Delivery assembly	4	Fuser
2	Interlock assembly	5	Laser scanner assembly
3	Lifter drive assembly	6	Registration density sensor assembly

Figure 4-59 Major components, printer base (3 of 5)

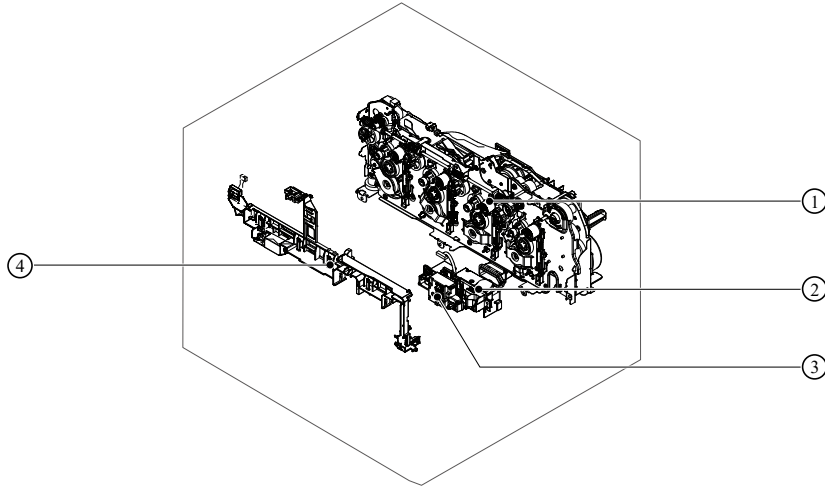

Item	Description	Item	Description
1	Main drive assembly	3	Tray 2 media size detect assembly
2	Auto close assembly	4	Pre-exposure PCA holder assembly

Figure 4-60 Major components, printer base (4 of 5)

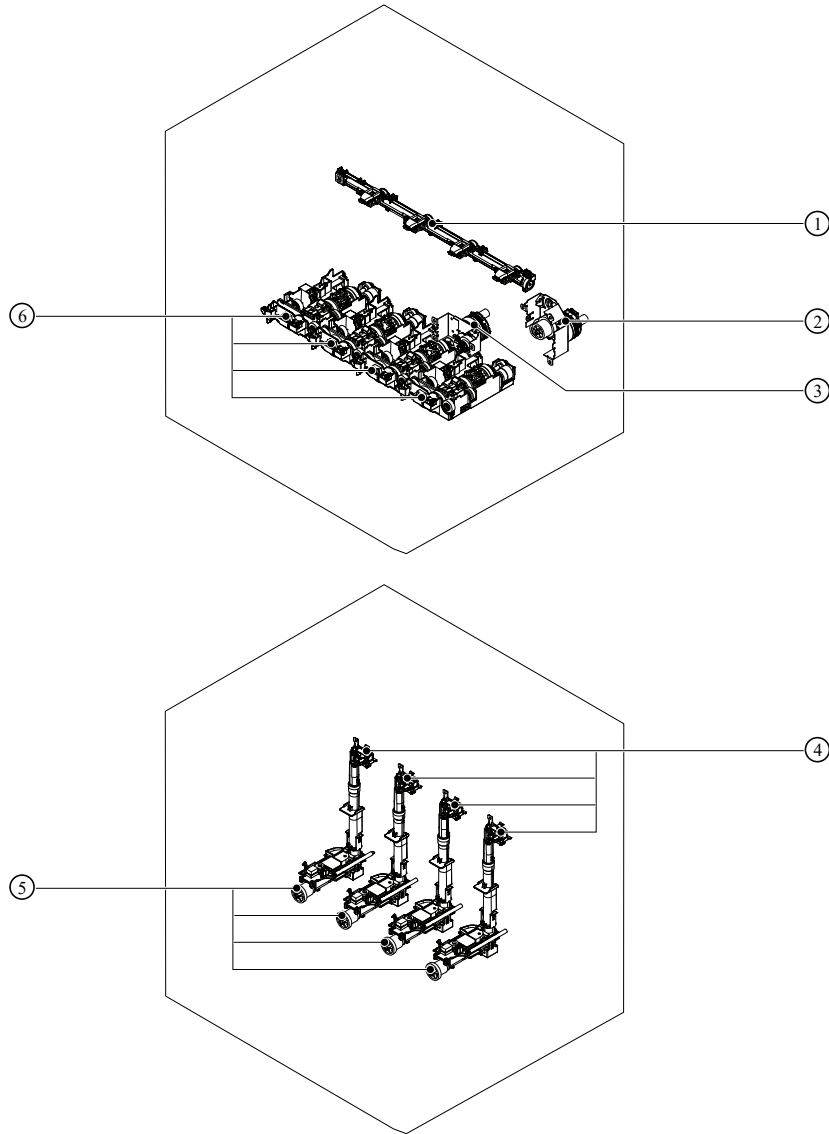

Item	Description	Item	Description
1	Waste toner feed assembly (X57945 models)	4	Toner supply assembly (X57945 models)
2	Feed drive assembly (X57945 models)	5	Toner supply buffer assembly/intermediate pipe (X57945 models)
3	Toner supply motor assembly (X57945 models)	6	Toner supply drive assembly (X57945 models)

Figure 4-61 Major components, printer base (5 of 5)

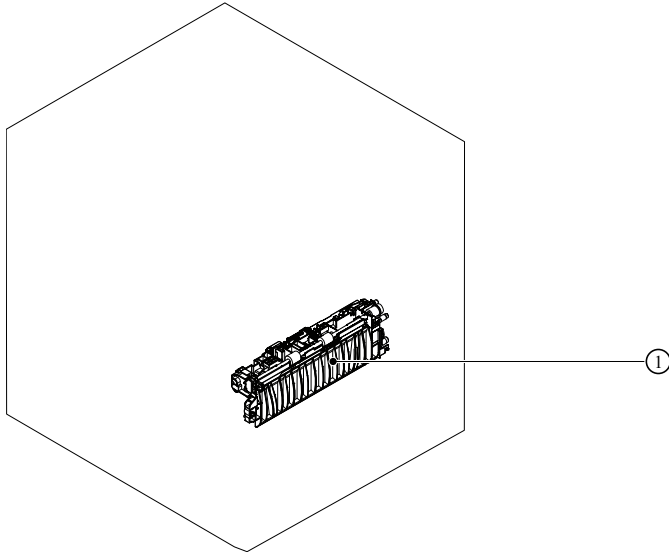

Item	Description
1	Feed assembly (X57945 models)

Motors, printer base

Figure 4-62 Motors, printer base

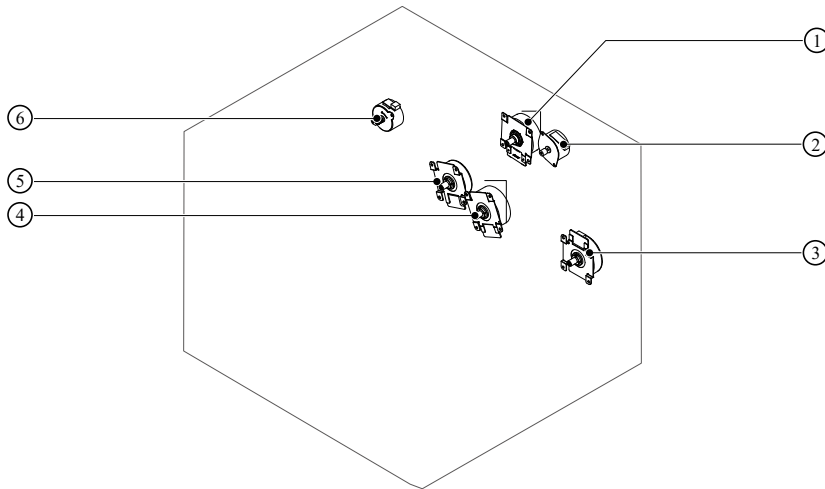

Item	Description	Item	Description
1	Fuser motor	4	Developer motor
2	Duplex motor	5	Drum motor
3	ITB motor	6	Developer alienation motor

Fans, printer base

Figure 4-63 Fans, printer base

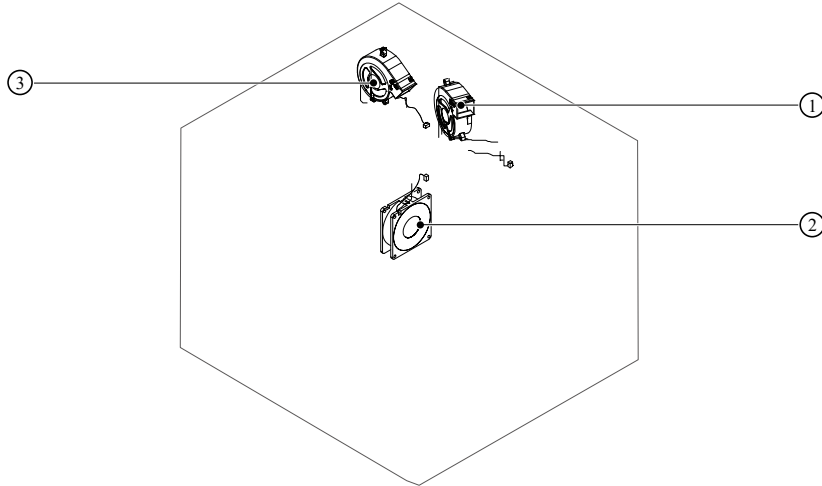

Item	Description	Item	Description
1	Fuser fan	3	Cartridge fan
2	Power supply fan		

Rollers and toner collection unit, printer base

Figure 4-64 Rollers and toner collection unit, printer base

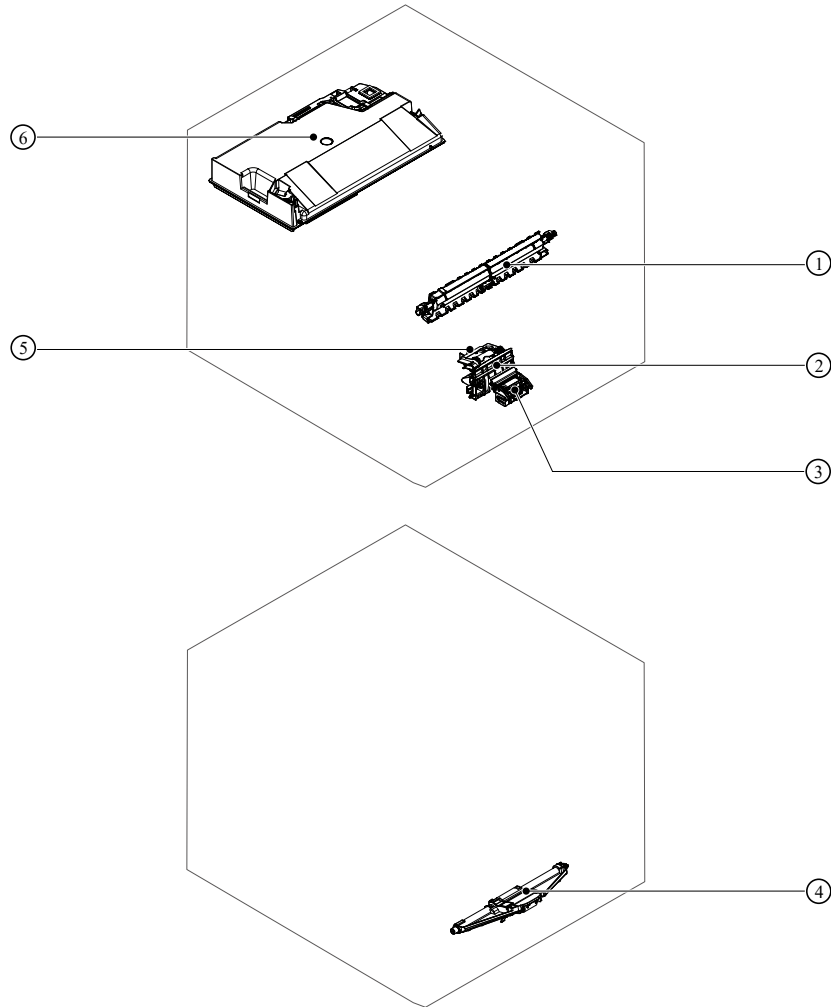

Item	Description	Item	Description
1	Secondary transfer roller assembly	4	Tray 1 pickup roller assembly
2	Tray 2 separation roller assembly	5	Tray 2 pickup roller assembly
3	Tray 1 separation roller assembly	6	Toner collection unit

Printed circuit assemblies, printer base

Figure 4-65 Printed circuit assemblies, printer base (1 of 2)

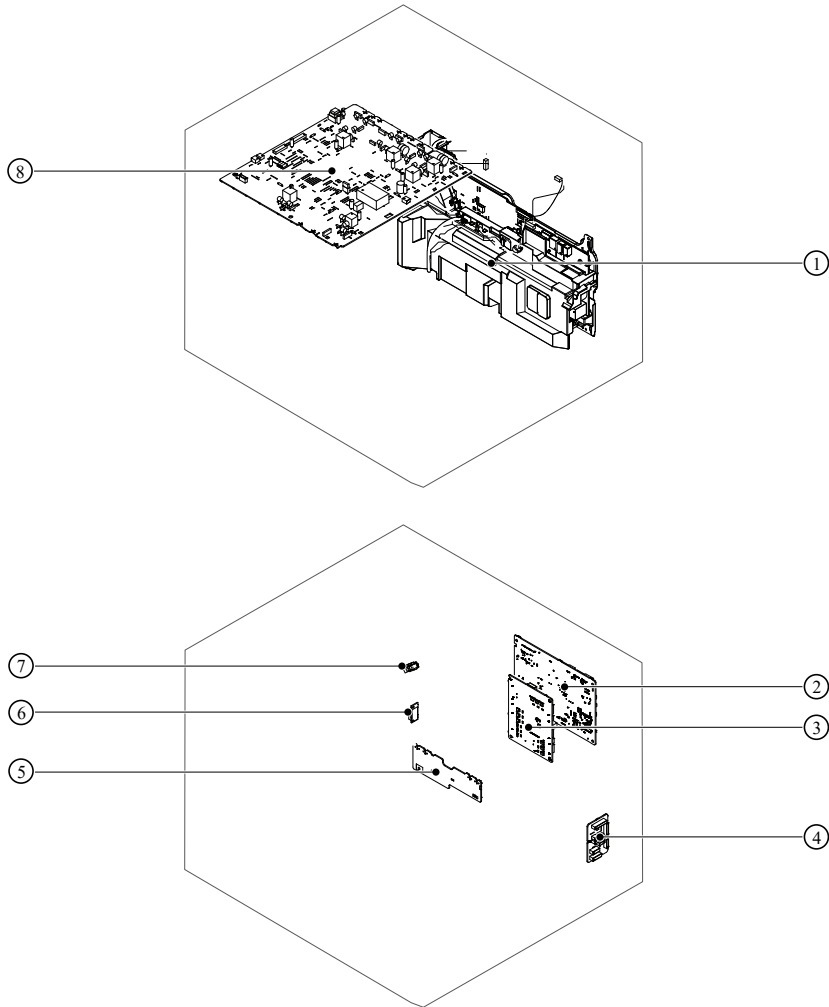

Item	Description	Item	Description
1	Low-voltage power supply	5	Rear PCA
2	DC controller	6	Environment sensor PCA
3	Drive PCA	7	Drum home position sensor PCA
4	Right PCA	8	High-voltage power supply

Figure 4-66 Printed circuit assemblies, printer base (2 of 2)

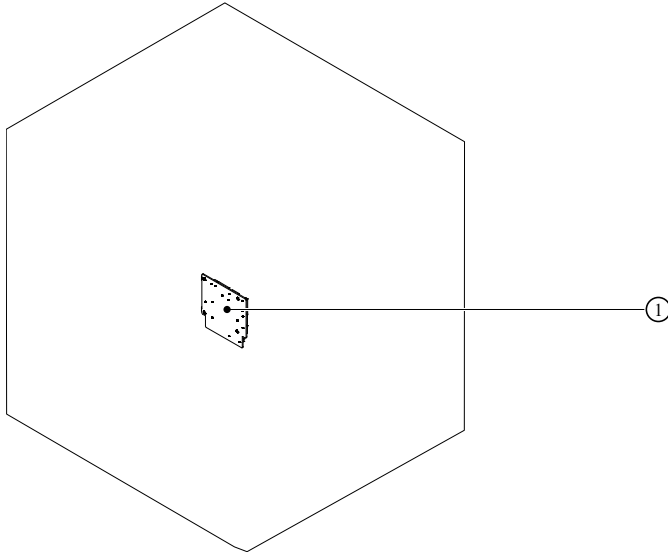

Item	Description
1	Feed/toner supply controller PCA

Major components, 550-sheet paper feeder

Figure 4-67 Covers and doors, 550-sheet paper feeder

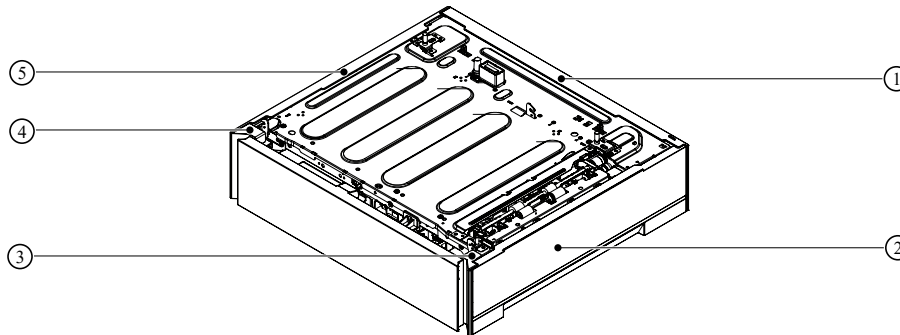

Item	Description	Item	Description
1	Rear cover	4	Front left cover
2	Right door	5	Left cover
3	Front right cover		

Figure 4-68 Major parts, 550-sheet paper feeder

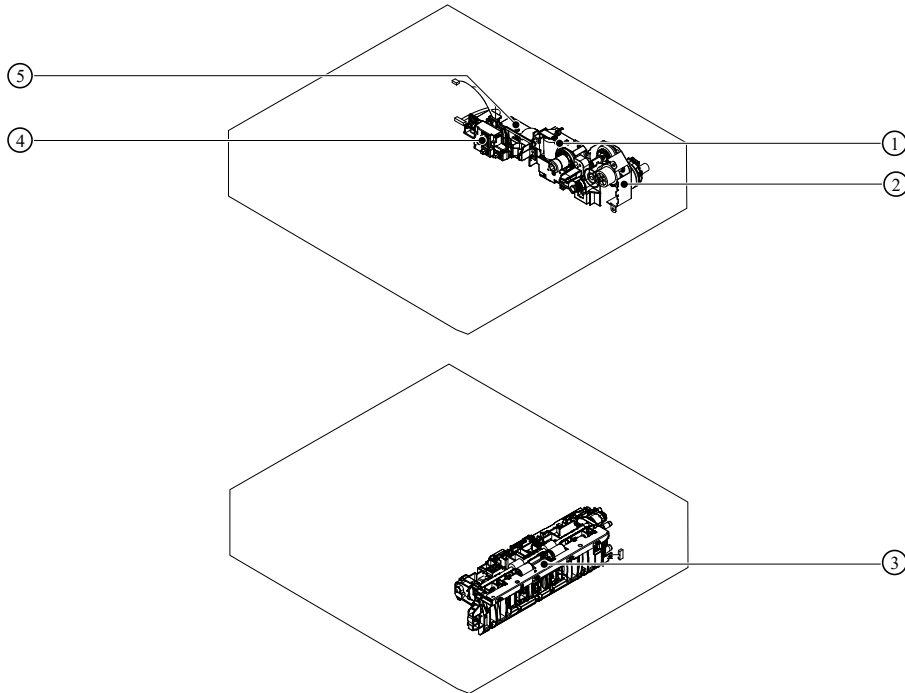

Item	Description	Item	Description
1	Lifter drive assembly	4	Paper feeder cassette media size detect assembly
2	Pickup drive assembly	5	Auto close assembly
3	Pickup assembly		

Figure 4-69 Printed circuit assemblies, 550-sheet paper feeder

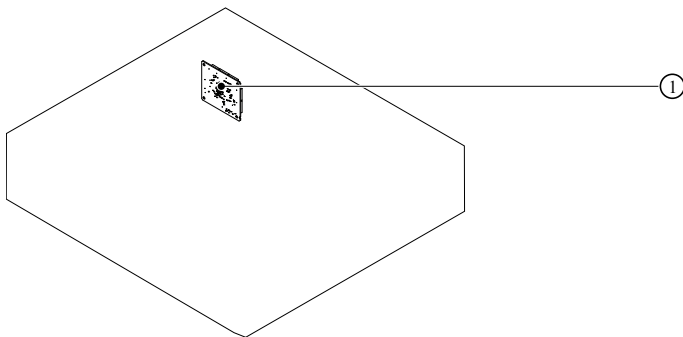

Item	Description
1	Controller PCA

Figure 4-70 Cassette assemblies, 550-sheet paper feeder

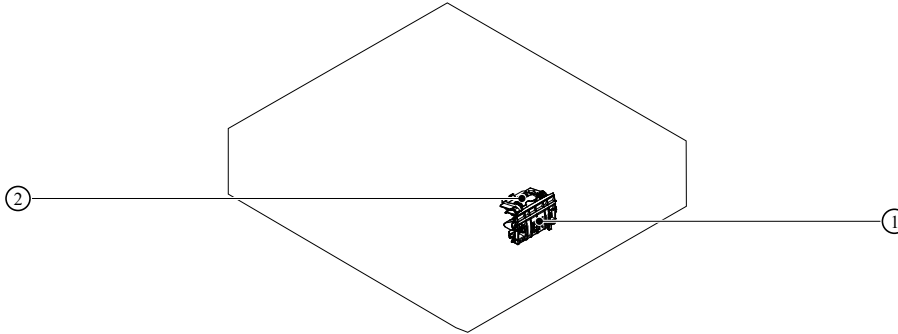

Item	Description	Item	Description
1	Cassette separation roller assembly	2	Cassette pickup roller assembly

Major components, HCI

Figure 4-71 Doors and covers, HCI

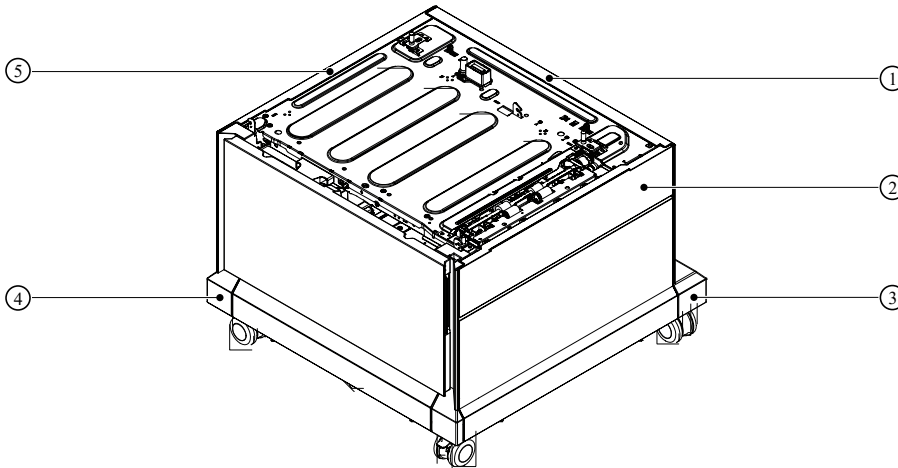

Item	Description	Item	Description
1	Rear cover	4	Front left cover
2	Right door	5	Left cover
3	Rear lower cover		

Figure 4-72 Main parts, HCI (1 of 2)

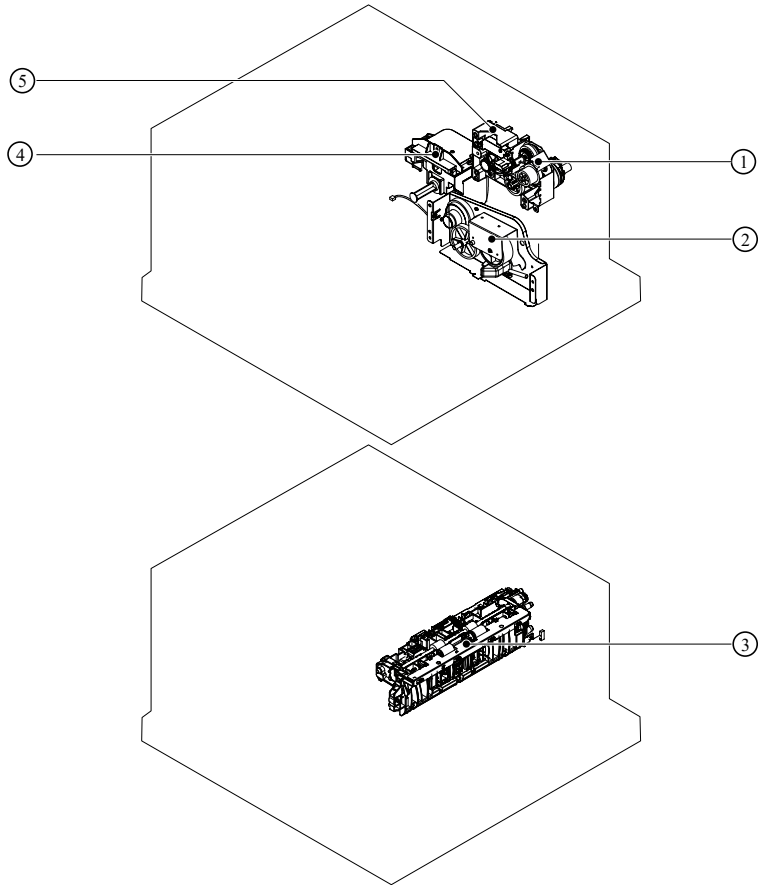

Item	Description	Item	Description
1	Pickup drive assembly	4	Auto close assembly
2	Lifter drive assembly	5	Pickup alienation assembly
3	Pickup assembly		

Figure 4-73 Main parts, HCI (2 of 2)

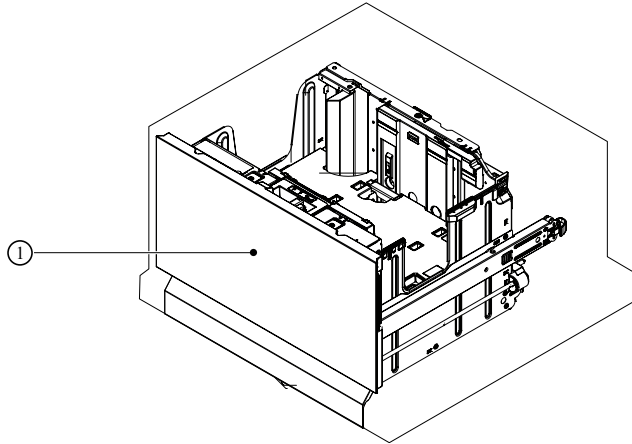

Item	Description
1	Cassette assembly

Figure 4-74 Printed circuit assemblies, HCI

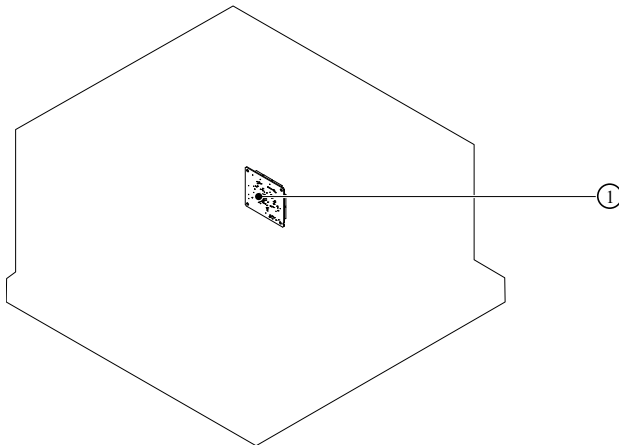

Item	Description
1	Controller PCA

Figure 4-75 Cassette assemblies, HCI

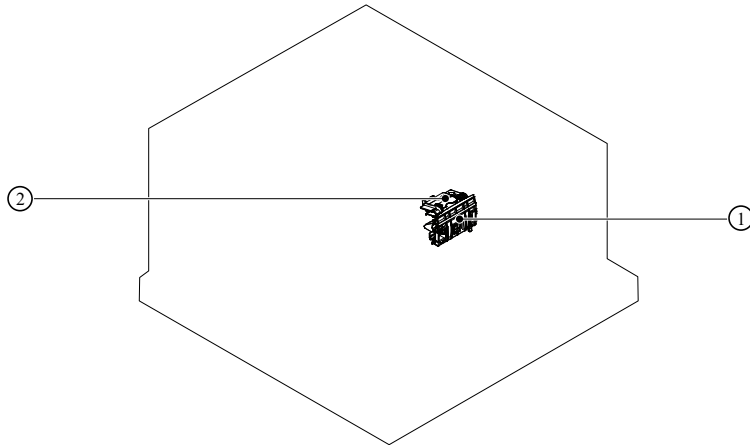

Item	Description	Item	Description
1	Cassette separation roller assembly	2	Cassette pickup roller assembly

Major components, 3-bin stapler-stacker

Figure 4-76 Doors and covers, 3-bin stapler-stacker

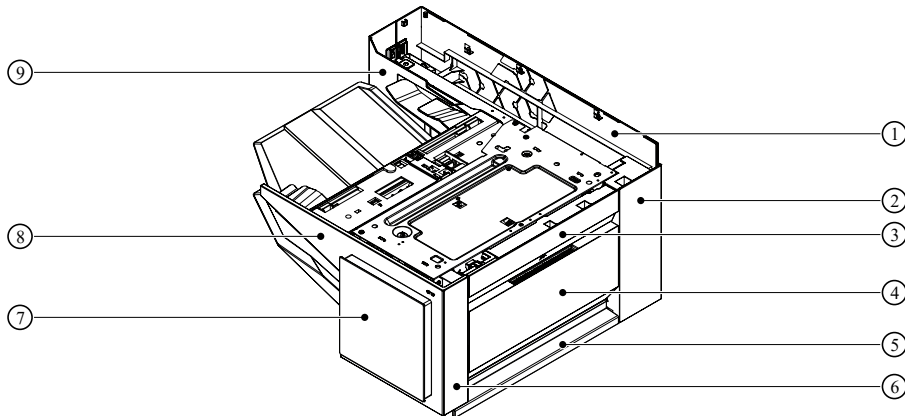

Item	Description	Item	Description
1	Rear cover	6	Staple rear cover
2	Right corner cover	7	Staple door
3	Right upper cover	8	Staple cover
4	Stapler-stacker door	9	Rear inner cover
5	Right lower cover		

Figure 4-77 Main parts, 3-bin stapler-stacker (1 of 2)

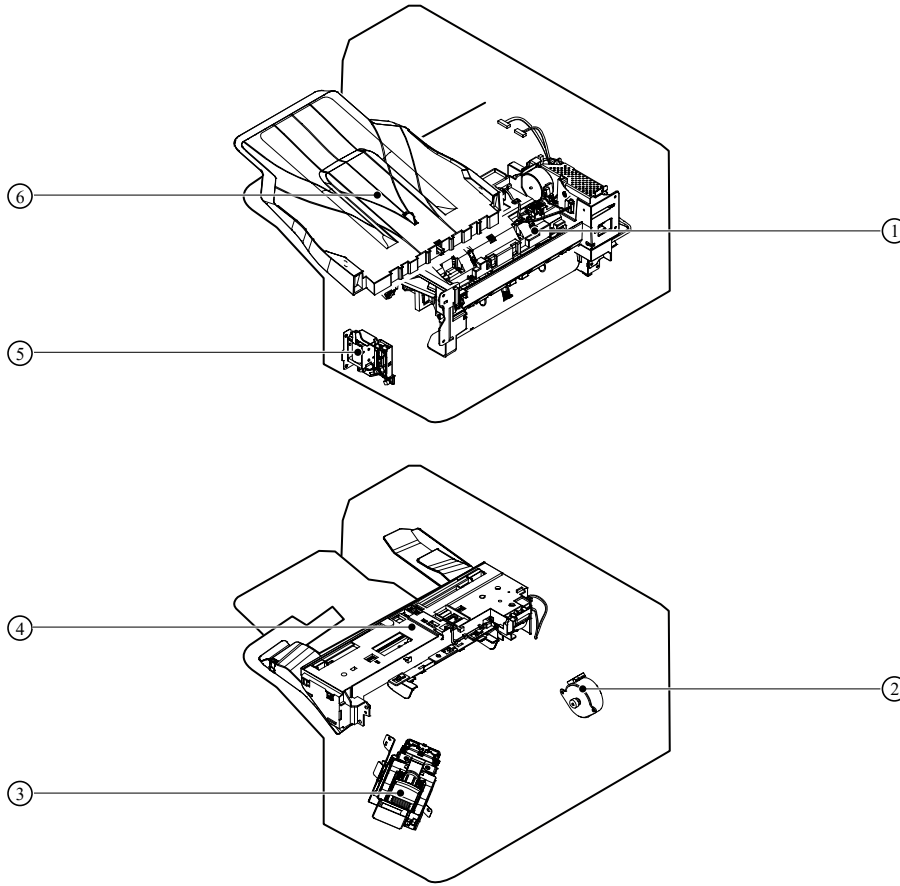

Item	Description	Item	Description
1	Upper feed assembly	4	Jogger assembly
2	Stapler-stacker feed motor	5	Solenoid assembly
3	Stapler assembly	6	Output bin 1 assembly

Figure 4-78 Main parts, 3-bin stapler-stacker (2 of 2)

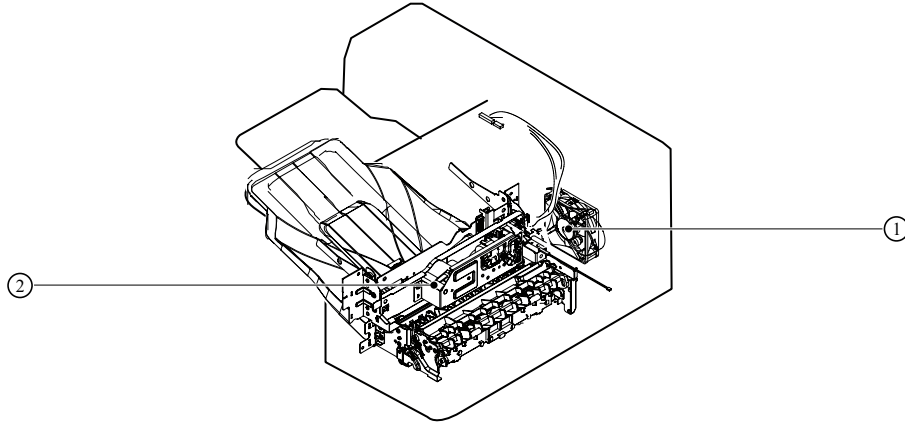

Item	Description	Item	Description
1	MBM fan	2	Lower feed assembly

Figure 4-79 Printed circuit assemblies, 3-bin stapler-stacker

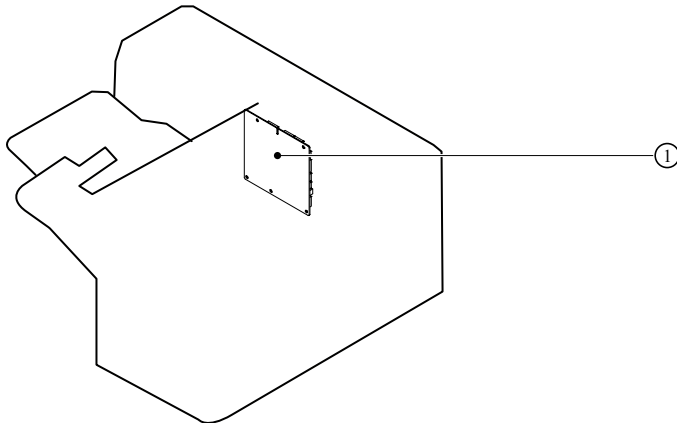

Item	Description
1	Controller PCA

Printed circuit assembly (PCA) connector locations

View printed circuit assembly (PCA) diagrams.

DC controller PCA connections

Figure 4-80 DC controller PCA connections

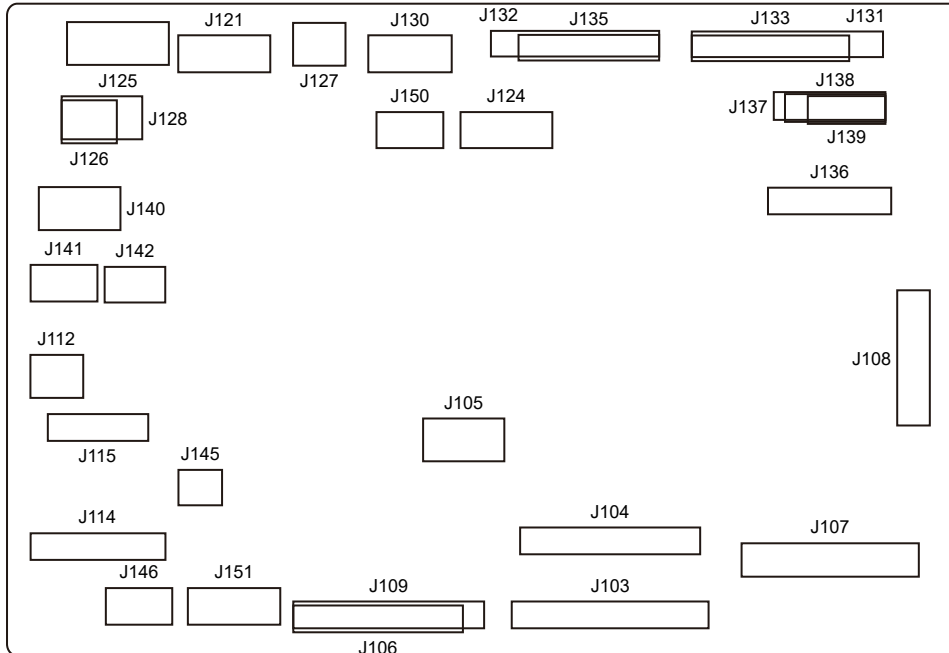

Item	Description	Item	Description
J103	Drive PCA	J130	Drive PCA
J104	Drive PCA	J131	High-voltage power supply (X57945 models)
J105	Formatter	J132	High-voltage power supply (X57945 models)
J106	Not used	J133	High-voltage power supply (5700/X557/5800 models)
J107	Laser scanner assembly	J135	High-voltage power supply (5700/X557/5800 models)
J108	Formatter	J136	Rear PCA
J109	Low-voltage power supply	J137	Rear PCA (X557 models)
J112	Front door switch Right door switch	J138	Rear PCA (5700/5800 models)
J114	Right PCA	J139	Rear PCA (X57945 models)
J115	Right PCA	J140	Not used
J121	Duplex flapper solenoid FD1 media full sensor Duplex flapper position sensor	J141	Not used
J124	Output accessory (MFP models)	J142	Not used
J125	Fuser	J145	Not used
J126	Not used	J146	Not used

Item	Description	Item	Description
J127	Duplex motor	J150	Cartridge access release motor (X557 models) Cartridge access home position sensor (X557 models)
J128	Fuser	J151	E-label (X57945 models)

Formatter PCA connections

Figure 4-81 Formatter PCA connections

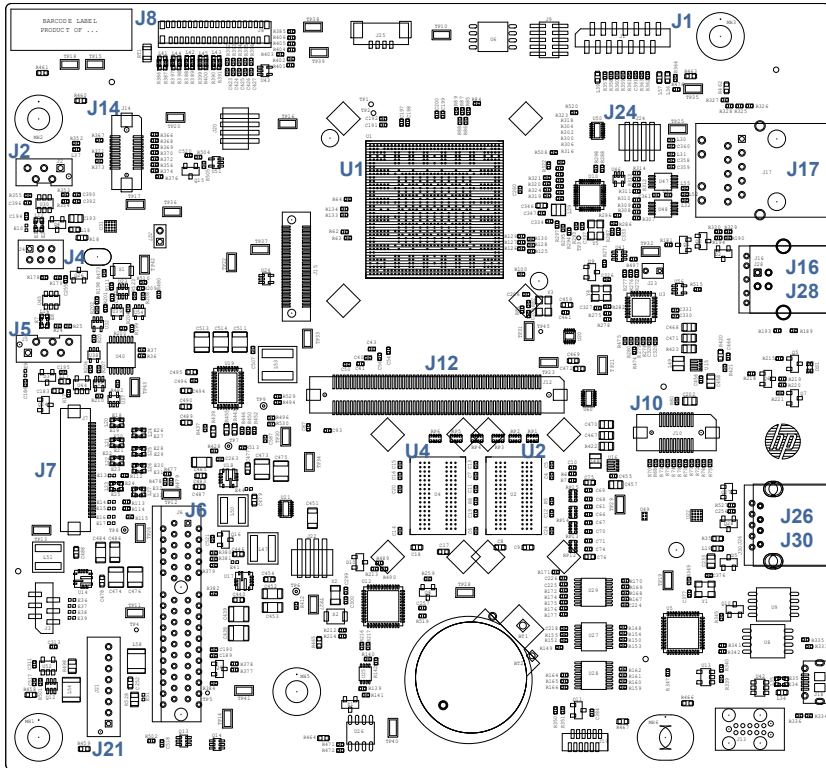

Item	Description	Item	Description
J1	WiFi	J16	USB device
J2	Island of Data (IOD)	J17	LAN
J4	USB (walk-up)	J21	Engine power
J5	UISB (HIP)	J24	BASH
J6	HDD riser	J26	USB host
J7	Engine VIF	J28	USB device
J8	Control panel	J30	USB host
J10	eMMC	U1	ASIC
J12	DIMM	U2	Memory
J14	Trusted Platform Module (TPM)	U4	Memory

550-sheet paper feeder PCA connectors

Figure 4-82 550-sheet paper feeder PCA connectors

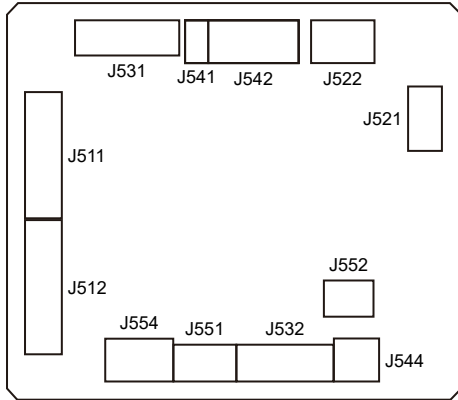

Item	Description	Item	Description
J511	Printer or paper feeder	J541	Media size switch 1 Media size switch 2 Media size switch 3 Media size switch 4
J512	Not used	J542	Not used
J521	Not used	J544	Door switch
J522	Not used	J551	Lifter motor Lifter motor rotation sensor
J531	Feed motor Pickup clutch	J552	Not used
J532	Media out sensor Feed sensor Media surface sensor	J554	Not used

HCI controller PCA connectors

Figure 4-83 HCl controller PCA connectors

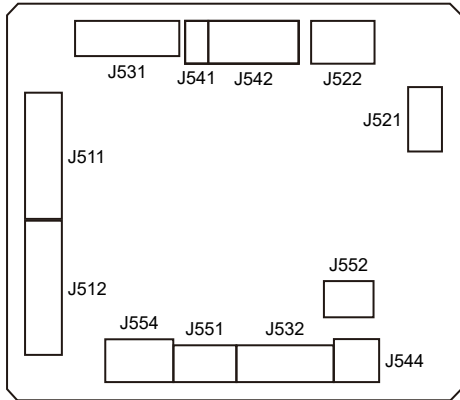

Item	Description	Item	Description
J511	Printer or paper feeder	J541	Not used
J512	Not used	J542	Media size switch 1 Media size switch 2 Lifting plate position switch
J521	Not used	J544	Door switch
J522	Not used	J551	Not used
J531	Feed motor Pickup clutch	J552	Lifter motor rotation sensor
J532	Media out sensor Feed sensor Media surface sensor	J554	Lifter motor

3-bin stapler-stacker controller PCA connectors

Figure 4-84 3-bin stapler-stacker controller PCA connectors

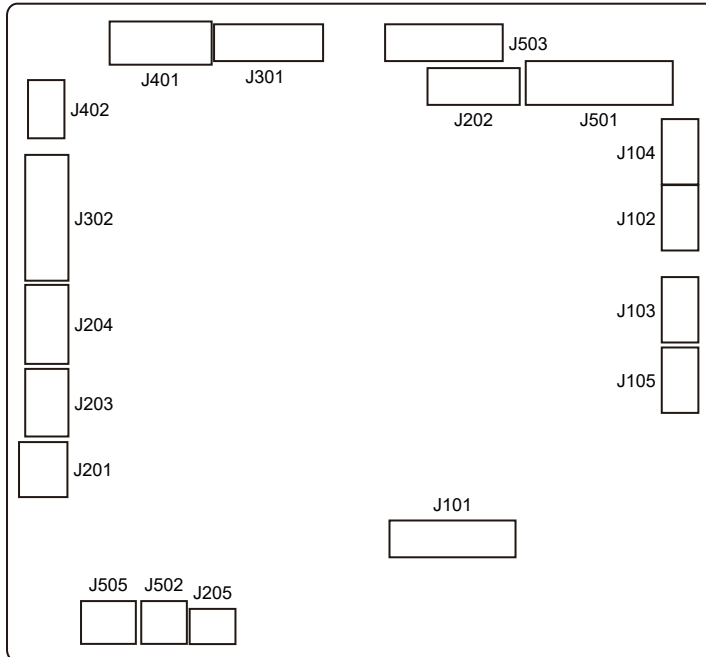

Item	Description	Item	Description
J101	Printer	J205	Staple door switch
J102	Not used	J301	Stapler-stacker output motor Y alignment home position sensor Bin 1 media full sensor 1
J103	Not used	J302	Y alignment motor Alienation home position sensor Stapler-stacker door switch
J104	Not used	J401	Jogger motor Jogger home position sensor
J105	Not used	J402	Stapler-stacker feed motor
J201	Interlock switch	J501	Bin 2 media presence sensor Bin 2 media full sensor Stapler-stacker inlet sensor Bin 2 flapper solenoid
J202	Lifter motor Bin 1 upper limit sensor Bin 1 lower limit sensor SS inlet sensor	J502	Inlet flapper solenoid

Item	Description	Item	Description
J203	Staple motor	J503	Bin 1 media presence sensor Stapler-stacker exit sensor Staple inlet sensor Stamp solenoid
J204	Staple low sensor Staple ready sensor Staple home position sensor	J505	Fan

Diagrams: General timing chart

View the printer timing chart diagram.

Figure 4-85 Timing chart

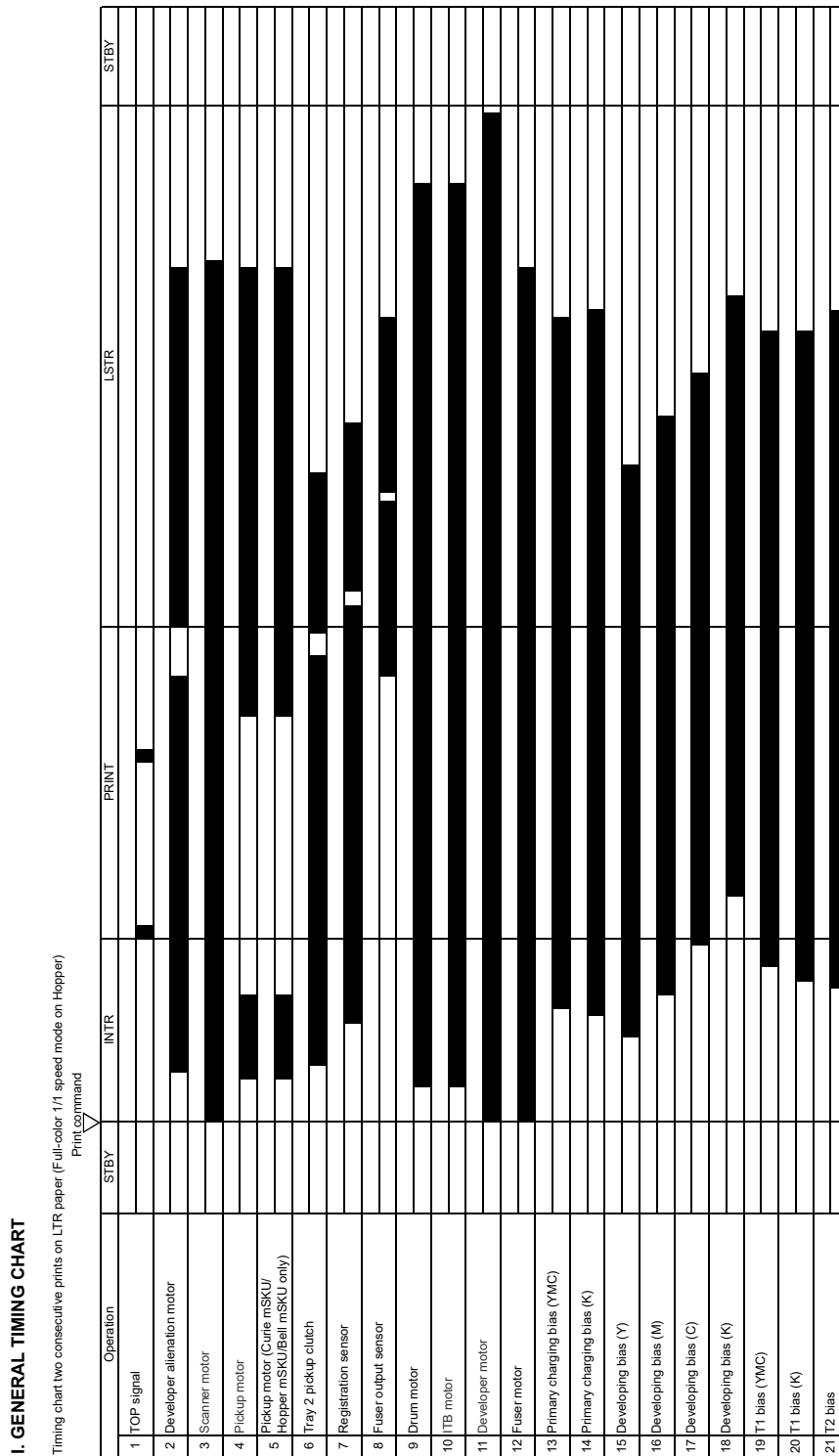

A - 1 - 1

Diagrams: General circuit diagrams

View the printer circuit diagrams.

Figure 4-86 General circuit diagram, base printer (1 of 7)

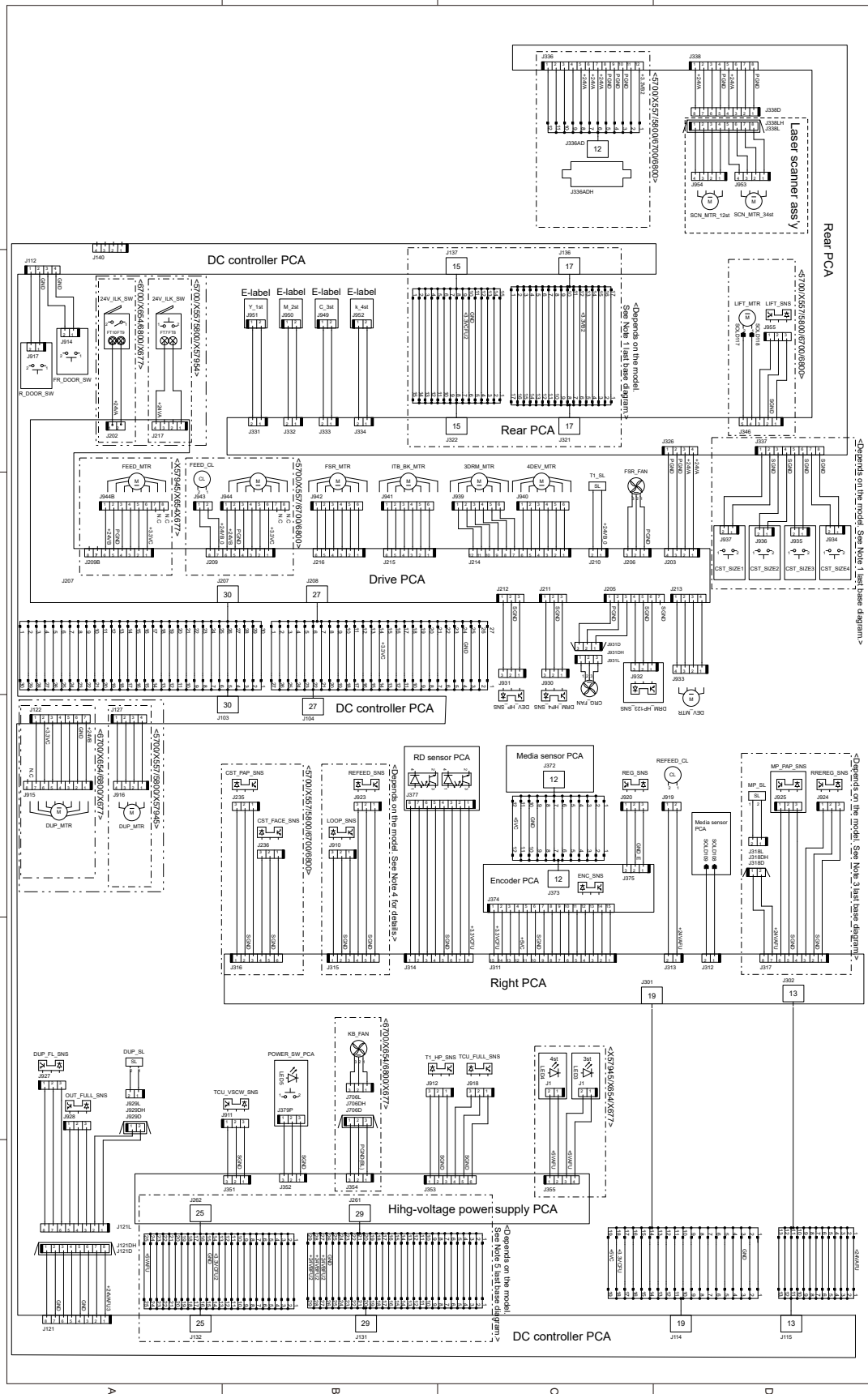

Figure 4-87 General circuit diagram, base printer (2 of 7)

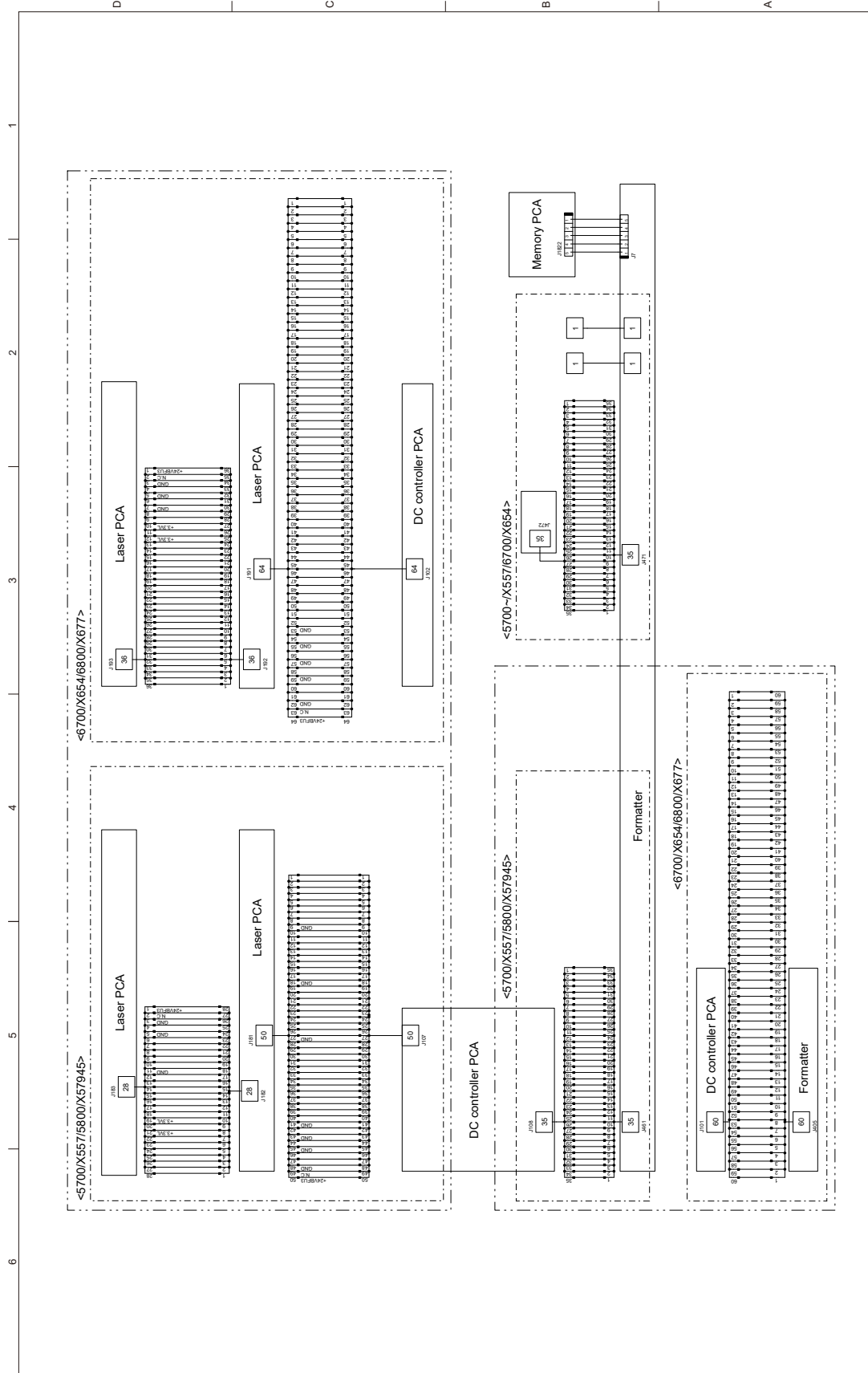

Figure 4-88 General circuit diagram, base printer (3 of 7)

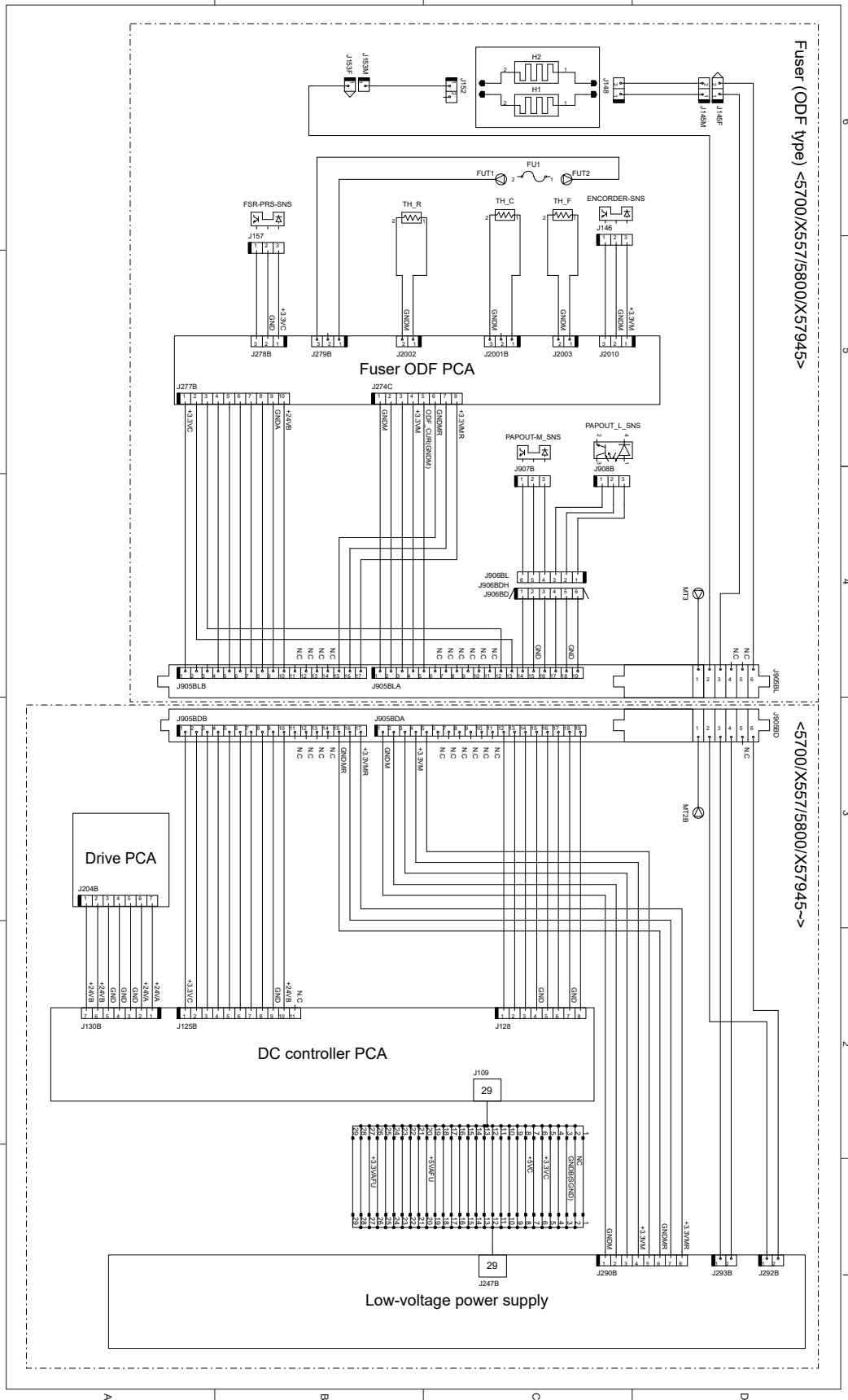

Figure 4-89 General circuit diagram, base printer (4 of 7)

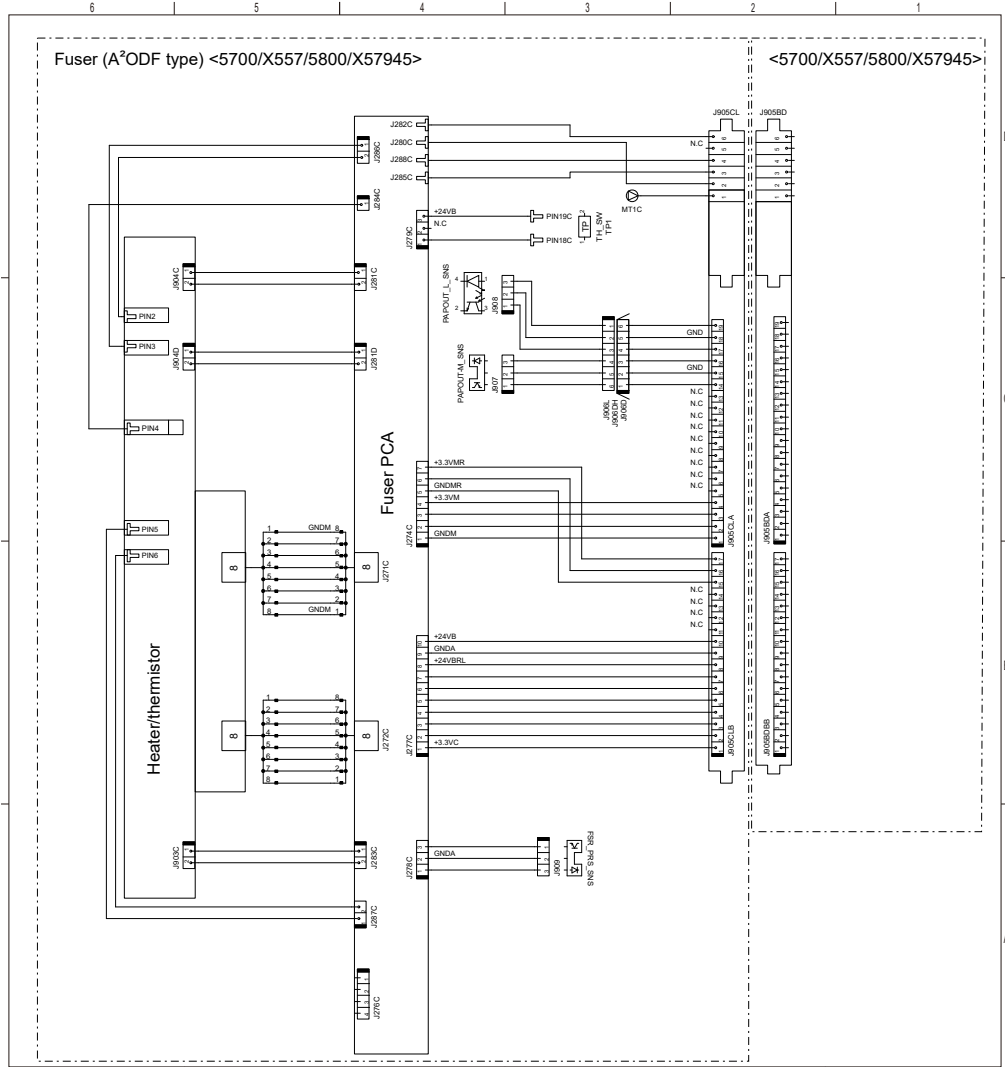

Figure 4-90 General circuit diagram, base printer (5 of 7)

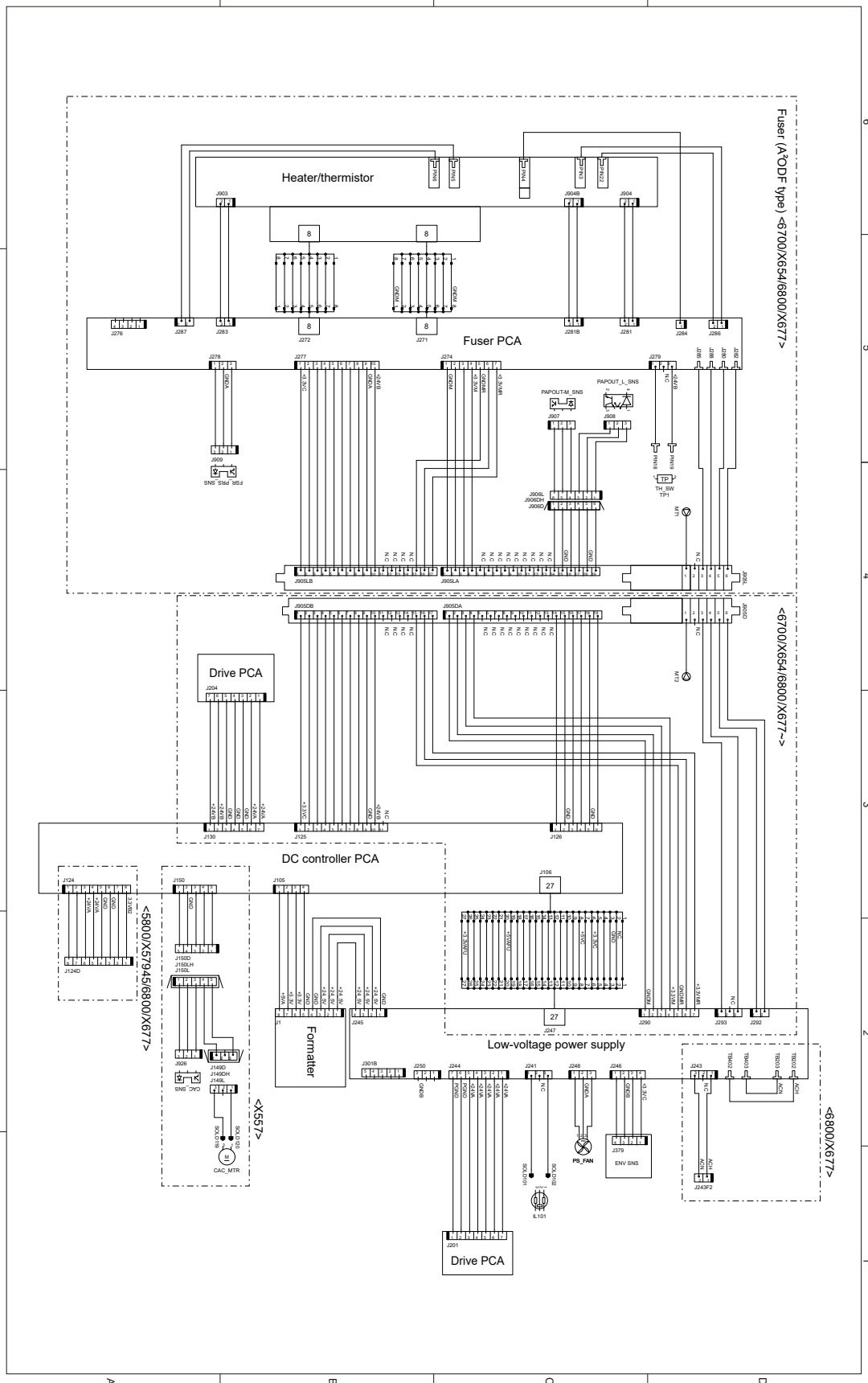

Figure 4-91 General circuit diagram, base printer (6 of 7)

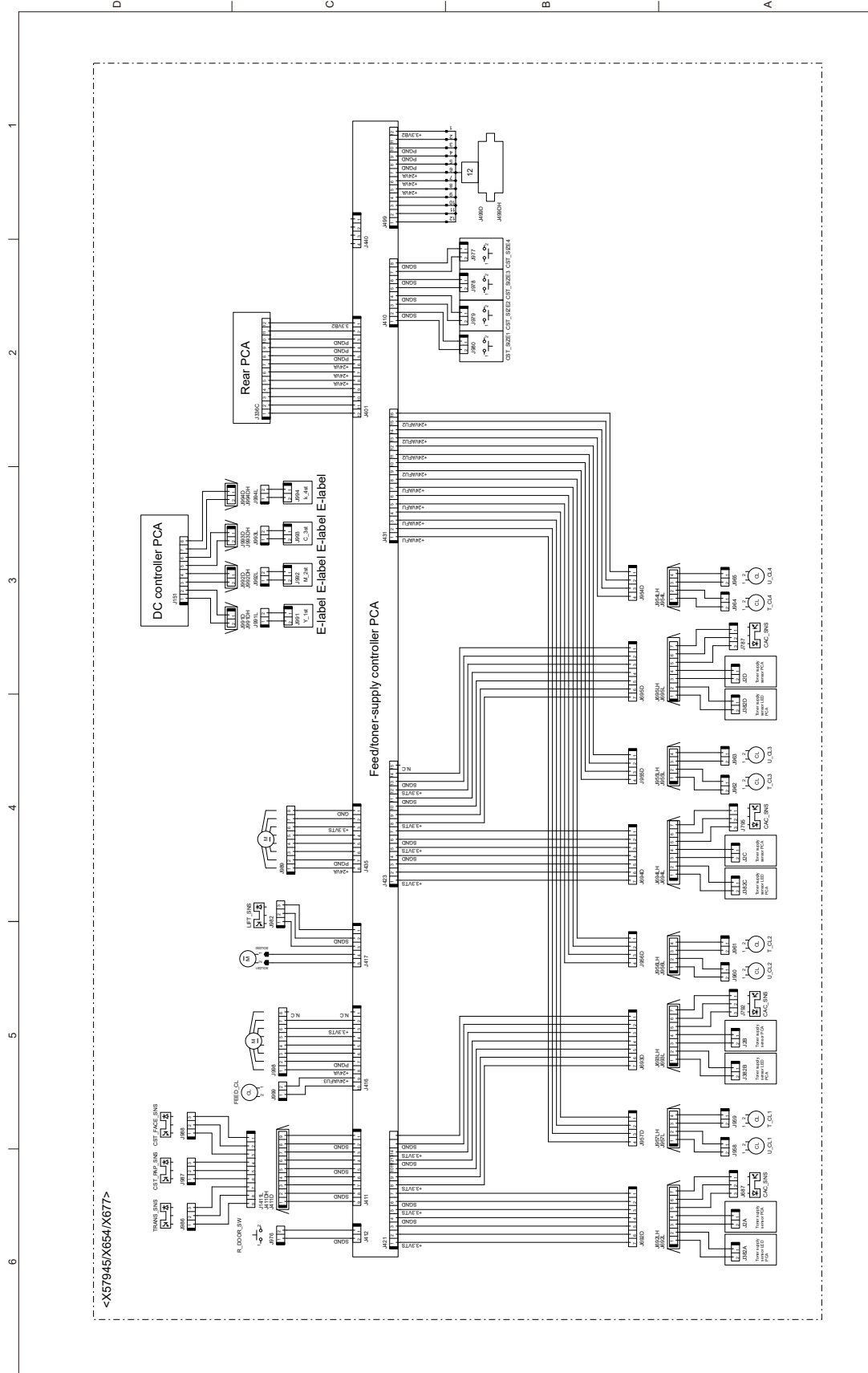

Figure 4-92 General circuit diagram, base printer (7 of 7)

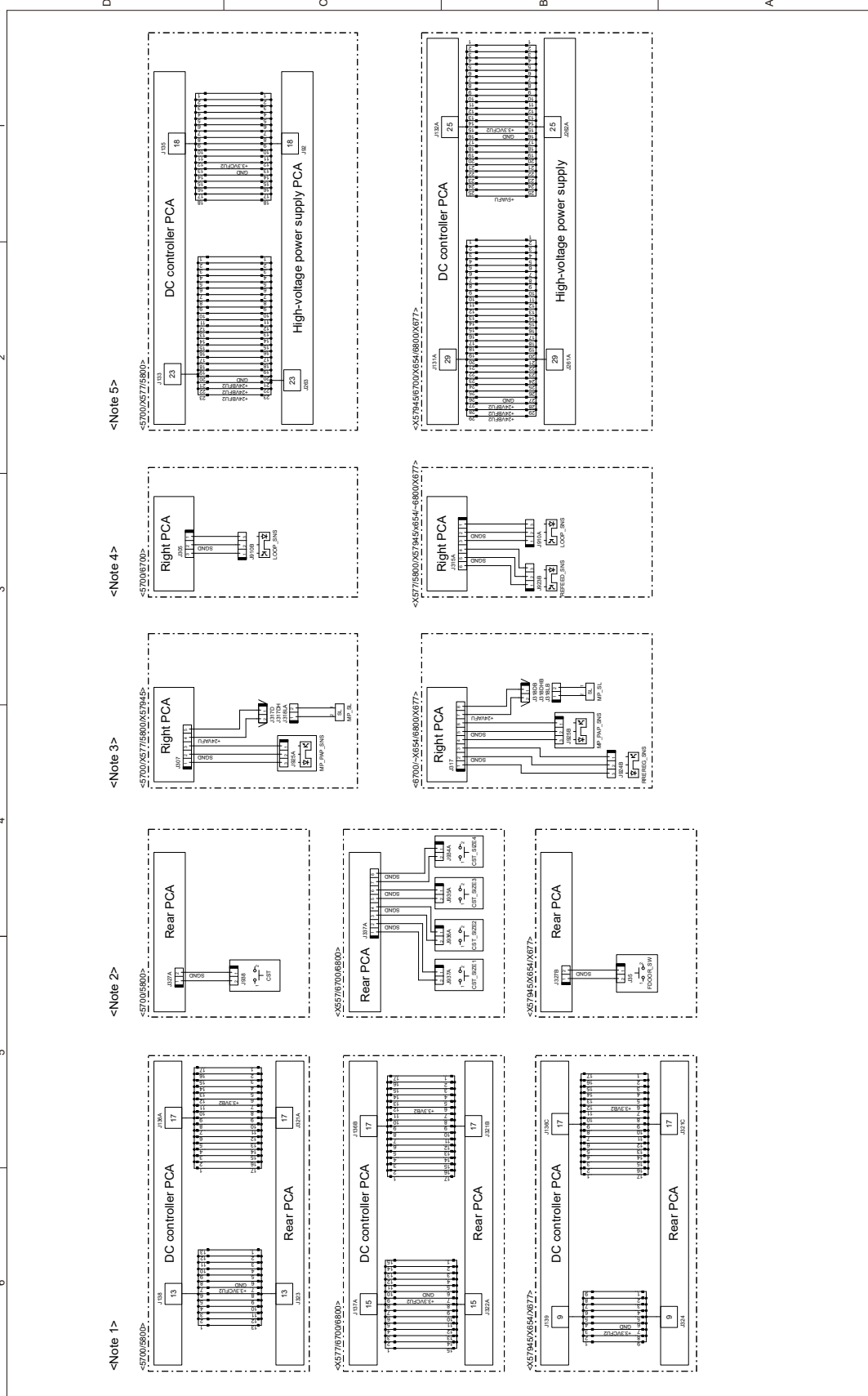

Figure 4-93 General circuit diagram, 550-sheet paper feeder

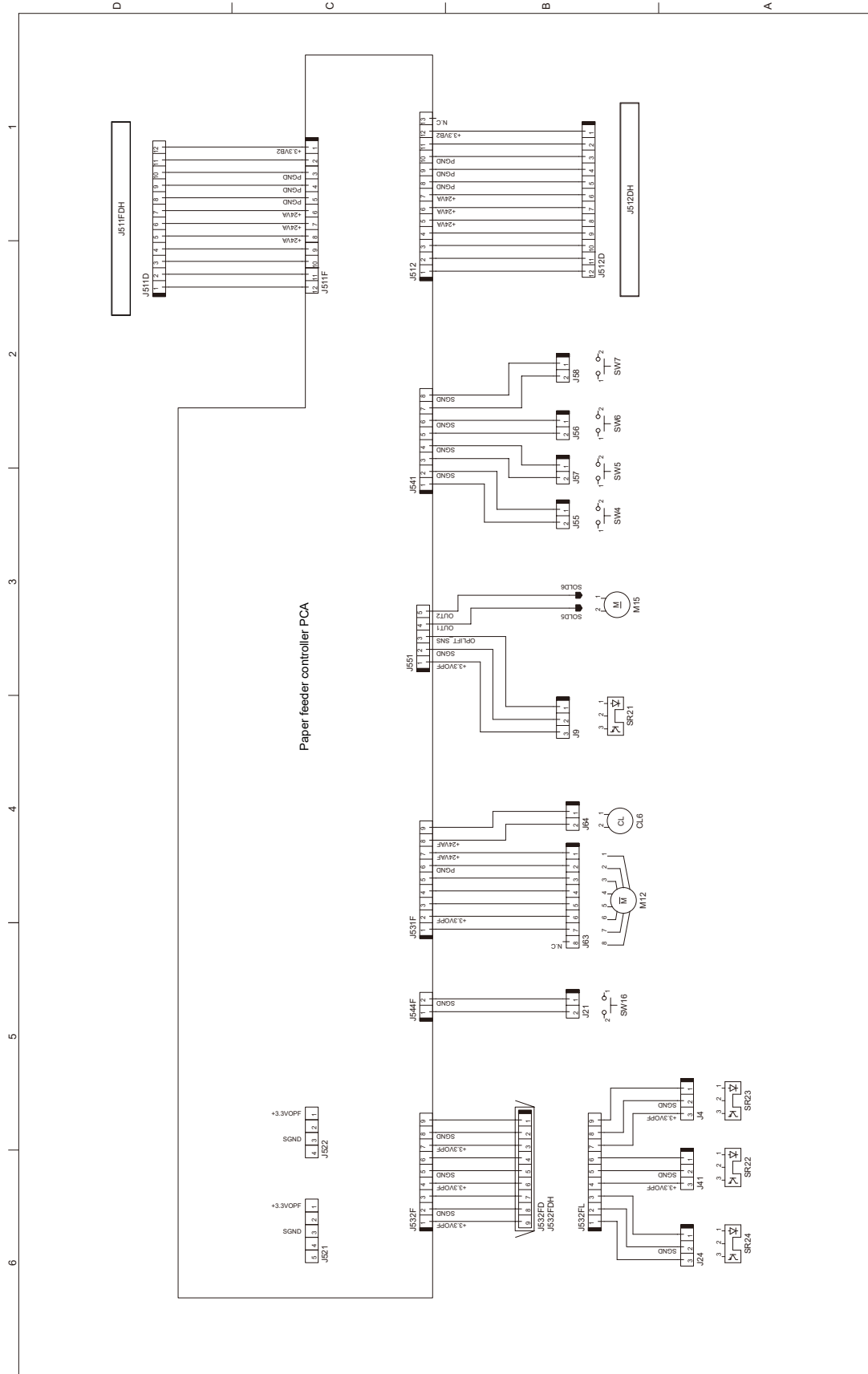

Figure 4-94 General circuit diagram, HCI

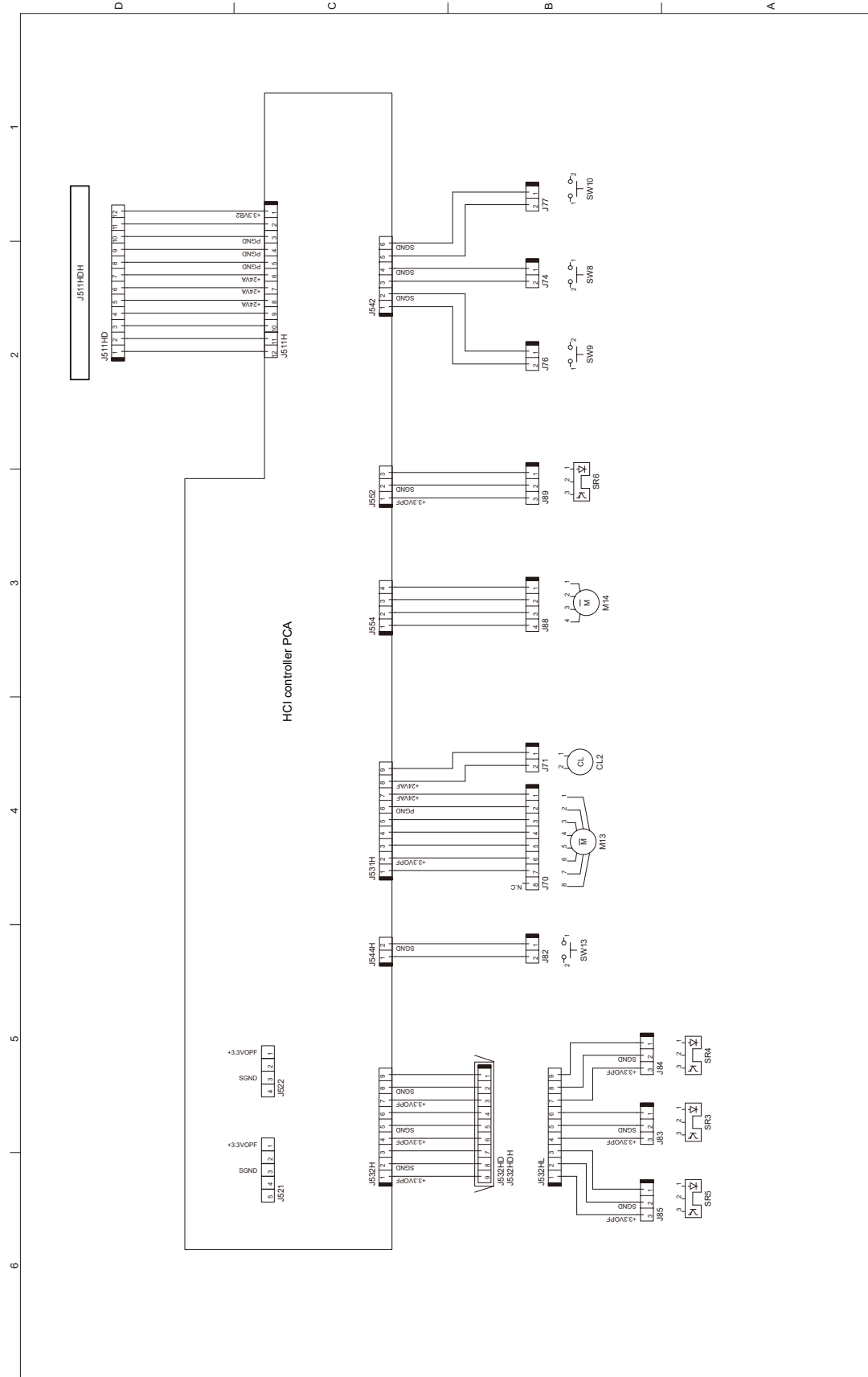
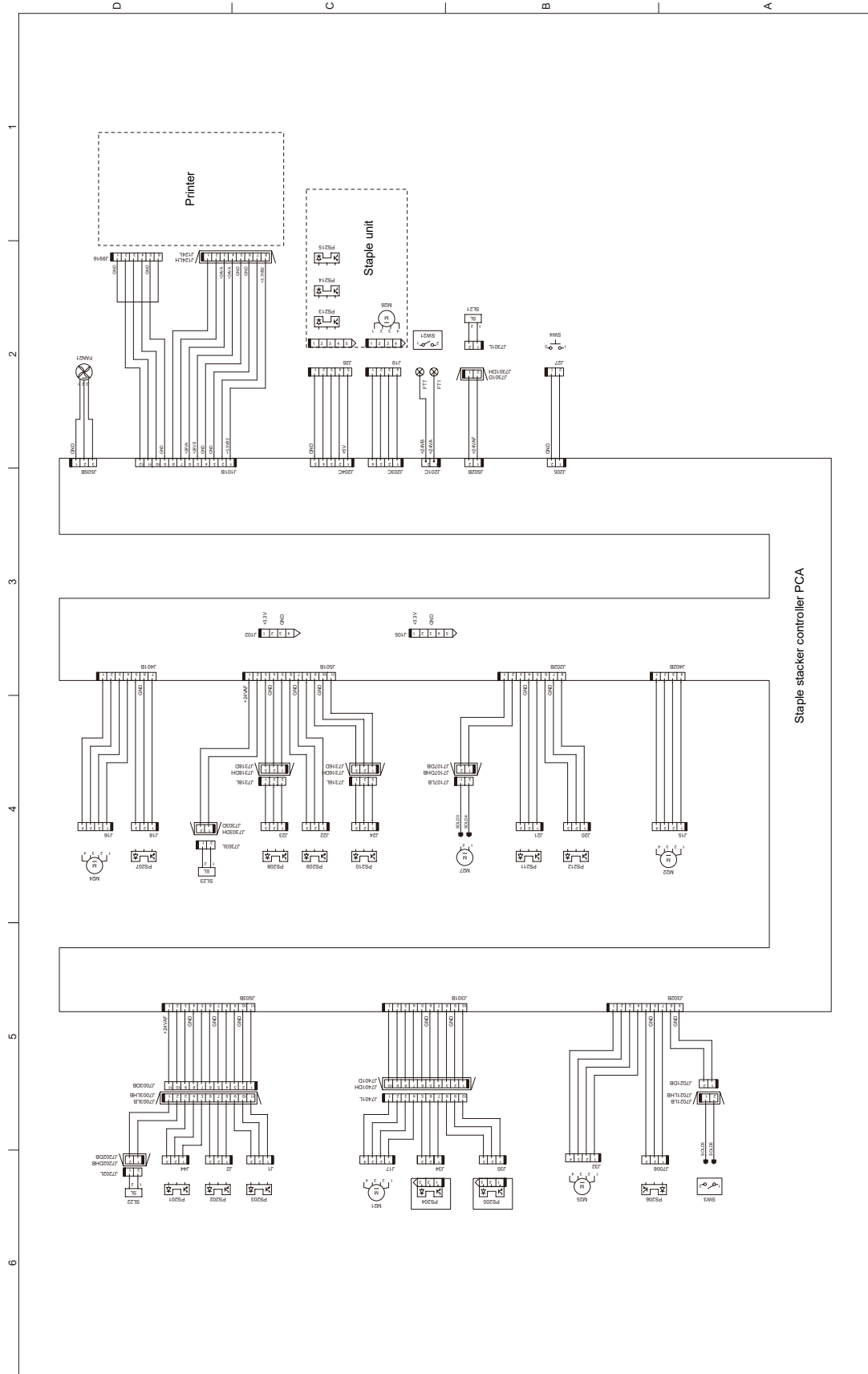

Figure 4-95 General circuit diagram, 3-bin stapler-stacker



Internal test and information pages

Learn about printer test and information pages.

Configuration and Jetdirect page

Print and find printer information on configuration and HP embedded Jetdirect information pages.



NOTE: Depending on the model, up to three pages print when printing a configuration page. In addition to the main configuration page, the HP embedded Jetdirect configuration and the wireless pages print.

Print the configuration page from a touchscreen control panel

1. From the [Home](#) screen on the printer control panel, scroll to and touch the [Reports](#) button.
2. Open the following menus:
 - [Configuration/Status pages](#)
3. Touch [Configuration Page](#) to select it.
4. Touch the print icon  to print the pages.

Figure 4-96 Configuration page

Configuration Page
HP LaserJet M404
Page 1

1 Device Information

Product Name: HP LaserJet M505
 Device Name: HP LaserJet M505
 Model Number: Q3XXXX
 DC Controller Version: 1.102
 Device Serial Number: XXXXXXXXXX
 Formatter Number: XXXXXXXXXX
 Firmware Bundle Version: 361a
 Firmware Revision: 2337930_482646
 Firmware Datecode: 20140617
 HP FutureSmart Level: HP FutureSmart 3
 NFC Revision: Not Installed
 Service ID: 00000
 Maintenance Kit Interval: 225000
 Pages Since Last Maintenance: 0
 PS Job Timeout: 300 seconds
 Engine Cycles*: 7
 *Not weighted for billing

2 Installed Personalities and Options

PCL: 2011940C
 PCLXL: 2011040C
 POSTSCRIPT: 2011C402
 PDI: 20130901
 AirPrint: 2040201
 Internal Disk: Hard Disk: Enabled
 Serial Number: DC160322
 Model: Toshiba 03040C
 Capacity: 3275 MB
 Hard Disk Encryption Status: Disk cannot be encrypted
 IP Printer Trusted Platform Module: Enabled
 Firmware: 01.02.149.32
 iLok Number: 04E91A0436783210A0F476798139EFC54E335A9
 SRK Thumbprint: 78361A0436783210A0F476798139EFC54E335A9
 Embedded HP JetDirect J.94C: NP7205E93
 Wireless HP JetDirect J8932E: 0.0.0.0

3 HP Web Services

IP Web Services: Disabled
 ePrint: Disabled

4 Memory

Total RAM: 512 MB

5 Event Log

Number of Entries in Use: 17
 Three Most Recent Entries:

Number	Cycles	Event
17	7	13.05.00
16	7	33.02.02
15	7	33.02.02

6 Security

Hard Disk Encryption Status:
 Internal Disk: Disk cannot be encrypted
 Job Data Encryption Status: Encrypted (AES-128)
 Job Data Persistence: [FullWrite]
 File Erase Mode: Non-Secure Fast Erase (No overwrite)
 Control Panel Password: Disabled
 Support Key: RSP 7PMS-UC35
 Post USB p.up and play: Enabled
 Device USB: Enabled

7 Paper Trays and Options

Default Paper Size: Letter
 Tray 1 Size: Any Size
 Tray 1 Type: Any Type
 Tray 2 Size: Letter
 Tray 2 Type: Plain
 1: Output Bin 1, 500 Sheets, Standard bin (correct order)
 2: Output Bin 2, 100 Sheets, Rear bin (straightest path)



Sep/13/2019 6:56:00 AM XXXXXX000000000000 4013301250485-34 English (United States)

Item	Description	Item	Description
1	Device information	5	Event log
2	Installed personalities and options	6	Security
3	HP Web services	7	Paper trays and options
4	Memory		

Certain information, such as the firmware date codes, the IP address, and the email gateways, is especially helpful while servicing the printer. This information is on the various configuration pages.

Table 4-10 Important information on the configuration pages

Type of information	Specific information	Configuration page
Firmware Bundle Version	Firmware information	Main configuration page (Device information)

Table 4-10 Important information on the configuration pages (continued)

Type of Information	Specific Information	Configuration page
Firmware Revision	Firmware information	Main configuration page (Device information)
Firmware Datecode	Firmware information	Main configuration page (Device information)
Accessories and internal storage All optional devices that are installed on the printer should be listed on the main configuration page. Separate pages print for the optional paper handling devices and the fax accessory. These pages list more-detailed information for those devices.	Optional installed formatter devices and accessories information	Main configuration page (Installed Personalities and Options)
Memory	Total RAM information	Main configuration page (Memory)
Tray and bin information	Size and type by tray (including installed optional paper feeders) information	Main configuration page (Paper Trays and Options)
Engine cycles, service ID, and cartridge information	Engine information	Main configuration page (Device Information)
Event-log information	Error information	Main configuration page (Event Log)

The second configuration page is the HP embedded Jetdirect page, which contains the following information:

Figure 4-97 HP embedded Jetdirect page

Embedded Jetdirect Page
HP LaserJet M406
Page 1

1 ----- General Information -----
Status: I/O Card Initializing
Model Number: J8932E
Hardware Address: ECC2:7245593
Firmware Version: J0:7430315
Port Config: Unknown
Auto Negotiation: On
Manufacturing ID: 0107510700***M
Build Date: 06/16/2014 06:00:50
MS Registration: Not Registered
ePrint: Not Applicable
Email: Not Applicable

2 ----- Security Settings -----
IPsec: Disabled
Secure Web: HTTPS Required
Cert. Expires: 2009-01-17 02:14 UTC
SNMP Versions: 1, 2
SNMP Set Only Name: Not Specified
SNMP Get Only Name: Not Specified/Default
Access List: Not Specified
Admin Password: Not Specified
Announcement Agent: Success
FTPS: Disabled

3 ----- Network Statistics -----
Total Packets Received: 0
Unicast Packets Received: 0
Bad Packets Received: 0
Framing Errors Received: 0
Total Packets Transmitted: 0
Unsendable Packets: 0
Transmit Collisions: 0
Transmit Late Collisions: 0
Last Make: 00000000000000000000000000000000
00000000000000000000000000000000
00000000000000000000000000000000

4 ----- TCP/IP -----
IPv4: Enabled
IPv6: Enabled
Host Name: NP1245593
IPv4 Domain Name: Not Specified
IPv6 Domain Name: Not Specified
Primary DNS Server: Not Specified
Secondary DNS Server: Not Specified
DNS(IPv4): Not Specified
DNS(IPv6): Not Specified
WINS Server: Not Specified
TCP Idle Timeout: 90 sec

5 ----- IPv4 -----
Status: Initializing
IP Address: 0.0.0.0
Subnet Mask: 0.0.0.0
Default Gateway: 0.0.0.0
Config By: Not Configured
BOOTP/DHCP Server: 0.0.0.0
TFTP Server: 0.0.0.0
Bonjour Service Name: Not Specified

6 ----- IPv6 -----
Status: Ready
Link Local: Not Configured
Siteless: Not Configured
DHCPv6: Not Configured
Manual: Not Configured

Sep/13/2019 6:56:00 AM
English (United States)

Item	Description
1	General Information indicates the printer status, model number, hardware firmware version, port select, port configuration, auto negotiation, manufacturing identification, and manufactured date.
2	Security Settings information
3	Network Statistics indicates the total packets received, unicast packets received, bad packets received, framing errors received, total packets transmitted, unsendable packets, transmit collisions, and transmit late collisions.
4	TCP/IP information, including the IP address
5	IPv4 information
6	IPv6 information

Reports menu

Learn about the control-panel [Reports](#) menu.

To display: At the printer control panel, select the [Reports](#) menu.

To print: At the printer control panel, touch the printer icon .

In the following table, asterisks (*) indicate the factory default setting.



NOTE: The [View](#) option is control-panel type dependent (might not be available).

Table 4-11 Reports menu

First level	Second level	Values	Description
Configuration/Status Pages	Settings Menu Map	Cancel View Print	Shows a map of the entire control panel system and the selected values for each setting.
Configuration/Status Pages	Current Settings Page	Cancel View Print	Shows a summary of the current settings for the printer. This might be helpful if you plan to make changes and need a record of the present configuration.
Configuration/Status Pages	Configuration Page	Cancel View Print	Shows the printer settings and installed accessories.
Configuration/Status Pages	How to Connect Page	Cancel View Print	Shows the network information typically needed to connect the printer to a network.
Configuration/Status Pages	Supplies Status Page	Cancel View Print	Shows the approximate remaining life for the supplies; reports statistics on total number of pages and jobs processed, serial number, page counts, and maintenance information. HP provides approximations of the remaining life for the supplies as a customer convenience. The actual remaining supply levels might be different than the approximations provided.
Configuration/Status Pages	Usage Page	Cancel View Print	Shows a count of all paper sizes that have passed through the printer; lists whether they were simplex or duplex, and reports the page count.

Table 4-11 Reports menu (continued)

First level	Second level	Values	Description
Configuration/Status Pages	File Directory Page	Cancel View Print	Shows the file name and folder name for files that are stored in the printer memory.
Configuration/Status Pages	Web Services Status Page	Cancel View Print	Shows the detected Web Services for the printer.
Fax Reports Fax models only	Fax Activity Log	Cancel View Print	Contains a list of the faxes that have been sent from or received by this printer.
Fax Reports Fax models only	Billing Codes Report	Cancel View Print	Provides a list of billing codes that have been used for outgoing faxes. This report shows how many sent faxes were billed to each code.
Fax Reports Fax models only	Blocked Fax List	Cancel View Print	A list of phone numbers that are blocked from sending faxes to this printer.
Fax Reports Fax models only	Speed Dial List	Cancel View Print	Shows the speed dials that have been set up for this printer.
Fax Reports Fax models only	Fax Call Report	Cancel View Print	A detailed report of the last fax operation, either sent or received.
Other Pages	PCL Font List	Cancel Print	Prints the available PCL fonts.
Other Pages	PS Font List	Cancel Print	Prints the available PS fonts.

Settings menu

Learn about the control-panel [Settings](#) menu.



NOTE: You can perform basic printer setup by using the [Settings](#) menu. Use the HP Embedded Web Server for more advanced printer setup. To open the HP Embedded Web Server, enter the printer IP address or host name in the address bar of a Web browser.



TIP: If prompted, enter the EWS personal identification number (PIN) from a sticker on the printer (typically located inside the front door or on a toner cartridge tray).

General menu

Learn about the control-panel [General \(Settings\)](#) menu.

To display: At the printer control panel, select the [Settings](#) menu, and then select the [General](#) menu.

To print: At the printer control panel, touch (MFP) or use the arrow buttons (SFP) to select the printer icon . For the SFP, press the [OK](#) button to print the pages.

In the following table, asterisks (*) indicate the factory default setting.

Table 4-12 General menu

First level	Second level	Third level	Fourth level	Values	Description
Date/Time Settings	Date/Time Format	Date Format		DD/MMM/YYYY	Use the Date/Time Settings menu to specify the date and time and to configure date/time settings.
				MMM/DD/YYYY	
				YYYY/MMM/DD	
Date/Time Settings	Date/Time Format	Time Format		12 hour (AM/PM)	Select the format that the printer uses to show the date and time, for example 12-hour format or 24-hour format.
				24 hours	
Date/Time Settings	Date/Time	Time Zone		Select the time zone from a list.	
Date/Time Settings	Date/Time	Date		Select the date from a pop-up calendar.	
Date/Time Settings	Date/Time	Time		Select the time from a pop-up keypad.	
Date/Time Settings	Date/Time	Adjust for Daylight Savings		Checkbox	If you are in an area that uses daylight savings time, select the Adjust for Daylight Savings box.
Energy Settings MFP	Sleep Schedule	A list of scheduled events displays.		+ (Add)	Use to configure the printer to automatically wake up or go to sleep at specific times on specific days. Using this feature saves energy.
				Edit	
				Delete	
					NOTE: You must configure the date and time settings before you can use this feature.

Table 4-12 General menu (continued)

First level	Second level	Third level	Fourth level	Values	Description
Energy Settings MFP	Sleep Schedule	A list of scheduled events displays.	Event Type	Wake Sleep	Select whether to add or edit a Wake event or a Sleep event, and then select the time and the days for the wake or sleep event.
Energy Settings MFP	Sleep Schedule	A list of scheduled events displays.	Event Time		
Energy Settings MFP	Sleep Schedule	A list of scheduled events displays.	Event Days	Select days of the week from a list.	
Energy Settings MFP	Sleep Timer Settings	Sleep Mode/Auto Off After		Range: 1 to 120 minutes Default = 60 minutes	Set the number of minutes after which the printer enters Sleep or Auto Off mode. Use the arrow buttons on the control panel to increase or decrease the number of minutes.
Energy Settings MFP	Wake/Auto On to These Events			All Events* Network port Power button only	
Energy Settings SFP	Sleep Timer Settings	Sleep/Auto Off Timer		Enabled* Disabled	Enable or disable the printer sleep or auto off function.
Energy Settings SFP	Sleep Timer Settings	Sleep Mode/Auto Off After		Range: 1 to 120 minutes Default = 60 minutes	Set the number of minutes after which the printer enters Sleep or Auto Off mode. Use the arrow buttons on the control panel to increase or decrease the number of minutes.
Display Settings	Display Brightness	A sliding bar displays with the indicator set in the middle. Use the arrow keys to select the desired brightness and then select Done .			Use to specify the intensity of the LCD control panel display.
Display Settings	System Sound			On* Off	Use to enable or disable sounds on the printer.

Table 4-12 General menu (continued)

First level	Second level	Third level	Fourth level	Values	Description
Display Settings	Language Settings	Language		Select from a list of languages that the printer supports.	Use to select a different language for control panel messages and specify the default keyboard layout. When you select a new language, the keyboard layout automatically changes to match the factory default for the selected language.
Display Settings		Keyboard Layout		Each language has a default keyboard layout. To change it, select from a list of layouts.	Select the default keyboard layout that matches the language you want to use.
Display Settings	Information Screen			Show connection information* Hide connection information	Use this menu item to display or hide connection information on the Home screen.
Display Settings	Inactivity Timeout			Range: 10-300 seconds Default = 60 seconds	Specifies the amount of time that elapses between any activity on the control panel and when the printer resets to the default settings. When the timeout expires, the control panel display returns to the Home menu, and any user signed in to the printer is signed out.

Table 4-12 General menu (continued)

First level	Second level	Third level	Fourth level	Values	Description
Display Settings	Clearable Warnings			Display during job* Display until cleared	Use this feature to set the period that a clearable warning displays on the control panel. If the On setting is selected, clearable warnings appear until the Clearable Warnings button is pressed. If the Job setting is selected, clearable warnings stay on the display during the job that generated the warning and disappear from the display when the next job starts.
Display Settings	Continuable Events			Auto-continue (10 seconds)* Touch OK to continue	Use this option to configure the printer behavior when the printer encounters certain errors. If the Auto-continue (10 seconds) option is selected, the job will continue after 10 seconds. If the Touch OK to continue option is selected, the job will stop and require the user to touch the OK button before continuing.
Enable Device USB				Enabled Disabled*	Enables the printer to open a file from a USB drive.
Quiet Mode				Off* On Automatic transition Range: 10-300 pages Default = 10 pages	Quiet Mode slows the printer down to reduce the noise the printer makes when printing. Automatic transition allows you to set a predetermined job size of 10 to 999 pages, and print jobs will print in Quiet Mode for all print jobs up to the predetermined page size.

Table 4-12 General menu (continued)

First level	Second level	Third level	Fourth level	Values	Description
Jam Recovery				Automatic* Off On	<p>This printer provides a jam recovery feature that reprints jammed pages. Select one of the following options:</p> <p>Automatic: The printer attempts to reprint jammed pages when sufficient memory is available. This is the default setting.</p> <p>Off: The printer does not attempt to reprint jammed pages. Because no memory is used to store the most recent pages, performance is optimal.</p> <p>NOTE: When using this option, if the printer runs out of paper and the job is being printed on both sides, some pages can be lost.</p> <p>On: The printer always reprints jammed pages. Additional memory is allocated to store the last few pages printed. This might cause overall performance to suffer.</p>
Auto Recovery				Enabled Disabled*	<p>If Auto Recovery is enabled and an unrecoverable error occurs in the device firmware, the device automatically turns off and turns back on to recover from the error.</p>

Table 4-12 General menu (continued)

First level	Second level	Third level	Fourth level	Values	Description
Enable Auto Send				Disabled* Enabled	<p>Browse to the HP Embedded Web Server AutoSend configuration page for advanced set up and the HP online Privacy Statement Information.</p> <p>Use the Enable Auto Send menu to enable or disable the AutoSend feature. The AutoSend feature enables your product to periodically send product configuration information including serial number, event logs, page usage counts and supplies status information to HP web addresses (URLs), or email addresses. Information sent to HP is used to improve products and services, and to monitor the product if you have a relationship with HP that provides you services such as proactive cartridge replacement, pay-per-page contracts, support agreements, or usage tracking.</p>
Hold Off Print Job				Enabled* Disabled	<p>Enable this feature if you want to prevent print jobs from starting while a user is initiating a copy job from the control panel. Held print jobs start printing after the copy job is finished, provided that no other copy job is in the print queue.</p>

Table 4-12 General menu (continued)

First level	Second level	Third level	Fourth level	Values	Description
Reset Factory Settings				Address Book (MFP)	Use to restore all printer settings to their factory defaults.
				Copy (MFP)	
				Digital Send (MFP)	
				E-mail (MFP)	
				Fax (MFP)	
				General (MFP)	
				Print (MFP)	
				Security (MFP)	
				Cancel (SFP)	
				Reset (SFP)	

Scan/Digital Send Settings menu (MFP)

Learn about the control-panel [Scan/Digital Send Settings](#) (MFP) menu.

To display: At the printer control panel, select the [Settings](#) menu, and then select the [Scan/Digital Send Settings](#) menu.

To print: At the printer control panel, touch (MFP) or use the arrow buttons (SFP) to select the printer icon . For the SFP, press the [OK](#) button to print the pages.

In the following table, asterisks (*) indicate the factory default setting.

Table 4-13 Scan/Digital Send Settings menu (MFP)

First level	Second level	Third level	Fourth level	Values	Description
Scan to Email Settings	E-mail Setup	E-mail Setup Wizard			Use to configure settings that apply to sending documents through email or saving documents to a folder on the network or on a USB multi-drive. The E-mail Setup Wizard feature configures the printer to send scanned images as email attachments. To open the printer HP Embedded Web Server and set up the email notification server, enter the printer IP address into a Web browser.
Scan to Network Folder Settings	NOTE: Email Settings only				
Scan to USB Drive Settings					
<p>NOTE: The same options are available for each of these features, except where noted.</p>					

Table 4-13 Scan/Digital Send Settings menu (MFP) (continued)

First level	Second level	Third level	Fourth level	Values	Description
	Default Job Options	Image Preview		<p>Make optional*</p> <p>Require preview</p> <p>Disable preview</p>	<p>Defines the default job options for each function. If you do not specify the job options when creating the job, the default options are used. For complete setup, go to the HP Embedded Web Server by typing the IP address of the printer into a Web browser.</p> <p>Use the Image Preview feature to scan a document and display a preview before completing the job. Select whether this feature is available on the printer.</p> <p>Make optional: The feature is optional, depending on the user who is signed in.</p> <p>Require preview Previews are required for all users.</p> <p>Disable preview: Previews are disabled for all users.</p>
		Default File Name		[Untitled]*	<p>The printer is shipped with a factory default file name of [Untitled] for any scanned files that are sent or saved. Use this feature to specify a different default file name. If you are saving a file to a network folder or USB storage device and a file with the default file name already exists, a number is appended to the file name, for example, [Untitled]001.</p>

Table 4-13 Scan/Digital Send Settings menu (MFP) (continued)

First level	Second level	Third level	Fourth level	Values	Description
		Document File Type		Select from a list of file types.	<p>PDF provides the best overall image and text quality.</p> <p>JPEG is a good choice for most graphics. Most computers have a browser that can view .JPEG files. This file type produces one file per page.</p> <p>TIFF is a standard file format that many graphics programs support. This file type produces one file per page.</p> <p>MTIFF: stands for multi-page TIFF. This file type saves multiple scanned pages in a single file.</p> <p>XPS (XML Paper Specification) creates an XAML file that preserves the original formatting of the document and supports color graphics and embedded fonts.</p> <p>PDF/A (Archivable): provides archivable text and image quality.</p> <p>NOTE: OCR file types are not supported on this printer unless attached to DSS.</p>

Table 4-13 Scan/Digital Send Settings menu (MFP) (continued)

First level	Second level	Third level	Fourth level	Values	Description
		Optimize Text/ Picture		Mixed* Text Printed picture Photograph	<p>Use to optimize the output for a particular type of content. You can optimize the output for text, printed pictures, or a mixture.</p> <p>Mixed: Use to optimize the setting for text and for pictures.</p> <p>Text: Use to optimize the text portion of the copy when text and/or pictures are on the original.</p> <p>Printed picture: Use for line drawings and preprinted images, such as magazine clippings or pages from books.</p> <p>Photograph: Best suited for making copies of printed pictures.</p>
		Quality and File Size		High (large file) Medium* Low (small file)	<p>Use to select the quality for the output. Higher-quality images require a larger file size than lower-quality images. Larger files take more time to send, and some recipients might have trouble receiving larger files.</p>

Table 4-13 Scan/Digital Send Settings menu (MFP) (continued)

First level	Second level	Third level	Fourth level	Values	Description
		Original Sides		1-sided 2-sided	Use to describe the layout for each side of the original document. First select whether the original document is printed on one side or both sides. Then touch the Orientation setting to indicate whether the original has portrait or landscape orientation. If it is printed on both sides, also select the 2-sided format that matches the original document.
			Orientation	Automatically detect Portrait* Landscape	For some features to work correctly, you must specify the way the content of the original document is placed on the page. Portrait orientation means the short edge of the page is along the top. Landscape orientation means the long edge of the page is along the top. In the Orientation area, select whether the original document has a portrait or landscape orientation.

Table 4-13 Scan/Digital Send Settings menu (MFP) (continued)

First level	Second level	Third level	Fourth level	Values	Description
		Resolution		600 dpi 400 dpi 300 dpi 200 dpi 150 dpi* 75 dpi	Sets the resolution for sent documents. Higher resolution images have more dots per inch (dpi), so they show more detail. Lower resolution images have fewer dots per inch and show less detail, but the file size is smaller. Some file types, for example a file that will be processed with OCR, require a specific resolution. When these file types are selected, the Resolution setting might automatically change to a valid value.
		Content Orientation	Orientation	Auto Detect Portrait* Landscape	For some features to work correctly, you must specify the way the content of the original document is placed on the page. Portrait orientation means the short edge of the page is along the top. Landscape orientation means the long edge of the page is along the top. In the Orientation area, select whether the original document has a portrait or landscape orientation.

Table 4-13 Scan/Digital Send Settings menu (MFP) (continued)

First level	Second level	Third level	Fourth level	Values	Description
		Color/Black		Automatically detect color or black*	Use to enable or disable color scanning.
				Automatically detect color or gray	Automatically detect color or black: When pages without color are detected, the printer creates an image of the page in 1-bit black if other settings allow. If the other settings don't allow (File Type, for example), the image is in grayscale.
				Color	
				Black	
				Black/Gray	Automatically detect color or gray: When pages without color are detected, the printer creates an image of the page in grayscale. Select this option for the best image quality for non-color pages.
					Color: Scans documents in color.
					Black/Gray: Scans documents in grayscale.
					Black: Scans documents in black and white with a compressed file size.
		Original Size		Select from a list of supported sizes.	Use to describe the page size of the original document.

Table 4-13 Scan/Digital Send Settings menu (MFP) (continued)

First level	Second level	Third level	Fourth level	Values	Description
		Notification		Do not notify* Notify when job completes Notify only if job fails	Configure to receive notification about the status of a sent document. Do not notify: Turns off this feature. Notify when job completes: Select to receive notification for this job only.
				Print E-mail	Notify only if job fails: Select to receive notification only if the job is not sent successfully. Print: Select to print the notification at this printer.
			Include Thumbnail		NOTE: When sending an analog fax, select Include Thumbnail to receive a thumbnail image of the first page of the fax in your notification.
			Notification E-mail address		E-mail: Select to receive the notification in an email. Touch the text box following Email Address , and then type the email address for the notification.
		Image Adjustment	Darkness		Use to improve the overall quality of the copy. Adjust the Darkness setting to increase or decrease the amount of white and black in the colors.

Table 4-13 Scan/Digital Send Settings menu (MFP) (continued)

First level	Second level	Third level	Fourth level	Values	Description
			Contrast		Adjust the Contrast setting to increase or decrease the difference between the lightest and darkest color on the page.
			Background Cleanup		Adjust the Background Cleanup setting if you are having trouble copying a faint image.
			Sharpness		Adjust the Sharpness setting to clarify or soften the image. For example, increasing the sharpness could make text appear crisper, but decreasing it could make photographs appear smoother.
			Automatic Tone		
			Default		Select this to make the selected Image Adjustment setting the default value.
		Cropping Options		Do not crop*	Use this menu item to automatically crop the scan for digital sending. Use the Crop to content option to scan the smallest possible area that has detectable content.
				Crop to content	
				Crop to paper	

Table 4-13 Scan/Digital Send Settings menu (MFP) (continued)

First level	Second level	Third level	Fourth level	Values	Description
		Erase Edges		Use Inches Back side erase Front side erase	Use this menu item to remove blemishes, such as dark borders or staple marks, by cleaning the specified edges of the scanned image. In each of the text boxes enter the measurements, in millimeters or inches, for how much of the top edge, bottom edge, left edge, and right edge to clean.
		Multi-feed Detection		On* Off	This setting stops the scanning process if it detects multiple-page feeds through the document feeder.
		Blank Page Suppression		Disabled* Enabled	Use to prevent blank pages in the original document from being included in the output document.
Digital Send Service Setup	Allow Usage of Digital Sending Software (DSS) Server			Enabled* Disabled	Configure how the printer interacts with the HP Digital Sending Software (DSS) server. HP DSS handles digital sending tasks, such as faxing, emailing, and sending scanned documents to a network folder or USB storage device. Use the Allow Usage of Digital Sending Software (DSS) Server option to configure the printer to use HP DSS.

Table 4-13 Scan/Digital Send Settings menu (MFP) (continued)

First level	Second level	Third level	Fourth level	Values	Description
	Allow Transfer to New Digital Sending Software (DSS) Server			Enabled*	Use the Allow Transfer to New Digital Sending Software (DSS) Server option to specify whether DSS management of a printer is transferable to a different DSS.
				Disabled	

Fax menu (MFP)

Learn about the control-panel [Fax](#) menu (MFP).

To display: At the printer control panel, select the [Settings](#) menu, and then select the [Fax](#) menu.

To print: At the printer control panel, touch (MFP) or use the arrow buttons (SFP) to select the printer icon . For the SFP, press the **OK** button to print the pages.

In the following table, asterisks (*) indicate the factory default setting.

Table 4-14 Fax menu (MFP)

First level	Second level	Third level	Fourth level	Values	Description
Internal Fax Modem Setup					Configure settings for sending faxes from the printer. Use the Internal Fax Modem Setup feature to set up options for faxing. NOTE: To set up LAN fax or Internet fax, use the HP Embedded Web Server. To open the HP Embedded Web Server, type the printer network address into a Web browser. To configure the fax features, select the Fax tab.
Fax Send Settings	Fax Send Setup	Fax Dialing Settings	Fax Dial Volume	Off Low* High	These settings control how the fax modem dials the outgoing fax number when faxes are sent.
Fax Send Settings	Fax Send Setup	Fax Dialing Settings	Dialing Mode	Tone* Pulse	

Table 4-14 Fax menu (MFP) (continued)

First level	Second level	Third level	Fourth level	Values	Description
Fax Send Settings	Fax Send Setup	Fax Dialing Settings	Redial Interval	1 - 5 Minutes Default = 5 minutes	
Fax Send Settings	Fax Send Setup	Fax Dialing Settings	Fax Send Speed	Fast* Medium Slow	
Fax Send Settings	Fax Send Setup	Fax Dialing Settings	Dialing Prefix		
Fax Send Settings	Fax Send Setup	Fax Dialing Settings	Detect Dial Tone		
Fax Send Settings	Fax Send Setup	Fax Dialing Settings	Redial on Error	Range: 0 - 9 Default = 2	
Fax Send Settings	Fax Send Setup	Fax Dialing Settings	Redial on No Answer	Range: 0 - 2 Default = 0	
Fax Send Settings	Fax Send Setup	Fax Dialing Settings	Redial on Busy	Range: 0 - 9 Default = 3	
Fax Send Settings	Fax Send Setup	General Fax Send Settings	Fax Number Confirmation	Enabled Disabled*	If this feature is enabled, you must enter the fax number twice.
Fax Send Settings	Fax Send Setup	General Fax Send Settings	PC Fax Send	Enabled* Disabled	Enables users who have the correct driver installed to send faxes through the printer from their computers.
Fax Send Settings	Fax Send Setup	General Fax Send Settings	JBIG Compression	Enabled* Disabled	The JBIG compression reduces fax-transmission time, which can result in lower phone charges. However, using JBIG compression sometimes causes compatibility problems with older fax machines. If this occurs, turn off the JBIG compression.

Table 4-14 Fax menu (MFP) (continued)

First level	Second level	Third level	Fourth level	Values	Description
Fax Send Settings	Fax Send Setup	General Fax Send Settings	Error Correction Mode	Enabled* Disabled	When error-correction mode is enabled and an error occurs during fax transmission, the printer sends or receives the error portion again.
Fax Send Settings	Fax Send Setup	General Fax Send Settings	Fax Header	Prepend* Overlay	Use to prepend or overlay the fax header page.
Fax Send Settings	Fax Send Setup	Billing Codes	Enable Billing Codes	Off On*	<p>When billing codes are enabled, a prompt displays that asks the user to enter the billing code for an outgoing fax. This prompt does not appear if the Allow users to edit billing codes check box is not checked.</p> <p>You can also use the billing codes report in the Reports menu to view the list of the billing codes that have been used for faxes that have been sent from the printer. The list is grouped by billing code and also shows fax details. This feature can be used for billing or usage tracking.</p>
Fax Send Settings	Fax Send Setup	Billing Codes	Default Billing Code		Specify a default billing code for faxing. If you specify a default billing code, this code displays in the Billing Code field when the user sends an outgoing fax. If this field is blank, no default billing code is provided for the user.

Table 4-14 Fax menu (MFP) (continued)

First level	Second level	Third level	Fourth level	Values	Description
Fax Send Settings	Fax Send Setup	Billing Codes	Minimum Length	Range: 1 - 16 Default = 1	Specify the required length of the billing code. Billing codes can be between 1 and 16 characters long.
Fax Send Settings	Fax Send Setup	Billing Codes	Allow users to edit billing codes	Off On*	
Fax Send Settings	Default Job Options	Image Preview		Make optional* Require preview Disable preview	Use the Image Preview feature to scan a document and display a preview before completing the job. Select whether this feature is available on the printer. Make optional : The feature is optional, depending on the user who is signed in. Require preview Previews are required for all users. Disable preview : Previews are disabled for all users.
Fax Send Settings	Default Job Options	Resolution		Standard (100 x 200dpi)* Fine (200 x 200dpi) Superfine (300 x 300dpi)	Select the resolution for outgoing faxes. If you increase the resolution, faxes might be clearer but they could transmit more slowly. Some file types, for example a file that will be processed with OCR, require a specific resolution. When these file types are selected, the Resolution setting might be automatically changed to a valid value.

Table 4-14 Fax menu (MFP) (continued)

First level	Second level	Third level	Fourth level	Values	Description
Fax Send Settings	Default Job Options	Original Sides		1-sided* 2-sided Pages flip up	<p>Use to describe the layout for each side of the original document. First select whether the original document is printed on one side or both sides. Then touch the Orientation setting to indicate whether the original has portrait or landscape orientation. If it is printed on both sides, also select the 2-sided format that matches the original document.</p> <p>If the Pages flip up option is selected, the back side of the page is printed upside-down. This option is for print jobs that are bound along the top edge.</p>
Fax Send Settings	Default Job Options	Original Sides	Orientation	Portrait* Landscape	<p>For some features to work correctly, you must specify the way the content of the original document is placed on the page.</p> <p>Portrait: This setting means the short edge of the page is along the top.</p> <p>Landscape: This setting means the long edge of the page is along the top.</p>

Table 4-14 Fax menu (MFP) (continued)

First level	Second level	Third level	Fourth level	Values	Description
Fax Send Settings	Default Job Options	Notification		Do not notify* Notify when job completes Notify only if job fails	Use to receive notification about the status of a sent document. Do not notify: Turns off this feature. Notify when job completes: Select to receive notification for this job only. Notify only if job fails: Select to receive notification only if the job is not sent successfully.
Fax Send Settings	Default Job Options	Notification		Print E-mail	Print: Select to print the notification at this printer. E-mail: Select to receive the notification in an email. Touch the text box following Email Address, and then enter the email address for the notification.
Fax Send Settings	Default Job Options	Notification	Include Thumbnail		When sending an analog fax, select Include Thumbnail to receive a thumbnail image of the first page of the fax in your notification.
Fax Send Settings	Default Job Options	Notification	Notification E-mail address		Provide the email address that will receive notifications.

Table 4-14 Fax menu (MFP) (continued)

First level	Second level	Third level	Fourth level	Values	Description
Fax Send Settings	Default Job Options	Content Orientation	Orientation	Portrait* Landscape	For some features to work correctly, you must specify the way the content of the original document is placed on the page. Portrait: This setting means the short edge of the page is along the top. Landscape: This setting means the long edge of the page is along the top.
Fax Send Settings	Default Job Options	Original Size		Select from a list of sizes that the printer supports.	Use to describe the page size of the original document.
Fax Send Settings	Default Job Options	Image Adjustment	Darkness		Use to improve the overall quality of the copy. Adjust the Darkness setting to increase or decrease the amount of white and black in the colors.
Fax Send Settings	Default Job Options	Image Adjustment	Contrast		Adjust the Contrast setting to increase or decrease the difference between the lightest and darkest color on the page.
Fax Send Settings	Default Job Options	Image Adjustment	Background Cleanup		Adjust the Background Cleanup setting if you are having trouble copying a faint image.

Table 4-14 Fax menu (MFP) (continued)

First level	Second level	Third level	Fourth level	Values	Description
Fax Send Settings	Default Job Options	Image Adjustment	Sharpness		Adjust the Sharpness setting to clarify or soften the image. For example, increasing the sharpness could make text appear crisper, but decreasing it could make photographs appear smoother.
Fax Send Settings	Default Job Options	Image Adjustment	Automatic Tone		The printer automatically adjusts the Darkness , Contrast , and Background Cleanup settings to the most appropriate for the scanned document.
Fax Send Settings	Default Job Options	Optimize Text/ Picture	Manually adjust*	Optimize For Text Printed picture Photograph	<p>Optimizes the output for a particular type of content. You can optimize the output for text, printed pictures, or a mixture.</p> <p>Manually adjust: Use to manually optimize the setting for text or for pictures.</p> <p>Text: Use to optimize the text portion of the copy where text and/or pictures are on the original.</p> <p>Printed picture: Use for line drawings and preprinted images, such as magazine clippings or pages from books.</p> <p>Photograph: Best suited for making copies of printed pictures.</p>

Table 4-14 Fax menu (MFP) (continued)

First level	Second level	Third level	Fourth level	Values	Description
Fax Send Settings	Default Job Options	Multi-feed Detection		Disabled Enabled*	This setting stops the scanning process if it detects multiple-page feeds through the document feeder.
Fax Send Settings	Default Job Options	Blank Page Suppression		Disabled* Enabled	Prevents blank pages in the original document from being included in the output document.
Fax Receive Settings	Fax Receive Setup	Ringer Volume		Off Low* High	Use to configure settings for receiving faxes.
Fax Receive Settings	Fax Receive Setup	Rings To Answer		Range: 1-6 Default = 1	
Fax Receive Settings	Fax Receive Setup	Fax Send Speed		Fast* Medium Slow	
Fax Receive Settings	Fax Receive Setup	Ring Interval		Range: 220-600 ms Default = 600 ms	
Fax Receive Settings	Fax Receive Setup	Ring Frequency		Range: 1-200 Default = 68hz	
Fax Receive Settings	Fax Printing Schedule			Always store faxes Always print faxes* Use schedule	If you have concerns about the security of private faxes, use this feature to store faxes rather than having them automatically print. Select Incoming Fax Options, and then you can choose to always store faxes, always print them, or you can set up a schedule for each day of the week.

Table 4-14 Fax menu (MFP) (continued)

First level	Second level	Third level	Fourth level	Values	Description
Fax Receive Settings	Fax Printing Schedule	Schedule Touch this to set up a fax printing schedule if you selected the Use Fax Printing Schedule option.	Add	Print incoming faxes	If you are using a fax printing schedule, use this menu to configure when to print faxes.
			Edit	Store incoming faxes	
			Delete	Time	
				Event Days	
Fax Receive Settings	Blocked Fax Numbers	Fax Number to Block			<p>The blocked fax list can contain up to 30 numbers. When the printer receives a call from one of the blocked fax numbers, it deletes the incoming fax. It also logs the blocked fax in the activity log along with job-accounting information.</p> <p>Add blocked numbers: Enter a fax number into the Fax Number to Block field, and then touch the arrow button to add a new number to the blocked fax list.</p> <p>To remove blocked numbers: Select a number and touch the Delete button to delete it from the blocked fax list.</p> <p>To clear all blocked numbers: Touch the Delete All button to clear all of the numbers from the blocked fax list.</p> <p>You can also use the Blocked Fax List report in the Information menu to view the list of the fax numbers that have been blocked on this printer.</p>

Table 4-14 Fax menu (MFP) (continued)

First level	Second level	Third level	Fourth level	Values	Description
Fax Receive Settings	Default Job Options	Notification		Do not notify*	Configure to receive notification about the status of a sent document.
				Notify when job completes	
				Notify only if job fails	Do not notify: Turns off this feature. Notify when job completes: Select to receive notification for this job only. Notify only if job fails: Select to receive notification only if the job is not sent successfully.
Fax Receive Settings	Default Job Options			Print	E-mail: Select to receive the notification in an email. Touch the text box following Email Address , and then enter the email address for the notification.
				E-mail*	
Fax Receive Settings	Default Job Options		Include Thumbnail		NOTE: When sending an analog fax, select Include Thumbnail to receive a thumbnail image of the first page of the fax in your notification.
Fax Receive Settings	Default Job Options		Notification E-mail address		
Fax Receive Settings	Default Job Options	Stamp Received Faxes		Enabled	Use this option to add the date, time, sender's phone number, and page number to each page of the faxes that this printer receives.
				Disabled*	

Table 4-14 Fax menu (MFP) (continued)

First level	Second level	Third level	Fourth level	Values	Description
Fax Receive Settings	Default Job Options	Fit to Page		Enabled*	Use to shrink faxes that are larger than Letter-size or A4-size so that they can fit onto a Letter-size or A4-size page. If this feature set to Disabled , faxes larger than Letter or A4 will flow across multiple pages.
				Disabled	
Fax Receive Settings	Default Job Options	Paper Selection		Automatic*	
				Select from a list of the trays.	
Fax Receive Settings	Default Job Options	Output sides		1-sided*	Use to describe the layout for each side of the original document. First select whether the original document is printed on one side or both sides. Then touch the Orientation setting to indicate whether the original has portrait or landscape orientation. If it is printed on both sides, also select the 2-sided format that matches the original document.
				2-sided	
				Pages flip up	
Fax Forwarding	Enable Fax Forwarding			Disabled*	Use to forward received faxes to another fax machine.
				Enabled	
Fax Forwarding	Type of Fax Job to Forward			All faxes	
				Sent faxes	
				Received faxes	
Fax Forwarding	Fax Forwarding Number				Enter the fax forwarding number.
Clear Fax Activity Log				Cancel	Clears all events from the Fax Activity Log list.
				Clear	

Manage Supplies menu

Learn about the control-panel [Manage Supplies](#) menu.

To display: At the printer control panel, select the [Settings](#) menu, and then select the [Manage Supplies](#) menu.

To print: At the printer control panel, touch (MFP) or use the arrow buttons (SFP) to select the printer icon . For the SFP, press the [OK](#) button to print the pages.

In the following table, asterisks (*) indicate the factory default setting.

Table 4-15 [Manage Supplies](#) menu

First level	Second level	Third level	Fourth level	Values	Description
Low Warning Thresholds	Cyan Cartridge			1-100%	Set the estimated percentage at which the printer notifies you when a toner cartridge is very low.
	Magenta Cartridge			Default = 4%	
	Yellow Cartridge				
	Black Cartridge				
Low Warning Thresholds	Document Feeder Kit			1-100%	Set the estimated percentage at which the printer notifies you when the document feeder kit is very low.
	MFP			Default = 10%	
Low Warning Thresholds	Maintenance Kit			1-100%	Set the estimated percentage at which the printer notifies you when the maintenance kit is very low.
	SFP			Default = 10%	
Low Warning Threshold Message				On*	Displays a message on the control panel when a cartridge is very low.
				Off	
Low Behavior				Continue*	Use one of these options to specify the action for the device to take when a supply reaches a low condition.
				Stop	
					<p>Stop: Stops the current print job.</p> <p>Continue: Completes the current print job.</p>

Table 4-15 Manage Supplies menu (continued)

First level	Second level	Third level	Fourth level	Values	Description
Very Low Behavior	Cyan Cartridge			Stop	Use one or more of these options to specify the action for the device to take when a supply reaches a very low condition. Stop: Stops the current print job. Continue: Completes the current print job. Prompt to continue: Allows the user to decide whether or not to finish printing.
	Magenta Cartridge			Continue*	
	Yellow Cartridge			Prompt to continue	
	Black Cartridge				
Very Low Behavior	Document Feeder Kit			Stop	Use one or more of these options to specify the action for the device to take when a supply reaches a very low condition. Stop: Stops the current print job. Continue: Completes the current print job. Prompt to continue: Allows the user to decide whether or not to finish printing.
	MFP			Continue	
				Prompt to continue*	
Very Low Behavior	Maintenance Kit			Stop	Use one or more of these options to specify the action for the device to take when a supply reaches a very low condition. Stop: Stops the current print job. Continue: Completes the current print job. Prompt to continue: Allows the user to decide whether or not to finish printing.
	SFP			Continue	
				Prompt to continue*	

Table 4-15 Manage Supplies menu (continued)

First level	Second level	Third level	Fourth level	Values	Description
Store Usage Data				On supplies* Not on supplies	Store Usage Data provides a way to suppress the toner cartridges from storing most of the information gathered exclusively for the purpose of understanding the usage of the printer. Select the On supplies setting to store the data on the toner cartridge memory chip. Select the Not on supplies setting to suppress the information from being stored on the memory chip.
Cartridge Protection				Off* Protect cartridges	Select to permanently protect cartridges so that they can be used only in this product or fleet of products.
Cartridge Policy				Off* Authorized HP	Set Authorized HP to allow only genuine HP cartridges to be used in this printer.
Reset Supplies	Document Feeder Kit MFP Maintenance Kit SFP			Reset Cancel	Select this option if you have installed a new document feeder kit or maintenance kit.

Networking menu

Learn about the control-panel [Networking](#) menu.

To display: At the printer control panel, select the [Settings](#) menu, and then select the [Networking](#) menu.

To print: At the printer control panel, touch (MFP) or use the arrow buttons (SFP) to select the printer icon . For the SFP, press the [OK](#) button to print the pages.

In the following table, asterisks (*) indicate the factory default setting.

Table 4-16 Networking menu

First level	Second level	Third level	Fourth level	Values	Description
Ethernet	Information	Print Security Report		Yes No*	<p>Yes: Prints a page that contains the current security settings on the HP Jetdirect print server.</p> <p>No: A security settings page is not printed.</p>
Ethernet	TCP/IP	Host Name		Use the arrow buttons to edit the host name. NPIXXXXXX*	<p>An alphanumeric string, up to 32 characters, used to identify the printer. This name is listed on the HP Jetdirect configuration page. The default host name is NPIxxxxxx, where xxxxxx is the last six digits of the LAN hardware (MAC) address.</p>

Table 4-16 Networking menu (continued)

First level	Second level	Third level	Fourth level	Values	Description
Ethernet	TCP/IP	IPv4 Settings	Config Method	Bootp DHCP* Auto IP Manual	<p>Specifies the method that TCP/IPv4 parameters will be configured on the HP Jetdirect print server.</p> <p>Bootp (Bootstrap Protocol): Use for automatic configuration from a BootP server.</p> <p>DHCP (Dynamic Host Configuration Protocol): Use for automatic configuration from a DHCPv4 server. If selected and a DHCP lease exists, the DHCP Release menu and the DHCP Renew menu are available to set DHCP lease options.</p> <p>Auto IP: Use for automatic link-local IPv4 addressing. An address in the form 169.254.x.x is assigned automatically.</p> <p>If you set this option to the Manual setting, use the Manual Settings menu to configure TCP/IPv4 parameters.</p>

Table 4-16 Networking menu (continued)

First level	Second level	Third level	Fourth level	Values	Description
Ethernet	TCP/IP	IPV4 Settings	Default IP	Auto IP* Legacy	Specify the IP address to default to when the print server is unable to obtain an IP address from the network during a forced TCP/IP reconfiguration (for example, when manually configured to use BootP or DHCP). NOTE: This feature assigns a static IP address that might interfere with a managed network. Auto IP: A link-local IP address 169.254.x.x is set. Legacy: The address 192.0.0.192 is set, consistent with older HP Jetdirect printers.
Ethernet	TCP/IP	IPV4 Settings	DHCP Release	Yes No*	
Ethernet	TCP/IP	IPV4 Settings	DHCP Renew	Yes No*	
Ethernet	TCP/IP	IPV4 Settings	Primary DNS	Range: 0-255 Default = xxx.xxx.xx.xx	Specify the IP address (n.n.n.n) of a Primary Domain Name System (DNS) Server.
Ethernet	TCP/IP	IPV4 Settings	Secondary DNS	Range: 0-255 Default = 0.0.0.0	Specify the IP address (n.n.n.n) of a Secondary DNS Server.
Ethernet	TCP/IP	IPV6 Settings	Enable	Off On*	Use this item to enable or disable IPv6 operation on the print server. Off: IPv6 is disabled. On: IPv6 is enabled.

Table 4-16 Networking menu (continued)

First level	Second level	Third level	Fourth level	Values	Description
Ethernet	TCP/IP	IPv6 Settings	Address	Manual Settings Enable Address	Use this item to enable and manually configure a TCP/IPv6 address.
Ethernet	TCP/IP	IPv6 Settings	DHCPv6 Policy	Router Specified Router Unavailable* Always	<p>Router Specified: The stateful auto-configuration method to be used by the print server is determined by a router. The router specifies whether the print server obtains its address, its configuration information, or both from a DHCPv6 server.</p> <p>Router Unavailable: If a router is not available, the print server should attempt to obtain its stateful configuration from a DHCPv6 server.</p> <p>Always: Whether a router is available, the print server always attempts to obtain its stateful configuration from a DHCPv6 server.</p>
Ethernet	TCP/IP	IPv6 Settings	Primary DNS	Range: 0-255 Default = xxx.xxx.xx.xx	Specify the IP address (n.n.n.n) of a Primary Domain Name System (DNS) Server.
Ethernet	TCP/IP	IPv6 Settings	Secondary DNS	Range: 0-255 Default = 0.0.0.0	Specify the IP address (n.n.n.n) of a Secondary DNS Server.

Table 4-16 Networking menu (continued)

First level	Second level	Third level	Fourth level	Values	Description
Ethernet	TCP/IP	Proxy Server		Select from a provided list.	<p>Specifies the proxy server to be used by embedded applications in the printer. A proxy server is typically used by network clients for Internet access. It caches Web pages, and provides a degree of Internet security for those clients.</p> <p>To specify a proxy server, enter its IPv4 address or fully-qualified domain name. The name can be up to 255 octets.</p> <p>For some networks, you might need to contact your Internet Service Provider (ISP) for the proxy server address.</p>
Ethernet	TCP/IP	Proxy Port		Range: 1-65535 Default = 00080	<p>Enter the port number used by the proxy server for client support. The port number identifies the port reserved for proxy activity on your network, and can be a value from 0 to 65535.</p>
Ethernet	TCP/IP	Idle Timeout		Range: 1-3600 Default = 0270	<p>The time period, in seconds, after which an idle TCP print data connection is closed (default is 270 seconds, 0 disables the timeout).</p>

Table 4-16 Networking menu (continued)

First level	Second level	Third level	Fourth level	Values	Description
I/O Timeout				Range: 5 - 300 sec Default = 10	Use to set the I/O timeout period in seconds. I/O timeout refers to the elapsed time before a print job fails. If the stream of data that the printer receives for a print job gets interrupted, this setting indicates how long the printer will wait before it reports that the job has failed.

Support Tools menu

Learn about the control-panel [Support Tools](#) menu.

 **NOTE:** The [Support Tools](#) sub-menu contains the options for maintaining the printer and troubleshooting printer problems.

Maintenance menu

Learn about the control-panel [Maintenance](#) menu.

Backup/Restore menu

Learn about the control-panel [Backup/Restore](#) menu.

To display: At the printer control panel, select the [Support Tools](#) menu, select the [Maintenance](#) menu, and then select the [Backup/Restore](#) menu.

To print: At the printer control panel, touch (MFP) or use the arrow buttons (SFP) to select the printer icon . For the SFP, press the **OK** button to print the pages.

In the following table, asterisks (*) indicate the factory default setting.

Table 4-17 Backup/Restore menu

First level	Second level	Third level	Values
Back up Data	Enable Scheduled Backups	Backup Time	Enter a time
Back up Data	Enable Scheduled Backups	Days Between Backups	Enter the number of days
Back up Data	Back up Now		
Back up Data	Export Last Backup		
Restore Data			Insert a USB drive that contains the backup file.

Calibration/Cleaning menu

Learn about the control-panel [Calibration/Cleaning](#) menu .

To display: At the printer control panel, select the [Support Tools](#) menu, select the [Maintenance](#) menu, and then select the [Calibration/Cleaning](#) menu.

To print: At the printer control panel, touch (MFP) or use the arrow buttons (SFP) to select the printer icon . For the SFP, press the [OK](#) button to print the pages.

In the following table, asterisks (*) indicate the factory default setting.

Table 4-18 Calibration/Cleaning menu

First level	Values	Description
Cleaning Page	Automatic Cleaning Interval	Use this menu to configure the settings for the product to automatically print a cleaning page.
	Off*	
	1000 pages	Select a cleaning interval to set the number of pages to be printed before an automatic cleaning page is printed.
	2000 pages	
	5000 pages	
	10000 pages	
20000 pages	Touch Print to manually print a cleaning page.	
		NOTE: Cleaning pages print on the default paper size configured for the printer.
Quick Calibration	Start	The printer automatically calibrates itself at various times. However, the user can calibrate the printer immediately if the printer experiences problems with print quality. Use this feature to perform a partial calibration. Use this calibration if color density or tone seem incorrect. Before calibrating, make sure that the Ready indicator displays on the control panel display. If a job is in progress, the calibration occurs when that job is complete.

Table 4-18 Calibration/Cleaning menu (continued)

First level	Values	Description
Full Calibration	Start	<p>The printer automatically calibrates itself at various times. However, the user can calibrate the printer immediately if the printer experiences problems with print quality. Use this feature to perform a full calibration, which can take up to three minutes. Use this calibration if the color layers seem to be shifted on the page.</p> <p>Before calibrating, make sure that the Ready indicator displays on the control panel display. If a job is in progress, the calibration occurs when that job is complete.</p>
Power on Calibration	No delay Delay 15 minutes	<p>This feature controls the timing of calibration when the printer wakes up or is turned on.</p>
Calibrate Scanner MFP	Done Start	<p>Touch Start to calibrate the device scanner. Messages on the control panel display will lead you through the calibration process.</p>
Reset Calibration	Reset Cancel	<p>Use this feature to return the product to the factory-set default values for color calibration.</p> <p>Select Reset to reset the color calibration. The printer will restart with the factory-set defaults.</p> <p>Select Cancel to close the menu without resetting the color calibration.</p>

USB Firmware Upgrade menu

Learn about the control-panel [USB Firmware Upgrade](#) menu.

To display: At the printer control panel, select the [Support Tools](#) menu, select the [Maintenance](#) menu, and then select the [USB Firmware Upgrade](#) menu.

Insert a USB storage device with a firmware upgrade bundle into the USB port, and follow the on-screen instructions.

Service menu

Learn about the control-panel [Service](#) menu.

To display: At the printer control panel, select the [Support Tools](#) menu, and then select the [Service](#) menu.

The [Service](#) menu is locked and requires a personal identification number (PIN) for access. This menu is intended for use by authorized service personnel. See the Service menu section of this manual.

Troubleshooting menu

Learn about the control-panel [Troubleshooting](#) menu.

To display: At the printer control panel, select the [Support Tools](#) menu, and then select the [Troubleshooting](#) menu.

In the following table, asterisks (*) indicate the factory default setting.

Table 4-19 Troubleshooting menu

First level	Second level	Third level	Fourth level	Values	Description
Reports	Configuration/ Status Pages			Settings Menu Map	Select the desired report and then select the print icon  to print the page.
				Current Settings Page	
				Configuration Page	
				Supplies Status Page	
				Usage Page	
				Paper Path Page	
				File Directory Page	
				Web Services Status Page	
				PCL Font List	
				PS Font List	
				Event Log	
				Warning Log Page	
				T.30 Protocol Trace	
		PQ Troubleshooting Pages			
		Paper Path Test			
Reports	Fax Reports			Fax Activity Log	Select the desired report and then select the print icon  to print the page.
				Billing Codes Report	
				Blocked Fax List	
				Fax Call Report	

Table 4-19 Troubleshooting menu (continued)

First level	Second level	Third level	Fourth level	Values	Description
Reports	Other Pages			PCL Font List PS Font List	Select the desired report and then select the print icon  to print the page.
Fax Tools Fax models only	Fax T.30 Trace Report			Never automatically print* Print after every fax Print only after fax send jobs Print only after received faxes Print only after fax send errors Print only after fax receive errors Print after any fax error	Use to print or configure the fax T.30 trace report. T.30 is the standard that specifies handshaking, protocols, and error correction between fax machines.
Fax Tools Fax models only	Fax V.34			Enable* Disable	Use to disable V.34 modulations if several fax failures have occurred or if phone line conditions require it.
Fax Tools Fax models only	JBIG Compression			On Off*	
Fax Tools Fax models only	Fax Speaker Mode			Normal* Diagnostic	Used by a technician to evaluate and diagnose fax issues by listening to the sounds of fax modulations
Fax Tools Fax models only	Fax Service Log			Print	The standard fax log includes basic information such as the time and whether the fax was successful. The detailed fax log shows the intermediate results of the redial process not shown in the standard fax log.

Table 4-19 Troubleshooting menu (continued)

First level	Second level	Third level	Fourth level	Values	Description
Print Quality Pages	PQ Troubleshooting Pages			Print	Use to print pages that help you resolve problems with print quality.
Event Log					Prints the 50 most recent events in the Event Log. For each event, the printed log shows the error number, page count, error code, and description or personality.
Paper Path Page				Print	Shows how many pages were printed from each tray.
Diagnostic Tests	Disable Cartridge Check			Continue	Use this diagnostic test to print internal pages or send an external job to the printer when the toner cartridge is removed or exchanged. Supply errors are ignored while the printer is in this mode.
Diagnostic Tests	Paper Path Test	Source Tray		Select from a list of the available trays.	Generates a test page for testing paper handling features. You can define the path that is used for the test in order to test specific paper paths
Diagnostic Tests	Paper Path Test	Number of Copies		Range: 1-500 Default = 1	Sets the default number of copies for a copy job. This default applies when the Copy or Quick Copy function is initiated from the printer Home screen. The factory default setting is 1.
Diagnostic Tests	Paper Path Test	Test Duplex Path		Enable Disable*	Prints on both sides of the paper.
Diagnostic Tests	Print/Stop Test				Specify the length of time in milliseconds (0-60,000).

Table 4-19 Troubleshooting menu (continued)

First level	Second level	Third level	Fourth level	Values	Description
Diagnostic Tests	Paper Path Sensor Test			Select from a list of the printer sensors.	Initiates a test of the paper path sensors.
Diagnostic Tests	Manual Sensor Test NOTE: This item appears in the control-panel menus. However, the function is not available for this printer			Select from a list of available components Reset	Test the printer sensors and switches for correct operation. Each sensor is displayed on the control-panel screen, along with its status. Manually trip each sensor and watch for it to change on the screen. Press the Stop button to abort the test.
Diagnostic Tests	Tray/Bin Manual Sensor Test NOTE: This item appears in the control-panel menus. However, the function is not available for this printer			Select from a list of available components Reset	Test the printer sensors and switches for correct operation. Each sensor is displayed on the control-panel screen, along with its status. Manually trip each sensor and watch for it to change on the screen. Press the Stop button to abort the test.
Diagnostic Tests	Component Test NOTE: This item appears in the control-panel menus. However, the function is not available for this printer			Select from a list of available components.	Use to exercise individual parts independently to isolate noise, leaking, or other issues. To start the test, select one of the components. The test will run the number of times specified by the Repeat option. You might be prompted to remove parts from the printer during the test. Press the Stop button to abort the test.
Diagnostic Tests	Continuous Scan MFP			2-sided	
Diagnostic Tests	Scanner Tests MFP			Sensors	

Table 4-19 Troubleshooting menu (continued)

First level	Second level	Third level	Fourth level	Values	Description
Generate Debug Data				Start	
Retrieve Diagnostic Data				Create device data file Create zipped debug information file Include crash dump files Clean up debug information Send to E-mail Export to USB	Create files that contain information about the printer that can help identify the cause of problems.
Retrieve Fax Diagnostic Data				Create device data file Create zipped debug information file Include crash dump files Clean up debug information Send to E-mail Export to USB	Create files that contain information about the printer that can help identify the cause of problems.

Service menu

Learn about the printer [Service](#) menu.

[Service](#) menu access is restricted by using a personal identification number (PIN). Only authorized service people should access the [Service](#) menu. When selecting [Service](#) from the list of menus, the printer prompts the user to enter an eight-digit PIN.



NOTE: The printer automatically exits the [Service](#) menu after about one minute if no items are selected or changed.

Open the [Service](#) menu from a SFP control panel

1. From the [Home](#) screen on the printer control panel, use the arrow buttons to navigate to [Support Tools](#), and then press the [OK](#) button.
2. Use the arrow buttons to scroll to [Service](#), and then press the [OK](#) button.
3. Make sure that [Service Access Code](#) is selected for the [Access Type](#) item.



NOTE: Use the arrow buttons to select and change the [Access Type](#) item if necessary.

4. Enter the following service access PIN for the printer:
 - 10570022 (SFP)
 - 10580022 (MFP)

Open the **Service** menu from an MFP control panel

1. From the **Home** screen on the printer control panel, scroll to and touch the **Support Tools** button.
2. Open the following menus:
 - **Service**
3. Make sure that **Service Access Code** is selected for the **Access Type** item.
4. Enter the following service access PIN for the printer:
 - 10570022 (SFP)
 - 10580022 (MFP)

Service menu table

The following menu items appear in the **Service** menu.

Table 4-20 Service menu

First level	Second level	Value	Description
Event Log	Print		Print or view the event log.
Clear Event Log	Clear		Use this item to clear the printer event log.
Cycle Counts	Total Engine Cycles		Set the page count that was stored in NVRAM prior to installing a new formatter.
Cycle Counts	Refurbish Cycle Count		Use this item to record the page count when the printer was refurbished.
Cycle Counts	Document Feeder MFP		Total number of pages since the document feeder kit was replaced.
Cycle Counts	Document Feeder Kit Interval MFP		Use this item to set the interval that causes the printer to prompt the customer to replace document feeder maintenance kit.
Cycle Counts	Clean Rollers Count MFP		Total number of pages since the document feeder rollers were cleaned.
Cycle Counts	Clean Rollers Interval MFP		Use this item to set the interval that causes the printer to prompt the customer to clean the document feeder rollers and separation pad.

Table 4-20 Service menu (continued)

First level	Second level	Value	Description
Cycle Counts	ADF Count MFP		Set the total pages fed through the document feeder.
Cycle Counts	Flatbed Count MFP		Set the total pages scanned from the flatbed.
Cycle Counts	ADF Simplex Count MFP		Set the total single-sided pages fed through the document feeder.
Cycle Counts	ADF Duplex Count MFP		Set the total two-sided pages fed through the document feeder.
Cycle Counts	Copy Scan Count MFP		Set the total copy pages that have been scanned.
Cycle Counts	Send Scan Count MFP		Set the number of scanned pages sent to email.
Cycle Counts	Fax Scan Count Fax models only		Set the number of scanned pages that have been faxed.
Cycle Counts	Copy Pages Count MFP		Set the number of scanned pages that have been printed.
Scanner Settings MFP	ADF Settings	Leading edge front Leading edge back Trailing edge front Trailing edge back Left side front Left side back	Set the calibration values. WARNING! Do not change these values unless instructed to do so.
Scanner Settings MFP	Glass Settings	Leading edge glass Left Side Glass	
Serial Number			Set the serial number.
Service ID			Use this item to show the date that the printer was first used on the control panel. This eliminates the need for users to keep paper receipts for proof of warranty.

Table 4-20 Service menu (continued)

First level	Second level	Value	Description
Cold Reset Paper			When you perform a cold reset, the paper size that is stored in NVRAM is reset to the default factory setting. If you replace a formatter board in a country/region that uses A4 as the standard paper size, use this menu to reset the default paper size to A4. LETTER and A4 are the only available values.
Low Alerts		Enable Disable	Turn on (or off) low alerts (for supplies).
Reset Low Alerts	<ul style="list-style-type: none"> • Reset to level 1 • Reset to level 2 • Reset to level 3 • Set to non-HP managed mode 		
PTT Test Mode Fax models only			Test the internal modem for the analog fax accessory.
PTT Test Mode Fax models only	Hook Operations	Off Hook On Hook	
PTT Test Mode Fax models only	Generate Random Data	Select a value from the list.	
PTT Test Mode Fax models only	Generate DTMF Tone Burst	Select a value from the list.	
PTT Test Mode Fax models only	Generate DTMF Continuous Tone	Select a value from the list.	
PTT Test Mode Fax models only	Generate Pulse Burst	Select a value from the list.	
PTT Test Mode Fax models only	Generate Tone Dial Number	Enter dial number.	
PTT Test Mode Fax models only	Generate Pulse Dial Number	Enter dial number.	
PTT Test Mode Fax models only	Generate Single Modem Tone	Range: 1100-2100 Hz Default = 2100 Hz	
PTT Test Mode Fax models only	Line Measurements		

Table 4-20 Service menu (continued)

First level	Second level	Value	Description
PTT Test Mode	Fax Transmit Signal Loss		
Fax models only			
Test Support	Continuous Scan	2-sided	
	MFP	Save to Disk	
Test Support	Continuous Copy	2-sided	
	MFP	Save to Disk	
Test Support	Raw Scan	2-sided	
	MFP	Mechanical Calibration	
Test Support	Continuous Print from USB		
Test Support	Automatic Calibrations	Disabled	
	MFP	Enabled*	
Test Support	Runtime Configuration	Standard	
		StandardEIC	
		Workflow	
		WorkflowEIC	
		Reconfigure	

Printer resets

Learn about the printer resets.

Restore factory-set defaults from a non-touchscreen control panel

1. From the [Home](#) screen on the printer control panel, use the arrow buttons to navigate to [Settings](#), and then press the [OK](#) button.
2. Use the arrow buttons to scroll to [General](#), and then press the [OK](#) button.
3. Use the arrow buttons to scroll to [Restore Factory Settings](#), and then press the [OK](#) button.
4. A verification message advises that completing the reset function might result in loss of data. Select the [Reset](#) button to complete the process.

Restore factory-set defaults from a touchscreen control panel

1. From the [Home](#) screen on the printer control panel, scroll to and touch the [Settings](#) button.
2. Open the following menus:
 - [General Settings](#)
 - [Reset Factory Settings](#)

3. A verification message advises that completing the reset function might result in loss of data. Touch the [Reset](#) button to complete the process.

Restore the Service ID

When replacing the formatter, the Service ID date is lost. Use this menu item to reset the date to the original date that the printer was first used. The date format is YYDDD. Use the following formula to calculate the Service ID.

Calculate the service ID

For the calculation below, the placed-in-service date is 17OCT2002.

1. To calculate YY, subtract 1990 from the calendar year. If the printer was first used in 2002, calculate YY as follows: $2002 - 1990 = 12$. YY = 12.
2. Subtract 1 from 10 (October is the tenth month of the year): $10 - 1 = 9$.
 - Multiply 9 by 30: $9 \times 30 = 270$ and add 17 to 270: $270 + 17 = 287$. Thus, DDD = 287.
3. In this example the Service ID is 12287.

Convert the Service ID to an actual date

Use the printer Service ID number to determine whether the printer is still under warranty. Use the following formula to convert the Service ID into the actual date the printer was placed-in-service. For the example below, use the Service ID previously calculated (12287).

1. Add 1990 to YY to get the actual year that the printer was installed.
2. Divide DDD by 30. If there is a remainder, add 1 to the result. This is the month.
3. The remainder from the calculation in step 2 is the date.
 - a. $12 + 1990 = 2002$, so the year is 2002.
 - b. 287 divided by 30 = 9 with a remainder of 17. Because there is a remainder, add 1 to 9 to get 10, which represents October.
 - c. The remainder in step 2 is 17, so that is the date. The complete date is 17-October-2002.



NOTE: A six-day grace period is built into the date system.

Cold reset using the Pre-boot menu from a non-touchscreen control panel

CAUTION: This procedure resets all printer configurations and settings to factory defaults (customer configurations and settings are lost).

1. Press the [Cancel](#) button when you see the [1/8](#) under the logo
2. Use the arrow buttons to highlight [+3:Administrator](#) item, and then press the [OK](#) button.
3. Use the arrow buttons to highlight [+8:Startup Options](#) item, and then press the [OK](#) button.
4. Use the arrow buttons to highlight [2 Cold Reset](#) item, and then press the [OK](#) button.

5. Press the Home button to return to the main Pre-boot menu and highlight the **1:Continue** item, and then press the **OK** button.



NOTE: The printer initializes.

Cold reset using the Pre-boot menu from a touchscreen control panel

- CAUTION:** This procedure resets all printer configurations and settings to factory defaults (customer configurations and settings are lost).
-

1. Touch the middle of the control-panel display when you see the **1/8** under the logo

Figure 4-98 Open the Pre-boot menu (MFP)

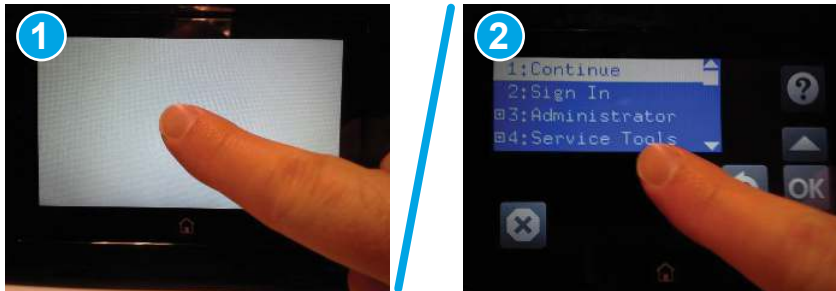

2. Use the arrow buttons to highlight **+3:Administrator** item, and then press the **OK** button.
3. Use the arrow buttons to highlight **+8:Startup Options** item, and then press the **OK** button.
4. Use the arrow buttons to highlight **2 Cold Reset** item, and then press the **OK** button.
5. Touch the Home button to return to the main Pre-boot menu and highlight the **1:Continue** item, and then press the **OK** button.



NOTE: The printer initializes.

Format Disk and Partial Clean functions

Learn about the printer [Format Disk](#) and [Partial Clean](#) functions.

Active and repository firmware locations

The firmware bundle consists of multiple parts. The main components are the Windows CE Operating System and the printer/peripheral firmware files.

There are two locations/partitions on the hard drive where the firmware components are stored:

- The Active, where the operating system and firmware currently are executing.
- The Repository, the recovery location.

If the Active location is damaged, or a [Partial Clean](#) was performed, the printer automatically copies over the OS and firmware files from the Repository location and the printer recovers.

If both the Active and Repository locations are damaged, or a [Format Disk](#) was performed, then both locations are gone and the error message **99.09.67** displays on the control-panel display. The user must upload the firmware to the printer in order for it to function again.

 **CAUTION:** The [Format Disk](#) option performs a disk initialization for the entire disk. The operating system, firmware files, and third party files (among other files) are completely lost. HP does not recommend this action.

Partial Clean

The [Partial Clean](#) option erases all partitions and data on the disk drive, except for the firmware repository where a backup copy of the firmware file is stored. This allows the disk drive to be reformatted without having to download a firmware upgrade file to return the printer to a bootable state.

Characteristics of a [Partial Clean](#)

- Customer-defined settings, third-party solutions, firmware files, and the operating system are deleted.
- Rebooting the printer restores the firmware files from the Repository location, but does not restore any customer-defined settings.
- For previous HP printers, a Hard Disk Initialization is similar to executing the [Partial Clean](#) function for this printer.

 **CAUTION:** HP recommends backing-up printer configuration data before executing a [Partial Clean](#) to retain customer-defined settings (if needed). See the [Backup/Restore](#) item in the [Device Maintenance](#) menu.

Reasons for performing [Partial Clean](#)

- The printer continually boots up in an error state.

 **NOTE:** Try clearing the error prior to executing a [Partial Clean](#).

- The printer will not respond to commands from the control panel.
- Executing the [Partial Clean](#) function is helpful for troubleshooting hard disk problems.
- To reset the printer by deleting all solutions and customer-defined settings.
- The printer default settings are not properly working.

Execute a [Partial Clean](#) from a non-touchscreen control panel

This procedure resets all printer configurations and settings to factory defaults (customer configurations and settings are lost).

1. Press the [Cancel](#) button when you see the [1/8](#) under the logo
2. Use the arrow buttons to highlight [+3:Administrator](#) item, and then press the [OK](#) button.
3. Use the arrow buttons to highlight [Partial Clean](#) item, and then press the [OK](#) button.
4. Press the [OK](#) button again.

5. Press the Home button to return to the main Pre-boot menu and highlight the **Continue** item, and then press the **OK** button.



NOTE: The printer initializes.

Execute a **Partial Clean** from a touchscreen control panel

This procedure resets all printer configurations and settings to factory defaults (customer configurations and settings are lost).

1. Touch the middle of the control-panel display when you see the **1/8** under the logo

Figure 4-99 Open the Pre-boot menu (MFP)

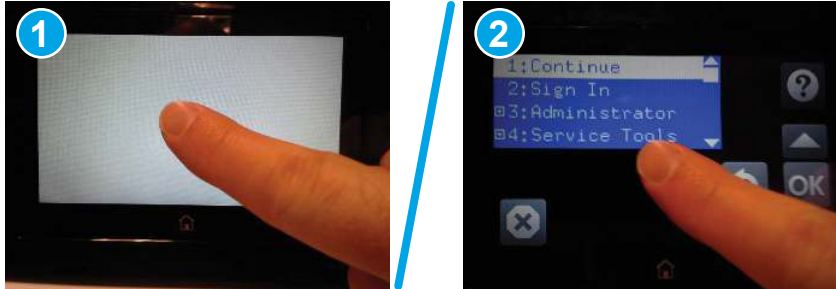

2. Use the arrow buttons to highlight **+3:Administrator** item, and then press the **OK** button.
3. Use the arrow buttons to highlight **Partial Clean** item, and then press the **OK** button.
4. Press the **OK** button again.
5. Touch the Home button to return to the main Pre-boot menu and highlight the **Continue** item, and then press the **OK** button.



NOTE: The printer initializes.

Format Disk

The **Format Disk** option erases the entire disk drive.

CAUTION: After executing a **Format Disk** option, the printer is not bootable.

Characteristics of a **Format Disk**

- Customer-defined settings, third-party solutions, firmware files, and the operating system are deleted.



NOTE: Rebooting the printer *does not* restore the firmware files

- Rebooting the printer restores the firmware files from the Repository location, but does not restore any customer-defined settings.
- After executing the **Format Disk** function, the message **99.09.67** displays on the control panel.
- After executing the **Format Disk** function, the printer firmware must be reloaded.

CAUTION: HP recommends not using the **Format Disk** option unless an error occurs and the solution in the printer service manual recommends this solution. After executing the **Format Disk** function, the printer is unusable.

HP recommends backing-up printer configuration data before executing a [Format Disk](#) to retain customer-defined settings (if needed). See the [Backup/Restore](#) item in the [Device Maintenance](#) menu.

Reasons for performing [Format Disk](#)

- The printer continually boots up in an error state.

 **NOTE:** Try clearing the error prior to executing a [Format Disk](#).

- The printer will not respond to commands from the control panel.
- Executing the [Format Disk](#) function is helpful for troubleshooting hard disk problems.
- To reset the printer by deleting all solutions and customer-defined settings.

Execute a [Format Disk](#) from a non-touchscreen control panel

This procedure resets all printer configurations and settings to factory defaults (customer configurations and settings are lost).

1. Press the [Cancel](#) button when you see the [1/8](#) under the logo
2. Use the arrow buttons to highlight [+3:Administrator](#) item, and then press the [OK](#) button.
3. Use the arrow buttons to highlight [Format Disk](#) item, and then press the [OK](#) button.
4. Press the [OK](#) button again.

 **NOTE:** When the [Format Disk](#) operation is complete, reload the printer firmware.

Execute a [Format Disk](#) from a touchscreen control panel

This procedure resets all printer configurations and settings to factory defaults (customer configurations and settings are lost).

1. Touch the middle of the control-panel display when you see the [1/8](#) under the logo

Figure 4-100 Open the Pre-boot menu (MFP)

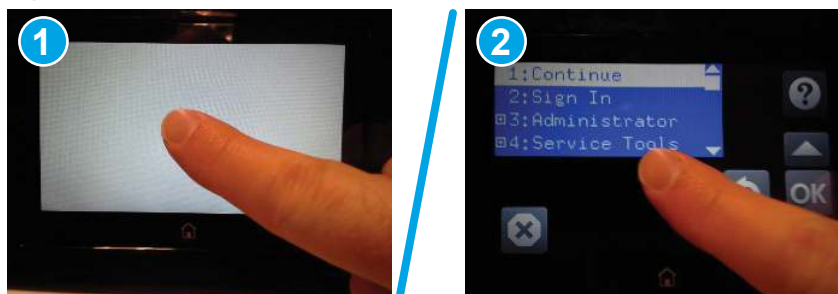

2. Use the arrow buttons to highlight [+3:Administrator](#) item, and then press the [OK](#) button.
3. Use the arrow buttons to highlight [Format Disk](#) item, and then press the [OK](#) button.
4. Press the [OK](#) button again.

 **NOTE:** When the [Format Disk](#) operation is complete, reload the printer firmware.

Power on troubleshooting

Learn about power on troubleshooting.

Power-on checks

Learn about power-on checks.

The basic printer functions should start up when the printer is connected into an electrical outlet and the power switch is pushed to the on position. If the printer does not start, use the information in this section to isolate and solve the problem.

If the control panel display remains blank, random patterns display, or asterisks remain on the control panel display, perform power-on checks to find the cause of the problem.

Power on troubleshooting overview

Learn about general power on troubleshooting.

During normal operation, a cooling fan begins to spin briefly after the printer power is turned on. Place a hand over the fan intake vents located on the right-side cover. When the fan is correctly operating, air passing into the printer is felt. Lean close to the printer to hear the fan operating. If the fan is operating, the dc side of the power supply is functioning.

After the fan is operating, the main motor turns on (unless the top cover is open, a jam condition is sensed, or the paper-path sensors are damaged). Visually and audibly determine that the main motor is turned on.

If the fan and main motor are operating correctly, the next troubleshooting step is to isolate print engine, formatter, and control panel problems. Perform an engine test. If the formatter is damaged, it might interfere with the engine test. If the engine-test page does not print, try removing the formatter, and then performing the engine test again. If the engine test is then successful, the problem is almost certainly with the formatter, the control panel, or the cable that connects them.

Troubleshooting power-on or blank control panel problems

If the printer is not powering on correctly, use the following steps to begin troubleshooting the problem.

1. Verify that power is available to the printer. If the printer is plugged into a surge protector or uninterruptible power supply (UPS), remove it. Plug the printer directly into a known operating wall receptacle (make sure that the wall receptacle provides the correct voltage and current for the printer).



NOTE: Unplug any other devices on the same circuit that the printer is using.

2. Try another known operating wall receptacle and a different power cord.
3. To eliminate a thermal switch issue, unplug the power cord and leave it unplugged for over 20 minutes. Re-attach the power cord, and then turn the power on again.
4. During normal operation, a cooling fan or fans begin to spin briefly after the printer power is turned on. Place a hand over the cover vent or vents to feel air passing out of the printer. Lean close to the printer to hear the fan or fans operating. Look for illuminated lights on the control panel and formatter LEDs.



NOTE: Operational fans, motors, and control-panel lights indicate the following:

- AC power is present at the printer.
 - The power supply is providing either or both 24 Vdc and 5 Vdc voltages.
 - The DC controller microprocessor is functioning.
-
5. If the printer powers on, but the control panel is blank, make sure that the control-panel display wire harness or harnesses and flat flexible cable or cables (FFCs) are connected.



NOTE: The following conditions indicate that the printer has frozen while in Sleep mode or Sleep delay. Opening a door or pressing a control-panel button should cause the printer to wake up from Sleep mode or Sleep delay.

- The control panel home button LED is illuminated
 - The power-switch LED flashes once every three to five seconds
-

If the control panel is not responding, or if it appears black or blank, try the following:

- Turn the printer power off, and then on again.
 - Verify that the system is correctly functioning by printing a test page. Does the test page print correctly?

Is the printer HP Embedded Web Server (EWS) accessible?
 - Verify that the control panel is correctly functioning. If it is not, turn the printer off and reseal the control-panel assembly cable connections at the control-panel assembly and the formatter.
 - Try upgrading the firmware. If the firmware upgrade fails to resolve the problem, and the printer still freezes while in Sleep mode or Sleep delay, elevate the case.
 - If the error persists and the EWS functions correctly, replace the control-panel assembly.
- If normal start-up noises are not heard, turn the printer off, and then remove any installed accessories (for example, envelope feeders, paper feeders, or output accessories).
 - Turn the printer on, and then listen for start-up noises. If normal start-up noises are heard, the problem might be with an accessory.
 - Perform an engine test. The engine test procedure varies by printer, so refer to the printer Service Manual to get instructions.
 - If the engine test page prints, the print engine is operating normally. Replace the formatter.

⚠ CAUTION: Under **NO** circumstances should a formatter from a different printer be installed during the repair or troubleshooting processes. The formatter stores important data specific to the model of printer it is installed in and is not designed to be swapped or repurposed in any way. Return a used formatter to HP.

Issues that can occur from swapping a formatter include:

- Serial number, product number, product name, page count, and supported cartridges information change and might make a product unusable
- 33.02.01 Used board/Disk installed errors

If a used formatter is installed and causes this issue, the **partner** must cover the costs of the repair in the form of a product replacement. **There is no method in the field to recover a printer where a used formatter is installed.**

For more information, see the following topic (c06360930):

- HP internal link: [33.02.01 error or printer name and/or product number changes after replacing the formatter](#)
- HP external partner link: [33.02.01 error or printer name and/or product number changes after replacing the formatter](#)

To access the HP partner link, you must first log in to the HP Partner First Portal and then connect to WISE.

 **NOTE:** If the engine test page does not print, turn the printer off, reconnect the formatter power connector, remove the embedded MultiMedia Card (eMMC), and then try the engine test again. If the page prints, the problem might be the eMMC.

10. If after replacing the formatter or eMMC normal start-up noises are still not heard, replace the DC controller.
11. If the print engine appears to be correctly operating (the engine test page successfully printed) and the control panel is still blank, replace the power supply.

Engine diagnostics

Learn about internal engine diagnostics that help in troubleshooting print quality, paper path, noise, assembly, and timing issues.

Engine test

Learn about troubleshooting the printer using the engine test diagnostic.

When the engine test is performed, a test page with lines prints if the engine is functioning correctly.

 **NOTE:** Depending on printer models, either a simplex engine test page, a duplex engine test page, or both simplex and duplex engine test pages might be available.

Use a small pointed object to depress and hold the engine test button (location varies depending on the printer model). An engine test page prints. The test page can use only Tray 2 as the paper source, so make sure that paper is loaded in Tray 2.

Possible engine test pages (printer dependent)

- A series of lines parallel to the **short** end of the page.
- A series of lines parallel to the **long** end of the page.

Figure 4-101 Engine test button

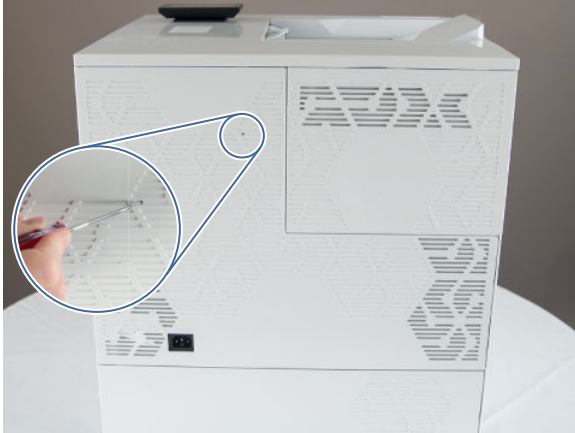

Defeating interlocks

Learn about defeating printer interlocks.

Different tests can be used to isolate different types of issues. For assembly or noise isolation, run the diagnostic test when the front, right or toner supply (model specific) door is open.

Defeating the door interlocks allows observation of the paper pick operation.

Defeat the front door interlock

1. Open the front door.
2. Insert a folded piece of paper into the slot.

 **TIP:** Fold a stiff piece of paper, for example a business card or index card, into a strip, and insert the strip into the slot for the door interlock logic switch.

It might be easier to use a small flat-blade screwdriver to defeat the door interlock.

Figure 4-102 Defeat the front door interlock



Defeat the right door interlock

1. Open the right door.

2. Insert a folded piece of paper into the slot.

 **TIP:** Fold a stiff piece of paper, for example a business card or index card, into a strip, and insert the strip into the slot for the door interlock logic switch.

It might be easier to use a small flat-blade screwdriver to defeat the door interlock.

Figure 4-103 Defeat the right door interlock

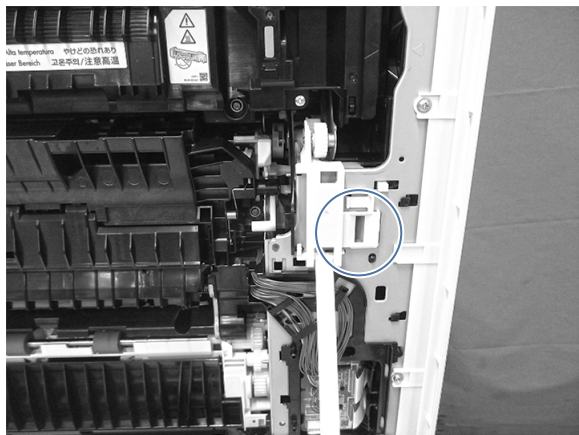

Defeat the toner supply door interlock (X57945 models)

1. Open the toner supply door.
2. Insert a folded piece of paper into the slot.

 **TIP:** Fold a stiff piece of paper, for example a business card or index card, into a strip, and insert the strip into the slot for the door interlock logic switch.

It might be easier to use a small flat-blade screwdriver to defeat the door interlock.

Figure 4-104 Defeat the toner supply door interlock (X57945 models)



Disable cartridge check

Learn about the disable cartridge check troubleshooting diagnostic.

 **CAUTION:** Do not perform a disable cartridge check on color printers that use a two-part cartridge design. Doing so might result in toner cross contamination in the supply lines.

Use this diagnostic test to print internal pages or send an external job to the printer when a toner cartridge is removed or exchanged. Supply errors are ignored while the printer is in this mode.

When the printer is in this mode, access the troubleshooting menus and print internal pages (the print quality pages will be the most useful). This test can be used to isolate problems, such as noise, and to isolate print-quality problems that are related to a toner cartridge.



NOTE: Do not remove or exchange the toner cartridge until after beginning the disable cartridge check diagnostic.

1. From the Home screen on the printer control panel, scroll to and touch the [Support Tools](#) button.
2. Open the following menus:
 - [Troubleshooting](#)
 - [Diagnostic Tests](#)
 - [Disable Cartridge Check](#)

LED diagnostics (formatter)

Learn about troubleshooting the printer using formatter LEDs.

The formatter has two network port LEDs. When the printer is connected to a properly working network through a network cable, the amber LED indicates network activity, and the green LED indicates the link status.

A blinking amber LED indicates network traffic. If the green LED is off, a link has failed. For link failures, check all of the network cable connections.

In addition, try to manually configure the network card link speed setting by using the printer control panel. To change the link speed, complete the following steps.

1. From the [Home](#) screen on the printer control panel, scroll to and touch the [Settings](#) button.
2. Open the following menus:
 - [Networking](#)
 - [Ethernet](#)
 - [Link Speed](#)
3. Touch the desired link speed setting, and then touch the [Done](#) button.

Use the solve problems checklist

Learn about using the solve problems checklist.

If the printer is not correctly functioning, complete the steps (in the order given) in the following checklist. If the printer fails a checklist step, follow the corresponding troubleshooting suggestions for that step. If a checklist step resolves the problem, skip the remaining checklist items.

1. If the control panel is blank or black, check the following before proceeding:
 - Check to make sure that the printer is not in Sleep mode (press a button on the control panel).
 - Check the power cable.

- Check that the power is turned on.
- Make sure that the line voltage is correct for the printer power configuration. (See the label that is on the back of the printer for voltage requirements.) If a power strip is in use, and its voltage is not within specifications, connect the printer directly into the electrical outlet. If it is already connected into the outlet, try a different outlet.



NOTE: The following conditions indicate that the printer has frozen while in Sleep mode. Opening a door or pressing a control-panel button causes the printer to wake up from Sleep mode.

- The control panel home button LED is illuminated
- The power-switch LED flashes once every three to five seconds

If the control panel is not responding, or if it appears black or blank, try the following:

- a. Turn the printer power off, and then on again.
- b. Verify that the system is correctly functioning.



TIP: The LED on the formatter will blink if the control panel is not detected or the cables are not properly seated.

- Try printing from a host computer. Does the printer print a test page?
 - Is the printer HP Embedded Web Server (EWS) accessible?
- c. Verify that the control panel is correctly functioning.
 - i. Turn the power off.
 - ii. Reseat the cable connections on the bottom of the control-panel assembly and the control-panel connectors at the formatter.
 - iii. Turn the printer power on, and then check for functionality of the control-panel by pressing a button on the control panel.
 - d. Try upgrading the firmware. If the firmware upgrade fails to resolve the problem, and the printer still freezes while in Sleep mode, elevate the case.
 - e. If the error persists and the EWS functions correctly, replace the control-panel assembly.
2. The control panel should indicate a **Ready**, **Paused**, or **Sleep mode on** status. If an error message displays, resolve the error.
 - Try using the Power-on checks section in this manual to solve the problem.
 3. For network connection errors, verify that the network port is active and that the cables are securely seated.
 - a. Check the network cable connections between the printer and the computer or network port. Make sure that the connections are secure.



NOTE: The network LEDs should be illuminated and flashing.



- b. Make sure that the cables are not faulty by trying different cables, if possible.
 - c. Check the network connection. Verify that the port is active.
4. Print a configuration page. If the printer is connected to a network, an HP Jetdirect page also prints.
- a. From the [Home](#) screen on the printer control panel, scroll to and touch the [Reports](#) button. Open the following menus:
 - i. [Configuration/Status Pages](#)
 - ii. [Configuration Page](#)
 - b. Touch [Configuration Page](#) to select it.

 **TIP:** Multiple report pages can be selected, and then printed together.

- c. Touch the [Print](#) button to print the pages.
- If the pages do not print, check that at least one tray contains paper.

 **TIP:** Make sure that the selected paper size and type meet HP specifications. Also open the **Trays** menu on the printer control panel and verify that the tray is configured correctly for the paper type and size.

- If the page jams in the printer, follow the instructions on the control panel to clear the jam.
 - If the page does not print correctly, the problem is with the printer hardware.
 - If the page prints correctly, the printer hardware is working. The problem is with the host computer, with the print driver, or with the program.
5. Print a supplies status page and then check that the maintenance items below are not at their end-of-life.

 **NOTE:** HP long-life consumables and maintenance kit life specifications are estimations. Actual individual life/yield during normal use varies depending on usage, environment, media, and other factors. Estimated life is not an implied guarantee or warrantable.

- a. From the [Home](#) screen on the printer control panel, scroll to and touch the [Reports](#) button. Open the following menus:
 - i. [Configuration/Status Pages](#)
 - ii. [Supplies Status Page](#)

- b. Touch [Supplies Status Page](#) to select it.



TIP: Multiple report pages can be selected, and then printed together.

- c. Touch the [Print](#) button to print the pages.

If a maintenance item needs to be replaced, order the replacement part.

6. Verify that the correct print driver for this printer is installed. Check the program to make sure that the print driver for this printer is used. The print driver is on the CD that came with the printer, or can be downloaded from this Web site: <http://www.hp.com/support/colorlj5700> or <http://www.hp.com/support/colorljX557> or <http://www.hp.com/support/colorlj5800MFP> or <http://www.hp.com/support/colorljX57945MFP>.
7. Print a short document from a different program that has worked in the past. If this solution works, the problem is with the program. If this solution does not work (the document does not print), complete these steps:
 - a. Try printing the job from another computer that has the printer software installed.
 - b. If the printer is connected to the network, connect the printer directly to a host computer with a USB cable. Redirect the printer to the correct port, or reinstall the software (make sure to select the new connection type).

Control panel troubleshooting

If the control panel is not responding normally or has display issues, use the following procedures to troubleshoot the issues.

Control panel system diagnostics

Learn about printer firmware control panel troubleshooting.

Use the diagnostics in this section to test the control panel hardware and display using the printer firmware system diagnostics.

Open the control panel system diagnostic tests

Learn about accessing the control panel system diagnostics tests from a touchscreen control panel.

Use the following procedure to open the control panel system diagnostics tests.

1. Turn the printer power off, and then on again.
2. Touch the middle of the control panel display when you see the [1/8](#) under the logo.

Figure 4-105 Open the Pre-boot menu

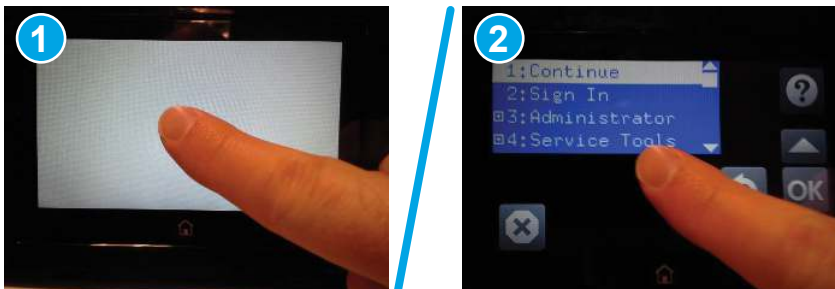

- On the **Pre-boot** menu screen, use the following buttons to navigate the tests.

Figure 4-106 Pre-boot menu

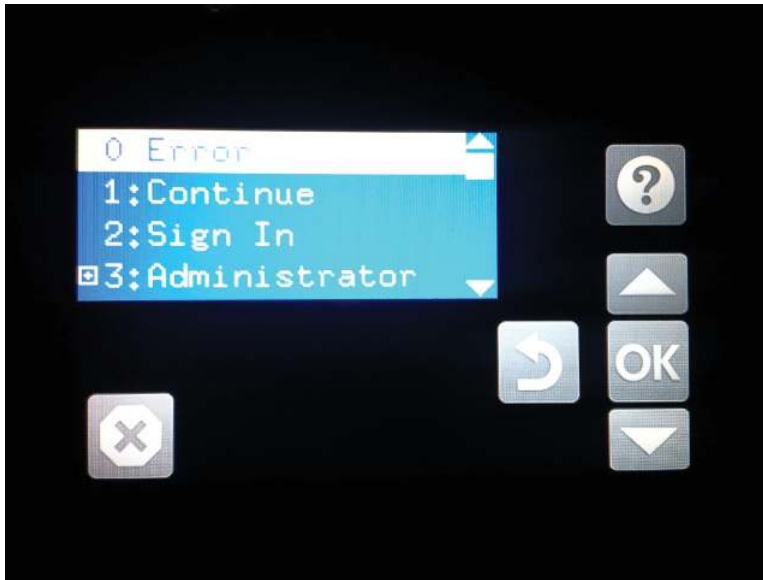
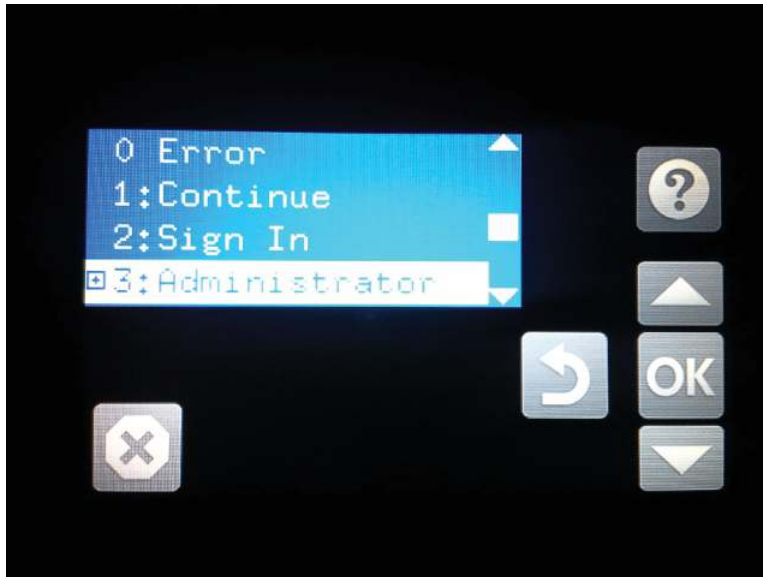

Table 4-21 Pre-boot menu button descriptions

Button	Description
	Use this button to see more information about a selected item.
	Use this button to scroll up through menu items.
	Use this button to select a highlighted menu item.
	Use this button to scroll down through menu items.
	Use this button to go back to the previous menu.
	Not used.

4. Use the **down arrow** ▼ button to scroll to **+3 Administration**, and then press the **OK** button to select it.

Figure 4-107 Access the administration menu



5. Use the **down arrow** ▼ button to scroll to **+E CP Diagnostics**, and then press the **OK** button to select it.

 **NOTE:** An administrator password might be required to continue.

Figure 4-108 Access the diagnostics menu



Screen test

Learn about the control panel system diagnostic screen test.

1. Open the control panel system diagnostic tests.

- With **1 Screen Test** highlighted, press the **OK** button to select it.

Figure 4-109 Open the screen test



The blue horizontal gradient screen appears.

Figure 4-110 Blue horizontal gradient screen

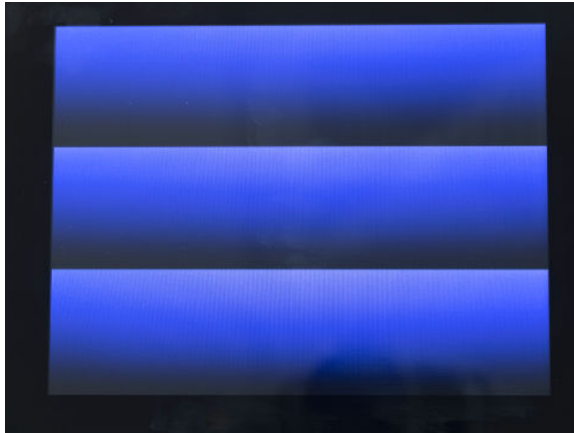

- Touch the touchscreen to scroll through the remaining touchscreen test screens.

 **NOTE:** Touch the **Home** button to exit the test.

Table 4-22 Touchscreen test screens

Screen	Description
	Green horizontal gradient

Table 4-22 Touchscreen test screens (continued)





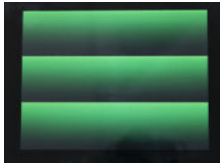

Screen	Description
 A square test screen with a horizontal gradient of red, transitioning from dark red at the top to bright red at the bottom.	Red horizontal gradient
 A square test screen with a vertical gradient of blue, transitioning from dark blue on the left to bright blue on the right.	Blue vertical gradient
 A square test screen with a vertical gradient of green, transitioning from dark green on the left to bright green on the right.	Green vertical gradient
 A square test screen with a vertical gradient of red, transitioning from dark red on the left to bright red on the right.	Red vertical gradient
 A square test screen with a blue gradient and horizontal interlaced lines, transitioning from dark blue on the left to bright blue on the right.	Blue with horizontal interlaced
 A square test screen with a green gradient and horizontal interlaced lines, transitioning from dark green on the left to bright green on the right.	Green with horizontal interlaced
 A square test screen with a red gradient and horizontal interlaced lines, transitioning from dark red on the left to bright red on the right.	Red with horizontal interlaced

Table 4-22 Touchscreen test screens (continued)

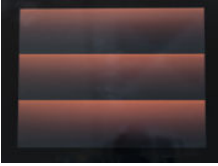

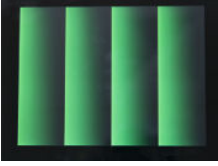
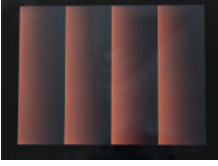



Screen	Description
	Blue with vertical interlaced
	Green with vertical interlaced
	Red with vertical interlaced
	Black with white center
	White with black center
	Checkerboard

Table 4-22 Touchscreen test screens (continued)

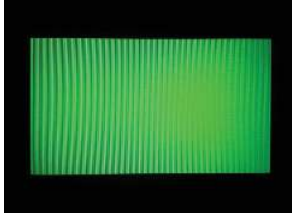
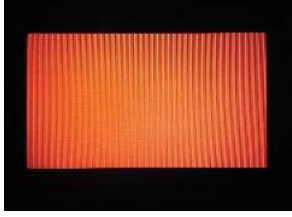
Screen	Description
	Multicolor stripes
	Blue green grid meshing

Touch test

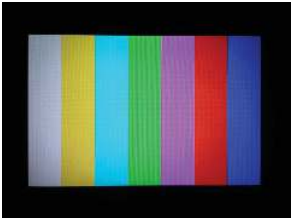
Learn about the control panel system diagnostic touch test.

1. Open the control panel system diagnostic tests.
2. Use the **down arrow ▼** button to scroll to **2 Touch Test**, and then press the **OK** button to select it.

Figure 4-111 Open the touch test

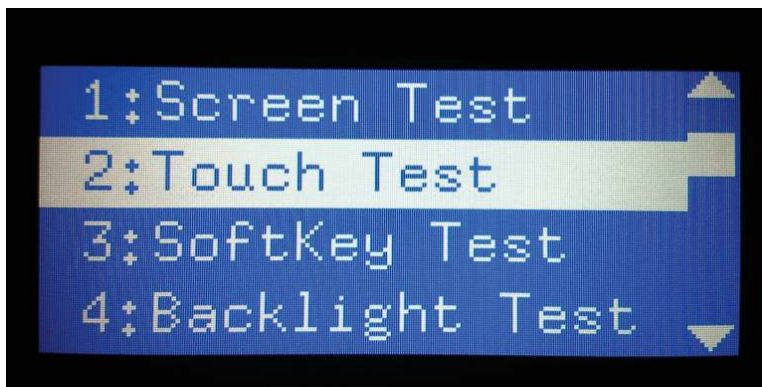

3. Use your finger to touch the white grid on the display.

Figure 4-112 Touch the white grid

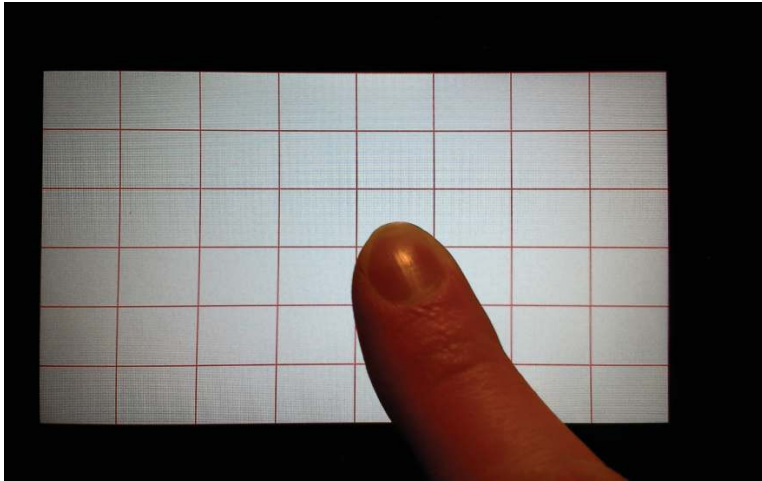

A mark appears on the grid where it was touched.

 **NOTE:** Touch the [Home](#) button to exit the test.

Figure 4-113 Verify the mark

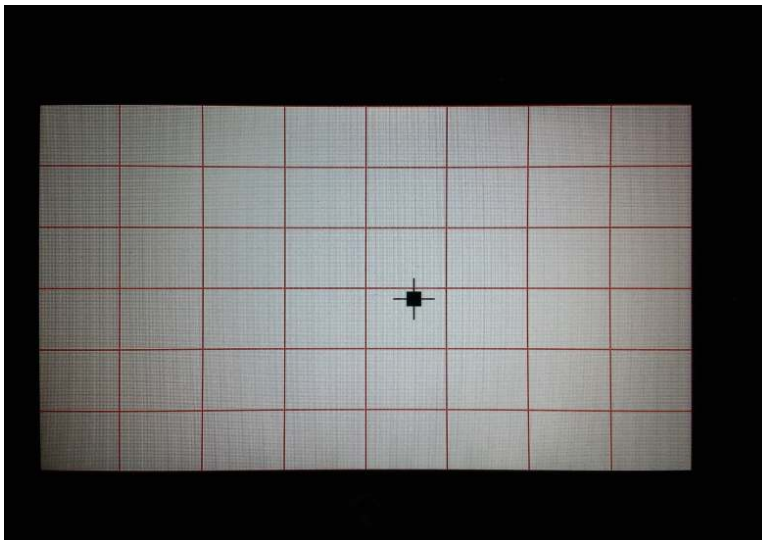

SoftKey test

Learn about the control panel system diagnostic SoftKey test.

1. Open the control panel system diagnostic tests.

- Use the [down arrow ▼](#) button to scroll to [3 SoftKey Test](#), and then press the [OK](#) button to select it.

Figure 4-114 Open the softkey test



- When prompted, touch the [Home](#) button.

Figure 4-115 Touch the [Home](#) button

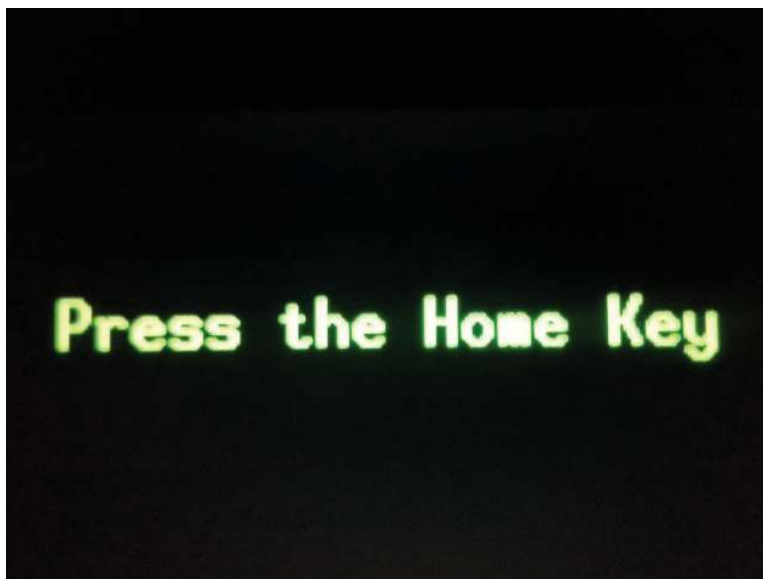

If the test is successful, the following screen appears on the display.

 **NOTE:** Touch the screen to exit the test.

Figure 4-116 Successful test



Backlight test

Learn about the control panel system diagnostic backlight test.

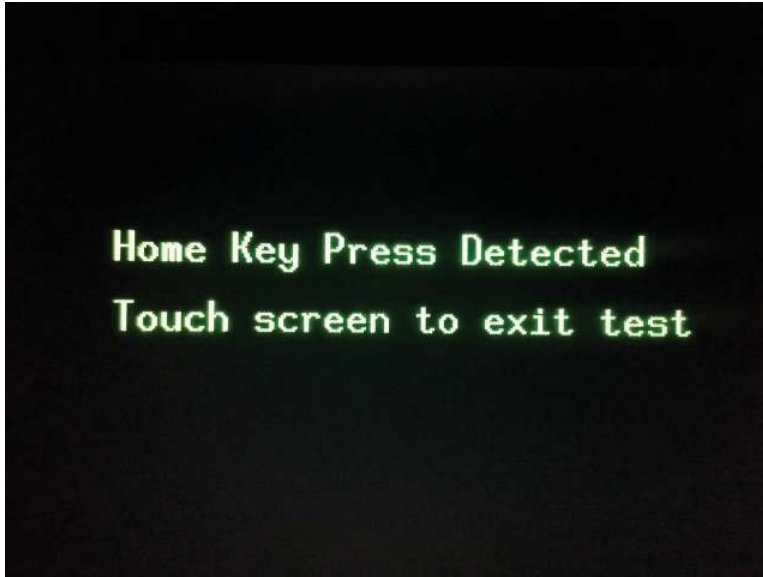
1. Open the control panel system diagnostic tests.
2. Use the [down arrow ▼](#) button to scroll to [4 Backlight Test](#), and then press the [OK](#) button to select it.

After selecting the [4 Backlight Test](#), the screen automatically dims, and then returns to full brightness.



NOTE: Touch any key to exit the test.

Figure 4-117 Open the backlight test

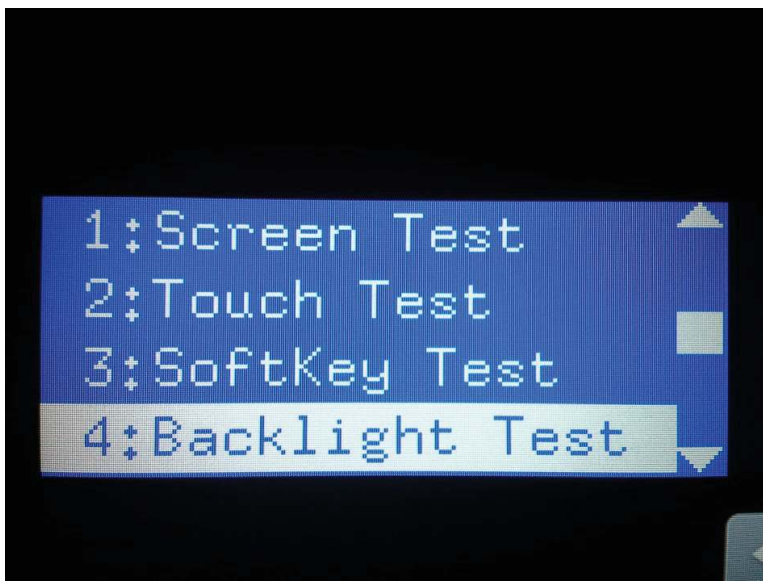

Sound test

Learn about the control panel system diagnostic sound test.

1. Open the control panel system diagnostic tests.
2. Use the **down arrow** ▼ button to scroll to **5 Sound Test**, and then press the **OK** button to select it.

After selecting the **5 Sound Test**, the printer emits a series of audible tones.

 **NOTE:** Touch any key to exit the test.

Figure 4-118 Open the sound test



Version

Learn about the control panel system diagnostic version information.

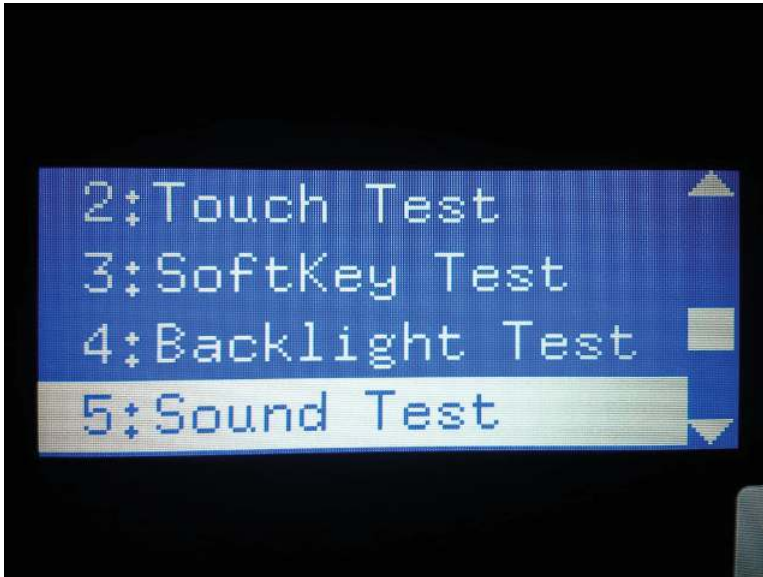
1. Open the control panel system diagnostic tests.
2. Use the **down arrow** ▼ button to scroll to **7 Version**, and then press the **OK** button to select it.

 **NOTE:** Touch any key to exit the test.

Select **7 Version** to view the following types of information:

 **NOTE:** The following types of information are for the control panel only, not the printer.

- Panel ID
- Hardware (version)
- Firmware (version)
- KB Hw (version)
- KB Firm (version)
- LCD Vendor

- Touch Controller Version

Figure 4-119 Open the version information

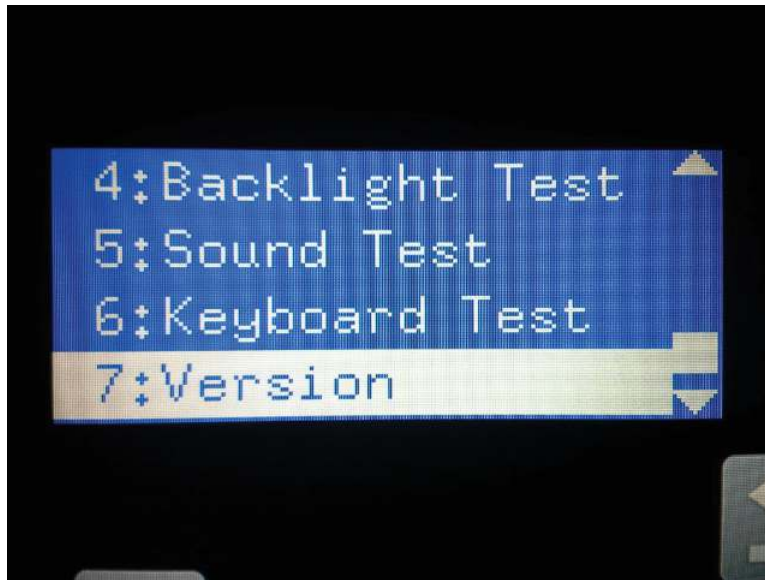

Control panel messages document (CPMD)

Learn about the printer control panel messages document (CPMD).



NOTE: A complete CPMD is not included in this service manual. Click on the links below to access a CPMD on the HP Web-based Interactive Search Engine (WISE) site.

[HP Color LaserJet Enterprise 5700, MFP 5800, HP Color LaserJet Managed X557 - Control Panel Message Document \(CPMD\)](#)

[HP Color LaserJet Enterprise MFP X57945, X58045 - Control Panel Message Document \(CPMD\)](#)

Print the supplies status page

The supplies status page indicates the cartridge status.

1. From the Home screen on the printer control panel, scroll to and touch the [Reports](#) menu icon.
2. Touch the [Configuration/Status Pages](#) menu.
3. Touch [Supplies Status Page](#), and then touch the Print icon  to print the page.

Pre-boot menu options

The [Pre-boot](#) menus are available prior to the printer initializing.



CAUTION: The [Format Disk](#) option performs a disk initialization for the entire disk. The operating system, firmware files, and third party files (among other files) will be completely lost. HP does not recommend this action unless it is specified as a solution in the CPMD.



TIP: The [Pre-boot](#) menu is also remotely accessible by using a telnet network protocol (Remote Admin) to establish an administration connection to the printer.

Open the Pre-boot menu from a touchscreen control panel

Use the following procedure to open the [Pre-boot](#) menu from a touchscreen control panel.

1. Turn the printer on.
2. Touch the middle of the control-panel display when you see the [1/8](#) under the logo.

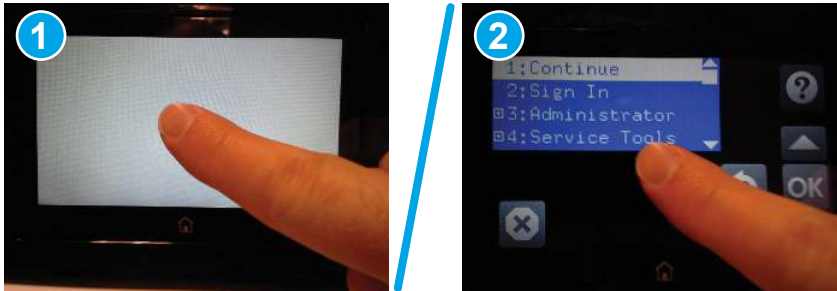

Figure 4-120 Open the [Pre-boot](#) menu





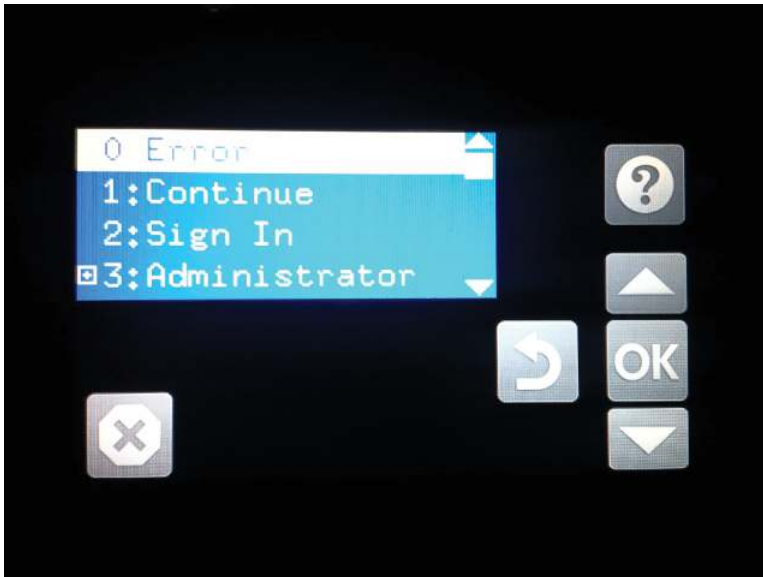

3. On the [Pre-boot](#) menu screen, use the following buttons to navigate the tests.

Figure 4-121 [Pre-boot](#) menu



Button	Description
	Use this button to see more information about a selected item.
	Use this button to scroll up through menu items.

Button	Description
	Use this button to select a highlighted menu item.
	Use this button to scroll down through menu items.
	Use this button to go back to the previous menu.
	Not used.

4. Use the arrow buttons on the touchscreen to navigate the [Pre-boot](#) menu.
5. Touch the [OK](#) button to select a menu item.

Cold reset using the Pre-boot menu from a touchscreen control panel

Use the following procedure to perform a cold reset using the [Pre-boot](#) menu from a touchscreen control panel.

⚠ CAUTION: This procedure resets all printer configurations and settings to factory defaults (customer configurations and settings are lost).

1. Touch the middle of the control-panel display when you see the [1/8](#) under the logo.

Figure 4-122 Open the [Pre-boot](#) menu

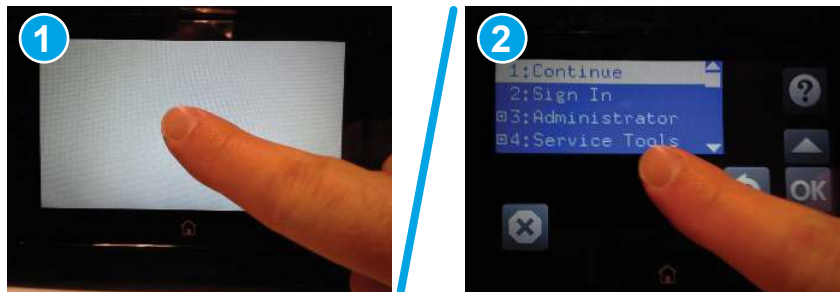

2. Use the down arrow ▼ button to highlight the [+3:Administrator](#) item, and then touch the [OK](#) button.
3. Use the down arrow ▼ button to highlight the [+8:Startup Options](#) item, and then touch the [OK](#) button.
4. Use the down arrow ▼ button to highlight the [2 Cold Reset](#) item, and then touch the [OK](#) button to select it.

5. Touch the Home button to return to the main **Pre-boot** menu and highlight the **1:Continue** item, and then touch the **OK** button.

 **NOTE:** The printer will initialize.

Remote Admin

Learn about the printer Remote Admin function.

The Remote Admin feature allows remote access the printer **Pre-boot** menu (BIOS environment). The printer functions as a telnet server which uses the telnet networking protocol to transmit text data. Any computer (with telnet installed and enabled) can function as the telnet client to remotely display and interact with the **Pre-boot** menu.

 **IMPORTANT:** While the Remote Admin function allows remote access the **Pre-boot** menu, for security reasons the Remote Admin connection must be initiated by a person that is physically present at the printer.

Required software and network connection

Before using the Remote Admin feature, make sure that the telnet network protocol is installed and enabled on the remote telnet client computer.

 **NOTE:** This section describes enabling and configuring the telnet feature for computers using a Windows® operating system.

HP recommends that the telnet client computer be a Windows-based system; however, there are other operating systems that support the telnet network protocol. For information about enabling and configuring the telnet network protocol for other operating systems, see the owner's manual for that operating system.

Enable the Windows telnet client

All computers using the Windows operating system have the telnet client installed, however, the telnet client function might not be enabled by default.

 **NOTE:** The figures and menus in this section are for the Windows 10® operating system. Screens and menu selections might vary slightly for other operating systems.

1. Use the **Start** menu to open the **Windows Settings** dialog box, and then search for **Turn Windows features on or off**. Click the **Turn Windows features on or off** item.

Figure 4-123 Open Windows Settings

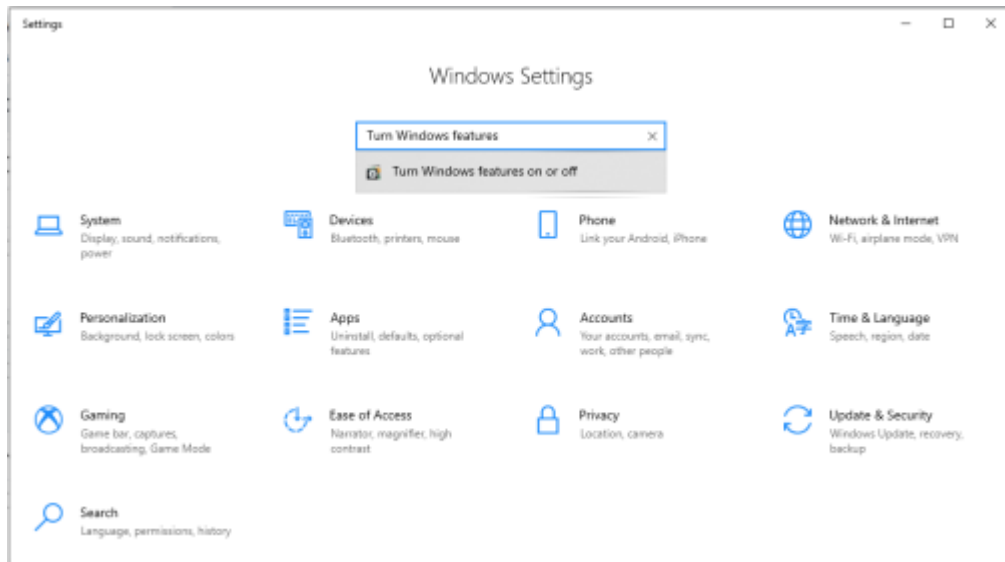

2. In the **Windows Features** box, scroll down to **Telnet Client**. If the check box is not checked, click the box to select it, and then click the **OK** button.

 **TIP:** If the check box is already checked then the telnet client function is already enabled. Click the **Cancel** button.

Figure 4-124 Enable the telnet client feature



Network connection

The remote telnet client computer must have direct network access to the printer for the Remote Admin function to operate. This means that the telnet client computer must be on the same network as the printer.

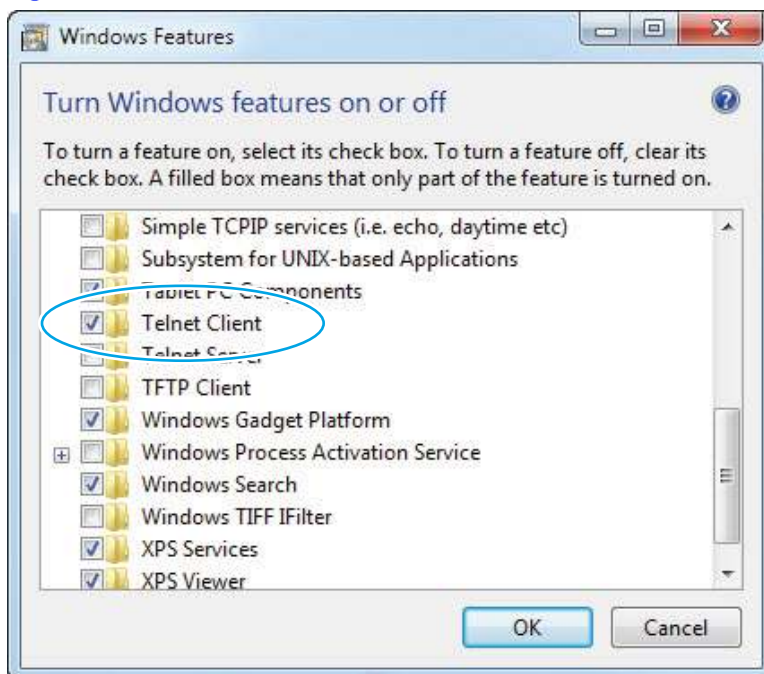
The Remote Admin function cannot be accessed through a network firewall or other remote access network security programs.

If a private network is not accessible, ask the network administrator to set up a virtual private network (VPN) connection to the network.

Connect a remote connection

Use the following procedures to connect a remote connection.

Start the telnet server function at the printer

For security reasons the Remote Admin feature must be initiated by a person that is physically present at the printer. The following steps must be performed by a person that is physically present at the printer.

 **NOTE:** This person might need to sign in with an administrator or service password depending on how the printer is configured.

1. Turn the printer on.
2. The HP logo displays on the printer control panel. When a 1/8 with an underscore displays, touch the middle of the screen to open the [Pre-boot](#) menu.
3. Use the arrow buttons on the touchscreen to scroll down and highlight the [+3:Administrator](#) item, and then touch the [OK](#) button to select it.

Figure 4-125 Select the [+3:Administrator](#) item

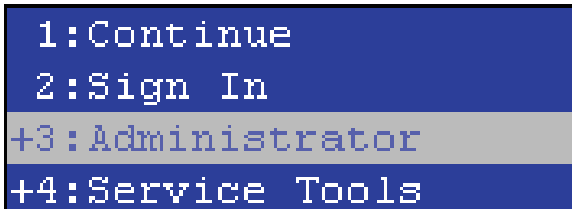

4. Use the arrow buttons on the touchscreen to scroll down and highlight the [+A:Remote Admin](#) item, and then touch the [OK](#) button to select it.

Figure 4-126 Select the [+A:Remote Admin](#) item

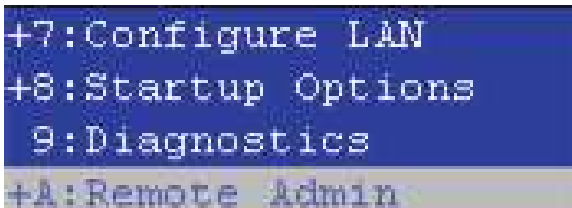

5. Use the arrow buttons on the touchscreen to scroll down and highlight the **1:Start Telnet** item, and then touch the **OK** button to select it.

Figure 4-127 Select the 1:Start Telnet item

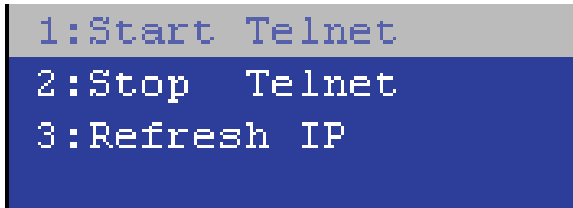

6. Do one of the following
 - If a connecting message displays briefly, go to vii..

Figure 4-128 Telnet connecting message

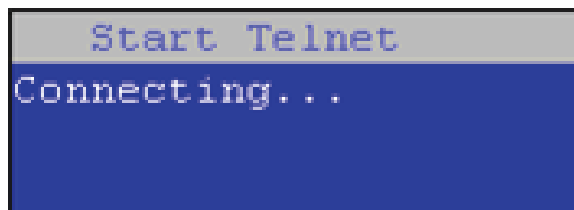

- If an error message displays, use the steps below to identify the problem.

Figure 4-129 Telnet error message

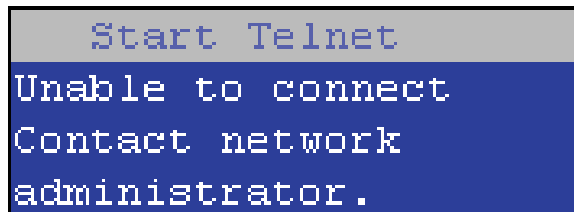

- a. The printer network cable is not correctly connected.
 - b. The BIOS LAN settings are incorrect.
 - The printer should be configured to use a static IP address, but is configured to use DHCP instead.
 - The printer is configured to use a static IP address, but the IP address is incorrect.
 - c. The printer is correctly configured to use DHCP, but the DHCP server is not turned on or is malfunctioning.
7. When the printer telnet server function is initialized, the following screen appears. Use the information on this screen to connect the remote telnet client computer to the printer.



NOTE: The printer is now ready to receive remote telnet client commands.

- **IP:** The static or dynamically allocated IP address for the printer.
- **Port:** The standard telnet port (23).
- **Pin:** A randomly generated 4-digit personal identification number (PIN).

Figure 4-130 Telnet server function initialized

```
Start Telnet
IP: 16.88.109.66
Port: 23
Pin : 4031
```

Start the telnet client function at the remote computer

The following steps establish a Remote Admin connection from a remote computer to the printer.

1. From the **Start** menu open the **Command Prompt** desktop application.

 **TIP:** Type `cmd` in the application search dialogue box to find the application.

2. From any displayed directory, type `telnet` at the prompt, and then press the **Enter** key.

Figure 4-131 Start a telnet session

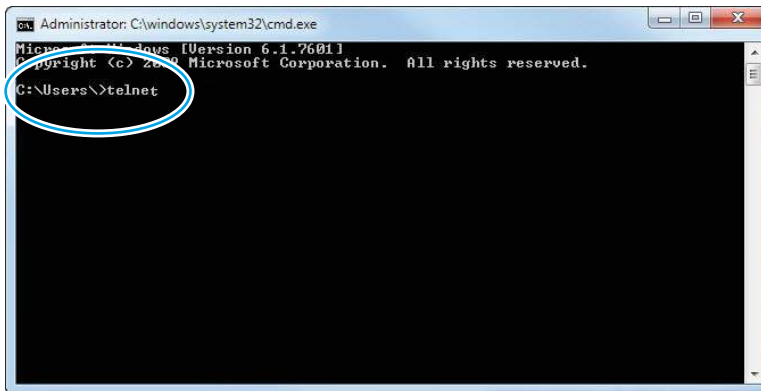

3. Type `<IP ADDRESS>` at the telnet prompt, and then press the **Enter** key.

 **NOTE:** For `<IP ADDRESS>`, substitute the IP address that was displayed in step 7 of the "Start the telnet server function at the printer" topic.

 **TIP:** If the telnet connection fails to establish a connection, the printer is probably behind a firewall or on a different network than the remote telnet client computer.

Figure 4-132 Establish a telnet connection



4. Type the PIN that was displayed in step 7 of then "Start the telnet server function at the printer" topic at the prompt, and then press the **Enter** key.

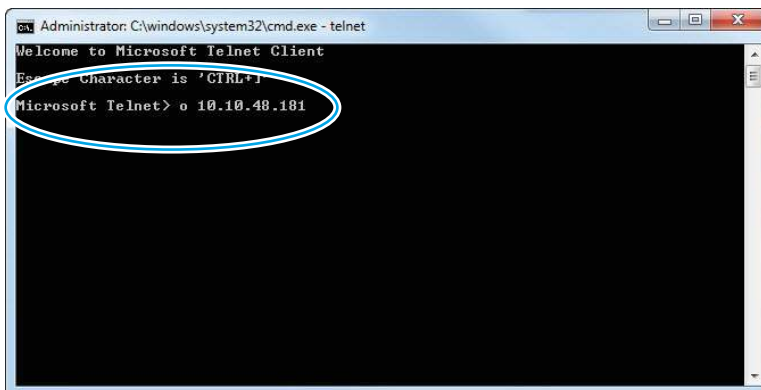

 **IMPORTANT:** Make sure to type the PIN correctly. After five incorrect PIN entries, the printer terminates the Remote Admin connection. The Remote Admin feature must be re-initiated at the printer. See the "Start the telnet server function at the printer" topic.

Figure 4-133 Enter the PIN



5. The following screen displays when the correct PIN is entered, and the Remote Admin connection is successful. For information about the Pre-boot menu and options, see "Pre-boot menu options" in the printer *Service Manual*.

 **NOTE:** Because a Remote Admin connection is an unsecured telnet network protocol connection, the following Pre-boot menu items are disabled for the remote telnet client computer.

- The **+3:Administrator** menu **4:Change Password** item.
- The **+3:Administrator** menu **5:Clear Password** item.
- The **+3:Administrator** menu **6:Disk Manage** item.

Figure 4-134 Remote Admin window



Disconnect a remote connection

The Remote Admin connection can be terminated from the printer control panel or the remote telnet client computer.

 **NOTE:** The following procedure describes terminating a Remote Admin connection from the remote telnet client computer.

1. From the Pre-boot main menu, use the arrow buttons on the keyboard to scroll down to the **+3:Administrator** item, and then press the **Enter** key.

Figure 4-135 Access the administrator menu

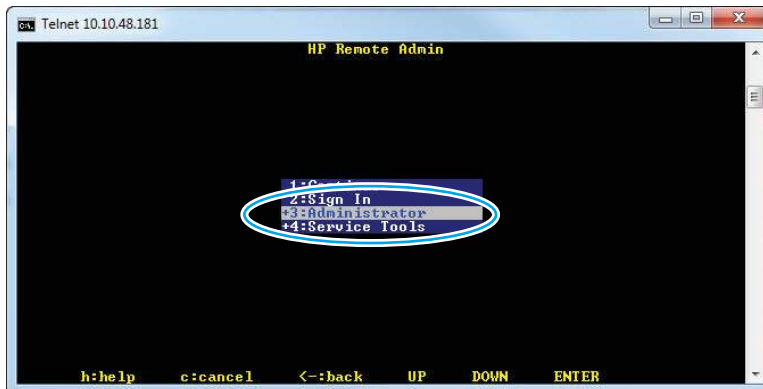

2. Use the arrow buttons on the keyboard to scroll down to the **+A:Remote Admin** item, and then press the **Enter** key.

Figure 4-136 Access the remote admin menu

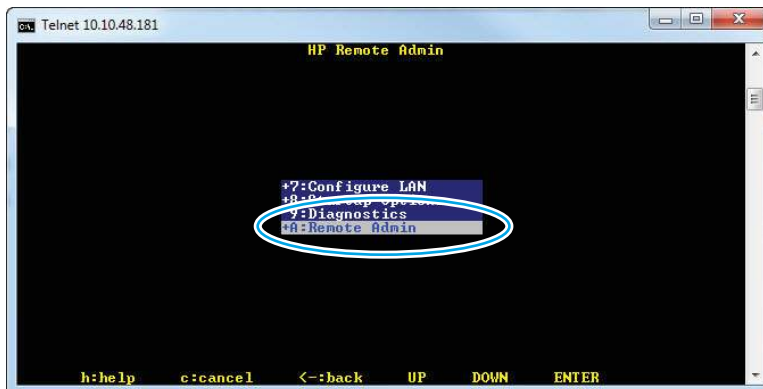

3. Use the arrow buttons on the keyboard to scroll down to the **2:Stop Telnet** item, and then press the **Enter** key. The Remote Admin connection between the printer and the remote telnet client computer terminates.

IMPORTANT: The printer remains in the Pre-boot menu. Have the person that is physically present at the printer do the following:

- Touch the **Home** button to return to the main Pre-boot menu and highlight the **1:Continue** item, and then touch the **OK** button. The printer will continue to initialize.

Figure 4-137 Terminate the telnet connection

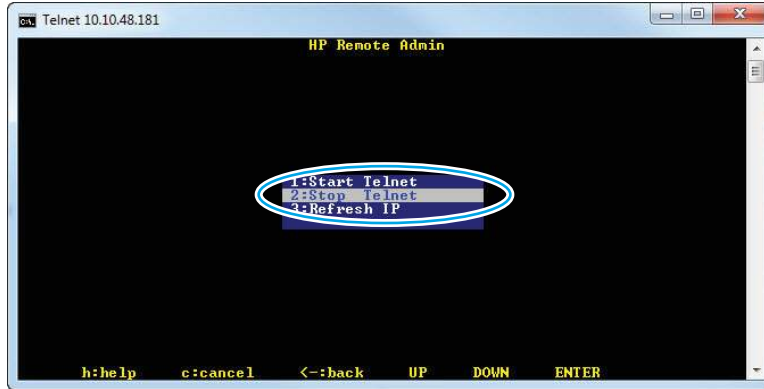

Print the event log

Learn how to print the event log.

Print the 50 most recent events in the Event Log. For each event, the printed log shows the error number, page count, error code, and description or personality.

1. From the Home screen on the printer control panel, scroll to and touch the [Troubleshooting](#) menu icon.
2. Touch [Event Log](#).
3. Touch the Print icon  to print the page.

How to search for printer documentation

The CPMD, error codes, and other support documentation for each printer is available on the HP portals.

For HP internal access to WISE, go to [WISE](#).

For HP channel partners access WISE, see [Accessing WISE for HP channel partners \(HP Partner Portal\) on page 111](#) or [Accessing WISE for HP channel partners \(CSDP\) on page 110](#).

WISE is available to call agents, service technicians, and HP internal users. The level of detail available depends on your access credentials. To learn how to find support content in WISE, [watch the video here](#).

How to search WISE for printer information and documentation

These instructions are for HP internal use by call agents, service technicians, and other internal users.

To learn how to find support content in WISE, watch the video here: [Finding Error Code and Control Panel Message Document in WISE](#).



TIP: The Product Detail Page (PDP) is available from the WISE home page. Enter, and then select a product name or number in the **Go to a Product Detail Page** area (callout 1), or select the **...or select your product from a list** item (callout 2) on the WISE home page.

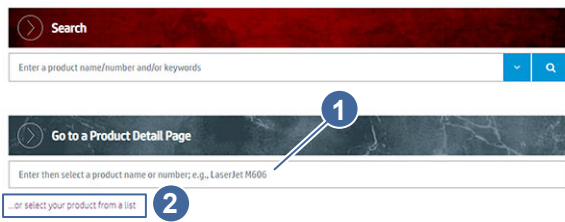

Many types of printer documentation and information are available on WISE. This section details methods for finding error code descriptions and solutions.

TIP: To view a list of control panel message documents (CPMD) per printer, search for the following topic in **WISE**: HP LaserJet, OfficeJet, PageWide, ScanJet Enterprise - Control panel message document (CPMD) list or click the link below.

- [HP LaserJet, HP OfficeJet, HP PageWide, HP ScanJet - Control panel messages document \(CPMD\), Service manual, and Service cost data list](#)

Use one of the following methods to search for CPMD error code information.

- [Method 1: Use the WISE home page Error Code Lookup tool on page 296](#)
- [Method 2: Search for error codes using the WISE search function on page 298](#)
- [Method 3: Search for error codes using the Product Detail Page on page 299](#)

Method 1: Use the WISE home page Error Code Lookup tool

Use the WISE Error Code Lookup tool to find error code troubleshooting procedures using the following steps.

1. On the WISE home page, click the **Error Code Lookup tool** icon.

Figure 4-138 WISE Error Code Lookup tool icon

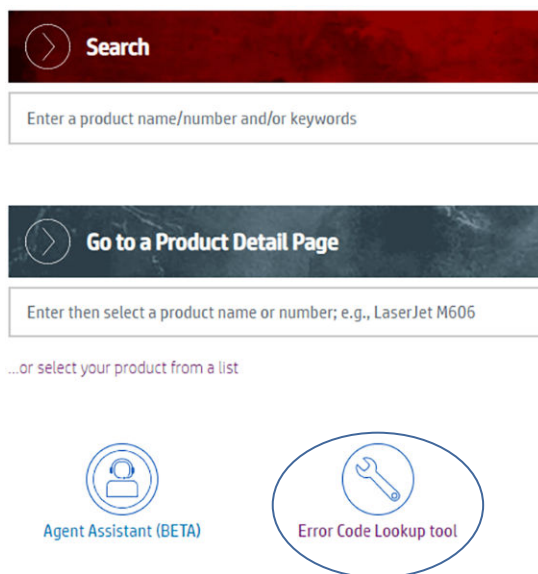

2. Enter a printer model number (for example, M606) in the **Error Code Lookup** dialog box.

Figure 4-139 WISE Error Code Lookup tool dialog box

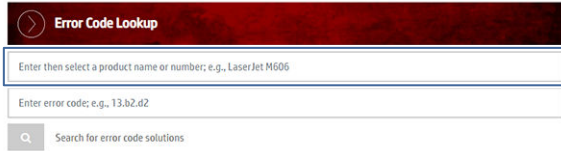

3. A drop-down list appears. Click on the full printer series name (for example, HP LaserJet Enterprise M606 series) in the list.



NOTE: Selecting the **series** item from the drop-down list is recommended for the most accurate search return.

Figure 4-140 WISE Error Code Lookup tool drop-down list

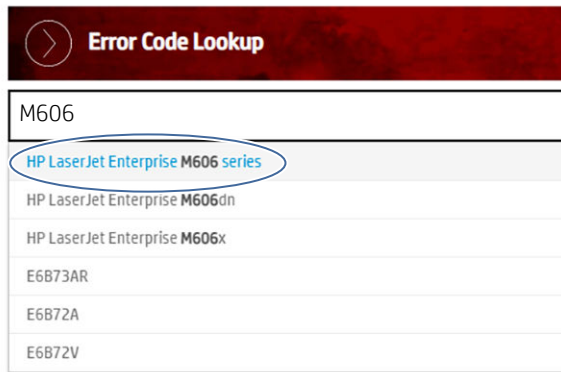

4. Type the error code (for example, 13.b2.d2) in the **Error Code Lookup** keyword field, and then select the search icon.

Figure 4-141 WISE Error Code Lookup tool search

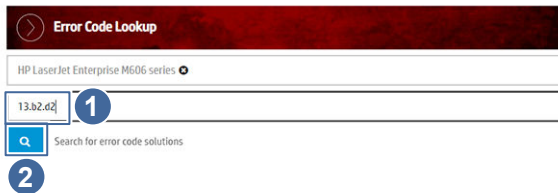

5. The error code troubleshooting content displays in the **All Search Results** area.

Figure 4-142 WISE Search results

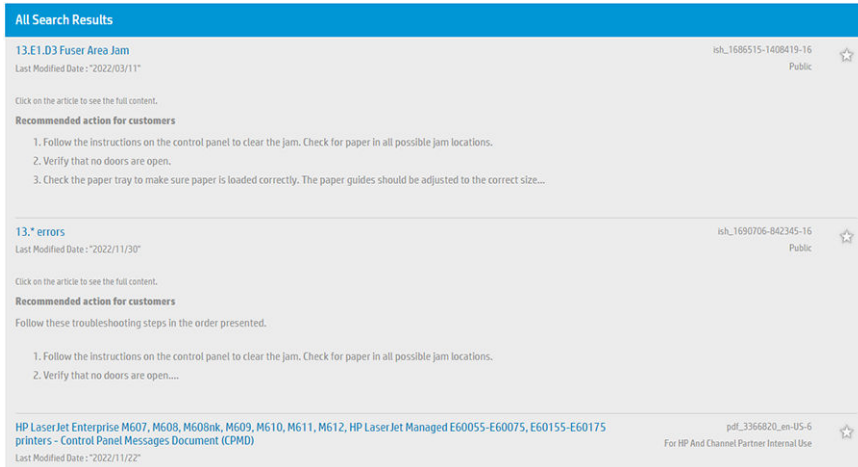

Method 2: Search for error codes using the WISE search function

Use the WISE search function to find error code troubleshooting procedures using the following steps.

1. On the WISE home page, enter a printer model number (for example, M606) in the **Search** dialog box.

Figure 4-143 WISE Search dialog box

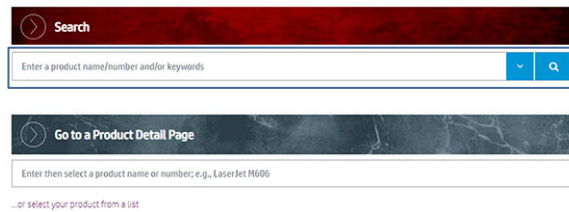

2. A drop-down list appears. Click on the full printer series name (for example, HP LaserJet Enterprise M606 series) in the list.



NOTE: Selecting the **series** item from the drop-down list is recommended for the most accurate search return.

Figure 4-144 WISE Search drop-down list

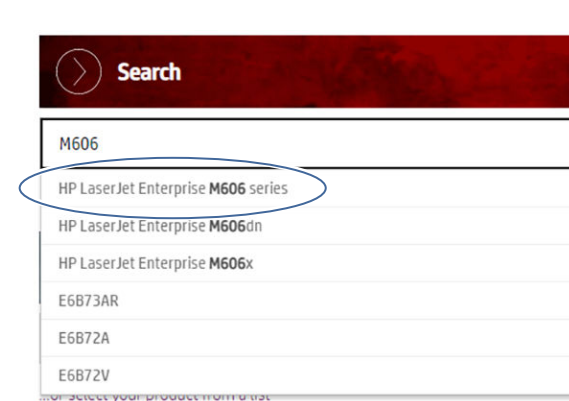

3. Type the error code (for example, 13.E1.D3) in the **Search** keyword field, and then select the search icon.

Figure 4-145 WISE Search



4. The error code troubleshooting content displays in the **All Search Results** area.

Figure 4-146 WISE Search results

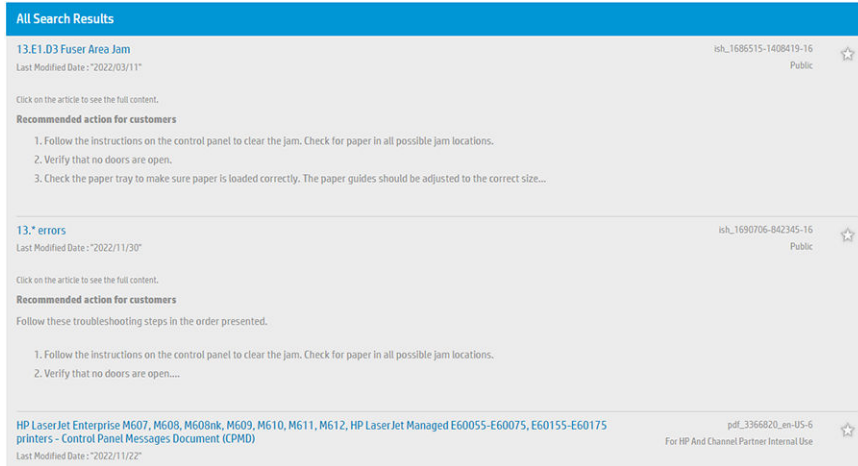

Method 3: Search for error codes using the Product Detail Page

Use the WISE Product Detail Page (PDP) to find error code troubleshooting procedures using the following steps.

1. On the WISE home page, enter a printer model number (for example, M606) in the **Go to a Product Detail page** dialog box.

 **TIP:** To find a PDP from a list of products by product type, select the **...or select your product from a list** item just below the dialog box.

Figure 4-147 WISE PDP dialog box



2. A drop-down list appears. Click on the full printer series name (for example, HP LaserJet Enterprise M606 series) in the list.

 **NOTE:** Selecting the **series** item from the drop-down list is recommended for the most accurate search return.

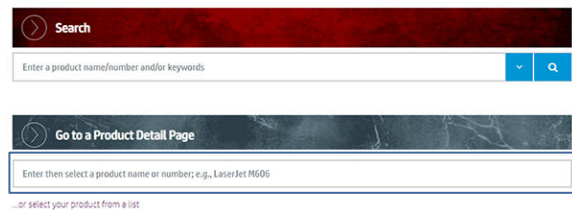
Figure 4-148 WISE PDP drop-down list



3. Type the error code (for example, 13.E1.D3) in the **Error Code Lookup** field, and then select the search icon.

Figure 4-149 WISE PDP search

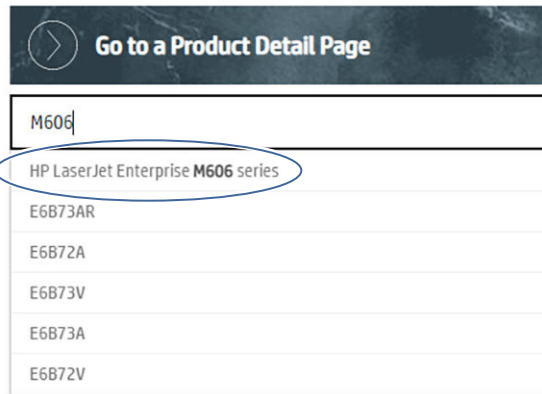
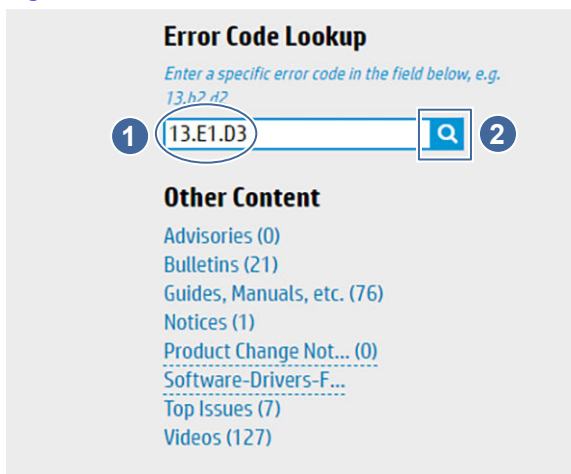

4. The error code troubleshooting content displays in the **All Search Results** area.

Figure 4-150 WISE PDP search results



Accessing WISE for HP channel partners (CSDP)

Learn how to access WISE by accessing the HP Channel Services Delivery Platform (CSDP) if you are an HP Channel Partner.

IMPORTANT: A Partner Admin must requested access, via the CSDP portal, to create a new user before you can sign into the CSDP portal.

1. Sign-in to the CSDP portal (click csdp.hp.com to access the sign-in page).

Figure 4-151 CSDP sign-in page

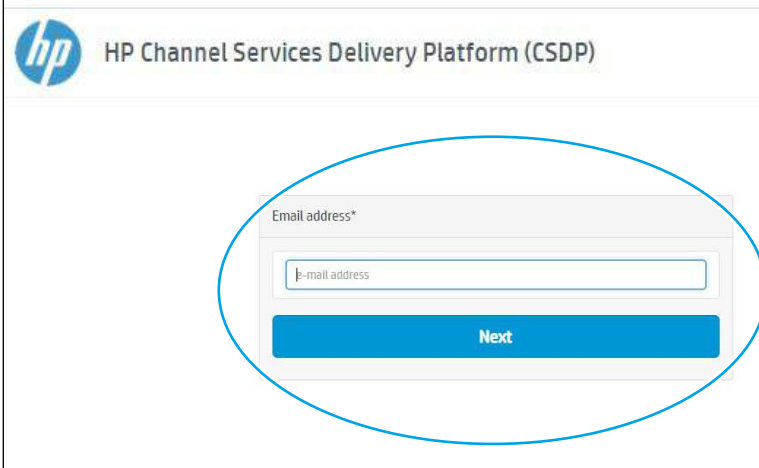

2. On the CSDP home page, click the **Knowledge and Training** item.

TIP: Use the **Knowledge and Training** item at the top of the CSDP home page (callout 1), or the **Knowledge and Training** action icon (callout 2).

Figure 4-152 CSDP portal home page

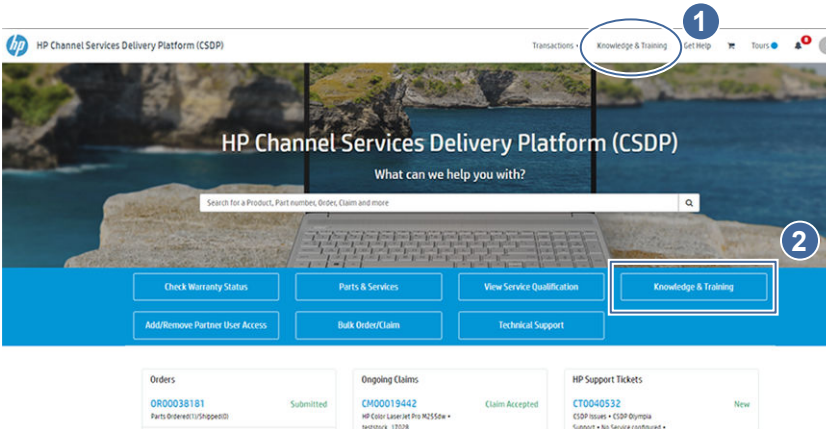

3. Select **HP Technical Documentation** on the **Knowledge and Training** page to open the WISE portal home page.

Figure 4-153 CSDP portal HP Knowledge and Training page

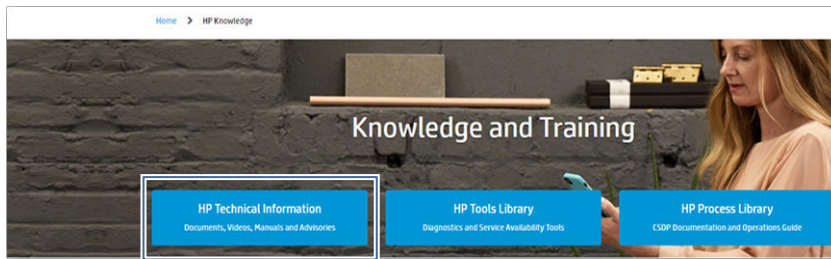

4. Use the WISE portal to search for printer information.

Figure 4-154 WISE portal home page

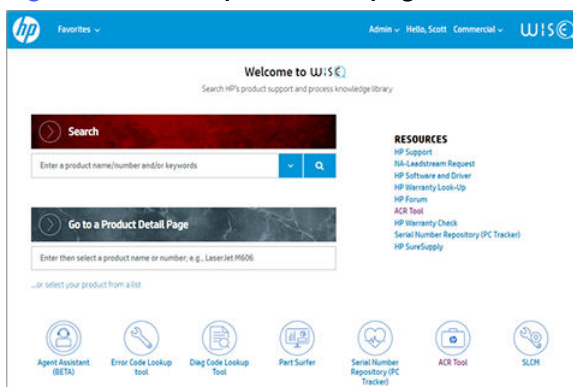

Accessing WISE for HP channel partners (HP Partner Portal)

Learn how to access WISE by accessing the HP Partner Portal if you are an HP Channel Partner.

NOTE: If this is your first visit to the HP Partner Portal, you will be asked to create an account. Follow the setup directions using your HP Partner credentials.

[View a video of how to access WISE for HP channel partners](#)

1. Sign-in to the HP Partner Portal (click <https://partner.hp.com> to access the sign-in page).

Figure 4-155 HP Partner Portal sign-in page

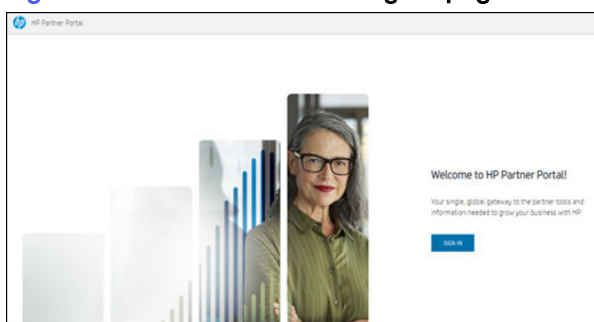

2. On the HP Partner Portal home page, click the **Services & Support** item.

Figure 4-156 HP Partner Portal home page

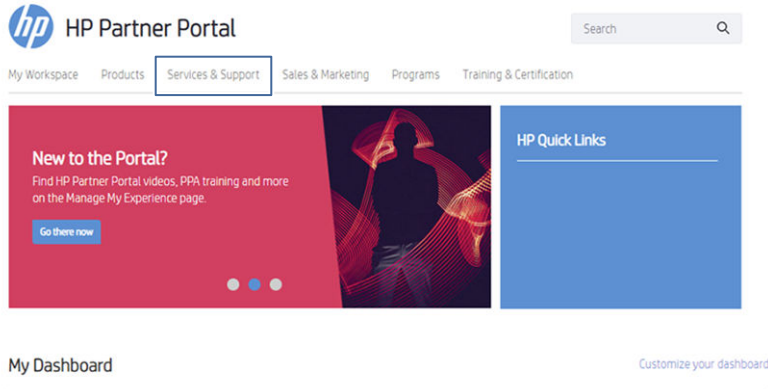

3. Select the **Technical Support (WISE)** item.

Figure 4-157 HP Partner Portal Service & Support page

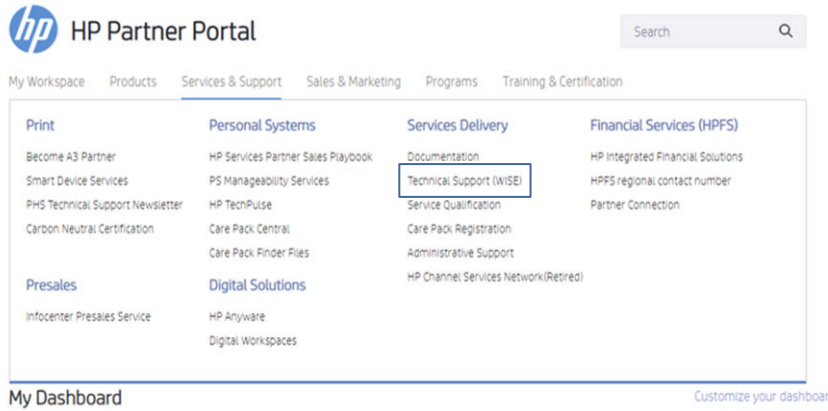

4. Select the **Technical Documentation** item.

Figure 4-158 HP Partner Portal Technical Support (WISE)page

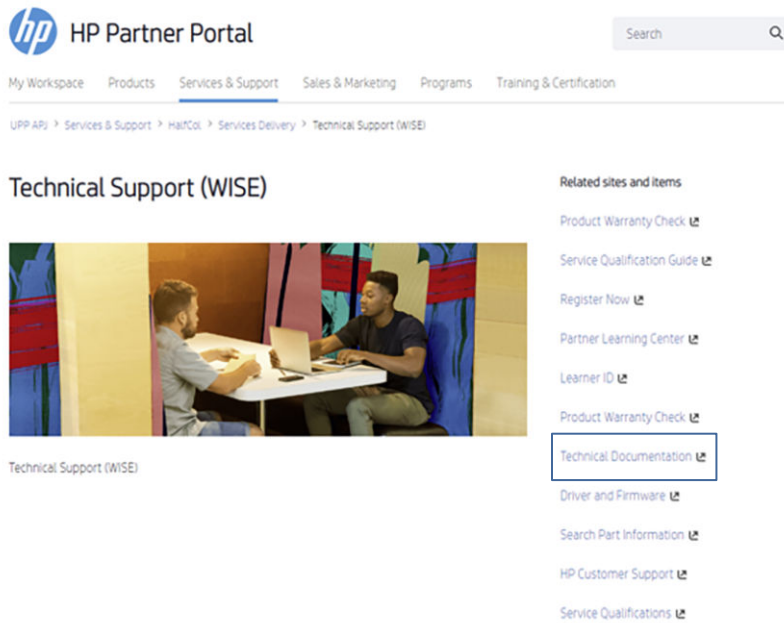

5. Use the WISE portal to search for printer information.

Figure 4-159 WISE portal home page

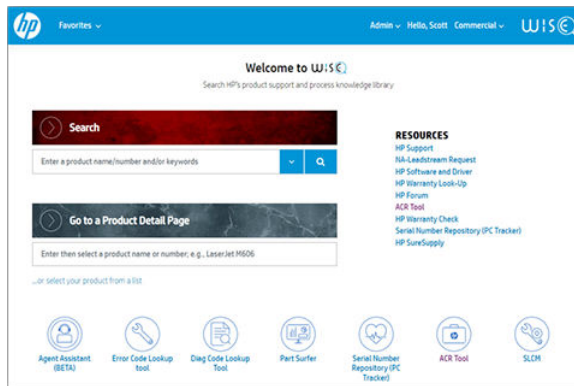

Error-code and control-panel-message troubleshooting overview

This section provides information on error codes and searching for information.

Error codes (types and structure)

Error codes and control-panel messages display on the printer control panel to indicate the current printer status or situations that might require action. Error codes are numerical, or alphanumeric, and have a set structure with six characters (example: 13.WX.YZ).

- The first two characters are numeric and represent the system component that is causing the error. For example, in error code 10 . 22 . 15, **10 = Supplies** for HP LaserJets.
- The remaining four characters (W, X, Y, and Z values) further define the error.

HP LaserJet and HP PageWide Enterprise error codes are documented in the control panel message document (CPMD) for each printer.

The CPMD is a comprehensive list of error codes, diagnostic and troubleshooting steps to clear or resolve the error, and other helpful information such as service mode pins and part numbers.

The CPMD is continually updated and republished with the latest information for the following error codes.

Table 4-23 ERROR CODES: The first two characters

Error code	System Component	System Error Description
10.WX.YZ	Supplies (LaserJet)	Supply error or supply memory error.
11.WX.YZ	Real-time clock	Internal error with the clock on the formatter.
13.WX.YZ	Jam (LaserJet)	Paper jam or open door jam error.
15.WX.YZ	Jam (PageWide)	Paper jam or open door jam error.
17.WX.YZ	Supplies (PageWide)	Supply error or supply memory error.
20.WX.YZ	Printer memory	Insufficient memory or buffering error.
21.WX.YZ	Page	Page complexity causing a decompression error when trying to process job.
30.WX.YZ	Scanner	Flatbed scanner error occurring inside the unit.
31.WX.YZ	Document feeder	Document feeder, scanner, or jam error.
32.WX.YZ	Backup, restore, or reset	Backup, restore, or reset notification or error.
33.WX.YZ	Security	Backup, Disk, EFI BIOS, Firmware integrity (SureStart), or Trusted Platform Module (TPM) notification or error.
40.WX.YZ	Input/Output (I/O)	Partition manager, secure erase, or USB accessory error.
41.WX.YZ	Fuser, Laser scanner, or Paper path	Miscellaneous error including general and misprint or mismatch errors typically involving (but not limited to) the fuser, the laser scanner, or the paper path.
42.WX.YZ	Firmware	Firmware failure involving the Event Log, Shell, System Manager, or other component.
44.WX.YZ	Firmware	Firmware failure involving a digital sending component.
45.WX.YZ	OXPd/Web Kit (PageWide)	Informational notifications involving the OXPd Web Kit (communications log).
46.WX.YZ	Engine (LaserJet)	Engine communication error.
47.WX.YZ	Firmware	Job parser or printer calibration error.
48.WX.YZ	Firmware	PJA job accounting, job management, or job pipeline error.
49.WX.YZ	Firmware	Firmware communication error.
50.WX.YZ	Fuser (LaserJet)	Fuser error.
51.WX.YZ	Laser scanner (LaserJet)	Laser scanner beam error.
52.WX.YZ	Laser scanner (LaserJet)	Laser scanner startup error.

Table 4-23 ERROR CODES: The first two characters (continued)

Error code	System Component	System Error Description
54.WX.YZ	Sensor	Sensor error (not jam related).
55.WX.YZ	DC controller (LaserJet)	DC controller communication error.
56.WX.YZ	Paper handling (LaserJet)	Paper input/output or accessory error.
57.WX.YZ	Fan	Fan error.
58.WX.YZ	Sensor	Engine sensor failure.
59.WX.YZ	Motor (LaserJet)	Motor error.
60.WX.YZ	Tray motor error (LaserJet)	Tray lifting or pick up error.
61.WX.YZ	Engine (PageWide)	Print engine error with the 8-bit data package.
62.WX.YZ	System (LaserJet)	LaserJet internal system error.
	Print bar (PageWide)	PageWide print system error.
63.WX.YZ	Engine (LaserJet)	General engine error (electrical, communication, etc.).
65.WX.YZ	Connector	Output accessory connection error.
66.WX.YZ	Output accessory	Output accessory error.
67.WX.YZ	Input accessory	Input accessory connection error
69.WX.YZ	Duplexer	Duplexer error.
70.WX.YZ	DC controller (LaserJet)	DC controller firmware error.
76.WX.YZ	DC controller (LaserJet)	Power supply fluctuations causes formatter and DC controller communication issue and results them not to be in synchronization.
80.WX.YZ	Managed device	Embedded Jetdirect error.
81.WX.YZ	Near Field Communication (NFC)	Wireless, Bluetooth or internal EIO error.
82.WX.YZ	Memory (hard disk, EMMC, etc.)	Disk hardware error.
90.WX.YZ	Internal diagnostics	Internal test of systems (i.e. disk, CPB, display) or interconnection error.
98.WX.YZ	Hard disk	Hard disk partition error.
99.WX.YZ	Firmware installer	Remote Firmware Upgrade (RFU), firmware install (engine or accessory), or disk error.

Solve paper handling problems

Review the following information to solve paper handling problems.

Clear paper jams (SFP models)

Use the procedures in this section to clear jammed paper from the printer paper path.

Paper jam locations

Jams can occur in these locations.

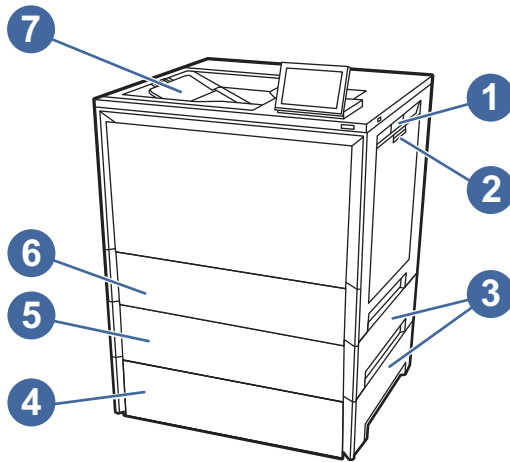

Item	Description
1	Right door and fuser area
2	Tray 1 (multipurpose tray)
3	Tray jam access doors
4	Optional Tray 4
5	Optional Tray 3
6	Tray 2
7	Output bin

Auto-navigation for clearing paper jams

Learn about printer jam clearing auto-navigation.

The auto-navigation feature assists in clearing jams by providing step-by-step instructions on the control panel.

When you complete a step, the printer displays instructions for the next step until you have completed all steps in the procedure.

Experiencing frequent or recurring paper jams?

To reduce the number of paper jams, try these solutions.

 [View a video that demonstrates how to load paper in a way that reduces the number of paper jams](#)

1. Use only paper that meets HP specifications for this printer.
2. Use paper that is not wrinkled, folded, or damaged. If necessary, use paper from a different package.
3. Use paper that has not previously been printed or copied on.

4. Make sure the tray is not overfilled. If it is, remove the entire stack of paper from the tray, straighten the stack, and then return some of the paper to the tray.
5. Make sure the paper guides in the tray are adjusted correctly for the size of paper. Adjust the guides so they are touching the paper stack without bending it.
6. Make sure that the tray is fully inserted in the printer.
7. If you are printing on heavy, embossed, or perforated paper, use the manual feed feature and feed sheets one at a time.
8. Open the **Trays** menu on the printer control panel. Verify that the tray is configured correctly for the paper type and size.
9. Make sure the printing environment is within recommended specifications.

13.B2.D1 jam error in Tray 1 (multipurpose tray)

Use the following procedure to clear paper jams in Tray 1 (multipurpose tray). When a jam occurs, the control panel displays an animation that assists in clearing the jam.

Recommended action for customers

When a jam occurs, the control panel displays a message and an animation that assists in clearing the jam.

- **13.B2.D1 Jam in tray 1**

 [View a video of how to clear a jam in Tray 1](#)

1. If you can see the jammed sheet in Tray 1, remove the jammed sheet by gently pulling it straight out.



2. Open the right door and remove paper from the area shown.

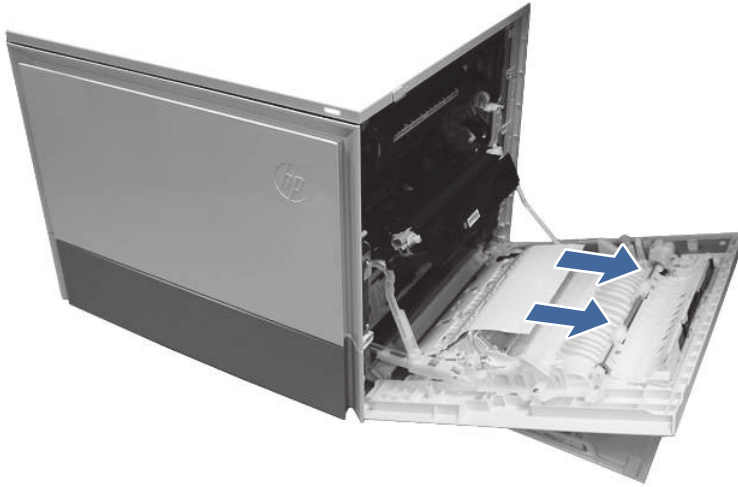

3. Close the right to allow the printer to clear the message.
4. Make sure the type and quality of the paper being used meets the HP specifications for the printer.
5. Make sure the Tray 1 guides are set to the correct paper size and that the paper tray is not overfilled (paper is below the 3 triangles on the right guide).

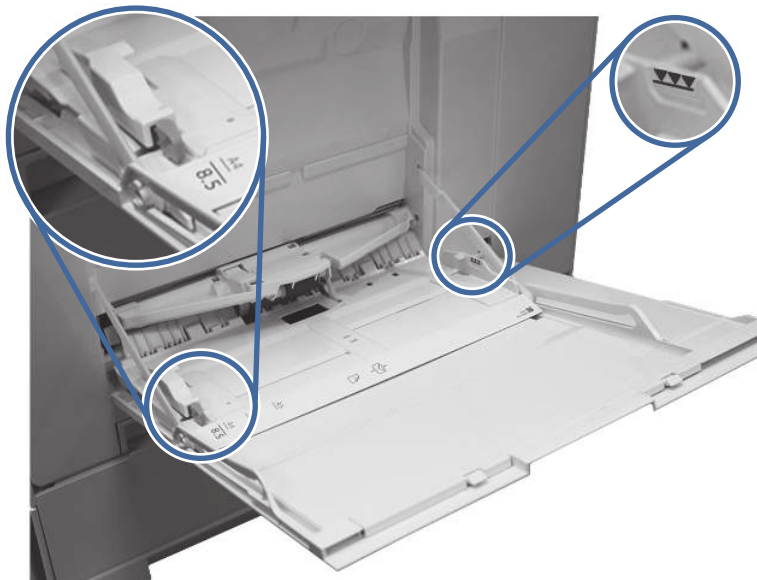

6. Load the paper back into the tray and restart the print job.
7. If the same jam appears remove and clean the tray 1 pick, feed and separation rollers.

- a. Locate and release the pickup roller assembly release tab.

Figure 4-160 Locate the pickup roller assembly tab

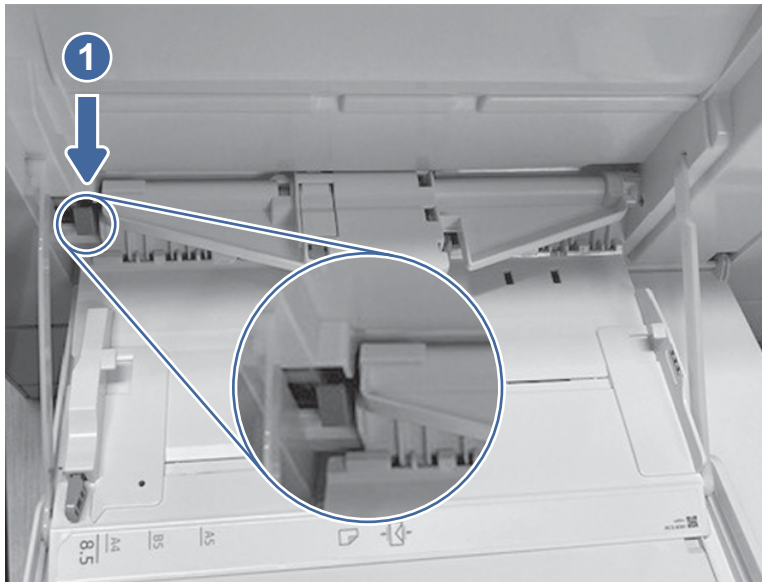

- b. Push the pickup roller assembly to the right and then away from the printer.

Figure 4-161 Remove the pickup roller assembly

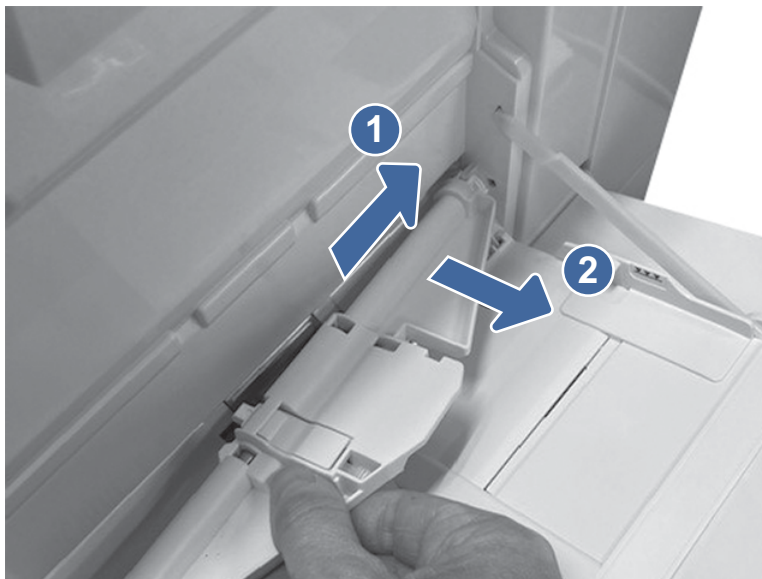

- c. Grasp the left- and right-side of the separation roller assembly, and then lift the assembly up.

Figure 4-162 Lift the separation roller assembly

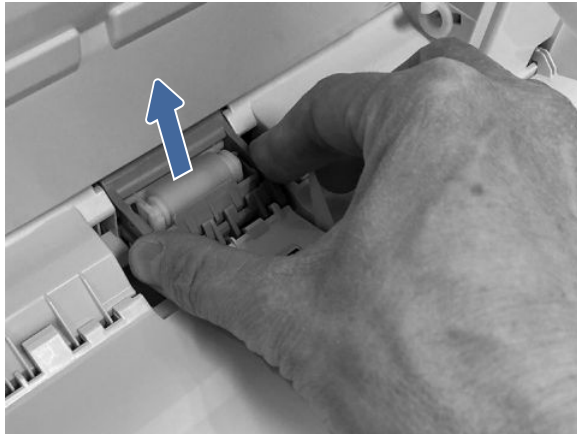

- d. Pull the separation roller assembly straight out to remove it.

Figure 4-163 Remove the separation roller assembly

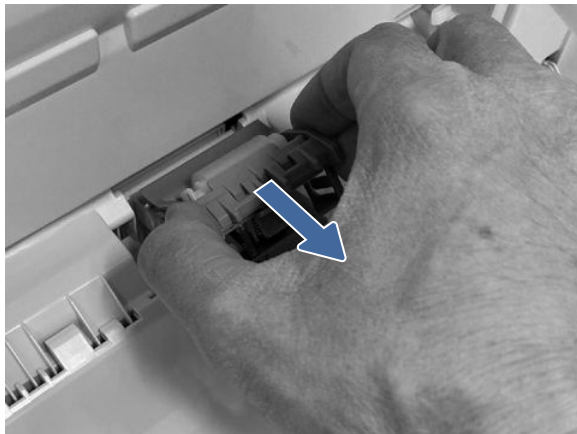

- e. Clean the roller with a dampened lint free cloth.
 - f. Install the rollers back into tray one and test the tray by printing from tray 1.
8. If the error persists, contact your HP-authorized service or support provider, or contact customer support at www.hp.com/go/contactHP.

13.B2.D2 jam error in Tray 2

Use the following procedure to check for paper in all possible jam locations related to Tray 2. When a jam occurs, the control panel displays an animation that assists in clearing the jam.

Recommended action for customers

When a jam occurs, the control panel displays a message and an animation that assists in clearing the jam.

- 13.B2.D2 Paper jam in tray 2



[View a video of how to clear a jam in Tray 2](#)

1. Open the right door.



2. Gently remove any jammed paper.

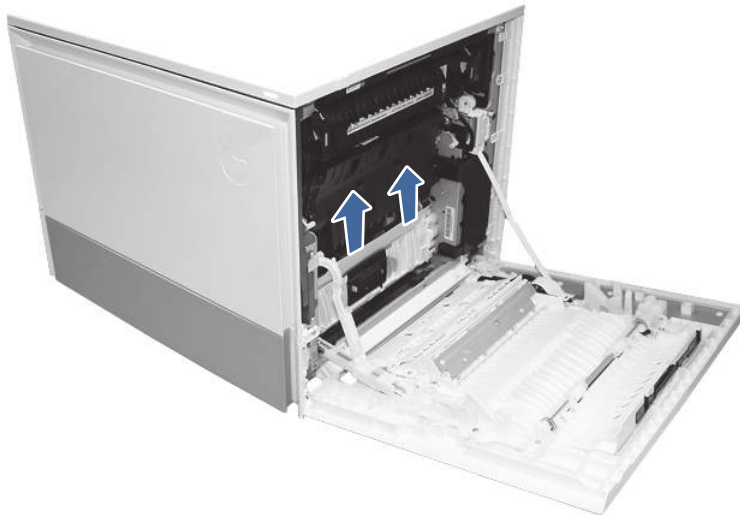

3. Close the right door to clear the control panel message.

4. Open Tray 2.



5. Remove the paper from the tray and discard any bent, curled, or damaged sheets.



6. Make sure that the tray width and length guides are set to the correct paper size for the paper being installed into the tray and that the tray is not over filled above the fill mark (line below 3 triangles on rear guide).

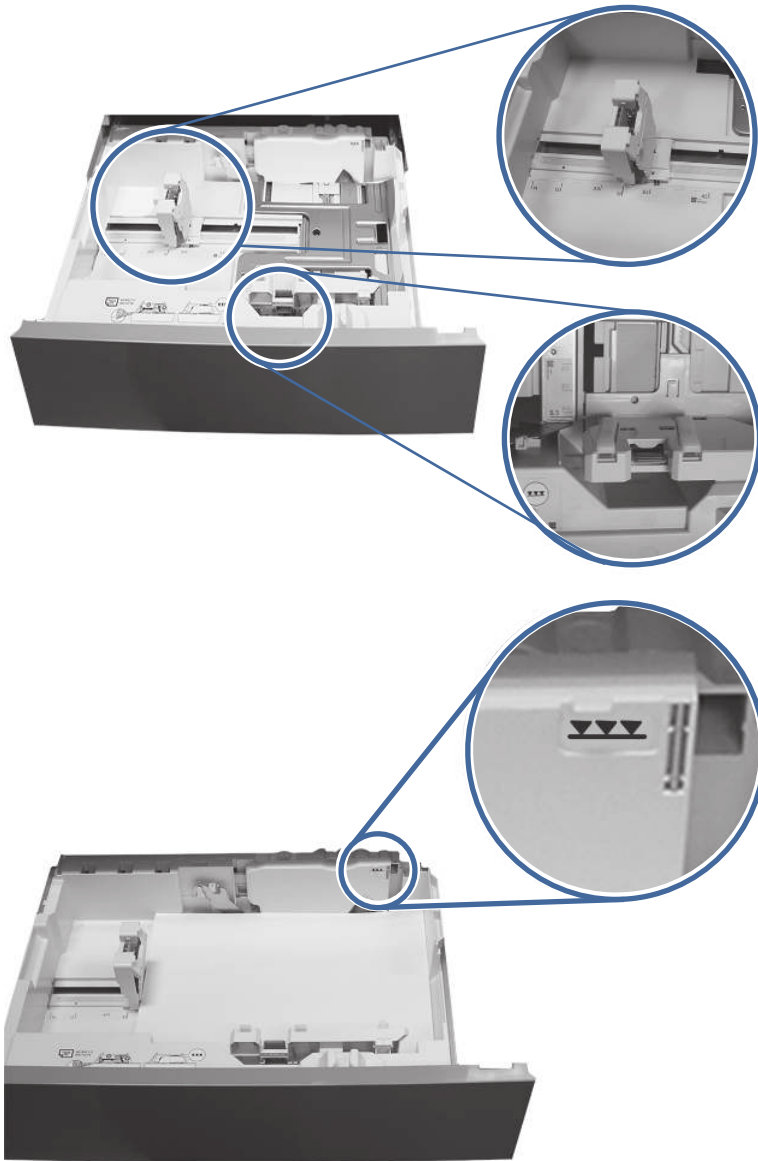

7. Ensure the type and quality of the paper being used meets the HP specifications for the printer.
8. If the error persists, clean the Tray 2 pick, feed, separation rollers.

- a. Open the right door to access the rollers.



- b. Locate and remove the Tray 2 separation roller.

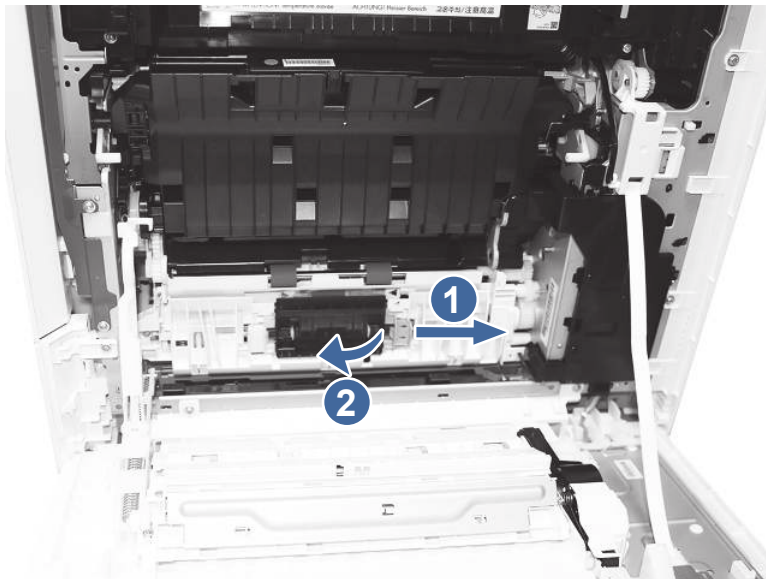

Call-out 1- slide blue locking lever

Call-out 2- Remove the roller assembly.

- c. Remove the Tray 2 pick and feed rollers.

To remove the roller assembly, gently pull on the side of the assembly and slide out as shown.



NOTE: Make sure your hands are clean before touching the rollers. Oils or debris from hands can cause paper pickup issues.

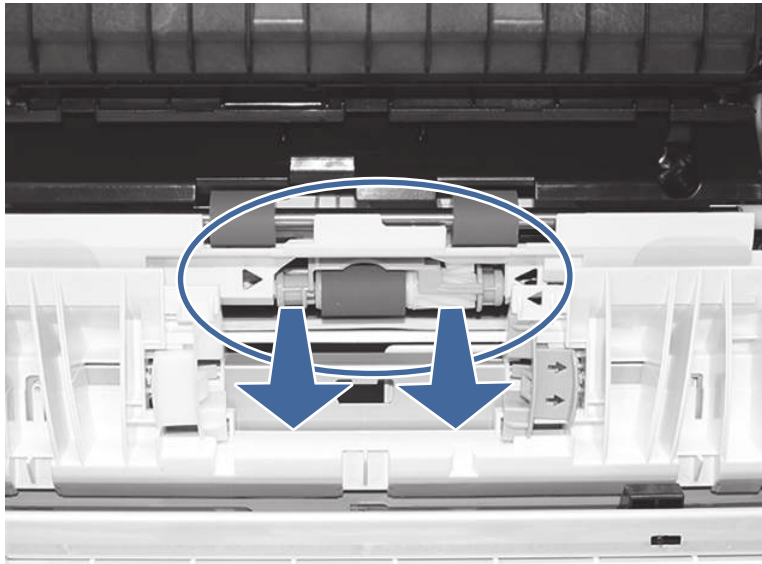

- d. Clean the rollers with a dampened lint free cloth.

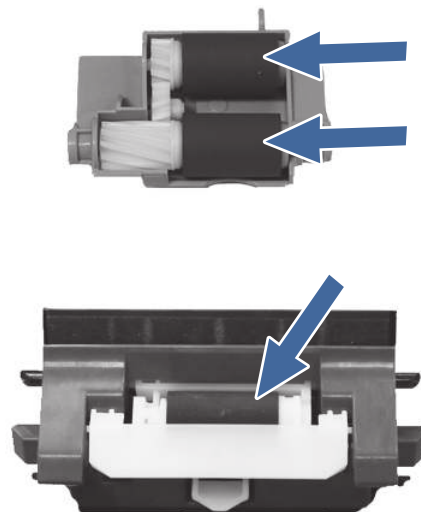

- e. Reinstall the roller assemblies and close the right door.
 - f. Run a print job from Tray 2.
9. If the error persists, contact your HP-authorized service or support provider, or contact customer support at www.hp.com/go/contactHP.

13.A3 jam error in Tray 3

Use the following procedure to check for paper in all possible jam locations related to Tray 3. When a jam occurs, the control panel displays an animation that assists in clearing the jam.

Recommended action for customers

Use the following procedure to check for paper in all possible jam locations related to the 550-sheet trays. When a jam occurs, the control panel displays an animation that assists in clearing the jam.

- 13.A3.A3 Jam in tray 3
- 13.A3.D3 Jam in tray 3

 [View a video of how to clear a jam in Tray 3, and the optional trays](#)

1. Open the Tray 3 right side access door.

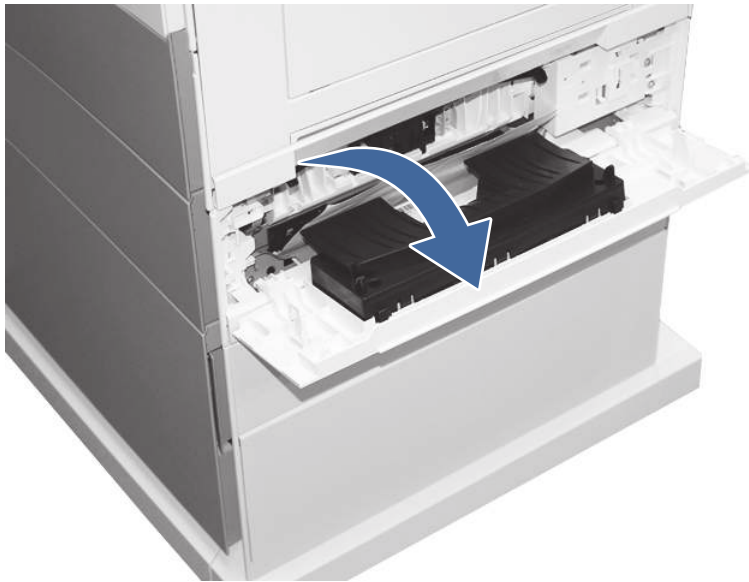

2. Remove any jammed paper found in access area.

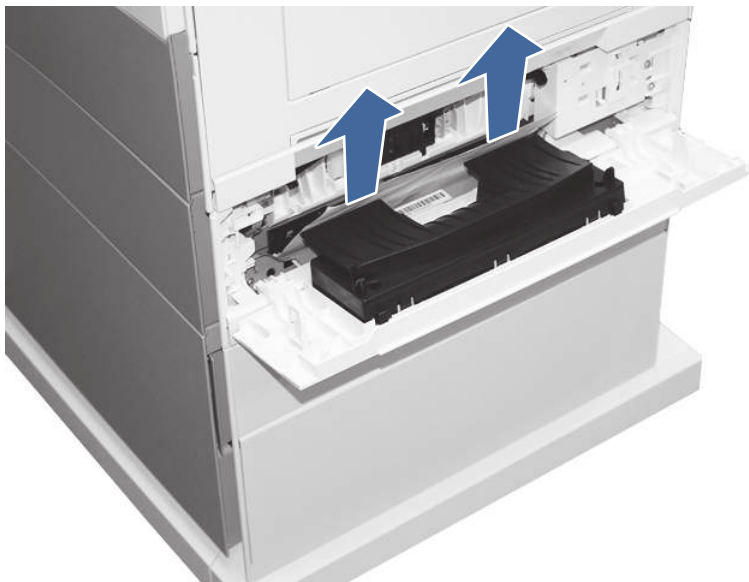

3. Open the right door.



4. Gently remove any jammed paper.

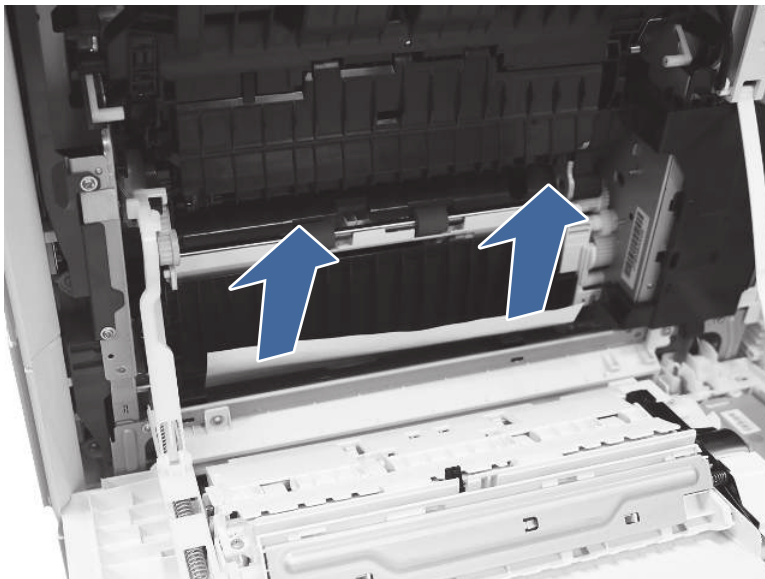

5. Open Tray 3.



6. Remove the paper from the tray and discard any bent, curled, or damaged sheets.

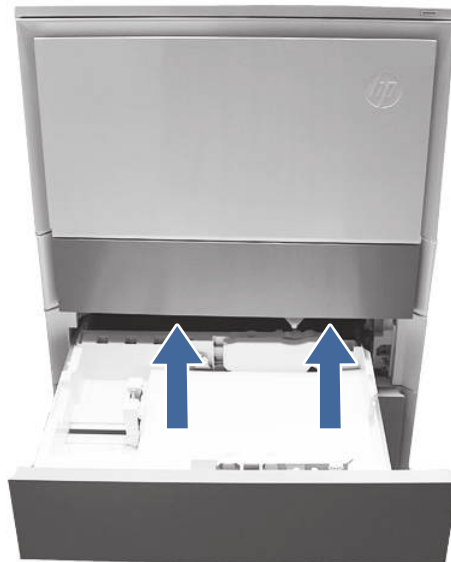

7. Make sure that the tray width and length guides are set to the correct paper size for the paper being installed into the tray and that the tray is not over filled above the fill mark (line below 3 triangles on rear guide).

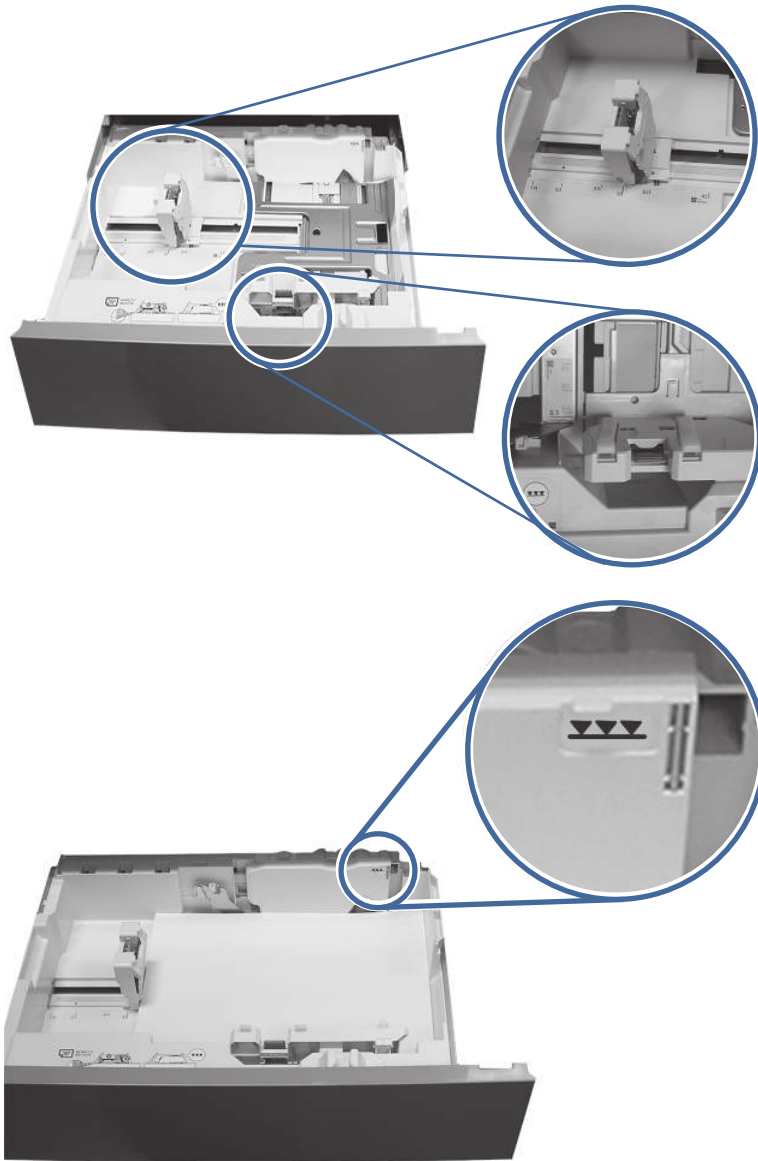

8. Ensure the type and quality of the paper being used meets the HP specifications for the printer.
9. If the error persists, clean the Tray 3 pick, feed, separation rollers.

- a. Open the Tray 3 right door to access the rollers.

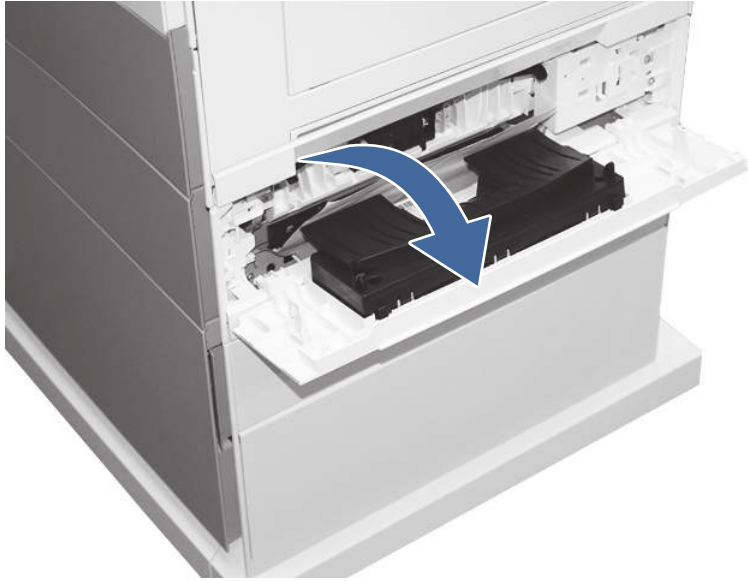

- b. Locate and remove the Tray 3 separation roller.

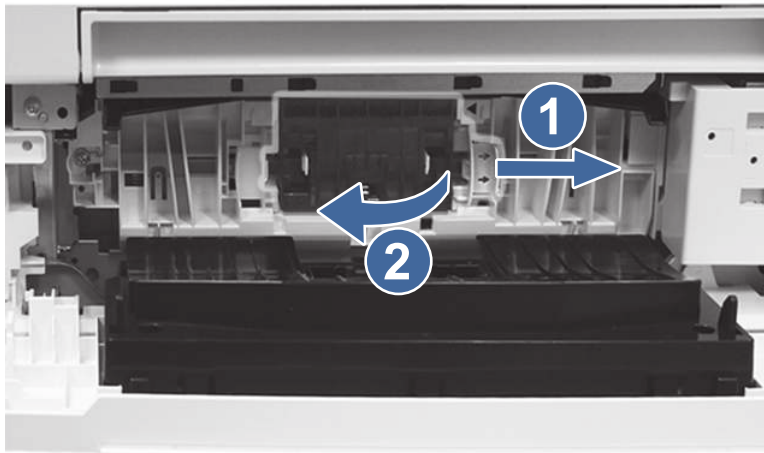

Call-out 1- slide blue locking lever

Call-out 2- Remove the roller assembly.

- c. Remove the Tray 3 pick and feed rollers.

To remove the roller assembly, gently pull on the side of the assembly and slide out as shown.



NOTE: Make sure your hands are clean before touching the rollers. Oils or debris from hands can cause paper pickup issues.

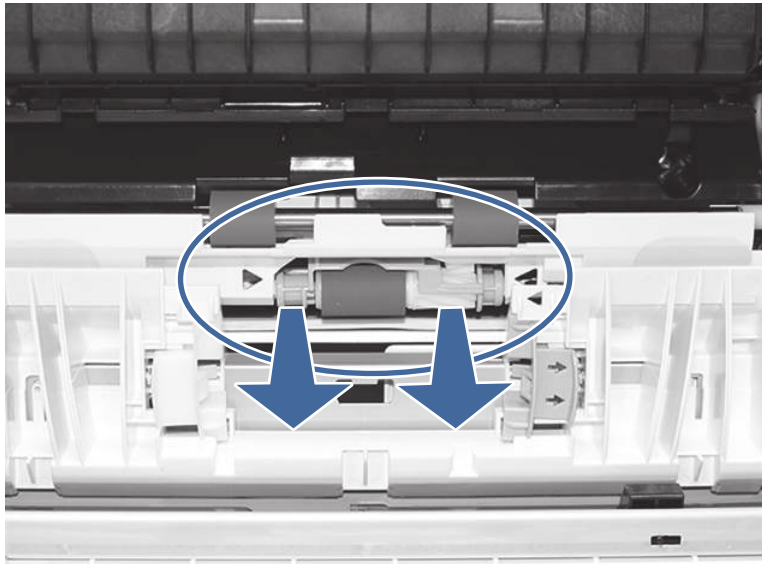

- d. Clean the rollers with a dampened lint free cloth.

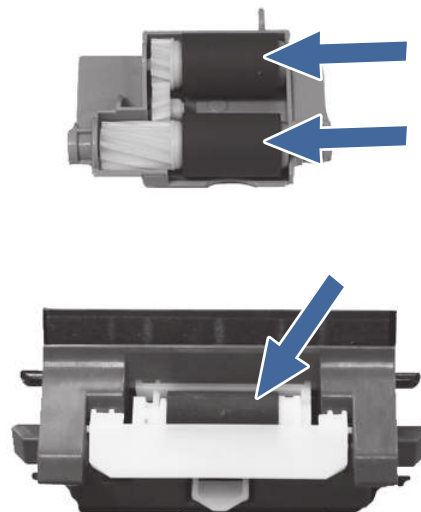

- e. Reinstall the roller assemblies and close the right door.
 - f. Run a print job from Tray 3.
10. If the error persists, contact your HP-authorized service or support provider, or contact customer support at www.hp.com/go/contactHP.

13.A4 jam error in Tray 4

Use the following procedure to check for paper in all possible jam locations related to the 550 sheet Tray 4. When a jam occurs, the control panel displays an animation that assists in clearing the jam.

Recommended action for customers

When a jam occurs, the control panel displays a message and an animation that assists in clearing the jam.

- 13.A4.A4 Paper jam in tray 4
- 13.A4.D4 Paper jam in tray 4

 [View a video of how to clear a jam in Tray 4](#)

1. Open the right door.



2. Gently remove any jammed paper.

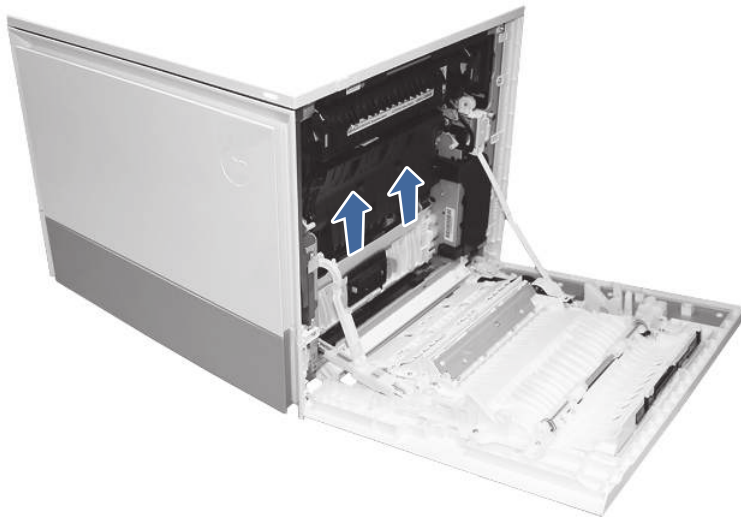

3. Open the Tray 4 right access door.



4. Gently remove any jammed paper.



5. Open the Tray 3 access door and gently remove any jammed paper.

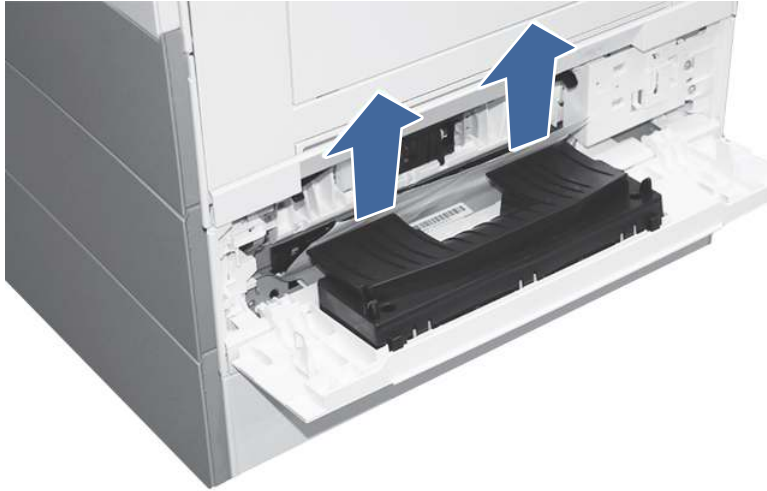

6. Close the right door to clear the control panel message.
7. Open Tray 4.

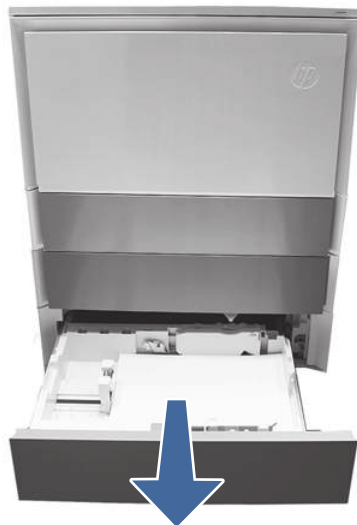

8. Remove the paper from the tray and discard any bent, curled, or damaged sheets.

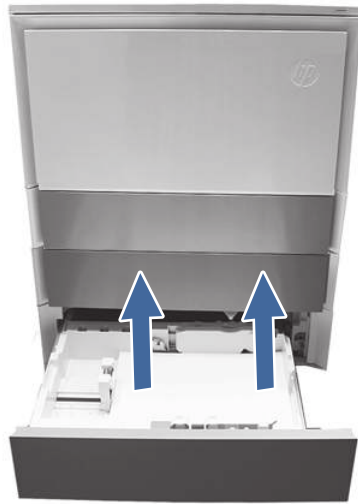

9. Make sure that the tray width and length guides are set to the correct paper size for the paper being installed into the tray and that the tray is not over filled above the fill mark (line below 3 triangles on rear guide).

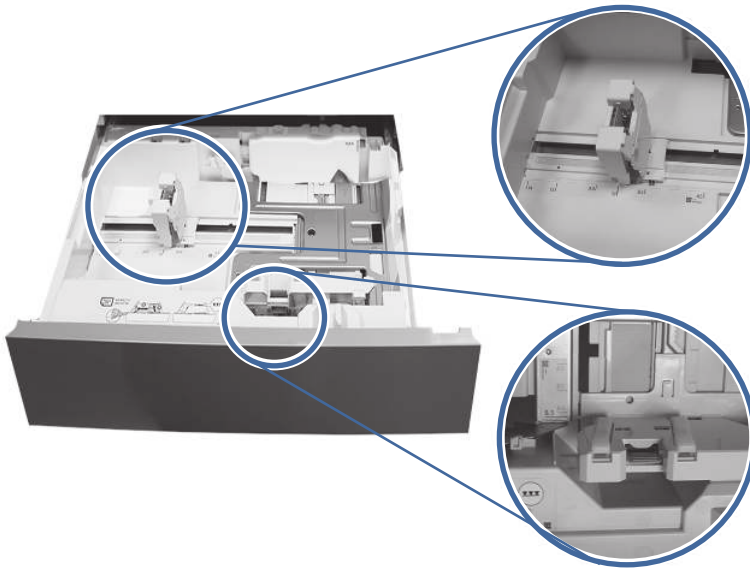

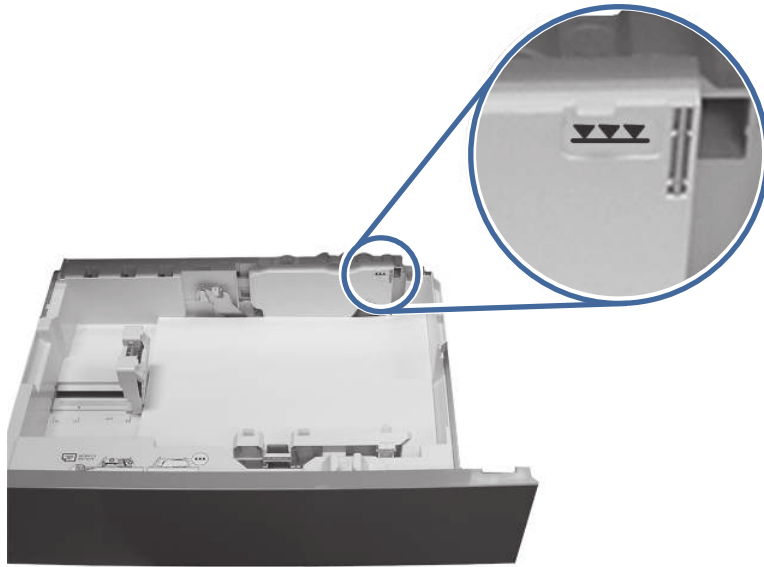

10. Ensure the type and quality of the paper being used meets the HP specifications for the printer.
11. If the error persists, clean the Tray 4 pick, feed, separation rollers.
 - a. Open the Tray 4 door to access the rollers.



- b. Locate and remove the Tray 4 separation roller.

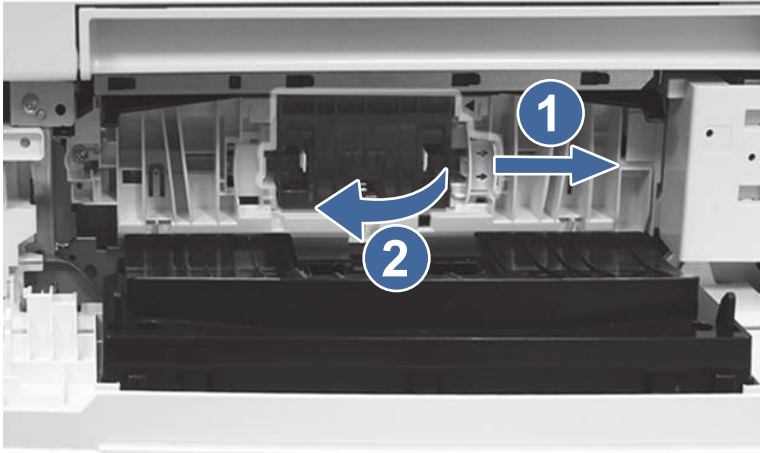

Call-out 1- slide blue locking lever

Call-out 2- Remove the roller assembly.

- c. Remove the Tray 4 pick and feed rollers.

To remove the roller assembly, gently pull on to the side of the rollers as shown.



NOTE: Make sure your hands are clean before touching the rollers. Oils or debris from hands can cause paper pickup issues.

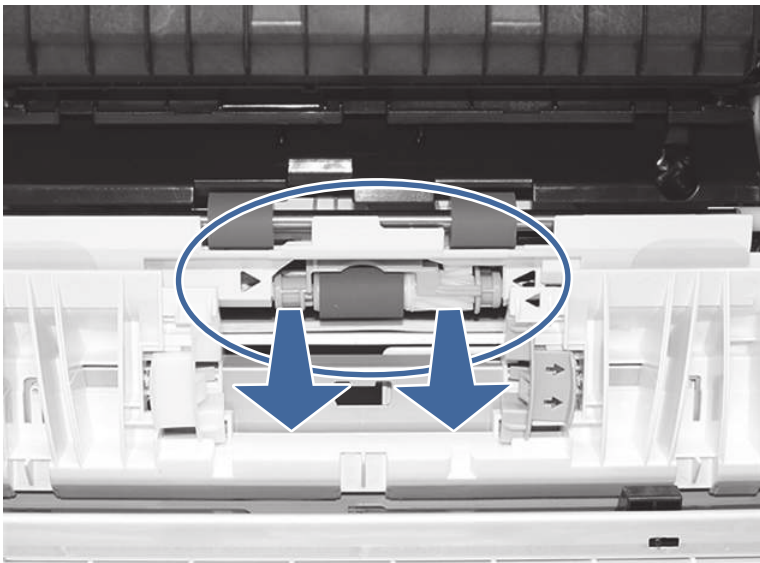

- d. Clean the rollers with a dampened lint free cloth.

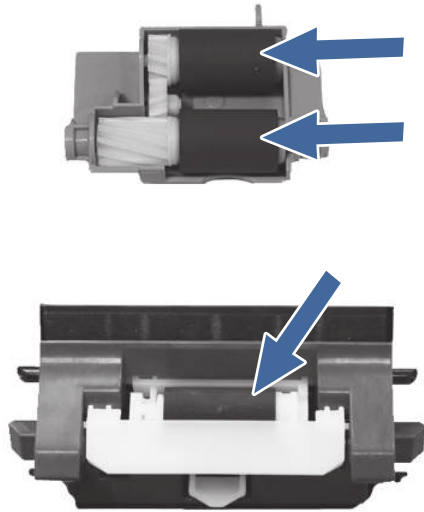

- e. Reinstall the roller assemblies and close the right door.
 - f. Run a print job from Tray 4.
12. If the error persists, contact your HP-authorized service or support provider, or contact customer support at www.hp.com/go/contactHP.

13.A4 jam error in Tray 4 (2,100 sheet feeder HCI)

Use the following procedure to check for paper in all possible jam locations related to the HCI Tray 4. When a jam occurs, the control panel displays an animation that assists in clearing the jam.

Recommended action for customers

When a jam occurs, the control panel displays a message and an animation that assists in clearing the jam.

- 13.A4.A4 Paper jam in tray 4
- 13.A4.D4 Paper jam in tray 4



[View a video of how to clear a jam in the high-capacity input Tray 4](#)

1. Open the printer right door.



2. Gently remove any jammed paper.

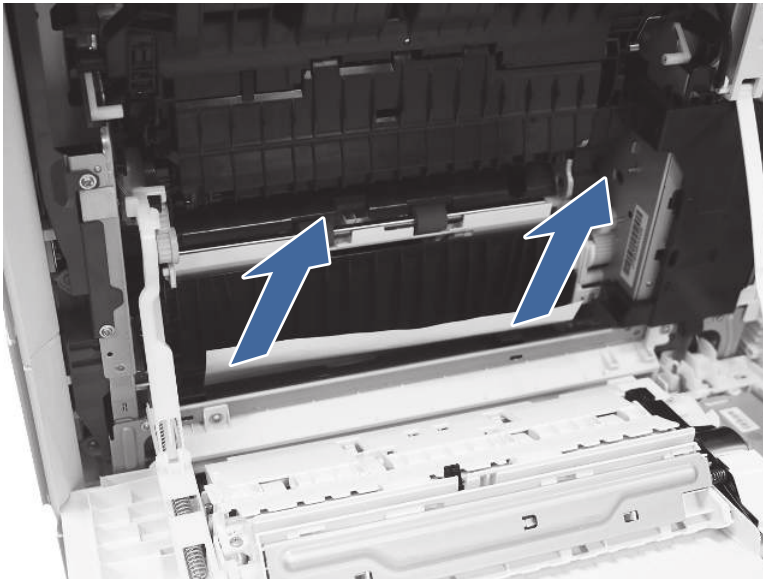

3. Open the Tray 4 right access door.



4. Gently remove any jammed paper.



5. Open the Tray 3 access door and gently remove any jammed paper.

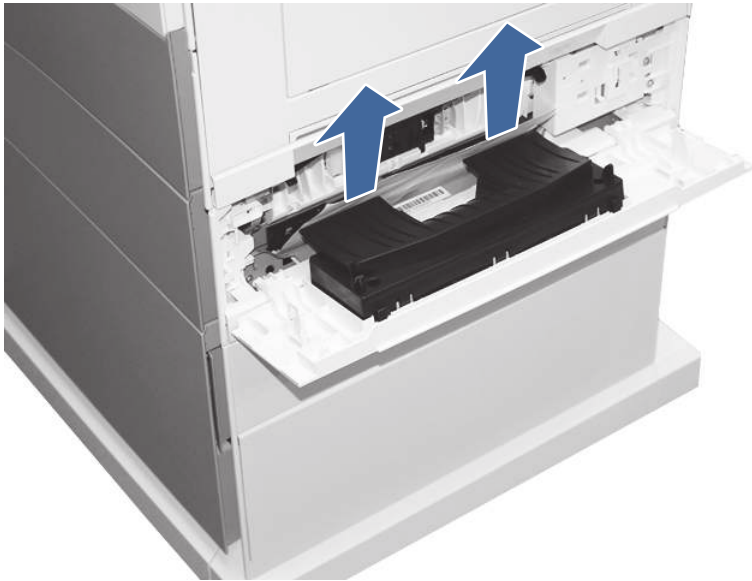

6. Close the right door to clear the control panel message.
7. Open Tray 4.

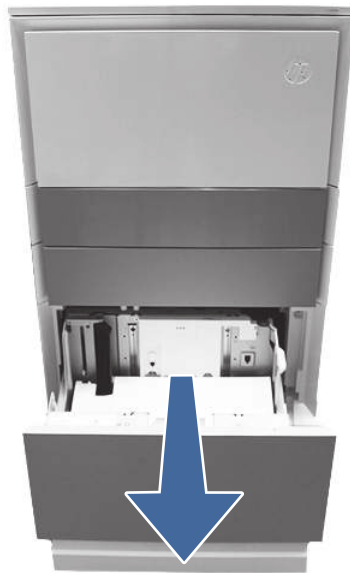

8. Remove the paper from the tray and discard any bent, curled, or damaged sheets.

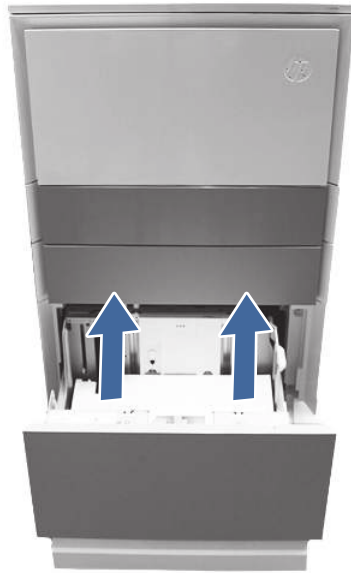

9. Make sure that the tray width guide is set to the correct paper size for the paper being installed into the tray and that the tray is not over filled above the fill mark (line below 3 triangles on rear guide).

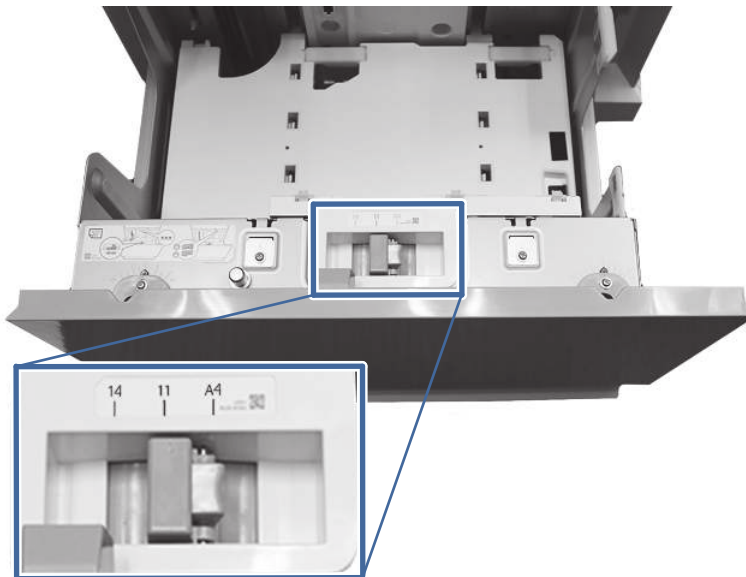

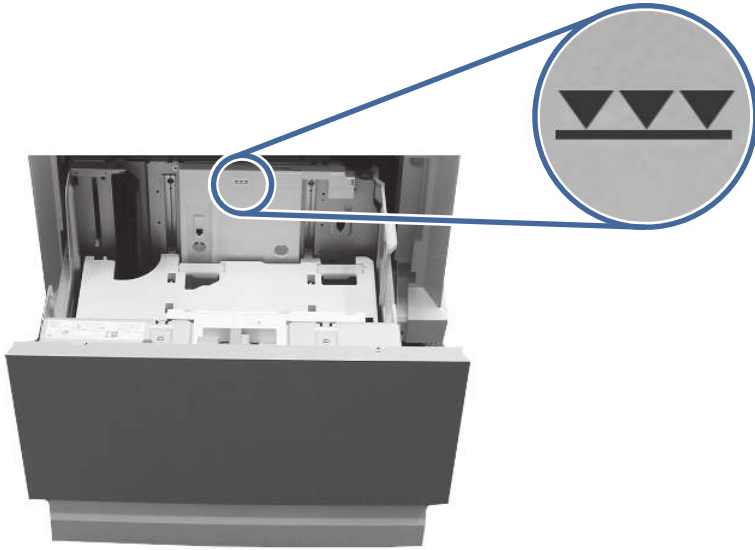

10. Ensure the type and quality of the paper being used meets the HP specifications for the printer.
11. If the error persists, clean the Tray 4 pick, feed, and separation rollers.
 - a. Open the Tray 4 door to access the rollers.



- b. Locate and remove the Tray 4 separation roller.

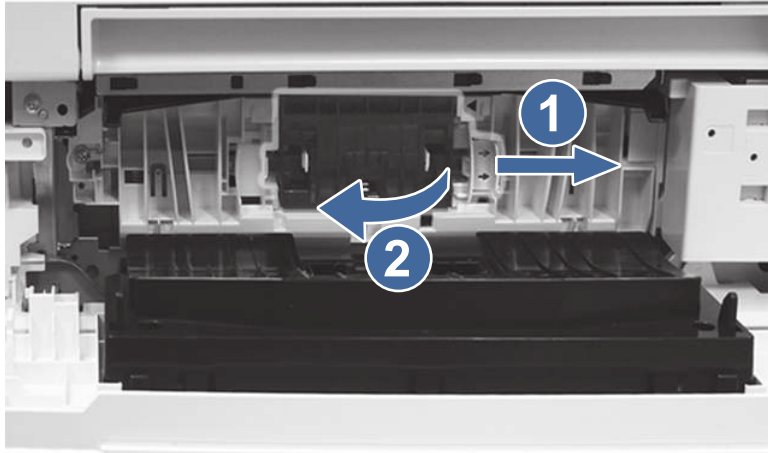

Call-out 1- slide locking lever

Call-out 2- Remove the roller assembly.

- c. Remove the Tray 4 pick and feed rollers.

To remove the roller assembly, gently pull on to the side of the rollers as shown.

 **NOTE:** Do not touch the rubber part of the rollers with hands. Oils or debris from hands can cause paper pickup issues.

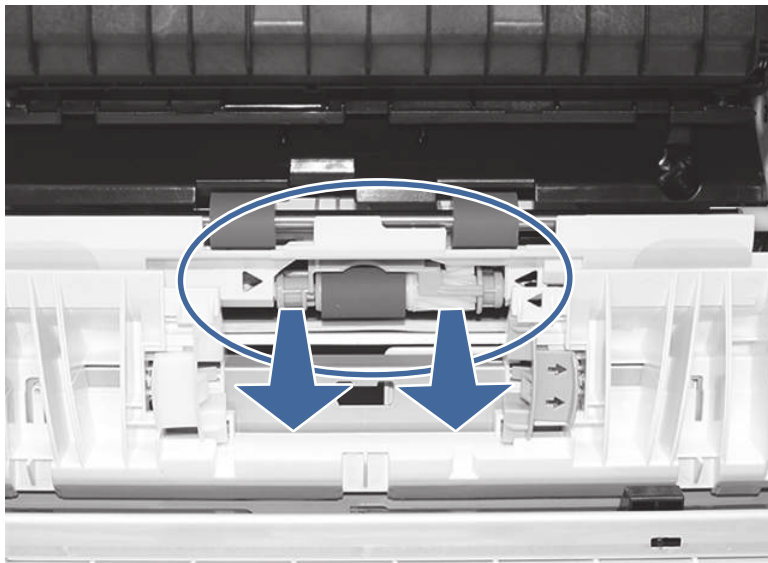

- d. Clean the rollers with a dampened lint free cloth.

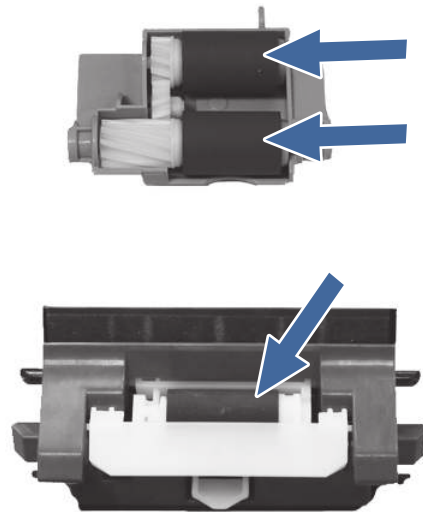

- e. Reinstall the roller assemblies and close the right door.
- f. Run a print job from Tray 4.
12. If the error persists, contact your HP-authorized service or support provider, or contact customer support at www.hp.com/go/contactHP.

13.B2 jam error in right door

Use the following procedure to clear paper jams in the right door and fuser area. When a jam occurs, the control panel displays an animation that assists in clearing the jam.

Recommended action for customers

When a jam occurs, the control panel displays a message and an animation that assists in clearing the jam.

- 13.B2.Az Stay jam in right door
- 13.B2.Dz Delay jam in right door
- 13.B2.5z Inappropriate page to the Delivery Path jam
- 13.B2.FF Residual paper jam in right door

z = paper tray. This can be trays 1-5 or "D" for duplex jobs

Or

z = Fuser mode. This can be 0-9 or A-F.



[View a video of how to clear a jam in the right door and fuser area](#)



CAUTION:



The fuser can be hot while the printer is in use. Wait for the fuser to cool before handling it.

1. Open the right door.

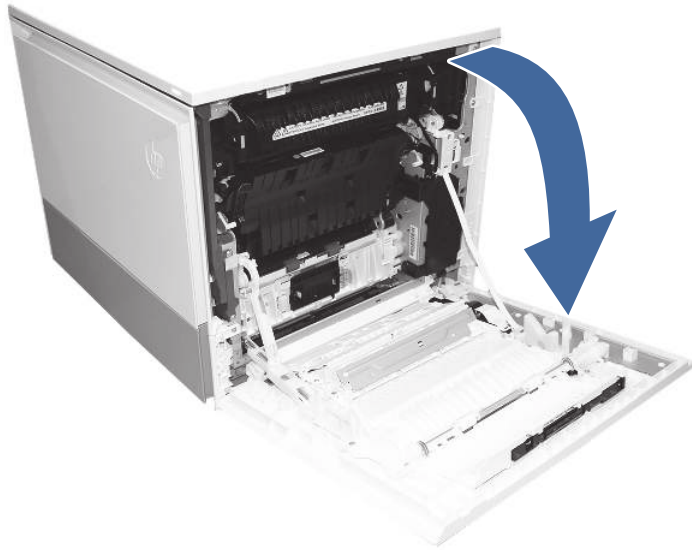

2. Gently remove any jammed paper.

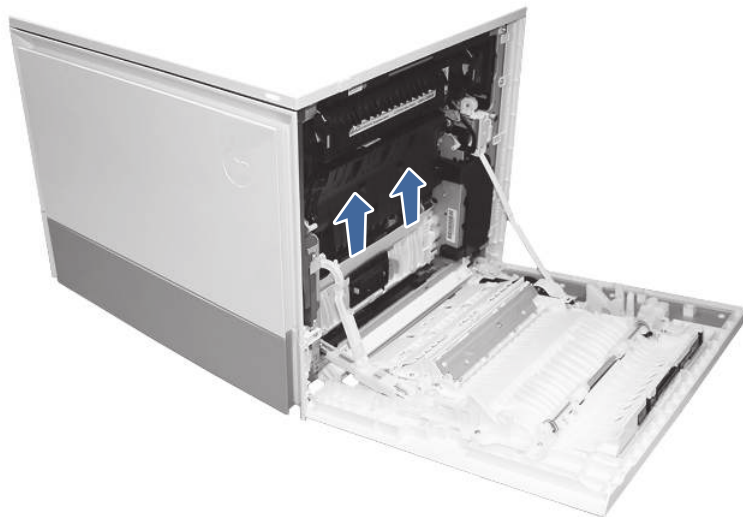

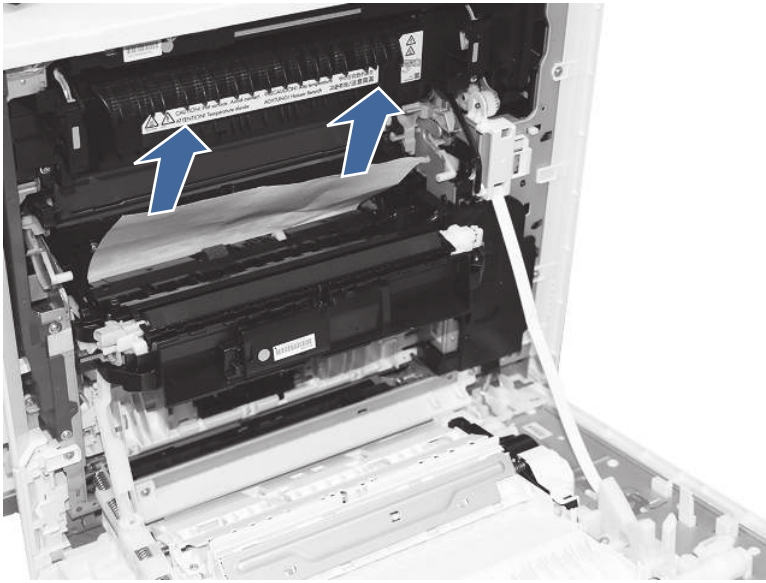

3. Gently remove any jammed paper from the duplexer paper path.

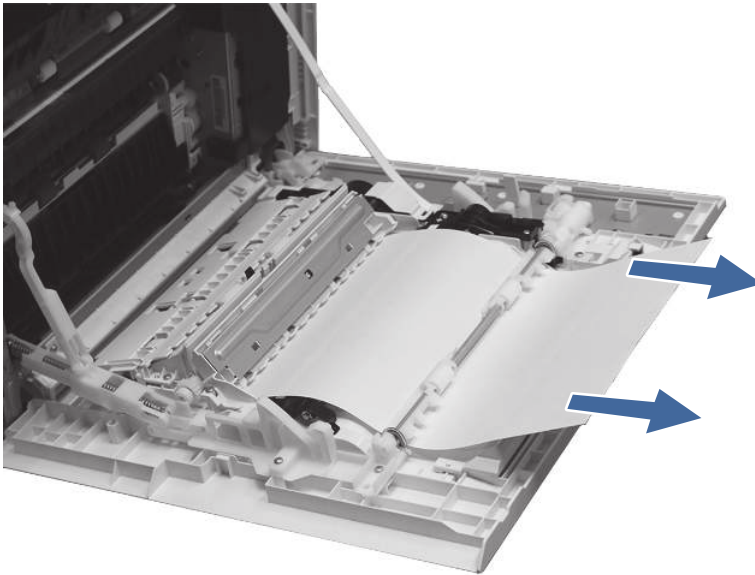

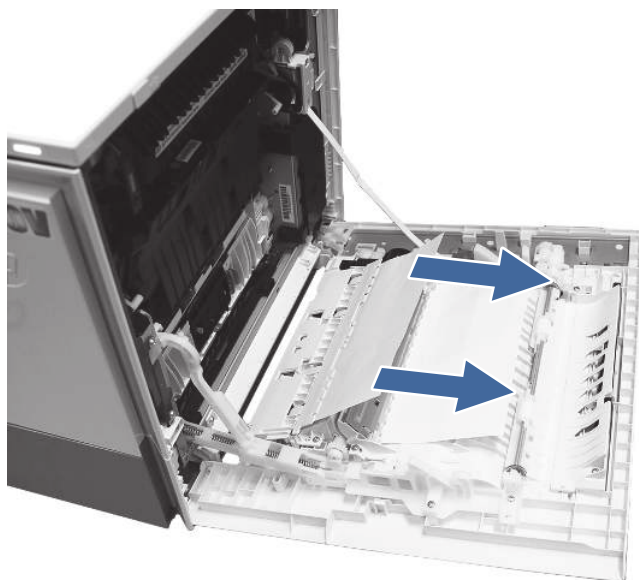

 **IMPORTANT:** Make sure the paper being used is not too short for the printer's duplex requirements.

4. Close the right door.
5. Ensure the type and quality of the paper being used meets the HP specifications for the printer.
6. Ensure the paper tray guides are set to the correct size for the paper loaded.
7. If the error persists, contact your HP-authorized service or support provider, or contact customer support at www.hp.com/go/contactHP.

13.B4 jam errors in the right door

Use the following procedure to clear paper jams in the right door and fuser area. When a jam occurs, the control panel displays an animation that assists in clearing the jam.

Recommended action for customers

When a jam occurs, the control panel displays a message and an animation that assists in clearing the jam.

- 13.B4.Cz Jam in right door
- 13.B4.FF Residual paper jam in right door

z = paper tray. This can be trays 1-5 or "D" for duplex print jobs.



[View a video of how to clear a jam in the right door and fuser area](#)



CAUTION:



The fuser can be hot while the printer is in use. Wait for the fuser to cool before handling it.

1. Open the right door.

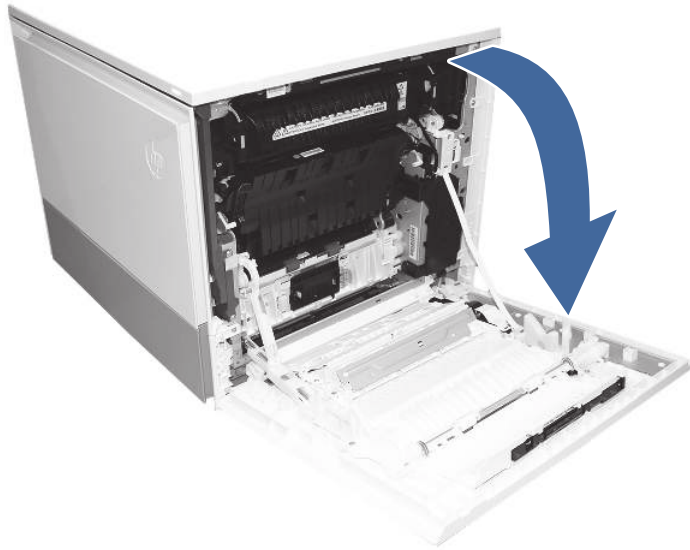

2. Gently remove any jammed paper.

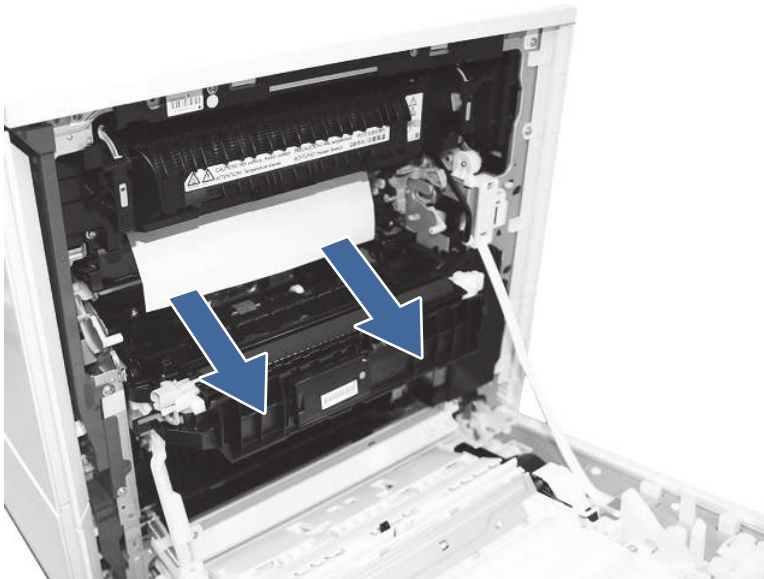

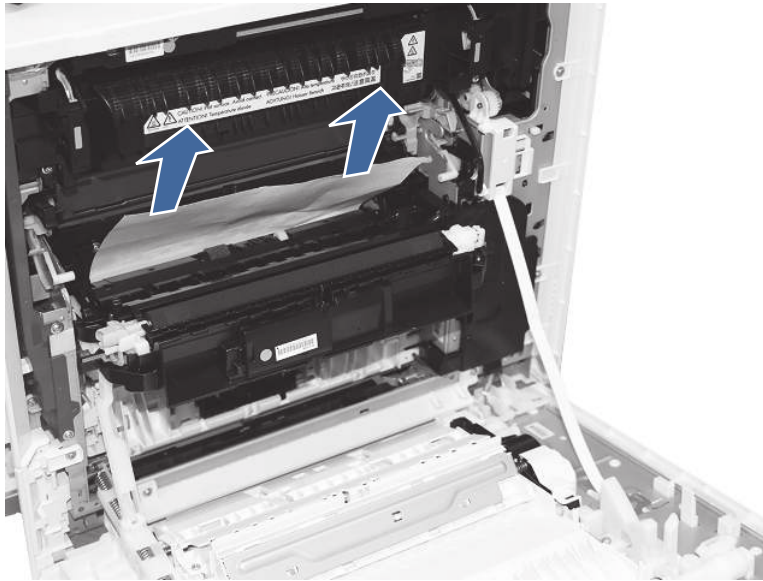

3. Close the right door.
4. Ensure the type and quality of the paper being used meets the HP specifications for the printer.
5. Ensure the paper tray guides are set to the correct size for the paper loaded.
6. If the error persists, contact your HP-authorized service or support provider, or contact customer support at www.hp.com/go/contactHP.

13.B9 jam errors in the fuser

Use the following procedure to clear paper jams in the right door and fuser area. When a jam occurs, the control panel displays an animation that assists in clearing the jam.

Recommended action for customers

When a jam occurs, the control panel displays a message and an animation that assists in clearing the jam.

- 13.B9.yz Jam in right door

y = jam type (A or D)

z = Paper tray. This can be 0-5 or "D" for duplex print jobs.

Or

z = Fuser mode. This can be 0-9 or A-F.

- 13.B9.Cz Jam in right door (Fuser wrap jam)

z = Fuser mode. This can be 0-9 or A-F.

- 13.B9.FF Residual paper jam in right door



[View a video of how to clear a jam in the right door and fuser area](#)



NOTE: The fuser is hot while the printer is in use. Wait for the fuser to cool before clearing jams.

1. Open the right door.

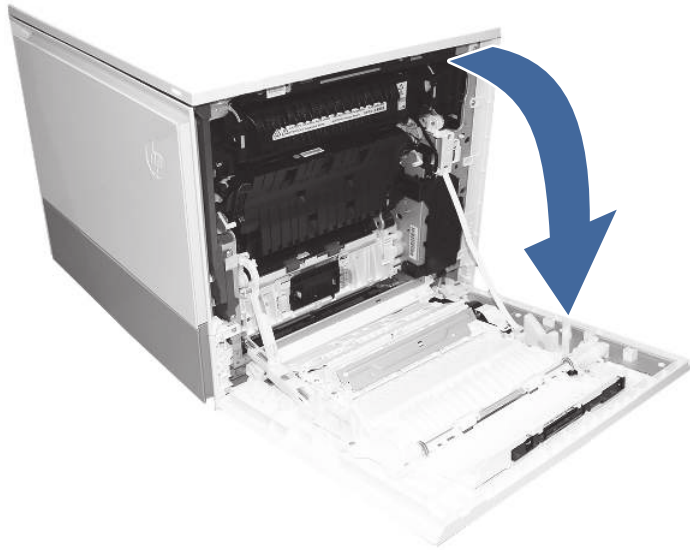

2. Gently remove any jammed paper from the fuser input.

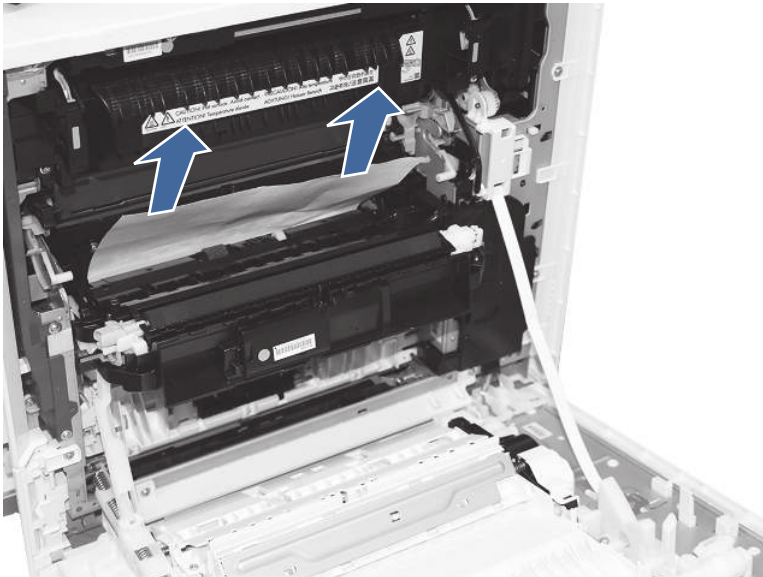

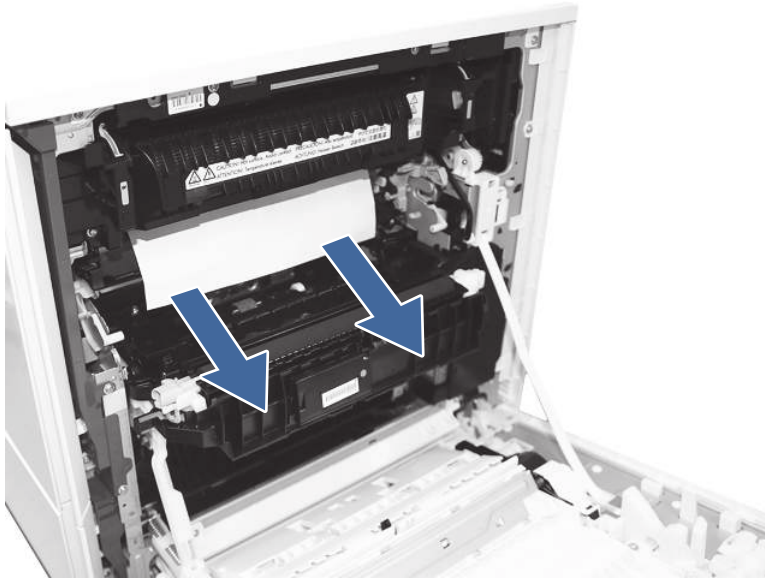

3. Remove the fuser and remove any jammed paper found.
 - a. Squeeze the release levers on the handles (circle call-outs) and then remove the fuser.

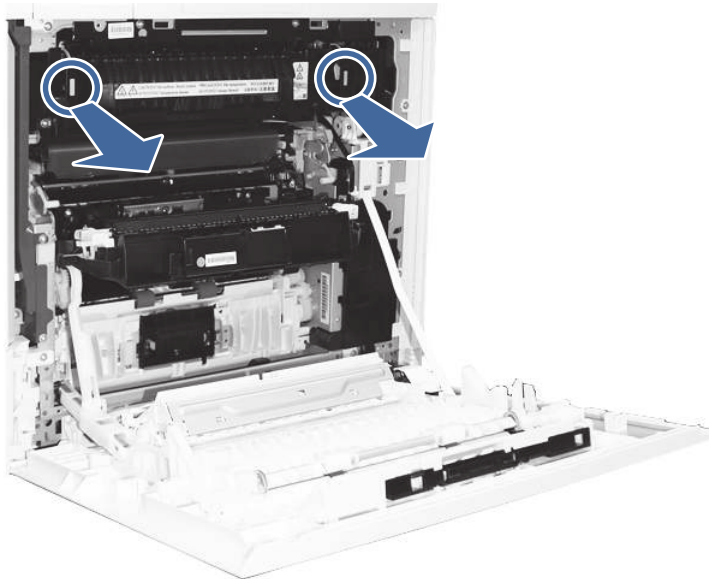

- b. Remove any paper from the exit of the fuser.

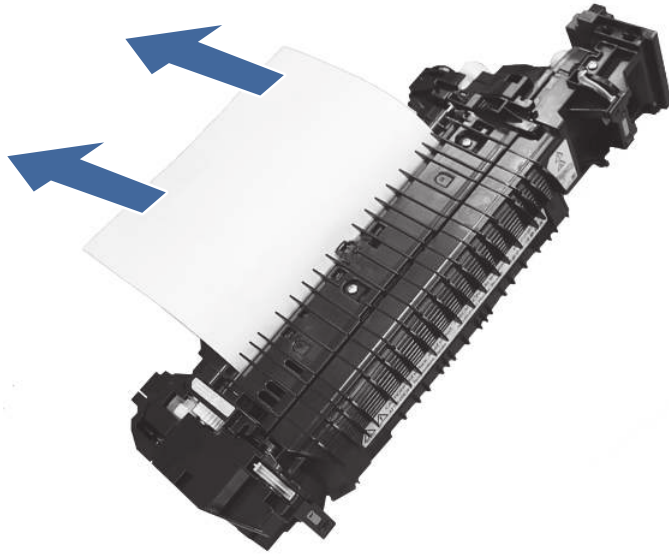

- c. Open the fuser access and check for a z-fold paper jam.

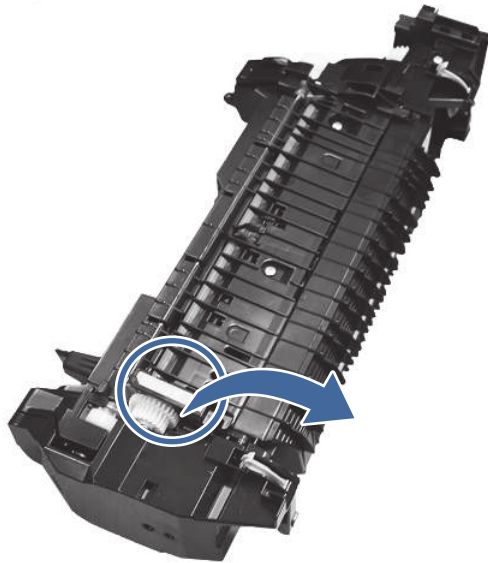

- d. Remove jammed paper from fuser.

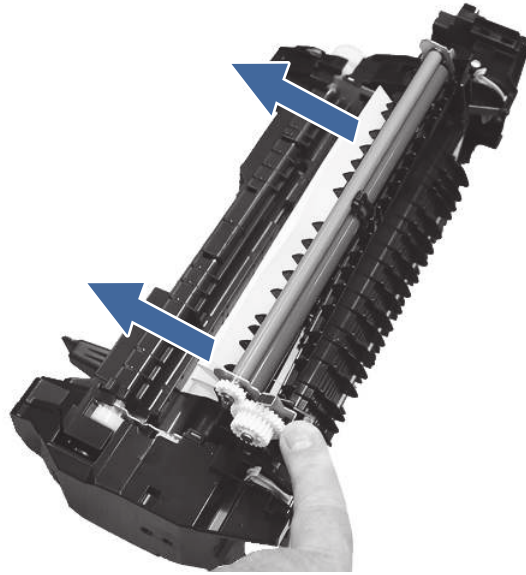

- e. Reinstall the fuser and close the right door.
4. If the error persists, ensure the type and quality of the paper being used meets the HP specifications for the printer.
 5. If the error persists, contact your HP-authorized service or support provider, or contact customer support at www.hp.com/go/contactHP.

13.D3 jam errors in the duplexer

Use the following procedure to clear paper jams in the duplexer area. When a jam occurs, the control panel displays an animation that assists in clearing the jam.

Recommended action for customers

When a jam occurs, the control panel displays a message and an animation that assists in clearing the jam.

- 13.D3.Dz Duplex delivery delay jam
- 13.D3.FF Residual paper jam in right door

z = Fuser mode. This can be 0-9 or A-F.



[View a video of how to clear a jam in the right door and fuser area](#)



NOTE: The fuser is hot while the printer is in use. Wait for the fuser to cool before clearing jams.

1. Open the right door.

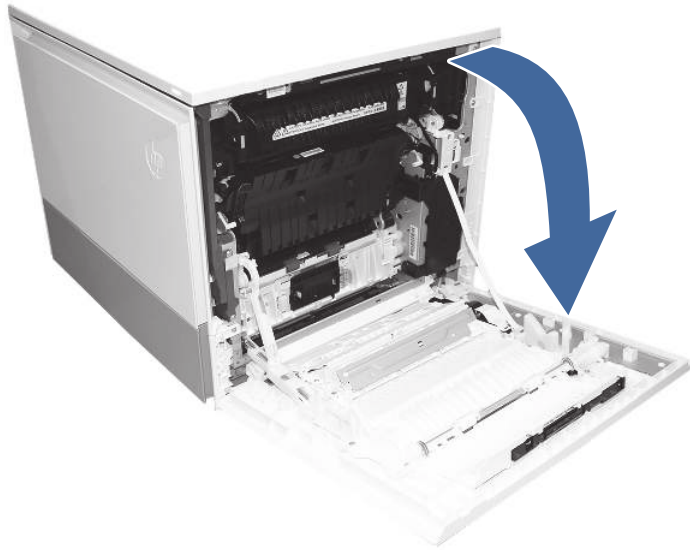

2. Gently remove any jammed paper from the duplexer paper path.

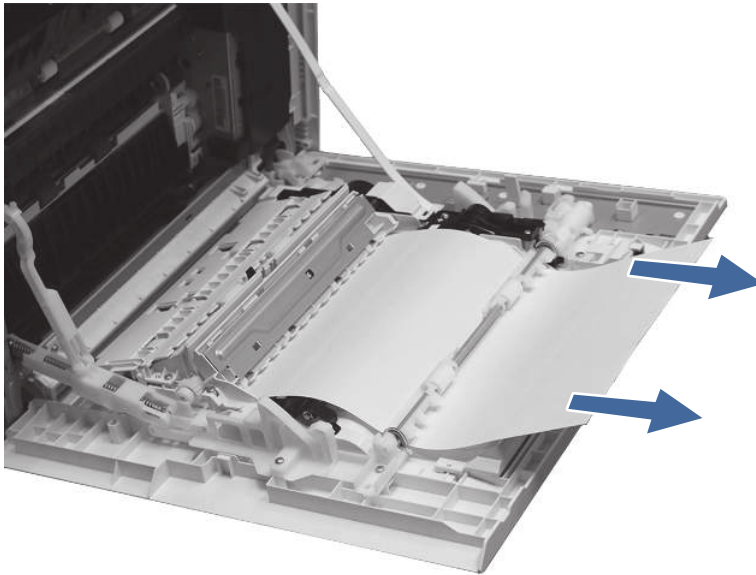

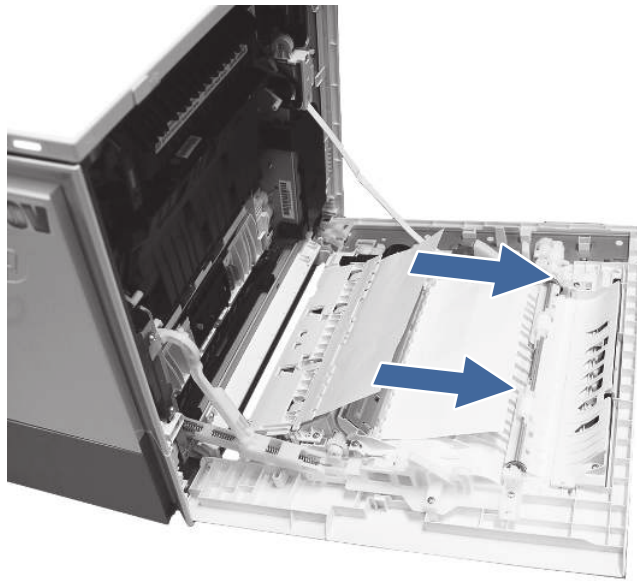

3. Close the right door.
4. If the error persists, ensure the type and quality of the paper being used meets the HP specifications for the printer.
5. If the error persists, contact your HP-authorized service or support provider, or contact customer support at www.hp.com/go/contactHP.

13.E1 jam error in the output bin

Use the following procedure to check for paper in all possible jam locations in the output bin. When a jam occurs, the control panel displays an animation that assists in clearing the jam.

Recommended action for customers

When a jam occurs, the control panel displays a message and an animation that assists in clearing the jam.

- 13.E1.Dz Jam in output bin
- 13.E1.FF Residual paper jam in output bin

z = paper type that is being printed on. This can be 0-9 or A-F.



[View a video of how to clear a jam in the output bin](#)

1. If paper is visible in the output bin, grasp the leading edge and remove it.



2. Ensure the type and quality of the paper being used meets the HP specifications for the printer.
3. If the error persists, contact your HP-authorized service or support provider, or contact customer support at www.hp.com/go/contactHP.

Clear paper jams (MFP models)

Use the procedures in this section to clear jammed paper from the printer paper path.

Paper jam locations

Jams can occur in these locations.

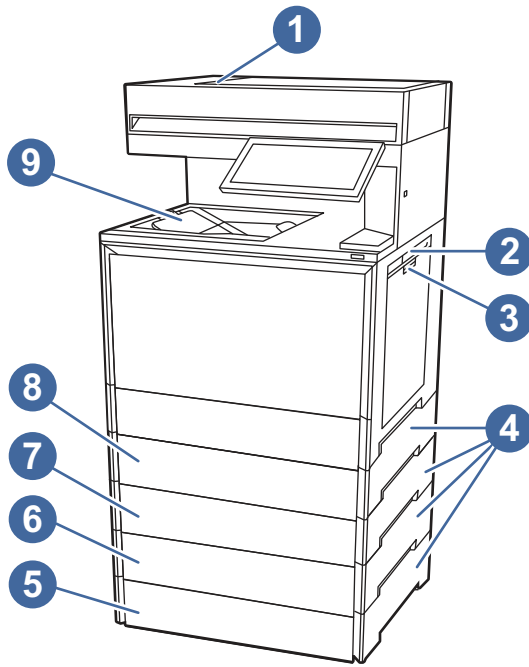

Item	Description
1	Document feeder
2	Right door and fuser area
3	Tray 1 (multipurpose tray)
4	Tray jam access doors
5	Optional Tray 5
6	Optional Tray 4
7	Optional Tray 3
8	Tray 2
9	Output bin

Auto-navigation for clearing paper jams

Learn about printer jam clearing auto-navigation.

The auto-navigation feature assists in clearing jams by providing step-by-step instructions on the control panel.

When you complete a step, the printer displays instructions for the next step until you have completed all steps in the procedure.

Experiencing frequent or recurring paper jams?

To reduce the number of paper jams, try these solutions.



[View a video that demonstrates how to load paper in a way that reduces the number of paper jams](#)

1. Use only paper that meets HP specifications for this printer.

2. Use paper that is not wrinkled, folded, or damaged. If necessary, use paper from a different package.
3. Use paper that has not previously been printed or copied on.
4. Make sure the tray is not overfilled. If it is, remove the entire stack of paper from the tray, straighten the stack, and then return some of the paper to the tray.
5. Make sure the paper guides in the tray are adjusted correctly for the size of paper. Adjust the guides so they are touching the paper stack without bending it.
6. Make sure that the tray is fully inserted in the printer.
7. If you are printing on heavy, embossed, or perforated paper, use the manual feed feature and feed sheets one at a time.
8. Open the [Trays](#) menu on the printer control panel. Verify that the tray is configured correctly for the paper type and size.
9. Make sure the printing environment is within recommended specifications.

31.13.yz jam error in the document feeder

The following information describes how to clear paper jams in the document feeder. When a jam occurs, the control panel displays an animation that assists in clearing the jam.

In addition to the instructions provided below



NOTE: The printer model referenced in this video might be different from your printer model, but the steps to clear the jam are the same.

Recommended action for customers

When a jam occurs, the control panel displays a message and an animation that assists in clearing the jam.

- 31.13.01 Jam in document feeder
- 31.13.02 Jam in document feeder
- 31.13.13 Jam in document feeder



[View a video of how to clear a jam in the document feeder](#)

1. Remove paper from the exit assembly of the document feeder.

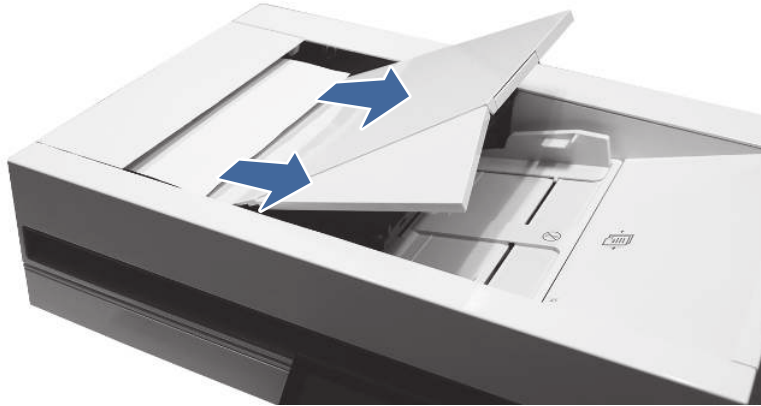

2. Open the document-feeder cover.



3. Remove any jammed paper from the document feeder input area.





4. Lift the document feeder and check the lower side of the feed path.



5. Make sure the guides in the document-feeder input tray are adjusted to the correct size for the document before loading paper.



-
-  **NOTE:** To avoid document feeder jams, to copy narrow documents, use the flatbed scanner. Remove all staples and paper clips from original documents. Do not feed damaged or wrinkled paper.
 -  **NOTE:** Original documents that are printed on heavy, glossy paper can jam more frequently than originals that are printed on plain paper.
 -  **IMPORTANT:** Warning: Do not run labels through the automatic document feeder (ADF).
-

6. If the paper continues to jam, remove and clean the document feeder rollers.
 - a. Open the document-feeder jam access door.

Figure 4-164 Open the document-feeder jam access door

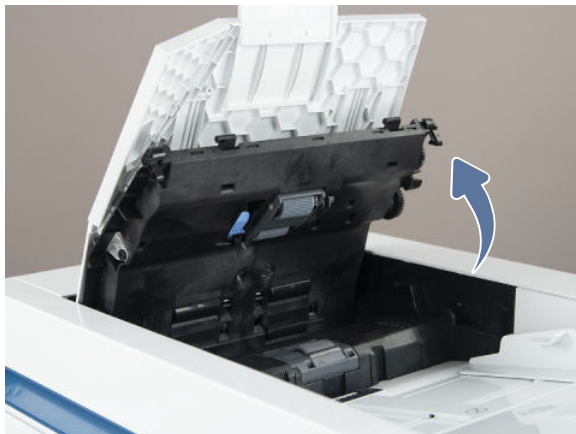

- b. Release the blue locking arm to drop the assembly down. Slide the pickup and feed roller assembly to the left, and then pull it away from the document feeder to remove it.

Figure 4-165 Release the blue locking arm

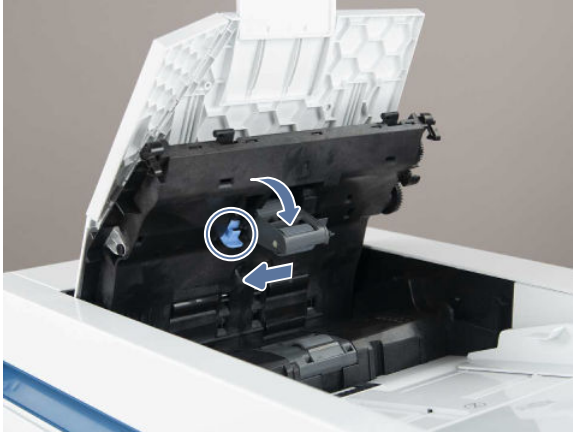

- c. Lift the roller cover up and then slide the roller toward the front of the printer to remove it.

Figure 4-166 Release the separation roller cover

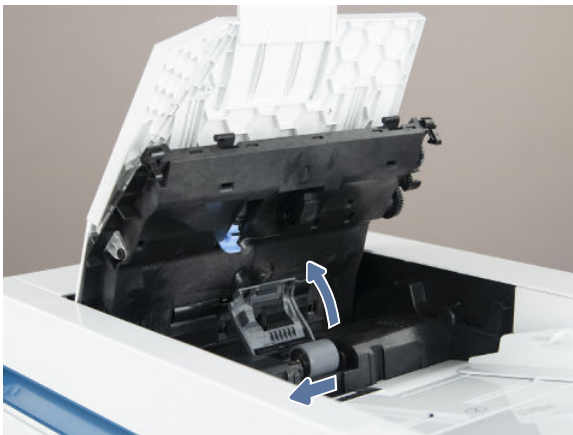

- d. Clean the rollers with a dampened lint free cloth.
 - e. Reinstall the rollers in the document feeder and perform a copy job to test.
7. If the error persists, contact your HP-authorized service or support provider, or contact customer support at www.hp.com/go/contactHP.

13.B2.D1 jam error in Tray 1 (multipurpose tray)

Use the following procedure to clear paper jams in Tray 1 (multipurpose tray). When a jam occurs, the control panel displays an animation that assists in clearing the jam.

Recommended action for customers

When a jam occurs, the control panel displays a message and an animation that assists in clearing the jam.

- 13.B2.D1 Jam in tray 1



[View a video of how to clear a jam in Tray 1](#)

1. If you can see the jammed sheet in Tray 1, remove the jammed sheet by gently pulling it straight out.



2. Open the right door and remove paper from the area shown.

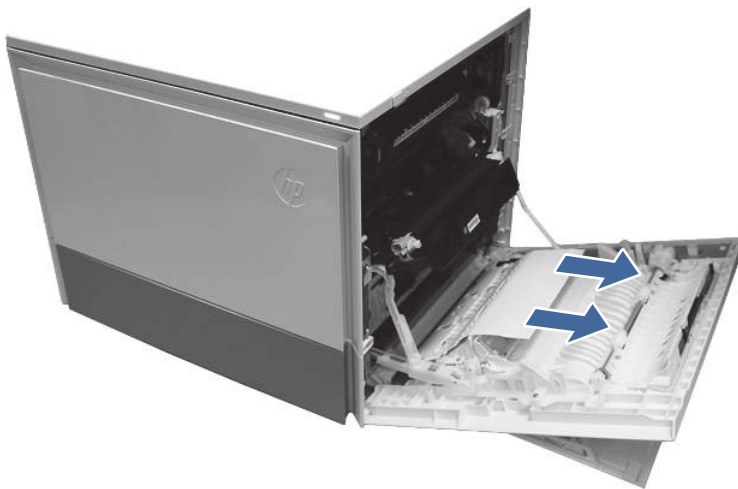

3. Close the right to allow the printer to clear the message.
4. Make sure the type and quality of the paper being used meets the HP specifications for the printer.

5. Make sure the Tray 1 guides are set to the correct paper size and that the paper tray is not overfilled (paper is below the 3 triangles on the right guide).

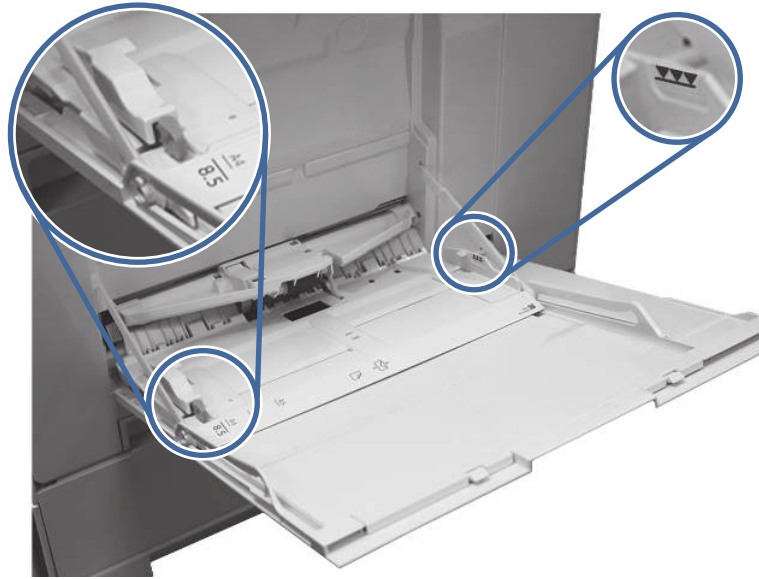

6. Load the paper back into the tray and restart the print job.
7. If the same jam appears remove and clean the tray 1 pick, feed and separation rollers.
 - a. Locate and release the pickup roller assembly release tab.

Figure 4-167 Locate the pickup roller assembly tab

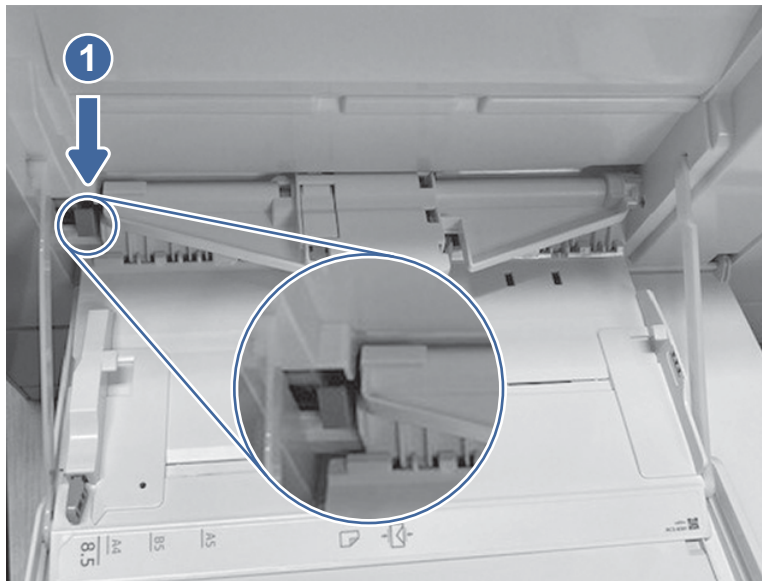

- b. Push the pickup roller assembly to the right and then away from the printer.

Figure 4-168 Remove the pickup roller assembly

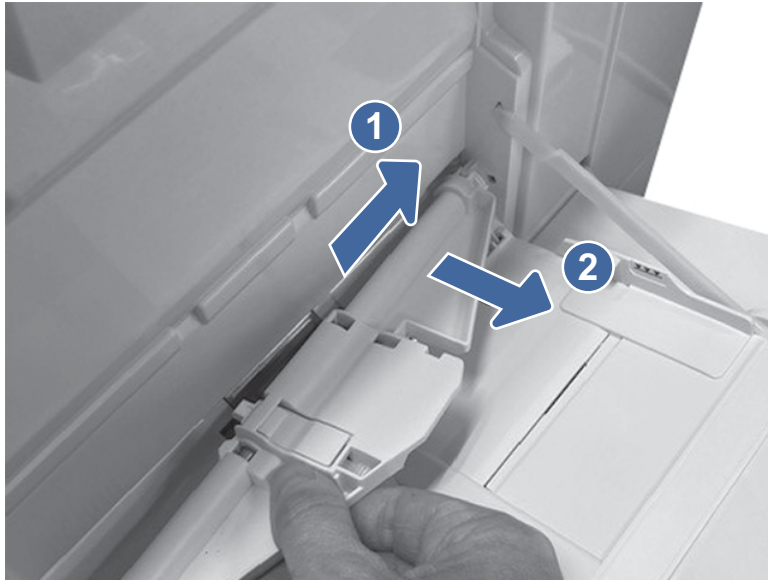

- c. Grasp the left- and right-side of the separation roller assembly, and then lift the assembly up.

Figure 4-169 Lift the separation roller assembly

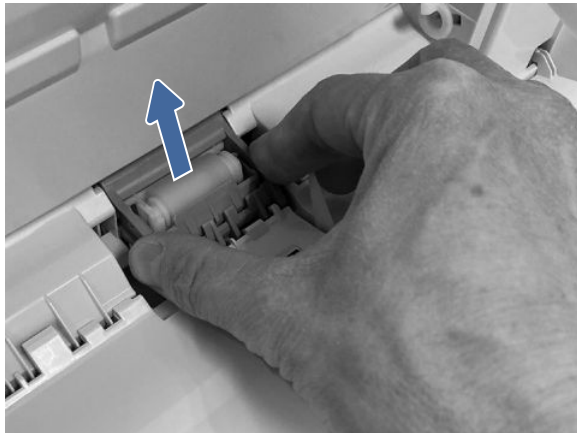

- d. Pull the separation roller assembly straight out to remove it.

Figure 4-170 Remove the separation roller assembly

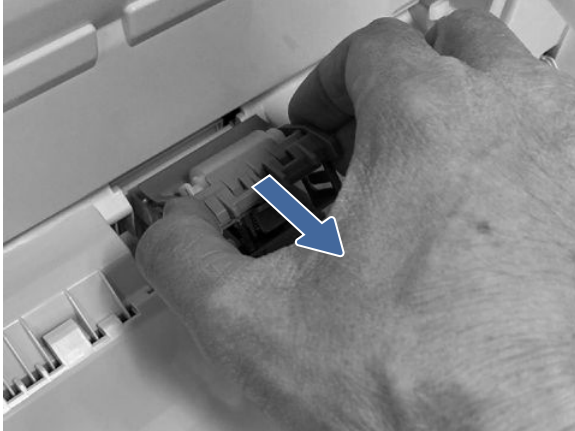

- e. Clean the roller with a dampened lint free cloth.
 - f. Install the rollers back into tray one and test the tray by printing from tray 1.
8. If the error persists, contact your HP-authorized service or support provider, or contact customer support at www.hp.com/go/contactHP.

13.B2.D2 jam error in Tray 2

Use the following procedure to check for paper in all possible jam locations related to Tray 2. When a jam occurs, the control panel displays an animation that assists in clearing the jam.

Recommended action for customers

When a jam occurs, the control panel displays a message and an animation that assists in clearing the jam.

- 13.B2.D2 Paper jam in tray 2

 [View a video of how to clear a jam in Tray 2](#)

1. Open the right door.



2. Gently remove any jammed paper.

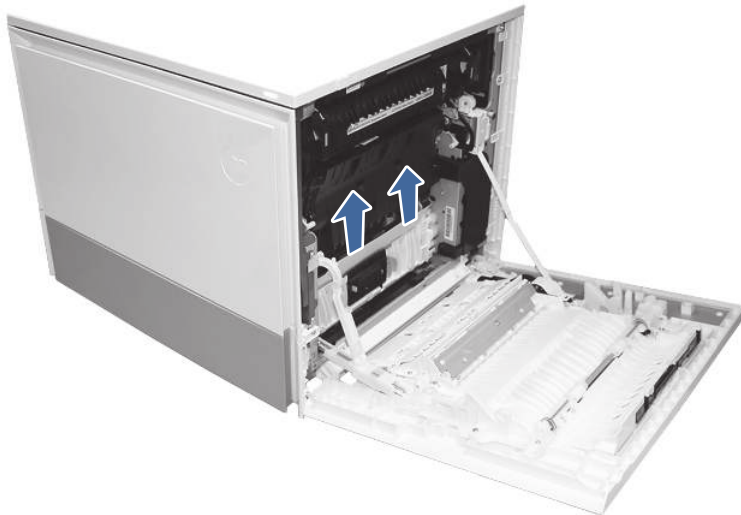

3. Close the right door to clear the control panel message.

4. Open Tray 2.



5. Remove the paper from the tray and discard any bent, curled, or damaged sheets.



6. Make sure that the tray width and length guides are set to the correct paper size for the paper being installed into the tray and that the tray is not over filled above the fill mark (line below 3 triangles on rear guide).

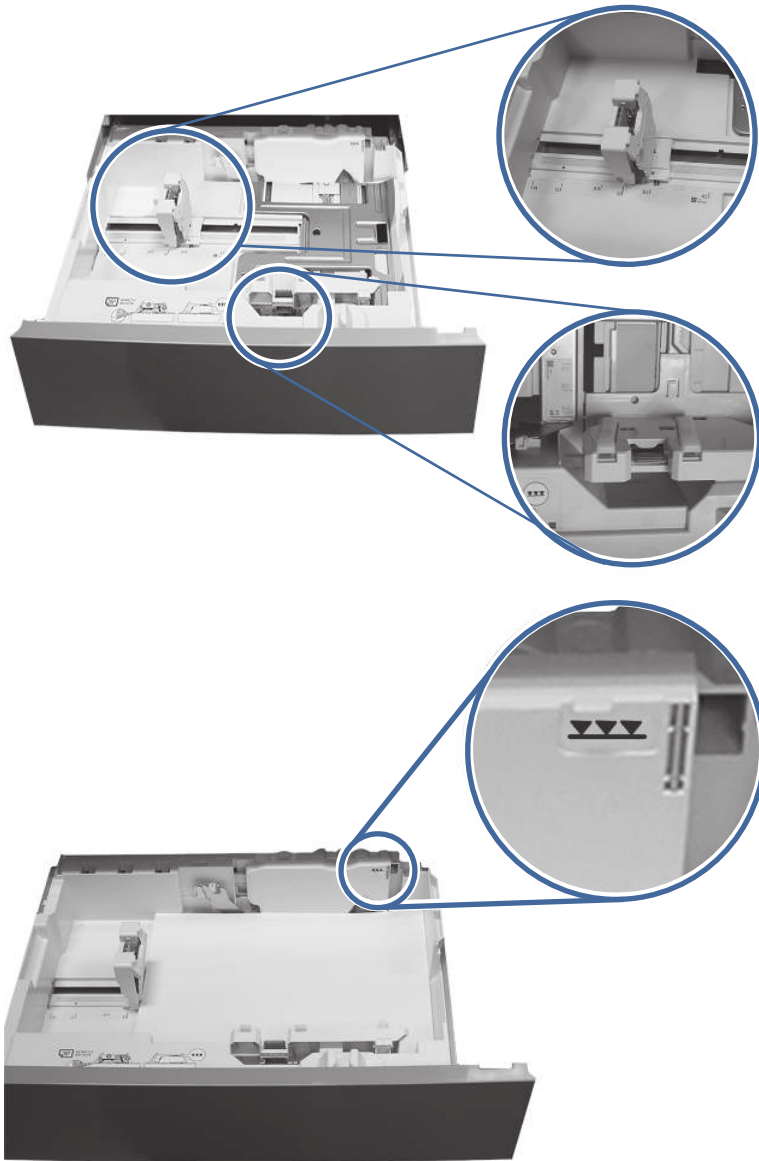

7. Ensure the type and quality of the paper being used meets the HP specifications for the printer.
8. If the error persists, clean the Tray 2 pick, feed, separation rollers.

- a. Open the right door to access the rollers.



- b. Locate and remove the Tray 2 separation roller.

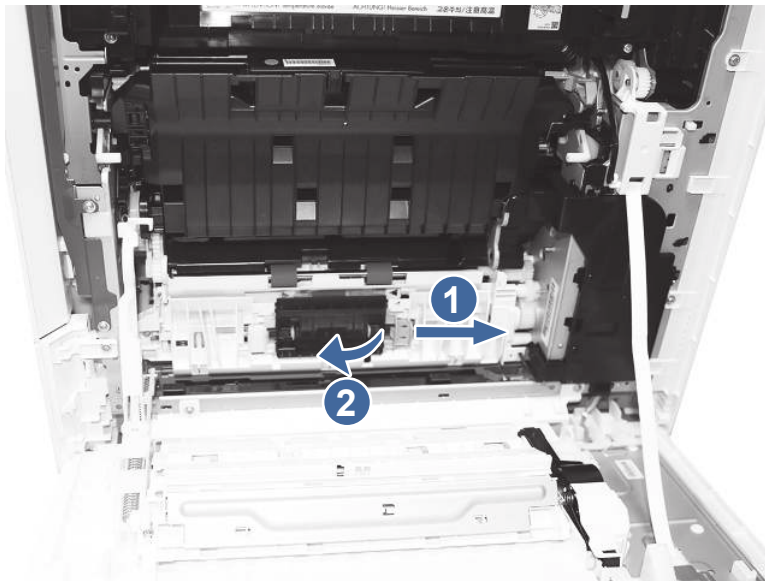

Call-out 1- slide blue locking lever

Call-out 2- Remove the roller assembly.

- c. Remove the Tray 2 pick and feed rollers.

To remove the roller assembly, gently pull on the side of the assembly and slide out as shown.



NOTE: Make sure your hands are clean before touching the rollers. Oils or debris from hands can cause paper pickup issues.

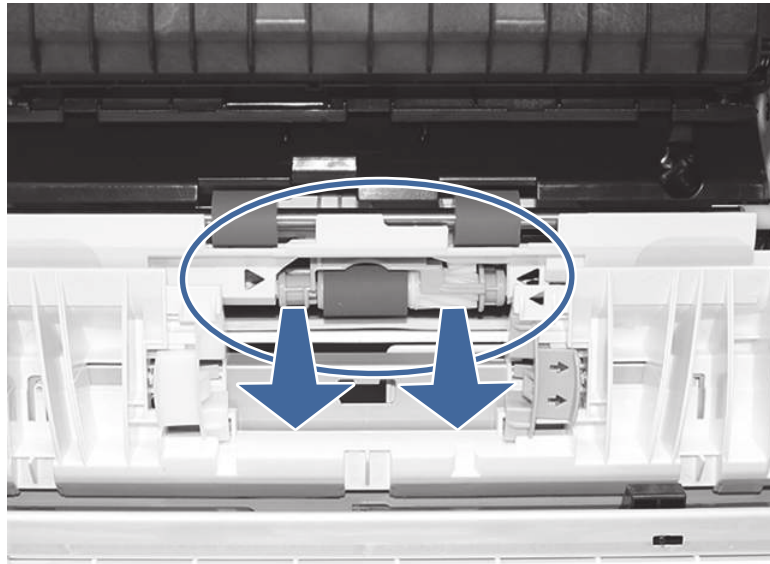

- d. Clean the rollers with a dampened lint free cloth.

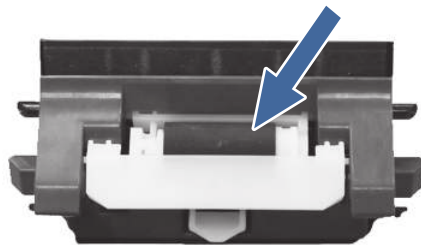
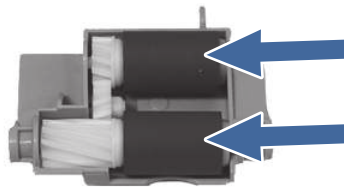

- e. Reinstall the roller assemblies and close the right door.
 - f. Run a print job from Tray 2.
9. If the error persists, contact your HP-authorized service or support provider, or contact customer support at www.hp.com/go/contactHP.

13.A3 jam error in Tray 3

Use the following procedure to check for paper in all possible jam locations related to Tray 3. When a jam occurs, the control panel displays an animation that assists in clearing the jam.

Recommended action for customers

Use the following procedure to check for paper in all possible jam locations related to the 550-sheet trays. When a jam occurs, the control panel displays an animation that assists in clearing the jam.

- 13.A3.A3 Jam in tray 3
- 13.A3.D3 Jam in tray 3

 [View a video of how to clear a jam in Tray 3, and the optional trays](#)

1. Open the Tray 3 right side access door.

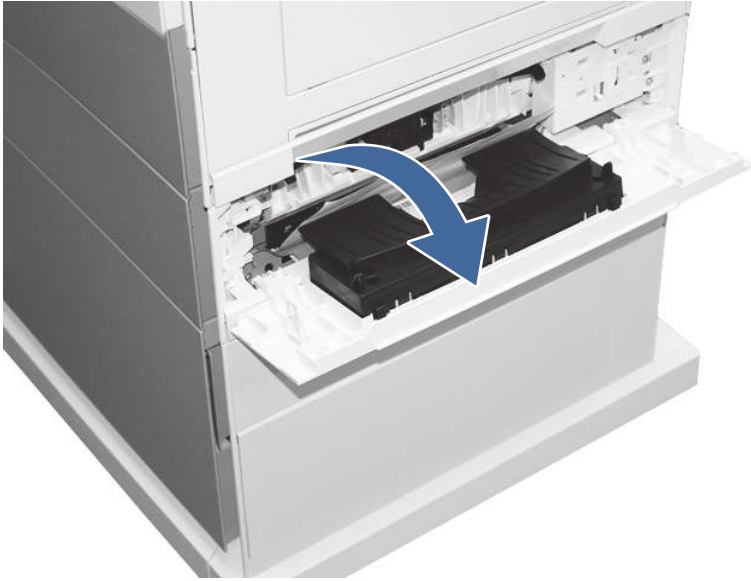

2. Remove any jammed paper found in access area.

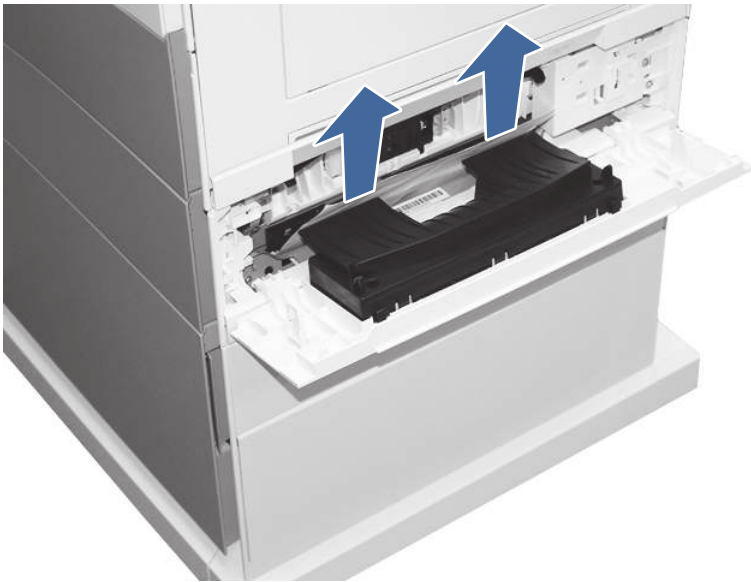

3. Open the right door.



4. Gently remove any jammed paper.

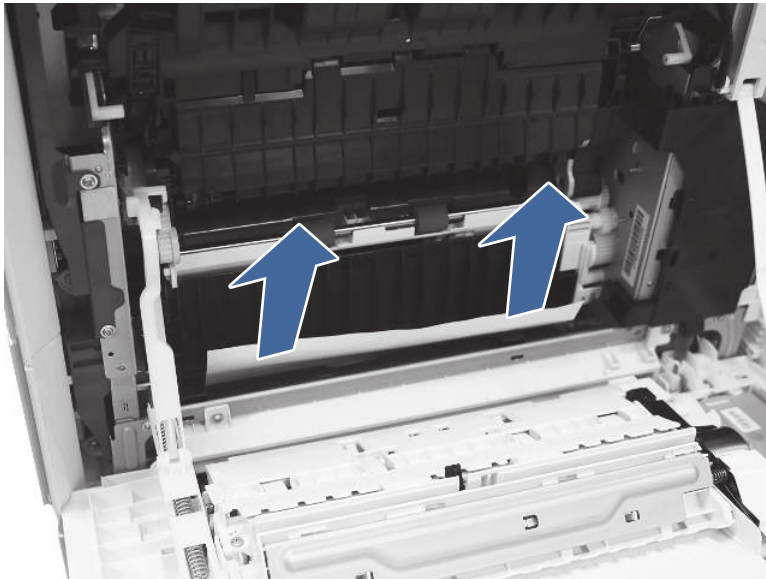

5. Open Tray 3.

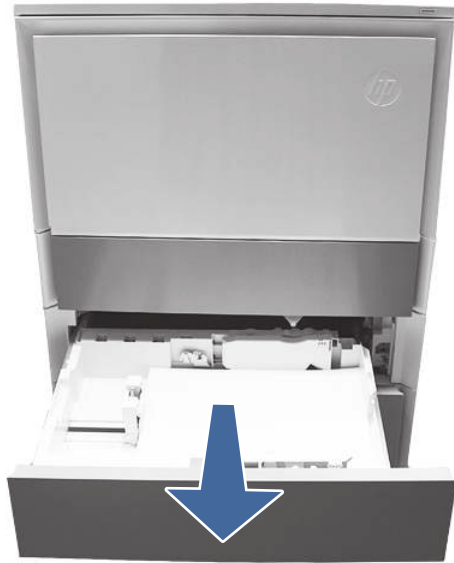

6. Remove the paper from the tray and discard any bent, curled, or damaged sheets.

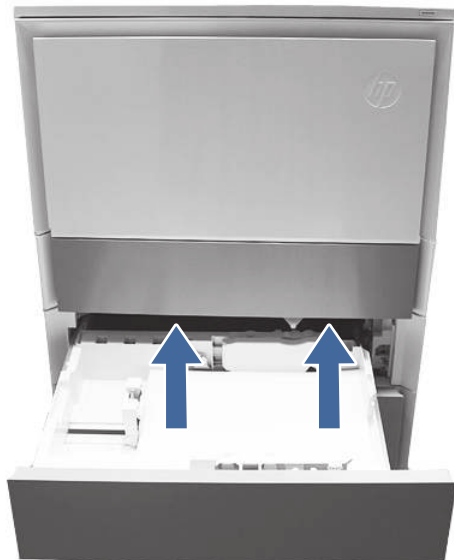

7. Make sure that the tray width and length guides are set to the correct paper size for the paper being installed into the tray and that the tray is not over filled above the fill mark (line below 3 triangles on rear guide).

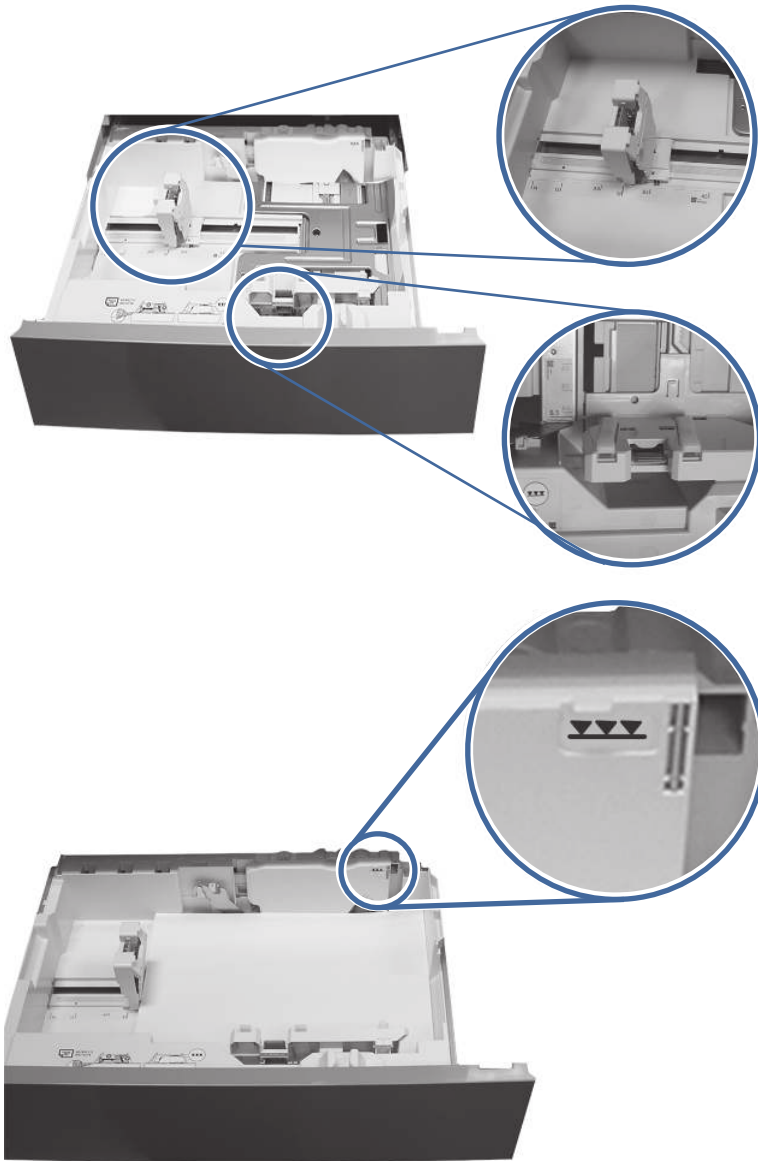

8. Ensure the type and quality of the paper being used meets the HP specifications for the printer.
9. If the error persists, clean the Tray 3 pick, feed, separation rollers.

- a. Open the Tray 3 right door to access the rollers.

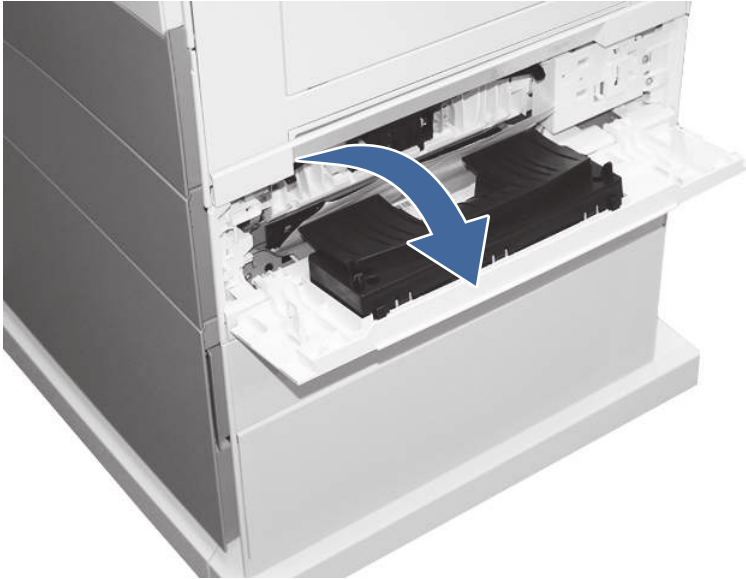

- b. Locate and remove the Tray 3 separation roller.

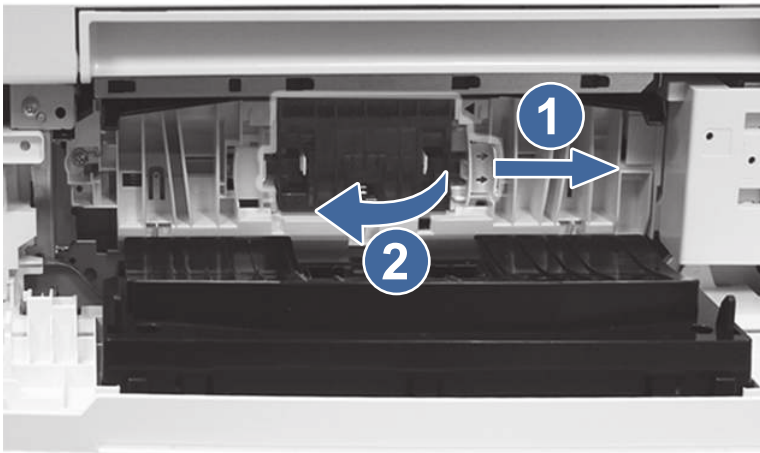

Call-out 1- slide blue locking lever

Call-out 2- Remove the roller assembly.

- c. Remove the Tray 3 pick and feed rollers.

To remove the roller assembly, gently pull on the side of the assembly and slide out as shown.



NOTE: Make sure your hands are clean before touching the rollers. Oils or debris from hands can cause paper pickup issues.

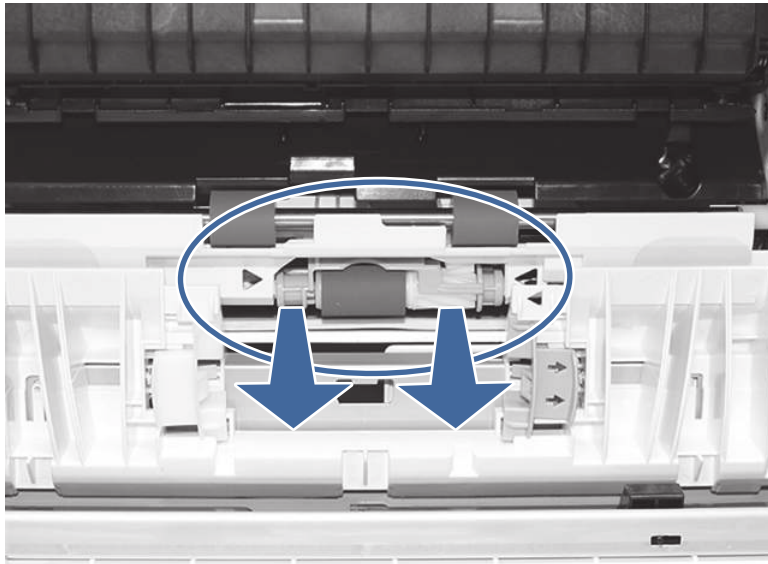

- d. Clean the rollers with a dampened lint free cloth.

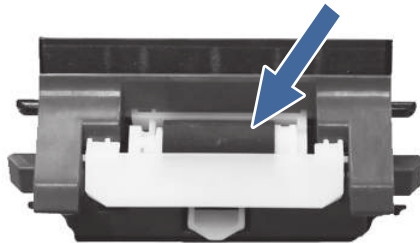
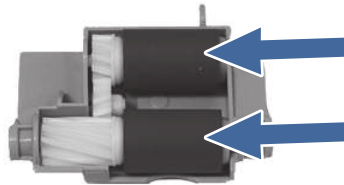

- e. Reinstall the roller assemblies and close the right door.
 - f. Run a print job from Tray 3.
10. If the error persists, contact your HP-authorized service or support provider, or contact customer support at www.hp.com/go/contactHP.

13.A4 jam error in Tray 4

Use the following procedure to check for paper in all possible jam locations related to the 550 sheet Tray 4. When a jam occurs, the control panel displays an animation that assists in clearing the jam.

Recommended action for customers

When a jam occurs, the control panel displays a message and an animation that assists in clearing the jam.

- 13.A4.A4 Paper jam in tray 4
- 13.A4.D4 Paper jam in tray 4

 [View a video of how to clear a jam in Tray 4](#)

1. Open the right door.



2. Gently remove any jammed paper.

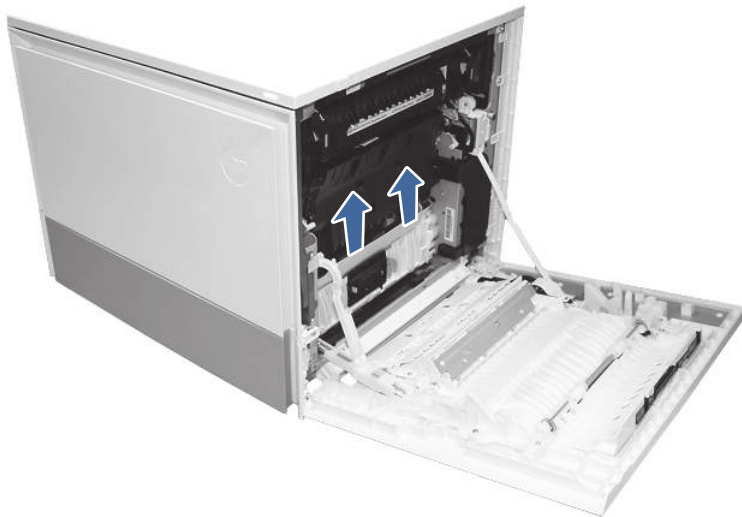

3. Open the Tray 4 right access door.



4. Gently remove any jammed paper.



5. Open the Tray 3 access door and gently remove any jammed paper.

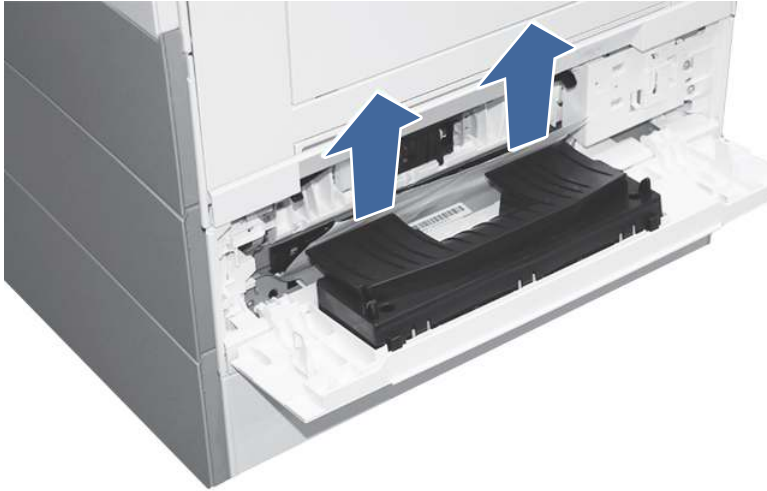

6. Close the right door to clear the control panel message.
7. Open Tray 4.

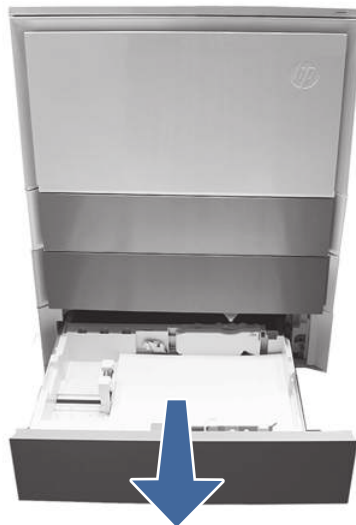

8. Remove the paper from the tray and discard any bent, curled, or damaged sheets.

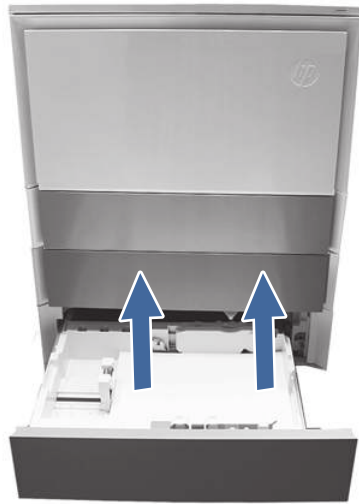

9. Make sure that the tray width and length guides are set to the correct paper size for the paper being installed into the tray and that the tray is not over filled above the fill mark (line below 3 triangles on rear guide).

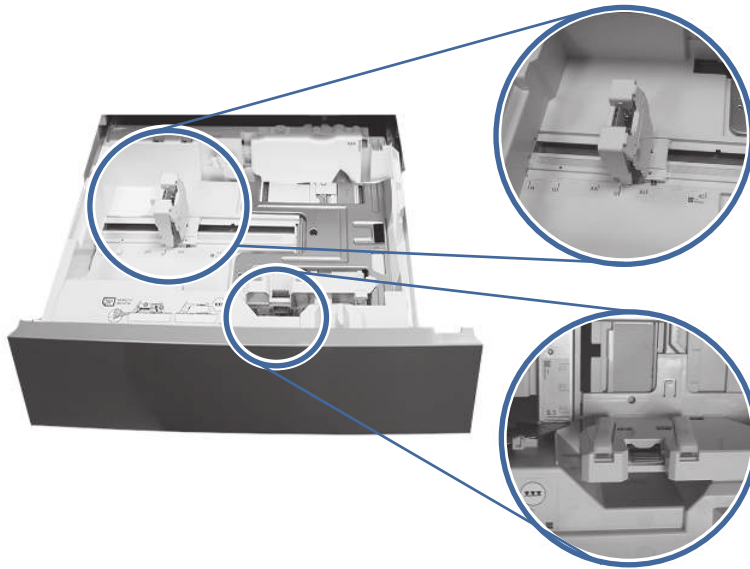

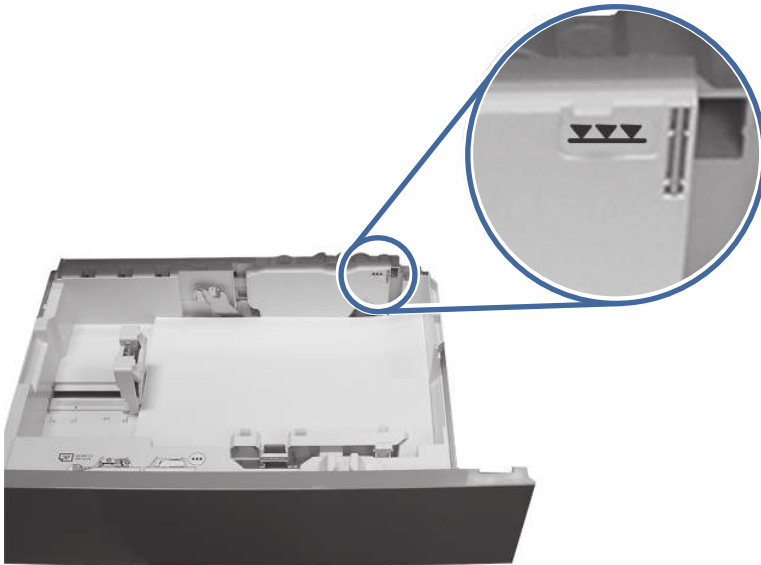

10. Ensure the type and quality of the paper being used meets the HP specifications for the printer.
11. If the error persists, clean the Tray 4 pick, feed, separation rollers.
 - a. Open the Tray 4 door to access the rollers.



- b. Locate and remove the Tray 4 separation roller.

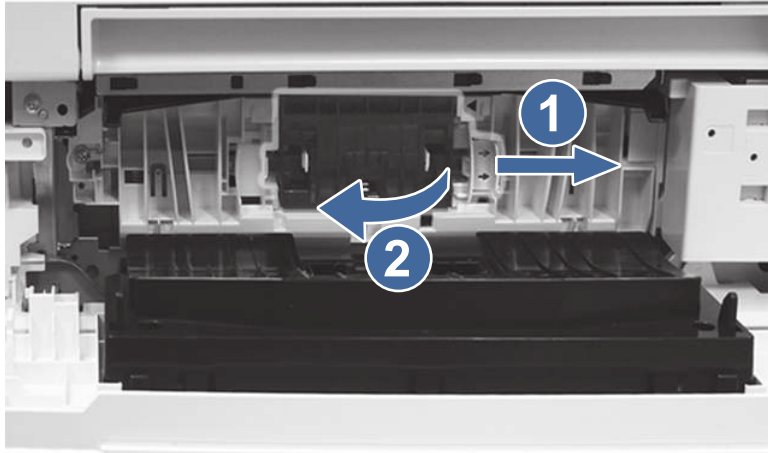

Call-out 1- slide blue locking lever

Call-out 2- Remove the roller assembly.

- c. Remove the Tray 4 pick and feed rollers.

To remove the roller assembly, gently pull on to the side of the rollers as shown.

 **NOTE:** Make sure your hands are clean before touching the rollers. Oils or debris from hands can cause paper pickup issues.

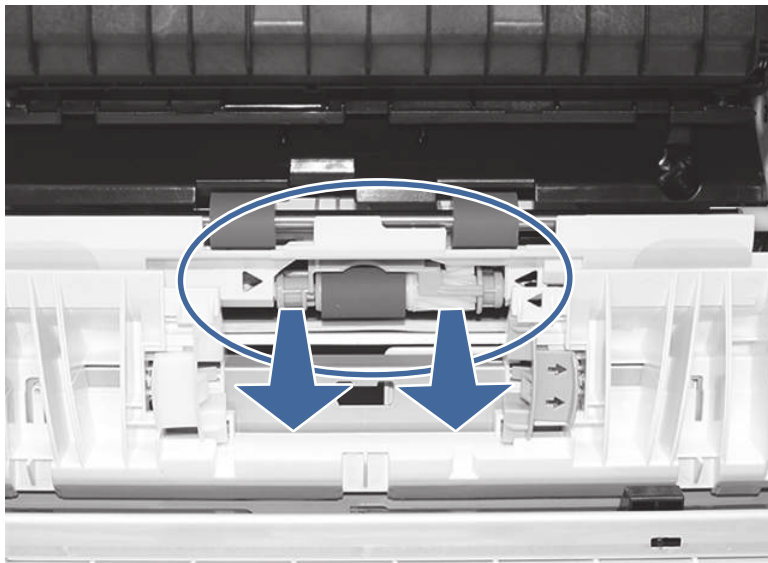

- d. Clean the rollers with a dampened lint free cloth.

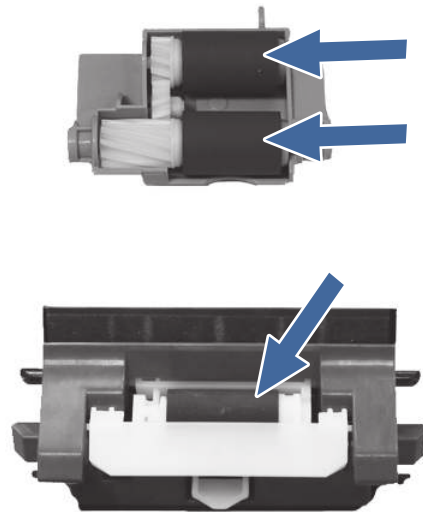

- e. Reinstall the roller assemblies and close the right door.
 - f. Run a print job from Tray 4.
12. If the error persists, contact your HP-authorized service or support provider, or contact customer support at www.hp.com/go/contactHP.

13.A4 jam error in Tray 4 (2,100 sheet feeder HCI)

Use the following procedure to check for paper in all possible jam locations related to the HCI Tray 4. When a jam occurs, the control panel displays an animation that assists in clearing the jam.

Recommended action for customers

When a jam occurs, the control panel displays a message and an animation that assists in clearing the jam.

- 13.A4.A4 Paper jam in tray 4
- 13.A4.D4 Paper jam in tray 4



[View a video of how to clear a jam in the high-capacity input Tray 4](#)

1. Open the printer right door.



2. Gently remove any jammed paper.

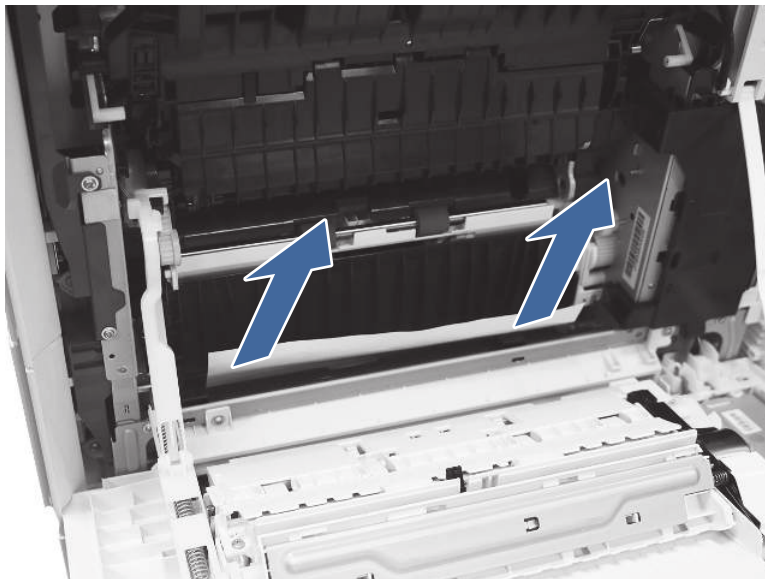

3. Open the Tray 4 right access door.



4. Gently remove any jammed paper.



5. Open the Tray 3 access door and gently remove any jammed paper.

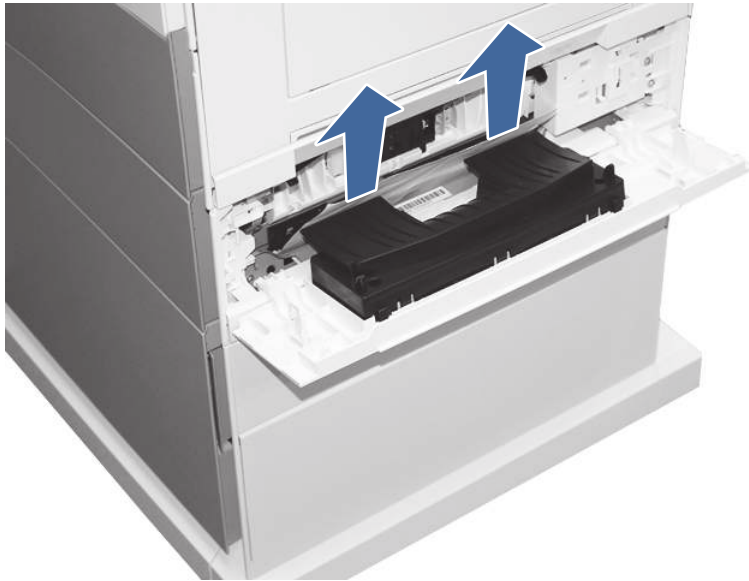

6. Close the right door to clear the control panel message.
7. Open Tray 4.

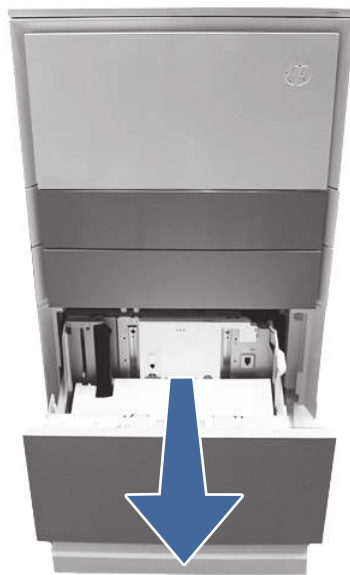

8. Remove the paper from the tray and discard any bent, curled, or damaged sheets.

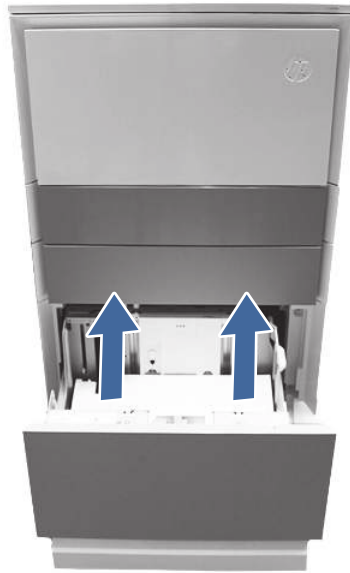

9. Make sure that the tray width guide is set to the correct paper size for the paper being installed into the tray and that the tray is not over filled above the fill mark (line below 3 triangles on rear guide).

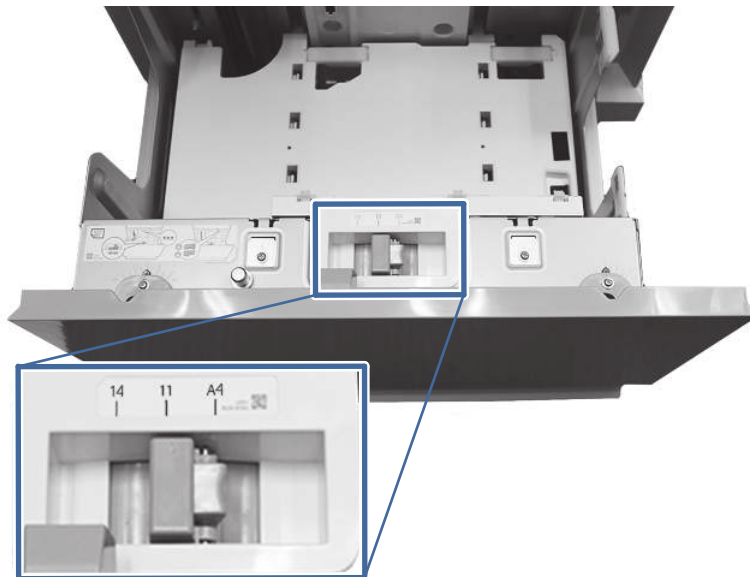

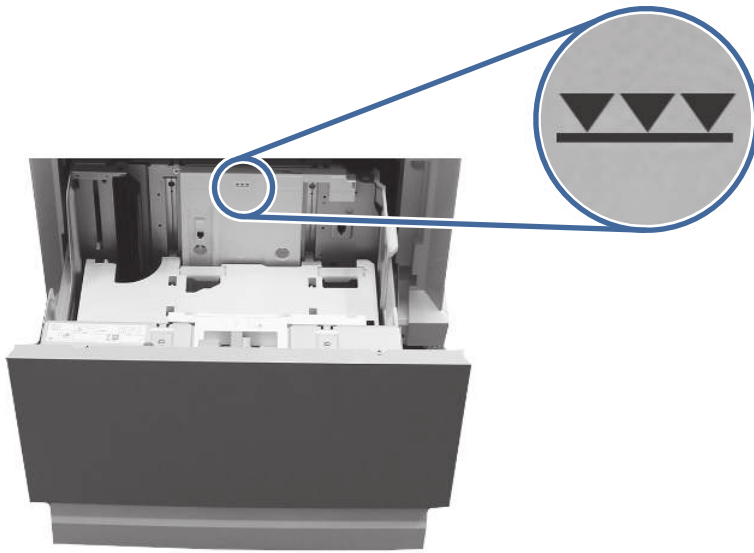

10. Ensure the type and quality of the paper being used meets the HP specifications for the printer.
11. If the error persists, clean the Tray 4 pick, feed, and separation rollers.
 - a. Open the Tray 4 door to access the rollers.



- b. Locate and remove the Tray 4 separation roller.

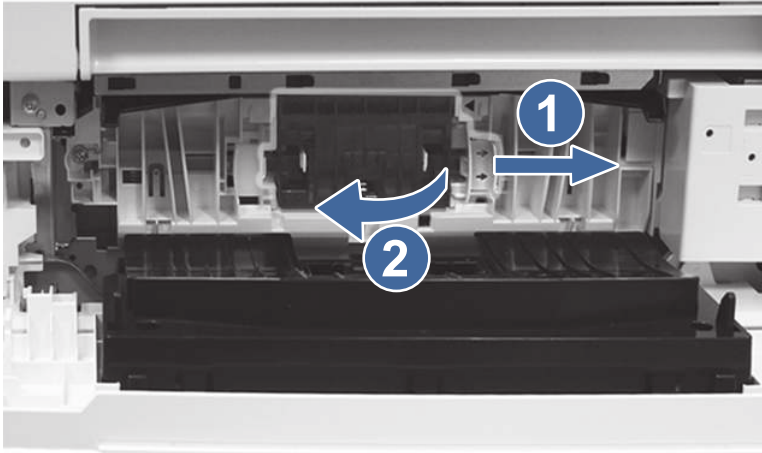

Call-out 1- slide locking lever

Call-out 2- Remove the roller assembly.

- c. Remove the Tray 4 pick and feed rollers.

To remove the roller assembly, gently pull on to the side of the rollers as shown.



NOTE: Do not touch the rubber part of the rollers with hands. Oils or debris from hands can cause paper pickup issues.

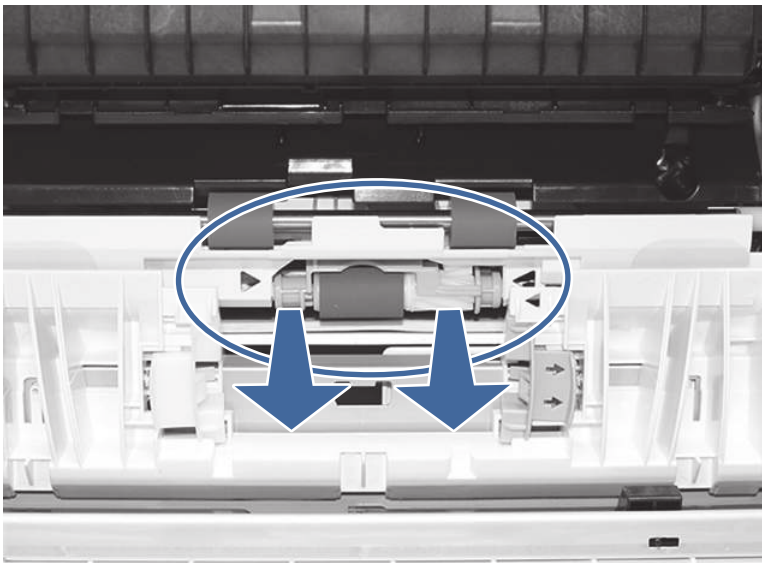

- d. Clean the rollers with a dampened lint free cloth.

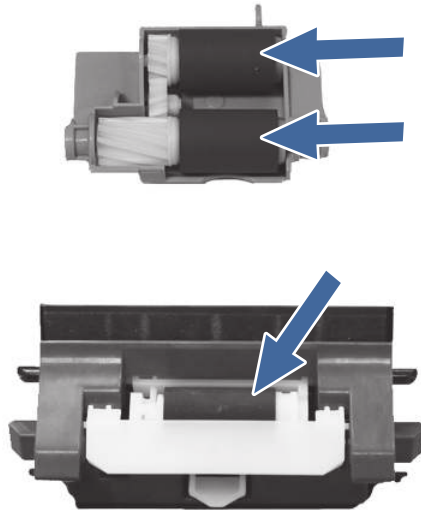

- e. Reinstall the roller assemblies and close the right door.
- f. Run a print job from Tray 4.
12. If the error persists, contact your HP-authorized service or support provider, or contact customer support at www.hp.com/go/contactHP.

13.B2 jam error in right door

Use the following procedure to clear paper jams in the right door and fuser area. When a jam occurs, the control panel displays an animation that assists in clearing the jam.

Recommended action for customers

When a jam occurs, the control panel displays a message and an animation that assists in clearing the jam.

- 13.B2.Az Stay jam in right door
- 13.B2.Dz Delay jam in right door
- 13.B2.5z Inappropriate page to the Delivery Path jam
- 13.B2.FF Residual paper jam in right door

z = paper tray. This can be trays 1-5 or "D" for duplex jobs

Or

z = Fuser mode. This can be 0-9 or A-F.



[View a video of how to clear a jam in the right door and fuser area](#)



CAUTION:



The fuser can be hot while the printer is in use. Wait for the fuser to cool before handling it.

1. Open the right door.

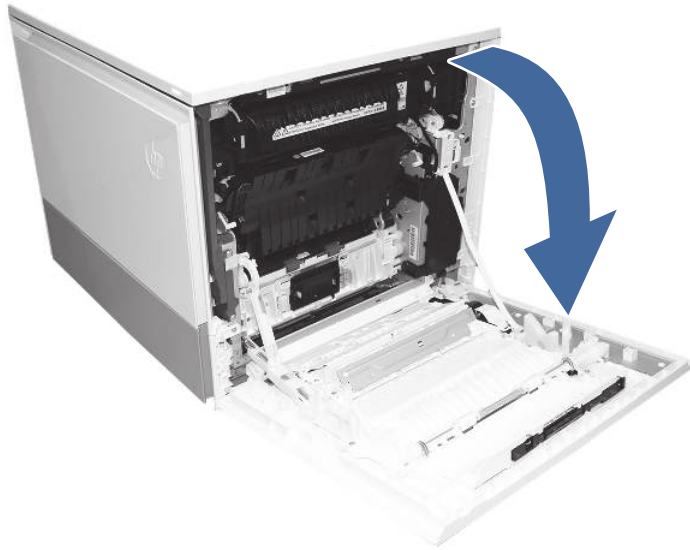

2. Gently remove any jammed paper.

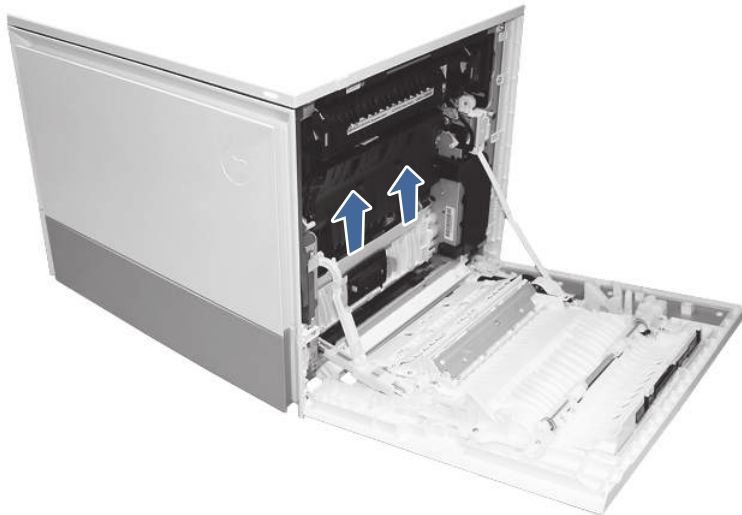

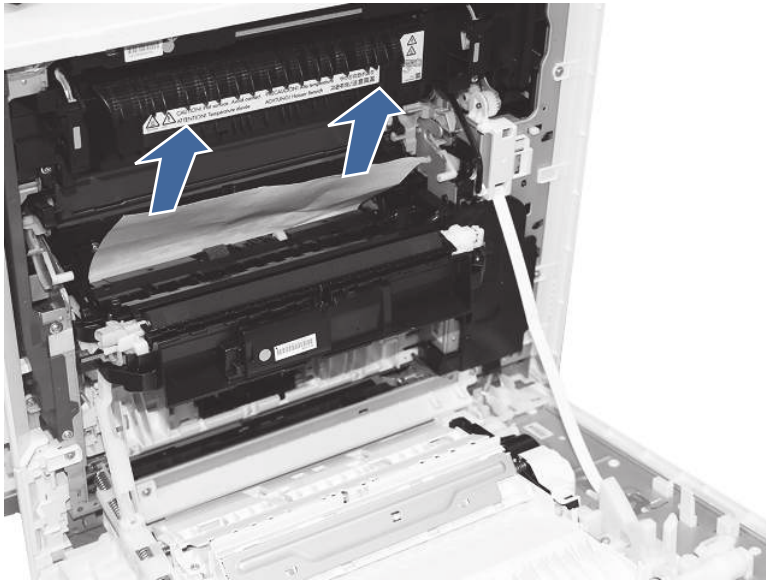

3. Gently remove any jammed paper from the duplexer paper path.

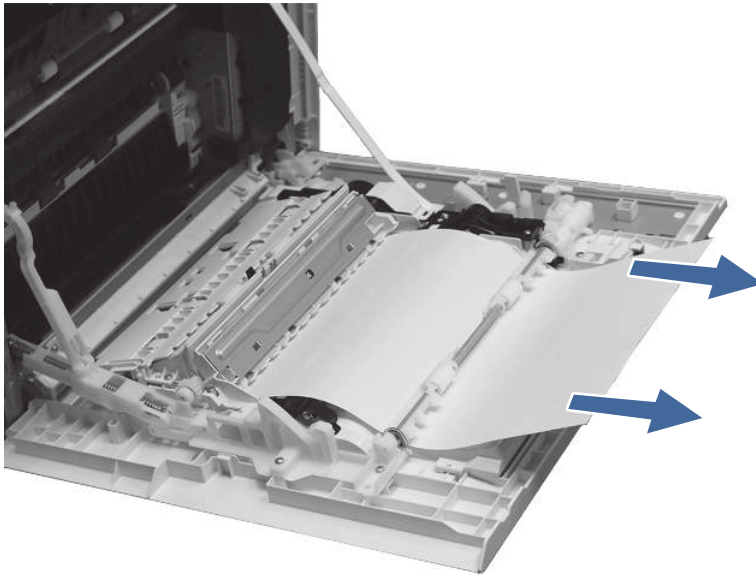

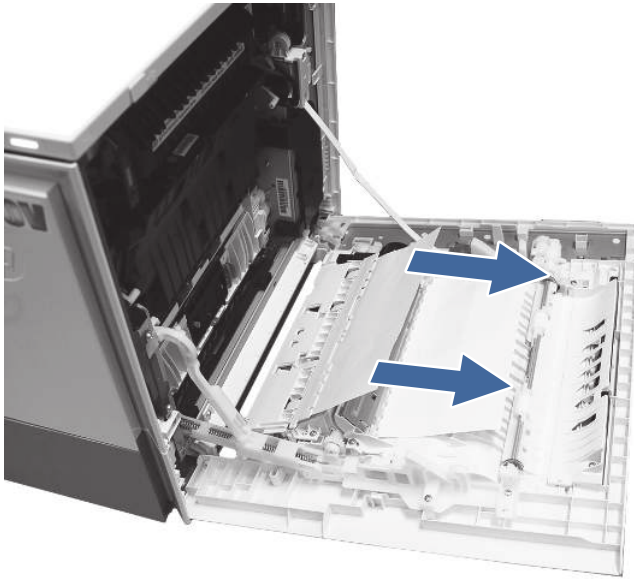

 **IMPORTANT:** Make sure the paper being used is not too short for the printer's duplexer requirements.

4. Close the right door.
5. Ensure the type and quality of the paper being used meets the HP specifications for the printer.
6. Ensure the paper tray guides are set to the correct size for the paper loaded.
7. If the error persists, contact your HP-authorized service or support provider, or contact customer support at www.hp.com/go/contactHP.

13.B4 jam errors in the right door

Use the following procedure to clear paper jams in the right door and fuser area. When a jam occurs, the control panel displays an animation that assists in clearing the jam.



Recommended action for customers

When a jam occurs, the control panel displays a message and an animation that assists in clearing the jam.

- 13.B4.Cz Jam in right door
- 13.B4.FF Residual paper jam in right door

z = paper tray. This can be trays 1-5 or "D" for duplex print jobs.

 [View a video of how to clear a jam in the right door and fuser area](#)

 **CAUTION:**  The fuser can be hot while the printer is in use. Wait for the fuser to cool before handling it.

1. Open the right door.

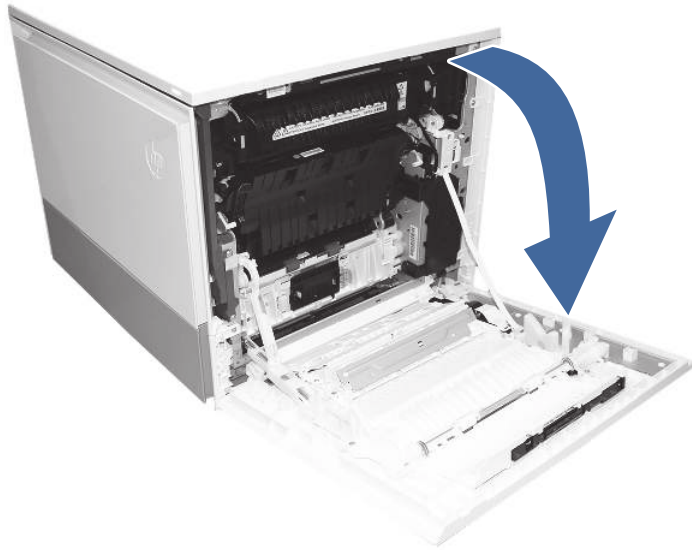

2. Gently remove any jammed paper.

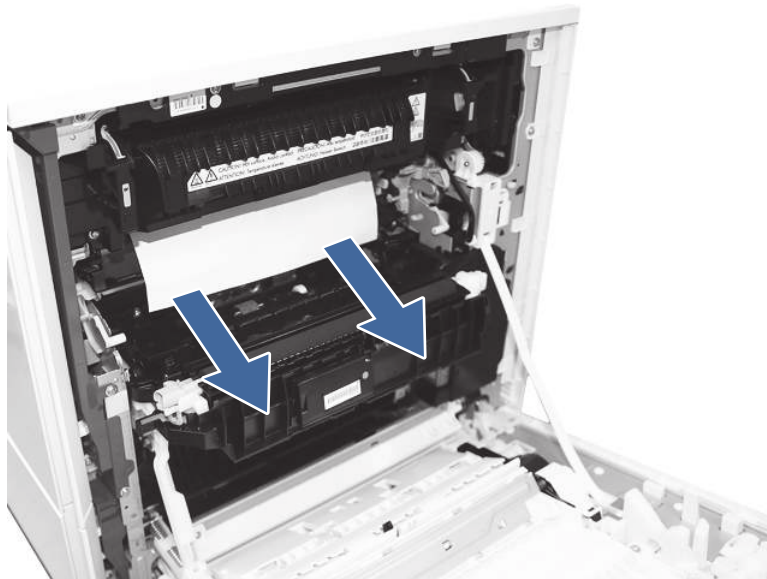

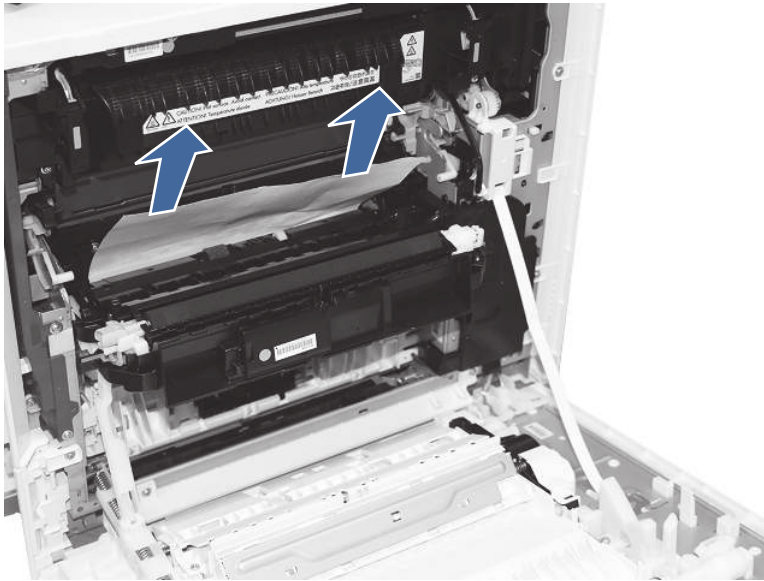

3. Close the right door.
4. Ensure the type and quality of the paper being used meets the HP specifications for the printer.
5. Ensure the paper tray guides are set to the correct size for the paper loaded.
6. If the error persists, contact your HP-authorized service or support provider, or contact customer support at www.hp.com/go/contactHP.

13.B9 jam errors in the fuser

Use the following procedure to clear paper jams in the right door and fuser area. When a jam occurs, the control panel displays an animation that assists in clearing the jam.

Recommended action for customers

When a jam occurs, the control panel displays a message and an animation that assists in clearing the jam.

- 13.B9.yz Jam in right door

y = jam type (A or D)

z = Paper tray. This can be 0-5 or "D" for duplex print jobs.

Or

z = Fuser mode. This can be 0-9 or A-F.

- 13.B9.Cz Jam in right door (Fuser wrap jam)

z = Fuser mode. This can be 0-9 or A-F.

- 13.B9.FF Residual paper jam in right door

 [View a video of how to clear a jam in the right door and fuser area](#)

 **NOTE:** The fuser is hot while the printer is in use. Wait for the fuser to cool before clearing jams.

1. Open the right door.

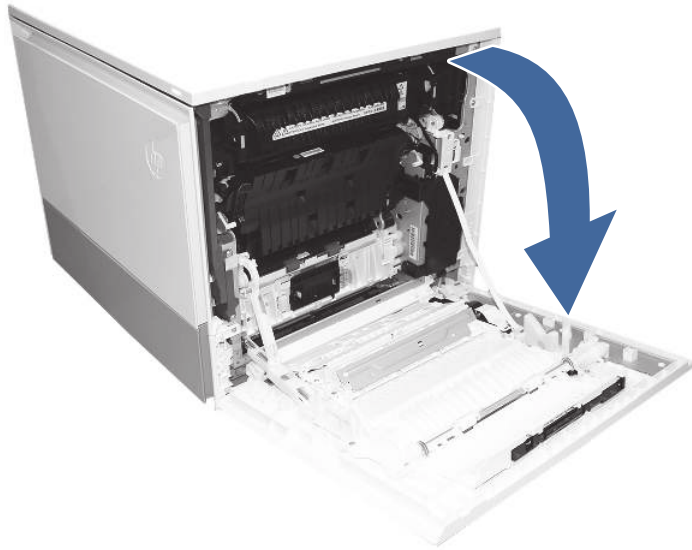

2. Gently remove any jammed paper from the fuser input.

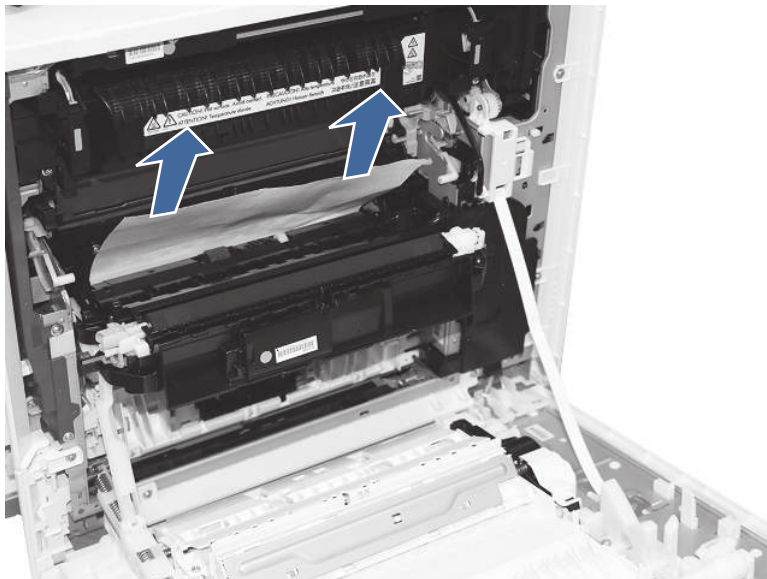

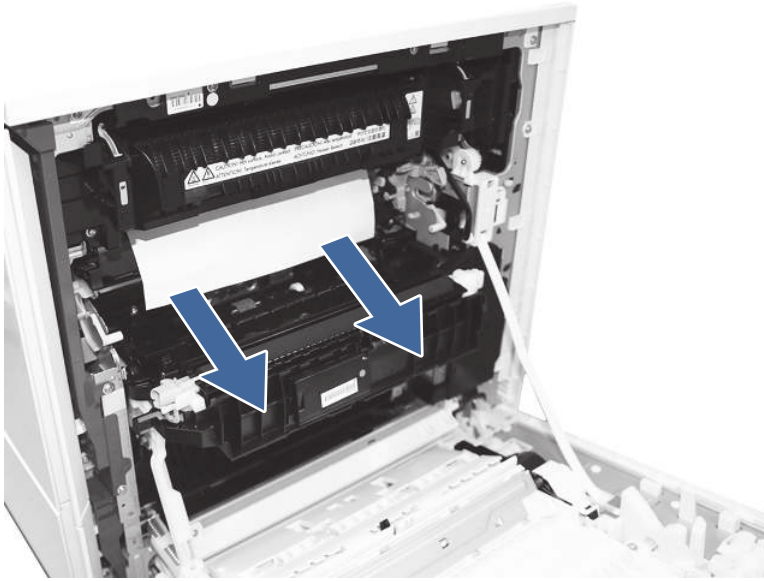

3. Remove the fuser and remove any jammed paper found.
 - a. Squeeze the release levers on the handles (circle call-outs) and then remove the fuser.

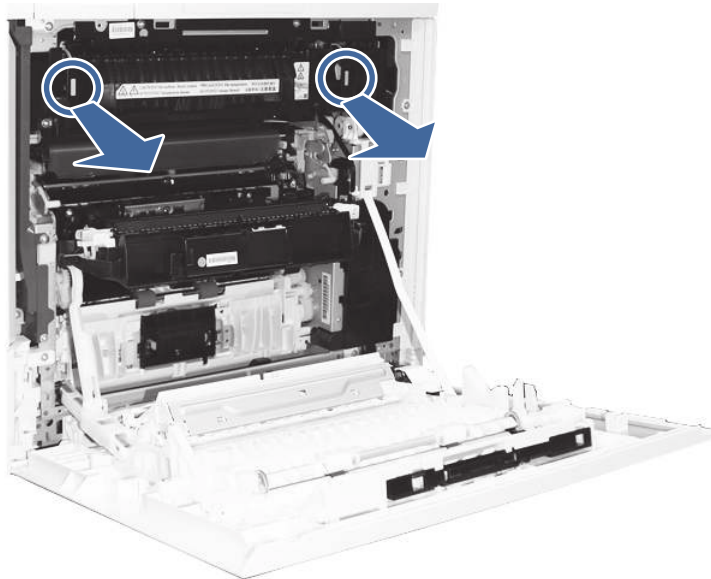

- b. Remove any paper from the exit of the fuser.

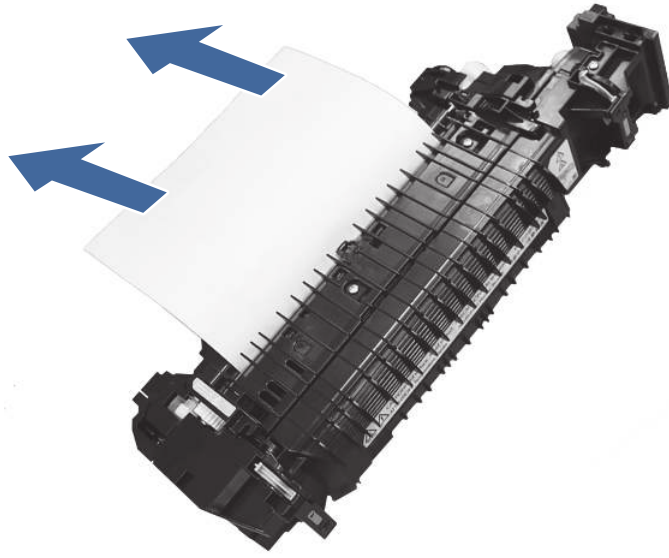

- c. Open the fuser access and check for a z-fold paper jam.

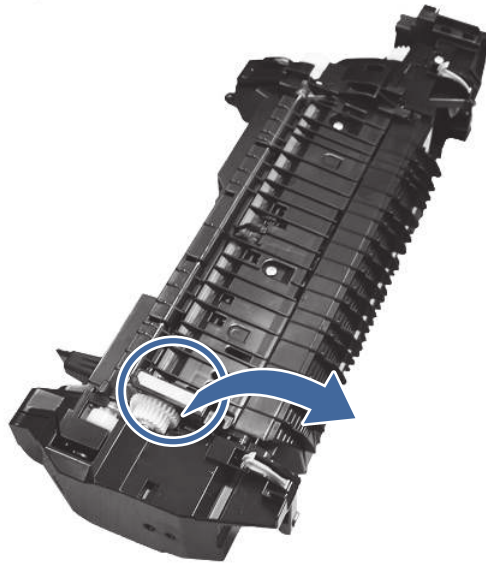

- d. Remove jammed paper from fuser.

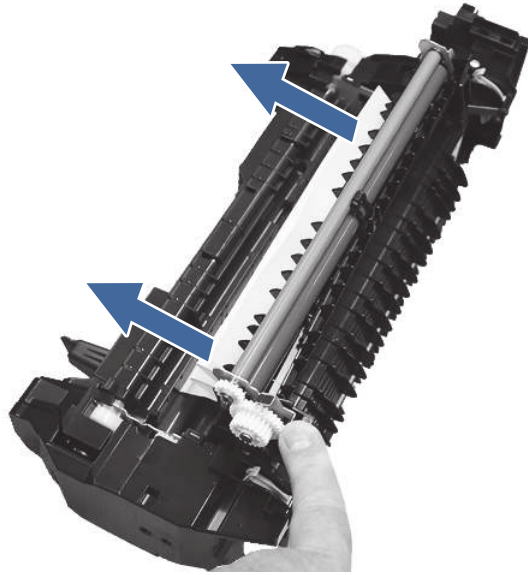

- e. Reinstall the fuser and close the right door.
4. If the error persists, ensure the type and quality of the paper being used meets the HP specifications for the printer.
 5. If the error persists, contact your HP-authorized service or support provider, or contact customer support at www.hp.com/go/contactHP.

13.D3 jam errors in the duplexer

Use the following procedure to clear paper jams in the duplexer area. When a jam occurs, the control panel displays an animation that assists in clearing the jam.

Recommended action for customers

When a jam occurs, the control panel displays a message and an animation that assists in clearing the jam.

- 13.D3.Dz Duplex delivery delay jam
- 13.D3.FF Residual paper jam in right door

z = Fuser mode. This can be 0-9 or A-F.



[View a video of how to clear a jam in the right door and fuser area](#)



NOTE: The fuser is hot while the printer is in use. Wait for the fuser to cool before clearing jams.

1. Open the right door.

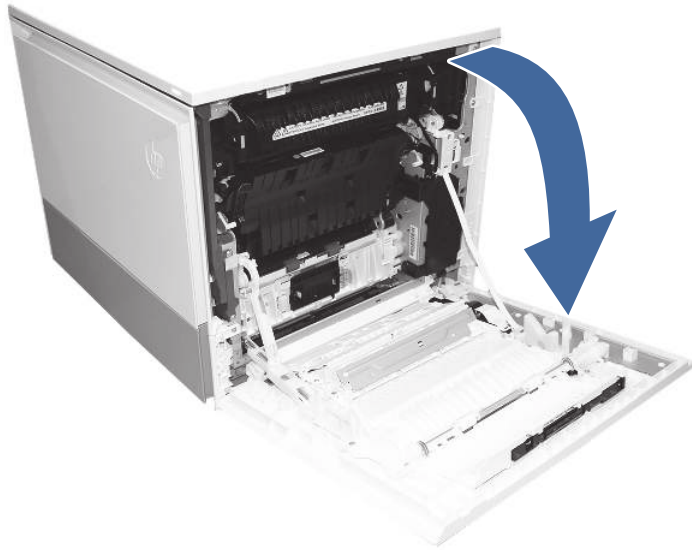

2. Gently remove any jammed paper from the duplexer paper path.

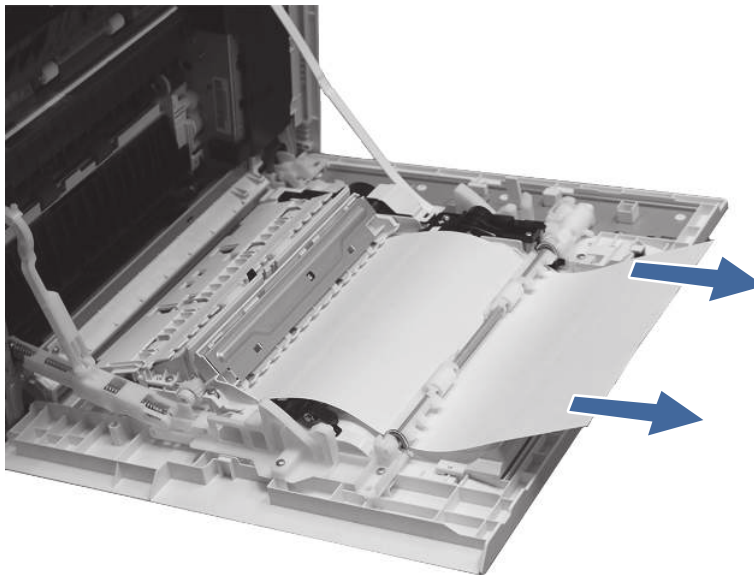

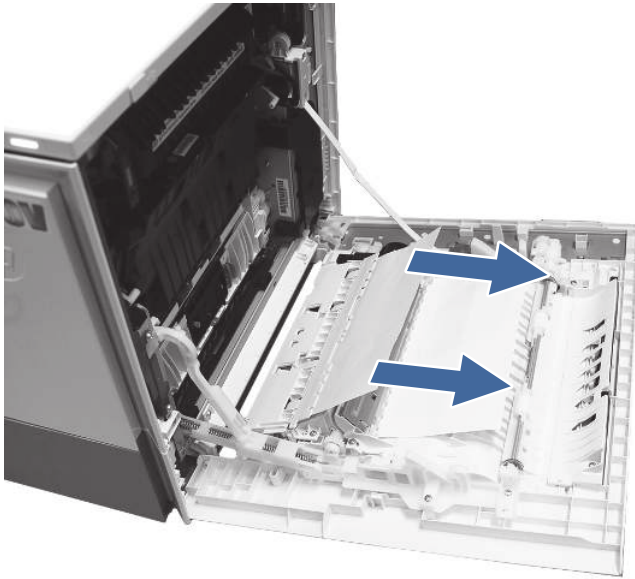

3. Close the right door.
4. If the error persists, ensure the type and quality of the paper being used meets the HP specifications for the printer.
5. If the error persists, contact your HP-authorized service or support provider, or contact customer support at www.hp.com/go/contactHP.

13.E1 jam error in the output bin

Use the following procedure to check for paper in all possible jam locations in the output bin. When a jam occurs, the control panel displays an animation that assists in clearing the jam.

Recommended action for customers

When a jam occurs, the control panel displays a message and an animation that assists in clearing the jam.

- 13.E1.Dz Jam in output bin
- 13.E1.FF Residual paper jam in output bin

z = paper type that is being printed on. This can be 0-9 or A-F.

 [View a video of how to clear a jam in the output bin](#)

1. If paper is visible in the output bin, grasp the leading edge and remove it.



2. Ensure the type and quality of the paper being used meets the HP specifications for the printer.
3. If the error persists, contact your HP-authorized service or support provider, or contact customer support at www.hp.com/go/contactHP.

13.E2 jam error in top cover

Use the following procedure to check for paper in all possible jam locations in the top cover area. When a jam occurs, the control panel displays an animation that assists in clearing the jam.

Recommended action for customers

When a jam occurs, the control panel displays a message and an animation that assists in clearing the jam.

- 13.E2.yz Jam in Top cover
y = "A" (stay jam) or "D" (delay jam)
z = 1-4 (output bin page is going to)

These jams can only be present if the floor standing finisher is installed

 [View a video of how to clear a jam in the output bin](#)

1. Open the printer top access cover.



2. Remove all paper from inside the top cover.





3. Make sure that the floor standing finisher is correctly secured to the printer.
4. Make sure the type and quality of the paper being used meets the HP specifications for the printer.
5. If the error persists, contact your HP-authorized service or support provider, or contact customer support at www.hp.com/go/contactHP.

13.60 jam errors in the fuser exit area when printing to a stapler/stacker or floor-standing finisher

Use the following procedure to check for paper in all possible jam locations in the fuser exit area when printing to a finisher. When a jam occurs, the control panel displays an animation that assists in clearing the jam.

Recommended action for customers

When a jam occurs, the control panel displays a message and an animation that assists in clearing the jam.

- 13.60.51, 13.60.52 Paper too short jam
- 13.60.61, 13.60.62, 13.60.63, 13.60.64 Inter-Page Gap Jam

 **NOTE:** The images provide do not show any accessories or copy module attached to the printer.

 [View a video of how to clear a jam in the output bin](#)

1. Open the right door.

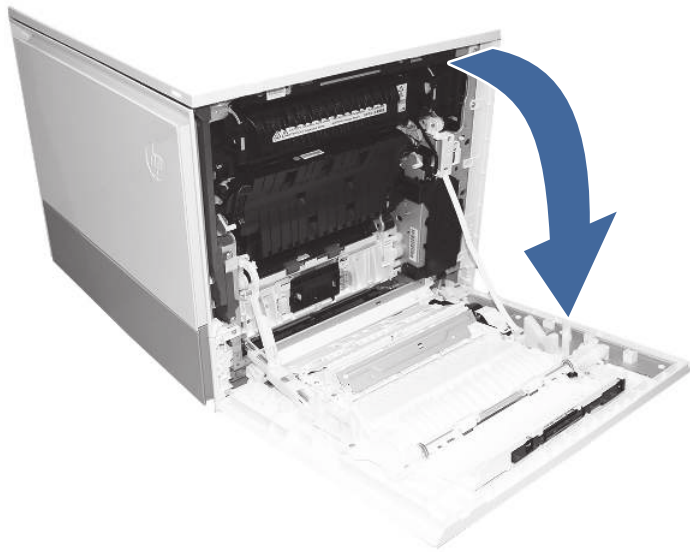

2. Remove the fuser and remove any jammed paper found.
 - a. Squeeze the release levers on the handles (circle call-outs) and then remove the fuser.

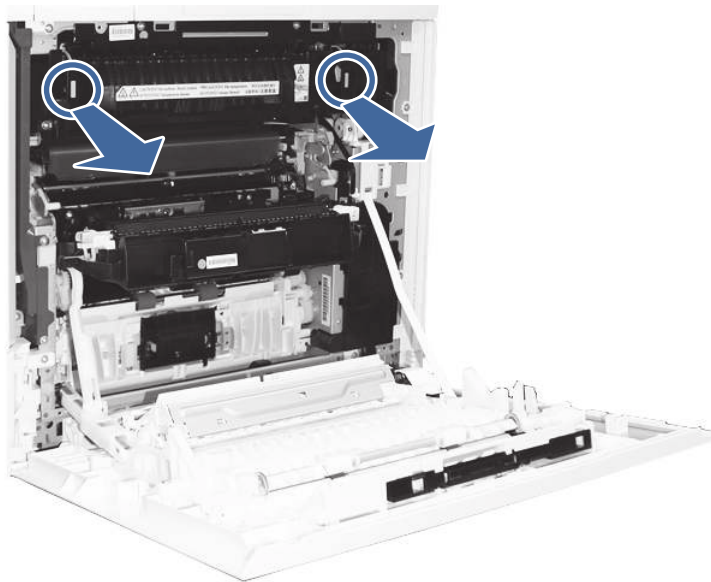

- b. Remove any paper jammed in the fuser exit area.

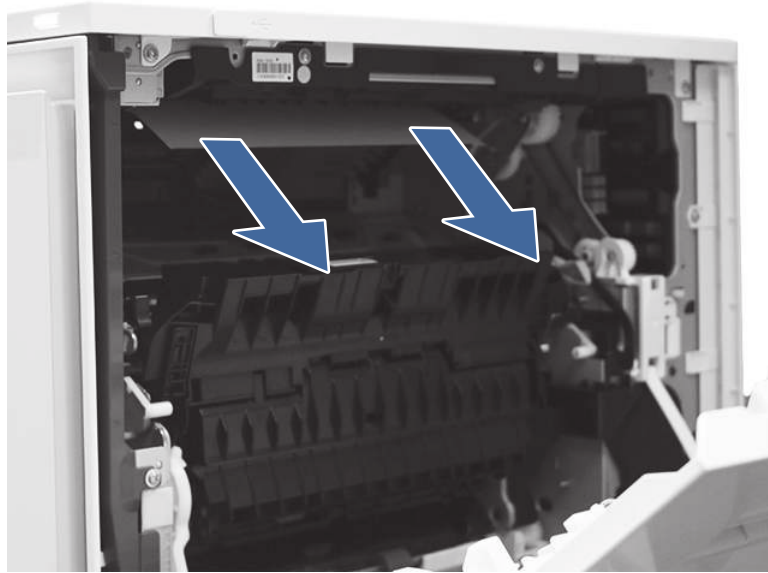

- c. Reinstall the fuser and close the right door.
3. Close right door to allow the printer to clear jam message.
4. Ensure the type and quality of the paper being used meets the HP specifications for the printer.
5. If the error persists, contact your HP-authorized service or support provider, or contact customer support at www.hp.com/go/contactHP.

13.80, 13.83, or 13.84 jam errors in the 3 Bin Stapler/Stacker

Use the following procedure to check for paper in all possible jam locations in the 3-bin stapler/stacker. When a jam occurs, the control panel displays an animation that assists in clearing the jam.

Recommended action for customers

When a jam occurs, the control panel displays a message and an animation that assists in clearing the jam.

- 13.80.yz Jam in 3 Bin stapler/stacker
- 13.83.yz Jam in 3 Bin stapler/stacker
- 13.84.yz Jam in 3 Bin stapler/stacker

y = "A" (stay jam), "B" (delay jam) "F" (residual jam)

z = Output destination tray 0-4



[View a video of how to clear a jam in the output bin](#)

1. Remove any paper from the output bins.



2. Clear all paper from upper right door.
 - a. Open the upper right door.



- b. Remove paper from input area inside the door.



- c. Remove paper from upper output area inside the door.



- d. Remove paper from upper standard exit area.

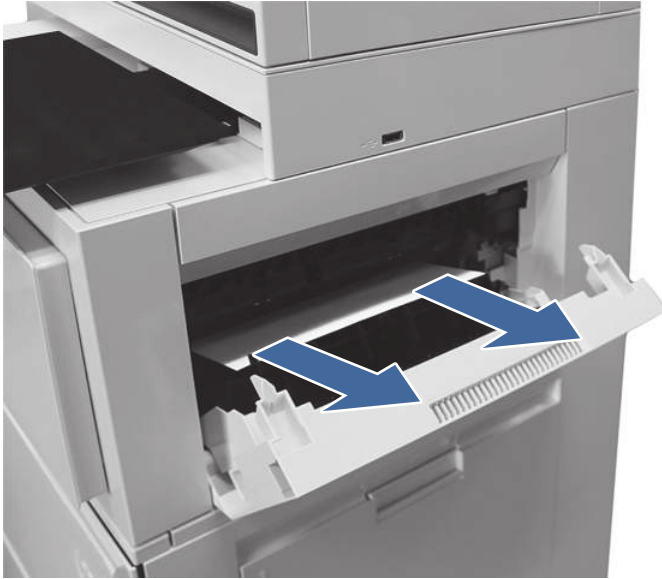

- e. Close the upper right door.

3. Open the right door.

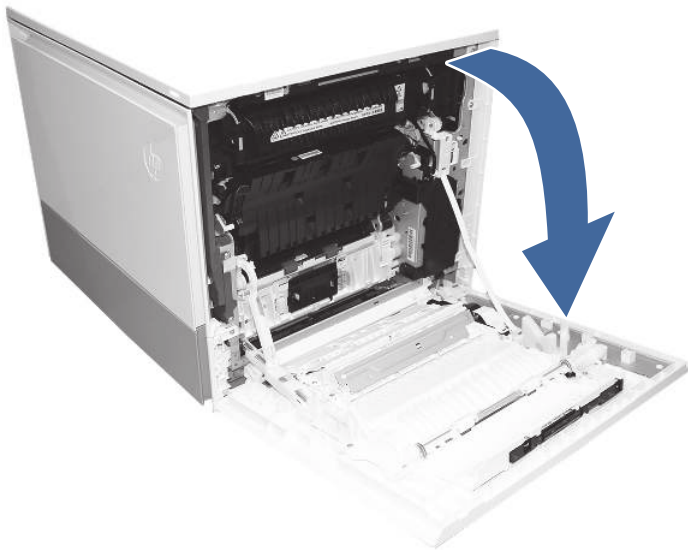

4. Remove the fuser and remove any jammed paper found.

- a. Squeeze the release levers on the handles (circle call-outs) and then remove the fuser.

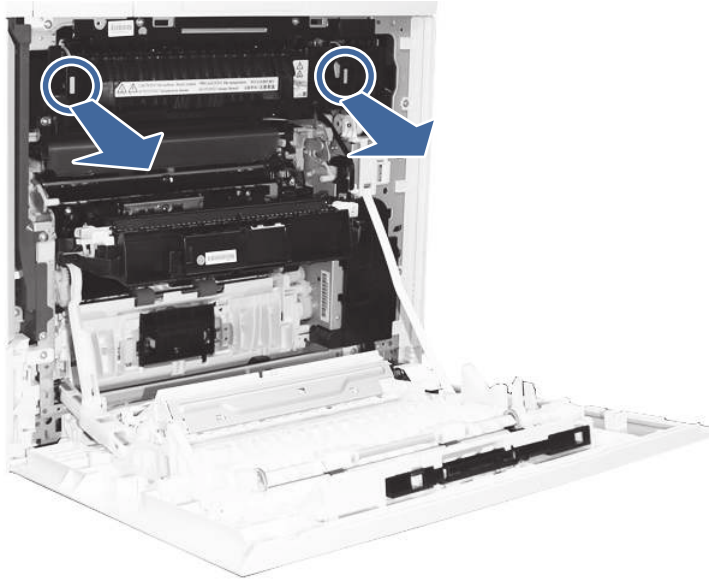

- b. Remove any paper jammed in the fuser exit area.

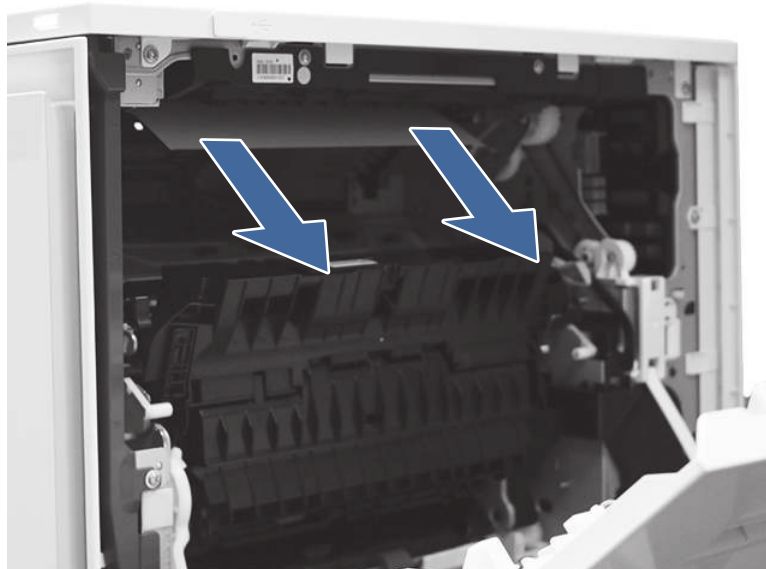

- c. Reinstall the fuser and close the right door.
5. Ensure the type and quality of the paper being used meets the HP specifications for the printer.
6. If the error persists, contact your HP-authorized service or support provider, or contact customer support at www.hp.com/go/contactHP.

Printer feeds incorrect page size

Review the following information when the printer feeds an incorrect page size.

Table 4-24 Printer feeds incorrect page size

Cause	Solution
The correct size paper is not loaded in the tray.	Load the correct size paper in the tray.
The correct size paper is not selected in the software program or printer driver.	Confirm that the settings in the software program and printer driver are correct, because the software program settings override the printer driver and control panel settings, and the printer driver settings override the control panel settings.
The correct size paper for the tray is not selected in the printer control panel.	From the control panel, select the correct size paper for the tray.
The paper size is not configured correctly for the tray.	Print a configuration page to determine the paper size for which the tray is configured.
The guides in the tray are not against the paper.	Verify that the paper guides are touching the paper.

Printer pulls from incorrect tray

Review the following information when the printer pulls from an incorrect tray.

Table 4-25 Printer pulls from incorrect tray

Cause	Solution
A driver for a different printer is in use.	Use a driver for this printer.
The specified tray is empty.	Load paper in the specified tray.
The paper size is not configured correctly for the input tray.	Print a configuration page or use the control panel to determine the paper size for which the tray is configured.
The guides in the tray are not against the paper.	Verify that the guides are touching the paper.

Printer will not duplex or duplexes incorrectly (duplex models)

Review the following information when the printer will not duplex or duplexes incorrectly.

Table 4-26 Printer will not duplex (print 2-sided jobs) or duplexes incorrectly

Cause	Solution
The duplex job is trying to use unsupported paper.	Verify that the paper is supported for duplex printing.
The printer driver is not set up for duplex printing.	Set up the printer driver to enable duplex printing.
The first page is printing on the back of preprinted forms or letterhead.	Load preprinted forms and letterhead in Tray 1 with the letterhead or printed side down, with the top of the page leading into the printer. For Tray 2-X, load the paper printed side up with the top of the page toward the right of the printer.
The printer model does not support automatic 2-sided printing.	The printer model does not support automatic 2-sided printing.

Paper does not feed from Tray 2-X

Review the following information when the paper does not feed from Tray 2-X.

Table 4-27 Paper does not feed from Tray 2-X

Cause	Solution
The correct size paper is not loaded.	Load the correct size paper.
The input tray is empty.	Load paper in the input tray.
The correct paper type for the input tray is not selected in the printer control panel.	From the printer control panel, select the correct paper type for the input tray. Trays configured for a paper type with a specific weight range will not match a print job that specifies an exact weight, even if the specified weight is within the weight range.
Paper from a previous jam has not been completely removed.	Open the printer and remove any paper in the paper path. Closely inspect the fuser area for jams.
None of the optional trays appear as input tray options.	The optional trays only display as available if they are installed. Verify that any optional trays are correctly installed. Verify that the printer driver has been configured to recognize the optional trays.
An optional tray is incorrectly installed.	Print a configuration page to confirm that the optional tray is installed. If not, verify that the tray is correctly attached to the printer.
The paper size is not configured correctly for the input tray.	Print a configuration page or use the control panel to determine the paper size for which the tray is configured.
The guides in the tray are not against the paper.	Verify that the guides are touching the paper.

Output is curled or wrinkled

Review the following information when the output is curled or wrinkled.

Table 4-28 Output is curled or wrinkled

Cause	Solution
Paper does not meet the specifications for this printer.	Use only paper that meets the HP paper specifications for this printer. Non-recycled, 75 g/m ² (20 lb) paper is optimal for office use.
The correct paper type for the input tray is not selected in the printer control panel.	From the printer control panel, select the correct paper type for the input tray. Trays configured for a paper type with a specific weight range will not match a print job that specifies an exact weight, even if the specified weight is within the weight range.
Paper is damaged or in poor condition.	Remove paper from the input tray and load paper that is in good condition.
The printer is operating in an excessively humid environment.	Verify that the printing environment is within humidity specifications.
The print job consist of large, solid-filled areas.	Large, solid-filled areas can cause excessive curl. Try using a different pattern.
Paper used was not stored correctly and might have absorbed moisture.	Remove paper and replace it with paper from a fresh, unopened package. Store paper in a plastic bag to protect it from humidity.
Paper has poorly cut edges.	Remove paper, flex it, rotate it 180 degrees or turn it over, and then reload it into the input tray. Do not fan paper. If the problem persists, replace the paper.

Table 4-28 Output is curled or wrinkled (continued)

Cause	Solution
The specific paper type was not configured for the tray or selected in the software.	Configure the software for the paper (see the software documentation). Configure the tray for the paper.
The paper has previously been used for a print job.	Do not re-use paper.

The printer does not pick up paper

If the printer does not pick up paper from the tray, try these solutions.



NOTE: Tray 1 and Tray 2 are optimal for paper pickup when using special paper or media other than 20lb plain paper. For Tray 1 and Tray 2 the printer increases the number of attempts to pick up a page, which increases the reliability of successfully picking the page from the tray and decreases the possibility of a mispick jam.

HP recommends using Tray 1 or Tray 2 if the printer is experiencing excessive or reoccurring jams from trays other than Tray 1 and Tray 2, or for print jobs that require media other than 20lb plain paper.

1. Open the printer and remove any jammed sheets of paper.
2. Load the tray with the correct size of paper for the job.
3. Make sure the paper size and type are set correctly on the printer control panel.
4. Make sure the paper guides in the tray are adjusted correctly for the size of paper. Adjust the guides to the appropriate indentation in the tray.
5. Check the printer control panel to see if the printer is waiting for an acknowledgment to the feed the paper manually prompt. Load paper, and continue.
6. The rollers above the tray might be contaminated. Clean the rollers with a lint-free cloth dampened with warm water.

The printer picks up multiple sheets of paper

If the printer picks up multiple sheets of paper from the tray, try these solutions.

1. Remove the stack of paper from the tray and flex it, rotate it 180 degrees, and flip it over. *Do not fan the paper.* Return the stack of paper to the tray.
2. Use only paper that meets HP specifications for this printer.
3. Use paper that is not wrinkled, folded, or damaged. If necessary, use paper from a different package.
4. Make sure the tray is not overfilled. If it is, remove the entire stack of paper from the tray, straighten the stack, and then return some of the paper to the tray.
5. Make sure the paper guides in the tray are adjusted correctly for the size of paper. Adjust the guides to the appropriate indentation in the tray.
6. Make sure the printing environment is within recommended specifications.
7. The tray pick and/or feed rollers might be contaminated. Clean the rollers with a lint-free cloth dampened with warm water.

The document feeder jams, skews, or picks up multiple sheets of paper (MFP)

Learn about MFP document feeder paper handling problems.

Review the following information when the document feeder jams, skews, or picks up multiple sheets of paper.

- Check to see if there are areas on the page that might have had staples removed. This can cause jams and/or mispicks.
- The original might have something on it, such as staples or self-adhesive notes that must be removed.
- Check that all rollers are in place and correctly installed.
- Make sure that the top document-feeder cover is closed.
- The pages might not be placed correctly. Straighten the pages and adjust the paper guides to center the stack.
- The paper guides must be touching the sides of the paper stack to work correctly. Make sure that the paper stack is straight, and the guides are against the paper stack.
- The document feeder input tray or output bin might contain more than the maximum number of pages. Make sure the paper stack fits below the guides in the input tray and remove pages from the output bin.
- Verify that there are no pieces of paper, staples, paper clips, or other debris in the paper path.
- Clean the document-feeder rollers and the separation pad. Use compressed air or a clean, lint-free cloth moistened with warm water. If misfeeds still occur, replace the rollers.
- Use the control panel menus to check the status of the document-feeder kit and replace it if necessary.

Paper does not feed automatically

Review the following information when the paper does not feed automatically.

Table 4-29 Paper does not feed automatically

Cause	Solution
Manual feed is selected in the software program.	Load Tray 1 with paper, or, if the paper is loaded, press the OK button.
The correct size paper is not loaded.	Load the correct size paper.
The input tray is empty.	Load paper into the input tray.
Paper from a previous jam has not been completely removed.	Open the printer and remove any paper in the paper path.
The paper size is not configured correctly for the input tray.	Print a configuration page or use the control panel to determine the paper size for which the tray is configured.
The guides in the tray are not against the paper.	Verify that the rear and width paper guides are touching the paper.

Image-quality troubleshooting

Learn about image-quality troubleshooting.

Use the information in this topic to troubleshoot and resolve image-quality (what you see on the final printed page) problems including copy-quality, print-quality, and color problems (color printers only).

Various printer hardware problems can cause image-quality defects. This topic is a guide to the steps used to isolate the specific areas of the printer that are causing image-quality defects on the printed page, and to provide solutions to resolve those image-quality defects.

Image-quality problems are defined as:

- **Print-quality (PQ) problems:** PQ problems are associated with the print engine (printer base) of an MFP printer (single function non MFP image-quality problems are always PQ defects). PQ defects appear on pages that are **printed** by the print engine and not fed through an integrated scanner assembly (ISA).
- **Copy-quality (CQ) problems:** CQ problems are associated with the integrated-scanner assembly (ISA) portion of an MFP printer. CQ defects appear on pages that are **copied** using the document feeder or flatbed glass.

If the print defect is already known to be a PQ or CQ problem, skip to the appropriate troubleshooting topic listed below. Otherwise, follow the steps in the next section below to get started troubleshooting image-quality problems.

- **Print-quality (PQ) problems:** See [Print-quality troubleshooting on page 409](#).
- **Copy-quality (CQ) problems:** See [Copy-quality troubleshooting on page 423](#).

Get started troubleshooting image-quality problems

Print a demonstration page to identify the defect as a PQ (print engine) or CQ (ISA) problem.



NOTE: If the image defect appears on the printed demonstration page, the issue is a print-quality (PQ) problem (associated with the print engine and not the document feeder or flatbed glass) and not a CQ problem.

Make sure that the demonstration page is printed on **plain paper**.

Enterprise printers

1. Select **Reports > Other pages**.
2. Select [Demonstration Page](#).

Pro printers

1. At the printer, scroll to or select [Setup](#).
2. Go to [Reports](#), and then select [Demonstration Page](#).

Does the demonstration page show any image-quality defects?

- **Yes:** If defects appear on the printed demonstration page the issue is PQ related. See [Print-quality troubleshooting on page 409](#).
- **No:** If defects does not appear on the printed demonstration page the issue is CQ related. See [Copy-quality troubleshooting on page 423](#).

Print-quality troubleshooting

Learn about the print-quality troubleshooting.

 **NOTE:** Print-quality (PQ) problems are associated with the print engine (printer base) of an MFP printer (single function non MFP image-quality problems are always PQ defects). PQ defects appear on pages that are **printed** by the print engine and not feed through an integrated scanner assembly (ISA).

Repetitive image defect ruler

Review the following information about a repetitive image defect ruler.

When troubleshooting the source of some print image defects, one solution is to identify if it is a repetitive defect (does the print quality defect appear multiple times on the printed page?). If this is the case, use a ruler to measure occurrences of repetitive image defects to help solve image-quality problems. For more information, see Using a ruler to measure between repetitive defects.

Use a ruler to measure occurrences of repetitive image defects to help solve image-quality problems. Place the ruler next to the first occurrence of the defect on the page. Find the distance between identical defects and use the table below to identify the component that is causing the defect.

 **CAUTION:** Do not use solvents or oils to clean rollers. Instead, rub the roller with a lint-free cloth. If dirt is difficult to remove, rub the roller with a lint-free cloth that has been dampened with water.

 **NOTE:** The primary charging roller, photosensitive drum, and developer roller cannot be cleaned because they are internal assemblies in the toner cartridge or imaging drum. If one of these assemblies is causing the defect, replace the toner cartridge. The primary fuser sleeve unit or pressure roller cannot be cleaned because they are internal assemblies in the fuser. If one of these assemblies is causing the defect, replace the fuse.

 **TIP:** To make a printer specific repetitive defect ruler, use a metric ruler to transfer the measurements in the table below to a transparency or the edge of a piece of paper—clearly label each ruler mark with the associated defective assembly.

Table 4-30 Repetitive defects

Assembly	Distance between defects	Notes
Registration roller	44 mm (1.7 in)	Appears as dirt or dirt on the back of the page.
Secondary transfer roller	50 mm (1.97 in)	Appears as dropouts or dirt on the back of the page.
Primary charging roller	26 mm (1 in)	Appears as dropouts.
Photosensitive drum	75 mm (2.95 in)	Appears as dirt or dropouts.
Developer roller	38 mm (1.5 in)	Appears as dropouts.
Fuser film	76 mm (3 in)	Appears as dirt, dropouts, or loose toner.
Pressure roller	79 mm (3.1 in)	Appears as dirt, loose toner, or dirt on the back of the page.

Use a ruler to measure between repetitive defects

The figures in this section show color repetitive defect pages. However, the process for measuring repetitive defects is valid for mono pages.

1. Identify a repetitive defect on the page.

 **TIP:** Print a cleaning page to see if that resolves the defect.

 **NOTE:** Some printers allow loading Letter and A4 media in short-edge-first or long-edge-first orientation in the paper trays. When measuring repetitive defects, make sure to place the ruler at the leading edge of the page. This is the edge of the page that feeds into the printer first.

The example pages below show the following types of repetitive defects.

- Lines (callout 1)
- Smudges (callout 2)
- Dots or spots (callout 3)

Figure 4-171 Examples of repetitive defects

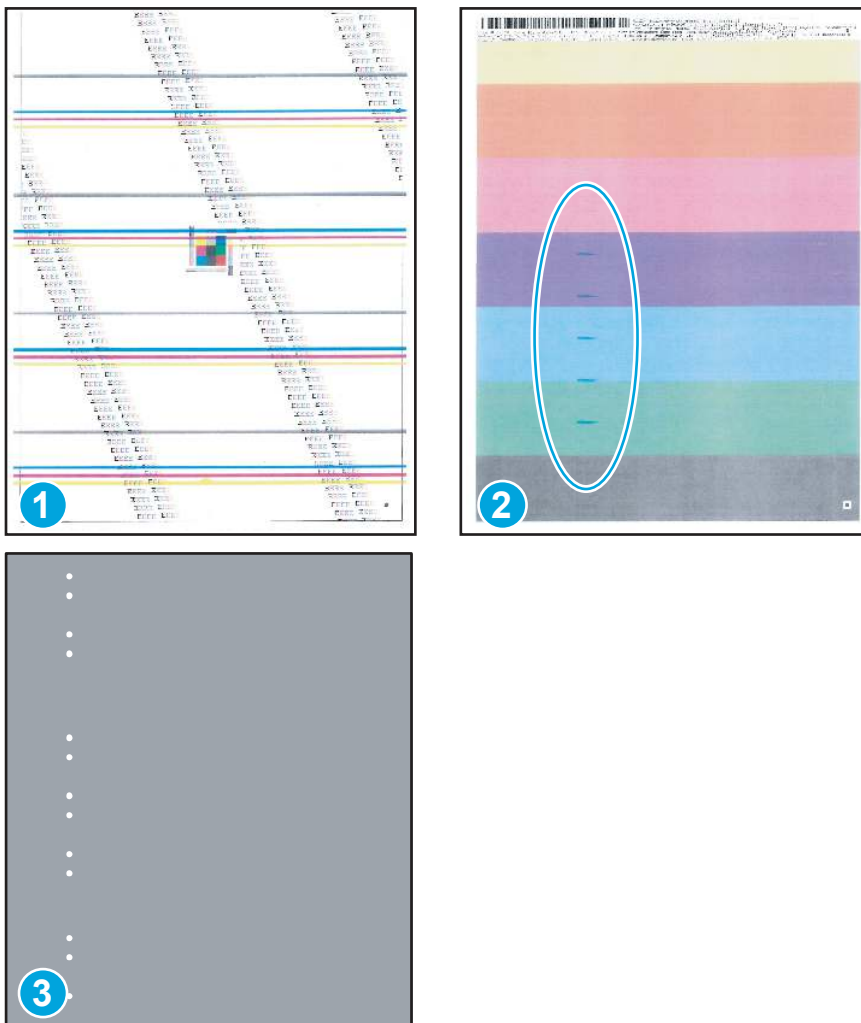

 **NOTE:** These are examples only, other types of repetitive defects might appear on a page.

2. Position a metric ruler on the page with the “zero” ruler mark at one occurrence of the defect (callout 1).

Figure 4-172 Place the ruler on the page

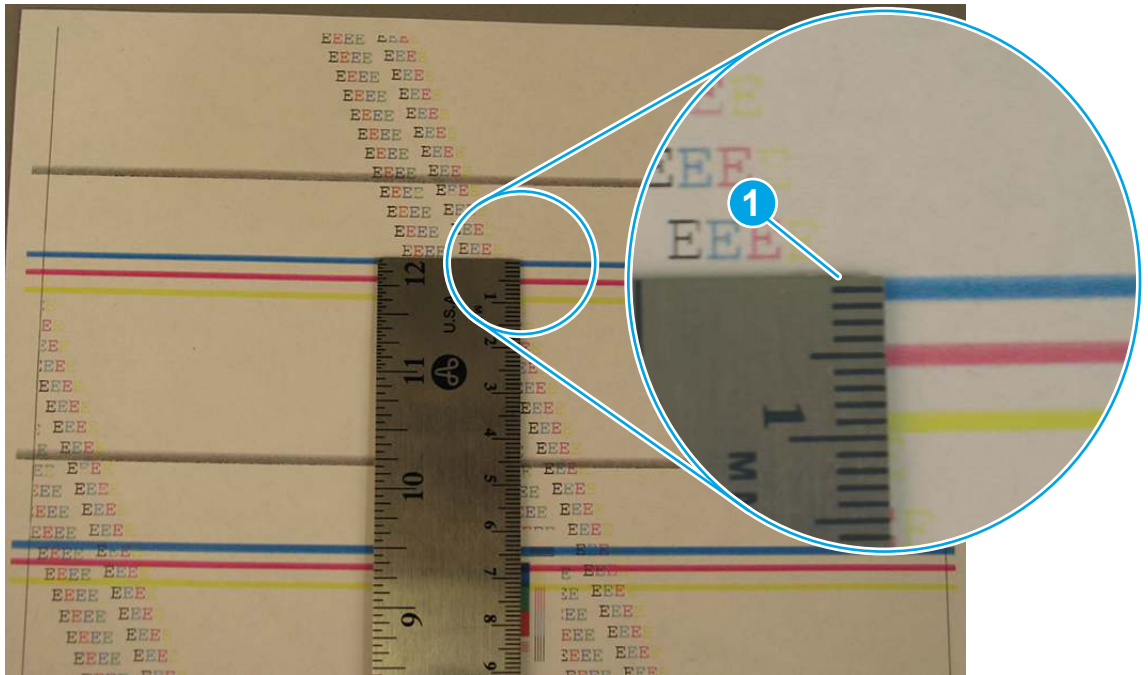

3. Locate the next occurrence of the defect (callout 1).

Figure 4-173 Locate the next repetitive defect

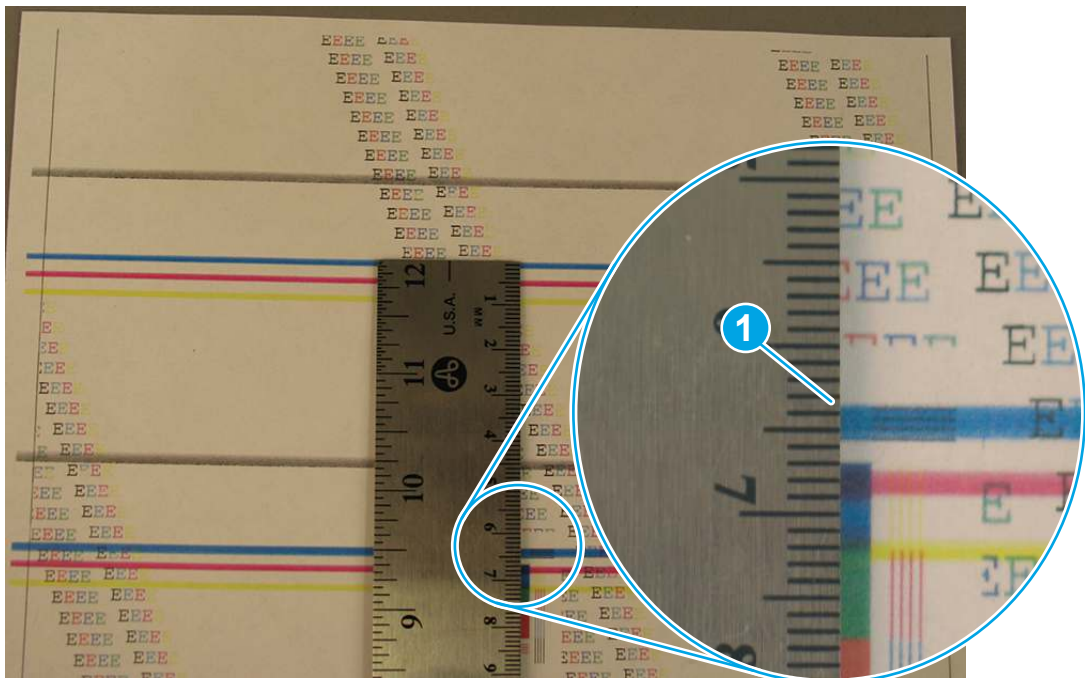

4. Measure the distance (in millimeters) between the two occurrences (callout 1), and then use the Repetitive defects table to determine the defective assembly.

 **TIP:** Always measure from and to the same point on the defects. For example, if the ruler is “zeroed” at the top edge of a defect, measure to the top edge of the next occurrence of that defect.

Figure 4-174 Determine the defective assembly



Print from a different software program

Try printing from a different software program.

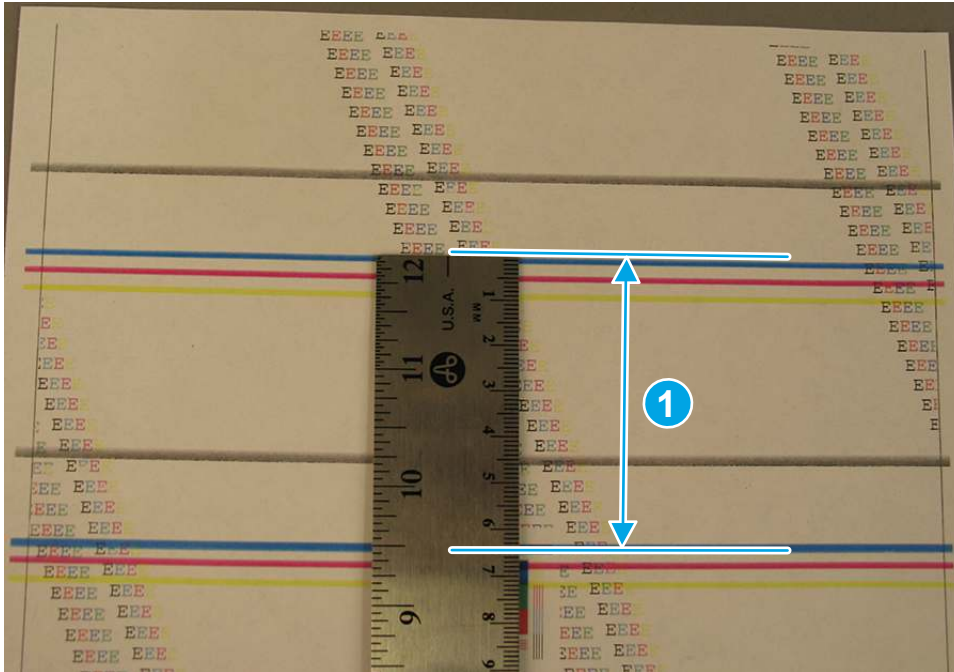
If the page prints correctly, the problem is with the software program from which you were printing.

Check the paper-type setting for the print job

Check the paper type setting when printing from a software program and the printed pages have smears, fuzzy or dark print, curled paper, scattered dots of toner, loose toner, or small areas of missing toner.

Check the paper type setting on the control panel

Check the paper type setting on the printer control panel, and change the setting as needed.

1. Open and close the paper tray.
2. Follow the control panel prompts to confirm or modify the paper type and size settings for the tray.
3. Make sure the paper loaded meets specifications.
4. Adjust the humidity and resistance setting on the control panel to match the environment.
 - a. Open the following menus:
 - i. Settings

- ii. Copy/Print
 - iii. Print quality
 - iv. Adjust paper type
 - b. Select the paper type that matches the type loaded in the tray.
 - c. Use the arrows to increase or decrease the humidity and resistance setting.
5. Make sure the driver settings match the control panel settings.



NOTE: The print driver settings will override any control panel settings.

Check the paper type setting (Windows)

Check the paper type setting for Windows, and change the setting as needed.



NOTE: The print driver settings will override any control panel settings.

1. From the software program, select the **Print** option.
2. Select the printer, and then click the **Properties** or **Preferences** button.
3. Click the **Paper/Quality** tab.
4. From the **Paper Type** drop-down list, click the **More...** option.
5. Expand the list of **Type Is:** options.
6. Expand the category of paper types that best describes your paper.
7. Select the option for the type of paper you are using, and click the **OK** button.
8. Click the **OK** button to close the **Document Properties** dialog box. In the **Print** dialog box, click the **OK** button to print the job.

Check the paper type setting (macOS)

Check the paper type setting for macOS, and change the setting as needed.

1. Click the **File** menu, and then click the **Print** option.
2. In the **Printer** menu, select the printer.
3. Click **Show Details** or **Copies & Pages**.
4. Open the menus drop-down list, and then click the **Paper/Quality** menu.
5. Select a type from the **Media Type** drop-down list.
6. Click the **Print** button.

Check toner-cartridge status

Follow these steps to check the estimated life remaining in the toner cartridges and if applicable, the status of other replaceable maintenance parts.

Step one: Print the Supplies Status Page

The supplies status page indicates the cartridge status.

1. From the Home screen on the printer control panel, select the [Reports](#) menu.
2. Select the [Configuration/Status Pages](#) menu.
3. Select [Supplies Status Page](#), and then select [Print](#) to print the page.

Step two: Check supplies status

Check the supplies status report as follows.

1. Look at the supplies status report to check the percent of life remaining for the toner cartridges and, if applicable, the status of other replaceable maintenance parts.

Print quality problems can occur when using a toner cartridge that is at its estimated end of life. The supplies status page indicates when a supply level is very low. After an HP supply has reached the very low threshold, HP's premium protection warranty on that supply has ended.

The toner cartridge does not need to be replaced now unless the print quality is no longer acceptable. Consider having a replacement available to install when print quality is no longer acceptable.

If you determine that you need to replace a toner cartridge or other replaceable maintenance parts, the supplies status page lists the genuine HP part numbers.

2. Check to see if you are using a genuine HP cartridge.

A genuine HP toner cartridge has the word "HP" on it, or has the HP logo on it. For more information on identifying HP cartridges go to www.hp.com/go/learnaboutsupplies.

Print a cleaning page

Learn how to print a cleaning page.

1. From the [Home](#) screen on the printer control panel, scroll to and touch the [Support Tools](#) button.
2. Open the following menus:
 - [Maintenance](#)
 - [Calibration/Cleaning](#)
3. Touch [Cleaning Page](#), and then touch the [Print](#) button to print the cleaning page.



NOTE: A **Cleaning...** message displays on the control-panel display. Do not turn the printer off until the cleaning process has finished. When it is finished, discard the printed page.



TIP: Use this screen to set up automatic cleaning page intervals if desired.

Check paper and the printing environment

Use the following information to check the paper selection and the printing environment.

Step one: Use paper that meets HP specifications

Some print-quality problems arise from using paper that does not meet HP specifications.

- Always use a paper type and weight that this printer supports.
- Use paper that is of good quality and free of cuts, nicks, tears, spots, loose particles, dust, wrinkles, voids, staples, and curled or bent edges.

- Use paper that has not been previously printed on.
- Use paper that does not contain metallic material, such as glitter.
- Use paper that is designed for use in laser printers. Do not use paper that is designed only for use in Inkjet printers.
- Use paper that is not too rough. Using smoother paper generally results in better print quality.

Step two: Check the environment

The environment can directly affect print quality and is a common cause of print-quality or paper-feeding issues. Try the following solutions:

- Move the printer away from drafty locations, such as open windows or doors, or air-conditioning vents.
- Make sure the printer is not exposed to temperatures or humidity outside of printer specifications.
- Do not place the printer in a confined space, such as a cabinet.
- Place the printer on a sturdy, level surface.
- Remove anything that is blocking the vents on the printer. The printer requires good air flow on all sides, including the top.
- Protect the printer from airborne debris, dust, steam, grease, or other elements that can leave residue inside the printer.

Step three: Set the individual tray alignment

Follow these steps when text or images are not centered or aligned correctly on the printed page when printing from specific trays.

1. From the Home screen on the printer control panel, select the **Settings** menu.
2. Select the following menus:
 - a. **Copy/Print** or **Print**
 - b. **Print Quality**
 - c. **Image Registration**
3. Select **Tray**, and then select the tray to adjust.
4. Select **Print Test Page**, and then follow the instructions on the printed pages.
5. Select **Print Test Page** again to verify the results, and then make further adjustments if necessary.
6. Select **Done** to save the new settings.

Try a different print driver

Try a different print driver when printing from a software program and the printed pages have unexpected lines in graphics, missing text, missing graphics, incorrect formatting, or substituted fonts.

Download a different print driver from the HP support Web site: <http://www.hp.com/support/colorlj5700> or <http://www.hp.com/support/colorljX557> or <http://www.hp.com/support/colorlj5800MFP> or <http://www.hp.com/support/colorljX57945MFP>.

Troubleshoot image defects

Review examples of image defects and steps to resolve these defects.

Table 4-31 Image defects table quick reference





Defect	Defect	Defect
<p data-bbox="252 373 560 401">Table 4-39 Light print on page 421</p> 	<p data-bbox="651 373 1032 426">Table 4-37 Gray background or dark print on page 420</p> 	<p data-bbox="1054 373 1433 426">Table 4-34 Blank page - No print on page 419</p> 
<p data-bbox="252 856 571 884">Table 4-33 Black page on page 418</p> 	<p data-bbox="651 856 1023 884">Table 4-32 Banding defects on page 418</p> 	<p data-bbox="1054 856 1410 884">Table 4-41 Streak defects on page 422</p> 

Table 4-31 Image defects table quick reference (continued)



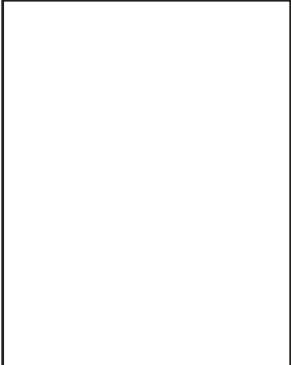

Defect	Defect	Defect
<p data-bbox="274 260 646 310">Table 4-36 Fixing/fuser defects on page 419</p> 	<p data-bbox="679 260 1051 310">Table 4-38 Image placement defects on page 421</p> 	<p data-bbox="1085 260 1457 310">Table 4-35 Color plane registrations defects (color models only) on page 419</p> 
<p data-bbox="274 749 646 779">Table 4-40 Output defects on page 422</p> 		

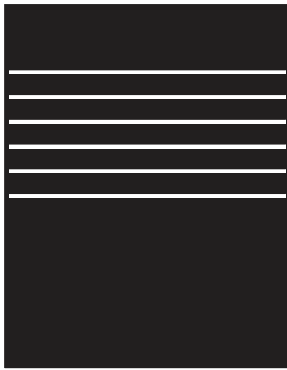
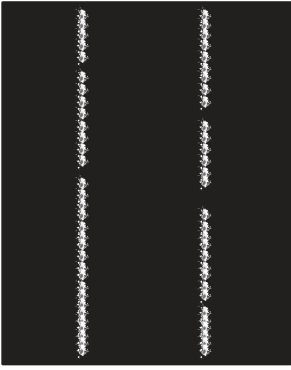
Image defects, no matter the cause, can often be resolved using the same steps. Use the following steps as a starting point for solving image defect issues.

1. Reprint the document. Print quality defects can be intermittent in nature or can go away completely with continued printing.
2. Check the condition of the cartridge or cartridges. If a cartridge is in a **Very Low** state (it has passed the rated life), replace the cartridge.
3. Make sure that the driver and tray print mode settings match the media that is loaded in the tray. Try using a different ream of media or a different tray. Try using a different print mode.
4. Make sure the printer is within the supported operating temperature/humidity range.
5. Make sure that the paper type, size, and weight are supported by the printer. See the printer support page at support.hp.com for a list of the supported paper sizes and types for the printer.

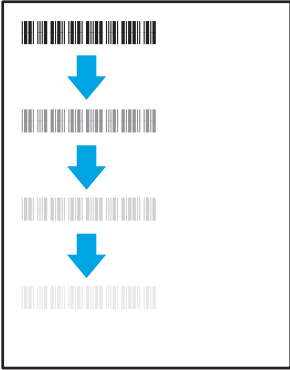
 **NOTE:** The term "fusing" refers to the part of the printing process where toner is affixed to paper.

The following examples depict letter-size paper that has passed through the printer with the short edge first.

Table 4-32 Banding defects

Sample	Description	Possible solutions
	<p>Dark or light lines which repeat down the length of the page, and are wide-pitch and/or impulse bands. They might be sharp or soft in nature. The defect displays only in areas of fill, not in text or sections with no printed content.</p>	<ol style="list-style-type: none"> 1. Reprint the document. 2. Try printing from another tray. 3. Replace the cartridge. 4. Use a different paper type. 5. Enterprise models only. From the Home screen on the printer control panel, go to the Adjust Paper Types menu, and then choose a print mode that is designed for a slightly heavier media than what you are using. This slows the print speed and might improve the print quality. 6. If the issue persists, go to support.hp.com.

Table 4-33 Black page

Sample	Description	Possible solutions
	<p>The entire printed page is black.</p>	<ol style="list-style-type: none"> 1. Visually inspect the cartridge to check for damage. 2. Make sure that the cartridge is installed correctly. 3. Replace the cartridge. 4. If the issue persists, go to support.hp.com.

Table 4-34 Blank page - No print

Sample	Description	Possible solutions
	The page is completely blank and contains no printed content.	<ol style="list-style-type: none"> 1. Make sure that the cartridges are genuine HP cartridges. 2. Make sure that the cartridge is installed correctly. 3. Print with a different cartridge. 4. Check the paper type in the paper tray and adjust the printer settings to match. If necessary, select a lighter paper type. 5. If the issue persists, go to support.hp.com.

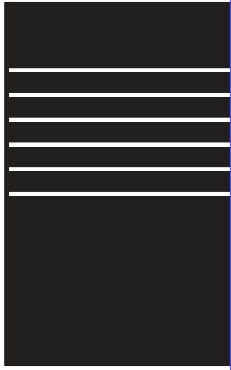
Table 4-35 Color plane registrations defects (color models only)

Sample	Description	Possible solutions
	One or more color plane(s) is not aligned with the other color planes. This registration error will typically occur with yellow.	<ol style="list-style-type: none"> 1. Reprint the document. 2. From the printer control panel, calibrate the printer. 3. If a cartridge has reached a Very Low state, or the printed output is severely faded, replace the cartridge. 4. From the printer control panel use the Restore Calibration feature to reset the printer's calibration settings to the factory defaults. 5. If the issue persists, go to support.hp.com.

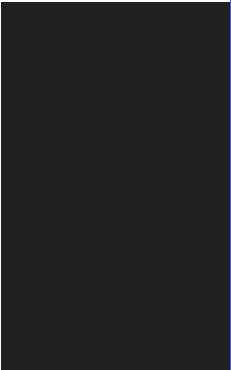
Table 4-36 Fixing/fuser defects

Sample	Description	Possible solutions
	Slight shadows or offsets of the image are repeated down the page. The repeated image might fade with each recurrence.	<ol style="list-style-type: none"> 1. Reprint the document. 2. Check the paper type in the paper tray and adjust the printer settings to match. If necessary, select a lighter paper type. 3. If the issue persists, go to support.hp.com.

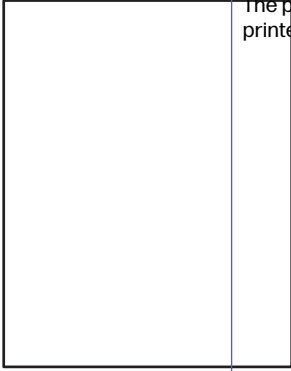
Table 4-36 Fixing/fuser defects (continued)

Sample	Description	Possible solutions
	<p>Toner rubs off along either edge of the page. This defect is more common at the edges of high-coverage jobs, and on light media types, but can occur anywhere on the page.</p>	<ol style="list-style-type: none"> 1. Reprint the document. 2. Check the paper type in the paper tray and adjust the printer settings to match. If necessary, select a heavier paper type. 3. Enterprise models only: From the printer control panel, go to the Edge-to-Edge menu and then select Normal. Reprint the document. 4. Enterprise models only: From the printer control panel, select Auto Include Margins and then reprint the document. 5. If the issue persists, go to support.hp.com.

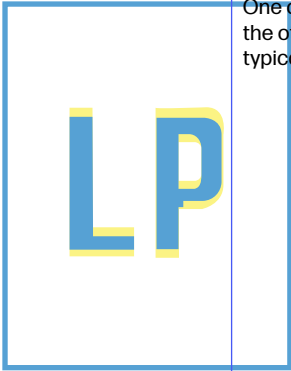
Table 4-37 Gray background or dark print

Sample	Description	Possible solutions
	<p>The image or text is darker than expected and/or the background is gray.</p>	<ol style="list-style-type: none"> 1. Make sure that the paper in the trays has not already been run through the printer. 2. Use a different paper type. 3. Reprint the document. 4. Mono models only: From the Home screen on the printer control panel, go to the Adjust Toner Density menu, and then adjust the toner density to a lower level. 5. Make sure that the printer is within the supported operating temperature and humidity range. 6. Replace the cartridge. 7. If the issue persists, go to support.hp.com.

Table 4-38 Image placement defects

Sample	Description	Possible solutions
	<p>The image is not centered, or is skewed on the page. The defect occurs when the paper is not positioned properly as it is pulled from the tray and moves through the paper path.</p>	<ol style="list-style-type: none"> 1. Reprint the document. 2. Remove the paper and then reload the tray. Make sure that all the paper edges are even on all sides. 3. Make sure that the top of the paper stack is below the tray-full indicator. Do not overfill the tray. 4. Make sure that the paper guides are adjusted to the correct size for the paper. Do not adjust the paper guides tightly against the paper stack. Adjust them to the indentations or markings in the tray. 5. If the issue persists, go to support.hp.com.

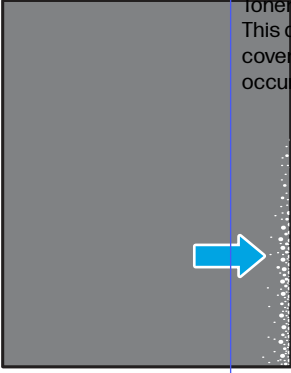
Table 4-39 Light print

Sample	Description	Possible solutions
	<p>The printed content is light or faded on the entire page.</p>	<ol style="list-style-type: none"> 1. Reprint the document. 2. Remove the cartridge, and then shake it to redistribute the toner. Reinsert the toner cartridges into the printer and close the cover. For a graphical representation of this procedure, see <i>Replace the toner cartridges</i>. 3. Mono models only: Make sure that the EconoMode setting is disabled, both at the printer control panel and in the print driver. 4. Make sure that the cartridge is installed correctly. 5. Print a Supplies Status Page and check the life and usage of the cartridge. 6. Replace the cartridge. 7. If the issue persists, go to support.hp.com.

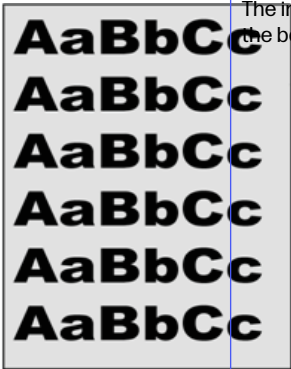
Table 4-40 Output defects

Sample	Description	Possible solutions
	<p>Printed pages have curled edges. The curled edge can be along the short or long side of the paper. Two types of curl are possible:</p> <ul style="list-style-type: none"> • Positive curl: The paper curls toward the printed side. The defect occurs in dry environments or when printing high-coverage pages. • Negative curl: The paper curls away from the printed side. The defect occurs in high-humidity environments or when printing low-coverage pages. 	<ol style="list-style-type: none"> 1. Reprint the document. 2. Positive curl: From the printer control panel, select a heavier paper type. The heavier paper type creates a higher temperature for printing. Negative curl: From the printer control panel, select a lighter paper type. The lighter paper type creates a lower temperature for printing. Try storing the paper in a dry environment prior to use, or use freshly opened paper. 3. Print in duplex mode. 4. If the issue persists, go to support.hp.com.
	<p>The paper does not stack well in the output tray. The stack might be uneven, skewed, or the pages might be pushed out of the tray and onto the floor. Any of the following conditions can cause this defect:</p> <ul style="list-style-type: none"> • Extreme paper curl • The paper in the tray is wrinkled or deformed • The paper is a non-standard paper type, such as envelopes • The output tray is too full 	<ol style="list-style-type: none"> 1. Reprint the document. 2. Extend the output bin extension. 3. If the defect is caused by extreme paper curl, refer to the troubleshooting steps for "Output curl." 4. Use a different paper type. 5. Use freshly opened paper. 6. Remove the paper from the output tray before the tray gets too full. 7. If the issue persists, go to support.hp.com.

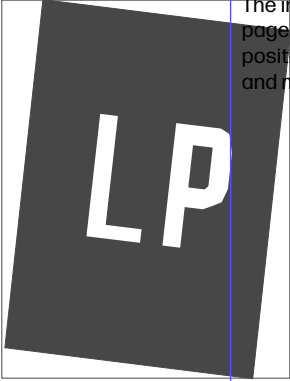
Table 4-41 Streak defects

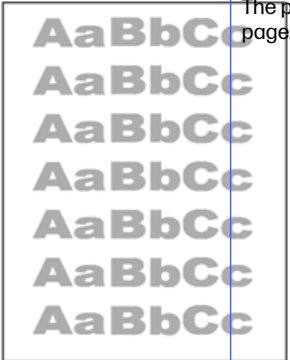

Sample	Description	Possible solutions
	<p>Light vertical streaks that usually span the length of the page. The defect displays only in areas of fill, not in text or sections with no printed content.</p>	<ol style="list-style-type: none"> 1. Reprint the document. 2. Remove the cartridge, and then shake it to redistribute the toner. Reinsert the toner cartridges into the printer and close the cover. For a graphical representation of this procedure, see <i>Replace the toner cartridges</i>. 3. If the issue persists, go to support.hp.com. <p>NOTE: Both light and dark vertical streaks can occur when the printing environment is outside the specified range for temperature or humidity. Refer to your printer's environmental specifications for allowable temperature and humidity levels.</p>

Table 4-41 Streak defects (continued)

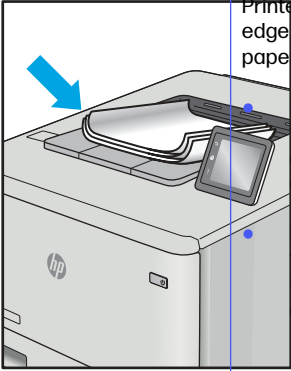
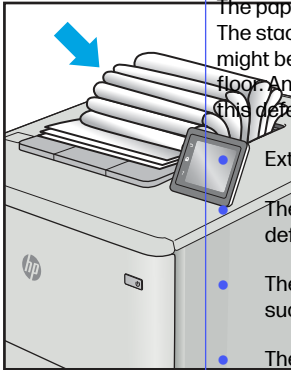
Sample	Description	Possible solutions
	<p>Dark vertical lines which occur down the length of the page. The defect might occur anywhere on the page, in areas of fill or in sections with no printed content. On color models, these lines or streaks will also be visible on the ITB cleaning page.</p>	<ol style="list-style-type: none"> 1. Reprint the document. 2. Remove the cartridge, and then shake it to redistribute the toner. Reinsert the toner cartridges into the printer and close the cover. For a graphical representation of this procedure, see <i>Replace the toner cartridges</i>. 3. Print a cleaning page. 4. Check the toner level in the cartridge. 5. If the issue persists, go to support.hp.com.

Copy-quality troubleshooting

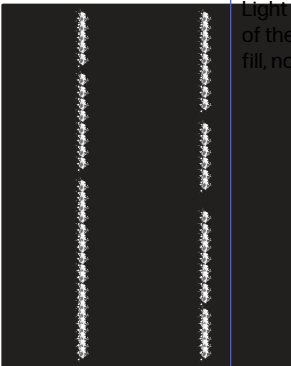
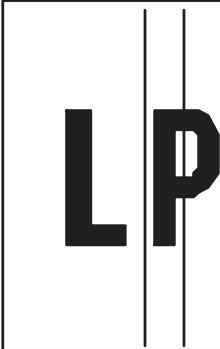
Learn about copy-quality troubleshooting.

 **NOTE:** Copy-quality (CQ) problems are associated with the integrated-scanner assembly (ISA) portion of an MFP printer. CQ defects appear on pages that are **copied** using the document feeder or flatbed glass.

Identify the location and type of the CQ problem

Resolving CQ problems involves isolating the defect to the document feeder or flatbed glass. Comparing printed output between the document feeder and the flatbed glass might determine the ISA location that is causing the CQ defect.

 **NOTE:** If a CQ defect appears on printed output from both the document feeder **and** the flatbed glass, carefully inspect the original source for a print-quality (PQ) problem.

Document feeder isolation test

1. Mark a printed page in a way that clearly identifies it as the source document used in this isolation procedure.
2. Place the source page in the document feeder, and then make a copy.
3. Mark the copied output page to clearly identify it as output from the document feeder.
4. Compare the original and copied pages. Defects appearing on the copied page are caused by a problem in the document feeder.

Flatbed isolation test

1. Mark a printed page in a way that clearly identifies it as the source document used in this isolation procedure.
2. Place the source page on the flatbed glass, and then make a copy.
3. Mark the copied output page to clearly identify it as output from the flatbed.
4. Compare the original and copied pages. Defects appearing on the copied page are caused by a problem in the flatbed.

Check the scanner glass for dirt and smudges

Learn about solving copy-quality debris problems.

Over time, specks of debris might collect on the scanner glass and document feeder white plastic backing, which might cause print defects. Use the following procedure to clean the scanner if the printed pages have streaks, unwanted lines, black dots, poor print quality, or unclear text.

 [View a video of cleaning the document feeder glass and flatbed glass.](#)

1. Press the power button to turn the printer off, and then disconnect the power cable from the electrical outlet.

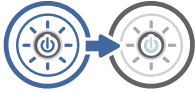

2. Open the scanner lid.

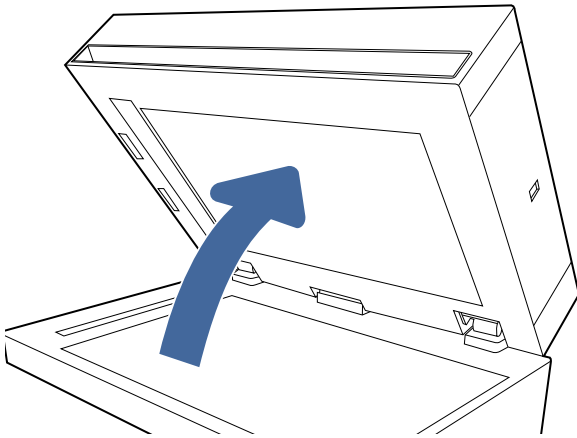

3. Clean the scanner glass (callout 1) and the document feeder strips (callout 2, callout 3) with a soft cloth or sponge that has been moistened with nonabrasive glass cleaner.

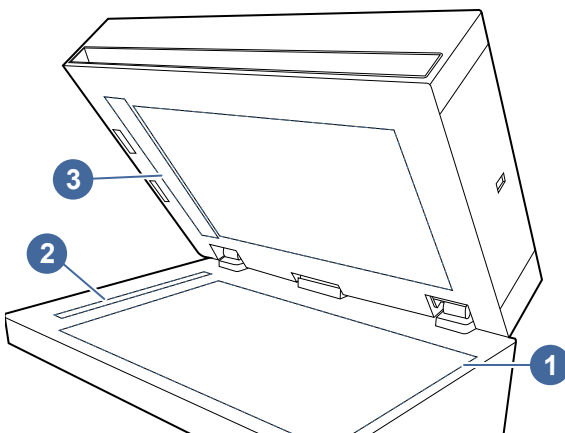

⚠ CAUTION: Do not use abrasives, acetone, benzene, ammonia, ethyl alcohol, or carbon tetrachloride on any part of the printer; these can damage the printer. Do not place liquids directly on the glass or platen. They might seep and damage the printer.

 **NOTE:** If you are having trouble with streaks on copies when you are using the document feeder, be sure to clean the small strips of glass on the left side of the scanner (callout 2, callout 3).

4. Dry the glass and white plastic parts with a chamois or a cellulose sponge to prevent spotting.
5. Close the scanner lid.

Figure 4-175 Close the scanner lid

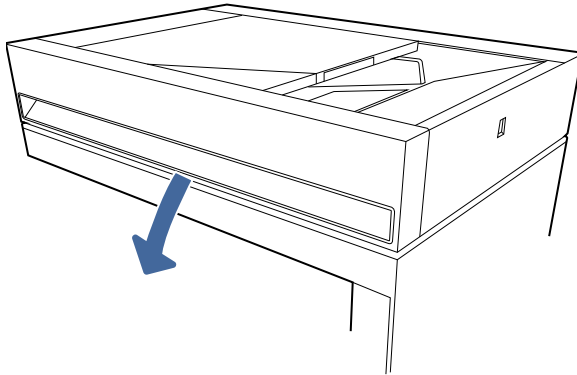

6. Connect the power cable to an outlet, and then press the power button to turn the printer on.

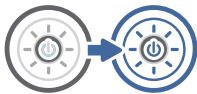

Vertical lines, bands, or streaks

Learn about vertical lines, bands, or streaks copy-quality problems.

Vertical lines or streaks appear on copies and/or scans in the same direction that the paper feeds when copying and/or scanning from the document feeder. Lines or streaks might be visible on the front and/or the back side of the page. Copies and/or scans from the flatbed glass look normal. Printouts also look normal.

The line or streak might be black or in color, and can also be present on fax or digital send output (for example, when using [Scan to folder](#) or [Scan to email](#) features).

 **NOTE:** HP has determined that **99%** of all lines and streaks on copies made by feeding the original documents through the document feeder are caused by **debris on the document feeder glass strip**. Even small specks can cause the light reflected off the original to be distorted, resulting in a line, streak, or smudge on copies or scans made from the document feeder.

Even if the document feeder glass strip and/or flatbed glass has been wiped clean, the defect might persist. Persistent vertical lines, bands, or streaks when copying from the document feeder might mean that the debris causing the print quality are not readily visible and cannot be removed with a quick cleaning.

Use the procedures below to resolve persistent lines, bands, or streak copy-quality (CO) problems.

Locate debris and thoroughly clean the document feeder glass

1. Place a blank sheet of paper in the document feeder and mark an **X** in the lower right corner as shown.

Figure 4-176 Load the document feeder



2. Press the **Start** button to make a copy of the blank page.
3. Place the copied paper face-up on the flatbed glass with the **X** located as shown.



NOTE: Make sure the upper left corner of the copy is aligned with the upper left corner of the flatbed glass.

Figure 4-177 Place the copy on the flatbed



4. Follow the line or streak on the paper to the area on the document feeder glass that is causing the CQ problem.

Figure 4-178 Identify the CQ defect location

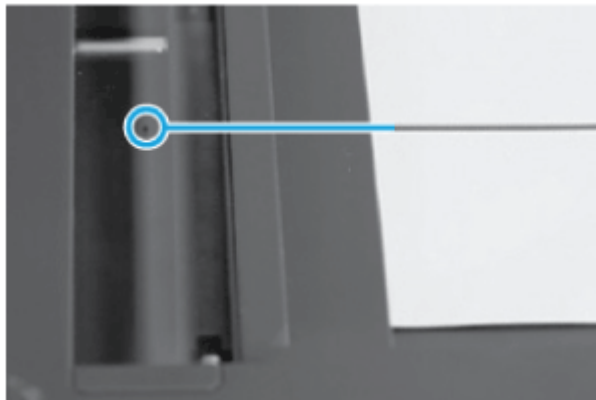

5. Use a fingernail to loosen any stubborn debris.

⚠ WARNING! Use only a fingernail. Other objects can scratch the document feeder glass.

Clean this specific area again (with a lint-free cloth dampened with water), and then dry the glass with a soft, lint-free cloth.

Figure 4-179 Clean the glass

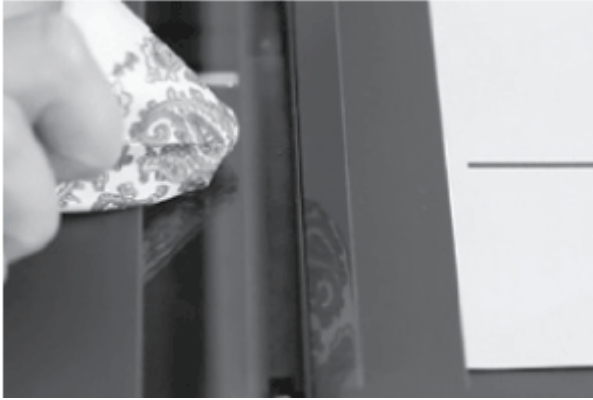

6. Make another copy or scan to determine if the defect is gone.

Clean the duplexer scanner glass (model specific)

📝 NOTE: Not all MFP printers use a background selector for duplex printing.

If a *Side 2 Background Selector* cannot be located for the printer (it might not include one) skip this procedure.

1. Release the latch and open the document feeder jam-access door.

Figure 4-180 Open the jam-access door

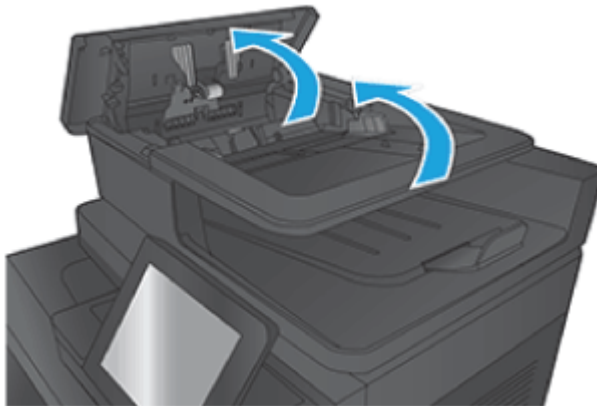

2. Unlock the Side 2 Background Selector by pressing and holding both green tabs inward towards each other.

Figure 4-181 Release the Side 2 Background Selector

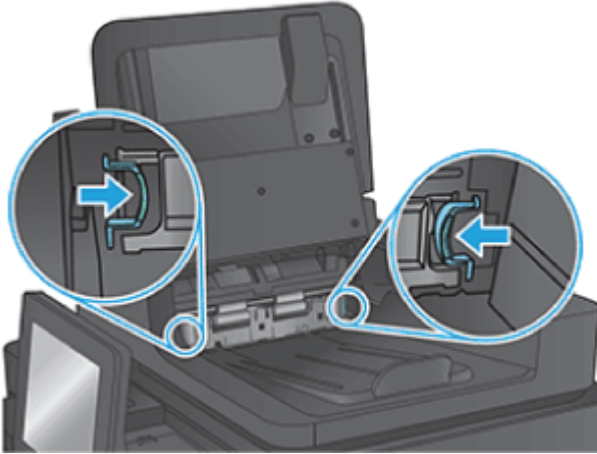

3. While holding the green tabs, pull out and remove the Side 2 Background Selector.

Figure 4-182 Remove the Side 2 Background Selector

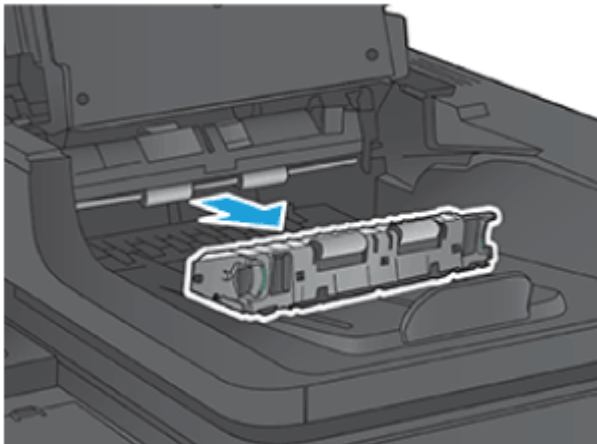

4. Rotate the top to reveal the white and black backside reflector (circled in blue).



NOTE: If the white and black areas do not come clean, wipe the surface thoroughly with a damp cloth again. Dry the area with a soft, dry cloth to prevent spotting.

Figure 4-183 Locate the backside reflector

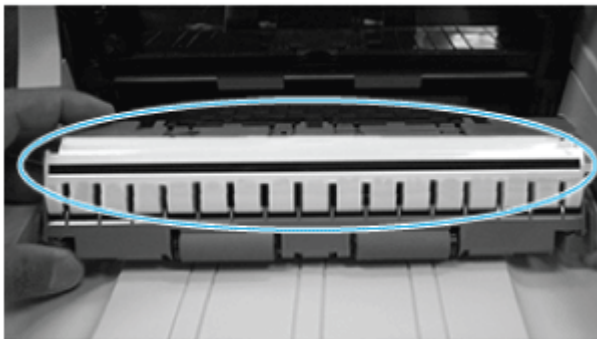

5. With the background selector removed from the document feeder, clean the inside of the scan module.
6. In the back area from where the background selector was removed, locate the Side 2 Scan Module glass found under the top area.

 **NOTE:** The glass surface of the Side 2 Scan module sits horizontally flat and might not be easily viewable.

7. Use a soft, lint-free cloth moistened with water and apply pressure upwards behind the rollers to clean the Side 2 Scan Module Glass, making sure to that the entire width of the glass is cleaned from left to right.

 **NOTE:** If needed, lens cleaner or non-abrasive glass cleaner can be applied to the cloth before cleaning the glass. Spray only onto the cloth and not directly onto the glass or device. Do not spray water or glass cleaner on the glass as it can seep under it and possibly damage the printer. Do not use abrasives, acetone, benzene, ethyl alcohol, or carbon tetrachloride on the glass; these can damage it and/or leave residue on the glass resulting in degraded copy/scan quality.

8. Reverse the removal steps to reinstall the Side 2 Background Selector.
9. Make another copy or scan to determine if the defect is gone.

Modify printer settings to improve scan or copy quality

Learn about printer settings to improve scan or copy quality.

Optimize printer settings to potentially improve scan or copy quality.



 **IMPORTANT:** The printer settings described in this section are firmware dependent and might not be available for a specific printer (for example, color adjustment settings do not apply to mono printers).

Image Adjustment settings

 **NOTE:** [Settings > Print \(SFP\) or Copy/Print \(MFP\) > Image Adjustment > Background Cleanup](#).

Use the sliders to perform a [Background Cleanup](#), adjust the image [Darkness](#) as well as changing the [Sharpness](#) and [Contrast](#).

Use this feature to improve the overall quality of the copy (for example, adjusting the [Darkness](#) and [Sharpness](#). Use the [Background Cleanup](#) setting to remove faint images from the background or to remove a light background color.

- [Darkness](#): Adjust this setting to increase or decrease the amount of white and black in the colors.
- [Contrast](#): Adjust this setting to increase or decrease the difference between the lightest and darkest color on the page.
- [Background Cleanup](#): Adjust this setting if copying a faint image is a problem.
- [Sharpness](#): Adjust this setting to clarify or soften the image. Increasing the sharpness might make text appear crisper, but decreasing it would make photographs appear smoother.

Optimize Text/Picture settings

 **NOTE:** [Settings > Scan/Digital Send Settings > Optimize Text/Picture](#).

Use to optimize the output for a particular type of content. You can optimize the output for text, printed pictures, or a mixture.

Use this setting to optimize the output for a particular type of content.

- **Mixed:** Use to optimize the setting for text and for pictures.
- **Text:** Use to optimize the text portion of the copy when text and/or pictures are on the original.
- **Printed picture:** Use to optimize line drawing and preprinted images such as magazine clippings or pages from a book. If you see bands of irregular intensity on copies, try selecting **Printed picture** to improve quality.
- **Photographs:** Use to optimize photographic prints.

Color/Black settings



NOTE: Settings > Scan/Digital Send Settings > Color/Black.

Use to enable or disable color scanning.(some highlighters will not auto detect as color).

- **Automatically detect color or black:** When pages without color are detected, the printer creates an image of the page in 1-bit black if other settings allow. If the other settings don't allow (File Type, for example), the image is in grayscale.
- **Automatically detect color or gray:** When pages without color are detected, the printer creates an image of the page in grayscale. Select this option for the best image quality for non-color pages.
- **Color:** Scans the documents in color.
- **Black:** Scans documents in black and white with a compressed file size.
- **Black/Gray:** Scans or prints documents in grayscale.

Light or faint copies (color models)

Learn how to resolve light or faint copy-quality problems.

Are you attempting to copy or scan highlighted text?



NOTE: When digitally sending or copying highlighted images or text objects, the image might appear lighter than expected or does not show up at all with certain brands/types of highlighter pens.

Highlighters come in bright, often fluorescent colors. Fluorescent highlighter inks tend to reflect more light than that which is absorbed by the paper source. This reflection might cause the image to not show up as well as non-fluorescent colors depending upon the scanner/MFP being used.

The most common color for highlighters is yellow, but many other colors are also found such as pink, blue, green, orange, and purples. Yellow is often the preferred color to use when making a photocopy as it tends to not produce as much of a shadow on copies or scans.

There are different color and ink properties depending upon the brand of highlighters used. Due to these differences, scanning of the images might vary greatly from not being seen at all to changing colors (for example, orange highlighter might appear brown in the copy or scan or yellow highlighter might appear green).

Automatic color detect

HP has a feature in all FutureSmart (LaserJet Enterprise Series only) printers which automatically detects color on each page. Depending upon the amount of color information on a page, the scanner might determine the page to be black and white due to a very, very small amount of color which might be considered background artifacts. This helps to reduce the file size of sent files as well as toner usage on a copied page. You might see small highlighted marks on pages print out in black and white or even disappear.

The black and white effect is due to the printer not seeing enough color on the page, in which case the whole image is rendered as a black and white page. The highlighted mark disappearing might be due to the marker characteristics not being detected by the scanner.

Does the printer have the latest firmware version installed?

No or I don't know.

A Firmware enhancement has been introduced for certain LaserJets to help with the reproduction of highlighted images.



NOTE: Some Multifunction Printers (MFPs) using FutureSmart firmware v3.5.3 or later have improved color reproduction of fluorescent highlighters when scanning or copying.

Use the following steps to identify the installed firmware version, and then upgrade the firmware if needed.

1. Print a configuration page (from the printer control panel).
2. On the printed configuration page look in the section marked **Device Information**, and then identify the **Firmware Datecode** and **Firmware Revision**.

This is the current version of firmware installed on this printer.

3. In the US, go to <http://www.hp.com/support/colorlj5700> or <http://www.hp.com/support/colorljX557> or <http://www.hp.com/support/colorlj5800MFP> or <http://www.hp.com/support/colorljX57945MFP>.
 - a. Select **Get drivers, Software, and Firmware**, and then select the appropriate product by name.



NOTE: More than one printer model might be listed. Make sure to select the correct model so that the upgraded firmware supports all of the printer functions.

- b. Select the driver language and operating system.
 - c. Locate the firmware download. If the firmware version is more recent than the one shown on the printed configuration page, select **Download**.
4. Outside the U.S., go to www.hp.com/support.
 - a. Select your country/region.
 - b. Select **Drivers & Downloads**.
 - c. Enter the product name in the **Find my product** dialogue box, and then select **Go**.



TIP: Click on the **How do I find my product name/number?** link to see a short video on identifying the printer name and number.

- d. Select the appropriate product by name.



NOTE: More than one printer model might be listed. Make sure to select the correct model so that the upgraded firmware supports all of the printer functions.

- e. Select the driver language and operating system.
 - f. Locate the firmware download. If the firmware version is more recent than the one shown on the printed configuration page, select **Download**.
5. Perform a firmware upgrade. See the *Firmware upgrades* topic in the product service manual.
 6. When the upgrade process is complete, print a configuration page and verify that the upgrade firmware version was installed.

Yes

These procedures help provide settings which affect the way highlighters are scanned or copied. A firmware enhancement is available for certain printers that helps with the reproduction of highlighted images.

- **Enable Firmware Enhancement**

1. From the Home screen, select the desired scanning application (for example, [Copy](#), [E-Mail](#), [Save to Network Folder](#)).
2. Select [More Options](#) > [Optimize Text/Picture](#) > [Text](#) button (not slider). This enables the improved color reproduction of fluorescent highlighters.



TIP: Administrators can set Text as the default setting on the device.

- **Alternative Settings**

See [Modify printer settings to improve scan or copy quality on page 429](#) for more information.

Performance and connectivity troubleshooting

Learn about performance and connectivity troubleshooting.

Solve fax or email problems

Learn about solving fax and email problems.

Fax or email troubleshooting information is not provided in this service manual. The most current information is available in WISE. Search using model number then use "fax troubleshooting" as the search term.

For HP Channel partners, open the HP Partner First Portal located at <https://partner.hp.com>, and then do the following:

1. Select the **Services & Support** tab, and then select **Technical Support**.
2. Select **Technical Documentation**.
3. You will be taken to the WISE portal.

For HP service personnel, go to one of the following Web-based Interactive Search Engines (WISE) sites:

Americas (AMS)

- [WISE - English](#)
- [WISE - Spanish](#)
- [WISE - Portuguese](#)
- [WISE - French](#)

Asia Pacific / Japan (APJ)

- [WISE - English](#)
- [WISE - Japanese](#)
- [WISE - Korean](#)
- [WISE - Chinese \(simplified\)](#)
- [WISE - Chinese \(traditional\)](#)
- [WISE - Thai](#)

Europe / Middle East / Africa (EMEA)

- [WISE - English](#)

Solve performance problems

Review the following information and procedures to solve performance problems.



NOTE: Tray 1 and Tray 2 are optimal for paper pickup when using special paper or media other than 75-80gsm (20lb) plain paper. For Tray 1 and Tray 2 the printer increases the number of attempts to pick up a page, which increases the reliability of successfully picking the page from the tray and decreases the possibility of a mis-pick jam.

HP recommends using Tray 1 or Tray 2 if the printer is experiencing excessive or reoccurring jams from trays other than Tray 1 and Tray 2, or for print jobs that require media other than 75-80gsm (20lb) plain paper.

Factors affecting print performance

Review the following information about factors affecting print performance.

Table 4-42 Solve performance problems

Problem	Cause	Solution
Pages print but are totally blank.	The document might contain blank pages.	Check the original document to see if content is present on all of the pages.
Pages print but are totally blank.	The printer might be malfunctioning.	To check the printer, print a Configuration page.

Table 4-42 Solve performance problems (continued)

Problem	Cause	Solution
Pages print but are totally blank.	Make sure that the printer is not feeding multiple pages (especially if very thin paper is used).	Make sure that the paper meets HP specifications for this printer. For a complete list of specific HP-brand paper that this printer supports, go to http://www.hp.com/support/colorlj5700 or http://www.hp.com/support/colorljX557 or http://www.hp.com/support/colorlj5800MFP or http://www.hp.com/support/colorljX57945MFP .
Pages print very slowly. NOTE: Some software programs process print jobs slowly.	Heavier paper types can slow the print job.	Print on a different type of paper.
Pages print very slowly. NOTE: Some software programs process print jobs slowly.	Complex pages can print slowly.	Proper fusing might require a slower print speed to ensure the best print quality.
Pages print very slowly. NOTE: Some software programs process print jobs slowly.	Large batches, narrow paper, and special paper such as gloss, transparency, cardstock, and HP Tough Paper can slow the print job.	Print in smaller batches, on a different type of paper, or on a different size of paper.
Pages did not print.	The printer might not be pulling paper correctly.	Make sure paper is loaded in the tray correctly.
Pages did not print.	The paper is jamming in the printer.	Clear the jam.
Pages did not print.	The USB cable might be defective or incorrectly connected.	<ul style="list-style-type: none"> • Disconnect the USB cable at both ends and reconnect it. • Try printing a job that has printed in the past. • Try using a different USB cable.
Pages did not print.	Other devices are running on the host computer.	The printer might not share a USB port. If an external hard drive or network switchbox is connected to the same port as the printer, the other device might be interfering with the printer. To connect and use the printer, disconnect the other device or use two USB ports on the host computer.
Pages did not print.	The print job might not have arrived at the printer.	Check the printer status queue. Also, the Printing message should appear on the control panel display.

Print speeds

Print speed is the number of pages that print in one minute. Print speed depends on different engine-process speeds or operational pauses between printed pages during normal printer operation. Factors that determine the print speed of the printer include the following:

- Page formatting time

The printer must pause for each page to be formatted before it prints. Complex pages take more time to format, resulting in reduced print speed. However, most jobs print at full engine speed.

- Media size

Legal-size media reduces print speed because it is longer than the standard Letter- or A4-size media. A reduce print speed is used when printing on narrow media to prevent the edges of the fuser from overheating.

- Media mode

Some media types require a reduced print speed to achieve maximum print quality on that media. For example, glossy, heavy, and specialty media (for example, envelopes or photos) require a reduced print speed. To maximize the print speed for special media types, make sure that the correct media type in the print driver is selected.

- Printer temperature

To prevent printer damage, print speed is reduced if the printer reaches a specific internal temperature (thermal slow down). The starting temperature of the printer, ambient environment temperature, and the print job size effect the number of pages that can be printed before the printer reduces the print speed. Thermal slow down reduces print speed by printing four pages and then pausing for an amount of time before printing continues.

- Other print speed reduction factors

Other factors (especially during large print jobs) that can cause reduced print speeds include:

- Density control sequence; occurs every 150 pages and takes about 120 seconds

The printer does not print

If the printer does not print at all, try the following solutions.

1. Make sure the printer is turned on and that the control panel indicates it is ready.
 - If the control panel does not indicate the printer is ready, turn the printer off and then on again.
 - If the control panel indicates the printer is ready, try sending the job again.
2. If the control panel indicates the printer has an error, resolve the error and then try sending the job again.
3. Make sure the cables are all connected correctly. If the printer is connected to a network, check the following items:
 - Check the bottom LED next to the network connection on the printer. If the network is active, the light is green.
 - Make sure that a network cable and not a phone cord is used to connect to the network.
 - Make sure the network router, hub, or switch is turned on and that it is working correctly.
4. Install the HP software for the printer. Using generic printer drivers can cause delays clearing jobs from the print queue.

5. From the list of printers on your computer, right-click the name of this product, click **Properties**, and open the **Ports** tab.
 - If a network cable is used to connect to the network, make sure the printer name listed on the **Ports** tab matches the one on the printer configuration page.
 - If a USB cable is used, and the printer is connected to a wireless network, make sure the box is checked next to **Virtual printer port for USB**.
6. If a personal firewall system on the computer is used, it might be blocking communication with the printer. Try temporarily disabling the firewall to see if it is the source of the problem.
7. If the host computer or the printer is connected to a wireless network, low signal quality or interference might be delaying print jobs.

The printer prints slowly

If the printer prints, but it seems slow, try the following solutions.

1. Make sure the computer meets the minimum specifications for this printer. For a list of specifications, go to this Web site: <http://www.hp.com/support/colorlj5700> or <http://www.hp.com/support/colorljX557> or <http://www.hp.com/support/colorlj5800MFP> or <http://www.hp.com/support/colorljX57945MFP>.
2. When the printer is configured to print on some paper types, such as heavy paper, the printer prints more slowly so it can correctly fuse the toner to the paper. If the paper type setting is not correct for the type of paper you are using, change the setting to the correct paper type.
3. If the host computer or the printer is connected to a wireless network, low signal quality or interference might be delaying print jobs.

Solve connectivity problems

Review the following information and procedures to solve connectivity problems.

Solve USB connection problems

If you have connected the product directly to a computer, check the cable.

- Verify that the cable is connected to the computer and to the product.
- Verify that the cable is not longer than 2 m (6.65 ft). Try using a shorter cable.
- Verify that the cable is working correctly by connecting it to another product. Replace the cable if necessary.

Solve wired network problems

Review the following information and procedures to solve wired network problems.

Introduction

Learn about solving wired network problems.

Certain types of problems can indicate there is a network communication problem. These problems include the following issues:

- The periodic loss of ability to communicate with the printer

- The printer cannot be found during driver installation
- A periodic failure to print

Check the items in this topic to verify that the printer is communicating with the network. Before beginning, print a configuration page from the printer control panel and locate the printer IP address that is listed on this page.

Poor physical connection

Use the following procedure when the printer has a poor physical connection.

1. Verify that the printer is attached to the correct network port using a cable of the correct length.
2. Verify that cable connections are secure.
3. Look at the network port connection on the back of the printer, and verify that the amber activity light and the green link-status light are lit.
4. If the problem continues, try a different cable or port on the hub.

The computer is using the incorrect IP address for the printer

Use the following procedure when the computer is using the incorrect IP address for the printer.

1. Open the printer properties and click the **Ports** tab. Verify that the current IP address for the printer is selected. The printer IP address is listed on the printer configuration page.
2. If you installed the printer using the HP standard TCP/IP port, select the box labeled **Always print to this printer, even if its IP address changes**.
3. If you installed the printer using a Microsoft standard TCP/IP port, use the hostname instead of the IP address.
4. If the IP address is correct, delete the printer and then add it again.

The computer is unable to communicate with the printer

Use the following procedure when the computer is unable to communicate with the printer.

1. Test network communication by pinging the network.
 - a. Open a command-line prompt on your computer.
 - For Windows, click **Start**, click **Run**, type `cmd`, and then press **Enter**.
 - For macOS, go to **Applications**, then **Utilities**, and open **Terminal**.
 - b. Type `ping` followed by the IP address for your printer.
 - c. If the window displays round-trip times, the network is working.
2. If the ping command failed, verify that the network hubs are on, and then verify that the network settings, the printer, and the computer are all configured for the same network.

The printer is using incorrect link and duplex settings for the network

HP recommends leaving these settings in automatic mode (the default setting). If you change these settings, you must also change them for your network.

New software programs might be causing compatibility problems

Verify that any new software programs are correctly installed and that they use the correct print driver.

The computer or workstation might be set up incorrectly

Use the following procedure when the computer or workstation might be set up incorrectly.

1. Check the network drivers, print drivers, and the network redirection settings.
2. Verify that the operating system is configured correctly.

The printer is disabled, or other network settings are incorrect

Use the following procedure when the printer is disabled, or other network settings are incorrect.

1. Review the configuration page to check the status of the network protocol. Enable it if necessary.
2. Reconfigure the network settings if necessary.

5 Removal and replacement

When servicing the printer, several items must be considered to ensure a successful repair and to avoid damage to the printer or personal injury. Learn about these considerations and find detailed instructions for removing and replacing printer parts.

Customer self-repair (CSR) A parts and accessories

Customer self-repair (CSR) A parts are parts that a customer replaces without assistance from a field technician. These parts can be replaced without the use of any tools.

Customer-replaceable units

Learn about customer-replaceable parts removal and replacement.

Internal parts and assemblies

Learn how to remove and replace the printer internal parts and assemblies.

Removal and replacement: Toner cartridges (5700/X557/5800 models)

This document provides the procedures to remove and replace the toner cartridges.



[View a video of removing and replacing the toner cartridges.](#)

Before performing service

⚠ CAUTION: To prevent damage to a toner cartridge, do not expose it to light for more than a few minutes. Cover the imaging drum if the toner cartridge must be removed from the printer for an extended period of time.

If toner gets on the skin or clothing, wipe it off with dry tissue paper and wash in cold water. Hot water sets toner and it might be difficult, or impossible, to remove.

Use the table below to identify the correct part number for your printer, and then go to <https://parts.hp.com/hpparts> to order the part.

Table 5-1 Part information

Part number	Part description
W2130A	HP 213A Black Original LaserJet Toner Cartridge with instruction guide
W2130A	HP 2130X High Yield Black Toner Cartridge with instruction guide
W2130Y	HP 213Y Extra High Yield Black Toner Cartridge with instruction guide

Table 5-1 Part information (continued)

Part number	Part description
W2131A	HP 213A Cyan Original LaserJet Toner Cartridge with instruction guide
W2131X	HP 2131X High Yield Cyan Toner Cartridge with instruction guide
W2131Y	HP 213Y Extra High Yield Cyan Toner Cartridge with instruction guide
W2132A	HP 213A Yellow Original LaserJet Toner with instruction guide
W2132X	HP 2132X High Yield Yellow Toner Cartridge with instruction guide
W2132Y	HP 213Y Extra High Yield Yellow Toner Cartridge with instruction guide
W2133A	HP 213A Magenta LaserJet Toner Cartridge with instruction guide
W2133X	HP 2133X High Yield Magenta Toner Cartridge with instruction guide
W2133Y	HP 213Y Extra High Yield Magenta Toner Cartridge with instruction guide

Required tools

- No special tools are required to remove or install this assembly.

After performing service

- Make sure that the cartridge door is fully closed after replacing a toner cartridge.

Post service test

Print any pages necessary to make sure the printer is functioning correctly.

1. Remove the toner cartridges (5700/X557/5800 models)

Follow these steps to remove a toner cartridge.

1. Open the front door.

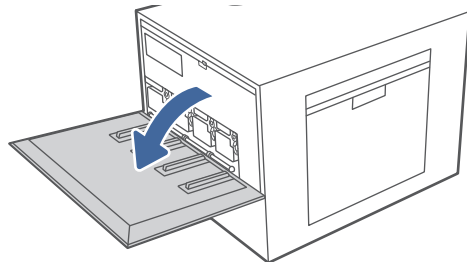

2. Grasp the end of the toner cartridge and pull it straight out of the printer.

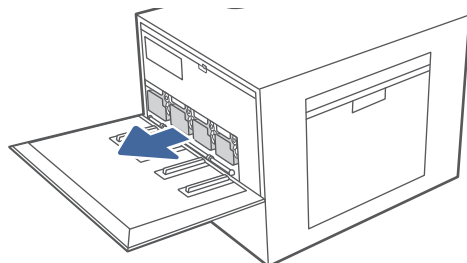

2. Unpack the replacement assembly

Follow these steps to unpack the replacement assembly.

1. Dispose of the defective part.

 **NOTE:** HP recommends responsible disposal of the part.

<http://www8.hp.com/us/en/hp-information/environment/product-recycling.html>

2. Unpack the replacement part from the packaging.

 **IMPORTANT:** Make sure that all of the shipping materials (for example shipping tape) are removed from the replacement part prior to installation.

3. Install the toner cartridges (5700/X557/5800 models)

Follow these steps to install a toner cartridge.

1. Remove the new toner cartridge from its package. Save all packaging for recycling the used toner cartridge.

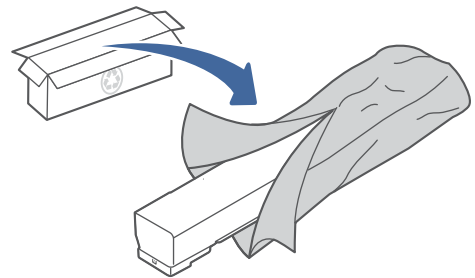

2. Hold both ends of the toner cartridge and rock it back and forth end to end to evenly distribute the toner that is inside.

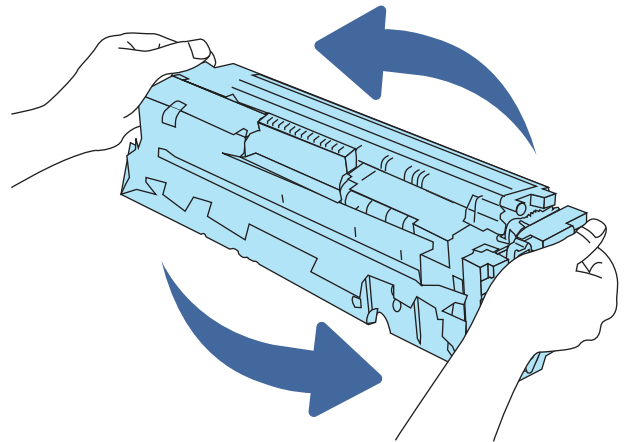

3. Align the toner cartridge with its slot and insert it into the printer.

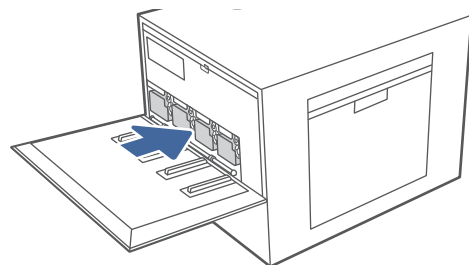

4. Close the front door.

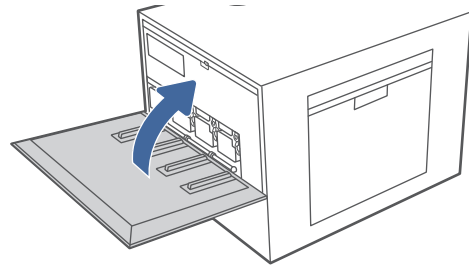

5. Pack the used toner cartridge into the box that the new toner cartridge came in. See the enclosed recycling guide for information about recycling.

In the U.S. and Canada, a pre-paid shipping label is included in the box. In other countries/regions, go to www.hp.com/recycle to print a pre-paid shipping label.

Adhere the pre-paid shipping label to the box, and return the used cartridge to HP for recycling.

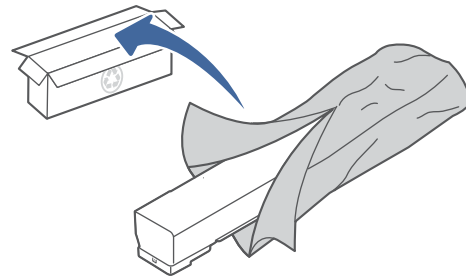

Removal and replacement: Toner cartridges (X57945 models)

This document provides the procedures to remove and replace the toner cartridges.

 [View a video of removing and replacing the toner cartridges.](#)

Before performing service

- ⚠ CAUTION:** To prevent damage to a toner cartridge, do not expose it to light for more than a few minutes. Cover the imaging drum if the toner cartridge must be removed from the printer for an extended period of time.

If toner gets on the skin or clothing, wipe it off with dry tissue paper and wash in cold water. Hot water sets toner and it might be difficult, or impossible, to remove.

Use the table below to identify the correct part number for your printer, and then go to <https://parts.hp.com/hpparts> to order the part.

Table 5-2 Part information

Part number	Part description
W9240MC	HP W9240MC Black Mngd LaserJet Toner Cartridge (SFP) with instruction guide
W9241MC	HP W9241MC Cyan Mngd LaserJet Toner Cartridge (SFP) with instruction guide
W9242MC	HP W9242MC Yellow Mngd LaserJet Toner Cartridge (SFP) with instruction guide
W9243MC	HP W9243MC Magenta Mngd LaserJet Toner Cartridge (SFP) with instruction guide
W9250MC	HP W9250MC Black Mngd LaserJet Toner Cartridge (MFP) with instruction guide
W9251MC	HP W9251MC Cyan Mngd LaserJet Toner Cartridge (MFP) with instruction guide
W9252MC	HP W9252MC Yellow Mngd LaserJet Toner Cartridge (MFP)with instruction guide

Table 5-2 Part information (continued)

Part number	Part description
W9253MC	HP W9253MC Magenta Mngd LaserJet Toner Cartridge (MFP) with instruction guide

Required tools

- No special tools are required to remove or install this assembly.

After performing service

- Make sure that the cartridge door is fully closed after replacing a toner cartridge.

Post service test

Print any pages necessary to make sure the printer is functioning correctly.

1. Eject the toner cartridges (X57945 models)

Follow these steps to eject a toner cartridge.

 **NOTE:** Two methods are available to eject a toner cartridge using the control panel.

- Eject a toner cartridge with the printer in the Ready state.
See [Eject a toner cartridge using the control panel \(Ready state\) on page 443](#).
- Eject a toner cartridge with the printer in a cartridge low or very low error state.
See [Eject a toner cartridge using the control panel \(error condition\) on page 444](#).

Eject a toner cartridge using the control panel (Ready state)

Use the following steps to eject a toner cartridge when the printer is in the Ready state.

1. From the control panel Home screen, scroll to and select the **Supplies** button.
2. Select the **Eject** button  (located below the **Cartridge Levels** indicators).

Figure 5-1 Eject the toner cartridge (Ready state)



3. A prompt appears on the control-panel display to open the toner cartridge door.

Eject a toner cartridge using the control panel (error condition)

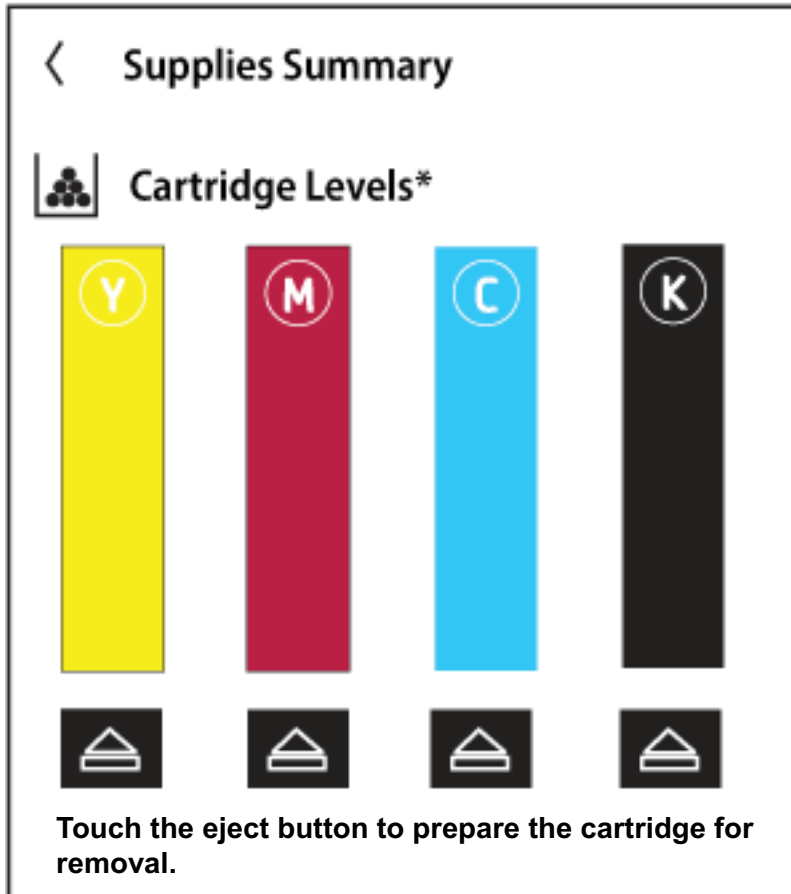
Use the following steps to eject a toner cartridge when the printer is in a cartridge low or very low error state.

1. On the control panel Home screen, Touch the error icon at the top of the display.

Figure 5-2 Eject the toner cartridge (error state) (1 of 2)

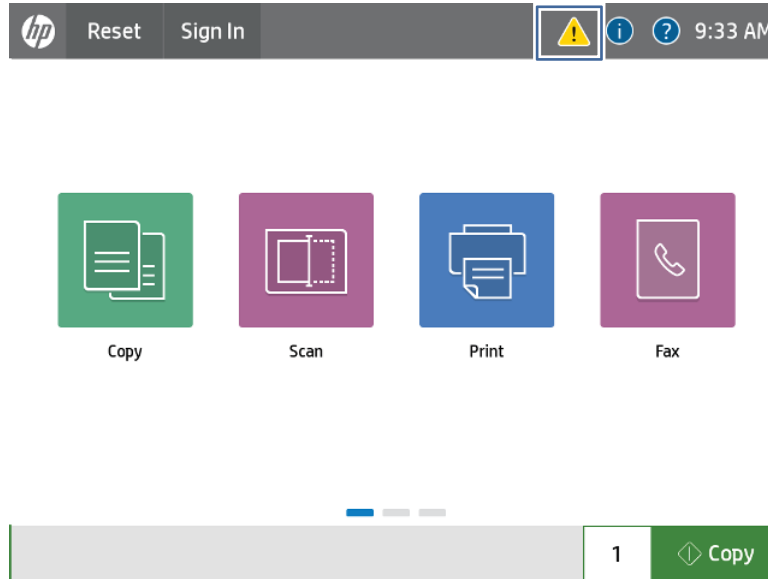

2. Touch the **Eject** button at the bottom of the display.

Figure 5-3 Eject the toner cartridge (error state) (2 of 2)

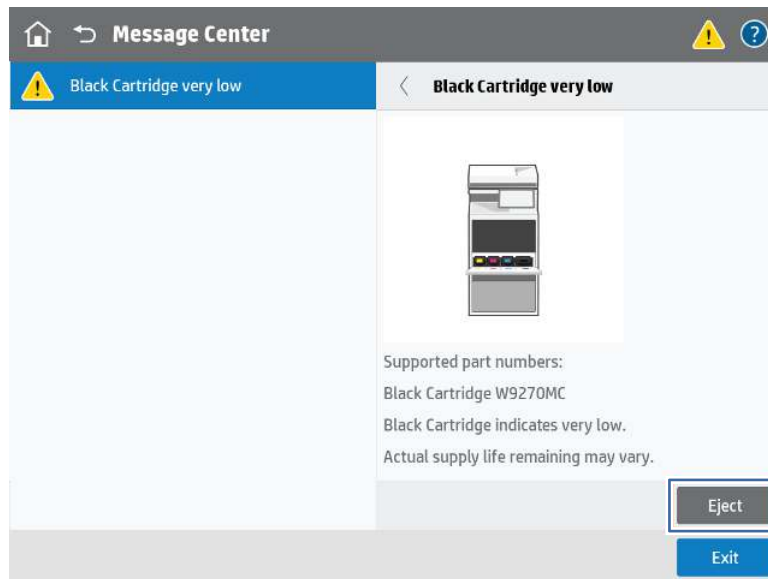

3. A prompt appears on the control-panel display to open the toner cartridge door.

2. Remove the toner cartridges (X579 models)

Follow these steps to remove a toner cartridge.



NOTE: The toner cartridges must be released before removing them. See [Eject the toner cartridges \(X57945 models\) on page 443](#).

1. Open the toner cartridge door on the front of the printer.

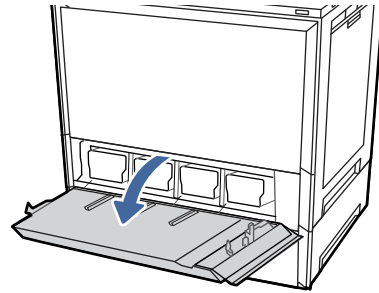

2. Grasp the end of the toner cartridge and pull it straight out of the printer.

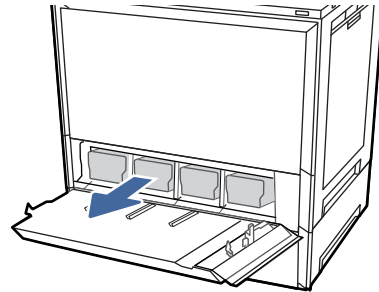

3. Unpack the replacement assembly

Follow these steps to unpack the replacement assembly.

1. Dispose of the defective part.



NOTE: HP recommends responsible disposal of the part.

<http://www8.hp.com/us/en/hp-information/environment/product-recycling.html>

2. Unpack the replacement part from the packaging.



IMPORTANT: Make sure that all of the shipping materials (for example shipping tape) are removed from the replacement part prior to installation.

4. Install the toner cartridges (X579 models)

Follow these steps to install a toner cartridge.

1. Remove the new toner cartridge from its package. Save all packaging for recycling the used toner cartridge.

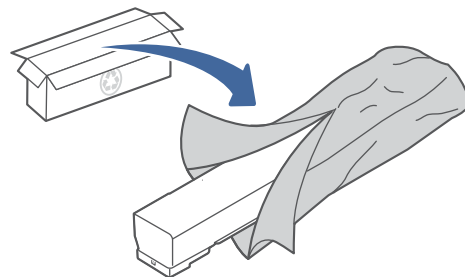

2. Hold both ends of the toner cartridge and rock it to evenly distribute the toner that is inside.

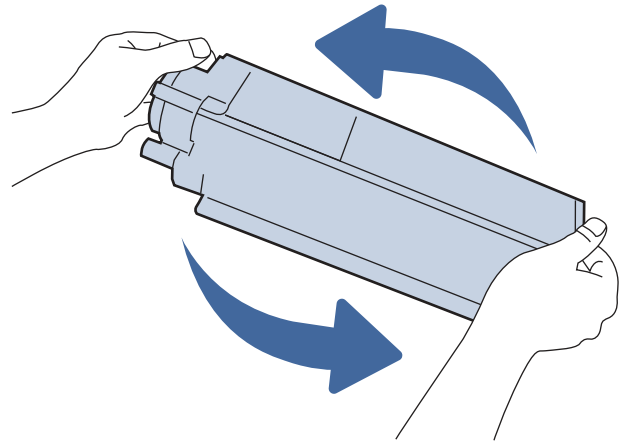

3. Align the toner cartridge with its slot and insert it into the printer.

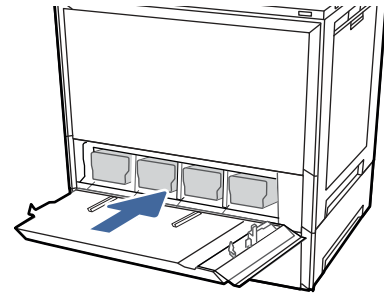

4. Close the toner cartridge door.

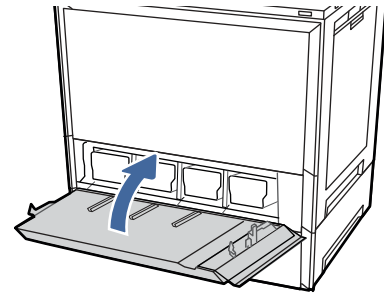

5. Pack the used toner cartridge into the box that the new toner cartridge came in. See the enclosed recycling guide for information about recycling.

In the U.S. and Canada, a pre-paid shipping label is included in the box. In other countries/regions, go to www.hp.com/recycle to print a pre-paid shipping label.

Adhere the pre-paid shipping label to the box, and return the used cartridge to HP for recycling.

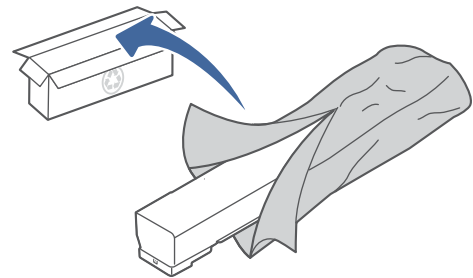

Removal and replacement: Imaging drums (X57945 models)

This document provides the procedures to remove and replace the imaging drums.



[View a video of removing and replacing the image drums.](#)

Before performing service

- ⚠ **CAUTION:** To prevent damage to an imaging drum, do not expose it to light for more than a few minutes. Cover the green imaging drum if it must be removed from the printer for an extended period of time.

If toner gets on the skin or clothing, wipe it off with dry tissue paper and wash in cold water. Hot water sets toner and it might be difficult, or impossible, to remove.

Use the table below to identify the correct part number for your printer, and then go to <https://parts.hp.com/hpparts> to order the part.

Table 5-3 Part information

Part number	Part description
W9280MC	HP W9280MC Black Mngd Imaging Drum with instruction guide
W9281MC	HP W9281MC Cyan Mngd Imaging Drum with instruction guide
W9282MC	HP W9282MC Yellow Mngd Imaging Drum with instruction guide
W9283MC	HP W9283MC Magenta Mngd Imaging Drum with instruction guide

Required tools

- No special tools are required to remove or install this assembly.

After performing service

- Make sure that the front door is fully closed after replacing an image drum.

Post service test

Print any pages necessary to make sure the printer is functioning correctly.

1. Remove the imaging drums (X579 models)

Follow these steps to remove an imaging drum.

1. Open the front door.

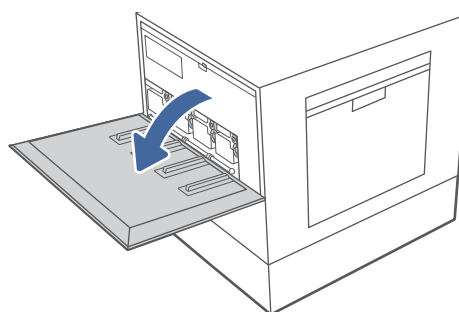

 **NOTE:** If necessary, remove two screws holding the imaging drum access cover in place, and then lower the cover to access the imaging drums. See the figure below.

Figure 5-4 Remove two screws, open the cover



2. Grasp the end of the imaging drum cartridge and pull it straight out of the printer.

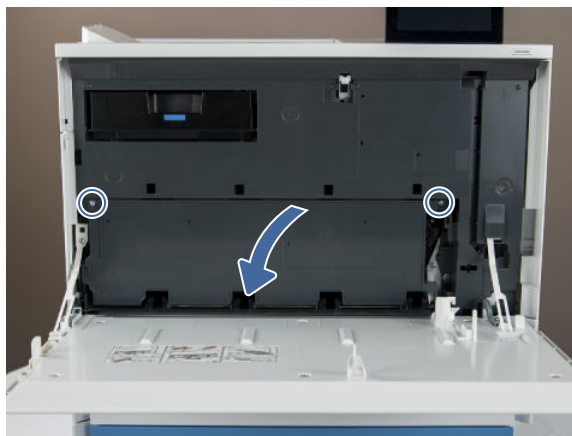
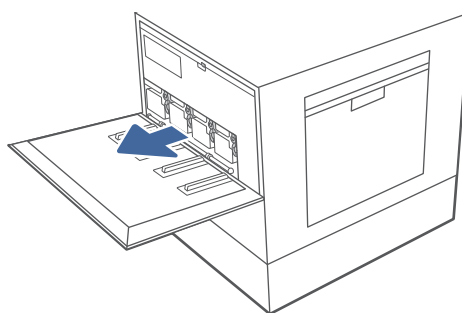

2. Unpack the replacement assembly

Follow these steps to unpack the replacement assembly.

1. Dispose of the defective part.



NOTE: HP recommends responsible disposal of the part.

<http://www8.hp.com/us/en/hp-information/environment/product-recycling.html>

2. Unpack the replacement part from the packaging.



IMPORTANT: Make sure that all of the shipping materials (for example shipping tape) are removed from the replacement part prior to installation.

3. Install the imaging drums (X579 models)

Follow these steps to install an imaging drum.

1. Remove the new imaging drum cartridge from its package. Save all packaging for recycling the used imaging drum.

CAUTION: To prevent damage to the imaging drum, do not expose it to light for more than a few minutes. Cover the blue imaging drum if the imaging drum cartridge must be removed from the printer for an extended period of time. Do not touch the blue imaging drum.

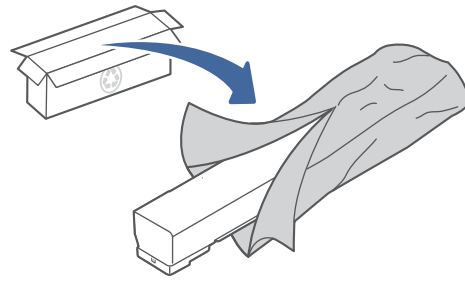

2. Hold both ends of the imaging drum cartridge and rock it back and forth end to end to evenly distribute the toner that is inside.

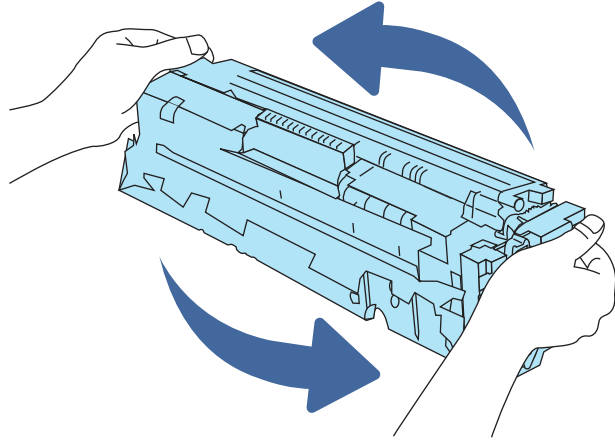

3. Align the imaging drum cartridge with its slot and insert it into the printer.

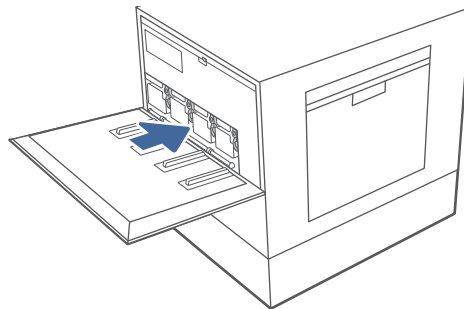

NOTE: If necessary, close the imaging drum access cover, and then install the two screws to secure the cover. See the figure below.

Figure 5-5 Close the cover, install two screws

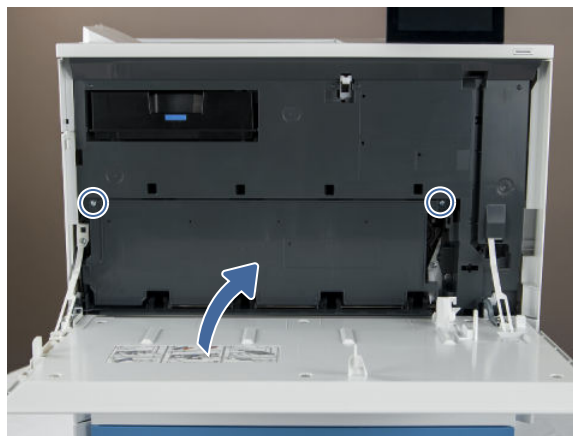

4. Close the front door.

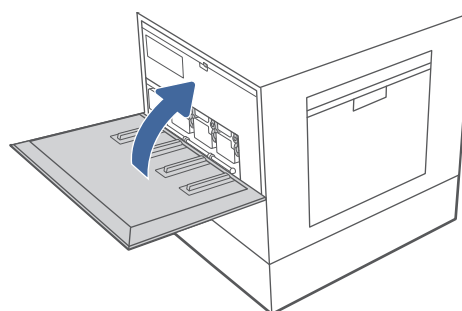

NOTE: If necessary, close the access cover and replace the two screws before closing the front door.

5. Pack the used imaging drum into the box that the new imaging drum came in. See the enclosed recycling guide for information about recycling.

In the U.S. and Canada, a pre-paid shipping label is included in the box. In other countries/regions, go to www.hp.com/recycle to print a pre-paid shipping label.

Adhere the pre-paid shipping label to the box, and return the used imaging drum to HP for recycling.

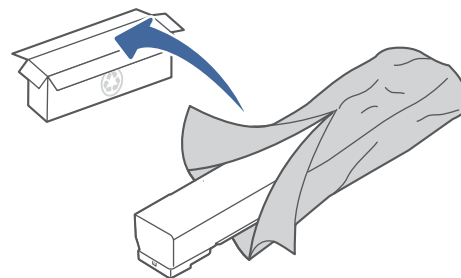

Removal and replacement: Toner collection unit (TCU)

Learn about removing and replacing the toner collection unit (TCU).



[View a video of removing and replacing the TCU.](#)

Before performing service

Use the table below to identify the correct part number for your printer, and then go to <https://parts.hp.com/hpparts> to order the part.

Table 5-4 Part information

Part number	Part description
527F9A	HP LaserJet Toner collection unit (TCU) with instruction guide

Required tools

- No special tools are required to remove or install this assembly.

After performing service

Make sure that the front door is fully closed after replacing the TCU.

Post service test

No post service test is available for this assembly.

1. Remove the toner collection unit (TCU)

Follow these steps to remove the toner collection unit (TCU).

1. Open the front door.

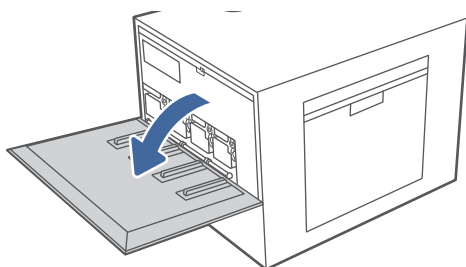

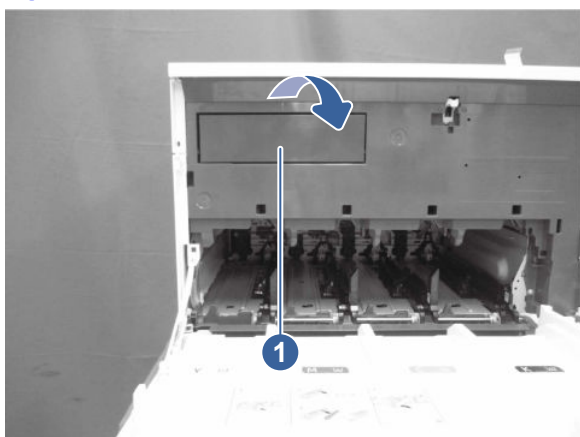

2. Rotate and then pull the TCU cover to remove it.

Figure 5-6 Remove the TCU cover

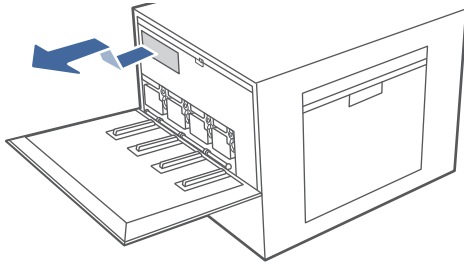

3. Lift the TCU slightly and then pull it out of the printer.



 **NOTE:** Maintain the position of the TCU as you pull it out from the printer. This will ensure that you do not spill any waste toner in the printer. Place the unit into the clear plastic bag the new TCU was packaged in.

2. Unpack the replacement assembly

Follow these steps to unpack the replacement assembly.

1. Dispose of the defective part.

 **NOTE:** HP recommends responsible disposal of the part.

<http://www8.hp.com/us/en/hp-information/environment/product-recycling.html>

2. Unpack the replacement part from the packaging.

 **IMPORTANT:** Make sure that all of the shipping materials (for example shipping tape) are removed from the replacement part prior to installation.

3. Install the TCU

Follow these steps to install the toner collection unit (TCU).

1. Remove the new TCU from its package. Save all packaging for recycling the used TCU.

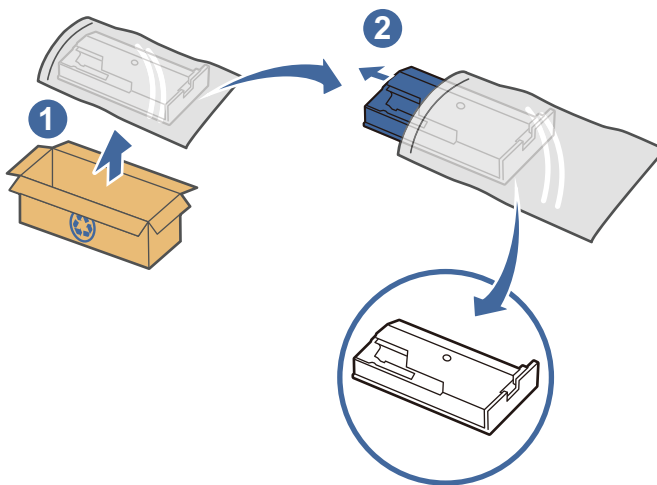

2. Install the new TCU by inserting it into the printer, and then lifting slightly to make sure it pushes all the way in.

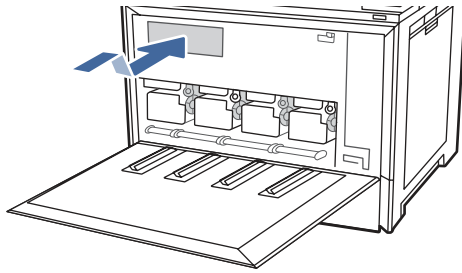

3. Replace the TCU cover.
4. Close the front door.

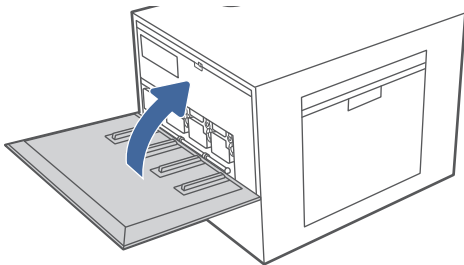

5. Pack the used TCU into the box that the new TCU came in. See the enclosed recycling guide for information about recycling.

In the U.S. and Canada, a pre-paid shipping label is included in the box. In other countries/regions, go to www.hp.com/recycle to print a pre-paid shipping label.

Adhere the pre-paid shipping label to the box, and return the used TCU to HP for recycling.

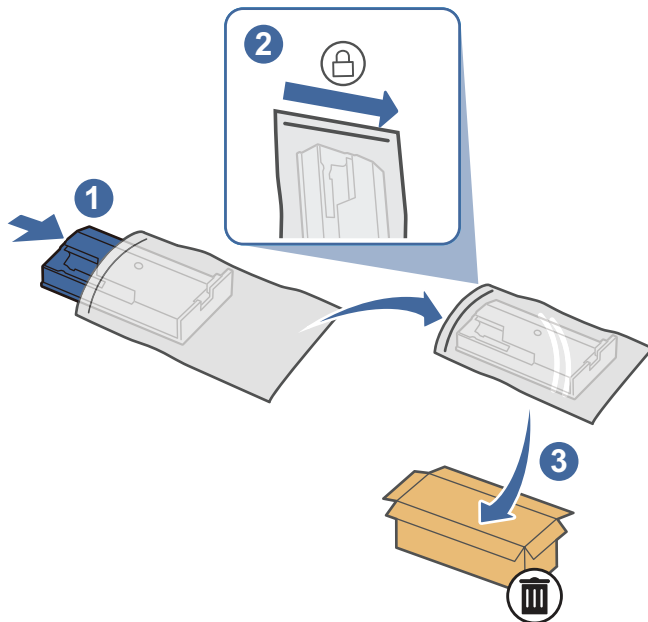

Removal and replacement: 3-bin stapler-stacker staple cartridge (3-bin stapler-stacker)

Learn about removing and replacing the 3-bin stapler/stacker staple cartridge.



[View a video of removing and replacing the staple cartridge.](#)

Before performing service

Use the table below to identify the correct part number for your printer, and then go to <https://parts.hp.com/hpparts> to order the part.

Table 5-5 Part information

Part number	Part description
J8J96AJ8J96A	HP Staple Cartridge Refill for the floor-standing finisher or 3-bin stapler-stacker

Required tools

- No special tools are required to remove or install this assembly.

Post service test

Use the stapler to staple two pages together.

1. Remove the staple cartridge (3-bin stapler-stacker)

Follow these steps to remove the 3-bin stapler-stacker staple cartridge.

1. Open the 3-bin stapler-stacker staple door.

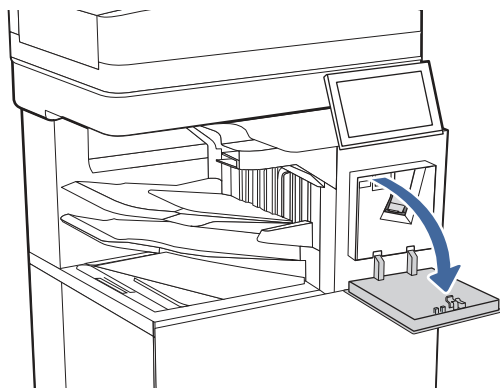

2. Pull down the colored handle on the staple carriage, and then pull the staple carriage straight out.

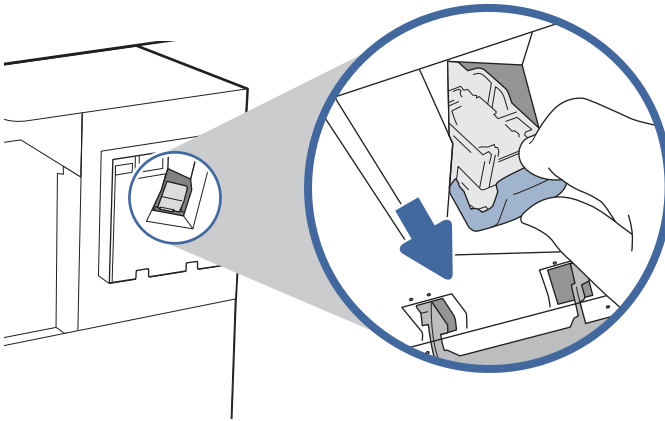

2. Unpack the replacement assembly

Follow these steps to unpack the replacement assembly.

1. Dispose of the defective part.



NOTE: HP recommends responsible disposal of the part.

<http://www8.hp.com/us/en/hp-information/environment/product-recycling.html>

2. Unpack the replacement part from the packaging.



IMPORTANT: Make sure that all of the shipping materials (for example shipping tape) are removed from the replacement part prior to installation.

3. Install the staple cartridge (3-bin stapler-stacker)

Follow these steps to install the 3-bin stapler-stacker staple cartridge.



NOTE: Do not dispose of the staple carriage. The carriage is not an orderable or replaceable part. If the carriage is disposed of, the entire staple cartridge assembly will need to be replaced.

1. Remove the staple cartridge from the carrier/sled and replace it with the new staple cartridge.



NOTE: Do not dispose of the staple carrier/sled. The sled is not an orderable or replaceable part.

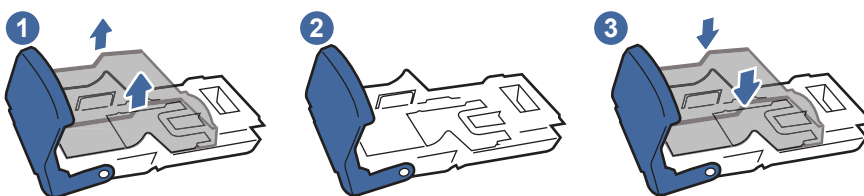

2. Reinstall the staple carriage into the stapler by pressing the colored handle inward until it snaps into place.

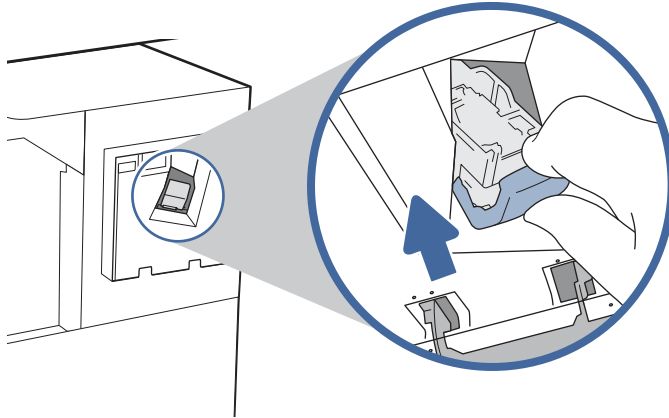

3. Close the 3-bin stapler-stacker staple door.

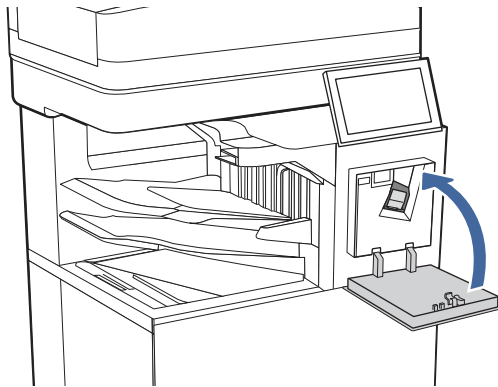

Removal and replacement: Convenience staple cartridge (convenience stapler models)

Learn about removing and replacing the convenience stapler staple cartridge.



[View a video of removing and replacing the staple cartridge.](#)

Before performing service

Use the table below to identify the correct part number for your printer, and then go to <https://parts.hp.com/hpparts> to order the part.

Table 5-6 Part information

Part number	Part description
Q7432A	HP Staple Cartridge Pack for the convenience stapler

Required tools

- No special tools are required to remove or install this assembly.

Post service test

Use the stapler to staple two pages together.

1. Remove the staple cartridge (convenience stapler)

Follow these steps to remove the convenience stapler staple cartridge.

1. Open the stapler door.

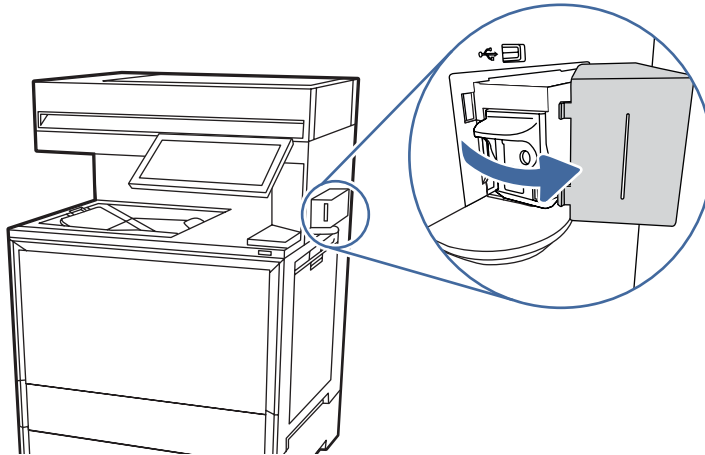

2. Pull the staple carriage straight out.

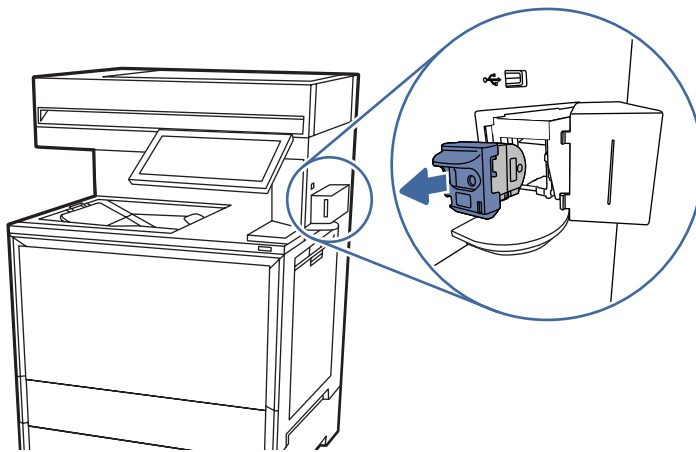

2. Unpack the replacement assembly

Follow these steps to unpack the replacement assembly.

1. Dispose of the defective part.



NOTE: HP recommends responsible disposal of the part.

<http://www8.hp.com/us/en/hp-information/environment/product-recycling.html>

2. Unpack the replacement part from the packaging.



IMPORTANT: Make sure that all of the shipping materials (for example shipping tape) are removed from the replacement part prior to installation.

3. Install the staple cartridge (convenience stapler)

Follow these steps to install the convenience stapler staple cartridge.

1. Insert the new staple carriage into the stapler.

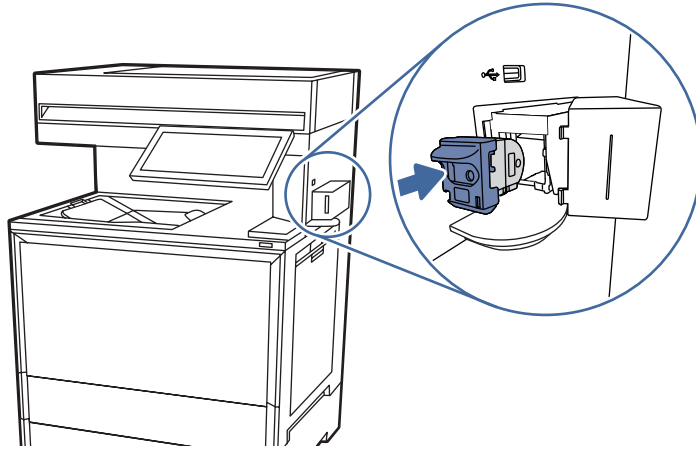

2. Close the stapler door.

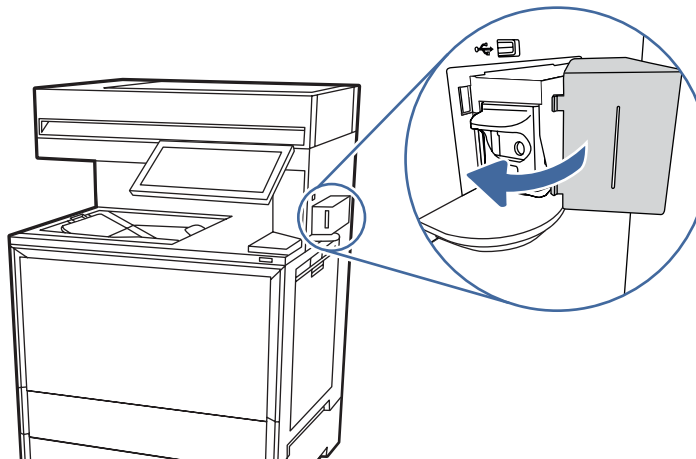

Removal and replacement: Fuser

This document provides the procedures to remove and replace the fuser.

 [View a video to remove and replace the fuser](#)

Mean time to repair: 5 minutes

Service level: Basic

Before performing service

⚠ WARNING! The fuser is hot. Wait at least 30 minutes after turning the printer power off before removing the fuser.

Use the table below to identify the correct part number for your printer. To order the part, go to www.hp.com/buy/parts.

Table 5-7 Part information

Part number	Part description
527G0A	HP LaserJet 110V Fuser Kit
527G1A	HP LaserJet 220V Fuser Kit
527G6A	HP LaserJet 110V Enhanced Fuser Kit
527G7A	HP LaserJet 220V Enhanced Fuser Kit

Required tools

No special tools are required to remove or install this assembly.

After performing service

Make sure that the right door is fully closed after replacing the fuser.

Post service test

Print a configuration page to make sure that the printer is functioning correctly.

1. Remove the fuser

Follow these steps to remove the fuser.

1. Open the right door.

⚠ CAUTION: The fuser is hot. Wait at least 10 minutes after turning the printer power off before removing the fuser.

Figure 5-7 Open the right door



2. Squeeze the release levers on the handles (circle callouts), and then remove the fuser.

Figure 5-8 Remove the fuser

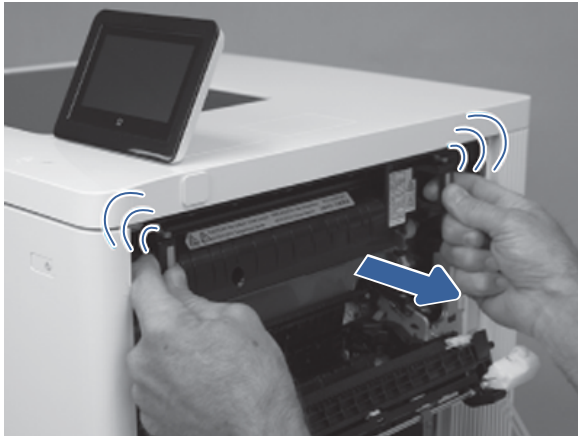

2. Unpack the replacement assembly

Follow these steps to unpack the replacement assembly.

1. Dispose of the defective part.



NOTE: HP recommends responsible disposal of the part.

<http://www8.hp.com/us/en/hp-information/environment/product-recycling.html>

2. Unpack the replacement part from the packaging.



IMPORTANT: Make sure that all of the shipping materials (for example shipping tape) are removed from the replacement part prior to installation.

3. Install the fuser

Follow these steps to install the fuser.

1. Align the fuser with the opening in the printer.

Figure 5-9 Align the fuser with the opening

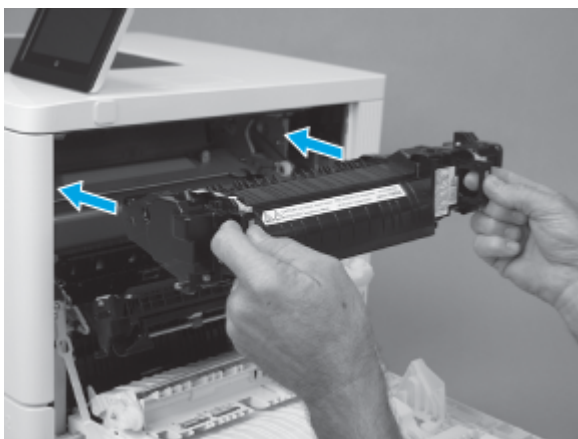

- Slide the fuser into the printer, push in to install it, and then make sure that it is fully seated.

 **TIP:** When the fuser is fully seated, the release levers on the handles make an audible click.

Figure 5-10 Install the fuser



- Close the right door.

Removal and replacement: Image transfer belt (ITB)

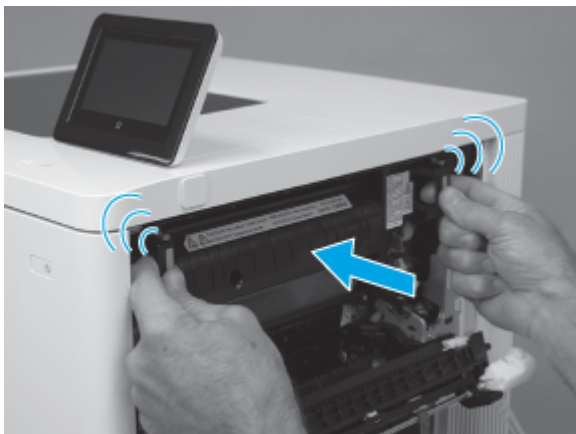
This document provides instructions about removing and replacing the image transfer belt (ITB) assembly.

 [View a video demonstration of removing and replacing the image transfer belt.](#)

Mean time to repair: 5 minutes

Service level: Basic

Before performing service

To order a replacement assembly, use the table below to identify the correct part number for your printer. To order the part, go to www.hp.com/buy/parts

Table 5-8 Part information

Part number	Part description
527G8A	HP LaserJet Image Transfer Belt

Required tools

No special tools are required to remove or install this assembly.

After performing service

Make sure that the right door is fully closed after replacing the ITB.

Post service test

Print a configuration page to make sure that the printer is functioning correctly.

1. Remove the ITB

Follow these steps to remove the ITB.

1. Open the right door.

Figure 5-11 Open the right door



2. Hold the two side levers and pull out the ITB assembly.

CAUTION: Do not touch the gray plastic belt. Skin oils and fingerprints on the belt can cause print-quality problems.

Figure 5-12 Release the ITB



2. Unpack the replacement assembly

Follow these steps to unpack the replacement assembly.

1. Dispose of the defective part.

NOTE: HP recommends responsible disposal of the part.

<http://www8.hp.com/us/en/hp-information/environment/product-recycling.html>

2. Unpack the replacement part from the packaging.

IMPORTANT: Make sure that all of the shipping materials (for example shipping tape) are removed from the replacement part prior to installation.

3. Install the ITB

Follow these steps to install the ITB.

1. Hold the ITB by the edges (do not touch the gray plastic belt).
2. Align the ITB with the slots in the printer, and then carefully push it into the printer.
3. Continue to carefully push the ITB into the printer until it is fully installed.
4. Close the right door.



TIP: The right door should close easily if the ITB assembly is correctly installed.

Removal and replacement: Secondary transfer roller

Learn about removing and replacing the secondary transfer roller.



[View a video of removing and replacing the T2 roller.](#)

Before performing service

Use the table below to identify the correct part number for your printer, and then go to <https://parts.hp.com/hpparts> to order the part.

Table 5-9 Part information

Part number	Part description
527H1MC	HP LaserJet Managed Trans Roller Kit

Required tools

- No special tools are required to remove or install this assembly.

After performing service

Make sure that the right door is fully closed after replacing the roller.

Post service test

Print any pages necessary to make sure the printer is functioning correctly.

1. Remove the secondary transfer roller

Follow these steps to remove the secondary transfer roller.

1. Open the right door.

Figure 5-13 Open the right door



2. Push the blue left end (callout 1) of the roller assembly to the right, and then lift that end of the secondary transfer roller (callout 2).

Figure 5-14 Release the left end of the secondary transfer roller

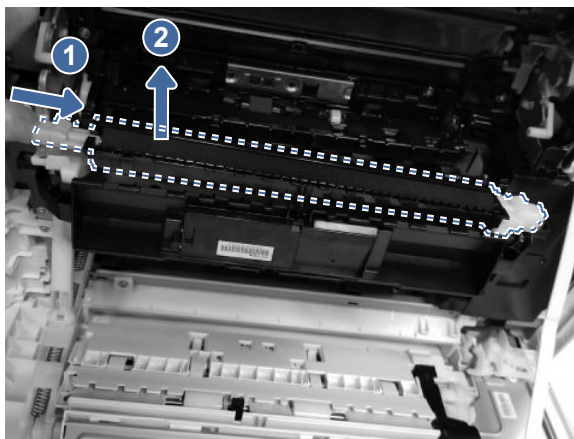

3. With the left end of the roller lifted up, pull the roller to the left and out of the printer. Take care in removing the right end of the roller from its holder.

Figure 5-15 Remove the secondary transfer roller

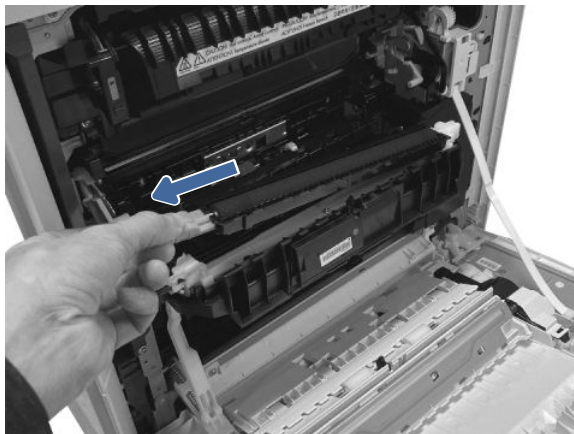

2. Unpack the replacement assembly

Follow these steps to unpack the replacement assembly.

1. Dispose of the defective part.

 **NOTE:** HP recommends responsible disposal of the part.

<http://www8.hp.com/us/en/hp-information/environment/product-recycling.html>

2. Unpack the replacement part from the packaging.

 **IMPORTANT:** Make sure that all of the shipping materials (for example shipping tape) are removed from the replacement part prior to installation.

3. Install the secondary transfer roller

Follow these steps to install the secondary transfer roller.

1. Carefully align and insert the right end of the replacement roller into the holder

 **IMPORTANT:** Make sure that right end of the roller assembly is fully seated in the holder.

Figure 5-16 Install right end of the secondary transfer roller



2. Push down on the blue left end until the roller snaps into place.

Figure 5-17 Secure the secondary transfer roller

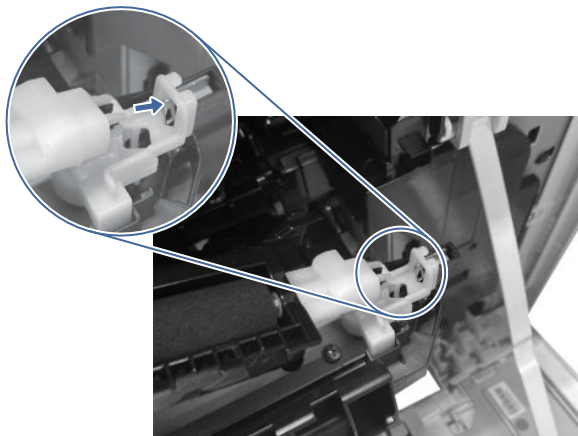

3. Close the right door.

Removal and replacement: Document feeder rollers (MFP models)

Learn about removing and replacing the document feeder rollers.



[View a video of removing and replacing the document feeder rollers.](#)

Before performing service

Use the table below to identify the correct part number for your printer, and then go to <https://parts.hp.com/hpparts> to order the part.

Table 5-10 Part information

Part number	Part description
6H121A	ADF Pick/Sep Roller Kit (5xxx Series)

Required tools

- No special tools are required to remove or install this assembly.

Post service test

Use the document feeder to copy a page, and then verify that the document correctly copies, scans, or prints.

1. Remove the ADF pickup and feed roller assembly

Follow these steps to remove the ADF pickup and feed roller assembly.

1. Open the document-feeder jam access door.

Figure 5-18 Open the document-feeder jam access door

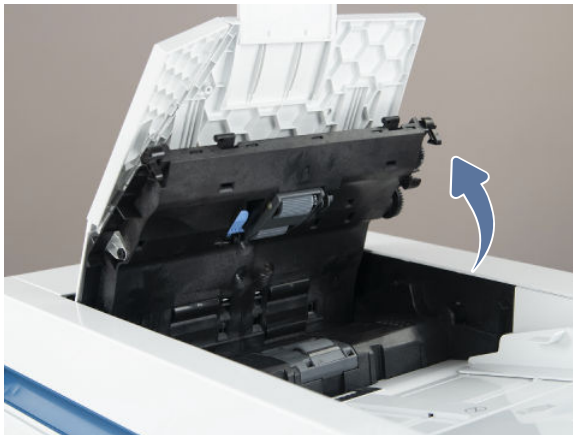

2. Release the blue locking arm to drop the assembly down. Slide the pickup and feed roller assembly to the left, and then pull it away from the document feeder to remove it.

Figure 5-19 Release the blue locking arm

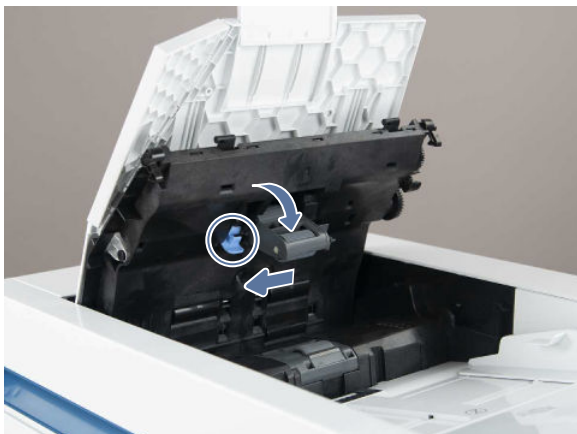

2. Remove the ADF separation roller

Follow these steps to remove the ADF separation roller.

- Lift the roller cover up and then slide the roller toward the front of the printer to remove it.

Figure 5-20 Release the separation roller cover

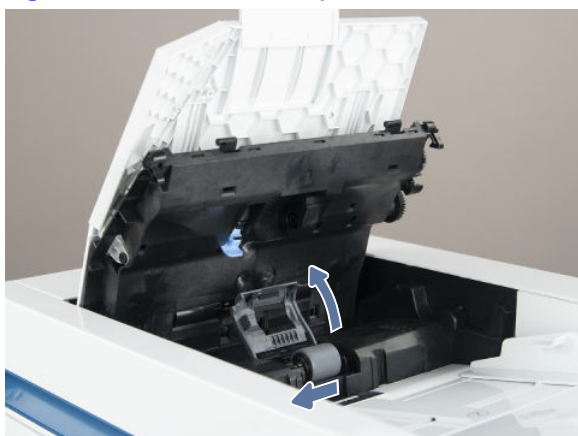

3. Unpack the replacement assembly

Follow these steps to unpack the replacement assembly.

1. Dispose of the defective part.



NOTE: HP recommends responsible disposal of the part.

<http://www8.hp.com/us/en/hp-information/environment/product-recycling.html>

2. Unpack the replacement part from the packaging.



IMPORTANT: Make sure that all of the shipping materials (for example shipping tape) are removed from the replacement part prior to installation.

4. Install the ADF separation roller

Follow these steps to install the ADF separation roller.

- Lower the separation roller into the document feeder, slide it to the right to install it, and then bring the cover down over the roller and snap it into place.

Figure 5-21 Install the ADF separation roller

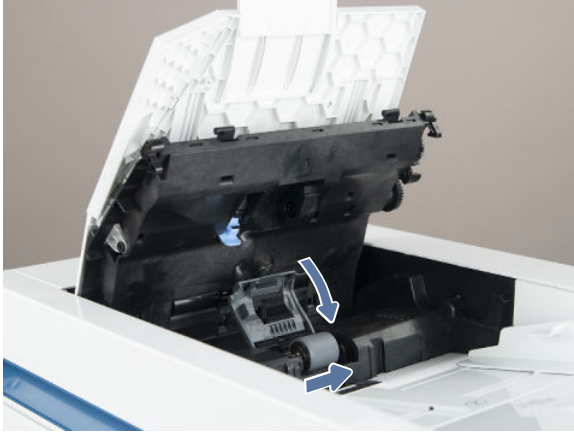

5. Install the ADF pickup and feed roller assembly

Follow these steps to install the pickup and feed roller assembly.

- Position the pickup and feed roller assembly in the document feeder, slide the assembly to the right to seat it in the ADF, and then push the lever up to lock the roller assembly in place.

Figure 5-22 Install the ADF pickup and feed roller assembly

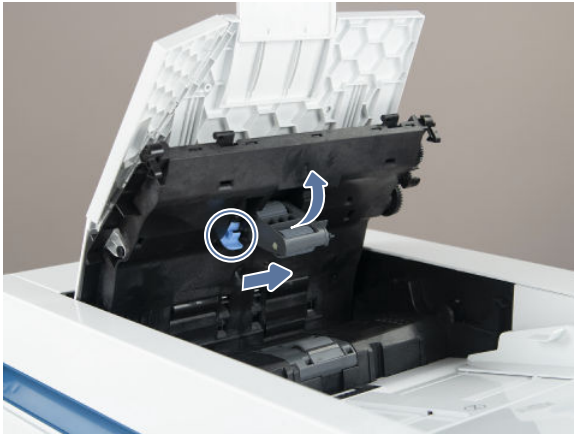

Installation: Keyboard overlay (MFP models)

Learn about installing a keyboard overlay.

Introduction

 [View a video of how to install the keyboard overlay.](#)

Before performing service

Turn the printer power off

- Disconnect the power cable.

⚠ WARNING! To avoid damage to the printer, turn the printer off, wait 30 seconds, and then remove the power cord before attempting to service the printer.

Use the table below to identify the correct part number for your printer, and then go to <https://parts.hp.com/hpparts> to order the part.

Table 5-11 Part information

Part number	Part description
A7W12A	Keyboard Overlay Kit - Chinese
A7W13A	Keyboard Overlay Kit - (DN/FR-Swiss/GN)
A7W14A	HP LaserJet Swedish Overlay Keyboard

Required tools

- No special tools are required to install this assembly.

After performing service

Turn the printer power on

- Connect the power cable.
- Use the power switch to turn the power on.

Post service test

Print any pages necessary to make sure the printer is functioning correctly.

1. Install the keyboard overlay (Flow MFP models)

Follow these steps to install the keyboard overlay.

1. Carefully peel the backing from the control panel overlay.

⚠ CAUTION: Do not touch the adhesive squares and be careful so that the adhesive squares do not come off with the backing.

Figure 5-23 Remove the backing

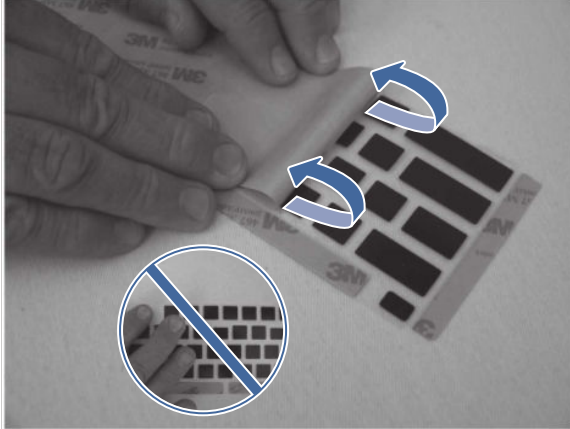

2. Position the keyboard overlay on the keyboard by aligning the upper edge of the overlay with the top edge of the keyboard.

Figure 5-24 Position the keyboard overlay top edge

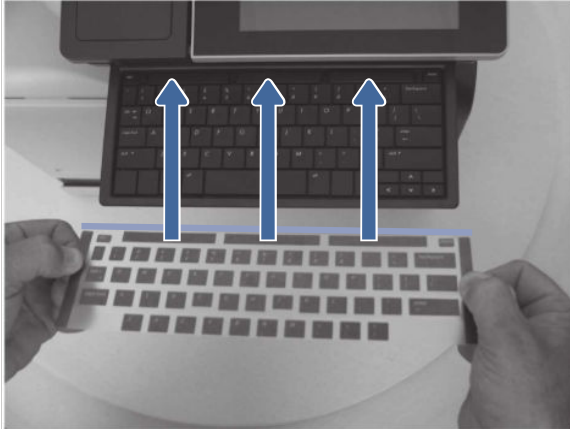

3. With the top edge positioned, align the side edges of the overlay with the keyboard edges.

Figure 5-25 Position the keyboard overlay side edges

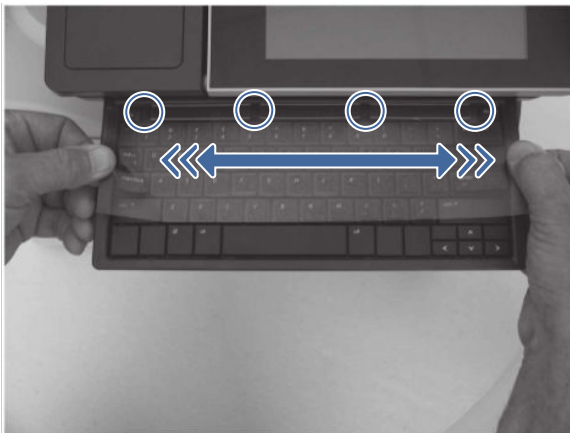

4. Place one hand under the keyboard and press upward (callout 1). Place the other hand on top of the keyboard overlay and press downward (callout 2). Continue to press while sliding both hands to the right (callout 3) to adhere the overlay to the keyboard.

Figure 5-26 Apply the keyboard overlay

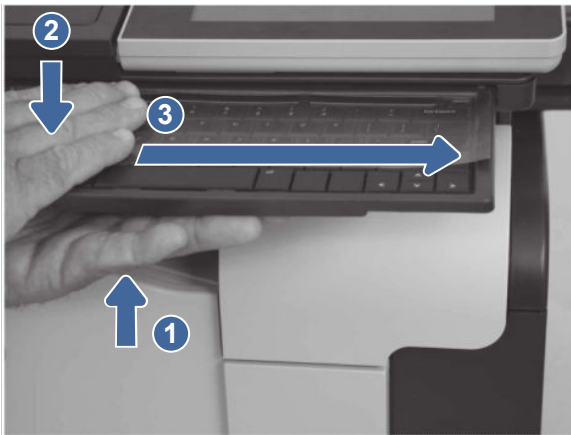

5. Carefully remove the protective top sheet from the keyboard overlay.

Figure 5-27 Apply the keyboard overlay



⚠ CAUTION: Make sure that the adhesive squares do not come off of the keyboard with the protective sheet.

Figure 5-28 Ensure that the squares do not stick to the top sheet

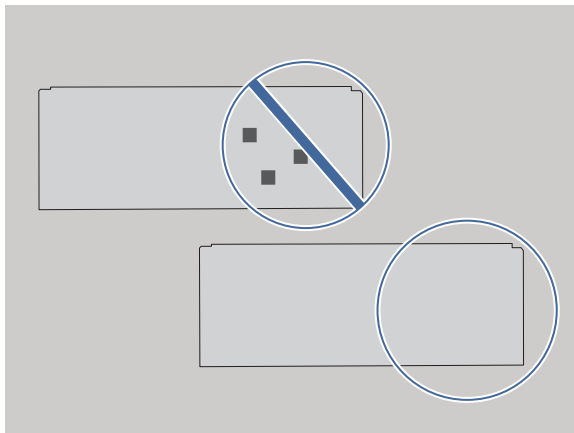

Removal and replacement: Tray 1 pickup and separation roller assemblies

Learn about removing and replacing the Tray 1 rollers.



[View a video of removing and replacing the Tray 1 rollers.](#)

Before performing service

If the part is damaged and cannot be cleaned, use the table below to identify the correct part number for your printer. To order the part, go to www.hp.com/buy/parts.

Table 5-12 Part information

Part number	Part description
527H3A	HP LaserJet MP Tray Roller Kit

Required tools

- No special tools are required to remove or install this assembly.

Post service test

Print any pages necessary to make sure the printer is functioning correctly.

1. Remove the Tray 1 pickup roller

Follow these steps to remove and replace the Tray 1 pickup roller.

1. On the right side of the printer, release the lower of the two latches to open Tray 1.

Figure 5-29 Open Tray 1

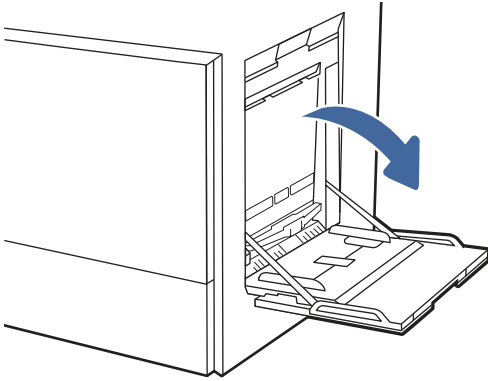

2. Locate and release the blue pickup roller assembly release tab (callout 1).

Figure 5-30 Locate the pickup roller assembly tab

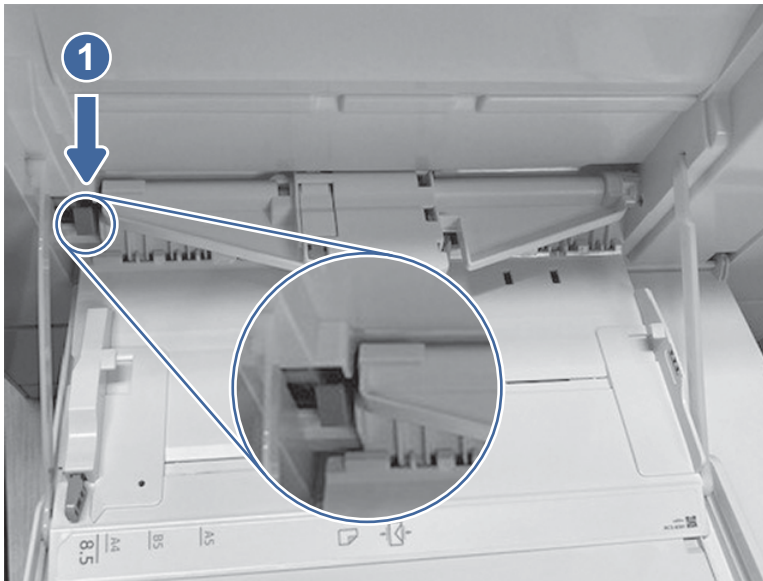

3. Push the pickup roller assembly to the right and then away from the printer.

Figure 5-31 Remove the pickup roller assembly

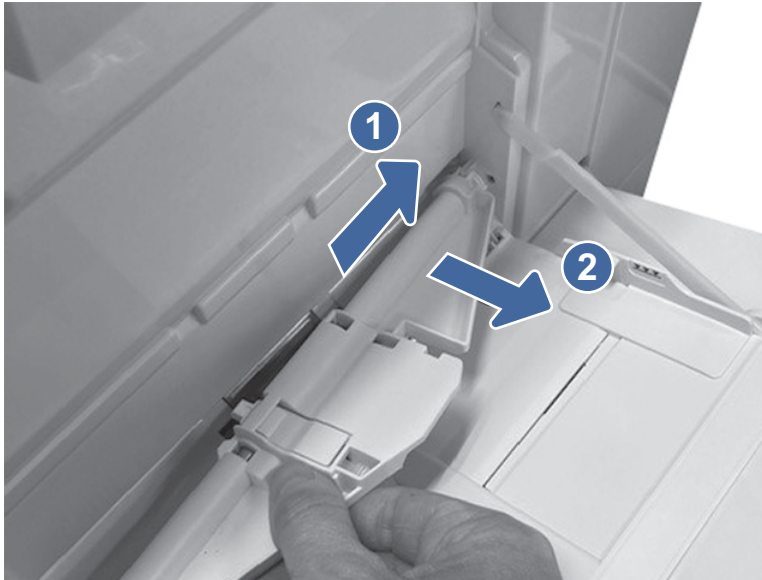

2. Remove the Tray 1 separation roller

Follow these steps to remove and replace the Tray 1 separation roller.

 **NOTE:** Even if you want to replace only the separation roller, you must first remove the pickup roller assembly.

1. Grasp the left- and right-side of the separation roller assembly, and then lift the assembly up.

Figure 5-32 Lift the separation roller assembly

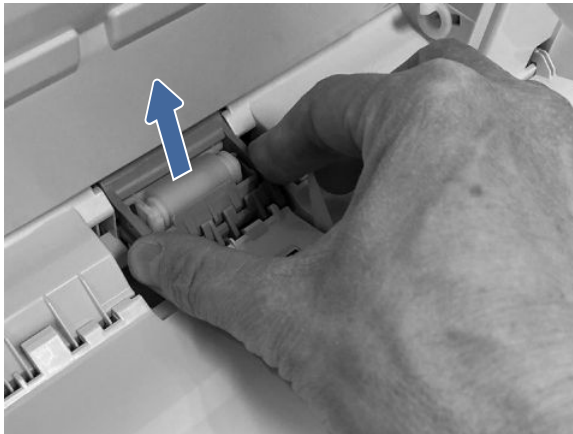

2. Pull the separation roller assembly straight out to remove it.

Figure 5-33 Remove the separation roller assembly

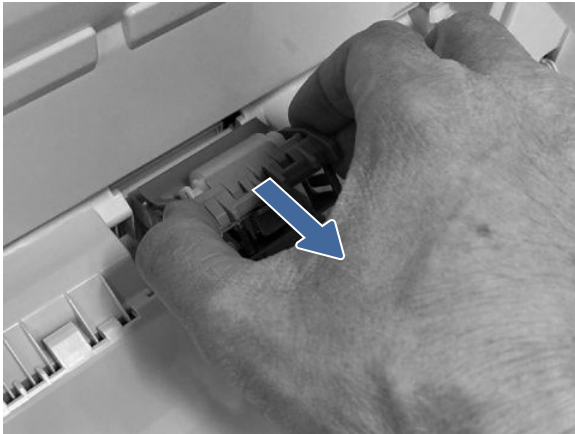

3. Unpack the replacement assembly

Follow these steps to unpack the replacement assembly.

1. Dispose of the defective part.



NOTE: HP recommends responsible disposal of the part.

<http://www8.hp.com/us/en/hp-information/environment/product-recycling.html>

2. Unpack the replacement part from the packaging.



IMPORTANT: Make sure that all of the shipping materials (for example shipping tape) are removed from the replacement part prior to installation.

4. Install the Tray 1 separation roller

Follow these steps to install the Tray 1 separation roller.

- CAUTION:** Do not touch the spongy portion of the roller. Skin oils on the roller can cause paper-handling and print-quality problems. HP recommends using disposable gloves or thoroughly washing your hands before handling the assembly.

1. Insert the separation roller assembly into the printer.

Figure 5-34 Insert the separation roller assembly

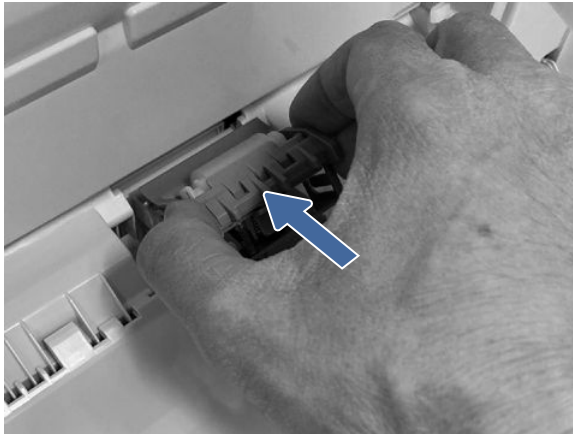

2. Push down on the Tray 1 separation roller until it snaps into place.

Figure 5-35 Secure the separation roller assembly

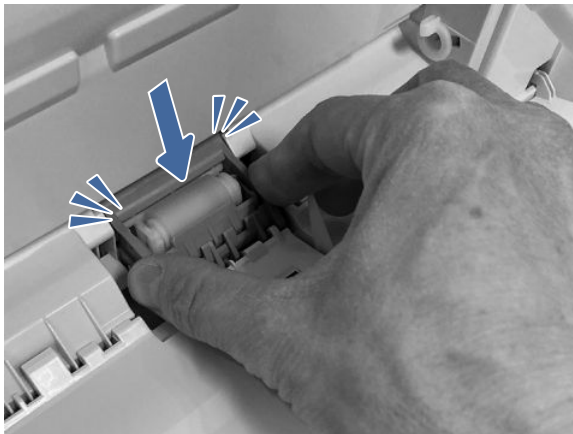

5. Install the Tray 1 pickup roller

Follow these steps to install the Tray 1 pickup roller.

-
- ⚠ CAUTION:** Do not touch the spongy portion of the roller. Skin oils on the roller can cause paper-handling and print-quality problems. HP recommends using disposable gloves or thoroughly washing your hands before handling the assembly.
-

- Insert the keyed right end of the pickup roller assembly into the provided slot, and then rotate the left end into place to install it.

Figure 5-36 Install the pickup roller assembly

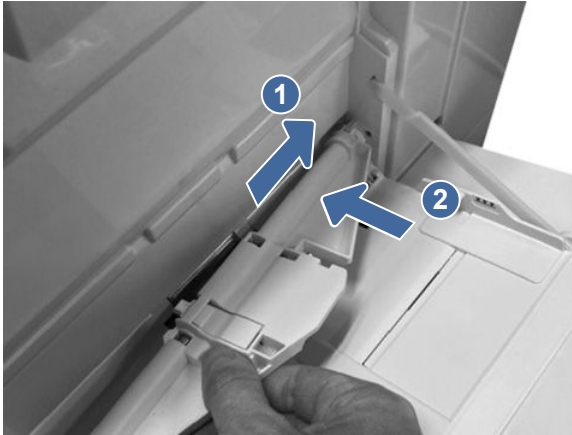

Removal and replacement: Tray 2 pickup and separation roller assemblies

Learn about removing and replacing the Tray 2 rollers.

 [View a video of removing and replacing the Tray 2 rollers.](#)

Before performing service

If the part is damaged and cannot be cleaned, use the table below to identify the correct part number for your printer. To order the part, go to www.hp.com/buy/parts.

Table 5-13 Part information

Part number	Part description
527H2A	HP LaserJet Tray 2-x Roller Kit

Required tools

- No special tools are required to remove or install this assembly.

Post service test

Print any pages necessary to make sure the printer is functioning correctly.

1. Remove the Tray 2 separation roller assembly

Learn about removing the Tray 2 separation roller assembly.

1. Depending on the printer model, perform one of the following steps.
 - 5700/X557/5800 models: Open the right door.
 - X57945 models: Open the lower right door.

2. Slide the blue lever (callout 1) to the right, and then remove the separation roller assembly (callout 2) by pulling it out from the printer.

Figure 5-37 Remove the separation roller assembly

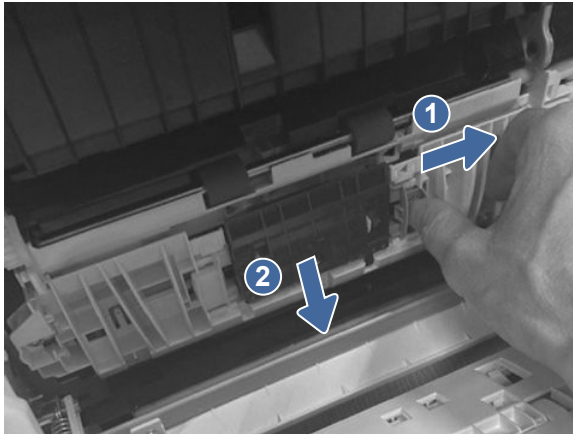

2. Remove the Tray 2 paper pickup roller assembly

Learn about removing the Tray 2 pickup rollers.

 **NOTE:** Even if you want to replace only the pickup roller assembly, you must first remove the separation roller assembly.

- Locate the pickup roller assembly, and then pull it away from the printer to remove it.

Figure 5-38 Remove the pickup roller assembly

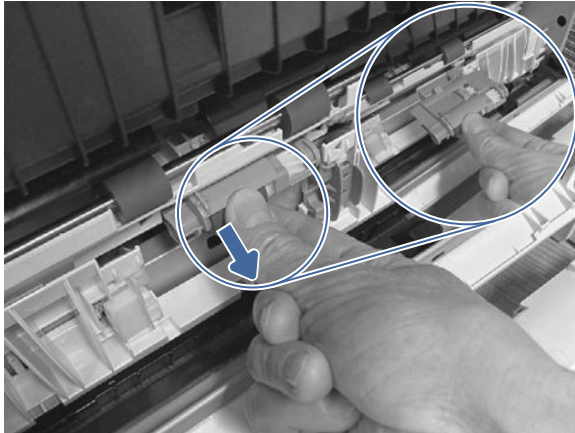

 **NOTE:** As the roller assembly can be hard to grip, you might need to reach under and behind the rollers to securely grip it.

3. Unpack the replacement assembly

Follow these steps to unpack the replacement assembly.

1. Dispose of the defective part.

 **NOTE:** HP recommends responsible disposal of the part.

<http://www8.hp.com/us/en/hp-information/environment/product-recycling.html>

2. Unpack the replacement part from the packaging.

 **IMPORTANT:** Make sure that all of the shipping materials (for example shipping tape) are removed from the replacement part prior to installation.

4. Install the Tray 2 paper pickup roller assembly

Learn about installing the Tray 2 pickup roller assembly.



-
-  **CAUTION:** Do not touch the spongy portion of the roller. Skin oils on the roller can cause paper-handling and print-quality problems. HP recommends using disposable gloves or thoroughly washing your hands before handling the assembly.
-
- Position the pickup roller assembly in the printer in the correct orientation, and then press the assembly into place.

Figure 5-39 Install the pickup roller assembly

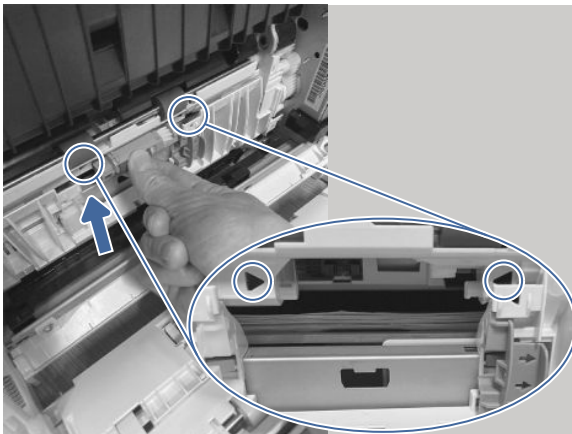

5. Install the Tray 2 separation roller assembly

Learn about installing the Tray 2 separation roller assembly.

-
-  **CAUTION:** Do not touch the spongy portion of the roller. Skin oils on the roller can cause paper-handling and print-quality problems. HP recommends using disposable gloves or thoroughly washing your hands before handling the assembly.
-

- Insert the separation roller assembly into the printer to install it.

Figure 5-40 Install the separation roller assembly



Customer self-repair (CSR) B parts and accessories

Customer self-repair (CSR) B parts are parts that a customer replaces without assistance from a field technician. These parts might require the use of tools.

Customer-replaceable units

Learn about customer-replaceable parts removal and replacement.

Internal parts and assemblies

Learn how to remove and replace the printer internal parts and assemblies.

Removal and replacement: Keyboard (MFP models)

Learn about removing and replacing the keyboard.

Introduction

 [View a video of how to remove and replace the keyboard.](#)

Before performing service

Turn the printer power off

- Disconnect the power cable.

 **WARNING!** To avoid damage to the printer, turn the printer off, wait 30 seconds, and then remove the power cord before attempting to service the printer.

Use the table below to identify the correct part number for your printer, and then go to <https://parts.hp.com/hpparts> to order the part.

Table 5-14 Part information

Part number	Part description
1M0Q2A	HP LaserJet Workflow Keyboard

Required tools

- Use the reversible screwdriver, the bracket, and the two screws included in the kit.

After performing service

Turn the printer power on

- Connect the power cable.
- Use the power switch to turn the power on.

Post service test

Print any pages necessary to make sure the printer is functioning correctly.

1. Remove the control panel (MFP)

Follow these steps to remove the control panel.

- Pull the control panel out and tilt it up, and then remove the two thumbscrews on the control panel arm. Remove the control panel by pulling it away from the printer.

Figure 5-41 Remove two thumbscrews

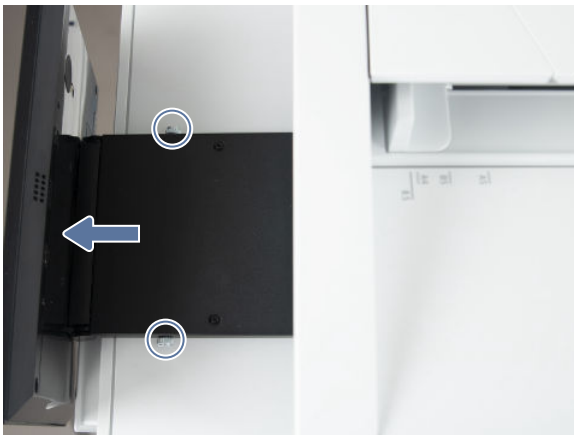

2. Remove the keyboard (MFP models)

Follow these steps to remove the keyboard.

1. On the back of the control panel, remove two screws, and then remove the bracket from the assembly.

Figure 5-42 Remove the bracket

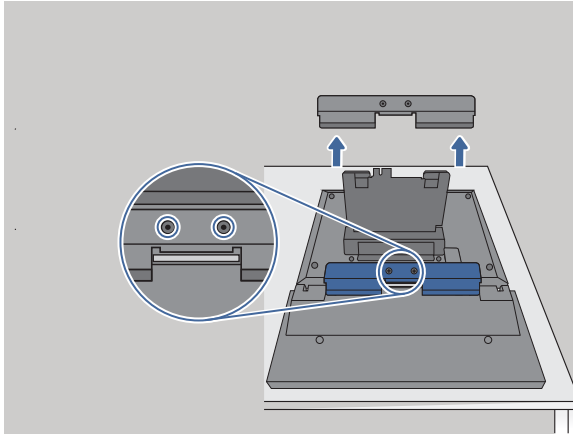

2. Remove the flat flexible cable (FFC) connector cover.

Figure 5-43 Remove the FFC connector cover

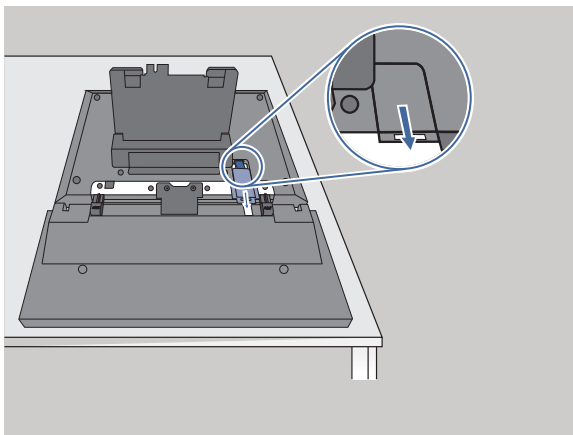

3. Use the pull tab to disconnect the FFC from the connector in the control panel.

Figure 5-44 Disconnect the keyboard FFC

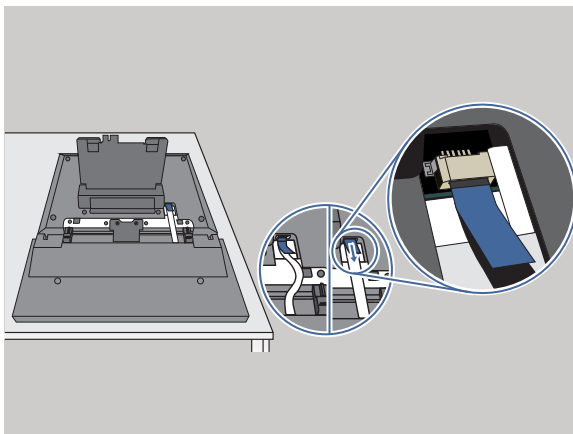

4. Pull the keyboard away from the control panel.

Figure 5-45 Remove the keyboard

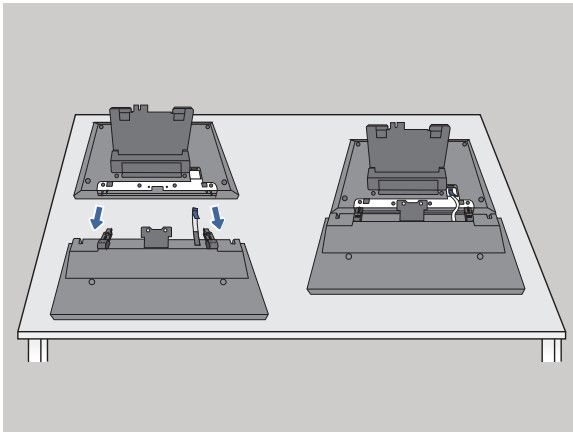

3. Unpack the replacement assembly

Follow these steps to unpack the replacement assembly.

1. Dispose of the defective part.



NOTE: HP recommends responsible disposal of the part.

<http://www8.hp.com/us/en/hp-information/environment/product-recycling.html>

2. Unpack the replacement part from the packaging.



IMPORTANT: Make sure that all of the shipping materials (for example shipping tape) are removed from the replacement part prior to installation.

4. Install the keyboard (MFP models)

Follow these steps to install the keyboard.

1. Align the back of the keyboard with the back of the control panel and then join them by connecting the hinges.

Figure 5-46 Connect the keyboard to the control panel

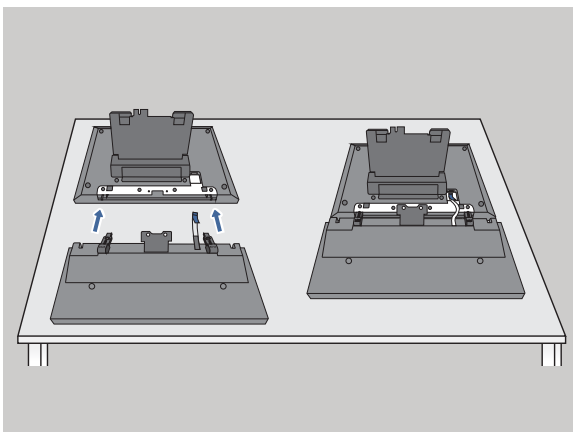

2. Connect the keyboard flat flexible cable (FFC) with the connector in the control panel.

Figure 5-47 Connect the keyboard FFC

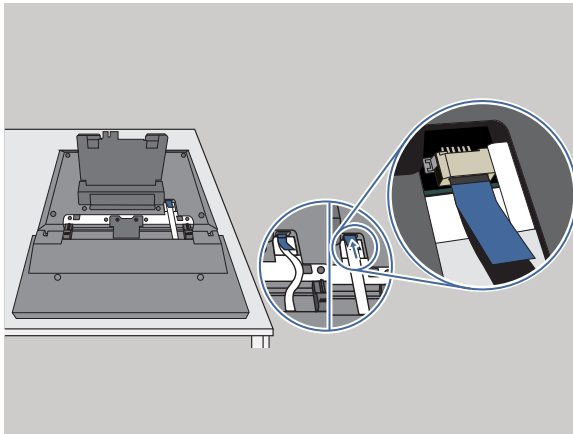

3. Install the FFC cover. Make sure that the FFC pull tab does not stick out after the cover is installed.

Figure 5-48 Install the FFC cover

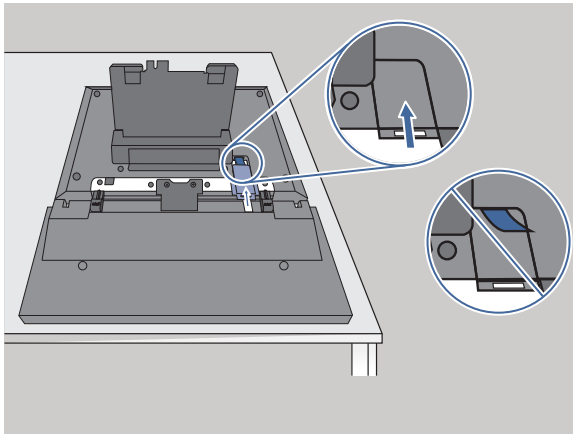

4. Use the reversible screwdriver to install the two bracket screws to attach the bracket to the control panel.

Figure 5-49 Install the bracket

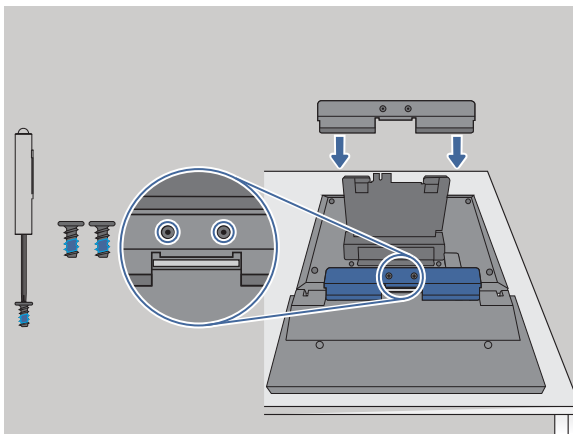

5. Install the control panel (MFP models)

Follow these steps to install the control panel.

- Slide the control panel into the control panel arm, and then install the two thumbscrews on the control panel arm.

Figure 5-50 Install the control panel

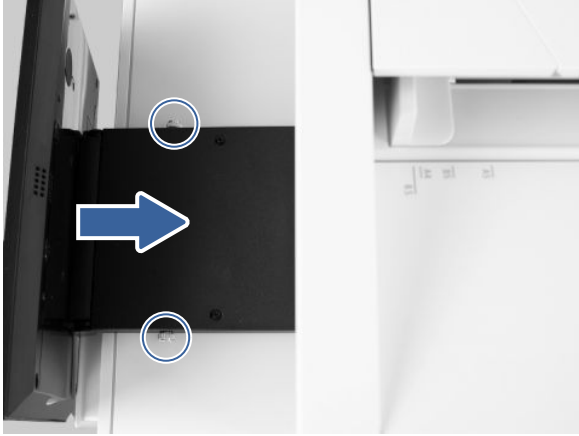

Removal and replacement: Hard-disk drive (HDD)

This document provides the procedures to remove and replace the hard-disk drive (HDD).

 [View a video demonstration of removing and replacing the hard-disk drive.](#)

Mean time to repair: 10 minutes

Service level: Basic

Before performing service

Turn the printer power off

- Disconnect the power cable.

 **WARNING!** To avoid damage to the printer, turn the printer off, wait 30 seconds, and then remove the power cord before attempting to service the printer.

 **IMPORTANT:** Do not replace the formatter, DC controller, and eMMC PCA or hard-disk drive simultaneously during a single printer servicing. Doing so might cause the printer to become unstable or inoperable.

Use the table below to identify the correct part number for your printer. To order the part, go to www.hp.com/buy/parts.

Table 5-15 Part information

Part number	Part description
L41606-011	HDD, 500GB 5400RPM SED
L42243-021	HDD, 500GB 5400RPM FIPS/CCC OPAL2 7MM
6HN31A	HP 500GB CCC FIPS TAA Hard Disk Drive

Table 5-15 Part information (continued)

Part number	Part description
9EQ11A	HP 500GB CCC FIPS Hard Disk Drive

Required tools

- #2 Phillips screwdriver with a magnetic tip and a 152 mm (6 in) shaft length

After performing service

Make sure that the formatter cover is fully seated, and that the screw is fastened.

Turn the printer power on

- Connect the power cable.
- Use the power switch to turn the power on.

Post service test

Print a configuration page to make sure that the printer is functioning correctly.

1. Remove the formatter cover

Follow these steps to remove the formatter cover.

- Remove one screw (callout 1), and then slide the formatter cover (callout 2) away from the printer to remove it.

 **TIP:** Reverse the removal steps to install the assembly.

Figure 5-51 Remove the formatter cover



2. Remove the hard-disk drive (HDD)

Follow these steps to remove the hard-disk drive (HDD).

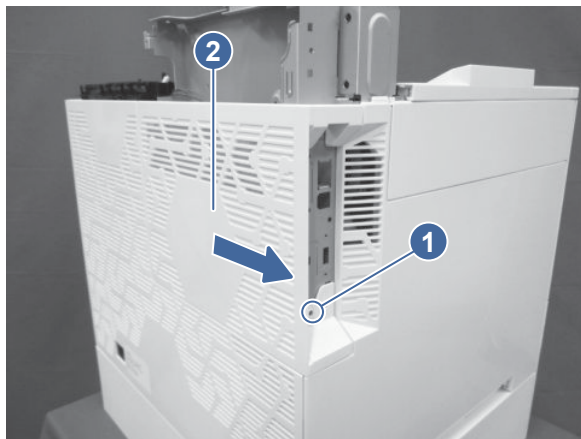
 **CAUTION:**  ESD sensitive part.

1. Release two pins from the formatter faceplate.

Figure 5-52 Release two pins

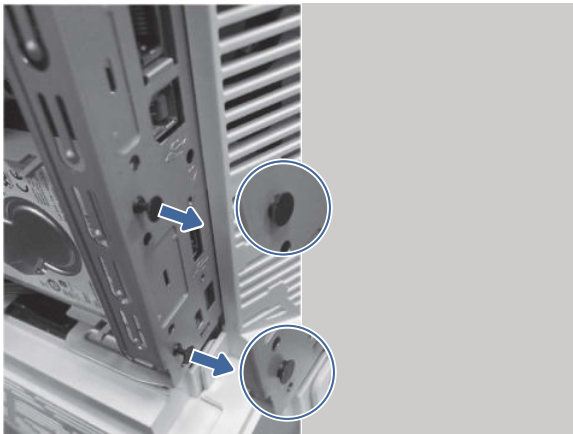

2. On the left side of the HDD, release the connector from the formatter, and then pull the HDD away from the formatter.

Figure 5-53 Release the HDD



3. Unpack the replacement assembly

Follow these steps to unpack the replacement assembly.

1. Dispose of the defective part.



NOTE: HP recommends responsible disposal of the part.

<http://www8.hp.com/us/en/hp-information/environment/product-recycling.html>

2. Unpack the replacement part from the packaging.



IMPORTANT: Make sure that all of the shipping materials (for example shipping tape) are removed from the replacement part prior to installation.

4. Install the hard-disk drive (HDD)

Follow these steps to install the hard-disk drive (HDD).

 **CAUTION:**  ESD sensitive part.

1. Align the connectors on the left side of the HDD with the connector on the formatter.

Figure 5-54 Align the connectors

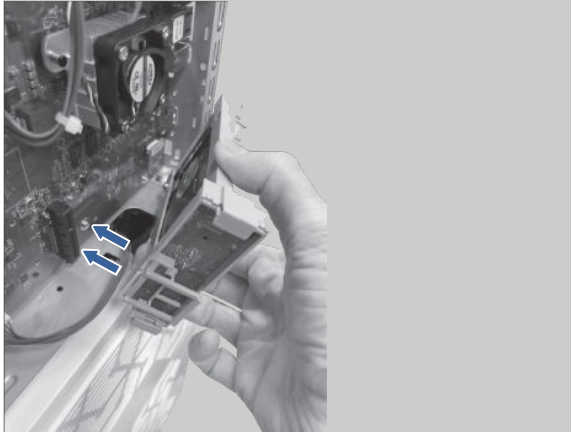

2. Press the connectors together to seat the HDD on the formatter.

Figure 5-55 Install the HDD

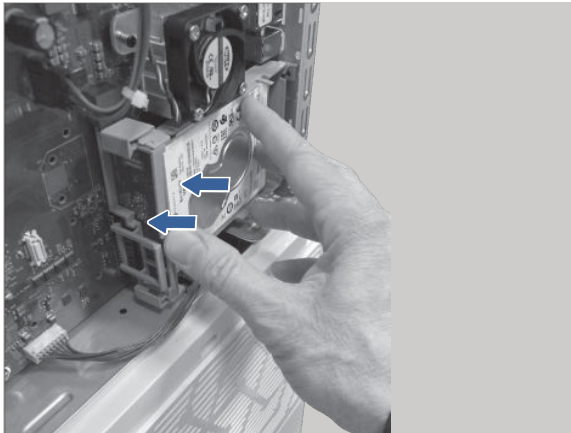

3. Install the two pins through the formatter plate to secure the HDD.

Figure 5-56 Install two pins

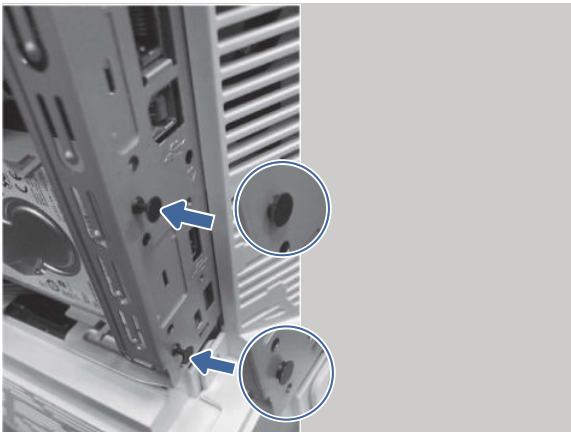

5. Install the formatter cover

Follow these steps to install the formatter cover.

- Slide the cover (callout 1) onto the printer, and then install one screw (callout 2) to secure it.

Figure 5-57 Install the cover

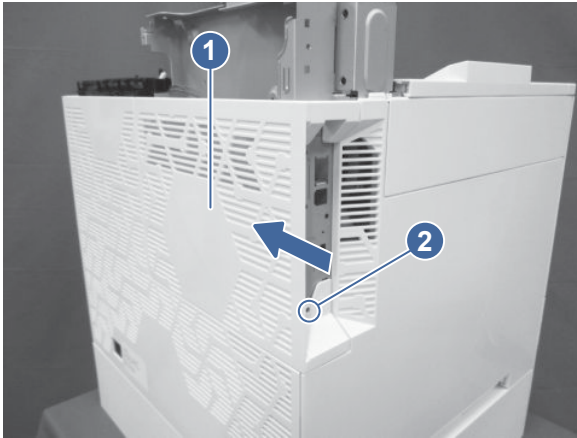

Removal and replacement: Dual in-line memory module (DIMM) (SFP models)

Learn about removing and replacing the dual in-line memory module (DIMM).

 [View a video demonstration of removing and replacing the DIMM.](#)

Before performing service

Turn the printer power off

- Disconnect the power cable.

⚠ WARNING! To avoid damage to the printer, turn the printer off, wait 30 seconds, and then remove the power cord before attempting to service the printer.

Use the table below to identify the correct part number for your printer, and then go to <https://parts.hp.com/hpparts> to order the part.

Table 5-16 Part information

Part number	Part description
6QY68A	HP 2GB DDR3Lx32 120-pin 933MHz DIMM

Required tools

- #2 Phillips screwdriver with a magnetic tip and a 152 mm (6 in) shaft length

After performing service

Turn the printer power on

- Connect the power cable.
- Use the power switch to turn the power on.

Post service test

No post service test is available for this assembly.

1. Remove the formatter cover

Follow these steps to remove the formatter cover.

- Remove one screw (callout 1), and then slide the formatter cover (callout 2) away from the printer to remove it.

 **TIP:** Reverse the removal steps to install the assembly.

Figure 5-58 Remove the formatter cover



2. Remove the dual in-line memory module (DIMM)

Follow these steps to remove the DIMM.

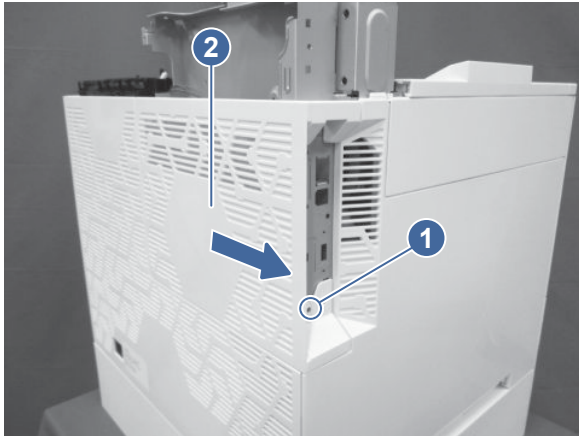
 **CAUTION:**  ESD sensitive part.

1. Pull the bottom edge of the DIMM away from the formatter to loosen the connector at the top of the DIMM.

Figure 5-59 Pull the bottom edge of the DIMM

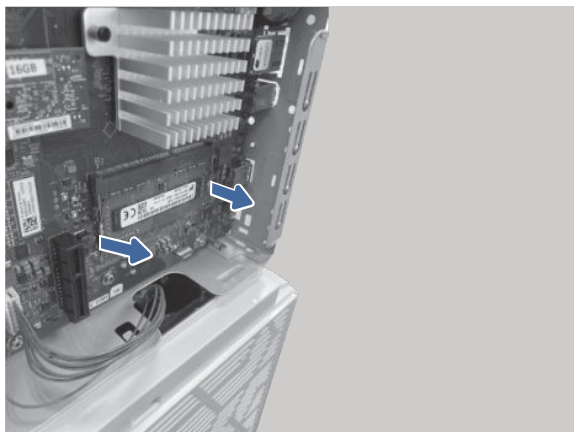

2. Pull down on the DIMM to remove it from the formatter.

Figure 5-60 Remove the DIMM

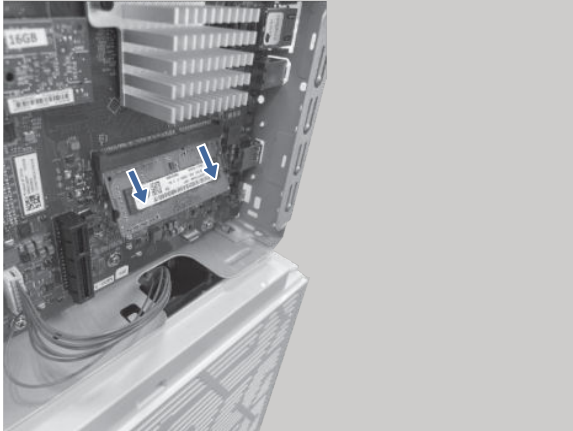

3. Unpack the replacement assembly

Follow these steps to unpack the replacement assembly.

1. Dispose of the defective part.



NOTE: HP recommends responsible disposal of the part.

<http://www8.hp.com/us/en/hp-information/environment/product-recycling.html>

2. Unpack the replacement part from the packaging.



IMPORTANT: Make sure that all of the shipping materials (for example shipping tape) are removed from the replacement part prior to installation.

4. Install the DIMM

Follow these steps to install the DIMM.



CAUTION:  ESD sensitive part.

1. Align the connector edge on the DIMM with the slot on the formatter.

Figure 5-61 Align the DIMM

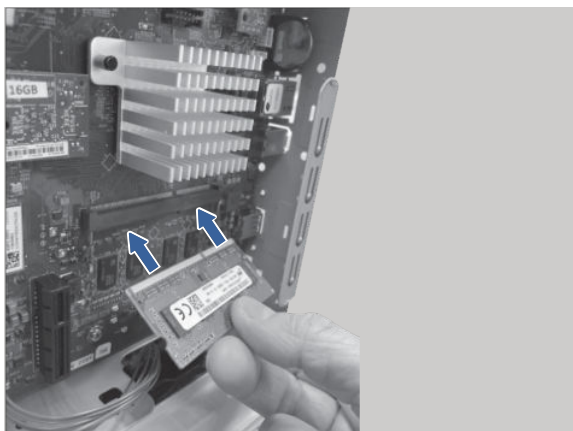

2. Gently insert the top edge of the DIMM up into the formatter slot.

Figure 5-62 Insert the top edge into the formatter



3. Press the bottom edge of the DIMM against the formatter to seat it firmly in the formatter slot.

Figure 5-63 Install the DIMM

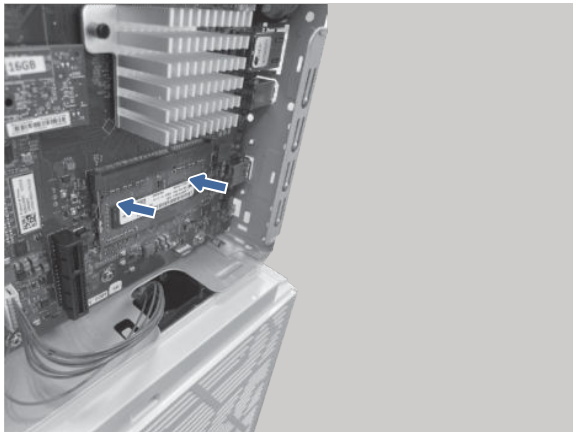

5. Install the formatter cover

Follow these steps to install the formatter cover.

- Slide the cover (callout 1) onto the printer, and then install one screw (callout 2) to secure it.

Figure 5-64 Install the cover

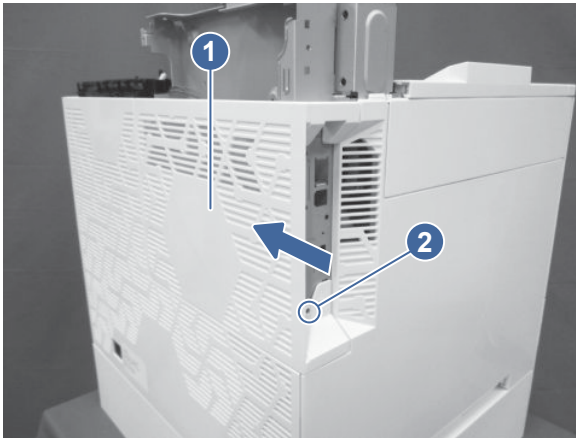

Removal and replacement: Fax PCA (fax models)

Learn about removing and replacing the fax PCA.

 [View a video demonstration of removing and replacing the fax PCA.](#)

Before performing service

Turn the printer power off

- Disconnect the power cable.

⚠ WARNING! To avoid damage to the printer, turn the printer off, wait 30 seconds, and then remove the power cord before attempting to service the printer.

If the part is damaged and cannot be cleaned, use the table below to identify the correct part number for your printer. To order the part, go to www.hp.com/buy/parts.

Table 5-17 Part information

Part number	Part description
B5L53-67901	Analog Fax Accessory 600

Required tools

- No special tools are required to remove or install this assembly.

After performing service

Turn the printer power on

- Connect the power cable.
- Use the power switch to turn the power on.

Post service test

If possible, send and receive a fax from the printer.

1. Remove the formatter cover

Follow these steps to remove the formatter cover.

- Remove one screw (callout 1), and then slide the formatter cover (callout 2) away from the printer to remove it.

 **TIP:** Reverse the removal steps to install the assembly.

Figure 5-65 Remove the formatter cover



2. Remove the fax PCA (fax MFP models)

Follow these steps to remove the fax PCA.

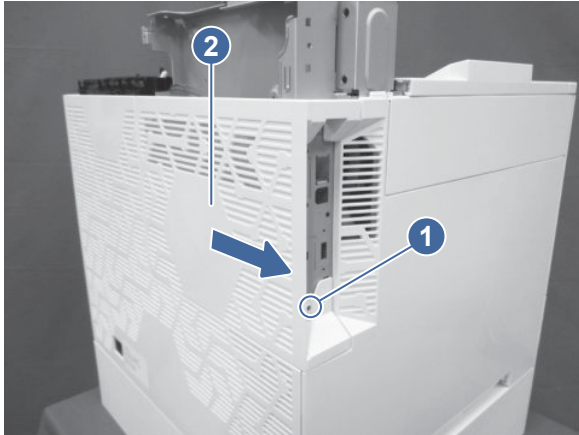
 **CAUTION:**  ESD sensitive part.

- Rotate end left end of the fax PCA away from the formatter (callout 1) to disconnect the connector, and then slide the card away from the formatter faceplate (callout 2) to remove it.

Figure 5-66 Remove the fax PCA

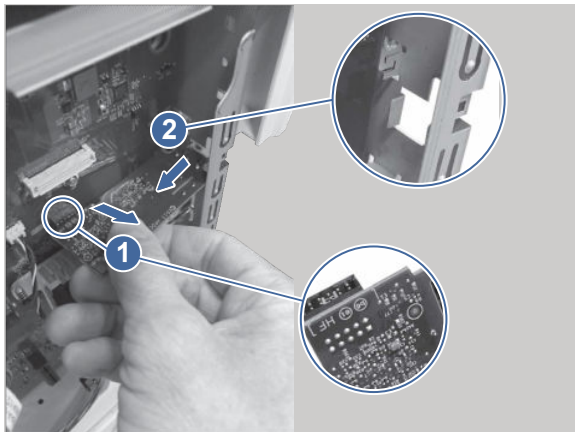

3. Unpack the replacement assembly

Follow these steps to unpack the replacement assembly.

1. Dispose of the defective part.

 **NOTE:** HP recommends responsible disposal of the part.

<http://www8.hp.com/us/en/hp-information/environment/product-recycling.html>

2. Unpack the replacement part from the packaging.

 **IMPORTANT:** Make sure that all of the shipping materials (for example shipping tape) are removed from the replacement part prior to installation.

4. Install the fax PCA (fax MFP models)

Follow these steps to install the fax PCA.

 **CAUTION:**  ESD sensitive part.

1. Align the fax port with the cut-out in the formatter faceplate, and then align the connector on the back of the card with the formatter connector. Press the connectors together to seat the card on the formatter.

Figure 5-67 Align the fax PCA

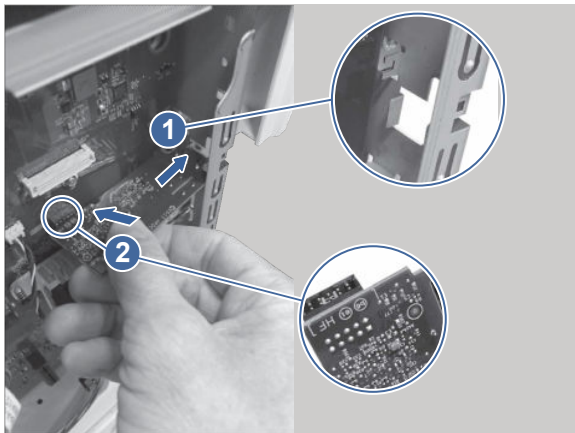

2. When installed, the port on the card should sit securely in the faceplate cut-out.

Figure 5-68 Check the fax PCA port

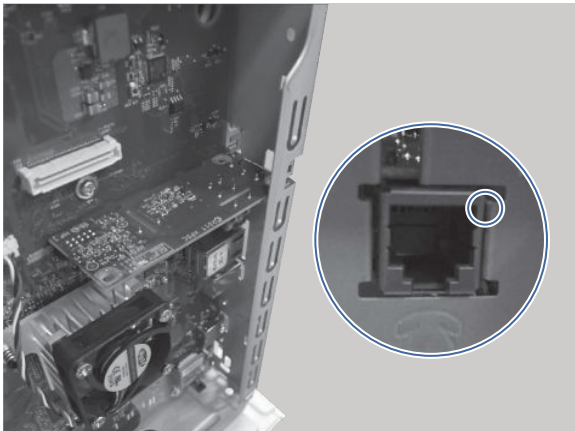

5. Install the formatter cover

Follow these steps to install the formatter cover.

- Slide the cover (callout 1) onto the printer, and then install one screw (callout 2) to secure it.

Figure 5-69 Install the cover

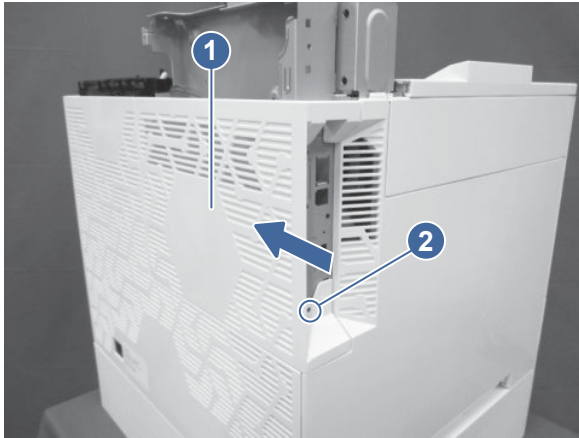

Removal and replacement: Workflow accelerator

Learn about removing and replacing the workflow accelerator card.



[View a video demonstration of removing and replacing the workflow accelerator.](#)

Before performing service

Turn the printer power off

- Disconnect the power cable.

⚠ WARNING! To avoid damage to the printer, turn the printer off, wait 30 seconds, and then remove the power cord before attempting to service the printer.

If the part is damaged and cannot be cleaned, use the table below to identify the correct part number for your printer. To order the part, go to www.hp.com/buy/parts.

Table 5-18 Part information

Part number	Part description
1M0Q5A	HP LaserJet Workflow Accelerator Card

Required tools

- #2 Phillips screwdriver with a magnetic tip and a 152 mm (6 in) shaft length

After performing service

Turn the printer power on

- Connect the power cable.
- Use the power switch to turn the power on.

Post service test

Print any pages necessary to make sure the printer is functioning correctly.

1. Remove the formatter cover

Follow these steps to remove the formatter cover.

- Remove one screw (callout 1), and then slide the formatter cover (callout 2) away from the printer to remove it.

 **TIP:** Reverse the removal steps to install the assembly.

Figure 5-70 Remove the formatter cover



2. Remove the workflow accelerator

Follow these steps to remove the workflow accelerator.

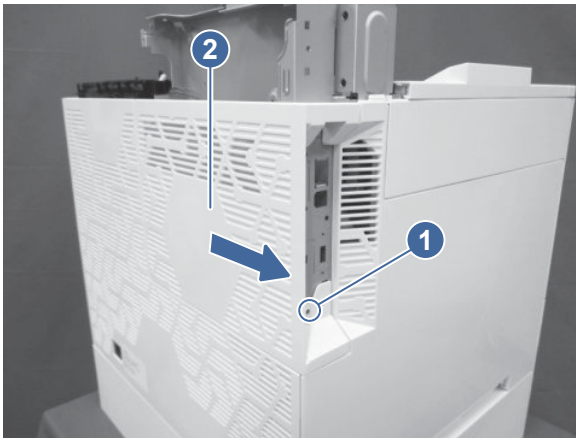
 **CAUTION:**  ESD sensitive part.

1. Pull the card away from the formatter to disconnect the connector and remove the card.

Figure 5-71 Remove the card

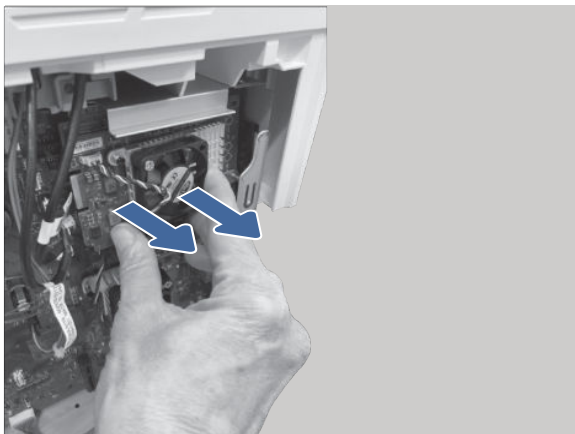

2. Remove the bracket from the workflow accelerator card.

Figure 5-72 Remove the bracket

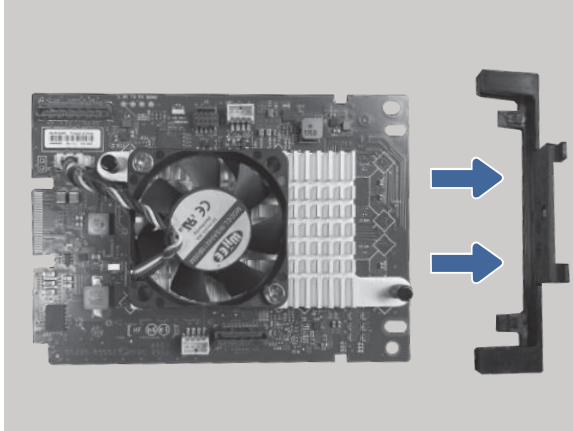

3. Unpack the replacement assembly

Follow these steps to unpack the replacement assembly.

1. Dispose of the defective part.

 **NOTE:** HP recommends responsible disposal of the part.

<http://www8.hp.com/us/en/hp-information/environment/product-recycling.html>

2. Unpack the replacement part from the packaging.

 **IMPORTANT:** Make sure that all of the shipping materials (for example shipping tape) are removed from the replacement part prior to installation.

4. Install the workflow accelerator

Follow these steps to install the workflow accelerator.

 **CAUTION:**  ESD sensitive part.

1. Slide the bracket onto the accelerator card.

Figure 5-73 Attach the bracket

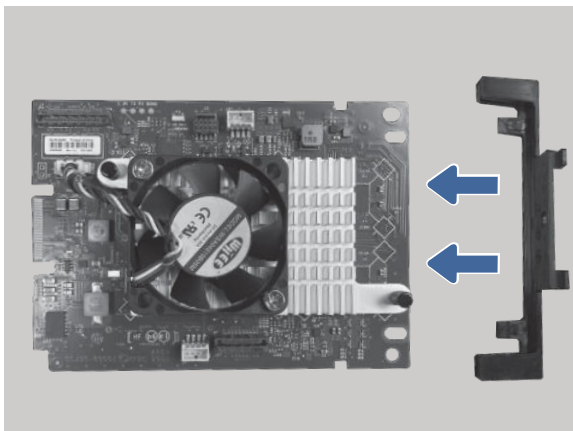

2. Push the right edge of the card into the faceplate slots, and then align the connector on the back of the card with the formatter connector.

Figure 5-74 Align the connectors

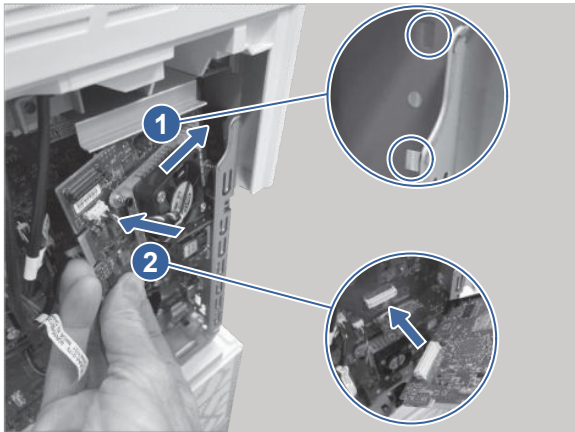

3. Press the connectors together to seat the card on the formatter.

Figure 5-75 Connect the connectors

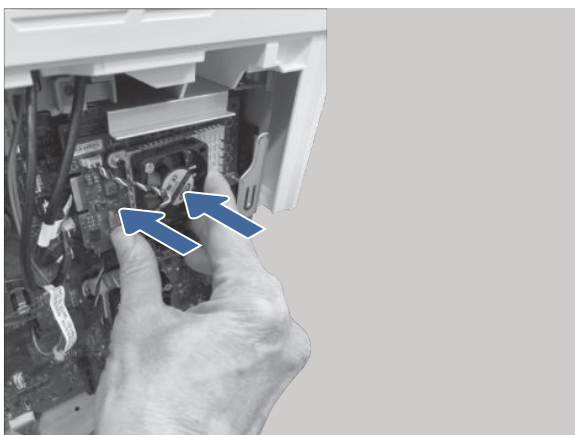

5. Install the formatter cover

Follow these steps to install the formatter cover.

- Slide the cover (callout 1) onto the printer, and then install one screw (callout 2) to secure it.

Figure 5-76 Install the cover

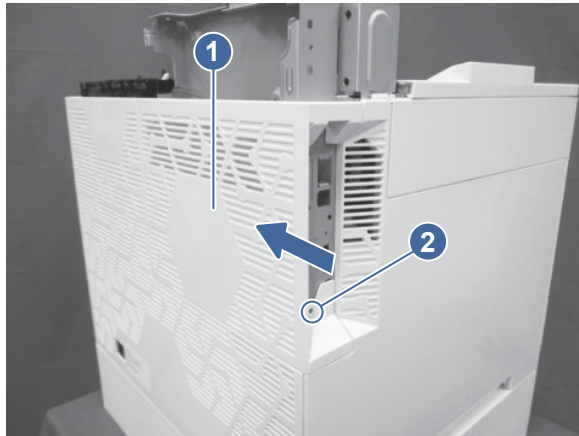

Removal and replacement: USB expansion kit

Learn about removing and replacing the USB expansion kit.

 [View a video demonstration of removing and replacing the USB expansion kit.](#)

Before performing service

Turn the printer power off

- Disconnect the power cable.

⚠ WARNING! To avoid damage to the printer, turn the printer off, wait 30 seconds, and then remove the power cord before attempting to service the printer.

If the part is damaged and cannot be cleaned, use the table below to identify the correct part number for your printer. To order the part, go to www.hp.com/buy/parts.

Table 5-19 Part information

Part number	Part description
4XN67A	HP Internal USB Expansion Kit

Required tools

- #2 Phillips screwdriver with a magnetic tip and a 152 mm (6 in) shaft length

After performing service

Turn the printer power on

- Connect the power cable.
- Use the power switch to turn the power on.

Post service test

Print any pages necessary to make sure the printer is functioning correctly.

1. Remove the formatter cover

Follow these steps to remove the formatter cover.

- Remove one screw (callout 1), and then slide the formatter cover (callout 2) away from the printer to remove it.

 **TIP:** Reverse the removal steps to install the assembly.

Figure 5-77 Remove the formatter cover



2. Remove the internal USB ports

Learn how to remove the internal USB ports.

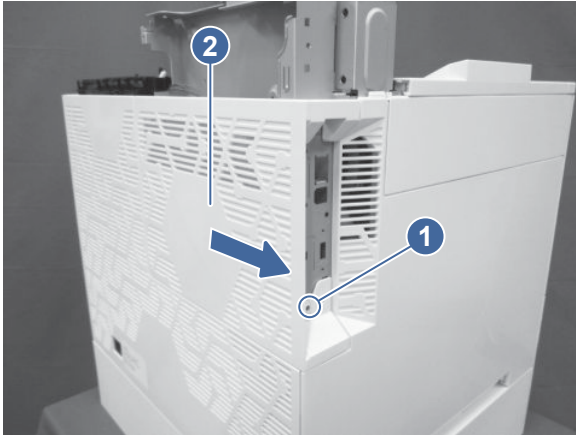
 **CAUTION:**  ESD sensitive part.

1. Pull the card away from the formatter to disconnect the connector.

Figure 5-78 Remove the USB ports card

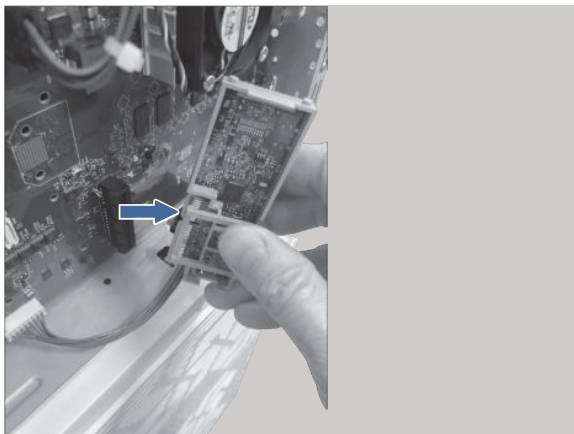

2. Pull the free end of the card away from the bracket, and then pull the captive end of the card out of the bracket.

Figure 5-79 Remove the bracket

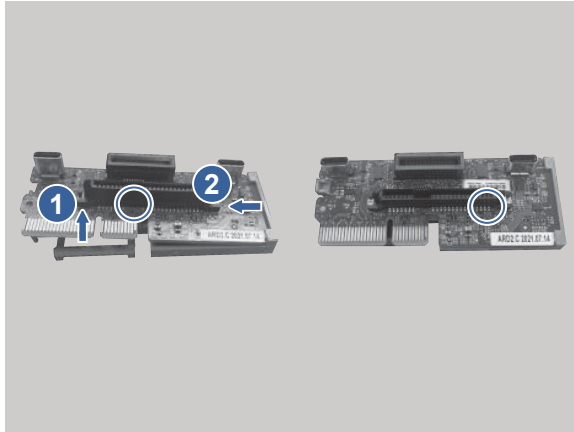

3. Unpack the replacement assembly

Follow these steps to unpack the replacement assembly.

1. Dispose of the defective part.

 **NOTE:** HP recommends responsible disposal of the part.

<http://www8.hp.com/us/en/hp-information/environment/product-recycling.html>

2. Unpack the replacement part from the packaging.

 **IMPORTANT:** Make sure that all of the shipping materials (for example shipping tape) are removed from the replacement part prior to installation.

4. Install the internal USB ports

Learn how to install the internal USB ports.

 **CAUTION:**  ESD sensitive part.

1. Push the short edge of the card into the bracket, and then press the card into the bracket until it is firmly seated.

Figure 5-80 Attach the bracket

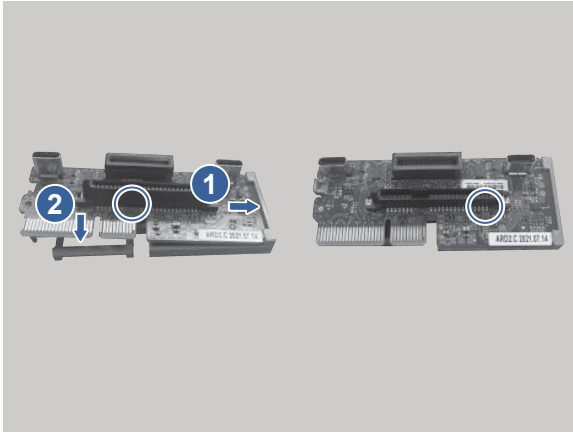

2. Align the connector on the card with the formatter connector, and then press the connectors together to seat the card on the formatter.

Figure 5-81 Install the card on the formatter

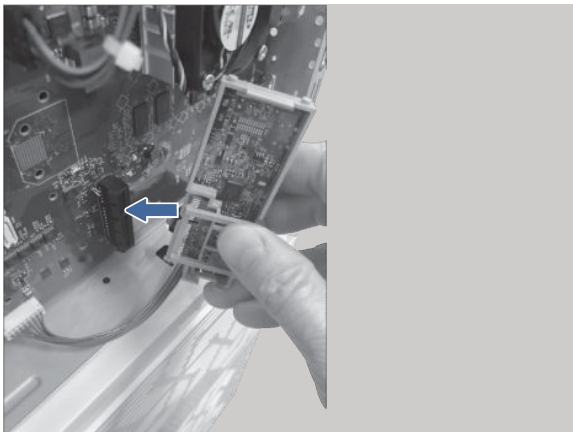

3. Install the formatter cover.

5. Install the formatter cover

Follow these steps to install the formatter cover.

- Slide the cover (callout 1) onto the printer, and then install one screw (callout 2) to secure it.

Figure 5-82 Install the cover

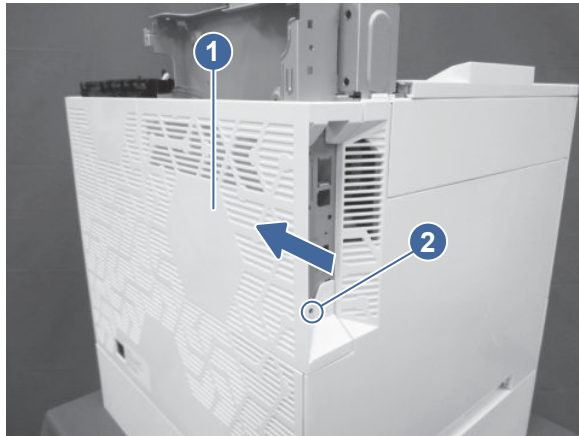

Removal and replacement: Solid state drive (SSD)

Learn about removing and replacing the solid state drive.

 [View a video demonstration of removing and replacing the SSD.](#)

Before performing service

Turn the printer power off

- Disconnect the power cable.

⚠ WARNING! To avoid damage to the printer, turn the printer off, wait 30 seconds, and then remove the power cord before attempting to service the printer.

If the part is damaged and cannot be cleaned, use the table below to identify the correct part number for your printer. To order the part, go to www.hp.com/buy/parts.

Table 5-20 Part information

Part number	Part description
1M0Q4A	HP LaserJet Secure Solid State Drive

Required tools

- #2 Phillips screwdriver with a magnetic tip and a 152 mm (6 in) shaft length

After performing service

Turn the printer power on

- Connect the power cable.
- Use the power switch to turn the power on.

Post service test

Print any pages necessary to make sure the printer is functioning correctly.

1. Remove the formatter cover

Follow these steps to remove the formatter cover.

- Remove one screw (callout 1), and then slide the formatter cover (callout 2) away from the printer to remove it.

 **TIP:** Reverse the removal steps to install the assembly.

Figure 5-83 Remove the formatter cover



2. Unpack the replacement assembly

Follow these steps to unpack the replacement assembly.

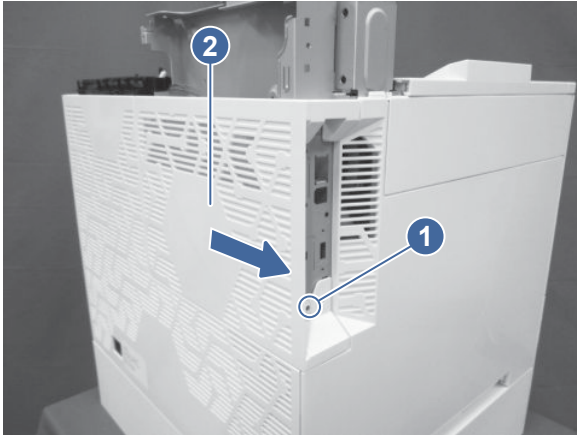
1. Dispose of the defective part.



NOTE: HP recommends responsible disposal of the part.

<http://www8.hp.com/us/en/hp-information/environment/product-recycling.html>

2. Unpack the replacement part from the packaging.



IMPORTANT: Make sure that all of the shipping materials (for example shipping tape) are removed from the replacement part prior to installation.

3. Install the SSD card only

Learn how to install the SSD card.



CAUTION:  ESD sensitive part.

1. Place one end of the riser PCA into the cradle, and then press the other end of the card into the cradle.

Figure 5-84 Install PCA in cradle



2. Verify that the PCA is properly installed by listening for a click when it is pressed into place. Also verify that the PCA is underneath the two indicated tabs at the end.

Figure 5-85 Verify PCA installation



3. Position the PCA cradle on the bracket.

Figure 5-86 Position the PCA cradle

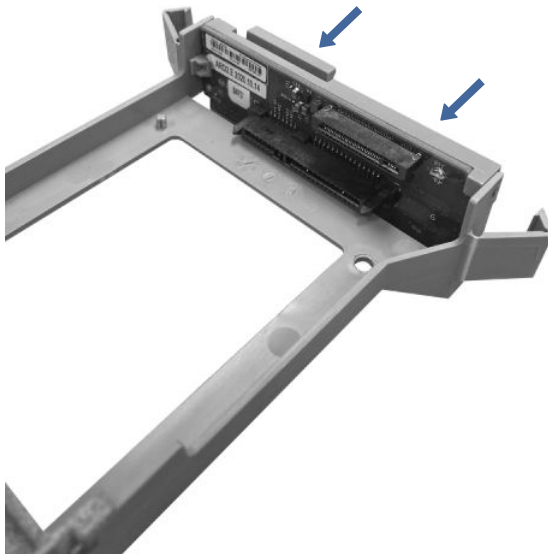

4. Close two clips at the end of the bracket to secure the PCA cradle.

Figure 5-87 Close the clips

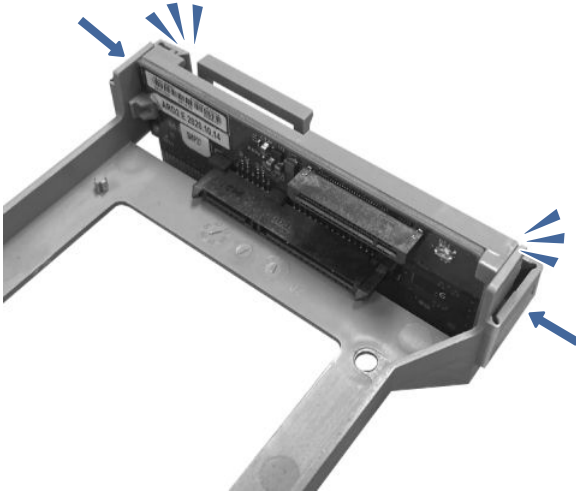

5. Install the support cross member onto the bracket.

Figure 5-88 Install the cross member

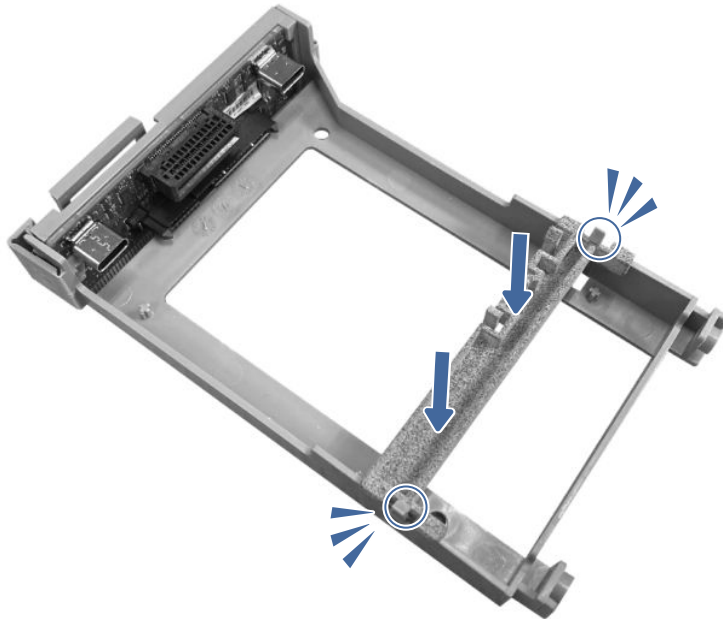

6. Align the SSD card with the connector on the PCA. Note how the end of the SSD is keyed so that it can be installed one way only.

Figure 5-89 Align the SSD card



7. Seat the SSD in the PCA connector, and then snap the other end of the SSD on the cross member.

Figure 5-90 Secure the SSD on the cross member

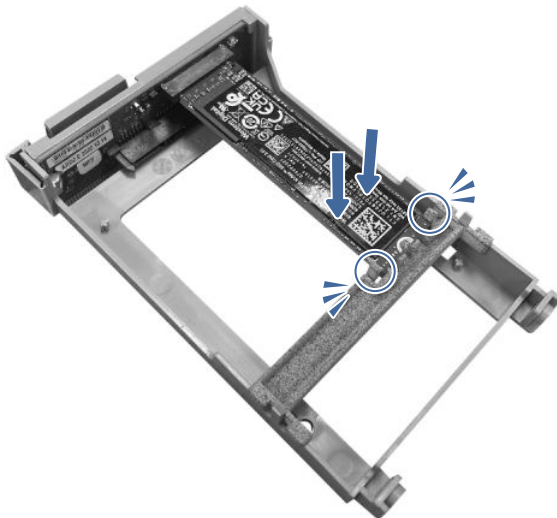

8. Align the bracket assembly with the formatter connector.

Figure 5-91 Align the bracket assembly

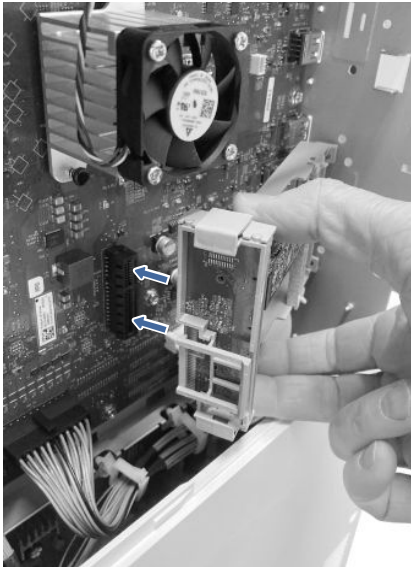

9. Press the bracket assembly to firmly seat it in the formatter connector.

Figure 5-92 Install the bracket assembly

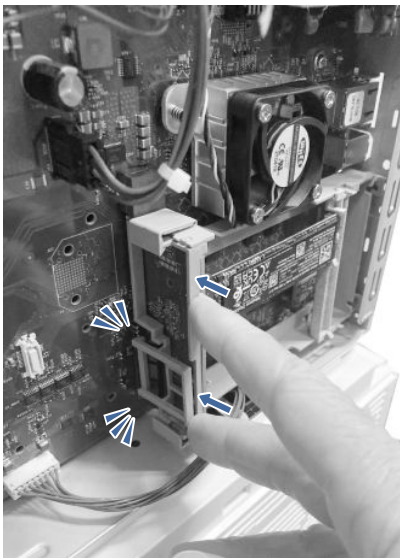

10. Install two pins to secure the bracket assembly to the formatter faceplate.

Figure 5-93 Install two pins

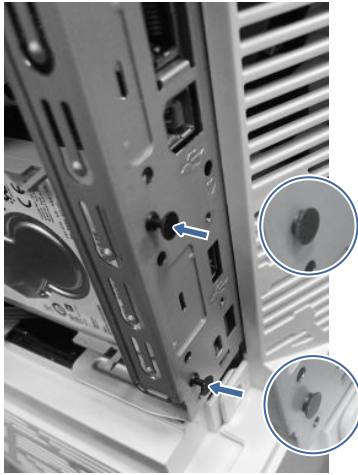

4. Install the SSD card with the HDD

Learn how to install the SSD card with an HDD.

 **CAUTION:**  ESD sensitive part.

1. Release two pins from the formatter faceplate.

Figure 5-94 Release two pins

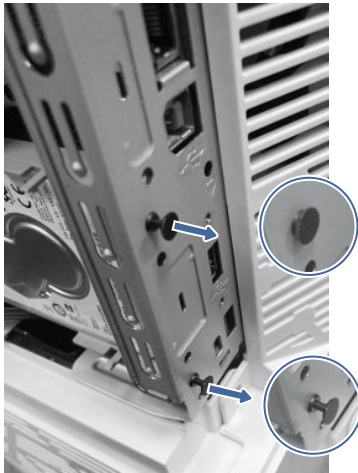

2. Remove the HDD assembly

Figure 5-95 Remove the HDD

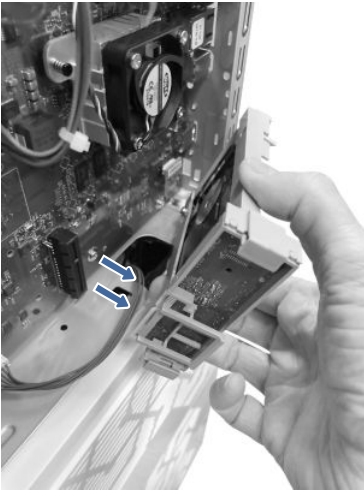

3. Open two clips on the HDD bracket.

Figure 5-96 Open two clips



4. Remove the PCA cradle from the HDD bracket.

Figure 5-97 Remove the PCA cradle



5. Release one tab (callout 1), raise the end of the PCA up and off the cradle (callout 2), and then remove the PCA from the cradle (callout 3).

Figure 5-98 Remove the PCA from the holder

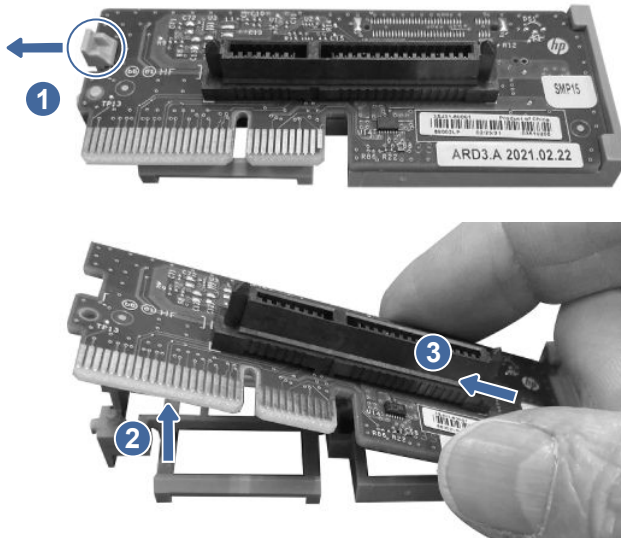

6. Place one end of the new PCA on the cradle (callout 1), and then rotate the other end down onto the cradle (callout 2). Make sure to orientate the PCA on the cradle as shown. Push down on the PCA to install it on the cradle (an audible click is heard when it snaps into place).

 **NOTE:** Make sure that the PCA is firmly seated under the clips on the cradle.

Figure 5-99 Install the PCA in the cradle



7. Align the PCA cradle with the bracket.

Figure 5-100 Align the PCA cradle

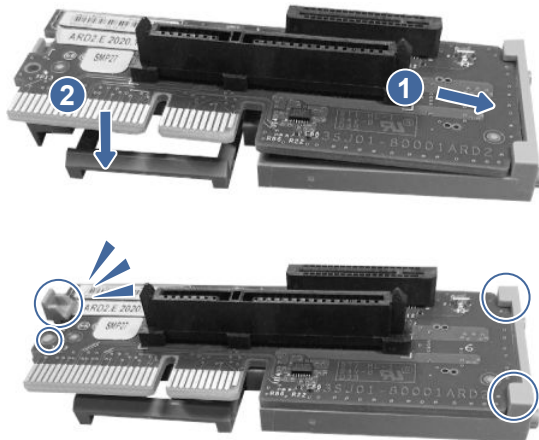

8. Close two clips to secure the PCA cradle to the bracket.

Figure 5-101 Close two clips



9. Install the support cross member onto the bracket.

Figure 5-102 Install the support cross member

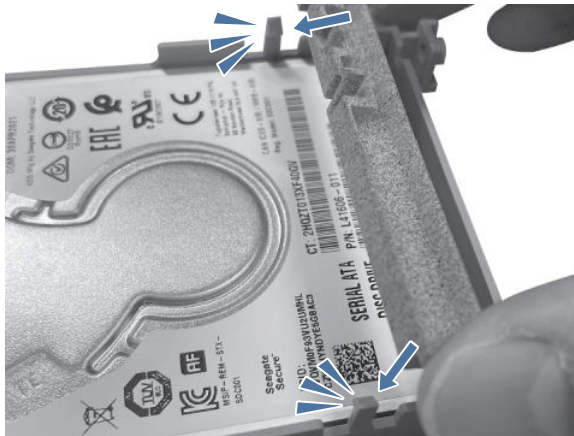

10. Align the SSD card with the PCA connector. Note how the end of the SSD is keyed so that it can be installed one way only.

Figure 5-103 Align the SSD card



11. Seat the SSD in the PCA connector, and then snap the other end of the SSD on the cross member.

Figure 5-104 Secure the SSD on the cross member

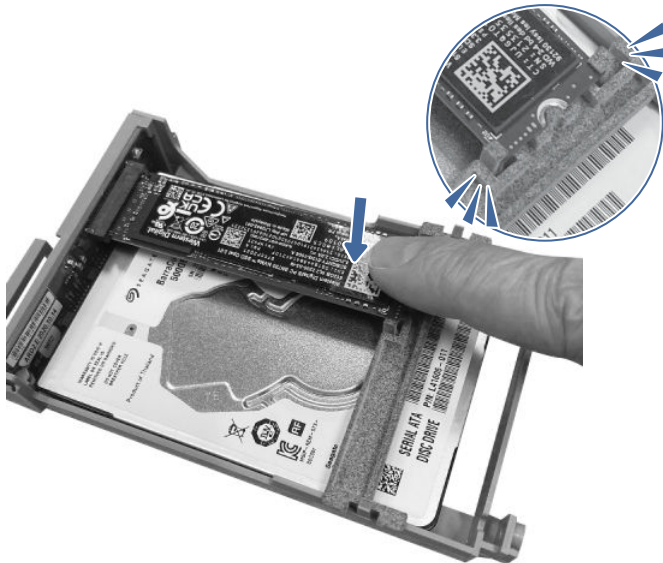

12. Align the bracket assembly with the formatter connector.

Figure 5-105 Align the bracket assembly

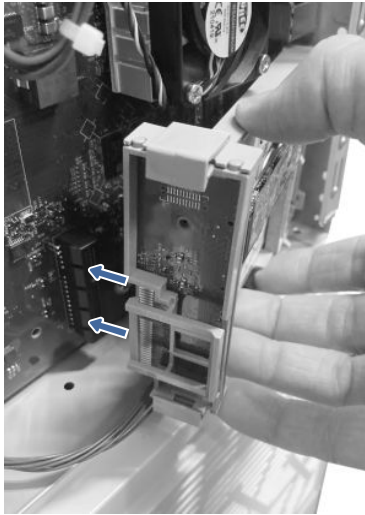

13. Press the bracket assembly to firmly seat it in the formatter connector.

Figure 5-106 Install the bracket assembly

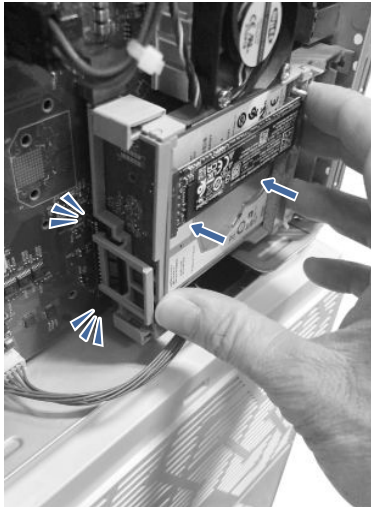

14. Install two pins to secure the bracket assembly to the formatter faceplate.

Figure 5-107 Install two pins

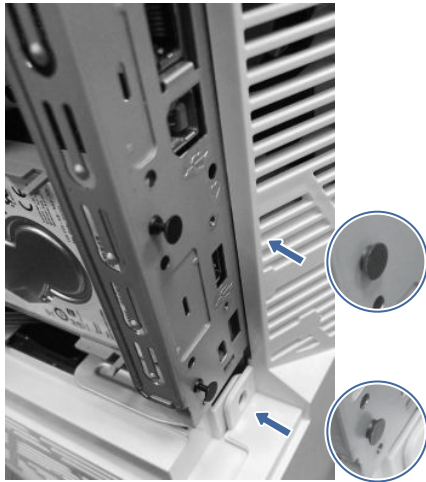

5. Install the SSD card with USB

Learn how to install the SSD card with a USB card.

 **CAUTION:**  ESD sensitive part.

1. Remove the USB PCA from the formatter connector.

Figure 5-108 Remove the USB PCA

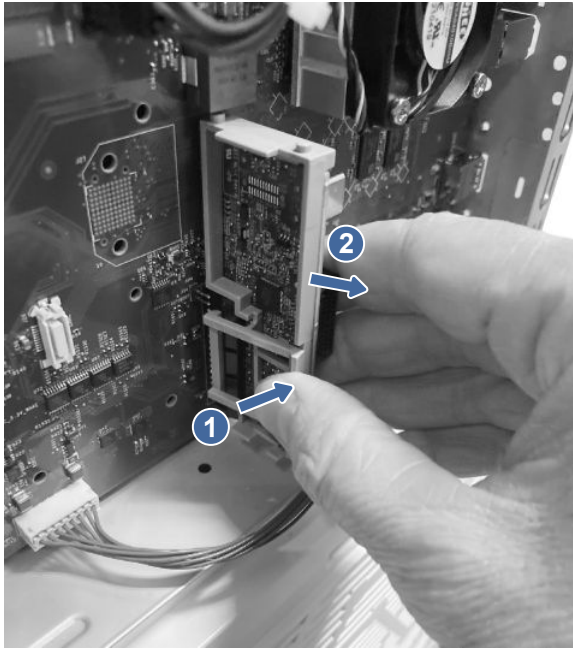

2. Install the SSD card on the board.

Figure 5-109 Install the SSD card

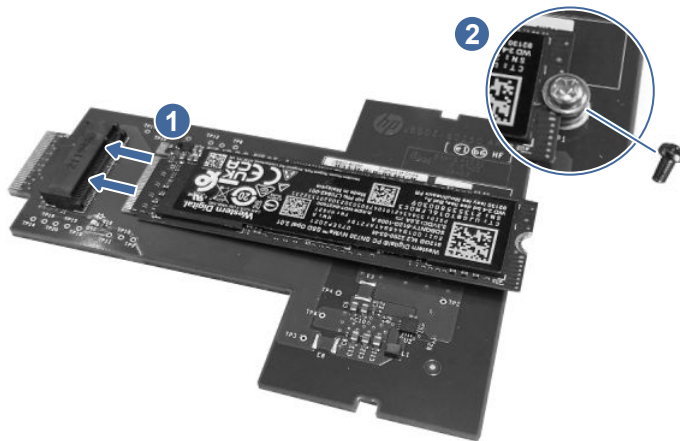

3. Position the PCA cradle on the bracket.

Figure 5-110 Position the PCA cradle

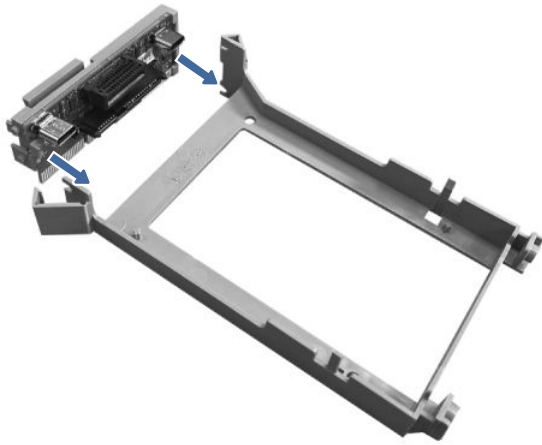

4. Close two clips to secure the PCA cradle to the bracket.

Figure 5-111 Close two clips

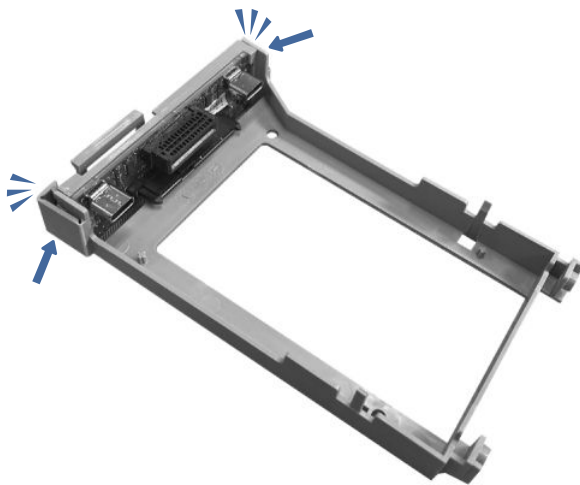

5. Insert the board into the PCA connector.

Figure 5-112 Insert the board

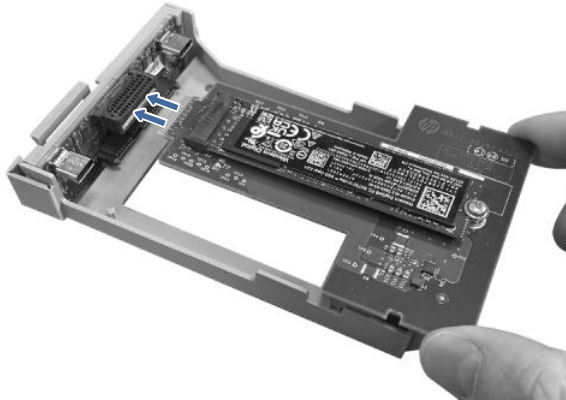

6. Secure the board to the bracket (an audible click is heard when it snaps into place).

Figure 5-113 Secure the board to the bracket

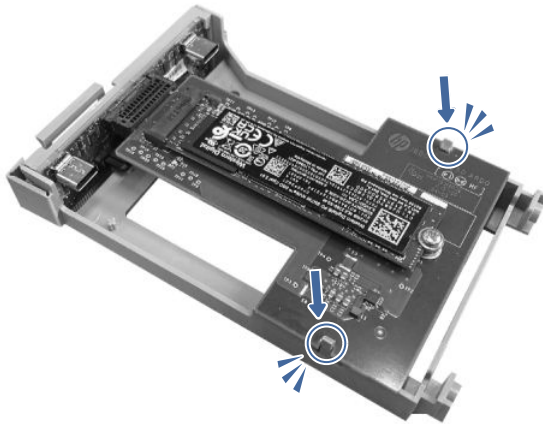

7. Align the bracket assembly with the formatter connector, and then press the bracket assembly to firmly seat it in the formatter connector.

Figure 5-114 Install the bracket assembly

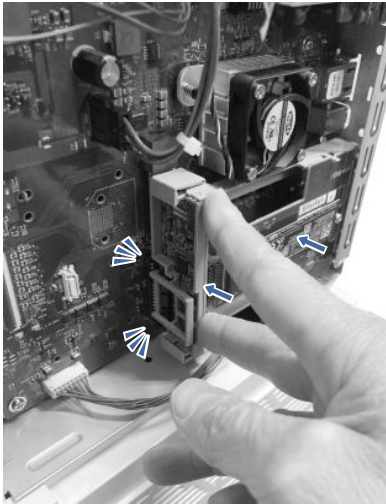

8. Install two pins to secure the bracket assembly to the formatter faceplate.

Figure 5-115 Install two pins

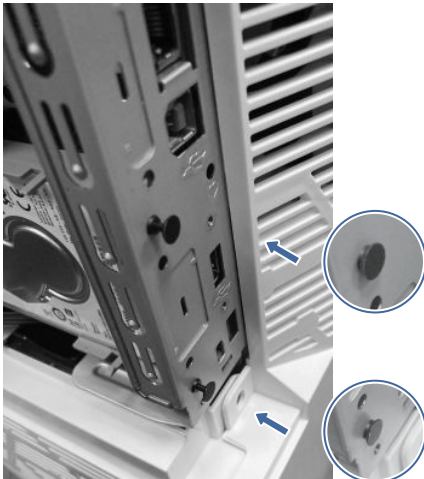

6. Install the formatter cover

Follow these steps to install the formatter cover.

- Slide the cover (callout 1) onto the printer, and then install one screw (callout 2) to secure it.

Figure 5-116 Install the cover

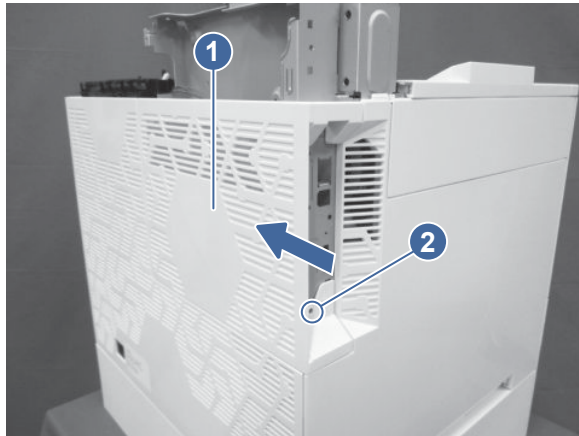

Removal and replacement: Near field communication (NFC) PCA (MFP models)

Learn about removing and replacing the NFC PCA.

 [View a video demonstration of removing and replacing the NFC PCA.](#)

Before performing service

Turn the printer power off

- Disconnect the power cable.

⚠ WARNING! To avoid damage to the printer, turn the printer off, wait 30 seconds, and then remove the power cord before attempting to service the printer.

If the part is damaged and cannot be cleaned, use the table below to identify the correct part number for your printer. To order the part, go to www.hp.com/buy/parts.

Table 5-21 Part information

Part number	Part description
1M0Q3A	HP JetDirect 3200w BLE/Wireless accessory
3JN69A	HP JetDirect 3100w BLE/NFC/Wireless accessory

Required tools

- #2 Phillips screwdriver with a magnetic tip and a 152 mm (6 in) shaft length

After performing service

Turn the printer power on

- Connect the power cable.
- Use the power switch to turn the power on.

Post service test

Print any pages necessary to make sure the printer is functioning correctly.

1. Remove the HIP cover

Follow these steps to remove the HIP cover.

1. Use a small flat-blade screwdriver to release the tabs on the HIP cover.

Figure 5-117 Release the cover



2. Rotate the cover up and off of the printer to remove it.

Figure 5-118 Remove the cover



2. Install the wireless print server with NFC

Learn how to install the wireless print server with NFC.

 **CAUTION:**  ESD sensitive part.

1. Connect the USB cable to the print server.

Figure 5-119 Connect the USB cable to the print server

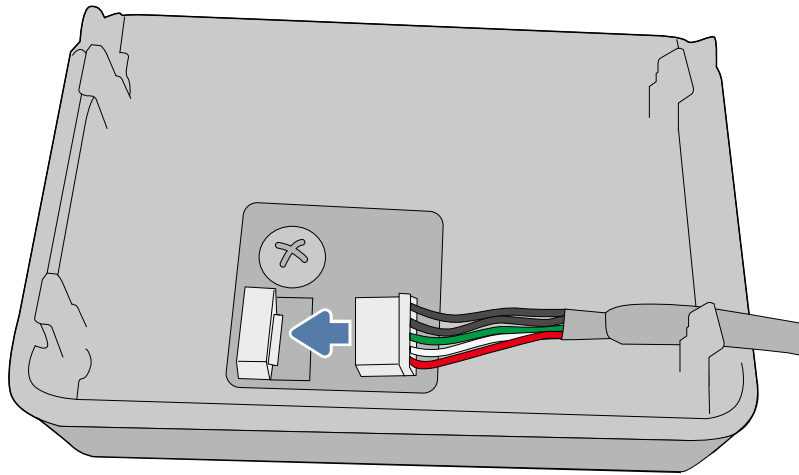

2. Connect the USB cable to the HIP port.

Figure 5-120 Connect the USB cable to the HIP port

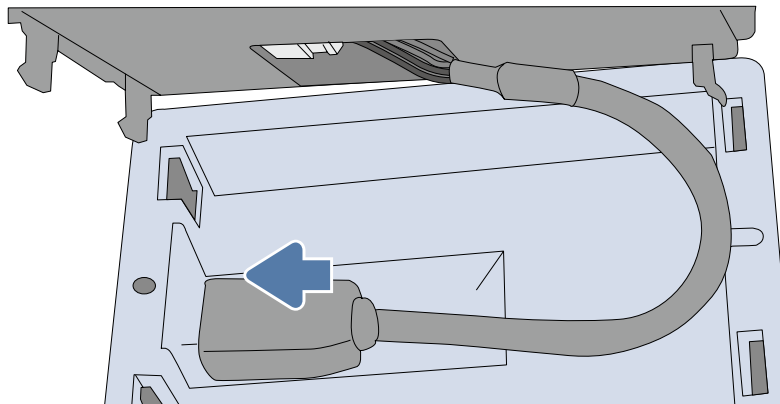

3. Install the printer server in the HIP cavity.

Figure 5-121 Install the printer server

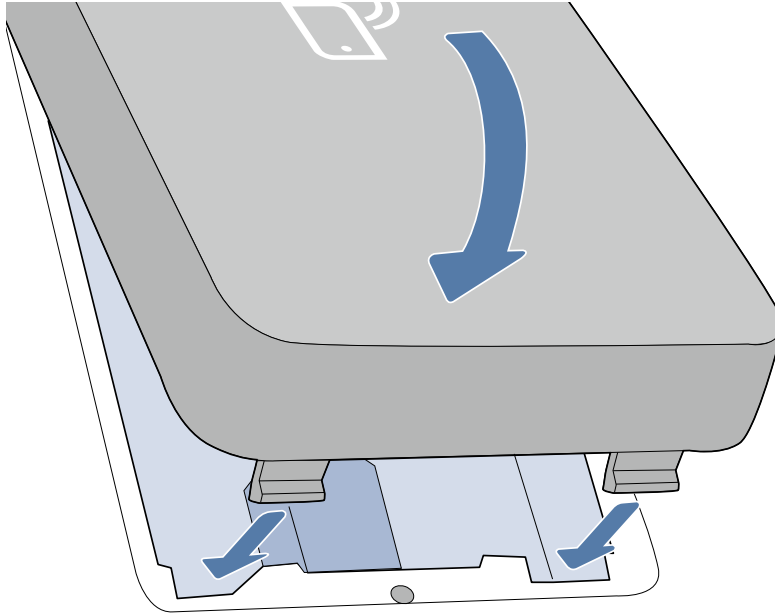

Removal and replacement: embedded MultiMedia Card (eMMC) (SFP models)

Learn about removing and replacing the embedded MultiMedia Card (eMMC).



[View a video demonstration of removing and replacing the eMMC.](#)

Before performing service

Turn the printer power off

- Disconnect the power cable.

⚠ WARNING! To avoid damage to the printer, turn the printer off, wait 30 seconds, and then remove the power cord before attempting to service the printer.

⚠ CAUTION: To prevent damage to a toner cartridge, do not expose it to light for more than a few minutes. Cover the green imaging drum if the toner cartridge must be removed from the printer for an extended period of time.

If toner gets on the skin or clothing, wipe it off with dry tissue paper and wash in cold water. Hot water sets toner and it might be difficult, or impossible, to remove.

Use the table below to identify the correct part number for your printer, and then go to <https://parts.hp.com/hpparts> to order the part.

Table 5-22 Part information

Part number	Part description
B5L32-60002	eMMC 16GB

Required tools

- No special tools are required to remove or install this assembly.

After performing service

Turn the printer power on

- Connect the power cable.
- Use the power switch to turn the power on.

Post service test

Print any pages necessary to make sure the printer is functioning correctly.

1. Remove the formatter cover

Follow these steps to remove the formatter cover.

- Remove one screw (callout 1), and then slide the formatter cover (callout 2) away from the printer to remove it.

 **TIP:** Reverse the removal steps to install the assembly.

Figure 5-122 Remove the formatter cover



2. Remove the embedded MultiMedia Card (eMMC)

Follow these steps to remove the eMMC.

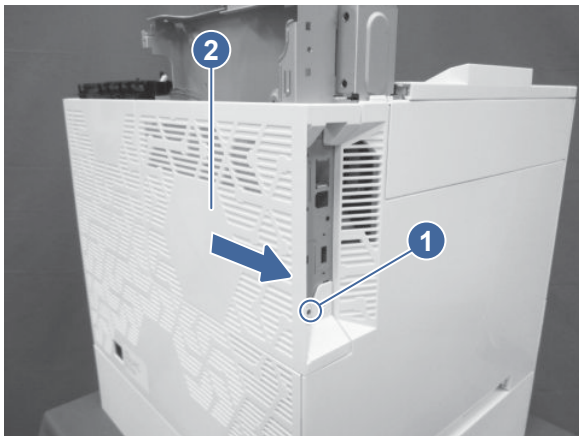
 **CAUTION:**  ESD sensitive part.

- Locate the eMMC component on the formatter, and then pull it straight off of the formatter to remove it.

Figure 5-123 Remove the eMMC (SFP/MFP)

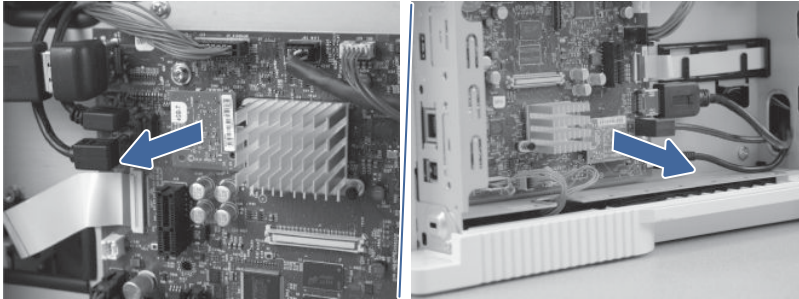

3. Unpack the replacement assembly

Follow these steps to unpack the replacement assembly.

1. Dispose of the defective part.



NOTE: HP recommends responsible disposal of the part.

<http://www8.hp.com/us/en/hp-information/environment/product-recycling.html>

2. Unpack the replacement part from the packaging.



IMPORTANT: Make sure that all of the shipping materials (for example shipping tape) are removed from the replacement part prior to installation.

4. Install the eMMC

Follow these steps to install the eMMC.



CAUTION:  ESD sensitive part.

1. Align the connector on the replacement eMMC (callout 1) with the connector on the formatter (callout 2), and then push the eMMC onto the formatter to install it.



NOTE: The eMMC can only be installed in one direction on the formatter

Figure 5-124 Install the eMMC

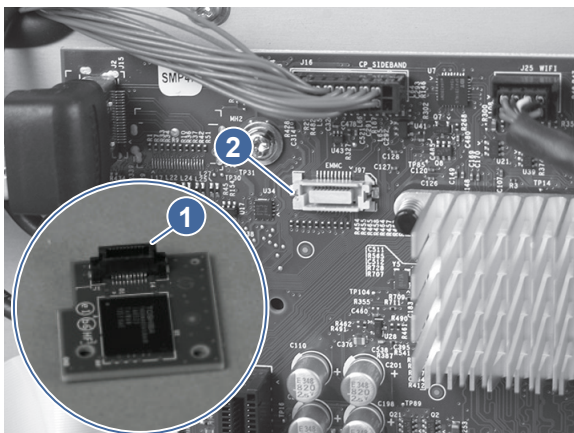

2. Push in on the eMMC to install it in the connector.

Figure 5-125 Install the eMMC (SFP/MFP)

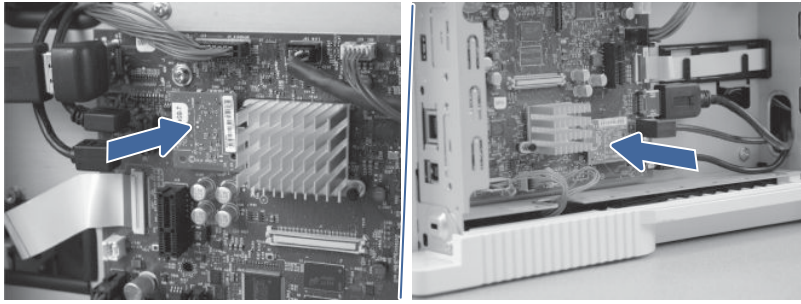

3. Verify that the eMMC is fully seated in the connector.

Figure 5-126 Verify the installation

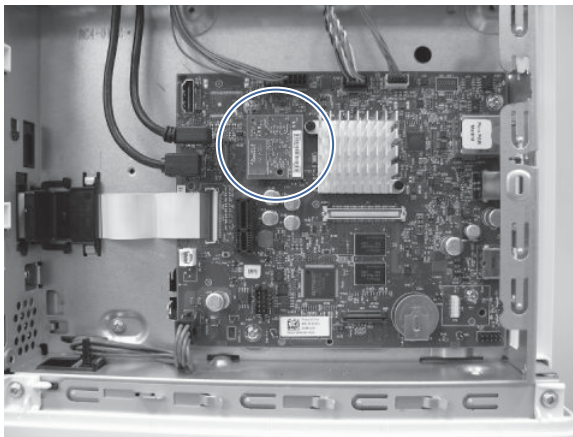

5. Install the formatter cover

Follow these steps to install the formatter cover.

- Slide the cover (callout 1) onto the printer, and then install one screw (callout 2) to secure it.

Figure 5-127 Install the cover

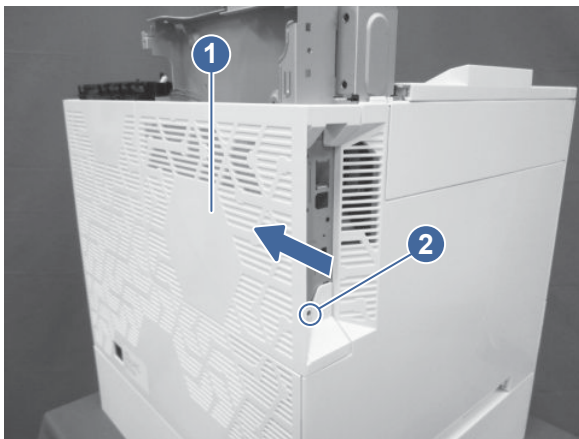

Document feeder / scanner

Learn about document feeder and scanner parts removal and replacement.

Field-replaceable units (FRUs)

Learn about FRU parts removal and replacement.

Internal parts and assemblies

Learn how to remove and replace the printer internal parts and assemblies.

Removal and replacement: Scanner control board (SCB) (MFP models)

This document provides the procedures to remove and replace the scanner control board (SCB).

Mean time to repair: 10 minutes

Service level: Intermediate

Before performing service

Turn the printer power off

- Disconnect the power cable.

⚠ WARNING! To avoid damage to the printer, turn the printer off, wait 30 seconds, and then remove the power cord before attempting to service the printer.

Use the table below to identify the correct part number for your printer. To order the part, go to www.hp.com/buy/parts.

Table 5-23 Part information

Part number	Part description
5851-8961	Scanner control interconnect board (SCIB) (6xxxx Series)

Required tools

- #2 Phillips screwdriver with a magnetic tip and a 152 mm (6 in) shaft length

After performing service

Turn the printer power on

- Connect the power cable.
- Use the power switch to turn the power on.

Post service test

No post service test is available for this assembly.

1. Remove the formatter cover

Follow these steps to remove the formatter cover.

- Remove one screw (callout 1), and then slide the formatter cover (callout 2) away from the printer to remove it.



 **TIP:** Reverse the removal steps to install the assembly.

Figure 5-128 Remove the formatter cover

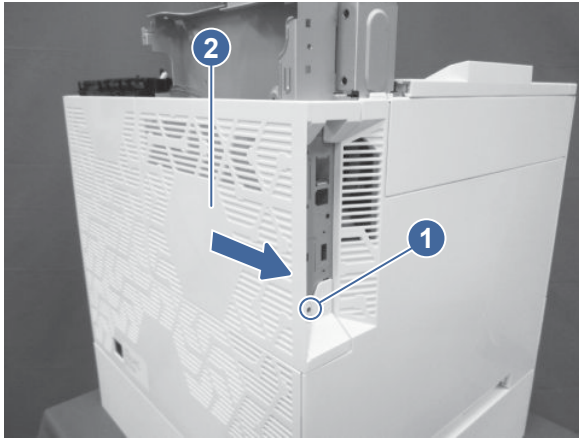

2. Remove the rear cover

Follow these steps to remove the rear cover.

 **NOTE:** The figures below show some assemblies (for example the top cover and formatter) removed that might still be installed on the printer. However, the steps to remove the cover are correct.

1. Open the right door, and remove two screws.

Figure 5-129 Remove two screws

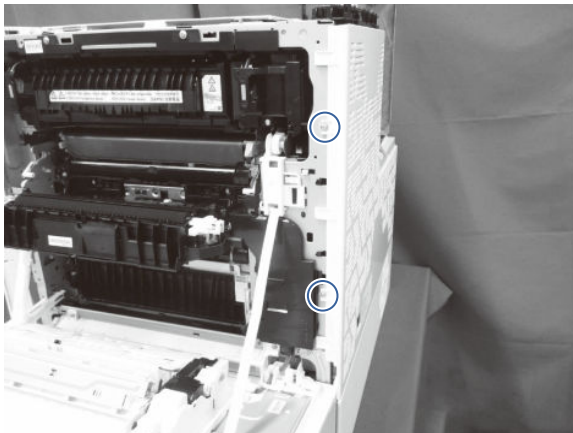

2. At the back of the printer, remove two screws, and then slide the rear cover as indicated to remove it.

Figure 5-130 Remove the rear cover

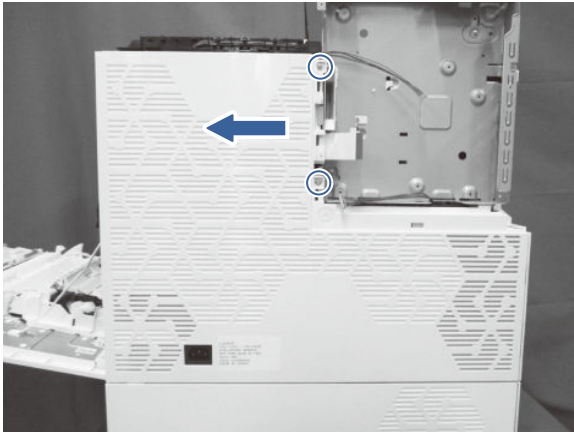

3. Remove the rear upper cover (MFP models)

Follow these steps to remove the rear upper cover.

 **NOTE:** The task below shows the rear upper cover on a 6800zfsw model. The cover on your model might look different, but the process is the same.

- Remove one screw, pry the right side away from printer, and then pull the cover in the direction indicated.

Figure 5-131 Remove the cover



4. Remove the document feeder

Follow these steps to remove the document feeder.

1. Remove two screws (callout 1).

 **TIP:** These are self-tapping screws for plastic. When reinstalling, rotate the screw counterclockwise to align it with the existing thread pattern, and then carefully turn it clockwise to tighten. Do not overtighten. This will prevent stripping the threads inside the screw hole.

Figure 5-132 Remove two screws



2. Disconnect one flat cable (callout 1), remove one ground screw (callout 2) to release the grounding cable, and then disconnect the indicated connectors (callout 3) on the scanner control board.

Figure 5-133 Disconnect the flat cable, ground cable, and connectors

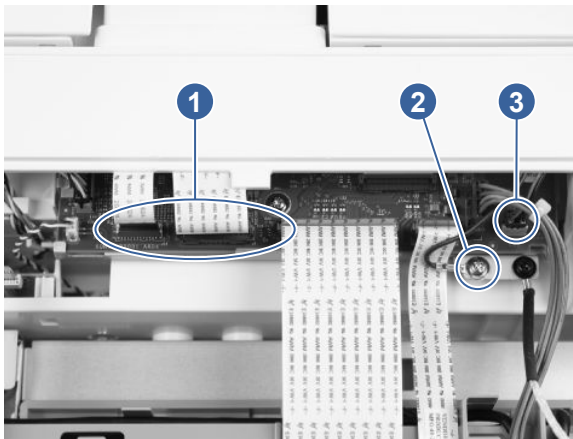

3. Tilt the document feeder back until it stops, and then lift it off of the scanner until it stops.
4. Support the document feeder, and then use a small flat-blade screwdriver to release two tabs on the document feeder hinges.

Figure 5-134 Release two tabs



5. Lift the document feeder up to remove it.



NOTE: While removing the document feeder, carefully pass the cables through the cable channel in the scanner bed.

5. Remove the flatbed scanner assembly

Follow these steps to remove the sub-scanner assembly (SSA).

1. On the SCB, disconnect the cables indicated below.

Figure 5-135 Disconnect SCB connectors

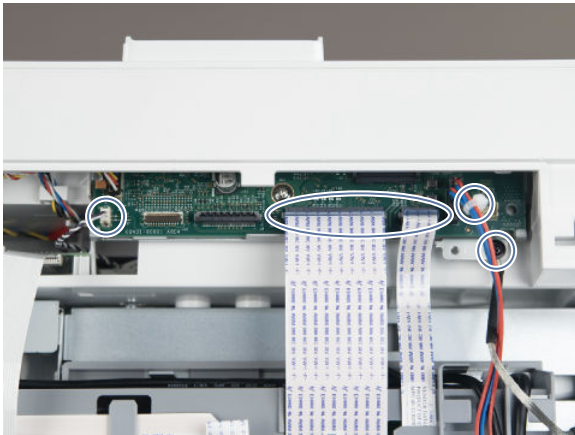

2. Remove four screws.

Figure 5-136 Remove four screws

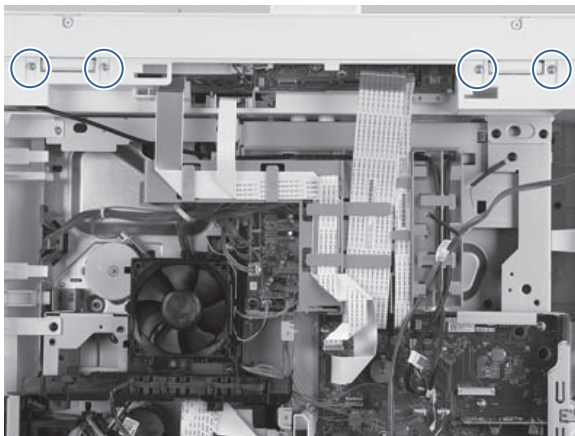

3. Pull the scan unit up to remove it from the printer.



NOTE: Carefully ensure that the cables do not catch on the cable guides as you lift the assembly.

6. Remove the scanner control board (SCB)

Follow these steps to remove the scanner control board (SCB).

- On the SCB, disconnect two connectors (callout 1), and then remove one screw (callout 2). Slide the SCB to the right, and then remove it from the integrated scanner assembly.

Figure 5-137 Disconnect connectors

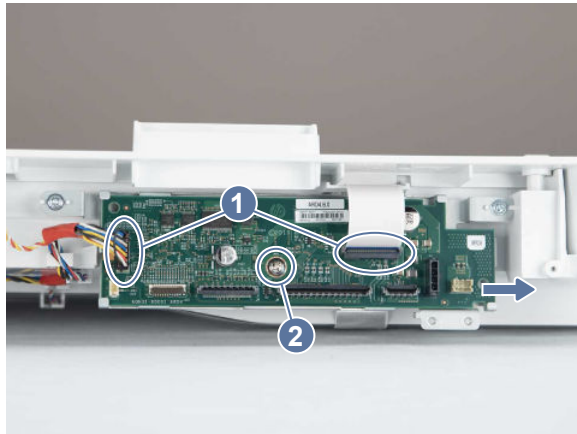

7. Unpack the replacement assembly

Follow these steps to unpack the replacement assembly.

1. Dispose of the defective part.



NOTE: HP recommends responsible disposal of the defective part.

<http://www8.hp.com/us/en/hp-information/environment/product-recycling.html>

2. Unpack the replacement part from the packaging.



CAUTION:  Some parts are sensitive to electrostatic discharge (ESD). Always perform service work at an ESD-protected workstation or mat. If an ESD workstation or mat is not available, touch the sheet-metal chassis to provide a static ground before touching an ESD-sensitive assembly. Protect the ESD-sensitive assemblies by placing them in ESD pouches when they are out of the printer.



IMPORTANT: Make sure that all of the shipping materials (for example shipping tape) are removed from the replacement part prior to installation.



NOTE: If the replacement part is a roller or pad, avoid touching the spongy part of it. Skin oils on the roller or pad can cause paper pickup and/or print-quality problems. HP recommends using disposable gloves when handling rollers or pads or washing your hands before touching rollers or pads.

3. To install an assembly, reverse the removal steps.



NOTE: When applicable, special installation instructions are provided for an assembly at the end of the removal procedure. Always completely read the removal instructions and follow all special installation instructions.

Removal and replacement: White backing (MFP models)

Learn about removing and replacing the document feeder white backing.

Before performing service

Turn the printer power off

- Disconnect the power cable.

 **WARNING!** To avoid damage to the printer, turn the printer off, wait 30 seconds, and then remove the power cord before attempting to service the printer.

Use the table below to identify the correct part number for your printer, and then go to <https://parts.hp.com/hpparts> to order the part.

Table 5-24 Part information

Part number	Part description
5851-8850	ADF white backing kit (5800/X57945 models)

Required tools

- No special tools are required to remove or install this assembly.

After performing service

Turn the printer power on

- Connect the power cable.
- Use the power switch to turn the power on.

Post service test

Print any pages necessary to make sure the printer is functioning correctly.

1. Unpack the replacement assembly



Follow these steps to unpack the replacement assembly.

1. Dispose of the defective part.

 **NOTE:** HP recommends responsible disposal of the defective part.

<http://www8.hp.com/us/en/hp-information/environment/product-recycling.html>

2. Unpack the replacement part from the packaging.

 **CAUTION:**  Some parts are sensitive to electrostatic discharge (ESD). Always perform service work at an ESD-protected workstation or mat. If an ESD workstation or mat is not available, touch the sheet-metal chassis to provide a static ground before touching an ESD-sensitive assembly. Protect the ESD-sensitive assemblies by placing them in ESD pouches when they are out of the printer.

 **IMPORTANT:** Make sure that all of the shipping materials (for example shipping tape) are removed from the replacement part prior to installation.

 **NOTE:** If the replacement part is a roller or pad, avoid touching the spongy part of it. Skin oils on the roller or pad can cause paper pickup and/or print-quality problems. HP recommends using disposable gloves when handling rollers or pads or washing your hands before touching rollers or pads.

3. To install an assembly, reverse the removal steps.



NOTE: When applicable, special installation instructions are provided for an assembly at the end of the removal procedure. Always completely read the removal instructions and follow all special installation instructions.

Whole-unit replacement (WUR)

Learn about WUR parts removal and replacement.

Automatic document feeder (WUR)

Learn about automatic document feeder whole-unit replacement.

Removal and replacement: Document feeder (MFP models)

This document provides the procedures to remove and replace the document feeder (MFP).

Mean time to repair: 20 minutes

Service level: Intermediate

Before performing service

Turn the printer power off

- Disconnect the power cable.

⚠ WARNING! To avoid damage to the printer, turn the printer off, wait 30 seconds, and then remove the power cord before attempting to service the printer.

Use the table below to identify the correct part number for your printer. To order the part, go to www.hp.com/buy/parts.

Table 5-25 Part information

Part number	Part description
C0M44-67002	ADF WUR (5xxx Series Non-Workflow)
C0M44-67003	ADF WUR (5xxx Series Workflow)

Required tools

- #2 Phillips screwdriver with a magnetic tip.
- Small flat-blade screwdriver.

After performing service

Turn the printer power on

- Connect the power cable.
- Use the power switch to turn the power on.

Post service test

Use the document feeder to make a copy to make sure that it is properly functioning.

1. Remove the formatter cover

Follow these steps to remove the formatter cover.

- Remove one screw (callout 1), and then slide the formatter cover (callout 2) away from the printer to remove it.



 **TIP:** Reverse the removal steps to install the assembly.

Figure 5-138 Remove the formatter cover

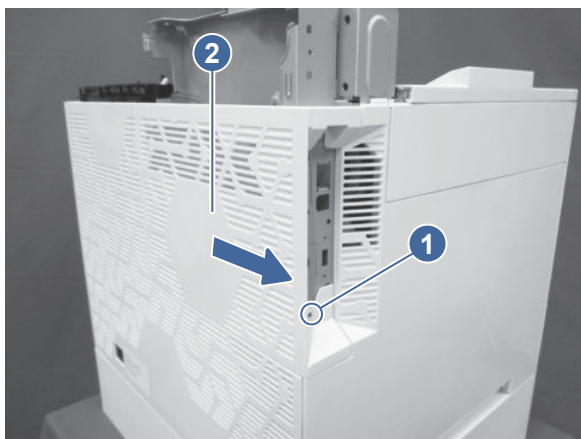

2. Remove the rear cover

Follow these steps to remove the rear cover.

 **NOTE:** The figures below show some assemblies (for example the top cover and formatter) removed that might still be installed on the printer. However, the steps to remove the cover are correct.

1. Open the right door, and remove two screws.

Figure 5-139 Remove two screws

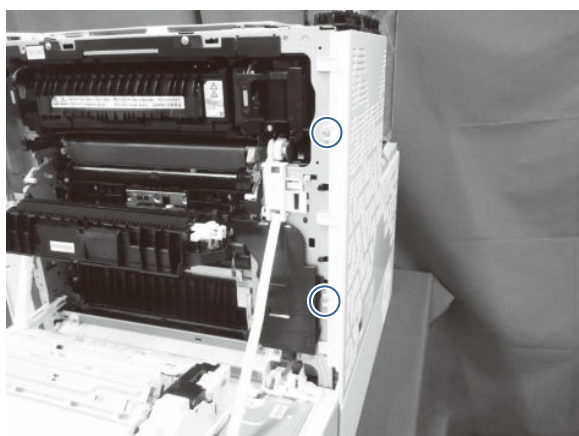

2. At the back of the printer, remove two screws, and then slide the rear cover as indicated to remove it.

Figure 5-140 Remove the rear cover

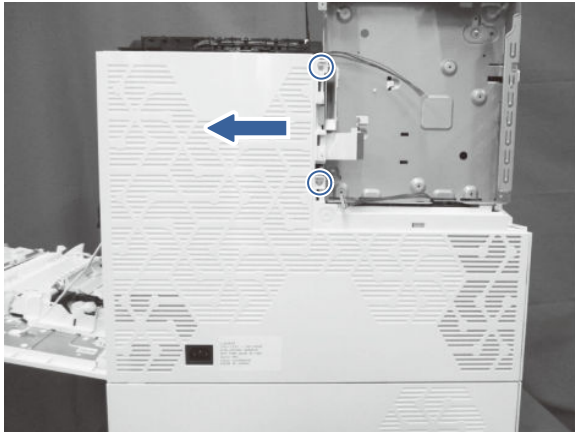

3. Remove the rear upper cover (MFP models)

Follow these steps to remove the rear upper cover.

 **NOTE:** The task below shows the rear upper cover on a 6800zfs model. The cover on your model might look different, but the process is the same.

- Remove one screw, pry the right side away from printer, and then pull the cover in the direction indicated.

Figure 5-141 Remove the cover



4. Remove the document feeder

Follow these steps to remove the document feeder.

1. Remove two screws (callout 1).

 **TIP:** These are self-tapping screws for plastic. When reinstalling, rotate the screw counterclockwise to align it with the existing thread pattern, and then carefully turn it clockwise to tighten. Do not overtighten. This will prevent stripping the threads inside the screw hole.

Figure 5-142 Remove two screws



2. Disconnect one flat cable (callout 1), remove one ground screw (callout 2) to release the grounding cable, and then disconnect the indicated connectors (callout 3) on the scanner control board.

Figure 5-143 Disconnect the flat cable, ground cable, and connectors

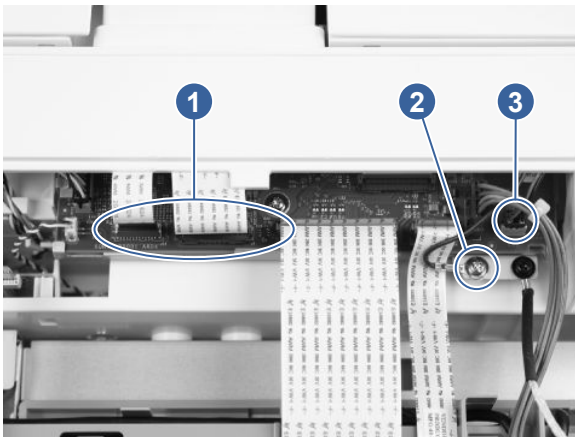

3. Tilt the document feeder back until it stops, and then lift it off of the scanner until it stops.
4. Support the document feeder, and then use a small flat-blade screwdriver to release two tabs on the document feeder hinges.

Figure 5-144 Release two tabs



5. Lift the document feeder up to remove it.

 **NOTE:** While removing the document feeder, carefully pass the cables through the cable channel in the scanner bed.

5. Unpack the replacement assembly



Follow these steps to unpack the replacement assembly.

1. Dispose of the defective part.

 **NOTE:** HP recommends responsible disposal of the defective part.

<http://www8.hp.com/us/en/hp-information/environment/product-recycling.html>

2. Unpack the replacement part from the packaging.

 **CAUTION:**  Some parts are sensitive to electrostatic discharge (ESD). Always perform service work at an ESD-protected workstation or mat. If an ESD workstation or mat is not available, touch the sheet-metal chassis to provide a static ground before touching an ESD-sensitive assembly. Protect the ESD-sensitive assemblies by placing them in ESD pouches when they are out of the printer.

 **IMPORTANT:** Make sure that all of the shipping materials (for example shipping tape) are removed from the replacement part prior to installation.

 **NOTE:** If the replacement part is a roller or pad, avoid touching the spongy part of it. Skin oils on the roller or pad can cause paper pickup and/or print-quality problems. HP recommends using disposable gloves when handling rollers or pads or washing your hands before touching rollers or pads.

3. To install an assembly, reverse the removal steps.

 **NOTE:** When applicable, special installation instructions are provided for an assembly at the end of the removal procedure. Always completely read the removal instructions and follow all special installation instructions.

Integrated scanner assembly (WUR)

Learn about integrated scanner assembly (ISA) whole-unit replacement.

Removal and replacement: Flatbed scanner assembly (MFP models)

Learn how to remove and replace the sub-scanner assembly (SSA).

Mean time to repair: 22 minutes

Service level: Medium

Before performing service

Turn the printer power off

- Disconnect the power cable.

 **WARNING!** To avoid damage to the printer, turn the printer off, wait 30 seconds, and then remove the power cord before attempting to service the printer.

Use the table below to identify the correct part number for your printer. To order the part, go to www.hp.com/buy/parts.

 **NOTE:** The integrated scanner assembly (ISA) includes the sub-scanner assembly (SSA) and the automatic document feeder (ADF).

Table 5-26 Part information

Part number	Part description
6QN29-67005	Flatbed scanner (5xxx Series)

Required tools

- Small flat-blade screwdriver
- #2 Phillips screwdriver with a magnetic tip and a 152 mm (6 in) shaft length

After performing service

Turn the printer power on

- Connect the power cable.
- Use the power switch to turn the power on.

Post service test

Make sure that the printer initializes to a **Ready** state.

Print any pages necessary to make sure the printer is functioning correctly.

1. Remove the formatter cover

Follow these steps to remove the formatter cover.

- Remove one screw (callout 1), and then slide the formatter cover (callout 2) away from the printer to remove it.



 **TIP:** Reverse the removal steps to install the assembly.

Figure 5-145 Remove the formatter cover

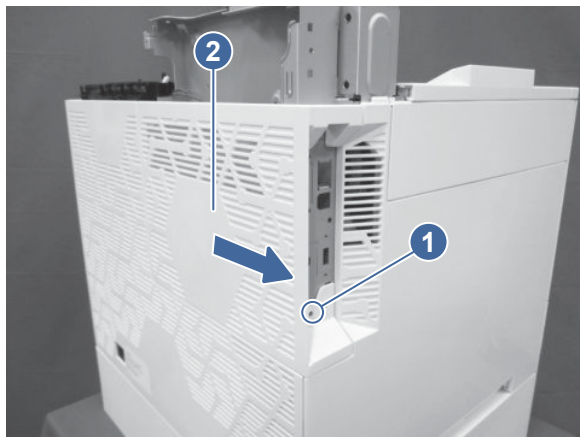

2. Remove the rear cover

Follow these steps to remove the rear cover.

 **NOTE:** The figures below show some assemblies (for example the top cover and formatter) removed that might still be installed on the printer. However, the steps to remove the cover are correct.

1. Open the right door, and remove two screws.

Figure 5-146 Remove two screws

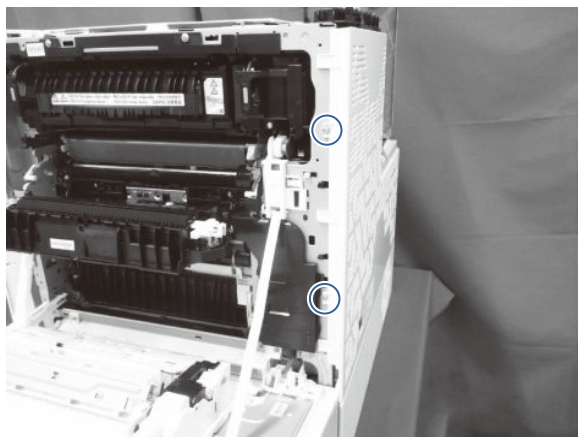

2. At the back of the printer, remove two screws, and then slide the rear cover as indicated to remove it.

Figure 5-147 Remove the rear cover

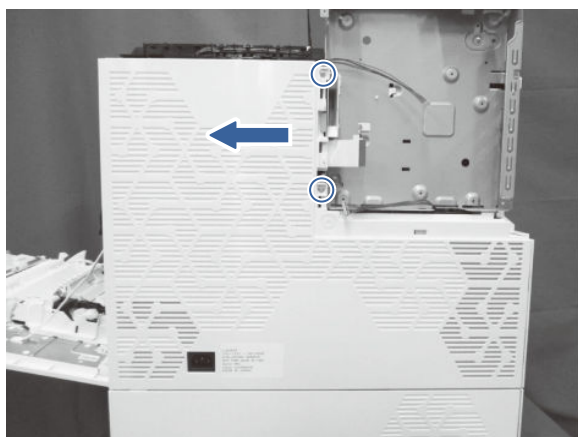

3. Remove the rear upper cover (MFP models)

Follow these steps to remove the rear upper cover.

 **NOTE:** The task below shows the rear upper cover on a 6800zfs model. The cover on your model might look different, but the process is the same.

- Remove one screw, pry the right side away from printer, and then pull the cover in the direction indicated.

Figure 5-148 Remove the cover



4. Remove the document feeder

Follow these steps to remove the document feeder.

1. Remove two screws (callout 1).

 **TIP:** These are self-tapping screws for plastic. When reinstalling, rotate the screw counterclockwise to align it with the existing thread pattern, and then carefully turn it clockwise to tighten. Do not overtighten. This will prevent stripping the threads inside the screw hole.

Figure 5-149 Remove two screws



2. Disconnect one flat cable (callout 1), remove one ground screw (callout 2) to release the grounding cable, and then disconnect the indicated connectors (callout 3) on the scanner control board.

Figure 5-150 Disconnect the flat cable, ground cable, and connectors

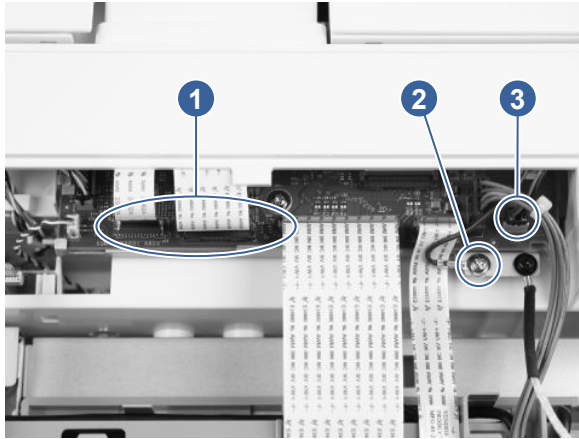

3. Tilt the document feeder back until it stops, and then lift it off of the scanner until it stops.
4. Support the document feeder, and then use a small flat-blade screwdriver to release two tabs on the document feeder hinges.

Figure 5-151 Release two tabs



5. Lift the document feeder up to remove it.



NOTE: While removing the document feeder, carefully pass the cables through the cable channel in the scanner bed.

5. Remove the flatbed scanner assembly

Follow these steps to remove the sub-scanner assembly (SSA).

1. On the SCB, disconnect the cables indicated below.

Figure 5-152 Disconnect SCB connectors

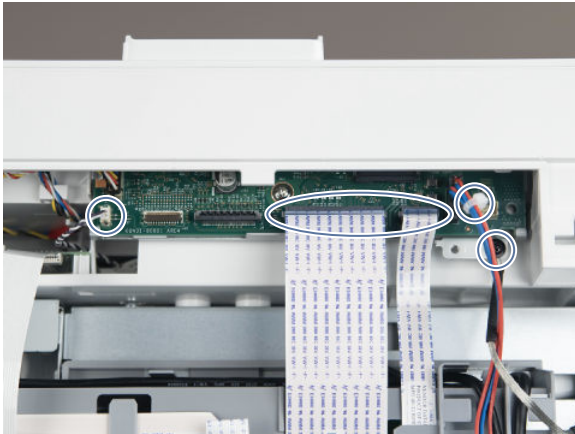

2. Remove four screws.

Figure 5-153 Remove four screws

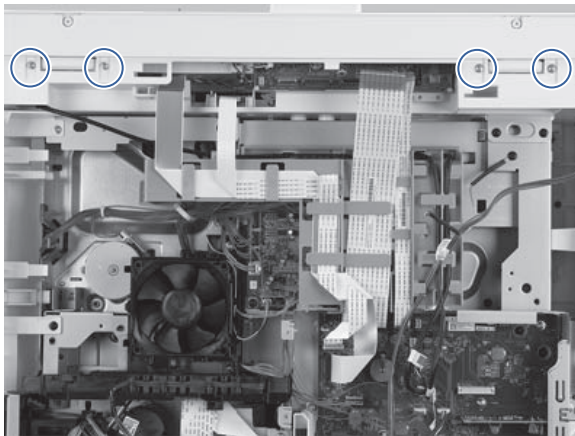

3. Pull the scan unit up to remove it from the printer.



NOTE: Carefully ensure that the cables do not catch on the cable guides as you lift the assembly.

6. Unpack the replacement assembly

Follow these steps to unpack the replacement assembly.

1. Dispose of the defective part.



NOTE: HP recommends responsible disposal of the defective part.

<http://www8.hp.com/us/en/hp-information/environment/product-recycling.html>

2. Unpack the replacement part from the packaging.



CAUTION:  Some parts are sensitive to electrostatic discharge (ESD). Always perform service work at an ESD-protected workstation or mat. If an ESD workstation or mat is not available, touch the sheet-metal chassis to provide a static ground before touching an ESD-sensitive assembly.

Protect the ESD-sensitive assemblies by placing them in ESD pouches when they are out of the printer.

 **IMPORTANT:** Make sure that all of the shipping materials (for example shipping tape) are removed from the replacement part prior to installation.

 **NOTE:** If the replacement part is a roller or pad, avoid touching the spongy part of it. Skin oils on the roller or pad can cause paper pickup and/or print-quality problems. HP recommends using disposable gloves when handling rollers or pads or washing your hands before touching rollers or pads.

3. To install an assembly, reverse the removal steps.

 **NOTE:** When applicable, special installation instructions are provided for an assembly at the end of the removal procedure. Always completely read the removal instructions and follow all special installation instructions.

Removal and replacement: Internal parts and assemblies (base printer)

Learn how to remove and replace the base printer internal parts and assemblies.

Field-replaceable units (FRUs)

Learn about FRU parts removal and replacement.

Covers, panels, and doors

Learn about covers, panels, and doors removal and replacement.

Removal and replacement: Formatter cover

Learn about removing and replacing the formatter cover.

Before performing service

Turn the printer power off

- Disconnect the power cable.

 **WARNING!** To avoid damage to the printer, turn the printer off, wait 30 seconds, and then remove the power cord before attempting to service the printer.

Use the table below to identify the correct part number for your printer, and then go to <https://parts.hp.com/hpparts> to order the part.

Table 5-27 Part information

Part number	Part description
RM2-4480-000CN	Formatter cover assembly(all models)
RM2-4530-000CN	Formatter cover assembly(Sub-cover MFP models only)

Required tools

- #2 Phillips screwdriver with a magnetic tip and a 152 mm (6 in) shaft length

After performing service

Turn the printer power on

- Connect the power cable.
- Use the power switch to turn the power on.

Post service test

No post service test is available for this assembly.

1. Remove the formatter cover

Follow these steps to remove the formatter cover.

- Remove one screw (callout 1), and then slide the formatter cover (callout 2) away from the printer to remove it.

 **TIP:** Reverse the removal steps to install the assembly.

Figure 5-154 Remove the formatter cover



2. Unpack the replacement assembly

Follow these steps to unpack the replacement assembly.

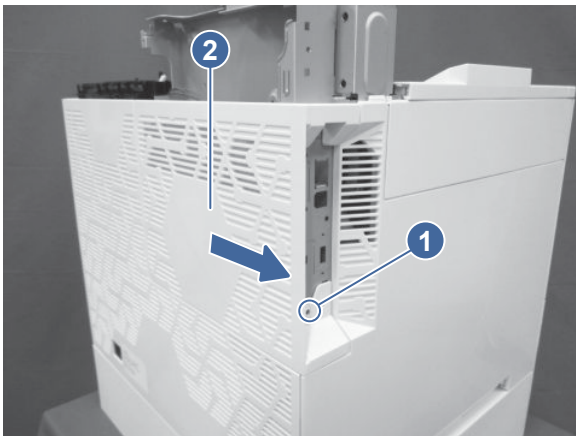
1. Dispose of the defective part.





NOTE: HP recommends responsible disposal of the defective part.

<http://www8.hp.com/us/en/hp-information/environment/product-recycling.html>

2. Unpack the replacement part from the packaging.



CAUTION:  Some parts are sensitive to electrostatic discharge (ESD). Always perform service work at an ESD-protected workstation or mat. If an ESD workstation or mat is not available, touch the sheet-metal chassis to provide a static ground before touching an ESD-sensitive assembly. Protect the ESD-sensitive assemblies by placing them in ESD pouches when they are out of the printer.

 **IMPORTANT:** Make sure that all of the shipping materials (for example shipping tape) are removed from the replacement part prior to installation.

 **NOTE:** If the replacement part is a roller or pad, avoid touching the spongy part of it. Skin oils on the roller or pad can cause paper pickup and/or print-quality problems. HP recommends using disposable gloves when handling rollers or pads or washing your hands before touching rollers or pads.

3. To install an assembly, reverse the removal steps.

 **NOTE:** When applicable, special installation instructions are provided for an assembly at the end of the removal procedure. Always completely read the removal instructions and follow all special installation instructions.

Removal and replacement: Front door

Learn about removing and replacing the front door.

Before performing service

Turn the printer power off

- Disconnect the power cable.

 **WARNING!** To avoid damage to the printer, turn the printer off, wait 30 seconds, and then remove the power cord before attempting to service the printer.

Use the table below to identify the correct part number for your printer, and then go to <https://parts.hp.com/hpparts> to order the part.

Table 5-28 Part information

Part number	Part description
RM2-4473-000CN	Front door assembly (5700/5800 models)
RM2-4479-000CN	Front door assembly (X57945/X654/X677 models)
RM2-4533-000CN	Front door assembly (X557/6700/6800 models)

Required tools

- #2 Phillips screwdriver with a magnetic tip and a 152 mm (6 in) shaft length

After performing service

Turn the printer power on

- Connect the power cable.
- Use the power switch to turn the power on.

Post service test

Make sure that the front door correctly opens and closes.

1. Remove Tray 2

Follow these steps to remove Tray 2.

1. Pull the tray out until it stops.

Figure 5-155 Pull the tray out



2. Lift the front of the tray, and then pull it out of the printer to remove it.

Figure 5-156 Remove the tray

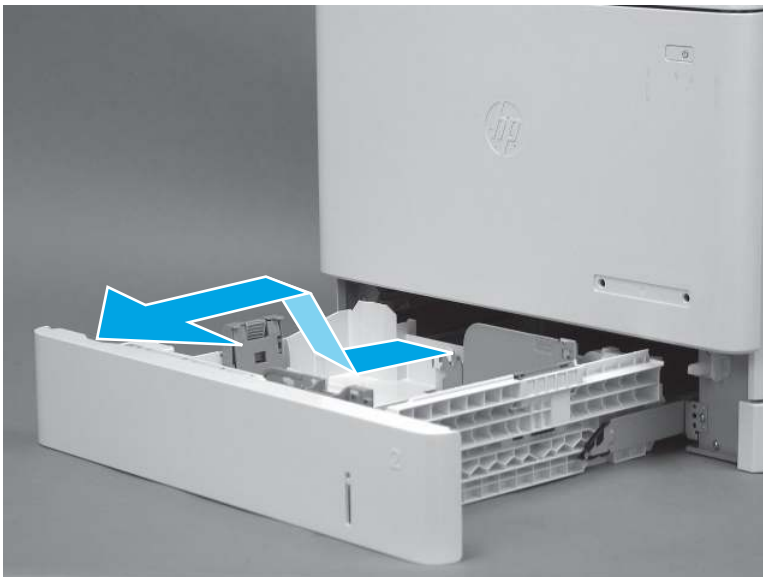

2. Remove the front door

Follow these steps to remove the front door.

1. Open the front door.

2. At the left side of the door, release the link arm (callout 1) from the clip (callout 2) on the front-door assembly.

Figure 5-157 Release the left link arm

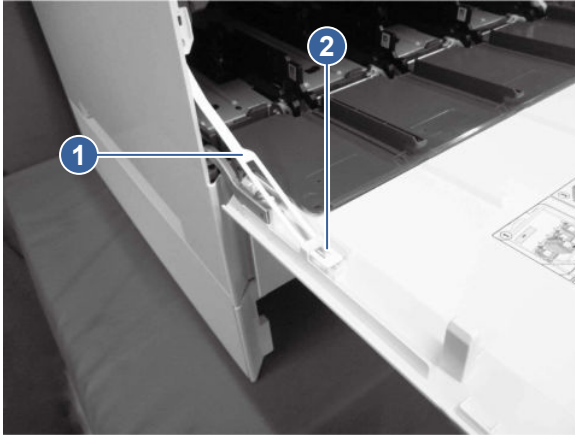

3. At the right side of the door, release the link arm (callout 1) from the clip (callout 2) on the front-door assembly.

Figure 5-158 Release the right link arm

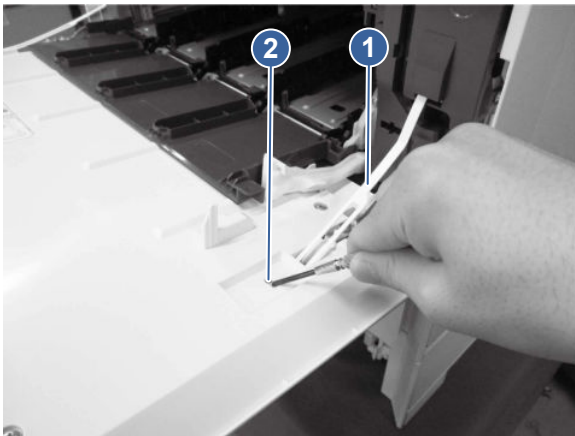

4. Remove two screws (callout 1), release the link lever (callout 2) from the front door assembly (callout 3), and then remove the front door.

Figure 5-159 Remove the door

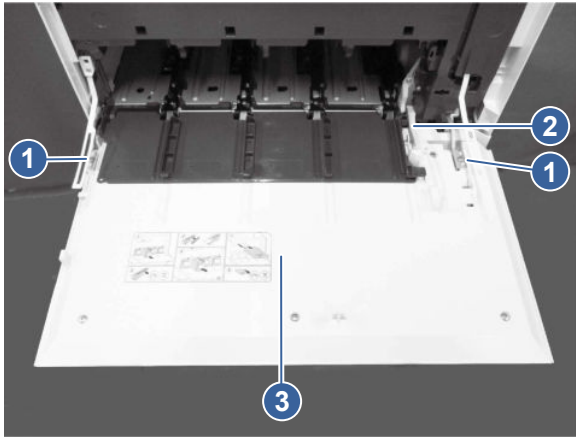

3. Unpack the replacement assembly



Follow these steps to unpack the replacement assembly.

1. Dispose of the defective part.

 **NOTE:** HP recommends responsible disposal of the defective part.

<http://www8.hp.com/us/en/hp-information/environment/product-recycling.html>

2. Unpack the replacement part from the packaging.

 **CAUTION:**  Some parts are sensitive to electrostatic discharge (ESD). Always perform service work at an ESD-protected workstation or mat. If an ESD workstation or mat is not available, touch the sheet-metal chassis to provide a static ground before touching an ESD-sensitive assembly. Protect the ESD-sensitive assemblies by placing them in ESD pouches when they are out of the printer.

 **IMPORTANT:** Make sure that all of the shipping materials (for example shipping tape) are removed from the replacement part prior to installation.

 **NOTE:** If the replacement part is a roller or pad, avoid touching the spongy part of it. Skin oils on the roller or pad can cause paper pickup and/or print-quality problems. HP recommends using disposable gloves when handling rollers or pads or washing your hands before touching rollers or pads.

3. To install an assembly, reverse the removal steps.

 **NOTE:** When applicable, special installation instructions are provided for an assembly at the end of the removal procedure. Always completely read the removal instructions and follow all special installation instructions.

Removal and replacement: Toner cartridge access door (X557/X57945 models)

Learn about removing and replacing the toner cartridge access door.

Before performing service

Turn the printer power off

- Disconnect the power cable.

⚠ WARNING! To avoid damage to the printer, turn the printer off, wait 30 seconds, and then remove the power cord before attempting to service the printer.

⚠ CAUTION: To prevent damage to a toner cartridge, do not expose it to light for more than a few minutes. Cover the green imaging drum if the toner cartridge must be removed from the printer for an extended period of time.

If toner gets on the skin or clothing, wipe it off with dry tissue paper and wash in cold water. Hot water sets toner and it might be difficult, or impossible, to remove.

Use the table below to identify the correct part number for your printer, and then go to <https://parts.hp.com/hpparts> to order the part.

Table 5-29 Part information

Part number	Part description
RM2-3678-000CN	Toner supply door assembly

Required tools

- #2 Phillips screwdriver with a magnetic tip and a 152 mm (6 in) shaft length

After performing service

Turn the printer power on

- Connect the power cable.
- Use the power switch to turn the power on.

Post service test

Make sure that the toner-cartridge door correctly opens and closes.

1. Remove Tray 2

Follow these steps to remove Tray 2.

1. Pull the tray out until it stops.

Figure 5-160 Pull the tray out



2. Lift the front of the tray, and then pull it out of the printer to remove it.

Figure 5-161 Remove the tray

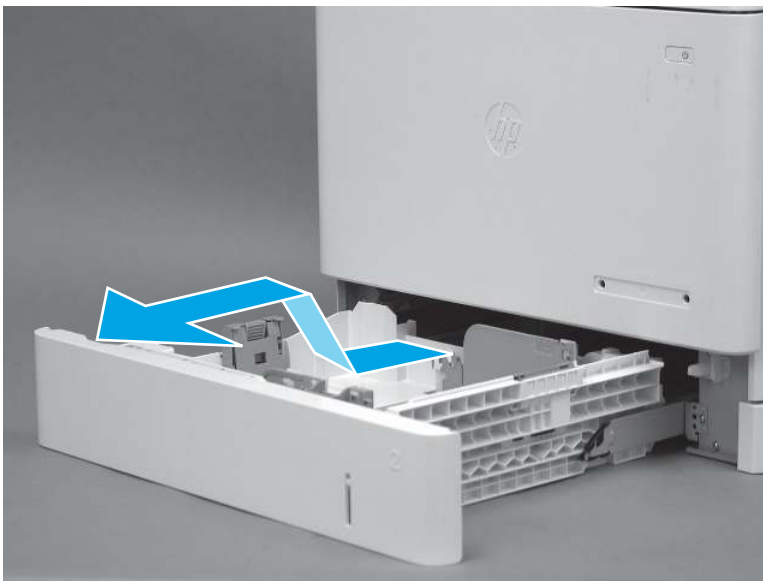

2. Remove the cartridge access door (X557/X57945 models)

Follow these steps to remove the cartridge access door.

1. Open the cartridge door.

2. At the right- and left-side of the door, remove two screws, and then remove the door.

Figure 5-162 Remove the door



3. Unpack the replacement assembly

Follow these steps to unpack the replacement assembly.

1. Dispose of the defective part.



NOTE: HP recommends responsible disposal of the defective part.

<http://www8.hp.com/us/en/hp-information/environment/product-recycling.html>

2. Unpack the replacement part from the packaging.



CAUTION:  Some parts are sensitive to electrostatic discharge (ESD). Always perform service work at an ESD-protected workstation or mat. If an ESD workstation or mat is not available, touch the sheet-metal chassis to provide a static ground before touching an ESD-sensitive assembly. Protect the ESD-sensitive assemblies by placing them in ESD pouches when they are out of the printer.



IMPORTANT: Make sure that all of the shipping materials (for example shipping tape) are removed from the replacement part prior to installation.



NOTE: If the replacement part is a roller or pad, avoid touching the spongy part of it. Skin oils on the roller or pad can cause paper pickup and/or print-quality problems. HP recommends using disposable gloves when handling rollers or pads or washing your hands before touching rollers or pads.

3. To install an assembly, reverse the removal steps.



NOTE: When applicable, special installation instructions are provided for an assembly at the end of the removal procedure. Always completely read the removal instructions and follow all special installation instructions.

Removal and replacement: Rear cover

Learn about removing and replacing the rear cover.

Before performing service

Turn the printer power off

- Disconnect the power cable.

⚠ WARNING! To avoid damage to the printer, turn the printer off, wait 30 seconds, and then remove the power cord before attempting to service the printer.

Use the table below to identify the correct part number for your printer, and then go to <https://parts.hp.com/hpparts> to order the part.

Table 5-30 Part information

Part number	Part description
RC5-9168-000CN	Cover, rear (all models)
RC5-9409-000CN	Cover, rear lower (X57945/X654/X677 models)

Required tools

- #2 Phillips screwdriver with a magnetic tip and a 152 mm (6 in) shaft length

After performing service

Turn the printer power on

- Connect the power cable.
- Use the power switch to turn the power on.

Post service test

No post service test is available for this assembly.

1. Remove the formatter cover

Follow these steps to remove the formatter cover.

- Remove one screw (callout 1), and then slide the formatter cover (callout 2) away from the printer to remove it.

💡 TIP: Reverse the removal steps to install the assembly.

Figure 5-163 Remove the formatter cover

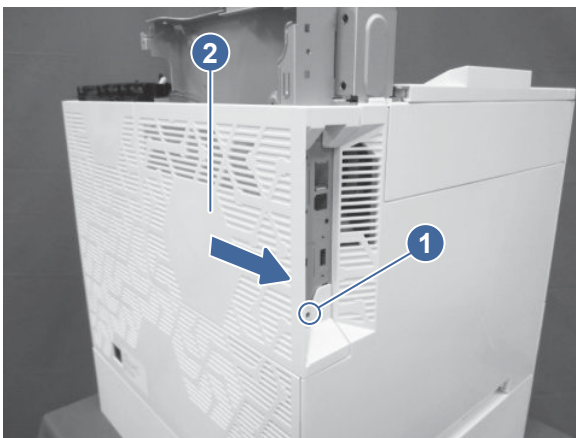

2. Remove the rear cover

Follow these steps to remove the rear cover.

 **NOTE:** The figures below show some assemblies (for example the top cover and formatter) removed that might still be installed on the printer. However, the steps to remove the cover are correct.

1. Open the right door, and remove two screws.

Figure 5-164 Remove two screws

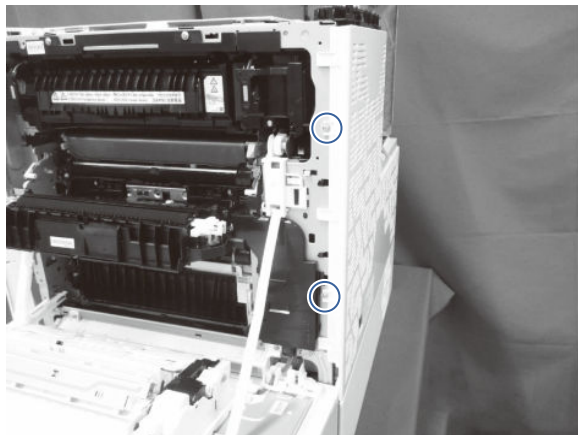

2. At the back of the printer, remove two screws, and then slide the rear cover as indicated to remove it.

Figure 5-165 Remove the rear cover

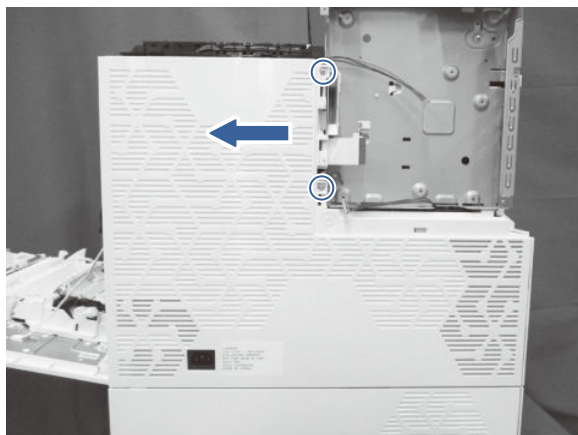

3. Unpack the replacement assembly



Follow these steps to unpack the replacement assembly.

1. Dispose of the defective part.

 **NOTE:** HP recommends responsible disposal of the defective part.

<http://www8.hp.com/us/en/hp-information/environment/product-recycling.html>

2. Unpack the replacement part from the packaging.

 **CAUTION:**  Some parts are sensitive to electrostatic discharge (ESD). Always perform service work at an ESD-protected workstation or mat. If an ESD workstation or mat is not available, touch the sheet-metal chassis to provide a static ground before touching an ESD-sensitive assembly. Protect the ESD-sensitive assemblies by placing them in ESD pouches when they are out of the printer.

 **IMPORTANT:** Make sure that all of the shipping materials (for example shipping tape) are removed from the replacement part prior to installation.

 **NOTE:** If the replacement part is a roller or pad, avoid touching the spongy part of it. Skin oils on the roller or pad can cause paper pickup and/or print-quality problems. HP recommends using disposable gloves when handling rollers or pads or washing your hands before touching rollers or pads.

3. To install an assembly, reverse the removal steps.

 **NOTE:** When applicable, special installation instructions are provided for an assembly at the end of the removal procedure. Always completely read the removal instructions and follow all special installation instructions.

Removal and replacement: Rear upper cover (MFP models)

Learn about removing and replacing the rear upper cover.

Before performing service

Turn the printer power off

- Disconnect the power cable.

 **WARNING!** To avoid damage to the printer, turn the printer off, wait 30 seconds, and then remove the power cord before attempting to service the printer.

Use the table below to identify the correct part number for your printer, and then go to <https://parts.hp.com/hpparts> to order the part.

Table 5-31 Part information

Part number	Part description
RC6-1305-000CN	Cover, rear upper

Required tools

- #2 Phillips screwdriver with a magnetic tip and a 152 mm (6 in) shaft length

After performing service

Turn the printer power on

- Connect the power cable.
- Use the power switch to turn the power on.

Post service test

No post service test is available for this assembly.

1. Remove the formatter cover

Follow these steps to remove the formatter cover.

- Remove one screw (callout 1), and then slide the formatter cover (callout 2) away from the printer to remove it.



 **TIP:** Reverse the removal steps to install the assembly.

Figure 5-166 Remove the formatter cover

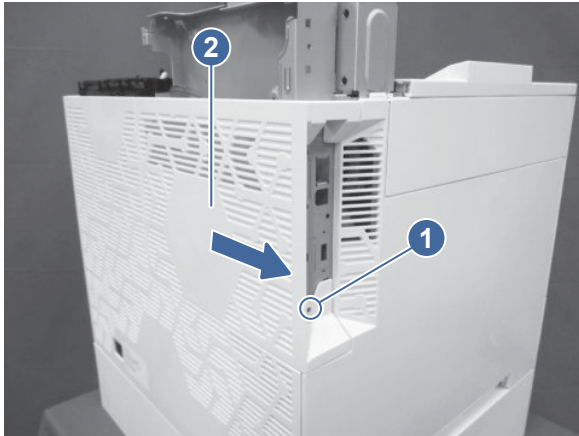

2. Remove the rear cover

Follow these steps to remove the rear cover.

 **NOTE:** The figures below show some assemblies (for example the top cover and formatter) removed that might still be installed on the printer. However, the steps to remove the cover are correct.

1. Open the right door, and remove two screws.

Figure 5-167 Remove two screws

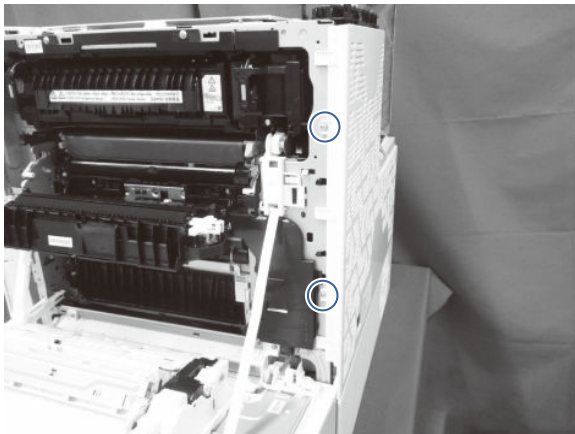

2. At the back of the printer, remove two screws, and then slide the rear cover as indicated to remove it.

Figure 5-168 Remove the rear cover

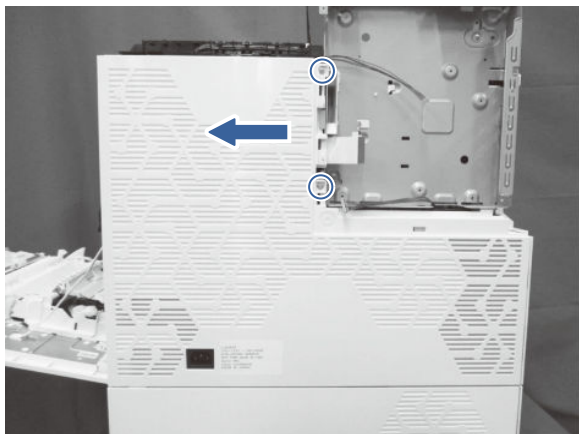

3. Remove the rear upper cover (MFP models)

Follow these steps to remove the rear upper cover.

 **NOTE:** The task below shows the rear upper cover on a 6800zfs model. The cover on your model might look different, but the process is the same.

- Remove one screw, pry the right side away from printer, and then pull the cover in the direction indicated.

Figure 5-169 Remove the cover



4. Unpack the replacement assembly



Follow these steps to unpack the replacement assembly.

1. Dispose of the defective part.

 **NOTE:** HP recommends responsible disposal of the defective part.

<http://www8.hp.com/us/en/hp-information/environment/product-recycling.html>

2. Unpack the replacement part from the packaging.

 **CAUTION:**  Some parts are sensitive to electrostatic discharge (ESD). Always perform service work at an ESD-protected workstation or mat. If an ESD workstation or mat is not available, touch the sheet-metal chassis to provide a static ground before touching an ESD-sensitive assembly. Protect the ESD-sensitive assemblies by placing them in ESD pouches when they are out of the printer.

 **IMPORTANT:** Make sure that all of the shipping materials (for example shipping tape) are removed from the replacement part prior to installation.

 **NOTE:** If the replacement part is a roller or pad, avoid touching the spongy part of it. Skin oils on the roller or pad can cause paper pickup and/or print-quality problems. HP recommends using disposable gloves when handling rollers or pads or washing your hands before touching rollers or pads.

3. To install an assembly, reverse the removal steps.

 **NOTE:** When applicable, special installation instructions are provided for an assembly at the end of the removal procedure. Always completely read the removal instructions and follow all special installation instructions.

Removal and replacement: Left upper cover (MFP models)

Learn about removing and replacing the left upper cover.

Before performing service

Turn the printer power off

- Disconnect the power cable.

 **WARNING!** To avoid damage to the printer, turn the printer off, wait 30 seconds, and then remove the power cord before attempting to service the printer.

Use the table below to identify the correct part number for your printer, and then go to <https://parts.hp.com/hpparts> to order the part.

Table 5-32 Part information

Part number	Part description
RC5-9204-000CN	Cover, left upper

Required tools

- Small flat-blade screwdriver

After performing service

Turn the printer power on

- Connect the power cable.
- Use the power switch to turn the power on.

Post service test

No post service test is available for this assembly.

1. Remove the left upper cover (MFP models)

Follow these steps to remove the left upper cover.

1. Open the front door.

⚠ CAUTION: If the cover is being removed to gain access to the main drive assembly, make sure that the front door remains open. This keeps the main drive properly aligned.

2. At the left side of the printer, insert the small flat-blade screwdriver into the slot to release one tab (callout 1).

Figure 5-170 Use a screwdriver to release the tab

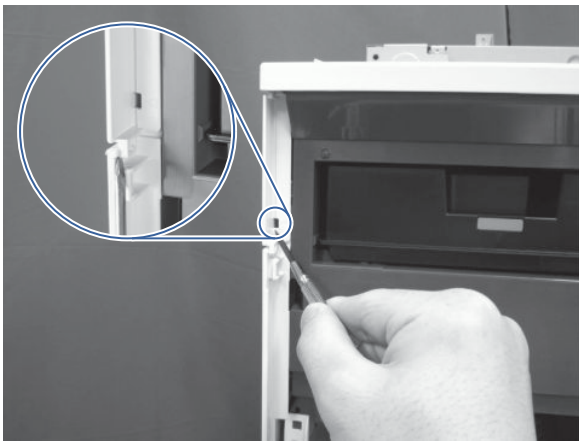

3. Toward the front of the printer, release another tab.

Figure 5-171 Release the tab

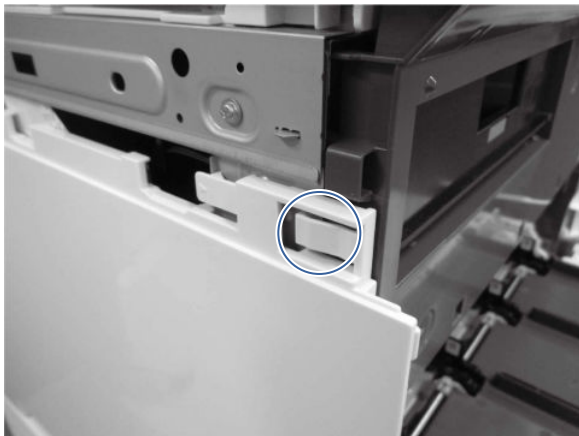

4. Rotate the cover up to remove it.

Figure 5-172 Remove the left upper cover

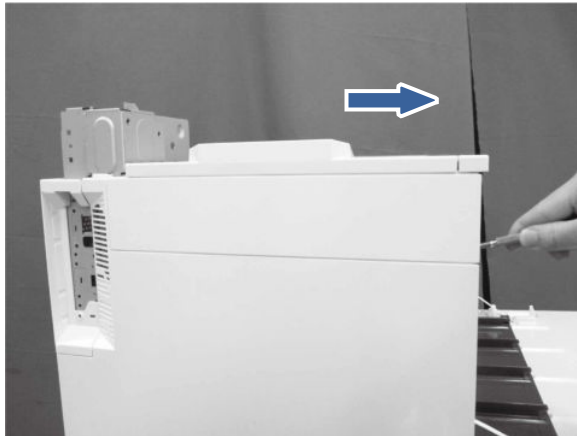

2. Unpack the replacement assembly

Follow these steps to unpack the replacement assembly.

1. Dispose of the defective part.



NOTE: HP recommends responsible disposal of the defective part.

<http://www8.hp.com/us/en/hp-information/environment/product-recycling.html>

2. Unpack the replacement part from the packaging.



CAUTION:  Some parts are sensitive to electrostatic discharge (ESD). Always perform service work at an ESD-protected workstation or mat. If an ESD workstation or mat is not available, touch the sheet-metal chassis to provide a static ground before touching an ESD-sensitive assembly. Protect the ESD-sensitive assemblies by placing them in ESD pouches when they are out of the printer.



IMPORTANT: Make sure that all of the shipping materials (for example shipping tape) are removed from the replacement part prior to installation.



NOTE: If the replacement part is a roller or pad, avoid touching the spongy part of it. Skin oils on the roller or pad can cause paper pickup and/or print-quality problems. HP recommends using disposable gloves when handling rollers or pads or washing your hands before touching rollers or pads.

3. To install an assembly, reverse the removal steps.



NOTE: When applicable, special installation instructions are provided for an assembly at the end of the removal procedure. Always completely read the removal instructions and follow all special installation instructions.

Removal and replacement: Left cover

Learn about removing and replacing the left cover.

Before performing service

Turn the printer power off

- Disconnect the power cable.

⚠ WARNING! To avoid damage to the printer, turn the printer off, wait 30 seconds, and then remove the power cord before attempting to service the printer.

Use the table below to identify the correct part number for your printer, and then go to <https://parts.hp.com/hpparts> to order the part.

Table 5-33 Part information

Part number	Part description
RM2-4535-000CN	Left cover assembly

Required tools

- #2 Phillips screwdriver with a magnetic tip and a 152 mm (6 in) shaft length

After performing service

Turn the printer power on

- Connect the power cable.
- Use the power switch to turn the power on.

Post service test

No post service test is available for this assembly.

1. Remove the formatter cover

Follow these steps to remove the formatter cover.

- Remove one screw (callout 1), and then slide the formatter cover (callout 2) away from the printer to remove it.

💡 TIP: Reverse the removal steps to install the assembly.

Figure 5-173 Remove the formatter cover

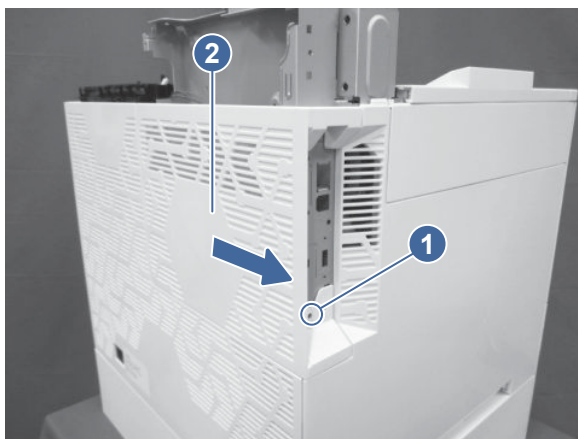

2. Remove the left upper cover (MFP models)

Follow these steps to remove the left upper cover.

1. Open the front door.

⚠ CAUTION: If the cover is being removed to gain access to the main drive assembly, make sure that the front door remains open. This keeps the main drive properly aligned.

2. At the left side of the printer, insert the small flat-blade screwdriver into the slot to release one tab (callout 1).

Figure 5-174 Use a screwdriver to release the tab

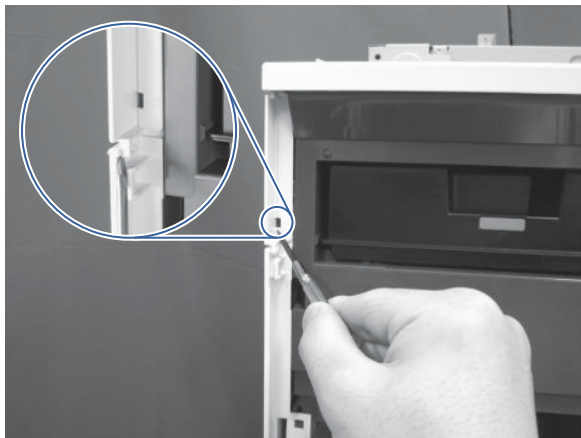

3. Toward the front of the printer, release another tab.

Figure 5-175 Release the tab

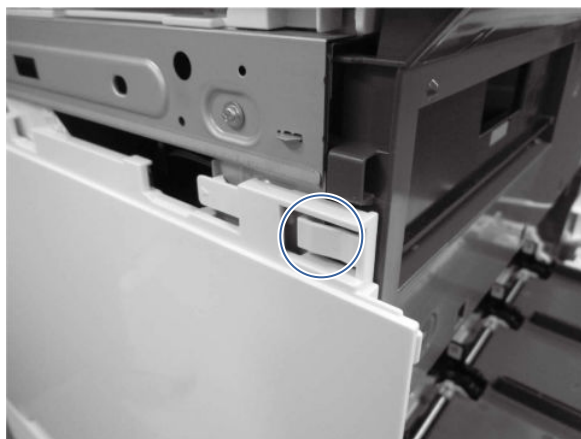

4. Rotate the cover up to remove it.

Figure 5-176 Remove the left upper cover

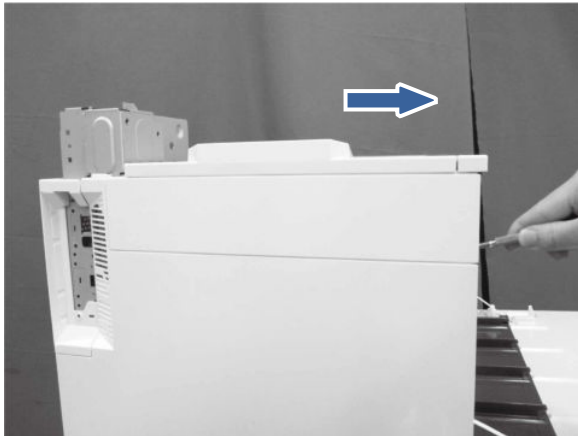

3. Remove the left cover

Follow these steps to remove the left cover.

- At the left side of the printer, remove one screw (callout 1), release one tab (callout 2), and then slide the cover (callout 3) toward the rear of the printer to release it.

Figure 5-177 Remove the left cover

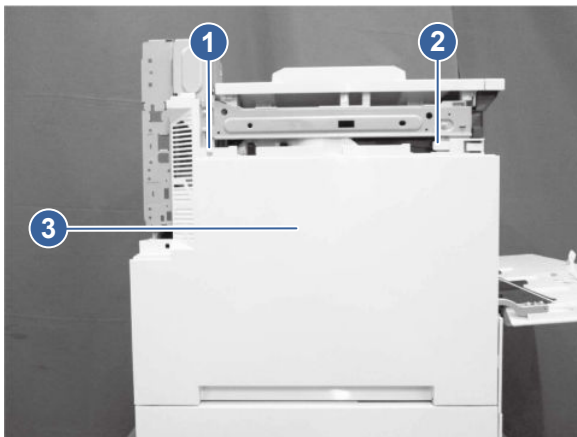

4. Unpack the replacement assembly



Follow these steps to unpack the replacement assembly.

1. Dispose of the defective part.

 **NOTE:** HP recommends responsible disposal of the defective part.

<http://www8.hp.com/us/en/hp-information/environment/product-recycling.html>

2. Unpack the replacement part from the packaging.

 **CAUTION:**  Some parts are sensitive to electrostatic discharge (ESD). Always perform service work at an ESD-protected workstation or mat. If an ESD workstation or mat is not available, touch the sheet-metal chassis to provide a static ground before touching an ESD-sensitive assembly.

Protect the ESD-sensitive assemblies by placing them in ESD pouches when they are out of the printer.

 **IMPORTANT:** Make sure that all of the shipping materials (for example shipping tape) are removed from the replacement part prior to installation.

 **NOTE:** If the replacement part is a roller or pad, avoid touching the spongy part of it. Skin oils on the roller or pad can cause paper pickup and/or print-quality problems. HP recommends using disposable gloves when handling rollers or pads or washing your hands before touching rollers or pads.

3. To install an assembly, reverse the removal steps.

 **NOTE:** When applicable, special installation instructions are provided for an assembly at the end of the removal procedure. Always completely read the removal instructions and follow all special installation instructions.

Removal and replacement: Left handle

Learn about removing and replacing the left handle.

Before performing service

Turn the printer power off

- Disconnect the power cable.

 **WARNING!** To avoid damage to the printer, turn the printer off, wait 30 seconds, and then remove the power cord before attempting to service the printer.

Use the table below to identify the correct part number for your printer, and then go to <https://parts.hp.com/hpparts> to order the part.

Table 5-34 Part information

Part number	Part description
RC5-9165-000CN	Handle, left

Required tools

- #2 Phillips screwdriver with a magnetic tip and a 152 mm (6 in) shaft length

After performing service

Turn the printer power on

- Connect the power cable.
- Use the power switch to turn the power on.

Post service test

No post service test is available for this assembly.

1. Remove the formatter cover

Follow these steps to remove the formatter cover.

- Remove one screw (callout 1), and then slide the formatter cover (callout 2) away from the printer to remove it.

 **TIP:** Reverse the removal steps to install the assembly.

Figure 5-178 Remove the formatter cover



2. Remove the left upper cover (MFP models)

Follow these steps to remove the left upper cover.

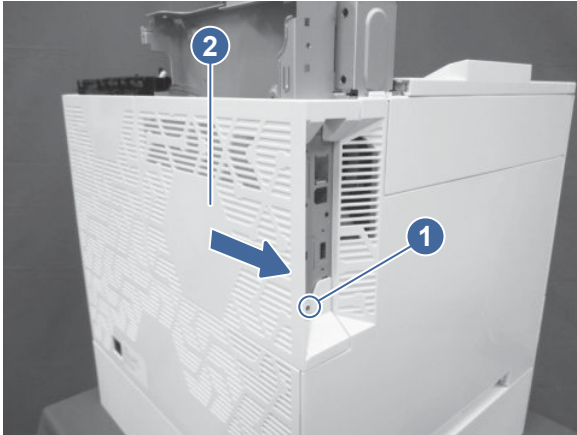
1. Open the front door.

 **CAUTION:** If the cover is being removed to gain access to the main drive assembly, make sure that the front door remains open. This keeps the main drive properly aligned.

2. At the left side of the printer, insert the small flat-blade screwdriver into the slot to release one tab (callout 1).

Figure 5-179 Use a screwdriver to release the tab

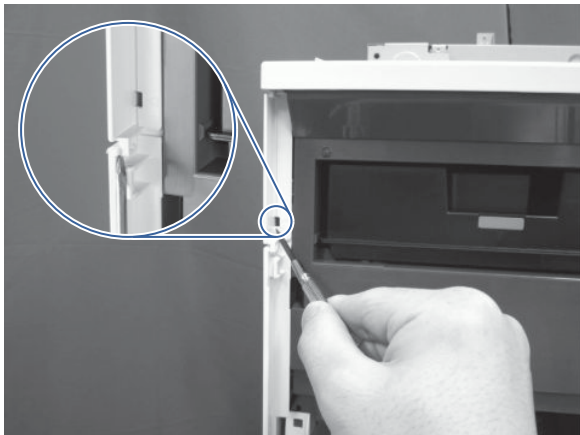

3. Toward the front of the printer, release another tab.

Figure 5-180 Release the tab

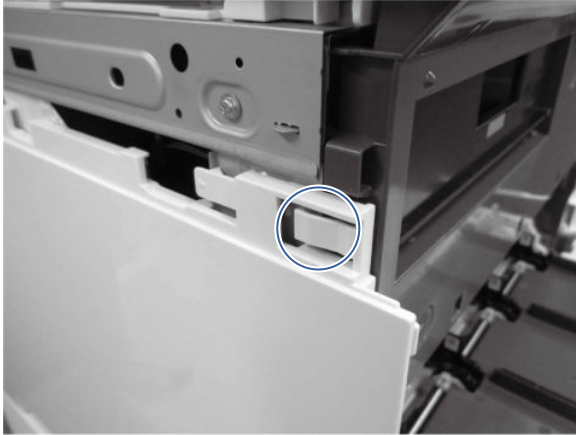

4. Rotate the cover up to remove it.

Figure 5-181 Remove the left upper cover

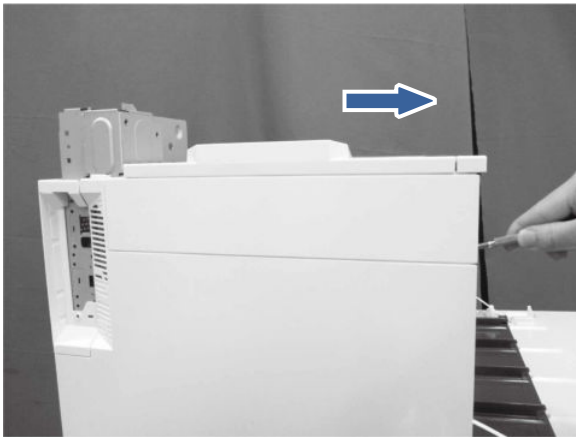

3. Remove the left cover

Follow these steps to remove the left cover.

- At the left side of the printer, remove one screw (callout 1), release one tab (callout 2), and then slide the cover (callout 3) toward the rear of the printer to release it.

Figure 5-182 Remove the left cover

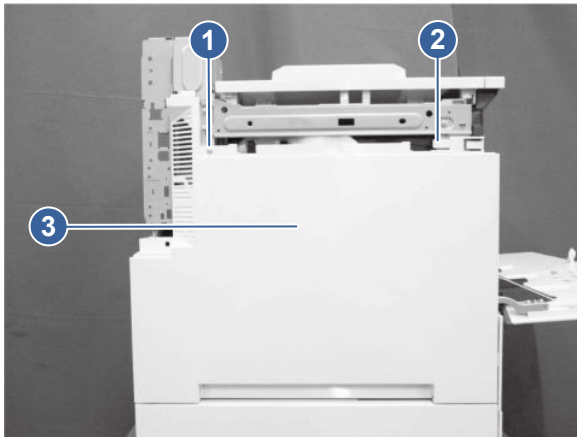

4. Remove the left handle

Follow these steps to remove the left handle.

- At the left side of the printer, release one tab, and then slide the handle as indicated to release it.

Figure 5-183 Remove the handle

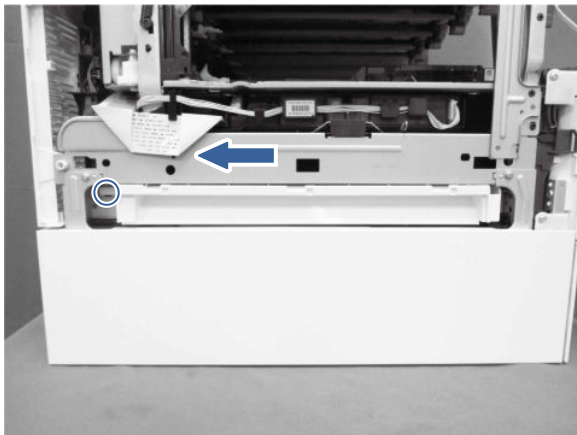

5. Unpack the replacement assembly

Follow these steps to unpack the replacement assembly.

1. Dispose of the defective part.



NOTE: HP recommends responsible disposal of the defective part.

<http://www8.hp.com/us/en/hp-information/environment/product-recycling.html>

2. Unpack the replacement part from the packaging.



CAUTION:  Some parts are sensitive to electrostatic discharge (ESD). Always perform service work at an ESD-protected workstation or mat. If an ESD workstation or mat is not available, touch the sheet-metal chassis to provide a static ground before touching an ESD-sensitive assembly.

Protect the ESD-sensitive assemblies by placing them in ESD pouches when they are out of the printer.

 **IMPORTANT:** Make sure that all of the shipping materials (for example shipping tape) are removed from the replacement part prior to installation.

 **NOTE:** If the replacement part is a roller or pad, avoid touching the spongy part of it. Skin oils on the roller or pad can cause paper pickup and/or print-quality problems. HP recommends using disposable gloves when handling rollers or pads or washing your hands before touching rollers or pads.

3. To install an assembly, reverse the removal steps.

 **NOTE:** When applicable, special installation instructions are provided for an assembly at the end of the removal procedure. Always completely read the removal instructions and follow all special installation instructions.

Removal and replacement: Front left cover

Learn about removing and replacing the front left cover.

Before performing service

Turn the printer power off

- Disconnect the power cable.

 **WARNING!** To avoid damage to the printer, turn the printer off, wait 30 seconds, and then remove the power cord before attempting to service the printer.

Use the table below to identify the correct part number for your printer, and then go to <https://parts.hp.com/hpparts> to order the part.

Table 5-35 Part information

Part number	Part description
RC5-9198-000CN	Cover, front left

Required tools

- No special tools are required to remove or install this assembly.

After performing service

Turn the printer power on

- Connect the power cable.
- Use the power switch to turn the power on.

Post service test

No post service test is available for this assembly.

1. Remove the front left cover

Follow these steps to remove the front left cover.

1. Perform one of the following steps.
 - **6700/6800 models:** Open the front door.
 - **X654/X677 models:** Open the toner cartridge access door.
2. Pull the top part of the front left cover (callout 1) in the direction indicated, release one tab (callout 2), and then slide the cover upward to release it.

Figure 5-184 Remove the cover

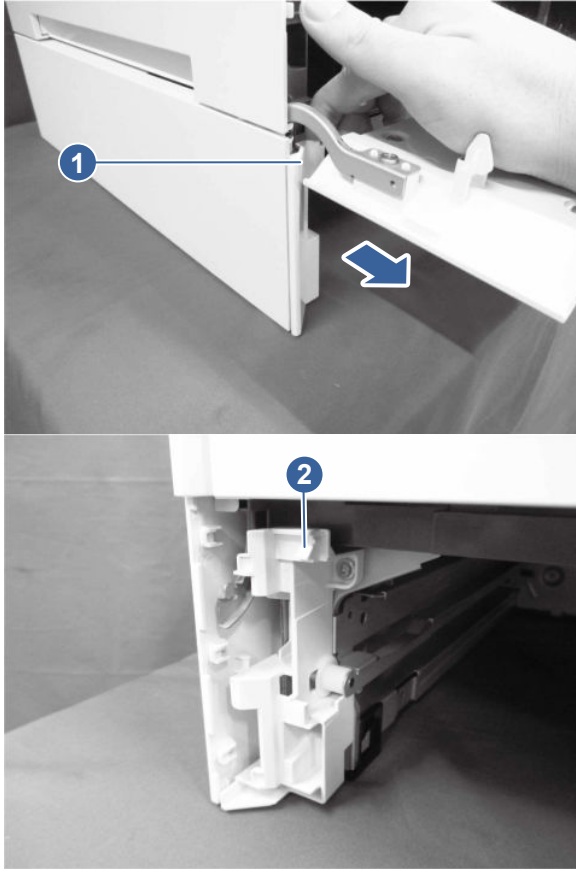

2. Unpack the replacement assembly

Follow these steps to unpack the replacement assembly.

1. Dispose of the defective part.



NOTE: HP recommends responsible disposal of the defective part.

<http://www8.hp.com/us/en/hp-information/environment/product-recycling.html>

2. Unpack the replacement part from the packaging.



CAUTION:  Some parts are sensitive to electrostatic discharge (ESD). Always perform service work at an ESD-protected workstation or mat. If an ESD workstation or mat is not available, touch

the sheet-metal chassis to provide a static ground before touching an ESD-sensitive assembly. Protect the ESD-sensitive assemblies by placing them in ESD pouches when they are out of the printer.

 **IMPORTANT:** Make sure that all of the shipping materials (for example shipping tape) are removed from the replacement part prior to installation.

 **NOTE:** If the replacement part is a roller or pad, avoid touching the spongy part of it. Skin oils on the roller or pad can cause paper pickup and/or print-quality problems. HP recommends using disposable gloves when handling rollers or pads or washing your hands before touching rollers or pads.

3. To install an assembly, reverse the removal steps.

 **NOTE:** When applicable, special installation instructions are provided for an assembly at the end of the removal procedure. Always completely read the removal instructions and follow all special installation instructions.

Removal and replacement: Front right cover

Learn about removing and replacing the front right cover.

Before performing service

Turn the printer power off

- Disconnect the power cable.

 **WARNING!** To avoid damage to the printer, turn the printer off, wait 30 seconds, and then remove the power cord before attempting to service the printer.

Use the table below to identify the correct part number for your printer, and then go to <https://parts.hp.com/hpparts> to order the part.

Table 5-36 Part information

Part number	Part description
RC5-9199-000CN	Cover, front right

Required tools

- No special tools are required to remove or install this assembly.

After performing service

Turn the printer power on

- Connect the power cable.
- Use the power switch to turn the power on.

Post service test

No post service test is available for this assembly.

1. Remove the front right cover

Follow these steps to remove the front right cover.

1. Perform one of the following steps.
 - **5700/X557/5800 models:** Open the front door.
 - **X57945 models:** Open the toner cartridge access door.
2. Perform one of the following steps.
 - **5700/X557/5800 models:** Open the right door.
 - **X57945 models:** Open the right lower door.
3. Release one tab, and then slide the front right cover upward to remove it.

Figure 5-185 Remove the front right cover

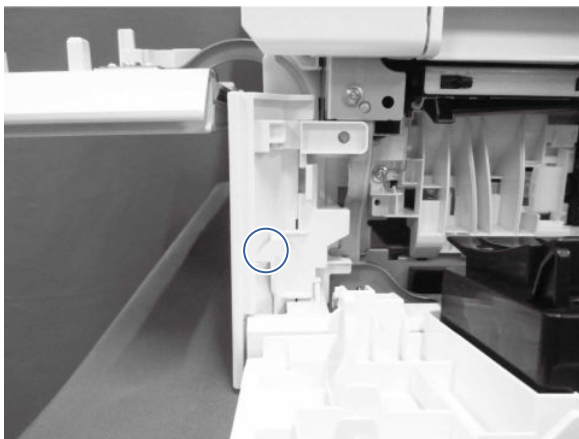

2. Unpack the replacement assembly

Follow these steps to unpack the replacement assembly.

1. Dispose of the defective part.



NOTE: HP recommends responsible disposal of the defective part.

<http://www8.hp.com/us/en/hp-information/environment/product-recycling.html>

2. Unpack the replacement part from the packaging.



CAUTION:  Some parts are sensitive to electrostatic discharge (ESD). Always perform service work at an ESD-protected workstation or mat. If an ESD workstation or mat is not available, touch the sheet-metal chassis to provide a static ground before touching an ESD-sensitive assembly. Protect the ESD-sensitive assemblies by placing them in ESD pouches when they are out of the printer.



IMPORTANT: Make sure that all of the shipping materials (for example shipping tape) are removed from the replacement part prior to installation.



NOTE: If the replacement part is a roller or pad, avoid touching the spongy part of it. Skin oils on the roller or pad can cause paper pickup and/or print-quality problems. HP recommends using

disposable gloves when handling rollers or pads or washing your hands before touching rollers or pads.

3. To install an assembly, reverse the removal steps.

 **NOTE:** When applicable, special installation instructions are provided for an assembly at the end of the removal procedure. Always completely read the removal instructions and follow all special installation instructions.

Removal and replacement: Right door

Learn about removing and replacing the right door.

Before performing service

Turn the printer power off

- Disconnect the power cable.

 **WARNING!** To avoid damage to the printer, turn the printer off, wait 30 seconds, and then remove the power cord before attempting to service the printer.

Use the table below to identify the correct part number for your printer, and then go to <https://parts.hp.com/hpparts> to order the part.

Table 5-37 Part information

Part number	Part description
RM2-3570-000CN	Right door (5700/X577/5800/X57945)

Required tools

- Small flat-blade screwdriver
- #2 Phillips screwdriver with a magnetic tip and a 152 mm (6 in) shaft length

After performing service

Turn the printer power on

- Connect the power cable.
- Use the power switch to turn the power on.

Post service test

No post service test is available for this assembly.

1. Remove the right door

Follow these steps to remove the right door.

1. Open the right door.

Figure 5-186 Open the right door



2. Perform one of the following steps.
 - **5700/X557/5800 models:** Open the right door.
 - **X579 models:** Open the right lower door.
3. **5700/X557/5800 models:** Remove the front right cover.
4. Release two tabs (callout 1), and then remove the PCA cover (callout 2).

Figure 5-187 Remove the PCA cover

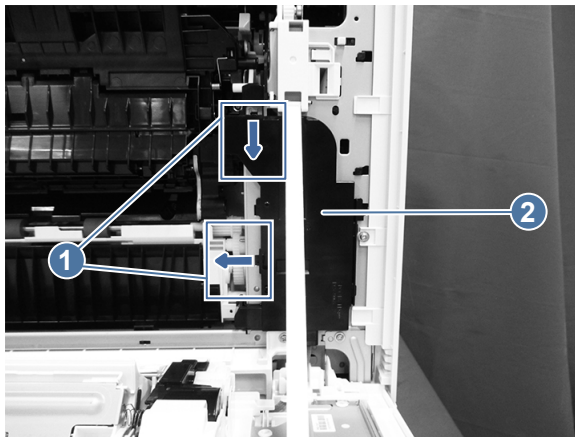

5. Disconnect one connector (callout 1), and then release the cable (callout 2) from the cable clamp (callout 3).

Figure 5-188 Disconnect one connector

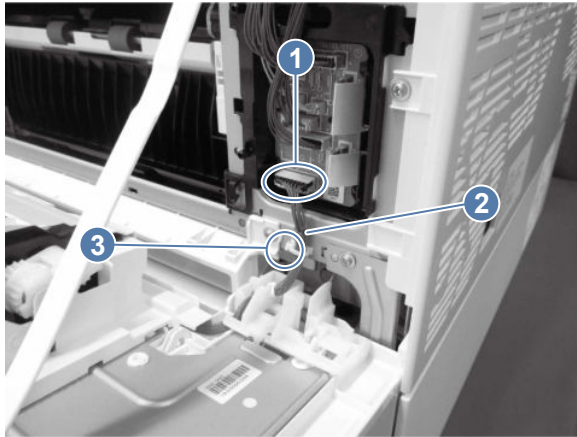

6. Release one tab (callout 1), slide the link arm (callout 2) in the direction indicated, and then remove it.

Figure 5-189 Remove the link arm

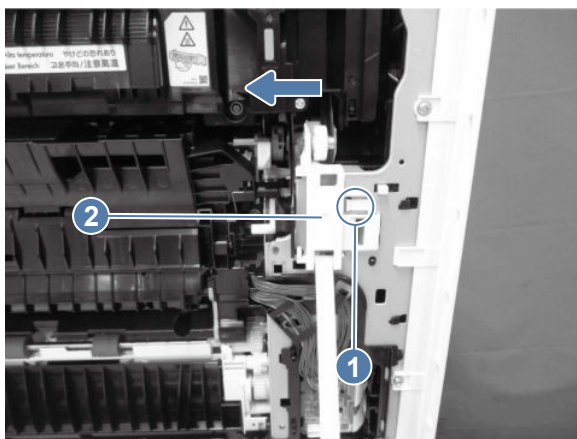

7. Close the front door a little, and then disconnect the joint that connects the two link arms.

Figure 5-190 Disconnect the link arms



8. Release two bosses (callout 1), and then remove the link arm (callout 2).

Figure 5-191 Remove the link arm

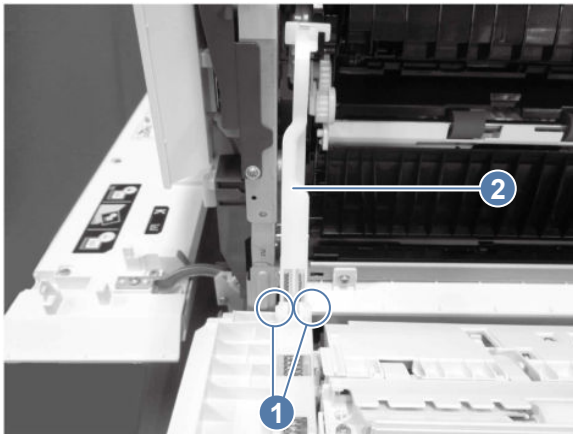

9. Close the front door a little, and then remove the spring (callout 1) from the link arm (callout 2) and from the shaft (callout 3).

Figure 5-192 Remove the spring

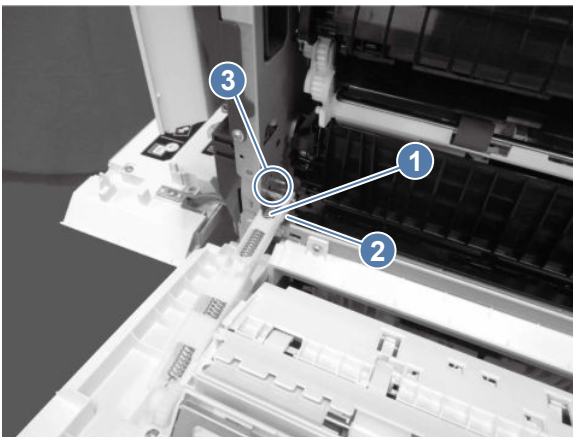

10. Release one tab (callout 1), slide the cable holder (callout 2) in the direction indicated, and then remove it.

Figure 5-193 Remove the cable holder

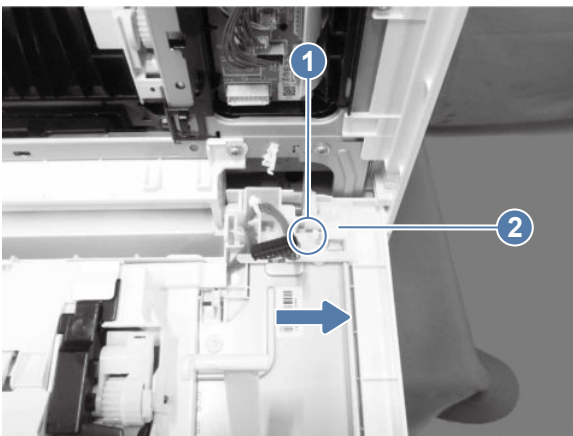

11. Remove the right door (callout 1) from the shaft (callout 2), and then unhook one spring (callout 3) from the frame (callout 4).

Figure 5-194 Remove the door from the shaft

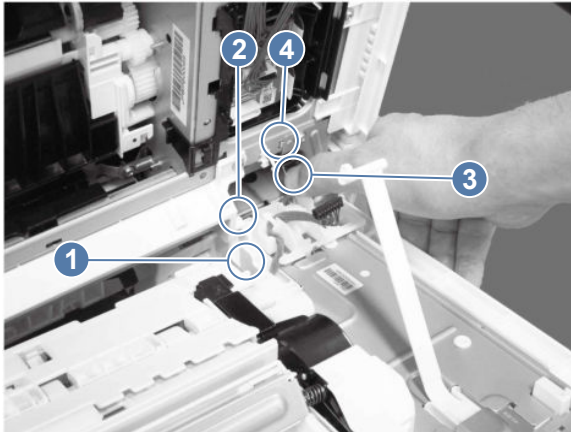

12. Slide the right door (callout 1) in the direction indicated to remove it.

Figure 5-195 Remove the door

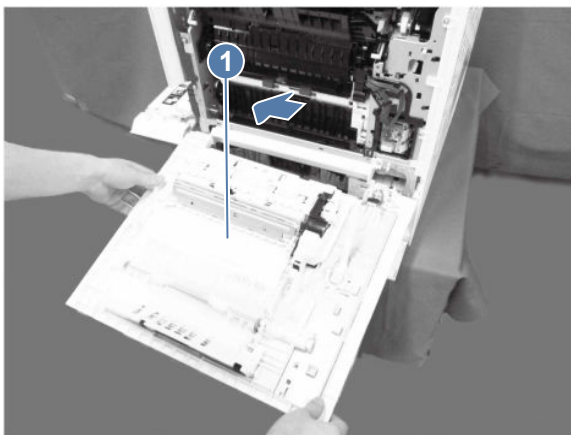

2. Unpack the replacement assembly

Follow these steps to unpack the replacement assembly.

1. Dispose of the defective part.





NOTE: HP recommends responsible disposal of the defective part.

<http://www8.hp.com/us/en/hp-information/environment/product-recycling.html>

2. Unpack the replacement part from the packaging.



CAUTION:  Some parts are sensitive to electrostatic discharge (ESD). Always perform service work at an ESD-protected workstation or mat. If an ESD workstation or mat is not available, touch the sheet-metal chassis to provide a static ground before touching an ESD-sensitive assembly. Protect the ESD-sensitive assemblies by placing them in ESD pouches when they are out of the printer.

 **IMPORTANT:** Make sure that all of the shipping materials (for example shipping tape) are removed from the replacement part prior to installation.

 **NOTE:** If the replacement part is a roller or pad, avoid touching the spongy part of it. Skin oils on the roller or pad can cause paper pickup and/or print-quality problems. HP recommends using disposable gloves when handling rollers or pads or washing your hands before touching rollers or pads.

3. To install an assembly, reverse the removal steps.

 **NOTE:** When applicable, special installation instructions are provided for an assembly at the end of the removal procedure. Always completely read the removal instructions and follow all special installation instructions.

Removal and replacement: Right lower door (X57945 models)

Learn about removing and replacing the right lower door.

Before performing service

Turn the printer power off

- Disconnect the power cable.

 **WARNING!** To avoid damage to the printer, turn the printer off, wait 30 seconds, and then remove the power cord before attempting to service the printer.

Use the table below to identify the correct part number for your printer, and then go to <https://parts.hp.com/hpparts> to order the part.

Table 5-38 Part information

Part number	Part description
RM3-0004-000CN	Right lower door assembly

Required tools

- Small flat-blade screwdriver
- #2 Phillips screwdriver with a magnetic tip and a 152 mm (6 in) shaft length

After performing service

Turn the printer power on

- Connect the power cable.
- Use the power switch to turn the power on.

Post service test

No post service test is available for this assembly.

1. Remove the front right cover

Follow these steps to remove the front right cover.

1. Open the toner cartridge access door.
2. Open the right lower door.
3. Release one tab, and then slide the front right cover upward to remove it.

Figure 5-196 Remove the front right cover

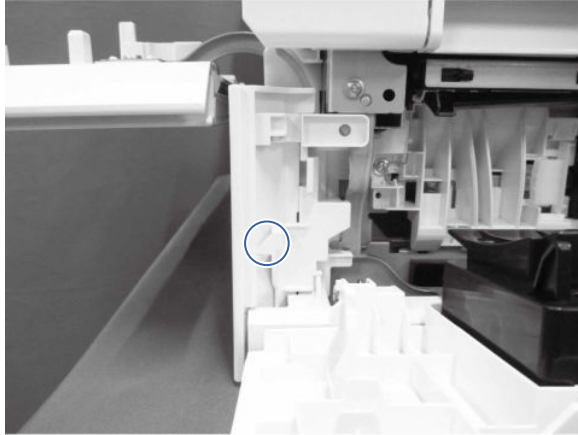

2. Remove the right lower door (X579 models)

Follow these steps to remove the right lower door.

1. Remove two screws (callout 1), and then remove the base frame (callout 2).

Figure 5-197 Remove the base frame

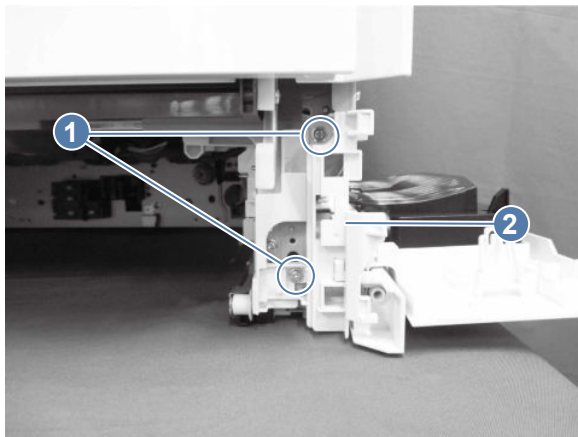

2. Remove one screw (callout 1), release one tab (callout 2), and then slide the rear inner cover (callout 3) downward to remove it.

Figure 5-198 Remove the rear inner cover

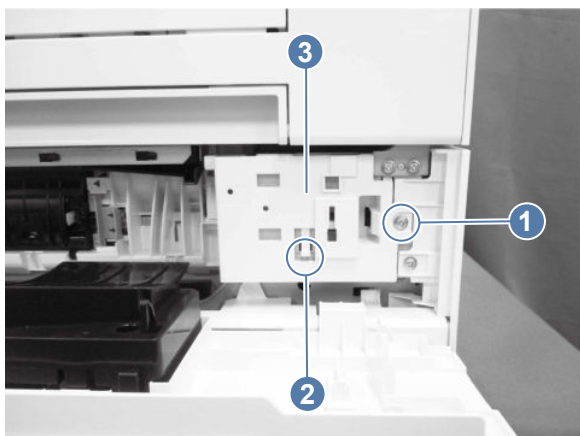

3. Release one tab (callout 1), and then slide the right lower door assembly (callout 2) in the direction indicated to remove it.

Figure 5-199 Remove the right lower door assembly

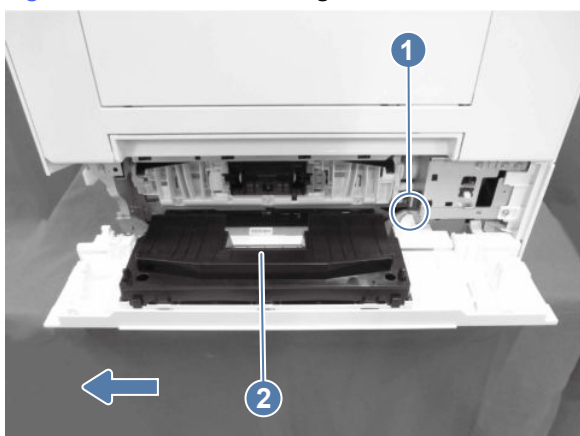

3. Unpack the replacement assembly

Follow these steps to unpack the replacement assembly.

1. Dispose of the defective part.





NOTE: HP recommends responsible disposal of the defective part.

<http://www8.hp.com/us/en/hp-information/environment/product-recycling.html>

2. Unpack the replacement part from the packaging.



CAUTION:  Some parts are sensitive to electrostatic discharge (ESD). Always perform service work at an ESD-protected workstation or mat. If an ESD workstation or mat is not available, touch the sheet-metal chassis to provide a static ground before touching an ESD-sensitive assembly. Protect the ESD-sensitive assemblies by placing them in ESD pouches when they are out of the printer.

 **IMPORTANT:** Make sure that all of the shipping materials (for example shipping tape) are removed from the replacement part prior to installation.

 **NOTE:** If the replacement part is a roller or pad, avoid touching the spongy part of it. Skin oils on the roller or pad can cause paper pickup and/or print-quality problems. HP recommends using disposable gloves when handling rollers or pads or washing your hands before touching rollers or pads.

3. To install an assembly, reverse the removal steps.

 **NOTE:** When applicable, special installation instructions are provided for an assembly at the end of the removal procedure. Always completely read the removal instructions and follow all special installation instructions.

Removal and replacement: Rear lower cover (X57945 models)

Learn about removing and replacing the rear lower cover.

Before performing service

Turn the printer power off

- Disconnect the power cable.

 **WARNING!** To avoid damage to the printer, turn the printer off, wait 30 seconds, and then remove the power cord before attempting to service the printer.

Use the table below to identify the correct part number for your printer, and then go to <https://parts.hp.com/hpparts> to order the part.

Table 5-39 Part information

Part number	Part description
RC5-9409-000CN	Cover, rear lower

Required tools

- Small flat-blade screwdriver
- #2 Phillips screwdriver with a magnetic tip and a 152 mm (6 in) shaft length

After performing service

Turn the printer power on

- Connect the power cable.
- Use the power switch to turn the power on.

Post service test

No post service test is available for this assembly.

1. Remove the front right cover

Follow these steps to remove the front right cover.

1. Open the toner cartridge access door.
2. Open the right lower door.
3. Release one tab, and then slide the front right cover upward to remove it.

Figure 5-200 Remove the front right cover

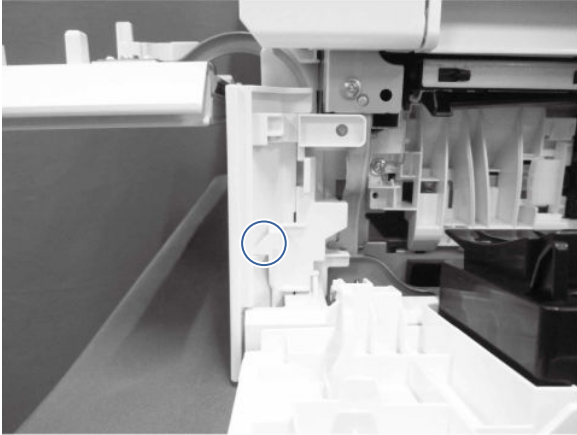

2. Remove the right lower door (X579 models)

Follow these steps to remove the right lower door.

1. Remove two screws (callout 1), and then remove the base frame (callout 2).

Figure 5-201 Remove the base frame

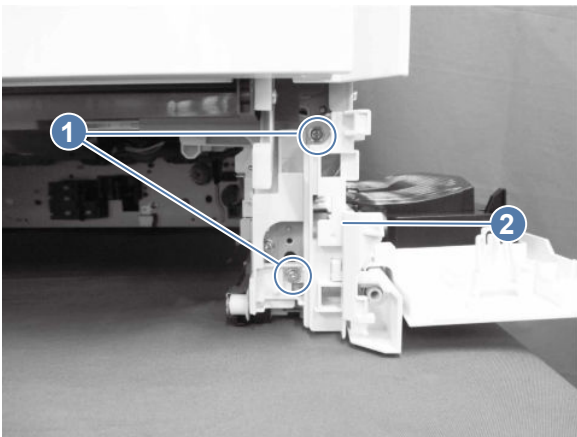

2. Remove one screw (callout 1), release one tab (callout 2), and then slide the rear inner cover (callout 3) downward to remove it.

Figure 5-202 Remove the rear inner cover

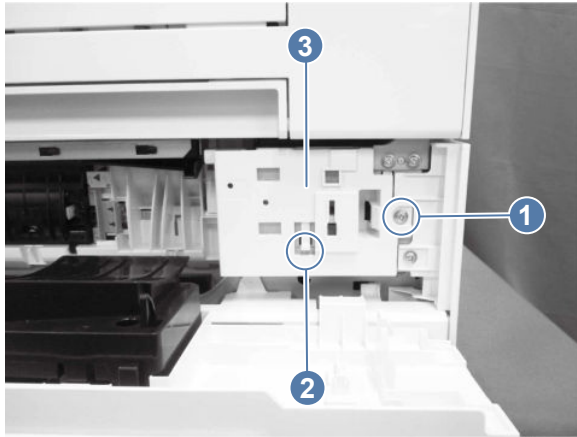

3. Release one tab (callout 1), and then slide the right lower door assembly (callout 2) in the direction indicated to remove it.

Figure 5-203 Remove the right lower door assembly

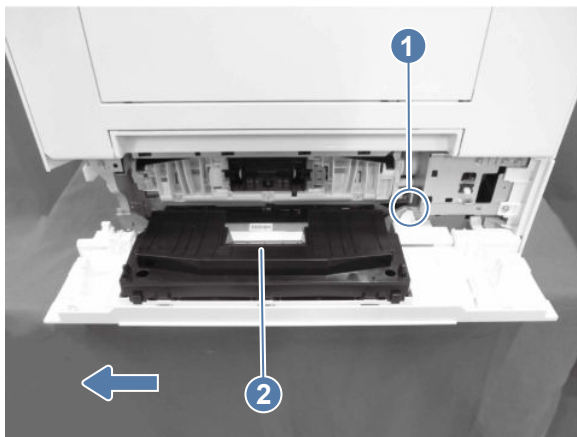

3. Remove the rear lower cover (X654/X677 models)

Follow these steps to remove the rear lower cover.

- Remove one screw (callout 1), slide the rear lower cover (callout 2) in the direction indicated below, and then remove it.

Figure 5-204 Remove the rear lower cover

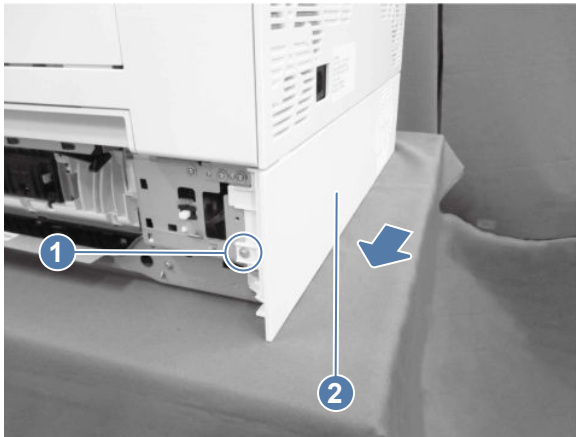

4. Unpack the replacement assembly



Follow these steps to unpack the replacement assembly.

1. Dispose of the defective part.

 **NOTE:** HP recommends responsible disposal of the defective part.

<http://www8.hp.com/us/en/hp-information/environment/product-recycling.html>

2. Unpack the replacement part from the packaging.

 **CAUTION:**  Some parts are sensitive to electrostatic discharge (ESD). Always perform service work at an ESD-protected workstation or mat. If an ESD workstation or mat is not available, touch the sheet-metal chassis to provide a static ground before touching an ESD-sensitive assembly. Protect the ESD-sensitive assemblies by placing them in ESD pouches when they are out of the printer.

 **IMPORTANT:** Make sure that all of the shipping materials (for example shipping tape) are removed from the replacement part prior to installation.

 **NOTE:** If the replacement part is a roller or pad, avoid touching the spongy part of it. Skin oils on the roller or pad can cause paper pickup and/or print-quality problems. HP recommends using disposable gloves when handling rollers or pads or washing your hands before touching rollers or pads.

3. To install an assembly, reverse the removal steps.

 **NOTE:** When applicable, special installation instructions are provided for an assembly at the end of the removal procedure. Always completely read the removal instructions and follow all special installation instructions.

Removal and replacement: Left lower cover (X57945 models)

Learn about removing and replacing the left lower cover.

Before performing service

Turn the printer power off

- Disconnect the power cable.

⚠ WARNING! To avoid damage to the printer, turn the printer off, wait 30 seconds, and then remove the power cord before attempting to service the printer.

Use the table below to identify the correct part number for your printer, and then go to <https://parts.hp.com/hpparts> to order the part.

Table 5-40 Part information

Part number	Part description
RC5-9408-000CN	Left lower cover

Required tools

- Small flat-blade screwdriver
- #2 Phillips screwdriver with a magnetic tip and a 152 mm (6 in) shaft length

After performing service

Turn the printer power on

- Connect the power cable.
- Use the power switch to turn the power on.

Post service test

No post service test is available for this assembly.

1. Remove the front right cover

Follow these steps to remove the front right cover.

1. Open the toner cartridge access door.
2. Open the right lower door.

3. Release one tab, and then slide the front right cover upward to remove it.

Figure 5-205 Remove the front right cover

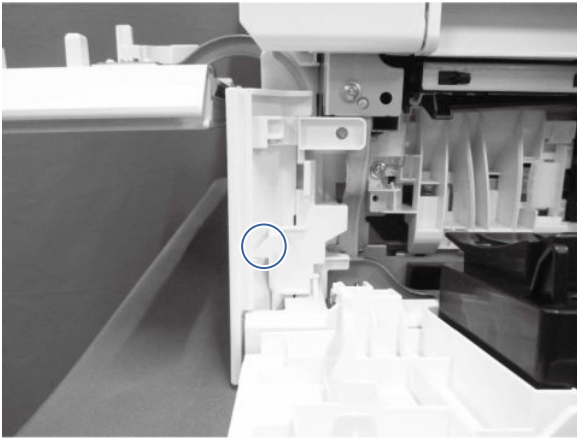

2. Remove the right lower door (X579 models)

Follow these steps to remove the right lower door.

1. Remove two screws (callout 1), and then remove the base frame (callout 2).

Figure 5-206 Remove the base frame

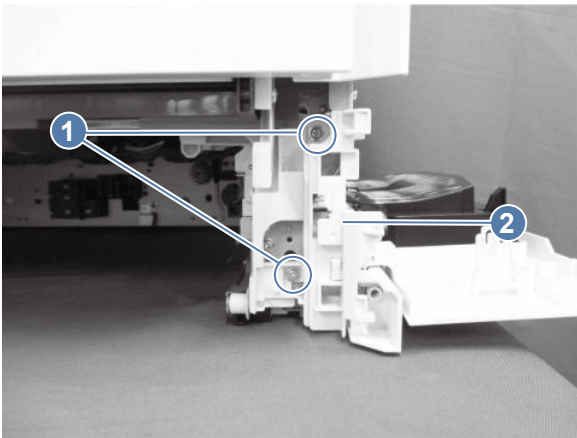

2. Remove one screw (callout 1), release one tab (callout 2), and then slide the rear inner cover (callout 3) downward to remove it.

Figure 5-207 Remove the rear inner cover

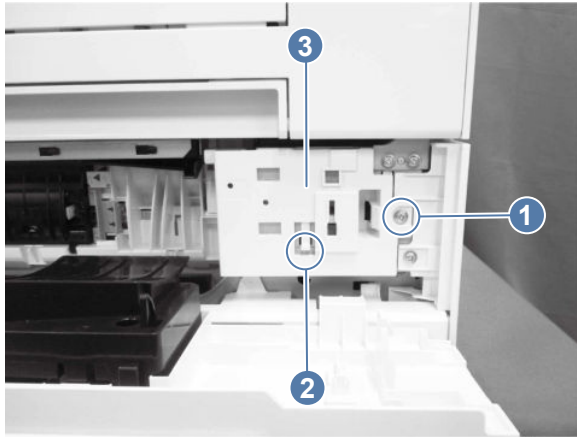

3. Release one tab (callout 1), and then slide the right lower door assembly (callout 2) in the direction indicated to remove it.

Figure 5-208 Remove the right lower door assembly

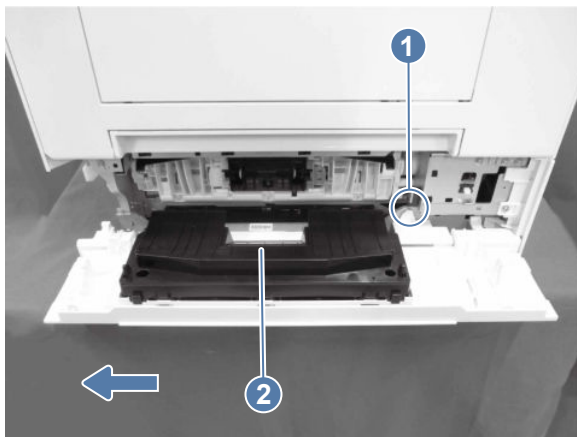

3. Remove the rear lower cover (X654/X677 models)

Follow these steps to remove the rear lower cover.

- Remove one screw (callout 1), slide the rear lower cover (callout 2) in the direction indicated below, and then remove it.

Figure 5-209 Remove the rear lower cover

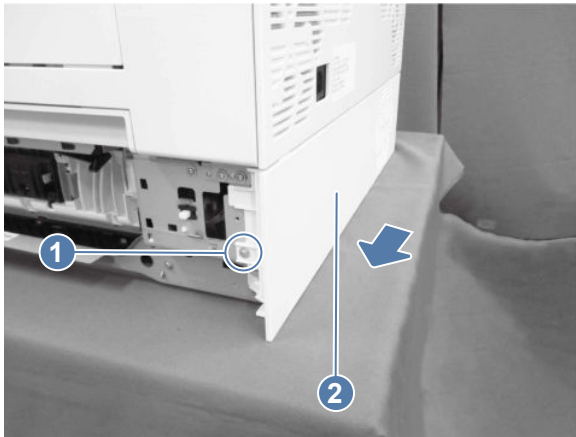

4. Remove the left lower cover (X579 models)

Follow these steps to remove the left lower cover.

- Slide the left lower cover in the direction indicated, and then remove it.

Figure 5-210 Remove the left lower cover



5. Unpack the replacement assembly

Follow these steps to unpack the replacement assembly.

1. Dispose of the defective part.



NOTE: HP recommends responsible disposal of the defective part.

<http://www8.hp.com/us/en/hp-information/environment/product-recycling.html>

2. Unpack the replacement part from the packaging.



CAUTION:  Some parts are sensitive to electrostatic discharge (ESD). Always perform service work at an ESD-protected workstation or mat. If an ESD workstation or mat is not available, touch the sheet-metal chassis to provide a static ground before touching an ESD-sensitive assembly.

Protect the ESD-sensitive assemblies by placing them in ESD pouches when they are out of the printer.

 **IMPORTANT:** Make sure that all of the shipping materials (for example shipping tape) are removed from the replacement part prior to installation.

 **NOTE:** If the replacement part is a roller or pad, avoid touching the spongy part of it. Skin oils on the roller or pad can cause paper pickup and/or print-quality problems. HP recommends using disposable gloves when handling rollers or pads or washing your hands before touching rollers or pads.

3. To install an assembly, reverse the removal steps.

 **NOTE:** When applicable, special installation instructions are provided for an assembly at the end of the removal procedure. Always completely read the removal instructions and follow all special installation instructions.

Removal and replacement: Output bin

Learn about removing and replacing the output bin.

Before performing service

Turn the printer power off

- Disconnect the power cable.

 **WARNING!** To avoid damage to the printer, turn the printer off, wait 30 seconds, and then remove the power cord before attempting to service the printer.

Use the table below to identify the correct part number for your printer, and then go to <https://parts.hp.com/hpparts> to order the part.

Table 5-41 Part information

Part number	Part description
RM2-4469-000CN	Face down tray assembly

Required tools

- Small flat-blade screwdriver
- #2 Phillips screwdriver with a magnetic tip and a 152 mm (6 in) shaft length

After performing service

Turn the printer power on

- Connect the power cable.
- Use the power switch to turn the power on.

Post service test

No post service test is available for this assembly.

1. Remove the toner collection unit (TCU)

Follow these steps to remove the toner collection unit (TCU).

1. Open the front door.

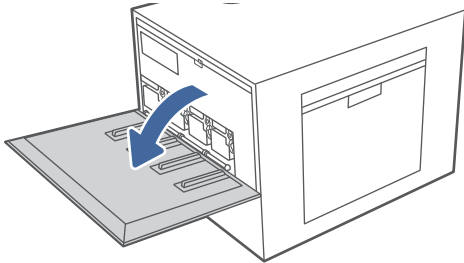

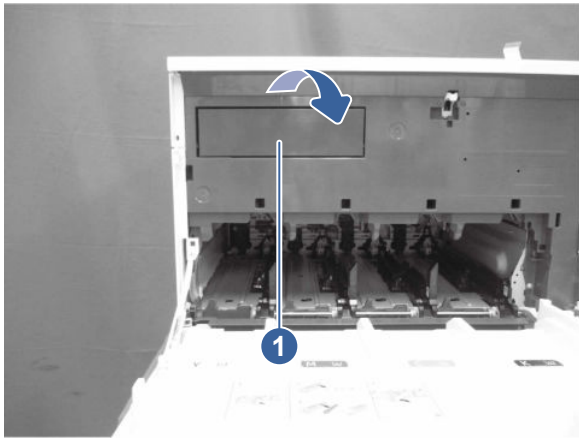

2. Rotate and then pull the TCU cover to remove it.

Figure 5-211 Remove the TCU cover

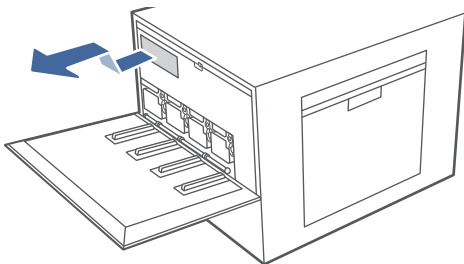

3. Lift the TCU slightly and then pull it out of the printer.



 **NOTE:** Maintain the position of the TCU as you pull it out from the printer. This will ensure that you do not spill any waste toner in the printer. Place the unit into the clear plastic bag the new TCU was packaged in.

2. Remove the left upper cover (MFP models)

Follow these steps to remove the left upper cover.

1. Open the front door.

⚠ CAUTION: If the cover is being removed to gain access to the main drive assembly, make sure that the front door remains open. This keeps the main drive properly aligned.

2. At the left side of the printer, insert the small flat-blade screwdriver into the slot to release one tab (callout 1).

Figure 5-212 Use a screwdriver to release the tab

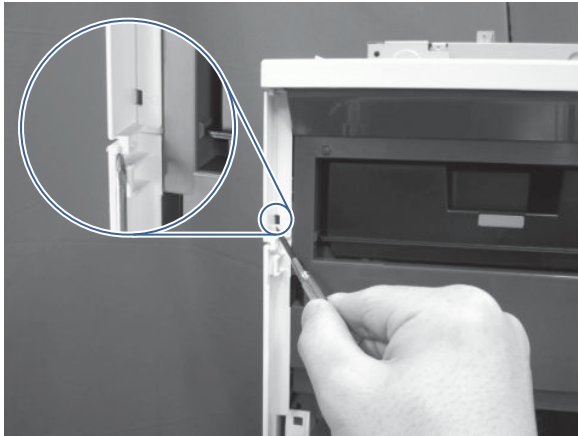

3. Toward the front of the printer, release another tab.

Figure 5-213 Release the tab

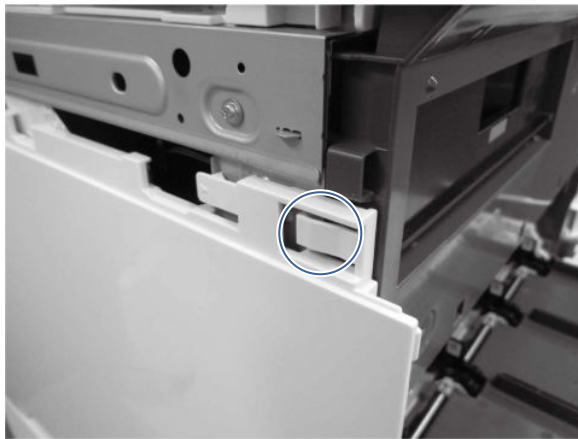

4. Rotate the cover up to remove it.

Figure 5-214 Remove the left upper cover

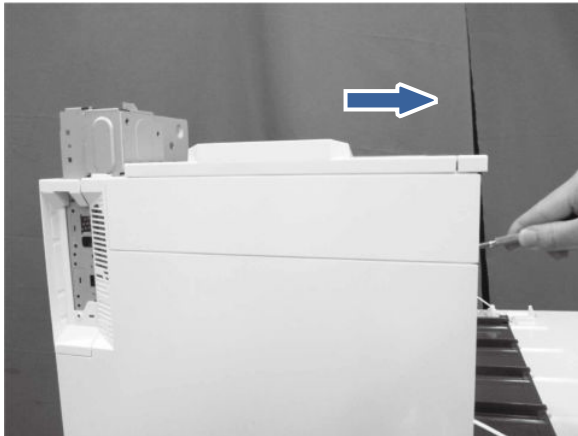

3. Remove the output bin

Follow these steps to remove the output bin.

- Remove two screws (callout 1), and then slide the output tray (callout 2) towards the front (SFP models) or left (MFP models) to remove it.

Figure 5-215 Remove the output bin

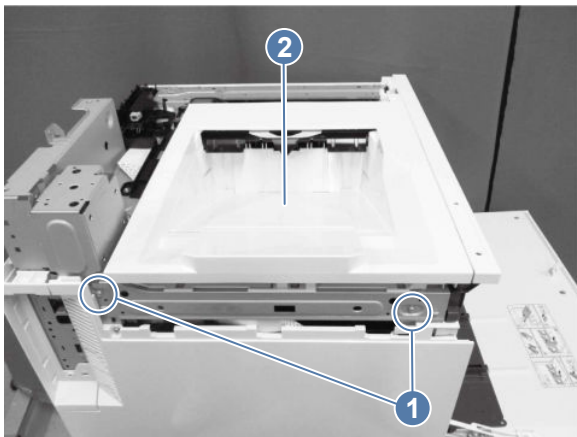

4. Unpack the replacement assembly



Follow these steps to unpack the replacement assembly.

1. Dispose of the defective part.

 **NOTE:** HP recommends responsible disposal of the defective part.

<http://www8.hp.com/us/en/hp-information/environment/product-recycling.html>

2. Unpack the replacement part from the packaging.

 **CAUTION:**  Some parts are sensitive to electrostatic discharge (ESD). Always perform service work at an ESD-protected workstation or mat. If an ESD workstation or mat is not available, touch the sheet-metal chassis to provide a static ground before touching an ESD-sensitive assembly.

Protect the ESD-sensitive assemblies by placing them in ESD pouches when they are out of the printer.

 **IMPORTANT:** Make sure that all of the shipping materials (for example shipping tape) are removed from the replacement part prior to installation.

 **NOTE:** If the replacement part is a roller or pad, avoid touching the spongy part of it. Skin oils on the roller or pad can cause paper pickup and/or print-quality problems. HP recommends using disposable gloves when handling rollers or pads or washing your hands before touching rollers or pads.

3. To install an assembly, reverse the removal steps.

 **NOTE:** When applicable, special installation instructions are provided for an assembly at the end of the removal procedure. Always completely read the removal instructions and follow all special installation instructions.

Removal and replacement: Right handle

Learn about removing and replacing the right handle.

Before performing service

Turn the printer power off

- Disconnect the power cable.

 **WARNING!** To avoid damage to the printer, turn the printer off, wait 30 seconds, and then remove the power cord before attempting to service the printer.

Use the table below to identify the correct part number for your printer, and then go to <https://parts.hp.com/hpparts> to order the part.

Table 5-42 Part information

Part number	Part description
RC5-8516-000CN	Handle, right door lower

Required tools

- #2 Phillips screwdriver with a magnetic tip and a 152 mm (6 in) shaft length

After performing service

Turn the printer power on

- Connect the power cable.
- Use the power switch to turn the power on.

Post service test

No post service test is available for this assembly.

1. Remove the right door

Follow these steps to remove the right door.

1. Open the right door.

Figure 5-216 Open the right door



2. Perform one of the following steps.
 - **6700/6800 models:** Open the right door.
 - **X654/X677 models:** Open the right lower door.
3. **6700/6800 models:** Remove the front right cover.
4. Release two tabs (callout 1), and then remove the PCA cover (callout 2).

Figure 5-217 Remove the PCA cover

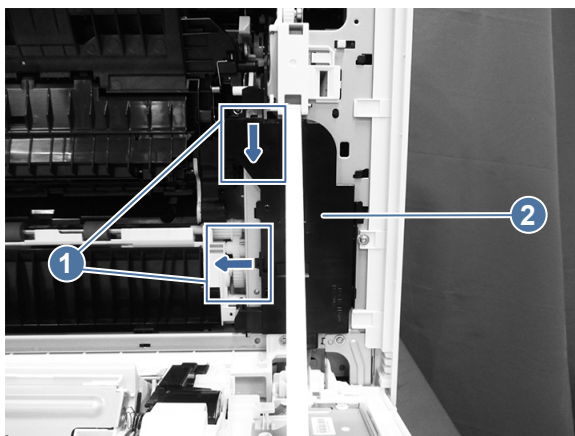

5. Disconnect one connector (callout 1), and then release the cable (callout 2) from the cable clamp (callout 3).

Figure 5-218 Disconnect one connector

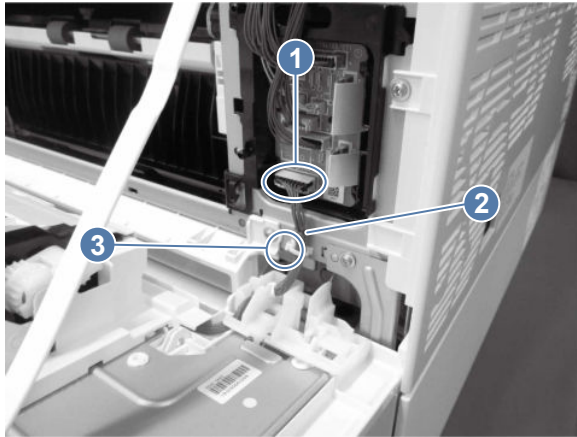

6. Release one tab (callout 1), slide the link arm (callout 2) in the direction indicated, and then remove it.

Figure 5-219 Remove the link arm

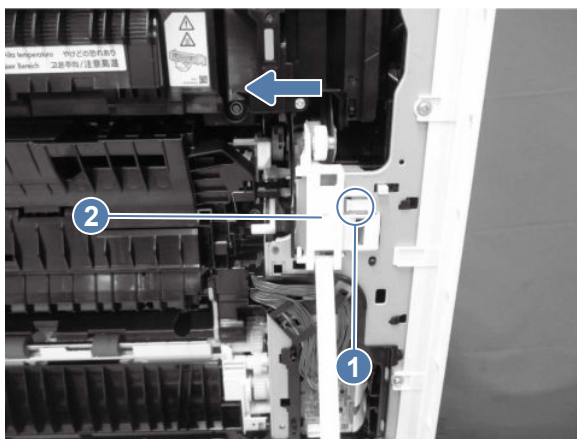

7. Close the front door a little, and then disconnect the joint that connects the two link arms.

Figure 5-220 Disconnect the link arms



8. Release two bosses (callout 1), and then remove the link arm (callout 2).

Figure 5-221 Remove the link arm

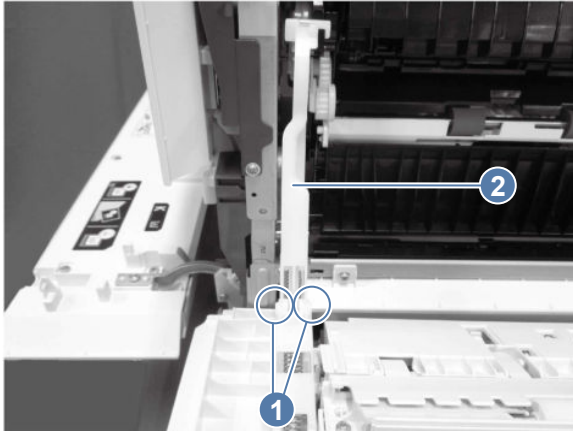

9. Close the front door a little, and then remove the spring (callout 1) from the link arm (callout 2) and from the shaft (callout 3).

Figure 5-222 Remove the spring

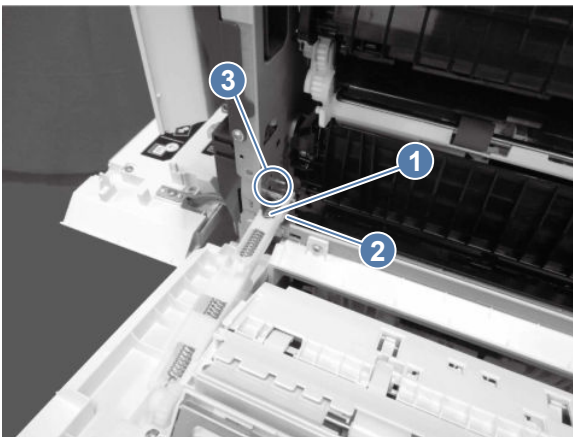

10. Release one tab (callout 1), slide the cable holder (callout 2) in the direction indicated, and then remove it.

Figure 5-223 Remove the cable holder

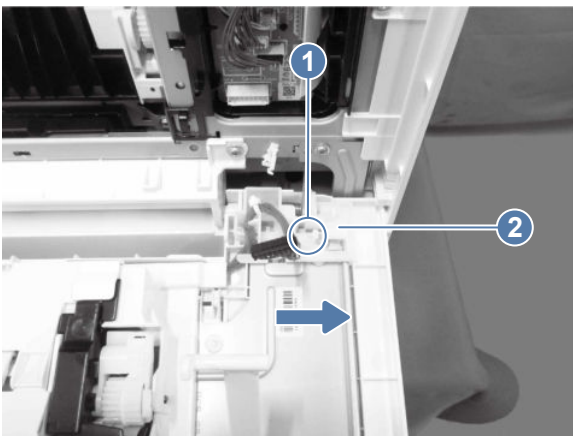

11. Remove the right door (callout 1) from the shaft (callout 2), and then unhook one spring (callout 3) from the frame (callout 4).

Figure 5-224 Remove the door from the shaft

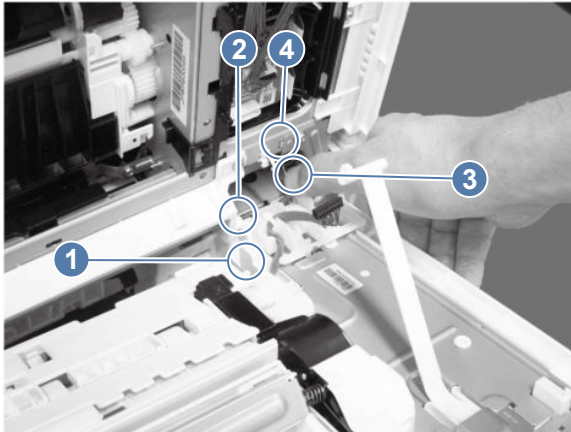

12. Slide the right door (callout 1) in the direction indicated to remove it.

Figure 5-225 Remove the door

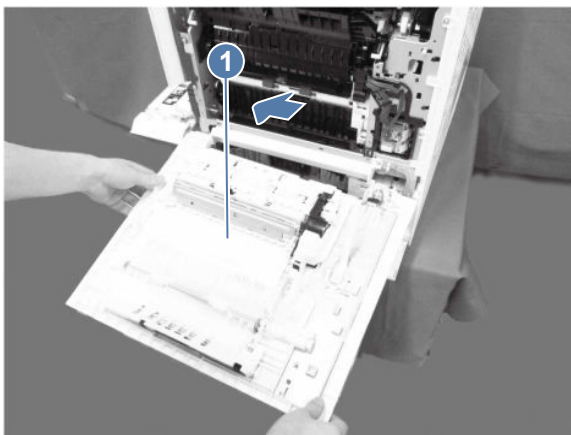

2. Remove the right handle

Follow these steps to remove the right handle.

- Remove two screws (callout 1), release one tab (callout 2), and then slide the right handle (callout 3) in the direction indicated to remove it.

Figure 5-226 Remove the handle

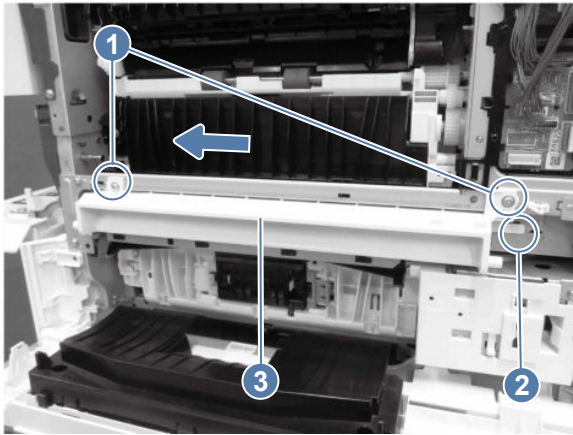

3. Unpack the replacement assembly

Follow these steps to unpack the replacement assembly.

1. Dispose of the defective part.



NOTE: HP recommends responsible disposal of the defective part.

<http://www8.hp.com/us/en/hp-information/environment/product-recycling.html>

2. Unpack the replacement part from the packaging.



CAUTION:  Some parts are sensitive to electrostatic discharge (ESD). Always perform service work at an ESD-protected workstation or mat. If an ESD workstation or mat is not available, touch the sheet-metal chassis to provide a static ground before touching an ESD-sensitive assembly. Protect the ESD-sensitive assemblies by placing them in ESD pouches when they are out of the printer.



IMPORTANT: Make sure that all of the shipping materials (for example shipping tape) are removed from the replacement part prior to installation.



NOTE: If the replacement part is a roller or pad, avoid touching the spongy part of it. Skin oils on the roller or pad can cause paper pickup and/or print-quality problems. HP recommends using disposable gloves when handling rollers or pads or washing your hands before touching rollers or pads.

3. To install an assembly, reverse the removal steps.



NOTE: When applicable, special installation instructions are provided for an assembly at the end of the removal procedure. Always completely read the removal instructions and follow all special installation instructions.

Removal and replacement: Top cover (SFP models)

Learn about removing and replacing the top cover.

Before performing service

Turn the printer power off

- Disconnect the power cable.

 **WARNING!** To avoid damage to the printer, turn the printer off, wait 30 seconds, and then remove the power cord before attempting to service the printer.

Use the table below to identify the correct part number for your printer, and then go to <https://parts.hp.com/hpparts> to order the part.

Table 5-43 Part information

Part number	Part description
RM2-4517-000CN	Top cover assembly

Required tools

- Small flat-blade screwdriver
- #2 Phillips screwdriver with a magnetic tip and a 152 mm (6 in) shaft length

After performing service

Turn the printer power on

- Connect the power cable.
- Use the power switch to turn the power on.

Post service test

No post service test is available for this assembly.

1. Remove the formatter cover

Follow these steps to remove the formatter cover.

- Remove one screw (callout 1), and then slide the formatter cover (callout 2) away from the printer to remove it.

 **TIP:** Reverse the removal steps to install the assembly.

Figure 5-227 Remove the formatter cover



2. Remove the toner collection unit (TCU)

Follow these steps to remove the toner collection unit (TCU).

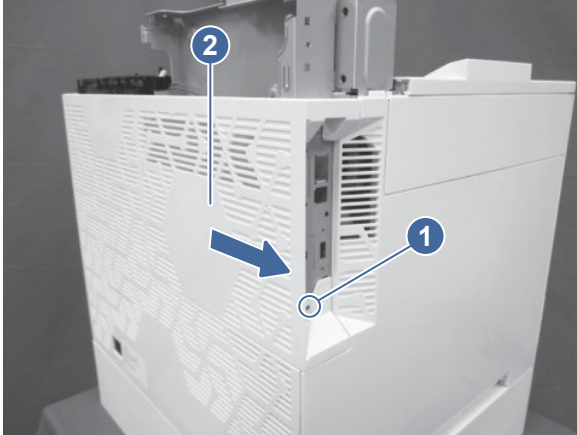
1. Open the front door.

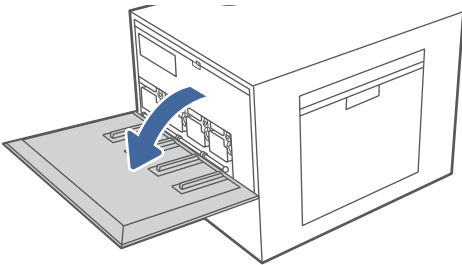

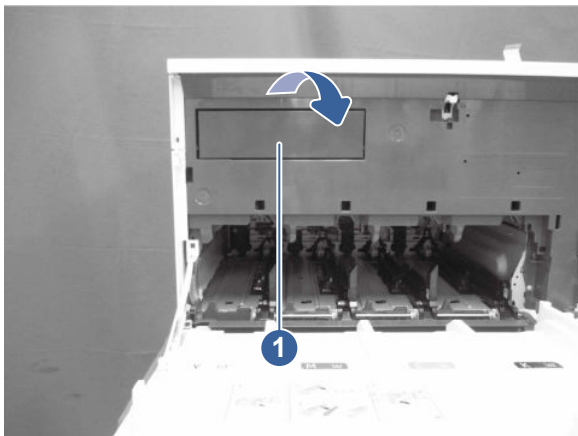

2. Rotate and then pull the TCU cover to remove it.

Figure 5-228 Remove the TCU cover

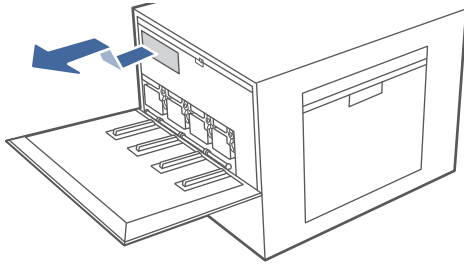

3. Lift the TCU slightly and then pull it out of the printer.



 **NOTE:** Maintain the position of the TCU as you pull it out from the printer. This will ensure that you do not spill any waste toner in the printer. Place the unit into the clear plastic bag the new TCU was packaged in.

3. Remove the output bin

Follow these steps to remove the output bin.

- Remove two screws (callout 1), and then slide the output tray (callout 2) towards the front (SFP models) or left (MFP models) to remove it.

Figure 5-229 Remove the output bin

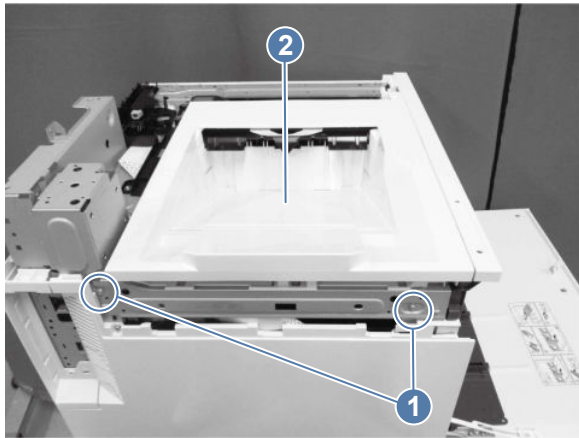

4. Remove the left cover

Follow these steps to remove the left cover.

- At the left side of the printer, remove one screw (callout 1), release one tab (callout 2), and then slide the cover (callout 3) toward the rear of the printer to release it.

Figure 5-230 Remove the left cover

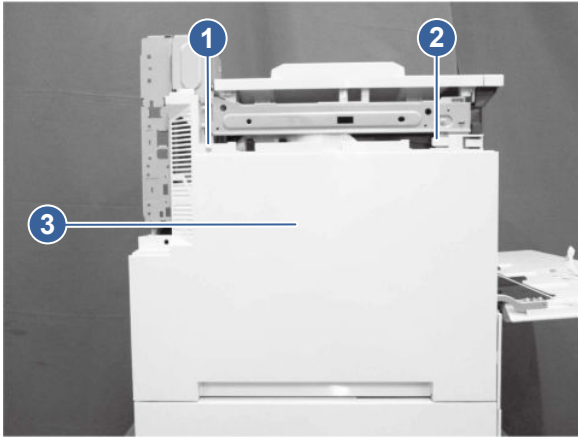

5. Remove the rear cover

Follow these steps to remove the rear cover.

 **NOTE:** The figures below show some assemblies (for example the top cover and formatter) removed that might still be installed on the printer. However, the steps to remove the cover are correct.

1. Open the right door, and remove two screws.

Figure 5-231 Remove two screws

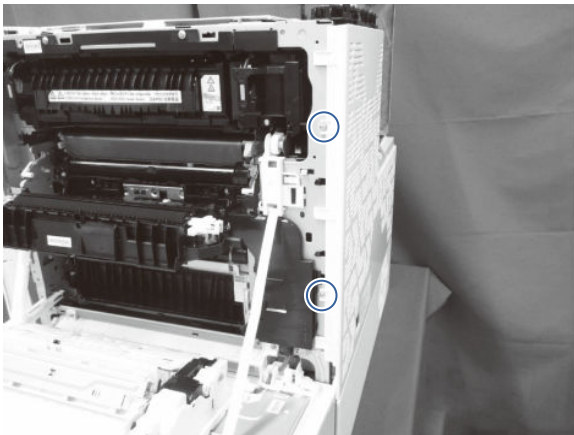

2. At the back of the printer, remove two screws, and then slide the rear cover as indicated to remove it.

Figure 5-232 Remove the rear cover

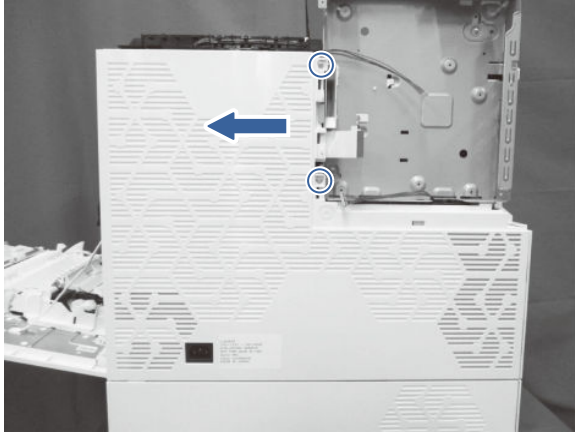

6. Remove the top cover (SFP models)

Follow these steps to remove the top cover.

1. Disconnect one connector (callout 1), and then release the cable (callout 2) from the cable guide (callout 3).

Figure 5-233 Disconnect the connector

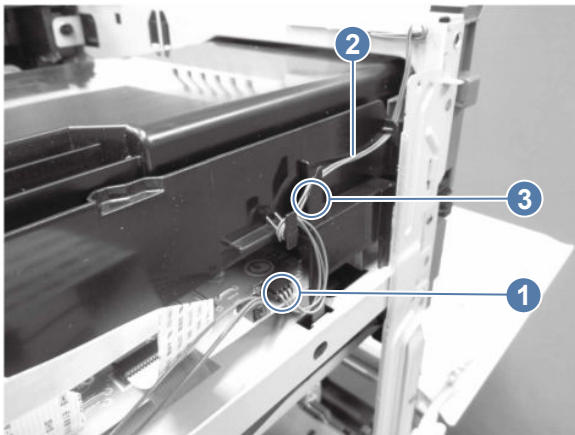

2. Remove two screws.

Figure 5-234 Remove two screws



3. Release one tab (callout 1), release two USB cables (callout 2) and another cable (callout 3) from the cable clamp (callout 4).

Figure 5-235 Release one tab

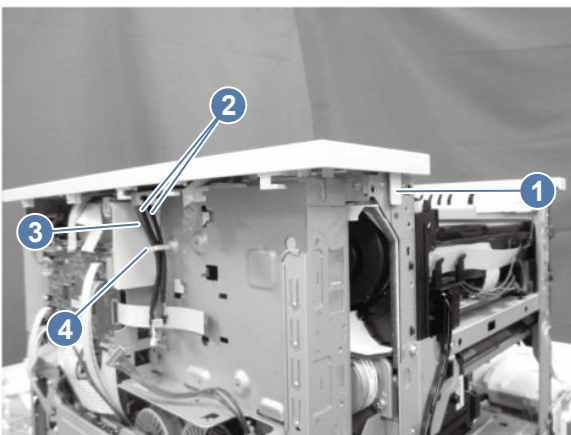

4. Remove two screws (callout 1), release two tabs (callout 2), and then remove the top cover (callout 3).

Figure 5-236 Remove the cover

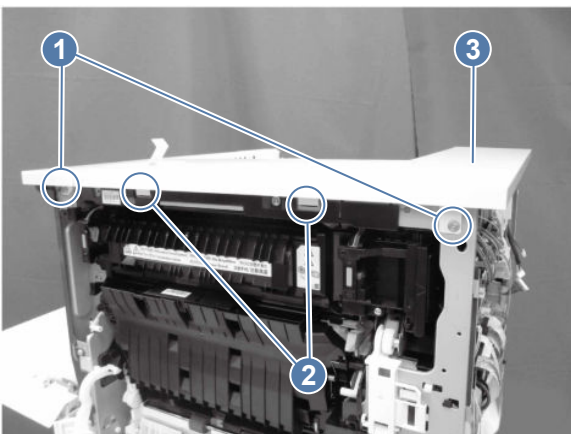

7. Unpack the replacement assembly

Follow these steps to unpack the replacement assembly.

1. Dispose of the defective part.



NOTE: HP recommends responsible disposal of the defective part.

<http://www8.hp.com/us/en/hp-information/environment/product-recycling.html>

2. Unpack the replacement part from the packaging.



CAUTION:  Some parts are sensitive to electrostatic discharge (ESD). Always perform service work at an ESD-protected workstation or mat. If an ESD workstation or mat is not available, touch the sheet-metal chassis to provide a static ground before touching an ESD-sensitive assembly. Protect the ESD-sensitive assemblies by placing them in ESD pouches when they are out of the printer.



IMPORTANT: Make sure that all of the shipping materials (for example shipping tape) are removed from the replacement part prior to installation.



NOTE: If the replacement part is a roller or pad, avoid touching the spongy part of it. Skin oils on the roller or pad can cause paper pickup and/or print-quality problems. HP recommends using disposable gloves when handling rollers or pads or washing your hands before touching rollers or pads.

3. To install an assembly, reverse the removal steps.



NOTE: When applicable, special installation instructions are provided for an assembly at the end of the removal procedure. Always completely read the removal instructions and follow all special installation instructions.

Removal and replacement: Top cover (MFP models)

Learn about removing and replacing the top cover.

Before performing service

Turn the printer power off

- Disconnect the power cable.



WARNING! To avoid damage to the printer, turn the printer off, wait 30 seconds, and then remove the power cord before attempting to service the printer.

Use the table below to identify the correct part number for your printer, and then go to <https://parts.hp.com/hpparts> to order the part.

Table 5-44 Part information

Part number	Part description
RC5-9172-000CN	Cover, top assembly

Required tools

- Small flat-blade screwdriver
- #2 Phillips screwdriver with a magnetic tip and a 152 mm (6 in) shaft length

After performing service

Turn the printer power on

- Connect the power cable.
- Use the power switch to turn the power on.

Post service test

No post service test is available for this assembly.

1. Remove the left upper cover (MFP models)

Follow these steps to remove the left upper cover.

1. Open the front door.

⚠ CAUTION: If the cover is being removed to gain access to the main drive assembly, make sure that the front door remains open. This keeps the main drive properly aligned.

2. At the left side of the printer, insert the small flat-blade screwdriver into the slot to release one tab (callout 1).

Figure 5-237 Use a screwdriver to release the tab

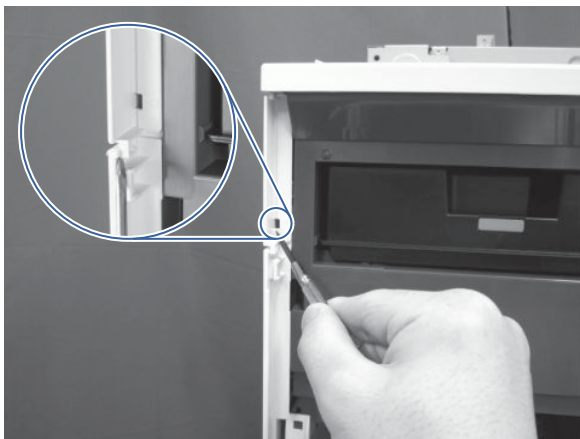

3. Toward the front of the printer, release another tab.

Figure 5-238 Release the tab

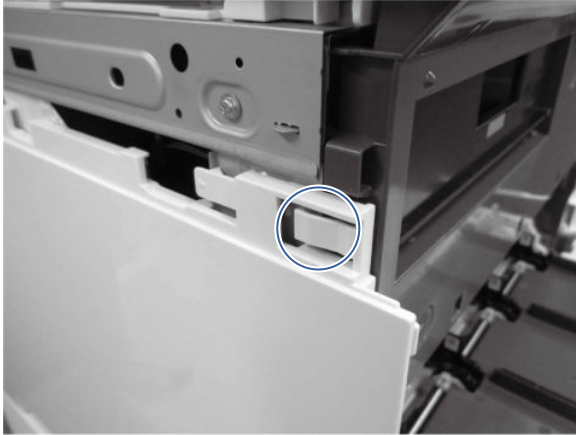

4. Rotate the cover up to remove it.

Figure 5-239 Remove the left upper cover

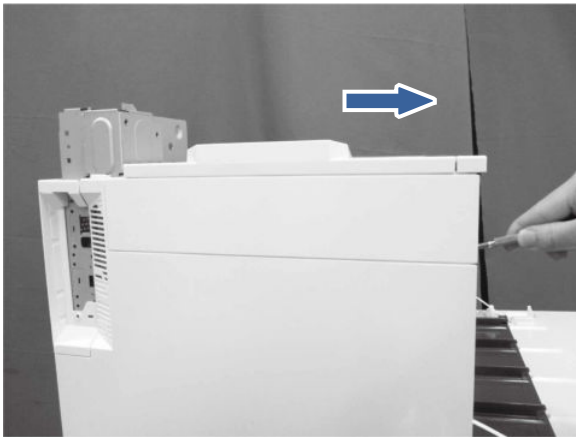

2. Remove the output bin

Follow these steps to remove the output bin.

- Remove two screws (callout 1), and then slide the output tray (callout 2) towards the front (SFP models) or left (MFP models) to remove it.

Figure 5-240 Remove the output bin

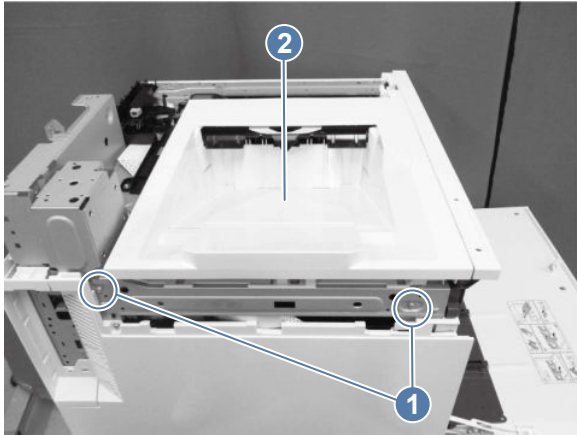

3. Remove the top cover (MFP models)

Follow these steps to remove the top cover.

- Remove one screw (callout 1), and then remove the top cover (callout 2).

Figure 5-241 Remove the top cover

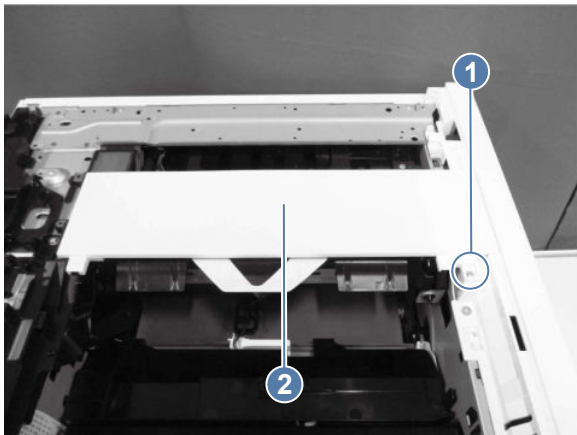

4. Unpack the replacement assembly



Follow these steps to unpack the replacement assembly.

1. Dispose of the defective part.

 **NOTE:** HP recommends responsible disposal of the defective part.

<http://www8.hp.com/us/en/hp-information/environment/product-recycling.html>

2. Unpack the replacement part from the packaging.

 **CAUTION:**  Some parts are sensitive to electrostatic discharge (ESD). Always perform service work at an ESD-protected workstation or mat. If an ESD workstation or mat is not available, touch the sheet-metal chassis to provide a static ground before touching an ESD-sensitive assembly.

Protect the ESD-sensitive assemblies by placing them in ESD pouches when they are out of the printer.

 **IMPORTANT:** Make sure that all of the shipping materials (for example shipping tape) are removed from the replacement part prior to installation.

 **NOTE:** If the replacement part is a roller or pad, avoid touching the spongy part of it. Skin oils on the roller or pad can cause paper pickup and/or print-quality problems. HP recommends using disposable gloves when handling rollers or pads or washing your hands before touching rollers or pads.

3. To install an assembly, reverse the removal steps.

 **NOTE:** When applicable, special installation instructions are provided for an assembly at the end of the removal procedure. Always completely read the removal instructions and follow all special installation instructions.

Removal and replacement: Top front cover (MFP models)

Learn about removing and replacing the top front cover.

Before performing service

Turn the printer power off

- Disconnect the power cable.

 **WARNING!** To avoid damage to the printer, turn the printer off, wait 30 seconds, and then remove the power cord before attempting to service the printer.

Use the table below to identify the correct part number for your printer, and then go to <https://parts.hp.com/hpparts> to order the part.

Table 5-45 Part information

Part number	Part description
RM2-4518-000CN	Top front cover assembly

Required tools

- Small flat-blade screwdriver
- #2 Phillips screwdriver with a magnetic tip and a 152 mm (6 in) shaft length

After performing service

Turn the printer power on

- Connect the power cable.
- Use the power switch to turn the power on.

Post service test

No post service test is available for this assembly.

1. Remove the formatter cover

Follow these steps to remove the formatter cover.

- Remove one screw (callout 1), and then slide the formatter cover (callout 2) away from the printer to remove it.

 **TIP:** Reverse the removal steps to install the assembly.

Figure 5-242 Remove the formatter cover



2. Remove the left upper cover (MFP models)

Follow these steps to remove the left upper cover.

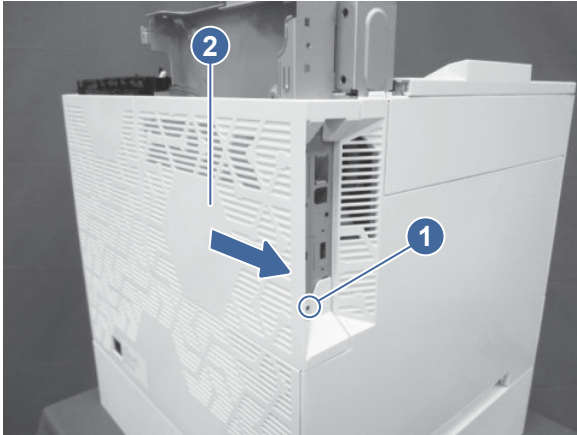
1. Open the front door.

 **CAUTION:** If the cover is being removed to gain access to the main drive assembly, make sure that the front door remains open. This keeps the main drive properly aligned.

2. At the left side of the printer, insert the small flat-blade screwdriver into the slot to release one tab (callout 1).

Figure 5-243 Use a screwdriver to release the tab

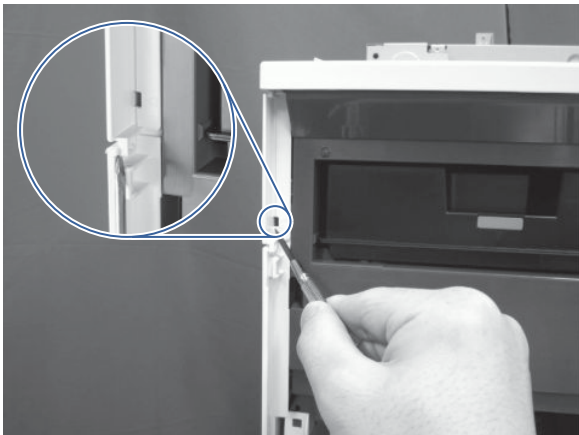

3. Toward the front of the printer, release another tab.

Figure 5-244 Release the tab

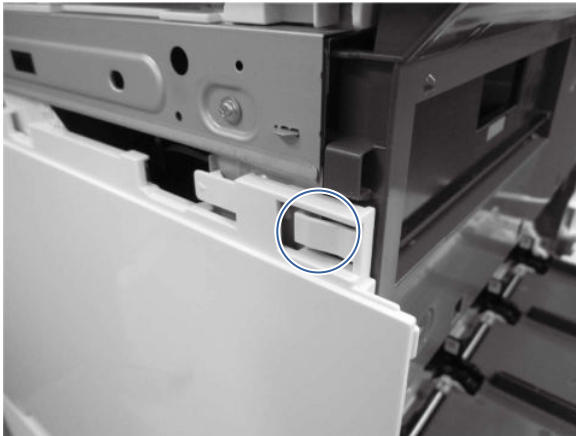

4. Rotate the cover up to remove it.

Figure 5-245 Remove the left upper cover

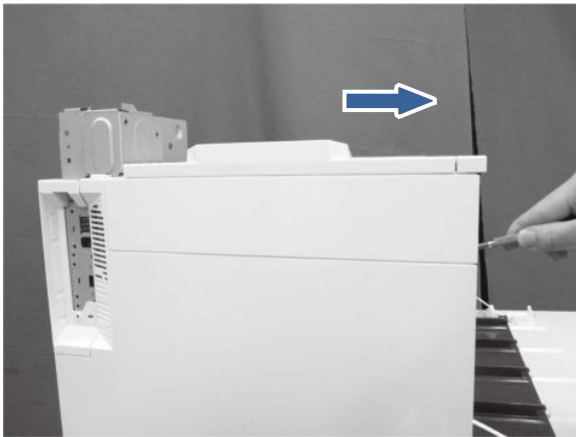

3. Remove the output bin

Follow these steps to remove the output bin.

- Remove two screws (callout 1), and then slide the output tray (callout 2) towards the front (SFP models) or left (MFP models) to remove it.

Figure 5-246 Remove the output bin

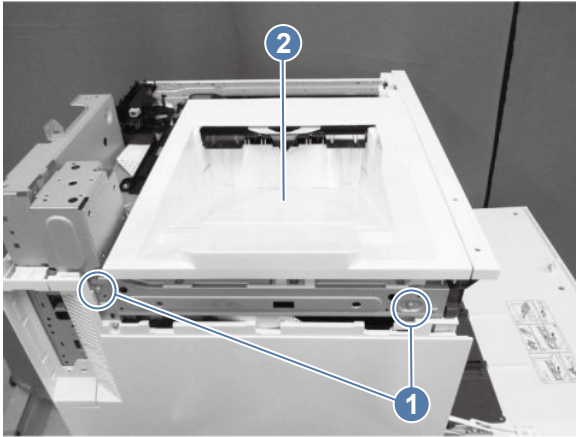

4. Remove the left cover

Follow these steps to remove the left cover.

- At the left side of the printer, remove one screw (callout 1), release one tab (callout 2), and then slide the cover (callout 3) toward the rear of the printer to release it.

Figure 5-247 Remove the left cover

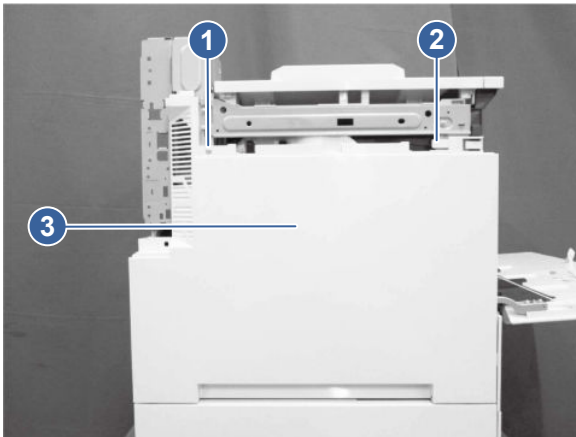

5. Remove the top cover (MFP models)

Follow these steps to remove the top cover.

- Remove one screw (callout 1), and then remove the top cover (callout 2).

Figure 5-248 Remove the top cover

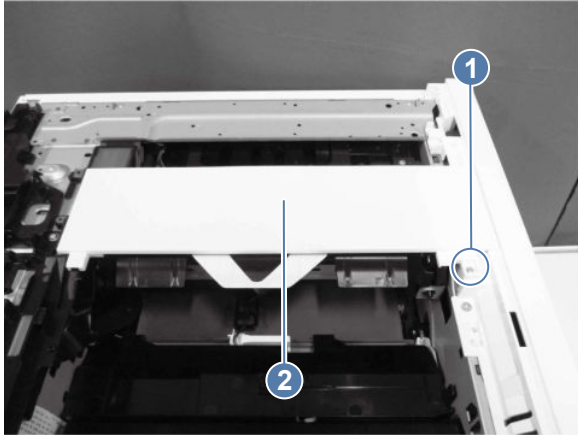

6. Remove the top front cover (MFP models)

Follow these steps to remove the top front cover.

1. Disconnect one connector (callout 1), and then release the cable (callout 2) from the cable guide (callout 3).

Figure 5-249 Disconnect one connector and release the cable

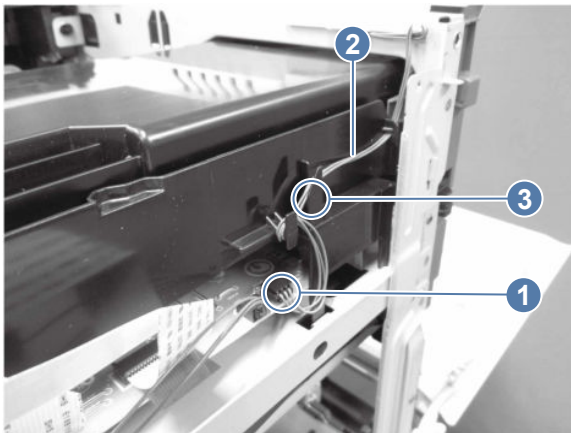

2. Remove two screws.

Figure 5-250 Remove two screws

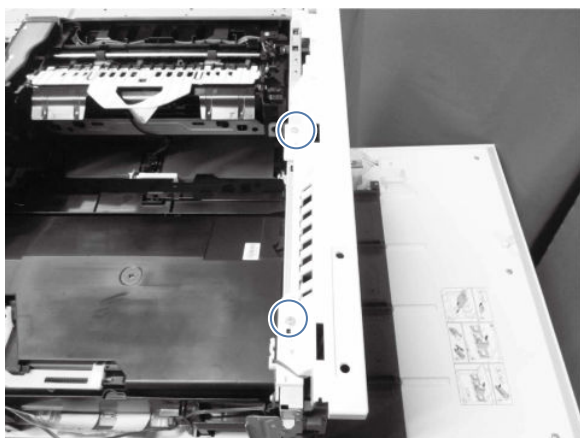

3. Remove one screw (callout 1), hold up the top front cover (callout 2), and then remove it.

Figure 5-251 Remove the top front cover

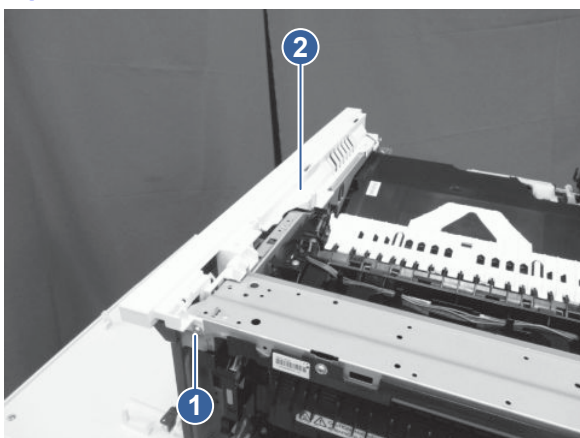

7. Unpack the replacement assembly

Follow these steps to unpack the replacement assembly.

1. Dispose of the defective part.



NOTE: HP recommends responsible disposal of the defective part.

<http://www8.hp.com/us/en/hp-information/environment/product-recycling.html>

2. Unpack the replacement part from the packaging.



CAUTION:  Some parts are sensitive to electrostatic discharge (ESD). Always perform service work at an ESD-protected workstation or mat. If an ESD workstation or mat is not available, touch the sheet-metal chassis to provide a static ground before touching an ESD-sensitive assembly. Protect the ESD-sensitive assemblies by placing them in ESD pouches when they are out of the printer.



IMPORTANT: Make sure that all of the shipping materials (for example shipping tape) are removed from the replacement part prior to installation.

 **NOTE:** If the replacement part is a roller or pad, avoid touching the spongy part of it. Skin oils on the roller or pad can cause paper pickup and/or print-quality problems. HP recommends using disposable gloves when handling rollers or pads or washing your hands before touching rollers or pads.

3. To install an assembly, reverse the removal steps.

 **NOTE:** When applicable, special installation instructions are provided for an assembly at the end of the removal procedure. Always completely read the removal instructions and follow all special installation instructions.

Removal and replacement: Hardware Integration Pocket (HIP) cover

Learn about removing and replacing the Hardware Integration Pocket (HIP) cover.

Before performing service

Turn the printer power off

- Disconnect the power cable.

 **WARNING!** To avoid damage to the printer, turn the printer off, wait 30 seconds, and then remove the power cord before attempting to service the printer.

Use the table below to identify the correct part number for your printer, and then go to <https://parts.hp.com/hpparts> to order the part.

Table 5-46 Part information

Part number	Part description
RC4-0213-000CN	Cover, Hardware integration pocket (HIP)

Required tools

- Small flat-blade screwdriver

After performing service

Turn the printer power on

- Connect the power cable.
- Use the power switch to turn the power on.

Post service test

No post service test is available for this assembly.

1. Remove the HIP cover

Follow these steps to remove the HIP cover.

1. Use a small flat-blade screwdriver to release the tabs on the HIP cover.

Figure 5-252 Release the cover



2. Rotate the cover up and off of the printer to remove it.

Figure 5-253 Remove the cover



2. Unpack the replacement assembly

Follow these steps to unpack the replacement assembly.

1. Dispose of the defective part.



NOTE: HP recommends responsible disposal of the defective part.

<http://www8.hp.com/us/en/hp-information/environment/product-recycling.html>

2. Unpack the replacement part from the packaging.



CAUTION:  Some parts are sensitive to electrostatic discharge (ESD). Always perform service work at an ESD-protected workstation or mat. If an ESD workstation or mat is not available, touch the sheet-metal chassis to provide a static ground before touching an ESD-sensitive assembly. Protect the ESD-sensitive assemblies by placing them in ESD pouches when they are out of the printer.



IMPORTANT: Make sure that all of the shipping materials (for example shipping tape) are removed from the replacement part prior to installation.

 **NOTE:** If the replacement part is a roller or pad, avoid touching the spongy part of it. Skin oils on the roller or pad can cause paper pickup and/or print-quality problems. HP recommends using disposable gloves when handling rollers or pads or washing your hands before touching rollers or pads.

3. To install an assembly, reverse the removal steps.

 **NOTE:** When applicable, special installation instructions are provided for an assembly at the end of the removal procedure. Always completely read the removal instructions and follow all special installation instructions.

Removal and replacement: Control panel (SFP models)

Learn about removing and replacing the control panel.

Before performing service

Turn the printer power off

- Disconnect the power cable.

 **WARNING!** To avoid damage to the printer, turn the printer off, wait 30 seconds, and then remove the power cord before attempting to service the printer.

Use the table below to identify the correct part number for your printer, and then go to <https://parts.hp.com/hpparts> to order the part.

Table 5-47 Part information

Part number	Part description
6QN28-67001	Control panel 10.9 cm (4.3 in)

Required tools

- #2 Phillips screwdriver with a magnetic tip and a 152 mm (6 in) shaft length

After performing service

Turn the printer power on

- Connect the power cable.
- Use the power switch to turn the power on.

Post service test

No post service test is available for this assembly.

1. Remove the control panel (SFP)

Follow these steps to remove the control panel.

1. Tilt the control panel up.

Figure 5-254 Remove one screw



2. Pull up the control panel cover. A small flat blade screwdriver might be helpful with this.

Figure 5-255 Remove the control panel cover



3. Remove one screw.

Figure 5-256 Remove one screw



4. Use a small flat blade screwdriver to pry and hold one tab (callout 1), push the assembly (callout 2) to the rear of the printer to release another tab (callout 3), and then lift the control panel up (callout 4), slightly and gently.

CAUTION: The control panel is still attached to the printer. Do not attempt to completely remove the control panel.

Figure 5-257 Release the tabs

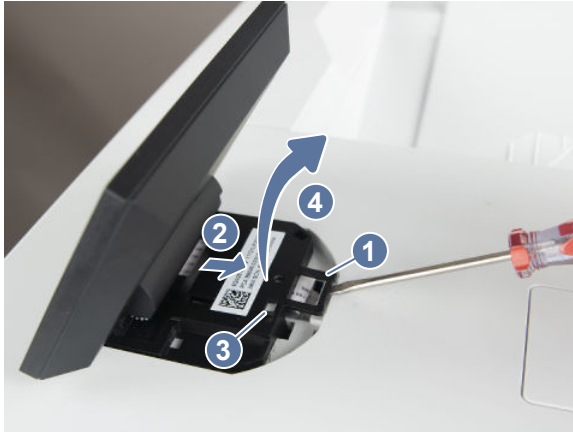

5. Disconnect one FFC, and then remove the control panel.

Figure 5-258 Remove the control panel



2. Unpack the replacement assembly

Follow these steps to unpack the replacement assembly.

1. Dispose of the defective part.



NOTE: HP recommends responsible disposal of the defective part.

<http://www8.hp.com/us/en/hp-information/environment/product-recycling.html>

2. Unpack the replacement part from the packaging.



CAUTION:  Some parts are sensitive to electrostatic discharge (ESD). Always perform service work at an ESD-protected workstation or mat. If an ESD workstation or mat is not available, touch the sheet-metal chassis to provide a static ground before touching an ESD-sensitive assembly.

Protect the ESD-sensitive assemblies by placing them in ESD pouches when they are out of the printer.

 **IMPORTANT:** Make sure that all of the shipping materials (for example shipping tape) are removed from the replacement part prior to installation.

 **NOTE:** If the replacement part is a roller or pad, avoid touching the spongy part of it. Skin oils on the roller or pad can cause paper pickup and/or print-quality problems. HP recommends using disposable gloves when handling rollers or pads or washing your hands before touching rollers or pads.

3. To install an assembly, reverse the removal steps.

 **NOTE:** When applicable, special installation instructions are provided for an assembly at the end of the removal procedure. Always completely read the removal instructions and follow all special installation instructions.

Removal and replacement: Control panel (MFP models)

Learn about removing and replacing the control panel.

 [View a video demonstration of removing and replacing the control panel.](#)

Before performing service

Turn the printer power off

- Disconnect the power cable.

 **WARNING!** To avoid damage to the printer, turn the printer off, wait 30 seconds, and then remove the power cord before attempting to service the printer.

Use the table below to identify the correct part number for your printer, and then go to <https://parts.hp.com/hpparts> to order the part.

Table 5-48 Part information

Part number	Part description
6QN37-60102	Control panel 23.3 cm (8 in)
6QN35-60129	Control panel 25.6 cm (10.1 in)

Required tools

- #2 Phillips screwdriver with a magnetic tip and a 152 mm (6 in) shaft length

After performing service

Turn the printer power on

- Connect the power cable.
- Use the power switch to turn the power on.

Post service test

No post service test is available for this assembly.

1. Remove the control panel (MFP)

Follow these steps to remove the control panel.

- Pull the control panel out and tilt it up, and then remove the two thumbscrews on the control panel arm. Remove the control panel by pulling it away from the printer.

Figure 5-259 Remove two thumbscrews

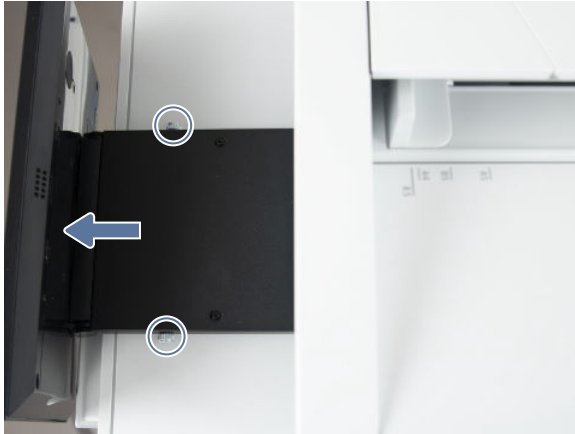

2. Unpack the replacement assembly

Follow these steps to unpack the replacement assembly.

1. Dispose of the defective part.



NOTE: HP recommends responsible disposal of the defective part.

<http://www8.hp.com/us/en/hp-information/environment/product-recycling.html>

2. Unpack the replacement part from the packaging.



CAUTION:  Some parts are sensitive to electrostatic discharge (ESD). Always perform service work at an ESD-protected workstation or mat. If an ESD workstation or mat is not available, touch the sheet-metal chassis to provide a static ground before touching an ESD-sensitive assembly. Protect the ESD-sensitive assemblies by placing them in ESD pouches when they are out of the printer.



IMPORTANT: Make sure that all of the shipping materials (for example shipping tape) are removed from the replacement part prior to installation.



NOTE: If the replacement part is a roller or pad, avoid touching the spongy part of it. Skin oils on the roller or pad can cause paper pickup and/or print-quality problems. HP recommends using disposable gloves when handling rollers or pads or washing your hands before touching rollers or pads.

3. To install an assembly, reverse the removal steps.



NOTE: When applicable, special installation instructions are provided for an assembly at the end of the removal procedure. Always completely read the removal instructions and follow all special installation instructions.

Internal parts and assemblies

Learn how to remove and replace the printer internal parts and assemblies.

Removal and replacement: Toner cartridges (manual unlock) (X57945 models)

Learn how to manually unlock the toner cartridges so that they can be removed to service other assemblies.



NOTE: This procedure describes manually unlocking the cartridges when the printer is not functioning.

To remove the cartridges by using the control-panel ejection method when the printer is operational, see the CSR instructions.



[View a video of removing and replacing the toner cartridges \(manual unlock\)](#)

Before performing service



CAUTION: To prevent damage to a toner cartridge, do not expose it to light for more than a few minutes. Cover the imaging drum if the toner cartridge must be removed from the printer for an extended period of time.

If toner gets on the skin or clothing, wipe it off with dry tissue paper and wash in cold water. Hot water sets toner and it might be difficult, or impossible, to remove.

Required tools

- Tool with a $\leq 3\text{mm}$ point and $< 120\text{mm}$ length

After performing service

- No post service test is available for this assembly.

Post service test

Print any pages necessary to make sure the printer is functioning correctly.

1. Remove Tray 2

Follow these steps to remove Tray 2.

1. Pull the tray out until it stops.

Figure 5-260 Pull the tray out



2. Lift the front of the tray, and then pull it out of the printer to remove it.

Figure 5-261 Remove the tray

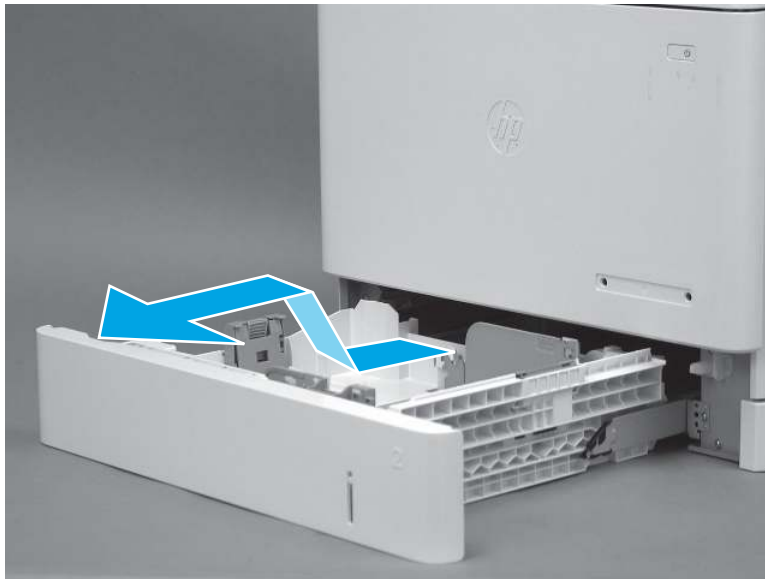

2. Manually unlock the toner cartridges (X57945 models)

Follow these steps to manually unlock the toner cartridges.

1. Locate the four toner cartridge drive units inside the Tray 2 cavity.

Figure 5-262 Locate the drive units

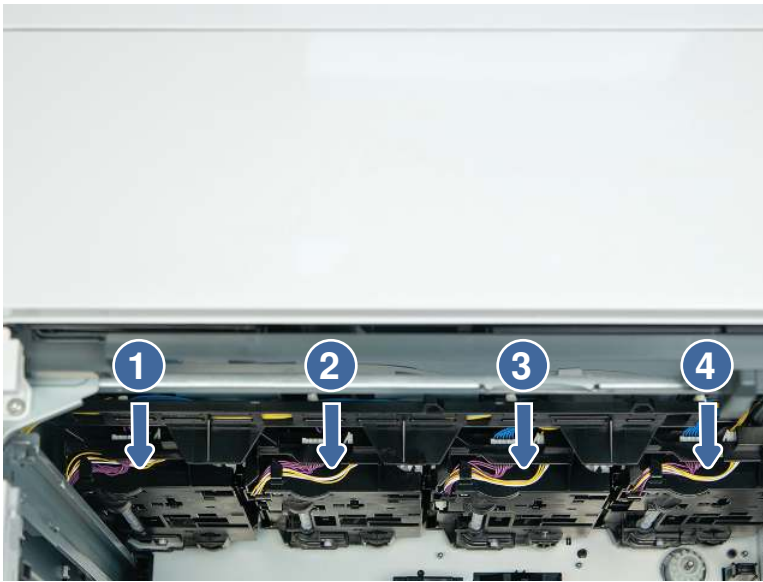

2. Locate the cartridge lock mechanism on one of the drive units.

Figure 5-263 Cartridge lock mechanism

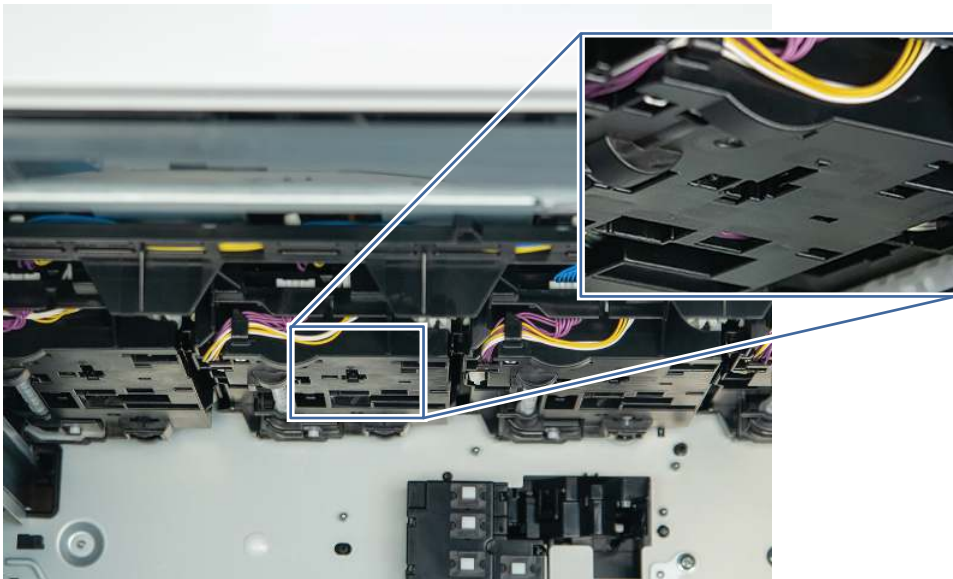

3. Open the cartridge door. Use a tool with a less-than 3mm tip (and less than 120mm in length) to release the lock mechanism.
 - a. Place the tip of the tool in the opening and under the lock mechanism (callout 1)
 - b. Rotate the tool to release the lock mechanism (callout 2).

 **NOTE:** When the lock mechanism is released, the corresponding toner cartridge extends out of the printer.

- c. Repeat these steps for each drive unit.

Figure 5-264 Release the lock mechanism

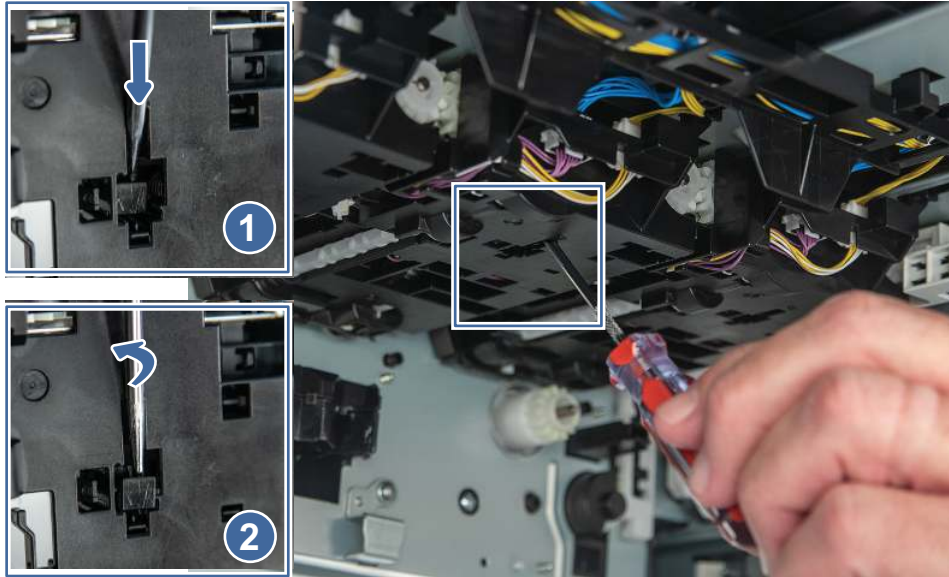

3. Remove the toner cartridges (X57945 models)

Follow these steps to remove a toner cartridges.

1. If the toner cartridge door is not open, open it now.
2. Grasp the end of the toner cartridge and pull it straight out of the printer.

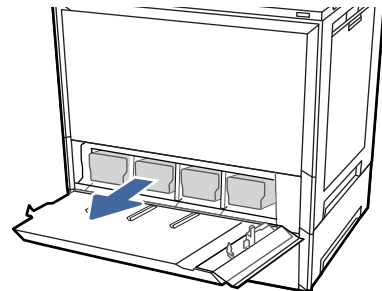
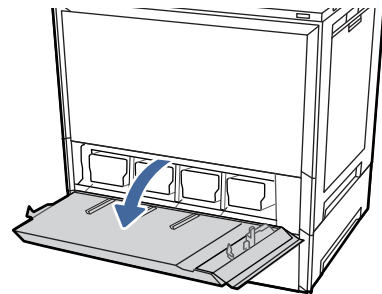

Removal and replacement: Secondary transfer assembly

Learn about removing and replacing the secondary transfer assembly.

Before performing service

Turn the printer power off

- Disconnect the power cable.

⚠ WARNING! To avoid damage to the printer, turn the printer off, wait 30 seconds, and then remove the power cord before attempting to service the printer.

Use the table below to identify the correct part number for your printer, and then go to <https://parts.hp.com/hpparts> to order the part.

Table 5-49 Part information

Part number	Part description
RM2-3586-000CN	Secondary transfer assembly (5700/6700)
RM2-3628-000CN	Secondary transfer assembly (5800/6800/X557/X57945)
RM2-3629-000CN	Secondary transfer assembly (X654/X677)

Required tools

- No special tools are required to remove or install this assembly.

After performing service

Turn the printer power on

- Connect the power cable.
- Use the power switch to turn the power on.

Post service test

Print any pages necessary to make sure the printer is functioning correctly.

1. Remove the secondary transfer assembly

Follow these steps to remove the secondary transfer assembly.

1. Open the right door.

Figure 5-265 Open the right door



2. Release two tabs (callout 1), and then remove the PCA cover (callout 2).

Figure 5-266 Remove the PCA cover

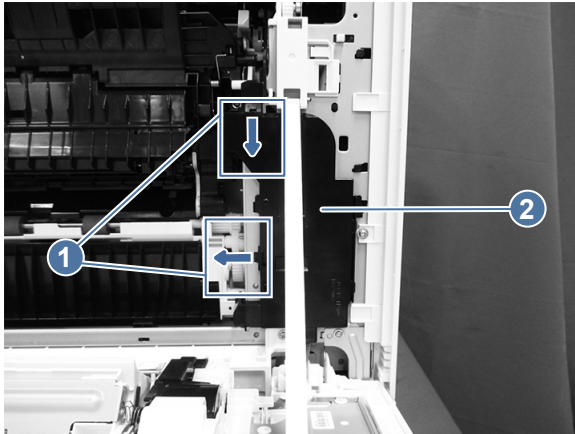

3. Disconnect one connector (callout 1), and then release the cable (callout 2) from the cable guide (callout 3).

 **Reinstallation tip:** When reinstalled, make sure the cable is correctly routed through the cable guide.

Figure 5-267 Release the cable



4. Perform one of the following steps.
 - **X557/5800/X57945 models:** Disconnect the J315 formatter connector.
 - **5700 models:** Disconnect the J305 formatter connector.

Figure 5-268 Disconnect a formatter connector

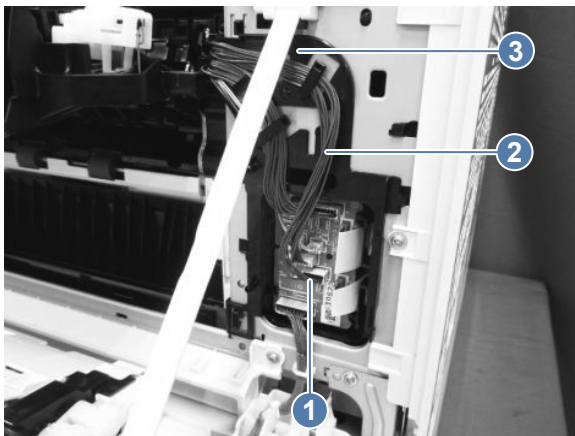
X557/MFP 5800/MFP X579

5700

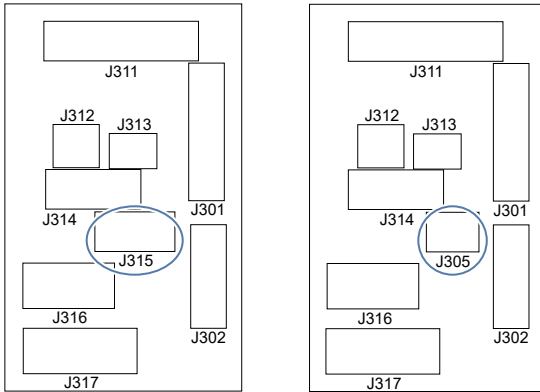

5. Release one tab (callout 1), and then lift up the registration assembly (callout 2) off the secondary transfer assembly (callout 3)

Figure 5-269 Release the tab

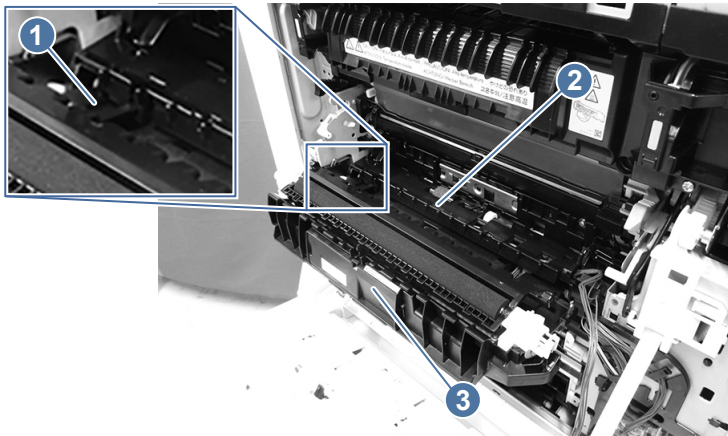



6. Close the secondary transfer assembly until it is only slightly open. Slide the assembly (callout 1) in the direction indicated below, and then dislodge the hinge pin (callout 2) from the holder to remove the assembly.

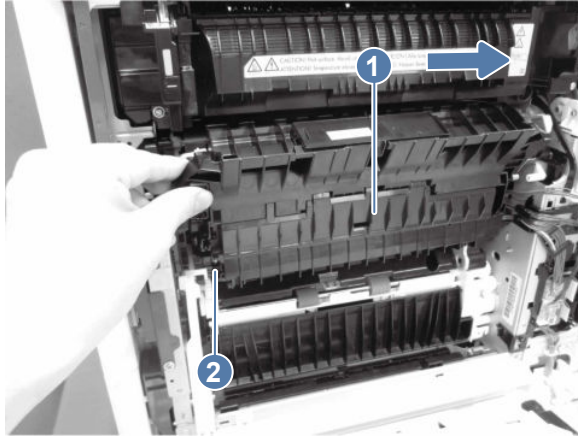

Reinstallation tip: Before removing the assembly, take note of where the assembly hinge pins fit into the holes provided in the printer.

Figure 5-270 Remove the secondary transfer assembly



 **Reinstallation tip:** On the assembly right side, make sure that the wire is nested in the plastic sleeve. Slide the wire sleeve into its place, depressing the spring, and then twist the left side of the assembly into place and allow the spring pressure to nest the hinge pin in its hole.

2. Unpack the replacement assembly

Follow these steps to unpack the replacement assembly.

1. Dispose of the defective part.



NOTE: HP recommends responsible disposal of the defective part.

<http://www8.hp.com/us/en/hp-information/environment/product-recycling.html>

2. Unpack the replacement part from the packaging.



CAUTION:  Some parts are sensitive to electrostatic discharge (ESD). Always perform service work at an ESD-protected workstation or mat. If an ESD workstation or mat is not available, touch the sheet-metal chassis to provide a static ground before touching an ESD-sensitive assembly. Protect the ESD-sensitive assemblies by placing them in ESD pouches when they are out of the printer.



IMPORTANT: Make sure that all of the shipping materials (for example shipping tape) are removed from the replacement part prior to installation.



NOTE: If the replacement part is a roller or pad, avoid touching the spongy part of it. Skin oils on the roller or pad can cause paper pickup and/or print-quality problems. HP recommends using disposable gloves when handling rollers or pads or washing your hands before touching rollers or pads.

3. To install an assembly, reverse the removal steps.



NOTE: When applicable, special installation instructions are provided for an assembly at the end of the removal procedure. Always completely read the removal instructions and follow all special installation instructions.

Removal and replacement: Registration density sensor assembly

Learn about removing and replacing the registration density sensor assembly.

Before performing service

Turn the printer power off

- Disconnect the power cable.

⚠ WARNING! To avoid damage to the printer, turn the printer off, wait 30 seconds, and then remove the power cord before attempting to service the printer.

Use the table below to identify the correct part number for your printer, and then go to <https://parts.hp.com/hpparts> to order the part.

Table 5-50 Part Information

Part number	Part description
RM2-4492-000CN	Density detect assembly

Required tools

- #2 Phillips screwdriver with a magnetic tip and a 152 mm (6 in) shaft length

After performing service

Turn the printer power on

- Connect the power cable.
- Use the power switch to turn the power on.

Post service test

Print any pages necessary to make sure the printer is functioning correctly.

1. Remove the ITB

Follow these steps to remove the ITB.

1. Open the right door.

Figure 5-271 Open the right door



2. Hold the two side levers and pull out the ITB assembly.

⚠ CAUTION: Do not touch the gray plastic belt. Skin oils and fingerprints on the belt can cause print-quality problems.

Figure 5-272 Release the ITB



2. Remove the secondary transfer assembly

Follow these steps to remove the secondary transfer assembly.

1. Open the right door.

Figure 5-273 Open the right door



2. Release two tabs (callout 1), and then remove the PCA cover (callout 2).

Figure 5-274 Remove the PCA cover

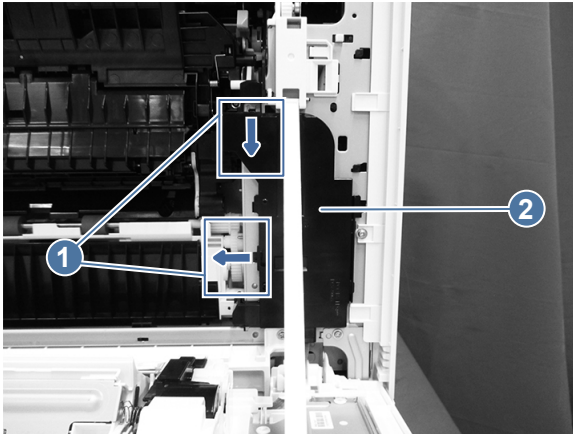

3. Disconnect one connector (callout 1), and then release the cable (callout 2) from the cable guide (callout 3).

 **Reinstallation tip:** When reinstalled, make sure the cable is correctly routed through the cable guide.

Figure 5-275 Release the cable



4. Perform one of the following steps.
 - **X557/5800/X57945 models:** Disconnect the J315 formatter connector.
 - **5700 models:** Disconnect the J305 formatter connector.

Figure 5-276 Disconnect a formatter connector

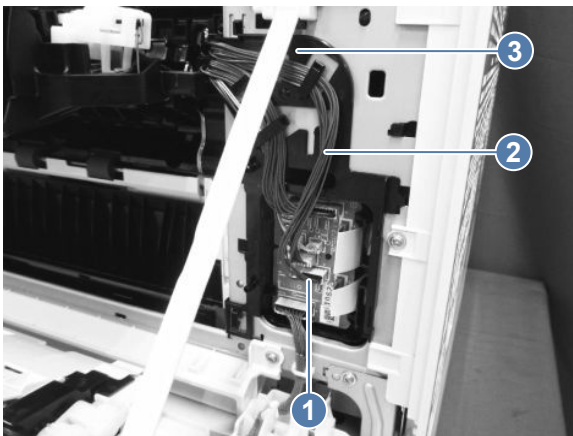
X557/MFP 5800/MFP X579

5700

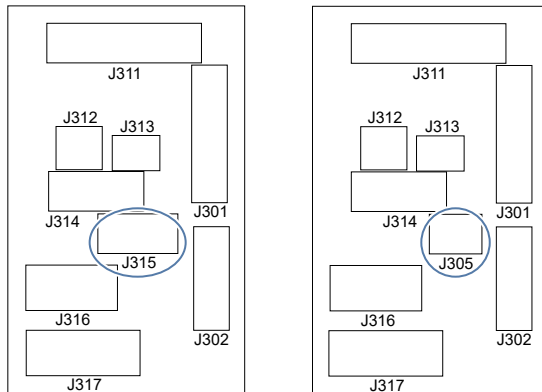

5. Release one tab (callout 1), and then lift up the registration assembly (callout 2) off the secondary transfer assembly (callout 3)

Figure 5-277 Release the tab

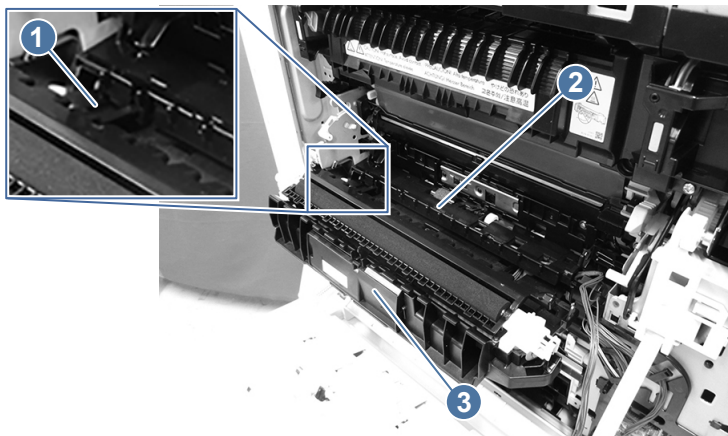

6. Close the secondary transfer assembly until it is only slightly open. Slide the assembly (callout 1) in the direction indicated below, and then dislodge the hinge pin (callout 2) from the holder to remove the assembly.

 **Reinstallation tip:** Before removing the assembly, take note of where the assembly hinge pins fit into the holes provided in the printer.

Figure 5-278 Remove the secondary transfer assembly



Reinstallation tip: On the assembly right side, make sure that the wire is nested in the plastic sleeve. Slide the wire sleeve into its place, depressing the spring, and then twist the left side of the assembly into place and allow the spring pressure to nest the hinge pin in its hole.

3. Remove the registration density sensor

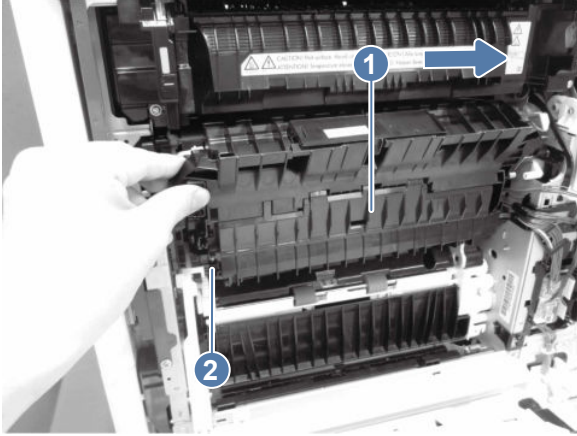
Follow these steps to remove the registration density sensor.

1. Disconnect one connector (J314; callout 1), and then release the cable (callout 2) from the cable guides (callout 3).

Figure 5-279 Disconnect one connector

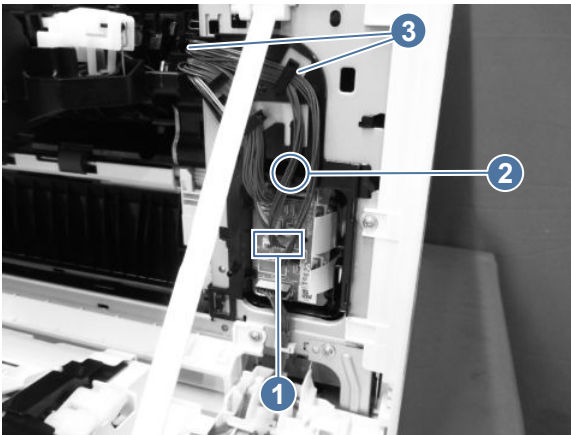

2. Remove two screws (callout 1). Pull out the registration density sensor assembly (callout 2) slightly towards you, and then move the registration density sensor assembly in the direction indicated below. Carefully pull out the right side first to remove the registration density sensor assembly.

NOTE: The shaft on the left side of the assembly is long and can break. Make sure to pivot the right side of the assembly out first to ensure that the shaft does not break. When installing a registration density sensor assembly, insert the shaft on the left side first, and then pivot the right side into the printer.

Figure 5-280 Release the assembly

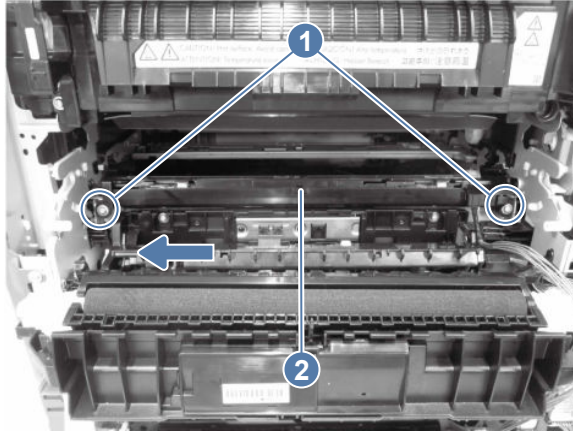

4. Unpack the replacement assembly

Follow these steps to unpack the replacement assembly.

1. Dispose of the defective part.



NOTE: HP recommends responsible disposal of the defective part.

<http://www8.hp.com/us/en/hp-information/environment/product-recycling.html>

2. Unpack the replacement part from the packaging.



CAUTION:  Some parts are sensitive to electrostatic discharge (ESD). Always perform service work at an ESD-protected workstation or mat. If an ESD workstation or mat is not available, touch the sheet-metal chassis to provide a static ground before touching an ESD-sensitive assembly. Protect the ESD-sensitive assemblies by placing them in ESD pouches when they are out of the printer.



IMPORTANT: Make sure that all of the shipping materials (for example shipping tape) are removed from the replacement part prior to installation.



NOTE: If the replacement part is a roller or pad, avoid touching the spongy part of it. Skin oils on the roller or pad can cause paper pickup and/or print-quality problems. HP recommends using disposable gloves when handling rollers or pads or washing your hands before touching rollers or pads.

3. To install an assembly, reverse the removal steps.



NOTE: When applicable, special installation instructions are provided for an assembly at the end of the removal procedure. Always completely read the removal instructions and follow all special installation instructions.

Removal and replacement: Registration assembly

Learn about removing and replacing the registration assembly.

Before performing service

Turn the printer power off

- Disconnect the power cable.

⚠ WARNING! To avoid damage to the printer, turn the printer off, wait 30 seconds, and then remove the power cord before attempting to service the printer.

If the part is damaged and cannot be cleaned, use the table below to identify the correct part number for your printer. To order the part, go to www.hp.com/buy/parts.

Table 5-51 Part information

Part number	Part description
RM2-4458-000CN	Registration assembly

Required tools

- #2 Phillips screwdriver with a magnetic tip and a 152 mm (6 in) shaft length

After performing service

Turn the printer power on

- Connect the power cable.
- Use the power switch to turn the power on.

Post service test

Print any pages necessary to make sure the printer is functioning correctly.

1. Remove the secondary transfer assembly

Follow these steps to remove the secondary transfer assembly.

1. Open the right door.

Figure 5-281 Open the right door



2. Release two tabs (callout 1), and then remove the PCA cover (callout 2).

Figure 5-282 Remove the PCA cover

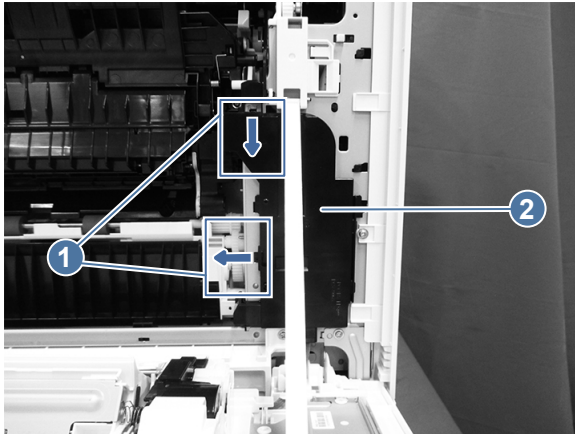

3. Disconnect one connector (callout 1), and then release the cable (callout 2) from the cable guide (callout 3).

 **Reinstallation tip:** When reinstalled, make sure the cable is correctly routed through the cable guide.

Figure 5-283 Release the cable



4. Perform one of the following steps.
 - **X557/5800/X57945 models:** Disconnect the J315 formatter connector.
 - **5700 models:** Disconnect the J305 formatter connector.

Figure 5-284 Disconnect a formatter connector

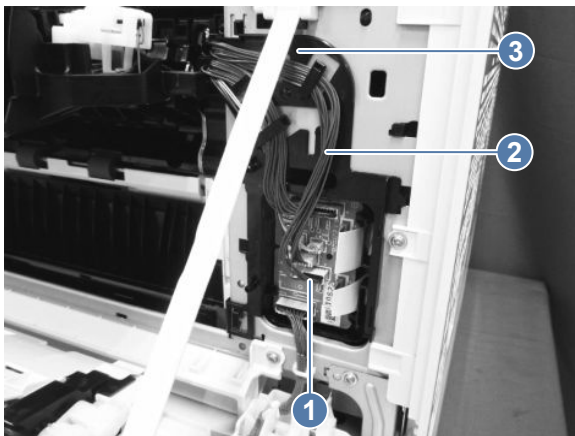
X557/MFP 5800/MFP X579

5700

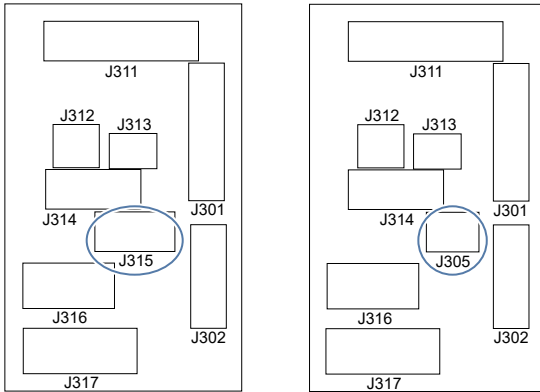

5. Release one tab (callout 1), and then lift up the registration assembly (callout 2) off the secondary transfer assembly (callout 3)

Figure 5-285 Release the tab

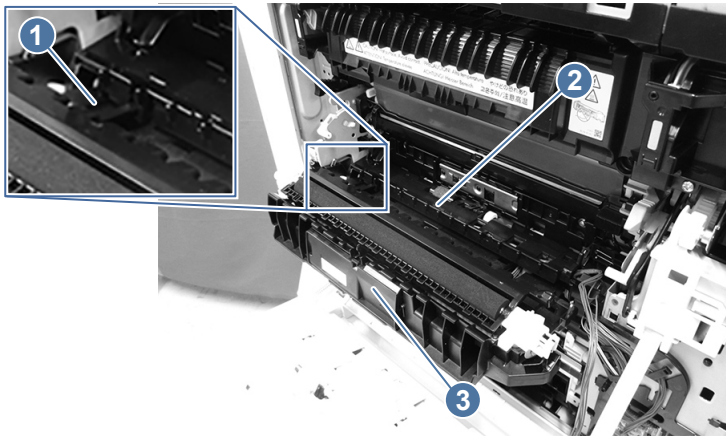



6. Close the secondary transfer assembly until it is only slightly open. Slide the assembly (callout 1) in the direction indicated below, and then dislodge the hinge pin (callout 2) from the holder to remove the assembly.

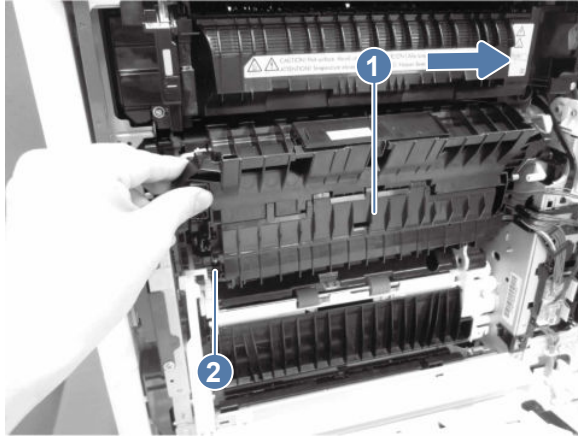

Reinstallation tip: Before removing the assembly, take note of where the assembly hinge pins fit into the holes provided in the printer.

Figure 5-286 Remove the secondary transfer assembly



 **Reinstallation tip:** On the assembly right side, make sure that the wire is nested in the plastic sleeve. Slide the wire sleeve into its place, depressing the spring, and then twist the left side of the assembly into place and allow the spring pressure to nest the hinge pin in its hole.

2. Remove the registration assembly

Follow these steps to remove the registration assembly.

1. Disconnect three connectors (callout 1), and then release the cable (callout 2) from the cable guide (callout 3).

Figure 5-287 Release the connectors

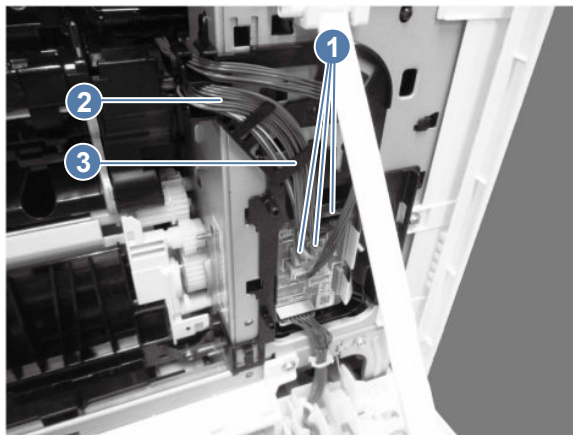

2. Release two bosses (callout 1), and then release the link arm (callout 2) from the door.

Figure 5-288 Release the link arm

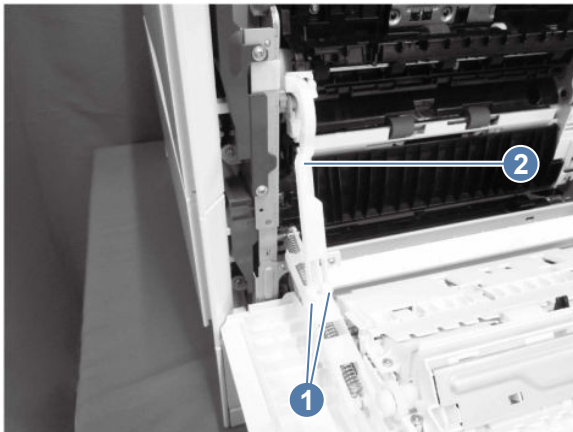

3. Remove four screws (callout 1), and then remove the registration assembly (callout 2).

Figure 5-289 Remove the registration assembly

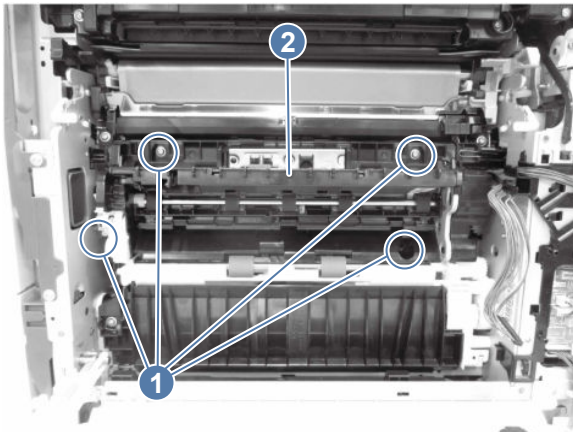

3. Unpack the replacement assembly

Follow these steps to unpack the replacement assembly.

1. Dispose of the defective part.



NOTE: HP recommends responsible disposal of the defective part.

<http://www8.hp.com/us/en/hp-information/environment/product-recycling.html>

2. Unpack the replacement part from the packaging.



CAUTION:  Some parts are sensitive to electrostatic discharge (ESD). Always perform service work at an ESD-protected workstation or mat. If an ESD workstation or mat is not available, touch the sheet-metal chassis to provide a static ground before touching an ESD-sensitive assembly. Protect the ESD-sensitive assemblies by placing them in ESD pouches when they are out of the printer.



IMPORTANT: Make sure that all of the shipping materials (for example shipping tape) are removed from the replacement part prior to installation.

 **NOTE:** If the replacement part is a roller or pad, avoid touching the spongy part of it. Skin oils on the roller or pad can cause paper pickup and/or print-quality problems. HP recommends using disposable gloves when handling rollers or pads or washing your hands before touching rollers or pads.

3. To install an assembly, reverse the removal steps.

 **NOTE:** When applicable, special installation instructions are provided for an assembly at the end of the removal procedure. Always completely read the removal instructions and follow all special installation instructions.

Removal and replacement: Paper pickup assembly (5700/X557/5800 models)

Learn about removing and replacing the paper pickup assembly.



[View a video demonstration of removing and replacing the paper pickup assembly.](#)

Before performing service

Turn the printer power off

- Disconnect the power cable.

 **WARNING!** To avoid damage to the printer, turn the printer off, wait 30 seconds, and then remove the power cord before attempting to service the printer.

If the part is damaged and cannot be cleaned, use the table below to identify the correct part number for your printer. To order the part, go to www.hp.com/buy/parts.

Table 5-52 Part information

Part number	Part description
RM2-3508-000CN	Paper pickup assembly (5700/5800 models)

Required tools

- #2 Phillips screwdriver with a magnetic tip and a 152 mm (6 in) shaft length

After performing service

Turn the printer power on

- Connect the power cable.
- Use the power switch to turn the power on.

Post service test

Print any pages necessary to make sure the printer is functioning correctly.

1. Remove the secondary transfer assembly

Follow these steps to remove the secondary transfer assembly.

1. Open the right door.

Figure 5-290 Open the right door



2. Release two tabs (callout 1), and then remove the PCA cover (callout 2).

Figure 5-291 Remove the PCA cover

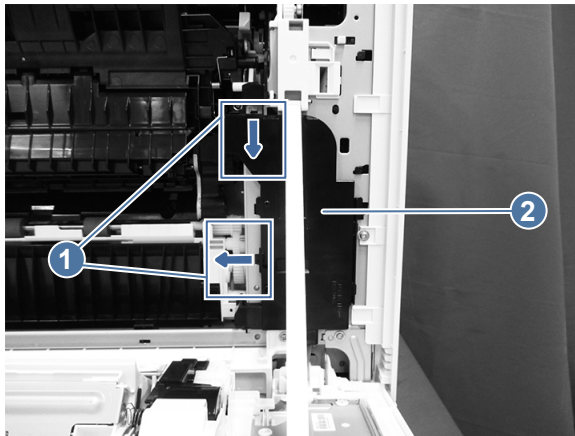

3. Disconnect one connector (callout 1), and then release the cable (callout 2) from the cable guide (callout 3).

 **Reinstallation tip:** When reinstalled, make sure the cable is correctly routed through the cable guide.

Figure 5-292 Release the cable



4. Perform one of the following steps.

- **X557/5800/X57945 models:** Disconnect the J315 formatter connector.
- **5700 models:** Disconnect the J305 formatter connector.

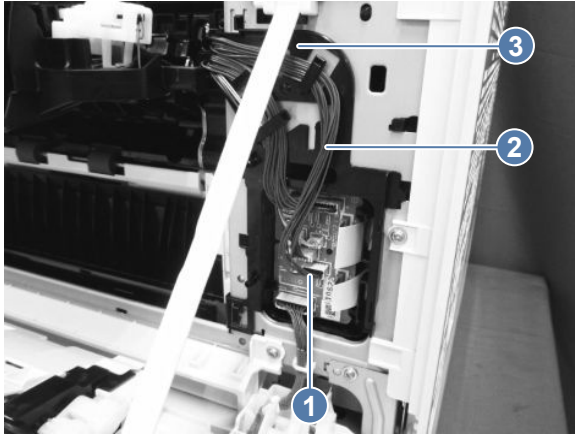
Figure 5-293 Disconnect a formatter connector

X557/MFP 5800/MFP X579

5700

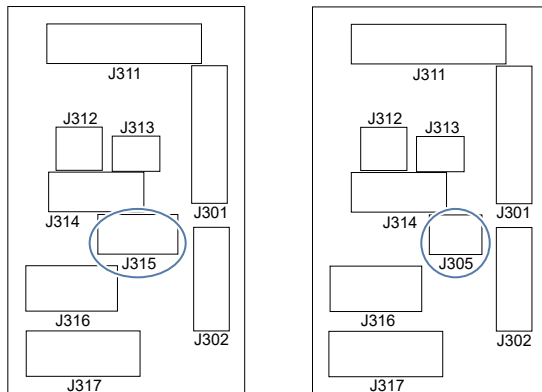

5. Release one tab (callout 1), and then lift up the registration assembly (callout 2) off the secondary transfer assembly (callout 3)

Figure 5-294 Release the tab

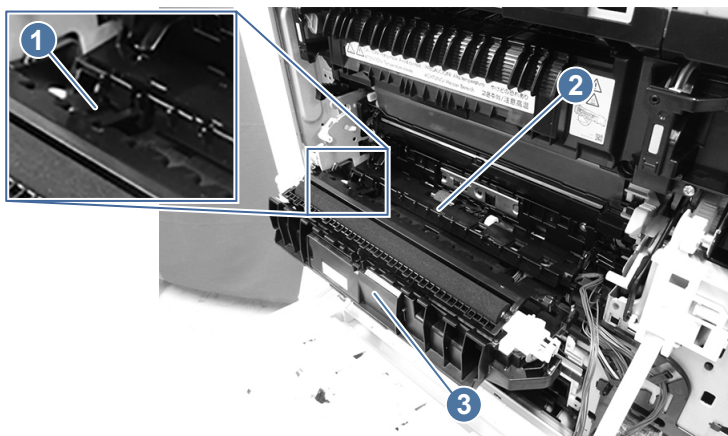

6. Close the secondary transfer assembly until it is only slightly open. Slide the assembly (callout 1) in the direction indicated below, and then dislodge the hinge pin (callout 2) from the holder to remove the assembly.



Reinstallation tip: Before removing the assembly, take note of where the assembly hinge pins fit into the holes provided in the printer.

Figure 5-295 Remove the secondary transfer assembly

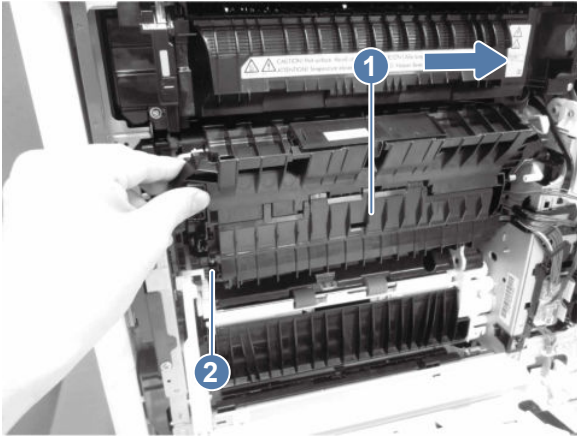

Reinstallation tip: On the assembly right side, make sure that the wire is nested in the plastic sleeve. Slide the wire sleeve into its place, depressing the spring, and then twist the left side of the assembly into place and allow the spring pressure to nest the hinge pin in its hole.

2. Remove the registration density sensor

Follow these steps to remove the registration density sensor.

1. Disconnect one connector (J314; callout 1), and then release the cable (callout 2) from the cable guides (callout 3).

Figure 5-296 Disconnect one connector

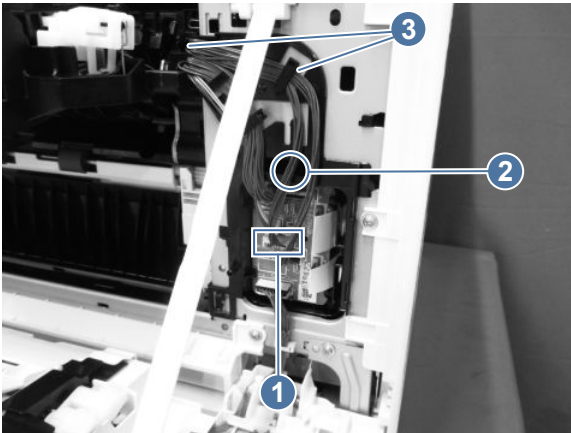

2. Remove two screws (callout 1). Pull out the registration density sensor assembly (callout 2) slightly towards you, and then move the registration density sensor assembly in the direction indicated below. Carefully pull out the right side first to remove the registration density sensor assembly.



NOTE: The shaft on the left side of the assembly is long and can break. Make sure to pivot the right side of the assembly out first to ensure that the shaft does not break. When installing a

registration density sensor assembly, insert the shaft on the left side first, and then pivot the right side into the printer.

Figure 5-297 Release the assembly

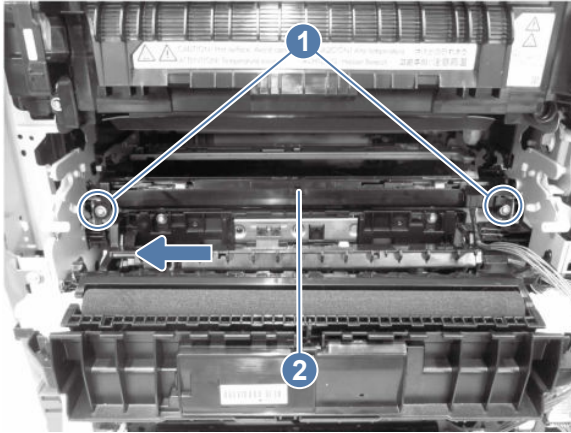



3. Remove the paper pickup assembly (5700/X557/5800 models)

Follow these steps to remove the paper pickup assembly.

1. Disconnect one connector (callout 1), release the cable (callout 2) from the cable guide (callout 3), remove one screw (callout 4), and then remove the pickup assembly (callout 5).

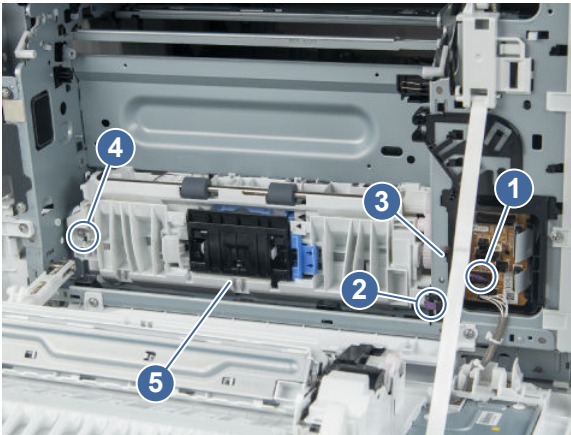
Figure 5-298 Remove the pickup assembly



 **Reinstallation tip:** When reinstalling, there are two holes. The screw goes in the upper hole where it comes into contact with the grounding wire.

2. Remove the gear (callout 1) from the assembly (callout 2).

Figure 5-299 Remove the gear

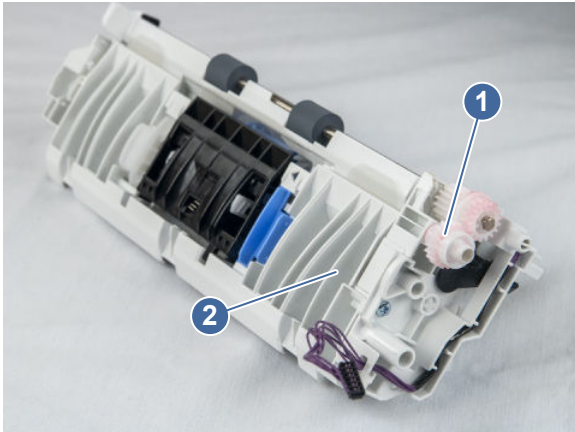

4. Unpack the replacement assembly

Follow these steps to unpack the replacement assembly.

1. Dispose of the defective part.



NOTE: HP recommends responsible disposal of the defective part.

<http://www8.hp.com/us/en/hp-information/environment/product-recycling.html>

2. Unpack the replacement part from the packaging.



CAUTION:  Some parts are sensitive to electrostatic discharge (ESD). Always perform service work at an ESD-protected workstation or mat. If an ESD workstation or mat is not available, touch the sheet-metal chassis to provide a static ground before touching an ESD-sensitive assembly. Protect the ESD-sensitive assemblies by placing them in ESD pouches when they are out of the printer.



IMPORTANT: Make sure that all of the shipping materials (for example shipping tape) are removed from the replacement part prior to installation.



NOTE: If the replacement part is a roller or pad, avoid touching the spongy part of it. Skin oils on the roller or pad can cause paper pickup and/or print-quality problems. HP recommends using disposable gloves when handling rollers or pads or washing your hands before touching rollers or pads.

3. To install an assembly, reverse the removal steps.



NOTE: When applicable, special installation instructions are provided for an assembly at the end of the removal procedure. Always completely read the removal instructions and follow all special installation instructions.

Removal and replacement: Paper pickup assembly (X57945 models)

Learn about removing and replacing the paper pickup assembly.

Before performing service

Turn the printer power off

- Disconnect the power cable.

⚠ WARNING! To avoid damage to the printer, turn the printer off, wait 30 seconds, and then remove the power cord before attempting to service the printer.

If the part is damaged and cannot be cleaned, use the table below to identify the correct part number for your printer. To order the part, go to www.hp.com/buy/parts.

Table 5-53 Part information

Part number	Part description
RM2-3509-000CN	Paper pickup assembly (X57945 models)

Required tools

- #2 Phillips screwdriver with a magnetic tip and a 152 mm (6 in) shaft length

After performing service

Turn the printer power on

- Connect the power cable.
- Use the power switch to turn the power on.

Post service test

Print any pages necessary to make sure the printer is functioning correctly.

1. Remove the front right cover

Follow these steps to remove the front right cover.

1. Open the toner cartridge access door.
2. Open the right lower door.
3. Release one tab, and then slide the front right cover upward to remove it.

Figure 5-300 Remove the front right cover

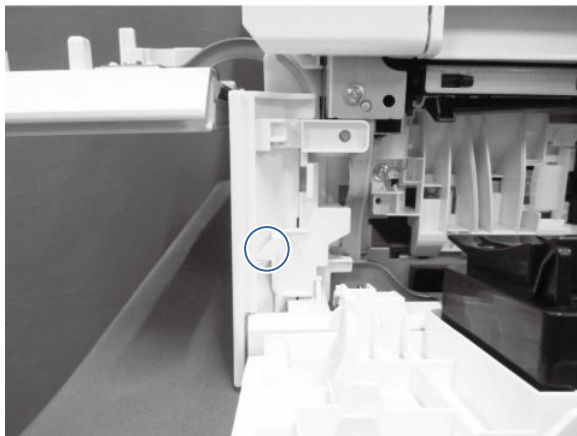

2. Remove the right lower door (X57945 models)

Follow these steps to remove the right lower door.

1. Remove two screws (callout 1), and then remove the base frame (callout 2).

Figure 5-301 Remove the base frame

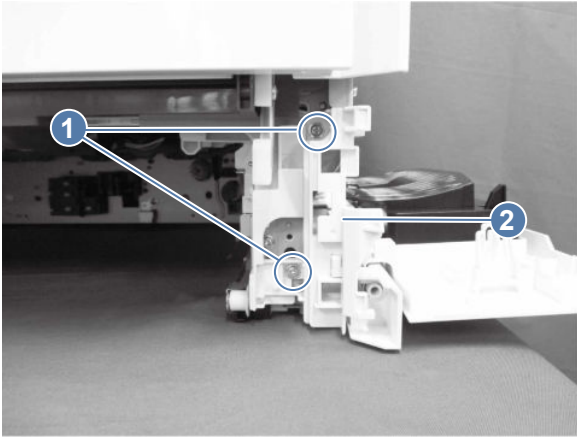

2. Remove one screw (callout 1), release one tab (callout 2), and then slide the rear inner cover (callout 3) downward to remove it.

Figure 5-302 Remove the rear inner cover

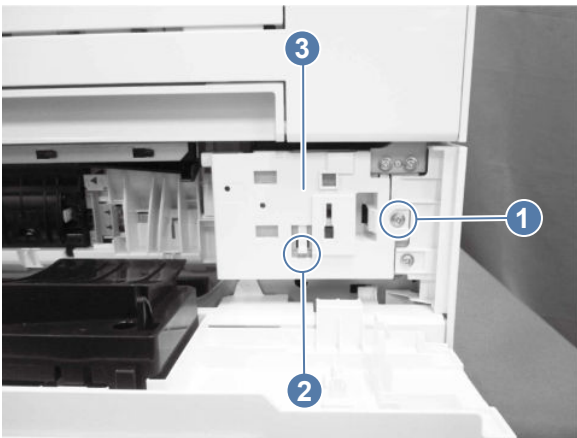

3. Release one tab (callout 1), and then slide the right lower door assembly (callout 2) in the direction indicated to remove it.

Figure 5-303 Remove the right lower door assembly

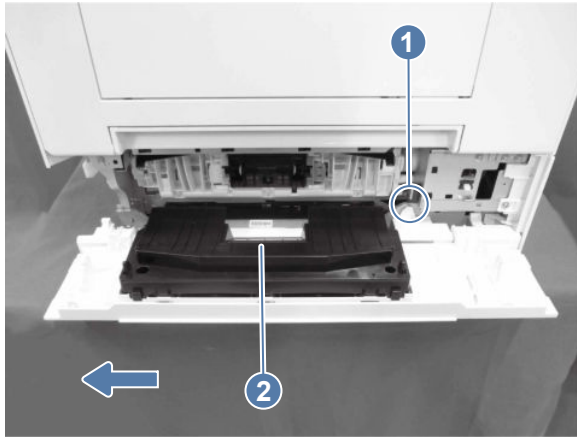



3. Remove the paper pickup assembly (X57945 models)

Follow these steps to remove the paper pickup assembly.

1. Remove one screw (callout 1), and then remove the pickup assembly (callout 2).

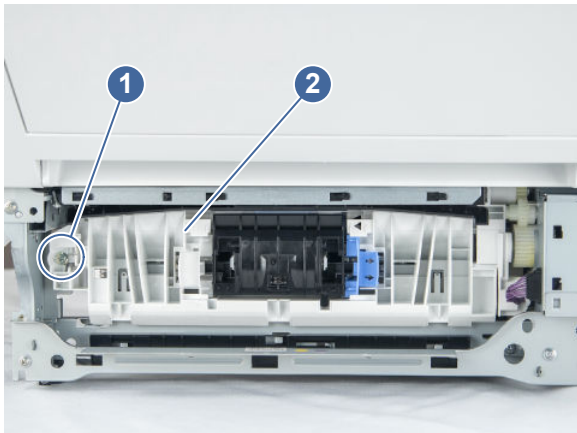
Figure 5-304 Remove the pickup assembly



 **Reinstallation tip:** When reinstalling, there are two holes. The screw goes in the upper hole where it comes into contact with the grounding wire.

2. Remove the gear (callout 1) from the pickup assembly (callout 2).

Figure 5-305 Remove the gear

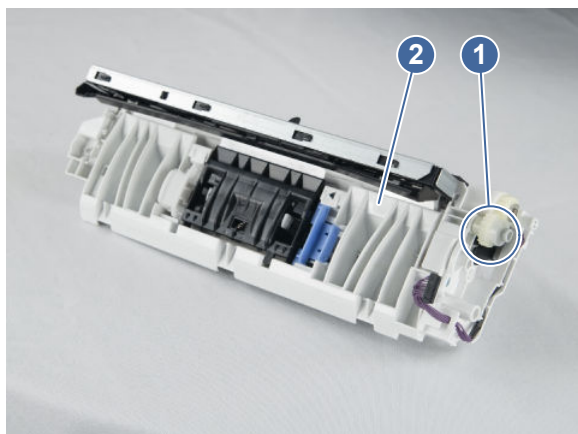

4. Unpack the replacement assembly

Follow these steps to unpack the replacement assembly.

1. Dispose of the defective part.



NOTE: HP recommends responsible disposal of the defective part.

<http://www8.hp.com/us/en/hp-information/environment/product-recycling.html>

2. Unpack the replacement part from the packaging.



CAUTION:  Some parts are sensitive to electrostatic discharge (ESD). Always perform service work at an ESD-protected workstation or mat. If an ESD workstation or mat is not available, touch the sheet-metal chassis to provide a static ground before touching an ESD-sensitive assembly. Protect the ESD-sensitive assemblies by placing them in ESD pouches when they are out of the printer.



IMPORTANT: Make sure that all of the shipping materials (for example shipping tape) are removed from the replacement part prior to installation.



NOTE: If the replacement part is a roller or pad, avoid touching the spongy part of it. Skin oils on the roller or pad can cause paper pickup and/or print-quality problems. HP recommends using disposable gloves when handling rollers or pads or washing your hands before touching rollers or pads.

3. To install an assembly, reverse the removal steps.



NOTE: When applicable, special installation instructions are provided for an assembly at the end of the removal procedure. Always completely read the removal instructions and follow all special installation instructions.

Removal and replacement: Delivery assembly

Learn about removing and replacing the delivery assembly.

Before performing service

Turn the printer power off

- Disconnect the power cable.

⚠ WARNING! To avoid damage to the printer, turn the printer off, wait 30 seconds, and then remove the power cord before attempting to service the printer.

If the part is damaged and cannot be cleaned, use the table below to identify the correct part number for your printer. To order the part, go to www.hp.com/buy/parts.

Table 5-54 Part information

Part number	Part description
RM2-3548-000CN	Paper delivery assembly (5700/X557)
RM2-3554-000CN	Paper delivery assembly (5800/X57945)

Required tools

- #2 Phillips screwdriver with a magnetic tip and a 152 mm (6 in) shaft length

After performing service

Turn the printer power on

- Connect the power cable.
- Use the power switch to turn the power on.

Post service test

Print any pages necessary to make sure the printer is functioning correctly.

1. Remove the fuser

Follow these steps to remove the fuser.

1. Open the right door.

⚠ CAUTION: The fuser is hot. Wait at least 10 minutes after turning the printer power off before removing the fuser.

Figure 5-306 Open the right door



2. Squeeze the release levers on the handles (circle callouts), and then remove the fuser.

Figure 5-307 Remove the fuser

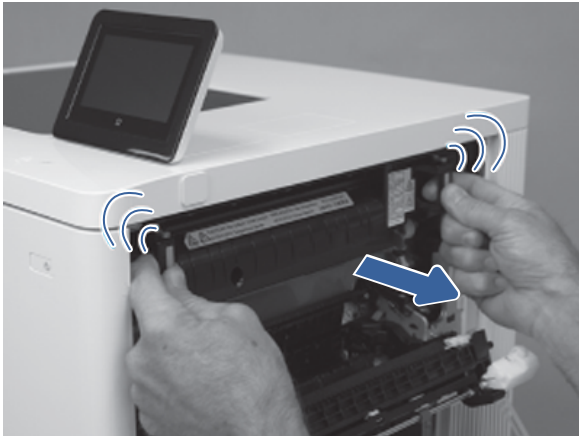

2. Remove the delivery assembly

Follow these steps to remove the delivery assembly.

1. Pull the lever (callout 1) at the back of the cable cover (callout 2) to release one tab (callout 3), and then remove the cable cover.

Figure 5-308 Remove the cable cover

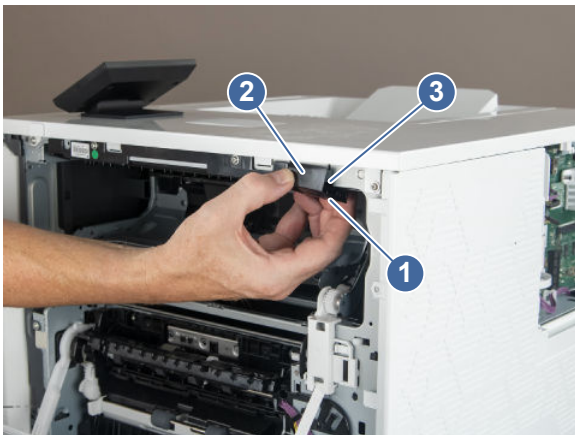

2. Disconnect one connector (callout 1).

Figure 5-309 Disconnect one connector

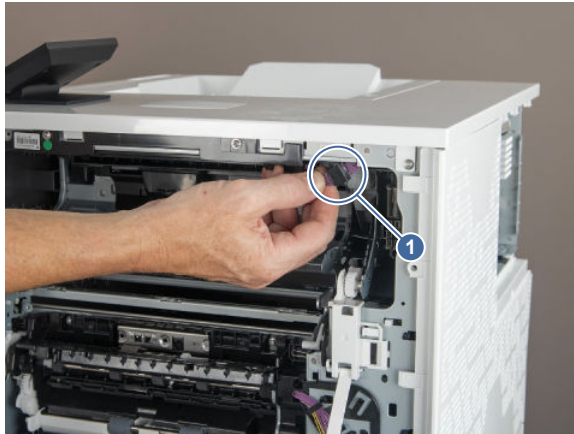

3. Remove three screws (callout 1), remove one binding screw (callout 2), and then pull out the delivery assembly (callout 3) away from the printer.

Figure 5-310 Remove the delivery assembly

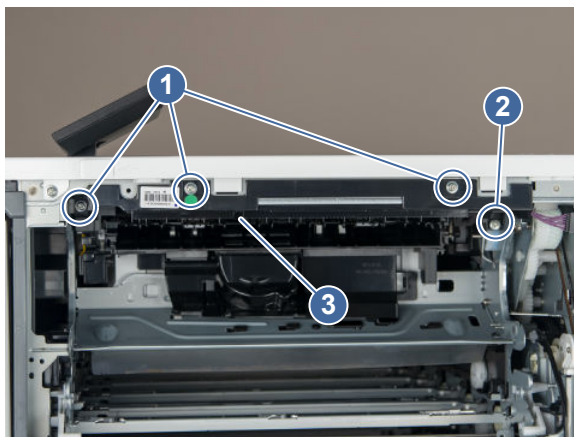

Reinstallation tip: When reinstalling, lift the flag (callout 1) to prevent the flag from entering the duct (callout 2)

Figure 5-311 Lift the flag

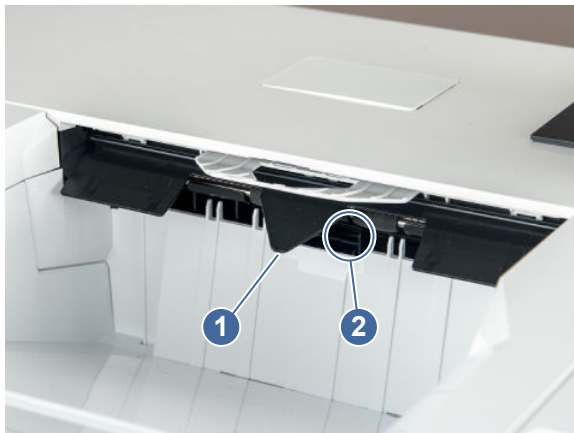

3. Unpack the replacement assembly

Follow these steps to unpack the replacement assembly.

1. Dispose of the defective part.



NOTE: HP recommends responsible disposal of the defective part.

<http://www8.hp.com/us/en/hp-information/environment/product-recycling.html>

2. Unpack the replacement part from the packaging.



CAUTION:  Some parts are sensitive to electrostatic discharge (ESD). Always perform service work at an ESD-protected workstation or mat. If an ESD workstation or mat is not available, touch the sheet-metal chassis to provide a static ground before touching an ESD-sensitive assembly. Protect the ESD-sensitive assemblies by placing them in ESD pouches when they are out of the printer.



IMPORTANT: Make sure that all of the shipping materials (for example shipping tape) are removed from the replacement part prior to installation.



NOTE: If the replacement part is a roller or pad, avoid touching the spongy part of it. Skin oils on the roller or pad can cause paper pickup and/or print-quality problems. HP recommends using disposable gloves when handling rollers or pads or washing your hands before touching rollers or pads.

3. To install an assembly, reverse the removal steps.



NOTE: When applicable, special installation instructions are provided for an assembly at the end of the removal procedure. Always completely read the removal instructions and follow all special installation instructions.

Removal and replacement: Laser scanner assembly

This document provides the procedures to remove and replace the laser scanner assembly.

Mean time to repair: 25 minutes

Service level: Intermediate

Before performing service

Turn the printer power off

- Disconnect the power cable.



WARNING! To avoid damage to the printer, turn the printer off, wait 30 seconds, and then remove the power cord before attempting to service the printer.

Use the table below to identify the correct part number for your printer, and then go to <https://parts.hp.com/hpparts> to order the part.

Table 5-55 Part information

Part number	Part description
RM2-3822-000CN	Laser scanner assembly (5700, 55745, 5800, 57945)

Table 5-55 Part information (continued)

Part number	Part description
RM2-3787-000CN	Laser scanner assembly (6700, 654, 6800, 677)

Required tools

- #2 Phillips screwdriver with a magnetic tip

After performing service

Make sure that all of the connectors on the HVPS are fully seated.

Make sure that all of the connectors on the LVPS are fully seated.

Make sure that all of the connectors on the formatter are fully seated.

Make sure that the formatter cover is fully seated.

Turn the printer power on

- Connect the power cable.
- Use the power switch to turn the power on.

Post service test

Print a configuration page to make sure that the printer is functioning correctly.

1. Remove the formatter cover

Follow these steps to remove the formatter cover.

- Remove one screw (callout 1), and then slide the formatter cover (callout 2) away from the printer to remove it.



TIP: Reverse the removal steps to install the assembly.

Figure 5-312 Remove the formatter cover

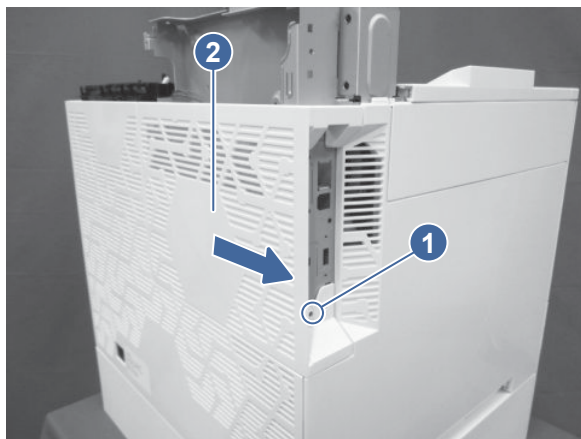

2. Remove the left upper cover (MFP models)

Follow these steps to remove the left upper cover.

1. Open the front door.

⚠ CAUTION: If the cover is being removed to gain access to the main drive assembly, make sure that the front door remains open. This keeps the main drive properly aligned.

2. At the left side of the printer, insert the small flat-blade screwdriver into the slot to release one tab (callout 1).

Figure 5-313 Use a screwdriver to release the tab

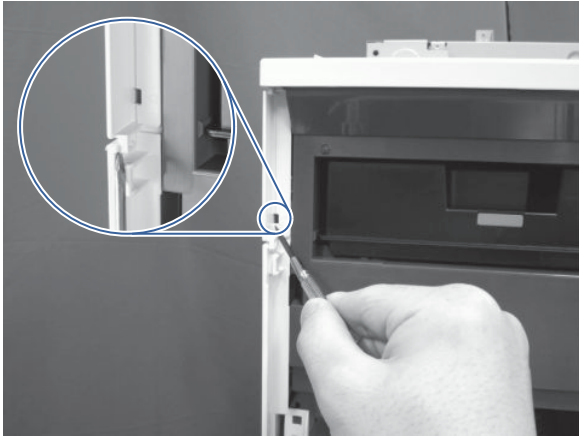

3. Toward the front of the printer, release another tab.

Figure 5-314 Release the tab

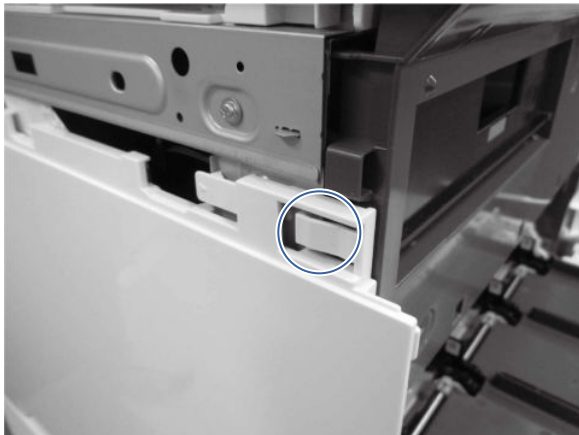

4. Rotate the cover up to remove it.

Figure 5-315 Remove the left upper cover

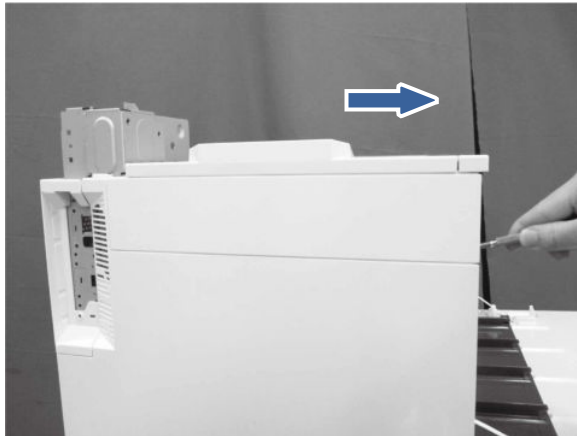

3. Remove the left cover

Follow these steps to remove the left cover.

- At the left side of the printer, remove one screw (callout 1), release one tab (callout 2), and then slide the cover (callout 3) toward the rear of the printer to release it.

Figure 5-316 Remove the left cover

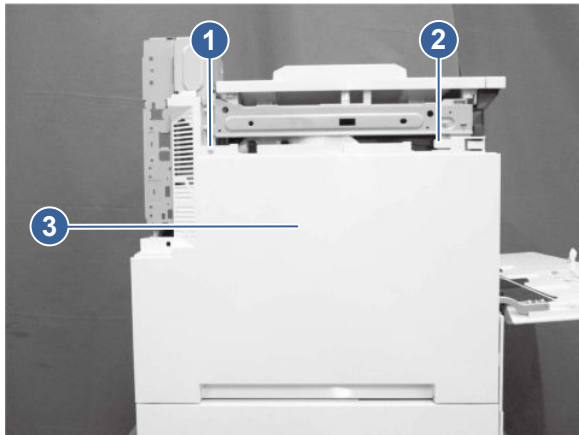

4. Remove the laser scanner assembly

Follow these steps to remove the laser scanner assembly.

1. Unhook the spring (callout 1), disconnect one connector (callout 2), release the cable (callout 3) from the laser scanner assembly (callout 4), and then pull out the laser scanner assembly slightly.

Figure 5-317 Unhook the spring

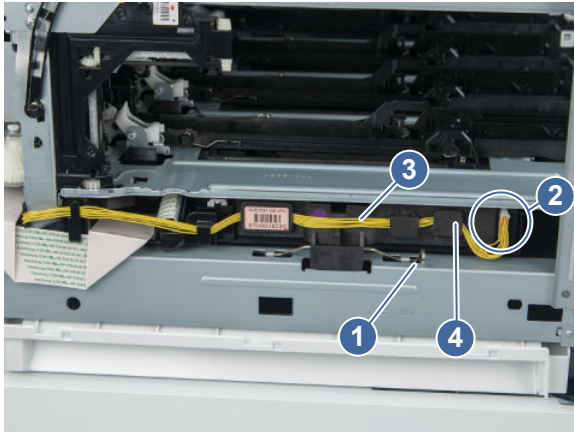

2. Disconnect the FFC (callout 1), and then pull the laser scanner assembly (callout 2) out of the printer.

Figure 5-318 Remove the assembly

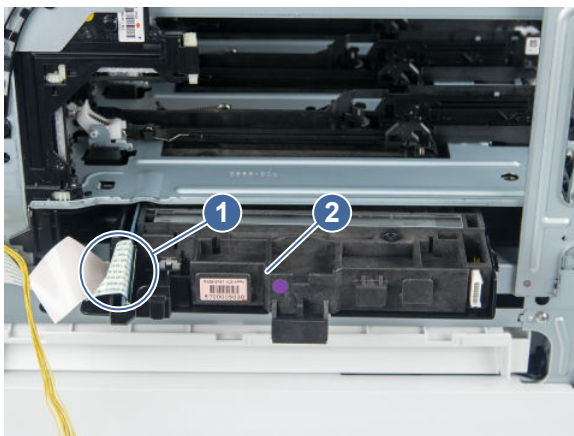

5. Unpack the replacement assembly

Follow these steps to unpack the replacement assembly.

1. Dispose of the defective part.





NOTE: HP recommends responsible disposal of the defective part.

<http://www8.hp.com/us/en/hp-information/environment/product-recycling.html>

2. Unpack the replacement part from the packaging.



CAUTION:  Some parts are sensitive to electrostatic discharge (ESD). Always perform service work at an ESD-protected workstation or mat. If an ESD workstation or mat is not available, touch the sheet-metal chassis to provide a static ground before touching an ESD-sensitive assembly. Protect the ESD-sensitive assemblies by placing them in ESD pouches when they are out of the printer.

 **IMPORTANT:** Make sure that all of the shipping materials (for example shipping tape) are removed from the replacement part prior to installation.

 **NOTE:** If the replacement part is a roller or pad, avoid touching the spongy part of it. Skin oils on the roller or pad can cause paper pickup and/or print-quality problems. HP recommends using disposable gloves when handling rollers or pads or washing your hands before touching rollers or pads.

3. To install an assembly, reverse the removal steps.

 **NOTE:** When applicable, special installation instructions are provided for an assembly at the end of the removal procedure. Always completely read the removal instructions and follow all special installation instructions.

Removal and replacement: DC controller (DCC)

This document provides the procedures to remove and replace the DC controller (DCC).

Mean time to repair: 30 minutes

Service level: Intermediate

Before performing service

Turn the printer power off

- Disconnect the power cable.

 **WARNING!** To avoid damage to the printer, turn the printer off, wait 30 seconds, and then remove the power cord before attempting to service the printer.

 **IMPORTANT:** Do not replace the formatter, DC controller, and eMMC PCA or hard-disk drive simultaneously during a single printer servicing. Doing so might cause the printer to become unstable or inoperable.

Use the table below to identify the correct part number for your printer, and then go to <https://parts.hp.com/hpparts> to order the part.

Table 5-56 Part information

Part number	Part description
RM3-7751-000CN	DC controller PCA (5700/X557)
RM3-7752-000CN	DC controller PCA (5800)
RM3-7756-000CN	DC controller PCA (X57945)

Required tools

- #2 Phillips screwdriver with a magnetic tip

After performing service

Make sure that all of the connectors on the DC controller are fully seated.

Make sure that the formatter cover is fully seated, and that the thumbscrews are finger tight after replacing it.

Turn the printer power on

- Connect the power cable.
- Use the power switch to turn the power on.

Post service test

Print a configuration page to make sure that the printer is functioning correctly.

1. Remove the formatter cover

Follow these steps to remove the formatter cover.

- Remove one screw (callout 1), and then slide the formatter cover (callout 2) away from the printer to remove it.



 **TIP:** Reverse the removal steps to install the assembly.

Figure 5-319 Remove the formatter cover

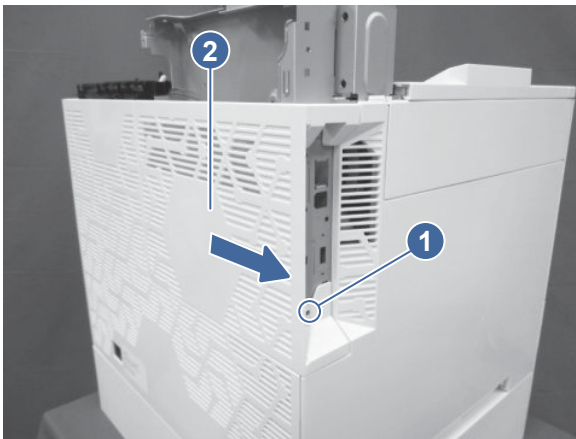

2. Remove the rear cover

Follow these steps to remove the rear cover.

 **NOTE:** The figures below show some assemblies (for example the top cover and formatter) removed that might still be installed on the printer. However, the steps to remove the cover are correct.

1. Open the right door, and remove two screws.

Figure 5-320 Remove two screws

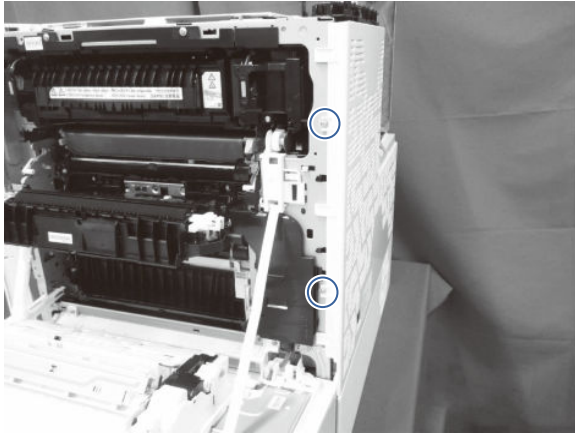

2. At the back of the printer, remove two screws, and then slide the rear cover as indicated to remove it.

Figure 5-321 Remove the rear cover

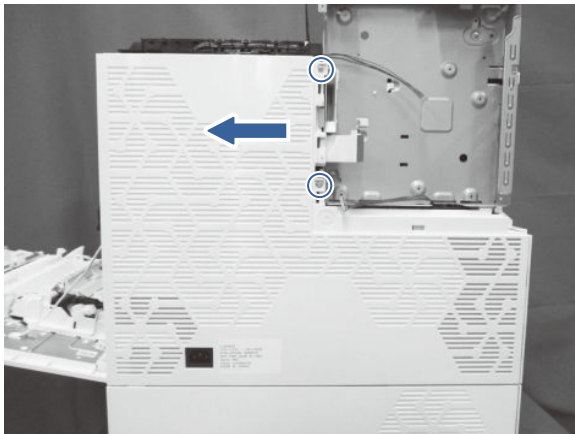

3. Remove the DC controller

Follow these steps to remove the DC controller.

- Disconnect all of the connectors on the DC controller, remove four screws (callout 1), and then remove the DC controller (callout 2).

 **IMPORTANT:** Some of the flat flexible cable (FFC) connectors use hinged retainers to secure them to the DC controller. The hinged retainers must be opened to release the FFCs.

Figure 5-322 Remove the DC controller



4. Unpack the replacement assembly

Follow these steps to unpack the replacement assembly.

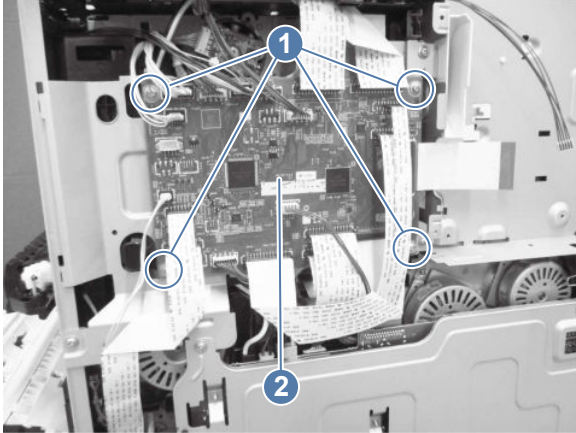
1. Dispose of the defective part.



NOTE: HP recommends responsible disposal of the defective part.

<http://www8.hp.com/us/en/hp-information/environment/product-recycling.html>

2. Unpack the replacement part from the packaging.



CAUTION:  Some parts are sensitive to electrostatic discharge (ESD). Always perform service work at an ESD-protected workstation or mat. If an ESD workstation or mat is not available, touch the sheet-metal chassis to provide a static ground before touching an ESD-sensitive assembly. Protect the ESD-sensitive assemblies by placing them in ESD pouches when they are out of the printer.



IMPORTANT: Make sure that all of the shipping materials (for example shipping tape) are removed from the replacement part prior to installation.



NOTE: If the replacement part is a roller or pad, avoid touching the spongy part of it. Skin oils on the roller or pad can cause paper pickup and/or print-quality problems. HP recommends using disposable gloves when handling rollers or pads or washing your hands before touching rollers or pads.

3. To install an assembly, reverse the removal steps.



NOTE: When applicable, special installation instructions are provided for an assembly at the end of the removal procedure. Always completely read the removal instructions and follow all special installation instructions.

Removal and replacement: Formatter

This document provides the procedures to remove and replace the formatter.

Mean time to repair: 10 minutes

Service level: Intermediate

Before performing service

Turn the printer power off

- Disconnect the power cable.

⚠ WARNING! To avoid damage to the printer, turn the printer off, wait 30 seconds, and then remove the power cord before attempting to service the printer.

⚠ CAUTION: Under **NO** circumstances should a formatter from a different printer be installed during the repair or troubleshooting processes. The formatter stores important data specific to the model of printer it is installed in and is not designed to be swapped or re-purposed in any way. Return a used formatter to HP.

Issues that can occur from swapping a formatter include:

- Serial number, product number, product name, page count, and supported cartridges information change and might make a product unusable.
- 33.02.01 Used board/Disk installed errors.

If a used formatter is installed and causes this issue, the partner must cover the costs of the repair in the form of a product replacement. **There is no method in the field to recover a printer where a used formatter is installed.**

🔧 IMPORTANT: Do not replace the formatter, DC controller, and hard-disk drive simultaneously during a single printer servicing. Doing so might cause the printer to become unstable or inoperable.

Use the table below to identify the correct part number for your printer, and then go to <https://parts.hp.com/hpparts> to order the part.

Table 5-57 Part information

Part number	Part description
6QN27-67002	Formatter (57xx / X55xxx)
6QN27-67004	Formatter (57xx / X55xxx) (China/India)
6QN29-67002	Formatter (58xx / X57xxx)
6QN29-67004	Formatter (58xx / X57xxx) (China/India)
6QN32-67002	Formatter (67xx / X65xxx)
6QN32-67004	Formatter (67xx / X65xxx) (China/India)
6QN35-67002	Formatter (68xx / X67xxx)
6QN35-67005	Formatter (68xx / X67xxx) (China/India)

Required tools

- #2 Phillips screwdriver with a magnetic tip

After performing service

Make sure that all of the connectors on the formatter are fully seated.

Make sure that the formatter cover is fully seated.

Turn the printer power on

- Connect the power cable.
- Use the power switch to turn the power on.

Post service test

Print a configuration page to make sure that the printer is functioning correctly.

1. Remove the formatter cover

Follow these steps to remove the formatter cover.

- Remove one screw (callout 1), and then slide the formatter cover (callout 2) away from the printer to remove it.

 **TIP:** Reverse the removal steps to install the assembly.

Figure 5-323 Remove the formatter cover



2. Remove the formatter

Follow these steps to remove the formatter.

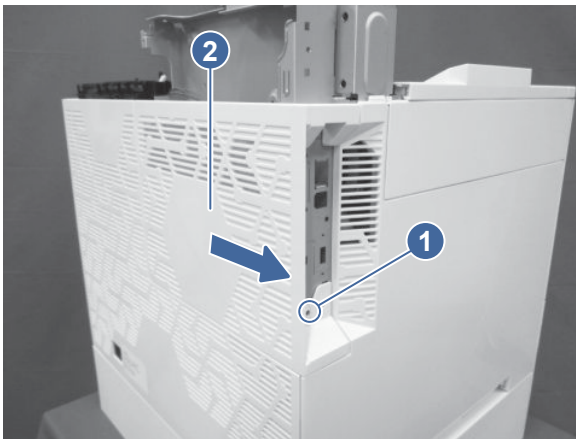
1. Disconnect all of the connectors on the formatter.

 **IMPORTANT:** Some of the flat flexible cable (FFC) connectors use hinged retainers to secure them to the DC controller. The hinged retainers must be opened to release the FFCs.

2. Remove the fax PCA (callout 1) and the hard disk drive (HDD) (callout 2), and then remove seven screws (callout 3) to remove the formatter.

Figure 5-324 Remove the formatter

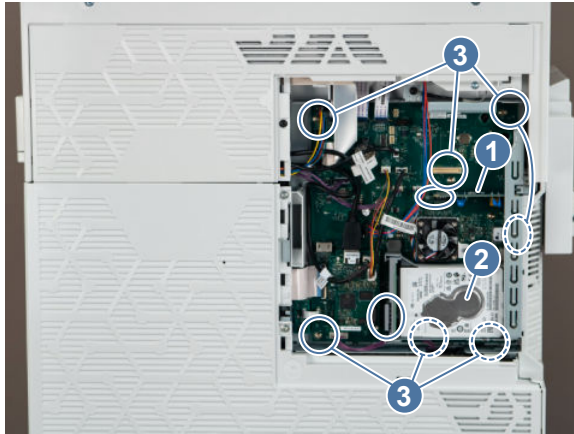

3. Unpack the replacement assembly

Follow these steps to unpack the replacement assembly.

1. Dispose of the defective part.



NOTE: HP recommends responsible disposal of the defective part.

<http://www8.hp.com/us/en/hp-information/environment/product-recycling.html>

2. Unpack the replacement part from the packaging.



CAUTION:  Some parts are sensitive to electrostatic discharge (ESD). Always perform service work at an ESD-protected workstation or mat. If an ESD workstation or mat is not available, touch the sheet-metal chassis to provide a static ground before touching an ESD-sensitive assembly. Protect the ESD-sensitive assemblies by placing them in ESD pouches when they are out of the printer.



IMPORTANT: Make sure that all of the shipping materials (for example shipping tape) are removed from the replacement part prior to installation.



NOTE: If the replacement part is a roller or pad, avoid touching the spongy part of it. Skin oils on the roller or pad can cause paper pickup and/or print-quality problems. HP recommends using disposable gloves when handling rollers or pads or washing your hands before touching rollers or pads.

3. To install an assembly, reverse the removal steps.



NOTE: When applicable, special installation instructions are provided for an assembly at the end of the removal procedure. Always completely read the removal instructions and follow all special installation instructions.

Removal and replacement: Formatter cage assembly (SFP models)

Learn about removing and replacing the formatter cage assembly for SFP models.

Before performing service

Turn the printer power off

- Disconnect the power cable.

⚠ WARNING! To avoid damage to the printer, turn the printer off, wait 30 seconds, and then remove the power cord before attempting to service the printer.

If the part is damaged and cannot be cleaned, use the table below to identify the correct part number for your printer. To order the part, go to www.hp.com/buy/parts.

Table 5-58 Part information

Part number	Part description
RM2-4520-000CN	Formatter cage assembly (SFP)

Required tools

- #2 Phillips screwdriver with a magnetic tip and a 152 mm (6 in) shaft length

After performing service

Turn the printer power on

- Connect the power cable.
- Use the power switch to turn the power on.

Post service test

Print any pages necessary to make sure the printer is functioning correctly.

1. Remove the formatter cover

Follow these steps to remove the formatter cover.

- Remove one screw (callout 1), and then slide the formatter cover (callout 2) away from the printer to remove it.

💡 TIP: Reverse the removal steps to install the assembly.

Figure 5-325 Remove the formatter cover

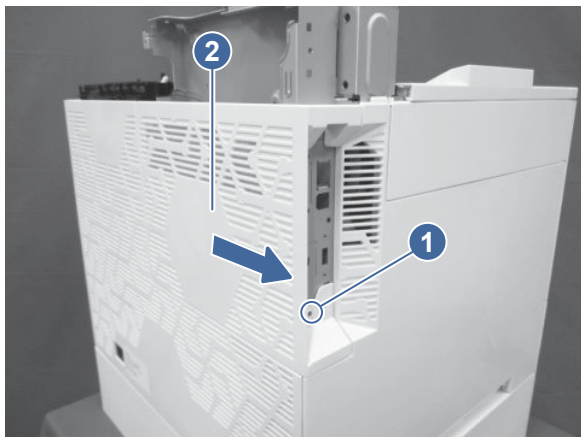

2. Remove the formatter

Follow these steps to remove the formatter.

1. Disconnect all of the connectors on the formatter.

 **IMPORTANT:** Some of the flat flexible cable (FFC) connectors use hinged retainers to secure them to the DC controller. The hinged retainers must be opened to release the FFCs.

2. Remove the fax PCA (callout 1) and the hard disk drive (HDD) (callout 2), and then remove seven screws (callout 3) to remove the formatter.

Figure 5-326 Remove the formatter

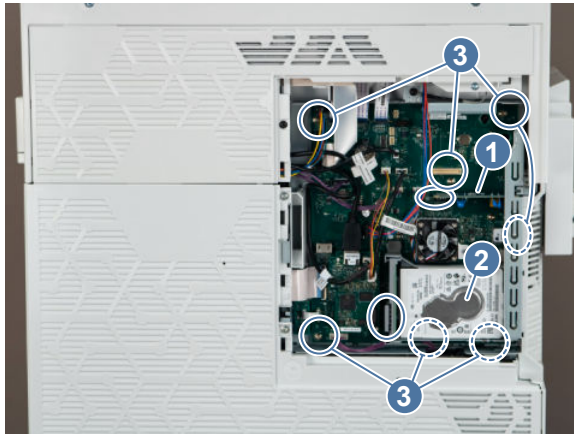

3. Remove the rear cover

Follow these steps to remove the rear cover.

 **NOTE:** The figures below show some assemblies (for example the top cover and formatter) removed that might still be installed on the printer. However, the steps to remove the cover are correct.

1. Open the right door, and remove two screws.

Figure 5-327 Remove two screws

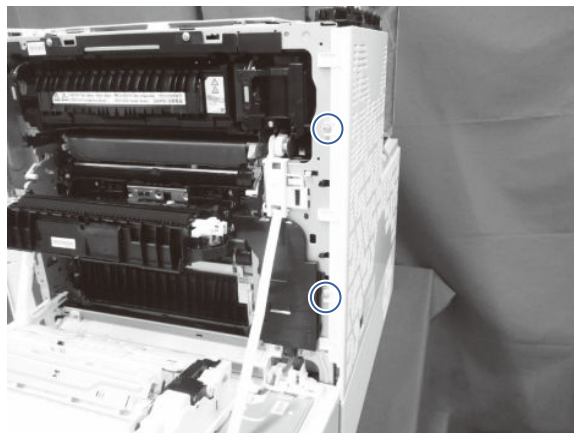

2. At the back of the printer, remove two screws, and then slide the rear cover as indicated to remove it.

Figure 5-328 Remove the rear cover

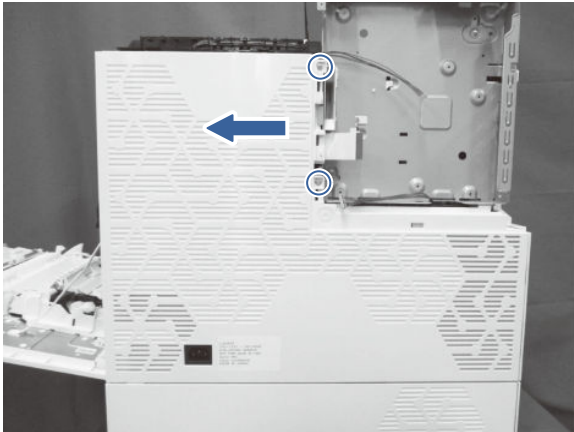

4. Remove the formatter cage (SFP models)

Follow these steps to remove the formatter cage.

1. Disconnect all the connectors on the DC controller PCA.

 **IMPORTANT:** Some of the flat flexible cable (FFC) connectors use hinged retainers to secure them to the DC controller. The hinged retainers must be opened to release the FFCs.

2. Remove the cable clamp (callout 1), remove four screws (callout 2), and then slide the DC controller stay (callout 3) out to remove it.

 **NOTE:** Be careful not to drop any of the screws into the low-voltage power supply assembly below the DC controller.

Figure 5-329 Remove the DC controller stay



3. Unhook one spring (callout 1), release the cable (callout 2) from the cable clamp (callout 3), remove four screws (callout 4), and then remove the formatter cage (callout 5).

Figure 5-330 Remove the formatter cage

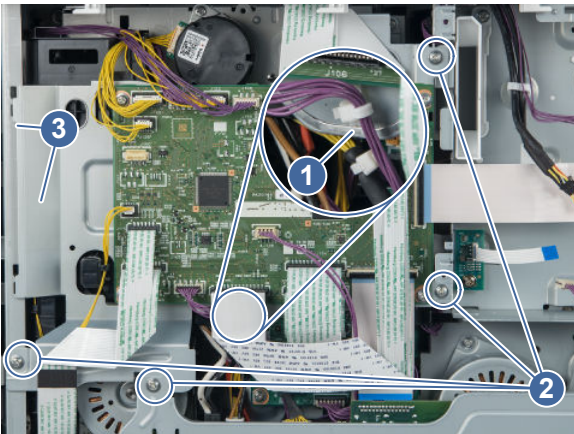
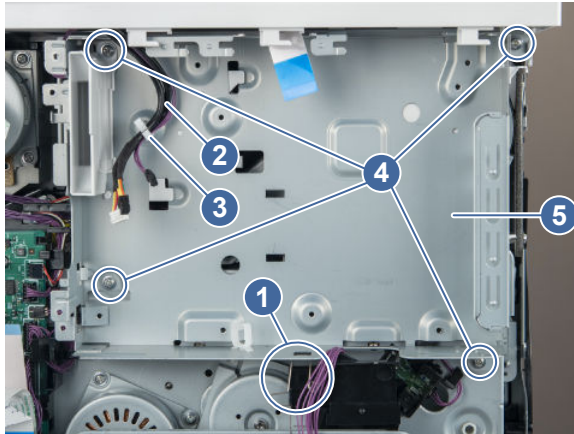

4. **For a replacement formatter cage only:** Release the cable (callout 1) from the cable guide (callout 2), release one tab (callout 3), and then remove the memory PCA (callout 4) from the formatter cage (callout 5).



NOTE: Install the PCA on the replacement formatter cage.

Figure 5-331 Remove the memory PCA

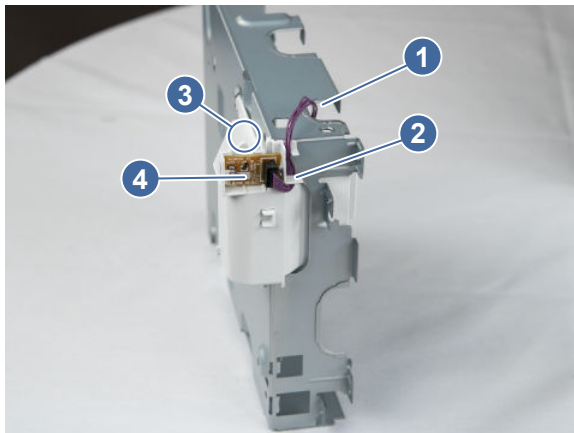

5. Unpack the replacement assembly

Follow these steps to unpack the replacement assembly.

1. Dispose of the defective part.



NOTE: HP recommends responsible disposal of the defective part.

<http://www8.hp.com/us/en/hp-information/environment/product-recycling.html>

2. Unpack the replacement part from the packaging.



CAUTION:  Some parts are sensitive to electrostatic discharge (ESD). Always perform service work at an ESD-protected workstation or mat. If an ESD workstation or mat is not available, touch the sheet-metal chassis to provide a static ground before touching an ESD-sensitive assembly.

Protect the ESD-sensitive assemblies by placing them in ESD pouches when they are out of the printer.

 **IMPORTANT:** Make sure that all of the shipping materials (for example shipping tape) are removed from the replacement part prior to installation.

 **NOTE:** If the replacement part is a roller or pad, avoid touching the spongy part of it. Skin oils on the roller or pad can cause paper pickup and/or print-quality problems. HP recommends using disposable gloves when handling rollers or pads or washing your hands before touching rollers or pads.

3. To install an assembly, reverse the removal steps.

 **NOTE:** When applicable, special installation instructions are provided for an assembly at the end of the removal procedure. Always completely read the removal instructions and follow all special installation instructions.

Removal and replacement: Formatter cage assembly (MFP models)

Learn about removing and replacing the formatter cage assembly for MFP models.

Before performing service

Turn the printer power off

- Disconnect the power cable.

 **WARNING!** To avoid damage to the printer, turn the printer off, wait 30 seconds, and then remove the power cord before attempting to service the printer.

If the part is damaged and cannot be cleaned, use the table below to identify the correct part number for your printer. To order the part, go to www.hp.com/buy/parts.

Table 5-59 Part information

Part number	Part description
RM2-4521-000CN	Formatter cage assembly (MFP)

Required tools

- #2 Phillips screwdriver with a magnetic tip and a 152 mm (6 in) shaft length

After performing service

Turn the printer power on

- Connect the power cable.
- Use the power switch to turn the power on.

Post service test

Print any pages necessary to make sure the printer is functioning correctly.

1. Remove the formatter cover

Follow these steps to remove the formatter cover.

- Remove one screw (callout 1), and then slide the formatter cover (callout 2) away from the printer to remove it.

 **TIP:** Reverse the removal steps to install the assembly.

Figure 5-332 Remove the formatter cover



2. Remove the formatter

Follow these steps to remove the formatter.

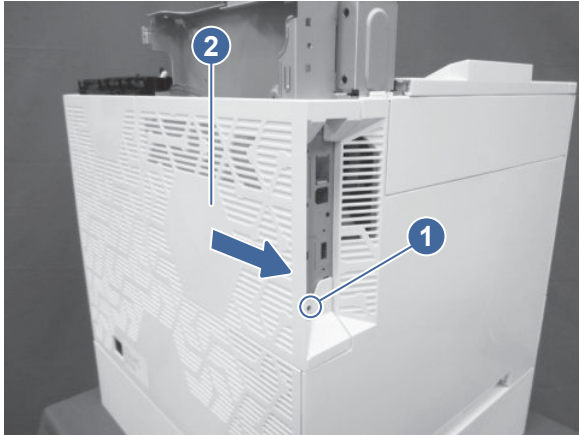
1. Disconnect all of the connectors on the formatter.

 **IMPORTANT:** Some of the flat flexible cable (FFC) connectors use hinged retainers to secure them to the DC controller. The hinged retainers must be opened to release the FFCs.

2. Remove the fax PCA (callout 1) and the hard disk drive (HDD) (callout 2), and then remove seven screws (callout 3) to remove the formatter.

Figure 5-333 Remove the formatter

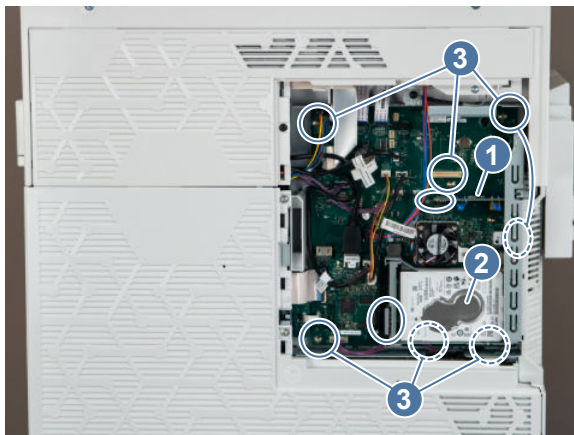

3. Remove the rear cover

Follow these steps to remove the rear cover.

 **NOTE:** The figures below show some assemblies (for example the top cover and formatter) removed that might still be installed on the printer. However, the steps to remove the cover are correct.

1. Open the right door, and remove two screws.

Figure 5-334 Remove two screws

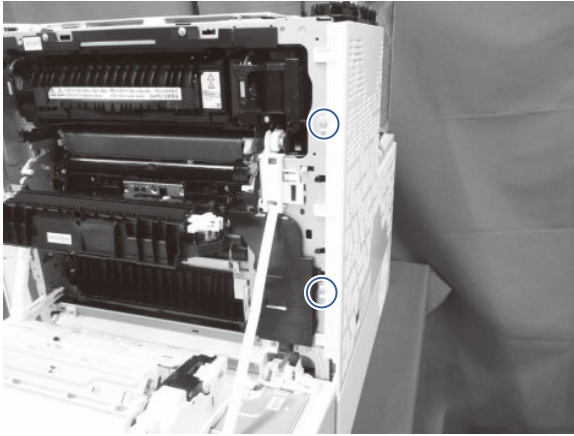

2. At the back of the printer, remove two screws, and then slide the rear cover as indicated to remove it.

Figure 5-335 Remove the rear cover

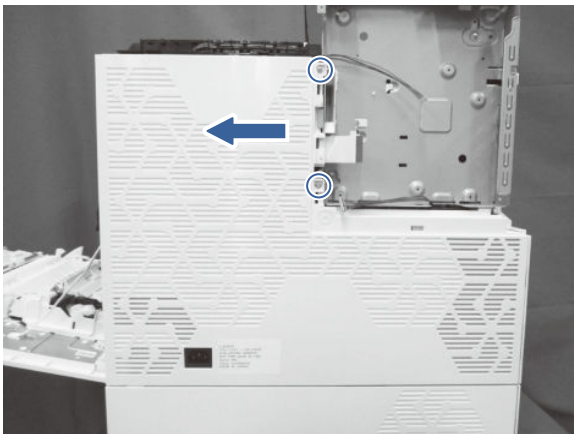

4. Remove the formatter cage (MFP models)

Follow these steps to remove the formatter cage.

1. Unhook one spring (callout 1), remove seven screws (callout 2), and then remove the formatter cage (callout 3).

Figure 5-336 Remove the formatter cage

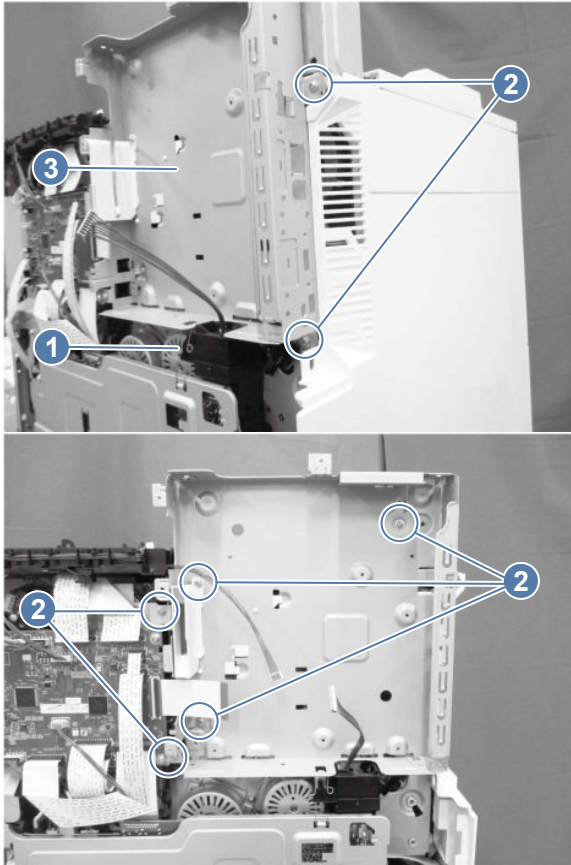

2. **For a replacement formatter cage only:** Release the cable (callout 1) from the cable guide (callout 2), release one tab (callout 3), and then remove the memory PCA (callout 4) from the formatter cage (callout 5).

 **NOTE:** Install the PCA on the replacement formatter cage.

Figure 5-337 Remove the memory PCA



5. Unpack the replacement assembly

Follow these steps to unpack the replacement assembly.

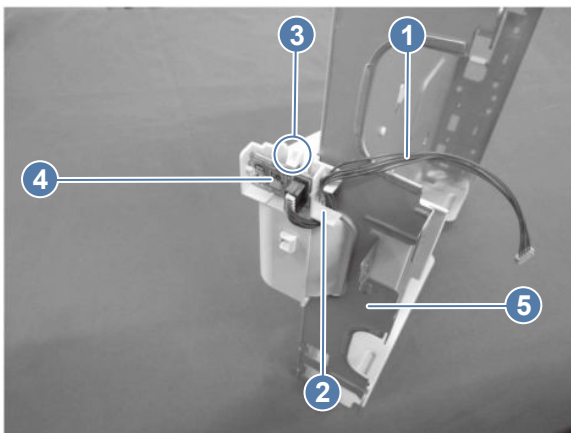
1. Dispose of the defective part.



NOTE: HP recommends responsible disposal of the defective part.

<http://www8.hp.com/us/en/hp-information/environment/product-recycling.html>

2. Unpack the replacement part from the packaging.



CAUTION:  Some parts are sensitive to electrostatic discharge (ESD). Always perform service work at an ESD-protected workstation or mat. If an ESD workstation or mat is not available, touch the sheet-metal chassis to provide a static ground before touching an ESD-sensitive assembly. Protect the ESD-sensitive assemblies by placing them in ESD pouches when they are out of the printer.



IMPORTANT: Make sure that all of the shipping materials (for example shipping tape) are removed from the replacement part prior to installation.



NOTE: If the replacement part is a roller or pad, avoid touching the spongy part of it. Skin oils on the roller or pad can cause paper pickup and/or print-quality problems. HP recommends using disposable gloves when handling rollers or pads or washing your hands before touching rollers or pads.

3. To install an assembly, reverse the removal steps.



NOTE: When applicable, special installation instructions are provided for an assembly at the end of the removal procedure. Always completely read the removal instructions and follow all special installation instructions.

Removal and replacement: Feed drive assembly (X57945 models)

Learn about removing and replacing the feed drive assembly.

Before performing service

Turn the printer power off

- Disconnect the power cable.



WARNING! To avoid damage to the printer, turn the printer off, wait 30 seconds, and then remove the power cord before attempting to service the printer.

If the part is damaged and cannot be cleaned, use the table below to identify the correct part number for your printer. To order the part, go to www.hp.com/buy/parts.

Table 5-60 Part information

Part number	Part description
RM2-3702-000CN	Paper pickup drive assembly (X57945)
RM2-3683-000CN	Paper pickup drive assembly (X654/X677)

Required tools

- #2 Phillips screwdriver with a magnetic tip and a 152 mm (6 in) shaft length

After performing service

Turn the printer power on

- Connect the power cable.
- Use the power switch to turn the power on.

Post service test

Print any pages necessary to make sure the printer is functioning correctly.

1. Remove the formatter cover

Follow these steps to remove the formatter cover.

- Remove one screw (callout 1), and then slide the formatter cover (callout 2) away from the printer to remove it.



 **TIP:** Reverse the removal steps to install the assembly.

Figure 5-338 Remove the formatter cover

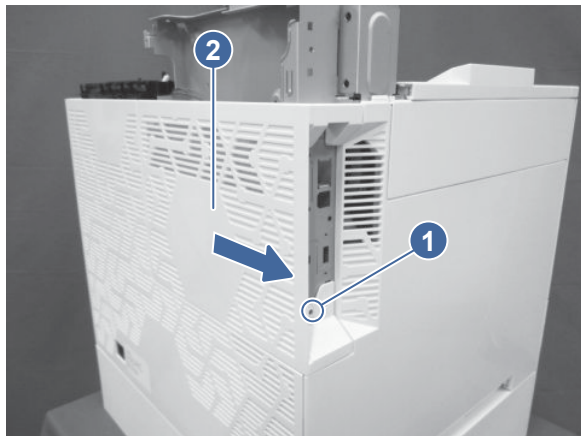

2. Remove the rear cover

Follow these steps to remove the rear cover.

 **NOTE:** The figures below show some assemblies (for example the top cover and formatter) removed that might still be installed on the printer. However, the steps to remove the cover are correct.

1. Open the right door, and remove two screws.

Figure 5-339 Remove two screws

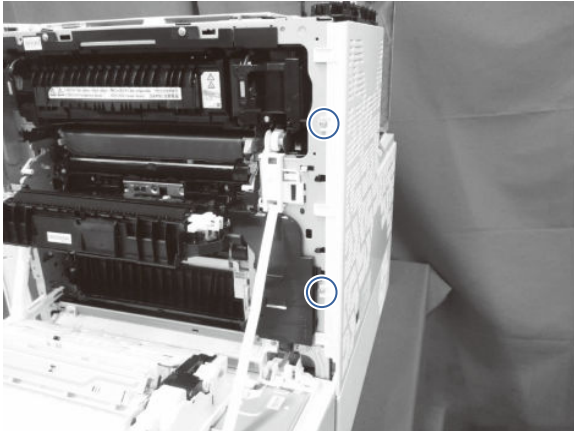

2. At the back of the printer, remove two screws, and then slide the rear cover as indicated to remove it.

Figure 5-340 Remove the rear cover

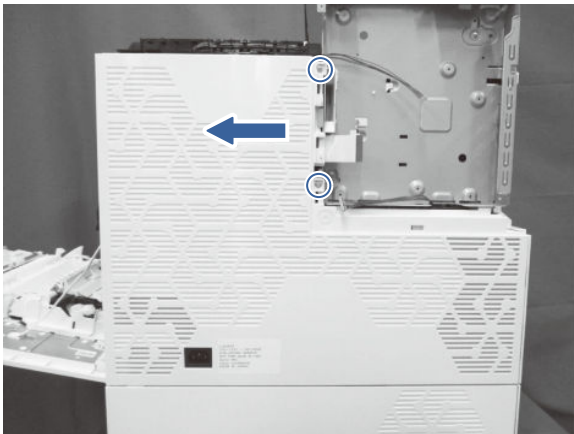

3. Remove the low-voltage power supply (LVPS)

Follow these steps to remove the low-voltage power supply (LVPS).

1. Unhook one spring (callout 1), and then disconnect two connectors (callout 2).



NOTE: Unhook the spring from the formatter cage, not the low-voltage power supply. The spring should remain attached to the LVPS.

Figure 5-341 Unhook the spring and disconnect two connectors

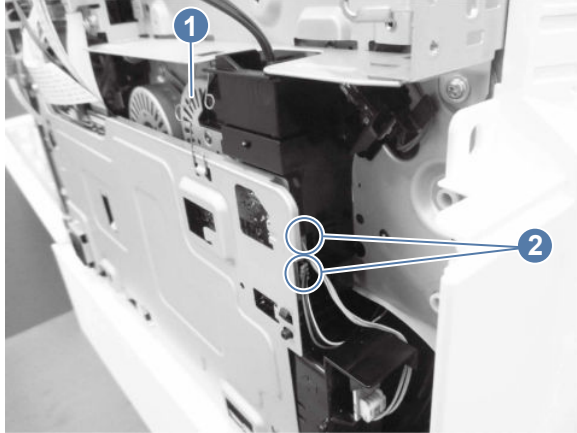

2. Remove the FFC (callout 1), and then disconnect five connectors (callout 2).

 **NOTE:** MFP only: Disconnect one additional connector (callout 3).

Figure 5-342 Disconnect the LVPS connectors



3. Remove four screws (callout 1), and then remove the low-voltage power supply assembly (callout 2).

 **NOTE:** The black ducting in the lower right corner can stick during the removal process.

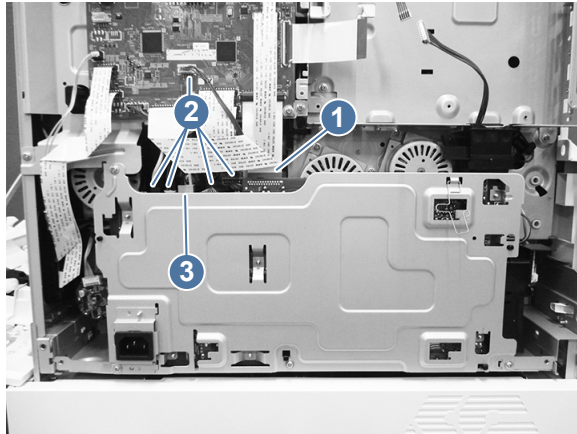
Replacement LVPS only: Remove the spring (callout 3), and then install it on the replacement LVPS.

Figure 5-343 Remove the LVPS

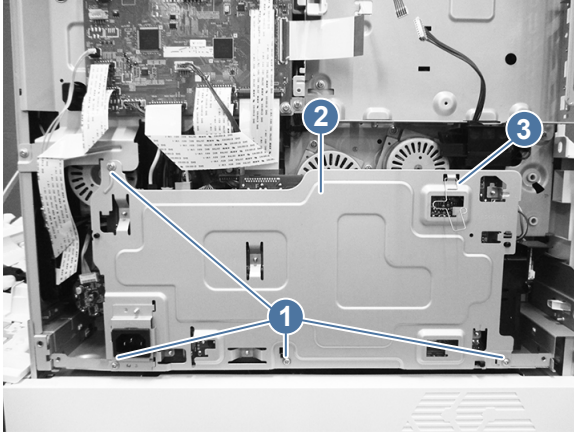

Reinstallation tip: When reinstalling the LVPS, make sure that the spring (callout 1) is attached to both the formatter cage (callout 2) and the LVPS (callout 3).

Figure 5-344 Reinstalling the LVPS

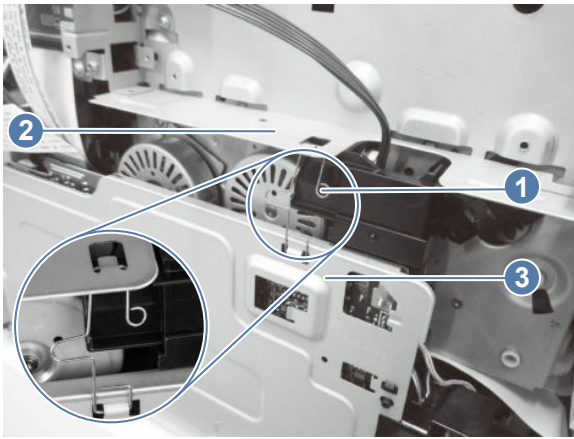

4. Remove the feed drive assembly (X57945 models)

Follow these steps to remove the feed drive assembly.

1. Disconnect one connector (callout 1), and then remove three screws (callout 2).

Figure 5-345 Disconnect connector, remove 3 screws

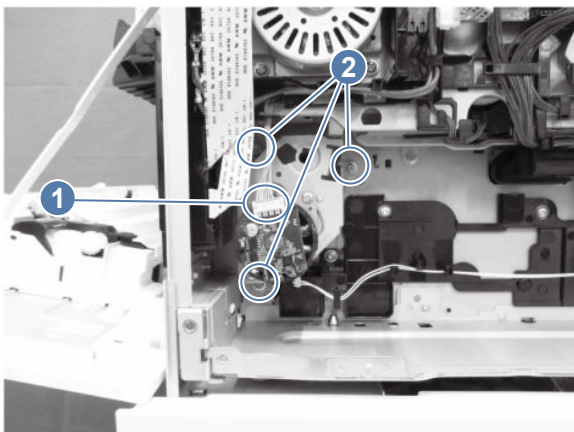

2. Release one tab (callout 1), and then remove the feed drive assembly (callout 2).

Figure 5-346 Remove the feed drive assembly

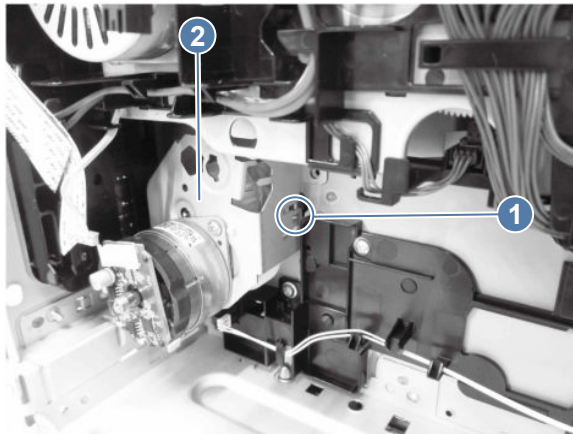

5. Unpack the replacement assembly

Follow these steps to unpack the replacement assembly.

1. Dispose of the defective part.



NOTE: HP recommends responsible disposal of the defective part.

<http://www8.hp.com/us/en/hp-information/environment/product-recycling.html>

2. Unpack the replacement part from the packaging.



CAUTION:  Some parts are sensitive to electrostatic discharge (ESD). Always perform service work at an ESD-protected workstation or mat. If an ESD workstation or mat is not available, touch the sheet-metal chassis to provide a static ground before touching an ESD-sensitive assembly. Protect the ESD-sensitive assemblies by placing them in ESD pouches when they are out of the printer.



IMPORTANT: Make sure that all of the shipping materials (for example shipping tape) are removed from the replacement part prior to installation.



NOTE: If the replacement part is a roller or pad, avoid touching the spongy part of it. Skin oils on the roller or pad can cause paper pickup and/or print-quality problems. HP recommends using disposable gloves when handling rollers or pads or washing your hands before touching rollers or pads.

3. To install an assembly, reverse the removal steps.



NOTE: When applicable, special installation instructions are provided for an assembly at the end of the removal procedure. Always completely read the removal instructions and follow all special installation instructions.

Removal and replacement: Pickup drive assembly (5700/X557/5800 models)

Learn about removing and replacing the pickup drive assembly.

Before performing service

Turn the printer power off

- Disconnect the power cable.

⚠ WARNING! To avoid damage to the printer, turn the printer off, wait 30 seconds, and then remove the power cord before attempting to service the printer.

If the part is damaged and cannot be cleaned, use the table below to identify the correct part number for your printer. To order the part, go to www.hp.com/buy/parts.

Table 5-61 Part information

Part number	Part description
RM2-3681-000CN	Paper pickup drive assembly (5700/X557/5800)
RM2-3682-000CN	Paper pickup drive assembly (6700/6800)

Required tools

- #2 Phillips screwdriver with a magnetic tip and a 152 mm (6 in) shaft length

After performing service

Turn the printer power on

- Connect the power cable.
- Use the power switch to turn the power on.

Post service test

Print any pages necessary to make sure the printer is functioning correctly.

1. Remove the formatter cover

Follow these steps to remove the formatter cover.

- Remove one screw (callout 1), and then slide the formatter cover (callout 2) away from the printer to remove it.

💡 TIP: Reverse the removal steps to install the assembly.

Figure 5-347 Remove the formatter cover

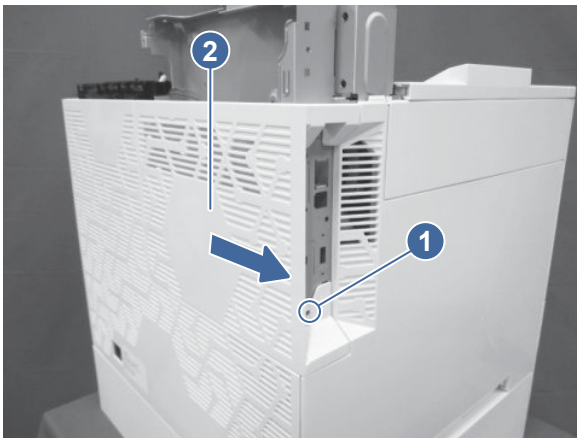

2. Remove the rear cover

Follow these steps to remove the rear cover.

 **NOTE:** The figures below show some assemblies (for example the top cover and formatter) removed that might still be installed on the printer. However, the steps to remove the cover are correct.

1. Open the right door, and remove two screws.

Figure 5-348 Remove two screws

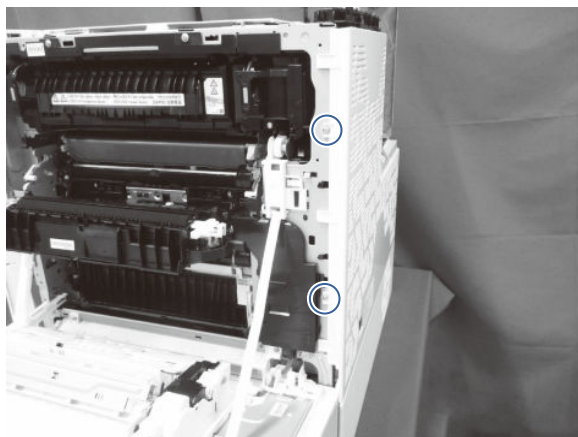

2. At the back of the printer, remove two screws, and then slide the rear cover as indicated to remove it.

Figure 5-349 Remove the rear cover

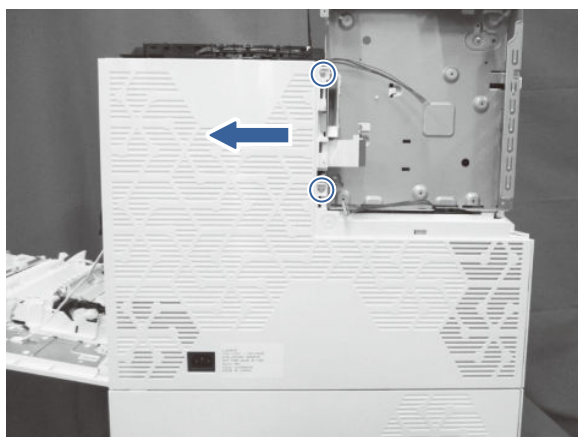

3. Remove the low-voltage power supply (LVPS)

Follow these steps to remove the low-voltage power supply (LVPS).

1. Unhook one spring (callout 1), and then disconnect two connectors (callout 2).

 **NOTE:** Unhook the spring from the formatter cage, not the low-voltage power supply. The spring should remain attached to the LVPS.

Figure 5-350 Unhook the spring and disconnect two connectors



2. Remove the FFC (callout 1), and then disconnect five connectors (callout 2).

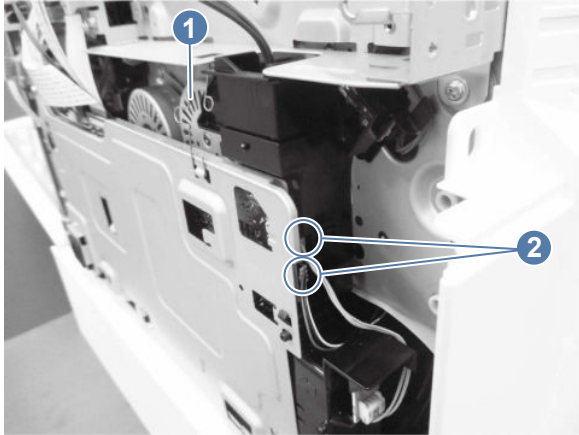

 **NOTE:** MFP only: Disconnect one additional connector (callout 3).

Figure 5-351 Disconnect the LVPS connectors

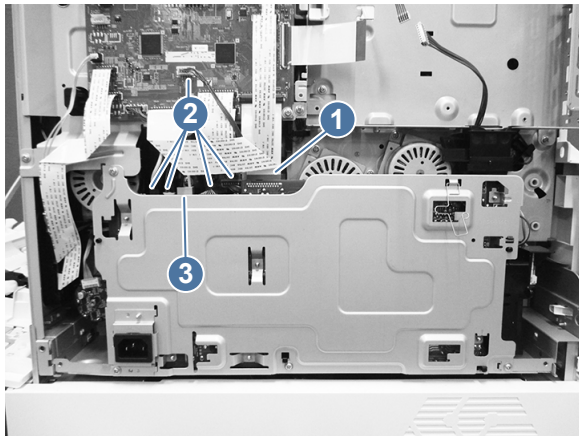

3. Remove four screws (callout 1), and then remove the low-voltage power supply assembly (callout 2).

 **NOTE:** The black ducting in the lower right corner can stick during the removal process.

Replacement LVPS only: Remove the spring (callout 3), and then install it on the replacement LVPS.

Figure 5-352 Remove the LVPS

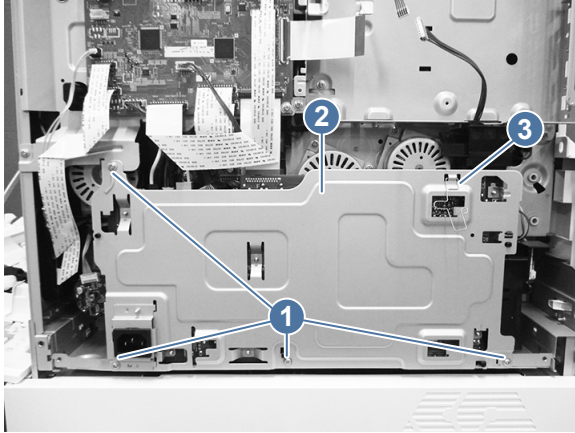

💡 Reinstallation tip: When reinstalling the LVPS, make sure that the spring (callout 1) is attached to both the formatter cage (callout 2) and the LVPS (callout 3).

Figure 5-353 Reinstalling the LVPS

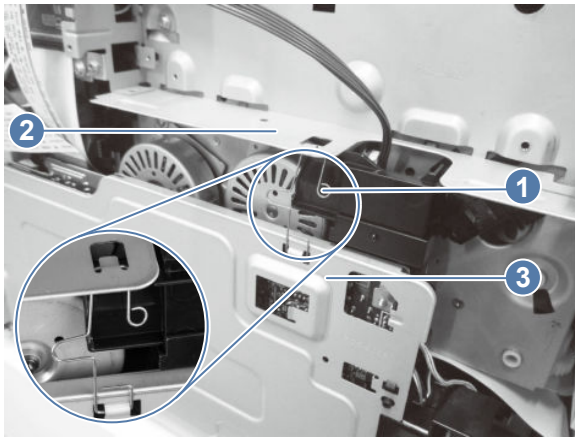

4. Remove the pickup drive assembly (5700/X557/5800 models)

Follow these steps to remove the pickup drive assembly.

1. Disconnect two connectors (callout 1), and then remove three screws (callout 2).

Figure 5-354 Disconnect two connectors, remove three screws

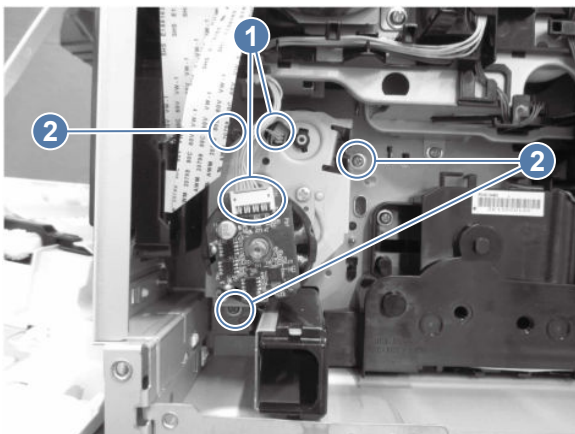

2. Release one tab (callout 1), and then remove the pickup drive assembly (callout 2).

Figure 5-355 Remove the pickup drive assembly

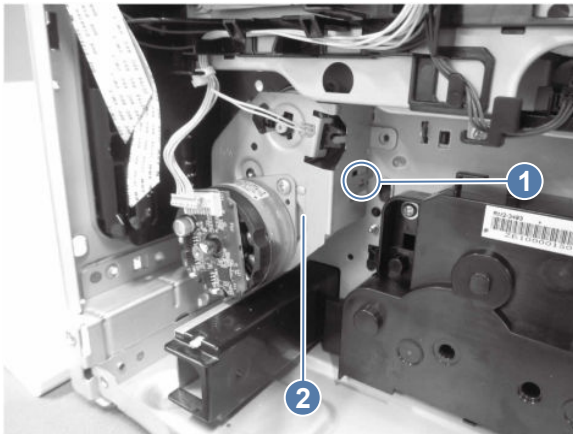

Reinstallation tip: The indicated gears (callout 1), clutch (callout 2), shaft (callout 3), and bushing (callout 4) are not fixed to the assembly plate. Ensure that these components do not fall apart when installing or removing the paper pickup drive assembly.

Figure 5-356 Do not lose unfastened components

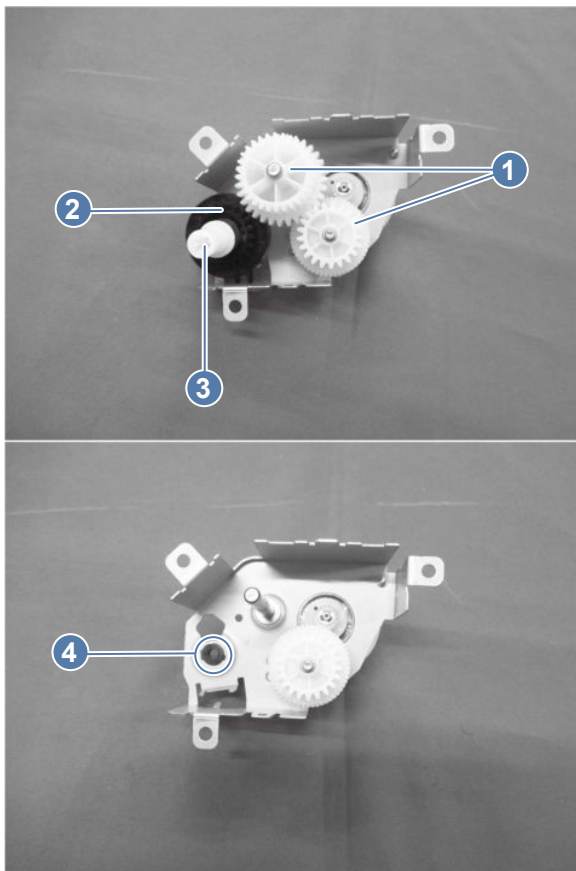

5. Unpack the replacement assembly



Follow these steps to unpack the replacement assembly.

1. Dispose of the defective part.

 **NOTE:** HP recommends responsible disposal of the defective part.

<http://www8.hp.com/us/en/hp-information/environment/product-recycling.html>

2. Unpack the replacement part from the packaging.

 **CAUTION:**  Some parts are sensitive to electrostatic discharge (ESD). Always perform service work at an ESD-protected workstation or mat. If an ESD workstation or mat is not available, touch the sheet-metal chassis to provide a static ground before touching an ESD-sensitive assembly. Protect the ESD-sensitive assemblies by placing them in ESD pouches when they are out of the printer.

 **IMPORTANT:** Make sure that all of the shipping materials (for example shipping tape) are removed from the replacement part prior to installation.

 **NOTE:** If the replacement part is a roller or pad, avoid touching the spongy part of it. Skin oils on the roller or pad can cause paper pickup and/or print-quality problems. HP recommends using disposable gloves when handling rollers or pads or washing your hands before touching rollers or pads.

3. To install an assembly, reverse the removal steps.

 **NOTE:** When applicable, special installation instructions are provided for an assembly at the end of the removal procedure. Always completely read the removal instructions and follow all special installation instructions.

Removal and replacement: Pickup drive assembly (X57945 models)

Learn about removing and replacing the pickup drive assembly.

Before performing service

Turn the printer power off

- Disconnect the power cable.

 **WARNING!** To avoid damage to the printer, turn the printer off, wait 30 seconds, and then remove the power cord before attempting to service the printer.

If the part is damaged and cannot be cleaned, use the table below to identify the correct part number for your printer. To order the part, go to www.hp.com/buy/parts.

Table 5-62 Part information

Part number	Part description
RM2-3683-000CN	Paper pickup drive assembly (X654/X677)
RM2-3702-000CN	Paper pickup drive assembly (X57945)

Required tools

- #2 Phillips screwdriver with a magnetic tip and a 152 mm (6 in) shaft length

After performing service

Turn the printer power on

- Connect the power cable.
- Use the power switch to turn the power on.

Post service test

Print any pages necessary to make sure the printer is functioning correctly.

1. Remove the front right cover

Follow these steps to remove the front right cover.

1. Open the toner cartridge access door.
2. Open the right lower door.
3. Release one tab, and then slide the front right cover upward to remove it.

Figure 5-357 Remove the front right cover

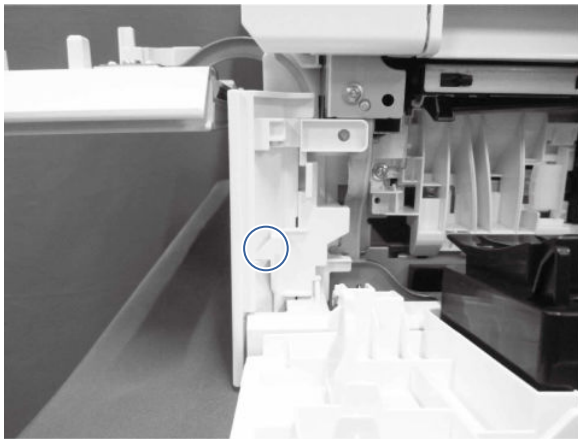

2. Remove the right lower door (X57945 models)

Follow these steps to remove the right lower door.

1. Remove two screws (callout 1), and then remove the base frame (callout 2).

Figure 5-358 Remove the base frame

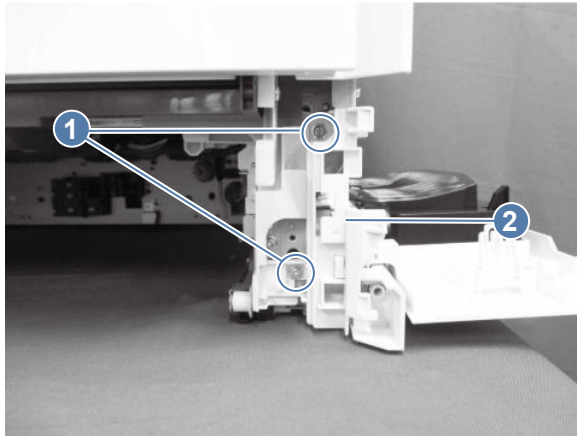

2. Remove one screw (callout 1), release one tab (callout 2), and then slide the rear inner cover (callout 3) downward to remove it.

Figure 5-359 Remove the rear inner cover

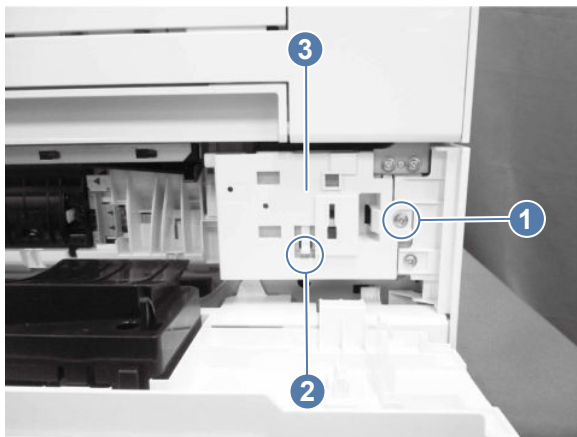

3. Release one tab (callout 1), and then slide the right lower door assembly (callout 2) in the direction indicated to remove it.

Figure 5-360 Remove the right lower door assembly

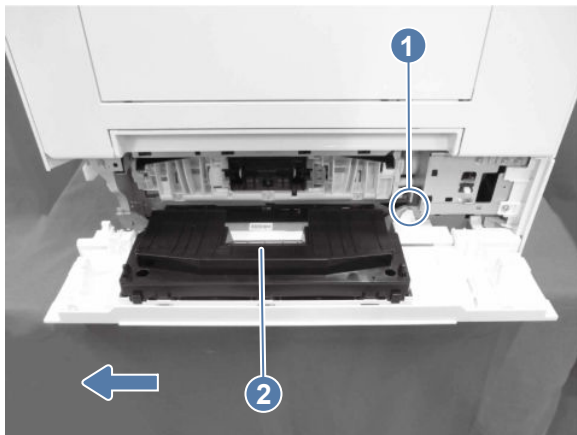

3. Remove the rear lower cover (X57945 models)

Follow these steps to remove the rear lower cover.

- Remove one screw (callout 1), slide the rear lower cover (callout 2) in the direction indicated below, and then remove it.

Figure 5-361 Remove the rear lower cover

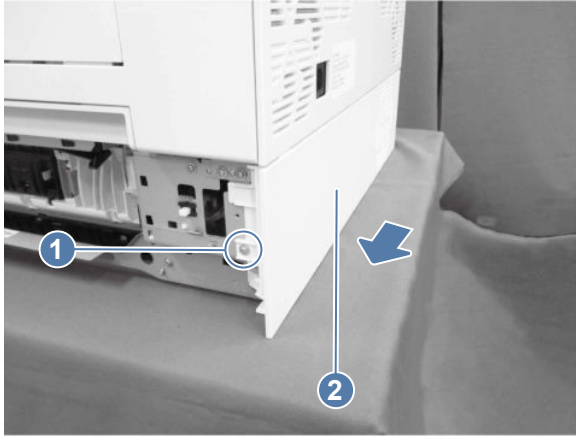

4. Remove the pickup drive assembly (X57945 models)

Follow these steps to remove the pickup drive assembly.

1. Disconnect three connectors (callout 1).

Figure 5-362 Disconnect three connectors

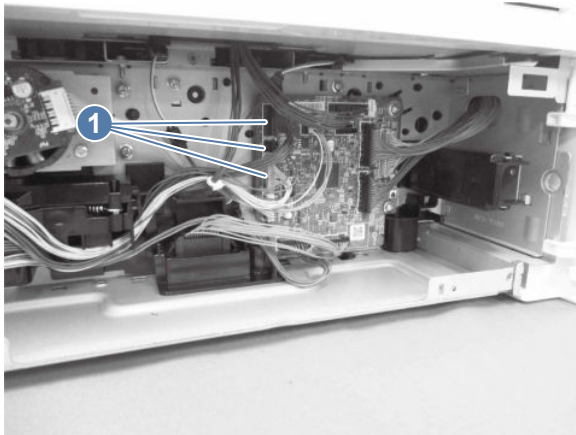

2. Release the cable (callout 1) from the auto close assembly (callout 2) and the lifter drive assembly (callout 3).

Figure 5-363 Release the cable

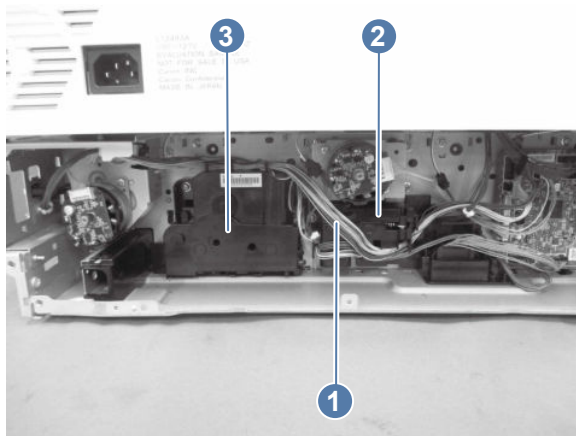

3. Remove the cable clamp (callout 1), disconnect two connectors (callout 2), and then remove three screws (callout 3).

Figure 5-364 Remove the cable clamp

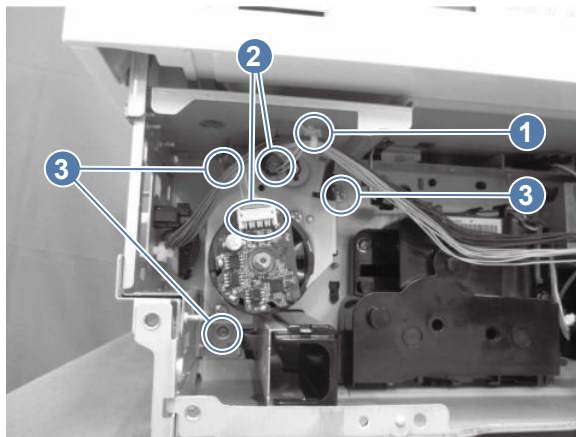

4. Release one tab (callout 1), and then remove the pickup drive assembly (callout 2).

Figure 5-365 Remove the pickup drive assembly

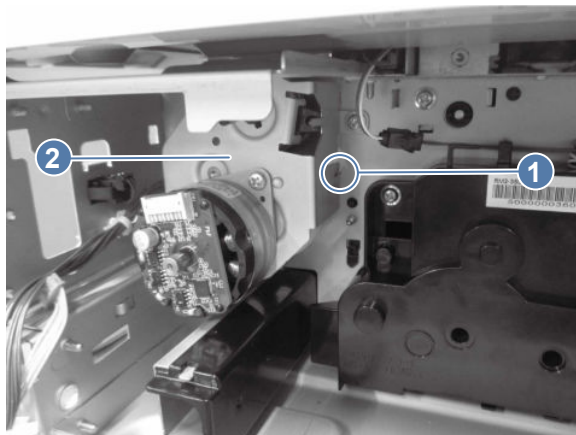

 **Reinstallation tip:** The indicated gears (callout 1), clutch (callout 2), shaft (callout 3), and bushing (callout 4) are not fixed to the assembly plate. Ensure that these components do not fall apart when installing or removing the paper pickup drive assembly.

Figure 5-366 Do not lose unfastened components



5. Unpack the replacement assembly

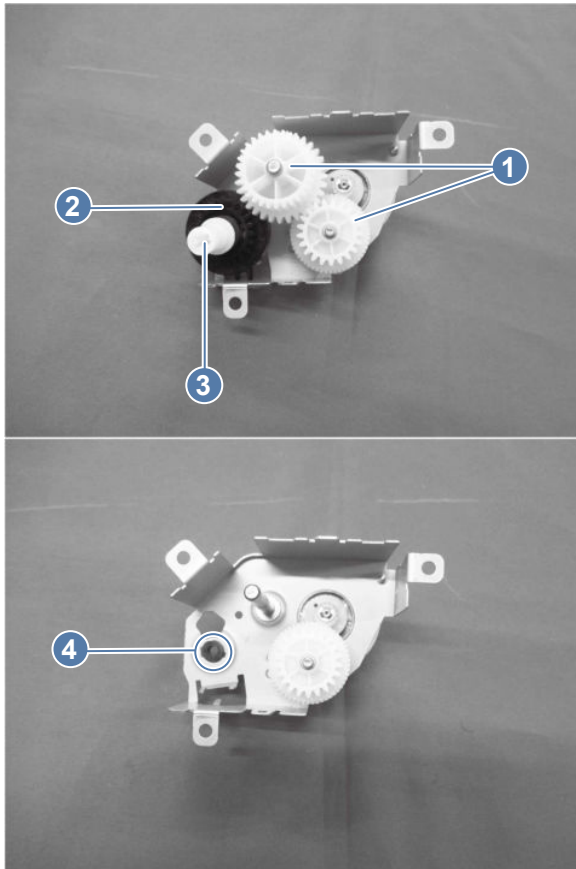

Follow these steps to unpack the replacement assembly.

1. Dispose of the defective part.

 **NOTE:** HP recommends responsible disposal of the defective part.

<http://www8.hp.com/us/en/hp-information/environment/product-recycling.html>

2. Unpack the replacement part from the packaging.

 **CAUTION:**  Some parts are sensitive to electrostatic discharge (ESD). Always perform service work at an ESD-protected workstation or mat. If an ESD workstation or mat is not available, touch the sheet-metal chassis to provide a static ground before touching an ESD-sensitive assembly. Protect the ESD-sensitive assemblies by placing them in ESD pouches when they are out of the printer.

 **IMPORTANT:** Make sure that all of the shipping materials (for example shipping tape) are removed from the replacement part prior to installation.

 **NOTE:** If the replacement part is a roller or pad, avoid touching the spongy part of it. Skin oils on the roller or pad can cause paper pickup and/or print-quality problems. HP recommends using disposable gloves when handling rollers or pads or washing your hands before touching rollers or pads.

3. To install an assembly, reverse the removal steps.

 **NOTE:** When applicable, special installation instructions are provided for an assembly at the end of the removal procedure. Always completely read the removal instructions and follow all special installation instructions.

Removal and replacement: Toner supply motor assembly (X57945 models)

Learn about removing and replacing the toner supply motor assembly.

Before performing service

Turn the printer power off

- Disconnect the power cable.

 **WARNING!** To avoid damage to the printer, turn the printer off, wait 30 seconds, and then remove the power cord before attempting to service the printer.

If the part is damaged and cannot be cleaned, use the table below to identify the correct part number for your printer. To order the part, go to www.hp.com/buy/parts.

Table 5-63 Part information

Part number	Part description
RM2-3612-000CN	Toner supply drive motor assembly (X57945 models)

Required tools

- #2 Phillips screwdriver with a magnetic tip and a 152 mm (6 in) shaft length

After performing service

Turn the printer power on

- Connect the power cable.
- Use the power switch to turn the power on.

Post service test

Print any pages necessary to make sure the printer is functioning correctly.

1. Remove the front right cover

Follow these steps to remove the front right cover.

1. Open the toner cartridge access door.
2. Open the right lower door.

3. Release one tab, and then slide the front right cover upward to remove it.

Figure 5-367 Remove the front right cover

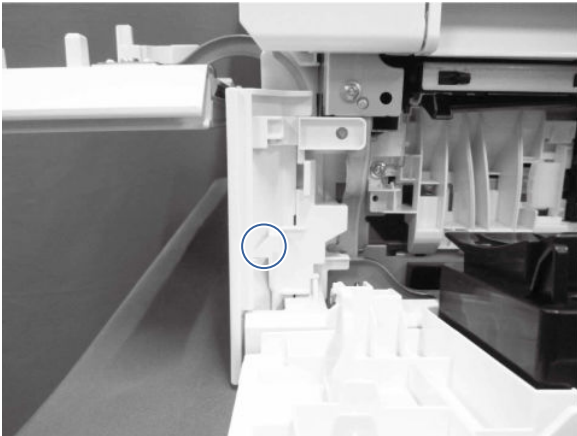

2. Remove the right lower door (X57945 models)

Follow these steps to remove the right lower door.

1. Remove two screws (callout 1), and then remove the base frame (callout 2).

Figure 5-368 Remove the base frame

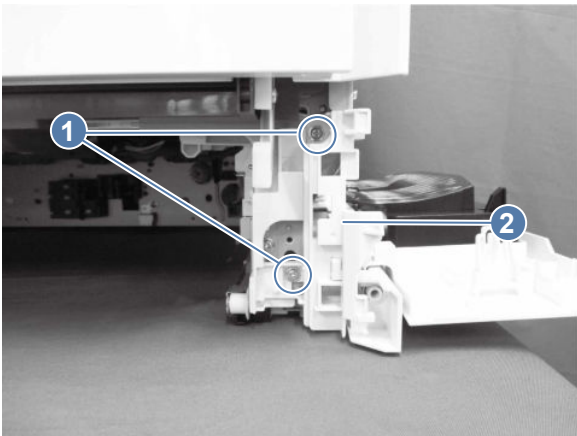

2. Remove one screw (callout 1), release one tab (callout 2), and then slide the rear inner cover (callout 3) downward to remove it.

Figure 5-369 Remove the rear inner cover

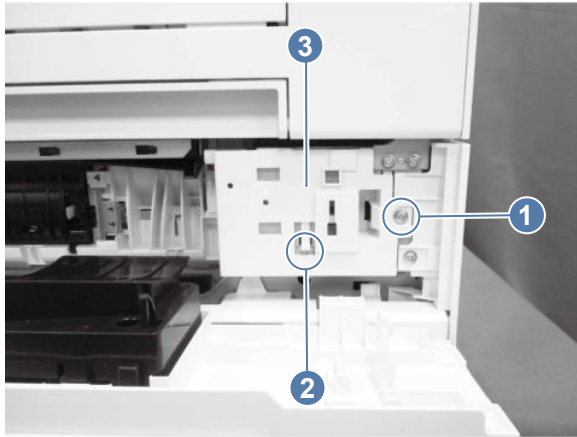

3. Release one tab (callout 1), and then slide the right lower door assembly (callout 2) in the direction indicated to remove it.

Figure 5-370 Remove the right lower door assembly

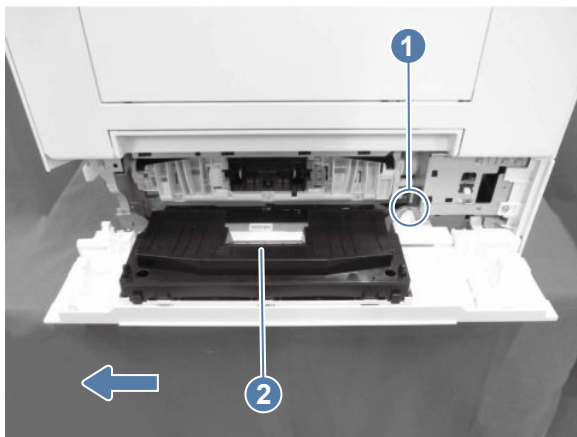

3. Remove the rear lower cover (X57945 models)

Follow these steps to remove the rear lower cover.

- Remove one screw (callout 1), slide the rear lower cover (callout 2) in the direction indicated below, and then remove it.

Figure 5-371 Remove the rear lower cover

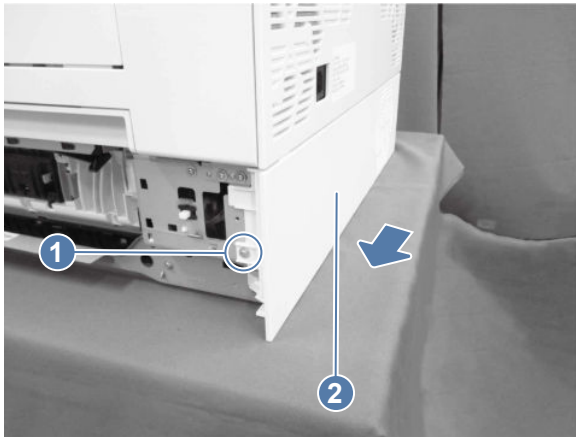

4. Remove the toner supply motor assembly (X57945 models)

Follow these steps to remove the toner supply motor assembly.

- Disconnect one connector (callout 1), remove three screws (callout 2), and then remove the toner supply motor assembly (callout 3).

Figure 5-372 Remove the assembly

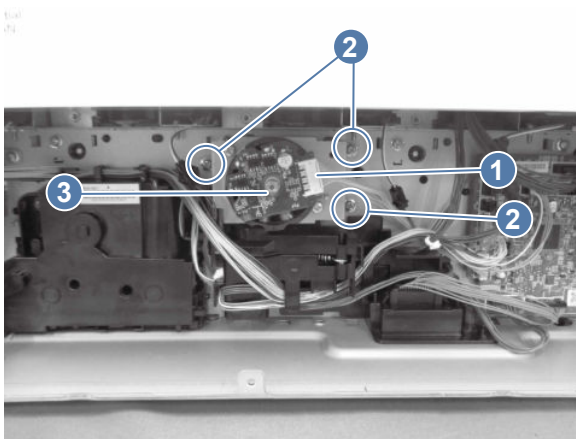

5. Unpack the replacement assembly

Follow these steps to unpack the replacement assembly.

1. Dispose of the defective part.



NOTE: HP recommends responsible disposal of the defective part.

<http://www8.hp.com/us/en/hp-information/environment/product-recycling.html>

2. Unpack the replacement part from the packaging.



CAUTION:  Some parts are sensitive to electrostatic discharge (ESD). Always perform service work at an ESD-protected workstation or mat. If an ESD workstation or mat is not available, touch

the sheet-metal chassis to provide a static ground before touching an ESD-sensitive assembly. Protect the ESD-sensitive assemblies by placing them in ESD pouches when they are out of the printer.

 **IMPORTANT:** Make sure that all of the shipping materials (for example shipping tape) are removed from the replacement part prior to installation.

 **NOTE:** If the replacement part is a roller or pad, avoid touching the spongy part of it. Skin oils on the roller or pad can cause paper pickup and/or print-quality problems. HP recommends using disposable gloves when handling rollers or pads or washing your hands before touching rollers or pads.

3. To install an assembly, reverse the removal steps.

 **NOTE:** When applicable, special installation instructions are provided for an assembly at the end of the removal procedure. Always completely read the removal instructions and follow all special installation instructions.

Removal and replacement: Lifter drive assembly (5700/X557/5800 models)

Learn about removing and replacing the lifter drive assembly.

 [View a video demonstration of removing and replacing the lifter drive assembly.](#)

Before performing service

Turn the printer power off

- Disconnect the power cable.

 **WARNING!** To avoid damage to the printer, turn the printer off, wait 30 seconds, and then remove the power cord before attempting to service the printer.

If the part is damaged and cannot be cleaned, use the table below to identify the correct part number for your printer. To order the part, go to www.hp.com/buy/parts.

Table 5-64 Part information

Part number	Part description
RM2-3493-000CN	Lifter drive assembly (5700/5800)
RM2-3500-000CN	Lifter drive assembly (X557/6700/6800)

Required tools

- #2 Phillips screwdriver with a magnetic tip and a 152 mm (6 in) shaft length

After performing service

Turn the printer power on

- Connect the power cable.
- Use the power switch to turn the power on.

Post service test

Print any pages necessary to make sure the printer is functioning correctly.

1. Remove the formatter cover

Follow these steps to remove the formatter cover.

- Remove one screw (callout 1), and then slide the formatter cover (callout 2) away from the printer to remove it.



 **TIP:** Reverse the removal steps to install the assembly.

Figure 5-373 Remove the formatter cover

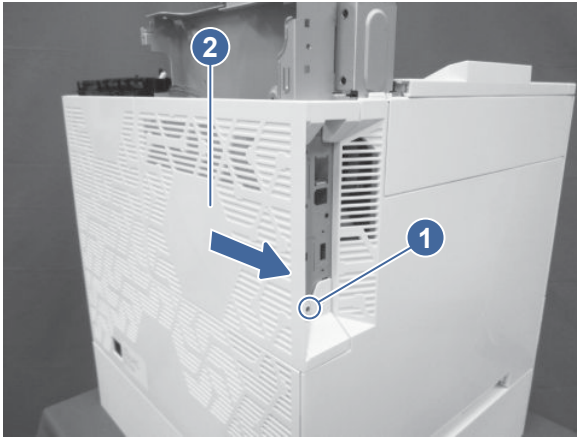

2. Remove the rear cover

Follow these steps to remove the rear cover.

 **NOTE:** The figures below show some assemblies (for example the top cover and formatter) removed that might still be installed on the printer. However, the steps to remove the cover are correct.

1. Open the right door, and remove two screws.

Figure 5-374 Remove two screws

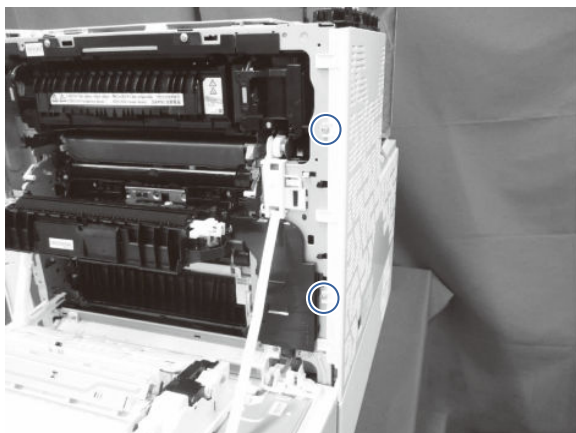

2. At the back of the printer, remove two screws, and then slide the rear cover as indicated to remove it.

Figure 5-375 Remove the rear cover

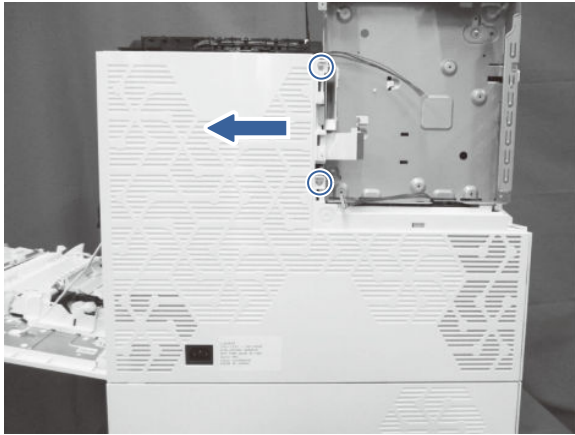

3. Remove the low-voltage power supply (LVPS)

Follow these steps to remove the low-voltage power supply (LVPS).

1. Unhook one spring (callout 1), and then disconnect two connectors (callout 2).

 **NOTE:** Unhook the spring from the formatter cage, not the low-voltage power supply. The spring should remain attached to the LVPS.

Figure 5-376 Unhook the spring and disconnect two connectors



2. Remove the FFC (callout 1), and then disconnect five connectors (callout 2).

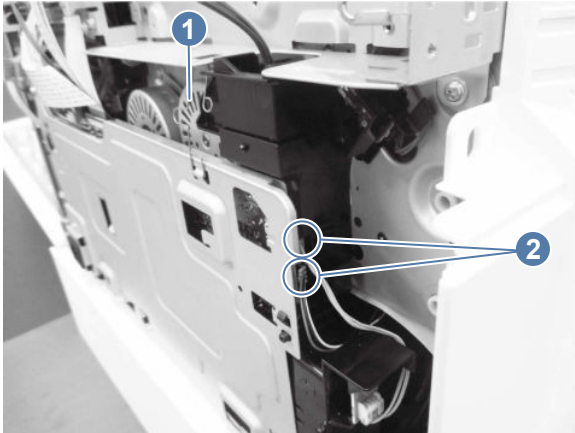

 **NOTE:** **MFP only:** Disconnect one additional connector (callout 3).

Figure 5-377 Disconnect the LVPS connectors

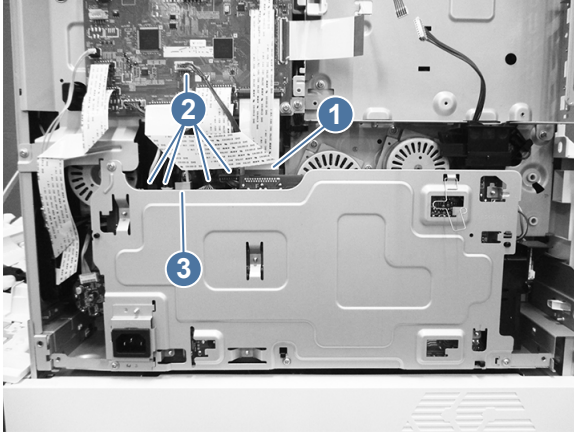

3. Remove four screws (callout 1), and then remove the low-voltage power supply assembly (callout 2).

 **NOTE:** The black ducting in the lower right corner can stick during the removal process.

Replacement LVPS only: Remove the spring (callout 3), and then install it on the replacement LVPS.

Figure 5-378 Remove the LVPS

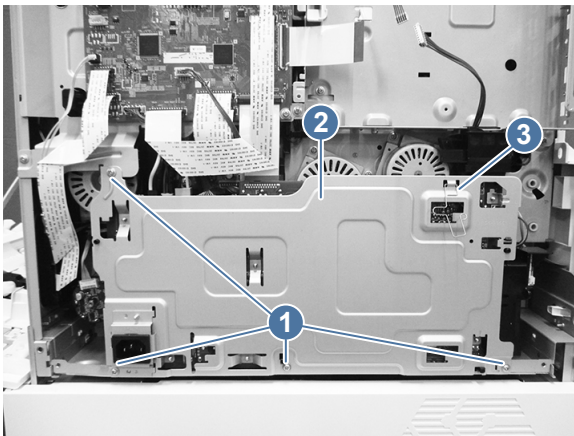

 **Reinstallation tip:** When reinstalling the LVPS, make sure that the spring (callout 1) is attached to both the formatter cage (callout 2) and the LVPS (callout 3).

Figure 5-379 Reinstalling the LVPS



4. Remove the lifter drive assembly (5700/X557/5800 models)

Follow these steps to remove the lifter drive assembly.

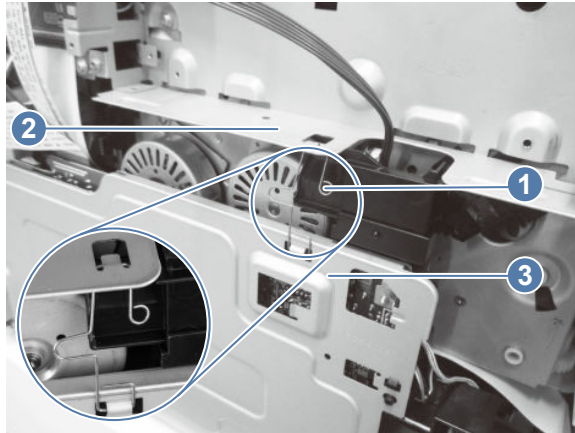
- Disconnect one connector (callout 1), disconnect one connector (callout 2), remove two screws (callout 3), and then remove the lifter drive assembly (callout 4).

Figure 5-380 Remove the assembly

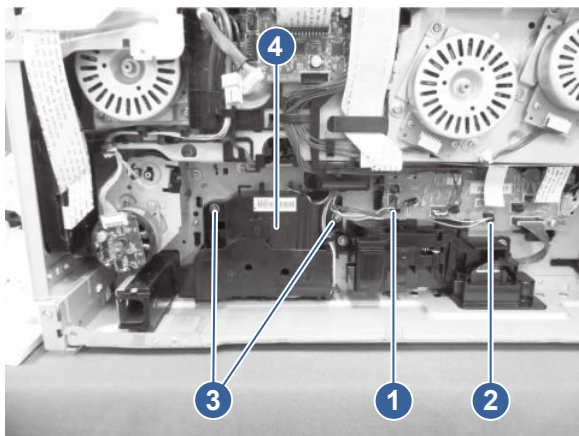

5. Unpack the replacement assembly

Follow these steps to unpack the replacement assembly.

1. Dispose of the defective part.





NOTE: HP recommends responsible disposal of the defective part.

<http://www8.hp.com/us/en/hp-information/environment/product-recycling.html>

2. Unpack the replacement part from the packaging.



CAUTION:  Some parts are sensitive to electrostatic discharge (ESD). Always perform service work at an ESD-protected workstation or mat. If an ESD workstation or mat is not available, touch the sheet-metal chassis to provide a static ground before touching an ESD-sensitive assembly. Protect the ESD-sensitive assemblies by placing them in ESD pouches when they are out of the printer.

 **IMPORTANT:** Make sure that all of the shipping materials (for example shipping tape) are removed from the replacement part prior to installation.

 **NOTE:** If the replacement part is a roller or pad, avoid touching the spongy part of it. Skin oils on the roller or pad can cause paper pickup and/or print-quality problems. HP recommends using disposable gloves when handling rollers or pads or washing your hands before touching rollers or pads.

3. To install an assembly, reverse the removal steps.

 **NOTE:** When applicable, special installation instructions are provided for an assembly at the end of the removal procedure. Always completely read the removal instructions and follow all special installation instructions.

Removal and replacement: Lifter drive assembly (X57945 models)

Learn about removing and replacing the lifter drive assembly.

Before performing service

Turn the printer power off

- Disconnect the power cable.

 **WARNING!** To avoid damage to the printer, turn the printer off, wait 30 seconds, and then remove the power cord before attempting to service the printer.

If the part is damaged and cannot be cleaned, use the table below to identify the correct part number for your printer. To order the part, go to www.hp.com/buy/parts.

Table 5-65 Part information

Part number	Part description
RM2-3501-000CN	Lifter drive assembly (X57945/X654/X677)

Required tools

- #2 Phillips screwdriver with a magnetic tip and a 152 mm (6 in) shaft length

After performing service

Turn the printer power on

- Connect the power cable.
- Use the power switch to turn the power on.

Post service test

Print any pages necessary to make sure the printer is functioning correctly.

1. Remove the front right cover

Follow these steps to remove the front right cover.

1. Open the toner cartridge access door.

2. Open the right lower door.
3. Release one tab, and then slide the front right cover upward to remove it.

Figure 5-381 Remove the front right cover

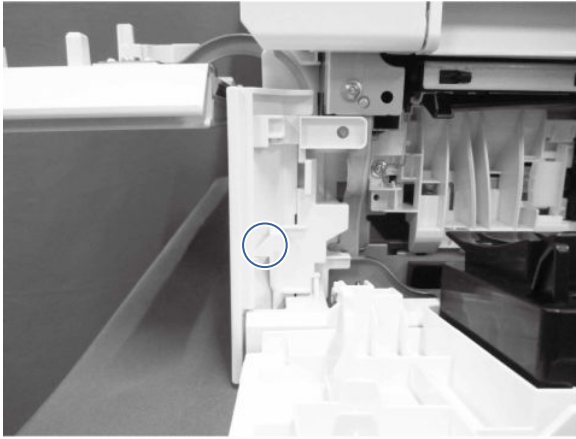

2. Remove the right lower door (X57945 models)

Follow these steps to remove the right lower door.

1. Remove two screws (callout 1), and then remove the base frame (callout 2).

Figure 5-382 Remove the base frame

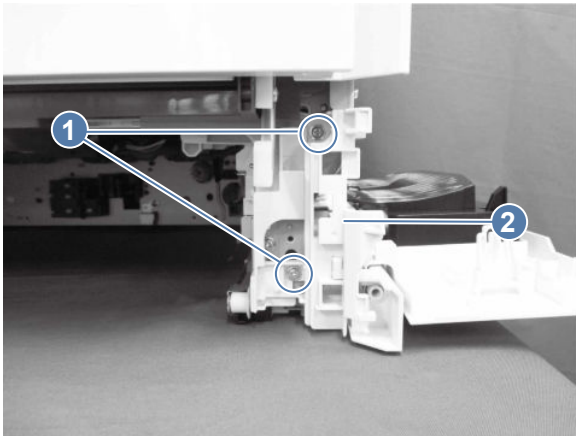

2. Remove one screw (callout 1), release one tab (callout 2), and then slide the rear inner cover (callout 3) downward to remove it.

Figure 5-383 Remove the rear inner cover

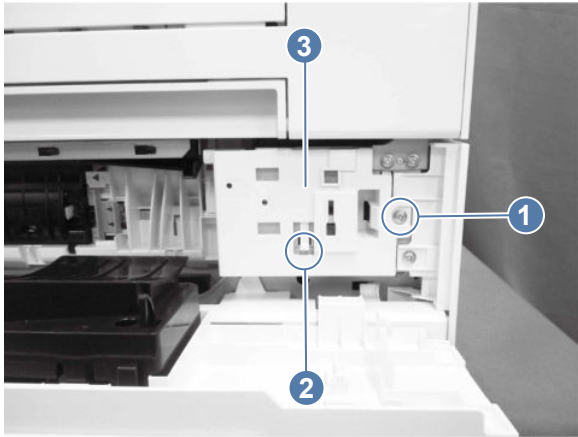

3. Release one tab (callout 1), and then slide the right lower door assembly (callout 2) in the direction indicated to remove it.

Figure 5-384 Remove the right lower door assembly

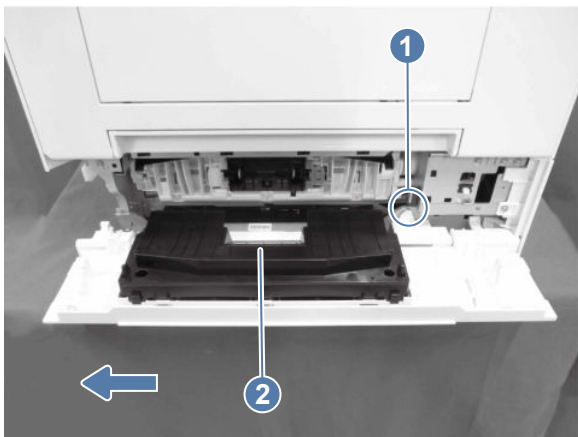

3. Remove the rear lower cover (X57945 models)

Follow these steps to remove the rear lower cover.

- Remove one screw (callout 1), slide the rear lower cover (callout 2) in the direction indicated below, and then remove it.

Figure 5-385 Remove the rear lower cover

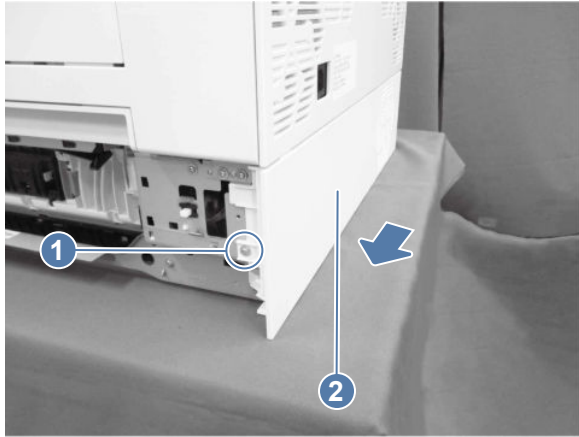

4. Remove the lifter drive assembly (X57945 models)

Follow these steps to remove the lifter drive assembly.

1. Disconnect four connectors (callout 1).

Figure 5-386 Disconnect four connectors

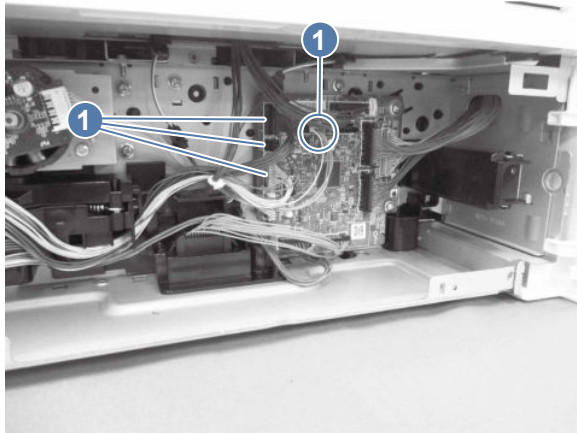

2. Release the cable (callout 1) from the auto close assembly (callout 2) and from the lifter drive assembly (callout 3).

Figure 5-387 Release the cable

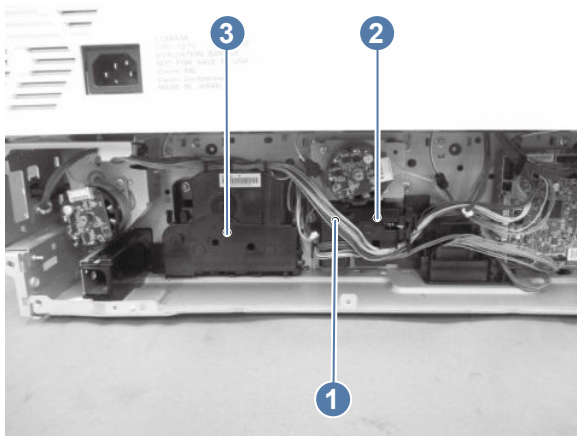

3. Remove two screws (callout 1), and then remove the lifter drive assembly (callout 2).

Figure 5-388 Remove the assembly

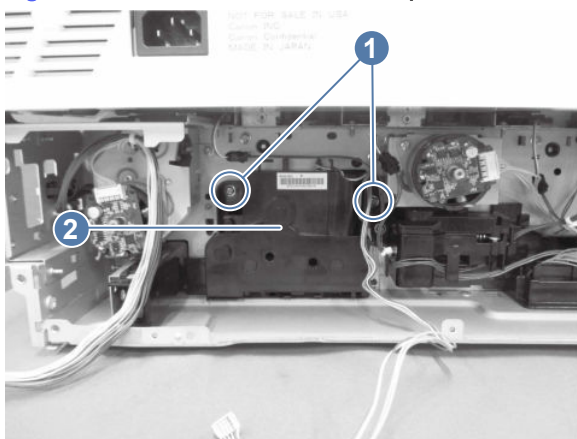

5. Unpack the replacement assembly

Follow these steps to unpack the replacement assembly.

1. Dispose of the defective part.





NOTE: HP recommends responsible disposal of the defective part.

<http://www8.hp.com/us/en/hp-information/environment/product-recycling.html>

2. Unpack the replacement part from the packaging.



CAUTION:  Some parts are sensitive to electrostatic discharge (ESD). Always perform service work at an ESD-protected workstation or mat. If an ESD workstation or mat is not available, touch the sheet-metal chassis to provide a static ground before touching an ESD-sensitive assembly. Protect the ESD-sensitive assemblies by placing them in ESD pouches when they are out of the printer.

 **IMPORTANT:** Make sure that all of the shipping materials (for example shipping tape) are removed from the replacement part prior to installation.

 **NOTE:** If the replacement part is a roller or pad, avoid touching the spongy part of it. Skin oils on the roller or pad can cause paper pickup and/or print-quality problems. HP recommends using disposable gloves when handling rollers or pads or washing your hands before touching rollers or pads.

3. To install an assembly, reverse the removal steps.

 **NOTE:** When applicable, special installation instructions are provided for an assembly at the end of the removal procedure. Always completely read the removal instructions and follow all special installation instructions.

Removal and replacement: Auto close assembly (5700/X557/5800 models)

Learn about removing and replacing the auto close assembly.

Before performing service

Turn the printer power off

- Disconnect the power cable.

 **WARNING!** To avoid damage to the printer, turn the printer off, wait 30 seconds, and then remove the power cord before attempting to service the printer.

If the part is damaged and cannot be cleaned, use the table below to identify the correct part number for your printer. To order the part, go to www.hp.com/buy/parts.

Table 5-66 Part information

Part number	Part description
RM2-3559-000CN	Auto close assembly

Required tools

- #2 Phillips screwdriver with a magnetic tip and a 152 mm (6 in) shaft length

After performing service

Turn the printer power on

- Connect the power cable.
- Use the power switch to turn the power on.

Post service test

No post service test is available for this assembly.

1. Remove the formatter cover

Follow these steps to remove the formatter cover.

- Remove one screw (callout 1), and then slide the formatter cover (callout 2) away from the printer to remove it.



 **TIP:** Reverse the removal steps to install the assembly.

Figure 5-389 Remove the formatter cover

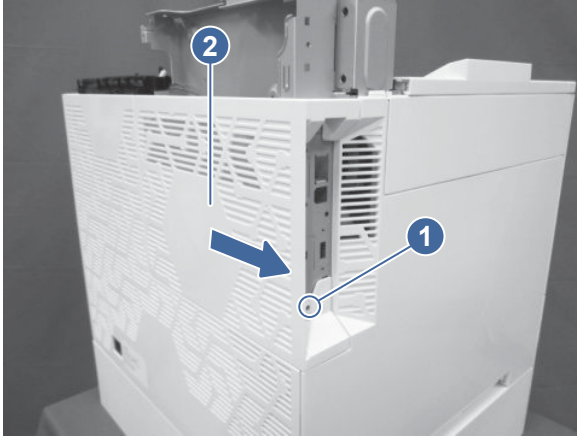

2. Remove the rear cover

Follow these steps to remove the rear cover.

 **NOTE:** The figures below show some assemblies (for example the top cover and formatter) removed that might still be installed on the printer. However, the steps to remove the cover are correct.

1. Open the right door, and remove two screws.

Figure 5-390 Remove two screws

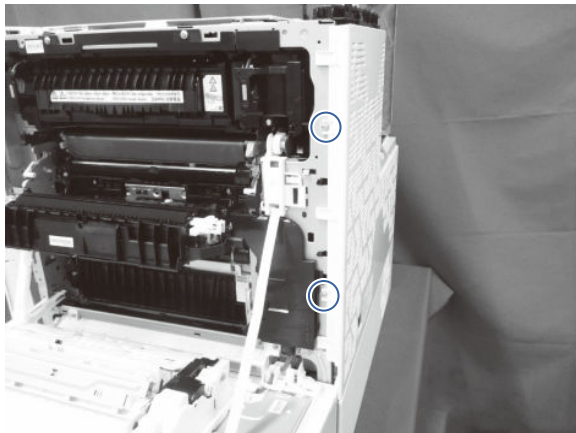

2. At the back of the printer, remove two screws, and then slide the rear cover as indicated to remove it.

Figure 5-391 Remove the rear cover

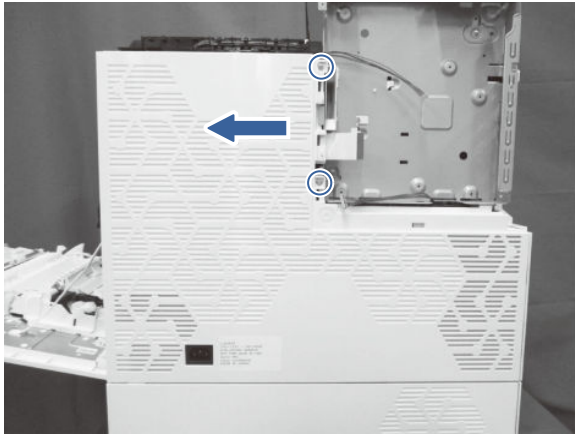

3. Remove the low-voltage power supply (LVPS)

Follow these steps to remove the low-voltage power supply (LVPS).

1. Unhook one spring (callout 1), and then disconnect two connectors (callout 2).

 **NOTE:** Unhook the spring from the formatter cage, not the low-voltage power supply. The spring should remain attached to the LVPS.

Figure 5-392 Unhook the spring and disconnect two connectors



2. Remove the FFC (callout 1), and then disconnect five connectors (callout 2).

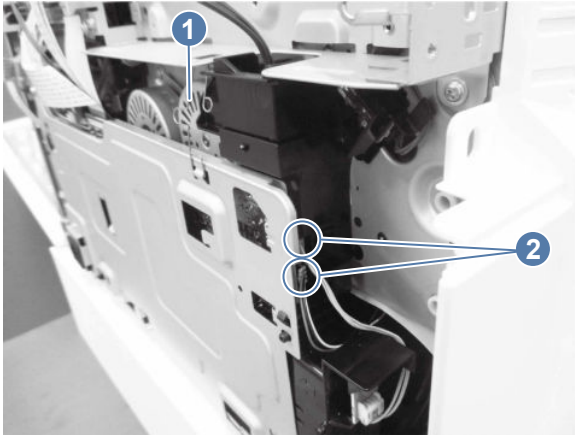

 **NOTE:** **MFP only:** Disconnect one additional connector (callout 3).

Figure 5-393 Disconnect the LVPS connectors

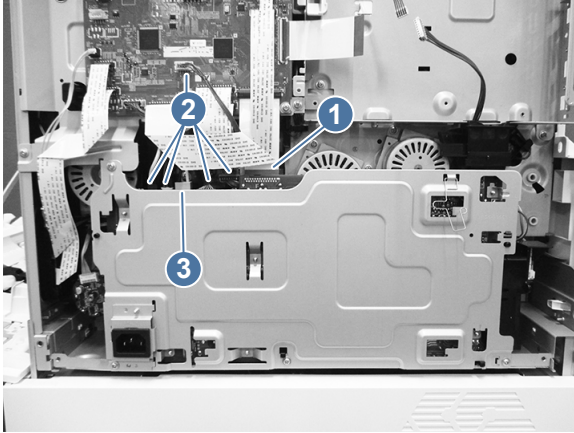

3. Remove four screws (callout 1), and then remove the low-voltage power supply assembly (callout 2).

 **NOTE:** The black ducting in the lower right corner can stick during the removal process.

Replacement LVPS only: Remove the spring (callout 3), and then install it on the replacement LVPS.

Figure 5-394 Remove the LVPS

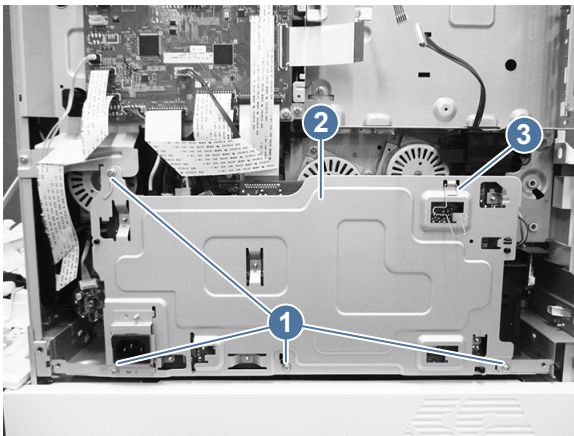

 **Reinstallation tip:** When reinstalling the LVPS, make sure that the spring (callout 1) is attached to both the formatter cage (callout 2) and the LVPS (callout 3).

Figure 5-395 Reinstalling the LVPS



4. Remove the auto close assembly (5700/X557/5800 models)

Follow these steps to remove the auto close assembly.

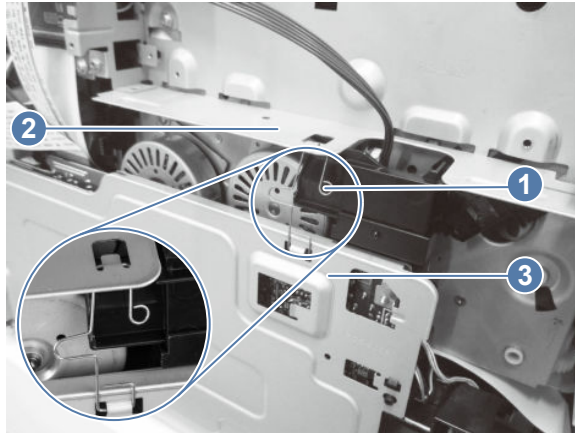
- Disconnect one connector (callout 1), disconnect one connector (callout 2), release the cables (callout 3) from the auto close assembly (callout 4), remove two screws (callout 5), remove the auto close assembly, and then remove the drawer connector (callout 6) from the auto close assembly.

Figure 5-396 Remove the auto close assembly

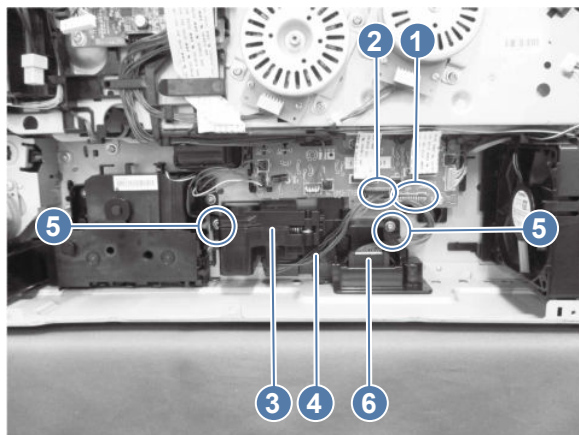

5. Unpack the replacement assembly

Follow these steps to unpack the replacement assembly.

1. Dispose of the defective part.



NOTE: HP recommends responsible disposal of the defective part.

<http://www8.hp.com/us/en/hp-information/environment/product-recycling.html>

2. Unpack the replacement part from the packaging.



CAUTION:  Some parts are sensitive to electrostatic discharge (ESD). Always perform service work at an ESD-protected workstation or mat. If an ESD workstation or mat is not available, touch the sheet-metal chassis to provide a static ground before touching an ESD-sensitive assembly.

Protect the ESD-sensitive assemblies by placing them in ESD pouches when they are out of the printer.

 **IMPORTANT:** Make sure that all of the shipping materials (for example shipping tape) are removed from the replacement part prior to installation.

 **NOTE:** If the replacement part is a roller or pad, avoid touching the spongy part of it. Skin oils on the roller or pad can cause paper pickup and/or print-quality problems. HP recommends using disposable gloves when handling rollers or pads or washing your hands before touching rollers or pads.

3. To install an assembly, reverse the removal steps.

 **NOTE:** When applicable, special installation instructions are provided for an assembly at the end of the removal procedure. Always completely read the removal instructions and follow all special installation instructions.

Removal and replacement: Auto close assembly (X57945 models)

Learn about removing and replacing the auto close assembly.

Before performing service

Turn the printer power off

- Disconnect the power cable.

 **WARNING!** To avoid damage to the printer, turn the printer off, wait 30 seconds, and then remove the power cord before attempting to service the printer.

If the part is damaged and cannot be cleaned, use the table below to identify the correct part number for your printer. To order the part, go to www.hp.com/buy/parts.

Table 5-67 Part information

Part number	Part description
RM2-3559-000CN	Auto close assembly

Required tools

- #2 Phillips screwdriver with a magnetic tip and a 152 mm (6 in) shaft length

After performing service

Turn the printer power on

- Connect the power cable.
- Use the power switch to turn the power on.

Post service test

No post service test is available for this assembly.

1. Remove the front right cover

Follow these steps to remove the front right cover.

1. Open the toner cartridge access door.
2. Open the right lower door.
3. Release one tab, and then slide the front right cover upward to remove it.

Figure 5-397 Remove the front right cover

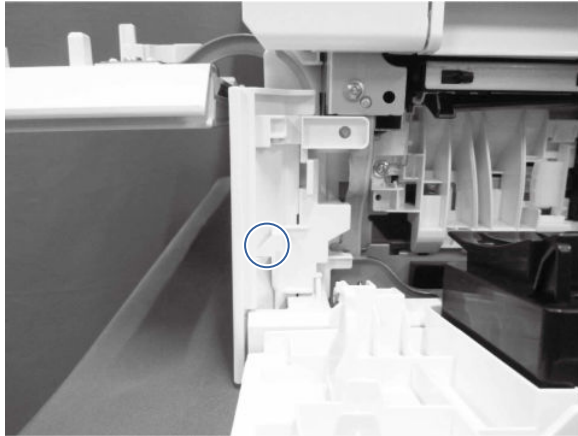

2. Remove the right lower door (X57945 models)

Follow these steps to remove the right lower door.

1. Remove two screws (callout 1), and then remove the base frame (callout 2).

Figure 5-398 Remove the base frame

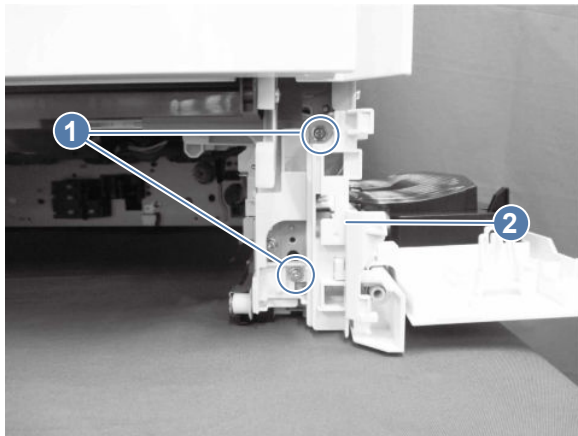

2. Remove one screw (callout 1), release one tab (callout 2), and then slide the rear inner cover (callout 3) downward to remove it.

Figure 5-399 Remove the rear inner cover

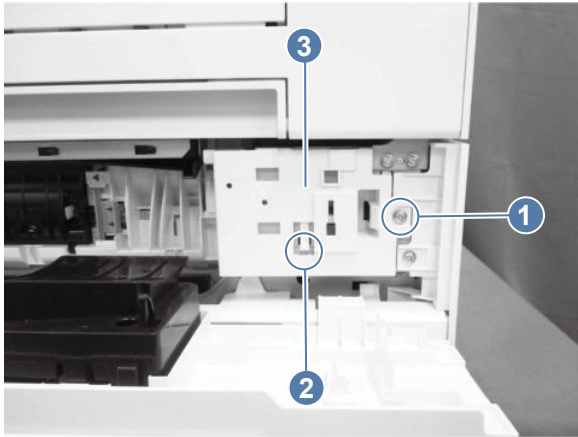

3. Release one tab (callout 1), and then slide the right lower door assembly (callout 2) in the direction indicated to remove it.

Figure 5-400 Remove the right lower door assembly

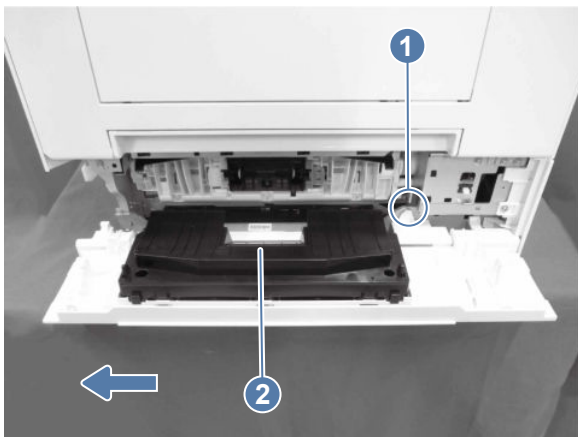

3. Remove the rear lower cover (X57945 models)

Follow these steps to remove the rear lower cover.

- Remove one screw (callout 1), slide the rear lower cover (callout 2) in the direction indicated below, and then remove it.

Figure 5-401 Remove the rear lower cover

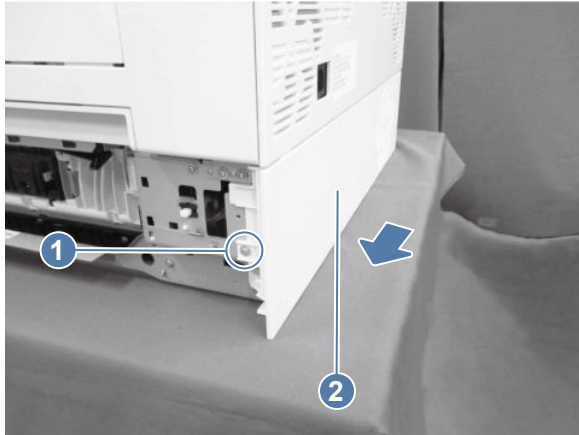

4. Remove the auto close assembly (X57945 models)

Follow these steps to remove the auto close assembly.

1. Disconnect six connectors (callout 1).

Figure 5-402 Disconnect six connectors

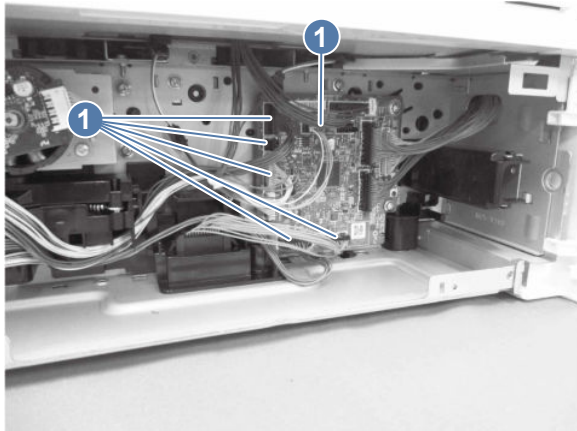

2. Release the cables (callout 1) from the auto close assembly (callout 2).

Figure 5-403 Release the cable

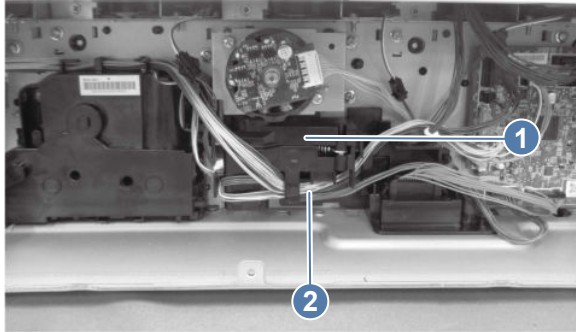

3. Remove two screws (callout 1), remove the auto close assembly (callout 2), and then remove the drawer connector (callout 3) from the auto close assembly.

Figure 5-404 Remove the auto close assembly

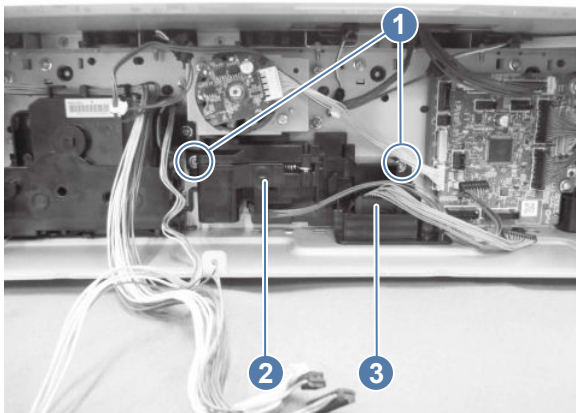

5. Unpack the replacement assembly

Follow these steps to unpack the replacement assembly.

1. Dispose of the defective part.





NOTE: HP recommends responsible disposal of the defective part.

<http://www8.hp.com/us/en/hp-information/environment/product-recycling.html>

2. Unpack the replacement part from the packaging.



CAUTION:  Some parts are sensitive to electrostatic discharge (ESD). Always perform service work at an ESD-protected workstation or mat. If an ESD workstation or mat is not available, touch the sheet-metal chassis to provide a static ground before touching an ESD-sensitive assembly. Protect the ESD-sensitive assemblies by placing them in ESD pouches when they are out of the printer.

 **IMPORTANT:** Make sure that all of the shipping materials (for example shipping tape) are removed from the replacement part prior to installation.

 **NOTE:** If the replacement part is a roller or pad, avoid touching the spongy part of it. Skin oils on the roller or pad can cause paper pickup and/or print-quality problems. HP recommends using disposable gloves when handling rollers or pads or washing your hands before touching rollers or pads.

3. To install an assembly, reverse the removal steps.

 **NOTE:** When applicable, special installation instructions are provided for an assembly at the end of the removal procedure. Always completely read the removal instructions and follow all special installation instructions.

Removal and replacement: Tray 2 media size detect assembly (X557 models)

Learn about removing and replacing the Tray 2 media size detect assembly.

Before performing service

Turn the printer power off

- Disconnect the power cable.

 **WARNING!** To avoid damage to the printer, turn the printer off, wait 30 seconds, and then remove the power cord before attempting to service the printer.

If the part is damaged and cannot be cleaned, use the table below to identify the correct part number for your printer. To order the part, go to www.hp.com/buy/parts.

Table 5-68 Part information

Part number	Part description
RM2-3585-000CN	Size detect assembly (6700/6800)
RM2-3634-000CN	Size detect assembly (5700/X557)
RM2-3614-000CN	Size detect assembly (5800)

Required tools

- #2 Phillips screwdriver with a magnetic tip and a 152 mm (6 in) shaft length

After performing service

Turn the printer power on

- Connect the power cable.
- Use the power switch to turn the power on.

Post service test

No post service test is available for this assembly.

1. Remove the formatter cover

Follow these steps to remove the formatter cover.

- Remove one screw (callout 1), and then slide the formatter cover (callout 2) away from the printer to remove it.



 **TIP:** Reverse the removal steps to install the assembly.

Figure 5-405 Remove the formatter cover

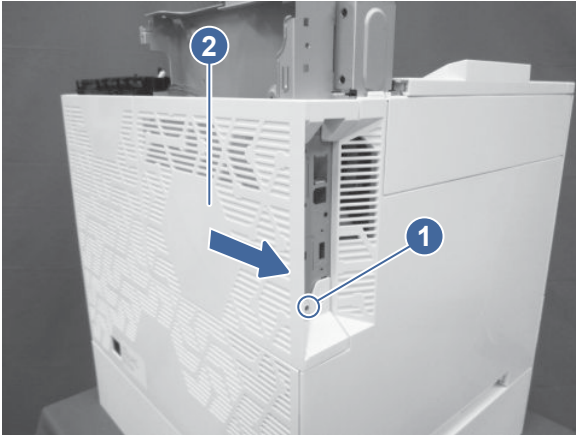

2. Remove the rear cover

Follow these steps to remove the rear cover.

 **NOTE:** The figures below show some assemblies (for example the top cover and formatter) removed that might still be installed on the printer. However, the steps to remove the cover are correct.

1. Open the right door, and remove two screws.

Figure 5-406 Remove two screws

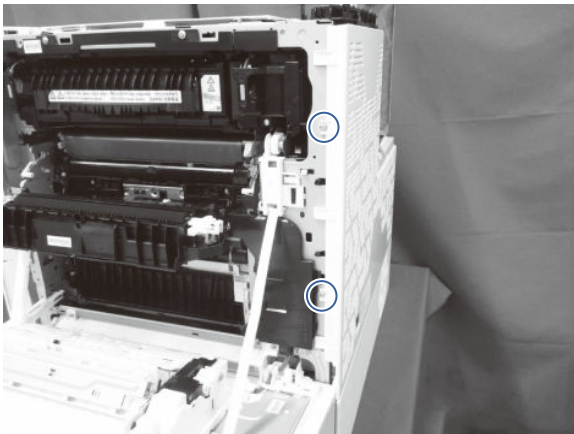

2. At the back of the printer, remove two screws, and then slide the rear cover as indicated to remove it.

Figure 5-407 Remove the rear cover

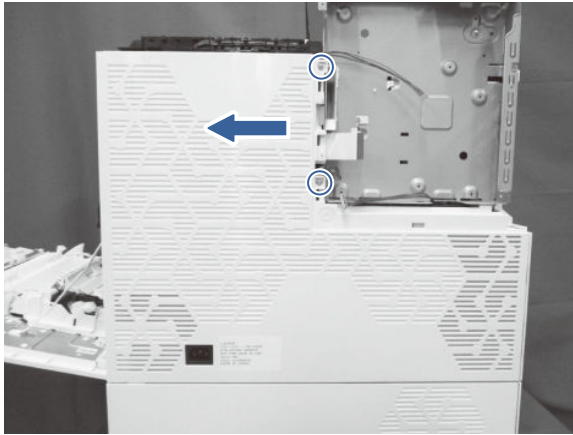

3. Remove the low-voltage power supply (LVPS)

Follow these steps to remove the low-voltage power supply (LVPS).

1. Unhook one spring (callout 1), and then disconnect two connectors (callout 2).

 **NOTE:** Unhook the spring from the formatter cage, not the low-voltage power supply. The spring should remain attached to the LVPS.

Figure 5-408 Unhook the spring and disconnect two connectors



2. Remove the FFC (callout 1), and then disconnect five connectors (callout 2).

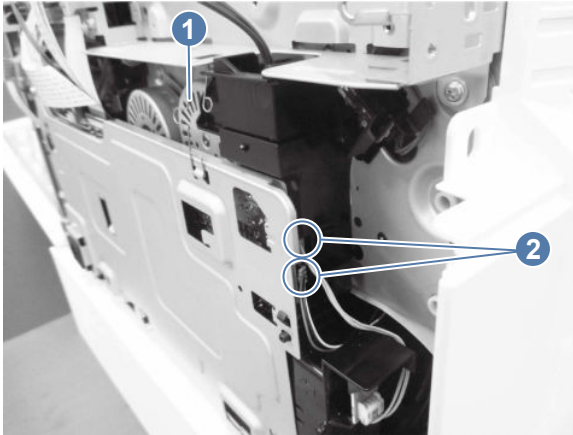

 **NOTE:** **MFP only:** Disconnect one additional connector (callout 3).

Figure 5-409 Disconnect the LVPS connectors

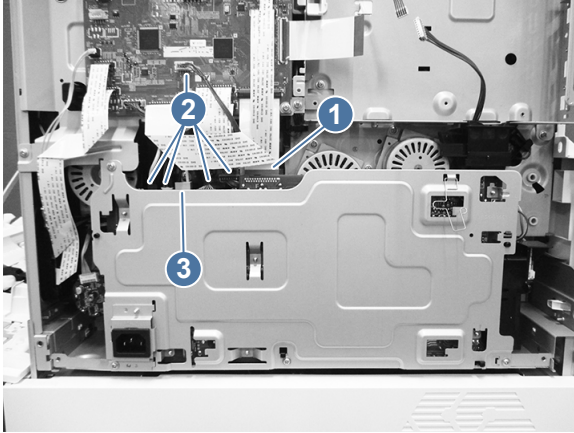

3. Remove four screws (callout 1), and then remove the low-voltage power supply assembly (callout 2).

 **NOTE:** The black ducting in the lower right corner can stick during the removal process.

Replacement LVPS only: Remove the spring (callout 3), and then install it on the replacement LVPS.

Figure 5-410 Remove the LVPS

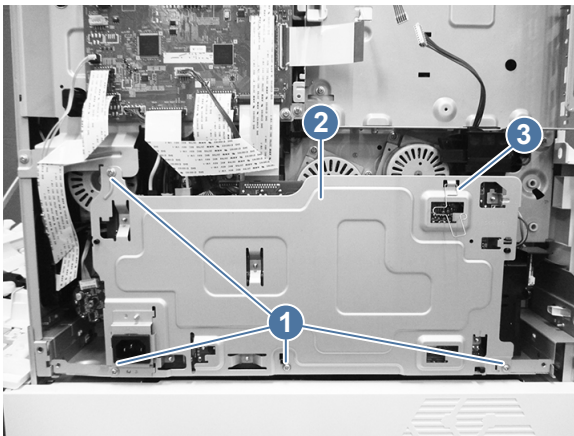

 **Reinstallation tip:** When reinstalling the LVPS, make sure that the spring (callout 1) is attached to both the formatter cage (callout 2) and the LVPS (callout 3).

Figure 5-411 Reinstalling the LVPS



4. Remove the auto close assembly (5700/X557/5800 models)

Follow these steps to remove the auto close assembly.

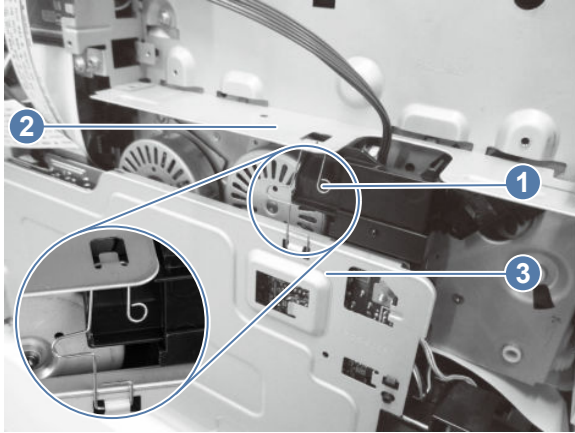
- Disconnect one connector (callout 1), disconnect one connector (callout 2), release the cables (callout 3) from the auto close assembly (callout 4), remove two screws (callout 5), remove the auto close assembly, and then remove the drawer connector (callout 6) from the auto close assembly.

Figure 5-412 Remove the auto close assembly

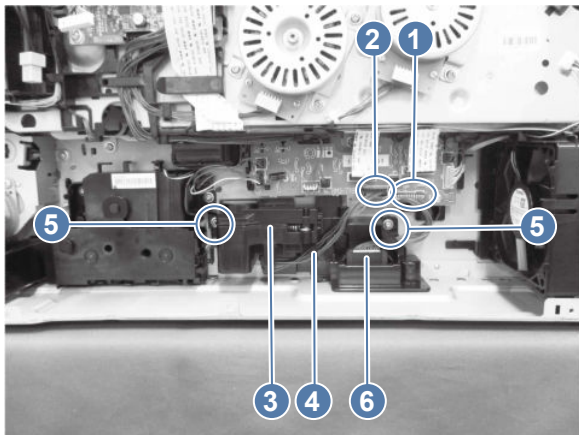

5. Remove the Tray 2 media size detect assembly (5700/X557/5800 models)

Follow these steps to remove the Tray 2 media size detect assembly.

- Pull out the Tray 2 media size detect assembly (callout 1) toward you.

Figure 5-413 Remove the Tray 2 media size detect assembly

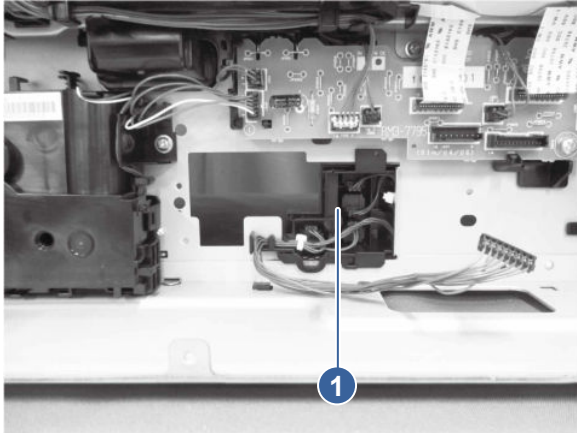

6. Remove the Tray 2 media size detect assembly (X557 models)

Follow these steps to remove the Tray 2 media size detect assembly.

- Pull out the Tray 2 media size detect assembly (callout 1) toward you.

Figure 5-414 Remove the Tray 2 media size detect assembly

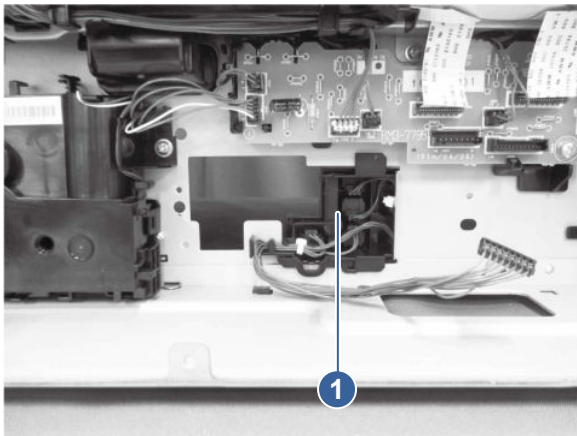

7. Unpack the replacement assembly

Follow these steps to unpack the replacement assembly.

1. Dispose of the defective part.



NOTE: HP recommends responsible disposal of the defective part.

<http://www8.hp.com/us/en/hp-information/environment/product-recycling.html>

2. Unpack the replacement part from the packaging.



CAUTION:  Some parts are sensitive to electrostatic discharge (ESD). Always perform service work at an ESD-protected workstation or mat. If an ESD workstation or mat is not available, touch the sheet-metal chassis to provide a static ground before touching an ESD-sensitive assembly.

Protect the ESD-sensitive assemblies by placing them in ESD pouches when they are out of the printer.

 **IMPORTANT:** Make sure that all of the shipping materials (for example shipping tape) are removed from the replacement part prior to installation.

 **NOTE:** If the replacement part is a roller or pad, avoid touching the spongy part of it. Skin oils on the roller or pad can cause paper pickup and/or print-quality problems. HP recommends using disposable gloves when handling rollers or pads or washing your hands before touching rollers or pads.

3. To install an assembly, reverse the removal steps.

 **NOTE:** When applicable, special installation instructions are provided for an assembly at the end of the removal procedure. Always completely read the removal instructions and follow all special installation instructions.

Removal and replacement: Tray 2 media size detect assembly (X57945 models)

Learn about removing and replacing the Tray 2 media size detect assembly.

Before performing service

Turn the printer power off

- Disconnect the power cable.

 **WARNING!** To avoid damage to the printer, turn the printer off, wait 30 seconds, and then remove the power cord before attempting to service the printer.

If the part is damaged and cannot be cleaned, use the table below to identify the correct part number for your printer. To order the part, go to www.hp.com/buy/parts.

Table 5-69 Part information

Part number	Part description
RM2-3614-000CN	Size detect assembly (X57945 models)

Required tools

- #2 Phillips screwdriver with a magnetic tip and a 152 mm (6 in) shaft length

After performing service

Turn the printer power on

- Connect the power cable.
- Use the power switch to turn the power on.

Post service test

No post service test is available for this assembly.

1. Remove the front right cover

Follow these steps to remove the front right cover.

1. Open the toner cartridge access door.
2. Open the right lower door.
3. Release one tab, and then slide the front right cover upward to remove it.

Figure 5-415 Remove the front right cover



2. Remove the right lower door (X57945 models)

Follow these steps to remove the right lower door.

1. Remove two screws (callout 1), and then remove the base frame (callout 2).

Figure 5-416 Remove the base frame

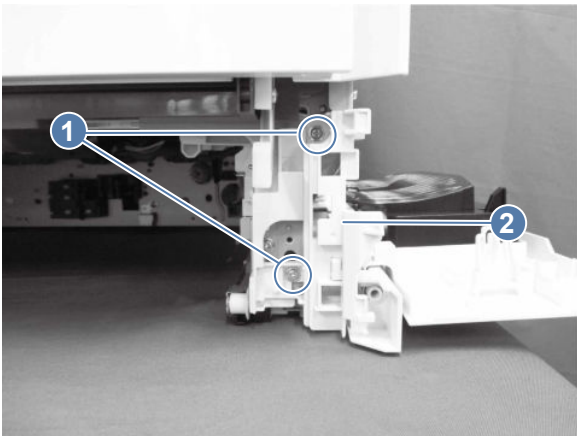

2. Remove one screw (callout 1), release one tab (callout 2), and then slide the rear inner cover (callout 3) downward to remove it.

Figure 5-417 Remove the rear inner cover

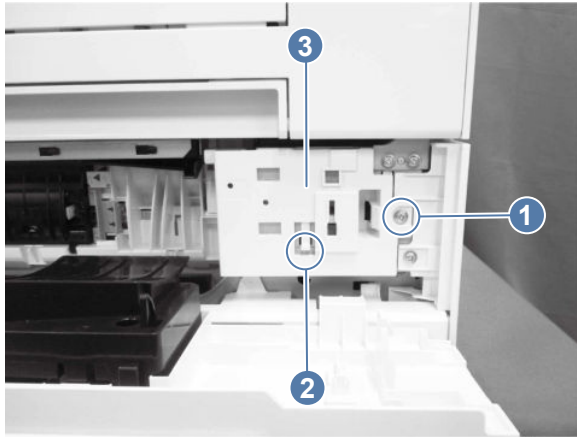

3. Release one tab (callout 1), and then slide the right lower door assembly (callout 2) in the direction indicated to remove it.

Figure 5-418 Remove the right lower door assembly

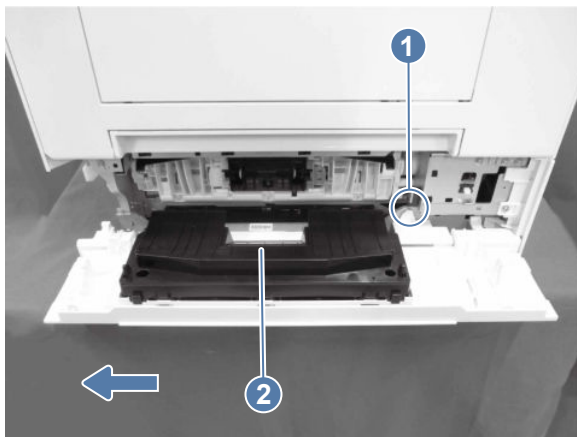

3. Remove the rear lower cover (X57945 models)

Follow these steps to remove the rear lower cover.

- Remove one screw (callout 1), slide the rear lower cover (callout 2) in the direction indicated below, and then remove it.

Figure 5-419 Remove the rear lower cover

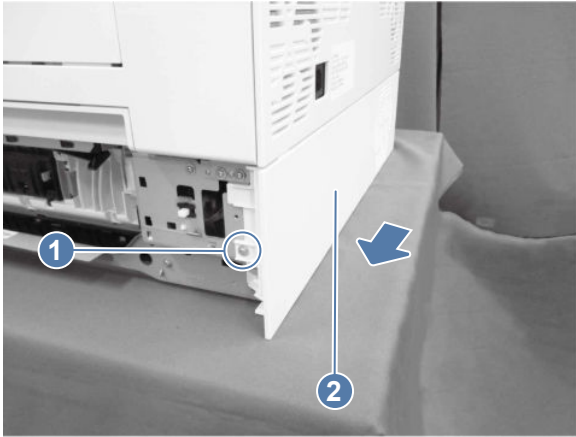

4. Remove the auto close assembly (X57945 models)

Follow these steps to remove the auto close assembly.

1. Disconnect six connectors (callout 1).

Figure 5-420 Disconnect six connectors

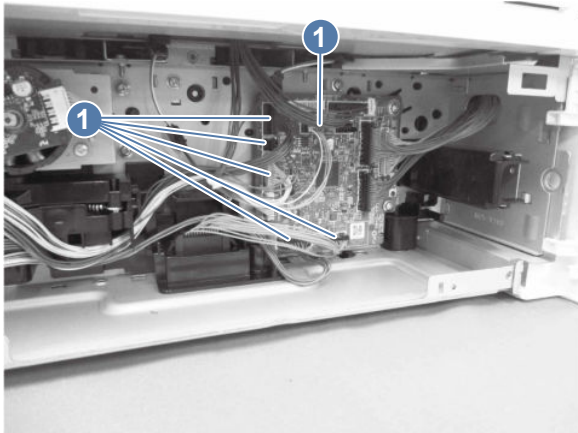

2. Release the cables (callout 1) from the auto close assembly (callout 2).

Figure 5-421 Release the cable

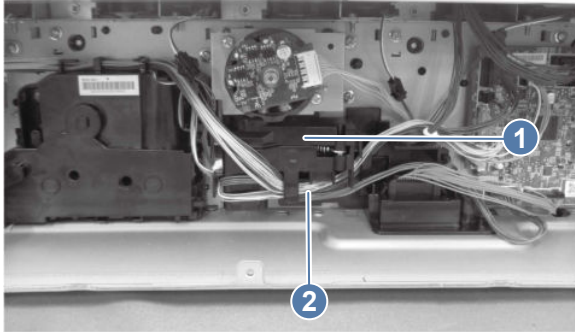

3. Remove two screws (callout 1), remove the auto close assembly (callout 2), and then remove the drawer connector (callout 3) from the auto close assembly.

Figure 5-422 Remove the auto close assembly

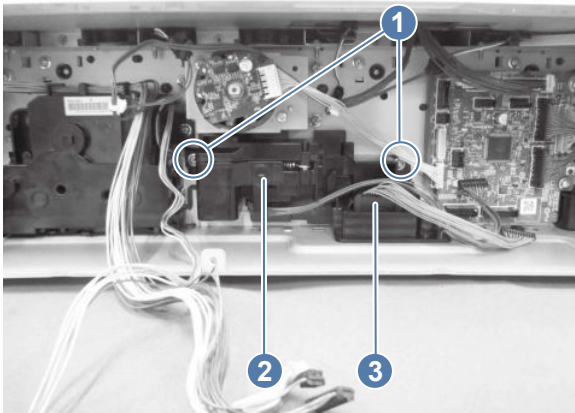

5. Remove the Tray 2 media size detect assembly (X57945 models)

Follow these steps to remove the Tray 2 media size detect assembly.

- Release one tab (callout 1), and then pull out the Tray 2 media size detect assembly (callout 2) toward you.

Figure 5-423 Remove the Tray 2 media size detect assembly

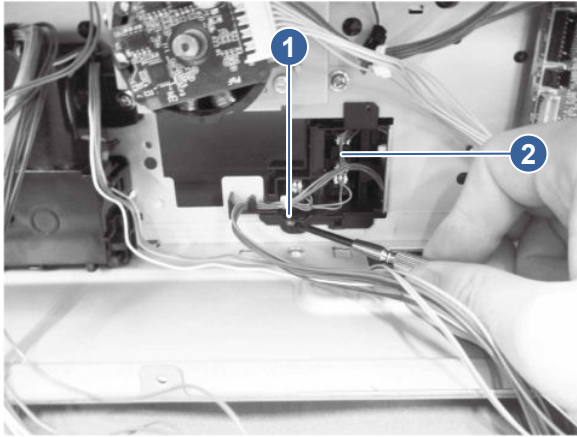

6. Unpack the replacement assembly



Follow these steps to unpack the replacement assembly.

1. Dispose of the defective part.

 **NOTE:** HP recommends responsible disposal of the defective part.

<http://www8.hp.com/us/en/hp-information/environment/product-recycling.html>

2. Unpack the replacement part from the packaging.

 **CAUTION:**  Some parts are sensitive to electrostatic discharge (ESD). Always perform service work at an ESD-protected workstation or mat. If an ESD workstation or mat is not available, touch the sheet-metal chassis to provide a static ground before touching an ESD-sensitive assembly. Protect the ESD-sensitive assemblies by placing them in ESD pouches when they are out of the printer.

 **IMPORTANT:** Make sure that all of the shipping materials (for example shipping tape) are removed from the replacement part prior to installation.

 **NOTE:** If the replacement part is a roller or pad, avoid touching the spongy part of it. Skin oils on the roller or pad can cause paper pickup and/or print-quality problems. HP recommends using disposable gloves when handling rollers or pads or washing your hands before touching rollers or pads.

3. To install an assembly, reverse the removal steps.

 **NOTE:** When applicable, special installation instructions are provided for an assembly at the end of the removal procedure. Always completely read the removal instructions and follow all special installation instructions.

Removal and replacement: Fuser drive assembly

Learn about removing and replacing the fuser drive assembly.

 [View a video demonstration of removing and replacing the fuser drive assembly.](#)

Before performing service

Turn the printer power off

- Disconnect the power cable.

⚠ WARNING! To avoid damage to the printer, turn the printer off, wait 30 seconds, and then remove the power cord before attempting to service the printer.

If the part is damaged and cannot be cleaned, use the table below to identify the correct part number for your printer. To order the part, go to www.hp.com/buy/parts.

Table 5-70 Part information

Part number	Part description
RM2-4485-000CN	Fixing drive assembly (5700/X577/5800/X57945)
RM2-4487-000CN	Fixing drive assembly (6700/X654/6800/X677)

Required tools

- #2 Phillips screwdriver with a magnetic tip and a 152 mm (6 in) shaft length

After performing service

Turn the printer power on

- Connect the power cable.
- Use the power switch to turn the power on.

Post service test

Print any pages necessary to make sure the printer is functioning correctly.

1. Remove the fuser

Follow these steps to remove the fuser.

1. Open the right door.

⚠ CAUTION: The fuser is hot. Wait at least 10 minutes after turning the printer power off before removing the fuser.

Figure 5-424 Open the right door



2. Squeeze the release levers on the handles (circle callouts), and then remove the fuser.

Figure 5-425 Remove the fuser

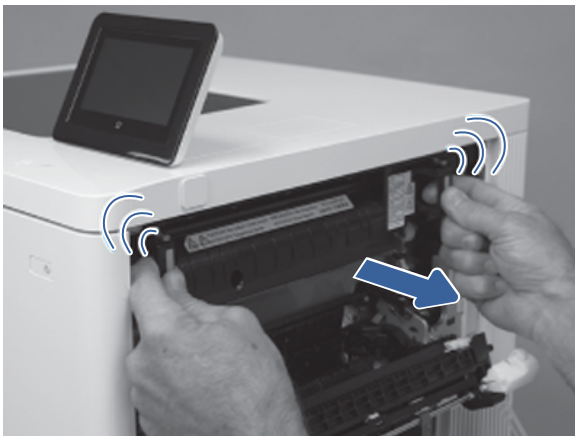

2. Remove the formatter cover

Follow these steps to remove the formatter cover.

- Remove one screw (callout 1), and then slide the formatter cover (callout 2) away from the printer to remove it.



 **TIP:** Reverse the removal steps to install the assembly.

Figure 5-426 Remove the formatter cover

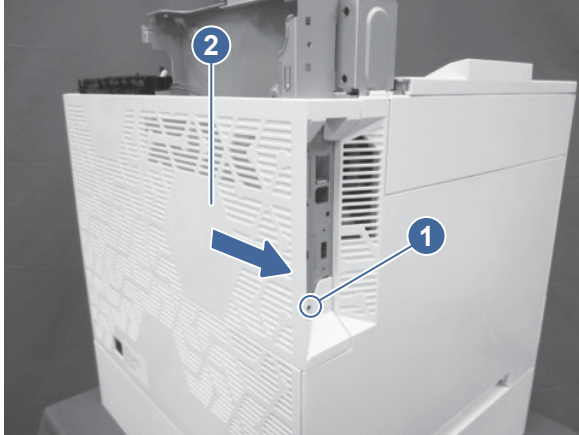

3. Remove the rear cover

Follow these steps to remove the rear cover.

 **NOTE:** The figures below show some assemblies (for example the top cover and formatter) removed that might still be installed on the printer. However, the steps to remove the cover are correct.

1. Open the right door, and remove two screws.

Figure 5-427 Remove two screws

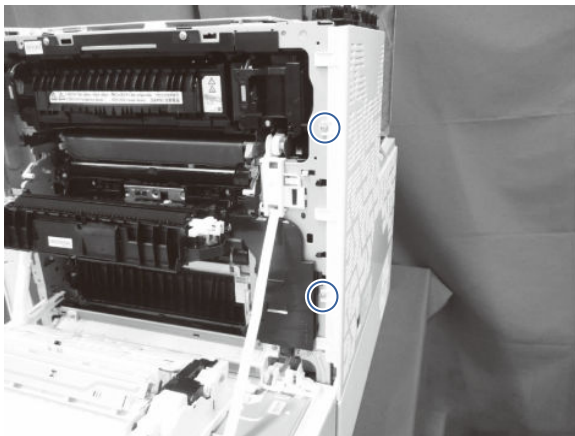

2. At the back of the printer, remove two screws, and then slide the rear cover as indicated to remove it.

Figure 5-428 Remove the rear cover

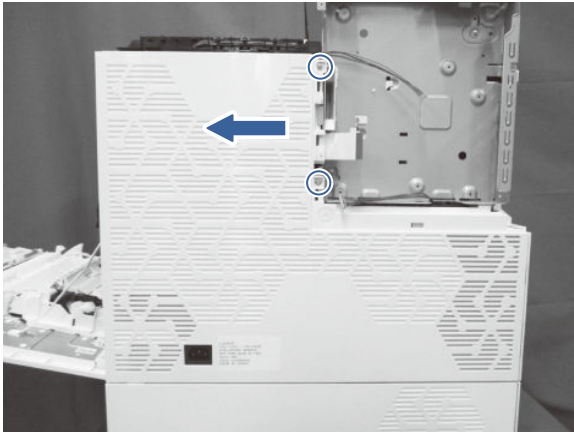

4. Remove the low-voltage power supply (LVPS)

Follow these steps to remove the low-voltage power supply (LVPS).

1. Unhook one spring (callout 1), and then disconnect two connectors (callout 2).

 **NOTE:** Unhook the spring from the formatter cage, not the low-voltage power supply. The spring should remain attached to the LVPS.

Figure 5-429 Unhook the spring and disconnect two connectors



2. Remove the FFC (callout 1), and then disconnect five connectors (callout 2).

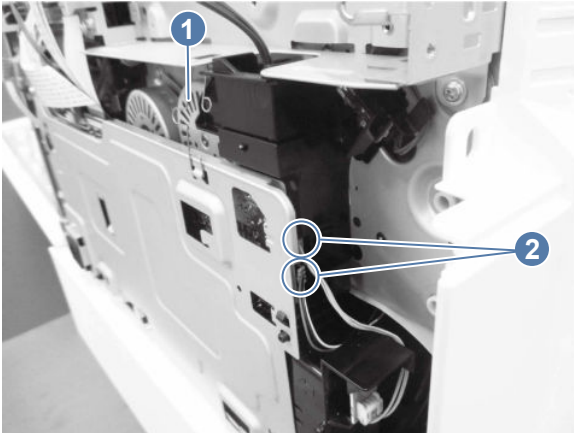

 **NOTE:** **MFP only:** Disconnect one additional connector (callout 3).

Figure 5-430 Disconnect the LVPS connectors

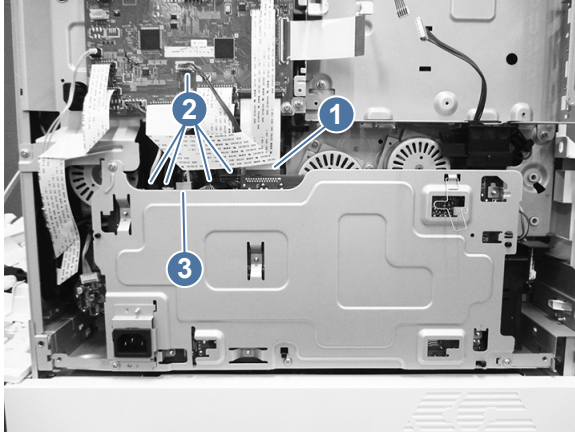

3. Remove four screws (callout 1), and then remove the low-voltage power supply assembly (callout 2).

 **NOTE:** The black ducting in the lower right corner can stick during the removal process.

Replacement LVPS only: Remove the spring (callout 3), and then install it on the replacement LVPS.

Figure 5-431 Remove the LVPS

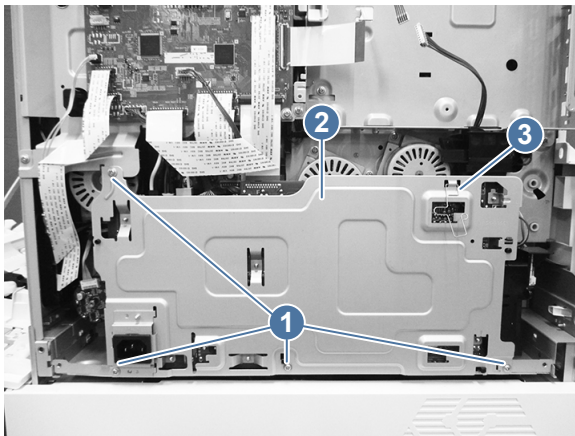

 **Reinstallation tip:** When reinstalling the LVPS, make sure that the spring (callout 1) is attached to both the formatter cage (callout 2) and the LVPS (callout 3).

Figure 5-432 Reinstalling the LVPS



5. Remove the fuser drive assembly

Follow these steps to remove the fuser drive assembly.

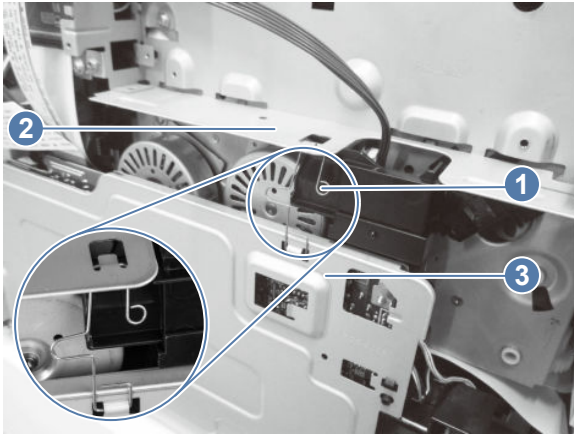
1. Disconnect all the connectors on the DC controller PCA, remove the cable clamp (callout 1), remove three screws (callout 2), slide the DC controller stay (callout 3) out to remove it.

Figure 5-433 Remove the DC controller stay

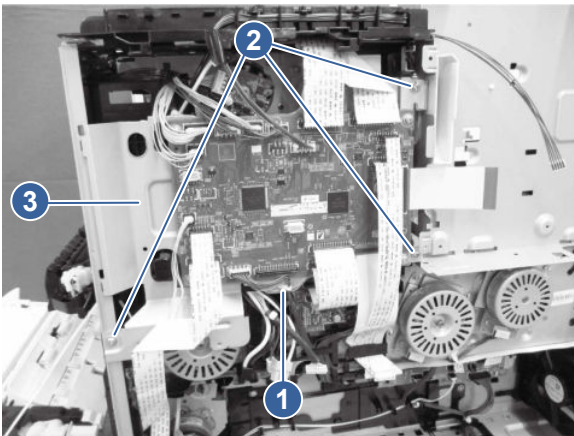

2. Pull the lever (callout 1) of the cable cover (callout 2), release one tab (callout 3), and then remove the cable cover.

Figure 5-434 Remove the cable cover

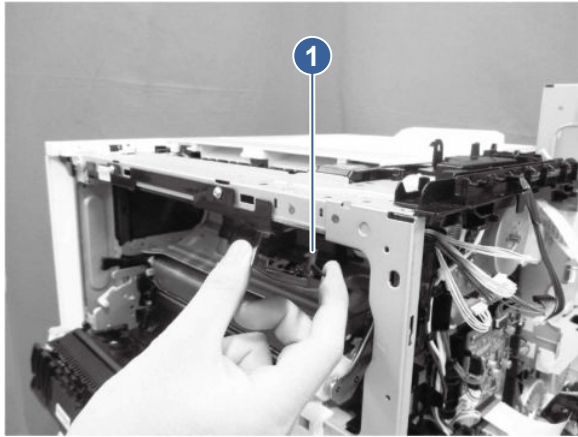

3. Disconnect one connector (callout 1).

Figure 5-435 Disconnect one connector

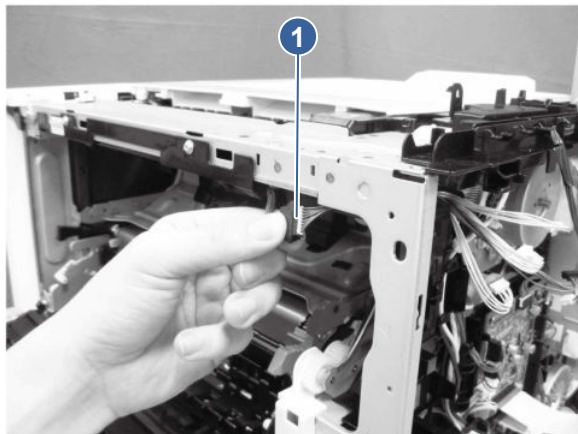

4. Disconnect one connector (callout 1), remove one screw (callout 2), release the cable (callout 3) from the cable guide (callout 4), release one tab (callout 5), and then slide the connector cover (callout 6) upward to remove it.

Figure 5-436 Remove the connector cover

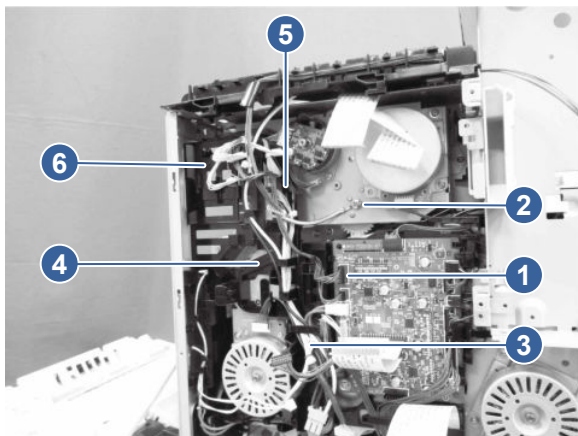

5. Disconnect two connectors (callout 1), remove four screws (callout 2), and then remove the fuser drive assembly (callout 3).

Figure 5-437 Remove the assembly

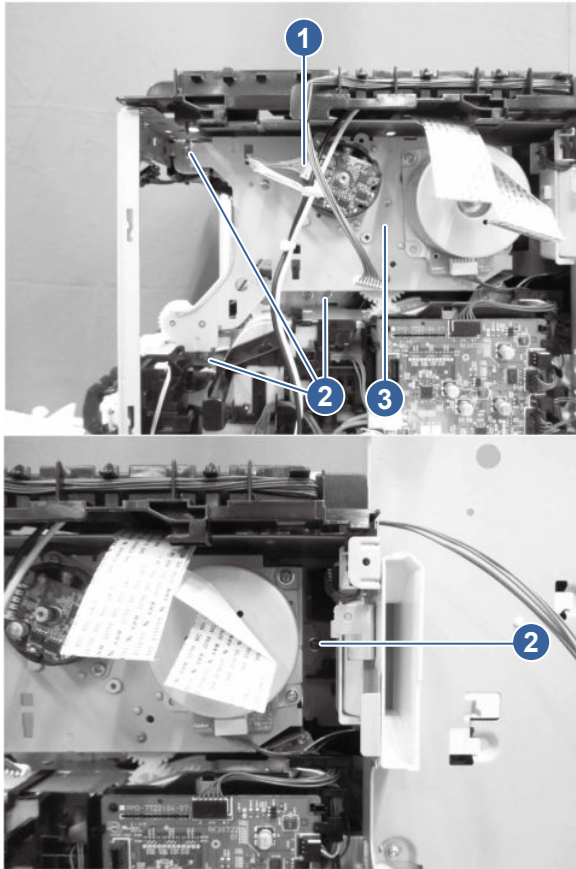

6. Unpack the replacement assembly

Follow these steps to unpack the replacement assembly.

1. Dispose of the defective part.



NOTE: HP recommends responsible disposal of the defective part.

<http://www8.hp.com/us/en/hp-information/environment/product-recycling.html>

2. Unpack the replacement part from the packaging.



CAUTION:  Some parts are sensitive to electrostatic discharge (ESD). Always perform service work at an ESD-protected workstation or mat. If an ESD workstation or mat is not available, touch the sheet-metal chassis to provide a static ground before touching an ESD-sensitive assembly. Protect the ESD-sensitive assemblies by placing them in ESD pouches when they are out of the printer.



IMPORTANT: Make sure that all of the shipping materials (for example shipping tape) are removed from the replacement part prior to installation.



NOTE: If the replacement part is a roller or pad, avoid touching the spongy part of it. Skin oils on the roller or pad can cause paper pickup and/or print-quality problems. HP recommends using

disposable gloves when handling rollers or pads or washing your hands before touching rollers or pads.

3. To install an assembly, reverse the removal steps.

 **NOTE:** When applicable, special installation instructions are provided for an assembly at the end of the removal procedure. Always completely read the removal instructions and follow all special installation instructions.

Removal and replacement: Main-drive assembly

Learn about removing and replacing the main drive assembly.



[View a video demonstration of removing and replacing the main drive assembly.](#)

Before performing service

Turn the printer power off

- Disconnect the power cable.

 **WARNING!** To avoid damage to the printer, turn the printer off, wait 30 seconds, and then remove the power cord before attempting to service the printer.

If the part is damaged and cannot be cleaned, use the table below to identify the correct part number for your printer. To order the part, go to www.hp.com/buy/parts.

Table 5-71 Part Information

Part number	Part description
RM2-3506-000CN	Main drive assembly (5700/5800)
RM2-3504-000CN	Main drive assembly (X557/6700/6800)
RM2-3497-000CN	Main drive assembly (X57945/X654/X677)

Required tools

- #2 Phillips screwdriver with a magnetic tip and a 152 mm (6 in) shaft length

After performing service

Turn the printer power on

- Connect the power cable.
- Use the power switch to turn the power on.

Post service test

Print any pages necessary to make sure the printer is functioning correctly.

1. Remove the fuser

Follow these steps to remove the fuser.

1. Open the right door.

⚠ CAUTION: The fuser is hot. Wait at least 10 minutes after turning the printer power off before removing the fuser.

Figure 5-438 Open the right door



2. Squeeze the release levers on the handles (circle callouts), and then remove the fuser.

Figure 5-439 Remove the fuser

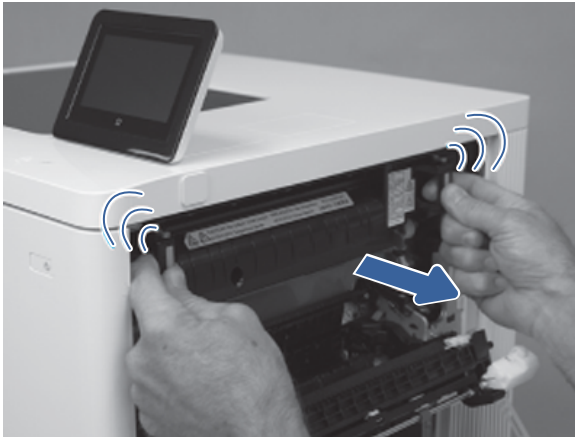

2. Remove the formatter cover

Follow these steps to remove the formatter cover.

- Remove one screw (callout 1), and then slide the formatter cover (callout 2) away from the printer to remove it.

💡 TIP: Reverse the removal steps to install the assembly.

Figure 5-440 Remove the formatter cover

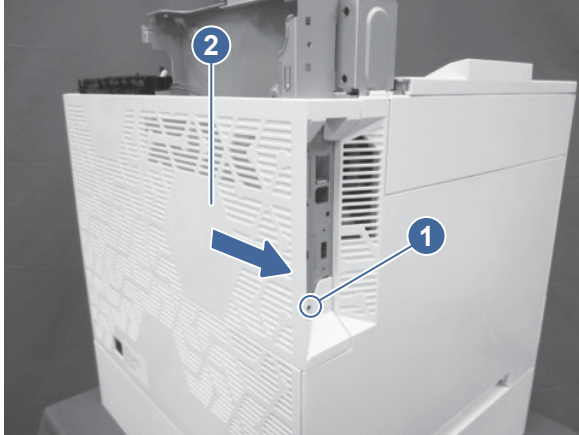

3. Remove the formatter

Follow these steps to remove the formatter.

1. Disconnect all of the connectors on the formatter.

 **IMPORTANT:** Some of the flat flexible cable (FFC) connectors use hinged retainers to secure them to the DC controller. The hinged retainers must be opened to release the FFCs.

2. Remove the fax PCA (callout 1) and the hard disk drive (HDD) (callout 2), and then remove seven screws (callout 3) to remove the formatter.

Figure 5-441 Remove the formatter

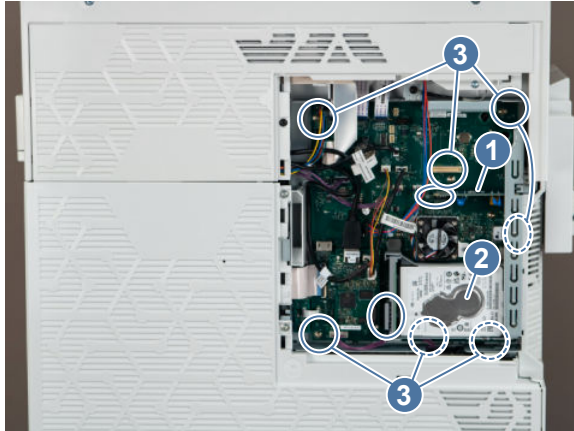

4. Remove the left upper cover (MFP models)

Follow these steps to remove the left upper cover.

1. Open the front door.

 **CAUTION:** If the cover is being removed to gain access to the main drive assembly, make sure that the front door remains open. This keeps the main drive properly aligned.

2. At the left side of the printer, insert the small flat-blade screwdriver into the slot to release one tab (callout 1).

Figure 5-442 Use a screwdriver to release the tab

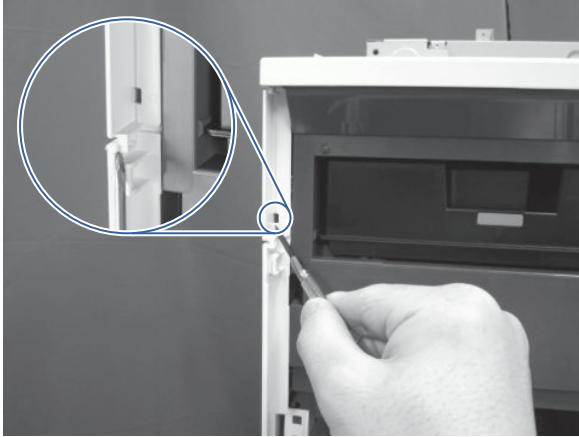

3. Toward the front of the printer, release another tab.

Figure 5-443 Release the tab

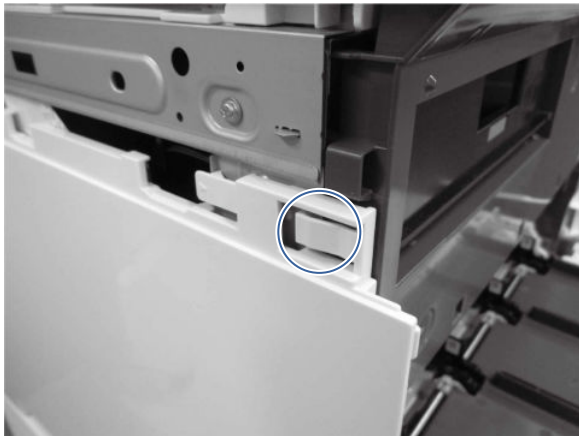

4. Rotate the cover up to remove it.

Figure 5-444 Remove the left upper cover

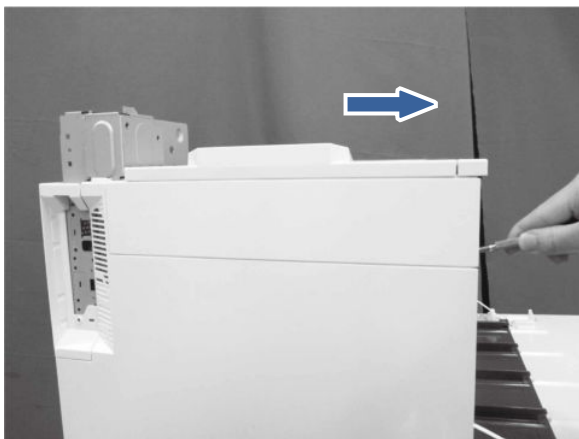

5. Remove the rear cover

Follow these steps to remove the rear cover.

 **NOTE:** The figures below show some assemblies (for example the top cover and formatter) removed that might still be installed on the printer. However, the steps to remove the cover are correct.

1. Open the right door, and remove two screws.

Figure 5-445 Remove two screws

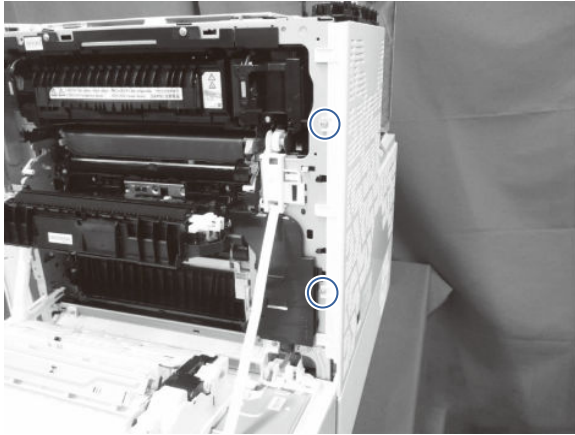

2. At the back of the printer, remove two screws, and then slide the rear cover as indicated to remove it.

Figure 5-446 Remove the rear cover

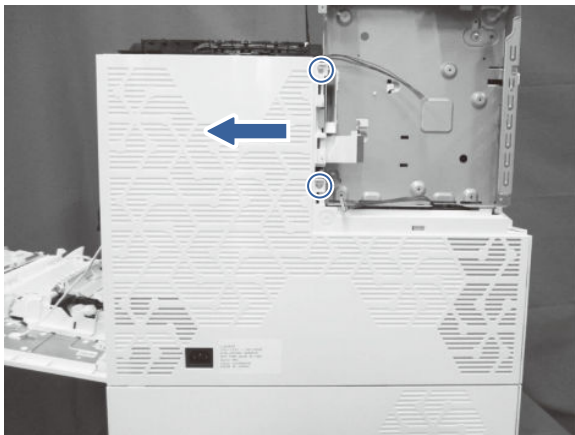

6. Remove the low-voltage power supply (LVPS)

Follow these steps to remove the low-voltage power supply (LVPS).

1. Unhook one spring (callout 1), and then disconnect two connectors (callout 2).

 **NOTE:** Unhook the spring from the formatter cage, not the low-voltage power supply. The spring should remain attached to the LVPS.

Figure 5-447 Unhook the spring and disconnect two connectors



2. Remove the FFC (callout 1), and then disconnect five connectors (callout 2).

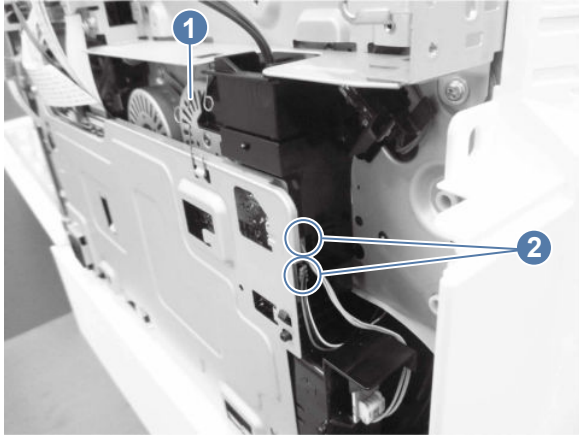

 **NOTE:** MFP only: Disconnect one additional connector (callout 3).

Figure 5-448 Disconnect the LVPS connectors

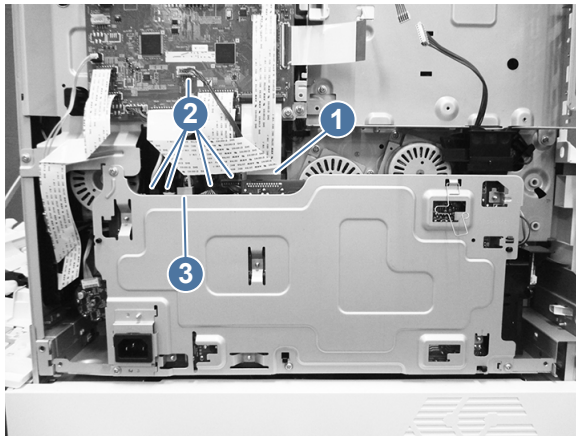

3. Remove four screws (callout 1), and then remove the low-voltage power supply assembly (callout 2).

 **NOTE:** The black ducting in the lower right corner can stick during the removal process.

Replacement LVPS only: Remove the spring (callout 3), and then install it on the replacement LVPS.

Figure 5-449 Remove the LVPS

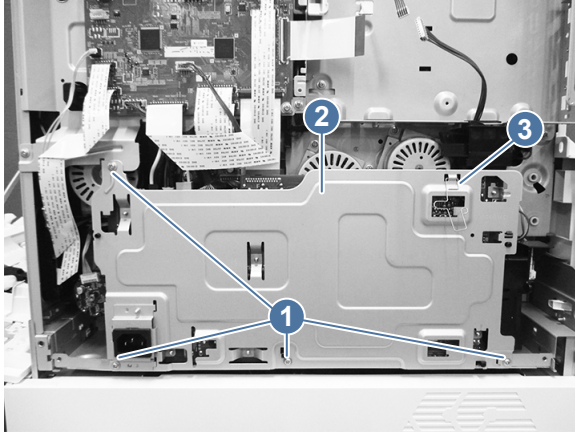

 **Reinstallation tip:** When reinstalling the LVPS, make sure that the spring (callout 1) is attached to both the formatter cage (callout 2) and the LVPS (callout 3).

Figure 5-450 Reinstalling the LVPS



7. Remove the DC controller

Follow these steps to remove the DC controller.

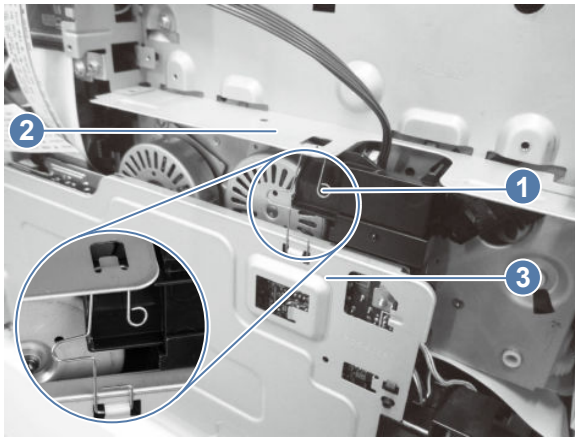
- Disconnect all of the connectors on the DC controller, remove four screws (callout 1), and then remove the DC controller (callout 2).

 **IMPORTANT:** Some of the flat flexible cable (FFC) connectors use hinged retainers to secure them to the DC controller. The hinged retainers must be opened to release the FFCs.

Figure 5-451 Remove the DC controller



8. Remove the formatter cage (SFP models)

Follow these steps to remove the formatter cage.

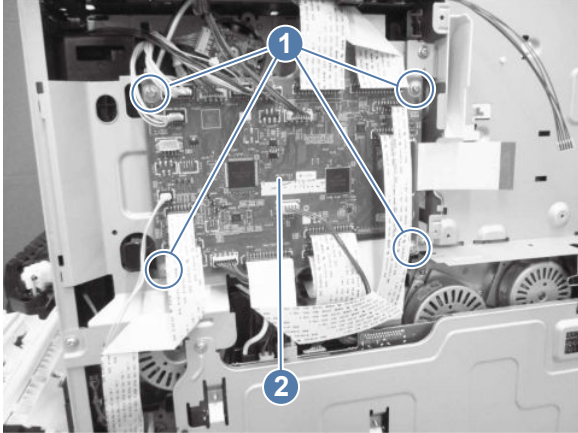
1. Disconnect all the connectors on the DC controller PCA.

 **IMPORTANT:** Some of the flat flexible cable (FFC) connectors use hinged retainers to secure them to the DC controller. The hinged retainers must be opened to release the FFCs.

2. Remove the cable clamp (callout 1), remove four screws (callout 2), and then slide the DC controller stay (callout 3) out to remove it.

 **NOTE:** Be careful not to drop any of the screws into the low-voltage power supply assembly below the DC controller.

Figure 5-452 Remove the DC controller stay



3. Unhook one spring (callout 1), release the cable (callout 2) from the cable clamp (callout 3), remove four screws (callout 4), and then remove the formatter cage (callout 5).

Figure 5-453 Remove the formatter cage

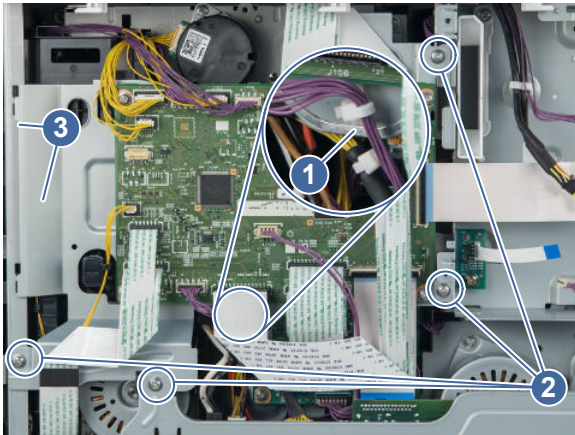
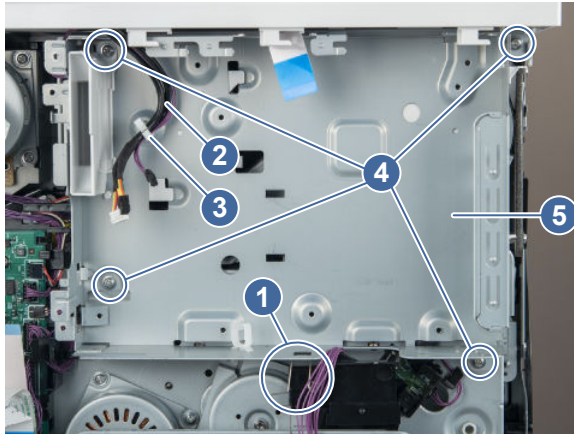

4. **For a replacement formatter cage only:** Release the cable (callout 1) from the cable guide (callout 2), release one tab (callout 3), and then remove the memory PCA (callout 4) from the formatter cage (callout 5).



NOTE: Install the PCA on the replacement formatter cage.

Figure 5-454 Remove the memory PCA

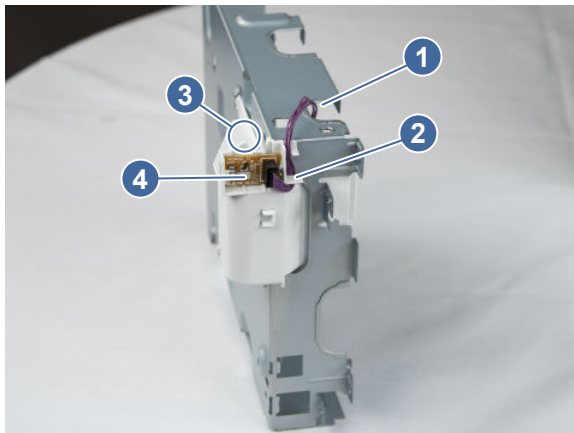

9. Remove the formatter cage (MFP models)

Follow these steps to remove the formatter cage.

1. Unhook one spring (callout 1), remove seven screws (callout 2), and then remove the formatter cage (callout 3).

Figure 5-455 Remove the formatter cage

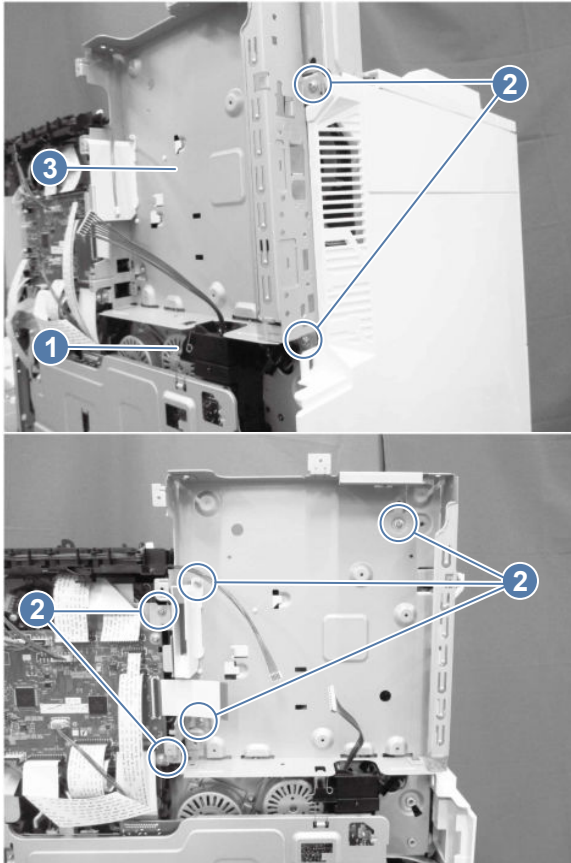

2. **For a replacement formatter cage only:** Release the cable (callout 1) from the cable guide (callout 2), release one tab (callout 3), and then remove the memory PCA (callout 4) from the formatter cage (callout 5).

 **NOTE:** Install the PCA on the replacement formatter cage.

Figure 5-456 Remove the memory PCA



10. Remove the drive PCA

Follow these steps to remove the drive PCA.

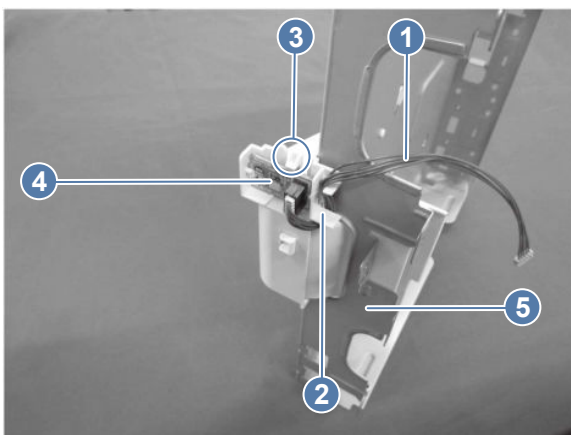
1. Disconnect all the connectors on the DC controller PCA, remove the cable clamp (callout 1), remove three screws (callout 2), and then slide the DC controller stay (callout 3) out to remove it.

Figure 5-457 Remove the DC controller stay

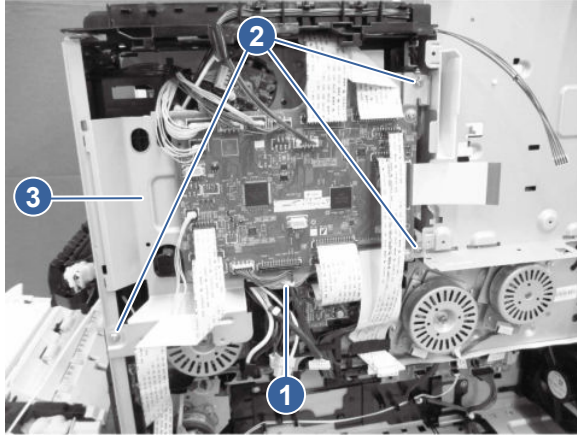

2. Disconnect all the connectors on the drive PCA, remove one screw (callout 1), release two tabs (callout 2), and then remove the drive PCA (callout 3).

 **IMPORTANT:** Some of these wires are very tightly connected. Take care when disconnecting them.

Figure 5-458 Remove the drive PCA

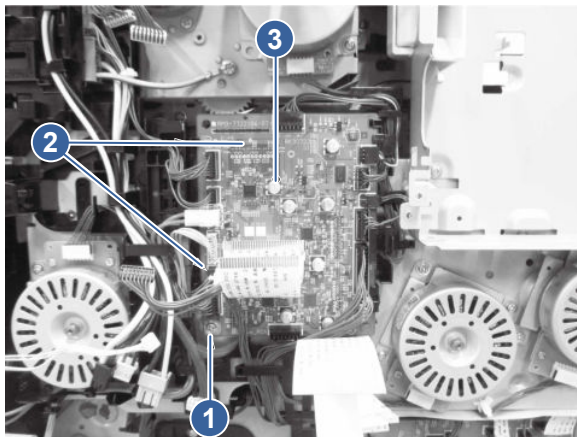

11. Remove the main-drive assembly

Follow these steps to remove the main-drive assembly.

 **NOTE:** Make sure that the front door is closed when performing this procedure.

1. Pull the lever (callout 1) of the cable cover (callout 2), release one tab (callout 3), and then remove the cable cover.

Figure 5-459 Remove the cable cover

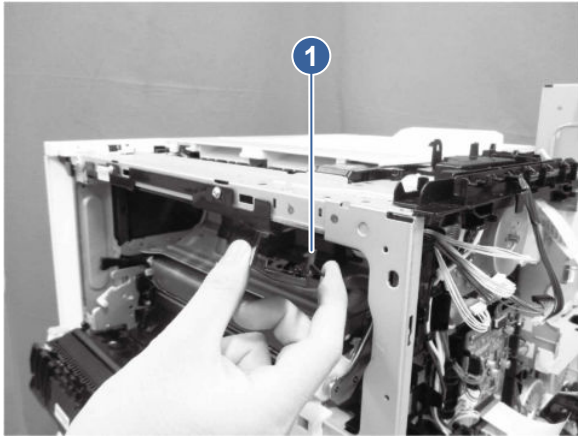

 **Reinstallation tip:** When reinstalling, align the pegs in the holes, and then set the cover against the frame and rotate it up and into position.

2. Disconnect one connector (callout 1).

Figure 5-460 Disconnect one connector

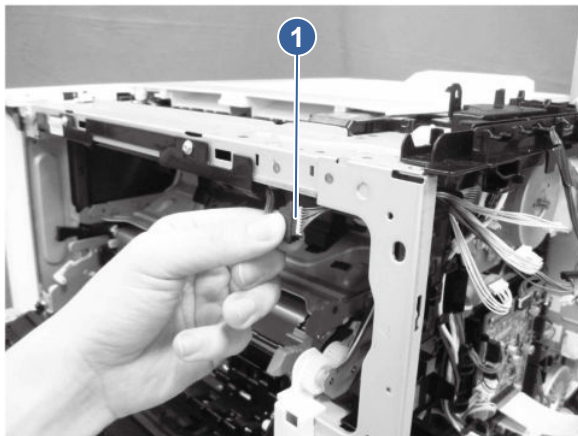

3. Remove one screw (callout 1), release the cable (callout 2) from the cable guide (callout 3), release one tab (callout 4), and then slide the connector cover (callout 5) upward to remove it.

Figure 5-461 Remove the connector cover

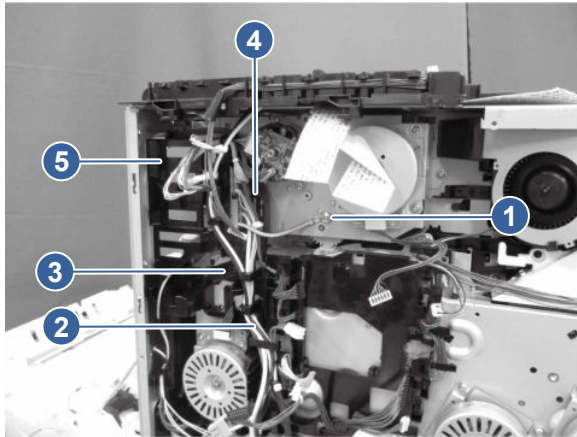

4. Release one tab (callout 1), and then slide the link cover (callout 2) in the direction indicated to remove it.

Figure 5-462 Remove the link cover

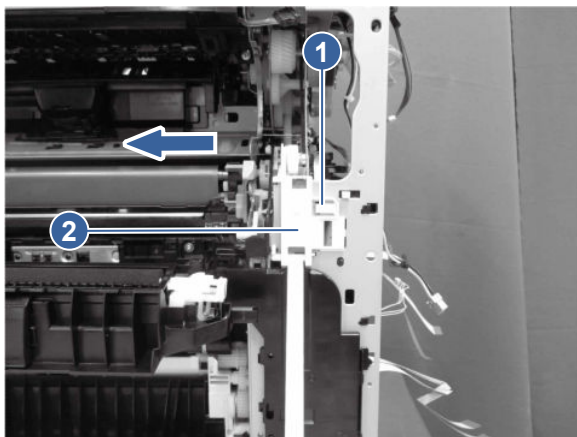

5. Close the right door a little, and then release the link arm (callout 1) from the coupling (callout 2).

 **NOTE:** This is a keyed connection. When disconnecting, make sure to line up the peg with the socket so that you do not strip the peg.

 **Reinstallation tip:** If the black link arm disconnects from the white link arm below it, it might be helpful for reinstallation purposes to reattach the two link arms.

Figure 5-463 Release the link arm



6. Disconnect one connector (callout 1), release the cable (callout 2) from the fan cover (callout 3), release four tabs (callout 4), and then remove the fan cover.

Figure 5-464 Remove the fan cover

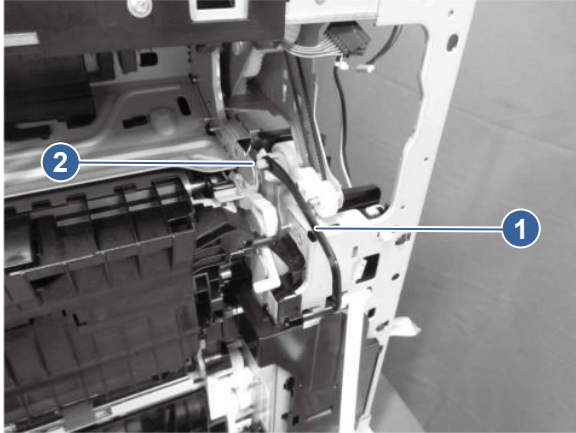
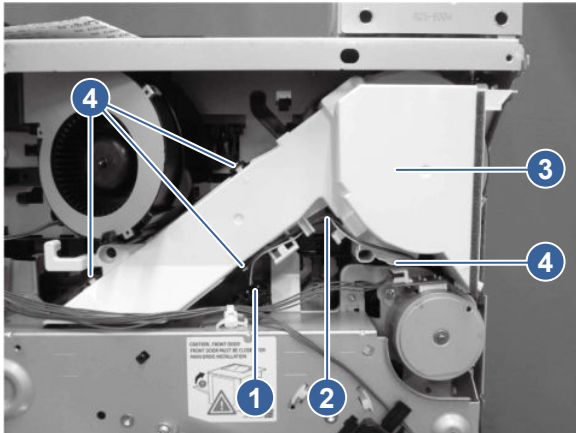

 **Reinstallation tip:** When reinstalling this cover, seat the right side pegs into the chassis slots first.

7. Release the cables (callout 1) and the remove FFC (callout 2) from the cable guide (callout 3).

Figure 5-465 Release the cables

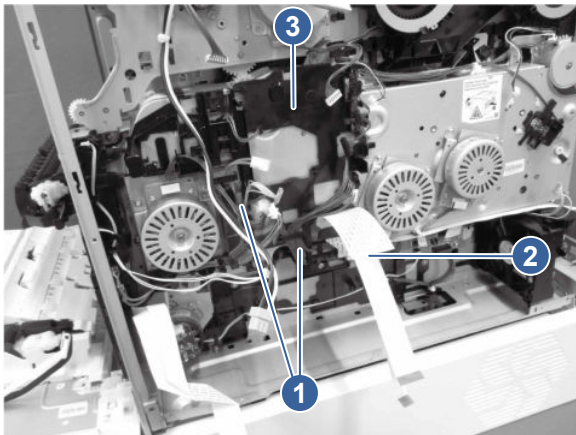

8. Remove seven screws (callout 1), release one tab (callout 2), and then remove the main drive assembly (callout 3).

 **NOTE:** All seven screws are on sheet metal tabs on the assembly.

 **NOTE:** Ensure that the screws do not fall into the assembly.

Figure 5-466 Remove the main drive assembly

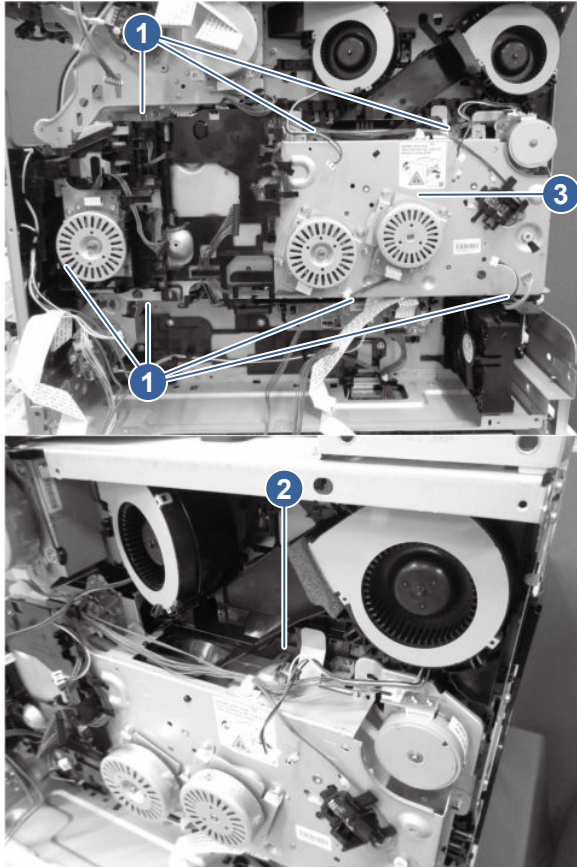

9. **Special installation instructions for a main drive assembly (replacement unit and serviced unit)**

- **Replacement unit:** A replacement unit is a new assembly that installs in place of a discarded in-service unit.
- **In-service unit:** An in-service unit is an existing assembly that has been removed for repair or to gain access to other assemblies.

 **CAUTION:** When the main drive assembly is installed (replacement units and service units), the front door **must** be closed.

 **IMPORTANT:** If you are installing a new main drive assembly (replacement unit), you **do not** need to perform the alignment steps below. New assemblies are **already** aligned.

- a. **Replacement unit and in-service unit:** On the printer engine, be careful to **not** depress the levers located behind the main drive assembly (when it is installed).
 - **Callout 1:** Levers in the correct raised position.
 - **Callout 2:** Lever in the incorrect depressed position.

Figure 5-467 Correct and incorrect lever positions

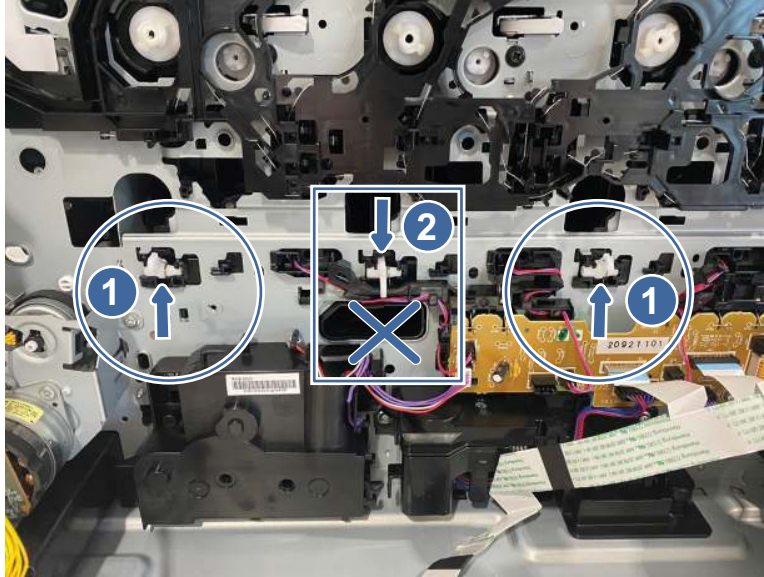

 **NOTE:** For a replacement unit install, skip the remaining alignment steps which are for in-service units only.

- b. **In-service unit:** There are four gears on the main drive assembly that need to be lined up correctly in order to successfully reinstall the main drive. For each gear, the triangle (callout 1) on the inside of the gear should line up with the triangle (callout 2) stamped on the sheet metal chassis. Also, the hole (callout 3) in the gear should line up with a hole in the chassis.

Figure 5-468 Correct gear alignment

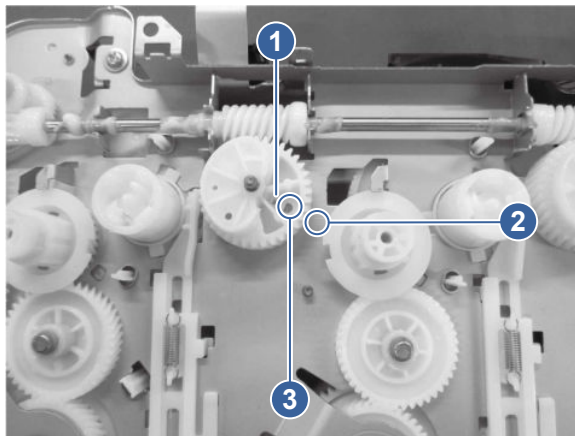

- c. **In-service unit:** In order to realign the four gears, you must remove the motor that locks the gear auger above the four gears. To do this, disconnect one connector (callout 1), remove two screws (callout 2), and then remove the motor (callout 3).

Figure 5-469 Remove the motor

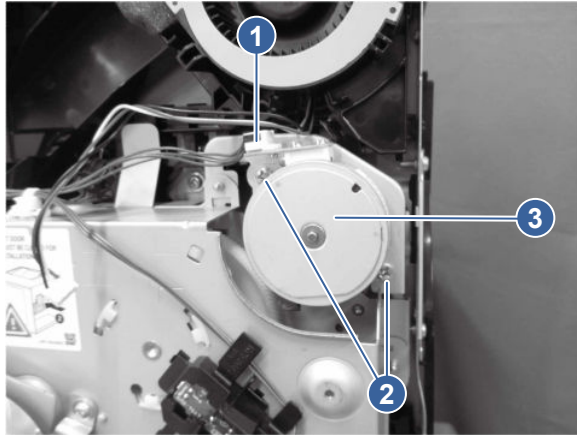

- d. **In-service unit:** To realign the four gears, turn the gear (callout 1) in the direction indicated. By turning that gear, the four gears (callout 2) that need to be in phase turn in tandem. Turn the four gears to the correct phase position.

Figure 5-470 Align the gears

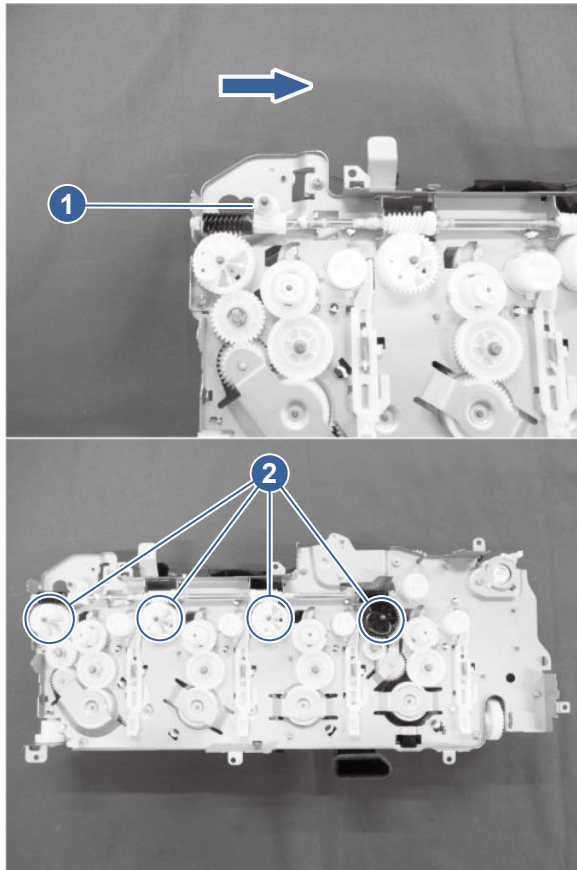

12. Unpack the replacement assembly



Follow these steps to unpack the replacement assembly.

1. Dispose of the defective part.

 **NOTE:** HP recommends responsible disposal of the defective part.

<http://www8.hp.com/us/en/hp-information/environment/product-recycling.html>

2. Unpack the replacement part from the packaging.

 **CAUTION:**  Some parts are sensitive to electrostatic discharge (ESD). Always perform service work at an ESD-protected workstation or mat. If an ESD workstation or mat is not available, touch the sheet-metal chassis to provide a static ground before touching an ESD-sensitive assembly. Protect the ESD-sensitive assemblies by placing them in ESD pouches when they are out of the printer.

 **IMPORTANT:** Make sure that all of the shipping materials (for example shipping tape) are removed from the replacement part prior to installation.

 **NOTE:** If the replacement part is a roller or pad, avoid touching the spongy part of it. Skin oils on the roller or pad can cause paper pickup and/or print-quality problems. HP recommends using disposable gloves when handling rollers or pads or washing your hands before touching rollers or pads.

3. To install an assembly, reverse the removal steps.

 **NOTE:** When applicable, special installation instructions are provided for an assembly at the end of the removal procedure. Always completely read the removal instructions and follow all special installation instructions.

Removal and replacement: Interlock assembly

Learn about removing and replacing the interlock assembly.

Before performing service

Turn the printer power off

- Disconnect the power cable.

 **WARNING!** To avoid damage to the printer, turn the printer off, wait 30 seconds, and then remove the power cord before attempting to service the printer.

If the part is damaged and cannot be cleaned, use the table below to identify the correct part number for your printer. To order the part, go to www.hp.com/buy/parts.

Table 5-72 Part information

Part number	Part description
RM2-3675-000CN	Interlock assembly (5700/X557/5800/X57945)
RM2-3676-000CN	Interlock assembly (6700/X654/6800/X677)

Required tools

- #2 Phillips screwdriver with a magnetic tip and a 152 mm (6 in) shaft length

After performing service

Turn the printer power on

- Connect the power cable.
- Use the power switch to turn the power on.

Post service test

Print any pages necessary to make sure the printer is functioning correctly.

1. Remove the fuser

Follow these steps to remove the fuser.

1. Open the right door.

⚠ CAUTION: The fuser is hot. Wait at least 10 minutes after turning the printer power off before removing the fuser.

Figure 5-471 Open the right door



2. Squeeze the release levers on the handles (circle callouts), and then remove the fuser.

Figure 5-472 Remove the fuser

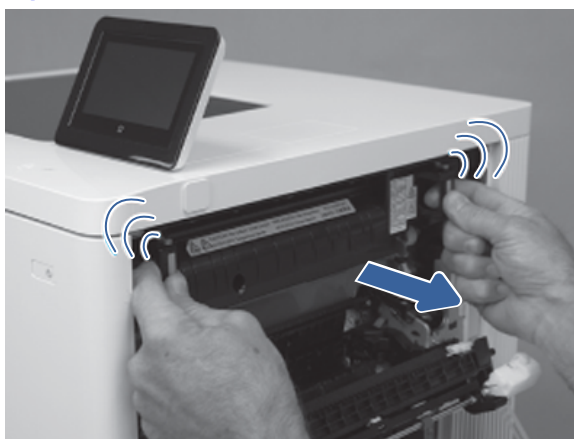

2. Remove the formatter cover

Follow these steps to remove the formatter cover.

- Remove one screw (callout 1), and then slide the formatter cover (callout 2) away from the printer to remove it.

 **TIP:** Reverse the removal steps to install the assembly.

Figure 5-473 Remove the formatter cover



3. Remove the formatter

Follow these steps to remove the formatter.

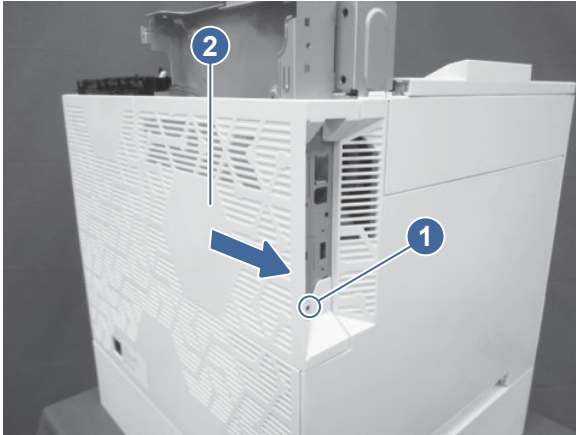
1. Disconnect all of the connectors on the formatter.

 **IMPORTANT:** Some of the flat flexible cable (FFC) connectors use hinged retainers to secure them to the DC controller. The hinged retainers must be opened to release the FFCs.

2. Remove the fax PCA (callout 1) and the hard disk drive (HDD) (callout 2), and then remove seven screws (callout 3) to remove the formatter.

Figure 5-474 Remove the formatter

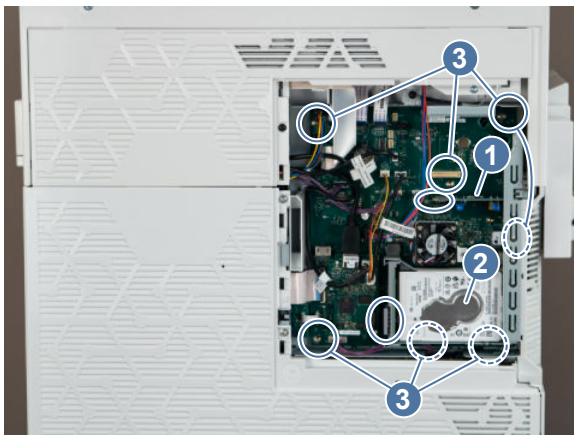

4. Remove the left upper cover (MFP models)

Follow these steps to remove the left upper cover.

1. Open the front door.

⚠ CAUTION: If the cover is being removed to gain access to the main drive assembly, make sure that the front door remains open. This keeps the main drive properly aligned.

2. At the left side of the printer, insert the small flat-blade screwdriver into the slot to release one tab (callout 1).

Figure 5-475 Use a screwdriver to release the tab

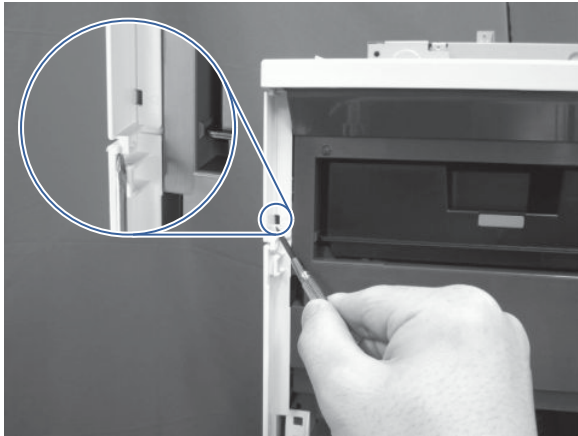

3. Toward the front of the printer, release another tab.

Figure 5-476 Release the tab

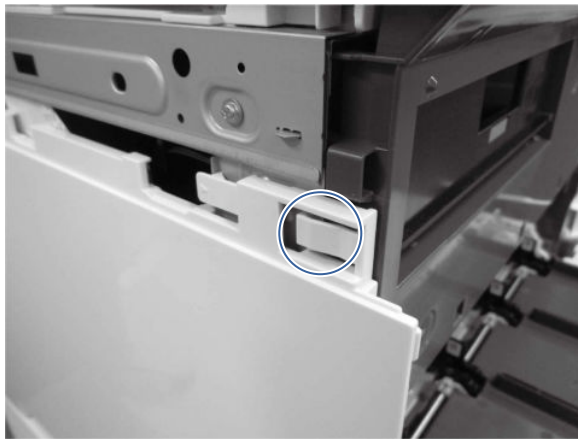

4. Rotate the cover up to remove it.

Figure 5-477 Remove the left upper cover

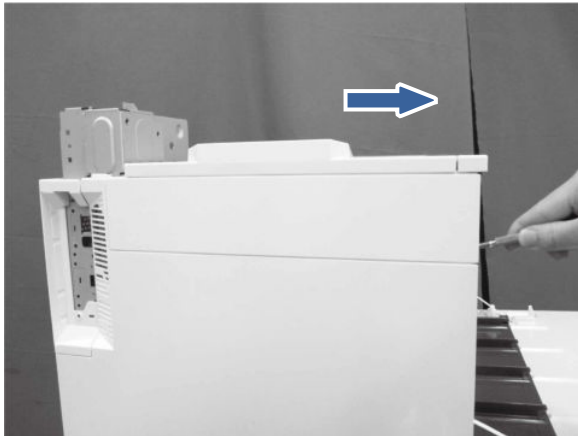

5. Remove the left cover

Follow these steps to remove the left cover.

- At the left side of the printer, remove one screw (callout 1), release one tab (callout 2), and then slide the cover (callout 3) toward the rear of the printer to release it.

Figure 5-478 Remove the left cover

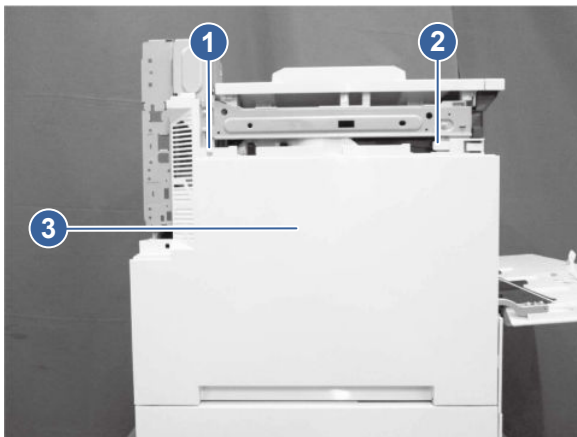

6. Remove the rear cover

Follow these steps to remove the rear cover.

-
-  **NOTE:** The figures below show some assemblies (for example the top cover and formatter) removed that might still be installed on the printer. However, the steps to remove the cover are correct.
-

1. Open the right door, and remove two screws.

Figure 5-479 Remove two screws

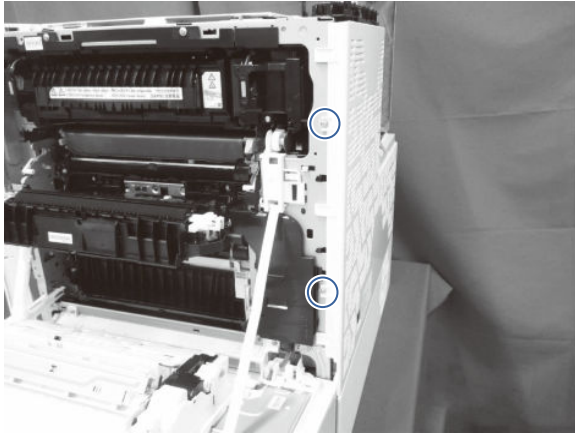

2. At the back of the printer, remove two screws, and then slide the rear cover as indicated to remove it.

Figure 5-480 Remove the rear cover

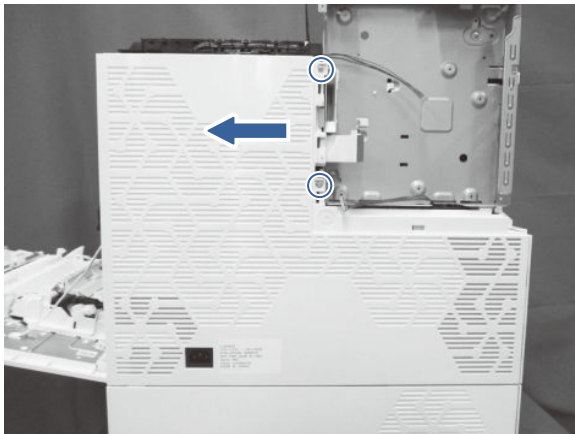

7. Remove the low-voltage power supply (LVPS)

Follow these steps to remove the low-voltage power supply (LVPS).

1. Unhook one spring (callout 1), and then disconnect two connectors (callout 2).

 **NOTE:** Unhook the spring from the formatter cage, not the low-voltage power supply. The spring should remain attached to the LVPS.

Figure 5-481 Unhook the spring and disconnect two connectors



2. Remove the FFC (callout 1), and then disconnect five connectors (callout 2).

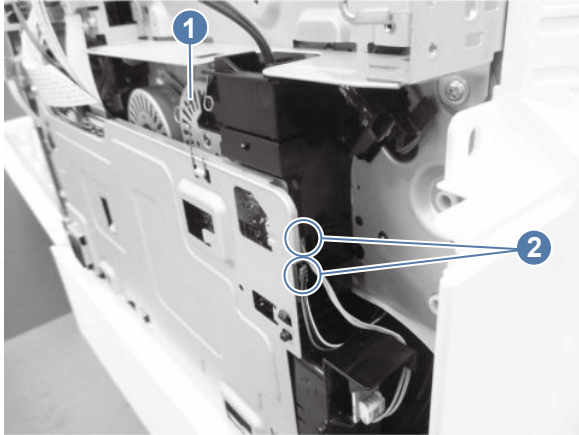

 **NOTE:** MFP only: Disconnect one additional connector (callout 3).

Figure 5-482 Disconnect the LVPS connectors

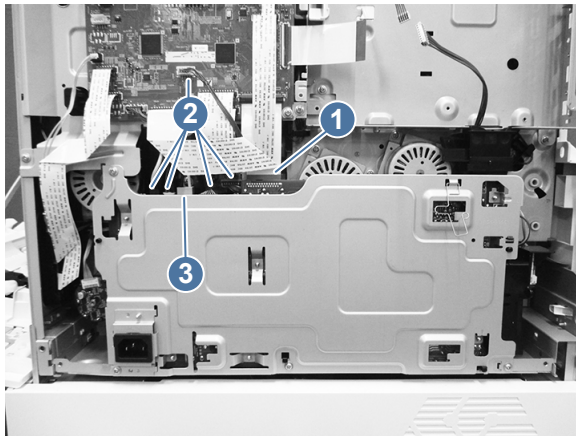

3. Remove four screws (callout 1), and then remove the low-voltage power supply assembly (callout 2).

 **NOTE:** The black ducting in the lower right corner can stick during the removal process.

Replacement LVPS only: Remove the spring (callout 3), and then install it on the replacement LVPS.

Figure 5-483 Remove the LVPS

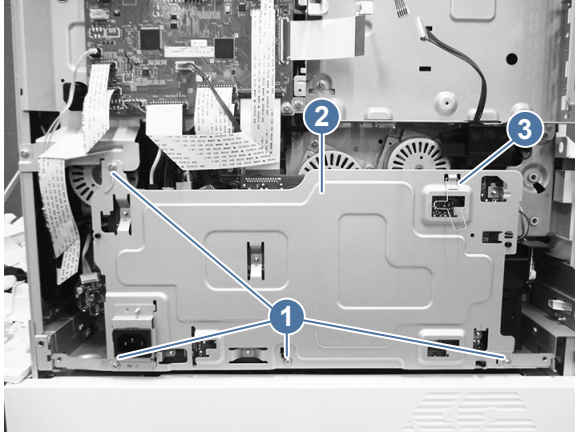

 **Reinstallation tip:** When reinstalling the LVPS, make sure that the spring (callout 1) is attached to both the formatter cage (callout 2) and the LVPS (callout 3).

Figure 5-484 Reinstalling the LVPS



8. Remove the DC controller

Follow these steps to remove the DC controller.

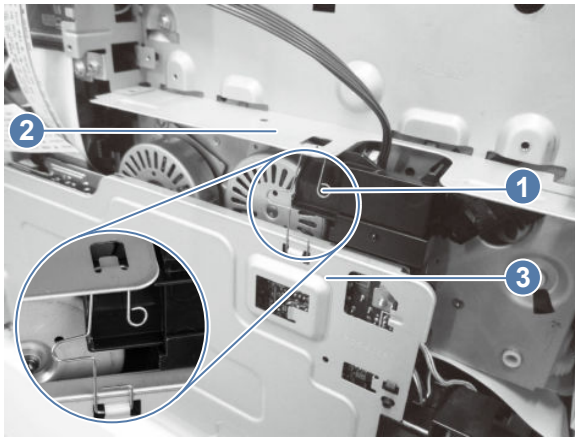
- Disconnect all of the connectors on the DC controller, remove four screws (callout 1), and then remove the DC controller (callout 2).

 **IMPORTANT:** Some of the flat flexible cable (FFC) connectors use hinged retainers to secure them to the DC controller. The hinged retainers must be opened to release the FFCs.

Figure 5-485 Remove the DC controller



9. Remove the formatter cage (SFP models)

Follow these steps to remove the formatter cage.

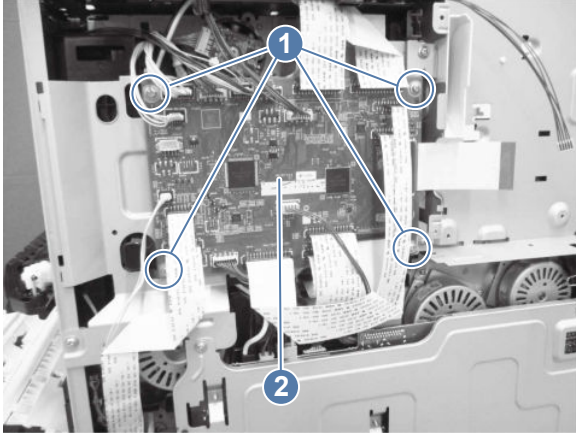
1. Disconnect all the connectors on the DC controller PCA.

 **IMPORTANT:** Some of the flat flexible cable (FFC) connectors use hinged retainers to secure them to the DC controller. The hinged retainers must be opened to release the FFCs.

2. Remove the cable clamp (callout 1), remove four screws (callout 2), and then slide the DC controller stay (callout 3) out to remove it.

 **NOTE:** Be careful not to drop any of the screws into the low-voltage power supply assembly below the DC controller.

Figure 5-486 Remove the DC controller stay



3. Unhook one spring (callout 1), release the cable (callout 2) from the cable clamp (callout 3), remove four screws (callout 4), and then remove the formatter cage (callout 5).

Figure 5-487 Remove the formatter cage

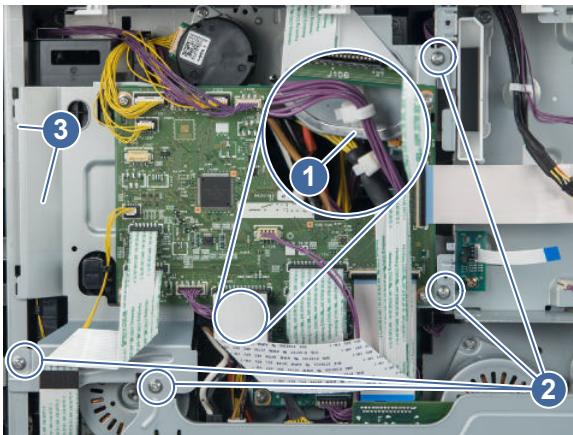
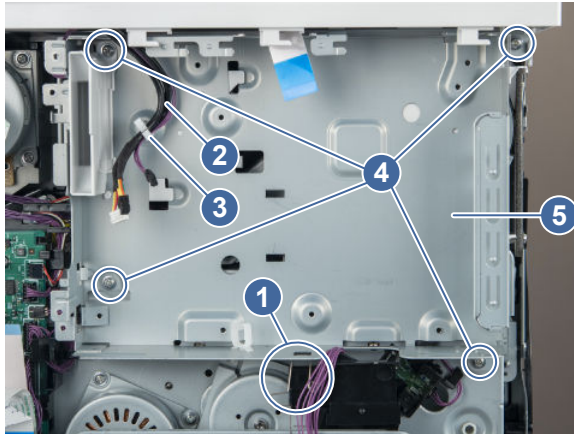

4. **For a replacement formatter cage only:** Release the cable (callout 1) from the cable guide (callout 2), release one tab (callout 3), and then remove the memory PCA (callout 4) from the formatter cage (callout 5).



NOTE: Install the PCA on the replacement formatter cage.

Figure 5-488 Remove the memory PCA

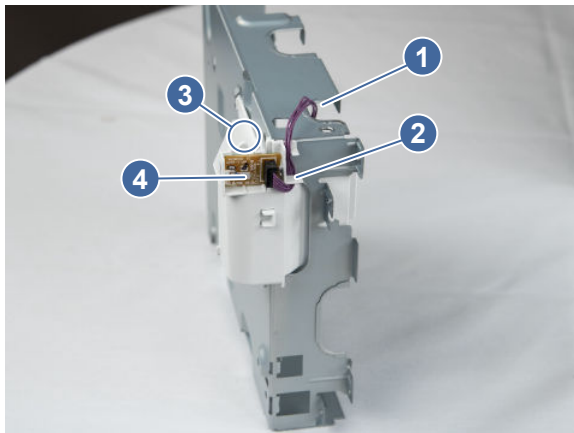

10. Remove the formatter cage (MFP models)

Follow these steps to remove the formatter cage.

1. Unhook one spring (callout 1), remove seven screws (callout 2), and then remove the formatter cage (callout 3).

Figure 5-489 Remove the formatter cage

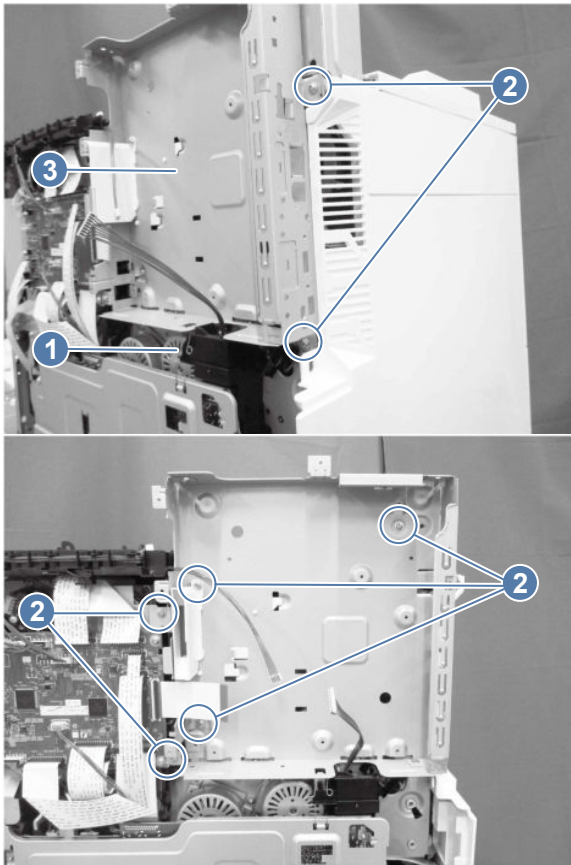

2. **For a replacement formatter cage only:** Release the cable (callout 1) from the cable guide (callout 2), release one tab (callout 3), and then remove the memory PCA (callout 4) from the formatter cage (callout 5).

 **NOTE:** Install the PCA on the replacement formatter cage.

Figure 5-490 Remove the memory PCA



11. Remove the drive PCA

Follow these steps to remove the drive PCA.

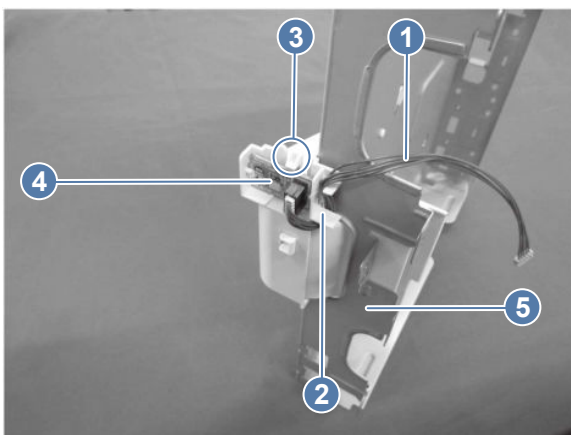
1. Disconnect all the connectors on the DC controller PCA, remove the cable clamp (callout 1), remove three screws (callout 2), and then slide the DC controller stay (callout 3) out to remove it.

Figure 5-491 Remove the DC controller stay

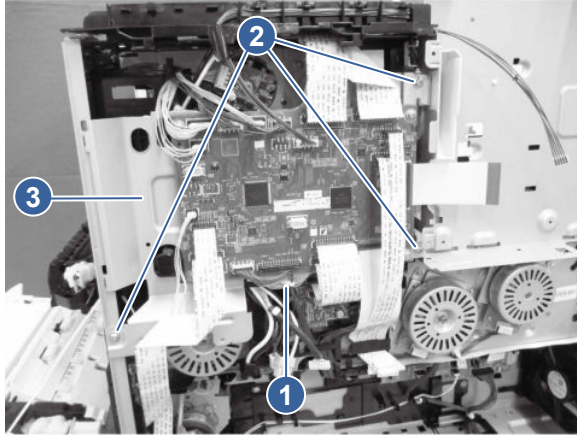

2. Disconnect all the connectors on the drive PCA, remove one screw (callout 1), release two tabs (callout 2), and then remove the drive PCA (callout 3).



 **IMPORTANT:** Some of these wires are very tightly connected. Take care when disconnecting them.

Figure 5-492 Remove the drive PCA

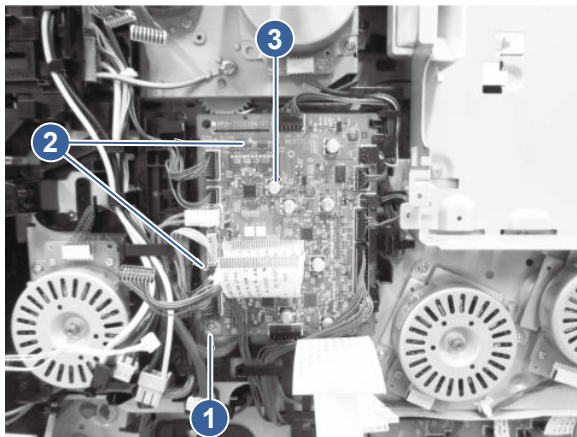

12. Remove the main-drive assembly

Follow these steps to remove the main-drive assembly.

 **NOTE:** Make sure that the front door is closed when performing this procedure.

1. Pull the lever (callout 1) of the cable cover (callout 2), release one tab (callout 3), and then remove the cable cover.

Figure 5-493 Remove the cable cover

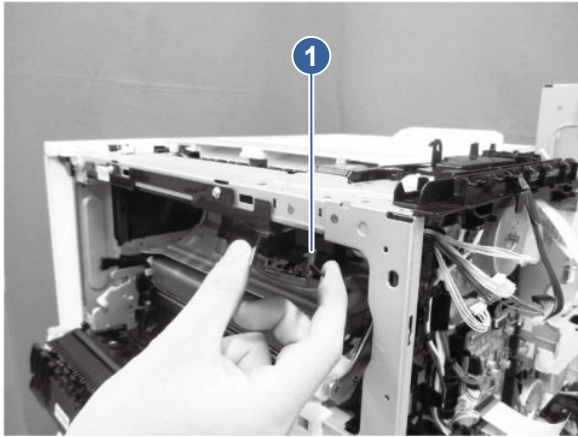

 **Reinstallation tip:** When reinstalling, align the pegs in the holes, and then set the cover against the frame and rotate it up and into position.

2. Disconnect one connector (callout 1).

Figure 5-494 Disconnect one connector

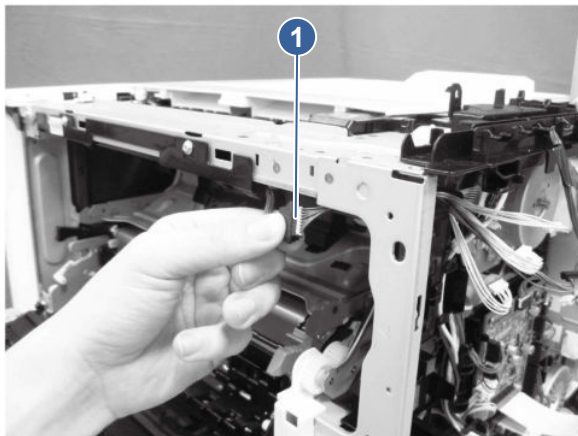

3. Remove one screw (callout 1), release the cable (callout 2) from the cable guide (callout 3), release one tab (callout 4), and then slide the connector cover (callout 5) upward to remove it.

Figure 5-495 Remove the connector cover

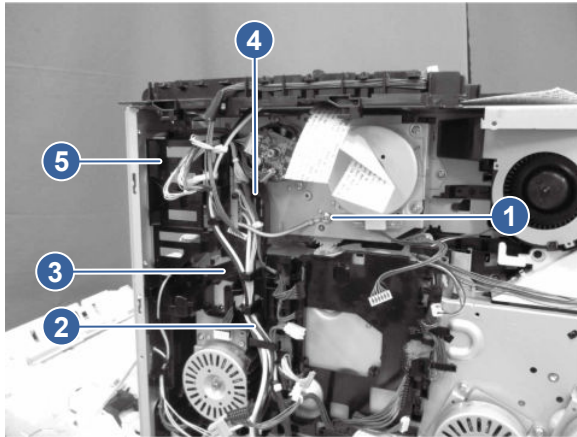

4. Release one tab (callout 1), and then slide the link cover (callout 2) in the direction indicated to remove it.

Figure 5-496 Remove the link cover

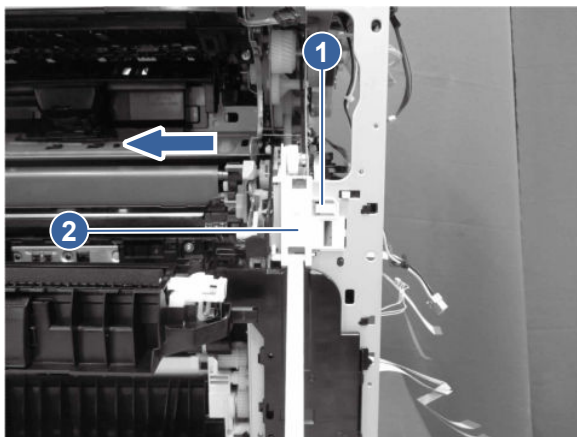

5. Close the right door a little, and then release the link arm (callout 1) from the coupling (callout 2).

 **NOTE:** This is a keyed connection. When disconnecting, make sure to line up the peg with the socket so that you do not strip the peg.

 **Reinstallation tip:** If the black link arm disconnects from the white link arm below it, it might be helpful for reinstallation purposes to reattach the two link arms.

Figure 5-497 Release the link arm



6. Disconnect one connector (callout 1), release the cable (callout 2) from the fan cover (callout 3), release four tabs (callout 4), and then remove the fan cover.

Figure 5-498 Remove the fan cover

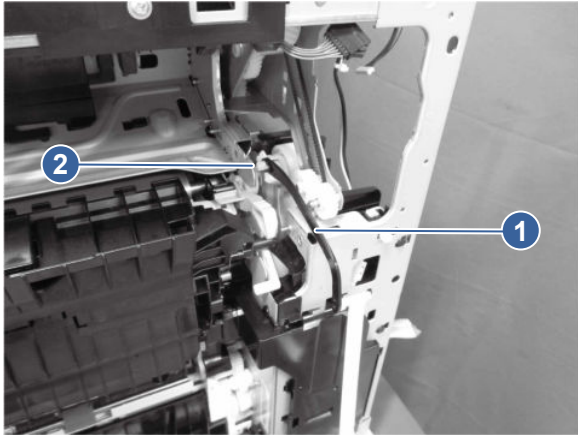
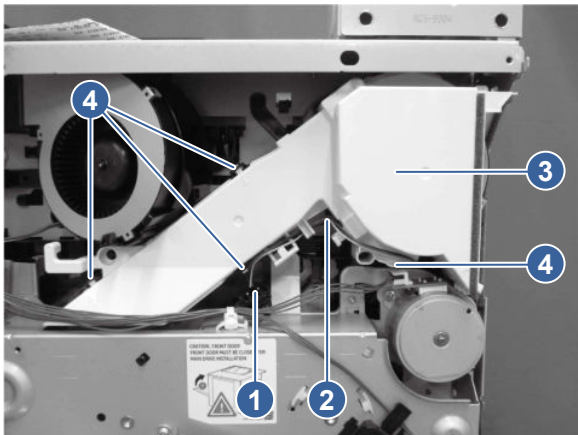

 **Reinstallation tip:** When reinstalling this cover, seat the right side pegs into the chassis slots first.

7. Release the cables (callout 1) and the remove FFC (callout 2) from the cable guide (callout 3).

Figure 5-499 Release the cables

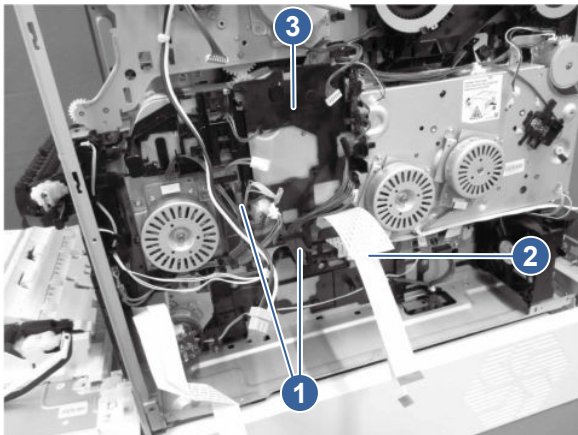

8. Remove seven screws (callout 1), release one tab (callout 2), and then remove the main drive assembly (callout 3).

 **NOTE:** All seven screws are on sheet metal tabs on the assembly.

 **NOTE:** Ensure that the screws do not fall into the assembly.

Figure 5-500 Remove the main drive assembly

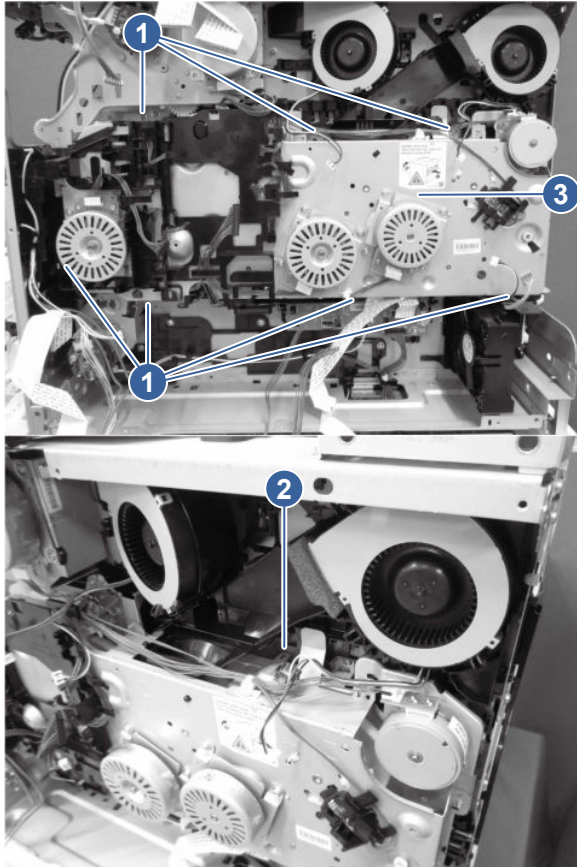

9. **Special installation instructions for a main drive assembly (replacement unit and serviced unit)**
 - **Replacement unit:** A replacement unit is a new assembly that installs in place of a discarded in-service unit.
 - **In-service unit:** An in-service unit is an existing assembly that has been removed for repair or to gain access to other assemblies.

 **CAUTION:** When the main drive assembly is installed (replacement units and service units), the front door **must** be closed.

 **IMPORTANT:** If you are installing a new main drive assembly (replacement unit), you **do not** need to perform the alignment steps below. New assemblies are **already** aligned.

- a. **Replacement unit and in-service unit:** On the printer engine, be careful to **not** depress the levers located behind the main drive assembly (when it is installed).
 - **Callout 1:** Levers in the correct raised position.
 - **Callout 2:** Lever in the incorrect depressed position.

Figure 5-501 Correct and incorrect lever positions

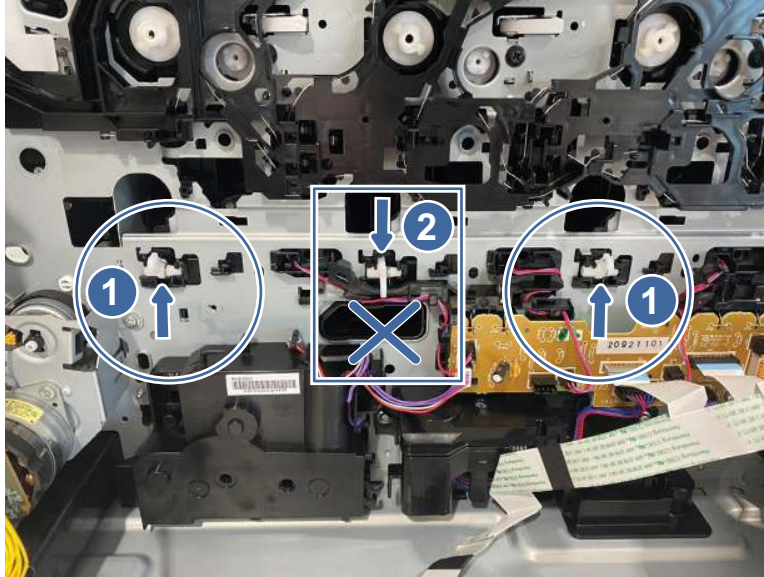

 **NOTE:** For a replacement unit install, skip the remaining alignment steps which are for in-service units only.

- b. **In-service unit:** There are four gears on the main drive assembly that need to be lined up correctly in order to successfully reinstall the main drive. For each gear, the triangle (callout 1) on the inside of the gear should line up with the triangle (callout 2) stamped on the sheet metal chassis. Also, the hole (callout 3) in the gear should line up with a hole in the chassis.

Figure 5-502 Correct gear alignment

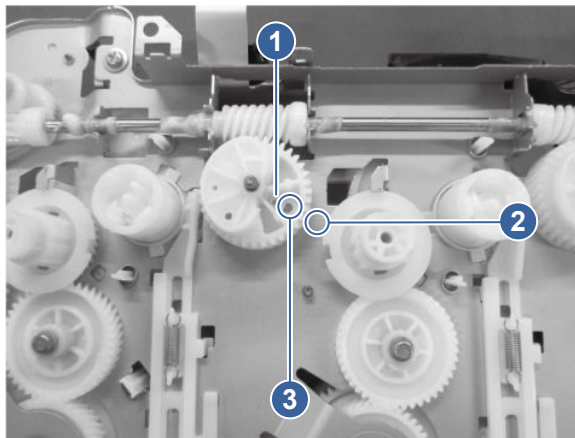

- c. **In-service unit:** In order to realign the four gears, you must remove the motor that locks the gear auger above the four gears. To do this, disconnect one connector (callout 1), remove two screws (callout 2), and then remove the motor (callout 3).

Figure 5-503 Remove the motor

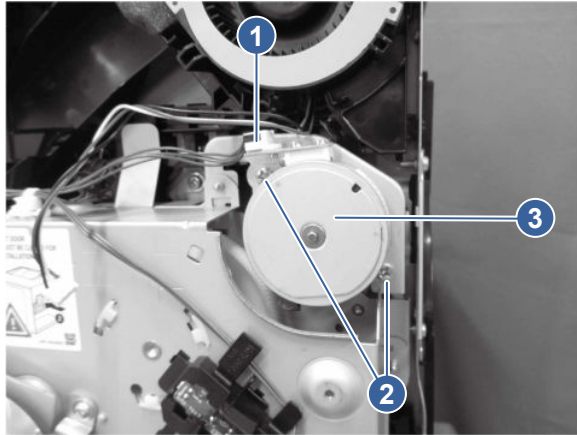

- d. **In-service unit:** To realign the four gears, turn the gear (callout 1) in the direction indicated. By turning that gear, the four gears (callout 2) that need to be in phase turn in tandem. Turn the four gears to the correct phase position.

Figure 5-504 Align the gears

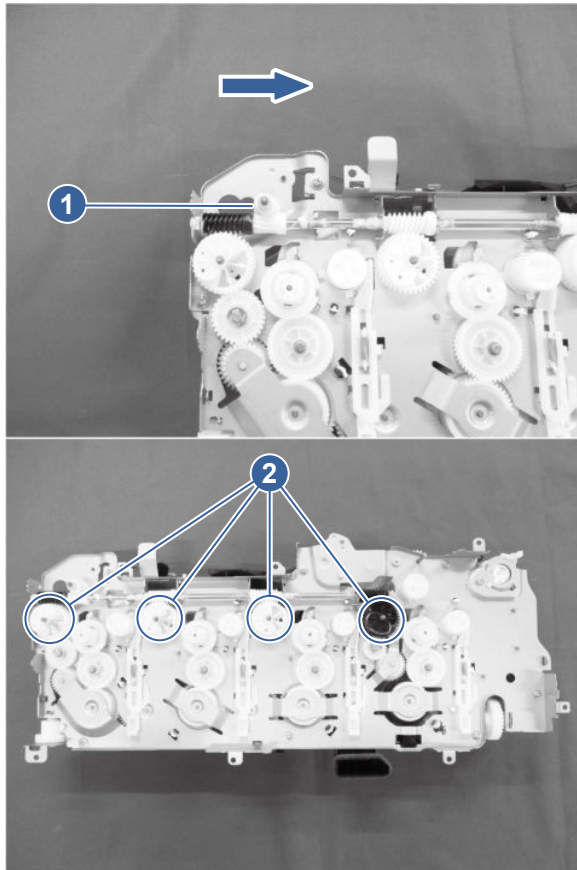

13. Remove the interlock assembly

Follow these steps to remove the interlock assembly.

- At the right side of the printer, release one boss (callout 1), and then slide the interlock assembly (callout 2) in the direction indicated to remove it.

Figure 5-505 Remove the interlock assembly

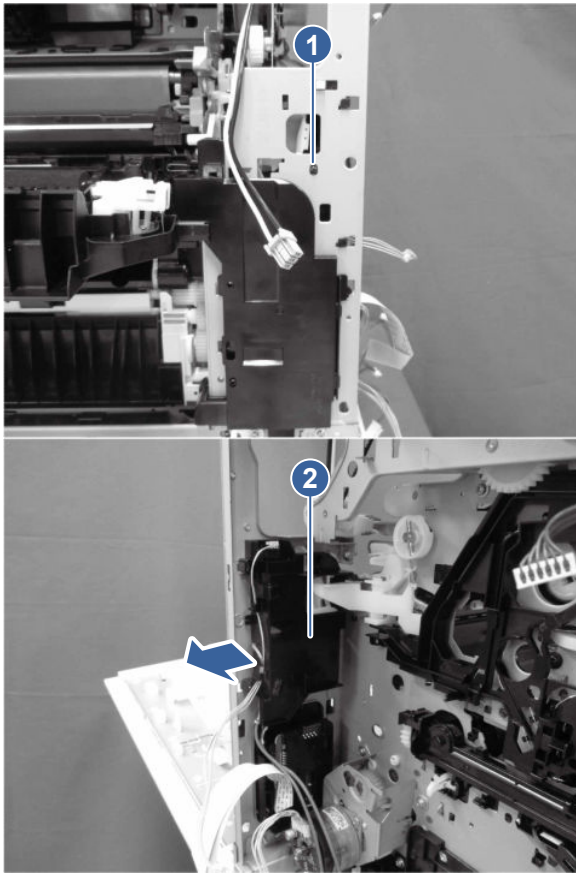

14. Unpack the replacement assembly

Follow these steps to unpack the replacement assembly.

1. Dispose of the defective part.



NOTE: HP recommends responsible disposal of the defective part.

<http://www8.hp.com/us/en/hp-information/environment/product-recycling.html>

2. Unpack the replacement part from the packaging.



CAUTION:  Some parts are sensitive to electrostatic discharge (ESD). Always perform service work at an ESD-protected workstation or mat. If an ESD workstation or mat is not available, touch the sheet-metal chassis to provide a static ground before touching an ESD-sensitive assembly. Protect the ESD-sensitive assemblies by placing them in ESD pouches when they are out of the printer.



IMPORTANT: Make sure that all of the shipping materials (for example shipping tape) are removed from the replacement part prior to installation.



NOTE: If the replacement part is a roller or pad, avoid touching the spongy part of it. Skin oils on the roller or pad can cause paper pickup and/or print-quality problems. HP recommends using

disposable gloves when handling rollers or pads or washing your hands before touching rollers or pads.

3. To install an assembly, reverse the removal steps.

 **NOTE:** When applicable, special installation instructions are provided for an assembly at the end of the removal procedure. Always completely read the removal instructions and follow all special installation instructions.

Removal and replacement: Waste toner duct assembly (X57945 models)

Learn about removing and replacing the waste toner duct assembly.

Before performing service

Turn the printer power off

- Disconnect the power cable.

 **WARNING!** To avoid damage to the printer, turn the printer off, wait 30 seconds, and then remove the power cord before attempting to service the printer.

If the part is damaged and cannot be cleaned, use the table below to identify the correct part number for your printer. To order the part, go to www.hp.com/buy/parts.

Table 5-73 Part information

Part number	Part description
RM2-3590-000CN	Waste toner duct assembly (X57945 models)

Required tools

- #2 Phillips screwdriver with a magnetic tip and a 152 mm (6 in) shaft length

After performing service

Turn the printer power on

- Connect the power cable.
- Use the power switch to turn the power on.

Post service test

Print any pages necessary to make sure the printer is functioning correctly.

1. Remove the fuser

Follow these steps to remove the fuser.

1. Open the right door.

 **CAUTION:** The fuser is hot. Wait at least 10 minutes after turning the printer power off before removing the fuser.

Figure 5-506 Open the right door



2. Squeeze the release levers on the handles (circle callouts), and then remove the fuser.

Figure 5-507 Remove the fuser

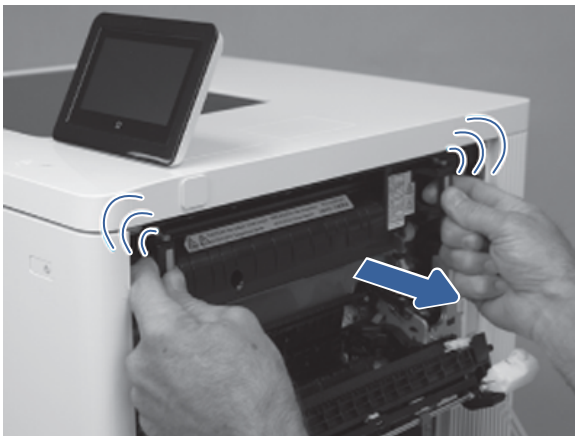

2. Unseat the ITB

Follow these steps to unseat the ITB.

1. Open the right door (if it is not already open).
2. Grasp the two levers on the ITB, and then slightly pull it out of the printer to unseat and disengage it.



Reinstallation tip: During Reinstallation of the target part, do not reseat the ITB too early in the process. The ITB must remain disengaged to make sure that the gear is correctly aligned.

A **46.00.0x** error occurs if the ITB is not seated if the procedure is completed with the ITB seated.

Figure 5-508 Disengage the ITB



3. Remove the formatter cover

Follow these steps to remove the formatter cover.

- Remove one screw (callout 1), and then slide the formatter cover (callout 2) away from the printer to remove it.

 **TIP:** Reverse the removal steps to install the assembly.

Figure 5-509 Remove the formatter cover



4. Remove the formatter

Follow these steps to remove the formatter.

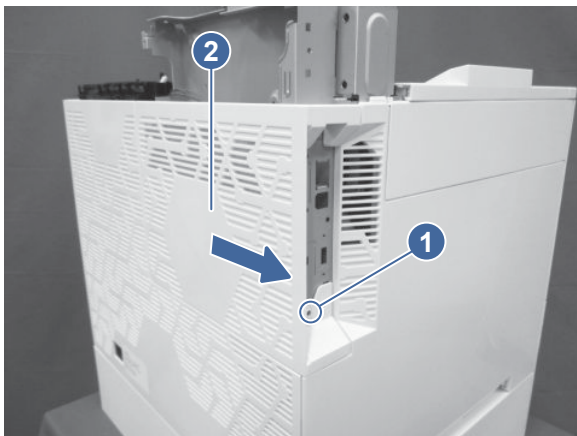
1. Disconnect all of the connectors on the formatter.

 **IMPORTANT:** Some of the flat flexible cable (FFC) connectors use hinged retainers to secure them to the DC controller. The hinged retainers must be opened to release the FFCs.

2. Remove the fax PCA (callout 1) and the hard disk drive (HDD) (callout 2), and then remove seven screws (callout 3) to remove the formatter.

Figure 5-510 Remove the formatter

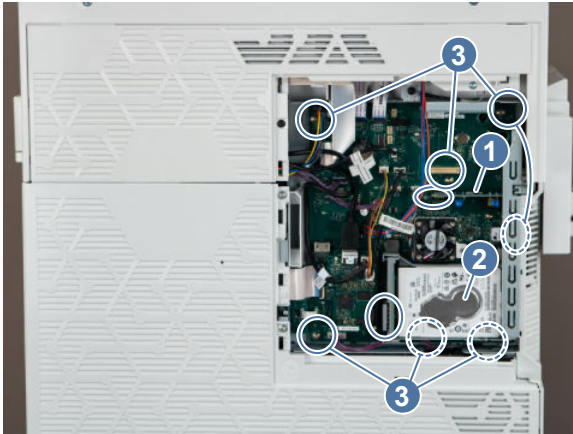

5. Remove the left upper cover (MFP models)

Follow these steps to remove the left upper cover.

1. Open the front door.

CAUTION: If the cover is being removed to gain access to the main drive assembly, make sure that the front door remains open. This keeps the main drive properly aligned.

2. At the left side of the printer, insert the small flat-blade screwdriver into the slot to release one tab (callout 1).

Figure 5-511 Use a screwdriver to release the tab

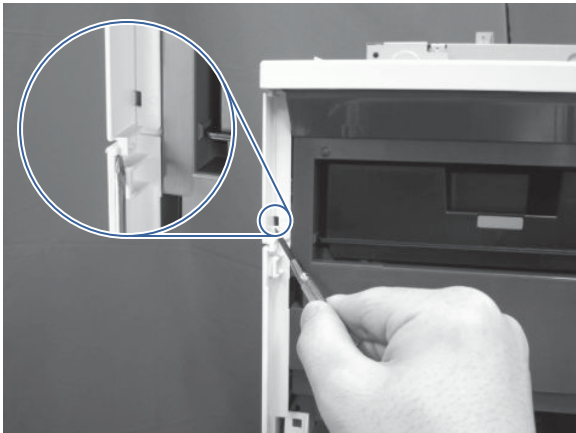

3. Toward the front of the printer, release another tab.

Figure 5-512 Release the tab

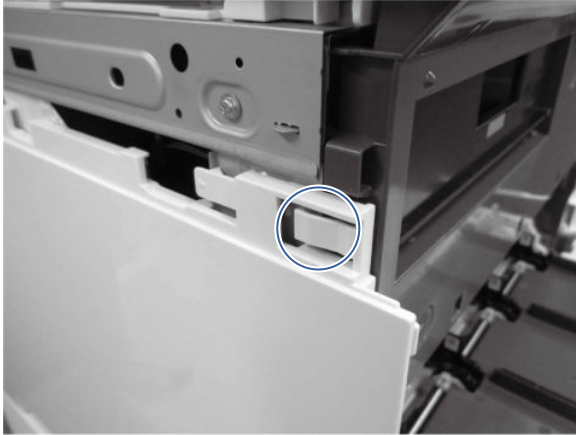

4. Rotate the cover up to remove it.

Figure 5-513 Remove the left upper cover

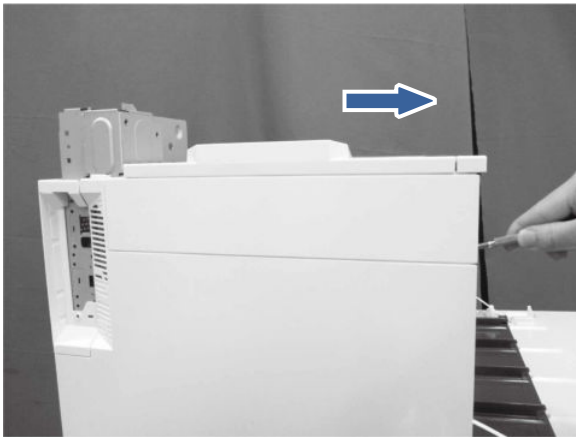

6. Remove the left cover

Follow these steps to remove the left cover.

- At the left side of the printer, remove one screw (callout 1), release one tab (callout 2), and then slide the cover (callout 3) toward the rear of the printer to release it.

Figure 5-514 Remove the left cover

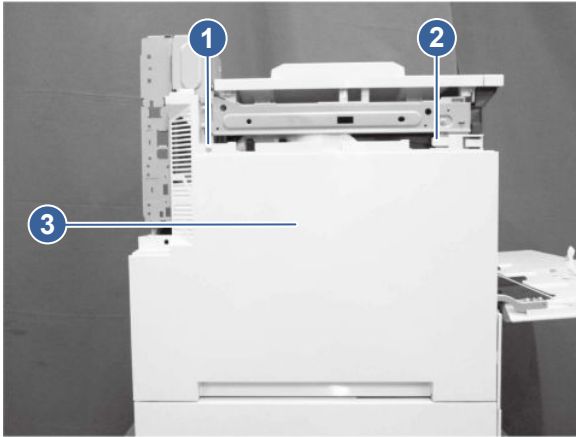

7. Remove the rear cover

Follow these steps to remove the rear cover.

 **NOTE:** The figures below show some assemblies (for example the top cover and formatter) removed that might still be installed on the printer. However, the steps to remove the cover are correct.

1. Open the right door, and remove two screws.

Figure 5-515 Remove two screws

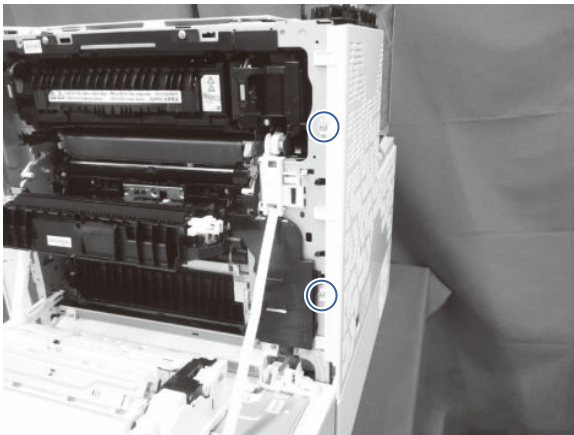

2. At the back of the printer, remove two screws, and then slide the rear cover as indicated to remove it.

Figure 5-516 Remove the rear cover

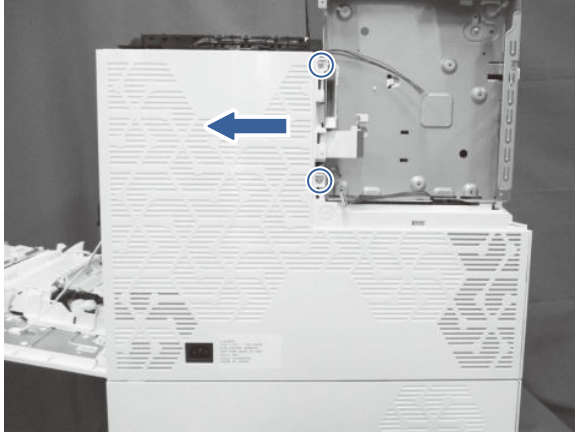

8. Remove the low-voltage power supply (LVPS)

Follow these steps to remove the low-voltage power supply (LVPS).

1. Unhook one spring (callout 1), and then disconnect two connectors (callout 2).

 **NOTE:** Unhook the spring from the formatter cage, not the low-voltage power supply. The spring should remain attached to the LVPS.

Figure 5-517 Unhook the spring and disconnect two connectors



2. Remove the FFC (callout 1), and then disconnect five connectors (callout 2).

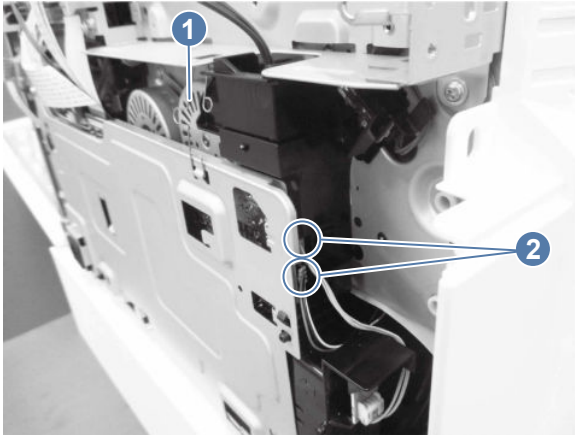

 **NOTE:** **MFP only:** Disconnect one additional connector (callout 3).

Figure 5-518 Disconnect the LVPS connectors

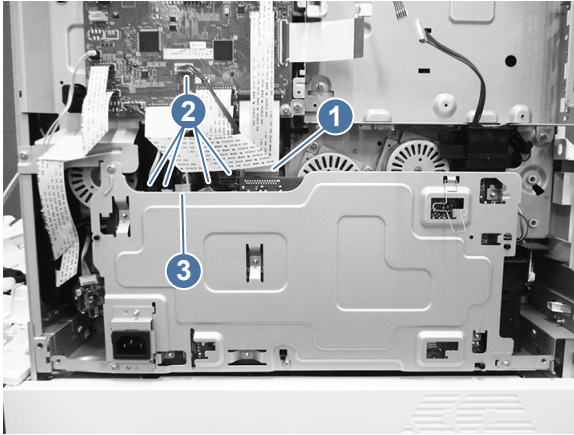

3. Remove four screws (callout 1), and then remove the low-voltage power supply assembly (callout 2).

 **NOTE:** The black ducting in the lower right corner can stick during the removal process.

Replacement LVPS only: Remove the spring (callout 3), and then install it on the replacement LVPS.

Figure 5-519 Remove the LVPS

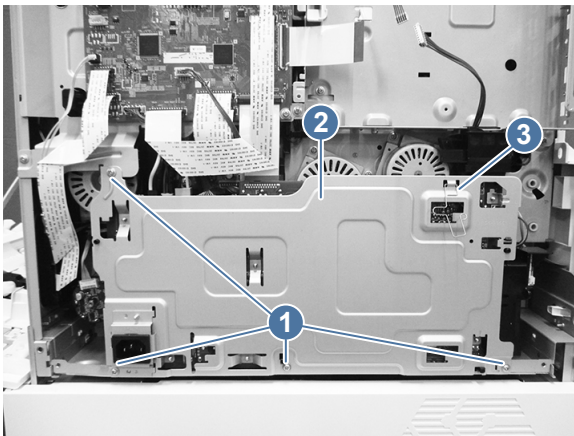

 **Reinstallation tip:** When reinstalling the LVPS, make sure that the spring (callout 1) is attached to both the formatter cage (callout 2) and the LVPS (callout 3).

Figure 5-520 Reinstalling the LVPS



9. Remove the DC controller

Follow these steps to remove the DC controller.

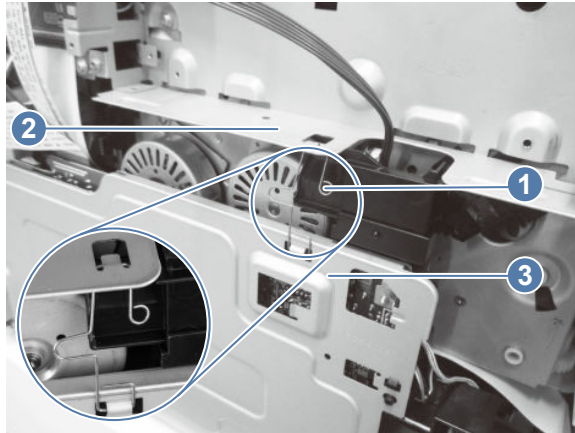
- Disconnect all of the connectors on the DC controller, remove four screws (callout 1), and then remove the DC controller (callout 2).

 **IMPORTANT:** Some of the flat flexible cable (FFC) connectors use hinged retainers to secure them to the DC controller. The hinged retainers must be opened to release the FFCs.

Figure 5-521 Remove the DC controller



10. Remove the formatter cage (SFP models)

Follow these steps to remove the formatter cage.

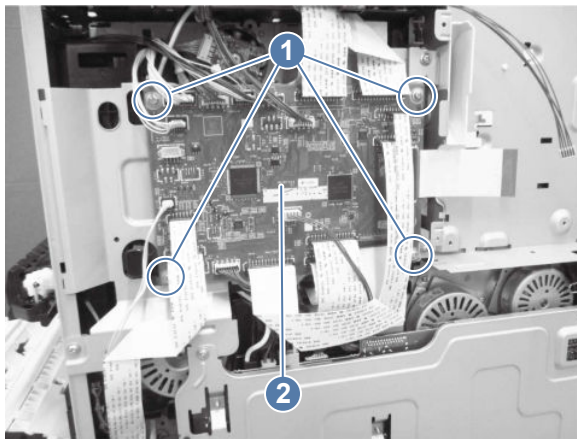
1. Disconnect all the connectors on the DC controller PCA.

 **IMPORTANT:** Some of the flat flexible cable (FFC) connectors use hinged retainers to secure them to the DC controller. The hinged retainers must be opened to release the FFCs.

2. Remove the cable clamp (callout 1), remove four screws (callout 2), and then slide the DC controller stay (callout 3) out to remove it.

 **NOTE:** Be careful not to drop any of the screws into the low-voltage power supply assembly below the DC controller.

Figure 5-522 Remove the DC controller stay



3. Unhook one spring (callout 1), release the cable (callout 2) from the cable clamp (callout 3), remove four screws (callout 4), and then remove the formatter cage (callout 5).

Figure 5-523 Remove the formatter cage

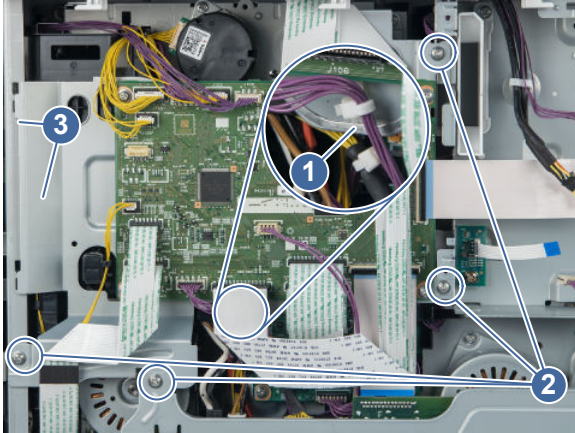
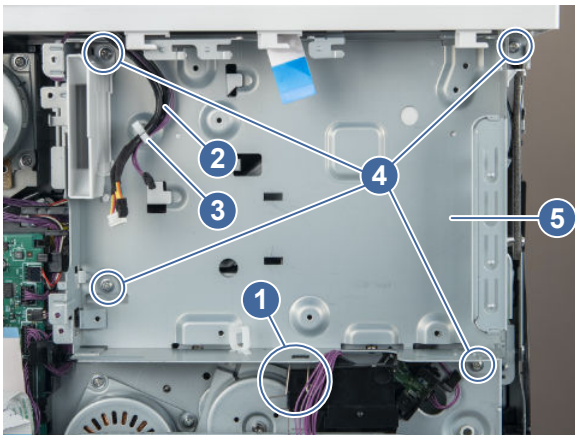

4. **For a replacement formatter cage only:** Release the cable (callout 1) from the cable guide (callout 2), release one tab (callout 3), and then remove the memory PCA (callout 4) from the formatter cage (callout 5).



NOTE: Install the PCA on the replacement formatter cage.

Figure 5-524 Remove the memory PCA

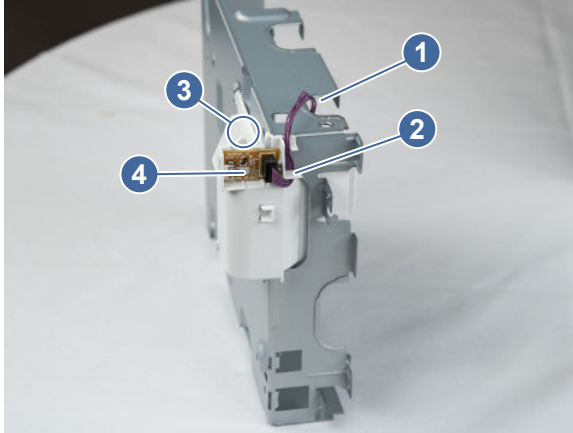

11. Remove the formatter cage (MFP models)

Follow these steps to remove the formatter cage.

1. Unhook one spring (callout 1), remove seven screws (callout 2), and then remove the formatter cage (callout 3).

Figure 5-525 Remove the formatter cage

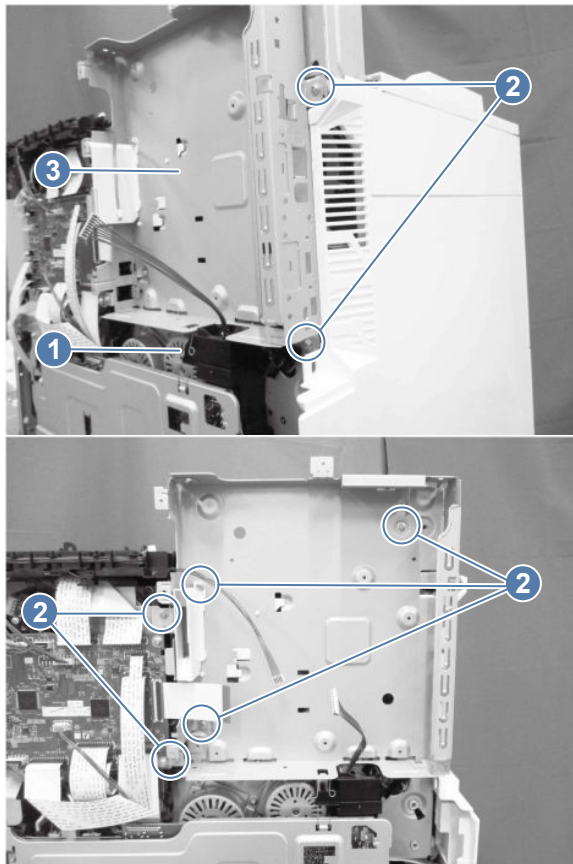

2. **For a replacement formatter cage only:** Release the cable (callout 1) from the cable guide (callout 2), release one tab (callout 3), and then remove the memory PCA (callout 4) from the formatter cage (callout 5).

 **NOTE:** Install the PCA on the replacement formatter cage.

Figure 5-526 Remove the memory PCA



12. Remove the drive PCA

Follow these steps to remove the drive PCA.

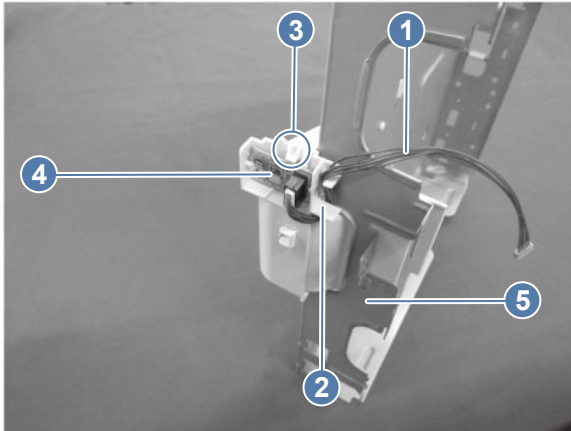
1. Disconnect all the connectors on the DC controller PCA, remove the cable clamp (callout 1), remove three screws (callout 2), and then slide the DC controller stay (callout 3) out to remove it.

Figure 5-527 Remove the DC controller stay

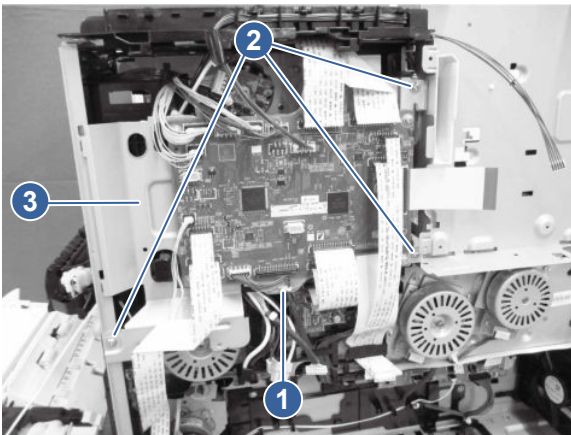

2. Disconnect all the connectors on the drive PCA, remove one screw (callout 1), release two tabs (callout 2), and then remove the drive PCA (callout 3).



 **IMPORTANT:** Some of these wires are very tightly connected. Take care when disconnecting them.

Figure 5-528 Remove the drive PCA

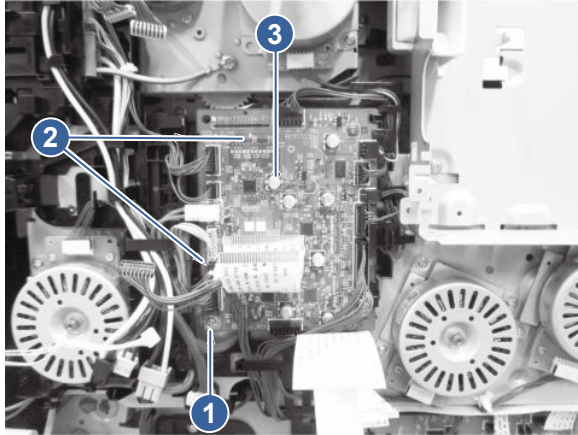

13. Remove the main-drive assembly

Follow these steps to remove the main-drive assembly.

 **NOTE:** Make sure that the front door is closed when performing this procedure.

1. Pull the lever (callout 1) of the cable cover (callout 2), release one tab (callout 3), and then remove the cable cover.

Figure 5-529 Remove the cable cover

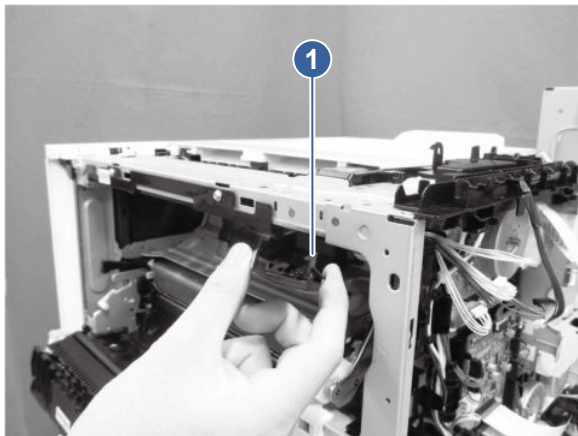

 **Reinstallation tip:** When reinstalling, align the pegs in the holes, and then set the cover against the frame and rotate it up and into position.

2. Disconnect one connector (callout 1).

Figure 5-530 Disconnect one connector

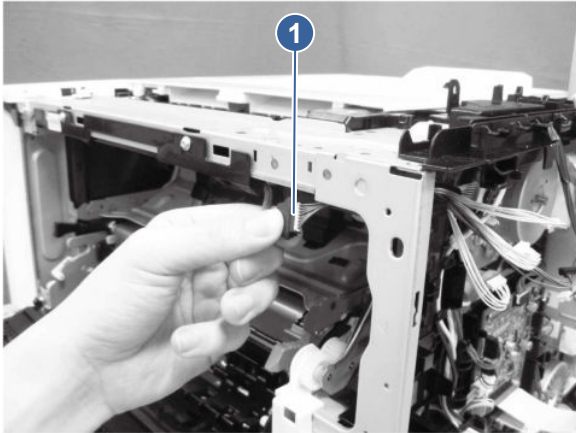

3. Remove one screw (callout 1), release the cable (callout 2) from the cable guide (callout 3), release one tab (callout 4), and then slide the connector cover (callout 5) upward to remove it.

Figure 5-531 Remove the connector cover

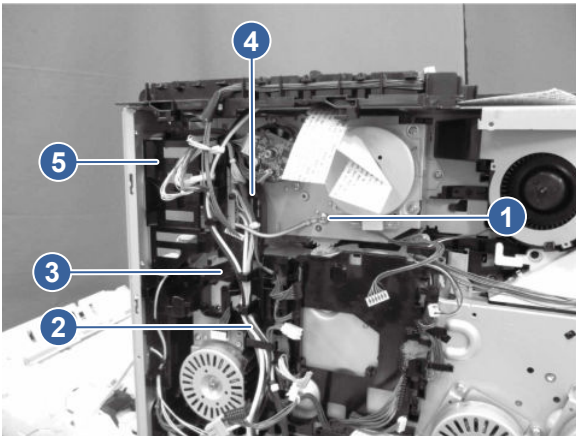

4. Release one tab (callout 1), and then slide the link cover (callout 2) in the direction indicated to remove it.

Figure 5-532 Remove the link cover

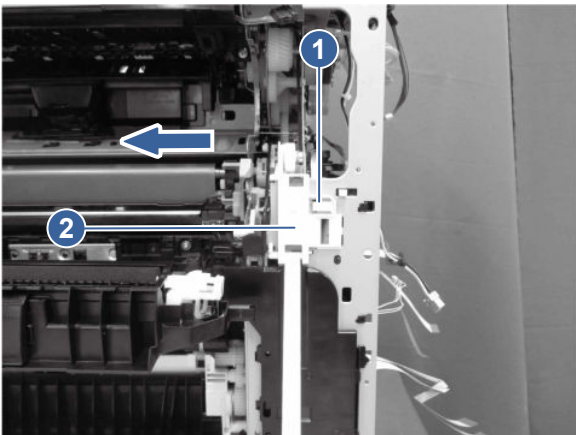

5. Close the right door a little, and then release the link arm (callout 1) from the coupling (callout 2).

 **NOTE:** This is a keyed connection. When disconnecting, make sure to line up the peg with the socket so that you do not strip the peg.

 **Reinstallation tip:** If the black link arm disconnects from the white link arm below it, it might be helpful for reinstallation purposes to reattach the two link arms.

Figure 5-533 Release the link arm



6. Disconnect one connector (callout 1), release the cable (callout 2) from the fan cover (callout 3), release four tabs (callout 4), and then remove the fan cover.

Figure 5-534 Remove the fan cover

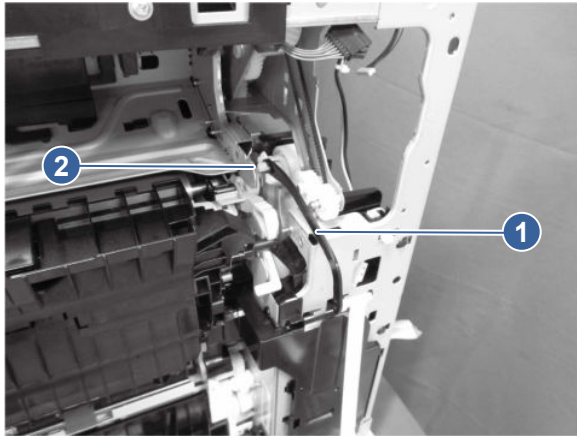
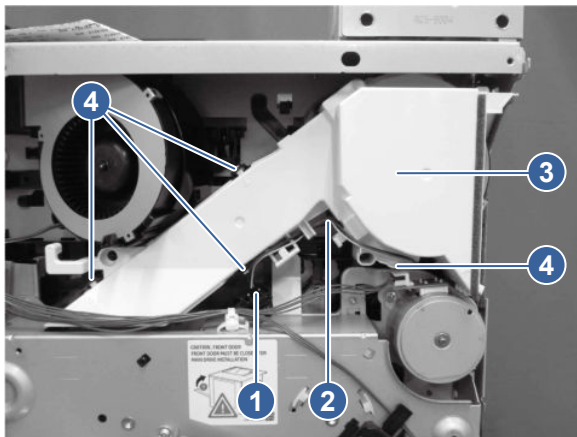

 **Reinstallation tip:** When reinstalling this cover, seat the right side pegs into the chassis slots first.

7. Release the cables (callout 1) and the remove FFC (callout 2) from the cable guide (callout 3).

Figure 5-535 Release the cables

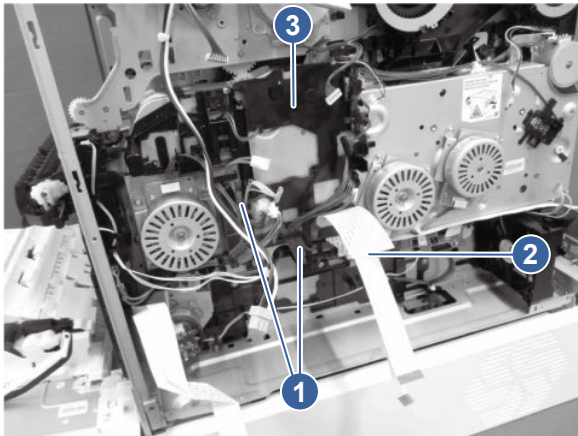

8. Remove seven screws (callout 1), release one tab (callout 2), and then remove the main drive assembly (callout 3).

 **NOTE:** All seven screws are on sheet metal tabs on the assembly.

 **NOTE:** Ensure that the screws do not fall into the assembly.

Figure 5-536 Remove the main drive assembly

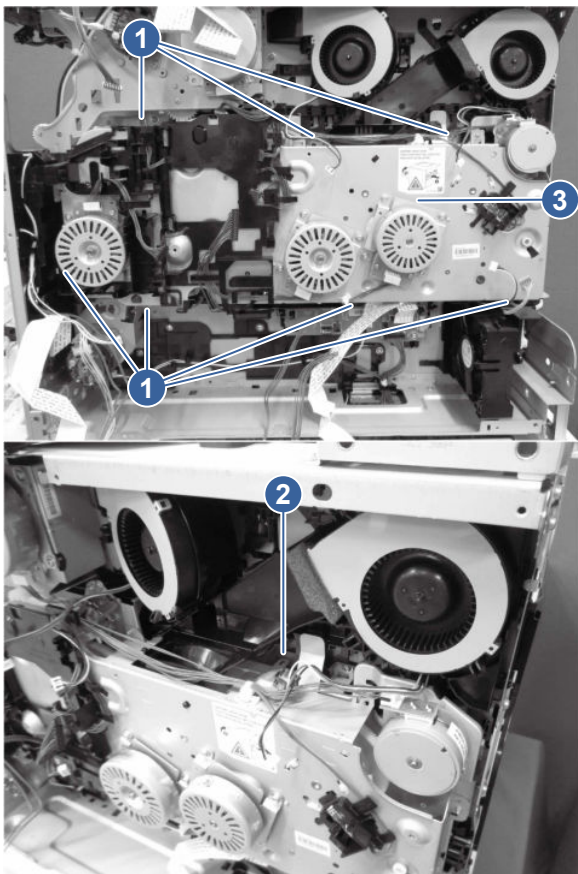

9. Special installation instructions for a main drive assembly (replacement unit and serviced unit)

- **Replacement unit:** A replacement unit is a new assembly that installs in place of a discarded in-service unit.
- **In-service unit:** An in-service unit is an existing assembly that has been removed for repair or to gain access to other assemblies.

CAUTION: When the main drive assembly is installed (replacement units and service units), the front door **must** be closed.

IMPORTANT: If you are installing a new main drive assembly (replacement unit), you **do not** need to perform the alignment steps below. New assemblies are **already** aligned.

- a. **Replacement unit and in-service unit:** On the printer engine, be careful to **not** depress the levers located behind the main drive assembly (when it is installed).
- **Callout 1:** Levers in the correct raised position.
 - **Callout 2:** Lever in the incorrect depressed position.

Figure 5-537 Correct and incorrect lever positions

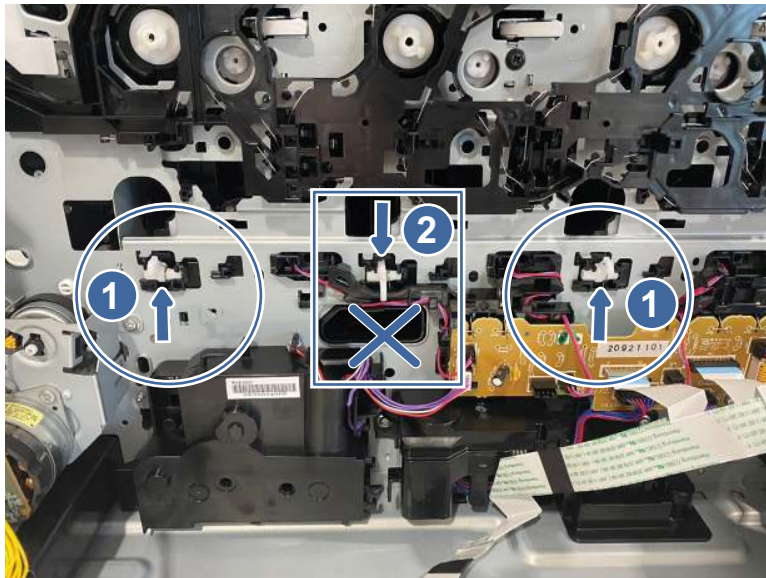

NOTE: For a replacement unit install, skip the remaining alignment steps which are for in-service units only.

- b. **In-service unit:** There are four gears on the main drive assembly that need to be lined up correctly in order to successfully reinstall the main drive. For each gear, the triangle (callout 1) on the inside of the gear should line up with the triangle (callout 2) stamped on the sheet metal chassis. Also, the hole (callout 3) in the gear should line up with a hole in the chassis.

Figure 5-538 Correct gear alignment

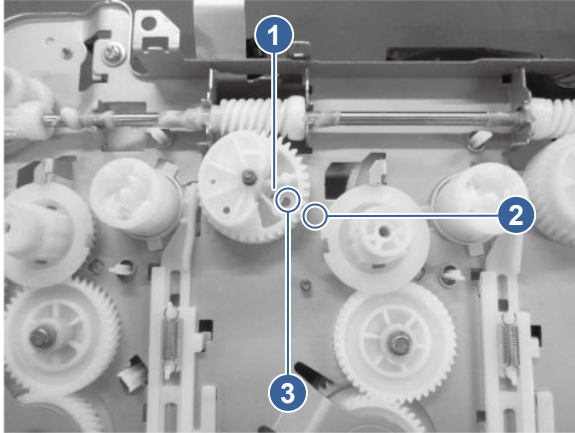

- c. **In-service unit:** In order to realign the four gears, you must remove the motor that locks the gear auger above the four gears. To do this, disconnect one connector (callout 1), remove two screws (callout 2), and then remove the motor (callout 3).

Figure 5-539 Remove the motor

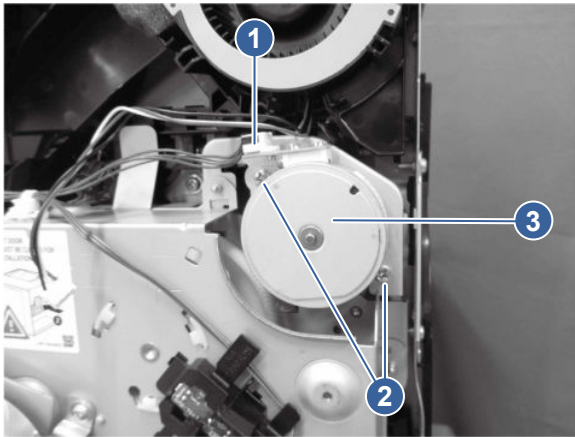

- d. **In-service unit:** To realign the four gears, turn the gear (callout 1) in the direction indicated. By turning that gear, the four gears (callout 2) that need to be in phase turn in tandem. Turn the four gears to the correct phase position.

Figure 5-540 Align the gears

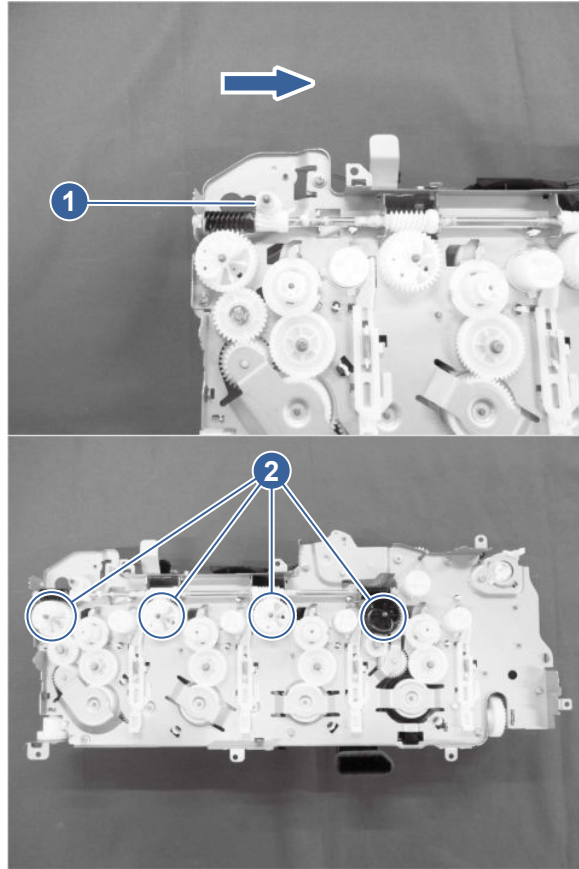

14. Remove the waste toner duct assembly (X57945 models)

Follow these steps to remove the waste toner duct assembly.

- Release one tab (callout 1), slide the waste toner duct assembly (callout 2) in the direction indicated, and then pull the waste toner duct assembly away from the printer.

Figure 5-541 Remove the waste toner duct assembly

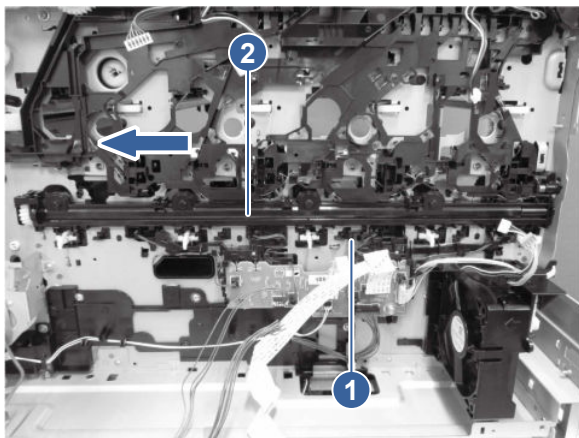

15. Unpack the replacement assembly



Follow these steps to unpack the replacement assembly.

1. Dispose of the defective part.

 **NOTE:** HP recommends responsible disposal of the defective part.

<http://www8.hp.com/us/en/hp-information/environment/product-recycling.html>

2. Unpack the replacement part from the packaging.

 **CAUTION:**  Some parts are sensitive to electrostatic discharge (ESD). Always perform service work at an ESD-protected workstation or mat. If an ESD workstation or mat is not available, touch the sheet-metal chassis to provide a static ground before touching an ESD-sensitive assembly. Protect the ESD-sensitive assemblies by placing them in ESD pouches when they are out of the printer.

 **IMPORTANT:** Make sure that all of the shipping materials (for example shipping tape) are removed from the replacement part prior to installation.

 **NOTE:** If the replacement part is a roller or pad, avoid touching the spongy part of it. Skin oils on the roller or pad can cause paper pickup and/or print-quality problems. HP recommends using disposable gloves when handling rollers or pads or washing your hands before touching rollers or pads.

3. To install an assembly, reverse the removal steps.

 **NOTE:** When applicable, special installation instructions are provided for an assembly at the end of the removal procedure. Always completely read the removal instructions and follow all special installation instructions.

Removal and replacement: Waste toner duct assembly (5700/X557/5800 models)

Learn about removing and replacing the waste toner duct assembly.

Before performing service

Turn the printer power off

- Disconnect the power cable.

 **WARNING!** To avoid damage to the printer, turn the printer off, wait 30 seconds, and then remove the power cord before attempting to service the printer.

If the part is damaged and cannot be cleaned, use the table below to identify the correct part number for your printer. To order the part, go to www.hp.com/buy/parts.

Table 5-74 Part information

Part number	Part description
RM2-3517-000CN	Waste toner duct assembly (5700/5800)
RM2-3518-000CN	Waste toner duct assembly (X557/6700/6800)

Required tools

- #2 Phillips screwdriver with a magnetic tip and a 152 mm (6 in) shaft length

After performing service

Turn the printer power on

- Connect the power cable.
- Use the power switch to turn the power on.

Post service test

Print any pages necessary to make sure the printer is functioning correctly.

1. Remove the toner collection unit (TCU)

Follow these steps to remove the toner collection unit (TCU).

1. Open the front door.

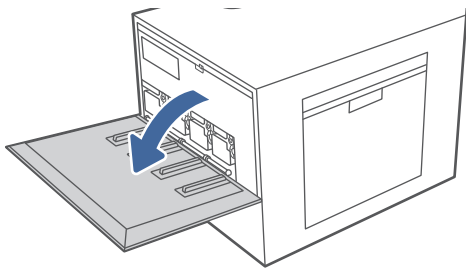

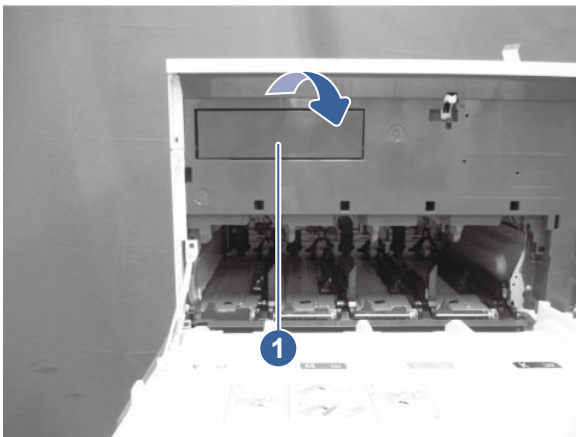

2. Rotate and then pull the TCU cover to remove it.

Figure 5-542 Remove the TCU cover

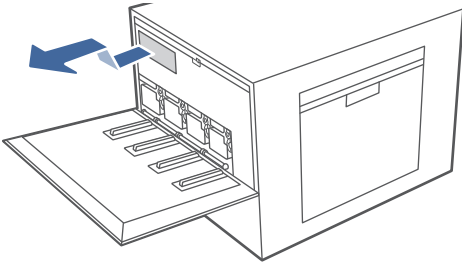

3. Lift the TCU slightly and then pull it out of the printer.



 **NOTE:** Maintain the position of the TCU as you pull it out from the printer. This will ensure that you do not spill any waste toner in the printer. Place the unit into the clear plastic bag the new TCU was packaged in.

2. Unseat the ITB

Follow these steps to unseat the ITB.

1. Open the right door (if it is not already open).
2. Grasp the two levers on the ITB, and then slightly pull it out of the printer to unseat and disengage it.

 **Reinstallation tip:** During Reinstallation of the target part, do not reseat the ITB too early in the process. The ITB must remain disengaged to make sure that the gear is correctly aligned.

A **46.00.0x** error occurs if the ITB is not disengaged if the procedure is completed with the ITB seated.

Figure 5-543 Disengage the ITB



3. Remove the formatter cover

Follow these steps to remove the formatter cover.

- Remove one screw (callout 1), and then slide the formatter cover (callout 2) away from the printer to remove it.

 **TIP:** Reverse the removal steps to install the assembly.

Figure 5-544 Remove the formatter cover



4. Remove the left upper cover (MFP models)

Follow these steps to remove the left upper cover.

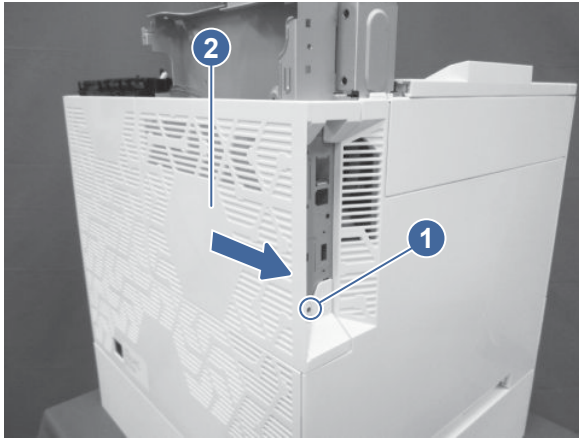
1. Open the front door.

 **CAUTION:** If the cover is being removed to gain access to the main drive assembly, make sure that the front door remains open. This keeps the main drive properly aligned.

2. At the left side of the printer, insert the small flat-blade screwdriver into the slot to release one tab (callout 1).

Figure 5-545 Use a screwdriver to release the tab

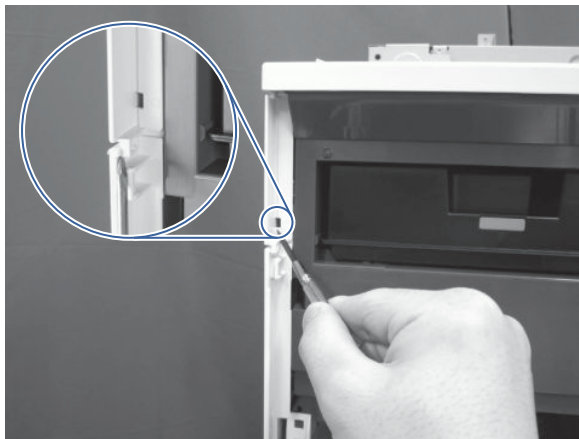

3. Toward the front of the printer, release another tab.

Figure 5-546 Release the tab

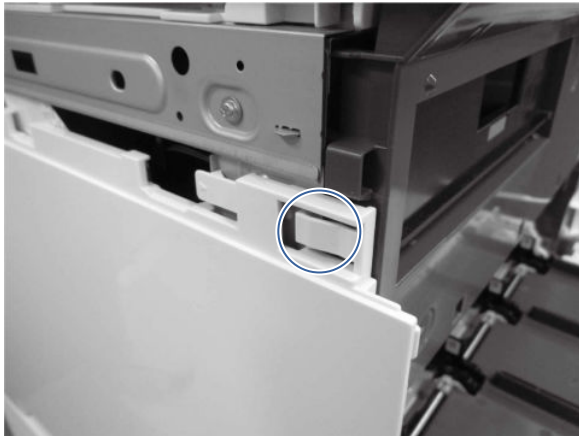

4. Rotate the cover up to remove it.

Figure 5-547 Remove the left upper cover

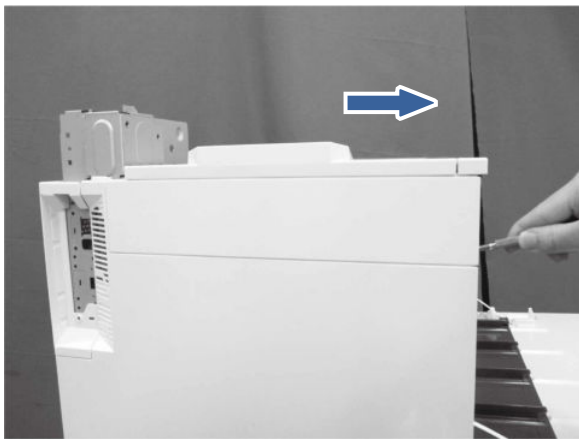

5. Remove the output bin

Follow these steps to remove the output bin.

- Remove two screws (callout 1), and then slide the output tray (callout 2) towards the front (SFP models) or left (MFP models) to remove it.

Figure 5-548 Remove the output bin

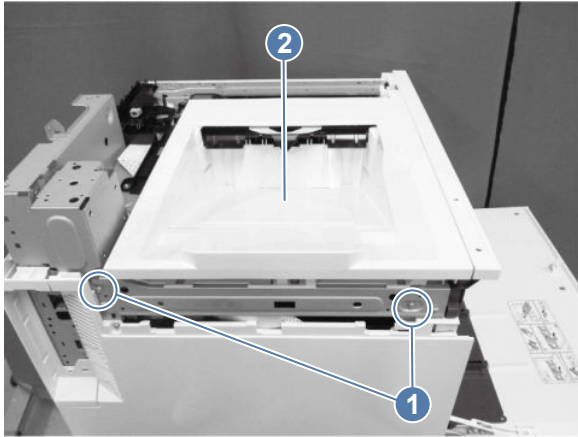

6. Remove the left cover

Follow these steps to remove the left cover.

- At the left side of the printer, remove one screw (callout 1), release one tab (callout 2), and then slide the cover (callout 3) toward the rear of the printer to release it.

Figure 5-549 Remove the left cover

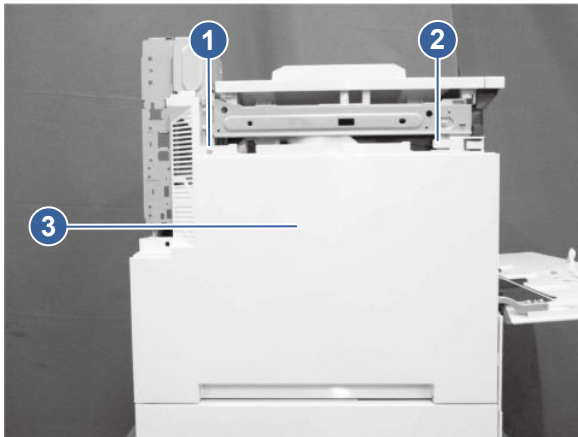

7. Remove the waste toner duct assembly (5700/X557/5800 models)

Follow these steps to remove the waste toner duct assembly.

1. Release one tab (callout 1), pull the upper part of the contact holder (callout 2) forward, slide the contact holder in the direction indicated, and then rotate the contact holder.

Figure 5-550 Slide the contact holder

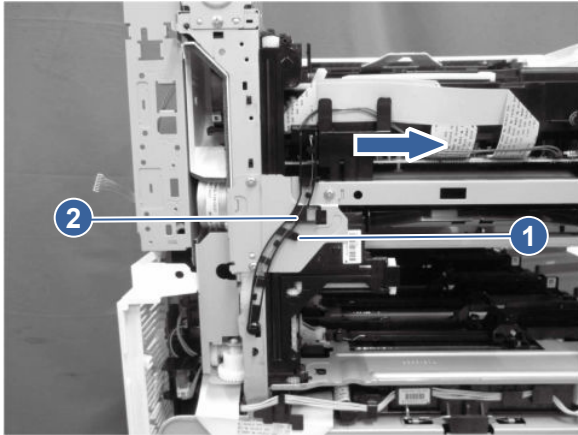

2. Slide the contact holder (callout 1) in the direction indicated to remove it.

Figure 5-551 Remove the contact holder

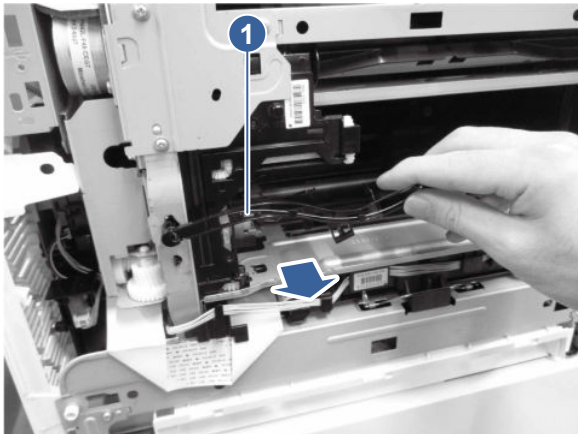

3. Remove three screws (callout 1), and then slide the support plate (callout 2) in the direction indicated to remove it.

Figure 5-552 Remove the support plate

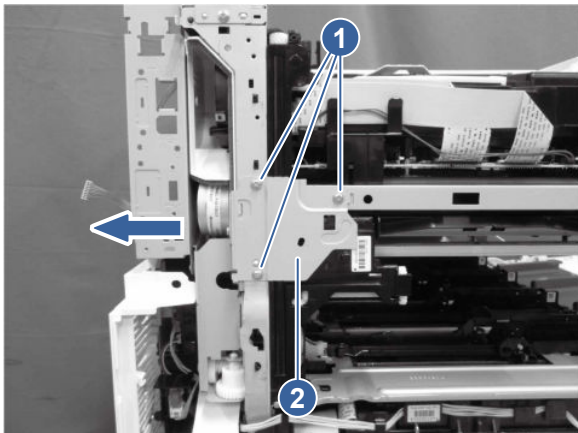

4. Disconnect one connector (callout 1), and then release the cable (callout 2) from the cable guide (callout 3).

Figure 5-553 Disconnect one connector

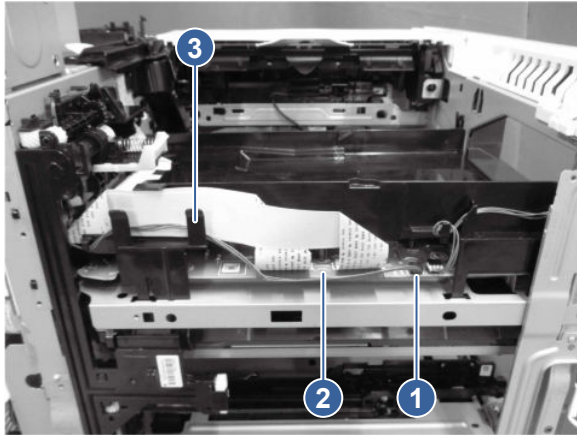

5. Release one tab (callout 1), and then slide the waste toner duct assembly (callout 2) upward to remove it.

Figure 5-554 Remove the waste toner duct assembly

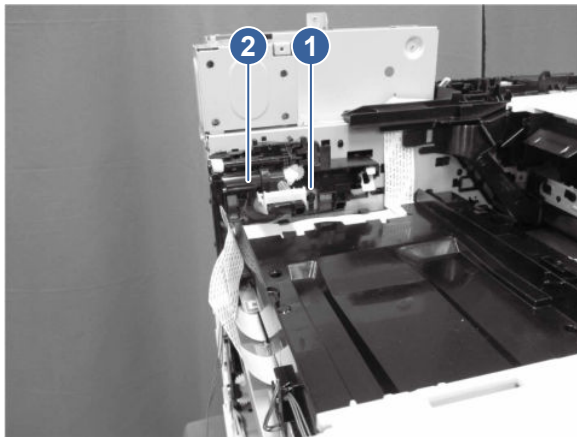

8. Unpack the replacement assembly

Follow these steps to unpack the replacement assembly.

1. Dispose of the defective part.





NOTE: HP recommends responsible disposal of the defective part.

<http://www8.hp.com/us/en/hp-information/environment/product-recycling.html>

2. Unpack the replacement part from the packaging.



CAUTION:  Some parts are sensitive to electrostatic discharge (ESD). Always perform service work at an ESD-protected workstation or mat. If an ESD workstation or mat is not available, touch the sheet-metal chassis to provide a static ground before touching an ESD-sensitive assembly. Protect the ESD-sensitive assemblies by placing them in ESD pouches when they are out of the printer.

 **IMPORTANT:** Make sure that all of the shipping materials (for example shipping tape) are removed from the replacement part prior to installation.

 **NOTE:** If the replacement part is a roller or pad, avoid touching the spongy part of it. Skin oils on the roller or pad can cause paper pickup and/or print-quality problems. HP recommends using disposable gloves when handling rollers or pads or washing your hands before touching rollers or pads.

3. To install an assembly, reverse the removal steps.

 **NOTE:** When applicable, special installation instructions are provided for an assembly at the end of the removal procedure. Always completely read the removal instructions and follow all special installation instructions.

Removal and replacement: Pre-exposure PCA holder assembly (5700/X557/5800 models)

Learn about removing and replacing the pre-exposure PCA holder assembly.

Before performing service

Turn the printer power off

- Disconnect the power cable.

 **WARNING!** To avoid damage to the printer, turn the printer off, wait 30 seconds, and then remove the power cord before attempting to service the printer.

If the part is damaged and cannot be cleaned, use the table below to identify the correct part number for your printer. To order the part, go to www.hp.com/buy/parts.

Table 5-75 Part information

Part number	Part description
RM2-3565-000CN	Pre-exposure PCA holder (5700/X557/5800 models)

Required tools

- #2 Phillips screwdriver with a magnetic tip and a 152 mm (6 in) shaft length

After performing service

Turn the printer power on

- Connect the power cable.
- Use the power switch to turn the power on.

Post service test

No post service test is available for this assembly.

1. Remove the toner collection unit (TCU)

Follow these steps to remove the toner collection unit (TCU).

1. Open the front door.

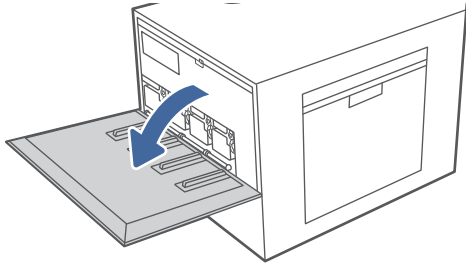

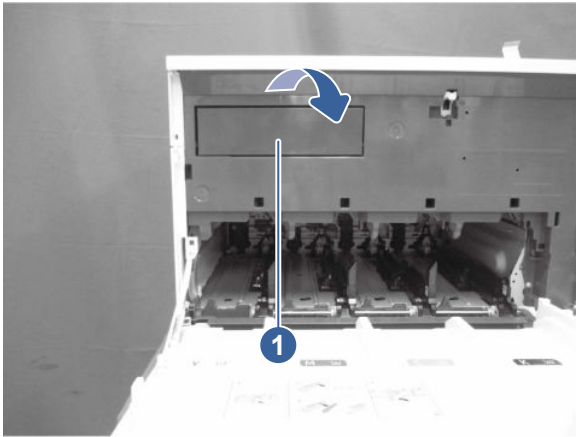

2. Rotate and then pull the TCU cover to remove it.

Figure 5-555 Remove the TCU cover

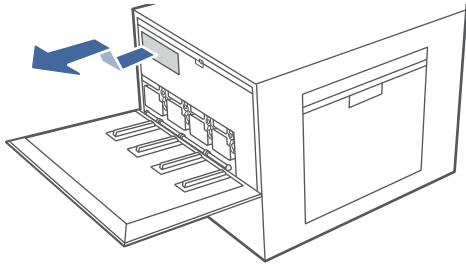

3. Lift the TCU slightly and then pull it out of the printer.



 **NOTE:** Maintain the position of the TCU as you pull it out from the printer. This will ensure that you do not spill any waste toner in the printer. Place the unit into the clear plastic bag the new TCU was packaged in.

2. Remove the fuser

Follow these steps to remove the fuser.

1. Open the right door.

 **CAUTION:** The fuser is hot. Wait at least 10 minutes after turning the printer power off before removing the fuser.

Figure 5-556 Open the right door



2. Squeeze the release levers on the handles (circle callouts), and then remove the fuser.

Figure 5-557 Remove the fuser

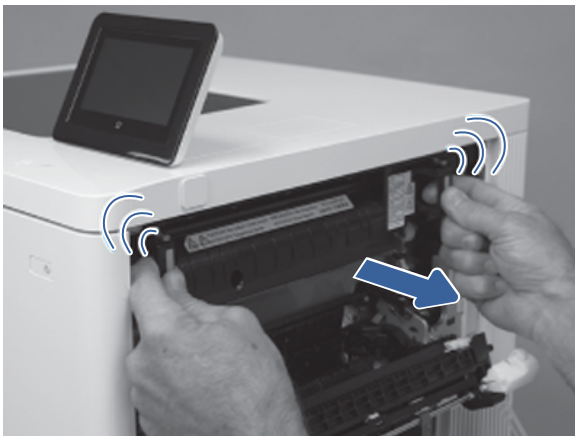

3. Remove the formatter cover

Follow these steps to remove the formatter cover.

- Remove one screw (callout 1), and then slide the formatter cover (callout 2) away from the printer to remove it.

 **TIP:** Reverse the removal steps to install the assembly.

Figure 5-558 Remove the formatter cover



4. Remove the front right cover

Follow these steps to remove the front right cover.

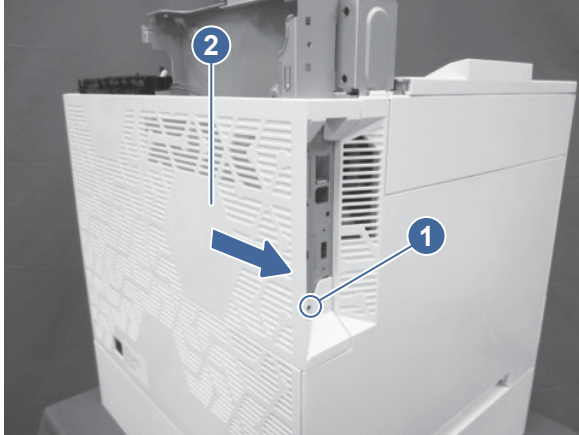
1. Perform one of the following steps.
 - **5700/X557/5800 models:** Open the front door.
 - **X57945 models:** Open the toner cartridge access door.
2. Perform one of the following steps.
 - **5700/X557/5800 models:** Open the right door.
 - **X57945 models:** Open the right lower door.
3. Release one tab, and then slide the front right cover upward to remove it.

Figure 5-559 Remove the front right cover

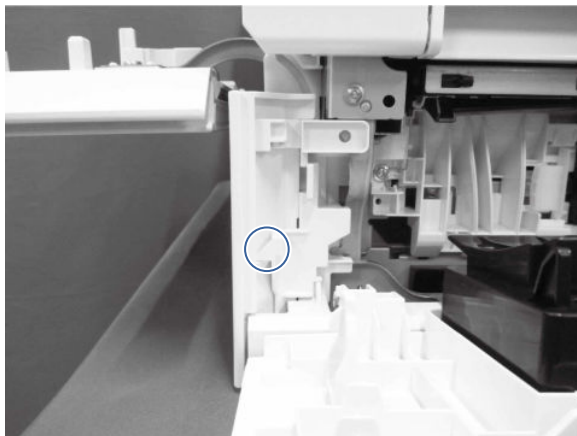

5. Remove the left upper cover (MFP models)

Follow these steps to remove the left upper cover.

1. Open the front door.

⚠ CAUTION: If the cover is being removed to gain access to the main drive assembly, make sure that the front door remains open. This keeps the main drive properly aligned.

2. At the left side of the printer, insert the small flat-blade screwdriver into the slot to release one tab (callout 1).

Figure 5-560 Use a screwdriver to release the tab

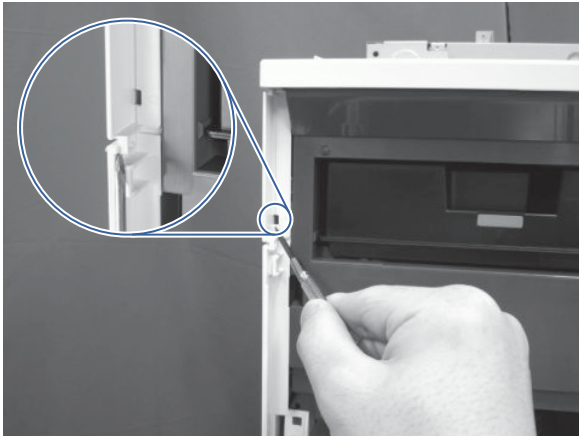

3. Toward the front of the printer, release another tab.

Figure 5-561 Release the tab

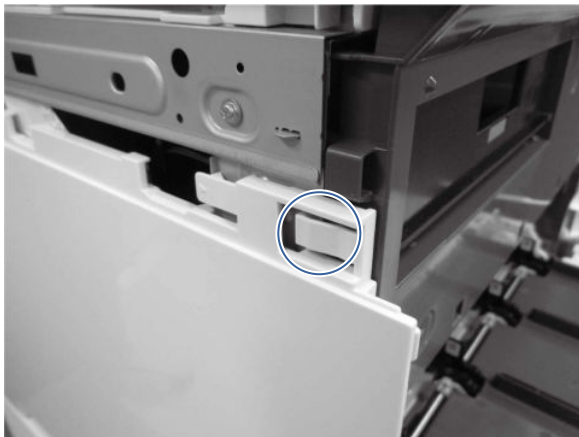

4. Rotate the cover up to remove it.

Figure 5-562 Remove the left upper cover

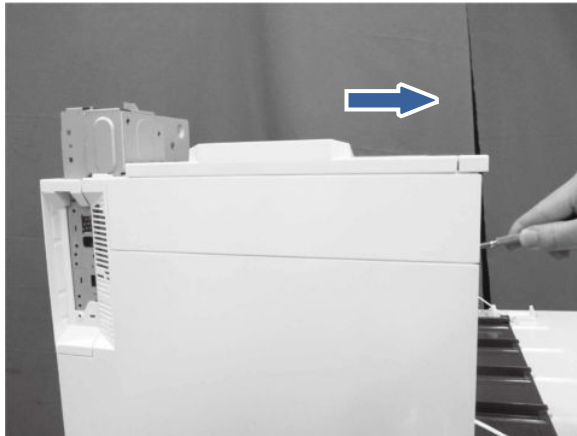

6. Remove the left cover

Follow these steps to remove the left cover.

- At the left side of the printer, remove one screw (callout 1), release one tab (callout 2), and then slide the cover (callout 3) toward the rear of the printer to release it.

Figure 5-563 Remove the left cover

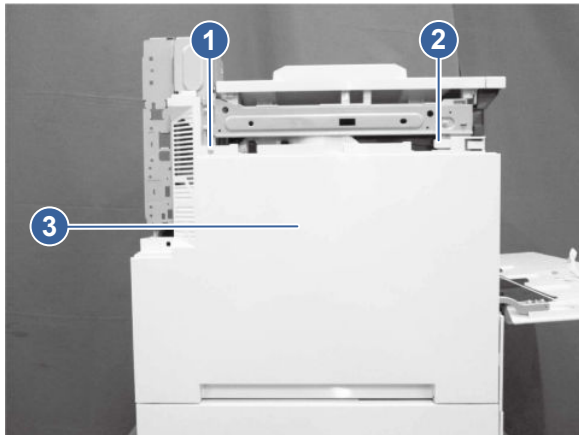

7. Remove the front door

Follow these steps to remove the front door.

1. Open the front door.

2. At the left side of the door, release the link arm (callout 1) from the clip (callout 2) on the front-door assembly.

Figure 5-564 Release the left link arm

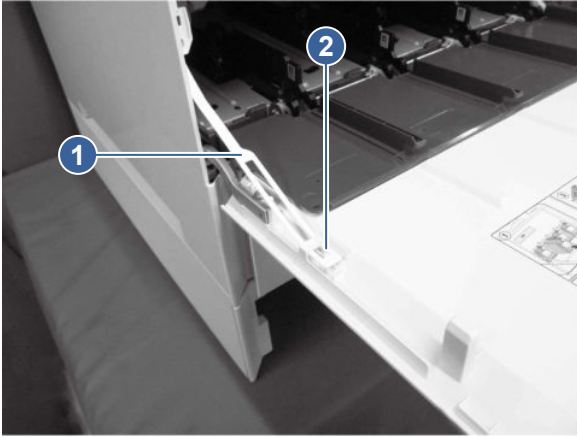

3. At the right side of the door, release the link arm (callout 1) from the clip (callout 2) on the front-door assembly.

Figure 5-565 Release the right link arm

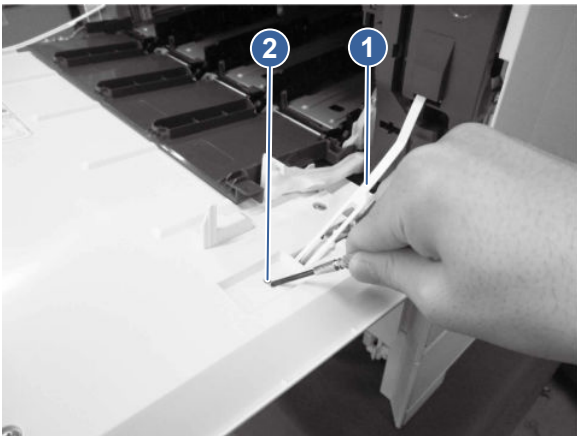

4. Remove two screws (callout 1), release the link lever (callout 2) from the front door assembly (callout 3), and then remove the front door.

Figure 5-566 Remove the door

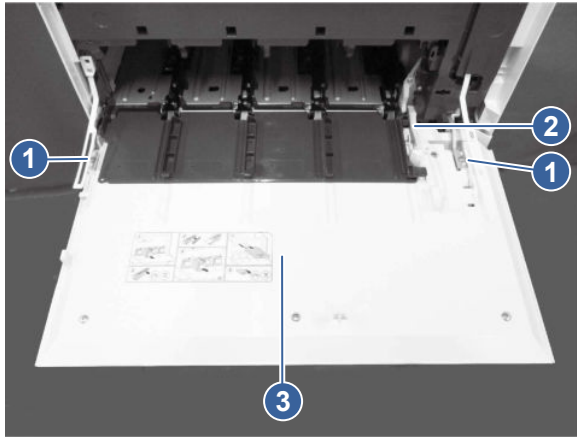

8. Remove the output bin

Follow these steps to remove the output bin.

- Remove two screws (callout 1), and then slide the output tray (callout 2) towards the front (SFP models) or left (MFP models) to remove it.

Figure 5-567 Remove the output bin

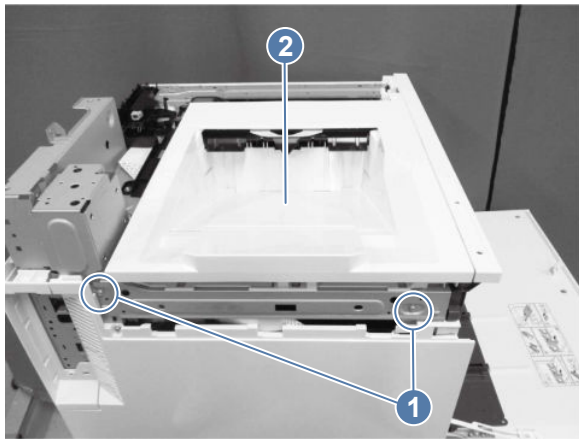

9. Remove the top cover (SFP models)

Follow these steps to remove the top cover.

1. Disconnect one connector (callout 1), and then release the cable (callout 2) from the cable guide (callout 3).

Figure 5-568 Disconnect the connector

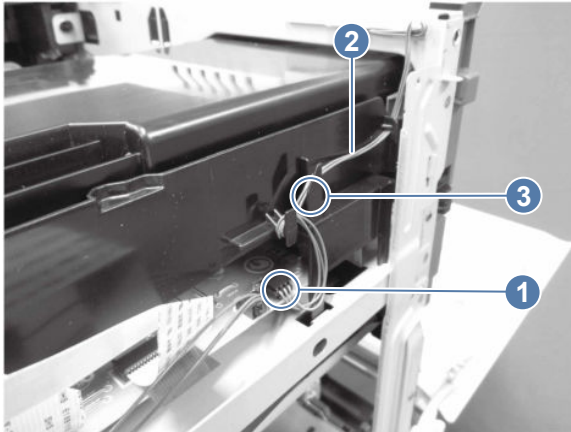

2. Remove two screws.

Figure 5-569 Remove two screws



3. Release one tab (callout 1), release two USB cables (callout 2) and another cable (callout 3) from the cable clamp (callout 4).

Figure 5-570 Release one tab

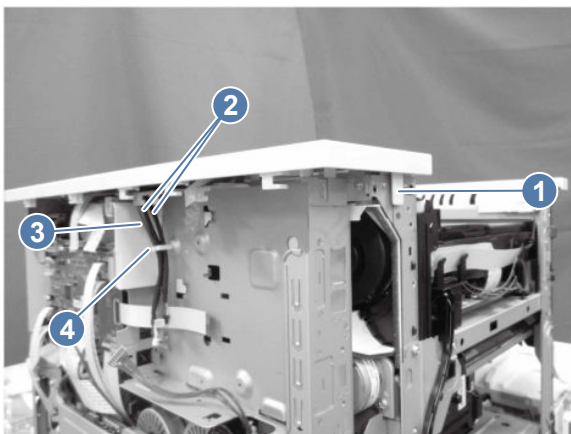

4. Remove two screws (callout 1), release two tabs (callout 2), and then remove the top cover (callout 3).

Figure 5-571 Remove the cover

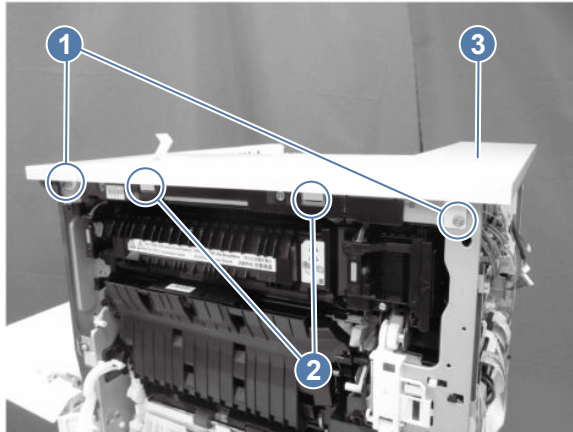

10. Remove the top cover (MFP models)

Follow these steps to remove the top cover.

- Remove one screw (callout 1), and then remove the top cover (callout 2).

Figure 5-572 Remove the top cover

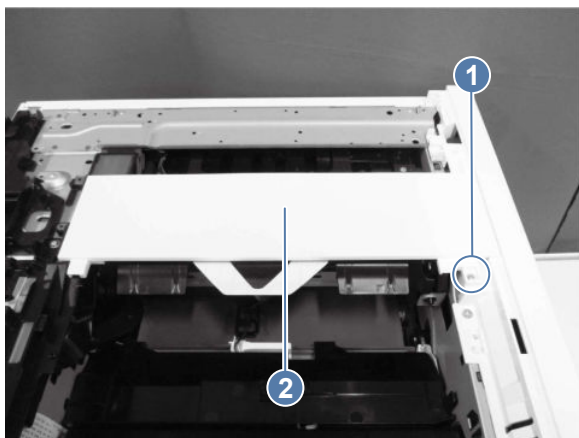

11. Remove the top front cover (MFP models)

Follow these steps to remove the top front cover.

1. Disconnect one connector (callout 1), and then release the cable (callout 2) from the cable guide (callout 3).

Figure 5-573 Disconnect one connector and release the cable

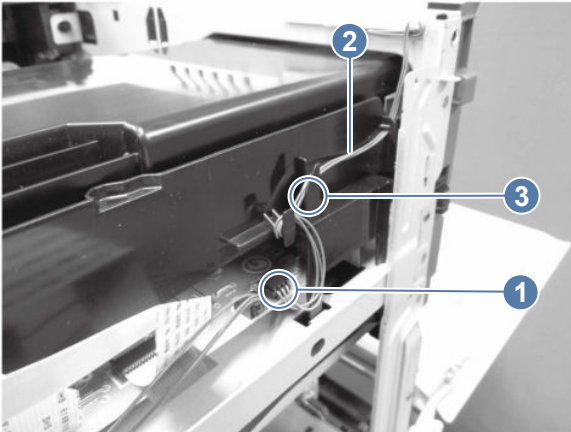

2. Remove two screws.

Figure 5-574 Remove two screws

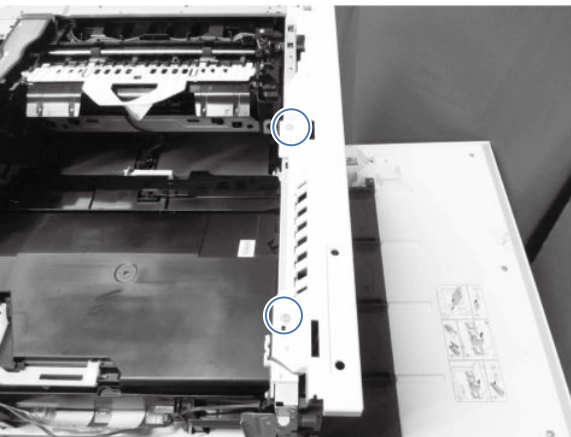

3. Remove one screw (callout 1), hold up the top front cover (callout 2), and then remove it.

Figure 5-575 Remove the top front cover

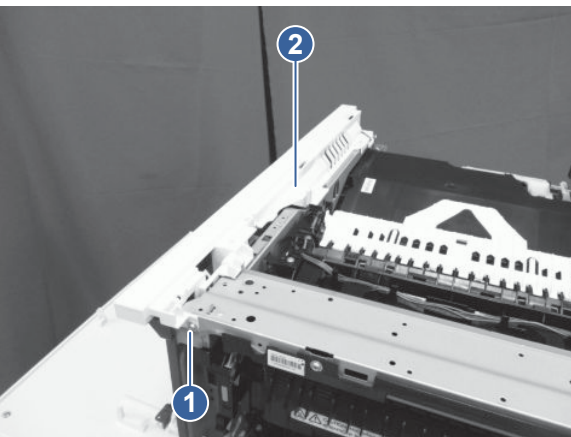

12. Remove the pre-exposure PCA holder assembly (5700/X557/5800 models)

Follow these steps to remove the pre-exposure PCA holder assembly.

1. Remove three screws (callout 1).

Figure 5-576 Remove three screws

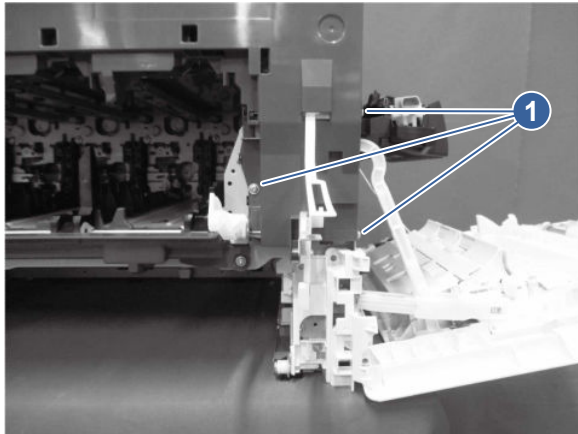

2. Release eight tabs (callout 1).

Figure 5-577 Release eight tabs

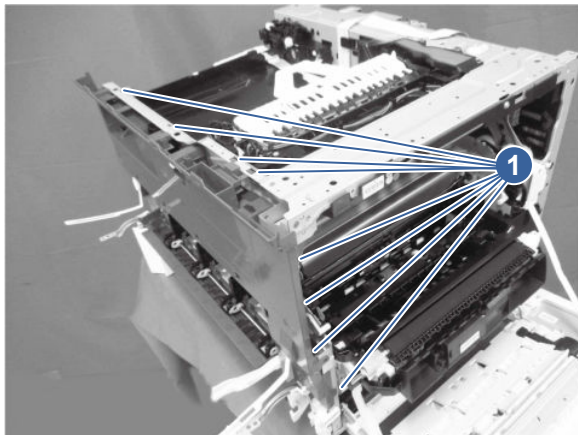

3. Release five tabs (callout 1), and then remove the front inner cover (callout 2).

Figure 5-578 Remove the front inner cover

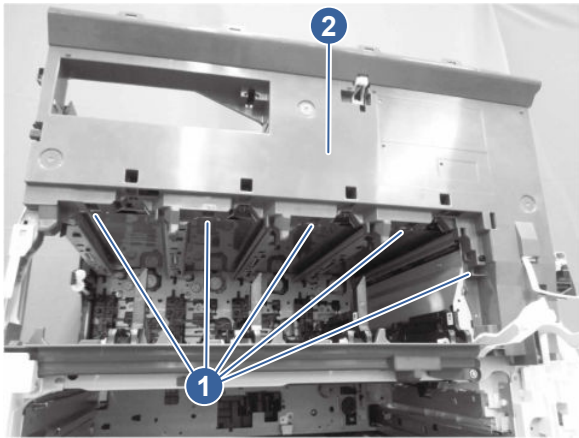

4. Release three tabs (callout 1), hold up the high-voltage PCA cover (callout 2), and then disconnect one connector (callout 3).

Figure 5-579 Release three tabs

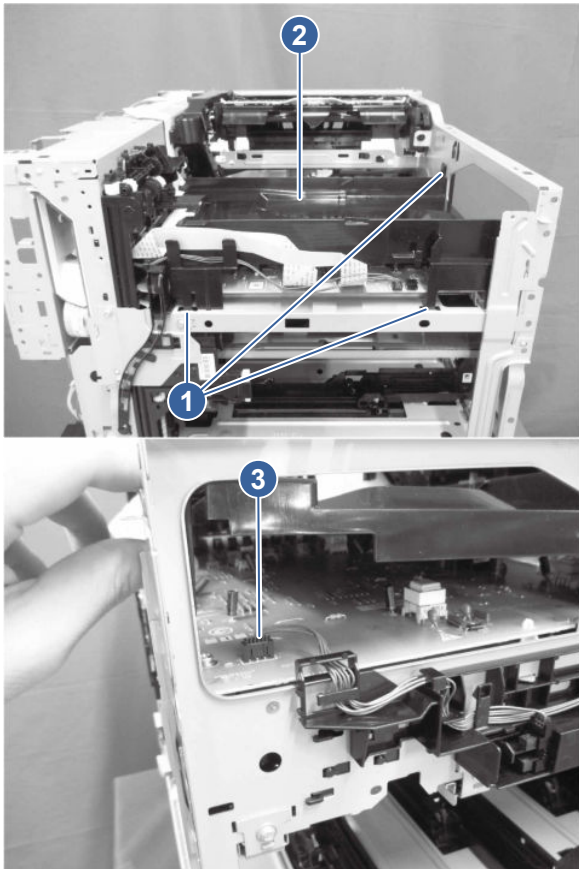

5. Release one tab (callout 1), and then slide the pre-exposure PCA holder assembly (callout 2) in the direction indicated to remove it.

Figure 5-580 Remove the pre-exposure PCA holder assembly

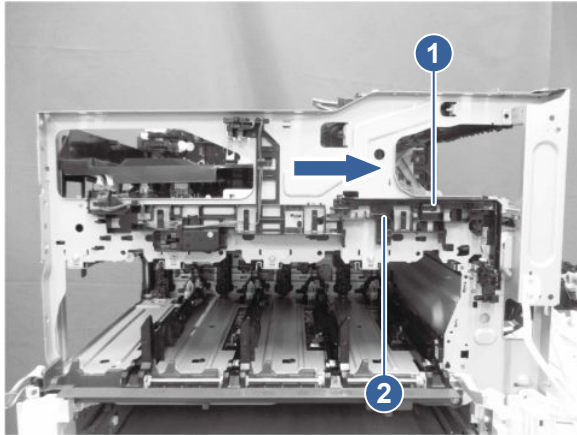

6. Remove the link lever (callout 1) from the pre-exposure PCA holder assembly (callout 2).

Figure 5-581 Remove the link lever

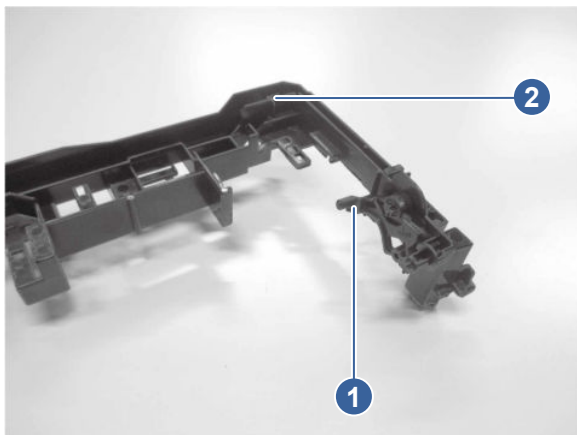

13. Unpack the replacement assembly

Follow these steps to unpack the replacement assembly.

1. Dispose of the defective part.





NOTE: HP recommends responsible disposal of the defective part.

<http://www8.hp.com/us/en/hp-information/environment/product-recycling.html>

2. Unpack the replacement part from the packaging.



CAUTION:  Some parts are sensitive to electrostatic discharge (ESD). Always perform service work at an ESD-protected workstation or mat. If an ESD workstation or mat is not available, touch the sheet-metal chassis to provide a static ground before touching an ESD-sensitive assembly. Protect the ESD-sensitive assemblies by placing them in ESD pouches when they are out of the printer.

 **IMPORTANT:** Make sure that all of the shipping materials (for example shipping tape) are removed from the replacement part prior to installation.

 **NOTE:** If the replacement part is a roller or pad, avoid touching the spongy part of it. Skin oils on the roller or pad can cause paper pickup and/or print-quality problems. HP recommends using disposable gloves when handling rollers or pads or washing your hands before touching rollers or pads.

3. To install an assembly, reverse the removal steps.

 **NOTE:** When applicable, special installation instructions are provided for an assembly at the end of the removal procedure. Always completely read the removal instructions and follow all special installation instructions.

Removal and replacement: Pre-exposure PCA holder assembly (X57945 models)

Learn about removing and replacing the pre-exposure PCA holder assembly.

Before performing service

Turn the printer power off

- Disconnect the power cable.

 **WARNING!** To avoid damage to the printer, turn the printer off, wait 30 seconds, and then remove the power cord before attempting to service the printer.

If the part is damaged and cannot be cleaned, use the table below to identify the correct part number for your printer. To order the part, go to www.hp.com/buy/parts.

Table 5-76 Part information

Part number	Part description
RM2-3673-000CN	Pre-exposure PCA holder (X57945 models)

Required tools

- #2 Phillips screwdriver with a magnetic tip and a 152 mm (6 in) shaft length

After performing service

Turn the printer power on

- Connect the power cable.
- Use the power switch to turn the power on.

Post service test

No post service test is available for this assembly.

1. Remove the toner collection unit (TCU)

Follow these steps to remove the toner collection unit (TCU).

1. Open the front door.

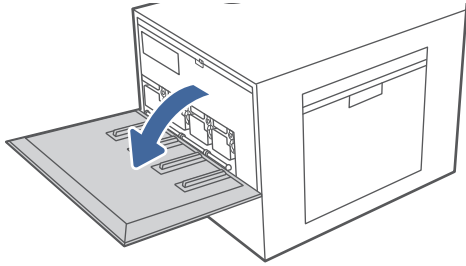

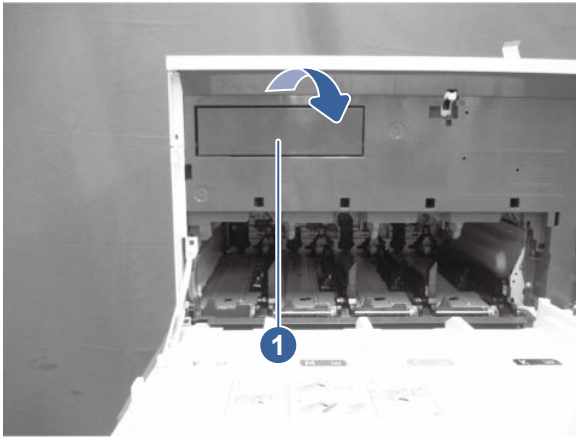

2. Rotate and then pull the TCU cover to remove it.

Figure 5-582 Remove the TCU cover

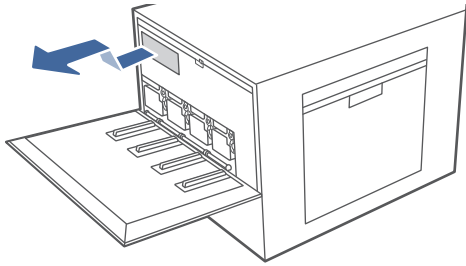

3. Lift the TCU slightly and then pull it out of the printer.



 **NOTE:** Maintain the position of the TCU as you pull it out from the printer. This will ensure that you do not spill any waste toner in the printer. Place the unit into the clear plastic bag the new TCU was packaged in.

2. Remove the fuser

Follow these steps to remove the fuser.

1. Open the right door.

 **CAUTION:** The fuser is hot. Wait at least 10 minutes after turning the printer power off before removing the fuser.

Figure 5-583 Open the right door



2. Squeeze the release levers on the handles (circle callouts), and then remove the fuser.

Figure 5-584 Remove the fuser

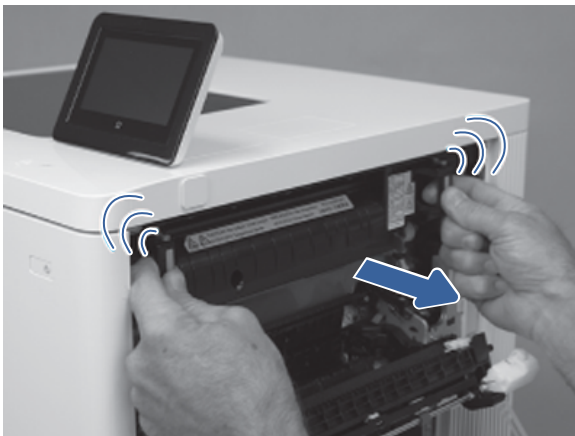

3. Remove the formatter cover

Follow these steps to remove the formatter cover.

- Remove one screw (callout 1), and then slide the formatter cover (callout 2) away from the printer to remove it.

 **TIP:** Reverse the removal steps to install the assembly.

Figure 5-585 Remove the formatter cover



4. Remove the front right cover

Follow these steps to remove the front right cover.

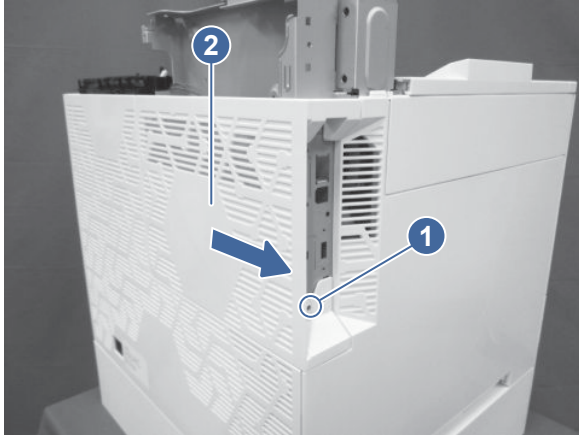
1. Perform one of the following steps.
 - **5700/X557/5800 models:** Open the front door.
 - **X57945 models:** Open the toner cartridge access door.
2. Perform one of the following steps.
 - **5700/X557/5800 models:** Open the right door.
 - **X57945 models:** Open the right lower door.
3. Release one tab, and then slide the front right cover upward to remove it.

Figure 5-586 Remove the front right cover

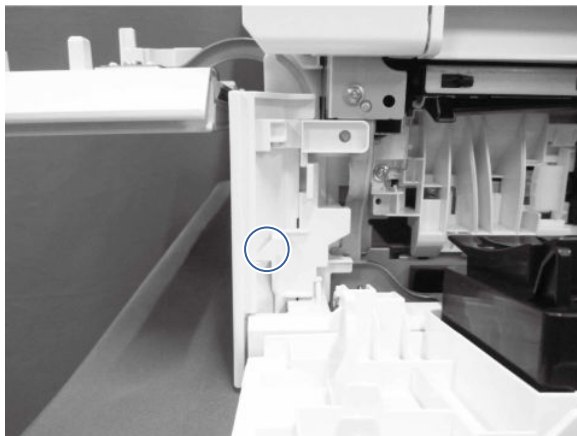

5. Remove the left upper cover (MFP models)

Follow these steps to remove the left upper cover.

1. Open the front door.

⚠ CAUTION: If the cover is being removed to gain access to the main drive assembly, make sure that the front door remains open. This keeps the main drive properly aligned.

2. At the left side of the printer, insert the small flat-blade screwdriver into the slot to release one tab (callout 1).

Figure 5-587 Use a screwdriver to release the tab

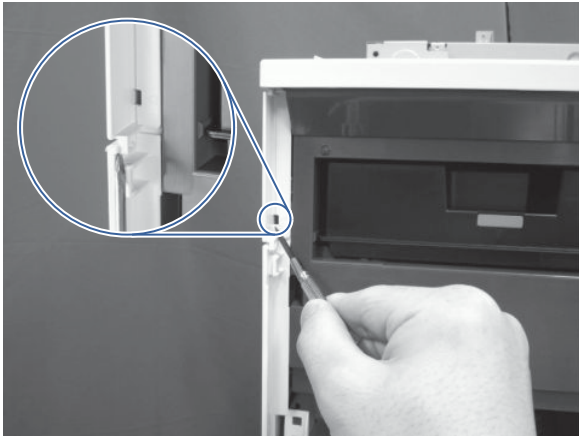

3. Toward the front of the printer, release another tab.

Figure 5-588 Release the tab

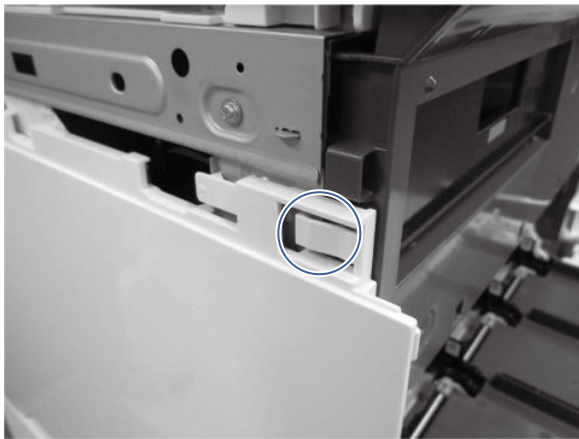

4. Rotate the cover up to remove it.

Figure 5-589 Remove the left upper cover

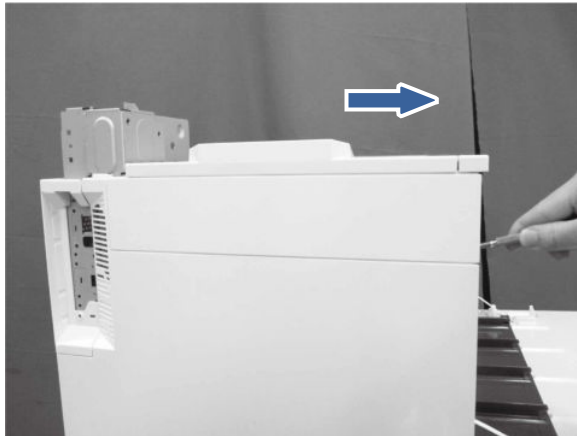

6. Remove the left cover

Follow these steps to remove the left cover.

- At the left side of the printer, remove one screw (callout 1), release one tab (callout 2), and then slide the cover (callout 3) toward the rear of the printer to release it.

Figure 5-590 Remove the left cover

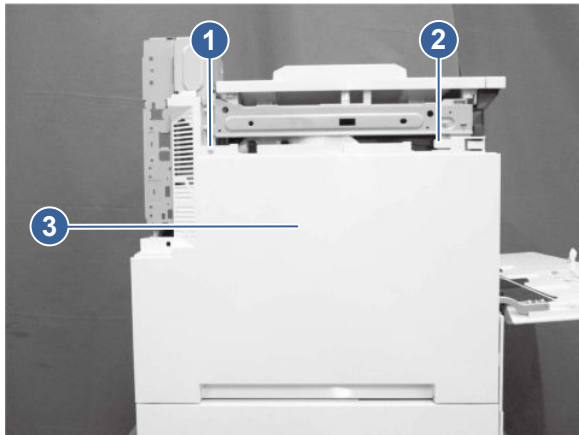

7. Remove the front door

Follow these steps to remove the front door.

1. Open the front door.

2. At the left side of the door, release the link arm (callout 1) from the clip (callout 2) on the front-door assembly.

Figure 5-591 Release the left link arm

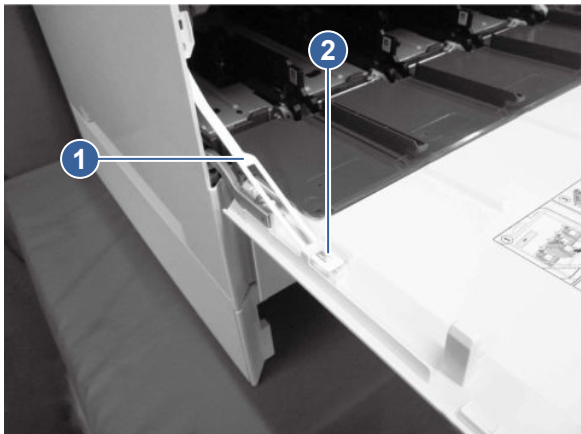

3. At the right side of the door, release the link arm (callout 1) from the clip (callout 2) on the front-door assembly.

Figure 5-592 Release the right link arm

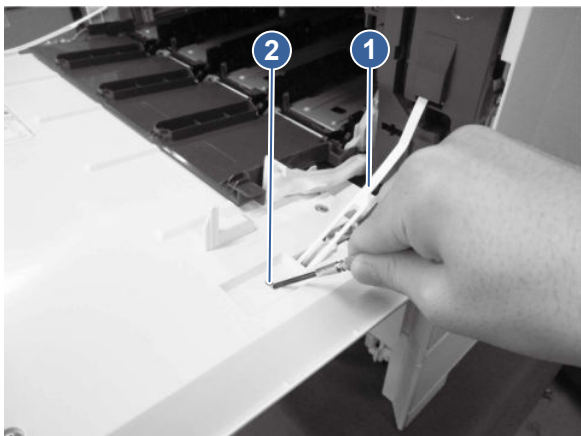

4. Remove two screws (callout 1), release the link lever (callout 2) from the front door assembly (callout 3), and then remove the front door.

Figure 5-593 Remove the door

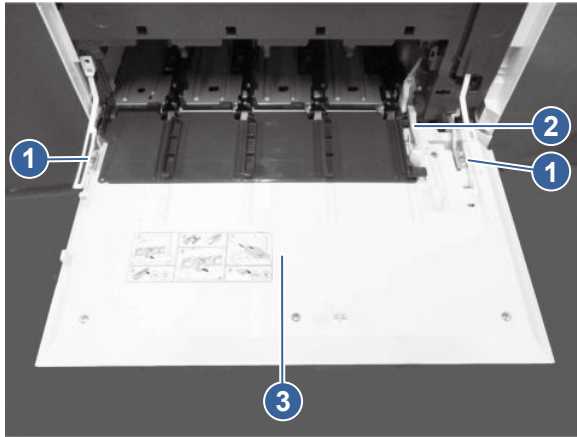

8. Remove the output bin

Follow these steps to remove the output bin.

- Remove two screws (callout 1), and then slide the output tray (callout 2) towards the front (SFP models) or left (MFP models) to remove it.

Figure 5-594 Remove the output bin

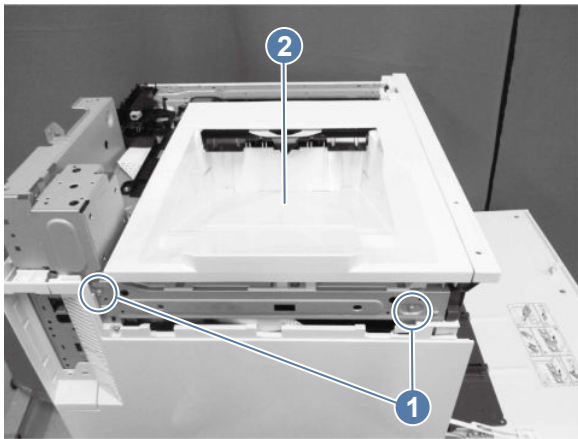

9. Remove the top cover (SFP models)

Follow these steps to remove the top cover.

1. Disconnect one connector (callout 1), and then release the cable (callout 2) from the cable guide (callout 3).

Figure 5-595 Disconnect the connector

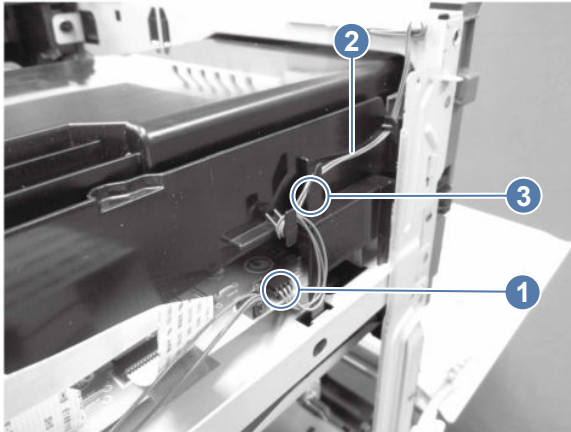

2. Remove two screws.

Figure 5-596 Remove two screws



3. Release one tab (callout 1), release two USB cables (callout 2) and another cable (callout 3) from the cable clamp (callout 4).

Figure 5-597 Release one tab

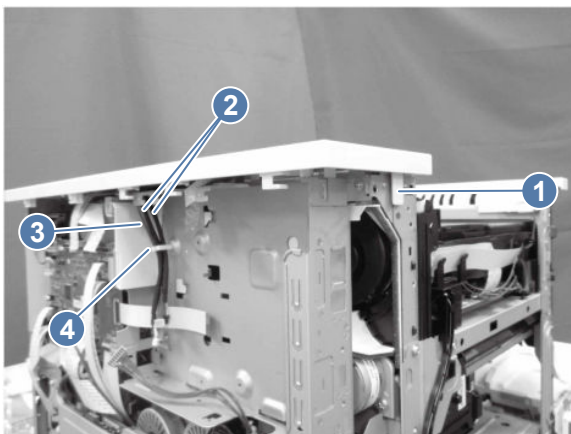

4. Remove two screws (callout 1), release two tabs (callout 2), and then remove the top cover (callout 3).

Figure 5-598 Remove the cover

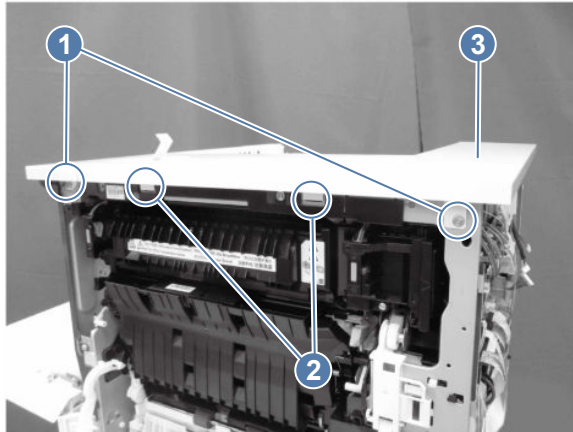

10. Remove the top cover (MFP models)

Follow these steps to remove the top cover.

- Remove one screw (callout 1), and then remove the top cover (callout 2).

Figure 5-599 Remove the top cover

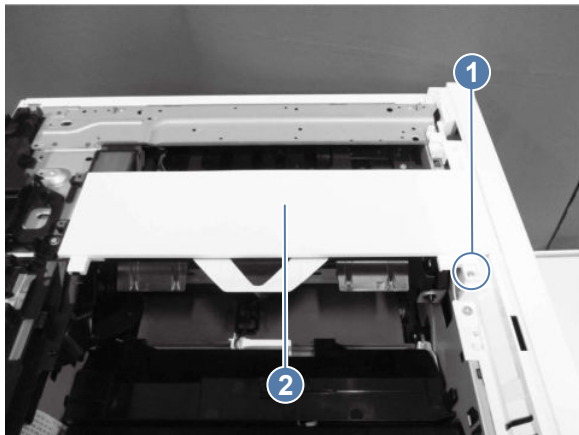

11. Remove the top front cover (MFP models)

Follow these steps to remove the top front cover.

1. Disconnect one connector (callout 1), and then release the cable (callout 2) from the cable guide (callout 3).

Figure 5-600 Disconnect one connector and release the cable

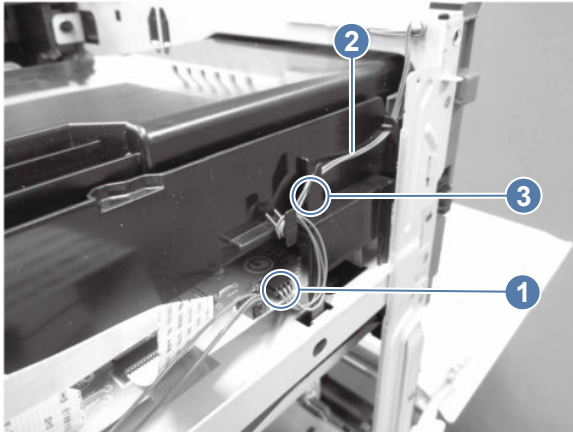

2. Remove two screws.

Figure 5-601 Remove two screws

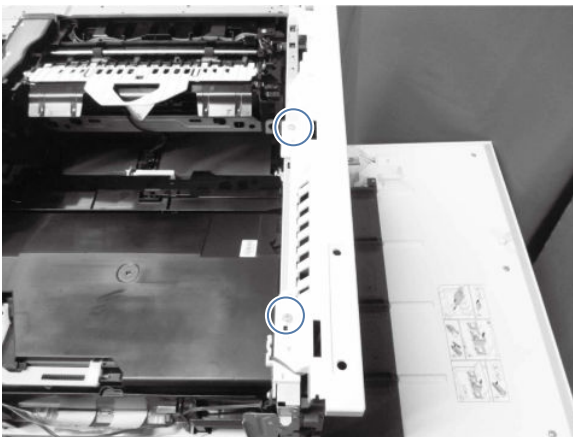

3. Remove one screw (callout 1), hold up the top front cover (callout 2), and then remove it.

Figure 5-602 Remove the top front cover

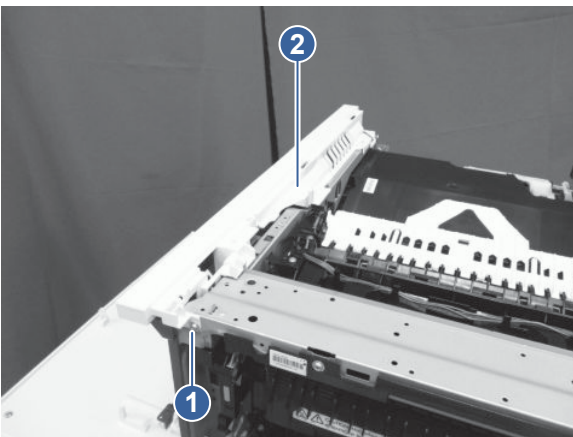

12. Remove the pre-exposure PCA holder assembly (X57945 models)

Follow these steps to remove the pre-exposure PCA holder assembly.

1. Open the toner supply door.

Figure 5-603 Open the toner supply door

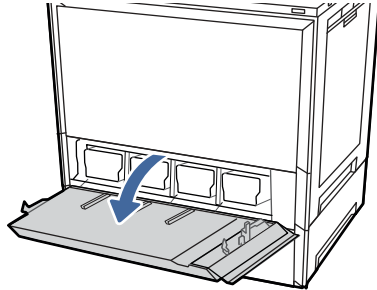

2. Remove three screws (callout 1).

Figure 5-604 Remove three screws

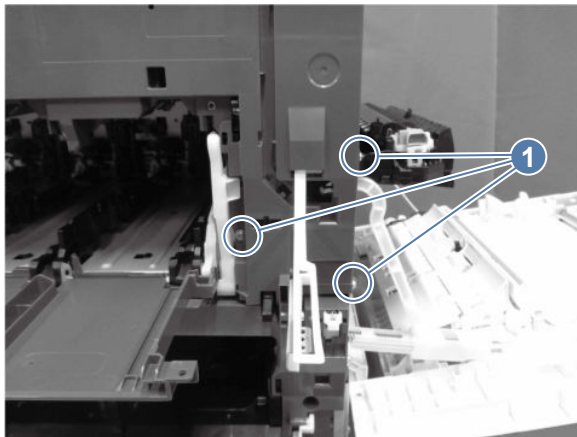

3. Release eight tabs (callout 1).

Figure 5-605 Release eight tabs

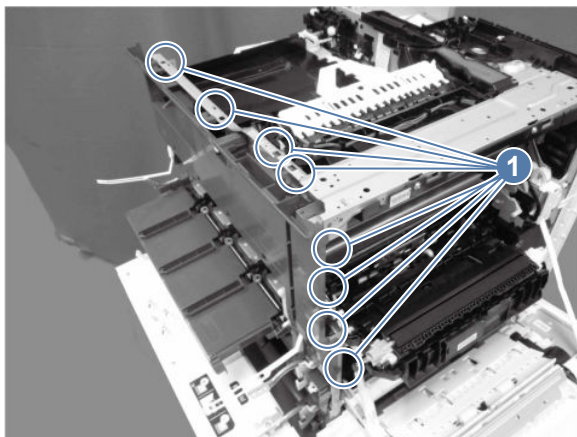

4. Release five tabs (callout 1), and then remove the front inner cover (callout 2).

Figure 5-606 Remove the front inner cover

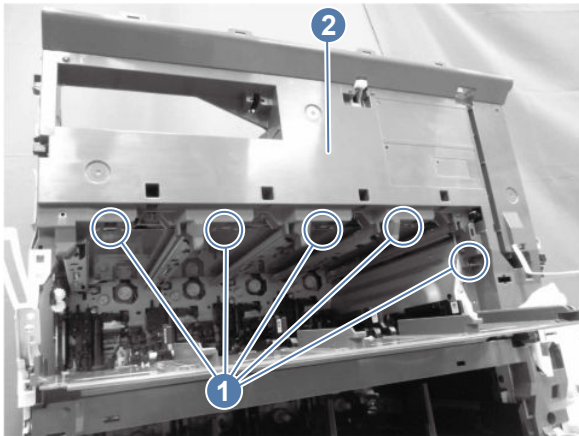

5. Release three tabs (callout 1), hold up the high-voltage PCA cover (callout 2), and then disconnect two connectors (callout 3).

Figure 5-607 Release three tabs

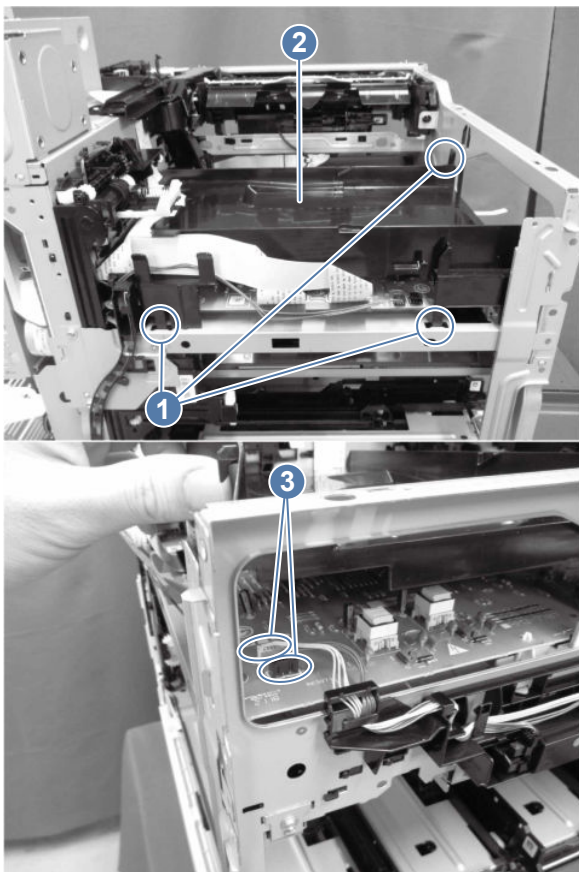

6. Release four tabs (callout 1), and then slide the pre-exposure PCA holder assembly (callout 2) upward.

Figure 5-608 Release four tabs

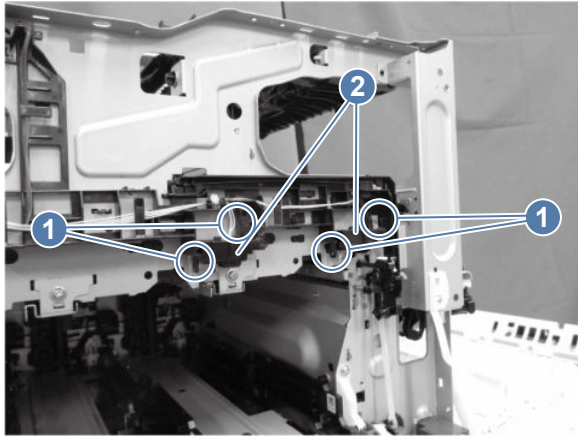

7. Release one tab (callout 1), and then slide the pre-exposure PCA holder assembly (callout 2) in the direction indicated to remove it.

Figure 5-609 Remove the pre-exposure PCA holder assembly

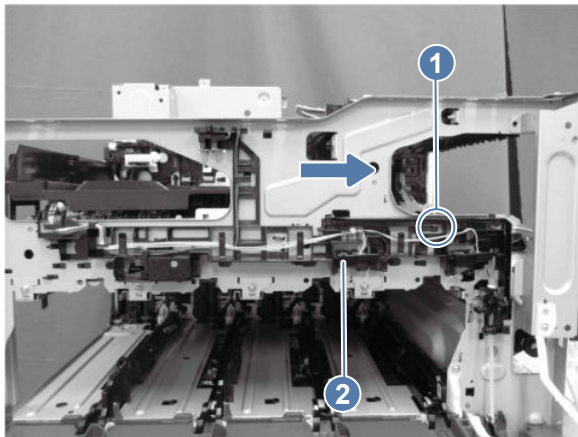

8. Remove the link arm (callout 1) and two link levers (callout 2) from the pre-exposure PCA holder assembly (callout 3).

Figure 5-610 Remove the link arm and two link levers

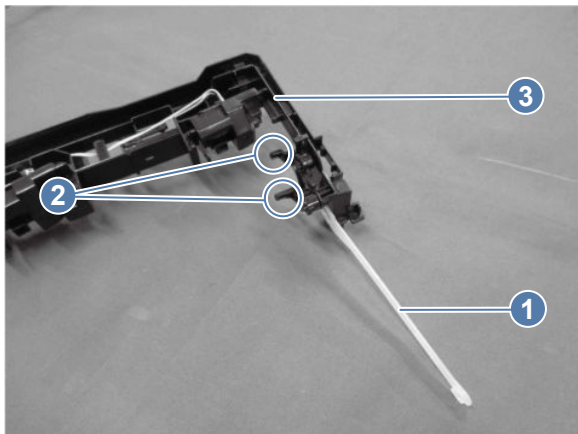

13. Unpack the replacement assembly

Follow these steps to unpack the replacement assembly.

1. Dispose of the defective part.



NOTE: HP recommends responsible disposal of the defective part.

<http://www8.hp.com/us/en/hp-information/environment/product-recycling.html>

2. Unpack the replacement part from the packaging.



CAUTION:  Some parts are sensitive to electrostatic discharge (ESD). Always perform service work at an ESD-protected workstation or mat. If an ESD workstation or mat is not available, touch the sheet-metal chassis to provide a static ground before touching an ESD-sensitive assembly. Protect the ESD-sensitive assemblies by placing them in ESD pouches when they are out of the printer.



IMPORTANT: Make sure that all of the shipping materials (for example shipping tape) are removed from the replacement part prior to installation.



NOTE: If the replacement part is a roller or pad, avoid touching the spongy part of it. Skin oils on the roller or pad can cause paper pickup and/or print-quality problems. HP recommends using disposable gloves when handling rollers or pads or washing your hands before touching rollers or pads.

3. To install an assembly, reverse the removal steps.



NOTE: When applicable, special installation instructions are provided for an assembly at the end of the removal procedure. Always completely read the removal instructions and follow all special installation instructions.

Removal and replacement: Toner supply drive assembly (X57945 models)

Learn about removing and replacing the toner supply drive assembly.

Before performing service

Turn the printer power off

- Disconnect the power cable.



WARNING! To avoid damage to the printer, turn the printer off, wait 30 seconds, and then remove the power cord before attempting to service the printer.

If the part is damaged and cannot be cleaned, use the table below to identify the correct part number for your printer. To order the part, go to www.hp.com/buy/parts.

Table 5-77 Part information

Part number	Part description
RM2-3607-000CN	Toner supply drive assembly
RM2-3608-000CN	Toner supply drive assembly
RM2-3609-000CN	Toner supply drive assembly

Required tools

- #2 Phillips screwdriver with a magnetic tip and a 152 mm (6 in) shaft length

After performing service

Turn the printer power on

- Connect the power cable.
- Use the power switch to turn the power on.

Post service test

Print any pages necessary to make sure the printer is functioning correctly.

1. Remove the toner supply drive assembly (X57945 models)

Follow these steps to remove the toner supply drive assembly.

Since the disassembly procedures of the following four toner supply drive assemblies are similar, the disassembly procedure of the 1st toner supply drive assembly (callout 1) is shown below as an example.

Figure 5-611 Toner supply drive assemblies

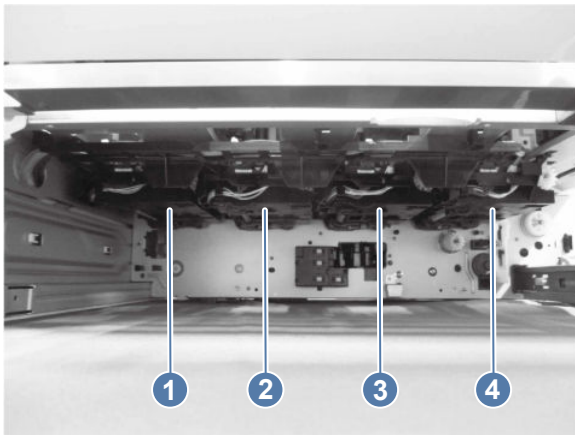

- First toner supply drive assembly (callout 1)
- Second toner supply drive assembly (callout 2)
- Third toner supply drive assembly (callout 3)
- Fourth toner supply drive assembly (callout 4)

1. Open the toner supply door.

Figure 5-612 Open the toner supply door

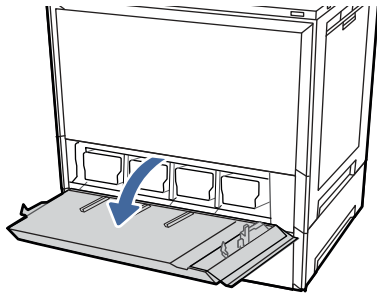

2. Remove the front left cover.
3. Remove two screws (callout 1), and then remove the base frame (callout 2).

Figure 5-613 Remove the base frame

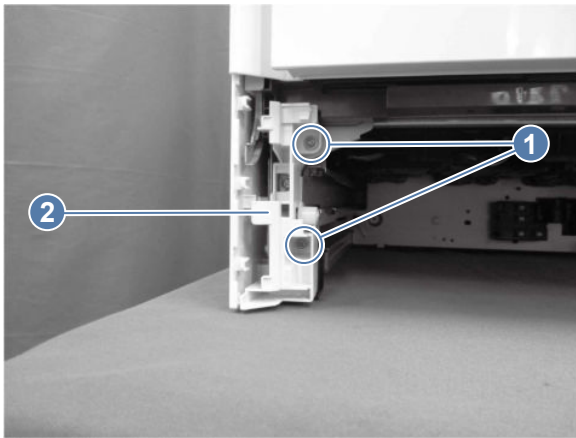

4. Remove one screw (callout 1), and then remove the cassette rail assembly (callout 2).

Figure 5-614 Remove the cassette rail assembly

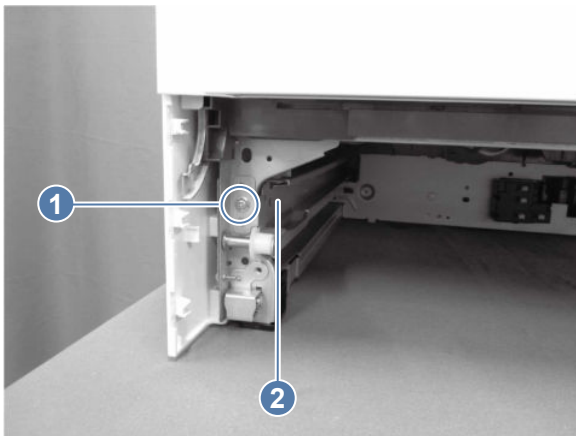

5. Release one tab (callout 1), and then slide the toner cartridge rail assembly (callout 2) towards the front to remove it.

Figure 5-615 Remove the toner cartridge rail assembly

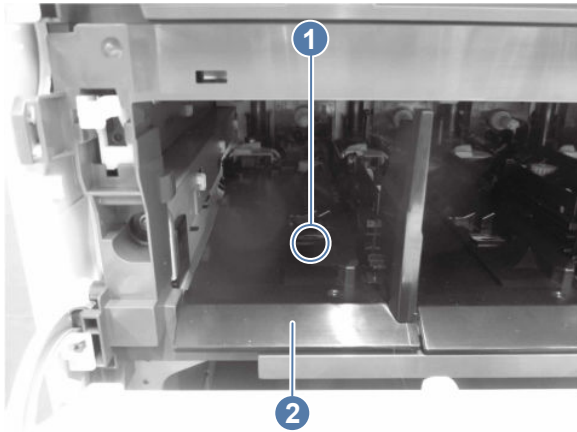

6. Disconnect two connectors (callout 1), remove one screw (callout 2), slide the toner supply drive assembly (callout 3) towards the front, and then slide the toner supply drive assembly downward to remove it.

Figure 5-616 Remove the toner supply drive assembly

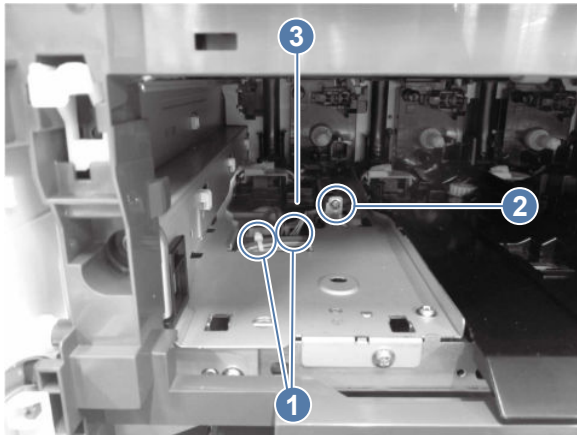

7. For reinstallation of the toner supply drive assembly, keep the following tips in mind.

 **Reinstallation tip:** Since a toner supply drive assembly can be installed in another station, be careful not to mix. The exception is assemblies 2 and 4, which are the same.

 **Reinstallation tip:** On the first toner supply drive assembly, there are no gears (callout 1) and no coupling (callout 2).

Figure 5-617 First toner supply drive assembly



Reinstallation tip: On the second and fourth toner supply drive assemblies, there are 3 gears (callout 1) and no coupling (callout 2).

Figure 5-618 Second and fourth toner supply drive assemblies

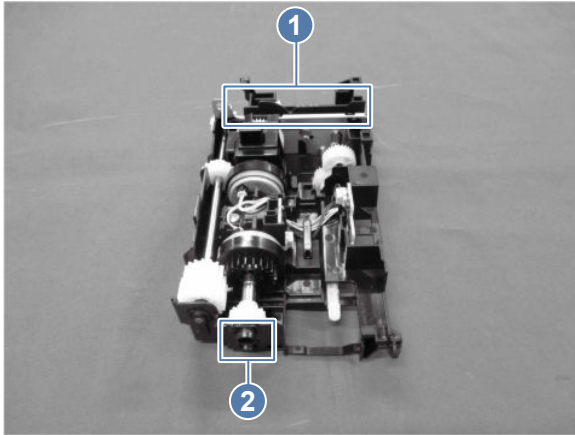
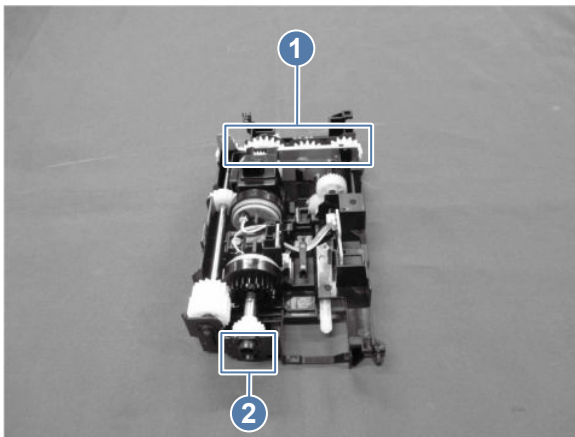

Reinstallation tip: On the third toner supply drive assembly, there are three gears (callout 1) and a coupling (callout 2).

Figure 5-619 Third toner supply drive assembly

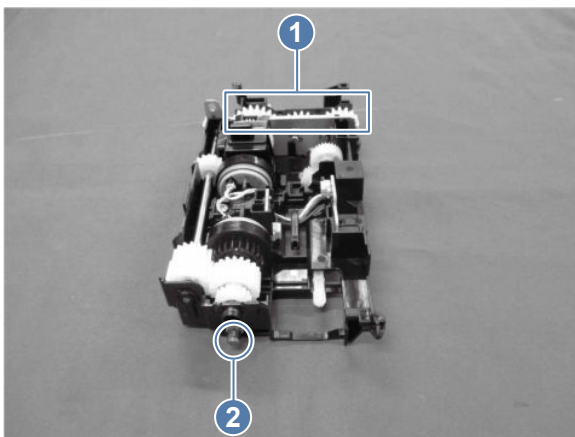

2. Unpack the replacement assembly

Follow these steps to unpack the replacement assembly.

1. Dispose of the defective part.



NOTE: HP recommends responsible disposal of the defective part.

<http://www8.hp.com/us/en/hp-information/environment/product-recycling.html>

2. Unpack the replacement part from the packaging.



CAUTION:  Some parts are sensitive to electrostatic discharge (ESD). Always perform service work at an ESD-protected workstation or mat. If an ESD workstation or mat is not available, touch the sheet-metal chassis to provide a static ground before touching an ESD-sensitive assembly. Protect the ESD-sensitive assemblies by placing them in ESD pouches when they are out of the printer.



IMPORTANT: Make sure that all of the shipping materials (for example shipping tape) are removed from the replacement part prior to installation.



NOTE: If the replacement part is a roller or pad, avoid touching the spongy part of it. Skin oils on the roller or pad can cause paper pickup and/or print-quality problems. HP recommends using disposable gloves when handling rollers or pads or washing your hands before touching rollers or pads.

3. To install an assembly, reverse the removal steps.



NOTE: When applicable, special installation instructions are provided for an assembly at the end of the removal procedure. Always completely read the removal instructions and follow all special installation instructions.

Removal and replacement: Toner supply assembly (X57945 models)

Learn about removing and replacing the toner supply assembly.

Before performing service

Turn the printer power off

- Disconnect the power cable.



WARNING! To avoid damage to the printer, turn the printer off, wait 30 seconds, and then remove the power cord before attempting to service the printer.

If the part is damaged and cannot be cleaned, use the table below to identify the correct part number for your printer. To order the part, go to www.hp.com/buy/parts.

Table 5-78 Part information

Part number	Part description
RM3-0846-000CN	HP Toner supply service kit

Required tools

- #2 Phillips screwdriver with a magnetic tip and a 152 mm (6 in) shaft length

After performing service

Turn the printer power on

- Connect the power cable.
- Use the power switch to turn the power on.

Post service test

Print any pages necessary to make sure the printer is functioning correctly.

1. Remove the toner supply assembly (X57945 models)

Follow these steps to remove the toner supply assembly.



NOTE: When replacing the toner supply assembly, always replace the toner supply buffer assembly/intermediate pipe at the same time.

Since the disassembly procedures of the following four toner supply assemblies are similar, the disassembly procedure of the first toner supply assembly (callout 1) is shown below as an example.

Figure 5-620 Toner supply assemblies

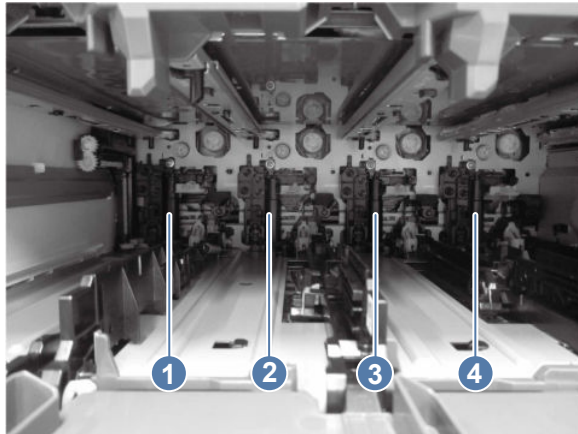

- First toner supply assembly (callout 1)
- Second toner supply assembly (callout 2)
- Third toner supply assembly (callout 3)
- Fourth toner supply assembly (callout 4)

1. Open the front door.

Figure 5-621 Open the front door

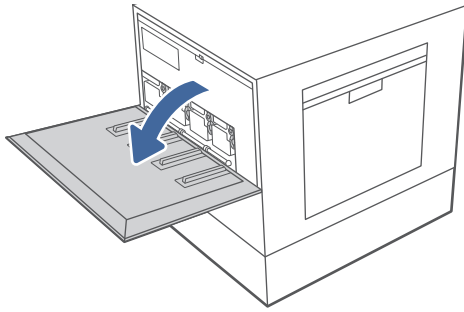

2. Remove one screw (callout 1), hold the handle (callout 2), and then release one tab (callout 3). Rotate the toner supply assembly (callout 4) in the direction indicated, and then slide the assembly upward to remove it.

Figure 5-622 Remove the assembly

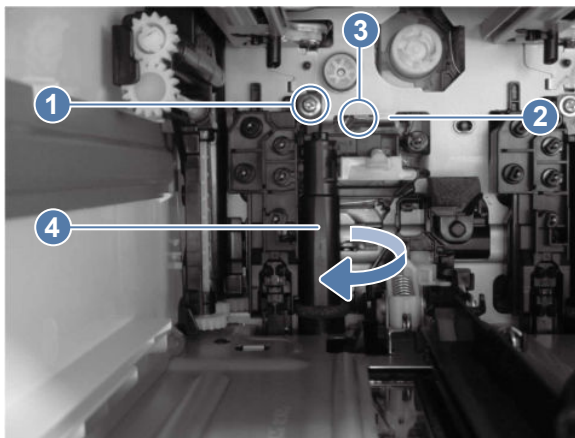

2. Unpack the replacement assembly

Follow these steps to unpack the replacement assembly.

1. Dispose of the defective part.



NOTE: HP recommends responsible disposal of the defective part.

<http://www8.hp.com/us/en/hp-information/environment/product-recycling.html>

2. Unpack the replacement part from the packaging.



CAUTION:  Some parts are sensitive to electrostatic discharge (ESD). Always perform service work at an ESD-protected workstation or mat. If an ESD workstation or mat is not available, touch the sheet-metal chassis to provide a static ground before touching an ESD-sensitive assembly. Protect the ESD-sensitive assemblies by placing them in ESD pouches when they are out of the printer.



IMPORTANT: Make sure that all of the shipping materials (for example shipping tape) are removed from the replacement part prior to installation.

 **NOTE:** If the replacement part is a roller or pad, avoid touching the spongy part of it. Skin oils on the roller or pad can cause paper pickup and/or print-quality problems. HP recommends using disposable gloves when handling rollers or pads or washing your hands before touching rollers or pads.

3. To install an assembly, reverse the removal steps.

 **NOTE:** When applicable, special installation instructions are provided for an assembly at the end of the removal procedure. Always completely read the removal instructions and follow all special installation instructions.

Removal and replacement: Toner supply buffer assembly/intermediate pipe (X57945 models)

Learn about removing and replacing the toner supply buffer assembly/intermediate pipe.

Before performing service

Turn the printer power off

- Disconnect the power cable.

 **WARNING!** To avoid damage to the printer, turn the printer off, wait 30 seconds, and then remove the power cord before attempting to service the printer.

If the part is damaged and cannot be cleaned, use the table below to identify the correct part number for your printer. To order the part, go to www.hp.com/buy/parts.

Table 5-79 Part information

Part number	Part description
RM3-0846-000CN	HP Toner supply service kit

Required tools

- #2 Phillips screwdriver with a magnetic tip and a 152 mm (6 in) shaft length

After performing service

Turn the printer power on

- Connect the power cable.
- Use the power switch to turn the power on.

Post service test

Print any pages necessary to make sure the printer is functioning correctly.

1. Remove the toner supply assembly (X57945 models)

Follow these steps to remove the toner supply assembly.

 **NOTE:** When replacing the toner supply assembly, always replace the toner supply buffer assembly/intermediate pipe at the same time.

Since the disassembly procedures of the following four toner supply assemblies are similar, the disassembly procedure of the first toner supply assembly (callout 1) is shown below as an example.

Figure 5-623 Toner supply assemblies

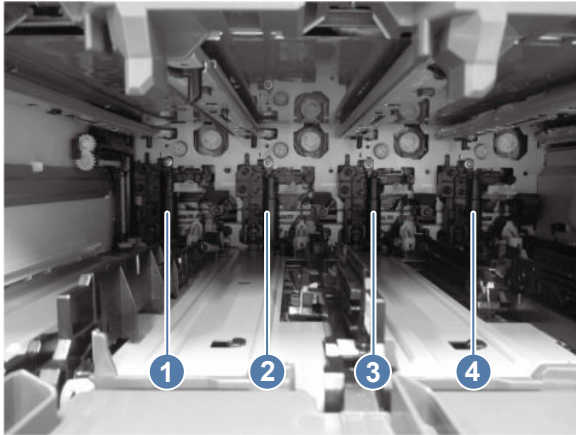

- First toner supply assembly (callout 1)
- Second toner supply assembly (callout 2)
- Third toner supply assembly (callout 3)
- Fourth toner supply assembly (callout 4)

1. Open the front door.

Figure 5-624 Open the front door

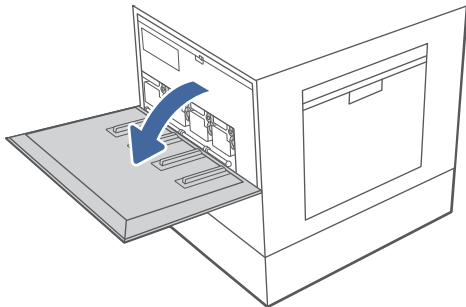

2. Remove one screw (callout 1), hold the handle (callout 2), and then release one tab (callout 3). Rotate the toner supply assembly (callout 4) in the direction indicated, and then slide the assembly upward to remove it.

Figure 5-625 Remove the assembly

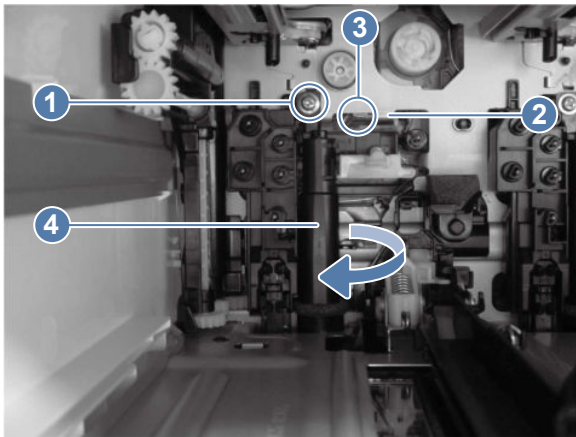

2. Remove the toner supply drive assembly (X57945 models)

Follow these steps to remove the toner supply drive assembly.

Since the disassembly procedures of the following four toner supply drive assemblies are similar, the disassembly procedure of the 1st toner supply drive assembly (callout 1) is shown below as an example.

Figure 5-626 Toner supply drive assemblies

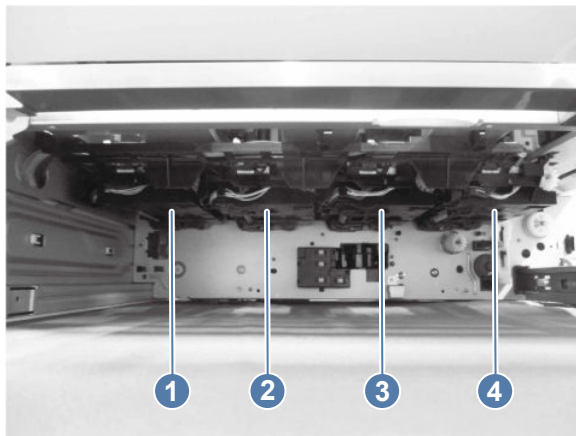

- First toner supply drive assembly (callout 1)
- Second toner supply drive assembly (callout 2)
- Third toner supply drive assembly (callout 3)
- Fourth toner supply drive assembly (callout 4)

1. Open the toner supply door.

Figure 5-627 Open the toner supply door

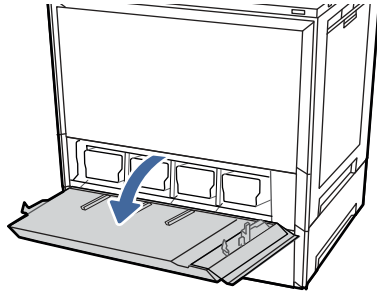

2. Remove the front left cover.
3. Remove two screws (callout 1), and then remove the base frame (callout 2).

Figure 5-628 Remove the base frame

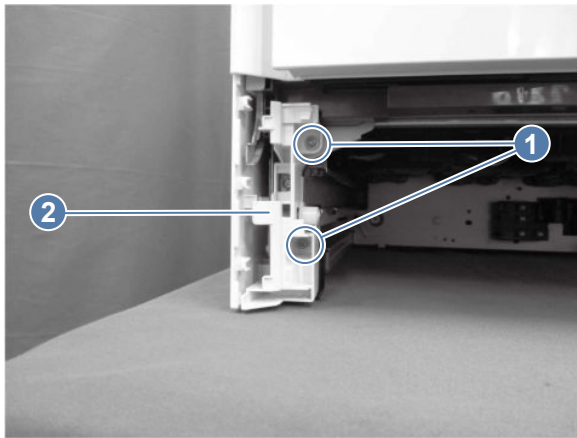

4. Remove one screw (callout 1), and then remove the cassette rail assembly (callout 2).

Figure 5-629 Remove the cassette rail assembly

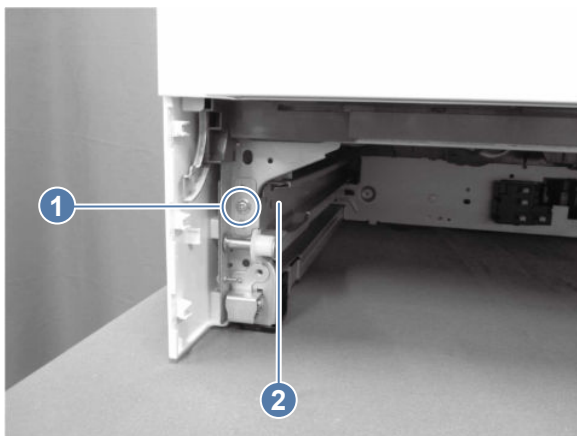

5. Release one tab (callout 1), and then slide the toner cartridge rail assembly (callout 2) towards the front to remove it.

Figure 5-630 Remove the toner cartridge rail assembly

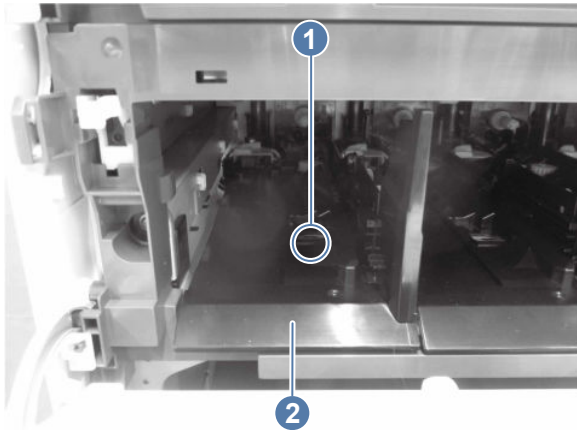

6. Disconnect two connectors (callout 1), remove one screw (callout 2), slide the toner supply drive assembly (callout 3) towards the front, and then slide the toner supply drive assembly downward to remove it.

Figure 5-631 Remove the toner supply drive assembly

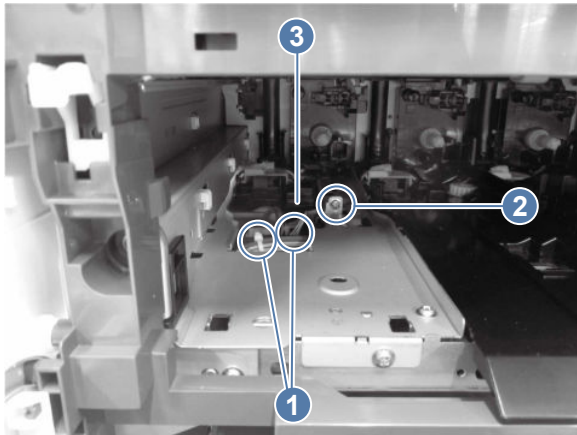

7. For reinstallation of the toner supply drive assembly, keep the following tips in mind.

 **Reinstallation tip:** Since a toner supply drive assembly can be installed in another station, be careful not to mix. The exception is assemblies 2 and 4, which are the same.

 **Reinstallation tip:** On the first toner supply drive assembly, there are no gears (callout 1) and no coupling (callout 2).

Figure 5-632 First toner supply drive assembly



Reinstallation tip: On the second and fourth toner supply drive assemblies, there are 3 gears (callout 1) and no coupling (callout 2).

Figure 5-633 Second and fourth toner supply drive assemblies

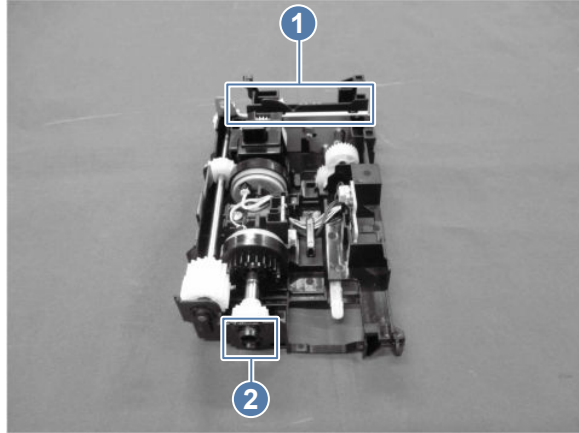
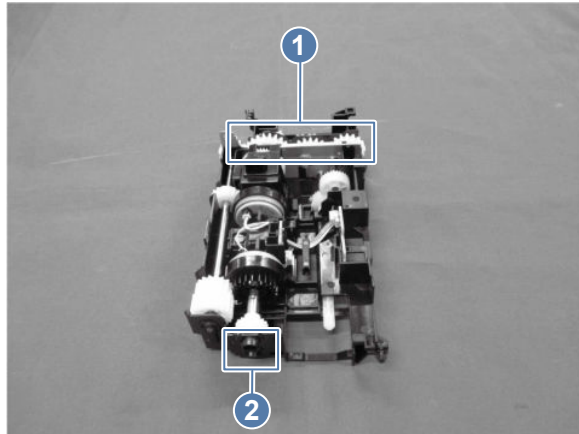

Reinstallation tip: On the third toner supply drive assembly, there are three gears (callout 1) and a coupling (callout 2).

Figure 5-634 Third toner supply drive assembly

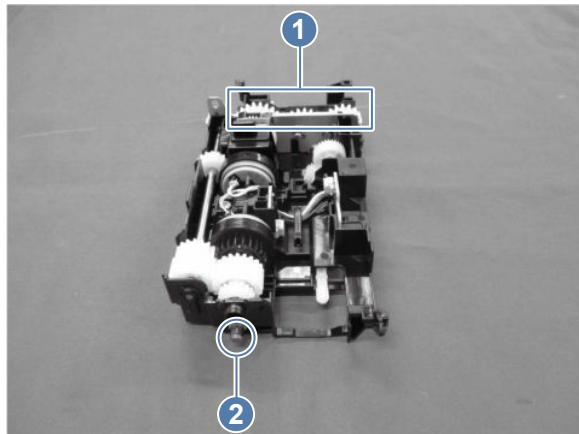

3. Remove the toner supply buffer assembly/intermediate pipe (X57945 models)

Follow these steps to remove the toner supply buffer assembly/intermediate pipe.

 **NOTE:** When replacing toner supply buffer assembly/intermediate pipe, always replace the toner supply assembly at the same time.

Since the disassembly procedures of the following four toner supply buffer assemblies are similar, the disassembly procedure of the first toner supply buffer assembly (callout 1) is shown below as an example.

Figure 5-635 Toner supply buffer assemblies

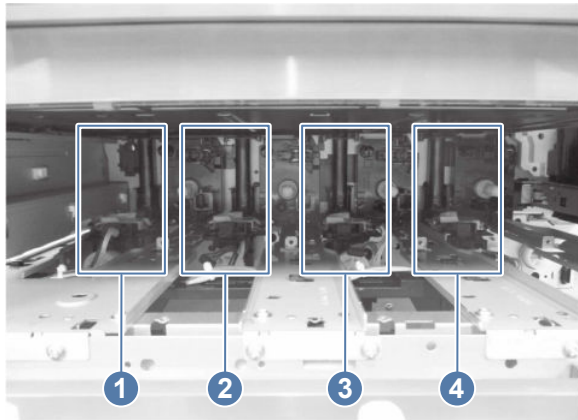

- First toner supply buffer assembly (callout 1)
- Second toner supply buffer assembly (callout 2)
- Third toner supply buffer assembly (callout 3)
- Fourth toner supply buffer assembly (callout 4)
- Slide the toner supply buffer assembly (callout 1) frontward, and then slide the toner supply buffer assembly (callout 1) and the intermediate pipe (callout 2) downward to remove them together.

Figure 5-636 Remove the assembly

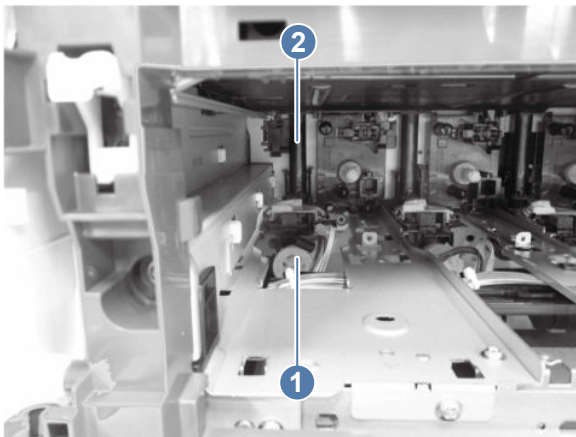

4. Unpack the replacement assembly



Follow these steps to unpack the replacement assembly.

1. Dispose of the defective part.

 **NOTE:** HP recommends responsible disposal of the defective part.

<http://www8.hp.com/us/en/hp-information/environment/product-recycling.html>

2. Unpack the replacement part from the packaging.

 **CAUTION:**  Some parts are sensitive to electrostatic discharge (ESD). Always perform service work at an ESD-protected workstation or mat. If an ESD workstation or mat is not available, touch the sheet-metal chassis to provide a static ground before touching an ESD-sensitive assembly. Protect the ESD-sensitive assemblies by placing them in ESD pouches when they are out of the printer.

 **IMPORTANT:** Make sure that all of the shipping materials (for example shipping tape) are removed from the replacement part prior to installation.

 **NOTE:** If the replacement part is a roller or pad, avoid touching the spongy part of it. Skin oils on the roller or pad can cause paper pickup and/or print-quality problems. HP recommends using disposable gloves when handling rollers or pads or washing your hands before touching rollers or pads.

3. To install an assembly, reverse the removal steps.

 **NOTE:** When applicable, special installation instructions are provided for an assembly at the end of the removal procedure. Always completely read the removal instructions and follow all special installation instructions.

Removal and replacement: Feed assembly (X57945 models)

Learn about removing and replacing the feed assembly.

Before performing service

Turn the printer power off

- Disconnect the power cable.

 **WARNING!** To avoid damage to the printer, turn the printer off, wait 30 seconds, and then remove the power cord before attempting to service the printer.

If the part is damaged and cannot be cleaned, use the table below to identify the correct part number for your printer. To order the part, go to www.hp.com/buy/parts.

Table 5-80 Part information

Part number	Part description
RM2-3479-000CN	Paper feed assembly

Required tools

- #2 Phillips screwdriver with a magnetic tip and a 152 mm (6 in) shaft length

After performing service

Turn the printer power on

- Connect the power cable.
- Use the power switch to turn the power on.

Post service test

Print any pages necessary to make sure the printer is functioning correctly.

1. Remove the secondary transfer assembly

Follow these steps to remove the secondary transfer assembly.

1. Open the right door.

Figure 5-637 Open the right door



2. Release two tabs (callout 1), and then remove the PCA cover (callout 2).

Figure 5-638 Remove the PCA cover

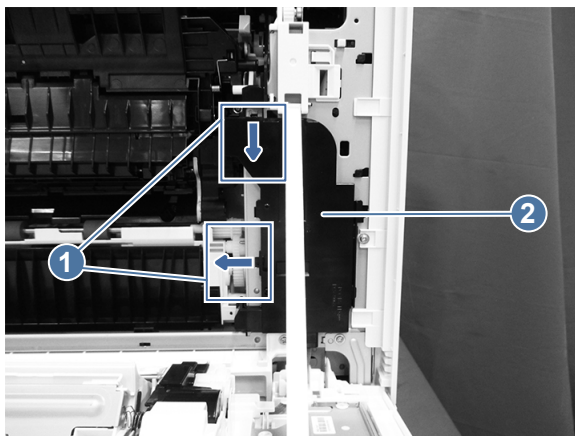

3. Disconnect one connector (callout 1), and then release the cable (callout 2) from the cable guide (callout 3).

 **Reinstallation tip:** When reinstalled, make sure the cable is correctly routed through the cable guide.

Figure 5-639 Release the cable



4. Perform one of the following steps.

- **X557/5800/X57945 models:** Disconnect the J315 formatter connector.
- **5700 models:** Disconnect the J305 formatter connector.

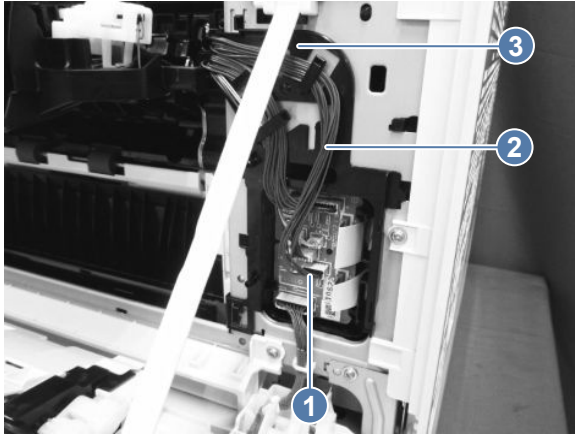
Figure 5-640 Disconnect a formatter connector

X557/MFP 5800/MFP X579

5700

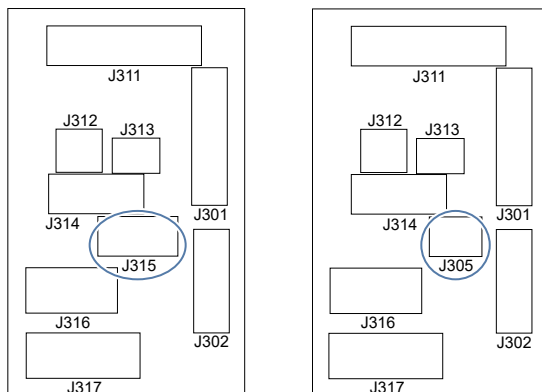

5. Release one tab (callout 1), and then lift up the registration assembly (callout 2) off the secondary transfer assembly (callout 3)

Figure 5-641 Release the tab

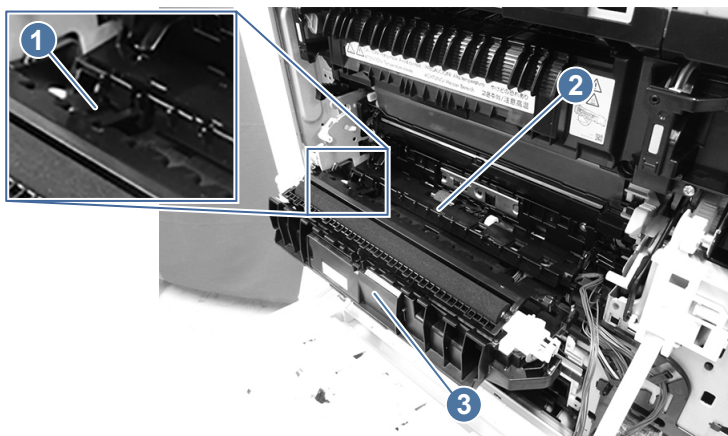

6. Close the secondary transfer assembly until it is only slightly open. Slide the assembly (callout 1) in the direction indicated below, and then dislodge the hinge pin (callout 2) from the holder to remove the assembly.



 **Reinstallation tip:** Before removing the assembly, take note of where the assembly hinge pins fit into the holes provided in the printer.

Figure 5-642 Remove the secondary transfer assembly

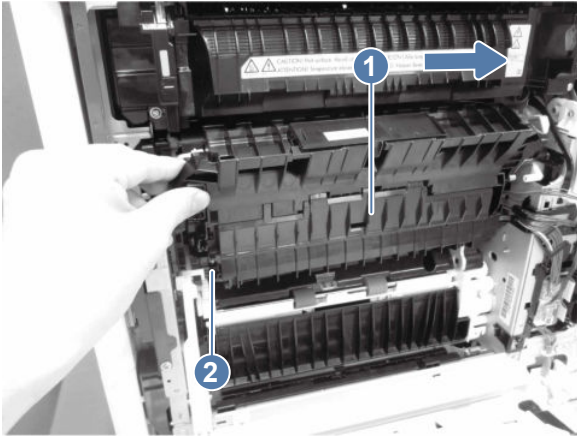

 **Reinstallation tip:** On the assembly right side, make sure that the wire is nested in the plastic sleeve. Slide the wire sleeve into its place, depressing the spring, and then twist the left side of the assembly into place and allow the spring pressure to nest the hinge pin in its hole.

2. Remove the registration assembly

Follow these steps to remove the registration assembly.

1. Disconnect three connectors (callout 1), and then release the cable (callout 2) from the cable guide (callout 3).

Figure 5-643 Release the connectors

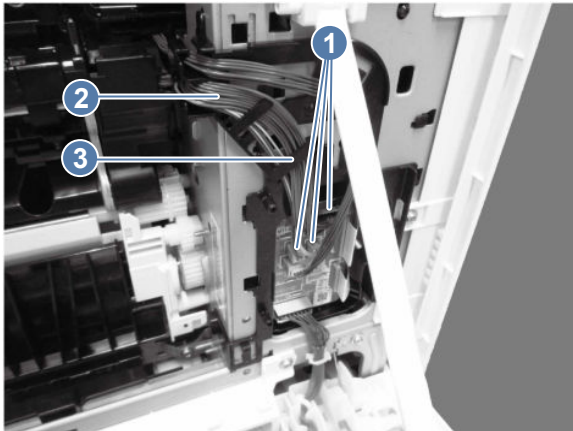

2. Release two bosses (callout 1), and then release the link arm (callout 2) from the door.

Figure 5-644 Release the link arm

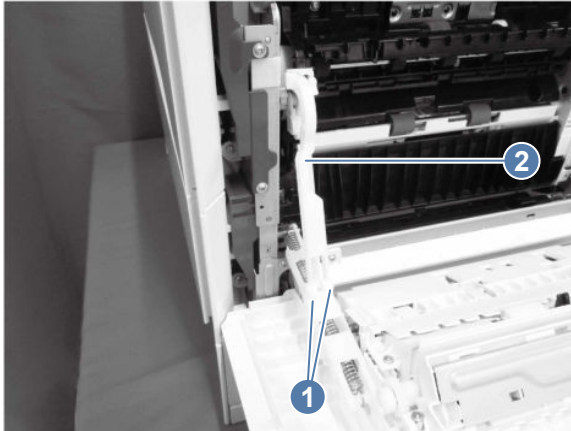

3. Remove four screws (callout 1), and then remove the registration assembly (callout 2).

Figure 5-645 Remove the registration assembly

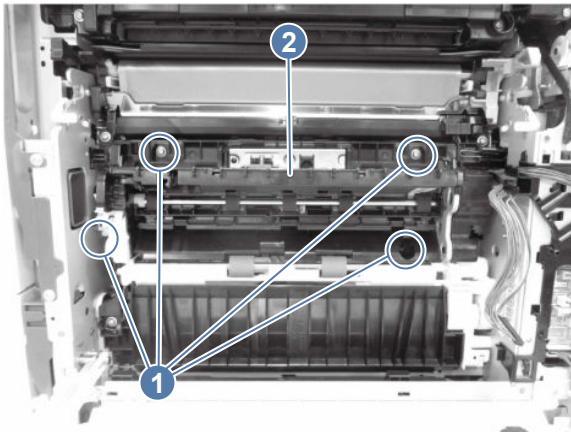

3. Remove the feed assembly (X57945 models)

Follow these steps to remove the feed assembly.

1. Remove one screw (callout 1), and then remove the feed assembly (callout 2).

Figure 5-646 Remove the feed assembly

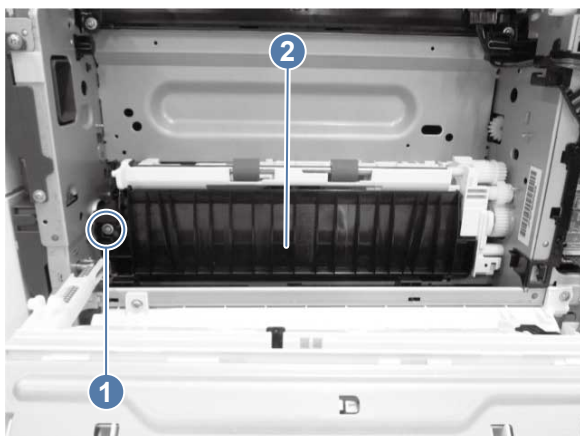

2. Remove the gear (callout 1) from the feed assembly (callout 2).

Figure 5-647 Remove the gear

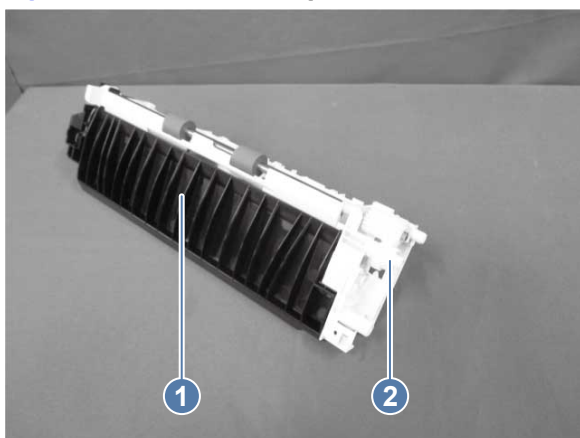

4. Unpack the replacement assembly

Follow these steps to unpack the replacement assembly.

1. Dispose of the defective part.



NOTE: HP recommends responsible disposal of the defective part.

<http://www8.hp.com/us/en/hp-information/environment/product-recycling.html>

2. Unpack the replacement part from the packaging.



CAUTION:  Some parts are sensitive to electrostatic discharge (ESD). Always perform service work at an ESD-protected workstation or mat. If an ESD workstation or mat is not available, touch the sheet-metal chassis to provide a static ground before touching an ESD-sensitive assembly. Protect the ESD-sensitive assemblies by placing them in ESD pouches when they are out of the printer.



IMPORTANT: Make sure that all of the shipping materials (for example shipping tape) are removed from the replacement part prior to installation.

 **NOTE:** If the replacement part is a roller or pad, avoid touching the spongy part of it. Skin oils on the roller or pad can cause paper pickup and/or print-quality problems. HP recommends using disposable gloves when handling rollers or pads or washing your hands before touching rollers or pads.

3. To install an assembly, reverse the removal steps.

 **NOTE:** When applicable, special installation instructions are provided for an assembly at the end of the removal procedure. Always completely read the removal instructions and follow all special installation instructions.

Removal and replacement: Low-voltage power supply (LVPS)

This document provides the procedures to remove and replace the low-voltage power supply (LVPS).

Mean time to repair: 25 minutes

Service level: Intermediate

Before performing service

Turn the printer power off

- Disconnect the power cable.

 **WARNING!** To avoid damage to the printer, turn the printer off, wait 30 seconds, and then remove the power cord before attempting to service the printer.

Use the table below to identify the correct part number for your printer, and then go to <https://parts.hp.com/hpparts> to order the part.

Table 5-81 LVPS part numbers

Part number	Part description
RM3-7724-000CN	LVPS (110-127V) (5700/X557)
RM3-7725-000CN	LVPS (220-240V) (5700/X557)
RM3-7726-000CN	LVPS (110-127V) (6700/X654)
RM3-7727-000CN	LVPS (220-240V) (6700/X654)
RM3-7728-000CN	LVPS (110-127V) (6800/X677)
RM3-7729-000CN	LVPS (220-240V) (6800/X677)
RM3-9012-000CN	LVPS (110-127V) (5800/X57945)
RM3-9013-000CN	LVPS (220-240V) (5800/X57945)

Required tools

- #2 Phillips screwdriver with a magnetic tip

After performing service

Make sure that all of the connectors on the LVPS are fully seated.

Make sure that all of the connectors on the formatter are fully seated.

Make sure that the formatter cover is fully seated.

Turn the printer power on

- Connect the power cable.
- Use the power switch to turn the power on.

Post service test

Print a configuration page to make sure that the printer is functioning correctly.

1. Remove the formatter cover

Follow these steps to remove the formatter cover.

- Remove one screw (callout 1), and then slide the formatter cover (callout 2) away from the printer to remove it.



 **TIP:** Reverse the removal steps to install the assembly.

Figure 5-648 Remove the formatter cover

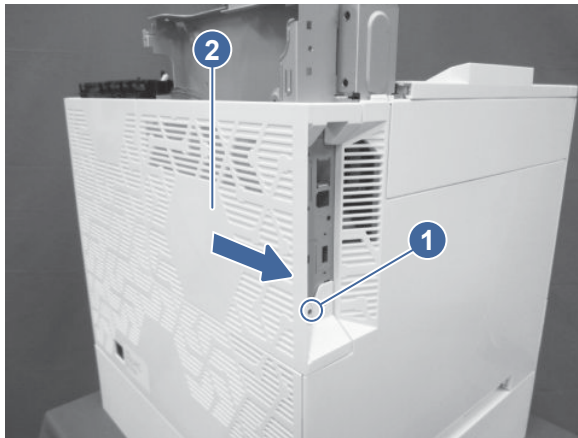

2. Remove the rear cover

Follow these steps to remove the rear cover.

 **NOTE:** The figures below show some assemblies (for example the top cover and formatter) removed that might still be installed on the printer. However, the steps to remove the cover are correct.

1. Open the right door, and remove two screws.

Figure 5-649 Remove two screws

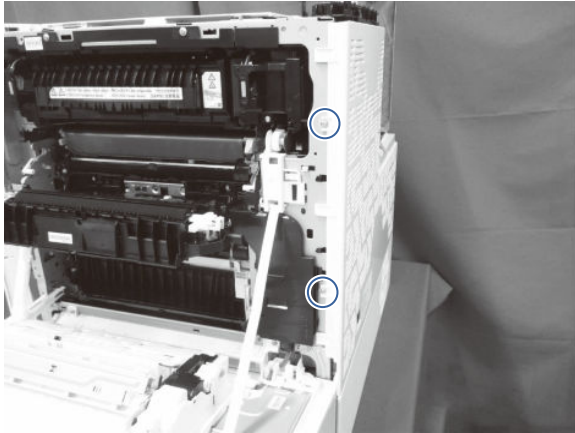

2. At the back of the printer, remove two screws, and then slide the rear cover as indicated to remove it.

Figure 5-650 Remove the rear cover

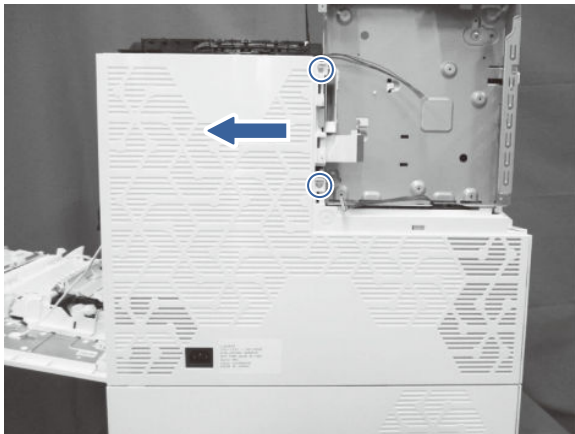

3. Remove the low-voltage power supply (LVPS)

Follow these steps to remove the low-voltage power supply (LVPS).

1. Unhook one spring (callout 1), and then disconnect two connectors (callout 2).

 **NOTE:** Unhook the spring from the formatter cage, not the low-voltage power supply. The spring should remain attached to the LVPS.

Figure 5-651 Unhook the spring and disconnect two connectors



2. Remove the FFC (callout 1), and then disconnect five connectors (callout 2).

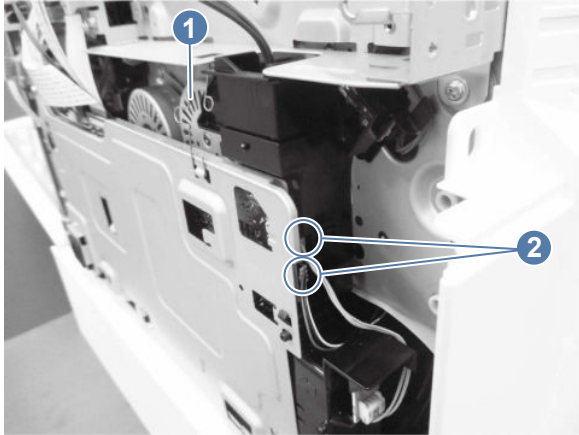

 **NOTE:** MFP only: Disconnect one additional connector (callout 3).

Figure 5-652 Disconnect the LVPS connectors

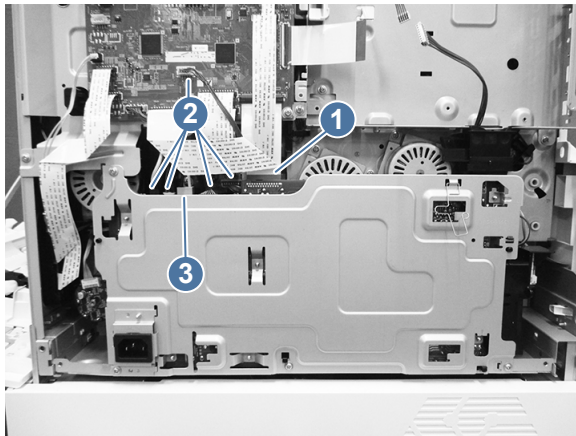

3. Remove four screws (callout 1), and then remove the low-voltage power supply assembly (callout 2).

 **NOTE:** The black ducting in the lower right corner can stick during the removal process.

Replacement LVPS only: Remove the spring (callout 3), and then install it on the replacement LVPS.

Figure 5-653 Remove the LVPS

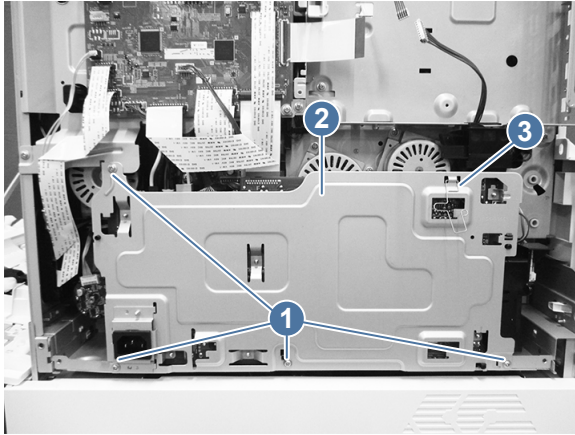

 **Reinstallation tip:** When reinstalling the LVPS, make sure that the spring (callout 1) is attached to both the formatter cage (callout 2) and the LVPS (callout 3).

Figure 5-654 Reinstalling the LVPS



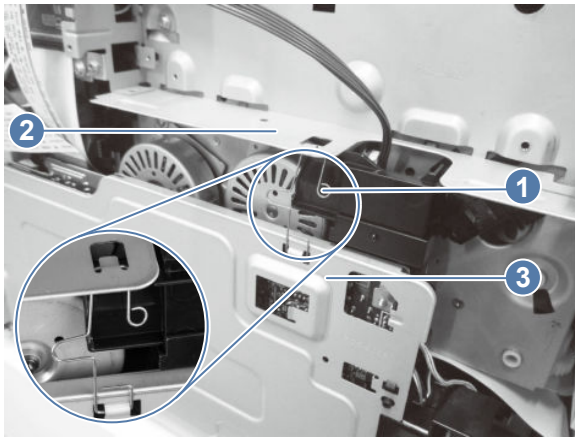

4. Unpack the replacement assembly

Follow these steps to unpack the replacement assembly.

1. Dispose of the defective part.

 **NOTE:** HP recommends responsible disposal of the defective part.
<http://www8.hp.com/us/en/hp-information/environment/product-recycling.html>

2. Unpack the replacement part from the packaging.

 **CAUTION:**  Some parts are sensitive to electrostatic discharge (ESD). Always perform service work at an ESD-protected workstation or mat. If an ESD workstation or mat is not available, touch the sheet-metal chassis to provide a static ground before touching an ESD-sensitive assembly. Protect the ESD-sensitive assemblies by placing them in ESD pouches when they are out of the printer.

 **IMPORTANT:** Make sure that all of the shipping materials (for example shipping tape) are removed from the replacement part prior to installation.

 **NOTE:** If the replacement part is a roller or pad, avoid touching the spongy part of it. Skin oils on the roller or pad can cause paper pickup and/or print-quality problems. HP recommends using disposable gloves when handling rollers or pads or washing your hands before touching rollers or pads.

3. To install an assembly, reverse the removal steps.

 **NOTE:** When applicable, special installation instructions are provided for an assembly at the end of the removal procedure. Always completely read the removal instructions and follow all special installation instructions.

Removal and replacement: High-voltage power supply (HVPS)

Learn about removing and replacing the high-voltage power supply PCA.

 [View a video demonstration of removing and replacing the HVPS.](#)

Before performing service

Turn the printer power off

- Disconnect the power cable.

 **WARNING!** To avoid damage to the printer, turn the printer off, wait 30 seconds, and then remove the power cord before attempting to service the printer.

If the part is damaged and cannot be cleaned, use the table below to identify the correct part number for your printer. To order the part, go to www.hp.com/buy/parts.

Table 5-82 Part information

Part number	Part description
RM3-9040-000CN	HV power supply PCA (5700/X557/5800)
RM3-9041-000CN	HV power supply PCA (6700/6800)
RM3-9042-000CN	HV power supply PCA (X57945)
RM3-9043-000CN	HV power supply PCA (X654/X677)

Required tools

- #2 Phillips screwdriver with a magnetic tip and a 152 mm (6 in) shaft length

After performing service

Turn the printer power on

- Connect the power cable.
- Use the power switch to turn the power on.

Post service test

Print any pages necessary to make sure the printer is functioning correctly.

1. Remove the toner collection unit (TCU)

Follow these steps to remove the toner collection unit (TCU).

1. Open the front door.

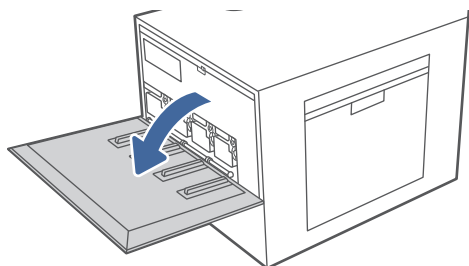

2. Rotate and then pull the TCU cover to remove it.

Figure 5-655 Remove the TCU cover

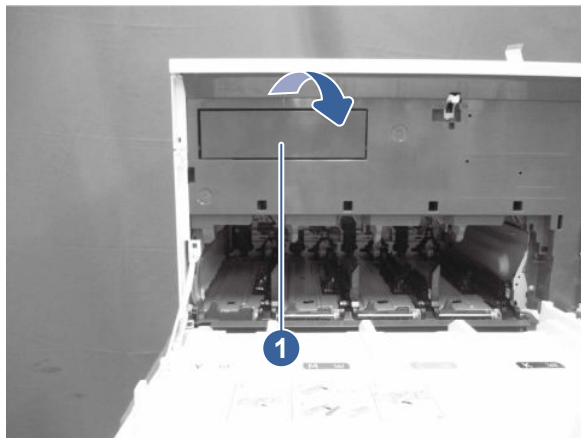

3. Lift the TCU slightly and then pull it out of the printer.

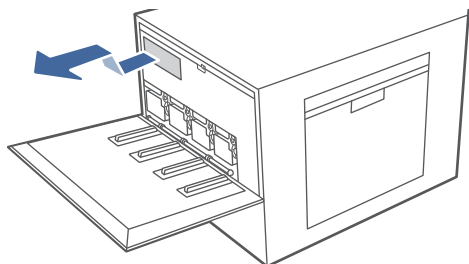

NOTE: Maintain the position of the TCU as you pull it out from the printer. This will ensure that you do not spill any waste toner in the printer. Place the unit into the clear plastic bag the new TCU was packaged in.

2. Remove the formatter cover

Follow these steps to remove the formatter cover.

- Remove one screw (callout 1), and then slide the formatter cover (callout 2) away from the printer to remove it.

 **TIP:** Reverse the removal steps to install the assembly.

Figure 5-656 Remove the formatter cover



3. Remove the left upper cover (MFP models)

Follow these steps to remove the left upper cover.

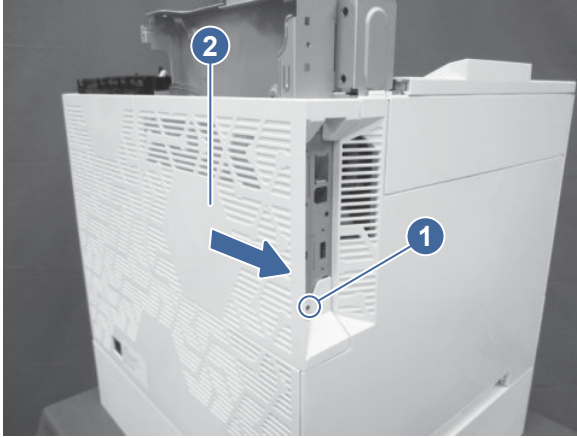
1. Open the front door.

 **CAUTION:** If the cover is being removed to gain access to the main drive assembly, make sure that the front door remains open. This keeps the main drive properly aligned.

2. At the left side of the printer, insert the small flat-blade screwdriver into the slot to release one tab (callout 1).

Figure 5-657 Use a screwdriver to release the tab

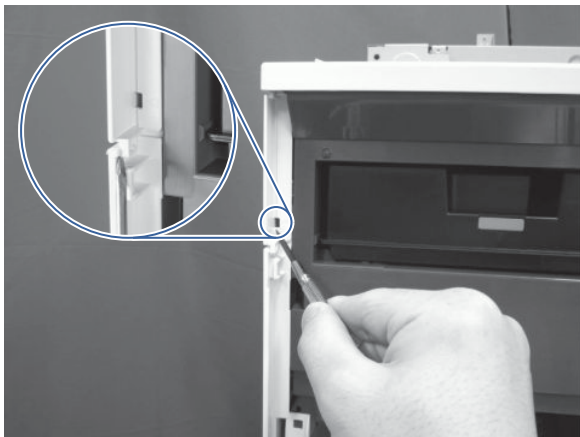

3. Toward the front of the printer, release another tab.

Figure 5-658 Release the tab

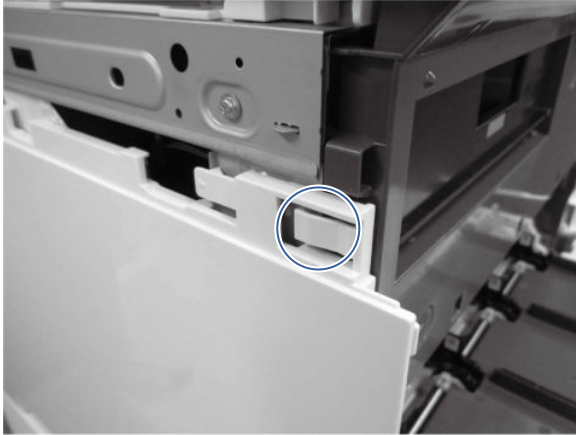

4. Rotate the cover up to remove it.

Figure 5-659 Remove the left upper cover

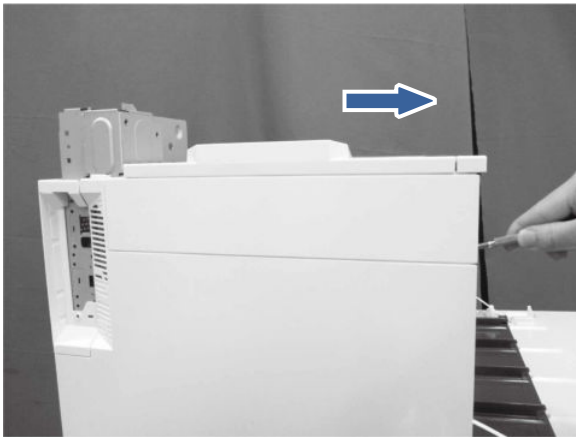

4. Remove the left cover

Follow these steps to remove the left cover.

- At the left side of the printer, remove one screw (callout 1), release one tab (callout 2), and then slide the cover (callout 3) toward the rear of the printer to release it.

Figure 5-660 Remove the left cover

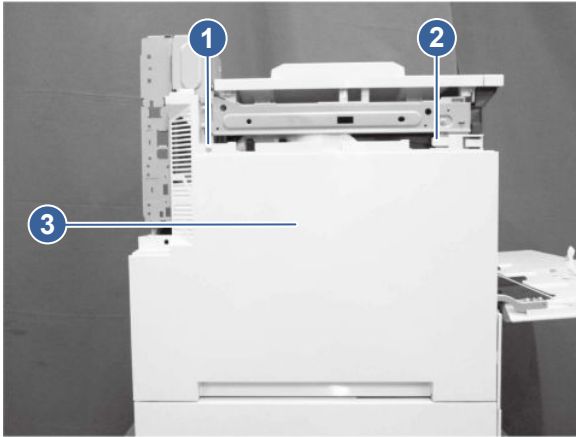

5. Remove the output bin

Follow these steps to remove the output bin.

- Remove two screws (callout 1), and then slide the output tray (callout 2) towards the front (SFP models) or left (MFP models) to remove it.

Figure 5-661 Remove the output bin

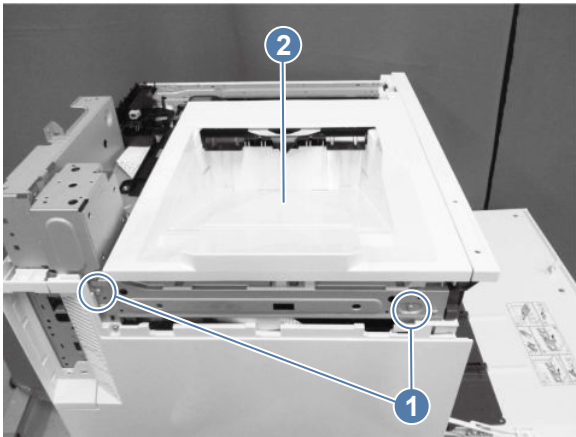

6. Remove the high-voltage power supply (HVPS)

Follow these steps to remove the high-voltage power supply (HVPS).

1. Remove two FFCs (callout 1) and disconnect two connectors (callout 2). Remove the FFC (callout 1) and cable (callout 4) from the high-voltage PCA cover (callout 3), release three tabs (callout 5), and then remove the high-voltage PCA cover.

Figure 5-662 Remove the high-voltage PCA cover

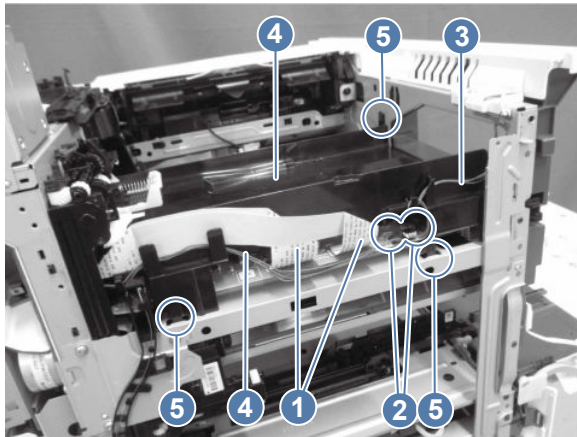

 **Reinstallation tip:** The FFC (callout 2) is attached to the high-voltage PCA cover (callout 1) by double sided tape. When removing the FFC from the high-voltage PCA cover, take care not to damage the FFC.

Figure 5-663 Use caution with the taped FFC



2. Disconnect two connector (callout 1/2). Disconnect one connector (callout 3) (X654/X677 models only). Remove one screw (callout 4), release two tabs (callout 5), and then remove the high-voltage power supply assembly (callout 6).

Figure 5-664 Remove the HVPS

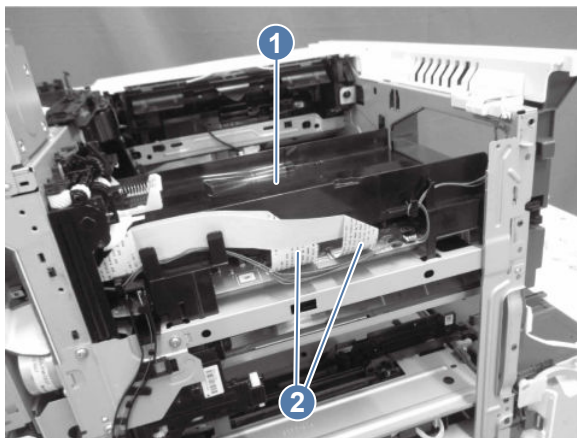
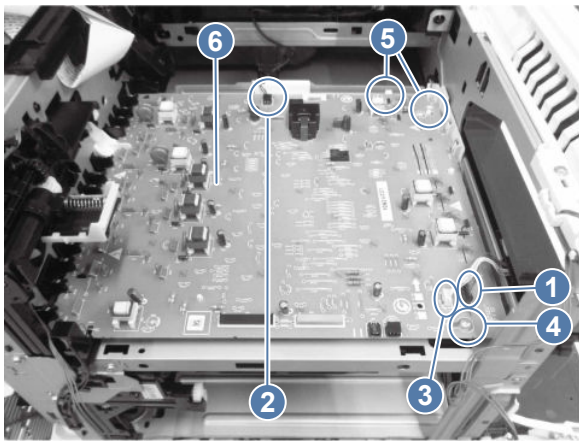

3. For reinstallation of the HVPS, keep the following tips in mind.

 **Reinstallation tip:** When installing the high-voltage power supply PCA (callout 1), confirm that the contact springs (callout 2) are in the correct position (so that the PCA engages with the spring).

Figure 5-665 Verify that the contact springs are in the correct position



 **Reinstallation tip:** When installing the high-voltage PCA cover, confirm that the contact spring (callout 1) is in the contact holder (callout 2).

Figure 5-666 Verify that the contact spring is in the holder

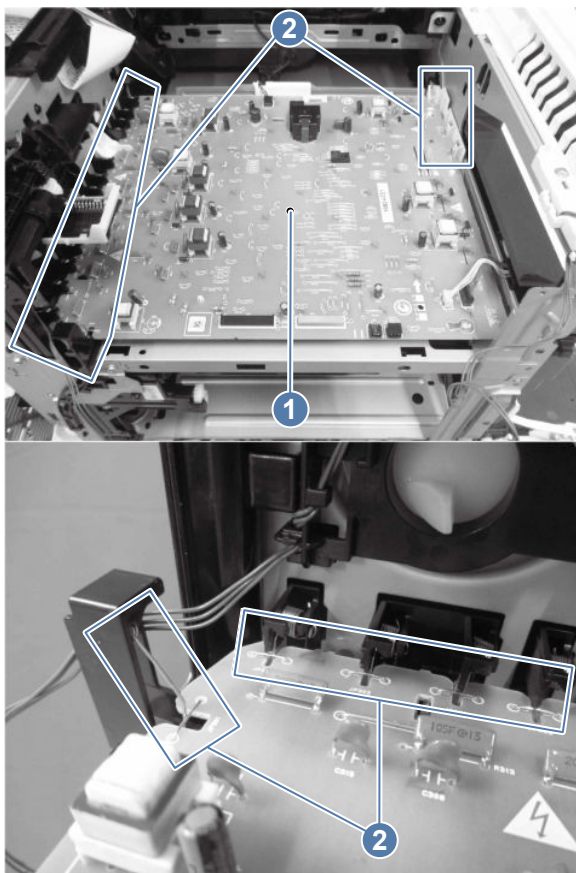

7. Unpack the replacement assembly

Follow these steps to unpack the replacement assembly.

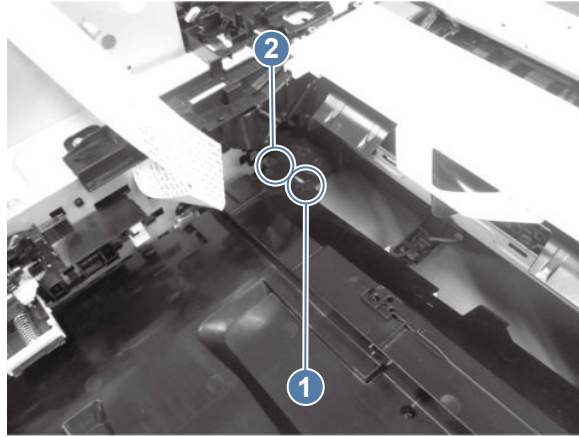
1. Dispose of the defective part.



NOTE: HP recommends responsible disposal of the defective part.

<http://www8.hp.com/us/en/hp-information/environment/product-recycling.html>

2. Unpack the replacement part from the packaging.



CAUTION:  Some parts are sensitive to electrostatic discharge (ESD). Always perform service work at an ESD-protected workstation or mat. If an ESD workstation or mat is not available, touch the sheet-metal chassis to provide a static ground before touching an ESD-sensitive assembly. Protect the ESD-sensitive assemblies by placing them in ESD pouches when they are out of the printer.



IMPORTANT: Make sure that all of the shipping materials (for example shipping tape) are removed from the replacement part prior to installation.



NOTE: If the replacement part is a roller or pad, avoid touching the spongy part of it. Skin oils on the roller or pad can cause paper pickup and/or print-quality problems. HP recommends using disposable gloves when handling rollers or pads or washing your hands before touching rollers or pads.

3. To install an assembly, reverse the removal steps.



NOTE: When applicable, special installation instructions are provided for an assembly at the end of the removal procedure. Always completely read the removal instructions and follow all special installation instructions.

Removal and replacement: Drive PCA

Learn about removing and replacing the drive PCA.



[View a video demonstration of removing and replacing the drive PCA.](#)

Before performing service

Turn the printer power off

- Disconnect the power cable.

 **WARNING!** To avoid damage to the printer, turn the printer off, wait 30 seconds, and then remove the power cord before attempting to service the printer.

If the part is damaged and cannot be cleaned, use the table below to identify the correct part number for your printer. To order the part, go to www.hp.com/buy/parts.

Table 5-83 Part information

Part number	Part description
RM3-7722-000CN	Driver PCA (6700/V654/6800/X677)
RM3-7723-000CN	Driver PCA (5700/X557/5800/X57945)

Required tools

- #2 Phillips screwdriver with a magnetic tip and a 152 mm (6 in) shaft length

After performing service

Turn the printer power on

- Connect the power cable.
- Use the power switch to turn the power on.

Post service test

Print any pages necessary to make sure the printer is functioning correctly.

1. Remove the formatter cover

Follow these steps to remove the formatter cover.

- Remove one screw (callout 1), and then slide the formatter cover (callout 2) away from the printer to remove it.



 **TIP:** Reverse the removal steps to install the assembly.

Figure 5-667 Remove the formatter cover

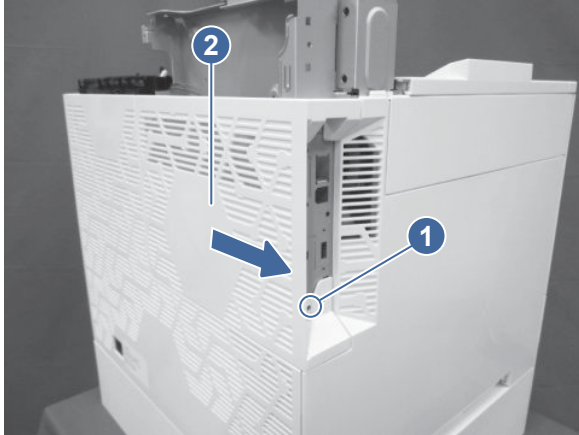

2. Remove the rear cover

Follow these steps to remove the rear cover.

 **NOTE:** The figures below show some assemblies (for example the top cover and formatter) removed that might still be installed on the printer. However, the steps to remove the cover are correct.

1. Open the right door, and remove two screws.

Figure 5-668 Remove two screws

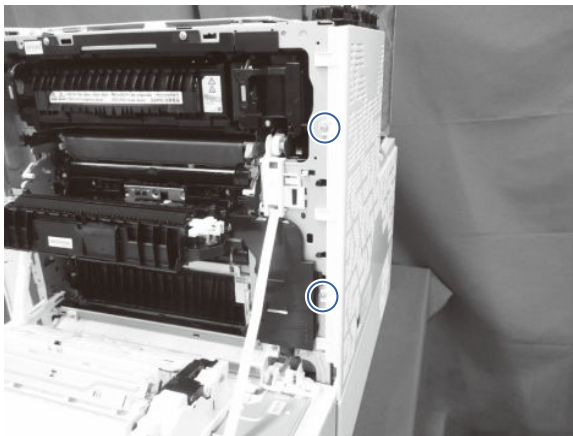

2. At the back of the printer, remove two screws, and then slide the rear cover as indicated to remove it.

Figure 5-669 Remove the rear cover

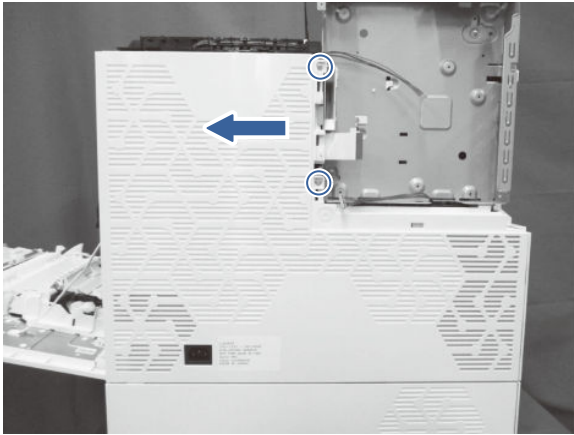

3. Remove the low-voltage power supply (LVPS)

Follow these steps to remove the low-voltage power supply (LVPS).

1. Unhook one spring (callout 1), and then disconnect two connectors (callout 2).

 **NOTE:** Unhook the spring from the formatter cage, not the low-voltage power supply. The spring should remain attached to the LVPS.

Figure 5-670 Unhook the spring and disconnect two connectors



2. Remove the FFC (callout 1), and then disconnect five connectors (callout 2).

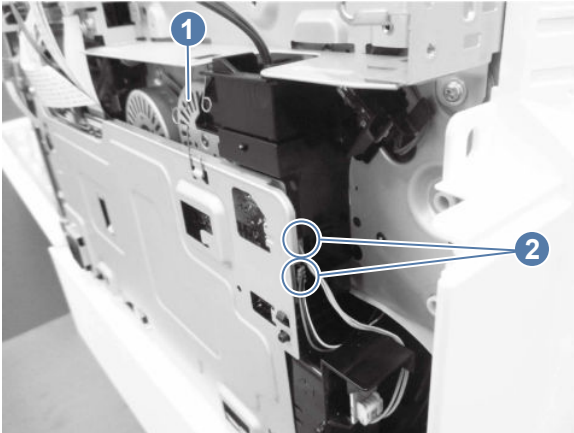

 **NOTE:** **MFP only:** Disconnect one additional connector (callout 3).

Figure 5-671 Disconnect the LVPS connectors

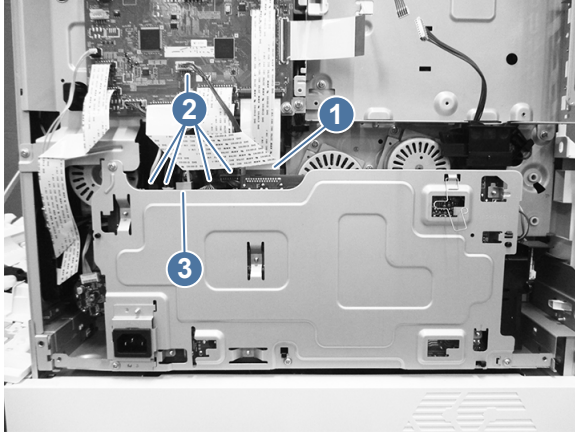

3. Remove four screws (callout 1), and then remove the low-voltage power supply assembly (callout 2).

 **NOTE:** The black ducting in the lower right corner can stick during the removal process.

Replacement LVPS only: Remove the spring (callout 3), and then install it on the replacement LVPS.

Figure 5-672 Remove the LVPS

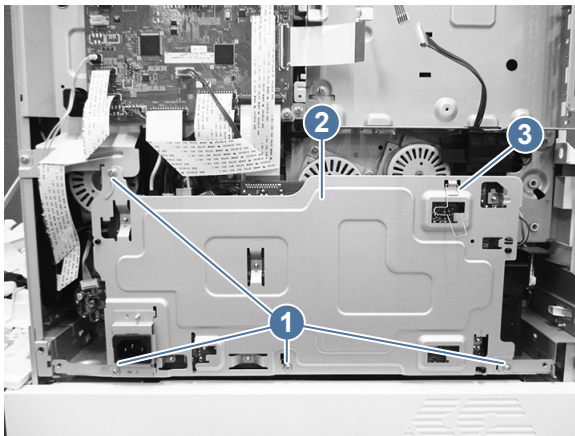

 **Reinstallation tip:** When reinstalling the LVPS, make sure that the spring (callout 1) is attached to both the formatter cage (callout 2) and the LVPS (callout 3).

Figure 5-673 Reinstalling the LVPS



4. Remove the drive PCA

Follow these steps to remove the drive PCA.

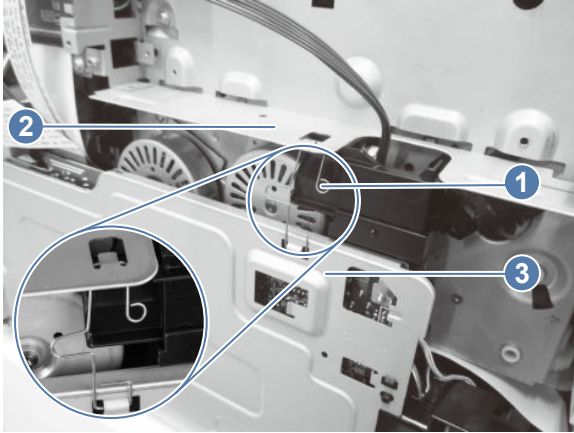
1. Disconnect all the connectors on the DC controller PCA, remove the cable clamp (callout 1), remove three screws (callout 2), and then slide the DC controller stay (callout 3) out to remove it.

Figure 5-674 Remove the DC controller stay

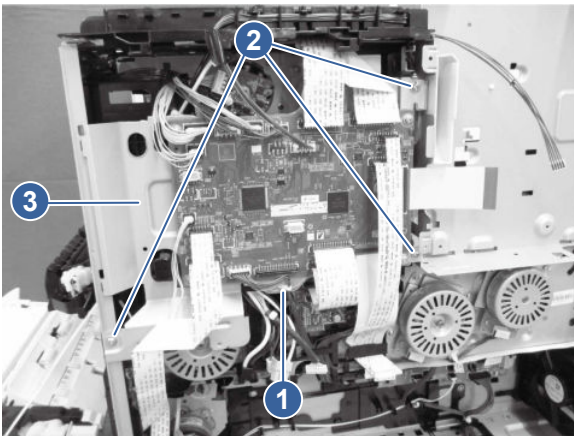

2. Disconnect all the connectors on the drive PCA, remove one screw (callout 1), release two tabs (callout 2), and then remove the drive PCA (callout 3).

 **IMPORTANT:** Some of these wires are very tightly connected. Take care when disconnecting them.

Figure 5-675 Remove the drive PCA



5. Unpack the replacement assembly

Follow these steps to unpack the replacement assembly.

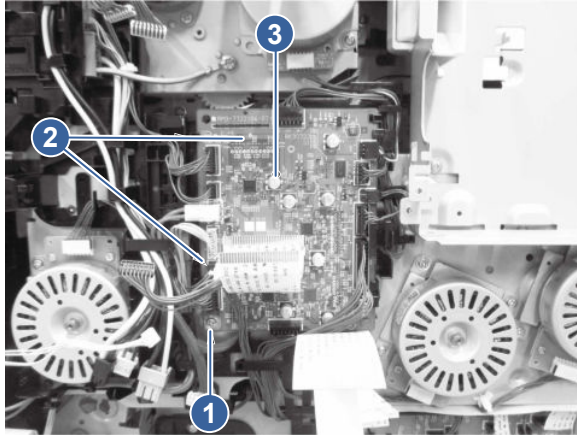
1. Dispose of the defective part.



NOTE: HP recommends responsible disposal of the defective part.

<http://www8.hp.com/us/en/hp-information/environment/product-recycling.html>

2. Unpack the replacement part from the packaging.



CAUTION:  Some parts are sensitive to electrostatic discharge (ESD). Always perform service work at an ESD-protected workstation or mat. If an ESD workstation or mat is not available, touch the sheet-metal chassis to provide a static ground before touching an ESD-sensitive assembly. Protect the ESD-sensitive assemblies by placing them in ESD pouches when they are out of the printer.



IMPORTANT: Make sure that all of the shipping materials (for example shipping tape) are removed from the replacement part prior to installation.



NOTE: If the replacement part is a roller or pad, avoid touching the spongy part of it. Skin oils on the roller or pad can cause paper pickup and/or print-quality problems. HP recommends using disposable gloves when handling rollers or pads or washing your hands before touching rollers or pads.

3. To install an assembly, reverse the removal steps.



NOTE: When applicable, special installation instructions are provided for an assembly at the end of the removal procedure. Always completely read the removal instructions and follow all special installation instructions.

Removal and replacement: Feed/toner supply controller PCA (X57945 models)

Learn about removing and replacing the feed/toner supply controller PCA.

Before performing service

Turn the printer power off

- Disconnect the power cable.

⚠ WARNING! To avoid damage to the printer, turn the printer off, wait 30 seconds, and then remove the power cord before attempting to service the printer.

If the part is damaged and cannot be cleaned, use the table below to identify the correct part number for your printer. To order the part, go to www.hp.com/buy/parts.

Table 5-84 Part information

Part number	Part description
RM3-771-000CN	Toner supply PCA (X57945 models)

Required tools

- #2 Phillips screwdriver with a magnetic tip and a 152 mm (6 in) shaft length

After performing service

Turn the printer power on

- Connect the power cable.
- Use the power switch to turn the power on.

Post service test

Print any pages necessary to make sure the printer is functioning correctly.

1. Remove the front right cover

Follow these steps to remove the front right cover.

1. Open the toner cartridge access door.
2. Open the right lower door.
3. Release one tab, and then slide the front right cover upward to remove it.

Figure 5-676 Remove the front right cover

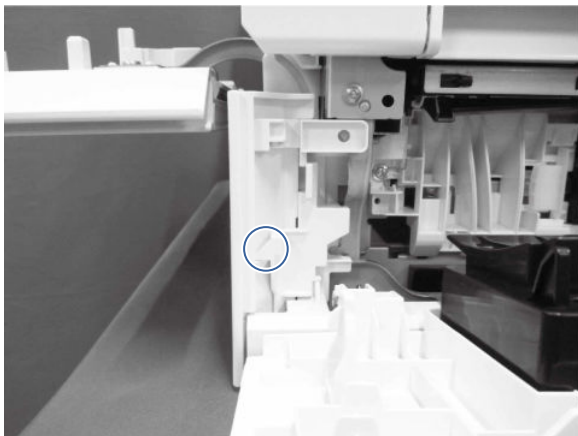

2. Remove the right lower door (X57945 models)

Follow these steps to remove the right lower door.

1. Remove two screws (callout 1), and then remove the base frame (callout 2).

Figure 5-677 Remove the base frame

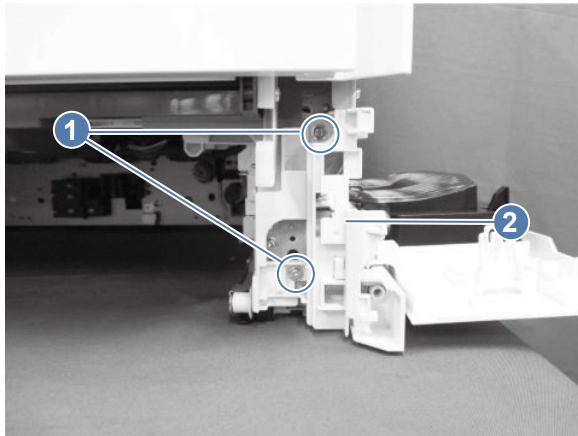

2. Remove one screw (callout 1), release one tab (callout 2), and then slide the rear inner cover (callout 3) downward to remove it.

Figure 5-678 Remove the rear inner cover

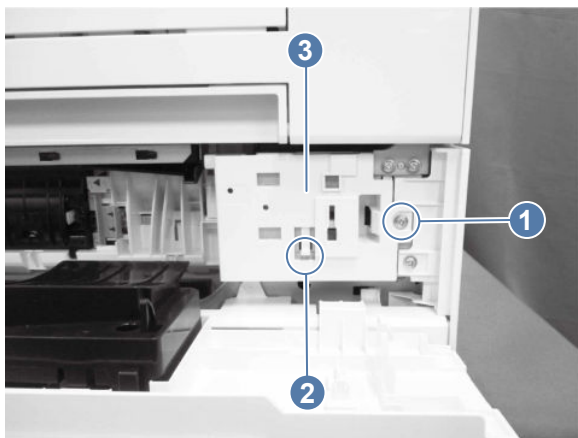

3. Release one tab (callout 1), and then slide the right lower door assembly (callout 2) in the direction indicated to remove it.

Figure 5-679 Remove the right lower door assembly

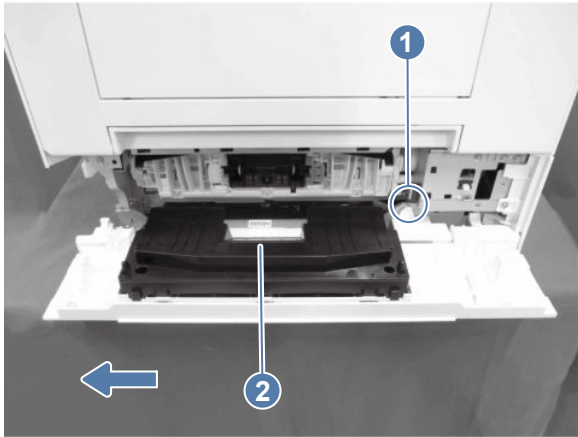

3. Remove the rear lower cover (X57945 models)

Follow these steps to remove the rear lower cover.

- Remove one screw (callout 1), slide the rear lower cover (callout 2) in the direction indicated below, and then remove it.

Figure 5-680 Remove the rear lower cover

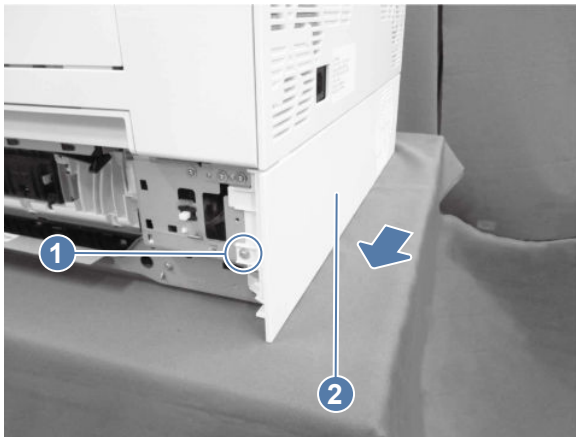

4. Remove the feed/toner supply controller PCA (X57945 models)

Follow these steps to remove the feed/toner supply controller PCA.

- Disconnect all the connectors on the feed/toner supply controller PCA. Remove two screws (callout 1), remove two PCA spacers (callout 2), and then remove the feed/toner supply controller PCA (callout 3).

Figure 5-681 Remove the feed/toner supply controller PCA

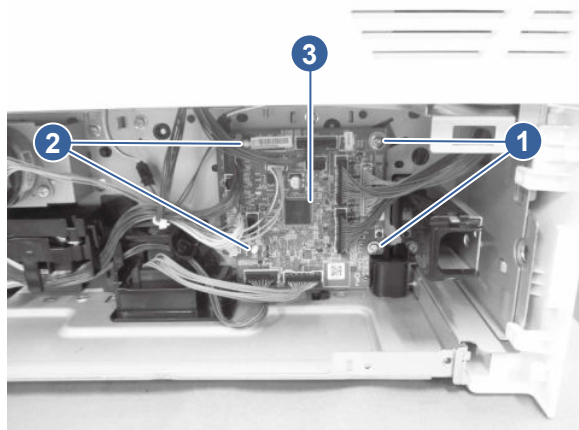

5. Unpack the replacement assembly



Follow these steps to unpack the replacement assembly.

1. Dispose of the defective part.

 **NOTE:** HP recommends responsible disposal of the defective part.

<http://www8.hp.com/us/en/hp-information/environment/product-recycling.html>

2. Unpack the replacement part from the packaging.

 **CAUTION:**  Some parts are sensitive to electrostatic discharge (ESD). Always perform service work at an ESD-protected workstation or mat. If an ESD workstation or mat is not available, touch the sheet-metal chassis to provide a static ground before touching an ESD-sensitive assembly. Protect the ESD-sensitive assemblies by placing them in ESD pouches when they are out of the printer.

 **IMPORTANT:** Make sure that all of the shipping materials (for example shipping tape) are removed from the replacement part prior to installation.

 **NOTE:** If the replacement part is a roller or pad, avoid touching the spongy part of it. Skin oils on the roller or pad can cause paper pickup and/or print-quality problems. HP recommends using disposable gloves when handling rollers or pads or washing your hands before touching rollers or pads.

3. To install an assembly, reverse the removal steps.

 **NOTE:** When applicable, special installation instructions are provided for an assembly at the end of the removal procedure. Always completely read the removal instructions and follow all special installation instructions.

Removal and replacement: Right PCA

Learn about removing and replacing the right PCA.

Before performing service

Turn the printer power off

- Disconnect the power cable.

⚠ WARNING! To avoid damage to the printer, turn the printer off, wait 30 seconds, and then remove the power cord before attempting to service the printer.

If the part is damaged and cannot be cleaned, use the table below to identify the correct part number for your printer. To order the part, go to www.hp.com/buy/parts.

Table 5-85 Part information

Part number	Part description
RM3-7740-000CN	Right PCA (5700)
RM3-7790-000CN	Right PCA (X557/5800)
RM3-7791-000CN	Right PCA (X57945)
RM3-7792-000CN	Right PCA (6700)
RM3-7793-000CN	Right PCA (6800)
RM3-7794-000CN	Right PCA (X654/X677)

Required tools

- #2 Phillips screwdriver with a magnetic tip and a 152 mm (6 in) shaft length

After performing service

Turn the printer power on

- Connect the power cable.
- Use the power switch to turn the power on.

Post service test

Print any pages necessary to make sure the printer is functioning correctly.

1. Remove the right PCA

Follow these steps to remove the right PCA.

1. Open the right door.

Figure 5-682 Open the right door



2. Release two tabs (callout 1), and then remove the PCA cover (callout 2).

Figure 5-683 Remove the PCA cover

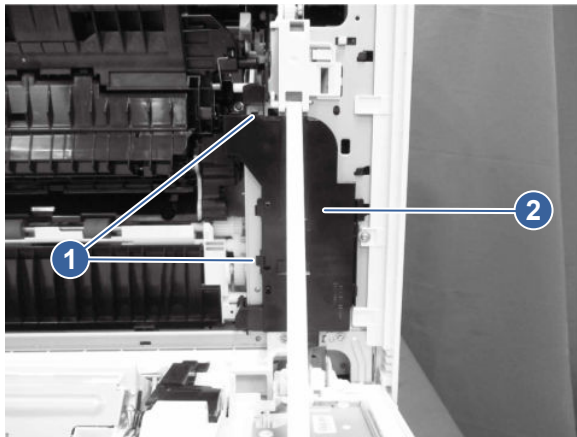

3. Disconnect all the connectors on the right PCA, release two tabs (callout 1), and then remove the right PCA (callout 2).

Figure 5-684 Remove the right PCA

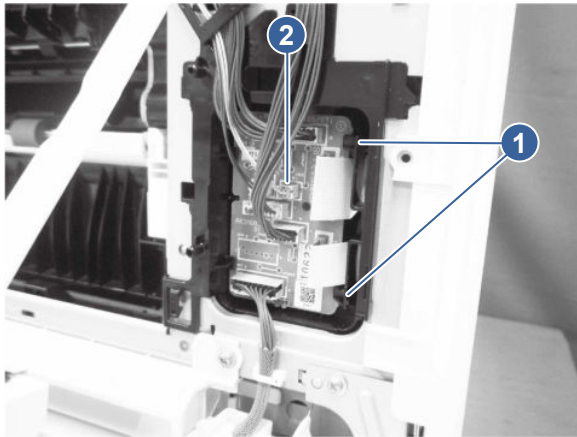

⚠ CAUTION: The FFCs are tightly packed and can be difficult to remove. A solution is to remove the FFCs from the rear of the unit, remove the PCA, and then remove the FFCs to reinstall them on the back. This option should be used *only* if needed and to ensure that the FFCs are not damaged.

2. Unpack the replacement assembly

Follow these steps to unpack the replacement assembly.

1. Dispose of the defective part.

📄 NOTE: HP recommends responsible disposal of the defective part.

<http://www8.hp.com/us/en/hp-information/environment/product-recycling.html>

2. Unpack the replacement part from the packaging.

⚠ CAUTION:  Some parts are sensitive to electrostatic discharge (ESD). Always perform service work at an ESD-protected workstation or mat. If an ESD workstation or mat is not available, touch the sheet-metal chassis to provide a static ground before touching an ESD-sensitive assembly. Protect the ESD-sensitive assemblies by placing them in ESD pouches when they are out of the printer.

📄 IMPORTANT: Make sure that all of the shipping materials (for example shipping tape) are removed from the replacement part prior to installation.

📄 NOTE: If the replacement part is a roller or pad, avoid touching the spongy part of it. Skin oils on the roller or pad can cause paper pickup and/or print-quality problems. HP recommends using disposable gloves when handling rollers or pads or washing your hands before touching rollers or pads.

3. To install an assembly, reverse the removal steps.

📄 NOTE: When applicable, special installation instructions are provided for an assembly at the end of the removal procedure. Always completely read the removal instructions and follow all special installation instructions.

Removal and replacement: Rear PCA

Learn about removing and replacing the rear PCA.



[View a video demonstration of removing and replacing the rear PCA.](#)

Before performing service

Turn the printer power off

- Disconnect the power cable.

⚠ WARNING! To avoid damage to the printer, turn the printer off, wait 30 seconds, and then remove the power cord before attempting to service the printer.

If the part is damaged and cannot be cleaned, use the table below to identify the correct part number for your printer. To order the part, go to www.hp.com/buy/parts.

Table 5-86 Part information

Part number	Part description
RM3-9044-000CN	Rear PCA (5700/5800)
RM3-9045-000CN	Rear PCA (X557/6700/6800)
RM3-9046-000CN	Rear PCA (X57945/X654/X677)

Required tools

- #2 Phillips screwdriver with a magnetic tip and a 152 mm (6 in) shaft length

After performing service

Turn the printer power on

- Connect the power cable.
- Use the power switch to turn the power on.

Post service test

Print any pages necessary to make sure the printer is functioning correctly.

1. Remove the formatter cover

Follow these steps to remove the formatter cover.

- Remove one screw (callout 1), and then slide the formatter cover (callout 2) away from the printer to remove it.



TIP: Reverse the removal steps to install the assembly.

Figure 5-685 Remove the formatter cover

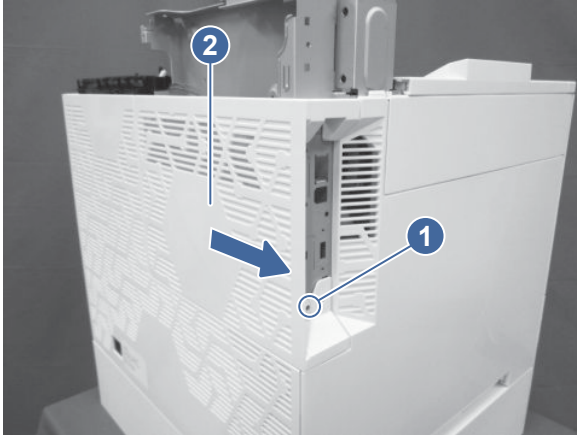

2. Remove the rear cover

Follow these steps to remove the rear cover.



NOTE: The figures below show some assemblies (for example the top cover and formatter) removed that might still be installed on the printer. However, the steps to remove the cover are correct.

1. Open the right door, and remove two screws.

Figure 5-686 Remove two screws

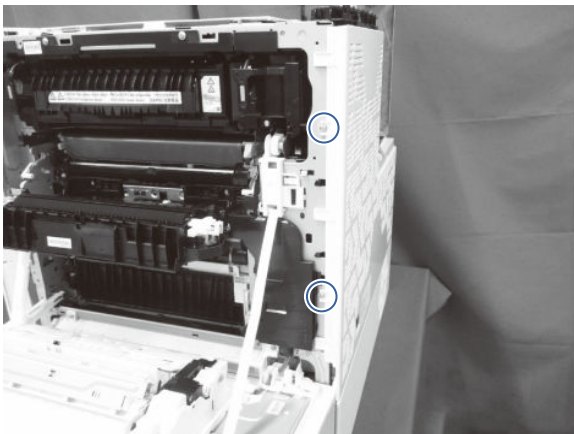

2. At the back of the printer, remove two screws, and then slide the rear cover as indicated to remove it.

Figure 5-687 Remove the rear cover

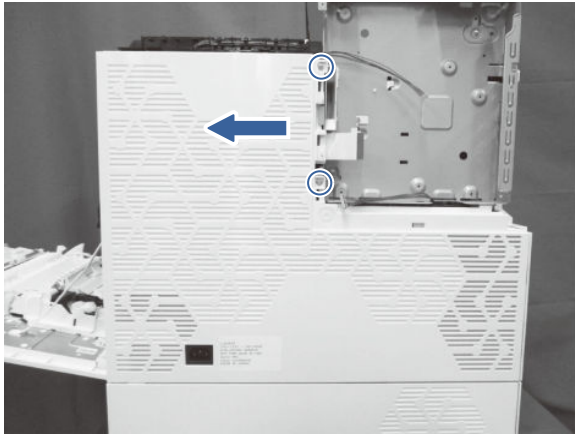

3. Remove the low-voltage power supply (LVPS)

Follow these steps to remove the low-voltage power supply (LVPS).

1. Unhook one spring (callout 1), and then disconnect two connectors (callout 2).

 **NOTE:** Unhook the spring from the formatter cage, not the low-voltage power supply. The spring should remain attached to the LVPS.

Figure 5-688 Unhook the spring and disconnect two connectors



2. Remove the FFC (callout 1), and then disconnect five connectors (callout 2).

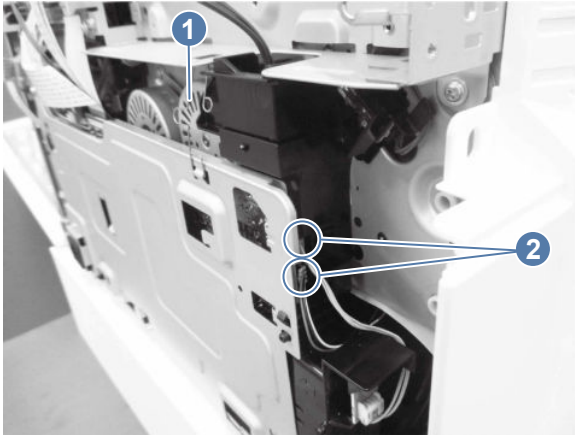

 **NOTE:** **MFP only:** Disconnect one additional connector (callout 3).

Figure 5-689 Disconnect the LVPS connectors

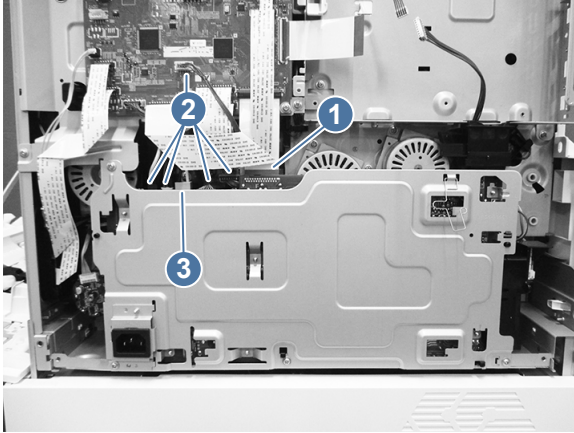

3. Remove four screws (callout 1), and then remove the low-voltage power supply assembly (callout 2).

 **NOTE:** The black ducting in the lower right corner can stick during the removal process.

Replacement LVPS only: Remove the spring (callout 3), and then install it on the replacement LVPS.

Figure 5-690 Remove the LVPS

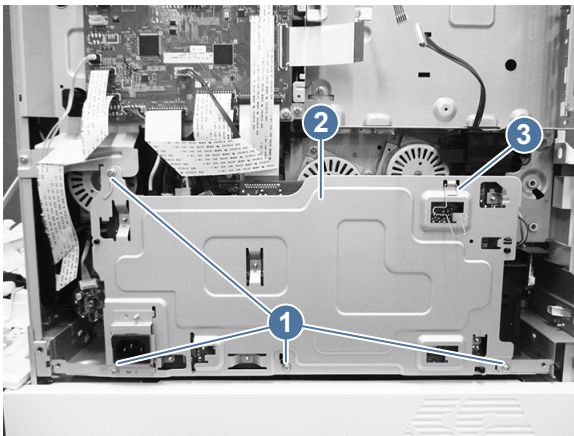

 **Reinstallation tip:** When reinstalling the LVPS, make sure that the spring (callout 1) is attached to both the formatter cage (callout 2) and the LVPS (callout 3).

Figure 5-691 Reinstalling the LVPS



4. Remove the rear PCA

Follow these steps to remove the rear PCA.

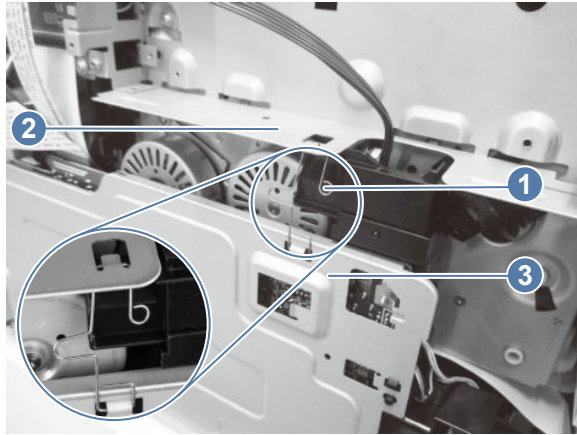
- Disconnect all the connectors on the rear PCA, remove one screw (callout 1), release two tabs (callout 2), and then remove the rear PCA (callout 3).

 **NOTE:** Grounding wires are mounted on the top of this PCA. Use care when removing it. Pull the bottom part out first, and then slide the assembly down to cleanly release from the spring wires at the top.

Figure 5-692 Remove the rear PCA



 **Reinstallation tip:** When installing the rear PCA, confirm that each contact spring (callout 1) is in the correct position (so that the PCA engages with the springs).

Figure 5-693 Correct spring position

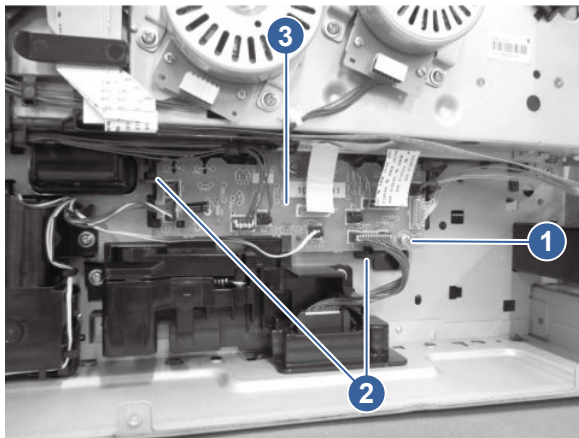

5. Unpack the replacement assembly

Follow these steps to unpack the replacement assembly.

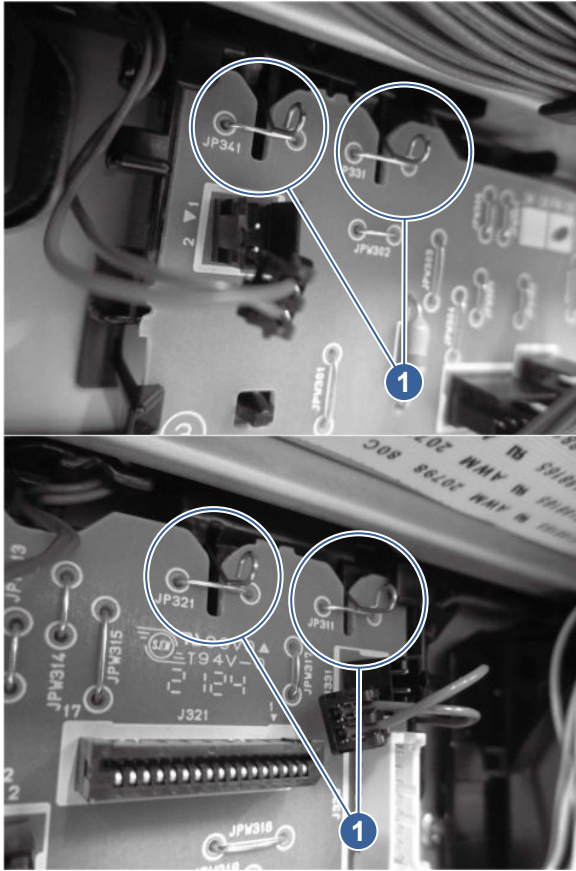
1. Dispose of the defective part.



NOTE: HP recommends responsible disposal of the defective part.

<http://www8.hp.com/us/en/hp-information/environment/product-recycling.html>

2. Unpack the replacement part from the packaging.



CAUTION:  Some parts are sensitive to electrostatic discharge (ESD). Always perform service work at an ESD-protected workstation or mat. If an ESD workstation or mat is not available, touch the sheet-metal chassis to provide a static ground before touching an ESD-sensitive assembly. Protect the ESD-sensitive assemblies by placing them in ESD pouches when they are out of the printer.



IMPORTANT: Make sure that all of the shipping materials (for example shipping tape) are removed from the replacement part prior to installation.



NOTE: If the replacement part is a roller or pad, avoid touching the spongy part of it. Skin oils on the roller or pad can cause paper pickup and/or print-quality problems. HP recommends using disposable gloves when handling rollers or pads or washing your hands before touching rollers or pads.

3. To install an assembly, reverse the removal steps.



NOTE: When applicable, special installation instructions are provided for an assembly at the end of the removal procedure. Always completely read the removal instructions and follow all special installation instructions.

Removal and replacement: Environmental sensor PCA

Learn about removing and replacing the environmental sensor PCA.

Before performing service

Turn the printer power off

- Disconnect the power cable.

⚠ WARNING! To avoid damage to the printer, turn the printer off, wait 30 seconds, and then remove the power cord before attempting to service the printer.

If the part is damaged and cannot be cleaned, use the table below to identify the correct part number for your printer. To order the part, go to www.hp.com/buy/parts.

Table 5-87 Part information

Part number	Part description
WP2-5473-000CN	Sensor, humidity HSU-08FDB2A

Required tools

- #2 Phillips screwdriver with a magnetic tip and a 152 mm (6 in) shaft length

After performing service

Turn the printer power on

- Connect the power cable.
- Use the power switch to turn the power on.

Post service test

Print any pages necessary to make sure the printer is functioning correctly.

1. Remove the formatter cover

Follow these steps to remove the formatter cover.

- Remove one screw (callout 1), and then slide the formatter cover (callout 2) away from the printer to remove it.



TIP: Reverse the removal steps to install the assembly.

Figure 5-694 Remove the formatter cover

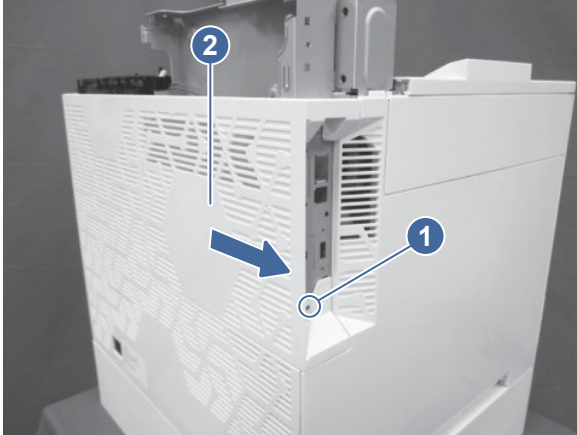

2. Remove the rear cover

Follow these steps to remove the rear cover.



NOTE: The figures below show some assemblies (for example the top cover and formatter) removed that might still be installed on the printer. However, the steps to remove the cover are correct.

1. Open the right door, and remove two screws.

Figure 5-695 Remove two screws

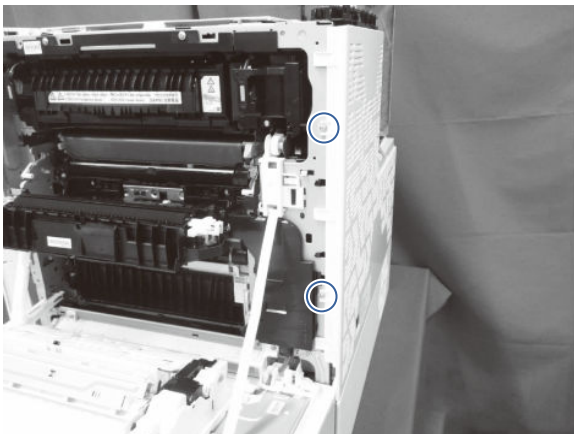

2. At the back of the printer, remove two screws, and then slide the rear cover as indicated to remove it.

Figure 5-696 Remove the rear cover

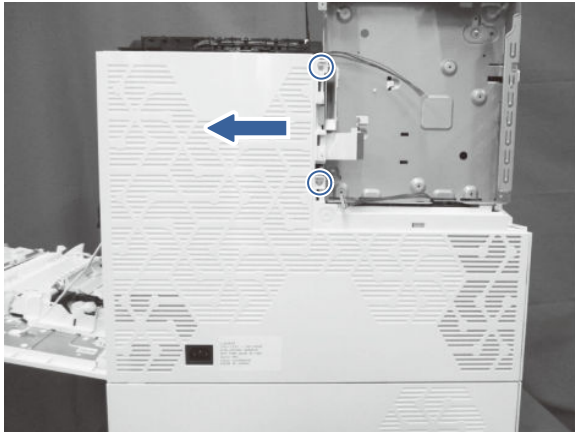

3. Remove the environmental sensor PCA

Follow these steps to remove the environmental sensor PCA.

- Disconnect one connector (callout 1), release one tab (callout 2), release one boss (callout 3), and then remove the environmental sensor PCA (callout 4).

Figure 5-697 Remove the environmental sensor PCA

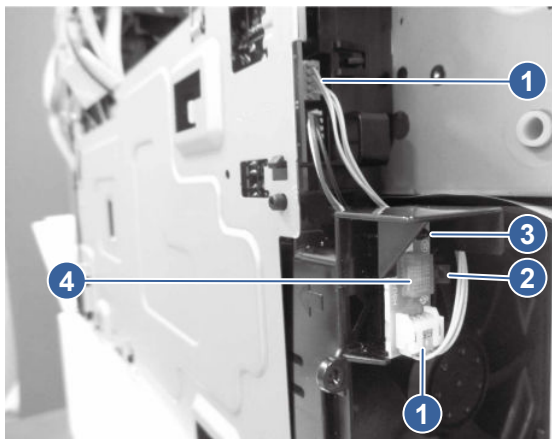

4. Unpack the replacement assembly

Follow these steps to unpack the replacement assembly.

1. Dispose of the defective part.



NOTE: HP recommends responsible disposal of the defective part.

<http://www8.hp.com/us/en/hp-information/environment/product-recycling.html>

2. Unpack the replacement part from the packaging.



CAUTION:  Some parts are sensitive to electrostatic discharge (ESD). Always perform service work at an ESD-protected workstation or mat. If an ESD workstation or mat is not available, touch

the sheet-metal chassis to provide a static ground before touching an ESD-sensitive assembly. Protect the ESD-sensitive assemblies by placing them in ESD pouches when they are out of the printer.

 **IMPORTANT:** Make sure that all of the shipping materials (for example shipping tape) are removed from the replacement part prior to installation.

 **NOTE:** If the replacement part is a roller or pad, avoid touching the spongy part of it. Skin oils on the roller or pad can cause paper pickup and/or print-quality problems. HP recommends using disposable gloves when handling rollers or pads or washing your hands before touching rollers or pads.

3. To install an assembly, reverse the removal steps.

 **NOTE:** When applicable, special installation instructions are provided for an assembly at the end of the removal procedure. Always completely read the removal instructions and follow all special installation instructions.

Removal and replacement: Drum home position PCA

Learn about removing and replacing the drum home position sensor PCA.

Before performing service

Turn the printer power off

- Disconnect the power cable.

 **WARNING!** To avoid damage to the printer, turn the printer off, wait 30 seconds, and then remove the power cord before attempting to service the printer.

If the part is damaged and cannot be cleaned, use the table below to identify the correct part number for your printer. To order the part, go to www.hp.com/buy/parts.

Table 5-88 Part information

Part number	Part description
RM3-7647-000CN	Drum position sensor PCA

Required tools

- #2 Phillips screwdriver with a magnetic tip and a 152 mm (6 in) shaft length

After performing service

Turn the printer power on

- Connect the power cable.
- Use the power switch to turn the power on.

Post service test

Print any pages necessary to make sure the printer is functioning correctly.

1. Remove the formatter cover

Follow these steps to remove the formatter cover.

- Remove one screw (callout 1), and then slide the formatter cover (callout 2) away from the printer to remove it.



 **TIP:** Reverse the removal steps to install the assembly.

Figure 5-698 Remove the formatter cover

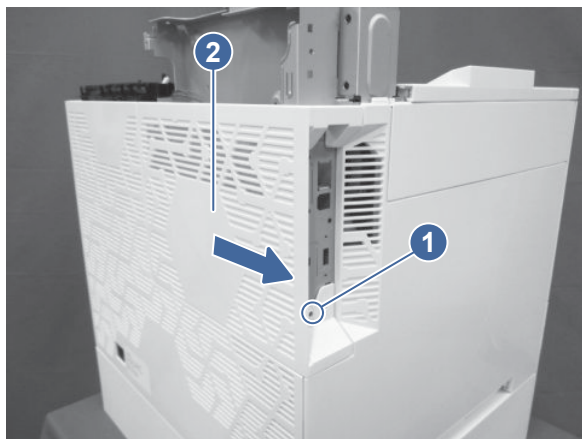

2. Remove the rear cover

Follow these steps to remove the rear cover.

 **NOTE:** The figures below show some assemblies (for example the top cover and formatter) removed that might still be installed on the printer. However, the steps to remove the cover are correct.

1. Open the right door, and remove two screws.

Figure 5-699 Remove two screws

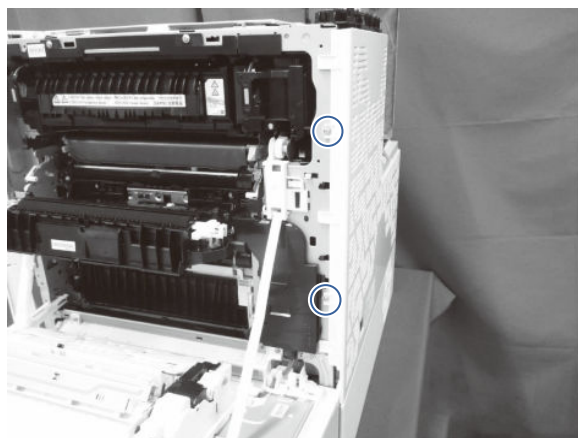

2. At the back of the printer, remove two screws, and then slide the rear cover as indicated to remove it.

Figure 5-700 Remove the rear cover

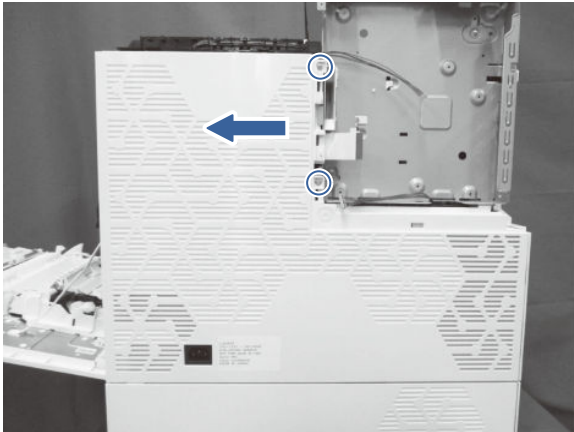

3. Remove the low-voltage power supply (LVPS)

Follow these steps to remove the low-voltage power supply (LVPS).

1. Unhook one spring (callout 1), and then disconnect two connectors (callout 2).

 **NOTE:** Unhook the spring from the formatter cage, not the low-voltage power supply. The spring should remain attached to the LVPS.

Figure 5-701 Unhook the spring and disconnect two connectors



2. Remove the FFC (callout 1), and then disconnect five connectors (callout 2).

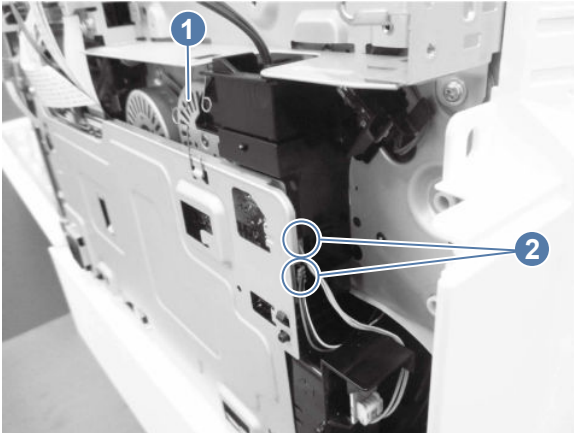

 **NOTE:** **MFP only:** Disconnect one additional connector (callout 3).

Figure 5-702 Disconnect the LVPS connectors

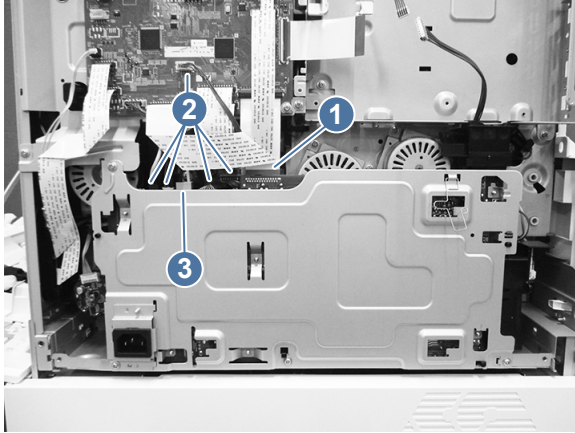

3. Remove four screws (callout 1), and then remove the low-voltage power supply assembly (callout 2).

 **NOTE:** The black ducting in the lower right corner can stick during the removal process.

Replacement LVPS only: Remove the spring (callout 3), and then install it on the replacement LVPS.

Figure 5-703 Remove the LVPS

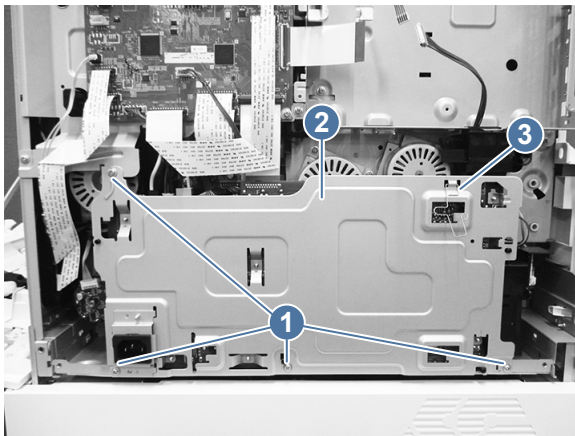

 **Reinstallation tip:** When reinstalling the LVPS, make sure that the spring (callout 1) is attached to both the formatter cage (callout 2) and the LVPS (callout 3).

Figure 5-704 Reinstalling the LVPS



4. Remove the drum home position sensor PCA

Follow these steps to remove the drum home position sensor PCA.

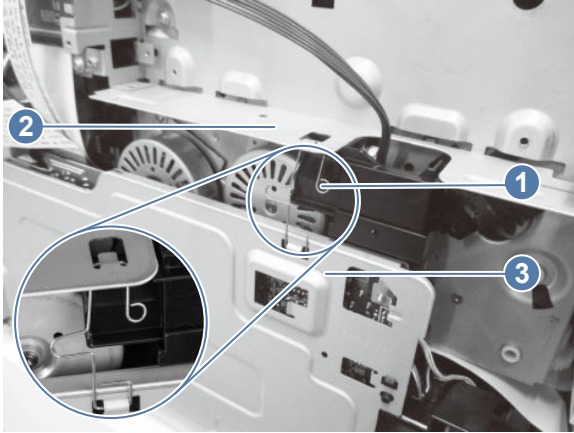
1. Release one tab (callout 1), and then slide the PCA holder (callout 2) in the direction indicated to remove it.

Figure 5-705 Remove the PCA holder

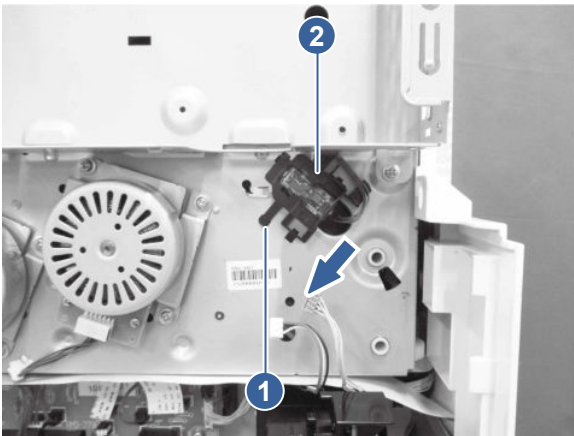

2. Disconnect one connector (callout 1), release two tabs (callout 2), and then remove the drum home position sensor PCA (callout 3).

Figure 5-706 Remove the drum home position sensor PCA

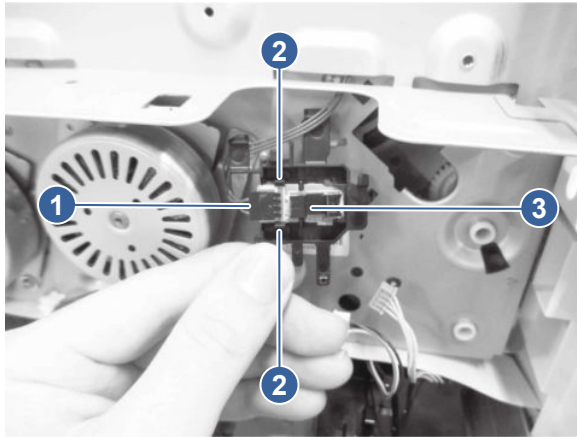

5. Unpack the replacement assembly

Follow these steps to unpack the replacement assembly.

1. Dispose of the defective part.



NOTE: HP recommends responsible disposal of the defective part.

<http://www8.hp.com/us/en/hp-information/environment/product-recycling.html>

2. Unpack the replacement part from the packaging.



CAUTION:  Some parts are sensitive to electrostatic discharge (ESD). Always perform service work at an ESD-protected workstation or mat. If an ESD workstation or mat is not available, touch the sheet-metal chassis to provide a static ground before touching an ESD-sensitive assembly. Protect the ESD-sensitive assemblies by placing them in ESD pouches when they are out of the printer.



IMPORTANT: Make sure that all of the shipping materials (for example shipping tape) are removed from the replacement part prior to installation.



NOTE: If the replacement part is a roller or pad, avoid touching the spongy part of it. Skin oils on the roller or pad can cause paper pickup and/or print-quality problems. HP recommends using disposable gloves when handling rollers or pads or washing your hands before touching rollers or pads.

3. To install an assembly, reverse the removal steps.



NOTE: When applicable, special installation instructions are provided for an assembly at the end of the removal procedure. Always completely read the removal instructions and follow all special installation instructions.

Removal and replacement: Drum motor

Learn about removing and replacing the drum motor.

Before performing service

Turn the printer power off

- Disconnect the power cable.

⚠ WARNING! To avoid damage to the printer, turn the printer off, wait 30 seconds, and then remove the power cord before attempting to service the printer.

If the part is damaged and cannot be cleaned, use the table below to identify the correct part number for your printer. To order the part, go to www.hp.com/buy/parts.

Table 5-89 Part information

Part number	Part description
RM3-7788-000CN	Drum motor assembly

Required tools

- #2 Phillips screwdriver with a magnetic tip and a 152 mm (6 in) shaft length

After performing service

Turn the printer power on

- Connect the power cable.
- Use the power switch to turn the power on.

Post service test

Print any pages necessary to make sure the printer is functioning correctly.

1. Remove the formatter cover

Follow these steps to remove the formatter cover.

- Remove one screw (callout 1), and then slide the formatter cover (callout 2) away from the printer to remove it.

💡 TIP: Reverse the removal steps to install the assembly.

Figure 5-707 Remove the formatter cover

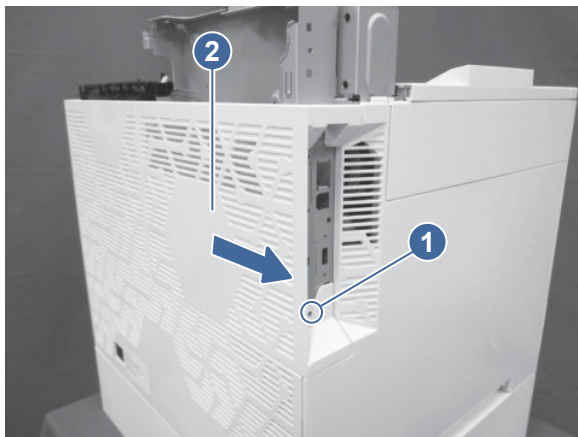

2. Remove the rear cover

Follow these steps to remove the rear cover.

 **NOTE:** The figures below show some assemblies (for example the top cover and formatter) removed that might still be installed on the printer. However, the steps to remove the cover are correct.

1. Open the right door, and remove two screws.

Figure 5-708 Remove two screws

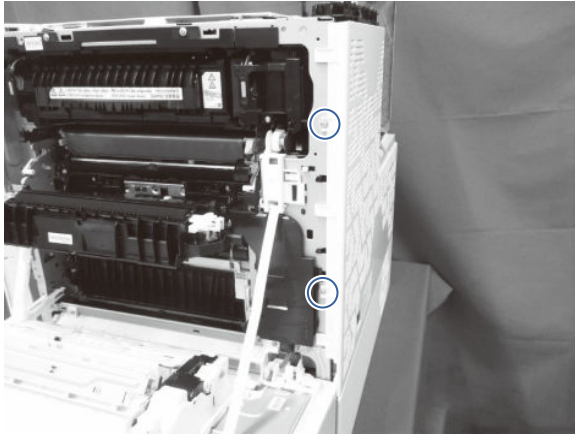

2. At the back of the printer, remove two screws, and then slide the rear cover as indicated to remove it.

Figure 5-709 Remove the rear cover

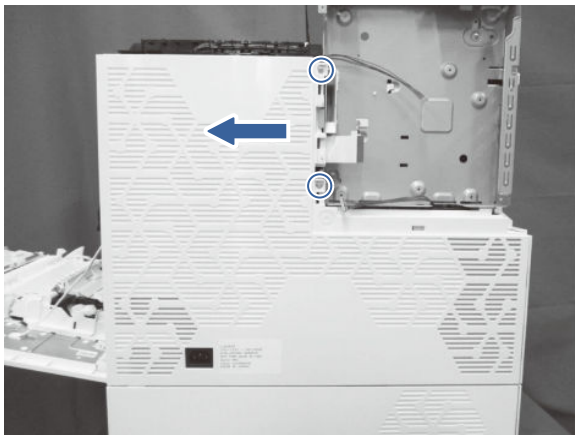

3. Remove the low-voltage power supply (LVPS)

Follow these steps to remove the low-voltage power supply (LVPS).

1. Unhook one spring (callout 1), and then disconnect two connectors (callout 2).

 **NOTE:** Unhook the spring from the formatter cage, not the low-voltage power supply. The spring should remain attached to the LVPS.

Figure 5-710 Unhook the spring and disconnect two connectors



2. Remove the FFC (callout 1), and then disconnect five connectors (callout 2).

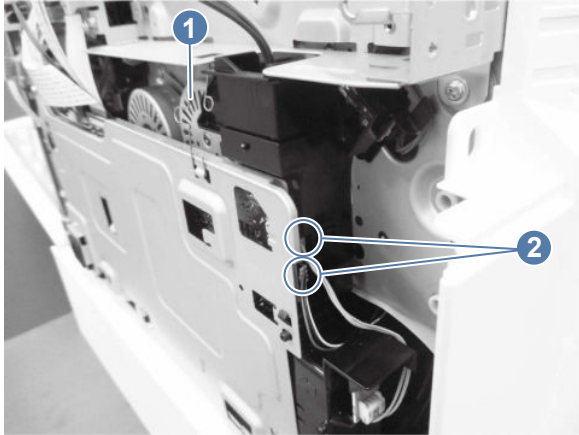

 **NOTE:** MFP only: Disconnect one additional connector (callout 3).

Figure 5-711 Disconnect the LVPS connectors

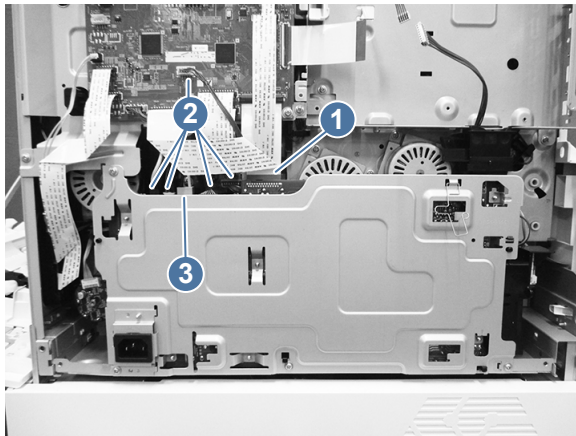

3. Remove four screws (callout 1), and then remove the low-voltage power supply assembly (callout 2).

 **NOTE:** The black ducting in the lower right corner can stick during the removal process.

Replacement LVPS only: Remove the spring (callout 3), and then install it on the replacement LVPS.

Figure 5-712 Remove the LVPS

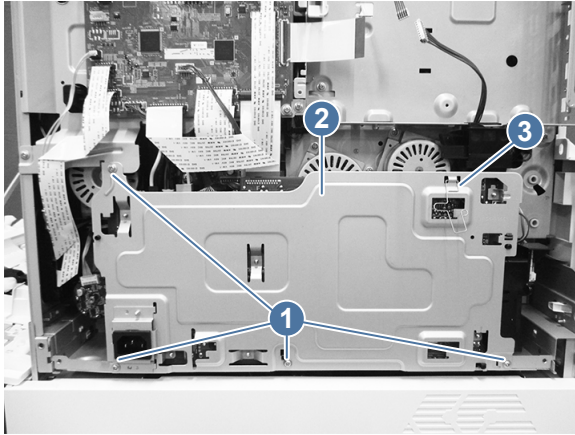

 **Reinstallation tip:** When reinstalling the LVPS, make sure that the spring (callout 1) is attached to both the formatter cage (callout 2) and the LVPS (callout 3).

Figure 5-713 Reinstalling the LVPS



4. Remove the drum motor

Follow these steps to remove the drum motor.

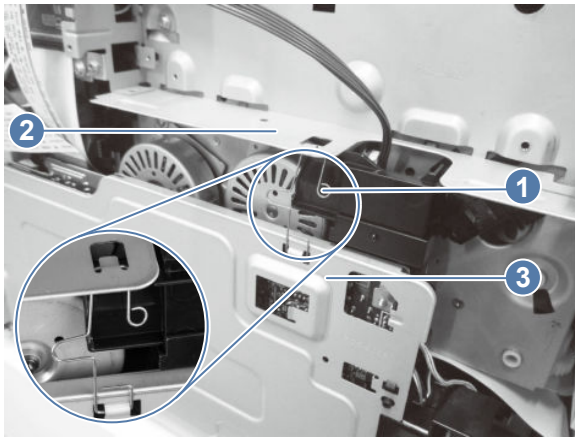
- Disconnect one connector (callout 1), remove four screws (callout 2), and then remove the drum motor (callout 3).

Figure 5-714 Remove the motor

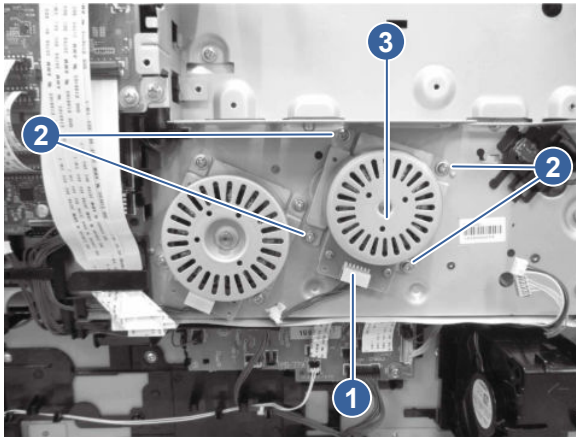

5. Unpack the replacement assembly



Follow these steps to unpack the replacement assembly.

1. Dispose of the defective part.

 **NOTE:** HP recommends responsible disposal of the defective part.

<http://www8.hp.com/us/en/hp-information/environment/product-recycling.html>

2. Unpack the replacement part from the packaging.

 **CAUTION:**  Some parts are sensitive to electrostatic discharge (ESD). Always perform service work at an ESD-protected workstation or mat. If an ESD workstation or mat is not available, touch the sheet-metal chassis to provide a static ground before touching an ESD-sensitive assembly. Protect the ESD-sensitive assemblies by placing them in ESD pouches when they are out of the printer.

 **IMPORTANT:** Make sure that all of the shipping materials (for example shipping tape) are removed from the replacement part prior to installation.

 **NOTE:** If the replacement part is a roller or pad, avoid touching the spongy part of it. Skin oils on the roller or pad can cause paper pickup and/or print-quality problems. HP recommends using disposable gloves when handling rollers or pads or washing your hands before touching rollers or pads.

3. To install an assembly, reverse the removal steps.

 **NOTE:** When applicable, special installation instructions are provided for an assembly at the end of the removal procedure. Always completely read the removal instructions and follow all special installation instructions.

Removal and replacement: Developer motor

Learn about removing and replacing the developer motor.

Before performing service

Turn the printer power off

- Disconnect the power cable.

⚠ WARNING! To avoid damage to the printer, turn the printer off, wait 30 seconds, and then remove the power cord before attempting to service the printer.

If the part is damaged and cannot be cleaned, use the table below to identify the correct part number for your printer. To order the part, go to www.hp.com/buy/parts.

Table 5-90 Part information

Part number	Part description
RM2-3625-000CN	Developing motor assembly

Required tools

- #2 Phillips screwdriver with a magnetic tip and a 152 mm (6 in) shaft length

After performing service

Turn the printer power on

- Connect the power cable.
- Use the power switch to turn the power on.

Post service test

Print any pages necessary to make sure the printer is functioning correctly.

1. Remove the formatter cover

Follow these steps to remove the formatter cover.

- Remove one screw (callout 1), and then slide the formatter cover (callout 2) away from the printer to remove it.

💡 TIP: Reverse the removal steps to install the assembly.

Figure 5-715 Remove the formatter cover

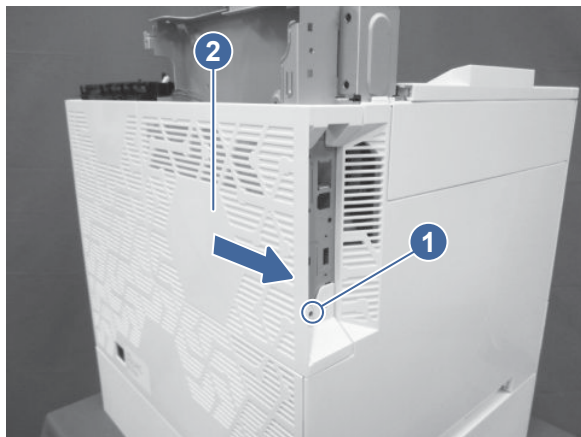

2. Remove the rear cover

Follow these steps to remove the rear cover.

 **NOTE:** The figures below show some assemblies (for example the top cover and formatter) removed that might still be installed on the printer. However, the steps to remove the cover are correct.

1. Open the right door, and remove two screws.

Figure 5-716 Remove two screws

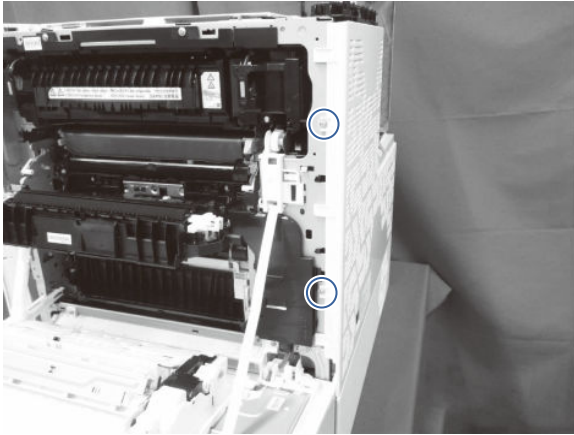

2. At the back of the printer, remove two screws, and then slide the rear cover as indicated to remove it.

Figure 5-717 Remove the rear cover

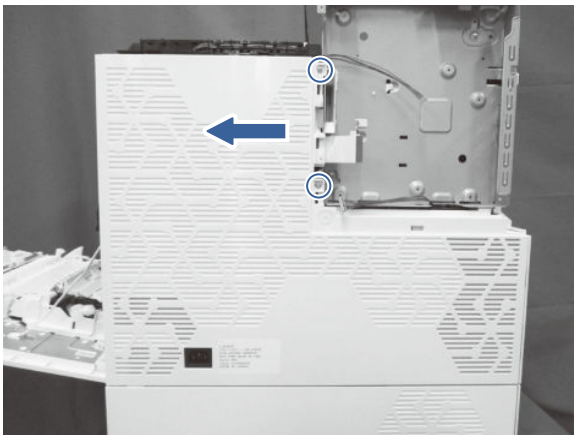

3. Remove the low-voltage power supply (LVPS)

Follow these steps to remove the low-voltage power supply (LVPS).

1. Unhook one spring (callout 1), and then disconnect two connectors (callout 2).

 **NOTE:** Unhook the spring from the formatter cage, not the low-voltage power supply. The spring should remain attached to the LVPS.

Figure 5-718 Unhook the spring and disconnect two connectors



2. Remove the FFC (callout 1), and then disconnect five connectors (callout 2).

 **NOTE:** **MFP only:** Disconnect one additional connector (callout 3).

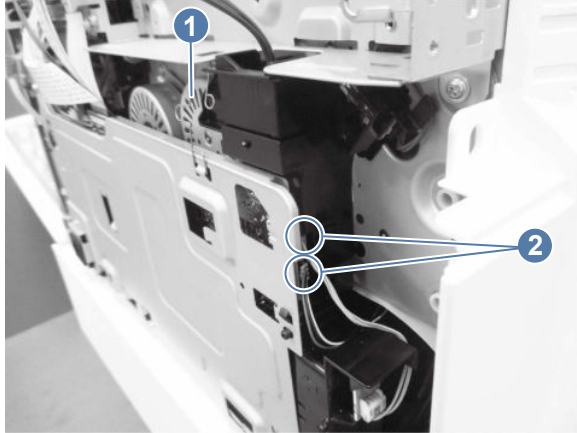
Figure 5-719 Disconnect the LVPS connectors



3. Remove four screws (callout 1), and then remove the low-voltage power supply assembly (callout 2).

 **NOTE:** The black ducting in the lower right corner can stick during the removal process.

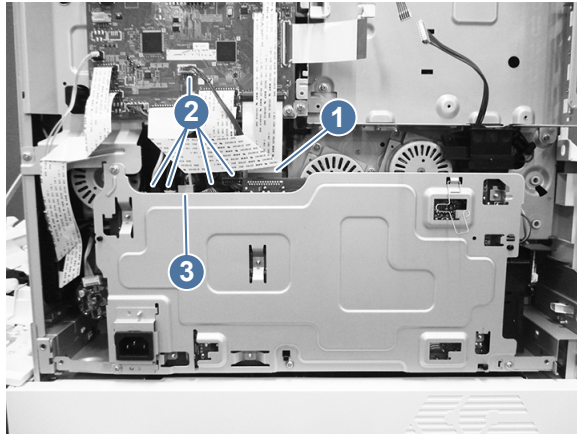
Replacement LVPS only: Remove the spring (callout 3), and then install it on the replacement LVPS.

Figure 5-720 Remove the LVPS

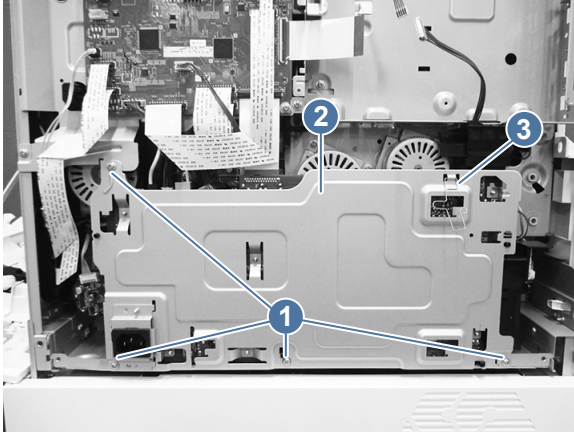

 **Reinstallation tip:** When reinstalling the LVPS, make sure that the spring (callout 1) is attached to both the formatter cage (callout 2) and the LVPS (callout 3).

Figure 5-721 Reinstalling the LVPS



4. Remove the developer motor

Follow these steps to remove the developer motor.

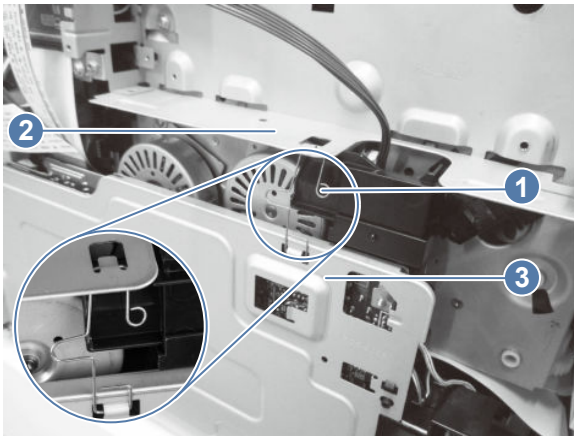
- Disconnect one connector (callout 1), remove four screws (callout 2), and then remove the motor (callout 3).

Figure 5-722 Remove the motor

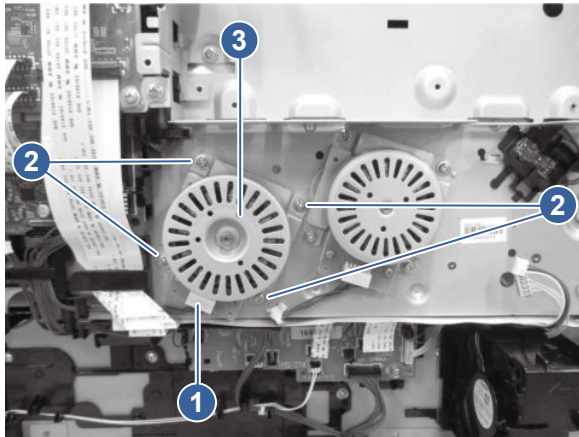

5. Unpack the replacement assembly

Follow these steps to unpack the replacement assembly.

1. Dispose of the defective part.



NOTE: HP recommends responsible disposal of the defective part.

<http://www8.hp.com/us/en/hp-information/environment/product-recycling.html>

2. Unpack the replacement part from the packaging.



CAUTION: Some parts are sensitive to electrostatic discharge (ESD). Always perform service work at an ESD-protected workstation or mat. If an ESD workstation or mat is not available, touch the sheet-metal chassis to provide a static ground before touching an ESD-sensitive assembly. Protect the ESD-sensitive assemblies by placing them in ESD pouches when they are out of the printer.



IMPORTANT: Make sure that all of the shipping materials (for example shipping tape) are removed from the replacement part prior to installation.



NOTE: If the replacement part is a roller or pad, avoid touching the spongy part of it. Skin oils on the roller or pad can cause paper pickup and/or print-quality problems. HP recommends using disposable gloves when handling rollers or pads or washing your hands before touching rollers or pads.

3. To install an assembly, reverse the removal steps.



NOTE: When applicable, special installation instructions are provided for an assembly at the end of the removal procedure. Always completely read the removal instructions and follow all special installation instructions.

Removal and replacement: Image transfer belt (ITB) motor

Learn about removing and replacing the ITB motor.

Before performing service

Turn the printer power off

- Disconnect the power cable.

⚠ WARNING! To avoid damage to the printer, turn the printer off, wait 30 seconds, and then remove the power cord before attempting to service the printer.

If the part is damaged and cannot be cleaned, use the table below to identify the correct part number for your printer. To order the part, go to www.hp.com/buy/parts.

Table 5-91 Part information

Part number	Part description
RM3-7797-000CN	ITB motor assembly

Required tools

- #2 Phillips screwdriver with a magnetic tip and a 152 mm (6 in) shaft length

After performing service

Turn the printer power on

- Connect the power cable.
- Use the power switch to turn the power on.

Post service test

Print any pages necessary to make sure the printer is functioning correctly.

1. Remove the formatter cover

Follow these steps to remove the formatter cover.

- Remove one screw (callout 1), and then slide the formatter cover (callout 2) away from the printer to remove it.

💡 TIP: Reverse the removal steps to install the assembly.

Figure 5-723 Remove the formatter cover

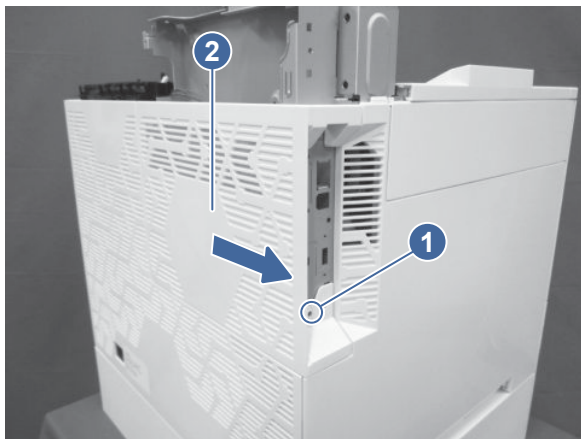

2. Remove the rear cover

Follow these steps to remove the rear cover.

 **NOTE:** The figures below show some assemblies (for example the top cover and formatter) removed that might still be installed on the printer. However, the steps to remove the cover are correct.

1. Open the right door, and remove two screws.

Figure 5-724 Remove two screws

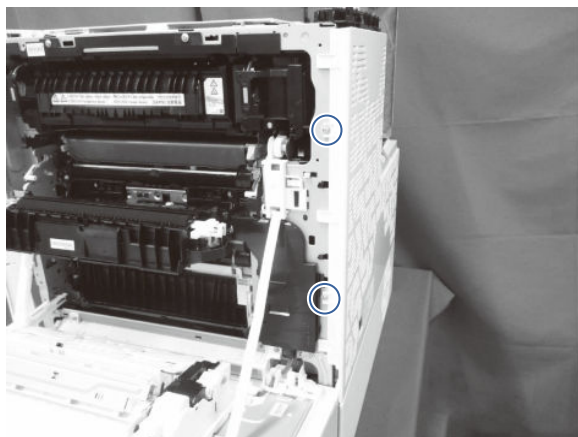

2. At the back of the printer, remove two screws, and then slide the rear cover as indicated to remove it.

Figure 5-725 Remove the rear cover

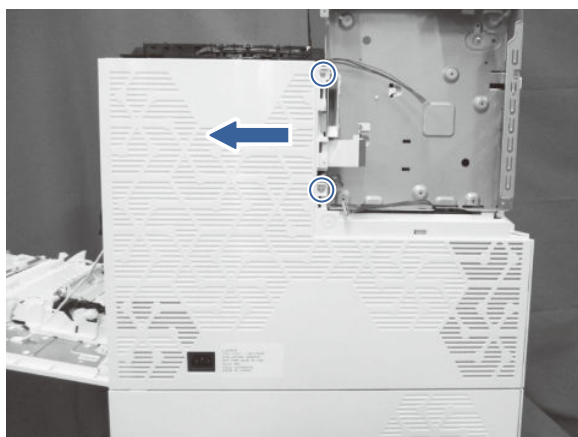

3. Remove the low-voltage power supply (LVPS)

Follow these steps to remove the low-voltage power supply (LVPS).

1. Unhook one spring (callout 1), and then disconnect two connectors (callout 2).

 **NOTE:** Unhook the spring from the formatter cage, not the low-voltage power supply. The spring should remain attached to the LVPS.

Figure 5-726 Unhook the spring and disconnect two connectors



2. Remove the FFC (callout 1), and then disconnect five connectors (callout 2).

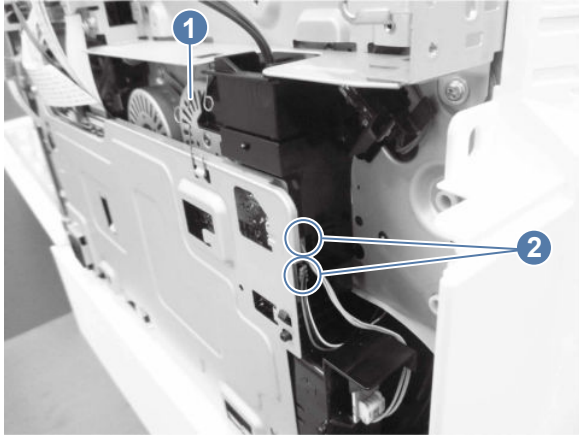

 **NOTE:** MFP only: Disconnect one additional connector (callout 3).

Figure 5-727 Disconnect the LVPS connectors

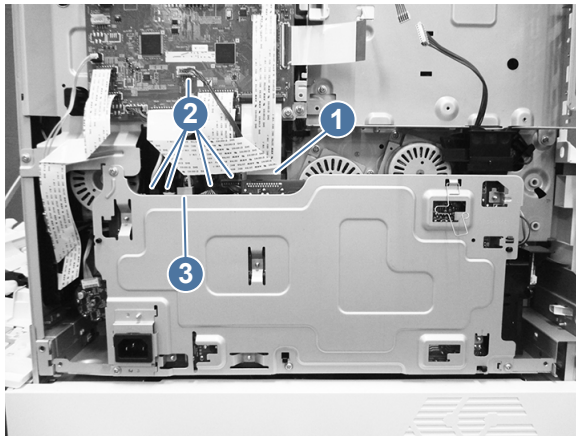

3. Remove four screws (callout 1), and then remove the low-voltage power supply assembly (callout 2).

 **NOTE:** The black ducting in the lower right corner can stick during the removal process.

Replacement LVPS only: Remove the spring (callout 3), and then install it on the replacement LVPS.

Figure 5-728 Remove the LVPS

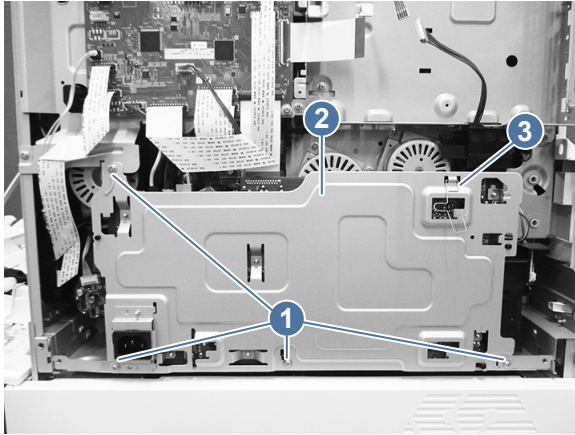

 **Reinstallation tip:** When reinstalling the LVPS, make sure that the spring (callout 1) is attached to both the formatter cage (callout 2) and the LVPS (callout 3).

Figure 5-729 Reinstalling the LVPS



4. Remove the image transfer belt (ITB) motor

Follow these steps to remove the image transfer belt (ITB) motor.

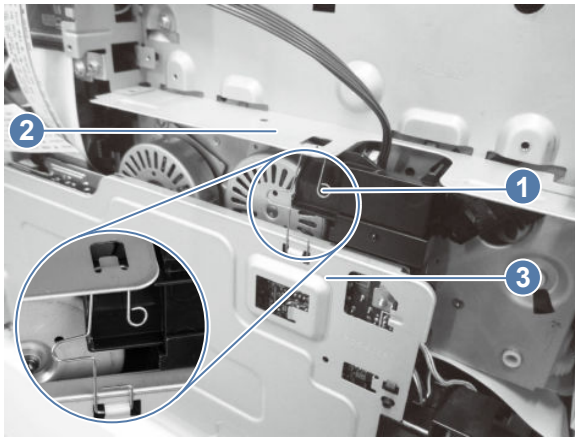
1. Disconnect all the connectors on the DC controller PCA, remove the cable clamp (callout 1), remove three screws (callout 2), slide the DC controller stay (callout 3) out to remove it.

Figure 5-730 Remove the DC controller stay

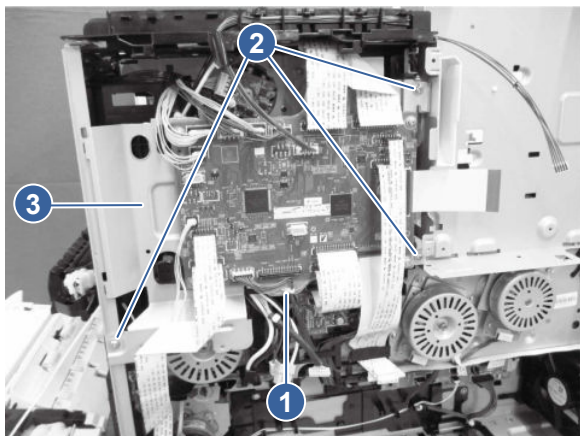

2. Disconnect one connector (callout 1), remove four screws (callout 2), and then remove the motor (callout 3).

Figure 5-731 Remove the motor

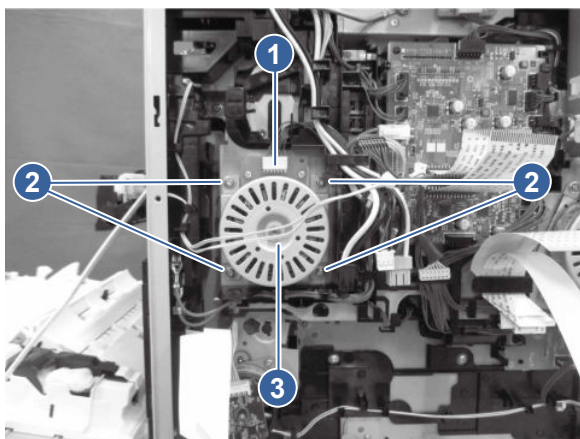

5. Unpack the replacement assembly

Follow these steps to unpack the replacement assembly.

1. Dispose of the defective part.





NOTE: HP recommends responsible disposal of the defective part.

<http://www8.hp.com/us/en/hp-information/environment/product-recycling.html>

2. Unpack the replacement part from the packaging.



CAUTION:  Some parts are sensitive to electrostatic discharge (ESD). Always perform service work at an ESD-protected workstation or mat. If an ESD workstation or mat is not available, touch the sheet-metal chassis to provide a static ground before touching an ESD-sensitive assembly. Protect the ESD-sensitive assemblies by placing them in ESD pouches when they are out of the printer.

 **IMPORTANT:** Make sure that all of the shipping materials (for example shipping tape) are removed from the replacement part prior to installation.

 **NOTE:** If the replacement part is a roller or pad, avoid touching the spongy part of it. Skin oils on the roller or pad can cause paper pickup and/or print-quality problems. HP recommends using disposable gloves when handling rollers or pads or washing your hands before touching rollers or pads.

3. To install an assembly, reverse the removal steps.

 **NOTE:** When applicable, special installation instructions are provided for an assembly at the end of the removal procedure. Always completely read the removal instructions and follow all special installation instructions.

Removal and replacement: Developer alienation motor

Learn about removing and replacing developer alienation motor.

Before performing service

Turn the printer power off

- Disconnect the power cable.

 **WARNING!** To avoid damage to the printer, turn the printer off, wait 30 seconds, and then remove the power cord before attempting to service the printer.

If the part is damaged and cannot be cleaned, use the table below to identify the correct part number for your printer. To order the part, go to www.hp.com/buy/parts.

Table 5-92 Part information

Part number	Part description
RK2-6027-000CN	Motor, stepping (Developer alienation motor)

Required tools

- #2 Phillips screwdriver with a magnetic tip and a 152 mm (6 in) shaft length

After performing service

Turn the printer power on

- Connect the power cable.
- Use the power switch to turn the power on.

Post service test

Print any pages necessary to make sure the printer is functioning correctly.

1. Remove the formatter cover

Follow these steps to remove the formatter cover.

- Remove one screw (callout 1), and then slide the formatter cover (callout 2) away from the printer to remove it.

 **TIP:** Reverse the removal steps to install the assembly.

Figure 5-732 Remove the formatter cover



2. Remove the formatter

Follow these steps to remove the formatter.

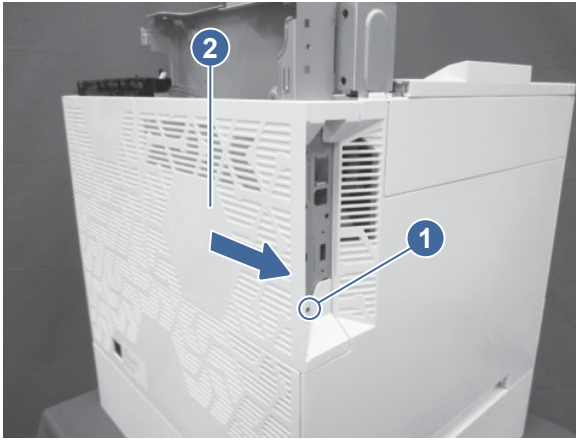
1. Disconnect all of the connectors on the formatter.

 **IMPORTANT:** Some of the flat flexible cable (FFC) connectors use hinged retainers to secure them to the DC controller. The hinged retainers must be opened to release the FFCs.

2. Remove the fax PCA (callout 1) and the hard disk drive (HDD) (callout 2), and then remove seven screws (callout 3) to remove the formatter.

Figure 5-733 Remove the formatter

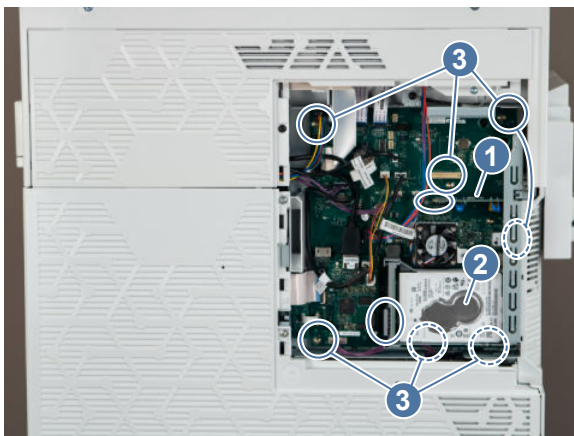

3. Remove the left upper cover (MFP models)

Follow these steps to remove the left upper cover.

1. Open the front door.

⚠ CAUTION: If the cover is being removed to gain access to the main drive assembly, make sure that the front door remains open. This keeps the main drive properly aligned.

2. At the left side of the printer, insert the small flat-blade screwdriver into the slot to release one tab (callout 1).

Figure 5-734 Use a screwdriver to release the tab

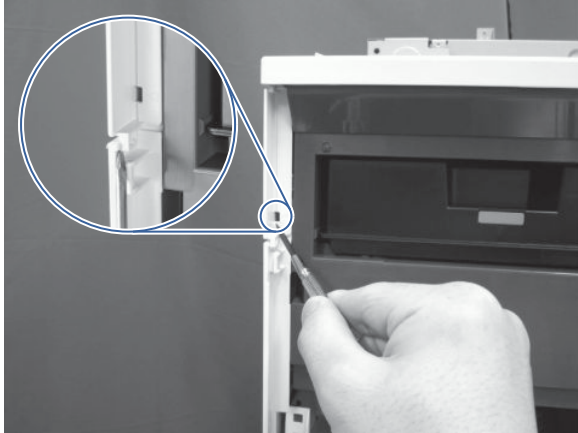

3. Toward the front of the printer, release another tab.

Figure 5-735 Release the tab

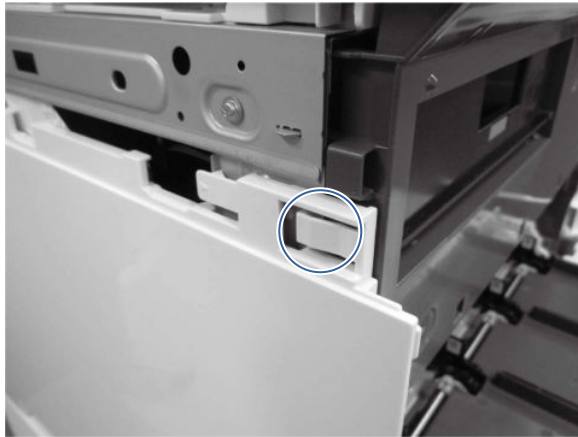

4. Rotate the cover up to remove it.

Figure 5-736 Remove the left upper cover

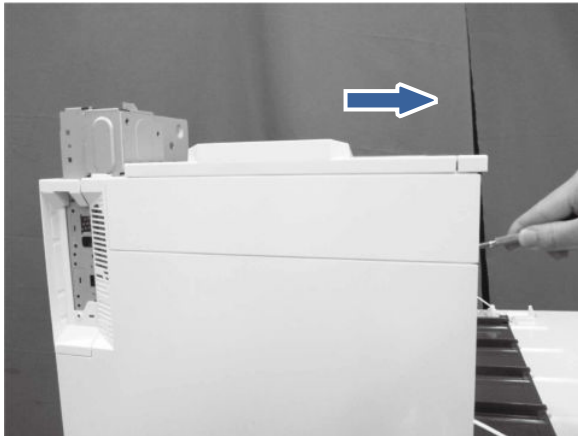

4. Remove the left cover

Follow these steps to remove the left cover.

- At the left side of the printer, remove one screw (callout 1), release one tab (callout 2), and then slide the cover (callout 3) toward the rear of the printer to release it.

Figure 5-737 Remove the left cover

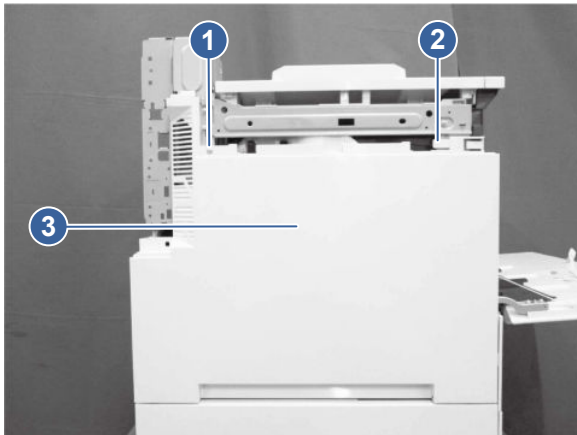

5. Remove the rear cover

Follow these steps to remove the rear cover.

-
-  **NOTE:** The figures below show some assemblies (for example the top cover and formatter) removed that might still be installed on the printer. However, the steps to remove the cover are correct.
-

1. Open the right door, and remove two screws.

Figure 5-738 Remove two screws

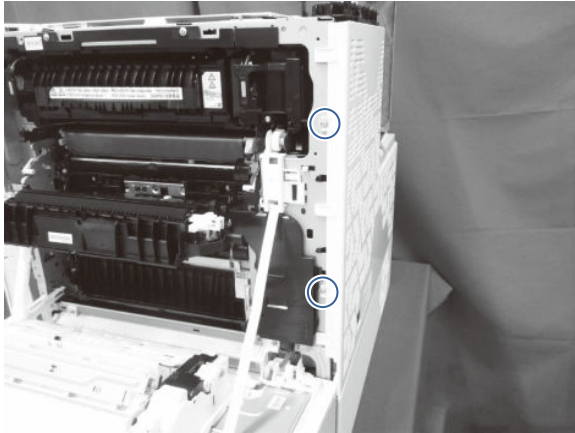

2. At the back of the printer, remove two screws, and then slide the rear cover as indicated to remove it.

Figure 5-739 Remove the rear cover

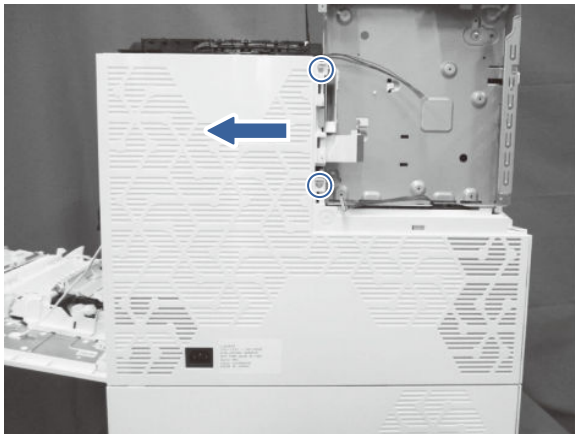

6. Remove the formatter cage (SFP models)

Follow these steps to remove the formatter cage.

1. Disconnect all the connectors on the DC controller PCA.

 **IMPORTANT:** Some of the flat flexible cable (FFC) connectors use hinged retainers to secure them to the DC controller. The hinged retainers must be opened to release the FFCs.

2. Remove the cable clamp (callout 1), remove four screws (callout 2), and then slide the DC controller stay (callout 3) out to remove it.

 **NOTE:** Be careful not to drop any of the screws into the low-voltage power supply assembly below the DC controller.

Figure 5-740 Remove the DC controller stay



3. Unhook one spring (callout 1), release the cable (callout 2) from the cable clamp (callout 3), remove four screws (callout 4), and then remove the formatter cage (callout 5).

Figure 5-741 Remove the formatter cage

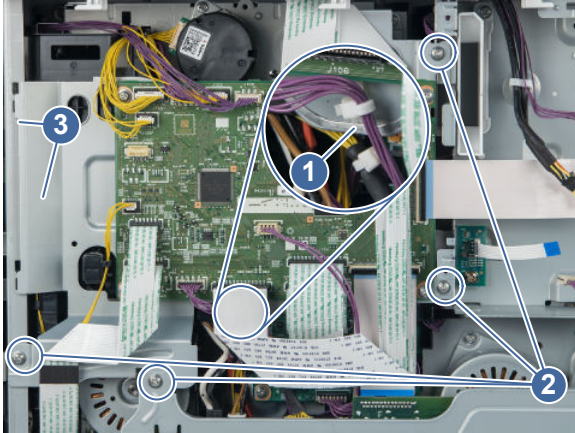
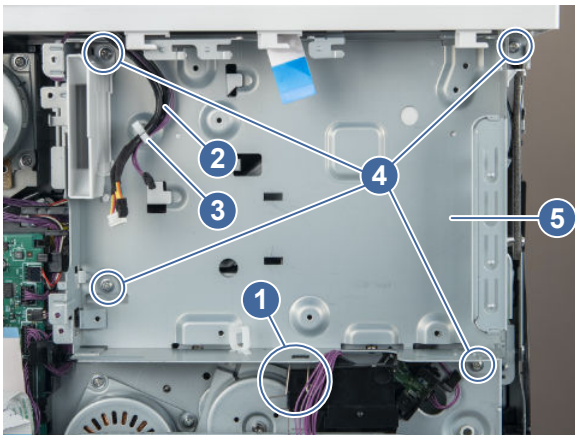

4. **For a replacement formatter cage only:** Release the cable (callout 1) from the cable guide (callout 2), release one tab (callout 3), and then remove the memory PCA (callout 4) from the formatter cage (callout 5).

 **NOTE:** Install the PCA on the replacement formatter cage.

Figure 5-742 Remove the memory PCA



7. Remove the formatter cage (MFP models)

Follow these steps to remove the formatter cage.

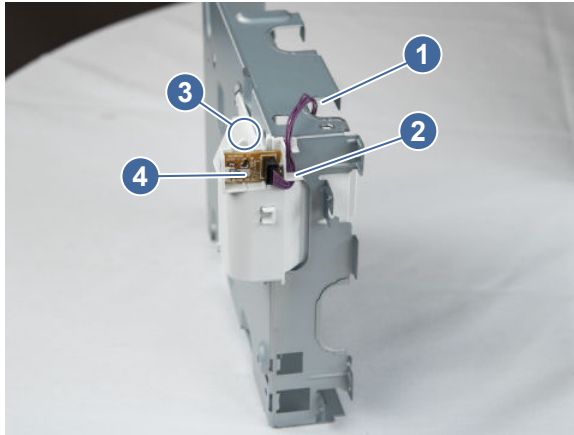
1. Unhook one spring (callout 1), remove seven screws (callout 2), and then remove the formatter cage (callout 3).

Figure 5-743 Remove the formatter cage

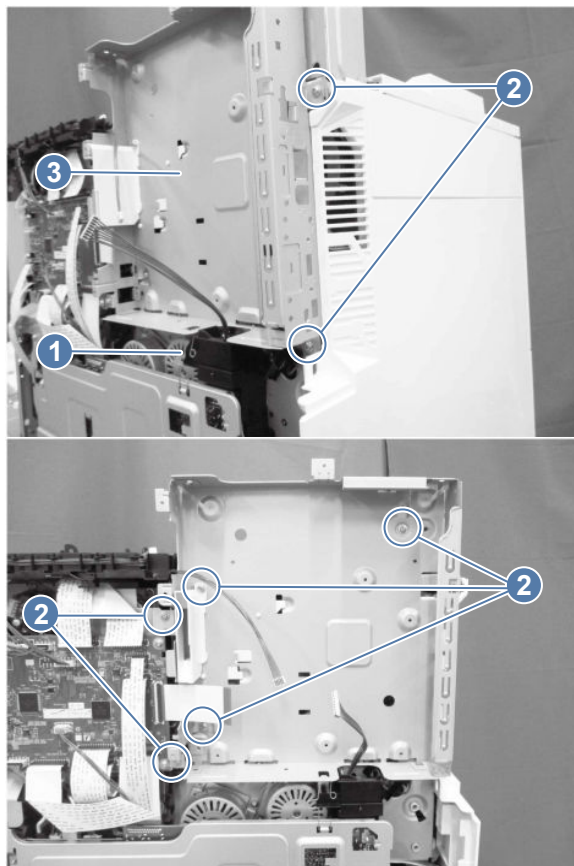

2. **For a replacement formatter cage only:** Release the cable (callout 1) from the cable guide (callout 2), release one tab (callout 3), and then remove the memory PCA (callout 4) from the formatter cage (callout 5).

 **NOTE:** Install the PCA on the replacement formatter cage.

Figure 5-744 Remove the memory PCA



8. Remove the developer alienation motor

Follow these steps to remove the developer alienation motor.

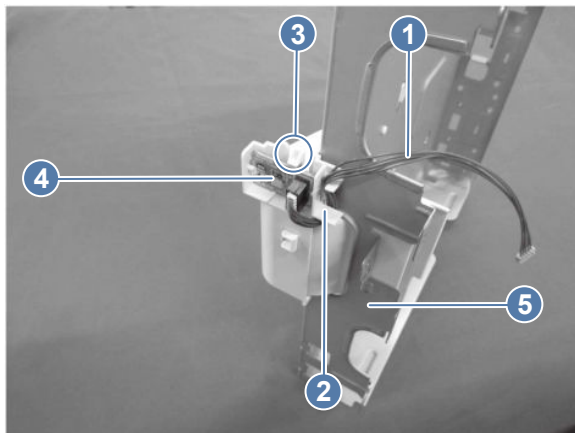
- Disconnect one connector (callout 1), remove two screws (callout 2), and then remove the motor (callout 3).

Figure 5-745 Remove the motor

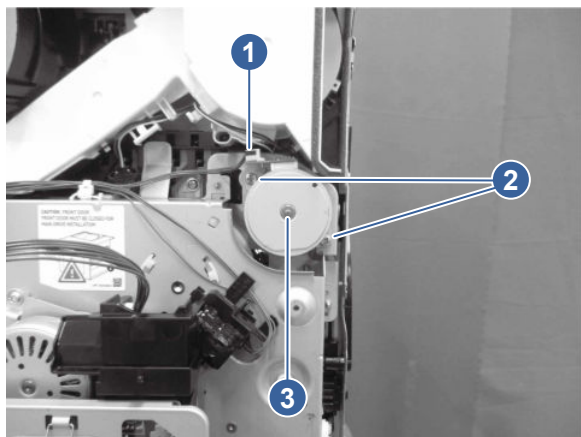

9. Unpack the replacement assembly



Follow these steps to unpack the replacement assembly.

1. Dispose of the defective part.

 **NOTE:** HP recommends responsible disposal of the defective part.

<http://www8.hp.com/us/en/hp-information/environment/product-recycling.html>

2. Unpack the replacement part from the packaging.

 **CAUTION:**  Some parts are sensitive to electrostatic discharge (ESD). Always perform service work at an ESD-protected workstation or mat. If an ESD workstation or mat is not available, touch the sheet-metal chassis to provide a static ground before touching an ESD-sensitive assembly. Protect the ESD-sensitive assemblies by placing them in ESD pouches when they are out of the printer.

 **IMPORTANT:** Make sure that all of the shipping materials (for example shipping tape) are removed from the replacement part prior to installation.

 **NOTE:** If the replacement part is a roller or pad, avoid touching the spongy part of it. Skin oils on the roller or pad can cause paper pickup and/or print-quality problems. HP recommends using disposable gloves when handling rollers or pads or washing your hands before touching rollers or pads.

3. To install an assembly, reverse the removal steps.

 **NOTE:** When applicable, special installation instructions are provided for an assembly at the end of the removal procedure. Always completely read the removal instructions and follow all special installation instructions.

Removal and replacement: Fuser motor

Learn about removing and replacing the fuser motor.

Before performing service

Turn the printer power off

- Disconnect the power cable.

 **WARNING!** To avoid damage to the printer, turn the printer off, wait 30 seconds, and then remove the power cord before attempting to service the printer.

If the part is damaged and cannot be cleaned, use the table below to identify the correct part number for your printer. To order the part, go to www.hp.com/buy/parts.

Table 5-93 Part information

Part number	Part description
RM2-4488-000CN	Fixing motor assembly (Fuser motor)

Required tools

- #2 Phillips screwdriver with a magnetic tip and a 152 mm (6 in) shaft length

After performing service

Turn the printer power on

- Connect the power cable.
- Use the power switch to turn the power on.

Post service test

Print any pages necessary to make sure the printer is functioning correctly.

1. Remove the formatter cover

Follow these steps to remove the formatter cover.

- Remove one screw (callout 1), and then slide the formatter cover (callout 2) away from the printer to remove it.



 **TIP:** Reverse the removal steps to install the assembly.

Figure 5-746 Remove the formatter cover

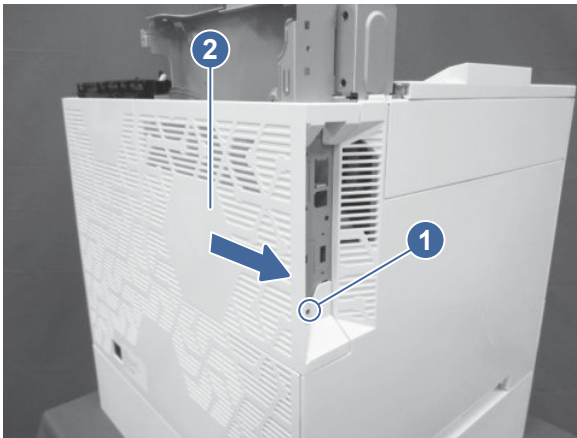

2. Remove the rear cover

Follow these steps to remove the rear cover.

 **NOTE:** The figures below show some assemblies (for example the top cover and formatter) removed that might still be installed on the printer. However, the steps to remove the cover are correct.

1. Open the right door, and remove two screws.

Figure 5-747 Remove two screws

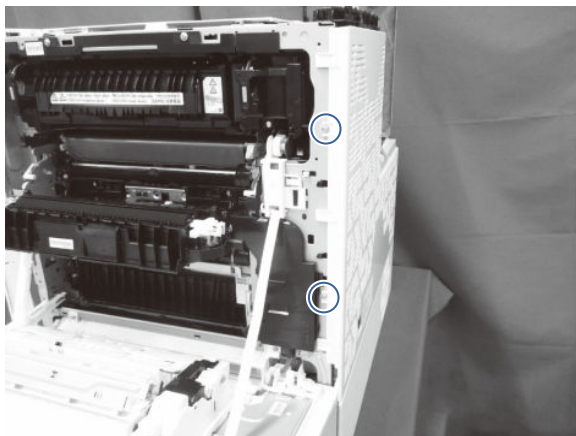

2. At the back of the printer, remove two screws, and then slide the rear cover as indicated to remove it.

Figure 5-748 Remove the rear cover

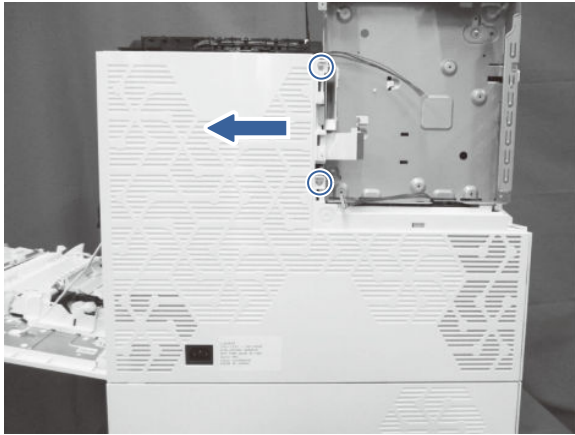

3. Remove the low-voltage power supply (LVPS)

Follow these steps to remove the low-voltage power supply (LVPS).

1. Unhook one spring (callout 1), and then disconnect two connectors (callout 2).

 **NOTE:** Unhook the spring from the formatter cage, not the low-voltage power supply. The spring should remain attached to the LVPS.

Figure 5-749 Unhook the spring and disconnect two connectors



2. Remove the FFC (callout 1), and then disconnect five connectors (callout 2).

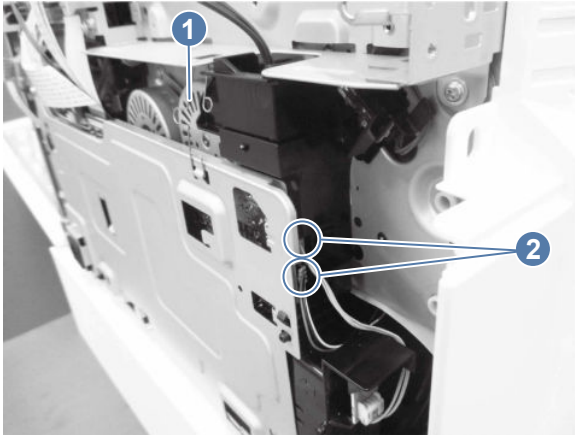

 **NOTE:** **MFP only:** Disconnect one additional connector (callout 3).

Figure 5-750 Disconnect the LVPS connectors

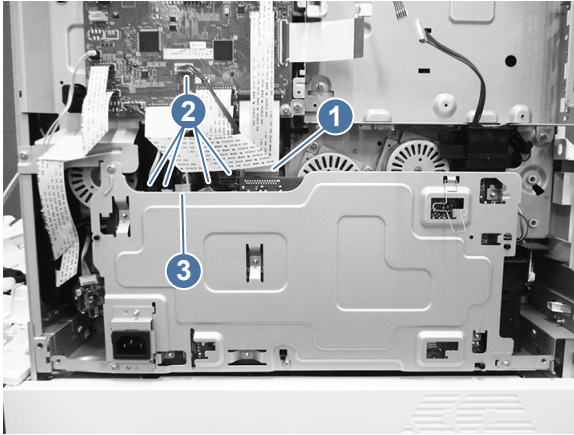

3. Remove four screws (callout 1), and then remove the low-voltage power supply assembly (callout 2).

 **NOTE:** The black ducting in the lower right corner can stick during the removal process.

Replacement LVPS only: Remove the spring (callout 3), and then install it on the replacement LVPS.

Figure 5-751 Remove the LVPS

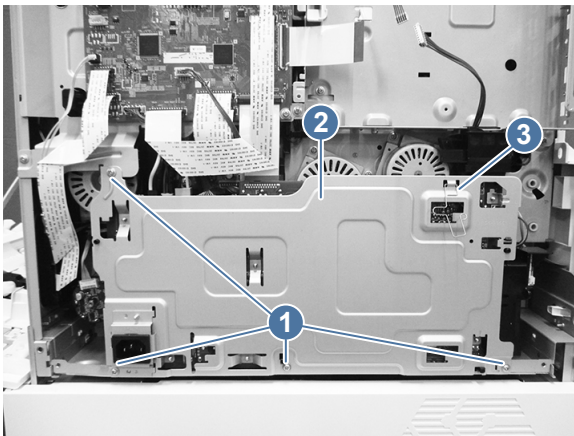

 **Reinstallation tip:** When reinstalling the LVPS, make sure that the spring (callout 1) is attached to both the formatter cage (callout 2) and the LVPS (callout 3).

Figure 5-752 Reinstalling the LVPS



4. Remove the fuser motor

Follow these steps to remove the fuser motor.

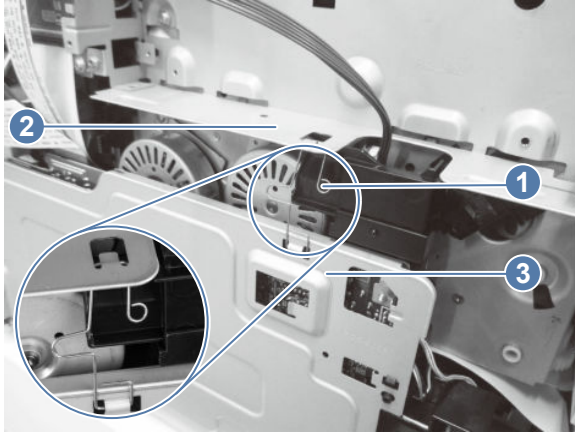
1. Disconnect all the connectors on the DC controller PCA, remove the cable clamp (callout 1), remove three screws (callout 2), slide the DC controller stay (callout 3) out to remove it.

Figure 5-753 Remove the DC controller stay

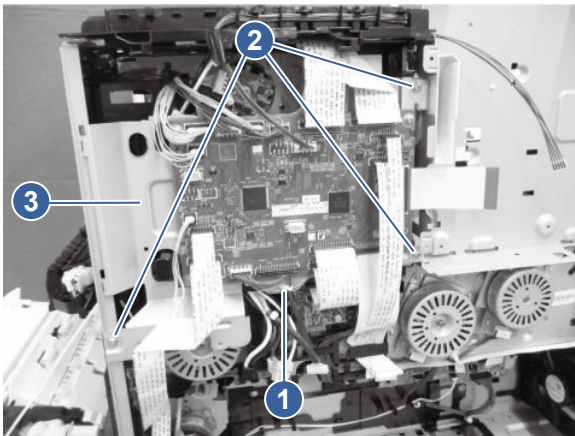

2. Disconnect one connector (callout 1), remove three screws (callout 2), and then remove the motor (callout 3).

Figure 5-754 Remove the motor

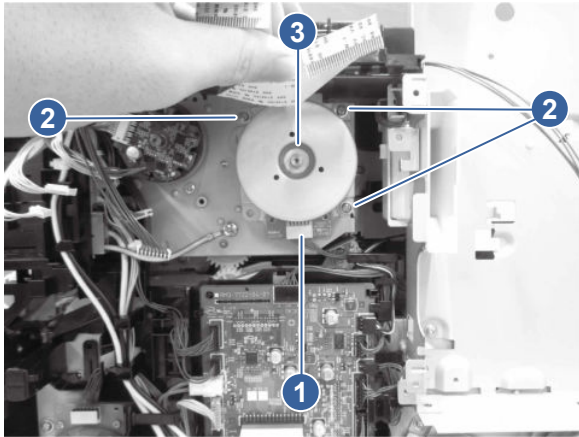

5. Unpack the replacement assembly

Follow these steps to unpack the replacement assembly.

1. Dispose of the defective part.



NOTE: HP recommends responsible disposal of the defective part.

<http://www8.hp.com/us/en/hp-information/environment/product-recycling.html>

2. Unpack the replacement part from the packaging.



CAUTION:  Some parts are sensitive to electrostatic discharge (ESD). Always perform service work at an ESD-protected workstation or mat. If an ESD workstation or mat is not available, touch the sheet-metal chassis to provide a static ground before touching an ESD-sensitive assembly. Protect the ESD-sensitive assemblies by placing them in ESD pouches when they are out of the printer.



IMPORTANT: Make sure that all of the shipping materials (for example shipping tape) are removed from the replacement part prior to installation.



NOTE: If the replacement part is a roller or pad, avoid touching the spongy part of it. Skin oils on the roller or pad can cause paper pickup and/or print-quality problems. HP recommends using disposable gloves when handling rollers or pads or washing your hands before touching rollers or pads.

3. To install an assembly, reverse the removal steps.



NOTE: When applicable, special installation instructions are provided for an assembly at the end of the removal procedure. Always completely read the removal instructions and follow all special installation instructions.

Removal and replacement: Duplex motor

Learn about removing and replacing the duplex motor.

Before performing service

Turn the printer power off

- Disconnect the power cable.

 **WARNING!** To avoid damage to the printer, turn the printer off, wait 30 seconds, and then remove the power cord before attempting to service the printer.

If the part is damaged and cannot be cleaned, use the table below to identify the correct part number for your printer. To order the part, go to www.hp.com/buy/parts.

Table 5-94 Part information

Part number	Part description
RK2-7751-000CN	Motor, stepping (Duplex motor; 5700/X557/5800/X57945)
RM2-4489-000CN	Motor assembly (Duplex motor; 6700/X654/6800/X677)

Required tools

- #2 Phillips screwdriver with a magnetic tip and a 152 mm (6 in) shaft length

After performing service

Turn the printer power on

- Connect the power cable.
- Use the power switch to turn the power on.

Post service test

Print any pages necessary to make sure the printer is functioning correctly.

1. Remove the formatter cover

Follow these steps to remove the formatter cover.

- Remove one screw (callout 1), and then slide the formatter cover (callout 2) away from the printer to remove it.

 **TIP:** Reverse the removal steps to install the assembly.

Figure 5-755 Remove the formatter cover



2. Remove the rear cover

Follow these steps to remove the rear cover.

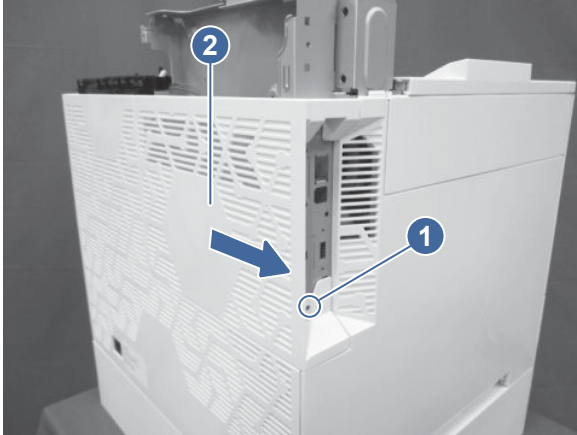

NOTE: The figures below show some assemblies (for example the top cover and formatter) removed that might still be installed on the printer. However, the steps to remove the cover are correct.

1. Open the right door, and remove two screws.

Figure 5-756 Remove two screws

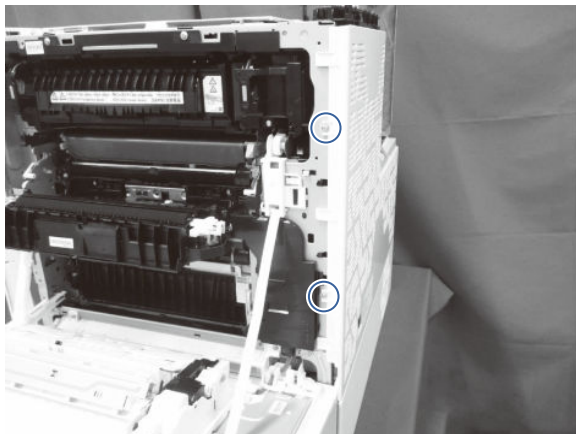

2. At the back of the printer, remove two screws, and then slide the rear cover as indicated to remove it.

Figure 5-757 Remove the rear cover

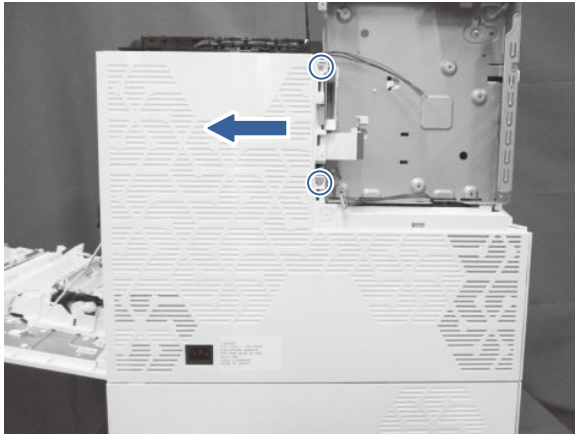

3. Remove the low-voltage power supply (LVPS)

Follow these steps to remove the low-voltage power supply (LVPS).

1. Unhook one spring (callout 1), and then disconnect two connectors (callout 2).

 **NOTE:** Unhook the spring from the formatter cage, not the low-voltage power supply. The spring should remain attached to the LVPS.

Figure 5-758 Unhook the spring and disconnect two connectors



2. Remove the FFC (callout 1), and then disconnect five connectors (callout 2).

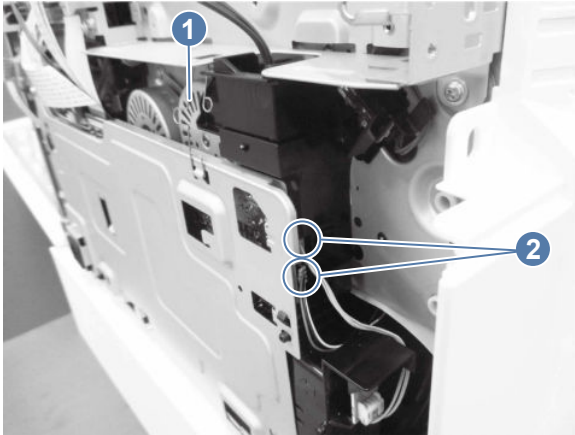

 **NOTE:** **MFP only:** Disconnect one additional connector (callout 3).

Figure 5-759 Disconnect the LVPS connectors

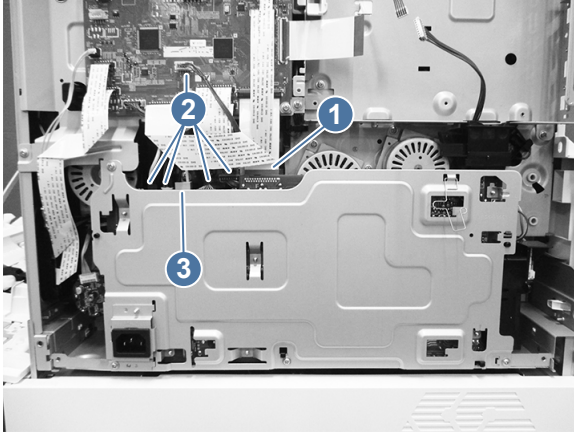

3. Remove four screws (callout 1), and then remove the low-voltage power supply assembly (callout 2).

 **NOTE:** The black ducting in the lower right corner can stick during the removal process.

Replacement LVPS only: Remove the spring (callout 3), and then install it on the replacement LVPS.

Figure 5-760 Remove the LVPS

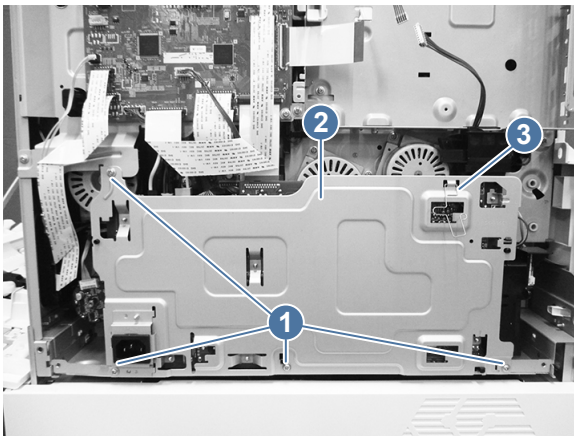

 **Reinstallation tip:** When reinstalling the LVPS, make sure that the spring (callout 1) is attached to both the formatter cage (callout 2) and the LVPS (callout 3).

Figure 5-761 Reinstalling the LVPS



4. Remove the duplex motor

Follow these steps to remove the duplex motor.

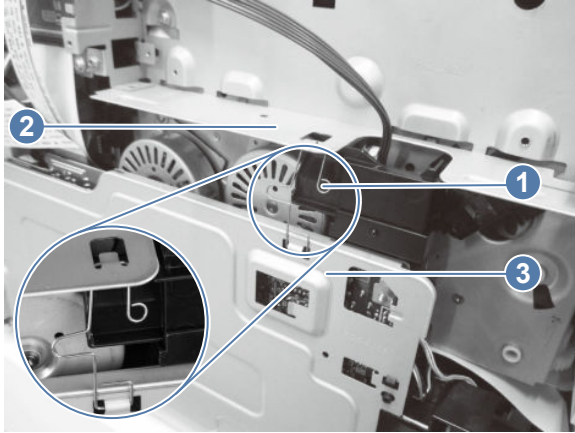
1. Disconnect all the connectors on the DC controller PCA, remove the cable clamp (callout 1), remove three screws (callout 2), slide the DC controller stay (callout 3) out to remove it.

Figure 5-762 Remove the DC controller stay

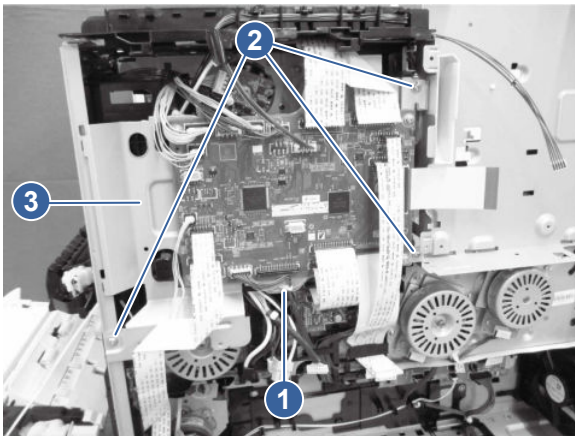

2. Disconnect one connector (callout 1), remove three screws (callout 2), and then remove the motor (callout 3).

Figure 5-763 Remove the motor

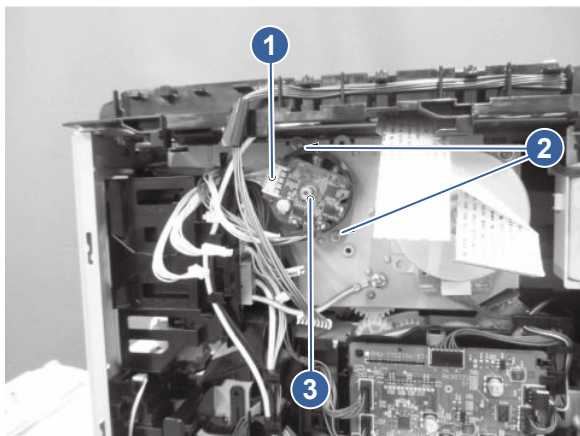

5. Unpack the replacement assembly



Follow these steps to unpack the replacement assembly.

1. Dispose of the defective part.

 **NOTE:** HP recommends responsible disposal of the defective part.

<http://www8.hp.com/us/en/hp-information/environment/product-recycling.html>

2. Unpack the replacement part from the packaging.

 **CAUTION:**  Some parts are sensitive to electrostatic discharge (ESD). Always perform service work at an ESD-protected workstation or mat. If an ESD workstation or mat is not available, touch the sheet-metal chassis to provide a static ground before touching an ESD-sensitive assembly. Protect the ESD-sensitive assemblies by placing them in ESD pouches when they are out of the printer.

 **IMPORTANT:** Make sure that all of the shipping materials (for example shipping tape) are removed from the replacement part prior to installation.

 **NOTE:** If the replacement part is a roller or pad, avoid touching the spongy part of it. Skin oils on the roller or pad can cause paper pickup and/or print-quality problems. HP recommends using disposable gloves when handling rollers or pads or washing your hands before touching rollers or pads.

3. To install an assembly, reverse the removal steps.

 **NOTE:** When applicable, special installation instructions are provided for an assembly at the end of the removal procedure. Always completely read the removal instructions and follow all special installation instructions.

Removal and replacement: Power-supply fan

Learn about removing and replacing power supply fan.

Before performing service

Turn the printer power off

- Disconnect the power cable.

⚠ WARNING! To avoid damage to the printer, turn the printer off, wait 30 seconds, and then remove the power cord before attempting to service the printer.

If the part is damaged and cannot be cleaned, use the table below to identify the correct part number for your printer. To order the part, go to www.hp.com/buy/parts.

Table 5-95 Part information

Part number	Part description
RK3-2277-000CN	Fan (Power supply fan)

Required tools

- #2 Phillips screwdriver with a magnetic tip and a 152 mm (6 in) shaft length

After performing service

Turn the printer power on

- Connect the power cable.
- Use the power switch to turn the power on.

Post service test

Print any pages necessary to make sure the printer is functioning correctly.

1. Remove the formatter cover

Follow these steps to remove the formatter cover.

- Remove one screw (callout 1), and then slide the formatter cover (callout 2) away from the printer to remove it.

💡 TIP: Reverse the removal steps to install the assembly.

Figure 5-764 Remove the formatter cover

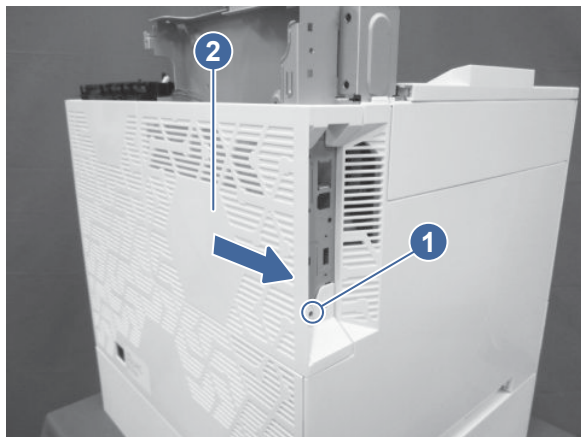

2. Remove the rear cover

Follow these steps to remove the rear cover.

 **NOTE:** The figures below show some assemblies (for example the top cover and formatter) removed that might still be installed on the printer. However, the steps to remove the cover are correct.

1. Open the right door, and remove two screws.

Figure 5-765 Remove two screws

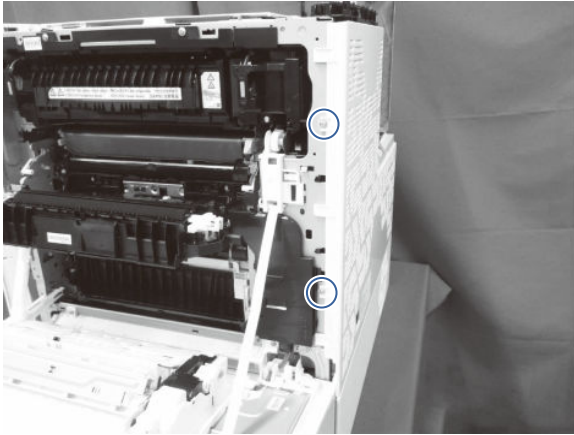

2. At the back of the printer, remove two screws, and then slide the rear cover as indicated to remove it.

Figure 5-766 Remove the rear cover

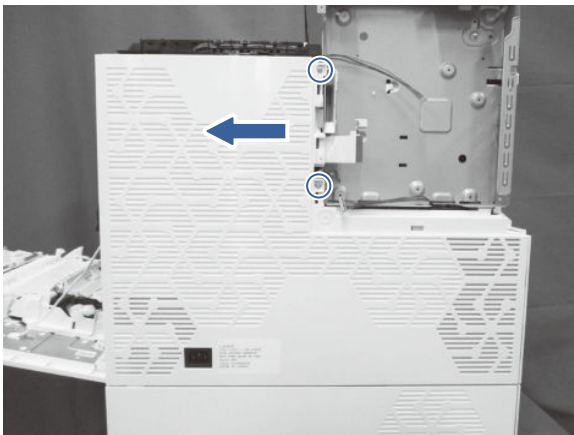

3. Remove the low-voltage power supply (LVPS)

Follow these steps to remove the low-voltage power supply (LVPS).

1. Unhook one spring (callout 1), and then disconnect two connectors (callout 2).

 **NOTE:** Unhook the spring from the formatter cage, not the low-voltage power supply. The spring should remain attached to the LVPS.

Figure 5-767 Unhook the spring and disconnect two connectors



2. Remove the FFC (callout 1), and then disconnect five connectors (callout 2).

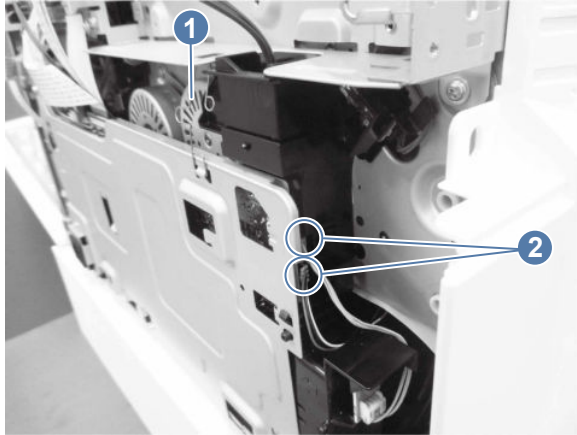

NOTE: MFP only: Disconnect one additional connector (callout 3).

Figure 5-768 Disconnect the LVPS connectors

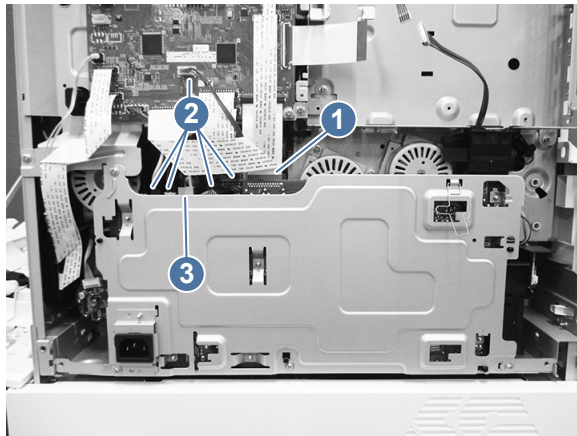

3. Remove four screws (callout 1), and then remove the low-voltage power supply assembly (callout 2).



NOTE: The black ducting in the lower right corner can stick during the removal process.

Replacement LVPS only: Remove the spring (callout 3), and then install it on the replacement LVPS.

Figure 5-769 Remove the LVPS

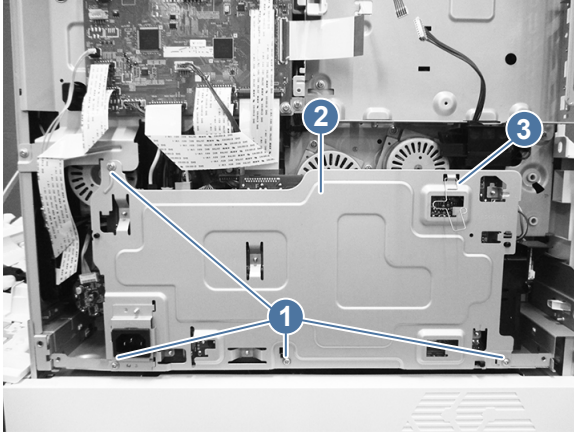

 **Reinstallation tip:** When reinstalling the LVPS, make sure that the spring (callout 1) is attached to both the formatter cage (callout 2) and the LVPS (callout 3).

Figure 5-770 Reinstalling the LVPS



4. Remove the power supply fan

Follow these steps to remove the power supply fan.

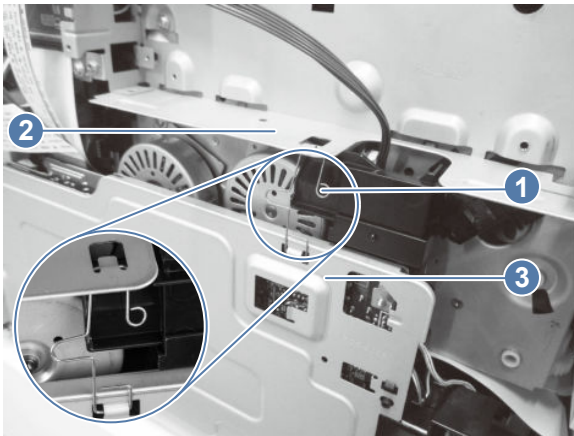
1. Release one tab (callout 1), and then slide the fan holder (callout 2) in the direction indicated to remove it.

 **NOTE:** Take care not to pull any cables as you remove this assembly.

Figure 5-771 Remove the fan holder



2. Release five tabs (callout 1), and then remove the power supply fan (callout 2).

Figure 5-772 Release the fan

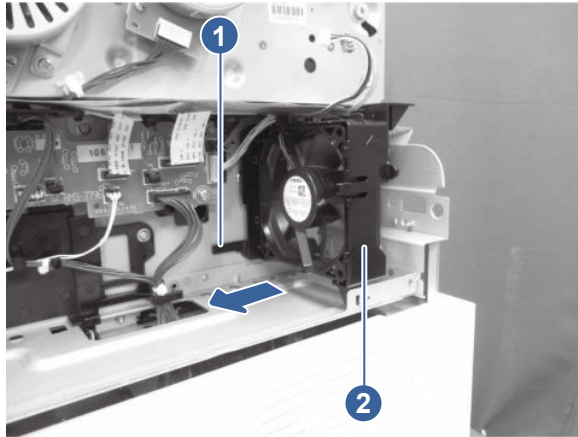
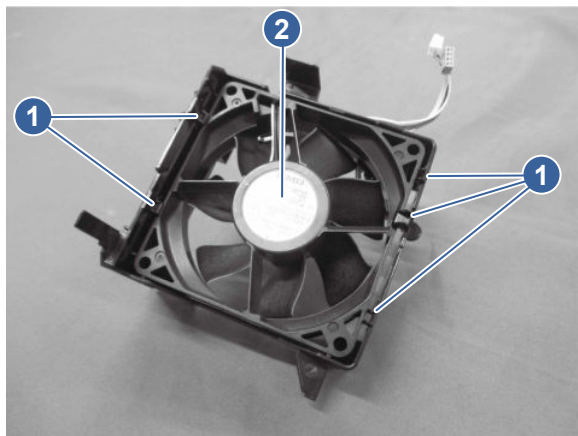

5. Unpack the replacement assembly

Follow these steps to unpack the replacement assembly.

1. Dispose of the defective part.



NOTE: HP recommends responsible disposal of the defective part.

<http://www8.hp.com/us/en/hp-information/environment/product-recycling.html>

2. Unpack the replacement part from the packaging.



CAUTION:  Some parts are sensitive to electrostatic discharge (ESD). Always perform service work at an ESD-protected workstation or mat. If an ESD workstation or mat is not available, touch the sheet-metal chassis to provide a static ground before touching an ESD-sensitive assembly. Protect the ESD-sensitive assemblies by placing them in ESD pouches when they are out of the printer.



IMPORTANT: Make sure that all of the shipping materials (for example shipping tape) are removed from the replacement part prior to installation.

 **NOTE:** If the replacement part is a roller or pad, avoid touching the spongy part of it. Skin oils on the roller or pad can cause paper pickup and/or print-quality problems. HP recommends using disposable gloves when handling rollers or pads or washing your hands before touching rollers or pads.

3. To install an assembly, reverse the removal steps.

 **NOTE:** When applicable, special installation instructions are provided for an assembly at the end of the removal procedure. Always completely read the removal instructions and follow all special installation instructions.

Removal and replacement: Cartridge fan

Learn about removing and replacing the cartridge fan.

Before performing service

Turn the printer power off

- Disconnect the power cable.

 **WARNING!** To avoid damage to the printer, turn the printer off, wait 30 seconds, and then remove the power cord before attempting to service the printer.

If the part is damaged and cannot be cleaned, use the table below to identify the correct part number for your printer. To order the part, go to www.hp.com/buy/parts.

Table 5-96 Part information

Part number	Part description
RK3-0762-000CN	Fan (Cartridge fan; X57945/6700/X654/6800/X677)
RK3-1637-000CN	Fan (Cartridge fan; 5700/X557/5800)

Required tools

- #2 Phillips screwdriver with a magnetic tip and a 152 mm (6 in) shaft length

After performing service

Turn the printer power on

- Connect the power cable.
- Use the power switch to turn the power on.

Post service test

Print any pages necessary to make sure the printer is functioning correctly.

1. Remove the formatter cover

Follow these steps to remove the formatter cover.

- Remove one screw (callout 1), and then slide the formatter cover (callout 2) away from the printer to remove it.



 **TIP:** Reverse the removal steps to install the assembly.

Figure 5-773 Remove the formatter cover

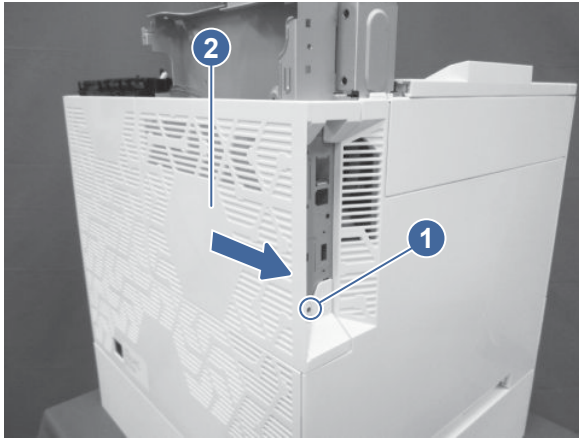

2. Remove the rear cover

Follow these steps to remove the rear cover.

 **NOTE:** The figures below show some assemblies (for example the top cover and formatter) removed that might still be installed on the printer. However, the steps to remove the cover are correct.

1. Open the right door, and remove two screws.

Figure 5-774 Remove two screws

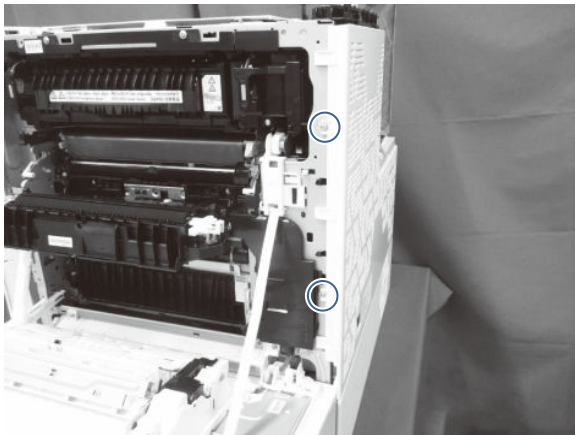

2. At the back of the printer, remove two screws, and then slide the rear cover as indicated to remove it.

Figure 5-775 Remove the rear cover

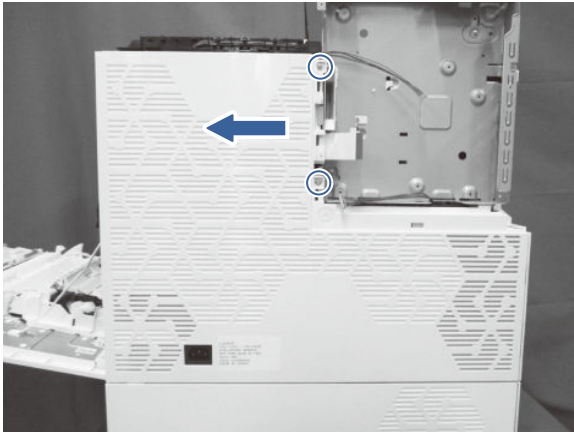

3. Remove the low-voltage power supply (LVPS)

Follow these steps to remove the low-voltage power supply (LVPS).

1. Unhook one spring (callout 1), and then disconnect two connectors (callout 2).

 **NOTE:** Unhook the spring from the formatter cage, not the low-voltage power supply. The spring should remain attached to the LVPS.

Figure 5-776 Unhook the spring and disconnect two connectors



2. Remove the FFC (callout 1), and then disconnect five connectors (callout 2).

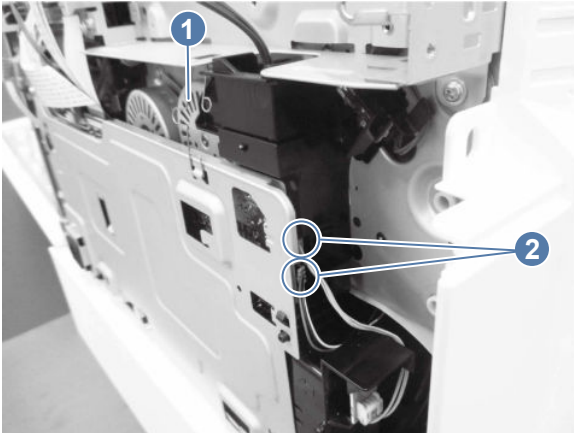

 **NOTE:** **MFP only:** Disconnect one additional connector (callout 3).

Figure 5-777 Disconnect the LVPS connectors

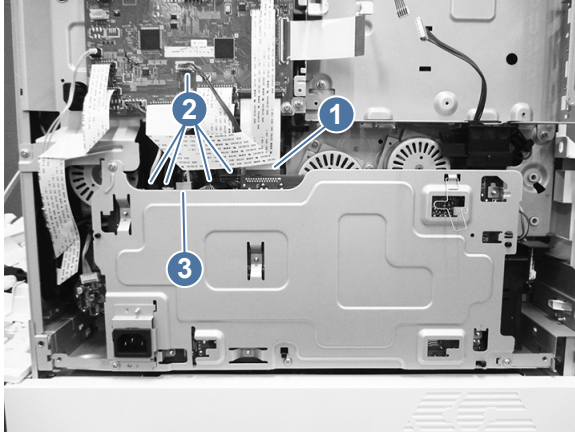

3. Remove four screws (callout 1), and then remove the low-voltage power supply assembly (callout 2).

 **NOTE:** The black ducting in the lower right corner can stick during the removal process.

Replacement LVPS only: Remove the spring (callout 3), and then install it on the replacement LVPS.

Figure 5-778 Remove the LVPS

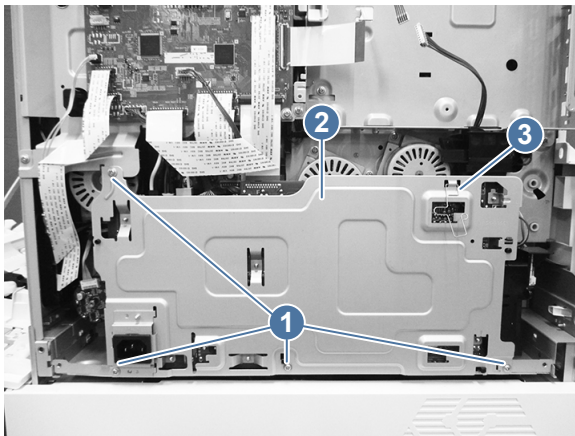

 **Reinstallation tip:** When reinstalling the LVPS, make sure that the spring (callout 1) is attached to both the formatter cage (callout 2) and the LVPS (callout 3).

Figure 5-779 Reinstalling the LVPS



4. Remove the cartridge fan

Follow these steps to remove the cartridge fan.

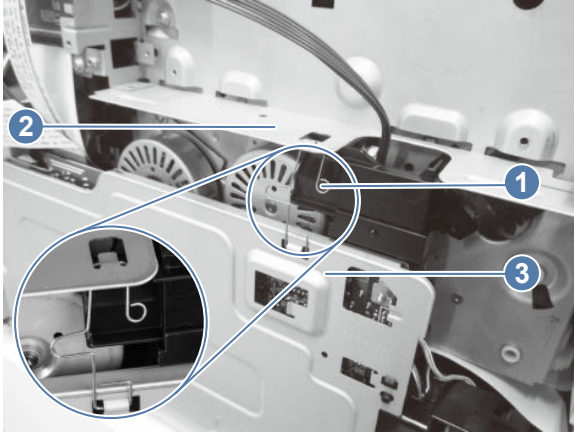
1. Disconnect one connector (callout 1), release the cable (callout 2) from the fan cover (callout 3), release four tabs (callout 4), and then remove the fan cover.

Figure 5-780 Remove the fan cover

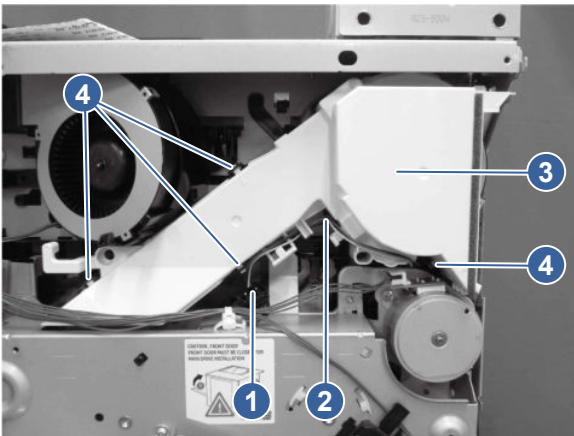

2. Pull out the cartridge fan (callout 1) toward you, and then remove the sponge (callout 2) from the cartridge fan.

Figure 5-781 Remove the fan sponge

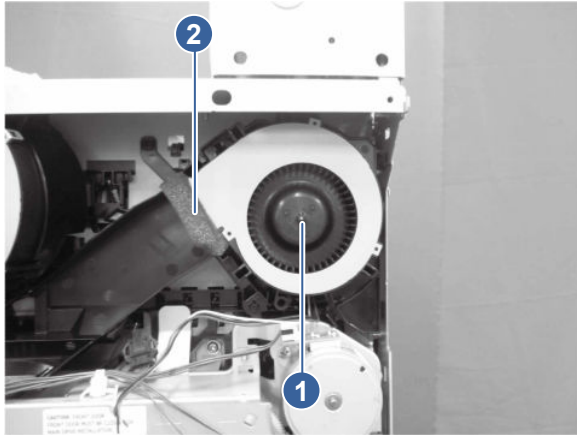

5. Unpack the replacement assembly

Follow these steps to unpack the replacement assembly.

1. Dispose of the defective part.



NOTE: HP recommends responsible disposal of the defective part.

<http://www8.hp.com/us/en/hp-information/environment/product-recycling.html>

2. Unpack the replacement part from the packaging.



CAUTION:  Some parts are sensitive to electrostatic discharge (ESD). Always perform service work at an ESD-protected workstation or mat. If an ESD workstation or mat is not available, touch the sheet-metal chassis to provide a static ground before touching an ESD-sensitive assembly. Protect the ESD-sensitive assemblies by placing them in ESD pouches when they are out of the printer.



IMPORTANT: Make sure that all of the shipping materials (for example shipping tape) are removed from the replacement part prior to installation.



NOTE: If the replacement part is a roller or pad, avoid touching the spongy part of it. Skin oils on the roller or pad can cause paper pickup and/or print-quality problems. HP recommends using disposable gloves when handling rollers or pads or washing your hands before touching rollers or pads.

3. To install an assembly, reverse the removal steps.



NOTE: When applicable, special installation instructions are provided for an assembly at the end of the removal procedure. Always completely read the removal instructions and follow all special installation instructions.

Removal and replacement: Fuser fan

Learn about removing and replacing the fuser fan.



[View a video demonstration of removing and replacing the fuser fan.](#)

Before performing service

Turn the printer power off

- Disconnect the power cable.

 **WARNING!** To avoid damage to the printer, turn the printer off, wait 30 seconds, and then remove the power cord before attempting to service the printer.

If the part is damaged and cannot be cleaned, use the table below to identify the correct part number for your printer. To order the part, go to www.hp.com/buy/parts.

Table 5-97 Part information

Part number	Part description
RK3-0762-000CN	Fan (Fuser fan)

Required tools

- #2 Phillips screwdriver with a magnetic tip and a 152 mm (6 in) shaft length

After performing service

Turn the printer power on

- Connect the power cable.
- Use the power switch to turn the power on.

Post service test

Print any pages necessary to make sure the printer is functioning correctly.

1. Remove the formatter cover

Follow these steps to remove the formatter cover.

- Remove one screw (callout 1), and then slide the formatter cover (callout 2) away from the printer to remove it.

 **TIP:** Reverse the removal steps to install the assembly.

Figure 5-782 Remove the formatter cover



2. Remove the formatter

Follow these steps to remove the formatter.

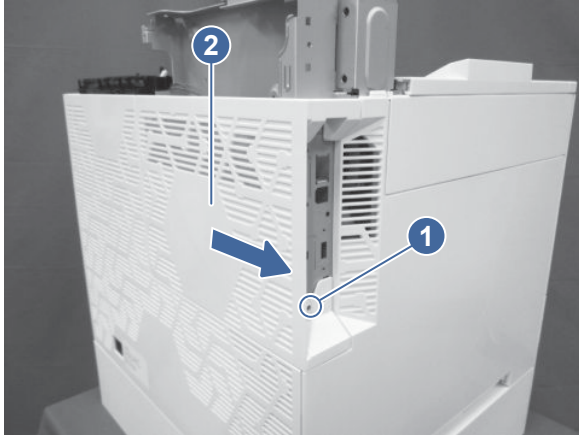
1. Disconnect all of the connectors on the formatter.

 **IMPORTANT:** Some of the flat flexible cable (FFC) connectors use hinged retainers to secure them to the DC controller. The hinged retainers must be opened to release the FFCs.

2. Remove the fax PCA (callout 1) and the hard disk drive (HDD) (callout 2), and then remove seven screws (callout 3) to remove the formatter.

Figure 5-783 Remove the formatter

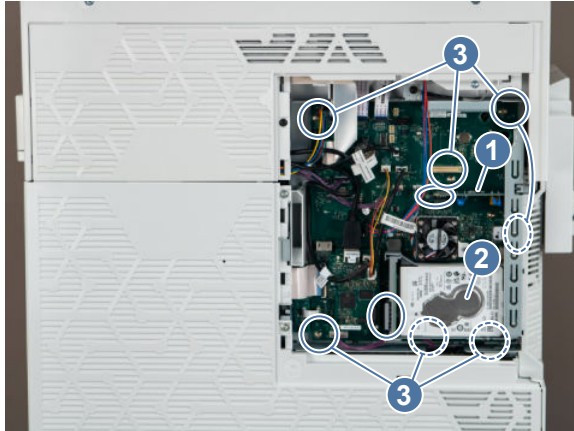

3. Remove the rear cover

Follow these steps to remove the rear cover.

 **NOTE:** The figures below show some assemblies (for example the top cover and formatter) removed that might still be installed on the printer. However, the steps to remove the cover are correct.

1. Open the right door, and remove two screws.

Figure 5-784 Remove two screws

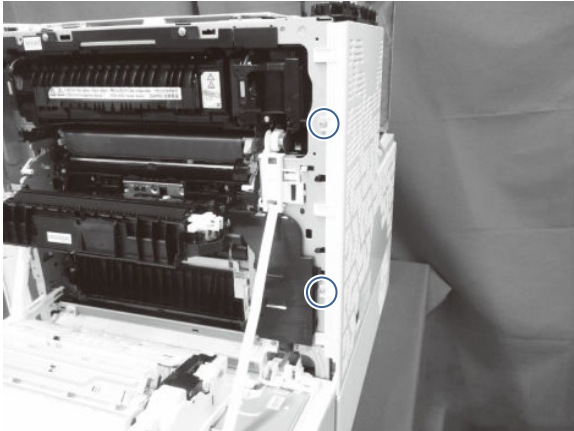

2. At the back of the printer, remove two screws, and then slide the rear cover as indicated to remove it.

Figure 5-785 Remove the rear cover

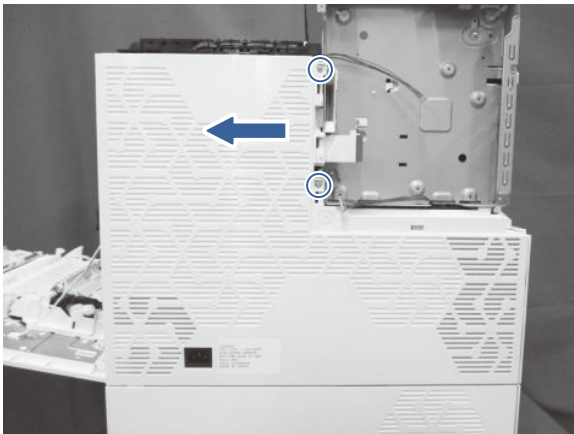

4. Remove the formatter cage (SFP models)

Follow these steps to remove the formatter cage.

1. Disconnect all the connectors on the DC controller PCA.

 **IMPORTANT:** Some of the flat flexible cable (FFC) connectors use hinged retainers to secure them to the DC controller. The hinged retainers must be opened to release the FFCs.

2. Remove the cable clamp (callout 1), remove four screws (callout 2), and then slide the DC controller stay (callout 3) out to remove it.

 **NOTE:** Be careful not to drop any of the screws into the low-voltage power supply assembly below the DC controller.

Figure 5-786 Remove the DC controller stay



3. Unhook one spring (callout 1), release the cable (callout 2) from the cable clamp (callout 3), remove four screws (callout 4), and then remove the formatter cage (callout 5).

Figure 5-787 Remove the formatter cage

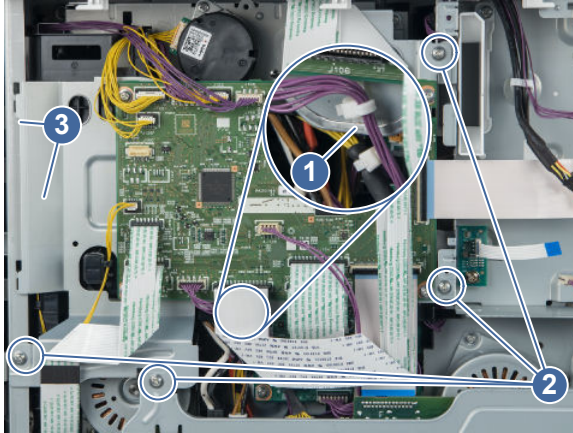
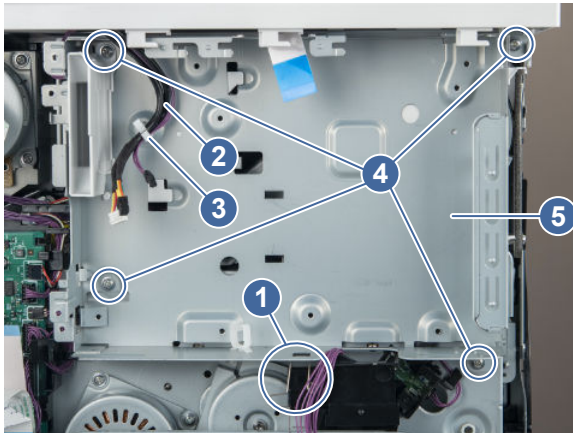

4. **For a replacement formatter cage only:** Release the cable (callout 1) from the cable guide (callout 2), release one tab (callout 3), and then remove the memory PCA (callout 4) from the formatter cage (callout 5).

 **NOTE:** Install the PCA on the replacement formatter cage.

Figure 5-788 Remove the memory PCA



5. Remove the formatter cage (MFP models)

Follow these steps to remove the formatter cage.

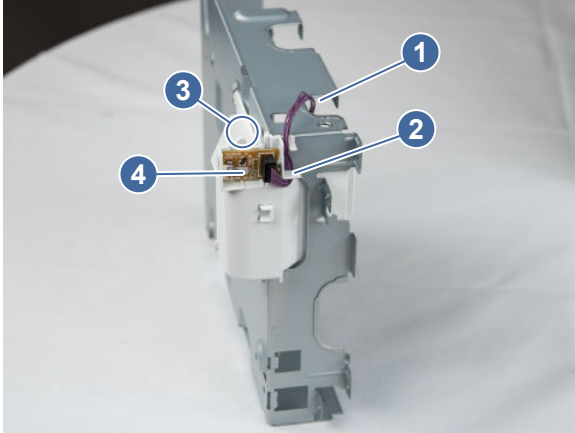
1. Unhook one spring (callout 1), remove seven screws (callout 2), and then remove the formatter cage (callout 3).

Figure 5-789 Remove the formatter cage

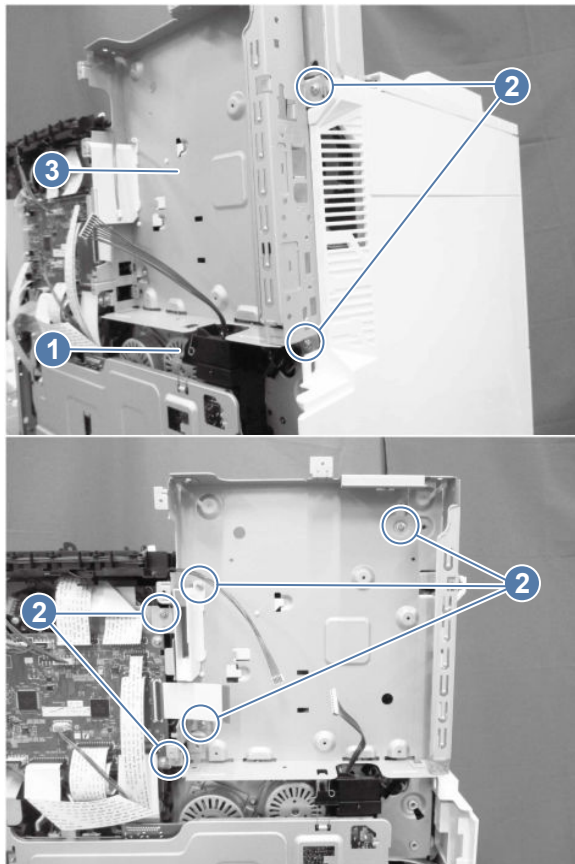

2. **For a replacement formatter cage only:** Release the cable (callout 1) from the cable guide (callout 2), release one tab (callout 3), and then remove the memory PCA (callout 4) from the formatter cage (callout 5).

 **NOTE:** Install the PCA on the replacement formatter cage.

Figure 5-790 Remove the memory PCA



6. Remove the fuser fan

Follow these steps to remove the fuser fan.

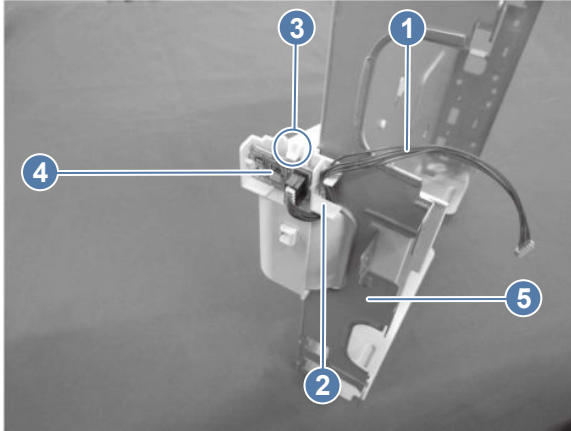
1. Disconnect one connector (callout 1), release one tab (callout 2), slide the fan holder (callout 3) in the direction indicated, and then pull the fan holder (callout 3) out of the printer.

Figure 5-791 Remove the fan holder

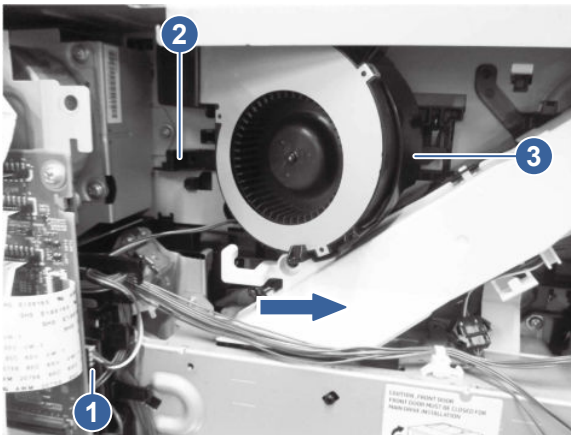

2. Release one tab (callout 1), and then remove the fuser fan (callout 2).

Figure 5-792 Remove the fan from the holder

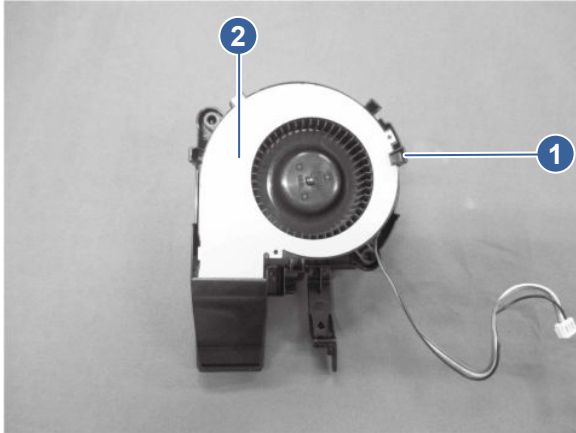

7. Unpack the replacement assembly

Follow these steps to unpack the replacement assembly.

1. Dispose of the defective part.



NOTE: HP recommends responsible disposal of the defective part.

<http://www8.hp.com/us/en/hp-information/environment/product-recycling.html>

2. Unpack the replacement part from the packaging.



CAUTION:  Some parts are sensitive to electrostatic discharge (ESD). Always perform service work at an ESD-protected workstation or mat. If an ESD workstation or mat is not available, touch the sheet-metal chassis to provide a static ground before touching an ESD-sensitive assembly. Protect the ESD-sensitive assemblies by placing them in ESD pouches when they are out of the printer.



IMPORTANT: Make sure that all of the shipping materials (for example shipping tape) are removed from the replacement part prior to installation.



NOTE: If the replacement part is a roller or pad, avoid touching the spongy part of it. Skin oils on the roller or pad can cause paper pickup and/or print-quality problems. HP recommends using disposable gloves when handling rollers or pads or washing your hands before touching rollers or pads.

3. To install an assembly, reverse the removal steps.



NOTE: When applicable, special installation instructions are provided for an assembly at the end of the removal procedure. Always completely read the removal instructions and follow all special installation instructions.

Input device - 550-sheet paper feeder

Learn how to remove and replace the 550-sheet paper feeder parts and assemblies.

Field-replaceable units (FRUs)

Learn about FRU parts removal and replacement.

Covers, panels, and doors

Learn about covers, panels, and doors removal and replacement.

Removal and replacement: Front left cover (550-sheet paper feeder)

Learn about removing and replacing the paper feeder left cover.

Before performing service

Turn the printer power off

- Disconnect the power cable.

⚠ WARNING! To avoid damage to the printer, turn the printer off, wait 30 seconds, and then remove the power cord before attempting to service the printer.

Use the table below to identify the correct part number for your printer, and then go to <https://parts.hp.com/hpparts> to order the part.

Table 5-98 Part information

Part number	Part description
RC5-9200-000CN	Cover, front left (1x550-sheet paper feeder)

Required tools

- No special tools are required to remove or install this assembly.

After performing service

Turn the printer power on

- Connect the power cable.
- Use the power switch to turn the power on.

Post service test

No post service test is available for this assembly.

1. Remove the front left cover (550-sheet paper feeder)

Follow these steps to remove the 550-sheet tray front left cover.

- Flex the upper part of the front left cover (callout 1) in the direction indicated, release one tab (callout 2), and then slide the front left cover upward to remove it.

Figure 5-793 Remove the front left cover (550-sheet paper feeder)

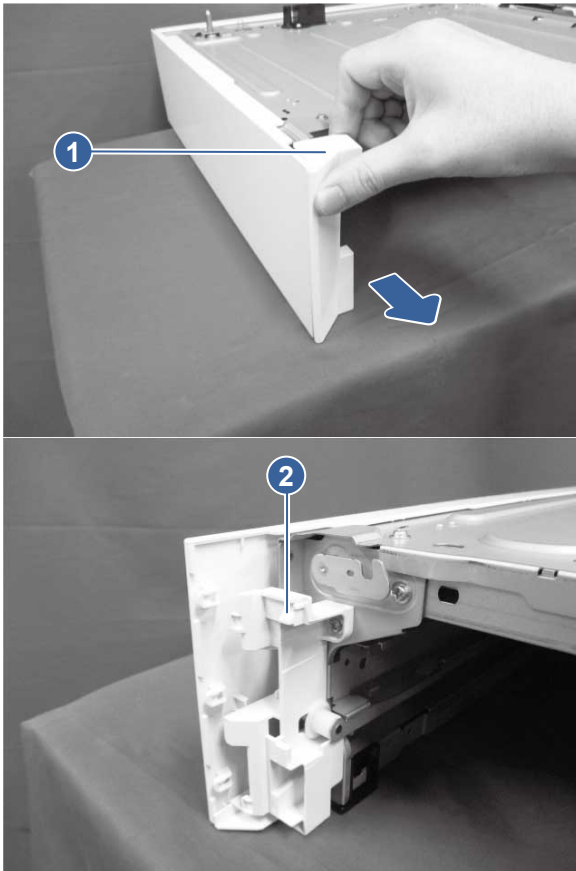

2. Unpack the replacement assembly

Follow these steps to unpack the replacement assembly.

1. Dispose of the defective part.



NOTE: HP recommends responsible disposal of the defective part.

<http://www8.hp.com/us/en/hp-information/environment/product-recycling.html>

2. Unpack the replacement part from the packaging.



CAUTION:  Some parts are sensitive to electrostatic discharge (ESD). Always perform service work at an ESD-protected workstation or mat. If an ESD workstation or mat is not available, touch the sheet-metal chassis to provide a static ground before touching an ESD-sensitive assembly. Protect the ESD-sensitive assemblies by placing them in ESD pouches when they are out of the printer.



IMPORTANT: Make sure that all of the shipping materials (for example shipping tape) are removed from the replacement part prior to installation.



NOTE: If the replacement part is a roller or pad, avoid touching the spongy part of it. Skin oils on the roller or pad can cause paper pickup and/or print-quality problems. HP recommends using

disposable gloves when handling rollers or pads or washing your hands before touching rollers or pads.

3. To install an assembly, reverse the removal steps.

 **NOTE:** When applicable, special installation instructions are provided for an assembly at the end of the removal procedure. Always completely read the removal instructions and follow all special installation instructions.

Removal and replacement: Front right cover (550-sheet paper feeder)

Learn about removing and replacing the paper feeder front right cover.

Before performing service

Turn the printer power off

- Disconnect the power cable.

 **WARNING!** To avoid damage to the printer, turn the printer off, wait 30 seconds, and then remove the power cord before attempting to service the printer.

Use the table below to identify the correct part number for your printer, and then go to <https://parts.hp.com/hpparts> to order the part.

Table 5-99 Part information

Part number	Part description
RC5-9201-000CN	Cover, front right (1x550-sheet paper feeder)

Required tools

- No special tools are required to remove or install this assembly.

After performing service

Turn the printer power on

- Connect the power cable.
- Use the power switch to turn the power on.

Post service test

No post service test is available for this assembly.

1. Remove the front right cover (550-sheet paper feeder)

Follow these steps to remove the 550-sheet tray front right cover.

1. Open the paper feeder right door.

2. Release one tab (callout 1), and then slide the front right cover (callout 2) upward to remove it.

Figure 5-794 Remove the front right cover (550-sheet paper feeder)

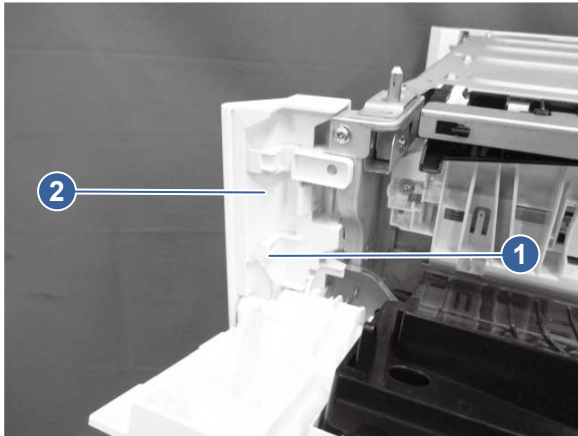

2. Unpack the replacement assembly

Follow these steps to unpack the replacement assembly.

1. Dispose of the defective part.



NOTE: HP recommends responsible disposal of the defective part.

<http://www8.hp.com/us/en/hp-information/environment/product-recycling.html>

2. Unpack the replacement part from the packaging.



CAUTION:  Some parts are sensitive to electrostatic discharge (ESD). Always perform service work at an ESD-protected workstation or mat. If an ESD workstation or mat is not available, touch the sheet-metal chassis to provide a static ground before touching an ESD-sensitive assembly. Protect the ESD-sensitive assemblies by placing them in ESD pouches when they are out of the printer.



IMPORTANT: Make sure that all of the shipping materials (for example shipping tape) are removed from the replacement part prior to installation.



NOTE: If the replacement part is a roller or pad, avoid touching the spongy part of it. Skin oils on the roller or pad can cause paper pickup and/or print-quality problems. HP recommends using disposable gloves when handling rollers or pads or washing your hands before touching rollers or pads.

3. To install an assembly, reverse the removal steps.



NOTE: When applicable, special installation instructions are provided for an assembly at the end of the removal procedure. Always completely read the removal instructions and follow all special installation instructions.

Removal and replacement: Right door (550-sheet paper feeder)

Learn about removing and replacing the paper right door.

Before performing service

Turn the printer power off

- Disconnect the power cable.

⚠ WARNING! To avoid damage to the printer, turn the printer off, wait 30 seconds, and then remove the power cord before attempting to service the printer.

Use the table below to identify the correct part number for your printer, and then go to <https://parts.hp.com/hpparts> to order the part.

Table 5-100 Part information

Part number	Part description
RM3-0004-000CN	Right door assembly (1x550-sheet paper feeder)

Required tools

- No special tools are required to remove or install this assembly.

After performing service

Turn the printer power on

- Connect the power cable.
- Use the power switch to turn the power on.

Post service test

No post service test is available for this assembly.

1. Remove the front right cover (550-sheet paper feeder)

Follow these steps to remove the 550-sheet tray front right cover.

1. Open the paper feeder right door.
2. Release one tab (callout 1), and then slide the front right cover (callout 2) upward to remove it.

Figure 5-795 Remove the front right cover (550-sheet paper feeder)

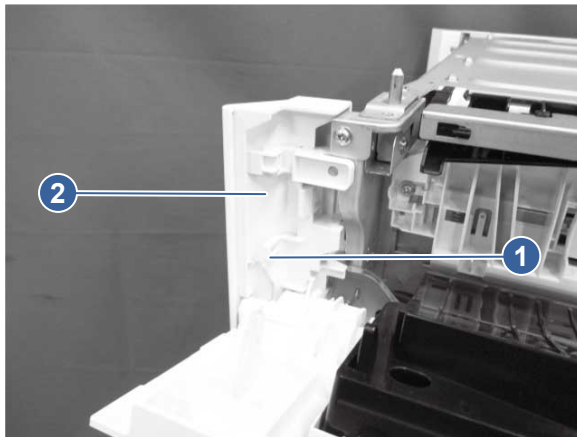

2. Remove the right door (550-sheet paper feeder)

Follow these steps to remove the 550-sheet tray right door.

1. Remove two screws (callout 1), and then remove the base frame (callout 2).

Figure 5-796 Remove the base frame

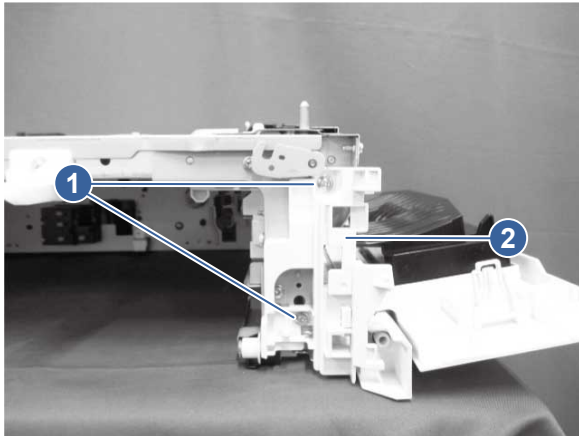

2. Remove one screw (callout 1), release one tab (callout 2), and then slide the rear inner cover (callout 3) downward to remove it.

Figure 5-797 Remove the rear inner cover

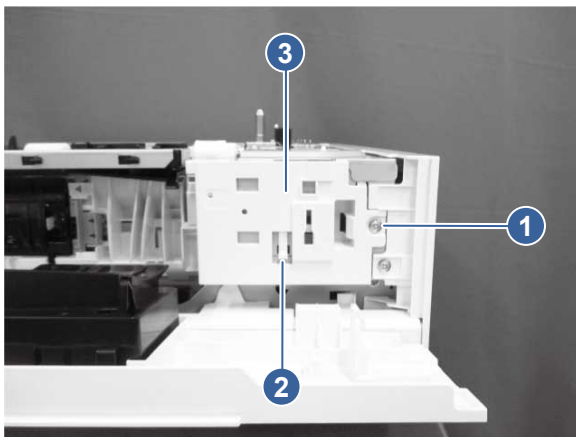

3. Release one tab (callout 1), and then slide the right door assembly (callout 2) in the direction indicated to remove it.

Figure 5-798 Remove the right door (550-sheet paper feeder)

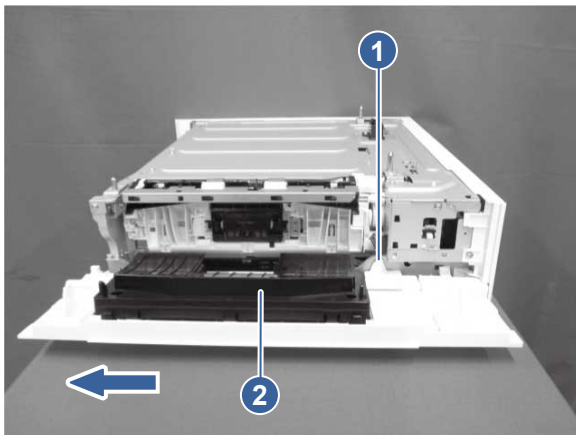

3. Unpack the replacement assembly

Follow these steps to unpack the replacement assembly.

1. Dispose of the defective part.



NOTE: HP recommends responsible disposal of the defective part.

<http://www8.hp.com/us/en/hp-information/environment/product-recycling.html>

2. Unpack the replacement part from the packaging.



CAUTION:  Some parts are sensitive to electrostatic discharge (ESD). Always perform service work at an ESD-protected workstation or mat. If an ESD workstation or mat is not available, touch the sheet-metal chassis to provide a static ground before touching an ESD-sensitive assembly. Protect the ESD-sensitive assemblies by placing them in ESD pouches when they are out of the printer.



IMPORTANT: Make sure that all of the shipping materials (for example shipping tape) are removed from the replacement part prior to installation.



NOTE: If the replacement part is a roller or pad, avoid touching the spongy part of it. Skin oils on the roller or pad can cause paper pickup and/or print-quality problems. HP recommends using disposable gloves when handling rollers or pads or washing your hands before touching rollers or pads.

3. To install an assembly, reverse the removal steps.



NOTE: When applicable, special installation instructions are provided for an assembly at the end of the removal procedure. Always completely read the removal instructions and follow all special installation instructions.

Removal and replacement: Rear cover (550-sheet paper feeder)

Learn about removing and replacing the paper feeder rear cover.

Before performing service

Turn the printer power off

- Disconnect the power cable.



WARNING! To avoid damage to the printer, turn the printer off, wait 30 seconds, and then remove the power cord before attempting to service the printer.

Use the table below to identify the correct part number for your printer, and then go to <https://parts.hp.com/hpparts> to order the part.

Table 5-101 Part information

Part number	Part description
RC5-9409-000CN	Cover, rear (1x550-sheet paper feeder)

Required tools

- No special tools are required to remove or install this assembly.

After performing service

Turn the printer power on

- Connect the power cable.
- Use the power switch to turn the power on.

Post service test

No post service test is available for this assembly.

1. Remove the front right cover (550-sheet paper feeder)

Follow these steps to remove the 550-sheet tray front right cover.

1. Open the paper feeder right door.
2. Release one tab (callout 1), and then slide the front right cover (callout 2) upward to remove it.

Figure 5-799 Remove the front right cover (550-sheet paper feeder)

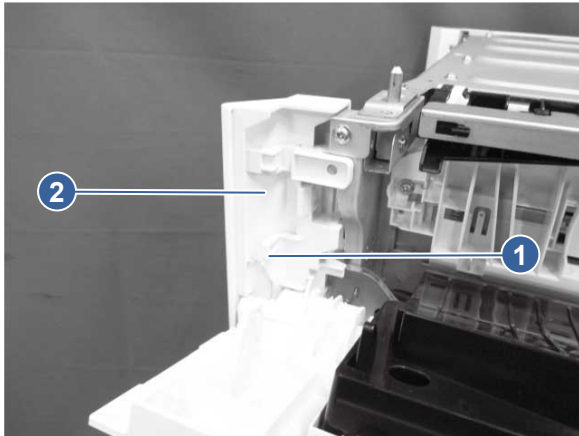

2. Remove the right door (550-sheet paper feeder)

Follow these steps to remove the 550-sheet tray right door.

1. Remove two screws (callout 1), and then remove the base frame (callout 2).

Figure 5-800 Remove the base frame

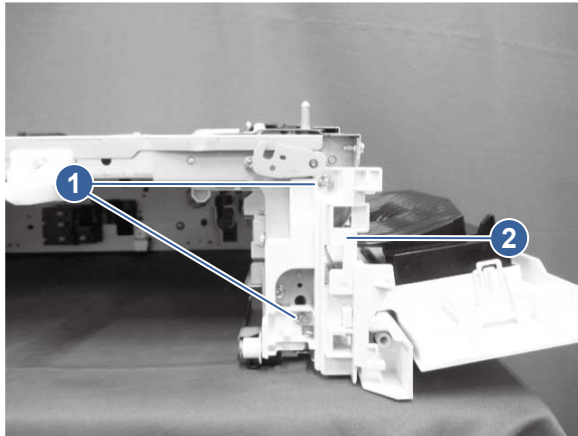

2. Remove one screw (callout 1), release one tab (callout 2), and then slide the rear inner cover (callout 3) downward to remove it.

Figure 5-801 Remove the rear inner cover

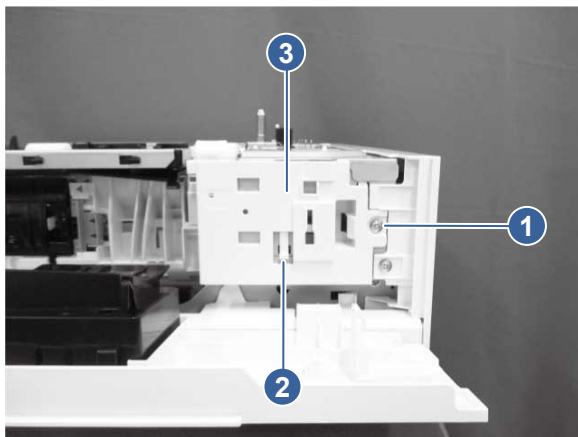

3. Release one tab (callout 1), and then slide the right door assembly (callout 2) in the direction indicated to remove it.

Figure 5-802 Remove the right door (550-sheet paper feeder)

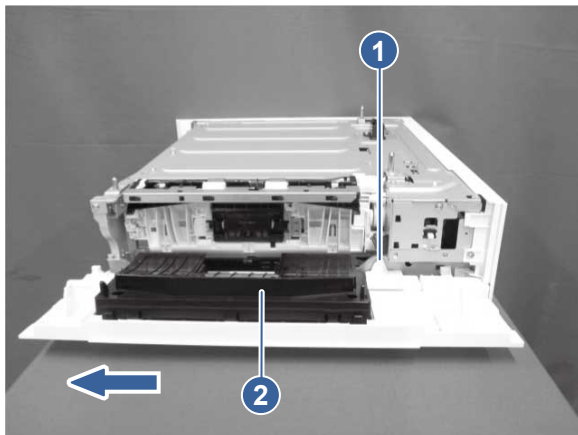

3. Remove the rear cover (550-sheet paper feeder)

Follow these steps to remove the 550-sheet tray rear cover.

- Remove one screw (callout 1), and then slide the rear cover (callout 2) in the direction indicated to remove it.

Figure 5-803 Remove the rear cover (550-sheet paper feeder)

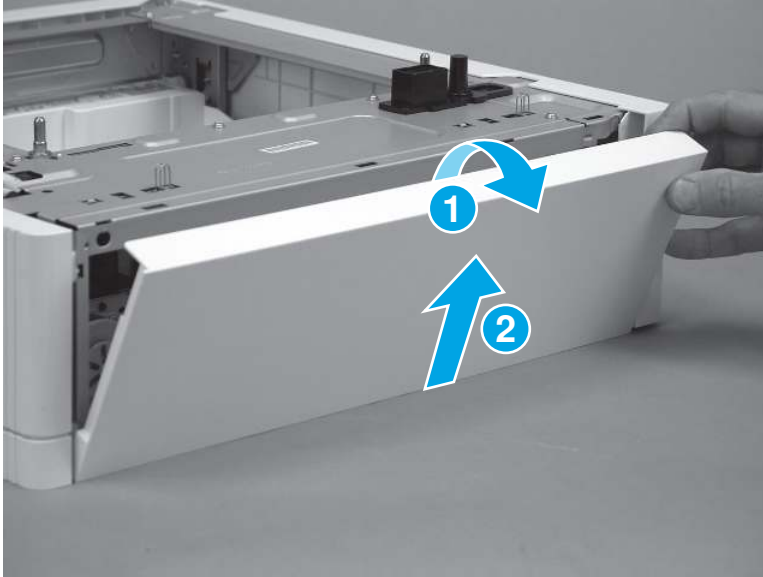

4. Unpack the replacement assembly

Follow these steps to unpack the replacement assembly.

1. Dispose of the defective part.



NOTE: HP recommends responsible disposal of the defective part.

<http://www8.hp.com/us/en/hp-information/environment/product-recycling.html>

2. Unpack the replacement part from the packaging.



CAUTION:  Some parts are sensitive to electrostatic discharge (ESD). Always perform service work at an ESD-protected workstation or mat. If an ESD workstation or mat is not available, touch the sheet-metal chassis to provide a static ground before touching an ESD-sensitive assembly. Protect the ESD-sensitive assemblies by placing them in ESD pouches when they are out of the printer.



IMPORTANT: Make sure that all of the shipping materials (for example shipping tape) are removed from the replacement part prior to installation.



NOTE: If the replacement part is a roller or pad, avoid touching the spongy part of it. Skin oils on the roller or pad can cause paper pickup and/or print-quality problems. HP recommends using disposable gloves when handling rollers or pads or washing your hands before touching rollers or pads.

- To install an assembly, reverse the removal steps.

 **NOTE:** When applicable, special installation instructions are provided for an assembly at the end of the removal procedure. Always completely read the removal instructions and follow all special installation instructions.

Removal and replacement: Left cover (550-sheet paper feeder)

Learn about removing and replacing the paper feeder left cover.

Before performing service

Turn the printer power off

- Disconnect the power cable.

 **WARNING!** To avoid damage to the printer, turn the printer off, wait 30 seconds, and then remove the power cord before attempting to service the printer.

Use the table below to identify the correct part number for your printer, and then go to <https://parts.hp.com/hpparts> to order the part.

Table 5-102 Part information

Part number	Part description
RC5-9408-000CN	Cover, left (1x550-sheet paper feeder)

Required tools

- No special tools are required to remove or install this assembly.

After performing service

Turn the printer power on

- Connect the power cable.
- Use the power switch to turn the power on.

Post service test

No post service test is available for this assembly.

1. Remove the front right cover (550-sheet paper feeder)

Follow these steps to remove the 550-sheet tray front right cover.

1. Open the paper feeder right door.

2. Release one tab (callout 1), and then slide the front right cover (callout 2) upward to remove it.

Figure 5-804 Remove the front right cover (550-sheet paper feeder)

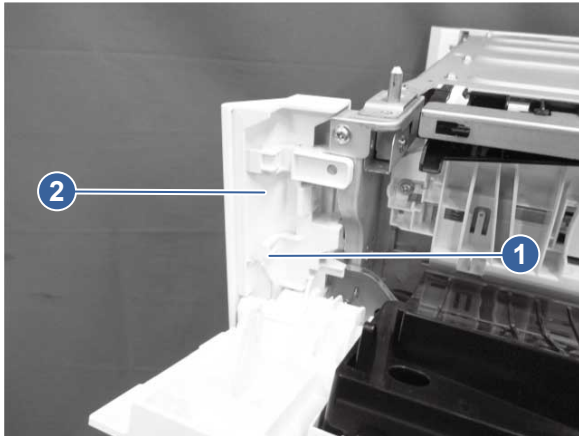

2. Remove the right door (550-sheet paper feeder)

Follow these steps to remove the 550-sheet tray right door.

1. Remove two screws (callout 1), and then remove the base frame (callout 2).

Figure 5-805 Remove the base frame

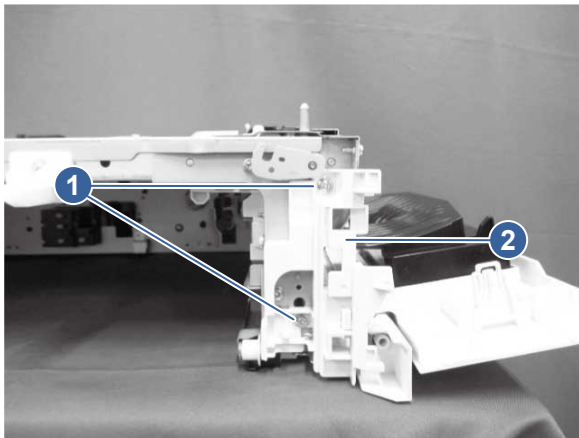

2. Remove one screw (callout 1), release one tab (callout 2), and then slide the rear inner cover (callout 3) downward to remove it.

Figure 5-806 Remove the rear inner cover

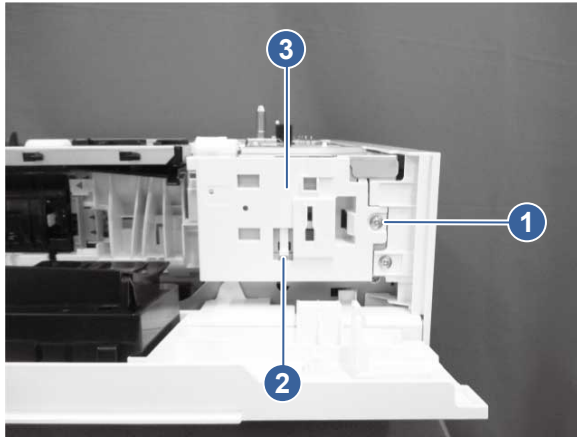

3. Release one tab (callout 1), and then slide the right door assembly (callout 2) in the direction indicated to remove it.

Figure 5-807 Remove the right door (550-sheet paper feeder)

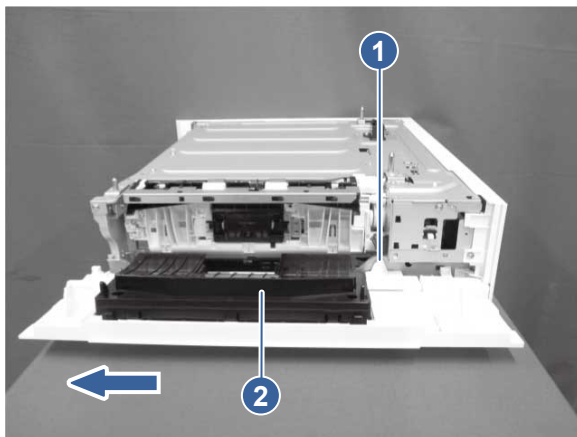

3. Remove the rear cover (550-sheet paper feeder)

Follow these steps to remove the 550-sheet tray rear cover.

- Remove one screw (callout 1), and then slide the rear cover (callout 2) in the direction indicated to remove it.

Figure 5-808 Remove the rear cover (550-sheet paper feeder)

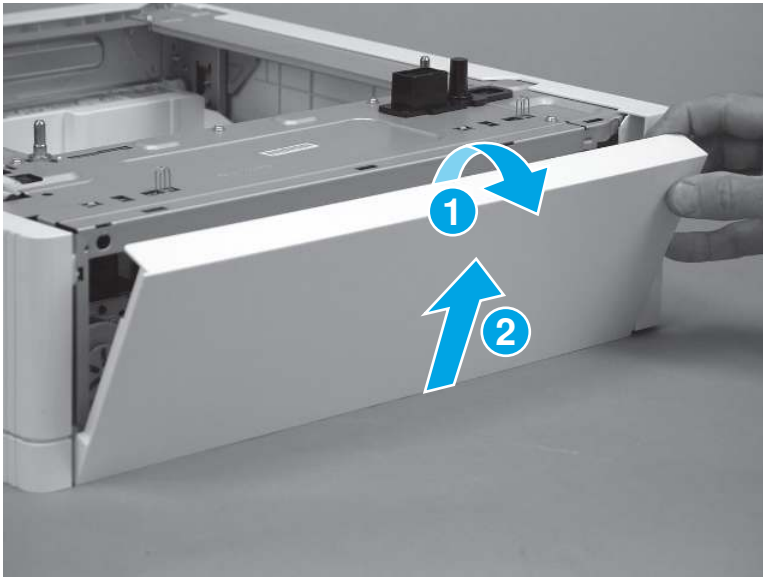

4. Remove the left cover (550-sheet paper feeder)

Follow these steps to remove the 550-sheet tray left cover.

- Slide the left cover (callout 1) in the direction indicated to remove it.

Figure 5-809 Remove the left cover

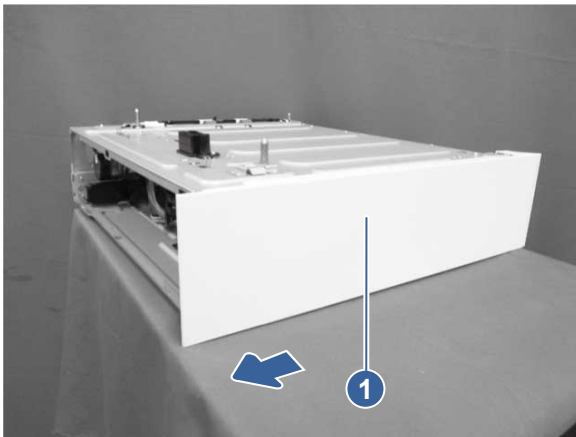

5. Unpack the replacement assembly

Follow these steps to unpack the replacement assembly.



1. Dispose of the defective part.





NOTE: HP recommends responsible disposal of the defective part.

<http://www8.hp.com/us/en/hp-information/environment/product-recycling.html>

2. Unpack the replacement part from the packaging.

 **CAUTION:**  Some parts are sensitive to electrostatic discharge (ESD). Always perform service work at an ESD-protected workstation or mat. If an ESD workstation or mat is not available, touch the sheet-metal chassis to provide a static ground before touching an ESD-sensitive assembly. Protect the ESD-sensitive assemblies by placing them in ESD pouches when they are out of the printer.

 **IMPORTANT:** Make sure that all of the shipping materials (for example shipping tape) are removed from the replacement part prior to installation.

 **NOTE:** If the replacement part is a roller or pad, avoid touching the spongy part of it. Skin oils on the roller or pad can cause paper pickup and/or print-quality problems. HP recommends using disposable gloves when handling rollers or pads or washing your hands before touching rollers or pads.

3. To install an assembly, reverse the removal steps.

 **NOTE:** When applicable, special installation instructions are provided for an assembly at the end of the removal procedure. Always completely read the removal instructions and follow all special installation instructions.

Internal parts and assemblies

Learn how to remove and replace the printer internal parts and assemblies.

Removal and replacement: Pickup assembly (550-sheet paper feeder)

Learn about removing and replacing the paper feeder pickup assembly.

Before performing service

Turn the printer power off

- Disconnect the power cable.

 **WARNING!** To avoid damage to the printer, turn the printer off, wait 30 seconds, and then remove the power cord before attempting to service the printer.

Use the table below to identify the correct part number for your printer, and then go to <https://parts.hp.com/hpparts> to order the part.

Table 5-103 Part information

Part number	Part description
RM2-3617-000CN	Paper pickup drive assembly (1x550-sheet paper feeder)

Required tools

- #2 Phillips screwdriver with a magnetic tip and a 152 mm (6 in) shaft length
- Small flat-blade screwdriver

After performing service

Turn the printer power on

- Connect the power cable.
- Use the power switch to turn the power on.

Post service test

Print any pages necessary to make sure the printer is functioning correctly.

1. Remove the front right cover (550-sheet paper feeder)

Follow these steps to remove the 550-sheet tray front right cover.

1. Open the paper feeder right door.
2. Release one tab (callout 1), and then slide the front right cover (callout 2) upward to remove it.

Figure 5-810 Remove the front right cover (550-sheet paper feeder)

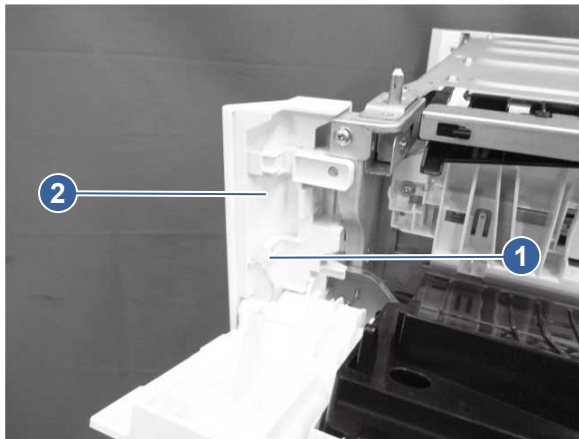

2. Remove the rear cover (550-sheet paper feeder)

Follow these steps to remove the 550-sheet tray rear cover.

- Remove one screw (callout 1), and then slide the rear cover (callout 2) in the direction indicated to remove it.

Figure 5-811 Remove the rear cover (550-sheet paper feeder)

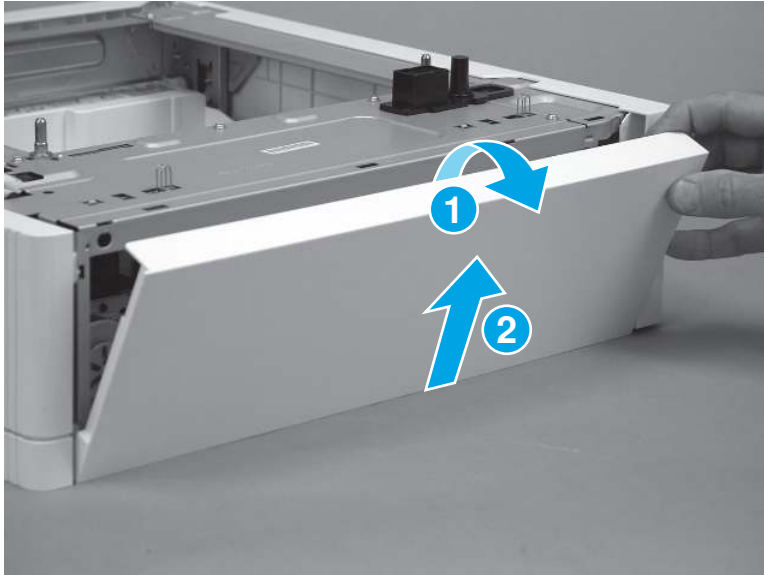

3. Remove the paper pickup assembly (550-sheet paper feeder)

Follow these steps to remove the paper pickup assembly.

1. Disconnect one connector (callout 1), remove one screw (callout 2), and then remove the pickup assembly (callout 3).

Figure 5-812 Remove the assembly

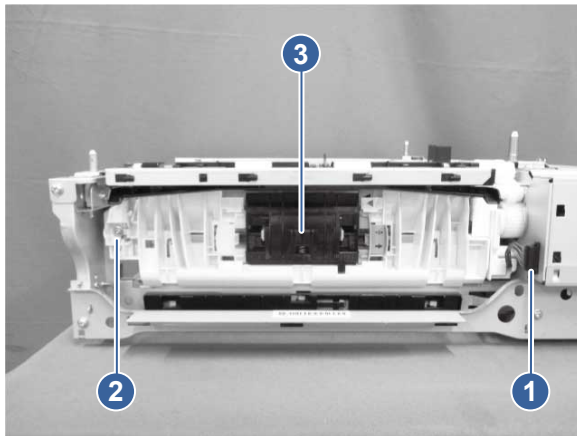

2. Remove the gear (callout 1) from the pickup assembly (callout 2).

Figure 5-813 Disconnect one connector

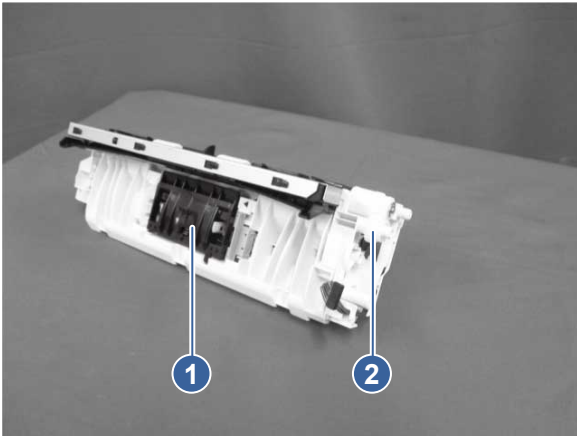

3. Remove three screws (callout 1).

Figure 5-814 Remove three screws

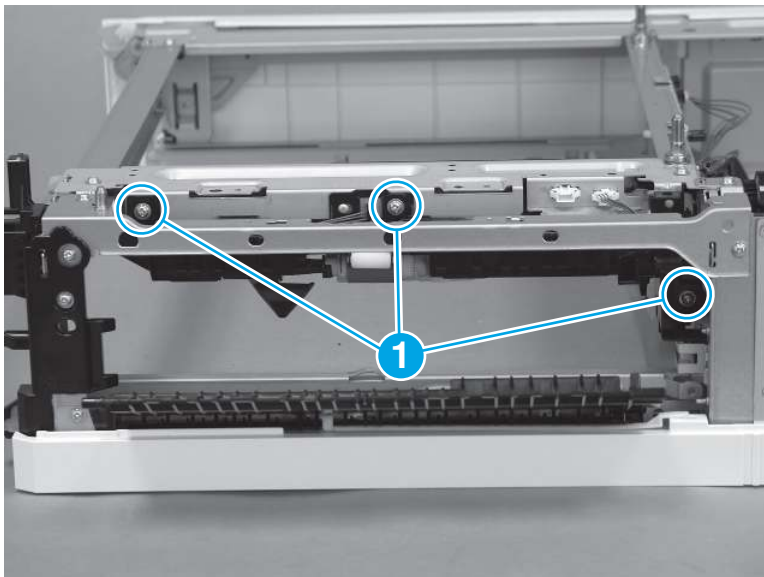

4. Release one alignment pins (callout 1), and then lower the left end of the assembly (callout 2)—the end near the tray cavity.

Figure 5-815 Lower the end of the assembly

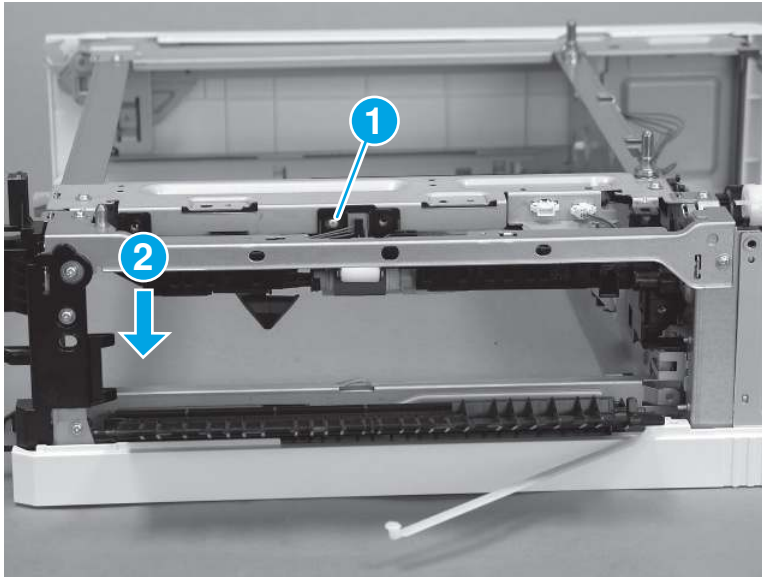

5. Slide the paper pickup assembly to the left to release it from the drive gear on the lifter drive assembly.

Figure 5-816 Release the assembly from the drive gear

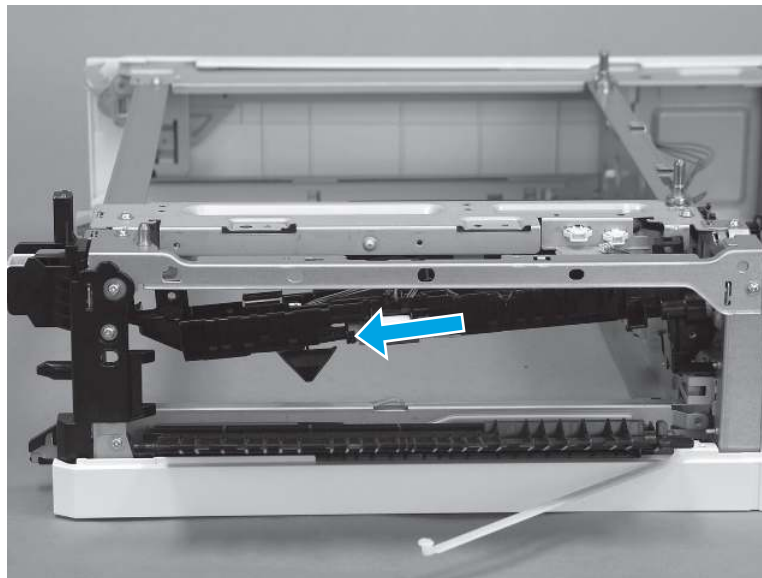

4. Unpack the replacement assembly

Follow these steps to unpack the replacement assembly.



1. Dispose of the defective part.





NOTE: HP recommends responsible disposal of the defective part.

<http://www8.hp.com/us/en/hp-information/environment/product-recycling.html>

2. Unpack the replacement part from the packaging.

 **CAUTION:**  Some parts are sensitive to electrostatic discharge (ESD). Always perform service work at an ESD-protected workstation or mat. If an ESD workstation or mat is not available, touch the sheet-metal chassis to provide a static ground before touching an ESD-sensitive assembly. Protect the ESD-sensitive assemblies by placing them in ESD pouches when they are out of the printer.

 **IMPORTANT:** Make sure that all of the shipping materials (for example shipping tape) are removed from the replacement part prior to installation.

 **NOTE:** If the replacement part is a roller or pad, avoid touching the spongy part of it. Skin oils on the roller or pad can cause paper pickup and/or print-quality problems. HP recommends using disposable gloves when handling rollers or pads or washing your hands before touching rollers or pads.

3. To install an assembly, reverse the removal steps.

 **NOTE:** When applicable, special installation instructions are provided for an assembly at the end of the removal procedure. Always completely read the removal instructions and follow all special installation instructions.

Removal and replacement: Lifter drive assembly (550-sheet paper feeder)

Learn about removing and replacing the paper feeder lifter drive assembly.

 [View a video demonstration of removing and replacing the lifter drive assembly.](#)

Before performing service

Turn the printer power off

- Disconnect the power cable.

 **WARNING!** To avoid damage to the printer, turn the printer off, wait 30 seconds, and then remove the power cord before attempting to service the printer.

Use the table below to identify the correct part number for your printer, and then go to <https://parts.hp.com/hpparts> to order the part.

Table 5-104 Part information

Part number	Part description
RM2-3501-000CN	Lifter drive assembly (1x550-sheet paper feeder)

Required tools

- #2 Phillips screwdriver with a magnetic tip and a 152 mm (6 in) shaft length
- Small flat-blade screwdriver

After performing service

Turn the printer power on

- Connect the power cable.
- Use the power switch to turn the power on.

Post service test

Print any pages necessary to make sure the printer is functioning correctly.

1. Remove the front right cover (550-sheet paper feeder)

Follow these steps to remove the 550-sheet tray front right cover.

1. Open the paper feeder right door.
2. Release one tab (callout 1), and then slide the front right cover (callout 2) upward to remove it.

Figure 5-817 Remove the front right cover (550-sheet paper feeder)

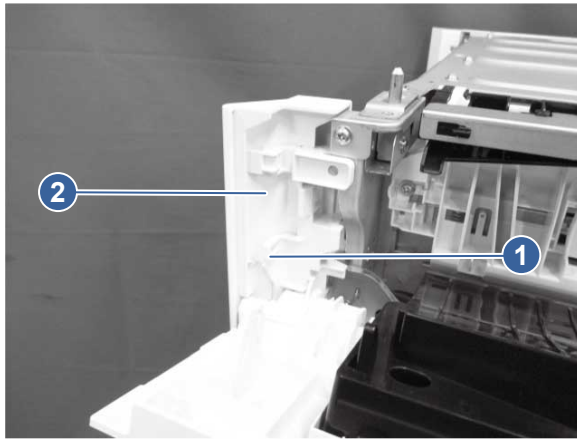

2. Remove the right door (550-sheet paper feeder)

Follow these steps to remove the 550-sheet tray right door.

1. Remove two screws (callout 1), and then remove the base frame (callout 2).

Figure 5-818 Remove the base frame

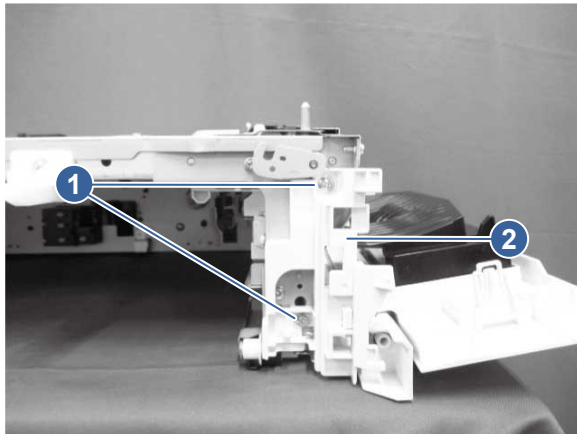

2. Remove one screw (callout 1), release one tab (callout 2), and then slide the rear inner cover (callout 3) downward to remove it.

Figure 5-819 Remove the rear inner cover

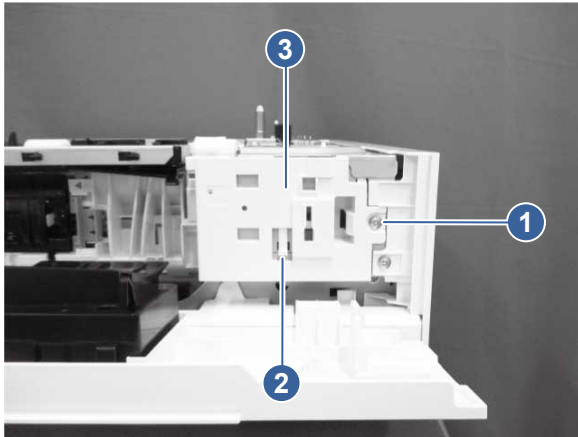

3. Release one tab (callout 1), and then slide the right door assembly (callout 2) in the direction indicated to remove it.

Figure 5-820 Remove the right door (550-sheet paper feeder)

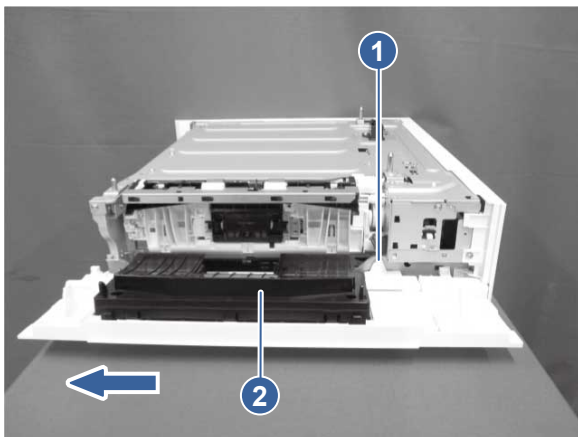

3. Remove the rear cover (550-sheet paper feeder)

Follow these steps to remove the 550-sheet tray rear cover.

- Remove one screw (callout 1), and then slide the rear cover (callout 2) in the direction indicated to remove it.

Figure 5-821 Remove the rear cover (550-sheet paper feeder)

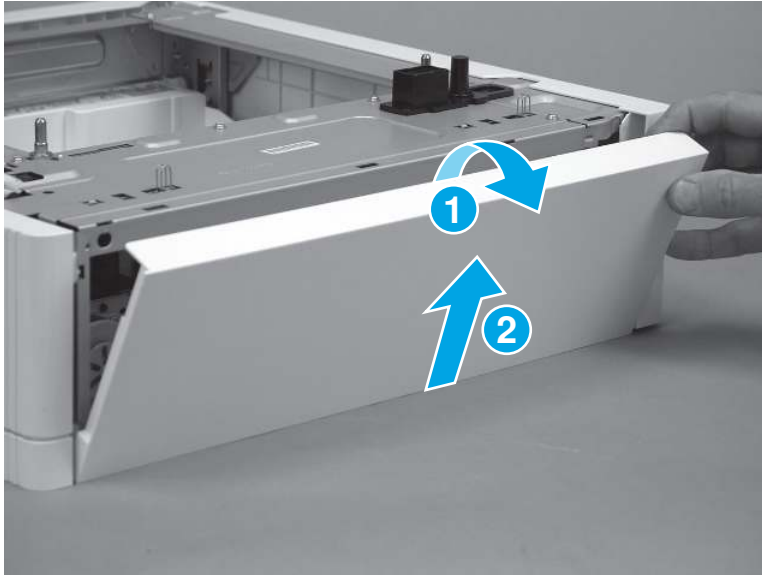

4. Remove the lifter drive assembly (550-sheet paper feeder)

Follow these steps to remove the lifter drive assembly.

1. Disconnect four connectors (callout 1).

Figure 5-822 Disconnect four connectors

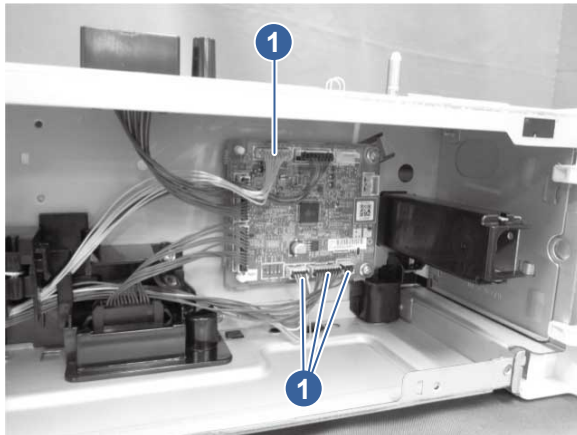

2. Release cables (callout 1) from the auto close assembly (callout 2) and the lifter drive assembly (callout 3). Remove two screws (callout 4), and then remove the lifter drive assembly.

Figure 5-823 Remove the lifter drive assembly (550-sheet paper feeder)

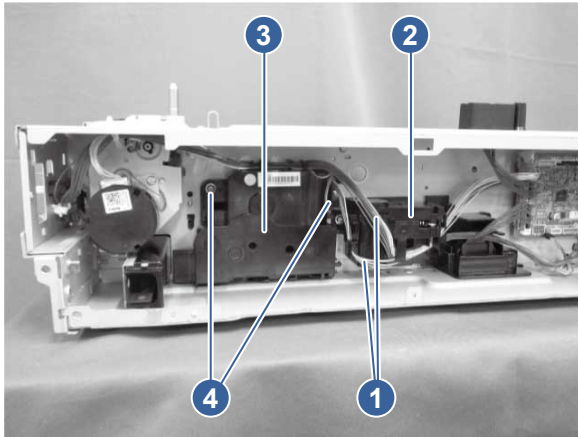

5. Unpack the replacement assembly



Follow these steps to unpack the replacement assembly.

1. Dispose of the defective part.

 **NOTE:** HP recommends responsible disposal of the defective part.

<http://www8.hp.com/us/en/hp-information/environment/product-recycling.html>

2. Unpack the replacement part from the packaging.

 **CAUTION:**  Some parts are sensitive to electrostatic discharge (ESD). Always perform service work at an ESD-protected workstation or mat. If an ESD workstation or mat is not available, touch the sheet-metal chassis to provide a static ground before touching an ESD-sensitive assembly. Protect the ESD-sensitive assemblies by placing them in ESD pouches when they are out of the printer.

 **IMPORTANT:** Make sure that all of the shipping materials (for example shipping tape) are removed from the replacement part prior to installation.

 **NOTE:** If the replacement part is a roller or pad, avoid touching the spongy part of it. Skin oils on the roller or pad can cause paper pickup and/or print-quality problems. HP recommends using disposable gloves when handling rollers or pads or washing your hands before touching rollers or pads.

3. To install an assembly, reverse the removal steps.

 **NOTE:** When applicable, special installation instructions are provided for an assembly at the end of the removal procedure. Always completely read the removal instructions and follow all special installation instructions.

Removal and replacement: Pickup drive assembly (550-sheet paper feeder)

Learn about removing and replacing the paper feeder pickup drive assembly.

 [View a video demonstration of removing and replacing the pickup drive assembly.](#)

Before performing service

Turn the printer power off

- Disconnect the power cable.

⚠ WARNING! To avoid damage to the printer, turn the printer off, wait 30 seconds, and then remove the power cord before attempting to service the printer.

Use the table below to identify the correct part number for your printer, and then go to <https://parts.hp.com/hpparts> to order the part.

Table 5-105 Part Information

Part number	Part description
RM2-3617-000CN	Paper pickup drive assembly (1x550-sheet paper feeder)

Required tools

- #2 Phillips screwdriver with a magnetic tip and a 152 mm (6 in) shaft length
- Small flat-blade screwdriver

After performing service

Turn the printer power on

- Connect the power cable.
- Use the power switch to turn the power on.

Post service test

Print any pages necessary to make sure the printer is functioning correctly.

1. Remove the front right cover (550-sheet paper feeder)

Follow these steps to remove the 550-sheet tray front right cover.

1. Open the paper feeder right door.

2. Release one tab (callout 1), and then slide the front right cover (callout 2) upward to remove it.

Figure 5-824 Remove the front right cover (550-sheet paper feeder)

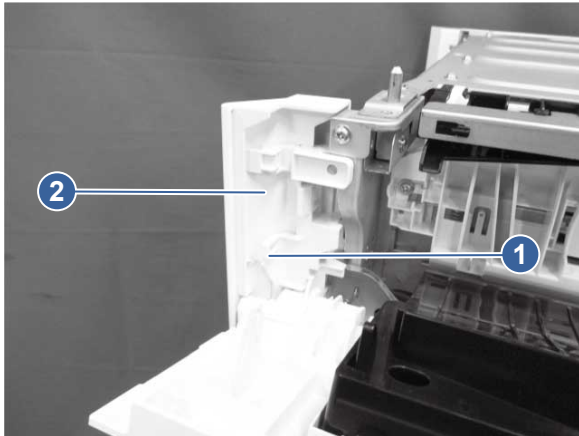

2. Remove the right door (550-sheet paper feeder)

Follow these steps to remove the 550-sheet tray right door.

1. Remove two screws (callout 1), and then remove the base frame (callout 2).

Figure 5-825 Remove the base frame

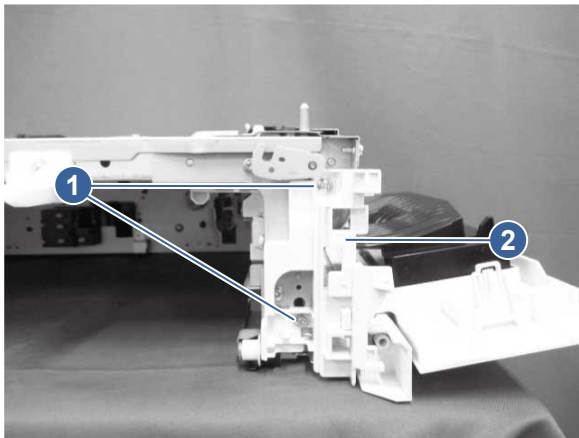

2. Remove one screw (callout 1), release one tab (callout 2), and then slide the rear inner cover (callout 3) downward to remove it.

Figure 5-826 Remove the rear inner cover

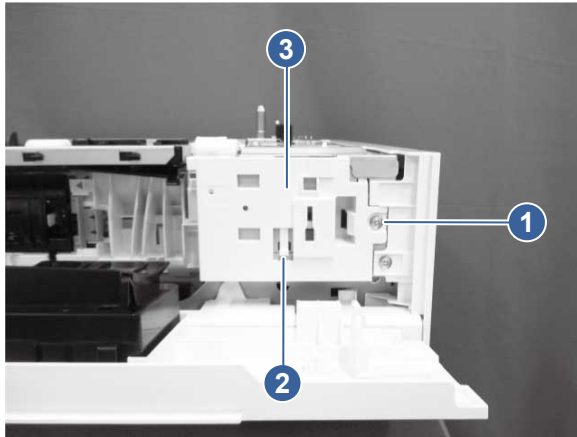

3. Release one tab (callout 1), and then slide the right door assembly (callout 2) in the direction indicated to remove it.

Figure 5-827 Remove the right door (550-sheet paper feeder)

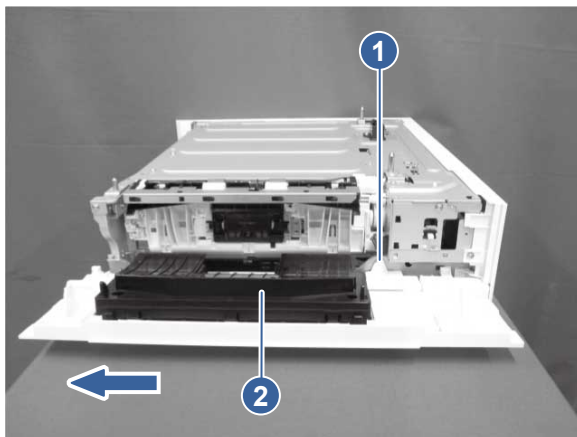

3. Remove the rear cover (550-sheet paper feeder)

Follow these steps to remove the 550-sheet tray rear cover.

- Remove one screw (callout 1), and then slide the rear cover (callout 2) in the direction indicated to remove it.

Figure 5-828 Remove the rear cover (550-sheet paper feeder)

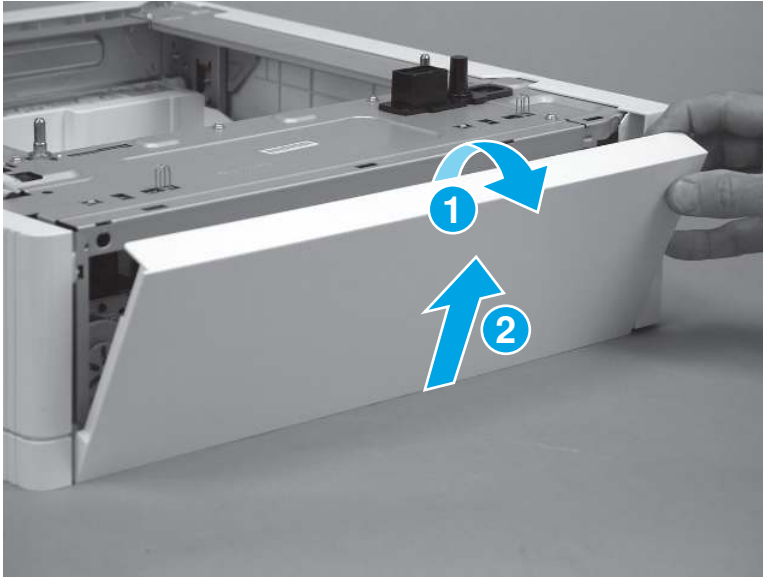

4. Remove the pickup drive assembly (550-sheet paper feeder)

Follow these steps to remove the pickup drive assembly.

1. Disconnect four connectors (callout 1).

Figure 5-829 Disconnect four connectors

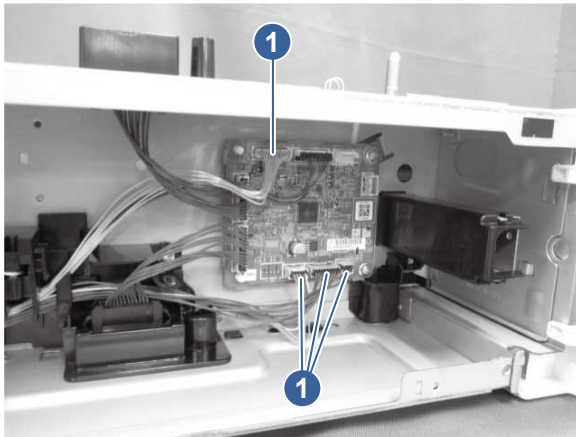

2. Release the cables (callout 1) from the auto close assembly (callout 2) and the lifter drive assembly (callout 3).

Figure 5-830 Release the cables

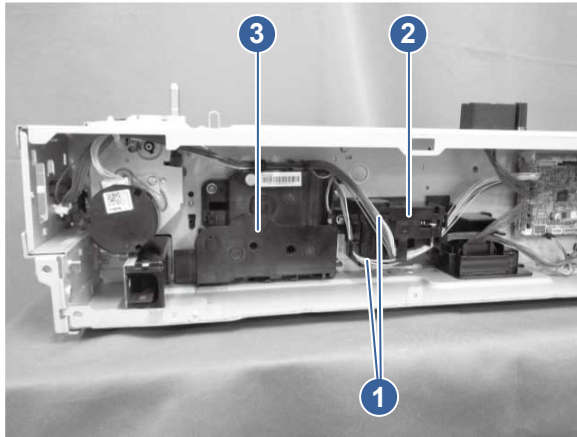

3. Remove the cable clamp (callout 1), disconnect two connectors (callout 2), and then remove three screws (callout 3).

Figure 5-831 Remove the cable clamp

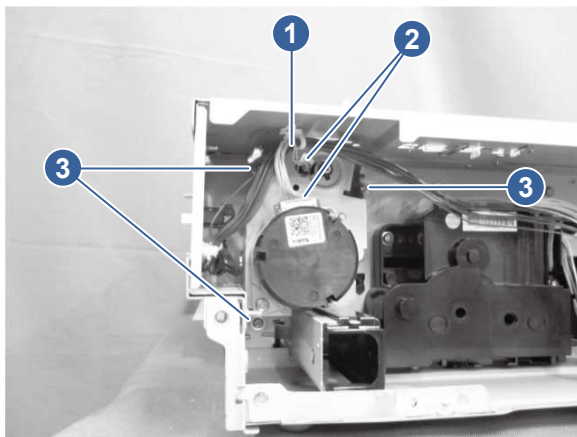

4. Release one tab (callout 1), and then remove the pickup drive assembly (callout 2).

Figure 5-832 Remove the pickup drive assembly (550-sheet paper feeder)

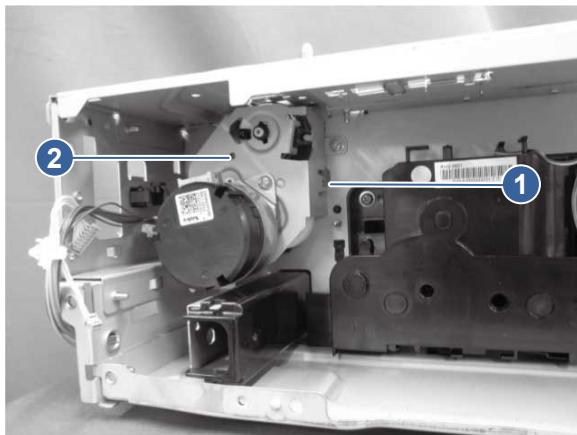

 **Reinstallation tip:** The indicated gears (callout 1), clutch (callout 2), shaft (callout 3), and bushing (callout 4) are not fixed to the assembly plate. Ensure that these components do not fall apart when installing or removing the paper pickup drive assembly.

Figure 5-833 Do not lose unfastened components



5. Unpack the replacement assembly

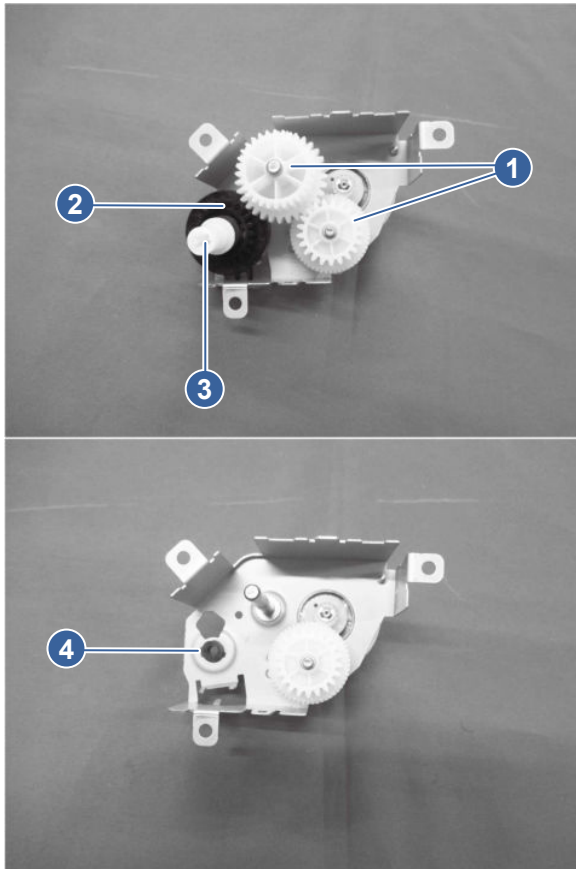

Follow these steps to unpack the replacement assembly.

1. Dispose of the defective part.

 **NOTE:** HP recommends responsible disposal of the defective part.

<http://www8.hp.com/us/en/hp-information/environment/product-recycling.html>

2. Unpack the replacement part from the packaging.

 **CAUTION:**  Some parts are sensitive to electrostatic discharge (ESD). Always perform service work at an ESD-protected workstation or mat. If an ESD workstation or mat is not available, touch the sheet-metal chassis to provide a static ground before touching an ESD-sensitive assembly. Protect the ESD-sensitive assemblies by placing them in ESD pouches when they are out of the printer.

 **IMPORTANT:** Make sure that all of the shipping materials (for example shipping tape) are removed from the replacement part prior to installation.

 **NOTE:** If the replacement part is a roller or pad, avoid touching the spongy part of it. Skin oils on the roller or pad can cause paper pickup and/or print-quality problems. HP recommends using disposable gloves when handling rollers or pads or washing your hands before touching rollers or pads.

3. To install an assembly, reverse the removal steps.

 **NOTE:** When applicable, special installation instructions are provided for an assembly at the end of the removal procedure. Always completely read the removal instructions and follow all special installation instructions.

Removal and replacement: Auto close assembly (550-sheet paper feeder)

Learn about removing and replacing the paper feeder auto close assembly.



[View a video demonstration of removing and replacing the auto close assembly.](#)

Before performing service

Turn the printer power off

- Disconnect the power cable.

 **WARNING!** To avoid damage to the printer, turn the printer off, wait 30 seconds, and then remove the power cord before attempting to service the printer.

Use the table below to identify the correct part number for your printer, and then go to <https://parts.hp.com/hpparts> to order the part.

Table 5-106 Part information

Part number	Part description
RM2-3559-000CN	Auto close assembly (1x550-sheet paper feeder)

Required tools

- #2 Phillips screwdriver with a magnetic tip and a 152 mm (6 in) shaft length

After performing service

Turn the printer power on

- Connect the power cable.
- Use the power switch to turn the power on.

Post service test

No post service test is available for this assembly.

1. Remove the front right cover (550-sheet paper feeder)

Follow these steps to remove the 550-sheet tray front right cover.

1. Open the paper feeder right door.

2. Release one tab (callout 1), and then slide the front right cover (callout 2) upward to remove it.

Figure 5-834 Remove the front right cover (550-sheet paper feeder)

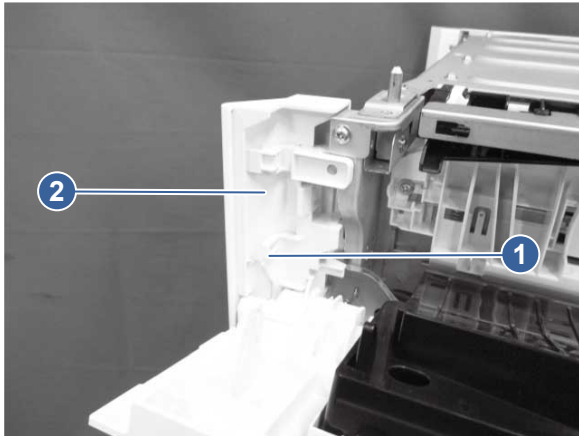

2. Remove the right door (550-sheet paper feeder)

Follow these steps to remove the 550-sheet tray right door.

1. Remove two screws (callout 1), and then remove the base frame (callout 2).

Figure 5-835 Remove the base frame

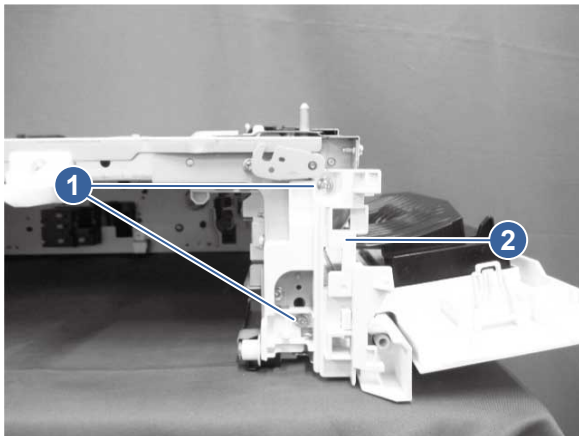

2. Remove one screw (callout 1), release one tab (callout 2), and then slide the rear inner cover (callout 3) downward to remove it.

Figure 5-836 Remove the rear inner cover

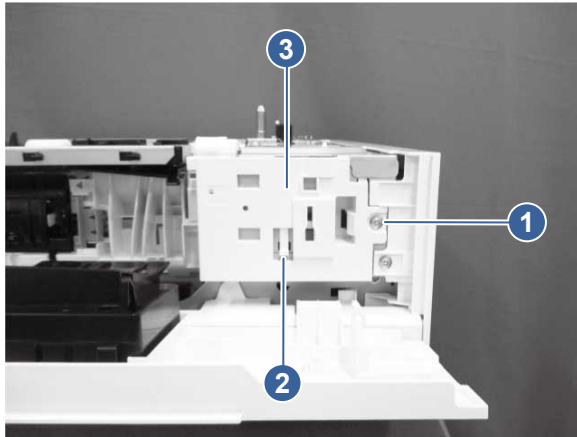

3. Release one tab (callout 1), and then slide the right door assembly (callout 2) in the direction indicated to remove it.

Figure 5-837 Remove the right door (550-sheet paper feeder)

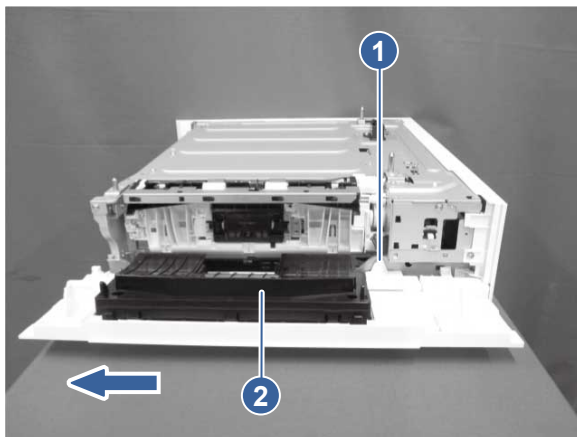

3. Remove the rear cover (550-sheet paper feeder)

Follow these steps to remove the 550-sheet tray rear cover.

- Remove one screw (callout 1), and then slide the rear cover (callout 2) in the direction indicated to remove it.

Figure 5-838 Remove the rear cover (550-sheet paper feeder)

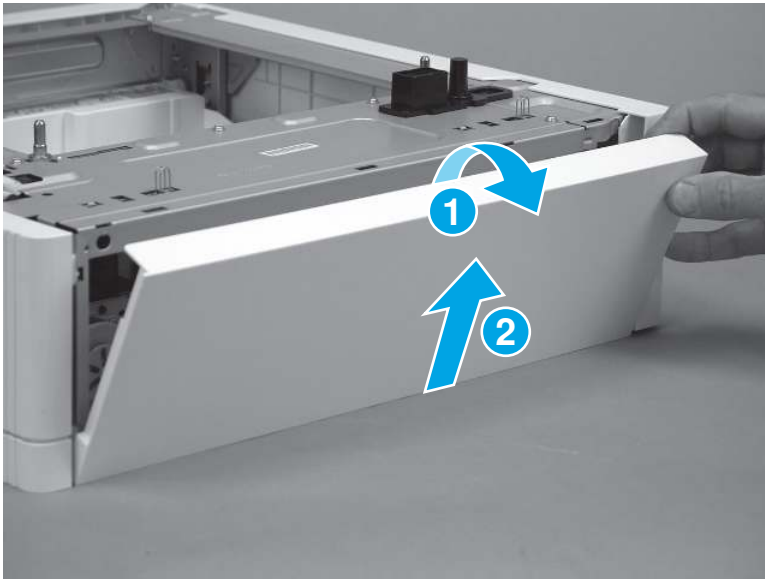

4. Remove the auto close assembly (550-sheet paper feeder)

Follow these steps to remove the auto close assembly.

1. Disconnect six connectors (callout 1).

Figure 5-839 Disconnect six connectors

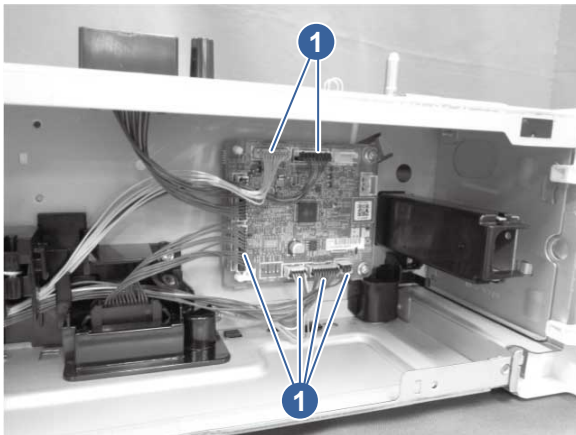

2. Release the cables (callout 1) from the auto close assembly (callout 2).

Figure 5-840 Release the cables

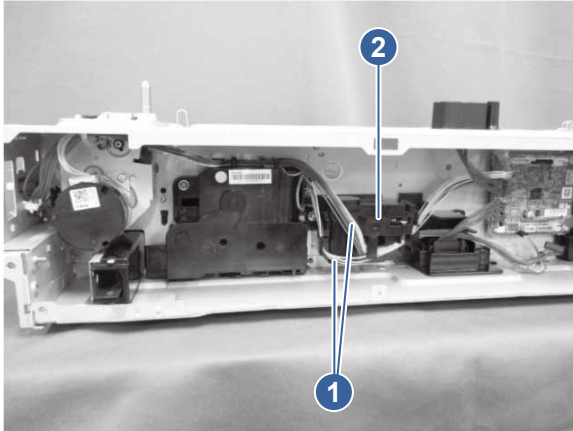

3. Remove two screws (callout 1), remove the auto close assembly (callout 2), and then remove the drawer connector (callout 3) from the auto close assembly.

Figure 5-841 Remove the assembly

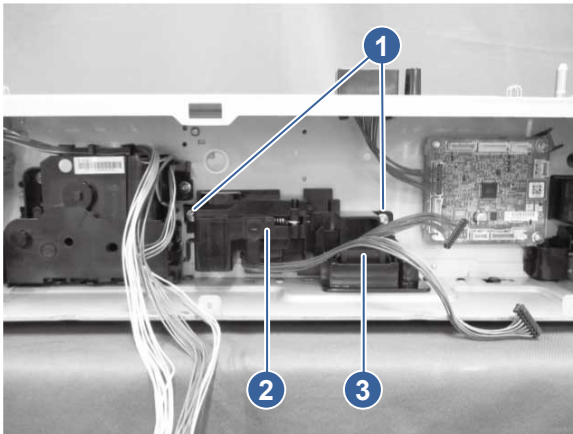

5. Unpack the replacement assembly

Follow these steps to unpack the replacement assembly.

1. Dispose of the defective part.





NOTE: HP recommends responsible disposal of the defective part.

<http://www8.hp.com/us/en/hp-information/environment/product-recycling.html>

2. Unpack the replacement part from the packaging.



CAUTION:  Some parts are sensitive to electrostatic discharge (ESD). Always perform service work at an ESD-protected workstation or mat. If an ESD workstation or mat is not available, touch the sheet-metal chassis to provide a static ground before touching an ESD-sensitive assembly. Protect the ESD-sensitive assemblies by placing them in ESD pouches when they are out of the printer.

 **IMPORTANT:** Make sure that all of the shipping materials (for example shipping tape) are removed from the replacement part prior to installation.

 **NOTE:** If the replacement part is a roller or pad, avoid touching the spongy part of it. Skin oils on the roller or pad can cause paper pickup and/or print-quality problems. HP recommends using disposable gloves when handling rollers or pads or washing your hands before touching rollers or pads.

3. To install an assembly, reverse the removal steps.

 **NOTE:** When applicable, special installation instructions are provided for an assembly at the end of the removal procedure. Always completely read the removal instructions and follow all special installation instructions.

Removal and replacement: Media size detection assembly (550-sheet paper feeder)

Learn about removing and replacing the paper feeder media size detection assembly.

 [View a video demonstration of removing and replacing the media size detection assembly.](#)

Before performing service

Turn the printer power off

- Disconnect the power cable.

 **WARNING!** To avoid damage to the printer, turn the printer off, wait 30 seconds, and then remove the power cord before attempting to service the printer.

Use the table below to identify the correct part number for your printer, and then go to <https://parts.hp.com/hpparts> to order the part.

Table 5-107 Part information

Part number	Part description
RM2-3614-000CN	Size detect assembly (1x550-sheet paper feeder)

Required tools

- No special tools are required to remove or install this assembly.

After performing service

Turn the printer power on

- Connect the power cable.
- Use the power switch to turn the power on.

Post service test

No post service test is available for this assembly.

1. Remove the front right cover (550-sheet paper feeder)

Follow these steps to remove the 550-sheet tray front right cover.

1. Open the paper feeder right door.
2. Release one tab (callout 1), and then slide the front right cover (callout 2) upward to remove it.

Figure 5-842 Remove the front right cover (550-sheet paper feeder)

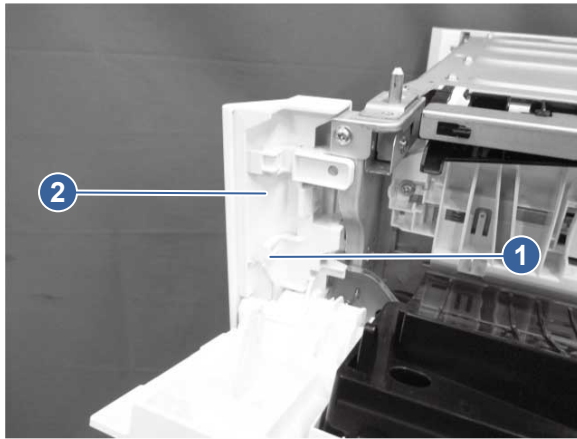

2. Remove the right door (550-sheet paper feeder)

Follow these steps to remove the 550-sheet tray right door.

1. Remove two screws (callout 1), and then remove the base frame (callout 2).

Figure 5-843 Remove the base frame

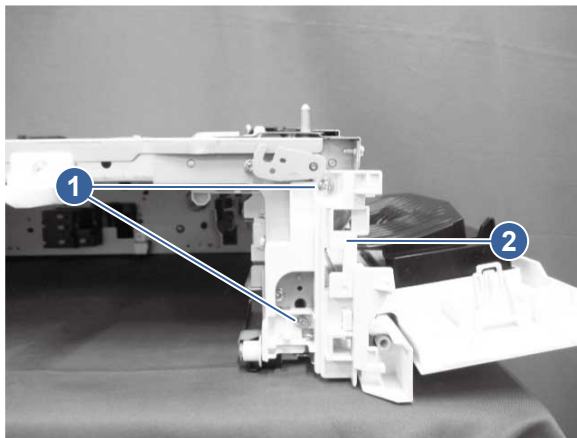

2. Remove one screw (callout 1), release one tab (callout 2), and then slide the rear inner cover (callout 3) downward to remove it.

Figure 5-844 Remove the rear inner cover

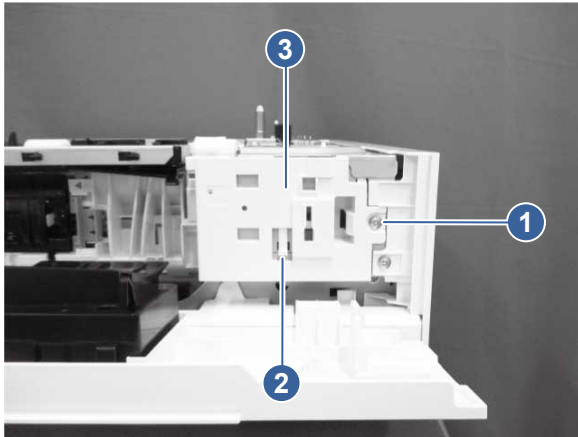

3. Release one tab (callout 1), and then slide the right door assembly (callout 2) in the direction indicated to remove it.

Figure 5-845 Remove the right door (550-sheet paper feeder)

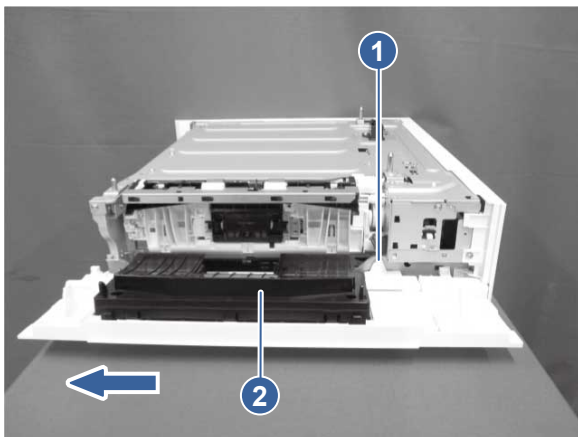

3. Remove the rear cover (550-sheet paper feeder)

Follow these steps to remove the 550-sheet tray rear cover.

- Remove one screw (callout 1), and then slide the rear cover (callout 2) in the direction indicated to remove it.

Figure 5-846 Remove the rear cover (550-sheet paper feeder)

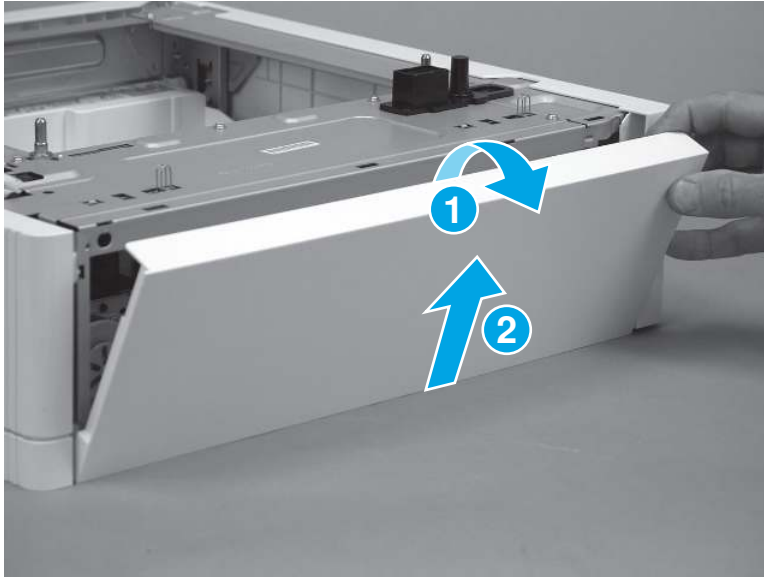

4. Remove the auto close assembly (550-sheet paper feeder)

Follow these steps to remove the auto close assembly.

1. Disconnect six connectors (callout 1).

Figure 5-847 Disconnect six connectors

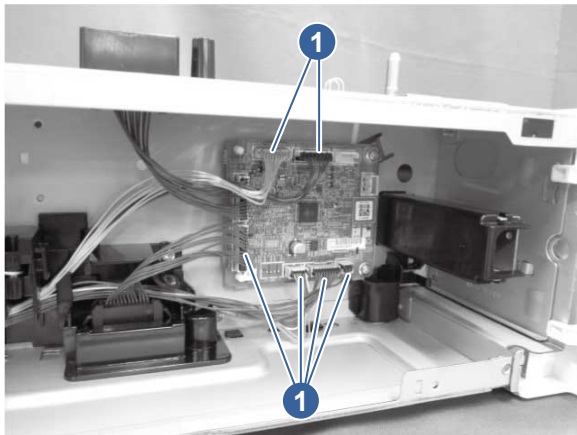

2. Release the cables (callout 1) from the auto close assembly (callout 2).

Figure 5-848 Release the cables

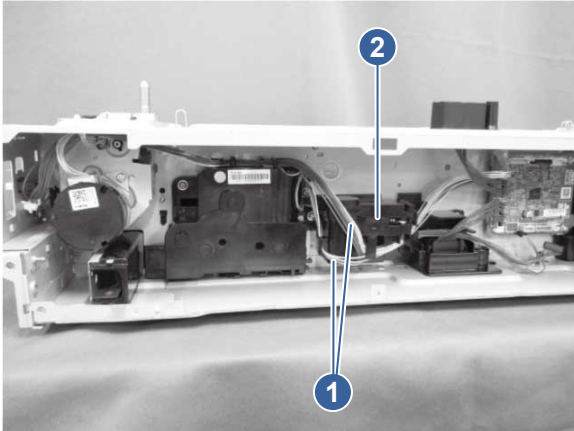

3. Remove two screws (callout 1), remove the auto close assembly (callout 2), and then remove the drawer connector (callout 3) from the auto close assembly.

Figure 5-849 Remove the assembly

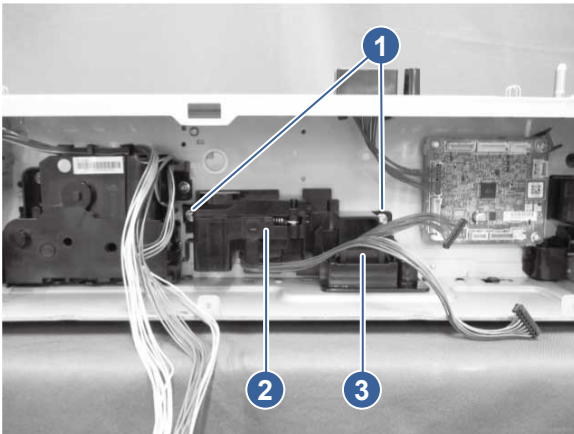

5. Remove the media size detection assembly (550-sheet paper feeder)

Follow these steps to remove the media size detection assembly.

- Release one tab (callout 1), and then pull the media size detect assembly (callout 2) toward you to remove it.

Figure 5-850 Release one tab

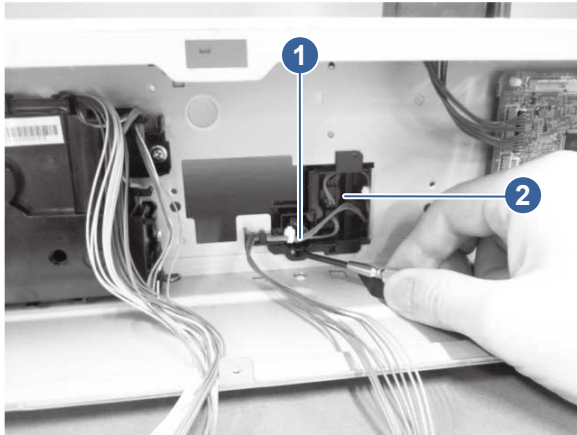

6. Unpack the replacement assembly

Follow these steps to unpack the replacement assembly.

1. Dispose of the defective part.



NOTE: HP recommends responsible disposal of the defective part.

<http://www8.hp.com/us/en/hp-information/environment/product-recycling.html>

2. Unpack the replacement part from the packaging.



CAUTION:  Some parts are sensitive to electrostatic discharge (ESD). Always perform service work at an ESD-protected workstation or mat. If an ESD workstation or mat is not available, touch the sheet-metal chassis to provide a static ground before touching an ESD-sensitive assembly. Protect the ESD-sensitive assemblies by placing them in ESD pouches when they are out of the printer.



IMPORTANT: Make sure that all of the shipping materials (for example shipping tape) are removed from the replacement part prior to installation.



NOTE: If the replacement part is a roller or pad, avoid touching the spongy part of it. Skin oils on the roller or pad can cause paper pickup and/or print-quality problems. HP recommends using disposable gloves when handling rollers or pads or washing your hands before touching rollers or pads.

3. To install an assembly, reverse the removal steps.



NOTE: When applicable, special installation instructions are provided for an assembly at the end of the removal procedure. Always completely read the removal instructions and follow all special installation instructions.

Removal and replacement: Controller PCA (550-sheet paper feeder)

Learn about removing and replacing the paper-feeder controller PCA.

Before performing service

Turn the printer power off

- Disconnect the power cable.

⚠ WARNING! To avoid damage to the printer, turn the printer off, wait 30 seconds, and then remove the power cord before attempting to service the printer.

Use the table below to identify the correct part number for your printer, and then go to <https://parts.hp.com/hpparts> to order the part.

Table 5-108 Part information

Part number	Part description
RM3-8051-000CN	Paper feeder controller PCA (1x550-sheet paper feeder)

Required tools

- #2 Phillips screwdriver with a magnetic tip and a 152 mm (6 in) shaft length

After performing service

Turn the printer power on

- Connect the power cable.
- Use the power switch to turn the power on.

Post service test

Print any pages necessary to make sure the printer is functioning correctly.

1. Remove the front right cover (550-sheet paper feeder)

Follow these steps to remove the 550-sheet tray front right cover.

1. Open the paper feeder right door.
2. Release one tab (callout 1), and then slide the front right cover (callout 2) upward to remove it.

Figure 5-851 Remove the front right cover (550-sheet paper feeder)

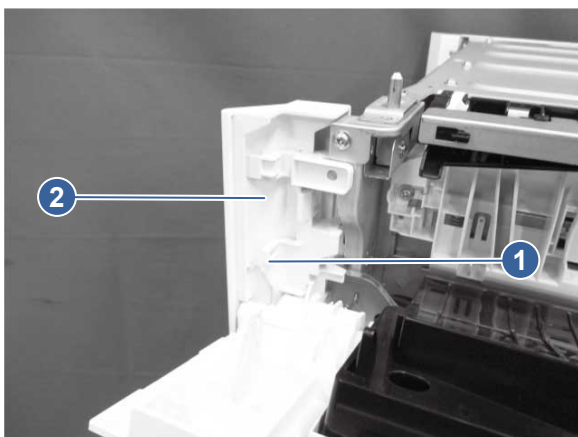

2. Remove the right door (550-sheet paper feeder)

Follow these steps to remove the 550-sheet tray right door.

1. Remove two screws (callout 1), and then remove the base frame (callout 2).

Figure 5-852 Remove the base frame

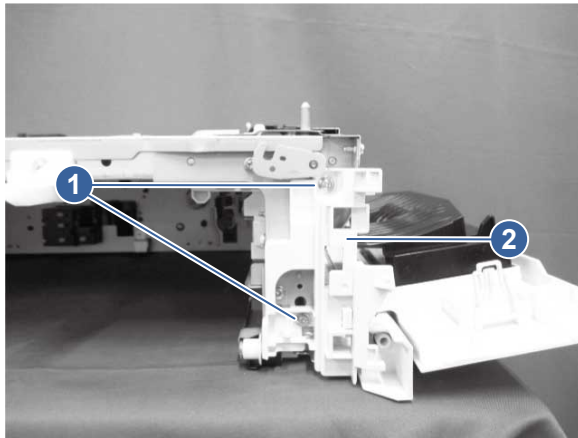

2. Remove one screw (callout 1), release one tab (callout 2), and then slide the rear inner cover (callout 3) downward to remove it.

Figure 5-853 Remove the rear inner cover

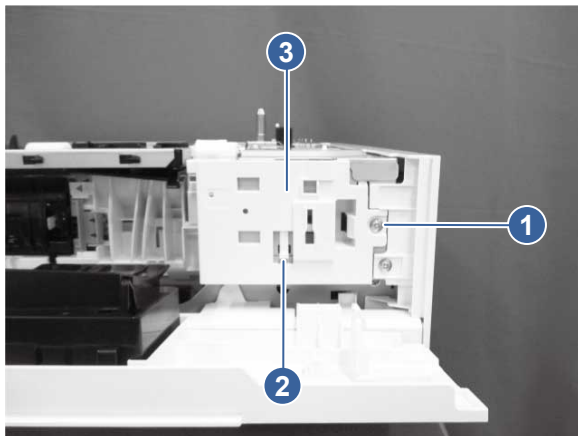

3. Release one tab (callout 1), and then slide the right door assembly (callout 2) in the direction indicated to remove it.

Figure 5-854 Remove the right door (550-sheet paper feeder)

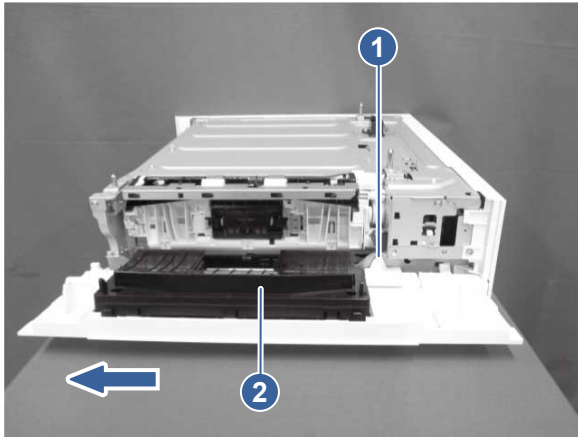

3. Remove the rear cover (550-sheet paper feeder)

Follow these steps to remove the 550-sheet tray rear cover.

- Remove one screw (callout 1), and then slide the rear cover (callout 2) in the direction indicated to remove it.

Figure 5-855 Remove the rear cover (550-sheet paper feeder)

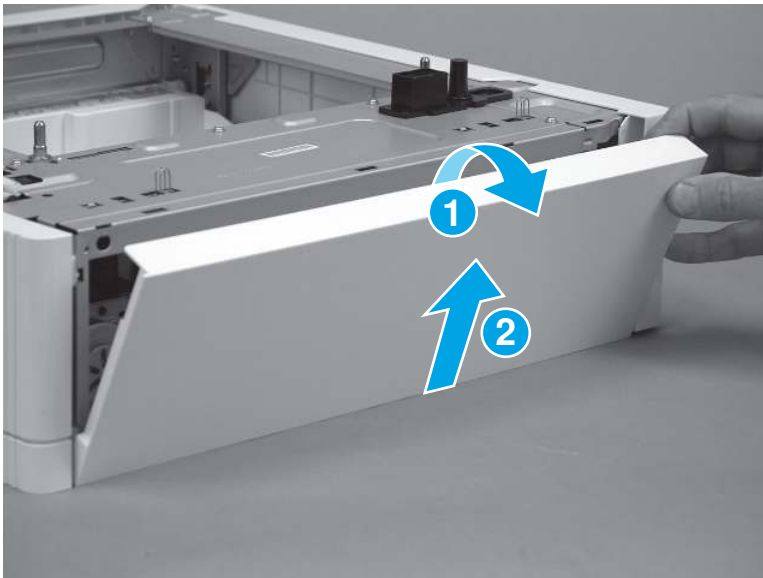

4. Remove the controller PCA (550-sheet paper feeder)

Follow these steps to remove the controller PCA.

- Disconnect all the connectors on the paper feeder controller PCA, remove two screws (callout 1), remove two PCA spacers (callout 2), and then remove the paper feeder controller PCA (callout 3).

Figure 5-856 Remove the controller PCA (550-sheet paper feeder)

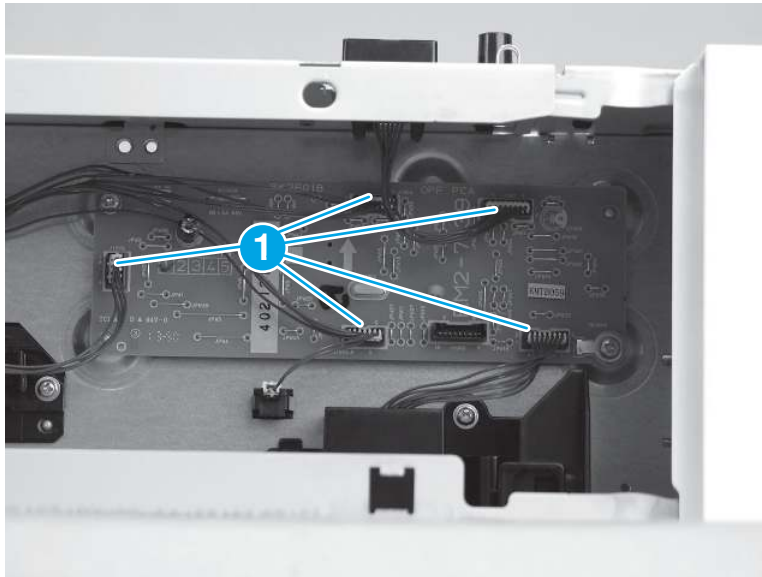

5. Unpack the replacement assembly

Follow these steps to unpack the replacement assembly.

1. Dispose of the defective part.



NOTE: HP recommends responsible disposal of the defective part.

<http://www8.hp.com/us/en/hp-information/environment/product-recycling.html>

2. Unpack the replacement part from the packaging.



CAUTION:  Some parts are sensitive to electrostatic discharge (ESD). Always perform service work at an ESD-protected workstation or mat. If an ESD workstation or mat is not available, touch the sheet-metal chassis to provide a static ground before touching an ESD-sensitive assembly. Protect the ESD-sensitive assemblies by placing them in ESD pouches when they are out of the printer.



IMPORTANT: Make sure that all of the shipping materials (for example shipping tape) are removed from the replacement part prior to installation.



NOTE: If the replacement part is a roller or pad, avoid touching the spongy part of it. Skin oils on the roller or pad can cause paper pickup and/or print-quality problems. HP recommends using disposable gloves when handling rollers or pads or washing your hands before touching rollers or pads.

3. To install an assembly, reverse the removal steps.



NOTE: When applicable, special installation instructions are provided for an assembly at the end of the removal procedure. Always completely read the removal instructions and follow all special installation instructions.

Removal and replacement: Separation roller assembly (550-sheet paper feeder)

Learn about removing and replacing the paper feeder separation roller assembly.

Before performing service

Turn the printer power off

- Disconnect the power cable.

⚠ WARNING! To avoid damage to the printer, turn the printer off, wait 30 seconds, and then remove the power cord before attempting to service the printer.

If the part is damaged and cannot be cleaned, use the table below to identify the correct part number for your printer. To order the part, go to www.hp.com/buy/parts.

Table 5-109 Part information

Part number	Part description
527H2A	HP LaserJet Tray 2-x Roller Kit (1x550-sheet paper feeder)

Required tools

- No special tools are required to remove or install this assembly.

After performing service

Turn the printer power on

- Connect the power cable.
- Use the power switch to turn the power on.

Post service test

Print any pages necessary to make sure the printer is functioning correctly.

1. Remove the separation roller assembly (550-sheet paper feeder)

Learn about removing the 550-sheet paper feeder separation roller assembly.

1. Open the right door.

2. Slide the lever (callout 1) to the right, and then remove the roller assembly (callout 2) by pulling it out from the printer.

Figure 5-857 Remove the roller assembly

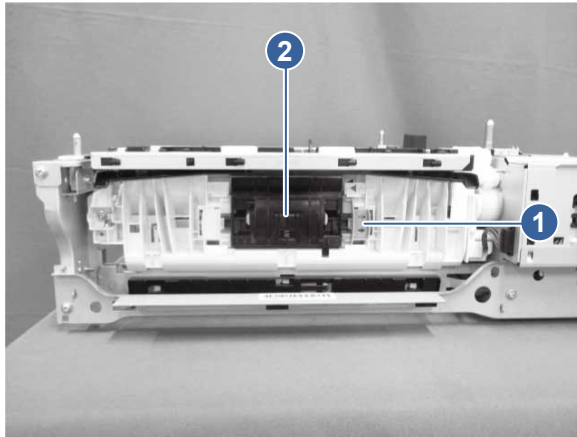

2. Unpack the replacement assembly

Follow these steps to unpack the replacement assembly.

1. Dispose of the defective part.



NOTE: HP recommends responsible disposal of the defective part.

<http://www8.hp.com/us/en/hp-information/environment/product-recycling.html>

2. Unpack the replacement part from the packaging.



CAUTION:  Some parts are sensitive to electrostatic discharge (ESD). Always perform service work at an ESD-protected workstation or mat. If an ESD workstation or mat is not available, touch the sheet-metal chassis to provide a static ground before touching an ESD-sensitive assembly. Protect the ESD-sensitive assemblies by placing them in ESD pouches when they are out of the printer.



IMPORTANT: Make sure that all of the shipping materials (for example shipping tape) are removed from the replacement part prior to installation.



NOTE: If the replacement part is a roller or pad, avoid touching the spongy part of it. Skin oils on the roller or pad can cause paper pickup and/or print-quality problems. HP recommends using disposable gloves when handling rollers or pads or washing your hands before touching rollers or pads.

3. To install an assembly, reverse the removal steps.



NOTE: When applicable, special installation instructions are provided for an assembly at the end of the removal procedure. Always completely read the removal instructions and follow all special installation instructions.

Removal and replacement: Pickup roller assembly (550-sheet paper feeder)

Learn about removing and replacing the paper feeder pickup roller assembly.

Before performing service

Turn the printer power off

- Disconnect the power cable.

⚠ WARNING! To avoid damage to the printer, turn the printer off, wait 30 seconds, and then remove the power cord before attempting to service the printer.

If the part is damaged and cannot be cleaned, use the table below to identify the correct part number for your printer. To order the part, go to www.hp.com/buy/parts.

Table 5-110 Part information

Part number	Part description
527H2A	HP LaserJet Tray 2-x Roller Kit

Required tools

- No special tools are required to remove or install this assembly.

After performing service

Turn the printer power on

- Connect the power cable.
- Use the power switch to turn the power on.

Post service test

Print any pages necessary to make sure the printer is functioning correctly.

1. Remove the separation roller assembly (550-sheet paper feeder)

Learn about removing the 550-sheet paper feeder separation roller assembly.

1. Open the right door.
2. Slide the lever (callout 1) to the right, and then remove the roller assembly (callout 2) by pulling it out from the printer.

Figure 5-858 Remove the roller assembly

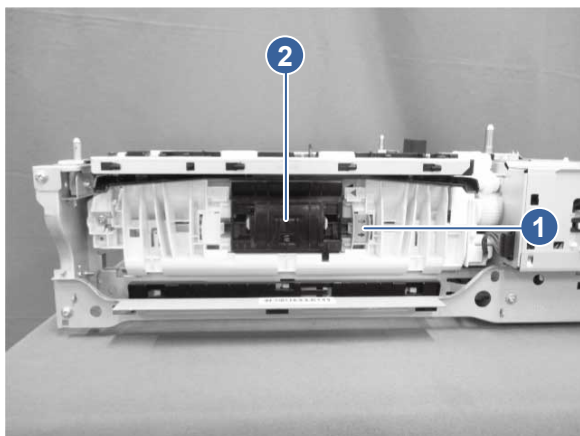

2. Remove the paper pickup roller assembly (550-sheet paper feeder)

Learn about removing the 550-sheet paper feeder pickup rollers.

 **NOTE:** Even if you want to replace only the pickup roller assembly, you must first remove the separation roller assembly.

- Locate the pickup roller assembly (callout 1) and then pull it away from the printer to remove it.

Figure 5-859 Remove the pickup roller assembly

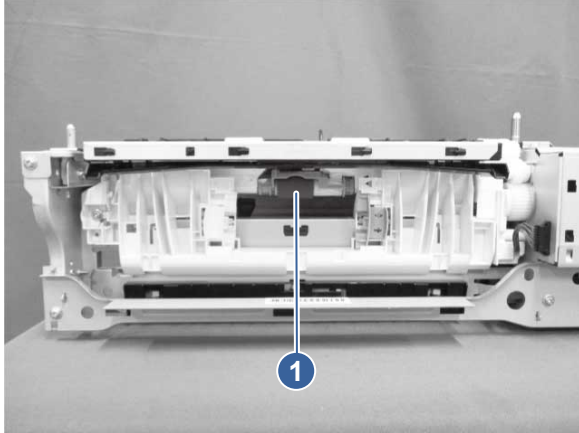

3. Unpack the replacement assembly



Follow these steps to unpack the replacement assembly.

1. Dispose of the defective part.

 **NOTE:** HP recommends responsible disposal of the defective part.

<http://www8.hp.com/us/en/hp-information/environment/product-recycling.html>

2. Unpack the replacement part from the packaging.

 **CAUTION:**  Some parts are sensitive to electrostatic discharge (ESD). Always perform service work at an ESD-protected workstation or mat. If an ESD workstation or mat is not available, touch the sheet-metal chassis to provide a static ground before touching an ESD-sensitive assembly. Protect the ESD-sensitive assemblies by placing them in ESD pouches when they are out of the printer.

 **IMPORTANT:** Make sure that all of the shipping materials (for example shipping tape) are removed from the replacement part prior to installation.

 **NOTE:** If the replacement part is a roller or pad, avoid touching the spongy part of it. Skin oils on the roller or pad can cause paper pickup and/or print-quality problems. HP recommends using disposable gloves when handling rollers or pads or washing your hands before touching rollers or pads.

3. To install an assembly, reverse the removal steps.

 **NOTE:** When applicable, special installation instructions are provided for an assembly at the end of the removal procedure. Always completely read the removal instructions and follow all special installation instructions.

Removal and replacement: 2,100-sheet paper deck

Learn how to remove and replace the 2,100-sheet paper deck parts and assemblies.

Field-replaceable units (FRUs)

Learn about FRU parts removal and replacement.

Covers, panels, and doors

Learn about covers, panels, and doors removal and replacement.

Removal and replacement: Right door (HCI)

Learn about removing and replacing the HCI right door.

Before performing service

Turn the printer power off

- Disconnect the power cable.

⚠ WARNING! To avoid damage to the printer, turn the printer off, wait 30 seconds, and then remove the power cord before attempting to service the printer.

Use the table below to identify the correct part number for your printer, and then go to <https://parts.hp.com/hpparts> to order the part.

Table 5-111 Part information

Part number	Part description
RM3-0035-000CN	Right door assembly (2,100-sheet paper deck HCI)

Required tools

- No special tools are required to remove or install this assembly.

After performing service

Turn the printer power on

- Connect the power cable.
- Use the power switch to turn the power on.

Post service test

No post service test is available for this assembly.

1. Remove the right door (HCI)

Follow these steps to remove the HCI right door.

1. Open the HCI tray, and then open the right door.

2. Remove two screws (callout 1), and then slide the right door (callout 2) in the direction indicated to remove it.

Figure 5-860 Remove the right door (HCI)

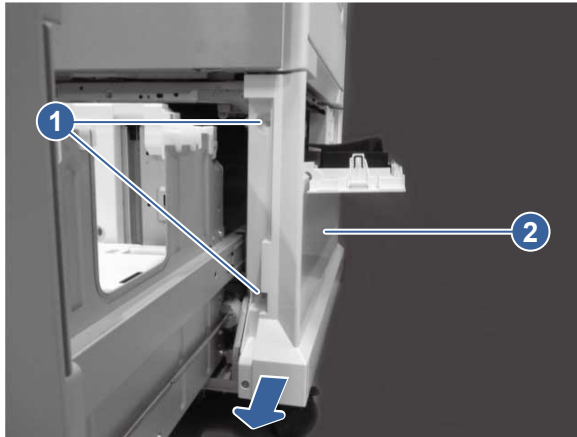

2. Unpack the replacement assembly

Follow these steps to unpack the replacement assembly.

1. Dispose of the defective part.



NOTE: HP recommends responsible disposal of the defective part.

<http://www8.hp.com/us/en/hp-information/environment/product-recycling.html>

2. Unpack the replacement part from the packaging.



CAUTION:  Some parts are sensitive to electrostatic discharge (ESD). Always perform service work at an ESD-protected workstation or mat. If an ESD workstation or mat is not available, touch the sheet-metal chassis to provide a static ground before touching an ESD-sensitive assembly. Protect the ESD-sensitive assemblies by placing them in ESD pouches when they are out of the printer.



IMPORTANT: Make sure that all of the shipping materials (for example shipping tape) are removed from the replacement part prior to installation.



NOTE: If the replacement part is a roller or pad, avoid touching the spongy part of it. Skin oils on the roller or pad can cause paper pickup and/or print-quality problems. HP recommends using disposable gloves when handling rollers or pads or washing your hands before touching rollers or pads.

3. To install an assembly, reverse the removal steps.



NOTE: When applicable, special installation instructions are provided for an assembly at the end of the removal procedure. Always completely read the removal instructions and follow all special installation instructions.

Removal and replacement: Front left cover/left cover (HCI)

Learn about removing and replacing the HCI front left cover/left cover.

Before performing service

Turn the printer power off

- Disconnect the power cable.

⚠ WARNING! To avoid damage to the printer, turn the printer off, wait 30 seconds, and then remove the power cord before attempting to service the printer.

Use the table below to identify the correct part number for your printer, and then go to <https://parts.hp.com/hpparts> to order the part.

Table 5-112 Part information

Part number	Part description
RC5-9696-000CN	Cover, front left (2,100-sheet paper deck HCI)
RC5-9692-000CN	Cover, left (2,100-sheet paper deck HCI)

Required tools

- No special tools are required to remove or install this assembly.

After performing service

Turn the printer power on

- Connect the power cable.
- Use the power switch to turn the power on.

Post service test

No post service test is available for this assembly.

1. Remove the right door (HCI)

Follow these steps to remove the HCI right door.

1. Open the HCI tray, and then open the right door.

2. Remove two screws (callout 1), and then slide the right door (callout 2) in the direction indicated to remove it.

Figure 5-861 Remove the right door (HCI)

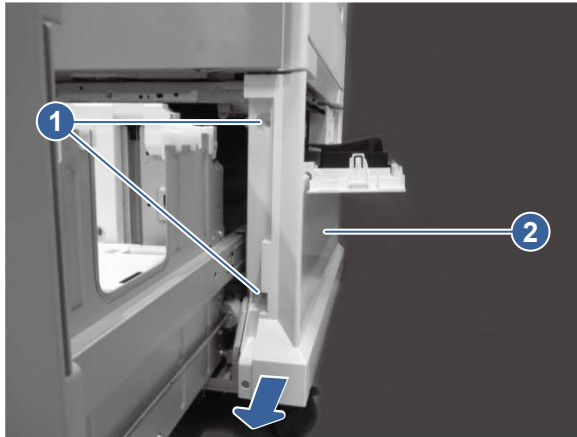

2. Remove the rear cover (HCI)

Follow these steps to remove the HCI rear cover.

- Remove one screw (callout 1), and then slide the rear cover (callout 2) in the direction indicated to remove it.

Figure 5-862 Remove the rear cover (HCI)

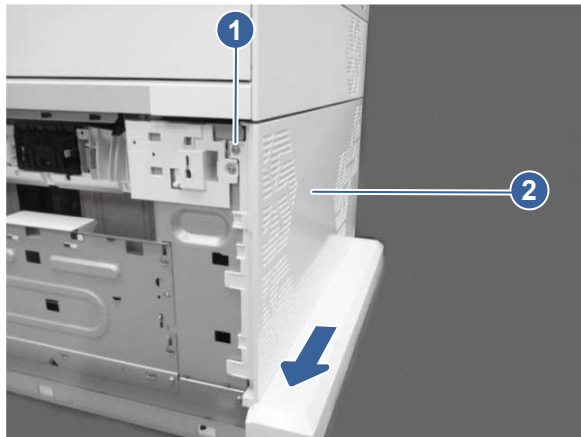

3. Remove the front left cover/left cover (HCI)

Follow these steps to remove the HCI front left cover/left cover.

1. Remove two screws (callout 1).

Figure 5-863 Remove two screws

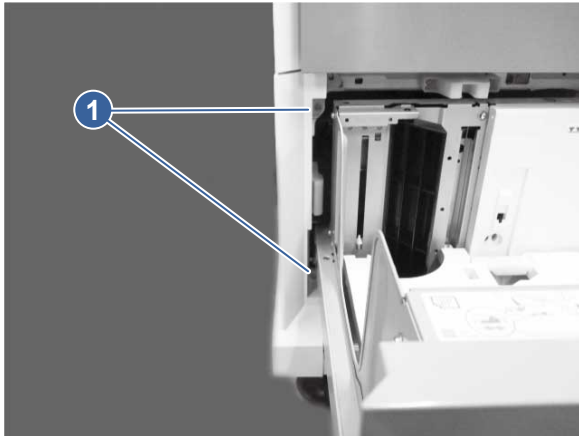

2. Remove the left cover (callout 1) together with the front left cover (callout 2). Release one tab (callout 3), and then slide the front left cover upward to remove it from the left cover.

Figure 5-864 Remove the front left cover from the left cover (HCI)

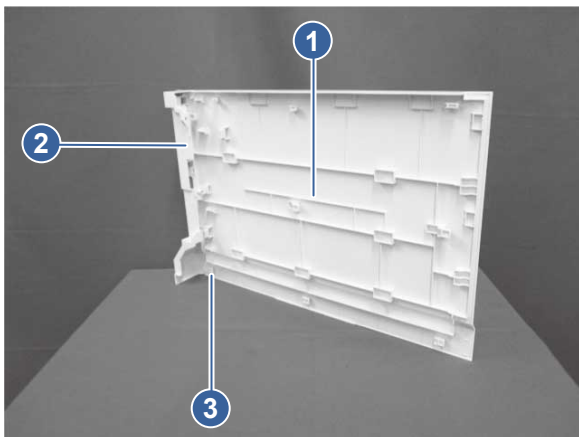

4. Unpack the replacement assembly

Follow these steps to unpack the replacement assembly.

1. Dispose of the defective part.





NOTE: HP recommends responsible disposal of the defective part.

<http://www8.hp.com/us/en/hp-information/environment/product-recycling.html>

2. Unpack the replacement part from the packaging.



CAUTION:  Some parts are sensitive to electrostatic discharge (ESD). Always perform service work at an ESD-protected workstation or mat. If an ESD workstation or mat is not available, touch the sheet-metal chassis to provide a static ground before touching an ESD-sensitive assembly. Protect the ESD-sensitive assemblies by placing them in ESD pouches when they are out of the printer.

 **IMPORTANT:** Make sure that all of the shipping materials (for example shipping tape) are removed from the replacement part prior to installation.

 **NOTE:** If the replacement part is a roller or pad, avoid touching the spongy part of it. Skin oils on the roller or pad can cause paper pickup and/or print-quality problems. HP recommends using disposable gloves when handling rollers or pads or washing your hands before touching rollers or pads.

3. To install an assembly, reverse the removal steps.

 **NOTE:** When applicable, special installation instructions are provided for an assembly at the end of the removal procedure. Always completely read the removal instructions and follow all special installation instructions.

Removal and replacement: Rear cover (HCI)

Learn about removing and replacing the HCI rear cover.

Before performing service

Turn the printer power off

- Disconnect the power cable.

 **WARNING!** To avoid damage to the printer, turn the printer off, wait 30 seconds, and then remove the power cord before attempting to service the printer.

Use the table below to identify the correct part number for your printer, and then go to <https://parts.hp.com/hpparts> to order the part.

Table 5-113 Part information

Part number	Part description
RC5-9693-000CN	Cover, rear (2,100-sheet paper deck HCI)

Required tools

- No special tools are required to remove or install this assembly.

After performing service

Turn the printer power on

- Connect the power cable.
- Use the power switch to turn the power on.

Post service test

No post service test is available for this assembly.

1. Remove the right door (HCI)

Follow these steps to remove the HCI right door.

1. Open the HCI tray, and then open the right door.

2. Remove two screws (callout 1), and then slide the right door (callout 2) in the direction indicated to remove it.

Figure 5-865 Remove the right door (HCI)

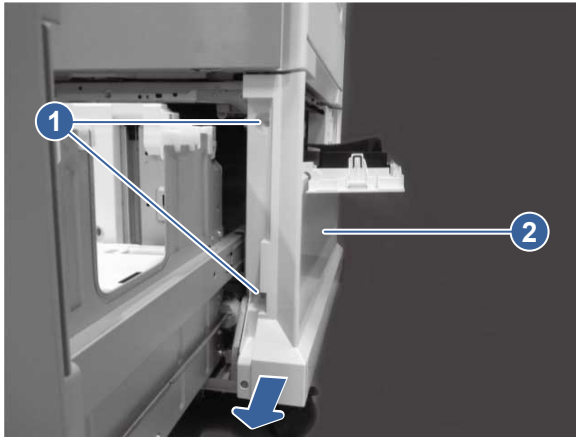

2. Remove the rear cover (HCI)

Follow these steps to remove the HCI rear cover.

- Remove one screw (callout 1), and then slide the rear cover (callout 2) in the direction indicated to remove it.

Figure 5-866 Remove the rear cover (HCI)

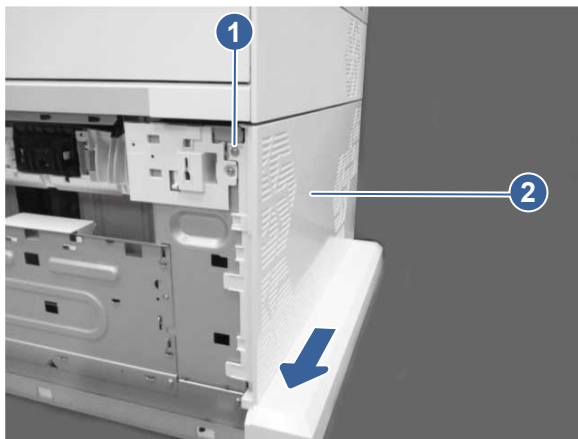

3. Unpack the replacement assembly



Follow these steps to unpack the replacement assembly.

1. Dispose of the defective part.

 **NOTE:** HP recommends responsible disposal of the defective part.

<http://www8.hp.com/us/en/hp-information/environment/product-recycling.html>

2. Unpack the replacement part from the packaging.

 **CAUTION:**  Some parts are sensitive to electrostatic discharge (ESD). Always perform service work at an ESD-protected workstation or mat. If an ESD workstation or mat is not available, touch

the sheet-metal chassis to provide a static ground before touching an ESD-sensitive assembly. Protect the ESD-sensitive assemblies by placing them in ESD pouches when they are out of the printer.

 **IMPORTANT:** Make sure that all of the shipping materials (for example shipping tape) are removed from the replacement part prior to installation.

 **NOTE:** If the replacement part is a roller or pad, avoid touching the spongy part of it. Skin oils on the roller or pad can cause paper pickup and/or print-quality problems. HP recommends using disposable gloves when handling rollers or pads or washing your hands before touching rollers or pads.

3. To install an assembly, reverse the removal steps.

 **NOTE:** When applicable, special installation instructions are provided for an assembly at the end of the removal procedure. Always completely read the removal instructions and follow all special installation instructions.

Removal and replacement: Rear lower cover (HCI)

Learn about removing and replacing the HCI rear lower cover.

Before performing service

Turn the printer power off

- Disconnect the power cable.

 **WARNING!** To avoid damage to the printer, turn the printer off, wait 30 seconds, and then remove the power cord before attempting to service the printer.

Use the table below to identify the correct part number for your printer, and then go to <https://parts.hp.com/hpparts> to order the part.

Table 5-114 Part information

Part number	Part description
RC5-9695-000CN	Cover, rear lower (2,100-sheet paper deck HCI)

Required tools

- No special tools are required to remove or install this assembly.

After performing service

Turn the printer power on

- Connect the power cable.
- Use the power switch to turn the power on.

Post service test

No post service test is available for this assembly.

1. Remove the right door (HCI)

Follow these steps to remove the HCI right door.

1. Open the HCI tray, and then open the right door.
2. Remove two screws (callout 1), and then slide the right door (callout 2) in the direction indicated to remove it.

Figure 5-867 Remove the right door (HCI)

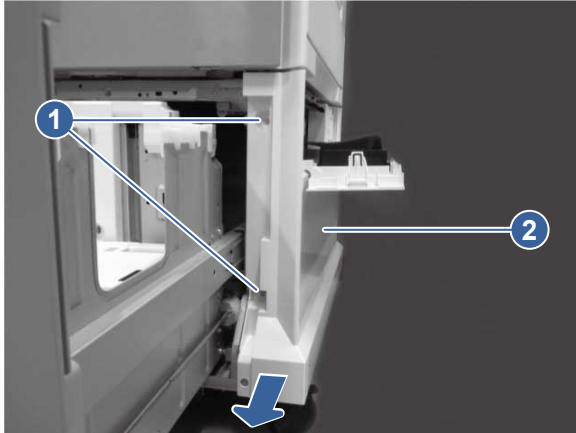

2. Remove the rear cover (HCI)

Follow these steps to remove the HCI rear cover.

- Remove one screw (callout 1), and then slide the rear cover (callout 2) in the direction indicated to remove it.

Figure 5-868 Remove the rear cover (HCI)

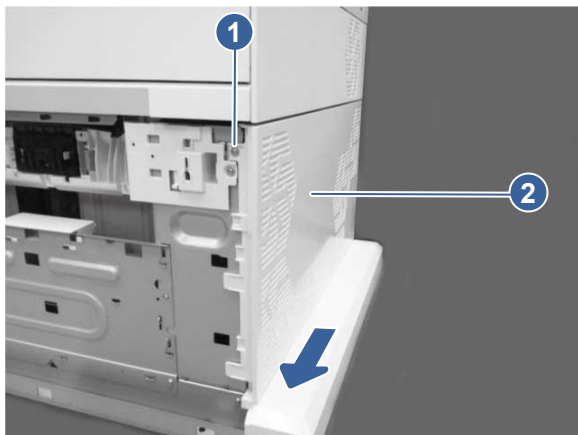

3. Remove the rear lower cover (HCI)

Follow these steps to remove the HCI rear lower cover.

- Bend the left edge of the rear lower cover (callout 1), release one tab (callout 2), and then pull the rear lower cover toward you from the left end of it to remove it.

Figure 5-869 Remove the rear lower cover (HCI)

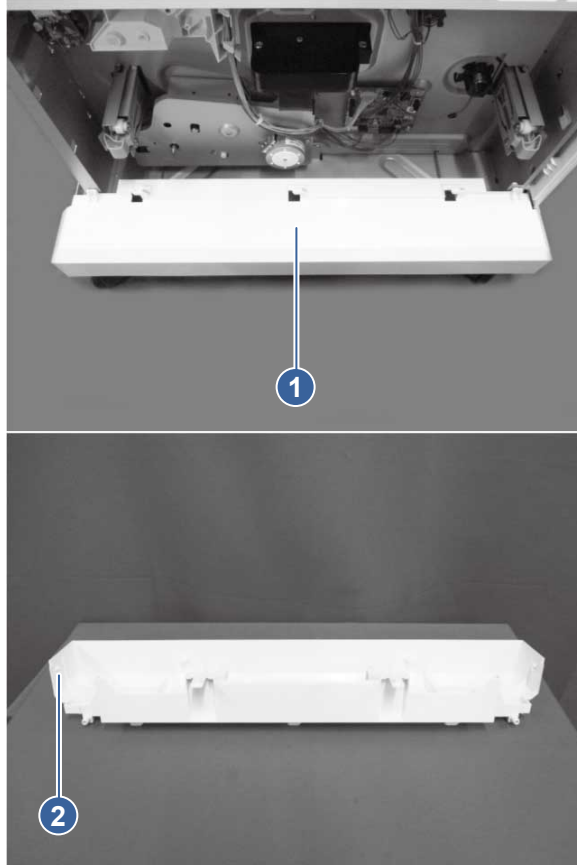

4. Unpack the replacement assembly

Follow these steps to unpack the replacement assembly.

1. Dispose of the defective part.



NOTE: HP recommends responsible disposal of the defective part.

<http://www8.hp.com/us/en/hp-information/environment/product-recycling.html>

2. Unpack the replacement part from the packaging.



CAUTION:  Some parts are sensitive to electrostatic discharge (ESD). Always perform service work at an ESD-protected workstation or mat. If an ESD workstation or mat is not available, touch the sheet-metal chassis to provide a static ground before touching an ESD-sensitive assembly. Protect the ESD-sensitive assemblies by placing them in ESD pouches when they are out of the printer.



IMPORTANT: Make sure that all of the shipping materials (for example shipping tape) are removed from the replacement part prior to installation.



NOTE: If the replacement part is a roller or pad, avoid touching the spongy part of it. Skin oils on the roller or pad can cause paper pickup and/or print-quality problems. HP recommends using

disposable gloves when handling rollers or pads or washing your hands before touching rollers or pads.

3. To install an assembly, reverse the removal steps.

 **NOTE:** When applicable, special installation instructions are provided for an assembly at the end of the removal procedure. Always completely read the removal instructions and follow all special installation instructions.

Internal parts and assemblies

Learn how to remove and replace the printer internal parts and assemblies.

Removal and replacement: Cassette assembly (HCI)

Learn about removing and replacing the HCI cassette.

Before performing service

Turn the printer power off

- Disconnect the power cable.

 **WARNING!** To avoid damage to the printer, turn the printer off, wait 30 seconds, and then remove the power cord before attempting to service the printer.

Use the table below to identify the correct part number for your printer, and then go to <https://parts.hp.com/hpparts> to order the part.

Table 5-115 Part information

Part number	Part description
RM3-0023-000CN	Tray assembly (2,100-sheet paper deck HCI)

Required tools

- #2 Phillips screwdriver with a magnetic tip and a 152 mm (6 in) shaft length
- Small flat-blade screwdriver

After performing service

Turn the printer power on

- Connect the power cable.
- Use the power switch to turn the power on.

Post service test

Print any pages necessary to make sure the printer is functioning correctly.

1. Remove the cassette (HCI)

Follow these steps to remove the HCI cassette.

1. Open the HCI cassette assembly.

Figure 5-870 Open the HCI cassette

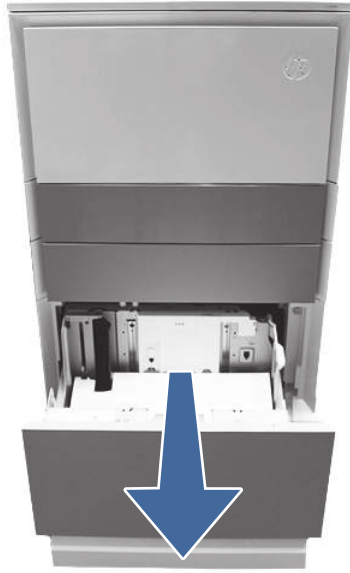

2. Press the left and right release levers (callout 1).

Figure 5-871 Press the release levers

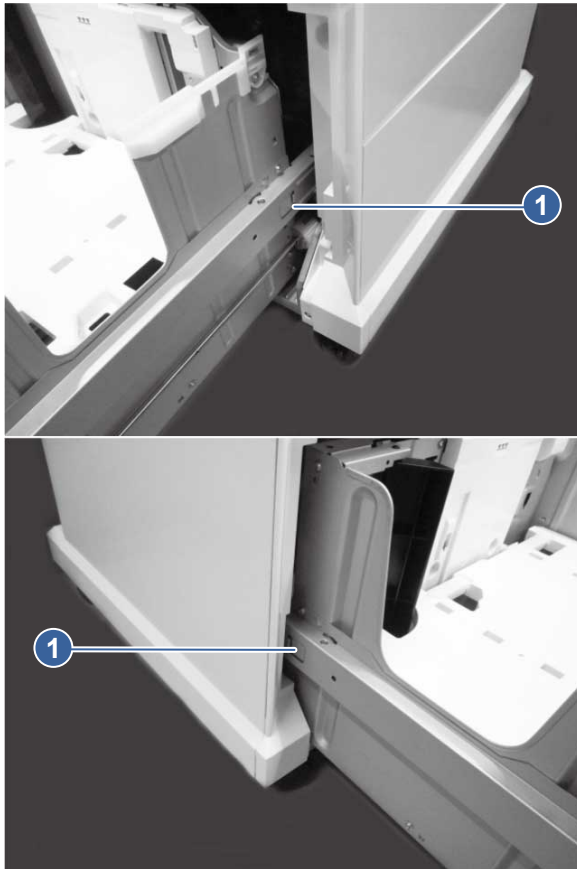

3. Pull the HCI cassette assembly (callout 1) out of the HCI chassis.

Figure 5-872 Remove the tray cassette (HCI)

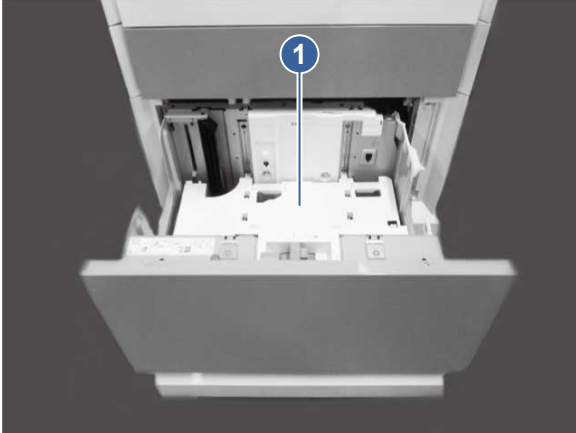

2. Unpack the replacement assembly

Follow these steps to unpack the replacement assembly.

1. Dispose of the defective part.



NOTE: HP recommends responsible disposal of the defective part.

<http://www8.hp.com/us/en/hp-information/environment/product-recycling.html>

2. Unpack the replacement part from the packaging.



CAUTION:  Some parts are sensitive to electrostatic discharge (ESD). Always perform service work at an ESD-protected workstation or mat. If an ESD workstation or mat is not available, touch the sheet-metal chassis to provide a static ground before touching an ESD-sensitive assembly. Protect the ESD-sensitive assemblies by placing them in ESD pouches when they are out of the printer.



IMPORTANT: Make sure that all of the shipping materials (for example shipping tape) are removed from the replacement part prior to installation.



NOTE: If the replacement part is a roller or pad, avoid touching the spongy part of it. Skin oils on the roller or pad can cause paper pickup and/or print-quality problems. HP recommends using disposable gloves when handling rollers or pads or washing your hands before touching rollers or pads.

3. To install an assembly, reverse the removal steps.



NOTE: When applicable, special installation instructions are provided for an assembly at the end of the removal procedure. Always completely read the removal instructions and follow all special installation instructions.

Removal and replacement: Pickup assembly (HCI)

Learn about removing and replacing the HCI paper pickup assembly.

Before performing service

Turn the printer power off

- Disconnect the power cable.

⚠ WARNING! To avoid damage to the printer, turn the printer off, wait 30 seconds, and then remove the power cord before attempting to service the printer.

Use the table below to identify the correct part number for your printer, and then go to <https://parts.hp.com/hpparts> to order the part.

Table 5-116 Part information

Part number	Part description
RM2-3509-000CN	Paper pickup assembly (2,100-sheet paper deck HCI)

Required tools

- #2 Phillips screwdriver with a magnetic tip and a 152 mm (6 in) shaft length
- Small flat-blade screwdriver

After performing service

Turn the printer power on

- Connect the power cable.
- Use the power switch to turn the power on.

Post service test

Print any pages necessary to make sure the printer is functioning correctly.

1. Remove the right door (HCI)

Follow these steps to remove the HCI right door.

1. Open the HCI tray, and then open the right door.
2. Remove two screws (callout 1), and then slide the right door (callout 2) in the direction indicated to remove it.

Figure 5-873 Remove the right door (HCI)

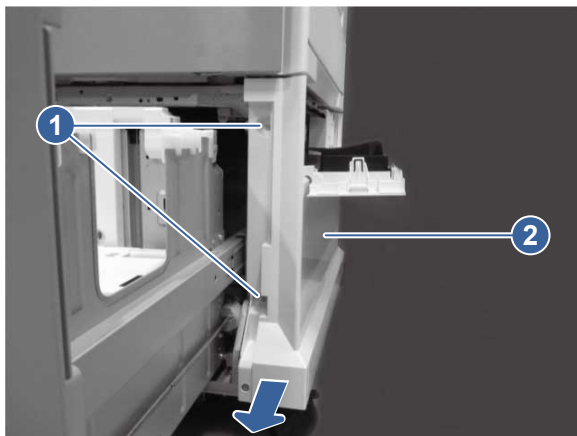

2. Remove the paper pickup assembly (HCI)

Follow these steps to remove the HCI paper pickup assembly.

1. Remove one screw (callout 1), release one tab (callout 2), and then slide the inner cover (callout 3) downward to remove it.

Figure 5-874 Remove the inner cover

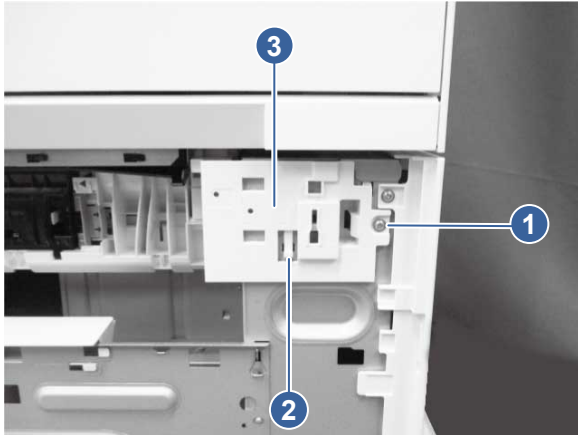

2. Disconnect one connector (callout 1), remove one screw (callout 2), and then remove the pickup assembly (callout 3).

Figure 5-875 Remove the pickup assembly (HCI)

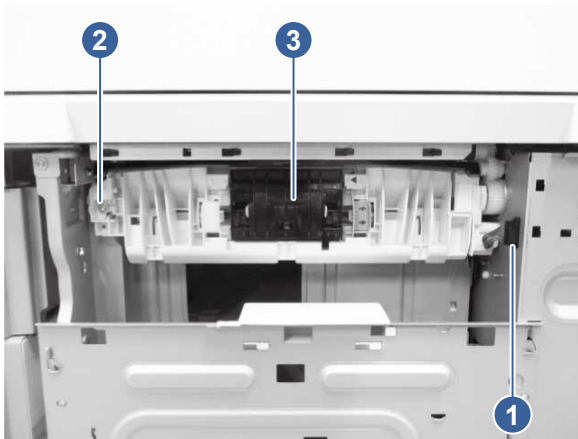

3. Remove the gear (callout 2) from the pickup assembly (callout 1).

Figure 5-876 Remove the gear

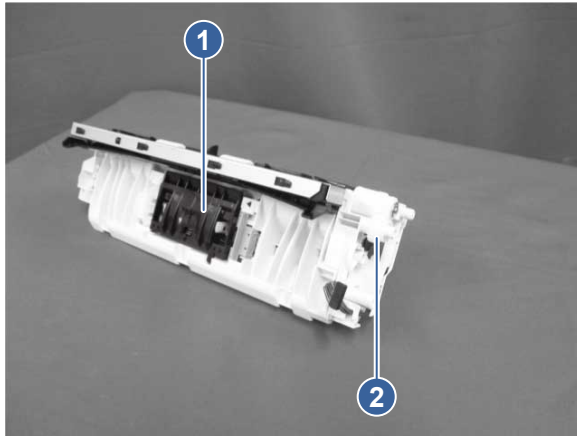

3. Unpack the replacement assembly

Follow these steps to unpack the replacement assembly.

1. Dispose of the defective part.



NOTE: HP recommends responsible disposal of the defective part.

<http://www8.hp.com/us/en/hp-information/environment/product-recycling.html>

2. Unpack the replacement part from the packaging.



CAUTION:  Some parts are sensitive to electrostatic discharge (ESD). Always perform service work at an ESD-protected workstation or mat. If an ESD workstation or mat is not available, touch the sheet-metal chassis to provide a static ground before touching an ESD-sensitive assembly. Protect the ESD-sensitive assemblies by placing them in ESD pouches when they are out of the printer.



IMPORTANT: Make sure that all of the shipping materials (for example shipping tape) are removed from the replacement part prior to installation.



NOTE: If the replacement part is a roller or pad, avoid touching the spongy part of it. Skin oils on the roller or pad can cause paper pickup and/or print-quality problems. HP recommends using disposable gloves when handling rollers or pads or washing your hands before touching rollers or pads.

3. To install an assembly, reverse the removal steps.



NOTE: When applicable, special installation instructions are provided for an assembly at the end of the removal procedure. Always completely read the removal instructions and follow all special installation instructions.

Removal and replacement: Auto close assembly (HCI)

Learn about removing and replacing the HCI auto close assembly.

Before performing service

Turn the printer power off

- Disconnect the power cable.

⚠ WARNING! To avoid damage to the printer, turn the printer off, wait 30 seconds, and then remove the power cord before attempting to service the printer.

Use the table below to identify the correct part number for your printer, and then go to <https://parts.hp.com/hpparts> to order the part.

Table 5-117 Part information

Part number	Part description
RM2-0918-000CN	Auto close assembly (2,100-sheet paper deck HCI)

Required tools

- #2 Phillips screwdriver with a magnetic tip and a 152 mm (6 in) shaft length

After performing service

Turn the printer power on

- Connect the power cable.
- Use the power switch to turn the power on.

Post service test

No post service test is available for this assembly.

1. Remove the cassette (HCI)

Follow these steps to remove the HCI cassette.

1. Open the HCI cassette assembly.

Figure 5-877 Open the HCI cassette

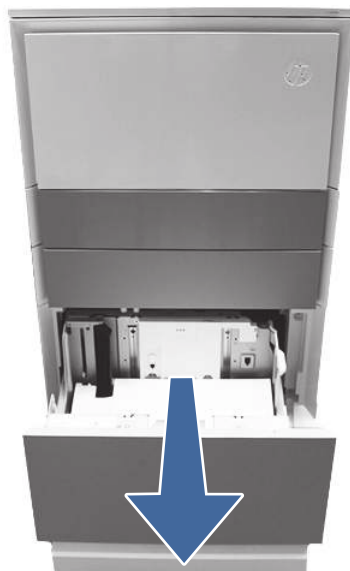

2. Press the left and right release levers (callout 1).

Figure 5-878 Press the release levers

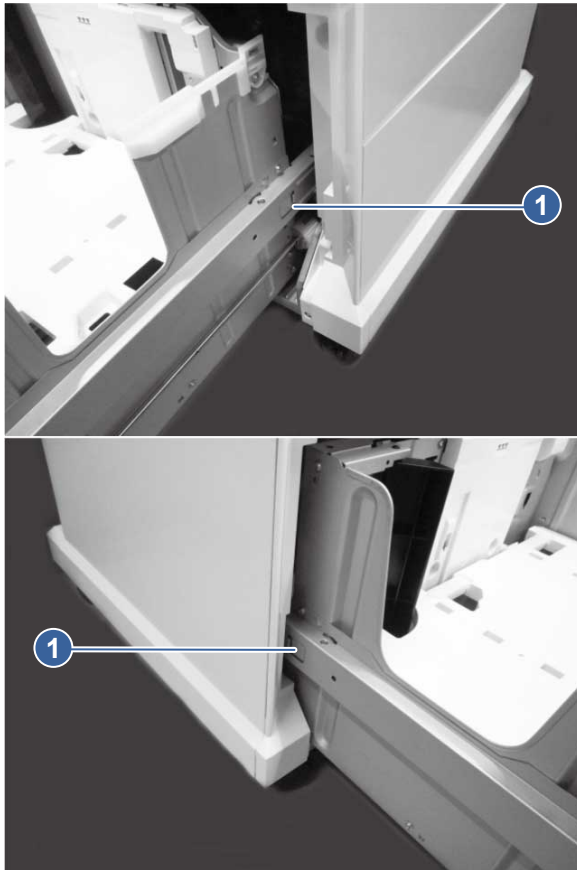

3. Pull the HCl cassette assembly (callout 1) out of the HCl chassis.

Figure 5-879 Remove the tray cassette (HCl)

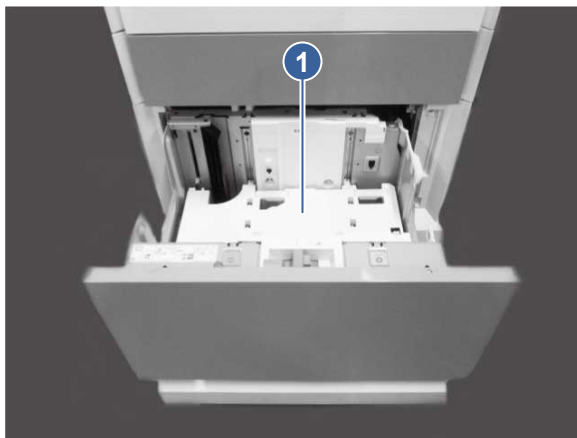

2. Remove the auto close assembly (HCl)

Follow these steps to remove the HCl auto close assembly.

- Remove three screws (callout 1), and then remove the auto close assembly (callout 2).

Figure 5-880 Remove the auto close assembly (HCI)

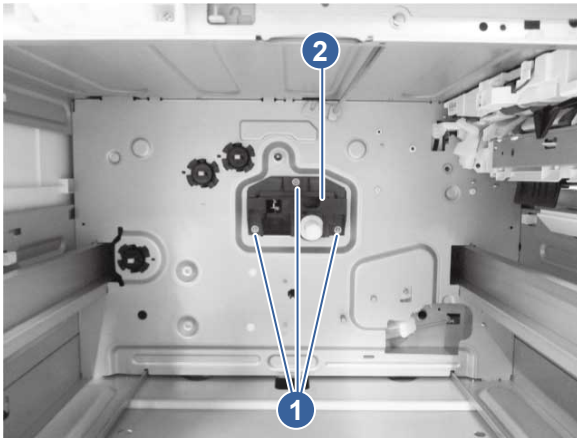

3. Unpack the replacement assembly

Follow these steps to unpack the replacement assembly.

1. Dispose of the defective part.



NOTE: HP recommends responsible disposal of the defective part.

<http://www8.hp.com/us/en/hp-information/environment/product-recycling.html>

2. Unpack the replacement part from the packaging.



CAUTION:  Some parts are sensitive to electrostatic discharge (ESD). Always perform service work at an ESD-protected workstation or mat. If an ESD workstation or mat is not available, touch the sheet-metal chassis to provide a static ground before touching an ESD-sensitive assembly. Protect the ESD-sensitive assemblies by placing them in ESD pouches when they are out of the printer.



IMPORTANT: Make sure that all of the shipping materials (for example shipping tape) are removed from the replacement part prior to installation.



NOTE: If the replacement part is a roller or pad, avoid touching the spongy part of it. Skin oils on the roller or pad can cause paper pickup and/or print-quality problems. HP recommends using disposable gloves when handling rollers or pads or washing your hands before touching rollers or pads.

3. To install an assembly, reverse the removal steps.



NOTE: When applicable, special installation instructions are provided for an assembly at the end of the removal procedure. Always completely read the removal instructions and follow all special installation instructions.

Removal and replacement: Lifter drive assembly (HCI)

Learn about removing and replacing the HCI lifter drive assembly.

Before performing service

Turn the printer power off

- Disconnect the power cable.

⚠ WARNING! To avoid damage to the printer, turn the printer off, wait 30 seconds, and then remove the power cord before attempting to service the printer.

Use the table below to identify the correct part number for your printer, and then go to <https://parts.hp.com/hpparts> to order the part.

Table 5-118 Part information

Part number	Part description
RM3-0021-000CN	Lifter drive assembly (2,100-sheet paper deck HCI)

Required tools

- #2 Phillips screwdriver with a magnetic tip and a 152 mm (6 in) shaft length
- Small flat-blade screwdriver

After performing service

Turn the printer power on

- Connect the power cable.
- Use the power switch to turn the power on.

Post service test

Print any pages necessary to make sure the printer is functioning correctly.

1. Remove the right door (HCI)

Follow these steps to remove the HCI right door.

1. Open the HCI tray, and then open the right door.
2. Remove two screws (callout 1), and then slide the right door (callout 2) in the direction indicated to remove it.

Figure 5-881 Remove the right door (HCI)

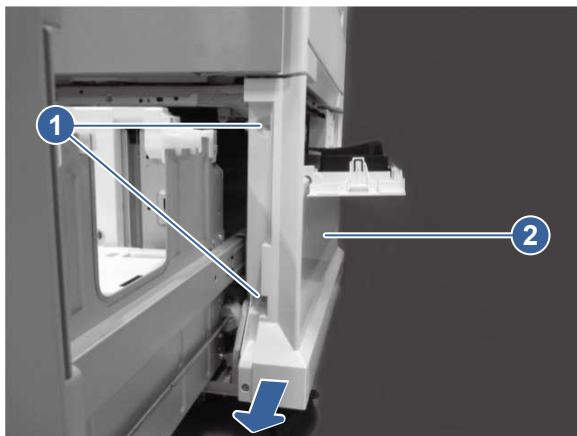

2. Remove the rear cover (HCI)

Follow these steps to remove the HCI rear cover.

- Remove one screw (callout 1), and then slide the rear cover (callout 2) in the direction indicated to remove it.

Figure 5-882 Remove the rear cover (HCI)

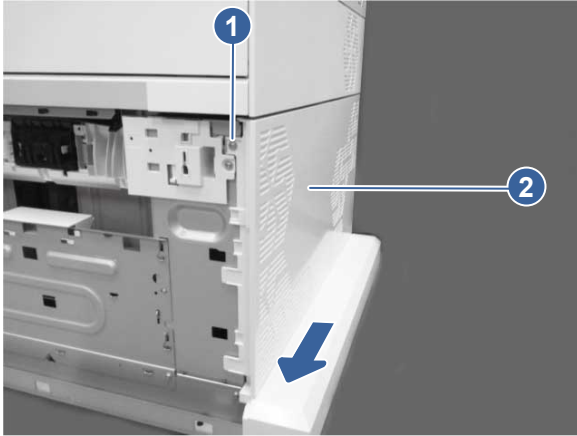

3. Remove the lifter drive assembly (HCI)

Follow these steps to remove the HCI lifter drive assembly.

1. Disconnect one connector (callout 1), release the cable (callout 2) from the cable clamps (callout 3).

Figure 5-883 Disconnect one connector

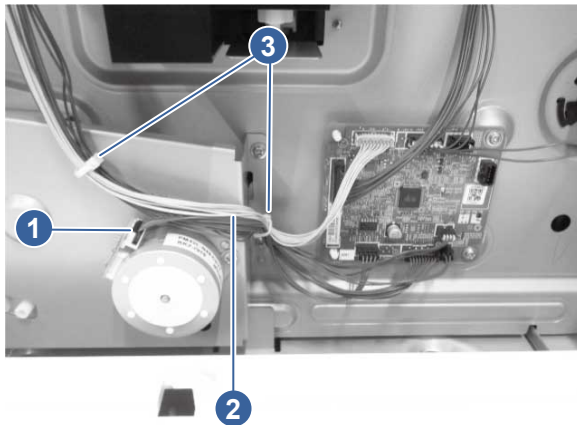

2. Remove three screws (callout 1), release one tab (callout 2), and then remove the lifter drive assembly (callout 3).

Figure 5-884 Remove the lifter drive assembly (HCI)

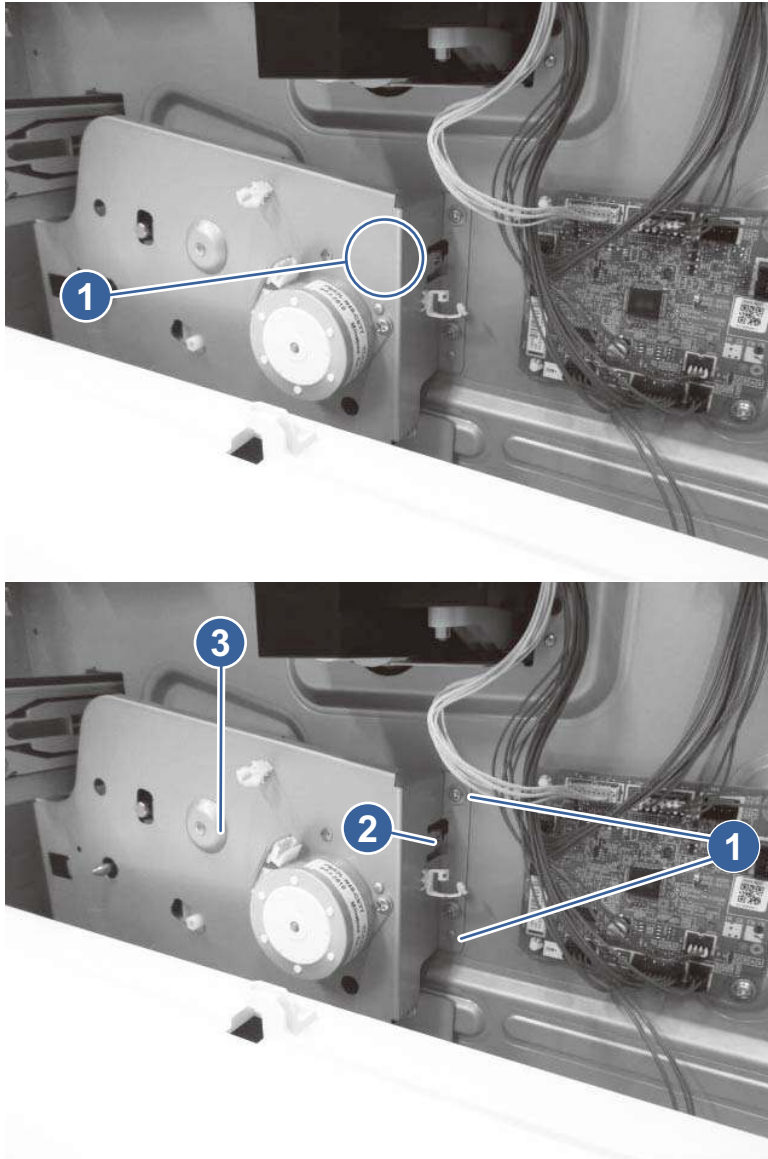

4. Unpack the replacement assembly

Follow these steps to unpack the replacement assembly.

1. Dispose of the defective part.



NOTE: HP recommends responsible disposal of the defective part.

<http://www8.hp.com/us/en/hp-information/environment/product-recycling.html>

2. Unpack the replacement part from the packaging.



CAUTION:  Some parts are sensitive to electrostatic discharge (ESD). Always perform service work at an ESD-protected workstation or mat. If an ESD workstation or mat is not available, touch

the sheet-metal chassis to provide a static ground before touching an ESD-sensitive assembly. Protect the ESD-sensitive assemblies by placing them in ESD pouches when they are out of the printer.

 **IMPORTANT:** Make sure that all of the shipping materials (for example shipping tape) are removed from the replacement part prior to installation.

 **NOTE:** If the replacement part is a roller or pad, avoid touching the spongy part of it. Skin oils on the roller or pad can cause paper pickup and/or print-quality problems. HP recommends using disposable gloves when handling rollers or pads or washing your hands before touching rollers or pads.

3. To install an assembly, reverse the removal steps.

 **NOTE:** When applicable, special installation instructions are provided for an assembly at the end of the removal procedure. Always completely read the removal instructions and follow all special installation instructions.

Removal and replacement: Pickup alienation assembly (HCI)

Learn about removing and replacing the HCI pickup alienation assembly.

Before performing service

Turn the printer power off

- Disconnect the power cable.

 **WARNING!** To avoid damage to the printer, turn the printer off, wait 30 seconds, and then remove the power cord before attempting to service the printer.

Use the table below to identify the correct part number for your printer, and then go to <https://parts.hp.com/hpparts> to order the part.

Table 5-119 Part information

Part number	Part description
RM3-0022-000CN	Pick estrangement assembly (2,100-sheet paper deck HCI)

Required tools

- No special tools are required to remove or install this assembly.

After performing service

Turn the printer power on

- Connect the power cable.
- Use the power switch to turn the power on.

Post service test

No post service test is available for this assembly.

1. Remove the right door (HCI)

Follow these steps to remove the HCI right door.

1. Open the HCI tray, and then open the right door.
2. Remove two screws (callout 1), and then slide the right door (callout 2) in the direction indicated to remove it.

Figure 5-885 Remove the right door (HCI)

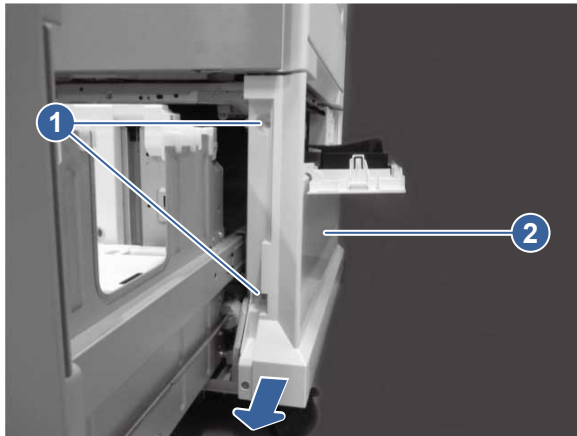

2. Remove the rear cover (HCI)

Follow these steps to remove the HCI rear cover.

- Remove one screw (callout 1), and then slide the rear cover (callout 2) in the direction indicated to remove it.

Figure 5-886 Remove the rear cover (HCI)

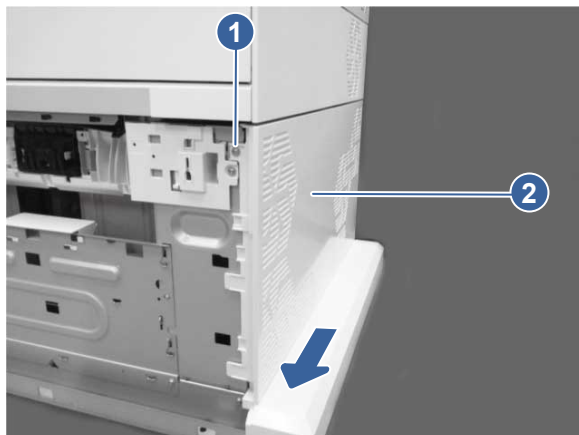

3. Remove the pickup alienation assembly (HCI)

Follow these steps to remove the HCI pickup alienation assembly.

1. Disconnect four connectors (callout 1), and then release the cable (callout 2) from the cable clamps (callout 3).

Figure 5-887 Disconnect four connectors

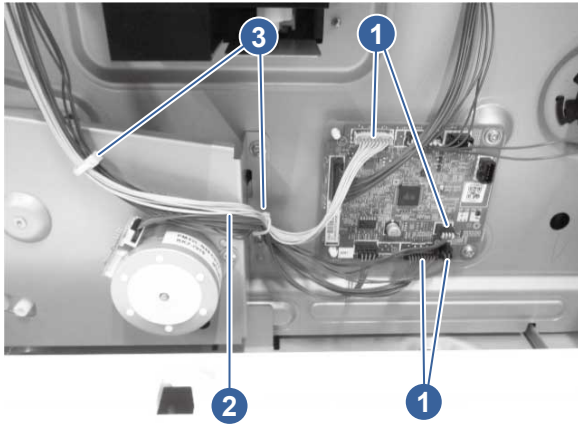

2. Release the cable (callout 1) from the pickup alienation assembly (callout 2), remove two screws (callout 3), and then remove the pickup alienation assembly.

Figure 5-888 Remove the pickup alienation assembly (HCI)

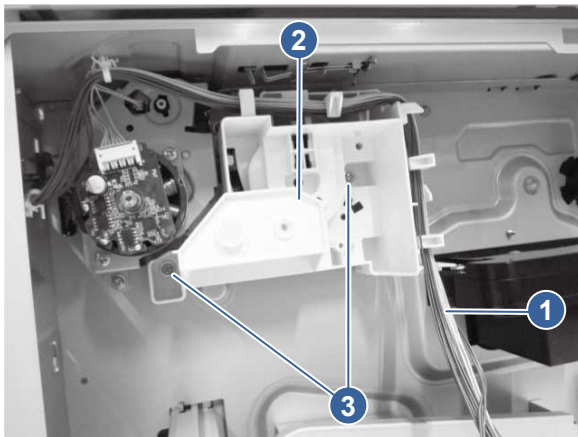

 **Reinstallation tip:** When reassembling the pickup alienation assembly, line up the hole (callout 1) in the gear overlaps the position of the hole (callout 2) in the pickup alienation assembly.

Figure 5-889 Align hole in gear with hole in chassis



4. Unpack the replacement assembly

Follow these steps to unpack the replacement assembly.

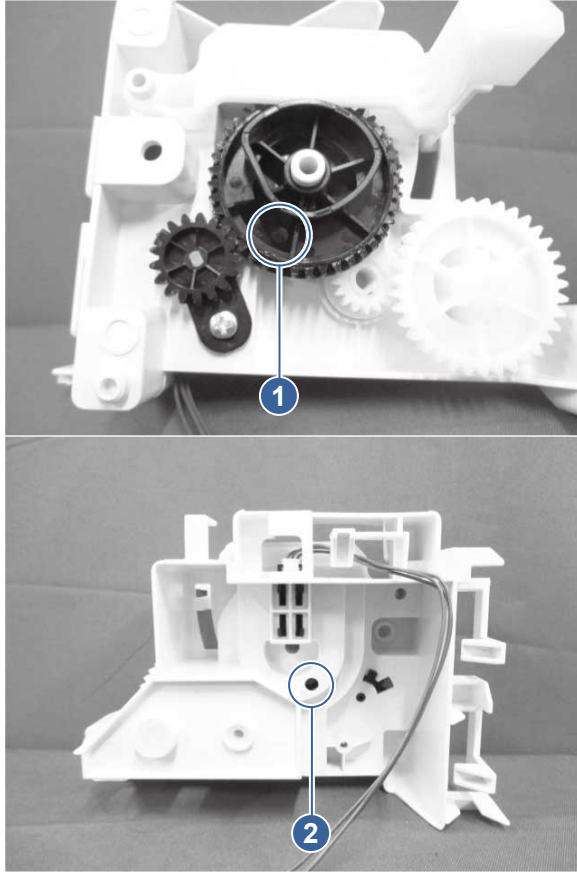
1. Dispose of the defective part.



NOTE: HP recommends responsible disposal of the defective part.

<http://www8.hp.com/us/en/hp-information/environment/product-recycling.html>

2. Unpack the replacement part from the packaging.



CAUTION:  Some parts are sensitive to electrostatic discharge (ESD). Always perform service work at an ESD-protected workstation or mat. If an ESD workstation or mat is not available, touch the sheet-metal chassis to provide a static ground before touching an ESD-sensitive assembly. Protect the ESD-sensitive assemblies by placing them in ESD pouches when they are out of the printer.



IMPORTANT: Make sure that all of the shipping materials (for example shipping tape) are removed from the replacement part prior to installation.



NOTE: If the replacement part is a roller or pad, avoid touching the spongy part of it. Skin oils on the roller or pad can cause paper pickup and/or print-quality problems. HP recommends using disposable gloves when handling rollers or pads or washing your hands before touching rollers or pads.

3. To install an assembly, reverse the removal steps.



NOTE: When applicable, special installation instructions are provided for an assembly at the end of the removal procedure. Always completely read the removal instructions and follow all special installation instructions.

Removal and replacement: Pickup drive assembly (HCI)

Learn about removing and replacing the HCI pickup drive assembly.



[View a video demonstration of removing and replacing the pickup drive assembly.](#)

Before performing service

Turn the printer power off

- Disconnect the power cable.

⚠ WARNING! To avoid damage to the printer, turn the printer off, wait 30 seconds, and then remove the power cord before attempting to service the printer.

Use the table below to identify the correct part number for your printer, and then go to <https://parts.hp.com/hpparts> to order the part.

Table 5-120 Part information

Part number	Part description
RM2-3617-000CN	Paper pickup drive assembly (2,100-sheet paper deck HCI)

Required tools

- #2 Phillips screwdriver with a magnetic tip and a 152 mm (6 in) shaft length
- Small flat-blade screwdriver

After performing service

Turn the printer power on

- Connect the power cable.
- Use the power switch to turn the power on.

Post service test

Print any pages necessary to make sure the printer is functioning correctly.

1. Remove the right door (HCI)

Follow these steps to remove the HCI right door.

1. Open the HCI tray, and then open the right door.

2. Remove two screws (callout 1), and then slide the right door (callout 2) in the direction indicated to remove it.

Figure 5-890 Remove the right door (HCI)

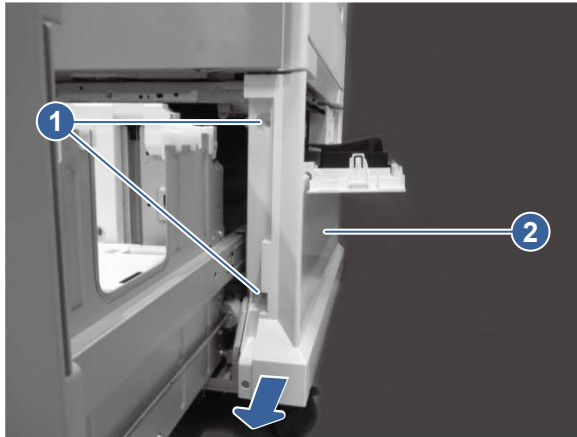

2. Remove the rear cover (HCI)

Follow these steps to remove the HCI rear cover.

- Remove one screw (callout 1), and then slide the rear cover (callout 2) in the direction indicated to remove it.

Figure 5-891 Remove the rear cover (HCI)

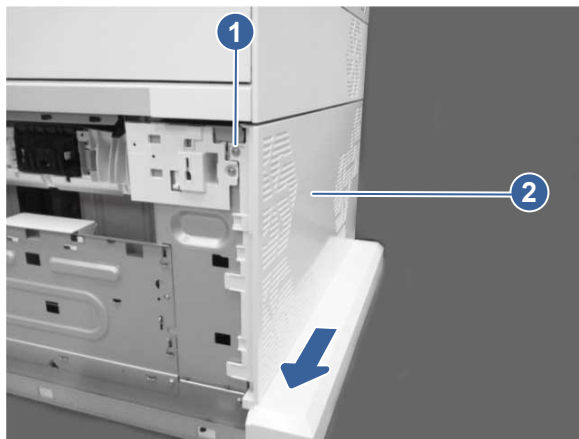

3. Remove the pickup alienation assembly (HCI)

Follow these steps to remove the HCI pickup alienation assembly.

1. Disconnect four connectors (callout 1), and then release the cable (callout 2) from the cable clamps (callout 3).

Figure 5-892 Disconnect four connectors

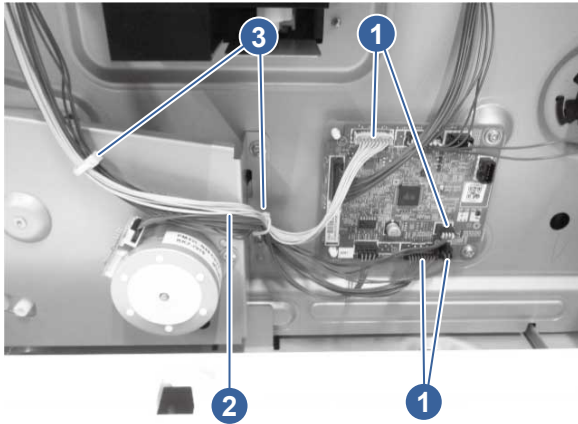

2. Release the cable (callout 1) from the pickup alienation assembly (callout 2), remove two screws (callout 3), and then remove the pickup alienation assembly.

Figure 5-893 Remove the pickup alienation assembly (HCI)

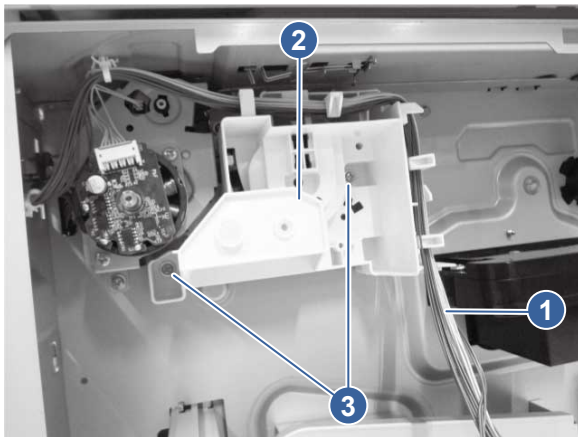

 **Reinstallation tip:** When reassembling the pickup alienation assembly, line up the hole (callout 1) in the gear overlaps the position of the hole (callout 2) in the pickup alienation assembly.

Figure 5-894 Align hole in gear with hole in chassis



4. Remove the pickup drive assembly (HCI)

Follow these steps to remove the HCI pickup drive assembly.

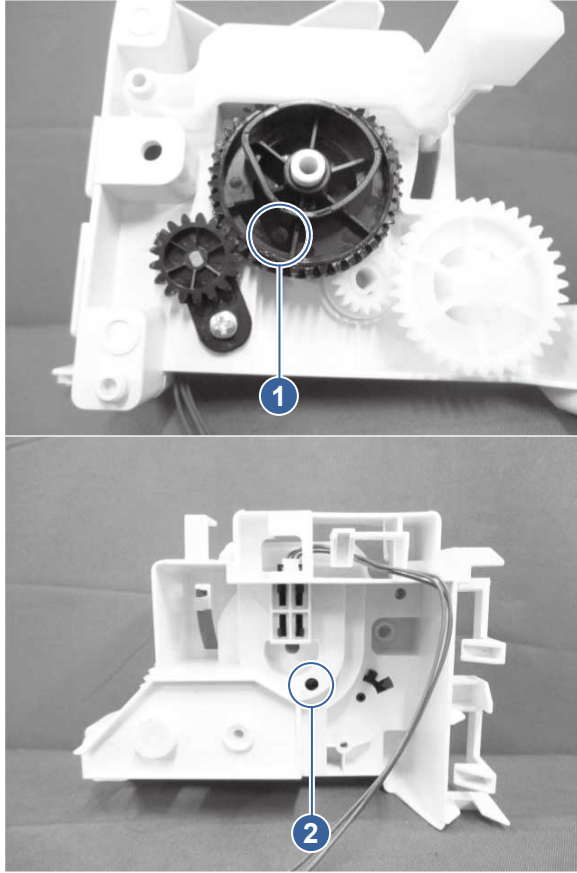
1. Remove the cable clamp (callout 1), disconnect two connectors (callout 2), and then remove three screws (callout 3).

Figure 5-895 Disconnect connectors and remove screws

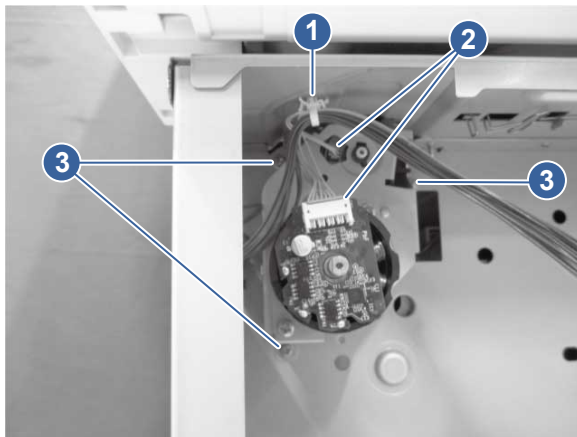

2. Release one tab (callout 1), and then remove the pickup drive assembly (callout 2).

Figure 5-896 Remove the pickup drive assembly (HCI)

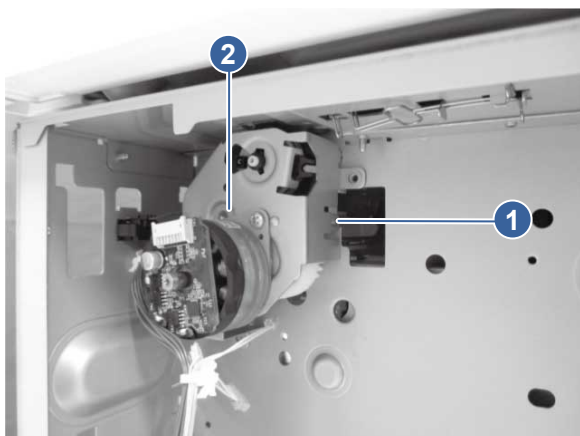

5. Unpack the replacement assembly

Follow these steps to unpack the replacement assembly.

1. Dispose of the defective part.



NOTE: HP recommends responsible disposal of the defective part.

<http://www8.hp.com/us/en/hp-information/environment/product-recycling.html>

2. Unpack the replacement part from the packaging.



CAUTION:  Some parts are sensitive to electrostatic discharge (ESD). Always perform service work at an ESD-protected workstation or mat. If an ESD workstation or mat is not available, touch the sheet-metal chassis to provide a static ground before touching an ESD-sensitive assembly. Protect the ESD-sensitive assemblies by placing them in ESD pouches when they are out of the printer.



IMPORTANT: Make sure that all of the shipping materials (for example shipping tape) are removed from the replacement part prior to installation.



NOTE: If the replacement part is a roller or pad, avoid touching the spongy part of it. Skin oils on the roller or pad can cause paper pickup and/or print-quality problems. HP recommends using disposable gloves when handling rollers or pads or washing your hands before touching rollers or pads.

3. To install an assembly, reverse the removal steps.



NOTE: When applicable, special installation instructions are provided for an assembly at the end of the removal procedure. Always completely read the removal instructions and follow all special installation instructions.

Removal and replacement: Controller PCA (HCI)

Learn about removing and replacing the HCI controller PCA.

Before performing service

Turn the printer power off

- Disconnect the power cable.

⚠ WARNING! To avoid damage to the printer, turn the printer off, wait 30 seconds, and then remove the power cord before attempting to service the printer.

Use the table below to identify the correct part number for your printer, and then go to <https://parts.hp.com/hpparts> to order the part.

Table 5-121 Part information

Part number	Part description
RM3-8071-000CN	HCI controller PCA (2,100-sheet paper deck HCI)

Required tools

- #2 Phillips screwdriver with a magnetic tip and a 152 mm (6 in) shaft length

After performing service

Turn the printer power on

- Connect the power cable.
- Use the power switch to turn the power on.

Post service test

Print any pages necessary to make sure the printer is functioning correctly.

1. Remove the cassette (HCI)

Follow these steps to remove the HCI cassette.

1. Open the HCI cassette assembly.

Figure 5-897 Open the HCI cassette

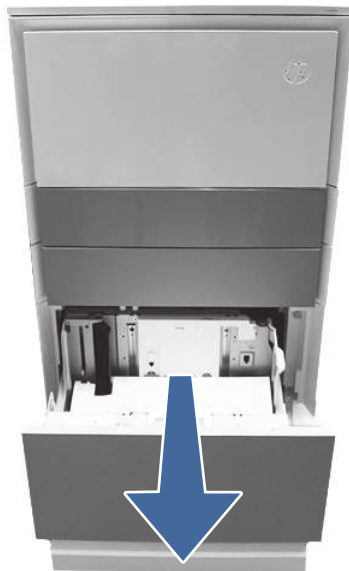

2. Press the left and right release levers (callout 1).

Figure 5-898 Press the release levers

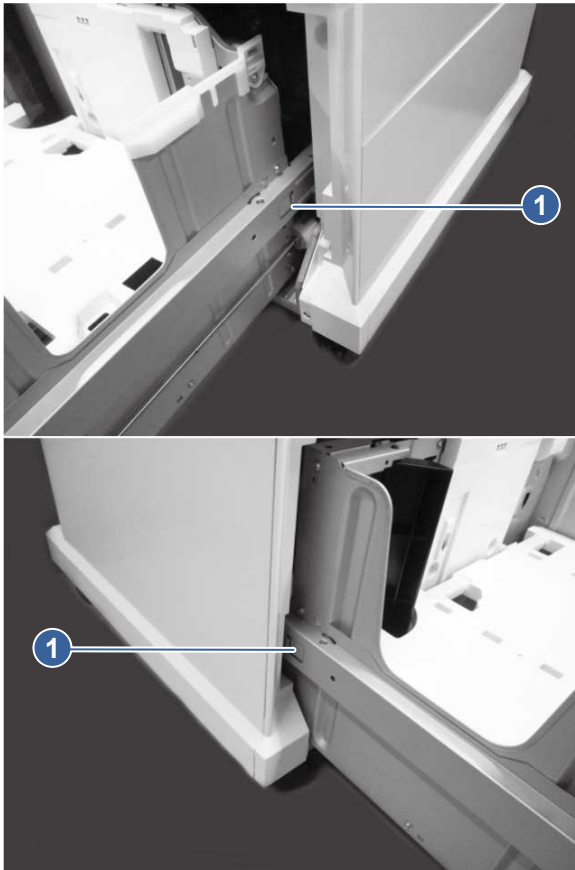

3. Pull the HCI cassette assembly (callout 1) out of the HCI chassis.

Figure 5-899 Remove the tray cassette (HCI)

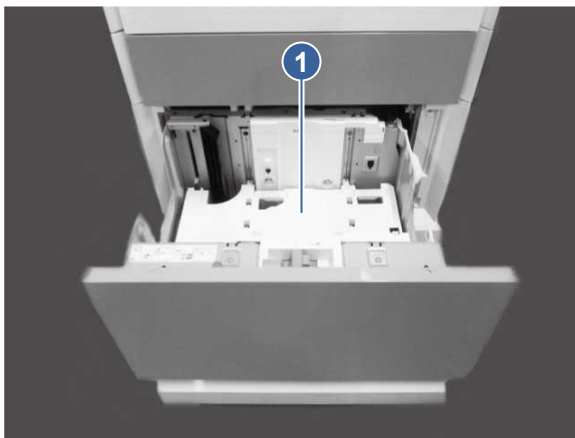

2. Remove the front left cover/left cover (HCI)

Follow these steps to remove the HCI front left cover/left cover.

1. Remove two screws (callout 1).

Figure 5-900 Remove two screws

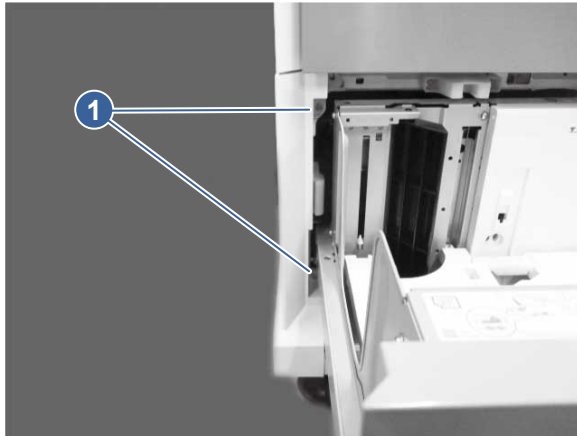

2. Remove the left cover (callout 1) together with the front left cover (callout 2). Release one tab (callout 3), and then slide the front left cover upward to remove it from the left cover.

Figure 5-901 Remove the front left cover from the left cover (HCI)

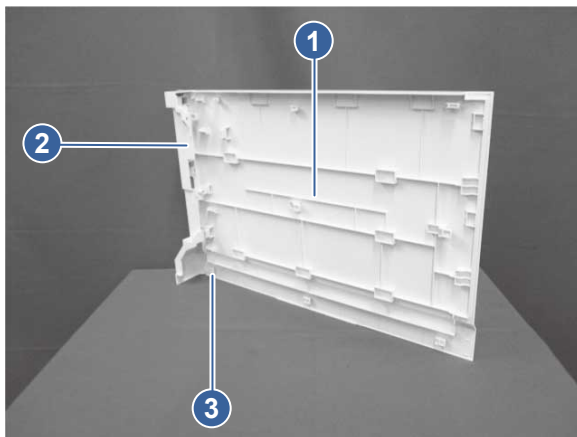

3. Remove the controller PCA (HCI)

Follow these steps to remove the HCI controller PCA.

- Disconnect all the connectors on the HCI controller PCA. Remove two screws (callout 1), remove two PCA spacers (callout 2), and then remove the HCI controller PCA (callout 3).

Figure 5-902 Remove the controller PCA (HCI)

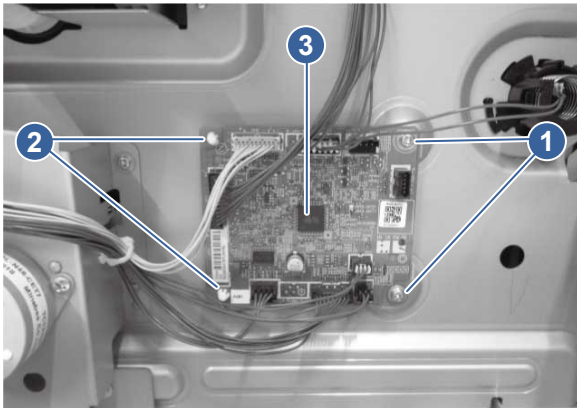

4. Unpack the replacement assembly

Follow these steps to unpack the replacement assembly.

1. Dispose of the defective part.



NOTE: HP recommends responsible disposal of the defective part.

<http://www8.hp.com/us/en/hp-information/environment/product-recycling.html>

2. Unpack the replacement part from the packaging.



CAUTION:  Some parts are sensitive to electrostatic discharge (ESD). Always perform service work at an ESD-protected workstation or mat. If an ESD workstation or mat is not available, touch the sheet-metal chassis to provide a static ground before touching an ESD-sensitive assembly. Protect the ESD-sensitive assemblies by placing them in ESD pouches when they are out of the printer.



IMPORTANT: Make sure that all of the shipping materials (for example shipping tape) are removed from the replacement part prior to installation.



NOTE: If the replacement part is a roller or pad, avoid touching the spongy part of it. Skin oils on the roller or pad can cause paper pickup and/or print-quality problems. HP recommends using disposable gloves when handling rollers or pads or washing your hands before touching rollers or pads.

3. To install an assembly, reverse the removal steps.



NOTE: When applicable, special installation instructions are provided for an assembly at the end of the removal procedure. Always completely read the removal instructions and follow all special installation instructions.

Removal and replacement: Separation roller assembly (HCI)

Learn about removing and replacing the HCI separation roller assembly.

Before performing service

Turn the printer power off

- Disconnect the power cable.

⚠ WARNING! To avoid damage to the printer, turn the printer off, wait 30 seconds, and then remove the power cord before attempting to service the printer.

If the part is damaged and cannot be cleaned, use the table below to identify the correct part number for your printer. To order the part, go to www.hp.com/buy/parts.

Table 5-122 Part information

Part number	Part description
527H2A	HP LaserJet Tray 2-x Roller Kit (2,100-sheet paper deck HCI)

Required tools

- No special tools are required to remove or install this assembly.

After performing service

Turn the printer power on

- Connect the power cable.
- Use the power switch to turn the power on.

Post service test

Print any pages necessary to make sure the printer is functioning correctly.

1. Remove the separation roller assembly (HCI)

Learn about removing the HCI separation roller assembly.

NOTE: The 550-sheet paper feeder is shown in the graphics below. The steps for the HCI rollers are the same.

1. Open the right door.

2. Slide the lever (callout 1) to the right, and then remove the roller assembly (callout 2) by pulling it out from the printer.

Figure 5-903 Remove the roller assembly

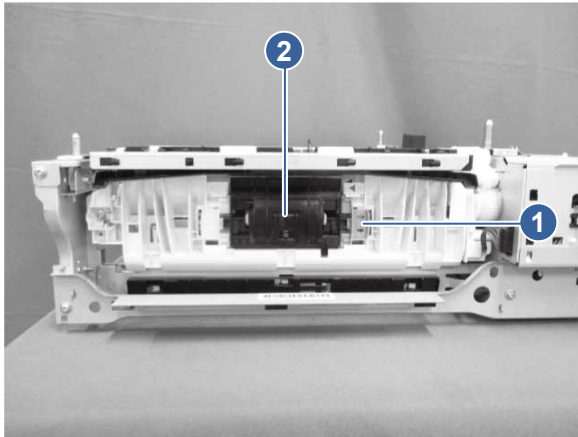

2. Unpack the replacement assembly

Follow these steps to unpack the replacement assembly.

1. Dispose of the defective part.



NOTE: HP recommends responsible disposal of the defective part.

<http://www8.hp.com/us/en/hp-information/environment/product-recycling.html>

2. Unpack the replacement part from the packaging.



CAUTION:  Some parts are sensitive to electrostatic discharge (ESD). Always perform service work at an ESD-protected workstation or mat. If an ESD workstation or mat is not available, touch the sheet-metal chassis to provide a static ground before touching an ESD-sensitive assembly. Protect the ESD-sensitive assemblies by placing them in ESD pouches when they are out of the printer.



IMPORTANT: Make sure that all of the shipping materials (for example shipping tape) are removed from the replacement part prior to installation.



NOTE: If the replacement part is a roller or pad, avoid touching the spongy part of it. Skin oils on the roller or pad can cause paper pickup and/or print-quality problems. HP recommends using disposable gloves when handling rollers or pads or washing your hands before touching rollers or pads.

3. To install an assembly, reverse the removal steps.



NOTE: When applicable, special installation instructions are provided for an assembly at the end of the removal procedure. Always completely read the removal instructions and follow all special installation instructions.

Removal and replacement: Pickup roller assembly (HCI)

Learn about removing and replacing the HCI pickup roller assembly.

Before performing service

Turn the printer power off

- Disconnect the power cable.

⚠ WARNING! To avoid damage to the printer, turn the printer off, wait 30 seconds, and then remove the power cord before attempting to service the printer.

If the part is damaged and cannot be cleaned, use the table below to identify the correct part number for your printer. To order the part, go to www.hp.com/buy/parts.

Table 5-123 Part information

Part number	Part description
527H2A	HP LaserJet Tray 2-x Roller Kit (2,100-sheet paper deck HCI)

Required tools

- No special tools are required to remove or install this assembly.

After performing service

Turn the printer power on

- Connect the power cable.
- Use the power switch to turn the power on.

Post service test

Print any pages necessary to make sure the printer is functioning correctly.

1. Remove the separation roller assembly (HCI)

Learn about removing the HCI separation roller assembly.

NOTE: The 550-sheet paper feeder is shown in the graphics below. The steps for the HCI rollers are the same.

1. Open the right door.

2. Slide the lever (callout 1) to the right, and then remove the roller assembly (callout 2) by pulling it out from the printer.

Figure 5-904 Remove the roller assembly

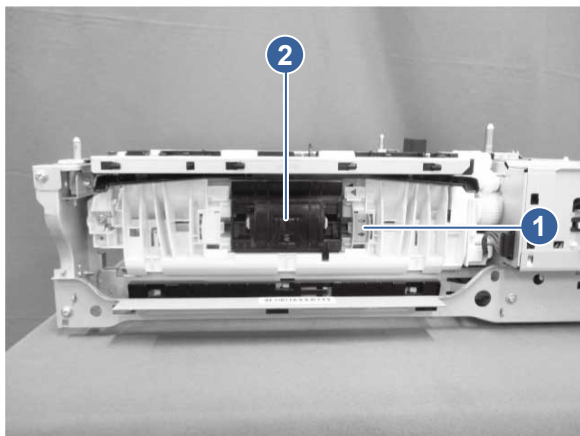

2. Remove the paper pickup roller assembly (HCI)

Learn about removing the HCI pickup rollers.

 **NOTE:** Even if you want to replace only the pickup roller assembly, you must first remove the separation roller assembly.

 **NOTE:** The 550-sheet paper feeder is shown in the graphics below. The steps for the HCI rollers are the same.

- Locate the pickup roller assembly (callout 1) and then pull it away from the printer to remove it.

Figure 5-905 Remove the pickup roller assembly

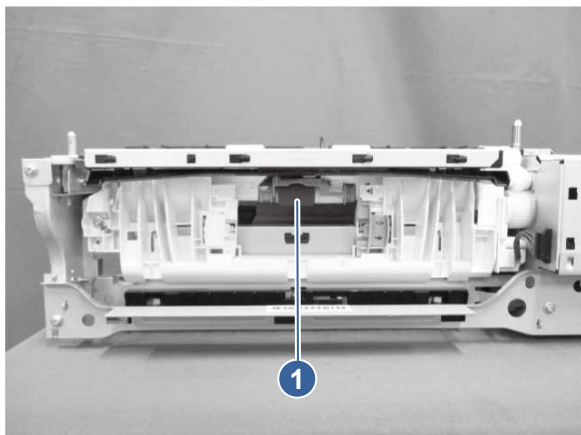

3. Unpack the replacement assembly



Follow these steps to unpack the replacement assembly.

1. Dispose of the defective part.

 **NOTE:** HP recommends responsible disposal of the defective part.

<http://www8.hp.com/us/en/hp-information/environment/product-recycling.html>

2. Unpack the replacement part from the packaging.

 **CAUTION:**  Some parts are sensitive to electrostatic discharge (ESD). Always perform service work at an ESD-protected workstation or mat. If an ESD workstation or mat is not available, touch the sheet-metal chassis to provide a static ground before touching an ESD-sensitive assembly. Protect the ESD-sensitive assemblies by placing them in ESD pouches when they are out of the printer.

 **IMPORTANT:** Make sure that all of the shipping materials (for example shipping tape) are removed from the replacement part prior to installation.

 **NOTE:** If the replacement part is a roller or pad, avoid touching the spongy part of it. Skin oils on the roller or pad can cause paper pickup and/or print-quality problems. HP recommends using disposable gloves when handling rollers or pads or washing your hands before touching rollers or pads.

3. To install an assembly, reverse the removal steps.

 **NOTE:** When applicable, special installation instructions are provided for an assembly at the end of the removal procedure. Always completely read the removal instructions and follow all special installation instructions.

Output device - 3-bin staple stacker multi-bin mailbox

Learn how to remove and replace the 3-bin staple stacker multi-bin mailbox parts and assemblies.

Field-replaceable units (FRUs)

Learn about FRU parts removal and replacement.

Covers, panels, and doors

Learn about covers, panels, and doors removal and replacement.

Removal and replacement: Rear cover (3-bin stapler-stacker)

Learn about removing and replacing the rear cover.

Before performing service

Turn the printer power off

- Disconnect the power cable.

 **WARNING!** To avoid damage to the printer, turn the printer off, wait 30 seconds, and then remove the power cord before attempting to service the printer.

Use the table below to identify the correct part number for your printer, and then go to <https://parts.hp.com/hpparts> to order the part.

Table 5-124 Part information

Part number	Part description
RC6-1305-000CN	Cover, rear (3-bin SS)

Required tools

- No special tools are required to remove or install this assembly.

After performing service

Turn the printer power on

- Connect the power cable.
- Use the power switch to turn the power on.

Post service test

No post service test is available for this assembly.

1. Remove the rear cover (3-bin stapler-stacker)

Learn about removing the 3-bin stapler-stacker rear cover.

1. Remove the printer formatter cover by removing one screw (callout 1) and then sliding the cover (callout 2) in the direction indicated. Slide the 3-bin stapler-stacker formatter cover assembly (callout 3) in the direction indicated to remove it.

Figure 5-906 Remove the 3-bin stapler-stacker formatter cover

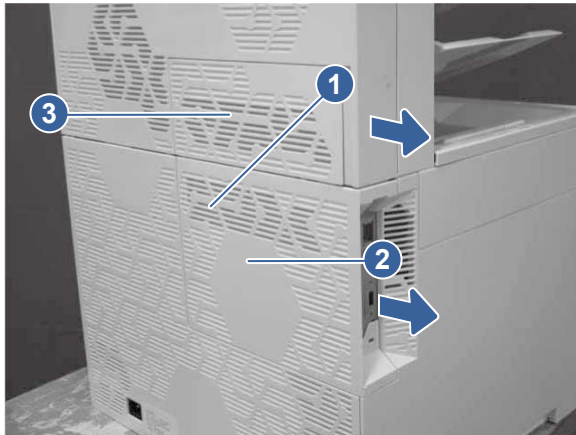

2. Remove two screws (callout 1), release three tabs (callout 2), and then remove the rear cover (callout 3).

Figure 5-907 Remove the rear cover

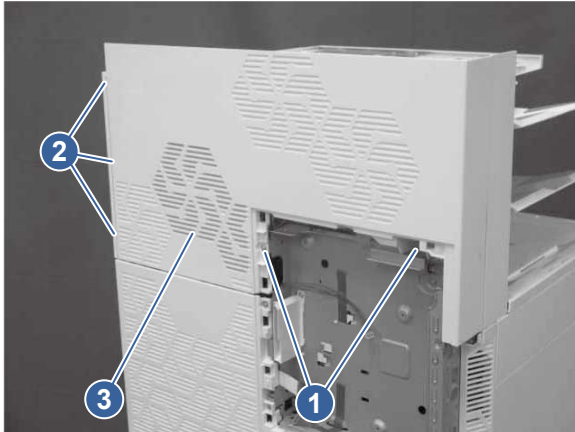

2. Unpack the replacement assembly

Follow these steps to unpack the replacement assembly.

1. Dispose of the defective part.



NOTE: HP recommends responsible disposal of the defective part.

<http://www8.hp.com/us/en/hp-information/environment/product-recycling.html>

2. Unpack the replacement part from the packaging.



CAUTION:  Some parts are sensitive to electrostatic discharge (ESD). Always perform service work at an ESD-protected workstation or mat. If an ESD workstation or mat is not available, touch the sheet-metal chassis to provide a static ground before touching an ESD-sensitive assembly. Protect the ESD-sensitive assemblies by placing them in ESD pouches when they are out of the printer.



IMPORTANT: Make sure that all of the shipping materials (for example shipping tape) are removed from the replacement part prior to installation.



NOTE: If the replacement part is a roller or pad, avoid touching the spongy part of it. Skin oils on the roller or pad can cause paper pickup and/or print-quality problems. HP recommends using disposable gloves when handling rollers or pads or washing your hands before touching rollers or pads.

3. To install an assembly, reverse the removal steps.



NOTE: When applicable, special installation instructions are provided for an assembly at the end of the removal procedure. Always completely read the removal instructions and follow all special installation instructions.

Removal and replacement: Staple cover and staple door (3-bin stapler-stacker)

Learn about removing and replacing the staple cover and door.

Before performing service

Turn the printer power off

- Disconnect the power cable.

⚠ WARNING! To avoid damage to the printer, turn the printer off, wait 30 seconds, and then remove the power cord before attempting to service the printer.

Use the table below to identify the correct part number for your printer, and then go to <https://parts.hp.com/hpparts> to order the part.

Table 5-125 Part information

Part number	Part description
RM3-0483-000CN	Staple cover assembly (3-bin SS)
RM3-0484-000CN	Staple door assembly (3-bin SS)

Required tools

- No special tools are required to remove or install this assembly.

After performing service

Turn the printer power on

- Connect the power cable.
- Use the power switch to turn the power on.

Post service test

No post service test is available for this assembly.

1. Remove the staple cover and staple door (3-bin stapler-stacker)

Learn about removing the 3-bin stapler-stacker staple cover and staple door.

1. Open the stapler-stacker door assembly and the stapler door.
2. Remove one screw (callout 1), and then release three tabs (callout 2).

Figure 5-908 Remove one screw

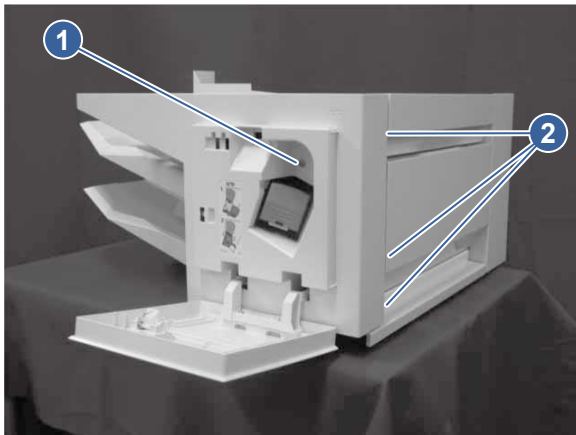

3. Release one tab (callout 1), and then remove the staple cover (callout 2) and the staple door (callout 3) together.

Figure 5-909 Release one tab

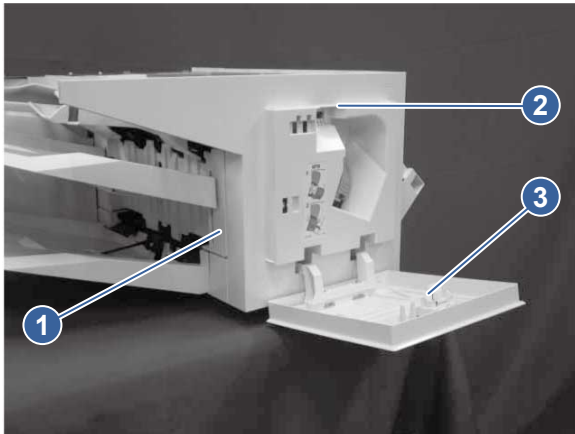

4. Remove two shafts (callout 1), and then remove the staple door (callout 2) from the staple cover (callout 3).

Figure 5-910 Remove the staple door from the staple cover

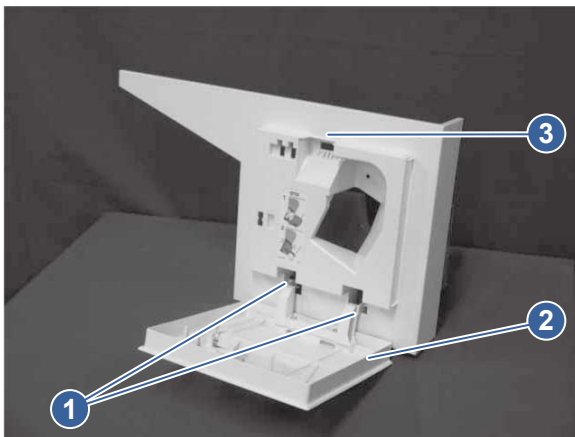

2. Unpack the replacement assembly

Follow these steps to unpack the replacement assembly.

1. Dispose of the defective part.





NOTE: HP recommends responsible disposal of the defective part.

<http://www8.hp.com/us/en/hp-information/environment/product-recycling.html>

2. Unpack the replacement part from the packaging.



CAUTION:  Some parts are sensitive to electrostatic discharge (ESD). Always perform service work at an ESD-protected workstation or mat. If an ESD workstation or mat is not available, touch the sheet-metal chassis to provide a static ground before touching an ESD-sensitive assembly. Protect the ESD-sensitive assemblies by placing them in ESD pouches when they are out of the printer.

 **IMPORTANT:** Make sure that all of the shipping materials (for example shipping tape) are removed from the replacement part prior to installation.

 **NOTE:** If the replacement part is a roller or pad, avoid touching the spongy part of it. Skin oils on the roller or pad can cause paper pickup and/or print-quality problems. HP recommends using disposable gloves when handling rollers or pads or washing your hands before touching rollers or pads.

3. To install an assembly, reverse the removal steps.

 **NOTE:** When applicable, special installation instructions are provided for an assembly at the end of the removal procedure. Always completely read the removal instructions and follow all special installation instructions.

Removal and replacement: Right upper cover (3-bin stapler-stacker)

Learn about removing and replacing the right upper cover.

Before performing service

Turn the printer power off

- Disconnect the power cable.

 **WARNING!** To avoid damage to the printer, turn the printer off, wait 30 seconds, and then remove the power cord before attempting to service the printer.

Use the table below to identify the correct part number for your printer, and then go to <https://parts.hp.com/hpparts> to order the part.

Table 5-126 Part information

Part number	Part description
RC6-1308-000CN	Cover, right upper (3-bin SS)

Required tools

- No special tools are required to remove or install this assembly.

After performing service

Turn the printer power on

- Connect the power cable.
- Use the power switch to turn the power on.

Post service test

No post service test is available for this assembly.

1. Remove the right upper cover (3-bin stapler-stacker)

Learn about removing the 3-bin stapler-stacker right upper cover.

1. Open the stapler-stacker door assembly.

2. Remove one screw (callout 1), release one tab (callout 2), and then remove the right upper cover (callout 3).

Figure 5-911 Remove the 3-bin stapler-stacker right upper cover

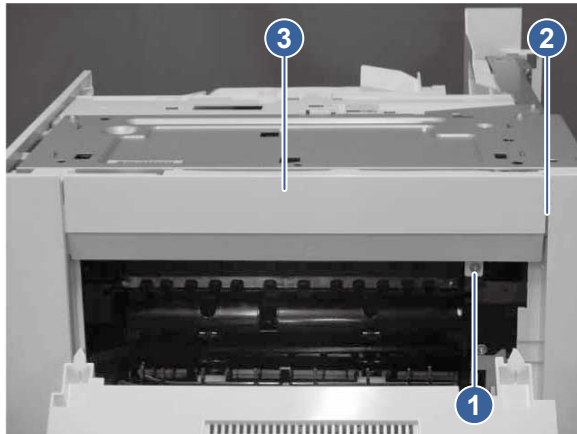

2. Unpack the replacement assembly

Follow these steps to unpack the replacement assembly.

1. Dispose of the defective part.



NOTE: HP recommends responsible disposal of the defective part.

<http://www8.hp.com/us/en/hp-information/environment/product-recycling.html>

2. Unpack the replacement part from the packaging.



CAUTION:  Some parts are sensitive to electrostatic discharge (ESD). Always perform service work at an ESD-protected workstation or mat. If an ESD workstation or mat is not available, touch the sheet-metal chassis to provide a static ground before touching an ESD-sensitive assembly. Protect the ESD-sensitive assemblies by placing them in ESD pouches when they are out of the printer.



IMPORTANT: Make sure that all of the shipping materials (for example shipping tape) are removed from the replacement part prior to installation.



NOTE: If the replacement part is a roller or pad, avoid touching the spongy part of it. Skin oils on the roller or pad can cause paper pickup and/or print-quality problems. HP recommends using disposable gloves when handling rollers or pads or washing your hands before touching rollers or pads.

3. To install an assembly, reverse the removal steps.



NOTE: When applicable, special installation instructions are provided for an assembly at the end of the removal procedure. Always completely read the removal instructions and follow all special installation instructions.

Removal and replacement: Right corner cover (3-bin stapler-stacker)

Learn about removing and replacing the right corner cover.

Before performing service

Turn the printer power off

- Disconnect the power cable.

⚠ WARNING! To avoid damage to the printer, turn the printer off, wait 30 seconds, and then remove the power cord before attempting to service the printer.

Use the table below to identify the correct part number for your printer, and then go to <https://parts.hp.com/hpparts> to order the part.

Table 5-127 Part information

Part number	Part description
RC6-1307-000CN	RC6-1307-000CN (3-bin SS)

Required tools

- No special tools are required to remove or install this assembly.

After performing service

Turn the printer power on

- Connect the power cable.
- Use the power switch to turn the power on.

Post service test

No post service test is available for this assembly.

1. Remove the rear cover (3-bin stapler-stacker)

Learn about removing the 3-bin stapler-stacker rear cover.

1. Remove the printer formatter cover by removing one screw (callout 1) and then sliding the cover (callout 2) in the direction indicated. Slide the 3-bin stapler-stacker formatter cover assembly (callout 3) in the direction indicated to remove it.

Figure 5-912 Remove the 3-bin stapler-stacker formatter cover

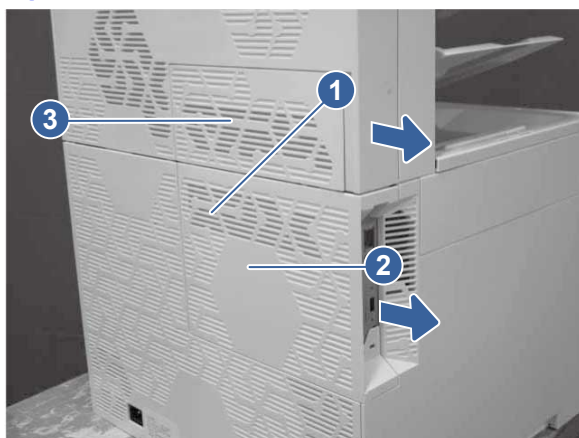

2. Remove two screws (callout 1), release three tabs (callout 2), and then remove the rear cover (callout 3).

Figure 5-913 Remove the rear cover

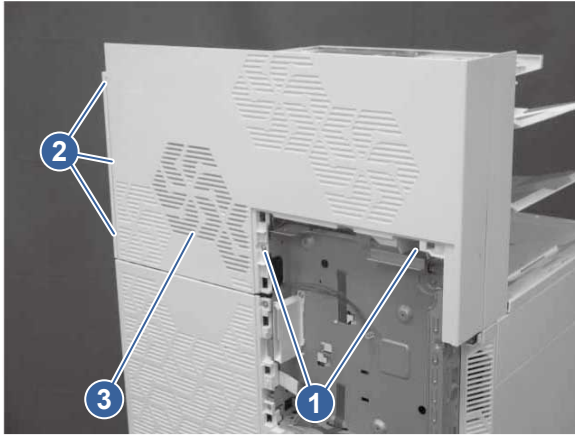

2. Remove the right upper cover (3-bin stapler-stacker)

Learn about removing the 3-bin stapler-stacker right upper cover.

1. Open the stapler-stacker door assembly.
2. Remove one screw (callout 1), release one tab (callout 2), and then remove the right upper cover (callout 3).

Figure 5-914 Remove the 3-bin stapler-stacker right upper cover

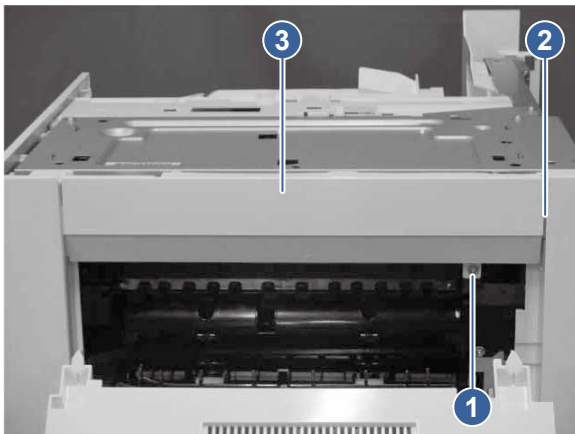

3. Remove the right corner cover (3-bin stapler-stacker)

Learn about removing the 3-bin stapler-stacker right corner cover.

- Remove one screw (callout 1), release two tabs (callout 2), and then remove the right corner cover (callout 3).

Figure 5-915 Remove the right corner cover

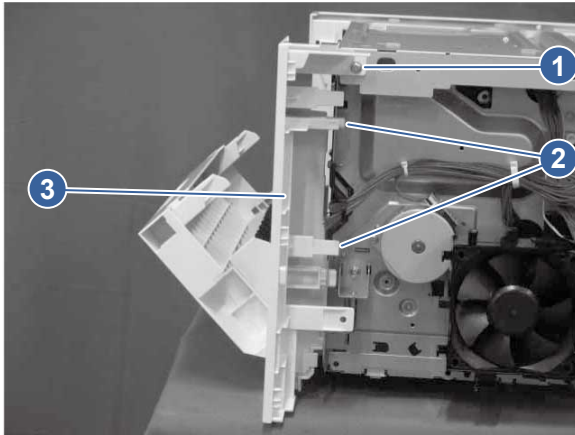

4. Unpack the replacement assembly



Follow these steps to unpack the replacement assembly.

1. Dispose of the defective part.

 **NOTE:** HP recommends responsible disposal of the defective part.

<http://www8.hp.com/us/en/hp-information/environment/product-recycling.html>

2. Unpack the replacement part from the packaging.

 **CAUTION:**  Some parts are sensitive to electrostatic discharge (ESD). Always perform service work at an ESD-protected workstation or mat. If an ESD workstation or mat is not available, touch the sheet-metal chassis to provide a static ground before touching an ESD-sensitive assembly. Protect the ESD-sensitive assemblies by placing them in ESD pouches when they are out of the printer.

 **IMPORTANT:** Make sure that all of the shipping materials (for example shipping tape) are removed from the replacement part prior to installation.

 **NOTE:** If the replacement part is a roller or pad, avoid touching the spongy part of it. Skin oils on the roller or pad can cause paper pickup and/or print-quality problems. HP recommends using disposable gloves when handling rollers or pads or washing your hands before touching rollers or pads.

3. To install an assembly, reverse the removal steps.

 **NOTE:** When applicable, special installation instructions are provided for an assembly at the end of the removal procedure. Always completely read the removal instructions and follow all special installation instructions.

Removal and replacement: Right lower cover (3-bin stapler-stacker)

Learn about removing and replacing the right lower cover.

Before performing service

Turn the printer power off

- Disconnect the power cable.

⚠ WARNING! To avoid damage to the printer, turn the printer off, wait 30 seconds, and then remove the power cord before attempting to service the printer.

Use the table below to identify the correct part number for your printer, and then go to <https://parts.hp.com/hpparts> to order the part.

Table 5-128 Part information

Part number	Part description
RC6-1309-000CN	Cover, right lower (3-bin SS)

Required tools

- No special tools are required to remove or install this assembly.

After performing service

Turn the printer power on

- Connect the power cable.
- Use the power switch to turn the power on.

Post service test

No post service test is available for this assembly.

1. Remove the rear cover (3-bin stapler-stacker)

Learn about removing the 3-bin stapler-stacker rear cover.

1. Remove the printer formatter cover by removing one screw (callout 1) and then sliding the cover (callout 2) in the direction indicated. Slide the 3-bin stapler-stacker formatter cover assembly (callout 3) in the direction indicated to remove it.

Figure 5-916 Remove the 3-bin stapler-stacker formatter cover

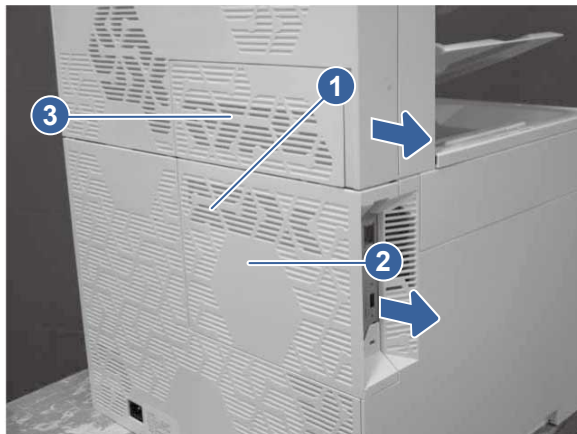

2. Remove two screws (callout 1), release three tabs (callout 2), and then remove the rear cover (callout 3).

Figure 5-917 Remove the rear cover

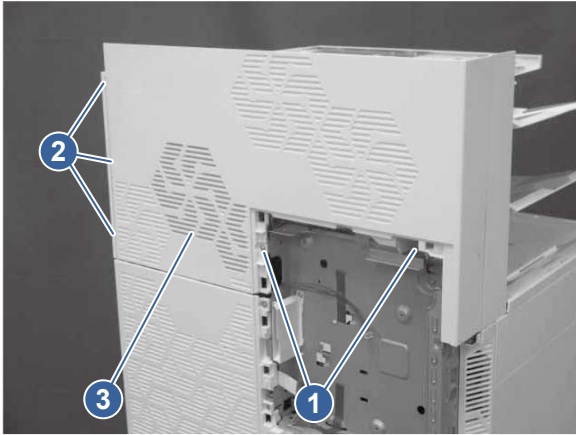

2. Remove the staple cover and staple door (3-bin stapler-stacker)

Learn about removing the 3-bin stapler-stacker staple cover and staple door.

1. Open the stapler-stacker door assembly and the stapler door.
2. Remove one screw (callout 1), and then release three tabs (callout 2).

Figure 5-918 Remove one screw

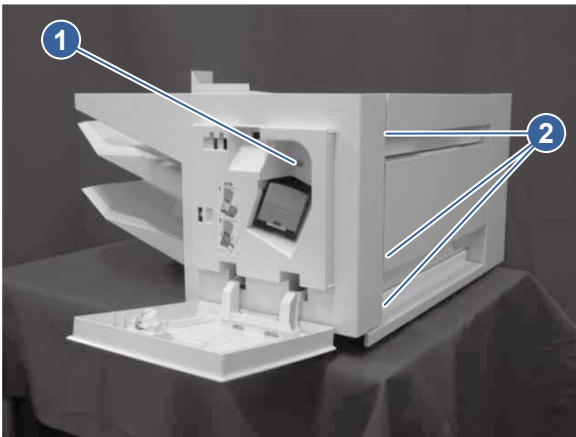

3. Release one tab (callout 1), and then remove the staple cover (callout 2) and the staple door (callout 3) together.

Figure 5-919 Release one tab

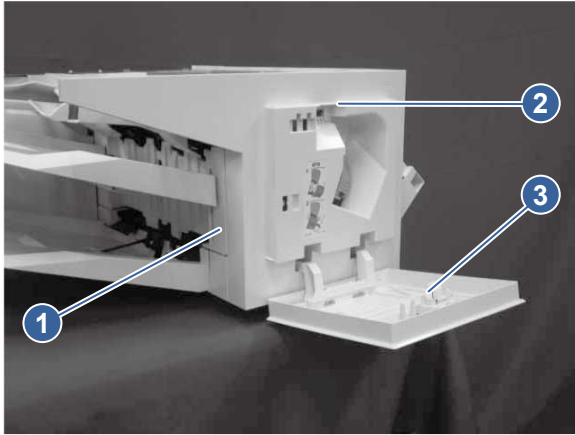

4. Remove two shafts (callout 1), and then remove the staple door (callout 2) from the staple cover (callout 3).

Figure 5-920 Remove the staple door from the staple cover

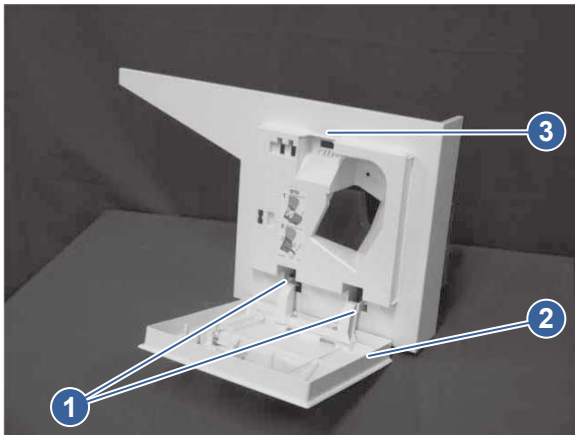

3. Remove the right upper cover (3-bin stapler-stacker)

Learn about removing the 3-bin stapler-stacker right upper cover.

1. Open the stapler-stacker door assembly.

2. Remove one screw (callout 1), release one tab (callout 2), and then remove the right upper cover (callout 3).

Figure 5-921 Remove the 3-bin stapler-stacker right upper cover

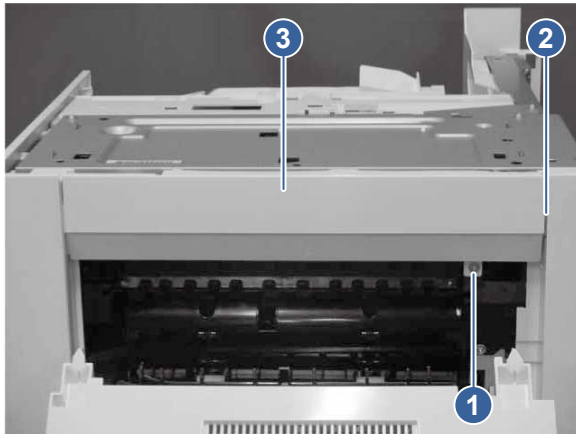

4. Remove the right corner cover (3-bin stapler-stacker)

Learn about removing the 3-bin stapler-stacker right corner cover.

- Remove one screw (callout 1), release two tabs (callout 2), and then remove the right corner cover (callout 3).

Figure 5-922 Remove the right corner cover

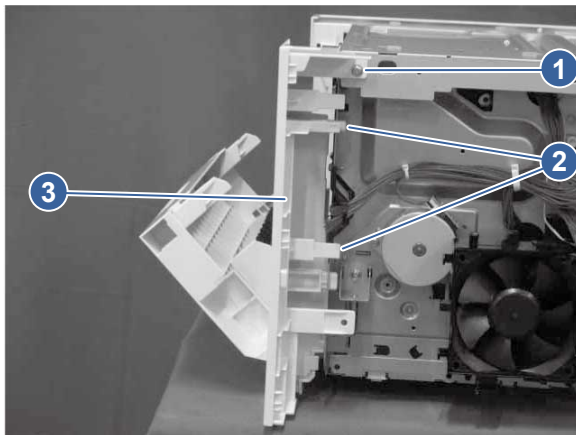

5. Remove the right lower cover (3-bin stapler-stacker)

Learn about removing the 3-bin stapler-stacker right lower cover.

- Release one tab (callout 1), and then slide the right lower cover (callout 2) in the direction indicated to remove it.

Figure 5-923 Remove the right lower cover

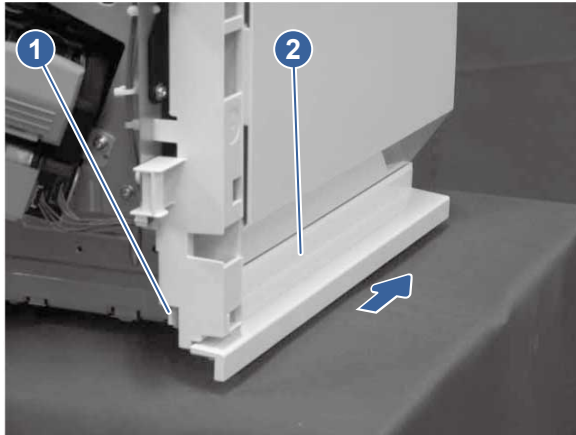

6. Unpack the replacement assembly

Follow these steps to unpack the replacement assembly.

1. Dispose of the defective part.



NOTE: HP recommends responsible disposal of the defective part.

<http://www8.hp.com/us/en/hp-information/environment/product-recycling.html>

2. Unpack the replacement part from the packaging.



CAUTION:  Some parts are sensitive to electrostatic discharge (ESD). Always perform service work at an ESD-protected workstation or mat. If an ESD workstation or mat is not available, touch the sheet-metal chassis to provide a static ground before touching an ESD-sensitive assembly. Protect the ESD-sensitive assemblies by placing them in ESD pouches when they are out of the printer.



IMPORTANT: Make sure that all of the shipping materials (for example shipping tape) are removed from the replacement part prior to installation.



NOTE: If the replacement part is a roller or pad, avoid touching the spongy part of it. Skin oils on the roller or pad can cause paper pickup and/or print-quality problems. HP recommends using disposable gloves when handling rollers or pads or washing your hands before touching rollers or pads.

3. To install an assembly, reverse the removal steps.



NOTE: When applicable, special installation instructions are provided for an assembly at the end of the removal procedure. Always completely read the removal instructions and follow all special installation instructions.

Removal and replacement: Rear inner cover (3-bin stapler-stacker)

Learn about removing and replacing the rear inner cover.

Before performing service

Turn the printer power off

- Disconnect the power cable.

⚠ WARNING! To avoid damage to the printer, turn the printer off, wait 30 seconds, and then remove the power cord before attempting to service the printer.

Use the table below to identify the correct part number for your printer, and then go to <https://parts.hp.com/hpparts> to order the part.

Table 5-129 Part information

Part number	Part description
RM3-0485-000CN	Rear inner cover assembly (3-bin SS)

Required tools

- No special tools are required to remove or install this assembly.

After performing service

Turn the printer power on

- Connect the power cable.
- Use the power switch to turn the power on.

Post service test

No post service test is available for this assembly.

1. Remove the rear cover (3-bin stapler-stacker)

Learn about removing the 3-bin stapler-stacker rear cover.

1. Remove the printer formatter cover by removing one screw (callout 1) and then sliding the cover (callout 2) in the direction indicated. Slide the 3-bin stapler-stacker formatter cover assembly (callout 3) in the direction indicated to remove it.

Figure 5-924 Remove the 3-bin stapler-stacker formatter cover

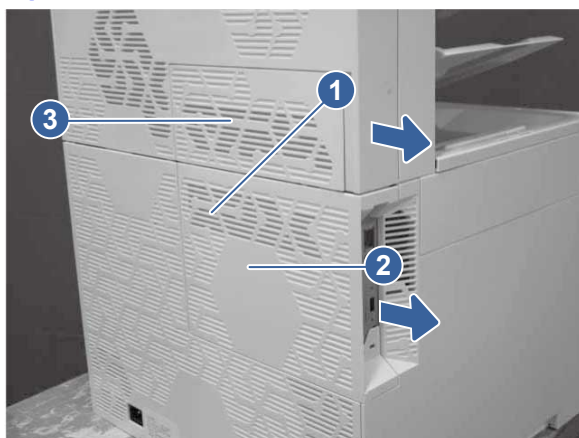

2. Remove two screws (callout 1), release three tabs (callout 2), and then remove the rear cover (callout 3).

Figure 5-925 Remove the rear cover

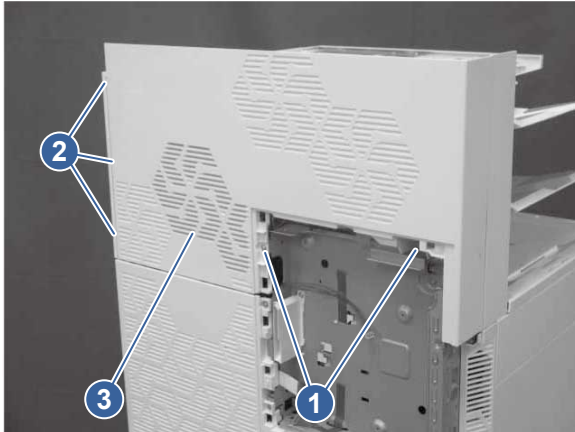

2. Remove the rear inner cover (3-bin stapler-stacker)

Learn about removing the 3-bin stapler-stacker rear inner cover.

- Remove one screw (callout 1) release three tabs (callout 2), and then remove the rear inner cover (callout 3).

Figure 5-926 Remove the rear inner cover

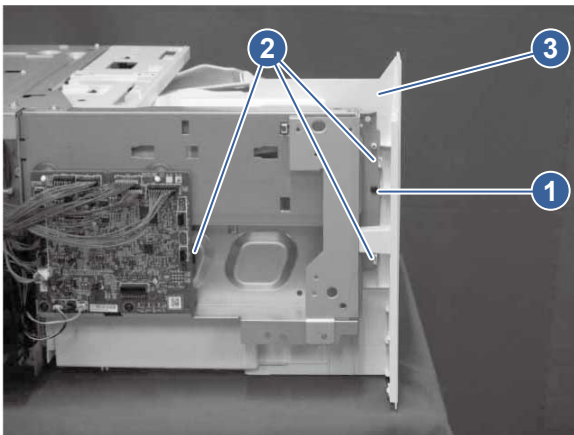

3. Unpack the replacement assembly

Follow these steps to unpack the replacement assembly.

1. Dispose of the defective part.



NOTE: HP recommends responsible disposal of the defective part.

<http://www8.hp.com/us/en/hp-information/environment/product-recycling.html>

2. Unpack the replacement part from the packaging.



CAUTION:  Some parts are sensitive to electrostatic discharge (ESD). Always perform service work at an ESD-protected workstation or mat. If an ESD workstation or mat is not available, touch

the sheet-metal chassis to provide a static ground before touching an ESD-sensitive assembly. Protect the ESD-sensitive assemblies by placing them in ESD pouches when they are out of the printer.

 **IMPORTANT:** Make sure that all of the shipping materials (for example shipping tape) are removed from the replacement part prior to installation.

 **NOTE:** If the replacement part is a roller or pad, avoid touching the spongy part of it. Skin oils on the roller or pad can cause paper pickup and/or print-quality problems. HP recommends using disposable gloves when handling rollers or pads or washing your hands before touching rollers or pads.

3. To install an assembly, reverse the removal steps.

 **NOTE:** When applicable, special installation instructions are provided for an assembly at the end of the removal procedure. Always completely read the removal instructions and follow all special installation instructions.

Removal and replacement: Stapler-stacker door assembly (3-bin stapler-stacker)

Learn about removing and replacing the stapler-stacker door.

Before performing service

Turn the printer power off

- Disconnect the power cable.

 **WARNING!** To avoid damage to the printer, turn the printer off, wait 30 seconds, and then remove the power cord before attempting to service the printer.

Use the table below to identify the correct part number for your printer, and then go to <https://parts.hp.com/hpparts> to order the part.

Table 5-130 Part information

Part number	Part description
RM2-4167-000CN	Right door assembly (3-bin SS)

Required tools

- No special tools are required to remove or install this assembly.

After performing service

Turn the printer power on

- Connect the power cable.
- Use the power switch to turn the power on.

Post service test

No post service test is available for this assembly.

1. Remove the rear cover (3-bin stapler-stacker)

Learn about removing the 3-bin stapler-stacker rear cover.

1. Remove the printer formatter cover by removing one screw (callout 1) and then sliding the cover (callout 2) in the direction indicated. Slide the 3-bin stapler-stacker formatter cover assembly (callout 3) in the direction indicated to remove it.

Figure 5-927 Remove the 3-bin stapler-stacker formatter cover

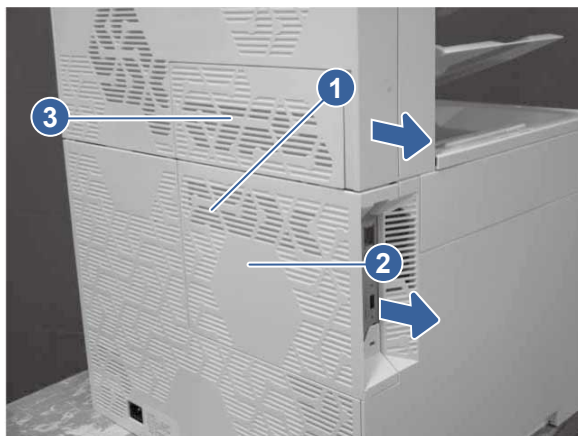

2. Remove two screws (callout 1), release three tabs (callout 2), and then remove the rear cover (callout 3).

Figure 5-928 Remove the rear cover

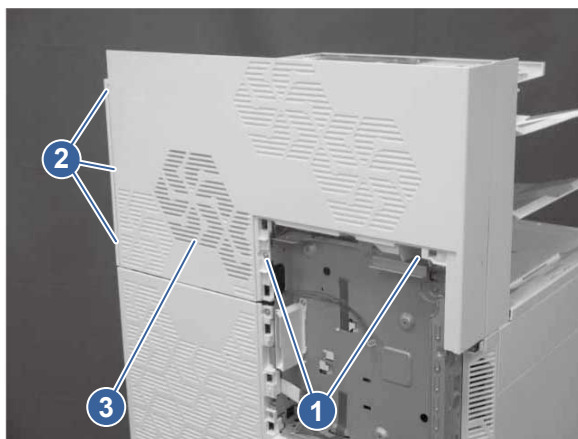

2. Remove the staple cover and staple door (3-bin stapler-stacker)

Learn about removing the 3-bin stapler-stacker staple cover and staple door.

1. Open the stapler-stacker door assembly and the stapler door.

2. Remove one screw (callout 1), and then release three tabs (callout 2).

Figure 5-929 Remove one screw

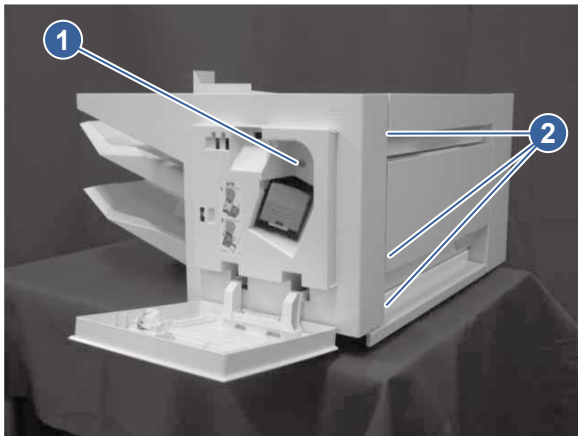

3. Release one tab (callout 1), and then remove the staple cover (callout 2) and the staple door (callout 3) together.

Figure 5-930 Release one tab

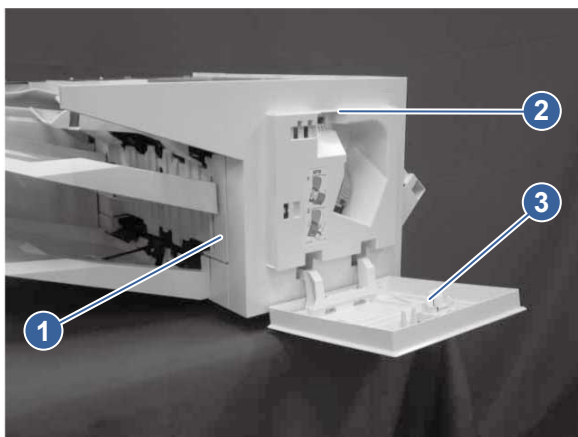

4. Remove two shafts (callout 1), and then remove the staple door (callout 2) from the staple cover (callout 3).

Figure 5-931 Remove the staple door from the staple cover

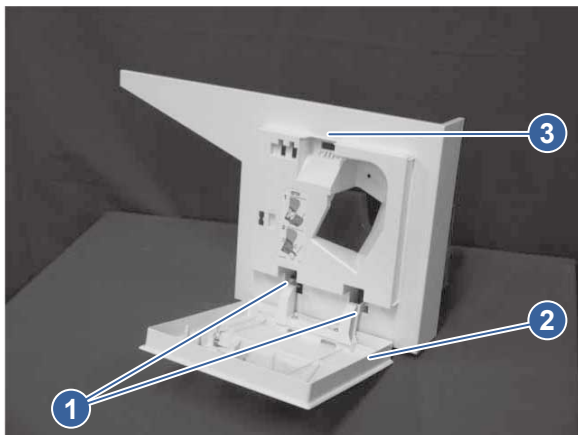

3. Remove the right upper cover (3-bin stapler-stacker)

Learn about removing the 3-bin stapler-stacker right upper cover.

1. Open the stapler-stacker door assembly.
2. Remove one screw (callout 1), release one tab (callout 2), and then remove the right upper cover (callout 3).

Figure 5-932 Remove the 3-bin stapler-stacker right upper cover

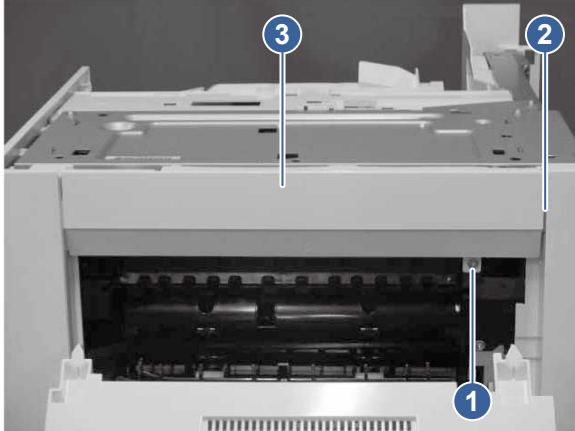

4. Remove the right corner cover (3-bin stapler-stacker)

Learn about removing the 3-bin stapler-stacker right corner cover.

- Remove one screw (callout 1), release two tabs (callout 2), and then remove the right corner cover (callout 3).

Figure 5-933 Remove the right corner cover

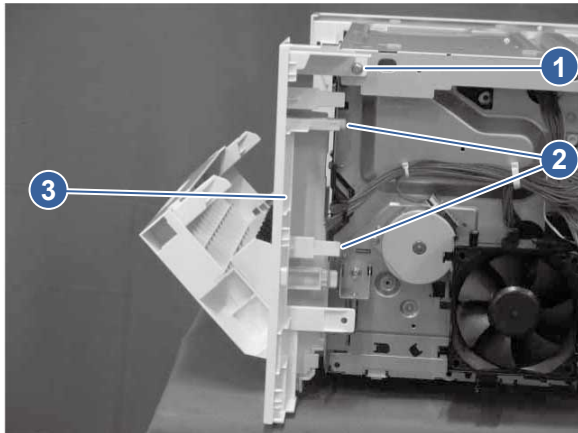

5. Remove the right lower cover (3-bin stapler-stacker)

Learn about removing the 3-bin stapler-stacker right lower cover.

- Release one tab (callout 1), and then slide the right lower cover (callout 2) in the direction indicated to remove it.

Figure 5-934 Remove the right lower cover

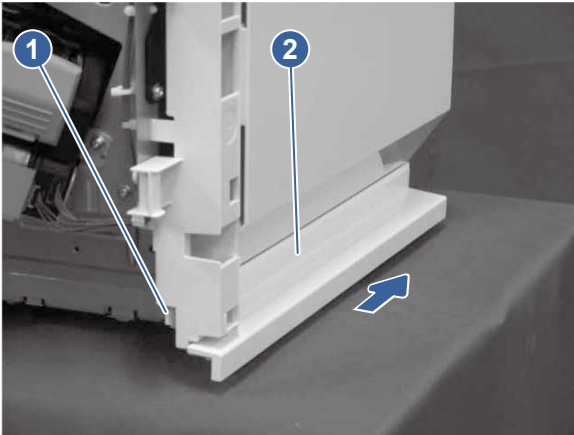

6. Remove the stapler-stacker door assembly (3-bin stapler-stacker)

Learn about removing the 3-bin stapler-stacker door assembly.

1. Remove two shafts (callout 1), and then open the feed guide (callout 2).

Figure 5-935 Remove two shafts

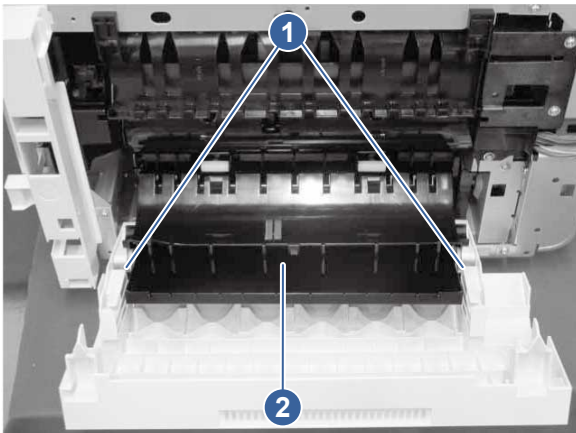

2. Release one tab (callout 1), and then slide the left bushing (callout 2) in the direction indicated to remove it.

Figure 5-936 Remove the left bushing

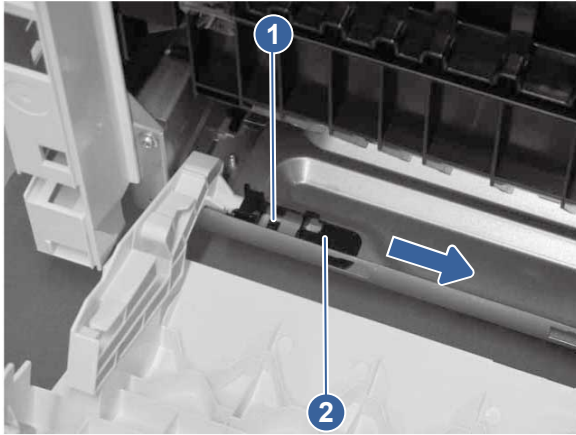

3. Release one tab (callout 1), and then slide the right bushing (callout 2) in the direction indicated to remove it.

Figure 5-937 Remove the right bushing

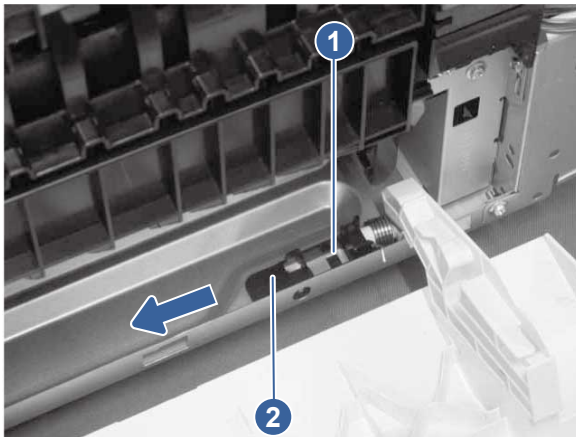

4. Remove right and left shafts (callout 1), and then remove the stapler-stacker door assembly (callout 2).

Figure 5-938 Remove the stapler-stacker door assembly

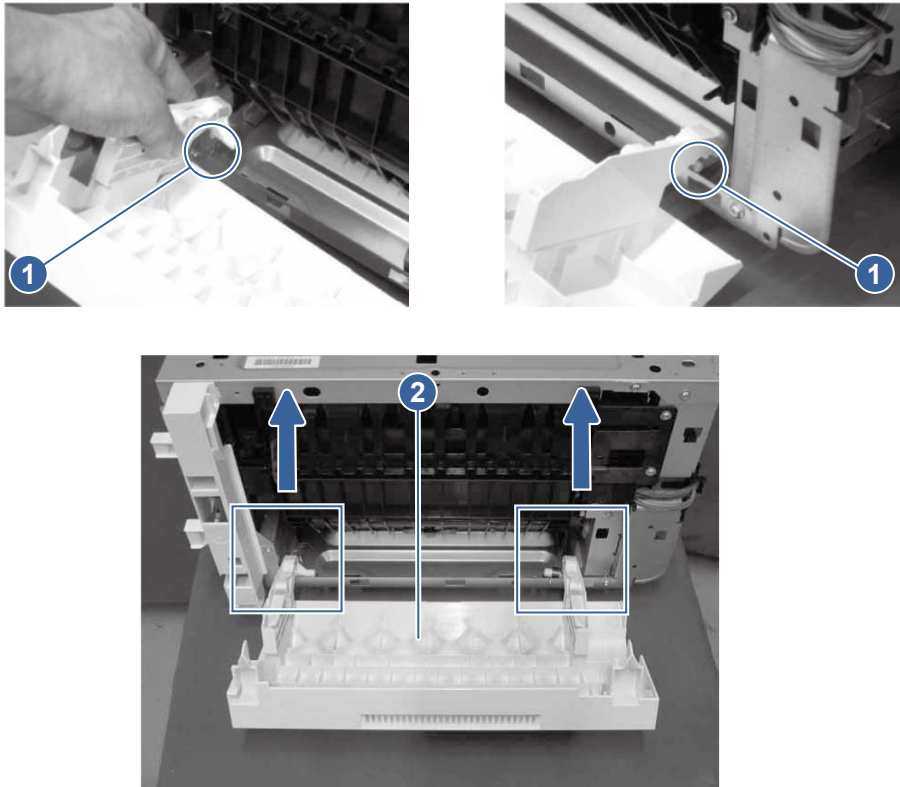

7. Unpack the replacement assembly

Follow these steps to unpack the replacement assembly.

1. Dispose of the defective part.



NOTE: HP recommends responsible disposal of the defective part.

<http://www8.hp.com/us/en/hp-information/environment/product-recycling.html>

2. Unpack the replacement part from the packaging.



CAUTION:  Some parts are sensitive to electrostatic discharge (ESD). Always perform service work at an ESD-protected workstation or mat. If an ESD workstation or mat is not available, touch the sheet-metal chassis to provide a static ground before touching an ESD-sensitive assembly. Protect the ESD-sensitive assemblies by placing them in ESD pouches when they are out of the printer.



IMPORTANT: Make sure that all of the shipping materials (for example shipping tape) are removed from the replacement part prior to installation.



NOTE: If the replacement part is a roller or pad, avoid touching the spongy part of it. Skin oils on the roller or pad can cause paper pickup and/or print-quality problems. HP recommends using disposable gloves when handling rollers or pads or washing your hands before touching rollers or pads.

- To install an assembly, reverse the removal steps.



NOTE: When applicable, special installation instructions are provided for an assembly at the end of the removal procedure. Always completely read the removal instructions and follow all special installation instructions.

Removal and replacement: Stacking wall assembly (3-bin stapler-stacker)

Learn about removing and replacing the stacking wall.

Before performing service

Turn the printer power off

- Disconnect the power cable.

⚠ WARNING! To avoid damage to the printer, turn the printer off, wait 30 seconds, and then remove the power cord before attempting to service the printer.

Use the table below to identify the correct part number for your printer, and then go to <https://parts.hp.com/hpparts> to order the part.

Table 5-131 Part information

Part number	Part description
RM3-0480-000CN	Stacking wall assembly (3-bin SS)

Required tools

- No special tools are required to remove or install this assembly.

After performing service

Turn the printer power on

- Connect the power cable.
- Use the power switch to turn the power on.

Post service test

No post service test is available for this assembly.

1. Remove the rear cover (3-bin stapler-stacker)

Learn about removing the 3-bin stapler-stacker rear cover.

1. Remove the printer formatter cover by removing one screw (callout 1) and then sliding the cover (callout 2) in the direction indicated. Slide the 3-bin stapler-stacker formatter cover assembly (callout 3) in the direction indicated to remove it.

Figure 5-939 Remove the 3-bin stapler-stacker formatter cover

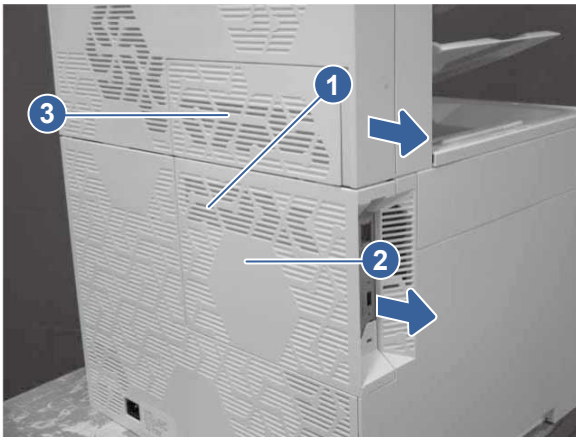

2. Remove two screws (callout 1), release three tabs (callout 2), and then remove the rear cover (callout 3).

Figure 5-940 Remove the rear cover

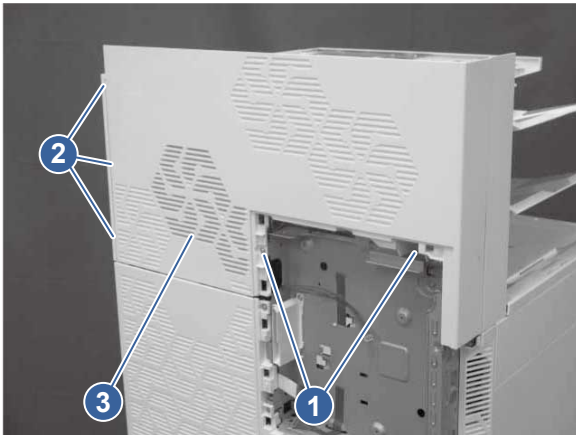

2. Remove the staple cover and staple door (3-bin stapler-stacker)

Learn about removing the 3-bin stapler-stacker staple cover and staple door.

1. Open the stapler-stacker door assembly and the stapler door.

2. Remove one screw (callout 1), and then release three tabs (callout 2).

Figure 5-941 Remove one screw

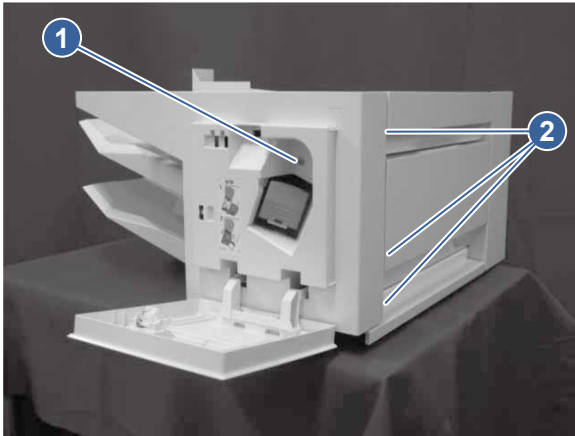

3. Release one tab (callout 1), and then remove the staple cover (callout 2) and the staple door (callout 3) together.

Figure 5-942 Release one tab

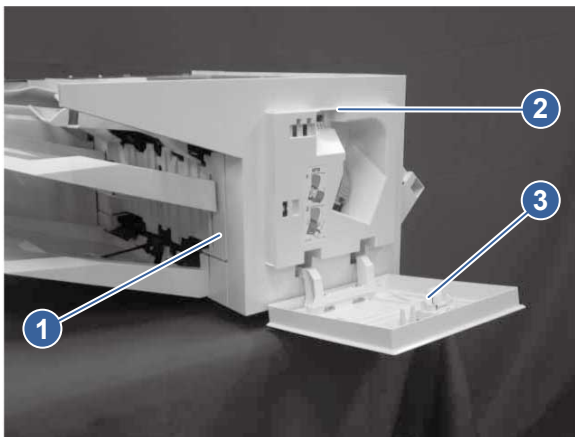

4. Remove two shafts (callout 1), and then remove the staple door (callout 2) from the staple cover (callout 3).

Figure 5-943 Remove the staple door from the staple cover

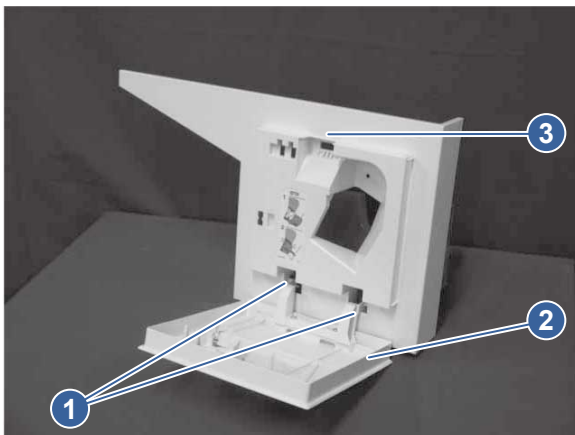

3. Remove the right upper cover (3-bin stapler-stacker)

Learn about removing the 3-bin stapler-stacker right upper cover.

1. Open the stapler-stacker door assembly.
2. Remove one screw (callout 1), release one tab (callout 2), and then remove the right upper cover (callout 3).

Figure 5-944 Remove the 3-bin stapler-stacker right upper cover

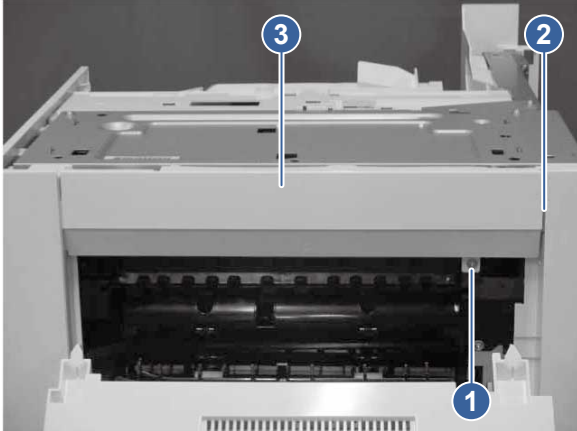

4. Remove the right corner cover (3-bin stapler-stacker)

Learn about removing the 3-bin stapler-stacker right corner cover.

- Remove one screw (callout 1), release two tabs (callout 2), and then remove the right corner cover (callout 3).

Figure 5-945 Remove the right corner cover

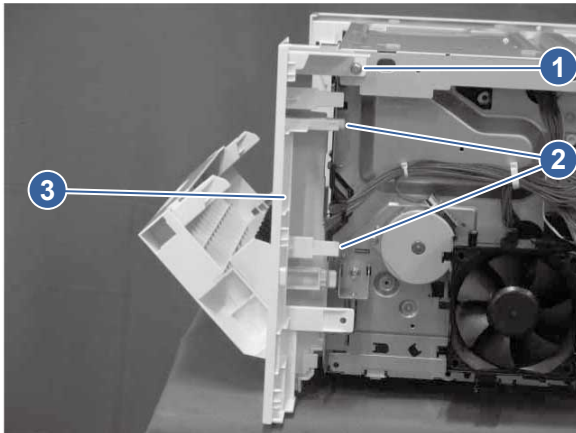

5. Remove the right lower cover (3-bin stapler-stacker)

Learn about removing the 3-bin stapler-stacker right lower cover.

- Release one tab (callout 1), and then slide the right lower cover (callout 2) in the direction indicated to remove it.

Figure 5-946 Remove the right lower cover

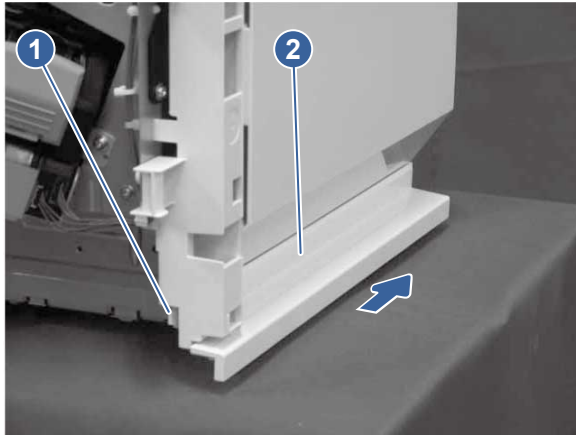

6. Remove the stapler-stacker door assembly (3-bin stapler-stacker)

Learn about removing the 3-bin stapler-stacker door assembly.

1. Remove two shafts (callout 1), and then open the feed guide (callout 2).

Figure 5-947 Remove two shafts

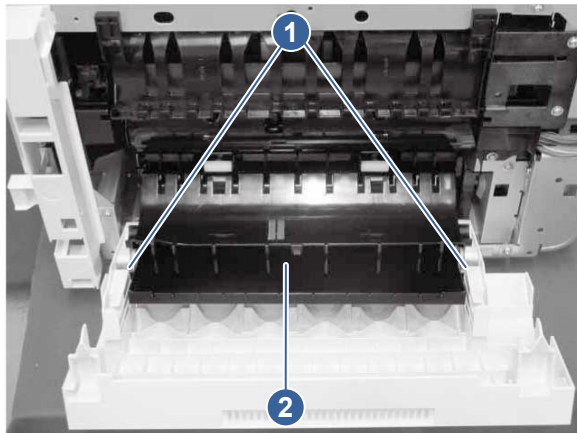

2. Release one tab (callout 1), and then slide the left bushing (callout 2) in the direction indicated to remove it.

Figure 5-948 Remove the left bushing

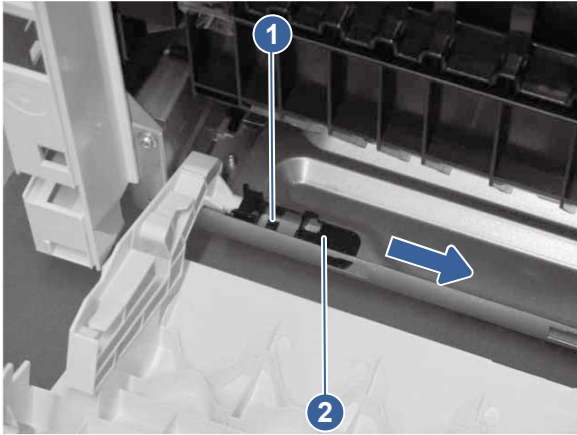

3. Release one tab (callout 1), and then slide the right bushing (callout 2) in the direction indicated to remove it.

Figure 5-949 Remove the right bushing

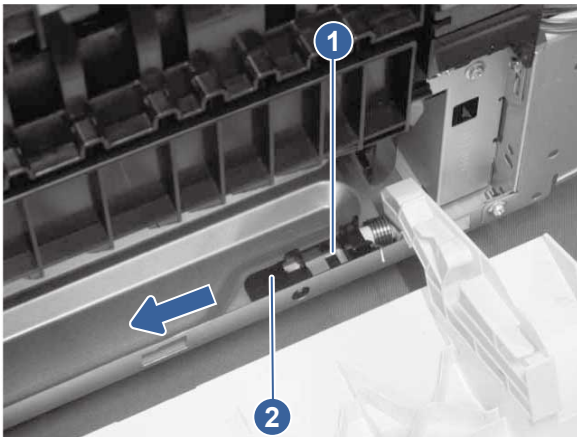

4. Remove right and left shafts (callout 1), and then remove the stapler-stacker door assembly (callout 2).

Figure 5-950 Remove the stapler-stacker door assembly

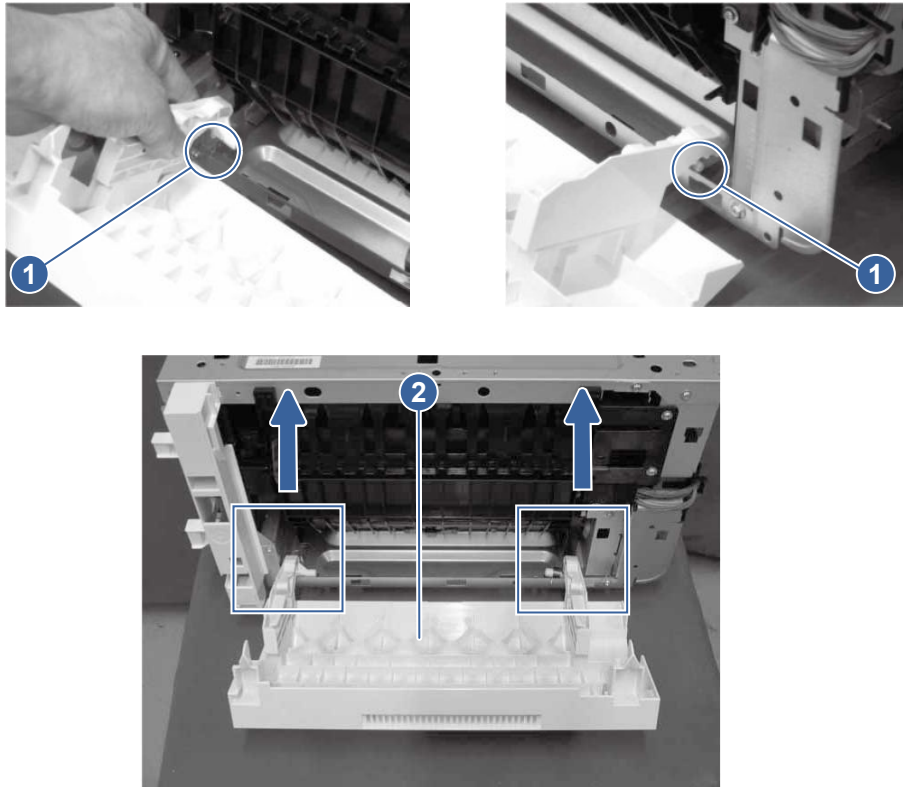

7. Remove the output bin 1 assembly (3-bin stapler-stacker)

Learn about removing the 3-bin stapler-stacker output bin 1 assembly.

1. Release one boss (callout 1), rotate the pin (callout 2) in the direction indicated, and then remove the pin.

Figure 5-951 Remove the pin

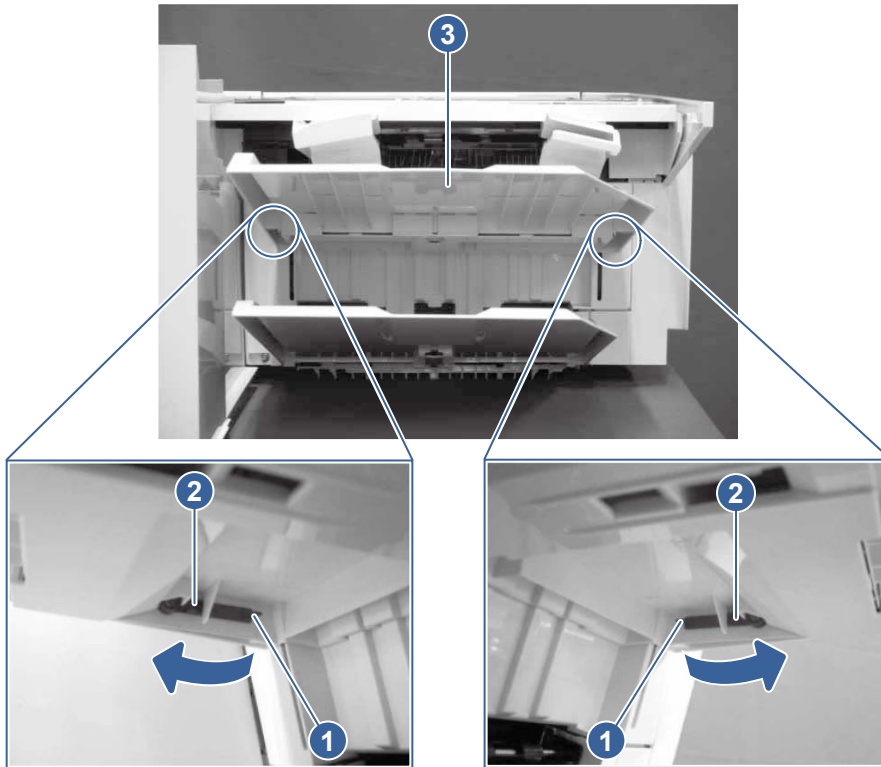

2. Remove the output bin 1 assembly (callout 1).

Figure 5-952 Remove the output bin

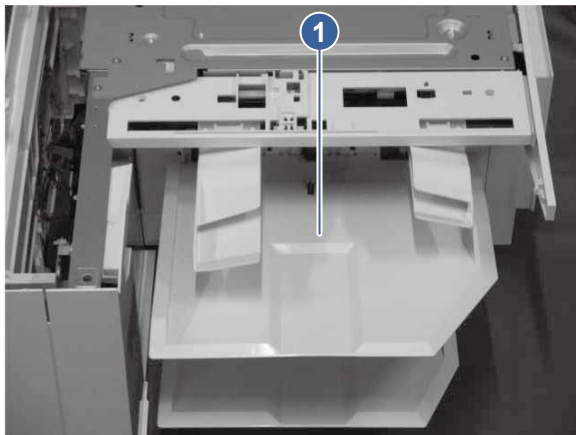

8. Remove the stapler assembly (3-bin stapler-stacker)

Learn about removing the 3-bin stapler-stacker stapler assembly.

1. Disconnect two connectors (callout 1), remove three screws (callout 2), and then remove the stapler assembly (callout 3) and the plate (callout 4) together.

Figure 5-953 Remove the stapler assembly and the plate

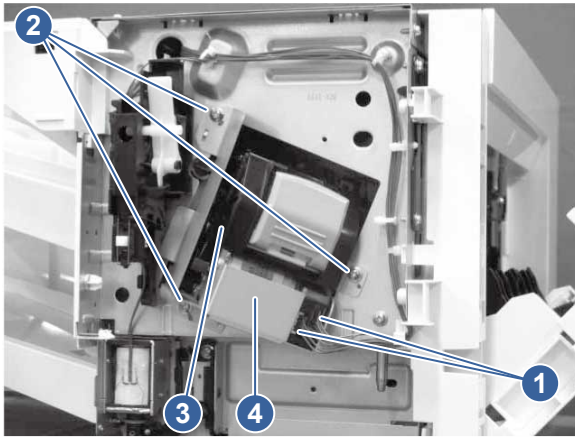

2. Remove two screws (callout 1), and then remove the plate (callout 2) from the stapler assembly (callout 3).

Figure 5-954 Remove the plate from the stapler assembly

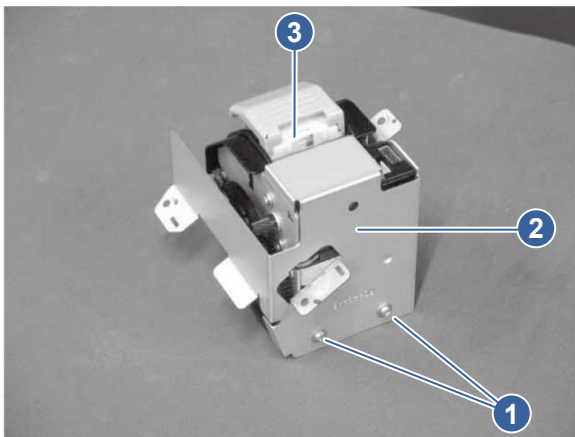

9. Remove the MBM fan (3-bin stapler-stacker)

Learn about removing the 3-bin stapler-stacker mailbox/booklet-maker fan.

1. Disconnect one connector (callout 1), remove one screw (callout 2), and then remove the fan holder (callout 3) together with the fan (callout 4).

Figure 5-955 Remove the fan holder and fan

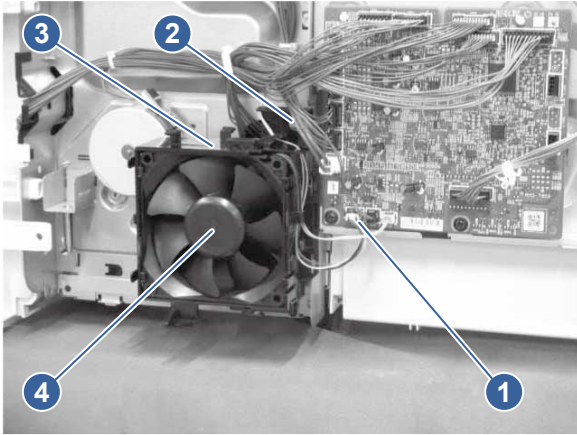

2. Release two tabs (callout 1), remove the duct 1 (callout 2) and the duct 2 (callout 3), and then remove the MBM fan (callout 4) from the holder.

Figure 5-956 Remove the fan from the holder

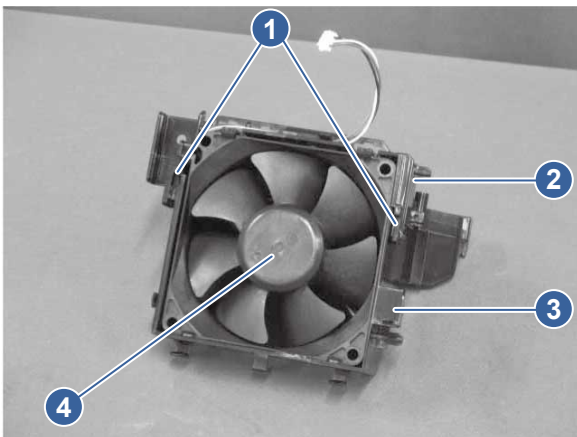

10. Remove the upper feed assembly (3-bin stapler-stacker)

Learn about removing the 3-bin stapler-stacker upper feed assembly.

1. Release the cable (callout 1) from cable guide (callout 2), release one tab (callout 3), and then remove the inner cover (callout 4).

Figure 5-957 Remove the inner cover

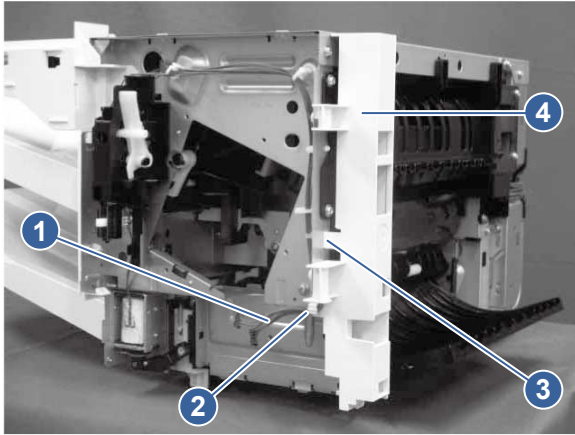

2. Release the cable (callout 1) from cable clamps (callout 2), and then disconnect three connectors (callout 3).

Figure 5-958 Release the cable

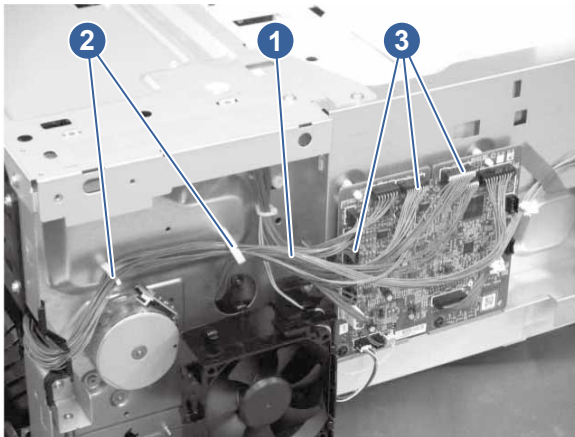

3. Release one tab (callout 1), and then remove the guide (callout 2).

Figure 5-959 Remove the guide

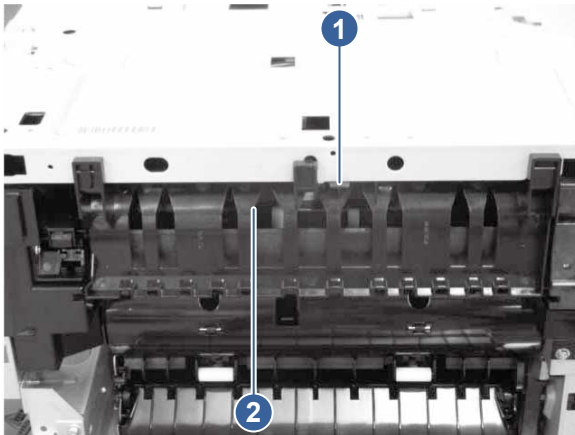

4. Remove six screws (callout 1), and then remove the upper feed assembly (callout 2).

⚠ CAUTION: Be sure that the paper guides extend into the tray area when reinstalling the upper feed assembly. The guides can be damaged if they are trapped behind the in-cave frame when the assembly is seated in the frame.

Figure 5-960 Remove the upper feed assembly

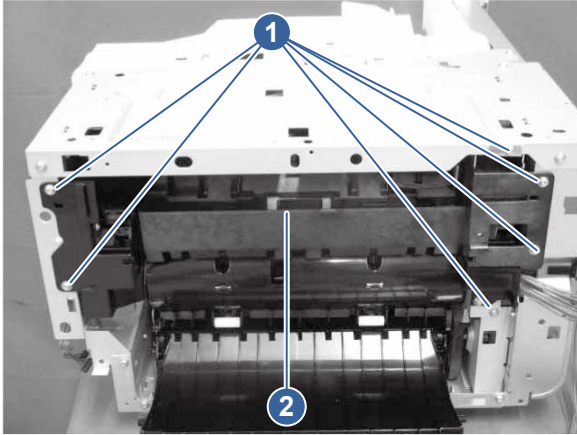

11. Remove the stacking wall assembly (3-bin stapler-stacker)

Learn about removing the 3-bin stapler-stacker stacking wall assembly.

1. Release one tab (callout 1).

Figure 5-961 Release one tab

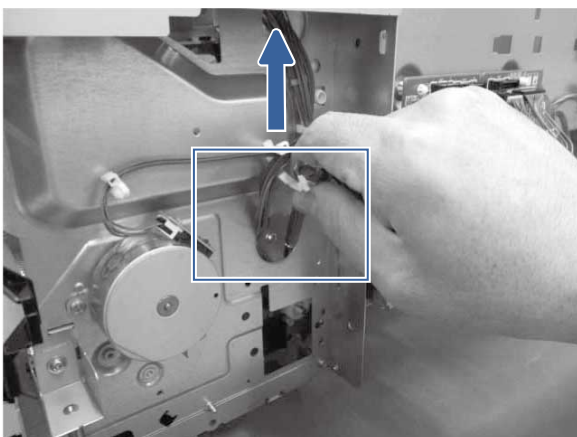
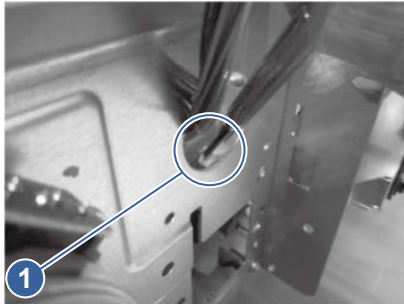

2. Release one tab (callout 1), and then remove the stacking wall assembly (callout 2).

Figure 5-962 Remove the stacking wall assembly

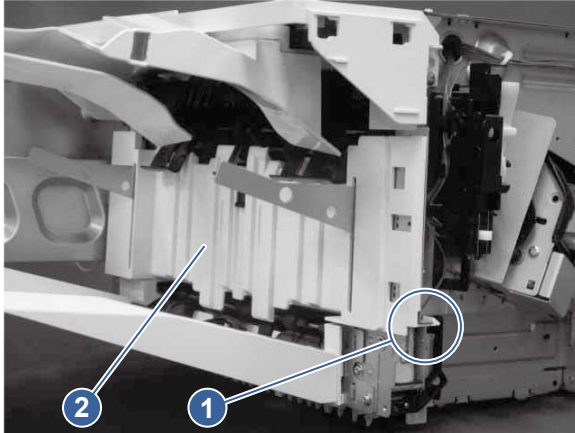

12. Unpack the replacement assembly

Follow these steps to unpack the replacement assembly.

1. Dispose of the defective part.



NOTE: HP recommends responsible disposal of the defective part.

<http://www8.hp.com/us/en/hp-information/environment/product-recycling.html>

2. Unpack the replacement part from the packaging.



CAUTION:  Some parts are sensitive to electrostatic discharge (ESD). Always perform service work at an ESD-protected workstation or mat. If an ESD workstation or mat is not available, touch the sheet-metal chassis to provide a static ground before touching an ESD-sensitive assembly. Protect the ESD-sensitive assemblies by placing them in ESD pouches when they are out of the printer.



IMPORTANT: Make sure that all of the shipping materials (for example shipping tape) are removed from the replacement part prior to installation.



NOTE: If the replacement part is a roller or pad, avoid touching the spongy part of it. Skin oils on the roller or pad can cause paper pickup and/or print-quality problems. HP recommends using disposable gloves when handling rollers or pads or washing your hands before touching rollers or pads.

3. To install an assembly, reverse the removal steps.



NOTE: When applicable, special installation instructions are provided for an assembly at the end of the removal procedure. Always completely read the removal instructions and follow all special installation instructions.

Internal parts and assemblies

Learn how to remove and replace the printer internal parts and assemblies.

Removal and replacement: Stapler assembly (3-bin stapler-stacker)

Learn about removing and replacing the stapler assembly.

Before performing service

Turn the printer power off

- Disconnect the power cable.

⚠ WARNING! To avoid damage to the printer, turn the printer off, wait 30 seconds, and then remove the power cord before attempting to service the printer.

Use the table below to identify the correct part number for your printer, and then go to <https://parts.hp.com/hpparts> to order the part.

Table 5-132 Part information

Part number	Part description
RK2-8148-000CN	Stapler assembly (3-bin SS)

Required tools

- #2 Phillips screwdriver with a magnetic tip and a 152 mm (6 in) shaft length
- Small flat-blade screwdriver

After performing service

Turn the printer power on

- Connect the power cable.
- Use the power switch to turn the power on.

Post service test

Print any pages necessary to make sure the printer is functioning correctly.

1. Remove the staple cover and staple door (3-bin stapler-stacker)

Learn about removing the 3-bin stapler-stacker staple cover and staple door.

1. Open the stapler-stacker door assembly and the stapler door.

2. Remove one screw (callout 1), and then release three tabs (callout 2).

Figure 5-963 Remove one screw

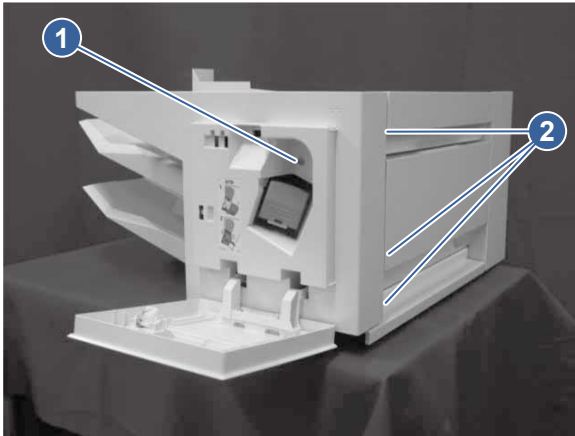

3. Release one tab (callout 1), and then remove the staple cover (callout 2) and the staple door (callout 3) together.

Figure 5-964 Release one tab

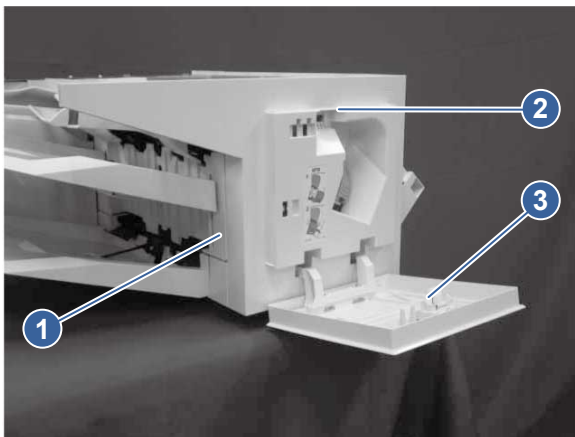

4. Remove two shafts (callout 1), and then remove the staple door (callout 2) from the staple cover (callout 3).

Figure 5-965 Remove the staple door from the staple cover

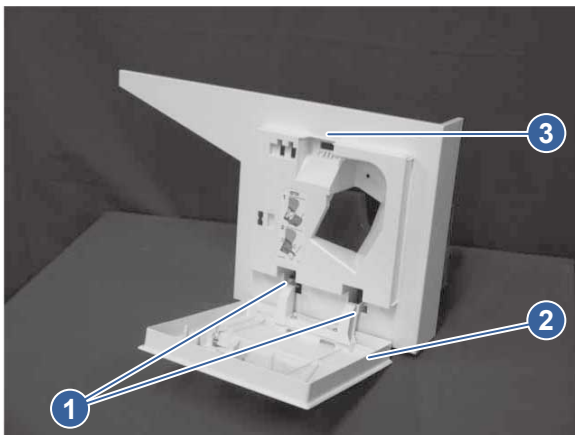

2. Remove the stapler assembly (3-bin stapler-stacker)

Learn about removing the 3-bin stapler-stacker stapler assembly.

1. Disconnect two connectors (callout 1), remove three screws (callout 2), and then remove the stapler assembly (callout 3) and the plate (callout 4) together.

Figure 5-966 Remove the stapler assembly and the plate

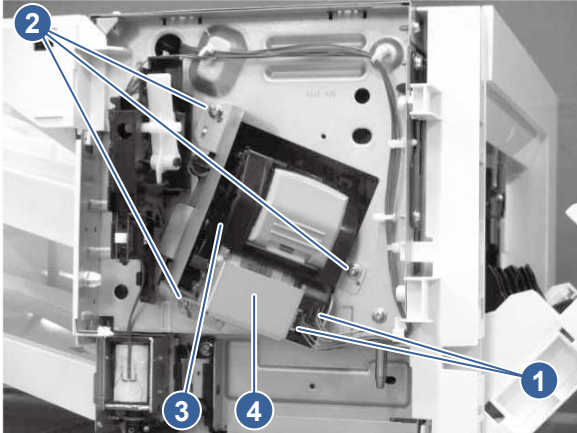

2. Remove two screws (callout 1), and then remove the plate (callout 2) from the stapler assembly (callout 3).

Figure 5-967 Remove the plate from the stapler assembly

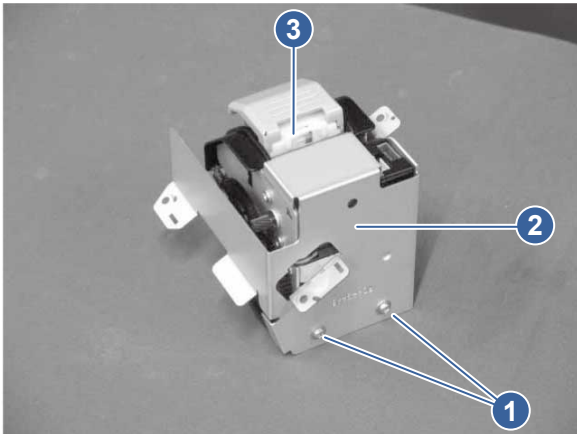

3. Unpack the replacement assembly

Follow these steps to unpack the replacement assembly.

1. Dispose of the defective part.



NOTE: HP recommends responsible disposal of the defective part.

<http://www8.hp.com/us/en/hp-information/environment/product-recycling.html>

2. Unpack the replacement part from the packaging.



CAUTION:  Some parts are sensitive to electrostatic discharge (ESD). Always perform service work at an ESD-protected workstation or mat. If an ESD workstation or mat is not available, touch the sheet-metal chassis to provide a static ground before touching an ESD-sensitive assembly.

Protect the ESD-sensitive assemblies by placing them in ESD pouches when they are out of the printer.

 **IMPORTANT:** Make sure that all of the shipping materials (for example shipping tape) are removed from the replacement part prior to installation.

 **NOTE:** If the replacement part is a roller or pad, avoid touching the spongy part of it. Skin oils on the roller or pad can cause paper pickup and/or print-quality problems. HP recommends using disposable gloves when handling rollers or pads or washing your hands before touching rollers or pads.

3. To install an assembly, reverse the removal steps.

 **NOTE:** When applicable, special installation instructions are provided for an assembly at the end of the removal procedure. Always completely read the removal instructions and follow all special installation instructions.

Removal and replacement: Jogger assembly (3-bin stapler-stacker)

Learn about removing and replacing the jogger assembly.

Before performing service

Turn the printer power off

- Disconnect the power cable.

 **WARNING!** To avoid damage to the printer, turn the printer off, wait 30 seconds, and then remove the power cord before attempting to service the printer.

Use the table below to identify the correct part number for your printer, and then go to <https://parts.hp.com/hpparts> to order the part.

Table 5-133 Part information

Part number	Part description
RM3-0481-000CN	Jog assembly (3-bin SS)

Required tools

- #2 Phillips screwdriver with a magnetic tip and a 152 mm (6 in) shaft length
- Small flat-blade screwdriver

After performing service

Turn the printer power on

- Connect the power cable.
- Use the power switch to turn the power on.

Post service test

Print any pages necessary to make sure the printer is functioning correctly.

1. Remove the rear cover (3-bin stapler-stacker)

Learn about removing the 3-bin stapler-stacker rear cover.

1. Remove the printer formatter cover by removing one screw (callout 1) and then sliding the cover (callout 2) in the direction indicated. Slide the 3-bin stapler-stacker formatter cover assembly (callout 3) in the direction indicated to remove it.

Figure 5-968 Remove the 3-bin stapler-stacker formatter cover

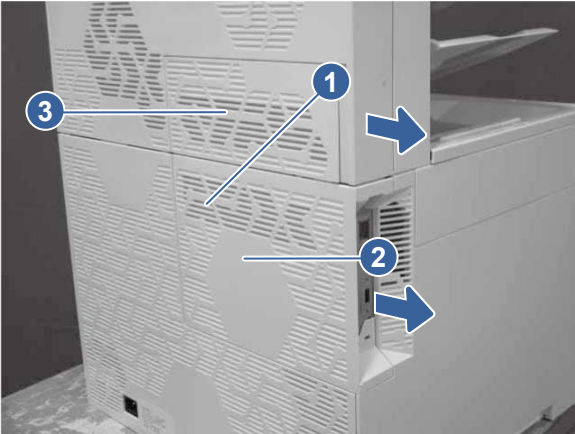

2. Remove two screws (callout 1), release three tabs (callout 2), and then remove the rear cover (callout 3).

Figure 5-969 Remove the rear cover

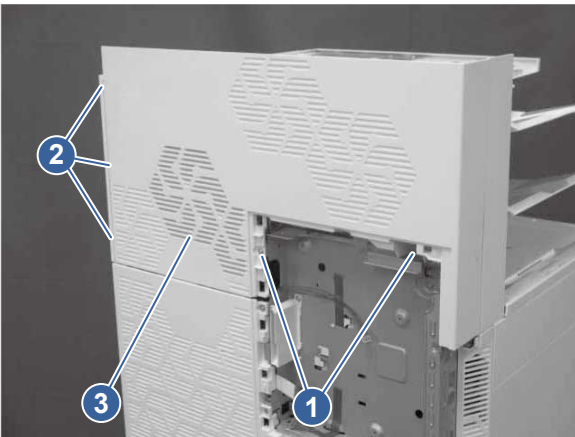

2. Remove the staple cover and staple door (3-bin stapler-stacker)

Learn about removing the 3-bin stapler-stacker staple cover and staple door.

1. Open the stapler-stacker door assembly and the stapler door.

2. Remove one screw (callout 1), and then release three tabs (callout 2).

Figure 5-970 Remove one screw

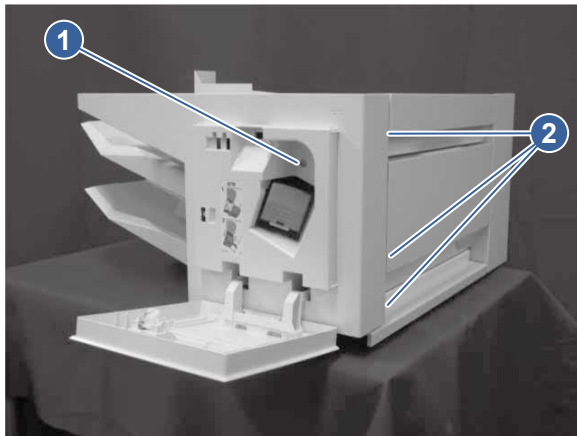

3. Release one tab (callout 1), and then remove the staple cover (callout 2) and the staple door (callout 3) together.

Figure 5-971 Release one tab

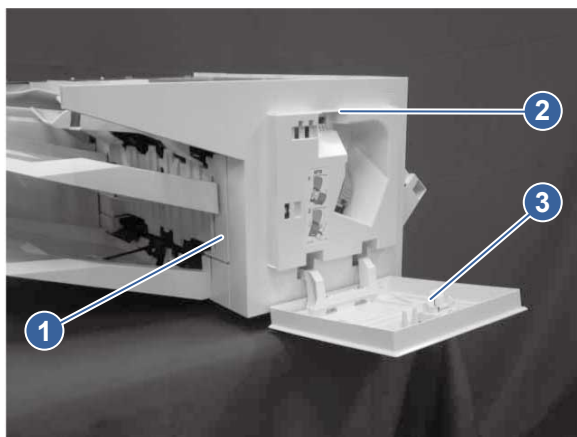

4. Remove two shafts (callout 1), and then remove the staple door (callout 2) from the staple cover (callout 3).

Figure 5-972 Remove the staple door from the staple cover

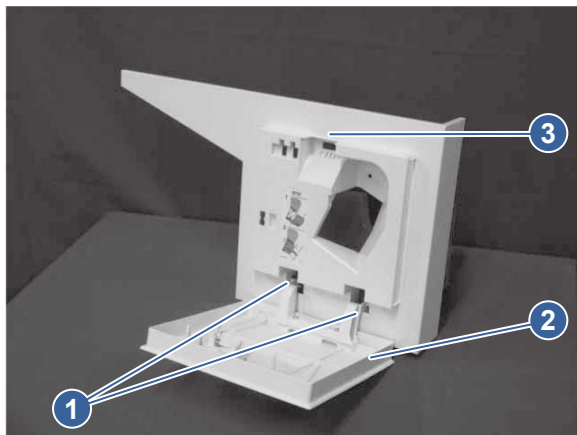

3. Remove the jogger assembly (3-bin stapler-stacker)

Learn about removing the 3-bin stapler-stacker jogger assembly.

1. Release the cable (callout 1) from the cable clamp (callout 2), and then disconnect one connector (callout 3).

Figure 5-973 Release the cable

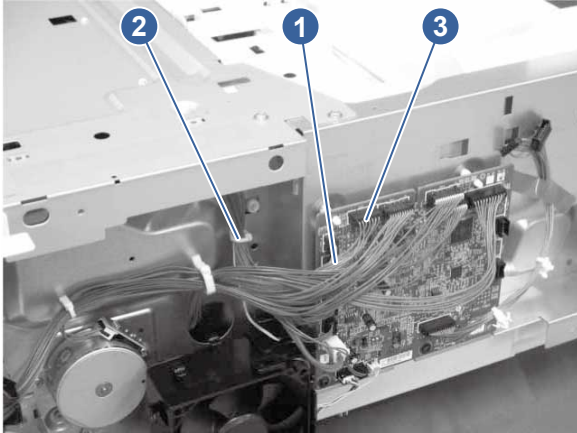

2. Remove one screw (callout 1), and then slide the jogger assembly (callout 2) in the direction indicated to remove it.

Figure 5-974 Remove the jogger assembly

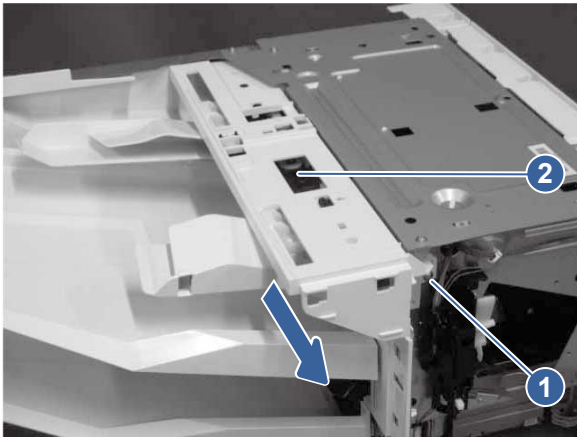

4. Unpack the replacement assembly

Follow these steps to unpack the replacement assembly.

1. Dispose of the defective part.



NOTE: HP recommends responsible disposal of the defective part.

<http://www8.hp.com/us/en/hp-information/environment/product-recycling.html>

2. Unpack the replacement part from the packaging.



CAUTION:  Some parts are sensitive to electrostatic discharge (ESD). Always perform service work at an ESD-protected workstation or mat. If an ESD workstation or mat is not available, touch the sheet-metal chassis to provide a static ground before touching an ESD-sensitive assembly.

Protect the ESD-sensitive assemblies by placing them in ESD pouches when they are out of the printer.

 **IMPORTANT:** Make sure that all of the shipping materials (for example shipping tape) are removed from the replacement part prior to installation.

 **NOTE:** If the replacement part is a roller or pad, avoid touching the spongy part of it. Skin oils on the roller or pad can cause paper pickup and/or print-quality problems. HP recommends using disposable gloves when handling rollers or pads or washing your hands before touching rollers or pads.

3. To install an assembly, reverse the removal steps.

 **NOTE:** When applicable, special installation instructions are provided for an assembly at the end of the removal procedure. Always completely read the removal instructions and follow all special installation instructions.

Removal and replacement: Output bin 1 (3-bin stapler-stacker)

Learn about removing and replacing output bin 1.

Before performing service

Turn the printer power off

- Disconnect the power cable.

 **WARNING!** To avoid damage to the printer, turn the printer off, wait 30 seconds, and then remove the power cord before attempting to service the printer.

Use the table below to identify the correct part number for your printer, and then go to <https://parts.hp.com/hpparts> to order the part.

Table 5-134 Part information

Part number	Part description
RM2-4173-000CN	Tray assembly (3-bin SS)

Required tools

- #2 Phillips screwdriver with a magnetic tip and a 152 mm (6 in) shaft length
- Small flat-blade screwdriver

After performing service

Turn the printer power on

- Connect the power cable.
- Use the power switch to turn the power on.

Post service test

Print any pages necessary to make sure the printer is functioning correctly.

1. Remove the output bin 1 assembly (3-bin stapler-stacker)

Learn about removing the 3-bin stapler-stacker output bin 1 assembly.

1. Release one boss (callout 1), rotate the pin (callout 2) in the direction indicated, and then remove the pin.

Figure 5-975 Remove the pin

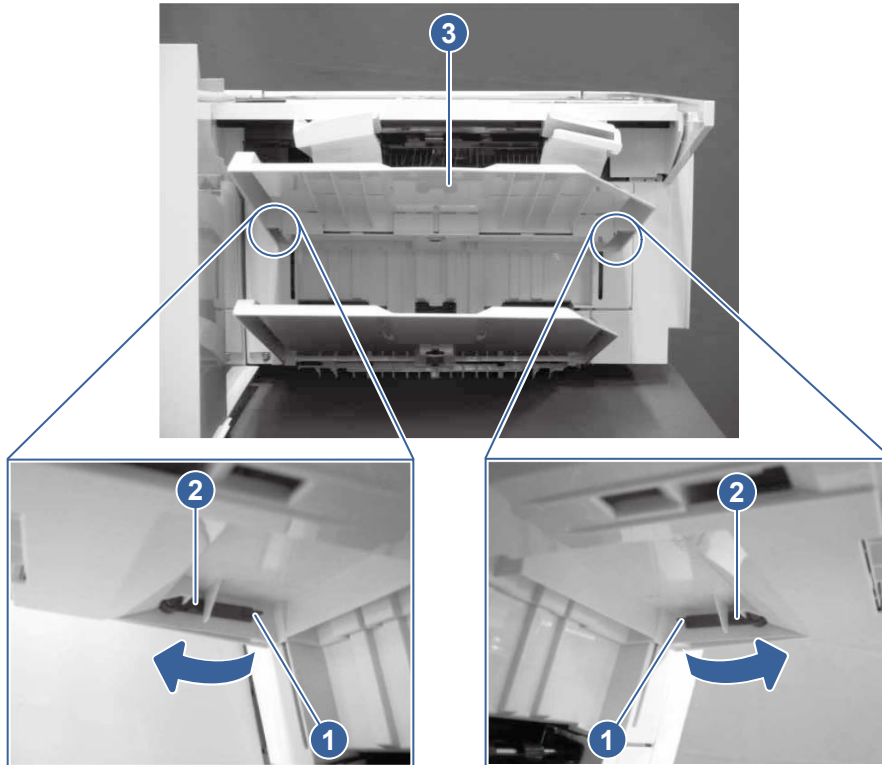

2. Remove the output bin 1 assembly (callout 1).

Figure 5-976 Remove the output bin

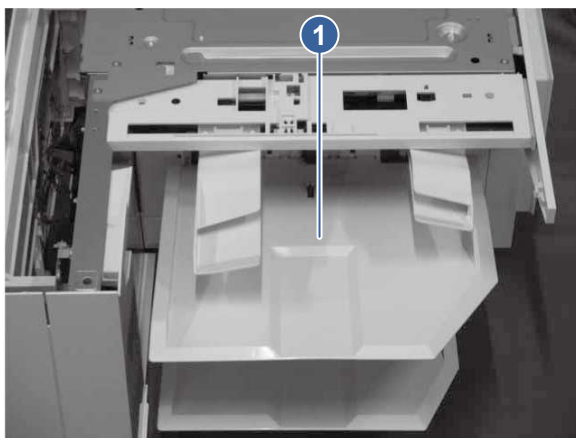

2. Unpack the replacement assembly

Follow these steps to unpack the replacement assembly.

1. Dispose of the defective part.



NOTE: HP recommends responsible disposal of the defective part.

<http://www8.hp.com/us/en/hp-information/environment/product-recycling.html>

2. Unpack the replacement part from the packaging.



CAUTION:  Some parts are sensitive to electrostatic discharge (ESD). Always perform service work at an ESD-protected workstation or mat. If an ESD workstation or mat is not available, touch the sheet-metal chassis to provide a static ground before touching an ESD-sensitive assembly. Protect the ESD-sensitive assemblies by placing them in ESD pouches when they are out of the printer.



IMPORTANT: Make sure that all of the shipping materials (for example shipping tape) are removed from the replacement part prior to installation.



NOTE: If the replacement part is a roller or pad, avoid touching the spongy part of it. Skin oils on the roller or pad can cause paper pickup and/or print-quality problems. HP recommends using disposable gloves when handling rollers or pads or washing your hands before touching rollers or pads.

3. To install an assembly, reverse the removal steps.



NOTE: When applicable, special installation instructions are provided for an assembly at the end of the removal procedure. Always completely read the removal instructions and follow all special installation instructions.

Removal and replacement: Upper feed assembly (3-bin stapler-stacker)

Learn about removing and replacing the upper feed assembly.



[View a video demonstration of removing and replacing the upper feed assembly.](#)

Before performing service

Turn the printer power off

- Disconnect the power cable.



WARNING! To avoid damage to the printer, turn the printer off, wait 30 seconds, and then remove the power cord before attempting to service the printer.

Use the table below to identify the correct part number for your printer, and then go to <https://parts.hp.com/hpparts> to order the part.

Table 5-135 Part information

Part number	Part description
RM2-4169-000CN	Upper paper feed assembly (3-bin SS)

Required tools

- #2 Phillips screwdriver with a magnetic tip and a 152 mm (6 in) shaft length

- Small flat-blade screwdriver

After performing service

Turn the printer power on

- Connect the power cable.
- Use the power switch to turn the power on.

Post service test

Print any pages necessary to make sure the printer is functioning correctly.

1. Remove the rear cover (3-bin stapler-stacker)

Learn about removing the 3-bin stapler-stacker rear cover.

1. Remove the printer formatter cover by removing one screw (callout 1) and then sliding the cover (callout 2) in the direction indicated. Slide the 3-bin stapler-stacker formatter cover assembly (callout 3) in the direction indicated to remove it.

Figure 5-977 Remove the 3-bin stapler-stacker formatter cover

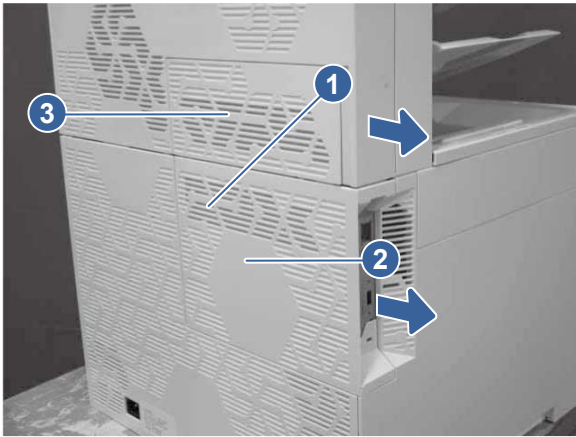

2. Remove two screws (callout 1), release three tabs (callout 2), and then remove the rear cover (callout 3).

Figure 5-978 Remove the rear cover

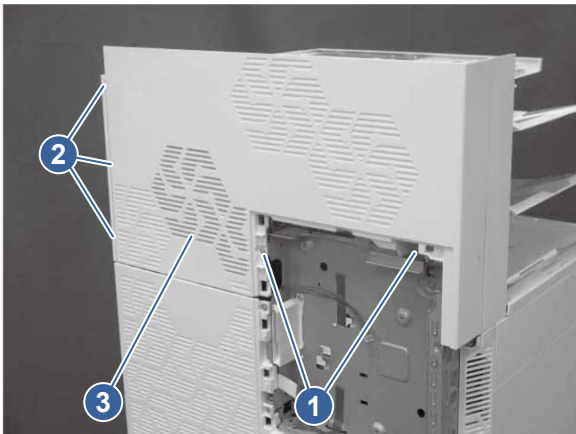

2. Remove the staple cover and staple door (3-bin stapler-stacker)

Learn about removing the 3-bin stapler-stacker staple cover and staple door.

1. Open the stapler-stacker door assembly and the stapler door.
2. Remove one screw (callout 1), and then release three tabs (callout 2).

Figure 5-979 Remove one screw

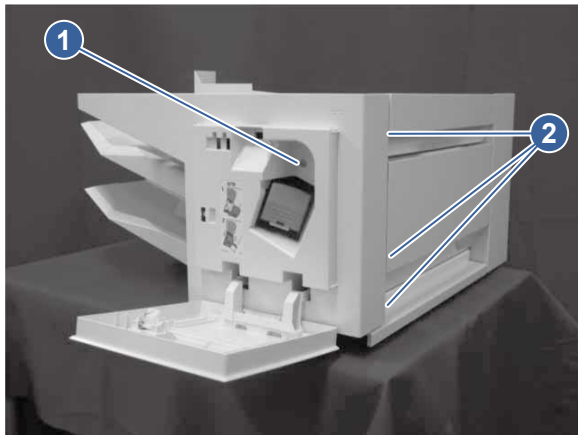

3. Release one tab (callout 1), and then remove the staple cover (callout 2) and the staple door (callout 3) together.

Figure 5-980 Release one tab

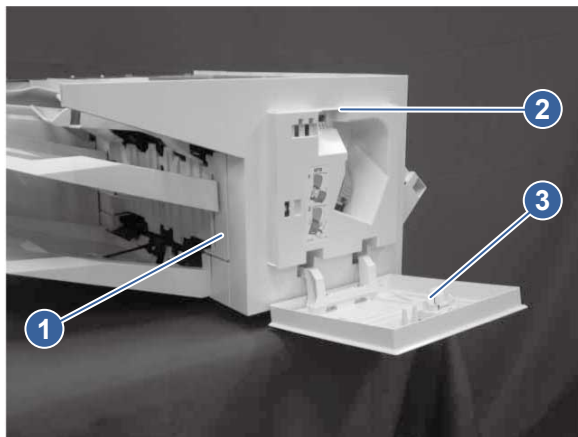

4. Remove two shafts (callout 1), and then remove the staple door (callout 2) from the staple cover (callout 3).

Figure 5-981 Remove the staple door from the staple cover

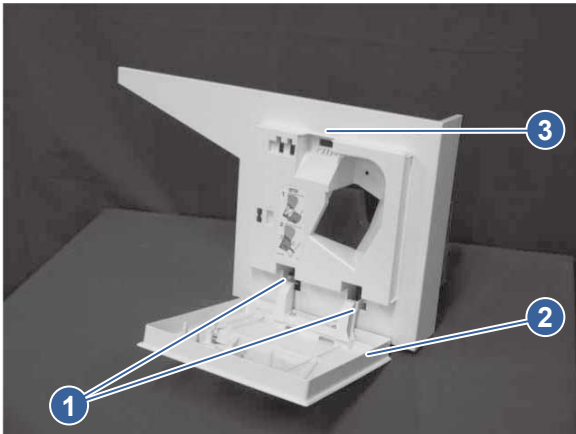

3. Remove the right upper cover (3-bin stapler-stacker)

Learn about removing the 3-bin stapler-stacker right upper cover.

1. Open the stapler-stacker door assembly.
2. Remove one screw (callout 1), release one tab (callout 2), and then remove the right upper cover (callout 3).

Figure 5-982 Remove the 3-bin stapler-stacker right upper cover

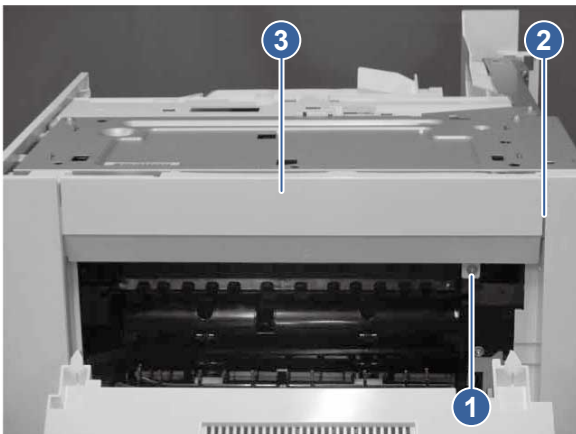

4. Remove the right corner cover (3-bin stapler-stacker)

Learn about removing the 3-bin stapler-stacker right corner cover.

- Remove one screw (callout 1), release two tabs (callout 2), and then remove the right corner cover (callout 3).

Figure 5-983 Remove the right corner cover

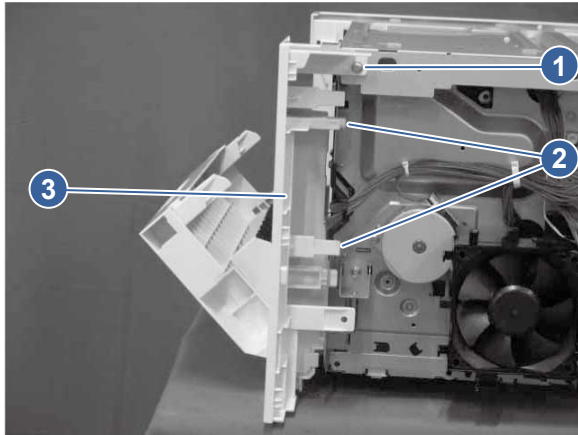

5. Remove the right lower cover (3-bin stapler-stacker)

Learn about removing the 3-bin stapler-stacker right lower cover.

- Release one tab (callout 1), and then slide the right lower cover (callout 2) in the direction indicated to remove it.

Figure 5-984 Remove the right lower cover

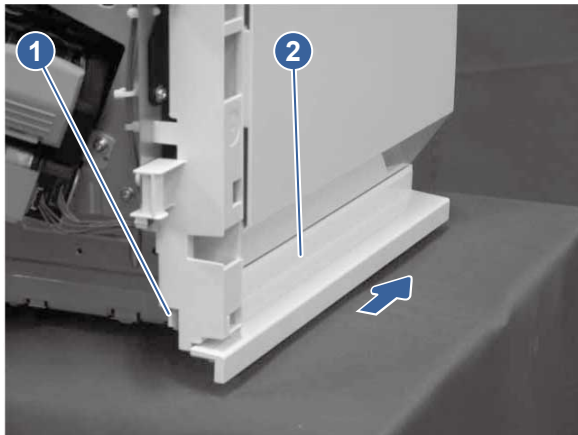

6. Remove the stapler-stacker door assembly (3-bin stapler-stacker)

Learn about removing the 3-bin stapler-stacker door assembly.

1. Remove two shafts (callout 1), and then open the feed guide (callout 2).

Figure 5-985 Remove two shafts

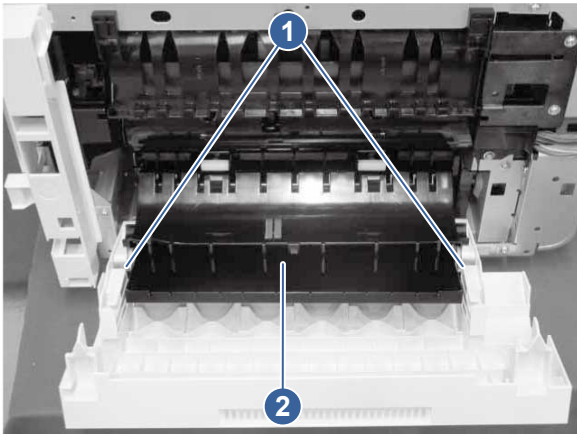

2. Release one tab (callout 1), and then slide the left bushing (callout 2) in the direction indicated to remove it.

Figure 5-986 Remove the left bushing

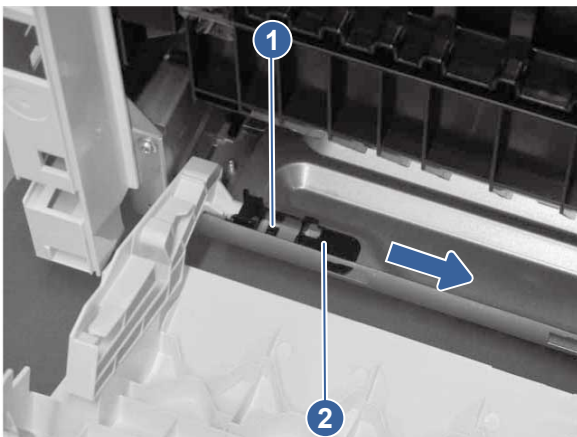

3. Release one tab (callout 1), and then slide the right bushing (callout 2) in the direction indicated to remove it.

Figure 5-987 Remove the right bushing

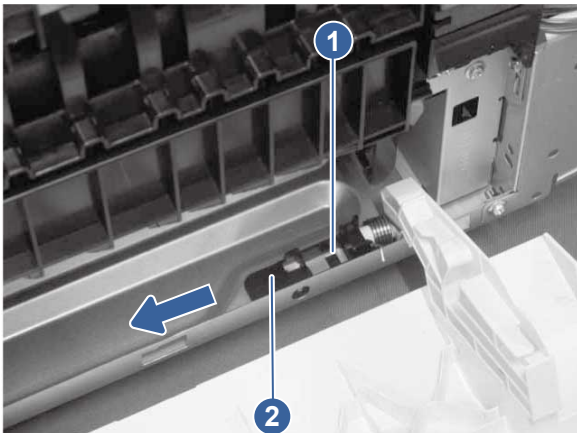

4. Remove right and left shafts (callout 1), and then remove the stapler-stacker door assembly (callout 2).

Figure 5-988 Remove the stapler-stacker door assembly

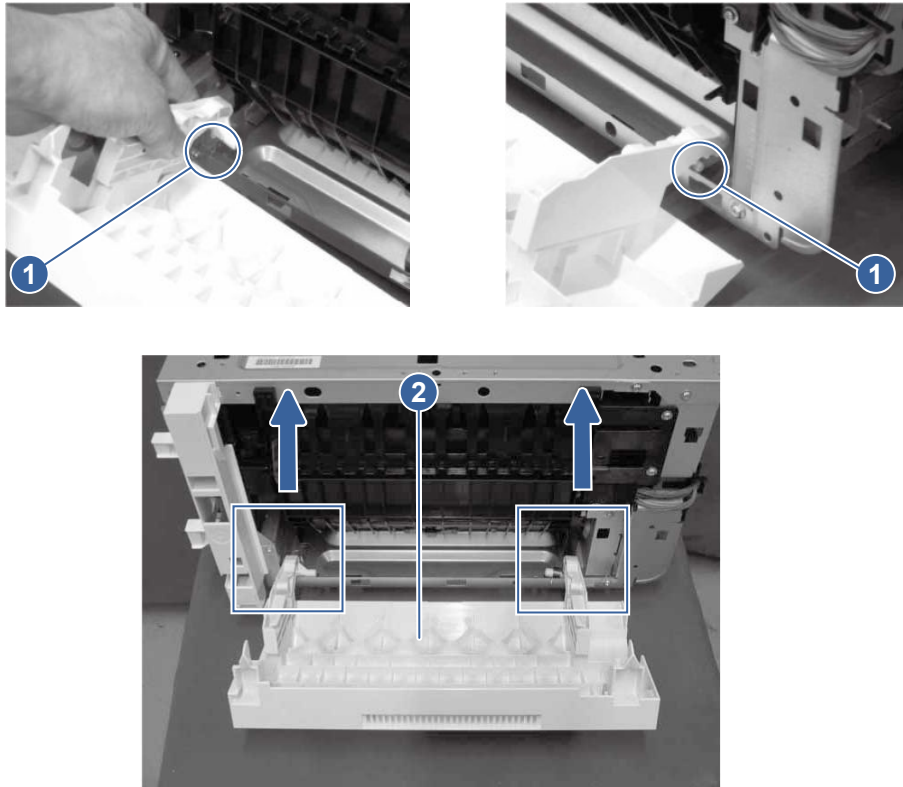

7. Remove the stapler assembly (3-bin stapler-stacker)

Learn about removing the 3-bin stapler-stacker stapler assembly.

1. Disconnect two connectors (callout 1), remove three screws (callout 2), and then remove the stapler assembly (callout 3) and the plate (callout 4) together.

Figure 5-989 Remove the stapler assembly and the plate

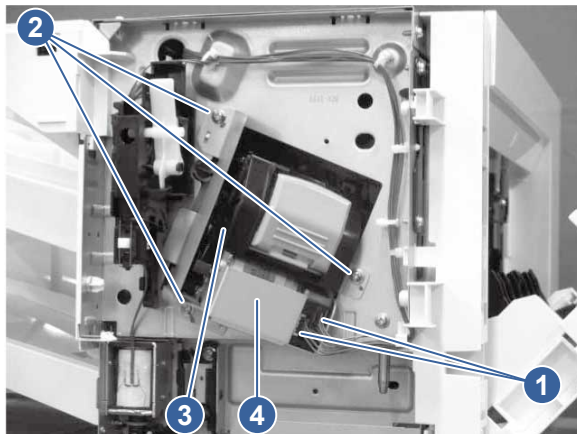

2. Remove two screws (callout 1), and then remove the plate (callout 2) from the stapler assembly (callout 3).

Figure 5-990 Remove the plate from the stapler assembly

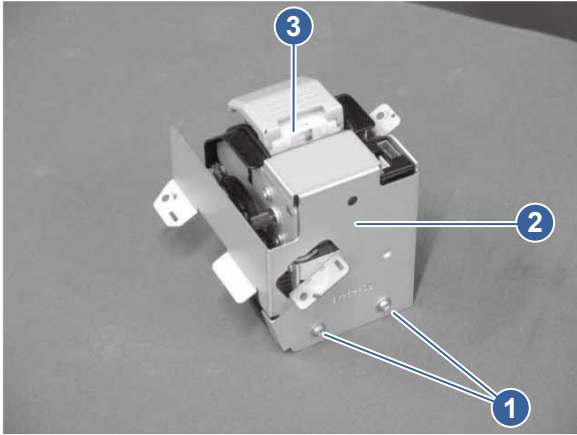

8. Remove the upper feed assembly (3-bin stapler-stacker)

Learn about removing the 3-bin stapler-stacker upper feed assembly.

1. Release the cable (callout 1) from cable guide (callout 2), release one tab (callout 3), and then remove the inner cover (callout 4).

Figure 5-991 Remove the inner cover

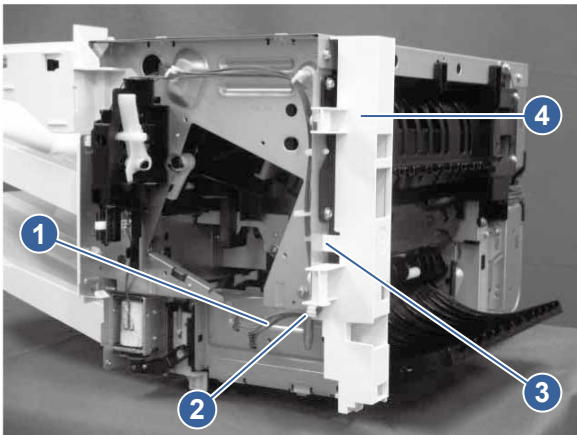

2. Release the cable (callout 1) from cable clamps (callout 2), and then disconnect three connectors (callout 3).

Figure 5-992 Release the cable

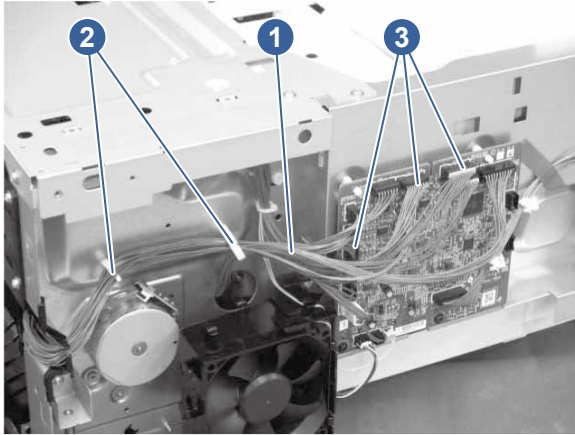

3. Release one tab (callout 1), and then remove the guide (callout 2).

Figure 5-993 Remove the guide

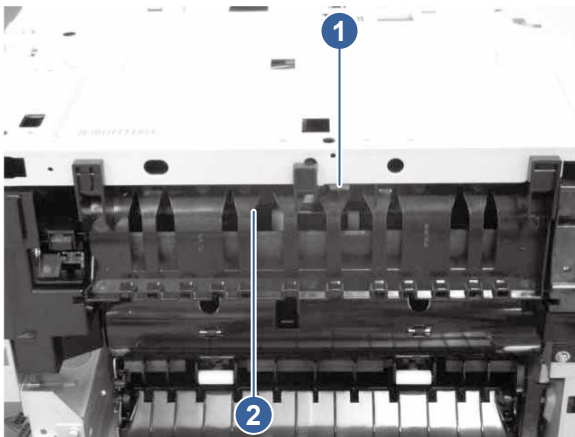

4. Remove six screws (callout 1), and then remove the upper feed assembly (callout 2).

⚠ CAUTION: Be sure that the paper guides extend into the tray area when reinstalling the upper feed assembly. The guides can be damaged if they are trapped behind the in-cave frame when the assembly is seated in the frame.

Figure 5-994 Remove the upper feed assembly

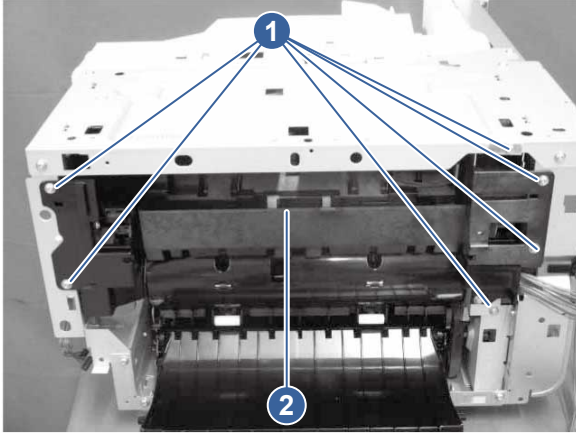

9. Unpack the replacement assembly

Follow these steps to unpack the replacement assembly.

1. Dispose of the defective part.



NOTE: HP recommends responsible disposal of the defective part.

<http://www8.hp.com/us/en/hp-information/environment/product-recycling.html>

2. Unpack the replacement part from the packaging.



CAUTION:  Some parts are sensitive to electrostatic discharge (ESD). Always perform service work at an ESD-protected workstation or mat. If an ESD workstation or mat is not available, touch the sheet-metal chassis to provide a static ground before touching an ESD-sensitive assembly. Protect the ESD-sensitive assemblies by placing them in ESD pouches when they are out of the printer.



IMPORTANT: Make sure that all of the shipping materials (for example shipping tape) are removed from the replacement part prior to installation.



NOTE: If the replacement part is a roller or pad, avoid touching the spongy part of it. Skin oils on the roller or pad can cause paper pickup and/or print-quality problems. HP recommends using disposable gloves when handling rollers or pads or washing your hands before touching rollers or pads.

3. To install an assembly, reverse the removal steps.



NOTE: When applicable, special installation instructions are provided for an assembly at the end of the removal procedure. Always completely read the removal instructions and follow all special installation instructions.

Removal and replacement: Lower feed assembly (3-bin stapler-stacker)

Learn about removing and replacing the lower feed assembly.



[View a video demonstration of removing and replacing the lower feed assembly.](#)

Before performing service

Turn the printer power off

- Disconnect the power cable.

⚠ WARNING! To avoid damage to the printer, turn the printer off, wait 30 seconds, and then remove the power cord before attempting to service the printer.

Use the table below to identify the correct part number for your printer, and then go to <https://parts.hp.com/hpparts> to order the part.

Table 5-136 Part information

Part number	Part description
RM2-4168-000CN	Lower paper feed assembly (3-bin SS)

Required tools

- #2 Phillips screwdriver with a magnetic tip and a 152 mm (6 in) shaft length
- Small flat-blade screwdriver

After performing service

Turn the printer power on

- Connect the power cable.
- Use the power switch to turn the power on.

Post service test

Print any pages necessary to make sure the printer is functioning correctly.

1. Remove the rear cover (3-bin stapler-stacker)

Learn about removing the 3-bin stapler-stacker rear cover.

1. Remove the printer formatter cover by removing one screw (callout 1) and then sliding the cover (callout 2) in the direction indicated. Slide the 3-bin stapler-stacker formatter cover assembly (callout 3) in the direction indicated to remove it.

Figure 5-995 Remove the 3-bin stapler-stacker formatter cover

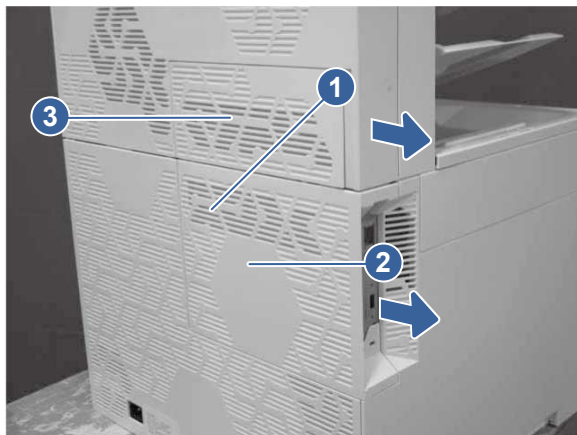

2. Remove two screws (callout 1), release three tabs (callout 2), and then remove the rear cover (callout 3).

Figure 5-996 Remove the rear cover

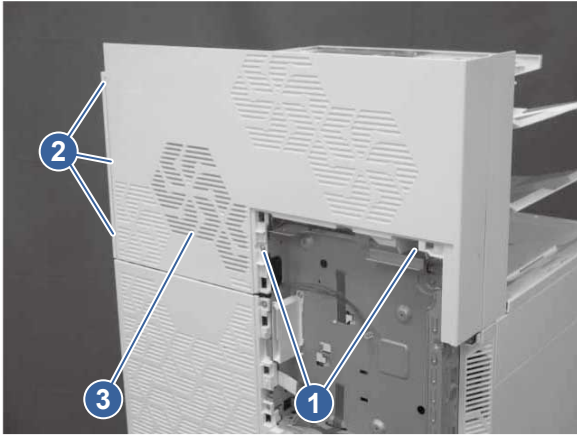

2. Remove the staple cover and staple door (3-bin stapler-stacker)

Learn about removing the 3-bin stapler-stacker staple cover and staple door.

1. Open the stapler-stacker door assembly and the stapler door.
2. Remove one screw (callout 1), and then release three tabs (callout 2).

Figure 5-997 Remove one screw

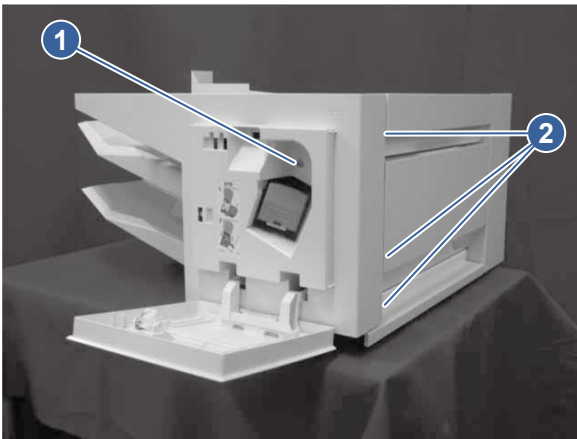

3. Release one tab (callout 1), and then remove the staple cover (callout 2) and the staple door (callout 3) together.

Figure 5-998 Release one tab

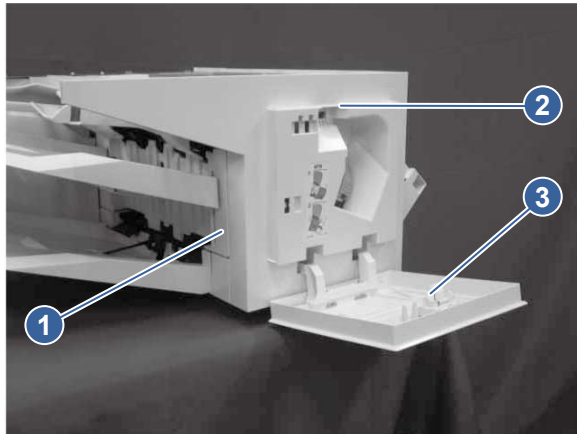

4. Remove two shafts (callout 1), and then remove the staple door (callout 2) from the staple cover (callout 3).

Figure 5-999 Remove the staple door from the staple cover

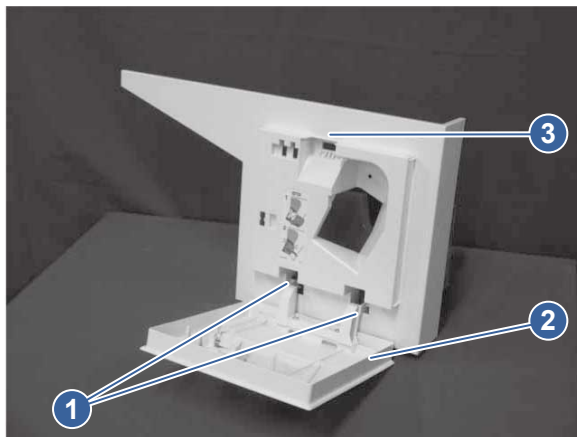

3. Remove the right upper cover (3-bin stapler-stacker)

Learn about removing the 3-bin stapler-stacker right upper cover.

1. Open the stapler-stacker door assembly.

2. Remove one screw (callout 1), release one tab (callout 2), and then remove the right upper cover (callout 3).

Figure 5-1000 Remove the 3-bin stapler-stacker right upper cover

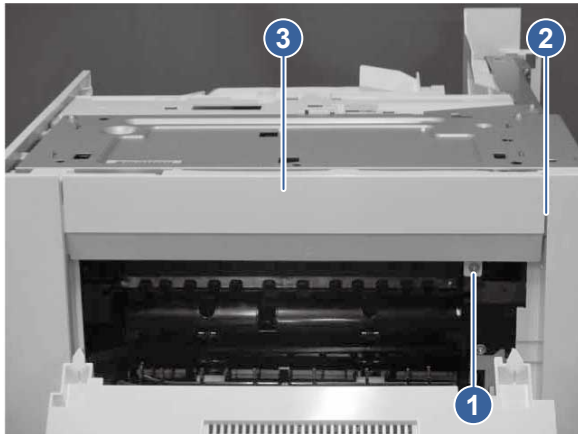

4. Remove the right corner cover (3-bin stapler-stacker)

Learn about removing the 3-bin stapler-stacker right corner cover.

- Remove one screw (callout 1), release two tabs (callout 2), and then remove the right corner cover (callout 3).

Figure 5-1001 Remove the right corner cover

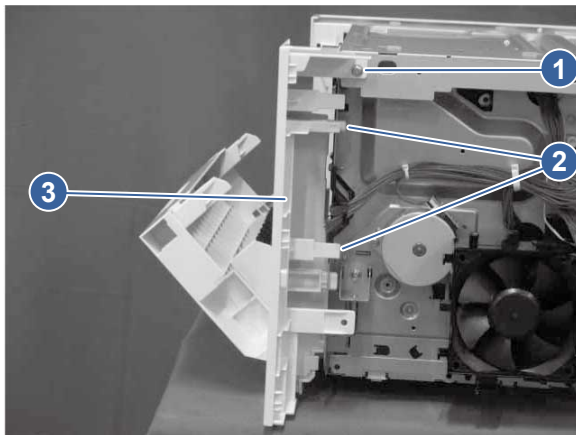

5. Remove the right lower cover (3-bin stapler-stacker)

Learn about removing the 3-bin stapler-stacker right lower cover.

- Release one tab (callout 1), and then slide the right lower cover (callout 2) in the direction indicated to remove it.

Figure 5-1002 Remove the right lower cover

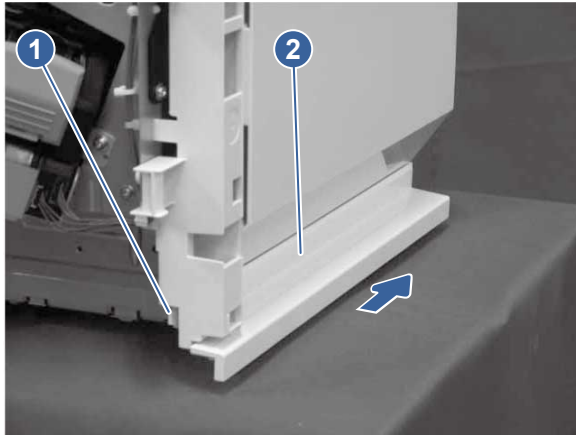

6. Remove the output bin 1 assembly (3-bin stapler-stacker)

Learn about removing the 3-bin stapler-stacker output bin 1 assembly.

1. Release one boss (callout 1), rotate the pin (callout 2) in the direction indicated, and then remove the pin.

Figure 5-1003 Remove the pin

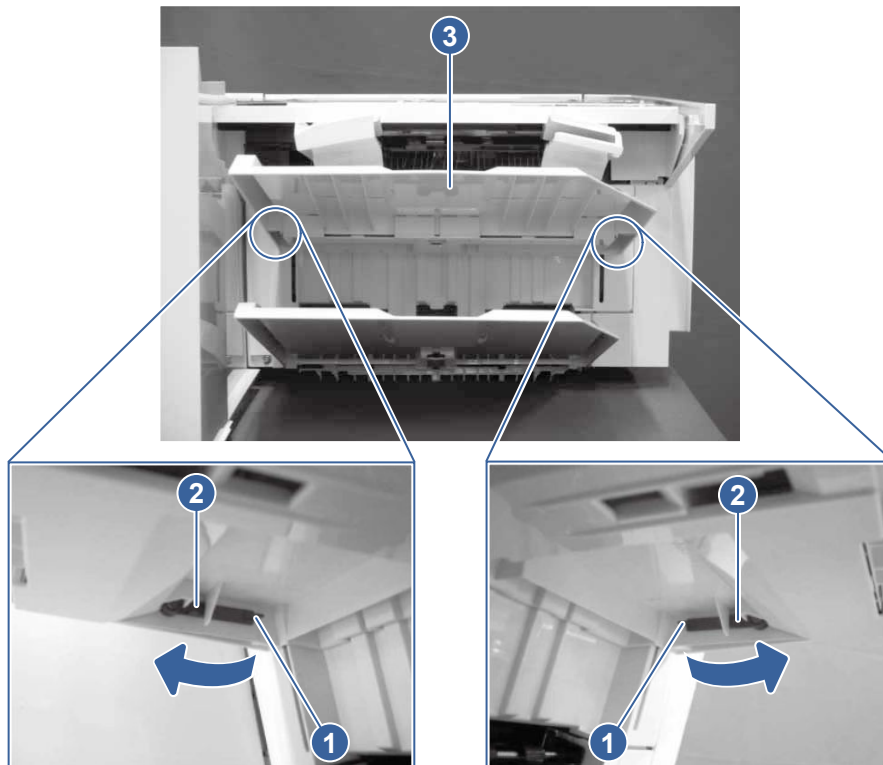

2. Remove the output bin 1 assembly (callout 1).

Figure 5-1004 Remove the output bin

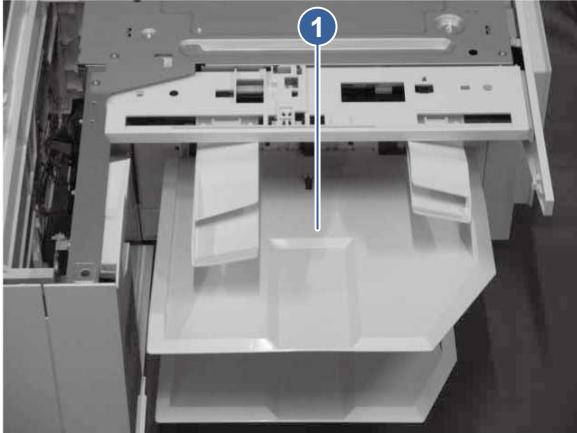

7. Remove the stapler-stacker door assembly (3-bin stapler-stacker)

Learn about removing the 3-bin stapler-stacker door assembly.

1. Remove two shafts (callout 1), and then open the feed guide (callout 2).

Figure 5-1005 Remove two shafts

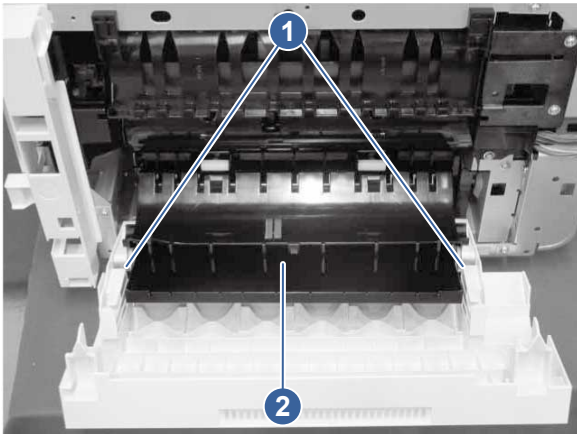

2. Release one tab (callout 1), and then slide the left bushing (callout 2) in the direction indicated to remove it.

Figure 5-1006 Remove the left bushing

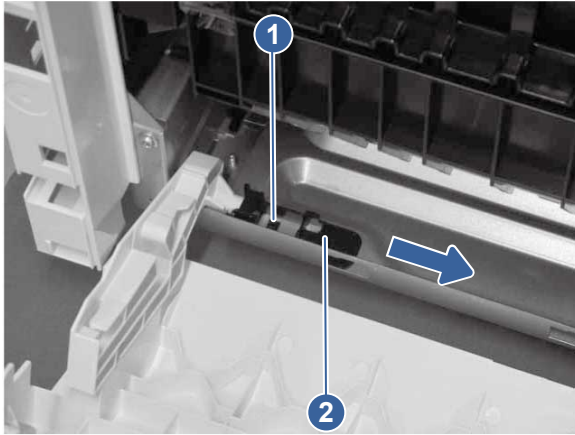

3. Release one tab (callout 1), and then slide the right bushing (callout 2) in the direction indicated to remove it.

Figure 5-1007 Remove the right bushing

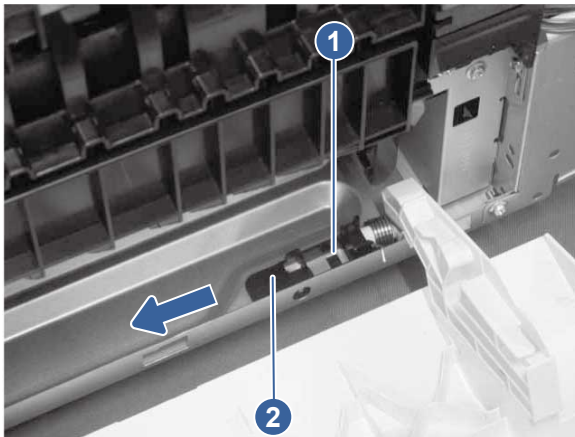

4. Remove right and left shafts (callout 1), and then remove the stapler-stacker door assembly (callout 2).

Figure 5-1008 Remove the stapler-stacker door assembly

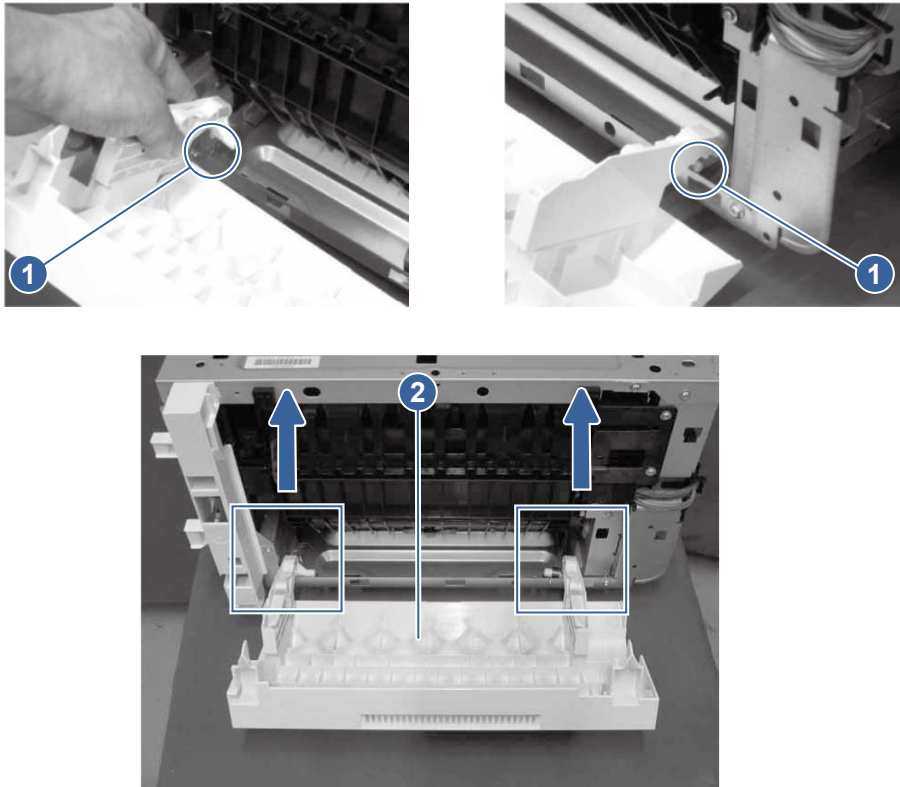

8. Remove the stapler assembly (3-bin stapler-stacker)

Learn about removing the 3-bin stapler-stacker stapler assembly.

1. Disconnect two connectors (callout 1), remove three screws (callout 2), and then remove the stapler assembly (callout 3) and the plate (callout 4) together.

Figure 5-1009 Remove the stapler assembly and the plate

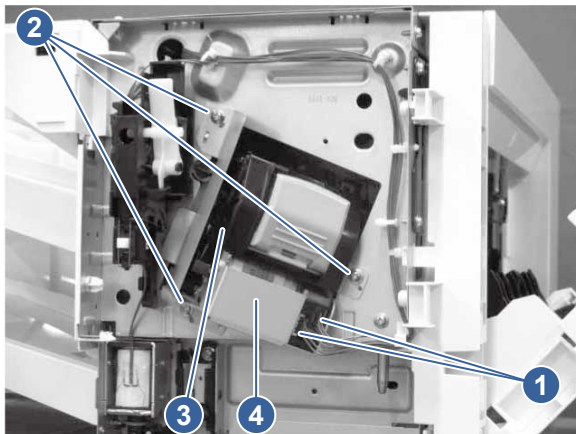

2. Remove two screws (callout 1), and then remove the plate (callout 2) from the stapler assembly (callout 3).

Figure 5-1010 Remove the plate from the stapler assembly

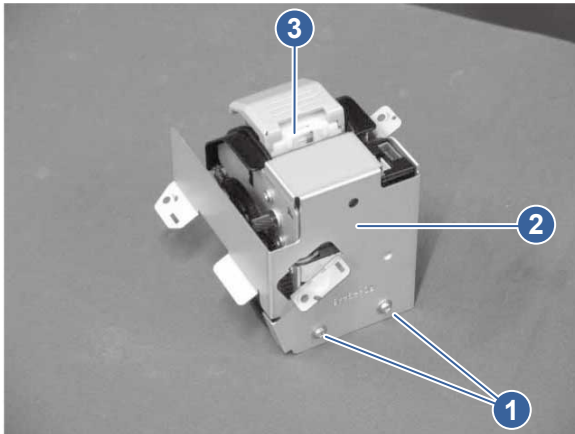

9. Remove the MBM fan (3-bin stapler-stacker)

Learn about removing the 3-bin stapler-stacker mailbox/booklet-maker fan.

1. Disconnect one connector (callout 1), remove one screw (callout 2), and then remove the fan holder (callout 3) together with the fan (callout 4).

Figure 5-1011 Remove the fan holder and fan

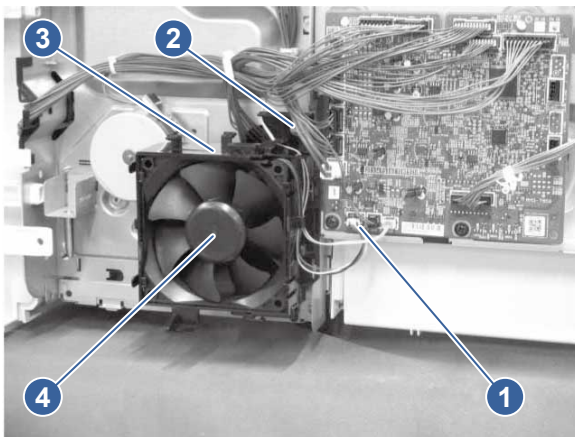

2. Release two tabs (callout 1), remove the duct 1 (callout 2) and the duct 2 (callout 3), and then remove the MBM fan (callout 4) from the holder.

Figure 5-1012 Remove the fan from the holder

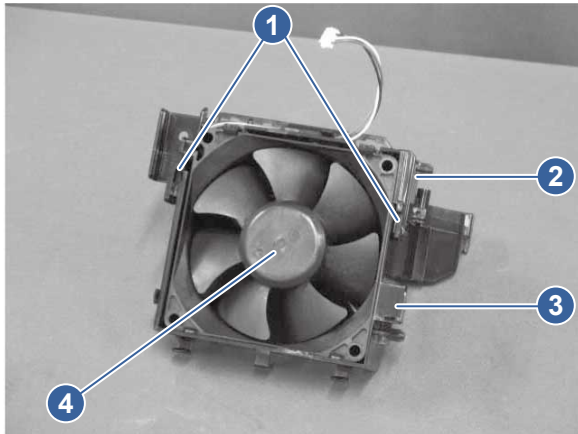

10. Remove the upper feed assembly (3-bin stapler-stacker)

Learn about removing the 3-bin stapler-stacker upper feed assembly.

1. Release the cable (callout 1) from cable guide (callout 2), release one tab (callout 3), and then remove the inner cover (callout 4).

Figure 5-1013 Remove the inner cover

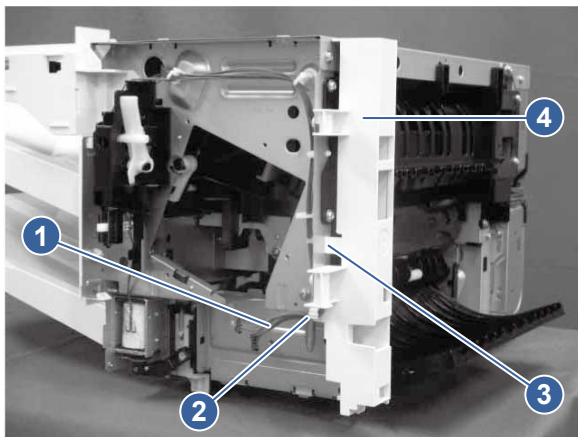

2. Release the cable (callout 1) from cable clamps (callout 2), and then disconnect three connectors (callout 3).

Figure 5-1014 Release the cable

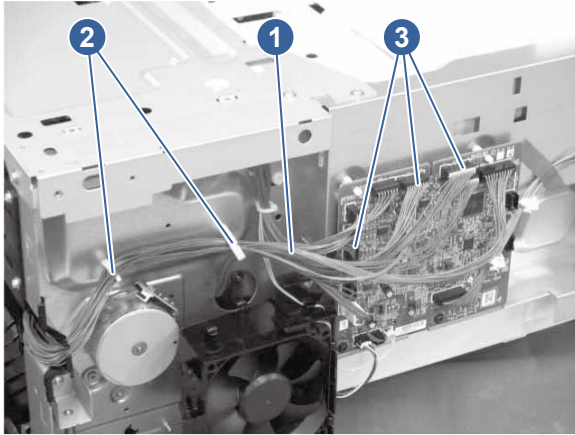

3. Release one tab (callout 1), and then remove the guide (callout 2).

Figure 5-1015 Remove the guide

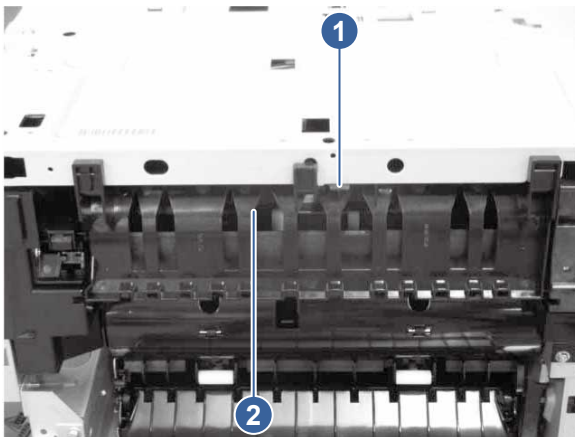

4. Remove six screws (callout 1), and then remove the upper feed assembly (callout 2).

⚠ CAUTION: Be sure that the paper guides extend into the tray area when reinstalling the upper feed assembly. The guides can be damaged if they are trapped behind the in-cave frame when the assembly is seated in the frame.

Figure 5-1016 Remove the upper feed assembly

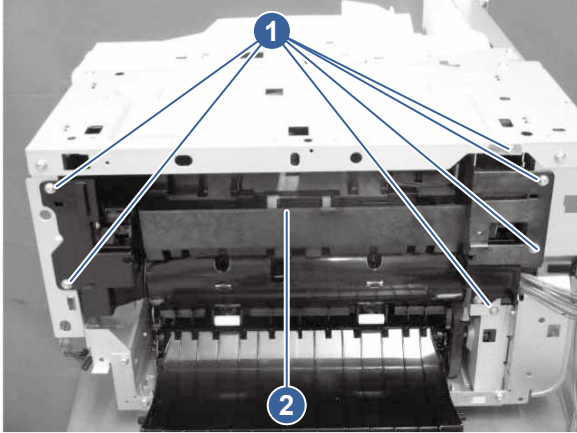

11. Remove the stacking wall assembly (3-bin stapler-stacker)

Learn about removing the 3-bin stapler-stacker stacking wall assembly.

1. Release one tab (callout 1).

Figure 5-1017 Release one tab

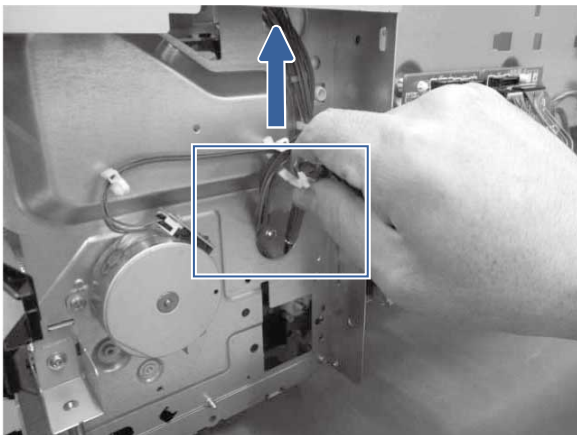
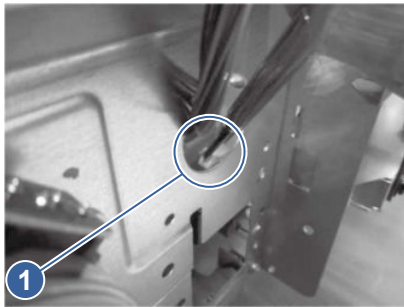

2. Release one tab (callout 1), and then remove the stacking wall assembly (callout 2).

Figure 5-1018 Remove the stacking wall assembly

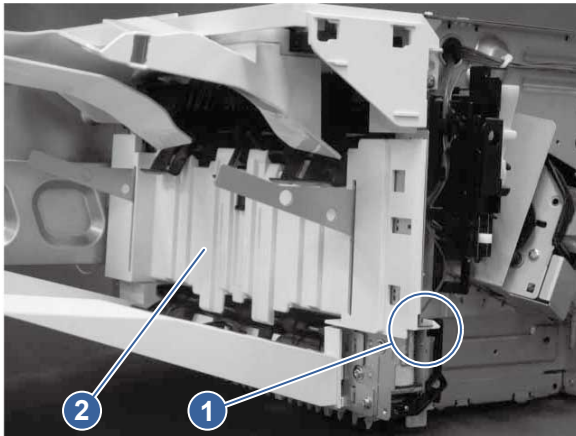

12. Remove the lower feed assembly (3-bin stapler-stacker)

Learn about removing the 3-bin stapler-stacker lower feed assembly.

1. Disconnect two connectors (callout 1), and then remove one screw (callout 2).

Figure 5-1019 Disconnect two connectors

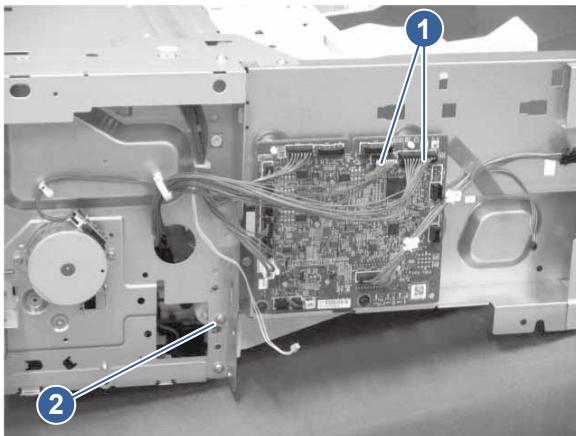

2. Remove the cable (callout 1) by pulling it through the chassis.

Figure 5-1020 Remove the cable

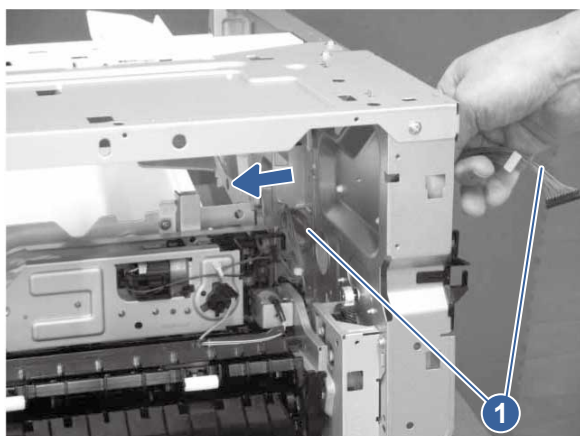

3. Remove one screw (callout 1), remove the cover (callout 2), remove three screws (callout 3), and then remove the lower feed assembly (callout 4).

Figure 5-1021 Remove the lower feed assembly

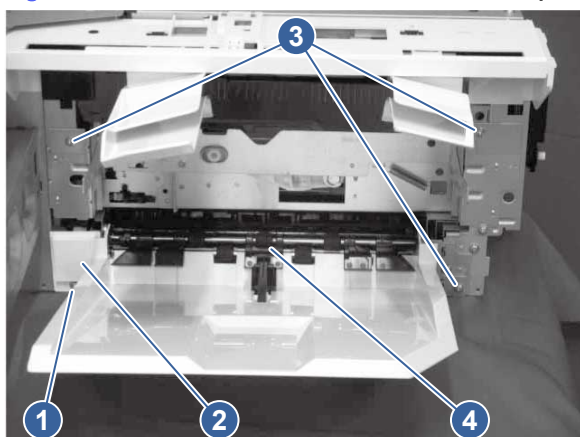

13. Unpack the replacement assembly

Follow these steps to unpack the replacement assembly.

1. Dispose of the defective part.





NOTE: HP recommends responsible disposal of the defective part.

<http://www8.hp.com/us/en/hp-information/environment/product-recycling.html>

2. Unpack the replacement part from the packaging.



CAUTION:  Some parts are sensitive to electrostatic discharge (ESD). Always perform service work at an ESD-protected workstation or mat. If an ESD workstation or mat is not available, touch the sheet-metal chassis to provide a static ground before touching an ESD-sensitive assembly. Protect the ESD-sensitive assemblies by placing them in ESD pouches when they are out of the printer.

 **IMPORTANT:** Make sure that all of the shipping materials (for example shipping tape) are removed from the replacement part prior to installation.

 **NOTE:** If the replacement part is a roller or pad, avoid touching the spongy part of it. Skin oils on the roller or pad can cause paper pickup and/or print-quality problems. HP recommends using disposable gloves when handling rollers or pads or washing your hands before touching rollers or pads.

3. To install an assembly, reverse the removal steps.

 **NOTE:** When applicable, special installation instructions are provided for an assembly at the end of the removal procedure. Always completely read the removal instructions and follow all special installation instructions.

Removal and replacement: Solenoid assembly (3-bin stapler-stacker)

Learn about removing and replacing the solenoid assembly.



[View a video demonstration of removing and replacing the solenoid assembly.](#)

Before performing service

Turn the printer power off

- Disconnect the power cable.

 **WARNING!** To avoid damage to the printer, turn the printer off, wait 30 seconds, and then remove the power cord before attempting to service the printer.

Use the table below to identify the correct part number for your printer, and then go to <https://parts.hp.com/hpparts> to order the part.

Table 5-137 Part information

Part number	Part description
RM21040-010CN	Solenoid assembly (3-bin SS)

Required tools

- #2 Phillips screwdriver with a magnetic tip and a 152 mm (6 in) shaft length
- Small flat-blade screwdriver

After performing service

Turn the printer power on

- Connect the power cable.
- Use the power switch to turn the power on.

Post service test

Print any pages necessary to make sure the printer is functioning correctly.

1. Remove the rear cover (3-bin stapler-stacker)

Learn about removing the 3-bin stapler-stacker rear cover.

1. Remove the printer formatter cover by removing one screw (callout 1) and then sliding the cover (callout 2) in the direction indicated. Slide the 3-bin stapler-stacker formatter cover assembly (callout 3) in the direction indicated to remove it.

Figure 5-1022 Remove the 3-bin stapler-stacker formatter cover

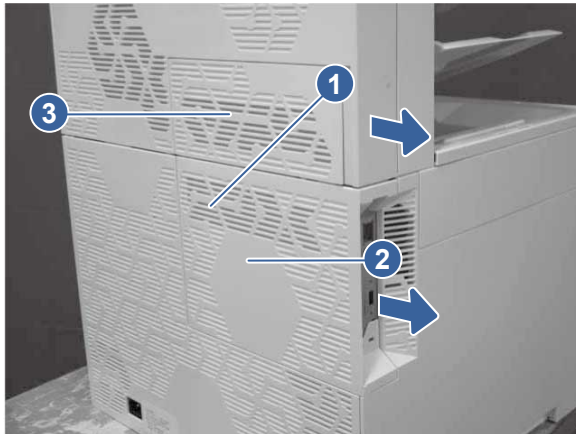

2. Remove two screws (callout 1), release three tabs (callout 2), and then remove the rear cover (callout 3).

Figure 5-1023 Remove the rear cover

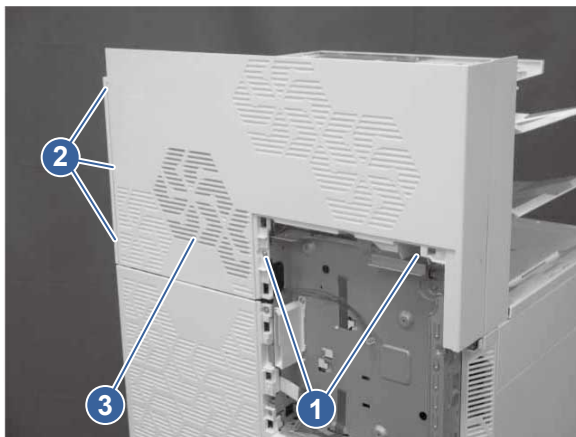

2. Remove the staple cover and staple door (3-bin stapler-stacker)

Learn about removing the 3-bin stapler-stacker staple cover and staple door.

1. Open the stapler-stacker door assembly and the stapler door.

2. Remove one screw (callout 1), and then release three tabs (callout 2).

Figure 5-1024 Remove one screw

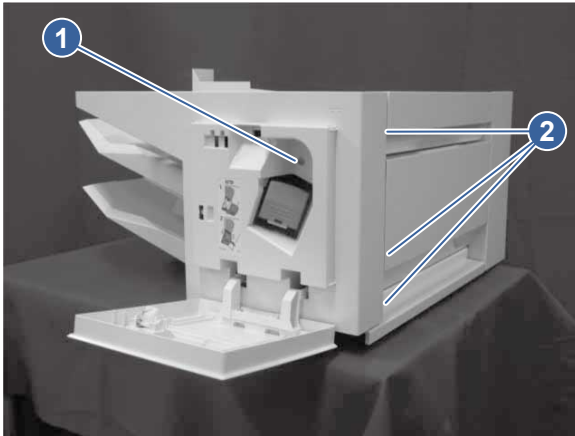

3. Release one tab (callout 1), and then remove the staple cover (callout 2) and the staple door (callout 3) together.

Figure 5-1025 Release one tab

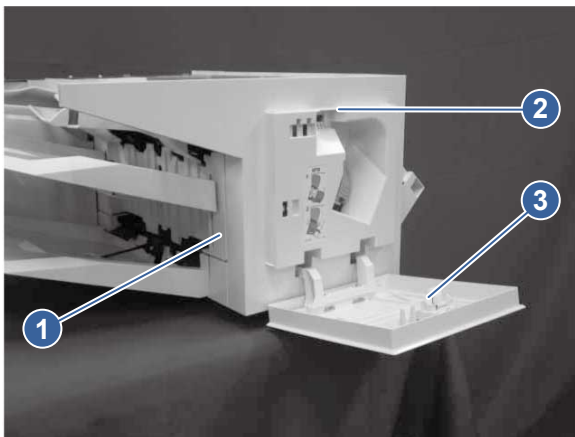

4. Remove two shafts (callout 1), and then remove the staple door (callout 2) from the staple cover (callout 3).

Figure 5-1026 Remove the staple door from the staple cover

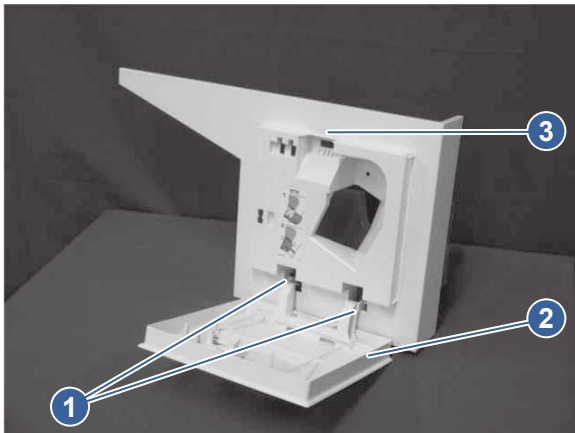

3. Remove the jogger assembly (3-bin stapler-stacker)

Learn about removing the 3-bin stapler-stacker jogger assembly.

1. Release the cable (callout 1) from the cable clamp (callout 2), and then disconnect one connector (callout 3).

Figure 5-1027 Release the cable

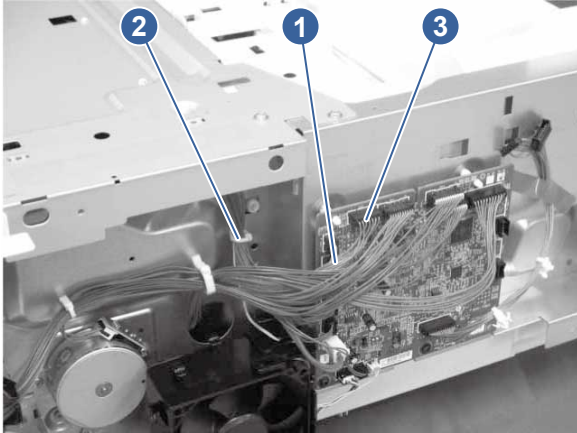

2. Remove one screw (callout 1), and then slide the jogger assembly (callout 2) in the direction indicated to remove it.

Figure 5-1028 Remove the jogger assembly

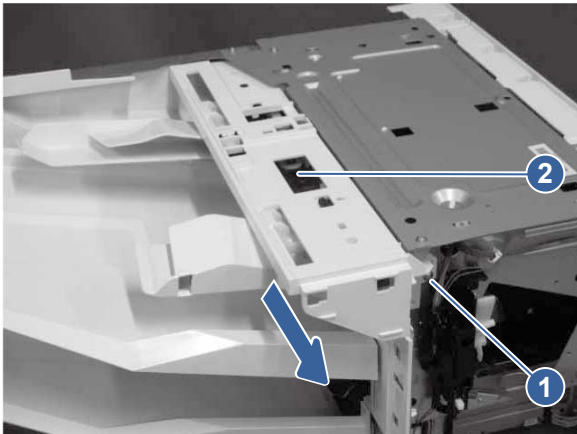

4. Remove the output bin 1 assembly (3-bin stapler-stacker)

Learn about removing the 3-bin stapler-stacker output bin 1 assembly.

1. Release one boss (callout 1), rotate the pin (callout 2) in the direction indicated, and then remove the pin.

Figure 5-1029 Remove the pin

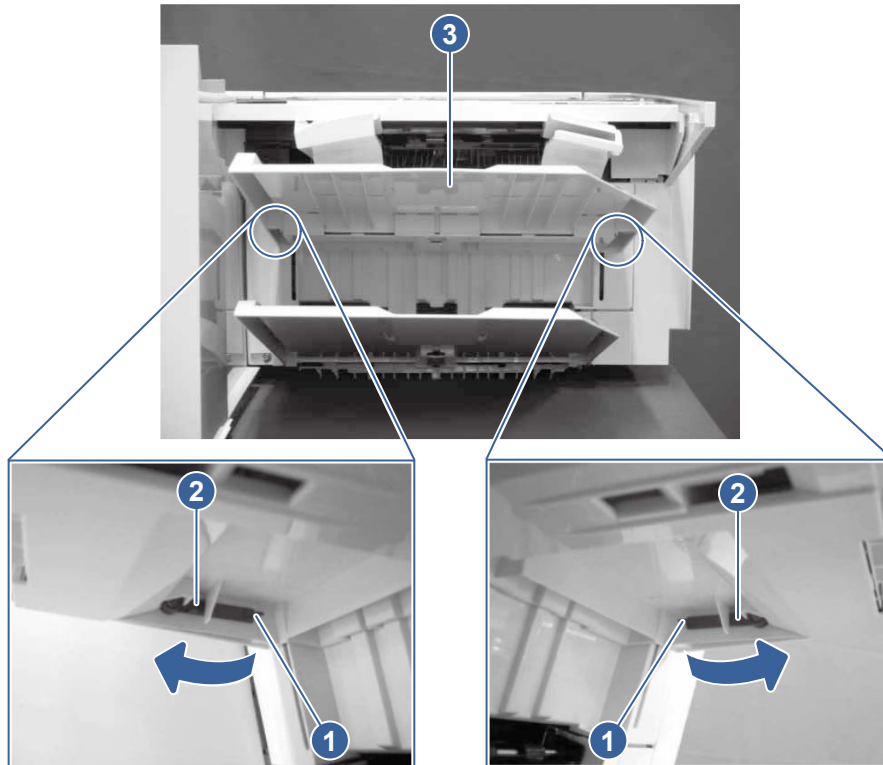

2. Remove the output bin 1 assembly (callout 1).

Figure 5-1030 Remove the output bin

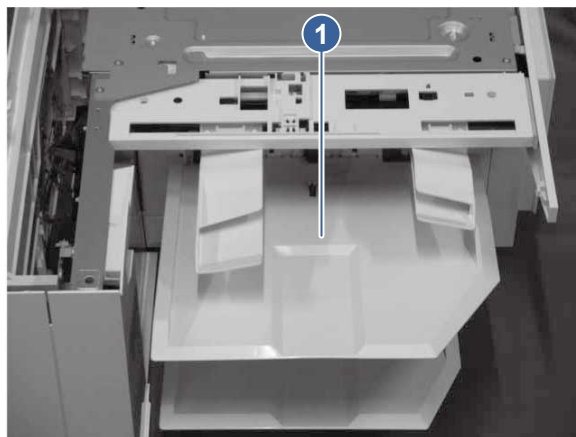

5. Remove the MBM fan (3-bin stapler-stacker)

Learn about removing the 3-bin stapler-stacker mailbox/booklet-maker fan.

1. Disconnect one connector (callout 1), remove one screw (callout 2), and then remove the fan holder (callout 3) together with the fan (callout 4).

Figure 5-1031 Remove the fan holder and fan

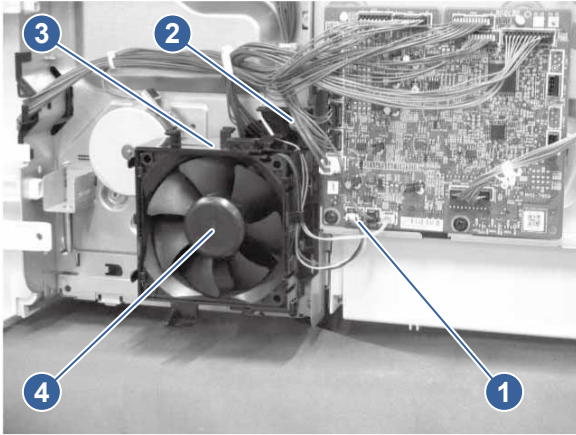

2. Release two tabs (callout 1), remove the duct 1 (callout 2) and the duct 2 (callout 3), and then remove the MBM fan (callout 4) from the holder.

Figure 5-1032 Remove the fan from the holder

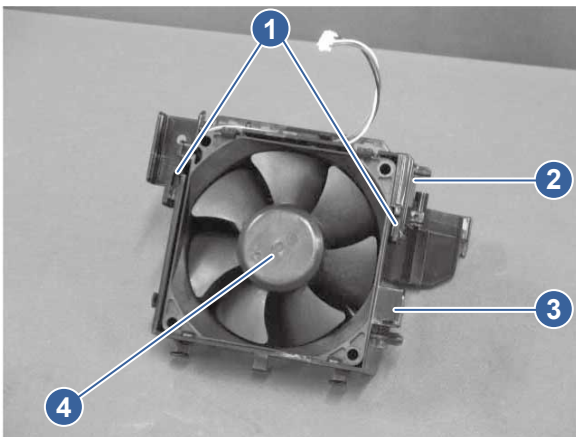

6. Remove the solenoid assembly (3-bin stapler-stacker)

Learn about removing the 3-bin stapler-stacker solenoid assembly.

1. Disconnect one connector (callout 1), and then release the cable (callout 2) from the cable stoppers (callout 3).

Figure 5-1033 Release the cable

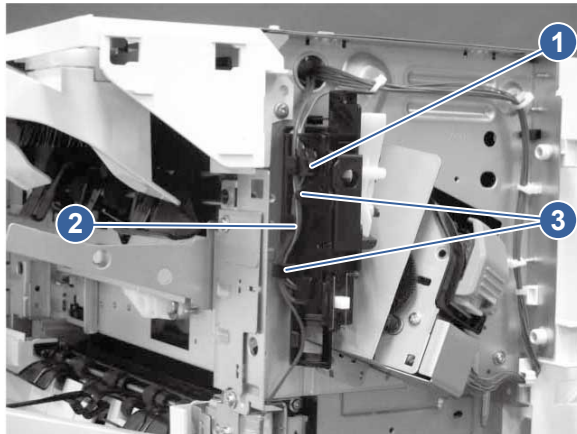

2. Remove three screws (callout 1), and then remove the solenoid assembly (callout 2).

Figure 5-1034 Remove the solenoid assembly

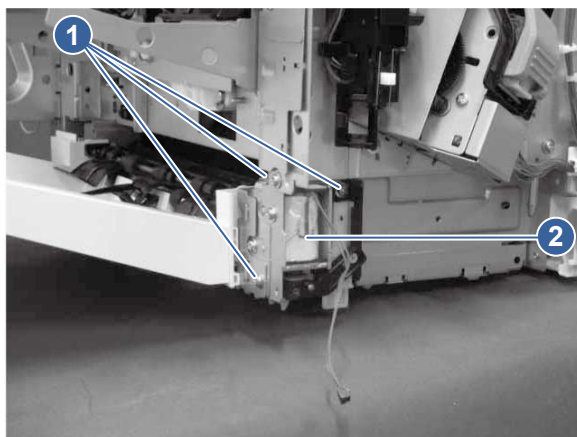

7. Unpack the replacement assembly

Follow these steps to unpack the replacement assembly.

1. Dispose of the defective part.





NOTE: HP recommends responsible disposal of the defective part.

<http://www8.hp.com/us/en/hp-information/environment/product-recycling.html>

2. Unpack the replacement part from the packaging.



CAUTION:  Some parts are sensitive to electrostatic discharge (ESD). Always perform service work at an ESD-protected workstation or mat. If an ESD workstation or mat is not available, touch the sheet-metal chassis to provide a static ground before touching an ESD-sensitive assembly. Protect the ESD-sensitive assemblies by placing them in ESD pouches when they are out of the printer.

 **IMPORTANT:** Make sure that all of the shipping materials (for example shipping tape) are removed from the replacement part prior to installation.

 **NOTE:** If the replacement part is a roller or pad, avoid touching the spongy part of it. Skin oils on the roller or pad can cause paper pickup and/or print-quality problems. HP recommends using disposable gloves when handling rollers or pads or washing your hands before touching rollers or pads.

3. To install an assembly, reverse the removal steps.

 **NOTE:** When applicable, special installation instructions are provided for an assembly at the end of the removal procedure. Always completely read the removal instructions and follow all special installation instructions.

Removal and replacement: MBM fan (3-bin stapler-stacker)

Learn about removing and replacing the 3-bin stapler-stacker mailbox/booklet-maker fan.

Before performing service

Turn the printer power off

- Disconnect the power cable.

 **WARNING!** To avoid damage to the printer, turn the printer off, wait 30 seconds, and then remove the power cord before attempting to service the printer.

Use the table below to identify the correct part number for your printer, and then go to <https://parts.hp.com/hpparts> to order the part.

Table 5-138 Part information

Part number	Part description
RK2-8153-000CN	Fan (3-bin SS)

Required tools

- #2 Phillips screwdriver with a magnetic tip and a 152 mm (6 in) shaft length
- Small flat-blade screwdriver

After performing service

Turn the printer power on

- Connect the power cable.
- Use the power switch to turn the power on.

Post service test

Print any pages necessary to make sure the printer is functioning correctly.

1. Remove the rear cover (3-bin stapler-stacker)

Learn about removing the 3-bin stapler-stacker rear cover.

1. Remove the printer formatter cover by removing one screw (callout 1) and then sliding the cover (callout 2) in the direction indicated. Slide the 3-bin stapler-stacker formatter cover assembly (callout 3) in the direction indicated to remove it.

Figure 5-1035 Remove the 3-bin stapler-stacker formatter cover

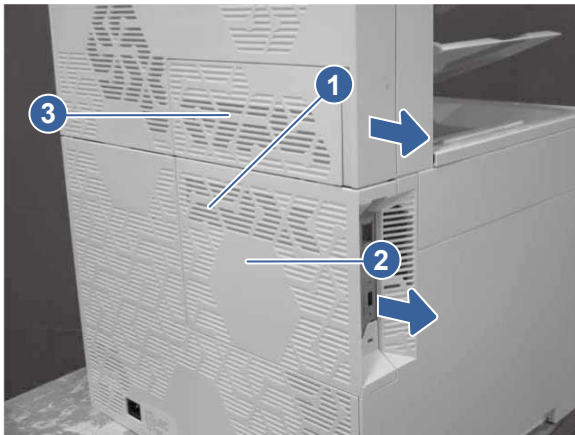

2. Remove two screws (callout 1), release three tabs (callout 2), and then remove the rear cover (callout 3).

Figure 5-1036 Remove the rear cover

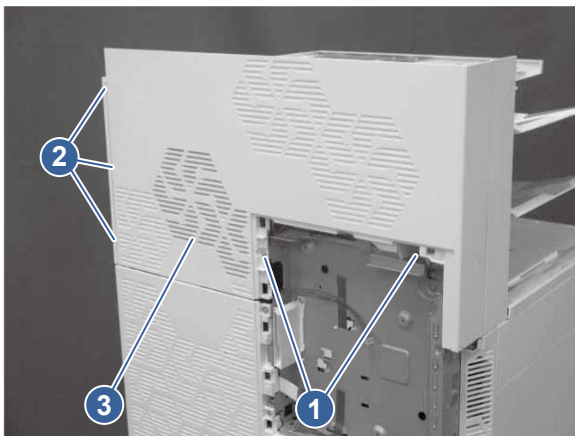

2. Remove the MBM fan (3-bin stapler-stacker)

Learn about removing the 3-bin stapler-stacker mailbox/booklet-maker fan.

1. Disconnect one connector (callout 1), remove one screw (callout 2), and then remove the fan holder (callout 3) together with the fan (callout 4).

Figure 5-1037 Remove the fan holder and fan

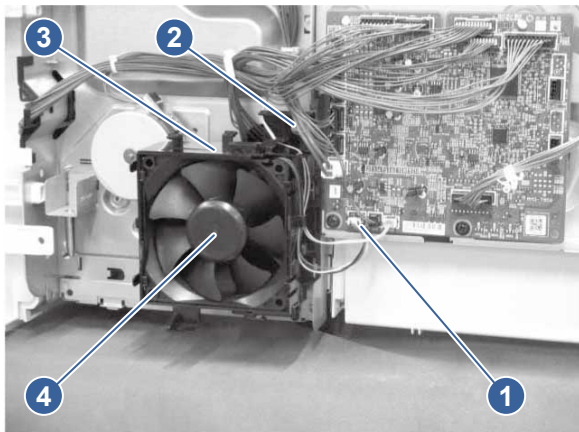

2. Release two tabs (callout 1), remove the duct 1 (callout 2) and the duct 2 (callout 3), and then remove the MBM fan (callout 4) from the holder.

Figure 5-1038 Remove the fan from the holder

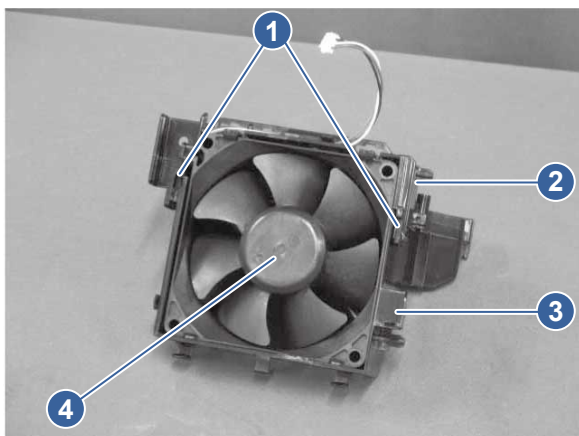

3. Unpack the replacement assembly

Follow these steps to unpack the replacement assembly.

1. Dispose of the defective part.





NOTE: HP recommends responsible disposal of the defective part.

<http://www8.hp.com/us/en/hp-information/environment/product-recycling.html>

2. Unpack the replacement part from the packaging.



CAUTION:  Some parts are sensitive to electrostatic discharge (ESD). Always perform service work at an ESD-protected workstation or mat. If an ESD workstation or mat is not available, touch the sheet-metal chassis to provide a static ground before touching an ESD-sensitive assembly. Protect the ESD-sensitive assemblies by placing them in ESD pouches when they are out of the printer.

 **IMPORTANT:** Make sure that all of the shipping materials (for example shipping tape) are removed from the replacement part prior to installation.

 **NOTE:** If the replacement part is a roller or pad, avoid touching the spongy part of it. Skin oils on the roller or pad can cause paper pickup and/or print-quality problems. HP recommends using disposable gloves when handling rollers or pads or washing your hands before touching rollers or pads.

3. To install an assembly, reverse the removal steps.

 **NOTE:** When applicable, special installation instructions are provided for an assembly at the end of the removal procedure. Always completely read the removal instructions and follow all special installation instructions.

Removal and replacement: Stapler-stacker feed motor (3-bin stapler-stacker)

Learn about removing and replacing the feed motor.

Before performing service

Turn the printer power off

- Disconnect the power cable.

 **WARNING!** To avoid damage to the printer, turn the printer off, wait 30 seconds, and then remove the power cord before attempting to service the printer.

Use the table below to identify the correct part number for your printer, and then go to <https://parts.hp.com/hpparts> to order the part.

Table 5-139 Part information

Part number	Part description
RK2-8149-000CN	Motor, stepping DC (3-bin SS)

Required tools

- #2 Phillips screwdriver with a magnetic tip and a 152 mm (6 in) shaft length
- Small flat-blade screwdriver

After performing service

Turn the printer power on

- Connect the power cable.
- Use the power switch to turn the power on.

Post service test

Print any pages necessary to make sure the printer is functioning correctly.

1. Remove the rear cover (3-bin stapler-stacker)

Learn about removing the 3-bin stapler-stacker rear cover.

1. Remove the printer formatter cover by removing one screw (callout 1) and then sliding the cover (callout 2) in the direction indicated. Slide the 3-bin stapler-stacker formatter cover assembly (callout 3) in the direction indicated to remove it.

Figure 5-1039 Remove the 3-bin stapler-stacker formatter cover

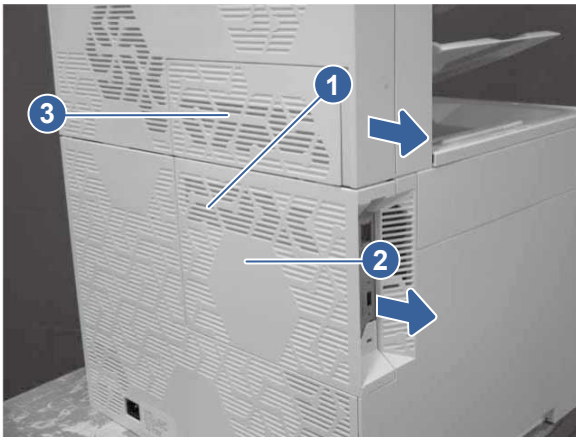

2. Remove two screws (callout 1), release three tabs (callout 2), and then remove the rear cover (callout 3).

Figure 5-1040 Remove the rear cover

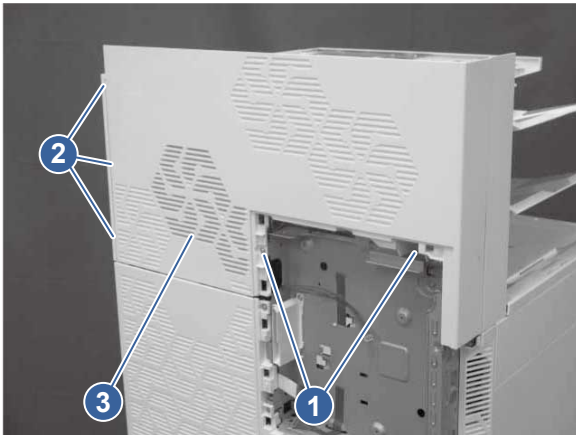

2. Remove the MBM fan (3-bin stapler-stacker)

Learn about removing the 3-bin stapler-stacker mailbox/booklet-maker fan.

1. Disconnect one connector (callout 1), remove one screw (callout 2), and then remove the fan holder (callout 3) together with the fan (callout 4).

Figure 5-1041 Remove the fan holder and fan

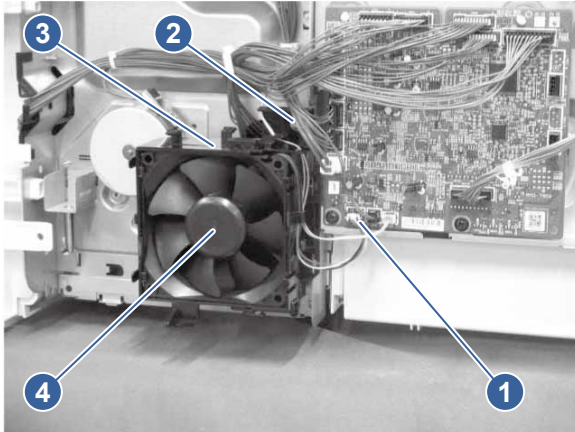

2. Release two tabs (callout 1), remove the duct 1 (callout 2) and the duct 2 (callout 3), and then remove the MBM fan (callout 4) from the holder.

Figure 5-1042 Remove the fan from the holder

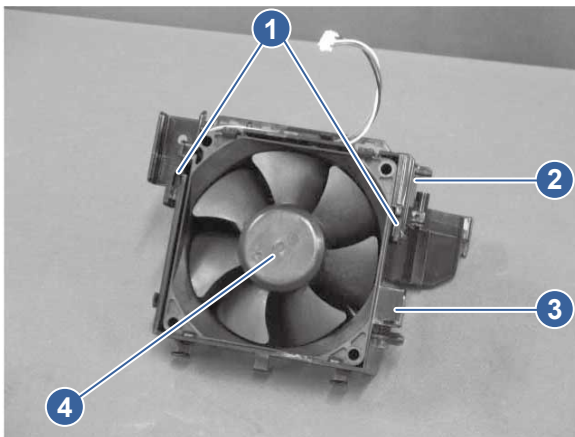

3. Remove the feed motor (3-bin stapler-stacker)

Learn about removing the 3-bin stapler-stacker feed motor.

- Release the cable (callout 1) from the cable clamp (callout 2), disconnect one connector (callout 3), remove two screws (callout 4), and then remove the stapler-stacker feed motor (callout 5).

Figure 5-1043 Remove the feed motor

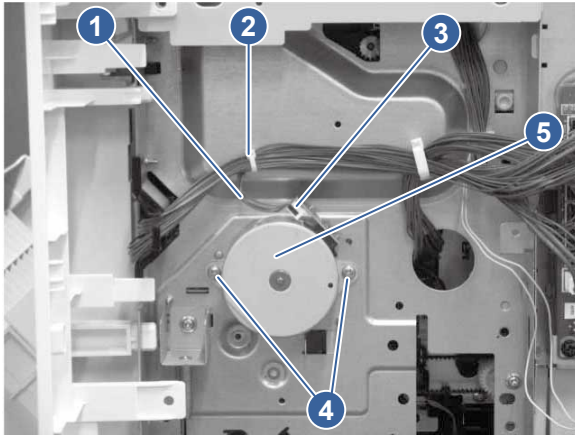

4. Unpack the replacement assembly



Follow these steps to unpack the replacement assembly.

1. Dispose of the defective part.

 **NOTE:** HP recommends responsible disposal of the defective part.

<http://www8.hp.com/us/en/hp-information/environment/product-recycling.html>

2. Unpack the replacement part from the packaging.

 **CAUTION:**  Some parts are sensitive to electrostatic discharge (ESD). Always perform service work at an ESD-protected workstation or mat. If an ESD workstation or mat is not available, touch the sheet-metal chassis to provide a static ground before touching an ESD-sensitive assembly. Protect the ESD-sensitive assemblies by placing them in ESD pouches when they are out of the printer.

 **IMPORTANT:** Make sure that all of the shipping materials (for example shipping tape) are removed from the replacement part prior to installation.

 **NOTE:** If the replacement part is a roller or pad, avoid touching the spongy part of it. Skin oils on the roller or pad can cause paper pickup and/or print-quality problems. HP recommends using disposable gloves when handling rollers or pads or washing your hands before touching rollers or pads.

3. To install an assembly, reverse the removal steps.

 **NOTE:** When applicable, special installation instructions are provided for an assembly at the end of the removal procedure. Always completely read the removal instructions and follow all special installation instructions.

Removal and replacement: Controller PCA (3-bin stapler-stacker)

Learn about removing and replacing the 3-bin stapler-stacker controller PCA.

Before performing service

Turn the printer power off

- Disconnect the power cable.

⚠ WARNING! To avoid damage to the printer, turn the printer off, wait 30 seconds, and then remove the power cord before attempting to service the printer.

Use the table below to identify the correct part number for your printer, and then go to <https://parts.hp.com/hpparts> to order the part.

Table 5-140 Part information

Part number	Part description
RM3-7950-000CN	Staple stacker PCA (3-bin SS)

Required tools

- #2 Phillips screwdriver with a magnetic tip and a 152 mm (6 in) shaft length
- Small flat-blade screwdriver

After performing service

Turn the printer power on

- Connect the power cable.
- Use the power switch to turn the power on.

Post service test

Print any pages necessary to make sure the printer is functioning correctly.

1. Remove the rear cover (3-bin stapler-stacker)

Learn about removing the 3-bin stapler-stacker rear cover.

1. Remove the printer formatter cover by removing one screw (callout 1) and then sliding the cover (callout 2) in the direction indicated. Slide the 3-bin stapler-stacker formatter cover assembly (callout 3) in the direction indicated to remove it.

Figure 5-1044 Remove the 3-bin stapler-stacker formatter cover

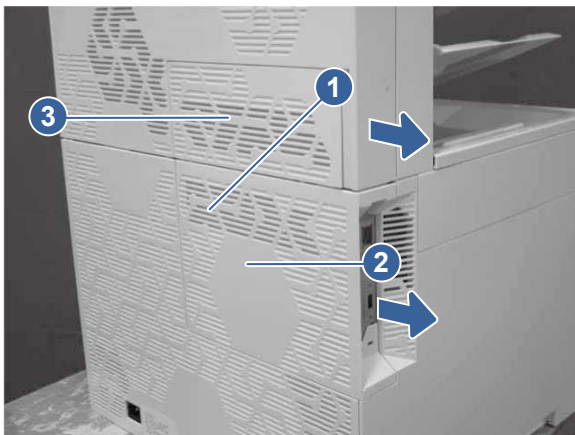

2. Remove two screws (callout 1), release three tabs (callout 2), and then remove the rear cover (callout 3).

Figure 5-1045 Remove the rear cover

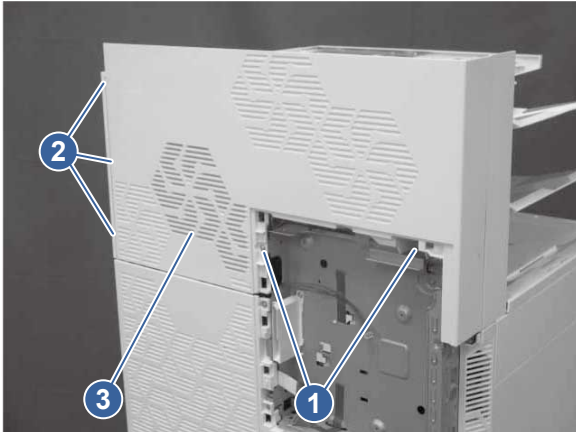

2. Remove the controller PCA (3-bin stapler-stacker)

Learn about removing the 3-bin stapler-stacker controller PCA.

1. Disconnect all the connectors on the controller PCA.
2. Remove one screw (callout 1), release two tabs (callout 2), and then remove the controller PCA (callout 3).

Figure 5-1046 Remove the controller PCA

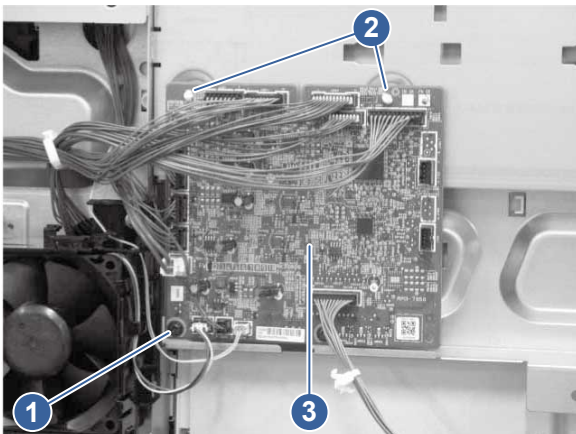

3. Unpack the replacement assembly

Follow these steps to unpack the replacement assembly.



1. Dispose of the defective part.





NOTE: HP recommends responsible disposal of the defective part.

<http://www8.hp.com/us/en/hp-information/environment/product-recycling.html>

2. Unpack the replacement part from the packaging.

 **CAUTION:**  Some parts are sensitive to electrostatic discharge (ESD). Always perform service work at an ESD-protected workstation or mat. If an ESD workstation or mat is not available, touch the sheet-metal chassis to provide a static ground before touching an ESD-sensitive assembly. Protect the ESD-sensitive assemblies by placing them in ESD pouches when they are out of the printer.

 **IMPORTANT:** Make sure that all of the shipping materials (for example shipping tape) are removed from the replacement part prior to installation.

 **NOTE:** If the replacement part is a roller or pad, avoid touching the spongy part of it. Skin oils on the roller or pad can cause paper pickup and/or print-quality problems. HP recommends using disposable gloves when handling rollers or pads or washing your hands before touching rollers or pads.

3. To install an assembly, reverse the removal steps.

 **NOTE:** When applicable, special installation instructions are provided for an assembly at the end of the removal procedure. Always completely read the removal instructions and follow all special installation instructions.

6 Parts and diagrams

Printer parts information including exploded assembly diagrams and part number lists.

Document feeder / scanner

Learn about the integrated scanner assembly (ISA) parts and assemblies.



NOTE: This section is for MFP printers only.

Integrated scanner assembly

Parts diagram and part list for the integrated scanner assembly (ISA).

Figure 6-1 Integrated scanner assembly

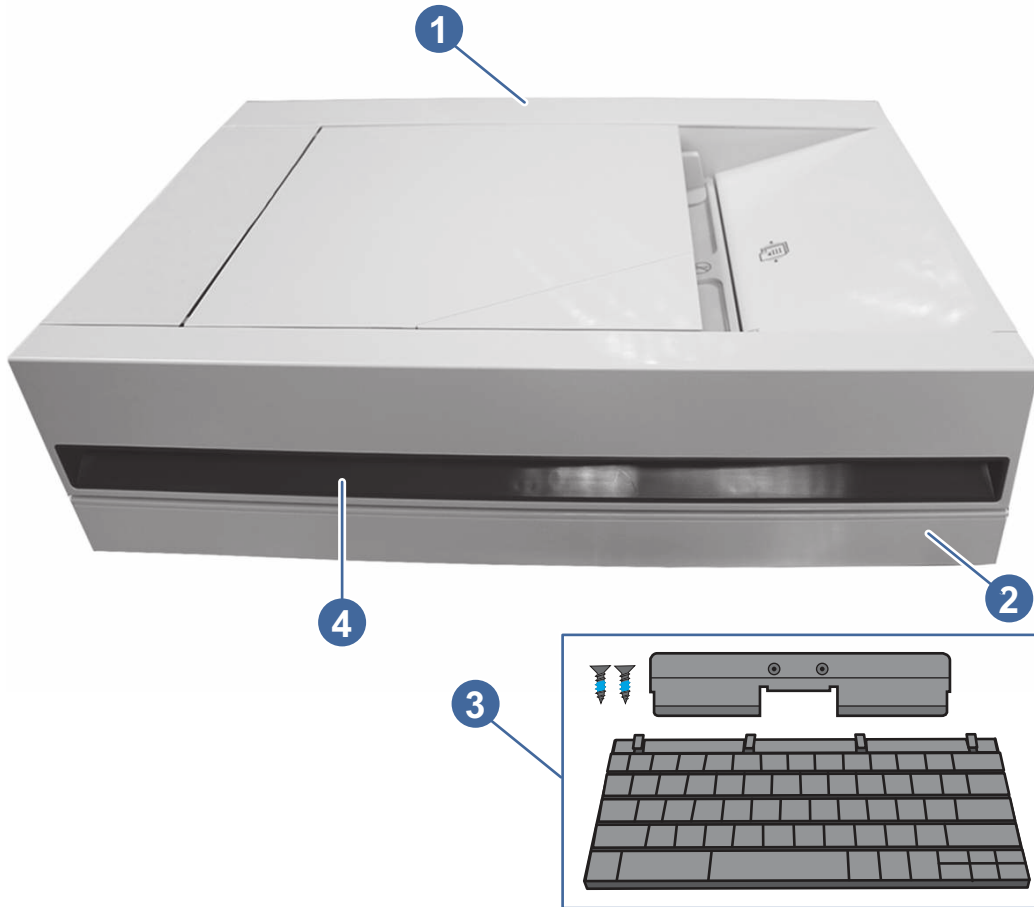

Table 6-1 Integrated scanner assembly

Ref No	Part number	Description	Qty
1	COM44-67002	ADF WUR (5xxx Series Non-Workflow)	1
1	COM44-67003	ADF WUR (5xxx Series Workflow)	1
2	6QN29-67005	Flatbed scanner	1
3	1M0Q2A	HP LaserJet Workflow Keyboard	1
4	5851-8688	Handle (Lunar Grey Dark/ Cement Dark)	1
4	5851-8689	Handle (Lunar Comet Red Dark)	1
4	5851-8690	Handle (Lunar Cosmic Green Dark)	1
4	5851-8691	Handle (Lunar Constellation Yellow)	1
4	5851-8692	Handle (Lunar Aurora Purple Dark)	1
4	5851-8693	Handle (OOV white)	1

Table 6-1 Integrated scanner assembly (continued)

Ref No	Part number	Description	Qty
Not shown	5851-8849	ADF damper	1
Not shown	5851-8841	ADF hinge kit (5xxx Series)	1
Not shown	5851-8850	ADF white backing kit	1
Not shown	6H121A	ADF Pick/Sep Roller Kit (5xxx Series)	1
Not shown	5851-8843	ADF roller cover (5xxx Series)	1
Not shown	A7W12A	Keyboard Overlay Kit - Chinese	1
Not shown	A7W13A	Keyboard Overlay Kit - (DN/FR-Swiss/GN)	1
Not shown	A7W14A	HP LaserJet Swedish Overlay Keyboard	1
Not shown	Scanner control interconnect board (SCIB) (5xxxx Series)	5851-8962	1

Base printer

Learn about the printer engine parts and assemblies.

Control panels

Parts diagrams and part lists for the control panels.

Control panels

Parts diagrams and parts lists for the printer control panels.

Figure 6-2 Control panels

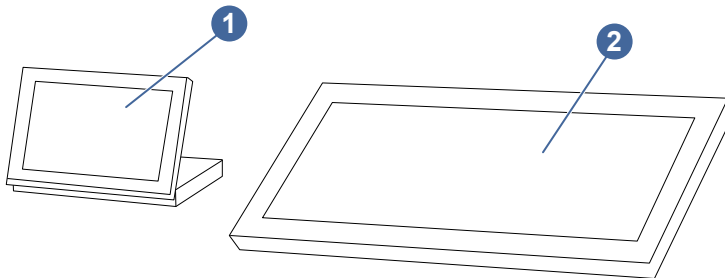

Table 6-2 Control panels

Ref No	Part number	Description	Qty
1	6QN28-67001	Control panel 10.9 cm (4.3 in)	1

Table 6-2 Control panels (continued)

Ref No	Part number	Description	Qty
2	6QN35-60129	Control panel 25.6 cm (10.1 in)	1
2	6QN37-60102	Control panel 23.3 cm (8 in)	

Covers, panels, and doors

Parts diagrams and part lists for the covers, panels, and doors.

Parts and diagrams: Covers 5700/X557 models

Parts diagram and parts list for the SFP printer covers.

Figure 6-3 Covers 5700/X557 models

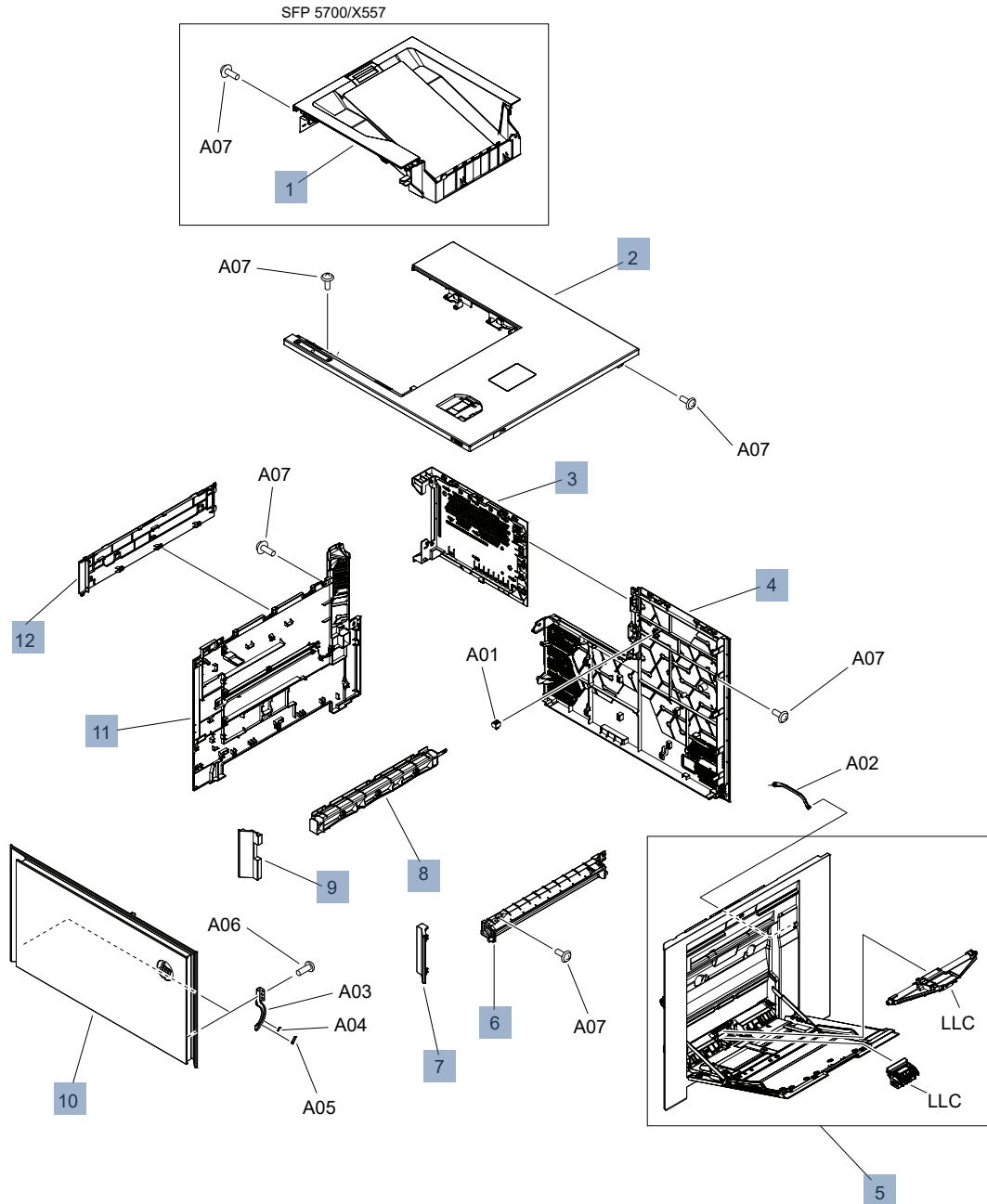

Table 6-3 Covers 5700/X557 models

Key No	Part number	Qty	Description
1	RM2-4469-000CN	1	Face down tray assembly
2	RM2-4517-000CN	1	Cover, top assembly
3	RM2-4480-000CN	1	Formatter cover assembly
4	RC5-9168-000CN	1	Cover, rear lower
5	RM2-3570-000CN	1	Right lower door assembly
6	RC5-8516-000CN	1	Handle, right door lower
7	RC5-9199-000CN	1	Cover, front right
8	RC5-9165-000CN	1	Handle, left
9	RC5-9198-000CN	1	Cover, front left
10	RM2-4473-000CN	1	Front door assembly(5700)
10	RM2-4533-000CN	1	Front door assembly(X557)
11	RM2-4535-000CN	1	Left cover assembly
12	RC5-9204-000CN	1	Cover, left upper
Not shown	RC4-0213-000CN	1	Cover, Hardware integration pocket (HIP)

Parts and diagrams: Covers 5800 models

Parts diagram and parts list for the MFP printer covers.

Figure 6-4 Covers 5800 models

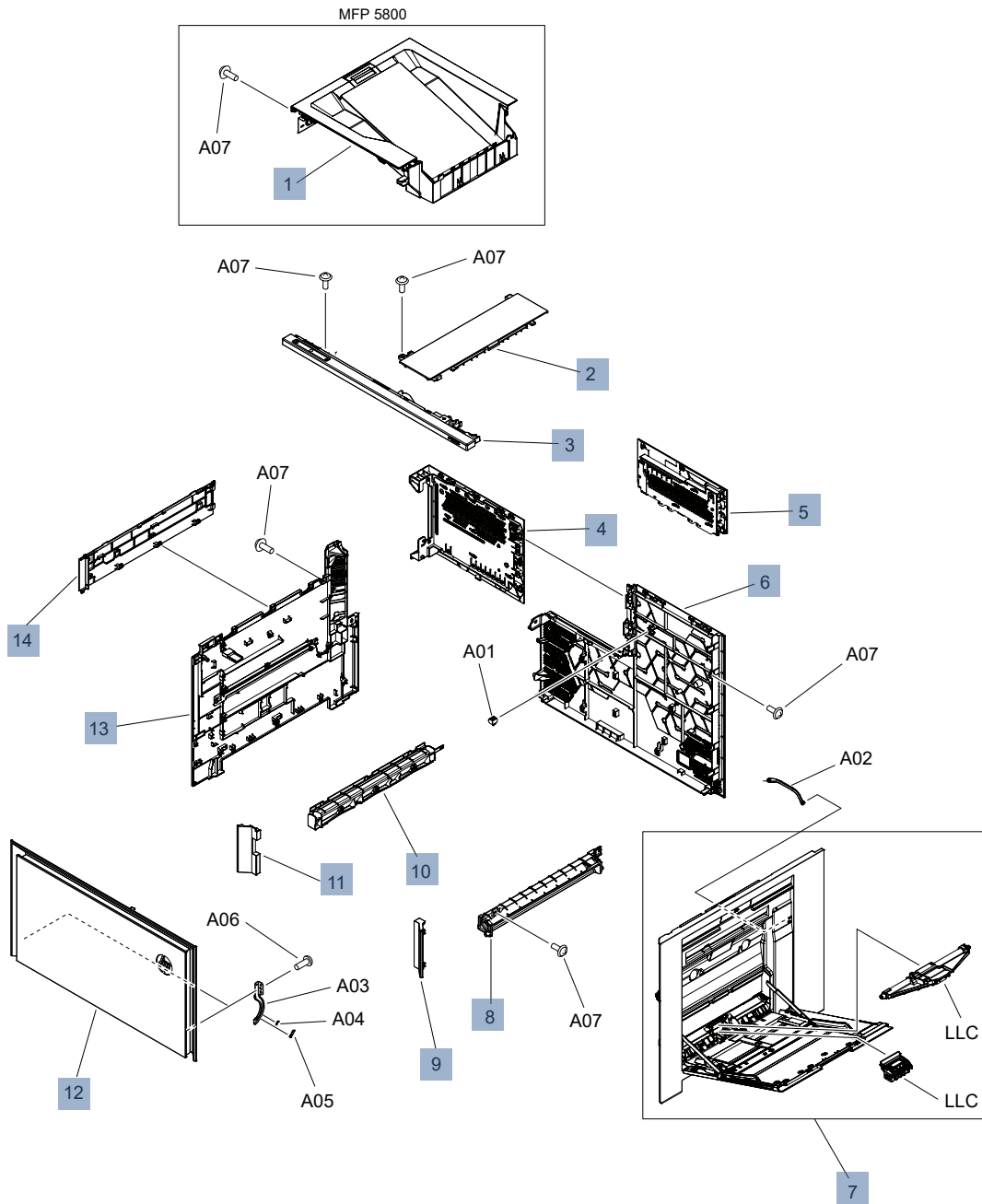

Table 6-4 Covers 5800 models

Key No	Part number	Qty	Description
1	RM2-4469-000CN	1	Face down tray assembly
2	RC5-9172-000CN	1	Cover, top assembly

Table 6-4 Covers 5800 models (continued)

Key No	Part number	Qty	Description
3	RM2-4518-000CN	1	Top front cover assembly
4	RM2-4480-000CN	1	Formatter cover assembly
5	RM2-4530-000CN	1	Formatter cover assembly
6	RC5-9168-000CN	1	Cover, rear lower
7	RM2-3570-000CN	1	Right lower door assembly
8	RC5-8516-000CN	1	Handle, right door lower
9	RC5-9199-000CN	1	Cover, front right
10	RC5-9165-000CN	1	Handle, left
11	RC5-9198-000CN	1	Cover, front left
12	RM2-4473-000CN	1	Front door assembly
13	RM2-4535-000CN	1	Left cover assembly
14	RC5-9204-000CN	1	Cover, left upper
Not shown	RC4-0213-000CN	1	Cover, Hardware integration pocket (HIP)

Parts and diagrams: Covers X57945 models

Parts diagram and parts list for the MFP printer covers.

Figure 6-5 Covers X57945 models

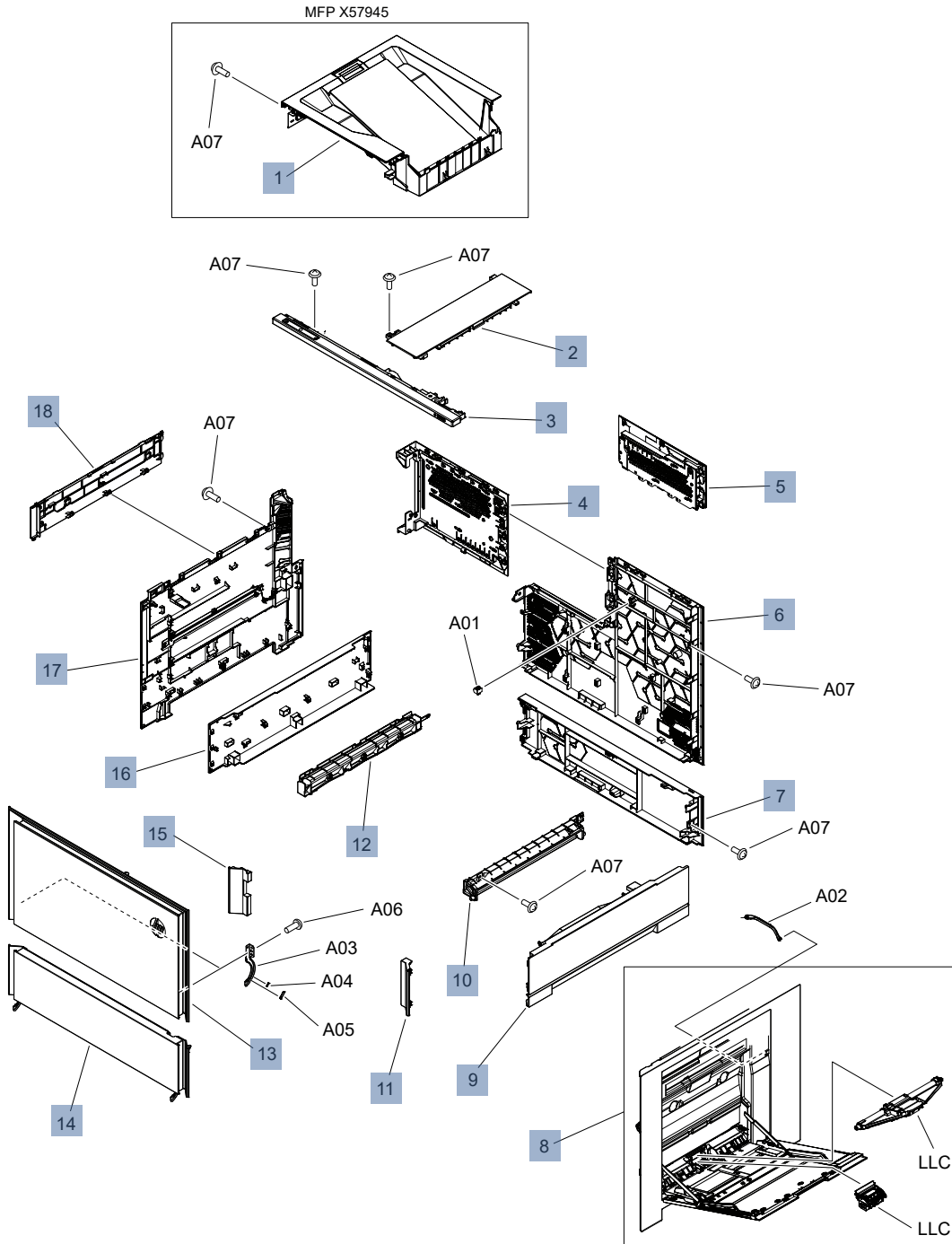

Table 6-5 Covers X57945 models

Key No	Part number	Qty	Description
1	RM2-4469-000CN	1	Face down tray assembly
2	RC5-9172-000CN	1	Cover, top assembly
3	RM2-4518-000CN	1	Top front cover assembly
4	RM2-4480-000CN	1	Formatter cover assembly
5	RM2-4530-000CN	1	Formatter cover assembly
6	RC5-9168-000CN	1	Cover, rear lower
7	RC5-9409-000CN	1	Cover, rear lower
8	RM2-3570-000CN	1	Right lower door assembly
9	RM3-0004-000CN	1	Right lower door assembly
10	RC5-8516-000CN	1	Handle, right door lower
11	RC5-9199-000CN	1	Cover, front right
12	RC5-9165-000CN	1	Handle, left
13	RM2-4479-000CN	1	Front door assembly
14	RM2-3678-000CN	1	Toner supply door assembly
15	RC5-9198-000CN	1	Cover, front left
16	RC5-9408-000CN	1	Left lower cover
17	RM2-4535-000CN	1	Left cover assembly
18	RC5-9204-000CN	1	Cover, left upper
Not shown	RC4-0213-000CN	1	Cover, Hardware integration pocket (HIP)

Table 6-6 Internal assemblies (1 of 9) X57945 models

Ref No	Part number	Qty	Description
1	RM2-3497-000CN		Main drive assembly
2	RM2-3625-000CN	1	Developing motor assembly
3	RM3-7647-000CN	1	Drum position sensor PCA
4	RM3-7788-000CN	1	Drum motor assembly
5	RM2-7360-000CN	1	T1 solenoid assembly
6	RK2-6027-000CN	1	Motor, stepping
7	RM3-7797-000CN	1	ITB motor assembly
8	RM3-7791-000CN	1	Right PCA
9	RM3-7723-000CN	1	Driver PCA
10	RM2-3822-000CN	1	Laser scanner assembly
11	RK3-0835-000CN	1	Cable, flat SCN

Parts and diagrams: Internal assemblies (2 of 9) X57945 models

Parts diagram and parts list for the internal printer assemblies.

Figure 6-7 Internal assemblies (2 of 9) X57945 models

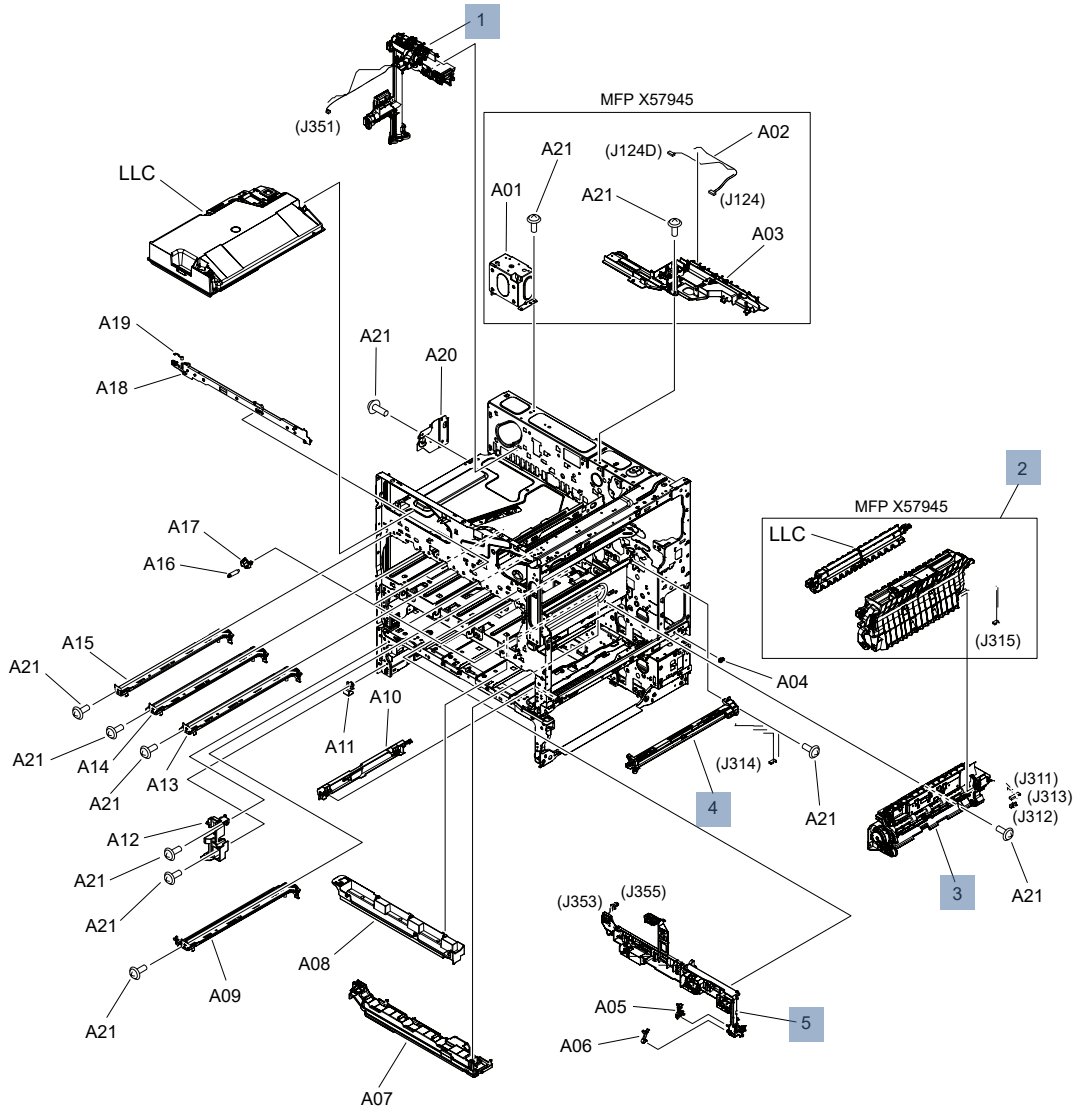

Table 6-7 Internal assemblies (2 of 9) X57945 models

Ref No	Part number	Qty	Description
1	RM2-3590-000CN	1	Waste toner duct assembly
2	RM2-3628-000CN	1	Secondary transfer assembly 6700
3	RM2-4458-000CN	1	Registration assembly
4	RM2-4492-000CN	1	Density detect assembly
5	RM2-3673-000CN	1	Pre-exposure PCA holder

Parts and diagrams: Internal assemblies (3 of 9) X57945 models

Parts diagram and parts list for the internal printer assemblies.

Figure 6-8 Internal assemblies (3 of 9) X57945 models

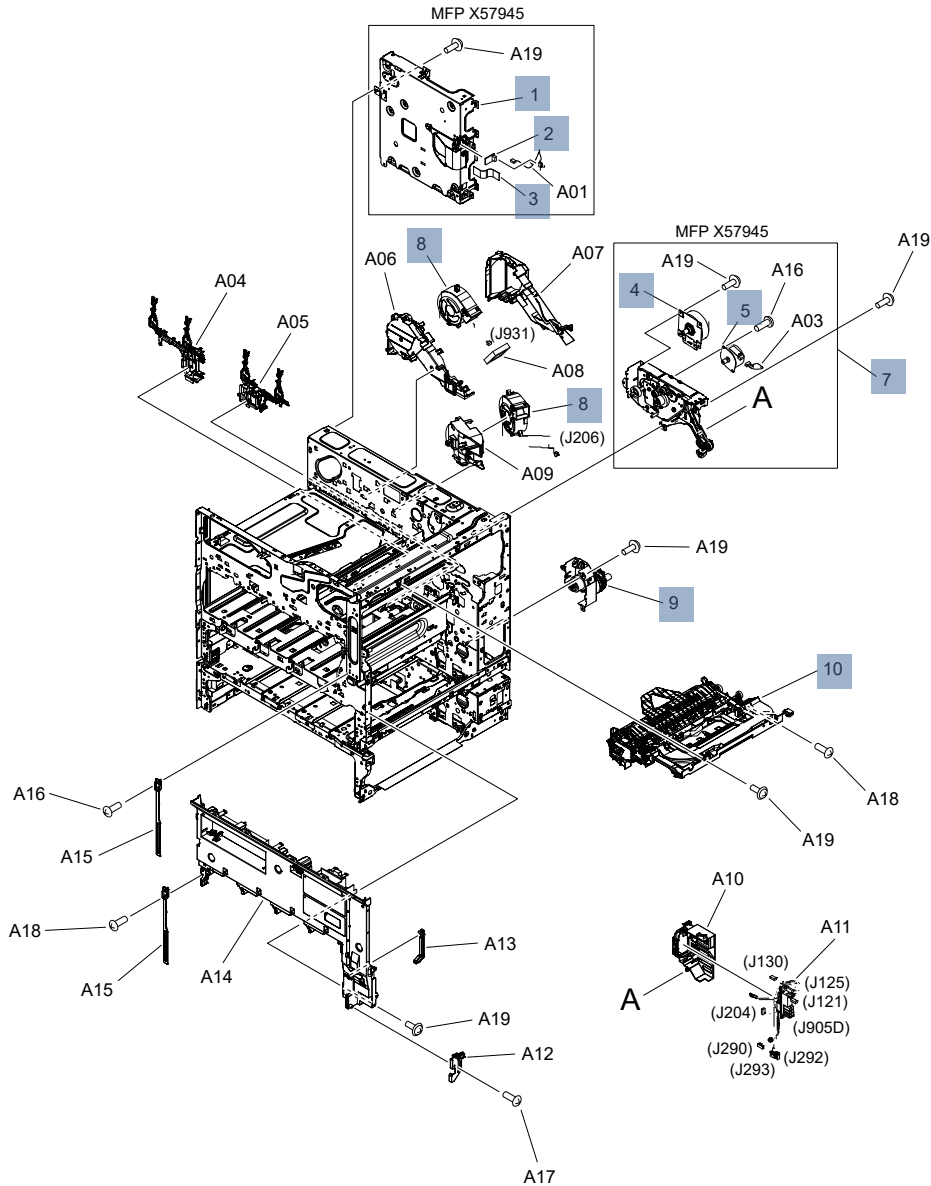

Table 6-8 Internal assemblies (3 of 9) X57945 models

Ref No	Part number	Qty	Description
1	RM2-4521-000CN	1	Formatter cage assembly
2	RM2-7138-000CN	1	Memory PC board assembly
3	RK3-0845-000CN	1	Cable, flat FMTR
4	RM2-4488-000CN	1	Fixing motor assembly
5	RK2-7751-000CN	1	Motor, stepping

Table 6-8 Internal assemblies (3 of 9) X57945 models (continued)

Ref No	Part number	Qty	Description
7	RM2-4485-000CN	1	Fixing drive assembly
8	RK3-0762-000CN	2	Fan
9	RM2-3702-000CN	1	Paper pickup drive assembly
10	RM2-3554-000CN	1	Paper delivery assembly

Parts and diagrams: Internal assemblies (4 of 9) X57945 models

Parts diagram and parts list for the internal printer assemblies.

Figure 6-9 Internal assemblies (4 of 9) X557/X57945 models

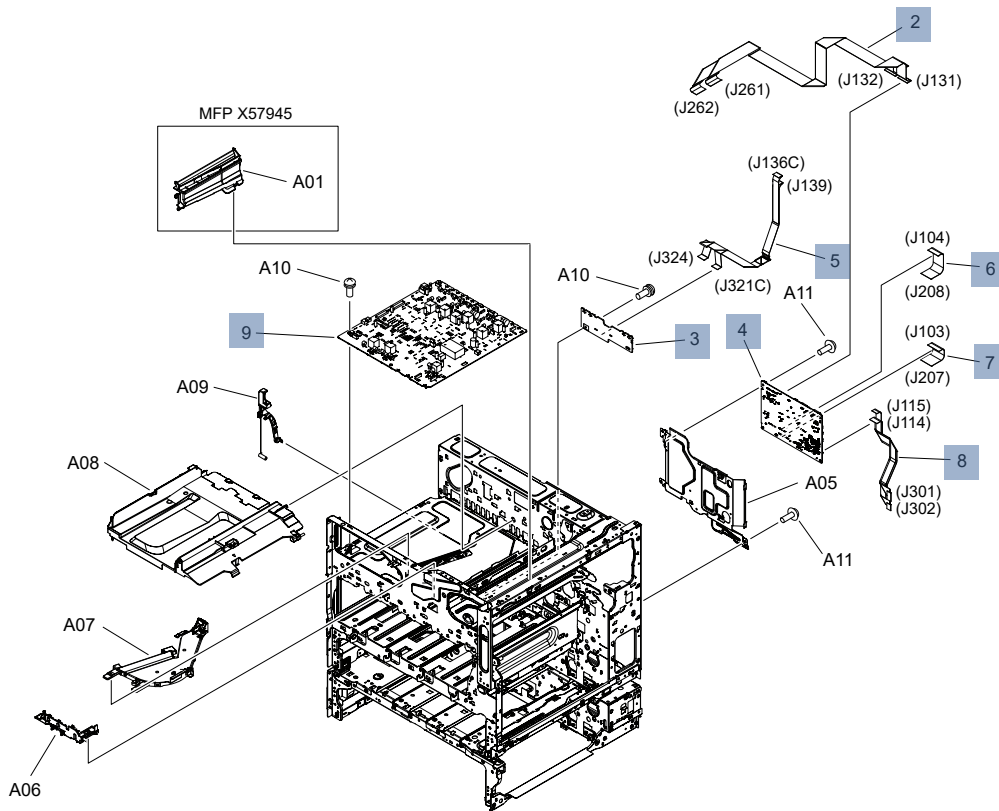

Table 6-9 Internal assemblies (4 of 9) X557/X57945 models

Ref No	Part number	Qty	Description
2	RK3-1509-000CN	1	Cable, flat HVT
3	RM3-9046-000CN	1	Rear PCA
4	RM3-7756-000CN	1	DC controller PCA
5	RK3-1693-000CN	1	Cable, flat rear
6	RK3-0821-000CN	1	Cable, flat drive
7	RK3-0819-000CN	1	Cable, flat drive
8	RK3-1694-000CN	1	Cable, flat right
9	RM3-9042-000CN	1	HV power supply PCA
Not shown	6QN27-67002	1	Formatter (58xx / X57xxx)
Not shown	6QN27-67004	1	Formatter (57xx / X55xxx) (China/India)
Not shown	6QN29-67002	1	Formatter (58xx / X57xxx)
Not shown	6QN29-67004	1	Formatter (58xx / X57xxx) (China/India)

Parts and diagrams: Internal assemblies (5 of 9) X57945 models

Parts diagram and parts list for the internal printer assemblies.

Figure 6-10 Internal assemblies (5 of 9) X57945 models

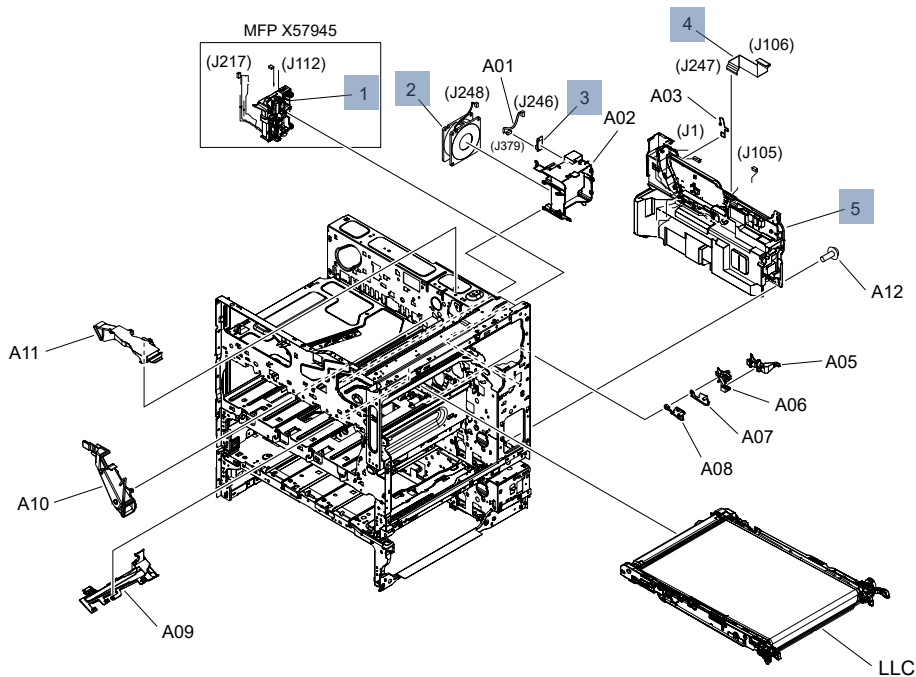

Table 6-10 Internal assemblies (5 of 9) X57945 models

Ref No	Part number	Qty	Description
1	RM2-3675-000CN	1	Interlock assembly
2	RK3-2277-000CN	1	Fan
3	WP2-5473-000CN	1	Sensor, humidity HSU-08FDB2A
4	RK3-2104-000CN	1	Cable, flat LVPS
5	RM3-9012-000CN	1	LVPS (110-127V)
5	RM3-9013-000CN	1	LVPS (220-240V)

Parts and diagrams: Internal assemblies (6 of 9) X57945 models

Parts diagram and parts list for the internal printer assemblies.

Figure 6-11 Internal assemblies (6 of 9) X57945 models

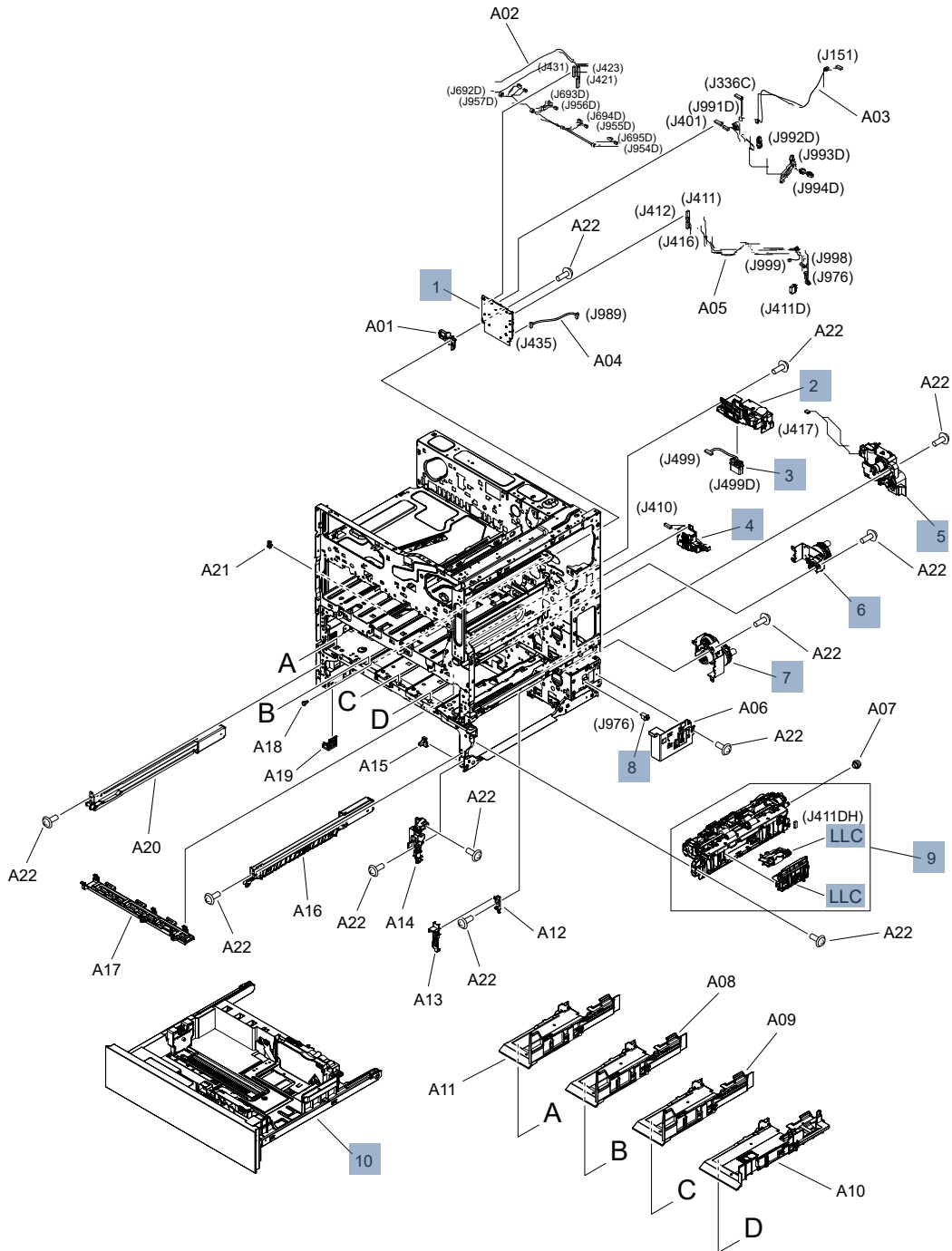

Table 6-11 Internal assemblies (6 of 9) X57945 models

Ref No	Part number	Qty	Description
1	RM3-7771-000CN	1	Toner supply PCA

Table 6-11 Internal assemblies (6 of 9) X57945 models (continued)

Ref No	Part number	Qty	Description
2	RM2-3559-000CN	1	Auto close assembly
3	RM3-8038-000CN	1	Drawer cable assembly
4	RM2-3614-000CN	1	Size detect assembly
5	RM2-3501-000CN	1	Lifter drive assembly
6	RM2-3612-000CN	1	Toner supply drive motor assembly
7	RM2-3617-000CN	1	Paper pickup drive assembly
8	5851-7005	1	Assy-USB A F Panel Mount To WTB 335mm
9	RM2-3509-000CN	1	Paper pickup assembly
10	RM2-3616-000CN	1	Cassette assembly

Parts and diagrams: Internal assemblies (7 of 9) X57945 models

Parts diagram and parts list for the internal printer assemblies.

Figure 6-12 Internal assemblies (7 of 9) X57945 models

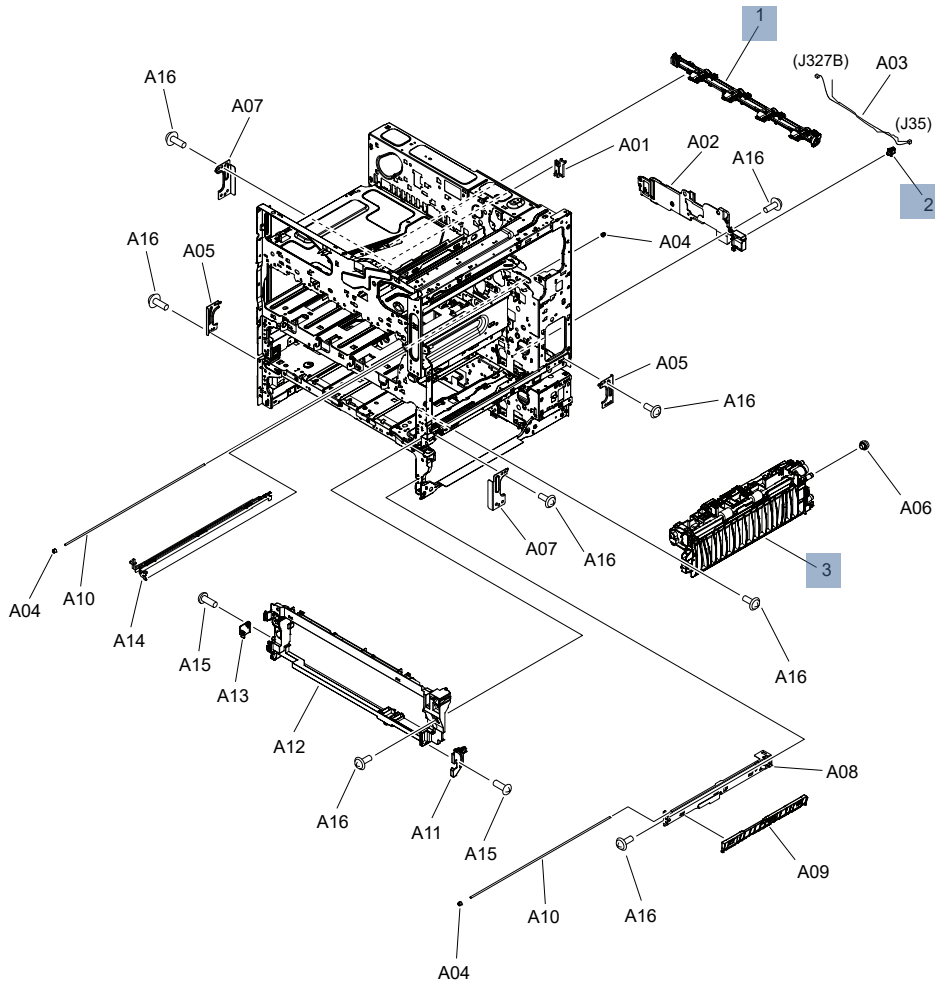

Table 6-12 Internal assemblies (7 of 9) X57945 models

Ref No	Part number	Qty	Description
1	RM2-3601-000CN	1	Waste toner carry assembly
2	5851-7005	1	Assy-USB A F Panel Mount To WTB 335mm
3	RM2-3479-000CN	1	Paper feed assembly

Parts and diagrams: Internal assemblies (8 of 9) X57945 models

Parts diagram and parts list for the internal printer assemblies.

Figure 6-13 Internal assemblies (8 of 9) X57945 models

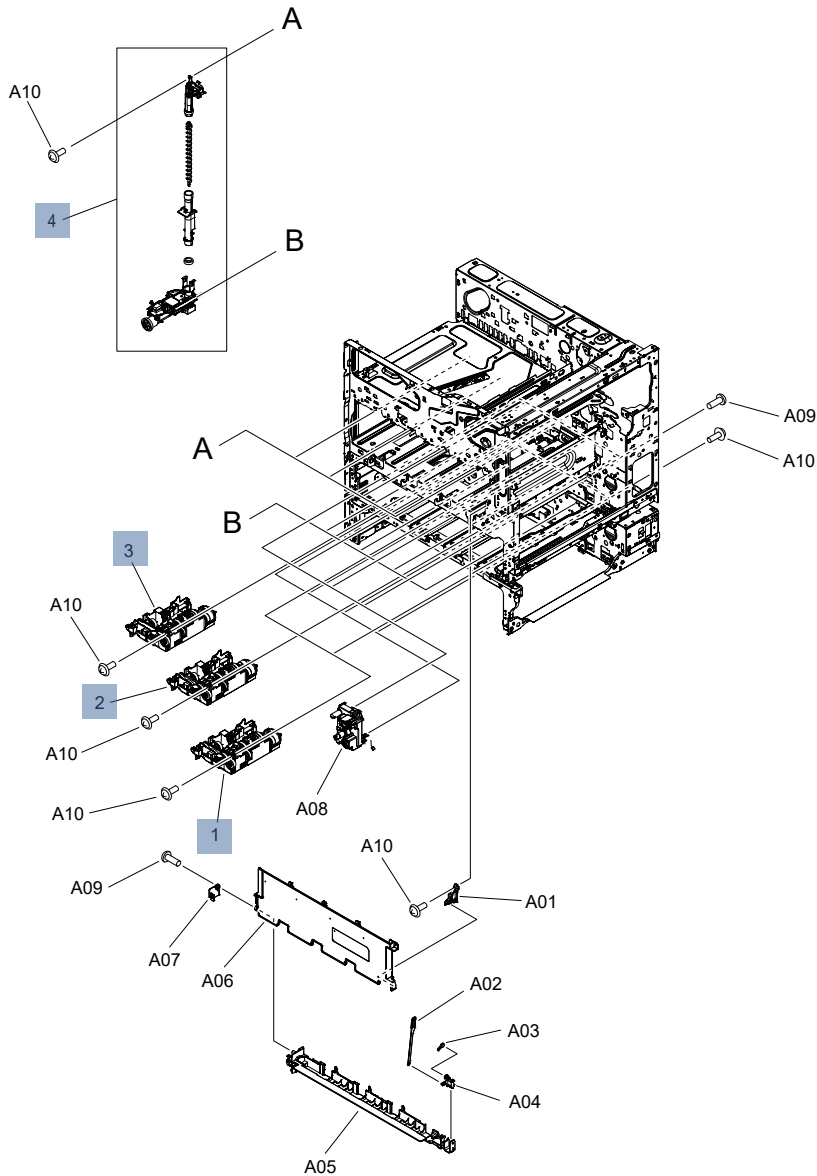

Table 6-13 Internal assemblies (8 of 9) X57945 models

Ref No	Part number	Qty	Description
1	RM2-3609-000CN	2	Toner supply drive assembly
2	RM2-3608-000CN	1	Toner supply drive assembly
3	RM2-3607-000CN	1	Toner supply drive assembly
4	RM3-0846-000CN	4	HP Toner supply service kit

Parts and diagrams: Internal assemblies (9 of 9) X57945 models

Parts diagram and parts list for the internal printer assemblies.

Figure 6-14 Internal assemblies (9 of 9) X57945 models

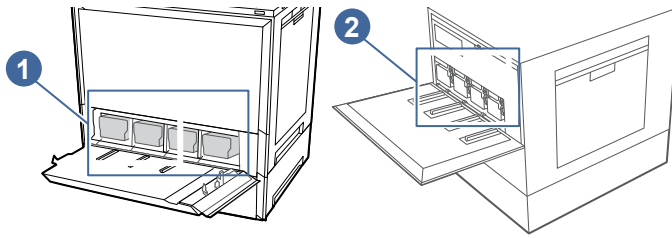

Table 6-14 Internal assemblies (9 of 9) X57945 models

Ref No	Part number	Qty	Description
1	W9250MC	1	HP W9250MC Black Mngd LaserJet Toner Cartridge (MFP)
1	W9251MC	1	HP W9251MC Cyan Mngd LaserJet Toner Cartridge (MFP)
1	W9252MC	1	HP W9252MC Yellow Mngd LaserJet Toner Cartridge (MFP)
1	W9253MC	1	HP W9253MC Magenta Mngd LaserJet Toner Cartridge (MFP)
2	W9280MC	1	HP W9280MC Black Mngd Imaging Drum
2	W9281MC	1	HP W9281MC Cyan Mngd Imaging Drum
2	W9282MC	1	HP W9282MC Yellow Mngd Imaging Drum
2	W9283MC	1	HP W9283MC Magenta Mngd Imaging Drum

Parts and diagrams: Internal assemblies (1 of 7) 5700/X557/5800 models

Parts diagram and parts list for the internal printer assemblies.

Figure 6-15 Internal assemblies (1 of 7) 5700/X557/5800 models

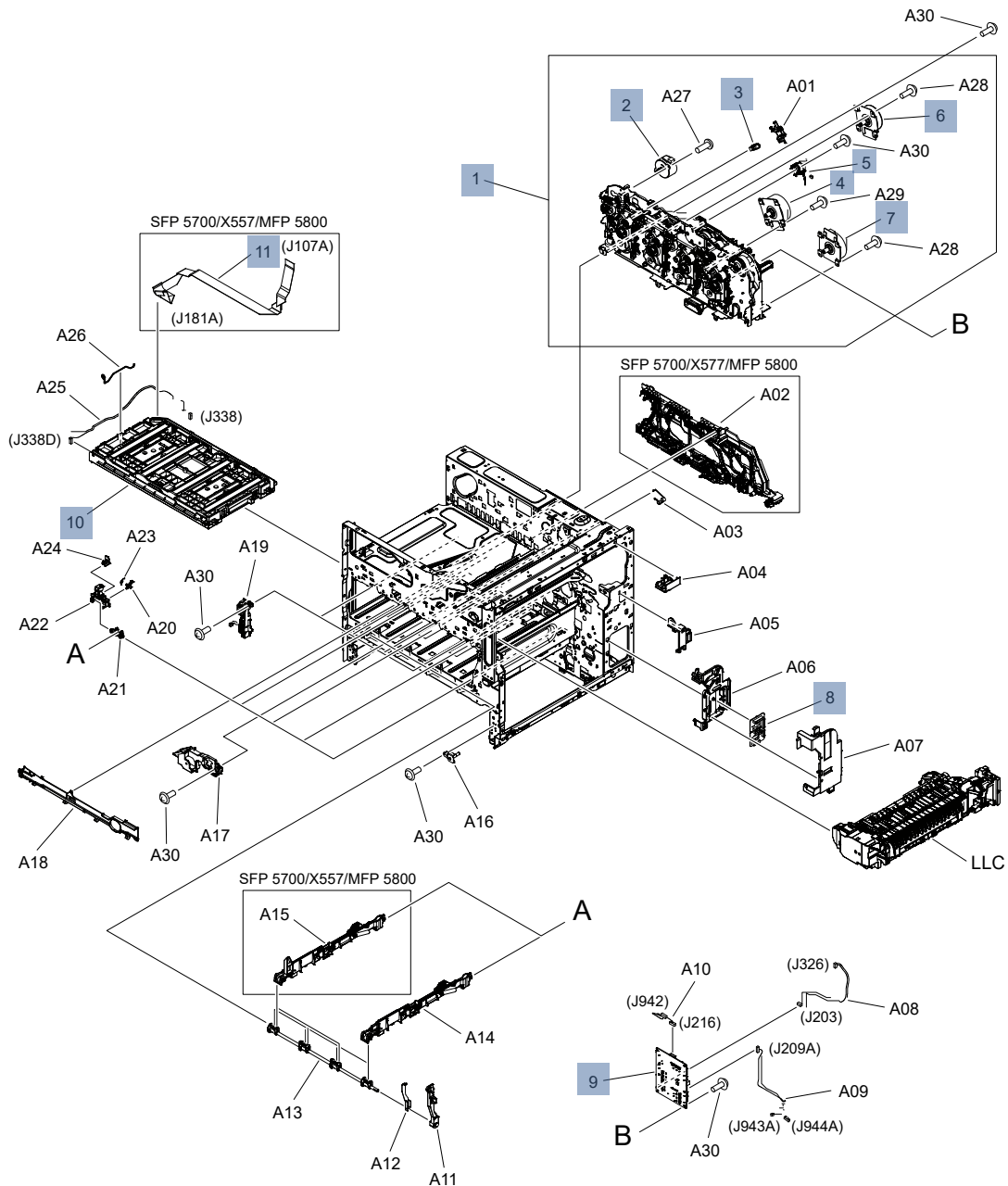

Table 6-15 Internal assemblies (1 of 7) 5700/X557/5800 models

Ref No	Part number	Qty	Description
1	RM2-3506-000CN	1	Main drive assembly (5700, 5800)
1	RM2-3504-000CN	1	Main drive assembly (X557)
2	RM2-3625-000CN	1	Developing motor assembly

Table 6-15 Internal assemblies (1 of 7) 5700/X557/5800 models (continued)

Ref No	Part number	Qty	Description
3	RM3-7647-000CN	1	Drum position sensor PCA
4	RM3-7788-000CN	1	Drum motor assembly
5	RM2-7360-000CN	1	T1 solenoid assembly
6	RK2-6027-000CN	1	Motor, stepping
7	RM3-7797-000CN	1	ITB motor assembly
8	RM3-7740-000CN	1	Right PCA (5700)
8	RM3-7790-000CN	1	Right PCA (X557, 5800)
9	RM3-7723-000CN	1	Driver PCA
10	RM2-3822-000CN	1	Laser scanner assembly
11	RK3-0835-000CN	1	Cable, flat SCN

Parts and diagrams: Internal assemblies (2 of 7)5700/X557/5800 models

Parts diagram and parts list for the internal printer assemblies.

Figure 6-16 Internal assemblies (2 of 7) 5700/X557/5800 models

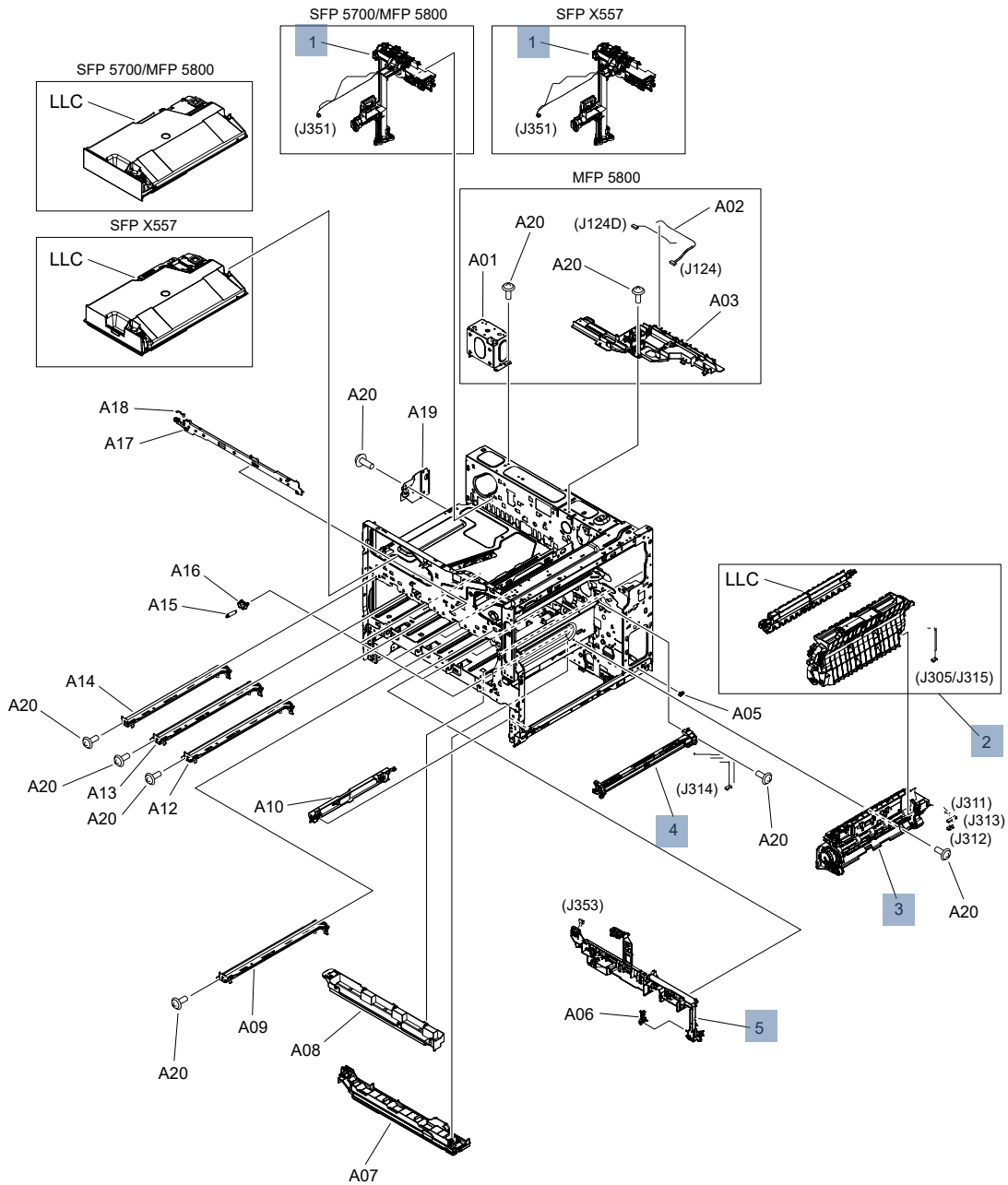

Table 6-16 Internal assemblies (2 of 7) 5700/X557/5800 models

Ref No	Part number	Qty	Description
1	RM2-3517-000CN	1	Waste toner duct assembly (5700, MFP 5800)
1	RM2-3518-000CN		Waste toner duct assembly (X557)
2	RM2-3586-000CN	1	Secondary transfer assembly (5700)

Table 6-16 Internal assemblies (2 of 7) 5700/X557/5800 models (continued)

Ref No	Part number	Qty	Description
2	RM2-3628-000CN	1	Secondary transfer assembly (X557)
3	RM2-4458-000CN	1	Registration assembly
4	RM2-4492-000CN	1	Density detect assembly
5	RM2-3565-000CN	1	Pre-exposure PCA holder

Parts and diagrams: Internal assemblies (3 of 7) 5700/X557/5800 models

Parts diagram and parts list for the internal printer assemblies.

Figure 6-17 Internal assemblies (3 of 7) 5700/X557/5800 models

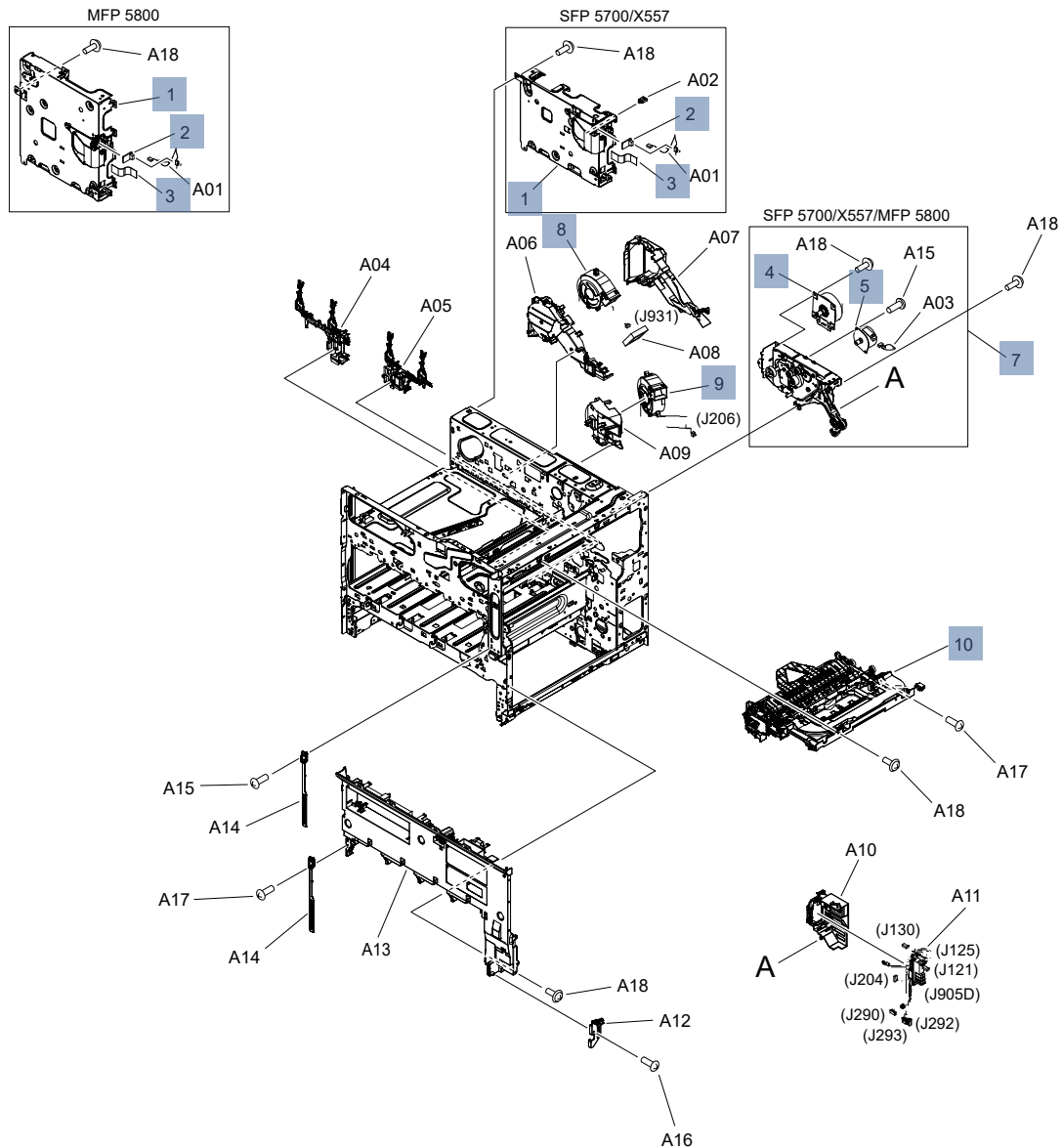

Table 6-17 Internal assemblies (3 of 7) 5700/X557/5800 models

Ref No	Part number	Qty	Description
1	RM2-4520-000CN	1	Formatter cage assembly (5700, X557)
1	RM2-4521-000CN	1	Formatter cage assembly (MFP 5800)
2	RK3-0847-000CN	1	Cable, flat FMTR
3	RK3-0845-000CN	1	Cable, flat FMTR (MFP 5800)
4	RM2-4488-000CN	1	Fixing motor assembly

Table 6-17 Internal assemblies (3 of 7) 5700/X557/5800 models (continued)

Ref No	Part number	Qty	Description
5	RK2-7751-000CN	1	Motor, stepping
7	RM2-4485-000CN	1	Fixing drive assembly
8	RK3-1637-000CN	1	Fan
9	RK3-0762-000CN	1	Fan
10	RM2-3548-000CN	1	Paper delivery assembly (5700, X557)
10	RM2-3554-000CN	1	Paper delivery assembly (MFP 5800)

Parts and diagrams: Internal assemblies (4 of 7) 5700/X557/5800 models

Parts diagram and parts list for the internal printer assemblies.

Figure 6-18 Internal assemblies (4 of 7) 5700/X557/5800 models

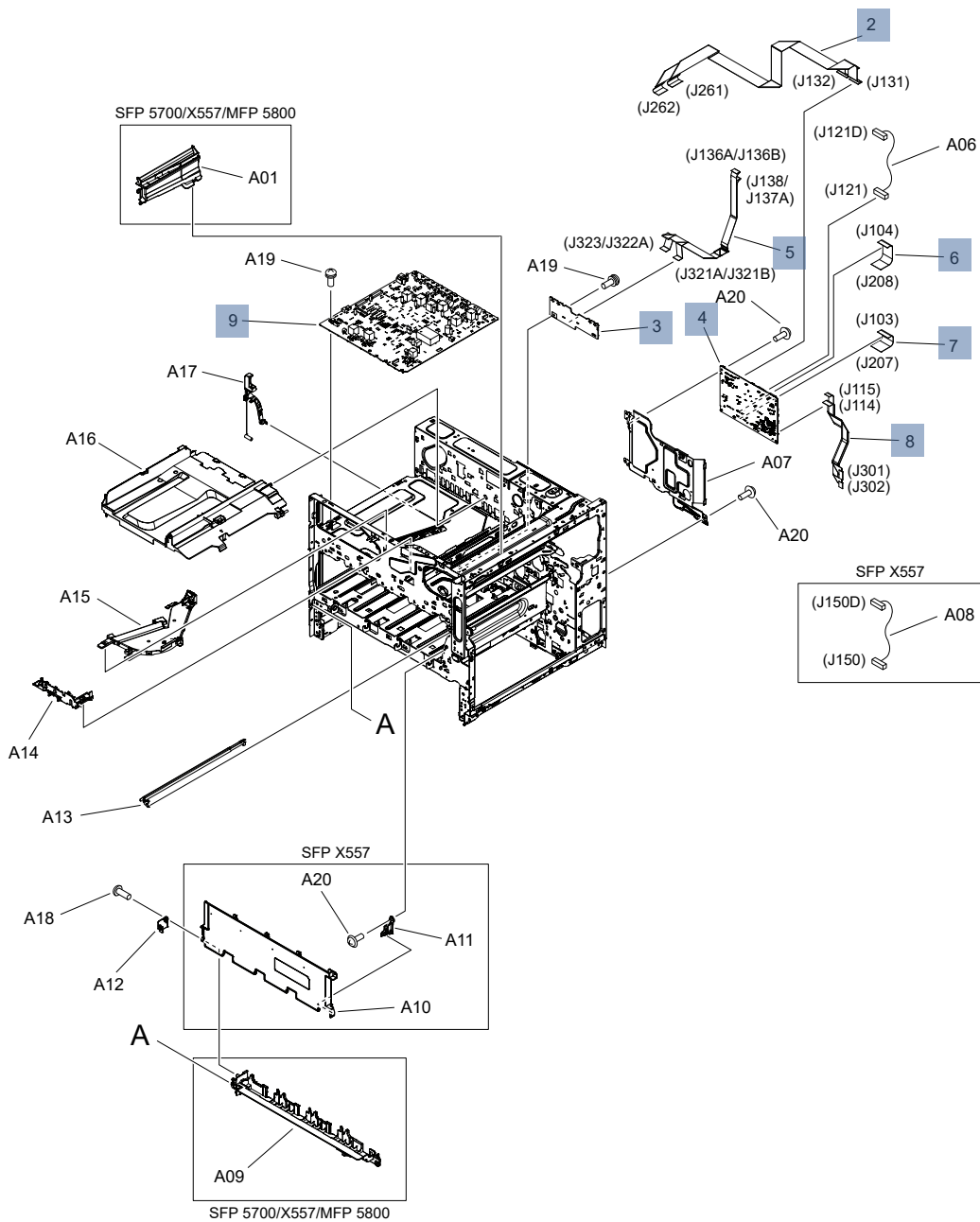

Table 6-18 Internal assemblies (4 of 7) 5700/X557/5800 models

Ref No	Part number	Qty	Description
2	RK3-1508-000CN	1	Cable, flat HVT
3	RM3-9044-000CN	1	Rear PCA (5700, MFP 5800)

Table 6-18 Internal assemblies (4 of 7) 5700/X557/5800 models (continued)

Ref No	Part number	Qty	Description
3	RM3-9045-000CN	1	Rear PCA (X557)
4	RM3-7751-000CN	1	DC controller PCA (5700)
4	RM3-7752-000CN	1	DC controller PCA (MFP 5800)
4	RM3-7755-000CN	1	DC controller PCA (X557)
5	RK3-1691-000CN	1	Cable, flat rear (5700, MFP 5800)
5	RK3-1692-000CN	1	Cable, flat rear (X557)
6	RK3-0821-000CN	1	Cable, flat drive
7	RK3-0819-000CN	1	Cable, flat drive
8	RK3-1694-000CN	1	Cable, flat right
9	RM3-9040-000CN	1	HV power supply PCA
Not shown	6QN27-67002	1	Formatter (57xx / X55xxx)
Not shown	6QN27-67004	1	Formatter (57xx / X55xxx) (China/India)
Not shown	6QN29-67002	1	Formatter (58xx / X57xxx)
Not shown	6QN29-67004	1	Formatter (58xx / X57xxx) (China/India)

Parts and diagrams: Internal assemblies (5 of 7) 5700/X557/5800 models

Parts diagram and parts list for the internal printer assemblies.

Figure 6-19 Internal assemblies (5 of 7) 5700/X557/5800 models

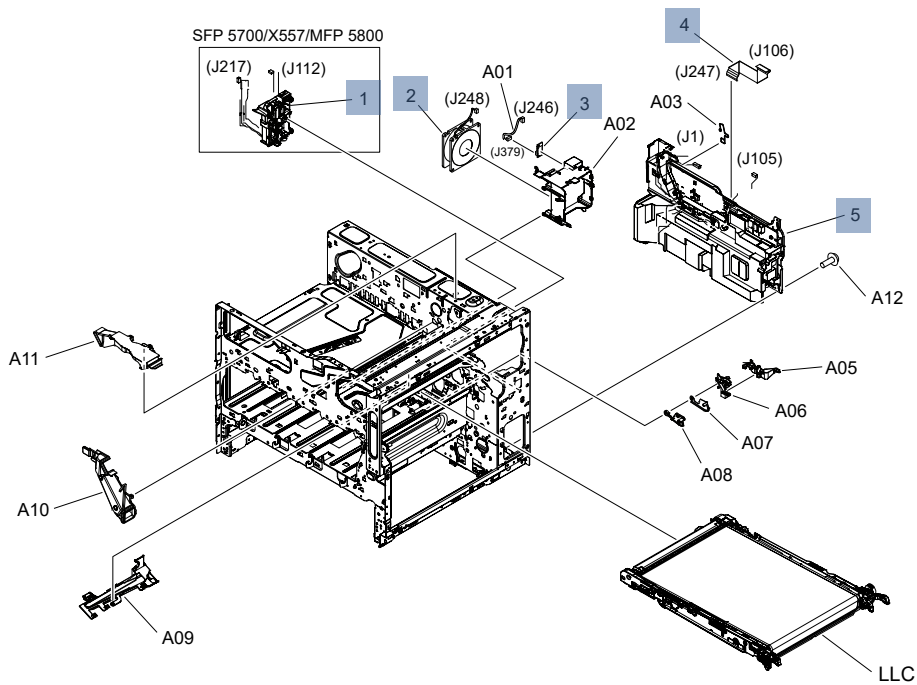

Table 6-19 Internal assemblies (5 of 7) 5700/X557/5800 models

Ref No	Part number	Qty	Description
1	RM2-3675-000CN	1	Interlock assembly
2	RK3-2277-000CN	1	Fan
3	WP2-5473-000CN	1	Sensor, humidity HSU-08FDB2A
4	RK3-2104-000CN	1	Cable, flat LVPS
5	RM3-7724-000CN	1	LVPS (110-127V) (5700, X557)
5	RM3-7725-000CN	1	LVPS (220-240V) (5700, X557))
5	RM3-9012-000CN	1	LVPS (110-127V) (MFP 5800)
5	RM3-9013-000CN	1	LVPS (220-240V) (MFP 5800)

Parts and diagrams: Internal assemblies (6 of 7) 5700/X557/5800 models

Parts diagram and parts list for the internal printer assemblies.

Figure 6-20 Internal assemblies (6 of 7) 5700/X557/5800 models

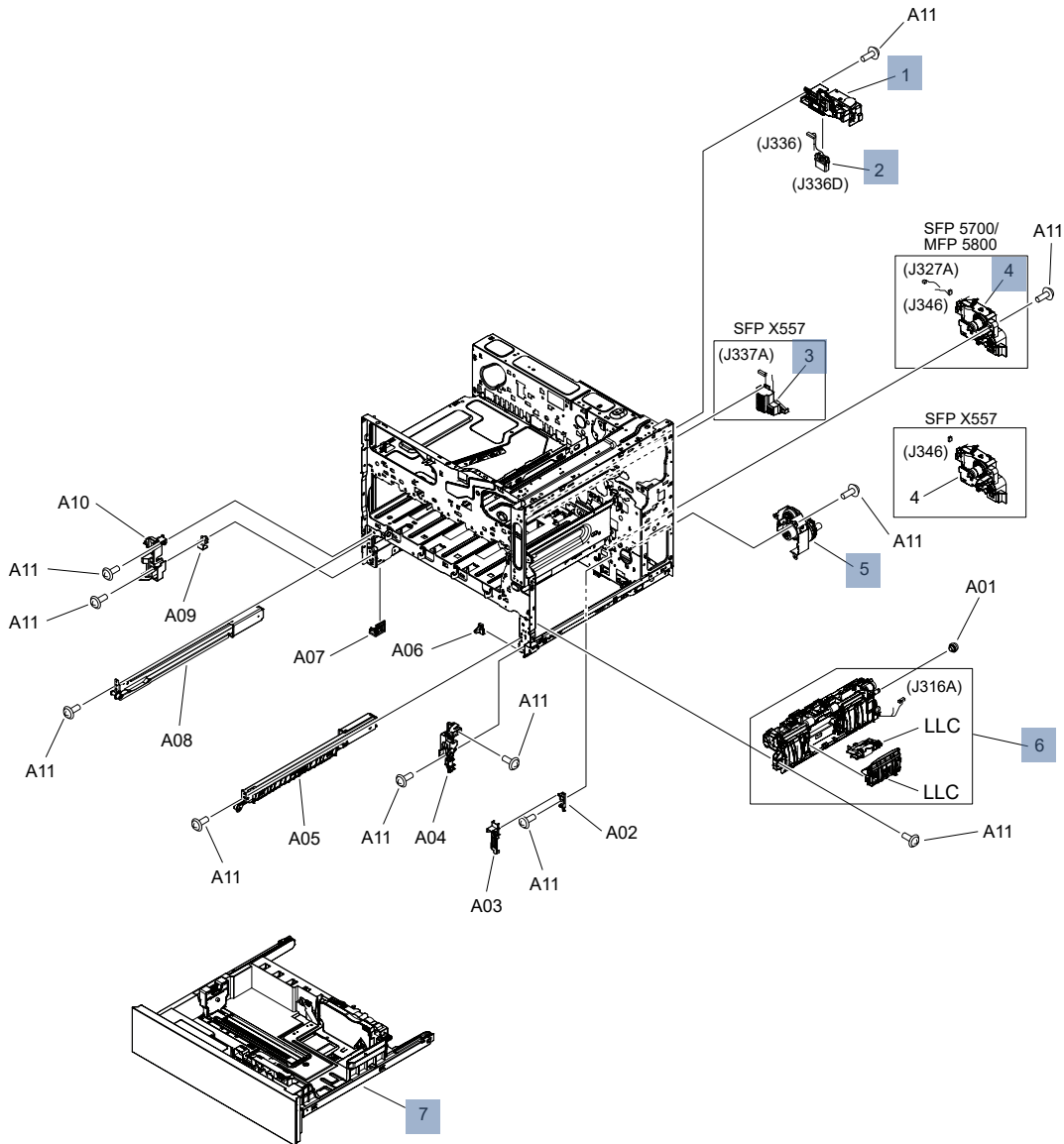

Table 6-20 Internal assemblies (6 of 7) 5700/X557/5800 models

Ref No	Part number	Qty	Description
1	RM2-3559-000CN	1	Auto close assembly
2	RM3-8001-000CN	1	Drawer cable assembly
3	RM2-3634-000CN	1	Size detect assembly (5700, X557)
3	RM2-3614-000CN		Size detect assembly (5800)
4	RM2-3493-000CN	1	Lifter drive assembly (5700, MFP 5800)

Table 6-20 Internal assemblies (6 of 7) 5700/X557/5800 models (continued)

Ref No	Part number	Qty	Description
4	RM2-3500-000CN	1	Lifter drive assembly (X557)
5	RM2-3681-000CN	1	Paper pickup drive assembly
6	RM2-3508-000CN	1	Paper pickup assembly
7	RM2-3615-000CN	1	Cassette assembly (5700, MFP 5800)
7	RM2-3616-000CN	1	Cassette assembly (X557)

Parts and diagrams: Internal assemblies (7 of 7) 5700/X557/5800 models

Parts diagram and parts list for the internal printer assemblies.

Figure 6-21 Internal assemblies (7 of 7) 5700/X557/5800 models

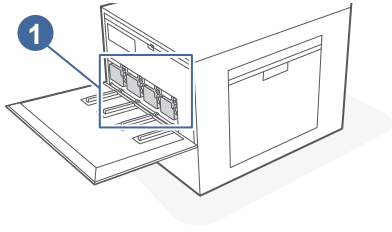

Table 6-21 Internal assemblies (7 of 7) 5700/X557/5800 models

Ref No	Part number	Qty	Description
1	W2130A	1	HP 213A Black Original LaserJet Toner Cartridge
1	W2130A	1	HP 2130X High Yield Black Toner Cartridge
1	W2130Y	1	HP 213Y Extra High Yield Black Toner Cartridge
1	W2130YC	1	HP W2130YC Black Contract Toner Cartridge
1	W2131A	1	HP 213A Cyan Original LaserJet Toner Cartridge
1	W2131X	1	HP 2131X High Yield Cyan Toner Cartridge
1	W2131X	1	HP 213Y Extra High Yield Cyan Toner Cartridge
1	W2131YC	1	HP W2131YC Cyan Contract Toner Cartridge
1	W2132A	1	HP 213A Yellow Original LaserJet Toner
1	W2132X	1	HP 2132X High Yield Yellow Toner Cartridge
1	W2132Y	1	HP 213Y Extra High Yield Yellow Toner Cartridge
1	W2132YC	1	HP W2132YC Yellow Contract Toner Cartridge
1	W2133A	1	HP 213A Magenta LaserJet Toner Cartridge
1	W2133X	1	HP 2133X High Yield Magenta Toner Cartridge
1	W2133Y	1	HP 213Y Extra High Yield Magenta Toner Cartridge
1	W2133YC	1	HP W2133YC Magenta Contract Toner Cartridge

Input devices

Learn about the input devices.

Input device - 550-sheet paper feeder

Learn about the 550-sheet paper feeder parts and assemblies.

Covers, panels, and doors

Parts diagrams and part lists for the covers, panels, and doors.

Covers, panels, and doors (550-sheet paper feeder)

Parts diagram and part list for the 550-sheet paper feeder covers, panels, and doors.

Figure 6-22 550-sheet paper feeder covers, panels, and doors

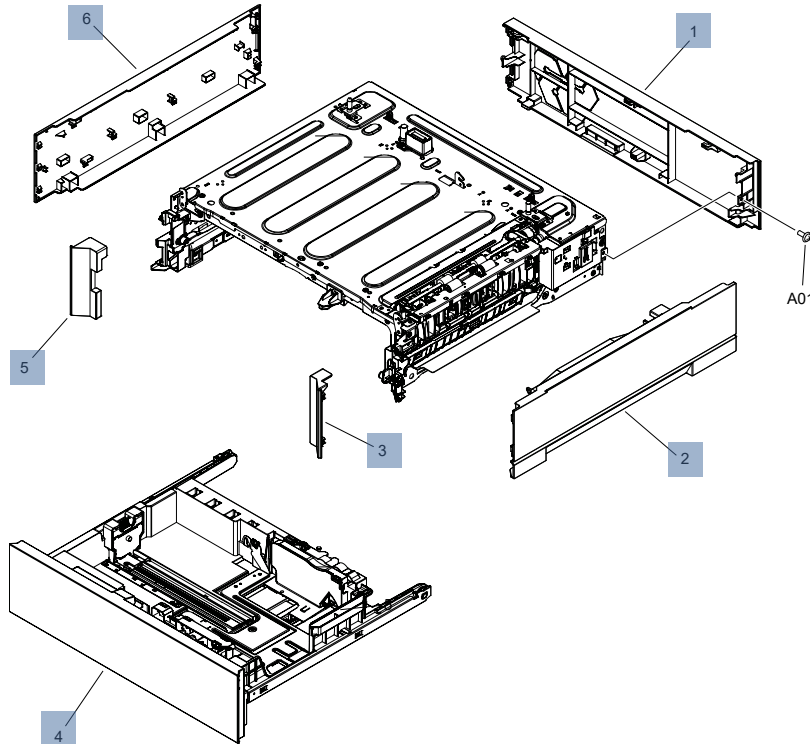

Table 6-22 550-sheet paper feeder covers, panels, and doors

Ref No	Part number	Description	Qty
1	RC5-9409-000CN	Cover, rear lower	1
2	RM3-0004-000CN	Right lower door assembly	1
3	RC5-9201-000CN	Cover, front right	1
4	RM2-3640-000CN	Cassette assembly	1
5	RC5-9200-000CN	Cover, front left	1
6	RC5-9408-000CN	Cover, left	1

Internal parts and assemblies

Parts diagrams and part lists for the internal parts and assemblies.

Internal parts and assemblies (550-sheet paper feeder)

Parts diagram and part list for the 550-sheet paper feeder main body.

Figure 6-23 550-sheet paper feeder internal parts and assemblies

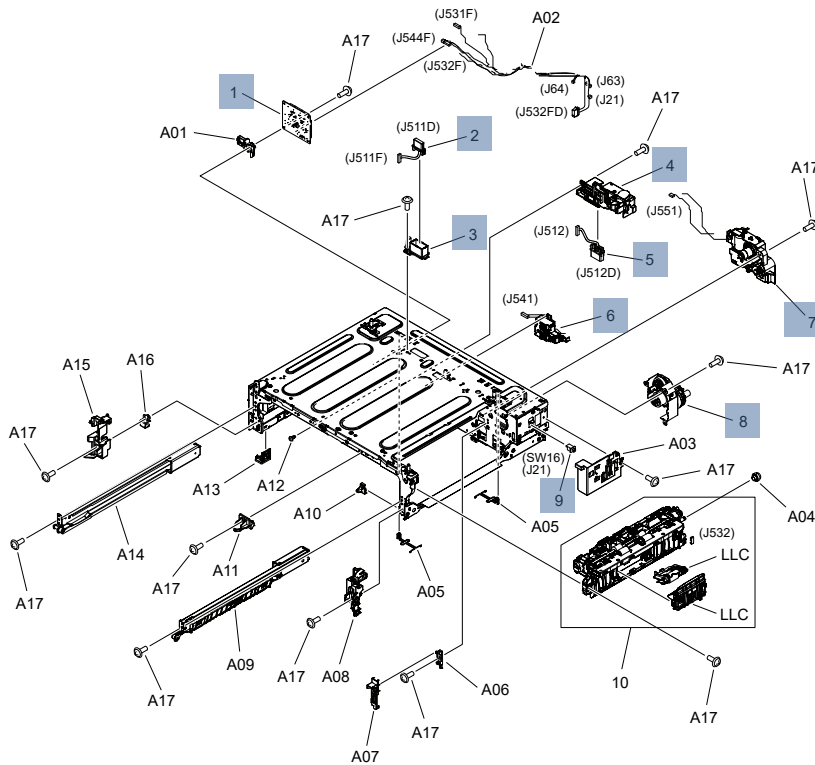

Table 6-23 550-sheet paper feeder internal parts and assemblies

Ref No	Part number	Description	Qty
1	RM3-8051-000CN	Paper feeder controller PCA	1
2	RM3-8058-000CN	Drawer upper cable assembly	1
3	RC5-9398-000CN	Holder, drawer connector upper	1
4	RM2-3559-000CN	Auto close assembly	2
5	RM3-8059-000CN	Drawer lower cable assembly	1
6	RM2-3614-000CN	Size detect assembly	1
7	RM2-3501-000CN	Lifter drive assembly	1
8	RM2-3617-000CN	Paper pickup drive assembly	1
9	5851-7005	Assy-USB A F Panel Mount To WTB 335mm	1
9	RM2-3509-000CN	Paper pickup assembly	1

Table 6-23 550-sheet paper feeder internal parts and assemblies (continued)

Ref No	Part number	Description	Qty
Not shown as Ref No	6QN57A	550-sheet paper feeder (tray)	1

Output devices

Learn about the output devices.

Output device - 3-bin staple stacker

Learn about the 3-bin staple stacker output device.

Covers, panels, and doors

Parts diagrams and part lists for the covers, panels, and doors.

Parts and diagrams: 3 bin staple stacker covers 5800/X57945 models

Parts diagram and parts list for the MFP printer covers.

Figure 6-24 3 bin staple stacker covers 5800/X57945 models

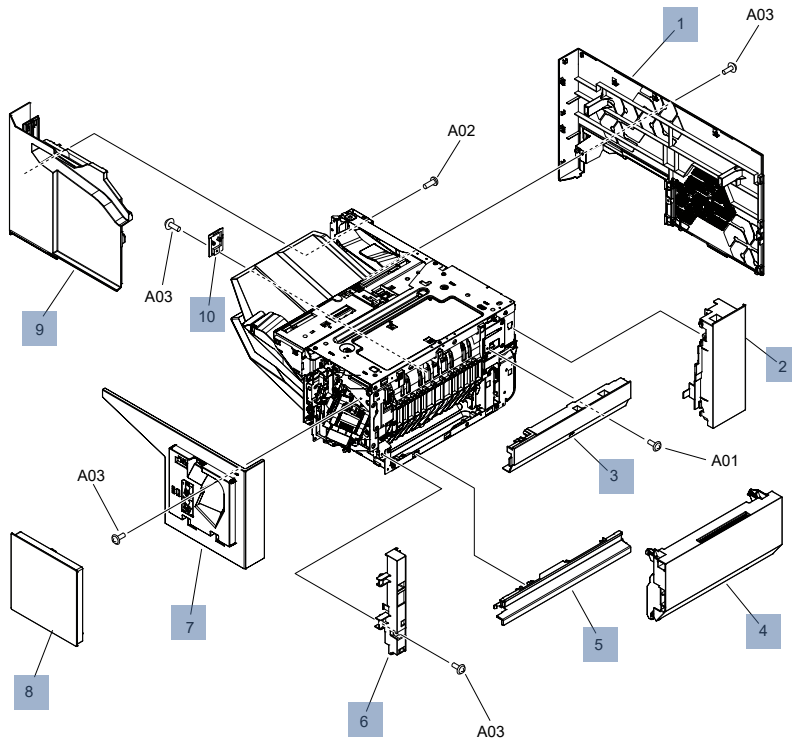

Table 6-24 3 bin staple stacker covers 5800/X57945 models

Key No	Part number	Qty	Description
1	RC6-1305-000CN	1	Cover, rear
2	RC6-1307-000CN	1	Cover, corner right
3	RC6-1308-000CN	1	Cover, right upper
4	RM2-4167-000CN	1	Right door assembly
5	RC6-1309-000CN	1	Cover, right lower
6	RC6-1310-000CN	1	Cover, stapler rear
7	RM3-0483-000CN	1	Staple cover assembly
8	RM3-0484-000CN	1	Staple door assembly
9	RM3-0485-000CN	1	Rear inner cover assembly
10	RC6-2356-000CN	1	Cover, left front

Internal parts and assemblies

Parts diagrams and part lists for the internal parts and assemblies.

Parts and diagrams: 3 bin staple stacker main body 5800/X57945 models

Parts diagram and parts list for the MFP printer covers.

Table 6-25 3 bin staple stacker main body 5800/X57945 models (continued)

Key No	Part number	Qty	Description
12	WC4-5136-000CN	1	Microswitch
13	RM3-0480-000CN	1	Stacking wall assembly

Alphabetical parts list

Table 6-26 Alphabetical parts list

Description	Part number	Table and page
550-sheet paper feeder (tray)	6QN57A	550-sheet paper feeder internal parts and assemblies on page 1156
ADF Pick/Sep Roller Kit (5xxx Series)	6H121A	Integrated scanner assembly on page 1119
ADF WUR (5xxx Series Non-Workflow)	C0M44-67002	Integrated scanner assembly on page 1119
ADF WUR (5xxx Series Workflow)	C0M44-67003	Integrated scanner assembly on page 1119
ADF damper	5851-8849	Integrated scanner assembly on page 1119
ADF hinge kit (5xxx Series)	5851-8841	Integrated scanner assembly on page 1119
ADF roller cover (5xxx Series)	5851-8843	Integrated scanner assembly on page 1119
ADF white backing kit	5851-8850	Integrated scanner assembly on page 1119
Assy-USB A F Panel Mount To WTB 335mm	5851-7005	Internal assemblies (6 of 9) X57945 models on page 1137
Assy-USB A F Panel Mount To WTB 335mm	5851-7005	Internal assemblies (7 of 9) X57945 models on page 1139
Assy-USB A F Panel Mount To WTB 335mm	5851-7005	550-sheet paper feeder internal parts and assemblies on page 1156
Assy-USB A F Panel Mount To WTB 335mm	5851-7005	3 bin staple stacker main body 5800/X57945 models on page 1159
Auto close assembly	RM2-3559-000CN	Internal assemblies (6 of 9) X57945 models on page 1137
Auto close assembly	RM2-3559-000CN	Internal assemblies (6 of 7) 5700/X557/5800 models on page 1152
Auto close assembly	RM2-3559-000CN	550-sheet paper feeder internal parts and assemblies on page 1156
Cable, flat FMTR	RK3-0845-000CN	Internal assemblies (3 of 9) X57945 models on page 1132
Cable, flat FMTR	RK3-0845-000CN	Internal assemblies (3 of 7) 5700/X557/5800 models on page 1147
Cable, flat FMTR	RK3-0847-000CN	Internal assemblies (3 of 7) 5700/X557/5800 models on page 1147

Table 6-26 Alphabetical parts list (continued)

Description	Part number	Table and page
Cable, flat HVT	RK3-1508-000CN	Internal assemblies (4 of 7) 5700/X557/5800 models on page 1149
Cable, flat HVT	RK3-1509-000CN	Internal assemblies (4 of 9) X557/X57945 models on page 1134
Cable, flat LVPS	RK3-2104-000CN	Internal assemblies (5 of 9) X57945 models on page 1136
Cable, flat LVPS	RK3-2104-000CN	Internal assemblies (5 of 7) 5700/X557/5800 models on page 1151
Cable, flat SCN	RK3-0835-000CN	Internal assemblies (1 of 9) X57945 models on page 1129
Cable, flat SCN	RK3-0835-000CN	Internal assemblies (1 of 7) 5700/X557/5800 models on page 1143
Cable, flat drive	RK3-0819-000CN	Internal assemblies (4 of 9) X557/X57945 models on page 1134
Cable, flat drive	RK3-0819-000CN	Internal assemblies (4 of 7) 5700/X557/5800 models on page 1149
Cable, flat drive	RK3-0821-000CN	Internal assemblies (4 of 9) X557/X57945 models on page 1134
Cable, flat drive	RK3-0821-000CN	Internal assemblies (4 of 7) 5700/X557/5800 models on page 1149
Cable, flat rear	RK3-1691-000CN	Internal assemblies (4 of 7) 5700/X557/5800 models on page 1149
Cable, flat rear	RK3-1692-000CN	Internal assemblies (4 of 7) 5700/X557/5800 models on page 1149
Cable, flat rear	RK3-1693-000CN	Internal assemblies (4 of 9) X557/X57945 models on page 1134
Cable, flat right	RK3-1694-000CN	Internal assemblies (4 of 9) X557/X57945 models on page 1134
Cable, flat right	RK3-1694-000CN	Internal assemblies (4 of 7) 5700/X557/5800 models on page 1149
Cassette assembly	RM2-3615-000CN	Internal assemblies (6 of 7) 5700/X557/5800 models on page 1152
Cassette assembly	RM2-3616-000CN	Internal assemblies (6 of 9) X57945 models on page 1137

Table 6-26 Alphabetical parts list (continued)

Description	Part number	Table and page
Cassette assembly	RM2-3616-000CN	Internal assemblies (6 of 7) 5700/X557/5800 models on page 1152
Cassette assembly	RM2-3640-000CN	550-sheet paper feeder covers, panels, and doors on page 1155
Control panel 10.9 cm 4.3 in	6QN28-67001	Control panels on page 1120
Control panel 23.3 cm 8 in	6QN37-60102	Control panels on page 1120
Control panel 25.6 cm 10.1 in	6QN35-60129	Control panels on page 1120
Cover, Hardware integration pocket (HIP)	RC4-0213-000CN	Covers 5700/X557 models on page 1123
Cover, Hardware integration pocket (HIP)	RC4-0213-000CN	Covers 5800 models on page 1124
Cover, Hardware integration pocket (HIP)	RC4-0213-000CN	Covers X57945 models on page 1127
Cover, corner right	RC6-1307-000CN	3 bin staple stacker covers 5800/X57945 models on page 1158
Cover, front left	RC5-9198-000CN	Covers 5700/X557 models on page 1123
Cover, front left	RC5-9198-000CN	Covers 5800 models on page 1124
Cover, front left	RC5-9198-000CN	Covers X57945 models on page 1127
Cover, front left	RC5-9200-000CN	550-sheet paper feeder covers, panels, and doors on page 1155
Cover, front right	RC5-9199-000CN	Covers 5700/X557 models on page 1123
Cover, front right	RC5-9199-000CN	Covers 5800 models on page 1124
Cover, front right	RC5-9199-000CN	Covers X57945 models on page 1127
Cover, front right	RC5-9201-000CN	550-sheet paper feeder covers, panels, and doors on page 1155
Cover, left	RC5-9408-000CN	550-sheet paper feeder covers, panels, and doors on page 1155
Cover, left front	RC6-2356-000CN	3 bin staple stacker covers 5800/X57945 models on page 1158
Cover, left upper	RC5-9204-000CN	Covers 5700/X557 models on page 1123
Cover, left upper	RC5-9204-000CN	Covers 5800 models on page 1124
Cover, left upper	RC5-9204-000CN	Covers X57945 models on page 1127

Table 6-26 Alphabetical parts list (continued)

Description	Part number	Table and page
Cover, rear	RC6-1305-000CN	3 bin staple stacker covers 5800/X57945 models on page 1158
Cover, rear lower	RC5-9168-000CN	Covers 5700/X557 models on page 1123
Cover, rear lower	RC5-9168-000CN	Covers 5800 models on page 1124
Cover, rear lower	RC5-9168-000CN	Covers X57945 models on page 1127
Cover, rear lower	RC5-9409-000CN	Covers X57945 models on page 1127
Cover, rear lower	RC5-9409-000CN	550-sheet paper feeder covers, panels, and doors on page 1155
Cover, right lower	RC6-1309-000CN	3 bin staple stacker covers 5800/X57945 models on page 1158
Cover, right upper	RC6-1308-000CN	3 bin staple stacker covers 5800/X57945 models on page 1158
Cover, stapler rear	RC6-1310-000CN	3 bin staple stacker covers 5800/X57945 models on page 1158
Cover, top assembly	RC5-9172-000CN	Covers 5800 models on page 1124
Cover, top assembly	RC5-9172-000CN	Covers X57945 models on page 1127
Cover, top assembly	RM2-4517-000CN	Covers 5700/X557 models on page 1123
DC controller PCA	RM3-7751-000CN	Internal assemblies (4 of 7) 5700/X557/5800 models on page 1149
DC controller PCA	RM3-7752-000CN	Internal assemblies (4 of 7) 5700/X557/5800 models on page 1149
DC controller PCA	RM3-7755-000CN	Internal assemblies (4 of 7) 5700/X557/5800 models on page 1149
DC controller PCA	RM3-7756-000CN	Internal assemblies (4 of 9) X557/X57945 models on page 1134
Density detect assembly	RM2-4492-000CN	Internal assemblies (2 of 9) X57945 models on page 1130
Density detect assembly	RM2-4492-000CN	Internal assemblies (2 of 7) 5700/X557/5800 models on page 1145
Developing motor assembly	RM2-3625-000CN	Internal assemblies (1 of 9) X57945 models on page 1129

Table 6-26 Alphabetical parts list (continued)

Description	Part number	Table and page
Developing motor assembly	RM2-3625-000CN	Internal assemblies (1 of 7) 5700/X557/5800 models on page 1143
Drawer cable assembly	RM3-8001-000CN	Internal assemblies (6 of 7) 5700/X557/5800 models on page 1152
Drawer cable assembly	RM3-8038-000CN	Internal assemblies (6 of 9) X57945 models on page 1137
Drawer lower cable assembly	RM3-8059-000CN	550-sheet paper feeder internal parts and assemblies on page 1156
Drawer upper cable assembly	RM3-8058-000CN	550-sheet paper feeder internal parts and assemblies on page 1156
Driver PCA	RM3-7723-000CN	Internal assemblies (1 of 9) X57945 models on page 1129
Driver PCA	RM3-7723-000CN	Internal assemblies (1 of 7) 5700/X557/5800 models on page 1143
Drum motor assembly	RM3-7788-000CN	Internal assemblies (1 of 9) X57945 models on page 1129
Drum motor assembly	RM3-7788-000CN	Internal assemblies (1 of 7) 5700/X557/5800 models on page 1143
Drum position sensor PCA	RM3-7647-000CN	Internal assemblies (1 of 9) X57945 models on page 1129
Drum position sensor PCA	RM3-7647-000CN	Internal assemblies (1 of 7) 5700/X557/5800 models on page 1143
Face down tray assembly	RM2-4469-000CN	Covers 5700/X557 models on page 1123
Face down tray assembly	RM2-4469-000CN	Covers 5800 models on page 1124
Face down tray assembly	RM2-4469-000CN	Covers X57945 models on page 1127
Fan	RK2-8153-000CN	3 bin staple stacker main body 5800/X57945 models on page 1159
Fan	RK3-0762-000CN	Internal assemblies (3 of 9) X57945 models on page 1132
Fan	RK3-0762-000CN	Internal assemblies (3 of 7) 5700/X557/5800 models on page 1147
Fan	RK3-1637-000CN	Internal assemblies (3 of 7) 5700/X557/5800 models on page 1147
Fan	RK3-2277-000CN	Internal assemblies (5 of 9) X57945 models on page 1136

Table 6-26 Alphabetical parts list (continued)

Description	Part number	Table and page
Fan	RK3-2277-000CN	Internal assemblies (5 of 7) 5700/X557/5800 models on page 1151
Fixing drive assembly	RM2-4485-000CN	Internal assemblies (3 of 9) X57945 models on page 1132
Fixing drive assembly	RM2-4485-000CN	Internal assemblies (3 of 7) 5700/X557/5800 models on page 1147
Fixing motor assembly	RM2-4488-000CN	Internal assemblies (3 of 9) X57945 models on page 1132
Fixing motor assembly	RM2-4488-000CN	Internal assemblies (3 of 7) 5700/X557/5800 models on page 1147
Flatbed scanner	6QN29-67005	Integrated scanner assembly on page 1119
Formatter (57xx / X55xxx)	6QN27-67002	Internal assemblies (4 of 7) 5700/X557/5800 models on page 1149
Formatter (57xx / X55xxx) (China/India)	6QN27-67004	Internal assemblies (4 of 9) X557/X57945 models on page 1134
Formatter (57xx / X55xxx) (China/India)	6QN27-67004	Internal assemblies (4 of 7) 5700/X557/5800 models on page 1149
Formatter (58xx / X57xxx)	6QN27-67002	Internal assemblies (4 of 9) X557/X57945 models on page 1134
Formatter (58xx / X57xxx)	6QN29-67002	Internal assemblies (4 of 9) X557/X57945 models on page 1134
Formatter (58xx / X57xxx)	6QN29-67002	Internal assemblies (4 of 7) 5700/X557/5800 models on page 1149
Formatter (58xx / X57xxx) (China/India)	6QN29-67004	Internal assemblies (4 of 9) X557/X57945 models on page 1134
Formatter (58xx / X57xxx) (China/India)	6QN29-67004	Internal assemblies (4 of 7) 5700/X557/5800 models on page 1149
Formatter cage assembly	RM2-4520-000CN	Internal assemblies (3 of 7) 5700/X557/5800 models on page 1147
Formatter cage assembly	RM2-4521-000CN	Internal assemblies (3 of 9) X57945 models on page 1132
Formatter cage assembly	RM2-4521-000CN	Internal assemblies (3 of 7) 5700/X557/5800 models on page 1147
Formatter cover assembly	RM2-4480-000CN	Covers 5700/X557 models on page 1123

Table 6-26 Alphabetical parts list (continued)

Description	Part number	Table and page
Formatter cover assembly	RM2-4480-000CN	Covers 5800 models on page 1124
Formatter cover assembly	RM2-4480-000CN	Covers X57945 models on page 1127
Formatter cover assembly	RM2-4530-000CN	Covers 5800 models on page 1124
Formatter cover assembly	RM2-4530-000CN	Covers X57945 models on page 1127
Front door assembly	RM2-4473-000CN	Covers 5700/X557 models on page 1123
Front door assembly	RM2-4473-000CN	Covers 5800 models on page 1124
Front door assembly	RM2-4479-000CN	Covers X57945 models on page 1127
Front door assembly	RM2-4533-000CN	Covers 5700/X557 models on page 1123
HP 2130X High Yield Black Toner Cartridge	W2130A	Internal assemblies (7 of 7) 5700/X557/5800 models on page 1154
HP 2131X High Yield Cyan Toner Cartridge	W2131X	Internal assemblies (7 of 7) 5700/X557/5800 models on page 1154
HP 2132X High Yield Yellow Toner Cartridge	W2132X	Internal assemblies (7 of 7) 5700/X557/5800 models on page 1154
HP 2133X High Yield Magenta Toner Cartridge	W2133X	Internal assemblies (7 of 7) 5700/X557/5800 models on page 1154
HP 213A Black Original LaserJet Toner Cartridge	W2130A	Internal assemblies (7 of 7) 5700/X557/5800 models on page 1154
HP 213A Cyan Original LaserJet Toner Cartridge	W2131A	Internal assemblies (7 of 7) 5700/X557/5800 models on page 1154
HP 213A Magenta LaserJet Toner Cartridge	W2133A	Internal assemblies (7 of 7) 5700/X557/5800 models on page 1154
HP 213A Yellow Original LaserJet Toner	W2132A	Internal assemblies (7 of 7) 5700/X557/5800 models on page 1154
HP 213Y Extra High Yield Black Toner Cartridge	W2130Y	Internal assemblies (7 of 7) 5700/X557/5800 models on page 1154
HP 213Y Extra High Yield Cyan Toner Cartridge	W2131X	Internal assemblies (7 of 7) 5700/X557/5800 models on page 1154

Table 6-26 Alphabetical parts list (continued)

Description	Part number	Table and page
HP 213Y Extra High Yield Magenta Toner Cartridge	W2133Y	Internal assemblies (7 of 7) 5700/X557/5800 models on page 1154
HP 213Y Extra High Yield Yellow Toner Cartridge	W2132Y	Internal assemblies (7 of 7) 5700/X557/5800 models on page 1154
HP LaserJet Swedish Overlay Keyboard	A7W14A	Integrated scanner assembly on page 1119
HP LaserJet Workflow Keyboard	1M0Q2A	Integrated scanner assembly on page 1119
HP Toner supply service kit	RM3-0846-000CN	Internal assemblies (8 of 9) X57945 models on page 1140
HP W2130YC Black Contract Toner Cartridge	W2130YC	Internal assemblies (7 of 7) 5700/X557/5800 models on page 1154
HP W2131YC Cyan Contract Toner Cartridge	W2131YC	Internal assemblies (7 of 7) 5700/X557/5800 models on page 1154
HP W2132YC Yellow Contract Toner Cartridge	W2132YC	Internal assemblies (7 of 7) 5700/X557/5800 models on page 1154
HP W2133YC Magenta Contract Toner Cartridge	W2133YC	Internal assemblies (7 of 7) 5700/X557/5800 models on page 1154
HP W9250MC Black Mngd LaserJet Toner Cartridge (MFP)	W9250MC	Internal assemblies (9 of 9) X57945 models on page 1142
HP W9251MC Cyan Mngd LaserJet Toner Cartridge (MFP)	W9251MC	Internal assemblies (9 of 9) X57945 models on page 1142
HP W9252MC Yellow Mngd LaserJet Toner Cartridge (MFP)	W9252MC	Internal assemblies (9 of 9) X57945 models on page 1142
HP W9253MC Magenta Mngd LaserJet Toner Cartridge (MFP)	W9253MC	Internal assemblies (9 of 9) X57945 models on page 1142
HP W9280MC Black Mngd Imaging Drum	W9280MC	Internal assemblies (9 of 9) X57945 models on page 1142
HP W9281MC Cyan Mngd Imaging Drum	W9281MC	Internal assemblies (9 of 9) X57945 models on page 1142
HP W9282MC Yellow Mngd Imaging Drum	W9282MC	Internal assemblies (9 of 9) X57945 models on page 1142
HP W9283MC Magenta Mngd Imaging Drum	W9283MC	Internal assemblies (9 of 9) X57945 models on page 1142
HV power supply PCA	RM3-9040-000CN	Internal assemblies (4 of 7) 5700/X557/5800 models on page 1149
HV power supply PCA	RM3-9042-000CN	Internal assemblies (4 of 9) X557/X57945 models on page 1134

Table 6-26 Alphabetical parts list (continued)

Description	Part number	Table and page
Handle (Lunar Aurora Purple Dark)	5851-8692	Integrated scanner assembly on page 1119
Handle (Lunar Comet Red Dark)	5851-8689	Integrated scanner assembly on page 1119
Handle (Lunar Constellation Yellow)	5851-8691	Integrated scanner assembly on page 1119
Handle (Lunar Cosmic Green Dark)	5851-8690	Integrated scanner assembly on page 1119
Handle (Lunar Grey Dark/ Cement Dark)	5851-8688	Integrated scanner assembly on page 1119
Handle (OOV white)	5851-8693	Integrated scanner assembly on page 1119
Handle, left	RC5-9165-000CN	Covers 5700/X557 models on page 1123
Handle, left	RC5-9165-000CN	Covers 5800 models on page 1124
Handle, left	RC5-9165-000CN	Covers X57945 models on page 1127
Handle, right door lower	RC5-8516-000CN	Covers 5700/X557 models on page 1123
Handle, right door lower	RC5-8516-000CN	Covers 5800 models on page 1124
Handle, right door lower	RC5-8516-000CN	Covers X57945 models on page 1127
Holder, drawer connector upper	RC5-9398-000CN	550-sheet paper feeder internal parts and assemblies on page 1156
ITB motor assembly	RM3-7797-000CN	Internal assemblies (1 of 9) X57945 models on page 1129
ITB motor assembly	RM3-7797-000CN	Internal assemblies (1 of 7) 5700/X557/5800 models on page 1143
Interlock assembly	RM2-3675-000CN	Internal assemblies (5 of 9) X57945 models on page 1136
Interlock assembly	RM2-3675-000CN	Internal assemblies (5 of 7) 5700/X557/5800 models on page 1151
Jog assembly	RM3-0481-000CN	3 bin staple stacker main body 5800/X57945 models on page 1159
Keyboard Overlay Kit - (DN/FR-Swiss/GN)	A7W13A	Integrated scanner assembly on page 1119
Keyboard Overlay Kit - Chinese	A7W12A	Integrated scanner assembly on page 1119

Table 6-26 Alphabetical parts list (continued)

Description	Part number	Table and page
LVPS (110-127V)	RM3-7724-000CN	Internal assemblies (5 of 7) 5700/X557/5800 models on page 1151
LVPS (110-127V)	RM3-9012-000CN	Internal assemblies (5 of 9) X57945 models on page 1136
LVPS (110-127V)	RM3-9012-000CN	Internal assemblies (5 of 7) 5700/X557/5800 models on page 1151
LVPS (220-240V)	RM3-7725-000CN	Internal assemblies (5 of 7) 5700/X557/5800 models on page 1151
LVPS (220-240V)	RM3-9013-000CN	Internal assemblies (5 of 9) X57945 models on page 1136
LVPS (220-240V)	RM3-9013-000CN	Internal assemblies (5 of 7) 5700/X557/5800 models on page 1151
Laser scanner assembly	RM2-3822-000CN	Internal assemblies (1 of 9) X57945 models on page 1129
Laser scanner assembly	RM2-3822-000CN	Internal assemblies (1 of 7) 5700/X557/5800 models on page 1143
Left cover assembly	RM2-4535-000CN	Covers 5700/X557 models on page 1123
Left cover assembly	RM2-4535-000CN	Covers 5800 models on page 1124
Left cover assembly	RM2-4535-000CN	Covers X57945 models on page 1127
Left lower cover	RC5-9408-000CN	Covers X57945 models on page 1127
Lifter drive assembly	RM2-3493-000CN	Internal assemblies (6 of 7) 5700/X557/5800 models on page 1152
Lifter drive assembly	RM2-3500-000CN	Internal assemblies (6 of 7) 5700/X557/5800 models on page 1152
Lifter drive assembly	RM2-3501-000CN	Internal assemblies (6 of 9) X57945 models on page 1137
Lifter drive assembly	RM2-3501-000CN	550-sheet paper feeder internal parts and assemblies on page 1156
Lower paper feed assembly	RM2-4168-000CN	3 bin staple stacker main body 5800/X57945 models on page 1159
Main drive assembly	RM2-3497-000CN	Internal assemblies (1 of 9) X57945 models on page 1129
Main drive assembly	RM2-3504-000CN	Internal assemblies (1 of 7) 5700/X557/5800 models on page 1143

Table 6-26 Alphabetical parts list (continued)

Description	Part number	Table and page
Main drive assembly	RM2-3506-000CN	Internal assemblies (1 of 7) 5700/X557/5800 models on page 1143
Memory PC board assembly	RM2-7138-000CN	Internal assemblies (3 of 9) X57945 models on page 1132
Microswitch	WC4-5136-000CN	3 bin staple stacker main body 5800/X57945 models on page 1159
Motor, stepping	RK2-6027-000CN	Internal assemblies (1 of 9) X57945 models on page 1129
Motor, stepping	RK2-6027-000CN	Internal assemblies (1 of 7) 5700/X557/5800 models on page 1143
Motor, stepping	RK2-7751-000CN	Internal assemblies (3 of 9) X57945 models on page 1132
Motor, stepping	RK2-7751-000CN	Internal assemblies (3 of 7) 5700/X557/5800 models on page 1147
Motor, stepping DC	RK2-8149-000CN	3 bin staple stacker main body 5800/X57945 models on page 1159
Paper delivery assembly	RM2-3548-000CN	Internal assemblies (3 of 7) 5700/X557/5800 models on page 1147
Paper delivery assembly	RM2-3554-000CN	Internal assemblies (3 of 9) X57945 models on page 1132
Paper delivery assembly	RM2-3554-000CN	Internal assemblies (3 of 7) 5700/X557/5800 models on page 1147
Paper feed assembly	RM2-3479-000CN	Internal assemblies (7 of 9) X57945 models on page 1139
Paper feeder controller PCA	RM3-8051-000CN	550-sheet paper feeder internal parts and assemblies on page 1156
Paper pickup assembly	RM2-3508-000CN	Internal assemblies (6 of 7) 5700/X557/5800 models on page 1152
Paper pickup assembly	RM2-3509-000CN	Internal assemblies (6 of 9) X57945 models on page 1137
Paper pickup assembly	RM2-3509-000CN	550-sheet paper feeder internal parts and assemblies on page 1156
Paper pickup drive assembly	RM2-3617-000CN	Internal assemblies (6 of 9) X57945 models on page 1137
Paper pickup drive assembly	RM2-3617-000CN	550-sheet paper feeder internal parts and assemblies on page 1156

Table 6-26 Alphabetical parts list (continued)

Description	Part number	Table and page
Paper pickup drive assembly	RM2-3681-000CN	Internal assemblies (6 of 7) 5700/X557/5800 models on page 1152
Paper pickup drive assembly	RM2-3702-000CN	Internal assemblies (3 of 9) X57945 models on page 1132
Pin, tray fixed	RC5-0353-000CN	3 bin staple stacker main body 5800/X57945 models on page 1159
Pre-exposure PCA holder	RM2-3565-000CN	Internal assemblies (2 of 7) 5700/X557/5800 models on page 1145
Pre-exposure PCA holder	RM2-3673-000CN	Internal assemblies (2 of 9) X57945 models on page 1130
Rear PCA	RM3-9044-000CN	Internal assemblies (4 of 7) 5700/X557/5800 models on page 1149
Rear PCA	RM3-9045-000CN	Internal assemblies (4 of 7) 5700/X557/5800 models on page 1149
Rear PCA	RM3-9046-000CN	Internal assemblies (4 of 9) X557/X57945 models on page 1134
Rear inner cover assembly	RM3-0485-000CN	3 bin staple stacker covers 5800/X57945 models on page 1158
Registration assembly	RM2-4458-000CN	Internal assemblies (2 of 9) X57945 models on page 1130
Registration assembly	RM2-4458-000CN	Internal assemblies (2 of 7) 5700/X557/5800 models on page 1145
Right PCA	RM3-7740-000CN	Internal assemblies (1 of 7) 5700/X557/5800 models on page 1143
Right PCA	RM3-7790-000CN	Internal assemblies (1 of 7) 5700/X557/5800 models on page 1143
Right PCA	RM3-7791-000CN	Internal assemblies (1 of 9) X57945 models on page 1129
Right door assembly	RM2-4167-000CN	3 bin staple stacker covers 5800/X57945 models on page 1158
Right lower door assembly	RM2-3570-000CN	Covers 5700/X557 models on page 1123
Right lower door assembly	RM2-3570-000CN	Covers 5800 models on page 1124
Right lower door assembly	RM2-3570-000CN	Covers X57945 models on page 1127

Table 6-26 Alphabetical parts list (continued)

Description	Part number	Table and page
Right lower door assembly	RM3-0004-000CN	Covers X57945 models on page 1127
Right lower door assembly	RM3-0004-000CN	550-sheet paper feeder covers, panels, and doors on page 1155
Scanner control interconnect board (SCIB) (5xxxx Series)	5851-8962	Integrated scanner assembly on page 1119
Secondary transfer assembly	RM2-3586-000CN	Internal assemblies (2 of 7) 5700/X557/5800 models on page 1145
Secondary transfer assembly	RM2-3628-000CN	Internal assemblies (2 of 9) X57945 models on page 1130
Secondary transfer assembly	RM2-3628-000CN	Internal assemblies (2 of 7) 5700/X557/5800 models on page 1145
Sensor, humidity HSU-08FDB2A	WP2-5473-000CN	Internal assemblies (5 of 9) X57945 models on page 1136
Sensor, humidity HSU-08FDB2A	WP2-5473-000CN	Internal assemblies (5 of 7) 5700/X557/5800 models on page 1151
Size detect assembly	RM2-3614-000CN	Internal assemblies (6 of 9) X57945 models on page 1137
Size detect assembly	RM2-3614-000CN	Internal assemblies (6 of 7) 5700/X557/5800 models on page 1152
Size detect assembly	RM2-3614-000CN	550-sheet paper feeder internal parts and assemblies on page 1156
Size detect assembly	RM2-3634-000CN	Internal assemblies (6 of 7) 5700/X557/5800 models on page 1152
Solenoid assembly	RM2-1040-010CN	3 bin staple stacker main body 5800/X57945 models on page 1159
Stacking wall assembly	RM3-0480-000CN	3 bin staple stacker main body 5800/X57945 models on page 1159
Staple cover assembly	RM3-0483-000CN	3 bin staple stacker covers 5800/X57945 models on page 1158
Staple door assembly	RM3-0484-000CN	3 bin staple stacker covers 5800/X57945 models on page 1158
Staple stacker PCA	RM3-7950-000CN	3 bin staple stacker main body 5800/X57945 models on page 1159
Stapler assembly	RK2-8148-000CN	3 bin staple stacker main body 5800/X57945 models on page 1159

Table 6-26 Alphabetical parts list (continued)

Description	Part number	Table and page
T1 solenoid assembly	RM2-7360-000CN	Internal assemblies (1 of 9) X57945 models on page 1129
T1 solenoid assembly	RM2-7360-000CN	Internal assemblies (1 of 7) 5700/X557/5800 models on page 1143
Toner supply PCA	RM3-7771-000CN	Internal assemblies (6 of 9) X57945 models on page 1137
Toner supply door assembly	RM2-3678-000CN	Covers X57945 models on page 1127
Toner supply drive assembly	RM2-3607-000CN	Internal assemblies (8 of 9) X57945 models on page 1140
Toner supply drive assembly	RM2-3608-000CN	Internal assemblies (8 of 9) X57945 models on page 1140
Toner supply drive assembly	RM2-3609-000CN	Internal assemblies (8 of 9) X57945 models on page 1140
Toner supply drive motor assembly	RM2-3612-000CN	Internal assemblies (6 of 9) X57945 models on page 1137
Top front cover assembly	RM2-4518-000CN	Covers 5800 models on page 1124
Top front cover assembly	RM2-4518-000CN	Covers X57945 models on page 1127
Tray assembly	RM2-4173-000CN	3 bin staple stacker main body 5800/X57945 models on page 1159
Upper paper feed assembly	RM2-4169-000CN	3 bin staple stacker main body 5800/X57945 models on page 1159
Waste toner carry assembly	RM2-3601-000CN	Internal assemblies (7 of 9) X57945 models on page 1139
Waste toner duct assembly	RM2-3517-000CN	Internal assemblies (2 of 7) 5700/X557/5800 models on page 1145
Waste toner duct assembly	RM2-3518-000CN	Internal assemblies (2 of 7) 5700/X557/5800 models on page 1145
Waste toner duct assembly	RM2-3590-000CN	Internal assemblies (2 of 9) X57945 models on page 1130

Numerical parts list

Table 6-27 Numerical parts list

Part number	Description	Table and page
1M0Q2A	HP LaserJet Workflow Keyboard	Integrated scanner assembly on page 1119
5851-7005	Assy-USB A F Panel Mount To WTB 335mm	Internal assemblies (6 of 9) X57945 models on page 1137
5851-7005	Assy-USB A F Panel Mount To WTB 335mm	Internal assemblies (7 of 9) X57945 models on page 1139
5851-7005	Assy-USB A F Panel Mount To WTB 335mm	550-sheet paper feeder internal parts and assemblies on page 1156
5851-7005	Assy-USB A F Panel Mount To WTB 335mm	3 bin staple stacker main body 5800/X57945 models on page 1159
5851-8688	Handle (Lunar Grey Dark/ Cement Dark)	Integrated scanner assembly on page 1119
5851-8689	Handle (Lunar Comet Red Dark)	Integrated scanner assembly on page 1119
5851-8690	Handle (Lunar Cosmic Green Dark)	Integrated scanner assembly on page 1119
5851-8691	Handle (Lunar Constellation Yellow)	Integrated scanner assembly on page 1119
5851-8692	Handle (Lunar Aurora Purple Dark)	Integrated scanner assembly on page 1119
5851-8693	Handle (OOV white)	Integrated scanner assembly on page 1119
5851-8841	ADF hinge kit (5xxx Series)	Integrated scanner assembly on page 1119
5851-8843	ADF roller cover (5xxx Series)	Integrated scanner assembly on page 1119
5851-8849	ADF damper	Integrated scanner assembly on page 1119
5851-8850	ADF white backing kit	Integrated scanner assembly on page 1119
5851-8962	Scanner control interconnect board (SCIB) (5xxxx Series)	Integrated scanner assembly on page 1119
6H121A	ADF Pick/Sep Roller Kit (5xxx Series)	Integrated scanner assembly on page 1119
6QN27-67002	Formatter (57xx / X55xxx)	Internal assemblies (4 of 7) 5700/X557/5800 models on page 1149
6QN27-67002	Formatter (58xx / X57xxx)	Internal assemblies (4 of 9) X557/X57945 models on page 1134

Table 6-27 Numerical parts list (continued)

Part number	Description	Table and page
6QN27-67004	Formatter (57xx / X55xxx) (China/India)	Internal assemblies (4 of 9) X557/X57945 models on page 1134
6QN27-67004	Formatter (57xx / X55xxx) (China/India)	Internal assemblies (4 of 7) 5700/X557/5800 models on page 1149
6QN28-67001	Control panel 10.9 cm 4.3 in	Control panels on page 1120
6QN29-67002	Formatter (58xx / X57xxx)	Internal assemblies (4 of 9) X557/X57945 models on page 1134
6QN29-67002	Formatter (58xx / X57xxx)	Internal assemblies (4 of 7) 5700/X557/5800 models on page 1149
6QN29-67004	Formatter (58xx / X57xxx) (China/India)	Internal assemblies (4 of 9) X557/X57945 models on page 1134
6QN29-67004	Formatter (58xx / X57xxx) (China/India)	Internal assemblies (4 of 7) 5700/X557/5800 models on page 1149
6QN29-67005	Flatbed scanner	Integrated scanner assembly on page 1119
6QN35-60129	Control panel 25.6 cm 10.1 in	Control panels on page 1120
6QN37-60102	Control panel 23.3 cm 8 in	Control panels on page 1120
6QN57A	550-sheet paper feeder (tray)	550-sheet paper feeder internal parts and assemblies on page 1156
A7W12A	Keyboard Overlay Kit - Chinese	Integrated scanner assembly on page 1119
A7W13A	Keyboard Overlay Kit - (DN/FR-Swiss/GN)	Integrated scanner assembly on page 1119
A7W14A	HP LaserJet Swedish Overlay Keyboard	Integrated scanner assembly on page 1119
COM44-67002	ADF WUR (5xxx Series Non-Workflow)	Integrated scanner assembly on page 1119
COM44-67003	ADF WUR (5xxx Series Workflow)	Integrated scanner assembly on page 1119
RC4-0213-000CN	Cover, Hardware integration pocket (HIP)	Covers 5700/X557 models on page 1123
RC4-0213-000CN	Cover, Hardware integration pocket (HIP)	Covers 5800 models on page 1124
RC4-0213-000CN	Cover, Hardware integration pocket (HIP)	Covers X57945 models on page 1127
RC5-0353-000CN	Pin, tray fixed	3 bin staple stacker main body 5800/X57945 models on page 1159

Table 6-27 Numerical parts list (continued)

Part number	Description	Table and page
RC5-8516-000CN	Handle, right door lower	Covers 5700/X557 models on page 1123
RC5-8516-000CN	Handle, right door lower	Covers 5800 models on page 1124
RC5-8516-000CN	Handle, right door lower	Covers X57945 models on page 1127
RC5-9165-000CN	Handle, left	Covers 5700/X557 models on page 1123
RC5-9165-000CN	Handle, left	Covers 5800 models on page 1124
RC5-9165-000CN	Handle, left	Covers X57945 models on page 1127
RC5-9168-000CN	Cover, rear lower	Covers 5700/X557 models on page 1123
RC5-9168-000CN	Cover, rear lower	Covers 5800 models on page 1124
RC5-9168-000CN	Cover, rear lower	Covers X57945 models on page 1127
RC5-9172-000CN	Cover, top assembly	Covers 5800 models on page 1124
RC5-9172-000CN	Cover, top assembly	Covers X57945 models on page 1127
RC5-9198-000CN	Cover, front left	Covers 5700/X557 models on page 1123
RC5-9198-000CN	Cover, front left	Covers 5800 models on page 1124
RC5-9198-000CN	Cover, front left	Covers X57945 models on page 1127
RC5-9199-000CN	Cover, front right	Covers 5700/X557 models on page 1123
RC5-9199-000CN	Cover, front right	Covers 5800 models on page 1124
RC5-9199-000CN	Cover, front right	Covers X57945 models on page 1127
RC5-9200-000CN	Cover, front left	550-sheet paper feeder covers, panels, and doors on page 1155
RC5-9201-000CN	Cover, front right	550-sheet paper feeder covers, panels, and doors on page 1155
RC5-9204-000CN	Cover, left upper	Covers 5700/X557 models on page 1123
RC5-9204-000CN	Cover, left upper	Covers 5800 models on page 1124
RC5-9204-000CN	Cover, left upper	Covers X57945 models on page 1127

Table 6-27 Numerical parts list (continued)

Part number	Description	Table and page
RC5-9398-000CN	Holder, drawer connector upper	550-sheet paper feeder internal parts and assemblies on page 1156
RC5-9408-000CN	Cover, left	550-sheet paper feeder covers, panels, and doors on page 1155
RC5-9408-000CN	Left lower cover	Covers X57945 models on page 1127
RC5-9409-000CN	Cover, rear lower	Covers X57945 models on page 1127
RC5-9409-000CN	Cover, rear lower	550-sheet paper feeder covers, panels, and doors on page 1155
RC6-1305-000CN	Cover, rear	3 bin staple stacker covers 5800/X57945 models on page 1158
RC6-1307-000CN	Cover, corner right	3 bin staple stacker covers 5800/X57945 models on page 1158
RC6-1308-000CN	Cover, right upper	3 bin staple stacker covers 5800/X57945 models on page 1158
RC6-1309-000CN	Cover, right lower	3 bin staple stacker covers 5800/X57945 models on page 1158
RC6-1310-000CN	Cover, stapler rear	3 bin staple stacker covers 5800/X57945 models on page 1158
RC6-2356-000CN	Cover, left front	3 bin staple stacker covers 5800/X57945 models on page 1158
RK2-6027-000CN	Motor, stepping	Internal assemblies (1 of 9) X57945 models on page 1129
RK2-6027-000CN	Motor, stepping	Internal assemblies (1 of 7) 5700/X557/5800 models on page 1143
RK2-7751-000CN	Motor, stepping	Internal assemblies (3 of 9) X57945 models on page 1132
RK2-7751-000CN	Motor, stepping	Internal assemblies (3 of 7) 5700/X557/5800 models on page 1147
RK2-8148-000CN	Stapler assembly	3 bin staple stacker main body 5800/X57945 models on page 1159
RK2-8149-000CN	Motor, stepping DC	3 bin staple stacker main body 5800/X57945 models on page 1159
RK2-8153-000CN	Fan	3 bin staple stacker main body 5800/X57945 models on page 1159

Table 6-27 Numerical parts list (continued)

Part number	Description	Table and page
RK3-0762-000CN	Fan	Internal assemblies (3 of 9) X57945 models on page 1132
RK3-0762-000CN	Fan	Internal assemblies (3 of 7) 5700/X557/5800 models on page 1147
RK3-0819-000CN	Cable, flat drive	Internal assemblies (4 of 9) X557/X57945 models on page 1134
RK3-0819-000CN	Cable, flat drive	Internal assemblies (4 of 7) 5700/X557/5800 models on page 1149
RK3-0821-000CN	Cable, flat drive	Internal assemblies (4 of 9) X557/X57945 models on page 1134
RK3-0821-000CN	Cable, flat drive	Internal assemblies (4 of 7) 5700/X557/5800 models on page 1149
RK3-0835-000CN	Cable, flat SCN	Internal assemblies (1 of 9) X57945 models on page 1129
RK3-0835-000CN	Cable, flat SCN	Internal assemblies (1 of 7) 5700/X557/5800 models on page 1143
RK3-0845-000CN	Cable, flat FMTR	Internal assemblies (3 of 9) X57945 models on page 1132
RK3-0845-000CN	Cable, flat FMTR	Internal assemblies (3 of 7) 5700/X557/5800 models on page 1147
RK3-0847-000CN	Cable, flat FMTR	Internal assemblies (3 of 7) 5700/X557/5800 models on page 1147
RK3-1508-000CN	Cable, flat HVT	Internal assemblies (4 of 7) 5700/X557/5800 models on page 1149
RK3-1509-000CN	Cable, flat HVT	Internal assemblies (4 of 9) X557/X57945 models on page 1134
RK3-1637-000CN	Fan	Internal assemblies (3 of 7) 5700/X557/5800 models on page 1147
RK3-1691-000CN	Cable, flat rear	Internal assemblies (4 of 7) 5700/X557/5800 models on page 1149
RK3-1692-000CN	Cable, flat rear	Internal assemblies (4 of 7) 5700/X557/5800 models on page 1149
RK3-1693-000CN	Cable, flat rear	Internal assemblies (4 of 9) X557/X57945 models on page 1134

Table 6-27 Numerical parts list (continued)

Part number	Description	Table and page
RK3-1694-000CN	Cable, flat right	Internal assemblies (4 of 9) X557/X57945 models on page 1134
RK3-1694-000CN	Cable, flat right	Internal assemblies (4 of 7) 5700/X557/5800 models on page 1149
RK3-2104-000CN	Cable, flat LVPS	Internal assemblies (5 of 9) X57945 models on page 1136
RK3-2104-000CN	Cable, flat LVPS	Internal assemblies (5 of 7) 5700/X557/5800 models on page 1151
RK3-2277-000CN	Fan	Internal assemblies (5 of 9) X57945 models on page 1136
RK3-2277-000CN	Fan	Internal assemblies (5 of 7) 5700/X557/5800 models on page 1151
RM2-1040-010CN	Solenoid assembly	3 bin staple stacker main body 5800/X57945 models on page 1159
RM2-3479-000CN	Paper feed assembly	Internal assemblies (7 of 9) X57945 models on page 1139
RM2-3493-000CN	Lifter drive assembly	Internal assemblies (6 of 7) 5700/X557/5800 models on page 1152
RM2-3497-000CN	Main drive assembly	Internal assemblies (1 of 9) X57945 models on page 1129
RM2-3500-000CN	Lifter drive assembly	Internal assemblies (6 of 7) 5700/X557/5800 models on page 1152
RM2-3501-000CN	Lifter drive assembly	Internal assemblies (6 of 9) X57945 models on page 1137
RM2-3501-000CN	Lifter drive assembly	550-sheet paper feeder internal parts and assemblies on page 1156
RM2-3504-000CN	Main drive assembly	Internal assemblies (1 of 7) 5700/X557/5800 models on page 1143
RM2-3506-000CN	Main drive assembly	Internal assemblies (1 of 7) 5700/X557/5800 models on page 1143
RM2-3508-000CN	Paper pickup assembly	Internal assemblies (6 of 7) 5700/X557/5800 models on page 1152
RM2-3509-000CN	Paper pickup assembly	Internal assemblies (6 of 9) X57945 models on page 1137
RM2-3509-000CN	Paper pickup assembly	550-sheet paper feeder internal parts and assemblies on page 1156

Table 6-27 Numerical parts list (continued)

Part number	Description	Table and page
RM2-3517-000CN	Waste toner duct assembly	Internal assemblies (2 of 7) 5700/X557/5800 models on page 1145
RM2-3518-000CN	Waste toner duct assembly	Internal assemblies (2 of 7) 5700/X557/5800 models on page 1145
RM2-3548-000CN	Paper delivery assembly	Internal assemblies (3 of 7) 5700/X557/5800 models on page 1147
RM2-3554-000CN	Paper delivery assembly	Internal assemblies (3 of 9) X57945 models on page 1132
RM2-3554-000CN	Paper delivery assembly	Internal assemblies (3 of 7) 5700/X557/5800 models on page 1147
RM2-3559-000CN	Auto close assembly	Internal assemblies (6 of 9) X57945 models on page 1137
RM2-3559-000CN	Auto close assembly	Internal assemblies (6 of 7) 5700/X557/5800 models on page 1152
RM2-3559-000CN	Auto close assembly	550-sheet paper feeder internal parts and assemblies on page 1156
RM2-3565-000CN	Pre-exposure PCA holder	Internal assemblies (2 of 7) 5700/X557/5800 models on page 1145
RM2-3570-000CN	Right lower door assembly	Covers 5700/X557 models on page 1123
RM2-3570-000CN	Right lower door assembly	Covers 5800 models on page 1124
RM2-3570-000CN	Right lower door assembly	Covers X57945 models on page 1127
RM2-3586-000CN	Secondary transfer assembly	Internal assemblies (2 of 7) 5700/X557/5800 models on page 1145
RM2-3590-000CN	Waste toner duct assembly	Internal assemblies (2 of 9) X57945 models on page 1130
RM2-3601-000CN	Waste toner carry assembly	Internal assemblies (7 of 9) X57945 models on page 1139
RM2-3607-000CN	Toner supply drive assembly	Internal assemblies (8 of 9) X57945 models on page 1140
RM2-3608-000CN	Toner supply drive assembly	Internal assemblies (8 of 9) X57945 models on page 1140
RM2-3609-000CN	Toner supply drive assembly	Internal assemblies (8 of 9) X57945 models on page 1140
RM2-3612-000CN	Toner supply drive motor assembly	Internal assemblies (6 of 9) X57945 models on page 1137

Table 6-27 Numerical parts list (continued)

Part number	Description	Table and page
RM2-3614-000CN	Size detect assembly	Internal assemblies (6 of 9) X57945 models on page 1137
RM2-3614-000CN	Size detect assembly	Internal assemblies (6 of 7) 5700/X557/5800 models on page 1152
RM2-3614-000CN	Size detect assembly	550-sheet paper feeder internal parts and assemblies on page 1156
RM2-3615-000CN	Cassette assembly	Internal assemblies (6 of 7) 5700/X557/5800 models on page 1152
RM2-3616-000CN	Cassette assembly	Internal assemblies (6 of 9) X57945 models on page 1137
RM2-3616-000CN	Cassette assembly	Internal assemblies (6 of 7) 5700/X557/5800 models on page 1152
RM2-3617-000CN	Paper pickup drive assembly	Internal assemblies (6 of 9) X57945 models on page 1137
RM2-3617-000CN	Paper pickup drive assembly	550-sheet paper feeder internal parts and assemblies on page 1156
RM2-3625-000CN	Developing motor assembly	Internal assemblies (1 of 9) X57945 models on page 1129
RM2-3625-000CN	Developing motor assembly	Internal assemblies (1 of 7) 5700/X557/5800 models on page 1143
RM2-3628-000CN	Secondary transfer assembly	Internal assemblies (2 of 9) X57945 models on page 1130
RM2-3628-000CN	Secondary transfer assembly	Internal assemblies (2 of 7) 5700/X557/5800 models on page 1145
RM2-3634-000CN	Size detect assembly	Internal assemblies (6 of 7) 5700/X557/5800 models on page 1152
RM2-3640-000CN	Cassette assembly	550-sheet paper feeder covers, panels, and doors on page 1155
RM2-3673-000CN	Pre-exposure PCA holder	Internal assemblies (2 of 9) X57945 models on page 1130
RM2-3675-000CN	Interlock assembly	Internal assemblies (5 of 9) X57945 models on page 1136
RM2-3675-000CN	Interlock assembly	Internal assemblies (5 of 7) 5700/X557/5800 models on page 1151
RM2-3678-000CN	Toner supply door assembly	Covers X57945 models on page 1127
RM2-3681-000CN	Paper pickup drive assembly	Internal assemblies (6 of 7) 5700/X557/5800 models on page 1152

Table 6-27 Numerical parts list (continued)

Part number	Description	Table and page
RM2-3702-000CN	Paper pickup drive assembly	Internal assemblies (3 of 9) X57945 models on page 1132
RM2-3822-000CN	Laser scanner assembly	Internal assemblies (1 of 9) X57945 models on page 1129
RM2-3822-000CN	Laser scanner assembly	Internal assemblies (1 of 7) 5700/X557/5800 models on page 1143
RM2-4167-000CN	Right door assembly	3 bin staple stacker covers 5800/X57945 models on page 1158
RM2-4168-000CN	Lower paper feed assembly	3 bin staple stacker main body 5800/X57945 models on page 1159
RM2-4169-000CN	Upper paper feed assembly	3 bin staple stacker main body 5800/X57945 models on page 1159
RM2-4173-000CN	Tray assembly	3 bin staple stacker main body 5800/X57945 models on page 1159
RM2-4458-000CN	Registration assembly	Internal assemblies (2 of 9) X57945 models on page 1130
RM2-4458-000CN	Registration assembly	Internal assemblies (2 of 7) 5700/X557/5800 models on page 1145
RM2-4469-000CN	Face down tray assembly	Covers 5700/X557 models on page 1123
RM2-4469-000CN	Face down tray assembly	Covers 5800 models on page 1124
RM2-4469-000CN	Face down tray assembly	Covers X57945 models on page 1127
RM2-4473-000CN	Front door assembly	Covers 5700/X557 models on page 1123
RM2-4473-000CN	Front door assembly	Covers 5800 models on page 1124
RM2-4479-000CN	Front door assembly	Covers X57945 models on page 1127
RM2-4480-000CN	Formatter cover assembly	Covers 5700/X557 models on page 1123
RM2-4480-000CN	Formatter cover assembly	Covers 5800 models on page 1124
RM2-4480-000CN	Formatter cover assembly	Covers X57945 models on page 1127
RM2-4485-000CN	Fixing drive assembly	Internal assemblies (3 of 9) X57945 models on page 1132
RM2-4485-000CN	Fixing drive assembly	Internal assemblies (3 of 7) 5700/X557/5800 models on page 1147

Table 6-27 Numerical parts list (continued)

Part number	Description	Table and page
RM2-4488-000CN	Fixing motor assembly	Internal assemblies (3 of 9) X57945 models on page 1132
RM2-4488-000CN	Fixing motor assembly	Internal assemblies (3 of 7) 5700/X557/5800 models on page 1147
RM2-4492-000CN	Density detect assembly	Internal assemblies (2 of 9) X57945 models on page 1130
RM2-4492-000CN	Density detect assembly	Internal assemblies (2 of 7) 5700/X557/5800 models on page 1145
RM2-4517-000CN	Cover, top assembly	Covers 5700/X557 models on page 1123
RM2-4518-000CN	Top front cover assembly	Covers 5800 models on page 1124
RM2-4518-000CN	Top front cover assembly	Covers X57945 models on page 1127
RM2-4520-000CN	Formatter cage assembly	Internal assemblies (3 of 7) 5700/X557/5800 models on page 1147
RM2-4521-000CN	Formatter cage assembly	Internal assemblies (3 of 9) X57945 models on page 1132
RM2-4521-000CN	Formatter cage assembly	Internal assemblies (3 of 7) 5700/X557/5800 models on page 1147
RM2-4530-000CN	Formatter cover assembly	Covers 5800 models on page 1124
RM2-4530-000CN	Formatter cover assembly	Covers X57945 models on page 1127
RM2-4533-000CN	Front door assembly	Covers 5700/X557 models on page 1123
RM2-4535-000CN	Left cover assembly	Covers 5700/X557 models on page 1123
RM2-4535-000CN	Left cover assembly	Covers 5800 models on page 1124
RM2-4535-000CN	Left cover assembly	Covers X57945 models on page 1127
RM2-7138-000CN	Memory PC board assembly	Internal assemblies (3 of 9) X57945 models on page 1132
RM2-7360-000CN	T1 solenoid assembly	Internal assemblies (1 of 9) X57945 models on page 1129
RM2-7360-000CN	T1 solenoid assembly	Internal assemblies (1 of 7) 5700/X557/5800 models on page 1143
RM3-0004-000CN	Right lower door assembly	Covers X57945 models on page 1127

Table 6-27 Numerical parts list (continued)

Part number	Description	Table and page
RM3-0004-000CN	Right lower door assembly	550-sheet paper feeder covers, panels, and doors on page 1155
RM3-0480-000CN	Stacking wall assembly	3 bin staple stacker main body 5800/X57945 models on page 1159
RM3-0481-000CN	Jog assembly	3 bin staple stacker main body 5800/X57945 models on page 1159
RM3-0483-000CN	Staple cover assembly	3 bin staple stacker covers 5800/X57945 models on page 1158
RM3-0484-000CN	Staple door assembly	3 bin staple stacker covers 5800/X57945 models on page 1158
RM3-0485-000CN	Rear inner cover assembly	3 bin staple stacker covers 5800/X57945 models on page 1158
RM3-0846-000CN	HP Toner supply service kit	Internal assemblies (8 of 9) X57945 models on page 1140
RM3-7647-000CN	Drum position sensor PCA	Internal assemblies (1 of 9) X57945 models on page 1129
RM3-7647-000CN	Drum position sensor PCA	Internal assemblies (1 of 7) 5700/X557/5800 models on page 1143
RM3-7723-000CN	Driver PCA	Internal assemblies (1 of 9) X57945 models on page 1129
RM3-7723-000CN	Driver PCA	Internal assemblies (1 of 7) 5700/X557/5800 models on page 1143
RM3-7724-000CN	LVPS (110-127V)	Internal assemblies (5 of 7) 5700/X557/5800 models on page 1151
RM3-7725-000CN	LVPS (220-240V)	Internal assemblies (5 of 7) 5700/X557/5800 models on page 1151
RM3-7740-000CN	Right PCA	Internal assemblies (1 of 7) 5700/X557/5800 models on page 1143
RM3-7751-000CN	DC controller PCA	Internal assemblies (4 of 7) 5700/X557/5800 models on page 1149
RM3-7752-000CN	DC controller PCA	Internal assemblies (4 of 7) 5700/X557/5800 models on page 1149
RM3-7755-000CN	DC controller PCA	Internal assemblies (4 of 7) 5700/X557/5800 models on page 1149

Table 6-27 Numerical parts list (continued)

Part number	Description	Table and page
RM3-7756-000CN	DC controller PCA	Internal assemblies (4 of 9) X557/X57945 models on page 1134
RM3-7771-000CN	Toner supply PCA	Internal assemblies (6 of 9) X57945 models on page 1137
RM3-7788-000CN	Drum motor assembly	Internal assemblies (1 of 9) X57945 models on page 1129
RM3-7788-000CN	Drum motor assembly	Internal assemblies (1 of 7) 5700/X557/5800 models on page 1143
RM3-7790-000CN	Right PCA	Internal assemblies (1 of 7) 5700/X557/5800 models on page 1143
RM3-7791-000CN	Right PCA	Internal assemblies (1 of 9) X57945 models on page 1129
RM3-7797-000CN	ITB motor assembly	Internal assemblies (1 of 9) X57945 models on page 1129
RM3-7797-000CN	ITB motor assembly	Internal assemblies (1 of 7) 5700/X557/5800 models on page 1143
RM3-7950-000CN	Staple stacker PCA	3 bin staple stacker main body 5800/X57945 models on page 1159
RM3-8001-000CN	Drawer cable assembly	Internal assemblies (6 of 7) 5700/X557/5800 models on page 1152
RM3-8038-000CN	Drawer cable assembly	Internal assemblies (6 of 9) X57945 models on page 1137
RM3-8051-000CN	Paper feeder controller PCA	550-sheet paper feeder internal parts and assemblies on page 1156
RM3-8058-000CN	Drawer upper cable assembly	550-sheet paper feeder internal parts and assemblies on page 1156
RM3-8059-000CN	Drawer lower cable assembly	550-sheet paper feeder internal parts and assemblies on page 1156
RM3-9012-000CN	LVPS (110-127V)	Internal assemblies (5 of 9) X57945 models on page 1136
RM3-9012-000CN	LVPS (110-127V)	Internal assemblies (5 of 7) 5700/X557/5800 models on page 1151
RM3-9013-000CN	LVPS (220-240V)	Internal assemblies (5 of 9) X57945 models on page 1136
RM3-9013-000CN	LVPS (220-240V)	Internal assemblies (5 of 7) 5700/X557/5800 models on page 1151

Table 6-27 Numerical parts list (continued)

Part number	Description	Table and page
RM3-9040-000CN	HV power supply PCA	Internal assemblies (4 of 7) 5700/X557/5800 models on page 1149
RM3-9042-000CN	HV power supply PCA	Internal assemblies (4 of 9) X557/X57945 models on page 1134
RM3-9044-000CN	Rear PCA	Internal assemblies (4 of 7) 5700/X557/5800 models on page 1149
RM3-9045-000CN	Rear PCA	Internal assemblies (4 of 7) 5700/X557/5800 models on page 1149
RM3-9046-000CN	Rear PCA	Internal assemblies (4 of 9) X557/X57945 models on page 1134
W2130A	HP 2130X High Yield Black Toner Cartridge	Internal assemblies (7 of 7) 5700/X557/5800 models on page 1154
W2130A	HP 213A Black Original LaserJet Toner Cartridge	Internal assemblies (7 of 7) 5700/X557/5800 models on page 1154
W2130Y	HP 213Y Extra High Yield Black Toner Cartridge	Internal assemblies (7 of 7) 5700/X557/5800 models on page 1154
W2130YC	HP W2130YC Black Contract Toner Cartridge	Internal assemblies (7 of 7) 5700/X557/5800 models on page 1154
W2131A	HP 213A Cyan Original LaserJet Toner Cartridge	Internal assemblies (7 of 7) 5700/X557/5800 models on page 1154
W2131X	HP 2131X High Yield Cyan Toner Cartridge	Internal assemblies (7 of 7) 5700/X557/5800 models on page 1154
W2131X	HP 213Y Extra High Yield Cyan Toner Cartridge	Internal assemblies (7 of 7) 5700/X557/5800 models on page 1154
W2131YC	HP W2131YC Cyan Contract Toner Cartridge	Internal assemblies (7 of 7) 5700/X557/5800 models on page 1154
W2132A	HP 213A Yellow Original LaserJet Toner	Internal assemblies (7 of 7) 5700/X557/5800 models on page 1154
W2132X	HP 2132X High Yield Yellow Toner Cartridge	Internal assemblies (7 of 7) 5700/X557/5800 models on page 1154
W2132Y	HP 213Y Extra High Yield Yellow Toner Cartridge	Internal assemblies (7 of 7) 5700/X557/5800 models on page 1154

Table 6-27 Numerical parts list (continued)

Part number	Description	Table and page
W2132YC	HP W2132YC Yellow Contract Toner Cartridge	Internal assemblies (7 of 7) 5700/X557/5800 models on page 1154
W2133A	HP 213A Magenta LaserJet Toner Cartridge	Internal assemblies (7 of 7) 5700/X557/5800 models on page 1154
W2133X	HP 2133X High Yield Magenta Toner Cartridge	Internal assemblies (7 of 7) 5700/X557/5800 models on page 1154
W2133Y	HP 213Y Extra High Yield Magenta Toner Cartridge	Internal assemblies (7 of 7) 5700/X557/5800 models on page 1154
W2133YC	HP W2133YC Magenta Contract Toner Cartridge	Internal assemblies (7 of 7) 5700/X557/5800 models on page 1154
W9250MC	HP W9250MC Black Mngd LaserJet Toner Cartridge (MFP)	Internal assemblies (9 of 9) X57945 models on page 1142
W9251MC	HP W9251MC Cyan Mngd LaserJet Toner Cartridge (MFP)	Internal assemblies (9 of 9) X57945 models on page 1142
W9252MC	HP W9252MC Yellow Mngd LaserJet Toner Cartridge (MFP)	Internal assemblies (9 of 9) X57945 models on page 1142
W9253MC	HP W9253MC Magenta Mngd LaserJet Toner Cartridge (MFP)	Internal assemblies (9 of 9) X57945 models on page 1142
W9280MC	HP W9280MC Black Mngd Imaging Drum	Internal assemblies (9 of 9) X57945 models on page 1142
W9281MC	HP W9281MC Cyan Mngd Imaging Drum	Internal assemblies (9 of 9) X57945 models on page 1142
W9282MC	HP W9282MC Yellow Mngd Imaging Drum	Internal assemblies (9 of 9) X57945 models on page 1142
W9283MC	HP W9283MC Magenta Mngd Imaging Drum	Internal assemblies (9 of 9) X57945 models on page 1142
WC4-5136-000CN	Microswitch	3 bin staple stacker main body 5800/X57945 models on page 1159
WP2-5473-000CN	Sensor, humidity HSU-08FDB2A	Internal assemblies (5 of 9) X57945 models on page 1136
WP2-5473-000CN	Sensor, humidity HSU-08FDB2A	Internal assemblies (5 of 7) 5700/X557/5800 models on page 1151

A Certificate of Volatility

Review the certificates of volatility for the printer.

Certificate of Volatility

Review the certificates of volatility for the printers.

Figure A-1 Certificate of Volatility SFP (1 of 2)

Hewlett-Packard Certificate of Volatility				
Model(s): HP Color LaserJet Enterprise X55745 and 5700	Part Number(s): X55745dn=6QP97A 5700dn=6QN28A	Address: Hewlett Packard Company 11311 Chinden Blvd Boise, ID 83714		
Volatile Memory				
Does the device contain volatile memory (Memory whose contents are lost when power is removed)? <input checked="" type="checkbox"/> Yes <input type="checkbox"/> No If Yes please describe the type, size, function, and steps to clear the memory below				
Type (SRAM, DRAM, etc): DRAM	Size: 1.5GB	User Modifiable: <input type="checkbox"/> Yes <input checked="" type="checkbox"/> No	Function: Temporary storage for system operation and print buffer	Steps to clear memory: When the printer is powered off the memory is erased
Non-Volatile Memory				
Does the device contain non-volatile memory (Memory whose contents are retained when power is removed)? <input checked="" type="checkbox"/> Yes <input type="checkbox"/> No If Yes please describe the type, size, function, and steps to clear the memory below				
Type (Flash, EEPROM, etc): EEPROM	Size: 32KB	User Modifiable: <input type="checkbox"/> Yes <input checked="" type="checkbox"/> No	Function: Store customer setting data for backup /restore	Steps to clear memory: There are no steps to clear this data
Type (Flash, EEPROM, etc): SPI	Size: 4MB	User Modifiable: <input type="checkbox"/> Yes <input checked="" type="checkbox"/> No	Function: BIOS	Steps to clear memory: There are no steps to clear this data
Mass Storage				
Does the device contain mass storage memory (Hard Disk Drive, Tape Backup)? <input checked="" type="checkbox"/> Yes <input type="checkbox"/> No If Yes please describe the type, size, function, and steps to clear the memory below				
Type (HDD, Tape, etc.): eMMC	Size: 16GB	User Modifiable: <input checked="" type="checkbox"/> Yes <input type="checkbox"/> No	Function: Stores data, OS, applications, digitally signed firmware images, persistent data, and temporary data for processing system functions	Steps to clear memory: Firmware update or Initiate a non-secure fast erase from the EWS
USB				
Does the item accept USB input and if so, for what purpose (i.e. Print Jobs, device firmware updates, scan upload)? <input checked="" type="checkbox"/> Yes <input type="checkbox"/> No If Yes please describe below				
Explanation: Print Jobs and device firmware updates				
Can any data other than scan upload be sent to the USB device? <input type="checkbox"/> Yes <input checked="" type="checkbox"/> No If Yes please describe below				
Explanation:				

Figure A-2 Certificate of Volatility SFP (2 of 2)

RF/RFID			
Does the item use RF or RFID for receive or transmit of any data including remote diagnostics? (e.g. Cellular phone, Bluetooth) <input type="checkbox"/> Yes <input checked="" type="checkbox"/> No If Yes please describe below			
Purpose:			
Frequency:		Bandwidth:	
Modulation:		Effective Radiate Power (ERP):	
Specifications:			
Other Transmission Capabilities			
Does the device employ any other methods of non-wired access to transmit or receive any data whatsoever (e.g. anything other than standard hard wired TCP/IP, direct USB, or parallel connections)? <input type="checkbox"/> Yes <input checked="" type="checkbox"/> No If Yes please describe below:			
Purpose:			
Frequency:		Bandwidth:	
Modulation:		Effective Radiate Power (ERP):	
Specifications:			
Other Capabilities			
Does the device employ any other method of communications such as a Modem to transmit or receive any data whatsoever? <input type="checkbox"/> Yes <input checked="" type="checkbox"/> No If Yes please describe below:			
Purpose:			
Specifications:			
Author Information			
Name	Title	Email	Business Unit
	System Engineer	Technical.Marketing@hp.com	IPG
Date Prepared: 11/07/2022			

Figure A-3 Certificate of Volatility MFP (1 of 2)

Hewlett-Packard Certificate of Volatility					
Model(s): HP Color LaserJet Enterprise X57945, X58045, and 5800	Part Number(s): X57945dn=6QP98A X57945z=6QP99A X57945zs=76H07A X58045dn=7E357A 5800dn=6QN29A 5800f=6QN30A 5800zf=58R10A			Address: Hewlett Packard Company 11311 Chinden Blvd Boise, ID 83714	
Volatile Memory					
Does the device contain volatile memory (Memory whose contents are lost when power is removed)? <input checked="" type="checkbox"/> Yes <input type="checkbox"/> No If Yes please describe the type, size, function, and steps to clear the memory below					
Type (SRAM, DRAM, etc): DRAM	Size: 6GB	User Modifiable: <input type="checkbox"/> Yes <input checked="" type="checkbox"/> No	Function: Temporary storage for system operation and print buffer	Steps to clear memory: When the printer is powered off the memory is erased	
Non-Volatile Memory					
Does the device contain non-volatile memory (Memory whose contents are retained when power is removed)? <input checked="" type="checkbox"/> Yes <input type="checkbox"/> No If Yes please describe the type, size, function, and steps to clear the memory below					
Type (Flash, EEPROM, etc): EEPROM	Size: 32KB	User Modifiable: <input type="checkbox"/> Yes <input checked="" type="checkbox"/> No	Function: Store customer setting data for backup /restore	Steps to clear memory: There are no steps to clear this data	
Type (Flash, EEPROM, etc): SPI	Size: 4MB	User Modifiable: <input type="checkbox"/> Yes <input checked="" type="checkbox"/> No	Function: BIOS	Steps to clear memory: There are no steps to clear this data	
Mass Storage					
Does the device contain mass storage memory (Hard Disk Drive, Tape Backup)? <input checked="" type="checkbox"/> Yes <input type="checkbox"/> No If Yes please describe the type, size, function, and steps to clear the memory below					
Type (HDD, Tape, etc.): eMMC	Size: 32GB	User Modifiable: <input checked="" type="checkbox"/> Yes <input type="checkbox"/> No	Function: Stores data, OS, applications, digitally signed firmware images, persistent data, and temporary data for processing system functions	Steps to clear memory: Firmware update or Initiate a non-secure fast erase from the EWS	
Type (HDD, Tape, etc.): HDD	Size: 500GB	User Modifiable: <input checked="" type="checkbox"/> Yes <input type="checkbox"/> No	Function: Stores data, OS, applications, digitally signed firmware images, persistent data, and temporary data for processing system functions	Steps to clear memory: Firmware update or Initiate a non-secure fast erase from the EWS	
USB					
Does the item accept USB input and if so, for what purpose (i.e. Print Jobs, device firmware updates, scan upload)? <input checked="" type="checkbox"/> Yes <input type="checkbox"/> No If Yes please describe below					
Explanation: Print Jobs, scan upload, and device firmware updates					
Can any data other than scan upload be sent to the USB device? <input type="checkbox"/> Yes <input checked="" type="checkbox"/> No If Yes please describe below					
Explanation:					

Figure A-4 Certificate of Volatility MFP (2 of 2)

RF/RFID			
Does the item use RF or RFID for receive or transmit of any data including remote diagnostics? (e.g. Cellular phone, Bluetooth) <input type="checkbox"/> Yes <input checked="" type="checkbox"/> No If Yes please describe below			
Purpose:			
Frequency:		Bandwidth:	
Modulation:		Effective Radiate Power (ERP):	
Specifications:			
Other Transmission Capabilities			
Does the device employ any other methods of non-wired access to transmit or receive any data whatsoever (e.g. anything other than standard hard wired TCP/IP, direct USB, or parallel connections)? <input type="checkbox"/> Yes <input checked="" type="checkbox"/> No If Yes please describe below:			
Purpose:			
Frequency:		Bandwidth:	
Modulation:		Effective Radiate Power (ERP):	
Specifications:			
Other Capabilities			
Does the device employ any other method of communications such as a Modem to transmit or receive any data whatsoever? <input type="checkbox"/> Yes <input checked="" type="checkbox"/> No If Yes please describe below:			
Purpose:			
Specifications:			
Author Information			
Name	Title	Email	Business Unit
	System Engineer	Technical.Marketing@hp.com	IPG
Date Prepared: 11/07/2022			

Glossary of terms

802.11

802.11 is a set of standards for wireless local area network (WLAN) communication, developed by the IEEE LAN/MAN Standards Committee (IEEE 802).

802.11b/g/n

802.11b/g/n can share the same hardware and use the 2.4 GHz band. 802.11b supports bandwidth up to 11 Mbps, 802.11n supports bandwidth up to 150 Mbps. 802.11b/g/n devices might occasionally suffer interferences from microwave ovens, cordless telephones, and Bluetooth devices.

AC

An electric current that reverses its direction many times a second at regular intervals. For example, the 110V line current found in a typical US electrical wall receptacle.

AC Control Module (PageWide)

The AC Control Module controls the heating elements in the airflow assembly. Functions include voltage monitoring (ensuring correct operation in a low-quality-power environment), isolation (low voltage heater control signals are isolated from the high voltage AC power for safety), AC switching (power is switched on/off to the heater), and heating element configuration (heating element configuration is changed between series and parallel for temperature predictability).

ADF

An Automatic Document Feeder (ADF) is a device that automatically feeds an original sheet (or multiple sheets) of paper into the image scanner. The document feeder is a component of the integrated scanner assembly (ADF and image scanner).

Airflow System (PageWide)

The airflow system conditions the printed pages to avoid page curling due to the ink on the page. The airflow system functionally consists of a fan and heating elements. The pressurized air is blown on the page through the nozzles that are placed on the paper path of the airflow system between print and eject zone.

BOOTP

Bootstrap Protocol. A network protocol used by a network client to obtain its IP address automatically. This is usually done in the bootstrap process of computers or operating systems running on them. The BOOTP servers assigns an IP address from a pool of addresses to each client. BOOTP enables “diskless workstation” computers to obtain an IP address prior to loading any advanced operating system.

CCD

A Charged Coupled Device (CCD) is the scanner module which enables a scan job. A CCD locking mechanism is used to hold the CCD module to prevent any damage when the printer is moved.

CIS

A Contact Image Sensor (CIS) scanner captures an image using the printer's optical path. Red, green, and blue LEDs sequentially illuminate a small strip of the document (often called a raster line), and the optical system captures each color in a single row of Charged Coupled Device (CCD) sensors that cover the entire page width.

Collation

Collation is a process of printing a multiple-copy job in sets. When collation is selected, the device prints an entire set before printing additional copies.

Control Panel

The control panel is a flat, typically vertical panel or screen where the user can control and/or monitor the printer. The control panel is found on the front of the printer.

Coverage

Coverage is the printing term used for a toner usage measurement on printing. For example, 5% coverage means that an A4 sided paper has about 5% image or text on it. If the paper or original has complicated images or a large amount of text, the coverage will be higher and at the same time, a toner usage will be as much as the coverage.

DC

An electric current flowing in one direction only. Typically, a low voltage load current supplied to an electrical assembly.

DCC

The DC controller (DCC) controls the operation of the printer sub-systems and electrical components. The DCC sends out various signals to operate motors, solenoids, and other printer components based on the print command and image data that the host computer sends the formatter.

Default

The value or setting that is in effect when a printer is unboxed, reset, or initialized.

DHCP

Dynamic Host Configuration Protocol (DHCP) is a client-server networking protocol. A DHCP server provides configuration parameters specific to the DHCP client host requesting, generally, information required by the client host to participate on an IP network. The DHCP also provides a mechanism for allocation of IP addresses to client hosts.

Digital Send Software

Digital send software allows a multi-function printer (MFP) to scan and send information quickly and securely to email, network folders, other printers, and fax services.

DIMM

A Dual Inline Memory Module (DIMM) is a small circuit board that holds memory. The DIMM stores all data within the printer, such as printing data and received fax data.

DPI

Dots Per Inch (DPI) is a measurement of resolution that is used for scanning and printing. Generally, higher DPI results in a higher resolution (more visible detail in the image and a larger file size).

Duplex

A mechanism that automatically turns over a sheet of paper so that the printer can print (or scan) on both sides of the paper. A printer equipped with a duplex unit can print on both sides of the paper during one print cycle.

Duty Cycle

Duty cycle is the page quantity which does not affect printer performance for a month. Generally, the printer has the lifespan limitation such as pages per year. The lifespan means the average capacity of print-outs, usually within the warranty period. For example, if the duty cycle is 48,000 pages per month the printer limit is 2,400 pages a day (assuming 20 working days/month).

Dynamic Security

Dynamic Security is a toner cartridge design and process for authenticating genuine HP supplies. HP printers use toner cartridges that have security chips or electronic circuitry. Cartridges using a non-HP chip, or modified chip, or non-HP circuitry might not work (now or in the future).

e-Duplex

Single-pass electronic duplex (e-Duplex) printer use two separate scan modules to scan the front-side and back-side of an e-duplex copy job page in a single pass through the document feeder.

EMC

EMC is a measure of a device's ability to operate as intended in its shared operating environment while, at the same time, not affecting the ability of other equipment within the same environment to operate as intended.

EMI

EMI is the electromagnetic energy which affects the functioning of an electronic device. Electronic devices (like printers) are a source of EMI. Because it is rare for electronics to operate in isolation, products are generally engineered to function in the presence of some amount of EMI.

eMMC

An embedded Multi-Media Card is a compact memory device consisting of NAND flash memory and a simple storage controller.

Emulation

Emulation is a technique of one machine obtaining the same results as another. An emulator duplicates the functions of one system with a different system, so that the second system behaves like the first system. Emulation focuses on exact reproduction of external behavior. This is different from simulation, which concerns an abstract model of the system being simulated, often considering its internal state.

EPS

Encapsulated PostScript (EPS) is a PostScript (PS) code file which is used for storing font and vector graphic image information.

ESD

An electrostatic discharge (ESD) is a sudden flow of electricity between two electrically charged objects caused by contact, an electrical short, or dielectric breakdown. Discharge of built up static electricity.

Ethernet

Ethernet is a frame-based computer networking technology for local area networks (LANs). It defines wiring and signaling for the physical layer, and frame formats and protocols for the media access control (MAC)/data link layer of the OSI model. Ethernet is mostly standardized as IEEE 802.3. Ethernet has become the most widespread LAN technology in use during the 1990s to present.

Ferrite

A ferrite is used to reduce the amount of radio frequency noise (or interference) in a wire or cable. A ferrite enables proper EMC/EMI performance for regulatory purposes.

FFC

Flat Flexible Cables (FFCs) are designed for Printed Circuit Assembly (PCA) to PCA connections (for example, connecting a fax PCA to the formatter).

FIH

A Foreign Interface Harness (FIH) is a port that enables HP multifunction printers (MFPs) to use third-party devices to extend the capabilities of the MFP.

Firmware

The formatter stores the printer firmware. A remote firmware upgrade process is used to overwrite and upgrade the firmware.

Flash memory

Flash memory is non-volatile, meaning it retains stored data even when the power is turned off.

Flow integrated scanner assembly

A printer scanner assembly that includes a slide-out external physical keyboard.

Formatter (LaserJet)

The formatter controls printer functions like receiving and processes print data, developing and coordinating data placement and timing with the DC controller PCA, storing font and customer configuration information, communicating with the host computer, and monitoring control panel functions and relaying printer status information through the control panel.

FTP

FTP stands for File Transfer Protocol. FTP is a protocol designed for transferring files over the Internet. Files stored on an FTP server can be accessed using an FTP client, such as a web browser, FTP software program, or a command line interface.

Fuser Unit

The fuser unit is part of a laser printer that adheres the toner onto the printed page. It consists of a heat roller and a pressure roller. After toner is transferred onto the paper, the fuser unit applies heat and pressure to make sure that the toner stays on the paper permanently (which is why paper is warm when it comes out of a laser printer).

Gateway

A connection between computer networks, or between a computer network and a telephone line. A gateway is used to connect two different computer networks, especially a connection to the Internet.

Grayscale

Shades of gray that represent light and dark portions of a color image printed in monochrome. Colors are represented by a range of gray shades from white to black.

Halftone

Halftone is a way of reproducing a photograph or other image in which the various tones of gray or color are produced by variously sized dots of ink or toner. Halftone simulates grayscale by varying the number of dots. Highly colored areas consist of a large number of dots, while lighter areas consist of a smaller number of dots.

HDD

A Hard-Disk Drive (HDD) (commonly referred to as a hard drive or hard disk) is a non-volatile storage device which stores digitally-encoded data on rapidly rotating platters with magnetic surfaces.

IEEE

The Institute of Electrical and Electronics Engineers (IEEE) is an international non-profit, professional organization for the advancement of technology related to electricity.

Image scanner

The image scanner (or Sub Scanner Assembly) contains the components to digitally scan an original source document. The image scanner is a component of the integrated scanner assembly (ADF and image scanner).

IP address

An Internet Protocol (IP) address is a unique number that a device uses in order to identify and communicate with other devices on a network utilizing the Internet Protocol standard.

IPM

The Images Per Minute (IPM) is a method of measuring the speed of a printer. An IPM rate indicates the number of single-sided sheets a printer can complete in one minute.

IPP

The Internet Printing Protocol (IPP) defines a standard protocol for printing and managing print jobs, media size, resolution, etc. IPP can be used locally, or over the internet to reach hundreds of printers. IPP also supports access control, authentication, and encryption, making it a capable and secure printing solution.

ISA

The Integrated Scanner Assembly (ISA) includes the document feeder and image scanner.

ISO

The International Organization for Standardization (ISO) is an international standard-setting body composed of representatives from national standards bodies. It produces world-wide industrial and commercial standards.

JBIG

Joint Bi-level Image Experts Group (JBIG) is an image compression standard with no loss of accuracy or quality. It was designed for compression of binary images, particularly for faxes, but can also be used for other images.

JPEG

Joint Photographic Experts Group (JPEG) is a commonly used standard method of loss compression for photographic images. It is the format used for storing and transmitting photographs on the World Wide Web.

LDAP

The Lightweight Directory Access Protocol (LDAP) is a networking protocol for querying and modifying directory services running over TCP/IP.

LED

A Light-Emitting Diode (LED) is a semiconductor device that can indicate the status of a printer (formatter LEDs) or a component in a contact image sensor (CIS) scanner that helps capture an image.

LEDM

Low end data model (LEDM) provides one consistent data representation method and defines the dynamic and capabilities tickets shared between clients and devices, as well as the access protocol, event, security, and discovery methods.

LPDC

Late point differentiation configuration (LPDC) allows the channel partner to configure the speed to the printer depending on the customer's order. LPDC configuration is stored on the Trusted Platform Module (TPM).

LVPS - SMPS

Low Voltage Power Supplies (LVPS) and Switching Mode Power Supplies (SMPS) supply direct current (DC) voltages to various printer components and assemblies.

MAC address

Media Access Control (MAC) address is a unique identifier associated with a network adapter. MAC address is a unique 48-bit identifier usually written as 12 hexadecimal characters grouped in pairs (for example, 00-00-0c-34-11-4e). This address is usually hard-coded into a Network Interface Card (NIC) by the manufacturer and used as an aid for routers trying to locate machines on a large network.

MEt

HP Memory Enhancement technology (MEt) effectively doubles the standard memory through a variety of font- and data-compression methods. MEt is available only in Printer Command Language (PCL) mode; it is not functional when printing in PostScript (PS) mode.

MFP

A Multi Function Printer (MFP) is a printer that incorporates multiple functionalities in a single physical body. For example, an MFP printer can scan, digitally send, fax, copy, and print.

MHV

Miniature High Voltage (MHV) is designed for high voltage applications of BNC connectors (DC voltage between 500 V and 5 kV).

Modem

A device that modulates a carrier signal to encode digital information, and also demodulates such a carrier signal to decode transmitted information.

MPCA (PageWide)

The MPCA integrates both formatter (LaserJet) and engine control electronics (DC controller) into a single assembly. The Main PCA (MPCA) controls printer functions like receiving and processes print data, developing and coordinating data placement, storing font and customer configuration information, communicating with the host computer, and monitoring control panel functions and relaying printer status information through the control panel.

NAND

NAND is not an acronym (the term is short for **NOT AND** a Boolean operator and logic gate). NAND (flash) memory is non-volatile, meaning it retains stored data even when the power is turned off.

NVRAM

Nonvolatile random access memory (NVRAM) is used to store I/O and information about the print environment configuration (stored data even when the power is turned off).

OPC

Organic Photo Conductor (OPC) is a mechanism that makes a virtual image for print using a laser beam emitted from a laser printer. It is usually green or rust colored and has a cylinder shape. An imaging unit containing a drum slowly wears the drum surface during its usage in the printer, and it should be replaced appropriately due to wear from contact with the cartridge development brush, cleaning mechanism, and paper.

Originals

The first example of something, such as a document, photograph, or text which is copied, reproduced, or translated to produce additional copies. The original itself is not copied or derived from something else.

PCA

Printed Circuit Assembly (PCA). Once the printed circuit board (PCB) is complete, electronic components must be assembled to form a functional printed circuit assembly or PCA.

PCL

Printer Command Language (PCL) is a Page Description Language (PDL) developed by HP as a printer protocol. PCL has become an industry standard. Originally developed for early Inkjet printers, PCL has been released in varying levels for thermal, dot matrix printers and laser printers.

PDF

Portable Document Format (PDF) is a proprietary file format developed by Adobe Systems. A PDF represents two dimension documents in a device independent and resolution independent format.

PJL

Printer job language (PJL) is an integral part of printer configuration, in addition to the standard PCL and PostScript (PS). With standard cabling, the printer can use PJL to perform a variety of functions like dynamic I/O switching, context-sensitive switching, and isolation of print environment settings from one print job to the next.

PML

Printer management language (PML) allows remote configuration of the printer and status read-back from the printer through the I/O ports.

PostScript (PS)

PostScript (PS) is a Page Description Language (PDL) and programming language used primarily in electronic and desktop publishing. PostScript is run in an interpreter to generate an image.

PPM

Pages Per Minute (PPM) is a method of measurement for determining how fast a printer works, meaning the number of pages a printer can produce in one minute.

Print Media

Media like paper, envelopes, labels, and transparencies which can be used in a printer, scanner, fax, or copier.

Printer Driver

A program used to send commands and transfer data from the computer to the printer.

Printhead (PageWide)

The printhead converts the digital firing instructions from the printer electronics into properly formed and timed microscopic drops of the four ink colors.

Printhead Wiper (PageWide)

The printhead wiper system keeps the printhead nozzles firing correctly throughout the life of the printer as it performs the wiping and capping functions. The wiping function cleans the nozzles of ink residue and particulates. The capping function keeps the nozzles moist during storage and when the printer is idle.

Protocol

A convention or standard that controls or enables the connection, communication, and data transfer between two computing endpoints.

RAM

Random Access Memory (RAM) is the printer memory device where the data in current use is kept so it can be quickly retrieved by the device's processor. This memory is an important factor in avoiding errors and printing documents properly. Printer memory is used to store, and process print jobs as they are sent to the printer from a computer. After printing, the job is cleared from the memory to make room for more print jobs. Printer memory is directly linked to two print characteristics: speed and print quality. More memory allows you to print faster and print larger, high-quality graphics.

REDI sensor

An optical reflective edge detection interrupter (REDI) sensor. Usually used in conjunction with mirrors to sense the presence or absence of paper in the paper path. These sensors are carefully aligned and calibrated at the factory, so care must be taken when servicing these sensors.

Resolution

The sharpness of an image is measured in Dots Per Inch (DPI). The higher the DPI, the greater the resolution.

SCB

The Scanner Control Board (SCB) controls the functions of the image scanner components in the Sub Scanner Assembly (SSA).

Service fluid and aerosol management systems (PageWide)

There are two types of service fluid, shipping fluid and ink. The service fluid management system is contained entirely within the duplex module. Service fluid is discharged as droplets from the printhead, and then collected in a container inside the duplex module. Some of the droplets are called aerosol because they are lighter than air. Aerosol can float inside the printer and collect on the lens of optical sensors, producing false failures. The aerosol management system transports the aerosol and collects it in a safe place. Aerosol management consists of an aerosol fan, mounted on the rear wall of the air flow assembly, which creates air flow that pulls the aerosol through the holes in the platen and into the aerosol filter inside the duplex module.

SFP

A single-function printer only processes print jobs sent from a host computer or from an USB port on the printer.

SMB

Server Message Block (SMB) is a network protocol mainly applied to share files, printers, serial ports, and miscellaneous communications between nodes on a network. SMB also provides an authenticated inter-process communication mechanism.

SMTP

Simple Mail Transfer Protocol (SMTP) is the standard for email transmissions across the internet. SMTP is a relatively simple, text-based protocol, where one or more recipient of a message is specified, and the message text is transferred. It is a client server protocol where the client transmits an email message to the server.

SODIMM

Small outline dual in-line memory module (SODIMM) is a thin profile memory storage device (a smaller alternative to a standard DIMM device).

SSA

The Sub-Scanner Assembly is the image scanner component of the Integrated Scanner Assembly (ISA, which includes the document feeder and the image scanner).

Subnet Mask

The subnet mask is used in conjunction with the network address to determine which part of the address is the network address and which part is the host address.

TCP/IP

The Transmission Control Protocol (TCP) and the Internet Protocol (IP) are the set of communications protocols that implement the protocol stack on which the internet and most commercial networks run.

TIFF

Tagged Image File Format (TIFF) is a variable-resolution bit mapped image format. TIFF describes image data that typically come from scanners. TIFF images use tags, keywords defining the characteristics of the image that is included in the file. This flexible and platform-independent format can be used for pictures that have been made by various image processing applications.

Toner Cartridge

A bottle or container that holds toner, which is used in a machine like a printer. Toner is a powder used in laser printers and photocopiers. The toner forms the text and images on printed paper. Toner can be fused by a combination of heat/pressure from the fuser, causing it to bind the fibers in the paper.

TPM

The HP Trusted Platform Module (TPM) is a security accessory for printers. The TPM strengthens protection of encrypted credentials and data stored on your printer. Certificate private keys are both generated by and protected by the TPM. Once installed, the printer and the TPM are sealed, and the printer owns the TPM. The TPM may not be moved to another device without losing its ownership from the original printer. Installing a TPM accessory might necessitate a firmware upgrade. The TPM prevents the printer from starting if the TPM is missing. If the TPM is removed from the printer, a control-panel error message appears indicating that the TPM is missing.



NOTE: The TPM is not a service part for some printer models. Check the printer service manual to determine if the TPM is a replaceable service part.

TWAIN

An industry standard for scanners and software. By using a TWAIN compliant scanner with TWAIN-compliant software, a scan can be initiated from the program. TWAIN is an image capture API for Microsoft Windows and Apple Macintosh operating systems.

URL

Uniform Resource Locator (URL) is the global address of documents and resources on the internet. The first part of the address indicates what protocol to use. The second part specifies the IP address or the domain name where the resource is located.

USB

Universal Serial Bus (USB) is a standard that was developed by the USB Implementers Forum, Inc., to connect computers and peripherals. Unlike the parallel port, USB is designed to concurrently connect a single computer USB port to multiple peripherals.

Walk-up USB

Some printers support direct printing from a USB flash drive (the walk-up USB port is usually near the control panel).

Watermark

A watermark is a recognizable image or pattern in paper that appears lighter when viewed by transmitted light. Watermarks were first introduced in Bologna, Italy in 1282. Watermarks have been used by paper makers to identify their product, and also on postage stamps, currency, and other government documents to discourage counterfeiting.

XPS

XML Paper Specification (XPS) is a specification for a Page Description Language (PDL) and a new document format developed by Microsoft. This has benefits for portable document and electronic documents. It is an XML-based specification based on a new print path and vector-based, device-independent document format.

ZIF Connector

Zero insertion force (ZIF) connectors use a mechanical locking method to secure Flat Flexible Cables (FFCs) to a Printed Circuit Assembly (PCA).

Index

Symbols/Numerics

10/100/1000 functions
theory of operations 48

3 bin staple stacker covers MFP
parts 1157

3 bin staple stacker main body
MFP
parts 1158

3-bin staple stacker output devices
parts and diagrams 1157

3-bin stapler-stacker
controller 98
delivery functions, other 98
electrical components 100
fan control 98
jam detection 98
motor control 98,102
other functions 102
output accessories 98
paper path 98

550-sheet paper feeder
controller 91
electrical components 91,92
input accessories 91
jam detection 91
motor control 91,93
other functions 94
paper path 91,98
parts and diagrams 1155
parts, main body 1156
pickup and feed functions,
other 91

550-sheet paper feeder covers,
panels, and doors
whole unit replacement 1155

550-sheet paper feeder paper
path
theory of operation 91,98

550-sheet tray
jams 348

550-sheet trays
jams 306

76.00.24 306

A

accessories, input
550-sheet paper feeder 91
HCI 94

accessories, output
3-bin stapler-stacker 98

acoustic specifications 21

assemblies 2,100-sheet paper
deck
remove and replace 992

assemblies 3-bin staple stacker
multi-bin mailbox
remove and replace 1031

assemblies 550-sheet paper
feeder
remove and replace 942

assemblies base printer, remove
and replace 547

auto on / auto off mode
setup and operation 45

automatic document feeder
whole-unit replacement 537

B

backup error
32.WX.YZ error 305
reset error 305
restore error 305

Backup/Restore (Maintenance)
menu
control-panel menu 249

base printer
configuration 7
information 2
parts and diagrams 1120
specifications 9

basic printer operation 43

bin, output
locating 4
locating SFP managed 3

locating SFP transactional 2

blank pages
troubleshooting 433

C

cables
USB, troubleshooting 433

Calibrate/Cleaning menu, control
panel 249

Calibrate/Cleaning menu, control-
panel menu 250

calibration
operations 79

calibration, color
theory 66

calibration)
operation 79

cartridge
developing unit engagement
and disengagement 66
eject 443
life detection 66
manually unlock 625
memory chip 66
presence detection 66
remove 440,445
remove (manually
unlocked) 627
replacing 441,446
toner level detection 66

caution iv

certificate of volatility 1189

Channel partners
WISE v

checklists
pre-troubleshooting 113,114

circuit base printer, diagrams 195

circuit diagrams
high-voltage power supply 49,
59
low-voltage power supply 49

cleaning page 249,250

- print 414
 - clutches
 - theory of operation 50
 - cold rest
 - reset 260
 - color self calibration
 - theory 66
 - component diagnostics
 - solve problems 165
 - components
 - DC controller 49, 50
 - engine-control unit 49
 - fuser control 60
 - intermediate transfer belt (ITB) 66, 77
 - low-voltage power supply 56
 - pickup, feed, and delivery 80
 - secondary transfer roller assembly 79
 - toner cartridge 66
 - configuration
 - base printer 7
 - printer 1
 - configuration page
 - determine installed firmware 117
 - find information 206
 - solve problems 206
 - configurations, 5700/X55745 7
 - configurations, 5800/X57945 8
 - connectivity and performance
 - troubleshooting 432
 - connector error
 - 65.WX.YZ error 306
 - connector locations
 - external plug and port diagrams 167
 - printed circuit assembly diagrams 188
 - control panel 47
 - locating 4
 - locating SFP managed 3
 - locating SFP transactional parts 1120
 - solve problems 121, 274
 - control panel diagnostic
 - flowcharts 134
 - control panel messages 285
 - control panel, system diagnostics
 - solve problems 274
 - control panels
 - parts and diagrams 1120
 - control-panel menu
 - Maintenance 249
 - control-panel menu
 - Service (Maintenance) 251
 - Troubleshooting (Maintenance) 252
 - USB Firmware Upgrade (Maintenance) 251
 - controller
 - 550-sheet paper feeder 91
 - floor-standing stapler-stacker 98
 - HCI 94
 - conventions used iv
 - cooling
 - areas and fans 49, 56
 - copy-quality problems
 - light or faint copies 430
 - modify printer settings to improve scan or copy quality 429
 - vertical lines, bands, or streaks 425
 - copy-quality troubleshooting 423
 - Copy/Print (Settings) menu (MFP)
 - control-panel menu 139
 - CoV
 - certificate of volatility 1189
 - covers
 - remove and replace parts 547, 943, 992, 1031
 - covers MFP
 - parts 1124, 1126
 - covers SFP
 - parts 1122
 - covers, panels, and doors
 - parts and diagrams 1122, 1155, 1157
 - CPMD 285
 - customer self-repair (CSR) A parts and accessories 439
 - customer self-repair (CSR) B parts and accessories 481
 - customer-replaceable units
 - remove and replace parts 439, 481
- D**
- DC controller
 - components 49
 - fans 49, 56
 - motors 49, 54
 - theory of operation 50
 - DC controller communication error
 - 55.WX.YZ error 306
 - DC controller firmware error
 - 70.WX.YZ error 306
 - DC motors 49, 54
 - defeating
 - interlocks 268
 - defeating interlocks
 - solve problems 161, 269
 - definitions and terms
 - glossary 1193
 - delivery functions, other
 - 3-bin stapler-stacker 98
 - determine problem source 113
 - development
 - image formation 72
 - development process 66, 68
 - devices, input
 - information 22
 - devices, output
 - information 24
 - diagnostics
 - component, solve problems 165
 - engine 268
 - diagram
 - 3-bin stapler-stacker 24
 - diagrams, block
 - solve problems 167
 - diagrams, external plug and port
 - locations 167
 - diagrams, general circuit base
 - printer 195
 - diagrams, major component
 - locations 172
 - diagrams, printed circuit assembly
 - connector locations 188
 - diagrams, sensors and
 - switches 168
 - diagrams, timing chart 194
 - digital sending error (firmware)
 - 44.WX.YZ error 305
 - dimensions, printer 15, 16, 18
 - disable cartridge check
 - solve problems 164, 270
 - document feeder
 - jams 348, 350
 - locating 4
 - locating SFP managed 3
 - paper-feeding problems (MFP) 407
 - remove and replace parts 530
 - whole unit replacement 1118
 - document feeder / scanner
 - information, configurations, and specifications 1
 - parts and diagrams 1118

- theory of operations 41
 - document feeder and scanner information 1
 - document feeder error 31.WX.YZ error 305
 - doors
 - parts and diagrams 1122, 1155, 1157
 - remove and replace parts 547, 943, 992, 1031
 - drum
 - remove 448
 - replacing 449
 - drum cleaning 66, 68
 - duplexer
 - jams 306, 348
 - duplexer error 69.WX.YZ error 306
 - duplexing unit
 - motors 49, 54
- E**
- easy-access USB port
 - locating SFP managed 3
 - eject
 - toner cartridges 443
 - electrical components
 - 550-sheet paper feeder 91
 - HCI 94
 - electrical specifications 21
 - email problems
 - get help from WISE 432
 - Embedded Jetdirect error 80.WX.YZ error 306
 - engine
 - diagnostics 268
 - test page 268
 - engine error (LaserJet)
 - 46.WX.YZ error 305
 - 63.WX.YZ error 306
 - engine error (PageWide)
 - 61.WX.YZ error 306
 - engine FRUs, internal
 - parts and diagrams 1128, 1156, 1158
 - engine laser scanner system
 - laser scanner safety 67
 - engine test
 - solve problems 120, 268
 - engine-control unit
 - components 49
 - engine, printer
 - parts and diagrams 1120
 - event log 295
 - event log error (firmware)
 - 42.WX.YZ error 305
 - exhaust fans 49, 56
 - external plug and port diagrams
 - locations 167
- F**
- factory settings
 - reset 260, 262
 - failure detection
 - laser/scanner 66
 - motors 49, 54
 - faint copies
 - copy-quality problems 430
 - fan control
 - 3-bin stapler-stacker 98
 - fan error 58.WX.YZ error 306
 - fans
 - DC controller 49, 56
 - exhaust 49, 56
 - intake 49, 56
 - theory of operation 50
 - Fax (Settings) menu (MFP)
 - control-panel menu 229
 - fax functions
 - theory of operations 48
 - fax ports
 - locating MFP 6
 - fax problems
 - get help from WISE 432
 - field-replaceable units
 - covers, panels, and doors 547, 943, 992, 1031
 - remove and replace
 - parts 530, 547, 943, 992, 1031
 - firmware
 - determine the installed version 117
 - theory of operations 48
 - firmware communication error 49.WX.YZ error 305
 - firmware install error 99.WX.YZ error 306
 - hard disk error 306
 - remote firmware upgrade
 - error 306
 - firmware locations
 - active and repository 262
 - firmware upgrade
 - firmware version
 - determine 117
 - firmware upgrade)
 - embedded web server 117
 - USB flash drive, control panel 117
 - USB flash drive, pre-boot menu 117
 - firmware, upgrade
 - downloading 117
 - firmware, version determine
 - find information 117
 - firmware, version determining 117
 - flash memory
 - theory of operations 48
 - flatbed
 - scanning and image capture
 - MFP only 42
 - flowcharts
 - troubleshooting 113, 115
 - format disk
 - solve problems 262
 - formatter
 - locating MFP 6
 - formatter control system 45
 - front door
 - locating 4
 - locating SFP managed 3
 - locating SFP transactional 2
 - FRUs
 - remove and replace
 - parts 530, 547, 943, 992, 1031
 - FRUS, internal
 - parts and diagrams 1128, 1156, 1158
 - functions
 - fuser control 60
 - low-voltage power supply 56, 58
 - toner cartridge 77
 - fuser
 - jams 339, 341, 345, 348, 386, 388, 392
 - fuser control
 - fuser control functions 66
 - theory of operation 60
 - fuser control functions
 - fuser control 66
 - fuser error
 - 41.WX.YZ error 305
 - laser scanner error 305
 - paper path error 305
 - fuser error (LaserJet)
 - 50.WX.YZ error 305
 - fuser heater
 - protection 65

- fusing
 - image formation 74
- fusing process 66, 68
- G**
- General (Settings) menu
 - control-panel menu 212
- glossary
 - terms and definitions 1193
- H**
- hard disk partition error
 - 98.WX.YZ error 306
- hardware integration pocket (HIP)
 - locating SFP managed 3
- hardware integration pocket (HIP)
 - is not functioning 134, 138
- HCI
 - controller 94
 - electrical components 94, 96
 - input accessories 94
 - jam detection 94
 - motor control 94, 97
 - other functions 97
 - paper path 94
 - pickup and feed functions,
 - other 94
- HCI paper path
 - theory of operation 94
- high-voltage power supply (HVPS)
 - operations 49, 59
- home button is
 - unresponsive 134, 137
- HP internal users
 - WISE v
- HVPS (high-voltage power supply)
 - operations 49, 59
- I**
- I/O functions
 - theory of operations 48
- image capture system
 - scanning MFP only 42
- image defects, repetitive
 - ruler 409
- image formation development
 - theory of operation 72
- image formation fusing
 - theory of operation 74
- image formation ITB cleaning
 - theory of operation 74
- image formation laser-beam
 - exposure
 - theory of operation 71
- image formation pre-exposure
 - theory of operation 70
- image formation primary charging
 - theory of operation 71
- image formation primary transfer
 - theory of operation 72
- image formation secondary
 - transfer
 - theory of operation 73
- image formation separation
 - theory of operation 73
- image quality
 - check toner-cartridge
 - status 413
- image-formation process
 - development process 66, 68
 - drum cleaning 66, 68
 - fusing process 66, 68
 - laser-beam exposure 66, 68
 - primary charging 66, 68
 - primary transfer process 66, 68
 - secondary transfer
 - process 66, 68
 - separation process 66, 68
- image-information system 66
- image-quality
 - troubleshooting 408
- imaging drums
 - remove 448
 - replacing 449
- individual component test
 - solve problems 166
- information
 - document feeder and
 - scanner 1
 - input devices 22
 - output devices 24
 - printer 1
 - printer base 2
- information pages
 - configuration page 206
 - Jetdirect page 206
- information, configurations, and
 - specifications
 - ADF / scanner 1
 - document feeder / scanner 1
 - scanner / document feeder 1
- initial rotation period 43
- input accessory error
 - 67.WX.YZ error 306
- input devices
 - information 22
 - parts and diagrams 1154
 - remove and replace, 2,100-sheet
 - paper deck 992
 - remove and replace, 550-sheet
 - paper feeder 942
- input, 550-sheet paper feeder
 - parts and diagrams 1155
- input/output error
 - 40.WX.YZ error 305
- input/output functions
 - theory of operations 48
- install
 - tray 1 pickup roller 477
- installation
 - printer 26
- installation, base printer 28
- installation, document feeder /
 - scanner 26
- intake fans 49, 56
- integrated scanner assembly (ISA)
 - ISA
 - whole-unit replacement,
 - integrated scanner
 - assembly 541
 - whole-unit replacement 541
- interface ports
 - locating MFP 6
 - locating SFP 3
- interlocks
 - defeating 268
- intermediate transfer belt (ITB)
 - components 66, 77
 - operations 66, 77
- internal assemblies (1 of 6),
 - parts 1143
- internal assemblies (1 of 9),
 - parts 1128
- internal assemblies (2 of 7),
 - parts 1145
- internal assemblies (2 of 9),
 - parts 1130
- internal assemblies (3 of 7),
 - parts 1147
- internal assemblies (3 of 9),
 - parts 1132
- internal assemblies (4 of 7),
 - parts 1149
- internal assemblies (4 of 9),
 - parts 1134
- internal assemblies (5 of 7),
 - parts 1151
- internal assemblies (5 of 9),
 - parts 1136

- internal assemblies (6 of 7), parts 1152
- internal assemblies (6 of 9), parts 1137
- internal assemblies (7 of 7), parts 1154
- internal assemblies (7 of 9), parts 1139
- internal assemblies (8 of 9), parts 1140
- internal assemblies (9 of 9), parts 1142
- internal assemblies 2,100-sheet paper deck 992
- internal assemblies 3-bin staple stacker multi-bin mailbox 1031
- internal assemblies 550-sheet paper feeder 942
- internal assemblies base printer 547
- internal diagnostics error
 - 90.WX.YZ error 306
 - video display error 306
- internal parts 2,100-sheet paper deck
 - remove and replace 992
- internal parts 3-bin staple stacker multi-bin mailbox
 - remove and replace 1031
- internal parts 550-sheet paper feeder
 - remove and replace 942
- internal parts and assemblies
 - parts and diagrams 1128, 1156, 1158
- internal parts and assemblies, remove and replace 439, 481, 530, 624, 957, 1002, 1067
- internal parts base printer, remove and replace 547
- internal test and information pages
 - solve problems 206
- ITB (intermediate transfer belt) operation 66, 77
- ITB cleaning
 - image formation 74

J

- jam detection
 - 3-bin stapler-stacker 98, 103
 - 550-sheet feeder 94
 - 550-sheet paper feeder 91
 - HCI 94, 98

- jam error (LaserJet)
 - 13.WX.YZ error 305
- jam error (PageWide)
 - 13.WX.YZ error 305
- jams
 - 3-bin stapler-stacker 103
 - 550-sheet feeder 94
 - 550-sheet tray 348
 - 550-sheet trays 306
 - auto-navigation 307, 349
 - causes of 307, 349
 - document feeder 348, 350
 - duplexer 306, 348
 - fuser 339, 341, 345, 348, 386, 388, 392
 - HCI 98
 - in right door 336, 383
 - locations 306, 307, 348
 - output bin 306, 347, 348, 394, 395, 397, 399
 - Tray 1 306, 348
 - Tray 2 306, 311, 348, 358
 - Tray 4 322, 329, 369, 376
- Jetdirect page
 - solve problems 206
- job accounting error (firmware)
 - 48.WX.YZ error 305
- job management error (firmware) 305
- job pipeline error (firmware) 305
- job parser error (firmware)
 - 47.WX.YZ error 305
- printer calibration error 305

K

- keyboard 47

L

- laser scanner
 - failure detection 67
- laser scanner error (LaserJet)
 - 51.WX.YZ error 305
 - 52.WX.YZ error 305
- laser scanner functions
 - failure detection 67
- laser scanner safety
 - engine laser scanner system 67
- laser-beam exposure 66, 68
 - image formation 71
- laser/scanner
 - failure detection 66
 - operations 66

- last rotation period 43
- latent image formation 66, 68
- light copies
 - copy-quality problems 430
- lines, bands, streaks
 - copy-quality problems 425
- link speed, change 162, 271
- low-voltage power supply
 - functions 58
 - over-current/over-voltage protection 58
 - safety 58
 - theory of operation 56
 - voltage descriptions 57
- low-voltage power supply (HVPS)
 - operations 49
- LVPS (low-voltage power supply)
 - operations 49

M

- maintenance
 - printer 26
- maintenance, base printer 28
- maintenance, document feeder / scanner 26
- major component diagrams
 - locations 172
- major component locations
 - diagrams 172
- Manage Supplies (Settings) menu
 - control-panel menu 240
- manual sensor test, tray/bin
 - solve problems 167
- manual sensor tests
 - solve problem 166
- memory
 - toner cartridge 66
- Memory Enhancement technology
 - theory of operations 48
- Memory Enhancement technology (MEt) 45
- memory error
 - 82.WX.YZ error 306
 - EMMC error 306
 - hard disk error 306
- memory functions
 - theory of operations 48
- memory, 5700
 - included 9
- memory, 5800
 - included 12
- memory, X55745
 - included 11

- memory, X57945
 - included 14
- menu, control panel
 - Backup/Restore (Maintenance) menu 249
 - Backup/Restore menu 249
 - Calibrate/Cleaning menu 249, 250
 - Copy/Print (Settings) menu (MFP) 139
 - Fax (Settings) menu (MFP) 229
 - General (Settings) menu 212
 - Manage Supplies (Settings) menu) 240
 - Networking (Settings) menu 243
 - Print (Settings) menu (SFP) 139
 - Reports menu 210
 - Scan/Digital Send (Settings) menu (MFP) 218
 - Service (Maintenance) menu 251
 - Service menu 249
 - Settings menu 211
 - Support Tools menu 249
 - Troubleshooting (Maintenance) menu 252
 - USB Firmware Upgrade (Maintenance) menu 251
 - USB Firmware Upgrade menu 249
- menus control panel, control panel
 - Calibrate/Cleaning) 249
- menus, control panel
 - Calibrate/Cleaning 250
- motor control
 - 3-bin stapler-stacker 98, 102
 - 550-sheet paper feeder 91, 93
 - HCI 94, 97
- motor error (LaserJet)
 - 59.WX.YZ error 306
- motors
 - DC controller 49, 54
 - failure detection 49, 54
 - pickup, feed, and delivery system 80, 84
 - stepping 49, 54
 - theory of operation 50
- movement of paper through printer
 - See* pickup, feed, and delivery

N

- Near Field Communication error
 - 81.WX.YZ error 306
 - Bluetooth error 306
 - external I/O card error 306
 - internal EIO error 306
 - wireless error 306
- network port
 - locating SFP 3
- Networking (Settings) menu
 - control-panel menu 243
- networks, 5700
 - supported 9
- networks, 5800
 - supported 12
- networks, X55745
 - supported 11
- networks, X57945
 - supported 14
- no control panel sound 134, 136
- note iv
- NVRAM
 - theory of operations 48

O

- on/off button
 - locating 4
 - locating SFP managed 3
 - locating SFP transactional 2
- operating-environment range
 - printer 22
- operation
 - Sleep delay 45
 - Sleep mode 45
- operation sequence 43
- operations
 - laser/scanner 66
 - toner cartridge memory 66
- other functions, 3-bin stapler-stacker
 - theory of operation 102
- other functions, 550-sheet paper feeder
 - theory of operation 94
- other functions, HCI
 - theory of operation 97
- output accessory error
 - 66.WX.YZ error 306
- output bin
 - clear jams 306, 347, 348, 394, 395, 399
 - locating 4
 - locating SFP managed 3
 - locating SFP transactional 2

- output device, 3-bin staple stacker
 - parts and diagrams 1157
- output devices
 - information 24
 - parts and diagrams 1157
 - remove and replace, 3-bin staple stacker multi-bin mailbox 1031
- over-current/over-voltage protection
 - low-voltage power supply 58
- OXPd/Web kit error
 - 45.WX.YZ error 305

P

- page error
 - 21.WX.YZ error 305
- pages
 - blank 433
 - not printing 433
 - printing slowly 433
- pages per minute, 5700 9
- pages per minute, 5800 12
- pages per minute, X55745 11
- pages per minute, X57945 14
- panels
 - parts and diagrams 1122, 1155, 1157
 - remove and replace parts 547, 943, 992, 1031
- paper
 - jams 306, 307, 348, 349
 - selecting 414
- paper feeder, 550-sheet
 - parts and diagrams 1155
 - parts, main body 1156
 - whole unit replacement part 1155
- paper handling
 - solve problems 306
- paper handling error (LaserJet)
 - 56.WX.YZ error 306
- paper jams
 - 550-sheet tray 348
 - 550-sheet trays 306
 - document feeder 348, 350
 - duplexer 306, 348
 - fuser 339, 341, 345, 348, 386, 388, 392
 - locations 306, 307, 348
 - output bin 306, 347, 348, 394, 395, 397, 399
 - right door 336, 383
 - Stapler stacker 397

- Tray 1 306, 348
- Tray 2 306, 311, 348, 358
- Tray 4 322, 329, 369, 376
- paper movement
 - operation 80
- paper path
 - 3-bin stapler-stacker 98
 - 550-sheet paper feeder 91
 - HCI 94
 - printer 80
- paper path sensors test (not available for this printer)
 - solve problems 166
- paper path test
 - solve problems 165
- partial clean (disk)
 - solve problems 262
- parts
 - 3 bin staple stacker covers
 - MFP 1157
 - 3 bin staple stacker main body
 - MFP 1158
 - 550-sheet paper feeder covers, panels, and doors 1155
 - 550-sheet paper feeder main body 1156
 - control panel 1120
 - covers MFP 1124, 1126
 - covers SFP 1122
 - document feeder and scanner whole units 1118
- parts and diagrams
 - 550-sheet paper feeder 1155
 - ADF / scanner 1118
 - base printer 1120
 - control panels 1120
 - covers, panels, and doors 1122, 1155, 1157
 - document feeder / scanner 1118
 - doors 1122, 1155, 1157
 - engine, printer 1120
 - f3-bin staple stacker output device 1157
 - input devices 1154
 - internal parts and assemblies 1128, 1156, 1158
 - output devices 1157
 - panels 1122, 1155, 1157
 - scanner / document feeder 1118
- parts internal 2,100-sheet paper deck
 - remove and replace 992
- parts internal 3-bin staple stacker multi-bin mailbox
 - remove and replace 1031
- parts internal 550-sheet paper feeder
 - remove and replace 942
- parts internal base printer, remove and replace 547
- parts, internal assemblies (1 of 6) 1143
- parts, internal assemblies (1 of 9) 1128
- parts, internal assemblies (2 of 7) 1145
- parts, internal assemblies (2 of 9) 1130
- parts, internal assemblies (3 of 7) 1147
- parts, internal assemblies (3 of 9) 1132
- parts, internal assemblies (4 of 7) 1149
- parts, internal assemblies (4 of 9) 1134
- parts, internal assemblies (5 of 7) 1151
- parts, internal assemblies (5 of 9) 1136
- parts, internal assemblies (6 of 7) 1152
- parts, internal assemblies (6 of 9) 1137
- parts, internal assemblies (7 of 7) 1154
- parts, internal assemblies (7 of 9) 1139
- parts, internal assemblies (8 of 9) 1140
- parts, internal assemblies (9 of 9) 1142
- performance and connectivity troubleshooting 432
- periods of the operation sequence 43
- personal identification number (PIN)
 - service menu 256
- pickup and feed functions, other
 - 550-sheet paper feeder 91
 - HCI 94
- pickup, feed, and delivery components 80
 - overview 80
- PJL (printer job language) 45, 47
- PML (printer management language) 45
- power
 - consumption 21
- power connection
 - locating SFP 3
- power management
 - theory of operation 45
- power on troubleshooting 266
- power on troubleshooting overview 266
- power switch
 - locating SFP transactional 2
- power-on checks
 - troubleshooting process 266
- pre-boot menu options 285
- pre-exposure
 - image formation 70
- pre-troubleshooting checklist 113, 114
- primary charging
 - image formation 71
- primary charging process 66, 68
- Print (Settings) menu (SFP)
 - control-panel menu 139
- print a cleaning page 414
- print bar error (PageWide) 62.WX.YZ error 306
- print-quality troubleshooting 409
- print/stop test
 - solve problems 164
- printed circuit assembly diagrams
 - connector locations 188
- printer
 - information, configuration, and specifications 1
 - installation and maintenance 26
 - operating-environment range 22
 - resets 260
 - space requirements 21
- printer engine
 - parts and diagrams 1120
- printer information, configuration, and specifications
 - document feeder and scanner specifications 1
 - document feeder and scanner views 1
- printer installation and maintenance
 - base printer 28
 - document feeder / scanner 26

- printer job language (PJM) 45, 47
- printer management language (PML) 45
- printer memory error
 - 20.WX.YZ error 305
- printer resets
 - solve problems 260
- printer settings
 - copy-quality problems 429
- printer, base
 - configuration 7
 - information 2
 - specifications 9
- printing
 - period in operation
 - sequence 43
 - troubleshooting 433
- Process Cleaning Page 249, 250
- protection
 - fuser heater 65

R

- RAM
 - theory of operations 48
- real-time clock error
 - 11.WX.YZ error 305
- removal and replacement 439
- remove
 - imaging drums 448
 - toner cartridges 440, 445
 - toner cartridges (manually unlocked) 627
 - tray 1 pickup roller 473
- remove and replace
 - 2,100-sheet paper deck, internal parts and assemblies 992
 - 3-bin staple stacker multi-bin mailbox, internal parts and assemblies 1031
 - 550-sheet paper feeder, internal parts and assemblies 942
- remove and replace parts
 - automatic document feeder, whole-unit replacement 537
 - covers, panels, and doors 547, 943, 992, 1031
 - customer-replaceable units 439, 481
 - document feeder / scanner 530
 - field-replaceable units 530, 547, 943, 992, 1031

- integrated scanner assembly (ISA), whole-unit replacement 541
- whole-unit replacement 537
- remove and replace, internal parts and assemblies 439, 481, 530, 624, 957, 1002, 1067
- remove and replace, internal parts and assemblies base printer 547
- repetitive image defect ruler 409
- replacing
 - imaging drums 449
 - toner cartridges 441, 446
- reports
 - event log 295
 - supplies status page 285
- Reports menu
 - control-panel menu 210
- resets
 - printer 260
- revision history iii
- right door
 - locating 4
 - locating SFP managed 3
 - locating SFP transactional 2
- Right door
 - jams 336, 383
- roller, tray 1 pickup
 - install 477
 - remove 473

S

- safety
 - low-voltage power supply 58
- scan or copy quality improvement
 - copy-quality problems 429
- Scan/Digital Send (Settings) menu (MFP)
 - control-panel menu 218
- scanner
 - remove and replace parts 530
- scanner and document feeder
 - information 1
- scanner error
 - 30.WX.YZ error 305
- scanner tests (MFP)
 - solve problems 163
 - troubleshooting 163
- scanner, image
 - whole unit replacement part 1118

- scanner/document feeder
 - information, configurations, and specifications 1
 - parts and diagrams 1118
 - theory of operations 41
- scanning
 - image capture MFP only 42
- secondary transfer
 - image formation 73
- secondary transfer assembly
 - operation 79
- secondary transfer
 - processes 66, 68
- secondary transfer roller
 - assembly
 - components 79
 - operations 79
- secondary transfer roller assembly)
 - operation 79
- security
 - dynamic security 66
- security error
 - 33.WX.YZ error 305
- sensor error
 - 54.WX.YZ error 306
 - 58.WX.YZ error 306
- sensors
 - pickup, feed, and delivery system 80, 82
 - theory of operation 50
- sensors and switches diagrams
 - 3-bin stapler-stacker 168
 - 550-sheet paper feeder 168
 - base printer 168
 - floor-standing stapler-stacker 168
 - HCI 168
- separation
 - image formation 73
- separation process 66, 68
- Service (Maintenance) menu
 - control-panel menu 251
- service and support
 - WISE v
- service ID
 - restore 260
- service menu
 - personal identification number (PIN) 256
 - solve problems 256
- Settings (Copy/Print, MFP) menu
 - control-panel menu 139
- Settings (Fax) menu (MFP)
 - control-panel menu 229

- Settings (General) menu
 - control-panel menu 212
 - Settings (Manage Supplies) menu)
 - control-panel menu 240
 - Settings (Networking) menu
 - control-panel menu 243
 - Settings (Print, SFP) menu
 - control-panel menu 139
 - Settings (Scan/Digital Send) menu (MFP)
 - control-panel menu 218
 - Settings menu
 - control-panel menu 211
 - sleep delay
 - operation 45
 - sleep mode
 - operation 45
 - sleep settings 45
 - solenoids
 - pickup, feed, and delivery system 80, 84
 - theory of operation 50
 - solve connectivity problems 436
 - solve performance problems 433
 - factors affecting print performance 433
 - print speeds 434
 - printer does not print 435
 - printer prints slowly 436
 - solve problems
 - circuit diagrams 195
 - configuration page 206
 - control panel 121, 274
 - control panel messages 285
 - copy-quality
 - troubleshooting 423
 - CPMD 285
 - defeating interlocks 161, 269
 - diagrams, block 167
 - disable cartridge check 164, 270
 - engine test 120, 268
 - external plug and port location diagrams 167
 - firmware upgrade 117
 - firmware, determine version 117
 - format disk and partial clean functions 262
 - image-quality
 - troubleshooting 408
 - individual component diagnostics 165
 - individual component test 166
 - internal test and information pages 206
 - LED diagnostics 162, 271
 - link speed 162, 271
 - major component locations diagrams 172
 - manual sensor test 166
 - output is curled or wrinkled 306, 405
 - paper does not feed automatically 306, 407
 - paper does not feed from Tray 2-X 306, 404
 - paper handling 306
 - paper path sensors test (not available for this printer) 166
 - paper path test 165
 - performance and connectivity troubleshooting 432
 - power-on checks 266
 - print-quality
 - troubleshooting 409
 - print/stop test 164
 - printed circuit assembly connector location diagrams 188
 - printer does not pick up paper 306
 - printer does not pick up paper or misfeeds 306
 - printer feeds incorrect page size 306, 403
 - printer picks up multiple sheets of paper 306
 - printer pulls from incorrect tray 306, 404
 - printer resets 260
 - printer will not duplex or duplexes incorrectly 306, 404
 - scanner tests (MFP) 163
 - sensors and switches diagrams 168
 - service menu 256
 - system diagnostics, control panel 274
 - timing chart diagrams 194
 - tray/bin manual sensor test 167
 - troubleshooting tools 120
 - solving
 - direct-connect problems 436
 - space requirements
 - printer 21
 - specifications
 - base printer 9
 - electrical and acoustic 21
 - printer 1
 - specifications, document feeder and scanner
 - printer information, configuration, and specifications 1
 - standby period 43
 - Stapler stacker
 - clear jams 397
 - stepping motors 49, 54
 - supplies
 - eject toner cartridges 443
 - remove imaging drums 448
 - remove toner cartridges 440, 445
 - remove toner cartridges (manually unlocked) 627
 - replacing imaging drums 449
 - replacing toner cartridges 441, 446
 - unlock manually the toner cartridges 625
 - supplies error (LaserJet) 10.WX.YZ error 305
 - supplies error (PageWide) 17.WX.YZ error 305
 - supplies status page 285
 - Support Tools menu
 - control-panel menu 249
 - switches
 - pickup, feed, and delivery system 80, 82
 - theory of operation 50
 - system error (LaserJet) 62.WX.YZ error 306
- T**
- terms and definitions
 - glossary 1193
 - tests
 - disable cartridge check 268
 - engine 268
 - theory of operation 41
 - 3-bin stapler-stacker other functions 102
 - 550-sheet paper feeder other functions 94
 - 550-sheet paper feeder paper path 91, 98
 - clutches 50
 - DC controller 50

- fans 50
- fuser control 60
- HCI other functions 97
- HCI paper path 94
- image formation
 - development 72
- image formation fusing 74
- image formation ITB
 - cleaning 74
- image formation laser-beam
 - exposure 71
- image formation pre-exposure 70
- image formation primary
 - charging 71
- image formation primary transfer 72
- image formation secondary
 - transfer 73
- image formation separation 73
- low-voltage power supply 56
- motors 50
- scanning and image
 - capture 42
- sensors 50
- solenoids 50
- switches 50
- toner cartridges 75
- theory of operations
 - 10/100/1000 functions 48
 - ADF / scanner 41
 - base printer 42
 - document feeder / scanner 41
 - fax functions 48
 - firmware 48
 - flash memory 48
 - I/O functions 48
 - input devices 91
 - input/output functions 48
 - Memory Enhancement technology 48
 - memory functions 48
 - NVRAM 48
 - output devices 98
 - printer, base 42
 - RAM 48
 - scanner / document feeder 41
 - USB functions 48
 - USB hosts functions 48
 - wireless functions 48
- timing chart, diagrams 194
- tip iv
- toner
 - image formation, use during 66, 68
- toner cartridge
 - developing unit engagement and disengagement 66
 - diagnostic test 268
 - functions 77
 - life detection 66
 - memory chip 66
 - presence detection 66
 - toner level detection 66
- toner cartridges 66
 - components 66
 - eject 443
 - error conditions 66
 - manually unlock 625
 - operations 66
 - remove 440, 445
 - remove (manually unlocked) 627
 - replacing 441, 446
 - theory of operation 75
- touchscreen blank, white, or dim (no image) 134
- touchscreen control panel 47
- touchscreen has an unresponsive zone 134, 135
- transfer processes 66, 68
- transfer unit
 - operation 66, 77
- tray
 - location assemblies, 550-sheet paper feeder 22
 - location assemblies, HCI paper feeder 23
- Tray 1
 - jams 306, 348
 - locating 4
 - locating SFP managed 3
 - locating SFP transactional 2
- tray 1 pickup roller
 - install 477
 - remove 473
- Tray 2
 - jams 306, 311, 348, 358
 - locating 4
 - locating SFP managed 3
 - locating SFP transactional 2
- Tray 3
 - locating 4
 - locating SFP managed 3
- Tray 4
 - jams 322, 329, 369, 376
 - locating 4
- tray motor error (LaserJet)
 - 60.WX.YZ error 306
- tray/bin, manual sensor test
 - solve problems 167
- trays
 - locating 4
 - locating SFP managed 3
 - locating SFP transactional 2
- trays, 5700
 - capacity 9
 - included 9
- trays, 5800
 - capacity 12
 - included 12
- trays, X55745
 - capacity 11
 - included 11
- trays, X57945
 - capacity 14
 - included 14
- troubleshooting
 - blank pages 433
 - check toner-cartridge status 413
 - checklist 113, 114
 - control panel 121, 274
 - defeating interlocks 161, 269
 - direct-connect problems 436
 - disable cartridge check 164, 270
 - engine test 120, 268
 - event log 295
 - flowchart 113, 115
 - format disk and partial clean functions 262
 - individual component test 166
 - jams 306, 307, 348, 349
 - LED diagnostics 162, 271
 - link speed 162, 271
 - manual sensor test 166
 - network problems 436
 - pages not printing 433
 - pages printing slowly 433
 - paper path sensors test (not available for this printer) 166
 - paper path test 165
 - print/stop test 164
 - printer resets 260
 - scanner tests (MFP) 163
 - service menu 256
 - supplies status page 285
 - system diagnostics, control panel 274

- tray/bin manual sensor
 - test 167
- USB cables 433
- wired network 436
- Troubleshooting (Maintenance)
 - menu
 - control-panel menu 252
- troubleshooting process
 - power on 266
 - power subsystem 266
 - power-on checks 266
- troubleshooting process overview
 - power on 266
- troubleshooting tools
 - control panel messages 285
 - copy-quality
 - troubleshooting 423
 - CPMD 285
 - determine the problem
 - source 113
 - diagrams, block 167
 - firmware upgrade 117
 - image-quality
 - troubleshooting 408
 - individual component
 - diagnostics 165
 - performance and connectivity
 - troubleshooting 432
 - print-quality
 - troubleshooting 409
 - solve problems 120

U

- unlock, manually
 - toner cartridges 625
- upgrade, product firmware 117
- USB Firmware Upgrade
 - (Maintenance) menu
 - control-panel menu 251
- USB functions
 - theory of operations 48
- USB hosts functions
 - theory of operations 48
- USB port
 - locating 4
 - locating SFP transactional 2
 - troubleshooting 433

V

- vertical lines, bands, or streaks
 - copy-quality problems 425

- views, document feeder and
 - scanner
 - printer information,
 - configuration, and
 - specifications 1
- voltage descriptions
 - low-voltage power supply 57

W

- waiting period 43
- warning iv
- Web-based Interactive Search
 - Engine (WISE)
 - HP internal users and Channel
 - partners v
- weight, printer 15, 16, 18
- whole-unit replacement
 - automatic document
 - feeder 537
 - integrated scanner assembly
 - (ISA) 541
 - remove and replace parts 537
- wireless functions
 - theory of operations 48
- WISE
 - email problems 432
 - fax problems 432
 - HP internal users and Channel
 - partners v
- WUR
 - automatic document
 - feeder 537
 - integrated scanner assembly
 - (ISA) 541
 - remove and replace parts 537