



LASERJET PRO 300 COLOR MFP
LASERJET PRO 400 COLOR MFP

Service Manual



M375
M475



HP LaserJet Pro 300 color MFP M375
and HP LaserJet Pro 400 color MFP
M475 Printers

Service Manual

Copyright and License

© 2012 Copyright Hewlett-Packard Development Company, L.P.

Reproduction, adaptation, or translation without prior written permission is prohibited, except as allowed under the copyright laws.

The information contained herein is subject to change without notice.

The only warranties for HP products and services are set forth in the express warranty statements accompanying such products and services. Nothing herein should be construed as constituting an additional warranty. HP shall not be liable for technical or editorial errors or omissions contained herein.

Part number: CE863-90966

Edition 1, 1/2012

Trademark Credits

Microsoft®, Windows®, Windows® XP, and Windows Vista® are U.S. registered trademarks of Microsoft Corporation.

ENERGY STAR and the ENERGY STAR mark are registered U.S. marks.

Conventions used in this guide

 **TIP:** Tips provide helpful hints or shortcuts.

 **NOTE:** Notes provide important information to explain a concept or to complete a task.

 **CAUTION:** Cautions indicate procedures that you should follow to avoid losing data or damaging the product.

 **WARNING!** Warnings alert you to specific procedures that you should follow to avoid personal injury, catastrophic loss of data, or extensive damage to the product.

Table of contents

1 Removal and replacement	1
Removal and replacement strategy	2
Introduction	2
Removal and replacement strategy	2
Electrostatic discharge	3
Required tools	3
Types of screws	4
Service approach	5
Before performing service	5
After performing service	5
Post-service tests	6
Test 1 (print-quality test)	6
Test 2 (copy-quality test)	6
Test 3 (fax-quality test; fax models only)	6
Parts removal order	7
Removal and replacement procedures	9
Rollers and pads	9
Transfer roller	9
Pickup roller (Tray 2 and Tray 3)	10
Separation roller (Trays 2 or 3)	13
Reinstall the separation roller	15
Document feeder pickup roller assembly	16
Pickup roller and separation pad (Tray 1)	17
Main assemblies	20
Print-cartridge drawer	20
DIMM cover	22
Right cover	23
Document feeder input tray	25
Scanner assembly	26
Right-front cover and power button	28
Rear-upper cover (duplex product)	30
Paper-feed guide assembly	31

Rear-door stopper and link caps (simplex product)	32
Rear door (simplex product)	33
Rear door (duplex product)	35
Rear cover and feed guide (simplex product)	37
Remove the rear cover and feed guide (simplex product)	37
Rear-lower cover and rear-door links (duplex product)	41
Remove the rear-lower cover and rear-door links (duplex product) ...	41
Rear-door rib assembly (duplex product)	45
Remove the rear-door rib assembly (duplex product)	45
Link guide	47
Control panel and right-arm mount	48
Reinstall the control panel and right-arm mount	49
Upper-cover assembly	51
Remove the upper-cover assembly	51
Reinstall the upper-cover assembly	53
Left cover	55
Remove the left cover	55
Reinstall the left cover	57
Front-door assembly	58
Remove the front-door assembly	58
Reinstall the front-door assembly	63
Intermediate transfer belt (ITB)	65
Reinstall the ITB	68
Drum motor (M1) and developer motor (M2)	69
Reinstall the drum motor (M1) and developer motor (M2)	74
Intermediate PCA	75
Formatter PCA and fax PCA	76
Remove the formatter PCA and fax PCA	76
Wireless PCA	79
DC controller PCA	80
Remove the DC controller PCA	81
Fuser-motor assembly	83
Remove the fuser-motor assembly	83
Reinstall the fuser-motor assembly	86
High-voltage power-supply PCA	87
Remove the high-voltage power-supply PCA	87
Color-misregistration sensor assembly	90
Remove the color-misregistration sensor assembly	90
Reinstall the color-misregistration sensor assembly	92
Fan (FM1)	94
USB PCA (fax/memory-card models)	96

Remove the USB PCA	96
Duplex-reverse drive assembly	97
Remove the duplex-reverse drive assembly	97
Fuser	100
Remove the fuser	101
Reinstall the fuser	106
Paper-delivery assembly	107
Remove the paper-delivery assembly	107
Tray cassettes and optional Tray 3 assembly	110
2 Solve problems	111
Solve problems checklist	112
Menu map	113
Troubleshooting process	114
Pretroubleshooting checklist	114
Power-on checks	115
Troubleshooting tools	116
Component diagnostics	116
LED diagnostics	116
Network LEDs (network models only)	116
Control panel LEDs	116
Memory card LED (memory-card models only)	116
Component tests	117
Control-panel tests	117
Diagrams	118
Plug/jack locations	118
Location of connectors	119
DC controller PCA	119
Location of major components	121
Major components	121
Motors and fans	123
Rollers	124
PCAs	125
Optional 250-sheet cassette	126
General timing diagram	127
General circuit diagram	128
CPU/ASIC diagrams	129
HVT/Toner EMP diagram	131
Driver PCA diagram	132
Duplexer PCA diagram	133
FSR diagram	134

Internal print quality test pages	135
Print quality troubleshooting page	135
Print quality assessment page	135
Print the Configuration Page	135
Service page	135
Clean the paper path	136
Print-quality troubleshooting tools	136
Repetitive image defects	136
Calibrate the product	137
Control panel menus	137
Setup Menu	137
HP Web Services menu	138
Reports menu	139
Quick Forms menu	140
Fax Setup menu	141
System Setup menu	144
Service menu	149
Network Setup menu	151
Function specific menus	152
Copy menu	152
Fax menu	154
Scan menu	156
USB Flash Drive	157
Interpret control panel messages	157
Control panel message types	157
Control panel messages	157
10.100X Supply Memory Error	157
49 Error, Turn off then on	158
50.x Fuser Error	158
52 Scanner Error	158
57 Fan Error, Turn off then on	159
79 Error Turn off then on	159
Black Cartridge Low	159
Black in wrong position	160
Black Very Low	160
Canceled scan. Clear document	160
Canceled send. Clear document	160
Communication error.	161
Cyan Cartridge Low	161
Cyan in wrong position	161
Cyan Very Low	161

Device error, press OK	162
Device is busy. Try again later	162
Document feeder door is open.	162
Document feeder jam. Clear and reload.	162
Document feeder mispick. Reload	163
Door open	163
Engine Communication Error	163
Engine error. Press OK to continue.	163
Fax is busy. Canceled send.	164
Fax is busy. Redial pending.	164
Fax receive error.	164
Fax Send error.	165
Fax storage is full. Canceling the fax receive.	165
Fax storage is full. Canceling the fax send.	166
Fit to Page on flatbed only	166
Genuine HP supply installed	166
Incompatible <color>	166
Install [color] cartridge	166
Invalid driver Press OK	167
Invalid entry	167
Jam in (area), Open door and clear jam	167
Jam in Tray 1, Clear jam and then press OK	167
Load paper	167
Load Tray 1 <TYPE> <SIZE>, Press OK to use available media	167
Load Tray 1, <PLAIN> <SIZE> / Cleaning mode, OK to start	168
Load tray <X> Press [OK] for available media	168
Magenta Cartridge Low	168
Magenta in wrong position	168
Magenta Very Low	168
Manual Duplex Load Tray 1, Press OK	169
Manual feed <SIZE> <TYPE>, Press OK to use available media	169
Memory is low. Press OK.	169
Memory is low. Try again later	169
Memory low Only 1 copy made. Press OK to continue.	170
Misprint, Press OK	170
No dial tone.	170
No fax answer. Canceled send.	170
No fax answer. Redial pending.	171
No fax detected.	171
Print failure, press OK. If error repeats, turn off then on.	172
Remove shipping lock from <color> cartridge	172

Remove shipping locks from cartridges	172
Replace [color]	172
Scanner error #, Turn off then on	172
Scanner reserved for PC scan	173
Scanning error Cannot connect	173
Settings cleared	173
Unexpected size in tray # Load <size> Press [OK]	173
Unsupported <color> Press [OK] to continue	174
Used <color> in use	174
Used [color] installed, to accept press OK	174
Used supplies in use	174
Yellow Cartridge Low	174
Yellow in wrong position	175
Yellow Very Low	175
Event-log messages	175
Print the event log	176
Event log messages	176
Clear jams	180
Common causes of jams	180
Jam locations	180
Clear jams from the document feeder	181
Clear jams in Tray 1	183
Clear jams in Tray 2	186
Clear jams in the fuser area	187
Clear jams in the output bin	188
Clear jams in the duplexer (duplexing models only)	189
Solve paper-handling problems	191
The product picks up multiple sheets of paper	191
The product does not pick up paper	191
Solve image-quality problems	192
Print quality examples	192
Color image defects	196
Clean the product	198
Clean the pickup and separation rollers	198
Clean the paper path	198
Clean the paper path from the product control panel	198
Clean the scanner glass strip and platen	199
Clean the document feeder pickup rollers and separation pad	200
Clean the touch screen	201
Solve performance problems	202
Factors affecting print performance	202

Print speeds	203
The product does not print or it prints slowly	204
The product does not print	204
The product prints slowly	205
Solve product connectivity problems	206
Solve direct-connect problems	206
Solve network problems	206
Poor physical connection	206
The computer is using the incorrect IP address for the product	206
The computer is unable to communicate with the product	207
The product is using incorrect link and duplex settings for the network	207
New software programs might be causing compatibility problems	207
The computer or workstation might be set up incorrectly	207
The product is disabled, or other network settings are incorrect	207
Solve wireless network problems	207
Wireless connectivity checklist	208
The control panel displays the message: The wireless feature on this product has been turned off	208
The product does not print after the wireless configuration completes	208
The product does not print, and the computer has a third-party firewall installed	209
The wireless connection does not work after moving the wireless router or product	209
Cannot connect more computers to the wireless product	209
The wireless product loses communication when connected to a VPN	210
The network does not appear in the wireless networks list	210
The wireless network is not functioning	210
Service mode functions	211
Service menu	211
Service menu settings	211
Secondary service menu	211
Open the secondary service menu	212
Secondary service menu structure	212
Product resets	213
Restore the factory-set defaults	213
NVRAM initialization	213
Solve fax problems	215
Fax troubleshooting checklist	215
Fax error messages	217
Communication error.	217
Document feeder door is open. Canceled fax.	217

Fax is busy. Canceled send.	217
Fax is busy. Redial pending.	218
Fax receive error.	218
Fax Send error.	219
Fax storage is full. Canceling the fax receive.	219
Fax storage is full. Canceling the fax receive.	219
Fax storage is full. Canceling the fax send.	220
No dial tone.	220
No fax answer. Canceled send.	220
No fax answer. Redial pending.	221
No fax detected.	221
Troubleshoot fax codes and trace reports	223
View and interpret fax error codes	223
Fax trace report	224
Fax logs and reports	224
Print all fax reports	225
Print individual fax reports	225
Set the fax error report	226
Change error correction and fax speed	226
Set the fax-error-correction mode	226
Change the fax speed	227
Solve problems sending faxes	227
An error message displays on the control panel	227
The Communication error. message displays	227
No dial tone.	228
The Fax is busy. message displays	229
The No fax answer. message displays	229
Document feeder paper jam	230
The Fax storage is full. message displays	230
Scanner error	230
The control panel displays a Ready message with no attempt to send the fax .	230
The control panel displays the message "Storing page 1" and does not progress beyond that message	231
Faxes can be received, but not sent	231
Unable to use fax functions from the control panel	231
Unable to use speed dials	232
Unable to use group dials	232
Receive a recorded error message from the phone company when trying to send a fax	232
Unable to send a fax when a phone is connected to the product	233
Solve problems receiving faxes	234

The fax does not respond	234
The fax has a dedicated phone line	234
An answering machine is connected to the product	234
A telephone handset is connected to the product	235
The Answer Mode setting is set to the Manual setting	235
Voice mail is available on the fax line	235
The product is connected to a DSL phone service	236
The product uses a fax over IP or VoIP phone service	236
An error message displays on the control panel	237
The No fax detected. message displays	237
The Communication error. message displays	237
The Fax storage is full. message displays	238
The Fax is busy. message displays	238
A fax is received but does not print	239
The Private Receive feature is on	239
Sender receives a busy signal	239
A handset is connected to the product	239
A phone line splitter is being used	239
No dial tone	239
Cannot send or receive a fax on a PBX line	239
Solve general fax problems	240
Faxes are sending slowly	240
Fax quality is poor	241
Fax cuts off or prints on two pages	241
Product updates	243

3 Parts and diagrams 245

Order parts by authorized service providers	246
Orderable parts	246
Whole unit replacement	246
Related documentation and software	247
Supplies and accessories	248
Service parts	248
How to use the parts lists and diagrams	249
Scanner and document feeder main assemblies	250
Covers	252
Internal assemblies	254
Internal assemblies (1 of 5)	254
Internal assemblies (2 of 5)	256
Internal components (3 of 5)	258
Internal assemblies (4 of 5)	260

Internal assemblies (5 of 5)	262
Internal assemblies (simplex models)	264
Internal assemblies (duplex models)	266
PCAs	268
Input device(s)	270
250-sheet paper feeder (optional Tray 3)	270
Alphabetical parts list	272
Numerical parts list	275

Appendix A Service and support 279

Hewlett-Packard limited warranty statement	280
HP's Premium Protection Warranty: LaserJet print cartridge limited warranty statement	282
Data stored on the print cartridge	283
End User License Agreement	284
OpenSSL	287
Customer support	288

Appendix B Product specifications 289

Physical specifications	290
Power consumption, electrical specifications, and acoustic emissions	290
Environmental specifications	290

Appendix C Regulatory information 291

FCC regulations	292
Environmental product stewardship program	292
Protecting the environment	292
Ozone production	292
Power consumption	292
Toner consumption	293
Paper use	293
Plastics	293
HP LaserJet print supplies	293
Return and recycling instructions	293
United States and Puerto Rico	293
Multiple returns (more than one cartridge)	294
Single returns	294
Shipping	294
Non-U.S. returns	294
Paper	295
Material restrictions	295

Disposal of waste equipment by users in private households in the European Union	295
Chemical substances	296
Material Safety Data Sheet (MSDS)	296
For more information	297
Declaration of conformity	298
Declaration of conformity (wireless models)	300
Certificate of volatility	302
Types of memory	302
Volatile memory	302
Non-volatile memory	302
Safety statements	303
Laser safety	303
Canadian DOC regulations	303
VCCI statement (Japan)	303
Power cord instructions	303
Power cord statement (Japan)	303
EMC statement (Korea)	304
Laser statement for Finland	304
GS statement (Germany)	305
Substances Table (China)	305
Restriction on Hazardous Substances statement (Turkey)	305
Restriction on Hazardous Substances statement (Ukraine)	305
Additional statements for telecom (fax) products	306
EU Statement for Telecom Operation	306
New Zealand Telecom Statements	306
Additional FCC statement for telecom products (US)	306
Telephone Consumer Protection Act (US)	307
Industry Canada CS-03 requirements	307
Vietnam Telecom wired/wireless marking for ICTQC Type approved products	308
Additional statements for wireless products	309
FCC compliance statement—United States	309
Australia statement	309
Brazil ANATEL statement	309
Canadian statements	309
European Union regulatory notice	309
Notice for use in France	310
Notice for use in Russia	310
Korean statement	310
Taiwan statement	311
Vietnam Telecom wired/wireless marking for ICTQC Type approved products	311

List of tables

Table 1-1	Common fasteners	4
Table 2-1	Major components	121
Table 2-2	Solenoid, sensors, and motors	123
Table 2-3	Rollers	124
Table 2-4	PCAs	125
Table 2-5	Optional 250-sheet cassette	126
Table 2-6	Repetitive image defects	136
Table 2-7	Event-log messages	176
Table 2-8	Event-log-only messages	178
Table 2-9	Secondary service menu	212
Table 3-1	Order parts, accessories, and supplies	246
Table 3-2	Pro 300 Color MFP M375nw	246
Table 3-3	Pro 400 Color MFP M475dn	246
Table 3-4	Pro 400 Color M475dw	246
Table 3-5	Related documentation and software	247
Table 3-6	Scanner and document feeder main assemblies	251
Table 3-7	Covers ^{1,2}	253
Table 3-8	Internal assemblies (1 of 7)	255
Table 3-9	Internal assemblies (2 of 7)	257
Table 3-10	Internal assemblies (3 of 7)	259
Table 3-11	Internal assemblies (4 of 7)	261
Table 3-12	Internal assemblies (5 of 7)	263
Table 3-13	Internal assemblies (simplex models)	265
Table 3-14	Internal assemblies (duplex models)	267
Table 3-15	PCAs	269
Table 3-16	250-sheet paper feeder (optional Tray 3)	271
Table 3-17	Alphabetical parts list	272
Table 3-18	Numerical parts list	275
Table B-1	Physical specifications	290
Table B-2	Environmental specifications ¹	290

List of figures

Figure 1-1	Phillips and pozidrive screwdriver comparison	3
Figure 1-2	Parts removal order (1 of 2)	7
Figure 1-3	Parts removal order (2 of 2)	8
Figure 1-4	Remove the pickup roller (1 of 2)	11
Figure 1-5	Remove the pickup roller (2 of 2)	12
Figure 1-6	Remove the pickup roller (1 of 3)	13
Figure 1-7	Remove the separation roller (2 of 3)	14
Figure 1-8	Remove the separation roller (3 of 3)	14
Figure 1-9	Reinstall the separation roller	15
Figure 1-10	Remove the document feeder pickup roller assembly (1 of 2)	16
Figure 1-11	Remove the document feeder pickup roller assembly (2 of 2)	16
Figure 1-12	Remove the Tray 1 pickup roller (1 of 3)	18
Figure 1-13	Remove the Tray 1 pickup roller (2 of 3)	18
Figure 1-14	Remove the Tray 1 pickup roller (3 of 3)	19
Figure 1-15	Remove the Tray 1 separation pad	19
Figure 1-16	Remove the print-cartridge drawer (1 of 3)	20
Figure 1-17	Remove the print-cartridge drawer (2 of 3)	20
Figure 1-18	Remove the print-cartridge drawer (3 of 3)	21
Figure 1-19	Remove the DIMM cover	22
Figure 1-20	Remove the right cover (1 of 3)	23
Figure 1-21	Remove the right cover (2 of 3)	23
Figure 1-22	Remove the right cover (3 of 3)	24
Figure 1-23	Remove the document feeder input tray (2 of 2)	25
Figure 1-24	Remove the document feeder input tray (2 of 2)	25
Figure 1-25	Remove the scanner assembly (1 of 4)	26
Figure 1-26	Remove the scanner assembly (2 of 4)	26
Figure 1-27	Remove the scanner assembly (3 of 4)	27
Figure 1-28	Remove the scanner assembly (4 of 4)	27
Figure 1-29	Remove the rear-upper cover (1 of 2)	30
Figure 1-30	Remove the rear-upper cover (2 of 2)	30
Figure 1-31	Remove the feed assembly (1 of 2)	31
Figure 1-32	Remove the feed assembly (2 of 2)	31

Figure 1-33	Remove the Rear-door stopper and link caps (simplex product) (1 of 2)	32
Figure 1-34	Remove the Rear-door stopper and link cap (simplex product) (2 of 2)	32
Figure 1-35	Remove the rear door (simplex product) (1 of 4)	33
Figure 1-36	Remove the rear door (simplex product) (2 of 4)	33
Figure 1-37	Remove the rear door (simplex product) (3 of 4)	34
Figure 1-38	Remove the rear door (simplex product) (4 of 4)	34
Figure 1-39	Remove the rear door (duplex product) (1 of 4)	35
Figure 1-40	Remove the rear door (duplex product) (2 of 4)	35
Figure 1-41	Remove the rear door (duplex product) (3 of 4)	36
Figure 1-42	Remove the rear door (duplex product) (4 of 4)	36
Figure 1-43	Remove the rear cover and feed guide (simplex product) (1 of 6)	37
Figure 1-44	Remove the rear cover and feed guide (simplex product) (2 of 6)	38
Figure 1-45	Remove the rear cover and feed guide (simplex product) (3 of 6)	38
Figure 1-46	Remove the rear cover and feed guide (simplex product) (4 of 6)	39
Figure 1-47	Remove the rear cover and feed guide (simplex product) (5 of 6)	40
Figure 1-48	Remove the rear cover and feed guide (simplex product) (6 of 6)	40
Figure 1-49	Remove the rear- lower cover and rear-door links (duplex product) (1 of 6)	41
Figure 1-50	Remove the rear-lower cover and rear-door links (duplex product) (2 of 6)	42
Figure 1-51	Remove the rear-lower cover and rear-door links (duplex product) (3 of 6)	42
Figure 1-52	Remove the rear-lower cover and link-guides (duplex product) (4 of 6)	43
Figure 1-53	Remove the rear-lower cover and link-guides (duplex product) (5 of 6)	43
Figure 1-54	Remove the rear-lower cover and rear-door links (duplex product) (6 of 6)	44
Figure 1-55	Remove the rear-door rib assembly (duplex product) (1 of 3)	45
Figure 1-56	Remove the rear-door rib assembly (duplex product) (2 of 3)	46
Figure 1-57	Remove the rear-door rib assembly (duplex product) (3 of 3)	46
Figure 1-58	Replace the link guide (simplex products)	47
Figure 1-59	Replace the link guide (duplex products)	47
Figure 1-60	Remove the control panel and right-arm mount (1 of 3)	48
Figure 1-61	Remove the control panel and right-arm mount (2 of 3)	48
Figure 1-62	Remove the control panel and right-arm mount (3 of 3)	49
Figure 1-63	Reinstall the control panel and right-arm mount (1 of 2)	49
Figure 1-64	Reinstall the control panel and right-arm mount (2 of 2)	50
Figure 1-65	Remove the upper-cover assembly (1 of 3)	51
Figure 1-66	Remove the upper-cover assembly (2 of 3)	52
Figure 1-67	Remove the upper-cover assembly (3 of 3)	52
Figure 1-68	Reinstall the upper-cover assembly (1 of 3)	53
Figure 1-69	Reinstall the upper-cover assembly (2 of 3)	53
Figure 1-70	Reinstall the upper-cover assembly (3 of 3)	54
Figure 1-71	Remove the left cover (1 of 3)	55
Figure 1-72	Remove the left cover (2 of 3)	56
Figure 1-73	Remove the left cover (3 of 3)	56

Figure 1-74	Reinstall the left cover (1 of 2)	57
Figure 1-75	Reinstall the left cover (2 of 2)	57
Figure 1-76	Remove the front-door assembly (1 of 10)	58
Figure 1-77	Remove the front-door assembly (2 of 10)	59
Figure 1-78	Remove the front-door assembly (3 of 10)	59
Figure 1-79	Remove the front-door assembly (4 of 10)	60
Figure 1-80	Remove the front-door assembly (5 of 10)	60
Figure 1-81	Remove the front-door assembly (6 of 10)	61
Figure 1-82	Remove the front-door assembly (7 of 10)	61
Figure 1-83	Remove the front-door assembly (8 of 10)	62
Figure 1-84	Remove the front-door assembly (9 of 10)	62
Figure 1-85	Remove the front-door assembly (10 of 10)	63
Figure 1-86	Reinstall the front-door assembly (1 of 2)	63
Figure 1-87	Reinstall the front-door assembly (2 of 2)	64
Figure 1-88	Remove the ITB (1 of 6)	65
Figure 1-89	Remove the ITB (2 of 6)	65
Figure 1-90	Remove the ITB (3 of 6)	66
Figure 1-91	Remove the ITB (4 of 6)	66
Figure 1-92	Remove the ITB (5 of 6)	67
Figure 1-93	Remove the ITB (6 of 6)	67
Figure 1-94	Reinstall the ITB	68
Figure 1-95	Remove motor M1 and motor M2 (1 of 6)	69
Figure 1-96	Remove motor M1 and motor M2 (2 of 6)	70
Figure 1-97	Remove motor M1 and motor M2 (3 of 6)	71
Figure 1-98	Remove motor M1 and motor M2 (4 of 6)	72
Figure 1-99	Remove motor M1 and motor M2 (5 of 6)	72
Figure 1-100	Remove motor M1 and motor M2 (6 of 6)	73
Figure 1-101	Reinstall the motor M1 and motor M2 wire-harness retainer	74
Figure 1-102	Remove the Intermediate PCA (1 of 2)	75
Figure 1-103	Remove the Intermediate PCA (2 of 2)	75
Figure 1-104	Remove the formatter (1 of 4; base model)	77
Figure 1-105	Remove the formatter (2 of 4; fax model)	77
Figure 1-106	Remove the formatter (3 of 4; base model)	78
Figure 1-107	Remove the formatter (4 of 4; fax model)	78
Figure 1-108	Remove the wirelss PCA (1 of 2)	79
Figure 1-109	Remove the wirelss PCA (2 of 2)	79
Figure 1-110	Remove the DC controller PCA (1 of 2)	81
Figure 1-111	Remove the DC controller PCA (2 of 2)	82
Figure 1-112	Remove the fuser-motor assembly (1 of 6)	83
Figure 1-113	Remove the fuser-motor assembly (2 of 6)	84
Figure 1-114	Remove the fuser-motor assembly (3 of 6)	84

Figure 1-115	Remove the fuser-motor assembly (4 of 6)	85
Figure 1-116	Remove the fuser-motor assembly (5 of 6)	85
Figure 1-117	Remove the fuser-motor assembly (6 of 6)	86
Figure 1-118	Reinstall the fuser-motor assembly	86
Figure 1-119	Remove the high-voltage power-supply PCA (1 of 5)	87
Figure 1-120	Remove the high-voltage power-supply PCA (2 of 5)	88
Figure 1-121	Remove the high-voltage power-supply PCA (3 of 5)	88
Figure 1-122	Remove the high-voltage power-supply PCA (4 of 5)	89
Figure 1-123	Remove the high-voltage power-supply PCA (5 of 5)	89
Figure 1-124	Remove the color-misregistration sensor assembly PCA (1 of 4)	90
Figure 1-125	Remove the color-misregistration sensor assembly PCA (2 of 4)	91
Figure 1-126	Remove the color-misregistration sensor assembly PCA (3 of 4)	91
Figure 1-127	Remove the color-misregistration sensor assembly PCA (4 of 4)	92
Figure 1-128	Reinstall the color-misregistration sensor assembly PCA (1 of 2)	92
Figure 1-129	Reinstall the color-misregistration sensor assembly PCA (2 of 2)	93
Figure 1-130	Remove the fan (FM1) (1 of 2)	94
Figure 1-131	Remove the fan (FM1) (2 of 2)	95
Figure 1-132	Remove the USB PCA (fax/memory-card models)	96
Figure 1-133	Remove the duplex-reverse drive assembly (1 of 4)	97
Figure 1-134	Remove the duplex-reverse drive assembly (2 of 4)	98
Figure 1-135	Remove the duplex-reverse drive assembly (3 of 4)	98
Figure 1-136	Remove the duplex-reverse drive assembly (4 of 4)	99
Figure 1-137	Remove the fuser (1 of 8)	101
Figure 1-138	Remove the fuser (2 of 8)	102
Figure 1-139	Remove the fuser (3 of 8)	102
Figure 1-140	Remove the fuser (4 of 8)	103
Figure 1-141	Remove the fuser (5 of 8)	103
Figure 1-142	Remove the fuser (6 of 8)	104
Figure 1-143	Remove the fuser (7 of 8)	104
Figure 1-144	Remove the fuser (8 of 8)	105
Figure 1-145	Reinstall the fuser	106
Figure 1-146	Remove the paper-delivery assembly (1 of 4)	107
Figure 1-147	Remove the paper-delivery assembly (2 of 4)	108
Figure 1-148	Remove the paper-delivery assembly (3 of 4)	108
Figure 1-149	Remove the paper-delivery assembly (4 of 4)	109
Figure 1-150	Remove the tray cassettes and optional Tray 3 assembly (1 of 2)	110
Figure 1-151	Remove the tray cassettes and optional Tray 3 assembly (2 of 2)	110
Figure 2-1	Control-panel test	117
Figure 2-2	DC controller connectors	119
Figure 2-3	Major components	121
Figure 2-4	Motors and fans	123

Figure 2-5	Rollers	124
Figure 2-6	PCAs	125
Figure 2-7	Optional 250-sheet cassette	126
Figure 2-8	Timing diagram	127
Figure 2-9	Circuit diagram	128
Figure 2-10	CPU diagram	129
Figure 2-11	ASIC diagram	130
Figure 2-12	HVT/Toner EMP diagram	131
Figure 2-13	Driver PCA diagram	132
Figure 2-14	Duplexer PCA diagram	133
Figure 2-15	FSR diagram	134
Figure 2-16	Control-panel test	175
Figure 2-17	Control-panel test	211
Figure 3-1	Scanner and document feeder main assemblies	250
Figure 3-2	External panels and covers	252
Figure 3-3	Internal assemblies (1 of 7)	254
Figure 3-4	Internal assemblies (2 of 2)	256
Figure 3-5	Internal assemblies (3 of 7)	258
Figure 3-6	Internal assemblies (4 of 7)	260
Figure 3-7	Internal assemblies (5 of 7)	262
Figure 3-8	Internal assemblies (simplex models)	264
Figure 3-9	Internal assemblies (duplex models)	266
Figure 3-10	PCAs	268
Figure 3-11	250-sheet paper feeder (optional Tray 3)	270

1 Removal and replacement

- [Removal and replacement strategy](#)
- [Service approach](#)
- [Removal and replacement procedures](#)

Removal and replacement strategy

This chapter discusses the removal and replacement of field replaceable units (FRUs) only.

Replacing FRUs is generally the reverse of removal. Occasionally, notes and tips are included to provide directions for difficult or critical replacement procedures.

HP does *not* support repairing individual subassemblies or problem solving at the component level.

Note the length, diameter, color, type, and location of each screw. Be sure to return each screw to its original location during reassembly.

Incorrectly routed or loose wire harnesses can interfere with other internal components and can become damaged or broken. Frayed or pinched harness wires can be difficult to locate. When replacing wire harnesses, always use the provided wire loops, lance points, or wire-harness guides.

Introduction

This chapter describes the removal and replacement of field-replaceable units (FRUs) only.

Replacing FRUs is generally the reverse of removal. Occasionally, notes and tips are included to provide directions for difficult or critical replacement procedures.

HP does *not* support repairing individual subassemblies or troubleshooting to the component level.

Note the length, diameter, color, type, and location of each screw. Be sure to return each screw to its original location during reassembly.

Incorrectly routed or loose wire harnesses can interfere with other internal components and can become damaged or broken. Frayed or pinched harness wires can be difficult to find. When replacing wire harnesses, always use the provided wire loops, lance points, or wire-harness guides and retainers.

Removal and replacement strategy

 **WARNING!** Turn the product off, wait 5 seconds, and then remove the power cord before attempting to service the product. If this warning is not followed, severe injury can result, in addition to damage to the product. The power must be on for certain functional checks during troubleshooting. However, disconnect the power supply during parts removal.

Never operate or service the product with the protective cover removed from the laser/scanner assembly. The reflected beam, although invisible, can damage your eyes.



The sheet-metal parts can have sharp edges. Be careful when handling sheet-metal parts.

 **CAUTION:** Do not bend or fold the flat flexible cables (FFCs) during removal or installation. Also, do not straighten pre-folds in the FFCs. You *must* fully seat all FFCs in their connectors. Failure to fully seat an FFC into a connector can cause a short circuit in a PCA.

 **NOTE:** To install a self-tapping screw, first turn it counterclockwise to align it with the existing thread pattern, and then carefully turn it clockwise to tighten. Do not overtighten. If a self-tapping screw-hole becomes stripped, repair the screw-hole or replace the affected assembly.

 **TIP:** For clarity, some photos in this chapter show components removed that would not be removed to service the product. If necessary, remove the components listed at the beginning of a procedure before proceeding to service the product.

Electrostatic discharge

 **CAUTION:**  Some parts are sensitive to electrostatic discharge (ESD). Look for the ESD reminder when removing product parts. Always perform service work at an ESD-protected workstation or mat, or use an ESD strap. If an ESD workstation, mat, or strap is not available, ground yourself by touching the sheet-metal chassis *before* touching an ESD-sensitive part.

Protect the ESD-sensitive parts by placing them in ESD pouches when they are out of the product.

Required tools

- Number 2 Phillips screwdriver with a magnetic tip and a 152-mm (6-inch) shaft length
- Precision slotted screwdriver with a 1 mm (0.04 in) blade width

 **NOTE:** This fine-point tool is required to release the front door pins. The width of the blade must be 2 mm (0.08 in) or less to be able to drive the door pins out of the mounting holes.

- Small, slotted screwdriver
- Needle-nose pliers
- Snap-ring pliers
- ESD mat (if one is available)
- Penlight (optional)

 **CAUTION:** Always use a Phillips screwdriver (callout 1). Do not use a pozidrive screwdriver (callout 2) or any motorized screwdriver. These can damage screws or screw threads.

Figure 1-1 Phillips and pozidrive screwdriver comparison





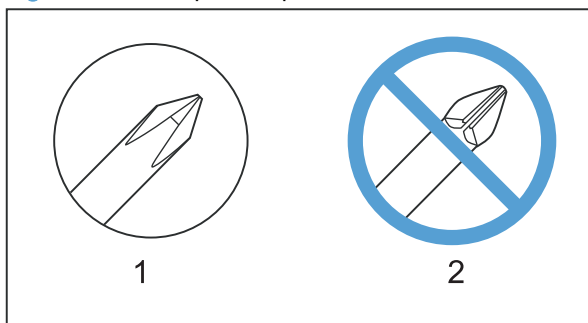

Types of screws

⚠ WARNING! Make sure that components are replaced with the correct screw type. Using the incorrect screw (for example, substituting a long screw for the correct shorter screw) can cause damage to the product or interfere with product operation. Do not intermix screws that are removed from one component by using the screws that are removed from another component.

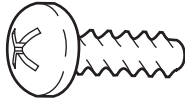
📝 NOTE: The screw illustrations in the following table are for reference only. Screws might vary in size and appearance from those shown in this table.

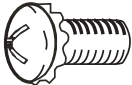
Table 1-1 Common fasteners

Example	Description	Size	Part Number
	Screw, with washer	M3X8	XA9-1420-000CN
		M4X6	XB2-7400-605CN
		M4X12	XA9-1422-000CN
	Screw, tapping, truss head	M4X10	XB4-7401-005CN
		M4X15	XB4-7401-609CN
	Screw, TP	M3X4	XB6-7300-405CN
		M3X6	XB6-7300-605CN
	Screw, D	M3X6	XA9-1670-000CN
		M3X8	XA9-1671-000CN
	Screw, machine	M3X4	XB6-7300-409CN
	Screw, machine, flat head	M3X4	XA9-0679-000CN
	Screw, machine, flanged pan head	M3X6	XB6-7300-805CN

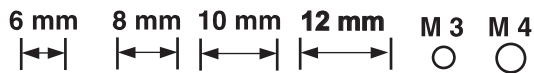

Service approach

Before performing service

- Remove all media from the product.
- Turn off the power using the power switch.
- Unplug the power cable and interface cable(s).
- Place the product on an ESD mat (if one is available). If an ESD workstation or mat is not available, ground yourself by touching the sheet-metal chassis *before* touching an ESD-sensitive part.
- Remove the toner cartridges.
- Remove the tray 2 cassette.

After performing service

- Connect the power cable.
- Reinstall the toner cartridges.
- Reinstall the tray 2 cassette.

Post-service tests

After service has been completed, perform the following tests to verify that the repair or replacement was successful.

Test 1 (print-quality test)

1. Verify that you have completed the necessary reassembly steps.
2. Make sure that the input tray contains clean, unmarked paper.
3. Attach the power cable and interface cable, and then turn on the product.
4. Verify that the expected start-up sounds occur.
5. Print a configuration page, and then verify that the expected printing sounds occur.
6. Print a demo page, and then verify that the print quality is as expected.
7. Send a print job from the host computer, and then verify that the output meets expectations.
8. If necessary, restore any customer-specified settings.
9. Clean the outside of the product by using a damp cloth.

Test 2 (copy-quality test)

1. Verify that you have completed the necessary reassembly steps.
2. Make sure that the input tray contains clean, unmarked paper.
3. Attach the power cable, and then turn on the product.
4. Verify that the expected start-up sounds occur.
5. Print a configuration page, and then verify that the expected printing sounds occur.
6. Place the configuration page in the document feeder.
7. Print a copy job, and then verify the results.
8. Clean the outside of the product by using a damp cloth.

Test 3 (fax-quality test; fax models only)

1. Place the configuration page in the document feeder.
2. Type a valid fax number and send the fax job.
3. Verify that the send quality and receive quality meet expectations.

Parts removal order

Figure 1-2 Parts removal order (1 of 2)

Component	Remove	Remove	Remove	Remove	Remove	Remove	Remove
Pickup roller (Tray 2 and Tray 3)	Tray 2						
Separation roller (Trays 2 or 3)	Tray 2						
Document feeder pickup roller assembly							
Pickup roller and separation part (Tray 1)	Tray 2						
Print-cartridge drawer							
DIMM cover							
Right cover							
Document feeder input tray							
Scanner assembly	Right cover						
Right-front cover and power button	Right cover						
Rear-upper cover (duplex product)							
Paper-feed guide assembly							
Rear door stopper and link caps (simplex product)							
Rear door (simplex product)							
Rear door (duplex product)							
Rear cover and feed guide (simplex product)	Right cover	Rear door stopper	Rear door				
Rear-lower cover and Rear door links (duplex product)	Right cover	Rear door		Rear-upper cover			
Rear door rib assembly (duplex product)	Right cover	Rear door		Rear-upper cover	Rear-lower cover		
Link guide							
Control panel and right-arm mount	Right cover						
Upper-cover assembly (Simplex products)	Right cover	Scanner assembly	Rear door	Rear cover	Control panel and right-arm mount	Right-front cover and power button	
Upper-cover assembly (Duplex products)	Right cover	Scanner assembly	Rear-upper cover	Control panel and right-arm mount	Right-front cover and power button		
Left cover (Simplex products)	Right cover	Scanner assembly	Rear door	Rear cover	Upper-cover assembly		
Left cover (Duplex products)	Right cover	Scanner assembly	Rear-lower cover	Upper-cover assembly			
Front-door assembly (Simplex products)	Print-cartridge drawer	Right cover	Scanner assembly	Rear door	Rear cover	Upper-cover assembly	Left cover
Front-door assembly (Duplex products)	Print-cartridge drawer	Right cover	Scanner assembly	Rear-upper cover	Rear door	Rear-lower cover	Upper-cover assembly
Intermediate transfer belt (ITB) drawer							Left cover
Drum motor (M1) and developer	Right cover						Right-front cover
Intermediate PCA	Right cover						
Formatter PCA and fax PCA	Right cover						

Figure 1-3 Parts removal order (2 of 2)

Component	Remove	Remove	Remove	Remove	Remove	Remove	Remove
Pickup roller (Tray 2 and Tray 3)	Tray 2						
Separation roller (Trays 2 or 3)	Tray 2						
Document feeder pickup roller assembly							
Pickup roller and separation pad (Tray 1)	Tray 2						
Print-cartridge drawer							
DIMM cover							
Right cover							
Document feeder input tray							
Scanner assembly	Right cover						
Right-front cover and power button	Right cover						
Rear-upper cover (duplex product)							
Paper-feed guide assembly							
Rear door stopper and link caps (simplex product)							
Rear door (simplex product)							
Rear door (duplex product)							
Rear cover and feed guide (simplex product)	Right cover	Rear door stopper	Rear door				
Rear-lower cover and Rear door links (duplex product)	Right cover	Rear door		Rear-upper cover			
Rear door rib assembly (duplex product)	Right cover	Rear door		Rear-upper cover	Rear-lower cover		
Link guide							
Control panel and right-arm mount	Right cover						
Upper-cover assembly (Simplex products)	Right cover	Scanner assembly	Rear door	Rear cover	Control panel and right-arm mount	Right-front cover and power button	
Upper-cover assembly (Duplex products)	Right cover	Scanner assembly	Rear-upper cover	Control panel and right-arm mount	Right-front cover and power button		
Left cover (Simplex products)	Right cover	Scanner assembly	Rear door	Rear cover	Upper-cover assembly		
Left cover (Duplex products)	Right cover	Scanner assembly	Rear-lower cover	Upper-cover assembly			
Front-door assembly (Simplex products)	Print-cartridge drawer	Right cover	Scanner assembly	Rear door	Rear cover	Upper-cover assembly	Left cover
Front-door assembly (Duplex products)	Print-cartridge drawer	Right cover	Scanner assembly	Rear-upper cover	Rear door	Rear-lower cover	Upper-cover assembly
Intermediate transfer belt (ITB) drawer							
Drum motor (M1) and developer motor (M2)	Right cover						
Intermediate PCA	Right cover						
Formatter PCA and fax PCA	Right cover						

Removal and replacement procedures

Rollers and pads

Transfer roller

The transfer roller is a component of the paper-feed assembly and not available as an individual FRU. To remove and replace the transfer roller, install a replacement paper-feed guide assembly. See [Paper-feed guide assembly on page 31](#).

Pickup roller (Tray 2 and Tray 3)

The roller must be rotated into the service position to remove it.

 **CAUTION:** Avoid touching the spongy roller surface unless you are going to replace the roller. Skin oils on the roller can cause paper pickup problems.

1. Turn the product on, and wait for it to reach the Ready state. Perform the following steps to rotate the roller to the service position.

 **NOTE:** If you have removed [Tray 2](#) to service the product, reinstall the tray before turning the power on.

 **TIP:** The following steps rotate the engine pickup roller *and* the [Tray 1](#) pickup roller into the service position.

- a. Simultaneously press the Left Arrow ◀ button and the Cancel ✕ button to open the [2ndry Service](#) menu.
- b. Touch the [Pick Roller](#) item.
Touch the [OK](#) button to confirm that you want the roller to rotate.
- c. Listen for the roller to rotate. When the roller is done rotating, unplug the power cable and then place the power button in the off position.

 **CAUTION:** It is important to place the power button in the off position **after** unplugging the power cable so that the product power does not come on immediately when the power cable is plugged in again.

- d. Remove [Tray 2](#).
- e. Perform the remaining steps in this procedure to remove the roller. After replacing the roller, plug the power cable into the product, and then use the power button to turn the power on.

2. Carefully raise the front of the product.

⚠ WARNING! Do not place the product face-up resting on the rear cover and rear door. Excess toner might enter the laser/scanner assembly and contaminate the mirrors, causing print-quality problems. The laser/scanner is not a FRU. If the laser/scanner mirrors are contaminated, the entire product must be replaced.

⚠ CAUTION: The document feeder and scanner cover are not captive and can open suddenly when the product is placed front-side face up. Always support the document feeder and scanner cover before placing the product front-side face up.

Do not lift the product grasping the front door and **Tray 2** cavity.

📝 NOTE: The roller is located inside the tray cavity.

Figure 1-4 Remove the pickup roller (1 of 2)



3. Use a pair of snap-ring pliers to release two locking tabs and remove the pickup roller.

CAUTION: Do not touch the spongy roller surface unless you are going to replace the roller. Skin oils on the roller can cause paper pickup problems.

NOTE: If you do not have a pair of snap-ring pliers, use your fingers to release the tabs.

Figure 1-5 Remove the pickup roller (2 of 2)

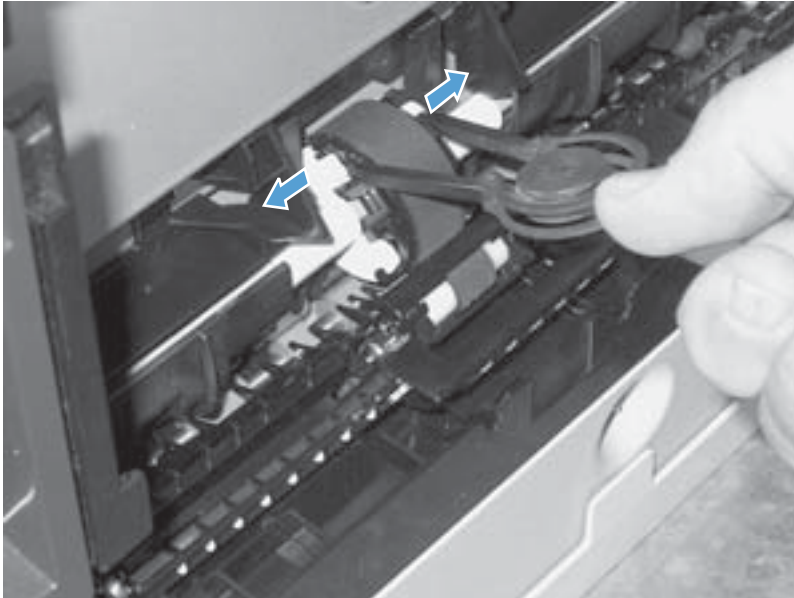

Separation roller (Trays 2 or 3)

⚠ CAUTION: Avoid touching the spongy roller surface unless you are going to replace the roller. Skin oils on the roller can cause paper pickup problems.

1. Remove Tray 2 (if installed), and then carefully raise the front of the product.

⚠ WARNING! Do not place the product face-up resting on the rear cover and rear door. Excess toner might enter the laser/scanner assembly and contaminate the mirrors, causing print-quality problems. The laser/scanner is not a FRU. If the laser/scanner mirrors are contaminated, the entire product must be replaced.

⚠ CAUTION: Do not lift the product grasping the front door and Tray 2 cavity.

📄 NOTE: The roller is located inside the tray cavity.

Figure 1-6 Remove the pickup roller (1 of 3)



2. Release the two roller-cover locking pins, and then remove the cover.

Figure 1-7 Remove the separation roller (2 of 3)

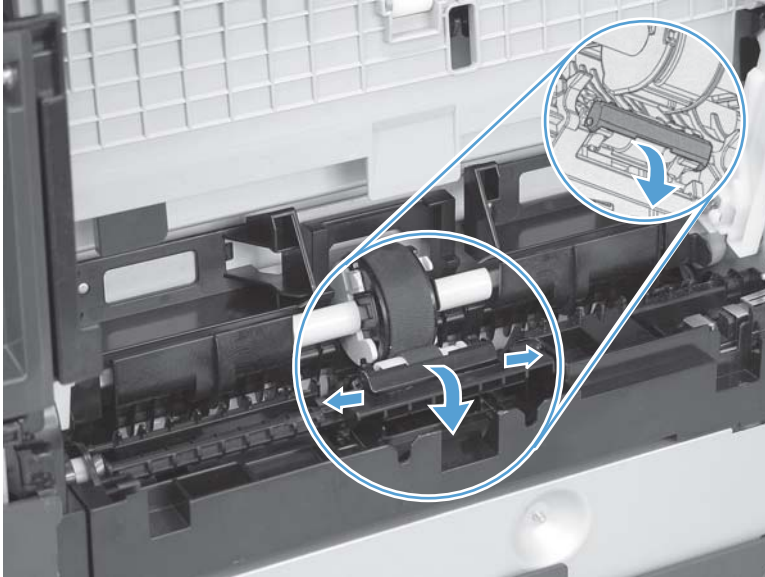

3. Release the roller holder to release the roller-locking pins. Remove the separation roller.

Figure 1-8 Remove the separation roller (3 of 3)

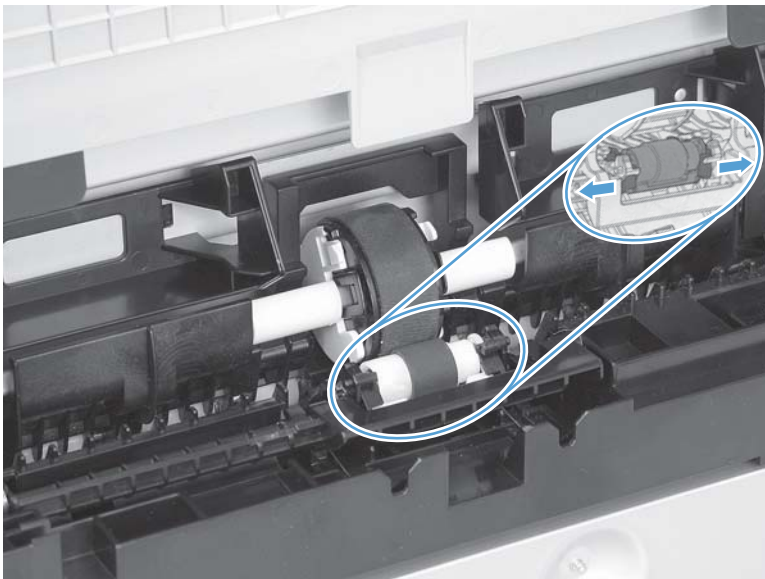

Reinstall the separation roller

1. Install the replacement separation roller.
2. Reinstall the separation roller cover on the locking pins, and then rotate it toward the roller until you hear it snap into place.

Figure 1-9 Reinstall the separation roller

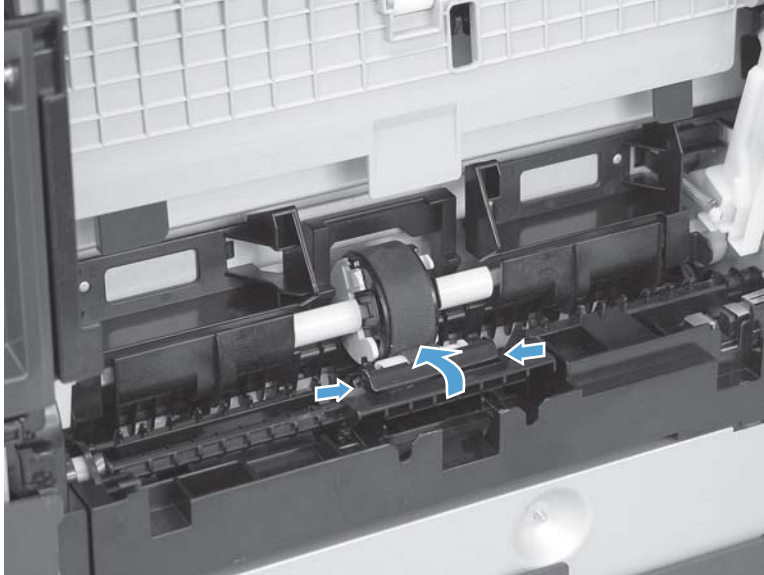

Document feeder pickup roller assembly

 **IMPORTANT:** The document feeder pickup roller must be shipped in the down position.

1. Open the document feeder cover.
2. Disconnect one spring (callout 1).

Figure 1-10 Remove the document feeder pickup roller assembly (1 of 2)

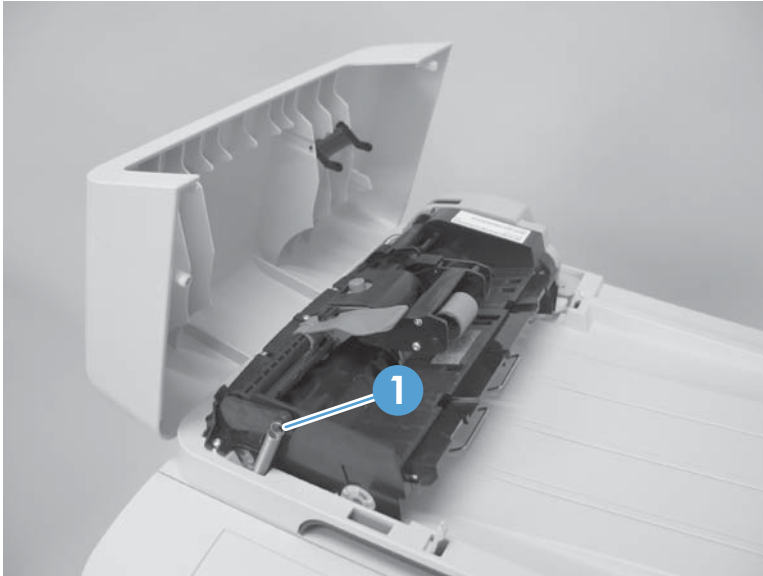

3. Lift up on the end of the assembly, and then slide it toward the control panel to remove it.

Figure 1-11 Remove the document feeder pickup roller assembly (2 of 2)

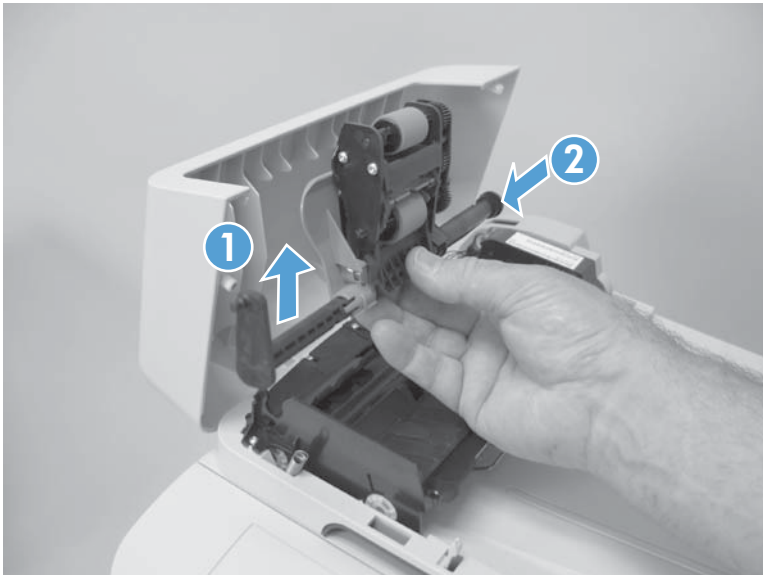

Pickup roller and separation pad (Tray 1)

The roller must be rotated into the service position to remove it.

 **CAUTION:** Avoid touching the spongy roller surface unless you are going to replace the roller. Skin oils on the roller can cause paper pickup problems.

 **NOTE:** Always replace the separation pad when replacing the pickup roller.

1. Turn the product on, and wait for it to reach the Ready state. Perform the following steps to rotate the roller to the service position.

 **NOTE:** If you have removed **Tray 2** to service the product, reinstall the tray before turning the power on.

 **TIP:** The following steps rotate the engine pickup roller *and* the **Tray 1** pickup roller into the service position.

- a. Open the **2ndry Service** menu by pressing the Left Arrow ◀ ◀ button and the Cancel ✕ button simultaneously.
- b. Use the arrow buttons to select **Pick Roller**, and then press the **OK** button.
Touch the **OK** button again to confirm that you want the roller to rotate.
- c. Listen for the roller to rotate. When the roller is done rotating, unplug the power cable and then place the power button in the off position.

 **NOTE:** Failure to unplug the product at this point will result in the roller being in the incorrect position for the repair procedure.

 **CAUTION:** It is important to place the power button in the off position **after** unplugging the power cable so that the product power does not come on immediately when the power cable is plugged in again.

- d. Remove **Tray 2**.
- e. Perform the remaining steps in this procedure to remove the roller. After replacing the roller, plug the power cable into the product, and then use the power button to turn the power on.

2. Lower the Tray 1 paper pickup assembly by pushing down on the edges of the assembly.

Figure 1-12 Remove the Tray 1 pickup roller (1 of 3)

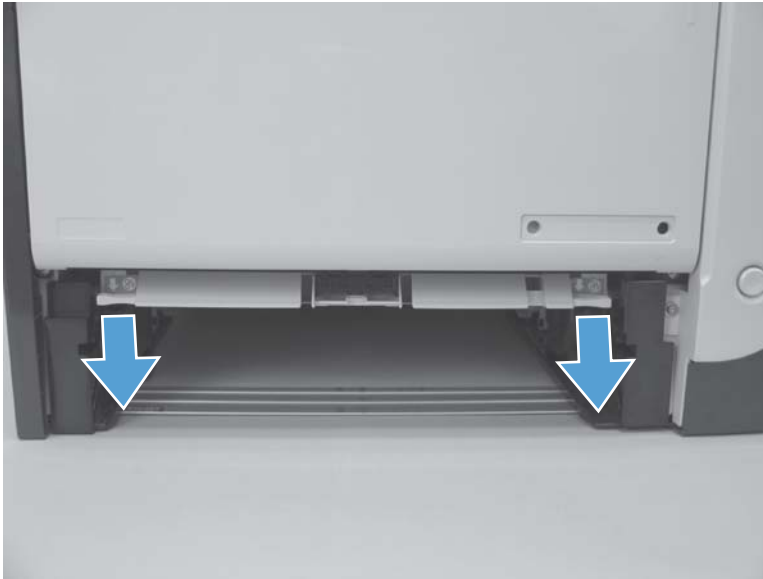

3. Carefully raise the front of the product.

⚠ WARNING! Do not place the product face-up resting on the rear cover and rear door. Excess toner might enter the laser/scanner assembly and contaminate the mirrors, causing print-quality problems. The laser/scanner is not a FRU. If the laser/scanner mirrors are contaminated, the entire product must be replaced.

⚠ CAUTION: The document feeder and scanner cover are not captive and can open suddenly when the product is placed front-side face up. Always support the document feeder and scanner cover before placing the product front-side face up.

CAUTION: Do not lift the product grasping the front door and Tray 2 cavity.

Figure 1-13 Remove the Tray 1 pickup roller (2 of 3)



4. Release two tabs, and then rotate the roller away from the product to remove it.

Figure 1-14 Remove the Tray 1 pickup roller (3 of 3)

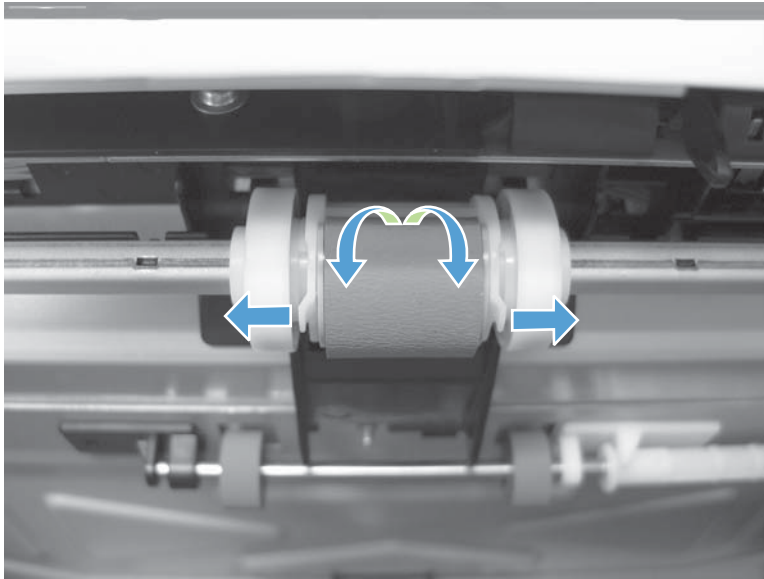

5. Release the retainer tabs, and then remove the separation pad from the base.

 **NOTE:** The separation pad base can easily be dislodged when the pad is removed. If the base is dislodged, do not loose the spring under the base (it is not captive).

Figure 1-15 Remove the Tray 1 separation pad



Main assemblies

Print-cartridge drawer

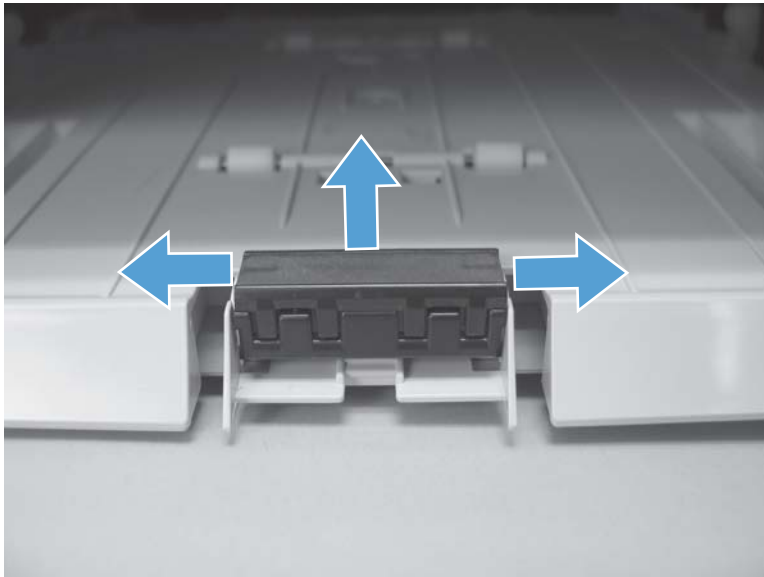
1. Open the front door.
2. Partially pull out the print-cartridge drawer, and then use a small flat blade screwdriver to release one tab (callout 1) on the left side of the product.

Figure 1-16 Remove the print-cartridge drawer (1 of 3)

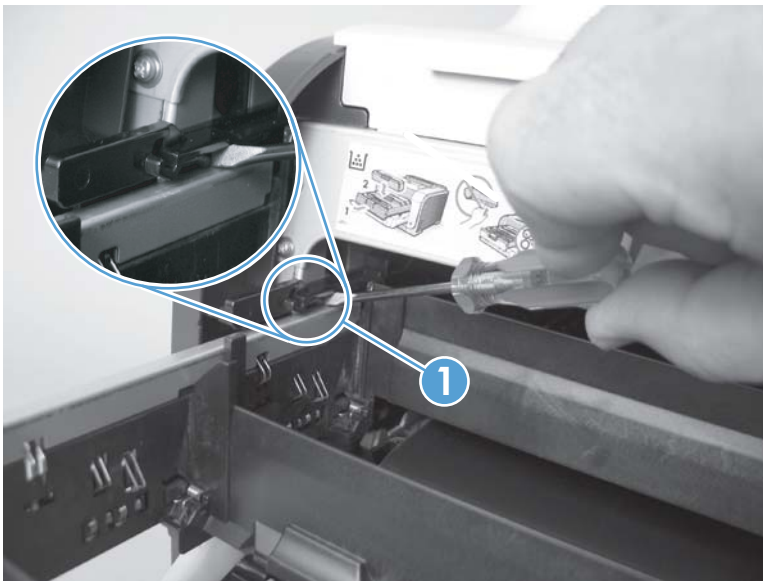

3. Carefully rotate the print-cartridge drawer toward the right side of the product to release it.

Figure 1-17 Remove the print-cartridge drawer (2 of 3)



4. Pull the print-cartridge drawer out of the product to remove it.

Figure 1-18 Remove the print-cartridge drawer (3 of 3)



DIMM cover

1. Open the DIMM cover.
2. Lift the cover up to release it, and then remove the cover.

Figure 1-19 Remove the DIMM cover



Right cover

 **NOTE:** For duplex products, open the rear door.

1. Remove three screws (callout 1).

Figure 1-20 Remove the right cover (1 of 3)

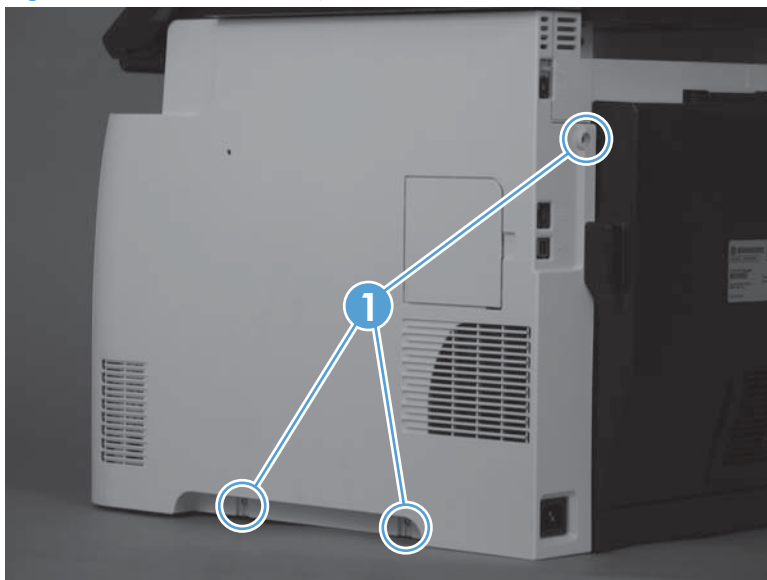

2. Slide the right cover toward the back of the product.

Figure 1-21 Remove the right cover (2 of 3)



3. Remove the right cover.

Figure 1-22 Remove the right cover (3 of 3)



Document feeder input tray

- ▲ Open the document feeder top cover.

Figure 1-23 Remove the document feeder input tray (2 of 2)



Rotate the document feeder input tray up to release it, and then remove the tray.

TIP: Hold down the scanner lid while removing the tray. It might take considerable pressure to release the tray from the document feeder.

Figure 1-24 Remove the document feeder input tray (2 of 2)

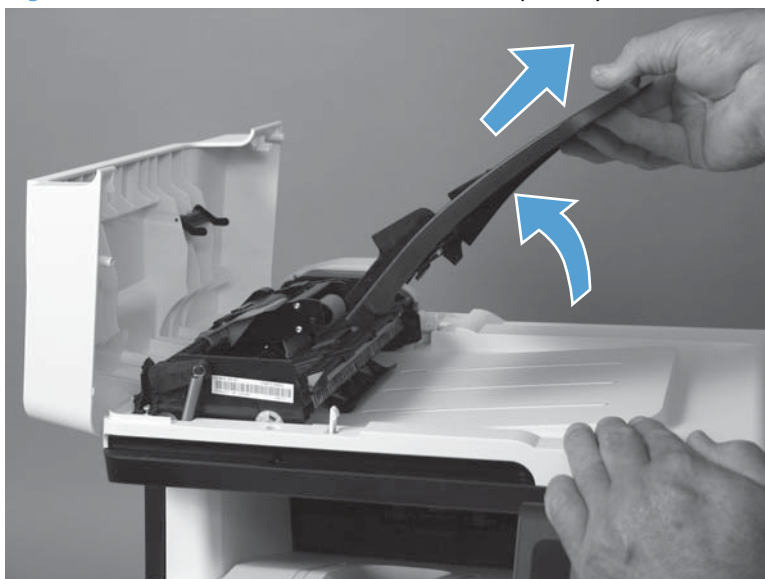

Scanner assembly

1. Remove the right cover. See [Right cover on page 23](#).
2. Disconnect one FFCs (callout 1), two connectors (callout 2), and one ground-wire connector (callout 3).

Figure 1-25 Remove the scanner assembly (1 of 4)

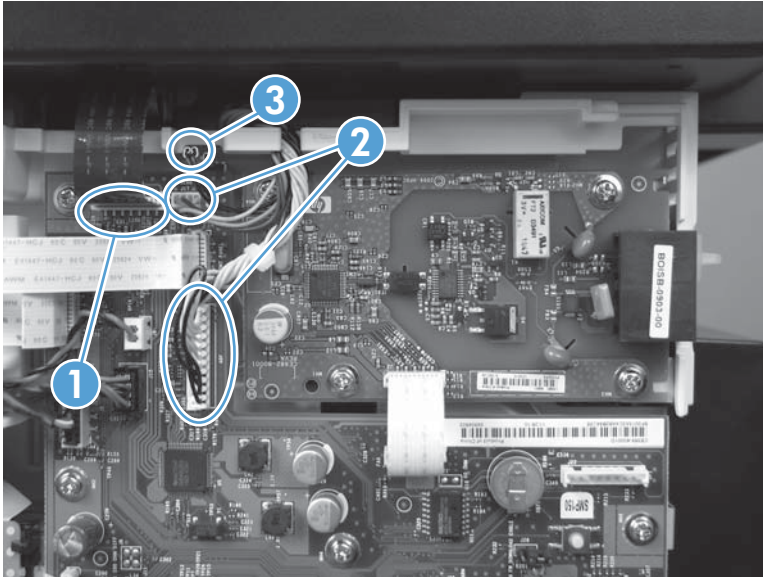

3. Remove four screws (callout 1).

Figure 1-26 Remove the scanner assembly (2 of 4)

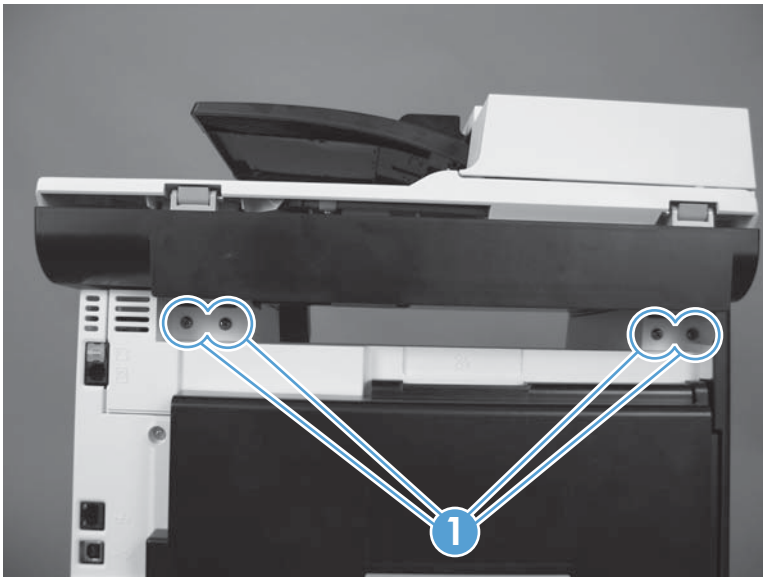

4. Slightly lift up the back of the scanner, and then slide it toward the front of the product.

Figure 1-27 Remove the scanner assembly (3 of 4)

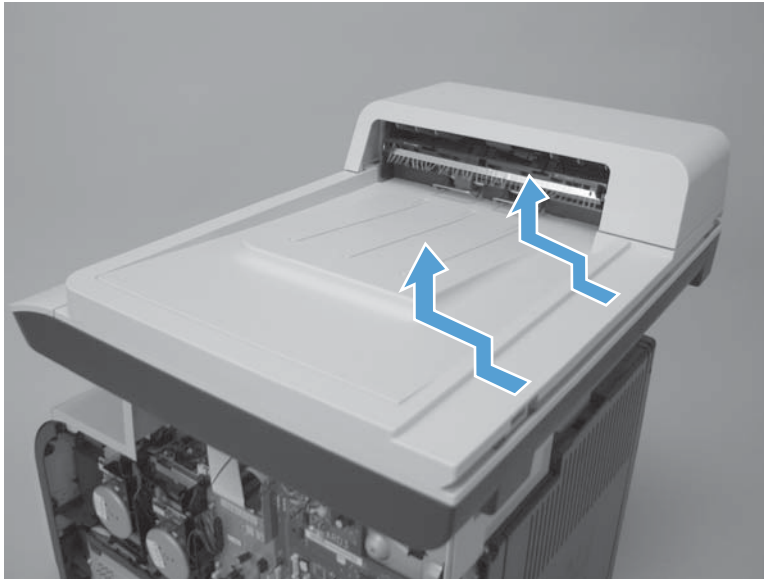

5. Lift the scanner straight up and off of the product.

Figure 1-28 Remove the scanner assembly (4 of 4)

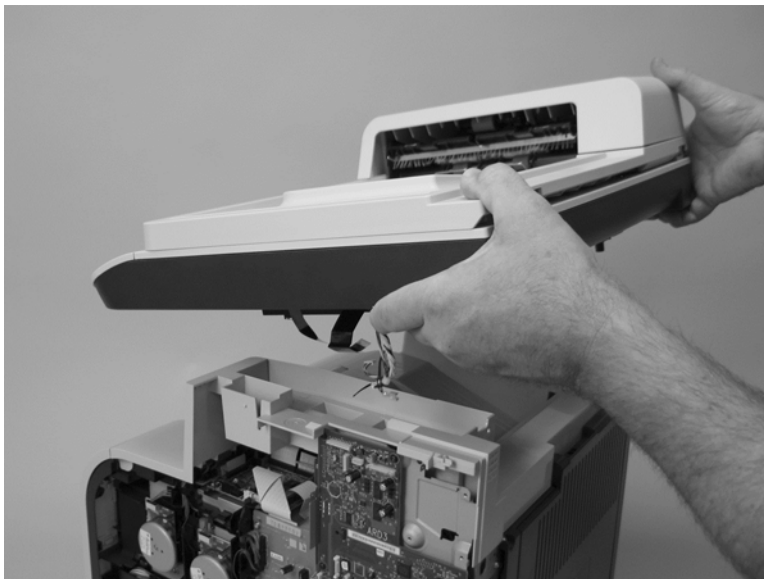

Right-front cover and power button

1. Remove the right cover. See [Right cover on page 23](#).
2. Disconnect the USB PCA connector from the formatter PCA (callout 1), and then release the wire from the retainer (callout 2).

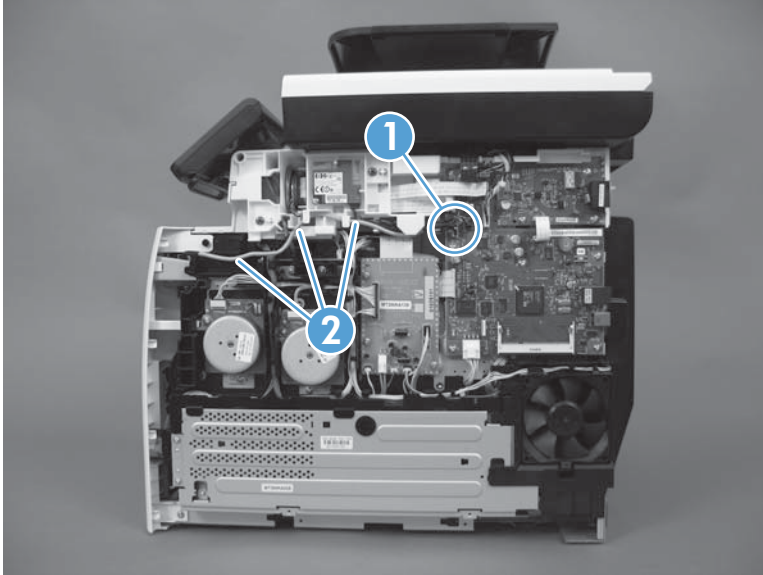

3. Open the front door, and then remove three screws (callout 1).

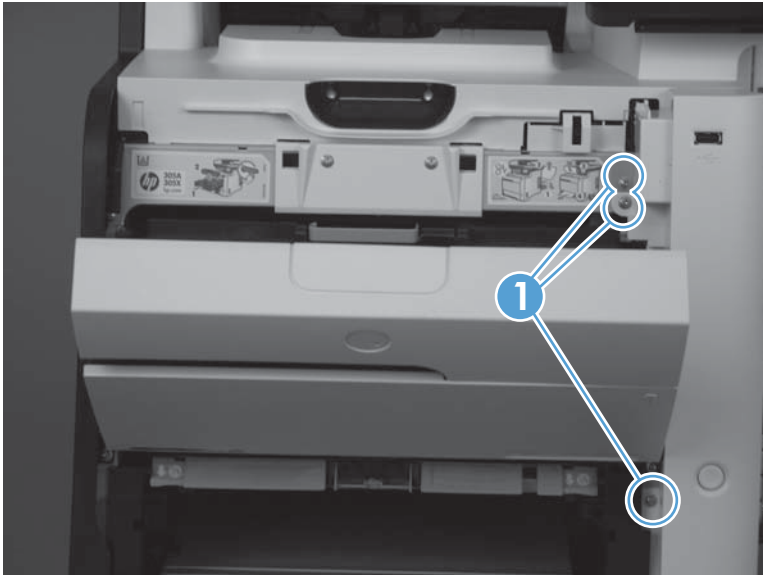

4. Remove one screw and retainer (callout 1), and then remove two screws (callout 2).

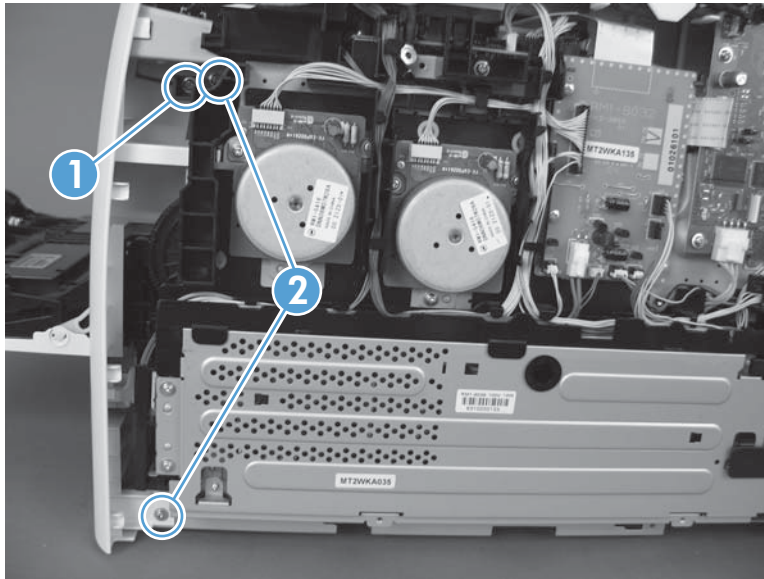

5. Slide the cover slightly toward the right to release three tabs (callout 1), and then remove the cover.

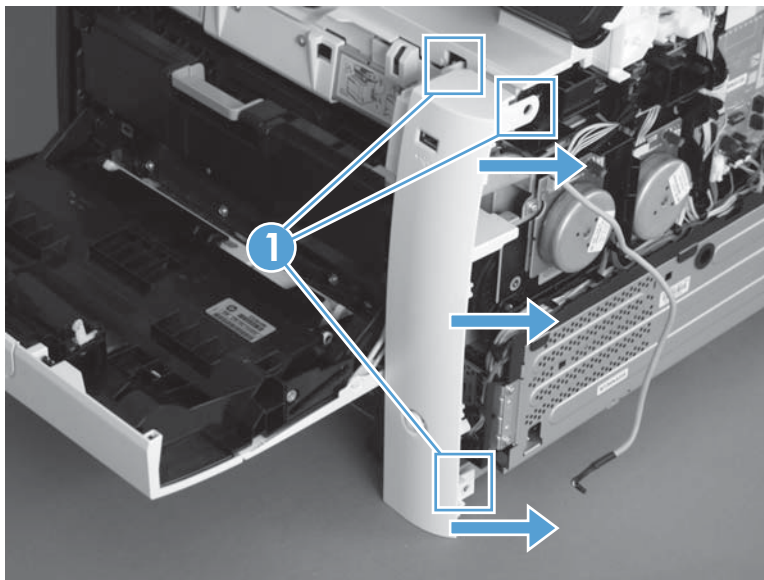

Rear-upper cover (duplex product)

1. Open the rear cover.
2. Remove two screws (callout 1).

Figure 1-29 Remove the rear-upper cover (1 of 2)

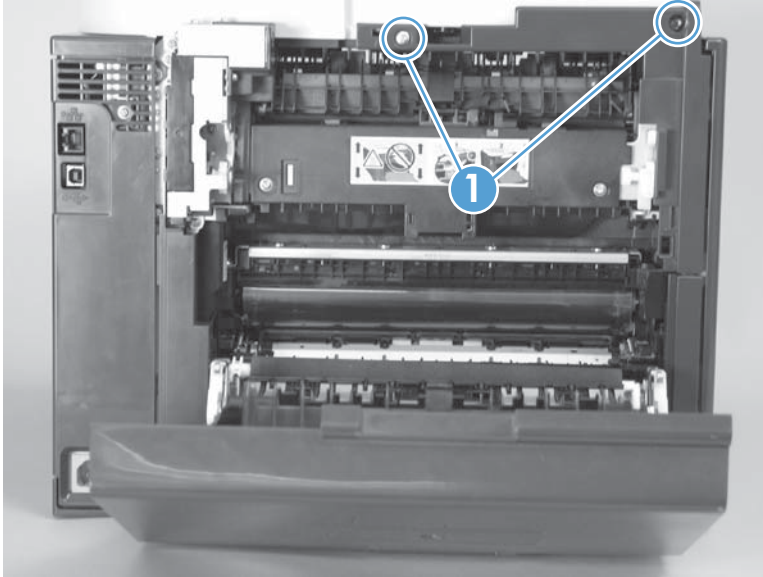

3. Slightly separate the cover from the product, and then rotate the cover down and then away from the product to remove it.

Figure 1-30 Remove the rear-upper cover (2 of 2)

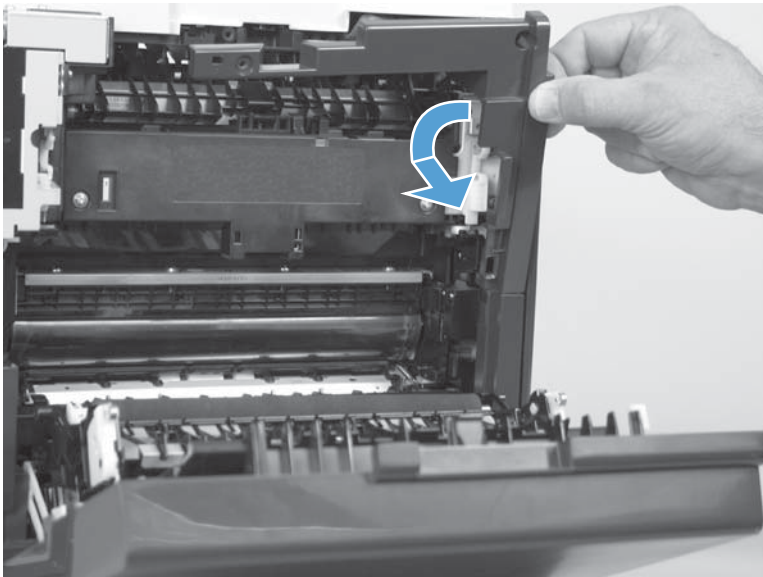

Paper-feed guide assembly

 **NOTE:** A simplex model is shown below. Duplex and simplex models use the same paper-feed guide assembly, and the removal and replacement processes are identical.

1. Release one screw (callout 1).

Figure 1-31 Remove the feed assembly (1 of 2)

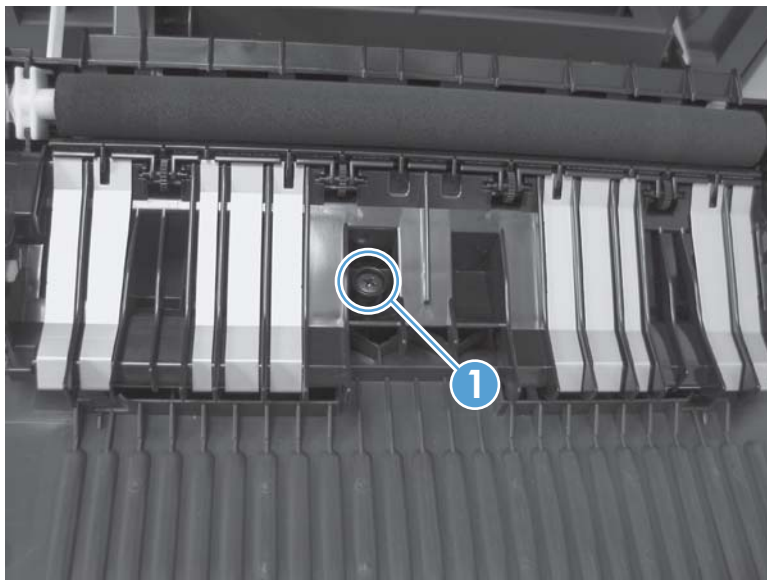

2. Remove the feed assembly.

 **TIP:** When the feed assembly is correctly reinstalled, the assembly will be able to move in relation to the door. It should not be secured firmly to the door.

Figure 1-32 Remove the feed assembly (2 of 2)



Rear-door stopper and link caps (simplex product)

1. Open the rear door.
2. Use a pair of needle-nose pliers to release two tabs, and then remove the link cap.

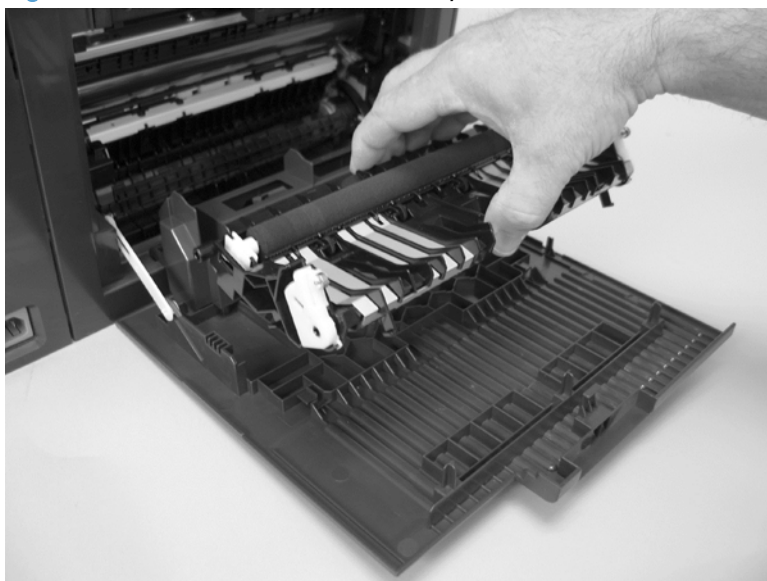
Figure 1-33 Remove the Rear-door stopper and link caps (simplex product) (1 of 2)



3. Use a small flat blade screwdriver to carefully remove the remaining link cap, and then remove the Rear-door stopper.

Figure 1-34 Remove the Rear-door stopper and link cap (simplex product) (2 of 2)



Rear door (simplex product)

1. Open the rear door.
2. Use a pair of needle-nose pliers to release two tabs, and then remove the link cap.

Figure 1-35 Remove the rear door (simplex product) (1 of 4)



3. Remove four screws (callout 1).

Figure 1-36 Remove the rear door (simplex product) (2 of 4)

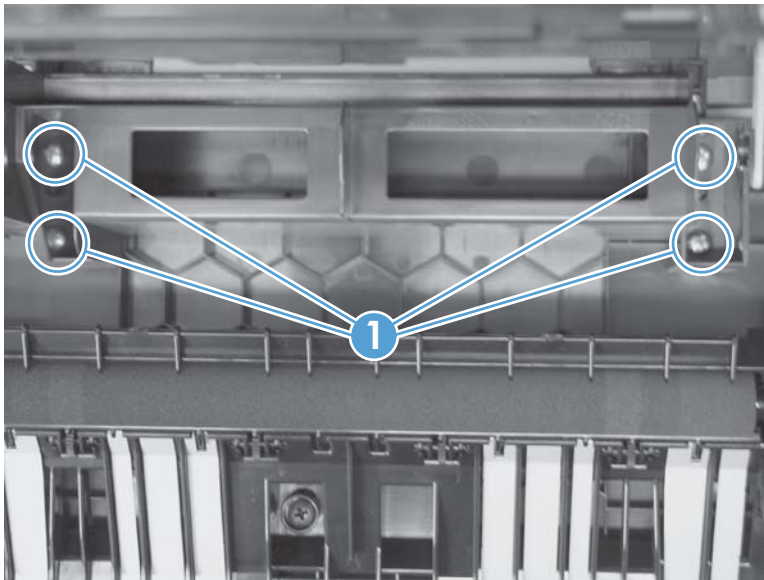

4. Before you remove the rear door, take note of the alignment pins on the door.

Figure 1-37 Remove the rear door (simplex product) (3 of 4)

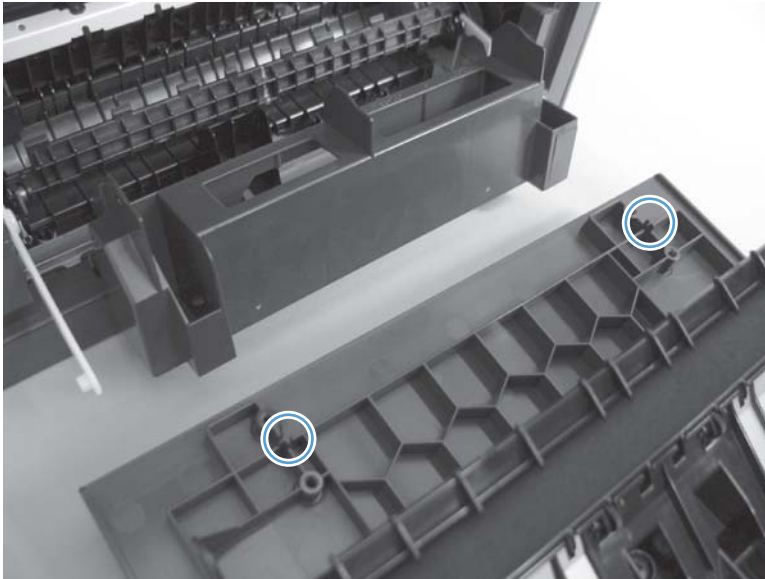

5. Remove the rear door.

Figure 1-38 Remove the rear door (simplex product) (4 of 4)

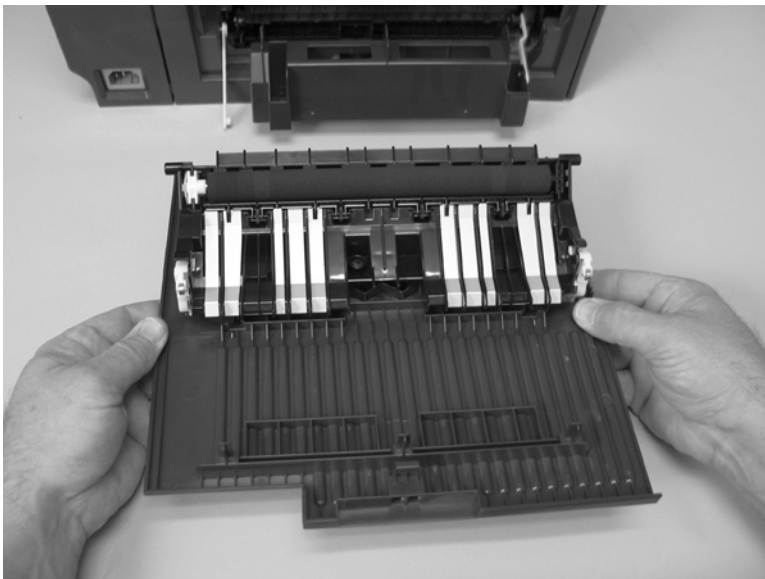

Rear door (duplex product)

1. Open the rear door.
2. Use the green handle to close the duplex-feed assembly.

Figure 1-39 Remove the rear door (duplex product) (1 of 4)

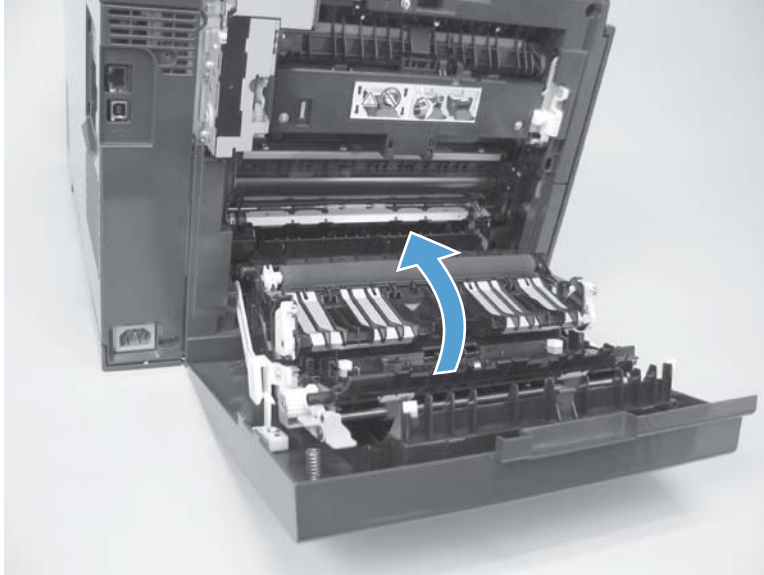

3. Remove two screws (callout 1).

Figure 1-40 Remove the rear door (duplex product) (2 of 4)

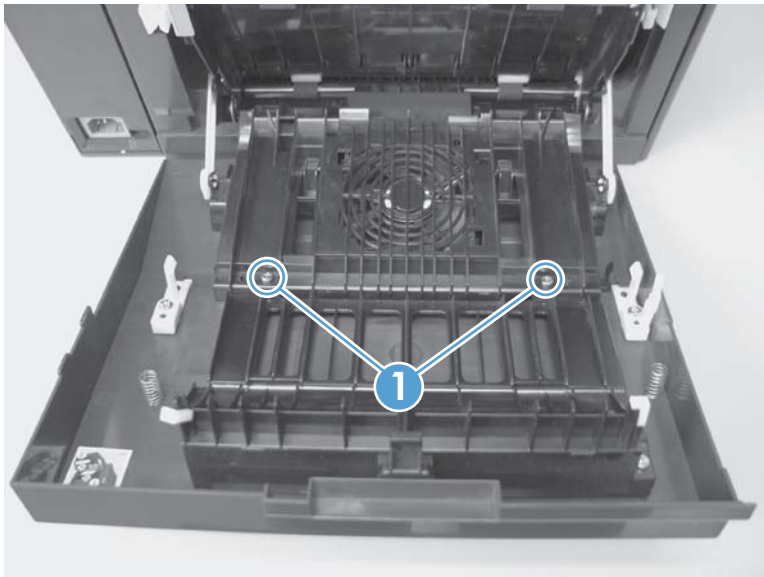

4. Before you remove the rear door, take note of the mounting tabs on the door.

Figure 1-41 Remove the rear door (duplex product) (3 of 4)

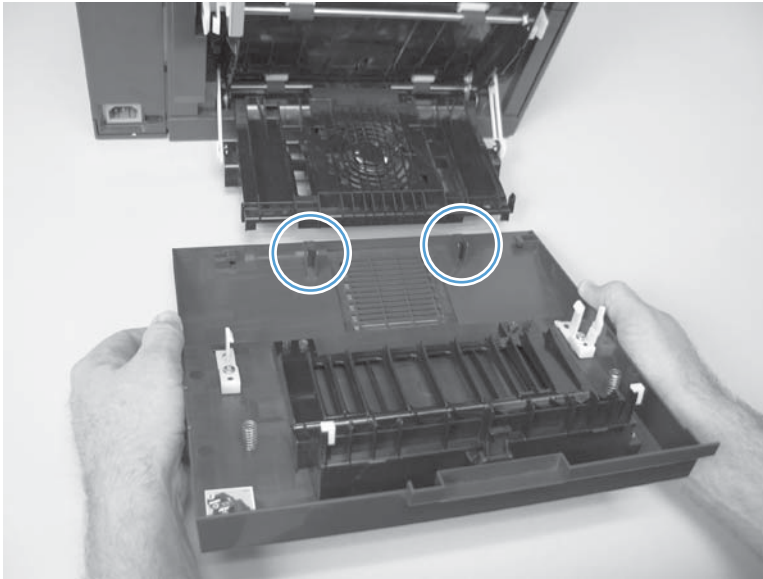

5. Slide the door away from the product to release two tabs, and then remove the door.

Figure 1-42 Remove the rear door (duplex product) (4 of 4)

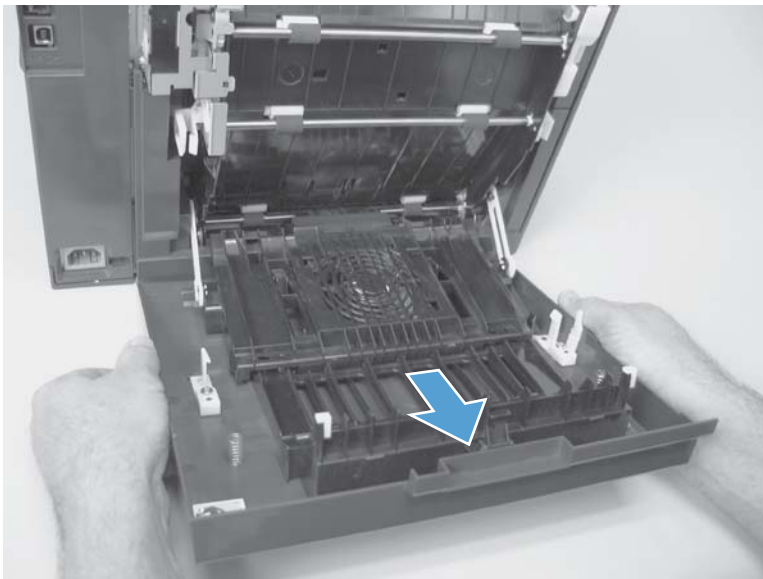

Rear cover and feed guide (simplex product)

Before proceeding, remove the following components:

- Right cover. See [Right cover on page 23](#).
- Rear-door stopper. See [Rear-door stopper and link caps \(simplex product\) on page 32](#).
- Rear door. See [Rear door \(simplex product\) on page 33](#) or [Rear door \(duplex product\) on page 35](#).

Remove the rear cover and feed guide (simplex product)

1. Carefully release the link guide from the pivot pin on the feed guide.

Figure 1-43 Remove the rear cover and feed guide (simplex product) (1 of 6)

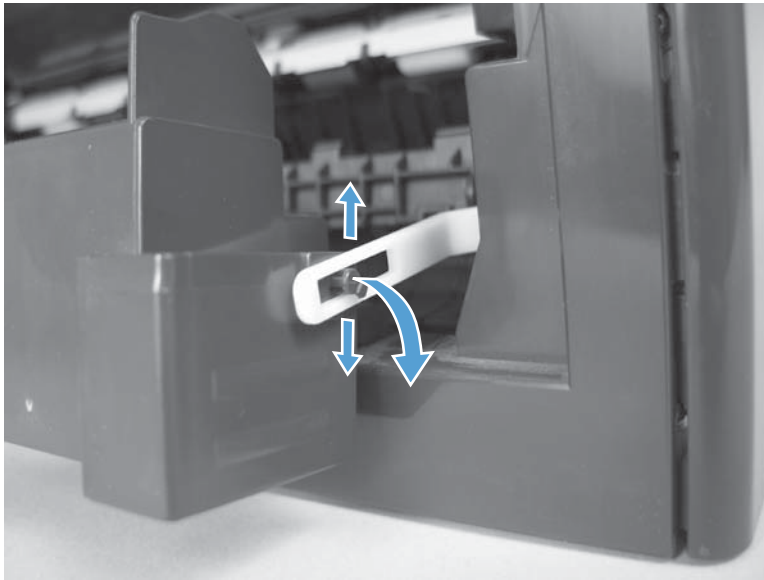

2. Remove three screws (callout 1).

Figure 1-44 Remove the rear cover and feed guide (simplex product) (2 of 6)

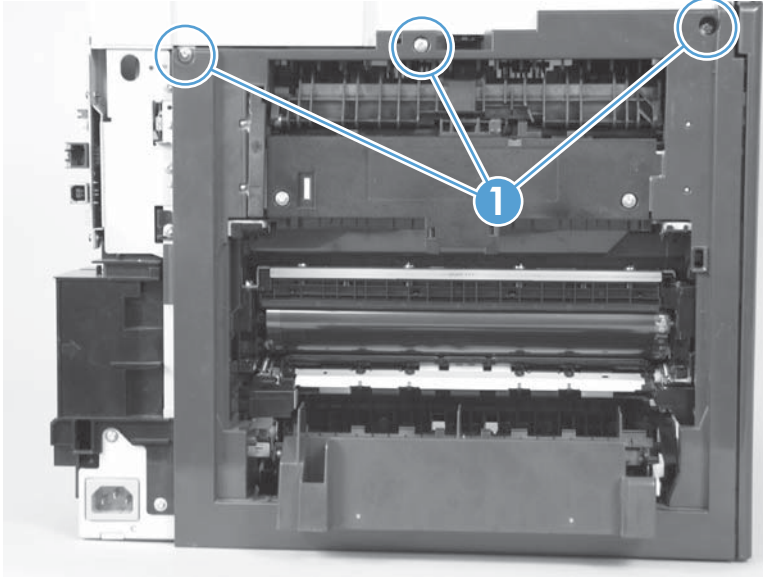

3. Release two tabs (callout 1).

Figure 1-45 Remove the rear cover and feed guide (simplex product) (3 of 6)

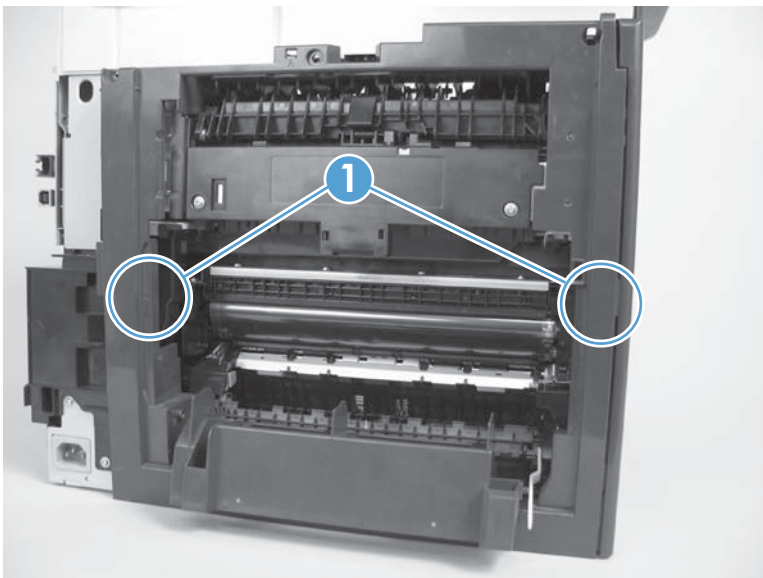

- Carefully lift the cover up and then rotate it away from the product to remove it.

Figure 1-46 Remove the rear cover and feed guide (simplex product) (4 of 6)

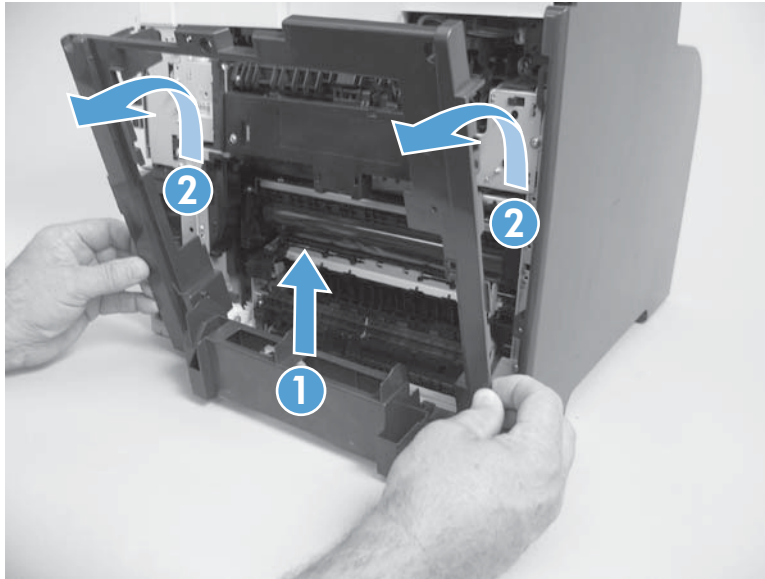

 **Reinstallation tip** Make sure that the wire harnesses at the top of the chassis near the left-side cover are correctly retained so that they are not pinched when the rear cover is reinstalled.

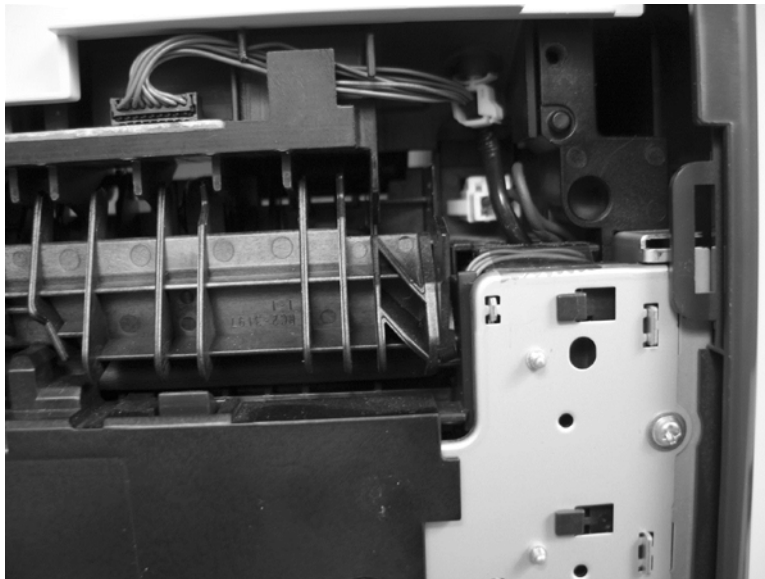

5. Carefully release a feed-guide hinge pin from the rear cover to release the feed guide.

Figure 1-47 Remove the rear cover and feed guide (simplex product) (5 of 6)



6. Remove the feed guide.

Figure 1-48 Remove the rear cover and feed guide (simplex product) (6 of 6)

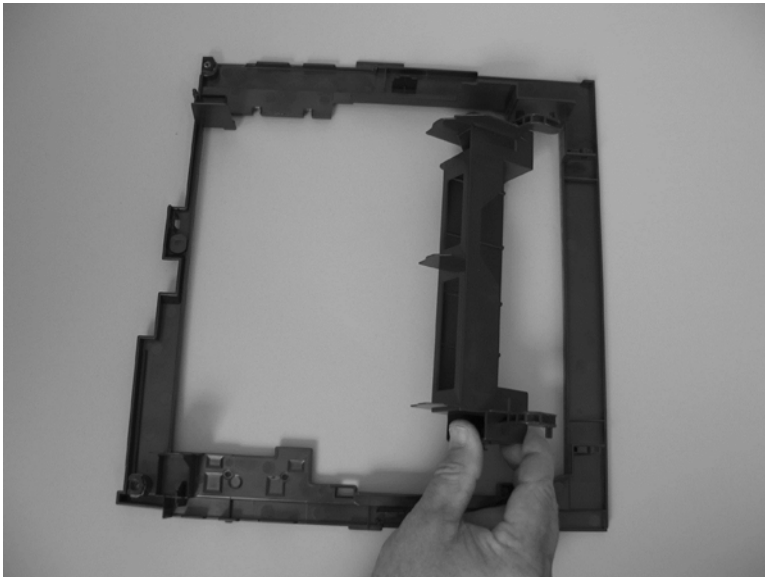

Rear-lower cover and rear-door links (duplex product)

Before proceeding, remove the following components:

- Right cover. See [Right cover on page 23](#).
- Rear door. See [Rear door \(simplex product\) on page 33](#) or [Rear door \(duplex product\) on page 35](#).
- Rear upper cover. See [Rear-upper cover \(duplex product\) on page 30](#).

Remove the rear-lower cover and rear-door links (duplex product)

1. Use a pair of needle-nose pliers to release two tabs, and then remove the rear-door link cap. Repeat this step for the remaining rear-door link cap.

Figure 1-49 Remove the rear-lower cover and rear-door links (duplex product) (1 of 6)

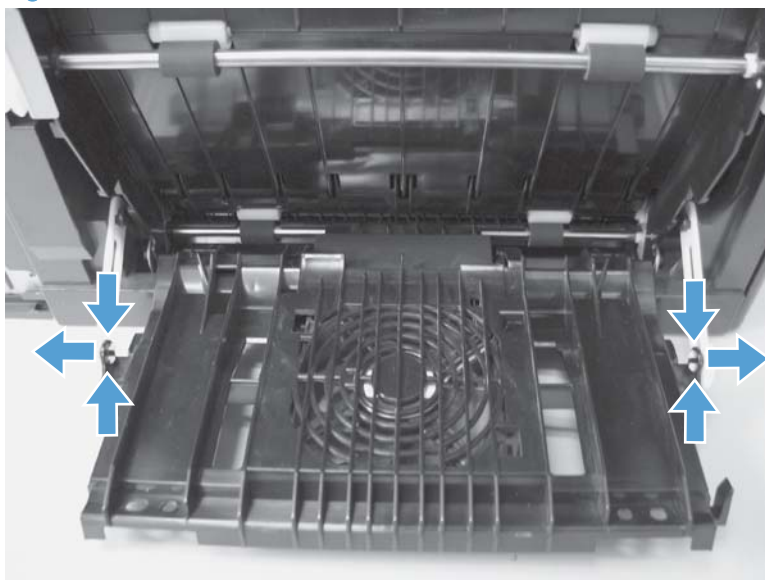

2. Open the duplex-feed assembly, release one tab (callout 1), and then slightly separate the cover from the product.

Figure 1-50 Remove the rear-lower cover and rear-door links (duplex product) (2 of 6)

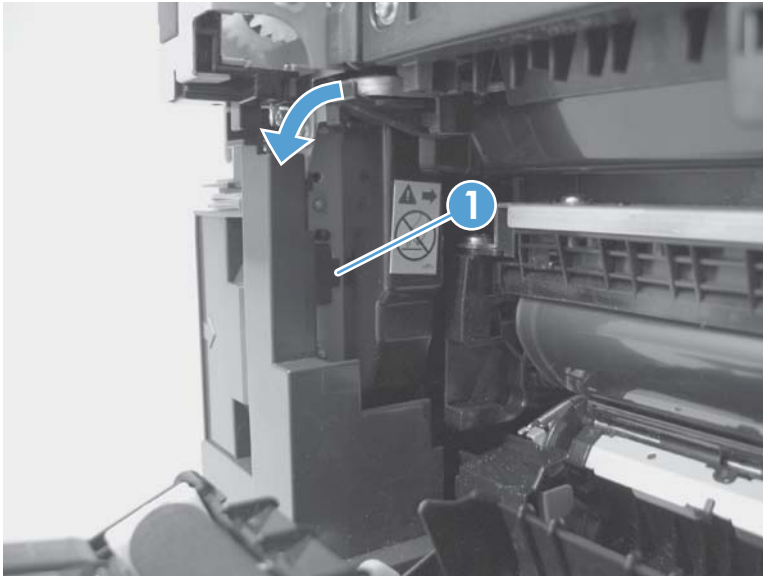

3. Release one tab (callout 1) and slightly separate the cover from the product.

Figure 1-51 Remove the rear-lower cover and rear-door links (duplex product) (3 of 6)

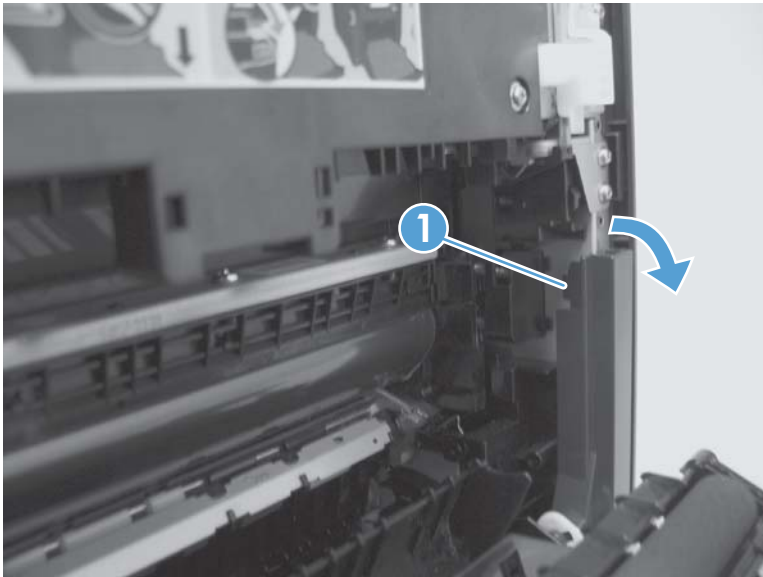

4. Close the duplex assembly, and then lift up on one side of the cover, and then the other side of the cover to release it.

Figure 1-52 Remove the rear-lower cover and link-guides (duplex product) (4 of 6)

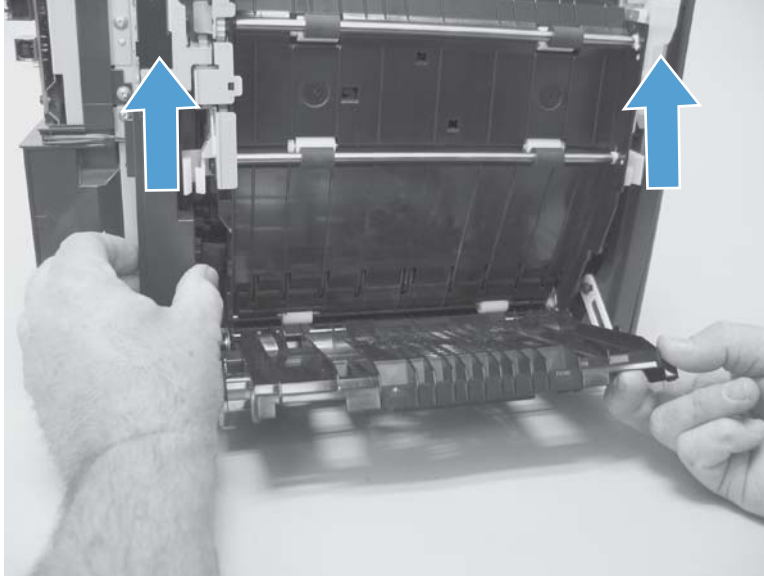

5. Slightly lift up the rear-door rib assembly, and then carefully slide the cover away from the product to remove it.

Figure 1-53 Remove the rear-lower cover and link-guides (duplex product) (5 of 6)

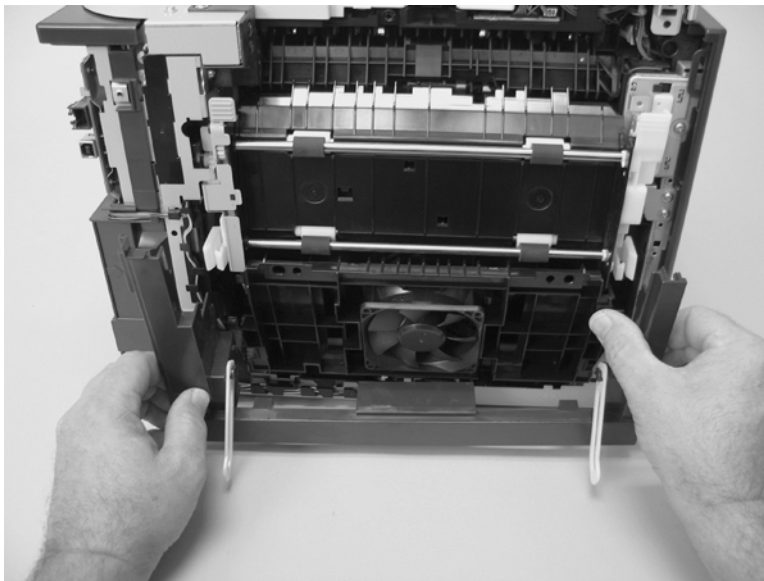

6. Rotate the rear-door link until the slot in the link aligns with the tap on the link-hinge pin, and then remove the rear-door link. Repeat this step for the remaining rear-door link.

 **NOTE:** If you are installing a replacement rear-lower cover, remove the rear-door links from the discarded cover, and then install them on the replacement cover.

Figure 1-54 Remove the rear-lower cover and rear-door links (duplex product) (6 of 6)



Rear-door rib assembly (duplex product)

Before proceeding, remove the following components:

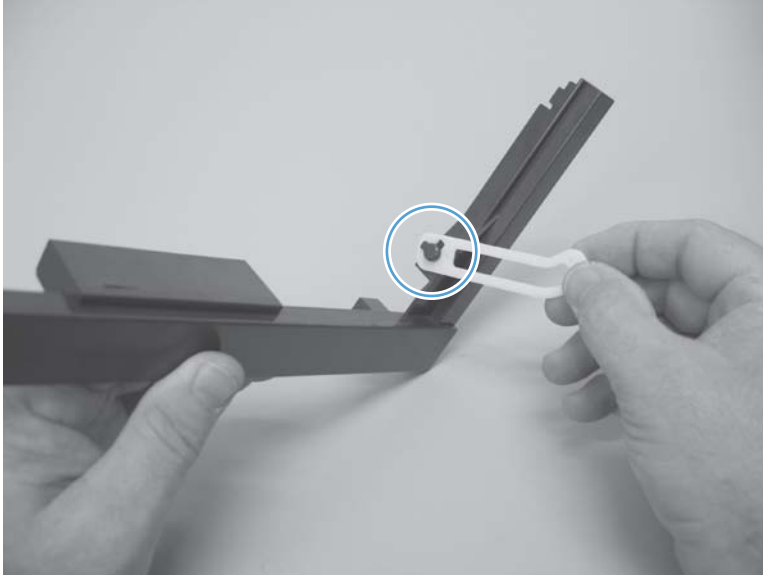
- Right cover. See [Right cover on page 23](#).
- Rear door. See [Rear door \(simplex product\) on page 33](#) or [Rear door \(duplex product\) on page 35](#).
- Rear upper cover. See [Rear-upper cover \(duplex product\) on page 30](#).
- Rear-lower cover. See [Rear-lower cover and rear-door links \(duplex product\) on page 41](#).

Remove the rear-door rib assembly (duplex product)

 **NOTE:** The duplex fan (FM2) is a component of the rear-door rib assembly.

1. Disconnect one connector (callout 1).

 **TIP:** The PCA can be dislodged when disconnecting the connector. To secure the PCA, carefully push it towards the inside of the product to clear the mounting tabs near the rib assembly (callout 2 shows the PCA correctly positioned under the tabs). Slide the PCA towards the rib assembly to position the edge of the PCA under the mounting tabs.

Figure 1-55 Remove the rear-door rib assembly (duplex product) (1 of 3)



2. Slide the assembly toward the power cable side of the product to release the hinge pin.

Figure 1-56 Remove the rear-door rib assembly (duplex product) (2 of 3)

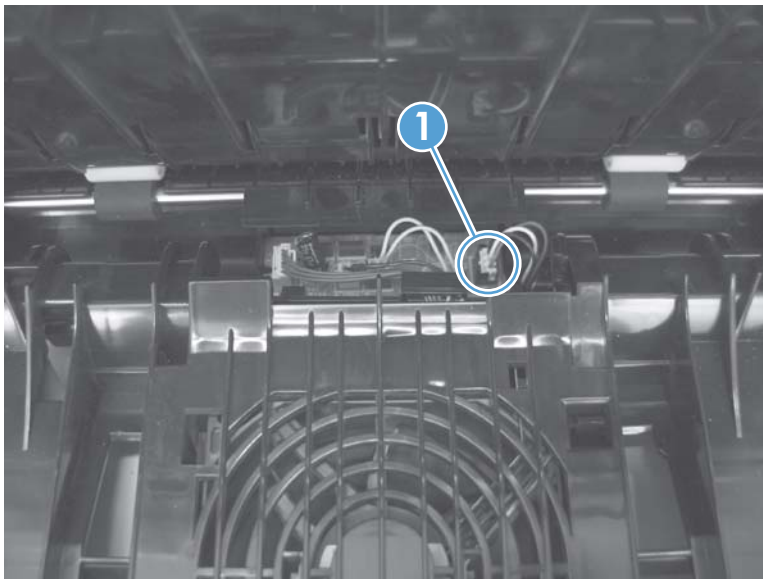
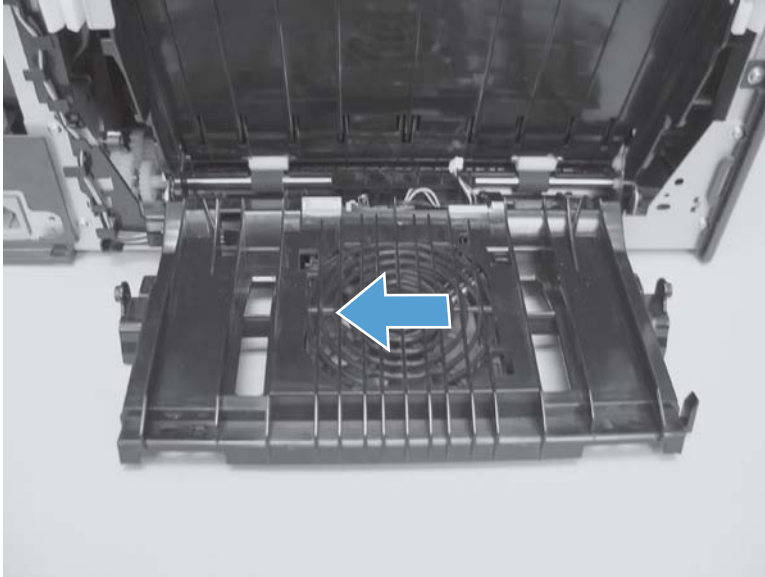

3. Remove the assembly.

Figure 1-57 Remove the rear-door rib assembly (duplex product) (3 of 3)

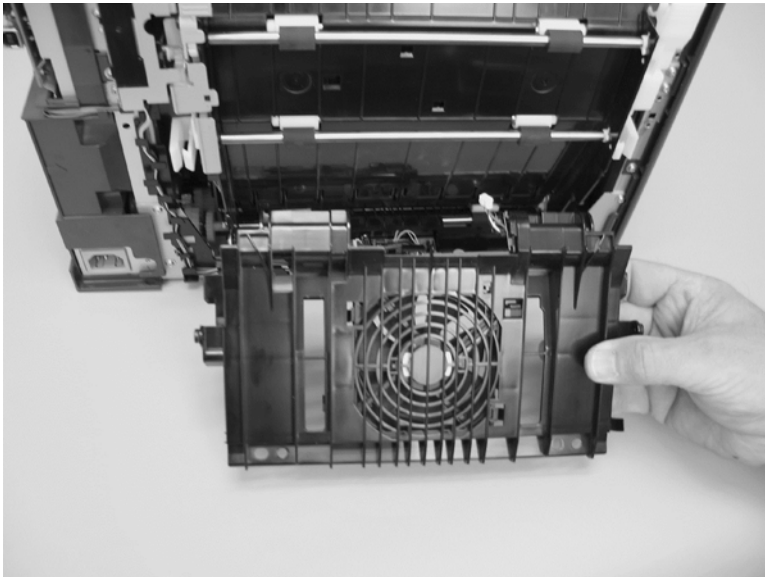

Link guide

The link guide rarely fails and is not a FRU.

The link is attached to the paper guide (callout 1) and the rear door (simplex products; callout 2) or duplexing-feed guide assembly (duplex products; callout 3).

If the link-guide attachment at the rear door or duplexing-feed guide assembly fails, replace the appropriate component.

The interior paper guide is not replaceable. If the link-guide to paper guide attachment fails, you must replace the entire product.

Figure 1-58 Replace the link guide (simplex products)

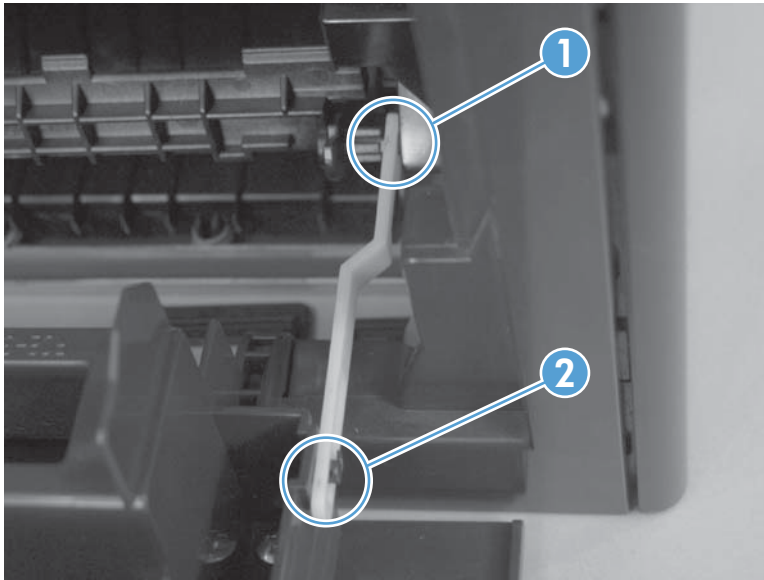
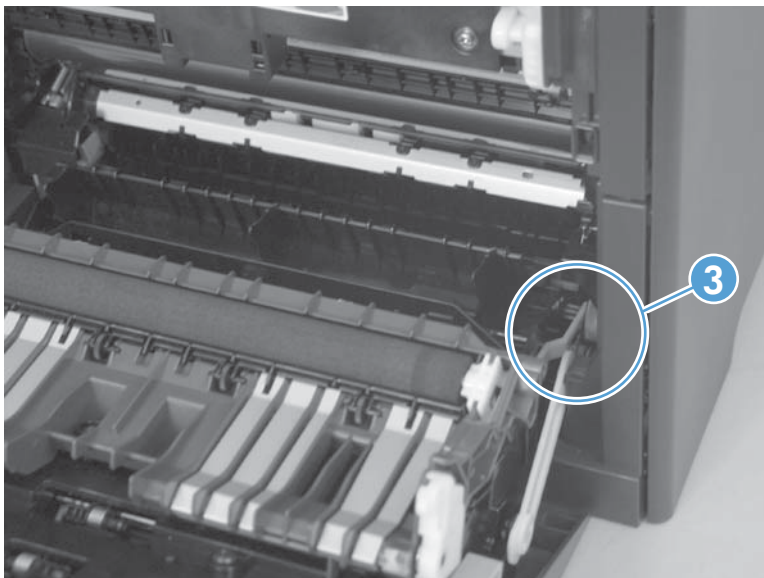

Figure 1-59 Replace the link guide (duplex products)



Control panel and right-arm mount

1. Remove the Right cover. See [Right cover on page 23](#).
2. Disconnect two FFCs and three connectors (callout 1) from the formatter PCA. Remove the USB PCA connector from the retainer.

Figure 1-60 Remove the control panel and right-arm mount (1 of 3)

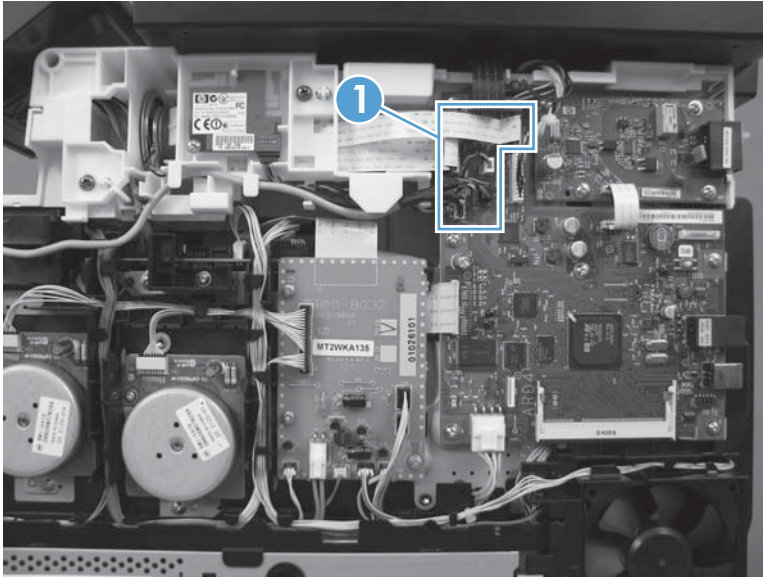

3. Remove three screws (callout 1) and disconnect the ground wire (callout 2).

Figure 1-61 Remove the control panel and right-arm mount (2 of 3)

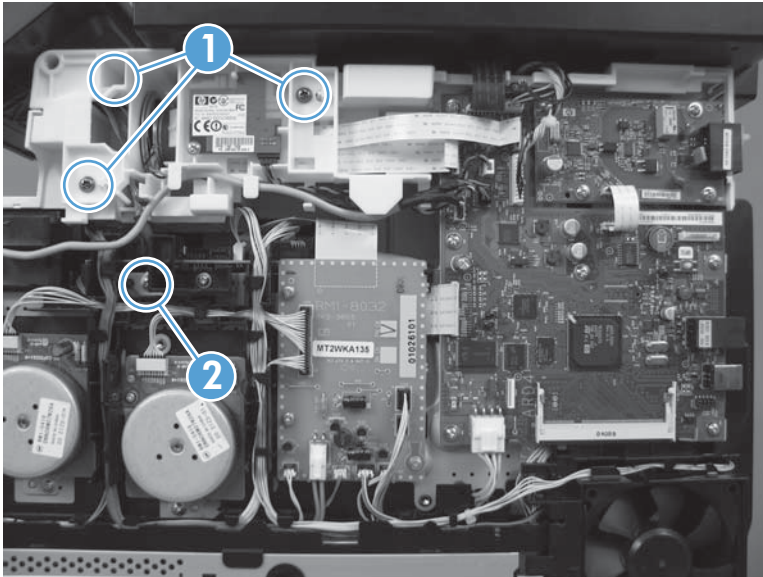

- Slide the control panel right-arm mount to the right to remove it from the scanner chassis.

Figure 1-62 Remove the control panel and right-arm mount (3 of 3)

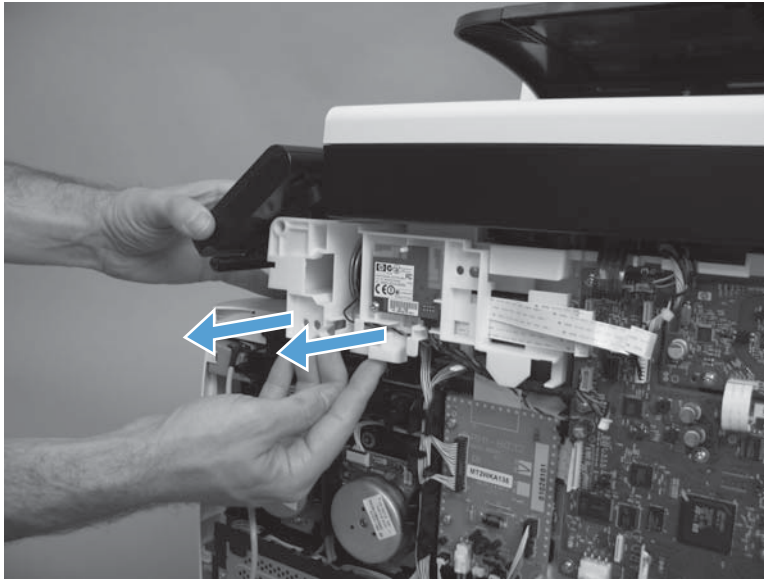

Reinstall the control panel and right-arm mount

- Slide the control panel right-arm mount assembly into the mounting points on the scanner chassis.
- Install three screws (callout 1) and attach the grounding wire (callout 2).

IMPORTANT: The grounding wire and the two FFCs must move freely. If the grounding wire is tangled with the FFCs, or is retracted too far into the control panel swivel, it might be too short to reach the mounting point on the chassis.

Figure 1-63 Reinstall the control panel and right-arm mount (1 of 2)

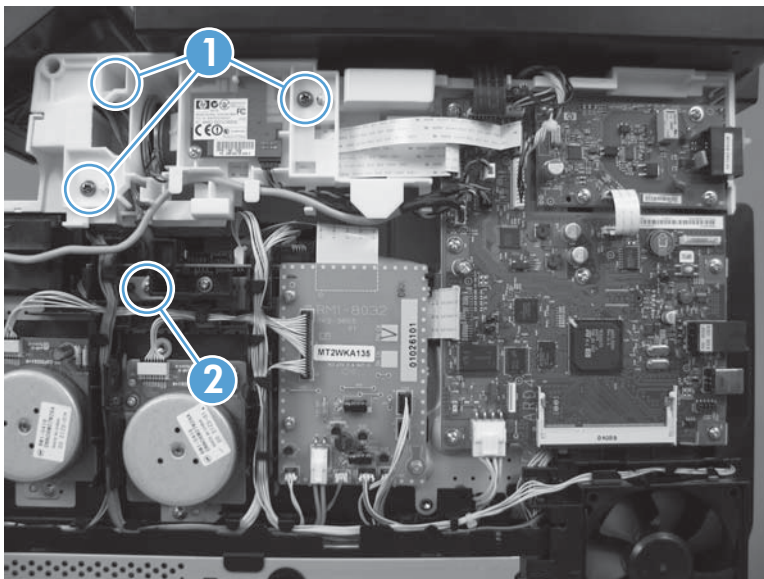

3. Attach two FFCs and three connectors (callout 1). Install the USB PCA connector in the retainer.

Figure 1-64 Reinstall the control panel and right-arm mount (2 of 2)

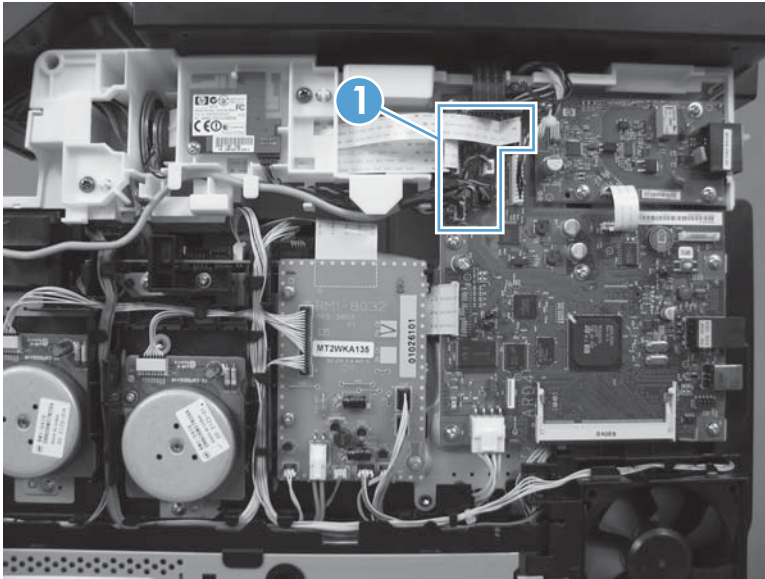

Upper-cover assembly

Before proceeding, remove the following components:

- Right cover. See [Right cover on page 23](#).
- Scanner assembly. See [Scanner assembly on page 26](#).
- Simplex products
 - Rear door. See [Rear door \(simplex product\) on page 33](#).
 - Rear cover. See [Rear cover and feed guide \(simplex product\) on page 37](#).
- Duplex products
 - Rear upper cover. See [Rear-upper cover \(duplex product\) on page 30](#).
- Control panel and right-arm mount. See [Control panel and right-arm mount on page 48](#).
- Right-front cover and power button. See [Right-front cover and power button on page 28](#).

Remove the upper-cover assembly

1. Remove four screws (callout 1).

Figure 1-65 Remove the upper-cover assembly (1 of 3)

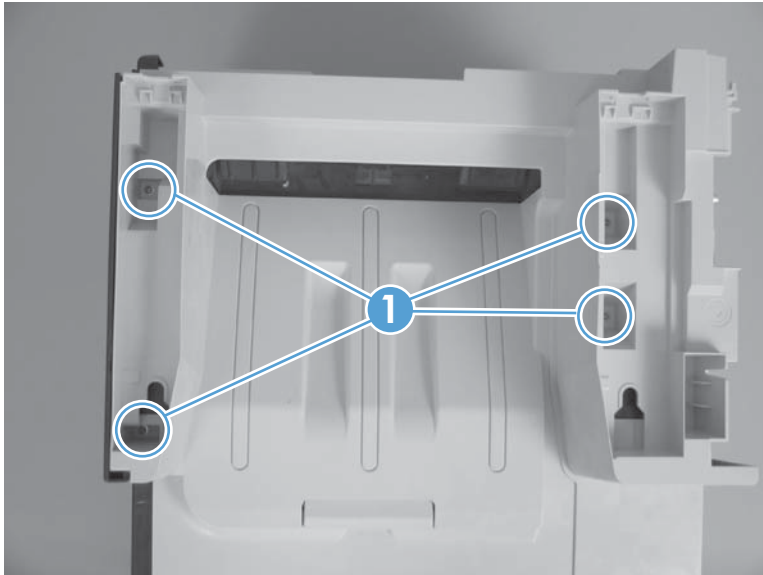

2. Slightly raise the back of the cover up and off of the product.

Figure 1-66 Remove the upper-cover assembly (2 of 3)

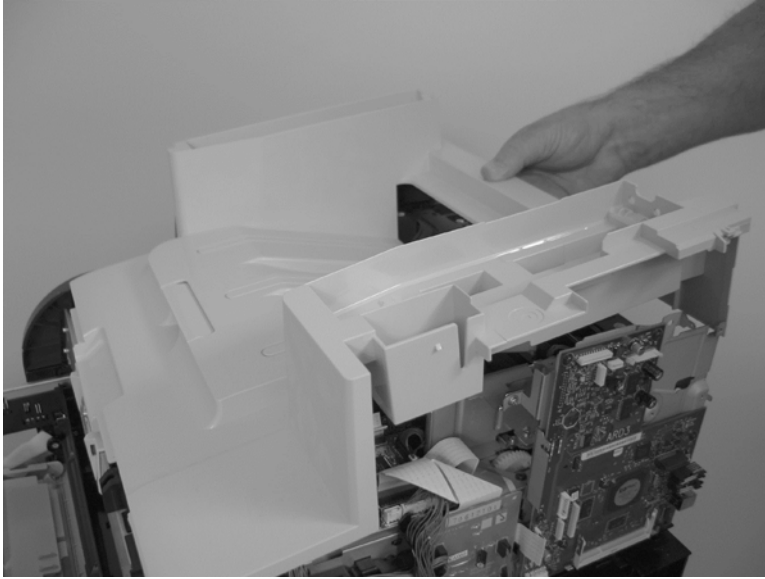

3. Slide the cover toward the back of the product to remove it.

Figure 1-67 Remove the upper-cover assembly (3 of 3)

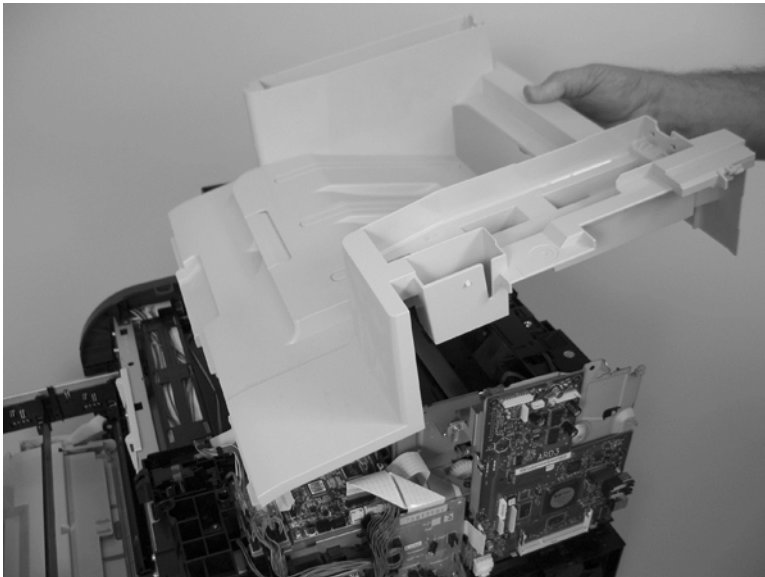

Reinstall the upper-cover assembly

1. Position the upper-cover so that the front-left corner of the upper cover engages the left-side cover (callout 1).

Figure 1-68 Reinstall the upper-cover assembly (1 of 3)



2. Slightly push the cover toward the front of the product to engage the front-locking tabs (callout 1) with the holes in the chassis.

 **NOTE:** Make sure that the right-front edge of the upper cover (where the product right-front cover will be installed) is correctly positioned on the chassis.

Figure 1-69 Reinstall the upper-cover assembly (2 of 3)



3. Carefully pry the right-rear corner of the upper cover away from the product until the cover fits over the chassis.

Lower the cover onto the product.

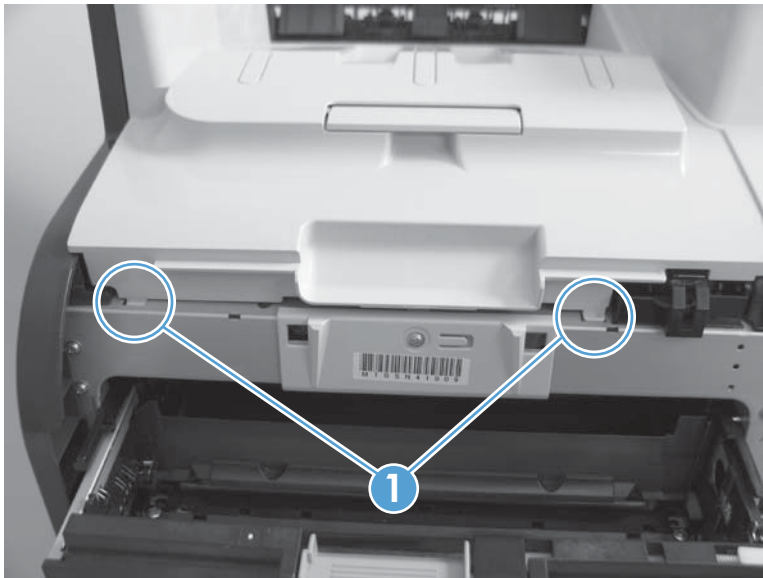
Figure 1-70 Reinstall the upper-cover assembly (3 of 3)

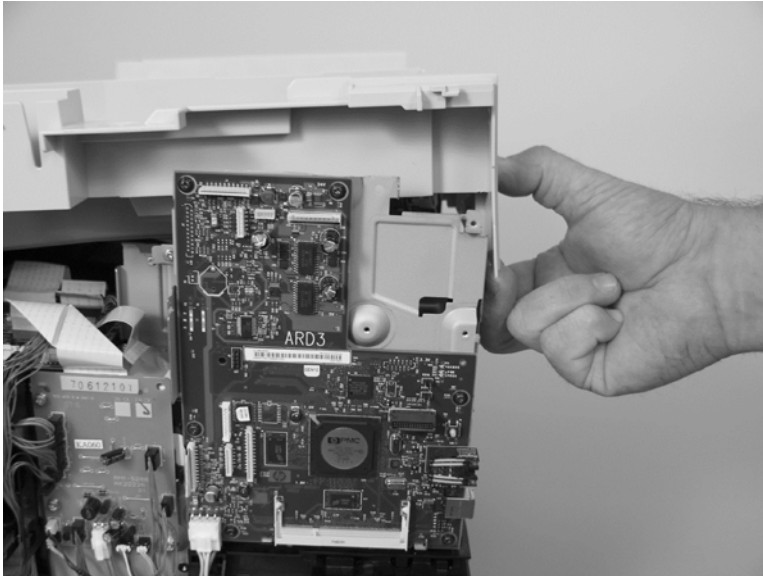

Left cover

Before proceeding, remove the following components:

- Right cover. See [Right cover on page 23](#).
- Scanner assembly. See [Scanner assembly on page 26](#).
- Simplex products
 - Rear door. See [Rear door \(simplex product\) on page 33](#).
 - Rear cover. See [Rear cover and feed guide \(simplex product\) on page 37](#).
- Duplex products
 - Rear-lower cover. See [Rear-lower cover and rear-door links \(duplex product\) on page 41](#).
- Upper-cover assembly. See [Upper-cover assembly on page 51](#).

Remove the left cover

1. Remove one screw (callout 1).

Figure 1-71 Remove the left cover (1 of 3)

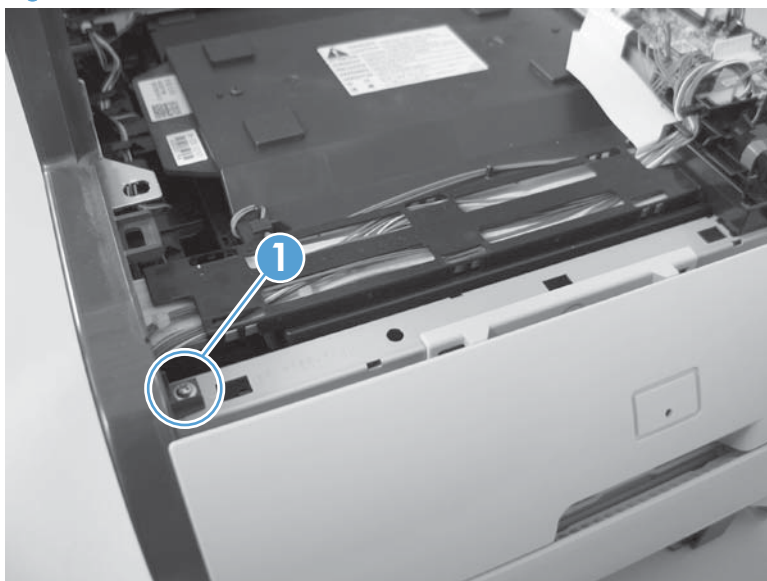

2. Slightly lift up on the cover, and then rotate the top of the cover away from the product.

Figure 1-72 Remove the left cover (2 of 3)

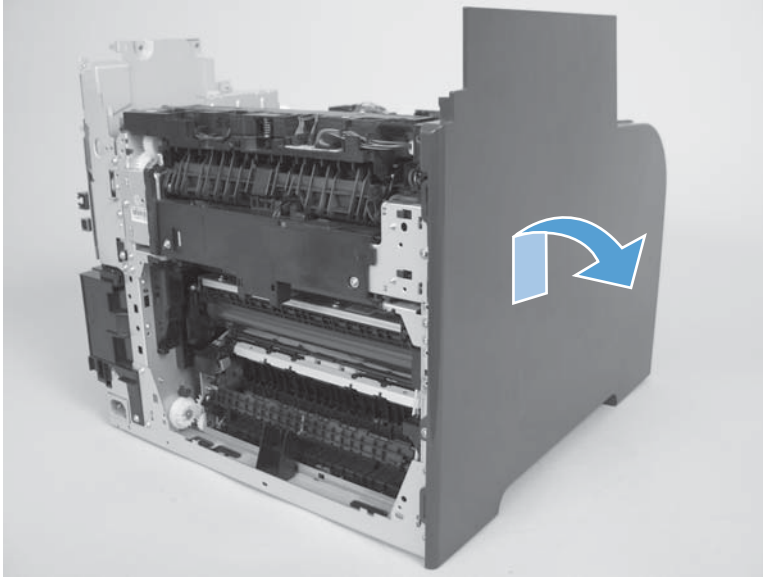

3. Remove the cover.

Figure 1-73 Remove the left cover (3 of 3)

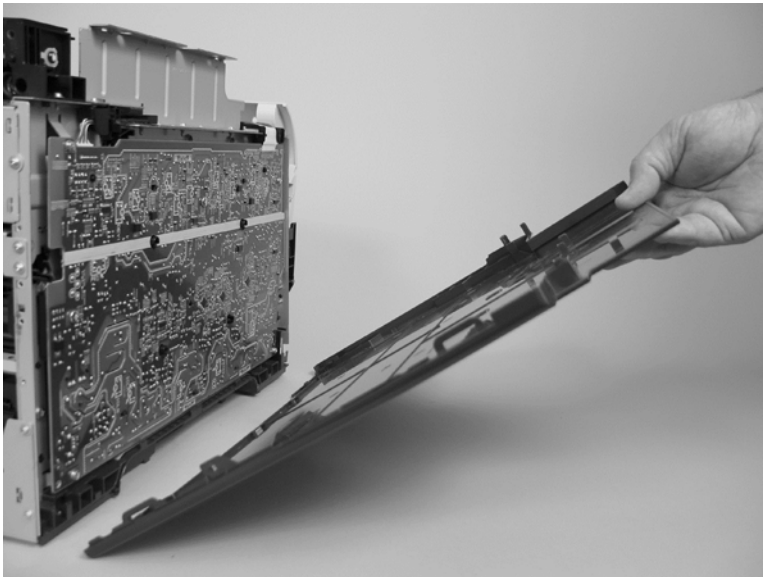

Reinstall the left cover

1. When you reinstall the left cover, make sure that the slot in the cover (callout 1) aligns with the tab (callout 2) on the product.

Figure 1-74 Reinstall the left cover (1 of 2)

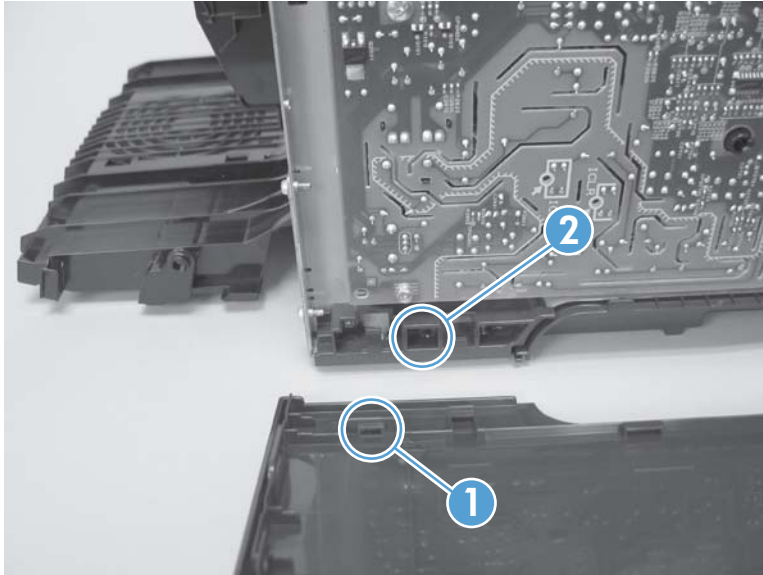

2. When you reinstall the left cover, make sure that the pin on the cover (callout 1) aligns with the slot (callout 2) in the product.

Figure 1-75 Reinstall the left cover (2 of 2)

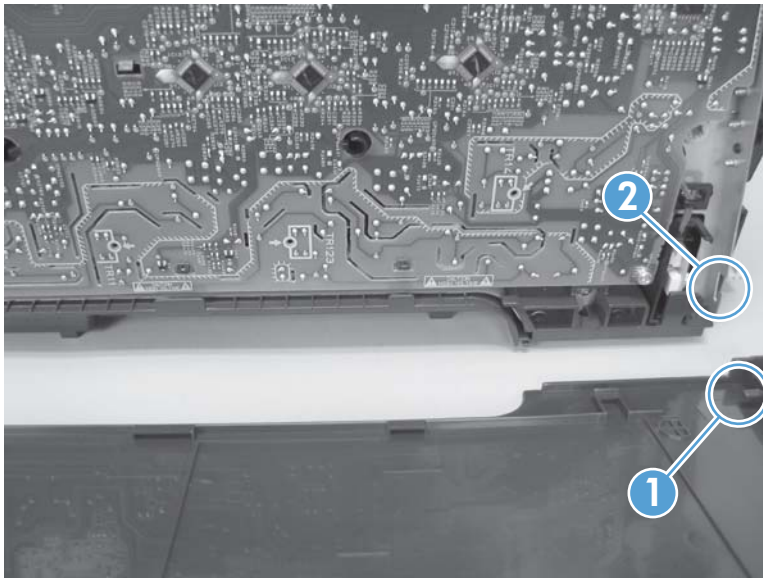

Front-door assembly

Before proceeding, remove the following components:

- Print-cartridge drawer. See [Print-cartridge drawer on page 20](#).
- Right cover. See [Right cover on page 23](#).
- Scanner assembly. See [Scanner assembly on page 26](#).
- Simplex product
 - Rear door. See [Rear door \(simplex product\) on page 33](#).
 - Rear cover. See [Rear cover and feed guide \(simplex product\) on page 37](#).
- Duplex product
 - Rear-upper cover. See [Rear-upper cover \(duplex product\) on page 30](#).
 - Rear door. See [Rear door \(duplex product\) on page 35](#).
 - Rear-lower cover. See [Rear-lower cover and rear-door links \(duplex product\) on page 41](#).
- Upper-cover assembly. See [Upper-cover assembly on page 51](#).
- Left cover. See [Left cover on page 55](#).
- Right-front cover. See [Right-front cover and power button on page 28](#).

Remove the front-door assembly

1. Locate the front-door pin on the left-side door link.

Figure 1-76 Remove the front-door assembly (1 of 10)

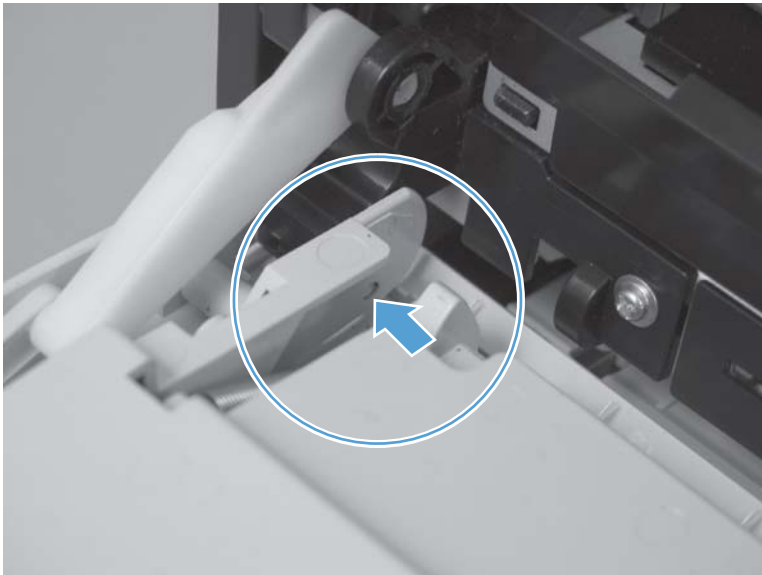

2. Use a precision point screwdriver to push the left-side door pin out of the link.

 **NOTE:** A precision point screwdriver is required to release the front door pins. The width of the blade must be 2 mm (0.08 in) or less to be able to push the door pins out of the mounting holes.

Figure 1-77 Remove the front-door assembly (2 of 10)



3. Use a precision point screwdriver to push the right-side door pin out of the link.

 **NOTE:** A precision point screwdriver is required to release the front door pins. The width of the blade must be 2 mm (0.08 in) or less to be able to push the door pins out of the mounting holes.

Figure 1-78 Remove the front-door assembly (3 of 10)



4. Remove two screws (callout 1) and the separate the door bushing (callout 2) from the chassis.

Figure 1-79 Remove the front-door assembly (4 of 10)

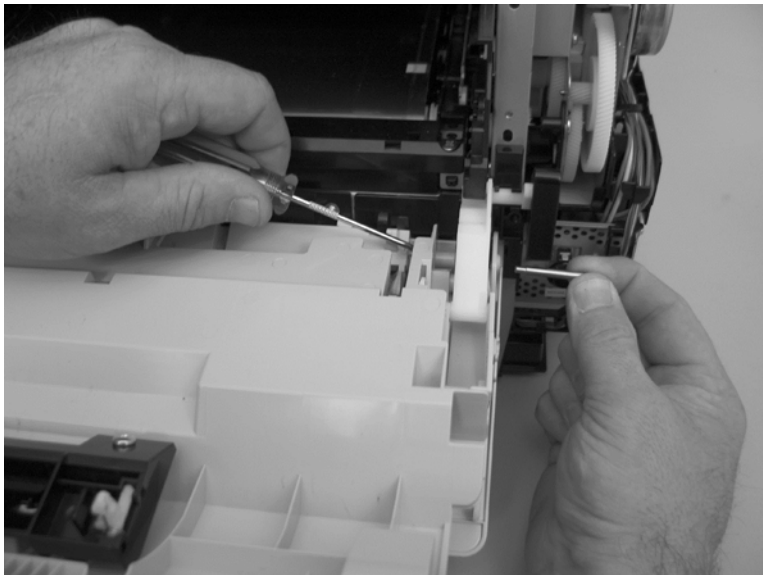
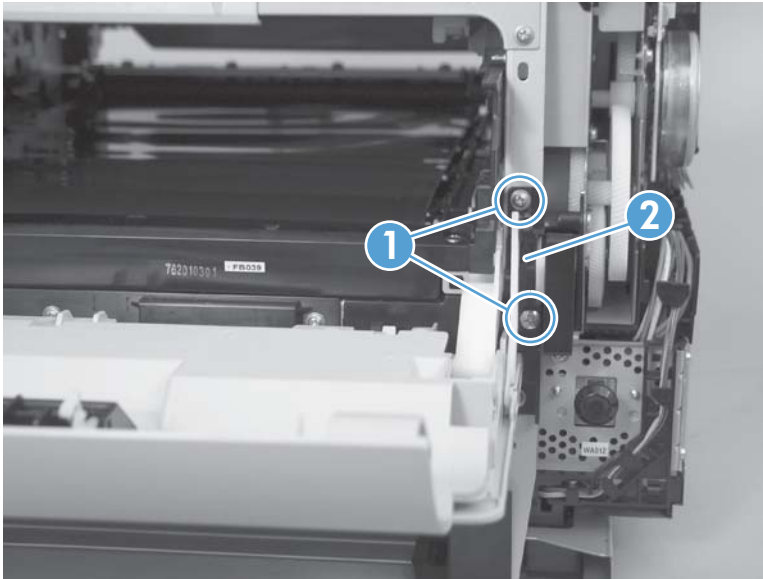

5. Release the bushing from the door-retainer link (callout 1).

Figure 1-80 Remove the front-door assembly (5 of 10)

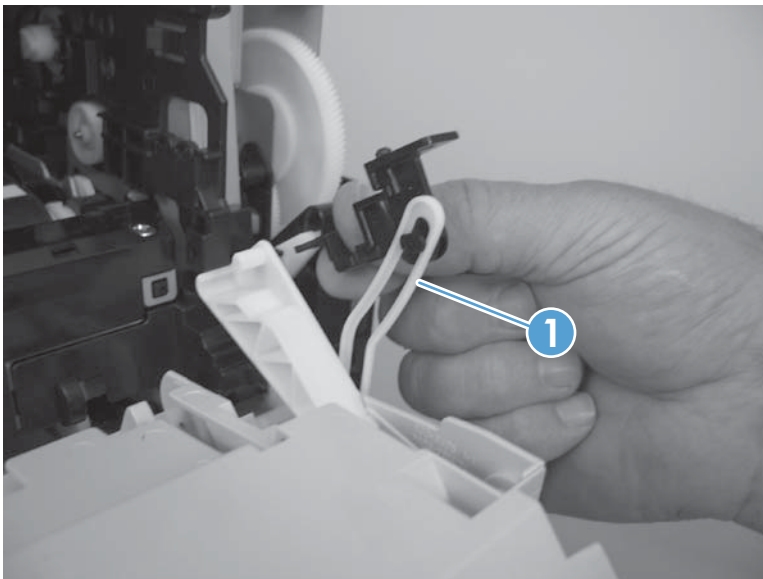

6. Support the door assembly, and carefully release the pin on the right-side link.

Figure 1-81 Remove the front-door assembly (6 of 10)

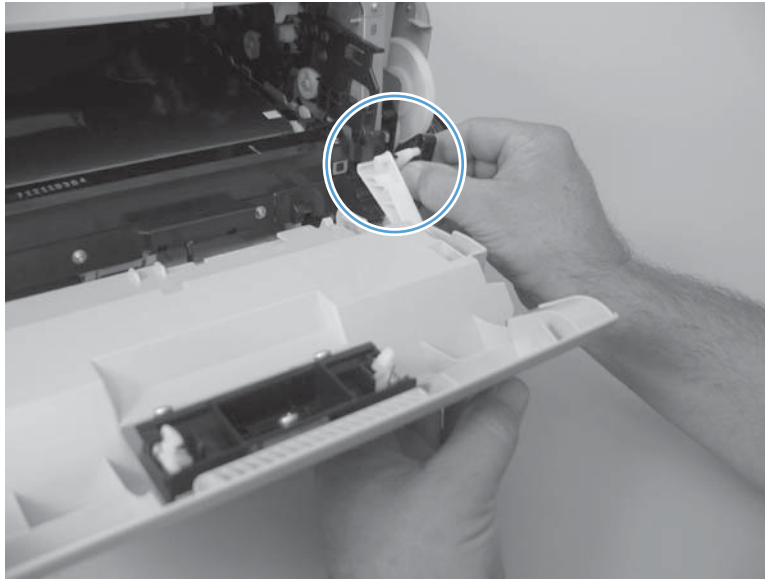

7. Support the door assembly, and carefully release the upper pin on the left-side link.

Figure 1-82 Remove the front-door assembly (7 of 10)

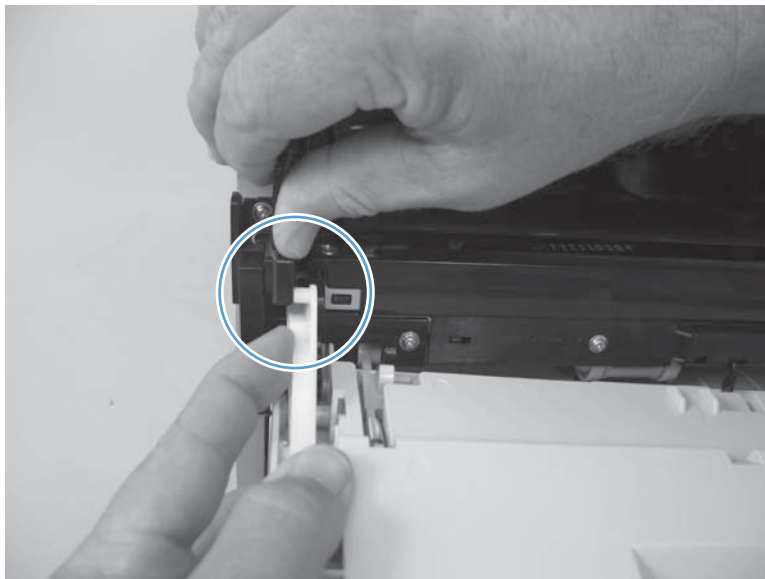

8. Push the black-plastic arm into the product.

Figure 1-83 Remove the front-door assembly (8 of 10)

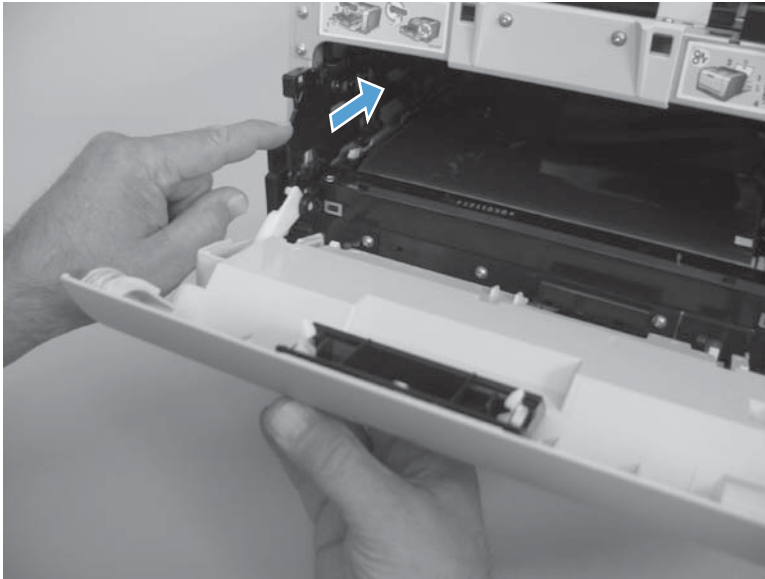

9. Support the door assembly, and carefully release the lower pin on the left-side link.

Figure 1-84 Remove the front-door assembly (9 of 10)

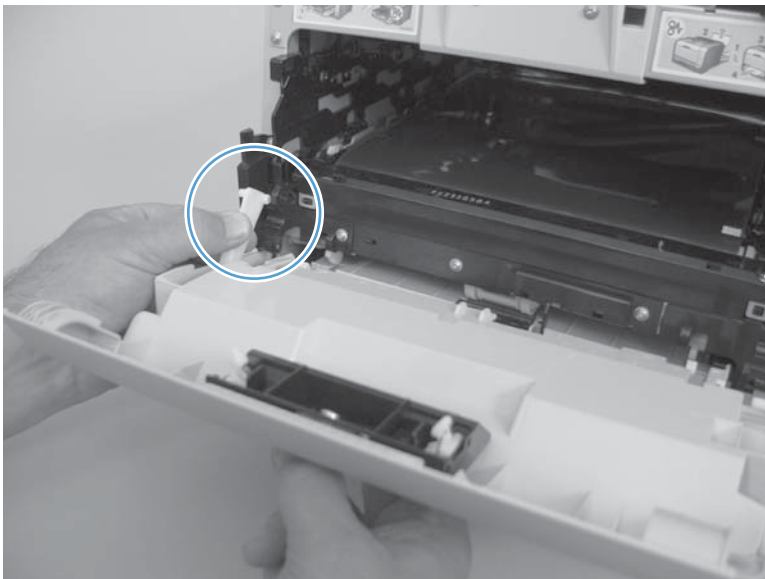

10. Remove the front-door assembly.

Figure 1-85 Remove the front-door assembly (10 of 10)

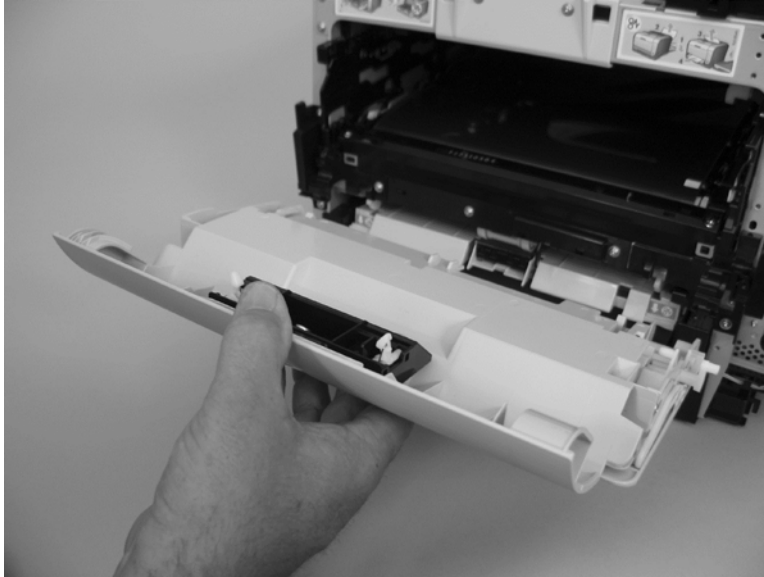

Reinstall the front-door assembly

Use this procedure if you are installing a *replacement* front-door assembly.

1. Open Tray 1, and then rotate the retainer arm (callout 1) until the tabs on the arm-hinge pin align with the slots in the mounting hole on Tray 1.

Figure 1-86 Reinstall the front-door assembly (1 of 2)

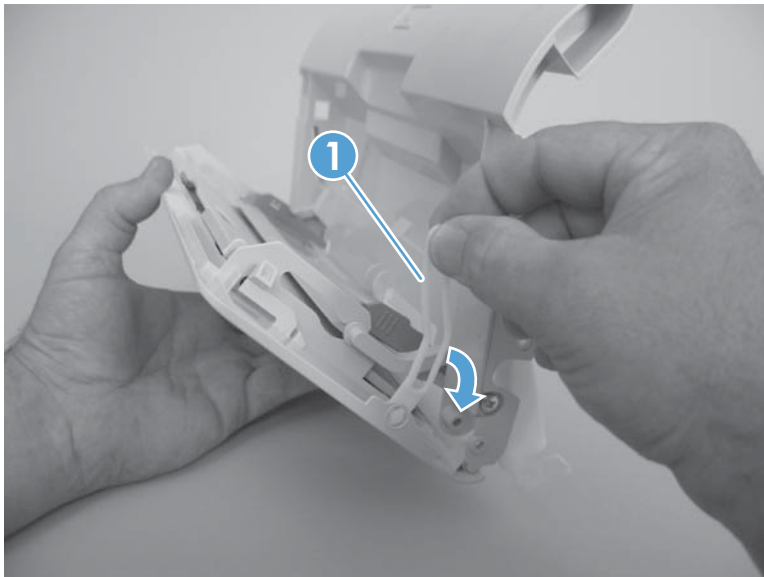

2. Remove the retainer arm from the door assembly, and then install it on the replacement door assembly.

Figure 1-87 Reinstall the front-door assembly (2 of 2)

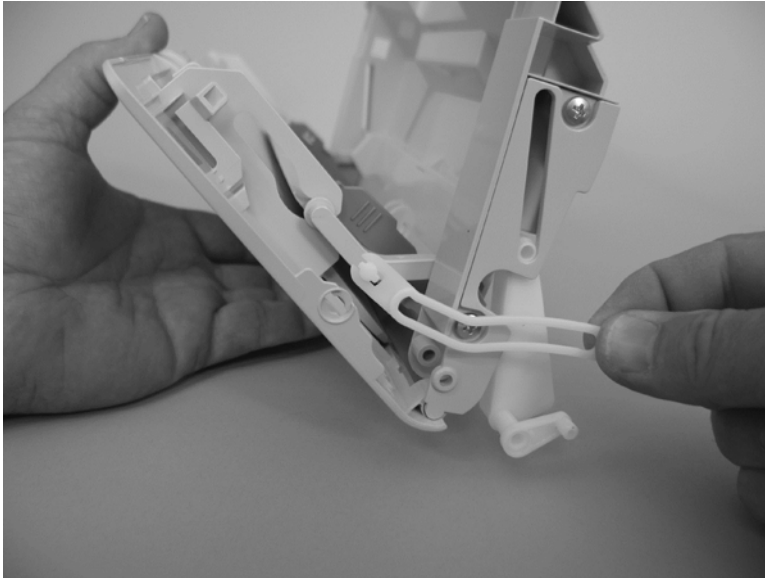

Intermediate transfer belt (ITB)

1. Remove the print-cartridge drawer. See [Print-cartridge drawer on page 20](#).
2. Open the front door, and then remove two screws (callout 1).

Figure 1-88 Remove the ITB (1 of 6)



3. Carefully rotate the color-misregistration sensor away from the ITB.

⚠ CAUTION: The sensor is still attached to the product and cannot be completely removed.

Figure 1-89 Remove the ITB (2 of 6)



4. Disconnect one connector (callout 1).

Figure 1-90 Remove the ITB (3 of 6)

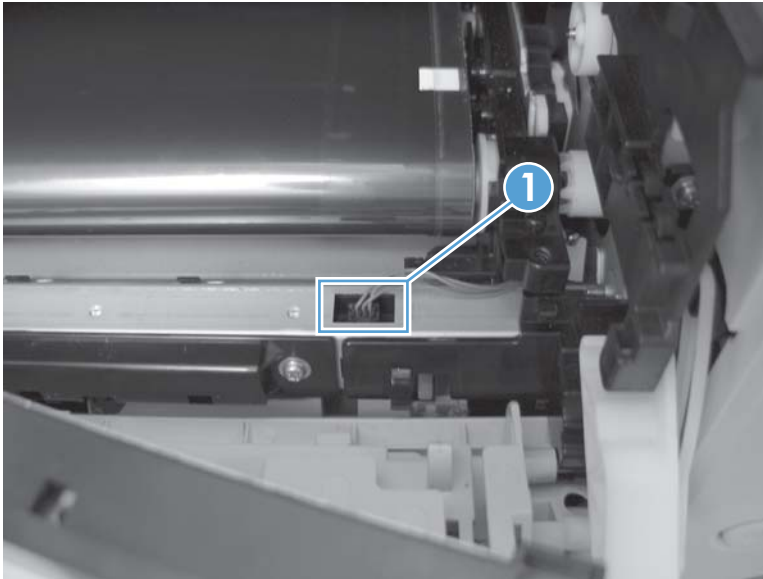

5. Carefully lift up on the front of the ITB to release it.

⚠ CAUTION: Avoid touching the black plastic transfer belt. Skin oils on the belt might cause print-quality problems. Lift the ITB as shown below, by using the hard-plastic edges of the ITB.

Figure 1-91 Remove the ITB (4 of 6)



6. Open the rear door, and carefully lift up on the sheet-metal portion (callout 1) of the ITB to release it.

CAUTION: Avoid touching the black plastic transfer belt. Skin oils on the belt might cause print-quality problems.

NOTE: You might need to reach in through the front door and support the front portion of the ITB to keep it from falling back into place as you perform this step.

Figure 1-92 Remove the ITB (5 of 6)

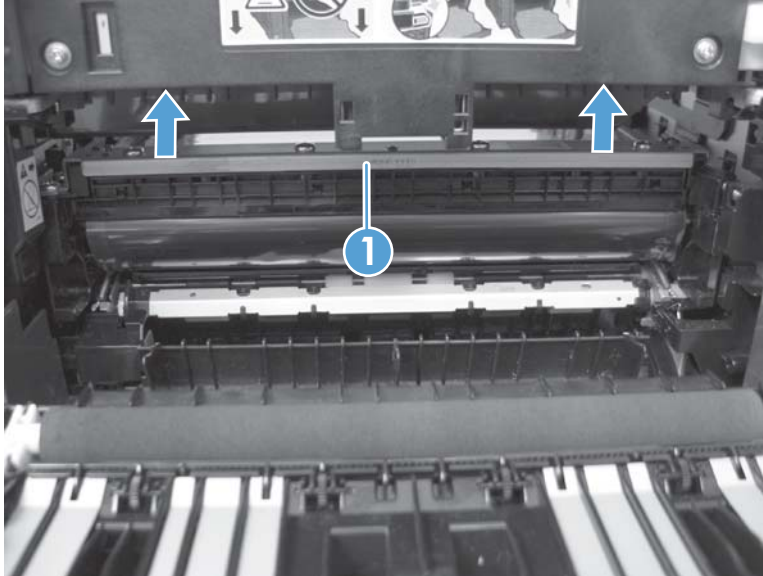

7. Carefully pull the ITB straight out of the product to remove it.

CAUTION: Avoid touching the black plastic transfer belt. Skin oils on the belt might cause print-quality problems. Handle the ITB as shown below.

Figure 1-93 Remove the ITB (6 of 6)



Reinstall the ITB

Use this procedure to verify that the ITB is correctly reinstalled.

1. Use the control panel to print the diagnostics pages.
2. Verify that rows **one** through **four**, columns **A** through **I** (callout 1) contain hexadecimal numbers.

If these rows and columns are all zero, ensure that the calibration sensor was correctly reinstalled. The sensor must be correctly positioned and fit securely against the chassis before the mounting screws are installed. See [1](#) and [2](#).

Figure 1-94 Reinstall the ITB

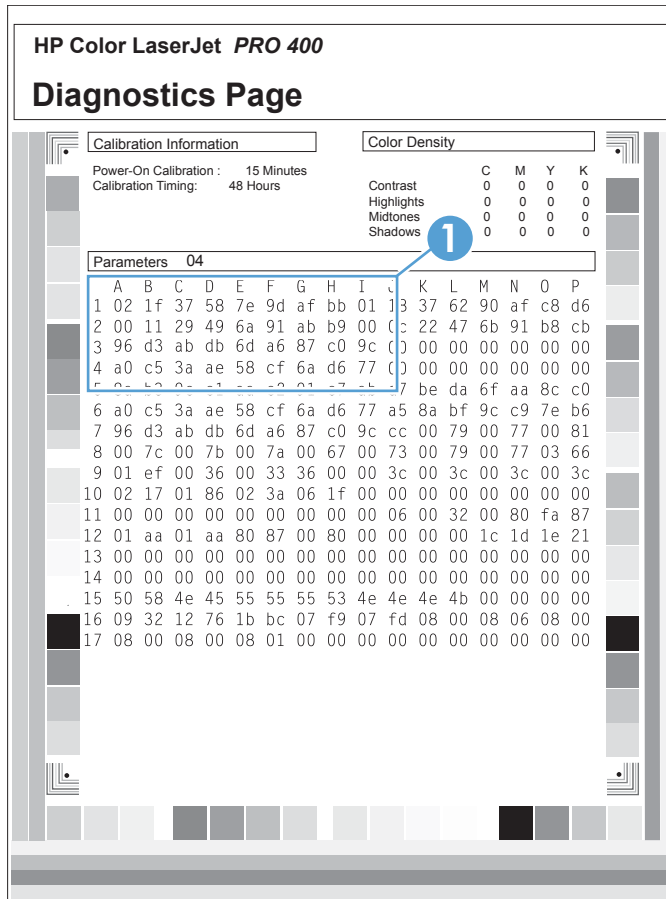

Drum motor (M1) and developer motor (M2)

This procedure can be used to remove the drum motor (M1) or the developer motor (M2). HP does not recommend removing both of the motors at the same time.

1. Remove the right cover. See [Right cover on page 23](#).
2. Disconnect one connector (callout 1) for motor M1 or motor M2.

 **NOTE:** The drum motor (callout 2) is motor M1. The developer motor (callout 3) is motor M2.

Figure 1-95 Remove motor M1 and motor M2 (1 of 6)

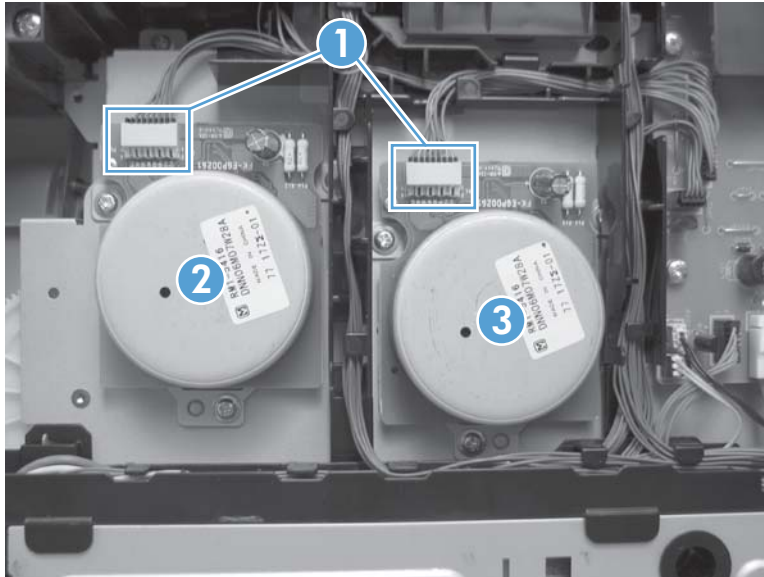

3. Remove one screw (callout 1), and then remove the black-plastic retainer (callout 2).



 **NOTE:** There is a small clip—the clip is used to activate the engine test button—attached to the retainer that can be easily dislodged when the retainer is removed. Do not lose this clip when handling the retainer.

Figure 1-96 Remove motor M1 and motor M2 (2 of 6)

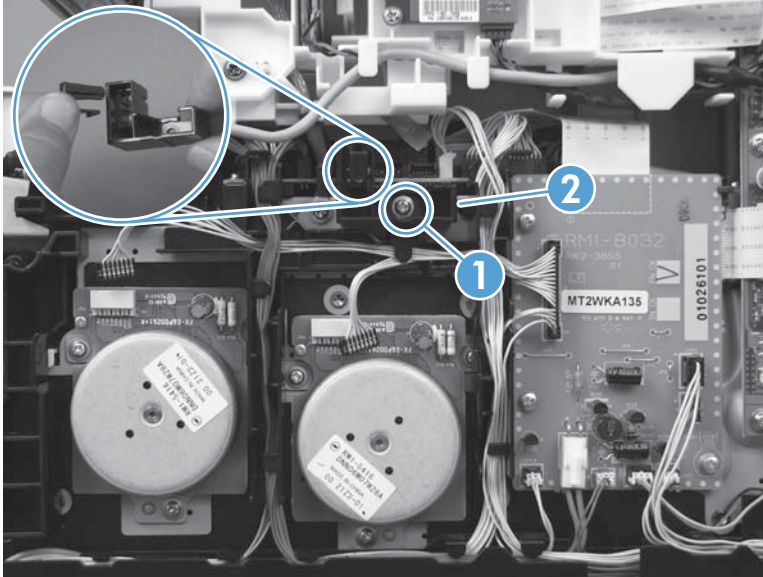

4. Release the wire harnesses from the retainer (callout 1).

 **NOTE:** One of the wire harnesses—behind the drum motor wire harness—is difficult to release from the retainer. Be careful to not damage this wire harness when releasing it.

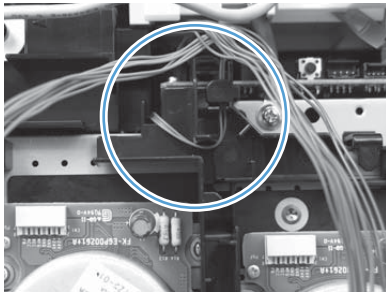

 **TIP:** Additional connectors might need to be disconnected to release the wire harnesses from the retainer.

Figure 1-97 Remove motor M1 and motor M2 (3 of 6)



5. Release one tab (callout 1).

Figure 1-98 Remove motor M1 and motor M2 (4 of 6)

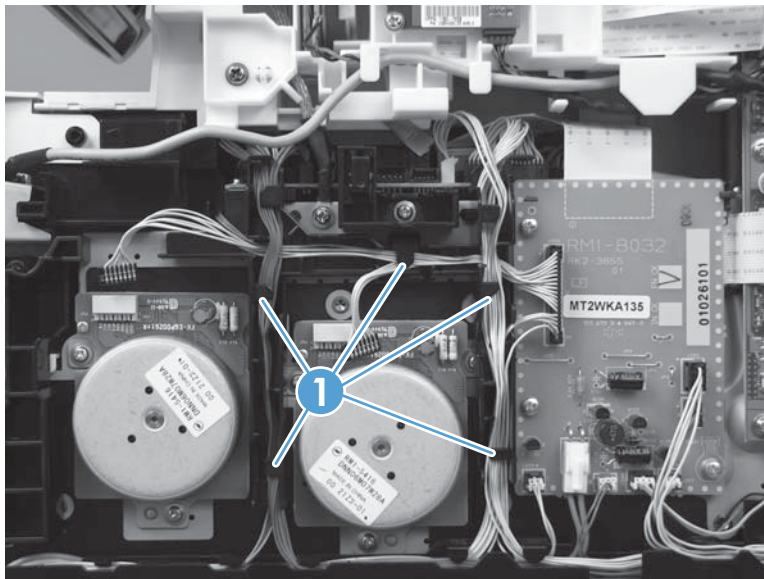
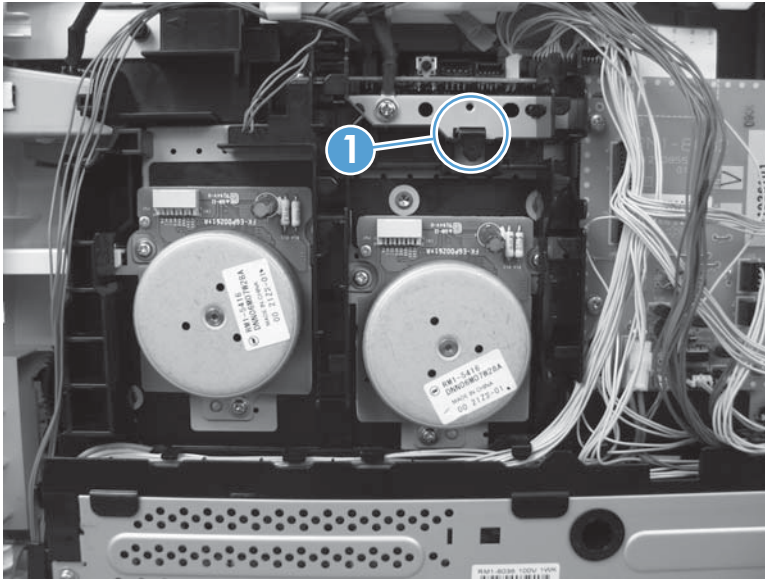

6. Rotate the top of the retainer away from the chassis, and then lift it up to remove it.

Figure 1-99 Remove motor M1 and motor M2 (5 of 6)

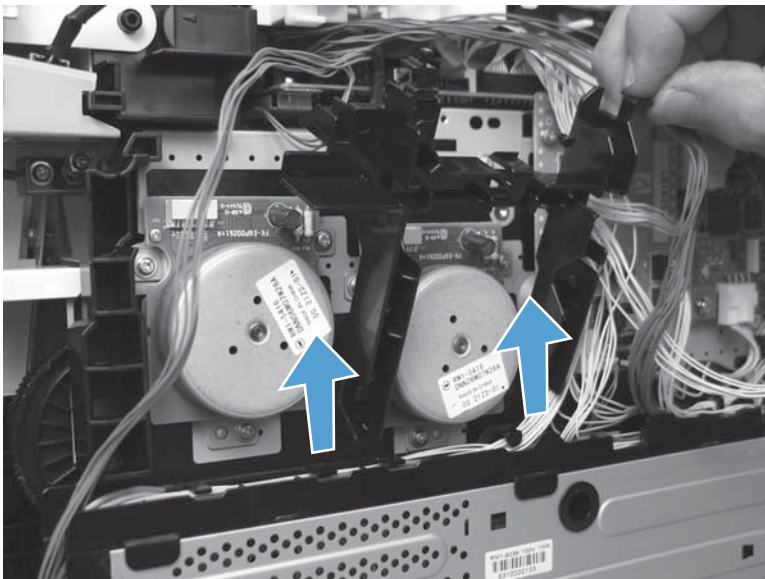

7. Remove three screws (callout 1) to remove motor M1, or remove three screws (callout 2) to remove motor M2.

Figure 1-100 Remove motor M1 and motor M2 (6 of 6)

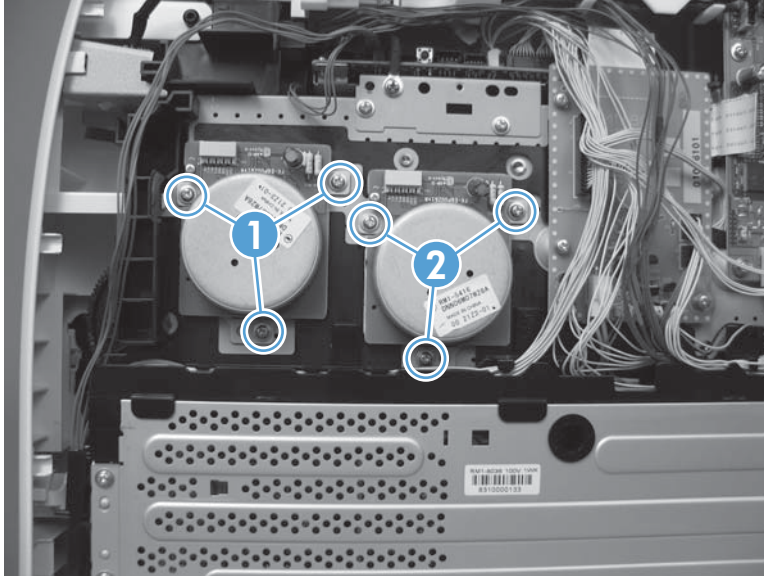

Reinstall the drum motor (M1) and developer motor (M2)

When the motor wire harness retainer is reinstalled, the two tabs at the bottom of the retainer must be positioned behind the retainer on the low-voltage power supply. The tab at the side of motor wire harness retainer must be positioned behind the PCA next to motor M2.

Figure 1-101 Reinstall the motor M1 and motor M2 wire-harness retainer

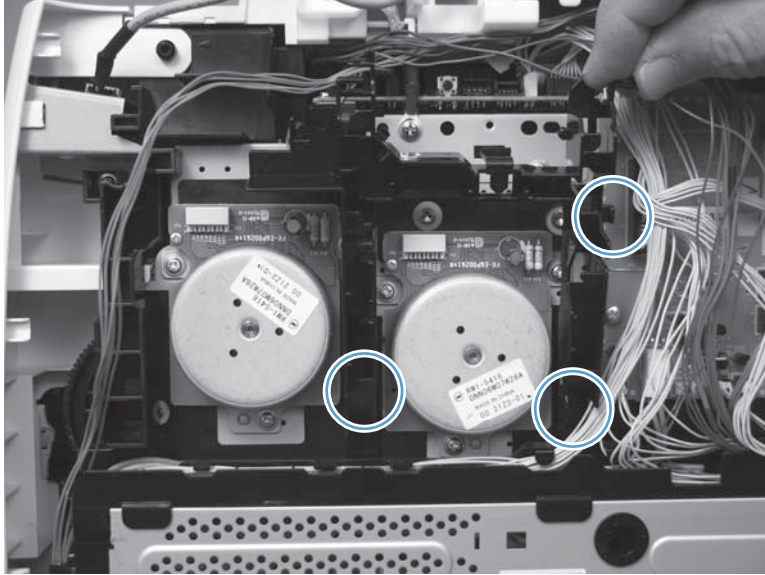

Intermediate PCA

1. Remove the right cover. See [Right cover on page 23](#).
2. Disconnect all of the connectors and one FFC (callout 1) on the PCA.

Figure 1-102 Remove the Intermediate PCA (1 of 2)

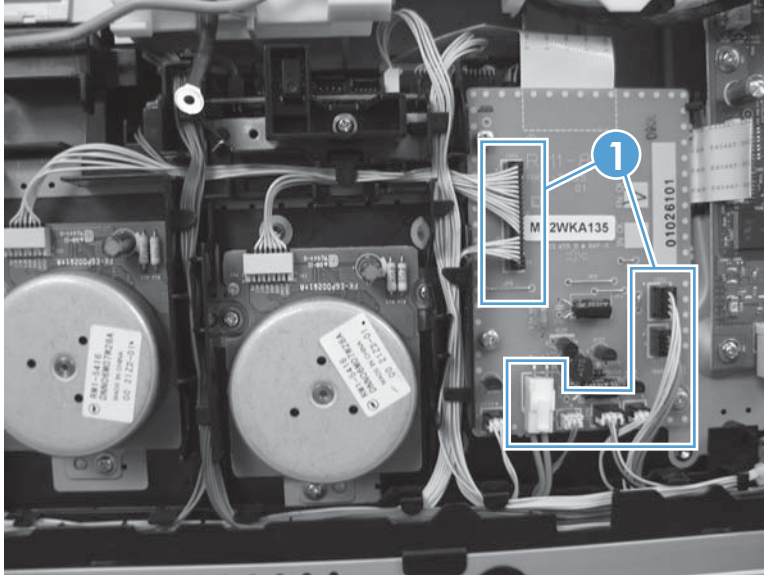

3. Remove three screws (callout 1), and then remove the intermediate PCA.

Figure 1-103 Remove the Intermediate PCA (2 of 2)

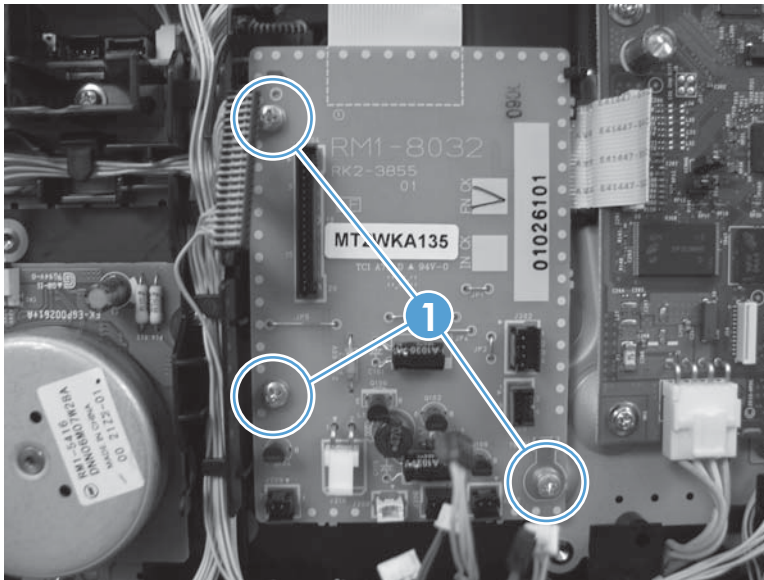

Formatter PCA and fax PCA

 **WARNING!** Do not install a *replacement* formatter PCA and DC controller PCA at the same time.

The formatter PCA and the DC controller PCA store important product configuration information (NVRAM data) that is lost if both PCAs are replaced at the same time. When the product power is turned on, the DC controller restores the NVRAM data on the replacement formatter.

Replacing both the formatter and the DC controller at the same time will result in severe print-quality problems.

 **NOTE:** The base model does not have a fax card installed.

Replacing the formatter PCA before the DC controller PCA

Use the following procedure if you need to install a replacement formatter PCA *and* a replacement DC controller.

 **NOTE:** If you are only installing a replacement formatter PCA, go to [Remove the formatter PCA and fax PCA on page 76](#).

1. Install a replacement formatter PCA.
2. Turn the product on, and wait for the print-cartridge volume indicators to appear on the control-panel display.

 **NOTE:** This allows important product information to be written to the replacement formatter PCA.

3. Turn the product off.
4. Install a replacement DC controller. See [DC controller PCA on page 80](#).
5. Turn the product on.

Remove the formatter PCA and fax PCA

 **CAUTION:** Do not bend or fold the flat flexible cables (FFCs) during removal or installation. Also, do not straighten pre-folds in the FFCs. You *must* make sure that all FFCs are fully seated in their connectors. Failure to fully seat an FFC into a connector can cause a short circuit in a PCA.

 Some parts are sensitive to electrostatic discharge (ESD). Always perform service work at an ESD-protected workstation or mat. If an ESD workstation or mat is not available, ground yourself by touching the sheet-metal chassis *before* touching an ESD-sensitive part.

 **NOTE:** The base model does not have a fax PCA.

1. Remove the right cover. See [Right cover on page 23](#).

2. Disconnect all of the connectors (callout 1).

Figure 1-104 Remove the formatter (1 of 4; base model)

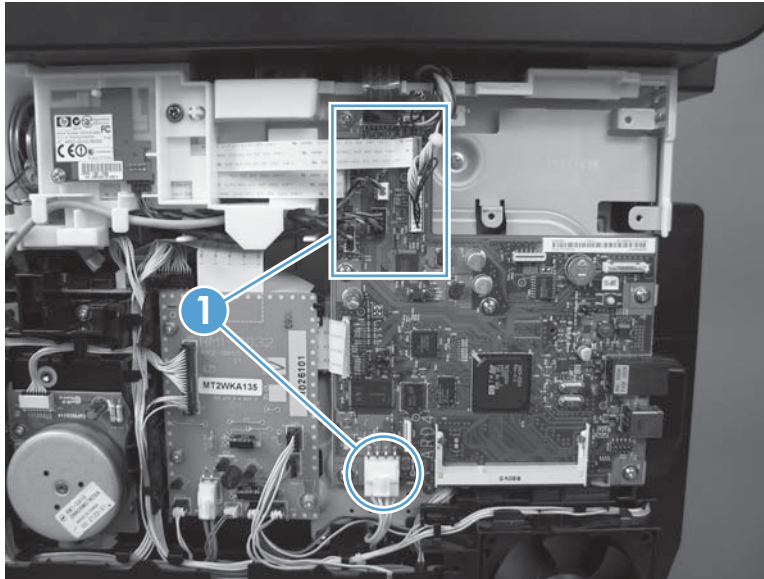
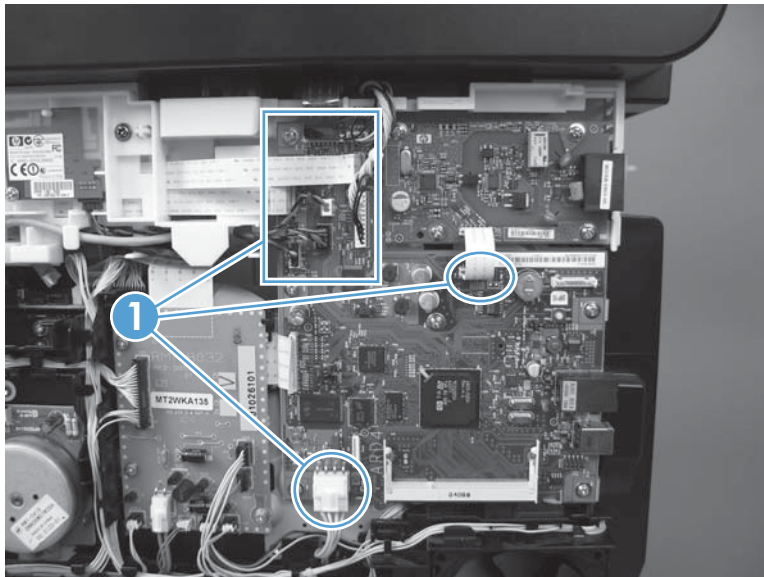

Figure 1-105 Remove the formatter (2 of 4; fax model)



3. Remove six screws for the base model or ten screws (callout 1) for the fax model, and then remove the formatter PCA and the fax PCA.

 **NOTE:** The base model does not have a fax PCA.

Figure 1-106 Remove the formatter (3 of 4; base model)

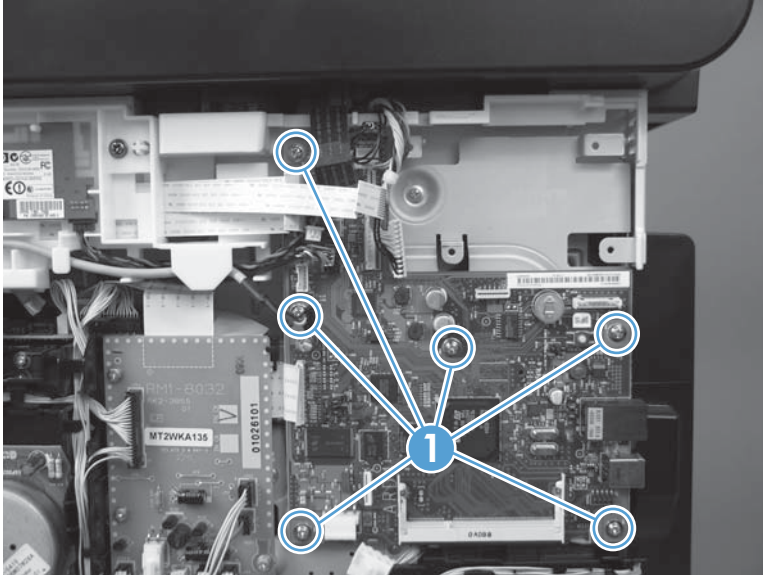
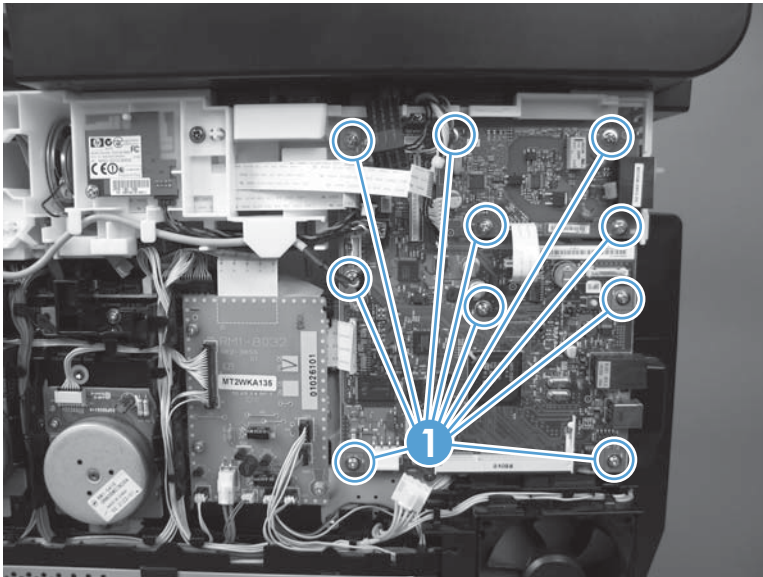

Figure 1-107 Remove the formatter (4 of 4; fax model)



Wireless PCA

1. Remove the right cover. See [Right cover on page 23](#)
2. Remove one screw (callout 1). Disconnect one connector (callout 2) at the formatter PCA if you are removing the wireless PCA, or disconnect one connector (callout 3) if you are replacing the wireless PCA.

Figure 1-108 Remove the wireless PCA (1 of 2)

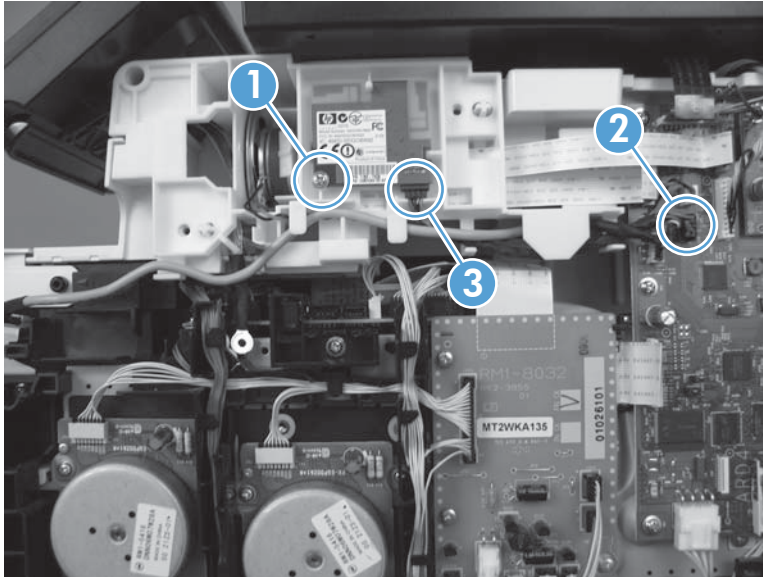

3. Remove the wireless PCA (callout 1).

Figure 1-109 Remove the wireless PCA (2 of 2)

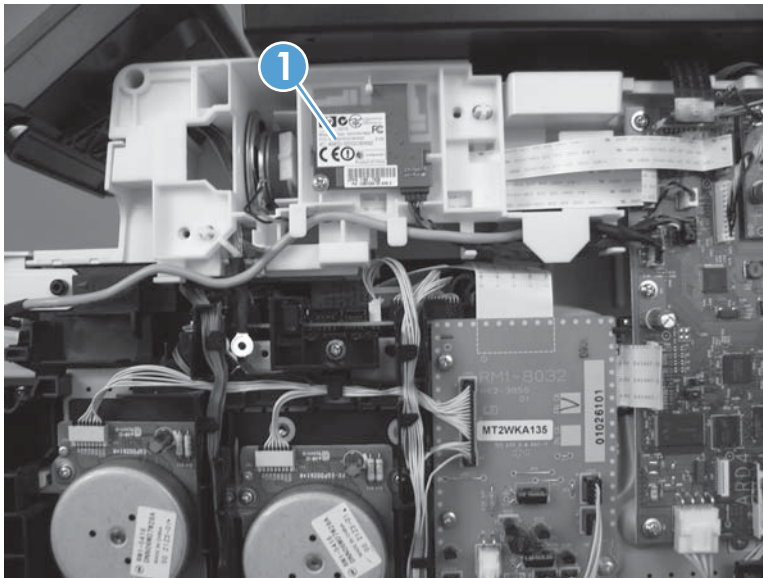

DC controller PCA

 **WARNING!** Do not install a *replacement* formatter PCA and a *replacement* DC controller PCA at the same time.

The formatter PCA and the DC controller PCA store important product configuration information (NVRAM data) that is lost if both PCAs are replaced at the same time. When the product power is turned on, the formatter restores the NVRAM data to a replacement DC controller.

Replacing both the DC controller and the formatter at the same time will result in severe print-quality problems.

Replacing the DC controller PCA before the formatter PCA

Use the following procedure if you need to install a replacement DC controller *and* a replacement formatter PCA.

1. Install a replacement DC controller PCA.
2. Turn the product on, and wait for the print-cartridge volume indicators to appear on the control-panel display.

 **NOTE:** This allows important product information to be written to the replacement DC controller PCA.

3. Turn the product off.
4. Install a replacement formatter PCA. See [Formatter PCA and fax PCA on page 76](#).
5. Turn the product on.

Before you proceed, remove the following components:

- Right cover. See [Right cover on page 23](#).
- Scanner assembly. See [Scanner assembly on page 26](#).
- Upper cover. See [Upper-cover assembly on page 51](#).

Remove the DC controller PCA

⚠ CAUTION: Do not bend or fold the flat flexible cables (FFCs) during removal or installation. Also, do not straighten pre-folds in the FFCs. You *must* make sure that all FFCs are fully seated in their connectors. Failure to fully seat an FFC into a connector can cause a short circuit in a PCA.

⚠ ESD Some parts are sensitive to electrostatic discharge (ESD). Always perform service work at an ESD-protected workstation or mat. If an ESD workstation or mat is not available, ground yourself by touching the sheet-metal chassis *before* touching an ESD-sensitive part.

1. Disconnect all of the connectors.

📄 NOTE: The DC controller is located along the top right of the product.

Figure 1-110 Remove the DC controller PCA (1 of 2)

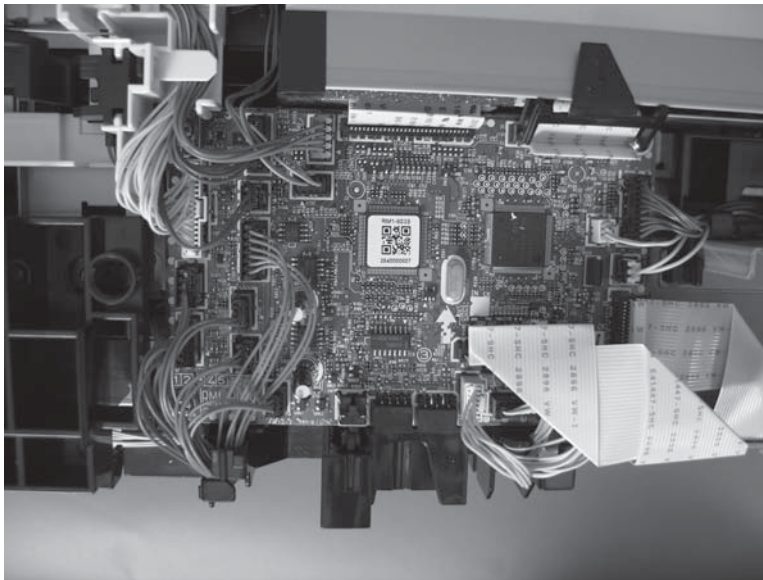

2. Remove four screws (callout 1) and then remove the DC controller PCA.

Figure 1-111 Remove the DC controller PCA (2 of 2)

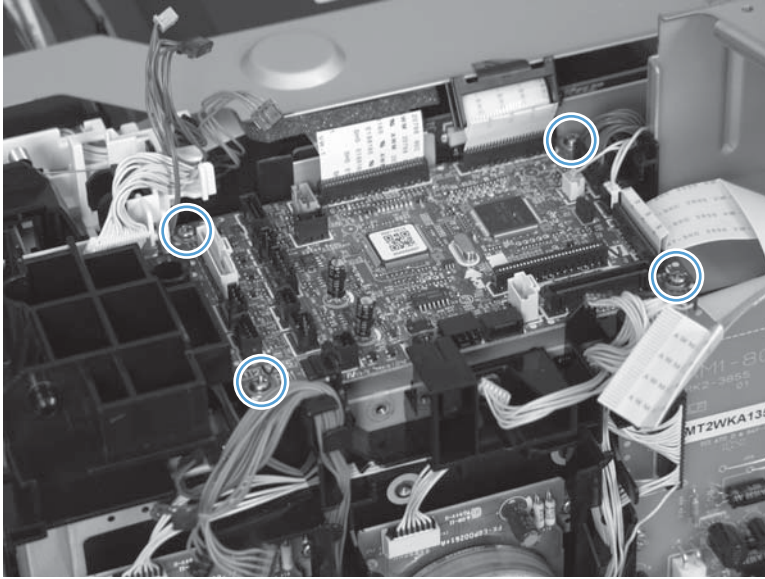

Fuser-motor assembly

Before proceeding, remove the following components:

- Right cover. See [Right cover on page 23](#).
- Control panel and right-arm mount. See [Control panel and right-arm mount on page 48](#).
- Formatter and fax PCAs. See [Formatter PCA and fax PCA on page 76](#).
- Simplex products
 - Rear door. See [Rear door \(simplex product\) on page 33](#).
 - Rear cover (simplex products). See [Rear cover and feed guide \(simplex product\) on page 37](#).
- Duplex products
 - Rear-upper cover. See [Rear-upper cover \(duplex product\) on page 30](#).

Remove the fuser-motor assembly

1. Remove 5 screws (callout 1) and 3 screws (callout 2).

Figure 1-112 Remove the fuser-motor assembly (1 of 6)

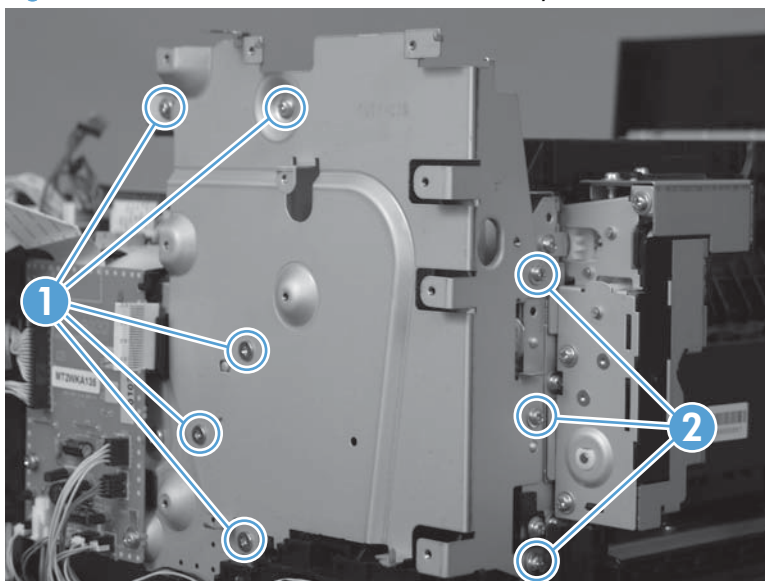

2. Remove three screws (callout 1) and release the wire harness from the retainer. Remove the fan assembly.

 **NOTE:** The fan assembly is still attached to the product. Move the fan assembly off to one side.

Figure 1-113 Remove the fuser-motor assembly (2 of 6)



3. Release three tabs (callout 1), and then remove the retainer.

Figure 1-114 Remove the fuser-motor assembly (3 of 6)

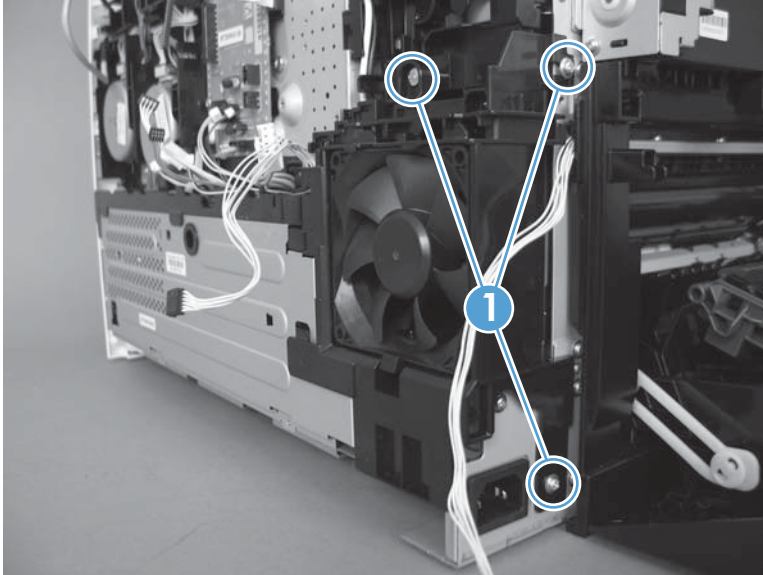
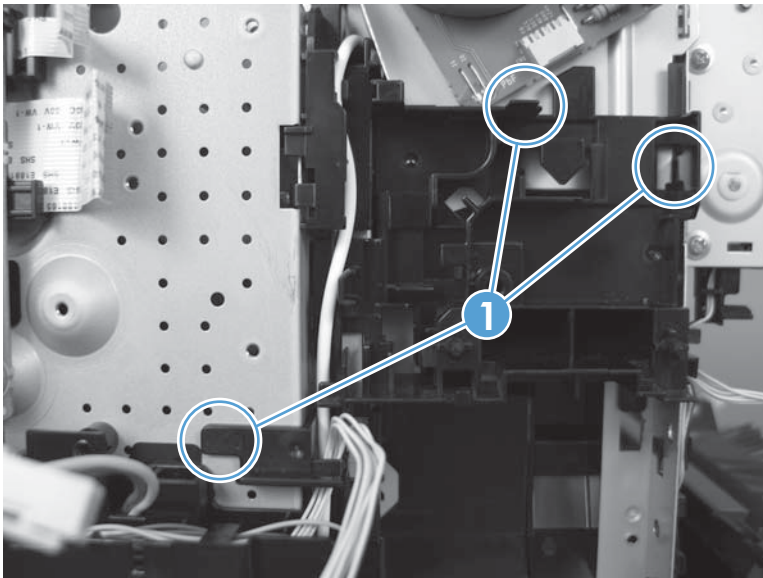

4. Disconnect one connector (callout 1) and remove the wire harness from the retainer (callout 2).

Figure 1-115 Remove the fuser-motor assembly (4 of 6)

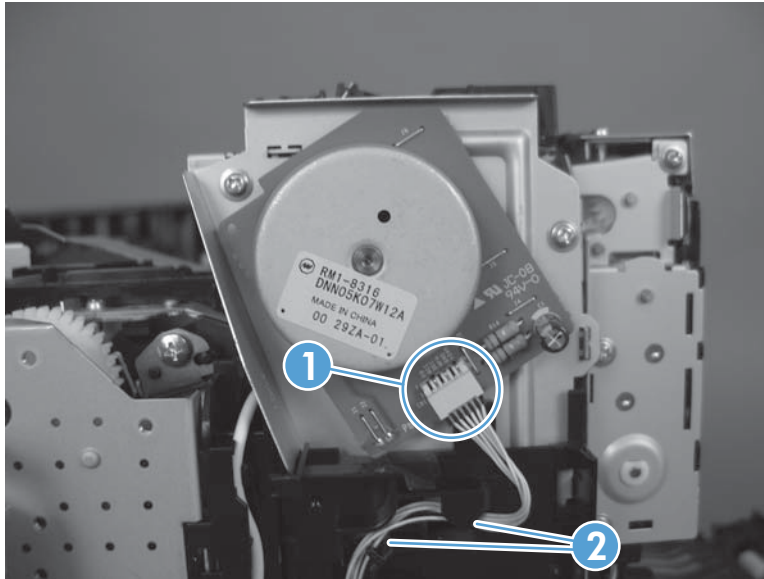

5. Remove three screws (callout 1), and then remove the fuser-motor assembly.

Figure 1-116 Remove the fuser-motor assembly (5 of 6)

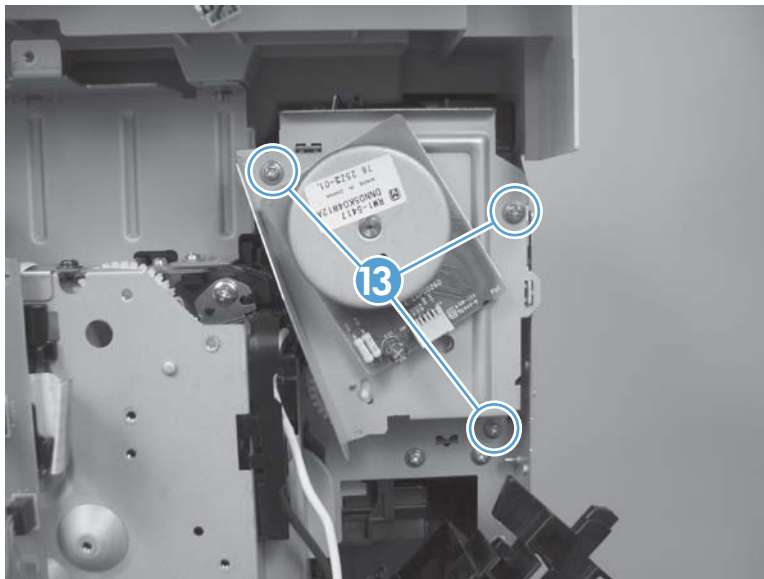

6. Before you proceed, take note that the spring and the gears behind the fuser-motor assembly are not captive.

CAUTION: Do not lose the spring or gears when you remove the fuser-motor assembly.

Figure 1-117 Remove the fuser-motor assembly (6 of 6)

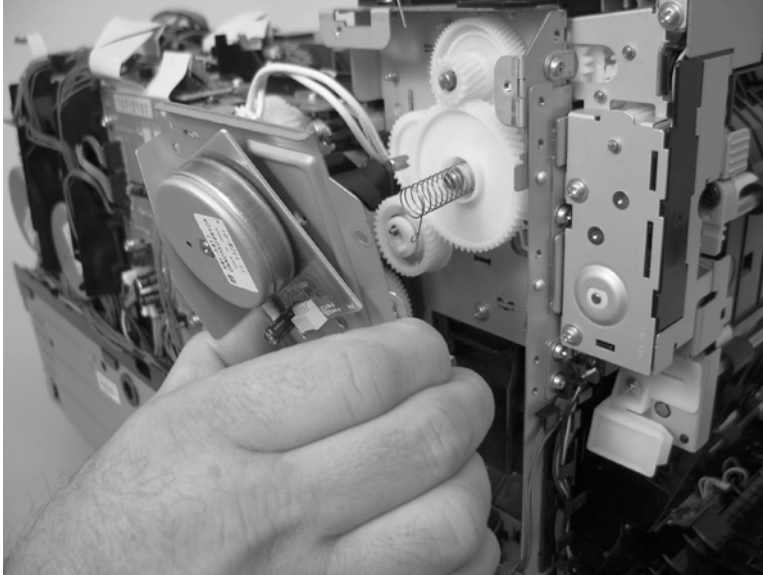

Reinstall the fuser-motor assembly

Make sure that the fuser-motor assembly spring (callout 1) and gear pin (callout 2) are correctly positioned in the hole and slot provided in the assembly mounting bracket. The assembly mounting bracket will fit flat against the product chassis when the fuser-motor assembly is correctly installed.

Figure 1-118 Reinstall the fuser-motor assembly

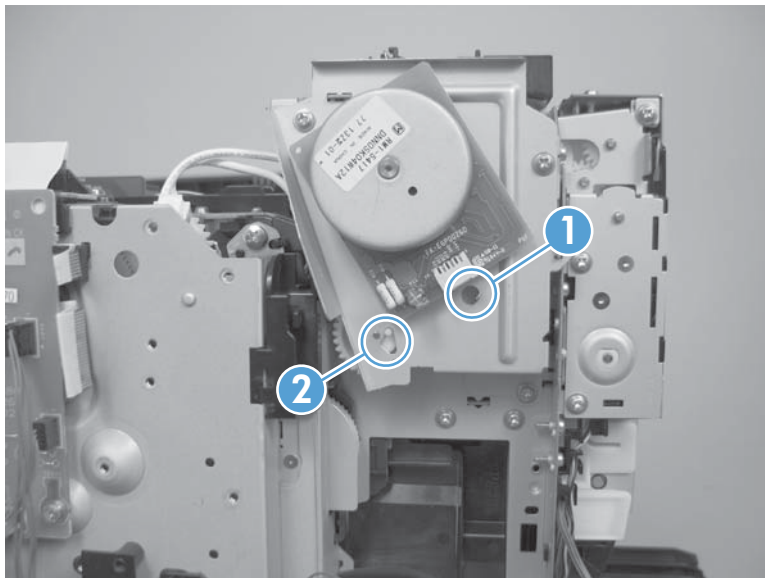

High-voltage power-supply PCA

Before proceeding, remove the following components:

- Right cover. See [Right cover on page 23](#).
- Scanner assembly. See [Scanner assembly on page 26](#).
- Simplex products
 - Rear door. See [Rear door \(simplex product\) on page 33](#).
 - Rear cover. See [Rear cover and feed guide \(simplex product\) on page 37](#).
- Duplex products
 - Rear door. See [Rear door \(duplex product\) on page 35](#).
 - Rear-lower cover. See [Rear-lower cover and rear-door links \(duplex product\) on page 41](#).
- Upper-cover assembly. See [Upper-cover assembly on page 51](#).
- Left cover. See [Left cover on page 55](#).

Remove the high-voltage power-supply PCA

1. Remove two screws (callout 1), and then remove the sheet-metal plate (callout 2).

Figure 1-119 Remove the high-voltage power-supply PCA (1 of 5)

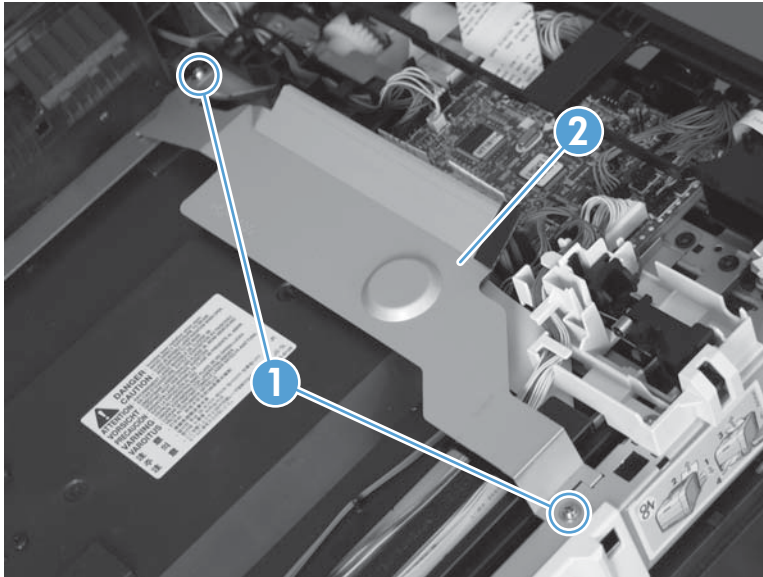

2. Release six tabs (callout 1), and then remove the black-plastic cover.

Figure 1-120 Remove the high-voltage power-supply PCA (2 of 5)

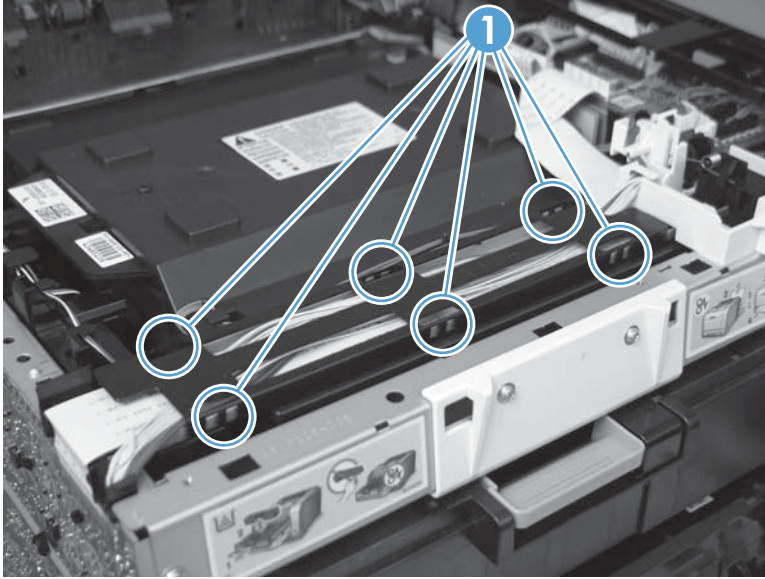

3. Disconnect one FFC (callout 1) on the DC controller.

Figure 1-121 Remove the high-voltage power-supply PCA (3 of 5)

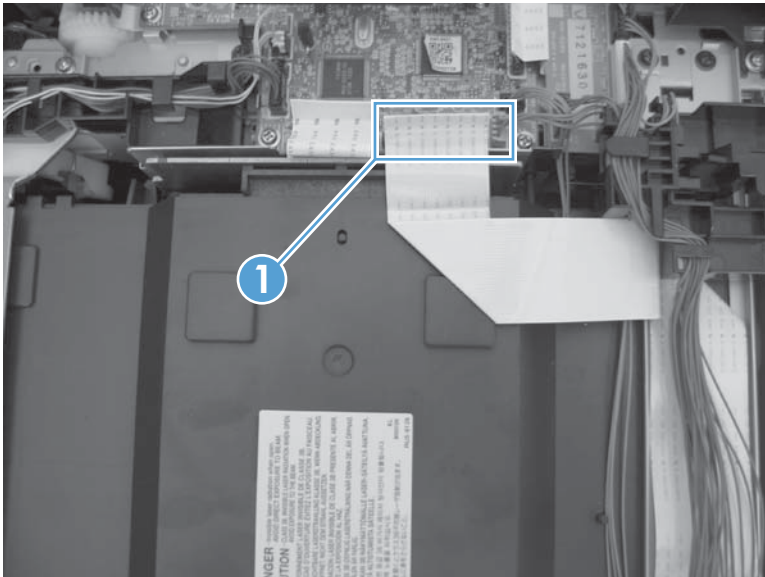

4. Disconnect one connector (callout 1), and then remove six screws (callout 2).

Figure 1-122 Remove the high-voltage power-supply PCA (4 of 5)

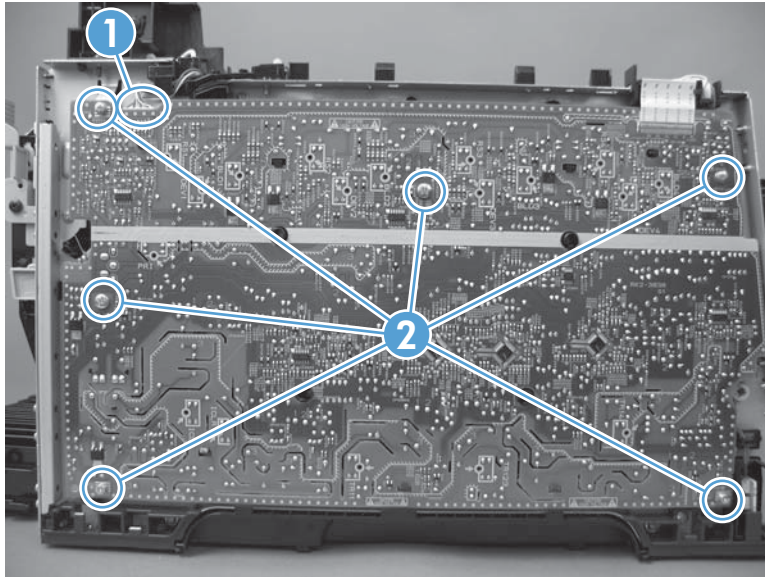

5. Release ten tabs (callout 1), and then remove the high-voltage power-supply PCA.

Figure 1-123 Remove the high-voltage power-supply PCA (5 of 5)

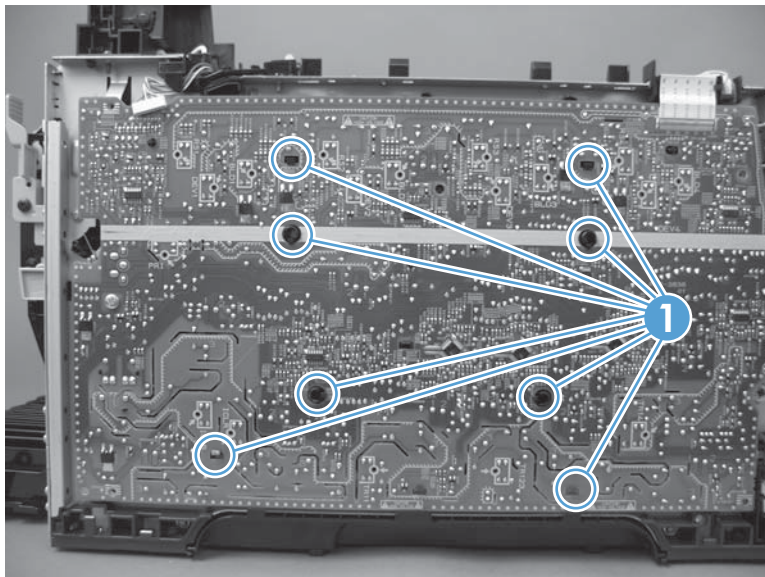

Color-misregistration sensor assembly

Before proceeding, remove the following components:

- Print-cartridge drawer. See [Print-cartridge drawer on page 20](#).
- Right cover. See [Right cover on page 23](#).
- Scanner assembly. See [Scanner assembly on page 26](#).
- Simplex products
 - Rear door. See [Rear door \(simplex product\) on page 33](#).
 - Rear cover. See [Rear cover and feed guide \(simplex product\) on page 37](#).
- Duplex products
 - Rear-lower cover. See [Rear-lower cover and rear-door links \(duplex product\) on page 41](#).
- Upper-cover assembly. See [Upper-cover assembly on page 51](#).
- Left cover. See [Left cover on page 55](#).
- High-voltage power-supply PCA. See [High-voltage power-supply PCA on page 87](#).

Remove the color-misregistration sensor assembly

1. Disconnect one connector (callout 1), and then release the wire harness from the guide (callout 2).

Figure 1-124 Remove the color-misregistration sensor assembly PCA (1 of 4)

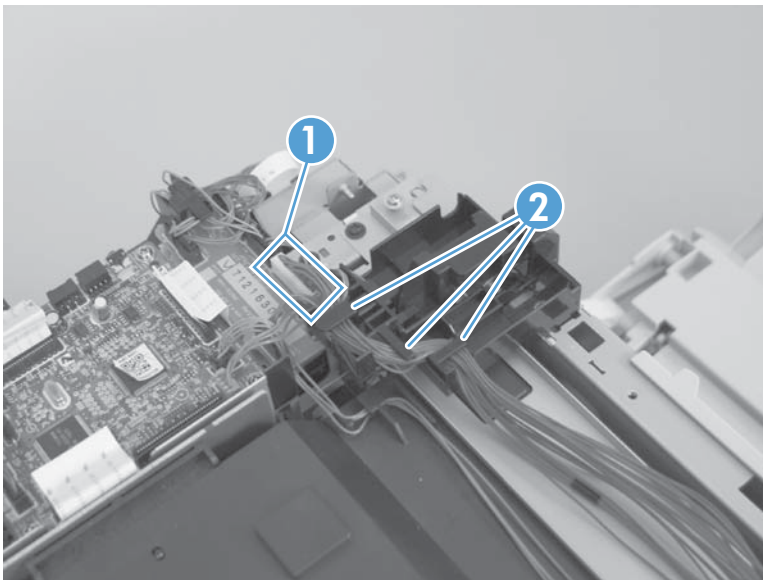

2. Release the wire harness from the guide (callout 1).

 **NOTE:** When you remove the sensor assembly later in this procedure, pass the connector and wire harness through the hole in the chassis (callout 2).

Figure 1-125 Remove the color-misregistration sensor assembly PCA (2 of 4)



3. Remove two screws (callout 1).

Figure 1-126 Remove the color-misregistration sensor assembly PCA (3 of 4)

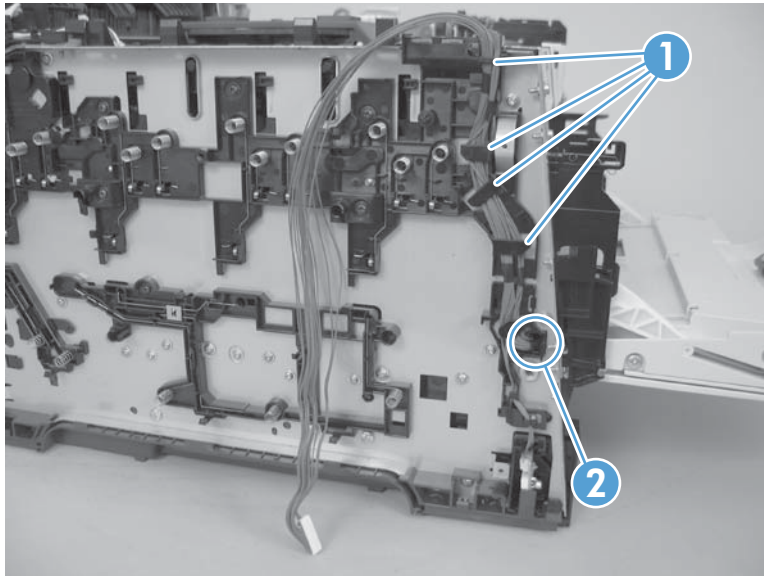
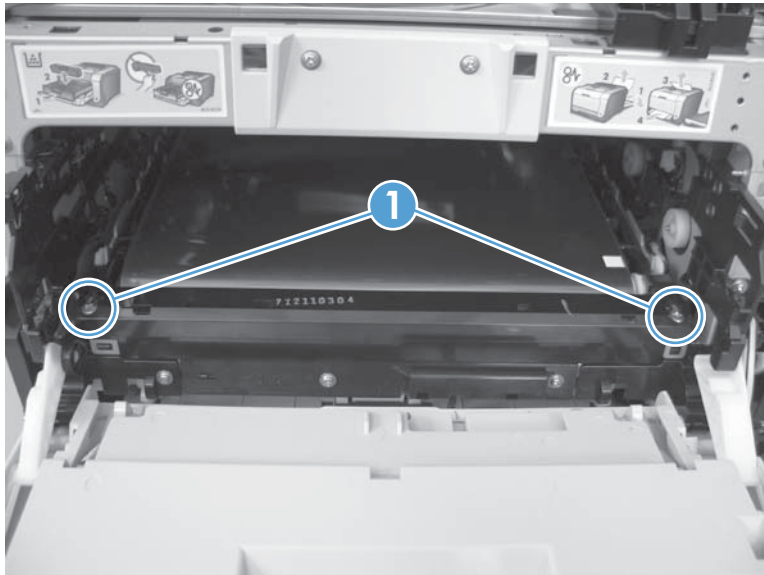

- Carefully separate the sensor assembly (callout 1) from the product, pass the wire harness through the hole in the chassis, and then remove the assembly.



 **NOTE:** Pass the connector and wire harness through the hole in the chassis. See [Figure 1-125 Remove the color-misregistration sensor assembly PCA \(2 of 4\) on page 91](#).

Figure 1-127 Remove the color-misregistration sensor assembly PCA (4 of 4)



Reinstall the color-misregistration sensor assembly

 **TIP:** You might have to attempt this reinstall procedure several times before you successfully pass the connector through the hole in the chassis.

- Push the sensor assembly wire-harness connector into the hole in the chassis from the ITB side of the product.

Figure 1-128 Reinstall the color-misregistration sensor assembly PCA (1 of 2)



2. Use a small flat blade screwdriver to guide the connector through the hole.

Figure 1-129 Reinstall the color-misregistration sensor assembly PCA (2 of 2)

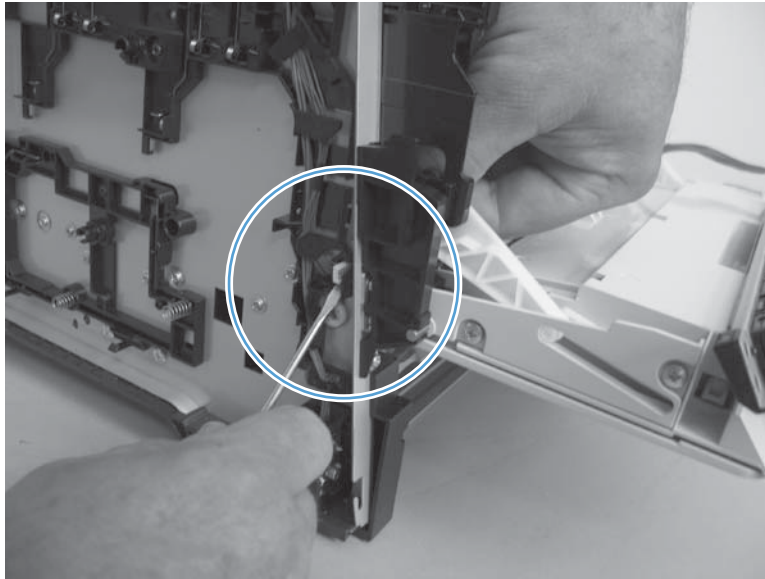

Fan (FM1)

CAUTION: When the fan is reinstalled, it must pull air into the product. The air-flow indicator arrow embossed on the fan chassis point into the fan duct when the fan is correctly installed.

1. Remove the right cover. See [Right cover on page 23](#).
2. Disconnect one connector (callout 1; J206)

Figure 1-130 Remove the fan (FM1) (1 of 2)

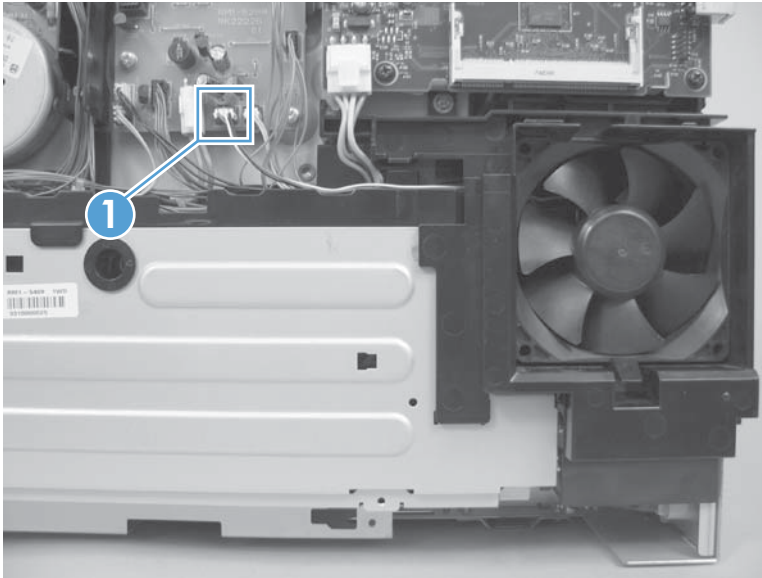

3. Release three tabs (callout 1), and then remove the fan.

 **NOTE:** As the fan is removed, you must feed the wire harness through an opening behind the fan duct.

 **TIP:** Use a small flat blade screwdriver to release the upper two tabs on the fan duct a second time when the fan is about half way out of the duct.

Figure 1-131 Remove the fan (FM1) (2 of 2)



USB PCA (fax/memory-card models)

Before proceeding, remove the following components:

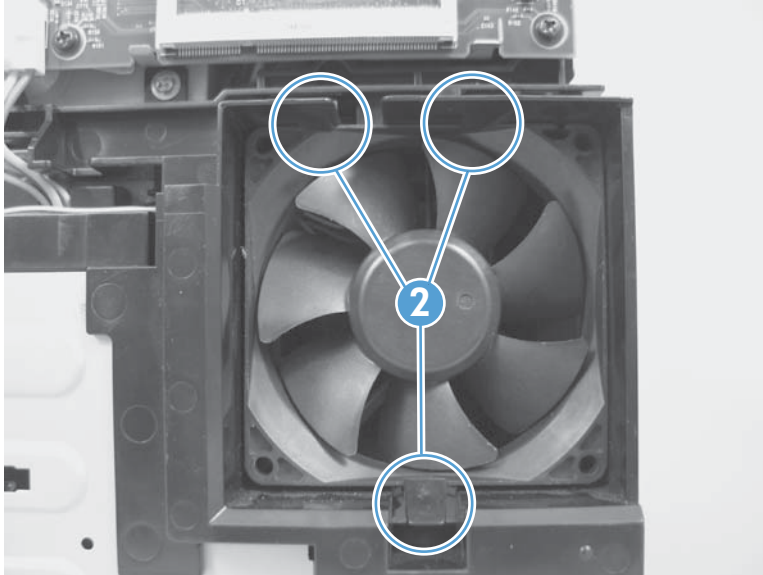
- Right cover. See [Right cover on page 23](#).
- Right-front cover and power button. See [Right-front cover and power button on page 28](#).

Remove the USB PCA

Release one tab (callout 1), and then remove the USB PCA.

Figure 1-132 Remove the USB PCA (fax/memory-card models)

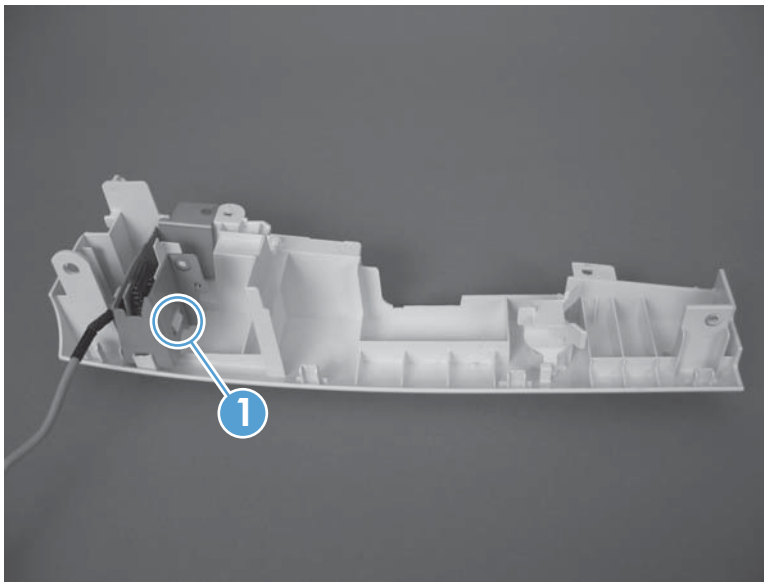

Duplex-reverse drive assembly

Before proceeding, remove the following components:

- Right cover. See [Right cover on page 23](#).
- Scanner assembly. See [Scanner assembly on page 26](#).
- Simplex product
 - Rear door. See [Rear door \(simplex product\) on page 33](#).
 - Rear cover. See [Rear cover and feed guide \(simplex product\) on page 37](#).
- Duplex product
 - Rear-upper cover. See [Rear-upper cover \(duplex product\) on page 30](#).
 - Rear door. See [Rear door \(duplex product\) on page 35](#).
 - Rear-lower cover. See [Rear-lower cover and rear-door links \(duplex product\) on page 41](#).
- Upper-cover assembly. See [Upper-cover assembly on page 51](#).

Remove the duplex-reverse drive assembly

1. Disconnect two connectors (callout 1), and then pass the connectors under the rear-door rib assembly.

Figure 1-133 Remove the duplex-reverse drive assembly (1 of 4)

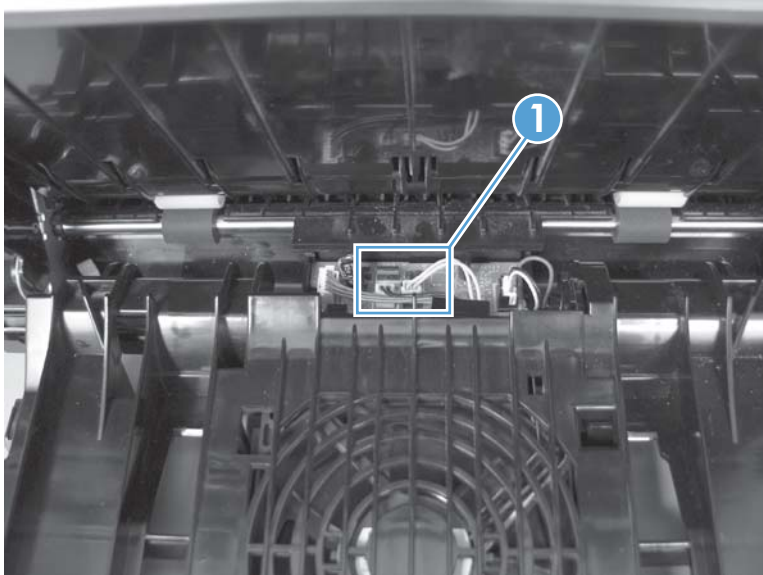

2. Release the wire harnesses from the retainer (callout 1).

Figure 1-134 Remove the duplex-reverse drive assembly (2 of 4)

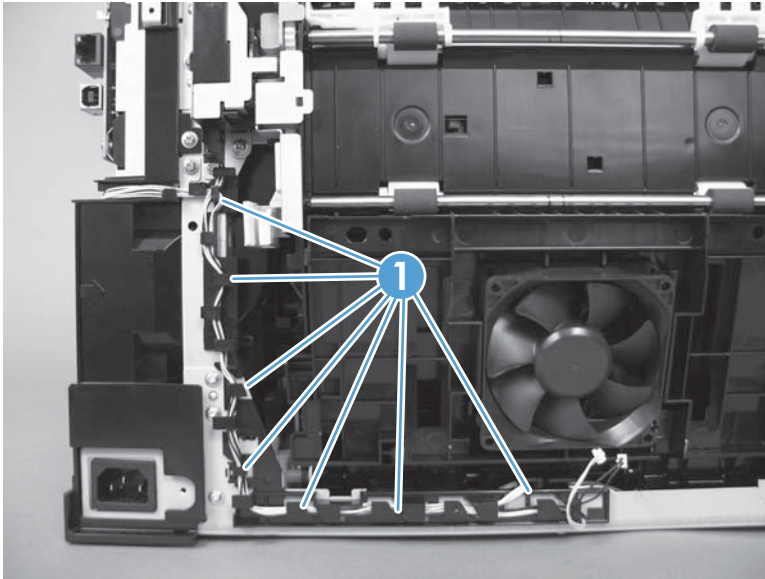

3. Remove three screws (callout 1).

Figure 1-135 Remove the duplex-reverse drive assembly (3 of 4)

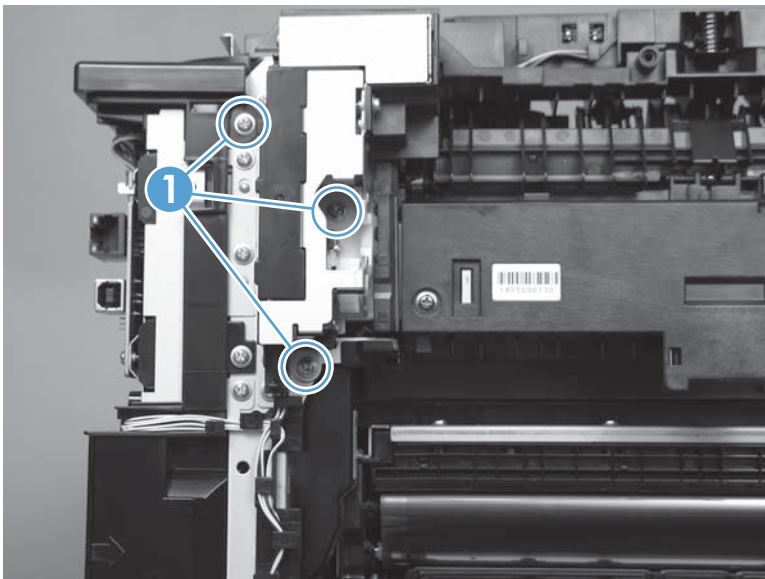

4. Remove the duplex-reverse drive assembly.

Figure 1-136 Remove the duplex-reverse drive assembly (4 of 4)



Fuser



NOTE: The fuser can be removed without removing the scanner assembly and the upper-cover assembly. However, it might be easier to access some of the connectors with these components removed.

Before proceeding, remove the following components:

- Right cover. See [Right cover on page 23](#).
- Scanner assembly. See [Scanner assembly on page 26](#).
- Simplex product
 - Rear door. See [Rear door \(simplex product\) on page 33](#).
 - Rear cover. See [Rear cover and feed guide \(simplex product\) on page 37](#).
- Duplex product
 - Rear-upper cover. See [Rear-upper cover \(duplex product\) on page 30](#).
 - Rear door. See [Rear door \(duplex product\) on page 35](#).
 - Rear-lower cover. See [Rear-lower cover and rear-door links \(duplex product\) on page 41](#).
- Upper-cover assembly. See [Upper-cover assembly on page 51](#).
- Left cover. See [Left cover on page 55](#).

Remove the fuser

⚠ WARNING! The fuser might be very hot. After turning off the product power, allow the fuser to cool for at least 5 minutes before removing it.

1. **Duplex models only:** Remove three screws (callout 1) and separate the duplex-reverse drive assembly from the product.

⚠ CAUTION: The duplex-reverse drive assembly is still attached to the product. Carefully set the assembly out of the way.

Figure 1-137 Remove the fuser (1 of 8)

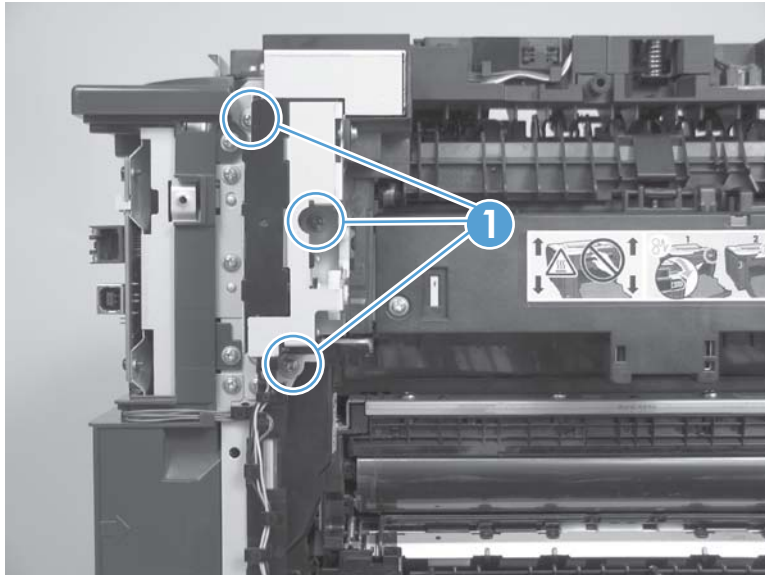

2. Disconnect two connectors (callout 1), and then release the wire harnesses from the guide (callout 2).

 **Reinstallation tip** When the upper cover is reinstalled, make sure that these wire harnesses (near the connectors) are correctly routed under the cover.

Figure 1-138 Remove the fuser (2 of 8)



3. Disconnect one connector (callout 1).

Figure 1-139 Remove the fuser (3 of 8)

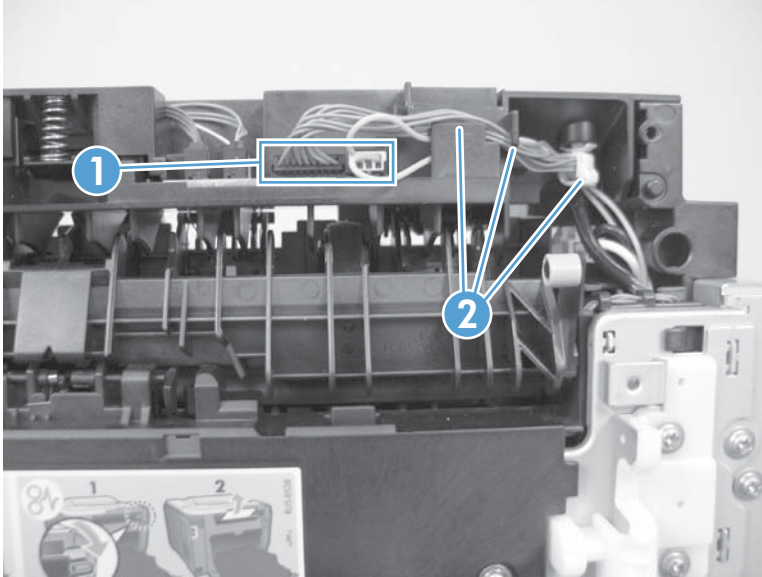
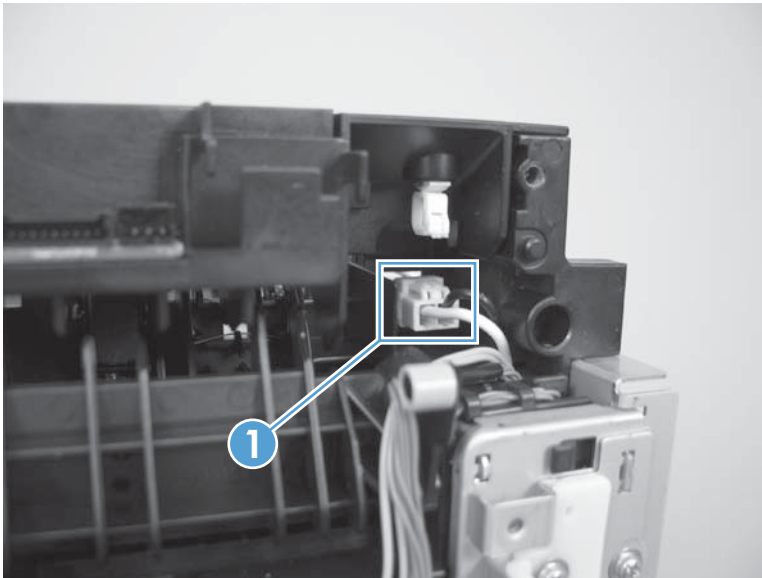

4. In the following step, the connector and guide will be separated from the fuser. You **must not** use too much force and damage the lower portion of the guide. If the guide is damaged, the fuser must be replaced.

Figure 1-140 Remove the fuser (4 of 8)

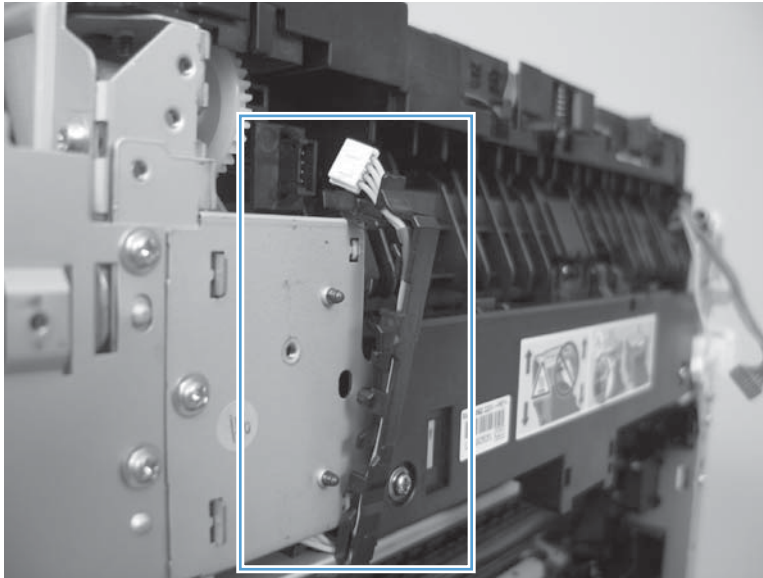

5. Carefully disconnect one connector (callout 1) and then rotate the connector and the top portion of the guide away from the fuser.

⚠ CAUTION: Do not separate the connector and guide more than is shown in [Figure 1-140 Remove the fuser \(4 of 8\) on page 103](#). If the guide is damaged, you must replace the fuser. Do not damage the connector.

Figure 1-141 Remove the fuser (5 of 8)

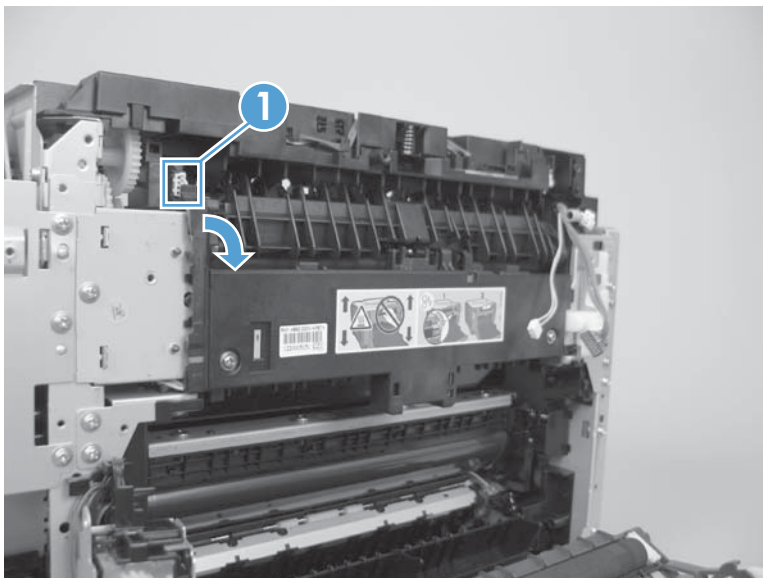

6. Remove two screws (callout 1).

Figure 1-142 Remove the fuser (6 of 8)

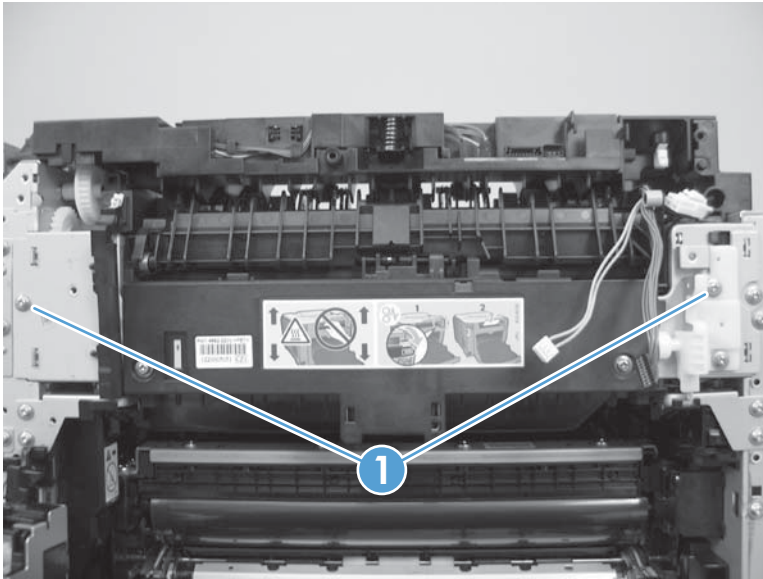

7. Remove the fuser.

Figure 1-143 Remove the fuser (7 of 8)

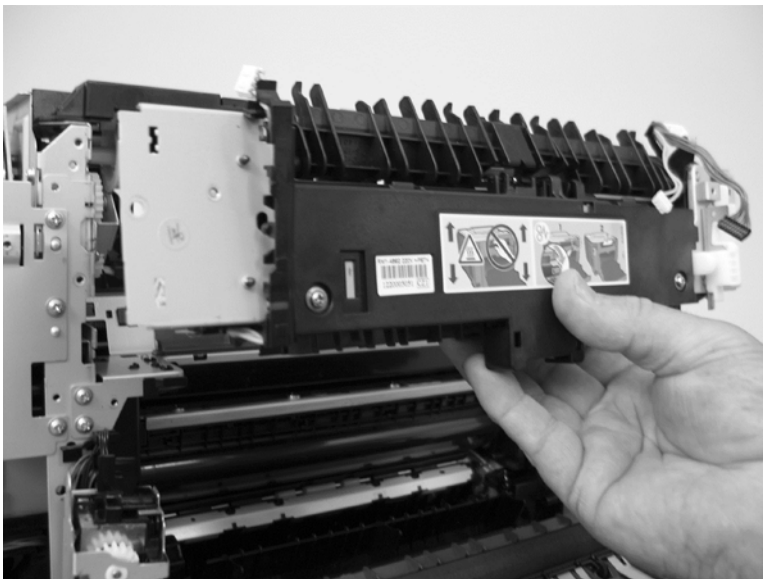

8. **Duplex models only:** Remove two screws (callout 1) and remove the duplex-gear assembly (callout 2). Install the assembly on the replacement fuser.

Figure 1-144 Remove the fuser (8 of 8)

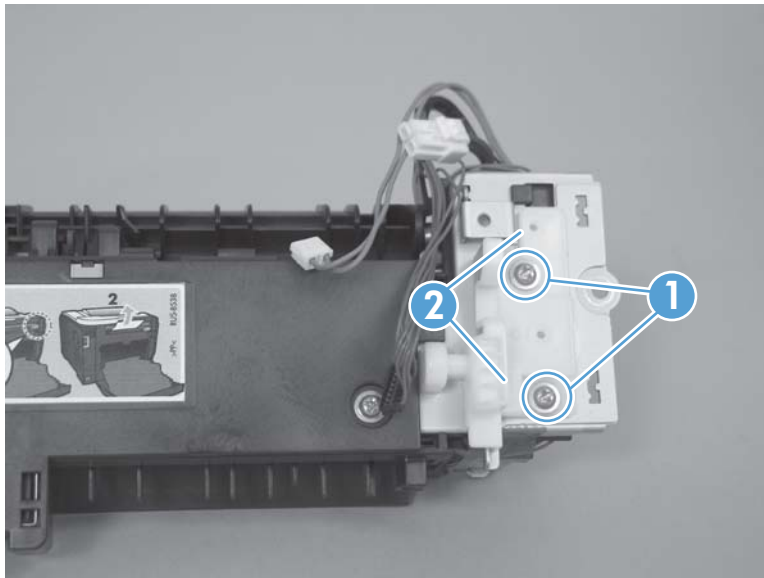

Reinstall the fuser

To reinstall you must insert the tabs (callout 1) on the fuser frame into the slots on the product chassis (callout 2).

⚠ CAUTION: The fuser frame must be flush with the product chassis before you install the two fuser mounting screws. **Do not** use the screws to pull the fuser frame against the chassis.

Figure 1-145 Reinstall the fuser

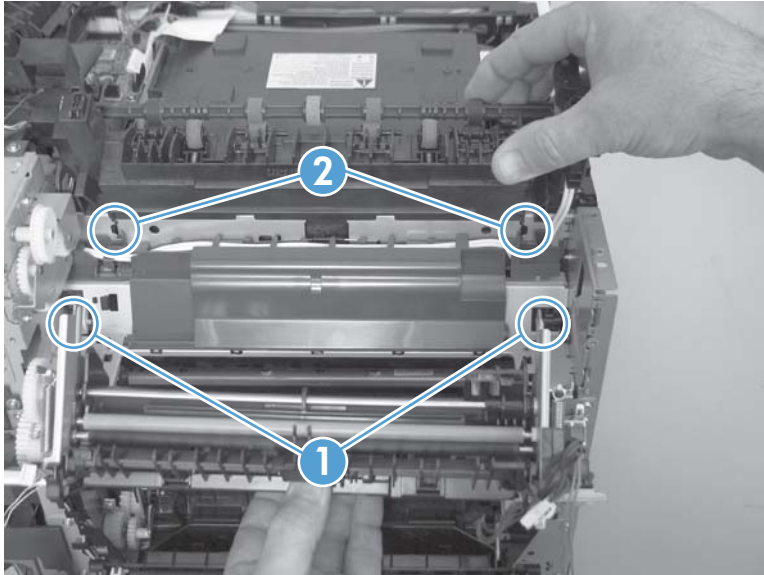

Paper-delivery assembly

Before proceeding, remove the following components:

- Right cover. See [Right cover on page 23](#).
- Scanner assembly. See [Scanner assembly on page 26](#).
- Simplex product
 - Rear door. See [Rear door \(simplex product\) on page 33](#).
 - Rear cover. See [Rear cover and feed guide \(simplex product\) on page 37](#).
- Duplex product
 - Rear-upper cover. See [Rear-upper cover \(duplex product\) on page 30](#).
 - Rear door. See [Rear door \(duplex product\) on page 35](#).
 - Rear-lower cover. See [Rear-lower cover and rear-door links \(duplex product\) on page 41](#).
- Upper-cover assembly. See [Upper-cover assembly on page 51](#).
- Left cover. See [Left cover on page 55](#).

Remove the paper-delivery assembly

1. Disconnect three connectors (callout 1), and then release the wire harnesses from the retainer (callout 2).

Figure 1-146 Remove the paper-delivery assembly (1 of 4)

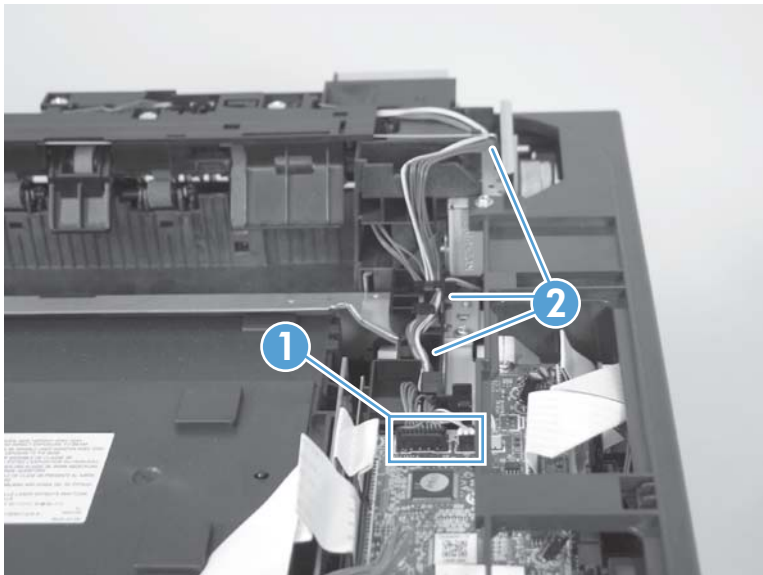

2. Disconnect two connectors (callout 1), and then release the wire harness from the wire clip (callout 2).

Figure 1-147 Remove the paper-delivery assembly (2 of 4)

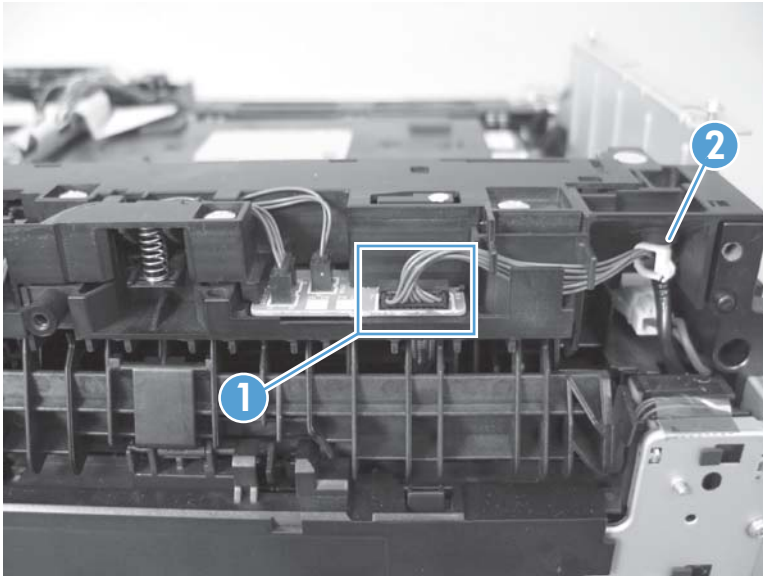

3. Remove three screws (callout 1).

Figure 1-148 Remove the paper-delivery assembly (3 of 4)

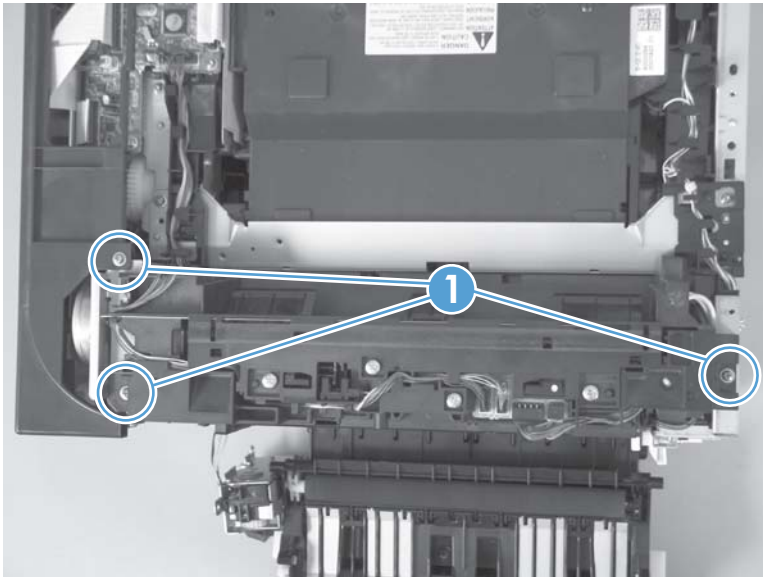

4. Remove the paper-delivery assembly.

Figure 1-149 Remove the paper-delivery assembly (4 of 4)

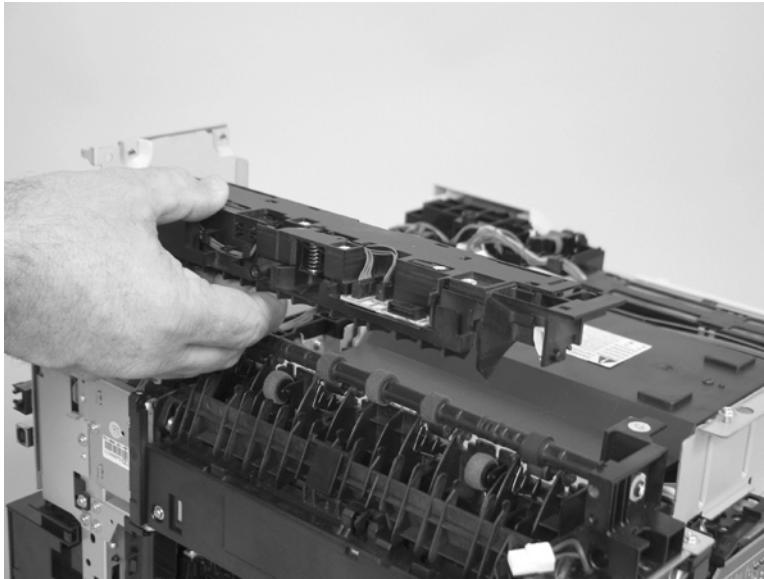

Tray cassettes and optional Tray 3 assembly

1. **Tray 2 and Tray 3 cassette:** Pull the tray straight out of the product to remove it.

Figure 1-150 Remove the tray cassettes and optional Tray 3 assembly (1 of 2)



2. **Optional Tray 3 assembly:** Lift the product straight up from the assembly, and then set the product on a sturdy, level surface.

CAUTION: Lift the product by using the right- and left-side hand-holds. Do not lift the product by grasping the Tray 2 cassette, or the cavity created if the cassette is removed.

Figure 1-151 Remove the tray cassettes and optional Tray 3 assembly (2 of 2)



2 Solve problems

To use the information in this chapter, you should have a basic understanding of the HP LaserJet printing process. Explanations of each mechanical assembly, the printer systems, and the basic theory of operation are contained in *LASERJET PRO 300/400 COLOR MFP Theory of Operation*. Do not perform any of these troubleshooting processes unless you understand the function of each product component.

- [Solve problems checklist](#)
- [Menu map](#)
- [Troubleshooting process](#)
- [Troubleshooting tools](#)
- [Clear jams](#)
- [Solve paper-handling problems](#)
- [Solve image-quality problems](#)
- [Clean the product](#)
- [Solve performance problems](#)
- [Solve product connectivity problems](#)
- [Service mode functions](#)
- [Solve fax problems](#)
- [Product updates](#)

Solve problems checklist

If you are experiencing problems with the product, use the following checklist to identify the cause of the problem:

- Is the product connected to power?
- Is the product on?
- Is the product in the **Ready** state?
- Are all necessary cables connected?
- Are any lights blinking or do any messages appear on the control panel?
- Are genuine HP supplies installed?
- Was a recently replaced toner cartridge installed correctly, and was the pull tab on the cartridge removed?

For additional information about installation and setup, see the product getting started guide.

If you cannot find solutions to problems in this guide, go to www.hp.com/go/LJColorMFPM375 or www.hp.com/go/LJColorMFPM475.

Menu map

Print a menu map

1. Touch the Setup  button.
2. Open the [Reports](#) menu, and then touch the [Menu Structure](#) item.

 **TIP:** Touch the area of the control-panel display where the Cancel  button would be to close the menus without printing the report.

Troubleshooting process

When the product malfunctions or encounters an unexpected situation, the product control panel alerts you to the situation. This chapter contains information to help diagnose and solve problems.

- Use the pre-troubleshooting checklist to evaluate the source of the problem and to reduce the number of steps that are required to fix the problem.
- Use the troubleshooting flowchart to pinpoint the root cause of hardware malfunctions. The flowchart guides you to the section of this chapter that contains steps for correcting the malfunction.

Before beginning any troubleshooting procedure, check the following issues:

- Are supply items within their rated life?
- Does the configuration page reveal any configuration errors?



NOTE: The customer is responsible for checking supplies and for using supplies that are in good condition.

Pretroubleshooting checklist

The following table includes basic questions to ask the customer to quickly help define the problem.

General topic	Questions
Environment	<ul style="list-style-type: none">• Is the product installed on a solid, level surface (+/- 1°)?• Is the power-supply voltage within ± 10 volts of the specified power source?• Is the power-supply plug inserted in the product and the outlet?• Is the operating environment within the specified parameters?• Is the product exposed to ammonia gas, such as that produced by diazo copiers or office cleaning materials? NOTE: Diazo copiers produce ammonia gas as part of the copying processes. Ammonia gas (from cleaning supplies or a diazo copier) can have an adverse affect on some product components (for example, the print-cartridge OPC).• Is the product exposed to direct sunlight?
Media	<ul style="list-style-type: none">• Does the customer use only supported media?• Is the media in good condition (no curls, folds, or distortion)?• Is the media stored correctly and within environmental limits?
Input trays	<ul style="list-style-type: none">• Is the amount of media in the tray within specifications?• Is the media correctly placed in the tray?• Are the paper guides aligned with the stack?• Is the cassette correctly installed in the product?

General topic	Questions
Toner cartridges	<ul style="list-style-type: none"> • Is each toner cartridge installed correctly?
Transfer unit and fuser	<ul style="list-style-type: none"> • Are the transfer unit and fuser installed correctly?
Doors	<ul style="list-style-type: none"> • Is the front door closed?
Condensation	<ul style="list-style-type: none"> • Does condensation occur following a temperature change (particularly in winter following cold storage)? If so, wipe affected parts dry or leave the product on for 10 to 20 minutes. • Was a toner cartridge opened soon after being moved from a cold to a warm room? If so, allow the toner cartridge to sit at room temperature for 1 to 2 hours.
Miscellaneous	<ul style="list-style-type: none"> • Check for and remove any non-HP components (for example, toner cartridges or memory modules) from the product. • Check to see whether the hardware or software configuration has changed or the problem is not associated with any specific software. • Remove the product from the network and ensure that the failure is associated with the product before beginning troubleshooting. • For any print-quality issues, calibrate the product. See Calibrate the product on page 137

Power-on checks

When you turn on the product, if it does not make any sound or if the control-panel display is blank, check the following items:

- Verify that the product is plugged directly into an active electrical outlet that has the correct voltage. Do not plug the product into a surge protector or power strip.
- Verify that the power button is in the on position.
- Verify that the formatter is seated correctly.
- Remove any HP Jetdirect or other devices, and then try to turn the product on again.
- Ensure that the control-panel display is connected.
- Check the two fuses on the power supply.
- If necessary, replace the power supply.
- If necessary, replace the DC controller.

Troubleshooting tools

Component diagnostics

LED diagnostics

Network LEDs (network models only)

The onboard network solution has two network port LEDs. When the product is connected to a properly working network through a network cable, the yellow LED indicates network activity, and the green LED indicates the link status. A blinking yellow LED indicates network traffic. If the green LED is off, a link has failed.

For link failures, check all of the network cable connections. In addition, you can try to manually configure the link settings on the onboard network solution by using the product control-panel menus.

1. Touch the Setup  button.
2. Scroll to, and then touch [Network Setup](#).
3. Scroll to, and then touch [Link Speed](#).
4. Touch the appropriate link speed.

Control panel LEDs

The state of the Ready light and Attention light on the product signal the product status. The following table outlines the possible control-panel light states.

Product state	Ready light state	Attention light state
Initializing	Blinking	Blinking
Ready	On	Off
Receiving data/processing job or cancelling job	Blinking	Off
Error message	Off	Blinking
Fatal error (49 or 79 error) ¹	On	On

¹ The product will power off and then power on after one of these errors occurs.

Memory card LED (memory-card models only)

When a memory card is inserted into the correct memory-card slot, this LED turns on. If the LED is not lighting, try the following actions:

- Make sure that the memory card is in the correct slot.
- Make sure that the memory card is not defective.

- Verify that the flat flexible cable connection from the formatter to the memory-card reader assembly is firmly connected.
- If the card is not defective and the card is in the correct slot, the circuit board might have been inadvertently damaged by an electrostatic discharge from someone inserting a memory card. If this is the case, replace the memory-card reader assembly. If the error still occurs, replace the formatter.

Component tests

The control-panel tests require touching the Left Arrow ◀ button and the Cancel ✖ button on the touchscreen when they are not illuminated. Use the figure below to locate these buttons on the touchscreen.

Figure 2-1 Control-panel test



Control-panel tests

Test the control-panel display

1. Touch the Setup ⚙️ button.
2. Touch the Left Arrow ◀ button and the Cancel ✖ button at the same time.
3. Touch the Setup ⚙️ button.
4. Open the [2ndry Service](#) menu.
5. Touch the [Dispaly Test](#) item.

Test the control-panel buttons

1. Touch the Setup ⚙️ button.
2. Touch the Left Arrow ◀ button and the Cancel ✖ button at the same time.
3. Touch the Setup ⚙️ button.

4. Open the [2ndry Service](#) menu.
5. Touch the [Button Test](#) item.

Diagrams

Plug/jack locations

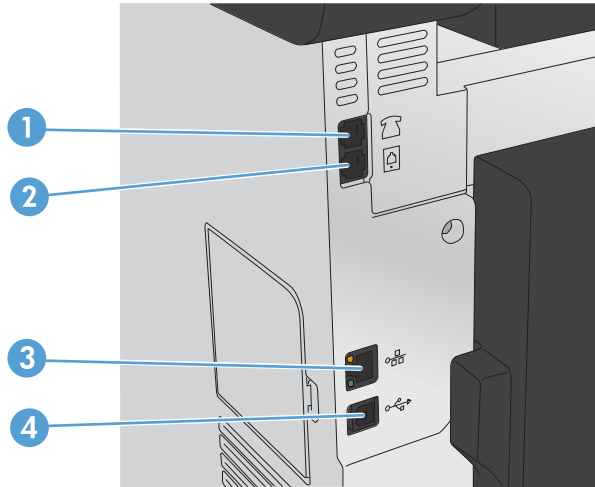

1	Telephone "line out" port for attaching an extension phone, answering machine, or other device
2	Fax "line in" port for attaching fax line to product
3	Network port
4	Hi-Speed USB 2.0 port

Location of connectors

DC controller PCA

Figure 2-2 DC controller connectors

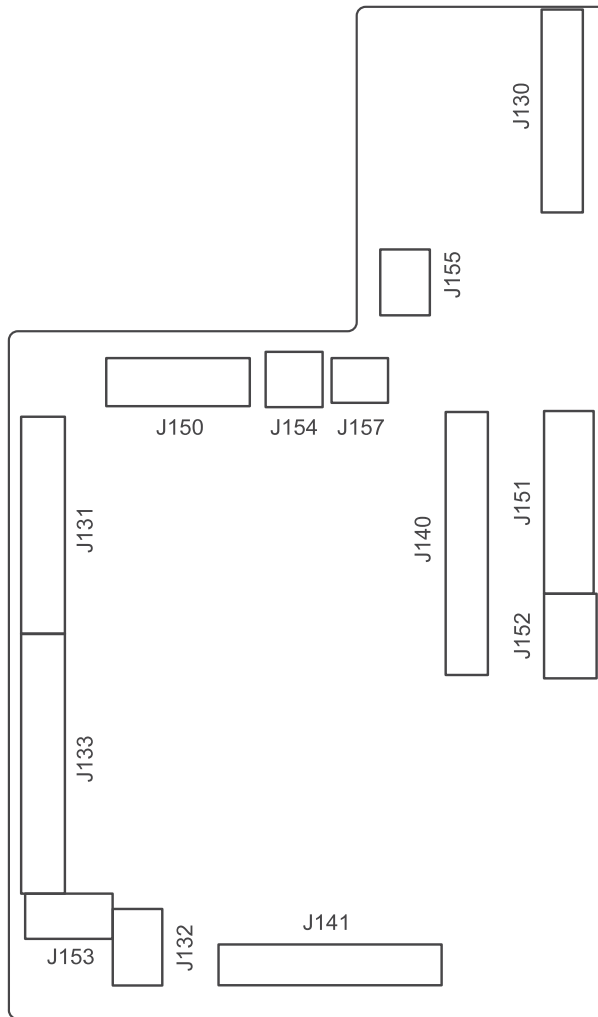

Loose DC controller connections can cause issues. Check the following connections when troubleshooting product problems.

Connector	Board
J130	DC controller
J131	DC controller
J132	DC controller
J133	DC controller
J140	DC controller
J141	DC controller
J150	DC controller

Connector	Board
J151	DC controller
J152	DC controller
J153	DC controller
J154	DC controller
J156	DC controller
J157	DC controller
J1	Formatter
J2	Formatter
J3	Formatter
J4	Formatter
J6	Formatter
J9	Formatter
J11	Formatter
P1	Formatter
P2	Formatter
P12	Formatter

Location of major components

Major components

Figure 2-3 Major components

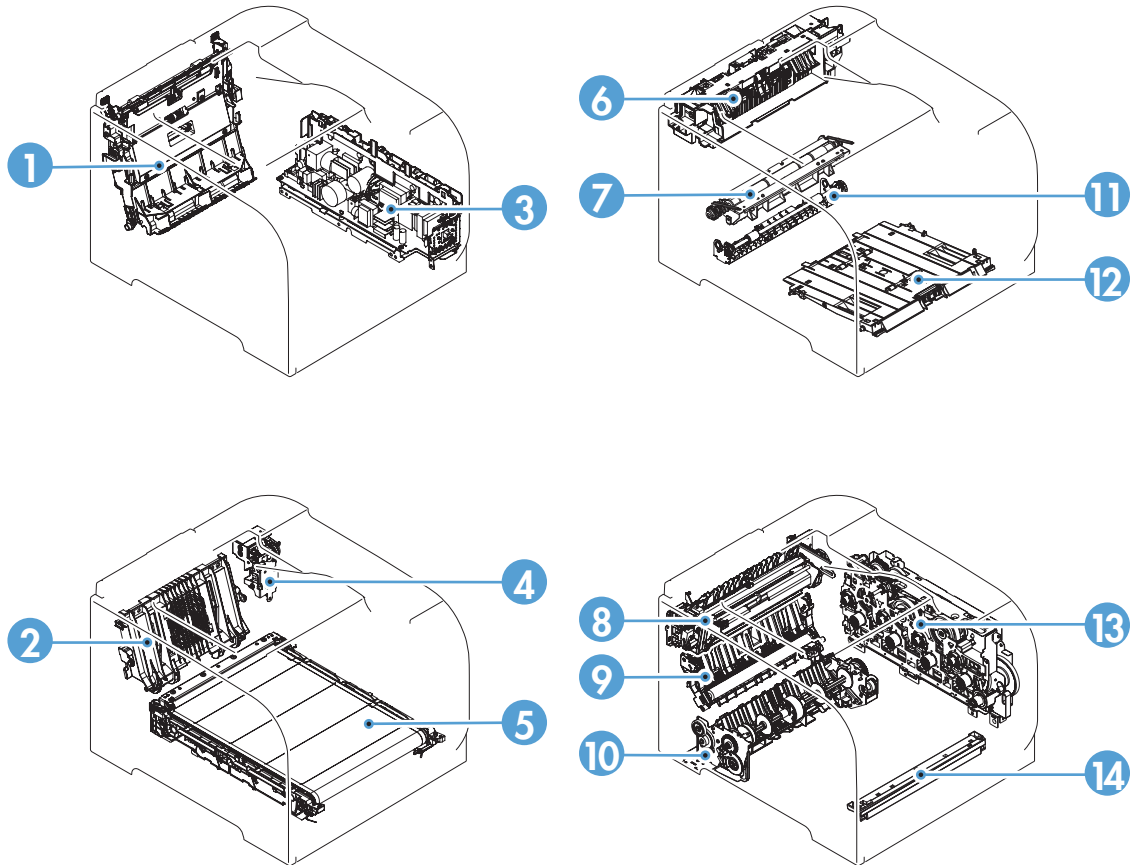

Table 2-1 Major components

Item	Description
1	Duplex feed assembly (duplex models only)
2	Rear door rib assembly (duplex models only)
3	Power supply assembly
4	Duplex reverse drive assembly (duplex models only)
5	ITB assembly
6	Delivery assembly
7	Registration assembly
8	Fuser assembly
9	Secondary transfer feed assembly
10	Cassette pickup assembly
11	Duplex re-pickup guide assembly (duplex models only)

Table 2-1 Major components (continued)

Item	Description
12	Multipurpose tray pickup assembly
13	Drive assembly
14	Color misregistration and density sensor

Motors and fans

Figure 2-4 Motors and fans



Table 2-2 Solenoid, sensors, and motors

Item	Description
1	Fuser motor
2	Drum motor (M1)
3	Developing motor (M2)
4	Fan 1
5	Fan 2 (duplex models only)
6	Pickup motor

Rollers

Figure 2-5 Rollers



Table 2-3 Rollers

Item	Description
1	Cassette pickup roller
2	Multipurpose tray pickup roller
3	Multipurpose tray separation pad
4	Cassette separation roller

Figure 2-6 PCAs

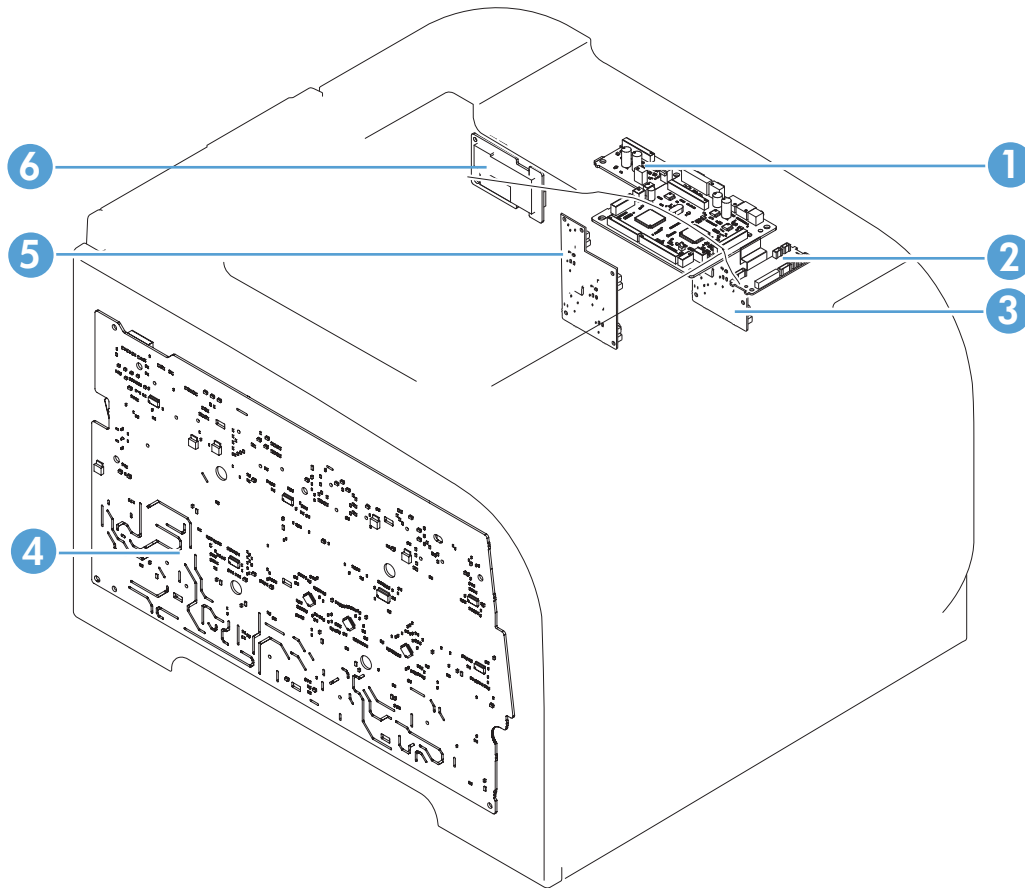

Table 2-4 PCAs

Item	Description
1	DC controller PCA
2	Connector PCA
3	Driver PCA
4	High-voltage power supply PCA
5	Formatter
6	Sub-power supply PCA

Optional 250-sheet cassette

Figure 2-7 Optional 250-sheet cassette

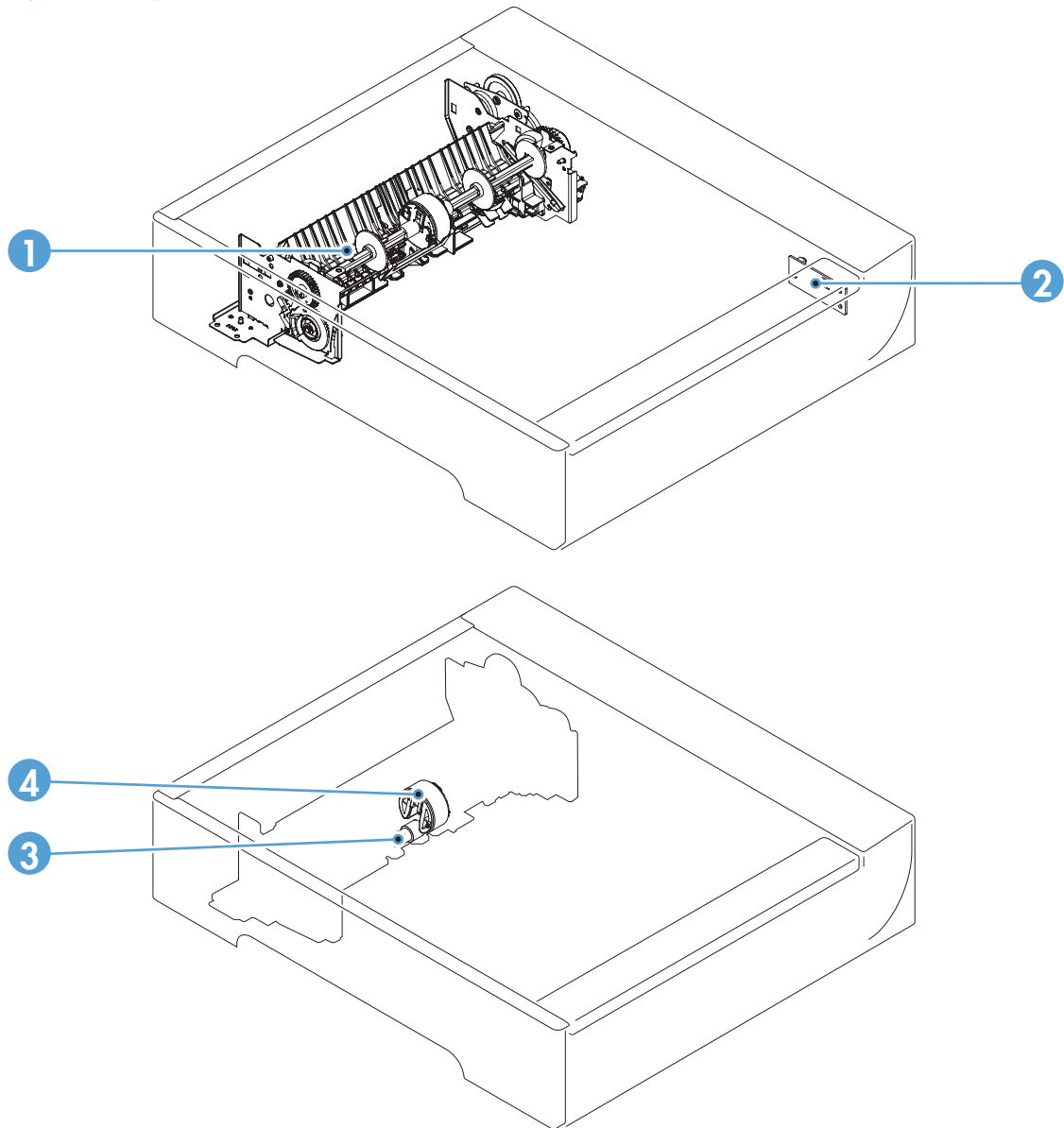

Table 2-5 Optional 250-sheet cassette

Item	Description
1	Paper feeder pickup assembly
2	Paper feeder connector PCA
3	Paper feeder separation roller
4	Paper feeder pickup roller

General timing diagram

Approximate timing in seconds.

Figure 2-8 Timing diagram

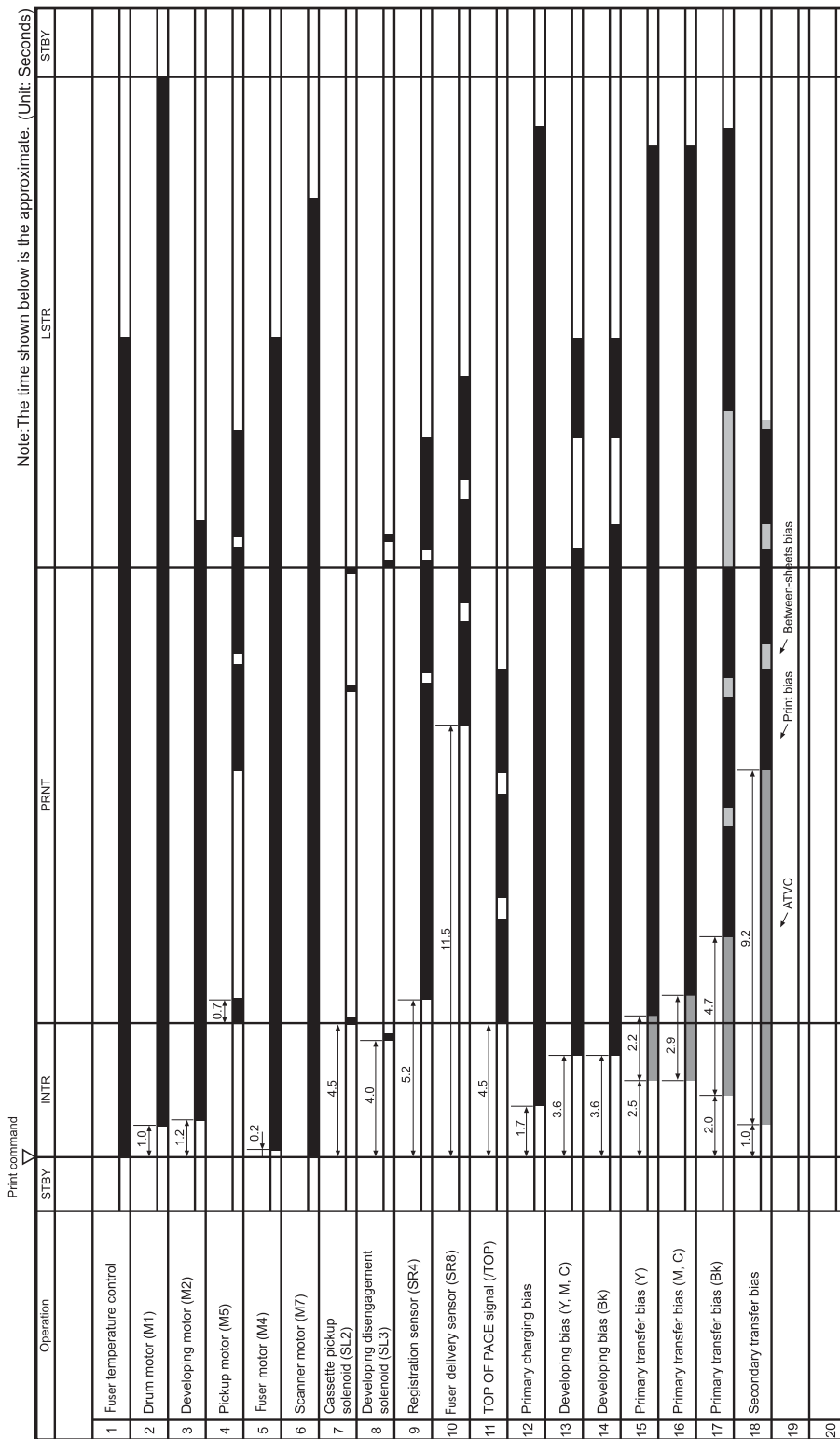

General circuit diagram

Figure 2-9 Circuit diagram

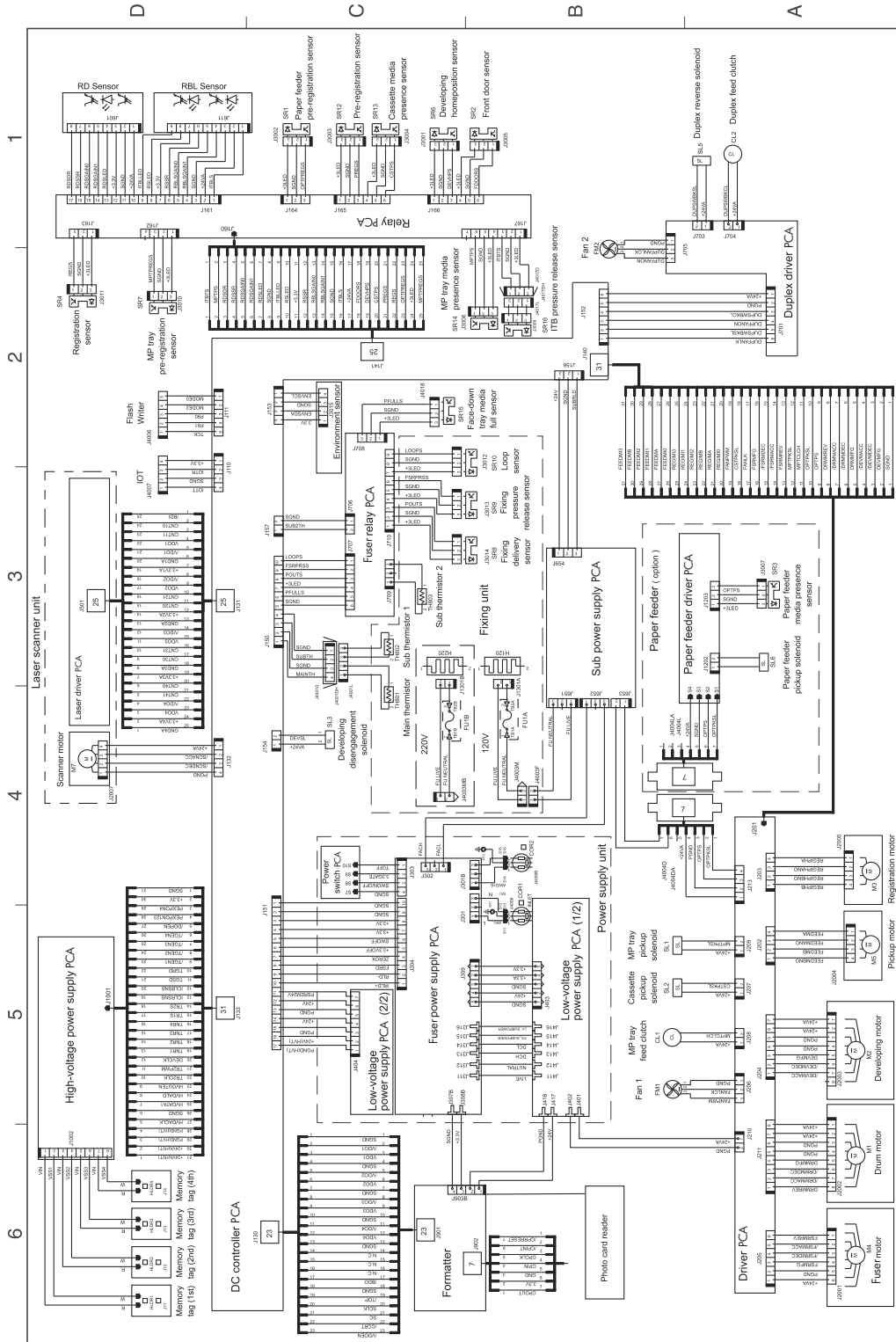

CPU/ASIC diagrams

Figure 2-10 CPU diagram

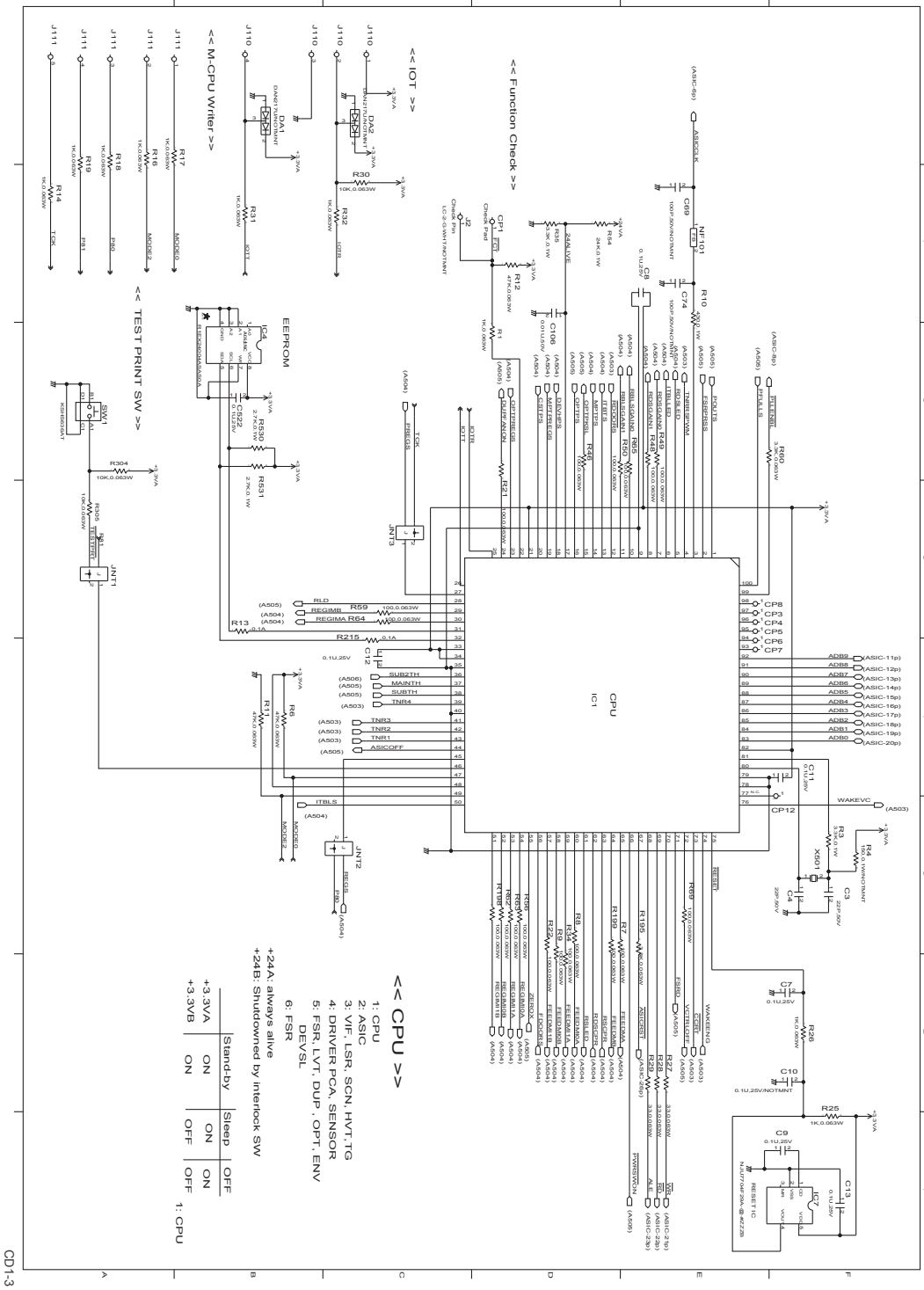
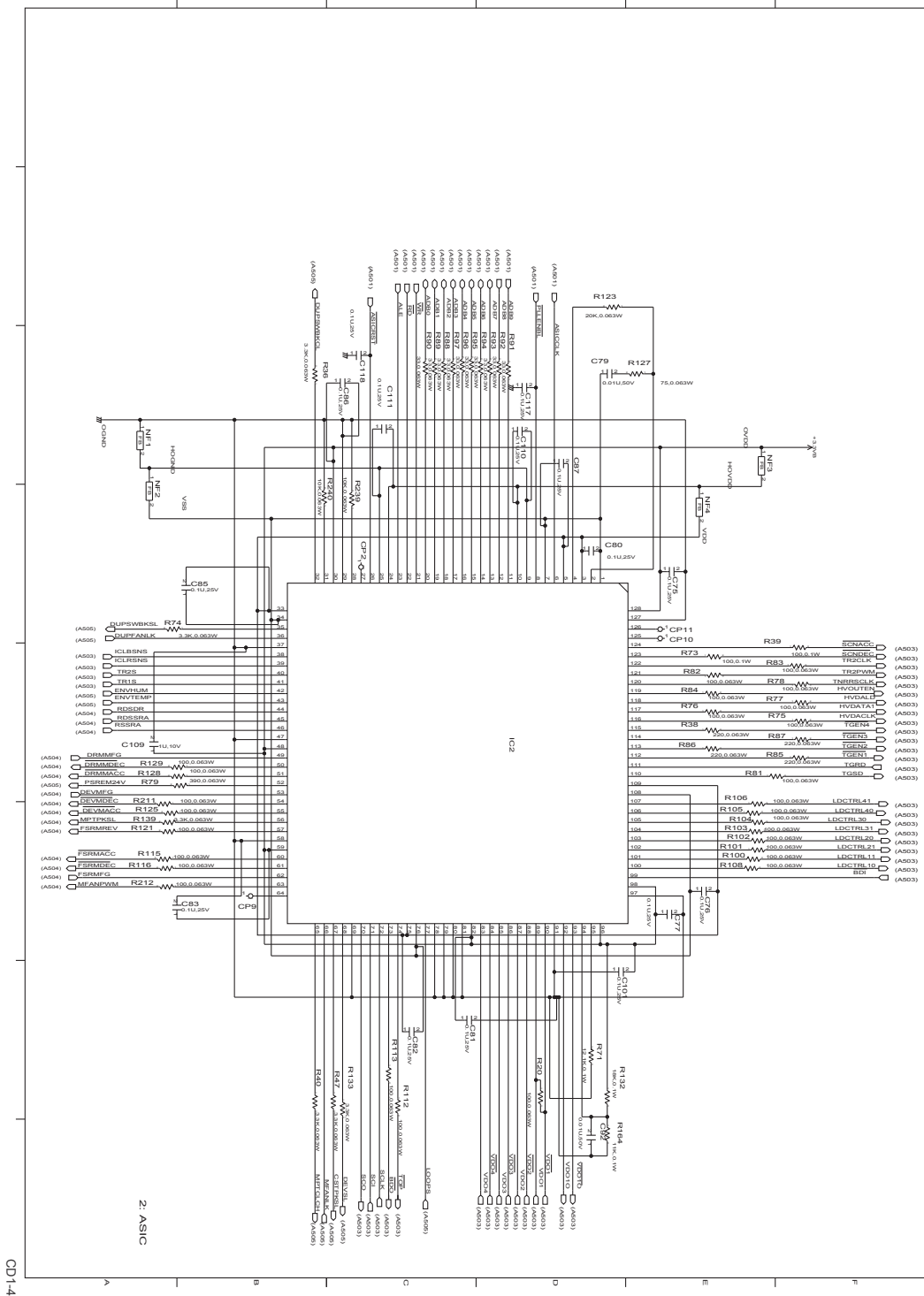
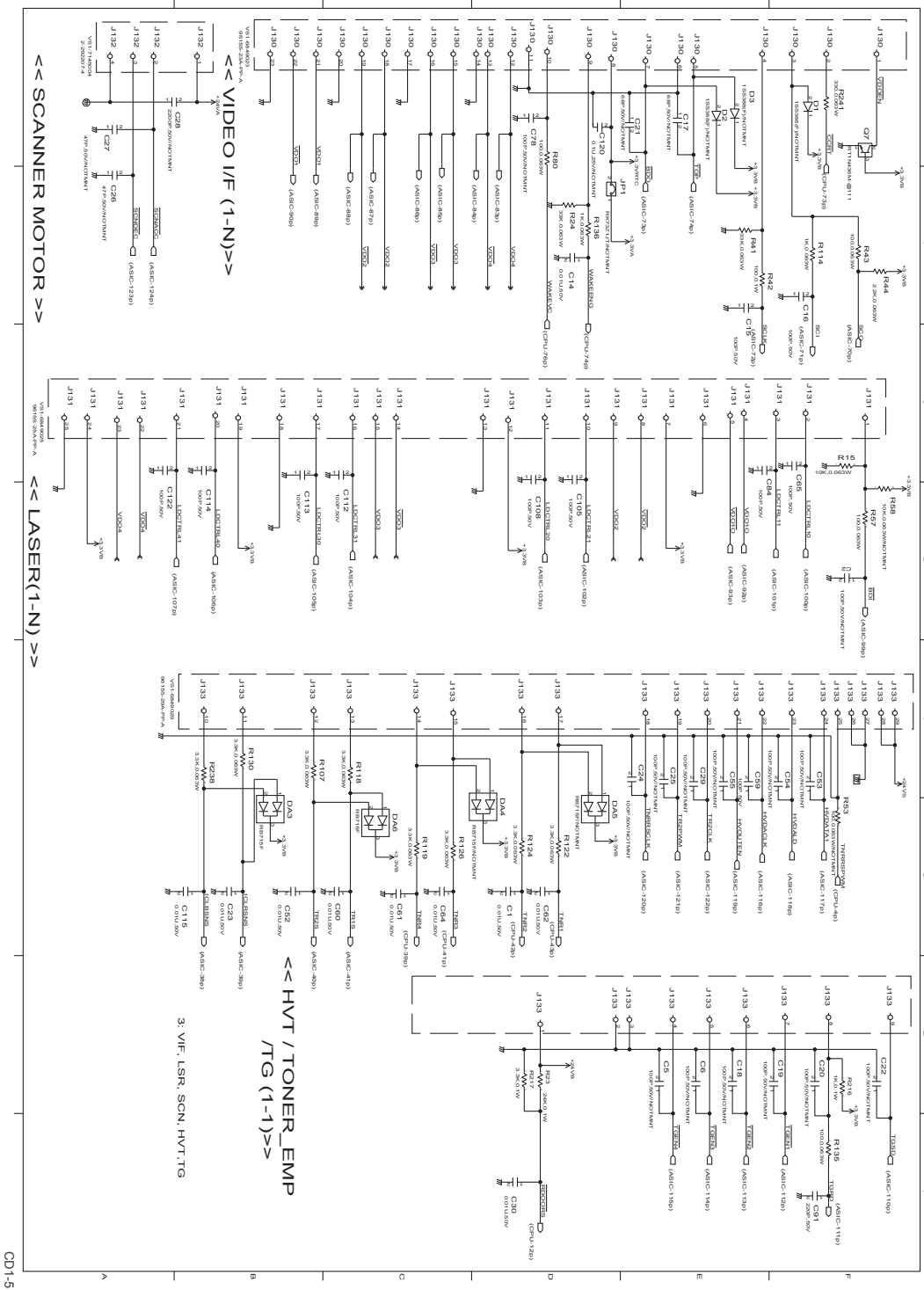

Figure 2-11 ASIC diagram



HVT/Toner EMP diagram

Figure 2-12 HVT/Toner EMP diagram



CD-1-5

Driver PCA diagram

Figure 2-13 Driver PCA diagram

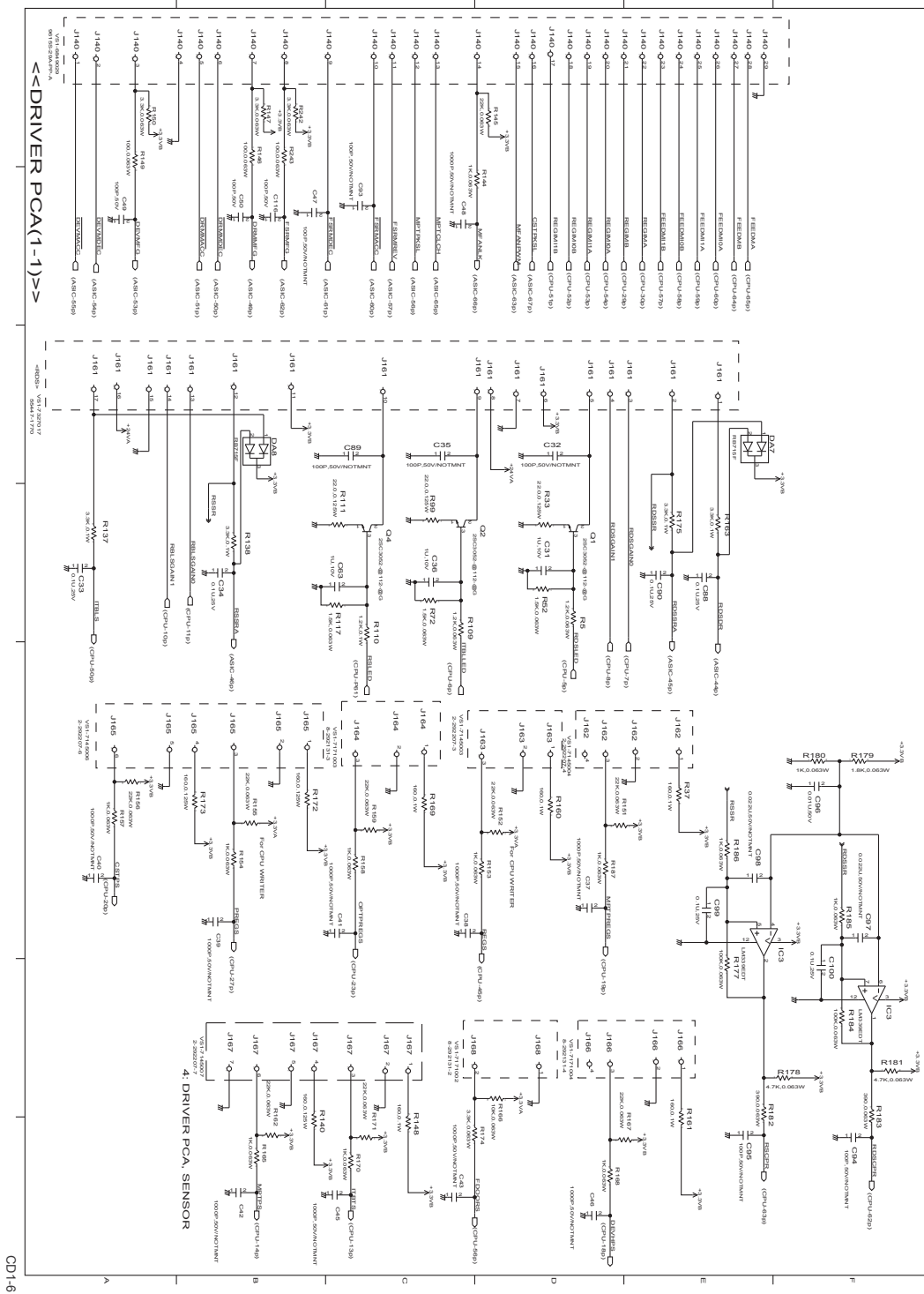

CD1-16

Duplexer PCA diagram

Figure 2-14 Duplexer PCA diagram

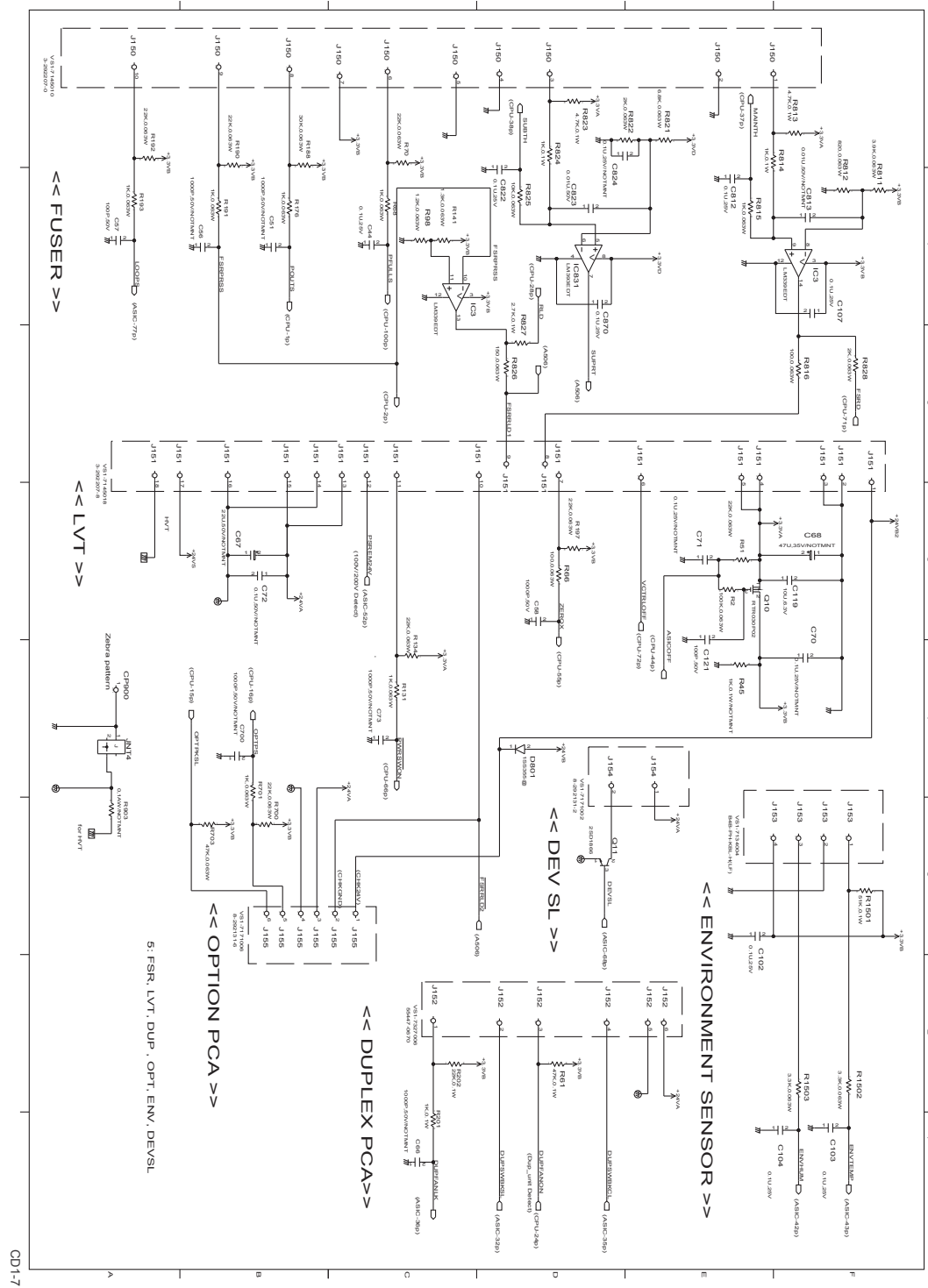

FSR diagram

Figure 2-15 FSR diagram

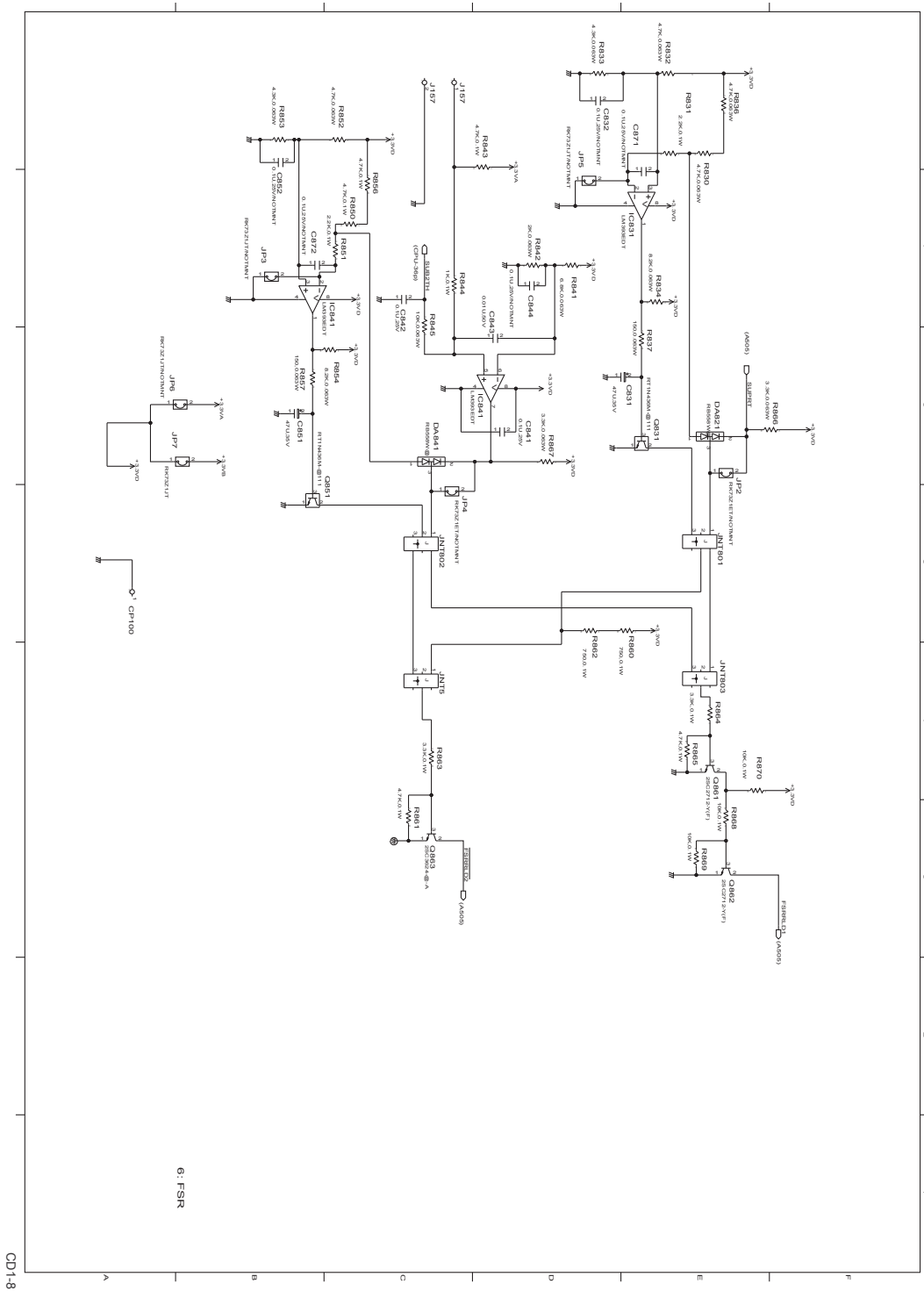

Internal print quality test pages

Print quality troubleshooting page

The print quality page helps solve problems with print quality.

Print a print quality page

1. Touch the Setup  button.
2. Open the [Reports](#) menu.
3. Scroll to, and then touch the [Print Quality Page](#) item.

Print quality assessment page

The print quality assessment page (diagnostics page) prints the calibration and color diagnostics pages.

On the first page, verify that all four toner cartridge colors appear on the page. Also, verify that the 90-degree angles in the corners are single toner colors and that the color plane registration is correct.

On the second page, verify that there are four print-cartridge color sweep bars near the top of the page. From right to left, there should be even steps of toner gradation from light to 100%. The other squares on the page are for use only during manufacturing.

Print a Diagnostics Page

1. Touch the Setup  button.
2. Open the [Reports](#) menu.
3. Touch the [Diagnostics Page](#) item.

Print the Configuration Page

The configuration page lists the current settings and properties of the product. You can use this page to check for color-plane registration and cartridge half tones. Print a configuration page from the product or from one of the Toolbox software programs.

Print a Configuration Page

1. Touch the Setup  button.
2. Open the [Reports](#) menu.
3. Touch the [Configuration Report](#) item.

Service page

The service page lists information about paper type settings, copy quality settings, and other status settings.

Print the Service Page

1. Touch the Setup  button.
2. Open the Reports menu.
3. Touch the Service Page item.

Clean the paper path

To clean the paper path, process a cleaning page.

Print the cleaning page

1. Touch the Setup  button.
2. Open the Service menu.
3. Touch the Cleaning Page item.

Print-quality troubleshooting tools

Repetitive image defects

If the product output has a consistent, repetitive defect, then use the table in this section to determine which part needs to be replaced based on the measured distance between the repetitions of the defect.



NOTE: The following table replaces the graphical repetitive defect ruler. You can make your own ruler by using these measurements. For the most accurate results, use a metric ruler.

Table 2-6 Repetitive image defects

Distance between identical defects	Component	Notes
22 mm (0.87 in)	Developer roller	Replace the toner cartridge.
38 mm (1.5 in)	Primary charging roller	Replace the toner cartridge.
44.0 mm (1.73 in)	Registration roller	Clean the roller. If dirt still displays on the page, replace the registration unit.
58 mm (2.3 in)	Fuser sleeve	Process a cleaning page. If dirt still displays on the page, replace the fuser.
58 mm (2.3 in)	Transfer roller	Replace the secondary transfer feed unit.
63 mm (2.5 in)	Pressure roller (one rotation)	Process a cleaning page. If dirt still displays on the page, replace the fuser.
75 mm (2.9 in)	OPC drum	Replace the toner cartridge.
78 mm (3 in)	ITB	Calibrate the product. If dirt still displays on the page, replace the ITB unit.

Calibrate the product

Calibration is a product function that optimizes print quality. If you experience any print-quality problems, calibrate the product.

Calibrate the product from the control panel

1. Touch the Setup  button.
2. Open the [System Setup](#) menu.
3. Open the [Print Quality](#) menu.
4. Open the [Color Calibration](#) menu.
5. Touch the [Calibrate Now](#) item.

Calibrate the product from HP ToolboxFX

1. Open HP ToolboxFX.
2. Click the **Device Settings** folder, and then click the **Print Quality** page.
3. In the area for Color Calibration, select the **Calibrate Now** check box.
4. Click the **Apply** item to calibrate the product immediately.

Control panel menus

Setup Menu

To open this menu, touch the Setup  button. The following sub menus are available:

- [HP Web Services](#)
- [Reports](#)
- [Quick Forms](#)
- [Fax Setup](#)
- [System Setup](#)
- [Service](#)
- [Network Setup](#)

HP Web Services menu

Menu item	Description
Enable Web Services	<p>Enables HP Web Services so you can use HP ePrint and the Apps menu.</p> <p>HP ePrint is a tool that prints documents by using any e-mail enabled device to send them to the product's e-mail address.</p> <p>Use the Apps menu to print directly from select Web applications.</p>
Display E-Mail Address	Select whether to display the product's IP address on the control panel.
Print Information Sheet	Print a page that contains the e-mail address for the product as well as other information for HP Web Services.
Turn ePrint On/Off	Turn HP ePrint on or off.
Turn Apps On/Off	Turn the Apps feature on or off.
Remove Web Services	Remove HP Web Services from this product.

Reports menu

Use the [Reports](#) menu to print reports that provide information about the product.

Menu item	Description
Demo Page	Prints a page that demonstrates print quality
Menu Structure	Prints a map of the control panel-menu layout. The active settings for each menu are listed.
Configuration Report	Prints a list of all the product settings. Includes basic network information when the product is connected to a network.
Supplies Status	Prints the status for each toner cartridge, including the following information: <ul style="list-style-type: none">• Estimated percentage of cartridge life remaining• Approximate pages remaining• Part numbers for HP toner cartridges• Number of pages printed• Information about ordering new HP toner cartridges and recycling used HP toner cartridges
Network Summary	Prints a list of all product network settings
Usage Page	Prints a page that lists pages that were jammed or mispicked in the product, monochrome (black and white) or color pages, and reports the count for pages scanned, faxed, and copied.
PCL Font List	Prints a list of all the PCL fonts that are installed.
PS Font List	Prints a list of all the PostScript (PS) fonts that are installed
PCL6 Font List	Prints a list of all the PCL6 fonts that are installed
Color Usage Log	Prints a report that shows the user name, application name, and color usage information on a job-by-job basis
Service Page	Prints the service report
Diagnostics Page	Prints the calibration and color diagnostics pages
Print Quality Page	Prints a page that helps solve problems with print quality

Quick Forms menu

Menu item	Sub-menu item	Description
Notebook Paper	Narrow Rule	Prints pages that have preprinted lines
	Wide Rule	
	Child Rule	
Graph Paper	1/8 inch	Prints pages that have preprinted graph lines
	5 mm	
Checklist	1-Column	Prints pages that have preprinted lines with check boxes
	2-Column	
Music Paper	Portrait	Prints pages that have preprinted lines for writing music
	Landscape	

Fax Setup menu

In the following table, items that have an asterisk (*) indicate the factory default setting.

Menu item	Sub-menu item	Sub-menu item	Description
Fax Set-Up Utility			This is a tool for configuring the fax settings. Follow the on-screen prompts and select the appropriate response for each question.
Basic Setup	Time/Date	(Settings for time format, current time, date format, and current date.)	Sets the time and date setting for the product.
	Fax Header	Enter your fax number. Enter company name.	Sets the identifying information that is sent to the receiving product.
	Answer Mode	Automatic* Manual TAM Fax/Tel	<p>Sets the type of answer mode. The following options are available:</p> <ul style="list-style-type: none"> • Automatic: The product automatically answers an incoming call on the configured number of rings. • Manual: The user must press the Start Fax button or use an extension phone (press buttons 1-2-3 on the extension phone) to make the product answer the incoming call. • TAM: A telephone answering machine (TAM) is attached to the Aux phone port of the product. The product will listen for fax tones after the answering machine has picked up the call and pick up a call if fax tones are detected. • Fax/Tel: The product will automatically pick up all calls and determine if the call is a voice or fax call. If the call is a fax call, the product handles the call as an incoming fax. If the incoming call is detected as a voice call, the product will generate an audible synthesized ring to alert the user of an incoming voice call.
	Rings to Answer		Sets the number of rings that must occur before the fax modem answers. The default setting is 5.
	Distinctive Ring	All Rings*	<p>If you have distinctive ring phone service, use this item to configure how the product responds to incoming calls.</p> <ul style="list-style-type: none"> • All Rings: The product answers all ring patterns or calls that come through the telephone line. • Single: The product answers any calls that produce a single-ring pattern. • Double: The product answers any calls that produce a double-ring pattern. • Triple: The product answers any calls that produce a triple-ring pattern. • Double and Triple: The product answers any calls that produce a double-ring or triple-ring pattern.
		Single	
		Double	
		Triple	
		Double and Triple	

Menu item	Sub-menu item	Sub-menu item	Description
	Dial Prefix	On Off*	Specifies a prefix number that must be dialed when sending faxes from the product. If you turn this feature on, the product prompts you to enter the number and then it automatically includes that number every time you send a fax.
Advanced Setup	Fax Resolution	Standard Fine* Superfine Photo	Sets the resolution for sent documents. Higher resolution images have more dots per inch (dpi), so they show more detail. Lower resolution images have fewer dots per inch and show less detail, but the document size is smaller and the fax takes less time to transmit.
	Lighter/Darker		Sets the darkness of outgoing faxes.
	Fit to Page	On* Off	Shrinks incoming faxes that are larger than the paper size set for the tray.
	Glass Size	Letter A4	Sets the default paper size for documents being scanned from the flatbed scanner.
	Dialing Mode	Tone* Pulse	Sets whether the product should use tone or pulse dialing.
	Redial if Busy	On* Off	Sets whether the product should attempt to redial if the line is busy.
	Redial if No Answer	On Off*	Sets whether the product should attempt to redial if the recipient fax number does not answer.
	Redial if Comm. Error	On* Off	Sets whether the product should attempt to redial the recipient fax number if a communication error occurs.
	Detect Dial Tone	On Off*	Sets whether the product should check for a dial tone before sending a fax.
	Billing Codes	On Off*	Enables the use of billing codes when set to On . A prompt displays where you can enter the billing code for an outgoing fax.
	Extension Phone	On* Off	When this feature is enabled, you can press the 1-2-3 buttons on the extension phone to cause the product to answer an incoming fax call.
	Stamp Faxes	On Off*	Sets the product to print the date, time, sender's phone number, and page number on each page of incoming faxes.

Menu item	Sub-menu item	Sub-menu item	Description
	Private Receive	On Off*	Setting the Private Receive feature to On requires you to set a product password. After setting the password, the following options are set: <ul style="list-style-type: none"> The Private Receive feature is turned on. All old faxes are deleted from memory. Fax forwarding is set to Off and is not allowed to be changed. All incoming faxes are stored in memory.
	Confirm Fax Number	On Off*	Confirm a fax number by entering it a second time.
	Allow Fax Reprint	On* Off	Sets whether incoming faxes are stored in memory for reprinting later.
	Fax/Tel Ring Time	20* 30 40 70	Sets the time, in seconds, after which the product should stop sounding the Fax/Tel audible ring to notify the user of an incoming voice call.
	Print Duplex	On Off*	Sets duplex printing as the default for faxes. NOTE: This item is available only for duplex models.
	Fax Speed	Fast (V.34)* Medium (V.17) Slow (V.29)	Sets the allowed fax communication speed.

System Setup menu

In the following table, items that have an asterisk (*) indicate the factory default setting.

Menu item	Sub-menu item	Sub-menu item	Sub-menu item	Description
Language	(List of available control-panel display languages.)			Sets the language in which the control panel displays messages and product reports.
Paper Setup	Default Paper Size	Letter		Sets the size for printing internal reports, faxes, or any print job that does not specify a size.
		A4		
		Legal		
	Default Paper Type	Lists available paper types.		Sets the type for printing internal reports, faxes, or any print job that does not specify a type.
Tray 1		Paper Type		Select the default size and type for Tray 1 from the list of available sizes and types.
		Paper Size		
Tray 2		Paper Type		Select the default size and type for Tray 2 from the list of available sizes and types.
		Paper Size		
Paper Out Action		Wait forever*		Determines how the product reacts when a print job requires a paper size or type that is unavailable or when the tray is empty. <ul style="list-style-type: none"> • Wait forever: The product waits until you load the correct paper. • Override: Print on a different size paper after a specified delay. • Cancel: Automatically cancel the print job after a specified delay. • If you select either the Override or Cancel item, the control panel prompts you for the number of seconds to delay.
		Cancel		
		Override		
Print Quality	Color Calibration	Calibrate Now		Performs a full calibration.
		Power-On Calibration		<ul style="list-style-type: none"> • Calibrate Now: Performs an immediate calibration. • Power-On Calibration: Specify the length of time the product should wait after you turn it on before it calibrates.
	Adjust Alignment	Print Test Page		Use this menu to shift the margin alignment to center the image on the page from top to bottom and from left to right. Before adjusting these values, print a test page. It provides alignment guides in the X and Y directions so you can determine which adjustments are necessary.

Menu item	Sub-menu item	Sub-menu item	Sub-menu item	Description
		Adjust Tray <X>	X1 Shift	Use the X1 Shift setting to center the image from side to side on a single-sided page or for the second side of a two-sided page.
			X2 Shift	
			Y Shift	
				Use the Y Shift setting to center the image from top to bottom on the page.
Energy Settings	Sleep Delay	15 Minutes*		Sets how long the product remains idle before it enters Sleep mode. The product automatically exits Sleep mode when you send a print job or press a control panel button. NOTE: The default Sleep Delay time is 15 minutes.
		30 Minutes		
		1 Hour		
		2 Hours		
		Off		
		1 Minute		
	Auto Power Down	Power Down Delay	30 Minutes*	Select the length of time after which the product automatically turns off. NOTE: The default Power Down Delay time is 30 minutes.
			1 Hour	
			2 Hours	
			4 Hours	
			8 Hours	
			24 Hours	
			Never	
		Wake Events	USB Job	Select whether the product wakes when it receives each of these types of jobs or actions. The default for each option is Yes .
			LAN Job	
			Wireless Job	
			Button Press	
Volume Settings	Alarm Volume			Set the volume levels for the product. The following options are available for each volume setting: <ul style="list-style-type: none"> • Off • Soft • Medium* • Loud
	Ring Volume			
	Key-Press Volume			
	Phone Line Volume			
Time/Date	(Settings for time format, current time, date format, and current date.)			Sets the time and date setting for the product.

Menu item	Sub-menu item	Sub-menu item	Sub-menu item	Description
Product Security	On Off			Sets the product-security feature. If you select the On setting, you must set a password.
USB Flash Drive	On Off			Enable or disable printing directly from the USB port on the front of the product.
Disable Fax	On Off			Enable or disable the Fax feature.
Supply Settings	Black Cartridge	Very Low Setting	Prompt Continue* Stop	<p>Set how the product behaves when the black toner cartridge reaches the very low threshold.</p> <ul style="list-style-type: none"> • Prompt: The product stops printing and prompts you to replace the toner cartridge. You can acknowledge the prompt and continue printing. A customer configurable option on this product is "Prompt to Remind Me in 100 pages, 200 pages, 300 pages, or never." This option is provided as a customer convenience and is not an indication these pages will have acceptable print quality. • Continue: The product alerts you that the toner cartridge is very low, but it continues printing. • Stop: The product stops printing until you replace the toner cartridge.
		Low Threshold	Enter percentage	<p>Use the arrow buttons to increase or decrease the percentage of estimated life remaining at which the product alerts you that the toner cartridge is low.</p> <p>For the black cartridge that ships with the product, the default is 27%. For the standard replacement black toner cartridge, the default is 15%. For the high-capacity replacement black toner cartridge, the default is 8%.</p> <p>The default values are intended to provide approximately two weeks of use before the cartridge reaches the very low state.</p>

Menu item	Sub-menu item	Sub-menu item	Sub-menu item	Description
	Color Cartridges	Very Low Setting	Stop	<p>Set how the product behaves when the one of the color toner cartridges reaches the very low threshold.</p> <ul style="list-style-type: none"> • Prompt: The product stops printing and prompts you to replace the toner cartridge. You can acknowledge the prompt and continue printing. A customer configurable option on this product is "Prompt to Remind Me in 100 pages, 200 pages, 300 pages, or never." This option is provided as a customer convenience and is not an indication these pages will have acceptable print quality. • Continue: The product alerts you that the toner cartridge is very low, but it continues printing. • Print Black: The product has been customer configured to print using only the black toner cartridge when the level of a color supply is very low. The color supply might still be able to produce acceptable print quality. To print in color, either replace the color supply or reconfigure the product. <p>When you choose to replace the very low toner cartridge, color printing resumes automatically.</p> <ul style="list-style-type: none"> • Stop: The product stops printing until you replace the toner cartridge.
			Prompt	
			Continue	
			Print Black*	
		Low Threshold	Cyan	Enter percentage
			Magenta	<p>Use the arrow buttons to increase or decrease the percentage of estimated life remaining at which the product alerts you that the toner cartridge is low.</p> <p>For the color toner cartridges that ship with the product, the default is 20%. For the replacement color toner cartridges, the default is 10%.</p> <p>The default values are intended to provide approximately two weeks of use before the cartridge reaches the very low state.</p>
			Yellow	

Menu item	Sub-menu item	Sub-menu item	Sub-menu item	Description
	Store Usage Data	On Supply*		<p>The product automatically stores toner cartridge usage data in its internal memory. It can also store this data on memory chips in the toner cartridges. Select the Not on Supply option to store the data only in the product memory.</p> <p>The information stored on the toner cartridge memory chip helps HP design future products to meet our customers' printing needs. HP collects a sampling of memory chips from toner cartridges returned to HP's free return and recycling program. The memory chips from this sampling are read and studied in order to improve future HP products.</p> <p>The data collected from the toner cartridge memory chip does not contain information that can be used to identify a customer or user of the toner cartridge or their product.</p>
		Not on Supply		
Courier Font	Regular			Sets Courier font values.
	Dark			
Color Copy	On			Enables or disables color copying.
	Off			

Service menu

In the following table, items that have an asterisk (*) indicate the factory default setting.

Menu item	Sub-menu item	Sub-menu item	Description	
Fax Service	Clear Saved Faxes		Clears all faxes in memory.	
	Run Fax Test		Performs a fax test to verify that the phone cord is plugged in the correct outlet and that there is a signal on the phone line. A fax test report is printed indicating the results.	
	Print T.30 Trace	Now		Prints or schedules a report that is used to troubleshoot fax transmission issues.
		Never*		
		If Error		
At End of Call				
Error Correction	On*		The error correction mode allows the sending device to re-transmit data if it detects an error signal.	
	Off			
	Fax Service Log		The fax service log prints out the last 40 entries in the fax log.	
Cleaning Page			<p>Cleans the product when specks or other marks appear on printed output. The cleaning process removes dust and excess toner from the paper path.</p> <p>When selected, the product prompts you to load plain Letter or A4 paper in Tray 1. Touch the OK button to begin the cleaning process. Wait until the process completes. Discard the page that prints.</p> <p>NOTE: For models that do not have an automatic duplexer, the product prints the first side and then prompts you to remove the page from the output bin and reload it in Tray 1, keeping the same orientation.</p>	
USB Speed	High*		Sets the USB speed for the USB connection to the computer. For the product to actually operate at high speed, it must have high speed enabled and be connected to an EHCI host controller that is also operating at high speed. This menu item also does not reflect the current operating speed of the product.	
	Full			
Less Paper Curl	On		When printed pages are consistently curled, this option sets the product to a mode that reduces curl.	
	Off*			
Archive Print	On		When printing pages that will be stored for a long time, this option sets the product to a mode that reduces toner smearing and dusting.	
	Off*			
Firmware Datecode			Displays the current firmware datecode	

Menu item	Sub-menu item	Sub-menu item	Description
Restore Defaults			Sets all settings to the factory default values
HP Smart Install	On*		Enable or disable the HP Smart Install tool.
	Off		Disable the tool if you want to connect to a network by using an Ethernet cable. If you disable HP Smart Install, you must use the product software CD to install the product software.

Network Setup menu

In the following table, items that have an asterisk (*) indicate the factory default setting.

Menu item	Sub-menu item	Sub-menu item	Description
Wireless Menu	Wireless Direct Settings	Wireless Direct On/Off	Enables or disables the Direct Wi-Fi wireless access feature.
		Wireless Direct Name	Set the product's Direct Wifi name, so you can access it from other wireless devices that support the Wi-Fi Direct protocol.
		Wireless Direct Mode	Set the product's Direct Wifi mode. <ul style="list-style-type: none"> Select the Print Only option (the default setting) to allow wireless access to only the product print functions from a mobile device. Select the Open Network option to allow wireless access to all product functions and settings from a mobile device.
	Wireless Setup Wizard	Guides you through the steps to set up the product on a wireless network	
	Wi-Fi Protected Setup	If your wireless router supports this feature, use this method to set up the product on a wireless network. This is the simplest method.	
	Run Network Test	Tests the wireless network and prints a report with the results.	
	Turn Wireless On/Off	Enables or disables the wireless network feature.	
TCP/IP Config	Automatic*	<p>Automatic: The product automatically configures all the TCP/IP settings via DHCP, BootP or AutoIP.</p> <p>Manual: You can manually configure the IP address, subnet mask, and default gateway. The control panel prompts you to specify values for each address section. As each address is completed, the product prompts for address confirmation before moving to the next one. After all three addresses are set, the network reinitializes.</p>	
	Manual		
Auto Crossover	On*	Enables or disables the use of a standard 10/100 network cable when the product is directly connected to a computer.	
	Off		
Network Services	IPv4	Enable or disable the IPv4 and IPv6 protocols. By default, each protocol is enabled.	
	IPv6		
Link Speed	Automatic*	Sets the link speed manually if needed.	
	10T Full	After setting the link speed, the product automatically restarts.	
	10T Half		
	100TX Full		
	100TX Half		

Menu item	Sub-menu item	Sub-menu item	Description
HTTPS Enforcement	Yes		Sets the product so that it communicates only with Web sites that use hypertext transfer protocol secure (HTTPS).
	No*		
Restore Defaults			Resets all network configurations to their factory defaults.

Function specific menus

The product features function-specific menus for copying, faxing, and scanning. To open these menus, touch the button for that function on the control panel.

Copy menu

To open this menu, touch the [Copy](#) button, and then touch the [Settings...](#) button.



NOTE: Settings that you change by using this menu expire 2 minutes after the last copy completes.

Menu item	Sub-menu item	Sub-menu item	Description
ID Copy			Copies both sides of identification cards, or other small-size documents, onto the same side of one sheet of paper.
NOTE: This item is available from the main Copy screen. You do not need to touch the Settings... button to access it.			
Number of Copies	(1-99)		Specifies the number of copies
Reduce/Enlarge	Original=100%*		Specifies the size of the copy.
	Legal to Letter=78%		
	Legal to A4=83%		
	A4 to Letter=94%		
	Letter to A4=97%		
	Full Page=91%		
	Fit to Page		
Lighter/Darker	2 Pages per Sheet		Specifies the contrast of the copy.
	4 Pages per Sheet		
	Custom: 25 to 400%		

Menu item	Sub-menu item	Sub-menu item	Description
Optimize	Describe Original	Auto Select* Mixed Text Picture	Specifies the type of content in the original document, so the copy is the best match for the original.
Paper	Paper Size Paper Type		Specifies the paper size and type for copies.
Multi-Page Copy	Off* On		When this feature is on, the product prompts you to load another page onto the scanner glass or to indicate that the job is complete.
Collation	On* Off		Specifies whether to collate copy jobs
Tray Select	Auto Select* Tray 1 Tray 2		Specifies which tray to use for copies.
Two Sided	1-Sided to 1-Sided* 1-Sided to 2-Sided 2-Sided to 1-Sided 2-Sided to 2-Sided		Specifies the duplex setting for copies. NOTE: This item is available for duplex models only.
Draft Mode	Off* On		Specifies whether to use draft-quality printing for copies
Image Adjustment	Lightness Contrast Sharpen Background Removal Color Balance Grayness		Adjusts the image quality settings for copies
Set as New Defaults			Saves any changes you have made to this menu as the new defaults
Restore Defaults			Restores the factory defaults for this menu

Fax menu

To open this menu, touch the [Fax](#) button, and then touch the [Fax Menu](#) button.

Menu item	Sub-menu item	Sub-menu item	Description
Fax Reports	Fax Confirmation	On Every Fax	Sets whether the product prints a confirmation report after a fax job.
		On Send Fax Only	
		On Receive Fax Only	
		Never*	
	Include First Page	On*	Sets whether the product includes a thumbnail image of the first page of the fax on the report.
		Off	
	Fax Error Report	On Every Error*	Sets whether the product prints a report after a failed fax job.
		On Send Error	
		On Receive Error	
		Never	
Print Last Call Report		Prints a detailed report of the last fax operation, either sent or received.	
Fax Activity Log	Print Log Now	Print Log Now: Prints a list of the faxes that have been sent from or received by this product.	
	Auto Log Print	Auto Log Print: Automatically prints a report after every fax job.	
Print Phone Book		Prints a list of the speed dials that have been set up for this product.	
Print Junk Fax list		Prints a list of phone numbers that are blocked from sending faxes to this product.	
Print Billing Report		Prints a list of billing codes that have been used for outgoing faxes. This report shows how many sent faxes were billed to each code. This menu item displays only when the billing codes feature is turned on.	
Print All Fax Reports		Prints all fax-related reports.	
Send Options	Send Fax Later	Allows a fax to be sent at a later time and date.	
	Broadcast Fax	Sends a fax to multiple recipients.	

Menu item	Sub-menu item	Sub-menu item	Description
	Fax Job Status		Displays pending fax jobs, and allows you to cancel pending fax jobs.
	Fax Resolution	Standard Fine Superfine Photo	Sets the resolution for sent documents. Higher resolution images have more dots per inch (dpi), so they show more detail. Lower resolution images have fewer dots per inch and show less detail, but the document size is smaller.
Receive Options	Print Private Faxes		Prints stored faxes when the private-receive feature is on. This menu item displays only when the private-receive feature is turned on. The product prompts you for the system password.
	Block Junk Faxes	Add Number Delete Number Delete All Numbers Print Junk Fax list	Modifies the junk fax list. The junk fax list can contain up to 30 numbers. When the product receives a call from one of the junk fax numbers, it deletes the incoming fax. It also logs the junk fax in the activity log along with job-accounting information.
	Reprint Faxes		Prints the received faxes stored in available memory. This item is available only if you have turned on the Allow Fax Reprint feature in the Fax Setup menu.
	Forward Fax	On Off*	Sets product to send all received faxes to another fax machine.
	Polling Receive		Allows the product to call another fax machine that has polling send enabled.
Phone Book Setup	Individual Setup		Edits the fax phone book speed dials and group-dial entries. The product supports up to 120 phone book entries, which can be either individual or group entries.
	Group Setup		
	Delete Entry	Deletes a specific phone book entry.	
	Delete All Entries	Deletes all entries in the phone book.	

Menu item	Sub-menu item	Sub-menu item	Description
	Print Report Now	Prints a list of all the individual and group dial entries in the phone book.	
Change Defaults			Opens the Fax Setup menu.

Scan menu

Menu item	Sub-menu item	Sub-menu item	Description
Scan to USB Drive	Scan File Type	JPEG PDF	Scans a document and stores it as a .PDF document or .JPEG image on the USB flash drive.
	Scan Resolution	75 dpi 150 dpi 300 dpi	Specifies the resolution to use for the scanned image. Scan quality increases by using higher resolution, but the document size also increases.
	Scan Paper Size	Letter Legal A4	Specifies the size of the page to use for the scanned document.
	Scan Source	Document Feeder Flatbed Scanner	Specifies whether the scanned page is in the document feeder or on the scanner glass.
	File Name Prefix		Provides a way to set a standard name prefix for scan job files.
	Output Color	Color Black & White	Specifies whether the scan output document will be a color image or a monochrome image.
	Set as New Defaults		Saves any changes you have made to this menu as the new defaults.

USB Flash Drive

Menu item	Description
Print Documents	<p>Prints documents stored on the USB drive. Use the arrow buttons to scroll through the documents. Touch the names of documents that you want to print.</p> <p>Touch the summary screen to change settings such as the number of copies, the paper size, or the paper type.</p> <p>Touch the Print button when you are ready to print the documents.</p>
View and Print Photos	<p>Previews photos on the USB drive. Use the arrow buttons to scroll through the photos. Touch the preview image for each photo that you want to print. You can adjust the settings, and you can save the changes as the new default settings. When you are ready to print the photos, touch the Print button.</p>
Scan to USB Drive	<p>Scans a document and stores it as a .PDF document or .JPEG image on the USB flash drive.</p>

Interpret control panel messages

MANY OF THE SOLUTION SAY PRESS OK, IS THIS CORRECT?

PLEASE PROVIDE SERVICE SOLUTIONS FOR ERRORS THAT NOW HAVE "CONTACT HP" AS THE ACTION ITEM.

Control panel message types

The control panel messages indicate the current product status or situations that might require action.

Alert and warning messages appear temporarily and might require you to acknowledge the message by pressing the **OK** button to resume or by pressing the **Cancel** **X** button to cancel the job. With certain warnings, the job might not complete or the print quality might be affected. If the alert or warning message is related to printing and the auto-continue feature is on, the product will attempt to resume the printing job after the warning has appeared for 10 seconds without acknowledgement.

Critical error messages can indicate some kind of failure. Turning off and then turning on the power might fix the problem. If a critical error persists, the product might require service.

Control panel messages

10.100X Supply Memory Error

Description

A specific toner cartridge has a faulty or missing memory chip.

"X" indicates the cartridge: 0=black, 1=cyan, 2=magenta, 3=yellow.

Recommended action

Check the memory chip. If it is broken or damaged, replace the cartridge.

Verify that the cartridge is installed in the correct location.

Reinstall the toner cartridge.

Turn off and then turn on the product.

If the error is with a color cartridge, try swapping it with a different color cartridge in the tray. If the same message displays, then there is an engine problem. If a different 10.100X message displays, replace the cartridge.

If the problem is not solved, replace the cartridge.

49 Error, Turn off then on

Description

The product has experienced an internal embedded software error. Under most conditions, the product automatically restarts.

Recommended action

Turn off the power by using the power switch, wait at least 30 seconds, and then turn on the power and wait for the product to initialize.

If the error persists, contact HP. See www.hp.com/go/LJColorMFPM375 or www.hp.com/go/LJColorMFPM475 or the support flyer that came in the product box.

50.x Fuser Error

Description

The product has experienced an internal hardware error.

Recommended action

1. Turn off the power by using the power switch, and then wait at least 30 seconds.
2. If a surge protector is being used, remove it. Connect the product directly into the wall socket.
3. Turn on the power and wait for the product to initialize.

If the error persists, contact HP. See www.hp.com/go/LJColorMFPM375 or www.hp.com/go/LJColorMFPM475 or the support flyer that came in the product box.

52 Scanner Error

Description

The product has experienced an internal hardware error.

Recommended action

Turn off the power by using the power switch, wait at least 30 seconds, and then turn on the power and wait for the product to initialize.

If a surge protector is being used, remove it. Connect the product directly into the wall socket. Use the power switch to turn the product on.

If the error persists, contact HP. See www.hp.com/go/LJColorMFPM375 or www.hp.com/go/LJColorMFPM475 or the support flyer that came in the product box.

57 Fan Error, Turn off then on

Description

The product has experienced a problem with its internal fan.

Recommended action

Turn off the power by using the power switch, wait at least 30 seconds, and then turn on the power and wait for the product to initialize.

If the error persists, contact HP. See www.hp.com/go/LJColorMFPM375 or www.hp.com/go/LJColorMFPM475 or the support flyer that came in the product box.

79 Error Turn off then on

Description

The product has experienced an internal firmware error. Under most conditions, the product automatically restarts.

Recommended action

Turn off the power by using the power switch, wait at least 30 seconds, and then turn on the power and wait for the product to initialize.

If a surge protector is being used, remove it. Connect the product directly into the wall socket. Use the power switch to turn the product on.

If the error persists, contact HP. See www.hp.com/go/LJColorMFPM375 or www.hp.com/go/LJColorMFPM475 or the support flyer that came in the product box.

Black Cartridge Low

Description

The toner cartridge is nearing the end of its useful life.

Recommended action

Printing can continue, but consider having a replacement supply on hand.

Black in wrong position

Description

The toner cartridge is installed in the incorrect slot.

Recommended action

Make sure that each toner cartridge is installed in the correct slot. From front to back, the toner cartridges are installed in this order: black, cyan, magenta, and yellow.

Black Very Low

Description

The toner cartridge is at the end of its useful life. The product continues printing to prevent fax interruptions.

Recommended action

To ensure optimal print quality, HP recommends replacing the toner cartridge at this point. You can continue printing until you notice a decrease in print quality. Actual cartridge life may vary.

Once an HP supply has reached very low, HP's premium Protection Warranty on that supply has ended. All print defects or cartridge failures incurred when an HP supply is used in continue at very low mode will not be considered to be defects in materials or workmanship in the supply under the HP Toner cartridge Warranty Statement.

Canceled scan. Clear document

Description

You touched the Cancel  button while scanning, faxing, or copying to cancel the current job while pages were feeding from the document feeder. The cancel process does not automatically clear the document feeder.

Recommended action

Remove the jammed item. Then, clear the items in the document feeder tray and start over.

Canceled send. Clear document

Description

You touched the Cancel  button while faxing to cancel the current job while pages were feeding from the document feeder. The cancel process does not automatically clear the document feeder.

Recommended action

Remove the jammed item. Then, clear the items in the document feeder tray and start over.

Communication error.

Description

A fax communication error occurred between the product and the sender or receiver.

Recommended action

Allow the product to retry sending the fax. Unplug the product telephone cord from the wall, plug in a telephone, and try making a call. Connect the product phone cord into a jack for another phone line.

Try a different phone cord.

Set the **Fax Speed** option to the **Slow (V.29)** setting or disable the **Fast (V.34)** setting.

Turn off the **Error Correction** feature to prevent automatic error correction.



NOTE: Turning off the **Error Correction** feature can reduce image quality.

Print the **Fax Activity Log** report from the control panel to determine if the error occurs by using a specific fax number.

If the error persists, contact HP. See www.hp.com/go/LJColorMFPM375 or www.hp.com/go/LJColorMFPM475 or the support flyer that came in the product box.

Cyan Cartridge Low

Description

The toner cartridge is nearing the end of its useful life.

Recommended action

Printing can continue, but consider having a replacement supply on hand.

Cyan in wrong position

Description

The toner cartridge is installed in the incorrect slot.

Recommended action

Make sure that each toner cartridge is installed in the correct slot. From front to back, the toner cartridges are installed in this order: black, cyan, magenta, and yellow.

Cyan Very Low

Description

The toner cartridge is at the end of its useful life. When a color toner cartridge becomes very low, the product prints in black only to prevent fax interruptions. When you choose to replace the very low toner cartridge, color printing resumes automatically.

Recommended action

To ensure optimal print quality, HP recommends replacing the toner cartridge at this point. You can continue printing until you notice a decrease in print quality. Actual cartridge life may vary.

Once an HP supply has reached very low, HP's premium Protection Warranty on that supply has ended. All print defects or cartridge failures incurred when an HP supply is used in continue at very low mode will not be considered to be defects in materials or workmanship in the supply under the HP Print Cartridge Warranty Statement.

Device error, press OK

Description

Generic engine error.

Recommended action

This is a warning message only. Job output might be affected.

Device is busy. Try again later

Description

The product is currently in use.

Recommended action

Wait for the product to finish the current job, or to finish initializing.

Document feeder door is open.

Description

The document feeder cover is open, or a sensor is malfunctioning.

Recommended action

Make sure that the document feeder cover is closed.

If the message persists, turn off the power by using the power switch, wait at least 30 seconds, and then turn on the power and wait for the product to initialize.

If the error persists, contact HP. See www.hp.com/go/LJColorMFPM375 or www.hp.com/go/LJColorMFPM475 or the support flyer that came in the product box.

Document feeder jam. Clear and reload.

Description

A piece of paper is jammed in the document feeder tray.

Recommended action

Clear the jam.

If the error persists, contact HP. See www.hp.com/go/LJColorMFPM375 or www.hp.com/go/LJColorMFPM475 or the support flyer that came in the product box.

Document feeder mispick. Reload

Description

The product did not pick up the paper in the document feeder.

Recommended action

Remove the paper from the document feeder tray, and then reload it.

If the error persists, contact HP. See www.hp.com/go/LJColorMFPM375 or www.hp.com/go/LJColorMFPM475 or the support flyer that came in the product box.

Door open

Description

The toner cartridge door is open.

Recommended action

Close the toner cartridge door.

Engine Communication Error

Description

The product has experienced an engine communication timeout error.

Recommended action

Turn off the power by using the power switch, wait at least 30 seconds, and then turn on the power and wait for the product to initialize.

If a surge protector is being used, remove it. Connect the product directly into the wall socket. Use the power switch to turn the product on.

If the error persists, contact HP. See www.hp.com/go/LJColorMFPM375 or www.hp.com/go/LJColorMFPM475 or the support flyer that came in the product box.

Engine error. Press OK to continue.

Description

The product experienced a print engine error.

Recommended action

This is a warning message only. Job output might be affected.

Fax is busy. Canceled send.

Description

The fax line to which you were sending a fax was busy. The product has canceled sending the fax.

Recommended action

Call the recipient to ensure that the fax machine is on and ready.

Check that you are dialing the correct fax number.

Check that the [Redial if Busy](#) option is enabled.

Open the [Service](#) menu, and touch the [Fax Service](#) button. Touch the [Run Fax Test](#) button. This test verifies that the phone cord is connected to the correct port and that the phone line has a signal. The product prints a report with the results.

If the error persists, contact HP. See www.hp.com/go/LJColorMFPM375 or www.hp.com/go/LJColorMFPM475 or the support flyer that came in the product box.

Fax is busy. Redial pending.

Description

The fax line to which you were sending a fax was busy. The product automatically redials the busy number.

Recommended action

Allow the product to retry sending the fax.

Call the recipient to ensure that the fax machine is on and ready.

Check that you are dialing the correct fax number.

Open the [Service](#) menu, and touch the [Fax Service](#) button. Touch the [Run Fax Test](#) button. This test verifies that the phone cord is connected to the correct port and that the phone line has a signal. The product prints a report with the results.

If the error persists, contact HP. See www.hp.com/go/LJColorMFPM375 or www.hp.com/go/LJColorMFPM475 or the support flyer that came in the product box.

Fax receive error.

Description

An error occurred while trying to receive a fax.

Recommended action

Ask the sender to resend the fax.

Try faxing back to the sender or another fax machine.

Check that the telephone cord is securely connected by unplugging and replugging the cord.

Make sure that you are using the telephone cord that came with the product.

Open the [Service](#) menu, and touch the [Fax Service](#) button. Touch the [Run Fax Test](#) button. This test verifies that the phone cord is connected to the correct port and that the phone line has a signal. The product prints a report with the results.

Decrease the fax speed. Ask the sender to resend the fax.

Turn off error-correction mode. Ask the sender to resend the fax.

 **NOTE:** Turning off error-correction mode can reduce the quality of the fax image.

Connect the product to a different phone line.

If the error persists, contact HP. See www.hp.com/go/LJColorMFPM375 or www.hp.com/go/LJColorMFPM475 or the support flyer that came in the product box.

Fax Send error.

Description

An error occurred while trying to send a fax.

Recommended action

Try resending the fax.

Try faxing to another fax number.

Check that the telephone cord is securely connected by unplugging and replugging the cord.

Make sure that you are using the telephone cord that came with the product.

Open the [Service](#) menu, and touch the [Fax Service](#) button. Touch the [Run Fax Test](#) button. This test verifies that the phone cord is connected to the correct port and that the phone line has a signal. The product prints a report with the results.

Connect the product to a different phone line.

Set the fax resolution to [Standard](#) instead of the default of [Fine](#).

If the error persists, contact HP. See www.hp.com/go/LJColorMFPM375 or www.hp.com/go/LJColorMFPM475 or the support flyer that came in the product box.

Fax storage is full. Canceling the fax receive.

Description

The amount of available memory for storing faxes is insufficient to store an incoming fax.

Recommended action

If you are using the [Private Receive](#) feature, print all received faxes to regain some memory.

If you still need more memory, clear faxes from memory. Open the [Service](#) menu. In the [Fax Service](#) menu, select the [Clear Saved Faxes](#) option.

Fax storage is full. Canceling the fax send.

Description

During the fax job, the memory filled. All pages of the fax have to be in memory for a fax job to work correctly. Only the pages that fit into memory were sent.

Recommended action

Cancel the current job. Turn the product off, and then turn it on again. Try sending the job again.

If the error reoccurs, cancel the job and turn the product off and then on a second time. The product might not have enough memory for some jobs.

Fit to Page on flatbed only

Description

The copy reduce/enlarge feature (called "Fit to Page") applies only to copies made from the flatbed scanner.

Recommended action

Use the flatbed or select another reduction/enlargement setting.

Genuine HP supply installed

Description

A genuine HP supply was installed.

Recommended action

No action necessary.

Incompatible <color>

Description

You have installed a toner cartridge that is intended for use in a different HP product model. The product might not function correctly with this toner cartridge installed.

Recommended action

Install the correct toner cartridge for this product.

Install [color] cartridge

Description

One of the color cartridges is not installed with the door closed.

Recommended action

Install the indicated color cartridge.

Invalid driver Press OK

Description

You are using the incorrect printer driver.

Recommended action

Select the printer driver that is appropriate for your product.

Invalid entry

Description

Invalid data or response.

Recommended action

Correct the entry.

Jam in (area), Open door and clear jam

Description

There is a paper jam in the print paper path or output bin.

Recommended action

Clear the jam from the area indicated on the product control panel, and then follow the control panel instructions.

Jam in Tray 1, Clear jam and then press OK

Description

The product has detected a jam in Tray 1.

Recommended action

Clear the jam, and then follow the control panel instructions.

Load paper

Description

The tray is empty.

Recommended action

Load paper in the tray.

Load Tray 1 <TYPE> <SIZE>, Press OK to use available media

Description

Device is processing a job, but no trays match.

Recommended action

Load paper in the correct orientation.

Touch the **OK** button to use existing tray settings.

Load Tray 1, <PLAIN> <SIZE> / Cleaning mode, OK to start**Description**

Cleaning mode paper prompt.

Recommended action

Load a clean sheet of paper in the correct orientation, then touch the **OK** button to begin the cleaning procedures.

Load tray <X> Press [OK] for available media**Description**

The tray is empty.

Recommended action

Load paper into the tray to continue printing. Press the **OK** button to select a different tray.

Magenta Cartridge Low**Description**

The toner cartridge is nearing the end of its useful life.

Recommended action

Printing can continue, but consider having a replacement supply on hand.

Magenta in wrong position**Description**

The toner cartridge is installed in the incorrect slot.

Recommended action

Make sure that each toner cartridge is installed in the correct slot. From front to back, the toner cartridges are installed in this order: black, cyan, magenta, and yellow.

Magenta Very Low**Description**

The toner cartridge is at the end of its useful life. When a color toner cartridge becomes very low, the product prints in black only to prevent fax interruptions. When you choose to replace the very low toner cartridge, color printing resumes automatically.

Recommended action

To ensure optimal print quality, HP recommends replacing the toner cartridge at this point. You can continue printing until you notice a decrease in print quality. Actual cartridge life may vary.

Once an HP supply has reached very low, HP's premium Protection Warranty on that supply has ended. All print defects or cartridge failures incurred when an HP supply is used in continue at very low mode will not be considered to be defects in materials or workmanship in the supply under the HP Print Cartridge Warranty Statement.

Manual Duplex Load Tray 1, Press OK**Description**

Manual duplex mode.

Recommended action

Load paper in the correct orientation.

Manual feed <SIZE> <TYPE>, Press OK to use available media**Description**

Print Manual Feed mode.

Recommended action

Load paper into Tray 1.

Memory is low. Press OK.**Description**

The product memory has been almost completely filled.

Recommended action

Touch the **OK** button to cancel the job.

Break the job into smaller jobs that contain fewer pages.

Turn the product off and then on to clear the memory.

Memory is low. Try again later**Description**

The product does not have enough memory to start a new job.

Recommended action

Wait until the current job is finished before starting a new job.

Turn the product off and then on to clear the memory.

Memory low Only 1 copy made. Press OK to continue.

Description

The product does not have enough memory to complete the collated copy job.

Recommended action

Break the job into smaller jobs that contain fewer pages.

Turn the product off and then on to clear the memory.

Misprint, Press OK

Description

Feed delay misprint.

Recommended action

Verify that paper is loaded in the input tray.

Reload paper.

No dial tone.

Description

The product could not detect a dial tone.

Recommended action

Check for a dial tone on the phone line by touching the [Start Fax](#) button.

Unplug the telephone cord from both the product and the wall and replug the cord.

Make sure that you are using the telephone cord that came with the product.

Open the [Service](#) menu, and touch the [Fax Service](#) button. Touch the [Run Fax Test](#) button. This test verifies that the phone cord is connected to the correct port and that the phone line has a signal. The product prints a report with the results.

If the error persists, contact HP. See www.hp.com/go/LJColorMFPM375 or www.hp.com/go/LJColorMFPM475 or the support flyer that came in the product box.

No fax answer. Canceled send.

Description

Attempts to redial a fax number failed, or the [Redial if No Answer](#) option was turned off.

Recommended action

Call the recipient to ensure that the fax machine is on and ready.

Check that you are dialing the correct fax number.

Check that the redial option is enabled.

Unplug the telephone cord from both the product and the wall and replug the cord.

Open the [Service](#) menu, and touch the [Fax Service](#) button. Touch the [Run Fax Test](#) button. This test verifies that the phone cord is connected to the correct port and that the phone line has a signal. The product prints a report with the results.

If the error persists, contact HP. See www.hp.com/go/LJColorMFPM375 or www.hp.com/go/LJColorMFPM475 or the support flyer that came in the product box.

No fax answer. Redial pending.

Description

The receiving fax line did not answer. The product attempts to redial after a few minutes.

Recommended action

Allow the product to retry sending the fax.

Call the recipient to ensure that the fax machine is on and ready.

Check that you are dialing the correct fax number.

If the product continues to redial, unplug the product telephone cord from the wall, connect a telephone, and try making a voice call.

Open the [Service](#) menu, and touch the [Fax Service](#) button. Touch the [Run Fax Test](#) button. This test verifies that the phone cord is connected to the correct port and that the phone line has a signal. The product prints a report with the results.

If the error persists, contact HP. See www.hp.com/go/LJColorMFPM375 or www.hp.com/go/LJColorMFPM475 or the support flyer that came in the product box.

No fax detected.

Description

The product answered the incoming call but did not detect that a fax machine was calling.

Recommended action

Allow the product to retry receiving the fax.

Open the [Service](#) menu, and touch the [Fax Service](#) button. Touch the [Run Fax Test](#) button. This test verifies that the phone cord is connected to the correct port and that the phone line has a signal. The product prints a report with the results.

If the error persists, contact HP. See www.hp.com/go/LJColorMFPM375 or www.hp.com/go/LJColorMFPM475 or the support flyer that came in the product box.

Print failure, press OK. If error repeats, turn off then on.

Description

The product could not print the current page because of its complexity.

Recommended action

Touch the **OK** button to clear the message.

Remove shipping lock from <color> cartridge

Description

A toner cartridge shipping lock is installed.

Recommended action

Pull the orange tab to remove the shipping lock from the cartridge.

Remove shipping locks from cartridges

Description

A toner cartridge shipping lock is installed on one or more toner cartridges.

Recommended action

Pull the orange tab to remove the shipping lock from the cartridge.

Replace [color]

Description

The toner cartridge is at the end of its useful life, and the product is customer-configured to stop printing when it reaches the very low state.

Recommended action

To ensure optimal print quality, HP recommends replacing the toner cartridge at this point. You can continue printing until you notice a decrease in print quality. Actual cartridge life may vary.

Once an HP supply has reached very low, HP's premium Protection Warranty on that supply has ended. All print defects or cartridge failures incurred when an HP supply is used in continue at very low mode will not be considered to be defects in materials or workmanship in the supply under the HP Print Cartridge Warranty Statement.

Scanner error #, Turn off then on

Description

The product has experienced an error in the scanner sub-assembly area.

Recommended action

Turn off the power by using the power switch, wait at least 30 seconds, and then turn on the power and wait for the product to initialize.

Do not open the scanner lid until the initialization process is complete.

If a surge protector is being used, remove it. Connect the product directly into the wall socket. Use the power switch to turn the product on.

If the error persists, contact HP. See www.hp.com/go/LJColorMFPM375 or www.hp.com/go/LJColorMFPM475 or the support flyer that came in the product box.

Scanner reserved for PC scan

Description

A computer is using the product to create a scan.

Recommended action

Wait until the computer scan has finished, or cancel the scan from the computer software, or touch the Cancel  button.

Scanning error Cannot connect

Description

The product cannot transmit scan information to a computer.

Recommended action

Verify that the connection cable is not loose or damaged. Replace the cable if necessary, and try the scan again.

Settings cleared

Description

The product has cleared job settings.

Recommended action

Re-enter any appropriate job settings.

Unexpected size in tray # Load <size> Press [OK]

Description

The product has detected paper in the tray that does not match the configuration for the tray.

Recommended action

Load the correct paper into the tray, or configure the tray for the size that you have loaded.

Unsupported <color> Press [OK] to continue

Description

The product has detected a toner cartridge that was not made by HP.

Recommended action

Press the **OK** button to continue printing.

If you believe you purchased an HP supply, go to www.hp.com/go/anticounterfeit. Service or repairs that are required as a result of using unsupported supplies is not covered under HP warranty.

Used <color> in use

Description

You are using a toner cartridge that reached the default low threshold while it was installed in a product.

Recommended action

Printing can continue, but consider having a replacement supply on hand.

Used [color] installed, to accept press OK

Description

A used color toner cartridge has been installed or moved.

Recommended action

Touch the **OK** button to return to the Ready state.

Used supplies in use

Description

You are using more than one toner cartridge that reached the default low threshold while it was installed in a product.

Recommended action

Printing can continue, but consider having replacement supplies on hand.

Yellow Cartridge Low

Description

The toner cartridge is nearing the end of its useful life.

Recommended action

Printing can continue, but consider having a replacement supply on hand.

Yellow in wrong position

Description

The toner cartridge is installed in the incorrect slot.

Recommended action

Make sure that each toner cartridge is installed in the correct slot. From front to back, the toner cartridges are installed in this order: black, cyan, magenta, and yellow.

Yellow Very Low

Description

The toner cartridge is at the end of its useful life. When a color toner cartridge becomes very low, the product prints in black only to prevent fax interruptions. When you choose to replace the very low toner cartridge, color printing resumes automatically.

Recommended action

To ensure optimal print quality, HP recommends replacing the toner cartridge at this point. You can continue printing until you notice a decrease in print quality. Actual cartridge life may vary.

Once an HP supply has reached very low, HP's premium Protection Warranty on that supply has ended. All print defects or cartridge failures incurred when an HP supply is used in continue at very low mode will not be considered to be defects in materials or workmanship in the supply under the HP Print Cartridge Warranty Statement.

Event-log messages

Accessing the event log requires touching the Left Arrow ◀ button and the Cancel ✖ button on the touchscreen when they are not illuminated. Use the figure below to locate these buttons on the touchscreen.





Figure 2-16 Control-panel test



Print the event log



NOTE: You can use HP ToolboxFX to view the event log from a computer.

1. Make sure the product is in the Ready state.
2. Touch the Setup  button.
3. Simultaneously touch the Left Arrow  button and the Cancel  button.
4. Touch the Setup  button.
5. Open the [2ndry Service](#) menu.
6. Open the [Service Reports](#) menu.
7. Touch the [Error Report](#) item.

Event log messages

The following table contains all event log codes for this product. Many event log codes correspond to a control-panel error message.

Some product events do not produce a message that displays on the control panel. Instead, they are only recorded in the event log.

Table 2-7 Event-log messages

Event code	Description
13.0000	Paper jam
20.0000	Memory out
21.0000	Page misfeed or misspick
41.2000	Beam detect malfunction
41.3000	Unexpected size
50.1000	Low fuser temperature error
50.2000	Slow fuser error
50.3000	High fuser temperature error
50.4000	Fuser drive circuit error
50.7000	Fuser open error
50.8000	Low sub-thermistor fuser error
50.9000	High sub-thermistor fuser error
51.2000	Black scanner laser error (inline devices only)
51.2100	Cyan scanner laser error (inline devices only)
51.2200	Magenta scanner laser error (inline devices only)

Table 2-7 Event-log messages (continued)

Event code	Description
51.2300	Yellow scanner laser error (inline devices only)
54.0100	Environmental sensor error
54.0600	Density sensor error
54.1100	Black density out of range
54.1101	Cyan density out of range
54.1102	Magenta density out of range
54.1103	Yellow density out of range
54.1200	Black density measurement abnormality
54.1201	Cyan density measurement abnormality
54.1202	Magenta density measurement abnormality
54.1203	Yellow density measurement abnormality
54.1400	Color plane registration sensor error (inline devices only)
54.1599	Black CPR pattern cannot be read
54.1501	Cyan CPR pattern cannot be read
54.1502	Magenta CPR pattern cannot be read
54.1503	Yellow CPR pattern cannot be read
54.1500	Yellow toner level sensor error
54.1600	Magenta toner level sensor error
54.1700	Cyan toner level sensor error
54.1800	Black toner level sensor error
54.1900	Bad top-of-page (TOP) sensor
54.2100	Beam detect (BD) error
54.2500	Top-of-page sensor error
55.0000	Engine internal communication error
55.0601	DC controller NVRAM data error
55.0602	DC controller NVRAM access error
55.1000	DC controller memory error
57.0100	Fan motor error
57.0200	Fan error
59.0160	ITB or main motor rotation error (59.A0)
59.0192	Developer motor rotation error (59.C0)
59.0240	Transfer alienation failure (59.F0)

Table 2-7 Event-log messages (continued)

Event code	Description
59.3000	Fuser motor startup error
59.4000	Fuser motor error
59.5000	Image drum motor startup error—black
59.5300	Image drum motor startup error—yellow
59.6000	Image drum motor rotation error—black
59.6300	Image drum motor rotation error—yellow
59.7000	Black developer motor startup error
59.7300	Yellow developer motor startup error
59.8000	Black developer motor rotation error
59.8300	Yellow developer motor rotation error
59.9000	ITB motor start error

Table 2-8 Event-log-only messages

Event code	Description	Solution
20.0000	Memory out	<ol style="list-style-type: none"> 1. Turn off the power by using the power switch, and then wait at least 30 seconds. 2. Turn on the power and wait for the product to initialize. <p>If the error persists, break the job into smaller jobs that contain fewer pages.</p> <p>If the error persists, update the firmware.</p> <p>NOTE: For memory-card models, adding memory to the DIMM slot might help solve this problem.</p>
54.0100	Environmental sensor error	<p>Verify that the DC controller connectors are firmly connected.</p> <p>If the error persists, replace the temperature/humidity sensor.</p> <p>If the error persists, replace the DC controller.</p>

Table 2-8 Event-log-only messages (continued)

Event code	Description	Solution
54.0600	Density sensor error	Verify that the cables between the DC controller and the ITB are firmly connected.
54.1100	Black density out of range	If the error persists, replace the color misregistration sensor.
54.1101	Cyan density out of range	If the error persists, replace the ITB.
54.1102	Magenta density out of range	If the error persists, replace the DC controller.
54.1103	Yellow density out of range	
54.1200	Black density measurement abnormality	
54.1201	Cyan density measurement abnormality	
54.1202	Magenta density measurement abnormality	
54.1203	Yellow density measurement abnormality	
54.1400	Color plane registration sensor error (inline devices only)	<ol style="list-style-type: none"> 1. Turn off the power by using the power switch, and then wait at least 30 seconds. 2. Turn on the power and wait for the product to initialize.
54.1501	Cyan CPR pattern cannot be read	If the error persists, verify that the cables between the color misregistration sensor and the DC controller are firmly connected.
54.1502	Magenta CPR pattern cannot be read	If the error persists, replace the color misregistration sensor.
54.1503	Yellow CPR pattern cannot be read	If the error persists, replace the ITB.
54.1599	Black CPR pattern cannot be read	If the error persists, replace the toner cartridge tray.
54.2100	Beam detect (BD) error	If the error persists, replace the DC controller.
		If the error persists, replace the product.
54.2500	Top-of-page sensor error	Verify that the DC controller connectors are firmly connected.
		If the error persists, replace the DC controller.

Clear jams

Common causes of jams

To reduce the number of paper jams, try these solutions.

1. Use only paper that meets HP specifications for this product.
2. Use paper that is not wrinkled, folded, or damaged. If necessary, use paper from a different package.
3. Use paper that has not previously been printed or copied on.
4. Make sure the tray is not overfilled. If it is, remove the entire stack of paper from the tray, straighten the stack, and then return some of the paper to the tray.
5. Make sure the paper guides in the tray are adjusted correctly for the size of paper. Adjust the guides so they are touching the paper stack without bending it.
6. Make sure that the tray is fully inserted in the product.
7. If you are printing on heavy, embossed, or perforated paper, use the manual feed feature and feed sheets one at a time.

Jam locations

Jams can occur in these locations:

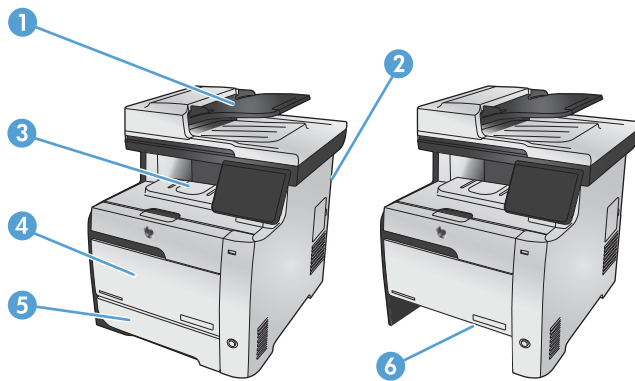

1	Document feeder
2	Rear door
3	Output bin
4	Tray 1

5	Tray 2
6	Tray 2 jam-access area

Loose toner might remain in the product after a jam. This problem typically resolves itself after a few sheets have been printed.

Clear jams from the document feeder

1. Turn the product off.

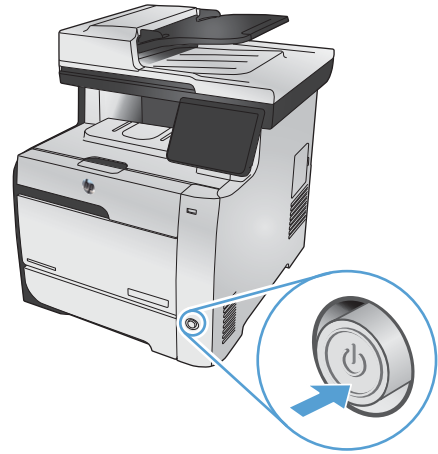

2. Open the document feeder cover.

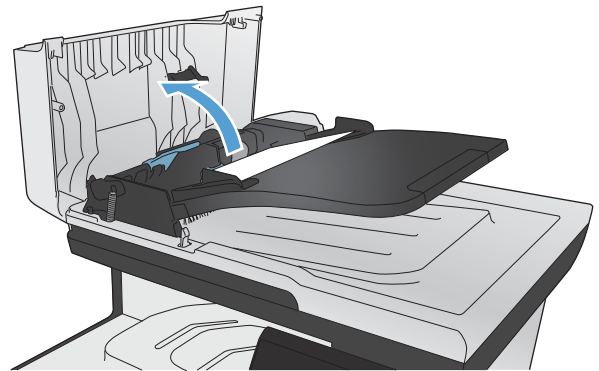

3. Lift the document feeder roller assembly, and gently pull the jammed paper out.

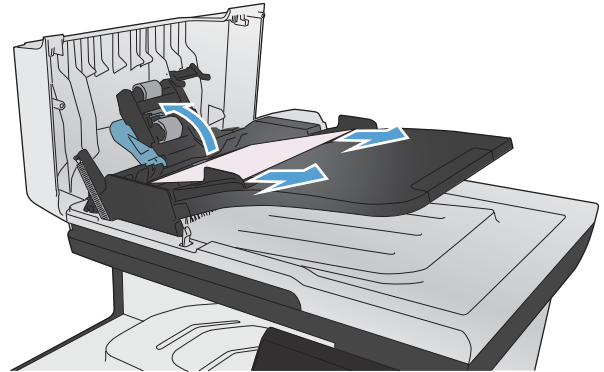

4. Close the document feeder roller assembly.

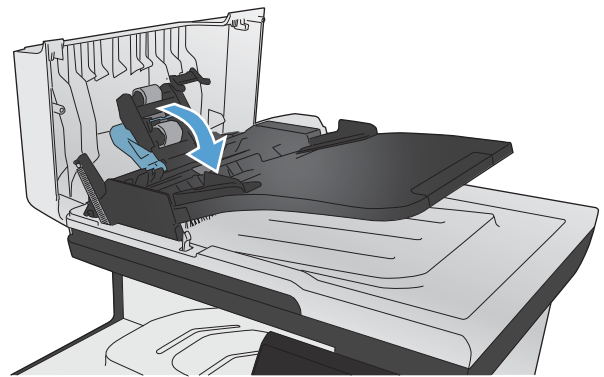

5. Close the document feeder cover.

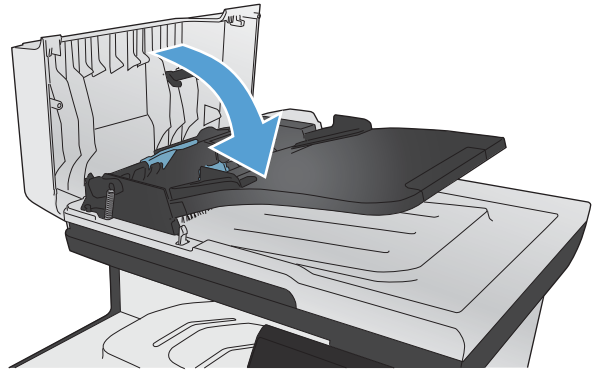

6. Open the scanner lid. If paper is jammed behind the white plastic backing, gently pull it out.

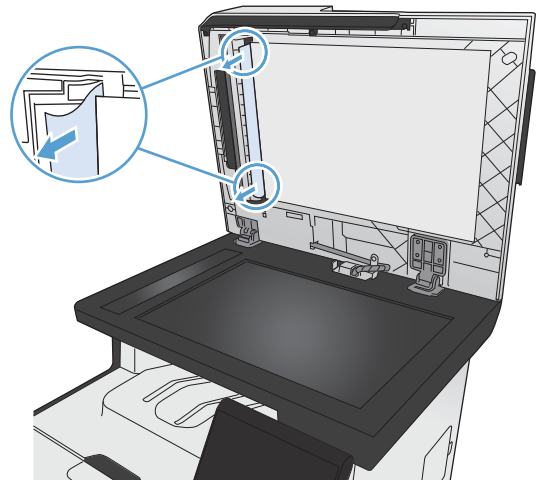

Clear jams in Tray 1

1. Pull the jammed sheet from Tray 1.

NOTE: If the sheet tears, make sure that all of the fragments are removed before you resume printing.

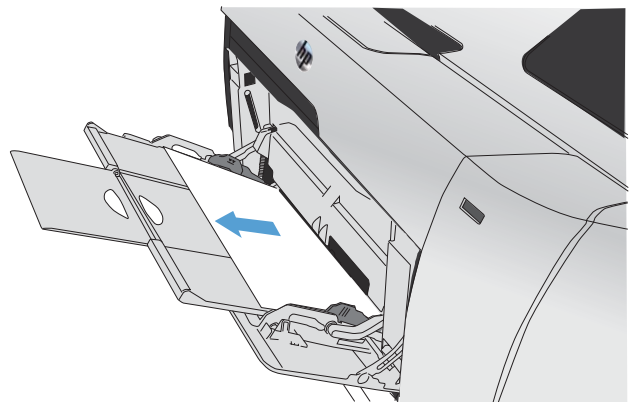

2. Pull out Tray 2 and place it on a flat surface.

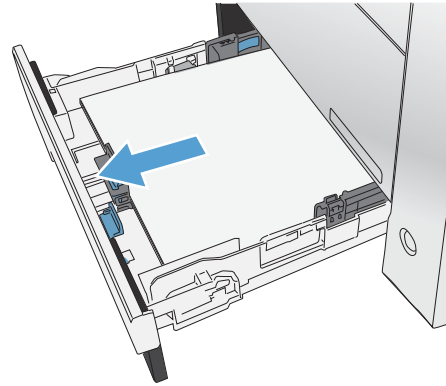

3. Lower the jam-access tray.

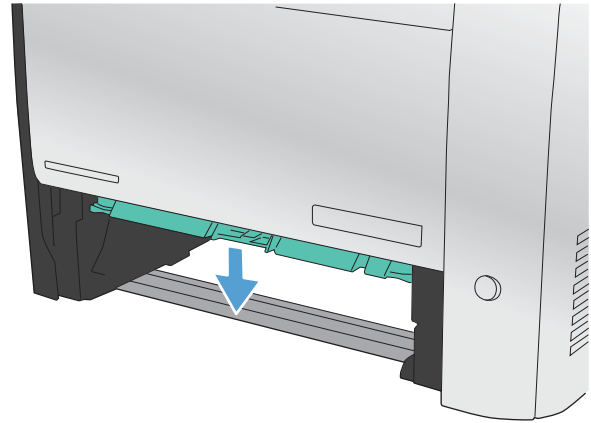

4. Remove the jammed sheet by pulling it straight out.

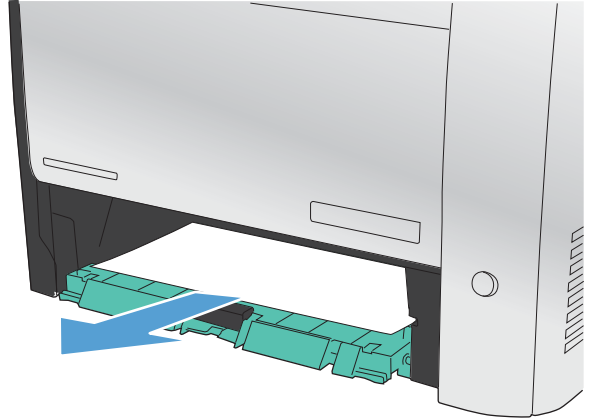

5. Push the jam-access tray up to close it, and then replace Tray 2.

NOTE: To close the tray, push in the middle or with even pressure on both sides. Avoid pushing on one side only.

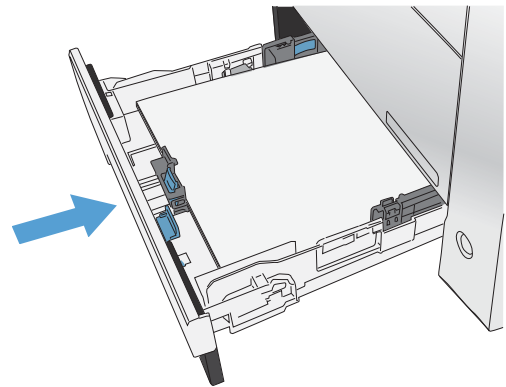

Clear jams in Tray 2

1. Open Tray 2.

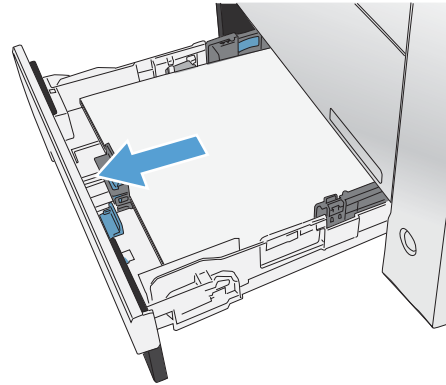

2. Remove the jammed sheet by pulling it straight out.

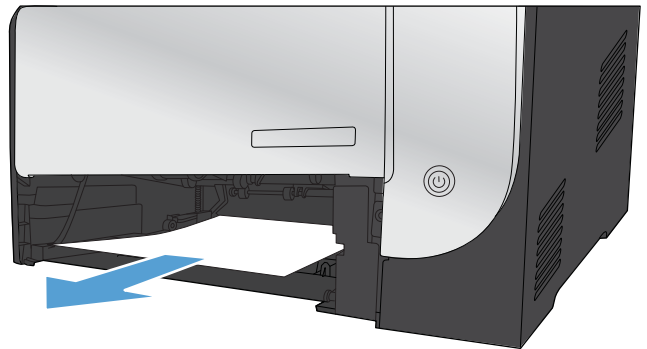

3. Close Tray 2.

NOTE: To close the tray, push in the middle or with even pressure on both sides. Avoid pushing on one side only.

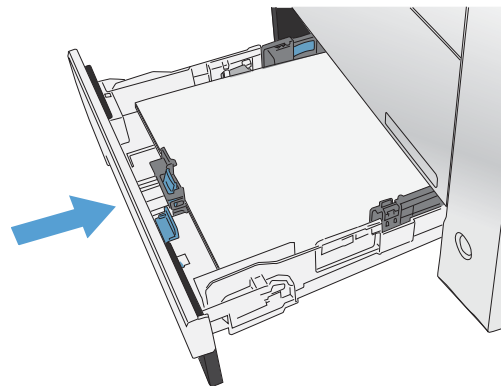

Clear jams in the fuser area

1. Open the rear door.

CAUTION: The fuser, located in the back of the product, is hot. Wait for the fuser to cool before continuing.

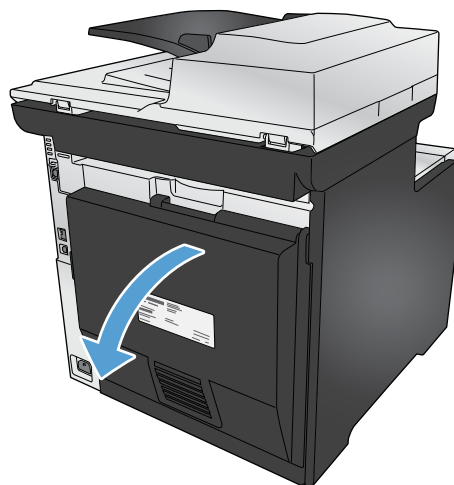

2. If necessary, push the guide (callout 1) and remove any visible paper (callout 2) from the bottom of the delivery area.

NOTE: If the sheet tears, make sure that all fragments are removed before you resume printing. Do not use sharp objects to remove fragments.

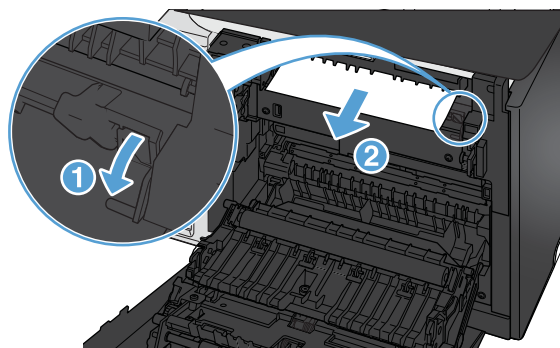

3. Close the rear door.

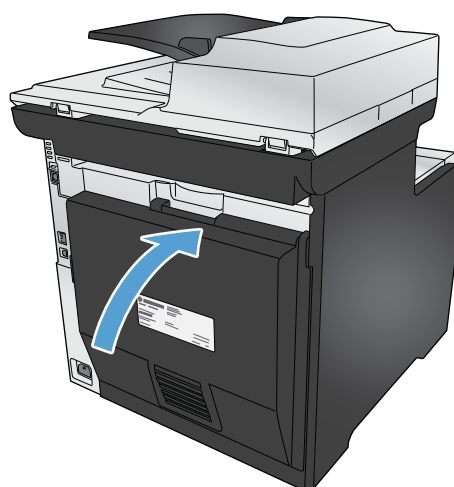

Clear jams in the output bin

1. Look for jammed paper in the output bin area.
2. Remove any visible media.

NOTE: If the sheet tears, make sure that all fragments are removed before resuming printing.

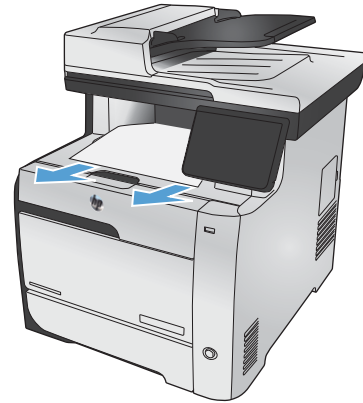

3. Open and then close the rear door to clear the message.

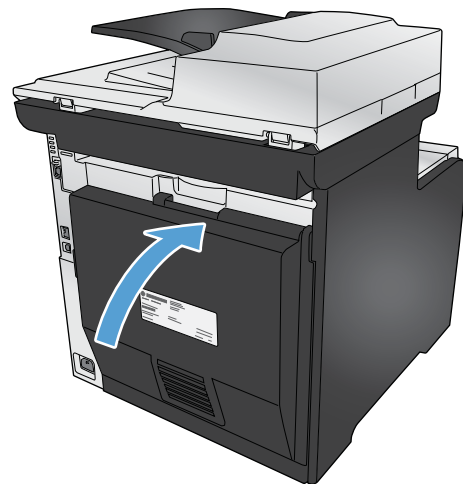

Clear jams in the duplexer (duplexing models only)

1. Open the rear door.

CAUTION: The fuser, located in the back of the product, is hot. Wait for the fuser to cool before continuing.

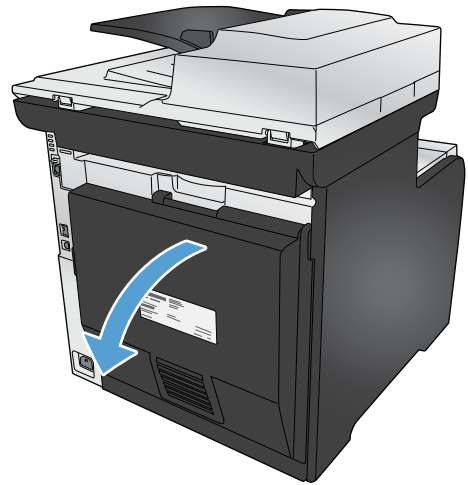

2. If necessary, pull the guide (callout 1) and remove any visible paper (callout 2) from the bottom of the delivery area.

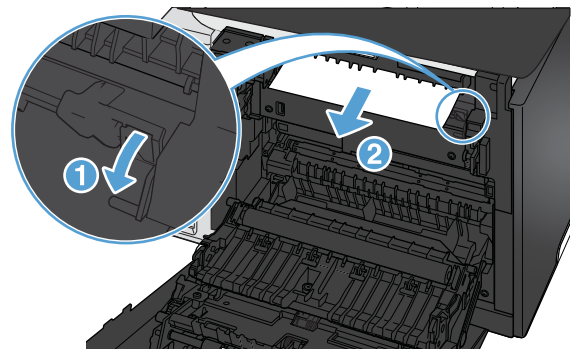

3. If necessary, remove any visible paper from bottom side of the duplexing unit.

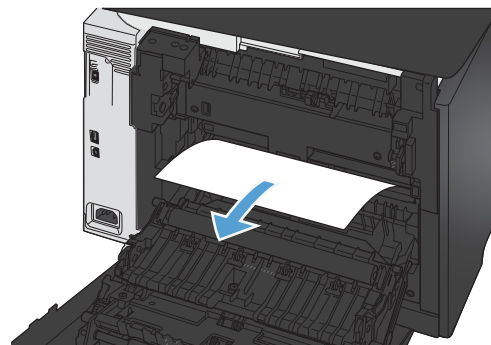

4. If you can not see any jammed paper, lift the duplexing unit using the tab on the side of the duplexing unit.

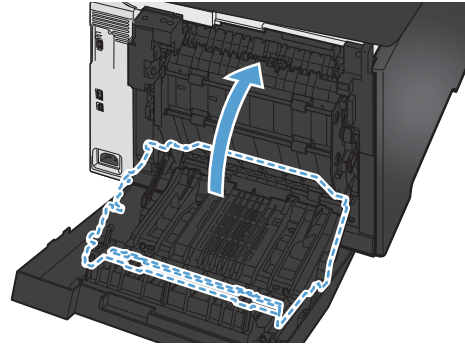

5. If you can see the trailing edge of the paper, remove the paper from the product.

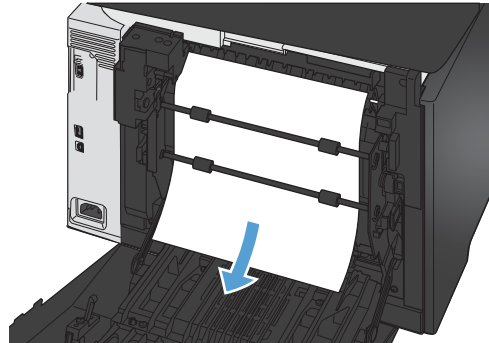

6. If you can see the leading edge of the paper, remove it from the product.

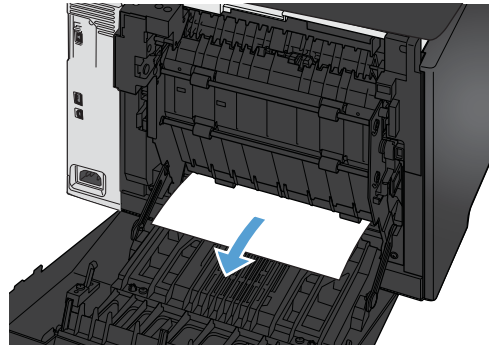

7. Close the rear door.

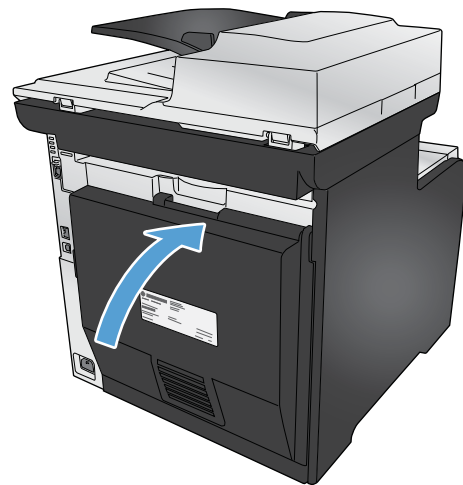

Solve paper-handling problems

The product picks up multiple sheets of paper

If the product picks up multiple sheets of paper from the tray, try these solutions.

1. Remove the stack of paper from the tray and flex it, rotate it 180 degrees, and flip it over. *Do not fan the paper.* Return the stack of paper to the tray.
2. Use only paper that meets HP specifications for this product.
3. Use paper that is not wrinkled, folded, or damaged. If necessary, use paper from a different package.
4. Make sure the tray is not overfilled. If it is, remove the entire stack of paper from the tray, straighten the stack, and then return some of the paper to the tray.
5. Make sure the paper guides in the tray are adjusted correctly for the size of paper. Align the guides with the paper-size markings in the bottom of the tray.

The product does not pick up paper



If the product does not pick up paper from the tray, try these solutions.



1. Open the product and remove any jammed sheets of paper.
2. Load the tray with the correct size of paper for your job.
3. Make sure the paper guides in the tray are adjusted correctly for the size of paper. Align the guides with the paper-size markings in the bottom of the tray.
4. Check the product control panel to see if the product is waiting for you to acknowledge a prompt to feed the paper manually. Load paper, and continue.

Solve image-quality problems

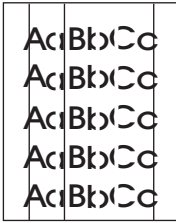

Print quality examples

The following examples depict Letter-size paper that has passed through the product short-edge first. These examples illustrate problems that would affect all the pages that you print, whether you print in color or in black only. The topics that follow list the typical cause and solution for each of these examples.

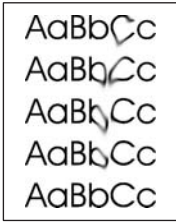
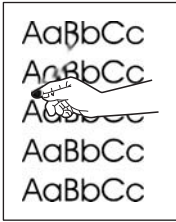
Problem	Cause	Solution
	The media might not meet HP specifications.	Use media that meets HP specifications.
	One or more toner cartridges might be defective.	Print the Supplies status page to check the remaining life. Replace any low toner cartridges.
	The product is set to override the Replace [color] message and to continue printing.	Replace any low toner cartridges.
	The print density settings might have been changed.	Set the print density setting to 0.
	The product might need to be calibrated.	Run a calibration.
	The media might not meet HP specifications.	Use only media that meets HP specifications.
	The paper path might need cleaning.	Clean the paper path. See the complete version of the English service manual.
	One or more of the cartridges might be leaking.	Try to verify the color of the toner specks and check the cartridge for leaks.
	The cartridge waste tank might be overfilled.	Check for error code 10.98.XX in the event log. The XX portion of the code identifies the cartridge (00 is black, 01 is cyan, 02 is magenta, 03 is yellow). If the error was logged, replace the appropriate cartridge.
	A single sheet of print media might be defective.	Try reprinting the job.
	The moisture content of the paper is uneven or the paper has moist spots on its surface.	Try different paper, such as high-quality paper that is intended for color laser printers.
	The media is flawed. The media manufacturing processes can cause some areas to reject toner.	Try different paper, such as high-quality paper that is intended for color laser printers.

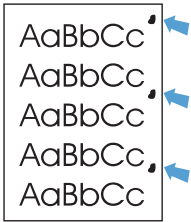
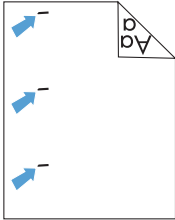
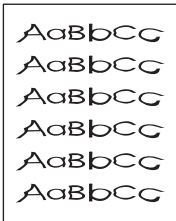
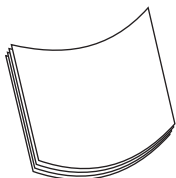

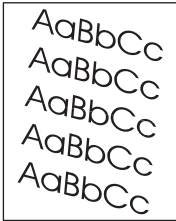
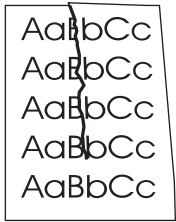
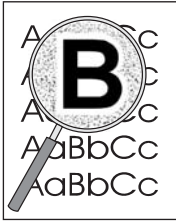
Problem	Cause	Solution
Vertical streaks or bands appear on the page.	One or more toner cartridges might be defective.	Print the Supplies status page to check the remaining life. Replace any low toner cartridges.
	The product is set to override the Replace [color] message and to continue printing.	Replace any low toner cartridges.
The amount of background toner shading becomes unacceptable.	Extreme dry (low humidity) conditions can increase the amount of background shading.	Check the device environment.
	The extended print mode setting is incorrect.	Try the print job again using the Transfer extended print mode, Dry paper setting.
	One or more toner cartridges might be defective.	Replace any low toner cartridges.
	The product is set to override the Replace [color] message and to continue printing.	Replace any low toner cartridges.
	Smooth media shows more background than plain media	Think about using rougher media.
Toner smears appear on the media.	The media might not meet HP specifications.	Use only media that meets HP specifications.
	If toner smears appear on the leading edge of the paper, the media guides are dirty, or debris has accumulated in the print path.	Clean the media guides. Clean the paper path.
	The toner smears easily when touched.	The device is not set to print on the type of media on which you want to print.
	The media might not meet HP specifications.	Use only media that meets HP specifications.
	The paper path might need cleaning.	Clean the paper path.



Problem	Cause	Solution
<p>Marks repeatedly appear at even intervals on the printed side of the page.</p> 	<p>The device is not set to print on the type of media on which you want to print.</p>	<p>In the printer driver, select the Paper tab and set Type is to match the type of paper on which you are printing. Print speed might be slower if you are using heavy paper.</p>
	<p>Internal parts might have toner on them.</p>	<p>The problem typically corrects itself after a few more pages.</p>
	<p>The paper path might need cleaning.</p>	<p>Clean the paper path.</p>
	<p>The fuser might be damaged or dirty.</p>	<p>To determine if the fuser has a problem. Print-quality diagnostics page.</p> <p>Clean the paper path.</p>
	<p>A toner cartridge might have a problem.</p>	<p>To determine which cartridge has a problem. Print the print-quality diagnostics page.</p>
<p>Marks repeatedly appear at even intervals on the unprinted side of the page.</p> 	<p>Internal parts might have toner on them.</p>	<p>The problem typically corrects itself after a few more pages.</p>
	<p>The paper path might need cleaning.</p>	<p>Clean the paper path.</p>
	<p>The fuser might be damaged or dirty.</p>	<p>To determine if the fuser has a problem. Print the print-quality diagnostics page.</p> <p>Clean the paper path.</p>
<p>The printed page contains misformed characters.</p> 	<p>The media might not meet HP specifications.</p>	<p>Use a different paper, such as high-quality paper that is intended for color laser printers.</p>
	<p>If characters are incorrectly formed so that they produce a wavy effect, the laser scanner might need service.</p>	<p>Verify that the problem also occurs on the configuration page.</p>
<p>The printed page is curled or wavy.</p> 	<p>The device is not set to print on the type of media on which you want to print.</p>	<p>In the printer driver, select the Paper tab and set Type is to match the type of paper on which you are printing. Print speed might be slower if you are using heavy paper.</p>
	<p>The Service menu item Less Paper Curl is set to Off.</p>	<p>Use the control-panel menus to change the setting.</p>
	<p>The media might not meet HP specifications.</p>	<p>Use a different paper, such as high-quality paper that is intended for color laser printers.</p>
	<p>Both high temperature and humidity can cause paper curl.</p>	<p>Check the device environment.</p>

Problem	Cause	Solution
Text or graphics are skewed on the printed page. 	The media might be loaded incorrectly. The media might not meet HP specifications.	Ensure that the paper or other print media is loaded correctly and that the media guides are not too tight or too loose against the stack. Use a different paper, such as high-quality paper that is intended for color laser printers.
The printed page contains wrinkles or creases. 	The media might be loaded incorrectly. The media might not meet HP specifications.	Verify that the media is loaded correctly and that the media guides are not too tight or too loose against the stack. Turn over the stack of paper in the input tray, or try rotating the paper 180° in the input tray. Use a different paper, such as high-quality paper that is intended for color laser printers.
Toner displays around the printed characters. 	The media might be loaded incorrectly. If large amounts of toner have scattered around the characters, the paper might have high resistivity.	Turn over the stack of paper in the tray. Use a different paper, such as high-quality paper that is intended for color laser printers.
An image that displays at the top of the page (in solid black) repeats farther down the page (in a gray field). 	Software settings might affect image printing. The order of images printed might affect printing. A power surge might have affected the device.	In your software program, change the tone (darkness) of the field in which the repeated image displays. In your software program, rotate the whole page 180° to print the lighter image first. Change the order in which the images are printed. For example, have the lighter image at the top of the page, and the darker image farther down the page. If the defect occurs later in a print job, turn the device off for 10 minutes, and then turn on the device to restart the print job. Use non-glossy media to help reduce the severity of the defect

Color image defects

This section describes issues that can occur when you print in color.

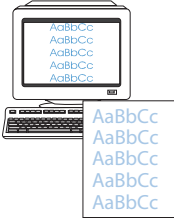
Problem	Cause	Solution
Only black is printing when the document should be printing in color.	Color mode is not selected in your program or printer driver.	Select color mode instead of gray scale mode.
	The correct printer driver might not be selected in the program.	Select the correct printer driver.
	The device might not be correctly configured.	Print a configuration page to check whether color displays on the configuration page.
	The color supply is out and the Color Supply Out menu setting is set to Continue Black .	Replace the color supply.
One or more colors are not printing, or are inaccurate.	Sealing tape might be on the toner cartridges.	Verify that the sealing tape has been completely removed from the toner cartridges.
	The media might not meet HP specifications.	Use a different paper, such as high-quality paper that is intended for color laser printers.
	The device might be operating in excessively humid conditions.	Verify that the device environment is within humidity specifications.
	One or more toner cartridges might be defective.	Replace any low toner cartridges.
	The product is set to override the Replace [color] message and to continue printing.	Replace any low toner cartridges.
	One or more of the cartridges might not have been engaged properly by the print engine.	Remove and reinstall the cartridges.
A color is printing inconsistently after you load a new toner cartridge.	Another toner cartridge might be defective.	Remove the toner cartridge for the color that is printing inconsistently and reinstall it.
	The product is set to override the Replace [color] message and to continue printing.	Replace any low toner cartridges.

Problem	Cause	Solution
<p>The colors on the printed page do not match the colors as they appear on the screen.</p>	<p>The colors on your computer monitor might differ from the device output.</p> <p>If extremely light colors or extremely dark colors on-screen are not printing, your software program might interpret extremely light colors as white or extremely dark colors as black.</p>	<p>See the product user guide.</p> <p>If possible, avoid using extremely light or extremely dark colors.</p>
	<p>The media might not meet HP specifications.</p>	<p>Use a different paper, such as high-quality paper that is intended for color laser printers.</p>
<p>The finish on the printed color page is inconsistent.</p>	<p>The media might be too rough.</p>	<p>Use a smooth paper or print media, such as a high-quality paper that is made for color laser printers. Generally, smoother media produces better the results.</p>
		

Clean the product

Clean the pickup and separation rollers

1. Turn off the product, unplug the power cable from the product, and then remove the rollers.
2. Dab a lint-free cloth in isopropyl alcohol, and then scrub the roller.

⚠ WARNING! Alcohol is flammable. Keep the alcohol and cloth away from an open flame. Before you close the product and connect the power cable, allow the alcohol to dry completely.

📝 NOTE: In certain areas of California (USA), air pollution control regulations restrict the use of liquid isopropyl alcohol (IPA) as a cleaning agent. In those areas of California, please disregard the previous recommendations and use a dry, lint free cloth, moistened with water, to clean the pickup roller.

3. Use a dry, lint free cloth, to wipe the rollers and remove loose dirt.

Clean the paper path

During the printing process, paper, toner, and dust particles can accumulate inside the product. Over time, this buildup can cause print-quality problems such as toner specks or smearing. This product has a cleaning mode that can correct and prevent these types of problems.

Clean the paper path from the product control panel

1. From the Home screen, touch the Setup  button.



2. Touch the **Service** menu.
3. Touch the **Cleaning Page** button.
4. Load plain letter or A4 paper when you are prompted.
5. Touch the **OK** button to begin the cleaning process.

A page feeds through the product slowly. Discard the page when the process is completed.

📝 NOTE: For models that do not have an automatic duplexer, the product prints the first side and then prompts you to remove the page from the output bin and reload it in Tray 1, keeping the same orientation.

Clean the scanner glass strip and platen

Over time, specks of debris might collect on the scanner glass and white plastic backing, which can affect performance. Use the following procedure to clean the scanner glass and white plastic backing.

1. Use the power switch to turn off the product, and then unplug the power cable from the electrical socket.
2. Open the scanner lid.
3. Clean the scanner glass and the white plastic backing with a soft cloth or sponge that has been moistened with nonabrasive glass cleaner.

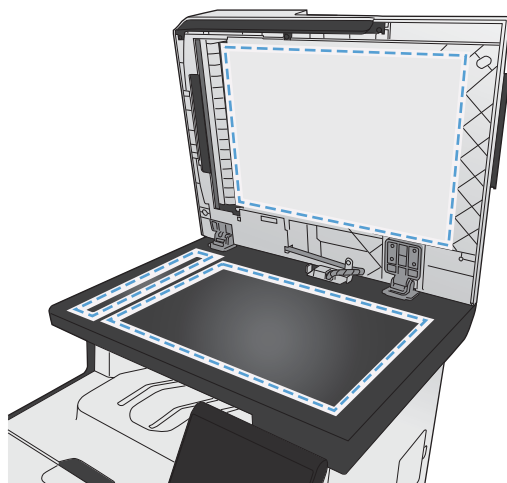

⚠ CAUTION: Do not use abrasives, acetone, benzene, ammonia, ethyl alcohol, or carbon tetrachloride on any part of the product; these can damage the product. Do not place liquids directly on the glass or platen. They might seep and damage the product.

4. Dry the glass and white plastic backing with a chamois or a cellulose sponge to prevent spotting.
5. Connect the product, and then use the power switch to turn on the product.

Clean the document feeder pickup rollers and separation pad

If the product document feeder experiences paper-handling problems, such as jams or multiple-page feeds, clean the document feeder rollers and separation pad.

1. Open the document feeder cover.

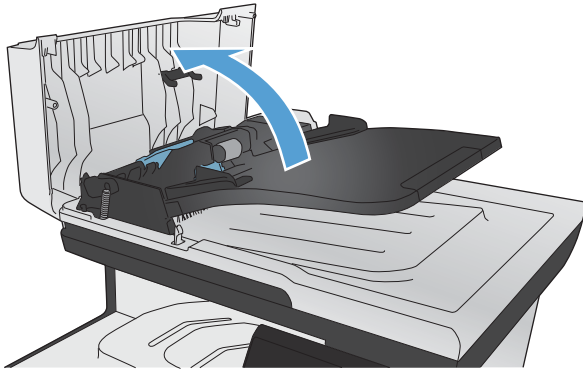

2. Use a moist, lint-free cloth to wipe both pickup rollers and the separation pad to remove dirt.

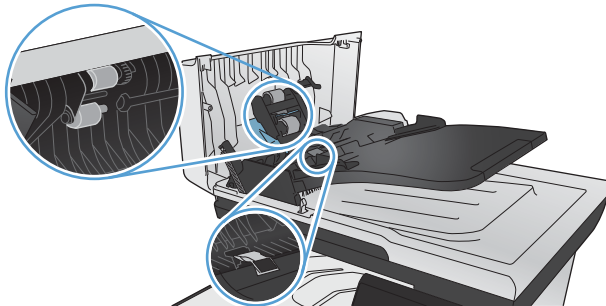

3. Close the document feeder cover.

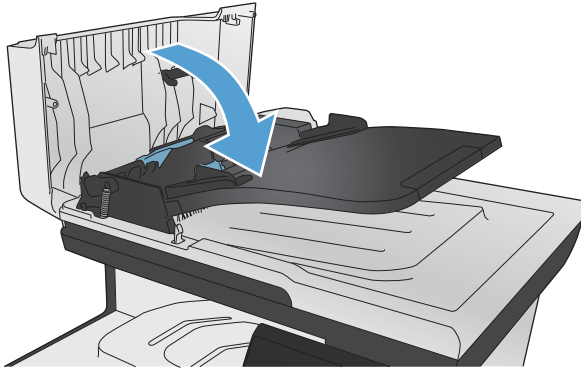

Clean the touch screen

Clean the touch screen whenever it is necessary to remove fingerprints or dust. Wipe the touch screen gently with a clean, water-dampened, lint-free cloth.

⚠ CAUTION: Use water only. Solvents or cleaners can damage the touch screen. Do not pour or spray water directly onto the touch screen.

Solve performance problems

Factors affecting print performance

Problem	Cause	Solution
Pages print but, are totally blank.	The sealing tape might still be in the toner cartridges.	Verify that the sealing tape has been completely removed from the toner cartridges.
	The document might contain blank pages.	Check the document that you are printing to see if content displays on all of the pages.
	The product might be malfunctioning.	To check the product, print a Configuration page.
Pages print very slowly. NOTE: The product print speed is effected by various factors (for example, media size or page complexity).	Heavier media types can slow the print job.	Print on a different type of media.
	Complex pages can print slowly.	Proper fusing might require a slower print speed to ensure the best print quality.
	Paper type not set correctly.	Select the type to match the paper.
Pages did not print.	The product might not be pulling media correctly.	Ensure paper is loaded in the tray correctly. If the problem persists, you might need to replace the pickup rollers and the separation pad.
	The media is jamming in the device.	Clear the jam.
	The USB cable might be defective or incorrectly connected.	<ul style="list-style-type: none">• Disconnect the USB cable at both ends and reconnect it.• Try printing a job that has printed in the past.• Try using a different USB cable.
	Other devices are running on your computer.	The product might not share a USB port. If you have an external hard drive or network switchbox that is connected to the same port as the product, the other device might be interfering. To connect and use the product, you must disconnect the other device or you must use two USB ports on the computer.

Print speeds

Print speed is the number of pages that print in one minute. Print speed depends on different engine-process speeds or operational pauses between printed pages during normal product operation. Factors that determine the print speed of the product include the following:

- Page formatting time

The product must pause for each page to be formatted before it prints. Complex pages take more time to format, resulting in reduced print speed. However, most jobs print at full engine speed (21 ppm on Letter-size media or 20 ppm on A4-size media).

- Color mode

Monochrome printing (black only) provides the maximum print speed. Full color print jobs cause a reduction in print speed.

- Media size

Legal-size media reduces print speed because it is longer than the standard Letter- or A4-size media. A reduce print speed is used when printing on narrow media to prevent the edges of the fuser from overheating.

- Media mode

Some media types require a reduced print speed to achieve maximum print quality on that media. For example, glossy, heavy, and specialty media (for example, envelopes or photos) require a reduced print speed. To maximize the print speed for special media types, ensure that you select the correct media type in the print driver.

- Product temperature

To prevent product damage, print speed is reduced if the product reaches a specific internal temperature (thermal slow down). The starting temperature of the product, ambient environment temperature, and the print job size effect the number of pages that can be printed before the product reduces the print speed. Thermal slow down reduces print speed by printing four pages and then pausing for an amount of time before printing continues.

- Other print speed reduction factors

Other factors (especially during large print jobs) that can cause reduced print speeds include:

- ITB cleaning and lubrication; occurs every 50 to 80 pages and takes about 60 seconds.
- CPR control sequence; occurs every 450 pages and takes about 90 seconds.
- Density control sequence; occurs every 150 pages and takes about 120 seconds.

The product does not print or it prints slowly

The product does not print

If the product does not print at all, try the following solutions.

1. Make sure the product is turned on and that the control panel indicates it is ready.
 - If the control panel does not indicate the product is ready, turn the product off and then on again.
 - If the control panel indicates the product is ready, try sending the job again.
2. If the control panel indicates the product has an error, resolve the error and then try sending the job again.
3. Make sure the cables are all connected correctly. If the product is connected to a network, check the following items:
 - Check the light next to the network connection on the product. If the network is active, the light is green.
 - Make sure that you are using a network cable and not a phone cord to connect to the network.
 - Make sure the network router, hub, or switch is turned on and that it is working correctly.
4. Install the HP software from the CD that came with the product. Using generic printer drivers can cause delays clearing jobs from the print queue.
5. From the list of printers on your computer, right-click the name of this product, click **Properties**, and open the **Ports** tab.
 - If you are using a network cable to connect to the network, make sure the printer name listed on the **Ports** tab matches the product name on the product configuration page.
 - If you are using a USB cable and are connecting to a wireless network, make sure the box is checked next to **Virtual printer port for USB**.
6. If you are using a personal firewall system on the computer, it might be blocking communication with the product. Try temporarily disabling the firewall to see if it is the source of the problem.
7. If your computer or the product is connected to a wireless network, low signal quality or interference might be delaying print jobs.

The product prints slowly

If the product prints, but it seems slow, try the following solutions.

1. Make sure the computer meets the minimum specifications for this product. For a list of specifications, go to this Web site: www.hp.com/go/LJColorMFPM375 or www.hp.com/go/LJColorMFPM475.
2. When you configure the product to print on some paper types, such as heavy paper, the product prints more slowly so it can correctly fuse the toner to the paper. If the paper type setting is not correct for the type of paper you are using, change the setting to the correct paper type.
3. If your computer or the product is connected to a wireless network, low signal quality or interference might be delaying print jobs.

Solve product connectivity problems

Solve direct-connect problems

If you have connected the product directly to a computer, check the cable.

- Verify that the cable is connected to the computer and to the product.
- Verify that the cable is not longer than 5 m (16.4 ft). Try using a shorter cable.
- Verify that the cable is working correctly by connecting it to another product. Replace the cable if necessary.

Solve network problems

Check the following items to verify that the product is communicating with the network. Before beginning, print a configuration page from the product control panel and locate the product IP address that is listed on this page.

- [Poor physical connection](#)
- [The computer is using the incorrect IP address for the product](#)
- [The computer is unable to communicate with the product](#)
- [The product is using incorrect link and duplex settings for the network](#)
- [New software programs might be causing compatibility problems](#)
- [The computer or workstation might be set up incorrectly](#)
- [The product is disabled, or other network settings are incorrect](#)

Poor physical connection

1. Verify that the product is attached to the correct network port using a cable of the correct length.
2. Verify that cable connections are secure.
3. Look at the network port connection on the back of the product, and verify that the amber activity light and the green link-status light are lit.
4. If the problem continues, try a different cable or port on the hub.

The computer is using the incorrect IP address for the product

1. Open the printer properties and click the **Ports** tab. Verify that the current IP address for the product is selected. The product IP address is listed on the product configuration page.
2. If you installed the product using the HP standard TCP/IP port, select the box labeled **Always print to this printer, even if its IP address changes**.

3. If you installed the product using a Microsoft standard TCP/IP port, use the hostname instead of the IP address.
4. If the IP address is correct, delete the product and then add it again.

The computer is unable to communicate with the product

1. Test network communication by pinging the network.
 - a. Open a command-line prompt on your computer. For Windows, click **Start**, click **Run**, and then type `cmd`.
 - b. Type `ping` followed by the IP address for your product.
 - c. If the window displays round-trip times, the network is working.
2. If the ping command failed, verify that the network hubs are on, and then verify that the network settings, the product, and the computer are all configured for the same network.

The product is using incorrect link and duplex settings for the network

Hewlett-Packard recommends leaving this setting in automatic mode (the default setting). If you change these settings, you must also change them for your network.

New software programs might be causing compatibility problems

Verify that any new software programs are correctly installed and that they use the correct printer driver.

The computer or workstation might be set up incorrectly

1. Check the network drivers, printer drivers, and the network redirection.
2. Verify that the operating system is configured correctly.

The product is disabled, or other network settings are incorrect

1. Review the configuration page to check the status of the network protocol. Enable it if necessary.
2. Change the network settings if necessary.

Solve wireless network problems

- [Wireless connectivity checklist](#)
- [The control panel displays the message: The wireless feature on this product has been turned off](#)
- [The product does not print after the wireless configuration completes](#)
- [The product does not print, and the computer has a third-party firewall installed](#)
- [The wireless connection does not work after moving the wireless router or product](#)

- [Cannot connect more computers to the wireless product](#)
- [The wireless product loses communication when connected to a VPN](#)
- [The network does not appear in the wireless networks list](#)
- [The wireless network is not functioning](#)

Wireless connectivity checklist

- The product and the wireless router are turned on and have power. Also make sure the wireless radio in the product is turned on.
- The service set identifier (SSID) is correct. Print a configuration page to determine the SSID. If you are not sure the SSID is correct, run the wireless setup again.
- With secured networks, make sure the security information is correct. If the security information is incorrect, run the wireless setup again.
- If the wireless network is working correctly, try accessing other computers on the wireless network. If the network has Internet access, try connecting to the Internet over a wireless connection.
- The encryption method (AES or TKIP) is the same for the product as it is for the wireless access point (on networks using WPA security).
- The product is within the range of the wireless network. For most networks, the product must be within 30 m (100 ft) of the wireless access point (wireless router).
- Obstacles do not block the wireless signal. Remove any large metal objects between the access point and the product. Make sure poles, walls, or support columns containing metal or concrete do not separate the product and wireless access point.
- The product is located away from electronic devices that might interfere with the wireless signal. Many devices can interfere with the wireless signal including motors, cordless phones, security system cameras, other wireless networks, and some Bluetooth devices.
- The printer driver is installed on the computer.
- You have selected the correct printer port.
- The computer and product connect to the same wireless network.

The control panel displays the message: The wireless feature on this product has been turned off

1. Touch the [Wireless Menu](#) button.
2. Touch the [Turn Wireless On/Off](#) button, and then touch the [On](#) button.

The product does not print after the wireless configuration completes

1. Make sure the product is turned on and in the ready state.
2. Make sure you are connecting to the correct wireless network.

3. Make sure that the wireless network is working correctly.
 - a. Open the [Network Setup](#) menu, and then open the [Wireless Menu](#) item.
 - b. Select the [Run Network Test](#) item to test the wireless network. The product prints a report with the results.
4. Make sure that the correct port or product is selected.
 - a. From the list of printers on your computer, right-click the name of this product, click **Properties**, and then open the **Ports** tab.
 - b. Make sure the box is checked next to **Virtual printer port for USB**.
5. Make sure that your computer is working correctly. If necessary, restart your computer.

The product does not print, and the computer has a third-party firewall installed

1. Update the firewall with the most recent update available from the manufacturer.
2. If programs request firewall access when you install the product or try to print, make sure you allow the programs to run.
3. Temporarily turn off the firewall, and then install the wireless product on the computer. Enable the firewall when you have completed the wireless installation.

The wireless connection does not work after moving the wireless router or product

Make sure that the router or product connects to the same network that your computer connects to.

1. Open the [Reports](#) menu, and select the [Configuration Report](#) item to print the report.
2. Compare the service set identifier (SSID) on the configuration report to the SSID in the printer configuration for your computer.
3. If the SSIDs are not the same, the devices are not connecting to the same network. Reconfigure the wireless setup for your product.

Cannot connect more computers to the wireless product

1. Make sure that the other computers are within the wireless range and that no obstacles block the signal. For most networks, the wireless range is within 30 m (100 ft) of the wireless access point.
2. Make sure the product is turned on and in the ready state.
3. Turn off any third-party firewalls on your computer.
4. Make sure that the wireless network is working correctly.
 - a. On the product control panel, open the [Network Setup](#) menu, and then open the [Wireless Menu](#) item.
 - b. Select the [Run Network Test](#) item to test the wireless network. The product prints a report with the results.

5. Make sure that the correct port or product is selected.
 - a. From the list of printers on your computer, right-click the name of this product, click **Properties**, and then open the **Ports** tab.
 - b. Click the **Configure Port** button to verify that the IP address matches the IP address listed on the Run Network Test report.
6. Make sure that your computer is working correctly. If necessary, restart your computer.

The wireless product loses communication when connected to a VPN

- Typically, you cannot connect to a VPN and other networks at the same time.

The network does not appear in the wireless networks list

- Make sure the wireless router is turned on and has power.
- The network might be hidden. However, you can still connect to a hidden network.

The wireless network is not functioning

1. To verify if the network has lost communication, try connecting other devices to the network.
2. Test network communication by pinging the network.
 - a. Open a command-line prompt on your computer. For Windows, click **Start**, click **Run**, and then type `cmd`.
 - b. Type `ping` followed by the service set identifier (SSID) for your network.
 - c. If the window displays round-trip times, the network is working.
3. Make sure that the router or product connects to the same network that your computer connects to.
 - a. Open the **Reports** menu, and select the **Configuration Report** item to print the report.
 - b. Compare the service set identifier (SSID) on the configuration report to the SSID in the printer configuration for your computer.
 - c. If the SSIDs are not the same, the devices are not connecting to the same network. Reconfigure the wireless setup for your product.

Service mode functions

Service menu

Use the control-panel [Service](#) menu to troubleshoot product problems.

Service menu settings

The [Service](#) menu is used to calibrate, restore factory default settings, and clean the print paper path.

The following [Service](#) menu items are available:

- [Fax Service](#)—used to test, diagnose, and maintain the fax functionality.
- [Cleaning Page](#)—used to remove dust and toner from the print paper path
- [PowerSave Time](#)—used to configure the amount of idle time before the engine enters sleep mode
- [USB Speed](#)—used to set the USB speed
- [Less Paper Curl](#)—used to decrease the fuser temperature, which can reduce paper curl
- [Archive Print](#)—used to decrease the likelihood of toner smearing on a print job
- [Restore Defaults](#)—used to reset all customer-accessible menu settings back to the factory default settings (except language) via the control panel or software

 **NOTE:** This menu item does not reset factory-settable settings, including formatter number, page counts, factory paper settings, language, and so on.



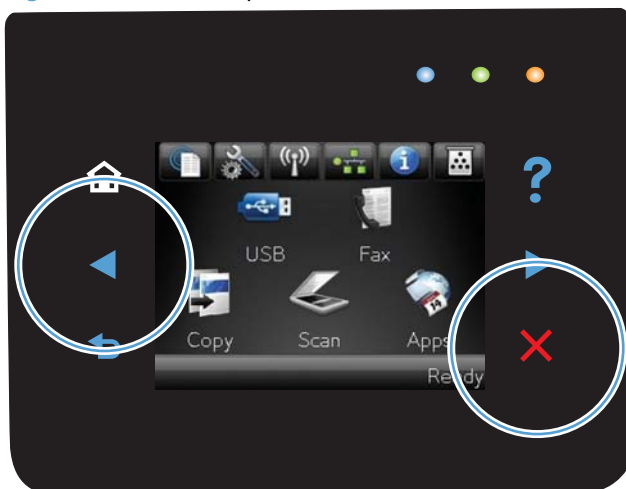

Secondary service menu

Accessing the Secondary service menu requires touching the Left Arrow ◀ button and the Cancel ✕ button on the touchscreen when they are not illuminated. Use the figure below to locate these buttons on the touchscreen.

Figure 2-17 Control-panel test



Open the secondary service menu

1. Make sure the product is in the Ready state.
2. Touch the Setup  button.
3. Simultaneously touch the Left Arrow  button and the Cancel  button.
4. Touch the Setup  button.
5. Open the [2ndry Service](#) menu.
6. Use the arrow keys to scroll through the menu.

Secondary service menu structure

Table 2-9 Secondary service menu

Menu item	Sub-menu item	Description
Service Reports	Cont. Self-Test	This item prints a continuous configuration page.
	Extended Keymap (fax/ memory-card models only)	This item prints an extended key map for the alphanumeric keypad on the control panel.
	Error Report	This item prints an error report.
Scan Calibration	Calibrate	This item calibrates the product.
	Corrected	
	Tables	
	Test	
Location	A list of available locations displays	<p>This item sets certain product parameters that are dependent on the location, such as the default paper size and the symbol set.</p> <p>Scroll to the appropriate location and select Yes to set the location. The product automatically restarts after you change the location.</p>
Display Test		<p>This test verifies that the LEDs and characters on the control-panel display function correctly.</p> <p>At the beginning of the test, each of the LEDs is turned on one-at-time. Touch OK to continue to the next LED.</p> <p>After the LED test is complete, the character test begins by testing the pixels on each line. Then, each of the 255 characters is displayed in groups of 16. Touch OK to continue to the next group of 16 characters. You can cancel the test at any time by touching Cancel .</p>
Button Test		This test verifies that the control-panel buttons function correctly. The display prompts you to touch each button.
Show Firmware Version		This item shows the current date code of the firmware.
Ethernet Reset (network models only)		This item resets the ethernet driver. This should be used when the network is not accessible. This is a low-level, internal reset and does not affect network settings.

Table 2-9 Secondary service menu (continued)

Menu item	Sub-menu item	Description
Memory Cards (fax/memory-card models only)	Enable	This item enables or disables the product memory-card functions.
	Disable	
Color Calibrate	Adjust Color	This item adjusts density settings for contrast, highlights, midtones, and shadows. Adjust each color individually.
	Timing	This item specifies how frequently the product should automatically perform a color calibration. The default setting is 48 hours. You can turn automatic calibration off.
Clean Belt		This item runs additional belt-cleaning cycles.
Pick Roller		This item puts the pickup roller in position for replacement.

Product resets

The product resets—[Restore Defaults](#) and the NVRAM initialization—perform the same function. If possible, use the [Restore Defaults](#) function in the [Service](#) menu. If that menu is not accessible, use the NVRAM sequence.

Restore the factory-set defaults

 **NOTE:** Before restoring defaults, print a menu structure report and a configuration page. Use the information on these pages to reset customer-specific settings.

 **CAUTION:** All onboard network settings are also reset. Be sure to print a configuration page before restoring defaults. Make note of the IP address that is listed on the Jetdirect configuration page. You might need to restore the IP address after restoring the defaults.

1. Touch the Setup  button.
2. Open the [Service](#) menu.
3. Touch the [Restore Defaults](#) item.

The product automatically restarts.

NVRAM initialization

Performing an NVRAM initialization resets the following settings and information:

- All menu settings are reset to factory default values.
- All localization settings, including language and country/region, are reset.

 **CAUTION:** All onboard network settings are also reset. Be sure to print a configuration page before restoring defaults. Make note of the IP address that is listed on the Jetdirect configuration page. You might need to restore the IP address after an NVRAM initialization.

After performing an NVRAM initialization, reconfigure any computers that print to this product. Uninstall and then reinstall the product software on the computers.

1. Turn the product off.
2. Simultaneously touch the Right Arrow ► button and the Cancel ✕ button. Continue touching these buttons, and then turn the product on.
3. When the **Permanent Storage Initialization** message displays, release both buttons.

When the product has finished the NVRAM initialization, it returns to the Ready state.

Solve fax problems

Fax troubleshooting checklist

- Several possible fixes are available. After each recommended action, retry faxing to see if the problem is resolved.
 - For best results during fax problem solving, make sure the line from the product is plugged directly into the wall phone port. Disconnect all other devices that are connected to the product.
1. Verify that the telephone cord is plugged into the correct port on the back of the product.
 2. Check the phone line by using the fax test:
 - a. On the control panel, open the Setup  menu, and then open the [Service](#) menu.
 - b. Select the [Fax Service](#) option.
 - c. Select the [Run Fax Test](#) option. The product prints a fax test report.

The report contains the following possible results:

- **Pass:** The report contains all of the current fax settings for review.
 - **Fail:** The cord is in the wrong port. The report contains suggestions for how to resolve the issue.
 - **Fail :** The phone line is not active. The report contains suggestions for how to resolve the issue.
3. Verify that the product firmware is current:
 - a. Print a configuration page from the control panel [Reports](#) menu to obtain the current firmware date code.
 - b. Go to www.hp.com.
 1. Click the **Support & Drivers** link.
 2. Click the **Download drivers and software (and firmware)** link option.
 3. In the **For product** box, type the product model number, and then click the **Go** button.

4. Click the link for your operating system.
5. Scroll to the Firmware section of the table.
 - If the listed version matches the version on the configuration page, you have the most current version.
 - If the versions are different, download the firmware upgrade and update the firmware on the product following the instructions onscreen.



NOTE: The product must be connected to a computer with internet access to upgrade firmware.

- Resend the fax.
4. Verify that the fax was set up when the product software was installed.

From the computer, in the HP program folder, run the Fax Setup Utility.
 5. Verify that the telephone service supports analog fax.
 - If using ISDN or digital PBX, contact your service provider for information about configuring to an analog fax line.
 - If using a VoIP service, change the **Fax Speed** setting to **Slow (V.29)** or disable **Fast (V.34)** from the control panel. Ask if your service provider supports fax and for the recommended fax modem speed. Some companies might require an adapter.
 - If using a DSL service, ensure that a filter is included on the phone line connection to the product. Contact the DSL service provider or purchase a DSL filter if you do not have one. If a DSL filter is installed, try another because these filters can be defective.
 6. If the error persists, find more detailed problem-solving solutions in the sections that follow this one.

Fax error messages

Alert and warning messages appear temporarily and might require you to acknowledge the message by touching the **OK** button to resume or by touching the **Cancel** **X** button to cancel the job. With certain warnings, the job might not complete or the print quality might be affected. If the alert or warning message is related to printing and the auto-continue feature is on, the product will attempt to resume printing the job after the warning has appeared for 10 seconds without acknowledgement.

Communication error.

Description

A fax communication error occurred between the product and the sender or receiver.

Recommended action

Allow the product to retry sending the fax. Unplug the product telephone cord from the wall, plug in a telephone, and try making a call. Connect the product phone cord into a jack for another phone line.

Try a different phone cord.

Set the **Fax Speed** option to the **Slow (V.29)** setting or disable the **Fast (V.34)** setting.

Turn off the **Error Correction** feature to prevent automatic error correction.



NOTE: Turning off the **Error Correction** feature can reduce image quality.

Print the **Fax Activity Log** report from the control panel to determine if the error occurs with a specific fax number.

If the error persists, contact HP. See www.hp.com/go/LJColorMFPM375 or www.hp.com/go/LJColorMFPM475 or the support flyer that came in the product box.

Document feeder door is open. Canceled fax.

Description

The cover at the top of the document feeder is open, and the product cannot send the fax.

Recommended action

Close the cover, and send the fax again.

Fax is busy. Canceled send.

Description

The fax line to which you were sending a fax was busy. The product has canceled sending the fax.

Recommended action

Call the recipient to ensure that the fax machine is on and ready.

Check that you are dialing the correct fax number.

Check that the [Redial if Busy](#) option is enabled.

Open the [Service](#) menu, and touch the [Fax Service](#) button. Touch the [Run Fax Test](#) button. This test verifies that the phone cord is connected to the correct port and that the phone line has a signal. The product prints a report with the results.

If the error persists, contact HP. See www.hp.com/go/LJColorMFPM375 or www.hp.com/go/LJColorMFPM475 or the support flyer that came in the product box.

Fax is busy. Redial pending.

Description

The fax line to which you were sending a fax was busy. The product automatically redials the busy number.

Recommended action

Allow the product to retry sending the fax.

Call the recipient to ensure that the fax machine is on and ready.

Check that you are dialing the correct fax number.

Open the [Service](#) menu, and touch the [Fax Service](#) button. Touch the [Run Fax Test](#) button. This test verifies that the phone cord is connected to the correct port and that the phone line has a signal. The product prints a report with the results.

If the error persists, contact HP. See www.hp.com/go/LJColorMFPM375 or www.hp.com/go/LJColorMFPM475 or the support flyer that came in the product box.

Fax receive error.

Description

An error occurred while trying to receive a fax.

Recommended action

Ask the sender to resend the fax.

Try faxing back to the sender or another fax machine.

Check for a dial tone on the phone line by touching the [Start Fax](#) button.

Check that the telephone cord is securely connected by unplugging and replugging the cord.

Make sure that you are using the telephone cord that came with the product.

Open the [Service](#) menu, and touch the [Fax Service](#) button. Touch the [Run Fax Test](#) button. This test verifies that the phone cord is connected to the correct port and that the phone line has a signal. The product prints a report with the results.

Decrease the fax speed. Ask the sender to resend the fax.

Turn off error-correction mode. Ask the sender to resend the fax.



NOTE: Turning off error-correction mode can reduce the quality of the fax image.

Connect the product to a different phone line.

If the error persists, contact HP. See www.hp.com/go/LJColorMFPM375 or www.hp.com/go/LJColorMFPM475 or the support flyer that came in the product box.

Fax Send error.

Description

An error occurred while trying to send a fax.

Recommended action

Try resending the fax.

Try faxing to another fax number.

Check for a dial tone on the phone line by touching the **Start Fax** button.

Check that the telephone cord is securely connected by unplugging and replugging the cord.

Make sure that you are using the telephone cord that came with the product.

Make sure that the phone is working by disconnecting the product, plugging in a telephone to the phone line, and making a voice call.

Connect the product to a different phone line.

Set the fax resolution to **Standard** instead of the default of **Fine**.

If the error persists, contact HP. See www.hp.com/go/LJColorMFPM375 or www.hp.com/go/LJColorMFPM475 or the support flyer that came in the product box.

Fax storage is full. Canceling the fax receive.

Description

During the fax transmission, the product ran out of memory. Only the pages that fit into memory will be printed.

Recommended action

Print all of the faxes, and then have the sender resend the fax. Have the sender divide the fax job into multiple jobs before resending. Cancel all fax jobs or clear the faxes from memory.

Fax storage is full. Canceling the fax receive.

Description

The amount of available memory for storing faxes is insufficient to store an incoming fax.

Recommended action

If you are using the [Private Receive](#) feature, print all received faxes to regain some memory.

If you still need more memory, clear faxes from memory. Open the [Service](#) menu. In the [Fax Service](#) menu, select the [Clear Saved Faxes](#) option.

Fax storage is full. Canceling the fax send.

Description

During the fax job, the memory filled. All pages of the fax have to be in memory for a fax job to work correctly. Only the pages that fit into memory were sent.

Recommended action

Cancel the current job. Turn the product off, and then turn it on again. Try sending the job again.

If the error reoccurs, cancel the job and turn the product off and then on a second time. The product might not have enough memory for some jobs.

No dial tone.

Description

The product could not detect a dial tone.

Recommended action

Check for a dial tone on the phone line by touching the [Start Fax](#) button.

Unplug the telephone cord from both the product and the wall and replug the cord.

Make sure that you are using the telephone cord that came with the product.

Unplug the product telephone cord from the wall, connect a telephone, and try making a voice call.

Make sure that the phone cord from the wall telephone jack is plugged into the line  port.

Connect the product phone cord into a jack for another phone line.

Check the phone line by using the [Run Fax Test](#) option from the [Service](#) menu on the control panel.

If the error persists, contact HP. See www.hp.com/go/LJColorMFPM375 or www.hp.com/go/LJColorMFPM475 or the support flyer that came in the product box.

No fax answer. Canceled send.

Description

Attempts to redial a fax number failed, or the [Redial if No Answer](#) option was turned off.

Recommended action

Call the recipient to ensure that the fax machine is on and ready.

Check that you are dialing the correct fax number.

Check that the redial option is enabled.

Unplug the telephone cord from both the product and the wall and replug the cord.

Unplug the product telephone cord from the wall, connect a telephone, and try making a voice call.

Make sure that the phone cord from the wall telephone jack is plugged into the line  port.

Connect the product phone cord into a jack for another phone line.

If the error persists, contact HP. See www.hp.com/go/LJColorMFPM375 or www.hp.com/go/LJColorMFPM475 or the support flyer that came in the product box.

No fax answer. Redial pending.

Description

The receiving fax line did not answer. The product attempts to redial after a few minutes.

Recommended action

Allow the product to retry sending the fax.

Call the recipient to ensure that the fax machine is on and ready.

Check that you are dialing the correct fax number.

If the product continues to redial, unplug the product telephone cord from the wall, connect a telephone, and try making a voice call.

Make sure that the phone cord from the wall telephone jack is plugged into the line  port.

Connect the product phone cord into a jack for another phone line.

Try a different phone cord.

If the error persists, contact HP. See www.hp.com/go/LJColorMFPM375 or www.hp.com/go/LJColorMFPM475 or the support flyer that came in the product box.

No fax detected.

Description

The product answered the incoming call but did not detect that a fax machine was calling.

Recommended action

Allow the product to retry receiving the fax.

Try a different phone cord.

Connect the product phone cord into a jack for another phone line.

If the error persists, contact HP. See www.hp.com/go/LJColorMFPM375 or www.hp.com/go/LJColorMFPM475 or the support flyer that came in the product box.

Troubleshoot fax codes and trace reports

View and interpret fax error codes

Use fax error codes from the fax activity log to solve problems with the product fax features.

Code number	Description
232	<p>Possible causes include the following:</p> <ul style="list-style-type: none">• A communication failure has occurred between the two machines.• The user at the remote machine may have pressed the Stop button.• The power at the remote machine has been interrupted, or deliberately turned off causing the fax session to be interrupted. <p>To solve the issue, try the following steps:</p> <ol style="list-style-type: none">1. Resend the fax at a different time when telephone line conditions have improved.2. If the error persists, and error correction is in use for the fax session, disable the Error Correction setting.
282	<p>The product has not received any data at the start of a page during reception in error correction mode, but the modem has not detected a remote disconnect. The remote machine is probably transmitting sync frames instead of data and has either jammed or broken.</p> <p>The remote machine is probably transmitting sync frames instead of data and has either jammed or broken. Have the sender resend the fax after first requesting that the sender verify that the sending machine is working correctly.</p>
321	<p>There was a communication error with the receiving fax machine due to poor telephone line conditions.</p> <p>Resend the fax at a different time when telephone line conditions have improved.</p>

Code number	Description
344-348	<p>Possible causes include the following:</p> <ul style="list-style-type: none"> • The remote machine has failed to respond to a fax command from the local machine due to the connection being interrupted. • The user at the remote machine may have pressed the Stop button. • In rare instances, incompatibility between the two machines can cause the remote machine to simply terminate the call. <p>To solve the issue, try the following steps:</p> <ol style="list-style-type: none"> 1. Resend the fax at a different time when telephone line conditions have improved. 2. If the error persists, and error correction is in use for the fax session, disable the Error Correction setting.
381	<p>Possible causes include the following:</p> <ul style="list-style-type: none"> • The remote machine has failed to respond to a fax command from the local machine due to the connection being interrupted. • The user at the remote machine may have pressed the Stop button. <p>To solve the issue, try the following steps:</p> <ol style="list-style-type: none"> 1. Resend the fax at a different time when telephone line conditions have improved. 2. If the error persists, and error correction is in use for the fax session, disable the Error Correction setting.

Fax trace report

A fax T.30 trace report has information that can help resolve fax transmission problems. If you call HP for help in resolving these problems, print a T.30 trace report before you call.

1. Touch the Setup  button.
2. Open the [Service](#) menu.
3. Open the [Fax Service](#) menu.
4. Open the [Print T.30 Trace](#) menu, and then touch the [Now](#) item.

 **NOTE:** This procedure prints a report for the last fax job, successful or not. To generate a report for each unsuccessful fax job, select the [If Error](#) setting. To generate a report for each fax job, select the [At End of Call](#) setting.

Fax logs and reports

Use the following instructions to print fax logs and reports:

Print all fax reports

Use this procedure to print all of the following reports at one time:

- Last Call Report
- Fax Activity Log
- Phone Book Report
- Junk Fax List
- Billing Report (when Billing Codes are turned on)
- Configuration Report
- Usage Page

1. Touch the **Fax** button.



2. Open the **Fax Menu** menu.
3. Open the **Fax Reports** menu.
4. Touch the **Print All Fax Reports** item.

Print individual fax reports

1. Touch the **Fax** button.



2. Open the **Fax Menu** menu.
3. Open the **Fax Reports** menu.
4. Touch the name of the report that you want to print.

Set the fax error report

A fax error report is a brief report that indicates the product experienced a fax job error. You can set it to print after the following events:

- Every fax error (the factory-set default)
- Send fax error
- Receive fax error
- Never

 **NOTE:** With this option, you will have no indication that a fax failed to be transmitted unless you print a fax activity log.

1. Touch the **Fax** button.



2. Open the **Fax Menu** menu.
3. Open the **Fax Reports** menu.
4. Open the **Fax Error Report** menu, and then touch the printing option that you want to use.

Change error correction and fax speed

Set the fax-error-correction mode

Usually, the product monitors the signals on the telephone line while it is sending or receiving a fax. If the product detects an error during the transmission and the error-correction setting is **On**, the product can request that the portion of the fax be resent. The factory-set default for error correction is **On**.

You should turn off error correction only if you are having trouble sending or receiving a fax, and you are willing to accept the errors in the transmission. Turning off the setting might be useful when you are trying to send a fax overseas or receive one from overseas, or if you are using a satellite telephone connection.

1. Touch the **Setup**  button.
2. Open the **Service** menu.
3. Open the **Fax Service** menu.
4. Open the **Error Correction** menu, and then touch the **On** button.

Change the fax speed

The fax-speed setting is the modem protocol that the product uses to send faxes. It is the worldwide standard for full-duplex modems that send and receive data across telephone lines at up to 33,600 bits per second (bps). The factory-set default for the fax-speed setting is [Fast \(V.34\)](#).

You should change the setting only if you are having trouble sending a fax to or receiving a fax from a particular device. Decreasing the fax speed might be useful when you are trying to send a fax overseas, or receive one from overseas, or if you are using a satellite telephone connection.

1. Touch the Setup  button.
2. Open the [Fax Setup](#) menu.
3. Open the [Advanced Setup](#) menu.
4. Open the [Fax Speed](#) menu, and then touch the speed setting that you want to use.

Solve problems sending faxes

- [An error message displays on the control panel](#)
- [The control panel displays a Ready message with no attempt to send the fax](#)
- [The control panel displays the message "Storing page 1" and does not progress beyond that message](#)
- [Faxes can be received, but not sent](#)
- [Unable to use fax functions from the control panel](#)
- [Unable to use speed dials](#)
- [Unable to use group dials](#)
- [Receive a recorded error message from the phone company when trying to send a fax](#)
- [Unable to send a fax when a phone is connected to the product](#)



An error message displays on the control panel

The Communication error. message displays

- Allow the product to retry sending the fax. Re-sending temporarily reduces the fax speed.
- Unplug the product telephone cord from the wall, connect a telephone, and try making a call. Connect the product phone cord into a jack for another phone line.

If the product is connected to a digital phone line, verify that you are using the correct filter and settings provided by the digital service provider.

- Try a different phone cord.

- From the control panel, change the **Fax Speed** option to the **Medium (V.17)** setting or **Slow (V.29)** setting.
 - a. Touch the **Setup**  button.
 - b. Open the **Fax Setup** menu.
 - c. Open the **Advanced Setup** menu.
 - d. Open the **Fax Speed** menu.
 - e. Select the correct setting.
- Turn off the **Error Correction** option.
 - a. Touch the **Setup**  button.
 - b. Open the **Service** menu.
 - c. Open the **Fax Service** menu.
 - d. Open the **Error Correction** menu.
 - e. Touch the **Off** setting.

 **NOTE:** Turning off the **Error Correction** option can reduce image quality.

- If the error persists, contact HP. See www.hp.com/go/LJColorMFPM375 or www.hp.com/go/LJColorMFPM475 or the support flyer that came in the product box.



No dial tone.

- Make sure that the telephone cord is plugged into the correct port on the product.
- Make sure that the telephone cord from the product is plugged directly into the wall telephone jack.
- Check for a dial tone on the phone line by using the **Start Fax** button.
- Unplug the product telephone cord from the wall, connect a telephone, and try making a voice call.
- Unplug the telephone cord from both the product and the wall and replug the cord.
- Make sure that you are using the telephone cord that came with the product.
- Connect the product phone cord into a jack for another phone line.
- Check the phone line by using the **Run Fax Test** option from the **Service** menu on the control panel.
 - a. Touch the **Setup**  button.
 - b. Open the **Service** menu.
 - c. Open the **Fax Service** menu.
 - d. Select the **Run Fax Test** item.

The Fax is busy. message displays

- Try sending the fax again.
- Call the recipient to ensure that the fax machine is on and ready.
- Check that you are dialing the correct fax number.
- Check for a dial tone on the phone line by using the **Start Fax** button.
- Make sure that the phone is working by disconnecting the product, plugging in a telephone to the phone line, and making a voice call.
- Connect the product phone cord into a jack for another phone line, and try sending the fax again.
- Try a different phone cord.
- Send the fax at a later time.
- If the error persists, contact HP. See www.hp.com/go/LJColorMFPM375 or www.hp.com/go/LJColorMFPM475 or the support flyer that came in the product box.

The No fax answer. message displays

- Try to resend the fax.
- Call the recipient to ensure that the fax machine is on and ready.
- Check that you are dialing the correct fax number.
- Unplug the product telephone cord from the wall, connect a telephone, and try making a voice call.
- Connect the product phone cord into a jack for another phone line.
- Try a different phone cord.
- Make sure that the phone cord from the wall telephone jack is plugged into the line  port.
- Check the phone line by using the **Run Fax Test** option from the **Service** menu on the control panel.
 - a. Touch the Setup  button.
 - b. Open the **Service** menu.
 - c. Open the **Fax Service** menu.
 - d. Select the **Run Fax Test** item.
- If the error persists, contact HP. See www.hp.com/go/LJColorMFPM375 or www.hp.com/go/LJColorMFPM475 or the support flyer that came in the product box.

Document feeder paper jam

- Verify that the paper meets product size requirements. The product does not support pages longer than 381 mm (15 in) for faxing.
- Copy or print the original to letter, A4, or legal size paper, and then resend the fax.

The Fax storage is full. message displays

- Turn the product off then on.
- Print stored faxes that have not been printed.
 - a. Touch the **Fax** button, and then open the **Fax Menu** menu.
 - b. Open the **Receive Options** menu.
 - c. Select the **Print Private Faxes** item.
 - d. Provide the password when the product prompts you.
- Delete stored faxes from memory.
 - a. Touch the Setup  button.
 - b. Open the **Service** menu.
 - c. Open the **Fax Service** menu.
 - d. Select the **Clear Saved Faxes** item.
- Divide the large fax job into smaller sections, and then fax them individually.

Scanner error

- Verify that the paper meets product size requirements. The product does not support pages longer than 381 mm (15 in) for faxing.
- Copy or print the original onto letter, A4, or legal size paper and then resend the fax.

The control panel displays a Ready message with no attempt to send the fax

- Check the fax activity log for errors.
 - a. Touch the **Fax** button, and then open the **Fax Menu** item.
 - b. Open the **Fax Reports** menu.
 - c. Open the **Fax Activity Log** menu.
 - d. Select the **Print Log Now** option.
- If a phone is connected to the product, make sure that the phone is hung up.
- Disconnect all other lines between the fax and the product.
- Connect the product directly into the wall telephone jack and resend the fax.

The control panel displays the message "Storing page 1" and does not progress beyond that message

- Delete stored faxes from memory.
 - a. Touch the Setup  button.
 - b. Open the [Service](#) menu.
 - c. Open the [Fax Service](#) menu.
 - d. Select the [Clear Saved Faxes](#) item.

Faxes can be received, but not sent

Send fax and nothing happens.

1. Check for a dial tone on the phone line by using the [Start Fax](#) button.
2. Turn the product off then on.
3. Use the control panel or the HP Fax Setup Wizard to configure the fax time, date, and fax header information.
 - a. Touch the Setup  button.
 - b. Open the [Fax Setup](#) menu.
 - c. Open the [Basic Setup](#) menu.
 - d. Open the [Fax Header](#) menu.
 - e. Enter the correct settings.
4. Verify that any extension phones on the line are hung up.
5. If using a DSL service, make sure that the phone line connection to the product includes a high-pass filter.

Unable to use fax functions from the control panel

- The product might be password protected. Use the HP Embedded Web Server, HP Toolbox software, or the control panel to set a password.
- If you do not know the password for the product, contact your system administrator.
- Verify with the system administrator that the fax functionality has not been disabled.

Unable to use speed dials

- Make sure that the fax number is valid.
- If an outside line requires a prefix, turn on the [Dial Prefix](#) option or include the prefix in the speed dial number.
 - a. Touch the Setup  button.
 - b. Open the [Fax Setup](#) menu.
 - c. Open the [Basic Setup](#) menu.
 - d. Open the [Dial Prefix](#) menu.
 - e. Select the [On](#) setting.

Unable to use group dials

- Make sure that the fax number is valid.
- If an outside line requires a prefix, turn on the [Dial Prefix](#) option or include the prefix in the speed dial number.
 - a. Touch the Setup  button.
 - b. Open the [Fax Setup](#) menu.
 - c. Open the [Basic Setup](#) menu.
 - d. Open the [Dial Prefix](#) menu.
 - e. Select the [On](#) setting.
- Set up all entries in the group with speed dial entries.
 - a. Open an unused speed dial entry.
 - b. Enter the fax number for the speed dial.
 - c. Touch the [OK](#) button to save the speed dial.

Receive a recorded error message from the phone company when trying to send a fax

- Make sure you dial the fax number correctly, and make sure that the phone service is not blocked. For example, some phone services might prevent long distance calling.
- If an outside line requires a prefix, turn on the [Dial Prefix](#) option or include the prefix in the speed dial number.
 - a. Touch the Setup  button.
 - b. Open the [Fax Setup](#) menu.
 - c. Open the [Basic Setup](#) menu.

- d. Open the **Dial Prefix** menu.
- e. Select the **On** setting.



NOTE: To send a fax without a prefix, when the **Dial Prefix** option is turned on, send the fax manually.

- Send a fax to an international number
 - a. If a prefix is required, manually dial the telephone number with the prefix.
 - b. Enter the country/region code before dialing the phone number.
 - c. Wait for pauses as you hear the tones on the phone.
 - d. Send the fax manually from the control panel.

Unable to send a fax when a phone is connected to the product

- Make sure that the telephone is hung up.
- Make sure that the telephone is not being used for a voice call when faxing.
- Unplug the phone from the line, and then try sending the fax.

Solve problems receiving faxes

- [The fax does not respond](#)
- [An error message displays on the control panel](#)
- [A fax is received but does not print](#)
- [Sender receives a busy signal](#)
- [No dial tone](#)
- [Cannot send or receive a fax on a PBX line](#)

The fax does not respond

The fax has a dedicated phone line

- Set the [Answer Mode](#) option to the [Automatic](#) setting from the control panel.
 - a. Touch the Setup  button.
 - b. Open the [Fax Setup](#) menu.
 - c. Open the [Basic Setup](#) menu.
 - d. Open the [Answer Mode](#) menu.
 - e. Select the [Automatic](#) setting.

An answering machine is connected to the product

- Set the [Answer Mode](#) option to the [TAM](#) setting and plug the answering machine into the “telephone” port.
 - a. Touch the Setup  button.
 - b. Open the [Fax Setup](#) menu.
 - c. Open the [Basic Setup](#) menu.
 - d. Open the [Answer Mode](#) menu.
 - e. Select the [TAM](#) setting.

If the [TAM](#) setting is unavailable, set the [Answer Mode](#) option to the [Automatic](#) setting.
- Set the [Rings to Answer](#) setting to at least one ring more than the number of rings for which the answering machine is set.
 - a. Touch the Setup  button.
 - b. Open the [Fax Setup](#) menu.
 - c. Open the [Basic Setup](#) menu.

- d. Open the [Rings to Answer](#) menu.
- e. Select the correct setting.
- Connect the answering machine into the “telephone” port.
- If the product has a telephone handset connected, set the [Answer Mode](#) option to the [Fax/Tel](#) setting to route calls to the correct device. When detecting a voice call, the product generates a ring tone that alerts you to pick up the telephone handset.
 - a. Touch the Setup  button.
 - b. Open the [Fax Setup](#) menu.
 - c. Open the [Basic Setup](#) menu.
 - d. Open the [Answer Mode](#) menu.
 - e. Select the [Fax/Tel](#) setting.

A telephone handset is connected to the product

Set the [Answer Mode](#) option to the [Automatic](#) setting.

1. Touch the Setup  button.
2. Open the [Fax Setup](#) menu.
3. Open the [Basic Setup](#) menu.
4. Open the [Answer Mode](#) menu.
5. Select the [Automatic](#) setting.

The Answer Mode setting is set to the Manual setting

- Touch the [Start Fax](#) button on the control panel.

Voice mail is available on the fax line

- Add a distinctive ring service to your telephone line and change the [Distinctive Ring](#) setting on the product to match the ring pattern supplied by the telephone company. Contact your telephone company for information.
 - a. Verify that the answer mode is set to the [Automatic](#) setting.
 - b. Touch the Setup  button.
 - c. Open the [Fax Setup](#) menu.
 - d. Open the [Basic Setup](#) menu.

- e. Open the [Distinctive Ring](#) menu.
- f. Select the correct setting.
- Buy a dedicated line for faxing.
- Set the [Answer Mode](#) option to the [Manual](#) setting.
 - a. Touch the Setup  button.
 - b. Open the [Fax Setup](#) menu.
 - c. Open the [Basic Setup](#) menu.
 - d. Open the [Answer Mode](#) menu.
 - e. Select the [Manual](#) setting.

 **NOTE:** You must be present to receive faxes.

The product is connected to a DSL phone service

- Check the installation and features. A DSL modem requires a high-pass filter on the phone line connection to the product. Contact your DSL service provider for a filter or buy a filter.
- Verify that the filter is plugged in.
- Replace the existing filter to make sure that it is not defective.

The product uses a fax over IP or VoIP phone service

- Set the [Fax Speed](#) option to the [Slow \(V.29\)](#) or [Medium \(V.17\)](#) setting, or disable the [Fast \(V.34\)](#) setting.
 - a. Touch the Setup  button.
 - b. Open the [Fax Setup](#) menu.
 - c. Open the [Advanced Setup](#) menu.
 - d. Open the [Fax Speed](#) menu.
 - e. Select the correct setting.
- Contact your service provider to make sure that fax is supported and for a recommended fax speed settings. Some companies might require an adapter.

An error message displays on the control panel

The No fax detected. message displays

 **NOTE:** This error does not always refer to a missed fax. If a voice call is made to a fax number by mistake and the caller hangs up, the **No fax detected.** message displays on the control panel.

- Ask the sender to resend the fax.
- Make sure that the telephone cord from the product is plugged into the wall telephone jack.
- Try a different phone cord.
- Connect the product phone cord into a jack for another phone line.
- Make sure the telephone line and phone wall jack are active by plugging in a telephone and checking for a dial tone.
- Make sure that the telephone cord is plugged into the “line” port on the product.
- Check the phone line by running a fax test from the control panel.
- If the error persists, contact HP. See www.hp.com/go/LJColorMFPM375 or www.hp.com/go/LJColorMFPM475 or the support flyer that came in the product box.

The Communication error. message displays

- Ask the sender to send the fax again or send at a later time when line conditions have improved.
- Unplug the product telephone cord from the wall, connect a telephone, and try making a call. Connect the product phone cord into a jack for another phone line.
- Try a different phone cord.
- Set the **Fax Speed** option to the **Slow (V.29)** or **Medium (V.17)** setting, or disable the **Fast (V.34)** setting.
 - a. Touch the **Setup**  button.
 - b. Open the **Fax Setup** menu.
 - c. Open the **Advanced Setup** menu.
 - d. Open the **Fax Speed** menu.
 - e. Select the correct setting.
- Turn off the **Error Correction** feature to prevent automatic error correction.

 **NOTE:** Turning off the **Error Correction** feature can reduce image quality.

- a. Touch the **Setup**  button.
- b. Open the **Service** menu.
- c. Open the **Fax Service** menu.

- d. Open the [Error Correction](#) menu.
 - e. Select the [Off](#) setting.
- Print the [Fax Activity Log](#) report from the control panel to determine if the error occurs with a specific fax number.
 - a. Touch the [Fax](#) button, and then touch the [Fax Menu](#) button.
 - b. Open the [Fax Reports](#) menu.
 - c. Open the [Fax Activity Log](#) menu.
 - d. Select the [Print Log Now](#) option.
- If the error persists, contact HP. See www.hp.com/go/LJColorMFPM375 or www.hp.com/go/LJColorMFPM475 or the support flyer that came in the product box.

The Fax storage is full. message displays

- Turn the product off then on.
- Print all of the faxes, and then have the sender resend the fax.
- Ask the sender to divide a large fax job into smaller sections, and then fax them individually.
- Make sure that the resolution of the sending fax machine is not set to the [Photo](#) setting or the [Superfine](#) setting.
 - a. Touch the Setup  button.
 - b. Open the [Fax Setup](#) menu.
 - c. Open the [Advanced Setup](#) menu.
 - d. Open the [Fax Resolution](#) menu.
 - e. Select the correct setting.
- Cancel all fax jobs or clear the faxes from memory.

The Fax is busy. message displays

- The product cannot receive a fax while attempting to send one. Cancel the fax send and try sending at a later time.
- Allow the product to try sending the fax again.

A fax is received but does not print

The Private Receive feature is on

- When the **Private Receive** feature is activated, received faxes are stored in memory. A password is required to print the stored faxes.
- Enter the password to print the fax. If you do not know the password, contact the product administrator.



NOTE: Memory errors might occur if the faxes are not printed. The product will not answer if the memory is full.

Sender receives a busy signal

A handset is connected to the product

- Make sure the phone is hung up.
- Change the **Answer Mode** option to match the product setup.
 - a. Touch the Setup  button.
 - b. Open the **Fax Setup** menu.
 - c. Open the **Basic Setup** menu.
 - d. Open the **Answer Mode** menu.
 - e. Select the setting that matches the product setup.

Set the **Answer Mode** option to the **Fax/Tel** setting to automatically receive faxes. The **Fax/Tel** setting automatically detects whether the incoming transmission is a fax or a voice call and routes the call to the appropriate device.

A phone line splitter is being used

- If you are using a phone line splitter, remove the splitter and set up the phone as a downstream phone.
- Make sure the phone is hung up.
- Make sure the phone is not being used for a voice call when faxing.

No dial tone

- If using a phone line splitter, remove the phone line splitter and set up the phone as a downstream phone.

Cannot send or receive a fax on a PBX line

- If you are using a PBX phone line, contact your PBX administrator to configure an analog fax line for your product.

Solve general fax problems



- [Faxes are sending slowly](#)
- [Fax quality is poor](#)
- [Fax cuts off or prints on two pages](#)

Faxes are sending slowly

The product is experiencing poor phone line quality.

- Retry sending the fax when the line conditions have improved.
- Check with the phone service provider that the line supports fax.
- Turn off the [Error Correction](#) setting.
 - a. Open the Setup  menu.
 - b. Open the [Service](#) menu.
 - c. Open the [Fax Service](#) menu.
 - d. Open the [Error Correction](#) menu.
 - e. Select the [Off](#) setting.

 **NOTE:** This can reduce image quality.

- Use white paper for the original. Do not use colors such as gray, yellow, or pink.
- Increase the [Fax Speed](#) setting.
 - a. Open the Setup  menu.
 - b. Open the [Fax Setup](#) menu.
 - c. Open the [Advanced Setup](#) menu.
 - d. Open the [Fax Speed](#) menu.
 - e. Select the correct setting.
- Divide large fax jobs into smaller sections, and then fax them individually.
- Change the fax settings on the control panel to a lower resolution.
 - a. Open the Setup  menu.
 - b. Open the [Fax Setup](#) menu.
 - c. Open the [Advanced Setup](#) menu.
 - d. Open the [Fax Resolution](#) menu.
 - e. Select the correct setting.

Fax quality is poor



Fax is blurry or light.

- Increase fax resolution when sending faxes. Resolution does not affect received faxes.
 - a. Open the Setup  menu.
 - b. Open the [Fax Setup](#) menu.
 - c. Open the [Advanced Setup](#) menu.
 - d. Open the [Fax Resolution](#) menu.
 - e. Select the correct setting.

 **NOTE:** Increasing resolution slows transmission speed.

- Turn on the [Error Correction](#) setting from the control panel.
 - a. Open the Setup  menu.
 - b. Open the [Service](#) menu.
 - c. Open the [Fax Service](#) menu.
 - d. Open the [Error Correction](#) menu.
 - e. Select the [On](#) setting.
- Check the print cartridges and replace if necessary.
- Ask the sender to darken the contrast setting on the sending fax machine, and then resend the fax.

Fax cuts off or prints on two pages

- Set the [Default Paper Size](#) setting. Faxes print on a single size of paper based on the [Default Paper Size](#) settings.
 - a. Open the Setup  menu.
 - b. Open the [System Setup](#) menu.
 - c. Open the [Paper Setup](#) menu.
 - d. Open the [Default Paper Size](#) menu.
 - e. Select the correct setting.
- Set the paper type and size for the tray used for faxes.
- Turn on the [Fit to Page](#) setting to print longer length faxes on letter or A4 size paper.
 - a. Open the Setup  menu.
 - b. Open the [Fax Setup](#) menu.

- c. Open the [Advanced Setup](#) menu.
- d. Open the [Fit to Page](#) menu.
- e. Select the [On](#) setting.

 **NOTE:** If the [Fit to Page](#) setting is off and the [Default Paper Size](#) setting is set to letter, a legal size original prints on two pages.

Product updates

Software and firmware updates and installation instructions for this product are available at www.hp.com/go/LJColorMFPM375 or www.hp.com/go/LJColorMFPM475. Click **Support & Drivers**, click the operating system, and then select the download for the product.

3 Parts and diagrams

- [Order parts by authorized service providers](#)
- [How to use the parts lists and diagrams](#)
- [Scanner and document feeder main assemblies](#)
- [Covers](#)
- [Internal assemblies](#)
- [Input device\(s\)](#)
- [Alphabetical parts list](#)
- [Numerical parts list](#)

Order parts by authorized service providers

Orderable parts

Table 3-1 Order parts, accessories, and supplies

Order supplies and paper	www.hp.com/go/suresupply
Order genuine HP parts or accessories	www.hp.com/buy/parts
Order through service or support providers	Contact an HP-authorized service or support provider.

Whole unit replacement

Table 3-2 Pro 300 Color MFP M375nw

Part number	Description
CE903-69009	Prod-Exchange 220V M375nw WUR EMEA
CE903-69010	Prod-Exchange 110V M375nw WUR NAR/TW
CE903-69011	Prod-Exchange 220V M375nw WUR AP/LAR
CE903-69012	Prod-Exchange 220V M375nw WUR CL/AR
CE903-67062	Prod-New 220V M375nw WUR CN/MY
CE903-67058	Prod-New 110V M375nw WUR BR

Table 3-3 Pro 400 Color MFP M475dn

Part number	Description
CE863-69001	Prod-Exchange 220V CM475dn WUR EMEA
CE863-69002	Prod-Exchange 110V CM475dn WUR NAR/TW
CE863-69003	Prod-Exchange 220V CM475dn WUR AP/LAR
CE863-69004	Prod-Exchange 220V CM475dn WUR CL/AR
CE863-67061	Prod-New 220V CM475dn WUR CN/MY
CE863-67062	Prod-New 110V CM475dn WUR BR

Table 3-4 Pro 400 Color M475dw

Part number	Description
CE864-69001	Prod-Exchange 220V CM475dw WUR EMEA
CE864-69002	Prod-Exchange 110V CM475dw WUR NAR/TW
CE864-69003	Prod-Exchange 220V CM475dw WUR AP/LAR

Table 3-4 Pro 400 Color M475dw (continued)

CE864-69004	Prod-Exchange 220V CM475dw WUR CL/AR
CE864-67061	Prod-New 220V CM475dw WUR CN/MY
CE864-67062	Prod-New 110V CM475dw WUR BR

Related documentation and software

Table 3-5 Related documentation and software

Item	Description	Part number
<i>HP LaserJet Pro 300 Color MFP HP LaserJet Pro 400 Color MFP User Guide</i>	Product user guide.	CE863-90907
<i>HP LaserJet Pro 300 Color MFP HP LaserJet Pro 400 Color MFP Service Manual</i>	English service manual (this manual)	CE863-90966

Supplies and accessories

Item	Part number	Cartridge number	Description
Toner cartridges	CE410-67901	305A	Standard-capacity black toner cartridge with HP ColorSphere toner
	CE411-67901	305A	Cyan toner cartridge with HP ColorSphere toner
	CE412-67901	305A	Yellow toner cartridge with HP ColorSphere toner
	CE413-67901	305A	Magenta toner cartridge with HP ColorSphere toner
Memory	CB423A		256 MB memory DIMM
Paper-handling accessories	RM1-8063-000C N		250-sheet paper feeder (optional Tray 3)
USB cable	8121-0868		2-meter A-to-B cable

 **NOTE:** For information about the yield for the cartridges, see www.hp.com/go/pageyield. Actual yield depends on specific use.

Service parts

 **NOTE:** The parts in the following table are not shown in the assembly illustrations in this chapter.

Item	Description	Part number
Regulatory label	Blank label	5969-9497

How to use the parts lists and diagrams

The figures in this chapter show the major subassemblies in the product and their component parts. A parts list table follows each exploded view assembly diagram. Each table lists the item number, the associated part number, and the description of each part. If a part is not listed in the table, then it is not a field replacement unit (FRU).

 **CAUTION:** Be sure to order the correct part. When looking for part numbers for electrical components, pay careful attention to the voltage that is listed in the description column. Doing so will ensure that the part number selected is for the correct all-in-one model.

 **NOTE:** In this manual, the abbreviation “PCA” stands for “printed circuit-board assembly.” Components described as a PCA might consist of a single circuit board or a circuit board plus other parts, such as cables and sensors.

Scanner and document feeder main assemblies

Figure 3-1 Scanner and document feeder main assemblies

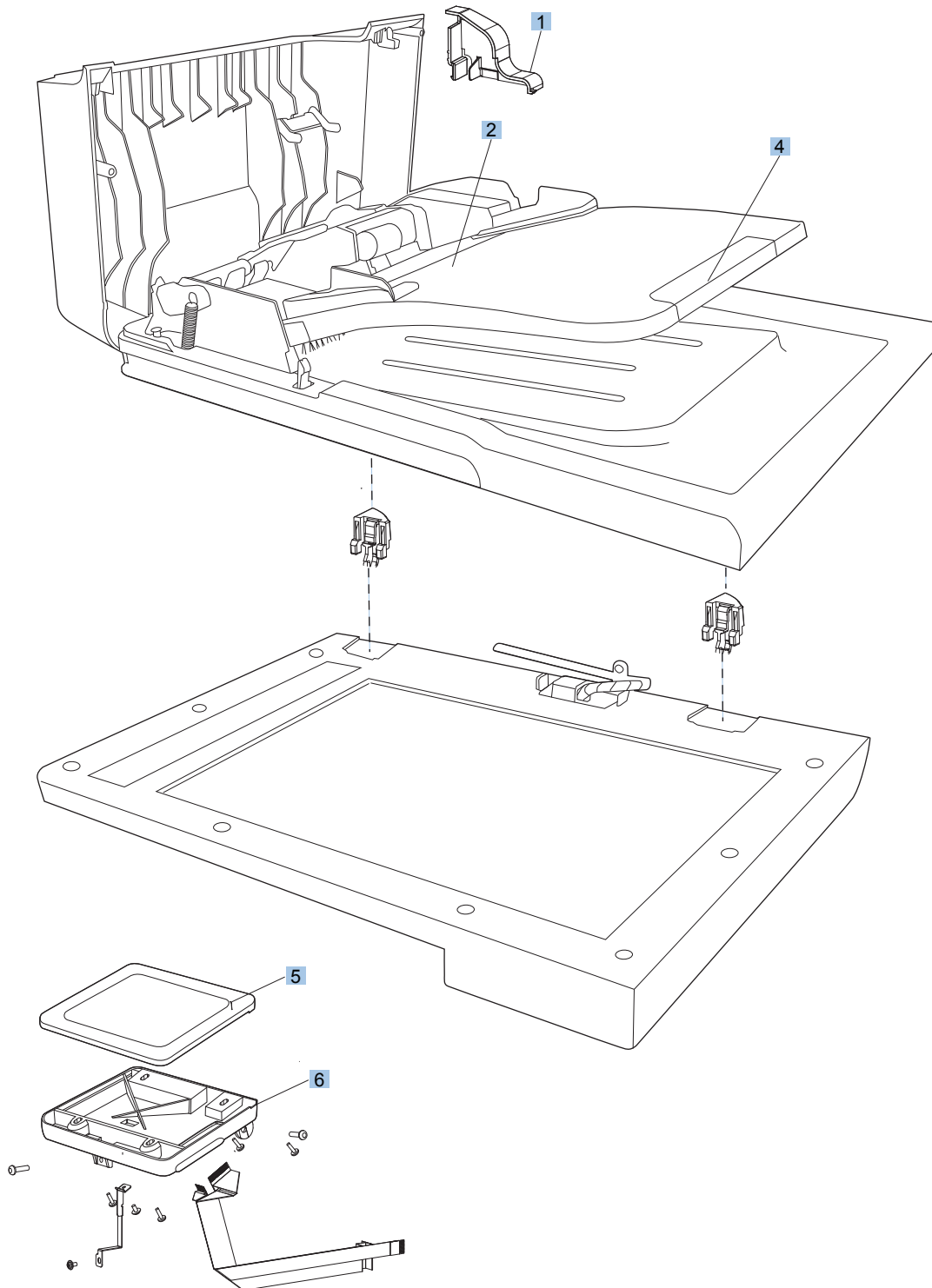

Table 3-6 Scanner and document feeder main assemblies

Ref	Description	Part number	Qty
1	Scanner assembly (simplex)	CE903-60101	1
1	Scanner assembly (duplex)	CE863-60119	1
2	Document feeder assembly (simplex)	CE863-60106	1
2	Document feeder assembly (duplex)	CE863-60101	1
3	Document feeder pickup assembly	5851-2559	1
4	Document feeder input tray	CE863-60113	1
5	Control-panel assembly	CE863-60015	1
6	Control-panel mount	CE863-40018	1

Covers

Figure 3-2 External panels and covers

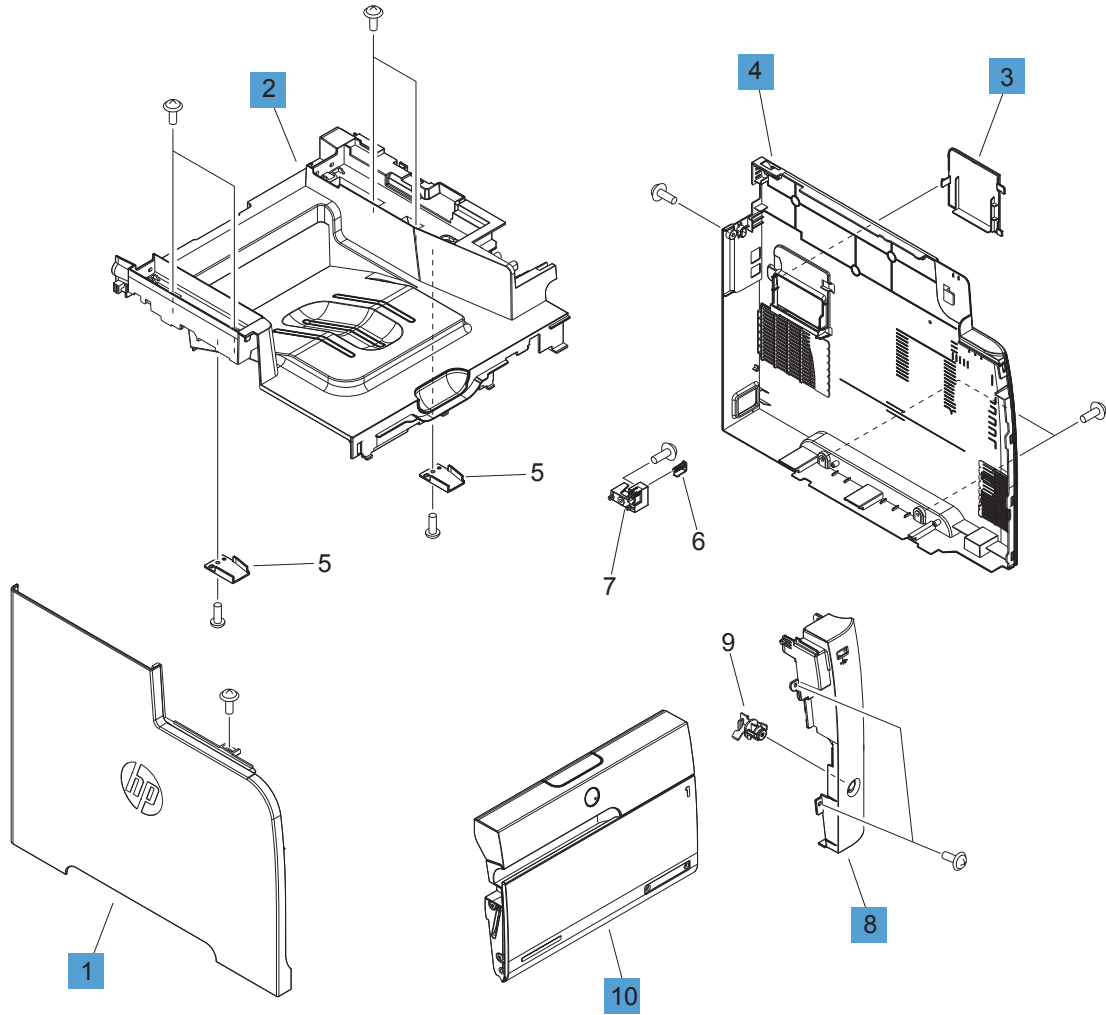

Table 3-7 Covers^{1,2}

Ref	Description	Part number	Qty
1	Cover, left	RL1-3063-000	1
2	Cover, upper assembly	RM1-8060-000	1
3	Cover, DIMM	RC3-1751-000	1
4	Cover, right	RC3-1732-000	1
8	Cover, right front	RC3-1733-000	1
10	Door, front assembly	RM1-8064-000	1

¹ For simplex products, the rear cover and the rear door are shown in [Figure 3-8 Internal assemblies \(simplex models\) on page 264](#).

² For duplex products, the upper-rear cover, lower-rear cover, and the rear door are shown in [Figure 3-9 Internal assemblies \(duplex models\) on page 266](#).

Internal assemblies

Internal assemblies (1 of 5)

Figure 3-3 Internal assemblies (1 of 7)

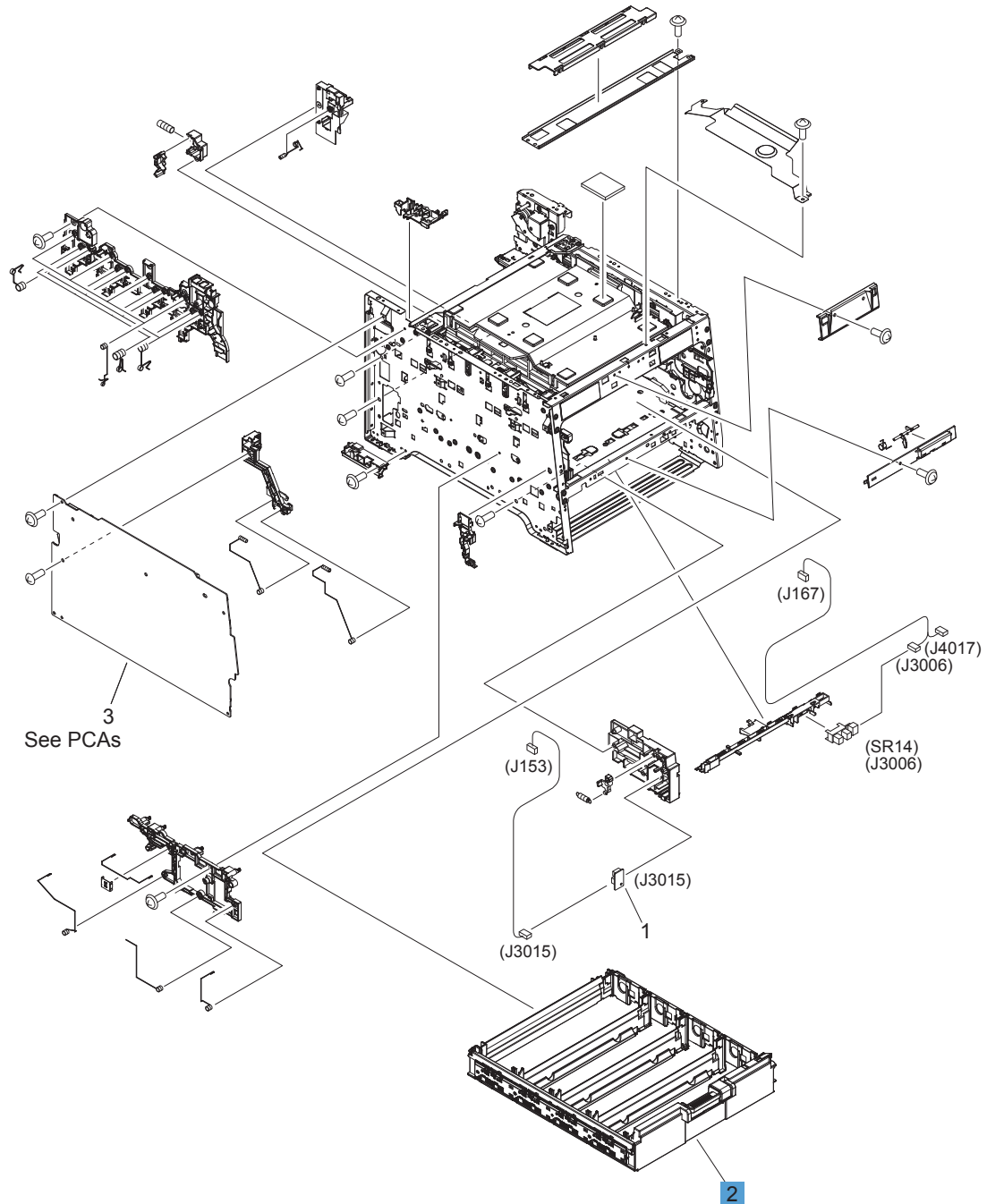

Table 3-8 Internal assemblies (1 of 7)

Ref	Description	Part number	Qty
2	Cartridge-tray assembly	RM1-8041-000	1

Internal assemblies (2 of 5)

Figure 3-4 Internal assemblies (2 of 2)

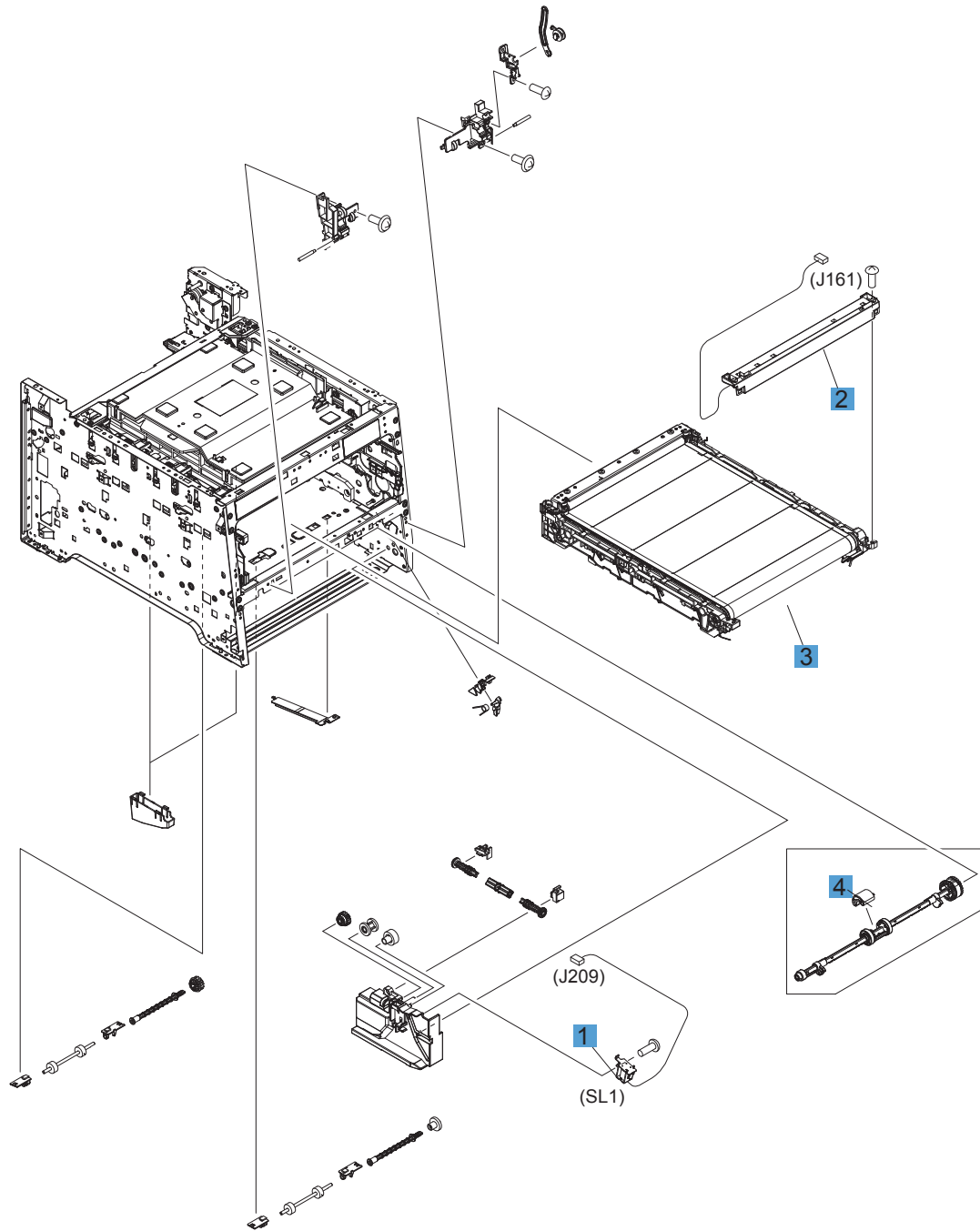

Table 3-9 Internal assemblies (2 of 7)

Ref	Description	Part number	Qty
1	Solenoid, Tray 1 (SL1; MP tray)	RM1-5420-000	1
2	Color misregistration sensor assembly	RM1-8029-000	1
3	Intermediate transfer belt (ITB)	RM1-4852-000	1
4	Roller, paper-pickup Tray 1	RL1-1802-000	1

Internal components (3 of 5)

Figure 3-5 Internal assemblies (3 of 7)

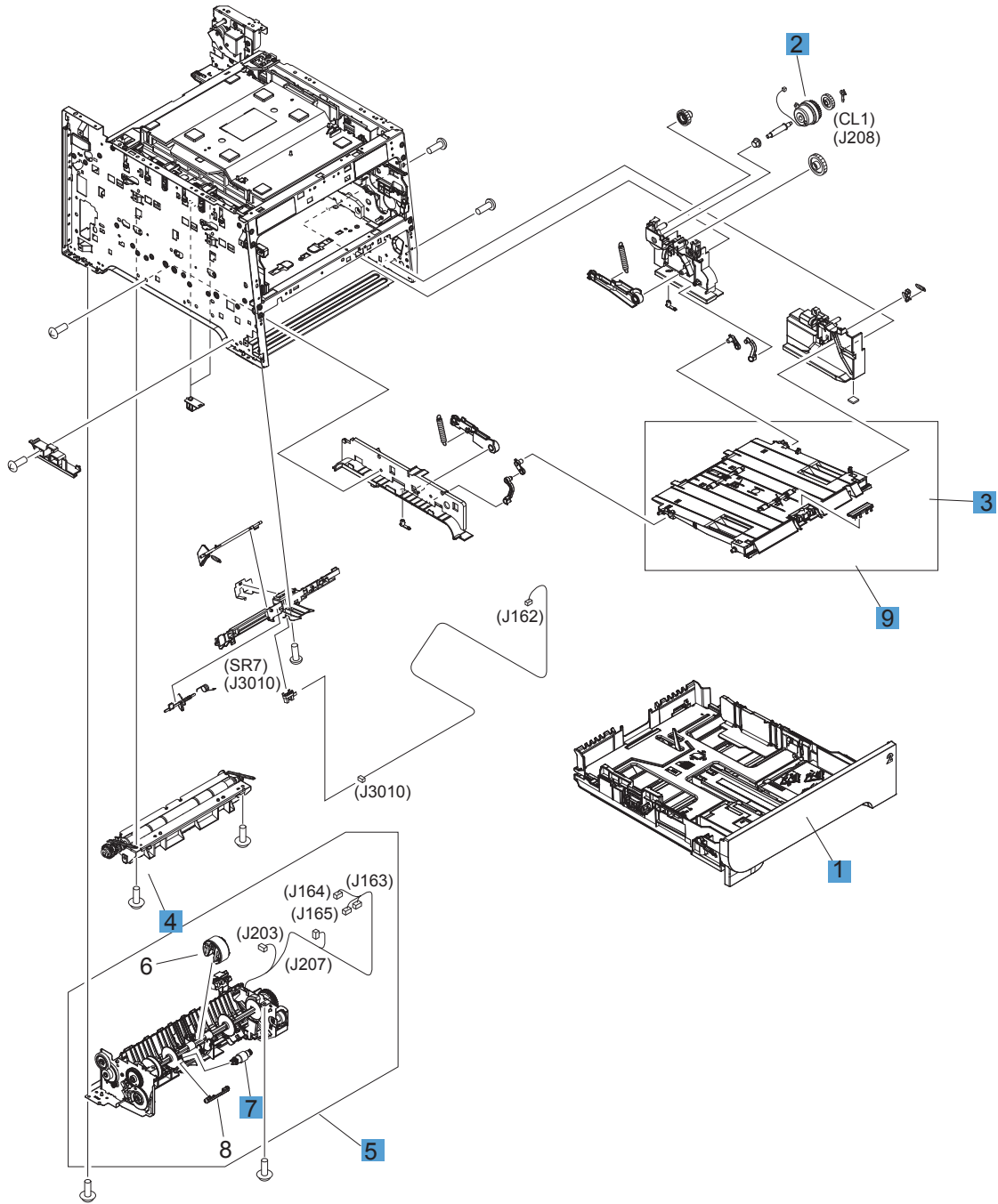

Table 3-10 Internal assemblies (3 of 7)

Ref	Description	Part number	Qty
1	Cassette, Tray 2	RM1-8063-000	1
2	Multi purpose clutch assembly	RM1-8318-000	1
3	Pad, separation Tray 1	RL1-1785-000CN	1
4	Registration assembly	RM1-4841-000	1
5	Paper pickup assembly	RM1-8045-000	1
6	Tray 2 paper pickup roller assembly	RM1-8047-000	1
7	Tray 2 separation roller assembly	RM1-4840-000	1
9	Multi purpose tray assembly	RM1-8610-000	1

Internal assemblies (4 of 5)

Figure 3-6 Internal assemblies (4 of 7)

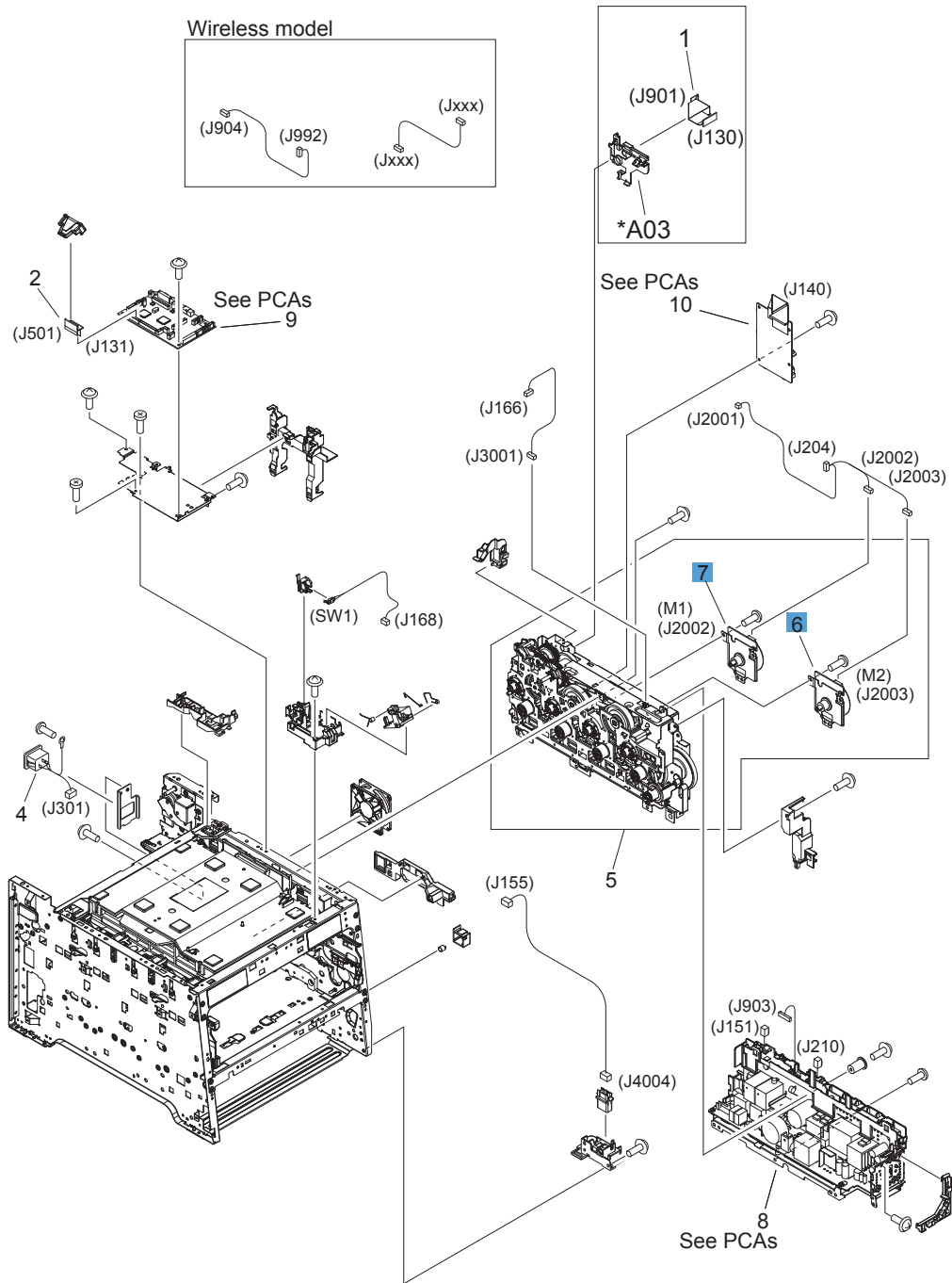

Table 3-11 Internal assemblies (4 of 7)

Ref	Description	Part number	Qty
6	Motor, developer DC (M1)	RL1-3053-000	1
7	Motor, drum DC (M2)	RL1-1800-000	1
8	Fan	RK2-3847-000	

Internal assemblies (5 of 5)

Figure 3-7 Internal assemblies (5 of 7)

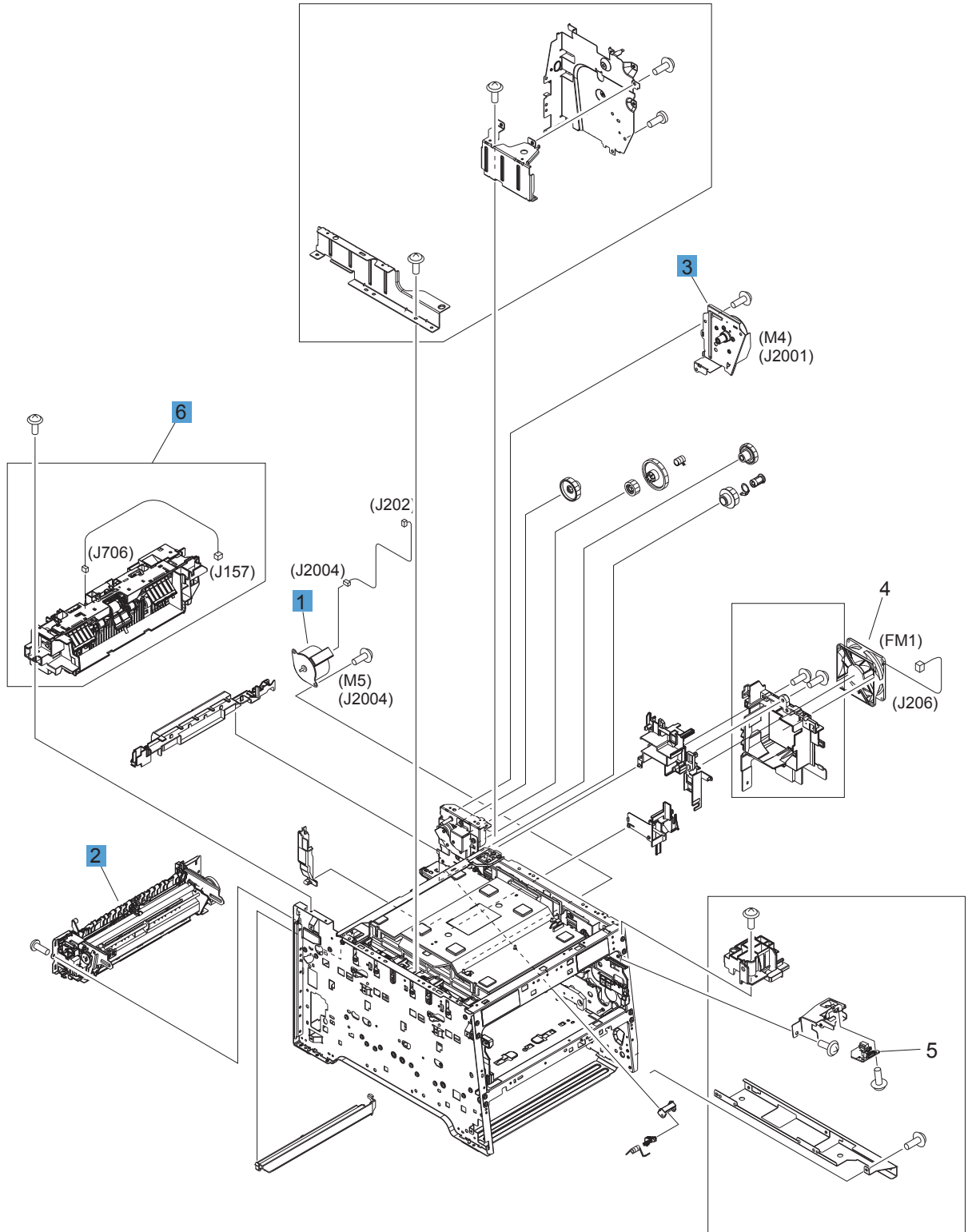

Table 3-12 Internal assemblies (5 of 7)

Ref	Description	Part number	Qty
1	Motor, feed assembly (M5)	RM1-5419-000	1
2	Fuser assembly (110v)	RM1-8061-000	1
2	Fuser assembly (220v)	RM1-8062-000	1
3	Motor, fuser assembly (M4)	RM1-8609-000	1
6	Paper delivery assembly	RM1-8049-000	1

Internal assemblies (simplex models)

Figure 3-8 Internal assemblies (simplex models)

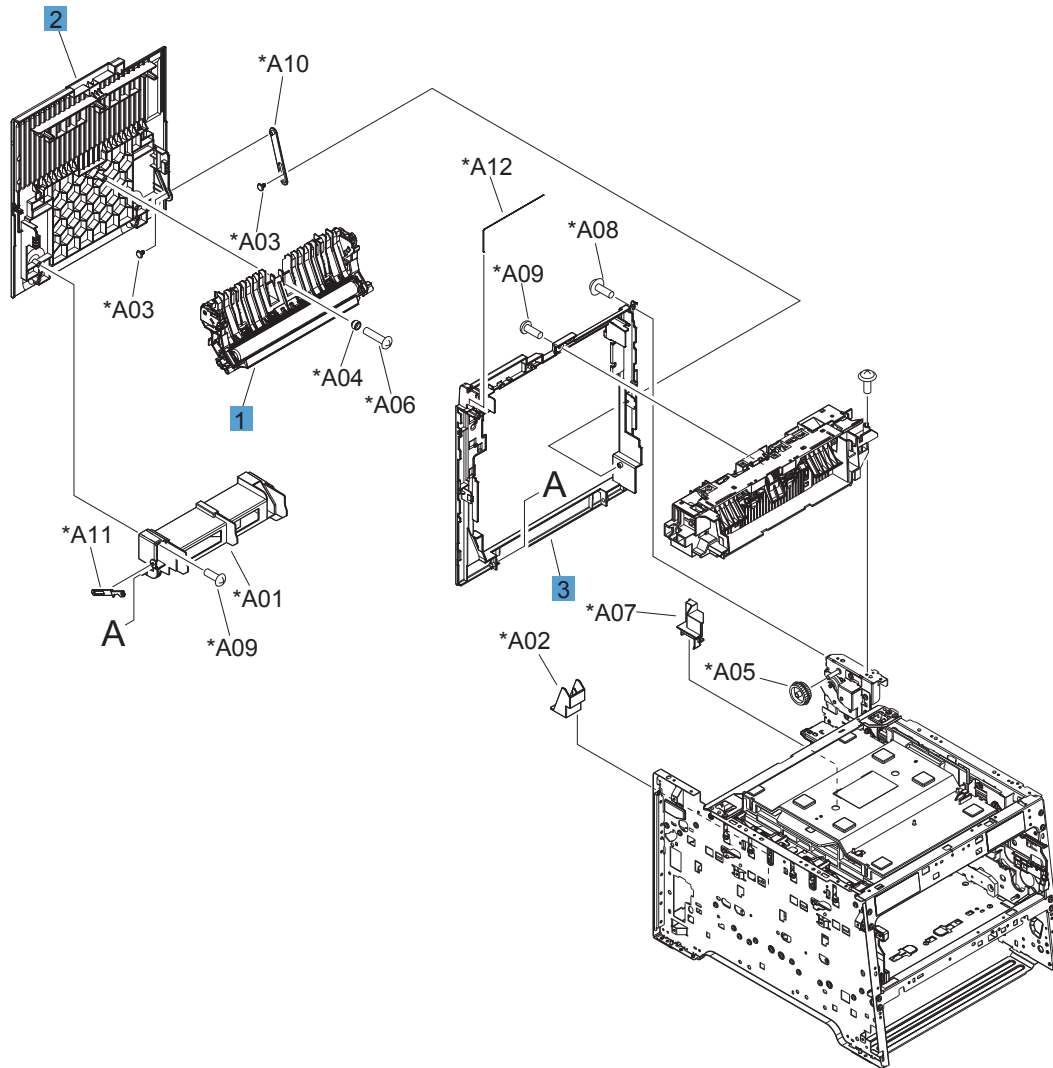

Table 3-13 Internal assemblies (simplex models)

Ref	Description	Part number	Qty
1	Paper feed guide assembly (simplex; includes transfer roller)	RM1-8043-000	1
2	Door, rear (simplex)	RC3-1665-000	1
3	Cover, rear (simplex)	RL1-3072-000	1

Internal assemblies (duplex models)

Figure 3-9 Internal assemblies (duplex models)

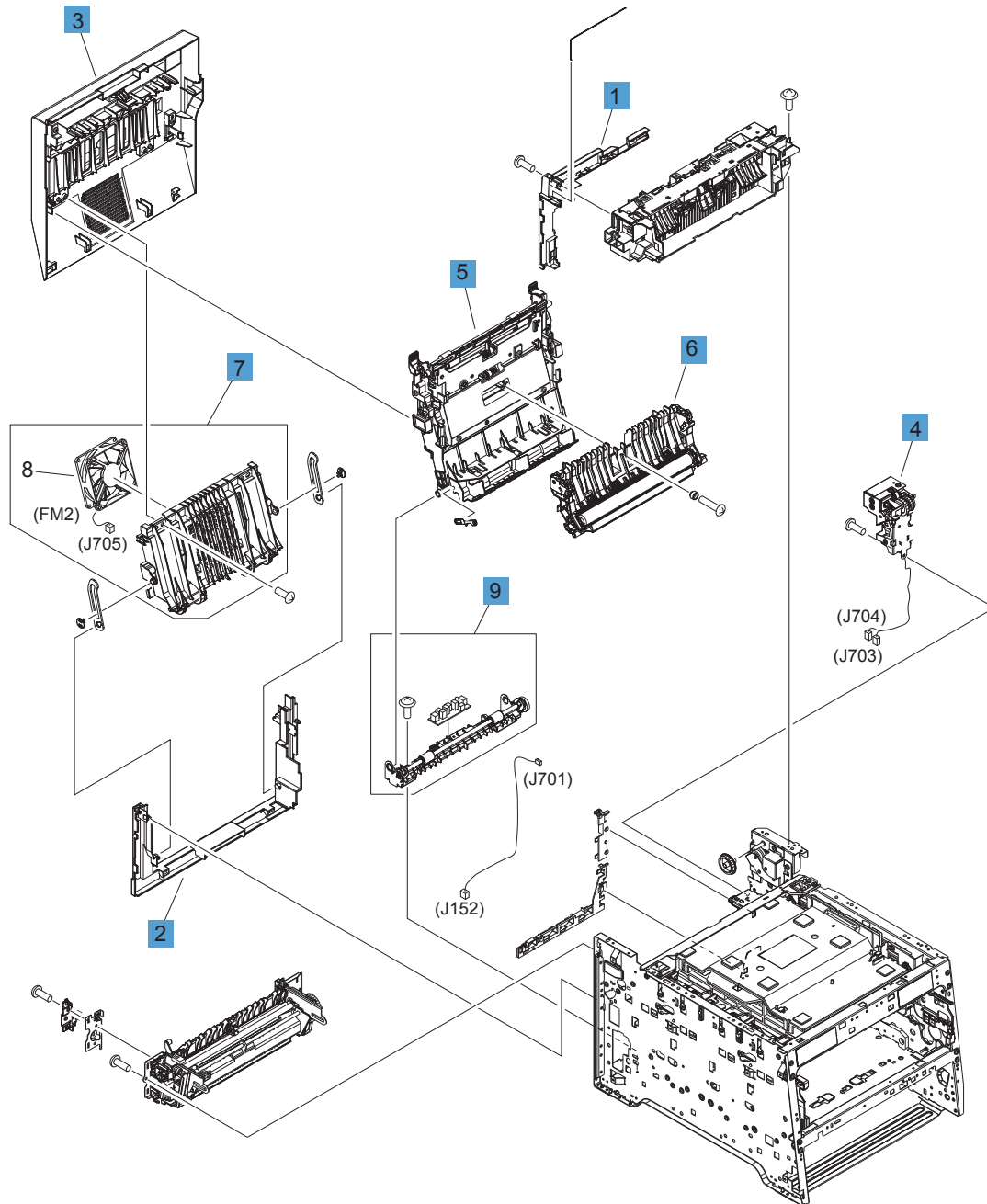

Table 3-14 Internal assemblies (duplex models)

Ref	Description	Part number	Qty
1	Cover, upper-rear (duplex)	RL1-3068-000	1
2	Cover, lower-rear (duplex)	RC3-1700-000	1
3	Door, rear (duplex)	RM1-8052-000	1
4	Reverse drive assembly (duplex)	RM1-4880-000	1
5	Feed guide, duplex assembly (duplex; includes transfer roller) ¹	RM1-4879-000	1
6	Paper feed guide assembly (duplex; includes transfer roller)	RM1-8043-000	1
7	Rib assembly, rear-door (duplex)	RM1-8053-000	1
9	Paper-pickup guide assembly (duplex)	RM1-8051-000	1

¹ For a broken link-guide: you must replace either the duplexing-feed guide assembly, or the entire product (the interior paper guide is not replaceable).

PCAs

Figure 3-10 PCAs

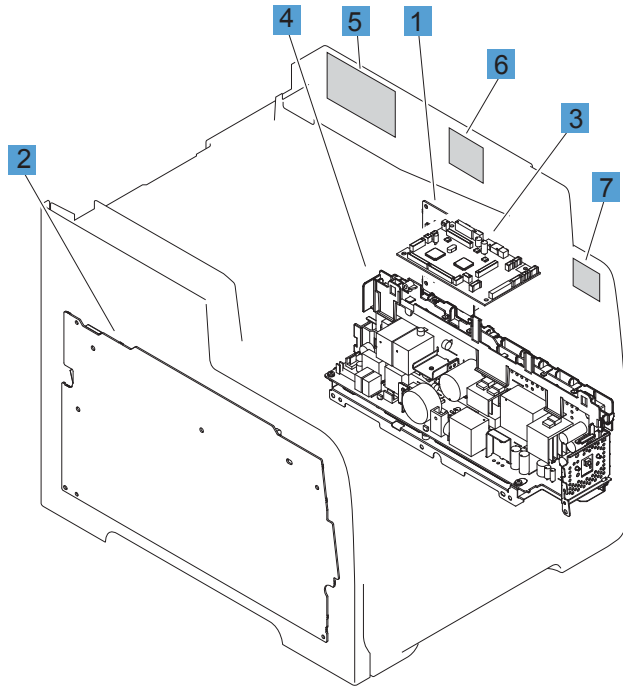

Table 3-15 PCAs

Ref	Description	Part number	Qty
1	Driver PCA	RM1-8032-000	1
2	High-voltage power supply	RM1-8031-000	1
3	DC controller	RM1-8039-000	1
4	Low-voltage power supply (110v)	RM1-9034-000	1
4	Low-voltage power supply (220v)	RM1-9036-000	1
5	Fax PCA	CE682-60001	1
5	Fax PCA (Europe only)	CE683-60001	1
6	Wireless controller PCA	1150-7938	1
7	USB connector PCA	RK2-3846-000	1
Not shown	Formatter PCA	CE855-60001	1

Input device(s)

250-sheet paper feeder (optional Tray 3)

Figure 3-11 250-sheet paper feeder (optional Tray 3)

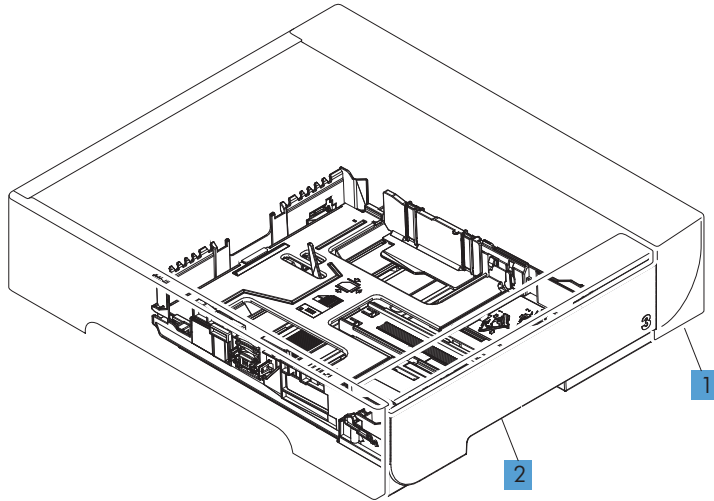

Table 3-16 250-sheet paper feeder (optional Tray 3)

Ref	Description	Part number	Qty
1	250-sheet paper feeder (optional Tray 3; includes cassette)	RM1-8544-000CN	1
2	Cassette (optional Tray 3)	RM1-8063-000CN	1

Alphabetical parts list

Table 3-17 Alphabetical parts list

Description	Part number	Table and page
250-sheet paper feeder (optional Tray 3; includes cassette)	RM1-8544-000CN	250-sheet paper feeder (optional Tray 3) on page 271
Cartridge-tray assembly	RM1-8041-000	Internal assemblies (1 of 7) on page 255
Cassette (optional Tray 3)	RM1-8063-000CN	250-sheet paper feeder (optional Tray 3) on page 271
Cassette, Tray 2	RM1-8063-000	Internal assemblies (3 of 7) on page 259
Color misregistration sensor assembly	RM1-8029-000	Internal assemblies (2 of 7) on page 257
Control-panel assembly	CE863-60015	Scanner and document feeder main assemblies on page 251
Control-panel mount	CE863-40018	Scanner and document feeder main assemblies on page 251
Cover, DIMM	RC3-1751-000	Covers^{1,2} on page 253
Cover, left	RL1-3063-000	Covers^{1,2} on page 253
Cover, lower-rear (duplex)	RC3-1700-000	Internal assemblies (duplex models) on page 267
Cover, rear (simplex)	RL1-3072-000	Internal assemblies (simplex models) on page 265
Cover, right	RC3-1732-000	Covers^{1,2} on page 253
Cover, right front	RC3-1733-000	Covers^{1,2} on page 253
Cover, upper assembly	RM1-8060-000	Covers^{1,2} on page 253
Cover, upper-rear (duplex)	RL1-3068-000	Internal assemblies (duplex models) on page 267
DC controller	RM1-8039-000	PCAs on page 269
Document feeder assembly (duplex)	CE863-60101	Scanner and document feeder main assemblies on page 251
Document feeder assembly (simplex)	CE863-60106	Scanner and document feeder main assemblies on page 251
Document feeder input tray	CE863-60113	Scanner and document feeder main assemblies on page 251
Document feeder pickup assembly	5851-2559	Scanner and document feeder main assemblies on page 251
Door, front assembly	RM1-8064-000	Covers^{1,2} on page 253

Table 3-17 Alphabetical parts list (continued)

Description	Part number	Table and page
Door, rear (duplex)	RM1-8052-000	Internal assemblies (duplex models) on page 267
Door, rear (simplex)	RC3-1665-000	Internal assemblies (simplex models) on page 265
Driver PCA	RM1-8032-000	PCAs on page 269
Fan	RK2-3847-000	Internal assemblies (4 of 7) on page 261
Fax PCA	CE682-60001	PCAs on page 269
Fax PCA (Europe only)	CE683-60001	PCAs on page 269
Feed guide, duplex assembly (duplex; includes transfer roller) ¹	RM1-4879-000	Internal assemblies (duplex models) on page 267
Formatter PCA	CE855-60001	PCAs on page 269
Fuser assembly (110v)	RM1-8061-000	Internal assemblies (5 of 7) on page 263
Fuser assembly (220v)	RM1-8062-000	Internal assemblies (5 of 7) on page 263
High-voltage power supply	RM1-8031-000	PCAs on page 269
Intermediate transfer belt (ITB)	RM1-4852-000	Internal assemblies (2 of 7) on page 257
Low-voltage power supply (110v)	RM1-9034-000	PCAs on page 269
Low-voltage power supply (220v)	RM1-9036-000	PCAs on page 269
Motor, developer DC (M1)	RL1-3053-000	Internal assemblies (4 of 7) on page 261
Motor, drum DC (M2)	RL1-1800-000	Internal assemblies (4 of 7) on page 261
Motor, feed assembly (M5)	RM1-5419-000	Internal assemblies (5 of 7) on page 263
Motor, fuser assembly (M4)	RM1-8609-000	Internal assemblies (5 of 7) on page 263
Multi purpose clutch assembly	RM1-8318-000	Internal assemblies (3 of 7) on page 259
Multi purpose tray assembly	RM1-8610-000	Internal assemblies (3 of 7) on page 259
Pad, separation Tray 1	RL1-1785-000CN	Internal assemblies (3 of 7) on page 259
Paper delivery assembly	RM1-8049-000	Internal assemblies (5 of 7) on page 263
Paper feed guide assembly (duplex; includes transfer roller)	RM1-8043-000	Internal assemblies (duplex models) on page 267

Table 3-17 Alphabetical parts list (continued)

Description	Part number	Table and page
Paper feed guide assembly (simplex; includes transfer roller)	RM1-8043-000	Internal assemblies (simplex models) on page 265
Paper pickup assembly	RM1-8045-000	Internal assemblies (3 of 7) on page 259
Paper-pickup guide assembly (duplex)	RM1-8051-000	Internal assemblies (duplex models) on page 267
Registration assembly	RM1-4841-000	Internal assemblies (3 of 7) on page 259
Reverse drive assembly (duplex)	RM1-4880-000	Internal assemblies (duplex models) on page 267
Rib assembly, rear-door (duplex)	RM1-8053-000	Internal assemblies (duplex models) on page 267
Roller, paper-pickup Tray 1	RL1-1802-000	Internal assemblies (2 of 7) on page 257
Scanner assembly (duplex)	CE863-60119	Scanner and document feeder main assemblies on page 251
Scanner assembly (simplex)	CE903-60101	Scanner and document feeder main assemblies on page 251
Solenoid, Tray 1 (SL1; MP tray)	RM1-5420-000	Internal assemblies (2 of 7) on page 257
Tray 2 paper pickup roller assembly	RM1-8047-000	Internal assemblies (3 of 7) on page 259
Tray 2 separation roller assembly	RM1-4840-000	Internal assemblies (3 of 7) on page 259
USB connector PCA	RK2-3846-000	PCAs on page 269
Wireless controller PCA	1150-7938	PCAs on page 269

Numerical parts list

Table 3-18 Numerical parts list

Part number	Description	Table and page
1150-7938	Wireless controller PCA	PCAs on page 269
5851-2559	Document feeder pickup assembly	Scanner and document feeder main assemblies on page 251
CE682-60001	Fax PCA	PCAs on page 269
CE683-60001	Fax PCA (Europe only)	PCAs on page 269
CE855-60001	Formatter PCA	PCAs on page 269
CE863-40018	Control-panel mount	Scanner and document feeder main assemblies on page 251
CE863-60015	Control-panel assembly	Scanner and document feeder main assemblies on page 251
CE863-60101	Document feeder assembly (duplex)	Scanner and document feeder main assemblies on page 251
CE863-60106	Document feeder assembly (simplex)	Scanner and document feeder main assemblies on page 251
CE863-60113	Document feeder input tray	Scanner and document feeder main assemblies on page 251
CE863-60119	Scanner assembly (duplex)	Scanner and document feeder main assemblies on page 251
CE903-60101	Scanner assembly (simplex)	Scanner and document feeder main assemblies on page 251
RC3-1665-000	Door, rear (simplex)	Internal assemblies (simplex models) on page 265
RC3-1700-000	Cover, lower-rear (duplex)	Internal assemblies (duplex models) on page 267
RC3-1732-000	Cover, right	Covers^{1,2} on page 253
RC3-1733-000	Cover, right front	Covers^{1,2} on page 253
RC3-1751-000	Cover, DIMM	Covers^{1,2} on page 253
RK2-3846-000	USB connector PCA	PCAs on page 269
RK2-3847-000	Fan	Internal assemblies (4 of 7) on page 261
RL1-1785-000CN	Pad, separation Tray 1	Internal assemblies (3 of 7) on page 259
RL1-1800-000	Motor, drum DC (M2)	Internal assemblies (4 of 7) on page 261
RL1-1802-000	Roller, paper-pickup Tray 1	Internal assemblies (2 of 7) on page 257

Table 3-18 Numerical parts list (continued)

Part number	Description	Table and page
RL1-3053-000	Motor, developer DC (M1)	Internal assemblies (4 of 7) on page 261
RL1-3063-000	Cover, left	Covers^{1,2} on page 253
RL1-3068-000	Cover, upper-rear (duplex)	Internal assemblies (duplex models) on page 267
RL1-3072-000	Cover, rear (simplex)	Internal assemblies (simplex models) on page 265
RM1-4840-000	Tray 2 separation roller assembly	Internal assemblies (3 of 7) on page 259
RM1-4841-000	Registration assembly	Internal assemblies (3 of 7) on page 259
RM1-4852-000	Intermediate transfer belt (ITB)	Internal assemblies (2 of 7) on page 257
RM1-4879-000	Feed guide, duplex assembly (duplex; includes transfer roller) ¹	Internal assemblies (duplex models) on page 267
RM1-4880-000	Reverse drive assembly (duplex)	Internal assemblies (duplex models) on page 267
RM1-5419-000	Motor, feed assembly (M5)	Internal assemblies (5 of 7) on page 263
RM1-5420-000	Solenoid, Tray 1 (SL1; MP tray)	Internal assemblies (2 of 7) on page 257
RM1-8029-000	Color misregistration sensor assembly	Internal assemblies (2 of 7) on page 257
RM1-8031-000	High-voltage power supply	PCAs on page 269
RM1-8032-000	Driver PCA	PCAs on page 269
RM1-8039-000	DC controller	PCAs on page 269
RM1-8041-000	Cartridge-tray assembly	Internal assemblies (1 of 7) on page 255
RM1-8043-000	Paper feed guide assembly (simplex; includes transfer roller)	Internal assemblies (simplex models) on page 265
RM1-8043-000	Paper feed guide assembly (duplex; includes transfer roller)	Internal assemblies (duplex models) on page 267
RM1-8045-000	Paper pickup assembly	Internal assemblies (3 of 7) on page 259
RM1-8047-000	Tray 2 paper pickup roller assembly	Internal assemblies (3 of 7) on page 259
RM1-8049-000	Paper delivery assembly	Internal assemblies (5 of 7) on page 263

Table 3-18 Numerical parts list (continued)

Part number	Description	Table and page
RM1-8051-000	Paper-pickup guide assembly (duplex)	Internal assemblies (duplex models) on page 267
RM1-8052-000	Door, rear (duplex)	Internal assemblies (duplex models) on page 267
RM1-8053-000	Rib assembly, rear-door (duplex)	Internal assemblies (duplex models) on page 267
RM1-8060-000	Cover, upper assembly	Covers^{1,2} on page 253
RM1-8061-000	Fuser assembly (110v)	Internal assemblies (5 of 7) on page 263
RM1-8062-000	Fuser assembly (220v)	Internal assemblies (5 of 7) on page 263
RM1-8063-000	Cassette, Tray 2	Internal assemblies (3 of 7) on page 259
RM1-8063-000CN	Cassette (optional Tray 3)	250-sheet paper feeder (optional Tray 3) on page 271
RM1-8064-000	Door, front assembly	Covers^{1,2} on page 253
RM1-8318-000	Multi purpose clutch assembly	Internal assemblies (3 of 7) on page 259
RM1-8544-000CN	250-sheet paper feeder (optional Tray 3; includes cassette)	250-sheet paper feeder (optional Tray 3) on page 271
RM1-8609-000	Motor, fuser assembly (M4)	Internal assemblies (5 of 7) on page 263
RM1-8610-000	Multi purpose tray assembly	Internal assemblies (3 of 7) on page 259
RM1-9034-000	Low-voltage power supply (110v)	PCAs on page 269
RM1-9036-000	Low-voltage power supply (220v)	PCAs on page 269

A Service and support

- [Hewlett-Packard limited warranty statement](#)
- [HP's Premium Protection Warranty: LaserJet print cartridge limited warranty statement](#)
- [Data stored on the print cartridge](#)
- [End User License Agreement](#)
- [OpenSSL](#)
- [Customer support](#)

Hewlett-Packard limited warranty statement

HP PRODUCT	DURATION OF LIMITED WARRANTY
HP LaserJet Pro 300 color MFP M375nw and HP LaserJet Pro 400 color MFP M475dn, and M475dw	One year from date of purchase

HP warrants to you, the end-user customer, that HP hardware and accessories will be free from defects in materials and workmanship after the date of purchase, for the period specified above. If HP receives notice of such defects during the warranty period, HP will, at its option, either repair or replace products which prove to be defective. Replacement products may be either new or equivalent in performance to new.

HP warrants to you that HP software will not fail to execute its programming instructions after the date of purchase, for the period specified above, due to defects in material and workmanship when properly installed and used. If HP receives notice of such defects during the warranty period, HP will replace software which does not execute its programming instructions due to such defects.

HP does not warrant that the operation of HP products will be uninterrupted or error free. If HP is unable, within a reasonable time, to repair or replace any product to a condition as warranted, you will be entitled to a refund of the purchase price upon prompt return of the product.

HP products may contain remanufactured parts equivalent to new in performance or may have been subject to incidental use.

Warranty does not apply to defects resulting from (a) improper or inadequate maintenance or calibration, (b) software, interfacing, parts or supplies not supplied by HP, (c) unauthorized modification or misuse, (d) operation outside of the published environmental specifications for the product, or (e) improper site preparation or maintenance.

TO THE EXTENT ALLOWED BY LOCAL LAW, THE ABOVE WARRANTIES ARE EXCLUSIVE AND NO OTHER WARRANTY OR CONDITION, WHETHER WRITTEN OR ORAL, IS EXPRESSED OR IMPLIED AND HP SPECIFICALLY DISCLAIMS ANY IMPLIED WARRANTIES OR CONDITIONS OF MERCHANTABILITY, SATISFACTORY QUALITY, AND FITNESS FOR A PARTICULAR PURPOSE. Some countries/regions, states or provinces do not allow limitations on the duration of an implied warranty, so the above limitation or exclusion might not apply to you. This warranty gives you specific legal rights and you might also have other rights that vary from country/region to country/region, state to state, or province to province.

HP's limited warranty is valid in any country/region or locality where HP has a support presence for this product and where HP has marketed this product. The level of warranty service you receive may vary according to local standards. HP will not alter form, fit or function of the product to make it operate in a country/region for which it was never intended to function for legal or regulatory reasons.

TO THE EXTENT ALLOWED BY LOCAL LAW, THE REMEDIES IN THIS WARRANTY STATEMENT ARE YOUR SOLE AND EXCLUSIVE REMEDIES. EXCEPT AS INDICATED ABOVE, IN NO EVENT WILL HP OR ITS SUPPLIERS BE LIABLE FOR LOSS OF DATA OR FOR DIRECT, SPECIAL, INCIDENTAL, CONSEQUENTIAL (INCLUDING LOST PROFIT OR DATA), OR OTHER DAMAGE, WHETHER BASED IN CONTRACT, TORT, OR OTHERWISE. Some countries/regions, states or provinces do not allow the exclusion or limitation of incidental or consequential damages, so the above limitation or exclusion may not apply to you.

THE WARRANTY TERMS CONTAINED IN THIS STATEMENT, EXCEPT TO THE EXTENT LAWFULLY PERMITTED, DO NOT EXCLUDE, RESTRICT OR MODIFY AND ARE IN ADDITION TO THE MANDATORY STATUTORY RIGHTS APPLICABLE TO THE SALE OF THIS PRODUCT TO YOU.

HP's Premium Protection Warranty: LaserJet print cartridge limited warranty statement

This HP product is warranted to be free from defects in materials and workmanship.

This warranty does not apply to products that (a) have been refilled, refurbished, remanufactured or tampered with in any way, (b) experience problems resulting from misuse, improper storage, or operation outside of the published environmental specifications for the printer product or (c) exhibit wear from ordinary use.

To obtain warranty service, please return the product to place of purchase (with a written description of the problem and print samples) or contact HP customer support. At HP's option, HP will either replace products that prove to be defective or refund your purchase price.

TO THE EXTENT ALLOWED BY LOCAL LAW, THE ABOVE WARRANTY IS EXCLUSIVE AND NO OTHER WARRANTY OR CONDITION, WHETHER WRITTEN OR ORAL, IS EXPRESSED OR IMPLIED AND HP SPECIFICALLY DISCLAIMS ANY IMPLIED WARRANTIES OR CONDITIONS OF MERCHANTABILITY, SATISFACTORY QUALITY, AND FITNESS FOR A PARTICULAR PURPOSE.

TO THE EXTENT ALLOWED BY LOCAL LAW, IN NO EVENT WILL HP OR ITS SUPPLIERS BE LIABLE FOR DIRECT, SPECIAL, INCIDENTAL, CONSEQUENTIAL (INCLUDING LOST PROFIT OR DATA), OR OTHER DAMAGE, WHETHER BASED IN CONTRACT, TORT, OR OTHERWISE.

THE WARRANTY TERMS CONTAINED IN THIS STATEMENT, EXCEPT TO THE EXTENT LAWFULLY PERMITTED, DO NOT EXCLUDE, RESTRICT OR MODIFY AND ARE IN ADDITION TO THE MANDATORY STATUTORY RIGHTS APPLICABLE TO THE SALE OF THIS PRODUCT TO YOU.

Data stored on the print cartridge

The HP print cartridges used with this product contain a memory chip that assists in the operation of the product.

In addition, this memory chip collects a limited set of information about the usage of the product, which might include the following: the date when the print cartridge was first installed, the date when the print cartridge was last used, the number of pages printed using the print cartridge, the page coverage, the printing modes used, any printing errors that might have occurred, and the product model. This information helps HP design future products to meet our customers' printing needs.

The data collected from the print cartridge memory chip does not contain information that can be used to identify a customer or user of the print cartridge or their product. However, a customer can choose not to store usage data on the memory chip through the control panel.

HP collects a sampling of the memory chips from print cartridges returned to HP's free return and recycling program (HP Planet Partners: www.hp.com/recycle). The memory chips from this sampling are read and studied in order to improve future HP products. HP partners who assist in recycling this print cartridge might have access to this data, as well.

Any third party possessing the print cartridge might have access to the anonymous information on the memory chip.

End User License Agreement

PLEASE READ CAREFULLY BEFORE USING THIS SOFTWARE PRODUCT: This End-User License Agreement (“EULA”) is a contract between (a) you (either an individual or the entity you represent) and (b) Hewlett-Packard Company (“HP”) that governs your use of the software product (“Software”). This EULA does not apply if there is a separate license agreement between you and HP or its suppliers for the Software, including a license agreement in online documentation. The term “Software” may include (i) associated media, (ii) a user guide and other printed materials, and (iii) “online” or electronic documentation (collectively “User Documentation”).

RIGHTS IN THE SOFTWARE ARE OFFERED ONLY ON THE CONDITION THAT YOU AGREE TO ALL TERMS AND CONDITIONS OF THIS EULA. BY INSTALLING, COPYING, DOWNLOADING, OR OTHERWISE USING THE SOFTWARE, YOU AGREE TO BE BOUND BY THIS EULA. IF YOU DO NOT ACCEPT THIS EULA, DO NOT INSTALL, DOWNLOAD, OR OTHERWISE USE THE SOFTWARE. IF YOU PURCHASED THE SOFTWARE BUT DO NOT AGREE TO THIS EULA, PLEASE RETURN THE SOFTWARE TO YOUR PLACE OF PURCHASE WITHIN FOURTEEN DAYS FOR A REFUND OF THE PURCHASE PRICE; IF THE SOFTWARE IS INSTALLED ON OR MADE AVAILABLE WITH ANOTHER HP PRODUCT, YOU MAY RETURN THE ENTIRE UNUSED PRODUCT.

1. **THIRD PARTY SOFTWARE.** The Software may include, in addition to HP proprietary software (“HP Software”), software under licenses from third parties (“Third Party Software” and “Third Party License”). Any Third Party Software is licensed to you subject to the terms and conditions of the corresponding Third Party License. Generally, the Third Party License is in a file such as “license.txt” or a “readme” file. You should contact HP support if you cannot find a Third Party License. If the Third Party Licenses include licenses that provide for the availability of source code (such as the GNU General Public License) and the corresponding source code is not included with the Software, then check the product support pages of HP's website (hp.com) to learn how to obtain such source code.
2. **LICENSE RIGHTS.** You will have the following rights provided you comply with all terms and conditions of this EULA:
 - a. **Use.** HP grants you a license to Use one copy of the HP Software. “Use” means installing, copying, storing, loading, executing, displaying, or otherwise using the HP Software. You may not modify the HP Software or disable any licensing or control feature of the HP Software. If this Software is provided by HP for Use with an imaging or printing product (for example, if the Software is a printer driver, firmware, or add-on), the HP Software may only be used with such product (“HP Product”). Additional restrictions on Use may appear in the User Documentation. You may not separate component parts of the HP Software for Use. You do not have the right to distribute the HP Software.
 - b. **Copying.** Your right to copy means you may make archival or back-up copies of the HP Software, provided each copy contains all the original HP Software’s proprietary notices and is used only for back-up purposes.
3. **UPGRADES.** To Use HP Software provided by HP as an upgrade, update, or supplement (collectively “Upgrade”), you must first be licensed for the original HP Software identified by HP as eligible for the Upgrade. To the extent the Upgrade supersedes the original HP Software, you may no longer use such HP Software. This EULA applies to each Upgrade unless HP provides other terms with the Upgrade. In case of a conflict between this EULA and such other terms, the other terms will prevail.

4. TRANSFER.
 - a. Third Party Transfer. The initial end user of the HP Software may make a one-time transfer of the HP Software to another end user. Any transfer will include all component parts, media, User Documentation, this EULA, and if applicable, the Certificate of Authenticity. The transfer may not be an indirect transfer, such as a consignment. Prior to the transfer, the end user receiving the transferred Software will agree to this EULA. Upon transfer of the HP Software, your license is automatically terminated.
 - b. Restrictions. You may not rent, lease or lend the HP Software or Use the HP Software for commercial timesharing or bureau use. You may not sublicense, assign or otherwise transfer the HP Software except as expressly provided in this EULA.
5. PROPRIETARY RIGHTS. All intellectual property rights in the Software and User Documentation are owned by HP or its suppliers and are protected by law, including applicable copyright, trade secret, patent, and trademark laws. You will not remove any product identification, copyright notice, or proprietary restriction from the Software.
6. LIMITATION ON REVERSE ENGINEERING. You may not reverse engineer, decompile, or disassemble the HP Software, except and only to the extent that the right to do so is allowed under applicable law.
7. CONSENT TO USE OF DATA. HP and its affiliates may collect and use technical information you provide in relation to (i) your Use of the Software or the HP Product, or (ii) the provision of support services related to the Software or the HP Product. All such information will be subject to HP's privacy policy. HP will not use such information in a form that personally identifies you except to the extent necessary to enhance your Use or provide support services.
8. LIMITATION OF LIABILITY. Notwithstanding any damages that you might incur, the entire liability of HP and its suppliers under this EULA and your exclusive remedy under this EULA will be limited to the greater of the amount actually paid by you for the Product or U.S. \$5.00. TO THE MAXIMUM EXTENT PERMITTED BY APPLICABLE LAW, IN NO EVENT WILL HP OR ITS SUPPLIERS BE LIABLE FOR ANY SPECIAL, INCIDENTAL, INDIRECT, OR CONSEQUENTIAL DAMAGES (INCLUDING DAMAGES FOR LOST PROFITS, LOST DATA, BUSINESS INTERRUPTION, PERSONAL INJURY, OR LOSS OF PRIVACY) RELATED IN ANY WAY TO THE USE OF OR INABILITY TO USE THE SOFTWARE, EVEN IF HP OR ANY SUPPLIER HAS BEEN ADVISED OF THE POSSIBILITY OF SUCH DAMAGES AND EVEN IF THE ABOVE REMEDY FAILS OF ITS ESSENTIAL PURPOSE. Some states or other jurisdictions do not allow the exclusion or limitation of incidental or consequential damages, so the above limitation or exclusion may not apply to you.
9. U.S. GOVERNMENT CUSTOMERS. Software was developed entirely at private expense. All Software is commercial computer software within the meaning of the applicable acquisition regulations. Accordingly, pursuant to US FAR 48 CFR 12.212 and DFAR 48 CFR 227.7202, use, duplication and disclosure of the Software by or for the U.S. Government or a U.S. Government subcontractor is subject solely to the terms and conditions set forth in this End User License Agreement, except for provisions which are contrary to applicable mandatory federal laws.
10. COMPLIANCE WITH EXPORT LAWS. You will comply with all laws, rules, and regulations (i) applicable to the export or import of the Software, or (ii) restricting the Use of the Software, including any restrictions on nuclear, chemical, or biological weapons proliferation.
11. RESERVATION OF RIGHTS. HP and its suppliers reserve all rights not expressly granted to you in this EULA.

© 2009 Hewlett-Packard Development Company, L.P.

Rev. 04/09

OpenSSL

This product includes software developed by the OpenSSL Project for use in the OpenSSL Toolkit (<http://www.openssl.org/>)

THIS SOFTWARE IS PROVIDED BY THE OpenSSL PROJECT ``AS IS'' AND ANY EXPRESSED OR IMPLIED WARRANTIES, INCLUDING, BUT NOT LIMITED TO, THE IMPLIED WARRANTIES OF MERCHANTABILITY AND FITNESS FOR A PARTICULAR PURPOSE ARE DISCLAIMED. IN NO EVENT SHALL THE OpenSSL PROJECT OR ITS CONTRIBUTORS BE LIABLE FOR ANY DIRECT, INDIRECT, INCIDENTAL, SPECIAL, EXEMPLARY, OR CONSEQUENTIAL DAMAGES (INCLUDING, BUT NOT LIMITED TO, PROCUREMENT OF SUBSTITUTE GOODS OR SERVICES;

LOSS OF USE, DATA, OR PROFITS; OR BUSINESS INTERRUPTION) HOWEVER CAUSED AND ON ANY THEORY OF LIABILITY, WHETHER IN CONTRACT, STRICT LIABILITY, OR TORT (INCLUDING NEGLIGENCE OR OTHERWISE) ARISING IN ANY WAY OUT OF THE USE OF THIS SOFTWARE, EVEN IF ADVISED OF THE POSSIBILITY OF SUCH DAMAGE.

This product includes cryptographic software written by Eric Young (ey@cryptsoft.com). This product includes software written by Tim Hudson (tjh@cryptsoft.com).

Customer support

Get telephone support for your country/region	Country/region phone numbers are on the flyer that was in the box with your product or at www.hp.com/support/ .
Have the product name, serial number, date of purchase, and problem description ready.	
Get 24-hour Internet support	www.hp.com/go/LJColorMFPM375 or www.hp.com/go/LJColorMFPM475
Get support for products used with a Macintosh computer	www.hp.com/go/macosex
Download software utilities, drivers, and electronic information	www.hp.com/go/LJColorMFPM375_software or www.hp.com/go/LJColorMFPM475_software
Order additional HP service or maintenance agreements	www.hp.com/go/carepack
Register your product	www.register.hp.com

B Product specifications

- [Physical specifications](#)
- [Power consumption, electrical specifications, and acoustic emissions](#)
- [Environmental specifications](#)

Physical specifications

Table B-1 Physical specifications

Product	Height	Depth	Width	Weight
HP LaserJet Pro 300 color MFP M375nw	500 mm (19.7 inches)	483 mm (19.0 inches)	420 mm (16.5 inches)	28.2 kg (62.2 lb)
HP LaserJet Pro 400 color MFP M475dn	500 mm (19.7 inches)	483 mm (19.0 inches)	420 mm (16.5 inches)	29.5 kg (65.0 lb)
HP LaserJet Pro 400 color MFP M475dw	500 mm (19.7 inches)	483 mm (19.0 inches)	420 mm (16.5 inches)	29.5 kg (65.0 lb)

Power consumption, electrical specifications, and acoustic emissions

See www.hp.com/go/LJColorMFPM375_regulatory or www.hp.com/go/LJColorMFPM475_regulatory for current information.

CAUTION: Power requirements are based on the country/region where the product is sold. Do not convert operating voltages. This will damage the product and void the product warranty.

Environmental specifications

Table B-2 Environmental specifications¹

	Recommended	Operating	Storage
Temperature	15° to 32.5° C (59° to 90.5° F)	15° to 32.5° C (59° to 90.5° F)	-20° to 40° C (-4° to 104° F)
Relative humidity	20 to 70%	10 to 80%	95% or less
Altitude		0 to 3048 m (0 to 10,000 ft)	

¹ Values are subject to change.

C Regulatory information

- [FCC regulations](#)
- [Environmental product stewardship program](#)
- [Declaration of conformity](#)
- [Declaration of conformity \(wireless models\)](#)
- [Certificate of volatility](#)
- [Safety statements](#)
- [Additional statements for telecom \(fax\) products](#)
- [Additional statements for wireless products](#)

FCC regulations

This equipment has been tested and found to comply with the limits for a Class B digital device, pursuant to Part 15 of the FCC rules. These limits are designed to provide reasonable protection against harmful interference in a residential installation. This equipment generates, uses, and can radiate radio frequency energy. If this equipment is not installed and used in accordance with the instructions, it may cause harmful interference to radio communications. However, there is no guarantee that interference will not occur in a particular installation. If this equipment does cause harmful interference to radio or television reception, which can be determined by turning the equipment off and on, the user is encouraged to try to correct the interference by one or more of the following measures:

- Reorient or relocate the receiving antenna.
- Increase separation between equipment and receiver.
- Connect equipment to an outlet on a circuit different from that to which the receiver is located.
- Consult your dealer or an experienced radio/TV technician.

 **NOTE:** Any changes or modifications to the printer that are not expressly approved by HP could void the user's authority to operate this equipment.

Use of a shielded interface cable is required to comply with the Class B limits of Part 15 of FCC rules.

Environmental product stewardship program

Protecting the environment

Hewlett-Packard Company is committed to providing quality products in an environmentally sound manner. This product has been designed with several attributes to minimize impacts on our environment.

Ozone production

This product generates no appreciable ozone gas (O₃).

Power consumption

Power usage drops significantly while in Ready or Sleep mode, which saves natural resources and saves money without affecting the high performance of this product. Hewlett-Packard printing and imaging equipment marked with the ENERGY STAR® logo is qualified to the U.S. Environmental Protection Agency's ENERGY STAR specifications for imaging equipment. The following mark will appear on ENERGY STAR qualified imaging products:



Additional ENERGY STAR qualified imaging product model information is listed at:

www.hp.com/go/energystar

Toner consumption

EconoMode uses less toner, which might extend the life of the print cartridge. HP does not recommend the full-time use of EconoMode. If EconoMode is used full-time, the toner supply might outlast the mechanical parts in the print cartridge. If print quality begins to degrade and is no longer acceptable, consider replacing the print cartridge.

Paper use

This product's manual/automatic duplex feature (two-sided printing) and N-up printing (multiple pages printed on one page) capability can reduce paper usage and the resulting demands on natural resources.

Plastics

Plastic parts over 25 grams are marked according to international standards that enhance the ability to identify plastics for recycling purposes at the end of the product's life.

HP LaserJet print supplies

It's easy to return and recycle your HP LaserJet print cartridges after use—free of charge—with HP Planet Partners. Multilingual program information and instructions are included in every new HP LaserJet print cartridge and supplies package. You help reduce the toll on the environment further when you return multiple cartridges together rather than separately.

HP is committed to providing inventive, high-quality products and services that are environmentally sound, from product design and manufacturing to distribution, customer use and recycling. When you participate in the HP Planet Partners program, we ensure your HP LaserJet print cartridges are recycled properly, processing them to recover plastics and metals for new products and diverting millions of tons of waste from landfills. Since this cartridge is being recycled and used in new materials, it will not be returned to you. Thank you for being environmentally responsible!

 **NOTE:** Use the return label to return original HP LaserJet print cartridges only. Please do not use this label for HP inkjet cartridges, non-HP cartridges, refilled or remanufactured cartridges or warranty returns. For information about recycling your HP inkjet cartridges please go to <http://www.hp.com/recycle>.

Return and recycling instructions

United States and Puerto Rico

The enclosed label in the HP LaserJet toner cartridge box is for the return and recycling of one or more HP LaserJet print cartridges after use. Please follow the applicable instructions below.

Multiple returns (more than one cartridge)

1. Package each HP LaserJet print cartridge in its original box and bag.
2. Tape the boxes together using strapping or packaging tape. The package can weigh up to 31 kg (70 lb).
3. Use a single pre-paid shipping label.

OR

1. Use your own suitable box, or request a free bulk collection box from www.hp.com/recycle or 1-800-340-2445 (holds up to 31 kg (70 lb) of HP LaserJet print cartridges).
2. Use a single pre-paid shipping label.

Single returns

1. Package the HP LaserJet print cartridge in its original bag and box.
2. Place the shipping label on the front of the box.

Shipping

For US and Puerto Rico HP LaserJet print cartridge recycling returns, use the pre-paid, pre-addressed shipping label contained in the box. To use the UPS label, give the package to the UPS driver during your next delivery or pick-up, or take it to an authorized UPS drop-off center. (Requested UPS Ground pickup will be charged normal pick-up rates) For the location of your local UPS drop-off center, call 1-800-PICKUPS or visit www.ups.com.

If you are returning the package with the FedEx label, give the package to either the U.S. Postal Service carrier or FedEx driver during your next pick-up or delivery. (Requested FedEx Ground pickup will be charged normal pick-up rates). Or, you can drop off your packaged print cartridge(s) at any U.S. Post Office or any FedEx shipping center or store. For the location of your nearest U.S. Post Office, please call 1-800-ASK-USPS or visit www.usps.com. For the location of your nearest FedEx shipping center/store, please call 1-800-GOFEDEX or visit www.fedex.com.

For more information, or to order additional labels or boxes for bulk returns, visit www.hp.com/recycle or call 1-800-340-2445. Information subject to change without notice.

Residents of Alaska and Hawaii

Do not use the UPS label. Call 1-800-340-2445 for information and instructions. The U.S. Postal Service provides no-cost cartridge return transportation services under an arrangement with HP for Alaska and Hawaii.

Non-U.S. returns

To participate in HP Planet Partners return and recycling program, just follow the simple directions in the recycling guide (found inside the packaging of your new product supply item) or visit www.hp.com/recycle. Select your country/region for information on how to return your HP LaserJet printing supplies.

Paper

This product is capable of using recycled papers when the paper meets the guidelines outlined in the *HP LaserJet Printer Family Print Media Guide*. This product is suitable for the use of recycled paper according to EN12281:2002.

Material restrictions

This HP product does not contain added mercury.

This HP product contains a battery that might require special handling at end-of-life. The batteries contained in or supplied by Hewlett-Packard for this product include the following:

HP LaserJet Pro 300 color MFP M375 and HP LaserJet Pro 400 color MFP M475	
Type	Carbon monofluoride lithium
Weight	0.8 g
Location	On formatter board
User-removable	No



廢電池請回收

For recycling information, you can go to www.hp.com/recycle, or contact your local authorities or the Electronics Industries Alliance: www.eiae.org.

Disposal of waste equipment by users in private households in the European Union

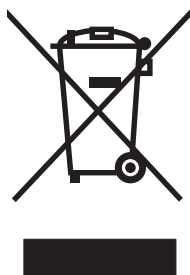

This symbol on the product or on its packaging indicates that this product must not be disposed of with your other household waste. Instead, it is your responsibility to dispose of your waste equipment by handing it over to a designated collection point for the recycling of waste electrical and electronic equipment. The separate collection and recycling of your waste equipment at the time of disposal will help to conserve natural resources and ensure that it is recycled in a manner that protects human health and the environment. For more information about where you can drop off your waste equipment for recycling, please contact your local city office, your household waste disposal service or the shop where you purchased the product.

Chemical substances

HP is committed to providing our customers with information about the chemical substances in our products as needed to comply with legal requirements such as REACH (Regulation EC No 1907/2006 of the European Parliament and the Council). A chemical information report for this product can be found at: www.hp.com/go/reach.

Material Safety Data Sheet (MSDS)

Material Safety Data Sheets (MSDS) for supplies containing chemical substances (for example, toner) can be obtained by accessing the HP Web site at www.hp.com/go/msds or www.hp.com/hpinfo/community/environment/productinfo/safety.

For more information

To obtain information about these environmental topics:

- Product environmental profile sheet for this and many related HP products
- HP's commitment to the environment
- HP's environmental management system
- HP's end-of-life product return and recycling program
- Material Safety Data Sheets

Visit www.hp.com/go/environment or www.hp.com/hpinfo/globalcitizenship/environment.

Declaration of conformity

Declaration of Conformity

according to ISO/IEC 17050-1 and EN 17050-1

Manufacturer's Name: Hewlett-Packard Company DoC#: BOISB-1002-03-rel.1.0

Manufacturer's Address: 11311 Chinden Boulevard
Boise, Idaho 83714-1021, USA

declares, that the product

Product Name: HP LaserJet Pro 400 color MFP M475dn

Regulatory Model Number²⁾ BOISB-1002-03
BOISB-0903-00 – (US-Fax Module LIU)
BOISB-0903-01 – (EURO-Fax Module LIU)

Product Options: ALL

Print Cartridges: CE410A, CE410X, CE411A, CE412A, CE413A

conforms to the following Product Specifications:

SAFETY: IEC 60950-1:2005 / EN60950-1: 2006+A11
IEC 60825-1:2007 / EN 60825-1:2007 (Class 1 Laser/LED Product)
IEC 62311:2007 / EN62311:2008

GB4943-2001

EMC: CISPR22:2005 +A1 / EN55022:2006 +A1 - Class B¹⁾
EN 61000-3-2:2006
EN 61000-3-3:2008
EN 55024:1998 +A1 +A2
FCC Title 47 CFR, Part 15 Class B¹⁾ / ICES-003, Issue 4
GB9254-2008, GB17625.1-2003

TELECOM: ES 203 021; FCC Title 47 CFR, Part 68³⁾

ENERGY USE: Regulation (EC) No. 1275/2008
ENERGY STAR® Qualified Imaging Equipment Typical Electricity Consumption (TEC) Test Procedure

Supplementary Information:

The product herewith complies with the requirements of the EMC Directive 2004/108/EC and the Low Voltage Directive 2006/95/EC, the R&TTE Directive 1999/5/EC (Annex II), the EuP Directive 2005/32/EC and carries the CE-Marking  accordingly.

This Device complies with Part 15 of the FCC Rules. Operation is subject to the following two Conditions: (1) this device may not cause harmful interference, and (2) this device must accept any interference received, including interference that may cause undesired operation.

1. The product was tested in a typical configuration with Hewlett-Packard Personal Computer Systems.
2. For regulatory purposes, this product is assigned a Regulatory model number. This number should not be confused with the product name or the product number(s).
3. Telecom approvals and standards appropriate for the target countries/regions have been applied to this product, in addition to those listed above.
4. This product uses an analog fax accessory module which Regulatory Model numbers are: BOISB-0903-00 (US-LIU) or BOISB-0903-01 (EURO LIU), as needed to meet technical regulatory requirements for the countries/regions this product will be sold.

Boise, Idaho USA

October 2011

For regulatory topics only:

European Contact: Your Local Hewlett-Packard Sales and Service Office or Hewlett-Packard GmbH, Department HQ-TRE / Standards Europe, Herrenberger Straße 140, D-71034, Böblingen (FAX: +49-7031-14-3143)
www.hp.eu/certificates

USA Contact: Product Regulations Manager, Hewlett-Packard Company, PO Box 15, Mail Stop 160, Boise, Idaho 83707-0015 (Phone: 208-396-6000)

Declaration of conformity (wireless models)

Declaration of Conformity

according to ISO/IEC 17050-1 and EN 17050-1

Manufacturer's Name: Hewlett-Packard Company DoC#: BOISB-1002-02&04 Rel.1.0

Manufacturer's Address: 11311 Chinden Boulevard
Boise, Idaho 83714-1021, USA

declares, that the product

Product Name: HP LaserJet Pro 300 color MFP M375nw
HP LaserJet Pro 400 color MFP M475dw

Regulatory Model Number²⁾ BOISB-1002-02, BOISB-1002-04
BOISB-0903-00 – (US-Fax Module LIU)
BOISB-0903-01 – (EURO-Fax Module LIU)
SDGOB – 0892 – (Radio Module)

Product Options: ALL

Print Cartridges: CE410A, CE410X, CE411A, CE412A, CE413A

conforms to the following Product Specifications:

SAFETY: IEC 60950-1:2005 / EN60950-1: 2006+A11
IEC 60825-1:2007 / EN 60825-1:2007 (Class 1 Laser/LED Product)
IEC 62311:2007 / EN 62311:2008
GB4943-2001

EMC: CISPR22:2005 +A1 / EN55022:2006 +A1 - Class B¹⁾
EN 61000-3-2:2006
EN 61000-3-3:2008
EN 55024:1998 +A1 +A2
FCC Title 47 CFR, Part 15 Class B¹⁾ / ICES-003, Issue 4
GB9254-2008, GB17625.1-2003

TELECOM: ES 203 021; FCC Title 47 CFR, Part 68³⁾

Radio⁵⁾ EN 301 489-1:V1.8.1 (2008-04) / EN 301 489-17:V2.1.1 (2009-05)
EN 300 328: V1.7.1 (2006-10)
FCC Title 47 CFR, Part 15 Subpart C (Section 15.247) / IC: RSS-210

ENERGY USE: Regulation (EC) No. 1275/2008
ENERGY STAR® Qualified Imaging Equipment Typical Electricity Consumption (TEC) Test Procedure

Supplementary Information:

The product herewith complies with the requirements of the R&TTE; Directive 1999/5/EC Annex II and Annex IV, EMC Directive 2004/108/EC, the Low Voltage Directive 2006/95/EC, the EuP Directive 2005/32/EC and carries the CE-Marking  accordingly.

This Device complies with Part 15 of the FCC Rules. Operation is subject to the following two Conditions: (1) this device may not cause harmful interference, and (2) this device must accept any interference received, including interference that may cause undesired operation.

1. The product was tested in a typical configuration with Hewlett-Packard Personal Computer Systems.
2. For regulatory purposes, this product is assigned a Regulatory model number. This number should not be confused with the product name or the product number(s).
3. Telecom approvals and standards appropriate for the target countries/regions have been applied to this product, in addition to those listed above.
4. This product uses an analog fax accessory module which Regulatory Model numbers are: BOISB-0903-00 (US-LIU) or BOISB-0903-01 (EURO LIU), as needed to meet technical regulatory requirements for the countries/regions this product will be sold.
5. This product uses a radio module device which Regulatory Model number is SDGOB-0892 as needed to meet technical regulatory requirements for the countries/regions this product will be sold.

Boise, Idaho USA

October 2011

For regulatory topics only:

European Contact: Your Local Hewlett-Packard Sales and Service Office or Hewlett-Packard GmbH, Department HQ-TRE / Standards Europe, Herrenberger Straße 140, D-71034, Böblingen (FAX: +49-7031-14-3143)
www.hp.eu/certificates

USA Contact: Product Regulations Manager, Hewlett-Packard Company, PO Box 15, Mail Stop 160, Boise, Idaho 83707-0015 (Phone: 208-396-6000)

Certificate of volatility

This is a statement regarding the volatility of customer data stored in memory. It also outlines how to securely erase data from the product.

Types of memory

Volatile memory

The product utilizes 192 MB of volatile memory (SDRAM) used for temporary storage during the process of jobs, and for applications running on the operating system. When the printer is powered off, the memory is erased.

Non-volatile memory

The product utilizes 2.1 GB of non-volatile memory (EEPROM, Flash) containing the boot code and factory product configuration data required for the device to function. No customer print data is stored in non-volatile memory. There are no steps to clear this data.

Safety statements

Laser safety

The Center for Devices and Radiological Health (CDRH) of the U.S. Food and Drug Administration has implemented regulations for laser products manufactured since August 1, 1976. Compliance is mandatory for products marketed in the United States. The device is certified as a “Class 1” laser product under the U.S. Department of Health and Human Services (DHHS) Radiation Performance Standard according to the Radiation Control for Health and Safety Act of 1968. Since radiation emitted inside the device is completely confined within protective housings and external covers, the laser beam cannot escape during any phase of normal user operation.

⚠ WARNING! Using controls, making adjustments, or performing procedures other than those specified in this user guide may result in exposure to hazardous radiation.

Canadian DOC regulations

Complies with Canadian EMC Class B requirements.

« Conforme à la classe B des normes canadiennes de compatibilité électromagnétiques. « CEM ». »

VCCI statement (Japan)

この装置は、情報処理装置等電波障害自主規制協議会（VCCI）の基準に基づくクラスB情報技術装置です。この装置は、家庭環境で使用することを目的としていますが、この装置がラジオやテレビジョン受信機に近接して使用されると、受信障害を引き起こすことがあります。
取扱説明書に従って正しい取り扱いをして下さい。

Power cord instructions

Make sure your power source is adequate for the product voltage rating. The voltage rating is on the product label. The product uses either 100-127 Vac or 220-240 Vac and 50/60 Hz.

Connect the power cord between the product and a grounded AC outlet.

⚠ CAUTION: To prevent damage to the product, use only the power cord that is provided with the product.

Power cord statement (Japan)

製品には、同梱された電源コードをお使い下さい。
同梱された電源コードは、他の製品では使用出来ません。

EMC statement (Korea)

B급 기기 (가정용 정보통신기기)

이 기기는 가정용으로 전자파적합등록을 한 기기로서
주거지역에서는 물론 모든지역에서 사용할 수 있습니다.

Laser statement for Finland

Luokan 1 laserlaite

Klass 1 Laser Apparat

HP LaserJet Pro 300 color MFP M375nw, HP LaserJet Pro 400 color MFP M475dn, M475dw, laserkirjoitin on käyttäjän kannalta turvallinen luokan 1 laserlaite. Normaalisti käytössä kirjoittimen suojakotelo estää lasersäteiden pääsyn laitteen ulkopuolelle. Laitteen turvallisuusluokka on määritetty standardin EN 60825-1 (2007) mukaisesti.

VAROITUS !

Laitteen käyttäminen muulla kuin käyttöohjeessa mainitulla tavalla saattaa altistaa käyttäjän turvallisuusluokan 1 ylittävälle näkymättömälle lasersäteilylle.

VARNING !

Om apparaten används på annat sätt än i bruksanvisning specificerats, kan användaren utsättas för osynlig laserstrålning, som överskrider gränsen för laserklass 1.

HUOLTO

HP LaserJet Pro 300 color MFP M375nw, HP LaserJet Pro 400 color MFP M475dn, M475dw - kirjoittimen sisällä ei ole käyttäjän huollettavissa olevia kohteita. Laitteen saa avata ja huoltaa ainoastaan sen huoltamiseen koulutettu henkilö. Tällaiseksi huoltotoimenpiteeksi ei katsota väriainekasetin vaihtamista, paperiradan puhdistusta tai muita käyttäjän käsikirjassa lueteltuja, käyttäjän tehtäväksi tarkoitettuja ylläpitotoimia, jotka voidaan suorittaa ilman erikoistyökaluja.

VARO !

Mikäli kirjoittimen suojakotelo avataan, olet alttiina näkymättömälle lasersäteilylle laitteen ollessa toiminnassa. Älä katso säteeseen.

VARNING !

Om laserprinterns skyddshölje öppnas då apparaten är i funktion, utsättas användaren för osynlig laserstrålning. Betrakta ej strålen.

Tiedot laitteessa käytettävän laserdiodin säteilyominaisuuksista: Aallonpituus 775-795 nm Teho 5 m W
Luokan 3B laser.

GS statement (Germany)

Das Gerät ist nicht für die Benutzung im unmittelbaren Gesichtsfeld am Bildschirmarbeitsplatz vorgesehen. Um störende Reflexionen am Bildschirmarbeitsplatz zu vermeiden, darf dieses Produkt nicht im unmittelbaren Gesichtsfeld platziert werden.

Substances Table (China)

有毒有害物质表

根据中国电子信息产品污染控制管理办法的要求而出台

部件名称	有毒有害物质和元素					
	铅 (Pb)	汞 (Hg)	镉 (Cd)	六价铬 (Cr(VI))	多溴联苯 (PBB)	多溴二苯醚 (PBDE)
打印引擎	X	0	X	0	0	0
复印机组件	X	0	0	0	0	0
控制面板	0	0	0	0	0	0
塑料外壳	0	0	0	0	0	0
格式化板组件	X	0	0	0	0	0
碳粉盒	X	0	0	0	0	0

3690

0：表示在此部件所用的所有同类材料中，所含的此有毒或有害物质均低于 SJ/T11363-2006 的限制要求。

X：表示在此部件所用的所有同类材料中，至少一种所含的此有毒或有害物质高于 SJ/T11363-2006 的限制要求。

注：引用的“环保使用期限”是根据在正常温度和湿度条件下操作使用产品而确定的。

Restriction on Hazardous Substances statement (Turkey)

Türkiye Cumhuriyeti: EEE Yönetmeliğine Uygundur

Restriction on Hazardous Substances statement (Ukraine)

Обладнання відповідає вимогам Технічного регламенту щодо обмеження використання деяких небезпечних речовин в електричному та електронному обладнанні, затвердженого постановою Кабінету Міністрів України від 3 грудня 2008 № 1057

Additional statements for telecom (fax) products

EU Statement for Telecom Operation

This product is intended to be connected to the analog Public Switched Telecommunication Networks (PSTN) of European Economic Area (EEA) countries/regions.

It meets requirements of EU R&TTE Directive 1999/5/EC (Annex II) and carries appropriate CE conformity marking.

For more details see Declaration of Conformity issued by the manufacturer in another section of this manual.

However due to differences between individual national PSTNs the product may not guarantee unconditional assurance of successful operation on every PSTN termination point. Network compatibility depends on the correct setting being selected by the customer in preparation of its connection to the PSTN. Please follow the instructions provided in the user manual.

If you experience network compatibility issues, please contact your equipment supplier or Hewlett-Packard help desk in the country/region of operation.

Connecting to a PSTN termination point may be the subject of additional requirements set out by the local PSTN operator.

New Zealand Telecom Statements

The grant of a Telepermit for any item of terminal equipment indicates only that Telecom has accepted that the item complies with minimum conditions for connection to its network. It indicates no endorsement of the product by Telecom, nor does it provide any sort of warranty. Above all, it provides no assurance that any item will work correctly in all respects with another item of Telepermitted equipment of a different make or model, nor does it imply that any product is compatible with all of Telecom's network services.

This equipment may not provide for the effective hand-over of a call to another device connected to the same line.

This equipment shall not be set up to make automatic calls to the Telecom "111" Emergency Service.

This product has not been tested to ensure compatibility with the FaxAbility distinctive ring service for New Zealand.

Additional FCC statement for telecom products (US)

This equipment complies with Part 68 of the FCC rules and the requirements adopted by the ACTA. On the back of this equipment is a label that contains, among other information, a product identifier in the format US:AAAEQ##TXXXX. If requested, this number must be provided to the telephone company.

The REN is used to determine the quantity of devices, which may be connected to the telephone line. Excessive RENs on the telephone line may result in the devices not ringing in response to an incoming call. In most, but not all, areas, the sum of the RENs should not exceed five (5.0). To be certain of the

number of devices that may be connected to the line, as determined by the total RENs, contact the telephone company to determine the maximum REN for the calling area.

This equipment uses the following USOC jacks: RJ11C.

An FCC-compliant telephone cord and modular plug is provided with this equipment. This equipment is designed to be connected to the telephone network or premises wiring using a compatible modular jack, which is Part 68 compliant. This equipment cannot be used on telephone company-provided coin service. Connection to Party Line Service is subject to state tariffs.

If this equipment causes harm to the telephone network, the telephone company will notify you in advance that temporary discontinuance of service may be required. If advance notice is not practical, the telephone company will notify the customer as soon as possible. Also, you will be advised of your right to file a complaint with the FCC if you believe it is necessary.

The telephone company may make changes in its facilities, equipment, operations, or procedures that could affect the operation of the equipment. If this happens, the telephone company will provide advance notice in order for you to make the necessary modifications in order to maintain uninterrupted service.

If trouble is experienced with this equipment, please see the numbers in this manual for repair and (or) warranty information. If the trouble is causing harm to the telephone network, the telephone company may request you remove the equipment from the network until the problem is resolved.

The customer can do the following repairs: Replace any original equipment that came with the device. This includes the print cartridge, the supports for trays and bins, the power cord, and the telephone cord. It is recommended that the customer install an AC surge arrester in the AC outlet to which this device is connected. This is to avoid damage to the equipment caused by local lightning strikes and other electrical surges.

Telephone Consumer Protection Act (US)

The Telephone Consumer Protection Act of 1991 makes it unlawful for any person to use a computer or other electronic device, including fax machines, to send any message unless such message clearly contains, in a margin at the top or bottom of each transmitted page or on the first page of the transmission, the date and time it is sent and an identification of the business, other entity, or individual sending the message and the telephone number of the sending machine or such business, or other entity, or individual. (The telephone number provided cannot be a 900 number or any other number for which charges exceed local or long distance transmission charges).

Industry Canada CS-03 requirements

Notice: The Industry Canada label identifies certified equipment. This certification means the equipment meets certain telecommunications network protective, operational, and safety requirements as prescribed in the appropriate Terminal Equipment Technical Requirement document(s). The Department does not guarantee the equipment will operate to the user's satisfaction. Before installing this equipment, users should ensure that it is permissible for the equipment to be connected to the facilities of the local telecommunications company. The equipment must also be installed using an acceptable method of connection. The customer should be aware that compliance with the above conditions may not prevent degradation of service in some situations. Repairs to certified equipment should be coordinated by a representative designated by the supplier. Any repairs or alterations made by the user to this equipment, or equipment malfunctions, may give the telecommunications company cause to

request the user to disconnect the equipment. Users should ensure for their own protection that the electrical ground connections of the power utility, telephone lines, and internal metallic water pipe system, if present, are connected together. This precaution can be particularly important in rural areas.

⚠ CAUTION: Users should not attempt to make such connections themselves, but should contact the appropriate electric inspection authority, or electrician, as appropriate. The Ringer Equivalence Number (REN) of this device is 0.0.

Notice: The Ringer Equivalence Number (REN) assigned to each terminal device provides an indication of the maximum number of terminals allowed to be connected to a telephone interface. The termination on an interface may consist of any combination of devices subject only to the requirement that the sum of the Ringer Equivalence Number of all the devices does not exceed five (5.0). The standard connecting arrangement code (telephone jack type) for equipment with direct connections to the telephone network is CA11A.

Vietnam Telecom wired/wireless marking for ICTQC Type approved products



Additional statements for wireless products

FCC compliance statement—United States

Exposure to radio frequency radiation

⚠ CAUTION: The radiated output power of this device is far below the FCC radio frequency exposure limits. Nevertheless, the device shall be used in such a manner that the potential for human contact during normal operation is minimized.

In order to avoid the possibility of exceeding the FCC radio frequency exposure limits, human proximity to the antenna shall not be less than 20 cm (8 in)) during normal operation.

This device complies with Part 15 of FCC Rules. Operation is subject to the following two conditions: (1) this device may not cause interference, and (2) this device must accept any interference, including interference that may cause undesired operation of the device.

⚠ CAUTION: Based on Section 15.21 of the FCC rules, changes of modifications to the operation of this product without the express approval by Hewlett-Packard Company may invalidate its authorized use.

Australia statement

This device incorporates a radio-transmitting (wireless) device. For protection against radio transmission exposure, it is recommended that this device be operated no less than 20 cm from the head, neck, or body.

Brazil ANATEL statement

Este equipamento opera em caráter secundário, isto é, não tem direito à proteção contra interferência prejudicial, mesmo de estações do mesmo tipo, e não pode causar interferência a sistemas operando em caráter primário.

Canadian statements

For Indoor Use. This digital apparatus does not exceed the Class B limits for radio noise emissions from digital apparatus as set out in the radio interference regulations of the Canadian Department of Communications. The internal wireless radio complies with RSS 210 of Industry Canada.

Pour l'usage d'intérieur. Le présent appareil numérique n'émet pas de bruits radioélectriques dépassant les limites applicables aux appareils numériques de Classe B prescrites dans le règlement sur le brouillage radioélectrique édicté par le Ministère des Communications du Canada. Le composant RF interne est conforme à la norme CNR-210 d'Industrie Canada.

European Union regulatory notice

The telecommunications functionality of this product may be used in the following EU and EFTA countries/regions:

Austria, Belgium, Bulgaria, Cyprus, Czech Republic, Denmark, Estonia, Finland, France, Germany, Greece, Hungary, Iceland, Ireland, Italy, Latvia, Liechtenstein, Lithuania, Luxembourg, Malta, Netherlands, Norway, Poland, Portugal, Romania, Slovak Republic, Slovenia, Spain, Sweden, Switzerland, and United Kingdom.

Notice for use in France

For 2.4 GHz Wireless LAN operation of this product certain restrictions apply: This equipment may be used indoor for the entire 2400-2483.5 MHz frequency band (channels 1-13). For outdoor use, only 2400-2454 MHz frequency band (channels 1-9) may be used. For the latest requirements, see www.arcep.fr.

L'utilisation de cet équipement (2.4 GHz Wireless LAN) est soumise à certaines restrictions : Cet équipement peut être utilisé à l'intérieur d'un bâtiment en utilisant toutes les fréquences de 2400-2483.5 MHz (Chaîne 1-13). Pour une utilisation en environnement extérieur, vous devez utiliser les fréquences comprises entre 2400-2454 MHz (Chaîne 1-9). Pour les dernières restrictions, voir, www.arcep.fr.

Notice for use in Russia

Существуют определенные ограничения по использованию беспроводных сетей (стандарта 802.11 b/g) с рабочей частотой 2,4 ГГц: Данное оборудование может использоваться внутри помещений с использованием диапазона частот 2400-2483,5 МГц (каналы 1-13). При использовании внутри помещений максимальная эффективная изотропно-излучаемая мощность (ЭИИМ) должна составлять не более 100мВт.

Korean statement

당해 무선설비는 운용 중 전파혼선 가능성이 있음

Taiwan statement

低功率電波輻射性電機管理辦法

第十二條 經型式認證合格之低功率射頻電機，非經許可，公司、商號或使用者均不得擅自變更頻率、加大功率或變更原設計之特性及功能。

第十四條 低功率射頻電機之使用不得影響飛航安全及干擾合法通信；經發現有干擾現象時，應立即停用，並改善至無干擾時方得繼續使用。
前項合法通信，指依電信法規定作業之無線電通信。
低功率射頻電機須忍受合法通信或工業、科學及醫療用電波輻射性電機設備之干擾。

Vietnam Telecom wired/wireless marking for ICTQC Type approved products



Index

Symbols/Numerics

2ndary service menu 211

A

accessories
 ordering 246
acoustic specifications 290
advanced setup
 fax 142
after service checklist 5

B

background, gray 193
bands, troubleshooting 193
batteries included 295
bin, output
 jams, clearing 188
black and white printing
 troubleshooting 196
blank pages, troubleshooting 202

C

cables
 USB, troubleshooting 202
calibrating color 137, 213
Canadian DOC regulations 303
cartridges
 recycling 293
 supplies status page 139
 warranty 282
cautions iii
characters, troubleshooting 194
checklist
 fax troubleshooting 215
checklists
 after service 5
 preservice 5
 pretroubleshooting 114
checklists, printing 140

circuit diagram 128
clean
 touch screen 201
cleaning
 glass 199
 mode 211
 page 136
 paper path 198
color
 calibrating 137, 213
 troubleshooting 196
color usage log 139
components
 diagram 121
configuration page 116, 139
connectivity
 solving problems 206
connectors
 DC controller 119
control panel
 blank, troubleshooting 115
 button test 212
 clean touch screen 201
 cleaning page, printing 198
 display test 212
 HP Web Services menu 138
 menu map, printing 139
 menus 137
 message types 157
 messages, troubleshooting 157
 reinstalling 49
 removing the control panel 48
 Reports menu 139
conventions, document iii
copy menu 152
copy-quality test 6
covers
 left, removing 55

 locations 252
 parts list 252
 right, removing 23
 upper, removing 51
creases, troubleshooting 195
crooked pages 195
curled media 194
customer support
 online 288

D

DC controller
 connectors 119
DC controller PCA, removing 80
defaults
 NVRAM initialization 213
 restoring 211, 213
defects, repetitive 136
demo page
 troubleshooting 116
diagrams 245
 covers 252
 internal assemblies 254
 troubleshooting 121
dimensions 290
disposal, end-of-life 295
document conventions iii
document feeder
 jams 181
document feeder pickup roller
 removing 16
doors
 front, removing 58
dots, troubleshooting 192
dpi (dots per inch)
 faxing 142
drive components
 diagrams 121

drivers
usage page 139

E

electrical specifications 290
electrostatic discharge (ESD) 3
end-of-life disposal 295
environmental specifications 290
environmental stewardship
program 292
ePrint
enabling or disabling 138
error messages
control panel 157
error report 175
event log 175
error messages, fax 217, 227,
234
error report, fax
printing 226
error-correction setting, fax 226
ESD (electrostatic discharge) 3
European Union, waste disposal
295
event log 116

F

factory defaults, restoring
NVRAM initialization 213
faded print 192
fans
location 123
fax
answer mode 141
error report, printing 226
error-correction 226
reports 154
reports, printing all 225
ring type 141
solve general problems 240
unable to receive 234
unable to send 227
V.34 setting 227
fax menu 154
fax PCA, removing 76
fax ports, locating 118
fax reports, printing 154
fax troubleshooting
checklist 215
fax-quality test 6

fax-quality test 6
Finnish laser safety statement 304
firmware
version 212
fonts
lists, printing 139
formatter PCA, removing 76
front door, removing 58
fuser
assembly diagrams 121
jams, clearing 187

G

glass, cleaning 199
graph paper, printing 140
gray background,
troubleshooting 193
grayscale
troubleshooting 196

H

HP Customer Care 288
HP ePrint
enabling or disabling 138
HP Jetdirect print server
NVRAM initialization 213
HP Web Services menu 138
humidity specifications
environment 290

I

image defects, troubleshooting
192
image quality
repetitive image defects 136
initialization
NVRAM 213
interface ports
locating 118
internal assemblies
parts list 254
internal assembly
locations 254
ITB
assembly diagrams 121

J

jams
causes of 180
document feeder, clearing
181

locating 180
output bin, clearing 188
paper path, clearing 187
tracking number of 139
Japanese VCCI statement 303
Jetdirect print server
NVRAM initialization 213

K

Korean EMC statement 304

L

laser safety statements 303, 304
LEDs, troubleshooting 116
left cover, removing 55
license, software 284
light print, troubleshooting 192
lightness
faded print, troubleshooting
192
lines, troubleshooting 193
printed pages 193
location
setting 212
logs, fax
error 226
printing all 225
loose toner, troubleshooting 193

M

Macintosh
support 288
material restrictions 295
Material Safety Data Sheet
(MSDS) 296
media
curled, troubleshooting 194
wrinkled 195
memory
NVRAM initialization 213
part number 248
memory chip, print cartridge
description 283
menu
control panel, access 137
copy 152
fax 154
Fax setup 141
Network config 151
Quick Forms 140
scan 156

- Service 149
- System setup 144
- USB 157
- menus, control panel
 - HP Web Services 138
 - map, printing 139
 - Reports 139
- mercury-free product 295
- messages
 - control panel 157
- motors
 - location 123
- music paper, printing 140

N

- network
 - configuring 151
- Network config menu 151
- network port
 - locating 118
- networks
 - configuration page 139
 - settings report 139
- notebook paper, printing 140
- notes iii
- NVRAM initialization 213

O

- online support 288
- operating environment, specifications 290
- ordering
 - product documents 247
 - supplies and accessories 246
- output bin
 - jams, clearing 188
- output quality
 - repetitive image defects 136

P

- page count 139
- pages
 - blank 202
 - not printing 202
 - printing slowly 202
 - skewed 195
- paper
 - curled, troubleshooting 194
 - jams 180
 - wrinkled 195
- paper jams. *See* jams

- paper path
 - jams, clearing 187
- paper pickup problems
 - solving 191
- parts 245
 - cover locations 252
 - internal assembly locations 254
 - screws 4
 - using lists and diagrams 249
- PCAs, diagrams 125
- PCL font list 139
- physical specifications 290
- pickup roller
 - locating 124
 - removing 10
- pliers, required 3
- ports
 - locating 118
- post-service tests 6
- power
 - consumption 290
 - supplies diagrams 121
- power-on
 - troubleshooting 115
- powersave 211
- preservice checklist 5
- pretroubleshooting checklist 114
- print cartridges
 - memory chips 283
 - recycling 293
 - warranty 282
- print quality
 - repetitive image defects 136
- print quality, troubleshooting
 - image defects 192
- print-quality test 6
- printing
 - troubleshooting 202
- problem-solving
 - no response 204
 - slow response 205
- protocol settings, fax 227
- PS font list 139

Q

- quality
 - repetitive image defects 136

R

- receiving faxes
 - error report, printing 226
- recycling 293
 - HP printing supplies returns and environmental program 293
- reinstalling parts
 - control panel 49
 - DC controller PCA 80
- removing parts
 - cautions for 2
 - checklists 5
 - control panel 48
 - DC controller PCA 80
 - document feeder pickup roller 16
 - fax PCA 76
 - formatter PCA 76
 - front door 58
 - left cover 55
 - pickup roller 10
 - right cover 23
 - rollers 9
 - separation roller 13
 - tools, required 3
 - upper cover 51
- repetitive defects, troubleshooting 136, 195
- replacing
 - parts 2
- reports
 - demo page 139
 - error 175, 212
 - fax 154
 - menu map 113
 - print quality page 139
 - service 212
- Reports menu 139
- reports, fax
 - error 226
 - printing all 225
- resets
 - NVRAM initialization 213
- restoring
 - default settings 213
 - defaults 211
 - factory defaults 213
 - NVRAM initialization 213
- right cover, removing 23

- rollers
 - locating 124
 - pickup and separation, removing 9
 - repetitive image defects 136
- rollers and pads removing 9
- S**
- safety statements 303, 304
- scan menu 156
- scanner
 - assembly, removing 26
 - glass cleaning 199
- scatter, troubleshooting 195
- screwdrivers, required 3
- screws
 - replacing 2
- secondary service menu 211
- sending faxes
 - error report, printing 226
- separation roller, removing 13
- separation rollers
 - locating 124
- service
 - tools, required 3
- Service menu 149, 211
 - cleaning mode 211
 - powersave 211
 - restoring defaults 211
 - secondary 211
 - settings 211
- service page 139
- settings
 - network report 139
- size 290
- skewed pages 195
- smear toner, troubleshooting 193
- software
 - software license agreement 284
- solve
 - fax problems 227
- solve problems
 - fax 240
- solving
 - direct-connect problems 206
 - network problems 206

- specifications
 - electrical and acoustic 290
 - environmental 290
 - physical 290
- specks, troubleshooting 192
- spots, troubleshooting 192
- static precautions 3
- status
 - page 116
 - supplies, printing report 139
- storing
 - environmental specifications 290
- streaks, troubleshooting 193
- supplies
 - ordering 246
 - recycling 293
- supplies status page 139
- support
 - online 288
- System setup menu 144
- T**
- technical support
 - online 288
- temperature specifications
 - environment 290
- tests
 - component 117
 - copy-quality 6
 - fax-quality 6
 - internal print quality 135
 - post-service 6
 - print-quality 6
 - service page 135
- text, troubleshooting
 - misformed characters 194
- timing diagram 127
- tips iii
- toner
 - loose, troubleshooting 193
 - scatter, troubleshooting 195
 - smear, troubleshooting 193
 - specks, troubleshooting 192
- toner cartridges
 - part numbers 248
 - supplies status page 139
- tools, required 3
- touch screen, clean 201

- Tray 1
 - jams, clearing 183
- Tray 2
 - jams, clearing 186
- Tray 3
 - part number 248
- trays
 - jams, clearing 186
- troubleshooting
 - about 114
 - blank pages 202
 - calibration 137
 - checklist 112, 114
 - color 196
 - configuration page 116
 - control panel messages 157
 - control-panel tests 117
 - curled media 194
 - demo page 116
 - diagrams 121
 - direct-connect problems 206
 - event log 116
 - faded print 192
 - fax error-correction setting 226
 - faxes 215
 - image defects 192
 - jams 180
 - LED diagnostics 116
 - lines, printed pages 193
 - loose toner 193
 - network problems 206
 - NVRAM initialization 213
 - pages not printing 202
 - pages printing slowly 202
 - power-on 115
 - receive fax 234
 - repetitive defects 195
 - reports and tools 116
 - send fax 227
 - skewed pages 195
 - status page 116
 - text 194
 - toner scatter 195
 - toner smear 193
 - toner specks 192
 - USB cables 202
 - using service mode 211
 - wrinkles 195

U

- upper cover, removing 51
- usage page 139
- USB cable, part number 248
- USB menu 157
- USB port
 - locating 118
 - troubleshooting 202

V

- V.34 setting 227
- vertical lines, troubleshooting 193
- volume
 - settings 145

W

- warnings iii
- warranty
 - license 284
 - print cartridges 282
 - product 280
- wavy paper, troubleshooting 194
- Web sites
 - customer support 288
 - Macintosh customer support 288
 - Material Safety Data Sheet (MSDS) 296
- weight 290
- wireless
 - configuring 151
- wrinkles, troubleshooting 195



CE863-90966

