

Dell™ C7765dn
Color Multifunction Printer
User's Guide

Regulatory Model: C7765dn

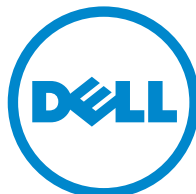

Information in this document is subject to change without notice.

© 2014 Dell Inc. All rights reserved.

Reproduction of these materials in any manner whatsoever without the written permission of Dell Inc. is strictly forbidden.

Trademarks used in this text: *Dell* and the *DELL* logo are trademarks of Dell Inc.; *Microsoft*, *Windows*, *Windows NT*, *Windows Server*, *Windows Vista*, *Microsoft Network*, and *Internet Explorer* are either trademarks or registered trademarks of Microsoft Corporation in the United States and/or other countries; *NetWare* is a registered trademark of Novell, Inc. in the United States and other countries; *EtherTalk*, *Macintosh*, and *Mac OS* are trademarks of Apple Inc., registered in the U.S. and other countries; *Adobe*, *Acrobat*, and *PostScript* are either registered trademarks or trademarks of Adobe Systems Incorporated in the United States and/or other countries; *PCL*, *HP-GL*, and *HP-GL/2* are registered trademarks of Hewlett-Packard Corporation; *ThinPrint* is a registered trademark of ThinPrint GmbH in Germany and other countries; *RSA* and *BSAFE* are either registered trademarks or trademarks of EMC Corporation in the United States and/or other countries.

XML Paper Specification (XPS): This product may incorporate intellectual property owned by Microsoft Corporation. The terms and conditions upon which Microsoft is licensing such intellectual property may be found at <http://go.microsoft.com/fwlink/?LinkId=52369>; *DES*: This product includes software developed by Eric Young (eay@mincom.oz.au); *AES*: Copyright (c) 2003, Dr Brian Gladman, Worcester, UK. All rights reserved. This product uses published AES software provided by Dr Brian Gladman under BSD licensing terms; *TIFF (libtiff)*: Copyright (c) 1988-1997 Sam Leffler and Copyright (c) 1991-1997 Silicon Graphics, Inc.; *ICC Profile (Little cms)*: Copyright (c) 1998-2004 Marti Maria.

Nuance™ OCR © 1994-2014 Nuance Communications. All Rights Reserved.

Other trademarks and trade names may be used in this document to refer to either the entities claiming the marks and names or their products. Dell Inc. disclaims any proprietary interest in trademarks and trade names other than its own.

The printer software uses some of the codes defined by the Independent JPEG Group.

WSD stands for Web Services on Devices.



SD Logo is a trademark of SD-3C, LLC.

As for RSA BSAFE



This printer includes RSA® BSAFE® Cryptographic software from EMC Corporation.

UNITED STATES GOVERNMENT RESTRICTED RIGHTS

This software and documentation are provided with RESTRICTED RIGHTS. Use, duplication or disclosure by the Government is subject to restrictions as set forth in subparagraph (c)(1)(ii) of the Rights in Technical Data and Computer Software clause at DFARS 252.227-7013 and in applicable FAR provisions: Dell Inc., One Dell Way, Round Rock, Texas, 78682, USA.

June 2014 Rev. A05

Table of Contents

Table of Contents	3
1 Before Using the Machine	17
Preface.....	18
Types of Manuals.....	19
Using This Guide.....	20
Organization of This Guide.....	20
Conventions.....	22
Technical Support	24
Dell™ Technical Support Policy.....	24
Warranty and Return Policy.....	24
Contacting Dell.....	24
About License	25
RSA BSAFE	25
Heimdal.....	25
JPEG Code	25
Libcurl	26
FreeBSD	26
OpenLDAP.....	27
DES.....	29
AES.....	29
TIFF (libtiff)	29
ICC Profile (Little cms)	29
XML Paper Specification (XPS).....	29
Cyrus SASL.....	29
Legal Notice.....	31
2 Product Overview	33
Machine Components	34
Power Source.....	41
Switching the Main Power On	41
Switching the Power On.....	41
Switching the Power Off	42
Switching the Main Power Off.....	43
Circuit Breaker	44
Power Saver Mode	46
Wakeup Motion Sensor	47
Entering the Power Saver Mode.....	47
Exiting the Power Saver Mode.....	47
Control Panel	49
Screens and Buttons Displayed	52
About the [Home] Screen	53
Entering Text.....	57
Installing the Tray Attachment on the Finisher-B1.....	58

3	Copy	59
	Copying Procedure	60
	Step 1 Loading Documents	60
	Step 2 Selecting Features	62
	Step 3 Entering a Quantity	63
	Step 4 Starting the Copy Job	64
	Step 5 Confirming the Copy Job in Job Status	65
	Operations during Copying	66
	Stopping the Copy Job	66
	Changing the Number of Copies	67
	Interrupting the Copy Job	68
	Simple Copy	69
	Paper Supply (Selecting the Paper for Copying)	69
	Reduce / Enlarge (Making Enlarged/Reduced Copies)	70
	2 Sided Copying (Making 2 Sided Copies)	71
	Auto / Color / Black & White (Selecting the Color for Copying)	72
	Lighten/Darken (Adjusting the Copy Density)	72
	2 Pages per Side (Copying Two Pages onto One Sheet)	73
	1 Staple	73
	Copy	74
	Reduce / Enlarge (Making Enlarged/Reduced Copies)	74
	Paper Supply (Selecting the Paper for Copying)	77
	Output Color (Selecting the Color for Copying)	81
	2 Sided Copying (Making 2 Sided Copies)	85
	Copy Output (Specifying Finishing Options)	85
	Pages per Side (Copying Multiple Pages onto One Sheet)	85
	Lighten/Darken (Adjusting the Copy Density)	86
	Image Quality	87
	Original Type (Selecting the Document Type)	87
	Image Options (Adjusting Copy Density/Sharpness/Saturation of Images)	89
	Image Enhancement (Erasing the Background Color of Documents/Adjusting Contrast)	90
	Color Effects (Selecting an Image Quality)	91
	Color Balance (Adjusting Color Balance)	92
	Color Shift (Adjusting the Color Tone)	93
	Layout Adjustment	94
	2 Sided Copying (Making 2 Sided Copies)	95
	Book Copying (Copying Facing Pages onto Separate Sheets)	96
	2 Sided Book Copying (Making 2 Sided Copies of Facing Pages)	98
	Original Size (Specifying the Scan Size for the Document)	99
	Mixed Size Originals (Scanning Different Size Documents Simultaneously)	100
	Edge Erase (Erasing Edges and Margin Shadows of the Document)	101
	Image Shift (Adjusting the Image Position)	103
	Invert Image (Making Reversed Copies of Images)	105
	Original Orientation (Specifying the Orientation of Loaded Documents)	106
	Image Rotation (Changing the Orientation of Images)	107
	Output Format	109
	2 Sided Copying (Making 2 Sided Copies)	109

Booklet Creation (Creating a Booklet).....	110
Covers (Attaching Covers to Copies).....	113
Pages per Side (Copying Multiple Pages onto One Sheet).....	114
Poster (Making Enlarged Copies Spread over Multiple Sheets).....	115
Repeat Image (Making Multiple Copies on One Sheet)	117
Annotations (Adding a Comment/a Date/Page Numbers to Copies)	118
Watermark (Printing Control Numbers on the Background of Copies)	124
Folding (Outputting Bi-Folded Paper).....	126
Preset Repeat Image (Making Multiple Copies on a Single Sheet).....	127
Transparency Options (Inserting Blank Sheets between Transparencies).....	128
Copy Output (Specifying Finishing Options)	129
ID Card Copy (Copying Both Sides of an ID Card)	133
Job Assembly	135
Build Job (Processing Documents Scanned with Different Settings as One Job)	135
Sample Job (Checking the Finished Output of the Copy)	139
Combine Original Sets (Adding Originals).....	140
Delete Outside / Delete Inside (Deleting Outside or Inside of the Selected Area)	142
Stored Programming (Calling a Stored Program for Build Job).....	143
4 Fax.....	145
Fax Procedure	146
Step 1 Loading Documents.....	146
Step 2 Selecting Features.....	148
Step 3 Specifying Destinations	149
Step 4 Starting the Fax Job	150
Step 5 Confirming the Fax Job in Job Status	152
Operations during Faxing.....	153
Stopping the Fax Job.....	153
Changing the Scan Settings.....	154
5 Scan.....	157
Scanning Procedure.....	158
Step 1 Loading Documents.....	158
Step 2 Selecting the Features.....	160
Step 3 Starting the Scan Job.....	162
Step 4 Confirming the Scan Job in Job Status	164
Step 5 Saving the Scanned Data	164
Operations during Scanning	165
Stopping the Scan Job	165
Previewing the Scanned Images during a Scan Job	166
Changing Scan Settings.....	167
6 Job Flow Sheets	169
Job Flow Procedure	170
Step 1 Opening the [Job Flow Sheets] Screen	170
Step 2 Selecting a Job Flow Sheet.....	170
Step 3 Confirming/Changing the Job Flow Sheet	171
Step 4 Starting the Job Flow Sheet	171
Selecting/Changing a Job Flow Sheet	172

7	Stored Programming	175
	Stored Programming Overview.....	176
	Registering/Deleting/Renaming Stored Programs.....	177
	Registering Stored Programs	178
	Notes and Restrictions on Registering Stored Programs	179
	Registering Stored Programs for Build Job.....	180
	Deleting Stored Programs.....	180
	Entering/Changing a Stored Program Name	181
	Assigning/Changing Icons for Stored Programs	182
	Calling a Stored Program.....	183
	Calling a Stored Program for Build Job	184
8	Web Applications	185
	Web Applications Overview	186
	Accessing Web Applications.....	187
	Accessing Using Buttons Registered on the [Home] Screen.....	188
9	Media Print (Text and Photos).....	189
	Overview of Media Print	190
	Supported Media and File Formats	191
	Notes and Restrictions on Media Print	191
	Inserting USB Memory Device.....	193
	Media Print - Text.....	196
	Selecting Files.....	196
	[Select From List] Screen	197
	Media Print - Photos	198
	Selecting Files.....	198
	[Select From List] Screen	199
	Selecting the Printing Options.....	200
	Media Print - Photos	200
	Media Print - Text.....	201
	Index Print.....	202
10	Job Status.....	203
	Job Status Overview	204
	Checking Current/Pending Jobs.....	205
	Checking Completed Jobs	207
	Printing and Deleting Stored Jobs	208
	Secure Print.....	208
	Sample Set.....	210
	Delayed Print.....	212
	Charge Print.....	213
	Private Charge Print.....	216
	Public Folder.....	218
	Undelivered Faxes.....	219
	Printing Pending Jobs	221
	Handling Error Terminations	222

11	Computer Operations	223
	Features Overview.....	224
12	Paper and Other Media	225
	Paper Types	226
	Loadable Quantity and Weight	226
	Supported Paper.....	226
	Loading Paper.....	237
	Loading Paper in Trays 1 to 4.....	237
	Loading Paper in Tray 5 (Bypass Tray).....	238
	Loading Paper in Tray 6 (HCF B1).....	239
	Changing the Paper Size	241
	Changing the Paper Size for Trays 1 to 4.....	241
	Changing the Paper Size for Tray 6 (HCF B1) (optional).....	242
	Changing the Paper Settings	244
13	Maintenance	247
	Replacing Consumables.....	248
	Replacing Toner Cartridges	248
	Replacing Waste Toner Container R5.....	250
	Replacing Drum Cartridges R1, R2, R3, or R4	253
	Replacing Staple Cartridge (for Finisher-B1)	256
	Replacing Booklet Staple Cartridge (for Booklet Maker Unit for Finisher-B1)	258
	Emptying the Hole Punch Waste Container (for Finisher-B1).....	259
	Cleaning the Machine.....	260
	Cleaning the Exterior.....	260
	Cleaning the Interior (LED Printheads)	260
	Cleaning the Touch Screen.....	262
	Cleaning Document Cover and Document Glass	262
	Cleaning Film and Constant Velocity Transport Glass.....	263
	Cleaning Document Feeder Rollers.....	263
	Executing Calibration	265
	Printing a Report/List	269
	Deleting a Private Charge Print Job with an Invalid User ID.....	270
	Setting Restore Tool.....	271
14	Machine Status	273
	Overview of Machine Status	274
	Machine Information.....	275
	General Information.....	275
	Paper Tray Status.....	276
	Print Reports	276
	Automatically Printed Reports/Lists.....	284
	Overwrite Hard Disk.....	285
	Print Mode.....	285
	Fax Receiving Mode.....	288
	Faults	289

Supplies.....	290
Billing Information	291
Billing Information	291
User Account Billing Information.....	292
15 Tools.....	295
System Settings Procedure	296
Step 1 Entering System Administration Mode	296
Step 2 Entering the System Administrator User ID and Passcode	296
Step 3 Selecting [Tools]	297
Step 4 Selecting a Tab on the [Tools] Screen	297
Step 5 Setting a Feature	299
Step 6 Exiting System Administration Mode	299
Tools Menu List.....	300
Common Service Settings.....	314
Machine Clock/Timers	314
Power Saver Settings	317
Audio Tones	317
Screen/Button Settings	319
Paper Tray Settings.....	321
Image Quality Adjustment.....	326
Reports.....	327
Maintenance.....	329
Watermark	330
Force Annotation.....	332
Print Universal Unique ID	333
Notify Job Completion by E-mail	333
Plug-in Settings	334
Other Settings.....	334
Copy Service Settings.....	348
Copy Tab - Features Allocation.....	348
Preset Buttons	349
Copy Defaults.....	349
Copy Control.....	354
Original Size Defaults	356
Reduce/Enlarge Presets	357
Custom Colors.....	357
Annotations - Create Comments	357
Connectivity & Network Setup	358
Port Settings	358
Protocol Settings	363
Machine's E-mail Address/Host Name	366
Proxy Server Settings	367
Outgoing/Incoming E-mail Settings	368
Remote Authentication/Directory Service.....	369
Security Settings	374
Other Settings.....	379
Print Service Settings.....	380

Allocate Memory	380
Delete Form	382
Other Settings	382
Scan Service Settings	387
Screen Defaults	387
Scan Defaults	388
Scan to PC Defaults	390
Original Size Defaults	391
Output Size Defaults	391
Reduce/Enlarge Presets	391
Other Settings	392
Fax Service Settings	394
Screen Defaults	394
Fax Defaults	395
Fax Control	396
Fax Received Options	401
Reduce/Enlarge Presets	401
Original Size Defaults	402
Local Terminal Information	402
Internet Fax Control	403
E-mail/Internet Fax Service Settings	406
E-mail Control	406
Address Book Settings	409
Folder Service Settings	410
Job Flow Service Settings	411
Media Print Service Settings	412
Stored File Settings	413
Web Applications Service Setup	415
Server Certificate Verification Settings	415
Server Setup	417
Other Settings	418
Web Browser Setup	419
Setup	421
Create Folder	421
Stored Programming	423
Create Job Flow Sheet	423
Create Job Flow Sheet Keyword	431
Add Address Book Entry	431
Create Fax Group Recipients	439
Add Fax Comment	440
Paper Tray Attributes	440
Accounting	441
Create/View User Accounts	441
View Accounts	444
Reset User Accounts	444
System Administrator's Meter (Copy Jobs)	445

Accounting Type	445
Accounting Login Screen Settings.....	446
Fax Billing Data.....	447
Accounting/Billing Device Settings	448
Authentication/Security Settings	450
System Administrator Settings	450
Authentication.....	451
Allow User to Disable Active Settings.....	458
Job Status Default	459
Overwrite Hard Disk.....	459
16 Dell Printer Configuration Web Tool Settings.....	461
Installation of Dell Printer Configuration Web Tool	462
Preparations	462
Configuration on the Machine	463
Starting Dell Printer Configuration Web Tool.....	464
Configuring Machine Settings Using Dell Printer Configuration Web Tool	465
17 Printer Environment Settings.....	469
Print Overview	470
Installation When Using USB Port	473
Step 1 Preparations	473
Step 2 Configuration on the Machine	473
Step 3 Configuration on the Computer	474
Dell Printer Configuration Web Tool Setting Items	474
Installation When Using TCP/IP (LPD/Port 9100).....	475
Step 1 Preparations	475
Step 2 Configuration on the Machine	475
Step 3 Configuration on the Computer	476
Dell Printer Configuration Web Tool Setting Items	476
Installation When Using NetWare	478
Step 1 Preparations	478
Step 2 Configuration on the Machine	478
Step 3 Configuration on the Computer	479
Dell Printer Configuration Web Tool Setting Items	480
Installation When Using Microsoft Network (SMB)	481
Step 1 Preparations	481
Step 2 Configuration on the Machine	481
Step 3 Configuration on the Computer	482
Dell Printer Configuration Web Tool Setting Items	482
Installation When Using Internet Printing Protocol (IPP)	483
Step 1 Preparations	483
Step 2 Configuration on the Machine	483
Step 3 Configuration on the Computer	484
Dell Printer Configuration Web Tool Setting Items	484
Installation When Using EtherTalk	485
Step 1 Preparations	485

Step 2 Configuration on the Machine	485
Step 3 Configuration on the Computer	486
Dell Printer Configuration Web Tool Setting Items.....	486
18 E-mail Environment Settings.....	487
E-mail Overview.....	488
Preparations	489
Installation Procedures	491
Step 1 Enabling Port and Setting up TCP/IP.....	491
Step 2 Configuring E-mail Environment.....	492
Dell Printer Configuration Web Tool Setting Items.....	494
19 Scanner Environment Settings	495
Scan Service Overview	496
Configuration of Store to Folder.....	498
Step 1 Enabling Port and Setting up TCP/IP.....	498
Step 2 Registering a Folder	499
Step 3 Configuring on the Computer.....	499
Configuration of Scan to PC.....	500
Step 1 Preparations	500
Step 2 Enabling Port and Setting up TCP/IP.....	501
Step 3 Configuration on the Computer	502
Configuration of Store to USB	503
Step 1 Available USB Memory Devices.....	503
Step 2 Dell Printer Configuration Web Tool Setting Items.....	503
Configuration of Job Flow Sheets	504
Step 1 Enabling Ports and Setting up TCP/IP.....	504
Step 2 Configuring the SNMP Port.....	505
Step 3 Configuration on the Computer	505
Configuration of Store & Send Link.....	506
Step 1 Configuring E-mail.....	506
Step 2 Enabling Authentication.....	506
Step 3 Other Settings.....	506
Step 4 Dell Printer Configuration Web Tool Setting Items.....	507
Configuration of Store to WSD	508
Step 1 Preparations	508
Step 2 Enabling Port	508
Step 3 Confirmation on the Computer.....	509
20 Using the Internet Fax Service	511
Internet Fax Overview	512
Preparations	512
System Requirements for the Machine.....	512
E-Mail Environment.....	512
Installation Procedures	514
Step 1 Enabling Port and Setting up TCP/IP.....	514
Step 2 Configuring E-mail Environment.....	515

Step 3 Testing the Internet Fax	516
21 Encryption and Digital Signature Settings.....	517
Encryption and Digital Signature Overview.....	518
Types of Certificate	518
Encryption Features for Communication.....	519
Encryption and Digital-Signature Features for Scan Files	520
Configuration of HTTP Communications Encryption	521
Installation Overview	521
Step1 Configuration on the Machine	521
Step2 Configuration on the Computer.....	522
Configuration of Encryption using IPSec.....	523
Installation Overview	523
Step1 Import and Configuration of a Certificate	523
Step2 Configuration on the Machine (Configuration of IPSec).....	524
Step3 Configuration on the Computer.....	525
Configuration of E-mail Encryption/Digital Signature.....	526
Installation Overview	526
Step1 Configuration on the Machine	526
Step2 Configuration on Sender and Recipient.....	528
Configuration of PDF/XPS Signature.....	530
Installation Overview	530
Step1 Configuration on the Machine	530
Step2 Configuration on the Computer.....	531
22 Authentication and Accounting Features	533
Overview of Authentication and Accounting Feature.....	534
Overview of Authentication Feature	534
Overview of Accounting Feature	535
Authentication.....	536
User Types Managed by Authentication Feature	536
User Roles and Authorization Groups.....	536
Types of Authentication	538
Types of Account Administration	539
Authentication and Accounting Relationship.....	540
Services Controlled by Authentication	541
Overview	541
Services Restricted by User ID Authentication	541
Services Restricted by the Combined Use of Smart Card Authentication and User ID Authentication.....	543
Authentication for Job Flow Sheets and Folders	546
Overview	546
When the Authentication Feature is Disabled	548
When the Authentication Feature is Enabled	551
Jobs Manageable by Account Administration	554
Configuration for Authentication.....	557
Installation Overview	557

Enabling Authentication	557
Changing the Default Authorization Group Settings	560
Creating an Authorization Group.....	560
Configuration for Account Administration.....	562
Step 1 Selecting an Accounting Type	562
Step 2 Registering User Information	562
User Authentication Operations	564
Authenticating Login Users.....	564
Changing Passcode	565
23 Problem Solving	567
Troubleshooting	568
Machine Trouble.....	569
Image Quality Trouble.....	573
Trouble during Copying	579
Unable to Copy.....	579
The Copy Result is Not What was Expected.....	580
Trouble during Printing.....	583
Unable to Print.....	583
The Print Result is Not What was Expected.....	584
Trouble during Faxing	586
Sending Problems.....	586
Receiving Problems.....	588
Trouble during Scanning.....	590
Unable to Scan with the Machine	590
Unable to Import Scanned Documents to the Computer.....	591
Unable to Send a Scanned Document over the Network (FTP/SMB)	592
Unable to Send E-mail.....	593
The Image is not What was Expected.....	593
Network-related Problems	595
When using SMB	595
When using NetWare	597
When using TCP/IP	601
When using EtherTalk.....	602
Dell Printer Configuration Web Tool Problems.....	603
E-mail Features Problems	604
Internet/Intranet Connection Problems	605
IPv4 and IPv6 Connection Problems.....	607
Media Print - Text Trouble	609
Media Print - Photos Trouble	610
Status Code	611
Other Errors	682
Paper Jams	683
Paper Jams in Upper Left Cover A	683
Paper Jams in Bottom Left Cover C	685
Paper Jams in Top Left Cover D	685

	Paper Jams in Trays 1 to 4	686
	Paper Jams in Tray 5 (Bypass Tray)	687
	Paper Jams in Tray 6 (HCF B1)	687
	Paper Jams in Duplex Module B	689
	Paper Jams in Finisher-B1	690
	Document Jams	692
	Duplex Automatic Document Feeder B1-C	692
	Stapler Faults	694
	Staple Jams in Staple Cartridge (for Finisher-B1)	695
24	Install Operation for Eco copy/My Forms/Shortcut Menu.....	697
	Before Installation.....	698
	Environment Settings	698
	SSL / TLS Settings in Dell Printer Configuration Web Tool	700
	Installation Procedures.....	702
	Installation	702
	Uninstallation/Version Upgrade	703
	About License.....	705
	About OSS	705
25	Install Operation for Access Google Drive™	719
	Before Installation.....	720
	Environment Settings	720
	SSL / TLS Settings in Dell Printer Configuration Web Tool	722
	Installation Procedures.....	725
	Installation	725
	Uninstallation/Version Upgrade	726
	About License.....	728
	About OSS	728
26	Using Eco copy.....	741
	About Eco copy	742
	Eco copy Procedure	743
	Problem Solving.....	745
	Troubleshooting	745
	View Detailed Information.....	745
	Notes and Restrictions	746
27	Using My Forms.....	747
	About My Forms	748
	Setup	749
	Creating Folders on the Machine	749
	Storing Files in a Folder on the Machine	749
	Using My Forms	750
	Printing Forms from the Folders on the Machine	750
	Problem Solving.....	751
	Troubleshooting	751

View Detailed Information	751
Notes and Restrictions	752
28 Using Shortcut Menu.....	753
About Shortcut Menu	754
Shortcut Menu Feature	754
Shortcut Menu Operation	755
Checking Your Environment	756
Shortcut Menu Settings.....	757
Adding/Deleting Function Buttons.....	757
Changing Function Button Name	760
Default Screen after Authentication	761
System Administrator Settings.....	762
Problem Solving	764
Warning/Error Notification	764
Checking Detail Information.....	764
Notes and Restrictions	765
29 Using Access Google Drive™.....	767
About Access Google Drive	768
Using Google Drive from the Machine	769
Log In / Log Out	769
About the Screens.....	771
Searching Files.....	774
Creating a New Collection.....	775
Printing Files.....	775
Uploading Data.....	777
Uploading Data Automatically from Folders.....	780
Settings by a System Administrator	785
Storing Authentication Information.....	785
Activating User History.....	787
Setting the Default Value.....	788
Entering Text.....	791
About the Input Screen	791
Setting Custom Text Strings.....	792
Problem Solving	793
Troubleshooting	793
Status Code	795
Checking the Content Status.....	798
Notes and Restrictions	799
About License	800
30 Google Cloud Print™.....	805
About Google Cloud Print.....	806
Overview of Google Cloud Print for Dell C7765dn	806
Operating Environment	806
Environment Settings	807

Configuring the Machine	807
Registering Devices to Google Cloud Print	808
Checking the Device Registration Status	811
Sharing a Device between Multiple Users	811
Cancelling the Registration of the Device from Google Cloud Print	811
Printing	812
Problem Solving.....	813
Problems on Registering	813
Problems on Printing	814
Status Code	815
Notes and Restrictions	817
Index.....	819

1 Before Using the Machine

This chapter describes how to use this guide, as well as legal notice you should read before using the machine.

- **Preface**18
- **Types of Manuals**19
- **Using This Guide**.....20
- **Technical Support**.....24
- **About License**.....25
- **Legal Notice**31

Preface

Thank you for selecting the Dell C7765dn Color Multifunction Printer (hereafter referred to as "the machine").

This guide is written for users who are new to the machine and provides information on copying, printing, scanning, and faxing operations, as well as troubleshooting, daily maintenance, and precautions users should take when operating the machine.

The guide assumes that you are familiar with a personal computer and that you are knowledgeable of computer networks. When you need additional information, refer to the manuals provided with the personal computer, operating system, and network products.

For information on optional components for the print feature, also refer to the guide provided with each optional accessory.

After reading this guide, be sure to keep it handy for quick reference. It will be useful in case you forget how to perform operations or if a problem occurs with the machine.

Types of Manuals

The following guides are provided with the machine.

Accompanying Manuals

PostScript User Guide (PDF)

The guide describes how to install the print driver and configure the functions in order to use the machine as a PostScript printer. This guide is included in the "PostScript Drivers" CD-ROM.

Driver CD Kit Documentation (HTML)

The documentation describes installation and configuration procedures for print drivers and the printer environment. This documentation is included in the Driver CD Kit.

Print Driver Help

The help describes print features and operations.

Guides for Optional Components

Optional components are available for the machine. Some of them come with user guides. The guides for optional components describe all the necessary steps for using the optional components and installing the software.

Using This Guide

This guide is intended for first time users of the machine. It provides information on copying, printing, e-mail, and faxing operations, as well as troubleshooting, daily maintenance, and precautions users should take when operating the machine.

Organization of This Guide

This guide consists of the following chapters:

1 Before Using the Machine

Describes how to use this guide, as well as legal notices and other important information you should read before using the machine.

2 Product Overview

Describes the basic information of the machine, such as the names of components, how to use the touch screen, how to switch the machine on and off, and how to exit the Power Saver mode.

3 Copy

Describes the basic operations and features for the Copy service.

4 Fax

Describes the basic operations and features for the Fax services.

5 Scan

Describes the basic operations and features for the Scan services.

6 Job Flow Sheets

Describes the operations to use a job flow created on a remote system.

7 Stored Programming

Describes the Stored Programming service that enables you to store customized job settings.

8 Web Applications

Describes the operations to connect to web applications.

9 Media Print (Text and Photos)

Describes the basic operations and features of Media Print that allows you to print image data and document files.

10 Job Status

Describes how to check job status and how to delete jobs.

11 Computer Operations

Describes operations performed from a computer, such as printing documents, importing scanned files, using Direct Fax, and operating Dell Printer Configuration Web Tool.

12 Paper and Other Media

Describes the types of paper and other media that you can use on the machine and how to load media in a tray.

13 Maintenance

Describes how to replace consumables and to clean the machine.

14 Machine Status

Describes how to check the faults that occurred on the machine and to print various reports/lists.

15 Tools

Describes the procedures to set up the system.

16 Dell Printer Configuration Web Tool Settings

Describes how to use Dell Printer Configuration Web Tool.

17 Printer Environment Settings

Describes the settings to use the Print feature on the machine.

18 E-mail Environment Settings

Describes the settings to use various services via e-mail on the machine.

19 Scanner Environment Settings

Describes the settings to use the Scan services on the machine.

20 Using the Internet Fax Service

Describes the settings to use the services via the Internet Fax service on the machine.

21 Encryption and Digital Signature Settings

Describes how to configure the machine to use the Encryption and the Digital Signature features with your communications and documents.

22 Authentication and Accounting Features

The machine has the Authentication feature to restrict the availability of services for each feature and the Accounting feature to manage the use of each feature based on the Login Type selected.

23 Problem Solving

Describes troubleshooting procedures to solve the problems with the machine.

24 Install Operation for Eco copy/My Forms/Shortcut Menu

Describes how to install Eco copy, My Forms, and Shortcut Menu.

25 Install Operation for Access Google Drive™

Describes how to install Access Google Drive.

26 Using Eco copy

Describes how to use Eco copy.

27 Using My Forms

Describes how to use My Forms.

28 Using Shortcut Menu

Describes how to use Shortcut Menu.

29 Using Access Google Drive™

Describes how to use Access Google Drive.

30 Google Cloud Print™

Describes how to use Google Cloud Print.

Conventions

- The screen shots and illustrations used in this guide vary depending on the machine configuration and optional components installed. Some of the items in the screen shots may not be displayed or available depending on the configuration of your machine.
- The procedures in this guide may vary depending on the driver and utility software being used due to the upgrades.
- In this guide, "Computer" refers to a personal computer or workstation.
- The following term is used in this guide:

Note : Additional information on operations or features.

- The following symbols are used in this guide:

" " : • A cross-reference included in this guide.
• Names of CD-ROM, features, and touch screen messages and input text.

[] : • Folders, files, applications, button or menu names displayed on the touch screen.
• Names of menus, commands, windows, or dialog boxes displayed on the computer screen and their buttons and menu names.

< > button : Hardware buttons on the control panel.

< > key : Keys on the keyboard of the computer.

> : • Path to a certain item within a procedure on the control panel.
For example: When you see the procedure "select [Tools] > [Setup] > [Create Folder]", this means that you need to select [Tools], select [Setup], and then select [Create Folder].

• Path to a certain item within a procedure on a computer.
For example: When you see the procedure "to search for files and folders, click [Start] > [Search] > [For Files or Folders]", this means that you need to click [Start], click [Search], and then click [For Files or Folders] to search for files and folders.

- Orientation of documents or paper is described in this guide as follows:

☐, ☐, Long Edge Feed (LEF): Loading the document or paper in portrait orientation when viewed from the front of the machine.

☐, ☐, Short Edge Feed (SEF): Loading the document or paper in landscape orientation when viewed from the front of the machine.

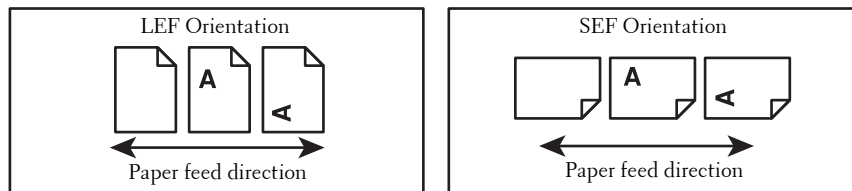

Technical Support

The following provides the technical support information for this product.

Dell™ Technical Support Policy

Technician-assisted technical support requires the cooperation and participation of the customer in the troubleshooting process and provides for restoration of the operating system, software program, and hardware drivers to the original default configuration as shipped from Dell, and verification of appropriate functionality of the printer and all Dell-installed hardware. In addition to this technician assisted technical support, online technical support is available at dell.com/support. Additional technical support options may be available for purchase.

Dell provides limited technical support for the printer and any Dell-installed software and peripherals. Support for third-party software and peripherals is provided by the original manufacturer, including those purchased and/or installed through Software & Peripherals (DellWare), ReadyWare, and Custom Factory Integration (CFI/DellPlus).

Online Services

You can learn about Dell products and services at dell.com.

You can access Dell Support through dell.com/support.

The Dell C7765dn Color Multifunction Printer is Blue Angel certified for Germany. You can access the Blue Angel techsheet at dell.com/support/manuals.

Warranty and Return Policy

Dell Computer Corporation ("Dell") manufactures its hardware products from parts and components that are new or equivalent to new in accordance with industry-standard practices. For information about the Dell warranty for your printer, see dell.com/support.

Recycling Information

It is recommended that customers dispose of their used computer hardware, monitors, printers, and other peripherals in an environmentally sound manner. Potential methods include reuse of parts or whole products and recycling of products, components, and/or materials.

For specific information on Dell's worldwide recycling programs, see dell.com/recycle.

Contacting Dell

You can access Dell Support at dell.com/support.

To contact Dell for technical support, sales, and customer service issues, see dell.com/contactdell.

About License

This section describes information about licenses. Be sure to read through it.

RSA BSAFE



This product includes RSA[®] BSAFE[®] Cryptographic software from EMC Corporation.

Heimdal

Copyright (c)2000 Kungliga Tekniska Högskolan (Royal Institute of Technology, Stockholm, Sweden). All rights reserved.

Redistribution and use in source and binary forms, with or without modification, are permitted provided that the following conditions are met:

1. Redistributions of source code must retain the above copyright notice, this list of conditions and the following disclaimer.
2. Redistributions in binary form must reproduce the above copyright notice, this list of conditions and the following disclaimer in the documentation and/or other materials provided with the distribution.
3. Neither the name of the Institute nor the names of its contributors may be used to endorse or promote products derived from this software without specific prior written permission.

THIS SOFTWARE IS PROVIDED BY THE INSTITUTE AND CONTRIBUTORS "AS IS" AND ANY EXPRESS OR IMPLIED WARRANTIES, INCLUDING, BUT NOT LIMITED TO, THE IMPLIED WARRANTIES OF MERCHANTABILITY AND FITNESS FOR A PARTICULAR PURPOSE ARE DISCLAIMED. IN NO EVENT SHALL THE INSTITUTE OR CONTRIBUTORS BE LIABLE FOR ANY DIRECT, INDIRECT, INCIDENTAL, SPECIAL, EXEMPLARY, OR CONSEQUENTIAL DAMAGES (INCLUDING, BUT NOT LIMITED TO, PROCUREMENT OF SUBSTITUTE GOODS OR SERVICES; LOSS OF USE, DATA, OR PROFITS; OR BUSINESS INTERRUPTION) HOWEVER CAUSED AND ON ANY THEORY OF LIABILITY, WHETHER IN CONTRACT, STRICT LIABILITY, OR TORT (INCLUDING NEGLIGENCE OR OTHERWISE) ARISING IN ANY WAY OUT OF THE USE OF THIS SOFTWARE, EVEN IF ADVISED OF THE POSSIBILITY OF SUCH DAMAGE.

JPEG Code

Our printer software uses some of the codes defined by the Independent JPEG Group.

Libcurl

COPYRIGHT AND PERMISSION NOTICE

Copyright (c) 1996 - 2006, Daniel Stenberg, <daniel@haxx.se>.

All rights reserved.

Permission to use, copy, modify, and distribute this software for any purpose with or without fee is hereby granted, provided that the above copyright notice and this permission notice appear in all copies.

THE SOFTWARE IS PROVIDED "AS IS", WITHOUT WARRANTY OF ANY KIND, EXPRESS OR IMPLIED, INCLUDING BUT NOT LIMITED TO THE WARRANTIES OF MERCHANTABILITY, FITNESS FOR A PARTICULAR PURPOSE AND NONINFRINGEMENT OF THIRD PARTY RIGHTS. IN NO EVENT SHALL THE AUTHORS OR COPYRIGHT HOLDERS BE LIABLE FOR ANY CLAIM, DAMAGES OR OTHER LIABILITY, WHETHER IN AN ACTION OF CONTRACT, TORT OR OTHERWISE, ARISING FROM, OUT OF OR IN CONNECTION WITH THE SOFTWARE OR THE USE OR OTHER DEALINGS IN THE SOFTWARE.

Except as contained in this notice, the name of a copyright holder shall not be used in advertising or otherwise to promote the sale, use or other dealings in this Software without prior written authorization of the copyright holder.

FreeBSD

This product contains the part of FreeBSD codes.

The FreeBSD Copyright

Copyright 1994-2006 The FreeBSD Project. All rights reserved.

Redistribution and use in source and binary forms, with or without modification, are permitted provided that the following conditions are met:

Redistributions of source code must retain the above copyright notice, this list of conditions and the following disclaimer.

Redistributions in binary form must reproduce the above copyright notice, this list of conditions and the following disclaimer in the documentation and/or other materials provided with the distribution.

THIS SOFTWARE IS PROVIDED BY THE FREEBSD PROJECT "AS IS" AND ANY EXPRESS OR IMPLIED WARRANTIES, INCLUDING, BUT NOT LIMITED TO, THE IMPLIED WARRANTIES OF MERCHANTABILITY AND FITNESS FOR A PARTICULAR PURPOSE ARE DISCLAIMED. IN NO EVENT SHALL THE FREEBSD PROJECT OR CONTRIBUTORS BE LIABLE FOR ANY DIRECT, INDIRECT, INCIDENTAL, SPECIAL, EXEMPLARY, OR CONSEQUENTIAL DAMAGES (INCLUDING, BUT NOT LIMITED TO, PROCUREMENT OF SUBSTITUTE GOODS OR SERVICES; LOSS OF USE, DATA, OR PROFITS; OR BUSINESS INTERRUPTION) HOWEVER CAUSED AND ON ANY THEORY OF LIABILITY, WHETHER IN CONTRACT, STRICT LIABILITY, OR TORT (INCLUDING NEGLIGENCE OR OTHERWISE) ARISING IN ANY WAY OUT OF THE USE OF THIS SOFTWARE, EVEN IF ADVISED OF THE POSSIBILITY OF SUCH DAMAGE.

The views and conclusions contained in the software and documentation are those of the authors and should not be interpreted as representing official policies, either expressed or implied, of the FreeBSD Project.

OpenLDAP

Copyright 1998-2006 The OpenLDAP Foundation All rights reserved.

Redistribution and use in source and binary forms, with or without modification, are permitted only as authorized by the OpenLDAP Public License.

A copy of this license is available in the file LICENSE in the top-level directory of the distribution or, alternatively, at <http://www.OpenLDAP.org/license.html>.

OpenLDAP is a registered trademark of the OpenLDAP Foundation.

Individual files and/or contributed packages may be copyright by other parties and/or subject to additional restrictions.

This work is derived from the University of Michigan LDAP v3.3 distribution. Information concerning this software is available at <http://www.umich.edu/~dirsvcs/ldap/ldap.html>.

This work also contains materials derived from public sources.

Additional information about OpenLDAP can be obtained at <http://www.openldap.org/>.

Portions Copyright 1998-2006 Kurt D. Zeilenga.

Portions Copyright 1998-2006 Net Boolean Incorporated.

Portions Copyright 2001-2006 IBM Corporation.

All rights reserved.

Redistribution and use in source and binary forms, with or without modification, are permitted only as authorized by the OpenLDAP Public License.

Portions Copyright 1999-2005 Howard Y.H. Chu.

Portions Copyright 1999-2005 Symas Corporation.

Portions Copyright 1998-2003 Hallvard B. Furuseth.

All rights reserved.

Redistribution and use in source and binary forms, with or without modification, are permitted provided that this notice is preserved.

The names of the copyright holders may not be used to endorse or promote products derived from this software without their specific prior written permission. This software is provided "as is" without express or implied warranty.

Portions Copyright (c) 1992-1996 Regents of the University of Michigan.

All rights reserved.

Redistribution and use in source and binary forms are permitted provided that this notice is preserved and that due credit is given to the University of Michigan at Ann Arbor. The name of the University may not be used to endorse or promote products derived from this software without specific prior written permission. This software is provided "as is" without express or implied warranty.

The OpenLDAP Public License

Version 2.8, 17 August 2003

Redistribution and use of this software and associated documentation ("Software"), with or without modification, are permitted provided that the following conditions are met:

1. Redistributions in source form must retain copyright statements and notices,
2. Redistributions in binary form must reproduce applicable copyright statements and notices, this list of conditions, and the following disclaimer in the documentation and/or other materials provided with the distribution, and
3. Redistributions must contain a verbatim copy of this document.

The OpenLDAP Foundation may revise this license from time to time.

Each revision is distinguished by a version number. You may use this Software under terms of this license revision or under the terms of any subsequent revision of the license.

THIS SOFTWARE IS PROVIDED BY THE OPENLDAP FOUNDATION AND ITS CONTRIBUTORS "AS IS" AND ANY EXPRESSED OR IMPLIED WARRANTIES, INCLUDING, BUT NOT LIMITED TO, THE IMPLIED WARRANTIES OF MERCHANTABILITY AND FITNESS FOR A PARTICULAR PURPOSE ARE DISCLAIMED. IN NO EVENT SHALL THE OPENLDAP FOUNDATION, ITS CONTRIBUTORS, OR THE AUTHOR(S) OR OWNER(S) OF THE SOFTWARE BE LIABLE FOR ANY DIRECT, INDIRECT, INCIDENTAL, SPECIAL, EXEMPLARY, OR CONSEQUENTIAL DAMAGES (INCLUDING, BUT NOT LIMITED TO, PROCUREMENT OF SUBSTITUTE GOODS OR SERVICES; LOSS OF USE, DATA, OR PROFITS; OR BUSINESS INTERRUPTION) HOWEVER CAUSED AND ON ANY THEORY OF LIABILITY, WHETHER IN CONTRACT, STRICT LIABILITY, OR TORT (INCLUDING NEGLIGENCE OR OTHERWISE) ARISING IN ANY WAY OUT OF THE USE OF THIS SOFTWARE, EVEN IF ADVISED OF THE POSSIBILITY OF SUCH DAMAGE.

The names of the authors and copyright holders must not be used in advertising or otherwise to promote the sale, use or other dealing in this Software without specific, written prior permission. Title to copyright in this Software shall at all times remain with copyright holders.

OpenLDAP is a registered trademark of the OpenLDAP Foundation.

Copyright 1999-2003 The OpenLDAP Foundation, Redwood City, California, USA. All Rights Reserved. Permission to copy and distribute verbatim copies of this document is granted.

DES

This product includes software developed by Eric Young (eay@mincom.oz.au)

AES

Copyright (c) 2003. Dr Brian Gladman. Worcester. UK. All rights reserved. This product uses published AES software provided by Dr Brian Gladman under BSD licensing terms.

TIFF (libtiff)

Lib TIFF copyright (c) 1988-1997 Sam leffler
Copyright (c) 1991-1997 Silicon Graphics. Inc.

ICC Profile (Little cms)

Little cms copyright (c) 1988-2004 Marti Maria

XML Paper Specification (XPS)

This product may incorporate intellectual property owned by Microsoft Corporation. The terms and conditions upon which Microsoft is licensing such intellectual property may be found at <http://go.microsoft.com/fwlink/?LinkId=52369>.

Cyrus SASL

Copyright (c) 1998-2003 Carnegie Mellon University. All rights reserved.

Redistribution and use in source and binary forms, with or without modification, are permitted provided that the following conditions are met:

1. Redistributions of source code must retain the above copyright notice, this list of conditions and the following disclaimer.
2. Redistributions in binary form must reproduce the above copyright notice, this list of conditions and the following disclaimer in the documentation and/or other materials provided with the distribution.

3. The name "Carnegie Mellon University" must not be used to endorse or promote products derived from this software without prior written permission. For permission or any other legal details, please contact

Office of Technology Transfer

Carnegie Mellon University

5000 Forbes Avenue

Pittsburgh, PA 15213-3890

(412) 268-4387, fax: (412) 268-7395

tech-transfer@andrew.cmu.edu

4. Redistributions of any form whatsoever must retain the following acknowledgment:

"This product includes software developed by Computing Services at Carnegie Mellon University (<http://www.cmu.edu/computing/>)."

CARNEGIE MELLON UNIVERSITY DISCLAIMS ALL WARRANTIES WITH REGARD TO THIS SOFTWARE, INCLUDING ALL IMPLIED WARRANTIES OF MERCHANTABILITY AND FITNESS, IN NO EVENT SHALL CARNEGIE MELLON UNIVERSITY BE LIABLE FOR ANY SPECIAL, INDIRECT OR CONSEQUENTIAL DAMAGES OR ANY DAMAGES WHATSOEVER RESULTING FROM LOSS OF USE, DATA OR PROFITS, WHETHER IN AN ACTION OF CONTRACT, NEGLIGENCE OR OTHER TORTIOUS ACTION, ARISING OUT OF OR IN CONNECTION WITH THE USE OR PERFORMANCE OF THIS SOFTWARE.

Legal Notice

Copying or printing certain documents may be illegal in your country. Penalties of fines or imprisonment may be imposed on those found guilty. The following are examples of items that may be illegal to copy or print in your country.

- Currency
- Banknotes and checks
- Bank and government bonds and securities
- Passports and identification cards
- Copyright material or trademarks without the consent of the owner
- Postage stamps and other negotiable instruments

This list is not inclusive and no liability is assumed for either its completeness or accuracy. In case of doubt, contact your legal counsel.

2 Product Overview

This chapter describes the basic information of the machine, such as machine components, how to switch the machine on and off, and how to use the touch screen.

- **Machine Components**.....34
- **Power Source**.....41
- **Circuit Breaker**.....44
- **Power Saver Mode**.....46
- **Control Panel**.....49
- **About the [Home] Screen**53
- **Entering Text**57
- **Installing the Tray Attachment on the Finisher-B1**58

Machine Components

The following describes machine components and their functions.

Main Body and HCF B1

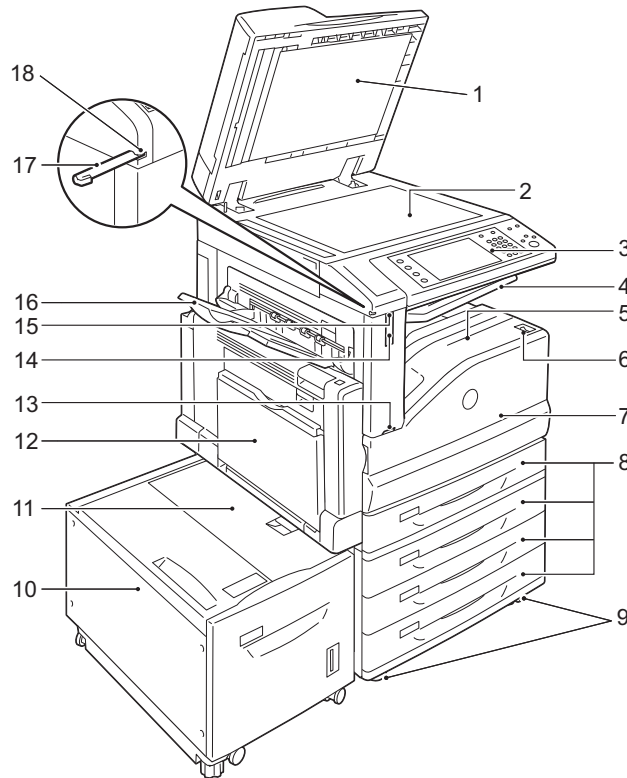

No.	Component	Function
1	Document cover	Holds a document in place.
2	Document glass	Load a document here.
3	Control panel	Consists of operation buttons, LED indicators, and the touch screen. Refer to "Control Panel" (P.49).
4	Exit 2 Tray	Outputs are delivered here by separating the center tray into two levels.
5	Lower Center Tray (output tray)	Copies and prints are delivered here, facing down.
6	Power switch	Switches the power of the machine on and off. Refer to "Power Source" (P.41).
7	Front cover	Open this cover to replace the consumables.
8	Tray 1 to 4	Load paper here.
9	Locking casters	Used for locking the wheels of the machine. Lock these casters after moving the machine to its installation site.
10	Tray 6 (HCF B1) (optional)	Load paper here.
11	Tray 6 top cover	Open this cover to clear paper jams after moving Tray 6 to the left.
12	Tray 5 (bypass tray)	Used for loading non-standard paper, such as thick-stock paper and other special media, that cannot be loaded in Trays 1 to 4.

No.	Component	Function
13	Wakeup motion sensor (pyroelectric sensor)	The wakeup motion sensor (pyroelectric sensor) works consistently, and when it detects human presence in the detectable area, the wakeup motion sensor (reflection sensor) starts working.
14	Wakeup motion sensor (reflection sensor)	When the wakeup motion sensor (pyroelectric sensor) detects human presence, the wakeup motion sensor (reflection sensor) starts working, and when it also detects human presence, the machine exits the Power Saver mode. While the wakeup motion sensor (reflection sensor) detects human presence, the machine will neither reset the settings automatically nor enter the Power Saver mode.
15	Wakeup Motion Sensor Access Lamp	The Access Lamp lights up while the wakeup motion sensor (reflection sensor) detects human presence.
16	Side Tray	Copies and prints are delivered here, facing up.
17	Stylus pen	Used for touching the touch screen on the control panel to configure settings. Note • You can directly touch the touch screen not only with the stylus pen but also with a finger.
18	Stylus pen holder	Stores the stylus pen.

Left side and rear views of the machine

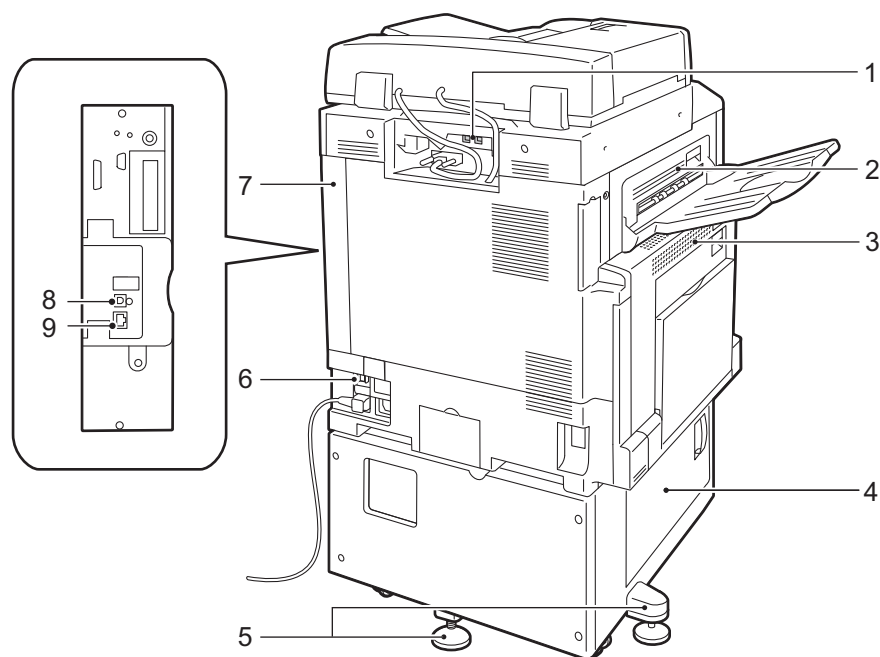

No.	Component	Function
1	USB 2.0 interface connector (optional)	Connects to the cable of the Memory Card Reader or a USB memory device.
2	Top left cover	Open this cover to clear paper jams.
3	Upper left cover	Open this cover by pressing the release lever to clear paper jams. Note • Before you open the upper left cover, exit the Sleep mode and then switch off the machine.
4	Bottom left cover	Open this cover to clear paper jams. When Tray 6 is installed, open this cover after moving Tray 6 to the left.

No.	Component	Function
5	Adjusting foot	Prevents the machine from toppling over. Move the machine to its installation site and then rotate this adjuster in clockwise direction until it touches a floor.
6	RESET button	Automatically switches the machine off when a current leakage is detected.
7	Rear right cover	Make sure that this cover is attached. Open this cover when connecting an interface cable.
8	USB 2.0 interface connector	Connects a USB memory cable for printing.
9	10BASE-T/100BASE-TX/ 1000BASE-T connector	Connects to a network cable.

Note • The Memory Card Reader and a USB memory device cannot be connected to the machine at the same time. The machine will recognize the one that is connected first.

Inside

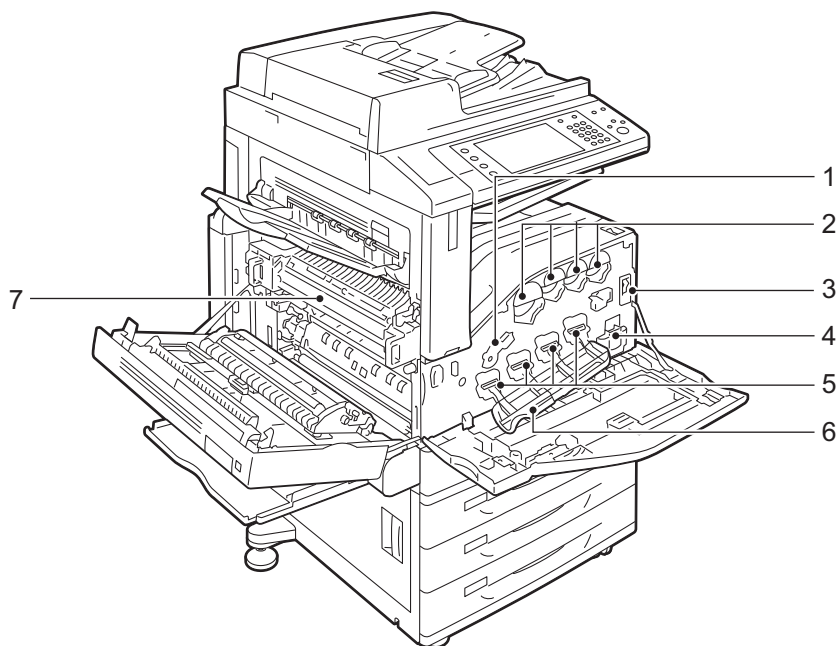

No.	Component	Function
1	Drum cartridge release lever	Unlock this lever when replacing a drum cartridge.
2	Toner cartridges	Contains Black (K), Cyan (C), Magenta (M), and Yellow (Y) toner (image forming powder).
3	Main power switch	Switches the main power on/off of the machine. Always follow the instructions by the system administrator. Note • Always switch the power off before switching the main power off. Refer to "Power Source" (P.41).
4	Waste toner container (R5)	Collects waste toner.
5	Drum cartridges (R1, R2, R3, R4)	Contains photoconductors R1, R2, R3, and R4.
6	Drum cartridge cover	Open this cover when replacing a drum cartridge or cleaning the interior of the machine.
7	Fusing unit (R8)	Fuses toner on paper. Do not touch this unit as it is extremely hot.

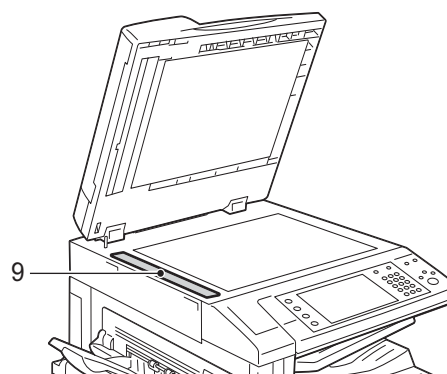
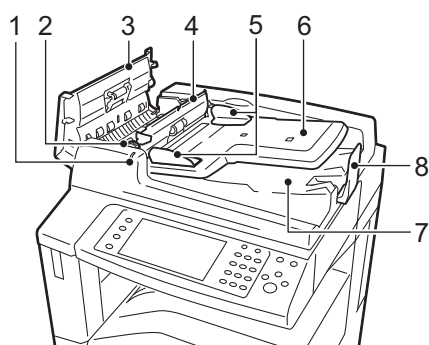
Duplex Automatic Document Feeder B1-C

No.	Component	Function
1	Confirmation indicator	Lights up when a document is loaded correctly.
2	Lever	Turn this lever to clear paper jams.
3	Left cover	Open this cover to clear paper jams.
4	Inner cover	Open this cover to clear paper jams.
5	Document guides	Use these guides to align the edges of documents.
6	Document feeder tray	Load documents here.
7	Document output tray	Scanned documents are delivered here.
8	Document stopper	Prevents outputs from falling off.
9	Constant velocity transport glass	Scans a loaded document.

Note • In this guide, "document feeder" means the Duplex Automatic Document Feeder B1-C.

Telephone line connectors

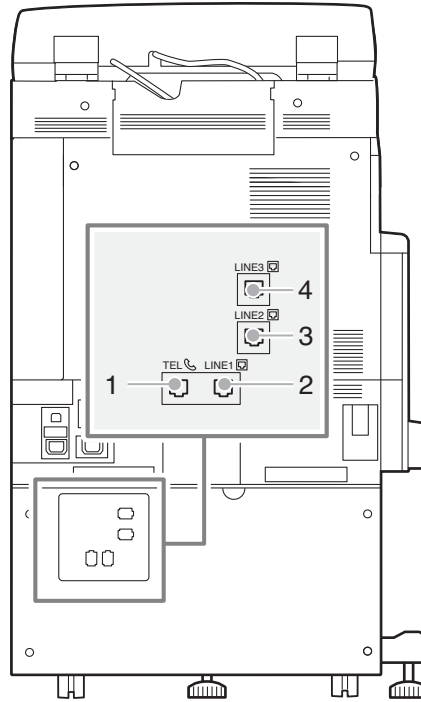

No.	Name marked on the cover of the machine	Name displayed on the touch screen	Function
1	TEL	-	Enables you to connect the machine to a telephone device.
2	LINE 1	Line 1	Use this connector to connect to a telephone line.
3	LINE 2	-	Not available.
4	LINE 3	-	Not available.

- Note**
- To use the Fax service, an optional component is required. For more information, contact Customer Support at dell.com/contactdell.

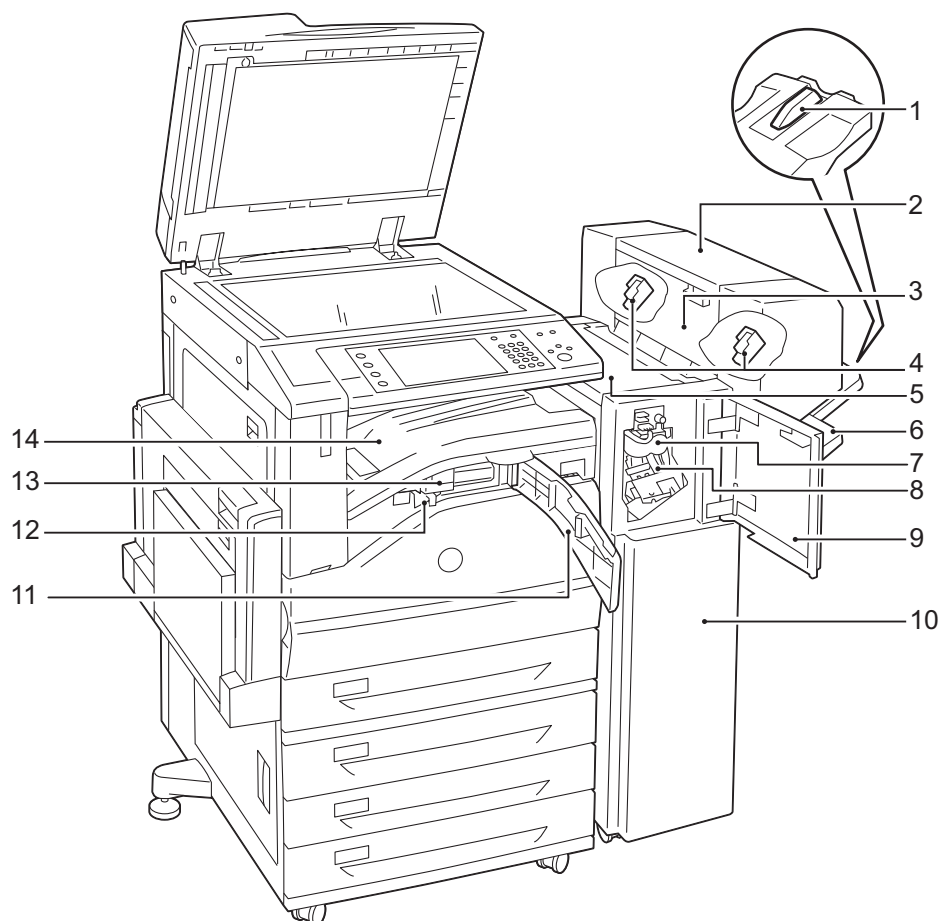
Finisher-B1 (optional)

No.	Component	Function
1	Tray attachment	Install this attachment when delivering A4 or B5 paper to the finisher tray without stapling. For more information, refer to "Installing the Tray Attachment on the Finisher-B1" (P.58).
2	Booklet unit (optional)	Staples creased outputs.
3	Booklet unit side cover	Open this cover when replacing the booklet staple cartridge.
4	Booklet staple cartridge	Contains staples. Remove this cartridge when replacing or adding staples, or clearing staple jams.
5	Top cover	Open this cover to clear paper jams.
6	Finisher tray	Stapled or creased outputs are delivered here.
7	Creaser unit	Creases outputs in half.
8	Staple cartridge	Contains staples.
9	Front cover	Open this cover when clearing paper jams or replacing staples.
10	Finisher-B1	Staples copies or prints.
11	Front transport cover	Open this cover when discarding punch scraps.
12	Hole punch waste container	Collects scraps from the puncher.

No.	Component	Function
13	US 2/3 Hole Punch Kit (optional) 2/4 Hole Punch Kit (optional)	Hole-punches outputs. Note <ul style="list-style-type: none"> • The distance between the two holes made with the US 2/3 Hole Punch Kit (US standard) is 70 mm, which is different from the 80 mm distance made with the 2/4 Hole Punch Kit.
14	Center tray (Top cover of the finisher transport)	Copies and prints are delivered here when they are unable to be delivered to the finisher tray. Pull the cover upward when clearing paper jams. Note <ul style="list-style-type: none"> • Remove outputs delivered to the center tray constantly.

- Note**
- The Finisher-B1 is optional. In this guide, the Finisher-B1 is referred to as the "finisher".
 - The power cord connected to the Finisher-B1 is a connecting cord dedicated to the machine. Do not connect this cord to any other devices than the machine.

Power Source

The machine is provided with the power switch and the main power switch.

Power switch

To use the machine, press the power switch to the [|] position to switch its power on. You can start operations after the machine warms up.

Main power switch

Press the main power switch to the [○] position. The <Main Power> indicator goes out on the right side of the control panel, and the machine powers off. Do not switch the main power off except when you connect a cable to the machine or clean the machine. Switching off the main power may erase the data in the memory when using the Fax service.

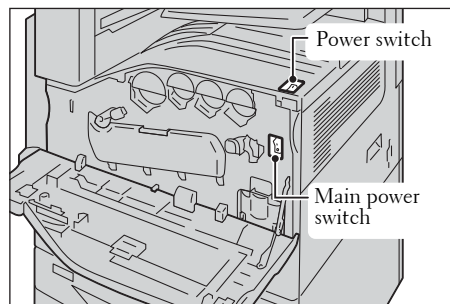

Switching the Main Power On

The following describes how to switch the main power on.

Note • Do not switch off the main power immediately after switching on the main power. This may damage the hard disk and the memory or cause a machine malfunction.

- 1 Make sure that the power cord is plugged in correctly.
- 2 Open the front cover.

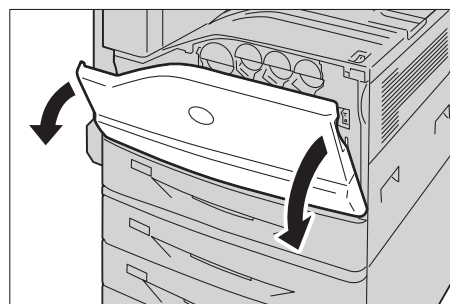

- 3 Press the main power switch to the [|] position to switch the main power on.
The <Main Power> indicator lights up on the control panel.

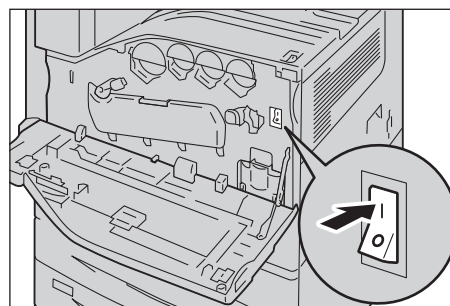

- 4 Close the front cover.

Switching the Power On

The following describes how to switch the power on.

The machine takes approximately 35 seconds to warm up and to be ready to copy or print after switching the power on. This may take more time depending on the configuration of your machine.

Switch the power off at the end of the day or when not using the machine for an extended period of time.

You can also use the Power Saver feature to save power consumption while the machine is not in use.

For information on the Power Saver feature, refer to "Power Saver Mode" (P.46).

Note • If the power is switched off, all the services of the machine will stop. When using the machine throughout the day for jobs such as receiving fax, do not switch the power off.

- 1 Press the power switch to the [|] position to switch the power on.

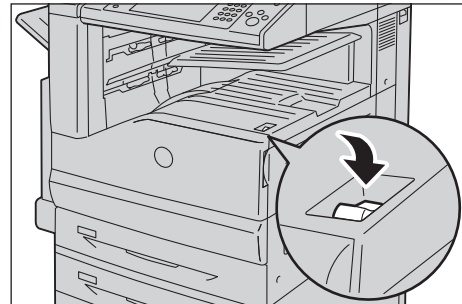

- When the Finisher-B1 (optional) is installed

Note • If the machine does not power on, check the following:

- The power cord is plugged in.
- The main power is switched on.
- The <RESET> button is set on and is in the depressed position.

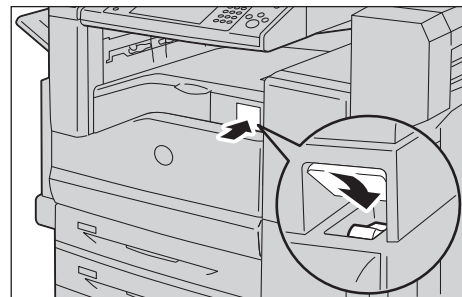

Switching the Power Off

The following describes how to switch the power off.

- 1 Before switching the power off, make sure that the machine has completed all copy or print jobs. Then, make sure that the <Data> indicator is not blinking.

Note • Do not switch the power off in the following situations. If the power is switched off, the data being processed may be erased.

- While data is being received
- While a job is being printed
- While a job is being copied
- While a job is being scanned

• When switching the power off, wait 5 seconds after outputs have been delivered.

- 2 Press the power switch to the [⏻] position.

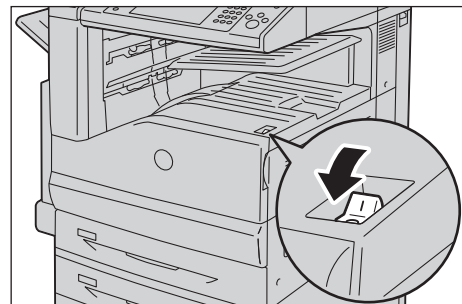

- When the Finisher-B1 (optional) is installed

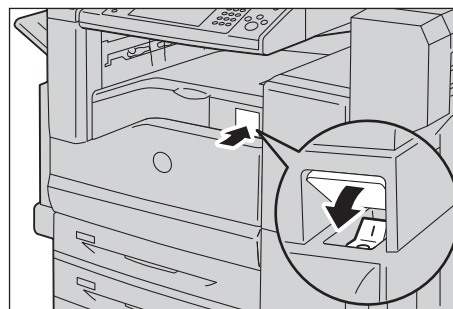

- Note**
- Power off processing is performed internally on the machine for a while after the power is switched off. Therefore, do not switch the main power off immediately after switching the power off.
 - When powering the machine on after it has been switched off, wait 10 seconds after the touch screen has gone dark.

Switching the Main Power Off

The following describes how to switch the main power off.

- Note**
- Do not switch the main power off when a screen is displayed on the touch screen or while the <Power Saver> button is blinking. Switching off the main power under such circumstances may damage the hard disk and the memory or cause a machine malfunction.
 - Switch the main power off first when unplugging the power cord. Unplugging the power cord with the main power on may damage the hard disk and the memory or cause a machine malfunction.

- 1 Make sure that the power is switched off.
- 2 Make sure that the touch screen is blank and the <Power Saver> button is not lit.
- 3 Open the front cover.

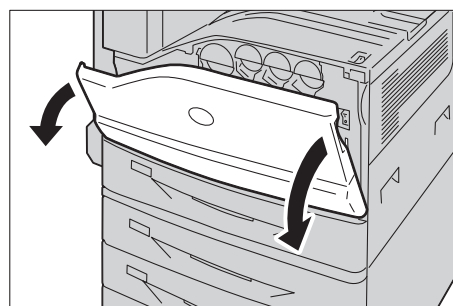

- 4 Press the main power switch to the [O] position to switch the main power off.
The <Main Power> indicator goes out on the control panel.

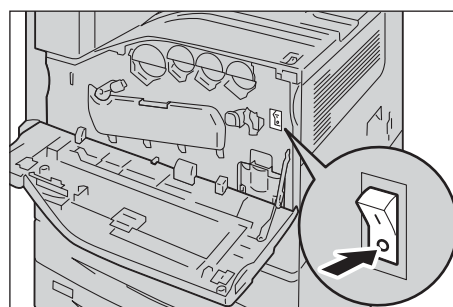

- 5 Close the front cover.

Circuit Breaker

The machine is provided with a circuit breaker.

In the event of a current leakage, the circuit breaker will automatically cut off the power circuit to prevent fire from occurring.

Check that the circuit breaker works properly at least once a month.

Be sure to establish a ground for the machine. Without a proper ground, the circuit breaker may be disabled, causing a risk of electric shock.

If you have any problems with the circuit breaker, contact Customer Support at dell.com/contactdell.

The following describes how to check the circuit breaker.

- 1 Press the power switch to the [⏻] position to switch the power off.

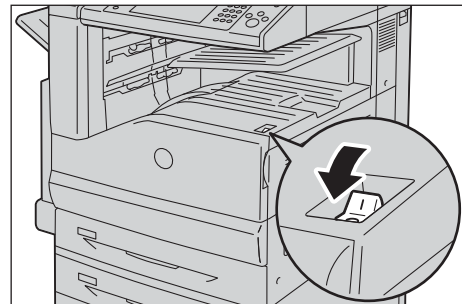

- 2 Make sure that the touch screen is blank and the <Power Saver> button does not light up.
- 3 Open the front cover.

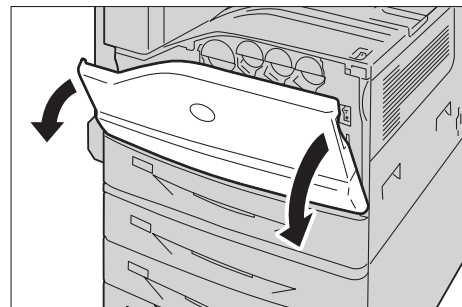

- 4 Press the main power switch to the [○] position to switch the main power off.

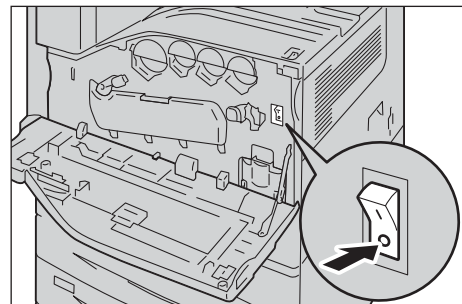

- 5 Press the <RESET> button. The button will be depressed even after the pushing force is released.

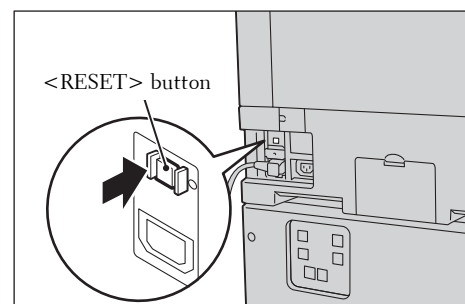

- 6** Press the <TEST> button lightly with a sharp edge such as a pen tip. The depressed <RESET> button will stick out again. This is the end of the check procedure.

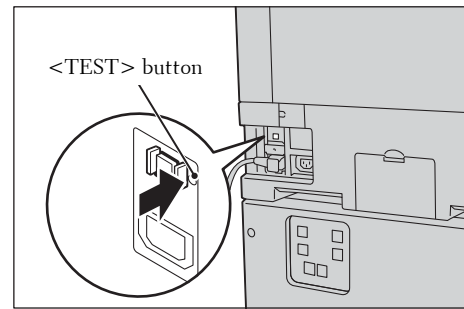

- 7** Press the <RESET> button back to the depressed position.

Power Saver Mode

The machine is installed with the Power Saver feature that will automatically reduce power consumption of the machine if no copy or print data is received for a certain duration.

The Power Saver feature has two modes: Low Power mode and Sleep mode.

The machine enters the Low Power mode after the preset time has elapsed if the machine is left unused for a fixed period of time.

The machine then enters the Sleep mode if a further preset time elapses.

To enter the Power Saver mode, press the <Power Saver> button on the control panel.

Low Power Mode

In this mode, the power to the control panel and fusing unit is lowered to save power.

The touch screen goes out, and the <Power Saver> button on the control panel lights up. To use the machine, press the <Power Saver> button. The <Power Saver> button goes out to indicate that the Low Power mode is exited.

Sleep Mode

In this mode, the power is lowered more than in the Low Power mode.

The touch screen goes out, and the <Power Saver> button on the control panel lights up. To use the machine, press the <Power Saver> button. The <Power Saver> button goes out to indicate that the Sleep mode is exited.

- Note**
- When you press the <Power Saver> button during the Power Saver mode, the touch screen lights up. At this point, the document scanning unit and the output devices remain the Power Saver mode. Afterwards, by operations such as using the touch screen and opening or closing of the document cover, you can make the devices necessary to activate the machine to exit the Power Saver mode and make the machine ready to start exiting the Power Saver mode.
 - When you make the machine exit the Power Saver mode by pressing the <Power Saver> button, the machine does not immediately identify the movements such as opening or closing of the front cover. To make the machine identify these operations, operate the control panel before opening the front cover.
 - If you replace toner cartridges or supply paper during the Power Saver mode, the machine does not identify these changes. Before performing these operations, exit the Power Saver mode by pressing the <Power Saver> button and the <Machine Status> button on the control panel.
 - The Power Saver mode is not exited by the following operations:
 - Charge print
 - Secure print
 - Delayed print
 - Private charge print
 - Fax using Folder Receive
 - Direct fax
 - Accessing a folder of the machine using Dell Printer Configuration Web Tool
 - The control panel remains lit off and only the output devices exit the Power Saver mode by the following operations.
 - Print
 - Sample print
 - Print fax
 - When the following device is connected to the machine and a user performs the following operation, the Low Power mode can be deactivated without pressing the <Power Saver> button. If the machine is in the Sleep mode, however, the Sleep mode will not be deactivated by the operation. By setting longer time to elapse until the machine enters the Sleep mode, you can make the machine exit the Power Saver mode without pressing the <Power Saver> button.
 - Placing a smart card on the smart card reader
 - When the machine enters the Low Power mode while a user is authenticated, the machine exits the Authentication mode.

Wakeup Motion Sensor

The machine provides human detection feature called the wakeup motion sensor. This feature controls to exit (or not to enter) the Power Saver mode or not to count the time to reset the settings automatically (Auto Clear) while the machine detects human presence. The Access Lamp lights up while the machine detects human presence.

- Note**
- The detectable area is up to 35 cm away from the front of the machine. Our service representative can change this value to up to 60 cm. For more information, contact Customer Support at dell.com/contactdell.
 - If you wear the cloth which reflects light such as a lame clothing and a sequin clothing, the feature may not work properly.
 - You can set whether to exit the Power Saver mode or not to enter the mode while the wakeup motion sensor detects human presence in the System Administration mode. For more information, refer to "Deactivate With wakeup motion sensor" (P.317).

Entering the Power Saver Mode

The following describes how to enter the Power Saver mode.

- Note**
- To enter the Power Saver mode by pressing the <Power Saver> button, specify a longer time period in [From Last Operation to Sleep Mode] than in [From Last Operation to Low Power Mode] under [Power Saver Timers]. For information on [Power Saver Timers], refer to "Power Saver Timers" (P.317).

1 Press the <Power Saver> button.

- Note**
- The touch screen is lit off by pressing the <Power Saver> button, and the machine enters the Power Saver mode.
 - The machine may not immediately exit the Power Saver mode when you press the <Power Saver> button soon after entering the Power Saver mode.
 - The machine will not enter the Power Saver mode while a job is being processed. Press the <Power Saver> button after the job is completed.
 - The machine will not enter the Power Saver mode when [Skip Blank Pages] is enabled. For information on [Skip Blank Pages], refer to "Skip Blank Pages" (P.395).
 - Sufficient distance from the machine is required to keep the energy saving state after pressing the <Power Saver> button. When the specified period of time elapses after pressing the button, the human motion sensor of the machine starts to detect human presence and then releases the Power Saver mode.
 - The time period from pressing the <Power Saver> button until entering the Power Saver mode can be set in the System Administration mode. For more information, refer to "Power Saver Timers" (P.317).

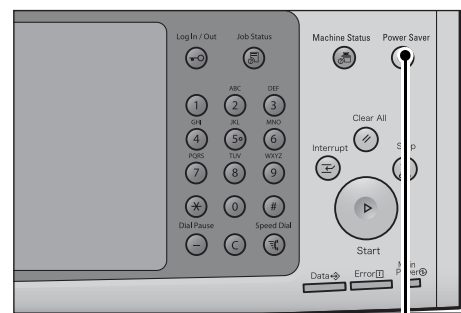

<Power Saver> button

Exiting the Power Saver Mode

The following describes how to exit the Power Saver mode.

The Power Saver mode is exited in the following instances:

The machine exits the Power Saver mode partially depending on the settings. For more information, refer to "Power Saver Deactivation" (P.317).

- Pressing the <Power Saver> button
- Receiving a job
- Selecting [Apply] in Dell Printer Configuration Web Tool
- Setting a document in the document feeder
- Opening the document cover

- Detecting human presence by the human motion sensor of the machine

Note • The machine may not immediately exit the Power Saver mode if the machine enters the mode by pressing the <Power Saver> button and press the button again in five seconds to exit.

When the following device is connected to the machine and a user performs the following operation, the Low Power mode can be deactivated without pressing the <Power Saver> button.

- Placing a smart card on the smart card reader

Note • If the machine is in the Sleep mode, however, the Sleep mode will not be deactivated by the operation above. Set a longer time to elapse until the machine enters the Sleep mode.

1 Press the <Power Saver> button.

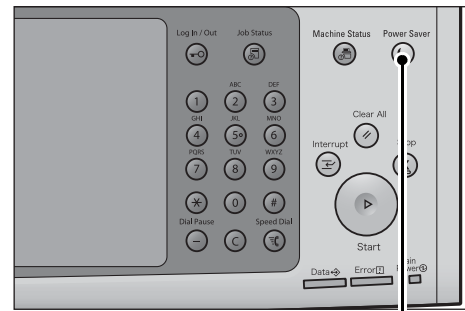

<Power Saver> button

Control Panel

The following describes the names and functions of components on the control panel.

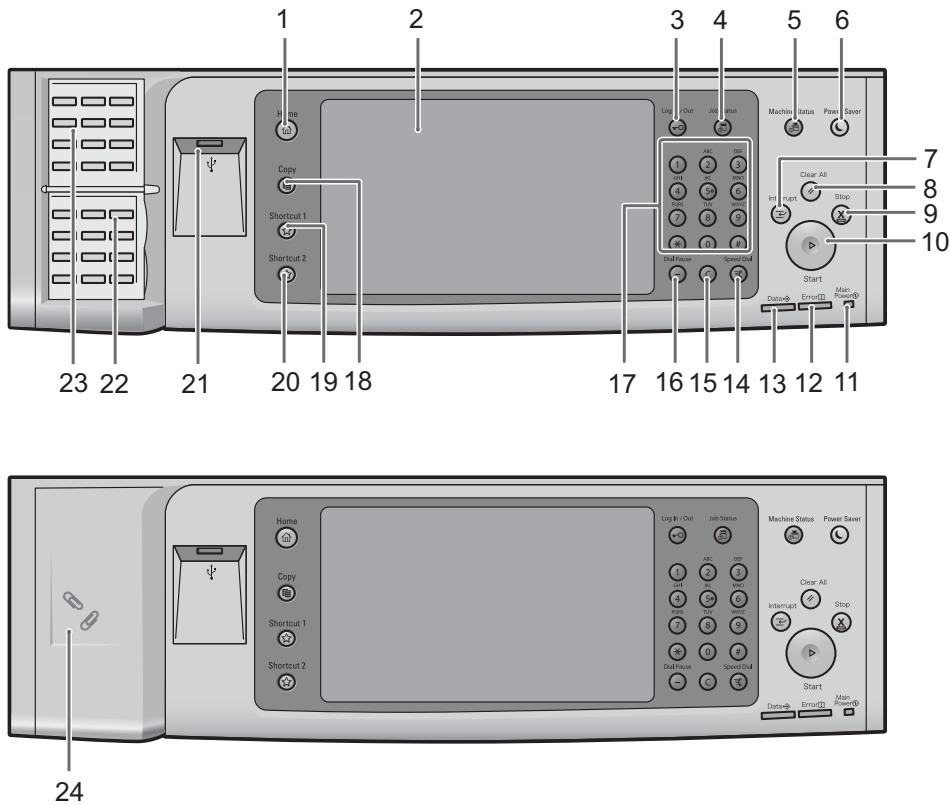

No.	Component	Function
1	<Home> button	Press this button to display the [Home] screen.
2	Touch screen	Displays messages required for operation, and buttons for various features. You can directly touch the touch screen to instruct operations and set features.
3	<Log In/Out> button	Lights up when a user is authenticated in the System Administration mode, the Authentication mode, or the Accounting mode. Displays the User ID entry screen for entering the System Administration mode, the Authentication mode, or the Accounting mode. Press this button to exit these modes.
4	<Job Status> button	Press this button to check or cancel the current job, to check or print stored jobs, or to check completed jobs.
5	<Machine Status> button	Press this button to check the machine status and meters, to check the status of consumables, and to print reports.
6	<Power Saver> button	When the machine is not used for a while, it enters the Power Saver mode to reduce power consumption. When the Power Saver mode is active, the <Power Saver> button lights up. Press this button to enter or exit the Power Saver mode.
7	<Interrupt> button	Press this button to suspend a copy or print job in progress to have the machine process another job. During the Interrupt mode, the <Interrupt> button lights up. Pressing the <Interrupt> button again exits the Interrupt mode and resumes the suspended job.
8	<Clear All> button	Returns the settings you made to the default values. The machine returns to the same state as when it is powered on.

No.	Component	Function
9	<Stop> button	Press this button to pause the current job or communications.
10	<Start> button	Press this button to start scanning a document.
11	<Main Power> indicator	Lights up when the main power is switched on. Note • If the main power is not switched on, the machine will not be powered on even when the power is switched on.
12	<Error> indicator	Blinks if a system error occurs. This indicator lights up when a problem other than a system error occurs with the machine, including paper jams and running out of paper or toner. If the <Error> indicator blinks, contact Customer Support at dell.com/contactdell . If the <Error> indicator lights up, refer to "Machine Trouble" (P.569).
13	<Data> indicator	Blinks when the machine is sending or receiving data to or from a client. This indicator lights up when data is stored in the machine's memory, when received faxes are waiting to be printed, or when faxes are stored in a folder. You can check stored scan files in a Folder List. For information on the Folder List, refer to "Folder List" (P.282). You can check stored fax files in a Stored File List. For information on the Stored File List, refer to "Stored File List" (P.277). You can change the lighting pattern of the <Data> indicator. For more information, refer to "Data Indicator" (P.347).
14	<Speed Dial> button	Press this button to specify a recipient with an address number when sending a fax or e-mail.
15	<C (Clear)> button	Press this button to cancel a numerical value you have entered with the numeric keypad.
16	<Dial Pause> button	Press this button to insert a pause into a destination number.
17	Numeric keypad	Use the numeric buttons on the keypad to enter the number of copies, passcodes, and other numerical values.
18	Custom Button 1 (Copy)	"Copy" is assigned to this button by default. Press this button to display the [Copy] screen.
19	Custom Button 2 (Shortcut 1)	Press this button to call its associated service. To the button, you can assign [Language] or any service displayed on the [Home] screen.
20	Custom Button 3 (Shortcut 2)	"Review" is assigned to this button by default. On the [Review] screen, you can check a list of the status of Copy, Fax, and Scan services whose settings have been changed from the defaults. You can also check the details of fax and e-mail recipients.
21	USB memory slot	Insert a USB 2.0 memory device here.

No.	Component	Function
22	One touch panels (Only available for machines with the Fax service)	<p>Contains one touch buttons. Turn over the panels to display buttons 1 - 70, M01, and M02. There are two ways in which address numbers and stored programs are assigned to the one touch buttons. Select either of the following:</p> <ul style="list-style-type: none"> • [Type 1] The buttons 1 to 70 are used for address numbers and they correspond to the registered address numbers 0001 to 0070, while the buttons M01 and M02 are used for stored programs and they correspond to the registered stored programs 1 and 2. • [Type 2] The buttons 1 to 60 are used for address numbers and they correspond to the registered address numbers 0001 to 0060, while the buttons 61 to 70, M01, and M02 are used for stored programs and they correspond to the registered stored programs 1 to 12. <p>Note</p> <ul style="list-style-type: none"> • By default, [Type 1] is selected. • An optional component is required to use this feature. For more information, contact Customer Support at dell.com/contactdell. <p>For information on how to change the settings registered to the one touch buttons, refer to "Screen/Button Settings" (P.319).</p>
23	One touch buttons (Only available for machines with the Fax service)	<p>Allows you to specify a recipient with the simple press of a button. You can use the buttons for the Fax, Internet Fax, Scan (E-mail), and Scan to PC jobs. Turn over the panels to display buttons 1 - 70, M01, and M02. There are two ways in which address numbers and stored programs are assigned to the one touch buttons. Select either of the following:</p> <ul style="list-style-type: none"> • [Type 1] The buttons 1 to 70 are used for address numbers and they correspond to the registered address numbers 0001 to 0070, while the buttons M01 and M02 are used for stored programs and they correspond to the registered stored programs 1 and 2. • [Type 2] The buttons 1 to 60 are used for address numbers and they correspond to the registered address numbers 0001 to 0060, while the buttons 61 to 70, M01, and M02 are used for stored programs and they correspond to the registered stored programs 1 to 12. <p>Note</p> <ul style="list-style-type: none"> • By default, [Type 1] is selected. • An optional component is required to use this feature. For more information, contact Customer Support at dell.com/contactdell. <p>For information on how to change the settings registered to the one touch buttons, refer to "Screen/Button Settings" (P.319).</p>
24	Paper clip tray	Used for placing paper clips and staples.

Screens and Buttons Displayed

You can register or change the services and buttons displayed on the touch screen. You can customize the following screens:

- Note**
- The following screens and buttons may have been changed by the system administrator. Use the machine according to the changes that have been made.

Setting the Initial Screen

You can set the screen displayed after switching the power on or exiting the Power Saver mode.

Setting the Screen Displayed after Auto Clear

You can select [Last Selection Screen] or [Home] for the screen to be displayed after Auto Clear.

Assigning Services to the Custom Buttons

You can assign services to the Custom buttons on the control panel: Custom 1 to Custom 3.

By assigning frequently-used services to the Custom buttons, you can switch to the services without returning to the [Home] screen.

- Note**
- By default, "Copy" is assigned to <Copy>, and "Review" is assigned to <Shortcut 2>. No service is assigned to <Shortcut 1>.

Customizing the [Home] Screen

You can customize the layout of services and buttons on the [Home] screen that is displayed when you press the <Home> button on the control panel.

About the [Home] Screen

This section describes the [Home] screen, which can be displayed by pressing the <Home> button.

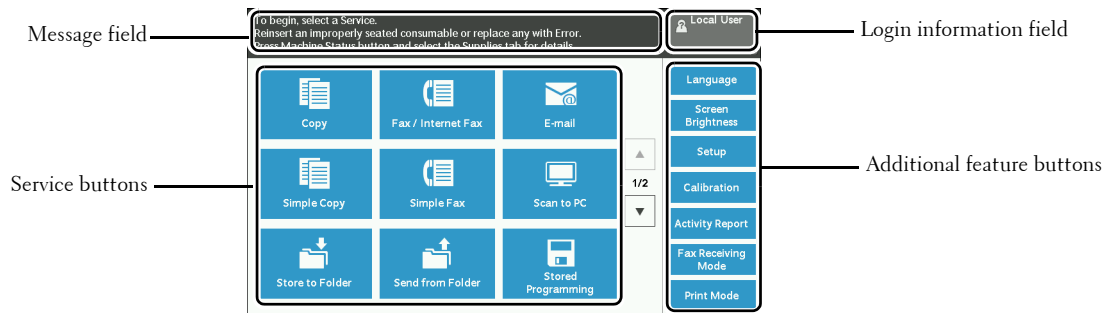

Next page

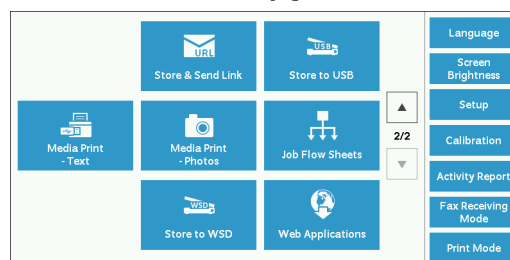

* WSD stands for Web Services on Devices.

Message Field

Displays a message.

Login Information Field

Select this field in the upper right corner of the touch screen to display the User ID entry screen for entering the System Administration mode, the Authentication mode, or the Accounting mode.

When a user is authenticated, the login information is displayed in this field.

- Note**
- You can also press the <Log In/Out> button on the control panel to enter the Authentication mode.
 - To exit the Authentication mode, press the <Log In/Out> button on the control panel. You can also select the login information field in the upper right corner of the touch screen.

For information on the Authentication or Accounting mode, refer to "Authentication and Accounting Features" (P.533).

Service Buttons

Allows you to set the features for each service.

Copy

You can set the features for the Copy service.
For more information, refer to "Copy" (P.59).

Fax / Internet Fax

You can set the features for the Fax service.
For more information, refer to "Fax" (P.145).

E-mail

You can scan documents and send the scanned data as an e-mail attachment.

Simple Copy

You can set the features for the Copy service. Selecting [Simple Copy] allows you to simply specify the basic copy features on a single screen.

For more information, refer to "Simple Copy" (P.69).

Simple Fax

You can set the features for the Fax service. Selecting [Simple Fax] allows you to easily specify the basic fax features on a single screen.

Scan to PC

You can scan documents and send the scanned data to a network computer via the FTP or SMB protocol.

Store to Folder

You can scan documents and save the scanned data in a folder of the machine.

Send from Folder

You can operate files stored in a folder of the machine.

Stored Programming

You can operate stored programs.

Stored Programming is a service that allows you to store settings that you expect to use frequently and call them with a single button operation.

For more information, refer to "Stored Programming" (P.175).

Store & Send Link

After you scan documents, the machine temporarily saves the scanned data and sends you e-mail attached with two URLs: one is for the location to retrieve the scanned data, and the other is for the location to delete the data.

Note • This service appears when using the Authentication feature.

Store to USB

You can scan documents and save the scanned data to a USB memory device.

Media Print - Text

You can print document files (PDF, TIFF, XML Paper Specification (XPS), and JPG (JFIF)) after retrieving the files from a CompactFlash card or a USB memory device. You can also print the scan data stored with the Store to USB service.

For more information, refer to "Media Print - Text" (P.201).

Media Print - Photos

You can print image data (DCF1.0) taken with a digital camera. You can retrieve the data only from a CompactFlash card.

For more information, refer to "Media Print - Photos" (P.200).

Job Flow Sheets

You can scan documents using a job flow sheet.

Job Flow Sheets is a service that allows you to set a flow of transfer settings of scan data for the efficient routine transfer.

For more information, refer to "Job Flow Sheets" (P.169).

Web Applications

You can access web applications via a network using the browser on the machine in order to display and store data.

For more information, refer to "Web Applications" (P.185).

Store to WSD

You can scan documents set on the machine and save the scanned data by operating from a computer on the network. Also, you can save the scanned data to a computer on the network.

Note • WSD stands for Web Services on Devices.

Additional Feature Buttons

Allows you to set the additional features that are not related to jobs.

Language

You can select the language to be displayed on the touch screen.

The setting here will be reset when the power is switched off and on.

- Note**
- When you select [English], only ASCII characters can be used.
 - When you set [Language] to [English] on the [Home] screen and an address book entry or contents of [Details] of Job Flow Sheets is entered in other than ASCII characters, the characters may not be displayed properly. When you use Dell Printer Configuration Web Tool to import a CSV file* that includes the characters other than those used for the language selected in [Language], the characters in the file may be garbled or the import may fail.
*: CSV (Comma Separated Values) is a file format that is often used for saving data by spreadsheets and database programs.
 - Under [Default Language] in the System Administration mode, you can select the standard language displayed on the touch screen when the power is switched on. For more information on how to set [Default Language], refer to "Default Language" (P.320).

Screen Brightness

You can adjust the screen brightness of the touch screen.

Lock Out Printer / Release Printer

You can set the machine to temporarily enable printing during the printer lockout period or to temporarily disable printing while [Release Printer] is displayed.

Note • You can assign this button when [Printer Lockout] is set to [On] under [Tools] > [Common Service Settings] > [Machine Clock / Timers] and the [Allow User to Lock Out] check box is selected. For information on how to assign the feature to the button, refer to "Screen/Button Settings" (P.319).

Setup

You can create or update folders, job flows, and the Address Book.
For more information, refer to "Setup" (P.421).

Calibration

The machine can automatically calibrate colors when the reproducibility of density or color in copies and prints deteriorates.

For more information, refer to "Executing Calibration" (P.265).

Activity Report

You can print an Activity Report to check if a transmission is successfully completed.

Fax Receiving Mode

You can specify a mode for receiving faxes.

For more information, refer to "Fax Receiving Mode" (P.288).

Print Mode

You can register a print mode and change its settings.

For more information, refer to "Print Mode" (P.285).

Entering Text

During operations, a screen for entering text sometimes appears. The following describes how to enter text.

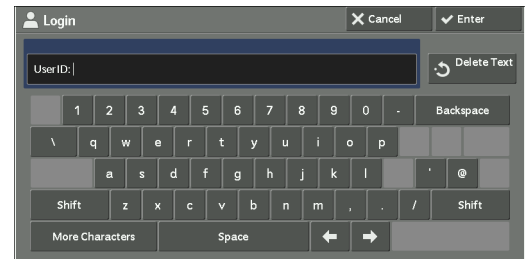

You can enter the following characters: numerals, alphabets, and symbols.

Item	Description
Entering alphabets and numerals	To enter uppercase letters, select [Shift]. To return to the lowercase letters, select [Shift] again.
Entering symbols	Select [More Characters]. Note <ul style="list-style-type: none"> Depending on the keyboard, you can select a symbol from the pull-up options displayed on the bottom left of the screen.
Entering a space	Select [Space].
Deleting characters	Select [Backspace] to delete one character at a time. Select [Delete Text] to delete all characters.

Installing the Tray Attachment on the Finisher-B1

Setting the tray attachment on the finisher tray may help you deliver and stack A4 and B5 sheets without staples more neatly on the finisher tray of Finisher-B1.

- 1 Remove the tray attachment from the rear of the finisher tray.

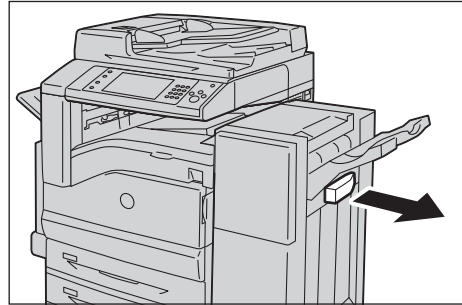

- 2 Install the tray attachment onto the middle of the finisher tray as shown in the diagram.

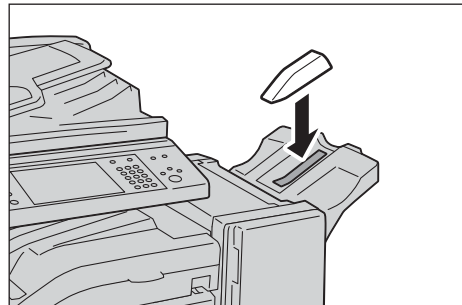

3 Copy

This chapter describes the basic operation and features for the Copy service.

- **Copying Procedure**.....60
- **Operations during Copying**.....66
- **Simple Copy**.....69
- **Copy**.....74
- **Image Quality**.....87
- **Layout Adjustment**.....94
- **Output Format**.....109
- **Job Assembly**.....135

Copying Procedure

This section describes the basic copy procedures. The following shows the reference section for each procedure.

Step 1 Loading Documents	60
Step 2 Selecting Features	62
Step 3 Entering a Quantity.....	63
Step 4 Starting the Copy Job.....	64
Step 5 Confirming the Copy Job in Job Status	65

Step 1 Loading Documents

The following two methods are available to load documents:

Document Feeder

- Single sheet
- Multiple sheets

Document Glass

- Single sheet
- Bound documents, such as books

Document Feeder

The document feeder supports single and multiple sheet documents with sizes from 125 x 85 mm (Standard size: A5, A5 \square) to 297 x 432 mm (Standard size: A3, 11 x 17").

The document feeder automatically detects standard size documents. For non-standard size documents, enter the size on the [Original Size] screen.

For information on document sizes that can be detected automatically and how to enter a non-standard document size, refer to "Original Size (Specifying the Scan Size for the Document)" (P.99).

The standard document sizes that can be detected automatically depend on [Paper Size Settings] in the System Administration mode. For information on [Paper Size Settings], refer to "Paper Size Settings" (P.335).

The document feeder accepts the following number of sheets.

Document Type (Weight)	Number of Sheets
Lightweight paper (38 - 49 gsm)	110 sheets
Plain paper (50 - 80 gsm)	110 sheets
Heavyweight paper (81 - 128 gsm)	75 sheets

- Note**
- To avoid paper jams, use the document glass for folded or wrinkled documents, cut-and-pasted documents, curled paper, or back carbon paper.
 - The lightweight paper of 38 - 49 gsm cannot be scanned 2 sided.

For information on how to copy mixed sized documents, refer to "Mixed Size Originals (Scanning Different Size Documents Simultaneously)" (P.100).

- 1 Remove any paper clips and staples before loading a document.

- 2 Load the document face up (when the document is 2-sided, load the front side up) in the center of the document feeder.

Note • The confirmation indicator lights up when the document is loaded correctly. If the indicator does not light, load the document again.

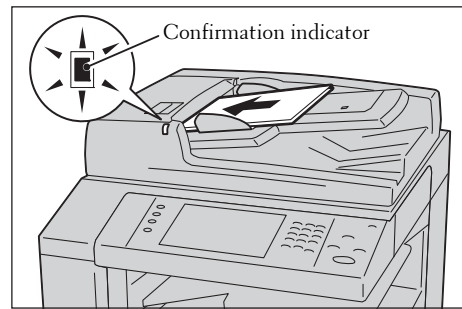

- 3 Adjust the document guides to match the size of the document loaded.

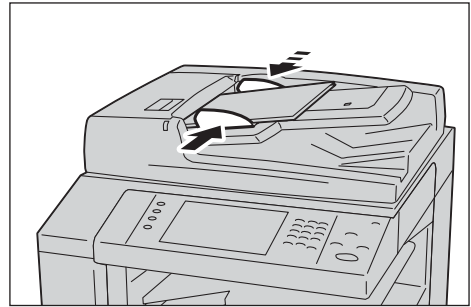

- 4 Pull out the document stopper.

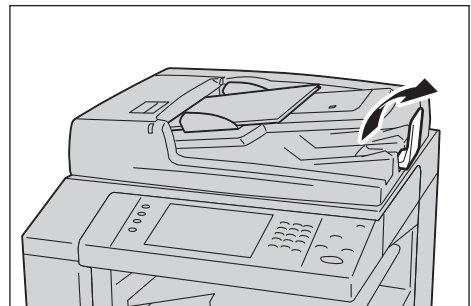

Document Glass

The document glass supports a single sheet, a book, or other similar documents with a size from 15 x 15 mm to 297 x 432 mm (Standard size: A3, 11 x 17").

Note • Always close the document cover after using the document glass.

The document glass automatically detects standard size documents. For non-standard size documents, enter the size on the [Original Size] screen.

For information on document sizes that can be detected automatically and how to enter a non-standard document size, refer to "Original Size (Specifying the Scan Size for the Document)" (P.99).

The standard document sizes that can be detected automatically depend on [Paper Size Settings] in the System Administration mode. For information on the paper size settings, refer to "Paper Size Settings" (P.335).

- 1 Open the document cover.

Note • Ensure that the touch screen is active, and then load a document. Otherwise, the machine may not properly detect the document size.

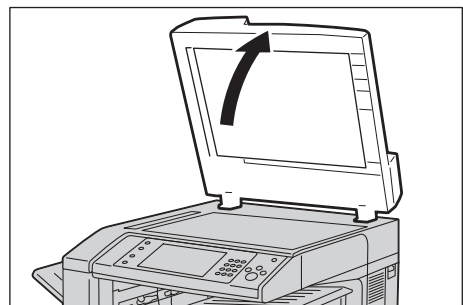

- 2 Load the document face down, and align it against the top left corner of the document glass.

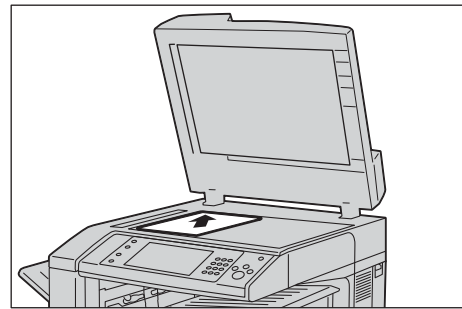

- 3 Close the document cover.

Note • When a standard size document is loaded on the document glass, the size of the document is displayed in the message field.

Step 2 Selecting Features

The following two services are available to copy documents.

Simple Copy

Allows you to only select basic features to copy documents.

Copy

Allows you to make detailed settings to copy documents.

The following describes how to select features on the [Copy] screen.

For information on Simple Copy, refer to "Simple Copy" (P.69).

Note • The features displayed on the screen depend on the configuration of your machine.
 • When the Authentication or Accounting feature is enabled, a user ID and passcode may be required. Ask your system administrator for the user ID and passcode.

- 1 Press the <Home> Button.

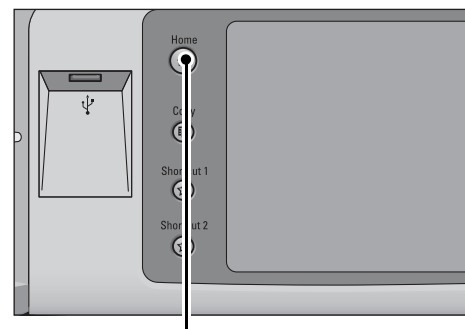

<Home> Button

- 2 Select [Copy].

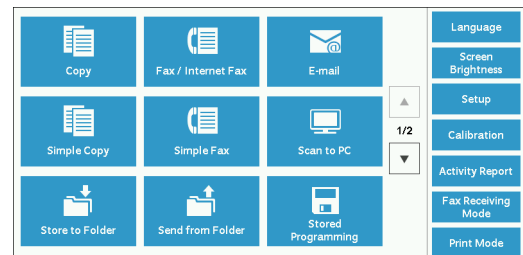

- 3 If the previous settings still remain, press the <Clear All> button.

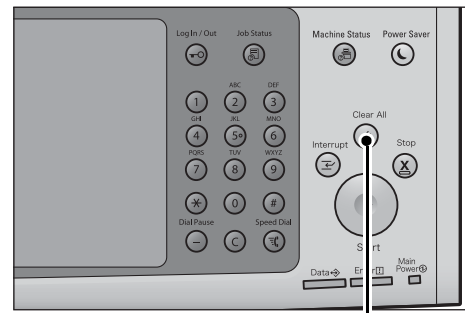

<Clear All> button

- 4 Select each tab, and configure features as necessary.

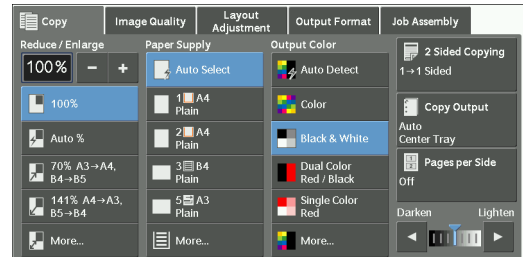

The following shows the reference section for each tab.

- "Copy" (P.74)
- "Image Quality" (P.87)
- "Layout Adjustment" (P.94)
- "Output Format" (P.109)
- "Job Assembly" (P.135)

Step 3 Entering a Quantity

The following describes how to enter the number of copy sets. You can enter up to 999 sets.

- 1 Enter the number of copies using the numeric keypad. The number of copies entered appears on the upper right of the touch screen.

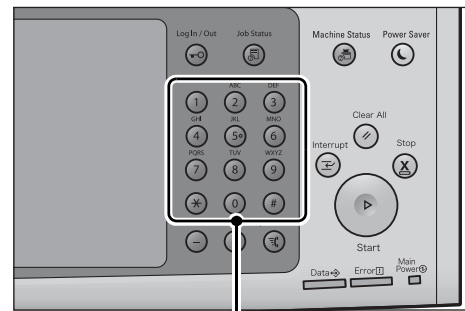

Numeric keypad

- 2 If you have entered an incorrect value, press the <C (Clear)> button and then enter the correct value.

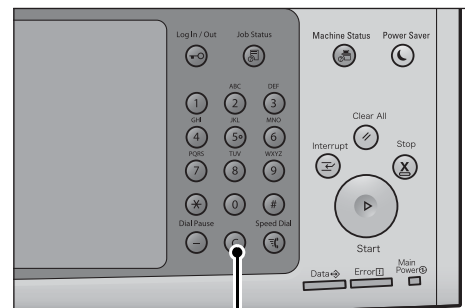

<C (Clear)> button

Step 4 Starting the Copy Job

The following describes how to start a copy job.

1 Press the <Start> button.

- Note**
- If the document has been loaded in the document feeder, do not hold down the document while it is being conveyed.
 - If a problem occurs, an error message appears on the touch screen. Solve the problem according to the message.
 - You can set the next job during copying.

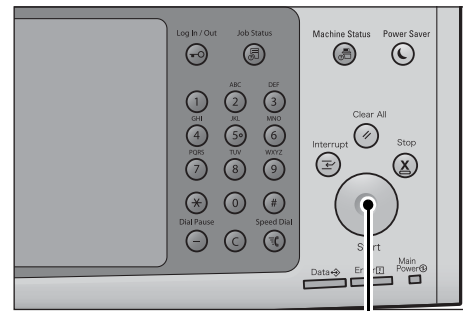

<Start> button

If you have more documents

If you have more documents to copy, select [Next Original] on the touch screen while the current document is being scanned. This allows you to scan the documents as a single set of data.

2 Select [Next Original] while scanning is in progress.

- Note**
- When using the document feeder, load the next document after the machine has finished scanning the first document.
 - When [Next Original] is displayed on the screen shown on the right and no operation is performed for a certain period of time, the machine automatically assumes that there are no more documents.
 - You can change the number of copies by selecting [Change Quantity] that is displayed after selecting [Delete].

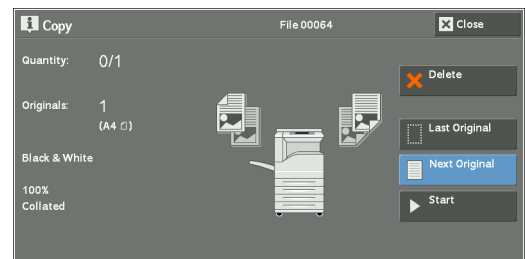

3 Load the next document.

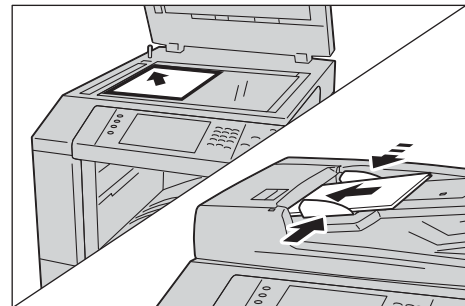

4 Press the <Start> button.

If you have more documents, repeat steps 3 and 4.

5 When all documents have been scanned, select [Last Original].



Step 5 Confirming the Copy Job in Job Status

If copies are not output after you start the copy job, the job may be in pending status. Use the following procedure to confirm the job status.

- 1 Press the <Job Status> button.

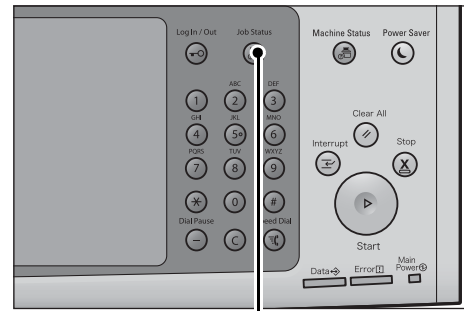

<Job Status> button

- 2 Confirm the job status.

Note

- Select [▲] to return to the previous screen or [▼] to move to the next screen.

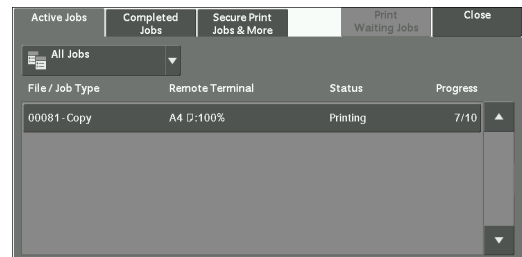

Operations during Copying

This section describes available operations during copying. The following shows the reference section for each operation.

Stopping the Copy Job.....	66
Changing the Number of Copies	67
Interrupting the Copy Job	68

Stopping the Copy Job

To cancel a copy job in progress, use the following procedure.

- 1 Press either the <Stop> button on the control panel or [Delete] on the touch screen.

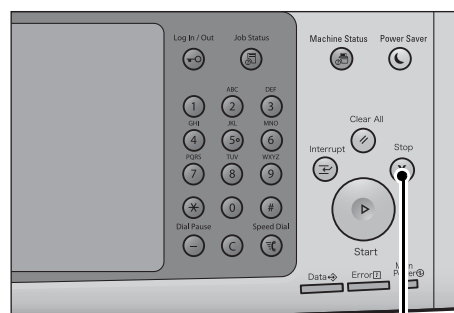

<Stop> button

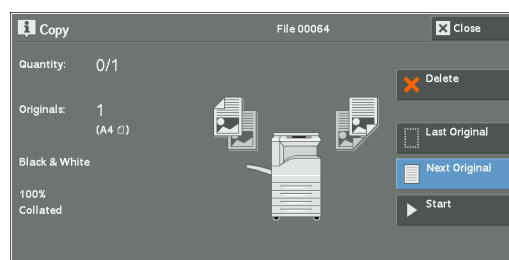

- 2 Select [Delete].



If [Delete] does not appear on the screen:

- 1 Press the <Job Status> button.

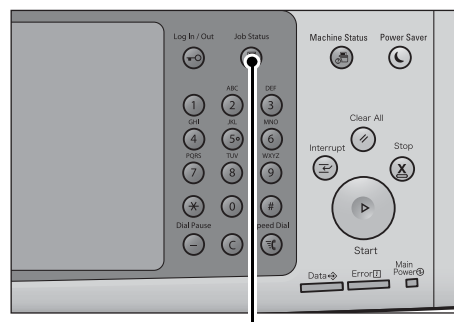

<Job Status> button

2 Select the job to cancel.

Note • Select [▲] to return to the previous screen or [▼] to move to the next screen.

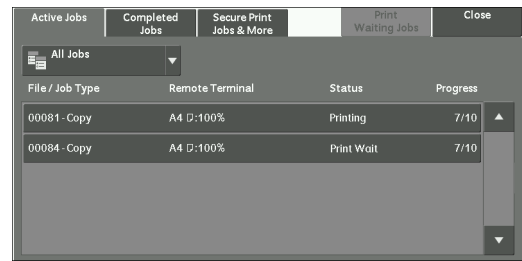

3 Select [Delete].

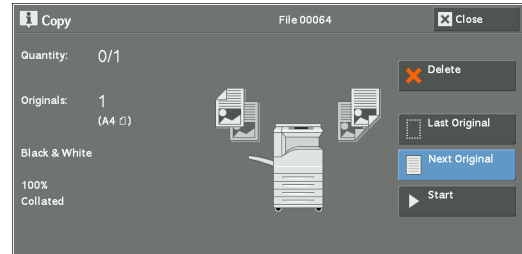

4 Select [Delete].



Changing the Number of Copies

To change the number of copy sets during scanning or copying, use the following procedure.

1 Press either the <Stop> button on the control panel or [Delete] on the touch screen.

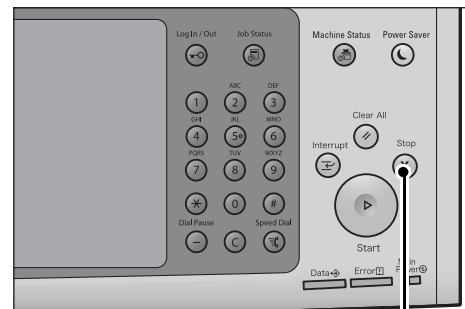

<Stop> button

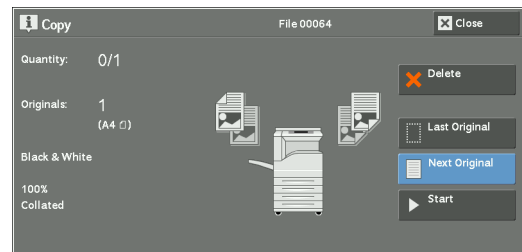

- 2 Select [Change Quantity].

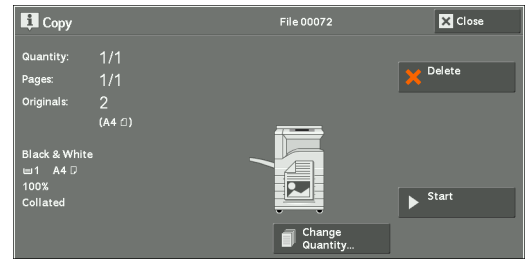

- 3 Specify the number of copy sets with the numeric keypad. The new quantity must include the number of copies that have already been printed. You cannot enter a number less than the number of copies that have already been printed.
- 4 Press the <Start> button.

Note • If you enter the same value as the number of copies that have already been printed, the machine will not execute a copy job even when you press the <Start> button.

Interrupting the Copy Job

You can temporarily stop the copy job to have the machine process another job.

Note • Press the <Interrupt> button only after all the documents have been scanned. The machine does not accept another job while it is scanning the documents, or when [Next Original] has been selected.

- 1 Press the <Interrupt> button.

The <Interrupt> button lights up to indicate that the machine is in the Interrupt mode.

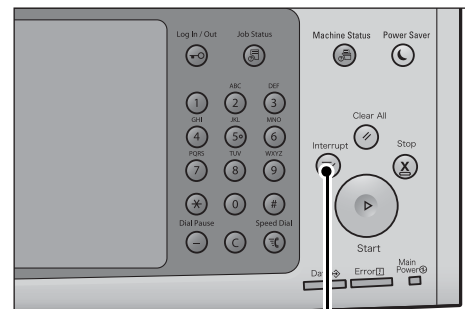

<Interrupt> button

- 2 Load a document and set features if necessary.
- 3 Specify the number of copy sets with the numeric keypad.
- 4 Press the <Start> button.
- 5 After you have finished making the interrupt copy, press the <Interrupt> button. The <Interrupt> button goes out to indicate that the Interrupt mode is exited.
- Note** • If you used the document glass to copy the document, remove the document from the document glass.
- 6 Press the <Start> button. The suspended copy job is resumed.

Simple Copy

You can select [Copy] or [Simple Copy] on the [Home] screen to set the features for the Copy service.

This section describes the features you can select on the [Simple Copy] screen. [Simple Copy] allows you to use only basic features to easily copy documents. The following shows the reference section for each feature.

Paper Supply (Selecting the Paper for Copying)	69
Reduce / Enlarge (Making Enlarged/Reduced Copies)	70
2 Sided Copying (Making 2 Sided Copies)	71
Auto / Color / Black & White (Selecting the Color for Copying)	72
Lighten/Darken (Adjusting the Copy Density)	72
2 Pages per Side (Copying Two Pages onto One Sheet)	73
1 Staple	73

- 1 Select [Simple Copy] on the [Home] screen.

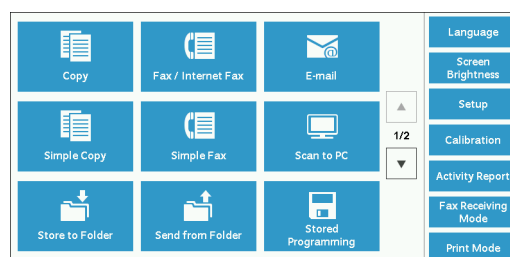

- 2 Select a feature on the [Simple Copy] screen.

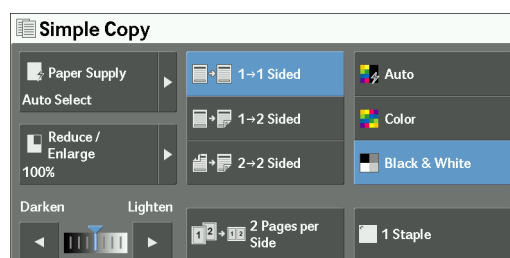

Paper Supply (Selecting the Paper for Copying)

This feature allows you to select the paper tray for copying.

- 1 Select [Paper Supply].

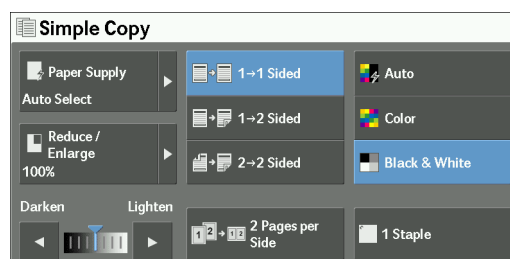

- 2 Select a paper tray to be used.

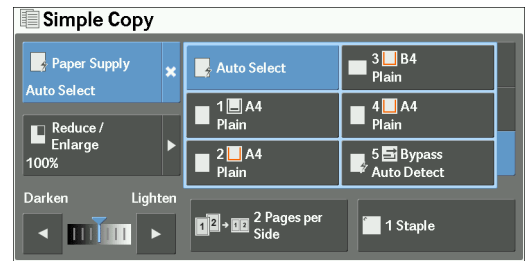

Auto Select

Automatically determines the tray holding the appropriate paper, based on the document size and the specified copy ratio.

Note • This cannot be selected together with [Auto %] under [Reduce / Enlarge].

Tray 1 - 4

Allows you to directly select the desired tray.

Tray 5 Bypass Auto Detect

Automatically detects the size of paper loaded in the bypass tray.

Checking the Remaining Amount of Paper in the Paper Tray

The icon displayed beside the tray number indicates the amount of paper remaining in the paper tray.

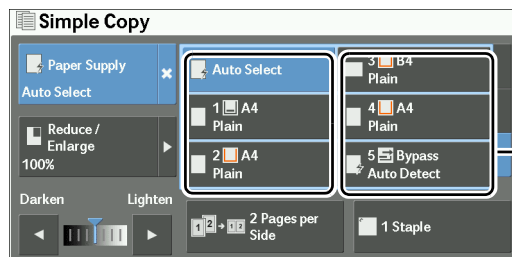

You can view the icons to check the remaining amount of paper in a tray.

 : Indicates that the remaining amount of paper is 25 to 100%.

 : Indicates that the remaining amount of paper is 25% or less.

 : Indicates that no paper is remaining in the paper tray.

Reduce / Enlarge (Making Enlarged/Reduced Copies)

This feature allows you to select a copy ratio to enlarge or reduce the size of copies.

- 1 Select [Reduce / Enlarge].

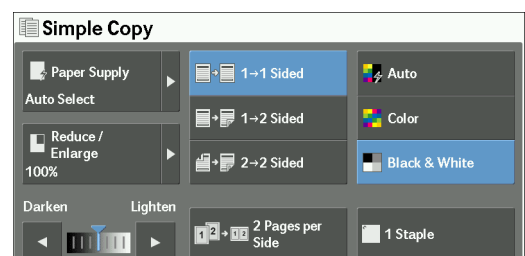

- 2 Select a copy ratio.

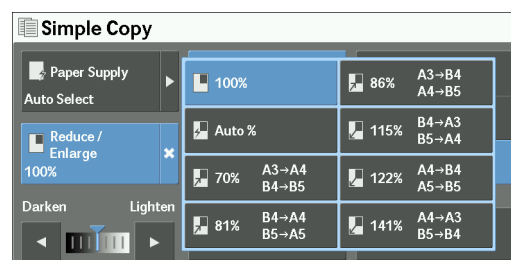

100%

Copies at the same image size as the original document.

Auto %

Automatically determines the copy ratio based on the document size and the paper size specified in [Paper Supply], and copies the document to fit into the paper.

Note • This cannot be selected together with [Auto Select] under [Paper Supply].

Ratios

Allows you to select from preset copy ratios.

2 Sided Copying (Making 2 Sided Copies)

This feature allows you to copy 1-sided and 2-sided documents on one side or both sides of paper.

- 1 Select any option.

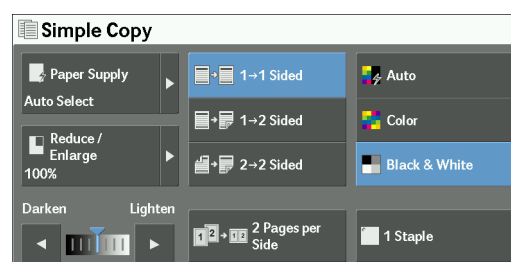

1→1 Sided

Makes a copy of a 1-sided document on one side of the paper.

1→2 Sided

Makes a copy of a 1-sided document on both sides of the paper.

2→2 Sided

Makes a copy of a 2-sided document on both sides of the paper.

Note • When you copy both sides of the 2-sided document to one side and the document size is bigger than A4, the orientation of the copied images may not be appropriate. To achieve the copy result with the correct orientation, scan Side 1 and Side 2 separately in different orientations, using the document glass.

Auto / Color / Black & White (Selecting the Color for Copying)

This feature allows you to select a color mode.

- 1 Select [Auto], [Color] or [Black & White].

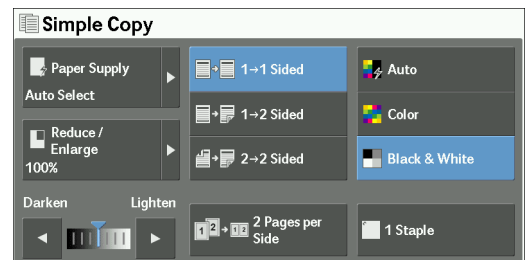

Auto

Detects if the original document is in color or black and white and prints the copy accordingly.

- Note**
- If the original color document is in any of the following conditions, the machine may print the copy in black and white.
 - The colored area is too small.
 - The colors are too light.
- In that case, change a level from the five levels which is used for the machine to recognize color. For more information, refer to "Output Color Recognition" (P.326).

Color

Copies in full color.

Black & White

Copies in black and white regardless of the colors in the original document.

- Note**
- Some colors may be restricted and may not be used for printing the copy. For more information, refer to "Account Limit" (P.443).

Lighten/Darken (Adjusting the Copy Density)

This feature allows you to select a copy-density level from seven levels.

- 1 Use [◀] and [▶] to select a density level.

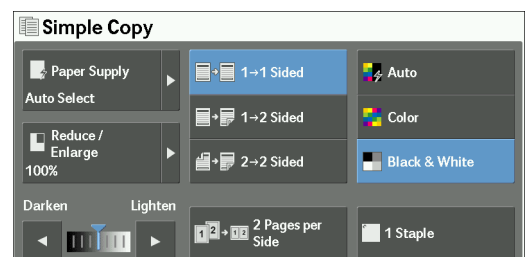

2 Pages per Side (Copying Two Pages onto One Sheet)

This feature allows you to copy two pages of a document on one side of a single sheet of paper.

When you select [2 Pages per Side], [Auto %] is automatically selected in [Reduce / Enlarge]. The machine automatically sets the copy ratio and makes copies of the images so that they fit on the selected paper.

- Note**
- When you deselect [Auto %] in [Reduce / Enlarge] (when you select another copy ratio), image loss may occur depending on the image size of the document.
 - Select a tray other than [Auto Select] in [Paper Supply]. When you select [Auto Select], the tray containing A4 paper is selected. If no tray contains A4 paper, the machine select a tray based on the [Auto Paper Off] setting. For information on [Auto Paper Off], refer to "Auto Paper Off" (P.354).
 - When you copy both sides of the 2-sided document to one side and the document size is bigger than A4, the orientation of the copied images may not be appropriate. To achieve the copy result with the correct orientation, scan Side 1 and Side 2 separately in different orientations, using the document glass.

For information on how to copy four or eight pages of a document together onto a single sheet of paper, refer to "Pages per Side (Copying Multiple Pages onto One Sheet)" (P.114).

- 1 Select [2 Pages per Side].

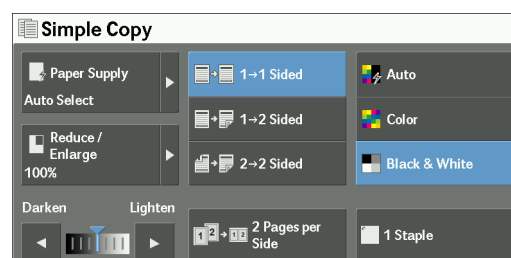

1 Staple

This feature allows you to select whether to staple copied outputs at the top left corner.

The number of sheets that can be stapled is 2 - 50 (when 80 gsm paper is used). Available paper types are: Bond, Plain, Recycled, Plain Reload, Lightweight, Heavyweight, Heavyweight Reload, Extra Heavyweight (170 - 220 gsm), Extra Heavyweight (170 - 220 gsm) Reload, Gloss, Gloss Reload, Heavyweight Gloss (170 - 220 gsm), Heavyweight Gloss (170 - 220 gsm) Reload, Punched, and Custom Paper 1 to 5.

- Note**
- An optional component is required to use this feature. For more information, contact Customer Support at dell.com/contactdell.

- 1 Select [1 Staple].

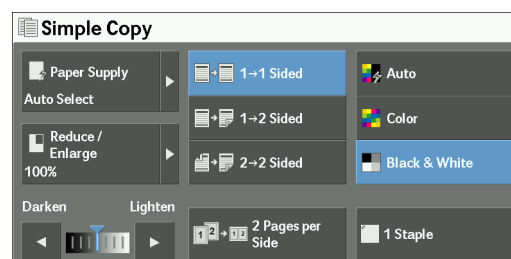

Copy

You can select [Copy] or [Simple Copy] on the [Home] screen to set the features for the Copy service.

This section describes the features you can select on the [Copy] screen. The following shows the reference section for each feature.

Reduce / Enlarge (Making Enlarged/Reduced Copies).....	74
Paper Supply (Selecting the Paper for Copying).....	77
Output Color (Selecting the Color for Copying).....	81
2 Sided Copying (Making 2 Sided Copies)	85
Copy Output (Specifying Finishing Options).....	85
Pages per Side (Copying Multiple Pages onto One Sheet)	85
Lighten/Darken (Adjusting the Copy Density).....	86

You can customize the layout of the features displayed on the [Copy] screen. For more information, refer to "Copy Tab - Features Allocation" (P.348).

- 1 Select [Copy] on the [Home] screen.

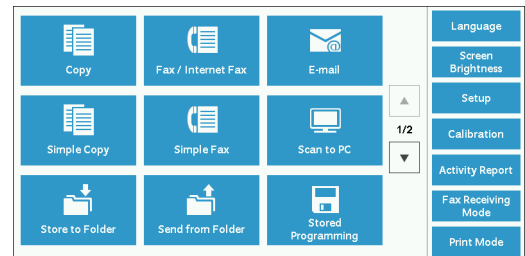

- 2 Select a feature on the [Copy] screen.

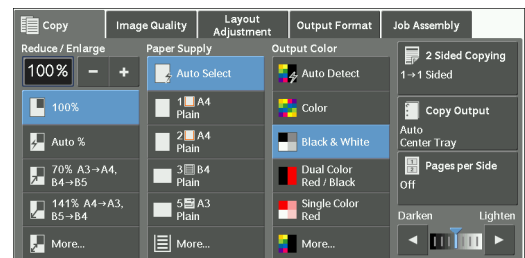

Reduce / Enlarge (Making Enlarged/Reduced Copies)

This feature allows you to select a copy ratio to enlarge or reduce the size of copies.

- 1 Specify a copy ratio. You can use the numeric keypad to specify a value, or [+] and [-] to specify reduction/enlargement ratios directly.

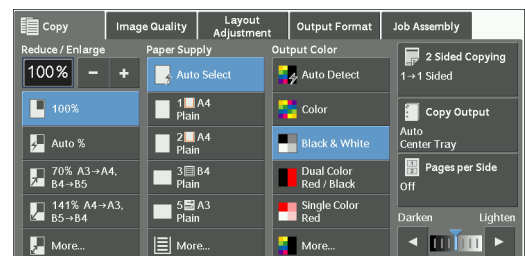

100%

Copies at the same image size as the original document.

Auto %

Automatically determines the copy ratio based on the document size and the paper size specified in [Paper Supply], and copies the document to fit into the paper.

Note • This cannot be selected together with [Auto Select] under [Paper Supply].

Ratios (3rd to 4th buttons on the screen)

Displays preset copy ratios.

You can change the copy ratio associated with each button. For information on the settings, refer to "Reduce/Enlarge - Button 3 - 4" (P.349).

More

Displays the [Reduce / Enlarge] screen on which you can set [Proportional %] and [Independent X - Y%].

For information on the settings on the [Reduce / Enlarge] screen, refer to "When [Proportional %] is Selected" (P.75) or "When [Independent X - Y%] is Selected" (P.76).

When [Proportional %] is Selected

You can select a ratio from the standard copy ratios, or can enter a ratio directly.

- 1 Select a copy ratio, or specify a value.

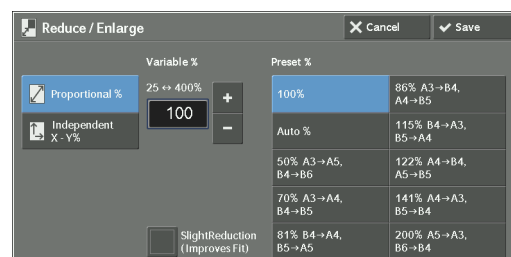

Variable %

Specify a ratio in the range from 25 to 400% in 1% increments. To specify a value, use the numeric keypad or [+] and [-]. Specifying "100%" allows you to make copies at the same image size as the original document.

When you make enlarged/reduced copies from standard sized documents on standard sized paper, the following copy ratios will be applied.

Copy / Original	A6	B6	A5	B5	A4	B4	A3
A6	100%	122%	141%	173%	200%	245%	283%
B6	82%	100%	116%	142%	164%	200%	232%
A5	71%	86%	100%	122%	141%	174%	200%
B5	58%	70%	81%	100%	115%	141%	163%
A4	50%	61%	70%	86%	100%	122%	141%
B4	41%	50%	58%	70%	81%	100%	115%
A3	35%	43%	50%	61%	70%	86%	100%

How to load a document depends on the size and orientation of a document. For more information, refer to "Step 1 Loading Documents" (P.60).

For information on paper that can be loaded, refer to "Paper Types" (P.226).

Preset %

Select a copy ratio from the following options.

- 100%

Copies at the same image size as the original document.

- Auto %

Automatically determines the copy ratio based on the document size and the paper size specified in [Paper Supply], and copies the document to fit into the paper.

Note • This cannot be selected together with [Auto Select] under [Paper Supply].

- Preset ratios

Select from the preset ratios.

You can change the copy ratio associated with each button. For information on the settings, refer to "Reduce/Enlarge Presets" (P.357).

SlightReduction (Improves Fit)

Select this check box to slightly reduce the specified copy ratio to copy the complete image onto the paper.

Note • If you select [SlightReduction (Improves Fit)] and you do not want to erase the edges of the document, set the amount of edge erase to 0 mm. Note that if the amount is set to 0 mm, the edges of the copied document may get dirty. You can set [Edge Erase] on the [Layout Adjustment] screen. For more information, refer to "Edge Erase (Erasing Edges and Margin Shadows of the Document)" (P.101).

When [Independent X - Y%] is Selected

You can specify reduction/enlargement ratios for the width and length individually.

- 1 Select any option.

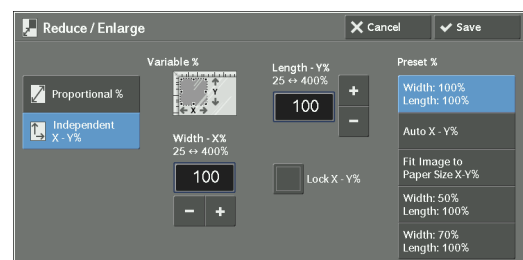
**Variable %**

- Width - X%, Length - Y%

Allows you to specify reduction/enlargement ratios for the width and length in the range from 25 to 400% in 1% increments. Use [+] and [-] or the numeric keypad to specify a ratio.

Lock X - Y%

Allows you to make the same ratio adjustment for the width and length at the same time.

Preset %

- Width: 100% Length: 100%

Copies at the same image size as the original document.

- Auto X - Y%

Automatically determines the reduction/enlargement ratios for the width and length so that the document image fits in the paper.

- Fit Image to Paper Size X-Y%

Automatically determines the reduction/enlargement ratios for the width and length so that the document image fits in the paper, and then slightly reduces the ratios so that the complete image is copied onto the paper.

- Width: XX% Length: XX%

Allows you to specify the preset reduction/enlargement ratios.

Paper Supply (Selecting the Paper for Copying)

This feature allows you to select the tray that holds the paper you want to use.

- 1 Select a paper tray.

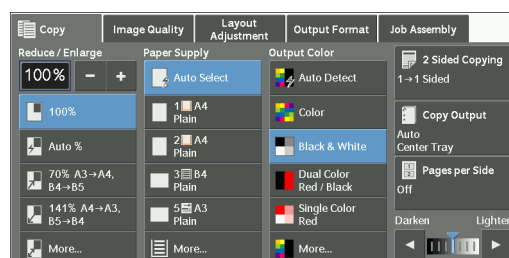

Auto Select

Automatically determines the tray holding the appropriate paper, based on the document size and the specified copy ratio.

Note • This cannot be selected together with [Auto %] under [Reduce / Enlarge].

Trays (2nd to 5th buttons on the screen)

Allows you to directly select the desired tray.

You can change the paper tray associated with each button on the [Copy] screen. For information on the settings, refer to "Paper Supply - Button 2 - 5" (P.349).

More

Displays the [Paper Supply] screen.

Refer to "[Paper Supply] Screen" (P.78).

Checking the Remaining Amount of Paper in the Paper Tray

The icon displayed beside the tray number indicates the amount of paper remaining in the paper tray.

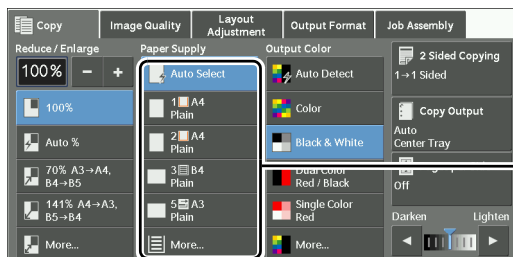

You can view the icons to check the remaining amount of paper in a tray.



: Indicates that the remaining amount of paper is 25 to 100%.



: Indicates that the remaining amount of paper is 25% or less.



: Indicates that no paper is in the paper tray.

[Paper Supply] Screen

This screen allows you to select a paper tray from all trays available on the machine.

- 1 Select a paper tray.

Tray	% Full	Size	Type	Color	Size Detection
1	0%	A4	Plain	White	Auto Detect
2	0%	A4	Plain	White	Auto Detect
3	0%	B4	Plain	White	Auto Detect
4	0%	A4	Plain	White	Auto Detect
5	Bypass	Auto Detect	Plain	-	-

Auto Select

Tray

Allows you to select a paper tray. When [Auto %] is selected in [Reduce / Enlarge], the machine automatically determines the tray holding the appropriate paper based on the document size and the specified copy ratio. When [Tray 5] is selected, the [Tray 5] screen is displayed where you can specify a paper type other than plain paper, and non-standard size paper.

For more information, refer to "[Tray 5] Screen" (P.79).

Note • Tray 6 is optional.

% Full

Displays the remaining amounts of paper loaded in trays.

Size

Displays paper sizes.

Type

Displays paper types.

Color

Displays paper colors.

For information on how to set [Paper Color], refer to "Paper Tray Attributes" (P.322).

Size Detection

Displays how the machine detects a paper size.

Note • The fixed paper sizes are set for Tray 3 and Tray 4. To change the paper sizes for Tray 3 and Tray 4, contact Customer Support at dell.com/contactdell.

For information on how to set [Size Detection], refer to "Paper Size Settings" (P.335).

[Tray 5] Screen

Set the paper loaded in Tray 5.

The [Tray 5] screen appears when you load paper in Tray 5.

For information on paper that can be loaded in Tray 5, refer to "Paper Types" (P.226).

- 1 Select a paper size and a paper type.

Note • Select [▲] to return to the previous screen or [▼] to move to the next screen.
• [Auto Detect] is available only when standard sized paper is loaded.

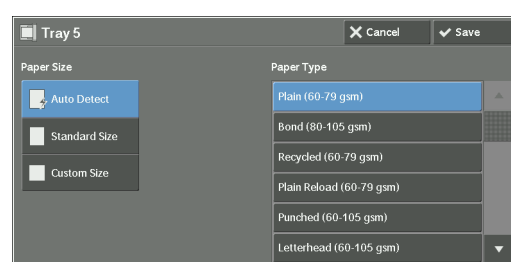

Paper Size

Select from [Auto Detect], [Standard Size], and [Custom Size].

When you select [Auto Detect], the paper size is identified automatically.

When you select [Standard Size] or [Custom Size], refer to "When [Standard Size] is Selected" (P.79) or "When [Custom Size] is Selected" (P.79), respectively.

Paper Type

Select a paper type.

When [Standard Size] is Selected

Select [Standard Size], and from the lists displayed, select a paper size and then a paper type.

- 1 Select a paper size and a paper type.

Note • Select [▲] to return to the previous screen or [▼] to move to the next screen.

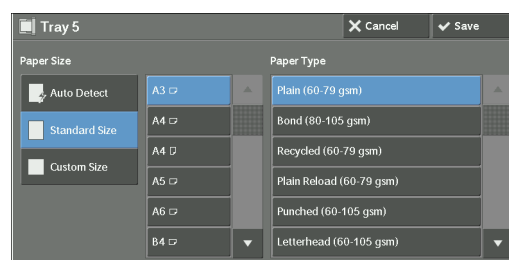

When [Custom Size] is Selected

Enter the width and length of the original document on the fields displayed after selecting [Custom Size].

Specify the X (width) in the range from 98 to 483 mm, and the Y (length) in the range from 89 to 320 mm in 1 mm increments.

- Note**
- If the X (width) of non-standard size paper is less than 140 mm, documents may not be copied properly.
 - When copying on both sides of non-standard size paper, specify the size in the range from 140 to 483 mm for the X (width) direction and from 128 to 320 mm for the Y (length) direction.

1 Enter a paper size using [+] and [-] or the numeric keypad.

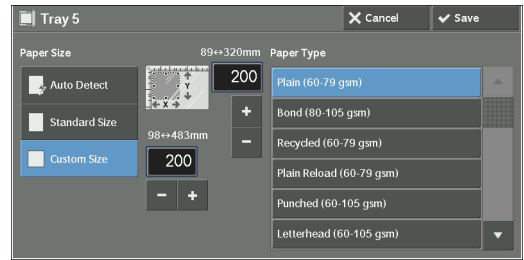

2 Select a paper type.

- Note**
- Select [▲] to return to the previous screen or [▼] to move to the next screen.

Output Color (Selecting the Color for Copying)

This feature allows you to select copy colors.

Note • If the use of certain colors is not allowed, the available colors will be restricted. For more information, refer to "Account Limit" (P.443).

1 Select a color mode.

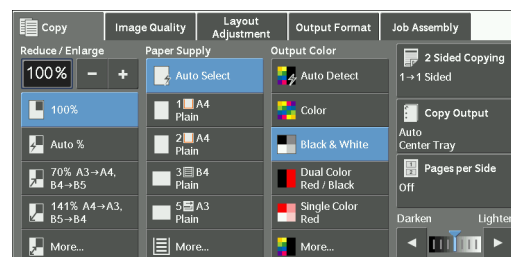

Auto Detect

The machine automatically determines the colors of the original document and makes copies in full color if the original document is colored, and in single color (black) if the document is black-and-white.

Note • If a color document is in one of the following conditions, the machine may copy the document in black and white.

- The colored area is too small.
- The colors are too light.

In that case, change a level from the five levels which is used for the machine to recognize color. For more information, refer to "Output Color Recognition" (P.326).

Color

Copies in full color.

Black & White

Copies in black and white regardless of the colors in the original document.

Dual Color

Copies color documents using two colors.

You can change the two colors. For more information, refer to "Dual Color - Non-target Area Color" (P.350).

Single Color

Copies color documents using one color.

You can change the red color to another one on the screen displayed after selecting [More] > [Single Color] > [Color]. For more information, refer to "Single Color" (P.350).

More

Displays the [Output Color] screen.

For more information, refer to "[Output Color] Screen" (P.82).

[Output Color] Screen

This screen allows you to make settings for full color, dual color, and single color.

1 Select [More].

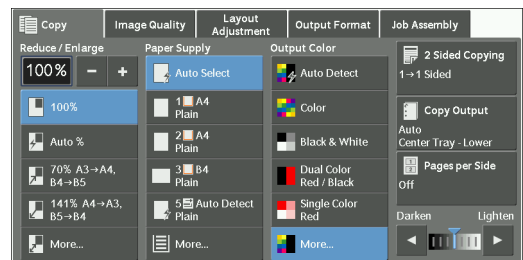

2 Select the desired output color mode.

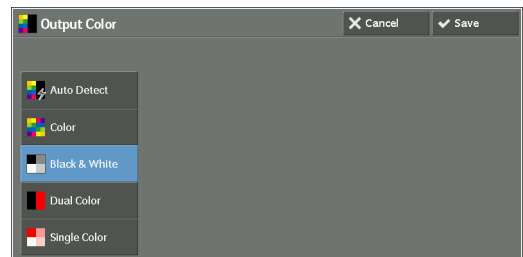

Auto Detect

Automatically determines the color of the original document and makes copies in full color if the original document is colored, or in single color (black) if the document is black-and-white.

Color

Copies in full color using all the four colors of toner: yellow, magenta, cyan, and black.

Black & White

Copies in black and white regardless of the colors in the original document.

Dual Color

Separates the colors of your document into the source colors and the other colors, and then copies the document using two colors. Selecting [Dual Color] allows you to set the following:

- Source Color

Displays the [Source Color] screen on which you can select one or more colors from your document to define them as source colors.

Refer to "[Source Color] Screen" (P.83).

- Target Area Color

Displays the [Target Area Color] screen on which you can select the target color to be used in place of the selected source colors.

Refer to "[Target Area Color] Screen" (P.83).

- Non-target Area Color

Displays the [Non-target Area Color] screen on which you can select the color to be used in place of the colors other than the selected source colors.

Refer to "[Non-target Area Color] Screen" (P.84).

Single Color

Copies in one specified color regardless of the color of the document.

Selecting this option displays [Color] on the screen. Select a color on the [Output Color - Color] screen which is displayed after selecting [Color].

Refer to "[Output Color - Color] Screen" (P.85).

[Source Color] Screen

This screen allows you to select one or more colors from your document to define them as source colors.

1 Select [Dual Color].

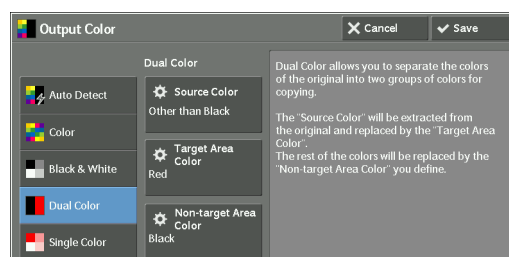

2 Select [Source Color].

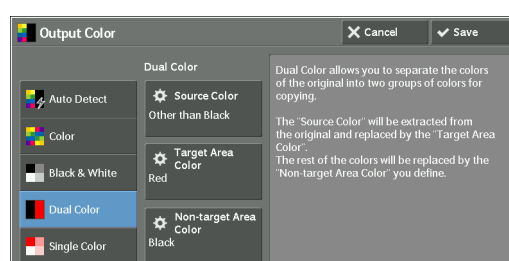

3 Select [Other than Black] or [Color].

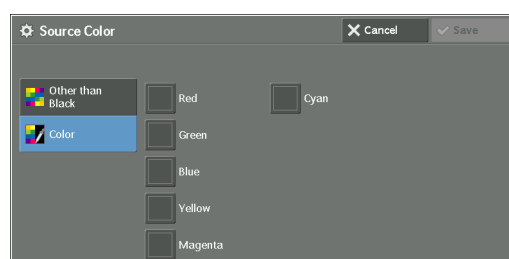

Other than Black

The colors other than black will be the source colors.

Color

Allows you to select one or more source colors from six preset options.

[Target Area Color] Screen

This screen allows you to select the target color to be used in place of the source colors specified in [Source Color]. You can select one color from seven preset and six custom options.

For information on how to set custom colors, refer to "Custom Colors" (P.357).

1 Select [Dual Color].

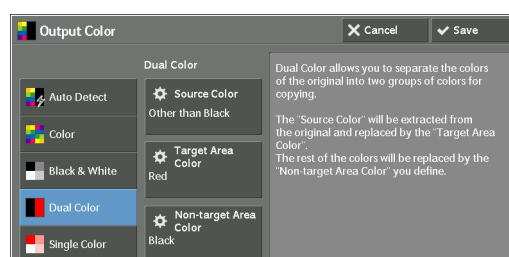

2 Select [Target Area Color].

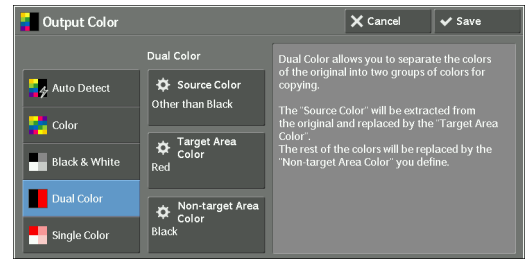

3 Select any color.

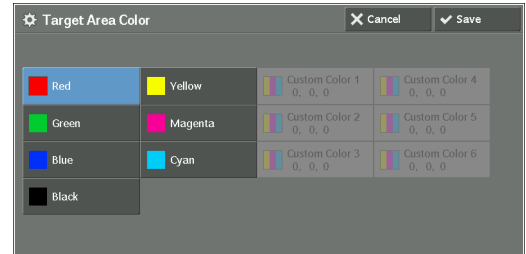

[Non-target Area Color] Screen

This screen allows you to select the color to be used in place of the colors other than the selected source colors. You can select one color from seven preset and six custom options. For information on how to set custom colors, refer to "Custom Colors" (P.357).

1 Select [Dual Color].

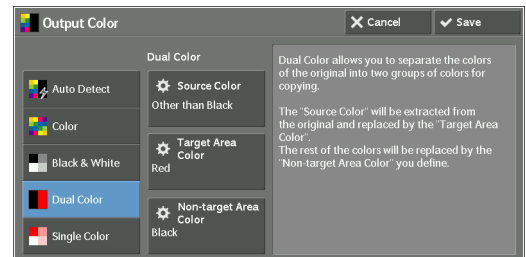

2 Select [Non-target Area Color].

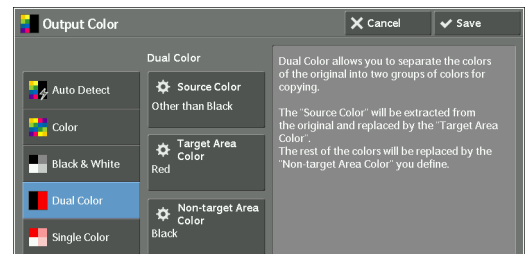

3 Select any color.

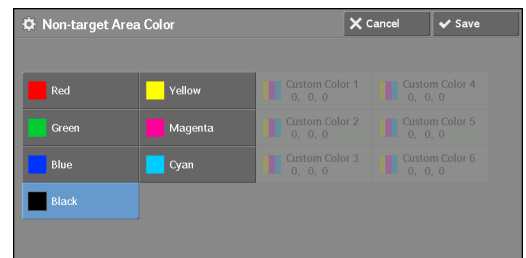

[Output Color - Color] Screen

This screen allows you to specify the color to be used for single-color copying regardless of the colors in the original document.

You can select one color from six preset and six custom options for [Single Color].

For information on how to set custom colors, refer to "Custom Colors" (P.357).

1 Select [Single Color].

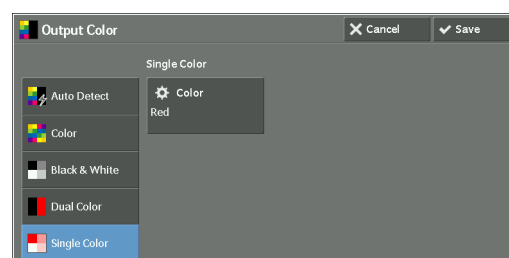

2 Select [Color].

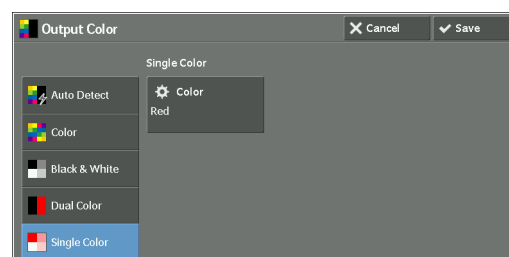

3 Select any color.

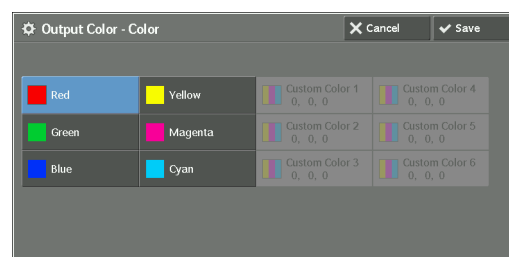

2 Sided Copying (Making 2 Sided Copies)

This feature is the same as [2 Sided Copying] on the [Layout Adjustment] screen. For more information, refer to "2 Sided Copying (Making 2 Sided Copies)" (P.95).

Copy Output (Specifying Finishing Options)

This feature is the same as [Copy Output] on the [Output Format] screen. For more information, refer to "Copy Output (Specifying Finishing Options)" (P.129).

Pages per Side (Copying Multiple Pages onto One Sheet)

This feature is the same as [Pages per Side] on the [Output Format] screen. For more information, refer to "Pages per Side (Copying Multiple Pages onto One Sheet)" (P.114).

Lighten/Darken (Adjusting the Copy Density)

This feature allows you to select a copy-density level from seven levels.

Note • [Lighten / Darken] on the [Copy], [Image Quality] and [Simple Copy] screens is the same.

- 1 Use [◀] and [▶] to select from seven density levels.

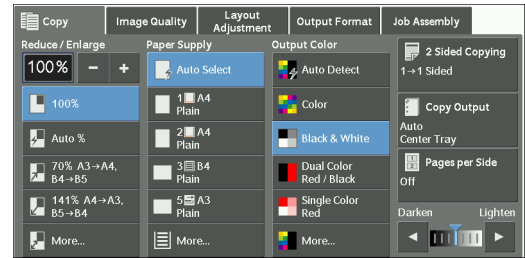
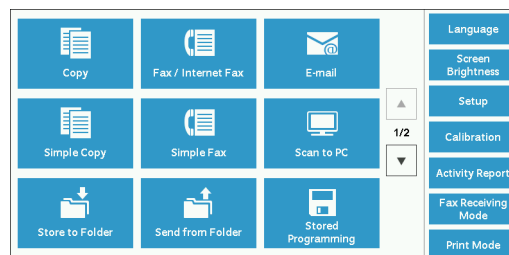

Image Quality

The section describes the features you can select on the [Image Quality] screen. The following shows the reference section for each feature.

Original Type (Selecting the Document Type).....	87
Image Options (Adjusting Copy Density/Sharpness/Saturation of Images).....	89
Image Enhancement (Erasing the Background Color of Documents/Adjusting Contrast)..	90
Color Effects (Selecting an Image Quality).....	91
Color Balance (Adjusting Color Balance).....	92
Color Shift (Adjusting the Color Tone).....	93

1 Select [Copy] on the [Home] screen.



2 Select a feature on the [Image Quality] screen.

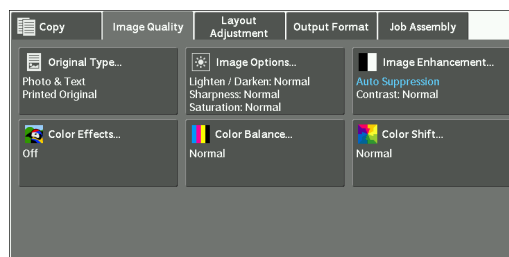

Note • If the color reproduction is unsatisfactory, perform calibration. For information on the calibration, refer to "Executing Calibration" (P.265).

Original Type (Selecting the Document Type)

This feature allows you to select the type of documents, such as text and photos. By selecting a document type, you can make copies at optimum image quality.

1 Select [Original Type].

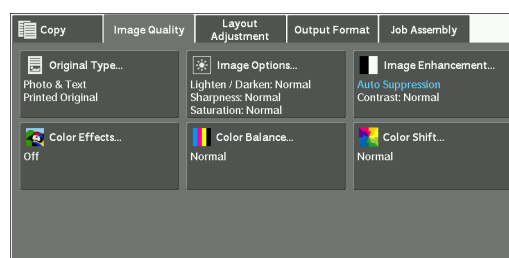

2 Select any option.

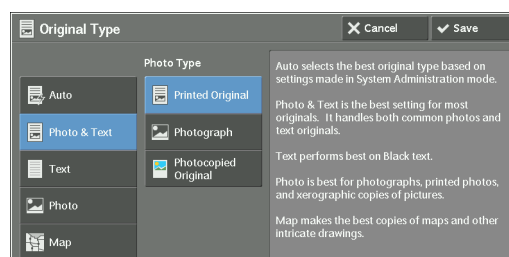

Auto

Automatically sets the document type based on the setting made in the System Administration mode and the setting made in [Output Color] on the [Copy] screen.

Photo & Text

Select this option when the document contains both text and photos. The machine automatically distinguishes the text and photo areas of the document and sets the appropriate image quality for each area. To process photo areas, select the photo type from [Printed Original], [Photograph], and [Photocopied Original].

- Printed Original

Select this option when the document contains printed photos, such as a brochure.

- Photograph

Select this option when the document contains pasted photos. This option prevents the copy from being reproduced bluish.

- Photocopied Original

Select this option when the document is a copy or print made with a color copying machine such as this machine. This option prevents the copy from being reproduced faintly.

Text

Select this option to copy text areas of the document sharply. This option is suitable for graphs and illustrations.

- Normal Text

Select this option for printed documents, or for documents written with ink.

- Light Text

Select this option for text that requires enhancement, such as handwritten pencil text.

- Text on See- Through Paper

Select this option to reduce blurs of tracing-paper documents or to suppress background shadows of lightweight documents.

[Text on See- Through Paper] may not be displayed depending on the setting in the System Administration mode. For information on how to display [Text on See- Through Paper], refer to "Original Type - See-Through Paper" (P.355).

Photo

Select this option to make copies of photos. Select the photo type from the same options as [Photo & Text]: [Printed Original], [Photograph], and [Photocopied Original].

Map

Select this option to make copies of documents that have text placed on color backgrounds, such as maps.

Image Options (Adjusting Copy Density/Sharpness/Saturation of Images)

This feature allows you to adjust the copy density, sharpness, and saturation levels.

- Note**
- [Lighten / Darken] under [Image Options] is the same as [Lighten / Darken] on the [Copy] screen.
 - If [Lighten / Darken], [Sharpness], or [Saturation] is set concurrently with [Color Effects], the setting made in [Color Effects] will be cleared.

1 Select [Image Options].

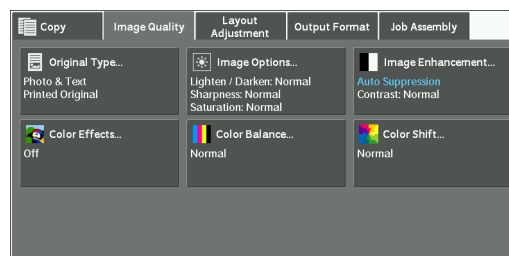

2 Adjust any option.

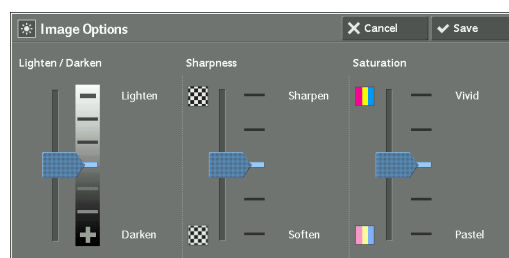

Lighten / Darken

Allows you to select from seven copy density levels between [Lighten] and [Darken].

Selecting an upper cell on the bar makes the copy density lighter and selecting a lower cell makes darker.

Sharpness

Allows you to select from five sharpness levels between [Sharpen] and [Soften].

Selecting an upper cell on the bar makes the contours of images sharper, and selecting a lower cell makes softer.

Saturation

Allows you to select from five saturation levels between [Vivid] and [Pastel].

Selecting an upper cell on the bar makes colors brighter, and selecting a lower cell makes less bright.

Image Enhancement (Erasing the Background Color of Documents/Adjusting Contrast)

This feature allows you to suppress the background color of documents, such as newspaper and colored paper. You can also adjust the contrast.

- Note**
- [Image Enhancement] is not available when [Original Type] is set to [Photo].
 - If [Suppress Background] or [Contrast] is set concurrently with [Color Effects], the setting made in [Color Effects] will be cleared.

1 Select [Image Enhancement].

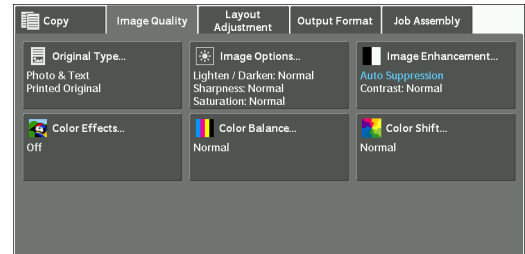

2 Set [Suppress Background] and [Contrast].

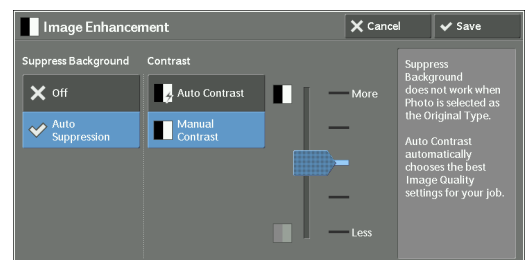

Suppress Background

- Off

Scans document backgrounds with no filtering.

- Auto Suppression

When [Output Color] is set to [Black & White], the background of a document printed on colored paper, such as newspaper, will be suppressed.

When [Output Color] is set to [Color], [Dual Color], or [Single Color], the color element on white-color paper such as the blot, the print on the other side which is seen through and so on will be suppressed.

- Note**
- When [Output Color] is set to [Color], you can change the level of background suppression. For more information, refer to "Background Suppression (Photo & Text)" (P.355) and "Background Suppression Level (Text)" (P.355).

Contrast

- Auto Contrast

Automatically adjusts the brightness and hue of the original document to sharpen the image.

- Note**
- [Auto Contrast] is not available when you use the document feeder.

- Manual Contrast

Allows you to select from the five levels between [More] and [Less].

Selecting an upper cell on the bar makes the difference between light and dark areas greater; light areas become lighter and dark areas darker. In contrast, selecting a lower cell on the bar makes the difference between light and dark areas smaller.

Color Effects (Selecting an Image Quality)

If you set this feature, the [Image Enhancement], [Image Options], [Color Shift], and [Color Balance] settings are automatically adjusted and copies are made at the specified quality.

- Note**
- When the Color Effects feature is used, [Auto Contrast] is not available.
 - If other image-quality settings are made after you set [Color Effects], the setting made in [Color Effects] will be cleared.

1 Select [Color Effects].

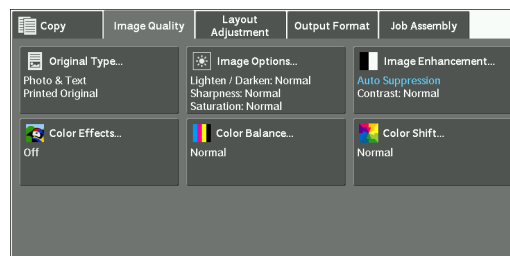

2 Select any option.

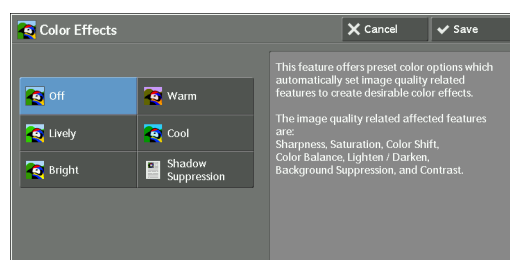

Off

Copies with the [Image Enhancement], [Image Options], [Color Shift], and [Color Balance] settings at their defaults.

Lively

Reproduces fresher, livelier images with increased color saturation.

Bright

Reproduces brighter images with enhanced contrast. This option is suitable for documents that are intended to attract people's attention, such as posters.

Warm

Reproduces brighter, warmer, more reddish images. This option is suitable when skin tones are to be reproduced more pinkish or when subdued images are to be reproduced more warmly.

Cool

Reproduces clearer blue colors. This option is suitable for water and sky images, and is also suitable when smoky blue colors are to be reproduced more clearly.

Shadow Suppression

Suppresses the colors on the reverse side of the original document from being reproduced in the copy.

Color Balance (Adjusting Color Balance)

This feature allows you to adjust the color balance of the four CMYK toner colors (cyan, magenta, yellow and black). You can select from seven levels for each density level: Highlights, Midtones, and Shadows.

The Color Balance feature finely adjusts the density level for each toner color to fine-tune the color balance, such as a reddish or bluish tint, while the Lighten/Darken feature adjusts the overall density level of four colors.

Note • If [Color Balance] is set concurrently with [Color Effects], the setting made in [Color Effects] will be cleared.

1 Select [Color Balance].

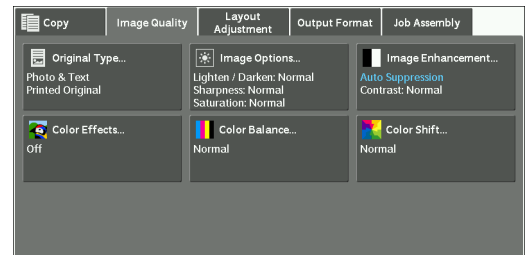

2 Select any option.

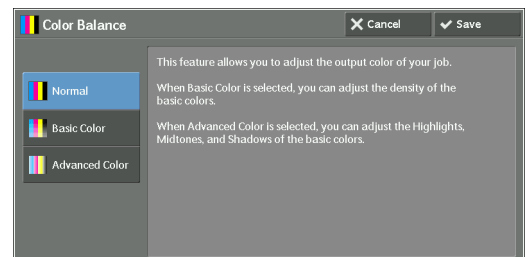

Normal

Always copies a document with the density balance set to "0" for the four toner colors: yellow, magenta, cyan, and black.

Basic Color

Allows you to adjust the density level for each toner color: yellow, magenta, cyan, and black.

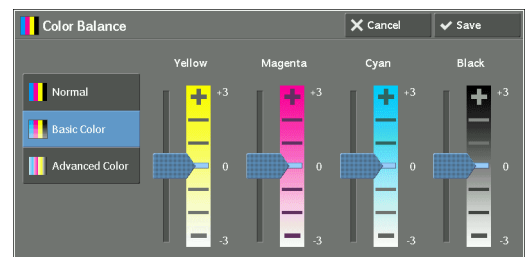

Advanced Color

Allows you to adjust the density level for each toner color (yellow, magenta, cyan, black) which is divided to [Highlights], [Midtones], and [Shadows].

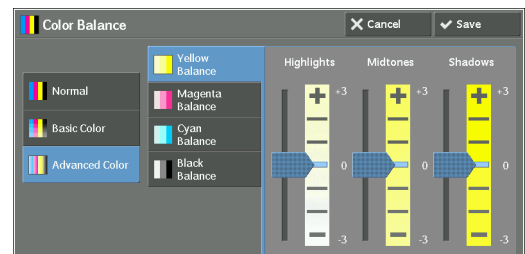

Highlights

Allows you to adjust the color strength of low-density areas.

Example:

If low-density yellow is printed darker, adjust the color strength in the minus (-) direction under [Yellow Balance] > [Highlights].

Midtones

Allows you to adjust the color strength of medium-density areas.

Example:

If medium-density yellow is printed lighter, adjust the color strength in the plus (+) direction under [Yellow Balance] > [Midtones].

Shadows

Allows you to adjust the color strength of high-density areas.

Example:

If high-density yellow is printed lighter, adjust the color strength in the plus (+) direction under [Yellow Balance] > [Shadows].

Color Shift (Adjusting the Color Tone)

This feature allows you to adjust the tone of the colors to be reproduced in copies, by a maximum of two levels in two directions.

On the screen, the [Original Color] slider represents the color tone of the original document, and the [Copy Color] slider represents the color tone of output copies. Selecting a button on the screen moves the [Original Color] slider to adjust the tone of the colors.

When the [Original Color] slider is moved to the left, the Y (yellow) cell on the [Original Color] slider becomes closer to the R (red) cell on the [Copy Color] slider, and thus a yellow fruit appears more reddish and riper-looking. At the same time, the tone of all the other colors changes. The red color appears more magentish, and the green color appears more yellowish.

Conversely, when the [Original Color] slider is moved to the right, the Y (yellow) cell on the [Original Color] slider becomes closer to the G (green) cell on the [Copy Color] slider, and thus a yellow fruit appears more greenish. At the same time, the tone of all the other colors changes. The magenta color appears more reddish, and the red color appears more yellowish.

- Note**
- Ensure that [Output Color] is set to [Color] on the [Copy] screen. [Color Shift] is not available when [Output Color] is set to [Black & White].
 - If [Color Shift] is set concurrently with [Color Effects], the setting made in [Color Effects] will be cleared.

1 Select [Color Shift].

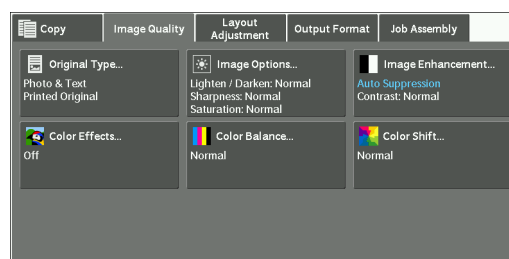

2 Select a button to adjust the color tone.

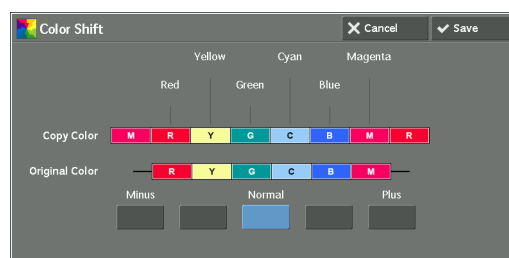

Layout Adjustment

This section describes the features you can select on the [Layout Adjustment] screen. The following shows the reference section for each feature.

- 2 Sided Copying (Making 2 Sided Copies)95
- Book Copying (Copying Facing Pages onto Separate Sheets)96
- 2 Sided Book Copying (Making 2 Sided Copies of Facing Pages)98
- Original Size (Specifying the Scan Size for the Document)99
- Mixed Size Originals (Scanning Different Size Documents Simultaneously)100
- Edge Erase (Erasing Edges and Margin Shadows of the Document)101
- Image Shift (Adjusting the Image Position).....103
- Invert Image (Making Reversed Copies of Images)105
- Original Orientation (Specifying the Orientation of Loaded Documents).....106
- Image Rotation (Changing the Orientation of Images)107

1 Select [Copy] on the [Home] screen.

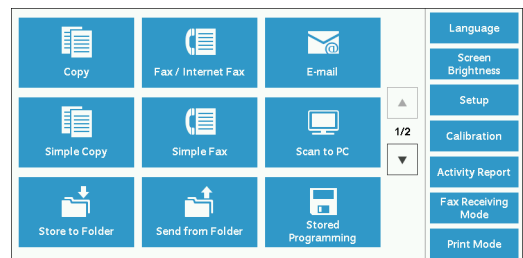

2 Select a feature on the [Layout Adjustment] screen.

Note • Select [▲] to return to the previous screen or [▼] to move to the next screen.

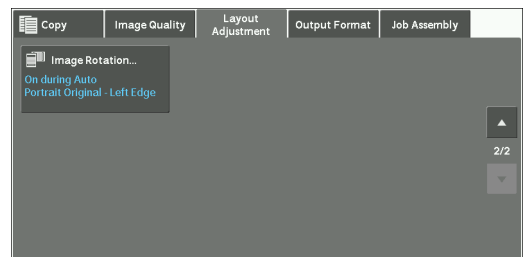
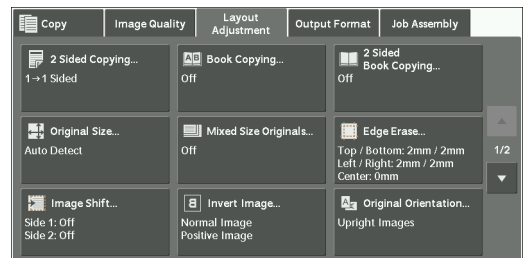

2 Sided Copying (Making 2 Sided Copies)

This feature allows you to make copies of 1-sided and 2-sided documents on one side or both sides of paper.

1 Select [2 Sided Copying].

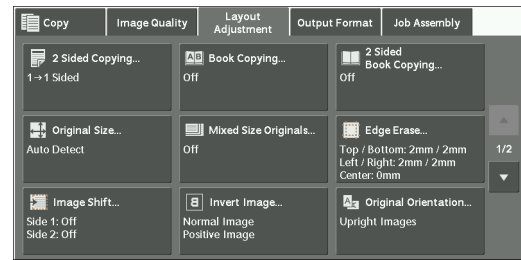

2 Select any option.

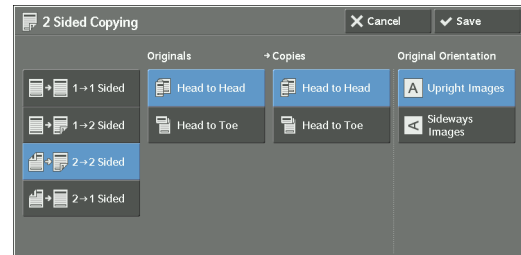

1 → 1 Sided

Makes a copy of a 1-sided document on one side of paper.

1 → 2 Sided

Makes a copy of a 1-sided document on both sides of paper.

Select this option when you copy 1-sided documents on both sides of paper.

2 → 2 Sided

Makes a copy of a 2-sided document on both sides of paper.

2 → 1 Sided

Makes a copy of a 2-sided document on one side of paper.

Originals

This option is displayed when you select [2 → 2 Sided] or [2 → 1 Sided].

- Head to Head

Select this option when the front and back sides of the document are in the same orientation.

- Head to Toe

Select this option when the front and back sides of the document are in opposite orientations.

Copies

This option is displayed when you select [1→2 Sided] or [2→2 Sided].

- Head to Head

Select this option when you want the orientation of the front and back sides of the copy to be the same as that of the document.

- Head to Toe

Select this option when you want the orientation of the front and back sides of the copy to be the opposite of that of the document.

Original Orientation

Allows you to specify the orientation of the document so that the machine can identify the top of the document.

Note • If the [Original Orientation] setting differs from the actual document orientation, the machine may not detect the top of the document correctly.

- Upright Images

Select this option when placing the top edge of the document against the top side of the document glass or document feeder.

- Sideways Images

Select this option when placing the top edge of the document against the left side of the document glass or document feeder.

Book Copying (Copying Facing Pages onto Separate Sheets)

This feature allows you to copy facing pages of a document on separate sheets of paper in page order.

This is useful when you need to make separate copies of facing pages of a bound document such as a booklet.

Note • You cannot use the document feeder with this feature.
• A non-standard size document or undetectable-size document may not be separated into two accurately.

- 1 Select [Book Copying].

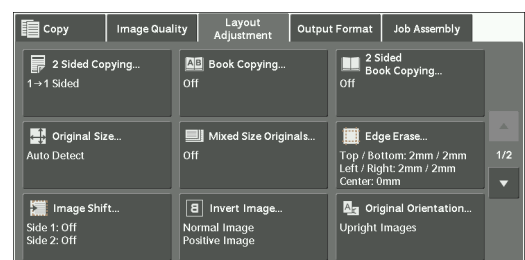

- 2 Select any option.

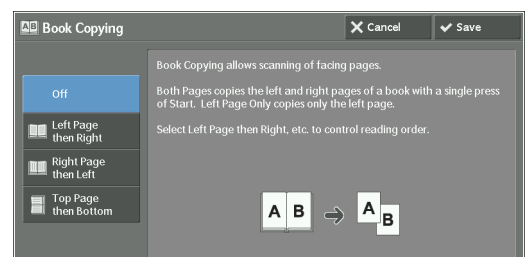

Off

Does not copy as a bound document.

Left Page then Right

Copies the left page and then the right page of facing pages.

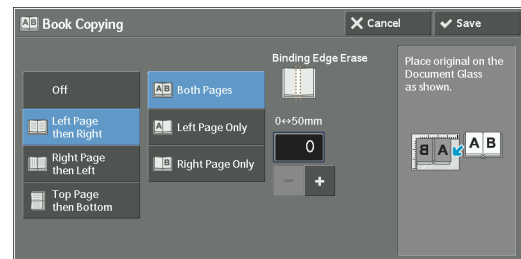
**Right Page then Left**

Copies the right page and then the left page of facing pages.

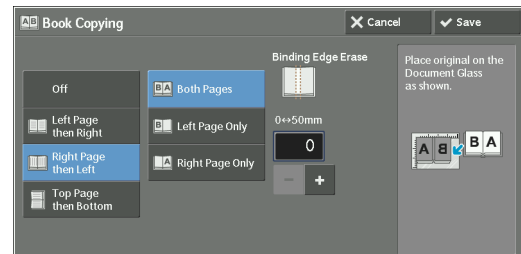
**Top Page then Bottom**

Copies the top page and then the bottom page of facing pages.

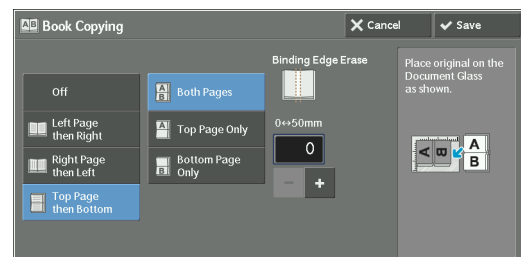
**Both Pages**

Copies both pages in page order.

Left Page Only

Copies the left page only. You can select this option when [Left Page then Right] or [Right Page then Left] is selected.

Right Page Only

Copies the right page only. You can select this option when [Left Page then Right] or [Right Page then Left] is selected.

Top Page Only

Copies the top page only. You can select this option when [Top Page then Bottom] is selected.

Bottom Page Only

Copies the bottom page only. You can select this option when [Top Page then Bottom] is selected.

Binding Edge Erase

Erases the shadow from the center section of the document. You can set the binding erase width in the range from 0 to 50 mm in 1 mm increments.

2 Sided Book Copying (Making 2 Sided Copies of Facing Pages)

This feature allows you to assign pages when making copies of facing pages in a bound document so that pages face each other in the same way as the document. You can also specify the starting and ending pages from the left and right of facing pages.

- Note**
- A non-standard size document or undetectable-size document will not be separated into two accurately.
 - Use the document glass to load a document.

1 Select [2 Sided Book Copying].

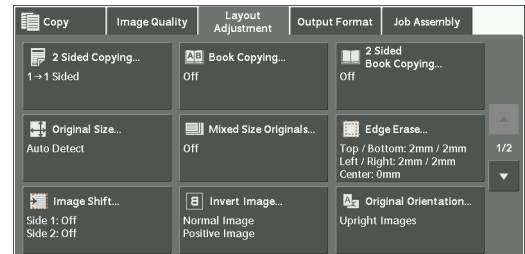

2 Select any option.

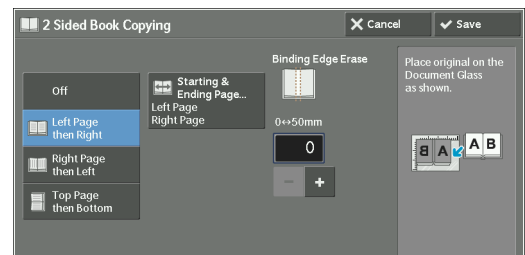

Off

Disables this feature.

Left Page then Right

Scans the left page and then the right page of facing pages, to make 2-sided copies.

Right Page then Left

Scans the right page and then the left page of facing pages, to make 2-sided copies.

Top Page then Bottom

Scans the top page and then the bottom page of facing pages, to make 2-sided copies.

Starting & Ending Page

Displays the [Starting & Ending Page] screen.

Refer to "[Starting & Ending Page] Screen" (P.99).

Binding Edge Erase

Erases the shadow from the center section of the document. You can set the binding erase width in the range from 0 to 50 mm in 1 mm increments.

[Starting & Ending Page] Screen

This screen allows you to set the starting and ending pages to be copied.

- 1 Set [Starting Page] and [Ending Page].

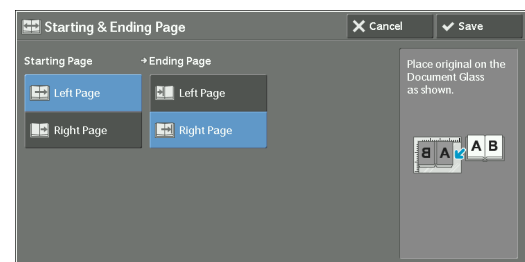

Starting Page

- [Left Page] / [Right Page]

You can select these options when [Left Page then Right] or [Right Page then Left] is selected.

- [Top Page] / [Bottom Page]

You can select these options when [Top Page then Bottom] is selected.

Ending Page

- [Left Page] / [Right Page]

You can select these options when [Left Page then Right] or [Right Page then Left] is selected.

- [Top Page] / [Bottom Page]

You can select these options when [Top Page then Bottom] is selected.

Original Size (Specifying the Scan Size for the Document)

This feature allows you to specify the scan size for a document.

Use this feature when a document is a non-standard size, or when you want to copy a document at a size different from the original size. You can also add margins, or delete unnecessary margins using this feature.

- 1 Select [Original Size].

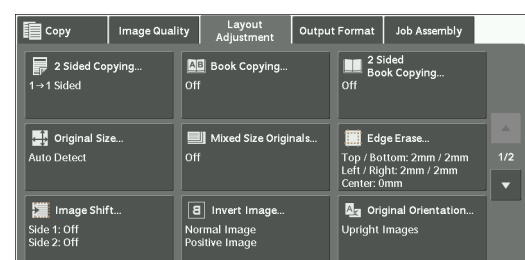

- 2 Select the size of the document.
If you select a non-standard size, specify values for the X and Y directions.

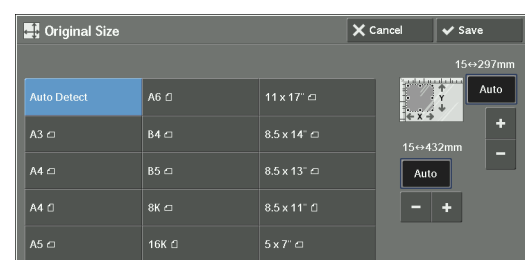

Auto Detect

Detects the document size automatically. The following table shows the document sizes that can be detected automatically.

	Document Feeder	Document Glass
Auto-detectable Document Size	B5, B5□, B4, A5, A5□, A4, A4□, A3, 8.5 x 11", 8.5 x 11"□, 11 x 17", 16K□, 8K	B6, B5, B5□, B4, A6, A5, A5□, A4, A4□, A3

Note • If the document size cannot be detected automatically, a screen to enter the document size appears. The document sizes that can be automatically detected depend on [Paper Size Settings] in the System Administration mode. For more information, refer to "Paper Size Settings" (P.335).

Standard Size

Select a document size from preset options.

You can change the sizes displayed on the screen. For information on the settings, refer to "Original Size Defaults" (P.356).

Variable Size

Enter the desired scan size when scanning a non-standard size document or when making copies at a size different from the original document size. You can specify a value in the range from 15 to 432 mm for the width (X), and a value in the range from 15 to 297 mm for the length (Y), in 1 mm increments. To help you specify values, use the scales attached on the upper and left edges of the document glass.

Note • When the document is loaded in the document feeder, the base point in the Y (length) direction is the center of the edge. If you specify 100 mm, the scan length will be from 50 mm above to 50 mm below the center of the document.

Mixed Size Originals (Scanning Different Size Documents Simultaneously)

You can scan documents of various sizes simultaneously and make copies on each size or a single size of paper. To use this feature, load the documents in the document feeder.

Note

- Load documents in landscape orientation. However, always load A5 documents in portrait orientation.
- When loading B5 documents together with A3 documents loaded in landscape orientation or A4 documents loaded in portrait orientation, load B5 documents in portrait orientation.
- If the top left corners of the documents are not aligned properly, the documents may not be scanned correctly.
- The recommended document size combinations are A4 portrait and A3 landscape, or B5 portrait and B4 landscape. If another combination of document sizes is used, the documents can be fed at an angle and may not be copied properly.

1 Select [Mixed Size Originals].

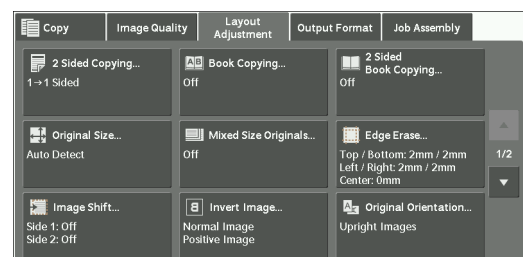

2 Select [On].

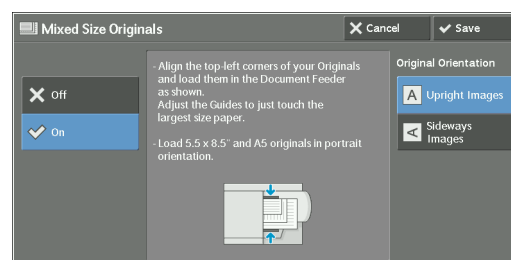

Off

Select this option when copying documents of the same size.

On

When documents of different sizes are copied, the machine automatically detects the size of each document.

Original Orientation

Allows you to specify the orientation of the document so that the machine can identify the top of the document.

- Note**
- The [Original Orientation] setting is based on the orientation of the first page of a document. Load the second and subsequent pages of the document based on this setting.
 - If the [Original Orientation] setting differs from the actual document orientation, the machine may not detect the top of the document correctly.

- Upright Images

Select this option when placing the top edge of the document against the top side of the document glass or document feeder.

- Sideways Images

Select this option when placing the top edge of the document against the left side of the document glass or document feeder.

Edge Erase (Erasing Edges and Margin Shadows of the Document)

When you copy a document with the document cover open or when you copy a book, the edges and center margin of the document may be printed as black shadows. The Edge Erase feature allows you to erase such shadows.

- Note**
- For 2-sided originals, the same edge erase amounts are set for the front and back sides.
 - If you set [Reduce / Enlarge], the edge erase amounts will be reduced or enlarged in proportion to the ratio you specified.
 - The binding shift specified in [Booklet Creation] will not affect the edge erase amounts.
 - If the original document is placed on the document glass and [1→2 Sided] is selected when using 2 Sided Copying feature, symmetrical edge erase amounts on both sides are not applied to output even if [Individual Edges] is specified and [Mirror Side 1] is selected as [2 Sided Original-Side 2] option. To apply symmetrical edge erase amounts on both sides, select [2→2 Sided] for 2 Sided Copying operation.
 - Even when the edge erase amount is set to 0 mm, full page copying cannot be made.

1 Select [Edge Erase].

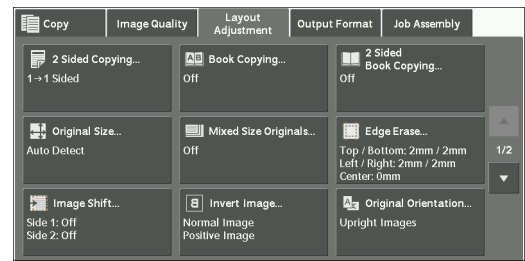

2 Select any option.

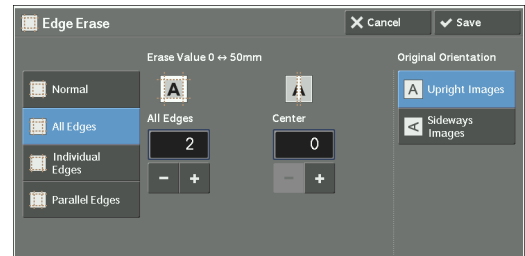

Normal

The edge width to erase is set to 2 mm for the top and bottom, and left and right edges.

All Edges

Erases the shadows of the four edges of a document, as well as the shadow in the center of the document if it is a bound document or a booklet. You can specify values for [All Edges] and [Center] individually.

Individual Edges

Erases the shadows of the top, bottom, left, and right edges of a document, as well as the shadow in the center of the document if it is a bound document or a booklet. You can specify values for [Top], [Bottom], [Left], [Right], and [Center] individually.

Parallel Edges

Erases the shadows of the top and bottom edges, and left and right edges of a document, as well as the shadow in the center of the document if it is a bound document or a booklet. You can specify values for [Top & Bottom], [Left & Right], and [Center] individually.

Erase Value

Allows you to specify values to erase the edges of a document.

- All Edges

Erases the shadows of the four edges of the document according to the orientation of the loaded document. You can specify the edge width you want to erase in the range from 0 to 50 mm in 1 mm increments.

- Top & Bottom (Top/Bottom)

Erases the shadows of top and bottom edges of the document according to the orientation of the loaded document. You can specify the edge width you want to erase in the range from 0 to 50 mm in 1 mm increments.

- Left & Right (Left/Right)

Erases the shadows of left and right edges of the document according to the orientation of the loaded document. You can specify the edge width you want to erase in the range from 0 to 50 mm in 1 mm increments.

- Center

Erases the shadow in the center of facing pages of a bound document or a booklet. You can set the binding erase width in the range from 0 to 50 mm in 1mm increments.

Original Orientation

Allows you to specify the orientation of the document so that the machine can identify the top of the document.

Note • If the [Original Orientation] setting differs from the actual document orientation, the machine may not detect the top of the document correctly.

- Upright Images

Select this option when placing the top edge of the document against the top side of the document glass or document feeder.

- Sideways Images

Select this option when placing the top edge of the document against the left side of the document glass or document feeder.

2 Sided Original-Side 2

You can select this option when [Individual Edges] is selected. Set whether the same value is set to the edge erase amount of Side 1 and Side 2.

- Same as Side 1

The same value is set to the edge erase amount of Side 1 and Side 2.

- Mirror Side 1

The edge erase amounts of Side 1 and Side 2 are set symmetrically.

Image Shift (Adjusting the Image Position)

This feature allows you to shift the position of document images so that the images are placed on the left, right, top, bottom, or center of paper. You can also adjust the amounts of the left, right, top, and bottom margins. If you make 2-sided copies, you can adjust the image positions for Side 1 and Side 2 individually.

Note • The image shift amount is set in accordance with the paper, and does not affect the setting made in [Reduce / Enlarge].

- 1 Select [Image Shift].

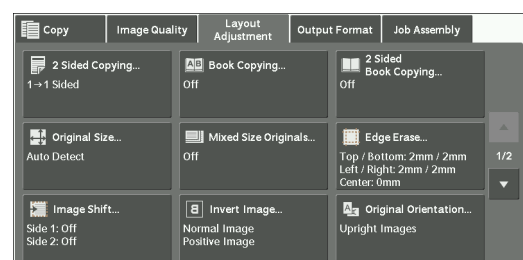

- 2 Select any option.

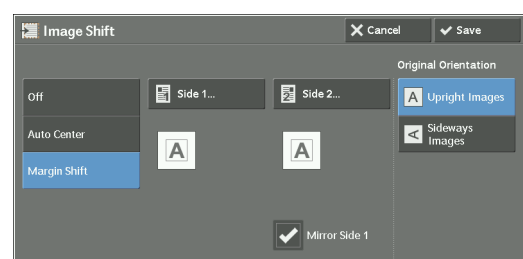

Off

Does not shift the position of document images.

Auto Center

Shifts document images so that they are placed in the center of paper.

Margin Shift

Allows you to specify the amounts of the top and bottom, and left and right margins in the range from 0 to 50 mm in 1 mm increments.

- Side 1

Displays the [Image Shift - Side 1] screen.

Refer to "[Image Shift - Side 1] Screen" (P.104).

- Side 2

Displays the [Image Shift - Side 2] screen.

Refer to "[Image Shift - Side 2] Screen" (P.105).

- Mirror Side 1

Select this check box when you want the positioning of Side 2 to match the positioning of Side 1.

Original Orientation

Allows you to specify the orientation of the document so that the machine can identify the top of the document.

Note • If the [Original Orientation] setting differs from the actual document orientation, the machine may not detect the top of the document correctly.

- Upright Images

Select this option when placing the top edge of the document against the top side of the document glass or document feeder.

- Sideways Images

Select this option when placing the top edge of the document against the left side of the document glass or document feeder.

[Image Shift - Side 1] Screen

This screen allows you to set the image shift for Side 1.

- 1 Select any option.

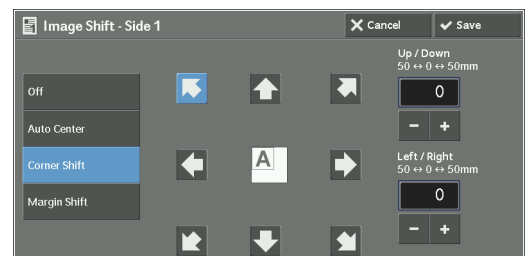
**Off**

Does not shift the position of document image.

Auto Center

Shifts document images so that they are placed in the center of paper.

Specify the amounts of the top and bottom, and left and right margins in the range from 0 to 50 mm in 1 mm increments.

Corner Shift

Shifts document images so that they are placed at an edge or corner of paper. You can select from 8 shift directions.

Specify the amounts of the top and bottom, and left and right margins in the range from 0 to 50 mm in 1 mm increments.

Margin Shift

Allows you to specify the amounts of the top and bottom, and left and right margins in the range from 0 to 50 mm in 1 mm increments.

[Image Shift - Side 2] Screen

This screen allows you to set the image shift for Side 2.

- 1 Select any option.

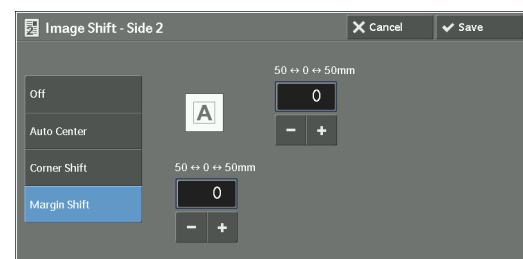

Off

Does not shift the position of document image.

Auto Center

Shifts document images so that they are placed in the center of paper.

Specify the amounts of the top and bottom, and left and right margins in the range from 0 to 50 mm in 1 mm increments.

Corner Shift

Shifts document images so that they are placed at an edge or corner of paper. You can select from 8 shift directions.

Specify the amounts of the top and bottom, and left and right margins in the range from 0 to 50 mm in 1 mm increments.

Margin Shift

Allows you to specify the amounts of the top and bottom, and left and right margins in the range from 0 to 50 mm in 1 mm increments.

Invert Image (Making Reversed Copies of Images)

This feature allows you to reverse the left and right sides of the document image or to create a negative image of the document when making copies.

- Note**
- When [Output Color] is set to [Black & White] or [Single Color], the black color on the document is inverted to white, and the white color to black.
 - When [Output Color] is set to [Color], the colors are inverted to their complementary colors.
 - When [Negative Image] and [Edge Erase] are set simultaneously, the edge erase area turns to white.

1 Select [Invert Image].

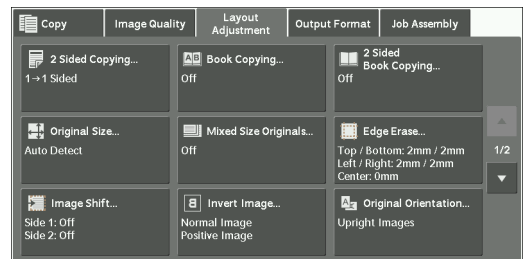

2 Select any option.

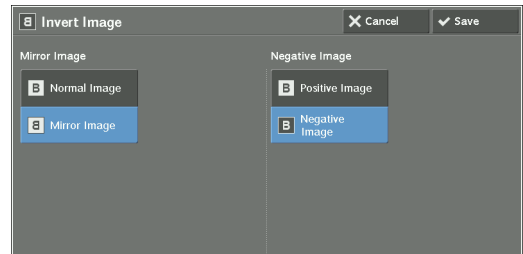

Mirror Image

Reverses the left and right sides of the document image.

Negative Image

Creates a negative image of the document.

Original Orientation (Specifying the Orientation of Loaded Documents)

This feature allows you to specify the orientation of a document so that the machine can identify the top of the document.

Note • If the [Original Orientation] setting differs from the actual document orientation, the machine may not detect the top of the document correctly.

1 Select [Original Orientation].

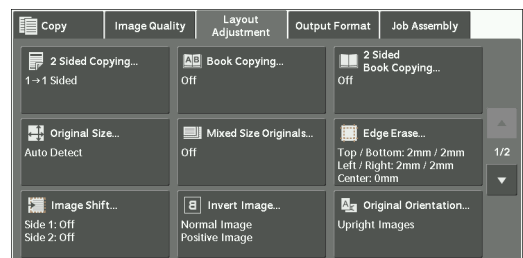

2 Select [Upright Images] or [Sideways Images] according to the orientation of the document loaded.

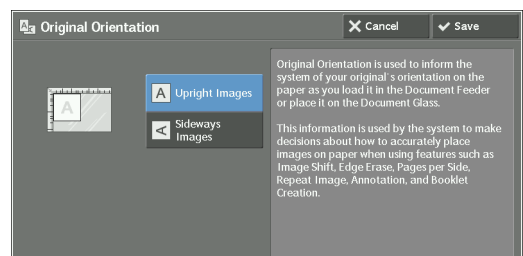

Upright Images

Select this option when placing the top edge of the document against the top side of the document glass or document feeder.

Sideways Images

Select this option when placing the top edge of the document against the left side of the document glass or document feeder.

Image Rotation (Changing the Orientation of Images)

If the orientation of the paper currently loaded in the tray differs from that of the document loaded, the machine automatically rotates the document image so that the orientation of the image matches that of the paper. You can also select a reference position for image rotation if documents are of mixed orientations.

This feature is available only when you make copies on A4, 8.5 x 11", or smaller size paper.

- 1 Select [Image Rotation].

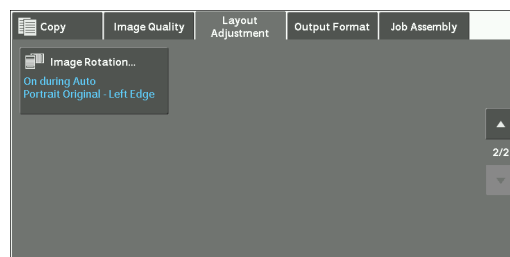

- 2 Select any option.

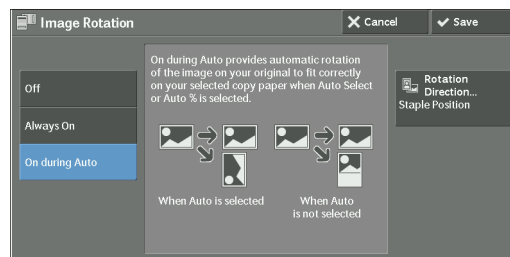

Off

Copies documents as they are, even if the orientation of the images does not match that of the paper.

Always On

Automatically rotates document images so that the orientation of the images matches that of the paper.

On during Auto

Automatically rotates document images so that the orientation of the images matches that of the paper only when [Auto %] is selected in [Reduce / Enlarge], or when [Auto Select] is selected in [Paper Supply].

Rotation Direction

Displays the [Image Rotation - Rotation Direction] screen.
Refer to "[Image Rotation - Rotation Direction] Screen" (P.108).

[Image Rotation - Rotation Direction] Screen

This screen allows you to set the reference position for rotation.

- 1 Select any option.

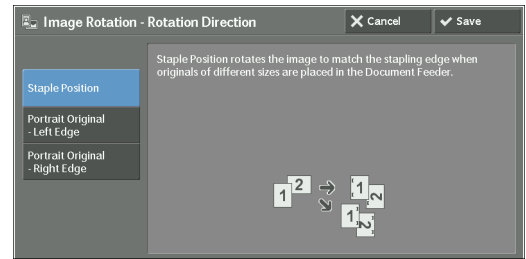

Staple Position

This option is displayed when the finisher is installed. If documents are of mixed orientations, the images will be rotated to match the stapling edge specified in the settings of the Staple feature.

Portrait Original - Left Edge

If documents are of mixed orientations, the images will be rotated so that the top edge of landscape documents is aligned with the left edge of portrait documents.

Portrait Original - Right Edge

If documents are of mixed orientations, the images will be rotated so that the top edge of landscape documents is aligned with the right edge of portrait documents.

Output Format

This section describes the features you can select on the [Output Format] screen. The following shows the reference section for each feature.

2 Sided Copying (Making 2 Sided Copies).....	109
Booklet Creation (Creating a Booklet)	110
Covers (Attaching Covers to Copies).....	113
Pages per Side (Copying Multiple Pages onto One Sheet)	114
Poster (Making Enlarged Copies Spread over Multiple Sheets).....	115
Repeat Image (Making Multiple Copies on One Sheet)	117
Annotations (Adding a Comment/a Date/Page Numbers to Copies)	118
Watermark (Printing Control Numbers on the Background of Copies).....	124
Folding (Outputting Bi-Folded Paper)	126
Preset Repeat Image (Making Multiple Copies on a Single Sheet)	127
Transparency Options (Inserting Blank Sheets between Transparencies)	128
Copy Output (Specifying Finishing Options).....	129
ID Card Copy (Copying Both Sides of an ID Card)	133

1 Select [Copy] on the [Home] screen.

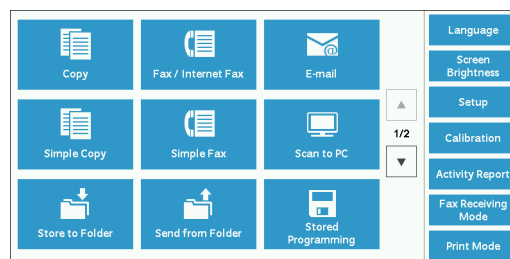

2 Select a feature on the [Output Format] screen.

Note • Select [▲] to return to the previous screen or [▼] to move to the next screen.

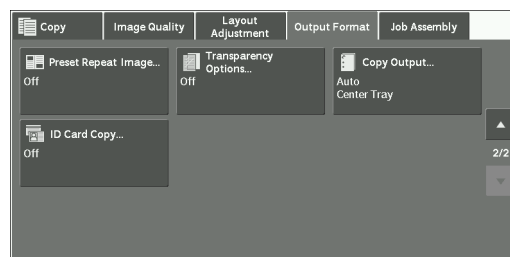
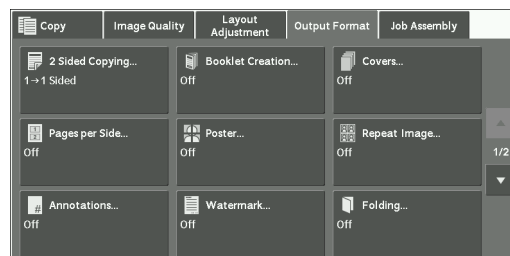

2 Sided Copying (Making 2 Sided Copies)

This feature is the same as [2 Sided Copying] on the [Layout Adjustment] screen. For more information, refer to "2 Sided Copying (Making 2 Sided Copies)" (P.95).

Booklet Creation (Creating a Booklet)

This feature allows you to layout the copied pages so that they will be in the right order when folded and bound as a booklet. You can also shift the pages for binding and add covers.

When the Booklet Maker Unit for Finisher-B1 (optional) is installed, you can also crease the output sheets in half, or staple the creased output sheets.

- Note**
- Ensure that the actual orientation of the original document matches the [Original Orientation] setting on the [Layout Adjustment] screen.
 - When the Finisher-B1 is installed, do not remove outputs from the finisher tray until all the output sheets have been delivered.
 - The machine copies four pages of the document onto one sheet of paper. If the number of pages in the booklet is not a multiple of four, the remaining pages will be output as blank pages.
 - If [Auto Select] is selected in [Paper Supply], a tray specified in [Auto Paper Off] is automatically selected. Change the setting if necessary. For information on [Auto Paper Off], refer to "Copy Control" (P.354).
 - An optional component is required to use this feature. For more information, contact Customer Support at dell.com/contactdell.

- 1 Specify the orientation of the document in [Original Orientation] on the [Layout Adjustment] screen.

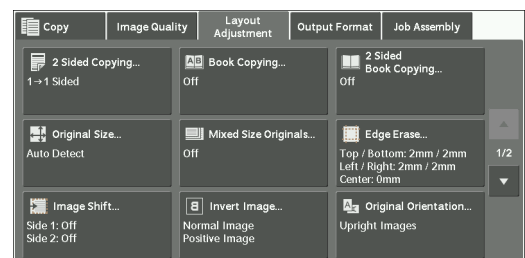

- 2 Select [Booklet Creation] on the [Output Format] screen.

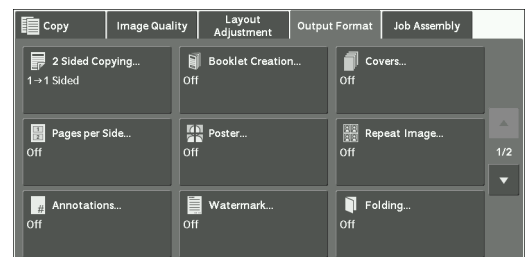

- 3 Select any option.

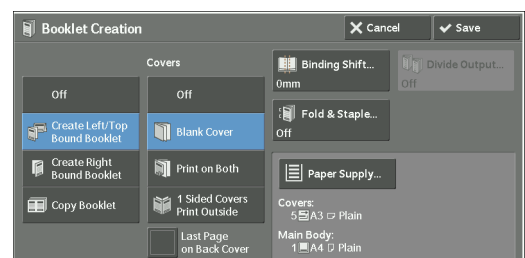

Off

Disables this feature.

Create Left / Top Bound Booklet

Copies are made to enable left binding or top binding.

Create Right Bound Booklet

Copies are made to enable right binding.

Copy Booklet

You can output the copies of scanned documents as they are by specifying [Fold & Staple]. Select this option when you do not need a document to be copied in booklet page order.

Note • An optional component is required to use this feature. For more information, contact Customer Support at dell.com/contactdell.

Covers

You can attach covers to a booklet.

- Off

No cover is attached.

- Blank Cover

A blank sheet of paper is attached as the cover.

- Print on Both

The first and second pages of the document are copied on both sides of the cover.

- 1 Sided Covers Print Outside

The first and the last pages of the document are copied on the front side of the cover.

- Last Page on Back Cover

Select this check box to copy the image of the last document page onto the last page of the copy sheets as a back cover. When you use [Divide Output] to divide a booklet into subsets, the image of the last document page will be copied onto the last page of the last subset.

Note • Depending on the number of pages in the original document, a blank page may be inserted before the last page of a booklet.

Binding Shift

Displays the [Booklet Creation - Binding Shift] screen.

Refer to "[Booklet Creation - Binding Shift] Screen" (P.111).

Divide Output

Displays the [Booklet Creation - Divide Output] screen.

Refer to "[Booklet Creation - Divide Output] Screen" (P.112).

Fold & Staple

Displays the [Booklet Creation - Fold & Staple] screen.

Refer to "[Booklet Creation - Fold & Staple] Screen" (P.112).

Note • An optional component is required to use this feature. For more information, contact Customer Support at dell.com/contactdell.

Paper Supply

Displays the [Booklet Creation - Paper Supply] screen.

Select the tray to be used for body pages from [Main Body Tray], and the tray for cover pages from [Cover Tray]. Select the same size of paper for [Main Body Tray] and [Cover Tray], and also select the trays with paper loaded in landscape orientation (☐).

When [Bypass] is selected, the [Tray 5] screen is displayed. For more information, refer to "[Tray 5] Screen" (P.79).

[Booklet Creation - Binding Shift] Screen

This screen allows you to specify the binding shift value in the range from 0 to 50 mm in 1 mm increments.

- 1 Use [+] and [-] or the numeric keypad to specify a binding shift value.

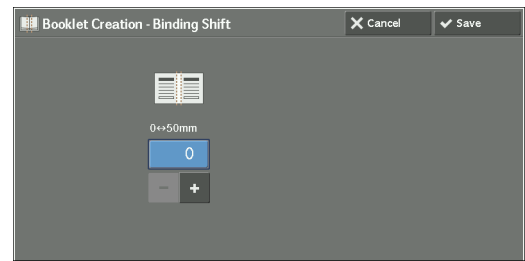

[Booklet Creation - Divide Output] Screen

You can divide the booklet into subsets of the specified number of sheets.

The number of sheets per subset can be in the range from 1 to 50 in 1 sheet increments.

Note • For stapling, specify a number from 1 to 15.

- 1 Select [On].

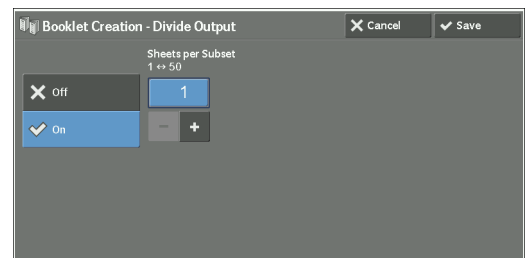

- 2 Specify the number of sheets per subset using [+] and [-] or the numeric keypad.

[Booklet Creation - Fold & Staple] Screen

When the Booklet Maker Unit for Finisher-B1 (optional) is installed, [Fold Only] and [Fold & Staple] are available.

- 1 Select any option.

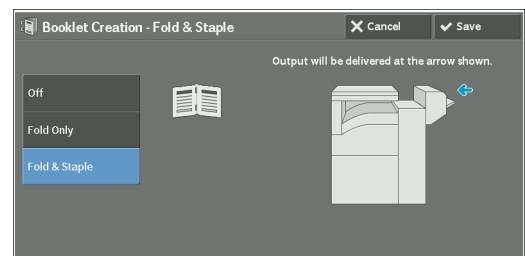

Off

The copies will not be creased, folded, nor stapled.

Fold Only

This option is displayed when the Booklet Maker Unit for Finisher-B1 (optional) is installed.

The output sheets will be creased at the center for folding. When the total number of sheets is more than 5, the booklet will be divided into subsets of 5 sheets.

Fold & Staple

This option is displayed when the Booklet Maker Unit for Finisher-B1 (optional) is installed.

The output sheets will be stapled at the center and will be creased for folding. When the total number of sheets is more than 15, the booklet will be divided into subsets of 15 sheets.

Covers (Attaching Covers to Copies)

This feature allows you to attach covers to copies.

You can use different types of paper (such as colored paper and heavyweight paper) as the front and back covers of copies.

- Note**
- When you select this feature, if the number of pages scanned by the machine exceeds the maximum, the machine will not print the already-scanned data. In that case, follow the instructions of the message displayed on the screen to cancel the job. The maximum number of pages that the machine can scan is 999 pages per job.

1 Select [Covers].

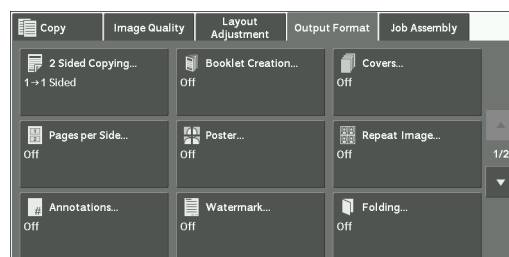

2 Select any option.

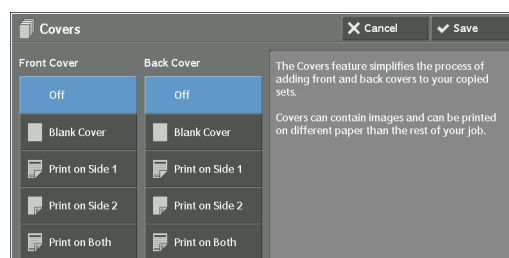

Front Cover

Attaches a front cover to the copies.

- Off
No front cover is attached.
- Blank Cover
Blank sheets of paper are attached as front covers.
- Print on Side 1
The first page of the document is copied on the front side of the front cover.
- Print on Side 2
The first page of the document is copied on the back side of the front cover.
- Print on Both
The first and second pages of the document are copied on the front and back sides of the front cover.

Back Cover

Attaches a back cover to the copies.

- Off
No back cover is attached.
- Blank Cover
Blank sheets of paper are attached as back covers.

- Print on Side 1

The first page of the document is copied on the front side of the back cover.

- Print on Side 2

The first page of the document is copied on the back side of the back cover.

- Print on Both

The first and second pages of the document are copied on the front and back sides of the back cover.

Paper Supply

Displays the [Covers - Paper Supply] screen.

Select a tray to be used.

- Front Cover Tray

Select the tray used for front covers.

- Back Cover Tray

Select the tray used for back covers.

- Main Body Tray

Select the tray used for the body pages of the document.

When you use the bypass tray, select [Bypass] on the [Covers - Paper Supply] screen. When [Bypass] is selected, the [Tray 5] screen is displayed. For more information, refer to "[Tray 5] Screen" (P.79).

Note • If [Covers] is set, [Auto Detect] cannot be selected in [Tray 5].

Front Cover Quantity

This option is displayed when you select [Blank Cover] in [Front Cover]. Specify the number of blank sheets to be used as front covers.

Back Cover Quantity

This option is displayed when you select [Blank Cover] in [Back Cover]. Specify the number of blank sheets to be used as back covers.

Pages per Side (Copying Multiple Pages onto One Sheet)

This feature allows you to copy two, four, or eight document pages onto one side of a single sheet of paper.

When you set [Pages per Side], [Auto %] is automatically selected in [Reduce / Enlarge]. The machine automatically sets the copy ratio and makes copies of the images so that they fit on the selected paper.

Note

- When you deselect [Auto %] in [Reduce / Enlarge] (when you select another copy ratio), image loss may occur depending on the image size of the document.
- When [Image Shift] is set, the image shift amounts are applied to the whole document. For this reason, image loss may occur depending on the image size of the document.
- When [Edge Erase] is set, the edge erase amounts are applied to each document page.
- Select a tray other than [Auto Select] in [Paper Supply] on the [Copy] screen. If [Auto Select] is selected in [Paper Supply], a tray specified in [Auto Paper Off] is automatically selected. Change the setting as necessary. For information on [Auto Paper Off], refer to "Auto Paper Off" (P.354).

1 Select [Pages per Side].

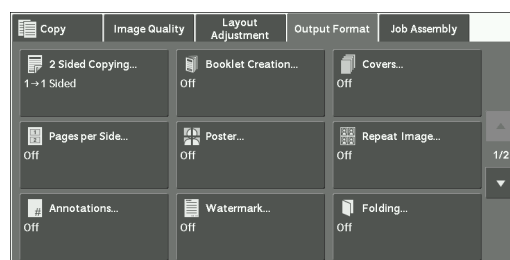

2 Select any option.

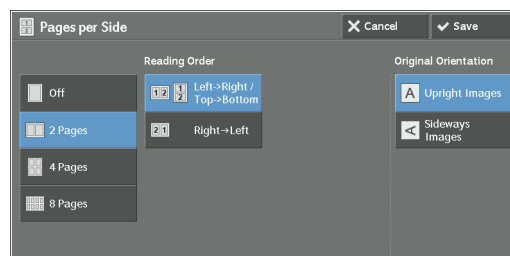

Off

Disables this feature.

2 Pages

Copies two document pages onto one side of a single sheet of paper.

4 Pages

Copies four document pages onto one side of a single sheet of paper.

8 Pages

Copies eight document pages onto one side of a single sheet of paper.

Reading Order

Allows you to select how to lay out images on a page.

Original Orientation

Allows you to specify the orientation of the document so that the machine can identify the top of the document.

Note • If the [Original Orientation] setting differs from the actual document orientation, the machine may not detect the top of the document correctly.

- Upright Images

Select this option when placing the top edge of the document against the top side of the document glass or document feeder.

- Sideways Images

Select this option when placing the top edge of the document against the left side of the document glass or document feeder.

Poster (Making Enlarged Copies Spread over Multiple Sheets)

An enlarged copy of a document can be made spread over multiple sheets.

This feature allows you to create a large poster by pasting together the copies spread over multiple sheets. Copied sheets are provided with a paste margin so that they can be pasted together. The paste margin is fixed to 10 mm.

- Note**
- Ensure that the actual orientation of the original document matches the [Original Orientation] setting on the [Layout Adjustment] screen.
 - You cannot use the document feeder with this feature.

1 Select [Poster].

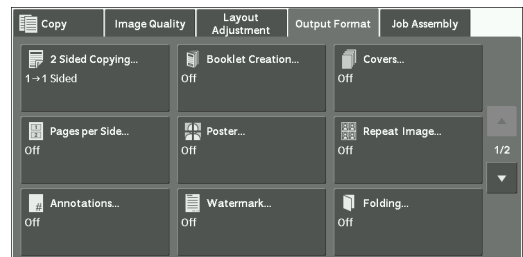

2 Select any option.

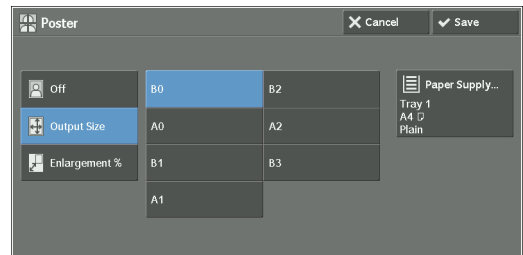

Off

No enlarged copies are made.

Output Size

Allows you to select the paper size.

Enlargement %

Refer to "When [Enlargement %] is Selected" (P.116).

Paper Supply

Displays the [Paper Supply] screen.

Select the paper tray to be used.

Note • When you use the bypass tray, select [Bypass] on the [Paper Supply] screen.

When [Bypass] is selected, the [Tray 5] screen is displayed. For more information, refer to "[Tray 5] Screen" (P.79).

When [Enlargement %] is Selected

This screen allows you to specify a different ratio for the width and length.

1 Use [+] and [-] to specify the copy ratios for the width and length.

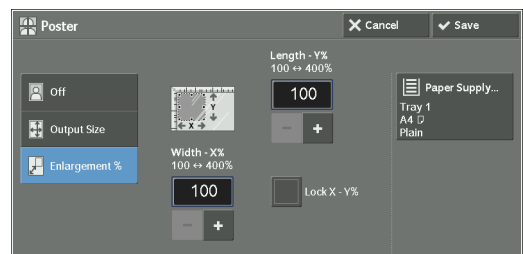

Width - X% / Length - Y%

Allows you to specify the copy ratios for the width and length in the range from 100 to 400% in 1% increments.

Lock X - Y%

Allows you to make the same ratio adjustment for the width and length at the same time.

Repeat Image (Making Multiple Copies on One Sheet)

This feature allows you to copy a document image on one sheet of paper repeatedly for a specified number of times.

When [Reduce / Enlarge] is set to [Auto %], the repeated copies of the image are reduced to fit on the selected paper. You can also specify how the repeated copies of the image are arranged.

- Note**
- When making copies at the same size as the document image, the number of repeats is specified so that the copies fit on the paper.
 - If [Auto Select] is selected in [Paper Supply], a tray specified in [Auto Paper Off] is automatically selected. Change the setting if necessary. For information on [Auto Paper Off], refer to "Auto Paper Off" (P.354).

1 Select [Repeat Image].

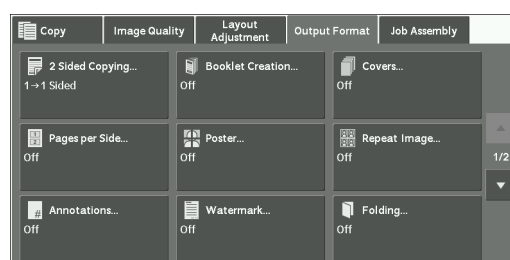

2 Select any option.

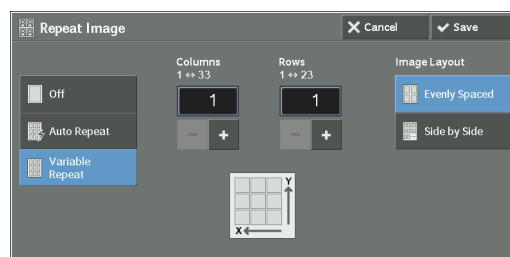
**Off**

Disables this feature.

Auto Repeat

Automatically determines the number of the repeated copies according to the document size, paper size, and copy ratio, and then repeatedly copies the document image onto the paper.

- Note**
- Copies cannot be made when the document image is larger than the specified paper size.

Variable Repeat

Allows you to specify how many copies to place along each of the long and short edges of paper. You can specify a value between 1 and 23 in the Y direction (Rows), and a value between 1 and 33 in the X direction (Columns).

Image Layout

- Evenly Spaced
The specified number of images are evenly arranged on the paper.
- Side by Side
The specified number of images are arranged with no space on the paper.

Annotations (Adding a Comment/a Date/Page Numbers to Copies)

This feature allows you to add a comment, date, and page numbers onto copies.

You can select a comment, date, and page numbers, and their print positions from preset formats.

- Note**
- When you select this feature, if the number of pages scanned by the machine exceeds the maximum, the machine will not print the already-scanned data. In that case, follow the instructions of the message displayed on the screen to cancel the job. The maximum number of pages that the machine can scan is 999 pages per job.
 - The setting in [Reduce / Enlarge] does not affect the annotation image and text sizes.
 - If you specify a comment, date, and page numbers together, make sure that their print positions do not overlap before making copies.
 - When [Pages per Side] is set, an annotation is added to the combined image.
 - When [Repeat Image] or [Booklet Creation] is set, an annotation is added to each copy image.
 - If a layout template is specified in [Apply Layout Template to Copy / Print Jobs] under [Force Annotation] in the System Administration mode, the comment, date, and page number specified here are overlapped with the text on the layout template when printed. For information on [Force Annotation], refer to "Force Annotation" (P.332).

1 Select [Annotations].

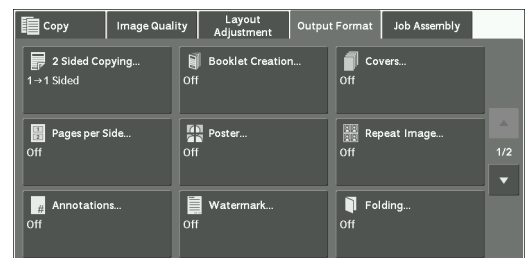

2 Select any option.

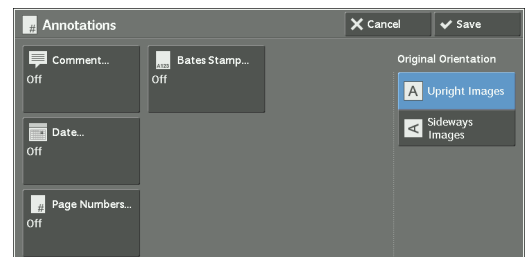

Comment

Displays the [Comment] screen.
Refer to "[Comment] Screen" (P.119).

Date

Displays the [Date] screen.
Refer to "[Date] Screen" (P.120).

Page Numbers

Displays the [Page Numbers] screen.
Refer to "[Page Numbers] Screen" (P.120).

Bates Stamp

Displays the [Bates Stamp] screen.
Refer to "[Bates Stamp] Screen" (P.122).

Original Orientation

Allows you to specify the orientation of the document so that the machine can identify the top of the document.

Note • If the [Original Orientation] setting differs from the actual document orientation, the machine may not detect the top of the document correctly.

- Upright Images

Select this option when placing the top edge of the document against the top side of the document glass or document feeder.

- Sideways Images

Select this option when placing the top edge of the document against the left side of the document glass or document feeder.

[Comment] Screen

This screen allows you to select a comment style and its position.

1 Select any option.

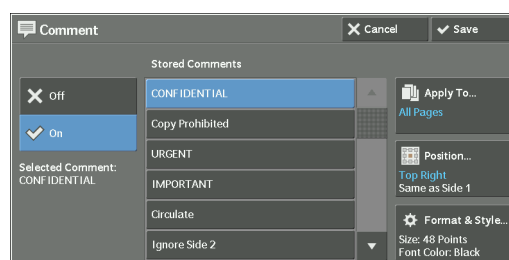

Off

No comment is added.

On

A comment is added.

Stored Comments

Allows you to select comment text from eight preset options, or text set in the System Administration mode.

For information on how to register text, refer to "Custom Watermark 1 to 3" (P.331).

Apply To

Displays the [Apply Comment To] screen.

You can select whether to add a comment onto the first copy page only, or onto each copy page.

Position

Displays the [Comment - Position] screen.

You can select a comment position from nine options.

For side 2 of copy sheets, you can select [Same as Side 1] or [Mirror Side 1].

Format & Style

Displays the [Comment - Format & Style] screen.

You can select a font size from three options, or can directly specify the size in the range from 6 to 64 points in 1 point increments. You can also select a font color from seven options.

- Note**
- When both [Date] and [Page Numbers] are set, or when [Force Annotation] is set, [Font Color] is set to [Black].

[Date] Screen

This screen allows you to add a date onto copies. The date shows when you started copying the document.

You can change the date format. For more information, refer to "Date Format" (P.330).

- 1 Select any option.

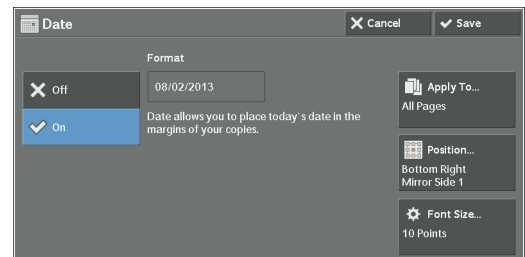

Off

No date is added.

On

A date is added.

Apply To

Displays the [Apply Date To] screen.

You can select whether to add a date onto the first copy page only, or onto each copy page.

Position

Displays the [Date - Position] screen.

You can select a date position from six options.

For side 2 of copy sheets, you can select [Same as Side 1] or [Mirror Side 1].

Font Size

Displays the [Date - Font Size] screen.

You can select a date size from three options, or can directly specify a size in the range from 6 to 24 points in 1 point increments.

[Page Numbers] Screen

This screen allows you to select a page-number style and its position.

- 1 Select any option.

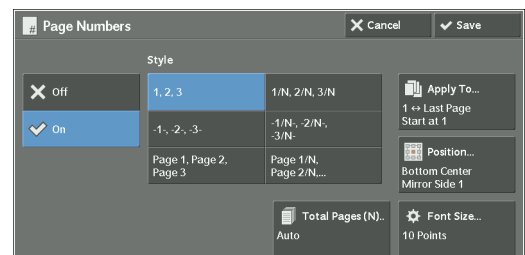

Off

No page number is added.

On

Page numbers are added onto copies.

Style

- 1, 2, 3
Adds page numbers only.
- -1-, -2-, -3-
Adds page numbers, and hyphens before and after each page number.
(Example: -1-, -2-)
- Page 1, Page 2, Page 3
Adds page numbers, and the text "Page" before each page number.
(Example: Page1, Page2)
- 1/N, 2/N, 3/N
Adds page numbers, and the total number of pages to the right of each page number.
(Example: 1/50, 2/50)
When you select [1/N, 2/N, 3/N], the value specified in [Total Pages (N)] is used.
- -1/N-, -2/N-, -3/N-
Adds page numbers followed by the total number of pages, and hyphens before and after the numbers.
(Example: -1/50-, -2/50-)
When you select [-1/N-, -2/N-, -3/N-], the value specified in [Total Pages (N)] is used.
- Page 1/N, Page 2/N
Adds page numbers followed by the total number of pages, and the text "Page" before each page number.
When you select [Page 1/N, Page 2/N], the value specified in [Total Pages (N)] is used.
- Total Pages (N)
Displays the [Total Pages (N)] screen.
 - Auto
Automatically calculates the total number of pages.
 - Enter Number
Allows you to specify the total number of pages in the range from 1 to 999.

Apply To

Displays the [Apply Page Numbers To] screen.
Refer to "[Apply Page Numbers To] Screen" (P.122).

Position

Displays the [Page Numbers - Position] screen.
You can select a page-number position from six options.
For side 2 of copy sheets, you can select [Same as Side 1] or [Mirror Side 1].

Font Size

Displays the [Page Numbers - Font Size] screen.
You can select a page-number size from three options, or can directly specify a size in the range from 6 to 24 points in 1 point increments.

[Apply Page Numbers To] Screen

This screen allows you to specify a page range to add page numbers.

- 1 Select any option.

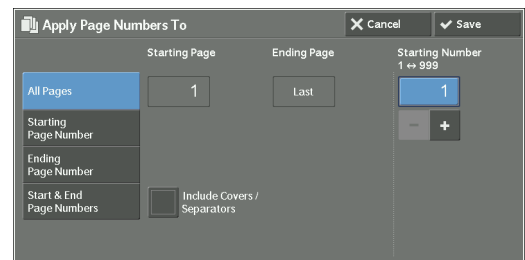

All Pages

Adds page numbers to all copy pages.

Starting Page Number

Allows you to specify the start page to add a page number, in the range from 1 to 999.

Note • Use [+] and [-], or the numeric keypad to enter the start page number.

Ending Page Number

Allows you to specify the end page to add a page number, in the range from 1 to 999. The start page is fixed to "1".

Note • Use [+] and [-], or the numeric keypad to enter the end page number.

Start & End Page Numbers

Allows you to specify the start and end pages to add page numbers, in the range from 1 to 999.

Note • Use [+] and [-], or the numeric keypad to enter the start and end page numbers.

Include Covers / Separators

This option is available when you select [All Pages]. Select this check box to include covers and separators.

Starting Number

Allows you to specify a starting page number to add page numbers, in the range from 1 to 999.

Note • Use [+] and [-], or the numeric keypad to enter a starting page number.

[Bates Stamp] Screen

This screen allows you to add prefix text and page numbers onto copies.

- 1 Select any option.

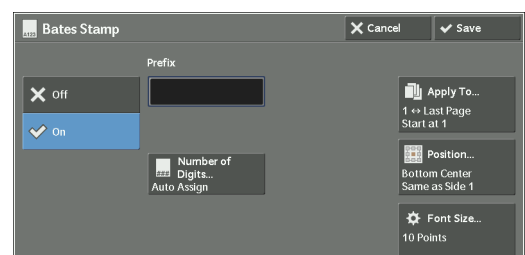

Off

Does not add prefix text and page numbers onto copies.

On

Adds prefix text and page numbers onto copies.

Prefix

Allows you to enter prefix text with up to 16 characters, using the displayed keyboard.

Number of Digits

Displays the [Bates Stamp - Number of Digits] screen.

You can select [Auto Assign] or [Manual Assign]. When you select [Manual Assign], you can specify the number of digits to be used for page numbers in the range from 1 to 9 in 1 digit increments.

Apply To

Displays the [Apply Bates Stamp To] screen.

Refer to "[Apply Bates Stamp To] Screen" (P.123).

Position

Displays the [Bates Stamp - Position] screen.

You can select a prefix and page-number position from six options.

For side 2 of copy sheets, you can select [Same as Side 1] or [Mirror Side 1].

Font Size

Displays the [Bates Stamp - Font Size] screen.

You can select a prefix and page-number size from three options, or can directly specify a size in the range from 6 to 24 points in 1 point increments.

[Apply Bates Stamp To] Screen

This screen allows you to specify a page range to add prefix text and page numbers.

- 1 Select any option.

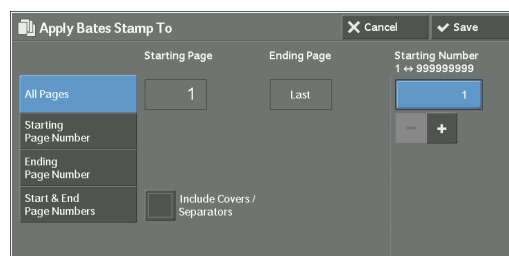
**All Pages**

Adds prefix text and page numbers to all pages.

Starting Page Number

Allows you to specify the start page to add prefix text and a page number, in the range from 1 to 999.

Note • Use [+] and [-], or the numeric keypad to enter the start page number.

Ending Page Number

Allows you to specify the end page to add prefix text and a page number, in the range from 1 to 999. The start page is fixed to "1".

Note • Use [+] and [-], or the numeric keypad to enter the end page number.

Start & End Page Numbers

Allows you to specify the start and end pages to add prefix text and page numbers, in the range from 1 to 999.

Note • Use [+] and [-], or the numeric keypad to enter the start and end page numbers.

Include Covers / Separators

This option is available when you select [All Pages]. Select this check box to include covers and separators.

Starting Number

You can specify a starting page number in the range from 1 to 999999999 when you do not set [Number of Digits], or can specify a starting page number of up to the allowable number of digits specified in [Number of Digits].

Note • Use [+] and [-], or the numeric keypad to enter the starting page number.
• If the page number exceeds the specified value (999999999 when [Number of Digits] is not set) during copying, the copy job will be canceled.

Watermark (Printing Control Numbers on the Background of Copies)

This feature allows you to faintly print a sequential control number in the background of each copy page.

If you set "1" as the starting number, "1" is printed on each page of the first copy set and "2" is printed on each page of the second set.

To prevent, for instance, the duplication of confidential documents that are to be distributed at a conference, you can use this feature to add sequential numbers to the copies, and associate the numbers with the conference members.

Note • When the number of already scanned pages of the Watermark job reaches the maximum number of pages that can be scanned per job, which is 999, a message appears, and even the already scanned pages will not be printed. Follow the instructions displayed on the screen and cancel the job.
• If a layout template is specified in [Apply Layout Template to Copy/Print Jobs] under [Force Annotation] in the System Administration mode, the watermark specified here is overlapped with the text on the layout template when printed. For information on [Force Annotation], refer to "Force Annotation" (P.332).
• When [Force Watermark - Copy] is set to [On], [Watermark] is fixed to [On], which cannot be changed. For more information on Watermark, refer to "Watermark" (P.330).

1 Select [Watermark].

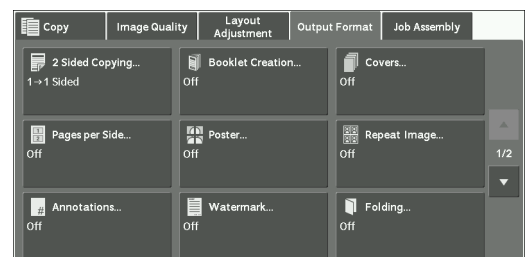

2 Select any option.

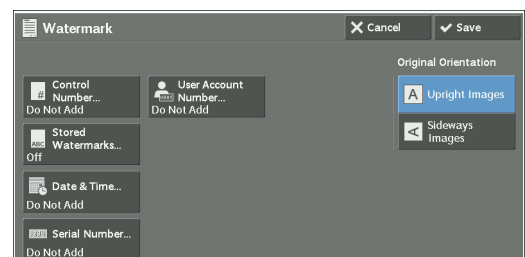

Control Number

- Do Not Add

No control number will be printed.

- Add

A control number is printed. Enter the starting number of the control number. You can specify a value in the range from 1 to 999, using [+] and [-] or the numeric keypad.

Stored Watermarks

Displays the [Stored Watermarks] screen.

Refer to "[Stored Watermarks] Screen" (P.125).

User Account Number

Allows you to select whether to print a user account number when the Authentication or Accounting feature is enabled. However, if a user is not authenticated, the account number will not be printed.

- Note**
- [User Account Number] is the No. (User Administration Number) registered by users with the Authentication and Accounting feature.
 - You can see if a user is authenticated by checking that the <Log In/Out> button lights up.

Date & Time

Allows you to select whether to print the date and time when the copy job started.

For information on the date format, refer to "Date Format" (P.330).

Serial Number

Allows you to select whether to print the serial number of the machine.

Original Orientation

Allows you to specify the orientation of the document so that the machine can identify the top of the document.

- Note**
- If the [Original Orientation] setting differs from the actual document orientation, the machine may not detect the top of the document correctly.

- Upright Images

Select this option when placing the top edge of the document against the top side of the document glass or document feeder.

- Sideways Images

Select this option when placing the top edge of the document against the left side of the document glass or document feeder.

[Stored Watermarks] Screen

This screen allows you to select text to print on copies.

- 1 Select [On].

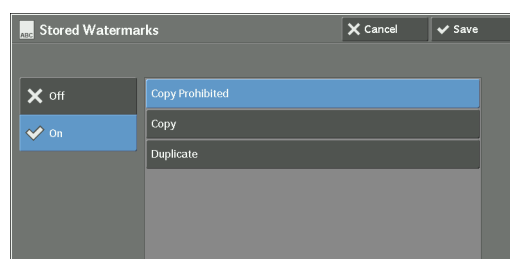

2 Select any text.

Off

No text is printed.



On

Text is printed. Select the text to be used for watermark. You can specify text from three preset options, or text registered in the System Administration mode.

For information on how to register text, refer to "Custom Watermark 1 to 3" (P.331).

Folding (Outputting Bi-Folded Paper)

This feature allows you to fold copies in half, or crease in half.

- Note**
- When the Finisher-B1 is installed, do not remove output copies from the finisher tray until all the output copies have been delivered.
 - The supported paper orientation is only . Select the tray whose orientation is set to .
 - An optional component is required to use this feature. For more information, contact Customer Support at dell.com/contactdell.

1 Select [Folding].

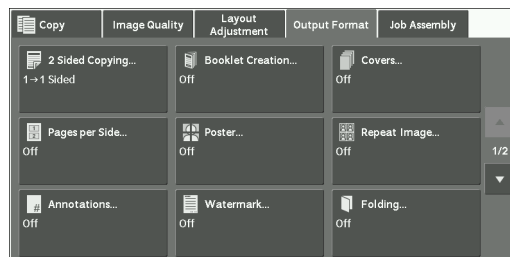

2 Select any option.

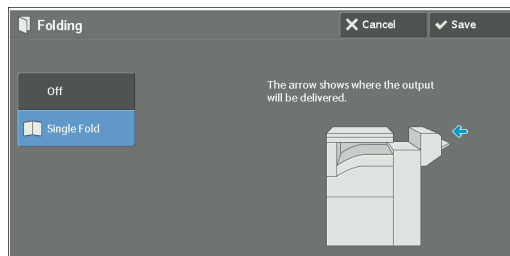

Off

Does not fold copies.

Single Fold

This option is displayed when the Booklet Maker Unit for Finisher-B1 (optional) is installed.

Creases copies in half.

Preset Repeat Image (Making Multiple Copies on a Single Sheet)

This feature allows you to repeatedly copy one original onto equally divided areas according to the specified number of copies.

Select [2 Times], [4 Times], or [8 Times] according to the number of times to repeat.

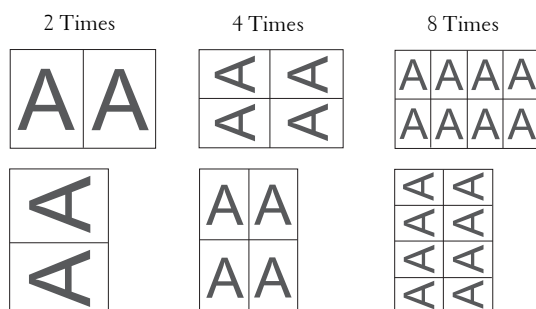

Note • When you select an option other than [Auto %] in [Reduce / Enlarge], image loss may occur depending on the image size of the document.

1 Select [Preset Repeat Image].

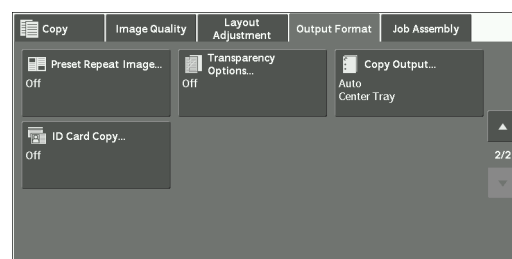

2 Select any option.

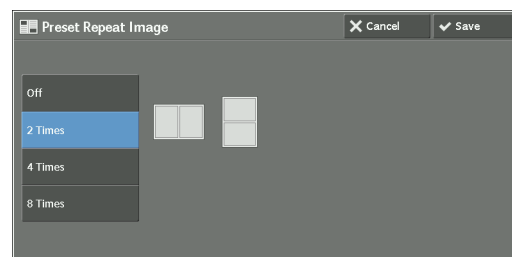

Off

Disables this feature.

2 Times

Makes two copies of the document image on a single sheet of paper.

4 Times

Makes four copies of the document image on a single sheet of paper.

8 Times

Makes eight copies of the document image on a single sheet of paper.

Transparency Options (Inserting Blank Sheets between Transparencies)

This feature allows you to insert blank separators between output transparency sheets. At the same time, you can make copies for handouts.

- Note**
- Using transparency sheets for color (with white border) may cause a malfunction or paper jam.
 - When loading A4 size transparencies on Tray 5 (Bypass), we recommend that you load them in portrait orientation.
 - Load transparency sheets in a tray in the same orientation as the paper to be used for handouts and separators.

1 Select [Transparency Options].

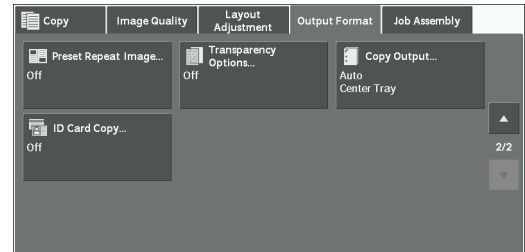

2 Select any option.

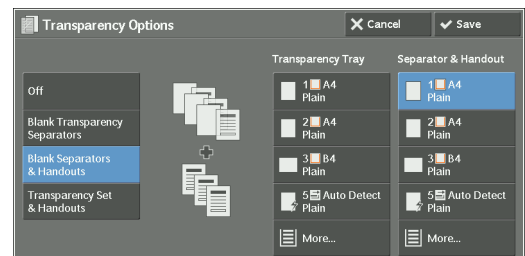

Off

Does not insert separators.

Blank Transparency Separators

Inserts a separator each time a transparency is copied. Only one set of copies can be made.

Blank Separators & Handouts

Inserts a separator each time a transparency is copied. At the same time, the required number of copies is made for handouts.

Transparency Set & Handouts

Makes copies on transparencies. At the same time, the required number of copies is made for handouts.

Transparency Tray

Allows you to select the paper tray to be used for the transparencies.

Select [More] to display the [Paper Supply - Transparency] screen on which you can select a tray.

- Note**
- When you use the bypass tray, select [Bypass] on the [Paper Supply - Transparency] screen. Select other than [Auto Detect] for [Paper Size] on the [Tray 5] screen.
 - For [Transparency Tray], select one of the paper trays. Auto Paper Select feature is not available.
 - The paper tray that you selected for [Transparency Tray] cannot be selected for [Separator Tray], [Separator & Handout], or [Handout Tray] at the same time.

When [Bypass] is selected, the [Tray 5] screen is displayed. For more information, refer to "[Tray 5] Screen" (P.79).

Separator Tray

Allows you to select the paper tray to be used for the separators.

Select [More] to display the [Paper Supply - Separator] screen on which you can select a tray.

- Note**
- When you use the bypass tray, select [Bypass] on the [Paper Supply - Separator] screen. Select an option other than [Auto Detect] for [Paper Size] on the [Tray 5] screen.
 - For [Transparency Tray], select one of the paper trays. Auto Paper Select feature is not available.
 - The paper tray that you selected for [Transparency Tray] cannot be selected for [Separator Tray] at the same time.

When [Bypass] is selected, the [Tray 5] screen is displayed. For more information, refer to "[Tray 5] Screen" (P.79).

Separator & Handout

Allows you to select the paper tray to be used for the separators and handouts.

Select [More] to display the [Paper Supply - Separator & Handout] screen on which you can select a tray.

- Note**
- When you use the bypass tray, select [Bypass] on the [Paper Supply - Separator & Handout] screen. Select an option other than [Auto Detect] for [Paper Size] on the [Tray 5] screen.
 - For [Separator & Handout], select one of the paper trays. Auto Paper Select feature is not available.
 - The paper tray that you selected for [Transparency Tray] cannot be selected for [Separator & Handout] at the same time.

When [Bypass] is selected, the [Tray 5] screen is displayed. For more information, refer to "[Tray 5] Screen" (P.79).

Handout Tray

Allows you to select the paper tray to be used for the handouts.

Select [More] to display the [Paper Supply - Handout] screen on which you can select a tray.

- Note**
- When you use the bypass tray, select [Bypass] on the [Paper Supply - Handout] screen. Select an option other than [Auto Detect] for [Paper Size] on the [Tray 5] screen.
 - For [Handout Tray], select one of the paper trays. Auto Paper Select feature is not available.
 - The paper tray that you selected for [Transparency Tray] cannot be selected for [Handout Tray] at the same time.

When [Bypass] is selected, the [Tray 5] screen is displayed. For more information, refer to "[Tray 5] Screen" (P.79).

Copy Output (Specifying Finishing Options)

This feature allows you to select finishing options.

- Note**
- An optional component is required to use this feature. For more information, contact Customer Support at dell.com/contactdell.
 - The items displayed vary depending on the options installed.

If the finisher is installed, each set of copies can be stapled, and then output.

When the Hole Punch Kit for Finisher-B1 is installed, copies can be punched.

- 1 Select [Copy Output].

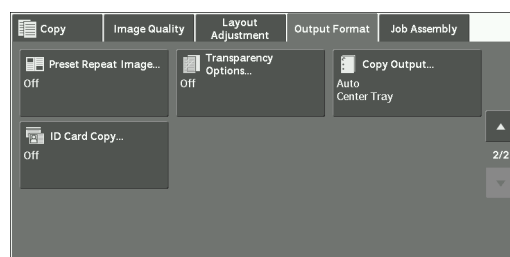

2 Select any option.

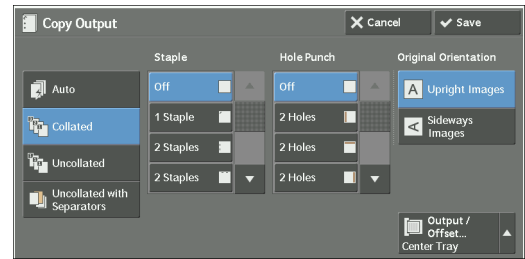

Auto

Copies are collated when the originals are loaded in the document feeder.

Copies are collated when originals are loaded on the document glass and any of the following features is used: 2 Sided Book Copying, Covers, [Blank Separators & Handouts] or [Transparency Set & Handouts] of Transparency Options, Booklet Creation, Stapling, Build Job, Sample Set, and Combine Original Sets.

Collated

The machine outputs sheets sorted into sets that are arranged in page order.

Uncollated

The machine outputs the specified number of copies and sorts sheets by page.

Uncollated with Separators

The machine outputs copies with inserting blank sheets as a separator and sorts sheets by page.

When [Bypass] is selected, the [Tray 5] screen is displayed. For more information, refer to "[Tray 5] Screen" (P.79).

Separator Tray

When you select [Uncollated with Separators], select the paper tray to be used for the separators.

Note • When you use the bypass tray, select [Bypass] on the [Separator Tray] screen.

Staple

Specify the position for stapling. The number of sheets that can be stapled is 2 - 50 (when 80 gsm paper is used). Available paper types are: Bond, Plain, Recycled, Plain Reload, Lightweight, Heavyweight, Heavyweight Reload, Extra Heavyweight (170 - 220 gsm), Extra Heavyweight (170 - 220 gsm) Reload, Gloss, Gloss Reload, Heavyweight Gloss (170 - 220 gsm), Heavyweight Gloss (170 - 220 gsm) Reload, Punched, and Custom Paper 1 to 5.

Note • In the following cases, the actual stapling position differs from the stapling position displayed on the screen:

- When [Original Orientation] is set to [Upright Images], and [Staple] is set to one position at the right side.
- When [Original Orientation] is set to [Sideways Images], and [Staple] is set to one position at the left side.

Hole Punch

Sets the position for punching.

Note • When the punching feature of a finisher is defective, output is delivered to the center tray instead of the finisher tray. Remove the output delivered to the center tray every now and then.

Original Orientation

Allows you to specify the orientation of the document so that the machine can identify the top of the document.

Note • If the [Original Orientation] setting differs from the actual document orientation, the machine may not detect the top of the document correctly.

- Upright Images

Select this option when placing the top edge of the document against the top side of the document glass or document feeder.

- Sideways Images

Select this option when placing the top edge of the document against the left side of the document glass or document feeder.

Output / Offset

This option is displayed when the output destination can be selected.

You can select the output destination tray. When you want to select both of the output destination tray and the offset operation, select [More].

When you select [More], the [Output Destination / Offset] screen will be displayed. For more information, refer to "[Output Destination / Offset] Screen" (P.131).

Offset Stacking

This option is displayed when the output destination can not be selected.

The [Offset Stacking] screen will be displayed.

For more information, refer to "[Offset Stacking] Screen" (P.131).

[Output Destination / Offset] Screen

Allows you to select the output destination tray and offset operation.

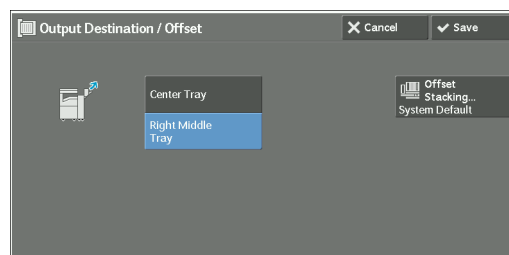

Offset Stacking

The [Offset Stacking] screen will be displayed.

For more information, refer to "[Offset Stacking] Screen" (P.131).

[Offset Stacking] Screen

Allows you to select the offset operation.

The offset function is for slightly offsetting and outputting each paper stack to allow you to distinguish the separations.





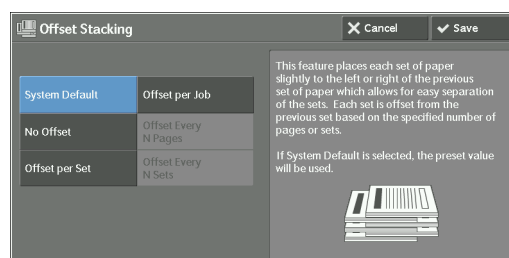







You can select from [System Default], [No Offset], [Offset per Set], [Offset per Job], [Offset Every N Pages], and [Offset Every N Sets].

Note • If you select [System Default], the setting in the System Administration mode will be effective. For information on how to change the setting, refer to "Output Destination" (P.352).



Paper Size and Stapling Position







- Finisher-B1

	1 Staple (Left)	1 Staple (Right)	2 Staples (Left)	2 Staples (Top)	2 Staples (Right)
A4, B5, 7.25 x 10.5", 8 x 10", 8.5 x 11", 16K					
A4, A3, B4, 8.5 x 11", 8.5 x 13", 8.5 x 14", 11 x 15", 11 x 17", 8K	 	 			

* :The staple orientation displayed on the touch screen differs from the actual staple orientation. Outputs are stapled in the orientation shown in the above table.







Paper Size and Punching Position (Finisher-B1)

- 2 holes*







	2 Holes (Left)	2 Holes (Top)	2 Holes (Right)
A4, B5, 7.25 x 10.5", 8 x 10", 8.5 x 11", 16K			
A4, A3, B4, 8 x 10", 8.5 x 11", 8.5 x 13", 11 x 15", 8.5 x 14", 11 x 17", 8K			

* :For the Finisher-B1, the distance between the two holes is 70 mm with the US 2/3 Hole Punch Kit, and is 80 mm with the 2/4 Hole Punch Kit, which is ordinary used.

- 3 holes

	3 Holes (Left)	3 Holes (Top)	3 Holes (Right)
A4, B5, 7.25 x 10.5", 8 x 10", 8.5 x 11", 16K			
A3, B4, 11 x 15", 11 x 17", 8K			

- 4 holes

	4 Holes (Left)	4 Holes (Top)	4 Holes (Right)
A4, B5, 7.25 x 10.5", 8.5 x 11", 16K			
A3, B4, 11 x 15", 11 x 17", 8K			

ID Card Copy (Copying Both Sides of an ID Card)

This feature allows you to copy both sides of a small undetectable original, such as an ID card, onto one side of paper.

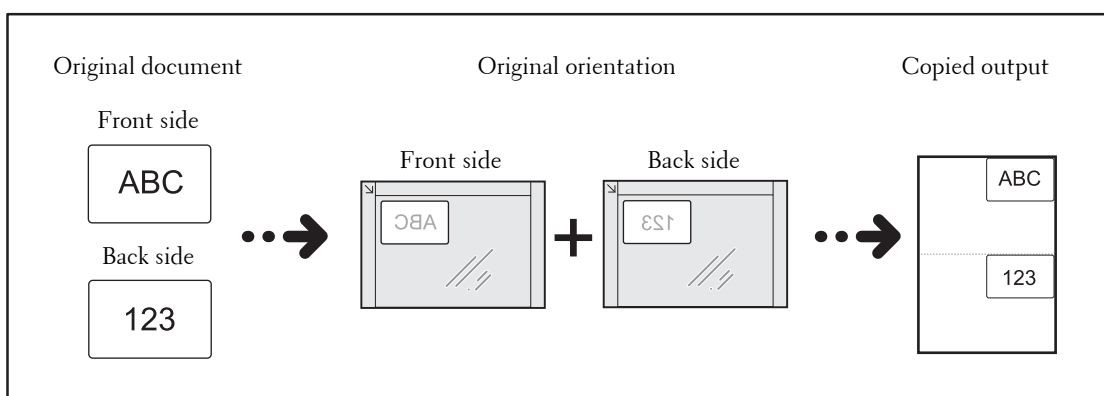

- 1 Specify the orientation of the document in [Original Orientation] on the [Layout Adjustment] screen.

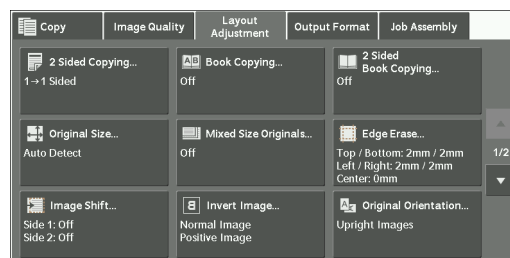

- 2 Place the document slightly away from the top left corner of the document glass, and close the document glass.

- Note**
- Always use the document glass when copying. You cannot use the document feeder with this feature.
 - Specify the orientation of the original document correctly.
 - If the edges of the image are missing, slightly move the card inward on the document glass so that the whole image can be scanned.
 - When the reduced size is specified to copy an ID card, the machine may copy the ID card in a different orientation from the original orientation depending on the magnification ratio specified. For information on the copy magnification ratio for ID Card Copy, refer to "ID Card Copy - Reduce/Enlarge" (P.355).

For information on how to specify the orientation of a document, refer to "Original Orientation (Specifying the Orientation of Loaded Documents)" (P.106).

3 Select [ID Card Copy] on the [Output Format] screen.

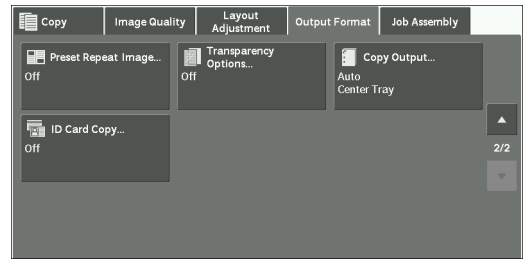

4 Select [On].

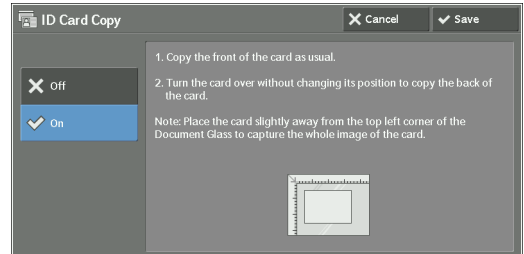

Off

Disables ID card copying.

On

Enables ID card copying.

Job Assembly

This section describes the features you can select on the [Job Assembly] screen. The following shows the reference section for each feature.

Build Job (Processing Documents Scanned with Different Settings as One Job)	135
Sample Job (Checking the Finished Output of the Copy)	139
Combine Original Sets (Adding Originals)	140
Delete Outside / Delete Inside (Deleting Outside or Inside of the Selected Area)	142
Stored Programming (Calling a Stored Program for Build Job)	143

- 1 Select [Copy] on the [Home] screen.

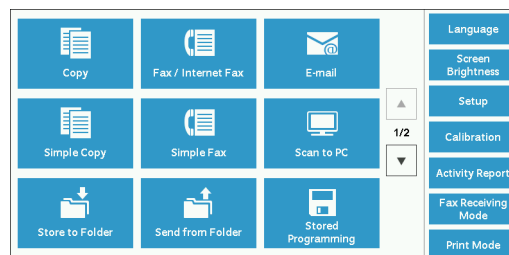

- 2 Select a feature on the [Job Assembly] screen.

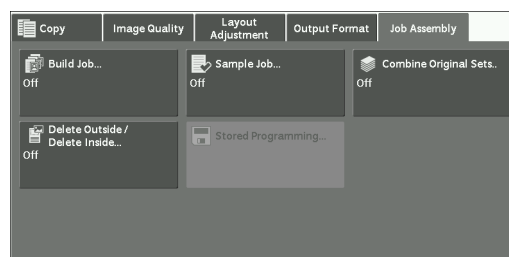

Build Job (Processing Documents Scanned with Different Settings as One Job)

This feature allows you to apply different copy settings to each document page or each document stack, and then output the copies as one job.

- 1 Select [Build Job].

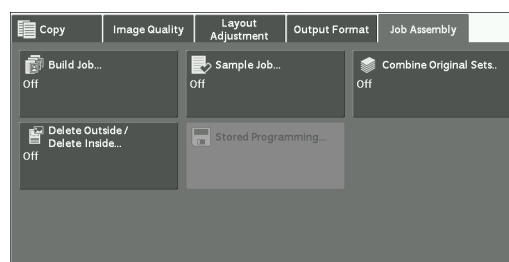

- 2 Select [On].

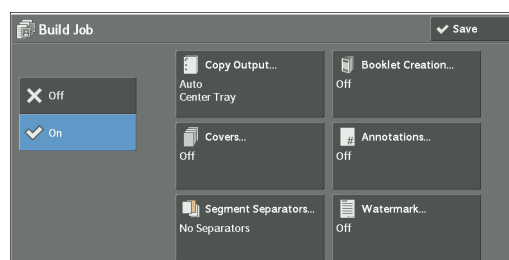

- 3 Select any option.

Note • Select [▲] to return to the previous screen or [▼] to move to the next screen.

Off

Build Job is not applied.

On

Build Job is applied. The feature buttons appear. Specify any option if necessary.

Note • The features selected here cannot be canceled or changed while the machine executes a copy job. For information on features available in Build Job, refer to "Features that can be set in Build Job" (P.136).

Features that can be set in Build Job**Copy Output**

For more information, refer to "Copy Output (Specifying Finishing Options)" (P.129).

Booklet Creation

For more information, refer to "Booklet Creation (Creating a Booklet)" (P.110).

Covers

Note • The machine does not copy on a cover when using the Build Job feature. For more information, refer to "Covers (Attaching Covers to Copies)" (P.113).

Annotations

For more information, refer to "Annotations (Adding a Comment/a Date/Page Numbers to Copies)" (P.118).

Segment Separators

For more information, refer to "[Segment Separators] Screen" (P.138).

Watermark

For more information, refer to "Watermark (Printing Control Numbers on the Background of Copies)" (P.124).

[Copy] Screen When Build Job is in Progress

The following describes the screen that appears while the Build Job is being executed.

**Chapter Start**

Displays the [Build Job - Chapter Start] screen. Refer to "[Build Job - Chapter Start] Screen" (P.137).

Insert Separators

Displays the [Segment Separators] screen. Refer to "[Segment Separators] Screen" (P.138).

Change Quantity

Displays the [Change Quantity] screen on which you can change the number of copy sets using the numeric keypad.

Change Settings

Displays the [Copy] screen on which you can change the settings for the next document. After changing the settings, press the <Start> button on the control panel to start scanning of the document. To return to the previous screen, press the < # > button.

When using a stored program for Build Job

While the machine makes copies using the Build Job feature, you can use a stored program.

- 1) Select [Change Settings].
- 2) Select the [Job Assembly] tab.
- 3) Select [Stored Programming].
- 4) Select the number of the stored program that contains the features you want to use.

For information on how to register a stored program, refer to "Registering Stored Programs for Build Job" (P.180).

Delete

Clears the document data stored by the Build Job feature, and cancels the job.

- Note**
- You can also press the <C (Clear)> or <Clear All> button on the control panel to perform the same operation.
 - While the machine is scanning the loaded document, [Delete] is displayed. Select [Delete] to pause scanning. Select [Start] on the touch screen, or press the <Start> button on the control panel to resume scanning.

Last Original

Select this button to end scanning of documents. The build job starts.

Next Original

Select this button when you have another document. This button is always selected when you use the Build Job feature.

Start

After loading the next document, select this button to scan the next document.

- Note**
- You can also press the <Start> button on the control panel to perform the same operation.

Sample Job

When making multiple sets of copies, you can print a sample set to check the finished output and then print the remaining copy sets. You can select to continue or cancel the job after the confirmation.

[Build Job - Chapter Start] Screen

This screen allows you to set the chapter start.

- 1 Select any option.

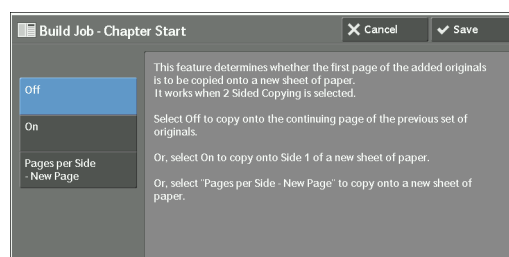

Off

The next stack of documents is copied after the previous stack.

On

The next stack of documents is copied from Side 1 of a new sheet of paper.

Pages per Side - New Page

When [Pages per Side] is set, even if all documents are divided for every chapter before all of them are assembled in the Pages per Side feature, the next stack of document is copied from Side 2 of the paper.

[Segment Separators] Screen

This screen allows you to insert a sheet of paper as a separator in between each stack of documents. You can specify the number of separators to insert in the range from 1 to 99 as necessary.

Note • You can specify different settings for each stack of documents. If you do not specify particular settings for each stack of documents, the previously specified settings are applied.

1 Select any option.

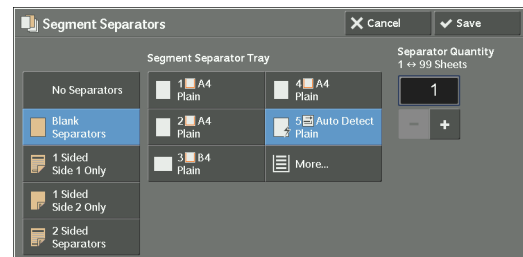

2 Select any option.

No Separators

Does not insert any separators.

Blank Separators

Inserts blank separators.

If you select this option, load documents, and press the <Start> button, the blank separators are inserted before the copies of the documents.

1 Sided Side 1 Only

A first page of the loaded documents is copied on the front side of a separator, and the rest of pages are copied on the paper other than a separator.

When [Pages per Side] is set, the number of pages (2 pages, 4 pages, or 8 pages) that you selected to copy onto one side of a single sheet, starting from the first page of the loaded documents, are copied onto the front page of a separator.

When you load a single sheet document, the document is copied onto a separator.

1 Sided Side 2 Only

A first page of the loaded documents is copied on the back side of a separator, and the rest of pages are copied on the paper other than a separator.

When [Pages per Side] is set, the number of pages (2 pages, 4 pages, 8 pages) that you selected to copy onto one side of a single sheet, starting from the first page of the loaded documents, are copied onto the back side of a separator.

When you load a single sheet document, the document is copied onto a separator.

2 Sided Separators

First two pages of the loaded documents are copied onto each side of a separator, and the rest of pages starting from the third page are copied onto the paper other than a separator.

When [Pages per Side] is set, the number of pages (2 pages, 4 pages, 8 pages) that you selected to copy onto one side of a single sheet, starting from the first page of the loaded documents, are copied onto each side of a separator.

When you load two-sheet documents, both sheets are copied onto each side of a separator.

Note

- To copy a one-page document on Side 1 of a separator and the first page of the next document on Side 2 of the same separator, select [No Separators] under [Insert Separators] when you load the next document. If not, the one-page document will be copied and printed one-sided, and the first and the second pages of the next document two-sided, on the next separator.

Segment Separator Tray

Allows you to select the tray, which is loaded with paper to be used as a separator.

When [Bypass] is selected, the [Tray 5] screen is displayed. For more information, refer to "[Tray 5] Screen" (P.79).

Separator Quantity

This option is available when you select [Blank Separators]. You can specify the number of separators in the range from 1 to 99.

Sample Job (Checking the Finished Output of the Copy)

When making multiple sets of copies, you can print a sample set to check the finished output and then print the remaining copy sets. You can select whether to continue or cancel the job after the confirmation. This feature also allows you to change the number of copy sets. The sample copy is included in the total number of copy sets.

Note

- After a sample set is output, the machine automatically outputs the data remained if the machine is left uninstruced for the period specified in [Auto Job Release]. For more information on [Auto Job Release], refer to "Auto Job Release" (P.315).

1 Select [Sample Job].

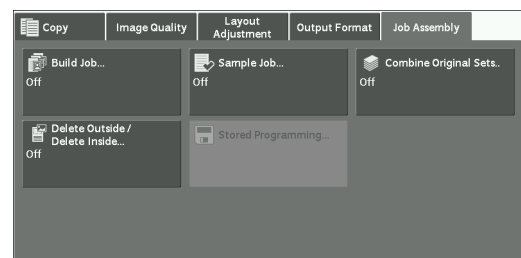

2 Select [On].

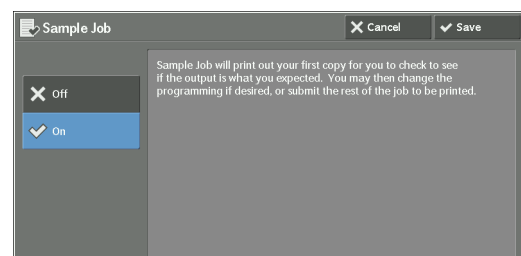

Off

No sample set is made.

On

A sample set is made.

[Copy] Screen When Sample Job is in Progress

After the sample set is copied, the machine pauses the job and displays the [Copy] screen.



Change Quantity

Displays the [Change Quantity] screen on which you can change the number of copies entered before. Enter a new quantity using the numeric keypad. The new value must include the number of the sample set that has already been printed. When reducing the quantity, specify a value between 1 (sample set) and the number of copies entered before.

Note • If you specify "1" as a new quantity and then press the <Start> button, the machine will not process the job.

Change Settings

Displays the [Change Settings] screen. To cancel the settings you have made, deselect the check box for the feature you want to cancel.

Delete

The remaining copies are canceled.

Start

The remaining copies are made.

Note • You can also press the <Start> button on the control panel to perform the same operation.

Combine Original Sets (Adding Originals)

Use this feature when you copy a document that has too many pages to be loaded into the document feeder at one time, or when you scan each document page using the document glass and have the machine process the pages as one job.

When you use this feature, [Next Original] is always selected on the screen during scanning documents with the document feeder or the document glass.

If [Copy Output] is set to [Auto], the output is automatically sorted.

When all documents have been scanned, select [Last Original].

Note • After the first original set is copied, the machine automatically outputs the data remained if the machine is left unused for the period specified in [Auto Clear]. For more information on [Auto Clear], refer to "Auto Clear" (P.315).

1 Select [Combine Original Sets].

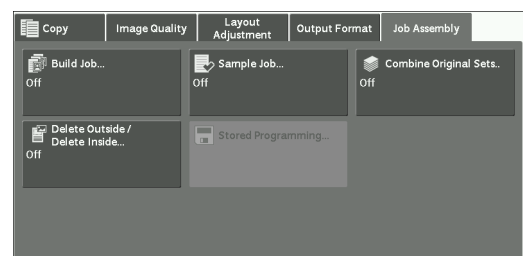

2 Select [On].

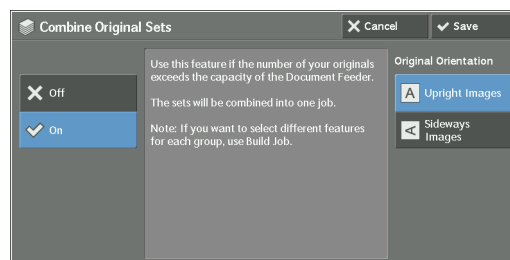

Off

Disables this feature.

On

Enables this feature.

Original Orientation

Allows you to specify the orientation of the document so that the machine can identify the top of the document.

Note • If the [Original Orientation] setting differs from the actual document orientation, the machine may not detect the top of the document correctly.

- Upright Images

Select this option when placing the top edge of the document against the top side of the document glass or document feeder.

- Sideways Images

Select this option when placing the top edge of the document against the left side of the document glass or document feeder.

[Copy] Screen When Combine Original Sets is in Progress

The [Copy] screen is displayed when copying starts.



Delete

Clears the document data stored with the Combine Original Sets feature, and cancels copying.

Note • You can also press the <C (Clear)> or <Clear All> button on the control panel to perform the same operation.

Last Original

Select this button to end scanning documents.

Next Original

Select this button when you have more documents to copy. This button is always selected when the Combine Original Sets feature is used.

Start

After loading the next document, select this button to scan the next document.

Note • You can also press the <Start> button on the control panel to perform the same operation.

Delete Outside / Delete Inside (Deleting Outside or Inside of the Selected Area)

This feature allows you specify the areas to be deleted from a document image. Up to three areas can be specified.

1 Select [Delete Outside / Delete Inside].

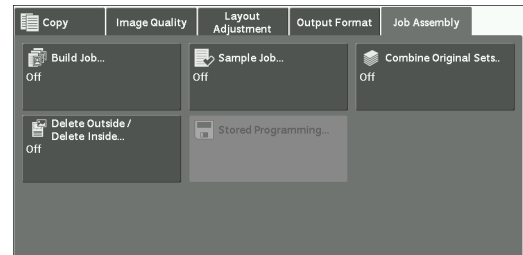

2 Select any option.

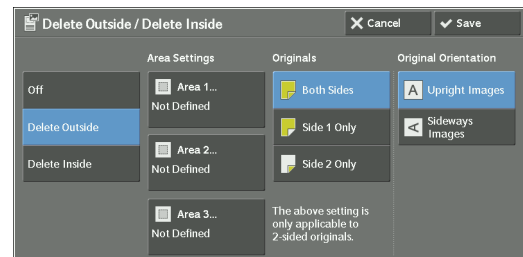
**Off**

No area is deleted.

Delete Outside

Deletes the outside of the selected area.

Delete Inside

Deletes the inside of the selected area.

Area Settings

Displays the [Delete Outside / Delete Inside - Area 1 (Area 2 or Area 3)] screen. You can specify up to three areas.

Refer to "[Delete Outside / Delete Inside - Area 1 (Area 2 or Area 3)] Screen" (P.143).

Originals

When the original document is a 2-sided document, specify from which side the specified area is to be deleted.

- Both Sides
Applies the settings to both sides of the document.
- Side 1 Only
Applies the settings to Side 1 of the document.
- Side 2 Only
Applies the settings to Side 2 of the document.

Original Orientation

Allows you to specify the orientation of the document so that the machine can identify the top of the document.

Note • If the [Original Orientation] setting differs from the actual document orientation, the machine may not detect the top of the document correctly.

- Upright Images

Select this option when placing the top edge of the document against the top side of the document glass or document feeder.

- Sideways Images

Select this option when placing the top edge of the document against the left side of the document glass or document feeder.

[Delete Outside / Delete Inside - Area 1 (Area 2 or Area 3)] Screen

This screen allows you to specify the area to be deleted. The area is defined by the rectangle formed between the points X1, Y1 and X2, Y2. The origin point is the top right corner of a document.

You can specify a value in the range from 0 to 432 mm for the width (X) and the length (Y) in 1 mm increments.

Note

- Specify the 2 coordinates from the top right corner of the document.
- When specifying multiple areas, the specified areas can overlap each other.
- When [Reduce / Enlarge] is set, the specified area will be reduced or enlarged accordingly.

1 Select [Area 1], [Area 2], or [Area 3].

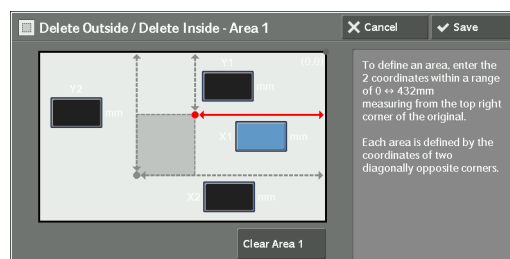

2 Select the text box for [X1], and enter the value for X1 using the numeric keypad.

3 Select the text box for [Y1], and enter the value for Y1 using the numeric keypad.

4 Select the text box for [X2], and enter the value for X2 using the numeric keypad.

5 Select the text box for [Y2], and enter the value for Y2 using the numeric keypad.

Note

- If all of [X1], [Y1], [X2], and [Y2] are set to [0], the area will be invalid. If no other area is specified, the Delete Outside/Delete Inside feature cannot be used.
- Pressing the <C (Clear)> button clears the value you have entered.

Clear Area 1 (Area 2 or Area 3)

Clears all the values set for Area 1 (Area 2 or Area 3).

Stored Programming (Calling a Stored Program for Build Job)

This feature allows you to call a stored program for Build Job.

For more information, refer to "Calling a Stored Program for Build Job" (P.184).

4 Fax

This chapter describes the basic operations and features for the Fax services.

Note • An optional component is required to use this feature. For more information, contact Customer Support at dell.com/contactdell.

- **Fax Procedure146**
- **Operations during Faxing.....153**

Fax Procedure

This section describes the basic fax procedures. The following shows the reference section for each procedure.

Step 1 Loading Documents	146
Step 2 Selecting Features	148
Step 3 Specifying Destinations.....	149
Step 4 Starting the Fax Job	150
Step 5 Confirming the Fax Job in Job Status	152

Step 1 Loading Documents

The following two methods are available to load documents:

Document Feeder

- Single sheet
- Multiple sheets

Document Glass

- Single sheet
- Bound documents, such as books

Document Feeder

The document feeder supports single and multiple sheet documents with sizes from 125 x 85 mm (Standard size: A5, A5 \square) to 297 x 600 mm (long) (Standard size: A3, 11 x 17").

The document feeder automatically detects documents of standard-size widths.

The standard document sizes that can be detected automatically depend on [Paper Size Settings] in the System Administration mode. For information on [Paper Size Settings], refer to "Paper Size Settings" (P.335).

The sizes on the left are detected as the sizes shown on the right as follows.

Original Document Size	Document Size Detected by the Document Feeder
8-inch width document	B5 width document
10-inch width document	B4 width document

The document feeder accepts the following number of sheets.

Document Type (Weight)	Number of Sheets
Lightweight paper (38 - 49 gsm)	110 sheets
Plain paper (50 - 80 gsm)	110 sheets
Heavyweight paper (81 - 128 gsm)	75 sheets

- Note**
- To avoid paper jams, use the document glass for folded or wrinkled documents, cut-and-pasted documents, curled paper, or back carbon paper.
 - The lightweight paper of 38 - 49 gsm cannot be scanned 2 sided.

- 1 Remove any paper clips and staples before loading the document.
- 2 Load the document face up (when the document is 2-sided, place the front side up) in the center of the document feeder.

Note

- The confirmation indicator lights up when the document is loaded correctly. If the indicator does not light, the machine may be detecting the document on the document glass. Load the document again.

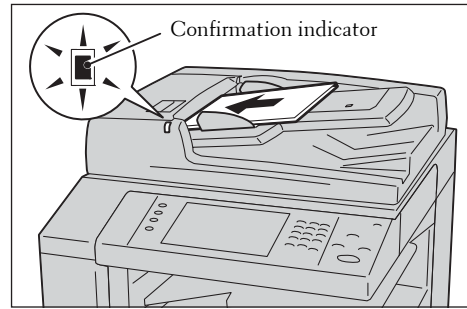

- 3 Adjust the document guides to match the size of the document loaded.

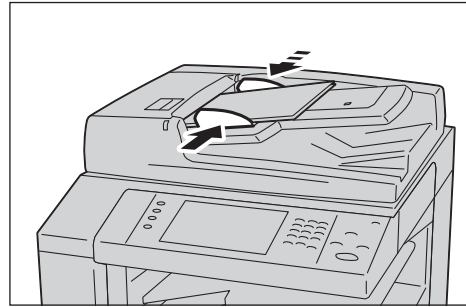

- 4 Open the document stopper.

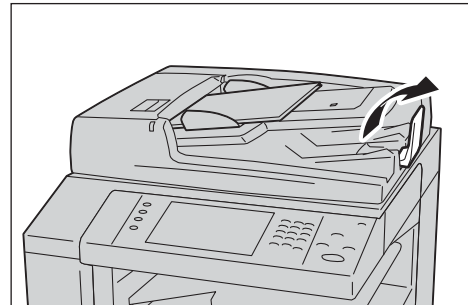

Document Glass

The document glass supports a single sheet, a book, or other similar documents with a size from 15 x 15 mm to 297 x 432 mm (Standard size: A3, 11 x 17").

Note

- Always close the document cover after using the document glass.

The document glass automatically detects standard size documents.

The standard document sizes that can be detected automatically depend on [Paper Size Settings] in the System Administration mode. For information on [Paper Size Settings], refer to "Paper Size Settings" (P.335).

- 1 Open the document cover.

Note

- Ensure that the touch screen is active, and then load a document. Otherwise, the machine may not properly detect the document size.

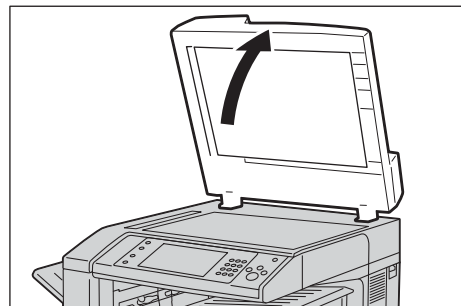

- 2 Load the document face down, and align it against the top left corner of the document glass.

Note

- When you load a A5, B5 or A4 document on the document glass in portrait orientation, the scanned image is transmitted with 180 degrees rotated.

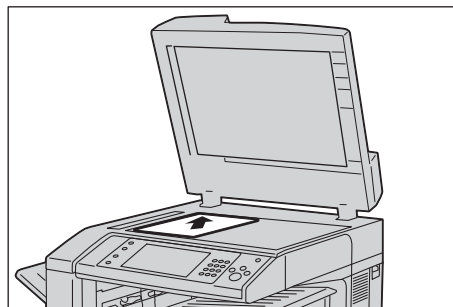

- 3 Close the document cover.

Note

- When a standard size document is loaded on the document glass, the size of the document is displayed in the message field.

Step 2 Selecting Features

The following two services are available to send faxes.

Simple Fax

Allows you to only select basic features to send faxes.

Fax / Internet Fax

Allows you to make detailed settings to send faxes.

The following procedure uses [Fax / Internet Fax] to describe how to select features.

Note

- The features to be displayed on the screen depend on the configuration of your machine.
- When the Authentication or Accounting feature is enabled, a user ID and passcode may be required. Ask your system administrator for the user ID and passcode.

- 1 Press the <Home> button.

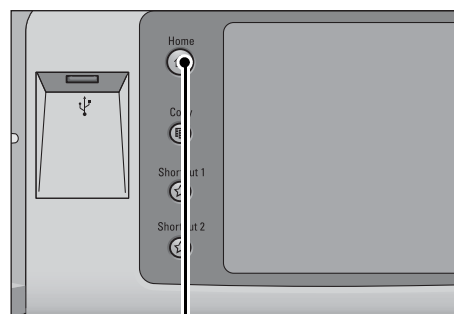

<Home> button

- 2 Select [Fax / Internet Fax].

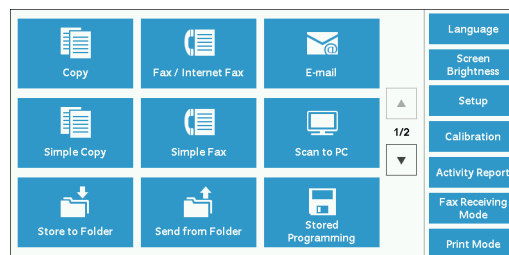

- 3 If the previous settings still remain, press the <Clear All> button.

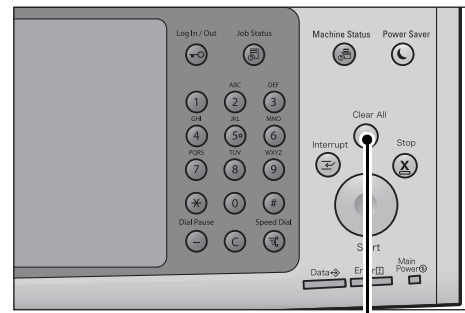

<Clear All> button

- 4 Select each tab, and select a feature as necessary.

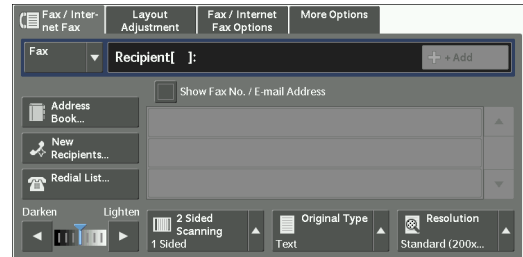

When you press the <Power Saver> button while configuring the features, you can select whether to enable the 2 Sided (Skip Blank Pages) feature.

Step 3 Specifying Destinations

Three methods are available to specify recipients: by phone number, by address number, and by group dial number. The following shows input methods supported by each method.

	Numeric Keypad	One Touch buttons	Address Book
Phone Number	O	X	X
Address Number (Speed Dialing)	4 digits (0001 to 2000)	2 digits (1 to 70) or (1 to 60)*	From the list tab and index
	3 digits + * (nnn0 to nnn9) 2 digits + * (nn00 to nn99)		
Group Dial Number	# + 2 digits	X	O

O :Available
X :Not available

* :There two ways in which address numbers and stored programs are assigned to the one touch buttons. Select either of the following:

- [Type 1] The buttons 1 to 70 are used for address numbers and they correspond to the registered address numbers 0001 to 0070, while the buttons M01 and M02 are used for stored programs and they correspond to the registered stored programs 1 and 2.
- [Type 2] The buttons 1 to 60 are used for address numbers and they correspond to the registered address numbers 0001 to 0060, while the buttons 61 to 70, M01, and M02 are used for stored programs and they correspond to the registered stored programs 1 to 12.

* :By default, [Type 1] is selected. For information on how to change the settings registered to the one touch buttons, refer to "Screen/Button Settings" (P.319).

You can specify multiple recipients (Broadcast Send) using the above methods. You can also use a combination of the methods.

If the same recipient was specified for several pending documents, you can send the documents with a single phone call. This feature is called Batch Send. Note that you cannot use Batch Send with Broadcast Send, Relay Broadcast, Remote Folder, and Delay Start when prior to the specified time. When using a redial, resend, or delayed start send transmission job, or authentication feature, to send to the same address from different users, then Batch Send is not possible.

Note • Confirm recipients before sending a fax.

The following describes how to enter a phone number with the numeric keypad as an example.

- 1 Enter a fax number using the numeric keypad.

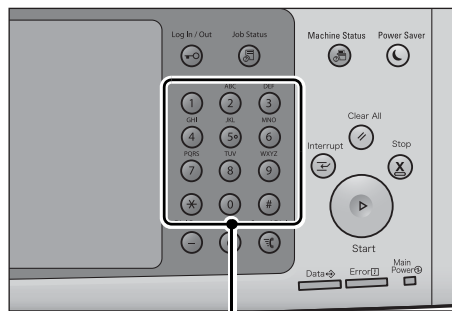

Numeric keypad

- 2 To specify multiple recipients, select [+ Add] on the touch screen.

Note • Select [Confirm] in the message field to check the entered value. You can hide [Confirm] to show the remaining memory capacity. For more information, refer to "Reconfirm Fax / Internet Fax Button" (P.321).

- If you have entered an incorrect value, press the <C (Clear)> button and enter the correct value.
- Depending on the settings, a screen to re-enter the recipient may be displayed after you specify the recipient and then select [+ Add]. In such case, re-enter the recipient.
- [+ Add] allows you to combine the fax numbers registered to the one touch buttons, the speed dial, or the Address Book and the numbers entered with the numeric keypad as one recipient. Select [+ Add] when you finish combining. You can specify whether to use the chain dial in the System Administration mode. For more information, refer to "Chain Dial" (P.397).

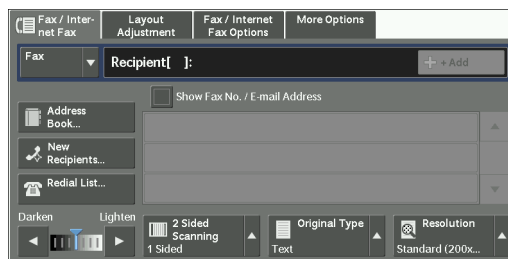

Step 4 Starting the Fax Job

The following describes how to start a fax job.

- 1 Press the <Start> button.

- Note**
- If the document has been loaded in the document feeder, do not hold down the document while it is being conveyed.
 - Fax cannot be sent if a copy protection code is detected.
 - Depending on the settings, the screen to re-enter the recipient may be displayed after pressing the <Start> button. In this case, re-enter the recipient.
 - If a problem occurs, an error message appears on the touch screen. Solve the problem according to the message.

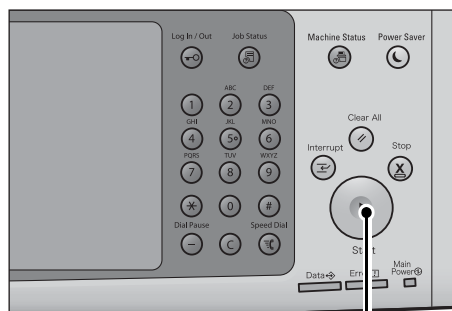

<Start> button

If you have more documents

If you have more documents to fax, select [Next Original] on the touch screen while the current document is being scanned. This allows you to send the documents as one set of data.

- 2 While documents are being scanned, select [Next Original].

- Note**
- When using the document feeder, load the next document after the machine has finished scanning the first document.
 - When [Next Original] is displayed on the screen shown on the right and no operation is performed during a certain period of time, the machine automatically assumes that there are no more documents.
 - You can change the scan settings of the next document by selecting [Resolution], [Original Size] and [Lighten / Darken] that are displayed after selecting [Next Original].

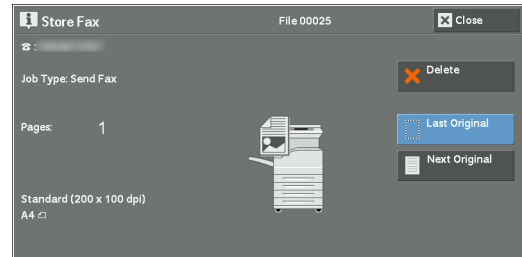

- 3 Load the next document.

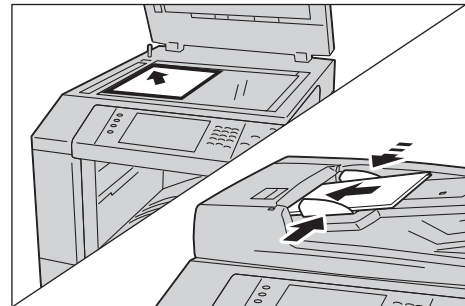

- 4 Press the <Start> button.
If you have more documents, repeat steps 3 and 4.

- 5 When all documents have been scanned, select [Last Original].

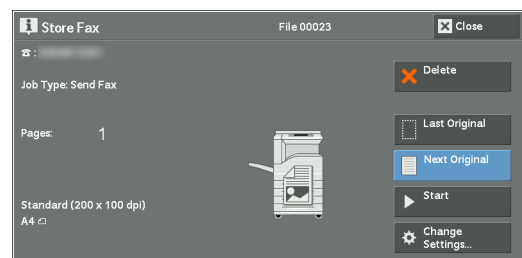

Step 5 Confirming the Fax Job in Job Status

The following describes how to confirm the status of a fax job.

- 1 Press the <Job Status> button.

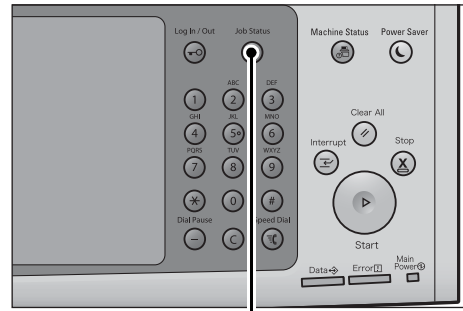

<Job Status> button

- 2 Confirm the job status.

- Note**
- Select [▲] to return to the previous screen or [▼] to move to the next screen.
 - From the drop-down menu, you can select [Scan, Fax, & Internet Fax Jobs] and display the desired job.

Active Jobs	Completed Jobs	Secure Print Jobs & More	Print Waiting Jobs	Close																								
<div style="border: 1px solid black; padding: 5px;"> <div style="display: flex; justify-content: space-between; align-items: center;"> All Jobs ✕ </div> <table border="1" style="width: 100%; border-collapse: collapse;"> <thead> <tr> <th>All Jobs</th> <th>Terminal</th> <th>Status</th> <th>Progress</th> </tr> </thead> <tbody> <tr> <td>Printer & Print from Folder Jobs</td> <td>D1</td> <td>Send Wait</td> <td>0/1 ▲</td> </tr> <tr> <td>Scan, Fax, & Internet Fax Jobs</td> <td>D1</td> <td>Send Wait</td> <td>0/1</td> </tr> <tr> <td>Job Flow & File Transfer Jobs</td> <td>D1</td> <td>Send Wait</td> <td>0/1</td> </tr> <tr> <td>00024 - Send Fax</td> <td></td> <td>Send Wait</td> <td>0/1</td> </tr> <tr> <td>00025 - Send Fax</td> <td></td> <td>Send Wait</td> <td>0/1 ▼</td> </tr> </tbody> </table> </div>					All Jobs	Terminal	Status	Progress	Printer & Print from Folder Jobs	D1	Send Wait	0/1 ▲	Scan, Fax, & Internet Fax Jobs	D1	Send Wait	0/1	Job Flow & File Transfer Jobs	D1	Send Wait	0/1	00024 - Send Fax		Send Wait	0/1	00025 - Send Fax		Send Wait	0/1 ▼
All Jobs	Terminal	Status	Progress																									
Printer & Print from Folder Jobs	D1	Send Wait	0/1 ▲																									
Scan, Fax, & Internet Fax Jobs	D1	Send Wait	0/1																									
Job Flow & File Transfer Jobs	D1	Send Wait	0/1																									
00024 - Send Fax		Send Wait	0/1																									
00025 - Send Fax		Send Wait	0/1 ▼																									

If undelivered faxes exist

You can confirm undelivered faxes on the [Job Status] screen or in an Activity Report. For information on how to resend or delete undelivered faxes, refer to "Job Status" (P.203).

Operations during Faxing

This section describes the available operations during faxing. The following shows the reference section for each operation.

Stopping the Fax Job..... 153
 Changing the Scan Settings..... 154

Stopping the Fax Job

To cancel scanning a fax document, use the following procedure.

- 1 Press either the <Stop> button on the control panel or [Delete] on the touch screen.

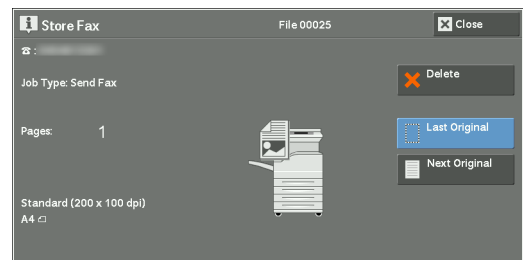
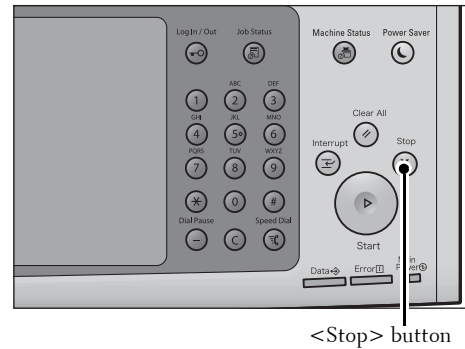

- 2 Select [Delete].

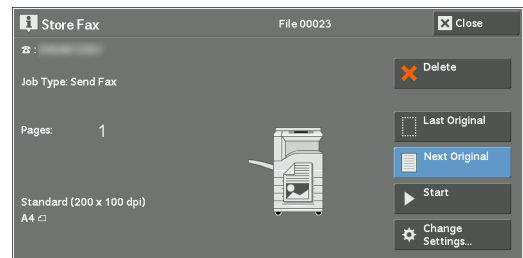

If [Delete] does not appear on the screen:

- 1 Press the <Job Status> button.

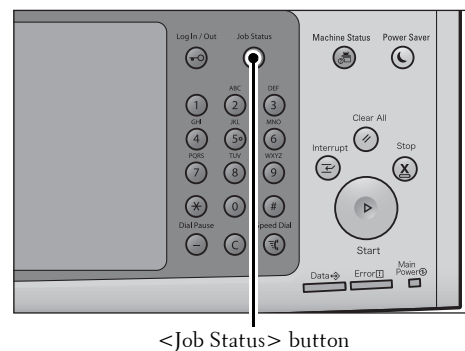

2 Select the job to cancel.

Note • Select [▲] to return to the previous screen or [▼] to move to the next screen.

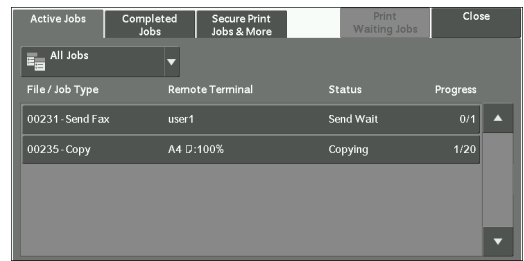

3 Select [Delete].

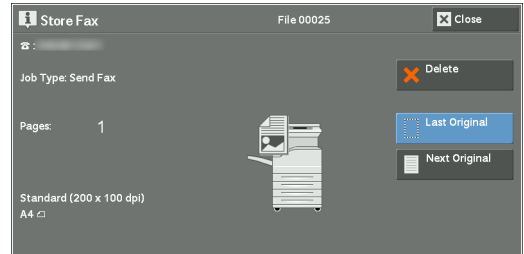

4 Select [Delete].

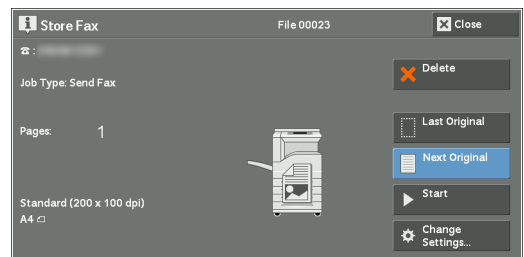

Changing the Scan Settings

You can change the scan settings while scanning a document.

1 Select [Next Original] on the touch screen.

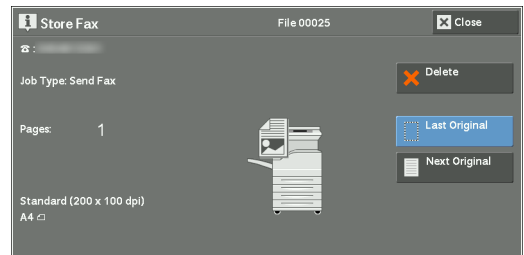

2 Select [Change Settings].

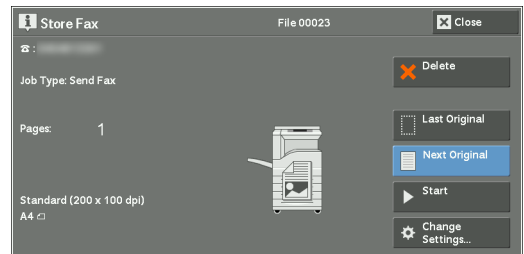

3 Set [Resolution], [Original Size], and the density.

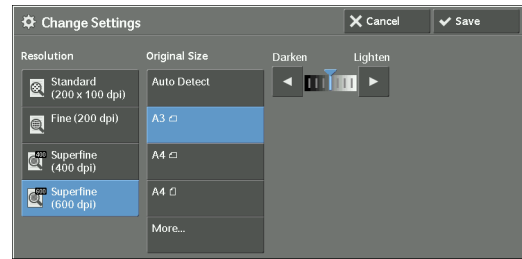

4 Select [Save].

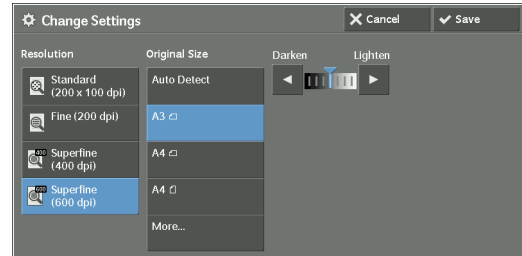

5 Press the <Start> button.

5 Scan

This chapter describes the basic operations and features for the Scan services.

To use the Scan services, network settings are required. For information on the network settings, refer to "Scanner Environment Settings" (P.495).

- **Scanning Procedure158**
- **Operations during Scanning.....165**

Scanning Procedure

This section describes the basic scanning procedure. The following shows the reference section for each procedure.

Step 1 Loading Documents	158
Step 2 Selecting the Features	160
Step 3 Starting the Scan Job.....	162
Step 4 Confirming the Scan Job in Job Status	164
Step 5 Saving the Scanned Data	164

Step 1 Loading Documents

The following two methods are available to load documents:

Document Feeder

- Single sheet
- Multiple sheets

Document Glass

- Single sheet
- Bound documents, such as books

Document Feeder

The document feeder supports single and multiple sheet documents with sizes from 125 x 85 mm (Standard size: A5, A5^{LF}) to 297 x 432 mm (Standard size: A3, 11 x 17").

The document feeder automatically detects standard size documents. For non-standard size documents, enter the size on the [Original Size] screen.

The standard document sizes that can be detected automatically depend on [Paper Size Settings] in the System Administration mode. For information on paper size settings, refer to "Paper Size Settings" (P.335).

The document feeder accepts the following number of sheets.

Document Type (Weight)	Number of Sheets
Lightweight paper (38 - 49 gsm)	110 sheets
Plain paper (50 - 80 gsm)	110 sheets
Heavyweight paper (81 - 128 gsm)	75 sheets

- Note**
- To avoid paper jams, use the document glass for folded or wrinkled documents, cut-and-pasted documents, curled paper, or back carbon paper.
 - The lightweight paper of 38 - 49 gsm cannot be scanned 2 sided.

- 1 Remove any paper clips and staples before loading a document.

- 2 Load the document face up (when the document is 2-sided, place the front side up) in the center of the document feeder.

- Note**
- In normal occasions, load the document in the [Sideways Images] orientation. The document is displayed in the [Upright Images] orientation when viewed on a computer.
 - The confirmation indicator lights up when the document is loaded correctly. If the indicator does not light, the machine may be detecting a document on the document glass. Load the document again.

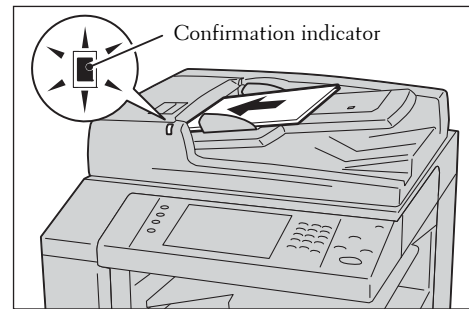

- 3 Adjust the document guides to match the size of the document loaded.

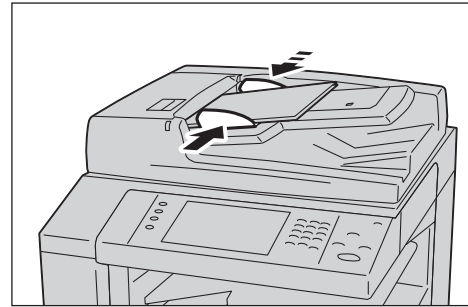

- 4 Open the document stopper.

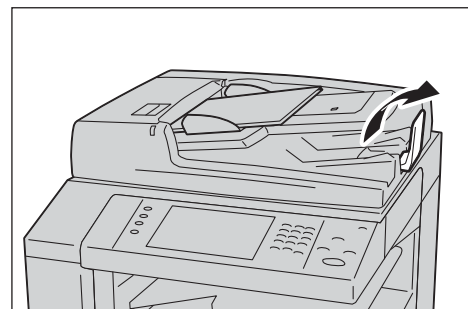

Document Glass

The document glass supports a single sheet, a book, or other similar documents with a size from 15 x 15 mm to 297 x 432 mm (Standard size: A3, 11 x 17").

- Note**
- Always close the document cover after using the document glass.

The document glass automatically detects standard size documents. For non-standard size documents, enter the size on the [Original Size] screen.

The standard document sizes that can be detected automatically depend on [Paper Size Settings] in the System Administration mode. For information on the paper size settings, refer to "Paper Size Settings" (P.335).

- 1 Open the document cover.

- Note**
- Ensure that the touch screen is active, and then load a document. Otherwise, the machine may not properly detect the document size.

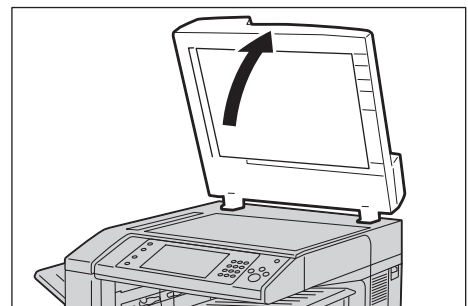

- 2 Load the document face down, and align it against the top left corner of the document glass.

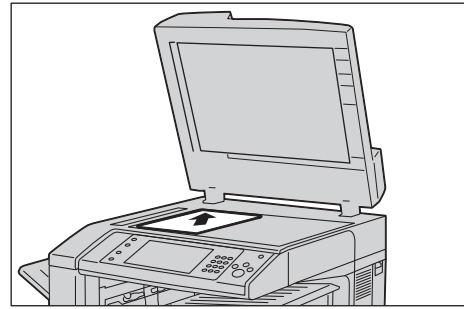

- 3 Close the document cover.

Step 2 Selecting the Features

On the [Home] screen, you can select the following Scan services: [E-mail], [Store to Folder], [Scan to PC], [Store to USB], [Store & Send Link], and [Store to WSD]. You can select features for each service.

- Note**
- WSD stands for Web Services on Devices.
 - The features to be displayed on the screen depend on the configuration of your machine.
 - When the Accounting feature is enabled, a user ID and passcode may be required. Ask your system administrator for the user ID and passcode.
 - To use the Scan services, network settings are required. For information on the network settings, refer to "Scanner Environment Settings" (P.495).

E-mail

Scans a document and sends the scanned data as an e-mail attachment after converting the data to TIFF, JPEG, PDF, or XML Paper Specification (XPS).

Store to Folder

Scans a document and saves the scanned data in a folder on the machine.

You need to create a folder in advance. For information on how to create a folder, refer to "Create Folder" (P.421).

Scan to PC

Scans a document and sends the scanned data to a network computer via the FTP or SMB protocol.

Store to USB

Scans a document and saves the scanned data to a USB memory device.

Store & Send Link

Scans a document and temporarily saves the scanned data on the machine. The user is notified by e-mail of the URL to the location where the scanned data is stored. Then, the user can access the URL to retrieve the scanned data.

Store to WSD

You can scan documents on the machine and save the scanned data to your computer. You can also save the scanned data to another computer on the network.

- Note**
- WSD stands for Web Services on Devices.

The following table shows file formats available for each Scan service.

Scan Service	File Format can be Selected When	File Format					
		PDF	XPS*1	TIFF	JPEG	BMP	PNG
E-mail	Using the control panel when scanning	O*2	O	O	O	X	X
Scan to PC		O*2	O	O	O	X	X
Store to USB		O*2	O	O	O	X	X
Store & Send Link		O*2	O	O	O	X	X
Store to Folder	Using Dell Printer Configuration Web Tool	O*2	O	O	O	X	X
	Stored File Manager 3®	X	X	O	O	X	X
	Using Adobe® Acrobat®*3	O*2	X	X	X	X	X
Job Flow Sheets	Creating a job flow	O*2	O	O	O	X	X
Store to WSD	Using [Scan Profiles] of Windows®*4	X	O	O	O	O	O

O :Available

X :Not available

*1 :XPS stands for XML Paper Specification.

*2 :Supported on Acrobat 4.0 or later

*3 :TWAIN compatible application

*4 :Windows Vista® Service Pack 2 or later

Note • If you do not specify a file name for the document to be saved, a file name is automatically assigned to each file or folder based on a particular rule. For example, the file name "img-123123456" indicates that the document was scanned at 12:34:56 on January 23.
X, Y, and Z represent October, November, and December, respectively.

The following describes how to store scanned data into a folder as an example.

1 Press the <Home> button.

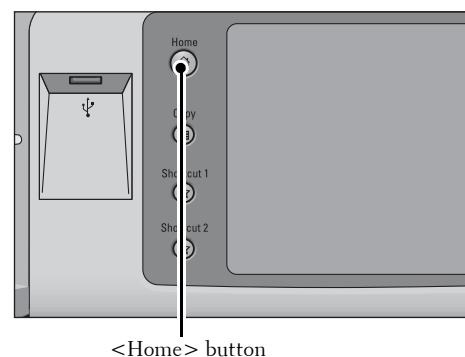

2 Select [Store to Folder].

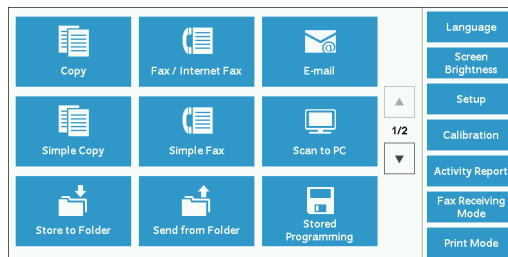

3 If the previous settings still remain, press the <Clear All> button.

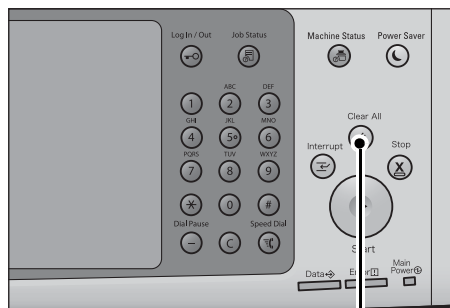

<Clear All> button

4 Specify a folder to save the data in.

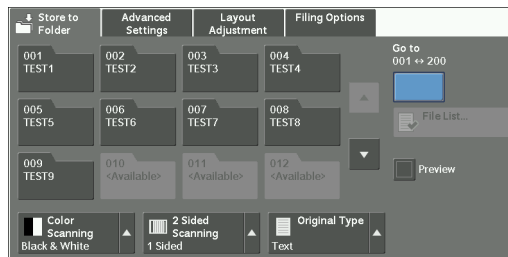

5 Select each tab, and configure features as necessary.

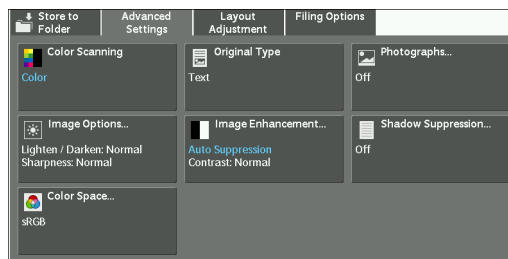

When you use another Scan service, [Store to Folder] is replaced with [E-mail], [Scan to PC], [Store to USB], [Store & Send Link], or [Store to WSD].

Note • WSD stands for Web Services on Devices.

Step 3 Starting the Scan Job

The following describes how to start a scan job.

Note • WSD stands for Web Services on Devices.

1 Press the <Start> button.

- Note**
- If the document has been loaded in the document feeder, do not hold down the document while it is being conveyed.
 - If a copy protection code is detected, the machine will not scan the document.
 - If a problem occurs, an error message appears on the touch screen. Solve the problem according to the message.
 - You can set the next job during scanning.

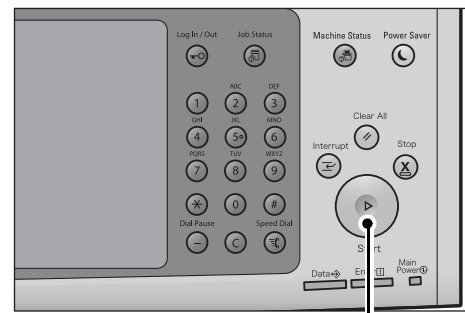

<Start> button

If you have more documents

If you have more documents to scan, select [Next Original] on the touch screen while the current document is being scanned. This allows you to scan the documents as a single set of data.

Up to 999 pages can be stored.

- Note**
- If the number of pages scanned by the machine exceeds the maximum, the machine stops scanning. Follow the message displayed on the screen, and either abort the operation or save the already-scanned data as a single set of data.

For information on how to set the maximum number of pages stored for a scan document, refer to "Maximum Stored Pages" (P.392).

2 While documents are being scanned, select [Next Original].

- Note**
- When using the document feeder, load the next document after the machine has finished scanning the first document.
 - When [Next Original] is displayed on the screen shown on the right and no operation is performed for a certain period of time, the machine automatically assumes that there are no more documents.
 - You can change the scan settings of the next document by selecting [Change Settings] that is displayed after selecting [Next Original].



3 Load the next document.

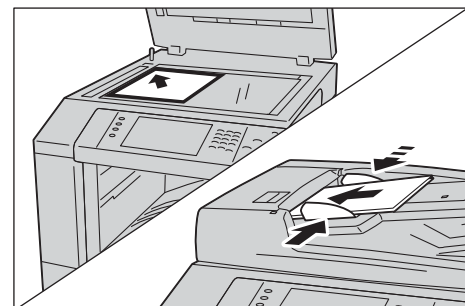

4 Press the <Start> button. If you have more documents, repeat steps 3 and 4.

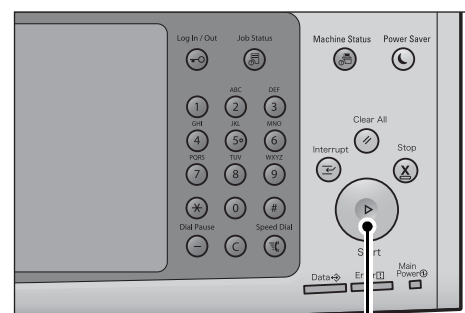

<Start> button

- 5 When all documents have been scanned, select [Last Original].



Step 4 Confirming the Scan Job in Job Status

The following describes how to confirm the status of a scan job.

- 1 Press the <Job Status> button.

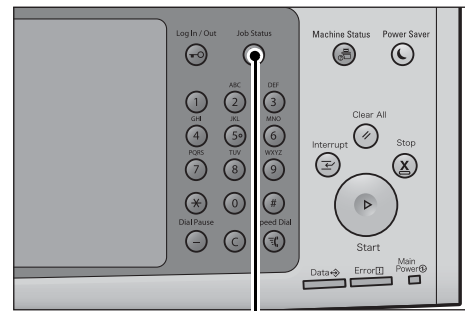

<Job Status> button

- 2 Confirm the job status.

- Note**
- Select [▲] to return to the previous screen or [▼] to move to the next screen.
 - From the drop-down menu, you can select [Scan, Fax, & Internet Fax Jobs] and display the desired job.

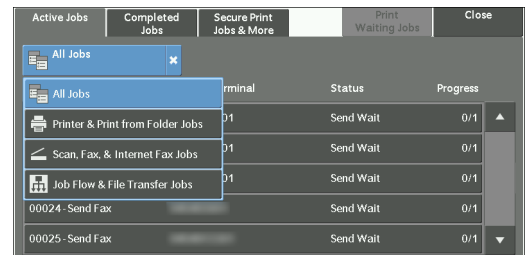

Step 5 Saving the Scanned Data

When you used the Store to Folder service, you can use the following methods to import the file stored in a folder of the machine to your computer:

Import using an application

Use Network Scanner Driver.

Import using Stored File Manager 3

Use Stored File Manager 3.

Import using Dell Printer Configuration Web Tool

Use Dell Printer Configuration Web Tool.

Operations during Scanning

The following describes the operations available during scanning. The following shows the reference section for each operation.

- Stopping the Scan Job..... 165
- Previewing the Scanned Images during a Scan Job 166
- Changing Scan Settings 167

Stopping the Scan Job

To cancel scanning a document, use the following procedure.

- 1 Press either the <Stop> button on the control panel or [Delete] on the touch screen.

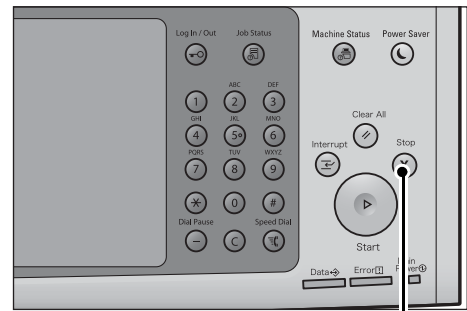

<Stop> button

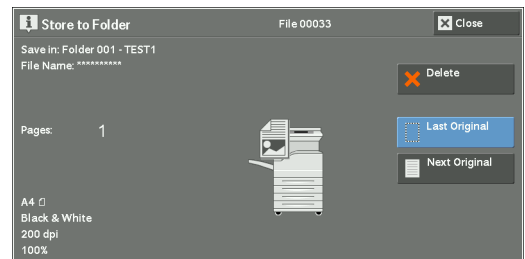

- 2 Select [Delete].

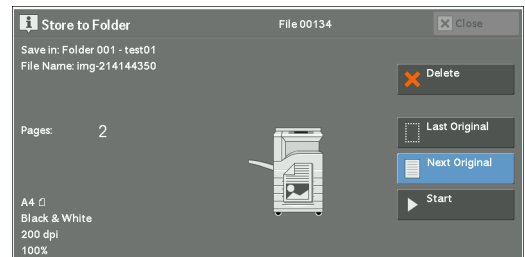

If [Delete] does not appear on the screen:

- 1 Press the <Job Status> button.

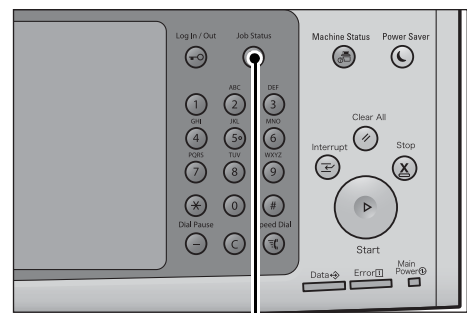

<Job Status> button

2 Select the job to cancel.

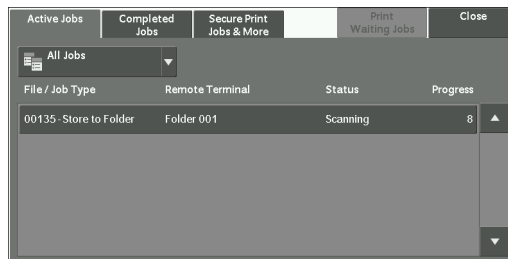

3 Select [Delete].



4 Select [Delete].

Note • If you cancel the job, the scanned data stored in the folder will also be deleted.

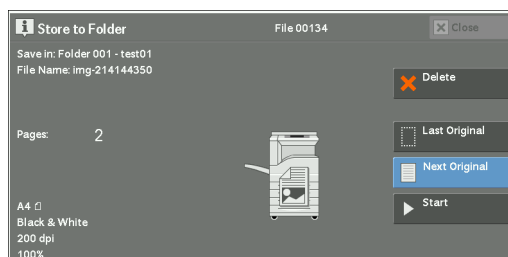

Previewing the Scanned Images during a Scan Job

You can preview the scanned images while scanning the document.

Note • If [MRC High Compression] is set to [On], you cannot preview the scanned images when the [Specific Color] check box is selected on the [File Format] screen.

• You cannot preview the scanned images on the touch screen of the machine for [Store to WSD]*.

* : WSD stands for Web Services on Devices.

1 Select [Next Original].



2 Select [Preview] to display a preview screen.
The first page of the last scanned document is displayed.



- 3 From the drop-down menu, specify the view size by selecting [Whole Page] or [Enlarged View], and set [Current Page].

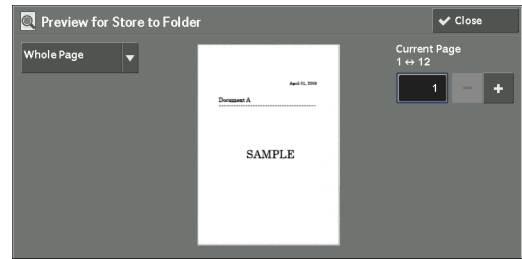

- 4 After the confirmation, select [Close] to close the preview screen.

Changing Scan Settings

You can change scan settings while scanning the document.

Note • For [Store to WSD]*, you cannot change the scan settings while scanning the document.

* : WSD stands for Web Services on Devices.

- 1 Select [Next Original].



- 2 Select [Change Settings].



- 3 Set [Color Scanning], [Original Type], [Resolution], [Lighten / Darken], [Original Orientation], [2 Sided Scanning], and [Original Size].
- 4 Press the <Start> button.

6 Job Flow Sheets

This chapter describes the scanning operation using a job flow sheet registered on the machine.

Job Flow Sheets is a service that allows you to register transfer settings of scan data, such as a transfer method and destination, to simplify data-transfer tasks.

- **Job Flow Procedure.....170**
- **Selecting/Changing a Job Flow Sheet.....172**

Job Flow Procedure

Job flow sheets are categorized into two types according to the target. One type of job flow sheets targets scanned documents, and the other type targets files stored in folders. This section describes the first type of job flow sheets, targeting scanned documents.

The following describes the procedure to operate a job flow. Refer to the following section for each procedure.

Step 1 Opening the [Job Flow Sheets] Screen	170
Step 2 Selecting a Job Flow Sheet.....	170
Step 3 Confirming/Changing the Job Flow Sheet.....	171
Step 4 Starting the Job Flow Sheet	171

To create and register a job flow sheet, use a computer.

Note • To create a job flow sheet, use Job Flow Editor in the Driver CD kit provided with the machine.

Step 1 Opening the [Job Flow Sheets] Screen

The following describes how to open the [Job Flow Sheets] screen.

- 1 Press the <Home> button.

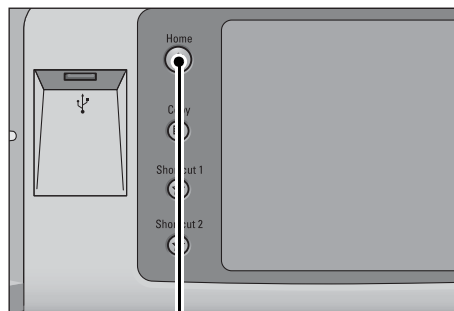

<Home> button

- 2 Select [Job Flow Sheets].

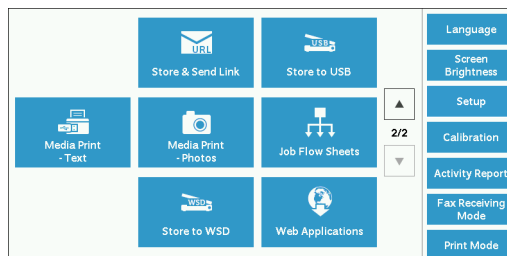

* WSD stands for Web Services on Devices.

Step 2 Selecting a Job Flow Sheet

- 1 Select a job flow sheet.

For more information on the [Job Flow Sheets] screen, refer to "Selecting/Changing a Job Flow Sheet" (P.172).

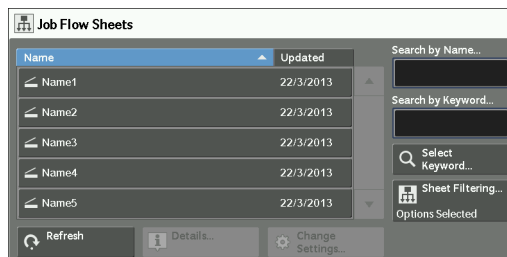

Step 3 Confirming/Changing the Job Flow Sheet

- 1 To confirm the details, select [Details]. To change the settings, select [Change Settings].

For information on how to check or change job flow settings, refer to "Selecting/Changing a Job Flow Sheet" (P.172).

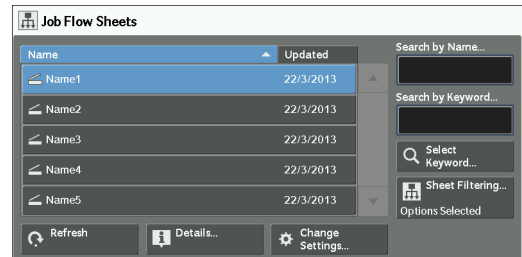

Step 4 Starting the Job Flow Sheet

- 1 Load a document.

Note • A job flow with an application linked does not require you to load a document.

- 2 Press the <Start> button.

Note • After executing the job flow, be sure to print a Job History Report to check the result. For information on the Job History Report, refer to "Job History Report" (P.328).

Selecting/Changing a Job Flow Sheet

This section describes how to select or edit a job flow sheet created on a network computer with Job Flow Editor.

- Note**
- If characters not supported by the machine are used in the name or description of a job flow sheet, the characters will not be displayed or will be garbled on the screen.
 - To communicate with network computers, enable the SOAP port on the machine.
 - A job flow sheet created on a network computer can be deleted, but cannot be changed or duplicated. However, you can temporarily change some items that are permitted to be changed.

For information on how to enable the port, refer to "Port Settings" (P.358).

1 Select a job flow sheet.

- Note**
- Displayed job flow sheets may vary depending on the settings of the Authentication feature. For more information, refer to "Job Flow Sheet Types and Overview" (P.546).
 - Select [▲] to return to the previous screen or [▼] to move to the next screen.
 - You can sort the list in ascending or descending order by selecting either [Name] or [Updated].

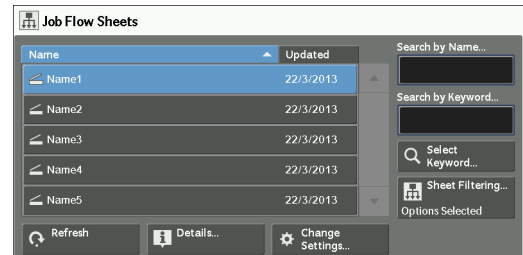

Refresh

Displays refreshed information.

Details

Displays the [Details] screen. You can confirm the details of a job flow such as the name, last updated date, target, owner and save location. When you select the [i] button, the whole text of the description which was registered when creating the job flow sheet is displayed.

Change Settings

Displays the [Change Settings] screen. You can change the job flow settings.

Refer to "[Change Settings] Screen" (P.173).

Search by Name

Searches for job flows that partially match the entry. The machine searches through job flow names that were registered upon each job flow creation. The entry can be up to 128 characters long.

Search by Keyword

Searches for job flows that fully match the entry. The machine searches through keywords that were registered upon each job flow creation. The entry can be up to 12 characters long. You can select from preset keywords if they have been registered in the System Administration mode.

Select Keyword

Displays the [Select Keyword] screen. Select a keyword registered in the System Administration mode to search for job flows. Job flows that fully match the entry are searched. The machine searches through keywords that were registered upon each job flow creation.

Sheet Filtering

Displays the [Sheet Filtering] screen on which you can filter the job flow sheets displayed.

Refer to "[Sheet Filtering] Screen" (P.174).

[Change Settings] Screen

1 Select [Change Settings].

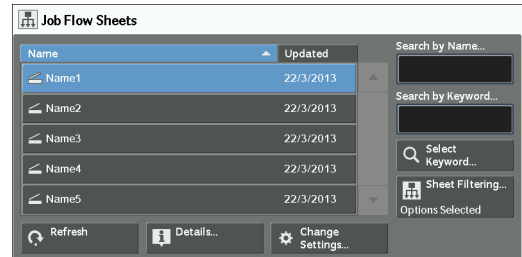

2 Select a group to be changed from [Group of Items].

Note • The screen on the right does not appear if only one group is registered.



3 Select the item to be changed.

Note • A triangle icon appears at the left of each mandatory item.

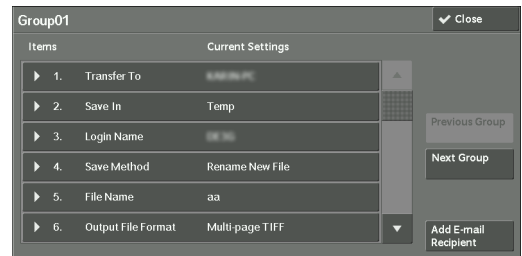

4 Select any option.

Items

Displays the items set for the job flow sheet.

Current Settings

Displays the values set for the job flow sheet.

Previous Group

Displays the items of the previous group.

Next Group

Displays the items of the next group.

Add E-mail Recipient

Adds recipients for the e-mail.

[Sheet Filtering] Screen

This screen allows you to filter the job flow sheets displayed.

Job flow sheets displayed vary depending on the settings of the Authentication feature. For more information, refer to "Job Flow Sheet Types and Overview" (P.546).

- 1 Select [Sheet Filtering].

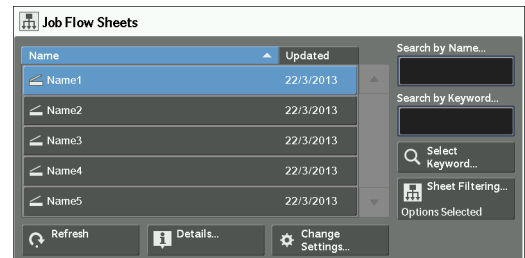

- 2 Select the filtering conditions, and select [Save].

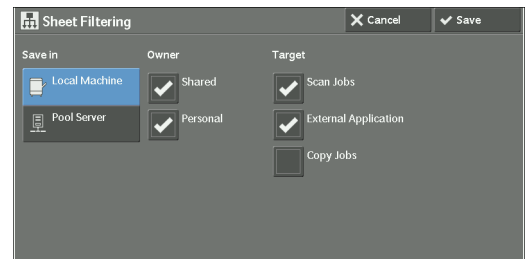

Owner

Select the owner of job flow sheets to filter.

Target

Select the target of job flow sheets to filter.

Note • Job flow sheets whose [Target] is [Folder] can be used only from [Send from Folder].

7 Stored Programming

This chapter describes the Stored Programming service that enables you to store customized job settings.

- **Stored Programming Overview.....176**
- **Registering/Deleting/Renaming Stored Programs.....177**
- **Calling a Stored Program.....183**

Stored Programming Overview

The Stored Programming service allows you to store settings that you expect to use frequently and call them with a single button operation. You can also assign a screen to a stored program button, to use the button as a short-cut to the screen.

A stored program can store not only settings of a feature, but a flow of settings configured on multiple screens.

For example, this service is available when you want to record a procedure starting from pressing the <Machine Status> button, to displaying the screen under [Print Reports] to print a Job History Report.

In addition, while Build Job is running, this service can be used for the remaining document stacks.

For information on Build Job, refer to "Build Job (Processing Documents Scanned with Different Settings as One Job)" (P.135).

The following shows the reference section for each feature.

Registering/Deleting/Renaming Stored Programs	177
Calling a Stored Program.....	183

Registering/Deleting/Renaming Stored Programs

You can register and delete stored programs on the [Stored Programming] screen.

- 1 Press the <Home> button.

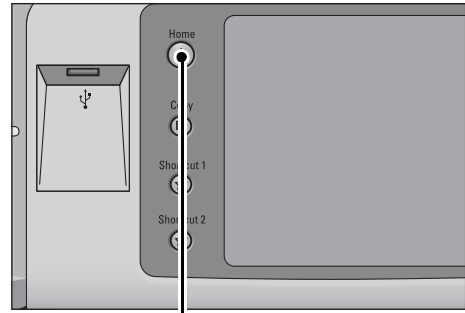

<Home> button

- 2 Select [Setup].

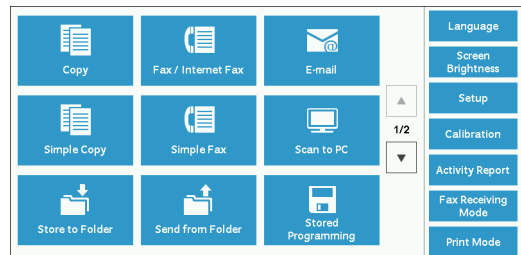

- 3 Select [Stored Programming].

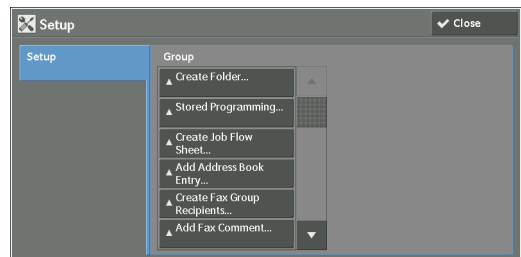

- 4 Select a feature.

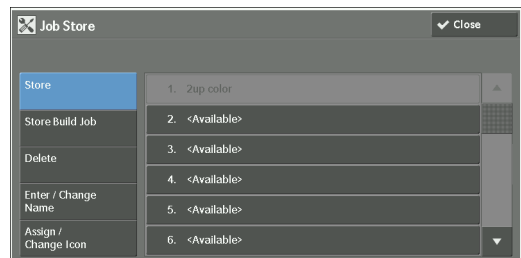

Store

Register a stored program.
Refer to "Registering Stored Programs" (P.178).

Store Build Job

Register a stored program for Build Job.
Refer to "Registering Stored Programs for Build Job" (P.180).

Delete

Deletes a stored program. Select the stored program number to be deleted.
Refer to "Deleting Stored Programs" (P.180).

Enter/Change Name

Enter or change the name of a stored program.

Refer to "Entering/Changing a Stored Program Name" (P.181).

Assign/Change Icon

Specify an icon for a registered stored program.

Refer to "Assigning/Changing Icons for Stored Programs" (P.182).

Registering Stored Programs

Up to 100 actions can be registered with one stored program. Up to 40 stored programs can be registered in the machine.

Actions registered in stored programs No.1 and 2 or No. 1 to No.12 can also be performed by using one touch buttons <M01> and <M02> or <61> to <M02>. (This feature is available only when the optional Fax service is installed).

The following describes how to register actions with stored programs.

- Note**
- If registered settings such as tray paper size and comments, or default values in the System Settings are changed after a stored program is registered, the program's content also changes.
 - Services using System Settings, Job Flow Sheet, or Address Book cannot be registered.
 - The registering procedure for a stored program is canceled when the <Interrupt> button is pressed, the Auto Clear feature causes a time-out, or a popup window (paper jam, etc.) appears.
 - There are two ways in which address numbers and stored programs are assigned to the one touch buttons. Select either of the following. By default, [Type 1] is selected. For information on how to change the settings registered to the one touch buttons, refer to "Screen/Button Settings" (P.319).
 - [Type 1]
The buttons 1 to 70 are used for address numbers and they correspond to the registered address numbers 0001 to 0070, while the buttons M01 and M02 are used for stored programs and they correspond to the registered stored programs 1 and 2.
 - [Type 2]
The buttons 1 to 60 are used for address numbers and they correspond to the registered address numbers 0001 to 0060, while the buttons 61 to 70, M01, and M02 are used for stored programs and they correspond to the registered stored programs 1 to 12.

1 Select [Store].

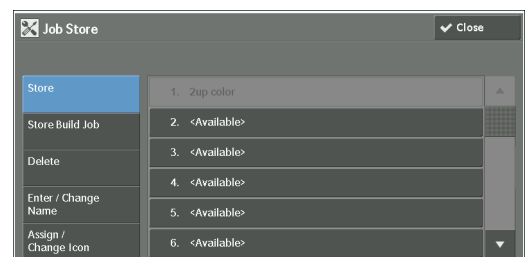

2 Select a number to register a stored program.

- Note**
- Once a job is stored to a button, it cannot be overwritten.
 - Select [▲] to return to the previous screen or [▼] to move to the next screen.

3 Set the feature you want to register.

- Note**
- The machine sounds an audible tone while a stored program is being registered.
 - Press the <Interrupt> button to cancel registration.

You can change the volume of the sound that notifies that a stored program is being registered. For information on the setting, refer to "Stored Programming Tone" (P.319).

4 Press the <Start> or <Clear All> button.

- Note**
- If no name is entered for a registered stored program, the name becomes "(No Name)".

For information on how to name a registered stored program, refer to "Entering/Changing a Stored Program Name" (P.181).

Notes and Restrictions on Registering Stored Programs

The following notes and restrictions apply when you register stored programs.

- When registering a stored program to select paper size or type loaded on the bypass tray, register both the paper size and the paper type. If only the paper size or type is registered, the stored program may not be called properly.
- If any of the following operations is performed while a stored program is being registered, the stored program may not be registered or may not work correctly.
 - Removing or inserting a paper tray
 - Loading or reloading paper in the bypass tray
- If any of the following operations is performed after a stored program is registered, the registered stored program may not be called properly.
 - If the stored program has the Watermark feature and the default values of that feature are changed.
 - If the stored program has an operation for a folder and the folder passcode is changed.
 - If the settings of the control panel are changed.
 - If the features assigned to the custom buttons are changed.
 - If any setting is changed under [Tools] > [System Settings] > [Copy Service Settings] > [Preset Buttons].
 - If the selection is made from a list of the Address Book or Job Flow Sheet.
 - If any optional components installed on the machine, such as a finisher, are changed, and thereby the associated buttons become no longer available.
 - If the measurement unit, millimeters or inches, is changed.
 - If a job is selected from the list of the stored jobs in [Secure Print Jobs & More] under Job Status.
 - Selecting items using the scroll bar
- The following features and operations cannot be registered in Stored Programming.
 - Registration and call of a stored program
 - System Settings
 - The [Media Print - Text] and [Media Print - Photos] buttons on the [Home] screen
 - The [Store to USB] button on the [Home] screen
 - The [Job Flow Sheets] and [Web Applications] buttons on the [Home] screen.
 - The custom button to which the Job Flow Sheets service is assigned.
 - The Address Book for the Fax/Internet Fax, E-mail, and Scan to PC services
 - Unselectable buttons
 - The [Language] button on the [Home] screen
 - The [Screen Brightness] button on the [Home] screen
 - Scrolling operation while previewing
 - The [Browse] button for the Scan to PC service
 - Operations to edit e-mail addresses for the E-mail service (the pop-up menu [Keyboard], [Remove], and [Edit] displayed by selecting [Recipient(s)] or [From]).
 - The <Power Saver> button
- A stored program registration is canceled when the <Interrupt> button is pressed, the Auto Clear feature causes a time-out, or a popup window (such as a paper jam window) appears.

- If the Fax service is available, one-touch buttons can be used.

Registering Stored Programs for Build Job

Up to 100 actions can be registered with one stored program for Build Job. Up to 40 stored programs can be registered in the machine.

The following describes how to register actions with stored programs.

1 Select [Store Build Job].

- Note**
- Once a job is stored to a button, it cannot be overwritten.
 - Select [▲] to return to the previous screen or [▼] to move to the next screen.

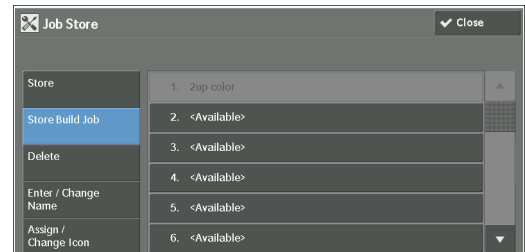

2 Select a number to register a stored program.

- Note**
- Once a job is stored to a button, it cannot be overwritten.
 - Select [▲] to return to the previous screen or [▼] to move to the next screen.

3 Set the feature you want to register.

- Note**
- The machine sounds an audible tone while a stored program is being registered.
 - Press the <Interrupt> button to cancel registration.

You can change the volume of the sound that notifies that a stored program is being registered. For information on the settings, refer to "Stored Programming Tone" (P.319).

4 Press the <Start> or <Clear All> button.

- Note**
- An icon is displayed to the left of each registered stored program for Build Job.
 - If no name is entered for a registered stored program, the name becomes "(No Name)".

For information on how to name a registered stored program, refer to "Entering/Changing a Stored Program Name" (P.181).

Deleting Stored Programs

The following describes how to delete stored programs.

1 Select [Delete].

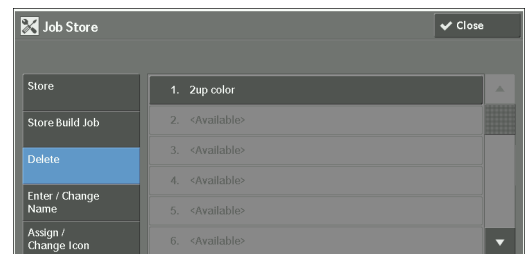

2 Select the number to delete.

- Note**
- Select [▲] to return to the previous screen or [▼] to move to the next screen.

3 Select [Delete].

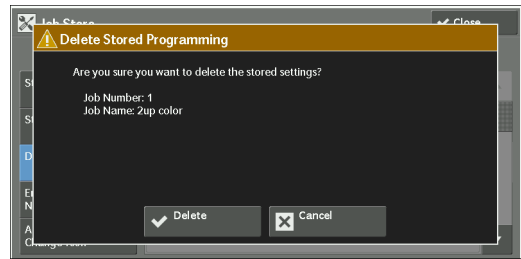

Delete

Deletes the stored program.

Note • Deleted stored programs cannot be restored.

Cancel

Cancels deleting the stored program.

Entering/Changing a Stored Program Name

The following describes how to enter or change the name of a stored program.

Up to 36 characters are allowed for a stored program's name.

For information on how to enter characters, refer to "Entering Text" (P.57).

1 Select [Enter/Change Name].

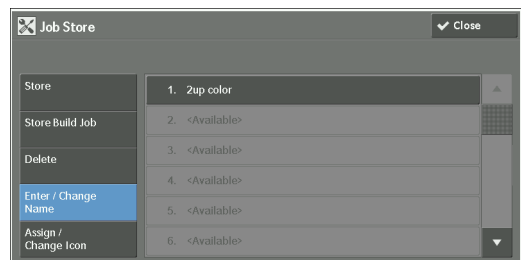

2 Select the number to register or change a name.

Note • Select [▲] to return to the previous screen or [▼] to move to the next screen.

3 Enter a name, and select [Save].

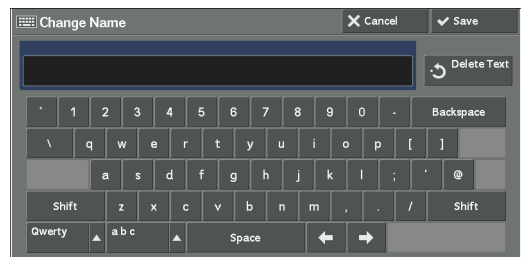

Assigning/Changing Icons for Stored Programs

The following describes how to assign or change an icon of a stored program.

You can select from 12 icons.

- 1 Select [Assign/Change Icon].

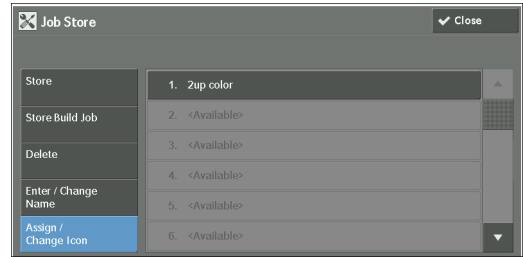

- 2 Select the number to assign or change an icon.

Note • Select [▲] to return to the previous screen or [▼] to move to the next screen.

- 3 Select an icon, and select [Save].

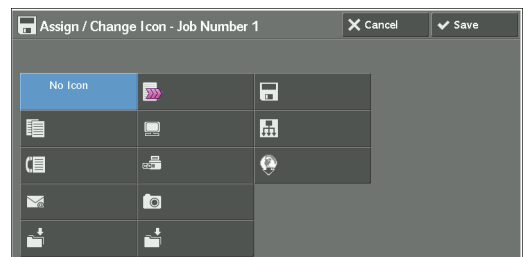

No Icon

No icon is assigned to a registered stored program.

Icon

Select an icon according to the content of the registered stored program.

Calling a Stored Program

The following describes how to call a stored program.

When you call a specified stored program, the last screen shown when you registered the stored program appears.

- 1 Press the <Home> button.

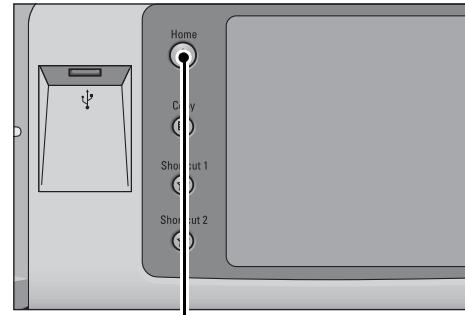

<Home> button

- 2 Select [Stored Programming].

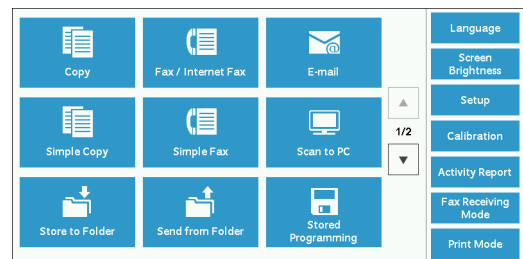

- 3 Select a number of a stored program containing the features you want to use.

- Note**
- You can only select registered numbers.
 - Select [▲] to return to the previous screen or [▼] to move to the next screen.
 - After the stored program has been called, the machine sounds an audible tone. If a failure occurs, the machine sounds a fault tone.

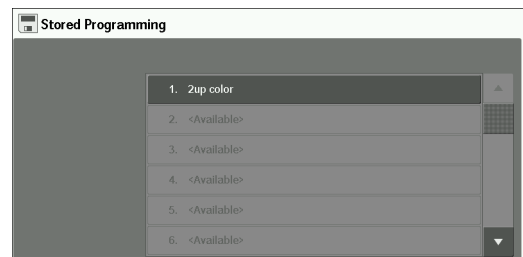

For information on how to change the volume of the sound that notifies that a stored program has been called, refer to "Stored Programming Complete Tone" (P.319).

- 4 After the stored program is called, select other features if necessary.

- 5 Press the <Start> button.

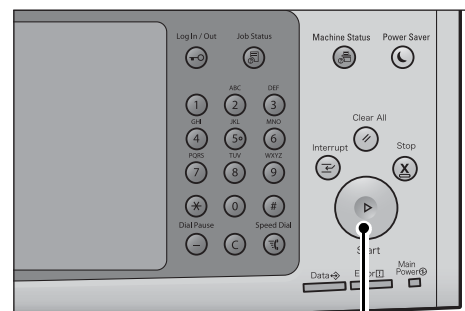

<Start> button

Calling a Stored Program for Build Job

You can call a stored program for Build Job on the [Copy] screen displayed while Build Job is running.

- 1 Select [Change Settings].



- 2 Select the [Job Assembly] tab.
- 3 Select [Stored Programming].
- 4 Select a number of a stored program containing the features you want to use.

- Note**
- You can only select registered numbers.
 - After the stored program has been called, the machine sounds an audible tone. If a failure occurs, the machine sounds a fault tone.

For information on how to change the volume of the sound that notifies that a stored program has been called, refer to "Stored Programming Complete Tone" (P.319).

8 Web Applications

This chapter describes how to operate web applications.

- **Web Applications Overview186**
- **Accessing Web Applications.....187**
- **Accessing Using Buttons Registered on the [Home] Screen.....188**

Web Applications Overview

Web Applications is a service that allows you to access to web applications via a network using the browser on the machine in order to display and store data.

The machine provides the following features:

- Accessing web applications from the machine, and displaying the web application screen on the machine
- Storing scanned documents directly in a web application folder
- Printing a file directly that is stored on a remote server

Note • The web applications that can be displayed on the machine are those which are compatible with the machine. You cannot access website on the Internet.

To access the web application on the machine, prior settings are required. For information on the settings, refer to "Web Applications Service Setup" (P.415).

Accessing Web Applications

The following describes how to access web applications.

You need to register an access destination in advance.

For information on how to register an access destination, refer to "Server Setup" (P.417).

- 1 Press the <Home> button.

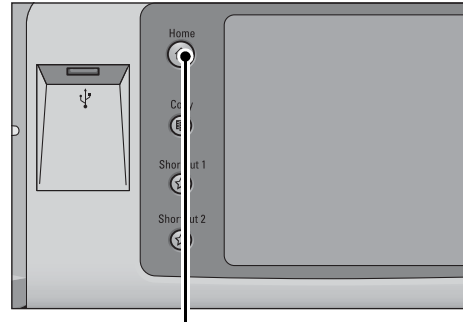

<Home> button

- 2 Select [Web Applications].

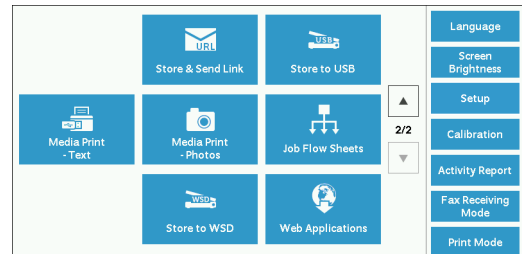

* WSD stands for Web Services on Devices.

- 3 Select an access destination.



- 4 Select [Open] from the pop-up menu displayed.

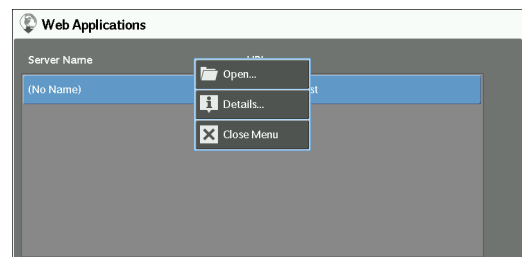

Open

Accesses the specified remote service.

Details

Displays the information of the specified remote service.

Close Menu

Hides the pop-up menu.

Accessing Using Buttons Registered on the [Home] Screen

You can register frequently used web applications on the [Home] screen as buttons. The following describes how to access the applications by selecting the buttons.

For information on how to register a web application to a button on the [Home] screen, refer to "Screen/Button Settings" (P.319).

- 1 Press the <Home> button.

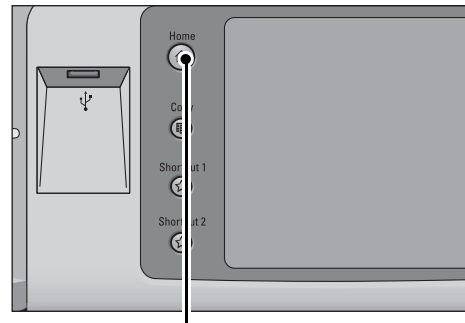

<Home> button

- 2 Select [Head Office] registered on the [Home] screen.

Note

- "Head Office" is registered as an example here. You can specify the name and the position of the button.

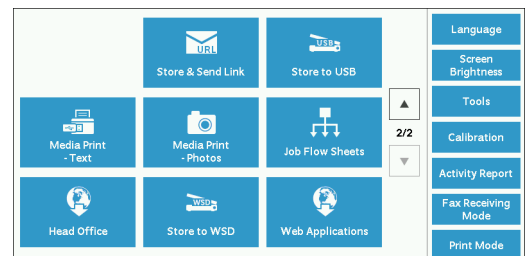

* WSD stands for Web Services on Devices.

9 Media Print (Text and Photos)

This chapter describes the basic procedures and features of Media Print - Text and Media Print - Photos.

- **Overview of Media Print.....190**
- **Inserting USB Memory Device.....193**
- **Media Print - Text.....196**
- **Media Print - Photos198**
- **Selecting the Printing Options.....200**

Overview of Media Print

If a USB memory device is connected to the machine, the data stored in the USB memory device can also be printed. You can also print scanned data stored with the Store to USB service.

The installation of commercially available Memory Card Reader allows the machine to retrieve and print image data (DCF1.0-compliant JPEG and TIFF) taken with a digital camera as well as document files (PDF, TIFF, XPS, and JPEG (JFIF)).

- Note**
- Data stored in USB memory device may be lost or damaged in the following cases. Make sure to back up data in media before use.
 - When disconnecting/connecting the USB memory device by methods other than those described in this guide
 - When receiving the effect of electrical noise or an electrical discharge
 - When a fault or failure occurs during operation
 - If the USB memory device receives mechanical damage
 - We assume no responsibility for any direct and indirect damages arising from or caused by such data loss.
 - For Media Print - Photos, images can be displayed in thumbnail view, but cannot be previewed. For Media Print - Text, files cannot be displayed in thumbnail view and cannot be previewed either.
 - XPS stands for XML Paper Specification.
 - Commercially available Memory Card Reader with single slot ^{*1} can be used for Media Print feature (text/photo), but its performance is not guaranteed. When a Memory Card Reader with multi-slot ^{*2} is used, only one particular slot is available. The available slot depends on the model, and the slot of media/Memory Card that you want to use is not always available. Safe performance of a Memory Card Reader with multi-slot is not guaranteed, either.
 - ^{*1} :Media/Memory Card that has one slot. Some allow only one type of media/Memory Card, while others allow more than one type (ex. SD card, xD-Picture Card).
 - ^{*2} :Media/Memory Card that has two or more slots.
 - This feature may not be available depending on the setting in the Dell Printer Configuration Web Tool. For more information, refer to "Configuring Machine Settings Using Dell Printer Configuration Web Tool" (P.465).
 - "Exif" is a file format that embeds information required to print the image data taken with a digital camera. The machine supports Exif 2.0 to 2.2.

The Media Print feature comprises two modes: Media Print - Photos and Media Print - Text. The Media Print - Photo mode prints data stored in the standard digital camera format, while the Media Print - Text mode prints data stored in text format. The feature also includes Index Printing that prints a list of files retrieved in the both modes.

Supported Media and File Formats

The machine supports USB memory devices.

Supported media and file formats are as follows.

Supported Media	Supported File Format	
	Media Print - Photos	Media Print - Text
<ul style="list-style-type: none"> • USB 2.0 memory 	<ul style="list-style-type: none"> • JPEG files • TIFF files Supports DCF1.0-compliant JPEG/TIFF files (Exif2.0, Exif2.1, Exif2.2)	<ul style="list-style-type: none"> • PDF files Extension: pdf, PDF 1.3 or later • TIFF files Extension: tif, Grayscale 4 bit/8bit uncompressed, 8bit/24 bit JPEG compressed, MH/MMR compressed • XPS files Extension: xps • JPEG (JFIF) Extension: jpg

- Note**
- When you specify the save location, only folder names are displayed in the list. File names and shortcuts (symbolic link or alias) are not displayed.
 - Folders that comply with the Design rule for Camera File system (DCF) standard used for digital cameras are not displayed.
 - If a full path (a string of folder and file names in all directories) of the file created exceeds 257 characters long, an error occurs.
 - If the medium contains more than 900 folders, the machine may not be able to recognize the medium correctly.
 - If a file name contains characters that are not supported by the machine, the file name will not be displayed on the screen.
 - XPS stands for XML Paper Specification.
 - In the Media Print - Photos mode, only 8 characters can be recognized as a file name. In the Media Print - Text mode, up to 255 characters can be recognized.
 - Up to 900 files can be processed with Media Print.
 - Use media formatted with digital cameras or computers (FAT12, FAT16, FAT32 only).
 - Use USB 2.0 compliant memory devices with the size up to 128 GB only. (USB 1.1 compliant memory devices are not supported.)
 - If a file name contains machine-dependent codes, the file may not be recognized or displayed on the screen correctly.

Notes and Restrictions on Media Print

The following notes and restrictions apply on the use of the Media Print service.

- Use the Media Print - Photos service with a medium inserted. Otherwise, a status code (016-794/116-212) will be displayed on the screen.
- Image files other than files in Exif format (JPEG/TIFF files created on computers) cannot be printed.
- Once an image file in Exif format is edited or saved on a computer, the file format is no longer the Exif format.
- If the medium fails, the process is terminated within a few minutes, and an error message is displayed.
- Eject the medium before switching off the power.

- Be sure to wait until printing is completed and then eject the medium by following the procedure described in this chapter.
- Always back up data in medium before use.
- Printing data may take from a few minutes to several tens of minutes, depending on the size and number of files in the medium.
- Before storing document files, format the USB memory with a computer (FAT12, FAT16, FAT32 only).
- When you print a PDF file using Media Print, [PDF Bridge] is selected regardless of the [Print Processing Mode] setting in [PDF Direct Print].
- You can use a USB host adapter to print from your USB memory device or via your USB cable (as necessary), but the operation is not guaranteed.
- Multiple USB memory devices cannot be used simultaneously.
- Use USB 2.0 compliant memory devices only. USB 1.1 compliant memory devices are not supported.
The following USB memory devices are not supported:
 - A USB memory device with multiple media partitions that require other utilities to access to the contents therein.
 - A USB memory device connected via an external hub.
- Do not use a medium if it stores data that cannot be backed up, such as music data with the copyright protection function. We assume no responsibility for any direct and indirect damages arising from or caused by such data loss.
- The machine does not display a menu to prevent you from removing a USB memory device while it is being accessed.

Inserting USB Memory Device

- 1 Insert the USB memory device into the USB memory slot on the control panel.
- 2 One of the following occurs.
 - The [USB Device Detected] screen appears.
 - The [Store to USB] screen appears.
 - The [Media Print - Text] screen appears.
 - The [Media Print - Photos] screen appears.
 - The screen display does not change.

- Note**
- The behavior depends on the settings. Ask your system administrator for more information.
 - When a USB memory device is inserted into the USB memory slot in the Power Saver mode, the touch screen does not light. After exiting the Power Saver mode by pressing the <Power Saver> button, insert the USB memory device again or select [Store to USB] on the [Home] screen. For information on other ways to exit the Power Saver mode, refer to "Exiting the Power Saver Mode" (P.47).
 - The screen status will be one of the above even when a USB memory device in which only encrypted data is stored is inserted or USB memory device in unsupported format is inserted. In such case, a warning message appears during operation and the operation is aborted.
 - The screen status will be one of the above when a commercially available Memory Card Reader is inserted into the USB memory slot of the machine. It is the same if no media is inserted into the Memory Card Reader.
 - If a commercially available Memory Card Reader is used and is left inserted all the time, the machine does not detect media even when they are inserted into the slot of the Memory Card Reader.
 - The screen display remains the same when the inserted USB memory device or Memory Card is removed. Press the <Home> button or do anything else to change the screen display before starting next operation.

When the [USB Device Detected] Screen Appears

- 1 Select [Media Print - Text] or [Media Print - Photos].

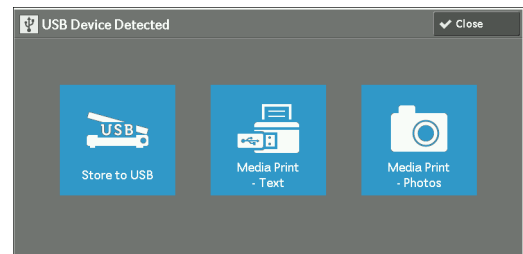

- 2 The [Media Print - Text] screen or the [Media Print - Photos] screen appears.

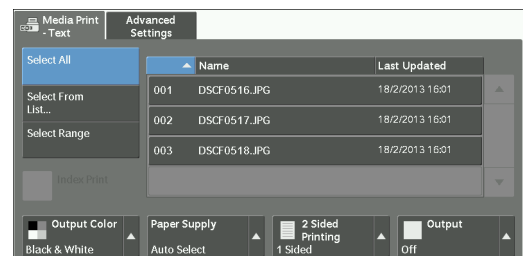

When the [Store to USB] Screen Appears

1 Press the <Home> button.

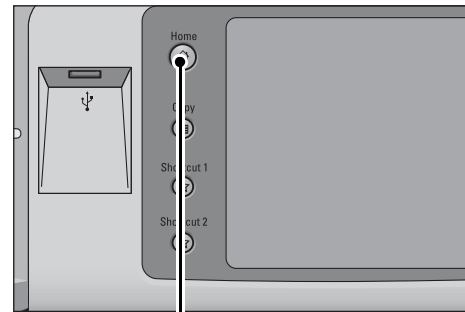
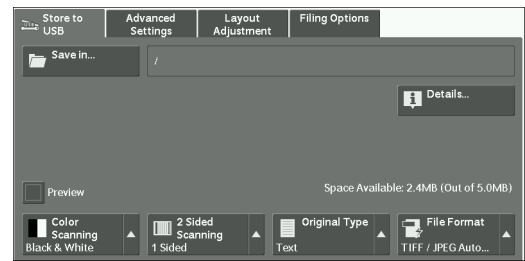

<Home> button

2 Select [Media Print - Text] or [Media Print - Photos] on the [Home] screen.

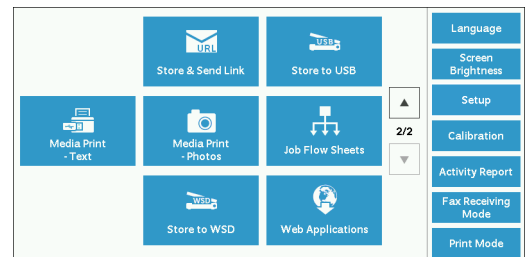

* WSD stands for Web Services on Devices.

3 The [Media Print - Text] screen or the [Media Print - Photos] screen appears.

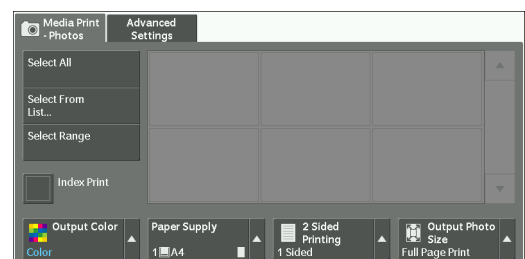
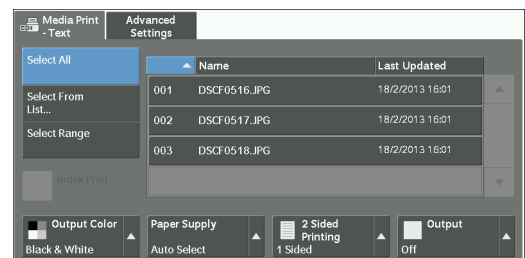

When the [Media Print - Text] Screen Appears

Select a feature on the [Media Print - Text] screen.

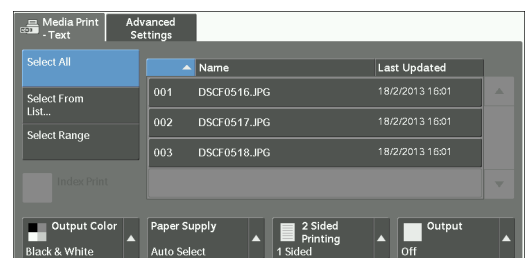

When the [Media Print - Photos] Screen Appears

Select a feature on the [Media Print - Photos] screen.

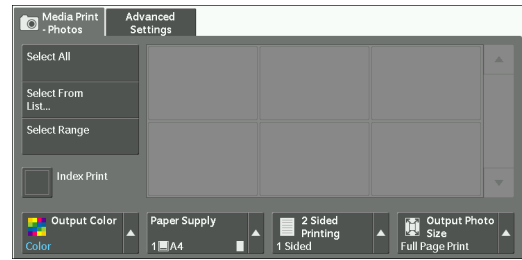

When the Screen Display Does Not Change

1 If a screen other than the [Home] screen is displayed, press the <Home> button.

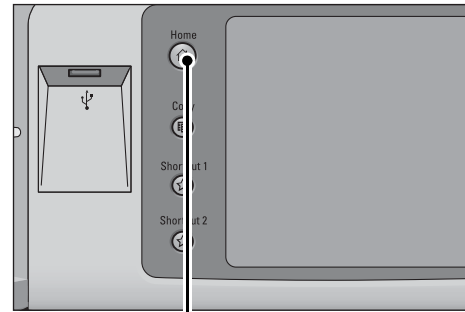

<Home> button

2 Select [Media Print - Text] or [Media Print - Photos] on the [Home] screen.

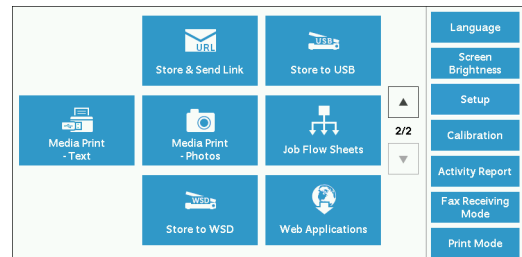

* WSD stands for Web Services on Devices.

3 The [Media Print - Text] screen or the [Media Print - Photos] screen appears.

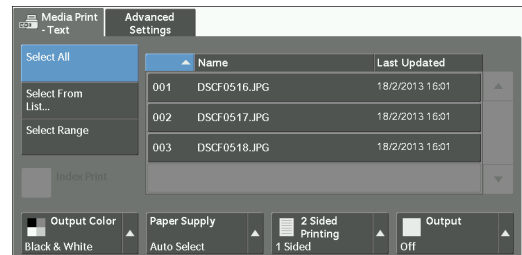

Note

- Data stored in a USB memory device may be lost or damaged in the following cases. Make sure to back up the data in the device before use.
 - When disconnecting/connecting the USB memory device by methods other than described in this guide
 - When receiving the effect of electrical noise or an electrical discharge
 - When a fault or failure occurs during operation
 - If the USB memory device receives mechanical damage
- We assume no responsibility for any direct and indirect damages arising from or caused by such data loss.
- If you do not specify the file storage location, the scanned data is saved in the root directory.

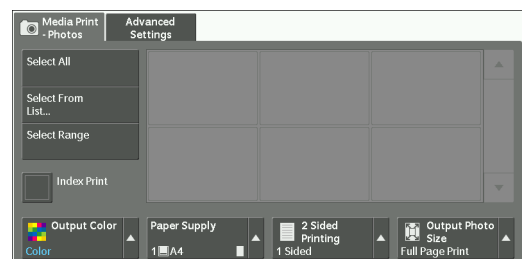

Media Print - Text

Selecting Files

You can select files using any of the following three methods:

- Selecting all files
- Selecting the desired files on the [Select From List] screen
- Selecting one file or a range of files with index numbers

Note • You can select up to 32 files simultaneously.

- 1 Select either [Select All], [Select From List], or [Select Range] to specify files.

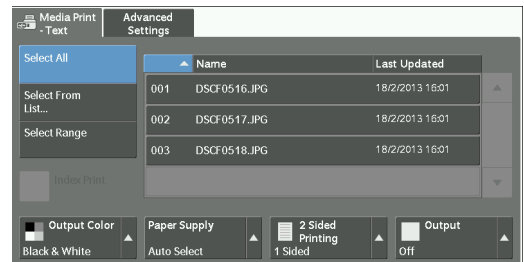

- 2 After selecting the files to be printed, set the printing options.

For more information on the printing options, refer to "Selecting the Printing Options" (P.200).

Note • On the pop-up menu displayed when selecting files, you can cancel the selection or display the details.
 • Select [▲] to return to the previous screen or [▼] to move to the next screen.

Select All

Selects all document files to be printed.

Note • Depending on the type of files stored in the medium or the directory configuration, some files may not be printed.

Select From List

Displays the [Select From List] screen.

Refer to "[Select From List] Screen" (P.197).

Select Range

Use [+] and [-] to specify the range of files to be printed in [First File] and [Last File].

Note • Select [Select From List] to display a list of files, and reference the list when selecting the range.

Index Print

Prints a list of the selected files with the index numbers automatically assigned.

For more information on Index Print, refer to "Index Print" (P.202).

[Select From List] Screen

This screen displays a list of files with their folder and file names and stored dates and times. You can select the desired files from a list of files.

- 1 Select the desired files from a list of files.

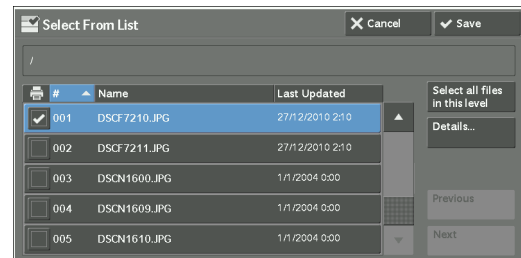

- Note**
- Select [▲] to return to the previous screen or [▼] to move to the next screen.
 - You can sort the list in ascending or descending order by selecting [# ▲], [Name], or [Last Updated].
 - A check mark is placed in the check box for each file selected. To deselect the file, select the file again while the file is selected (highlighted).
 - If a folder or file name has more than 170 characters long, the folder or file name is not displayed.
 - Folder names which include characters that the machine does not support may not be correctly displayed. If you specify the folders as file storage locations, an error occurs. For more information on characters that the machine supports, refer to "Entering Text" (P.57).
 - The machine does not distinguish between upper and lower cases of folder and file names that are created in Windows environment and that consist of eight characters or less. The names for these folders and files are displayed in capital letters.

Select all files in this level

Selects all files in the current folder.

Details

Displays detailed information on the selected (highlighted) file. To print the file, select the [Print] check box on the [Details] screen.

Previous

Allows you to move to the upper directory.

- Note**
- This button is grayed out if there is no upper directory.

Next

Allows you to move to the lower directory.

- Note**
- This button is available when a folder is selected.

Media Print - Photos

Selecting Files

You can select files using any of the following three methods:

- Selecting all files
- Selecting the desired files on the [Select From List] screen. You can select up to 100 files simultaneously
- Selecting one file or a range of files with index numbers

- 1 Select either [Select All], [Select From List], or [Select Range] to specify files.

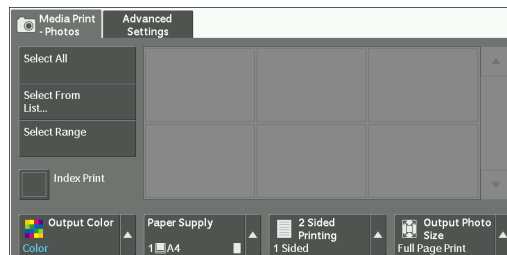

- 2 After selecting the files to be printed, set the printing options.

For more information on the printing options, refer to "Selecting the Printing Options" (P.200).

- Note**
- On the pop-up menu displayed when selecting files, you can cancel the selection or display the details.
 - Select [▲] to return to the previous screen or [▼] to move to the next screen.

Select All

Selects all image data to be printed.

- Note**
- Depending on the type of files stored in the medium or the directory configuration, some files may not be printed.

Select From List

Displays the [Select From List] screen.

Refer to "[Select From List] Screen" (P.199).

Select Range

Use [+] and [-] to specify the range of files to be printed in [First picture] and [Last picture] under [Media Print - Photos].

- Note**
- Select [Select From List] to display a list of files, and reference the list when selecting the range.

Index Print

Prints a list of the selected files with the index numbers automatically assigned.

For more information on Index Print, refer to "Index Print" (P.202).

[Select From List] Screen

You can select the desired files from a list of files.

- Note**
- Select [▲] to return to the previous screen or [▼] to move to the next screen.
 - A check mark is placed in the check box for each file selected. To deselect the file, select the file again while the file is selected (highlighted).

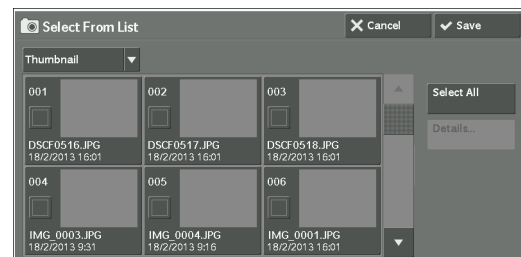

List

Display a list of files with their names and stored dates and times.

- Note**
- You can sort the list in ascending or descending order by selecting [# ▲], [Name], or [Date & Time]. The number of files selected appears on the top on the screen.

Thumbnail

Displays a list of the images and names of the files.

- Note**
- The thumbnail view may not be available for some files. If a file is not displayed in thumbnail view, display it in list view or in Index Print.
 - Characters and images may not be correctly displayed in thumbnail view because they are reduced in size.
 - An image is displayed in thumbnail view in the orientation with which the file was stored.

Details

Displays detailed information on the selected (highlighted) file. To print the file, select the [Print] check box on the [Details] screen.

Deselect All

Deselects all selected files.

Select All

Selects all files.

Selecting the Printing Options

You can set the printing options on the [Media Print -Text] or [Media Print - Photos], and [Advanced Settings] tabs.

By default, pressing the <Shortcut 2> button on the control panel allows you to view a list of the setting values.

Media Print - Photos

Tab	Item	Setting Value
-	Quantity	Specify the number of print sets in the range of 1 - 999, using the numeric keypad.
Media Print Photos	Output Color	Color, Black & White
	Paper Supply	Trays 1 - 6 Note <ul style="list-style-type: none"> • Select the tray in which any of the following sizes of paper is loaded: SRA3, A3, B4, A4, A4, B5, B5, 8.5 x 11", 8.5 x 11", 100 x 148 mm. • When the desired tray is not displayed, select [More], and select the tray on the displayed screen. When you select [More] and then [Bypass], you can set [Paper Size] and [Paper Type]. <ul style="list-style-type: none"> • Paper Size Select the paper size to be used from the list: SRA3, A3, B4, A4, A4, B5, B5, 8.5 x 11", 8.5 x 11", 100 x 148 mm. • Paper Type Select the paper type to be used from the list.
	2 Sided Printing	Off, Long Edge Flip, Short Edge Flip
	Output Photo Size	<ul style="list-style-type: none"> • Full Page Print • 5 x 7" When you select [Output Size] on the screen displayed after selecting [More], the following sizes are selectable: A4, 8.5 x 11", 100 x 148 mm, 3.5 x 5", 5 x 7" Note <ul style="list-style-type: none"> • According to the size selected here and the paper size, only the photos fitting on one sheet of paper are aligned and printed. If you select [1 Picture per Page], one sheet of paper is used for one file and printed. <ul style="list-style-type: none"> • 3 Pictures per Page (Center) When you select [Pictures per Page] on the screen displayed after selecting [More], the following options are available: 2 Pictures, 3 Pictures (Center), 3 Pictures (Left), 4 Pictures, 6 Pictures, 8 Pictures
Advanced Settings	Bitmap Smoothing	Off, On

- Note**
- When you select a paper size smaller than the image size, the image is automatically reduced. When you select a paper size larger than the image size, the image is printed at its original size.
 - The features displayed on the [Media Print - Photos] and [Advanced Settings] screens may vary depending on the combination of the optional components installed on the machine.

Media Print - Text

Tab	Item	Setting Value
-	Quantity	Specify the number of print sets in the range of 1 - 999, using the numeric keypad.
Media Print Text	Output Color	Color, Black & White
	Paper Supply	<p>Auto Select, Trays 1 - 6</p> <p>Note</p> <ul style="list-style-type: none"> • Select [Auto Select] or the tray in which any of the following sizes of paper is loaded: A3, B4, A4, A4☐, B5, B5☐, A5, A5☐, 8.5 x 11", 8.5 x 11"☐, 8.5 x 14", 11 x 17". • When you select [Auto Select], the machine automatically selects a tray that contains the same size of paper as the document, and prints the document at its original size. • When the desired tray is not displayed, select [More], and on the screen displayed, select the tray. <p>When you select [More] and then [Bypass], you can set [Paper Size] and [Paper Type].</p> <ul style="list-style-type: none"> • Paper Size Select the paper size to be used from the list: A3, B4, A4, A4☐, B5, B5☐, A5, A5☐, 8.5 x 11", 8.5 x 11"☐, 8 x 14", 11 x 17". • Paper Type Select the paper type to be used from the list.
	2 Sided Printing	1 Sided, Long Edge Flip, Short Edge Flip
	Staple	<p>Specify the stapling/punching positions. When the desired stapling/punching positions are not displayed, select [More].</p> <p>Note</p> <ul style="list-style-type: none"> • If you select and print multiple documents, all of the documents are stapled together. To staple only one document, print only that document.
Advanced Settings	Pages per Side	Off, 2 Pages, 4 Pages
	Bitmap Smoothing	Off, On

- Note**
- When you select a paper size smaller than the document size, the document image is automatically reduced. When you select a paper size larger than the document size, the document is printed at its original size.
 - The features displayed on the [Media Print - Text] and [Advanced Settings] screens may vary depending on the combination of the optional components installed on the machine.

Index Print

- In the Media Print - Photos mode, a list of 30 x 40 mm reduced images, plus index numbers, file names, and dates when images were stored in the medium are printed.
- In the Media Print - Text mode, names, dates when files were stored in the medium, and the total number of files are printed.

You can specify only the number of print sets for Index Print, in the range from 1 - 999 sets in 1 set increments. For other printing options, the settings you have specified for Media Print - Text or Media Print - Photos before selecting the [Index Print] check box will be effective. To change these settings, deselect the [Index Print] check box, change the print settings, and then perform Index Print. The setting values return to the defaults if the machine is rebooted.

The following setting items are restricted when you select Index Print.

Setting Item	Value
Output Color	In the Media Print - Photos mode <ul style="list-style-type: none"> • Color only In the Media Print - Text mode <ul style="list-style-type: none"> • Black & White only
Paper Supply	Trays 1 - 6 Note • Select the tray in which any of the following sizes of paper is loaded: A3, A4, or 8.5 x 11".
2 Sided Printing	Not available
Staple	Not available
Pages per Side	Not available

10 Job Status

This chapter describes how to check the status of jobs and operate the jobs.

- **Job Status Overview**204
- **Checking Current/Pending Jobs**.....205
- **Checking Completed Jobs**207
- **Printing and Deleting Stored Jobs**208
- **Printing Pending Jobs**221
- **Handling Error Terminations**222

Job Status Overview

The Job Status feature allows you to check current, pending, and completed jobs. You can also cancel printing and print jobs that are waiting to be output or resumed.

- 1 Press the <Job Status> button.

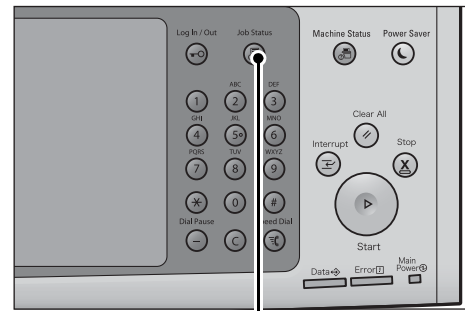

<Job Status> button

You can operate the following on the [Job Status] screen.

Checking current/pending jobs

Lists current and pending jobs, and displays their details. Also allows you to cancel current or pending jobs.

For more information, refer to "Checking Current/Pending Jobs" (P.205).

Checking completed jobs

Displays the status of completed jobs, and their details.

For more information, refer to "Checking Completed Jobs" (P.207).

Checking stored jobs

Prints or deletes jobs stored using the Charge Print, Secure Print, Private Charge Print, Sample Set, and Delayed Print features.

For more information, refer to "Printing and Deleting Stored Jobs" (P.208).

Printing pending jobs

Prints jobs that are waiting to be output or resumed.

For more information, refer to "Printing Pending Jobs" (P.221).

Checking Current/Pending Jobs

This section describes how to check current or pending jobs. On the status screen, you can cancel or preferentially execute jobs.

1 Press the <Job Status> button.

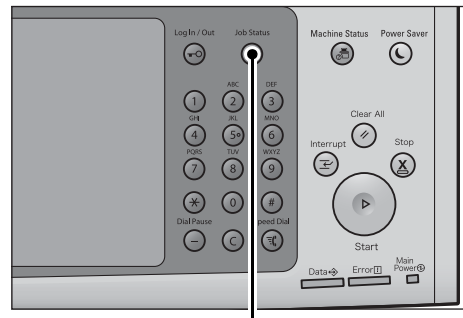

<Job Status> button

2 Select the job to be canceled or preferentially executed.

- Note**
- Select [▲] to return to the previous screen or [▼] to move to the next screen.
 - From the drop-down menu, you can select and display the desired type of jobs.

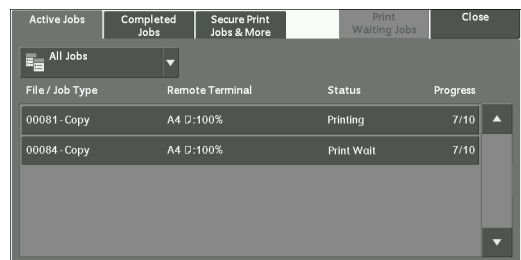

3 Select [Delete] or [Promote Job].

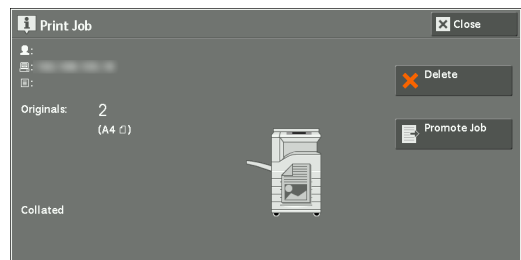

Print Waiting Jobs

Prints the jobs that are waiting to be output or resumed.
For more information, refer to "Printing Pending Jobs" (P.221).

Delete

Cancels the current or pending job.

Promote Job

Preferentially executes the selected job.

If you select this button, [📄] appears under the [Status] of the selected job.

Delete

Stops processing the job.

Last Original

Select this button to end scanning of documents. The job is then executed.

Next Original

Select this button when you have another document to scan.

Start

Resumes the suspended job.

Change Quantity

Displays the [Change Quantity] screen, on which you can change the number of print sets. Enter the number using the numeric keypad.

Checking Completed Jobs

This section describes how to check completed jobs.

You can check whether a job has been completed successfully. Selecting a job allows you to see its details.

1 Press the <Job Status> button.

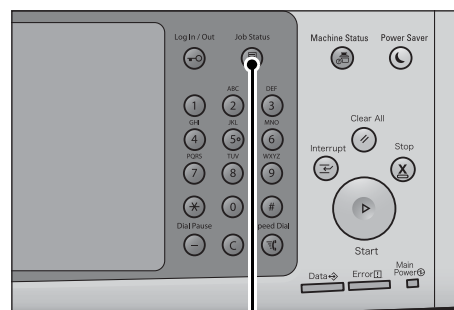

<Job Status> button

2 Select the [Completed Jobs] tab.

- Note**
- Select [▲] to return to the previous screen or [▼] to move to the next screen.
 - From the drop-down menu, you can select and display the desired type of jobs.
 - Deselect the [Group Parent Jobs] check box to display child jobs of the completed Broadcast Sends. Select a child job from the list to show its details.

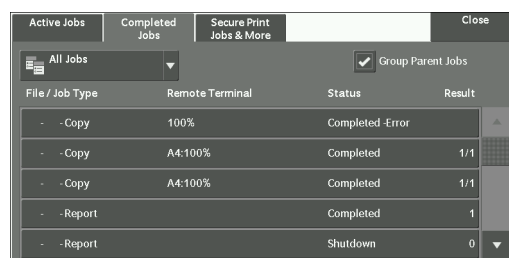

When the [Group Parent Jobs] check box is selected, select a parent job to show its child jobs, and select a child job from the list to show its details.

- In the [Result] column, the number of copies will be shown for a Copy job, the number of pages for a Print job, and the scaling factor (%) for a Scan job. To confirm what value is shown, select the job and switch to the Job Status screen.

3 Select a job to see the details.

4 Select [Close] after the confirmation.

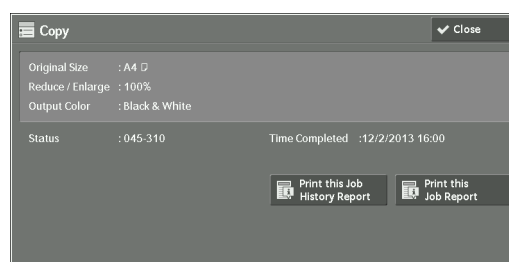

Group Parent Jobs

Allows you to check the list or history of related jobs (such as job flow jobs).

Show Child Jobs

Displays a job list.

Print this Job History Report

Prints the Job History Report.

Print this Job Report

Prints the Job Report.

Printing and Deleting Stored Jobs

This section describes how to print or delete jobs stored with the Secure Print or Sample Set feature, or stored with the [Receive Control] setting of the Charge Print feature. The [Secure Print Jobs & More] screen allows you to print or delete stored jobs.

The following shows the reference section for each feature.

Secure Print	208
Sample Set	210
Delayed Print	212
Charge Print	213
Private Charge Print	216
Public Folder	218
Undelivered Faxes	219

1 Press the <Job Status> button.

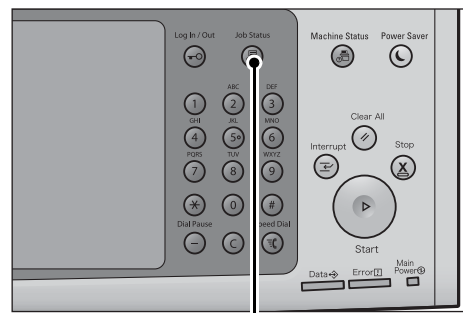

<Job Status> button

2 Select the [Secure Print Jobs & More] tab.

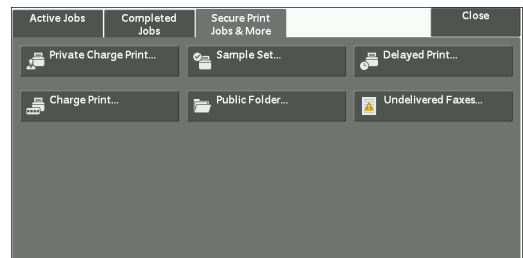

[Secure Print] and [Private Charge Print] are not displayed simultaneously on the screen. For more information on the settings, refer to "Charge/Private Print Settings" (P.456).

Secure Print

This feature allows you to temporarily store print data in the machine to print it with the print command from the machine. The feature also enables you to set a passcode, which is helpful to print confidential documents.

The following describes how to print or delete jobs stored with the Secure Print feature.

- Note**
- This feature does not appear when [Receive Control] in [Charge / Private Print Settings] is set to either of the following:
 - Select [According to Print Accounting], and then select [Save as Private Charge Print Job] in [Job Login Success].
 - Select [Save as Private Charge Print Job].

When [Save as Private Charge Print Job] or [Save as Charge Print Job] is selected in [Receive Control] under [Charge / Private Print Settings], jobs will not be saved in [Secure Print] under [Secure Print Jobs & More] even if you select [Secure Print] on the print driver. For more information, refer to "Charge/Private Print Settings" (P.456).

For information on how to operate a Secure Print job, refer to the print driver's help.

- 1 Select [Secure Print].
- 2 Select the user to be checked, and select [Job List].

- Note**
- Select [Refresh] to display the updated information.
 - Select [▲] to return to the previous screen or [▼] to move to the next screen.
 - You can enter a user ID in [Go to] using the numeric keypad to display the user ID at the top of the list.

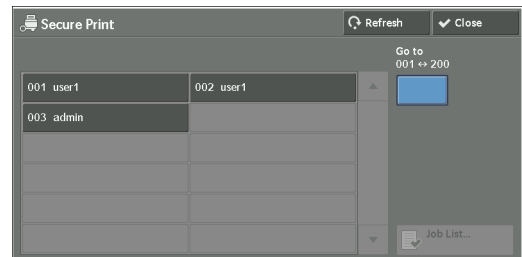

- 3 Enter the passcode, and select [Confirm].

- Note**
- If the passcode is not set, the passcode entry screen does not appear.

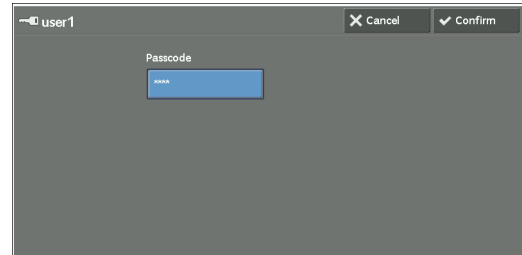

- 4 Select the job to be printed or deleted.

- Note**
- You can select up to 100 files simultaneously to print or delete the files. If you select multiple files, they are printed in the selected order.

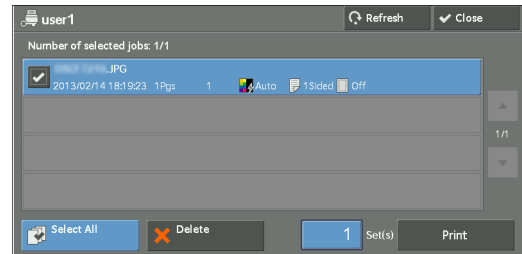

- 5 Select any option.
- 6 When printing, specify the number of print sets using the numeric keypad.

Select All

Selects all jobs. To deselect all the jobs, select this button again.

Delete

Deletes the Secure Print job.

- Note**
- If jobs with the same Billing ID are all deleted, the Billing ID will be deleted. Refer to "When [Delete] is Selected" (P.210).

Print Quantity

Specify the number of print sets using the numeric keypad.

Print

Prints the Secure Print job. After printing, the job is deleted. Refer to "When [Print] is Selected" (P.210).

When [Delete] is Selected

- 1 Select [Delete].

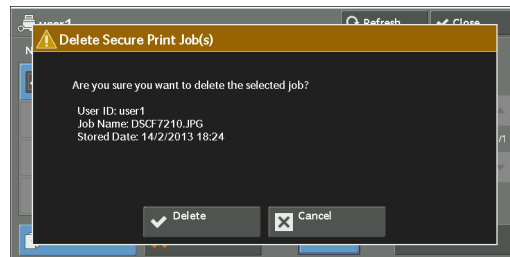

Delete

Deletes the job.

Note • Once the job is deleted, it cannot be restored.

Cancel

Cancels deleting the job.

When [Print] is Selected

- 1 Specify how to process the job after printing.

Note • The screen as shown on the right does not appear if [Print Job Confirmation Screen] is set to [Disabled] in the System Administration mode. If [Disabled] is selected, the machine automatically deletes the job after printing without displaying the confirmation screen. For more information, refer to "Print Job Confirmation Screen" (P.414).

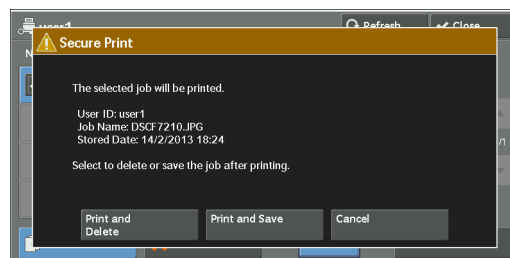

Print and Delete

Starts printing the job. After printing, the job is deleted.

Print and Save

Starts printing the job. After printing, the job remains undeleted.

Cancel

Cancels printing the job.

Sample Set

The following describes how to print or delete jobs stored with the Sample Set feature.

Before printing multiple sets of a document, you can first print one set for trial, and then print the remaining sets from the machine.

For information on how to operate a Sample Set job, refer to the print driver's help.

Note • When [Save as Private Charge Print Job] or [Save as Charge Print Job] is selected in [Receive Control] under [Charge / Private Print Settings], jobs will not be saved in [Sample Set] under [Secure Print Jobs & More] even if you select [Sample Set] on the print driver.

For more information, refer to "Charge/Private Print Settings" (P.456).

- 1 Select [Sample Set].

2 Select the user to be checked, and select [Job List].

- Note**
- Select [Refresh] to display the updated information.
 - Select [▲] to return to the previous screen or [▼] to move to the next screen.
 - You can enter a user ID in [Go to] using the numeric keypad to display the user ID at the top of the list.

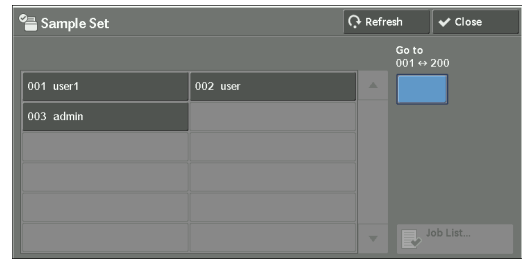

3 Select the job to be printed or deleted.

- Note**
- You can select up to 100 files simultaneously to print or delete the files. If you select multiple files, they are printed in the selected order.

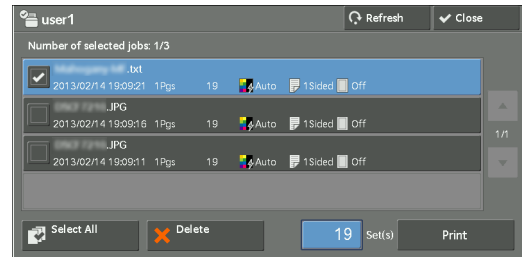

4 Select any option.

5 When printing, specify the number of print sets using the numeric keypad.

Select All

Selects all jobs. To deselect all the jobs, select this button again.

Delete

Deletes the Sample Set job.
Refer to "When [Delete] is Selected" (P.211).

Print Quantity

Specify the number of print sets using the numeric keypad.

Print

Prints the Sample Set job. After printing the remaining sets of the job, the job is deleted.
Refer to "When [Print] is Selected" (P.212).

When [Delete] is Selected

1 Select [Delete].

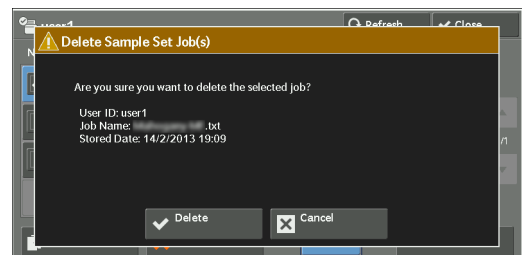

Delete

Deletes the job.

- Note**
- Once the job is deleted, it cannot be restored.

Cancel

Cancels deleting the job.

When [Print] is Selected

1 Select [Yes].

- Note**
- The screen as shown on the right does not appear if [Print Job Confirmation Screen] is set to [Disabled] in the System Administration mode. If [Disabled] is selected, the machine automatically deletes the job after printing without displaying the confirmation screen. For more information, refer to "Print Job Confirmation Screen" (P.414).

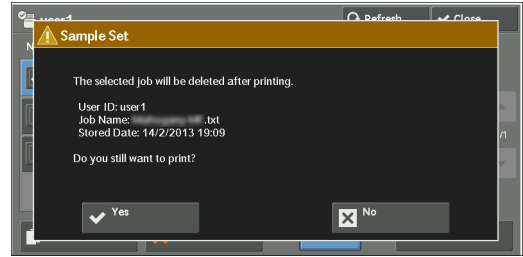

Yes

Starts printing the job. After printing, the job is deleted.

- Note**
- After a sample set is output, the remaining sets will automatically be output if the machine is not instructed for the period specified in [Auto Job Release]. To prevent the remaining sets from being output automatically, set [Auto Job Release] to [Off]. For information on how to set [Auto Job Release], refer to "Auto Job Release" (P.315).

No

Cancels printing the job.

Delayed Print

This feature allows you to temporarily store print data on the machine to print it at specified time.

Up to 100 jobs can be stored (queued) simultaneously for the Delayed Print feature. If the power is switched off when jobs are in queue (before the specified print time), the jobs whose print time has elapsed will automatically be printed immediately after the power is switched on again.

The following describes how to print or delete jobs stored with the Delayed Print feature. For information on how to operate a Delayed Print job, refer to the print driver's help.

- Note**
- When [Save as Private Charge Print Job] or [Save as Charge Print Job] is selected in [Receive Control] under [Charge / Private Print Settings], jobs will not be saved in [Delayed Print] under [Secure Print Jobs & More] even if you select [Delayed Print] on the print driver. For more information, refer to "Charge/Private Print Settings" (P.456).

1 Select [Delayed Print].

2 Select the job to be printed or deleted.

- Note**
- Select [Refresh] to display the updated information.
 - Select [▲] to return to the previous screen or [▼] to move to the next screen.
 - [Print Time] shows the time to start printing.

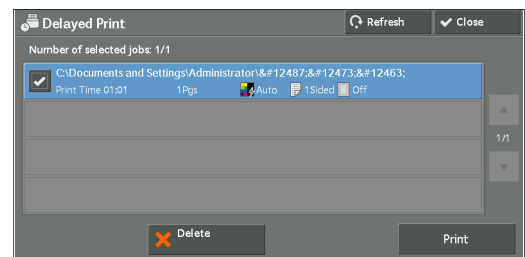

3 Select any option.

Delete

Deletes the Delayed Print job.

Refer to "When [Delete] is Selected" (P.213).

Print

Prints the Delayed Print job. After printing, the job is deleted. If printed manually, the job will not be printed at the specified time.

Refer to "When [Print] is Selected" (P.213).

When [Delete] is Selected

- 1 Select [Delete].

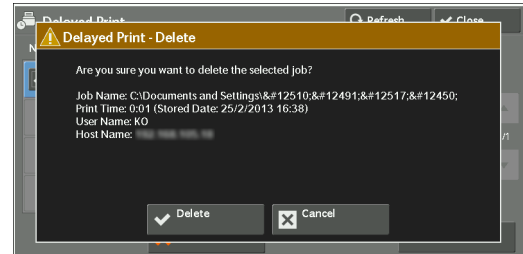

Delete

Deletes the job.

Note • Once the job is deleted, it cannot be restored.

Cancel

Cancels deleting the job.

When [Print] is Selected

- 1 Select [Yes].

Note • The screen as shown on the right does not appear if [Print Job Confirmation Screen] is set to [Disabled] in the System Administration mode. If [Disabled] is selected, the machine automatically deletes the job after printing without displaying the confirmation screen. For more information, refer to "Print Job Confirmation Screen" (P.414).

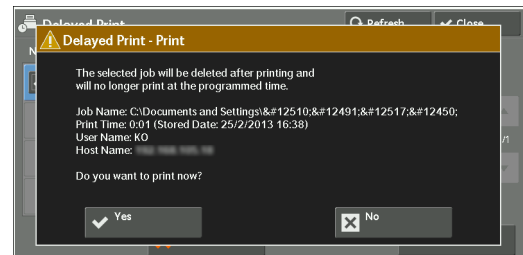

Yes

Starts printing the job. After printing, the job is deleted.

No

Cancels printing the job.

Charge Print

This feature authenticates users on the machine to prevent unauthorized users from operating print jobs. When this feature is enabled, the machine prints only the jobs of authenticated users. You can also configure the machine to store print jobs temporarily, and then print them from the machine's control panel.

If received print jobs are set to be saved as Charge Print under [Tools] > [Authentication / Security Settings] > [Authentication] > [Charge / Private Print Settings] > [Receive Control], the jobs are saved for each Billing ID. Any jobs that were not given a Billing ID on the print driver are saved in [(No User ID)].

For more information on how to register user IDs on the machine, refer to "Create/View User Accounts" (P.441).

- Note**
- Unlike the Private Charge Print feature, the Charge Print feature can store jobs without a user ID, such as e-mail printing and print jobs sent from Dell Printer Configuration Web Tool, and can print the jobs after authenticating users.
 - [Charge Print] appears when [Save as Charge Print Job] is selected by using one of the following procedures in the System Administration mode:
 - Select [Save as Charge Print Job] in [Receive Control].
 - Select [According to Print Accounting] in [Receive Control], and then select [Save as Charge Print Job] in [Job Login Failure].
 - Select [According to Print Accounting] or [Save as Private Charge Print Job] in [Receive Control], and then select [Save as Charge Print Job] in [Job Without User ID].

For information on how to set Charge Print, refer to "Charge/Private Print Settings" (P.456).

The following describes how to print and delete a job stored with the Charge Print feature.

1 Press the <Log In/Out> button on the control panel, or select the login information field on the touch screen.

2 Enter the user ID, and select [Enter].

- Note**
- When the passcode is set, enter the user ID and select [Next]. Then, enter the passcode and select [Enter].
 - While a user is authenticated, the <Log In/Out> button lights up on the control panel.
 - To log out of the machine, press the <Log In/Out> button on the control panel.

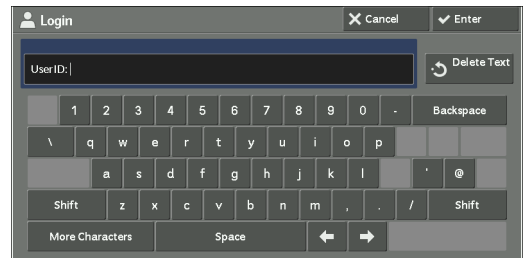

3 Select [Charge Print].

4 Select the user to be checked, and select [Job List].

- Note**
- Select [Refresh] to display the updated information.
 - Select [▲] to return to the previous screen or [▼] to move to the next screen.
 - You can enter a user ID in [Go to] using the numeric keypad to display the user ID at the top of the list.

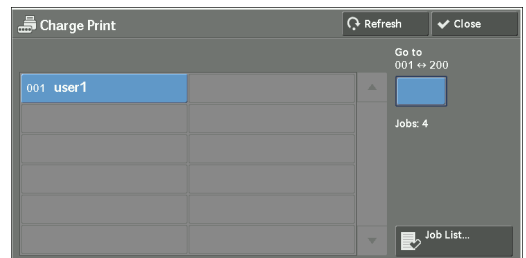

5 Enter the passcode, and select [Confirm].

- Note**
- If the passcode is not set, the passcode entry screen does not appear.

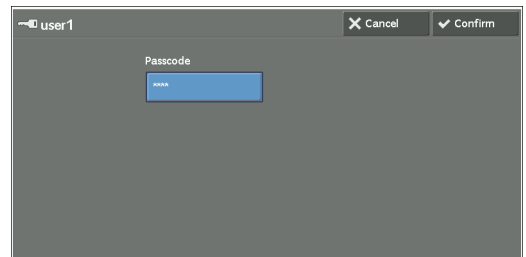

6 Select the job to be printed or deleted.

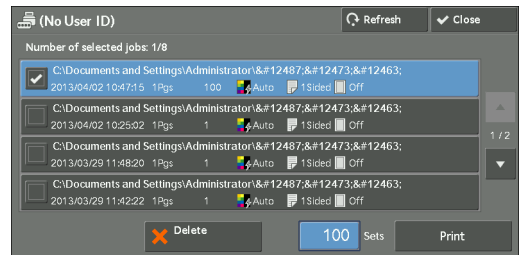

7 Select any option.

8 When printing, specify the number of print sets using the numeric keypad.

Delete

Deletes the Charge Print job.
Refer to "When [Delete] is Selected" (P.215).

Print Quantity

Specify the number of print sets using the numeric keypad.

Print

Prints the Charge Print job. After printing, the job is deleted.
Refer to "When [Print] is Selected" (P.215).

When [Delete] is Selected

- 1 Select [Delete].

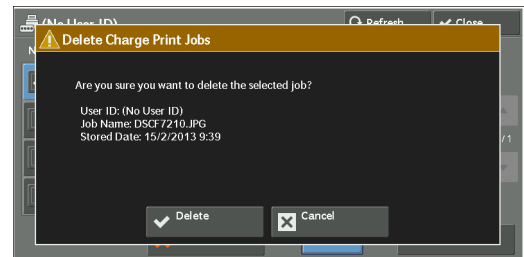

Delete

Deletes the job.
Note • Once the job is deleted, it cannot be restored.

Cancel

Cancels deleting the job.

When [Print] is Selected

- 1 Specify how to process the job after printing.

Note • The screen as shown on the right does not appear if [Print Job Confirmation Screen] is set to [Disabled] in the System Administration mode. If [Disabled] is selected, the machine automatically deletes the job after printing without displaying the confirmation screen. For more information, refer to "Print Job Confirmation Screen" (P.414).

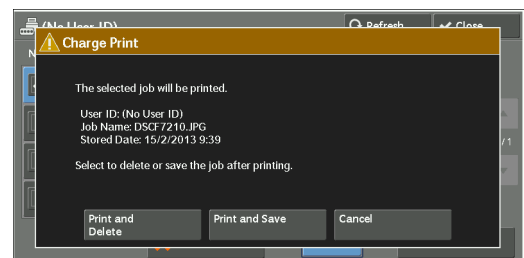

Print and Delete

Starts printing the job. After printing, the job is deleted.

Print and Save

Starts printing the job. After printing, the job remains undeleted.

Cancel

Cancels printing the job.

Private Charge Print

This feature allows you to temporarily store print data in the machine for each authentication user ID, and request on the machine's control panel to print the data. As the feature enables you to select and print only necessary jobs, you can avoid printing unnecessary jobs. Furthermore, the machine displays only the jobs of authenticated users and their associated sub users to securely protect the privacy of the users. The Private Print feature is suitable for authenticating and managing specific users managed by the system administrator.

If received print jobs are set to be saved with Private Charge Print, the jobs are saved for each authentication user ID.

- Note**
- [Private Charge Print] is displayed when [Receive Control] in [Charge / Private Print Settings] is set to either of the following:
 - Select [According to Print Accounting] in [Receive Control], and then select [Save as Private Charge Print Job] in [Job Login Success].
 - Select [Save as Private Charge Print Job] in [Receive Control].
 - When the Private Charge Print feature is selected, you cannot specify normal print, Secure Print, Sample Set, Delayed Print on the print driver.

The Private Charge Print feature restricts the use of the machine through either user ID authentication or card authentication, or the combination of both. For information of the types of authentication, refer to "Types of Authentication" (P.538).

To delete a print job instructed with an invalid user ID, display the list of print jobs after logging in as a system administrator, and then select the job to be deleted. For more information, refer to "Deleting a Private Charge Print Job with an Invalid User ID" (P.270). For information on how to set a User ID, refer to "Charge/Private Print Settings" (P.456).

The following describes how to print or delete a job stored with the Private Charge Print feature.

- 1 Press the <Log In/Out> button on the control panel, or select the login information field on the touch screen.
- 2 Enter the user ID, and select [Enter].

- Note**
- When the passcode is set, enter the user ID and select [Next]. Then, enter the passcode and select [Enter].
 - While the user is authenticated, the <Log In/Out> button lights up on the control panel.
 - To log out of the machine, press the <Log In/Out> button on the control panel.

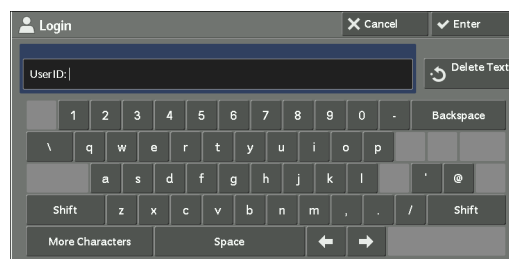

- 3 Select [Private Charge Print].

- Note**
- If you are authenticated as a system administrator, selecting [Private Charge Print] will display a list of authentication user IDs. Select a user ID from the list, and then select [Job List] to display a list of jobs stored for the selected user.

- 4 Select the job to be printed or deleted.

- Note**
- You can select up to 100 files simultaneously to print or delete the files. If you select multiple files, they are printed in the selected order.

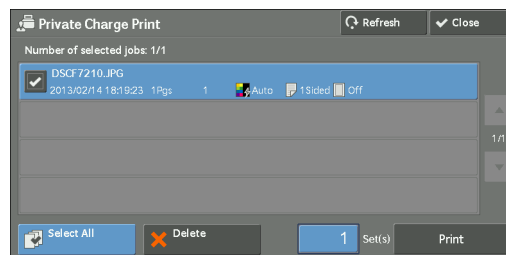

- 5 Select any option.
- 6 When printing, specify the number of print sets using the numeric keypad.

Select All

Selects all jobs. To deselect all the jobs, select this button again.

Delete

Deletes the Private Charge Print job.

Note • If jobs with the same user ID are all deleted, the user ID will be deleted.
Refer to "When [Delete] is Selected" (P.217).

Print Quantity

Specify the number of print sets using the numeric keypad.

Print

Prints the Private Charge Print job. After printing, the job is deleted.
Refer to "When [Print] is Selected" (P.217).

When [Delete] is Selected

- 1 Select [Delete].

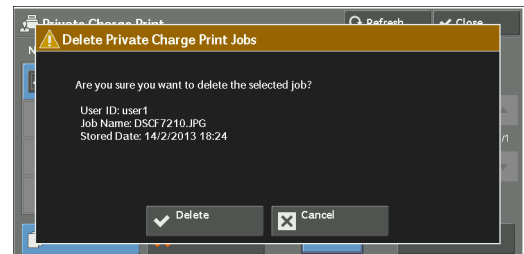

Delete

Deletes the job.

Note • Once the job is deleted, it cannot be restored.

Cancel

Cancels deleting the job.

When [Print] is Selected

- 1 Specify how to process the job after printing.

Note • The screen as shown on the right does not appear if [Print Job Confirmation Screen] is set to [Disabled] in the System Administration mode. If [Disabled] is selected, the machine automatically deletes the job after printing without displaying the confirmation screen. For more information, refer to "Print Job Confirmation Screen" (P.414).

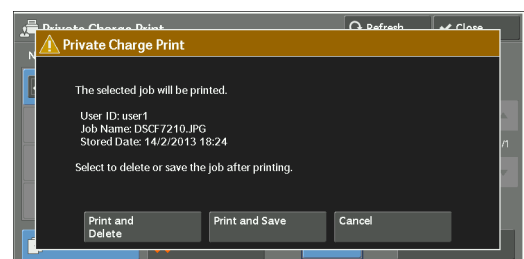

Print and Delete

Starts printing the job. After printing, the job is deleted.

Print and Save

Starts printing the job. After printing, the job remains undeleted.

Cancel

Cancels printing the job.

Public Folder

This feature allows you to store data in the machine and send the data by operating on a remote machine.

The following describes how to print or delete a job stored in a public folder.

Note • An optional component is required to use this feature. For more information, contact Customer Support at dell.com/contactdell.

1 Select [Public Folder].

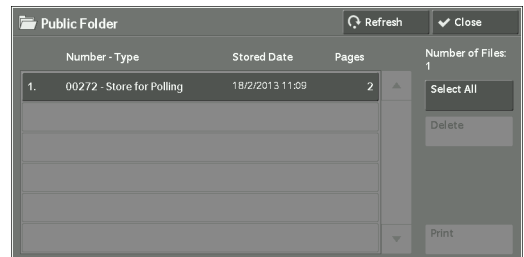

2 Select the job to be printed or deleted.

Note • Select [Refresh] to display the updated information.
• Select [▲] to return to the previous screen or [▼] to move to the next screen.

3 Select any option.

Select All

Selects all jobs. To deselect all the jobs, select this button again.

Delete

Deletes the selected job stored in the public folder.
Refer to "When [Delete] is Selected" (P.218).

Print

Prints the selected job stored in the public folder.
Refer to "When [Print] is Selected" (P.219).

When [Delete] is Selected

1 Select [Delete].

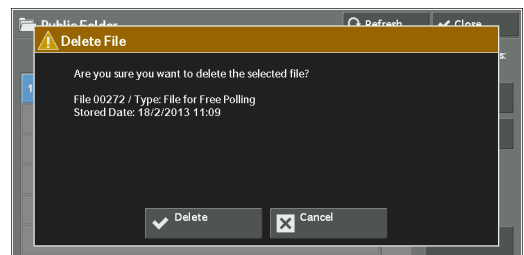

Delete

Deletes the job.

Note • Once the job is deleted, it cannot be restored.

Cancel

Cancels deleting the job.

When [Print] is Selected

Starts printing the job.

Undelivered Faxes

The following describes how to re-send or delete an undelivered fax job.

- Note**
- This feature may not appear depending on the settings in the System Administration mode.
 - An optional component is required to use this feature. For more information, contact Customer Support at dell.com/contactdell.

- 1 Select [Undelivered Faxes].
- 2 Select the job to be re-sent or deleted.

Note

 - Select [Refresh] to display the updated information.
 - Select [▲] to return to the previous screen or [▼] to move to the next screen.



- 3 Select any option.
To re-send to the previously specified fax number, press the <Start> button.



Delete This Fax

Deletes the undelivered fax job.
Refer to "When [Delete This Fax] is Selected" (P.219).

Change Recipients

Allows you to change the fax recipient and re-send the undelivered fax job.
Refer to "When [Change Recipients] is Selected" (P.220).

When [Delete This Fax] is Selected

- 1 Select [Delete].

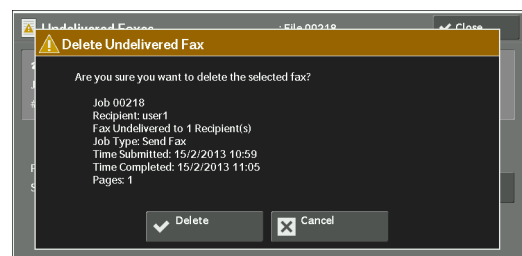

Delete

Deletes the undelivered fax job.

Cancel

Cancels deleting the undelivered fax job.

When [Change Recipients] is Selected

Specify a fax recipient for the undelivered fax job.

Besides the fax recipient, the following features can be changed on the control panel:

- Fax type
- Starting Rate

Note • If the fax recipient has been changed, header information will not be added even if [Transmission Header Text] is set to [Display Header].

For information on how to specify fax recipients, refer to "Step 3 Specifying Destinations" (P.149).

Printing Pending Jobs

After the last user operation on the control panel of the machine, a job is waiting to be printed until the period of time specified in [Auto Print] elapses, instead of being printed immediately. You can forcibly print this pending job without waiting for this time period to elapse.

If a job is paused by the <Stop> button and is waiting to be resumed, you can also resume the job. If there are multiple jobs, subsequent jobs are printed after the paused job has been printed.

Note • If there are no pending jobs, the [Print Waiting Jobs] button is disabled.

For information on how to set [Auto Print], refer to "Auto Print" (P.315).

1 Press the <Job Status> button.

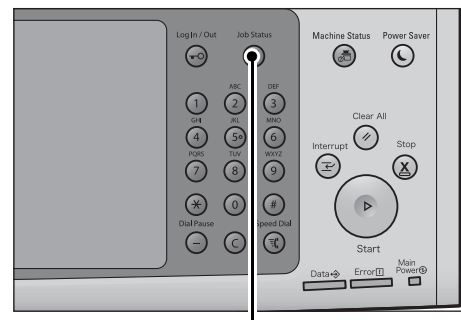

<Job Status> button

2 Select [Print Waiting Jobs].

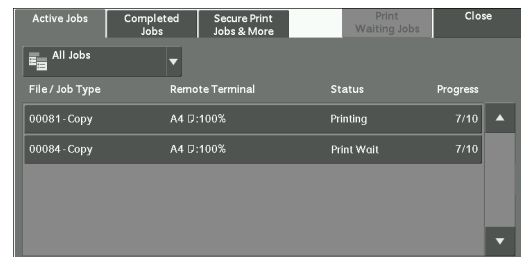

Handling Error Terminations

This section describes how to handle error terminations.

For a Print Job

Select a job shown as an error termination on the [Completed Jobs] tab to check the status code. Follow the instructions of the status code to solve the problem.

If an error occurs during a print job, the machine can be configured either to pause the print job until the error is confirmed by the user, or to automatically cancel the error job so that subsequent jobs can be printed.

For more information on the setting, refer to "Print Service Settings" (P.380).

For information on status codes, refer to "Status Code" (P.611).

For a Fax Job

A Transmission Report - Job Undelivered is printed.

For more information on the Transmission Report - Job Undelivered, refer to "Transmission Report - Job Undelivered" (P.284). For more information on how to print the Transmission Report - Job Undelivered automatically, refer to "Transmission Report - Job Undelivered" (P.328).

For a Scan Job

A Transmission Report - Job Undelivered is printed.

For more information on the Transmission Report - Job Undelivered, refer to "Transmission Report - Job Undelivered" (P.284). For more information on how to print the Transmission Report - Job Undelivered automatically, refer to "Transmission Report - Job Undelivered" (P.328).

For Other Jobs

Print a Job History Report, and check the execution results.

For information on the Job History Report, refer to "Job History Report" (P.328).

When a status code is listed in the Transmission Report - Job Undelivered or the Job History Report, refer to "Status Code" (P.611).

11 Computer Operations

This chapter describes how to print documents, import scanned files, use Direct Fax, and operate Dell Printer Configuration Web Tool on your computer.

- Note**
- An optional component is required to use this feature. For more information, contact Customer Support at dell.com/contactdell.
 - The computer screen images shown in this chapter are as of August 2013.
 - The procedures in this chapter may vary depending on the driver and utility software being used due to the upgrades.

- **Features Overview**224

Features Overview

This section describes an overview of features you can perform from a computer.

Printing

Submits a print job to the machine from a computer.

E-mail Printing

Submits a print job to the machine from a computer by sending e-mail attached with a document. The received e-mail is automatically printed from the machine according to the settings on the machine.

Sending Fax

Sends a fax directly from a computer.

Importing Scanned Data

Imports files stored in a folder of the machine to a computer.

Dell Printer Configuration Web Tool

Displays the machine status and job status. The feature also allows you to change settings as well as to import files stored in a folder.

12 Paper and Other Media

This chapter describes the paper that can be used with the machine, precautions when handling paper, and how to load paper in trays.

- **Paper Types**226
- **Loading Paper**237
- **Changing the Paper Size**241
- **Changing the Paper Settings**.....244

Paper Types

This section describes the paper that can be used with this machine.

Use of unrecommended paper may result in paper jams, lower print quality, malfunctions, or damage to the machine. To achieve optimum performance of the machine, we recommend that you use only paper recommended by Dell.

If you desire to use paper other than the paper recommended by Dell, contact Customer Support at dell.com/contactdell.

Note • Moisture generated by water, rain, or vapor may cause the printed images to fade. For more information, contact Customer Support at dell.com/contactdell.

Loadable Quantity and Weight

Paper Tray	Loadable Paper	Loadable Quantity*
Trays 1 to 4	Basis Weight: 60 to 256 gsm Ream Weight: 51.6 - 220.1 kg	500 sheets
Tray 5 (bypass tray)	Basis Weight: 55 to 280 gsm Ream Weight: 47.3 - 240.7 kg	Up to 10 mm 90 sheets
Tray 6 (HCF B1) (optional)	Basis Weight: 55 to 216 gsm Ream Weight: 47.3 - 186 kg	2,030 sheets

* :When using 80 gsm paper

Note

- Printing on paper that differs from the paper type and size selected in the print driver, or printing from a tray that does not support the loaded paper may result in a paper jam. To ensure correct printing, select the correct paper size, paper type, and paper tray.
- Basis weight is the weight of 1 m² of a paper sheet.
- Ream weight is the weight of 1,000 sheets of duodecimo size (788 x 1,091 mm) paper.
- When copying on non-standard size paper from Tray 5, you must enter the paper size. Furthermore, if you frequently copy on non-standard size paper, you can preset the size on the machine. That size then appears under [Standard Size] on the [Tray 5] screen. For more information on the settings, refer to "Tray 5 - Paper Size Defaults" (P.323).
- Most ideal image quality with the paper can be obtained by setting the image quality for each type of paper. For more information on the settings, refer to "Image Quality" (P.324).

Supported Paper

Standard Paper

When printing or copying on commonly used paper (plain paper), use paper meeting the standards described below. To copy or print as clear as possible, we recommend the following standard paper.

Paper Name	Size	Basis Weight	Paper Type* ¹	Image Quality* ²	Notes / Countermeasure
Xerox Business 4200	8.5 x 11", 11 x 17"	75 gsm / 20 lb.	Plain	Plain E	
Xerox Color Xpressions Select	8.5 x 11", 11 x 17"	90 gsm / 24 lb.	Bond	Plain A	
Xerox Premier	A4, A3	80 gsm	Plain	Plain F	

Paper Name	Size	Basis Weight	Paper Type *1	Image Quality *2	Notes / Countermeasure
Xerox Colotech+ (Gold label)	A4, A3	90 gsm	Bond	Plain A	

*1 : Select the paper type setting for the paper loaded on a tray. For more information, refer to "Changing the Paper Settings" (P.244).

*2 : Most ideal image quality with the paper can be obtained by setting the image quality for each type of paper. For more information on the settings, refer to "Image Quality" (P.324).

Semi Standard Paper

In addition to the standard paper, the following paper can also be used.

Paper Name	Size	Basis Weight	Paper Type *1	Image Quality *2	Notes / Countermeasure
Xerox Business 4200	8.5 x 14"	75 gsm / 20 lb.	Plain	Plain E	
Xerox Color Xpressions Select	8.5 x 14"	90 gsm / 24 lb.	Bond	Plain A	
Xerox Business	A4, A3	80 gsm	Plain	Plain F	• Dog ear defect and wrinkles may occur under high humidity conditions.
Xerox Recycled Supreme	A4, A3	80 gsm	Recycled	Plain F	
Xerox Exclusive	A4, A3	80 gsm	Plain	Plain F	
Xerox Digital Colour Colotech+	A4, A3	90 gsm	Bond	Plain F	
	A4, A3	100 gsm	Bond	Plain F	

*1 : Select the paper type setting for the paper loaded on a tray. For more information, refer to "Changing the Paper Settings" (P.244).

*2 : Most ideal image quality with the paper can be obtained by setting the image quality for each type of paper. For more information on the settings, refer to "Image Quality" (P.324).

Usable Paper

In addition to the standard paper, the following paper can also be used.

Paper Name	Size	Basis Weight	Paper Type *1	Image Quality *2	Notes / Countermeasure
Xerox Business 4200 (3-hole)	8.5 x 11"	75 gsm / 20 lb.	Plain	Plain E	
Xerox Business Recycled Paper	8.5 x 11", 8.5 x 14", 11 x 17"	75 gsm / 20 lb.	Recycled	Plain E	
Xerox Business Recycled Paper (3-hole)	8.5 x 11"	75 gsm / 20 lb.	Recycled	Plain E	
Xerox Color Xpressions Select (3-hole)	8.5 x 11"	90 gsm / 24 lb.	Bond	Plain A	

Paper Name	Size	Basis Weight	Paper Type *1	Image Quality *2	Notes / Countermeasure
Xerox Color Xpressions Elite	8.5 x 11", 17 x 11", 18 x 12"	120 gsm / 32 lb.	Heavyweight	HW 1A	• Tray 1 does not support 18 x 12 paper.
	8.5 x 11", 17 x 11", 18 x 12"	163 gsm / 60 lb. cover	Heavyweight	HW 1A	• Tray 1 does not support 18 x 12 paper.
	8.5 x 11", 17 x 11", 18 x 12"	215 gsm / 80 lb. cover	Extra Heavyweight	HW 2A	• Tray 1 does not support 18 x 12 paper. • When you use Tray 5, automatic duplexing is not available.
	8.5 x 11", 17 x 11", 18 x 12"	270 gsm / 100 lb. cover	Extra Heavyweight Plus	HW 2A	• Load the paper into Tray 5. • Automatic duplexing is not available.
Xerox Color Xpressions Planet 20	8.5 x 11", 17 x 11", 18 x 12"	175 gsm / 65 lb. cover	Extra Heavyweight	HW 2A	• Tray 1 does not support 18 x 12 paper. • When you use Tray 5, automatic duplexing is not available.
	8.5 x 11", 17 x 11", 18 x 12"	270 gsm / 100 lb. cover	Extra Heavyweight Plus	HW 2A	• Load the paper into Tray 5. • Automatic duplexing is not available.
Xerox Business Index	8.5 x 11", 17 x 11"	163 gsm / 90 lb.	Heavyweight	Coated 1	• Manually feed one paper at a time, using Tray 5.
Xerox Premier	A4	60 gsm	Plain	Plain F	
	A4, A3	90 gsm	Bond	Plain F	
	A4	120 gsm	Heavyweight	HW 1A	
Xerox Exclusive (4-hole)	A4	80 gsm	Plain	Plain F	
Xerox Exclusive	A4, A3	90 gsm	Bond	Plain A	
Xerox Colour Impressions	A4, A3	80 gsm	Plain	Plain F	
	A4	90 gsm	Bond	Plain F	
	A3, SRA3	120 gsm	Heavyweight	HW 1A	• Tray 1 does not support SRA3.
Xerox Colour Impressions	A3, SRA3	250 gsm	Extra Heavyweight	HW 2A	• Tray 1 does not support SRA3. • Duplexing is supported by Tray 5 only. Automatic duplexing is not available.

Paper Name	Size	Basis Weight	Paper Type *1	Image Quality *2	Notes / Countermeasure
Xerox Digital Colour Colotech+	A3+, SRA3	90 gsm	Bond	Plain F	• Load the paper into paper trays other than Tray 1.
	A3+, SRA3	100 gsm	Bond	Plain F	• Load the paper into paper trays other than Tray 1.
	A4, A3, A3+, SRA3	120 gsm	Heavyweight	HW 1A	• Tray 1 does not support A3+ and SRA3.
	A4, A3, A3+, SRA3	160 gsm	Heavyweight	HW 1A	• Tray 1 does not support A3+ and SRA3.
	A4, A3, A3+, SRA3	200 gsm	Extra Heavyweight	HW 2A	• Tray 1 does not support A3+ and SRA3. • When you use Tray 5, automatic duplexing is not available.
	A4, A3, A3+, SRA3	220 gsm	Extra Heavyweight	HW 2A	• Tray 1 does not support A3+ and SRA3. • When you use Tray 5, automatic duplexing is not available.
	A4, A3, SRA3	250 gsm	Extra Heavyweight	HW 2A	• Tray 1 does not support SRA3. • Duplexing is supported by Tray 5 only. Automatic duplexing is not available.
Xerox Colotech+ (Gold label)	A4, A3, SRA3	250 gsm	Extra Heavyweight	HW 2A	• Tray 1 does not support SRA3. • Duplexing is supported by Tray 5 only. Automatic duplexing is not available.
	SRA3	90 gsm	Bond	Plain A	• Load the paper into paper trays other than Tray 1.
	A4, A3, SRA3	100 gsm	Bond	Plain A	• Tray 1 does not support SRA3.
	A4, A3, SRA3	120 gsm	Heavyweight	HW 1A	• Tray 1 does not support SRA3.
	A4, A3, SRA3	160 gsm	Heavyweight	HW 1A	• Tray 1 does not support SRA3.
	A4, A3, SRA3	200 gsm	Extra Heavyweight	HW 2A	• Tray 1 does not support SRA3. • When you use Tray 5, automatic duplexing is not available.
	A4, A3, SRA3	220 gsm	Extra Heavyweight	HW 2A	• Tray 1 does not support SRA3. • When you use Tray 5, automatic duplexing is not available.

Paper Name	Size	Basis Weight	Paper Type *1	Image Quality *2	Notes / Countermeasure
XeroxColotech+ Natural White	A4, A3, A3+, SRA3	100 gsm	Bond	Plain A	• Tray 1 does not support A3+ and SRA3.
	A4, A3, A3+, SRA3	160 gsm	Heavyweight	HW 1A	• Tray 1 does not support A3+ and SRA3.
	A4, A3, A3+, SRA3	200 gsm	Extra Heavyweight	HW 2A	• Tray 1 does not support A3+ and SRA3. • When you use Tray 5, automatic duplexing is not available.

*1 :Select the paper type setting for the paper loaded on a tray. For more information, refer to "Changing the Paper Settings" (P.244).

*2 :Most ideal image quality with the paper can be obtained by setting the image quality for each type of paper. For more information on the settings, refer to "Image Quality" (P.324).

Special Media

You can use the following special media such as postcards and envelopes:

Paper Name	Size	Basis Weight	Paper Type *1	Image Quality *2	Notes / Countermeasure
Xerox Transparency - Removable Stripe	8.5 x 11"	-	Transparency	Transparency	<ul style="list-style-type: none"> • Load the paper with the paper stripe at the trail edge. • It is not recommended to output more than 20 transparencies at a time. • Duplexing is not available. • Place plain paper underneath the transparency sheet if misfeeds occur.
Envelopes	4.1 x 9.5"	75 - 90 gsm	No. 10 Envelope (4.1 x 9.5")	Envelope	<ul style="list-style-type: none"> • Load the paper into Tray 5. • Duplexing is not available.
	3.9 x 7.5"	75 - 90 gsm	Monarch Envelope (3.9 x 7.5")	Envelope	<ul style="list-style-type: none"> • Load the paper into Tray 5. • Duplexing is not available.
Xerox Colour Laser Labels	A4	-	Label	HW 2A	<ul style="list-style-type: none"> • Load the paper into Tray 1 or Tray 5. • Duplexing is not available.
XeroxHighSpeed Laser Removable Labels	A4	-	Labels	HW 2A	<ul style="list-style-type: none"> • Load the paper into Tray 1 or Tray 5. • Duplexing is not available.
XeroxHighSpeed Laser Labels	A4	-	Labels	HW 2A	<ul style="list-style-type: none"> • Load the paper into Tray 1 or Tray 5. • Duplexing is not available.

Paper Name	Size	Basis Weight	Paper Type* ¹	Image Quality* ²	Notes / Countermeasure
Xerox Plain Transparency for Colour	A4	-	Transparency	-	<ul style="list-style-type: none"> • Duplexing is not available. • It is not recommended to output more than 20 transparencies at a time. • Place plain paper underneath the transparency sheet if misfeeds occur.

*1 : Select the paper type setting for the paper loaded on a tray. For more information, refer to "Changing the Paper Settings" (P.244).

*2 : Most ideal image quality with the paper can be obtained by setting the image quality for each type of paper. For more information on the settings, refer to "Image Quality" (P.324).

Note • For more information on special paper such as other heavyweight paper, contact Customer Support at dell.com/contactdell.

Limited Paper

You can use the following paper with limitations:

Paper Name	Size	Basis Weight	Paper Type* ¹	Image Quality* ²	Notes / Countermeasure
Xerox Color Xpressions Elite	8.5 x 11", 17 x 11"	105 gsm / 28 lb.	Bond	Plain A	
Xerox Color Xpressions Elite (3-hole)	8.5 x 11"	105 gsm / 28 lb.	Bond	Plain A	
Xerox Color Xpressions Planet 20	8.5 x 11", 17 x 11", 18 x 12"	105 gsm / 28 lb.	Bond	Plain A	<ul style="list-style-type: none"> • If misregistration occurs when output sheets are delivered to Finisher-B1, invert the paper in the paper tray.
	8.5 x 11", 17 x 11", 18 x 12"	215 gsm / 80 lb. cover	Extra Heavyweight	HW 2A	<ul style="list-style-type: none"> • Tray 1 does not support 18 x 12 paper. • When you use Tray 5, automatic duplexing is not available.
Xerox Digital Color Elite Silk Text and Cover (C2S)	8.5 x 11", 17 x 11", 18 x 12"	120 gsm / 80 lb. text	Gloss	Coated 1	<ul style="list-style-type: none"> • Manually feed one sheet at a time, using Tray 5.
	8.5 x 11", 17 x 11", 18 x 12"	140 gsm / 100 lb. text	Gloss	Coated 1	<ul style="list-style-type: none"> • Manually feed one sheet at a time, using Tray 5.
	8.5 x 11", 17 x 11", 18 x 12"	210 gsm / 80 lb. cover	Heavyweight Gloss	Coated 2	<ul style="list-style-type: none"> • Manually feed one sheet at a time, using Tray 5. • Automatic duplexing is not available.

Paper Name	Size	Basis Weight	Paper Type*¹	Image Quality*²	Notes / Countermeasure
Xerox Digital Color Elite Gloss Text and Cover (C2S)	8.5 x 11", 17 x 11", 18 x 12"	120 gsm / 80 lb. text	Gloss	Coated 1	• Manually feed one sheet at a time, using Tray 5.
	8.5 x 11", 17 x 11", 18 x 12"	140 gsm / 100 lb. text	Gloss	Coated 1	• Manually feed one sheet at a time, using Tray 5.
	8.5 x 11", 17 x 11", 18 x 12"	210 gsm / 80 lb. cover	Heavyweight Gloss	Coated 2	• Manually feed one sheet at a time, using Tray 5. • Automatic duplexing is not available.
	8.5 x 11", 17 x 11", 18 x 12"	280 gsm / 100 lb. cover	Extra Heavyweight Gloss	Coated 2	• Manually feed one sheet at a time, using Tray 5. • Automatic duplexing is not available.
Xerox Digital Color Select Gloss Text and Cover (C2S)	17 x 11", 18 x 12"	120 gsm / 80 lb. text	Gloss	Coated 1	• Manually feed one sheet at a time, using Tray 5.
	17 x 11", 18 x 12"	210 gsm / 80 lb. cover	Heavyweight Gloss	Coated 2	• Manually feed one sheet at a time, using Tray 5. • Automatic duplexing is not available.
Xerox Digital Color Supreme Gloss FSC (C1S)	8.5 x 11", 17 x 11", 18 x 12"	8 pt / 160 gsm	Gloss	Coated 1	• Manually feed one sheet at a time, using Tray 5. • Set the output destination to other than [Center Tray - Upper] ([Center Tray] when a finisher is installed).
	8.5 x 11", 17 x 11", 18 x 12"	12 pt / 247 gsm	Heavyweight Gloss	Coated 2	• Manually feed one sheet at a time, using Tray 5. • Automatic duplexing is not available. • Set the output destination to other than [Center Tray - Upper] ([Center Tray] when a finisher is installed).
Xerox Business Index	8.5 x 11"	199 gsm / 110 lb.	Extra Heavyweight	Coated 2	• Manually feed one sheet at a time, using Tray 5. • Automatic duplexing is not available.
Xerox Digital Color Select Gloss Labels	8.5 x 11"	-	Labels	HW 2A	• Manually feed one sheet at a time, using Tray 5. • Duplexing is not available.
Xerox Matte Coated Labels	8.5 x 11"	-	Labels	HW 2A	• Manually feed one sheet at a time, using Tray 5. • Duplexing is not available.

Paper Name	Size	Basis Weight	Paper Type *1	Image Quality *2	Notes / Countermeasure
Xerox Phase Professional Transparency	8.5 x 11"	-	Transparency	Transparency	<ul style="list-style-type: none"> • It is not recommended to output more than 20 transparencies at a time. • Duplexing is not available. • Place plain paper underneath the transparency sheet if misfeeds occur.
Xerox Digital EA Color Transfer Paper	8.5 x 11", 17 x 11"	-	Heavyweight	HW 1A	<ul style="list-style-type: none"> • Load the paper into Tray 5. • Duplexing is not available.
Xerox Colour Impressions	A3, SRA3	90 gsm	Bond	Plain F	
	A4, A3, SRA3	100 gsm	Bond	Plain F	
XeroxColotech + Gloss Coated	A4, A3, SRA3	120 gsm	Gloss	Coated 1	<ul style="list-style-type: none"> • Manually feed one sheet at a time, using Tray 5. • Blisters may occur on a printed page under high temperature and humidity conditions.
	A4, A3, SRA3	140 gsm	Gloss	Coated 1	<ul style="list-style-type: none"> • Manually feed one sheet at a time, using Tray 5.
	A4, A3, SRA3	170 gsm	Heavyweight Gloss	Coated 2	<ul style="list-style-type: none"> • Manually feed one sheet at a time, using Tray 5. • Automatic duplexing is not available.
	A4, A3, SRA3	210 gsm	Heavyweight Gloss	Coated 2	<ul style="list-style-type: none"> • Manually feed one sheet at a time, using Tray 5. • Automatic duplexing is not available.
	A4, A3, SRA3	250 gsm	Heavyweight Gloss	Coated 2	<ul style="list-style-type: none"> • Manually feed one sheet at a time, using Tray 5. • Automatic duplexing is not available.
XeroxColotech + Silk Coated	A4, A3, SRA3	120 gsm	Gloss	Coated 1	<ul style="list-style-type: none"> • Manually feed one sheet at a time, using Tray 5.
	A4, A3, SRA3	140 gsm	Gloss	Coated 1	<ul style="list-style-type: none"> • Manually feed one sheet at a time, using Tray 5.
	A4, A3, SRA3	170 gsm	Heavyweight Gloss	Coated 2	<ul style="list-style-type: none"> • Manually feed one sheet at a time, using Tray 5. • Automatic duplexing is not available.
	A4, A3, SRA3	210 gsm	Heavyweight Gloss	Coated 2	<ul style="list-style-type: none"> • Manually feed one sheet at a time, using Tray 5. • Automatic duplexing is not available.
	A4, A3, SRA3	250 gsm	Heavyweight Gloss	Coated 2	<ul style="list-style-type: none"> • Manually feed one sheet at a time, using Tray 5. • Automatic duplexing is not available.

Paper Name	Size	Basis Weight	Paper Type*1	Image Quality*2	Notes / Countermeasure
XeroxColotech+ Supergloss	A4	135 gsm	Gloss	Coated 1	<ul style="list-style-type: none"> Manually feed one sheet at a time, using Tray 5. Set the output destination to other than [Center Tray - Upper] ([Center Tray] when a finisher is installed).
	A4, A3	160 gsm	Gloss	Coated 1	<ul style="list-style-type: none"> Manually feed one sheet at a time, using Tray 5. Set the output destination to other than [Center Tray - Upper] ([Center Tray] when a finisher is installed).
	A4, A3, SRA3	210 gsm	Heavyweight Gloss	Coated 2	<ul style="list-style-type: none"> Manually feed one sheet at a time, using Tray 5. Automatic duplexing is not available. Set the output destination to other than [Center Tray - Upper] ([Center Tray] when a finisher is installed).
Xerox Dura Paper Labels	A4	-	Label	HW 2A	<ul style="list-style-type: none"> Load the paper into Tray 1 or Tray 5. Duplexing is not available.
XeroxColotech Supergloss Labels	A4, SRA3	-	Heavyweight Gloss	Coated 2	<ul style="list-style-type: none"> Manually feed one sheet at a time, using Tray 5. Duplexing is not available. Set the output destination to other than [Center Tray - Upper] ([Center Tray] when a finisher is installed).
Xerox Colotech Super Gloss CD Labels	A4	-	Heavyweight Gloss	Coated 2	<ul style="list-style-type: none"> Manually feed one sheet at a time, using Tray 5. Duplexing is not available. Set the output destination to other than [Center Tray - Upper] ([Center Tray] when a finisher is installed).
Xerox Colour Laser Matte CD Labels, Combi Box	A4	-	Heavyweight	-	<ul style="list-style-type: none"> Manually feed one sheet at a time, using Tray 5. Duplexing is not available.
Xerox DocuPac Folders High Gloss White	A4+	210 gsm	Heavyweight Gloss	-	<ul style="list-style-type: none"> Manually feed one sheet at a time, using Tray 5. Duplexing is not available.
Xerox DocuPac Folders Matte White	A4+	180 gsm	Extra Heavyweight	-	<ul style="list-style-type: none"> Manually feed one sheet at a time, using Tray 5. Duplexing is not available.
Xerox Digital EA Color Transfer paper	A4, A3	-	Heavyweight	-	<ul style="list-style-type: none"> Load the paper into Tray 5. Duplexing is not available.

Paper Name	Size	Basis Weight	Paper Type *1	Image Quality *2	Notes / Countermeasure
Envelopes	9 x 6.4", 8.7 x 4.3"	75 - 90 gsm	Envelope	-	<ul style="list-style-type: none"> • Load the paper into Tray 5. • Duplexing is not available. • Wrinkles with certain brands and types are possible. If wrinkles are encountered, try a different brand or type.

*1 : Select the paper type setting for the paper loaded on a tray. For more information, refer to "Changing the Paper Settings" (P.244).

*2 : Most ideal image quality with the paper can be obtained by setting the image quality for each type of paper. For more information on the settings, refer to "Image Quality" (P.324).

Note

- "High temperature and humidity conditions" in the above table means an environment with temperature of 28 °C and humidity of 85%, and "low temperature and humidity conditions" means an environment with temperature of 10 °C and humidity of 15%.

Unusable Paper

Using paper and transparencies not recommended by Dell may cause a paper jam or machine malfunction. Use paper and transparencies recommended by Dell.

- Transparencies
- Damp or wet paper
- Paper pre-printed with another printer or copying machine
- Wrinkled, creased, or ripped paper
- Envelopes that are not flat, or that have clasps
- Color paper with surface treatments
- Paper with rough surface, such as pulp paper or fibrous paper
- Symphony (Pastel Pink etc.) A4 80 gsm

Storing and Handling Paper

Please keep the following points in mind when storing paper

- Store paper inside a cabinet or other dry place. Paper that has absorbed moisture can result in paper jams and lower image quality.
- After opening a package of paper, wrap and store any remaining paper. We recommend that you store remaining paper in moisture prevention packets.
- Store paper on a flat surface to prevent bends or warping.

Please adhere to the following points when loading paper in a tray

- Align the stack of paper neatly before setting it in a tray.
- Do not use paper that is creased or wrinkled.
- Do not use warped or curled paper.
- Do not load paper of mixed sizes together into a tray.
- Carefully fan transparencies and labels before use. Otherwise, the paper may stick together, resulting in paper jams, or multiple sheets being fed to the machine simultaneously.
- When continuously outputting on transparencies, transparency sheets may stick together. After printing 20 or more sheets, remove them from the output tray and fan them to cool them down.

Loading Paper

This section describes how to load paper.

Types of paper loaded in trays

The machine automatically detects the size and orientation of loaded paper in a tray, but not a paper type. Normally, each tray is set to plain paper. When loading paper other than plain paper, you must change the paper type setting. You can name paper types and can set up to five paper types as user-defined paper.

For information on changing the paper type settings, refer to "Changing the Paper Settings" (P.244).

Automatic Tray Selection

If you set paper source on the [Paper/Output] tab to [Paper Tray] in the PCL print driver's screen when printing, the machine automatically selects the paper tray according to the size and orientation of the document to be printed. This is called the Automatic Tray Selection.

When copying, selecting [Auto Select] for [Paper Supply] enables automatic tray selection. If the machine detects two or more corresponding trays for the automatic tray selection, the machine selects the tray with the highest priority specified in [Paper Type Priority] among the trays set under [Paper Type]. Trays whose [Paper Type Priority] setting is set to [Auto Paper Off] are ignored in automatic tray selection. Also, if the [Paper Type Priority] settings are identical, the tray priority is determined by [Paper Tray Priority].

- Note**
- Some trays may not be selected in automatic tray selection depending on the setting of that tray for [Auto Paper Select]. For more information, refer to "Change Settings" (P.322).
 - Tray 5 cannot be selected in automatic tray selection.
 - When the paper runs out during copying or printing, select a tray containing the same sized paper and orientation, and the machine continues copying or printing (Auto Tray Switching feature). The machine cannot switch to a tray containing a paper type for which [Paper Type Priority] is set to [Auto Paper Off].

For information about [Paper Type], [Paper Type Priority], and [Paper Tray Priority] settings, and the paper substitute feature, refer to "Paper Tray Settings" (P.321). You can also set these settings from Dell Printer Configuration Web Tool.

Adding paper

When the machine runs out of paper during copying or printing, a message appears on the touch screen. Add paper according to the message instructions. Copying or printing automatically resumes when paper is added.

- Note**
- Carefully fan the paper before loading it in a tray. Otherwise, the paper may stick together, resulting in paper jams, or multiple sheets being fed to the machine simultaneously.

Loading Paper in Trays 1 to 4

The following describes the procedures to load paper in Trays 1 to 4.

When the machine runs out of paper during copying or printing, a message appears on the touch screen. Add paper according to the message instructions. Copying or printing automatically resumes when paper is added.

- Note**
- Carefully fan the paper before loading it in a tray. Otherwise, the paper may stick together, resulting in paper jams.

For information on changing the paper size and orientation, refer to "Changing the Paper Size for Trays 1 to 4" (P.241).

1 Pull out the tray until it stops.

- Note**
- While the machine is processing a job, do not pull out the tray that is being used for the job.
 - To prevent paper jams or erroneous detection of loaded paper in a tray by the machine, do not add paper on top of any remaining paper in the tray. Remove any remaining paper in the tray, and then load that paper on top of the newly loaded paper.

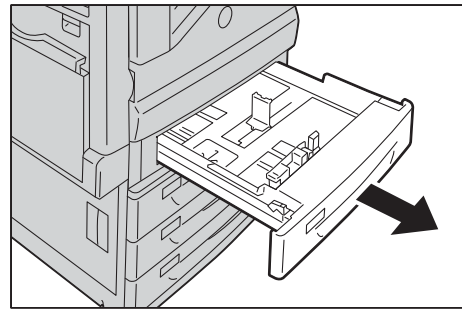

- Do not pull out all the trays at the same time. Otherwise, the machine gets inclined and turns over, which may cause injuries.

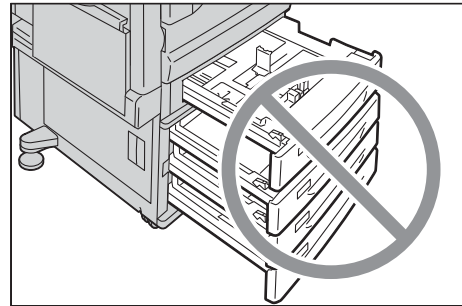

2 Load and align the edge of the paper against the left edge of the tray, with the side to be copied or printed on facing up.

- Note**
- Do not load paper above the maximum fill line ("MAX" in the right figure). It may cause paper jams or machine malfunction.
 - Do not place any paper or objects in the empty space on the right side of Trays 1 to 4. It may cause paper jams or machine malfunction.

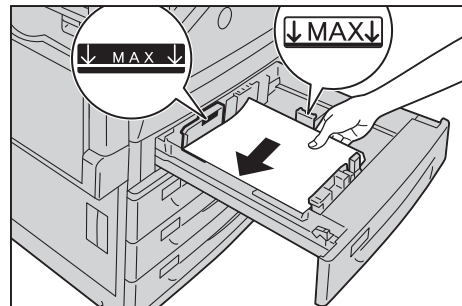

3 Push the tray in gently until it stops.

- Note**
- When inserting the tray, push it gently. Forcibly pushing the tray in may cause machine malfunction.

Loading Paper in Tray 5 (Bypass Tray)

When printing or copying on a size or type of paper that cannot be set in Trays 1 to 4, use Tray 5 (bypass tray). The following describes the procedures to load paper in Tray 5. To use Tray 5 when printing, select Tray 5 and specify the paper type on the [Paper/Output] tab of the print driver.

- Note**
- To prevent paper jams and erroneous detection of paper loaded in the tray by the machine, do not take out paper of a package until the tray runs out of paper.
 - Carefully fan the paper before loading it in a tray. Otherwise, the paper may stick together, resulting in paper jams, or multiple sheets being fed to the machine simultaneously.

1 Open Tray 5.

- Note**
- If necessary, pull out the extension tray. The extension tray can be extended in two stages. Pull out the extension tray gently.

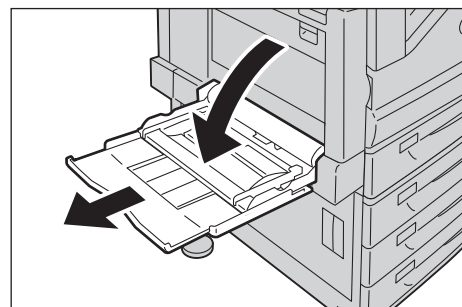

- 2 Load paper with the side to be copied or printed on facing down, inserting the paper until its edge lightly touches against the paper feed entrance.

- Note**
- Do not load mixed paper types into the tray.
 - Do not load paper above the maximum fill line. It may cause paper jams or machine malfunction.
 - Depending on the type of the heavyweight paper, paper may not be fed to the machine or image quality may deteriorate.

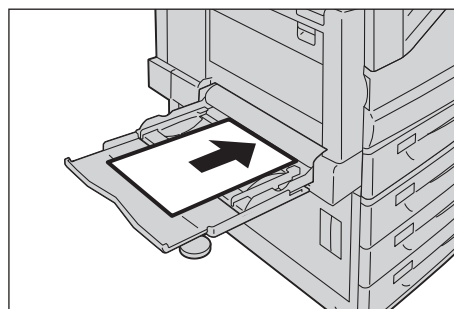

- 3 Adjust the paper guides to align the edges of the paper loaded.

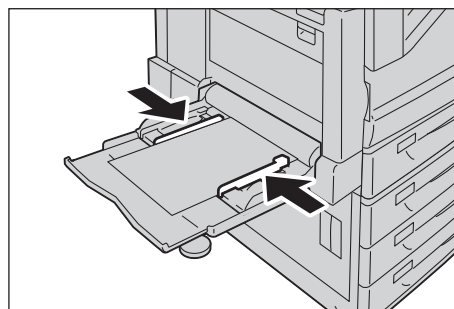

- 4 Instruct a copy or print job.

Loading Paper in Tray 6 (HCF B1)

The following describes the procedure for loading paper into Tray 6 (HCF B1).

When the machine runs out of paper during copying or printing, a message is displayed on the touch screen. Add paper according to the displayed instructions. Copying or printing is automatically resumed when paper is added.

- Note**
- Carefully fan the paper before loading it in a tray. Otherwise, the paper may stick together, resulting in paper jams.

For information on changing the paper size and orientation, refer to "Changing the Paper Size" (P.241).

- 1 Pull out Tray 6 until it stops.

- Note**
- While the machine is processing a job, do not pull out the tray that is being used for the job.
 - To prevent paper jams or erroneous detection of loaded paper in a tray by the machine, do not add paper on top of any remaining paper in the tray.

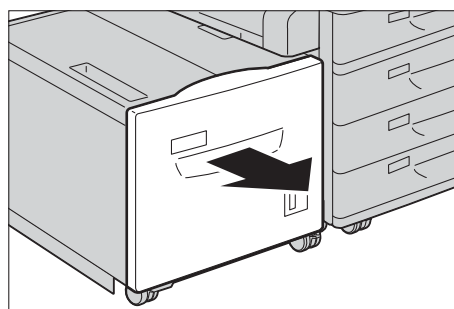

- 2 Load and align the edge of the paper against the right edge of the tray with the side to be copied or printed on facing down.

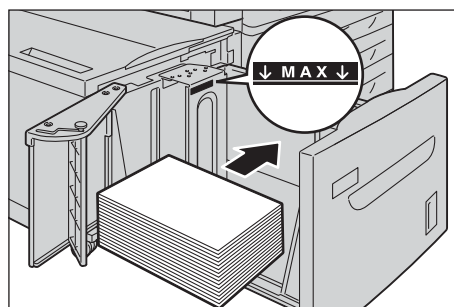

- Note**
- Do not load paper above the maximum fill line ("MAX" in the right figure). It may cause paper jams or machine malfunction.

3 Push the tray in gently until it stops.

Changing the Paper Size

This section describes how to change the paper size in Trays 1 to 4, and 6.

- Note**
- The types of paper in Trays 1 to 4, and 6 are preset. Normally, Trays 1 to 4 are set to plain paper. When changing to a different paper type, change the paper quality settings to match the type of paper to be loaded so that you can maintain high quality printing.
For more information on paper type settings, refer to "Changing the Paper Settings" (P.244).
 - Non-standard size paper can be loaded in Trays 1 to 4. When loading non-standard size paper, you must register the paper size. For information on registering paper sizes, refer to "Paper Size" (P.322).

For more information on corresponding paper sizes, refer to "Paper Size Settings" (P.335).

For more information on how to copy on non-standard size paper, refer to "Paper Supply (Selecting the Paper for Copying)" (P.69). For more information on how to print on non-standard size paper, refer to the help of the print driver.

- Note**
- Do not load paper of mixed sizes together into a tray.

Changing the Paper Size for Trays 1 to 4

The following describes how to change paper size in Trays 1 to 4.

- Note**
- The types of paper in Trays 1 to 4 are preset. There are 16 paper types: Plain paper, Bond paper, Recycled paper, Transparency, Heavyweight paper, Gloss, Labels, Punched, Letterhead, Pre-Print, Other, and Custom paper 1 to 5, and normally, plain paper is set. When changing to a different paper type, change the paper quality settings to match the type of paper to be loaded so that you can maintain high quality printing.
For more information on paper type settings, refer to "Changing the Paper Settings" (P.244).
 - When loading non-standard size paper, you must register the paper size. For information on registering paper sizes, refer to "Paper Tray Attributes" (P.322).

For more information on how to copy on non-standard size paper, refer to "Paper Supply (Selecting the Paper for Copying)" (P.69). For more information on how to print on non-standard size paper, refer to the help of the print driver.

- 1 Pull out the Tray until it stops.

- Note**
- While the machine is processing a job, do not pull out the tray that is being used for the job.
 - To prevent paper jams or erroneous detection of loaded paper in a tray by the machine, do not add paper on top of any remaining paper in the tray.

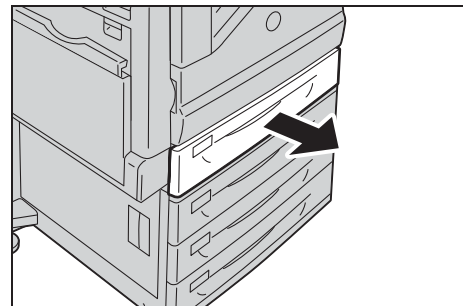

- 2 Remove any paper loaded in the tray.

- 3 While pinching the two paper guides, move them to the edges of the paper.

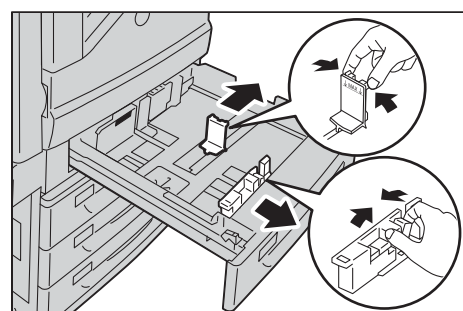

- 4 Load and align the edge of the paper against the left side of the tray, with the side to be copied or printed on facing up.

Note

- Do not load paper above the maximum fill line ("MAX" in the right figure).

- 5 Push the tray in gently until it stops.

Note

- When inserting the tray, push it gently. Forcibly pushing the tray in may cause machine malfunction.
- Affix the paper size label to the front of the paper tray.

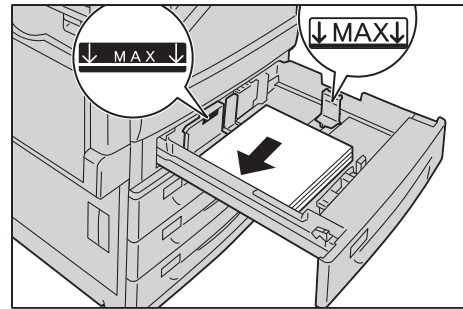

For more information on paper type settings, refer to "Changing the Paper Settings" (P.244).

Changing the Paper Size for Tray 6 (HCF B1) (optional)

The following describes how to change paper size in Tray 6 (HCF B1) (optional).

- 1 Pull out the Tray 6 until it stops.

Note

- While the machine is processing a job, do not pull out the tray that is being used for the job.
- To prevent paper jams or erroneous detection of loaded paper in a tray by the machine, do not add paper on top of any remaining paper in the tray.

- 2 Remove any paper loaded in the tray.

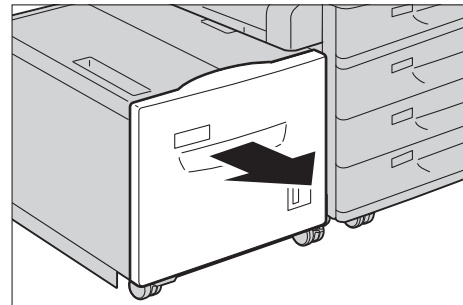

- 3 Open the end guide (1) and unscrew the screw (2). And then remove the guide from the tray.

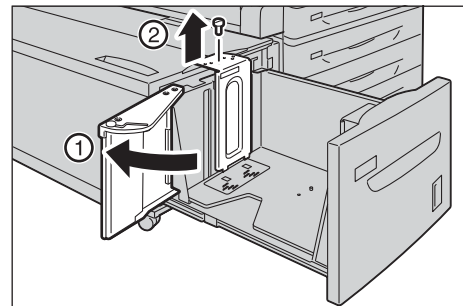

- 4 Insert the small protrusions at the bottom of the guide into the holes corresponding to the paper size (1). Insert the protrusion on the tray into a hole corresponding to the paper size on the top of the guide, and tighten up the screw (2).

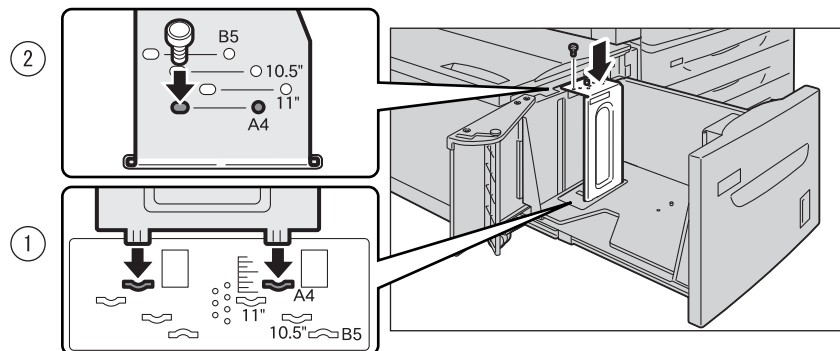

- 5 Unscrew the screw of the front guide and remove the guide from the tray.

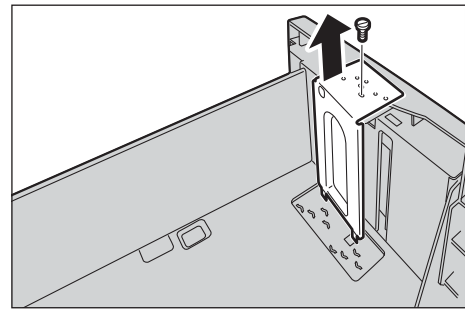

- 6 Insert the small protrusions at the bottom of the guide into the holes corresponding to the paper size (1). Insert the protrusion on the tray into a hole corresponding to the paper size on the top of the guide, and tighten up the screw (2).

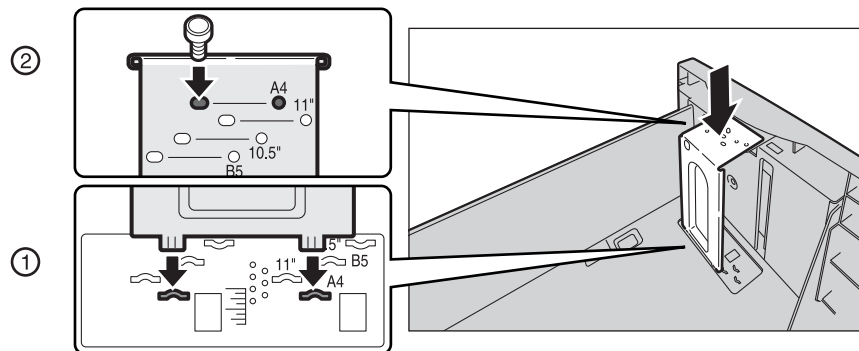

- 7 Pull up the lever of the end guide (1). Move the lever along the slot, and set it at the position corresponding to the paper size (2). And then press the lever down (3).

- Note**
- Adjust the end guide correctly to the size of the paper. If the end guide is not adjusted correctly, the machine cannot feed the paper properly, resulting in paper jams.
 - The slot to the left of 8.5" is not used.

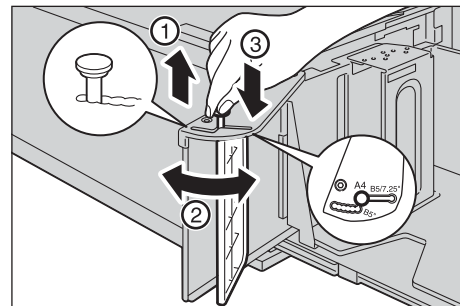

- 8 Open the end guide (1), and load and align the edge of the paper against the right edge of the tray with the side to be copied or printed on facing down (2).

- Note**
- Do not load paper above the maximum fill line ("MAX" in the right figure). It may cause paper jams or machine malfunction.

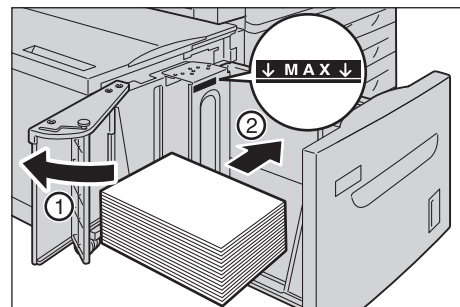

- 9 Close the end guide securely.

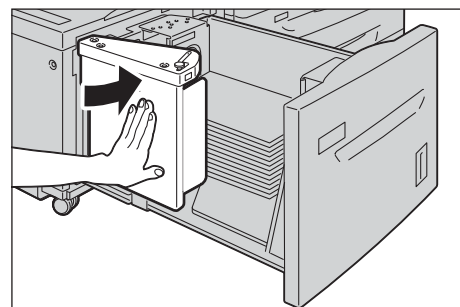

- 10 Push the tray in gently until it stops.

Changing the Paper Settings

This section describes how to change the paper type for Trays and how to set image quality processing by the individual paper type.

After loading paper in a tray, specify the type of paper loaded and select image quality for the paper type. Setting image quality for each paper type enables you to print with the most suitable image quality for the paper type.

For information on image quality processing for each paper type, refer to "Image Quality" (P.324).

- Note**
- Users can name Custom 1 to Custom 5 displayed in the paper type settings. For information on how to set names to Custom 1 to Custom 5, refer to "Custom Paper Name/Color" (P.321).
 - You can change the paper type setting without entering to the System Administration mode on the [Setup] screen, which is displayed by selecting [Setup] in the [Home] screen if you configure the settings in advance. For more information, refer to "Customize Paper Supply Screen" (P.322).

- 1 Press the <Log In/Out> button.

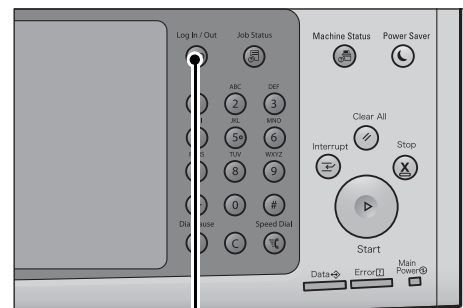

<Log In/Out> button

- 2 Enter the system administrator's user ID with the numeric keypad or the keyboard displayed on the screen, and select [Enter].

When a passcode is required, select [Next] and enter the system administrator's passcode, and select [Enter].

- Note**
- The default user ID is "admin".
 - The default passcode is "1111".

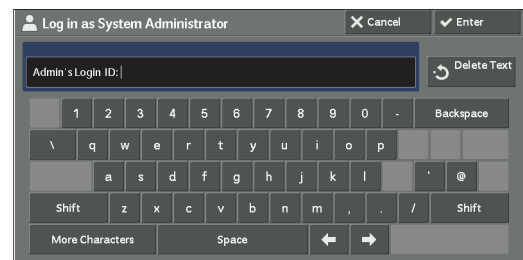

- 3 Select [Tools] on the [Home] screen.

- Note**
- When the [Home] screen is not displayed on the touch screen, press the <Home> button.

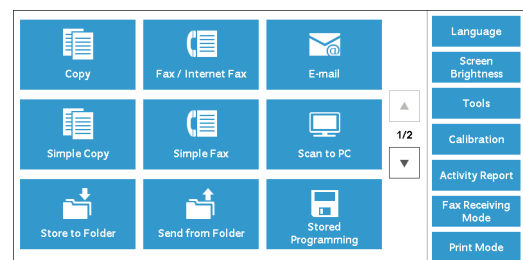

- 4 Select [System Settings] > [Common Service Settings] > [Paper Tray Settings].

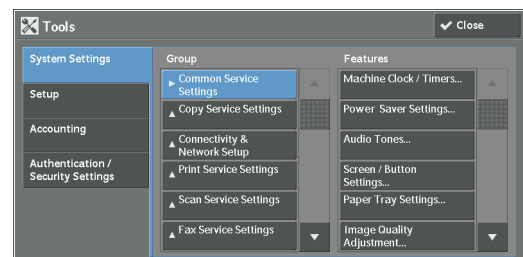

5 Select [Paper Tray Attributes].



6 Select a paper tray for changing the paper type setting under [Items].

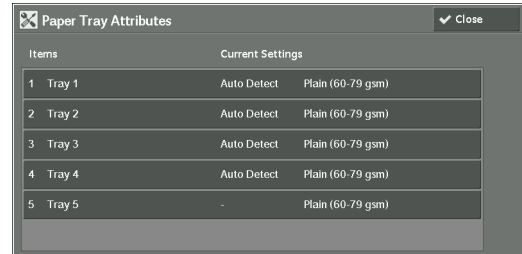

7 Select [Change Settings].

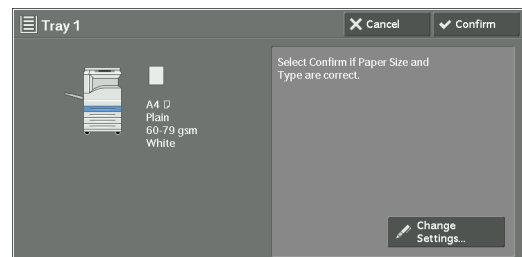

8 Select the [Paper Type], [Paper Size], [Paper Color], and [Auto Paper Select] respectively.

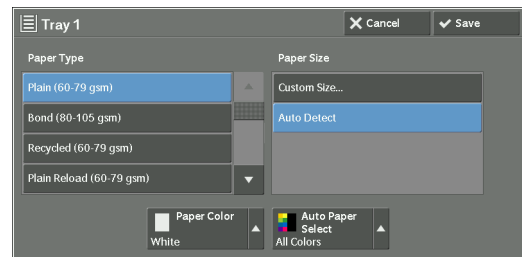

9 Select [Save], [Confirm], or [Close] repeatedly until the [Paper Tray Settings] screen is displayed.

10 Select [Image Quality].

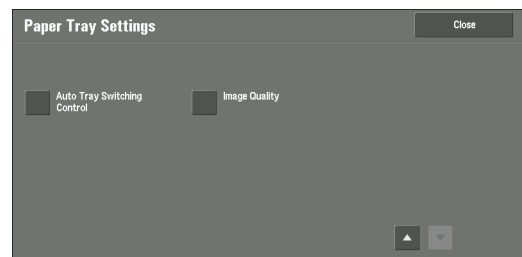

11 Select the paper type for changing the image quality settings under [Items], and then select [Change Settings].

Note • Select [▲] to display the previous screen or [▼] to display the next screen.

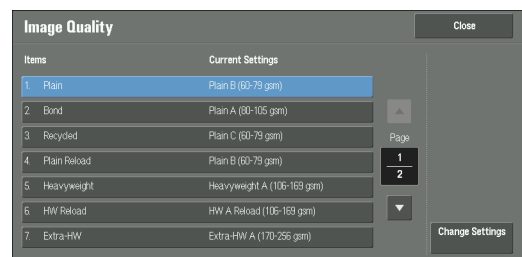

- 12** Select the image quality, and then select [Save].



- 13** Make sure that the paper type you selected is displayed under [Current Settings] of [Items], and then select [Close].
- 14** Select [Close] repeatedly until the [Tools] screen is displayed.
- 15** Select [Close].

13 Maintenance

This chapter describes how to replace consumables, clean the machine, calibrate colors, print a report/list, and delete a print job with an invalid User ID.

- **Replacing Consumables.....248**
- **Cleaning the Machine260**
- **Executing Calibration.....265**
- **Printing a Report/List.....269**
- **Deleting a Private Charge Print Job with an Invalid User ID270**
- **Setting Restore Tool.....271**

Replacing Consumables

Use the supplies recommended by Dell. Visit the Dell Printer Supplies website at dell.com/supplies, or order Dell Printer Supplies by phone.

Handling consumables/periodic replacement parts

- Do not store boxes of consumables/periodic replacement parts upright.
- Do not unpack consumables/periodic replacement parts before use. Avoid storing consumables/periodic replacement parts in the following locations:
 - In high temperature and humid locations
 - Near heat-generating devices
 - Areas exposed to direct sunlight
 - Dusty areas
- When using consumables/periodic replacement parts, carefully read precautions for use. Precautions for use are instructed on their bodies or packages, or a precaution sheet is included in their packages.
- We recommend always keeping spare consumables/periodic replacement parts in stock.
- When calling customer support to order consumables/periodical replacement parts, have your Dell printer Service Tag available.
- The use of consumables/periodic replacement parts not recommended by Dell could impair machine quality and performance. Use only consumables/periodic replacement parts recommended by Dell.

Checking the status of consumables

You can check the status of consumables on the [Supplies] screen.
For information on consumables, refer to "Supplies" (P.290).

The following shows the reference section for each procedure.

Replacing Toner Cartridges.....	248
Replacing Waste Toner Container R5.....	250
Replacing Drum Cartridges R1, R2, R3, or R4.....	253
Replacing Staple Cartridge (for Finisher-B1).....	256
Replacing Booklet Staple Cartridge (for Booklet Maker Unit for Finisher-B1).....	258
Emptying the Hole Punch Waste Container (for Finisher-B1).....	259

Replacing Toner Cartridges

The following messages are displayed on the touch screen depending on the amount of toner remaining. Replace the toner cartridge according to the message.

Message*1	Remaining Page Yield*2	Solution
Please order a Yellow Toner [Y] Cartridge.	Black: Approx. 3,500 pages Other than Black: Approx. 2,500 pages	You do not need to replace the Toner Cartridge immediately. Order the Toner Cartridge displayed on the screen.
Yellow Toner [Y] Cartridge needs to be replaced soon.	Approx. 40 pages	Replace the toner cartridge with a new one.

Message*1	Remaining Page Yield*2	Solution
Yellow Toner [Y] Cartridge needs to be replaced.	-	The machine will stop. Replace the toner cartridge with a new one.

*1 :The messages in the above table apply to Yellow Toner. "Yellow Toner [Y]" shown in the messages varies depending on the color and number of the applicable toner.

*2 :The remaining page yield for copy/print jobs is applicable when A4 paper LEF () is used. The value is an estimate and varies depending on the conditions such as the content printed, dot coverage (area coverage), paper size, paper type, copy/print density, output image type, and the machine operating environment.

- Note**
- When replacing a toner cartridge, toner may spill and soil the floor. We recommend laying paper on the floor beforehand.
 - The use of toner cartridges not recommended by Dell may degrade image quality and performance. Use only toner cartridges recommended by Dell.
 - When the remaining amount of toner is low, the machine may stop printing and display a message. If this occurs, replace the toner cartridge to resume copying or printing.
 - Replace toner cartridges while the machine is on.
 - Copy or print density may decrease slightly after the message "Please order a XXX Toner Cartridge" appears on the touch screen.
 - If you replace a toner cartridge with a partially used toner cartridge, the number of pages that you can copy or print after the message "Please order a XXX Toner Cartridge" is displayed may differ significantly from the values described in the above table.

1 Make sure that the machine is not operating, and open the front cover.

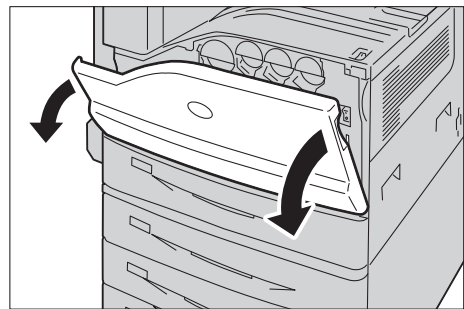

2 Put your hand under the dent of the toner cartridge indicated in the message, and slightly lift up the cartridge.

- Note**
- "Y", "M", "C", or "K" indicates Yellow, Magenta, Cyan, and Black, respectively.

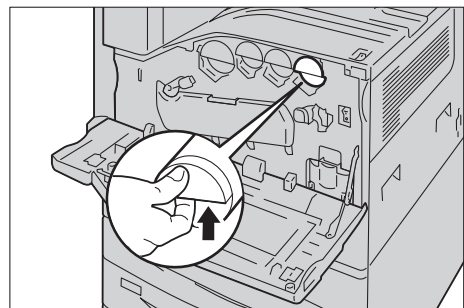

3 Pull out the toner cartridge slowly, and slide it out.

- Note**
- Slide out the toner cartridge gently. Otherwise, toner may spill from the cartridge.

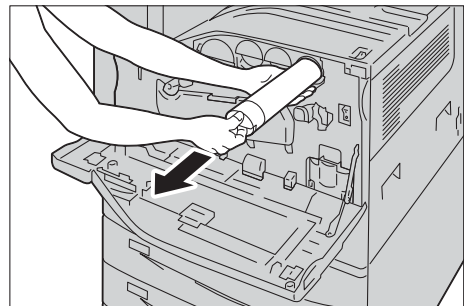

- 4 Take the new toner cartridge of the same color out of the box, and shake the cartridge up and down and left and right for ten times.

Note • Do not touch the shutter part.

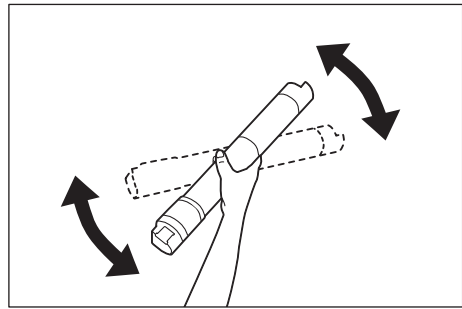

- 5 Hold the cartridge with the arrow facing up, and push the cartridge in slowly until it stops.

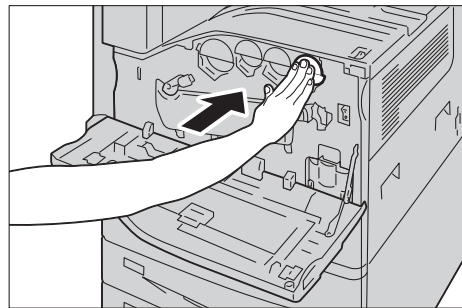
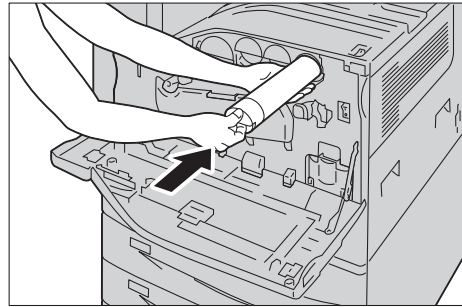

- 6 Close the front cover.

Note • If the front cover is not closed completely, a message appears and the machine will remain paused.

Replacing Waste Toner Container R5

The waste toner container holds used toner. The following messages are displayed on the touch screen according to the status of the waste toner container. Follow the messages as necessary.

Message	Remaining Page Yield*	Solution
Please order a Waste Toner Container.	Approx. 1,200 pages	Order the waste toner container.
The Waste Toner Container needs to be replaced.	-	The machine will stop. Replace the waste toner container with a new one.

*: The remaining page yield for copy/print jobs is applicable when A4 paper LEF (☐) is used. The value is an estimate and varies depending on the conditions such as the content printed, dot coverage (area coverage), paper size, paper type, copy/print density, output image type, and machine operating environment.

When replacing the waste toner container, clean the LED printhead with the supplied cleaning bar to prevent inconsistencies in density or color in copies and prints.

- Note**
- Do not touch the five gray-colored sponge parts on the back side of the waste toner container. Otherwise, your hands may get dirty with toner.
 - When replacing the waste toner container, toner may spill and soil the floor. We recommend laying paper on the floor beforehand.
 - The proper disposal of used waste toner containers is required.
 - The use of waste toner containers not recommended by Dell may degrade image quality and performance. Use only waste toner containers recommended by Dell.

1 Make sure that the machine is not operating, and open the front cover.

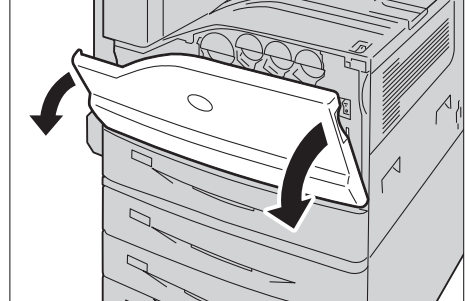

2 Pull out the waste toner container slowly while holding its left side with one hand.

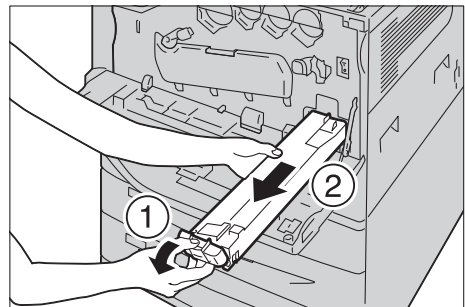

3 Prepare a new waste toner container out of a box.

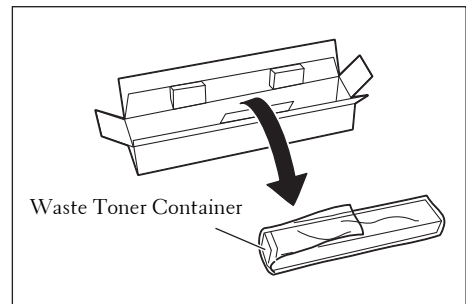

4 While holding the left side of the waste toner container, push the container in until it clicks.

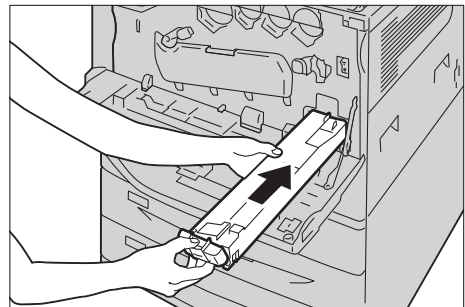

5 Insert the used waste toner container into the supplied plastic bag and then seal it firmly with the zipper.

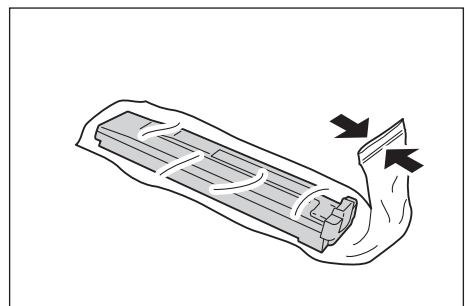

- 6 Carefully place the old waste toner container into the empty box with both hands.

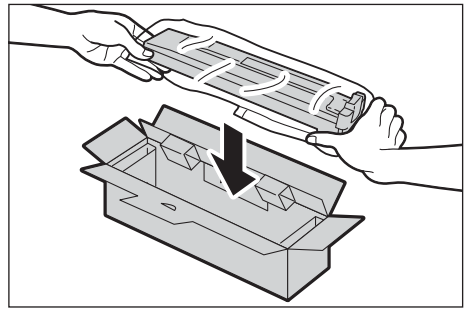

- 7 Rotate the release lever of the drum cartridge cover counterclockwise.

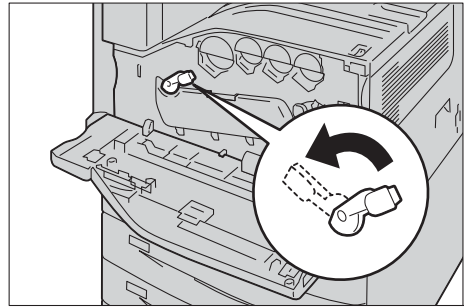

- 8 Lower the cover.

Note • You can now see the drum cartridge.

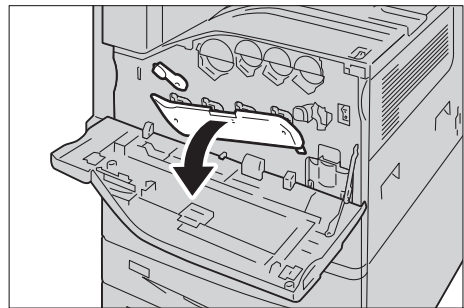

- 9 Slowly slide out the cleaning bar housed within the LED printhead until it stops. The cleaning bars are located in the cleaning connection just under the drum cartridges R1, R2, R3, and R4.

Note • Slide out the cleaning bar until you see "●●●".
• Do not remove the cleaning bar from the housing.

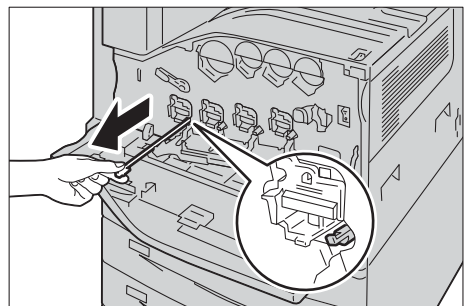

- 10 Slowly slide the cleaning bar back into place.

Note • Clean the four LED printheads R1 to R4 by sliding the cleaning bar back and forth for two or three times respectively.

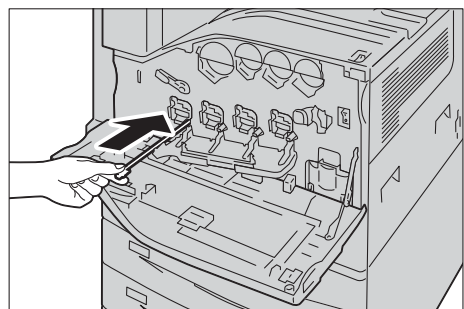

11 Return the cover to the original position.

Note • Push the cover until it clicks into place.

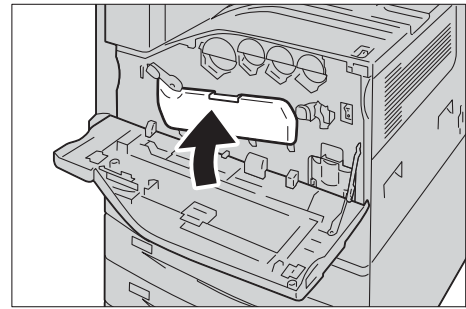

12 Rotate the release lever clockwise to lock the cover.

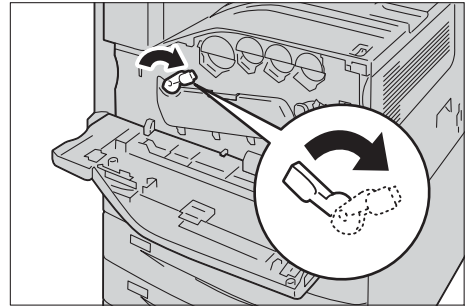

13 Close the front cover.

Note • If the front cover is not closed completely, a message appears and the machine will remain paused.

Replacing Drum Cartridges R1, R2, R3, or R4

The machine displays the following messages when a drum cartridge R1, R2, R3 or R4 needs to be replaced. When the message is displayed, contact Customer Support at dell.com/contactdell.

If you continue to copy or print without replacing the drum cartridge after the message is displayed on the touch screen, the machine will stop after copying or printing the number of pages shown in the following table.

Message	Remaining Page yield	Solution
Please order a Drum Cartridge RX.	Black: Approx. 3,000 pages Other than Black: Approx. 3,000 pages	You do not need to replace the Drum Cartridge immediately. Order the Drum Cartridge displayed on the screen.
Drum Cartridge needs to be replaced.	-	Replace the drum cartridge with a new one.

- Note**
- The use of drum cartridges not recommended by Dell may degrade image quality and performance. Use only drum cartridges recommended by Dell.
 - Do not expose drum cartridges to direct sunlight or strong light from indoor fluorescent lighting. Do not touch or scratch the surface of the drum. Doing so may result in unsatisfactory printing.
 - The remaining page yield is applicable when A4 paper LEF () is used. The value is an estimate and varies depending on the conditions such as the paper size, the paper orientation, the number of pages continuously print, and the machine operating environment.
 - Images output from the machine may get dirty after the message "Please order a Drum Cartridge XXX RX" appears on the touch screen.

- 1 Make sure that the machine is not operating, and open the front cover.

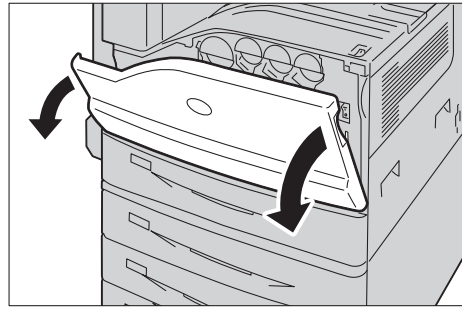

- 2 Rotate the release lever of the drum cartridge cover counterclockwise.

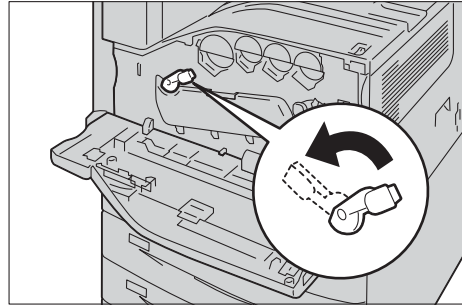

- 3 Lower the cover.

Note • The drum cartridge is unlocked.

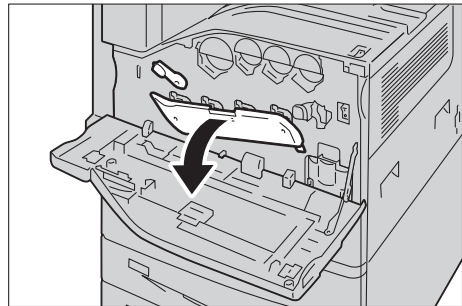

- 4 Grasp the handle of the drum cartridge R1, R2, R3, or R4 indicated in the message and gently slide out the cartridge.

Note

- When removing the drum cartridge, be careful not to drop it on the floor.
- The illustrations in this section explain how to replace the drum cartridge R1, as an example.

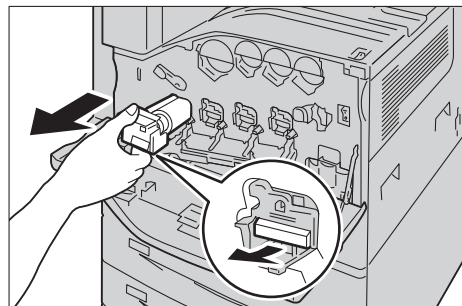

- 5 Hold the bottom of the drum cartridge as shown in the illustration, and pull it out from the machine.

Note • Be careful not to touch the toner attached to the cartridge.

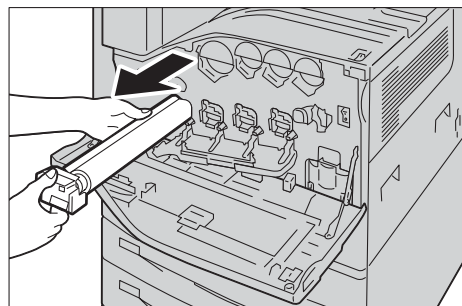

- 6 Take the new drum cartridge out of the box, and insert the used drum cartridge into the supplied plastic bag and place it into the box.

Note • Do not place the new drum cartridge in an upright position.

- 7 Insert the front two points of the new drum cartridge with protective cover in the holes on the machine.

Note • Insert the two points as shown in the illustration on the right.

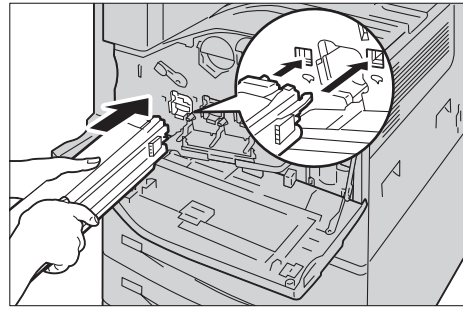

- 8 Pull out the black paper while holding the protective cover with one hand. While doing so, keep the two points inserted in the holes.

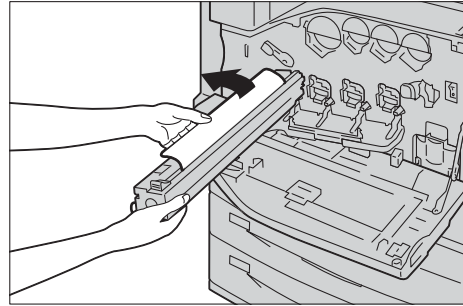

- 9 Grasp the tab on top of the cartridge and slide it toward the machine while holding the protective cover with one hand.

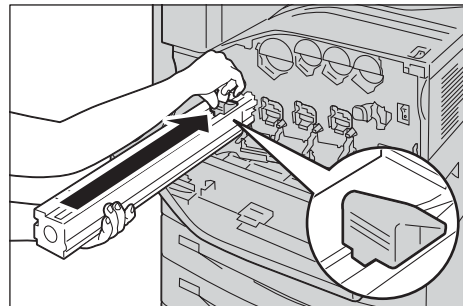

- 10 Slide the tab until it stops.

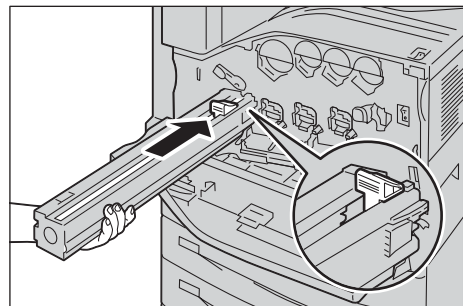

- 11 Carefully remove the protective cover.

- 12 Push the drum cartridge straight in the housing until it stops.

Note • Place the protective cover into the box.

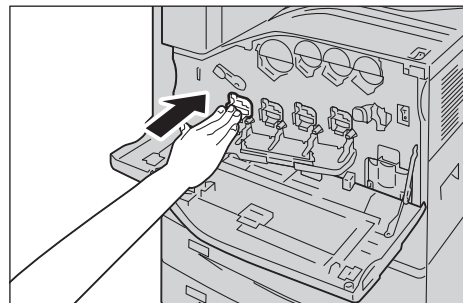

13 Return the cover to the original position.

Note • Push the cover until it clicks into place.

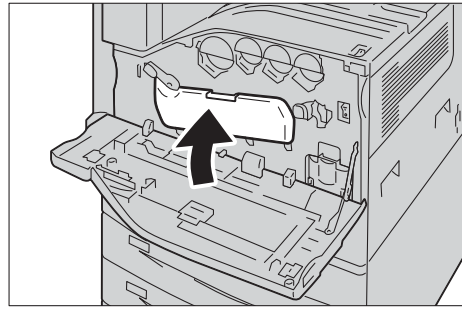

14 Rotate the release lever clockwise to lock the cover.

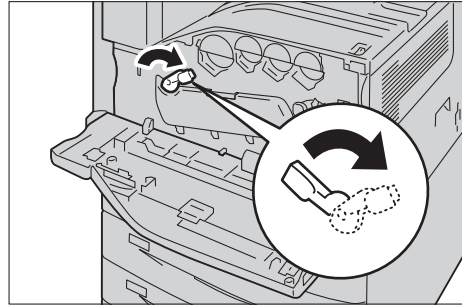

15 Close the front cover.

Note • If the front cover is not closed completely, a message appears and the machine will remain paused.

Replacing Staple Cartridge (for Finisher-B1)

When the optional Finisher-B1 is installed and the staple cartridge needs to be replaced, a message appears on the touch screen. When the message appears, load a new staple case into the staple cartridge.

Note • The use of staple cartridges not recommended by Dell may degrade quality and performance. Use only staple cartridges recommended by Dell.

1 Make sure that the machine is not operating, and open the finisher front cover.

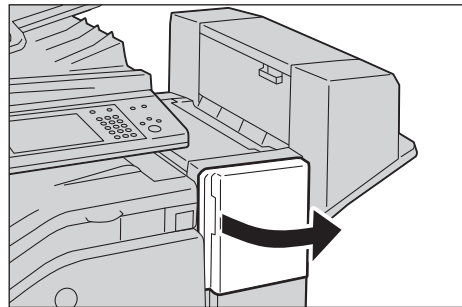

2 Grasp the handle and pull out the staple cartridge holder to the right, towards you.

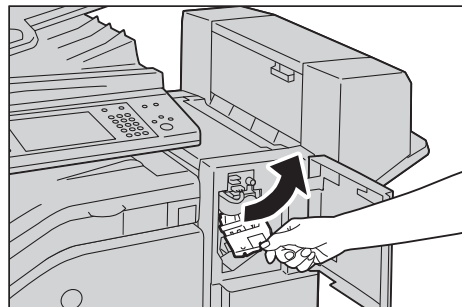

3 Take the staple cartridge out of the finisher.

Note • The staple cartridge is firmly inserted. A slight force is required to pull the cartridge out of the finisher.

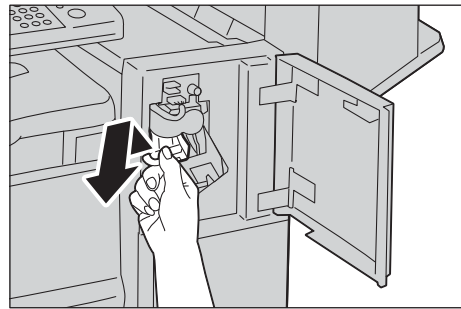

4 Pinch both sides of the empty staple case with your fingers (1), and remove the staple case from the cartridge (2).

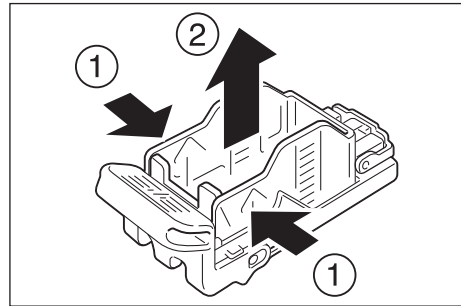

5 Insert the front side of the new staple case into the staple cartridge (1), and then push the rear side into the cartridge (2).

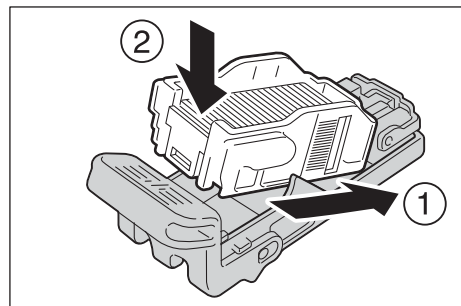

6 Push the staple cartridge into the finisher until it clicks into place.

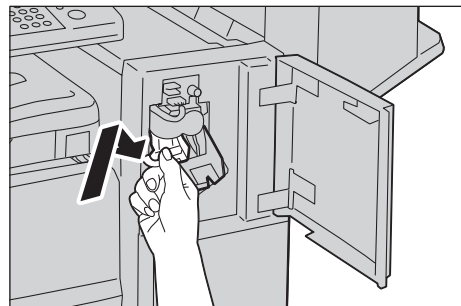

7 Close the finisher front cover.

Note • If the front cover is not closed completely, a message appears and the machine will remain paused.

Replacing Booklet Staple Cartridge (for Booklet Maker Unit for Finisher-B1)

When the optional Booklet Maker Unit for Finisher-B1 is installed and the booklet staple cartridges need to be replaced, a message appears on the touch screen. When the message appears, replace the booklet staple cartridges with new ones.

Note • The use of booklet staple cartridges not recommended by Dell may degrade quality and performance. Use only booklet staple cartridges recommended by Dell.

- 1 Make sure that the machine is not operating, and open the finisher side cover.

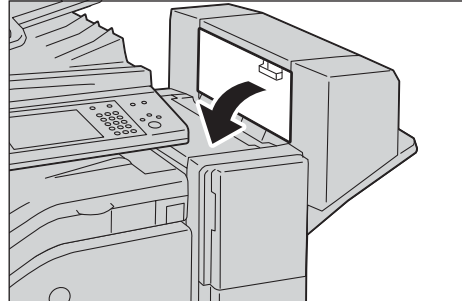

- 2 Hold the tabs on both sides of the booklet staple cartridge and pull it out.

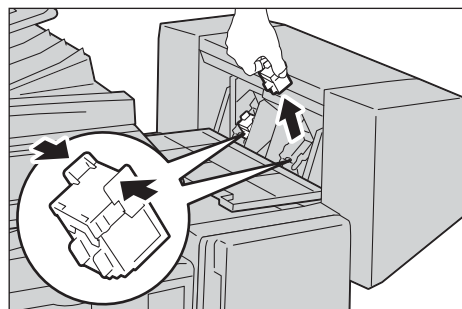

- 3 Hold the tabs on both sides of a new booklet staple cartridge, and insert it into the finisher until it clicks.

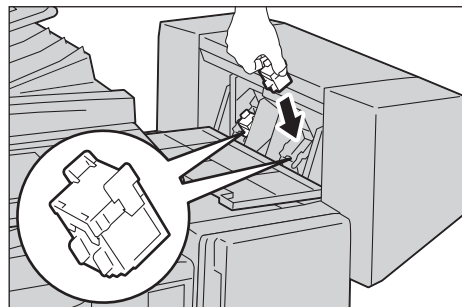

- 4 Do the same for the booklet staple cartridge on the other side.
- 5 Close the finisher side cover.

Note • If the cover is not closed completely, a message appears and the machine will remain paused.

Emptying the Hole Punch Waste Container (for Finisher-B1)

When the optional Finisher-B1 is installed and the hole punch waste container becomes full, a message appears on the touch screen. When the message appears, empty the hole punch waste container as instructed.

Make sure to discard all paper chads when emptying the hole punch waste container. Not doing so will cause the container to fill up before the message telling you to empty the container appears again, and this can cause machine malfunction.

Note • Empty the hole punch waste container when the machine is on. If you empty the container while the machine is off, the machine does not recognize that the container has been emptied.

- 1 Make sure that the machine is not operating, lift the top transport cover, and then open the front transport cover of the finisher.

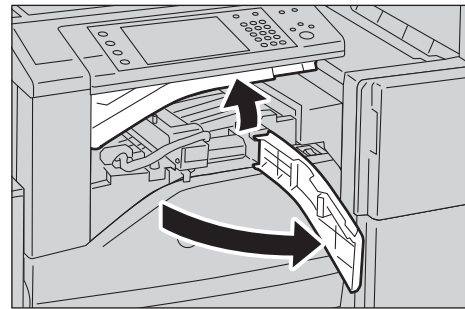

- 2 Pull out the hole punch waste container.

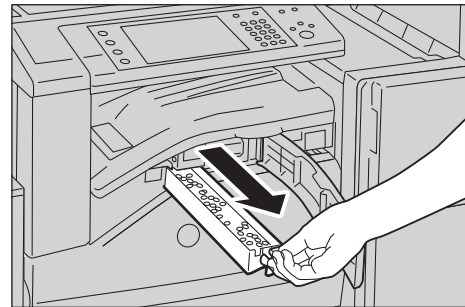

- 3 Empty the container.

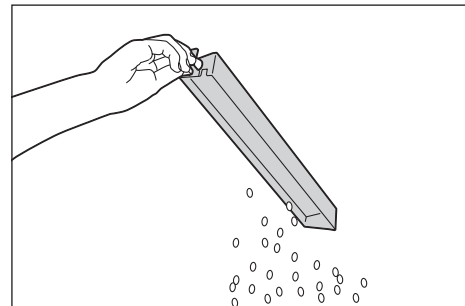

- 4 Insert the emptied hole punch waste container into the finisher until it stops.

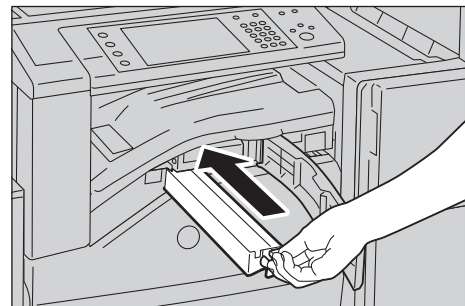

- 5 Close the front transport cover, and then close the top transport cover of the finisher.

Note • If the cover is not completely closed, a message will appear and the machine remain paused.

Cleaning the Machine

This section describes how to clean the machine such as the machine exterior, document cover, document feeder, and document glass.

Cleaning the Exterior

The following describes how to clean the exterior of the machine.

- Note**
- Do not use benzene, paint thinner, or other volatile liquids or spray insect repellent on the machine as they might discolor, deform, or crack covers.
 - Cleaning the machine with an excessive amount of water may cause the machine to malfunction or damage documents during copying.

- 1 Wipe the exterior with a firmly wrung soft cloth moistened with water.

- Note**
- Do not use cleaning agents other than water or neutral detergent.
 - If you cannot remove the dirt easily, gently wipe the machine with a soft cloth moistened with a small amount of neutral detergent.

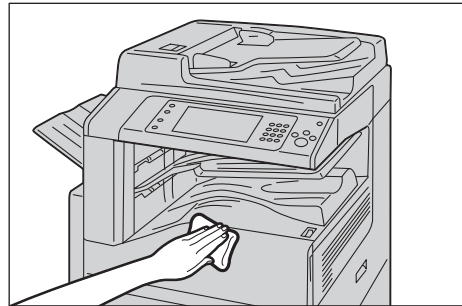

- 2 Wipe off any excess water with a soft cloth.

Cleaning the Interior (LED Printheads)

The following describes how to clean the interior (LED printheads) of the machine.

Normally, clean the LED printheads when you replace the waste toner container. However, if you have image quality problems such as white or colored stripes appear on copied or printed outputs, clean the LED printheads.

- Note**
- Clean the LED printheads periodically when you replace the waste toner container.

- 1 Make sure that the machine is not operating, and open the front cover.

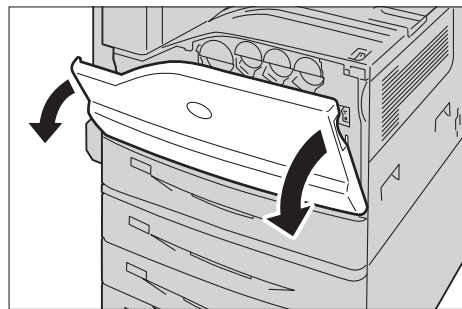

- 2 Rotate the release lever of the drum cartridge cover counterclockwise.

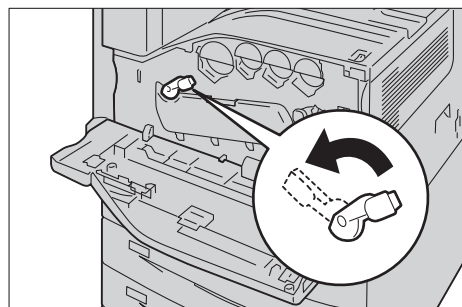

3 Lower the cover.

Note • You can now see the drum cartridge.

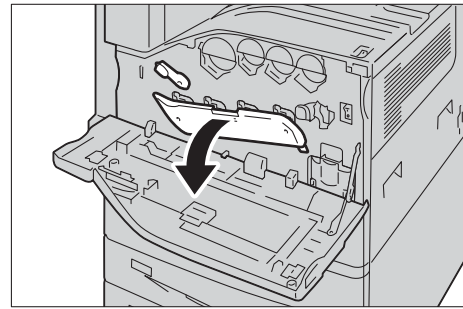

4 Slowly slide out the cleaning bar housed within the LED printhead until it stops. The cleaning bars are located in the cleaning connection just under the drum cartridges R1, R2, R3, and R4.

Note • Slide out the cleaning bar until you see "●●●".
• Do not remove the cleaning bar from the housing.

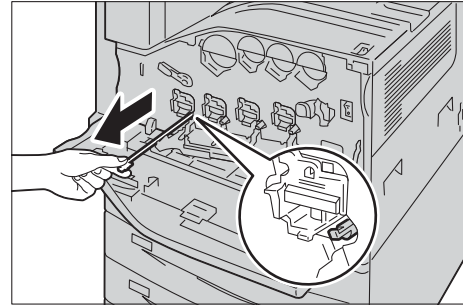

5 Slowly slide the cleaning bar back into place.

Note • Clean the four LED printheads R1 to R4 by sliding the cleaning bar back and forth for two or three times respectively.

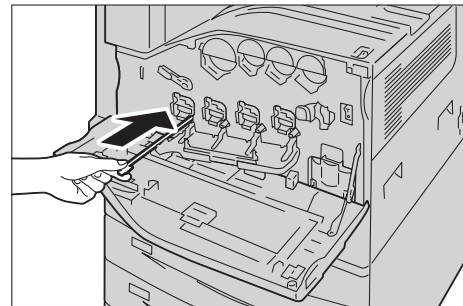

6 Return the cover to the original position.

Note • Push the cover until it clicks into place.

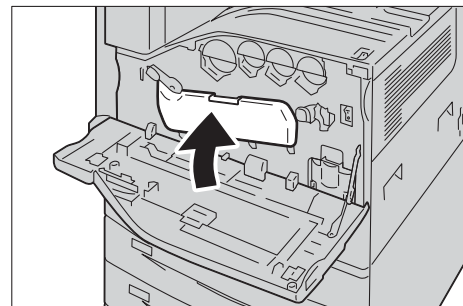

7 Rotate the release lever clockwise to lock the cover.

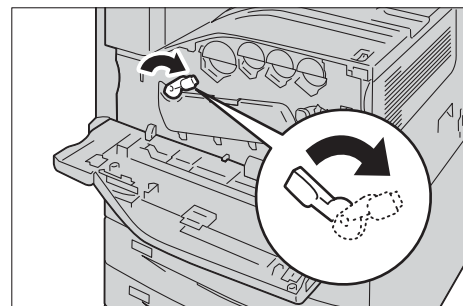

8 Close the front cover.

Note • If the front cover is not closed completely, a message appears and the machine will remain paused.

Cleaning the Touch Screen

This section describes how to clean the touch screen of the machine.

- 1 Wipe the LCD only with a soft cloth moistened with neutral detergent or alcohol.

- Note**
- Do not apply too much neutral detergent or alcohol. Squeeze out excess moisture before you wipe the LCD if the fluid drips.
 - Do not use volatile solvent such as benzene and paint thinner or insect killer. Doing so might cause discolored, deformed, or cracked parts.
 - Wipe the panel softly, otherwise, the parts might be damaged.

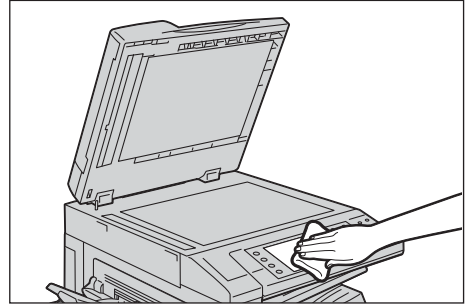

Cleaning Document Cover and Document Glass

If the document cover and document glass become soiled, smudges may appear on copies, faxes, or scanned documents and the machine may not properly detect document sizes.

To ensure clear copies at all times, clean the document cover and the document glass once a month.

- Note**
- Do not use benzene, paint thinner, or other organic solvents. Doing so might damage paint or coating on plastic parts.
 - Cleaning the machine with an excessive amount of water may cause the machine to malfunction or damage documents during copying, faxing, or scanning.

- 1 Wipe the document cover with a soft cloth moistened with water to remove any dirt, and then wipe it with a soft, dry cloth.

- Note**
- Do not use cleaning agents other than water or neutral detergent.
 - If you cannot remove dirt easily, gently wipe the document cover with a soft cloth moistened with a small amount of neutral detergent.

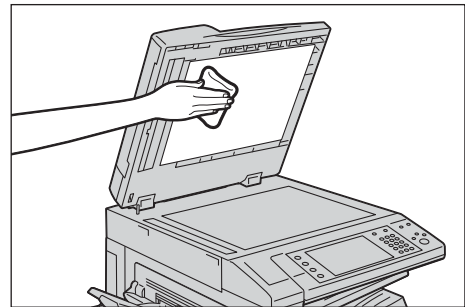

- 2 Wipe the document glass with a soft cloth moistened with water to remove any dirt, and then wipe it with a soft, dry cloth.

- Note**
- Do not use cleaning agents other than water or neutral detergent.
 - If you cannot remove dirt easily, gently wipe the document glass with a soft cloth moistened with a small amount of neutral detergent.

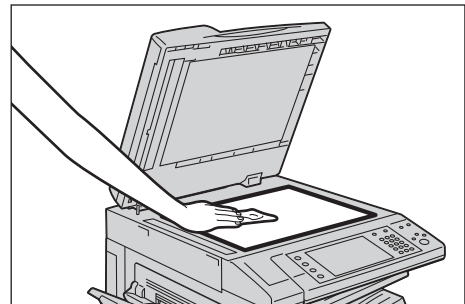

Cleaning Film and Constant Velocity Transport Glass

If the film or constant velocity transport glass become soiled, smudges may appear on copies, faxes, or scanned documents and the machine may not properly detect document sizes.

To ensure clear copies at all times, clean the film and the constant velocity transport glass once a month.

- Note**
- Do not use benzene, paint thinner, or other organic solvents. Doing so might damage paint or coating on plastic parts.
 - Cleaning the machine with an excessive amount of water may cause the machine to malfunction or damage documents during copying, faxing, or scanning.

- 1 Wipe the film with a soft cloth moistened with water to remove any dirt, and then wipe it with a soft, dry cloth.

- Note**
- Do not press the film with an excessive force as it can be easily damaged.
 - Do not use cleaning agents other than water or neutral detergent.
 - If you cannot remove dirt easily, gently wipe the film with a soft cloth moistened with a small amount of neutral detergent.

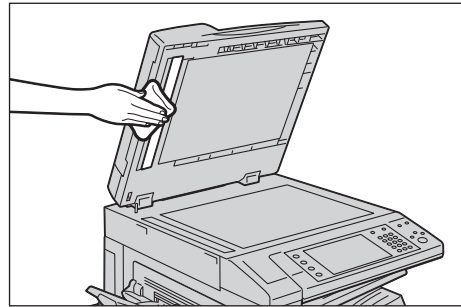

- 2 Wipe the constant velocity transport glass with a soft cloth moistened with water to remove any dirt, and then wipe it with a soft dry cloth.

- Note**
- Do not use cleaning agents other than water or neutral detergent.
 - If you cannot remove dirt easily, gently wipe the glass with a soft cloth moistened with a small amount of neutral detergent.

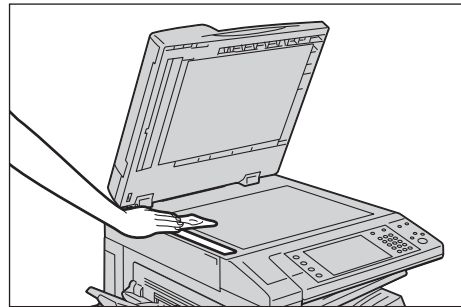

Cleaning Document Feeder Rollers

If the document feeder rollers become soiled, smudges may appear on copies, faxes, or scanned documents and paper jams may occur.

To ensure clean copies at all times, clean the document feeder roller about once a month.

- Note**
- Do not use benzene, paint thinner, or other organic solvents. Doing so might damage paint or coating on plastic parts.
 - Cleaning the machine with an excessive amount of water may cause the machine to malfunction or damage documents during copying, faxing, scanning, or printing.

- 1 Pull up the knob on the left cover of the document feeder, and open the cover completely.

- Note**
- When you fully open the cover, it enters a fixed position. Open the cover gently.

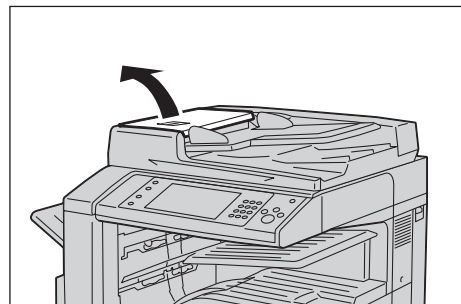

- 2 While turning the rollers, wipe them with a soft cloth moistened with water.

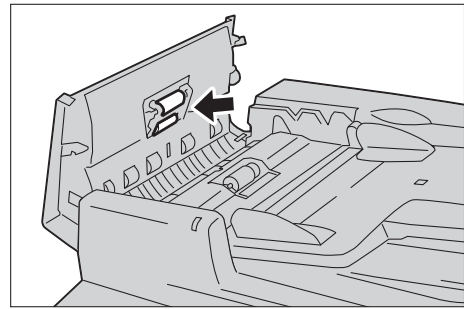

Note

- Do not use cleaning agents other than water or neutral detergent.
- Use a cloth firmly wrung to prevent water drops from falling into the machine. If water gets into the machine, it may cause the machine to malfunction.
- If you cannot remove dirt easily, gently wipe the rollers with a soft cloth moistened with a small amount of neutral detergent.

- 3 Close the document feeder left cover until it clicks into place, and confirm that there is no space between the near or far side of the cover and the document feeder.

Executing Calibration

Calibrate the machine regularly to correct and ensure consistency of printing colors over time, environment and devices.

Select a screen type on the [Calibration] screen and execute calibration, and calibration data for that screen type will be saved. The saved calibration data will be applied to the job when that type of screen is to be used for the job. Which type of screen is to be used for the job will be determined by the job settings.

The following four screen types can be selected on the [Calibration] screen.

- Copy Job 1

The calibration data for [Copy Job 1] will be applied when [Text], [Photo & Text], or [Map] is selected for [Original Type].

- Copy Job 2

The calibration data for [Copy Job 2] will be applied when [Photo] is selected for [Original Type].

- Print Job 1

For PCL print drivers

- The calibration data for [Print Job 1] will be applied when the screen for [Image Quality], [Image Adjustment Mode], and [Image Types], which can be specified on the [Color Options] tab, is to be used.
- The calibration data for [Print Job 1] will be applied when [Auto Screening], [Fineness], or [Standard] is selected for [Screen] on the [Advanced] tab.

For PostScript print drivers

- The calibration data for [Print Job 1] will be applied when [High Quality] or [High Resolution] is selected for [Image Quality] and [Auto Screening], [Fineness], or [Standard] is selected for [Screen] on the [Color Options] tab.
- The calibration data for [Print Job 1] will be applied when [High Speed] is selected for [Image Quality] and [Fineness] or [Standard] is selected for [Screen] on the [Color Options] tab.

- Print Job 2

For PCL print drivers

- The calibration data for [Print Job 2] will be applied when [Gradation] is selected for [Screen] on the [Advanced] tab unless [High Resolution] is selected for [Image Quality].
- The calibration data for [Print Job 2] will be applied when [Print Page Mode] is selected on the [Advanced] tab unless [High Resolution] is specified for [Image Quality].

For PostScript print drivers

- The calibration data for [Print Job 2] will be applied when [High Speed] is selected for [Image Quality] and [Auto Screening] or [Fineness] is selected for [Screen] on the [Color Options] tab.

Note

- It is recommended to execute calibration for each of the four screen types. After calibration for the first screening type, select the next screen type and repeat the procedure.
- When the printed colors do not seem to have been corrected properly despite regular calibration, contact Customer Support at dell.com/contactdell.
- Make sure that the following settings are specified under [Tools] > [System Settings] > [Copy Service Settings] > [Copy Defaults] in the System Administration mode before calibration.
 - Lighten/Darken: Normal
 - Contrast: Normal
 - Sharpness: Normal

- Saturation: Normal
- Color Balance: 0, 0, 0
- Color Shift: Normal

- You can change the above [Copy Defaults] settings after calibration.
- For information on [Copy Defaults], refer to "Copy Defaults" (P.349).
- During calibration, the machine cannot receive print jobs or faxes.

The following describes how to calibrate the machine.

1) Select [Calibration] on the [Home] screen.

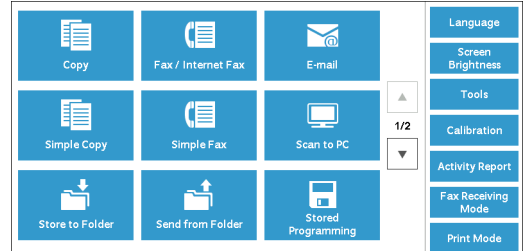

When [Calibration] is not displayed, follow the procedure below.

1) Press the <Log In/Out> button.

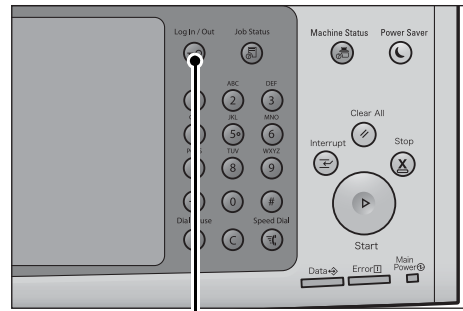

<Log In/Out> button

2) Enter the System Administrator's user ID with the numeric keypad or the keyboard displayed on the screen, and select [Enter].

When a passcode is required, select [Next] and enter the System Administrator's passcode, and select [Enter].

- Note**
- The default user ID is "admin".
 - The default passcode is "1111".

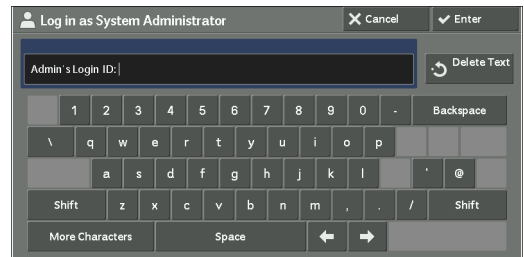

3) Select [Tools] on the [Home] screen.

- Note**
- When the [Home] screen is not displayed on the touch screen, press the <Home> button.

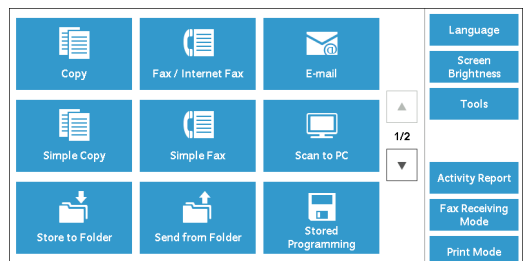

- 4) Select [System Settings] > [Common Service Settings] > [Image Quality Adjustment].

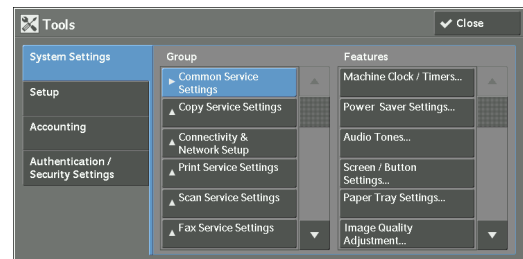

- 5) Select [Calibration].



- 2 Set [Screen Type] and [Paper Supply].

- Note**
- [Copy Job 1] is selected here as an example.
 - Make sure that [Target] is set to [Copy & Print Jobs]. If not, calibration will not be effective for jobs outside the selected range.

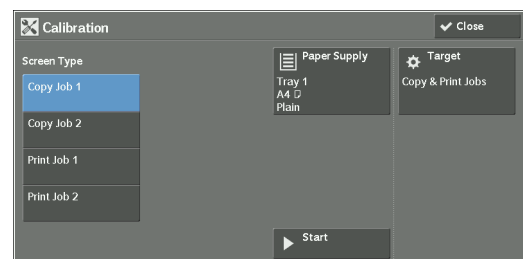

- 3 Select [Start].

- Note**
- A message saying "Outputting the Calibration Chart... - Copy Job 1" appears, and the machine prints the Calibration Chart.

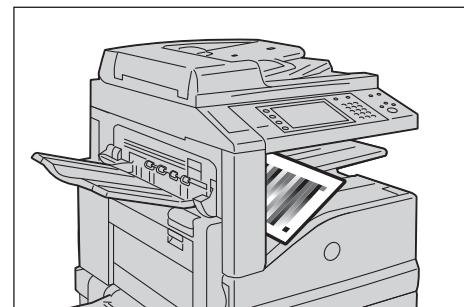

- 4 Place the Calibration Chart face down on the document glass with the magenta marks on corners on your left hand side.

- Note**
- Place the Calibration Chart on the document glass.

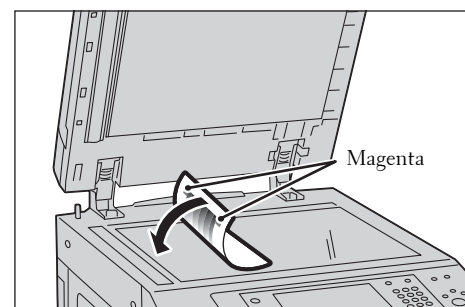

- 5 Place at least five sheets of white paper on the Calibration Chart to cover the Chart and close the document cover.

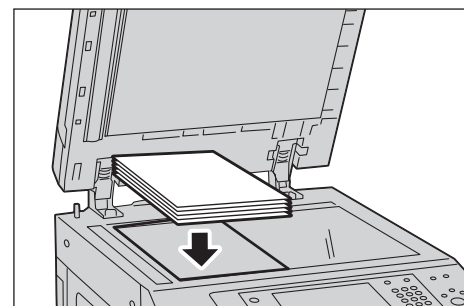

6 Select [Start].

The machine starts calibration. It takes about 10 seconds to complete the calibration.
The calibration result will be shown on the screen.

7 Select [Confirm].

8 To execute calibration for another screen type, repeat steps 2 to 7.

9 Select [Close] repeatedly until the [Tools] screen is displayed.

10 Select [Close].

11 Copy to confirm the image quality.

Note • During calibration, the machine cannot receive print jobs or faxes.

12 Select [Close].

Printing a Report/List

You can print a report/list to check the settings and communication status.

This section describes how to print a report/ list.

For information on the types of report/list, refer to "Print Reports" (P.276).

Note • When the <Data> indicator is not lit, you cannot print the Stored File List.

1 Press the <Machine Status> button.

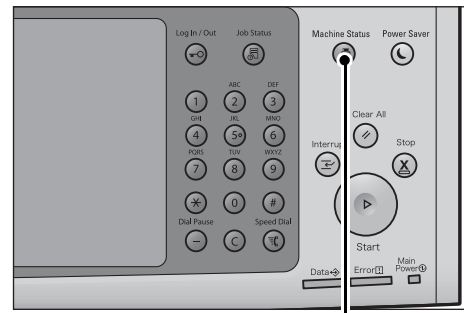

<Machine Status> button

2 Select [Print Reports].

Note • If [Print Reports Button] under [Reports] is set to [Disabled], the [Print Reports] button appears only when the [Tools] button is displayed on the [Home] screen. For more information on [Reports], refer to "Reports" (P.327).

• If you want to print [Billing Data List] or [Acctg Report (Fax Jobs)], insert a card to the machine before instructing print.

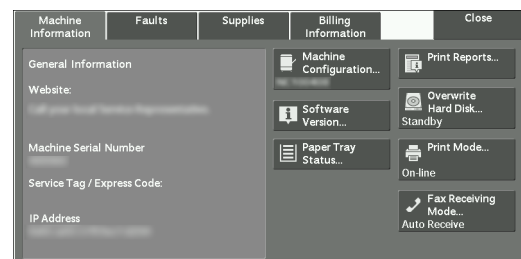

3 Select a report or list to print, and then press the <Start> button.

Note • The reports and the lists to be displayed on the screen depend on the configuration of your machine.

Deleting a Private Charge Print Job with an Invalid User ID

When the Private Charge Print feature is used, all the print jobs with a User ID, regardless of its validity, are stored with the Private Charge Print feature. The system administrator can set the expiration date and can set up the machine to delete the expired jobs automatically, or manually delete them.

This section describes how to delete documents with an invalid User ID stored with the Private Charge Print feature.

For more information on the Private Charge Print feature, refer to "Printing and Deleting Stored Jobs" (P.208).

For more information on how to set the period of time save jobs, refer to "Stored File Settings" (P.413).

- 1 Press the <Log In/Out> button.
- 2 Enter the system administrator's user ID with the numeric keypad or the keyboard displayed on the screen, and select [Enter].

When a passcode is required, select [Next] and enter the system administrator's passcode, and select [Enter].

Note

- The default user ID is "admin".
- The default passcode is "1111".

- 3 Press the <Job Status> button.
- 4 Select the [Secure Print Jobs & More] tab.

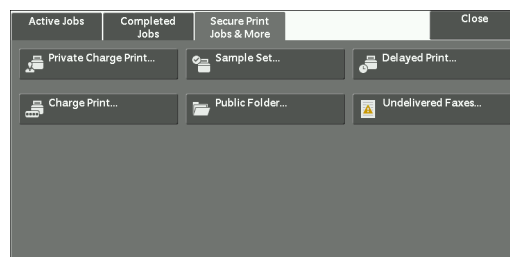
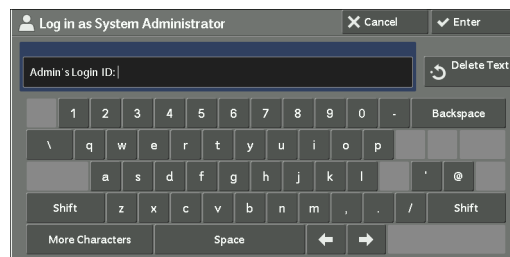

- 5 Select [Private Charge Print].
- 6 Select the User ID of the job to delete, and then select [Job List].
- 7 Select the job to delete, and then select [Delete].

Setting Restore Tool

Setting Restore Tool backs up the settings data of the machine to a network-connected computer to prevent the loss of data resulting from the malfunction of the machine's hard disk.

The feature is designed to restore data to the machine after the hard disk is replaced.

For more information on Setting Restore Tool, contact Customer Support at dell.com/contactdell.

The following data can be backed up on the computer:

- Address Book
- Folder (except for document files)
- User account list
- Job Flow
- Stored Programming
- Job log
- Error log
- Accounting log
- Other information such as user setting data

Users cannot replace the hard disk by themselves. When replacing the hard disk, contact Customer Support at dell.com/contactdell.

14 Machine Status

This chapter describes the features for checking the machine status.

- **Overview of Machine Status**.....274
- **Machine Information**275
- **Faults**.....289
- **Supplies**.....290
- **Billing Information**291

Overview of Machine Status

You can check machine status and the number of printed pages on the screen. You can also print various reports/lists to check the job history, settings and registered information.

- 1 Press the <Machine Status> button.

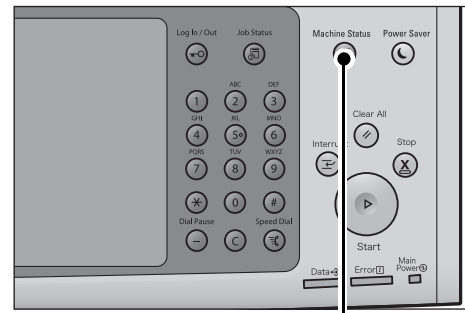

<Machine Status> button

You can check the following information on the [Machine Status] screen:

Machine Information

You can check the machine configuration, paper tray status, and hard disk overwriting status. You can also change or set print modes, and check the number of pages printed per meter or per user. You can also print various reports/lists to check the job history, settings and registered information.

For more information, refer to "Machine Information" (P.275).

Faults

You can check the information on errors that occurred on the machine.

For more information, refer to "Faults" (P.289).

Supplies

You can check the status of consumables.

For more information, refer to "Supplies" (P.290).

Billing Information

You can check the number of pages printed by meter.

For more information, refer to "Billing Information" (P.291).

Machine Information

On the [Machine Information] screen, you can check the machine configuration and paper tray status, print various reports/lists, and change and set print mode settings.

The following shows the reference section for each item.

General Information.....	275
Paper Tray Status	276
Print Reports.....	276
Automatically Printed Reports/Lists	284
Overwrite Hard Disk	285
Print Mode.....	285
Fax Receiving Mode.....	288

- 1 Press the <Machine Status> button.
- 2 On the [Machine Information] screen displayed, you can check the machine status.

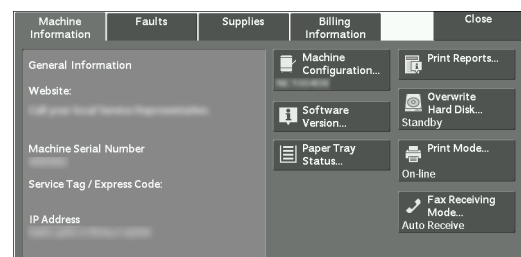

General Information

In the [General Information] area, you can check the serial number of the machine, machine configuration, and software version.

- 1 Check the general information.

Website:

Tells you whom to contact when making inquiries about maintenance and operation.

Machine Serial Number:

Indicates the serial number of the machine.

Service Tag / Express Code:

Displays the Service Tag and the Express Code of the machine.

IP Address

Indicates the IP address of the machine.

Machine Configuration

Displays the [Machine Configuration] screen.

For more information, refer to "[Machine Configuration] Screen" (P.276).

Software Version

Displays the [Software Version] screen.

For more information, refer to "[Software Version] Screen" (P.276).

[Machine Configuration] Screen

You can check the machine configuration.

- 1 Select [Machine Configuration].
- 2 Check the machine configuration on the screen displayed.

Note • Select [▲] to display the previous screen or [▼] to display the next screen.

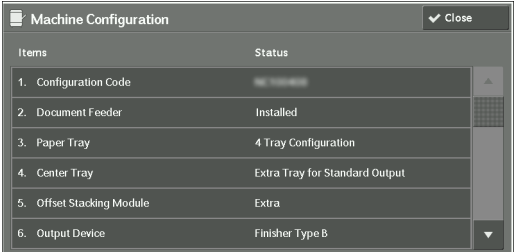

Items	Status
1. Configuration Code	00000000
2. Document Feeder	Installed
3. Paper Tray	4 Tray Configuration
4. Center Tray	Extra Tray for Standard Output
5. Offset Stacking Module	Extra
6. Output Device	Finisher Type B

[Software Version] Screen

You can check the software version.

- 1 Select [Software Version].
- 2 Check the software versions.



Items	Status
1. Controller ROM	6.113.0
2. IOT ROM	04.7.0
3. Finisher B ROM	1.3.0
4. ADF ROM	12.3.0
5. Fax ROM	1.1.02
6. Boot ROM	1.0.07

Paper Tray Status

You can check the paper trays set on the machine. On the screen, you can check the following items:

- Status
- % Full (Amount of paper remaining)
- Paper Size
- Paper Type

- 1 Select [Paper Tray Status].
- 2 Check the status of the paper trays.

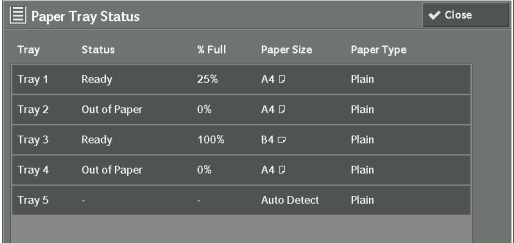

Tray	Status	% Full	Paper Size	Paper Type
Tray 1	Ready	25%	A4 D	Plain
Tray 2	Out of Paper	0%	A4 D	Plain
Tray 3	Ready	100%	B4 D	Plain
Tray 4	Out of Paper	0%	A4 D	Plain
Tray 5	-	-	Auto Detect	Plain

Print Reports

The following describes how to print a report and a list.

Note • The items displayed vary depending on the optional features installed.

- 1 Select [Print Reports].
- 2 Select the type of a report or a list to print.

Job Status / Activity Report

- 1 Select [Job Status / Activity Report].
 - Note**
 - To display the [Job Status / Activity Report] screen, press the <Machine Status> button, and then select [Machine Information] > [Print Reports] > [Job Status / Activity Report].
- 2 Select a report or a list to print.

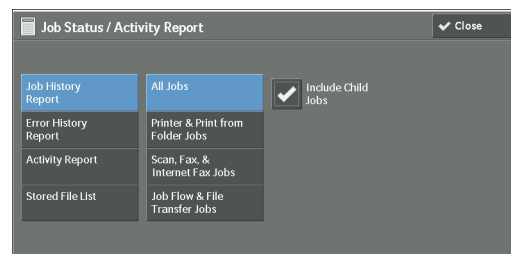

- 3 Press the <Start> button.

Job History Report

You can check the status or result of each job. Up to 200 latest jobs can be printed. Select a report to print from [All Jobs], [Printer & Print from Folder Jobs], [Scan, Fax, & Internet Fax Jobs], [File Transfer Jobs], or [Job Flow & File Transfer Jobs].

Selecting [Include Child Jobs] check box prints each related job on each line. Deselecting this check box prints the multiple related jobs (such as job flow jobs) on one line.

You can also set up the machine to automatically print a [Job History Report] every 50 jobs. For information on the auto print of a job history report, refer to "Reports" (P.327). When you set the machine to print a job history report automatically, the machine prints the results of all jobs.

Error History Report

You can print information on errors occurred in the machine. The latest 50 errors are printed.

Activity Report

You can check whether transmissions completed successfully or not. The remote terminal name and the result and status are recorded by sorting into incoming or outgoing fax.

The following information is not included in the Activity Report.

- Redialed transmissions and pollings.
- When the power is shut off, or when a system error occurs during an activity.
- Deleted documents that were waiting to be transmitted.

You can also set up the machine to automatically print the [Activity Report] every 100 activities.

For information on the settings, refer to "Reports" (P.327).

Stored File List

You can print a list of uncompleted jobs (uncompleted transmissions/receptions or those stored for polling) stored in folders.

Copy Reports

- 1 Select [Copy Reports].

- Note**
- To display the [Copy Reports] screen, press the <Machine Status> button, and then select [Machine Information] > [Print Reports] > [Copy Reports].

- 2 Select [Configuration Report].
- 3 Press the <Start> button.



Configuration Report

You can check the hardware configuration, network information, and print and copy settings of the machine.

- Note**
- The contents of [Configuration Report] are identical whether it is printed from [Copy Reports], [Printer Reports], [Scan Reports], or [Fax Reports].

Printer Reports

- 1 Select [Printer Reports].

- Note**
- To display the [Printer Reports] screen, press the <Machine Status> button, and then select [Machine Information] > [Print Reports] > [Printer Reports].

- 2 Select a list to print.

- Note**
- The items displayed vary depending on the options installed.

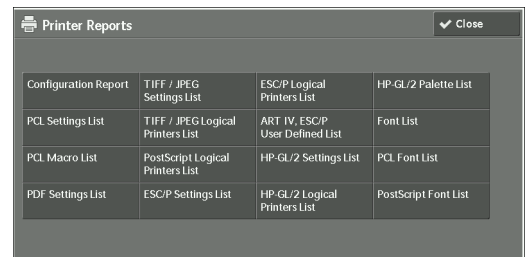

- 3 Press the <Start> button.

Configuration Report

You can check the hardware configuration, network information, and print and copy settings of the machine with the report.

- Note**
- The contents of [Configuration Report] are identical whether it is printed from [Copy Reports], [Printer Reports], [Scan Reports], or [Fax Reports].

PCL Settings List

Prints the settings for the PCL printer.

PCL Macro List

Prints the list of forms registered for PCL.

PDF Settings List

Prints the settings configured in the PDF printer mode.

TIFF / JPEG Settings List

Prints the settings configured in the TIFF and JPEG printer mode.

TIFF / JPEG Logical Printers List

Prints the list of logical printers created in the TIFF and JPEG printer mode.

- Note** • You can configure the setting for TIFF and JPEG logical printers using Dell Printer Configuration Web Tool.

PostScript Logical Printers List

Prints the list of logical printers created in PostScript.

- Note** • You can configure the setting for PostScript logical printers using Dell Printer Configuration Web Tool.

ESC/P Settings List

Prints the settings configured in the ESC/P-K emulation mode.

ESC/P Logical Printers List

Prints the programming settings configured in the ESC/P-K emulation mode.

HP-GL/2 Settings List

Prints the settings for the HP-GL[®], HP-GL/2[®] and HP-RTL emulation modes.

HP-GL/2 Logical Printers List

Prints the stored programming settings for the HP-GL, HP-GL/2, and HP-RTL emulation modes.

HP-GL/2 Palette List

Prints the sample list in 256 colors that can be set with the pen attribute on HP-GL and HP-GL/2 emulation modes.

Font List

Prints the list of fonts available on the machine.

- Note** • Information printed varies depending on the options installed.

PCL Font List

Prints the fonts available in PCL.

PostScript Font List

Prints the fonts available in PostScript.

Scan Reports

- 1 Select [Scan Reports].

- Note** • To display the [Scan Reports] screen, press the <Machine Status> button, and then select [Machine Information] > [Print Reports] > [Scan Reports].

- 2 Select a list to print.

- 3 Press the <Start> button.

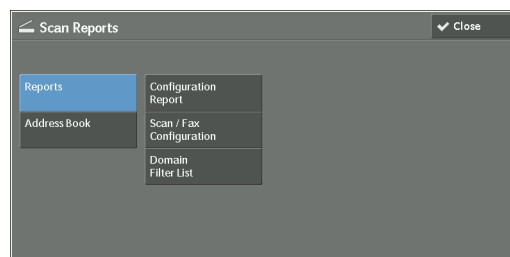

Reports

You can print the Configuration Report, Scan/Fax Configuration Report, and Domain Filter List. Select a list to print, and then press the <Start> button.

- Configuration Report

You can check the hardware configuration, network information, and print and copy settings of the machine.

Note • The contents of [Configuration Report] are identical whether it is printed from [Copy Reports], [Printer Reports], [Scan Reports], or [Fax Reports].

- Scan / Fax Configuration

You can check the settings configured for the Scan feature and the Fax feature.

- Domain Filter List

You can check the settings configured for the domain which filters data transmissions.

Address Book

You can check the settings for the address numbers. When you specify a range of address numbers, the list of settings for the specified address numbers is printed. Each page contains the settings information on 50 address numbers.

- 1 Select [Address Book].
- 2 Specify a range of address numbers to print.
- 3 Press the <Start> button.

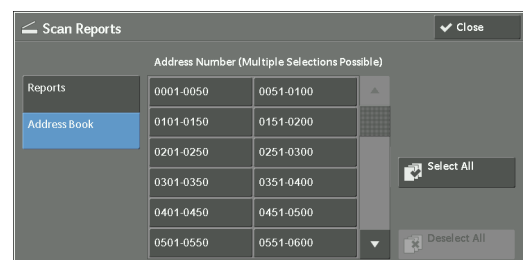

Fax Reports

- 1 Select [Fax Reports].

Note • To display the [Fax Reports] screen, press the <Machine Status> button, and then select [Machine Information] > [Print Reports] > [Fax Reports].

- 2 Select a list to print.
- 3 Press the <Start> button.

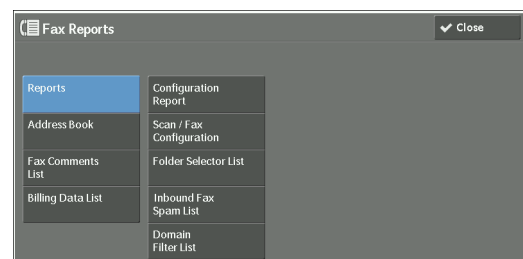

Reports

You can print the Configuration Report, Scan/Fax Configuration Report, Folder Selector List, Inbound Fax Spam List, and Domain Filter List. Select a list to print, and then press the <Start> button.

- Configuration Report

You can check the hardware configuration, network information, and print and copy settings of the machine.

Note • The contents of [Configuration Report] are identical whether it is printed from [Copy Reports], [Printer Reports], [Scan Reports], or [Fax Reports].

- Scan / Fax Configuration

You can check the settings configured for the Fax feature and the Scan feature.

Note • The contents of [Configuration Report] are identical whether it is printed from [Copy Reports], [Printer Reports], [Scan Reports], or [Fax Reports].

- Folder Selector List

You can check the settings for the Folder Sorting feature.

- Inbound Fax Spam List

You can check the settings for the G3-ID (telephone numbers) for which fax reception is restricted.

- Domain Filter List

You can check the settings configured for the domain which filters data transmissions.

Address Book

You can check the settings for the address numbers (speed dial), fax group recipients, and relay stations.

When you specify a range of address numbers, the lists of settings for the specified address numbers and relay stations are printed. Each page contains the settings information on 50 address numbers.

For information on how to register speed dial and fax group recipients, refer to "Add Address Book Entry" (P.431) and "Create Fax Group Recipients" (P.439).

Selecting [Address Book] displays the screen for specifying a range of address numbers. Select a range of numbers, and then press the <Start> button.

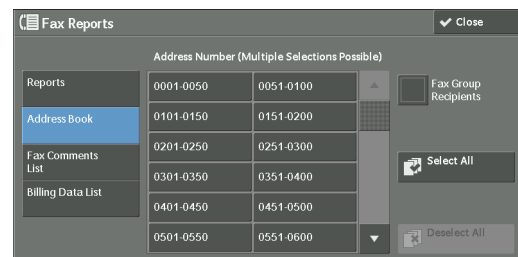

- Fax Group Recipients

You can print the list of settings for Fax Group Recipients.

- Select All

You can print the lists of settings for all address numbers, fax group recipients, and relay stations.

Fax Comments List

You can check the registered comments to use on fax cover sheets.

Billing Data List

You can check the registration status of the billing data.

Note • [Billing Data List] is displayed when [Fax / Internet Fax Service] is set to [Enable Accounting] under [Accounting] > [Accounting Type] > [Local Accounting] > [Accounting Mode].

Selecting [Billing Data List] displays the screen for specifying a range of address numbers. Select a range of numbers, and then press the <Start> button.

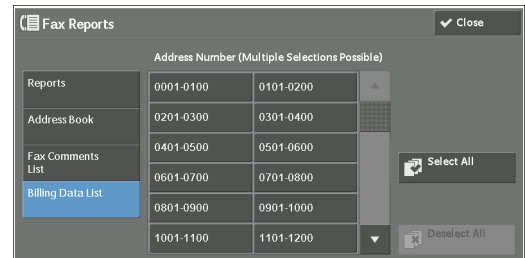

- Select All
You can print the list of all billing data.

Folder List

Prints the list of folder settings and the procedure for saving files to folders.

Note • [Folder List] appears when the [Tools] button is displayed on the [Home] screen. For information on how to create a folder, refer to "Create Folder" (P.421).

1 Select [Folder List].

Note • To display the [Folder List] screen, press the <Machine Status> button, and then select [Machine Information] > [Print Reports] > [Folder List].

2 Select a range of folder numbers to print.

3 Press the <Start> button.

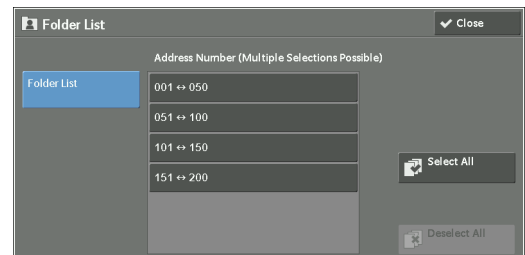

Job Counter Report

Prints the counter report for each job. You can check the breakdown of the number of actual use of the machine by feature (such as the number of pages printed and the number of times used) and cumulative time when the machine is used (such as runtime, standby time, Low Power mode, Sleep mode, and power-off time) by minutes on the Job Counter Report.

Note • [Job Counter Report] appears when the [Tools] button is displayed on the [Home] screen.

1 Select [Job Counter Report].

Note • To display the [Job Counter Report] screen, press the <Machine Status> button, and then select [Machine Information] > [Print Reports] > [Job Counter Report].

2 Select [Job Counter Report].

3 Press the <Start> button.

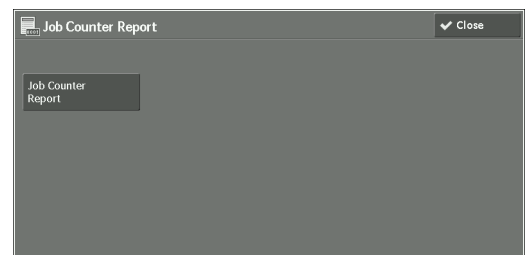

Accounting Reports

You can print an accounting report by each user. Note that the content on the screen differs depending on whether the Accounting mode for services is enabled or not.

- Note**
- [Accounting Reports] appears when the [Tools] button is displayed on the [Home] screen.
 - You cannot output the report to a file.

When [Accounting Type] is set to other than [Local Accounting]

When [Accounting Type] of each service is set to other than [Local Accounting], the following screen appears, allowing you to print a Meter Report (Print Jobs).

1 Select [Accounting Reports].

- Note**
- To display the [Accounting Reports] screen, press the <Machine Status> button, and then select [Machine Information] > [Print Reports] > [Accounting Reports].

2 Select [Meter Report (Print Jobs)].

3 Press the <Start> button.

Meter Report (Print Jobs)

You can check the total number of printed pages and sheets of paper used for each client (job owner). [Meter Report (Print Jobs)] counts pages from the time at which the data is initialized.

When [Accounting Type] is set to [Local Accounting]

When [Accounting Type] is set to [Local Accounting], the [Accounting Reports] screen appears. You can print the accounting report per user for the services of which the Accounting mode is set to [Enable Accounting].

For information on enabling the Accounting feature for each service, refer to "Accounting" (P.441).

1 Select [Accounting Reports].

- Note**
- To display the [Accounting Reports] screen, press the <Machine Status> button, and then select [Machine Information] > [Print Reports] > [Accounting Reports].

2 Select an accounting report to print.

3 Select a range of user numbers to print.

- Note**
- Selecting [Select All] selects all users.

4 Press the <Start> button.

Acctg Report (Copy Jobs)

You can check the total number of pages copied and printed on the machine. If the limit is set for the number of pages or colors that can be scanned, you can also check the limit value. [Acctg Report (Copy Jobs)] counts pages from the time at which the data is initialized.

- Note**
- The number of pages copied or printed to be displayed on the report is the User Account Number assigned when a user is registered under [Accounting] or [Authentication / Security Settings].

Acctg Report (Print Jobs)

You can check the total number of pages printed and sheets of paper used for each client (job owner). [Acctg Report (Print Jobs)] counts pages from the time at which the data is initialized.

- Note**
- When [Print Service] is set to [Disable Accounting] in [Accounting Mode] under [Accounting Type], [Meter Report (Print Jobs)] is displayed instead of [Acctg Report (Print Jobs)]. For more information on [Meter Report (Print Jobs)], refer to "Meter Report (Print Jobs)" (P.283).
 - The number of pages printed to be displayed on the report is the User Account Number assigned when a user is registered under [Accounting] or [Authentication / Security Settings].

Acctg Report (Scan Jobs)

You can check the total number of pages scanned with the machine. If the limit is set for the number of pages that can be scanned, you can also check the limit value. [Acctg Report (Scan Jobs)] counts pages from the time at which the data is initialized.

Note • The number of pages scanned to be displayed on the report is the User Account Number assigned when a user is registered under [Accounting] or [Authentication / Security Settings].

Acctg Report (Fax Jobs)

You can check the total number of fax transmissions/receptions and the total number of pages transmitted for each user.

Note • The number of pages faxed to be displayed on the report is the User Account Number assigned when a user is registered under [Accounting] or [Authentication / Security Settings].

Automatically Printed Reports/Lists

Some reports/lists related to the Fax and Scan services can be printed only automatically. The following describes reports/lists that can be printed automatically.

Transmission Report - Job Undelivered

The report is automatically printed when a transmission of scanned data to a computer on a network or a transmission of scanned data by e-mail fails. When a fax or the Internet Fax transmission fails, this report is also printed. You can check a thumbnail of the scanned data and its transmission result.

You can set not to print out the Transmission Report - Undelivered automatically.

For information on setting whether to print the report for e-mails automatically, refer to "Scan File Transfer Report" (P.328).

For information on setting whether to print the report for faxes automatically, refer to "Transmission Report - Job Undelivered" (P.328).

Transmission Report

The report is automatically printed when a transmission of scanned data to a computer on a network or a transmission of scanned data by e-mail succeeds. When a fax or the Internet Fax transmission succeeds, this report is also printed. You can check a thumbnail of the scanned data and its transmission result.

You can set not to print out the Transmission Report - Undelivered automatically.

For information on setting whether to print the report for e-mails automatically, refer to "Scan File Transfer Report" (P.328).

For information on setting whether to print the report for faxes automatically, refer to "Transmission Report - Job Undelivered" (P.328).

Folder Report

You can confirm that a document is stored in a folder.

For information on setting whether to print the report automatically, refer to "Folder Report" (P.328).

Broadcast Report

You can check the result of a broadcast transmission. The recipients and transmission result/status are recorded.

If you set to print this report automatically, it is printed each time a broadcast transmission is completed.

For information on setting whether to print the report automatically, refer to "Broadcast/Multi-Poll Report" (P.328).

Multi-Poll Report

You can check the result of a multi-poll communication (polling from multiple recipients). The remote terminal name and transmission result/status are recorded.

If you set to print this report automatically, it is printed each time a multi-poll transmission is completed.

For information on setting whether to print the report automatically, refer to "Broadcast/Multi-Poll Report" (P.328).

Job Flow Error Report

This report notifies job flow errors. The date and time of the status occurred and the status codes are printed.

You can set not to print out the Job Flow Error Report automatically.

For information on setting whether to print the report automatically, refer to "Job Flow Error Report" (P.328).

Overwrite Hard Disk

You can check the overwriting status of the hard disk. "Overwriting" indicates that the overwriting is in progress. "Standby" indicates that the overwriting is completed.

Note • [Overwrite Hard Disk] appears when [Overwrite Hard Disk] is enabled under [Authentication / Security Settings]. For more information, refer to "Overwrite Hard Disk" (P.459).

- 1 Select [Overwrite Hard Disk].
- 2 Check the overwriting status of the hard disk.



Print Mode

You can print the programming settings configured in the ESC/P-K emulation mode and retrieve the programming.

Note • The items displayed vary depending on the options installed.

- 1 Select [Print Mode].
- 2 Select [Off-line] or [On-line].

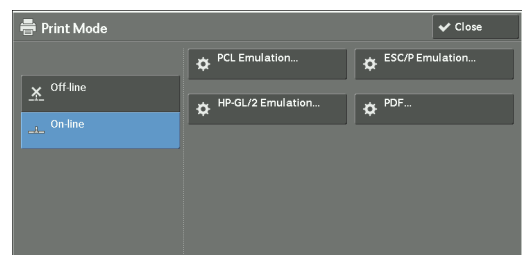

Off-line

The machine does not accept data from a computer. Any data being sent is cancelled and not printed.

On-line

The machine accepts data from a computer.

3 Select a printer language to set a print mode.

4 Set each item.

Note • The items displayed vary depending on the printer language.

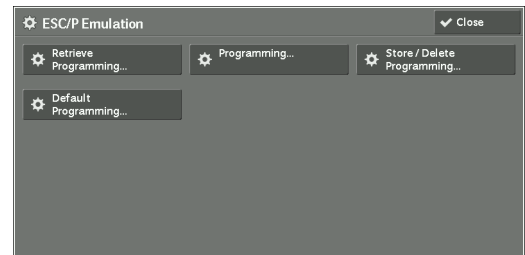
**Retrieve Programming**

You can retrieve and use settings registered in memory.

1 Select [Retrieve Programming].

2 Select the memory number to use.

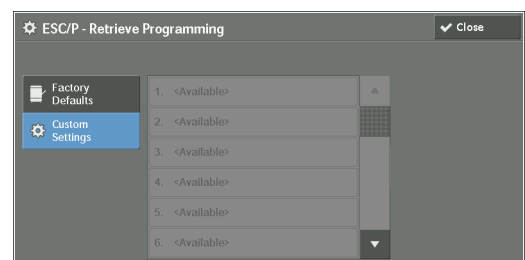
**Factory Defaults**

You can use the factory default settings.

Custom Settings

Displays the numbers stored in the memory.

Programming

You can check or change the value set for the print mode item number.

1 Select [Programming].

2 Enter the item number of the feature to set in [Item Number] with the numeric keypad.

3 Select [Confirm].

4 Select [Change Value].

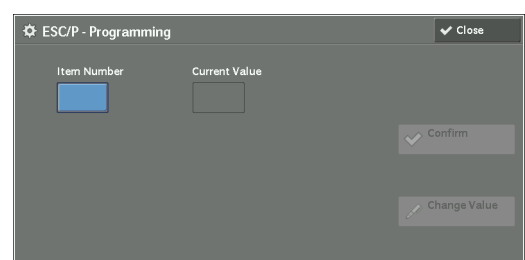

- 5 Enter [New Value] with the numeric keypad.
- 6 Select [Save].

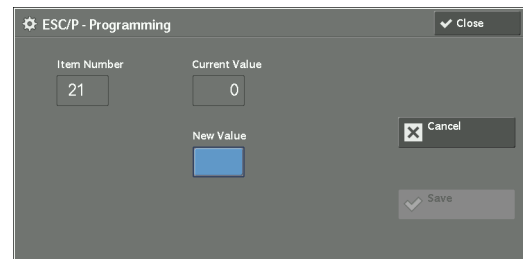

Store / Delete Programming

For ESC/P-K and HP-GL/2 emulations, you can register settings in memory. You can register up to 20 print modes for ESC/P-K and HP-GL/2 emulations.

- 1 Select [Store / Delete Programming].
- 2 Select [Store Current Selections] or [Delete].

Store Current Selections

Stores the current selections. If you select a number already used, its settings will be overwritten with the new settings. The overwritten settings cannot be restored.

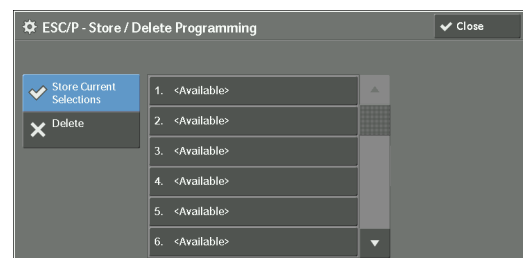

Delete

Select this to delete a programming.

Note • Deleted settings cannot be restored.

- 3 Select the memory number to store or to delete.

Default Programming

You can start the machine using the settings stored in memory as default settings.

- 1 Select [Default Programming].
- 2 Select [Factory Defaults] or [Custom Settings].

Factory Defaults

You can use the factory default settings.

Custom Settings

Displays the numbers stored in memory.

- 3 When you select [Custom Settings], select a memory number to use.
- 4 Select [Save].

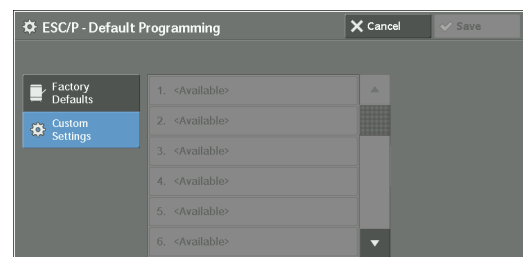

Password

For PDF Direct Print, if a password is set for files, set the password here in advance. PDF files can be printed only when the passwords assigned and entered are the same.

You can use up to 32 characters for the password.

- 1 Select [Password].
- 2 Enter a password of up to 32 single-byte characters with the keyboard displayed, and select [Save].

Fax Receiving Mode

You can set a mode for receiving faxes.

- 1 Select [Fax Receiving Mode].
- 2 Select a fax receiving mode.

Manual Receive

The machine manually receives faxes from a remote machine. This mode is convenient to confirm the sender or use an external telephone before receiving faxes.

Auto Receive

The machine automatically receives faxes.

- 3 Select [Save].

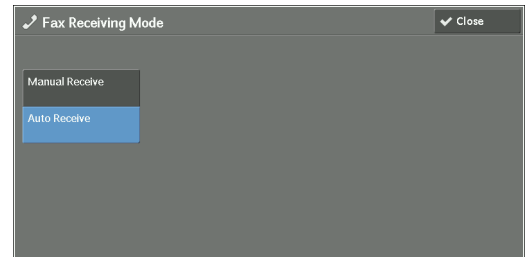

Faults

This section describes how to check the information on errors that occurred on the machine. The error history report shows the list of the latest 50 errors. The items printed include the date and time, status code, and error category.

The following describes how to print the error history report.

- 1 Press the <Machine Status> button.
- 2 Select the [Faults] tab.
- 3 Select [Error History Report].
- 4 Press the <Start> button.

- Note**
- You can also access [Error History Report] under [Machine Information] > [Print Reports] > [Job Status / Activity Report].
 - If [Print Reports Button] under [Reports] is set to [Disabled], the [Error History Report] button does not appear on the screen. For more information on [Reports], refer to "Reports" (P.327).



Supplies

You can check the status of consumables on the [Supplies] screen. The status of consumables is shown as "OK", "Replace Soon (Order Now)", or "Replace Now".

The following describes the procedure to check the status of consumables.

For information on replacing consumables, refer to "Maintenance" (P.247).

- 1 Press the <Machine Status> button.
- 2 Select the [Supplies] tab and confirm the status of the toners.

Note • Pressing a supply name displays a screen about the status of the supply.

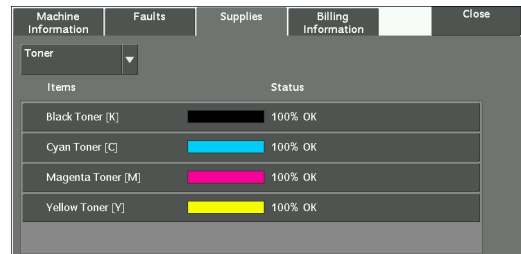

- 3 Select [Toner] from the drop-down list box, and then select [Other Consumables] and confirm the status of the consumables.

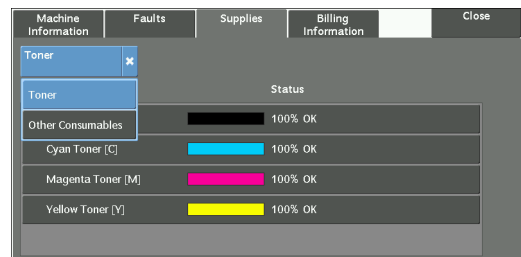

On the [Supplies] screen, you can check the following items:

- Black Toner [K]
- Cyan Toner [C]
- Magenta Toner [M]
- Yellow Toner [Y]
- Drum Cartridge [R1]
- Drum Cartridge [R2]
- Drum Cartridge [R3]
- Drum Cartridge [R4]
- Waste Toner Container [R5]
- Staple Cartridge [R1]
- Booklet Staple Cartridge [R2]
- Booklet Staple Cartridge [R3]
- Hole Punch Waste Container [R4]

Note

- If you replace a toner cartridge with a partially used toner cartridge (such as a toner cartridge removed from another Dell C7765dn Color Multifunction Printer), the status displayed may differ from the actual remaining amount. When replacing toner cartridges, we recommend that you use new ones.
- Pressing a supply name displays a screen about the status of the supply.
- The items displayed vary depending on the options installed.

Billing Information

On the [Billing Information] screen, you can check the number of pages printed per meter or user.

The following shows the reference section for each item.

Billing Information	291
User Account Billing Information	292

- 1 Press the <Machine Status> button.
- 2 Select the [Billing Information] tab.

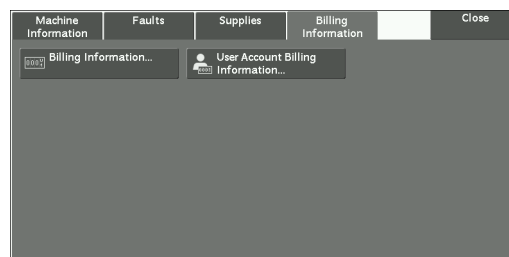

Billing Information

You can check the total number of copies and pages printed by individual meters.

- 1 Select [Billing Information].
- 2 On the screen, check each meter.

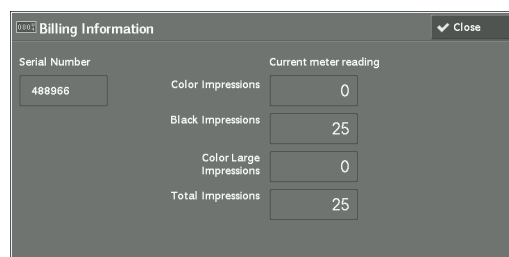

Serial Number

Displays the serial number of the machine.

Color Impressions

Displays the total number of pages copied or printed in full color.

Black Impressions

Displays the total number of pages copied or printed in black and white, and pages faxed ^{*1}.

Color Large Impressions

Displays the total number of pages printed in large-size full color ^{*2}.

Total Impressions

Displays the total number of Color Impressions and Black Impressions.

- Note**
- When print data resulting from color conversion using an ICC profile, for example, on the application is printed at Auto (Color/B/W), even documents that appear in black-and-white on the monitor are printed in color. In this case, Color Impressions is used for counting the number of prints.
 - *1 is applied on machines equipped with the Fax features. Only B/W and not color is supported for Faxes.
 - For *2, large-size full color is counted as a print at either of number of full color copies or number of full color prints in Color Impressions if a copy or print is made on paper of 279 mm x 400 mm or larger (279 mm or more in the primary scanning direction and 400 mm or more in the secondary scanning direction) when the user has selected color (4-color or 3-color) for copying or printing or a color document has been recognized during document scanning on the scanner.

User Account Billing Information

You can check the number of pages printed by user.

When the Accounting mode is enabled, you can check the billing meters for the currently authenticated user ID.

- Note**
- [User Account Billing Information] is displayed when the [Accounting Type] is set to [Local Accounting].

For more information on the Accounting mode, refer to "Accounting" (P.441).

1 Press the <Log In/Out> button.

To check the billing meter of a currently authenticated user ID

- 1) Enter the user ID with the numeric keypad or the keyboard displayed on the screen, and select [Enter].

When a password is required, select [Next] and enter the user's passcode, and select [Enter].

- 2) Press the <Machine Status> button.

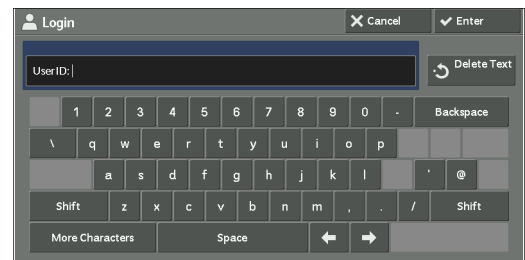

To check the system administrator meter

- 1) Enter the system administrator's user ID with the numeric keypad or the keyboard displayed on the screen, and select [Enter].

When a passcode is required, select [Next] and enter the system administrator's passcode, and select [Enter].

- Note**
- The default user ID is "admin".
 - The default passcode is "1111".

- 2) Press the <Machine Status> button.

2 Select the [Billing Information] tab.

3 Select [User Account Billing Information].

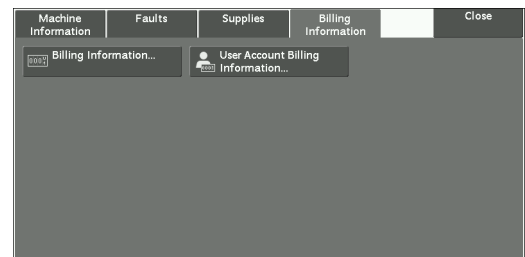

4 Select a meter to check.

- Note**
- The meters are displayed only for the features set to [Enable Accounting] in the Accounting mode.

	Color	Black & White
This Session	0	0
Total	0	0
Account Limit	9999999	9999999
Available Balance	9999999	9999999

Meter (Copy Jobs)

Displays the number of pages copied.

Meter (Scan Jobs)

Displays the number of pages scanned.

Meter (Print Jobs)

Displays the number of pages printed.

- Note**
- [Meter (Print Jobs)] is not displayed for the system administrator.

15 Tools

Each feature of the machine is set to the factory default (initial) settings, but you can customize these settings in accordance with your environment. To change or customize these settings, enter the System Administration mode and make changes in the [Tools] screen.

This chapter describes the features that can be changed and the procedures to change the settings.

• System Settings Procedure	296
• Tools Menu List	300
• Common Service Settings	314
• Copy Service Settings	348
• Connectivity & Network Setup	358
• Print Service Settings	380
• Scan Service Settings	387
• Fax Service Settings	394
• E-mail/Internet Fax Service Settings	406
• Address Book Settings	409
• Folder Service Settings	410
• Job Flow Service Settings	411
• Media Print Service Settings	412
• Stored File Settings	413
• Web Applications Service Setup	415
• Web Browser Setup	419
• Setup	421
• Accounting	441
• Authentication/Security Settings	450

System Settings Procedure

To change or customize the system settings, enter the System Administration mode.

This section describes the basic procedures for system settings. The following shows the reference section for each procedure.

- Step 1 Entering System Administration Mode296
- Step 2 Entering the System Administrator User ID and Passcode296
- Step 3 Selecting [Tools]297
- Step 4 Selecting a Tab on the [Tools] Screen297
- Step 5 Setting a Feature299
- Step 6 Exiting System Administration Mode.....299

Step 1 Entering System Administration Mode

- 1 Press the <Log In/Out> button or the login information field on the touch screen.

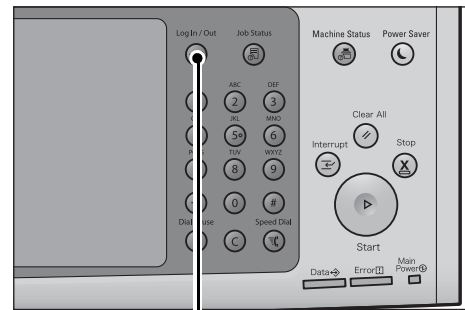

<Log In/Out> button

Step 2 Entering the System Administrator User ID and Passcode

To enter the System Administration mode, enter the System Administrator's User ID. If [Passcode Entry for Control Panel Login] is set to [On] under [Tools] > [Authentication/ Security Settings] > [Authentication] > [Passcode Policy], you need to enter the passcode.

We recommend that you change the System Administrator's User ID and passcode immediately after installing the machine.

For more information on how to change the passcode, refer to "System Administrator Settings" (P.450).

- 1 Enter the system administrator's user ID with the numeric keypad or the keyboard displayed on the screen, and select [Enter].

When a passcode is required, select [Next] and enter the system administrator's passcode, then select [Enter].

- Note**
- The default user ID is "admin".
 - The default passcode is "1111".
 - The screen may differ depending on the settings of the machine.
 - The <Log In/Out> button is lit when the machine enters the System Administration mode.

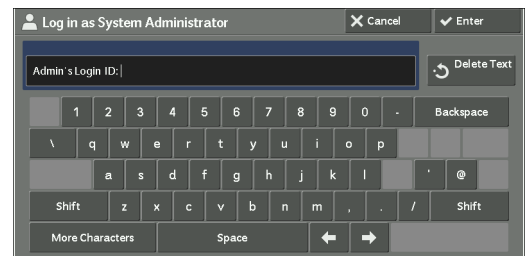

Step 3 Selecting [Tools]

- 1 Select [Tools] on the [Home] screen.

Note

- When the [Home] screen is not displayed on the touch screen, press the <Home> button.

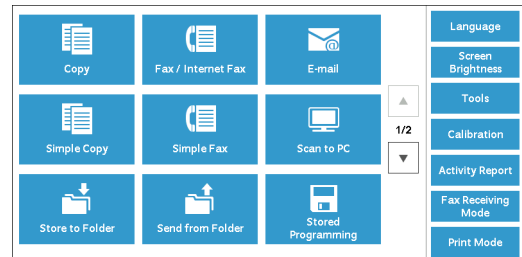

Step 4 Selecting a Tab on the [Tools] Screen

On the [Tools] screen, select a tab to set.

For the settings that can be selected on the [Tools] screen, refer to "Tools Menu List" (P.300).

- 1 Select a tab.

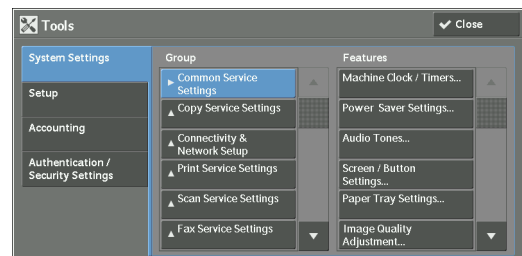

System Settings

You can set or change the default values of each service.

Common Service Settings

Allows you to configure the general settings of the machine.

For more information, refer to "Common Service Settings" (P.314).

Copy Service Settings

Allows you to configure the copy service settings such as copy feature defaults, copy operation control, and button indications.

For more information, refer to "Copy Service Settings" (P.348).

Connectivity & Network Setup

Allows you to configure the network related settings such as ports and protocols.

For more information, refer to "Connectivity & Network Setup" (P.358).

Print Service Settings

Allows you to configure the print service settings such as memory settings and print operation control.

For more information, refer to "Print Service Settings" (P.380).

Scan Service Settings

Allows you to configure the scan service settings such as scanner defaults and button indications.

For more information, refer to "Scan Service Settings" (P.387).

Fax Service Settings

Allows you to configure the fax service settings such as setting defaults, fax control and button settings.

For more information, refer to "Fax Service Settings" (P.394).

E-mail/Internet Fax Service Settings

Allows you to configure the e-mail and Internet fax transmission specifications settings.

For more information, refer to "E-mail/Internet Fax Service Settings" (P.406).

Address Book Settings

Allows you to configure the Address Book settings.

For more information, refer to "Address Book Settings" (P.409).

Folder Service Settings

Allows you to configure the settings relating to folders.

For more information, refer to "Folder Service Settings" (P.410).

Job Flow Service Settings

Allows you to configure the settings relating to Job Flow.

Job Flow is a function to execute a series of registered operations.

For more information, refer to "Job Flow Service Settings" (P.411).

Media Print Service Settings

Allows you to configure the settings relating to Media Print (Text and Photo).

For more information, refer to "Media Print Service Settings" (P.412).

Stored File Settings

Allows you to set how to delete files in a folder and print documents stored in the machine.

For more information, refer to "Stored File Settings" (P.413).

Web Applications Service Setup

Allows you to configure a remote access destination server.

For more information, refer to "Web Applications Service Setup" (P.415).

Web Browser Setup

Allows you to configure the settings relating to the web browser when accessing a remote destination server.

For more information, refer to "Web Browser Setup" (P.419).

Setup

You can create and change folders, job flow sheets, and the Address Book (speed dial numbers).

For more information, refer to "Setup" (P.421).

Accounting

You can register users and configure the settings for account administration.

For more information, refer to "Accounting" (P.441).

Authentication/Security Settings

You can configure the authentication and security settings.

For more information, refer to "Authentication/Security Settings" (P.450).

Step 5 Setting a Feature

1 Select any feature.

- Note**
- Select a submenu from the [Group] list, and then select a feature from the [Features] list.
 - Select [▲] or [▼] as required.

2 Select an item to set.

3 After setting the feature, select [Save].

4 Select [Close] repeatedly until the [Home] screen is displayed.

- Note**
- If rebooting the machine is required to enable the new settings, when you select [Close] in the [Tools] screen, a message may be displayed. Follow the message and reboot the machine. After the machine reboots, it exits from the System Administration mode, and the <Log In/Out> button is unlit.

Step 6 Exiting System Administration Mode

1 Press the <Log In/Out> button.

- Note**
- You can also log out by pressing the login information field on the touch screen, and then selecting [Logout].
 - The <Log In/Out> button is unlit when the machine exits from the System Administration mode.

Tools Menu List

The following tables list the items that can be set on the [Tools] screen. Note that the some items may not appear depending on the configuration of the machine.

System Settings

Common Service Settings

"Machine Clock/Timers" (P.314)	<ul style="list-style-type: none"> • "Date" (P.314) • "Time" (P.314) • "NTP Time Synchronization" (P.315) • "Connection Interval" (P.315) • "Time Server Address" (P.315) • "Auto Clear" (P.315) • "Auto Job Release" (P.315) • "Auto Print" (P.315) • "Printer Lockout" (P.316) • "Time Zone" (P.316) • "Daylight Savings" (P.316) • "Print-On-Demand Duration" (P.316)
"Power Saver Settings" (P.317)	<ul style="list-style-type: none"> • "Power Saver Timers" (P.317) • "Power Saver Deactivation" (P.317) • "Deactivate With wakeup motion sensor" (P.317)
"Audio Tones" (P.317)	<ul style="list-style-type: none"> • "Control Panel Select Tone" (P.318) • "Control Panel Alert Tone" (P.318) • "Base Tone" (P.318) • "Machine Ready Tone" (P.318) • "Job Complete Tone 1, 2" (P.318) • "Fault Tone" (P.318) • "Auto Clear Alert Tone" (P.318) • "Alert Tone" (P.318) • "Out of Paper Warning Tone" (P.318) • "Low Toner Alert Tone" (P.318) • "Stored Programming Tone" (P.319) • "Stored Programming Complete Tone" (P.319) • "Line Monitor Volume" (P.319) • "Ring Volume" (P.319)
"Screen/Button Settings" (P.319)	<ul style="list-style-type: none"> • "Screen Default" (P.319) • "Screen After Auto Clear" (P.319) • "Auto Display of Login Screen" (P.319) • "Custom Buttons 1 to 3" (P.319) • "One-touch Buttons" (P.319) • "Home" (P.320) • "Home - Additional Features" (P.320) • "Job Type on Job Status screen" (P.320) • "Default Language" (P.320) • "Screen Brightness" (P.320) • "Reconfirm E-mail Recipient" (P.320) • "Reconfirm Fax/Internet Fax Recipient" (P.320) • "Reconfirm E-mail Recipient Button" (P.321) • "Reconfirm Fax / Internet Fax Button" (P.321) • "Screen After Inserting USB" (P.321)

"Paper Tray Settings" (P.321)	<ul style="list-style-type: none"> • "Custom Paper Name/Color" (P.321) • "Paper Tray Attributes" (P.322) • "Customize Paper Supply Screen" (P.322) • "Paper Tray Attributes on Setup Screen" (P.323) • "Paper Tray Attributes During Loading" (P.323) • "Paper Tray Priority" (P.323) • "Paper Type Priority" (P.323) • "Tray 5 - Paper Size Defaults" (P.323) • "Auto Tray Switching Control" (P.324) • "Image Quality" (P.324)
"Image Quality Adjustment" (P.326)	<ul style="list-style-type: none"> • "Image Quality" (P.326) • "Calibration" (P.327)
"Reports" (P.327)	<ul style="list-style-type: none"> • "Print Reports Button" (P.327) • "Job History Report" (P.328) • "Activity Report" (P.328) • "Transmission Report - Job Undelivered" (P.328) • "Transmission Report - Job Deleted" (P.328) • "Folder Report" (P.328) • "Broadcast/Multi-Poll Report" (P.328) • "Scan File Transfer Report" (P.328) • "2 Sided Report" (P.328) • "Activity Report - Recipient" (P.328) • "Job Flow Error Report" (P.328)
"Maintenance" (P.329)	<ul style="list-style-type: none"> • "Initialize Hard Disk" (P.329) • "Delete All Data" (P.329) • "Software Options" (P.329) • "Power on Self Test" (P.329) • "Check Smart Card Details" (P.329) • "Finisher Adjustment" (P.329) • "Adjust Image Transfer" (P.329) • "Adjust Paper Registration" (P.330) • "Delete All Certificates/Initialize Settings" (P.330) • "Quick Setup Home" (P.330)
"Watermark" (P.330)	<ul style="list-style-type: none"> • "Date Format" (P.330) • "Default Watermark" (P.330) • "Font Size" (P.330) • "Background Pattern" (P.330) • "Font Color" (P.330) • "Density" (P.331) • "Watermark/Background Contrast" (P.331) • "Force Watermark - Copy" (P.331) • "Force Watermark - Client Print" (P.331) • "Force Watermark - Print Stored File" (P.331) • "Force Watermark - Media Print" (P.331) • "Custom Watermark 1 to 3" (P.331) • "Print this Sample List" (P.331)
"Force Annotation" (P.332)	<ul style="list-style-type: none"> • "Apply Layout Template to Copy/Prints Jobs" (P.332) • "Delete Layout Template" (P.333) • "Create Text String" (P.333)
"Print Universal Unique ID" (P.333)	<ul style="list-style-type: none"> • "Print Universal Unique ID" (P.333) • "Print Position" (P.333) • "Print Position Adjustment" (P.333) • "Print Position (Side 2)" (P.333)
"Notify Job Completion by E-mail" (P.333)	<ul style="list-style-type: none"> • "Targeted Jobs" (P.333) • "E-mail Addresses 1 to 5" (P.334) • "E-mail Message" (P.334)

"Plug-in Settings" (P.334)	<ul style="list-style-type: none"> • "Embedded Plug-ins" (P.334) • "List of Embedded Plug-ins" (P.334)
"Other Settings" (P.334)	<ul style="list-style-type: none"> • "Offset Stacking (Center Tray)" (P.334) • "Offset Stacking (Center Tray - Upper)" (P.334) • "Offset Stacking (Center Tray - Lower)" (P.334) • "Offset Stacking (Right Middle Tray)" (P.335) • "Booklet Offset" (P.335) • "Auto Job Promotion" (P.335) • "Default Print Paper Size" (P.335) • "Odd Page 2 Sided" (P.335) • "Paper Size Settings" (P.335) • "Millimeters/Inches" (P.344) • "Keyboard Input Restriction" (P.344) • "Operation of Up/Down Buttons" (P.344) • "Display Consumables Screen" (P.344) • "Data Encryption" (P.344) • "Encryption Key for Confidential Data" (P.346) • "Service Rep. Restricted Operation" (P.346) • "Software Download" (P.347) • "Drum Cartridge Conservation Mode" (P.347) • "Restrict Recipient Selection Method" (P.347) • "Restrict User to Edit Address Book" (P.347) • "Auto Validation of Speed Dial Entry" (P.347) • "Data Indicator" (P.347)

Copy Service Settings

"Copy Tab - Features Allocation" (P.348)	-
"Preset Buttons" (P.349)	<ul style="list-style-type: none"> • "Paper Supply - Button 2 - 5" (P.349) • "Reduce/Enlarge - Button 3 - 4" (P.349) • "Front Cover Tray - Button 1 - 3" (P.349) • "Back Cover Tray - Button 1 - 3" (P.349) • "Transparency Tray - Button 1 - 3" (P.349) • "Separator & Handout Tray - Button 1 - 3" (P.349)

"Copy Defaults" (P.349)

- "Paper Supply" (P.349)
- "Reduce/Enlarge" (P.349)
- "Output Color" (P.350)
- "Output Color (Simple Copy)" (P.350)
- "Single Color" (P.350)
- "Dual Color - Source Color" (P.350)
- "Dual Color - Target Area Color" (P.350)
- "Dual Color - Non-target Area Color" (P.350)
- "Original Type" (P.350)
- "Original Type - Auto (Non-Black & White)" (P.350)
- "Original Type - Auto (Black & White)" (P.350)
- "Lighten/Darken" (P.350)
- "Contrast" (P.351)
- "Sharpness" (P.351)
- "Saturation" (P.351)
- "Background Suppression" (P.351)
- "Color Balance - Yellow / Color Balance - Magenta / Color Balance - Cyan / Color Balance - Black" (P.351)
- "Color Shift" (P.351)
- "2 Sided Copying" (P.351)
- "Mixed Size Originals" (P.351)
- "Edge Erase - Top Edge" (P.351)
- "Edge Erase - Bottom Edge" (P.351)
- "Edge Erase - Left Edge" (P.352)
- "Edge Erase - Right Edge" (P.352)
- "Center Erase/Binding Edge Erase" (P.352)
- "Edge Erase - 2 Sided Original - Side 2" (P.352)
- "Image Shift - Side 1" (P.352)
- "Image Shift - Side 2" (P.352)
- "Image Rotation" (P.352)
- "Image Rotation - Rotation Direction" (P.352)
- "Original Orientation" (P.352)
- "Pages per Side" (P.352)
- "Copy Output" (P.352)
- "Uncollated - Default Separator Tray" (P.352)
- "Output Destination" (P.352)
- "Output Destination (Simple Copy)" (P.353)
- "Sample Job" (P.353)
- "Annotations - Stored Comment" (P.353)
- "Annotations - Comment on Side 1 and Side 2" (P.353)
- "Annotations - Comment - Font Size" (P.353)
- "Annotations - Comment - Font Color" (P.353)
- "Date - Position on Side 1 and Side 2" (P.353)
- "Date - Font Size" (P.353)
- "Page Numbers - Style" (P.353)
- "Page Numbers - Position on Side 1 and Side 2" (P.353)
- "Page Numbers - Font Size" (P.353)
- "Bates Stamp - Number of Digits" (P.353)
- "Bates Stamp - Position on Side 1 and Side 2" (P.354)
- "Bates Stamp - Font Size" (P.354)
- "Booklet Creation - Default Cover Tray" (P.354)
- "Covers - Default Front Cover Tray, Default Back Cover Tray" (P.354)
- "Separators - Default Separator Tray" (P.354)

"Copy Control" (P.354)	<ul style="list-style-type: none"> • "Memory Full Procedure" (P.354) • "Maximum Stored Pages" (P.354) • "Auto Paper Off" (P.354) • "Mixed Size Originals - 2 Sided Copy" (P.354) • "Fine-tune 100%" (P.355) • "ID Card Copy - Reduce/Enlarge" (P.355) • "Background Suppression (Photo & Text)" (P.355) • "Background Suppression Level (Text)" (P.355) • "Photo & Text / Printed Original" (P.355) • "Original Type - See-Through Paper" (P.355) • "Annotations - Comment Density" (P.356) • "Comment Position - Top Left, - Top Center, - Top Right, - Left Center, - Center, - Right Center, - Bottom Left, - Bottom Center, and - Bottom Right" (P.356) • "Date Position - Top Left, - Top Center, - Top Right, - Bottom Left, - Bottom Center, and - Bottom Right" (P.356) • "Page Number Position - Top Left, - Top Center, - Top Right, - Bottom Left, - Bottom Center, and - Bottom Right" (P.356) • "Bates Stamp - Top Left, - Top Center, - Top Right, - Bottom Left, - Bottom Center, and - Bottom Right" (P.356) • "Quantity Display" (P.356) • "Maximum Number of Sets" (P.356)
"Original Size Defaults" (P.356)	-
"Reduce/Enlarge Presets" (P.357)	-
"Custom Colors" (P.357)	-
"Annotations - Create Comments" (P.357)	-

Connectivity & Network Setup

"Port Settings" (P.358)	<ul style="list-style-type: none"> • "USB" (P.358) • "LPD" (P.359) • "NetWare" (P.359) • "SMB" (P.359) • "IPP" (P.360) • "EtherTalk" (P.360) • "Bonjour" (P.360) • "Port 9100" (P.360) • "SNMP" (P.360) • "FTP Client" (P.360) • "Receive E-mail" (P.361) • "Send E-mail" (P.361) • "E-mail Notification Service" (P.361) • "UPnP Discovery" (P.361) • "WSD" (P.361) ^{*1} • "Internet Services (HTTP)" (P.362) • "SOAP" (P.362) • "WebDAV" (P.362) • "ThinPrint" (P.363)
-------------------------	--

"Protocol Settings" (P.363)	<ul style="list-style-type: none"> • "Ethernet Rated Speed" (P.363) • "TCP/IP - IP Mode" (P.363) • "IPv4 - IP Address Resolution" (P.364) • "IPv4 - IP Address" (P.364) • "IPv4 - Subnet Mask" (P.364) • "IPv4 - Gateway Address" (P.364) • "IPv4 - DNS Server Setup" (P.365) • "IPv4 - IP Filter" (P.365) • "IPv6 Address Manual Configuration" (P.365) • "Manually Configured IPv6 Address" (P.365) • "Manually Configured IPv6 Address Prefix" (P.365) • "Manually Configured IPv6 Gateway" (P.365) • "IPv6 - DNS Server Setup" (P.365) • "Automatically Configured IPv6 Address" (P.366) • "IPv6 - IP Filter" (P.366)
"Machine's E-mail Address/Host Name" (P.366)	<ul style="list-style-type: none"> • "E-mail Address" (P.366) • "Machine Name" (P.366) • "Host Name" (P.366) • "Domain Name" (P.367)
"Proxy Server Settings" (P.367)	<ul style="list-style-type: none"> • "Use Proxy Server" (P.367) • "Proxy Server Setup" (P.367) • "Addresses to Bypass Proxy Server" (P.367) • "HTTP Proxy Server Name" (P.367) • "HTTP Proxy Server Port Number" (P.367) • "HTTP Proxy Server Authentication" (P.367) • "HTTP Proxy Server Login Name" (P.367) • "HTTP Proxy Server Password" (P.367) • "HTTPS Proxy Server Name" (P.367) • "HTTPS Proxy Server Port Number" (P.367) • "HTTPS Proxy Server Authentication" (P.367) • "HTTPS Proxy Server Login Name" (P.368) • "HTTPS Proxy Server Password" (P.368)
"Outgoing/Incoming E-mail Settings" (P.368)	<ul style="list-style-type: none"> • "POP3 Server Settings" (P.368) • "SMTP Server Settings" (P.368)
"Remote Authentication/Directory Service" (P.369)	<ul style="list-style-type: none"> • "Authentication System Setup" (P.369) • "Kerberos Server Settings" (P.369) • "LDAP Server/Directory Service Settings" (P.370) • "SMB Server Settings" (P.374)
"Security Settings" (P.374)	<ul style="list-style-type: none"> • "SSL/TLS Settings" (P.374) • "S/MIME Settings" (P.375) • "PDF/XPS Signature Settings" (P.376) *2 • "IPSec Settings" (P.376) • "IEEE 802.1x Settings" (P.377) • "Certificate Revocation Retrieval Settings" (P.378) • "Other Settings" (P.379)
"Other Settings" (P.379)	<ul style="list-style-type: none"> • "Protocol to Receive E-mail" (P.379) • "Add Domain Name to User Name" (P.379) • "Output Destination for E-mail" (P.379) • "Domain Filtering" (P.379)

*1 :WSD stands for Web Services on Devices.

*2 :XPS stands for XML Paper Specification.

Print Service Settings

"Allocate Memory" (P.380)	<ul style="list-style-type: none"> • "PostScript Memory" (P.380) • "ART IV, ESC/P, 201H Form Memory" (P.380) • "HP-GL/2 Auto Layout Memory" (P.380) • "Job Ticket Memory" (P.380) • "Receiving Buffer - USB" (P.381) • "Receiving Buffer - LPD" (P.381) • "Receiving Buffer - NetWare" (P.381) • "Receiving Buffer - SMB" (P.381) • "Receiving Buffer - IPP" (P.382) • "Receiving Buffer - EtherTalk" (P.382) • "Receiving Buffer - Port 9100" (P.382)
"Delete Form" (P.382)	-
"Other Settings" (P.382)	<ul style="list-style-type: none"> • "Print Area" (P.382) • "Substitute Tray" (P.383) • "Paper Type Mismatch" (P.383) • "Unregistered Forms" (P.383) • "Resume Job After Print Error" (P.384) • "When Paper Jam Occurs" (P.384) • "Print User ID" (P.384) • "Banner Sheet" (P.384) • "Banner Sheet Offset" (P.385) • "Banner Sheet Tray" (P.385) • "PostScript Default Color" (P.385) • "PostScript Paper Supply" (P.385) • "PostScript Font Absence" (P.385) • "PostScript Font Substitution" (P.385) • "XPS Print Ticket Processing" (P.385)* • "LPD Print Queue" (P.386) • "OCR Font Glyphs (0 x 5C)" (P.386)

* :XPS stands for XML Paper Specification.

Scan Service Settings

"Screen Defaults" (P.387)	<ul style="list-style-type: none"> • "Email Screen Default" (P.387) • "Scan to PC Screen Default" (P.387) • "1st Tab - Features Allocation" (P.387) • "Reduce/Enlarge - Buttons 2 to 5" (P.388)
---------------------------	---

"Scan Defaults" (P.388)	<ul style="list-style-type: none"> • "Color Scanning" (P.388) • "Original Type" (P.388) • "File Format" (P.388) • "Optimize PDF For Quick Web View" (P.388) • "Thumbnail - Outgoing E-mail" (P.388) • "Thumbnail - Scan to PC" (P.388) • "Lighten/Darken" (P.388) • "Contrast" (P.388) • "Sharpness" (P.388) • "Background Suppression" (P.389) • "Shadow Suppression" (P.389) • "Color Space" (P.389) • "Original Orientation" (P.389) • "Resolution" (P.389) • "Mixed Size Originals" (P.389) • "Edge Erase" (P.389) • "Edge Erase - Top & Bottom Edges" (P.389) • "Edge Erase - Left & Right Edges" (P.389) • "Center Erase/Binding Edge Erase" (P.389) • "Quality/File Size" (P.389) • "E-mail Subject" (P.389) • "Store & Send Link - E-mail Subject" (P.390) • "E-mail Encryption" (P.390) • "Searchable Text" (P.390) • "Language of the Original" (P.390) • "Searchable - Text Compression" (P.390)
"Scan to PC Defaults" (P.390)	<ul style="list-style-type: none"> • "Transfer Protocol" (P.390) • "Login Credential to Access Destination" (P.390) • "User Name for FTP Scan" (P.390)
"Original Size Defaults" (P.391)	-
"Output Size Defaults" (P.391)	-
"Reduce/Enlarge Presets" (P.391)	-
"Other Settings" (P.392)	<ul style="list-style-type: none"> • "Memory Full Procedure" (P.392) • "Maximum Stored Pages" (P.392) • "Saturation" (P.392) • "Background Suppression Level" (P.392) • "Shadow Suppression Level" (P.392) • "Color Space" (P.392) • "TIFF Format" (P.392) • "Image Transfer Screen" (P.392) • "Searchable - Page Orientation" (P.393) • "URL File Expiration" (P.393) • "Generation of URL Link" (P.393) • "Store & Send Link - Maximum File Size" (P.393) • "Print Login Name on PDF Files" (P.393)

Fax Service Settings

"Screen Defaults" (P.394)	<ul style="list-style-type: none"> • "Fax Screen Default" (P.394) • "1st Tab - Features Allocation" (P.394) • "Reduce / Enlarge - Button 3 - 5" (P.394) • "Transmission Screen" (P.394)
---------------------------	---

"Fax Defaults" (P.395)	<ul style="list-style-type: none"> • "Resolution" (P.395) • "Original Type" (P.395) • "Lighten / Darken" (P.395) • "Mixed Size Originals" (P.395) • "Skip Blank Pages" (P.395) • "Starting Rate" (P.395) • "Delay Start - Specific Time" (P.395) • "Transmission Header Text" (P.395) • "Confirmation Options" (P.395) • "Delivery Receipts/Read Receipts" (P.395) • "Internet Fax Profile" (P.395) • "Internet Fax Subject" (P.396) • "Internet Fax Encryption" (P.396)
"Fax Control" (P.396)	<ul style="list-style-type: none"> • "Re-enter Recipients" (P.396) • "Re-enter Broadcast Recipients" (P.396) • "Re-enter Speed Dial Recipients" (P.396) • "Re-enter Group Recipients" (P.396) • "Broadcast Checkbox on 1st Tab" (P.397) • "Chain Dial" (P.397) • "Manual Redial List - Saved Entries" (P.397) • "Manual Redial List - Dial Mode" (P.397) • "Transmission Header Text - Polling" (P.397) • "Polled Files - Auto Delete" (P.397) • "Rotate 90 degrees" (P.397) • "G3 Sender ID - Fax" (P.397) • "Save Undelivered Faxes" (P.397) • "Save Deleted Faxes" (P.397) • "Saved Faxes - Auto Delete" (P.398) • "Transmission Interval" (P.398) • "Batch Send" (P.398) • "Manual Send/Receive Default" (P.398) • "Fax Receiving Mode" (P.398) • "Border Limit" (P.398) • "Auto Reduce On Receipt" (P.398) • "Receiving Paper Size" (P.398) • "2 Pages Up On Receipt" (P.399) • "2 Sided Printing" (P.399) • "Edge Erase - Top & Bottom Edges" (P.399) • "Edge Erase - Left & Right Edges" (P.399) • "Reduce 8.5 x 11" <input type="checkbox"/> Original to A4 <input type="checkbox"/> (P.399) • "Pseudo-Photo Gradation Mode" (P.399) • "Folder Selector Setup" (P.399) • "Memory Full Procedure" (P.400) • "Maximum Stored Pages" (P.400) • "Mixed Size Originals Scan Mode" (P.400) • "Skip Blank Pages" (P.400) • "Fax Data in Folder Priority 1 to 3" (P.400) • "Direct Fax" (P.400) • "Block Inbound Faxes" (P.400) • "Block Unknown Fax Numbers" (P.401)
"Fax Received Options" (P.401)	<ul style="list-style-type: none"> • "Folder Selector Setup" (P.401) • "Output Destination Setup" (P.401)
"Reduce/Enlarge Presets" (P.401)	-
"Original Size Defaults" (P.402)	-

"Local Terminal Information" (P.402)	<ul style="list-style-type: none"> • "Local Name" (P.402) • "Company Logo" (P.402) • "Machine Password" (P.402) • "Line 1 - Company Logo" (P.402) • "G3 Line 1 - Fax ID" (P.403) • "G3 Line 1 - Dial Type" (P.403) • "G3 Line 1 - Line Type" (P.403)
"Internet Fax Control" (P.403)	<ul style="list-style-type: none"> • "Internet Fax Path" (P.403) • "Profile for Broadcast Job" (P.404) • "Broadcast Starting Rate" (P.404) • "Delivery Confirmation Method" (P.404) • "Incoming Internet Fax Print Options" (P.404) • "Internet Fax Output Destination" (P.405) • "Fax Transfer from Address Book" (P.405) • "Transmission Header Text - Fax Transfer" (P.405) • "Fax Transfer Maximum Data Size" (P.405)

E-mail/Internet Fax Service Settings

"E-mail Control" (P.406)	<ul style="list-style-type: none"> • "Maximum Address Entries" (P.406) • "Incoming E-mail Print Options" (P.406) • "Print Error Notification E-mail" (P.406) • "Response to Read Receipts" (P.406) • "Read Receipts" (P.407) • "Print Delivery Confirmation Mail" (P.407) • "Split Send Method" (P.407) • "Maximum Data Size per E-mail" (P.407) • "Maximum Total Data Size" (P.407) • "Maximum Split Count" (P.407) • "Allow Casual Users to Edit From Field" (P.408) • "Allow Guest Users to Edit From Field" (P.408) • "Allow to edit From if Search Found" (P.408) • "Allow to edit From if Search Failed" (P.408) • "E-mail Sending When Search Failed" (P.408) • "Add Me to "To" Field" (P.408) • "Add Me to "Cc" Field" (P.408) • "Edit E-mail Recipients" (P.408)
--------------------------	---

Address Book Settings

"Address Book Settings" (P.409)	<ul style="list-style-type: none"> • "Address Book Type" (P.409) • "Directory Service" (P.409) • "Address Book Default - Scan" (P.409) • "Address Book Default - Fax" (P.409) • "Search Display Default" (P.409) • "Fax Speed Dial Default" (P.409)
---------------------------------	---

Folder Service Settings

"Folder Service Settings" (P.410)	<ul style="list-style-type: none"> • "Files Retrieved By Client" (P.410) • "File Display Default" (P.410) • "Print & Delete Confirmation Screen" (P.410) • "Convert Custom Size to Standard Size" (P.410) • "Standard Size Threshold Value" (P.410) • "Internet Fax to Internet Fax" (P.410) • "Internet Fax to E-mail" (P.410) • "Quality/File Size for Retrieval" (P.410)
-----------------------------------	---

Job Flow Service Settings

"Job Flow Service Settings" (P.411)	<ul style="list-style-type: none"> • "Pool Server" (P.411) • "Pool Server Login Method" (P.411) • "Job Flow Sheet List Default" (P.411) • "Fax Transfer Resolution" (P.411)
-------------------------------------	---

Media Print Service Settings

"Media Print Service Settings" (P.412)	<ul style="list-style-type: none"> • "Text - Paper Supply - Button 2 to 5" (P.412) • "Photos - Paper Supply - Button 1 to 5" (P.412)
--	--

Stored File Settings

"Stored File Settings" (P.413)	<ul style="list-style-type: none"> • "Expiration Date for Files in Folder" (P.413) • "Stored Job Expiration Date" (P.413) • "Display Details of Stored Print Job List" (P.414) • "Print Job Confirmation Screen" (P.414) • "Minimum Passcode Length for Stored Jobs" (P.414) • "Print Order for All Selected Files" (P.414)
--------------------------------	---

Web Applications Service Setup

"Server Setup" (P.417)	<ul style="list-style-type: none"> • "URL" (P.417) • "Server Name" (P.417) • "Description" (P.417) • "Use User ID" (P.418) • "User ID" (P.418) • "Password" (P.418) • "Machine/Authentication Notification" (P.418) • "Notify User Authorization Information" (P.418) • "Delete All Settings" (P.418)
"Other Settings" (P.418)	<ul style="list-style-type: none"> • "When Sending User Details" (P.418)

Web Browser Setup

"Web Browser Setup" (P.419)	<ul style="list-style-type: none"> • "Web Applications Version" (P.419) • "Delete Persistent Cookie Upon Closing" (P.419) • "Clear Cache Upon Closing" (P.419) • "Use Cache" (P.419) • "Accept Cookies" (P.419) • "Use TLS1.0" (P.419) • "Use SSL3.0" (P.419) • "When SSL Certificate Verification Fails" (P.419) • "Enable File Printing" (P.420)
-----------------------------	---

Setup

"Create Folder" (P.421)	<ul style="list-style-type: none"> • "Folder Name" (P.422) • "Check Folder Passcode" (P.422) • "Delete Files After Retrieval" (P.422) • "Delete Expired Files" (P.422) • "Link Job Flow Sheet to Folder" (P.423) • "When the [Delete Folder] Button is Selected" (P.423)
-------------------------	--

"Stored Programming" (P.423)	-
"Create Job Flow Sheet" (P.423)	<ul style="list-style-type: none"> • "Restrictions on Using Job Flow" (P.424) • "Create New Job Flow Sheet" (P.425) • "Name" (P.426) • "Description" (P.426) • "Keyword" (P.426) • "Send as Fax" (P.426) • "Send as Internet Fax" (P.426) • "Send as E-mail" (P.427) • "Transfer via FTP (1), Transfer via FTP (2)" (P.428) • "Transfer via SMB (1), Transfer via SMB (2)" (P.429) • "Print" (P.430) • "E-mail Notification" (P.430) • "Edit/Delete" (P.431)
"Create Job Flow Sheet Keyword" (P.431)	-
"Add Address Book Entry" (P.431)	<ul style="list-style-type: none"> • "Address Type" (P.433) • "E-mail Address" (P.433) • "Name" (P.434) • "Index" (P.434) • "Surname" (P.434) • "Given Name" (P.434) • "Custom Item 1" (P.434) • "Custom Item 2" (P.434) • "Custom Item 3" (P.434) • "S/MIME Certificate" (P.434) • "Transfer Protocol" (P.435) • "Server Name/IP address" (P.435) • "Shared Name (SMB Only)" (P.435) • "Save in" (P.435) • "User Name" (P.435) • "Password" (P.435) • "Port Number" (P.435) • "Fax Number" (P.436) • "Index" (P.436) • "Starting Rate" (P.436) • "Resolution" (P.436) • "Cover Page" (P.436) • "Maximum Image Size" (P.436) • "Delay Start" (P.437) • "Remote Folder" (P.437) • "F Code" (P.437) • "Relay Broadcast" (P.437) • "Billing - Day Time, Billing - Night Time, Billing - Midnight" (P.438) • "Internet Fax Profile" (P.438) • "When the [Delete Entry] Button is Selected" (P.438)
"Create Fax Group Recipients" (P.439)	-
"Add Fax Comment" (P.440)	-
"Paper Tray Attributes" (P.440)	-

Accounting

"Create/View User Accounts" (P.441)	<ul style="list-style-type: none"> • "User ID" (P.442) • "User Name" (P.442) • "Passcode" (P.442) • "E-mail Address" (P.442) • "Device Access" (P.442) • "Service Access" (P.442) • "User Role" (P.443) • "Reset Account" (P.444) • "Reset Total Impressions" (P.444)
"View Accounts" (P.444)	-
"Reset User Accounts" (P.444)	-
"System Administrator's Meter (Copy Jobs)" (P.445)	-
"Accounting Type" (P.445)	<ul style="list-style-type: none"> • "Accounting Disabled" (P.445) • "Local Accounting" (P.445) • "Network Accounting" (P.445) • "ColorTrack" (P.446) • "Accounting Mode" (P.446) • "Verify User Details" (P.446) • "Customize User Prompts" (P.446)
"Accounting Login Screen Settings" (P.446)	<ul style="list-style-type: none"> • "Alternative Name for User ID" (P.446) • "Mask User ID (***)" (P.447) • "Alternative Name for Account ID" (P.447) • "Mask Account ID (***)" (P.447) • "Display Billing Information Upon Login" (P.447) • "Store User Details" (P.447)
"Fax Billing Data" (P.447)	-
"Accounting/Billing Device Settings" (P.448)	<ul style="list-style-type: none"> • "Connect with Account/Billing Device" (P.448) • "Accounting/Billing Device" (P.448) • "Track Print Jobs" (P.448) • "Track Scan/Fax Jobs" (P.449) • "Interrupt Mode" (P.449) • "Job with Insufficient Credit" (P.449) • "Charge Print Jobs" (P.449) • "Track with Cumulative Device" (P.449) • "Scan Ahead for Copy Job" (P.449)

Authentication/Security Settings

"System Administrator Settings" (P.450)	<ul style="list-style-type: none"> • "System Administrator's Login ID" (P.450) • "System Administrator's Passcode" (P.450)
"Authentication" (P.451)	<ul style="list-style-type: none"> • "Login Type" (P.451) • "Access Control" (P.451) • "Create/View User Accounts" (P.453) • "Reset User Accounts" (P.453) • "Create Authorization Groups" (P.453) • "User Details Setup" (P.454) • "Maximum Login Attempts by System Administrator" (P.456) • "Passcode Policy" (P.456) • "Charge/Private Print Settings" (P.456) • "Receive Control" (P.457)

"Allow User to Disable Active Settings" (P.458)	-
"Job Status Default" (P.459)	<ul style="list-style-type: none">• "Active Jobs View" (P.459)• "Completed Jobs View" (P.459)
"Overwrite Hard Disk" (P.459)	<ul style="list-style-type: none">• "Number of Overwrites" (P.459)

Common Service Settings

In [Common Service Settings], you can make settings relating to the machine's common features. The following shows the reference section for each item.

Machine Clock/Timers	314
Power Saver Settings.....	317
Audio Tones	317
Screen/Button Settings	319
Paper Tray Settings	321
Image Quality Adjustment	326
Reports.....	327
Maintenance.....	329
Watermark	330
Force Annotation	332
Print Universal Unique ID.....	333
Notify Job Completion by E-mail	333
Plug-in Settings	334
Other Settings	334

- 1 On the [Tools] screen, select [System Settings] > [Common Service Settings].
For information on how to display the [Tools] screen, refer to "System Settings Procedure" (P.296).
- 2 Select an item to set or change.

Machine Clock/Timers

You can set the machine clock or the time intervals of the machine to reset settings.

Date

Set the date in the system clock of the machine. The date set here will be printed on all lists and reports.

- 1 Select [Date], and then select [Change Settings].
- 2 Select a date format.
- 3 Specify [Year], [Month], and [Day].
- 4 Select [Save].

Time

Set the time in the system clock of the machine, using 12-hour or 24-hour format. The time set here will be printed on all lists and reports.

- 1 Select [Time], and then select [Change Settings].

- 2 Select the time format.
- 3 When you select [12 Hour Clock], set [AM] or [PM].
- 4 Specify [Hours] and [Minutes].
- 5 Select [Save].

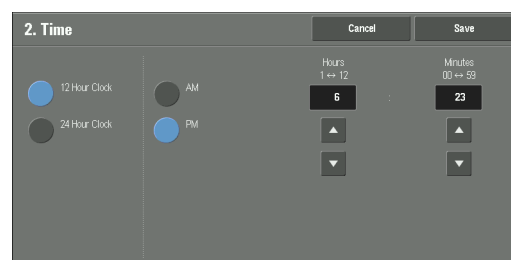

NTP Time Synchronization

You can synchronize the machine clock with a time server (NTP: Network Time Protocol), receiving time information from the server.

To connect to a time server, select [On] for [NTP Time Synchronization], and set the IP address of the time server in [Time Server Address].

Connection Interval

Select the time interval to connect to the time server.

You can select from 1 to 500 hours in 1 hour increments.

Time Server Address

Set the server name or IP address of the time server.

- Note**
- For IPv4, enter the IP address in xxx.xxx.xxx.xxx format, where "xxx" is a value between 0 and 255.
 - For IPv6, enter the IP address in xxxx:xxxx:xxxx:xxxx:xxxx:xxxx:xxxx:xxxx format, where "xxxx" is a hexadecimal number.

Auto Clear

Specify the time lapsed without any operation until the machine resets the settings automatically.

When you select [On], specify a value between 10 and 900 seconds in 1 second increments. To disable this feature, select [Off].

- Note**
- When [Off] is selected, the machine will cancel the standby status and begin processing a document after one minute has elapsed in anticipation of a job command.
 - The timer does not start counting until the operator leaves the detectable area of the wakeup motion sensor.

Auto Job Release

Specify the time lapsed until the machine cancels the active job and starts the next job if an error such as document or paper jams and running out of paper occurs during copying or scanning. In that case, only those jobs not affected by the error can be processed.

When you select [On], specify a value in 1 minute increments. To disable this feature, select [Off].

Auto Print

Set the time period to start the next print job after the operation of the control panel (except for the <Start> and <Clear All> buttons) after the end time of the Printer Lockout Duration passed.

When you select [On], specify a value between 1 and 240 seconds in 1 second increments. When you select [Off], printing starts immediately after the machine is ready.

Printer Lockout

You can set the machine to disable printing during the specified time period or to temporarily disable printing.

Selecting [On] allows you to set [Set Lockout Duration] and/or [Allow User to Lock Out]. When [Allow User to Lock Out] is selected, the [Lock Out Printer] button needs to be displayed on the right side of the [Home] screen.

Set Lockout Duration

Set the time period to disable printing. Specify the start and end time to disable printing in 1 minute increments.

Allow User to Lock Out

Selecting [Lock Out Printer] on the [Home] screen temporarily disables printing. [Release Printer] is displayed during the printer lockout duration. Selecting [Release Printer] enables printing.

- Note**
- A job started before the start time will be printed continuously even after elapsing the start time. The job will be printed continuously even if you select [Lock Out Printer] while printing. After the job is completed, the machine enters the printer lockout status.
 - When both [Set Lockout Duration] and [Allow User to Lock Out] are set and the start time comes while the [Release Printer] button is displayed, the machine automatically enters the printer lockout status.
 - When you select [Release Printer] during the printer lockout duration, printing is enabled, and when you then select [Lock Out Printer], the machine resumes the printer lockout status.
 - The printer lockout status is not released automatically even after the end time elapsed. To release the printer lockout status, the control panel operation is required.
 - The printer lockout duration will not be released even when you switch the power off and then on again, or even when you press the <Power Saver> button while the machine is in the Power Saver mode (Low Power mode or Sleep mode).
 - The machine starts printing in accordance with the setting in [Auto Print] when [Release Printer] is selected. Thus the printing may not start just after [Release Printer] is selected.
 - You can also print during the printer lockout duration by selecting a job in [Active Jobs] on the [Job Status] screen and then selecting [Promote Job].
 - When the [Allow User to Lock Out] check box is deselected, [Disable Auto Printing] in [Home - Additional Features] is displayed as [(Not Assigned)].

Time Zone

Set the time difference from GMT between -12 and +12 hours.

- Note**
- GMT stands for Greenwich Mean Time.

Daylight Savings

You can set daylight saving time. During daylight saving time period, the machine moves the clock forward by one hour.

Select from [Adjust Off], [Adjust by Day, Month & Time], or [Adjust by Month, Week, Day of Week & Time].

If you select [Adjust by Day, Month & Time], specify the month, day, and time for [Start Date] and [End Date].

If you select [Adjust by Month, Week, Day of Week & Time], specify the month, week, day of week, and time for [Start Date] and [End Date].

Print-On-Demand Duration

Specify the duration for the machine to receive a print job from web applications. Unless the machine receives full data of the print job within the specified period of time, the machine does not process the print job.

Specify the time duration between 0 and 255 minutes in 1 minute increments. If you specify [0], it means that there is no time limit set on the machine for receiving data.

- Note**
- When you send a print job that contains a large amount of data or a print job whose contents take a while to be processed, transmission may be timed out before the machine receives the last page of the print job. If transmission is timed out, the print job will be canceled. Therefore, you should consider the machine usage when you set the time duration.

Power Saver Settings

You can configure the following settings of the Power Saver mode.

Power Saver Timers

The Power Saver mode has two modes: the Low Power and Sleep modes. When a specified period of time has elapsed, the machine switches to these modes in the following order to reduce power consumption.

Last operation on the machine g Low Power mode g Sleep mode

For more information on the setting procedure, refer to "Power Saver Mode" (P.46).

- Note**
- You cannot configure the machine not to switch to the Low Power mode or the Sleep mode.

From Last Operation to Low Power Mode

Specify a time period between 1 and 120 minutes in 1 minute increments to enter the Low Power mode after the last operation.

- Note**
- The timer does not start counting until the operator leaves the detectable area of the wakeup motion sensor. The Access Lamp will be lit while the machine detects human presence.

From Last Operation to Sleep Mode

Specify a time period between 1 to 120 minutes in 1 minute increments to enter the Sleep mode after the last operation.

- Note**
- Configure the [From Last Operation to Sleep Mode] time to be longer than the [From Last Operation to Low Power Mode] time.
 - The timer does not start counting until the operator leaves the detectable area of the wakeup motion sensor. The Access Lamp will be lit while the machine detects human presence.

Power Saver Deactivation

Select whether to disable the Power Saver mode fully or partially when exiting the mode.

Deactivate All

All devices of the machine exit the Power Saver mode.

Deactivate Partially As Required

Only the devices necessary for the operation exit the Power Saver mode.

You can select from [Always On] or [When Printing / Job Auto Processing].

- Note**
- This is not effective when [EtherTalk Compatible - Port Status] is set to [Enabled]. For more information on the port setting, refer to "Port Settings" (P.358).

Deactivate With wakeup motion sensor

Set whether or not to allow the wakeup motion sensor to deactivate the Power Saver mode.

Audio Tones

Select whether to sound an alarm when a job ends or a fault occurs.

Control Panel Select Tone

Set the volume to be sounded when a button displayed on the screen is correctly selected. You can select from [Soft], [Normal], or [Loud]. To disable the sound, select [Off].

Control Panel Alert Tone

Set the volume to be sounded when a button that cannot be selected is selected, or an error occurs.

You can select from [Soft], [Normal], or [Loud]. To disable the sound, select [Off].

Base Tone

Set the volume for the base tone of the toggle button, which changes setting each time it is pressed. The machine plays this sound when it exits the Interrupt mode.

You can select from [Soft], [Normal], or [Loud]. To disable the sound, select [Off].

Machine Ready Tone

Set the volume to be sounded when the machine is ready to copy or print, or powered on.

You can select from [Soft], [Normal], or [Loud]. To disable the sound, select [Off].

Job Complete Tone 1, 2

Set the volume to be sounded when a job is completed normally.

You can select from [Soft], [Normal], or [Loud]. To disable the sound, select [Off].

You can select the target jobs to play the sound.

Fault Tone

Set the volume to be sounded when a job fails.

You can select from [Soft], [Normal], or [Loud]. To disable the sound, select [Off].

You can select the target jobs to play the sound.

Auto Clear Alert Tone

Set the volume to be sounded at five seconds before automatically returning to the initial screen when [Auto Clear] is set to [On].

You can select from [Soft], [Normal], or [Loud]. To disable the sound, select [Off].

For more information, refer to "Auto Clear" (P.315).

Alert Tone

Set the volume to be sounded when a fault such as a paper jam occurs, and the job remains in failure state.

You can select from [Soft], [Normal], or [Loud]. To disable the sound, select [Off].

Out of Paper Warning Tone

Set the volume to be sounded when a job is suspended because there is no paper in a tray.

You can select from [Soft], [Normal], or [Loud]. To disable the sound, select [Off].

Low Toner Alert Tone

Set the volume to be sounded when the toner cartridge needs replacing.

You can select from [Soft], [Normal], or [Loud]. To disable the sound, select [Off].

Stored Programming Tone

Set the volume to be sounded while a stored program is being registered.

You can select from [Soft], [Normal], or [Loud].

This tone cannot be disabled.

Stored Programming Complete Tone

Set the volume to be sounded when the call of a stored programming registered is completed.

You can select from [Soft], [Normal], or [Loud]. To disable the sound, select [Off].

Line Monitor Volume

You can relay the sound on the telephone line until the connection is made through the speakers on the machine. This is convenient for Fax Information Services without using the telephone receiver.

You can select a volume level from [Soft], [Normal], or [Loud]. To disable the sound, select [Off].

Ringing Volume

Set the volume to be sounded when the machine receives a fax.

You can select from [Soft], [Normal], or [Loud]. To disable the sound, select [Off].

Screen/Button Settings

Set screens and buttons.

Screen Default

Set the screen displayed after powering on the machine or canceling the Power Saver mode.

Screen After Auto Clear

Set the screen displayed after Auto Clear.

Auto Display of Login Screen

When the Authentication feature is enabled on the machine, set whether or not to automatically display the login screen after turning on the machine or canceling the Power Saver mode.

Custom Buttons 1 to 3

You can assign services such as Copy and Send from Folder to the custom buttons on the control panel: Custom Button 1 to Custom Button 3.

To leave a feature unassigned, select [(Not Set)].

Note • Copy service is assigned to [Custom Button 1] and Review is assigned to [Custom Button 3] by factory default.

One-touch Buttons

Set the number of address numbers that are assigned to the one touch buttons.

Type 1

Assigns the one touch buttons 1 to 70 to the address numbers 0001 to 0070, and buttons M01 and M02 to the stored programming jobs 1 and 2.

Type 2

Assigns the one touch buttons 1 to 60 to the address numbers 0001 to 0060, and buttons 61 to 72, and M01 and M02 to the stored programming jobs 1 and 12.

Note • [Type 1] is selected by factory default.

Home

Set the layout of service buttons that appear on the [Home] screen.

Home - Additional Features

Set the layout of additional feature buttons that appear on the [Home] screen.

Note • If you do not want to display [Setup] as an additional feature button, select the [Show this in Admin mode] check box. You can set or change settings with the machine only when it is in the System Administration mode.

Job Type on Job Status screen

Select the job types to be shown on the [Completed Jobs] screen under the [Job Status] screen that is displayed when the <Job Status> button on the control panel is pressed.

Select from [All Jobs], [Printer & Print from Folder Jobs], [Scan, Fax, & Internet Fax Jobs], or [Job Flow & File Transfer Jobs].

Default Language

You can select the language displayed on the machine.

There are two ways of selecting the language: set in the System Administration mode and set by local users.

- Setting in the System Administration mode

The language set here is the standard language that is retained even when the machine is powered off and on.

- Setting by in the Local User mode

The language setting in [Language] in the [Home] screen is lost when the machine is powered off.

Note • When [English] is selected, only ASCII characters can be used.
• When you set [Language] to [English] on the [Home] screen and an address book entry or contents of [Details] of Job Flow Sheets is entered in other than ASCII characters, the characters may not be displayed properly. When you use Dell Printer Configuration Web Tool to import a CSV file* that includes the characters other than those used for the language selected in [Language], the characters in the file may be garbled or the import may fail.
* : CSV (Comma Separated Values) is a file format that is often used for saving data by spreadsheets and database programs.

Screen Brightness

You can adjust the screen brightness of the control panel between -16 and +16.

Reconfirm E-mail Recipient

Select whether or not to display the screen to confirm e-mail recipients when sending e-mails.

Select from [Confirmation Not Required], [Always Reconfirm Recipient], or [Reconfirm if Multiple Recipients].

Reconfirm Fax/Internet Fax Recipient

Set whether or not to display a screen to confirm fax/Internet fax recipients when sending faxes / Internet faxes.

First Tab - Reconfirm Recipients

Select from [Off], [Always Reconfirm Recipient], and [Reconfirm if Multiple Recipients].

Start Job at Other Tabs

Select from [Disabled] and [Enabled].

Note • When you select [Disabled], you cannot confirm the e-mail recipients in other Tabs.

Reconfirm Recipient at Other Tabs

Select from [Off], [Always Reconfirm Recipient], and [Reconfirm if Multiple Recipients].

Note

- This item is not displayed when you select [Disabled] for [Start Job at Other Tabs].
- [Off] cannot be selected when you select [Reconfirm if Multiple Recipients] for [First Tab - Reconfirm Recipients]. And [Off] and [Reconfirm if Multiple Recipients] cannot be selected when you select [Always Reconfirm Recipient] for [First Tab - Reconfirm Recipients].

Reconfirm E-mail Recipient Button

Set whether or not to display a screen to check available memory when sending e-mails. Select from [Disabled (Show Memory)] and [Enabled].

Reconfirm Fax / Internet Fax Button

Set whether or not to display a screen to check available memory when sending faxes / Internet faxes.

Select from [Disabled (Show Memory)] and [Enabled].

Screen After Inserting USB

Select whether or not to display the screen when the machine detects USB memory device insertion, and also select the screen type at the time.

Select from [Off], [Store to USB], [Media Print - Text], [Media Print - Photos], and [Service Selection Screen].

Note

- If you select [Service Selection Screen], the [USB Device Detected] screen is displayed when a USB memory device is inserted. You can select [Store to USB], [Media Print - Text], or [Media Print - Photos].
- If a USB memory device is inserted when the machine is switched off, and then you switch on, the [Home] screen is displayed.
- When a USB memory device is inserted into the USB memory slot during the Power Saver mode, the touch screen does not light up. After exiting the Power Saver mode by pressing the <Power Saver> button, insert the USB memory device again or select the feature to be used on the [Home] screen.
- If a commercially available Memory Card Reader is used and it is left inserted all the time, the screen is not switched to the selected screen even when a medium is inserted into the slot of the Memory Card Reader.

Paper Tray Settings

You can name the Custom Paper Type 1-5, which can be specified for [Paper Type], and the Custom Paper Color 1-5, which can be specified for [Paper Color] under [Paper Tray Attributes].

Custom Paper Name/Color

You can name Custom Paper Types 1 to 5 which you can select in [Paper Type] and Custom Paper Colors 1 to 5 which you can select in [Paper Color] of [Paper Tray Attributes].

You can use letters, numerals, and symbols of up to 24 characters for each name and color.

For example, you can use a name showing its usage, such as "Color" for colored paper, and "Covers" for bond paper.

For information about how to enter characters, refer to "Entering Text" (P.57).

Paper Tray Attributes

You can set the size and type of paper loaded in trays.

For more information, refer to "Changing the Paper Settings" (P.244).

Change Settings

Select this button, if you change the paper size for the tray or the setting of auto paper selection.

When you load non-standard size paper in a tray, select [Custom Size], and specify the width and length. When you load standard size paper in a tray, select [Auto Detect].

Note • Align the paper guides against the paper to prevent paper jams or errors. If the machine cannot detect a tray, use Tray 5.

- Paper Type

Select the type of paper to load in the trays.

For information about paper types available on the machine, refer to "Loadable Quantity and Weight" (P.226).

- Paper Size

When using Trays 1 to 4, you can load both standard size paper and non-standard size paper. When you load non-standard size paper, select [Custom Size], and then set the size in the X (width) direction and in the Y (length) direction. For Tray 1, set the size in X (width) direction between 182 and 432 mm and the Y (length) direction between 140 and 297 mm in 1 mm increments. For Trays 2 to 4, set the X (width) direction between 182 to 457 mm and the Y (length) direction between 140 to 320 mm in 1 mm increments. When you load standard size paper, select [Auto Detect].

For Tray 6 (optional HCF B1), select [Auto Detect] because only standard size paper can be loaded.

- Paper Color

Set the color of paper. The paper color selected here is displayed as the paper color on the [Paper Supply] screen.

- Auto Paper Select

Set the condition for Auto Paper selection. When the color mode selected is used, Auto Paper selection is enabled. Select from [All Colors], [Color], and [Black & White].

Automatic tray selection means that a tray containing the appropriate paper is automatically selected by the machine for copying or printing.

Customize Paper Supply Screen

Select whether the setting items specified in [Paper Size] or [Auto Paper Select] under [Paper Tray Attributes] are to be displayed on the [Paper Supply] screen.

Disabled

Does not display the items specified in [Paper Size].

Size Detection

Displays the setting in [Paper Size].

Usage (Auto Paper Select)

Displays the setting in [Auto Paper Select].

Paper Tray Attributes on Setup Screen

Select whether or not to display [Paper Tray Attributes] in the [Setup] screen or not.

This setting allows you to select the size and type of paper without entering the System Administration mode.

Paper Tray Attributes During Loading

Select whether or not to display the [Paper Tray Attributes] screen after the tray is pulled out or inserted in.

This setting applies to Trays 1 to 4, 6 (optional). You cannot set this setting to Tray 5.

Paper Tray Priority

Set the priority of the trays to use when paper of the same size and the same orientation is set in the multiple trays or print data does not include the paper tray information.

Auto Paper selection means that a tray containing the appropriate paper is automatically selected by the machine for copying or printing.

This setting applies to Trays 1 to 4, 6 (optional). You cannot set this setting to Tray 5.

Note • When a logical printer is used and if you specify the paper tray with the print driver, this setting will be ignored.

Paper Type Priority

Set the priority of the trays to use when paper of the same size and the same orientation is set in the multiple trays.

Auto Paper selection means that a tray containing the appropriate paper is automatically selected by the machine for copying or printing.

You can set Bond paper, Plain paper, Recycled paper, Plain Reload paper, Heavyweight (HW) paper, Gloss paper, Heavyweight (HW) A paper, Heavyweight (HW) B paper, Heavyweight (HW) C paper, Heavyweight (HW) S paper, and Custom Paper 1 to 5.

The paper type setting is prioritized over the paper tray priority settings.

If, however, different paper types appear in the same priority sequence, the paper is determined by paper tray priority sequence. The tray containing paper type set to [Auto Paper Off] is not selected by automatic tray selection.

For more information about the tray priority sequence, refer to "Paper Tray Priority" (P.323).

Tray 5 - Paper Size Defaults

Select the paper sizes displayed in the [Tray 5] screen in [Paper Supply] when copying with Tray 5.

You can assign the paper size selected here to the buttons for [Standard Size] in the [Tray 5] screen.

If you frequently use non-standard size paper for copying, assigning the paper sizes to the buttons will save your time to specify the size each time. For your convenience, set the commonly used paper sizes in the upper level.

A/B Series Size

You can select from sizes of A and B series.

Inch Size

You can select from sizes of inch series.

Others

You can select from other sizes.

Custom Size

You can enter any size. Set the X width between 98 and 483 mm, and the Y length between 89 and 320 mm in 1 mm increments.

Note • For envelopes, enter the size with the flap size excluded.

Auto Tray Switching Control

Set the alternative tray or paper when running out of paper loaded in the tray selected.

Auto Tray Switching

You can select from [Always Enable], [Enable during Auto Select], or [Enable for Same Paper Type/Color].

When [Enable during Auto Select] is selected, the machine switches the tray when [Auto Select] is selected in the [Copy] screen or [Paper Select] of the print driver.

Note • The machine does not switch the tray automatically in the following cases:

- Tray 5 is selected.
- The tray containing paper that is set as [Auto Paper Off] in [Paper Type Priority] is selected.

Targeted Paper Type (Copy Jobs)

You can select paper types.

When [According to Priority Assigned] is selected, the paper type is determined according to the settings in [Paper Type Priority]. When selecting [Selected Paper Type Only], you can specify the paper type.

Targeted Paper Color (Copy Jobs)

You can target all paper colors or only one paper color.

Image Quality

You can specify the image quality processing method for each of bond paper, plain paper, recycled paper, plain reload paper, heavyweight paper, heavyweight reload paper, extra heavyweight paper, extra heavyweight reload paper, and custom paper 1 to 5.

When copying or printing a document, the machine controls the image quality according to the type of paper set in [Image Quality] and the image quality processing method specified for that type of paper.

The following table shows available settings.

For information about paper characteristics and notes, refer to "Loadable Quantity and Weight" (P.226).

Setting values	Meaning
Plain A (80-105 gsm)	Default setting for bond paper. The image quality is suitable for color printing. Paper having ream weight of 80 - 105 gsm.
Plain B (60-79 gsm)	Paper having ream weight of 60 - 79 gsm.
Plain C (60-79 gsm)	Default setting for recycled paper. The image quality is suitable for the recycled paper that contains 70% or more recycled pulp. Paper having ream weight of 60 - 79 gsm.
Plain D (60-79 gsm)	Normally, do not select this value.
Plain E (60-79 gsm)	Default setting for plain paper (North American model). This image quality is suitable for general office use. Paper having ream weight of 60 - 79 gsm.
Plain F (60-79 gsm)	Default setting for plain paper (European model). This image quality is suitable for general office use. Paper having ream weight of 60 - 79 gsm.

Setting values	Meaning
Plain G (80-105 gsm)	Normally, do not select this value.
Plain S (60-105 gsm)	This is for custom settings.
Heavyweight (HW) A (106-169 gsm)	Default setting for heavyweight 1 paper. The image quality is suitable for the bond paper and eco-friendly paper that is made of 100% of farmed trees. Paper having ream weight of 106 - 169 gsm.
Heavyweight (HW) B (106-169 gsm)	This is for custom settings.
Heavyweight (HW) C (106-169 gsm)	This is for custom settings.
Heavyweight (HW) S (106-169 gsm)	Normally, do not select this value.
Heavyweight A Reload (106-169 gsm)	Default setting for Heavyweight Reload paper. The image quality is suitable for side 2 of the Heavyweight A paper.
Heavyweight B Reload (106-169 gsm)	The image quality is suitable for side 2 of the Heavyweight B paper.
Heavyweight C Reload (106-169 gsm)	The image quality is suitable for side 2 of the Heavyweight C paper.
Heavyweight S Reload (106-169 gsm)	Normally, do not select this value.
Extra Heavyweight (X-HW) A (170-256 gsm)	Default setting for Extra Heavyweight paper. The image quality is suitable for the bond paper, eco-friendly paper which is made of 100% of farmed trees, postcards, and envelopes. Paper having ream weight of 170 - 256 gsm.
Extra Heavyweight (X-HW) B (170-256 gsm)	This is for custom settings.
Extra Heavyweight (X-HW) C (170-256 gsm)	This is for custom settings.
Extra Heavyweight (X-HW) D (170-256 gsm)	This is for custom settings.
Extra Heavyweight (X-HW) S (170-256 gsm)	Normally, do not select this value.
Extra Heavyweight (X-HW) A Reload (170-256 gsm)	Default setting for Extra Heavyweight Reload paper. The image quality is suitable for side 2 of the Extra Heavyweight A paper.
Extra Heavyweight (X-HW) B Reload (170-256 gsm)	The image quality is suitable for side 2 of the Extra Heavyweight B paper.
Extra Heavyweight (X-HW) C Reload (170-256 gsm)	The image quality is suitable for side 2 of the Extra Heavyweight C paper.
Extra Heavyweight (X-HW) D Reload (170-256 gsm)	The image quality is suitable for side 2 of the Extra Heavyweight D paper.
Extra Heavyweight (X-HW) S Reload (170-256 gsm)	Normally, do not select this value.

Image Quality Adjustment

You can set the image quality and calibration settings.

Image Quality

You can select the image quality processing method when the machine scans a document.

Photo & Text Recognition

Allows you to change a level with which the machine determines a document as text or photos. This setting is used when you select [Photo & Text] for [Original Type] on the [Image Quality] screen.

Selecting [More Text] enables the machine to easily recognize very fine print as text.

Selecting [More Photo] enables the machine to easily recognize halftone images from newspapers and advertisements as photos.

Output Color Recognition

Allows you to change a level from the five levels with which the machine determines a document as monochrome or color. This setting is used when you select [Auto Detect] for [Output Color] on the [Copy] screen.

Selecting [More Black & White] enables the machine to easily recognize monochrome documents.

Selecting [More Color] enables the machine to easily recognize color documents.

Photo Reproduction Level

When copying with [Original Type] in the [Image Quality] screen set to [Photo & Text], you can adjust the color reproduction level in the areas determined by the machine as photos.

Selecting [More Text] yields a bold copy effect, emphasizing the dense parts of an image.

Selecting [More Photo] softens the image gradation of the photo aspects of an image, enhancing the reproducibility of subtle colors.

Photo Image Quality

[Photo Image Quality] is valid when [Photo] is selected for [Original Type] on the [Image Quality] screen.

Selecting [High Speed] copies a document without reducing the processing speed. Selecting [High Quality] creates a near-quality reproduction of the document.

Note • Selecting [High Quality] may reduce the copy speed.

Background Suppression (Color Copy)

Set the method of background suppression to be used when making color copies.

Background suppression is the function to detect the density of colors and suppress the scan of background colors when a document has background colors on colored paper.

Select [High Speed] to sample a section of the document and detect the background color.

Select [High Quality] to conduct a pre-scan, and sample the whole document to detect the background color.

Note • When you select [High Quality], and [Corner Shift] is selected in [Image Shift] with a ratio of 60% or less is specified in [Reduce/Enlarge], a part of the image may not be printed or blank paper may be output.

Background Suppression (Black Copy)

Set the method of background suppression to be used when making monochrome copies.

Background suppression is the function to detect the density of colors and suppress the scan of background colors when a document has background colors on colored paper.

Select [High Speed] to sample a section of the document and detect the background color.

Select [High Quality] to conduct a pre-scan, and sample the whole document to detect the background color.

Note • When you select [High Quality], and [Corner Shift] is selected in [Image Shift] with a ratio of 60% or less is specified in [Reduce/Enlarge], a part of the image may not be printed or blank paper may be output.

Background Suppression (Scan Jobs)

Set the method of background suppression to be used for scan operations.

Set how the machine detects density and deletes the background color.

Select [High Speed] to sample a section of the document and detect the background color.

Select [High Quality] to conduct a pre-scan, and sample the whole document to detect the background color.

Image Enhancement

Allows you to select whether to carry out image enhancement. If you select [On], the machine gives the image a smoother appearance when printed.

Calibration

Calibrate the machine regularly to correct and ensure consistency of printing colors over time, environment and devices.

For more information, refer to "Executing Calibration" (P.265).

When the printed colors do not seem to have been corrected properly despite regular calibration, contact Customer Support at dell.com/contactdell.

Screen Type

Select from [Copy Job 1], [Copy Job 2], [Print Job 1], and [Print Job 2].

For more information about screen type, refer to "Executing Calibration" (P.265).

Paper Supply

Select a paper tray.

Target

Select from [Copy & Print Jobs], [Copy Jobs Only], [Print Jobs Only], and [None].

Reports

You can configure settings related to printing reports.

Print Reports Button

Set the display method of [Print Reports] under the [Machine Information] screen and [Error History Report] under the [Faults] screen displayed by pressing the <Machine Status> button.

If you select [Disabled], the [Print Reports] button under [Machine Status] > [Machine Information] and the [Error History Report] button under [Faults] are displayed only in the System Administration mode.

For information on Print Reports, refer to "Print Reports" (P.276).

For information on Error History Reports, refer to "Faults" (P.289).

Job History Report

Select whether or not to automatically print a Job History Report when a total of 50 jobs have been processed. All jobs are automatically listed on the printed report.

For information on how to print a Job History Report manually, refer to "Print Reports" (P.276).

Activity Report

Select whether or not to automatically print an Activity Report when a total of 100 communication results have been accumulated.

For information on how to print an Activity Report manually, refer to "Job Status / Activity Report" (P.277).

Transmission Report - Job Undelivered

Select whether or not to automatically print a Transmission Report - Job Undelivered.

Transmission Report - Job Deleted

Select whether or not to automatically print a Transmission Report - Job Deleted for a cancelled document.

Folder Report

Select whether or not to automatically print a Folder Report.

Broadcast/Multi-Poll Report

Select whether or not to automatically print a Broadcast Report and a Multi-Poll Report.

Scan File Transfer Report

Select whether or not to print the report for data transmission results when the scanned data is transferred to the computer on the network or is sent via e-mail.

Off

Does not print a report regardless of the data transmission result.

On

Automatically prints a Transmission Report when data is sent successfully and a Transmission Report - Job Undelivered when data transmission failed.

Print when delivery fails

Prints a Transmission Report - Job Undelivered when the data transmission failed.

2 Sided Report

Select whether or not to print a report on one side of the paper or both sides when printing a report/list.

Activity Report - Recipient

Select how the information on recipients is shown when printing an Activity Report: the first 40 characters or the last 40 characters.

Job Flow Error Report

Select whether or not to automatically print a Job Flow Error Report.

Maintenance

You can initialize or delete data from the hard disk of the machine.

Initialize Hard Disk

Initializes the hard disk.

Note • The secure print documents and logs are not erased.

Data deleted by initialization includes supplementary fonts and ESC/P forms.

Delete All Data

This feature is designed to prevent the leakage of confidential information of a customer when the machine is returned to Dell. By executing [Start], all data registered on the machine is deleted.

Note • It takes several minutes to several hours to delete all data. (The time taken depends on the machine configuration or the hard disk capacity.)

Software Options

This feature is for service representative use. For more information, contact Customer Support at dell.com/contactdell.

Power on Self Test

Set whether or not to perform self test when the machine is turned on and started up.

If any abnormal condition such as intentional program modification is found during the program diagnosis, the machine stops starting up and records the information in the audit log.

Note • The information may not be recorded in the audit log depending on the status of program malfunction.
• If the machine does not start, contact Customer Support at dell.com/contactdell.

Check Smart Card Details

When you select [Check Smart Card Details] and touch your smart card to the smart card reader, the information of the smart card appears on the touch screen.

Note • You can register the authentication information using Dell Printer Configuration Web Tool.

Finisher Adjustment

This feature is displayed only when the Finisher-B1 (optional), the Booklet Maker Unit for Finisher-B1 (optional), or the Hole Punch Unit (optional) is installed.

Hole Punch Tool

Specify either 2/4 Hole Punch or 2/3 Hole Punch (US Specification).

Adjust Punch Position/Booklet Fold Position

Set the punch position and booklet fold position for paper smaller than B4 or larger than or equal to B4.

Adjust Image Transfer

You can specify the transfer output value for each paper type. This is useful when the toner image does not transfer to the paper properly.

Adjust Paper Registration

Allows you to adjust the print image position vertically and horizontally. Enter values from -2.0 to + 2.0, and select [Adjust].

When you enter the [Number of Sheets] value and select [Sample Printout], the machine prints a sample with the image position adjusted.

Delete All Certificates/Initialize Settings

Deletes all certificates stored in the machine and initializes the security settings associated with certificates. This feature is designed to use when you cannot use a certificate data in the machine because of an abnormality of certificate file even when the certificate is set to enabled for [SSL/TLS Settings] under [Connectivity & Network Setup] > [Security Settings].

Quick Setup Home

Starts the installation wizard for the machine.

You can configure the Screen/Button Setup, the Network Setup, and the Fax Setup.

For more information on the setting items, refer to "Screen/Button Settings" (P.319), "Connectivity & Network Setup" (P.358), and "Fax Service Settings" (P.394).

Watermark

You can print watermark text or pattern as the background of the main document to protect the document from unauthorized copying.

The following Watermark settings can be specified.

Date Format

Specify the format of the date to print as watermark. The format specified here will also be used for Annotation and Force Annotation.

The following three formats are available: "YYYY/MM/DD", "MM/DD/YYYY", and "DD/MM/YYYY".

Default Watermark

Specify the text to print as watermark.

You can select the text from [Copy Prohibited], [Copy], [Duplicate], and the text specified for Custom Watermark 1 to 3.

For more information about custom text, refer to "Custom Watermark 1 to 3" (P.331).

Font Size

Specify the font size of watermark.

You can set the font size from 24 to 80 points in 1 point increments.

Background Pattern

Specify the background pattern to print as watermark.

The following eight patterns are available: [Wave], [Circle], [Stripe], [Chain], [Beam], [Rhombic], [Sunflower], and [Fan].

Font Color

Specify the color of watermark.

You can select from [Black], [Magenta], and [Cyan].

- Note**
- The Watermark will be printed in black on faxes regardless of this setting.

Density

Specify the density of watermark.

You can select from [Lighten], [Normal], and [Darken].

Watermark/Background Contrast

Specify the contrast level of watermark text and pattern.

You can select a level from 1 to 9. To print samples, select [Print this Sample List].

Force Watermark - Copy

Specify whether to force printing watermark on every copied document. When [On] is selected, the [Watermark] setting on the [Output Format] screen will be fixed to [On] and unchangeable. The user ID, the machine ID, and the date and time will be printed as watermark.

- Note**
- You can authorize a user to temporarily cancel the Force Watermark settings. For more information, refer to "User Roles and Authorization Groups" (P.536).

Force Watermark - Client Print

Specify whether to force printing watermark on every document printed from a computer. To apply the Watermark settings of the machine, select [Allow Device Settings to Override]. To apply the settings specified from an application or a print server, select [Allow Client Settings to Override]. When [Allow Device Settings to Override] is selected, the user ID, the machine ID, and the date and time will be printed as watermark.

Force Watermark - Print Stored File

Specify whether to force printing watermark on every document printed from a folder on the machine. The user ID, the machine ID, and the date and time will be printed as watermark.

- Note**
- You can authorize a user to temporarily cancel the Force Watermark settings. For more information, refer to "User Roles and Authorization Groups" (P.536).

Force Watermark - Media Print

Specify whether to force printing watermark on a Media Print job.

The user ID, the machine ID, and the date and time will be printed as watermark.

- Note**
- You can authorize a user to temporarily cancel the Force Watermark settings. For more information, refer to "User Roles and Authorization Groups" (P.536).

Custom Watermark 1 to 3

You can register 3 custom watermarks of up to 32 single-byte characters. The registered custom watermarks will be specifiable for [Default Watermark].

For information about how to enter characters, refer to "Entering Text" (P.57).

Print this Sample List

Prints samples of watermarks with different background contrasts, which is useful for selecting the contrast level for [Watermark/Background Contrast].

Force Annotation

The string such as a user name and a date (Annotation) is forcibly printed out according to the layout template associated with each job type.

Note • When a watermark or Universal Unique ID is to be printed on the copies, it may overlap the text printed by the Force Annotation feature.

The layout templates, Preset 1 to Preset 4, are provided with the machine. The printed items with the templates as follows:

- Preset 1 and Preset 2

The string registered on [Create Text String 1] is printed faintly at an angle in the center of paper.

The following items are printed at the bottom right for Preset 1 or bottom left for Preset 2 of paper.

- first line: file name and the IP address of the computer that send a print job
- second line: user name, user ID, card ID, and date and time

- Preset 3 and Preset 4

The string registered on [Create Text String 1] is printed faintly at an angle in the center of paper.

The following items are printed at the bottom right for Preset 3 or bottom left for Preset 4 of paper.

- user ID and date and time



Note

- Some items may not be printed depending on the job type and performance conditions.
- Force annotation is not printed on a blank paper generated by the machine.
- When the Force Annotation is enabled, you cannot select [Auto Detect] for [Tray 5].
- A time printed faintly using the Force Annotation feature may differ from the time the print job is submitted depending on the status and settings of the machine and the contents of the print job. In this case, the print job start time is printed as a watermark.

For information about how to enter characters, refer to "Entering Text" (P.57).

Apply Layout Template to Copy/Prints Jobs

Set the association with layout templates. You can associate layout templates with the following types of jobs.

- Copy
- Client Print
- Print Stored File
- Media Print
- Print Fax
- Print E-mail
- Report

- Note**
- You can associate a layout template with Client Print when a print job is sent from a computer.
 - You can associate a layout template with Print Stored File when printing a file in a folder.

Delete Layout Template

Deletes a layout template.

- Note**
- The provided layout templates, Preset 1 to Preset 4, cannot be deleted.

Create Text String

Register text strings for the Force Annotation feature. You can register up to eight types of strings in [Create Text String 1] to [Create Text String 8]. You can enter up to 64 single-byte characters.

- Note**
- The available text for the provided layout templates, Preset 1 to Preset 4, is the text strings registered in [Create Text String 1].

Print Universal Unique ID

You can print Universal Unique IDs (UUIDs) for each print job to identify each job.

- Note**
- You can authorize a user to temporarily cancel force watermark printing. For more information, refer to "User Roles and Authorization Groups" (P.536).
 - If a layout template is specified in [Apply Layout Template on Copy/Print Jobs] under [Force Annotation], UUIDs are overlapped with the text on the layout template.

For details on Force Annotation, refer to "Force Annotation" (P.332).

Print Universal Unique ID

Select whether or not to print Universal Unique IDs.

- Note**
- If [Print Universal Unique ID] is set to [Yes], you cannot select [Auto Detect] for [Tray 5].

Print Position

Select a print position from six positions: [Top Left], [Bottom Left], [Top Center], [Bottom Center], [Top Right], or [Bottom Right].

Print Position Adjustment

Adjust print positions vertically and horizontally from 0 to 100 mm and from 0 to 200 mm respectively, in 0.5 mm increments.

- Note**
- 0 mm is at the edge of paper. Increasing the value moves the print position toward the center of the paper. However, for [Top Center] or [Bottom Center], the horizontal value for the center of paper is set to 100 mm. Therefore, when you select [Top Center] or [Bottom Center], set the value to 100 mm and then specify desired value.

Print Position (Side 2)

Select the position to print the UUID on Side 2 from [Same as Side 1] or [Mirror Side 1] when making 2 sided copies.

Notify Job Completion by E-mail

You can receive the results of jobs performed by an e-mail notification.

Targeted Jobs

Select the service whose job result you want to receive by an e-mail notification. When the target job is already selected, [Selected] is displayed.

You can select more than one target job from [Copy], [Fax], [Scan], [Print], or [Report].

Select the notification timing from [Notify at the End of Job] or [Notify when Error Only].

E-mail Addresses 1 to 5

Specify the e-mail addresses to notify the result of the jobs.

Note • When you select [Save] to exit this screen without specifying an e-mail address, the setting of [Targeted Jobs] or [E-mail Message] is deleted.

E-mail Message

Enter a comment attached to the e-mail.

Plug-in Settings

When you use custom services, you can set whether to enable embedded plug-ins and display the list of the plug-ins.

Embedded Plug-ins

Set whether to enable embedded plug-ins.

List of Embedded Plug-ins

Displays [Name] and [Status] of embedded plug-ins.

Other Settings

You can configure other settings related to the machine.

Offset Stacking (Center Tray)

Offsetting means that each set of copies is delivered to the center tray and shifted slightly to separate it from the previous job. When a set of copies is delivered to the front of the tray, the next set is delivered to the rear of the tray. Set the offset function for the Center Tray. Select from [No Offset], [Offset per Set], and [Offset per Job]. When [Offset per Set] or [Offset per Job] is selected, the machine slightly shifts the output position per set or per job (print job) respectively.

Offset Stacking (Center Tray - Upper)

Offsetting means that each set of copies is delivered to the center tray and shifted slightly to separate it from the previous job. When a set of copies is delivered to the front of the tray, the next set is delivered to the rear of the tray. Set the offset function for the Center Tray - Upper. Select from [No Offset], [Offset per Set], and [Offset per Job]. When [Offset per Set] or [Offset per Job] is selected, the machine slightly shifts the output position per set or per job (print job) respectively.

Offset Stacking (Center Tray - Lower)

Offsetting means that each set of copies is delivered to the center tray and shifted slightly to separate it from the previous job. When a set of copies is delivered to the front of the tray, the next set is delivered to the rear of the tray. Set the offset function for the Center Tray - Lower. Select from [No Offset], [Offset per Set], and [Offset per Job]. When [Offset per Set] or [Offset per Job] is selected, the machine slightly shifts the output position per set or per job (print job) respectively.

Offset Stacking (Right Middle Tray)

Offsetting means that each set of copies is delivered to the center tray and shifted slightly to separate it from the previous job. When a set of copies is delivered to the front of the tray, the next set is delivered to the rear of the tray. Set the offset function for the Right Middle Tray. Select from [No Offset], [Offset per Set], and [Offset per Job]. When [Offset per Set] or [Offset per Job] is selected, the machine slightly shifts the output position per set or per job (print job) respectively.

Note • An optional component is required to use this feature. For more information, contact Customer Support at dell.com/contactdell.

Booklet Offset

When [Offset Stacking (Center Tray)] or [Offset Stacking (Right Middle Tray)] is set to [Offset per Set], the paper is output to the tray by being slightly displaced by set. If, however, [Fold & Staple] is selected for booklet settings, the paper is not output by set.

Note • An optional component is required to use this feature. For more information, contact Customer Support at dell.com/contactdell.

Auto Job Promotion

You can select whether or not to allow another job to automatically bypass the current job when the machine is unable to start an operation for any reason, (for example, running out of paper in a tray when starting copying or printing).

Note • Stored documents such as Secure Print and Sample Set documents cannot be used with the Auto Job Promotion feature.

• When [Enabled] is selected and there is a job bypassed because of paper out, a message stating the reason of the job promotion appears. The job bypassed can be processed after you take proper measures by following the instruction of the message. Or, you can cancel the job by pressing the <Clear All> button. When multiple jobs are bypassed, a screen that lists the bypassed jobs appears. This screen allows you to display the details screen and to delete the jobs.

Default Print Paper Size

You can set the most commonly-used paper size, A4 or 8.5 x 11", to print reports and/or lists.

Odd Page 2 Sided



























You can specify whether or not to add a blank page when a document containing an odd number of pages is printed in 2-sided.



















Paper Size Settings



You can specify the size of paper to be automatically detected when you use standard sizes of a document or the machine is set to detect sizes of a document.

You can select from the following tables: [A/B Series (8 x 13")], [A/B Series], [A/B Series (8K/16K)], [A/B Series (8 x 13"/8 x 14")], and [Inch Series].



























Refer to the following tables for a combination of sizes that can be detected automatically.



















Paper size group	AB series (8 × 13")						AB series					
	Document glass	Document feeder	Tray 1	Trays 2 to 4	Tray 5	Tray 6 (HCF B1)	Document glass	Document feeder	Tray 1	Trays 2 to 4	Tray 5	Tray 6 (HCF B1)
Size / Orientation												
A6 	O	X	X	X	X	X	O	X	X	X	X	X
A5 	O	O	O	O	O	X	O	O	O	O	O	X
A5 	O	X	X	X	X	X	O	O	X	X	O	X
A4 	O	O	O	O	X	X	O	O	O	O	O	X
A4 	O	O	O	O	X	O	O	O	O	O	O	O
A3 	O	O	O	O	X	X	O	O	O	O	O	X
B6 	O	X	X	X	O	X	O	X	X	X	X	X
B6 	X	X	X	X	X	X	X	X	X	X	O	X
B5 	O	X	O	O	O	X	O	O	O	O	O	X
B5 	O	O	X	X	X	X	O	O	O	O	O	O
B4 	O	O	O	O	X	X	O	O	O	O	O	X
5.5 × 8.5" 	X	X	X	X	X	X	X	X	X	X	X	X
5.5 × 8.5" 	O	O	X	X	O	X	X	X	X	X	X	X
7.25 × 10.5" 	X	O	O	O	X	O	X	X	X	X	X	X
8 × 10" 	X	X	X	X	X	X	X	X	X	X	X	X
8 × 10" 	X	X	X	X	X	X	X	X	X	X	X	X
8.5 × 11" 	O	O	O	O	O	X	X	O	O	O	X	X
8.5 × 11" 	O	O	O	O	O	O	X	O	O	O	X	O
8.5 × 13" 	X	O	O	O	O	X	X	X	O	O	X	X
8.5 × 14" 	X	X	O	O	O	X	X	X	O	O	X	X
11 × 17" 	O	O	O	O	O	X	X	O	O	O	X	X
12 × 18" 	X	X	X	X	X	X	X	X	X	X	X	X
SRA3 	X	X	X	O	X	X	X	X	X	O	X	X
16 K  (Taiwan)	X	X	X	X	X	X	X	X	X	X	X	X
16 K  (Taiwan)	X	X	X	X	X	X	X	O	O	O	X	X
8 K  (Taiwan)	X	X	X	X	X	X	X	O	O	O	X	X



Paper size group	AB series (8 × 13")						AB series					
	Document glass	Document feeder	Tray 1	Trays 2 to 4	Tray 5	Tray 6 (HCF B1)	Document glass	Document feeder	Tray 1	Trays 2 to 4	Tray 5	Tray 6 (HCF B1)
16 K  (mainland China)	X	X	X	X	X	X	X	X	X	X	X	X
16 K  (mainland China)	X	X	X	X	X	X	X	O	O	O	X	X
8 K  (mainland China)	X	X	X	X	X	X	X	O	O	O	X	X
Postcard 	X	X	X	X	X	X	X	X	X	X	O	X
Envelope (120 x 235 mm) 	X	X	X	X	X	X	X	X	X	X	O	X
Envelope (90 x 205 mm) 	X	X	X	X	X	X	X	X	X	X	O	X
Envelope (240 x 332 mm) 	X	X	X	X	X	X	X	X	X	X	O	X
Envelope (162 x 229 mm) 	X	X	X	X	X	X	X	X	X	X	O	X
Envelope (229 x 324 mm) 	X	X	X	X	X	X	X	X	X	X	O	X
Envelope (235 x 120 mm) 	X	X	X	X	X	X	X	X	X	X	O	X
Envelope (114 x 162 mm) 	X	X	X	X	X	X	X	X	X	X	O	X
Envelope (98 x 148 mm) 	X	X	X	X	X	X	X	X	X	X	O	X
Envelope (105 x 235 mm) 	X	X	X	X	X	X	X	X	X	X	O	X
Commercial #10 envelopes 	X	X	X	X	O	X	X	X	X	X	X	X
Monarch 7.3/4 envelopes 	X	X	X	X	X	X	X	X	X	X	X	X
DL envelopes 	X	X	X	X	X	X	X	X	X	X	X	X
C4 envelopes 	X	X	X	X	X	X	X	X	X	X	X	X
C5 envelopes 	X	X	X	X	X	X	X	X	X	X	X	X
Postcard (4 × 6") 	X	X	X	X	X	X	X	X	X	X	X	X

Paper size group	AB series (8 × 13")						AB series					
	Document glass	Document feeder	Tray 1	Trays 2 to 4	Tray 5	Tray 6 (HCF B1)	Document glass	Document feeder	Tray 1	Trays 2 to 4	Tray 5	Tray 6 (HCF B1)
Loading Position												
Size / Orientation												
Photograph 2L (5 × 7") 	X	X	X	X	X	X	X	X	X	X	X	X
Postcard (6 × 9") 	X	X	X	X	X	X	X	X	X	X	X	X

O :Available
X :Not available



























Paper size group	AB series (8 K / 16 K)						AB series (8 × 13" / 8 × 14")					
	Document glass	Document feeder	Tray 1	Trays 2 to 4	Tray 5	Tray 6 (HCF B1)	Document glass	Document feeder	Tray 1	Trays 2 to 4	Tray 5	Tray 6 (HCF B1)
Loading Position												
Size / Orientation												
A6 	O	X	X	X	X	X	O	X	X	X	X	X
A5 	O	O	O	O	O	X	O	O	O	O	O	X
A5 	O	O	X	X	O	X	O	X	X	X	X	X
A4 	O	O	O	O	O	X	O	O	O	O	X	X
A4 	O	O	O	O	O	O	O	O	O	O	X	O
A3 	O	O	O	O	O	X	O	O	O	O	X	X
B6 	O	X	X	X	X	X	O	X	X	X	O	X
B6 	X	X	X	X	O	X	X	X	X	X	X	X
B5 	O	O	O	O	O	X	O	X	O	O	O	X
B5 	O	O	O	O	O	O	O	O	X	X	X	X
B4 	O	O	O	O	O	X	O	O	O	O	X	X
5.5 × 8.5" 	X	X	X	X	X	X	X	X	X	X	X	X
5.5 × 8.5" 	X	X	X	X	X	X	O	O	X	X	O	X
7.25 × 10.5" 	X	X	X	X	X	X	X	O	O	O	X	O
8 × 10" 	X	X	X	X	X	X	X	X	X	X	X	X
8 × 10" 	X	X	X	X	X	X	X	X	X	X	X	X
8.5 × 11" 	X	O	O	O	X	X	O	O	O	O	O	X
8.5 × 11" 	O	O	O	O	X	O	O	O	O	O	O	O
8.5 × 13" 	X	X	O	O	X	X	X	O	O	O	O	X
8.5 × 14" 	X	X	O	O	X	X	X	X	O	O	O	X
11 × 17" 	O	O	O	O	X	X	O	O	O	O	O	X
12 × 18" 	X	X	X	X	X	X	X	X	X	X	X	X
SRA3 	X	X	X	O	X	X	X	X	X	O	X	X
16 K 	O	X	X	X	X	X	X	X	X	X	X	X
16 K 	O	O	O	O	X	X	X	X	X	X	X	X
8 K 	O	O	O	O	X	X	X	X	X	X	X	X





















Paper size group	AB series (8 K / 16 K)						AB series (8 × 13" / 8 × 14")					
	Document glass	Document feeder	Tray 1	Trays 2 to 4	Tray 5	Tray 6 (HCF B1)	Document glass	Document feeder	Tray 1	Trays 2 to 4	Tray 5	Tray 6 (HCF B1)
16 K  (mainland China)	O	X	X	X	X	X	X	X	X	X	X	X
16 K  (mainland China)	O	O	O	O	X	X	X	X	X	X	X	X
8 K  (mainland China)	O	O	O	O	X	X	X	X	X	X	X	X
Postcard 	X	X	X	X	O	X	X	X	X	X	X	X
Envelope (120 x 235 mm) 	X	X	X	X	O	X	X	X	X	X	X	X
Envelope (90 x 205 mm) 	X	X	X	X	O	X	X	X	X	X	X	X
Envelope (240 x 332 mm) 	X	X	X	X	O	X	X	X	X	X	X	X
Envelope (162 x 229 mm) 	X	X	X	X	O	X	X	X	X	X	X	X
Envelope (229 x 324 mm) 	X	X	X	X	O	X	X	X	X	X	X	X
Envelope (235 x 120 mm) 	X	X	X	X	O	X	X	X	X	X	X	X
Envelope (114 x 162 mm) 	X	X	X	X	O	X	X	X	X	X	X	X
Envelope (98 x 148 mm) 	X	X	X	X	O	X	X	X	X	X	X	X
Envelope (105 x 235 mm) 	X	X	X	X	O	X	X	X	X	X	X	X
Commercial #10 envelopes 	X	X	X	X	X	X	X	X	X	X	O	X
Monarch 7.3/4 envelopes 	X	X	X	X	X	X	X	X	X	X	X	X
DL envelopes 	X	X	X	X	X	X	X	X	X	X	X	X
C4 envelopes 	X	X	X	X	X	X	X	X	X	X	X	X
C5 envelopes 	X	X	X	X	X	X	X	X	X	X	X	X
Postcard (4 × 6") 	X	X	X	X	X	X	X	X	X	X	X	X

Paper size group	AB series (8 K / 16 K)						AB series (8 × 13" / 8 × 14")					
	Document glass	Document feeder	Tray 1	Trays 2 to 4	Tray 5	Tray 6 (HCF B1)	Document glass	Document feeder	Tray 1	Trays 2 to 4	Tray 5	Tray 6 (HCF B1)
Loading Position												
Size / Orientation												
Photo 2L (5 × 7") 	X	X	X	X	X	X	X	X	X	X	X	X
Postcard (6 × 9") 	X	X	X	X	X	X	X	X	X	X	X	X

O :Available

X :Not available

Paper size group	Inch series					
	Document glass	Document feeder	Tray 1	Trays 2 to 4	Tray 5	Tray 6 (HCF B1)
Loading Position						
Size / Orientation						
A6 	O	X	X	X	X	X
A5 	O	X	X	X	X	X
A5 	O	X	X	X	X	X
A4 	O	O	O	O	X	X
A4 	O	O	O	O	X	X
A3 	O	O	O	O	X	X
B6 	O	X	X	X	X	X
B6 	X	X	X	X	X	X
B5 	O	X	O	O	X	X
B5 	O	O	X	X	X	X
B4 	O	O	O	O	X	X
5.5 × 8.5" 	X	O	O	O	X	X
5.5 × 8.5" 	O	O	X	X	O	X
7.25 × 10.5" 	X	O	O	O	X	O
8 × 10" 	X	X	X	X	X	X
8 × 10" 	X	X	X	X	X	X
8.5 × 11" 	O	O	O	O	O	X
8.5 × 11" 	O	O	O	O	O	O
8.5 × 13" 	X	X	O	O	O	X
8.5 × 14" 	X	O	O	O	O	X
11 × 17" 	O	O	O	O	O	X
12 × 18" 	X	X	X	O	X	X
SRA3 	X	X	X	X	X	X
16 K  (Taiwan)	X	X	X	X	X	X
16 K  (Taiwan)	X	X	X	X	X	X
8 K  (Taiwan)	X	X	X	X	X	X

Paper size group	Inch series					
	Document glass	Document feeder	Tray 1	Trays 2 to 4	Tray 5	Tray 6 (HCF B1)
16 K  (mainland China)	X	X	X	X	X	X
16 K  (mainland China)	X	X	X	X	X	X
8 K  (mainland China)	X	X	X	X	X	X
Postcard 	X	X	X	X	X	X
Envelope (120 x 235 mm) 	X	X	X	X	X	X
Envelope (90 x 205 mm) 	X	X	X	X	X	X
Envelope (240 x 332 mm) 	X	X	X	X	X	X
Envelope (162 x 229 mm) 	X	X	X	X	X	X
Envelope (229 x 324 mm) 	X	X	X	X	X	X
Envelope (235 x 120 mm) 	X	X	X	X	X	X
Envelope (114 x 162 mm) 	X	X	X	X	X	X
Envelope (98 x 148 mm) 	X	X	X	X	X	X
Envelope (105 x 235 mm) 	X	X	X	X	X	X
Commercial #10 envelopes 	X	X	X	X	O	X
Monarch 7.3/4 envelopes 	X	X	X	X	O	X
DL envelopes 	X	X	X	X	O	X
C4 envelopes 	X	X	X	X	O	X
C5 envelopes 	X	X	X	X	O	X
Postcard (4 × 6") 	X	X	X	X	O	X
Photo 2L (5 × 7") 	X	X	X	X	O	X

Paper size group	Inch series						
	Loading Position	Document glass	Document feeder	Tray 1	Trays 2 to 4	Tray 5	Tray 6 (HCF B1)
Size / Orientation							
Postcard (6 × 9") 	X	X	X	X	O	X	X

O :Available

X :Not available

Millimeters/Inches

Allows you to select unit of measurement displayed on the screen from [Millimeters] or [Inches].

Keyboard Input Restriction

Allows you to select whether or not to restrict the display of the virtual keyboard of the machine. To prevent characters from being garbled when switching character sets, you can limit input to ASCII characters. If you select [On (ASCII Only)], the keyboard displayed shows ASCII characters only.

Operation of Up/Down Buttons

Allows you to whether or not to enable continuous scrolling when pressing the scroll buttons.

Display Consumables Screen

Allows you to select whether or not to display the consumables status when a replacement is required.

Off

Does not display the consumables status screen.

When power is switched on

Displays the consumables status screen at startup.

When Auto Clear is activated

Displays the consumables status screen when Auto Clear is executed.

Data Encryption

Allows you to select whether or not to encrypt data recorded on the hard disk of the machine. When you enable data encryption, the machine encrypts automatically copy, scan, or print data written to the hard disk. You cannot select whether or not to encrypt by feature. This prevents unauthorized access to the stored data. To activate this feature, set an encryption key.

- 1 Select [Data Encryption], and then [Change Settings].

2 Select [On].



3 Select [New Encryption Key], and enter an encryption key of 1 to 12 single-byte characters, and then select [Save].

4 Select [Re-enter Encryption Key].

5 Enter the same encryption key, and then select [Save].

6 Select [Save].

Data Restoration

The encrypted data cannot be restored in the following cases:

- When a problem occurs with the hard disk.
- When you have forgotten the encryption key.
- When you have forgotten the system administrator's user ID and a passcode when [On] is selected in [Service Rep. Restricted Operation].

Starting the Data Encryption and Changing Settings

When you change the Data Encryption setting or the encryption key, you must restart the machine. When the machine reboots, the machine initializes part of the disk area. The previous data is not secured.

The disk area stores the following data.

- Spooled print data
- Print data including Secure Print and Sample Set
- Forms for the Form Overlay feature
- Folder and job flow sheet settings (folder name, passcode, etc.)
- Files in folders
- Address book data

- Note**
- Be sure to save all necessary settings and files before using data encryption or changing any settings.
 - Make sure that the hard disk and encryption settings match. Otherwise, an error will occur. For information on error messages and their remedies, refer to "Other Errors" (P.682).
 - The following procedure is recommended for changing the encryption settings while a large amount of data (100 jobs or more) is stored in a folder, and [Number of Overwrites] is set to [1 Overwrite] or [3 Overwrites] under [Overwrite Hard Disk].
 1. Select [Tools] > [Setup] > [Create Folder] to display the [Create Folder] screen.
 2. Select the folder, then select [Delete Folder].
 3. Select [Close].
 4. Press the <Machine Status> button, and confirm that [Standby] in [Overwrite Hard Disk] is displayed.
 5. Enter the System Administration mode, and change the data encryption settings.
For information on how to enter the System Administration mode, refer to "System Settings Procedure" (P.296).
 - Our service representative cannot restore the encryption key.
 - When our service representative replaces the electrical circuit board, the encryption key is initialized. Do not lose the encrypted information.

Encryption Key for Confidential Data

Allows you to set an encryption key to encrypt confidential information such as the passcode of the system administrator and a folder. Encrypting confidential information prevents a network hacking and an unauthorized access to the information.

Enter an encryption key of 4 to 12 single-byte characters using alphanumeric characters.

- Note**
- If you change the existing encryption key, you may not restore confidential information from a backup.
 - The factory default encryption key is "admin".

- 1 Select [Encryption Key for Confidential Data], and then [Change Settings].
- 2 Select [New Encryption Key], and enter an encryption key of 4 to 12 digits, and then select [Save].
- 3 Select [Re-enter Encryption Key].
- 4 Enter the same encryption key, and then select [Save].
- 5 Select [Save] to display a confirmation screen. Select [Yes] on the screen to save the setting.

Service Rep. Restricted Operation

Allows you to select whether or not to restrict the operation by our service representative to protect the security settings from being altered by someone impersonating our service representative.

Off

The operation by our service representative is not restricted.

On

Our service representative cannot change the following settings:

- "Delete All Data" (P.329)
- "Print Universal Unique ID" (P.333)
- "Data Encryption" (P.344)
- "Encryption Key for Confidential Data" (P.346)
- "Service Rep. Restricted Operation" (P.346)
- "SSL/TLS Settings" (P.374)
- "S/MIME Settings" (P.375)
- "IPSec Settings" (P.376)
- "System Administrator Settings" (P.450)
- "Maximum Login Attempts by System Administrator" (P.456)
- "Overwrite Hard Disk" (P.459)
- Creating/Changing Users with System Administrator Rights
- Changing SNMP v3 Setting

When [On] is set, you can set a maintenance passcode of 4 to 12 digits in the [Maintenance Passcode] screen.

Entering the passcode is required when our service representative performs maintenance.

- Note**
- When [On] is set, note the followings:
 - If you lose the System Administrator's user ID and passcode, the items restricted to the service representative cannot be changed.

- If you lose the passcode, our service representative cannot perform maintenance in the case when an error occurs in the machine.

- To change the restricted items or perform maintenance, the electric circuit board of the machine must be replaced.

You will be charged for the electrical circuit board and handling cost.

Be sure not to lose the System Administrator's user ID and passcode.

For information on the system administrator permissions, refer to "User Roles" (P.537).

Software Download

You can select whether or not to permit software downloading. This feature is for service representative use. For more information, contact Customer Support at dell.com/contactdell.

Drum Cartridge Conservation Mode

Specifies the operation when [Auto Detect] is selected for [Output Color]. Select either [On] or [Off].

If the machine is set to automatically switch the type of a document (color/monochrome), select [On], If not, select [Off]. Selecting [Off] outputs in color.

Restrict Recipient Selection Method

Allows you to select whether or not to restrict a fax/Internet fax or an e-mail transmissions to addresses not registered on the Address Book.

Selecting [Only From Address Book] disables address entry using the keyboard or numeric keypad, and permits only transmission to addresses registered on the Address Book.

- Note**
- You can also give users authority to deactivate [Restrict Recipient Selection Method]. For more information, refer to "User Roles and Authorization Groups" (P.536).

Restrict User to Edit Address Book

Specify whether or not to permit Local Users to add and edit recipients in the Address Book.

When you select [Yes], Local Users cannot add or edit the Address Book.

- Note**
- You can also give users authority to deactivate [Restrict User to Edit Address Book]. For more information, refer to "User Roles and Authorization Groups" (P.536).

Auto Validation of Speed Dial Entry

Allows you to select whether the machine automatically validate the number when you use speed dial. When you select [Validate entry after a fixed time], you can select the time to auto-validation from [Shorter], [Default], or [Longer].

- Note**
- An optional component is required to use this feature.

Data Indicator

Allows you to set the lighting pattern of the <Data> indicator.

Pattern 1

Lights up when a document is stored in the hard disk of the machine.

Pattern 2

Lights up when a fax document is in a print queue or a fax received with the Store Fax - Local Folder feature is stored in the folder.

Pattern 3

Lights up for 30 seconds after a job in the print queue is printed.

Copy Service Settings

In [Copy Service Settings], you can configure settings related to the Copy feature. The following shows the reference section for each procedure.

Copy Tab - Features Allocation	348
Preset Buttons	349
Copy Defaults	349
Copy Control.....	354
Original Size Defaults.....	356
Reduce/Enlarge Presets.....	357
Custom Colors	357
Annotations - Create Comments.....	357

- 1 On the [Tools] screen, select [System Settings] > [Copy Service Settings].
For the method of displaying the [Tools] screen, refer to "System Settings Procedure" (P.296).
- 2 Select an item to set or change.

Copy Tab - Features Allocation

You can customize the features displayed on the [Copy] screen. Setting the most frequently used features enables you to avoid extra operations such as selecting tabs.

- 1 Select the number of features displayed on the [Copy] screen.

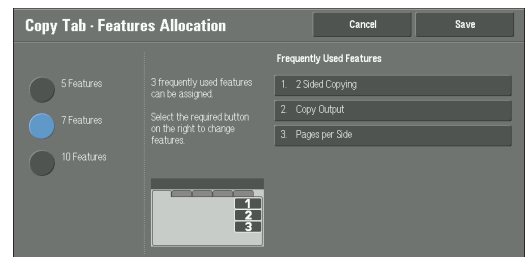

5 Features

The following features are shown on the screen: [Output Color], [Reduce/Enlarge], [Paper Supply], [2 Sided Copying], and [Copy Output]. Features and positions displayed cannot be changed.

7 Features

Allows you to set features appearing in the fourth column from the left of the [Copy] screen.

Note • [Output Color], [Reduce/Enlarge] and [Paper Supply] cannot be specified.

10 Features

Allows you to set features appearing in the third and fourth columns from the left of the [Copy] screen.

Note • [Output Color], [Reduce/Enlarge] and [Paper Supply] cannot be specified.

- 2 From [Frequently Used Features] on the right of the screen, select a button and the position of the button where you want to allocate a feature.

Note • The position of each button on the right side corresponds to the position on the [Copy] screen.

- 3 Select a feature to display, and select [Save].
 - Note** • Select [▲] to display the previous screen or [▼] to display the next screen.
- 4 Repeat steps 2 and 3 as required, and then select [Save].

Preset Buttons

Paper Supply - Button 2 - 5

You can select the paper tray displayed in the second to fifth buttons in [Paper Supply] on the [Copy] screen.

Reduce/Enlarge - Button 3 - 4

You can select the magnification ratio displayed in the third and fourth buttons in [Reduce/Enlarge] on the [Copy] screen.

Select the ratio from the Reduce/Enlarge Preset buttons registered.

Front Cover Tray - Button 1 - 3

Set the default value of the tray displayed in [Paper Supply] when an option that printed on Front Cover is selected for [Front Cover] under [Output Format] > [Covers].

Back Cover Tray - Button 1 - 3

Set the default value of the tray displayed in [Paper Supply] when an option that printed on Back Cover is selected for [Back Cover] under [Output Format] > [Covers].

Transparency Tray - Button 1 - 3

Set the default value of the transparency tray displayed in [Transparency Options] on the [Output Format] screen.

Separator & Handout Tray - Button 1 - 3

Set the default value of the separator & handout tray displayed in [Transparency Options] on the [Output Format] screen.

Copy Defaults

You can set the default settings of the Copy feature. When the machine is turned on, or the machine exits the Power Saver mode, or when the <Clear All> button is pressed, the machine resets to the default values set here. Setting frequently used features and values as the defaults can avoid extra operations required during the use of the machine.

For more information on each setting item, refer to "Copy" (P.59).

Paper Supply

Set the default value for [Paper Supply] in the [Copy] screen.

When the default value of [Reduce/Enlarge] is set to [Auto %], [Auto Select] cannot be selected for [Paper Supply].

Reduce/Enlarge

Set the default value for [Reduce/Enlarge] in the [Copy] screen.

Select the ratio from [100%], [Auto %], and the buttons registered as Reduce/Enlarge Preset buttons.

When the default value of [Paper Supply] is set to [Auto Select], [Auto %] cannot be selected for [Reduce/Enlarge].

For information on the Reduce/Enlarge Preset buttons, refer to "Reduce/Enlarge Presets" (P.357).

Output Color

Set the default value for [Output Color] in the [Copy] screen.

When [No Default] is selected, select the output color in the [Copy] screen before making copies.

Output Color (Simple Copy)

Set the default value for [Output Color] in the [Simple Copy] screen. You can select from [Auto Detect], [Color], and [Black & White].

Single Color

Set the default value for [Single Color] in [More] of [Output Color] in the [Copy] screen. You can select from six preset colors and six custom colors.

For information about custom colors, refer to "Custom Colors" (P.357).

Dual Color - Source Color

Set the default value for [Source Color] that appears when [Dual Color] is selected for [More] of [Output Color] in the [Copy] screen.

Selecting [Color] enables you to select from six colors.

Dual Color - Target Area Color

Set the default value for [Target Area Color] that appears when [Dual Color] is selected for [More] of [Output Color] in the [Copy] screen. You can select from seven preset colors and six custom colors.

For information about custom colors, refer to "Custom Colors" (P.357).

Dual Color - Non-target Area Color

Set the default value for [Non-target Area Color] that appears when [Dual Color] is selected for [More] of [Output Color] in the [Copy] screen. You can select from seven preset colors and six custom colors.

For information about custom colors, refer to "Custom Colors" (P.357).

Original Type

Set the default value for [Original Type] on the [Image Quality] screen.

Original Type - Auto (Non-Black & White)

Set the default value for [Original Type] on the [Image Quality] screen.

This is valid when a color other than [Black & White] is selected for [Output Color] in the [Copy] screen.

Original Type - Auto (Black & White)

Set the default value for [Original Type] in the [Image Quality] screen.

This is valid when [Black & White] is selected for [Output Color] in the [Copy] screen.

Lighten/Darken

Set the default value for [Lighten/Darken] of [Image Options] in the [Image Quality] screen.

Contrast

Set the default value for [Contrast] of [Image Enhancement] in the [Image Quality] screen.

Sharpness

Set the default value for [Sharpness] of [Image Options] in the [Image Quality] screen.

Saturation

Set the default value for [Saturation] of [Image Options] in the [Image Quality] screen.

Background Suppression

Set the default value for [Suppress Background] of [Image Enhancement] in the [Image Quality] screen.

[Background Suppression] is valid when [Original Type] is set to [Photo & Text], [Text], or [Map].

Color Balance - Yellow / Color Balance - Magenta / Color Balance - Cyan / Color Balance - Black

Set the default density levels for the [Color Balance] in the [Image Quality] screen.

You can set density levels of each color for each of the [Highlights], [Midtones], and [Shadows].

- Note**
- Depending on the density level settings, [Color Balance] in the [Image Quality] screen is set as follows:
 - When the density levels of all colors are set to [0, 0, 0], [Color Balance] in the [Image Quality] screen is set to [Normal].
 - When the same value is set to all levels for each color (for example: [0, 0, 0] or [1, 1, 1]), [Color Balance] in the [Image Quality] screen is set to [Basic Color].
 - When the settings other than the ones described above are applied, [Color Balance] in the [Image Quality] screen is set to [Advanced Color].

Color Shift

Set the default value for [Color Shift] in the [Image Quality] screen.

2 Sided Copying

Set the default value for [2 Sided Copying] in the [Copy] screen, [Layout Adjustment] screen, and [Output Format] screen.

Mixed Size Originals

Set the default value for [Mixed Size Originals] in the [Layout Adjustment] screen.

Edge Erase - Top Edge

Set the default value for the amount of edge erased from the original in the top directions in [Edge Erase] in the [Layout Adjustment] screen. Set the value from 0 to 50 mm in 1 mm increments.

Edge Erase - Bottom Edge

Set the default value for the amount of edge erased from the original in the bottom directions in [Edge Erase] in the [Layout Adjustment] screen. Set the value from 0 to 50 mm in 1 mm increments.

Edge Erase - Left Edge

Set the default value for the amount of edge erased from the original in the left directions in [Edge Erase] in the [Layout Adjustment] screen. Set the value from 0 to 50 mm in 1 mm increments.

Edge Erase - Right Edge

Set the default value for the amount of edge erased from the original in the right directions in [Edge Erase] in the [Layout Adjustment] screen. Set the value from 0 to 50 mm in 1 mm increments.

Center Erase/Binding Edge Erase

Set the default value for [Center] in [Edge Erase] in the [Layout Adjustment] screen. Set the value from 0 to 50 mm in 1 mm increments.

Edge Erase - 2 Sided Original - Side 2

Set the default value for [2 Sided Original - Side 2] of [Edge Erase] in the [Layout Adjustment] screen.

Image Shift - Side 1

Set the default value for [Side 1] of [Image Shift] in the [Layout Adjustment] screen.

Image Shift - Side 2

Set the default value for [Side 2] of [Image Shift] in the [Layout Adjustment] screen.

Image Rotation

Set the default value for [Image Rotation] in the [Layout Adjustment] screen.

Image Rotation - Rotation Direction

Set the default value for [Image Rotation - Rotation Direction] of [Image Rotation] in the [Layout Adjustment] screen.

Original Orientation

Set the default value for [Original Orientation] in the [Layout Adjustment] screen.

Pages per Side

Set the default value for [Pages per Side] in the [Copy] and [Output Format] screens.

Copy Output

Set the default value for [Copy Output] in the [Copy] and [Output Format] screens.

Note • To use the [Collated] feature, an optional component is required. If the optional component is not installed, the machine behaves as [Uncollated] is selected.

Uncollated - Default Separator Tray

Set the default value for [Separator Tray] under [Copy Output] > [Uncollated with Separators] in the [Copy] and [Output Format] screens.

Output Destination

Set the default value for [Output Destination/Offset] under [Copy Output] in the [Copy] and [Output Format] screens.

Note • An optional component is required to use this feature. For more information, contact Customer Support at dell.com/contactdell.

Output Destination (Simple Copy)

Set the output destination when you start copying from the [Simple Copy] screen.

- Note**
- If paper cannot be output to the tray you set, the destination may be changed automatically.
 - When the [Simple Copy] screen is displayed, you can confirm the output destination on the [Review] screen, which can be displayed by pressing the <Shortcut 2> button. For information on the <Shortcut 2> button, refer to "Control Panel" (P.49).

Sample Job

Set the default value for [Sample Job] in the [Job Assembly] screen.

Annotations - Stored Comment

Set the default value for [Stored Comments] displayed when [Comment] is selected for [Annotations] in the [Output Format] screen.

You can select a comment type from eight preset types and custom text registered.

For information about how to set custom text, refer to "Annotations - Create Comments" (P.357).

Annotations - Comment on Side 1 and Side 2

Set the default value for [Position] displayed when [Comment] is selected for [Annotations] in the [Output Format] screen.

Annotations - Comment - Font Size

Set the default value for [Font Size] under [Format & Style] displayed when [Comment] is selected for [Annotations] in the [Output Format] screen.

Annotations - Comment - Font Color

Set the default value for [Font Color] under [Format & Style] displayed when [Comment] is selected for [Annotations] in the [Output Format] screen.

Date - Position on Side 1 and Side 2

Set the default value for [Position] displayed when [Date Stamp] is selected for [Annotations] in the [Output Format] screen.

Date - Font Size

Set the default value for [Font Size] under [Font Size] displayed when [Date Stamp] is selected for [Annotations] in the [Output Format] screen.

Page Numbers - Style

Set the default value for [Style] displayed when [Page Numbers] is selected for [Annotations] in the [Output Format] screen.

Page Numbers - Position on Side 1 and Side 2

Set the default value for [Position] displayed when [Page Numbers] is selected for [Annotations] in the [Output Format] screen.

Page Numbers - Font Size

Set the default value for [Font Size] under [Font Size] displayed when [Page Numbers] is selected for [Annotations] in the [Output Format] screen.

Bates Stamp - Number of Digits

Set the default value for [Number of Digits] displayed when [Bates Stamp] is selected for [Annotations] in the [Output Format] screen.

Bates Stamp - Position on Side 1 and Side 2

Set the default value for [Position] displayed when [Bates Stamp] is selected for [Annotations] in the [Output Format] screen.

Bates Stamp - Font Size

Set the default value for [Font Size] under [Font Size] displayed when [Bates Stamp] is selected for [Annotations] in the [Output Format] screen.

Booklet Creation - Default Cover Tray

Set the default value for [Covers] which is displayed when you select a Cover page option in the [Booklet Creation] screen.

Covers - Default Front Cover Tray, Default Back Cover Tray

Set the default value for [Front Cover] and [Back Cover] which are displayed when you select a Front Cover and Back Cover option in the [Covers] screen.

Separators - Default Separator Tray

Set the default value for [Segment Separator Tray] under [Segment Separators] which is displayed when you set [Build Job] to [On] in the [Job Assembly] screen.

Copy Control

You can configure settings related to copy operation control.

Memory Full Procedure

If there is insufficient hard disk memory while scanning a document, a screen appears asking you how you want to handle the partially stored data.

Set the process you want the machine to perform for the partially stored data after a certain time has elapsed in the confirmation screen.

You can set the time until the memory full procedure is carried out. For more information, refer to "Auto Job Release" (P.315).

Delete Job

Deletes the data partially stored.

Run Job

Treats the read-in data as valid, and start copying the document partially stored.

Maximum Stored Pages

Set the maximum number of pages stored for a copy document. You can set from 1 to 999 pages.

Auto Paper Off

Select the tray used when [Auto Select] of [Paper Supply] in the [Copy] screen is cancelled. [Auto Select] of [Paper Supply] is cancelled when [Auto %], [Auto X-Y %] for [Independent X-Y %], or [Slight Reduction (Improves Fit)] is selected.

Mixed Size Originals - 2 Sided Copy

Specify paper to copy side 2 of a document: in 2 sided copying, if the size of side 1 and side 2 of a document is different, and the machine detects different paper size for sides 1 and 2.

- Note**
- When the side 1 and side 2 are different sizes and if the side 2 is copied on the sheet on which the side 1 has been printed, a part of the image may be missing.

Copy to new sheet

Side 2 is copied as side 1 on a new sheet of paper.

Copy to Side 2

Side 2 is copied on the reverse side of side 1 without changing paper size.

Fine-tune 100%

You can fine-tune magnification when copying at 100% (actual size). The set value is applied to [100%] in the [Copy] screen is set to 100%.

Set the value in the X/Y direction between 98 and 102% in 0.1% increments.

- Note**
- This feature is applied only when a copy is made using the document glass. This setting is not reflected in the magnification (100%) under [Independent X-Y%] or [Calculator %].
 - A magnification displays [100%] even if [Fine-tune 100%] is selected.

ID Card Copy - Reduce/Enlarge

Set the copy magnification ratio when to copy ID cards. Selecting [Allow to Change] allows you to specify the ratio between 25 to 400 % in 1 % increments.

- Note**
- The machine may copy an ID card in a different orientation from the original orientation depending on the magnification ratio you specified.

Background Suppression (Photo & Text)

Set the background suppression level for color copying. This setting is valid when [Photo & Text] is selected for [Original Type] in the [Image Quality] screen.

The larger the value the stronger the effect of removing background noise is.

Background Suppression Level (Text)

Set the background suppression level for color copying. This setting is valid when [Text] is selected for [Original Type] in the [Image Quality] screen.

The larger the value the stronger the effect of removing background noise is.

Photo & Text / Printed Original

Set the type of document when [Printed Original] of [Photo & Text] is selected for [Original Type] in the [Image Quality] screen.

Normal

Copies with standard image quality.

Inkjet Originals

Select [Inkjet Originals] when copying a document printed with an inkjet printer. This improves the recognition of inkjet colors.

Highlighted Originals

Select [Highlighted Originals] when copying an original marked with a highlight pen. This improves the recognition of the colors of highlight pen.

Original Type - See-Through Paper

When [Text] is selected for [Original Type] in the [Image Quality] screen, set whether to display [Text on See-Through Paper].

Annotations - Comment Density

Set the translucency of the comment printed as annotation.

You can select from three translucency values: Darken, Normal, and Lighten. Darken represents no translucency.

Note • If a stamp set to [Darken] density is printed over text, the text may be unreadable.

Comment Position - Top Left, - Top Center, - Top Right, - Left Center, - Center, - Right Center, - Bottom Left, - Bottom Center, and - Bottom Right

You can adjust the position to print a comment finely.

Date Position - Top Left, - Top Center, - Top Right, - Bottom Left, - Bottom Center, and - Bottom Right

You can adjust the position to print a date stamp finely.

Page Number Position - Top Left, - Top Center, - Top Right, - Bottom Left, - Bottom Center, and - Bottom Right

You can adjust the position to print a page number finely.

Bates Stamp - Top Left, - Top Center, - Top Right, - Bottom Left, - Bottom Center, and - Bottom Right

You can adjust the position to print a bates stamp finely.

Quantity Display

You can select how you want to display the counter in the Copy service.

Select from [Quantity], [Quantity and Memory], and [Quantity and Original Count].

Maximum Number of Sets

Set the maximum number of allowed sets to copy between 1 and 999. Users will not be able to specify a larger number of sets to copy than the value set here.

Original Size Defaults

Set the original sizes displayed in [Original Size] in the [Layout Adjustment] screen.

You can assign original sizes to the buttons other than [Auto Detect].

If you frequently make copies of non-standard size document, setting non-standard size as the default can avoid extra operations required during the use of the machine.

A/B Series Size

You can select from A and B series sizes.

Inch Size

You can select from inch series sizes.

Others

You can select from other sizes.

Custom Size

You can enter any size. Set the width (X) from 15 to 432 mm, and the height (Y) from 15 to 297 mm in 1 mm increments.

Reduce/Enlarge Presets

Set the magnifications displayed as [Preset %] which are displayed when [Proportional %] is selected under [Reduce/Enlarge] in the [Copy] screen.

You can assign any magnification to the Reduce/Enlarge Preset buttons other than [100%] and [Auto %].

Custom Colors

Set the custom colors used for [Single Color] and [Dual Color] in the [Output Color] screen.

You can assign custom colors with yellow (0 to 100%), magenta (0 to 100%), and cyan (0 to 100%) to each custom color buttons 1 to 6.

Note • Adjust so that the total of yellow, magenta, and cyan does not exceed 240%.

Annotations - Create Comments

Register text to print with [Comment] under [Annotations]. You can enter up to 64 single-byte characters.

For information about how to enter characters, refer to "Entering Text" (P.57).

Connectivity & Network Setup

In [Connectivity & Network Setup], you can configure settings related to the Connectivity & Network feature.

For information on Connectivity and Network Settings, refer to "Printer Environment Settings" (P.469) or "E-mail Environment Settings" (P.487).

If you use Dell Printer Configuration Web Tool, more detailed settings are possible. For more information, refer to "Dell Printer Configuration Web Tool Settings" (P.461).

The following shows the reference section for each setting.

Port Settings	358
Protocol Settings	363
Machine's E-mail Address/Host Name	366
Proxy Server Settings	367
Outgoing/Incoming E-mail Settings	368
Remote Authentication/Directory Service	369
Security Settings	374
Other Settings	379

- 1 On the [Tools] screen, select [System Settings] > [Connectivity & Network Setup].
For the method of displaying the [Tools] screen, refer to "System Settings Procedure" (P.296).
- 2 Select an item to set or change.

Port Settings

Set the interface of the machine connected to a client. In [Port Settings], you can configure the following settings.

- Note**
- For LPD, Port9100, and HTTP-SSL/TLS, do not use a number that is the same as a port number of another port.
For a port that uses HTTP (IPP, Internet Service (HTTP), UPnP Discovery, SOAP, WebDAV, and Web Services on Devices (WSD)), do not use a number that is the same as a port number of LPD, Port9100, and HTTP-SSL/TLS.
Furthermore, if any of the above are set to one of the port numbers indicated below, operation may no longer be performed properly depending on the setting conditions of the port:
25, 139, 427, 445, 631, 15000

For information on HTTP-SSL/TLS port, refer to "HTTP - SSL/TLS Port Number" (P.374).

USB

Port Status

Select [Enabled] to use a USB interface.

Print Mode

Select the printer language use on the machine. Selecting [Auto] enables the machine to automatically determine and use the most suitable language to print data received from the host device.

PJL

PJL (Printer Job Language) is a job control language and a PJL command is data prepended to the top of the print jobs. Usually select [Enabled].

Auto Eject Time

Configure the time that the data so far received by the machine will automatically be printed since data is no longer sent to the printer.

You can enter a time between 5 and 1275 seconds in 5 seconds increments.

Adobe Communication Protocol

- Standard

Select this when the output protocol of the print driver is in the ASCII format.

- Binary

Select this when the output protocol of the print driver is in the BCP format.

- TBCP

Select this when the output protocol of the print driver is in the TBCP format.

- RAW

Select this when the output protocol of the print driver is in the ASCII or binary format.

The data is printed without being controlled by the Adobe communication protocol.

PostScript Wait Timeout

The machine automatically terminates a connection when the machine does not receive data for a certain period of time. When data is being printed with [RAW] is selected for [Adobe Communication Protocol], select [Disabled] if you want to use the time period set in [Auto Eject Time] or select [Enabled] if you want to use the timeout period of PostScript.

LPD**Port Status**

Select [Enabled] to use LPD.

Port Number

Enter a port number for LPD from 1 to 65535.

The default value is 515.

Note • Do not use the numbers assigned to the other ports.

Maximum Number of Sessions

Enter the maximum number of client sessions using LPD. You can enter a number from 1 to 10 in 1 session increments.

The default value is 5.

NetWare**Port Status**

Select [Enabled] to use NetWare®.

SMB**Port Status**

Select [Enabled] to use SMB when you use the Scan to PC (SMB) service or share the machine on the network.

IPP

Port Status

Select [Enabled] to use IPP.

Set this when you want to use IPP (Internet Printing Protocol) to print via the Internet.

Added Port Number

Select [Disabled] when you want to set the machine does not accept IPP from other than the standard port number, or select [Enabled] when accepts all port numbers.

Enter a port number for IPP other than the standard port number from 1 to 65535.

The default value is 80.

- Note**
- Do not use a number that is the same as a port number of another port. However, you can use the same port number for a port that uses HTTP (IPP, Internet Services (HTTP), UPnP Discovery, SOAP, WebDAV, and Web Services on Devices (WSD)).
 - [Added Port Number] cannot be configured if [Port Status] is set to [Disabled]. To configure [Added Port Number], enable port status and reboot the machine, and then configure [Added Port Number].

EtherTalk

Port Status

Select [Enabled] to use EtherTalk.

Bonjour

Port Status

Select [Enabled] to use Bonjour.

- Note**
- To print from a printer detected by [Bonjour], the LPD port must be activated in advance.

Port 9100

Port Status

Select [Enabled] to use Port9100.

Select this option when the communication protocol is in RAW format for Windows[®] Standard TCP/IP port monitor.

Port Number

Enter a port number for Port9100 from 1 to 65535.

The default value is 9100.

- Note**
- Do not use the numbers assigned to the other ports.

SNMP

Port Status

Select [Enabled] to use SNMP, when you use any web applications to control the machine on the network.

FTP Client

Port Status

Select [Enabled] when you use the Scan to PC service with FTP transmission.

- Note**
- Select a communication mode to send data scanned via FTP from [Passive Mode] and [Active Mode]. [Passive Mode] is selected by factory default. You can change the setting from Dell Printer Configuration Web Tool.

Receive E-mail

Port Status

Select [Enabled] when you receive e-mails or Internet faxes.

Send E-mail

Port Status

Select [Enabled] when you send e-mails or Internet faxes.

E-mail Notification Service

Port Status

Select [Enabled] when you use the E-mail Notification Service. The E-mail Notification Service notifies you of the machine status or the completion of a print job and a direct fax job by e-mail.

- Note**
- [Consumables Status], [Parts Status], [Paper Tray Status], [Output Tray Status], [Jam Status], [Interlock Status], and [Fault Notice] are notified as the machine status.
 - You can configure the E-mail Notification Service in Dell Printer Configuration Web Tool.

UPnP Discovery

Port Status

Select [Enabled] to use UPnP.

Port Number

Enter a port number for UPnP communication from 1 to 65535.

The default value is 80.

- Note**
- Do not use a number that is the same as a port number of another port. However, you can use the same port number for a port that uses HTTP (IPP, Internet Services (HTTP), UPnP Discovery, SOAP, WebDAV, and Web Services on Devices (WSD)).

WSD

- Note**
- WSD stands for Web Services on Devices.

WSD Print - Port Status

Select [Enabled] to use WSD Print.

Set this when you search a device on a network from Windows Vista[®], Windows 7, and Windows 8.

WSD Scan - Port Status

Select [Enabled] to use WSD Scan.

Set this when you search a device on a network from Windows Vista, Windows 7, and Windows 8.

Port Number

Enter a port number from 1 to 65535.

The default value is 80.

- Note**
- Do not use a number that is the same as a port number of another port. However, you can use the same port number for a port that uses HTTP (IPP, Internet Services (HTTP), UPnP Discovery, SOAP, WebDAV, and Web Services on Devices (WSD)).

Internet Services (HTTP)

Port Status

Select [Enabled] to use Dell Printer Configuration Web Tool.

For more information about Dell Printer Configuration Web Tool, refer to "Dell Printer Configuration Web Tool Settings" (P.461).

Port Number

Enter a port number for the Internet Services from 1 to 65535.

The default value is 80.

- Note**
- Do not use a number that is the same as a port number of another port. However, you can use the same port number for a port that uses HTTP (IPP, Internet Services (HTTP), UPnP Discovery, SOAP, WebDAV, and Web Services on Devices (WSD)).
 - You cannot select [Port Number], if HTTP port is disabled.
To configure [Port Number], enable port status and reboot the machine, and then configure [Port Number].

SOAP

Port Status

Select [Enabled] when you use an application program.

Port Number

Enter a port number for SOAP from 1 to 65535.

The default value is 80.

- Note**
- Do not use a number that is the same as a port number of another port. However, you can use the same port number for a port that uses HTTP (IPP, Internet Services (HTTP), UPnP Discovery, SOAP, WebDAV, and Web Services on Devices (WSD)).

WebDAV

Port Status

Select [Enabled] when you use an application program such as Dell Network Scanner Utility 3 to access folders in the machine.

- Note**
- You cannot select [Port Number] and [Operation Time-Out], if WebDAV port is disabled.
To configure [Port Number] and [Operation Time-Out], enable port status and reboot the machine, and then configure [Port Number] and [Operation Time-Out].

Port Number

Enter a port number for WebDAV from 1 to 65535.

The default value is 80.

- Note**
- Do not use a number that is the same as a port number of another port. However, you can use the same port number for a port that uses HTTP (IPP, Internet Services (HTTP), UPnP Discovery, SOAP, WebDAV, and Web Services on Devices (WSD)).

Operation Time-Out

You can enter an operation time-out period between 1 and 65535 seconds in 1 second increments.

ThinPrint

Port Status

You can use the machine for print in the ThinPrint environment. The machine decompresses and prints the compressed print data sent from the server.

Select [Enabled] when you use ThinPrint®.

Port Number

Enter a port number for ThinPrint from 1 to 65535.

The default value is 4000.

- Note**
- Do not use any numbers assigned to the other ports.
 - ThinPrint is available when the communication protocol uses IPv4.
 - The maximum of three connections are possible at a time.

Protocol Settings

Set the parameters required for communications. In [Protocol Settings], you can set the following items.

Ethernet Rated Speed

Set the communication speed for the Ethernet interface.

Auto (Up to 100 Mbps)

Select this to detect the Ethernet transmission rate up to 100 Mbps automatically.

100 Mbps Full-Duplex

Select this to set 100BASE-TX (Full Duplex) as the default value.

100 Mbps Half-Duplex

Select this to set 100BASE-TX (Half Duplex) as the default value.

10 Mbps Full-Duplex

Select this to set 10BASE-T (Full Duplex) as the default value.

10 Mbps Half-Duplex

Select this to set 10BASE-T (Half Duplex) as the default value.

Auto (Up to 1 Gbps)

Select this to detect the Ethernet transmission rate up to 1 Gbps automatically.

1000 Mbps

Select this to set 1000BASE-T as the default value.

TCP/IP - IP Mode

Allows you to select the TCP/IP operation mode.

IPv4 Mode

Select this option for IPv4.

IPv6 Mode

Select this option for IPv6.

Dual Stack

Select this option for an environment using both IPv4 and IPv6.

IPv4 - IP Address Resolution

Allows you to select a method for obtaining the IP address, subnet mask, and gateway address.

DHCP

The address, subnet mask, and gateway address will automatically be set via DHCP.

BOOTP

The address, subnet mask, and gateway address will automatically be set via BOOTP.

RARP

The address, subnet mask, and gateway address will automatically be set via RARP.

DHCP/Autonet

The address, subnet mask, and gateway address will automatically be set via DHCP/Autonet. If the machine fails to communicate with the DHCP server, the AutoIP function is automatically enabled and the machine is assigned an IP address (169.254.xxx.xxx). When communication between the machine and the DHCP server recovers, the machine is re-assigned an IP address, a subnet mask, and a gateway address by the DHCP server.

STATIC

Allows you to manually specify an IP address, a subnet mask, and a gateway address.

Note • To configure a subnet mask and a gateway address, an IP Address must be set first.

IPv4 - IP Address

Enter the IP address using the keyboard displayed or the numeric keypad when selecting [STATIC] at [IPv4 - IP Address Resolution].

Note

- Enter the address in the format "xxx.xxx.xxx.xxx", where "xxx" is a numeric value from 0 to 255.
- Specify an IP address using numbers (0 to 9) and periods (.). If you mistyped a character on the screen, select [Backspace] to delete the character.

IPv4 - Subnet Mask

Enter the subnet mask using the keyboard displayed or the numeric keypad when selecting [STATIC] at [IPv4 - IP Address Resolution].

Note

- Enter the address in the format "xxx.xxx.xxx.xxx", where "xxx" is a numeric value from 0 to 255.
- Specify a subnet mask using numbers (0 to 9) and periods (.). If you mistyped a character on the screen, select [Backspace] to delete the character.

IPv4 - Gateway Address

Enter the gateway address using the keyboard displayed or the numeric keypad when selecting [STATIC] at [IPv4 - IP Address Resolution].

Note

- Enter the address in the format "xxx.xxx.xxx.xxx", where "xxx" is a numeric value from 0 to 255.
- Specify a gateway address using numbers (0 to 9) and periods (.). If you mistyped a character on the screen, select [Backspace] to delete the character.

IPv4 - DNS Server Setup

Set the DNS server.

Get IP Address from DHCP

Set whether or not to automatically obtain the address of the DNS server from the DHCP server.

DNS Server IP Address

When [Get IP Address from DHCP] is set to [Disabled], manually set the DNS server address.

IPv4 - IP Filter

Select whether or not to limit IPv4 addresses that can access the machine.

- Note**
- [IPv4 - IP Filter] applies to all features using TCP/IP, such as Print, and Store to Folder.
 - To set the IPv4 IP addresses that the machine accepts connection from, use [IP Filtering] in Dell Printer Configuration Web Tool. For more information, refer to "Dell Printer Configuration Web Tool Settings" (P.461).
 - When [IP Filtering] is enabled, make sure to switch the FTP transfer mode to [Active Mode] to transfer the scanned image from the machine via FTP. You can switch the FTP transfer mode from Dell Printer Configuration Web Tool.

IPv6 Address Manual Configuration

Allows you to select whether or not to configure the IPv6-address settings manually.

Manually Configured IPv6 Address

This setting is configurable when [IPv6 Address Manual Configuration] is set to [Enable]. Specify an IPv6 address.

- Note**
- Enter the address in the format "xxxx:xxxx:xxxx:xxxx:xxxx:xxxx:xxxx:xxxx", where "xxxx" is a hexadecimal value.
 - Specify an address using alphanumeric characters (0 to 9, and A to F) and colons (:). If you mistyped a character on the screen, select [Backspace] to delete the character.

Manually Configured IPv6 Address Prefix

This setting is configurable when [Manually Configured IPv6 Address] is set. Specify a prefix length from 0 to 128.

Manually Configured IPv6 Gateway

This setting is configurable when [Manually Configured IPv6 Address] is set. Specify a gateway address.

- Note**
- Enter the address in the format "xxxx:xxxx:xxxx:xxxx:xxxx:xxxx:xxxx:xxxx", where "xxxx" is a hexadecimal value.

IPv6 - DNS Server Setup

Set the DNS server for IPv6.

Get IP Address from DHCP

Set whether or not to automatically obtain the address of the DNS server from the DHCP server.

DNS Server IP Address

When [Get IP Address from DHCP] is set to [Disabled], manually set the DNS server address.

Automatically Configured IPv6 Address

Displays the following addresses automatically assigned.

- Link-local Address
- Auto Stateless Address 1 and Prefix Length
- Auto Stateless Address 2 and Prefix Length
- Auto Stateless Address 3 and Prefix Length
- Auto Gateway Address

IPv6 - IP Filter

Select whether or not to limit IPv6 addresses that can access the machine.

- Note**
- [IPv6 - IP Filter] applies to all features using TCP/IP, such as the Print, Store to Folder, Web Applications services, and Dell Printer Configuration Web Tool.
 - To set the IPv6 addresses that the machine accepts connection from, use [IP Filtering] in Dell Printer Configuration Web Tool. For more information, refer to "Dell Printer Configuration Web Tool Settings" (P.461).
 - When [IP Filtering] is enabled, make sure to switch the FTP transfer mode to [Active Mode] to transfer the scanned image from the machine via FTP. You can switch the FTP transfer mode from Dell Printer Configuration Web Tool.

Machine's E-mail Address/Host Name

Set the e-mail address, host name, and domain name of the machine.

E-mail Address

Enter the E-mail address of the machine with up to 128 single-byte characters.

When receiving E-mail via SMTP

You can set any name for the account (on the left side of @). Set the address section (on the right side of @), with the combination of the host name and domain name. An alias cannot be set.

For Example: mymail@myhost.example.com

- Account name: mymail
- Host name: myhost
- Domain Name: example.com

When receiving E-mails via POP3

Enter the POP user name (on the left side of @) and incoming POP3 mail server name in the address section (on the right side of @). You can set an alias, such as mymail@example.com.

For Example: mymail@myhost.example.com

- Account name: mymail

Machine Name

Enter the machine name with up to 32 single-byte characters.

Host Name

Enter the host name with up to 32 single-byte characters.

- Note**
- For SMB, only the first 15 single-byte characters will be used as the Host Name.

Domain Name

Enter the domain name with up to 64 single-byte characters.

Proxy Server Settings

Configure the settings for a proxy server.
Configure a proxy server when using inbound/outbound access.

Note • Do not set this item unless you use services requiring proxy server settings.

Use Proxy Server

Select whether or not to use a proxy server.

Proxy Server Setup

Select the proxy server specification from [Same Proxy for All Protocols] or [Different Proxy for Each Protocol].

Addresses to Bypass Proxy Server

Enter addresses not using the proxy server. You can specify the addresses by IPv4 address, IPv6 address, and FQDN. You can use wildcards "*" for specifying the addresses.

HTTP Proxy Server Name

Enter the server name or IP address of the HTTP proxy server. Up to 255 characters are allowed. You can specify the addresses by IPv4 address, IPv6 address, and FQDN.

HTTP Proxy Server Port Number

Set the HTTP proxy server port number from 1 to 65535.

The default value is 8080.

Note • Do not use the numbers assigned to the other ports.

HTTP Proxy Server Authentication

Select [Enabled] when authentication is required to connect to the HTTP proxy server.

HTTP Proxy Server Login Name

Enter a login name of the HTTP proxy server. Up to 31 characters are allowed.

HTTP Proxy Server Password

Enter a password of the HTTP proxy server. Up to 31 characters are allowed.

HTTPS Proxy Server Name

Enter the HTTPS proxy server name or the IP address. Up to 255 characters are allowed. You can specify the addresses by IPv4 address, IPv6 address, and FQDN.

HTTPS Proxy Server Port Number

Set the HTTPS proxy server port number from 1 to 65535.

The default value is 8080.

Note • Do not use the numbers assigned to the other ports.

HTTPS Proxy Server Authentication

Select [Enabled] when authentication is required to connect to the HTTPS proxy server.

HTTPS Proxy Server Login Name

Enter a login name of the HTTPS proxy server. Up to 31 characters are allowed.

HTTPS Proxy Server Password

Enter a password of the HTTPS proxy server. Up to 31 characters are allowed.

Outgoing/Incoming E-mail Settings

Set e-mail transmission and reception settings.

POP3 Server Settings

Set the POP3 server. In [POP3 Server Settings], you can set the following items:

- Note**
- For IPv4, enter the address in the format "xxx.xxx.xxx.xxx", where "xxx" is a numeric value from 0 to 255.
 - For IPv6, enter the address in the format "xxxx:xxxx:xxxx:xxxx:xxxx:xxxx:xxxx:xxxx", where "xxxx" is a hexadecimal value.
 - When you make an entry mistake, press the <C> (Clear) button and enter again.

Server Name/IP Address

Enter a server name or IP address with up to 128 characters, and then select [Save].

Port Number

Enter a port number from 1 to 65535.

The default value is 110.

- Note**
- Do not use the numbers assigned to the other ports.

Polling Interval

Set the interval for checking the e-mail on the POP3 server from 1 to 120 minutes in 1 minute increments.

Login Name

Enter the name to login to the POP3 server with up to 64 characters.

Password

Enter a password for the POP3 server with up to 64 characters.

Enter the same password in [New Password] and [Retype Password] using the numeric keypad displayed by selecting [Keyboard]. If you do not set the password, leave the text boxes blank and select [Save].

POP Password Encryption

Select [On (APOP)] to encrypt the password.

SMTP Server Settings

Set the SMTP server. In [SMTP Server Settings], you can set the following items:

- Note**
- For IPv4, enter the address in the format "xxx.xxx.xxx.xxx", where "xxx" is a numeric value from 0 to 255.
 - For IPv6, enter the address in the format "xxxx:xxxx:xxxx:xxxx:xxxx:xxxx:xxxx:xxxx", where "xxxx" is a hexadecimal value.
 - When you make an entry mistake, press the <C> (Clear) button and enter again.

SMTP Server Name/IP Address

Enter a server name or IP address, and then select [Save]. Up to 128 characters are allowed.

SMTP Server Port Number

Enter a port number in the range from 1 to 65535.

The default value is 25.

Note • Do not use the numbers assigned to the other ports.

E-mail Send Authentication

Select one from [Off], [POP before SMTP], or [SMTP AUTH].

Note • If [POP before SMTP] is selected, the POP3 settings must be set.
• AUTH GSSAPI (only for Kerberos), AUTH NTLMv2, AUTH NTLMv1, AUTH PLAIN, AUTH-LOGIN, or AUTH CRAM-MD5 can be used as an authentication method.

Login Credentials for E-mail Send

Select the login user name when sending e-mails from [Remotely Authenticated User] and [System]. When [Remotely Authenticated User] is selected and if the machine tries authenticating the remote server before a job startup, the machine performs verification at the time of transmission with the remotely authenticated user name and password. You can also select the post-failure behavior of the machine from [Cancel E-mail Send] and [Relogin using System Data]. If you do not set remote authentication, the machine uses the user ID and passcode of the machine for authentication.

SMTP AUTH Login Name

Enter the user name for verification purposes at the SMTP server with up to 64 characters.

SMTP AUTH Password

Enter the password for verification purposes at the SMTP server. Up to 64 single-byte characters are allowed.

Note • If you do not set the password, leave the text boxes blank and select [Save].

Remote Authentication/Directory Service

You can make the settings for the remote authentication server and directory service.

Authentication System Setup

Authentication System

Allows you to select the authentication system from [Kerberos (Windows 2000)], [Kerberos (Solaris)], [LDAP], [SMB], and [Authentication Agent].

After you change the authentication system, personal folders and personal sheets used with the previous authentication system are not deleted automatically. If these folders or job flow sheets are no longer needed, delete them from the machine. If the same user IDs are also used on the new authentication system, personal folders and personal job flow sheets can be used by the same users.

Server Response Time-Out

Set the server time-out response between 1 and 75 seconds in 1 second increments.

Search Time-Out

Set the user information search time-out between 1 and 120 seconds in 1 second increments.

Kerberos Server Settings

Configure the Kerberos Servers 1 to 5.

The settings in [Kerberos Server 1 (Default)] will be the default settings for authentication.

Primary Server Name/Address

Enter the primary server name or IP address.

- Note**
- For IPv4, enter the address in the format "xxx.xxx.xxx.xxx", where "xxx" is a numeric value from 0 to 255.
 - For IPv6, enter the address in the format "xxxx:xxxx:xxxx:xxxx:xxxx:xxxx:xxxx:xxxx", where "xxxx" is a hexadecimal value.

Primary Server - Port Number

Set the primary server port number from 1 to 65535.

The default value is 88.

- Note**
- Do not use the numbers assigned to the other ports.

Secondary Server Name/Address

Enter the secondary server name or IP address.

- Note**
- For IPv4, enter the address in the format "xxx.xxx.xxx.xxx", where "xxx" is a numeric value from 0 to 255.
 - For IPv6, enter the address in the format "xxxx:xxxx:xxxx:xxxx:xxxx:xxxx:xxxx:xxxx", where "xxxx" is a hexadecimal value.

Secondary Server - Port Number

Set the secondary server port number in the range from 1 to 65535.

The default value is 88.

- Note**
- Do not use the numbers assigned to the other ports.

Domain Name

When you use Active Directory of Windows Server[®] 2003, Windows Server 2008, or Windows Server 2012 as server, specify the domain name of Active Directory in [Domain Name]. Up to 64 characters are allowed.

- Note**
- Enter a realm name in uppercase characters. Otherwise, an authentication error occurs.

LDAP Server/Directory Service Settings

Configure the directory server, authentication method, and search attributes and ranges for LDAP authentication and the Address Book search by LDAP.

Primary Server Name/Address

Enter the primary server name or IP address.

- Note**
- For IPv4, enter the address in the format "xxx.xxx.xxx.xxx", where "xxx" is a numeric value from 0 to 255.
 - For IPv6, enter the address in the format "xxxx:xxxx:xxxx:xxxx:xxxx:xxxx:xxxx:xxxx", where "xxxx" is a hexadecimal value.

Primary Server - Port Number

Set the Primary server port number from 1 to 65535.

The default value is 389.

- Note**
- Do not use the numbers assigned to the other ports.

Secondary Server Name/Address

Enter the secondary server name or IP address.

- Note**
- For IPv4, enter the address in the format "xxx.xxx.xxx.xxx", where "xxx" is a numeric value 0 to 255.
 - For IPv6, enter the address in the format "xxxx:xxxx:xxxx:xxxx:xxxx:xxxx:xxxx:xxxx", where "xxxx" is a hexadecimal value.

Secondary Server - Port Number

Set the secondary server port number from 1 to 65535.

The default value is 389.

Note • Do not use the numbers assigned to the other ports.

Authentication Method

Select a method to perform LDAP authentication from [Direct Authentication] and [Authentication of User Attributes].

- Direct Authentication
User ID and password entered by a user are used for LDAP authentication.
- Authentication of User Attributes
The user ID entered is used as an attribute specified in [Attribute of Typed User Name] to perform a search on the LDAP server. [Attribute of Login User Name] of a user found through the search is used as the user ID of a job and the owner of a job flow sheet and a folder.

Attribute of Typed User Name

When [Authentication of User Attributes] is used for LDAP authentication, set the attribute of the user ID entered. Up to 32 characters are allowed.

Set the attribute of the User Attribute information registered on the LDAP server that corresponds to the value to be entered as the user name from the control panel. For example, when you want a user to enter the mail address, set "mail."

Attribute of Login User Name

Enter an attribute to be used for LDAP authentication using User Attribute information registered on the LDAP server. Up to 32 characters are allowed.

Use Added Text String

Select whether or not to automatically add text strings in [Text String Added to User Name] when you enter the authentication information from the control panel.

Text String Added to User Name

Enter text strings for [Text String Added to User Name] when you use additional text strings. Up to 64 characters are allowed.

When [Use Added Text String] is set to [Enabled], enter the corresponding fixed text string.

For Example:

When "mail" is set for [Attribute of Typed User Name] and the information registered for the target user is "mail@myhost.example.com," you will need to enter "mail@myhost.example.com".

However, if [Use Added Text String] is set to [Enabled] and "@myhost.example.com" is specified for [Text String Added to User Name], you will only need to enter "mail" from the control panel because the machine adds "@myhost.example.com" to the end of the string.

Attribute of Smart Card

When a smart card is used for LDAP authentication, set the attribute of the card ID to perform a search on the LDAP server to authenticate the user who has the card. Up to 32 characters are allowed.

Note • This item is displayed when [Passcode Entry for Smart Card Login] under [Tools] > [Authentication/ Security Settings] > [Authentication] > [Passcode Policy] is set to [Off].

Network User ID Attribute

When a smart card is used for LDAP authentication, set the attribute of the user name to be used for a smart card ID search. The user name is given to the remote service as the authentication information. Up to 32 characters are allowed.

- Note**
- This item is displayed when [Passcode Entry for Smart Card Login] under [Tools] > [Authentication/ Security Settings] > [Authentication] > [Passcode Policy] is set to [Off].

Login Credentials to Search Entries

Select which users are allowed to search the Address Book.

You can select from [Remotely Authenticated User] or [System].

Login Name

Set a user name for the Address Book search and access to the directory server using [Authentication of User Attributes] method for LDAP authentication. Set this item only when authentication is required for the search for the directory service. Up to 255 characters are allowed.

Password

Set a login password for the user specified in [Login Name]. Up to 32 characters are allowed.

Search Directory Root

Enter a search root character string with up to 255 characters.

- Note**
- Enter the distinguished name of the root node. (Example: CN=users, DC=mydomain, DC=dell, DC=com)

Scope of Search from Root Entry

Select the search range from the root entry.

- Root entry only
 - Searches the root level only.
- One level below root entry only
 - Searches from the root level to one level below the root level.
- All levels below root entry
 - Searches from the root level to all lower levels below the root level.

Object Class of Search Target

Enter the object class to search with up to 32 characters.

LDAP Referrals

Specify whether or not to re-establish connection to another LDAP server if a currently connected LDAP server requests to do so.

LDAP Referral Hop Limit

When using the Referral feature, specify how many times that a user is allowed to hop servers within 1 to 5 times.

LDAP Server

Select the software used by the directory server from [Microsoft Active Directory], [Microsoft Exchange], [Novell NetWare], [IBM Lotus Domino 6.*], and [Other Applications].

Search Entries by Common Name

Set whether or not to use [Attribute Type of Name] as a search entry when a name is used as a search key.

Search Entries by Surname

Set whether or not to use [Attribute Type of Surname] when a name is used as a search key.

Search Entries by Given Name

Set whether or not to use [Attribute Type of Given Name] when a name is used as a search key.

Attribute Type of Name

Set the recipient name attribute type. Enter a field attribute name to be used as a recipient name from user information registered on the LDAP server. Up to 32 characters are allowed. For Windows, enter "cn" for an attribute name used as a recipient name.

Attribute Type of Surname

Set the sender's family name attribute type. Up to 32 characters are allowed.

Attribute Type of Given Name

Set the sender's first name attribute type. Up to 32 characters are allowed.

Attribute Type of E-mail Address

Set the e-mail address attribute type. Enter a field attribute name to be used as e-mail information from the user information registered on the LDAP server. Up to 32 characters are allowed. For Windows, enter "mail" for an attribute name used as e-mail information.

Attribute Type of Fax Number

Set the fax number attribute type. Up to 32 characters are allowed.

Attribute Type of E-mail (Internet Fax)

Set the Internet fax address attribute type. Up to 32 characters are allowed.

Attribute Type of Custom Items 1, 2, and 3

Set the LDAP attribute type of custom items 1 to 3. In addition to [Attribute Type of Name] and [Attribute Type of E-mail Address], you can assign user attributes registered on the LDAP server for a search. Up to 32 characters are allowed.

Attribute Name of Custom Items 1, 2, and 3

Set the attribute names assigned to custom items 1 to 3. Up to 16 single-byte characters are allowed.

Attribute Type of Certificate

Set the certificate attribute type. Select and enter the field name to use as a certificate from among the user information registered on the LDAP server. Up to 32 characters are allowed.

For Windows, enter "userCertificate;binary" for an attribute name used as certificate information. The information is used as an S/MIME certificate when you specify an address using the directory service to encrypt e-mail transmission by S/MIME.

Note • To encrypt communications using this feature, a trusted root certificate authority and all intermediate certificate authorities that are registered in the path of a certificate to use must be registered.

Maximum Number of Search Results

Set a maximum number of address to display from search results from 5 to 100. If the search results exceed the maximum, the search stops at the maximum number set. The default value is 50.

Search Time-Out

Select whether or not to set a search time-out. Set the value from 5 to 120 seconds in 1 second increments.

SMB Server Settings

SMB Server Setup

Select the server specification method from [By Domain Name] and [By Domain & Server Names/IP Address].

According to the option you selected here, set [Domain Name] and [Server Name/IP Address] for SMB servers 1 to 5 respectively. The setting for SMB server 1 is used as the default setting for authentication.

Domain Name

Enter the domain name of the server. Up to 64 characters are allowed.

This setting is mandatory regardless of the SMB server specification method selected for [SMB Server Setup].

Note • Use the NetBIOS or Active Directory domain name for the domain name.

Server Name/IP Address

Enter the server name or IP address.

This setting is valid when [SMB Server Setup] is set to [By Domain & Server Names/IP Address].

Note • Use the NetBIOS computer name or full computer name with DNS suffix for the server name.
• For IPv4, enter the address in the format "xxx.xxx.xxx.xxx", where "xxx" is a numeric value from 0 to 255.

Security Settings

Set the security settings.

SSL/TLS Settings

Configure the SSL/TLS settings.

Device Certificate - Server

Select a certificate for HTTP SSL/TLS communications.

HTTP - SSL/TLS Communication

Select whether or not to enable HTTP SSL/TLS communications.

HTTP - SSL/TLS Port Number

Set the port number used for HTTP SSL/TLS communication from 1 to 65535.

The default value is 443.

Note • Do not use the numbers assigned to the other ports.

LDAP - SSL/TLS Communication

Set whether or not to enable the SSL/TLS communications for authentication and searches.

If you enable the LDAP SSL/TLS communications, you must set [Primary Server - Port Number] and [Secondary Server - Port Number] under [LDAP Server/Directory Service Settings].

The port number for SSL/TLS communications of the LDAP directory server is normally set to 636.

SMTP-SSL/TLS Communication

Configure the SSL/TLS communications.

- Disabled
The machine does not communicate in SSL/TLS.
- STARTTLS (If Available)
The machine verifies the certificate and communicates in SSL/TLS. If the verification fails, the machine does not communicate in SSL/TLS.
- STARTTLS
The machine verifies the certificate and communicates in SSL/TLS. If the verification fails, the machine cannot perform communication.
- SSL/TLS
The machine communicates in SSL/TLS.

Note • The Internet Fax Direct (P2P) feature does not support SMTP-SSL/TLS communication.

ThinPrint-SSL/TLS Communication

Select whether or not to enable the SSL/TLS communications.

Device Certificate - Client

Select a certificate for HTTP SSL/TLS communications.

Verify Remote Server Certificate

When the machine is operated as an SSL client, select whether or not to verify the certificate of the remote server.

S/MIME Settings

Configure S/MIME settings.

Device Certificate - S/MIME

Select a certificate for S/MIME communications.

For more information on the certificate, refer to "Encryption and Digital Signature Settings" (P.517).

S/MIME Communication

Select whether or not to enable S/MIME communications.

Receive Untrusted E-mail

If you select [No], the machine does not receive the following e-mail:

- E-mails other than e-mail sent by S/MIME when [S/MIME Communication] is set to [Enabled].
- E-mails that fail to attach a signature or verification.
- E-mails that are attached with an expired certificate.

Receive Untrusted Internet Fax

If you select [No], the machine does not receive the following Internet fax:

- Internet faxes other than the Internet fax sent by S/MIME when [S/MIME Communication] is set to [Enabled].
- Internet faxes that fail to attach a signature or verification.
- Internet faxes that are attached with an expired certificate.

Message Digest Algorithm

Select a message digest algorithm. Select from [SHA-1], [MD5] and [SHA-256].

Message Encryption Method

Set the encryption method for mail contents. Select from [3DES], [RC2-40], [RC2-64], [RC2-128], [AES-128], [AES-192], and [AES-256].

Split Encrypted E-mail

Select whether or not to split an outgoing encrypted e-mail for each recipient.

Split Encrypted Internet Fax

Select whether or not to split an outgoing encrypted Internet fax for each recipient.

Digital Signature - Outgoing E-mail

Select whether or not to always add a digital signature to outgoing e-mails. You can also select the setting in which the machine asks to add a digital signature to the e-mail whenever you send.

Signing Certificate for E-mail Attachment

Select the certificate to use for attaching a signature to e-mails.

Digital Signature - Outgoing Internet Fax

Select whether or not to always add a digital signature to outgoing Internet faxes. You can also select the setting in which the machine asks to add a digital signature to the Internet fax whenever you send.

Certificate Auto Store

Select whether or not to automatically store an S/MIME certificate attached with the e-mail when receiving e-mail from an address registered on the Address Book.

PDF/XPS Signature Settings

Configure signature settings of PDF/XPS documents.

Note • XPS stands for XML Paper Specification.

Device Certificate

Select a certificate to use for the signature.

For more information on the certificate, refer to "Encryption and Digital Signature Settings" (P.517).

PDF Signature

Select the setting for PDF Signature from [Do not add signature], [Always add visible signature], [Always add invisible signature], or [Select during send].

PDF Signature Hash Algorithm

Select the setting for PDF Signature Hash Algorithm from [SHA-1] or [SHA-256].

XPS Signature

Select the setting for XPS Signature from [Do not add signature], [Always add invisible signature], or [Select during send].

IPSec Settings

Configure the IPSec settings.

Note • For [IKE Authentication Method], [Preshared Key], [DH Group], and [PFS Settings], consult your network administrator.

IKE Authentication Method

Set the IKE authentication method. Select from [Authenticate by Preshared Key] or [Authenticate by Digital Signature].

Preshared Key

Enter a preshared key. This setting is valid when [IKE Authentication Method] is set to [Authenticate by Preshared Key].

Device Certificate

Select a certificate for IPSec communications.

Select a certificate when [IKE Authentication Method] is set to [Authenticate by Digital Signature]. A self-signed certificate created by Dell Printer Configuration Web Tool cannot be used.

For more information on a certificate, refer to "Types of Certificate" (P.518).

IPSec Communication

Select whether or not to enable IPSec communications.

IKE SA Life Time

Specify IKE SA lifetime from 5 to 28800 minutes in 1 minute increments.

Note • The value must be greater than the value set in [IPSec SA Life Time].

IPSec SA Life Time

Specify IPSec SA lifetime from 300 to 172800 seconds in 1 second increments.

Note • The value must be smaller than the value set in [IKE SA Life Time].

DH Group

Set DH group. Select from [G1] or [G2].

PFS Settings

Select whether or not to enable PFS.

Destination IPv4 Address

Set the IPv4 address of the destination.

When entering an IP address, enter the address in the format "xxx.xxx.xxx.xxx", where "xxx" is a numeric value from 0 to 255.

Destination IPv6 Address

Set the IPv6 address of the destination.

When entering an IP address, enter the address in the format "xxxx:xxxx:xxxx:xxxx:xxxx:xxxx:xxxx:xxxx", where "xxxx" is a hexadecimal value.

Communicate with Non-IPSec Devices

Select whether or not to communicate with non-IPSec devices.

IEEE 802.1x Settings

Configure the IEEE 802.1x settings.

IEEE 802.1x

Set whether or not to use IEEE 802.1x authentication.

Authentication Method

Select from [EAP-MD5], [EAP-MS-CHAPv2], [PEAP/MS-CHAPv2], or [EAP-TLS].

Login User Name

Enter the login user name with up to 128 characters.

Login Password

Enter the login password with up to 128 characters.

Server Certificate Verification

Select whether or not to verify a server certificate when [PEAP/MS-CHAPv2] is selected in [Authentication Method].

Certificate Revocation Retrieval Settings

Configure the settings for certificate revocation retrieval.

Level of Certificate Verification

Select a level of certificate verification from [Low], [Medium], or [High].

Selecting [Low] does not verify the validity of certificates.

Selecting [Medium] verifies the validity of certificates. If a certificate cannot be verified because of a network error or any other problems, the certificate is determined as valid.

Selecting [High] verifies the validity of certificates, and determines only certificates that have not been revoked as valid.

Retrieval of Certificate Status

Select the method to verify the validity of certificates. Select [By Retrieving CRL] if the machine retrieves a CRL (Certificate Revocation List) from the validation authority to verify the revocation status of the certificate. Select [By OCSP] if the machine uses OCSP (Online Certificate Status Protocol), which can verify the validity revocation status of the certificate, to have the certificate authority or validation authority check the revocation status.

Auto Retrieval of CRL

Select whether or not to automatically retrieve a CRL.

CRL Retrieval Time-Out

Specify a time-out value to retrieve a CRL from 5 to 60 seconds in 1 second increments.

Send Query to OCSP Responder With

Select how to access an OCSP responder from [URL as Specified in Certificate] or [URL as Specified by Administrator].

URL of OCSP Responder

Enter the URL of an OCSP responder when [URL as Specified by Administrator] has been selected for [Send Query to OCSP Responder With]. Up to 255 characters are allowed.

OCSP Communication Time-Out

Specify a time-out value for OCSP communication from 5 to 60 seconds in 1 second increments.

Other Settings

You can configure other settings related to security.

FIPS140 Validation Mode

Select whether or not to enable FIPS140 validation mode.

Other Settings

You can set the following network related items:

Protocol to Receive E-mail

Select from [SMTP] or [POP3] depending on your environment.

Add Domain Name to User Name

Select whether or not to add domain names to user names.

Output Destination for E-mail

Specify an output destination for e-mail print. Selecting [Auto] enables the machine to select the output destination, which is set as the default output destination.

Domain Filtering

Set the domain filtering settings for the E-mail and Internet Fax features.

Domain Filtering

When [Allow Domains] is selected, you can specify domains to permit transmissions. When [Block Domains] is selected, you can specify domains to prohibit transmissions.

Domains 1 to 50

When [Domain Filtering] is set to [Allow Domains] or [Block Domains], you can specify up to 50 domains to allow or block transmissions.

Selecting [Change Settings] allows you to enter the domain name using a keyboard displayed with up to 64 characters.

Print Service Settings

In [Print Service Settings], you can configure settings related to the Print feature. Using Dell Printer Configuration Web Tool, you can make more detailed settings. For more information, refer to "Dell Printer Configuration Web Tool Settings" (P.461).

The following shows the reference section for each setting.

Allocate Memory	380
Delete Form	382
Other Settings	382

- 1 On the [Tools] screen, select [System Settings] > [Print Service Settings].
For the method of displaying the [Tools] screen, refer to "System Settings Procedure" (P.296).
- 2 Select an item to set or change.

Allocate Memory

For each interface, set the memory capacity of the receiving buffer (temporary storage for data sent from the client).

You can change the receiving buffer capacity according to its use and purpose. Increasing the receiving buffer capacity may allow a client to be released sooner from an interface.

- Note**
- If you change the capacity memory, the memory is reset, thus all data stored in memory area is erased.
 - You cannot allocate more memory beyond its memory capacity. When you turn the machine on, and the size set exceeds the total memory size, the system automatically adjusts the memory size.
 - When a port is set to [Disabled], the corresponding items to the port do not appear.
 - Depending on the amount of data sent from the client, increasing the memory capacity may not change the time taken to release the client.

PostScript Memory

Specify a value for the PostScript memory capacity from 70.00 to 128.00 MB in 0.25 MB increments.

- Note**
- The maximum amount of memory you can allocate varies according to the amount of free space available in memory.

ART IV, ESC/P, 201H Form Memory

Displays where to save forms for use with ESC/P-K.

HP-GL/2 Auto Layout Memory

The working memory area for the HP-GL/2 auto layout feature is fixed to the hard disk.

Job Ticket Memory

Specify the amount of memory to use for job tickets from 0.25 to 8.00 MB in 0.25 MB increments.

- Note**
- The maximum amount of memory you can allocate varies according to the amount of free space available in memory.

Receiving Buffer - USB

Set the receiving buffer for USB.

You can specify a value from 64 to 1024 KB in 32 KB increments.

Receiving Buffer - LPD

Note • You may not be able to change the [Receiving Buffer - LPD] setting because of the setting of [LPD Print Queue].

For more information on [LPD Print Queue], refer to "LPD Print Queue" (P.386).

No Spooling

Does not use spooling. While LPD printing is performed for one client, data cannot be received over the same interface from another client.

Specify a value for the dedicated LPD receiving buffer memory capacity from 1024 to 2048 KB in 32 KB increments.

Spool to Memory

Carries out spooling. The receiving buffer for spooling uses memory. When this setting is selected, specify the memory capacity of a receiving buffer for spooling from 0.50 MB to 32.00 MB in 0.25 MB increments.

Note that print data exceeding the memory capacity set is not accepted. In such cases, select [Spool to Hard Disk] or [No Spooling].

Spool to Hard Disk

Carries out spooling. The receiving buffer for spooling uses the hard disk.

Receiving Buffer - NetWare

Set the NetWare receiving buffer.

Specify a value from 64 to 1024 KB in 32 KB increments.

Receiving Buffer - SMB

No Spooling

Does not use spooling. While SMB printing is performed for one client, data cannot be received over the same interface from another client.

Specify a value for the dedicated SMB receiving buffer memory capacity from 64 to 1024 KB in 32 KB increments.

Note • If you select [No Spooling], job names are displayed as "unknown document name".

Spool to Memory

Carries out spooling. The receiving buffer for spooling uses memory. When this setting is selected, specify the memory capacity of a receiving buffer for spooling from 0.50 MB to 32.00 MB in 0.25 MB increments.

Note that print data exceeding the memory capacity set is not accepted. In such cases, select [Spool to Hard Disk] or [No Spooling].

Spool to Hard Disk

Carries out spooling. The receiving buffer for spooling uses the hard disk.

Receiving Buffer - IPP

No Spooling

Does not use spooling. While IPP printing is performed for one client, data cannot be received over the same interface from another client.

Specify a value for the dedicated IPP receiving buffer memory capacity from 64 to 1024 KB in 32 KB increments.

Spool to Hard Disk

Carries out spooling. The receiving buffer for spooling uses the hard disk.

Receiving Buffer - EtherTalk

Set the EtherTalk receiving buffer.

Specify a value from 1024 to 2048 KB in 32 KB increments.

Receiving Buffer - Port 9100

Set the Port 9100 receiving buffer.

Specify a value from 64 to 1024 KB in 32 KB increments.

Delete Form

You can delete registered ESC/P-K forms.

- 1 Select [Delete Form].
- 2 Select the print mode to delete forms.
- 3 Enter the form number with the numeric keypad, and select [Confirm].

ESC/P

Deletes ESC/P-K emulation forms.

Form Number

When you select an item to delete, you can enter the form number.

Form Name

After you enter the form number and select [Confirm], the form name matching the form number entered appears.

- 4 Check the form name, and then select [Delete Data].

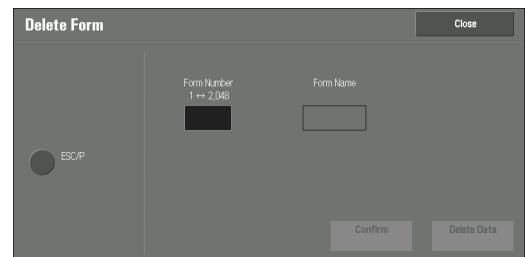

Other Settings

You can configure other settings related to the paper used in the printer.

Print Area

Set whether or not to expand the print area.

Substitute Tray

When there is no tray containing the paper size selected by the Auto Paper selection, select whether or not to print with paper loaded in another paper tray. In the event of using a substitute tray, select the paper size from [Use Larger Size], [Use Closest Size], or [Select Tray 5].

- Note**
- When documents are printed using emulation such as ESC/P-K and HP-GL/2, the substitute tray setting is not valid and a message prompting you to load paper displayed on the screen.

Display Message

Does not use a substitute tray, but displays a paper loading message.

Use Larger Size

Switches to the next larger size of paper than previously selected and prints at the same magnification.

Use Closest Size

Switches to the closest size of paper to previously selected and prints. If necessary, the image is automatically reduced in size on the paper.

- Note**
- If there is a client specification, the client specification is prioritized.

Select Tray 5

Prints using the paper loaded in Tray 5.

Paper Type Mismatch

Set an action to take when the paper type loaded in the paper tray does not match the paper type specified.

Print

Prints using the paper loaded in the tray.

Display Confirmation Screen

A confirmation screen appears to ask whether or not to print the job.

If a paper type mismatch occurs during printing, the machine ignores the paper type specified in the print driver and prints the job on another type of paper loaded in the machine.

For more information, refer to "Automatic Tray Selection" (P.237).

Display Paper Supply Screen

The [Paper Supply] screen appears, prompting you to load another type of paper in the selected tray. The job can be printed if you follow the instructions displayed on the screen.

- Note**
- The machine keeps the changed paper type setting after the printing.
 - Even if you select the [Start] button without loading another type of paper in the selected tray, the machine considers the paper type has been changed and prints the job. Consequently, the print quality cannot be guaranteed because the paper type loaded in the paper tray does not match the paper type specified.

Unregistered Forms

Set whether or not to print a job if a form specified for printing in a form data file (overlay printing) is not registered on the machine. If you specify [Print], only the data is printed because the specified form is not present.

Resume Job After Print Error

Set whether or not to automatically cancel a print job when the print job was suspended because of an error.

Note • The machine will enter the off-line state to restrict subsequent print jobs.

Job Resumes Automatically

Automatically cancels the print job to print subsequent jobs.

Resume by User

Displays a confirmation screen before cancelling the print job. After the confirmation, the machine cancels the print job to print the subsequent jobs.

Note • When [Resume by User] is selected, the machine will not temporarily stop printing even when the <Interrupt> button is pressed.

When Paper Jam Occurs

Specify how the machine handles print jobs after a paper jam is cleared.

Resume Job after Jam Clearance

When a paper jam is cleared, the machine automatically resumes printing from the next page of the page which was output correctly.

Delete Job

The machine cancels printing and removes the print job.

Note • For print files stored in a folder such as Charge Print, Private Charge Print, Secure Print, and Sample Print, the machine resumes printing after the paper jam is cleared.

Print User ID

When printing using a print driver, specify whether or not to print user ID set in the print driver on paper. The first 64 letters of the user ID are printed.

Select a position to print from [Top Left], [Top Right], [Bottom Left], and [Bottom Right].

Note • To use the Print User ID feature, the user ID must be set in the print driver beforehand. For more information, refer to the help of the print driver.
• When user ID set in the print driver is not available, "Unknown User" is printed.

Banner Sheet

You can output a banner sheet to separate different jobs by users not to be mixed the outputs. The machine outputs the banner sheet before or after the job.

A date, time, user name, and file name are printed on the banner sheet.

Note • Even if stapling is selected, banner sheets are not stapled.
• When a document is printed from a Macintosh, the document name is not printed on the banner sheet.
• When printed, banner sheets are counted by meter.

Off

Does not print banner sheets.

Start Sheet

Prints a banner sheet before a print job.

End Sheet

Prints a banner sheet after a print job.

Start Sheet & End Sheet

Prints a banner sheet before and after a print job.

Allow Print Driver to Override

Select the check box to print a banner sheet according to the banner sheet print settings of the print driver.

Banner Sheet Offset

Set whether or not to offset when banner sheets are output.

Banner Sheet Tray

Select a paper tray used for banner sheets.

This setting applies to Trays 1 to 4 and 6 (optional). You cannot apply this setting to Tray 5.

PostScript Default Color

Set the default value for Post Script output color.

PostScript Paper Supply

Select whether the PostScript Deferred Media Selection feature is enabled or disabled when the paper tray is selected. Select [Auto Select] to enable the PostScript Deferred Media Selection feature, or [Select Paper Tray] to disable the feature.

When PostScript data generated by other than the print driver is printed, the tray is not selected as intended depending on the description method of the PostScript data. In this case, select [Select Paper Tray].

Note • Even when you select [Auto Select], the setting is automatically changed to [Select Paper Tray] when [Use Larger Size] or [Use Closest Size] is selected for [Substitute Tray] and print PostScript data.

PostScript Font Absence

Set an action to take when a PostScript font specified in a job is not present.

Cancel Printing

Cancels printing.

Substitute Font and Print

Prints using a substitute font. Courier is used as the substitute font.

PostScript Font Substitution

Set whether or not to use ATCx as a substitute if a PostScript font specified in a job is not present.

XPS Print Ticket Processing

Set how the machine processes the print tickets written in XPS documents.

Note • XPS stands for XML Paper Specification.

Off

Does not process print tickets.

Standard Mode

Uses the standard mode to process print tickets.

Compatible Mode

Uses the Microsoft®-compliant mode to process print tickets.

LPD Print Queue

Set the LPD print sequence.

- Note**
- If you change the [LPD Print Queue] setting, the [Receiving Buffer - LPD] setting may automatically be changed. For more information on Receiving Buffer - LPD Spool, refer to "Receiving Buffer - LPD" (P.381).

Data Processing Order

Prints jobs in the order of becoming print-ready status after receiving the jobs.

When you print jobs of multiple documents continuously, the machine may preferentially print the next job in the middle of processing depending on the processing time.

Job Submission Order

Prints jobs in the order of lpr print submission.

- Note**
- This setting is valid only when [Receiving Buffer - LPD] is set to [Spool to Hard Disk]. When any other setting, printing is performed in [Data Processing Order].

OCR Font Glyphs (0 x 5C)

Allows you to select [Backslash] or [Japanese Yen Sign] to print 0x5C character when the OCR fonts are used.

Scan Service Settings

You can configure settings related to the Scan services.

Note • When [Scan to Fax Server] is selected in the System Settings, [Scan Service Settings] is replaced with [Scan/Fax Service Settings].

For information on scanner environment settings, refer to "Scanner Environment Settings" (P.495).

The following shows the reference section for each setting.

Screen Defaults	387
Scan Defaults.....	388
Scan to PC Defaults.....	390
Original Size Defaults	391
Output Size Defaults	391
Reduce/Enlarge Presets	391
Other Settings	392

1 On the [Tools] screen, select [System Settings] > [Scan Service Settings].

For the method of displaying the [Tools] screen, refer to "System Settings Procedure" (P.296).

2 Select an item to set or change.

Screen Defaults

You can set the items that appear in the First Tab screen. The First Tab means the screen displayed when you select the following tabs in the [E-mail], [Store to Folder], [Scan to PC], [Store & Send Link], and [Store to USB] screens.

- The [E-mail] tab of the E-mail service
- The [Store to Folder] tab of the Store to Folder service
- The [Scan to PC] tab of the Scan to PC service
- The [Store & Send Link] tab of the Store & Send Link service
- The [Store to USB] tab of the Store to USB service

Email Screen Default

Set the default screen that appears when [E-mail] on the [Home] screen is selected. Select from [First Tab] and [Address Book].

Scan to PC Screen Default

Set the default screen that appears when [Scan to PC] on the [Home] screen is selected. Select from [First Tab] and [Address Book].

1st Tab - Features Allocation

You can set the features that appear in the second to the fourth column of the lower part in the First Tab screen.

Select a column by choosing from [Feature in 1st Column] to [Feature in 4th Column]. And set the item to be displayed from [Not Selected], [Color Scanning], [2 Sided Scanning], [Original Type], [File Format], [Resolution], [Lighten / Darken], [Reduce / Enlarge], [Mixed Size Originals], and [Original Orientation].

Reduce/Enlarge - Buttons 2 to 5

This item can be set when [Reduce/Enlarge] is selected for one of the features that appear in the second to the fourth column in [1st Tab - Features Allocation].

Select the magnification ratio displayed in [Reduce/Enlarge] from the Reduce/Enlarge Presets registered.

For information about the Reduce/Enlarge Preset buttons, refer to "Reduce/Enlarge Presets" (P.391).

Scan Defaults

You can set the default settings of the Scan services. When the machine is turned on, or the machine exits the Power Saver mode, or when the <Clear All> button is pressed, the machine resets to the default values set here. Setting frequently used features and values as the defaults can avoid extra operations required during the use of the machine.

The values set here become valid after the machine turned off and then on.

Color Scanning

Set the default value for [Color Scanning] in the First Tab.

Original Type

Set the default value for [Original Type] in the First Tab.

File Format

Set the default value for [File Format] in the First Tab.

Optimize PDF For Quick Web View

Set the default value for [Optimize For Quick Web View] of [File Format] in the First Tab.

Thumbnail - Outgoing E-mail

For the E-mail feature, set the default value for [Add Thumbnail] when [XPS] is selected for [File Format] in the First Tab.

Note • XPS stands for XML Paper Specification.

Thumbnail - Scan to PC

For the Scan to PC feature, set the default value for [Add Thumbnail] when [XPS] is selected for [File Format] in the First Tab.

Note • XPS stands for XML Paper Specification.

Lighten/Darken

Set the default value for [Lighten/Darken] of [Image Options] in the [Advanced Settings] screen.

Contrast

Set the default value for [Contrast] of [Image Enhancement] in the [Advanced Settings] screen. The contrast setting is valid when [Color Scanning] is set to [Color] or [Grayscale].

Sharpness

Set the default value for [Sharpness] of [Image Options] in the [Advanced Settings] screen.

Background Suppression

Set the default value for [Background Suppression] of [Image Enhancement] in the [Advanced Settings] screen.

Shadow Suppression

Set the default value for [Shadow Suppression] in the [Advanced Settings] screen.

Color Space

Set the default value for [Color Space] in the [Advanced Settings] screen.

Note • When [Device Color Space] is selected as default and [Color Space] under [Other Settings] is set to [Disabled], [Auto Detect] of [Color Scanning] in the First Tab, and [MRC High Compression] and [Specific Color] under [File Format] do not appear.

Original Orientation

Set the default value for [Original Orientation] in the [Layout Adjustment] screen.

Resolution

Set the default value for [Resolution] in the [Layout Adjustment] screen.

You can select from [200 dpi], [300 dpi], [400 dpi], or [600 dpi].

Mixed Size Originals

Set the default value for [Mixed Size Originals] in the [Layout Adjustment] screen.

Edge Erase

Set the default value for [Edge Erase] in the [Layout Adjustment] screen. You can select from [All Edges] or [Parallel Edges].

Edge Erase - Top & Bottom Edges

Set the default value for [Top & Bottom] in [Edge Erase] in the [Layout Adjustment] screen. Specify a value from 0 to 50 mm in 1 mm increments.

Edge Erase - Left & Right Edges

Set the default value for [Left & Right] in [Edge Erase] in the [Layout Adjustment] screen. Specify a value from 0 to 50 mm in 1 mm increments.

Center Erase/Binding Edge Erase

Set the default value for [Center] in [Edge Erase] in the [Layout Adjustment] screen. Specify a value from 0 to 50 mm in 1 mm increments.

Quality/File Size

Set the default value for [Quality/File Size] in the [Filing Options] screen. Select from [Quality: Normal/File Size: Small], [Quality: Higher +1/File Size: Larger +1], [Quality: Higher +2/File Size: Larger +2], [Quality: Higher +3/File Size: Larger +3], or [Quality: Maximum/File Size: Largest].

E-mail Subject

Set the default value for the e-mail subject. Up to 128 characters can be entered for the subject.

Store & Send Link - E-mail Subject

Set the default value for the subject used for the Store & Send Link feature. Up to 128 characters can be entered for the subject.

For more information on the Store & Send Link feature, refer to "Step 2 Selecting the Features" (P.160).

E-mail Encryption

Set the default value for [Encryption] in the [E-mail Options] in the [E-mail] screen.

Note • This feature appears only when the root certificate for a remote authentication server is set.

Searchable Text

Set the default value for [Searchable Text] in the [File Format] screen under the First Tab.

Language of the Original

Set the default language to identify the text on a document.

Searchable - Text Compression

Set whether or not to compress searchable text when using the OCR feature.

Scan to PC Defaults

Transfer Protocol

Set the default value for the transfer protocol used for transfer from [FTP], [SMB], or [SMB (UNC Format)].

Login Credential to Access Destination

Set whether or not to use a user authenticated by the remote server when the user logs in to the destination computer for the Scan to PC service. This setting is effective for remote authentication.

None

Does not use the remotely authenticated user.

Remotely Authenticated User

Uses the user name and the password of the remotely authenticated user for login.

User Name for FTP Scan

When the remotely authenticated user name is used as a login user name for FTP transfers for the Scan to PC service, specify whether or not to include the domain part of the credentials.

User Name Only

Uses only the user name part (before "@") of the login credential for the login name. The domain part is not used.

Add Domain Name

Uses the full login credential name, including the domain name (after "@"), for the user name.

Original Size Defaults

Set the document size displayed in [Original Size] in the [Layout Adjustment] screen. You can assign a document size to each of the 17 buttons other than [Auto Detect].

If you frequently use non-standard size paper for scanning, assigning the paper sizes to the buttons will save your time to specify the size each time.

A/B Series Size

You can select from sizes of A and B series such as A4 and B5.

Inch Size

You can select from size of Inch series such as 8.5 x 11" and 11 x 17".

Others

You can select from sizes of other than the above series such as photo and postcard sizes.

Custom Size

You can enter any size. Set the width (X) from 15 to 432 mm, and the height (Y) from 15 to 297 mm in 1 mm increments.

Output Size Defaults

Set the sizes to display in [Output Size] when selecting [Enter Output Size] for scanning documents at [Reduce/Enlarge] in the [Layout Adjustment] screen.

You can assign any output size to output size buttons. Assigning the output sizes to the buttons will save your time to specify the size each time.

A/B Series Size

You can select from sizes of A and B series such as A4 and B5.

Inch Size

You can select from size of Inch series such as 8.5 x 11" and 11 x 17".

Others

You can select from sizes of other than the above series such as photo and postcard sizes.

Reduce/Enlarge Presets

Set the magnifications displayed as [Preset %] which are displayed when [Proportional %] is selected under [Reduce/Enlarge] in the [Layout Adjustment] screen.

You can assign any magnification to the Reduce/Enlarge Preset buttons other than [100%].

Preset %

Select from standard magnification ratios.

Variable %

You can specify a magnification from 25 to 400% in 1% increments.

Other Settings

You can configure other settings related to the Scan services specifications.

Memory Full Procedure

If there is insufficient hard disk memory while scanning a document, a screen appears asking you how you want to handle the partially stored data.

Set the process you want the machine to perform for the partially stored data after a certain time has elapsed in the confirmation screen.

You can set the time until the memory full procedure is carried out. For more information, refer to "Auto Job Release" (P.315).

Delete Job

Deletes the data partially stored.

Run Job

Treats the read-in data as valid, and starts sending the document partially stored.

Maximum Stored Pages

Set the maximum number of pages stored for a scan document. You can specify from 1 to 999 pages.

Saturation

Set the saturation when scanning a full color document. When a document is scanned, saturation is automatically adjusted according to the value set here.

Background Suppression Level

Set the background suppression level. This is valid when [Background Suppression] is set to [Auto Suppression].

The larger the value the stronger the effect of removing background noise is.

Shadow Suppression Level

Set the shadow suppression level. This is valid when [Shadow Suppression] is set to [Auto Suppression].

Color Space

Set whether or not to display the Color Space feature.

When you select [Enabled], the [Color Space] button is displayed on the [Advanced Settings] screen for the [E-mail], [Store to Folder], and [Scan to PC].

Note • When [Disabled] is selected as default and [Color Space] under [Scan Defaults] is set to [Device Color Space], [Auto Detect] of [Color Scanning] in the First Tab ([E-mail]/[Store to Folder]/[Scan to PC]), and [MRC High Compression] and [Specific Color] under [File Format] do not appear. For more information on Color Space, refer to "Color Space" (P.389).

TIFF Format

Set the TIFF format for scanned data. You can select either [TIFF V6] or [TTN2].

Image Transfer Screen

Select whether or not to display a message when the scan of a document completes.

Disabled

Does not display a scan completion message.

Display Message at End of Scanning

Displays a scan completion message.

Display Scan & Transfer Screens

Displays the transfer screen after scan completion. The scan completion message is not displayed.

Display Message at End of Transfer

Displays a transfer completion message.

Searchable - Page Orientation

Set whether or not to handle the character orientation to be upright when the machine scans a document with OCR (Optical Character Recognition).

Auto Upright Orientation

Handles the character orientation upright regardless of the document orientation.

According to Original Orientation

Handles the character orientation depending on the document orientation.

URL File Expiration

Set the retention period for files stored with the Store & Send Link feature. You can specify a value from 1 to 168 hours in 1 hour increments. The default value is 3 hours.

Generation of URL Link

Set the format of URLs generated with the Store & Send Link feature. Select either [Use IP Address] or [Use FQDN].

The following are examples of URLs:

If [Use IP Address] is selected:

`http://192.0.2.1/scanUrl/doc1/get.htm`

If [Use FQDN] is selected:

`http://pc1.mycompany.co.jp/scanUrl/doc1/get.htm`

Store & Send Link - Maximum File Size

Set the maximum data size of files that can be stored for the Store & Send Link feature. You can specify the value from 1 to 200 MB in 1 MB increments. The default value is 200 MB.

Print Login Name on PDF Files

If scanning a document in PDF format when local machine authentication or remote authentication is enabled, you can set whether to add an authentication user name as the Author in the document properties of the PDF document.

Fax Service Settings

In [Fax Service Settings], you can configure settings related to the Fax service.

- Note**
- An optional component is required to use this feature. For more information, contact Customer Support at dell.com/contactdell.
 - You can register new address book entries in [Add Address Book Entry] under [Setup]. For more information, refer to "Add Address Book Entry" (P.431).

The following shows the reference section for each setting.

Screen Defaults	394
Fax Defaults	395
Fax Control	396
Fax Received Options	401
Reduce/Enlarge Presets	401
Original Size Defaults	402
Local Terminal Information	402
Internet Fax Control	403

- 1 On the [Tools] screen, select [System Settings] > [Fax Service Settings].
For the method of displaying the [Tools] screen, refer to "System Settings Procedure" (P.296).
- 2 Select an item to set or change.

Screen Defaults

You can set items displayed on the [Fax/Internet Fax] screen.

Fax Screen Default

Set the default screen that appears when the [Fax/Internet Fax] screen is selected in the [Home] screen.
Select from [Fax Tab] or [Address Book].

1st Tab - Features Allocation

Set the features that appear on the [Fax/Internet Fax] screen.

Feature in 2nd to 4th Column

You can set the features that appear in the second to the fourth column of the lower part on the [Fax/Internet Fax] screen.

Select the item to be displayed from [Not Selected], [2 Sided Faxing], [Original Type], [Resolution], [Confirmation Options], [Starting Rate], [Transmission Header], [Mixed Size Originals], and [Reduce / Enlarge].

Reduce / Enlarge - Button 3 - 5

This item can be set when [Reduce/Enlarge] is selected in [Feature in 2nd to 4th Column].
You can set the magnifications displayed as [Preset %] which are displayed under [Reduce/Enlarge] in the [Layout Adjustment] screen. You can assign any magnification to the Reduce / Enlarge - Button 3 - 5.

Transmission Screen

Set whether or not to display transmission status during transmission.

Fax Defaults

You can set the default settings of the Fax services. When the machine is turned on, or the machine exits from the Power Saver mode, or when the <Clear All> button is pressed, the machine resets to the default values specified under this menu. By setting frequently used features and values as the defaults, you can simplify operations.

Resolution

Set the default value for [Resolution] in the [Fax/Internet Fax] screen.

Original Type

Set the default value for [Original Type] in the [Fax/Internet Fax] screen.

Lighten / Darken

Set the default value for [Lighten/Darken] in the [Fax/Internet Fax] screen.

Mixed Size Originals

Set the default value for [Mixed Size Originals] in the [Layout Adjustment] screen.

Skip Blank Pages

Set the default value for [2 Sided Scanning] in the [Fax/Internet Fax] and [Layout Adjustment] screens to [2 Sided (First Page 1 Sided)].

Note • This feature is for service representative use. For more information, contact Customer Support at dell.com/contactdell.

Starting Rate

Set the default value for [Starting Rate] in the [Fax/Internet Fax Options] screen.

Delay Start - Specific Time

Set the default value for [Specific Time] of [Priority Send/Delay Start] in the [Fax/Internet Fax Options] screen when [Specific Time] is selected for [Delay Start].

Transmission Header Text

Set the default value for [Transmission Header Text] in the [Fax/Internet Fax Options] screen.

Confirmation Options

Set the default value for [Confirmation Options] of [Acknowledgement Report] in the [Fax/Internet Fax Options] screen.

Note • You can select Delivery Receipts or Read Receipts in [Delivery Confirmation Method]. For more information on the delivery confirmation method, refer to "Delivery Confirmation Method" (P.404).

Delivery Receipts/Read Receipts

Set the default value for [Read Receipts] or [Delivery Receipts] of [Acknowledgement Report] in the [Fax/Internet Fax Options] screen.

Note • You can select Delivery Receipts or Read Receipts in [Delivery Confirmation Method]. For more information on the delivery confirmation method, refer to "Delivery Confirmation Method" (P.404).

Internet Fax Profile

Set the default value for [Internet Fax Profile] in the [Fax/Internet Fax Options] screen.

Internet Fax Subject

Set the default value for [Internet Fax Subject] in the [Fax/Internet Fax Options] screen. Up to 128 single-byte characters can be entered for the subject.

Internet Fax Encryption

Set the default value for [Encryption] in the [Fax/Internet Fax Options] screen.

Note • This feature appears only when the root certificate for a remote server for remote authentication is set.

Fax Control

You can configure the settings related to fax control.

Re-enter Recipients

Set whether to re-enter the recipient after once specifying the recipient, to reduce the risk of sending a fax or an Internet fax to the wrong address. When Re-enter Recipients is set to [Enter Twice], if you specify the recipient by entering the phone number, or by selecting from the Address Book, the screen prompting you to re-enter the recipient appears. If the same recipient has been entered, the transmission process will start.

Re-enter Broadcast Recipients

This setting is required when you selected [Enter Twice] for [Re-enter Recipients]. Set whether or not to allow the Broadcast Send.

- Enter Once Only
Allows the Broadcast Send. No need to re-enter the recipient.
- Enter Twice
Allows the Broadcast Send. Re-entering the recipient is required.
- Broadcast Disabled
No Broadcast Send is allowed.

Re-enter Speed Dial Recipients

This setting is required when you selected [Enter Twice] for [Re-enter Recipients]. Select how to re-enter a recipient after the first entry.

- Enter Once Only
No need to re-enter the recipient.
- Enter Twice
Use the Speed Dial feature to re-enter the recipient.
- Re-enter Fax Number or E-mail
You cannot enter the speed dial when you re-enter the number or address. Use the fax number, phone number, or e-mail address to enter the recipient.

Re-enter Group Recipients

Specifies whether you need to re-enter group addresses after entering a group address.

- Group Send Disabled
No group recipient is allowed.

- Enter Once Only
No need to re-enter the group recipient.
- Enter Twice
Re-entering the group recipient is required.

Broadcast Checkbox on 1st Tab

Specify whether or not to show the [Enable Broadcast] checkbox in the [Fax/Internet Fax] screen to explicitly express broadcast directions.

Chain Dial

Allows you to combine the fax numbers registered in one touch button, speed dial, and address book respectively and the numbers entered using the numeric keypad to specify as one recipient. You can select from [No] or [Yes].

Note • This item is available when [Type 1] is set for [Address Book Type] under [Tools] > [System Settings] > [Address Book Settings].

Manual Redial List - Saved Entries

Specify the number of redial destinations saved.

Manual Redial List - Dial Mode

Specify the destination type saved as a redial destination number.
When you deselect all the check boxes, the Redial feature becomes disabled.

Transmission Header Text - Polling

Set whether or not to attach a transmission header to a polling file.

A "polling file" means that a document is stored in the machine's public folder for polling, and can then be sent by an operation from the other party.

Polled Files - Auto Delete

Set whether or not to automatically delete a polling file after transmission.

Rotate 90 degrees

Set whether or not to automatically rotate a document if its image must be reduced in size unless it is rotated.

Note • If an arbitrary magnification is specified in [Reduce/Enlarge], the Rotate 90 Degrees feature does not function.

G3 Sender ID - Fax

When using G3 communications, you can select whether to notify G3-ID to recipients for fax.

Save Undelivered Faxes

Set whether or not to save a fax document if a fax transmission fails. When [Yes] is selected, the [Undelivered Faxes] button appears on the [Secure Print Jobs & More] tab of the [Job Status] screen. Select this button to send the fax document again.

For details on Undelivered Faxes, refer to "Undelivered Faxes" (P.219).

Save Deleted Faxes

When [Yes] is selected for [Save Undelivered Faxes], set whether or not to save cancelled faxes.

Saved Faxes - Auto Delete

When [Yes] is selected for [Save Undelivered Faxes], set whether or not to automatically delete saved faxes in 24 hours.

Transmission Interval

Specify a value for the interval between the end of one transmission and the beginning of the next, from 3 to 255 seconds in 1 second increments.

A longer transmission interval increases the total time to send a broadcast transmission, but allows calls to be received during the standby time.

Batch Send

When the machine stores multiple faxes addressed to a destination, enabling the Batch Send feature allows you to send them all at the same time in a single fax transmission. By using this feature, you can reduce your communication costs.

Select whether or not to enable the Batch Send feature.

Note that a batch send is not available for manual transmissions, broadcasts, relay broadcasts, remote folder, and delayed start transmission with a specified time before the specified time. When a redial, resend, delayed start transmission job, or the Authentication feature is used and different users send to the same address, a batch send is not possible.

Manual Send/Receive Default

When on-hook or off-hook is used when sending a fax, select either [Manual Receive] or [Manual Send].

Fax Receiving Mode

Set the default value for [Fax Receiving Mode] in the [Machine Information] screen displayed by pressing the <Machine Status> button. Select whether or not to receive a fax automatically or manually.

Border Limit

Set the length to make a page break that will be applied when the length of a received fax document is longer than the paper length. You can specify a value from 0 to 127 mm in 1 mm increments.

This setting can conveniently be used together with the following Auto Reduce on Receipt feature.

Auto Reduce On Receipt

When the length of a received fax document exceeds the paper length but is within the page break threshold value, select whether or not to automatically reduce the image to fit the page.

This setting can conveniently be used together with the Border Limit feature. If you select [No], the part of the image beyond the paper length is ignored.

Receiving Paper Size

Set the method of notifying the paper size on which the received fax document will be printed, from the receiver to the sender.

Tray Mode

Specify the paper tray for printing the received fax document. Only the specified paper tray will be used for printing the received document. Multiple paper trays can be specified except for Tray 5. If the fax document cannot be printed on the paper loaded in the specified paper trays, the machine displays a message stating that it will be printed on the paper loaded in Tray 5. Load paper in Tray 5 and press the <Start> button to print the document. To cancel printing, press the <Clear All> button.

User Mode

Specify the paper sizes to use for printing received fax documents. Regardless of whether the paper is loaded in the trays, only the specified size paper is used for printing. When you select [User Mode], select paper sizes from [A3☐], [A4☐], [A4☐], [A5☐], [B4☐], [B5☐], [8.5 x 11"☐], and [Select All]. You can select one or more paper sizes.

2 Pages Up On Receipt

Set whether or not to print two pages of a fax document on one side of a sheet. This is convenient for saving paper.

For example, when two A5 pages are received, they are printed on a single A4 sheet. However, if paper of the same paper size as the received document is specified in [Receiving Paper Size], it is printed on the specified size of paper. Depending on the sizes of the received document, multiple-up printing may not be possible.

2 Sided Printing

Set whether or not to print received fax documents (including the Internet fax received documents) as 2 sided. This is convenient for saving paper.

Note • Even if you select [On], depending on the data, 2 sided printing may not always be possible.

Edge Erase - Top & Bottom Edges

Specify the amount of edges erased from the document in the top and bottom directions. Specify a value from 0 to 20 mm in 1 mm increments.

Edge Erase - Left & Right Edges

Specify the amount of edges erased from the document in the left and right directions. Specify a value from 0 to 20 mm in 1 mm increments.

Reduce 8.5 x 11"☐ Original to A4☐

When [Reduce/Enlarge] in the [Layout Adjustment] screen is set to [Auto %], you can set whether or not to reduce 8.5 x 11"☐ size document to A4☐, while scanning the document.

Pseudo-Photo Gradation Mode

You can select a gradation expression mode. Selecting this mode enables the machine to change the processing method for gray part (halftone) to achieve near-photo quality. Select either [Error Diffusion] or [Dither].

Changing this setting also changes the photo gradation mode for Color Scanning (Black & White).

Folder Selector Setup

Select whether or not to use the Folder Selector Setup feature.

The Folder Selector Setup feature allows you to classify received faxes by line type and store them in folders specified.

Memory Full Procedure

If there is insufficient hard disk memory while scanning a document, a screen appears asking you how you want to handle the partially stored data.

Set the process you want the machine to perform for the partially stored data after a certain time has elapsed in the confirmation screen.

You can set the time until the memory full procedure is carried out. For more information, refer to "Auto Job Release" (P.315).

Delete Job

Deletes the data partially stored.

Run Job

Treats the read-in data as valid, and start scanning the document partially stored.

Maximum Stored Pages

Set the maximum number of pages stored for a fax document. You can specify from 1 to 999 pages.

Mixed Size Originals Scan Mode

Set the scan mode when the machine scans documents of various sizes simultaneously with the document feeder. If only documents of standard sizes are to be scanned, we recommend that you select [Standard Size Mode].

- Note**
- When [Standard Size Mode] is selected, image loss may occur if the following types of documents are scanned:
 - Non-standard size documents
 - B4 size documents with the inch series setting in [Paper Size Settings].

Skip Blank Pages

Set whether or not to detect blank pages while scanning 2 sided documents and transmits only pages that are not blank.

- Note**
- This feature is for service representative use. For more information, contact Customer Support at dell.com/contactdell.

Fax Data in Folder Priority 1 to 3

Set the priority to display the fax information received using folders. For instance, when using Dell Network Scanner Utility 3, the fax information is displayed in the [Recipient] section of the file list screen.

There are priority levels from 1 to 3. All priority can be set, however, if you want to display only one priority level, make the settings of all priority levels the same.

Direct Fax

Set whether or not to receive a fax, which is instructed using a fax driver from a computer. When you select [Disabled], the Direct Fax feature becomes unavailable.

Block Inbound Faxes

Set a G3-ID (fax number) from which you want to reject a fax reception. You can specify up to 50 G3-IDs.

You can find the G3-ID of the sender that you want to reject in "Remote Station" column of an Activity Report or "Input Source" column of a Job History Report.

Block Unknown Fax Numbers

Set whether or not to receive faxes from unknown G3-ID fax numbers. When [Yes] is selected, the machine does not receive faxes from unknown fax numbers.

Fax Received Options

Fax Received Options allows you to specify a method for classifying received fax documents into specified folders.

Folder Selector Setup

If you set the classification by line type, the machine classifies the received documents by line type and store them in the folders specified.

- 1 Select [Folder Selector Setup].
- 2 Select the line to register, and then select [Change Settings].

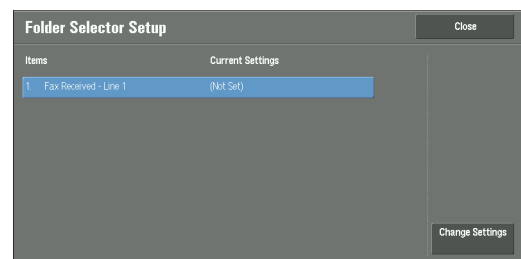

- 3 Select [On].



- 4 Enter the folder number (three-digits) where you want to store the faxes with the numeric keypad.
- 5 Select [Save].

Output Destination Setup

In [Output Destination Setup], you can set the output destination.

Fax Received - Line 1

Specify output tray for line 1.

Public Folder Printed Files

Specifies output tray for public folder for polling.

Reduce/Enlarge Presets

You can set the magnifications displayed as [Preset %] which are displayed under [Reduce/Enlarge] in the [Layout Adjustment] screen. You can assign any magnification to the Reduce/Enlarge Preset buttons other than [100%] and [Auto %].

Preset %

You can select from preset ratios.

Variable %

You can specify a magnification from 50 to 400% in 1% increments.

Original Size Defaults

You can set the original sizes displayed in [Original Size] in the [Layout Adjustment] screen.

You can assign original sizes to the buttons other than [Auto Detect].

If you frequently use non-standard size paper for scanning, setting non-standard size as the default will save your time to specify the size each time.

A/B Series Size

You can select from sizes of A and B series such as A4 and B5.

Inch Size

You can select from size of Inch series such as 8.5 x 11" and 11 x 17".

Others

You can select from sizes of other than the above series such as photo and postcard sizes.

Local Terminal Information

You can set the local terminal information, including a local name and company logo.

- Note**
- The displayed items may vary depending on the options installed.
 - For each line, you can set a company logo, G3 ID (fax number), G3 dial type, and G3 line type.

For information about how to enter characters, refer to "Entering Text" (P.57).

Local Name

Register the name of the local terminal as the local name.

The local name is shown in the recipient's touch screen or Activity Report. Depending on the recipient's device, however, it may not be displayed.

Specify a local name with up to 20 single-byte characters using the keyboard displayed or the numeric keypad.

Company Logo

Register the sender name (company logo). The company logo is printed in the Transmission Header Text or Cover Page. Specify a company log with up to 60 single-byte characters using the keyboard displayed or the numeric keypad.

- Note**
- If [Line 1 - Company Logo] is not registered, the company logo is used.

Machine Password

Set the machine password when you want to limit the other parties that can send faxes.

When the machine password is set, only a party that sends the correct machine password by F code is allowed to send or poll. Note that this means that faxes cannot be accepted from a fax without the F Code feature.

Line 1 - Company Logo

Register the sender name for line 1. The sender name is printed in the Transmission Header Text or Cover Page. Enter up to 60 single-byte characters using the keyboard displayed or the numeric keypad.

G3 Line 1 - Fax ID

When using G3 communications, register the G3 ID. The G3 ID is normally set to the local terminal fax number.

Specify a G3 ID with up to 20 digits using the keyboard displayed or the numeric keypad.

Note • A G3 ID (fax number) can consist of not more than 20 digits, including 0 to 9, +, and space.

G3 Line 1 - Dial Type

Set the dial type.

Tone

Tone dialing line.

10pps

Pulse dialing line.

G3 Line 1 - Line Type

Set the line type.

PSTN

Subscriber telephone line.

PBX

Private branch exchange.

Internet Fax Control

You can configure the settings related to the Internet fax control.

Internet Fax Path

Set the Internet fax communication path.

Via E-mail Server

Sends e-mail via an SMTP server.

Direct (P2P)

Directly sends to the machine with the Internet Fax feature, without going through an SMTP server.

You can specify the following two types of e-mail address for the Internet Fax feature:

- Specifying a host name
 - @ must be followed by FQDN.
 - Example: local-part@device.domain.jp
- Specifying an IP address
 - @ must be followed by an IP address with brackets.
 - Example: local-part@[192.0.2.1]

Profile for Broadcast Job

Set the default value for an Internet fax profile when performing an Internet fax broadcast send.

A profile is specified to restrict attribute information such as image resolution and paper size for transmissions between Internet Fax-enabled machines.

Note • The supported TIFF-file profiles vary depending on the destination Internet Fax-enabled machine. Before specifying a profile, check the profile that the destination machine supports.

TIFF-S

The Internet fax standard profile. For documents larger than A4, the size is automatically reduced to A4 when transmission.

TIFF-F

Select this profile when you specify [Superfine] for [Resolution] or when you send A3 or B4 documents.

TIFF-J

Select this profile for sending documents in JBIG.

Broadcast Starting Rate

Set the default value for the communications mode for the broadcasting for the Internet fax.

Delivery Confirmation Method

Set the default value for the method of confirming that an Internet fax sent has arrived or not.

To print a transmission result, set [Print Delivery Confirmation Mail] to [On] under [E-mail/Internet Fax Service Settings] > [E-mail Control].

Note • You can select [Delivery Receipts] when the destination machine supports the DSN feature. You can use [Read Receipts] when the destination machine supports the MDN feature.

Delivery Receipts

You can confirm whether the Internet fax you sent is delivered to the recipient's folder successfully.

Read Receipts

You can confirm whether the Internet fax including attachments you sent is processed properly at the recipient.

Incoming Internet Fax Print Options

When an e-mail sent from an Internet fax compatible machine to the e-mail address of the machine is received, you can select the print operation.

Print Attachment Only

Only prints the attached documents.

Attachment, Full Headers & Message

Prints the e-mail header and body of e-mails.

Attachment, Basic Headers & Message

Prints the part of headers (From/To/Subject/Date) and the contents of e-mails.

When you select [Do not print if no message], the machine prints only e-mail that has contents.

Internet Fax Output Destination

Set the output tray to use for printed Internet fax documents.

Note • An optional component is required to use this feature. For more information, contact Customer Support at dell.com/contactdell.

Fax Transfer from Address Book

Set whether to permit forwarding of Internet fax data received by e-mail via SMTP when the forwarding destination is not registered on the Address Book.

Off

Permits forwarding.

On

Checks whether the forwarding fax number is listed in the Address Book, and if not, rejects receiving the e-mail and deletes it.

Transmission Header Text - Fax Transfer

When forwarding received e-mail from Internet fax to fax, select whether or not to add a Transmission Header Text (start time, company logo, recipient name, G3 ID, and number of pages).

Fax Transfer Maximum Data Size

When forwarding a received e-mail from Internet fax to fax, set the maximum data size.

No Limit

No limit on data size.

Limit Size

Specify a value from 1 to 65535 KB in 1 KB increments. If a data size exceeds the specified value, the data is deleted.

E-mail/Internet Fax Service Settings

In [E-mail/Internet Fax Service Settings], you can configure settings related to the e-mail and the Internet Fax service.

- 1 On the [Tools] screen, select [System Settings] > [E-mail/Internet Fax Service Settings].
For the method of displaying the [Tools] screen, refer to "System Settings Procedure" (P.296).
- 2 Select an item to set or change.

E-mail Control

You can configure the settings for e-mail and Internet fax transmissions.

Maximum Address Entries

Set the maximum number of addresses that can be specified when sending an e-mail. The number of addresses is the total number of To:/Cc:/Bcc:.

You can set the maximum number of addresses from 1 to 100. If the maximum number of addresses exceeds, the e-mail transmission is aborted.

Note • This option is not applicable to the Internet Fax service.

Incoming E-mail Print Options

When an e-mail sent to the e-mail address of the machine is received, you can select the print operation.

Print Attachment Only

Only prints the attached documents.

Attachment, Full Headers & Message

Prints the e-mail headers and body of e-mails.

When you select [Attachment, Full Headers & Message (with S/MIME Info)], S/MIME Information is also printed.

Attachment, Basic Headers & Message

Prints the part of headers (From/To/Subject/Date) and the contents of e-mails.

When you select [Do not print if no message], the machine prints only e-mail that has contents.

Print Error Notification E-mail

Select whether the error e-mail because of an incorrect address or transmission error should be automatically printed.

Note • The job for printing error e-mail is displayed as an error on the [Job Status] screen and a Job History Report even when the job has been complete successfully.

Response to Read Receipts

Set whether or not to respond when a read receipt (MDN) is requested.

Off

Does not respond.

On

Automatically notifies the sender that the e-mail has been processed.

Read Receipts

When an e-mail is sent from the machine, select whether or not to use the Read Receipts feature.

Off

The Read Receipts feature is disabled.

On

Uses the Read Receipts feature.

Note • For the Internet fax read receipts setting, select either [Delivery Receipts] or [Read Receipts] in [Delivery Confirmation Method] under [Tools] > [System Settings] > [Fax Service Settings] > [Internet Fax Control].

Print Delivery Confirmation Mail

Select whether or not to automatically print transmission result e-mails (DSN response/MDN response).

Off

Does not print transmission result e-mails.

On

Transmission result e-mails are automatically printed regardless of success or failure of the transmission.

Print when delivery fails

Prints only when the transmission failed.

Split Send Method

Set the default value for the mail split method.

Split into Pages

Splits into pages.

Split by Data Size

Splits by the data size set in [Maximum Data Size per E-mail].

Maximum Data Size per E-mail

Set the upper limit of the data size for splitting mail.

Specify a value from 512 to 20480 KB in 1 KB increments. The default value is 10240 KB.

Maximum Total Data Size

Set the upper limit of the data size of mail.

Specify a value from 512 to 200000 KB in 1 KB increments. The default value is 200000 KB.

Maximum Split Count

Set the split upper limit for when splitting mail.

Specify not to split mail or a value from 2 to 500.

Allow Casual Users to Edit From Field

Set whether or not to protect e-mail addresses from being changed by unregistered users under [From] on the [E-mail] tab.

Allow Guest Users to Edit From Field

Set whether or not to protect e-mail addresses from being changed by guest users under [From] on the [E-mail] tab.

Allow to edit From if Search Found

Set whether or not to protect e-mail addresses from being changed under [From] on the [E-mail] tab when a login user retrieves an e-mail address.

Allow to edit From if Search Failed

Set whether to protect e-mail addresses from being changed under [From] on the [E-mail] tab when a login user fails to retrieve an e-mail address.

E-mail Sending When Search Failed

Set whether or not to disable the [E-mail] service when a login user fails to retrieve an e-mail address.

Add Me to "To" Field

Set whether or not to automatically add the sender's address to the To field.

Add Me to "Cc" Field

Set whether or not to automatically add the sender's address to the CC field.

Edit E-mail Recipients

Set whether or not to permit to edit e-mail recipients (To, CC, BCC). Selecting [No] prevents e-mails from being sent to unintended destinations.

Note • If you set [Edit E-mail Recipients] to [No], set [Add Me to "To" Field] to [Yes].

Address Book Settings

In [Address Book Settings], you can configure settings related to the e-mail and the address book.

- 1 On the [Tools] screen, select [System Settings] > [Address Book Settings].
For the method of displaying the [Tools] screen, refer to "System Settings Procedure" (P.296).
- 2 Select an item to set or change.

Address Book Type

Select the type of the Address Book from [Type 1] or [Type 2].

Directory Service

Select whether or not to use an address book stored on the directory server.

Even when [Enabled] is selected, the address book of the directory server will not be started unless the following conditions are satisfied.

- The IP address of the machine must be set.
- The IP address or Internet address of the directory server (primary) must be set.
- The port numbers used for LDAP communication must be set on the directory server and the machine.

Address Book Default - Scan

Select from [Public Entries] or [Network Entries].

Address Book Default - Fax

Select from [Public Entries] or [Network Entries].

Search Display Default

Select from [Advanced Search] or [Simple Search].

Note • This item can be set when [Address Book Type] is set to [Type 1].

Fax Speed Dial Default

Specify the default speed dial to display at the top of the [Fax Address Book] screen.

Set the number from 1 to 2000.

Note • Available numbers to assign to speed dials depend on the configuration of your machine. For more information, contact Customer Support at dell.com/contactdell.

Folder Service Settings

In [Folder Service Settings], you can configure settings to handle files stored in folders.

- 1 On the [Tools] screen, select [System Settings] > [Folder Service Settings].
For the method of displaying the [Tools] screen, refer to "System Settings Procedure" (P.296).
- 2 Select an item to set or change.

Files Retrieved By Client

Set whether or not to delete a file stored in a folder when a client retrieves it.

Delete according to Folder settings

Operates following the settings for individual folder.

For more information about setting folders, refer to "Delete Files After Retrieval" (P.422).

Force Delete

Ignores the settings for individual folder, and when a file is retrieved by a client, the retrieved file is forcibly deleted.

File Display Default

Set the display method of the file list screen. Select from [List] or [Thumbnail].

Print & Delete Confirmation Screen

Set whether or not to display a confirmation screen for automatically deleting files after printing the files stored in a folder.

Convert Custom Size to Standard Size

Set whether or not to convert custom size to standard size when transferring a fax/Internet fax received or a file for Secure Polling in the folder.

Standard Size Threshold Value

Specify a threshold value for converting custom size to standard size when [Convert Custom Size to Standard Size] is set to [Yes (Fax & Internet Fax files only)].

Specify the value from 0 to 10 mm in 1 mm increments.

Internet Fax to Internet Fax

Select whether or not to permit Internet fax forwarding of files received in a folder.

Internet Fax to E-mail

Select whether or not to permit e-mail forwarding of files received in a folder.

Quality/File Size for Retrieval

Select a quality and size for files highly compressed and retrieved from folders. Select from [Quality: Normal, File Size: Small], [Quality: Higher, File Size: Larger], or [Quality: Maximum, File Size: Largest].

Job Flow Service Settings

In [Job Flow Service Settings], you can configure the settings related to the Job Flow. The Job Flow is a function to perform a series of jobs registered.

Also, in [Job Flow Service Settings], you can configure a pool server. As for [Pool Server], [Pool Server Login Method], and [Job Flow Sheet List Default], however, leave the default settings unchanged because a pool server is not available for the machine.

You can select a resolution in [Fax Transfer Resolution] when you transfer a scanned document as a fax.

Pool Server

Leave the default setting unchanged.

Pool Server Login Method

Leave the default setting unchanged.

Job Flow Sheet List Default

Set the default values for [Save in], [Owner], and [Target] of Job flow sheets which are displayed when you select [Job Flow Sheets] on the [Home] screen.

Save in

Leave the default setting unchanged.

Owner

Select the owner of job flow sheets from Administrator and Non-System Administrator to filter.

Note • When the machine is in the Authentication mode, select the owner from Shared or Personal.

Target

Select the target of job flow sheets from Scan Jobs, External Application, and Copy to filter.

Fax Transfer Resolution

Select the resolution setting when you send a color document as a fax using the Job Flow feature.

Same Resolution (High Quality)

Converts color images to black and white images on a document with the same resolution when the document is transferred as a fax. Conversion of high resolution color images will take longer.

200 dpi (High Speed)

Converts color images to black and white images of 200 dpi on a document when the document is transferred as a fax.

Reduces the time when converting color images of 300 dpi or higher to black and white images. 200 dpi is equivalent to [Fine] in fax transmission.

Media Print Service Settings

In [Media Print Service Settings], you can select the paper trays displayed for [Paper Supply] in the [Media Print - Text] and [Media Print - Photos] screens.

You can import and print image data (DCF1.0 (Exif 2.0 - 2.2 compliant JPEG/TIFF files)) from a digital camera and document files (PDF, TIFF, XML Paper Specification (XPS), or JPEG (JFIF)). This feature is called the Media Print feature.

- 1 On the [Tools] screen, select [System Settings] > [Media Print Service Settings].
For the method of displaying the [Tools] screen, refer to "System Settings Procedure" (P.296).
- 2 Select an item to set or change.

Text - Paper Supply - Button 2 to 5

Select the paper tray displayed in the second to fifth columns for [Paper Supply] on the [Media Print - Text] screen.

Photos - Paper Supply - Button 1 to 5

Select the paper tray displayed in the first to fifth columns for [Paper Supply] on the [Media Print - Photos] screen.

Stored File Settings

In [Stored File Settings], you can select whether to automatically delete files stored to the folders of the machine. Set the expiration date and the time of deletion.

You can also specify the types of the files to delete.

- 1 On the [Tools] screen, select [System Settings] > [Stored File Settings].

For the method of displaying the [Tools] screen, refer to "System Settings Procedure" (P.296).

- 2 Select an item to set or change.

Expiration Date for Files in Folder

You can set expiration date for the file in a folder. To delete stored files automatically, specify an expiration date and deletion time. The settings apply to all stored files.

Off

Does not automatically delete the print files stored in the machine.

On

Allows you to set the file retention period and the expiration date. The stored files will be deleted after the time specified in [Files deleted at] passed.

Files kept for

Set the file retention period from 1 to 14 days.

Files deleted at

Set the deletion time for the expired files from 1 to 12 hours for AM or PM and 0 to 59 minutes.

Note • When you select [24 Hour Clock] for [Time] under [Tools] > [System Settings] > [Common Service Settings] > [Machine Clock/Timers], set the deletion time from 0 to 23 hours and 00 to 59 minutes.

To automatically delete files at the time specified here, you need to set [Delete Expired Files] to [Yes]. For more information, refer to "Delete Expired Files" (P.422).

Stored Job Expiration Date

You can set whether or not to automatically delete print files (Charge Print, Private Charge Print, Secure Print, or Sample Print) stored in the machine.

Options

Set the retention period for stored jobs.

Select from [Off], [On], and [Same Date as Files in Folder]. When [On] is selected, set the value for [Files kept for] from 1 to 23 hours in 1 hour increments. When the time elapses, print files stored in the machine will be deleted. When [Same Date as Files in Folder] is selected, print files stored in the machine will be deleted in accordance with the setting in [Expiration Date for Files in Folder].

Power Off Deletes Jobs

Allows you to set whether or not to delete stored jobs when the machine is turned off and then on. When [Yes] is selected, all the stored jobs will be deleted. When [No] is selected, only the expired jobs will be deleted.

Note • When [Yes] is selected, all the stored jobs will be deleted regardless of the [Files kept for] settings.

Display Details of Stored Print Job List

Set whether or not to display detailed information such as output color and 2 sided in the stored job list of print files (Charge Print, Secure Print, Sample Print, or Delayed Print). When you select [On], detailed information is displayed in the list. When you select [Off], you can see more jobs at a time since detailed information is not displayed.

Print Job Confirmation Screen

Set whether or not to display a print confirmation screen for deletion of the print files stored in the machine after printing. When [Enabled] is selected, the confirmation message appears. You can change the number of print sets when the print settings are allowed to be changed. When [Disabled] is selected, print files stored in the machine are automatically deleted after printing.

Minimum Passcode Length for Stored Jobs

Set the minimum number of allowed passcode digits between 0 and 12 digits. A passcode is required when Secure Print or Private Charge Print files are to be stored or printed.

A passcode must be a string consisting of the number of digits that is equal to or larger than the value specified here.

Note • Specify "0" if you do not set passcodes or the minimum number of digits.

Print Order for All Selected Files

Specify the printing order when you select to print all print files stored.

Date & Time: Oldest First

Prints files in chronological order.

Date & Time: Newest First

Prints files in reverse chronological order.

File Name: Ascending

Prints files in ascending order by file name.

File Name: Descending

Prints files in descending order by file name.

Web Applications Service Setup

In [Web Applications Service Setup], you can specify the remote access destination.

Remote access allows you to view web application services, which are compatible with the machine, directly on the touch screen, to upload a document that has been scanned on the machine to the web applications, and to directly select and print a document that is stored in the remote server. It also allows you to directly upload and print a file without going through another computer.

Note • To use this feature, any web application (purchased separately) is required.

- 1 On the [Tools] screen, select [System Settings] > [Web Applications Service Setup].
For the method of displaying the [Tools] screen, refer to "System Settings Procedure" (P.296).
- 2 Select an item to set or change.

Server Certificate Verification Settings

When the machine is connected to a remote server (ASP) that is located in the Internet zone, server certificate verification is available to prevent phishing attempts as with a Windows web browser. Configure the following settings.

Preparations

Download a root certificate (CA certificate) of the root certification authority, which issues the server certificate for the remote server to be connected, to a computer connected to Dell Printer Configuration Web Tool.

The CA certificate formats that can be used are as follows:

- DER encoded binary X.509 (.CER)
- Base 64 encoded X.509 (.CER)
- Cryptographic Message Syntax Standard - PKCS #7 Certificates (.P7B)

Setting Procedure

- 1 Start Dell Printer Configuration Web Tool.
For information on how to start Dell Printer Configuration Web Tool, refer to "Starting Dell Printer Configuration Web Tool" (P.464).
- 2 Generate a certificate.
If you use an approved device certificate, proceed to step 3.
 - 1) Click the [Properties] tab.
 - 2) Click [Security] to display the items in the folder.
 - 3) Click [Machine Digital Certificate Management].
 - 4) Click the [Create New Certificate] button.

Note • If [Create New Self Signed Certificate] is displayed, click it and go to step 6).

 - 5) Select [Self-Signed Certificate] and click [Continue].
 - 6) Set [Public Key Size] and [Issuer], and then click [Apply].
After a short while, [Settings have been changed.] is displayed.

3 Enable SSL/TLS communication.

- 1) Click [SSL/TLS Settings].
- 2) Select the [Enabled] check box for [HTTP - SSL/TLS Communication].
- 3) Select the [Enabled] check box for [Verify Remote Server Certificate].
- 4) Click [Apply].
- 5) When the right frame on the web browser will change to the machine reboot display, click [Reboot Machine]. The machine reboots and the setting values are enabled.

4 Import the root certificate of the remote server.

- 1) Refresh the web browser to reload Dell Printer Configuration Web Tool.

Note • An address beginning with "https" instead of "http" is displayed in the address box in the web browser.

- 2) Click the [Properties] tab.
- 3) Click [Security] to display the items in the folder.
- 4) Click [Machine Digital Certificate Management].
- 5) Click [Upload Signed Certificate].
- 6) Enter a file name you want to import, or select a file to be imported from a dialog box displayed by clicking the [Browse] button.
- 7) Click the [Import] button.
After a short while, [Settings have been changed.] is displayed.
- 8) Refresh the web browser to reload Dell Printer Configuration Web Tool.

5 Confirm that the certificate has been imported.

Otherwise, proceed to step 6.

- 1) Click [Certificate Management].
- 2) Select [Trusted Certificate Authorities] for [Category], and then click the [Display the list] button.
- 3) Select the check box next to the certificate you want to confirm.
- 4) Click the [Certificate Details] button.

6 Configure connection settings for the remote server.

- 1) Click the [Properties] tab.
- 2) Click [General Setup] to display the items in the folder.
- 3) Click [Dell Printer Configuration Web Tool Settings].
- 4) Configure connection settings for the remote server.
- 5) Click [Edit].
Configure connection settings for the remote server again.

Note • Enter an address beginning with "https" instead of "http" into the address box in the web browser.

- 6) Click [Apply].
After a short while, [Settings have been changed.] is displayed.

Server Setup

This section describes how to register a server on access web applications.

Note • If there are one or more servers to register, it is helpful to assign the servers to the buttons displayed on the [Home] screen.

- 1 Select [Server Setup].
- 2 Select an access destination you want to register, and then select [Change Settings].
- 3 Enter the URL of the access destination, if you register an access destination in a new entry.

URL

Enter the URL of the access destination with up to 256 single-byte characters, and select [Save]. URL must begin with the type of the protocol used.

Use the version of a web application that is set [Web Applications Version] in "Web Browser Setup" (P.419).

For example:

- http://www.example.com
- http://192.0.2.1 (IPv4)
- http://[2001:DB8::1234] (IPv6)
- https://www.example.com
- https://192.0.2.1 (IPv4)
- https://[2001:DB8::1234] (IPv6)
- When specified with V2 (old version)
 - http-v2://www.example.com
 - http-v2://192.0.2.1 (IPv4)
 - http-v2://[2001:DB8::1234] (IPv6)
- When specified with V3
 - http-v3://www.example.com
 - http-v3://192.0.2.1 (IPv4)
 - http-v3://[2001:DB8::1234] (IPv6)
- When specified with V4 (new version)
 - http-v4://www.example.com
 - http-v4://192.0.2.1 (IPv4)
 - http-v4://[2001:DB8::1234] (IPv6)

Note • When the URL is specified with V3, V4 (new version) is used for connection.
• Begin with "https" for a protocol with an encryption feature.

- 4 Configure other settings as necessary.

Server Name

Enter the access destination name with up to 32 single-byte characters.

Description

Enter the description of the access destination with up to 128 single-byte characters.

Use User ID

- No
 - When [Login Type] is set to [Login to Remote Accounts]:
The machine accesses the remote service using the user information authenticated on the machine.
 - When [Login Type] is set to [No Login Required] or [Login to Local Accounts]:
The machine prompts the user to input User ID and password to access Web applications.
- Yes
Allows you to enter a user ID and password into [User ID] and [Password] respectively, which are used when the machine accesses the remote service.

User ID

Enter the User ID to access the remote service with up to 128 characters.

- Note**
- Depending on the settings on the remote service, the entry for [User ID] may be invalid. Check the settings on the remote service.
 - Along with [User ID], set also [Password]. [User ID] will be invalid unless [Password] is set.
 - All the specified settings are ignored if the remote service to be connected requires other than a user ID and its password for authentication.

Password

Enter the password for the User ID with up to 128 characters.

Machine/Authentication Notification

Set whether or not to notify the remote server of machine information and user authentication information every time the machine connects to the remote service.

- Note**
- The remote service determines whether to use the information. No need to configure settings on the control panel.

Notify User Authorization Information

Set whether or not to notify the remote service of user authorization information every time the machine connects to the remote service.

Delete All Settings

Deletes all settings registered.

Other Settings

When Sending User Details

Set whether or not to display a confirmation screen when the machine send user authorization information (authorized User ID, password, e-mail address, and the services restricted) to the remote server.

- Note**
- Even when you select [No Confirmation Required], if there is a flaw in the authentication information, a confirmation screen is displayed.

Web Browser Setup

In [Web Browser Setup], you can configure the settings for the web browser to be used when the machine accesses a web application using the Web Applications feature.

Remote access allows you to view web application services, which are compatible with the machine, directly on the touch screen, to upload a document that has been scanned on the machine to the web applications, and to directly select and print a document that is stored in the remote server. It also allows you to directly upload and print a file without going through another computer.

Note • To use this feature, any web application (purchased separately) is required.

1 On the [Tools] screen, select [System Settings] > [Web Browser Setup].

For the method of displaying the [Tools] screen, refer to "System Settings Procedure" (P.296).

2 Select an item to set or change.

Web Applications Version

Select a version of the Web applications service from [V2 (Old Version)] and [V4 (New Version)].

Note

- If [V2 (Old Version)] is selected, the following settings become invalid: [Delete Persistent Cookie Upon Closing], [Clear Cache Upon Closing], [Use Cache], [Accept Cookies], [Use TLS1.0], [Use SSL3.0], [When SSL Certificate Verification Fails], and [Enable File Printing].
- When you use V3 of the web application version, select [V4 (New Version)].

Delete Persistent Cookie Upon Closing

Specify whether to delete persistent cookie when connection to a Web application ends.

Clear Cache Upon Closing

Specify whether to delete cache when connection to a Web application ends.

Use Cache

Specify whether to use cache.

Accept Cookies

Specify whether to accept cookies.

Select from [No], [Yes], and [Warn user when cookie is offered].

When you select [Warn user when cookie is offered], the machine behaves as when you select [Yes].

Use TLS1.0

Specify whether to use TLS 1.0.

Use SSL3.0

Specify whether to use SSL 3.0.

When SSL Certificate Verification Fails

Specify whether to stop accessing the site or to display a confirmation screen for access if SSL certificate verification fails.

Enable File Printing

Specify whether to use the File Printing feature.

The File Printing feature allows you to directly print the printable files obtained from the remote Web server.

Setup

In [Setup], you can create or update folders, job flows, and the Address Book.

The following shows the reference section for each setting.

Create Folder.....	421
Stored Programming	423
Create Job Flow Sheet.....	423
Create Job Flow Sheet Keyword	431
Add Address Book Entry	431
Create Fax Group Recipients	439
Add Fax Comment.....	440
Paper Tray Attributes.....	440

- 1 On the [Tools] screen, select [Setup].
For the method of displaying the [Tools] screen, refer to "System Settings Procedure" (P.296).
- 2 Select an item to set or change.

Create Folder

Using the Folder function enables you to store scanned documents using the machine, fax received documents, or print documents sent from a computer in the machine.

You can also send a file stored in a folder via e-mail or retrieve a file stored in a computer on a network.

You can create a private folder and a public folder in the machine and use them separately depending on your purpose.

You can create up to 200 folders.

You can check the current folders in a Folder List. For more information, refer to "Folder List" (P.282).

- 1 Select [Create Folder].
- 2 Select the folder to create.

- Note**
- Select [▲] to display the previous screen or [▼] to display the next screen.
 - Entering a 3-digit folder number with the numeric keypad displays the specified folder at the top of the column.

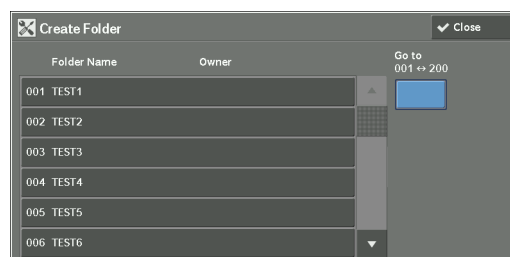

- 3 When you create a folder, the [New Folder - Passcode] screen appears. Select items, and then select [Save].

- Note**
- When you select a folder already created, the [Folder XXX - Create/Delete] screen appears.

For more information on assigning a passcode, refer to "Check Folder Passcode" (P.422).

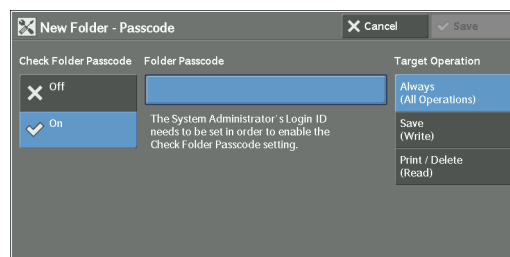

- 4 Select items and set the required settings.
- 5 When you finish required settings, select [Save].

Folder Name

Set the folder name. Enter up to 20 single-byte characters using the keyboard displayed or the numeric keypad.

For information about how to enter characters, refer to "Entering Text" (P.57).

Check Folder Passcode

Set an access restriction to permit operations for specified users only.

Check Folder Passcode

Set whether or not to set a passcode.

- Off

Does not set an access restriction.

- On

Set a passcode for access restriction.

Folder Passcode

To use the Check Folder Passcode feature, enter a passcode. You can enter a passcode of up to 20 numeric digits (0 to 9).

Target Operation

Set the operations to be restricted.

- Always (All Operations)

A passcode entry is required when a folder is selected or a file in a folder is printed or deleted.

- Save (Write)

A passcode entry is required when a folder is selected.

- Print/Delete (Read)

A passcode entry is required when printing or deleting the file in the folder.

Delete Files After Retrieval

When a file stored in a folder is printed or is retrieved from a remote server, set whether the file should be deleted.

No

The file is left stored.

Yes

After the file is printed, or is retrieved by an external source, it is automatically deleted.

Note • If you select [Yes], a file is not deleted when retrieved from Dell Printer Configuration Web Tool.

Delete Expired Files

Specify whether or not to enable the operation to delete files stored in a folder at a specified time after a retention period has elapsed.

No

Even when the retention period has elapsed, files are not deleted.

Yes

Deletes expired files at the specified time. If, however, the expiration date has not been specified, files are not deleted even when [Yes] is selected.

Note • When the machine is off at the deletion time of an expired file, the file is deleted next time the deletion time comes after the machine is turned on.

For information on setting the file retention period, refer to "Expiration Date for Files in Folder" (P.413).

Link Job Flow Sheet to Folder

You can link a job flow sheet to a folder. Linking a job flow in which a series of actions is recorded to a folder enables you to set the processing method for files stored in a folder.

For information on how to register a job flow, refer to "Create Job Flow Sheet" (P.423).

Cut Link

Cancels the link between a folder and a linked job flow sheet.

Create/Change Link

A screen to link a job flow sheet appears. You can select the existing job flow sheets or create a new job flow sheet.

For more information about the operation, refer to "Create Job Flow Sheet" (P.423).

Auto Start

If you select the [Auto Start] check box, when a file is stored in a folder, the procedures registered on the job flow linked automatically starts.

When the [Delete Folder] Button is Selected

Selecting this button deletes the selected folder. Any files stored in the folder are also deleted.

If [Login Type] is set to [No Login Required], all the job flow sheets, including a Local User created on the [Create Folder] screen or job flow sheets created on the [Send from Folder] screen, are deleted as well.

Note • Once files or job flow sheets are deleted, they cannot be restored.

Stored Programming

The Stored Programming feature enables you to register frequently used settings and record a series of operations.

For more information on operation, refer to "Registering/Deleting/Renaming Stored Programs" (P.177).

Create Job Flow Sheet

Job flow is a feature to execute a series of registered actions. Up to 1000 job flow sheets can be created.

The target of a job flow is files stored in a folder. A job flow can be executed by using one of the following three methods:

- by automatically starting a job flow when a file is stored in a folder
- by selecting a file stored in a folder to manually execute the associated job flow
- by selecting a file stored in a folder to select a job flow and execute manually

To start a job flow automatically, you must link the job flow to a folder. When a file is stored in the folder, it is automatically processed in accordance with the job flow sheet linked.

Note • To link a folder with a job flow sheet created with [Create Job Flow Sheet], start from [Send from Folder] or [Create Folder]. For more information, refer to "Create Folder" (P.421).

Features that can be registered are listed below.

- Forward to (FTP, SMB, e-mail, fax, and Internet fax)
- Print

Depending on the method of storing in the folder, there are restrictions on the combination of features.

Output Input	Print	Fax	Internet Fax *1	Mail	FTP	SMB
Fax Documents for Secure Polling	○	○	○	○	○	○
Scanning	○	○	○	○	○	○
Fax to Folder	○*2	○	○	○	○	○
Internet Fax Received	○	○	△	△	○	○
Print Stored	X	X	X	X	X	X

○ :Available

X :Not available

△ :Available depending on the System Administration mode settings

*1 :Load an A4 document in landscape orientation when TIFF-S has been selected for the Internet fax forwarding profile. Loading the document in portrait orientation will reduce the size of the Internet fax image.

*2 :If the fax USB cable is disconnected while a received fax file in a folder is being printed, the file is not deleted after printing, even if the delete after printing setting is enabled in the folder settings.

Restrictions on Using Job Flow

A job flow can be used by single or multiple users, or can be used by linking to a specific folder. The Authentication feature restricts the use of the job flows.

For information on the available Job Flow features and restrictions on use, refer to "Authentication for Job Flow Sheets and Folders" (P.546).

- 1 Select [Create Job Flow Sheet].
- 2 Carry out the job flow operation in accordance with your purpose.

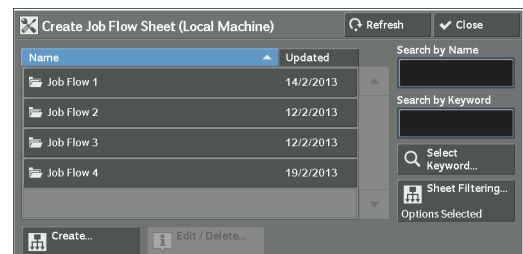

Sheet Filtering

You can filter the job flow sheets to display.

Select the filtering conditions, and then select [Save].

- Note**
- The screen displayed varies depending on the Login Type selected.

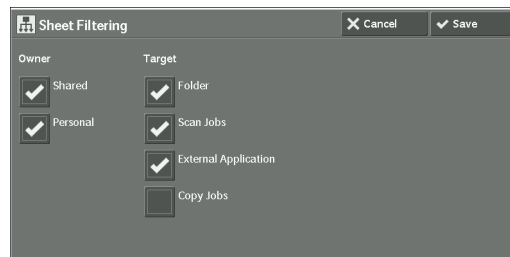

- Owner
Filters job flow sheets by owner type.
- Target
Filters job flow sheets by target, such as scan jobs and folders.

Create

Displays the [Create New Job Flow Sheet] screen.

Refer to "Create New Job Flow Sheet" (P.425).

Edit/Delete

Displays the [Details] screen.

Refer to "Edit/Delete" (P.431).

Search by Name

Searches for job flows that partially match the entry. The machine searches through job flow names that were registered upon each job flow creation. You can enter up to 128 single-byte characters.

For information about how to enter characters, refer to "Entering Text" (P.57).

Search by Keyword

Searches for job flows that fully match the entry. The machine searches through keywords that were registered upon each job flow creation.

For information about how to enter characters, refer to "Entering Text" (P.57).

Select Keyword

Displays the [Select Keyword] screen. Select a keyword registered in the System Settings to search for job flows. Job flows that fully match the entry are searched. The machine searches through keywords that were registered upon each job flow creation.

For information on the keyword registry, refer to "Create Job Flow Sheet Keyword" (P.431).

Create New Job Flow Sheet

Create a new job flow.

- 1 Select an item to set, and then select [Edit].

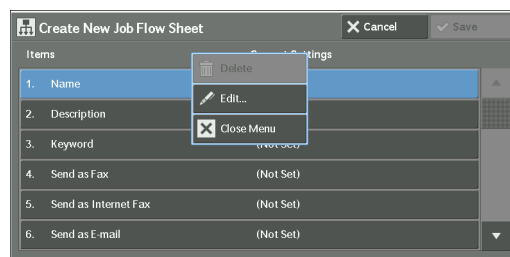

Delete

Deletes all setting values of the selected item.

Edit

Confirm or change the settings of the selected item.

Close Menu

Deselect the selected item.

Name

Set the name for the job flow sheet with up to 128 single-byte characters.

Description

Set the description of the job flow sheet with up to 256 single-byte characters.

Keyword

Enter a keyword with up to 12 single-byte characters for job flow search. You can also use the keywords that are registered for [Create Job Flow Sheet Keyword].

For information on the job flow keyword search, refer to "Create Job Flow Sheet Keyword" (P.431).

Send as Fax

Specify destinations for fax transmission. You can specify a total of 100 destinations, either by selecting from the Address Book or by direct input.

Note • You cannot use wildcards or group dial numbers.

Speed Dial

Specify an address with a speed dial. Enter the speed dial with the numeric keypad, and select [Save]. The address specified appears in [Name/Fax Number] in the [Send Fax] screen.

New Recipient

Specify a new address. The address specified appears in [Name/Fax Number] in the [Send Fax] screen.

Name/Fax Number

Displays the recipient name or fax number specified.

Delete Recipient

Deletes all information for the selected recipient.

Edit

Displays the [Edit Recipient] screen, which allows you to check or change the recipient selected.

Cancel

Deselect the selected item.

Send as Internet Fax

Specify destinations for fax transmission. You can specify a total of 100 destinations, either by selecting from the Address Book or by direct input.

Note • You cannot use wildcards or group dial numbers.

Speed Dial

Specify an address with a speed dial. Enter the speed dial with the numeric keypad, and select [Save]. The address specified appears in [Name/E-mail Address] in the [Send Internet Fax] screen.

New Recipient

Specify a new address. The address specified appears in [Name/E-mail Address] in the [Send Internet Fax] screen.

Name/E-mail Address

Displays the recipient name or address specified.

Delete Recipient

Deletes all information for the selected recipient.

Edit

Displays the [Edit Recipient] screen, which allows you to check or change the recipient selected.

Close Menu

Deselect the selected item.

Message

Enter body message of an Internet fax with the keyboard displayed.

Internet Fax Profile

Select an Internet fax profile.

A profile is specified to restrict attribute information such as image resolution and paper size for transmissions between Internet Fax-enabled machines.

Resend Attempts

Set whether or not to try sending again if a transmission fails. If you select [On], set the number of resend attempts and interval.

- Resend Attempts
Set the transmission retry count from 1 to 5.
- Resend Interval
Set the transmission retry interval from 30 to 300 seconds.

Transmission Header Text

Set whether or not to add a Transmission Header Text to an Internet fax.

Send as E-mail

Specify the recipients for e-mail transmission.

You can specify a total of 100 addresses, either by selecting from the Address Book or by direct input.

If [Encryption] is set to [On], you cannot specify a recipient by selecting [New Recipient].

Address Book

You can specify the recipients from the Address Book. The address specified appears in [Name/E-mail] in the [Send E-mail] screen.

New Recipient

Specify a new address. The address specified appears in [Name/E-mail] in the [Send E-mail] screen.

Name/E-mail Address

Displays the recipient name or e-mail address specified.

Subject

Enter a subject using the keyboard displayed.

Delete Recipient

Deletes all information for the selected recipient information.

Edit

Displays the [Edit Recipient] screen, which allows you to check or change the recipient selected.

File Format

Select an output file format.

Resend Attempts

Set whether or not to try sending again if a transmission fails. If you select [On], set the number of resend attempts and interval.

- Resend Attempts
Set the transmission retry count from 1 to 5.
- Resend Interval
Set the transmission retry interval from 30 to 300 seconds.

Encryption

Set whether or not to encrypt the e-mail transmission.

- Note**
- To encrypt e-mail transmission, the configuration of S/MIME is required.
 - To encrypt e-mail transmission, a certificate is required.
 - To enable encryption, select [On] before specifying an address. [On] will be disabled after an address is specified.

Digital Signature

Select whether or not to add digital signature.

- Note**
- To add digital signature, the configuration of S/MIME is required.
 - To add digital signature, a certificate is required.

Transfer via FTP (1), Transfer via FTP (2)

[Transfer via FTP (2)] will be displayed when [Transfer via FTP (1)] is configured.

Specify where FTP forwarding is to be stored.

Address Book

When the server address is registered on the Address Book, you can specify the address from the Address Book. The specified address appears in the [Transfer via FTP (1)] or [Transfer via FTP (2)] screen.

For more information on the Address Book, refer to "Add Address Book Entry" (P.431).

File Format

Specify an output file format.

Resend Attempts

Set whether or not to try sending again if a transmission fails. If you select [On], set the number of resend attempts and interval.

- Resend Attempts

Set the transmission retry count from 1 to 5.

- Resend Interval

Set the transmission retry interval from 30 to 300 seconds.

Name, Server, Save in, User Name, and Password

Select [Name], [Server], [Save in], [User Name], or [Password] to display an input screen.

The numbers of characters you can input are as follows:

- Name: Up to 18 single-byte characters
- Server: Up to 64 single-byte characters
- Save in: Up to 128 single-byte characters
- User Name: Up to 97 single-byte characters
- Password: Up to 32 single-byte characters

Transfer via SMB (1), Transfer via SMB (2)

Specify where SMB forwarding is to be stored.

[Transfer via SMB (2)] will be displayed when [Transfer via SMB (1)] is configured.

Address Book

When the server address is registered on the Address Book, you can specify the address from the Address Book. The specified address appears in the [Transfer via SMB (1)] or [Transfer via SMB (2)] screen.

For more information on the Address Book, refer to "Add Address Book Entry" (P.431).

File Format

Specify an output file format.

Resend Attempts

Set whether or not to try sending again if a transmission fails. If you select [On], set the number of resend attempts and interval.

- Resend Attempts

Set the transmission retry count from 1 to 5.

- Resend Interval

Set the transmission retry interval from 30 to 300 seconds.

Name, Server, Shared Name, Save in, User Name, and Password

Select [Name], [Server], [Shared Name], [Save in], [User Name], or [Password] to display an input screen.

The numbers of characters you can input are as follows:

- Name: Up to 18 single-byte characters
- Server: Up to 64 single-byte characters

- Shared Name: Up to 64 single-byte characters
- Save in: Up to 128 single-byte characters
- User Name:
For domain users: up to 97 characters with the format of "user name@domain name" or "domain name\user name"
(user name and domain name must be up to 32 and 64 single-byte characters, respectively)
For local users: up to 32 single-byte characters
- Password: Up to 32 single-byte characters

Print

Configure print settings. When [On] is selected, you can configure the settings for the Print feature.

Print Quantity

Set the number of copy sets from 1 to 999 in 1 set increments.

Paper Supply

Select a paper tray for printing. When [Auto Select] is selected, the same paper size as the document size is used.

- Auto Select
A suitable paper tray is automatically selected.
- Trays 1 to 4 and 6 (optional)
Select paper from five trays.
- Bypass
Prints on paper loaded in Tray 5.

2 Sided Printing

Set the 2 sided printing option.

Output

Configure the stapling, hole punch, and output destination settings.

- Staple
Set the position for stapling.
- Hole Punch
Set the position for punching.
- Output Destination
Set the output destination.

E-mail Notification

You can receive an e-mail notification when a file is saved in a folder or a job flow ends.

Name/E-mail Address

Set the recipient of the e-mail notification.

Message

Enter a message that is displayed in the e-mail message body.

When to Notify

Select the e-mail notification timing from [When file is stored] and [At the end of Job Flow].

Delete Recipient

Deletes all information for the selected recipient.

Edit

Allows you to check or change the recipient selected.

Close Menu

Deselects the selected item.

Edit/Delete

You can check the content of a job flow sheet, and edit, copy, or delete it.

Note • Some operations may be restricted according to types of job flow owners, authentication settings, and user types. For more information, refer to "Authentication for Job Flow Sheets and Folders" (P.546).

Delete

Deletes the selected job flow sheet.

Copy

Creates a duplicate of the selected job flow sheet. You can create a new job flow sheet based on the duplicate.

The procedure of creation is the same as creation of a new job flow sheet. For more information, refer to "Create New Job Flow Sheet" (P.425).

Edit

You can edit the selected job flow sheet.

The procedure of change is the same as creation of a new job flow sheet. For more information, refer to "Create New Job Flow Sheet" (P.425).

Create Job Flow Sheet Keyword

You can register job flow search keywords. The registered keywords will be displayed under [Select Keyword] and can be used for searching job flow sheets. The keywords are also available from a list under [Keyword] that is displayed when you create a new job flow sheet. Up to 12 single-byte characters are allowed for a job flow search keyword.

Add Address Book Entry

You can register frequently used addresses on the Address Book. Select an address type from Fax, Internet Fax, E-mail, and Server (FTP/SMB).

When an address is registered, you can search for it with [Address Book] on the [Fax], [Internet Fax], and [E-mail] screens.

You can store a total of 2000 addresses for Fax, Internet Fax, E-mail, and Server (FTP/SMB).

Note • The following address types can be selected when you add an address to Address Book: Fax, Internet Fax, E-mail, and Server (FTP/SMB)
When you register an address on the Address Book, select an address type in accordance with the service. The address book entry registered with the wrong address type cannot be selected from the original service.

- The address numbers correspond to the one touch buttons. The one touch buttons are available for fax and Internet Fax. For more information on the relationship between the address numbers and the one touch buttons, refer to "One-touch Buttons" (P.319).
- To specify an e-mail or server (FTP/SMB) address (for insertion in the Address Book), it is not possible to use a speed dial specified with the numeric keypad, one-touch dialing, or a group dial number.
- To specify an e-mail address or a server address for the Scan services, use the Address Book. The speed dial with the numeric keypad, the one touch buttons, and the group address created using the Group Recipients feature cannot be used to specify such addresses.
- You can register, edit, delete, or view the Address Book from Dell Printer Configuration Web Tool.

1 Select [Add Address Book Entry].

Note • To display the [Add Address Book Entry] screen, press the <Log In/Out> button and enter the system administrator's user ID, and then select [Tools] > [Setup] > [Add Address Book Entry]. If [Setup] is displayed on the [Home] screen, select [Setup] > [Add Address Book Entry].

2 Press a speed dial to register.

Note • Select [▲] to display the previous screen or [▼] to display the next screen.
 • Entering a speed dial number with the numeric keypad displays the specified number at the top of the column.

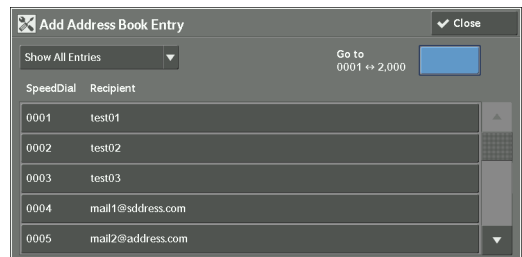

3 Select [Address Type].

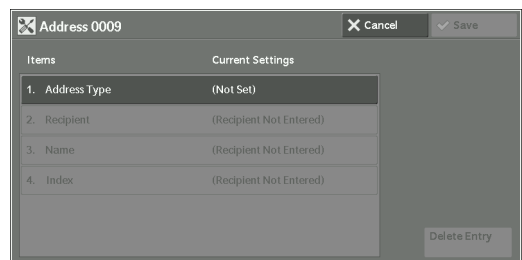

4 Select the address type, and then select [Save].

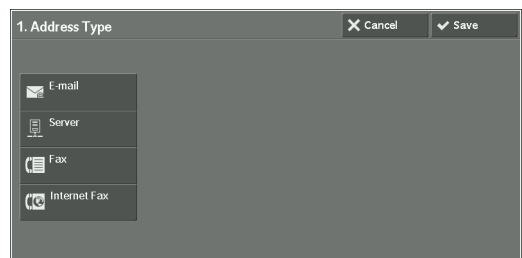

5 Select an item to set and set.

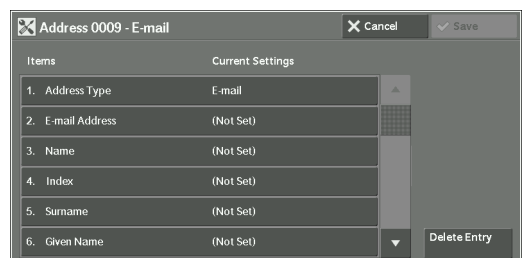

6 When the settings are completed, select [Save].

When selecting [E-mail] as the address type

The following items appear:

- Address Type
- E-mail Address
- Name
- Index
- Surname
- Given Name
- Custom Item 1 (Telephone Number*)
- Custom Item 2 (Office*)
- Custom Item 3 (Department*)
- S/MIME Certificate

* : Factory default setting

When selecting [Server] as the address type

The following items appear:

- Address Type
- Name
- Index
- Transfer Protocol
- Server Name/IP Address
- Save in
- User Name
- Password
- Port Number
- Shared Name (SMB Only)

When selecting [Fax] as the address type

The following items appear:

- Address Type
- Fax Number
- Name
- Index
- Starting Rate
- Resolution
- Cover Page
- Maximum Image Size
- Delay Start
- Remote Folder
- F Code
- Relay Broadcast
- Billing - Day Time
- Billing - Night Time
- Billing - Midnight

When selecting [Internet Fax] as the address type

The following items appear:

- Address Type
- E-mail Address
- Name
- Index
- S/MIME Certificate
- Starting Rate
- Resolution
- Maximum Image Size
- Internet Fax Profile

Address Type

Allows you to change an address type.

E-mail Address

Enter an e-mail address with up to 128 single-byte characters.

For information about how to enter characters, refer to "Entering Text" (P.57).

Name

Enter a recipient name with up to 18 single-byte characters.
For information about how to enter characters, refer to "Entering Text" (P.57).

Index

You can register a single alphanumeric index character so that you can use it as a search keyword when the registered recipients are listed in alphabetical order.
For information about how to enter characters, refer to "Entering Text" (P.57).

Surname

Enter a recipient surname with up to 32 single-byte characters.
For information about how to enter characters, refer to "Entering Text" (P.57).

Given Name

Enter a recipient given name with up to 32 single-byte characters.
For information about how to enter characters, refer to "Entering Text" (P.57).

Custom Item 1

The attribute name set as [Attribute Name of Custom Item 1] is shown as the item name.
You can input any information as an auxiliary item. Up to 20 single-byte characters are allowed. This item is suitable for information represented by a shorter character string, such as telephone number and employee number.
For more information on the attribute name, refer to "Attribute Name of Custom Items 1, 2, and 3" (P.373).

Custom Item 2

The attribute name set as [Attribute Name of Custom Item 2] is shown as the item name.
You can input any information as an auxiliary item. Up to 40 single-byte characters can be used. This item is suitable for information represented by a longer character string, such as company name and department name.
For more information on the attribute name, refer to "Attribute Name of Custom Items 1, 2, and 3" (P.373).

Custom Item 3

The attribute name set as [Attribute Name of Custom Item 3] is shown as the item name.
You can input any information as an auxiliary item. Up to 60 single-byte characters can be used. This item is suitable for information represented by a much longer character string, such as company division name and company address.
For more information on the attribute name, refer to "Attribute Name of Custom Items 1, 2, and 3" (P.373).

S/MIME Certificate

Allows you to link an S/MIME certificate. The S/MIME certificate must be registered in advance.

To link a certificate, select [Attach/Change Link] and select a certificate in a screen displayed. To remove a link, select [Remove Certificate].

- Note**
- If a certificate linked to an S/MIME certificate in the Address Book is deleted by some reasons such as hard disk initialization and the deletion of the certificate, the certificate linked to the S/MIME certificate will be invalid. Even if you re-register the S/MIME certificate, you have to manually link it again.
 - If many certificates are registered on the machine, it may take a long time to link a certificate.

For more information on the certificate, refer to "Encryption and Digital Signature Settings" (P.517).

Transfer Protocol

Set the transfer protocol. You can select either [FTP] or [SMB].

Server Name/IP address

Enter a name or an IP address of a forwarding destination server.

Shared Name (SMB Only)

Enter the shared name set for the SMB folder.

- Note**
- If the "/" mark is used at the top of a shared name, a job flow cannot read the shared name correctly. Do not use the "/" mark at the top of a shared name.

Save in

Enter the directory for storing files. When SMB is selected, use a UNC format.

- Transferring via FTP
For example: aaa/bbb
When you save files in the bbb directory under the aaa directory in the root directory.
- Transferring via SMB
For example: aaa\bbb
When you save files in the bbb directory under the aaa directory in a specified volume.

User Name

Set the user name when a user name is required to be input by the forwarding destination server.

When [FTP] is selected for [Transfer Protocol], up to 97 characters are allowed.

When [SMB] is selected for [Transfer Protocol], use one of the following formats:

- For Active Directory:
User name@Domain name (User name: up to 32 characters / Domain name: up to 64 characters)
For example: abc@example.com ("abc" is a user name and "example.com" is a domain name)
- For Windows NT[®] domains:
Domain name\User name (Domain name: up to 64 characters / User name: up to 32 characters)
For example: example\abc ("example" is a domain name and "abc" is a user name)
- For workgroups:
Local User (up to 32 characters)
For example: ABC

Password

Set a password when the forwarding destination server prompts a password entry. You can enter up to 32 single-byte characters for a password.

Port Number

Set the forwarding destination port number. Specify a number from 1 to 65535.

Fax Number

Enter a fax number with up to 128 digits.

For information about how to enter characters, refer to "Entering Text" (P.57).

Index

You can register a single alphanumeric index character for use as a keyword to search with the Address Book.

For information about how to enter characters, refer to "Entering Text" (P.57).

Starting Rate

Set a communications mode. You can select either [G3 Auto] or [Forced 4800 bps].

When the destination is specified by a speed dial number with the communications mode set, you cannot change the communications mode in the [Fax/Internet Fax] screen.

Resolution

Set image quality for transmission.

Select from [Panel] (image quality selected on the control panel), [Standard (200x100 dpi)], [Fine (200 dpi)], [Superfine (400 dpi)], or [Superfine (600 dpi)].

Cover Page

Select whether or not to attach a cover page to a fax or an internet fax. On the cover page, you can print a Recipient's Comment and a Sender's Comment.

Comments must be registered in advance.

For information on comment registration, refer to "Add Fax Comment" (P.440).

- 1 Select [Print Cover Page].
- 2 Select [Comments].
- 3 Select any comment from the list of comments displayed under [Recipient's Comment] and [Sender's Comment].

Note • Select [▲] to display the previous screen or [▼] to display the next screen.

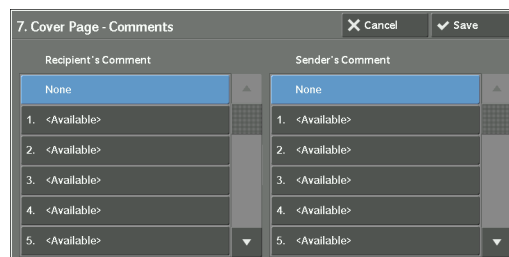
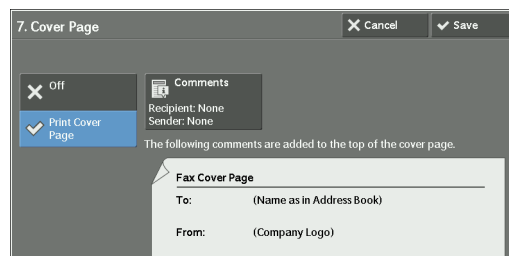

- 4 Select [Save]. The image of the Fax Cover Page is displayed.
- 5 Select [Save].

Maximum Image Size

Select the maximum image size from [A3], [B4], or [A4] to match the recipient's paper size or available profile.

Delay Start

Set whether or not to use a delayed start transmission.

If the machine's system clock is set to the 24-hour display, [AM] and [PM] do not appear. For information on the system clock, refer to "Time" (P.314).

Remote Folder

Select whether or not to send a fax or an Internet fax to a recipient's folder. To use folder communications, you must obtain the recipient's folder number and passcode in advance.

- 1 Select [On].
- 2 Enter a recipient's folder number with the numeric keypad.
- 3 If a passcode is set, enter the passcode with the numeric keypad.

Note • If no passcode is set, leave the text boxes blank and select [Save].

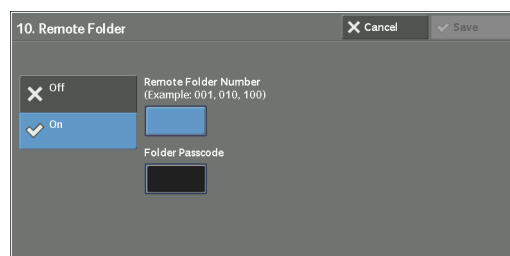

F Code

Select whether or not to use F code communications.

F Code is the transmission procedure set by the Communications and Information Network Association of Japan and is the T.30 (communication protocol) method for using sub-addresses that are standardized by the ITU-T.

For F code (sub address) and password, you can use up to 20 digits 0 to 9, *, and #.

- 1 Select [On].
- 2 Enter the F code with the numeric keypad.
- 3 Enter the password as required with the numeric keypad, and then select [Save].

Note • You can enter up to 20 digits for the password.

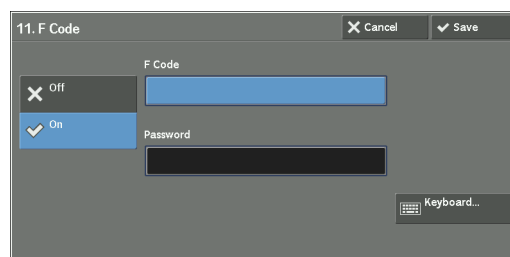

Relay Broadcast

Set the instruction given to a relay station, which is used when the machine is a base station and the registered speed dial is a relay station for relay broadcast.

When selecting [On], set [Relay Station ID], [Print at Relay Station], and [Broadcast Recipients].

- 1 Select [On].
- 2 Enter a 2-digit relay station ID with the numeric keypad.
- 3 Select [Speed Dial 001 <-> 099].
- 4 Enter a speed dial number of broadcast destination (001 to 099) or group number (#01 to #09) registered on the relay station with the numeric keypad, and then select [Add].

Note • If there are more than one broadcast destinations, repeat step 4.

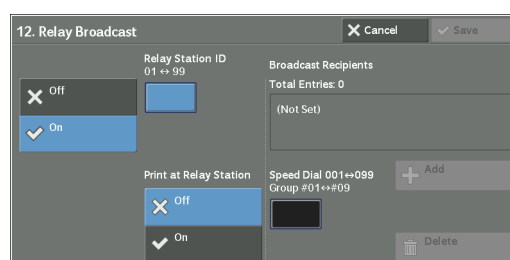

- 5 To print a document also at the relay station, under select [On] for [Print at Relay Station].
- 6 Select [Save].

Billing - Day Time, Billing - Night Time, Billing - Midnight

Set the connection time for one unit charge in each of the time bands (daytime/night/midnight).

You can set a value from 0.1 to 255.9 seconds in 0.1 second increments.

This item is displayed when [Accounting] > [Accounting Type] is set to [Local Accounting] and [Fax/Internet Fax Service] is set to [Enable Accounting] under [Accounting Mode]. For information on how to enable the feature, refer to "Accounting Mode" (P.446).

The information registered can be confirmed by printing a Billing Data List. For information about how to print, refer to "Billing Data List" (P.281).

- 1 Select one of [Billing - Day Time], [Billing - Night Time], and [Billing - Midnight].
- 2 Select [Billing].
- 3 Enter the time for one unit charge from 0.1 to 255.9 seconds in 0.1 second increments with the numeric keypad.
- 4 Select [Save].

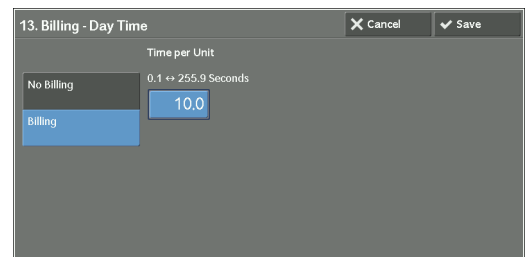

Internet Fax Profile

Set the format of the Internet fax profile.

A profile is specified to restrict attribute information such as image resolution and paper size for transmissions between Internet Fax-enabled machines.

TIFF-S

The Internet fax standard profile. For documents larger than A4, the size is automatically reduced to A4 when transmission.

TIFF-F

Select this profile when you specify [Superfine] for [Resolution] or when you send A3 or B4 documents.

TIFF-J

Select this profile for sending documents in JBIG.

When the [Delete Entry] Button is Selected

Selecting this button deletes all the information registered for the address selected. To delete all information registered, select [Delete].

Note • Deleted information cannot be restored.

Create Fax Group Recipients

You can register addresses for broadcast transmission as a group. Each group can include up to 20 address numbers. The maximum number of groups that can be registered is 50.

Note that recipients to be added to a group must be registered in the speed dials on the Address Book.

- Note**
- Even when the speed dial number of fax recipients (address book entries) are included in a group, the machine does not send faxes to the recipients if their address types are set to [Email] or [Server].
 - You cannot include a group in another group.
 - You can use wildcards for specifying the numbers in the last one or two digits as shown in the following example:
 - 001*:Specifies the 10 addresses with address numbers 0010 to 0019.
 - ****:Specifies all address numbers.

1 Select [Create Fax Group Recipients].

2 Select a group number to register.

- Note**
- Select [▲] to display the previous screen or [▼] to display the next screen.

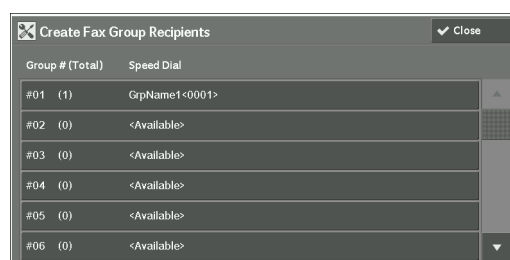

3 Select [Group Name] and enter a group name to register, and then select [Save].

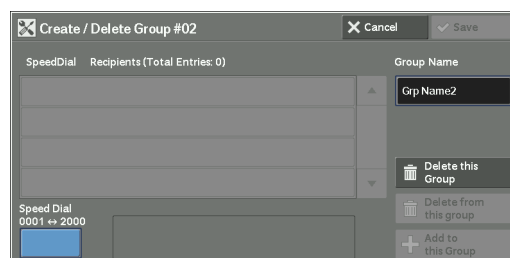

4 Enter a speed dial number (four digits) to register with the numeric keypad, and then select [Add to this Group].

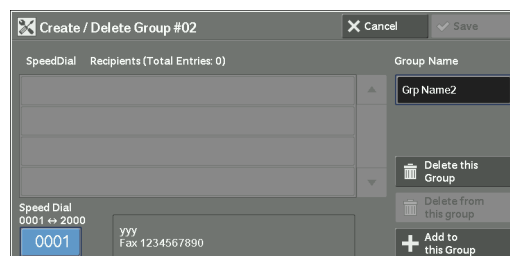

5 Repeat step 4 to register the address numbers.

6 Select [Save].

Delete this group

Deletes all information registered on a group.

Delete from this group

Deletes a registered address. Select the speed dial or enter the speed dial number to delete with the numeric keypad, and then select [Delete from this group].

Add Fax Comment

You can register comments to be printed on cover sheets. A maximum of 50 comments can be registered, each of which can be up to 36 single-byte characters.

For information about how to enter characters, refer to "Entering Text" (P.57).

Paper Tray Attributes

Set a paper size and a paper type load in each tray.

Refer to "Paper Tray Attributes" (P.322).

Accounting

In [Accounting], you can register the users that will use the machine, and set the operation settings of the Accounting feature.

For more information about this feature, refer to "Authentication and Accounting Features" (P.533).

The following shows the reference section for each setting.

Create/View User Accounts	441
View Accounts	444
Reset User Accounts.....	444
System Administrator's Meter (Copy Jobs)	445
Accounting Type	445
Accounting Login Screen Settings	446
Fax Billing Data.....	447
Accounting/Billing Device Settings	448

- 1 On the [Tools] screen, select [Accounting].

For the method of displaying the [Tools] screen, refer to "System Settings Procedure" (P.296).

- 2 Select an item to set or change.

Create/View User Accounts

To enable the Accounting feature, register user IDs and user names to authenticate registered users.

You can set a limit on the number of pages for each user of the machine. You can also check the cumulative number of pages for each user registered. Up to 1,000 user data can be registered. The settings described here are identical with [Create/View User Accounts] under [Authentication] of [Authentication/Security Settings].

- Note**
- Before registering users, refer to "Accounting Type" (P.445) and set the Accounting Type you use.
 - This item does not appear when [Network Accounting] is selected in "Accounting Type" (P.445).

- 1 Select [Create/View User Accounts].
- 2 Select a User ID to register, and then select [Create/Delete].

- Note**
- A 4-digit number displayed on the left of the User ID is the User Account Number.
 - Selecting [<Available>] displays the screen to enter the User ID. Enter the User ID, and then select [Save].
 - Select [▲] to display the previous screen or [▼] to display the next screen.
 - Entering a 4-digit User ID number with the numeric keypad displays the specified number at the top of the column.

- 3 Specify the settings.

- 4 Select [Close].

User ID

Enter a user ID to use the machine. Up to 32 single-byte characters are allowed.

User Name

Set a user name. Up to 32 single-byte characters are allowed.

For information about how to enter characters, refer to "Entering Text" (P.57).

Passcode

Set a passcode. Setting a passcode is strongly recommended for security. Set a passcode from 4 to 12 digits.

Note • When [Passcode Entry for Control Panel Login] is set to [On], a passcode entry is required upon user authentication.

For information on how to change your passcode later, refer to "Changing Passcode" (P.565).

E-mail Address

Enter an e-mail address with up to 128 characters. The address set here will be set as [From] under [E-mail].

For information about how to enter characters, refer to "Entering Text" (P.57).

Device Access

Set whether to allow the machine use.

Enabled

Allows the machine use. When the smart card reader is connected, you can select the settings for each Login Type.

Disabled

Prohibits the machine use.

Service Access

You can place restrictions on the use and the maximum number of allowed pages for each of the Copy, Fax, Scan, and Print features.

- 1 Select [Service Access].
- 2 Select a feature to restrict.

- 3 To set account limits, select [Change Account Limit], and then enter the maximum number of pages with the numeric keypad.

Feature Access

Set access restrictions on features.

- Free Access
The feature is not restricted.
- No Access to Copy/Fax/Scan/Print Service
Allows you to restrict the use of the Copy, Fax, Scan, or Print service.

Account Limit

Set the maximum number of pages for copying, scanning, or printing.

You can specify a number from 1 to 9,999,999 (7 digits) pages in 1 page increments.

- The following limits can be placed on the Copy service for each user:
Permission to use: [Free Access], [Black & White Only], [Color Only], or [No Access to Copy Service]
Maximum number of color pages allowed: 1 to 9,999,999
Maximum number of black-and-white pages allowed: 1 to 9,999,999
- The following limits can be placed on the Fax service for each user:
Permission to use: [Free Access] or [No Access to Fax Service]
- The following limits can be placed on the Scan service for each user:
Permission to use: [Free Access], [Black & White Only], [Color Only], or [No Access to Scan Service]
Maximum number of color pages allowed: 1 to 9,999,999
Maximum number of black-and-white pages allowed: 1 to 9,999,999
- The following limits can be placed on the Print service for each user:
Permission to use: [Free Access], [Black & White Only], or [No Access to Print Service]
Maximum number of color pages allowed: 1 to 9,999,999
Maximum number of black-and-white pages allowed: 1 to 9,999,999

User Role

User Role

Allows you to select a user role for a user.

- User
No special authority is given to this user role.
- System Administrator
The same authority as a system administrator is given except for the following operation:
 - Operate folders
 - Operate job flow sheets
 - Change the passcode of the system administrator
- Account Administrator
The following authorities are given:
 - Create, delete, change (except for passcode), and view (unavailable depending on some settings) user information
 - Create, delete, change, and view accounting
 - Change an Alternative Name for Account ID or Mask Account ID
 - Print an Accounting Report for each user

Add This User to Authorization Group

Allows you to select an authorization group for a user.

Reset Account

Deletes all registered information for a selected user.

Reset

Deletes the registered user data. Once deleted, the data cannot be restored.

Note • All job flow sheets, folders, and files within folders belonging to the user are deleted. If the user is owner of a large amount of material (when a large quantity of files is left remaining within a folder for example), the deletion will take a considerable time.

Cancel

Cancels the deletion of the user data.

Reset Total Impressions

Resets the current cumulative number of pages for a selected user, returning it to zero.

Reset

Resets the current cumulative number of pages for users. Once reset, the previous count cannot be restored.

Cancel

Cancels resetting the cumulative number of pages.

View Accounts

Selecting [ColorTrack] on the [Accounting Type] screen allows you to check the following for each registered user or group: (1) the maximum number of times that the account can be used for each service, and (2) how many times the account has been used for each service.

- 1 Click [View Accounts].
- 2 Select [User Account] or [Group Account]. If you select [User Account], select also the User ID to check.
- 3 Click [Account Details].

Reset User Accounts

You can delete all registered information for all registered users in a single operation, or reset the accounting data. It is also available to print contents for confirmation before resetting. The settings described here are identical with [Reset User Accounts] under [Authentication] of [Authentication/Security Settings].

Note • This item does not appear when [Network Accounting] or [ColorTrack] is selected in [Accounting Type].

All User Accounts

Deletes all information registered for each user. It also deletes all data including the maximum number of pages, cumulative number of pages, and printer accounting data.

Note • All job flow sheets, folders, and documents within folders belonging to the user are deleted. If the user is owner of a large amount of material (when a large quantity of files is left remaining within a folder for example), the deletion will take a considerable time.

All Feature Access Settings

Resets the feature access limit for all users.

All Account Limits

Resets the maximum number of pages for all users to the default (9,999,999 pages).

Total Impressions

Resets all accounting data for all users including the system administrator. The number of pages is also reset to 0.

All Authorization Groups

Delinks users from authorization groups, and links those users to the default authorization group.

Meter (Print Jobs)

Resets all printer accounting, and deletes automatically registered job owner names. The number of pages printed is also reset to 0.

Note • [Meter (Print Jobs)] is displayed when [Disable Accounting] is selected for [Print Service] in the [Accounting Mode] screen under [Accounting Type].

Print the Meter Report

Prints a meter report, which is helpful when you check counters before you reset or delete them.

Note • [Meter (Print Jobs)] is displayed when [Disable Accounting] is selected for [Print Service] in the [Accounting Mode] screen under [Accounting Type].

Print the Accounting Report

Prints a report including contents registered information to reset or a report including contents administration data to reset.

The report is available for confirmation before resetting.

Reset

Deletes or resets the data for the selected item.

System Administrator's Meter (Copy Jobs)

You can check or reset the total impression copied using the System Administration mode on the screen.

The total impressions are counted up to 9,999,999 pages.

Note • This item does not appear when [Network Accounting] is selected in [Accounting Type].

Accounting Type

You can select whether or not to use the Accounting feature.

Accounting Disabled

Does not perform accounting.

Local Accounting

Performs accounting.

Network Accounting

Performs accounting based on the user information managed on a remote service. User information is registered on the remote service.

- Note**
- When [Network Accounting] is selected, users are prompted to enter their Account ID on the [Login] screen that is displayed when attempting to use services required for accounting.

For more information on Network Accounting, refer to "Types of Account Administration" (P.539).

ColorTrack

Accounting is carried out based on the user information and account information pre-registered on the machine.

Accounting Mode

accountingAllows you to set whether or not to enable the Accounting feature for the following services:

- Copy
- E-mail
- Store & Send Link
- Media Print - Photos
- Fax/Internet Fax
- Scan to PC
- Store to WSD
- Print
- Store to Folder
- Store to USB
- Media Print - Text

- Note**
- WSD stands for Web Services on Devices.
 - The services displayed on the screen vary depending on the machine configuration.
 - When [Enable Accounting] is selected for a service, [] is displayed on the button of the applicable service on the [Home] screen. Also, [: Requires Login] is displayed at the lower left of the [Home] screen. [] and [: Requires Login] are not displayed after authentication.
 - Print jobs may be canceled depending on the settings in "Receive Control" (P.457).

Verify User Details

Allows you to set whether or not to verify user information.

Selecting [Yes] also allows you to select [For printer/Direct Fax Jobs].

Customize User Prompts

Allows you to set the type of user information used for authentication.

- Note**
- Account ID is used for accounting.
 - Display User ID & Account ID Prompts
Prompts users to enter both their user ID and Account ID.
 - Display User ID Prompt Only
Prompts users to enter their user ID only.
 - Display Account ID Prompt Only
Prompts users to enter their Account ID only.
 - Display No Prompts
Does not prompt users to enter their user ID or Account ID.

Accounting Login Screen Settings

You can configure Accounting settings.

Alternative Name for User ID

If required, you can change the indication "Account ID" on the [Login] screen that appears when the <Log In/Out> button on the control panel or the login information area on the touch screen is pressed to another name such as "Account Name" or "Number". The alias can be set to 1 to 15 single-byte characters.

- Note**
- The name changed is also printed in a report or a list.

Mask User ID (***)

You can set how an entered user ID is shown on the screen. Use this feature to enhance security as required.

Show

As you enter the user ID, the characters are echoed on the screen in the normal way.

Hide

As you enter the user ID, the character string is hidden as a row of asterisks (*****).

Alternative Name for Account ID

If required, you can change the indication "Account ID" on the [Login] screen that appears when the <Log In/Out> button on the control panel or the login information field on the touch screen is pressed to another name such as "Account Name" or "Number". The alias can be set to 1 to 15 single-byte characters.

- Note**
- This item is displayed when [Network Accounting] is selected in [Accounting Type].
 - The name changed is also printed in a report or a list.

Mask Account ID (***)

You can set how an entered Account ID is shown on the screen. Use this feature to enhance security as required.

- Note**
- This item is displayed when [Network Accounting] is selected in [Accounting Type].

Show

As you enter the Account ID, the characters are echoed on the screen in the normal way.

Hide

As you enter the Account ID, the character string is hidden as a row of asterisks (*****).

Display Billing Information Upon Login

Select whether or not to display the billing information of the user upon logging in. When [Enabled] is selected, [Impressions], [Account Limit] and [Balance] of Copy, Print and Scan will be displayed.

- Note**
- This item is displayed when [Login to Local Accounts] is selected in [Login Type] and [Local Accounting] is selected in [Accounting Type].
 - The restricted items will not be displayed.
 - This is ineffective in the System Administration mode.

Store User Details

You can set the destination to save authentication information. Select [NVM] or [Hard Disk].

- Note**
- This item is displayed when [Network Accounting] is selected in [Accounting Type].
 - NVM stands for nonvolatile memory and the data on it is stable after the machine is turned off.

Fax Billing Data

You can configure fax billing settings.

- Note**
- To register the billing data, enable the Accounting feature for fax/Internet fax under Accounting in advance. For details on how to enable the Accounting feature, refer to "Accounting Mode" (P.446).
 - Set the connection time for one unit charge in each of the time bands (daytime/night/midnight) in [Billing]. For more information on how to set [Billing], refer to "Billing - Day Time, Billing - Night Time, Billing - Midnight" (P.438).

- The registered details can be confirmed by printing the Billing Data List. For information on how to print, refer to "Billing Data List" (P.281).

- 1 Select [Fax Billing Data].
- 2 Select [Charge Rate per Unit].

Charge Rate per Unit

This is a communication charge per unit. You can set a value from 0.1 to 255.9 seconds in 0.1 second increments.

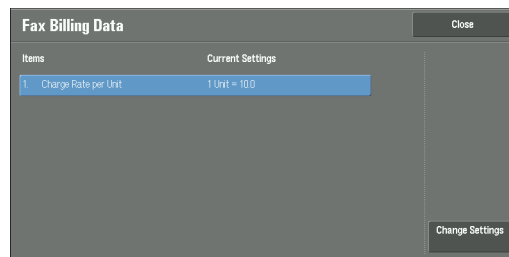

- 3 Select [Change Settings].
- 4 Enter an amount with the keyboard displayed on the screen or the numeric keypad.
- 5 Select [Save].

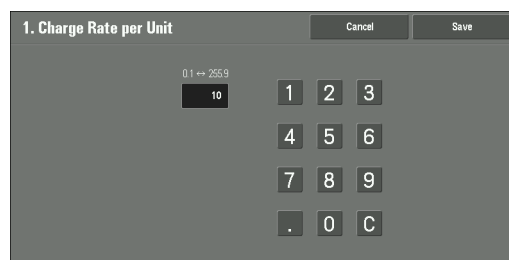

Accounting/Billing Device Settings

You can configure the accounting or billing device settings.

- Note**
- When an accounting or a billing device is connected to the machine, be sure to set a password and that users other than the system administrator do not disconnect the device by mistake.
 - Optional components or related products are required to use the features. For more information, contact Customer Support at dell.com/contactdell.

Connect with Account/Billing Device

Allows you to select whether or not to use the connected accounting or billing device from [None] or [Connected].

- Note**
- While a device for maintenance is connected, you cannot change the setting.

Accounting/Billing Device

Select the type of the accounting/billing device connected to the machine.

- Note**
- If a device connected does not match the device selected in [Accounting/Billing Device], an error occurs. Jobs related to the accounting/billing device cannot be performed until the error is resolved. For information on how to resolve the error, refer to "Status Code" (P.611).

Track Print Jobs

The feature is effective for the Print service.

Select whether or not to track billing information for the print jobs. Select from [No Tracking] and [Track with Accounting/Billing Device].

This feature is available for all accounting/billing devices.

Track Scan/Fax Jobs

The feature is effective for the Scan, Fax, and Internet Fax services.

Select whether or not to track billing information for the scan, fax, and Internet fax jobs. Select from [No Tracking] and [Track with Accounting/Billing Device].

Interrupt Mode

The feature is effective for the Copy service.

Select whether or not to enable the Interrupt mode. Select from [Disabled] and [Enabled].

This feature is available for accounting/billing devices other than Card Activated - Cumulative and Smart Card Reader.

Job with Insufficient Credit

The feature is effective for the Copy, Print, and Scan services.

Select the operation of the machine when the amount remaining in the accounting/billing device becomes insufficient. Select from [Delete Job Immediately] and [Hold Job].

This feature is available for accounting/billing devices other than Card Activated - Cumulative and Smart Card Reader.

Charge Print Jobs

The feature is effective for the Print service.

Select how the print job performed is charged. Select from [Charge by Card Number] and [Do not Charge by Card Number].

This feature is available for Card Activated - Cumulative and Card Activated - Subtractive.

Track with Cumulative Device

The feature is effective for the Copy and Print services.

Select the timing that the amount for copy or print job is charged. Select from [Track with Accounting Device] and [High Speed Printing].

This feature is available for Card Activated - Cumulative.

Scan Ahead for Copy Job

The feature is effective for the Copy service.

Select whether or not to enable the Scan Ahead feature for copy jobs. Select from [Disabled] and [Enabled].

This feature is available for Card Activated - Cumulative, Card Activated - Subtractive, and Smart Card Reader.

Note • Some of the products listed above may not be available for this feature depending on the types and settings.

Authentication/Security Settings

In [Authentication/Security Settings], you can configure the authentication and security settings.

For more information about the feature, refer to "Authentication and Accounting Features" (P.533).

The following shows the reference section for each setting.

System Administrator Settings.....	450
Authentication	451
Allow User to Disable Active Settings.....	458
Job Status Default.....	459
Overwrite Hard Disk.....	459

- 1 On the [Tools] screen, select [Authentication/Security Settings].

For the method of displaying the [Tools] screen, refer to "System Settings Procedure" (P.296).

- 2 Select an item to set or change.

System Administrator Settings

In [System Administrator Settings], you can set the system administrator ID and passcode.

We recommend setting the system administrator ID and passcode to prevent unauthorized setting changes and ensure security.

System Administrator's Login ID

Set the system administrator's user ID. Enter the ID from 1 to 32 single-byte characters.

Note • The default of the system administrator's user ID is "admin".

- 1 Select [System Administrator's Login ID].
- 2 Select [On].
- 3 Select [Keyboard].
- 4 Enter the system administrator's ID with up to 32 characters, and then select [Save].
- 5 Repeat steps 3 and 4 to re-enter the same system administrator's ID in [Re-enter System Administrator's Login ID].
- 6 Select [Save].
- 7 A confirmation window appears. Select [Yes] to confirm your entry.

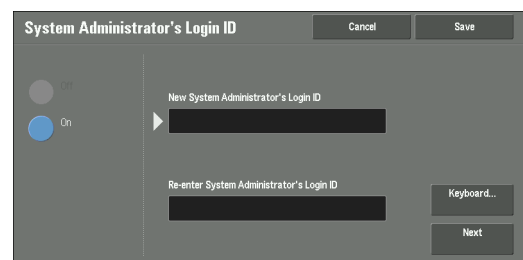

System Administrator's Passcode

Set the passcode for the System Administration mode.

Setting a passcode is strongly recommended to enhance security.

Note • The default of the system administrator's passcode is "1111".

The system administrator's passcode set here is used when [Passcode Entry for Control Panel Login] is set to [On] under [Authentication/Security Settings] > [Passcode Policy].

Set the passcode after setting the system administrator's user ID. You can set the passcode from 4 to 12 numeric digits.

For more information about [Passcode Entry for Control Panel Login], refer to "Passcode Policy" (P.456).

- 1 Select [System Administrator's Passcode].
- 2 Select [New Passcode].
- 3 Enter a new passcode (4 to 12 digits) using the keyboard displayed, and then select [Save].

Note • If no passcode is set, leave the text boxes blank and select [Save].

- 4 Select [Retype Passcode], enter the same passcode, and then select [Save].
- 5 Select [Save].
- 6 A confirmation window appears. Select [Yes] to confirm your entry.

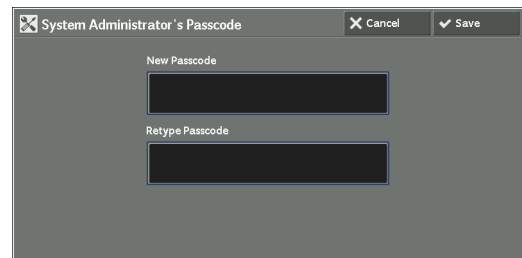

Authentication

In [Authentication], you can set the following items.

The following shows the reference section for each setting.

Login Type	451
Access Control	451
Create/View User Accounts	453
Reset User Accounts	453
Create Authorization Groups	453
User Details Setup	454
Maximum Login Attempts by System Administrator	456
Passcode Policy	456
Charge/Private Print Settings	456
Receive Control	457

Login Type

Allows you to select a type of authentication.

No Login Required

Does not use the Authentication feature.

Login to Local Accounts

Authenticates users based on the user information registered on the machine.

Note • When [Login to Local Accounts] is selected, the machine enters the Login mode and [Login] is displayed at the lower left of the [Home] screen.

Login to Remote Accounts

Authenticates users based on the user information registered on a remote authentication server.

Note • The machine enters the Login mode, and [Login] is displayed at the lower left of the [Home] screen.

Access Control

Allows you to restrict access to the machine or each service. Once the access control is enabled, user authentication is required to use the machine or the services.

- Note**
- When a user is authenticated by a remote authentication server, the authenticated user can access the services through the control panel based on the permission information obtained from the remote server.
 - When a guest user is permitted to use the machine, access restriction for each service cannot be specified for the guest user. If you want to restrict a guest user to use the machine, refer to "Guest User" (P.455).

Device Access

Allows you to restrict buttons operation on the control panel of the machine.

Select [Unlocked] or [Locked].

Service Access

Allows you to restrict access to each of the following services.

- Note**
- When [Locked (Show Icon)] is selected for a service, [🔒] is displayed on the button of the applicable service on the [Home] screen. Also, [🔒 : Requires Login] is displayed at the lower left of the [Home] screen. [🔒] and [🔒 : Requires Login] are not displayed after authentication.
 - When [Locked (Hide Icon)] is selected for a service, the applicable service is not displayed on the [Home] screen. It will be displayed after authentication.

For more information on [Login Type], refer to "Login Type" (P.451).

- Copy

Restricts access to the Copy service on the machine.

If a stored programming contains steps to use the Copy service, the use of the store programming is also restricted.

- Fax/Internet Fax

Restricts access to the Fax / Internet Fax / Direct Fax service on the machine.

If a stored programming contains steps to use the Fax / Internet Fax service, the use of the store programming is also restricted.

- Scan

Restricts access to the E-mail, Store to Folder, Scan to PC, Store to USB, Store & Send Link, and Scan to WSD services and features on the machine.

If a stored programming contains steps to use the Scan services, the use of the store programming is also restricted.

- Note**
- WSD stands for Web Services on Devices.

- Media Print - Text

Restricts access to the Media Print - Text service on the machine.

- Media Print - Photos

Restricts access to the Media Print - Photos service on the machine.

- Send from Folder

Restricts access to the Send from Folder service on the machine.

- Stored Programming

Restricts access to the Stored Programming service on the machine.

- Job Flow Sheets

Restricts access to the Job Flow Sheets service on the machine.

- Web Applications

Restricts access to the Web Applications service.

- Custom Services

Restricts access to custom services on the machine.

Note • This feature is for service representative use. For more information, contact Customer Support at dell.com/contactdell.

- Print

Restricts users to print jobs stored on the machine, such as the Secure Print and Sample Set jobs.

This feature also restricts the submission of print jobs from a computer via a network.

To use the Authentication feature, authentication information such as a user ID and passcode needs to be entered in a print driver.

If authentication fails, the print data sent to the machine is saved in the machine or deleted according to the Charge Print settings.

Feature Access

Set [Color Copying], [Print Files from Folder], and [Retrieve Files from Folder].

Create/View User Accounts

To enable the Accounting feature, register user IDs and user names to authenticate registered users.

You can set a limit on the number of pages for each user of the machine. You can also check the cumulative number of pages for each user registered. Up to 1,000 user data can be registered. The settings described here are identical with [Create/View User Accounts] under [Accounting].

Refer to "Create/View User Accounts" (P.441).

Reset User Accounts

You can delete all registered information for all registered users in a single operation, or reset the accounting data. It is also available to print contents for confirmation before resetting. The settings described here are identical with [Reset User Accounts] under [Accounting].

Refer to "Reset User Accounts" (P.444).

Create Authorization Groups

System administrators can give login users authority to use some features that are restricted for login users. The login users can be divided into different authorization groups.

Note • Up to 20 groups can be registered.

- 1 Select [Create Authorization Groups].
- 2 Select a registration number, and then select [Create/Delete].
- 3 Select and set any item.

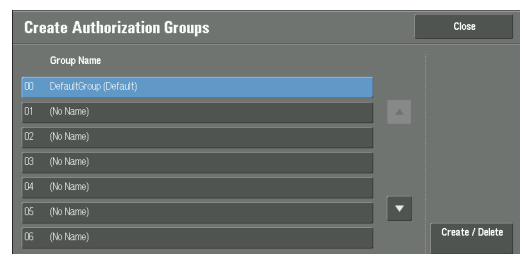

Group Name

Enter a group name with up to 32 single-byte characters.

Restrict Recipient Selection Method

Select whether or not to remove restriction when a transmission to a recipient who is not registered on the Address Book is restricted for the Fax/Internet Fax or Scan feature.

Restrict User to Edit Address Book

Select whether or not to remove restriction when the edit of the Address Book is restricted.

Allow User to Disable Active Settings

Select whether or not to permit the group members to temporarily disable the forcible printing features, such as the Force Watermark, Print Universal Unique ID, and Force Annotation features, and to allow the machine to process a job.

User Details Setup

Set the information required when carrying out authentication.

Alternative Name for User ID

If required, you can change the indication "UserID" on the [Login] screen that appears when the <Log In/Out> button on the control panel is pressed to another name such as "User Name" or "Number". The alias can be set to 1 to 15 single-byte characters.

Note • The name changed is also printed in a report or a list.

Mask User ID (*)**

You can set how an entered user ID is shown on the screen. Use this feature to enhance security as required.

When you select [Show], the characters you enter are echoed on the screen in the normal way as you enter the user ID. When you select [Hide], the characters you enter is hidden as a row of asterisks (*****) as you enter the user ID.

Failed Access Log

Set the failure count to detect unauthorized access. An error is logged if authentication fails the number of times specified here within a predetermined time (10 minutes).

Logout Confirmation Screen

Set whether or not to display a logout confirmation screen every time a user session ends.

User ID for Login

Set whether or not to make the user ID entry field on the user login screen case-sensitive.

When you select [Case Sensitive], authentication is performed using the User ID as registered (including upper and lower cases). When you select [Non-Case Sensitive], authentication is performed with case ignored even if the User ID has both upper and lower cases.

Note

- Do not change the setting while a file is stored for the Private Charge Print. Otherwise, you may encounter problems, such as being unable to print. Change the setting after the machine prints all the files stored.
- Do not select [Case Sensitive] when the machine stores User IDs such as "ABC" and "abc" which are regarded as the same ID under the setting. If you select [Case Sensitive], it may cause the problem and those IDs may not be displayed. Before you select the setting, correct those User IDs to distinguish them.

When Smart Card Reader is Connected

Set whether or not to enable the user ID authentication when the smart card reader is connected. When [Smart Card Login] is selected, the user ID authentication cannot be used. When [Smart Card or Control Panel Login] is selected, both smart card authentication and user ID authentication can be used.

Account Auto Setup for Card Login

Set whether or not to register new user information when an unregistered user holds a card over the smart card reader.

When [Disabled] is selected, the machine does not register the user. When [Enabled] is selected, the machine registers the user automatically.

- Note**
- When [Auto Assign] is selected, [User Name], [Service Access], and [Add User To Authorization Group] will be displayed.
 - Set the user name by selecting [User Name].
 - When [Service Access] is selected, [Copy], [Fax], [Scan], and [Print] will be displayed. You can set [Feature Access] and [Change Account Limit] for each item.
 - When [Add User To Authorization Group] is selected, you can select a user role and an authorization group for the user.
 - When [Passcode Entry for Smart Card Login] under [Tools] > [Authentication/Security Settings] > [Authentication] > [Passcode Policy] is set to [On], you need to enter the passcode twice for the auto assign.

Guest User

Set whether or not to permit a guest user when [Login to Remote Accounts] is selected. Set the guest user passcode from 4 to 12 digits.

- Note**
- Access restriction for each service cannot be specified for the guest user.

Use of Smart Card

Set whether or not to use smart card authentication.

Smart Card Link Mode

Set whether or not to require a passcode for smart card authentication when [Login to Remote Accounts] is selected.

Smart Card Certificate Verification

Set whether or not to verify the smart card certificate when a user uses the smart card.

When [Enabled] is selected, the owner of the smart card is verified not only by PIN code verification but by certification verification of the smart card and private key match. In this case, the upper level CA certificate of the smart card certification must be registered on the machine.

When [Disabled] is selected, the owner of the smart card is verified by PIN code verification.

Smart Card Logout Timing

Select the logout method for smart card authentication when a contactless smart card is used for authentication.

When [Log Out when Card is Removed] is selected, you can logout from the machine by removing the smart card from the smart card reader. When [Log Out from Control Panel] is selected, you can logout by operating the touch screen or control panel.

Save remote accounts in this machine

Select whether or not to save the user information used for remote authentication. While the user information is saved in the machine, the machine can authenticate the user using the information saved in the machine even when the remote server is off.

- Note**
- This setting applies only to a user who is authenticated by smart cards.

Delete Remote Accounts

Select whether or not to delete the user information saved in the machine for remote authentication. Select from [Do Not Delete], [Weekly], and [Monthly].

For [Weekly], you can set the day and time. For [Monthly], set the date and time.

- Note**
- This setting applies only to a user who is authenticated by smart cards.

Maximum Login Attempts by System Administrator

This feature protects the settings from being changed by someone impersonating your system administrator. If authentication for a system administrator's ID fails more than specified times continuously, access is denied.

You can specify a login attempt count from 1 to 10.

- Note**
- The failure count is reset when the machine is restarted.
 - To cancel the access rejection state, restart the machine by switching off and on the power.

Passcode Policy

Passcode Entry for Control Panel Login

You can set whether a passcode is required when the system administrator or a user uses the machine. Selecting [On] enables [System Administrator's Passcode] setting and [Passcode] setting for [Create/View User Accounts].

Selecting [Off] does not require the passcode, even if a passcode is set in the above settings.

- Note**
- The setting of [Passcode Entry for Control Panel Login] is used for authentication on the machine. A passcode must always be entered when accessing from remote devices using Dell Printer Configuration Web Tool or the like, regardless of the use of passcode setting. Depending on authentication procedures, a passcode may be required for other processes as well.
 - The system administrator's passcode is also required when you change settings from Dell Printer Configuration Web Tool.

Passcode Entry for Smart Card Login

You can set whether to require the passcode when the system administrator or a user uses the machine.

Minimum Passcode Length

Set this item when you specify the minimum number of digits allowed for a passcode.

Set a value from 4 to 12 in 1 digit increments.

- Note**
- This is only applicable to login users (not applicable to the system administrator and guests).
 - Registered users can be authenticated with a passcode less than the minimum number of digits.

Charge/Private Print Settings

You can set how received print jobs should be handled.

You can directly print jobs and temporarily store print jobs to Charge Print or Private Charge Print for stored files.

The Charge Print feature prints the print jobs of authenticated users. But, using this feature, you can also temporarily store print jobs and print them later by operating the machine. If [Save as Charge Print Job] is selected, print jobs received are saved by a user ID for storage set in a print driver.

The Private Charge Print feature stores jobs to the machine, using the login User ID or Sub User ID at print instruction. You can print the jobs later by operating the machine. Only the files of the login user and sub users linked are displayed on the touch screen, therefore, it can help ensure privacy protection as well as prevent output from being left in the tray.

- Note**
- For more information on the sub user, refer to "Sub User" (P.536).
 - For more information on the Charge Print and Private Charge Print features, refer to "Printing and Deleting Stored Jobs" (P.208).

To use Charge Print or Private Charge Print, [Receive Control] must be set. For more information, refer to "Receive Control" (P.457).

Receive Control

You can set how received print jobs should be handled.

For information about printing or deleting the print job saved, refer to "Private Charge Print" (P.216), and about deleting a Private Charge Print job with an invalid User ID, refer to "Deleting a Private Charge Print Job with an Invalid User ID" (P.270).

- 1 Select [Receive Control], and then select [Change Settings].
- 2 Select any item.
- 3 According to the selected item, set the processing to apply to jobs.
- 4 Select [Save] after the setting is completed.

According to Print Accounting

Specifies how print jobs should be handled when the Authentication and Accounting features are enabled and [Print] under [Service Access] is set to [Locked].

Note • When the Authentication and Accounting features are disabled and [Print] under [Service Access] is set to [Unlocked], the settings specified in the print driver are applied.

When [According to Print Accounting] is selected, [Job Login Success], [Job Login Failure], and [Job Without User ID] are displayed.

- Job Login Success

Set the processing to apply to successfully authenticated jobs.

- To print jobs, select [Print Job].
- To save jobs as Private Charge Print, select [Save as Private Charge Print Job].

Note • When [Save as Private Charge Print Job] is selected, the Secure Print, Sample Set, Store in Remote Folder, and Delayed Print settings specified in the print driver will be ignored.

- Job Login Failure

Set the processing to apply to jobs authentication failed (whose information such as the user ID and passcode has been incorrectly registered on the print driver).

- To save jobs as Private Charge Print, select [Save as Charge Print Job].
- To delete jobs, select [Delete Job].

- Job Without User ID

Set the processing to apply to jobs with no authentication user ID attached (such as print jobs sent from Dell Printer Configuration Web Tool or e-mail print).

- To print jobs, select [Print Job].
- To save jobs as Charge Print, select [Save as Charge Print Job].
- To delete jobs, select [Delete Job].

Note • [Job Without User ID] is automatically changed to [Print Job] on the machine when you select as follows on Dell Printer Configuration Web Tool: [Properties] > [Security] > [Authentication Configuration] > [Non-Account Print]. When [Job Without User ID] is set to [Save as Charge Print Job] or [Delete Job], the [Non-account Print] check box on Dell Printer Configuration Web Tool is deselected automatically.

Save as Private Charge Print Job

Regardless of whether the Authentication feature is being used or not, all jobs that have a user ID are saved as Private Charge Print. You can also specify how to handle the job that does not have a User ID or a PjL command.

Note • When [Save as Private Charge Print Job] is selected, all the print jobs that have User IDs are saved regardless of whether or not being successfully authenticated. To minimize the unnecessary print jobs, specify an expiration date, so that they can be automatically deleted after a specified period of

time. Or the system administrator can manually delete them. For details on how to specify an expiration date, refer to "Stored File Settings" (P.413). For details on how to delete the print jobs manually, refer to "Deleting a Private Charge Print Job with an Invalid User ID" (P.270).

- When [Save as Private Charge Print Job] is selected, the Secure Print, Sample Set, Store in Remote Folder, and Delayed Print settings specified in the print driver will be ignored.

When [Save as Private Charge Print Job] is selected, [Job Without User ID] and [Non-PJL Command Job(s)] are displayed.

- **Job Without User ID**

Set how to process jobs with no user ID attached.

- To print jobs, select [Print Job].
- To save jobs as Charge Print job, select [Save as Charge Print Job].
- To delete jobs, select [Delete Job].

Note

- [Job Without User ID] is automatically changed to [Print Job] on the machine when you select as follows on Dell Printer Configuration Web Tool: [Properties] > [Security] > [Authentication Configuration] > [Non-Account Print]. When [Job Without User ID] is set to [Save as Charge Print Job] or [Delete Job], the [Non-account Print] check box on Dell Printer Configuration Web Tool is deselected automatically.

- **Non-PJL Command Job(s)**

Set how to handle the job that does not have a PJL command. The job will be distinguished by the existence of the User ID, and will be handled according to the following settings.

- Select [Do Not Use At All] to apply the [Job Without User ID] setting regardless of whether the job has a User ID.
- Select [Use When Available] to specify how to handle the job that has a User ID.
 - To print jobs, select [Print Job].
 - To save jobs as Charge Print, select [Save as Charge Print Job].
 - To save jobs as Private Charge Print, select [Save as Private Charge Print Job].
 - To delete jobs, select [Delete Job].

Save as Charge Print Job

Regardless of whether the Authentication feature is being used or not, all received jobs are saved as Charge Print.

Note

- When using [Save as Charge Print Job], all the print jobs are saved regardless of whether or not being successfully authenticated. To minimize the unnecessary print jobs, specify an expiration date, so that they can be automatically deleted after a specified period of time. Or the system administrator can manually delete them. For details on how to specify an expiration date, refer to "Stored File Settings" (P.413). For details on how to delete the print jobs manually, refer to "Charge Print" (P.213).
- When [Save as Charge Print Job] is selected, the Secure Print, Sample Set, Store in Remote Folder, and Delayed Print settings specified in the print driver will be ignored.

Allow User to Disable Active Settings

Use this feature when you want use active settings for most jobs but not for specific jobs.

You can temporarily disable active settings such as Force Watermark, Print Universal Unique ID and Force Annotation features that have been enabled.

This feature is applicable to Copy, Print from Folder, Print Stored File, Media Print - Text, and Media Print - Photos jobs when [Enable Active Settings] is selected (for jobs such as Fax, Client Print, and Report, you cannot disable active settings).

This option is displayed when [Enable Active Settings] is selected for [Allow User to Disable Active Settings] for the authorization group where the login user belongs.

- Note**
- If this setting is set to [Enable Active Settings] while a job is in progress, the setting is not effective for the job.
 - You can disable active settings even when you select a file in a folder using the Job Flow feature and manually execute a job.
 - Users with system administrator role can configure this feature regardless of authorization group.

For more information about Force Watermark, refer to "Watermark" (P.330).

For more information about Print Universal Unique ID, refer to "Print Universal Unique ID" (P.333).

For settings of authorization group, refer to "Authentication and Accounting Features" (P.533).

Job Status Default

You can hide active jobs, completed jobs, and job logs from unauthenticated users or non-job owners, to protect privacy and prevent leakage of confidential information.

- Note**
- If you set to hide job details, you cannot stop or delete jobs you instructed. Therefore, you cannot cancel jobs in the case of operational error of copies or wrong transmission of faxes.

Active Jobs View

Select whether or not to hide active jobs from local users.

Completed Jobs View

Select from [Allow Job Viewing at All Times], [Require Login to View Jobs], or [No Job Viewing].

Access To

This feature is displayed when [Require Login to View Jobs] is selected.

Select either [All Jobs] or [Jobs Run By Login User Only].

Hide Job Details

This feature is displayed when [Allow Job Viewing at All Times] or [Require Login to View Jobs] is selected.

Select either [No] or [Yes].

Overwrite Hard Disk

Select whether or not to conduct hard disk overwriting. If you overwrite the hard disk, you can select whether to overwrite once or three times.

When copy, fax, scan, or print processing is completed, the data is deleted from the hard disk and the area on which the deleted data was stored is automatically overwritten with blank data. This feature prevents unauthorized retrieval or restoration of the data recorded on the hard disk. It also applies to copy document and other information stored temporarily by the system.

The following option can be configured.

Number of Overwrites

You can select the number of overwrites either once or three times.

- Note**
- If the machine is turned off during the overwriting, unfinished files may remain on the hard disk. The overwriting will resume if you turn the machine on again with the unfinished files remaining on the hard disk.
 - Overwriting once erases the data, but overwriting three times makes it even more definite that the data cannot be restored. It does, however, take longer.
 - During overwriting, normal operations may be slowed down.

For more information on how to check the status during overwriting, refer to "Overwrite Hard Disk" (P.285).

Prerequisite for Using Data Security Feature

The system administrator must follow the instructions below:

- To protect the data deleted from or stored on the hard disk, the following settings are required:
 - Number of Overwrites: [1 Overwrite] or [3 Overwrites]
 - Data Encryption: [On]: an encryption key of 12 digits
 - Service Representative Restricted Operation: [Yes]
- Change the system administrator's factory default passcode (1111). Register a new passcode of 7 characters or more (maximum 12 characters). Be careful not to register a passcode that can be easily assumed and not to store the registered passcode on a location that is easily accessible to other persons.

Note • If the system administrator's user ID and passcode are forgotten, the machine configuration will not be able to recover in case of malfunction.

- Set [Passcode Entry for Control Panel Login] to [On].
- Set [Maximum Login Attempts by System Administrator] to 5 times.
- Note that the hard disk security will not be warranted if you do not correctly follow the above setting instructions.

For more information on how to set data encryption, refer to "Data Encryption" (P.344).

For more information on how to set service representative restricted operation, refer to "Service Rep. Restricted Operation" (P.346).

For more information on how to set [Passcode Entry for Control Panel Login], refer to "Passcode Policy" (P.456).

For more information on how to set the system administrator's user ID, refer to "System Administrator's Login ID" (P.450).

The manager (of the organization that this machine is used for) must follow the instructions below:

- Assign an appropriate person as a system administrator and manage and train he/she properly.
- When turning off the machine, make sure no operation is running. Train the users to turn off the machine after an active operation completes, if any.
- Note that this feature is used to protect deleted document data from being recovered; it does not protect files stored in folders in the hard disk.
- Install an anti-bugging device on the internal network that the machine is located on, and perform the network settings properly to protect the machine from interceptions.
- To block unauthorized access, install a firewall device between the external network and the internal network that the machine is located on.
- Set the passcode and encryption key according to the following rules:
 - Do not use easily assured character string
 - Use both characters and numerics

For more information on encryption key, refer to "Encryption Key for Confidential Data" (P.346).

16 Dell Printer Configuration Web Tool Settings

This chapter describes how to set up Dell Printer Configuration Web Tool.

- **Installation of Dell Printer Configuration Web Tool462**
- **Starting Dell Printer Configuration Web Tool.....464**
- **Configuring Machine Settings Using Dell Printer Configuration Web Tool465**

Installation of Dell Printer Configuration Web Tool

Dell Printer Configuration Web Tool provides services such as displaying the status of the machine and jobs, and altering configurations using a web browser in a TCP/IP environment.

Preparations

Prepare a computer supporting the TCP/IP protocol to use Dell Printer Configuration Web Tool.

Dell Printer Configuration Web Tool supports the following browsers:

For Windows 8

- Microsoft® Internet Explorer® 10.0

For Windows 7

- Microsoft Internet Explorer 8.0

For Windows Vista

- Microsoft Internet Explorer 7.0

For Windows XP

- Mozilla® Firefox® 3.0
- Microsoft Internet Explorer 6.0 Service Pack 3

For OS X 10.8

- Safari 5

For Mac OS X 10.7

- Safari 5

For Mac OS X 10.6

- Safari 5
- Mozilla Firefox 3.0

For Mac OS X 10.5

- Mozilla Firefox 3.0

For Mac OS X 10.4

- Safari 3
- Mozilla Firefox 3.0

For Mac OS X 10.3.9

- Safari 1.3

For more information, refer to "Dell Printer Configuration Web Tool Problems" (P.603).

Configuration on the Machine

The following describes the configuration procedure for using Dell Printer Configuration Web Tool on the machine.

1 Display the [Tools] screen.

- 1) Press the <Log In/Out> button.
- 2) Enter the system administrator's user ID with the numeric keypad or the keyboard displayed on the screen, and select [Enter].

When a passcode is required, select [Next] and enter the system administrator's passcode, then select [Enter].

- Note**
- The default user ID is "admin".
 - The default passcode is "1111".

- 3) Select [Tools] on the [Home] screen.
- 4) Select [System Settings].

2 Enable the Internet Services (HTTP) port on the machine.

- 1) Select [Connectivity & Network Setup].
- 2) Select [Port Settings].
- 3) Select [Internet Services (HTTP)], and then select [Change Settings].
- 4) Select [Port Status], and then select [Change Settings].
- 5) Select [Enabled], and then select [Save].
- 6) Select [Close] repeatedly until the [Tools] screen is displayed.

3 Set an IP address.

If an IP address is already set, you can skip this step. For an environment with DHCP or BOOTP, configure the method for obtaining the address. If an IP address cannot be obtained automatically or manual configuration is preferred, confirm the settings of an IP address, a subnet mask, and a gateway address.

For information on how to set an IP address, refer to "Protocol Settings" (P.363).

4 Select [Close] repeatedly until the [Tools] screen appears.

5 Select [Close].

- Note**
- Rebooting the machine may be required depending on the settings. When a message displayed on the screen, follow the message and reboot the machine.

6 After the machine reboots, you can print out a configuration report to confirm that the port for Dell Printer Configuration Web Tool is enabled and TCP/IP is set up correctly.

For information on how to print a configuration report, refer to "Print Reports" (P.276).

7 Start Dell Printer Configuration Web Tool to confirm whether the service is available or not.

For information on how to start Dell Printer Configuration Web Tool, refer to "Starting Dell Printer Configuration Web Tool" (P.464).

Starting Dell Printer Configuration Web Tool

To use Dell Printer Configuration Web Tool, perform the following procedure on your computer.

When Login Type is selected on the machine, authentication is required to access the machine via a web browser.

- 1 Start a web browser.
- 2 Enter the machine's IP address or the Internet address in the address box on the web browser, and press the <Enter> key.

- Example of the IP address entry

http://192.0.2.1/ (IPv4)

http://[2001:DB8::1234] (IPv6)

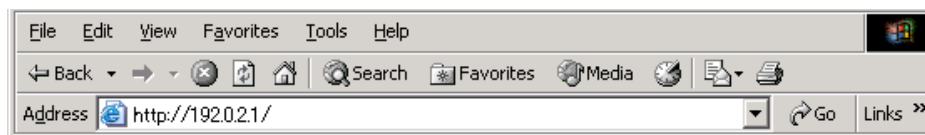

- Example of the Internet address entry (when the machine's Internet address is myhost.example.com)

http://myhost.example.com/

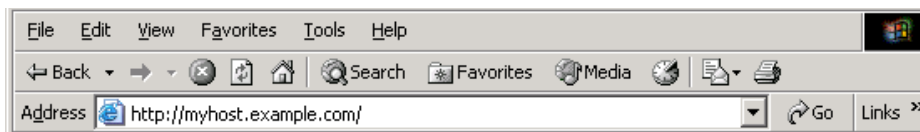

Note

- If your network uses DNS (Domain Name System) and the machine's host name is registered on the domain name server, you can access the machine using the Internet address combining the host name and the domain name. For example, if the host name is "myhost", and the domain name is "example.com" then the Internet address is "myhost.example.com".
- When specifying a port number, add ":" and the port number after the Internet address.
- If using the Authentication feature on the machine, enter a user ID and passcode in the [User Name] and [Password] fields. If you are not sure about the user ID and passcode, consult your system administrator.
The features you can operate vary depending on the system administrator's authority that was given to a user.
- If communications are encrypted; when the [Enabled] check box is selected under [Security] > [SSL/TLS Settings] > [HTTP-SSL/TLS Communication] on the [Properties] tab, you must specify an address that starts with "https" instead of "http" to access Dell Printer Configuration Web Tool.
Example of the IP address entry
https://192.0.2.1/ (IPv4)
https://[2001:DB8::1234] (IPv6)
Example of the Internet address entry
https://myhost.example.com/

If Dell Printer Configuration Web Tool is not displayed, refer to "Dell Printer Configuration Web Tool Problems" (P.603).

Configuring Machine Settings Using Dell Printer Configuration Web Tool

Dell Printer Configuration Web Tool enables you to change various settings on the machine from a computer.

- Note**
- Confirm that the port in use is enabled in [Properties] tab > [Connectivity] > [Port Settings] of Dell Printer Configuration Web Tool when an item that you want to set is not displayed.
 - You cannot change settings from Dell Printer Configuration Web Tool while the wakeup motion sensor is detecting human presence or the control panel is being used. You can change settings after the machine resets the settings automatically (Auto Clear). For information about Auto Clear, refer to "Auto Clear" (P.315).
 - You may be prompted to enter your user name and passcode when you attempt to change settings on Dell Printer Configuration Web Tool. In that case, enter the system administrator's user ID and passcode into the [User Name] and [Password] fields. The default user ID is "admin" and passcode is "1111".

You can configure the following settings with Dell Printer Configuration Web Tool:

Item	How to Select	Overview/Reference
Usage Counters	Select from [Status] tab > [Counters]	Displays the total number of pages printed for each service.
Total Runtime	Select from [Status] tab	Displays the cumulative time of runtime (printing or scanning), standby time, Sleep mode time, warm-up time, and power-off time of the machine by minutes.
Folder	Select from [Scan] tab	Refer to "Create Folder" (P.421).
Job Flow Sheets		Refer to "Create Job Flow Sheet" (P.423).
Add New Name	Select from [Address Book] tab	Refer to "Add Address Book Entry" (P.431).
Job Management	Select from [Properties] tab > [General Setup]	Allows you to configure the delete method of jobs.
Paper Tray Attributes		Refer to "Changing the Paper Settings" (P.244).
Paper Settings		Refer to "Changing the Paper Settings" (P.244).
Energy Saver Settings		Allows you to configure the settings for the Power Saver feature.
Stored Job Settings		Refer to "Stored File Settings" (P.413).
Memory Settings		Refer to "Allocate Memory" (P.380).
Web Browser Setup		Refer to "Web Browser Setup" (P.419).
Dell Printer Configuration Web Tool Settings		Allows you to configure the auto refresh interval and the display language of the Dell Printer Configuration Web Tool settings.
Pool Server Settings		Leave the default settings unchanged because a pool server is not available for the machine. Refer to "Job Flow Service Settings" (P.411).
Web Applications Service Setup		Refer to "Web Applications Service Setup" (P.415).

Item	How to Select	Overview/Reference
Cloning	Select from [Properties] tab > [General Setup]	Allows you to save the settings of the machine in a file, and copy the file to the other machine of the same model but not to the other models.
Notify Job Completion by E-mail	Select from [Properties] tab > [General Setup] > [Alert Notification]	Refer to "Notify Job Completion by E-mail" (P.333).
E-mail Notification for Machine Status		Allows you to configure the recipient of the notification and a status of which to be notified.
Port Settings	Select from [Properties] tab > [Connectivity]	Refer to "Port Settings" (P.358).
Physical Connections		Refer to "Port Settings" (P.358).
Protocols		Refer to "Protocol Settings" (P.363).
Language Emulations	Select from [Properties] tab > [Services] > [Printing]	Refer to "Print Mode" (P.285).
E-mail	Select from [Properties] tab > [Services]	Refer to "E-mail/Internet Fax Service Settings" (P.406).
Internet Fax		Refer to "E-mail/Internet Fax Service Settings" (P.406).
Fax		Refer to "Fax Service Settings" (P.394).
Scan to PC		Refer to "Configuration of Scan to PC" (P.500).
Store & Send Link		Refer to "Configuration of Store & Send Link" (P.506).
Store to USB		Refer to "Store to USB" (P.496).
Media Print		Allows you to enable and disable the Media Print - Text and Media Print - Photos services.
USB		Allows you to enable and disable Store to USB, Media Print - Text, and Media Print - Photo settings.
Accounting		Select from [Properties] tab
Authentication Configuration	Select from [Properties] tab > [Security]	Refer to "Authentication" (P.451).
User Details Setup		Refer to "User Details Setup" (P.454).
Create Authorization Groups		Refer to "Create Authorization Groups" (P.453).
Remote Authentication Servers		Refer to "Remote Authentication/Directory Service" (P.369).
IP Filtering		Allows you to configure the IPs to permit access, for IPv4 and IPv6 respectively.
Unbounded Port		Allows you to set unbounded port numbers.
Audit Log		Allows you to enable the Audit Log feature that logs the operation on the machine, and retrieve the audit log.

Item	How to Select	Overview/Reference
Machine Digital Certificate Management	Select from [Properties] tab > [Security]	Allows you to create a self-signed certificate and import a certificate to the machine.
IPSec		Refer to "Configuration of Encryption using IPSec" (P.523).
Certificate Management		Displays the certificates registered on the machine. Also allows you to select, delete, and export of the certificate.
Certificate Revocation Retrieval Settings		Refer to "Certificate Revocation Retrieval Settings" (P.378).
IEEE 802.1x		Refer to "IEEE 802.1x Settings" (P.377).
SSL/TLS Settings		Refer to "SSL/TLS Settings" (P.374).
S/MIME Settings		Refer to "S/MIME Settings" (P.375).
PDF/XPS* Signature Settings		Refer to "PDF/XPS Signature Settings" (P.376).
Watermark		Refer to "Watermark" (P.330)
Force Annotation		Refer to "Force Annotation" (P.332).
Job Status Default		Allows you to configure the display/hide settings for completed and active jobs.
Plug-in Settings		Allows you to configure the settings for plug-ins.
Service Representative Restricted Operation		Allows you to restrict the operation of service representatives. Prevents the machine from being altered by someone impersonating our service representative.
System Administrator Settings		Refer to "System Administrator Settings" (P.450).
Smart Card Settings	Allows you to configure the smart card settings and backup the settings.	

* :XPS stands for XML Paper Specification.

17 Printer Environment Settings

This chapter describes the settings to use the Print feature on the machine.

- **Print Overview**470
- **Installation When Using USB Port**.....473
- **Installation When Using TCP/IP (LPD/Port 9100)**.....475
- **Installation When Using NetWare**478
- **Installation When Using Microsoft Network (SMB)**481
- **Installation When Using Internet Printing Protocol (IPP)**483
- **Installation When Using EtherTalk**485

Print Overview

This machine can be set up as a local printer by directly connecting the machine to a computer using a USB interface cable. Similarly, it can be set up as a network printer by connecting the machine to a network.

Enable the necessary port using the control panel or Dell Printer Configuration Web Tool.

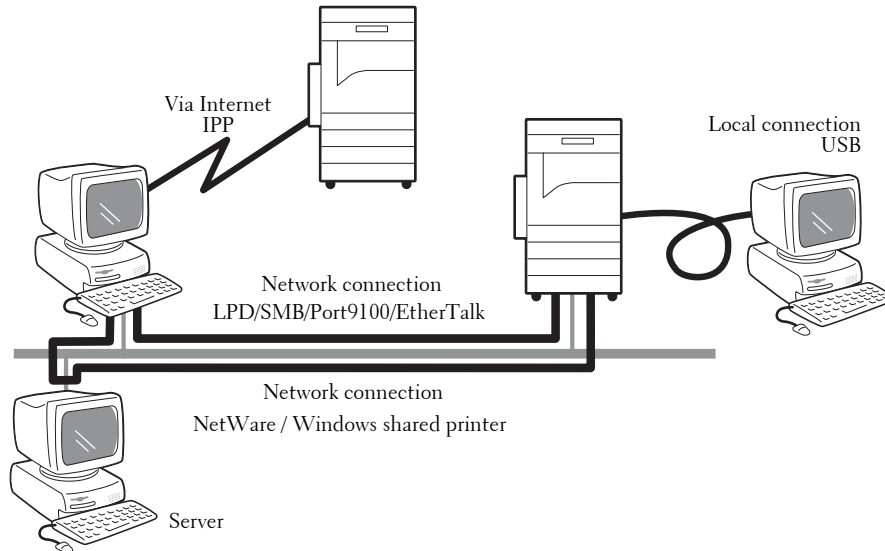

- Note**
- The print drivers are contained in the Driver CD Kit. For information on the driver installation procedures, refer to the manual contained in the Driver CD Kit.
 - You can download the latest print driver from our web site.

Using the Machine as a Local Printer

USB

Use a USB interface cable to directly connect the machine to a computer.

For more information on how to set up the machine using USB connection, refer to "Installation When Using USB Port" (P.473).

Using the Machine as a Network Printer

To set up the machine as a network printer, the following protocols are available to connect the machine.

LPD

Use LPD when direct communication between the machine and a computer via TCP/IP is available.

For more information on how to set up the machine using LPD, refer to "Installation When Using TCP/IP (LPD/Port 9100)" (P.475).

NetWare

The machine supports the PServer mode using Netware directory service and bindery service. The PServer mode enables the machine to function as a printer server, and to retrieve print jobs in the print queue to output. The printer created for the machine consumes one user license of the file server.

- Note**
- The machine does not support Remote Printer (RPrinter) mode.
 - You can use the machine as a printer in a NDPS environment by using a Novell® NDPS Gateway. To use the machine as a printer in a NDPS environment, you need to have the machine operating in a NetWare print environment beforehand, or enable LPD in advance and set it as a gateway destination in a Novell NDPS Gateway setup. Attributes, however, that can be set or obtained by NDPS are not supported.
- Supported interfaces
 - 1000BASE-T
 - 100BASE-TX
 - 10BASE-T
 - Supported frame types
 - Ethernet II specification
 - IEEE802.3 specification
 - IEEE802.3 / IEEE802.2 specification
 - IEEE802.3 / IEEE802.2 / SNAP specification

- Note**
- The machine sends out packets of each frame type on the network, and will initialize for the same frame type as that of the first reply packet received. The frame type can also be fixed. If, however, there are multiple protocols running on the same network, use Ethernet II specification.
 - Some network equipment, such as hubs, may not be compatible with the automatic frame type detection. If a data link indicator corresponding to the port of the network equipment connected with the machine is not lit up, change the frame type settings of the machine accordingly with that of the file server. Use Dell Printer Configuration Web Tool to change these settings.

For more information on how to set up the machine using NetWare, refer to "Installation When Using NetWare" (P.478).

SMB

Use SMB to print using Microsoft Networks.

For more information on how to set up the machine using SMB, refer to "Installation When Using Microsoft Network (SMB)" (P.481).

IPP

Use IPP to print via the Internet.

For more information on how to set up the machine using IPP, refer to "Installation When Using Internet Printing Protocol (IPP)" (P.483).

Port 9100

Use Port9100 when the machine uses Port 9100.

For more information on how to set up the machine using Port 9100, refer to "Installation When Using TCP/IP (LPD/Port 9100)" (P.475).

EtherTalk

Use EtherTalk when you print from a Macintosh computer.

For more information on how to set up the machine using EtherTalk, refer to "Installation When Using EtherTalk" (P.485).

Supported Operating Systems

Connection method		Local connection	Network connection										
Port		USB 2.0*1	LPD	NetWare			SMB		IPP	Port 9100	WSD*2	Ether Talk	Bonjour
Protocol		-	TCP/IP	TCP/IP	IPX/SPX	Net BEUI	TCP/IP	TCP/IP	TCP/IP	WSD*2	Apple Talk	Bonjour	
OS	Windows 2000	○	○	○	○	○	○	○	○				
	Windows XP	○	○	○	○		○	○	○				
	Windows Server 2003	○	○	○	○		○	○	○				
	Windows Server 2008	○	○	○	○		○	○	○				
	Windows Vista	○	○	○	○		○	○	○	○			
	Windows 7	○	○				○	○	○	○			
	Windows 8	○	○				○	○	○	○			
	Windows 8.1	○	○				○	○	○	○			
	Windows Server 2012	○	○				○	○	○	○			
	Mac OS	○*3	○*3							○*3		○*4	○*3

○ : Available

Blank : Not available

*1 : A USB 2.0 port is required on a computer to connect.

*2 : WSD stands for Web Services on Devices.

*3 : Supports Mac OS X 10.5/10.6/10.7/10.8.

*4 : The machine does not support Mac OS X 10.7 Lion.

For information on network environments, refer to the manual contained in the Driver CD Kit.

Installation When Using USB Port

This section describes how to install the machine using a USB interface.

The following shows the reference section for each procedure.

Step 1 Preparations.....	473
Step 2 Configuration on the Machine	473
Step 3 Configuration on the Computer.....	474
Dell Printer Configuration Web Tool Setting Items	474

Step 1 Preparations

The following items are required to connect the machine to a computer via a USB interface.

- USB cable
- The Driver CD Kit (provided with the machine)

Step 2 Configuration on the Machine

The following describes the configuration procedures to use a USB interface on the machine.

- Note**
- To print binary data using a USB interface, set [Adobe Communication Protocol] to [RAW]. For more information, refer to "USB" (P.358).
 - You can configure the settings using Dell Printer Configuration Web Tool. For items that can be configured using Dell Printer Configuration Web Tool, refer to "Dell Printer Configuration Web Tool Setting Items" (P.474).

- 1 Display the [Tools] screen.
 - 1) Press the <Log In/Out> button.
 - 2) Enter the system administrator's user ID with the numeric keypad or the keyboard displayed on the screen, and select [Enter].

When a passcode is required, select [Next] and enter the system administrator's passcode, and select [Enter].

Note

 - The default user ID is "admin".
 - The default passcode is "1111".
 - 3) Select [Tools] on the [Home] screen.
- 2 Enable the USB port on the machine.
 - 1) Select [Port Settings].
 - 2) Select [Connectivity & Network Setup].
 - 3) Select [USB], and then select [Change Settings].
 - 4) Select [Port Status], and then select [Change Settings].
 - 5) Select [Enabled], and then select [Save].
- 3 Configure [Print Mode] or [Auto Eject Time] as necessary.

For information on the setting items, refer to "USB" (P.358)
- 4 Select [Close] repeatedly until the [Tools] screen is displayed.
- 5 Select [Close].

- Note** • Rebooting the machine may be required depending on the settings. When a message displayed on the screen, follow the message and reboot the machine.

6 Print a configuration report to confirm that the USB port is enabled.

For information on how to print a configuration report, refer to "Printer Reports" (P.278).

Step 3 Configuration on the Computer

To print a document from your computer, you need to install a print driver on your computer.

For information on the supported operating systems, refer to "Supported Operating Systems" (P.472).

For information on the driver installation procedures, refer to the manual contained in the Driver CD Kit.

Dell Printer Configuration Web Tool Setting Items

You can configure the following setting items using Dell Printer Configuration Web Tool:

For information on how to start Dell Printer Configuration Web Tool, refer to "Starting Dell Printer Configuration Web Tool" (P.464).

- Receiving buffer size for the USB interface
([Properties] > [General Setup] > [Memory Settings] > [USB])
- Port Settings
- Bi-directional Communication
- Auto Eject Time
- Adobe Communication Protocol
- PostScript Wait Timeout

Installation When Using TCP/IP (LPD/Port 9100)

This section describes how to install the machine using TCP/IP.

The following shows the reference section for each procedure.

Step 1 Preparations.....	475
Step 2 Configuration on the Machine	475
Step 3 Configuration on the Computer.....	476
Dell Printer Configuration Web Tool Setting Items	476

Step 1 Preparations

The following items are required to use the machine via TCP/IP (LPD/Port 9100).

- TCP/IP network environment
- The Driver CD Kit (provided with the machine)

Step 2 Configuration on the Machine

The following describes the configuration procedures to use TCP/IP (LPD/Port 9100) on the machine. Enable the LPD port or the Port 9100 port, and then configure TCP/IP settings.

Note • You can configure the settings using Dell Printer Configuration Web Tool.

For the items that can be configured using Dell Printer Configuration Web Tool, refer to "Dell Printer Configuration Web Tool Setting Items" (P.476).

- 1 Display the [Tools] screen.
 - 1) Press the <Log In/Out> button.
 - 2) Enter the system administrator's user ID with the numeric keypad or the keyboard displayed on the screen, and select [Enter].

When a passcode is required, select [Next] and enter the system administrator's passcode, and select [Enter].

Note • The default user ID is "admin".
• The default passcode is "1111".

 - 3) Select [Tools] on the [Home] screen.
- 2 Enable the LPD port or Port 9100 port as appropriate.
In this example, the LPD port is enabled.
 - 1) Select [Connectivity & Network Setup].
 - 2) Select [Port Settings].
 - 3) Select [LPD], and then select [Change Settings].
 - 4) Select [Port Status], and then select [Change Settings].
 - 5) Select [Enabled], and then select [Save].
 - 6) Select [Close] repeatedly until the [Tools] screen is displayed.
- 3 Set an IP address and the other addresses.
Skip this step if an IP address is already set.
If DHCP or BOOTP is available in your environment, configure the method for obtaining the address. The configuration of an IP address, a subnet mask, and a gateway address is not required.
For information on how to set an IP address, refer to "Protocol Settings" (P.363).

- 4 If the operating system on the client is Mac OS X 10.5 or later, enable the Bonjour port, and the Discovery feature that automatically detects printers on the IP network can be enabled.
Note • To print from a printer detected by Bonjour, the LPD port must be enabled in advance.
 - 1) Select [Connectivity & Network Setup].
 - 2) Select [Port Settings].
 - 3) Select [Bonjour], and then select [Change Settings].
 - 4) Select [Port Status], and then select [Change Settings].
 - 5) Select [Enabled], and then select [Save].
- 5 Select [Close] repeatedly until the [Tools] screen is displayed.
- 6 Select [Close].
Note • Rebooting the machine may be required depending on the settings. When a message displayed on the screen, follow the message and reboot the machine.
- 7 Print a configuration report to confirm that the LPD port is enabled and that TCP/IP is set up correctly.
For information on how to print a configuration report, refer to "Print Reports" (P.276).
- 8 Configure other LPD or Port 9100 settings as necessary.
For information on how to set up the LPD port or Port 9100, refer to "Dell Printer Configuration Web Tool Setting Items" (P.476).

Step 3 Configuration on the Computer

To print from the machine, you need to install a print driver on your computer.

For information on the supported operating systems, refer to "Supported Operating Systems" (P.472).

For information on the driver installation procedures, refer to the manual contained in the Driver CD Kit.

You can print via TCP/IP (LPD) from a Macintosh computer for Mac OS X 10.5/10.6/10.7/10.8. For information on the installation procedures of the print driver for Mac OS X, refer to the manual contained in the CD-ROM provided with the driver.

Dell Printer Configuration Web Tool Setting Items

You can configure the following setting items using Dell Printer Configuration Web Tool:

For information on how to start Dell Printer Configuration Web Tool, refer to "Starting Dell Printer Configuration Web Tool" (P.464).

- Spool Destination for Jobs
([Properties] > [General Setup] > [Memory Settings] > [LPD])
- Note** • The spool destination can be configured when the LPD port is enabled.
- Receiving buffer size for Port 9100
([Properties] > [General Setup] > [Memory Settings] > [Port 9100])
- Port Settings
- IP Mode
- Host Name
- IPv4
 - IP Address Resolution
 - Port Settings
 - IP Address

- Subnet Mask
- Gateway Address
- IPv6
 - Enable Manual Address
 - IP Address
 - Link-Local Address
 - Gateway Address
- Domain Name
- DNS Configuration
 - IPv4
 - IPv6
- DHCP/DDNS
- WINS Server
- Port Number
- TBCP Filter
- Connection Time-Out
- Maximum Number of Sessions

Note • The Maximum Number of Sessions can be configured when the LPD port is enabled.

- TCP-MSS Mode
- IPv4 Subnet Mask when TCP-MSS Mode is enabled
- IP Filtering
 - IPv4 Filtering
 - IPv6 Filtering

Installation When Using NetWare

This section describes how to install the machine using Netware.

The following shows the reference section for each procedure.

Step 1 Preparations	478
Step 2 Configuration on the Machine	478
Step 3 Configuration on the Computer	479
Dell Printer Configuration Web Tool Setting Items.....	480

Step 1 Preparations

The following items are required to set up the machine to use NetWare.

- NetWare server
- TCP/IP or IPX/SPX network environment
- The Driver CD Kit (provided with the machine)

Step 2 Configuration on the Machine

The following describes the configuration procedures to use NetWare on the machine.

Note • You can configure the settings using Dell Printer Configuration Web Tool.

For the items that can be configured using Dell Printer Configuration Web Tool, refer to "Dell Printer Configuration Web Tool Setting Items" (P.480).

Using IPX/SPX

- 1 Display the [Tools] screen.
 - 1) Press the <Log In/Out> button.
 - 2) Enter the system administrator's user ID with the numeric keypad or the keyboard displayed on the screen, and select [Enter].

When a passcode is required, select [Next] and enter the system administrator's passcode, and select [Enter].
- 2 Enable the NetWare port.
 - 1) Select [Connectivity & Network Setup].
 - 2) Select [Port Settings].
 - 3) Select [NetWare], and then select [Change Settings].
 - 4) Select [Port Status], and then select [Change Settings].
 - 5) Select [Enabled], and then select [Save].
- 3 Select [Close] repeatedly until the [Tools] screen is displayed.
- 4 Select [Close].

Note • Rebooting the machine may be required depending on the settings. When a message displayed on the screen, follow the message and reboot the machine.

- 5 Print a configuration report to confirm that the NetWare port is enabled, and confirm the NetWare device name and the network address.

For information on how to print a configuration report, refer to "Print Reports" (P.276).

Using an LPD Port in NDPS

- 1 Display the [Tools] screen.
- 1) Press the <Log In/Out> button.
 - 2) Enter the system administrator's user ID with the numeric keypad or the keyboard displayed on the screen, and select [Enter].
- Note**
- The default user ID is "admin".
 - The default passcode is "1111".
- 3) Select [Tools] on the [Home] screen.
- 2 Enable the LPD port.
- 1) Select [Connectivity & Network Setup].
 - 2) Select [Port Settings].
 - 3) Select [LPD], and then select [Change Settings].
 - 4) Select [Port Status], and then select [Change Settings].
 - 5) Select [Enabled], and then select [Save].
 - 6) Select [Close] repeatedly until the [Tools] screen is displayed.
- 3 Set an IP address and the other addresses.
- Skip this step if an IP address is already set.
- If DHCP or BOOTP is available in your environment, configure the method for obtaining the address. The configuration of an IP address, a subnet mask, and a gateway address is not required.
- For information on how to set an IP address, refer to "Protocol Settings" (P.363).
- 4 Select [Close] repeatedly until the [Tools] screen is displayed.
- 5 Select [Close].
- Note**
- Rebooting the machine may be required depending on the settings. When a message displayed on the screen, follow the message and reboot the machine.
- 6 Print a configuration report to confirm that the LPD port is enabled and that TCP/IP is set up correctly.
- For information on how to print a configuration report, refer to "Print Reports" (P.276).
- Configure other LPD settings as necessary. For information on the LPD settings, refer to "Installation When Using TCP/IP (LPD/Port 9100)" (P.475).

Step 3 Configuration on the Computer

To print from the machine, you need to install a print driver on your computer.

For information on the supported operating systems, refer to "Supported Operating Systems" (P.472).

For information on the driver installation procedures, refer to the manual contained in the Driver CD Kit.

Dell Printer Configuration Web Tool Setting Items

You can configure the following setting items using Dell Printer Configuration Web Tool:
For information on how to start Dell Printer Configuration Web Tool, refer to "Starting Dell Printer Configuration Web Tool" (P.464).

- Receiving buffer size for the NetWare interface
([Properties] > [General Setup] > [Memory Settings] > [NetWare])
- Port Settings
- Transport Protocol (IPX/SPX) Frame Type
- Queue Poll Interval
- Printer Server Name
- Password
- Active Mode
- Number of Searches
- TBCP Filter
- File Server Name

Note • The File Server Name can be configured when the operation mode is in Bindery Service.

- NDS[®] Tree/NDS Context

Note • The DNS Tree/NDS Context can be configured only when the operation mode is in Bindery Service.

- SLP Active Discovery
 - Version
 - Active Discovery
 - Use SLP for Name Resolution
 - Scope
 - SLP Server

Installation When Using Microsoft Network (SMB)

This section describes how to install the machine using Microsoft Network (SMB).

The following shows the reference section for each procedure.

Step 1 Preparations.....	481
Step 2 Configuration on the Machine	481
Step 3 Configuration on the Computer.....	482
Dell Printer Configuration Web Tool Setting Items	482

Step 1 Preparations

The following items are required to set up the machine to use Microsoft Network (SMB).

- NetWare server
- TCP/IP or NetBEUI network environment
- The Driver CD Kit (provided with the machine)

Step 2 Configuration on the Machine

The following describes the configuration procedures to use Microsoft Networks (SMB) on the machine. Enable the LPD Port, and then configure TCP/IP settings.

Note • You can configure the settings using Dell Printer Configuration Web Tool.

For the items that can be configured using Dell Printer Configuration Web Tool, refer to "Dell Printer Configuration Web Tool Setting Items" (P.482).

1 Display the [Tools] screen.

- 1) Press the <Log In/Out> button.
- 2) Enter the system administrator's user ID with the numeric keypad or the keyboard displayed on the screen, and select [Enter].

When a passcode is required, select [Next] and enter the system administrator's passcode, and select [Enter].

Note • The default user ID is "admin".
• The default passcode is "1111".

- 3) Select [Tools].

2 Enable the SMB port.

- 1) Select [Connectivity & Network Setup].
- 2) Select [Port Settings].
- 3) Select [SMB], and then select [Change Settings].
- 4) Select [Port Status], and then select [Change Settings].
- 5) Select [Enabled], and then select [Save].
- 6) Select [Close] repeatedly until the [Tools] screen is displayed.

3 Set an IP address and the other addresses.

Skip this step if an IP address is already set.

If DHCP or BOOTP is available in your environment, configure the method for obtaining the address. The configuration of an IP address, a subnet mask, and a gateway address is not required.

For information on how to set an IP address, refer to "Protocol Settings" (P.363).

4 Select [Close] repeatedly until the [Tools] screen is displayed.

5 Select [Close].

Note • Rebooting the machine may be required depending on the settings. When a message displayed on the screen, follow the message and reboot the machine.

6 Print a configuration report to confirm that the SMB port is enabled and that TCP/IP is set up correctly.

For information on how to print a configuration report, refer to "Print Reports" (P.276).

Note • If NetBEUI protocol is used as the transport protocol, select [NetBEUI] on the [Port Settings] screen for SMB in Dell Printer Configuration Web Tool.

7 Configure the other SMB settings as necessary.

For information on the SMB settings, refer to "Dell Printer Configuration Web Tool Setting Items" (P.482).

Step 3 Configuration on the Computer

To print from the machine, you need to install a print driver on your computer.

For information on the supported operating systems, refer to "Supported Operating Systems" (P.472).

For information on the driver installation procedures, refer to the manual contained in the Driver CD Kit.

Dell Printer Configuration Web Tool Setting Items

You can configure the following setting items using Dell Printer Configuration Web Tool:

For information on how to start Dell Printer Configuration Web Tool, refer to "Starting Dell Printer Configuration Web Tool" (P.464).

- Spool Destination for Jobs
([Properties] > [General Setup] > [Memory Settings] > [SMB])
- Port Settings
- Transport Protocol
- Maximum Connections
- Workgroup
- Server Name
- TBCP Filter
- Unicode® Support
- Auto Master Mode
- Password Encryption
- Obtain WINS Server Address Automatically
- Primary Server IP Address & Port
- Secondary Server IP Address & Port

Installation When Using Internet Printing Protocol (IPP)

This section describes how to install the machine using Internet Printing Protocol (IPP).

The following shows the reference section for each procedure.

Step 1 Preparations.....	483
Step 2 Configuration on the Machine	483
Step 3 Configuration on the Computer.....	484
Dell Printer Configuration Web Tool Setting Items	484

Note • If the size of print data sent via IPP is larger than the value set in the proxy server, the machine cannot receive the data. In this case, set a larger value in the proxy server or change your browser setting not to use the proxy server.

Step 1 Preparations

The following items are required to set up the machine to use Internet Printing Protocol (IPP).

- TCP/IP network environment
- The Driver CD Kit (provided with the machine)

Step 2 Configuration on the Machine

The following describes the configuration procedures to use Internet Printing Protocol (IPP) on the machine. Enable the IPP port, and then configure TCP/IP settings.

Note • You can configure the settings using Dell Printer Configuration Web Tool.

For the items that can be configured using Dell Printer Configuration Web Tool, refer to "Dell Printer Configuration Web Tool Setting Items" (P.484).

1 Display the [Tools] screen.

- 1) Press the <Log In/Out> button.
- 2) Enter the system administrator's user ID with the numeric keypad or the keyboard displayed on the screen, and select [Enter].

When a passcode is required, select [Next] and enter the system administrator's passcode, and select [Enter].

Note • The default user ID is "admin".

• The default passcode is "1111".

- 3) Select [Tools] on the [Home] screen.

2 Enable the IPP port.

- 1) Select [Connectivity & Network Setup].
- 2) Select [Port Settings].
- 3) Select [IPP], and then select [Change Settings].
- 4) Select [Port Status], and then select [Change Settings].
- 5) Select [Enabled], and then select [Save].
- 6) Select [Close] repeatedly until the [Tools] screen is displayed.

- 3 Set an IP address and the other addresses.
Skip this step if an IP address is already set.
If DHCP or BOOTP is available in your environment, configure the method for obtaining the address. The configuration of an IP address, a subnet mask, and a gateway address is not required.
For information on how to set an IP address, refer to "Protocol Settings" (P.363).
- 4 Select [Close] repeatedly until the [Tools] screen is displayed.
- 5 Select [Close].
Note • Rebooting the machine may be required depending on the settings. When a message displayed on the screen, follow the message and reboot the machine.
- 6 Print a configuration report to confirm that the IPP port is enabled and that TCP/IP is set up correctly.
For information on how to print a configuration report, refer to "Print Reports" (P.276).
- 7 Configure other IPP settings as necessary.
Refer to "Dell Printer Configuration Web Tool Setting Items" (P.484).

Step 3 Configuration on the Computer

To print from the machine, you need to install a print driver on your computer.
For information on the supported operating systems, refer to "Supported Operating Systems" (P.472).
For information on the driver installation procedures, refer to the manual contained in the Driver CD Kit.

Dell Printer Configuration Web Tool Setting Items

You can configure the following setting items using Dell Printer Configuration Web Tool:
For information on how to start Dell Printer Configuration Web Tool, refer to "Starting Dell Printer Configuration Web Tool" (P.464).

- Spool Destination for Jobs
([Properties] > [General Setup] > [Memory Settings] > [IPP])
- Port Settings
- Add Port Number
- TBCP Filter
- Administrator Mode
- DNS
- Connection Time-Out

Installation When Using EtherTalk

This section describes how to install the machine using EtherTalk.

The following shows the reference section for each procedure.

Step 1 Preparations.....	485
Step 2 Configuration on the Machine	485
Step 3 Configuration on the Computer.....	486
Dell Printer Configuration Web Tool Setting Items	486

Step 1 Preparations

The following items are required to set up the machine to use the EtherTalk interface.

- EtherTalk network environment

Step 2 Configuration on the Machine

The following describes the configuration procedures to use EtherTalk on the machine.

Note • You can configure the settings using Dell Printer Configuration Web Tool. For the items that can be configured using Dell Printer Configuration Web Tool, refer to "Dell Printer Configuration Web Tool Setting Items" (P.486).

1 Display the [Tools] screen.

- 1) Press the <Log In/Out> button.
- 2) Enter the system administrator's user ID with the numeric keypad or the keyboard displayed on the screen, and select [Enter].

When a passcode is required, select [Next] and enter the system administrator's passcode, and select [Enter].

Note • The default user ID is "admin".
• The default passcode is "1111".

- 3) Select [Tools] on the [Home] screen.

2 Enable the EtherTalk port.

- 1) Select [Connectivity & Network Setup].
- 2) Select [Port Settings].
- 3) Select [EtherTalk], and then select [Change Settings].
- 4) Select [Port Status], and then select [Change Settings].
- 5) Select [Enabled], and then select [Save].

3 Select [Close] repeatedly until the [Tools] screen is displayed.

4 Select [Close].

Note • Rebooting the machine may be required depending on the settings. When a message displayed on the screen, follow the message and reboot the machine.

5 Print a configuration report to confirm that the EtherTalk port is enabled.

For information on how to print a configuration report, refer to "Print Reports" (P.276).

6 Configure other EtherTalk settings as necessary.

For information on the EtherTalk settings, refer to "Dell Printer Configuration Web Tool Setting Items" (P.486).

Step 3 Configuration on the Computer

To print from the machine, you need to install a print driver on your computer.
For information on the supported operating systems, refer to "Supported Operating Systems" (P.472).

Dell Printer Configuration Web Tool Setting Items

You can configure the following setting items using Dell Printer Configuration Web Tool:
For information on how to start Dell Printer Configuration Web Tool, refer to "Starting Dell Printer Configuration Web Tool" (P.464).

- Receiving buffer size for the AppleTalk interface
([Properties] > [General Setup] > [Memory Settings] > [EtherTalk])
- Port Settings
- Printer Name
- Zone Name

18 E-mail Environment Settings

This chapter describes the settings to use various services via e-mail on the machine.

- **E-mail Overview**488
- **Preparations**489
- **Installation Procedures**.....491

E-mail Overview

The machine can send and receive e-mails.

The following services and features are available using e-mail:

- E-mail
- Store & Send Link
- Internet Fax Service
- Print E-mail
- E-mail Notification (Consumable Status)
- Job Completion Notice

E-mail

Scanned documents can be converted into electronic form and transmitted via e-mail.

Store & Send Link

The machine can convert a document scanned by a user authenticated by the machine into electronic form, store it in the hard disk, and send a URL that indicates the location of the document.

Internet Fax Service

Unlike the normal fax transmissions via telephone lines, faxed data is transmitted via a corporate intranet or the Internet as an e-mail attachment.

The message body of e-mail is processed according to the settings in [Incoming Internet Fax Print Options] of Dell Printer Configuration Web Tool.

Print E-mail

You can send and transfer e-mails with files attached from computers. File formats that can be attached to the e-mails are TIFF, PDF, JPEG (JFIF), and XPS.

The message body of e-mail is processed according to the settings in [Incoming E-mail Print Options] of Dell Printer Configuration Web Tool.

Note • XPS stands for XML Paper Specification.

E-mail Notification (Consumable Status)

The machine can notify the status information such as consumable status, parts status, and paper tray status that is set in [E-mail Notification for Machine Status] of Dell Printer Configuration Web Tool to a specified recipient. By receiving the statuses of consumables periodically or when they need to be replaced soon, you can properly determine when to replace the toner and drum cartridges.

It is recommended that you register the address of the system administrator or a shared address as the recipient of the e-mail.

Job Completion Notice

The following methods can be used to notify the completion of the jobs. Register the address of the network administrator or a shared address as necessary.

- Notify the Completion of Jobs by E-mail

When a computer submitted a print job or a Direct Fax job to the machine, its completion can be notified by e-mail. For more information, refer to the help of the print driver.

- Notify Job Completion by E-mail

You can receive the result of the jobs performed by e-mail. For more information, refer to "Notify Job Completion by E-mail" (P.333).

- E-mail Notification

You can receive an e-mail notification when a file is saved in a folder or a job flow ends. For more information, refer to "E-mail Notification" (P.430).

Preparations

The following items must be set to use the E-mail feature.

For more information on the preparations to use the Internet Fax feature, refer to "Preparations" (P.512).

Configuration on the Machine

Item	Description	E-mail	Store & Send Link	Print E-mail		E-mail Notification	Job Completion Notice
				via SMTP	via POP3		
TCP/IP address	The TCP/IP address for the machine. E-mails are sent via TCP/IP.	○	○	○	○	○	○
Subnet mask	Required when the network is divided into subnets.	△	△	△	△	△	△
Gateway address	Required when multiple networks are connected by gateways.	△	△	△	△	△	△
Machine e-mail address	Set the E-mail address of the machine.	○	○	○	○	○	○
DNS server address	Required when the addresses for a POP3 server and an SMTP server are set with a domain name format instead of their IP addresses. You can also acquire this from DHCP.	△	△	△	△	△	△
SMTP server address	The machine uses an SMTP server to send e-mails. The SMTP server can also be used for receiving e-mails.	○	○	○	△	○	○
SMTP AUTH login name and password	If an SMTP server requires authentication, specify an authentication user name. Also specify a password as required.	△	△	△	△	△	△

Item	Description	E-mail	Store & Send Link	Print E-mail		E-mail Notification	Job Completion Notice
				via SMTP	via POP3		
POP3 server	Set the POP3 server address.	Δ	Δ	-	○	Δ	Δ
POP login name and password	Set the POP receiving user name. Also specify a password as required.	Δ	Δ	-	○	Δ	Δ
S/MIME settings	Set the S/MIME information.	Δ	X	Δ	Δ	X	X

- :Required to be set
 Δ :Set as required
 - :Not required to be set
 X :Not supported

Note • To transmit e-mails encrypted by S/MIME or with digital signatures attached, a certificate must be ready in advance. For more information on a certificate, refer to "Configuration of E-mail Encryption/ Digital Signature" (P.526).

Configuration on the Server

Note • Information on server settings, contact your System Administrator.

Item	Description	E-mail	Store & Send Link	Print E-mail		E-mail Notification	Job Completion Notice
				via SMTP	via POP3		
Machine e-mail address	When using the E-mail feature on the machine, an e-mail account of the machine must be registered on a mail server in advance.	○	○	○	○	○	○
Host name	Set the host name and domain name of the machine along with the TCP/IP address for the machine on the DNS server.	Δ	Δ	Δ	Δ	Δ	Δ
Domain name		Δ	Δ	Δ	Δ	Δ	Δ

- :Required to be set
 Δ :Set as required

Installation Procedures

This section describes how to configure the machine to use the E-mail service.

The following shows the reference section for each procedure.

Step 1 Enabling Port and Setting up TCP/IP	491
Step 2 Configuring E-mail Environment	492
Dell Printer Configuration Web Tool Setting Items	494

Step 1 Enabling Port and Setting up TCP/IP

Enable the E-mail port, and set the IP address.

Note • You can configure the settings using Dell Printer Configuration Web Tool. For information on how to use Dell Printer Configuration Web Tool, refer to "Dell Printer Configuration Web Tool Settings" (P.461).

- 1 Display the [Tools] screen.
 - 1) Press the <Log In/Out> button.
 - 2) Enter the system administrator's user ID with the numeric keypad or the keyboard displayed on the screen, and select [Enter].

When a passcode is required, select [Next] and enter the system administrator's passcode, and select [Enter].

Note • The default user ID is "admin".
• The default passcode is "1111".

 - 3) Select [Tools] on the [Home] screen.
- 2 Enable ports to use for the E-mail feature.
 - 1) Select [Connectivity & Network Setup].
 - 2) Select [Port Settings].
 - 3) Select [Send E-mail], and then select [Change Settings].
 - 4) Select [Port Status], and then select [Change Settings].
 - 5) Select [Enabled], and then select [Save].
 - 6) Select [Close].
 - 7) Select [Enabled] on the [Receive E-mail - Port Status] screen under [Receive E-mail] as described above to use the Print E-mail feature.
 - 8) Select [Enabled] on the [E-mail Notification - Port Status] screen under [E-mail Notification Service] as described above to use the E-mail Notification or the Job Completion Notification feature.
 - 9) Select [Close] repeatedly until the [Tools] screen is displayed.
- 3 Set an IP address and the other addresses.

Skip this step if an IP address is already set.

If DHCP or BOOTP is available in your environment, configure the method for obtaining the address. If an IP address cannot be obtained automatically or manual configuration is preferred, confirm the settings of an IP address, a subnet mask, and a gateway address.

For information on how to set an IP address, refer to "Protocol Settings" (P.363).
- 4 Select [Close] repeatedly until the [Tools] screen is displayed.
- 5 Select [Close].

- Note**
- Rebooting the machine may be required depending on the settings. When a message displayed on the screen, follow the message and reboot the machine.

- 6 Print a configuration report to confirm that the ports are enabled and that TCP/IP is set up correctly.

For information on how to print a configuration report, refer to "Print Reports" (P.276).

Step 2 Configuring E-mail Environment

The following describes the configuration procedures to use the E-mail features.

You can configure the settings using Dell Printer Configuration Web Tool. For the items that can be configured using Dell Printer Configuration Web Tool, refer to "Dell Printer Configuration Web Tool Setting Items" (P.494).

For information on how to start Dell Printer Configuration Web Tool, refer to "Starting Dell Printer Configuration Web Tool" (P.464).

- 1 Display the [Tools] screen.

- 1) Press the <Log In/Out> button.
- 2) Enter the system administrator's user ID with the numeric keypad or the keyboard displayed on the screen, and select [Enter].

When a passcode is required, select [Next] and enter the system administrator's passcode, and select [Enter].

- Note**
- The default user ID is "admin".
 - The default passcode is "1111".

- 3) Select [Tools] on the [Home] screen.

- 2 Set up the e-mail address of the machine.

- 1) Select [Connectivity & Network Setup].
- 2) Select [Machine's E-mail Address/Host Name], and then configure items.

For information on how to set an e-mail address, refer to "Machine's E-mail Address/Host Name" (P.366).

- 3) Select [Close] repeatedly until the [Tools] screen is displayed.

- 3 Set up the protocol to receive e-mails.

- 1) Select [Connectivity & Network Setup].
- 2) Select [Other Settings].
- 3) Select [Protocol to Receive E-mail], and then select [Change Settings].
- 4) Select either [SMTP] or [POP3] as appropriate for your environment.
- 5) Select [Save].
- 6) Select [Close] repeatedly until the [Tools] screen is displayed.

- 4 Configure the server settings for receiving e-mails.

- 1) Select [Connectivity & Network Setup].
- 2) Select [Outgoing/Incoming E-mail Settings].

When [SMTP] is selected for [Protocol to Receive E-mail]

Configure the SMTP server.

For information on how to configure the SMTP server, refer to "SMTP Server Settings" (P.368).

For information on how to set the machine's e-mail address when you receive e-mails via SMTP, refer to "Machine's E-mail Address/Host Name" (P.366).

For information on how to set the machine's e-mail address when you receive e-mails via SMTP, refer to "Machine's E-mail Address/Host Name" (P.366)

When [POP3] is selected for [Protocol to Receive E-mail]

Configure the POP3 server.

For information on how to configure the POP3 server, refer to "POP3 Server Settings" (P.368).

For information on how to set the machine's e-mail address when you receive e-mails via POP3, refer to "Machine's E-mail Address/Host Name" (P.366)

5 Configure the server settings for sending e-mails.

Note • To send e-mails, SMTP server settings are required. When [POP3] is selected in [Protocol to Receive E-mail], configure the SMTP server in [Outgoing/Incoming E-mail Settings].

For information on how to configure the e-mail transmission, refer to "SMTP Server Settings" (P.368).

6 Select [Close] repeatedly until the [Tools] screen is displayed.**7** Configure the domain filtering for receiving e-mails as necessary.

For information on how to configure the domain filtering, refer to "Domain Filtering" (P.379).

8 Set up the S/MIME information.

1) Select [Connectivity & Network Setup].

2) Select [Security Settings].

3) Select [S/MIME Settings], and then set the items.

For more information on how to configure S/MIME, refer to "S/MIME Settings" (P.375).

9 Select [Close] repeatedly until the [Tools] screen is displayed.**10** Select [Close].

Note • Rebooting the machine may be required depending on the settings. When a message displayed on the screen, follow the message and reboot the machine.

11 Print a configuration report to confirm that the settings of each item.

For information on how to print a configuration report, refer to "Print Reports" (P.276).

Dell Printer Configuration Web Tool Setting Items

You can configure the following setting items using Dell Printer Configuration Web Tool:
For information on how to start Dell Printer Configuration Web Tool, refer to "Starting Dell Printer Configuration Web Tool" (P.464).

- Machine's E-mail Address
- Setup E-mail Notification
- Port Settings
- SMTP Server Settings
- POP3 Server Settings
- Receiving Protocol
- Domain Filtering
- S/MIME Settings

19 Scanner Environment Settings

- **Scan Service Overview.....496**
- **Configuration of Store to Folder498**
- **Configuration of Scan to PC500**
- **Configuration of Store to USB503**
- **Configuration of Job Flow Sheets504**
- **Configuration of Store & Send Link506**
- **Configuration of Store to WSD.....508**

Scan Service Overview

The machine is equipped with scanning capabilities.

The following scan services are available on the machine:

- E-mail
- Store to Folder
- Scan to PC
- Store to USB
- Job Flow Scanning
- Store & Send Link
- Store to WSD

Note • WSD stands for Web Services on Devices.

E-mail

Scanned documents can be converted into electronic data and sent via e-mail.

For information on e-mail environment settings, refer to "E-mail Environment Settings" (P.487).

Store to Folder

You can scan a document you want to retrieve as electronic data, and store it in a folder. The document can be accessed later from any computers on the network.

For information on the Store to Folder service, refer to "Configuration of Store to Folder" (P.498).

Scan to PC

When the machine is connected to a network, you can store the scanned data on network computers using the FTP or SMB protocol.

You can scan a document you want to retrieve as electronic data, and store it on a computer connected to a network.

For information on the Scan to PC service, refer to "Configuration of Scan to PC" (P.500).

Store to USB

You can store the scanned data to a USB memory device when you insert the USB 2.0 memory device into the USB memory slot of the control panel of the machine. You can also select data stored in the USB memory device and print the data directly.

For information on the Store to USB service settings, refer to "Configuration of Store to USB" (P.503).

Job Flow Scanning

You can scan a document with a job flow process from a computer on a network.

For information on how to configure job flow scanning, refer to "Configuration of Job Flow Sheets" (P.504).

Store & Send Link

The machine can convert a scanned document into electronic form, store it in the hard disk, and send a URL that indicates the location of the document.

Note • To use the Store & Send Link feature, you need to configure the authentication settings.

For information on the Store & Send Link service, refer to "Configuration of Store & Send Link" (P.506).

Store to WSD

You can scan and store the document by operation from a computer on the network. To specify the destination computer, use the control panel of the machine.

Note • WSD stands for Web Services on Devices.

For more information on the Store to WSD service, refer to "Configuration of Store to WSD" (P.508).

Configuration of Store to Folder

This section describes configuration procedures to use the Store to Folder service on the machine.

The following shows the reference section for each procedure.

Step 1 Enabling Port and Setting up TCP/IP.....	498
Step 2 Registering a Folder.....	499
Step 3 Configuring on the Computer.....	499

Step 1 Enabling Port and Setting up TCP/IP

To use Dell Network Scanner Utility 3 (Scan Driver and Stored File Manager 3), which supports WebDAV protocol, enable the WebDAV, SNMP, and SOAP ports and set up an IP address.

Note • You can configure the settings using Dell Printer Configuration Web Tool. For information on how to use Dell Printer Configuration Web Tool, refer to "Configuring Machine Settings Using Dell Printer Configuration Web Tool" (P.465).

1 Display the [Tools] screen.

- 1) Press the <Log In/Out> button.
- 2) Enter the system administrator's user ID with the numeric keypad or the keyboard displayed on the screen, and select [Enter].

When a passcode is required, select [Next] and enter the system administrator's passcode, and select [Enter].

Note • The default user ID is "admin".
• The default passcode is "1111".

3) Select [Tools] on the [Home] screen.

2 Enable the ports.

- 1) Select [Connectivity & Network Setup].
- 2) Select [Port Settings].
- 3) Select [SNMP], and then select [Change Settings].
- 4) Select [Port Status], and then select [Change Settings].
- 5) Select [Enabled], and then select [Save].
- 6) Select [Close].
- 7) Select [SOAP], and then select [Change Settings].
- 8) Select [Port Status], and then select [Change Settings].
- 9) Select [Enabled], and then select [Save].
- 10) Select [Close].
- 11) Select [WebDAV], and then select [Change Settings].
- 12) Select [Port Status], and then select [Change Settings].
- 13) Select [Enabled], and then select [Save].
- 14) Select [Close] repeatedly until the [Tools] screen is displayed.

- 3** Set an IP address and the other addresses.
Skip this step if an IP address is already set.
If DHCP or BOOTP is available in your environment, configure the method for obtaining the address. If an IP address cannot be obtained automatically or manual configuration is preferred, confirm the settings of an IP address, a subnet mask, and a gateway address.
For information on how to set an IP address, refer to "Protocol Settings" (P.363).
- 4** Select [Close] repeatedly until the [Tools] screen is displayed.
- 5** Select [Close].
Note • Rebooting the machine may be required depending on the settings. When a message displayed on the screen, follow the message and reboot the machine.
- 6** Print a configuration report to confirm that the WebDAV port is enabled and that TCP/IP is set up correctly.
For information on how to print a configuration report, refer to "Print Reports" (P.276).

Step 2 Registering a Folder

Register a folder to store scanned data.

For information on registering a folder, refer to "Create Folder" (P.421).

Step 3 Configuring on the Computer

To use Dell Network Scanner Utility 3, install Dell Network Scanner Utility 3 on a computer. Dell Network Scanner Utility 3 is included in the Driver CD Kit provided with the machine. For information on how to install the Dell Network Scanner Utility 3, refer to the manual contained in the Driver CD Kit.

Configuration of Scan to PC

This section describes how to configure the machine to use the Scan to PC service.

The following shows the reference section for each procedure.

Step 1 Preparations	500
Step 2 Enabling Port and Setting up TCP/IP	501
Step 3 Configuration on the Computer	502

Step 1 Preparations

The following items are required to use the Scan to PC feature.

Using FTP

To transfer data via FTP, one of the following FTP servers and an account to the FTP server (login name and password) are required.

- Microsoft Windows Server 2003, Microsoft Windows Server 2008, Microsoft Windows Server 2008 R2, Microsoft Windows Vista, Microsoft Windows 7, Microsoft Windows 8, and Microsoft Windows 8.1

FTP service of Microsoft Internet Information Server 6.0

- Microsoft Windows 2000 Server, Microsoft Windows 2000 Professional, or Microsoft Windows XP

FTP service of Microsoft Internet Information Server 3.0 or later

- Mac OS X

FTP service of Mac OS X 10.2.X/10.3.8/10.3.9/10.4.2/10.4.4/10.4.8/10.4.9/10.4.10/10.4.11/10.5/10.6

- Novell NetWare

FTP service of NetWare 5.11 or 5.12

For information on how to configure the FTP service, refer to the manual provided with the software.

For information on how to configure the settings on Mac OS X v10.7 Lion, refer to the official website of Apple Inc.

Using SMB

To transfer data via SMB, your computer must run on one of the following operating systems that includes folder sharing.

For Mac OS X, a shared user account is required on the Mac OS X.

- Microsoft Windows 2000
- Microsoft Windows Server 2003
- Microsoft Windows Server 2008
- Microsoft Windows Server 2008 R2
- Microsoft Windows XP
- Microsoft Windows Vista
- Microsoft Windows 7
- Microsoft Windows 8
- Microsoft Windows 8.1

- Mac OS X 10.2.x/10.3.x/10.4.x/10.5/10.6

Step 2 Enabling Port and Setting up TCP/IP

To use Scan to PC service, enable the port (SMB or FTP client) and set the IP address. The following describes the configuration procedures on the machine.

Note • You can configure the settings using Dell Printer Configuration Web Tool. For information on how to use Dell Printer Configuration Web Tool, refer to "Configuring Machine Settings Using Dell Printer Configuration Web Tool" (P.465).

1 Display the [Tools] screen.

- 1) Press the <Log In/Out> button.
- 2) Enter the system administrator's user ID with the numeric keypad or the keyboard displayed on the screen, and select [Enter].

When a passcode is required, select [Next] and enter the system administrator's passcode, and select [Enter].

Note • The default user ID is "admin".
• The default passcode is "1111".

- 3) Select [Tools] on the [Home] screen.

2 Enable the port.

Using SMB

Enable the SMB port.

- 1) Select [Connectivity & Network Setup].
- 2) Select [Port Settings].
- 3) Select [SMB], and then select [Change Settings].
- 4) Select [Port Status], and then select [Change Settings].
- 5) Select [Enabled], and then select [Save].
- 6) Select [Close] repeatedly until the [Tools] screen is displayed.

Using FTP

Enable the FTP port.

- 1) Select [Connectivity & Network Setup].
- 2) Select [Port Settings].
- 3) Select [FTP Client], and then select [Change Settings].
- 4) Select [Port Status], and then select [Change Settings].
- 5) Select [Enabled], and then select [Save].
- 6) Select [Close] repeatedly until the [Tools] screen is displayed.

3 Set the IP address of the machine and the other addresses.

Skip this step if an IP address is already set.

If DHCP or BOOTP is available in your environment, configure the method for obtaining the address. If an IP address cannot be obtained automatically or manual configuration is preferred, confirm the settings of an IP address, a subnet mask, and a gateway address.

For information on how to set an IP address, refer to "Protocol Settings" (P.363).

4 Select [Close] repeatedly until the [Tools] screen is displayed.

5 Select [Close].

Note • Rebooting the machine may be required depending on the settings. When a message displayed on the screen, follow the message and reboot the machine.

6 Print a configuration report to confirm that the SMB port or FTP client is enabled and that TCP/IP is set up correctly.

For information on how to print a configuration report, refer to "Print Reports" (P.276).

Step 3 Configuration on the Computer

Create a destination folder on your computer.

- Using FTP

Create a destination folder on the server where you login and set write rights on the folder.

- Using SMB

Create a shared folder on your computer and set the write rights on the shared folder.

Note • To use SMB on Mac OS X, set [Windows Sharing] to [On] in the [Service] tab of [Sharing] under [System Preferences].

Configuration of Store to USB

This section describes how to configure the machine to use the Store to USB service.

The following shows the reference section for each procedure.

Step 1 Available USB Memory Devices.....	503
Step 2 Dell Printer Configuration Web Tool Setting Items.....	503

Step 1 Available USB Memory Devices

The Store to USB service allows you to directly save the scanned data to a USB 2.0 memory device which is inserted into the USB memory slot on the control panel of the machine.

- USB 2.0 memory devices
- USB memory devices with the capacity of up to 128 GB
- USB memory devices that support FAT12, FAT16, FAT32, or VFAT (long name)

Note • USB memory devices that are encrypted with software cannot be used with the machine.

Step 2 Dell Printer Configuration Web Tool Setting Items

You can enable/disable the Store to USB service using Dell Printer Configuration Web Tool. When you disable the service, the Store to USB button is not displayed on the [Home] screen, and you cannot use the service.

The Store to USB service is set to enabled by the factory default.

For information on how to start Dell Printer Configuration Web Tool, refer to "Starting Dell Printer Configuration Web Tool" (P.464).

Configuration of Job Flow Sheets

This section describes how to configure the machine to use the Job Flow Sheets service.

The following shows the reference section for each procedure.

Step 1 Enabling Ports and Setting up TCP/IP	504
Step 2 Configuring the SNMP Port	505
Step 3 Configuration on the Computer	505

Step 1 Enabling Ports and Setting up TCP/IP

To use the Job Flow Sheets service, enable the SOAP, SNMP, and Internet Services (HTTP) ports, and set an IP address and other addresses. The following describes the configuration procedures on the machine.

Note • You can configure the settings using Dell Printer Configuration Web Tool. For information on how to use Dell Printer Configuration Web Tool, refer to "Dell Printer Configuration Web Tool Settings" (P.461).

1 Display the [Tools] screen.

- 1) Press the <Log In/Out> button.
- 2) Enter the system administrator's user ID with the numeric keypad or the keyboard displayed on the screen, and select [Enter].

When a passcode is required, select [Next] and enter the system administrator's passcode, and select [Enter].

Note • The default user ID is "admin".
• The default passcode is "1111".

- 3) Select [Tools] on the [Home] screen.

2 Enable the SOAP port.

- 1) Select [Connectivity & Network Setup].
- 2) Select [Port Settings].
- 3) Select [SOAP], and then select [Change Settings].
- 4) Select [Port Status], and then select [Change Settings].
- 5) Select [Enabled], and then select [Save].
- 6) Select [Close] repeatedly until the [Port Settings] screen is displayed.

3 Enable the SNMP port.

- 1) Select [SNMP], and then select [Change Settings].
- 2) Select [Port Status], and select [Change Settings].
- 3) Select [Enabled], and then select [Save].
- 4) Select [Close] repeatedly until the [Port Settings] screen is displayed.
- 5) Enable the Internet Services (HTTP) port as described above.
- 6) Select [Close] repeatedly until the [Tools] screen is displayed.

4 Set an IP address and the other addresses.

Skip this step if an IP address is already set.

If DHCP or BOOTP is available in your environment, configure the method for obtaining the addresses. If an IP address cannot be obtained automatically or manual configuration is preferred, confirm the settings of an IP address, a subnet mask, and a gateway address.

For information on how to set an IP address, refer to "Protocol Settings" (P.363).

- 5 Select [Close] repeatedly until the [Tools] screen is displayed.
- 6 Select [Close].

Note • Rebooting the machine may be required depending on the settings. When a message displayed on the screen, follow the message and reboot the machine.

- 7 Print a configuration report to confirm that the SOAP, SNMP, and Internet Services (HTTP) ports are enabled and that TCP/IP is set up correctly.

For information on how to print a configuration report, refer to "Print Reports" (P.276).

Step 2 Configuring the SNMP Port

Configure the transport protocol for the SNMP port using Dell Printer Configuration Web Tool.

- 1 Start Dell Printer Configuration Web Tool.

For information on how to start Dell Printer Configuration Web Tool, refer to "Starting Dell Printer Configuration Web Tool" (P.464).

- 2 Configure the transport protocol for the SNMP port.
 - 1) Click the [Properties] tab.
 - 2) Click [Connectivity].
 - 3) Click [Port Settings].
 - 4) Select the [UDP] check box under [SNMP].
 - 5) Click [Apply].
 - 6) The right frame of the web browser changes to the machine reboot display.
 - 7) Click [Reboot Machine]. The machine reboots and the settings are enabled.

Step 3 Configuration on the Computer

Create job flows using Job Flow Editor to use for scanned documents.

Note • Job Flow Editor is included in the Driver CD Kit.

Configuration of Store & Send Link

This section describes how to configure the machine to use the Store & Send Link service.

- Note**
- When a user is notified by e-mail of a URL location to retrieve scanned data, the e-mail message is not encrypted, which enables the user to retrieve the data without password authentication. Thus, in case the URL information is leaked on the e-mail transmission path due to any attempts, other parties to whom the information is leaked cannot be tracked. To prevent others from viewing scanned data, select [PDF] in [File Format] and set a password in [PDF Security] before scanning a document.
 - To use the Store & Send Link service, the configuration for authentication is required.

The following shows the reference section for each procedure.

Step 1 Configuring E-mail.....	506
Step 2 Enabling Authentication.....	506
Step 3 Other Settings.....	506
Step 4 Dell Printer Configuration Web Tool Setting Items	507

Step 1 Configuring E-mail

Configure the e-mail settings on the machine.

For information on how to configure e-mail settings, refer to "E-mail Environment Settings" (P.487).

Step 2 Enabling Authentication

Configure the authentication settings on the machine.

For information on how to configure e-mail settings, refer to "Configuration for Authentication" (P.557).

Step 3 Other Settings

Configure the following items if necessary.

- URL File Expiration
- Generation of URL Link
- Store & Send Link - Maximum File Size
- Print Login Name on PDF Files

For information about URL File Expiration, refer to "URL File Expiration" (P.393).

For information about Generation of URL Link, refer to "Generation of URL Link" (P.393).

For information about Store & Send Link - Maximum File Size, refer to "Store & Send Link - Maximum File Size" (P.393).

For information about Print Logon Name on PDF Files, refer to "Print Login Name on PDF Files" (P.393).

Step 4 Dell Printer Configuration Web Tool Setting Items

You can configure the following items using Dell Printer Configuration Web Tool:

- URL File Expiration
- Generation of URL Link
- Maximum File Size
- Subject
- Message
- Attachment
- Device Information
- Signature

For information on how to start Dell Printer Configuration Web Tool, refer to "Starting Dell Printer Configuration Web Tool" (P.464).

Configuration of Store to WSD

This section describes how to configure the machine to use the Store to WSD service.

Note • WSD stands for Web Services on Devices.

The following shows the reference section for each procedure.

Step 1 Preparations	508
Step 2 Enabling Port	508
Step 3 Confirmation on the Computer	509

Step 1 Preparations

The following environment is required to use the Store to WSD feature on the machine.

- The following operation system must be installed on a destination computer.
 - Microsoft Windows 8
 - Microsoft Windows 7
 - Microsoft Windows Vista Service Pack 2

Note • WSD stands for Web Services on Devices.

Step 2 Enabling Port

To use the Store to WSD service, enable the WSD scan port. The following describes the configuration procedures on the machine.

Note • WSD stands for Web Services on Devices.

- You can configure the settings using Dell Printer Configuration Web Tool. For information on how to use Dell Printer Configuration Web Tool, refer to "Configuring Machine Settings Using Dell Printer Configuration Web Tool" (P.465).

1 Display the [Tools] screen.

- 1) Press the <Log In/Out> button.
- 2) Enter the system administrator's user ID with the numeric keypad or the keyboard displayed on the screen, and select [Enter]. When a passcode is required, select [Next] and enter the system administrator's passcode, and select [Enter].

Note • The default user ID is "admin".

- The default passcode is "1111".

3) Select [Tools] on the [Home] screen.

2 Enable the port.

- 1) Select [Connectivity & Network Setup].
- 2) Select [Port Settings].
- 3) Select [WSD], and then select [Change Settings].
- 4) Select [WSD Scan - Port Status], and then select [Change Settings].
- 5) Select [Enabled], and then select [Save].
- 6) Select [Close] repeatedly until the [Tools] screen is displayed.

3 Select [Close].

Note • Rebooting the machine may be required depending on the settings. When a message displayed on the screen, follow the message and reboot the machine.

- 4 Print a configuration report to confirm that the WSD port is set up correctly.

For information on how to print a configuration report, refer to "Print Reports" (P.276).

Step 3 Confirmation on the Computer

Confirm that the machine name is displayed on the computer as a network device.

On Windows Vista, select [Control Panel] > [Hardware and Sound] > [Scanners and Cameras] (On Windows 7 or later, select [Control Panel] > [Devices and Printers]), and confirm the machine name on the screen.

It is convenient to configure the settings such as the color format, file type, and resolution in [Scan Profiles] and save them in advance.

For more information, refer to Windows Help.

- Note**
- On Windows Vista Home Basic or Home Premium, scanning with [Windows Fax and Scan] is not supported. Use other features such as [From scanner or camera] in [Microsoft Paint] for scanning.

20 Using the Internet Fax Service

This chapter describes the settings to use services via the Internet Fax on the machine.

Note • An optional component is required to use this feature. For more information, contact Customer Support at dell.com/contactdell.

- **Internet Fax Overview**512
- **Preparations**512
- **Installation Procedures**.....514

Internet Fax Overview

When the Fax feature is available, the machine can transmit scanned data as an e-mail attachment using a corporate intranet or the Internet, unlike conventional fax machines which use public phone lines. Also, the machine can receive e-mails transmitted from the Internet Fax-enabled machines.

Preparations

This section describes the prerequisites to use the Internet Fax on the machine.

System Requirements for the Machine

- The machine is connected to a network via TCP/IP.
- The environment is prepared for e-mail transmissions.

E-Mail Environment

To use the Internet Fax feature, configure the following settings for your e-mail environment.

Item	Description	Internet Fax		Internet Fax Direct*
		via SMTP	via POP3	via SMTP
TCP/IP address	TCP/IP address of the machine. TCP/IP protocol is used for e-mail transmissions.	○	○	○
Subnet mask	The subnet mask is required when a network is divided into subnetworks.	△	△	△
Gateway address	The gateway address is required when multiple networks are used via gateways.	△	△	△
The machine's e-mail address	Set the machine's e-mail address.	○	○	○
DNS server address	The address is required when the address of POP3 or SMTP server is set not using an IP address but a domain name. The address can be obtained by DHCP.	△	△	△
SMTP server address	SMTP server is used for sending e-mails from the machine. The SMTP server can also be used for receiving e-mails.	○	○	×
SMTP AUTH login name, password	When a certification-required SMTP server is used, configure a user name for authentication. Set the password as necessary.	△	△	△
POP3 server	Set the POP3 server address.	×	○	×
POP user name	Configure the user name for POP receiving. Set the password as necessary.	×	○	×
S/MIME settings*	Configure S/MIME.	△	△	△

- O :Required
- Δ :Set as required
- X :Not supported

* :When you use the Internet Fax Direct feature, set [Tools] > [System Settings] > [Fax Service Settings] > [Internet Fax Control] > [Internet Fax Path] to [Direct (P2P)].

- Note**
- To transmit e-mails encrypted by S/MIME or with digital signatures attached, a certificate must be ready in advance. For more information on a certificate, refer to "Configuration of E-mail Encryption/Digital Signature" (P.526).

Installation Procedures

This section describes the configuration procedures to use the Internet Fax feature on the machine.

The following shows the reference section for each procedure.

Step 1 Enabling Port and Setting up TCP/IP.....	514
Step 2 Configuring E-mail Environment.....	515
Step 3 Testing the Internet Fax	516

Step 1 Enabling Port and Setting up TCP/IP

To use the Internet Fax feature on the machine, enable the ports for the E-mail feature, and set the IP address. The following shows the configuration procedures on the machine.

Note • You can configure the settings using Dell Printer Configuration Web Tool.

For information on how to use Dell Printer Configuration Web Tool, refer to "Configuring Machine Settings Using Dell Printer Configuration Web Tool" (P.465).

1 Display the [Tools] screen.

- 1) Press the <Log In/Out> button.
- 2) Enter the system administrator's user ID with the numeric keypad or the keyboard displayed on the screen, and select [Enter].

When a passcode is required, select [Next] and enter the system administrator's passcode, and select [Enter].

Note • The default user ID is "admin".
• The default passcode is "1111".

- 3) Select [Tools] on the [Home] screen.

2 Enable ports to use for the E-mail feature.

- 1) Select [Connectivity & Network Setup].
- 2) Select [Port Settings].
- 3) Select [Receive E-mail], and then select [Change Settings].
- 4) Select [Port Status], and then select [Change Settings].
- 5) Select [Enabled], and then select [Save].
- 6) Select [Close].
- 7) Select [Enabled] for [Send E-mail - Port Status] on the [Send E-mail] screen as described above.
- 8) Select [Close] repeatedly until the [Tools] screen is displayed.

3 Set an IP address and the other addresses.

Skip this step if an IP address is already set.

If DHCP or BOOTP is available in your environment, configure the method for obtaining the address. If an IP address cannot be obtained automatically, or if manual configuration is preferred, confirm the settings of an IP address, a subnet mask, and a gateway address.

For information on how to set an IP address, refer to "Protocol Settings" (P.363).

4 Select [Close] repeatedly until the [Tools] screen is displayed.

5 Select [Close].

- Note**
- Rebooting the machine may be required depending on the settings. When a message displayed on the screen, follow the message and reboot the machine.

- 6** Print a configuration report to confirm that the ports are enabled and that TCP/IP is set up correctly.

For information on how to print a Configuration Report, refer to "Print Reports" (P.276).

Step 2 Configuring E-mail Environment

The following describes the configuration procedures to use the E-mail features.

You can configure the settings using Dell Printer Configuration Web Tool. For the items that can be configured using Dell Printer Configuration Web Tool, refer to "Dell Printer Configuration Web Tool Setting Items" (P.494).

For information on how to start Dell Printer Configuration Web Tool, refer to "Starting Dell Printer Configuration Web Tool" (P.464).

- 1** Display the [Tools] screen.

- 1) Press the <Log In/Out> button.
- 2) Enter the system administrator's user ID with the numeric keypad or the keyboard displayed on the screen, and select [Enter].

When a passcode is required, select [Next] and enter the system administrator's passcode, and select [Enter].

- Note**
- The default user ID is "admin".
 - The default passcode is "1111".

- 3) Select [Tools] on the [Home] screen.

- 2** Set up the e-mail address of the machine.

- 1) Select [Connectivity & Network Setup].
- 2) Select [Machine's E-mail Address/Host Name], and then set the items.

For information on how to set an e-mail address, refer to "Machine's E-mail Address/Host Name" (P.366).

- 3) Select [Close] repeatedly until the [Tools] screen is displayed.

- 3** Set up the protocol to receive e-mails.

- 1) Select [Connectivity & Network Setup].
- 2) Select [Other Settings].
- 3) Select [Protocol to Receive E-mail], and then select [Change Settings].
- 4) Select either [SMTP] or [POP3] as appropriate for your environment.
- 5) Select [Save].
- 6) Select [Close] repeatedly until the [Tools] screen is displayed.

- 4** Configure the server settings for receiving e-mails.

- 1) Select [Connectivity & Network Setup].
- 2) Select [Outgoing/Incoming E-mail Settings].

When [SMTP] is selected for [Protocol to Receive E-mail]

Configure the SMTP server.

For information on how to configure the SMTP server, refer to "SMTP Server Settings" (P.368).

For information on how to set the machine's e-mail address when you receive e-mails via SMTP, refer to "Machine's E-mail Address/Host Name" (P.366).

When [POP3] is selected for [Protocol to Receive E-mail]

Configure the POP3 server.

For information on how to configure the POP3 server, refer to "POP3 Server Settings" (P.368).

For information on how to set the machine's e-mail address when you receive e-mails via POP3, refer to "Machine's E-mail Address/Host Name" (P.366).

3) Select [Close].

5 Configure the server settings for sending e-mails.

Note • To send e-mails, SMTP server settings are required. When [POP3] is selected in [Protocol to Receive E-mail], configure the SMTP server in [Outgoing/Incoming E-mail Settings].

For information on how to configure the e-mail transmission, refer to "SMTP Server Settings" (P.368).

6 Configure the domain filtering for sending and receiving e-mails as necessary.

For information on how to configure the domain filtering, refer to "Domain Filtering" (P.379).

7 Set up the S/MIME information.

1) Select [Connectivity & Network Setup].

2) Select [Security Settings].

3) Select [S/MIME Settings], and then set the items.

For more information on how to configure S/MIME settings, refer to "S/MIME Settings" (P.375).

8 Select [Close] repeatedly until the [Tools] screen is displayed.

9 Select [Close].

Note • Rebooting the machine may be required depending on the settings. When a message displayed on the screen, follow the message and reboot the machine.

10 After the machine reboots, you can print a configuration report to confirm that the settings of each item.

For information on how to print a configuration report, refer to "Print Reports" (P.276).

Step 3 Testing the Internet Fax

Test the Internet fax transmission from the machine.

1 Select [Fax/Internet Fax] on the [Home] screen to display the [Fax/Internet Fax] screen.

2 Select [Internet Fax] from the drop-down menu.

3 Enter a destination address.

4 Press the <Start> button to transmit.

5 Check whether the computer received the e-mail.

If the computer cannot receive the e-mail, refer to "Problem Solving" (P.567).

21 Encryption and Digital Signature Settings

This chapter describes the settings to use the Encryption feature and the Digital Signature feature on the machine.

- **Encryption and Digital Signature Overview518**
- **Configuration of HTTP Communications Encryption521**
- **Configuration of Encryption using IPSec523**
- **Configuration of E-mail Encryption/Digital Signature.....526**
- **Configuration of PDF/XPS Signature530**

Encryption and Digital Signature Overview

Types of Certificate

To use the Encryption feature and the Signature feature on the machine, a certificate is required.

The following two types of device certificate can be used on the machine:

- A self-signed certificate created by Dell Printer Configuration Web Tool (The valid period can be specified from 1 to 9,999 days.)
- A certificate issued by another CA

When you use a certificate issued by another CA, import the certificate using Dell Printer Configuration Web Tool.

Types of Certificate / Types of Encryption	Self-Signed Certificate	Certificate Issued by Another CA
Encrypting HTTP communications from a client to the machine (SSL/TLS server)	O	O
Encrypting HTTP communications from the machine to a remote server (SSL/TLS client)	X	O
Encryption using IPsec	X	Δ ^{*1}
E-mail encryption/digital signature	X	O
PDF signature/XPS ^{*2} signature	O	O

O :Available

Δ :Set as necessary

X :Not available

*1 :Available when [IKE Authentication Method] is set to [Authenticate by Digital Signature].

*2 :XPS stands for XML Paper Specification.

Requesting another CA to issue a certificate

If [Create New Certificate] is displayed under [Properties] > [Security] > [Machine Digital Certificate Management] on Dell Printer Configuration Web Tool, you can create a CSR required to get a certificate issued by another CA in the following procedures.

1 Start Dell Printer Configuration Web Tool.

For more information on how to start Dell Printer Configuration Web Tool, refer to "Starting Dell Printer Configuration Web Tool" (P.464).

2 Click the [Properties] tab.

3 Click [Security] to display the items in the folder.

4 Click [Machine Digital Certificate Management].

5 Click [Create New Certificate].

6 Select [Certificate Signing Request (CSR)] and click [Continue].

7 Make the following settings and click [Apply].

- 2 Letter Country Code

- Organization Name
- Organization Unit

Note • Confirm that the e-mail address displayed here is the same with the machine's e-mail address configured in "Machine's E-mail Address/Host Name" (P.366).

8 Click [Download] to save the CSR.

9 E-mail the file to a trusted certificate authority and receive the signed certificate back from them.

Encryption Features for Communication

The data sent between the machine and computers on a network can be encrypted.

Encrypting HTTP Communications from a Client to the Machine (SSL/TLS Server)

The SOAP, Internet Services (HTTP), IPP, and WebDAV ports use the HTTP server of the machine.

The SSL/TLS protocol is used to encrypt the HTTP communications between a client and the machine.

To encrypt communications, either one of the device certificate is required: a self-signed certificate or a certificate issued by another CA.

Note • By encrypting HTTP communications, communications data can be encrypted at the time of printing using IPP (SSL encrypted communications).

Encrypting HTTP Communications from the Machine to a Remote Server (SSL/TLS Client)

The SSL/TLS protocol is used to encrypt the HTTP communications between a remote server and the machine.

No certificate is required in general. However; if a remote server is set to require an SSL client certificate, you can use a certificate issued by another CA.

When verification of server certificates is enabled to verify the SSL/TLS certificate of a remote server, import a certificate issued by another CA using Dell Printer Configuration Web Tool to the machine.

Encryption using IPSec

IPSec enables IP-level (not application-level) encrypted communications with remote devices.

If you select [Authenticate by Digital Signature] for [IKE Authentication Method], a certificate issued by another CA is required.

If you select [Authenticate by Preshared Key], no device certificate is required.

Note • If the certificate for IPSec contains the V3 extension (keyUsage), "digitalSignature" bit must be asserted.

For information on IKE authentication methods, refer to "IKE Authentication Method" (P.377).

To verify the certificate of the remote device, you must register a root certificate created by a CA of the remote device on the machine.

Note • To use certificates that have already been created, import them with Dell Printer Configuration Web Tool.

E-mail Encryption/Digital Signature

S/MIME is used for E-mail Encryption/Digital Signature. To use S/MIME on the machine, S/MIME certificates are used.

For an S/MIME certificate, you can use a certificate issued by another CA.

The personal certificates or the device certificates of destinations are required for encrypted communications.

- Note**
- If the certificate for S/MIME contains an "email Address" or a V3 extension (keyUsage), "digitalSignature" and "keyEncipherment" must be asserted. If the certificate contains v3 extension (extendedKeyUsage), "emailProtection" must be set.

Encryption and Digital-Signature Features for Scan Files

Encrypting PDF Documents

PDF documents can be encrypted and protected by a password.

Encryption/Digital Signature of PDF/XPS Documents

Digital signatures are available for PDF and XPS documents.

To use the digital signature, a device certificate is required.

For a device certificate, you can use any registered certificates.

- Note**
- XPS stands for XML Paper Specification.

Configuration of HTTP Communications Encryption

This section describes the settings to encrypt HTTP communications.

The following shows the reference section for each procedure.

Installation Overview	521
Step1 Configuration on the Machine	521
Step2 Configuration on the Computer.....	522

Installation Overview

To encrypt HTTP communications, configure the machine and your computer as follows:

Configuration on the Machine

Configure a certificate on the machine. No certificate is registered on the machine by factory default. Configure certificates for an SSL server as needed.

- Configuring certificates by Dell Printer Configuration Web Tool

The following two methods are available depending on types of certificates.

- Create a self-signed certificate on the machine, and then enable HTTPS.
- Enable HTTPS, and then import a certificate issued by another CA to the machine.

Configuration on the Computer

To encrypt communications between a web browser and the machine, enter an address beginning with "https" instead of "http" into the address box of the web browser.

Step1 Configuration on the Machine

Configure a certificate on the machine. No certificate is registered to the machine by factory default. Configure certificates for an SSL server as needed.

The following describes the procedures to set up a certificate by Dell Printer Configuration Web Tool.

Setting up a Certificate using Dell Printer Configuration Web Tool

To set up a certificate using Dell Printer Configuration Web Tool, you can have the machine create a self-signed certificate for SSL server or can import any registered certificate (issued by another CA) to the machine.

- Note**
- When performing SSL communications using a self-signed certificate created on the machine, or a certificate with which the character code is encoded with UTF-8, you will not be able to connect with SSL if Internet Explorer is used with Mac OS X v10.2 or later. This is because the operating system cannot recognize the character code (UTF-8) of the certificate. Use Netscape 7 in the above-mentioned OS environments.
 - You cannot import a certificate that has been already registered in [Local Device] or [Others]. Delete the registered certificate before importing.

1 Start Dell Printer Configuration Web Tool.

For more information on how to start Dell Printer Configuration Web Tool, refer to "Starting Dell Printer Configuration Web Tool" (P.464).

2 Create a certificate.

- 1) Click the [Properties] tab.
- 2) Click [Security] to display the items in the folder.

3) Click [Machine Digital Certificate Management].

4) Click the [Create New Certificate] button.

Note • If [Create New Self Signed Certificate] is displayed, click it and go to step 6).

5) Select [Self-Signed Certificate] and click [Continue].

6) Set [Digital Signature Algorithm] as necessary.

7) Set [Public Key Size] as necessary.

8) Set [Issuer] as necessary.

9) Set [Days of Validity] as necessary.

10) Click [Apply].

11) Refresh the web browser.

3 Set up the SSL/TLS information.

1) Click [Security] to display the items in the folder.

2) Click [SSL/TLS Settings].

3) Select the [Enabled] check box for [HTTP - SSL/TLS Communication].

4) Set up [HTTP - SSL/TLS Communication Port Number].

Note • Do not use the numbers of any other ports.

5) Click [Apply].

6) When the right frame of the web browser changes to the machine reboot display, click [Reboot Machine]. The machine reboots and the settings are enabled.

Step2 Configuration on the Computer

To encrypt communications between a web browser and the machine, enter an address beginning with "https" instead of "http" in the address box of the web browser.

• Example of IP address entry:

https://192.0.2.1/ (IPv4)

https://[2001:DB8::1234]/ (IPv6)

• Example of Internet address entry:

https://myhost.example.com/

When encrypting IPP communications (Internet printing) and adding a printer from [Add Printer], enter an address beginning with "https" instead of "http" as the URL of the printer.

For information on the settings, refer to the manual contained in the Driver CD Kit.

Configuration of Encryption using IPsec

This section describes how to encrypt communications using IPsec.

When the IKE authentication method is set to [Authenticate by Preshared Key], skip step 1 "Import and Configuration of a Certificate" and go to step 2 "Configuration on the Machine (Configuration of IPsec)".

For IKE authentication methods, refer to "IKE Authentication Method" (P.377).

Step1 Import and Configuration of a Certificate	523
Step2 Configuration on the Machine (Configuration of IPsec)	524
Step3 Configuration on the Computer	525

Installation Overview

To encrypt communications using IPsec, configure the machine and your computer as follows:

Configuration on the Machine

When [IKE Authentication Method] is set to [Authenticate by Digital Signature], configure a certificate on the machine. No certificate is registered on the machine by factory default. After importing a certificate, configure IPsec.

Configure the following setting to set up a certificate on the machine.

- Configuring certificates by Dell Printer Configuration Web Tool
 - Enable HTTPS, and then import a certificate issued by another CA to the machine.

Note • If a certificate to be imported as an IPsec certificate contains V3 extension "KeyUsage", "digitalSignature" bit must be asserted.

Configuration on the Computer

Configure the following settings to encrypt communications between a computer and the machine.

- Create an IP security policy
- Assign the IP security policy

Step1 Import and Configuration of a Certificate

The following describes configuration procedures to set up a certificate with Dell Printer Configuration Web Tool.

To configure a certificate using Dell Printer Configuration Web Tool, configure the encryption settings for HTTP communications, and then import a certificate issued by another CA to use it for the IPsec certificate.

Note • You cannot use a self-signed certificate created with Dell Printer Configuration Web Tool for IPsec.
 • The machine supports the capability to import the RSA[®] public key (up to 4096 bits).

For details on how to configure the encryption settings for HTTP communication, refer to "Configuration of HTTP Communications Encryption" (P.521).

1 Start Dell Printer Configuration Web Tool.

For more information on how to start Dell Printer Configuration Web Tool, refer to "Starting Dell Printer Configuration Web Tool" (P.464).

2 Import a certificate.

- Note**
- You cannot import a certificate that has been already registered in [Local Device] or [Others]. Delete the registered certificate before importing.
 - If the certificate to be imported contains the V3 extension "keyUsage", "digitalSignature" must be asserted.

- 1) Click the [Properties] tab.
 - 2) Click [Security] to display the items in the folder.
 - 3) Click [Machine Digital Certificate Management].
 - 4) Click [Upload Signed Certificate].
 - 5) Enter [Password].
 - 6) Enter [Retype Password].
 - 7) Enter a file name you want to import or select a file to import from a dialog box displayed by clicking the [Browse] button, and then select [Save].
 - 8) Click the [Import] button.
 - 9) Refresh the web browser.
- 3** Configure the certificate.
- 1) Click [Security].
 - 2) Click [Certificate Management].
 - 3) Select [Local Device] for [Category] and [IPSec] for [Certificate Purpose], and then click the [Display the list] button.
 - 4) Select the check box next to the certificate to set.
 - 5) Click the [Certificate Details] button.
 - 6) Click the [Use this certificate] button.
 - 7) Click [Reboot Machine]. The machine reboots and the settings are enabled.

Step2 Configuration on the Machine (Configuration of IPSec)

The following describes configuration procedures to set up IPSec on the machine.

- 1** Press the <Log In/Out> button.
- 2** Enter the system administrator's user ID with the numeric keypad or the keyboard displayed on the screen, and select [Enter].
When a passcode is required, select [Next] and enter the system administrator's passcode, and select [Enter].
Note
 - The default user ID is "admin".
 - The default passcode is "1111".
- 3** Select [Tools] on the [Home] screen.
- 4** Select [Connectivity & Network Setup].
- 5** Select [Security Settings].
- 6** Select [IPSec Settings].
- 7** Configure the required settings.
For details on the settings, refer to "IPSec Settings" (P.376).
- 8** Select [Close].

Step3 Configuration on the Computer

The following describes the configuration procedures on the computer.

Configure the following settings on the computer.

- Create an IP security policy
- Assign the IP security policy

For details on the settings, refer to the help of the computer.

Configuration of E-mail Encryption/Digital Signature

This section describes how to encrypt e-mails and how to attach a digital signature to e-mails.

The following shows the reference section for each procedure.

Step1 Configuration on the Machine	526
Step2 Configuration on Sender and Recipient	528

Installation Overview

To encrypt e-mails and attach a digital signature, configure the machine and your computer as follows:

- Note**
- To encrypt e-mails and attach a digital signature to e-mails between the machine and a computer, a personal or device certificate for S/MIME of a recipient and the device certificate of the machine must be set on the computer. Configure the following settings to the certificates:
 - "e-mail address"
 - If the certificate contains V3 extension "keyUsage", "digitalSignature" and "keyEncipherment" must be asserted.
 - If the certificate contains V3 extension "extendedKeyUsage", "emailProtection" must be set.
 - Up to 100 addresses can be encrypted with S/MIME.

Configuration on the Machine

Configure a certificate on the machine. No certificate is registered on the machine by factory default.

Configure the following settings to set up a certificate on the machine.

- Configuring certificates by Dell Printer Configuration Web Tool
 - Set up HTTPS communications encryption settings, and then configure a certificate on the machine.

Configuration on Sender and Recipient

To transmit e-mails encrypted by S/MIME and with digital signatures attached, register the required certificate on equipment of a sender and a recipient.

Step1 Configuration on the Machine

This section describes configuration procedures to set up a certificate with Dell Printer Configuration Web Tool.

- Note**
- You cannot use a self-signed certificate created with Dell Printer Configuration Web Tool for S/MIME.
 - The machine supports the capability to import the RSA public key (up to 4096 bits).

Setting up a Certificate using Dell Printer Configuration Web Tool

To configure a certificate using Dell Printer Configuration Web Tool, configure the encryption settings for HTTP communications, and then import a certificate issued by another CA to enable S/MIME.

For details on how to configure the encryption settings for HTTP communication, refer to "Configuration of HTTP Communications Encryption" (P.521).

1 Start Dell Printer Configuration Web Tool.

For more information on how to start Dell Printer Configuration Web Tool, refer to "Starting Dell Printer Configuration Web Tool" (P.464).

2 Import a certificate.

- Note**
- You cannot import a certificate that has been already registered in [Local Device] or [Others]. Delete the registered certificate before importing.

- 1) Click the [Properties] tab.
- 2) Confirm that [Machine's E-mail Address] of [Description] is entered.
- 3) Click [Security] to display the items in the folder.
- 4) Click [Machine Digital Certificate Management].
- 5) Click [Upload Signed Certificate].
- 6) Enter [Password].
- 7) Enter [Retype Password].
- 8) Enter a file name you want to import or select a file to import from a dialog box displayed by clicking the [Browse] button, and then select [Save].
- 9) Click the [Import] button.
- 10) Refresh the web browser.

3 Configure the certificate.

- 1) Click [Security] to display the items in the folder.
- 2) Click [Certificate Management].
- 3) Select [Local Device] for [Category] and [S/MIME] for [Certificate Purpose], and then click the [Display the list] button.
- 4) Select the check box next to the certificate to set.
- 5) Click the [Certificate Details] button.
- 6) Click the [Use this certificate] button.
- 7) Click [Reboot Machine]. The machine reboots and the settings are enabled.
- 8) Refresh the web browser.

4 Enable [S/MIME Communication].

- 1) Click [Security] to display the items in the folder.
- 2) Click [SSL/TLS Settings].
- 3) Select the [Enabled] check box for [S/MIME Communication].
- 4) Click [Apply].
- 5) When the right frame on the web browser changes to the machine reboot display, click [Reboot Machine]. The machine reboots and the settings are enabled.

5 Configure the settings for S/MIME.

- 1) Refresh the web browser.
- 2) Click [Security] to display the items in the folder.
- 3) Click [S/MIME Settings] and configure the following settings.
 - Message Digest Algorithm
Select a message digest algorithm from [SHA1], [MD5] or [SHA256].
 - Message Encryption Method
Select an encryption method for the e-mail message body from [3DES], [RC2-40], [RC2-64], [RC2-128], [AES-128], [AES-192], or [AES-256] when you send an e-mail from the machine.

- **Certificate Auto Store**
Select whether to automatically store the certificate when receiving an e-mail with an S/MIME certificate attached from an address registered in the Address Book.
 - **Receive Untrusted E-mail**
Set whether or not to receive untrusted e-mails such as an e-mail with expired certificate attached or no certificate attached.
 - **Digital Signature - Outgoing E-mail**
Set whether to always attach a digital signature to an outgoing e-mail or to select a digital signature when sending e-mail from the machine.
 - **Receive Untrusted Internet Fax**
Set whether or not to receive untrusted Internet faxes such as an e-mail with expired certificate attached or with no certificate attached.
 - **Digital Signature - Outgoing Internet Fax**
Set whether to always attach a digital signature to an outgoing Internet fax or to select a digital signature when sending Internet fax from the machine.
- 4) Click [Apply].

Step2 Configuration on Sender and Recipient

To transmit e-mails encrypted or with digital signature attached, a device certificate and a personal certificate must be registered with each machine.

This section describes certificates required for destination and source, and registration procedures.

Note • Required certificates include a trusted root certificate authority and all intermediate certificate authorities that are registered in the path of a certificate to use.

When source is the machine and destination is a computer

The personal certificate of a computer must be registered on the machine. And the device certificate of the machine must be registered on a computer.

To register the computer's personal certificate, use Dell Printer Configuration Web Tool.

There are two methods to register the machine's device certificate to a computer:

- Send an e-mail with S/MIME digital signature to a computer from the machine and register it to the certificate store of an e-mail application in the computer.

To send an e-mail with S/MIME digital signature, select [Always add signature] or [Select during send] for [Digital Signature - Outgoing E-mail] under [Tools] > [System Settings] > [Connectivity & Network Setup] > [Security Settings] > [S/MIME Settings] in advance.

- Export the certificate of the machine to a computer using Dell Printer Configuration Web Tool, and register it to the certificate store of an e-mail application in the computer.

For information on how to import and export a certificate using Dell Printer Configuration Web Tool, refer to "Importing/exporting a certificate using Dell Printer Configuration Web Tool" (P.529).

For information on how to register a certificate to the certificate store of an e-mail application, refer to the manual of your e-mail software.

When source is the machine and destination is another multifunctional machine

The device certificate of another multifunctional machine must be registered on the machine. And the device certificate of the machine must be registered on another multifunctional machine.

To register the device certificate of another multifunctional machine, start Dell Printer Configuration Web Tool of another multifunctional machine from a computer and export the certificate to the computer. And then, start Dell Printer Configuration Web Tool of the machine and import the certificate.

To register the device certificate of the machine, perform the same procedure as described above.

For information on how to import and export a certificate using Dell Printer Configuration Web Tool, refer to "Importing/exporting a certificate using Dell Printer Configuration Web Tool" (P.529).

When source is a computer and destination is the machine

The device certificate of the machine must be registered on a computer. The registration of the personal certificate of a computer to the machine is not required.

There are two methods to register the machine's device certificate to a computer:

- Send an e-mail with S/MIME digital signature to a computer from the machine (or another multifunctional machine) and register it to the certificate store of an e-mail application in the computer.

To send an e-mail with S/MIME digital signature, select [Always add signature] or [Select during send] for [Digital Signature - Outgoing E-mail] under [Tools] > [System Settings] > [Connectivity & Network Setup] > [Security Settings] > [S/MIME Settings] in advance.

- Export the certificate of the machine to a computer using Dell Printer Configuration Web Tool, and register it to the certificate store of an e-mail application in the computer.

For information on how to import and export a certificate using Dell Printer Configuration Web Tool, refer to "Importing/exporting a certificate using Dell Printer Configuration Web Tool" (P.529).

For information on how to register a certificate to the certificate store of e-mail software, refer to the manual of your e-mail application.

The following e-mail applications can transmit e-mails between the machine and a computer:

- Windows XP: Microsoft® Outlook® Express 6
- Windows Vista, Windows 7: Microsoft® Outlook® 2007, Microsoft® Outlook® 2010
- Mac OS X: Mail 2.1.1

Importing/exporting a certificate using Dell Printer Configuration Web Tool

To import a certificate, select the [Properties] tab > [Security] > [Machine Digital Certificate Management] > [Upload Signed Certificate].

To export a certificate, select the [Properties] tab > [Security] > [Certificate Management] and select a certificate to export, and then click the [Export this certificate] button.

Configuration of PDF/XPS Signature

This section describes the settings to send scanned documents in PDF or XPS format with a digital signature (PDF or XPS) attached.

Note • XPS stands for XML Paper Specification.

The following shows the reference section for each procedure.

Installation Overview	530
Step1 Configuration on the Machine	530
Step2 Configuration on the Computer	531

Installation Overview

To attach a signature (PDF signature/XPS signature) to a scanned document to send as a PDF or XPS document, configure the machine and your computer as follows:

Note • XPS stands for XML Paper Specification.

Configuration on the Machine

Configure a certificate on the machine. No certificate is registered on the machine by factory default.

Configure the following setting to set up a certificate on the machine.

- Configuring certificates by Dell Printer Configuration Web Tool

Set up HTTPS communications encryption settings, and then configure a certificate on the machine.

Configuration on the Computer

- Sending a PDF or XPS signature file from the machine to a computer

Make sure that the root certificate of the certificate to be used for the scan file signature of the machine is registered on the recipient's computer.

Step1 Configuration on the Machine

This section describes configuration procedures to set up a certificate with Dell Printer Configuration Web Tool.

Setting up a Certificate using Dell Printer Configuration Web Tool

To configure a certificate using Dell Printer Configuration Web Tool, configure the encryption settings for HTTP communications, and then import a certificate issued by another CA to enable S/MIME.

For details on how to configure the encryption settings for HTTP communication, refer to "Configuration of HTTP Communications Encryption" (P.521).

1 Start Dell Printer Configuration Web Tool.

For more information on how to start Dell Printer Configuration Web Tool, refer to "Starting Dell Printer Configuration Web Tool" (P.464).

2 Import a certificate.

Note • You cannot import a certificate that has been already registered in [Local Device] or [Others]. Delete the registered certificate before importing.

1) Click the [Properties] tab.

- 2) Click [Security] to display the items in the folder.
 - 3) Click [Machine Digital Certificate Management].
 - 4) Click [Upload Signed Certificate].
 - 5) Enter [Password].
 - 6) Enter [Retype Password].
 - 7) Enter a file name you want to import or select a file to import from a dialog box displayed by clicking the [Browse] button, and then select [Save].
 - 8) Click the [Import] button.
 - 9) Refresh the web browser.
- 3** Configure the certificate.
- 1) Click [Security].
 - 2) Click [Certificate Management].
 - 3) Select [Local Device] for [Category] and [Scan File] for [Certificate Purpose], and then click the [Display the list] button.
 - 4) Select the check box next to the certificate to set.
 - 5) Click the [Certificate Details] button.
 - 6) Click the [Use this certificate] button.
 - 7) Click [Reboot Machine]. The machine reboots and the settings are enabled.
- 4** Configure the settings for PDF Signature/XPS Signature.
- Note** • XPS stands for XML Paper Specification.
- 1) Refresh the web browser.
 - 2) Click [Security] to display the items in the folder.
 - 3) Click [PDF/XPS Security Settings] and configure the following settings.
 - PDF Signature

Select the setting for PDF signature from [Do not add signature], [Always add visible signature], [Always add invisible signature], or [Select during send].
 - PDF Signature Hash Algorithm

Select the setting for PDF Signature Hash Algorithm from [SHA-1] or [SHA-256].
 - XPS Signature

Select the setting for XPS signature from [Do not add signature], [Always add signature], or [Select during send].
 - 4) Click [Apply].

Step2 Configuration on the Computer

- Sending a PDF or XPS signature file from the machine to a computer

Make sure that the root certificate of the certificate to be used for the scan file signature of the machine is registered on the recipient's computer.

Note • XPS stands for XML Paper Specification.

22 Authentication and Accounting Features

The machine provides the Authentication feature to restrict the availability of services for each feature and the Accounting feature to manage the use of each feature based on the Login Type selected.

This chapter describes the settings to restrict the availability of services and to manage account usage on the machine.

- **Overview of Authentication and Accounting Feature534**
- **Authentication.....536**
- **Services Controlled by Authentication541**
- **Authentication for Job Flow Sheets and Folders546**
- **Jobs Manageable by Account Administration554**
- **Configuration for Authentication.....557**
- **Configuration for Account Administration562**
- **User Authentication Operations564**

Overview of Authentication and Accounting Feature

This section overviews the Authentication feature and the Accounting feature.

The following shows the reference section for each feature.

Overview of Authentication Feature.....	534
Overview of Accounting Feature.....	535

Overview of Authentication Feature

Types of Users

The users include the System Administrator, Login User, Unregistered User, and Local User. For more information about the feature, refer to "User Types Managed by Authentication Feature" (P.536).

User Role/Authorization Group

Allows you to assign a user role and an authorization group to each user.

When you assign [System Administrator] in [User Role] to a user, for example, the user has almost the same privileges as the System Administrator.

For more information about the feature, refer to "User Roles and Authorization Groups" (P.536).

Types of Authentication

The machine supports two authentication types: [Login to Local Accounts] that authenticates users based on the user information registered on the machine, and [Login to Remote Accounts] that authenticates users based on the user information registered on a remote server.

For more information about the feature, refer to "Types of Authentication" (P.538).

Note • The available remote servers are LDAP, Kerberos, and SMB servers.

Access Control

Allows you to prohibit the operation of the control panel buttons.

For more information, refer to "Device Access" (P.452).

Allows you to configure whether to restrict the availability per service such as Copy, Fax, and Scan.

For more information about the feature, refer to "Service Access" (P.452).

Allows you to restrict users from making color copies, or from printing or retrieving files stored in folders per user.

For more information about the feature, refer to "Feature Access" (P.453).

Account Limit for Each User

- Allows you to restrict access to each service and to set the maximum number of pages allowed for the service per user.

For more information about the feature, refer to "Services Controlled by Authentication" (P.541).

- Allows you restrict creating/editing/using job flow sheets and folders per user.

For more information about the feature, refer to "Authentication for Job Flow Sheets and Folders" (P.546).

Overview of Accounting Feature

Accounting Type

The machine supports the following types of account administration: Local Accounting, Network Accounting, and ColorTrack.

For more information, refer to "Types of Account Administration" (P.539).

Available Combinations of Login and Accounting Types

You can select the Login and Accounting Types individually, but some combinations are not available.

For more information, refer to "Authentication and Accounting Relationship" (P.540).

Authentication

This section describes the Authentication feature used with the machine.

User Types Managed by Authentication Feature.....	536
User Roles and Authorization Groups	536
Types of Authentication	538
Types of Account Administration	539
Authentication and Accounting Relationship.....	540

User Types Managed by Authentication Feature

The following describes the types of users that can be managed with the Authentication feature.

User information can be registered on the machine.

Types of User

Users are classified into the following four types. The Authentication feature restricts operations according to the user type.

System Administrator

The System Administrator can register and change system settings to adapt to the environment to be used.

A system administrator uses a specific user ID called a system administrator's user ID.

To login as the system administrator, enter the system administrator's user ID in the user ID entry field on the screen.

Login User

A Login User is a user registered on the machine or a remote server.

To use restricted services, enter the user ID and passcode on the screen.

Note • Users who are assigned as [System Administrator] in [User Role] have almost the same privileges as the system administrator. For more information, refer to "User Roles and Authorization Groups" (P.536).

Unregistered User

Unregistered User is a user not registered on the machine.

An unregistered user cannot use restricted services.

Local User

A user who does not login to the machine is called a Local User.

Sub User

You can associate sub users with a user ID of a login user in accordance with the intended use. Up to 10 Sub User IDs can be associated with a User ID.

User Roles and Authorization Groups

You can select a user role and an authorization group for each user when registering a user on the machine.

Note • When the Login Type is [Login to Local Accounts] and the Accounting Type is [Network Accounting], an authorization group cannot be assigned to a user. Therefore, the features configured for the authorization group, such as the feature to temporarily disable forcible printing, are not available.

User Roles

The following three user roles are available:

User

No special authority is given to this user role.

System Administrator

The same authority as a system administrator is given except for the following operations:

- Operate folders
- Operate job flows sheets
- Change the passcode of the system administrator

Account Administrator

The following authorities are given:

- Create, delete, change (except for passcode), and view (unavailable depending on some settings) user information
- Create, delete, change, and view accounting
- Change Alternative Name for Account ID or Mask Account ID
- Print an Accounting Report for each user

Authorization Groups

The following three settings can be configured for each authorization group.
For details on authorization groups, refer to "Create Authorization Groups" (P.453).

Restrict Recipient Selection Method

Allows you to set whether or not to permit the group members to specify recipients when [Restrict Recipient Selection Method] is set to [Only From Address Book].

For details on the Restrict Recipient Selection Method setting, refer to "Restrict Recipient Selection Method" (P.347).

Restrict User to Edit Address Book

Allows you to set whether or not to permit the group members to edit the Address Book in the machine when editing the Address Book is prohibited.

For details on the Restrict User to Edit Address Book setting, refer to "Restrict User to Edit Address Book" (P.347).

Allow User to Disable Active Settings

Allows you to set whether or not to permit the group members to disable active settings, such as Force Watermark or Print Universal Unique ID, and perform a job. This setting enables users belonging to an authorization group to disable active settings from [Tools] on the [Home] screen.

For details on the Watermark and UUID settings, refer to "Watermark" (P.330) and "Print Universal Unique ID" (P.333).

For information on how to temporarily disable active settings, refer to "Allow User to Disable Active Settings" (P.458).

Types of Authentication

The following describes the types of authentication (Login Type) available on the machine. The following authentication methods are available.

User ID Authentication

The machine requires users to enter their user IDs and passcodes with the numeric keypad or the touch screen of the machine.

Authentication is performed using user information registered on the machine or user information registered on a remote server.

The following two types of authentication methods are available according to the registration condition of user information.

Login to Local Accounts

Login to Local Accounts uses the user information registered on the machine to manage authentication.

A print job directly sent to the machine from a computer can be received on the machine after being authenticated through cross-checking process whereby the authentication information configured on the client's driver with the information registered on the machine.

For information on driver settings, refer to the help of the driver.

Login to Remote Accounts

Authentication is performed for a remote server. User information is not registered on the machine.

Login to Remote Accounts uses the user information registered on a remote authentication server (LDAP, Kerberos, or SMB) to perform authentication.

- Note**
- When a user is authenticated by a remote authentication server, the authenticated user can access the services through the control panel based on the permission information obtained from the remote server.
 - When you change Login Type to or from [Login to Remote Accounts], user information, private folders, and Personal Sheets registered on the machine will be deleted.
 - When you register user information on a remote authentication server, use up to 32 single-byte characters for a user ID and up to 128 single-byte characters for a password. Note, however, that up to 32 single-byte characters are allowed for an SMB authentication password.

Smart Card Authentication

Authentication is performed using the IC Card Reader.

- Note**
- Set whether or not to enable user ID authentication when the smart card reader is connected. For more information, refer to "When Smart Card Reader is Connected" (P.454).

Combined Use of Smart Card Authentication and User ID Authentication

Authentication is performed using the user ID of the card pre-registered on the machine or the remote server.

- Note**
- When remote authentication is used, the registration of the user ID on the machine is not required.

Types of Account Administration

The following describes the types of account administration (Accounting Type) available on the machine.

- Note**
- Some Accounting Types may be grayed out and not selectable depending on the Login Type selected. For more information, refer to "Authentication and Accounting Relationship" (P.540).

The Account Administration feature is classified into the following two types:

Local Accounting

Local Accounting performs account administration on the machine.

In Local Accounting, account administration is performed using the login users' information registered on the machine. Also, accounting information is counted using various counters automatically created for each user. To print accounting reports for each user, you must be authenticated as the system administrator, a user with the System Administrator user role, or a user with the Account Administrator user role.

For information on the types of jobs that can be monitored with account administration, refer to "Jobs Manageable by Account Administration" (P.554).

For information on how to print reports, refer to "Print Reports" (P.276).

Network Accounting

Network Accounting performs account administration using user information managed by a remote service.

In Network Accounting, the remote server collects job data stored on the machine and counts up the numbers of pages processed for each user.

User information managed by the remote service is sent to be registered on the machine. When the user information on the remote service is updated, the updated information must be sent from the remote service to the machine.

Accounting using Authentication Server

Account administration is performed using a remote authentication server.

In this accounting, the remote server collects job data stored on the machine and counts up the numbers of pages processed for each user.

The authentication server manages the user's authorization information and obtains accounting information from a remote server.

ColorTrack

Account administration is performed using the user information and account information registered on the machine. Also, accounting information is counted using various counters automatically created for each user. Accounting reports are created in CSV format using Dell Printer Configuration Web Tool.

For information on driver settings, refer to the help of the driver.

- Note**
- When setting the user information or account information for another machine, we recommend that you use the Cloning feature of Dell Printer Configuration Web Tool.

Authentication and Accounting Relationship

You can individually select Login and Accounting Types, and can combine them as described in the following table.

		Accounting Types				
		Accounting Disabled	Local Accounting	Network Accounting	Authentication Server	ColorTrack
Login Types	No Login Required	O ^{*1}	X	O	X	O
	Login to Local Accounts	X	O ^{*1}	O	X	O
	Login to Remote Accounts	O ^{*2}	X	X	O ^{*3}	X

O :Available

X :Not available

*1 :Default

*2 :When [Login Type] is [Login to Remote Accounts] and [Authentication System] is not set to [Authentication Agent], [Accounting Type] will automatically be set to [Accounting Disabled].

*3 :When [Login Type] is [Login to Remote Accounts] and [Authentication System] is set to [Authentication Agent], [Accounting Type] will automatically be set to [Authentication Server].

Services Controlled by Authentication

This section describes the features that are controlled by the Authentication feature.

The restricted features vary depending on how the machine is used.

For information on the folder and job flow sheet restrictions when the Authentication feature is enabled, refer to "Authentication for Job Flow Sheets and Folders" (P.546).

Overview	541
Services Restricted by User ID Authentication	541
Services Restricted by the Combined Use of Smart Card Authentication and User ID Authentication.....	543

Overview

The services can be controlled as follows.

Some restrictions can be set for each user, and other restrictions can be set for the machine as a whole.

For information on the restrictions that can be set for each user, refer to "Service Access" (P.442), and for information on the restrictions that can be set for the machine as a whole, refer to "Service Access" (P.452).

Services Restricted by User ID Authentication

For User ID Authentication, the services restricted by authentication and account administration differ depending on the combination of the Authentication and Accounting modes.

When [Login Type] is [Login to Local Accounts] and [Accounting Type] is [Local Accounting]

The following services are controlled.

Services	Authentication *1	Restrictions per user		Per-user Usage Count
	User ID	Feature restrictions *2	Account Limit *3	
Copy	○	○	○	○
Print	○	○	○	○
Charge Print, Private Charge Print	○	○	○	○
Scan	○	○	○	○
Fax, Internet Fax	○	○	-	○
Direct Fax	○	○	-	○
Report/List	-	-	-	-

○ :Available

- :Not available

*1 :This column shows whether authentication is required for each service. "O" indicates that authentication is required.

*2 :You can select features available for each user. For more information, refer to "Service Access" (P.442).

*3 :This feature stops machine operation when the number of pages specified in the account limit is processed. For more information, refer to "Service Access" (P.442).

When [Login Type] is [Login to Local Accounts] and [Accounting Type] is [Network Accounting]

The following services are controlled.

Services	Authentication *1	Restrictions per user		Per-user Usage Count
	User ID	Feature restrictions *2	Account Limit *3	
Copy	O	O	-	-
Print	O	O	-	-
Charge Print, Private Charge Print	O	O	-	-
Scan	O	O	-	-
Fax, Internet Fax	O	O	O	-
Direct Fax	O	O	-	-
Report/List	-	-	-	-

O :Available

- :Not available

*1 :This column shows whether authentication is required for each service. "O" indicates that authentication is required.

*2 :You can select features available for each user. The settings can be configured with the remote service.

*3 :This feature stops machine operation when the number of pages specified in the account limit is processed. The settings can be configured with the remote service.

When [Login Type] is [Login to Remote Accounts]

The following services are controlled.

Services	Authentication *1	Restrictions per user		Per-user Usage Count
	User ID	Feature restrictions	Account Limit	
Copy	O	O	-	-
Print	O*2	O	-	-
Charge Print, Private Charge Print	O	O	-	-
Scan	O	O	-	-
Fax, Internet Fax	O	O	-	-
Direct Fax	-*3	-	-	-
Report/List	-	-	-	-

O :Available

- :Not available

*1 :This column shows whether authentication is required for each service. "O" indicates that authentication is required.

*2 :When [Login Type] is set to [Login to Remote Accounts], the Print feature cannot be restricted. To restrict print operations, use the Charge Print or Private Charge Print feature.

*3 :When [Login Type] is [Login to Remote Accounts], the Direct Fax feature cannot be restricted. To disable the Direct Fax feature, refer to "Direct Fax" (P.400).

When [Login Type] is [Login to Local Accounts] and [Accounting Type] is [ColorTrack]

The following services are controlled.

Services	Authentication *1		Restrictions per user		Per-user Usage Count
	User ID		Feature restrictions	Account Limit *2	
Copy	O		O	O	O
Print	O		O	O	O
Charge Print, Private Charge Print	O		O	O	O
Scan	O		O	O	O
Fax, Internet Fax	O		O	O	O
Direct Fax	O		O	O	O
Report/List	-		-	-	-

O :Available
 - :Not available

*1 :This column shows whether authentication is required for each service. "O" indicates that authentication is required.

*2 :This feature stops machine operation when the number of pages specified in the account limit is processed.

Services Restricted by the Combined Use of Smart Card Authentication and User ID Authentication

For the combined use of Smart Card Authentication and User ID Authentication, the services restricted by authentication and account administration differ depending on the combination of the Authentication (local machine authentication or remote authentication) and Accounting modes.

When [Login Type] is [Login to Local Accounts] and [Accounting Type] is [Local Accounting]

The following services are controlled.

Services	Authentication *1		Restrictions per user		Per-user Usage Count
	User ID	Card *2	Feature restrictions *3	Account Limit *4	
Copy	- *5	O	O	O	O
Print*4	O	- *5	O	O	O
Charge Print, Private Charge Print	- *5	O	O	O	O
Scan	- *5	O	O	O	O
Fax, Internet Fax	-	O	O	-	O

Services	Authentication *1		Restrictions per user		Per-user Usage Count
	User ID	Card *2	Feature restrictions *3	Account Limit *4	
Direct Fax	O	-	O	-	O
Report/List	-	O*6	-	-	-

O :Available
 - :Not available

*1 :This column shows whether authentication is required for each service. "O" indicates that authentication is required.

*2 :The user ID of the card is checked against the user ID registered on the machine when IC Card Reader is used.

*3 :You can select features available for each user. For more information, refer to "Service Access" (P.442).

*4 :This feature stops machine operation when the number of pages specified in the account limit is processed. For more information, refer to "Service Access" (P.442).

*5 :When you set [When Smart Card Reader is Connected] under [Tools] > [Authentication/Security Settings] > [Authentication] > [User Details Setup] to [Smart Card or Control Panel Login], authentication is required. For more information, refer to "When Smart Card Reader is Connected" (P.454).

*6 :Report and List can be printed using a smart card not registered on the machine.

When [Login Type] is [Login to Local Accounts] and [Accounting Type] is [Network Accounting]

The following services are controlled.

Services	Authentication *1		Restrictions per user		Per-user Usage Count
	User ID	Card *2	Feature restrictions *3	Account Limit *4	
Copy	-*5	O	O	-	-
Print	O	-*5	O	-	-
Charge Print, Private Charge Print	-*5	O	O	-	-
Scan	-*5	O	O	-	-
Fax, Internet Fax	-	O	O	-	-
Direct Fax	O	-	O	-	-
Report/List	-	O*6	-	-	-

O :Available
 - :Not available

*1 :This column shows whether authentication is required for each service. "O" indicates that authentication is required.

*2 :The user ID of the card is checked against the user ID registered on the machine when IC Card Reader is used.

*3 :You can select features available for each user. The settings can be configured with the remote service.

*4 :This feature stops machine operation when the number of pages specified in the account limit is processed. The settings can be configured with the remote service.

*5 :When you set [When Smart Card Reader is Connected] under [Tools] > [Authentication/Security Settings] > [Authentication] > [User Details Setup] to [Smart Card or Control Panel Login], authentication is required. For more information, refer to "When Smart Card Reader is Connected" (P.454).

*6 :Report and List can be printed using a smart card not registered on the machine.

For more information on Network Accounting, refer to "Network Accounting" (P.539).

When [Login Type] is [Login to Remote Accounts]

When IC Card Reader is used, authentication in combination with remote authentication is available.

The following services are controlled.

Note • Only IC Card Reader can be connected as an authentication device for remote authentication. Remote authentication cannot be performed with other devices than IC Card Reader.

Services	Authentication *1		Restrictions per user		Per-user Usage Count
	User ID	Card	Feature restrictions	Account Limit	
Copy	O	O	O	-	-
Print	- *2	O *3	O	-	-
Charge Print, Private Charge Print	O	O *4	O	-	-
Scan	O	O	O	-	-
Fax, Internet Fax	-	O	O	-	-
Direct Fax	- *5	-	-	-	-
Report/List	-	O	-	-	-

O :Available

- :Not available

*1 :This column shows whether authentication is required for each service. "O" indicates that authentication is required.

*2 :When [Login Type] is set to [Login to Remote Accounts], the Print feature cannot be restricted. To restrict print operations, use the Charge Print or Private Charge Print feature.

*3 :When you hold your card over IC Card Reader, the machine automatically prints the print job being paused. We recommend that you use Charge Print or Private Charge Print to avoid unintended printing.

*4 :The user ID of the card is checked against the user ID registered on the machine.

*5 :When [Login Type] is [Login to Remote Accounts], the Direct Fax feature cannot be restricted. To disable the Direct Fax feature, refer to "Direct Fax" (P.400).

Note • Authentication is not performed when [Verify User Details] is set to [No] under [Tools] > [Accounting] > [Accounting Type] > [Network Accounting].

Authentication for Job Flow Sheets and Folders

This section describes the restrictions of job flows, folders, and job flow sheets and folder links when the Authentication feature is enabled.

Overview	546
When the Authentication Feature is Disabled	548
When the Authentication Feature is Enabled	551

Overview

Job Flow Sheet Types and Overview

Job flow sheets that you can create on the machine targets the documents stored in folders. You can create job flow sheets that can handle documents in folders and scanned documents using Job Flow Editor from a computer on the network.

Note • Job Flow Editor is included in the Driver CD Kit.

You can create job flow sheets for folder operations on the machine. Job flow sheets for scanner operations can be created using software on a computer connected to a network.

The job flow sheets created on the computer cannot be edited or copied on the machine.

The following four types of job flow sheets are available for the machine:

General Shared Job Flow Sheets

This is a job flow sheet created on the [Create Job Flow Sheet] screen by a Local User when the Authentication feature is disabled.

When the Authentication feature is disabled, this type of job flow sheet can be shared and its settings can be changed by any machine user.

When the Authentication feature is enabled, this type of job flow sheet can be operated only by the system administrator.

Folder Job Flow Sheets

This is a job flow sheet created by a Local User or the System Administrator on the [Create Folder] or [Send from Folder] screen when the Authentication feature is disabled.

The owner of the job flow sheet is the "folder" from which it was created. For example, the owner of a job flow sheet created in Folder 001 will be "Folder 001", and the job flow sheet can be used only in Folder 001.

Any users who have access to the folder upon the job flow sheet creation can use the job flow and change its settings.

This job flow sheet can be used by any machine user when the Authentication feature is disabled. When the Authentication feature is enabled, this job flow sheet can be operated only by the system administrator.

Personal Job Flow Sheets

This is a job flow sheet created by a login user when the Authentication feature is enabled.

When the Authentication feature is enabled, this type of job flow sheet is available for the login user who created the job flow sheet and for the system administrator.

Administrator Shared Job Flow Sheets

This is a job flow sheet created by the system administrator.

When the Authentication feature is disabled, any machine user can use this type of job flow sheet.

When the Authentication feature is enabled, any login user can use the job flow sheet.

Only the system administrator, however, can change its settings.

To create administrator shared job flow sheets, you must press the <Log In/Out> button and operate the machine as the system administrator.

The available operations for job flow sheets vary depending on whether the Authentication feature is enabled or disabled.

Job Flow Sheet Types	When Authentication is Disabled			When Authentication is Enabled		
	Create	Edit/Delete	Use *	Create	Edit/Delete	Use *
General Shared Job Flow Sheet	O	O	O	X	X	Δ
Folder Job Flow Sheet						
Personal Job Flow Sheet	X	X	Δ	O	O	O
Administrator Shared Job Flow Sheet	Δ	Δ	O	Δ	Δ	O

O :Available

X :Not available

Δ :Available to the System Administrator only

* : Viewing, copying, selecting, and executing job flow sheets

Types of Folders and Overview

The following three types of folders can be used with the machine:

General Shared Folder

This is a folder created by a Local User when the Authentication feature is not enabled.

When the Authentication feature is not enabled, this folder is shared and its settings can be changed by any user.

When the Authentication feature is enabled, this folder can be operated only by the system administrator.

Personal Folder

This is a folder created by a login user when the Authentication feature is enabled.

The login user who created it and the system administrator can use it.

When the Authentication feature is not enabled, this folder can be operated only by the system administrator.

The methods you can use folders differ depending on whether the Authentication feature is enabled.

Administrator Shared Folder

This is a folder created by the system administrator.

When the Authentication feature is not enabled, this folder can be shared by all users. When the Authentication feature is enabled, this folder can be shared by all login users.

Only the system administrator, however, can change the settings.

To create an administrator shared folder, you must press the <Log In/Out> button and operate the machine as the system administrator.

The available operations for folders vary depending on whether the Authentication feature is enabled or disabled.

Types of Folders	When Authentication is Disabled			When Authentication is Enabled		
	Create	Edit/Delete	Use *	Create	Edit/Delete	Use *
General Shared Folder	O	O	O	X	Δ	Δ
Personal Folder	X	X	Δ	O	O	O
Administrator Shared Folder	Δ	Δ	O	Δ	Δ	O

O :Available

X :Not available

Δ :Available to the System Administrator only

* :Viewing folders, viewing, deleting, registering, and outputting files, and viewing and starting job flow sheets

Linking Job Flow Sheets to Folders

The methods to link job flow sheets to folders vary depending on whether the Authentication feature is enabled.

The types of job flow sheets and folders to be linked vary depending on whether the Authentication feature is enabled or disabled.

Folder / Job Flow	When Authentication is Disabled			When Authentication is Enabled		
	General shared	Personal	Admin shared	General shared	Personal	Admin shared
Folder	O	Δ	Δ	Δ	Δ	Δ
General shared	O	Δ	Δ	Δ	Δ	Δ
Personal	Δ	Δ	Δ	Δ	O	Δ
Admin shared	Δ	Δ	Δ	Δ	O	Δ

O :Available

Δ :Available to the System Administrator only

When the Authentication Feature is Disabled

Available Job Flow Sheet Operations

If you change the authentication setting from "enabled" to "disabled", delete all existing personal job flow sheets, and create general shared and folder job flow sheets.

When the Authentication feature is disabled, the relationships between users and job flows are as follows.

The available job flow sheet operations differ between the job flow sheets created on the [Create Folder] under [Setup] or [Send from Folder] screens and those created on the [Create Job Flow Sheet] screen under [Setup].

[Create Folder] screen / [Send from Folder] screen

The following table describes the operations that can be performed on the [Create Folder] screen under [Setup] or on the [Send from Folder] screen.

Job Flow operation	General Users				System Administrators			
	General shared	Folder	Admin shared	Personal	General shared	Folder	Admin shared	Personal
Create/Register	-	○	-	-	-	-	○	-
Display	○	○	○	-	○	○	○	○
Edit	○	○	-	-	○	○	○	○
Copy *	○	○	○	-	○	○	○	○
Delete	○	○	-	-	○	○	○	○
Select/Run	○	○	○	-	○	○	○	○
Link to folder	○	○	○	-	○	○	○	○

○ :Available

- :Not available

* :The owner of a copied job flow sheet is the user who copied the document.

Note

- A job flow sheet created on the [Create Folder] screen under [Setup] or on the [Send from Folder] screen can be edited, copied, deleted, or selected/run only from the folder where the job flow sheet was created. The applicable users are all users who can use the folders.
- If job flow sheets, which are no longer available for use as a result of a change in the Login Type, are linked to folders, they cannot be edited or copied, but still can be used. If you cancel the links, however, the job flow sheets will no longer be displayed and will be unavailable.

[Create Job Flow Sheet] under [Setup]

The following table describes the operations that can be performed on the [Create Job Flow Sheet] screen under [Setup].

Job Flow operation	General Users				System Administrators			
	General shared	Folder	Admin shared	Personal	General shared	Folder	Admin shared	Personal
Create/Register	○	-	-	-	-	-	○	-
Display	○	-	○	-	○	○	○	○
Edit	○	-	-	-	○	○	○	○
Copy *	○	-	○	-	○	○	○	○
Delete	○	-	-	-	○	○	○	○
Select/Run	○	-	○	-	○	○	○	○

○ :Available

- :Not available

* :The owner of a copied job flow sheet is the user who copied the document.

Available Folder Operations

If you change the Authentication feature from "enabled" to "disabled", delete all existing personal folders, and create general shared folders.

When the Authentication feature is disabled, the relationships between users and folders are as follows.

Folder operation		General Users			System Administrators		
		General shared	Admin shared	Personal	General shared	Admin shared	Personal
Create/Register		O	-	-	-	O	-
Display		O	O	-	O	O	O
Delete		O	-	-	O	O	O
Change Settings		O	-	-	O	O	O
Display File		O	O	-	O	O	O
Delete File		O	O	-	O	O	O
Register File *		O	O	-	O	O	O
Output File *		O	O	-	O	O	O
Job Flow Sheet	Display	O	O	-	O	O	O
	Link	O	-	-	O	O	O
	Auto Start	O	O	-	O	O	O
	Manual Run	O	O	-	O	O	O

O :Available

- :Not available

* :The following operations are not authenticated:

- Document retrieval using Dell Network Scanner Utility 3

Note • If job flow sheets, which are no longer available for use as a result of a change in the Login Type, are linked to folders, they cannot be edited or copied, but still can be used. If you cancel the links, however, the job flow sheets will no longer be displayed and will be unavailable.

Linking Job Flow Sheets and Folders

If job flow sheets, which are no longer available for use as a result of a change in the Login Type, are linked to folders, they cannot be edited or copied, but still can be used. If you cancel the links, however, the job flow sheets will no longer be displayed and will be unavailable.

When the Authentication feature is disabled, the relationships between users and folders are as follows.

Folder / Job Flow	General Users			System Administrators		
	General shared	Admin shared	Personal	General shared	Admin shared	Personal
Folder	O	-	-	O	O	O
General shared	O	-	-	O	O	O
Admin shared	O	-	-	O	O	O
Personal	-	-	-	O	O	O

○ :Available
 - :Not available

When the Authentication Feature is Enabled

Available Job Flow Sheet Operations

If you change the authentication setting from "disabled" to "enabled", delete all existing general shared and folder job flow sheets, and create personal job flow sheets.

When the Authentication feature is enabled, the relationships between users and job flows are as follows.

The same operations can be used on [Create Folder] under the [Setup] and [Create Job Flow Sheet] screens.

For information on the Authentication feature, refer to "Overview of Authentication Feature" (P.534).

When [Login to Local Accounts] is selected, when [Verify User Details] is set to [Yes] in [Network Accounting] and [Customize User Prompts] is set to [Display User ID & Account ID Prompts] or [Display User ID Prompt Only], or when authenticated as a user other than a guest user in [Login to Remote Accounts]

Note • If authenticated as a guest user in [Login to Remote Accounts], you are treated as an unregistered user (local user) and cannot operate job flow sheets.

Job flow operation	Unregistered Users (Local Users)				Local Users					System Administrators			
	General shared	Folder	Admin shared	Personal	General shared	Folder	Admin shared	Personal (owner)	Personal (Non-owner)	General shared	Folder	Admin shared	Personal
Create/ Register	-	-	-	-	-	-	-	○	-	-	-	○	-
Display	-	-	-	-	-	-	○	○	-	○	○	○	○
Edit	-	-	-	-	-	-	-	○	-	○	○	○	○
Copy *	-	-	-	-	-	-	○	○	-	○	○	○	○
Delete	-	-	-	-	-	-	-	○	-	○	○	○	○
Select/Run	-	-	-	-	-	-	○	○	-	○	○	○	○
Link to Folder	-	-	-	-	-	-	○	○	-	○	○	○	○

○ :Available
 - :Not available

* : The owner of a copied job flow sheet is the user who copied the document.

Available Folder Operations

If you change the authentication setting from "disabled" to "enabled", delete all existing general shared folders, and create personal folders.

When the Authentication feature is enabled, the relationships between users and job flows are as follows.

For information on the Authentication feature, refer to "Overview of Authentication Feature" (P.534).

When [Login to Local Accounts] is selected, when [Verify User Details] is set to [Yes] in [Network Accounting] and [Customize User Prompts] is set to [Display User ID & Account ID Prompts] or [Display User ID Prompt Only], or when authenticated as a user other than a guest user in [Login to Remote Accounts]

Note • If authenticated as a guest user in [Login to Remote Accounts], you are treated as an unregistered user (local user) and cannot operate folders.

Folder operation		Unregistered Users (Local Users)			Login Users				System Administrators		
		General shared	Admin shared	Personal	General shared	Admin shared	Personal (owner)	Personal (Non-owner)	General shared	Admin shared	Personal
Create/Register		-	-	-	-	-	○	-	-	○	-
Display		-	○ ^{*1}	-	-	○	○	-	○	○	○
Delete		-	-	-	-	-	○	-	○	○	○
Change Settings		-	-	-	-	-	○	-	○	○	○
Display File		-	○ ^{*1}	-	-	○	○	-	○	○	○
Delete File		-	○ ^{*1}	-	-	○	○	-	○	○	○
Register File		-	○ ^{*1}	-	-	○	○	-	○	○	○
Output File		-	○ ^{*1}	-	-	○	○	-	○	○	○
Job Flow Sheet	Display	-	- ^{*2}	-	-	○	○	-	○	○	○
	Link	-	-	-	-	-	○	-	○	○	○
	Auto Start	-	- ^{*2}	-	-	○	○	-	○	○	○
	Manual Run	-	- ^{*2}	-	-	○	○	-	○	○	○

○ :Available

- :Not available

*1 :Available only when the folder operations are permitted in the Authentication feature settings of the System Administration mode.

*2 :You can perform display, auto run and manual run operations for job flow sheets linked to folders.

Note • If job flow sheets, which are no longer available for use as a result of a change in the Login Type, are linked to folders, they cannot be edited or copied, but still can be used. If you cancel the links, however, the job flow sheets will no longer be displayed and will be unavailable.

Linking Job Flow Sheets and Folders

When the Authentication feature is enabled, the relationships between users and folders are as follows.

For information on the Authentication feature, refer to "Overview of Authentication Feature" (P.534).

When [Login to Local Accounts] is selected, when [Verify User Details] is set to [Yes] in [Network Accounting] and [Customize User Prompts] is set to [Display User ID & Account ID Prompts] or [Display User ID Prompt Only], or when authenticated as a user other than a guest user in [Login to Remote Accounts]

Note • If authenticated as a guest user in [Login to Remote Accounts], you are treated as an unregistered user (local user) and cannot operate job flow sheets or folders.

Folder / Job Flow	Unregistered Users (Local Users)			Login Users				System Administrators		
	General shared	Admin shared	Personal	General shared	Admin shared	Personal (owner)	Personal (Non- owner)	General shared	Admin shared	Personal
General shared	-	-	-	-	-	-	-	○	○	○
Admin shared	-	-	-	-	-	○	-	○	○	○
Personal (Owner)	-	-	-	-	-	○	-	○	○	○
Personal (Non-owner)	-	-	-	-	-	-	-	○	○	○

○ :Available

- :Not available

Jobs Manageable by Account Administration

This section describes the information that can be managed for the jobs for each service.

Print

You can manage the following print job information using the Accounting feature:

Services (Jobs)		Authentication	Target User	Managed Items
Normal Print	Machine's print driver	Required	Login user	Pages/sheets
	Other than machine's print driver	- *1	Unregistered user	Pages/sheets
Secure Print	Store Files	Required	-	-
	Print Files	Not required *2	Login user	Pages/sheets
Sample Set	Store Files, Print first set	Required	Login user	Pages/sheets
	Print remaining sets	Not required *2	Login user	Pages/sheets
Print Stored File	Store Files	Required	-	-
	Print Files	Required/ Not required *3	Login user	Pages/sheets
Delayed Print	Store Files	Required	-	-
	Print Files	Not required *3	Login user	Pages/sheets
Charge Print	Store Files	Not required	-	-
	Print Files	Required	Login user	Pages/sheets
Private Charge Print	Store Files	Required/ Not required *4	-	-
	Print Files	Required	Login user	Pages/sheets
Print E-mail		- *1	Unregistered user	Pages/sheets

*1 : Printing is available only when [Non-account Print] is set to [Enabled] in Dell Printer Configuration Web Tool.

*2 : Authentication is not required for printing because each print job has been authenticated when received by the machine.

*3 : Depends on the [Send from Folder] setting under "Feature Access" (P.453) in the System Administration mode.

*4 : Depends on the "Receive Control" (P.457) setting in the System Administration mode.

Scan

You can manage the following scan job information using the Accounting feature:

Corresponding Service	Authentication	Target User	Managed Items
E-mail	Required	Login user	Scanned pages, mail transmission pages
Store to Folder	Required	Login user	Scanned pages
Scan to PC	Required	Login user	Scanned pages, file transfer pages
Store & Send Link	Required	Login user	Scanned pages
Store to USB	Required	Login user	Scanned pages

Fax

You can manage the following fax job information using the Accounting feature:

Services (Jobs)		Authentic ation	Target User	Managed Items
Send as Fax	Automatic Send	Required	Login user	Transmissions/pages, charging units
	Manual Send (Call-in, Call-out)	Required	Login user	Transmissions/pages, charging units
Receive Fax/Print Fax	Automatic Reception/Print	Not required	Fax reception	Receptions/pages, charging units, printed pages/number of sheets
	Manual Reception/Print (Call-in, Call-out)	Required	Fax reception	Receptions/pages, charging units, printed pages/number of sheets
Store Fax - Local Folder	Automatic Reception to Folder	Not required	Fax reception	Receptions/pages, charging units
	Print Folder-received Fax	Required*	Login user	Printed pages/number of sheets
Fax Polling	Storing for Polling (Folders, Polling Folders)	Required*	-	-
	Automatic Send (to Folder)	Not required	Unregistered user	Transmissions/pages
	Automatic Reception/Print	Required	Login user	Polls/pages, charging units, printed pages/number of sheets
	Polling File Sample Printout (Folders, Polling Folders)	Required*	Login user	Pages/number of sheets
Fax Relay Broadcast	Relay Broadcasting, Printing	Not required	Relay Broadcast	Transmissions/pages, charging units, printed pages/number of sheets
Direct Fax transmission		Required	Login user	Transmissions/pages, charging units
Send as Internet Fax		Required	Login user	Transmissions/pages
Receive Internet Fax/Print Internet Fax	Automatic Reception/Print	Not required	Internet Fax Received	Receptions/pages, printed pages/number of sheets
	Automatic Reception to Folder	Not required	Internet Fax Received	Receptions/pages
	Print Folder-received Fax	Required*	Login user	Pages/number of sheets
Receive Internet Fax/Internet Fax Transfer	Automatic Transmission (Transfer)	Not required	Internet Fax reception/fax forwarding	Transmissions/pages, charging units

* : When you select [Unlocked] for [Print Files from Folder] under [Tools] > [Authentication/Security Settings] > [Authentication] > [Access Control] > [Feature Access], authentication is not required to access folders shared by system administrators, and the machine prints jobs as unregistered user.

Restriction on Using the Accounting feature on Fax Jobs:

Note the following conditions when you use the Accounting feature on fax jobs.

- Sending files from different user accounts to the same destination is not counted as a batch send.
- The number of charging units is calculated using the machine's built-in timer. Therefore, the communications charges calculated from the number of charging units may slightly differ from the charges invoiced by the telecommunications company.
- When fax-received pages are split for printing, the number of pages counted will be those received, not those printed.
- The number of charging units is not counted for the following communications:
 - When dialing a fax number using the numeric keypad or the On-hook/Off-hook feature.
 - When using an address number in which the billing data is not registered.
 - When a phone conversation took place, including the one before a transmission.

Billing for Fax Jobs

Fax jobs are not billed for the following communications:

- When dialing a fax number using the numeric keypad or the On-hook/Off-hook feature.
- When using an address number in which the billing data is not registered.
- Manual Receive, Manual Send, or Manual Polling is used.
- When a phone conversation took place, including the one before a transmission.

Configuration for Authentication

This section describes the settings to use the Authentication feature on the machine.

The following shows the reference section for each procedure.

Installation Overview	557
Enabling Authentication.....	557
Changing the Default Authorization Group Settings.....	560
Creating an Authorization Group	560

Installation Overview

To use the Authentication feature, configure the following settings.

- Note**
- If job flow sheets, which are no longer available for use because of a change in the Login Type, are linked to folders, they cannot be edited or copied, but still can be used. If you cancel the links, however, the job flow sheets will no longer be displayed and will be unavailable.

Login to Local Accounts

Specify the Login Type and access control, and then create a user.

Login to Remote Accounts

Specify the Login Type, access control, and remote authentication server.

Change the default authorization group settings and add an authorization group, as necessary.

Enabling Authentication

This section describes the procedures for [Login to Local Accounts] and [Login to Remote Accounts] respectively.

When [Login to Local Accounts] is Selected

Perform the following procedures to use local authentication.

- 1 Press the <Log In/Out> button.
- 2 Enter the system administrator's user ID with the numeric keypad or the keyboard displayed on the screen, and select [Enter].
When a passcode is required, select [Next] and enter the system administrator's passcode, and select [Enter].

- Note**
- The default user ID is "admin".
 - The default passcode is "1111".

- 3 Select [Tools] on the [Home] screen.
- 4 Select [Authentication/Security Settings].
- 5 Select [Authentication].
- 6 Select [Login Type].
- 7 Select [Login to Local Accounts], and then select [Save].

For more information, refer to "Login Type" (P.451).

- 8 Select [Access Control].
- 9 Select [Service Access].
- 10 Select [Unlocked] for the required services to permit users unlimited access, and then select [Save].
- 11 After you finish settings for each feature, select [Close].
- 12 To disable button operations on the control panel, select [Device Access] and select [Locked], and then select [Save] and then [Close].
- 13 Select [Passcode Entry for Control Panel Login] under [Passcode Policy].
Select [On] to prompt users to enter their passcode, or select [Off] if the passcode entry is not required, and then select [Save] and then [Close].
- 14 Select [Create/View User Accounts].
- 15 Select a user displayed as [<Available>], and then select [Create/Delete].
- 16 Enter a User ID and select [Save].
- 17 Select [Account Limit].
- 18 Configure the [Account Limit] and [Feature Access] settings for each service, and then select [Close].
- 19 If necessary, select a user role and an authorization group for the user under [User Role] and [Add This User To Authorization Group] respectively, and then select [Save].
- 20 Select [Close] repeatedly until the [Tools] screen is displayed.
- 21 Select [Close].

- Note**
- Rebooting the machine may be required depending on the settings. When a message displayed on the screen, follow the message and reboot the machine.
 - The machine enters the Login mode, and [Login] is displayed at the lower left of the [Home] screen.
 - When [Locked (Show Icon)] is selected for a service under [Service Access], [] is displayed on the button of the applicable service on the [Home] screen. Also, [: Requires Login] is displayed at the lower left of the [Home] screen. [] and [: Requires Login] are not displayed after authentication.
 - When [Locked (Hide Icon)] is selected for a service under [Service Access] the applicable service is not displayed on the [Home] screen. The services is displayed after authentication.

When [Login to Remote Accounts] is Selected

Perform the following procedures to use remote authentication.

- 1 Press the <Log In/Out> button.
 - 2 Enter the system administrator's user ID with the numeric keypad or the keyboard displayed on the screen, and select [Enter].
When a passcode is required, select [Next] and enter the system administrator's passcode, and select [Enter].
- Note**
- The default user ID is "admin".
 - The default passcode is "1111".
- 3 Select [Tools] on the [Home] screen.
 - 4 Select [Authentication/Security Settings].
 - 5 Select [Authentication].
 - 6 Select [Login Type].

- 7 Select [Login to Remote Accounts], and then select [Save].
For more information, refer to "Login Type" (P.451).
- 8 Select [Yes].
- 9 Select [Access Control].
- 10 Select [Service Access].
- 11 Select [Unlocked] for the required services to permit users unlimited access, and then select [Save].
- 12 Select [Close] repeatedly until the [Tools] screen is displayed.
- 13 Select [System Settings].
- 14 Select [Connectivity & Network Setup].
- 15 Select [Remote Authentication/Directory Service].
- 16 Select [Authentication System Setup] > [Authentication System], and then select a remote authentication server.
For more information, refer to "Remote Authentication/Directory Service" (P.369).
 - Note**
 - The available options are [Kerberos (Windows 2000)], [Kerberos (Solaris)], [LDAP], [SMB], and [Authentication Agent].
- 17 Configure the settings for the remote authentication server.
For more information on the Authentication feature, refer to "Kerberos Server Settings" (P.369), "LDAP Server/Directory Service Settings" (P.370), and "SMB Server Settings" (P.374).
- 18 Select [Close] repeatedly until the [Tools] screen is displayed.
- 19 Select [Close].
 - Note**
 - Rebooting the machine may be required depending on the settings. When a message displayed on the screen, follow the message and reboot the machine.
 - The machine enters the Login mode, and [Login] is displayed at the lower left of the [Home] screen.
 - When [Locked (Show Icon)] is selected for a service under [Service Access], [] is displayed on the button of the applicable service on the [Home] screen. Also, [: Requires Login] is displayed at the lower left of the [Home] screen. [] and [: Requires Login] are not displayed after authentication.
 - When [Locked (Hide Icon)] is selected for a service under [Service Access] the applicable service is not displayed on the [Home] screen. The services is displayed after authentication.

When an LDAP server is used as a remote authentication server

Set the user authorization on the LDAP server using the following steps.

- 1 Start Dell Printer Configuration Web Tool.
- 2 Click the [Properties] tab.
- 3 Click [Connectivity] > [Protocols] > [LDAP] > [LDAP Authorization Access].
- 4 Set attributes in [System Administrator Access] and [Accounting Administrator Access].
Setting example:
System Administrator Access: CN=SA,CN=Users,DC=secEQ,DC=local
Accounting Administrator Access: CN=AA,CN=Users,DC=secEQ,DC=local
- 5 Click [Apply].

Changing the Default Authorization Group Settings

Perform the following procedures to change the settings of the default authentication group. The settings changed here will be used as the default value of the authorization group for a created user.

- 1 Press the <Log In/Out> button.
- 2 Enter the system administrator's user ID with the numeric keypad or the keyboard displayed on the screen, and select [Enter].
When a passcode is required, select [Next] and enter the system administrator's passcode, and select [Enter].
Note
 - The default user ID is "admin".
 - The default passcode is "1111".
- 3 Select [Tools] on the [Home] screen.
- 4 Select [Authentication/Security Settings].
- 5 Select [Authentication].
- 6 Select [Create Authorization Groups].
- 7 Select the group displayed as [DefaultGroup (Default)], and then select [Create/Delete].
- 8 Set each item.
For more information, refer to "Create Authorization Groups" (P.453).
- 9 Select [Close] repeatedly until the [Tools] screen is displayed.
- 10 Select [Close].

Creating an Authorization Group

Perform the following procedures to add authorization groups, if necessary.

- 1 Press the <Log In/Out> button.
- 2 Enter the system administrator's user ID with the numeric keypad or the keyboard displayed on the screen, and select [Enter].
When a passcode is required, select [Next] and enter the system administrator's passcode, and select [Enter].
Note
 - The default user ID is "admin".
 - The default passcode is "1111".
- 3 Select [Tools] on the [Home] screen.
- 4 Select [Authentication/Security Settings].
- 5 Select [Authentication].
- 6 Select [Create Authorization Groups].
- 7 Select a group displayed as [(No Name)], and then select [Create/Delete].
- 8 Enter a group name into [Group Name].
- 9 Set the other items.
For more information, refer to "Create Authorization Groups" (P.453).

10 Select [Close] repeatedly until the [Tools] screen is displayed.

11 Select [Close].

Configuration for Account Administration

This section describes the settings to use the Accounting feature on the machine.

The following shows the reference section for each procedure.

Step 1 Selecting an Accounting Type	562
Step 2 Registering User Information.....	562

Step 1 Selecting an Accounting Type

The following describes the configuration procedures to use the Accounting feature.

Note • For information on relationships between the Authentication and Accounting modes, refer to "Authentication and Accounting Relationship" (P.540).

- 1 Press the <Log In/Out> button.
- 2 Enter the system administrator's user ID with the numeric keypad or the keyboard displayed on the screen, and select [Enter].
When a passcode is required, select [Next] and enter the system administrator's passcode, and select [Enter].
Note • The default user ID is "admin".
• The default passcode is "1111".
- 3 Select [Tools] on the [Home] screen.
- 4 Select [Accounting].
- 5 Select [Accounting Type].
- 6 Select an accounting type, and then select [Save].
Note • You can select the accounting type from [Local Accounting] and [ColorTrack].
For information on accounting types, refer to "Accounting Type" (P.445).
- 7 Select [Close] repeatedly until the [Tools] screen is displayed.
- 8 Select [Close].

Step 2 Registering User Information

- 1 Press the <Log In/Out> button.
- 2 Enter the system administrator's user ID with the numeric keypad or the keyboard displayed on the screen, and select [Enter].
When a passcode is required, select [Next] and enter the system administrator's passcode, and select [Enter].
Note • The default user ID is "admin".
• The default passcode is "1111".
- 3 Select [Tools] on the [Home] screen.
- 4 Select [Accounting].
- 5 Select [Create/View User Accounts].

- 6** Select [**<Available>**], and then select [**Create/Delete**].
- 7** Enter a User ID and select [**Save**].
- 8** Select [**Service Access**].
- 9** Configure the [**Service Access**] and [**Feature Access**] settings for each service, and then select [**Save**].

For more information, refer to "Service Access" (P.442).

- 10** If necessary, select a user role and an authorization group for the user under [**User Role**], and then select [**Save**].

Note • [**User Role**] is displayed only when [**Login Type**] is set to [**Login to Local Accounts**].

For more information, refer to "User Role" (P.443).

- 11** Select [**Close**] repeatedly until the [**Tools**] screen is displayed.
- 12** Select [**Close**].

User Authentication Operations

The machine has the Authentication feature to restrict the services available. This section describes the authentication method to use the restricted services. The following shows the reference section for each procedure.

Authenticating Login Users.....	564
Changing Passcode	565

Authenticating Login Users

There are two methods to authenticate login users: using the control panel of the machine and touching the smart card to the IC Card Reader.

To authenticate the login users using the operator panel, the user must enter the user ID. In addition, the passcode entry is also required when [Passcode Entry for Control Panel Login] is set to [On] under [Authentication/Security Settings] > [Authentication] > [Passcode Policy].

For more information on the passcode policy, refer to "Passcode Policy" (P.456).

For more information on user registration from the touch screen, refer to "Create/View User Accounts" (P.453).

Note • An optional component is required to use this feature. For more information, contact Customer Support at dell.com/contactdell.

Log In/Log Out from the Operator Panel

User Authentication

- 1 Press the <Log In/Out> button or the login information field on the touch screen.
- 2 Enter the user ID with the numeric keypad or the keyboard displayed on the screen, and select [Enter].

When a passcode is required, select [Next] and enter the passcode, and select [Enter].

Note

- Finish user authentication before you cancel the Interrupt mode.
- When you select the service restricted, the [Log In] screen may appear. Enter the user ID and/or the passcode to use the service.
- When the user is authenticated, the <Log In/Out> button is lit.

Logging Out of User Authentication

- 1 Press the <Log In/Out> button.

Note

- You can also log out by pressing the login information field on the touch screen, and then select [Logout].
- When the user is logged out, the <Log In/Out> button light goes out.

Log In/Log Out by Touching the IC Card Reader

User Authentication

- 1 Touch the smart card to the IC Card Reader.

Note

- A passcode may be required depending on the settings. To re-enter the passcode after entering a wrong one, press the <Log In/Out> button to exit the Authentication mode, and then hold your smart card over the IC Card Reader again.

Logging Out of User Authentication

The logging out method vary depending on the Smart Card Logout Timing setting. For more information, refer to "Smart Card Logout Timing" (P.455).

- When you select [Log Out when Card is Removed], the user is authenticated while the smart card is being touched to the IC Card Reader.
- When you select [Log Out from Control Panel], the user can log out by using the same log out method as using the control panel.

Changing Passcode

You can change the passcode to use for user authentication. Change the passcode by following the steps in this section.

Changing Passcode by User

When a user is authenticated, the user can change his/her own passcode.

- 1 Select [Setup] on the [Home] screen.
- 2 Select [User Details Setup].
- 3 Select [Change Passcode].
- 4 Enter the current passcode, and then select [Next].
- 5 Select [New Passcode] and enter a new passcode, and then select [Save].
- 6 Select [Retype Passcode] and re-enter the new passcode, and then select [Save].
- 7 Select [Close].

Setting or Changing Passcode by System Administrator

The system administrator can set or change passcodes using Dell Printer Configuration Web Tool.

For more information on setting or changing passcodes from the touch screen, refer to "Create/View User Accounts" (P.453).

- 1 Start Dell Printer Configuration Web Tool.
For information on how to start Dell Printer Configuration Web Tool, refer to "Starting Dell Printer Configuration Web Tool" (P.464).
- 2 Click the [Properties] tab.
- 3 Click [Security], and then click [Authentication Configuration].
- 4 Click [Next].
- 5 Enter the account number of the user to set or change in [Account Number], and then click [Edit].
- 6 Enter a new passcode in [Password].
- 7 Re-enter the new passcode in [Retype Password].
- 8 Click [Apply].

23 Problem Solving

This chapter describes solutions to various problems you may have with the machine.

- **Troubleshooting**.....568
- **Machine Trouble**569
- **Image Quality Trouble**573
- **Trouble during Copying**579
- **Trouble during Printing**583
- **Trouble during Faxing**.....586
- **Trouble during Scanning**.....590
- **Network-related Problems**.....595
- **Media Print - Text Trouble**.....609
- **Media Print - Photos Trouble**610
- **Status Code**.....611
- **Paper Jams**683
- **Document Jams**692
- **Stapler Faults**694

Troubleshooting

This section describes troubles that may occur with the machine and their solutions. Follow the troubleshooting procedure below to solve the problems.



If the error is not resolved even after following the above procedure, contact Customer Support at dell.com/contactdell.

Machine Trouble

Before you conclude that the machine is defective, check the machine status again.

Symptom	Cause	Remedy
The machine is not powered on.	Is the main power and power switched on?	Switch the main power and power on. Refer to "Product Overview" (P.33).
	Is the power cord plugged into the power outlet?	Switch the main power and power off, and then firmly plug the power cord into the connector of the machine and power outlet. Then switch the main power and power on. Refer to "Product Overview" (P.33).
	Is the power cord disconnected from the machine?	
	Does the AC outlet supply power properly?	Connect another appliance to the outlet to verify the power supply. Refer to "Before Using the Machine" (P.17).
The <Error> indicator is blinking.	The system of the machine or the components installed may have a trouble.	Switch the main power and power off and then on. If the error still is not resolved, contact Customer Support at dell.com/contactdell .
The <Error> indicator is lit.	Is paper or a document jammed?	Remove the jammed paper or document. If paper is jammed, refer to "Paper Jams" (P.683), and a document is jammed, refer to "Document Jams" (P.692).
	Is the front cover or top cover open?	Solve the problem by following the message displayed.
	Is a message displayed on the touch screen prompting you to replace the consumables?	Replace the consumables indicated in the message. Refer to "Replacing Consumables" (P.248).
	Is a message displayed in the upper part of the touch screen?	Check the message and solve the problem. If a status code such as "016-450" is displayed, check the status code list and solve the problem. Refer to "Status Code" (P.611).
The touch screen is too dark.	Is the <Power Saver> button lit?	The machine is in the Power Saver mode. Press the <Power Saver> button on the control panel to exit the Power Saver mode. Refer to "Product Overview" (P.33).
	Is the screen brightness too low?	Adjust the screen brightness on the [Screen Brightness] screen.
Unable to print, or unable to copy.	Is a message displayed on the touch screen?	Follow the instructions displayed to resolve the problem.
	Is the memory capacity insufficient?	Perform one of the following: <ul style="list-style-type: none"> Set [Image Quality] to [Standard] in the print driver, or try printing again by setting [Print Page Mode] to [On]. Set the status of the unused ports to [Disabled].

Symptom	Cause	Remedy
Unable to print, or unable to copy.	Is the print mode [Off-line]?	Press the <Machine Status> button to check the [Print Mode] on the [Machine Status] screen. If [Print Mode] is set to [Off-line], select [On-line].
	Is the power cord disconnected from the machine?	Switch the main power and power off, and then firmly plug the power cord into the connector of the machine and power outlet. Then switch the main power and power on. Refer to "Power Source" (P.41).
The <Data> indicator does not light even though you instructed the machine to print.	Is the interface cable connected?	Check the interface cable connection.
	Is the computer's environment correctly set?	Check the computer environment such as print driver settings.
	Is the required port status set to [Enabled]?	Check the status of the port to use, and then set the port status to [Enabled]. Refer to "Port Settings" (P.358).
Paper is not fed from Tray 5.	Is the specified size paper loaded in the tray?	Follow the instructions displayed to load paper of correct size, and then try again. Refer to "Loading Paper in Tray 5 (Bypass Tray)" (P.238).
Unsatisfactory print quality.	A probable cause is an image defect.	Resolve the problem by referring to "Image Quality Trouble". Refer to "Image Quality Trouble" (P.573).
Unable to print text correctly. (Text is garbled.)	Non-standard fonts are used for printing.	Check the application or print driver settings. If PostScript is being used, download the required fonts.
Unable to insert or remove a paper tray.	Did you open a cover or turn the machine off during printing?	Do not forcibly insert or remove the paper tray. Switch off the power. In a few seconds, switch on the power. When the machine is ready to receive data, insert or remove the paper tray.
Unable to copy with the specified size.	Is the document glass or the document cover dirty?	Clean the document glass and the document cover. Refer to "Cleaning Document Cover and Document Glass" (P.262).
	Is the document a transparent type such as a transparency film?	Place the document on the document glass, and place a white sheet on top of the document when copying.
	Is the document in the correct position?	Load the document correctly. Refer to "Copying Procedure" (P.60).
	Is the document loaded correctly?	
	Are the document guides on the document feeder set in the correct positions?	Adjust the document guide positions. Refer to "Copying Procedure" (P.60).
	Is the document folded?	Unfold and correctly load the document. Refer to "Copying Procedure" (P.60).
	Is the document a non-standard size?	Specify the document size. Refer to "Copying Procedure" (P.60).

Symptom	Cause	Remedy
Paper is often jammed or wrinkled.	Is the paper loaded correctly in the tray?	Load the paper correctly. Refer to "Loading Paper" (P.237).
	Is the paper tray inserted correctly?	Firmly push in the paper tray until it stops to insert it correctly. Refer to "Loading Paper" (P.237).
	Is the paper damp?	Replace the paper with new one. Refer to "Loading Paper" (P.237).
	Is the paper curled?	Turn over the paper in the tray, or replace the paper with new one. Refer to "Loading Paper" (P.237).
	Are the paper and paper tray settings correct?	Correctly set the paper and paper trays to correspond to the paper. Refer to "Changing the Paper Settings" (P.244).
	Are any torn pieces of paper remaining or is there a foreign object in the machine?	Open the cover of the machine or slide out the paper tray to remove the torn pieces or the foreign object. Refer to "Paper Jams" (P.683) or "Loading Paper" (P.237).
	Is non-standard paper loaded in the tray?	Replace with paper that meets machine specifications. Refer to "Paper Types" (P.226) or "Loading Paper" (P.237).
	Is paper exceeding the maximum fill line in the tray?	Load paper in the paper tray so that it does not exceed the maximum fill line. Refer to "Loading Paper" (P.237).
	Are the paper guides set correctly?	Load the paper correctly, and align the paper guides to the paper. Refer to "Loading Paper" (P.237) or "Changing the Paper Size" (P.241).
	Is the image nearly the same size as the paper?	Increase the edge erase widths. For more information, refer to "Copy" (P.59) when you copying, or to the help of the print driver when printing.
	Is the paper finely cut out?	Some types of paper may not be cut out finely. Load the paper after fanning it well.
A document is not fed into the document feeder.	Is the document small?	The minimum size of the document that can be loaded on the document feeder is 125 x 85 mm (Standard size: A5, A5 ). Refer to "Copying Procedure" (P.60).
An error message appears after paper is loaded in Tray 5 and the <Start> button is pressed.	Check the positions of the paper guides of Tray 5.	Adjust the paper guides to the correct positions. Refer to "Loading Paper in Tray 5 (Bypass Tray)" (P.238).



Symptom	Cause	Remedy
Documents are often jammed.	Are suitable types of documents being used?	Correctly load documents suitable for the document feeder. Refer to "Copying Procedure" (P.60).
	Are you trying to use irregular shaped documents, business cards, transparencies, or thin documents?	
	Are you trying to use documents with sticky tags, paper clips or adhesive tape?	Remove sticky tags, paper clips or adhesive tape from the document before copying.
	Are the document guides set in the correct positions?	Adjust the document guide positions. Refer to "Copying Procedure" (P.60).
	Is a piece of torn paper remaining in the document feeder?	Open the document feeder cover and check inside. Refer to "Document Jams" (P.692).
	Is the [Mixed Size Originals] setting set to [Off] when you copy originals of different sizes?	Set [Mixed Size Originals] to [On]. Refer to "Mixed Size Originals (Scanning Different Size Documents Simultaneously)" (P.100).
	Is an A5 document loaded in landscape orientation (☐) on the document feeder when [Mixed Size Originals] is set to [On]?	Load the A5 document in portrait orientation (☐).
An edge of the document is folded.	Is the document curled?	Flatten the curl and load the document again.
Cannot copy in color.	Is [Output Color] set to [Black & White]?	Set [Output Color] to [Color]. Refer to "Output Color (Selecting the Color for Copying)" (P.81).
	Is a message displayed on the touch screen prompting you to replace the toner cartridge?	Replace the toner cartridge of the color indicated in the message. Refer to "Replacing Toner Cartridges" (P.248).
	Is a message displayed on the touch screen prompting you to replace the drum cartridge?	Replace the drum cartridge indicated in the message. Refer to "Replacing Drum Cartridges R1, R2, R3, or R4" (P.253).
Cannot staple properly	Is staple jam occurred in the staple cartridge?	Remove the staple jammed in the cartridge. Refer to "Stapler Faults" (P.694).
	Is the print driver set correctly?	Check the [Staple] setting in [Print Setup] in the print driver when you send a print job from the computer.

Image Quality Trouble





If the image quality of printed documents is poor, identify the symptom in the following table to perform the remedy.

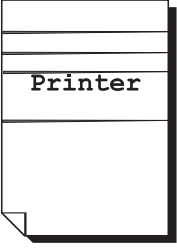
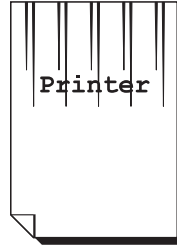
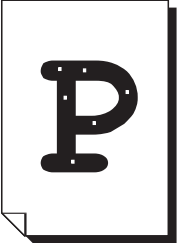

If image quality does not improve even after the remedy, contact Customer Support at dell.com/contactdell.

Symptom	Cause	Remedy
The copy is dirty.	Is the document glass or the document cover dirty?	Clean the document glass and the document cover. Refer to "Cleaning Document Cover and Document Glass" (P.262).
	Is the document a transparent type such as a transparency film?	If the document is transparent, dirt on the document cover will be copied. Place a white sheet of paper on top of the document when copying.
	Is the document colored, rough, or a blueprint?	Adjust the copy density or image quality. Refer to "Image Quality" (P.87).
	Is the document glossy printing paper?	Glossy printing paper easily sticks to the document glass, and shadows are sometimes copied, soiling the image. Place a transparency film under the document when copying.
The copy has black lines.	Is the constant velocity transport glass on the document feeder dirty?	Clean the constant velocity transport document glass. Refer to "Cleaning Film and Constant Velocity Transport Glass" (P.263).
The copy is too dark.	Is the copy density set to [Darken]?	Adjust the copy density. Refer to "Image Quality" (P.87).
The copy is too light.	Is the document faint?	
	Is the copy density set to [Lighten]?	
The copy is slightly misaligned.	Are the paper edges aligned and the leading edge adjusted to the tray corners?	Align the paper edges, adjust them to the tray's top corners, and reload the paper. Refer to "Loading Paper" (P.237).
The copy is misaligned or skewed.	Is the document loaded correctly?	Load the document correctly. Refer to "Copying Procedure" (P.60).
	Is the paper loaded correctly in the tray?	Load the paper correctly. Refer to "Loading Paper" (P.237).
	Are the paper guides of Tray 5 correctly aligned to the paper?	Load the paper correctly and align the document guides to the document edges. Refer to "Loading Paper in Tray 5 (Bypass Tray)" (P.238).
	Are the document guides on the document feeder set in the correct positions?	Load the document correctly, and align the document guides to the document edges. Refer to "Copying Procedure" (P.60).
	Is the paper tray inserted correctly?	Firmly push in the tray until it stops to insert it properly. Refer to "Loading Paper" (P.237).

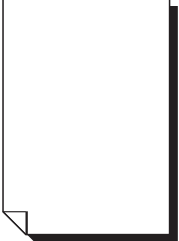
Symptom	Cause	Remedy
Part of the image is missing on the copy.	Is the paper damp?	If the paper is damp, the copy image may be partially missing or unclear. Replace the paper with new one. Refer to "Loading Paper" (P.237).
	Is folded or wrinkled paper included in the tray?	Remove the unsuitable paper or replace all of the paper with new one. Refer to "Loading Paper" (P.237).
	Is the document pasted or folded?	The pasted or folded section may not be laying flat on the document glass. Place a stack of white sheets on top of the document to flatten the document against the document glass.
The copy has a stripe pattern.	Is the enlargement ratio too large?	Vertical stripes may be printed on the copies depending on the ratio. Adjust the ratio to eliminate the stripes. Refer to "Reduce / Enlarge (Making Enlarged/ Reduced Copies)" (P.70).
Color shift of color copies is poor, resulting in unsatisfactory image quality.	Is the color calibration incorrect?	Execute auto calibration. Refer to "Executing Calibration" (P.265).
	Is the machine set where it is exposed to direct sunlight?	If the document glass is exposed to strong light when you turn the machine on or cancel the Power Saver mode, color shift may occur. Close the document cover and turn the machine on, and when the machine becomes ready to copy or print, turn the machine off and then on one more time.
Printing is faint. (smudged, unclear) 	The paper is damp.	Replace the paper with new one. Refer to "Loading Paper" (P.237).
	The drum cartridge has deteriorated or is damaged.	Replace the drum cartridge with a new one. Refer to "Replacing Drum Cartridges R1, R2, R3, or R4" (P.253).
	There is no toner left in the toner cartridge.	Replace the toner cartridge with a new one. Refer to "Replacing Toner Cartridges" (P.248).
Black dots are printed. 	The drum cartridge has deteriorated or is damaged.	Replace the drum cartridge with a new one. Refer to "Replacing Drum Cartridges R1, R2, R3, or R4" (P.253).

Symptom	Cause	Remedy
<p>Black or colored lines are printed.</p>  	<p>The drum cartridge has deteriorated or is damaged.</p> <p>The machine interior (LED printhead) is dirty.</p> <p>The constant velocity transport glass on the document feeder is dirty.</p>	<p>Replace the drum cartridge with a new one. Refer to "Replacing Drum Cartridges R1, R2, R3, or R4" (P.253).</p> <p>Clean the machine interior. Refer to "Cleaning the Interior (LED Printheads)" (P.260).</p> <p>Clean the constant velocity transport glass. Refer to "Cleaning Film and Constant Velocity Transport Glass" (P.263).</p>
<p>Dirt appears at equal intervals.</p>  <p>Paper feed direction →</p>	<p>The paper path is dirty.</p> <p>The drum cartridge has deteriorated or is damaged.</p>	<p>Print a few pages to remove the dirt.</p> <p>Replace the drum cartridge with a new one. Refer to "Replacing Drum Cartridges R1, R2, R3, or R4" (P.253).</p>
<p>White dots appear in black filled areas.</p> 	<p>The paper is unsuitable.</p> <p>The drum cartridge has deteriorated or is damaged.</p>	<p>Load suitable paper. Refer to "Loading Paper" (P.237).</p> <p>Replace the drum cartridge with a new one. Refer to "Replacing Drum Cartridges R1, R2, R3, or R4" (P.253).</p>

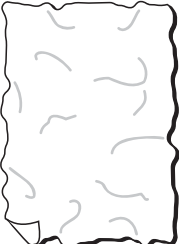
Symptom	Cause	Remedy
Printed toner smudges when rubbed with your finger. Toner is not fused. The paper is soiled with toner. 	The paper is damp.	Replace the paper with new one. Refer to "Loading Paper" (P.237).
	The paper is unsuitable.	Load suitable paper. Refer to "Loading Paper" (P.237).
The entire paper area is printed black. 	The drum cartridge has deteriorated or is damaged.	Replace the drum cartridge with a new one. Refer to "Replacing Drum Cartridges R1, R2, R3, or R4" (P.253).
	High-voltage power supply may have malfunctioned.	Contact Customer Support at dell.com/contactdell .
Nothing is printed. 	Two or more sheets of paper are being fed simultaneously (double-feed).	Fan the paper well and load it again. Refer to "Loading Paper" (P.237).
	No toner remains in the toner cartridge.	Replace the toner cartridge with a new one. Refer to "Replacing Toner Cartridges" (P.248).
	Power supply or high-voltage power supply may have malfunctioned.	Contact Customer Support at dell.com/contactdell .
White areas or white or colored stripes appear. 	The machine interior (LED printheads) may be soiled.	Clean the interior. Refer to "Cleaning the Interior (LED Printheads)" (P.260).
	The paper is damp.	Replace the paper with new one. Refer to "Loading Paper" (P.237).
	The paper is unsuitable.	Load suitable paper. Refer to "Loading Paper" (P.237).

Symptom	Cause	Remedy
The entire output is faint. 	When Tray 5 is used, the size and type of the loaded paper are different from the settings on the print driver.	Load paper of the correct type and size into Tray 5. Refer to "Loading Paper in Tray 5 (Bypass Tray)" (P.238).
	Two or more sheets may be fed simultaneously.	Fan the paper well and load it again. Refer to "Loading Paper" (P.237).
Paper becomes wrinkled. 	The paper is unsuitable.	Replace the paper with new one. Refer to "Loading Paper" (P.237).
	Paper has been added to the paper loaded.	
	The paper is damp.	
Text is blurred. 	The paper is unsuitable.	Replace the paper with new one. Refer to "Loading Paper" (P.237).
	Paper has been added to the paper loaded.	
	The paper is damp.	
White or color patches appear vertically. 	The drum cartridge has deteriorated or is damaged.	Replace the drum cartridge with a new one. Refer to "Replacing Drum Cartridges R1, R2, R3, or R4" (P.253).
	No toner remains in the toner cartridge.	Replace the toner cartridge with a new one. Refer to "Replacing Toner Cartridges" (P.248).
	The machine interior (LED printheads) may be soiled.	Clean the interior. Refer to "Cleaning the Interior (LED Printheads)" (P.260).

Symptom	Cause	Remedy
<p data-bbox="344 219 555 309">Text or images are printed at an angle.</p> 	<p data-bbox="571 219 914 309">The paper guides in the paper tray are not set in the correct positions.</p>	<p data-bbox="930 219 1377 320">Adjust the horizontal and vertical paper guides to the correct positions. Refer to "Loading Paper" (P.237).</p>

Trouble during Copying

This section describes how to resolve copy problems.

Unable to Copy

If you cannot copy a document, identify the symptom in the following table to perform the remedy.

Symptom	Cause	Remedy
The document is not correctly fed from the document feeder.	The document is too small.	The minimum size of document that can be loaded on the document feeder is 125 x 85 mm (A5, A5 ^{LF}). Refer to "Copying Procedure" (P.60).
	The document type is unsuitable.	The document feeder does not feed irregular sized documents, business cards, transparencies, or thin documents. In addition, the document feeder does not feed documents with sticky tags, paper clips, or adhesive tape. Refer to "Copying Procedure" (P.60).
	The document guides are set in incorrect positions.	Adjust the document guides to the document. Refer to "Copying Procedure" (P.60).
	A piece of torn paper remains in the document feeder.	Open the document feeder cover, and remove the piece. Refer to "Document Jams" (P.692).
	Documents of mixed sizes are loaded.	When loading documents of mixed sizes, be sure to set [Mixed Size Originals] to [On]. Otherwise, a paper jam will occur. Refer to "Mixed Size Originals (Scanning Different Size Documents Simultaneously)" (P.100).

The Copy Result is Not What was Expected

If the copy result is not what was expected, identify the symptom in the following table to perform the remedy.

Symptom	Cause	Remedy
The copy is dirty.	The document glass or the document cover is soiled.	Clean the document glass or the document cover. Refer to "Cleaning Document Cover and Document Glass" (P.262).
	The document is a transparent type such as a transparency film.	If the document is transparent, dirt on the document cover may be copied. Place a white sheet of paper on top of the document when copying.
	The document is colored, rough, or a blueprint.	The paper's background color is copied. Adjust the copy density or image quality, or specify [Suppress Background].
	The document is glossy printing paper.	Glossy printing paper easily sticks to the document glass, and shadows are sometimes copied, soiling the image. Place a transparency film under the document when copying.
The copy is too dark or light.	The copy density is set to [Darken] or [Lighten].	Adjust the copy density. Refer to "Image Quality" (P.87).
	The document density is too light.	Adjust the copy density. Refer to "Image Quality" (P.87).
	The setting for [Original Type] is inappropriate for the document.	Copy black text. If the printout is too light, select [Text] for [Original Type]. Refer to "Image Quality" (P.87).
The color of the document and of the copy differ.	Is the color calibration incorrect?	Execute auto calibration. Refer to "Executing Calibration" (P.265).
	The document type selected is not suitable.	Set the suitable value for [Original Type]. Refer to "Original Type (Selecting the Document Type)" (P.87).
	The image quality selected is unsuitable for the document.	Copy black text. If the printout is too light, select [Text] for [Original Type]. Refer to "Image Quality" (P.87).
The copy is slightly misaligned.	Paper is misaligned in the tray.	Align the paper edges, and adjust them to the tray's top corners to reload the paper. Refer to "Loading Paper" (P.237).

Symptom	Cause	Remedy
Part of the image is missing on the copy.	The paper is damp.	If the paper is damp, the copy image may be partially missing or unclear. Replace the paper with new one. Refer to "Loading Paper" (P.237).
	Folded or wrinkled paper is included in the tray.	Remove the unsuitable paper or replace all of the paper with new one. Refer to "Loading Paper" (P.237).
	The document is pasted or folded.	The pasted or folded section may not be laying flat on the document glass. Place a stack of white sheets on top of the document to flatten the document against the document glass.
The copy has a stripe pattern.	The document enlargement ratio is too large.	Vertical stripes may be printed on the copies depending on the ratio. Adjust the ratio to eliminate the stripes. Refer to "Reduce / Enlarge (Making Enlarged/ Reduced Copies)" (P.70).
The copy is misaligned or skewed.	The document is not loaded correctly.	Load the document correctly. Refer to "Copying Procedure" (P.60).
	The document guides on the document feeder are not set in the correct positions.	Load the document correctly, and align the document guides to the document. Refer to "Copying Procedure" (P.60).
	The paper tray is not inserted correctly.	Firmly push in the tray until it stops to set it properly. Refer to "Loading Paper" (P.237).
	The paper guides in Tray 5 are not set in the correct positions.	Load the paper correctly, and align the paper guides to the paper edges. Refer to "Loading Paper in Tray 5 (Bypass Tray)" (P.238).
Unable to copy with the specified size.	The document glass or the document cover is dirty.	Clean the document glass or the document cover. Refer to "Cleaning Document Cover and Document Glass" (P.262).
	The document is a transparent type such as a transparency film.	Place a white sheet of paper on top of the document when copying.
	The document is misaligned.	Load the document correctly. Refer to "Copying Procedure" (P.60).
	The document guides on the document feeder are not set in the correct positions.	Load the document correctly, and align the document guides to the document. Refer to "Copying Procedure" (P.60).
	The document is a non-standard size.	Specify the document size, and then copy. Refer to "Copying Procedure" (P.60).
	The document is folded.	Flatten the curl and load the document again. Refer to "Copying Procedure" (P.60).

Symptom	Cause	Remedy
Unable to copy in color.	[Output Color] is set to [Black & White].	Set [Output Color] to [Auto Detect] or [Color]. Refer to "Output Color (Selecting the Color for Copying)" (P.81).
The document edges are missing on the copy.	The document is larger than the printable area.	Adjust [Reduce / Enlarge] to copy the document smaller.
Outputs are not stapled.	The Finisher is not attached.	The Finisher is required to staple. Install the Finisher, or change the print option settings to cancel stapling.
	The number of pages to be stapled exceeds the maximum number for stapling.	You cannot staple more than 50 pages. Reduce the number of pages to 50 or fewer.

Trouble during Printing

This section describes how to resolve print problems.

Unable to Print

If you cannot print a document, identify the symptom in the following table to perform the remedy.

Symptom	Cause	Remedy
Data remains in the printer icon.	The machine is not powered on.	Switch the main power and power on.
	The network cable is disconnected from the computer.	Connect the network cable to the computer.
	The network cable is disconnected from the machine.	Connect the network cable to the machine.
	The print mode is [Off-line] on the machine.	Press the <Machine Status> button to check the [Print Mode] on the [Machine Status] screen. If [Print Mode] is set to [Off-line], select [On-line].
	An error occurred in the machine.	Check the error details and take an appropriate action.
	The IP address or SMB network path is not correctly set.	Set the correct IP address or SMB network path. Refer to "Printer Environment Settings" (P.469).
	The network between the computer and machine is abnormal.	Check with your network administrator.
	The port is not enabled.	Enable the port. Refer to "Port Settings" (P.358).
	The hard disk space of the machine is insufficient.	Delete unnecessary data such as stored documents (Charge Print, Private Charge Print, and Secure Print) in folders to increase free space.
	The machine is connected to multiple computers.	Wait for a while, and then try printing again.
The data has been sent to the machine.	The machine is out of paper.	Load paper in the machine.
	No paper is loaded for the specified paper size.	Load paper of the size specified. Refer to "Loading Paper" (P.237).
	Printing is interrupted by a copy operation.	Cancel the interrupting operation.
	An error occurred in the machine.	Check the error details and take an appropriate action.

The Print Result is Not What was Expected

If the print result is not what was expected, identify the symptom in the following table to perform the remedy.

Symptom	Cause	Remedy
Cannot print in color.	[Output Color] is set to [Black & White].	Set [Output Color] to [Auto Detect] or [Color].
Outputs are not stapled.	The Finisher is not installed.	The Finisher is required to staple. Install the Finisher, or change the print option settings to cancel stapling.
	The number of pages to be stapled exceeds the maximum number for stapling.	You cannot staple more than 50 pages. Reduce the number of pages to 50 or fewer.
The document is printed on a different paper size than specified.	The document size is different from the paper size loaded in the specified tray.	Change the size of paper in the tray, or change the print option to specify a tray that contains the correct sized paper.
The image on the document edges is missing on the output.	The image is larger than the printable area.	Expand the printable area of the machine, or reduce the image size on the printout.
The printed font differs from the font specified on the computer.	Font replacement is set on the print driver.	Check the font replacement table.
The printout is not offset.	The machine does not offer the Offset feature.	To output offset, the Offset Stacking Module or the Finisher is required.
Printing is slow.	[High Resolution] is selected for [Image Quality].	When image data, such as photos, is printed with the high resolution, the print speed becomes slow. Select [Standard] for [Image Quality].
The specified print options are not enabled.	The print driver for another model is used.	Install the print driver for the model.
	The required optional kit is not installed on the machine.	Check the optional components installed on the machine, and set [Installable Options] under [Configuration] in the print driver again.
The document edges are missing on the printout.	The image is larger than the printable area.	Expand the printable area of the machine, or reduce the image size on the printout.
The output color differs between Secure Print and Print Stored File.	This is because the print path is different. The output color of Print Stored File is reproduced by the presence or absence of dots, as with copying or faxing. On the other hand, the output color of Secure Print is reproduced using density by default, as with printing.	To closer match the color of Secure Print and files in folder, select [On] in [Image Options] > [Print Page Mode] on the [Advanced] tab of the print driver settings.

Symptom	Cause	Remedy
The print color differs from before.	The color calibration is incorrect.	Execute auto calibration. Refer to "Executing Calibration" (P.265).
Black lines are printed.	The job is output from a print driver for another machine.	Output the job from a print driver for the machine to be used for printing.

Trouble during Faxing

This section describes how to resolve fax problems.

- Note**
- For troubles during Internet faxing, refer to "E-mail Features Problems" (P.604).
 - An optional component is required to use the Fax features. For more information, contact Customer Support at dell.com/contactdell.

Sending Problems

If you cannot send a fax, identify the symptom in the following table to perform the remedy.

Symptom	Cause	Remedy
A Transmission Report - Job Undelivered is output.	The fax was not sent because of an error.	Check the Transmission Results in the Transmission Report - Job Undelivered. If a status code is displayed, refer to "Status Code" (P.611).
Unable to communicate (general fax)	The phone line is not connected correctly.	The machine is equipped with connectors to which to connect phone lines. Communication is enabled only when the phone line is connected to the correct connector. When the cable connection is correct, the On-hook feature allows you to call via general lines.
	The phone dialing method is not available.	Specify the same dialing method as the one (Tone/10pps) subscribed for the machine.
	An error occurred with the phone line.	Use a telephone near the machine to check whether you can make a phone call. If the phone call is disabled, the problem is in the phone line, not in the machine.
	The destination machine is abnormal.	The data cannot be sent if the machine of the recipient is turned off, is set to "manual" receiving mode, or does not support G3 reception. Call the recipient to confirm the machine condition.
	An incorrect fax number is used.	Check the fax number and try sending again.
	The number is not for fax number.	If no peep sound is heard from the receiver when you call the number, the number is not for a fax number.
	You forgot the external access number.	When calling from an extension line, the external access number is required. When dialing, dial the external access number such as "0", and then dial the fax number. When the switchboard is changed and you cannot send faxes, try the external access number "0*" instead of "0".

Symptom	Cause	Remedy
Unable to communicate (general fax)	When calling from an abbreviated telephone number, an external access number is appended.	When calling from an abbreviated telephone number to an external line, an external access number such as "0" may be registered for the abbreviated telephone number. Confirm the telephone number of the receiver on the Transmission Report - Job Undelivered.
	You are using a feature such as the Polling feature that is not supported by the destination fax.	Confirm whether the destination fax supports the feature.
	The Authentication/Accounting feature is being used and the fax is being sent directly from the computer.	When the Authentication/Accounting feature is used and you send a fax directly from the computer, you must set the user ID and passcode registered on the machine to the fax driver. For details on the Authentication/Accounting feature, refer to "Authentication and Accounting Features" (P.533).
The image quality is poor.	The document glass is dirty.	Clean the document glass. Refer to "Cleaning Film and Constant Velocity Transport Glass" (P.263).
	The fax density is inappropriate.	Adjust the fax density.
	The sender's machine has a problem.	Confirm with the sender. Note • Image quality may be affected by a problem of the sender's machine, not just by a problem of the machine.

Receiving Problems

If you cannot receive a fax, identify the symptom in the following table to perform the remedy.

Symptom	Cause	Remedy
Unable to communicate (general fax)	The phone line is not connected correctly.	The machine is equipped with connectors to which to connect phone lines. Communication is enabled only when the phone line is connected to the correct connector. When the cable connection is correct, the On-hook feature allows you to call via general lines.
	An error occurred with the phone line.	Use a telephone near the machine to check whether you can make a phone call. If the phone call is disabled, the problem is in the phone line, not in the machine.
	The machine is turned off.	The machine cannot receive a fax when turned off. Switch the main power and power on.
	No paper is set.	Load paper in the machine to receive faxes.
	Paper is jammed.	Follow the instructions displayed on the control panel to remove the jammed paper. Refer to "Paper Jams" (P.683).
	The machine is in the System Administration mode.	The machine cannot receive a fax in the System Administration mode. Exit the System Administration mode.
	A machine password has been set.	When a machine password has been set, the machine accepts only data or polling fax sent with the correct machine password in F code.
	The machine is in manual receive mode.	Receive the fax manually, or set [Fax Receiving Mode] to [Auto Receive]. Refer to "Fax Receiving Mode" (P.288).
	The machine is in manual send mode.	To use Fax information service, set the reception mode to [Manual Send] on the on-hook screen, enter an information code, and press the <Start> button.
	The document is not correctly loaded on the sender's machine.	Check with the sender. Note <ul style="list-style-type: none"> Image quality may be affected by a problem of the sender's machine, not just by a problem of the machine.

Symptom	Cause	Remedy									
<p>The image quality is poor.</p>	<p>The drum cartridge is damaged.</p>	<p>Copy a document. If the image quality is poor, replace the drum cartridge with a new one. Refer to "Replacing Drum Cartridges R1, R2, R3, or R4" (P.253).</p>									
	<p>The document glass of the sender's machine is dirty.</p>	<p>Check with the sender. Note • Image quality may be affected by a problem of the sender's machine, not just by a problem of the machine.</p>									
	<p>The resolution setting on the sender's machine is too low.</p>	<p>Check with the sender. Note • Image quality may be affected by a problem of the sender's machine, not just by a problem of the machine.</p>									
<p>The one-page document is received split into multiple pages.</p>	<p>When scanned on the sender's machine, the document was enlarged for some reason.</p>	<p>You can set the machine to process such a document by using the Auto Reduce on Receipt feature and a border limit value for page splitting. According to the setting combination specified, the received document is printed as follows:</p> <table border="1" data-bbox="954 929 1428 1388"> <thead> <tr> <th data-bbox="954 929 1106 1088">AutoReduce on Receipt / Page Split Border Limit</th> <th data-bbox="1106 929 1273 1088">Auto Reduce on Receipt ON</th> <th data-bbox="1273 929 1428 1088">Auto Reduce on Receipt OFF</th> </tr> </thead> <tbody> <tr> <td data-bbox="954 1088 1106 1283">Within border limit</td> <td data-bbox="1106 1088 1273 1283">Automatically reduces image size and prints it on one page.</td> <td data-bbox="1273 1088 1428 1283">Trims the portion exceeding standard size and then prints.</td> </tr> <tr> <td data-bbox="954 1283 1106 1388">Exceeding border limit</td> <td data-bbox="1106 1283 1273 1388">Splits data at equal ratio and prints.</td> <td data-bbox="1273 1283 1428 1388">-</td> </tr> </tbody> </table> <p>Refer to "Border Limit" (P.398), or "Auto Reduce On Receipt" (P.398).</p>	AutoReduce on Receipt / Page Split Border Limit	Auto Reduce on Receipt ON	Auto Reduce on Receipt OFF	Within border limit	Automatically reduces image size and prints it on one page.	Trims the portion exceeding standard size and then prints.	Exceeding border limit	Splits data at equal ratio and prints.	-
AutoReduce on Receipt / Page Split Border Limit	Auto Reduce on Receipt ON	Auto Reduce on Receipt OFF									
Within border limit	Automatically reduces image size and prints it on one page.	Trims the portion exceeding standard size and then prints.									
Exceeding border limit	Splits data at equal ratio and prints.	-									
<p>Although the Folder Selector feature is set, however, the received document is printed, and cannot be stored in the folder.</p>	<p>An unregistered folder is specified on the Folder Selector feature.</p>	<p>When using the Folder Selector feature, specify a registered folder. If an unregistered folder is selected, the received document cannot be stored in the folder, and will be automatically printed. For information on how to register the folder, refer to "Create Folder" (P.421). For information on the setting of the Folder Selector, refer to "Fax Received Options" (P.401).</p>									

Trouble during Scanning

This section describes how to resolve scan problems.

Unable to Scan with the Machine

If you cannot scan with the machine, identify the symptom in the following table to perform the remedy.

Symptom	Cause	Remedy
The document is not correctly fed from the document feeder.	The document is too small.	The minimum size of the document that can be loaded on the document feeder is 125 x 85 mm (Standard size: A5, A5 ^z). Refer to "Scanning Procedure" (P.158).
	The document type is unsuitable.	The document feeder does not feed irregular sized documents, business cards, transparencies, or thin documents. In addition, the document feeder does not feed documents with sticky tags, paper clips, or adhesive tape. Refer to "Scanning Procedure" (P.158).
	The document guides are set in incorrect positions.	Adjust the document guides to the document. Refer to "Scanning Procedure" (P.158).
	A piece of torn paper remains in the document feeder.	Open the document feeder cover, and remove the piece. Refer to "Document Jams" (P.692).
	Documents of mixed sizes are loaded.	When loading documents of mixed sizes, be sure to set [Mixed Size Originals] to [On]. Otherwise, a paper jam will occur.

Unable to Import Scanned Documents to the Computer

If you cannot import scanned documents to the computer, identify the symptom in the following table to perform the remedy.

Symptom	Cause	Remedy
Unable to find the scanner.	The machine is not turned on.	Switch the main power and power on.
	The network cable is disconnected from the computer.	Connect the network cable to the computer.
	The network cable is disconnected from the machine.	Connect the network cable to the machine.
	The network between the computer and machine is abnormal.	Check with your network administrator.
Unable to open a folder.	The folder is unregistered.	Register the folder. Refer to "Create Folder" (P.421).
	The folder passcode has been forgotten.	The passcode cannot be retrieved. Set the passcode to [Off], and then set the passcode again. Refer to "Create Folder" (P.421).
Unable to import data from the scanner because of a TWAIN transmission error.	The scan driver is not installed.	Install the scan driver.
Operation terminates during scanning.	The file size is too large.	Lower the resolution, and import again.

Unable to Send a Scanned Document over the Network (FTP/SMB)

If you cannot send a scanned document over the network, identify the symptom in the following table to perform the remedy.

Symptom	Cause	Remedy
A Transmission Report - Job Undelivered is output.	Unable to transmit because of the error.	Check the Transmission Results in the Transmission Report - Job Undelivered. If a status code is displayed, refer to "Status Code" (P.611).
Unable to send data over the network.	The server is not correctly specified.	Correctly specify the server.
	The save destination is not correctly specified.	Correctly specify the save destination.
	When SMB is selected, the shared name is not correctly specified.	Correctly specify the shared name.
	When SMB (UNC Format) is selected, the save destination is not correctly specified.	Correctly specify the save destination.
	The login name is not entered correctly.	Correctly enter the login name.
	The password is not correctly entered.	Correctly enter the password.
	The time set on the machine does not agree with that of Windows, when SMB transmission is performed to Windows Server 2003 or Windows Server 2008.	Synchronize the time settings of the machine and Windows.
	On Windows Server 2003, Windows Server 2008, or Windows XP, users who do not set a password cannot use SMB transmission.	Follow the steps below to change the settings of network access: <ol style="list-style-type: none"> 1. Start Windows, and select [Control Panel] > [Administrative Tools] > [Local Security Policy]. 2. Select [Security Settings] > [Local Policies] > [Security Options]. 3. Change [Account: Limit local account use of blank passwords to console logon only] to [Disabled].
	Is the root of the DFS name space (\\Domain name\Shared name) specified with more than three characters.	Specify a DFS name space with a root comprised of less than four characters.

Unable to Send E-mail

If you cannot send a scanned document using the E-mail feature, identify the symptom in the following table to perform the remedy.

Symptom	Cause	Remedy
A Transmission Report - Job Undelivered is output.	Unable to transmit because of an error.	Check the Transmission Results in the Transmission Report - Job Undelivered. If the status code is displayed, refer to "Status Code" (P.611).
Unable to send e-mail.	The mail address is incorrect.	Enter the correct mail address.
	The data size exceeded the maximum e-mail size.	Change the maximum e-mail size, or lower the resolution. Refer to "Maximum Total Data Size" (P.407).

The Image is not What was Expected

If the image is not what was expected, identify the symptom in the following table to perform the remedy.

Symptom	Cause	Remedy
The image is dirty.	The document glass or the document cover is soiled.	Clean the document glass or the document cover. Refer to "Cleaning Document Cover and Document Glass" (P.262).
	The document is a transparent type such as a transparency film.	If the document is transparent, dirt on the document cover may be copied on the image. Place a white sheet of paper on top of the document when scanning.
	The document is colored, rough, or a blueprint.	Adjust the copy density or image quality when scanning.
	The document is glossy printing paper.	Glossy printing paper easily sticks to the document glass, and shadows are sometimes scanned, soiling the image. Place a transparency film under the document when scanning.
The image is too dark, or too light.	The scan density is set to [Darken] or [Lighten].	Adjust the scan density.
	The setting for [Original Type] is inappropriate for the document.	Select an image quality appropriate for the document.
Part of the image is missing.	The document is pasted or folded.	The pasted or folded section may not be laying flat on the document glass. Place a stack of white sheets on top of the document to flatten the document against the document glass.

Symptom	Cause	Remedy
The image is not the desired size.	The document glass or the document cover is dirty.	Clean the document glass or the document cover. Refer to "Cleaning Document Cover and Document Glass" (P.262).
	The document is a transparent type such as a transparency film.	Place a white sheet of paper on top of the document when scanning.
	The document is misaligned.	Load the document correctly. Refer to "Scanning Procedure" (P.158).
	The document guides on the document feeder are not set in the correct positions.	Load the document correctly, and align the document guides to the document. Refer to "Scanning Procedure" (P.158).
	The document is a non-standard size.	Specify the document size. Refer to "Scanning Procedure" (P.158).
	The document is folded.	Flatten the curl and load the document again. Refer to "Scanning Procedure" (P.158).
The image is not scanned in color.	[Color Scanning] is set to [Black & White], or [Grayscale].	Set [Color Scanning] to [Color].
The image is coarse.	The resolution is too low.	Set the resolution higher.
	Image is saved with high compression.	Select a lower compression ratio in [Quality / File Size].
Black-and-white gradation is not reproduced properly.	[Black & White] is selected for [Color Scanning].	Set [Color Scanning] to [Grayscale].

Network-related Problems

This section describes how to resolve network related problems.

When using SMB

When SMB is used, identify the symptom in the following table to perform the remedy.

When you cannot communicate with the machine

Cause	Check point	Remedy
The computer and the machine are using different protocols.	Although you can find the machine from [Start] > [Search], [Network Computer] does not display the machine.	Configure the machine and each computer to use the same SMB operational protocol.
The machine belongs to different network (subnet).	Although you can find the machine from [Start] > [Search], [Network Computer] does not display the machine.	If the machine and the computers are set to different networks, consult your network administrator.
The host name specified for the machine is already in use.	Print out Configuration Report to confirm whether "Repetitive Host Name" is printed in the SMB status information.	Use Dell Printer Configuration Web Tool to change the host name to a unique name, or restore the machine settings to the default settings.

When you cannot communicate with the machine or other SMB machines

Cause	Check point	Remedy
If [Auto Master Mode] of SMB is set to [On], the number of machines whose information can be stored is limited. The number depends on the network environment.	The machine or other SMB machines cannot be searched from the Network Computers icon.	Confirm the setting of [Auto Master Mode] of SMB. If the setting is enabled, change it to [Off].

When you cannot print

Cause	Check point	Remedy
The machine is processing a print job from a different computer. (When [SMB (Spool)] is set to [Off])	Confirm whether the machine is processing a print job. (A write error dialog is displayed to indicate that there is no room to store your print job.)	Wait until the machine completes processing the print job, or change the machine setting to the [Spool] mode.
The connections to the machine exceeded the maximum number allowed.	Confirm whether the machine is processing simultaneous requests (print requests, status queries, etc.) from multiple computers. (A write error dialog is displayed to indicate that no more remote computers can be connected.)	Wait for a while and try printing again.

When you cannot delete documents from the [Print] window

Cause	Check point	Remedy
You are trying to delete all print data displayed in the [Print] window. (Only the system administrator is allowed to delete all data.)	Confirm whether you are trying to delete the print data from the [Print] menu. ([Cancel All Documents] menu.)	Select the print data to delete, and delete from the [Document] menu in the [Print] window. (Select [Cancel].)
The print data has a different owner.	Confirm whether the name displayed as the owner for the selected print data and the user's login name to Windows are the same.	Login to Windows using the name displayed as the owner of the print data, and then delete the print data.

Others

Symptom	Remedy
The message "Unknown document name" is displayed for the job name in the job history instead of the correct job name.	Change the setting of the SMB receiving buffer to [Hard Disk Spool] or [Memory Spool].

When using NetWare

The possible causes, check points, and remedies for problems when using NetWare are as follows:

When you cannot print

Cause	Check point	Remedy
Network equipment, such as hubs, does not support automatic frame type detection.	Confirm whether the data link indicator of the network equipment port to which the machine is connected is lit. Confirm whether the frame types used by the file servers on the network are standardized.	Specify the frame type set on the connected file server as the frame type for the machine.
A problem occurred on the network between the computer and the machine.	Use NWADMIN on the computer to confirm whether the machine object can be browsed.*	Replace the faulty network cable connected between the computer and the machine.
Job sender (user or group name) is not specified in [User] for the print queue.	Use NWADMIN from a computer to confirm whether the print queue object's [User] information lists the job sender (user or group name).*	Re-send the print data to the print queue for which the job sender (user or group name) is registered as the [User].
		Use NWADMIN from a computer to register job sender (user or group name) to [User] of [Print Queue].*
Job transmission to the print queue is prohibited.	Use PCONSOLE to confirm whether [User can register to the queue] is set to [Yes] under [Current Queue Status] of [Print Queue].	Use PCONSOLE to set the item to [Yes].
	Use NWADMIN on the computer to confirm whether the operator flag is being confirmed with [Recognition] of the print queue.*	Use NWADMIN on a computer to confirm whether each item of the operator flag is being confirmed with [Recognition] of the print queue.*
Job sender (user or group name) is not specified in the user setting for the print server.	Use NWADMIN from a computer to confirm that the print server's [User] information lists the job sender (user or group name).*	Re-send the print data to the print queue whose [User] of [Print Server Information] includes the job sender (user or group name).
		Use NWADMIN from a computer to register job sender (user or group name) to [User] information of the print server.*
The print queue where the user has transmitted the print data, is not assigned to the machine.	Use NWADMIN from a computer to check the print queue's [Assignment] whether the machine is assigned in the printer list serviced by the print queue.*	Re-send the print data to the print queue which is assigned to the machine.*
		Use NWADMIN from a computer to add the print queue to the machine.*

Cause	Check point	Remedy
Print data format and the print environment settings on the computer do not match.	-	If the computer is running on Windows, set it not to output Ctrl-D.
The number of print queues set for the machine exceeds the maximum number allowed.	Use NWADMIN from a computer to check on the print queue list of [Assignment] for the machine whether the desired print queue is assigned.*	Re-send the print data to the print queue which is assigned to the machine.*
The slave file server is not configured. ([Bindery Service] mode)	Use PCONSOLE from a computer to confirm whether the slave file server is registered to [Service NetWare Server] on the print server indicated by [Print Server Information].*	Use PCONSOLE from computer to register the slave file server and reflect the configured settings.*
The slave file server configuration is mismatched. ([Bindery Service] mode)	Use PCONSOLE from a computer to confirm whether the printer type is set to [Defined Elsewhere] under [Print Server Information] > [Printer] > [Printer xxx Environment Settings].*	If the printer type is not set to [Defined Elsewhere], change it to [Defined Elsewhere], and then reflect the configured settings.*
The form number on the print data and the form number set to the printer do not match.	Use NWADMIN on a computer to select the machine and confirm whether the start number of the form in the environment settings matches the number in the print data.*	Use NWADMIN from a computer to match the [Start Form] number in the machine's environment settings to the number in the print data.*
The level settings for the IPX checksum do not match.	Use the set command from the console screen on the file server to confirm whether the IPX checksum is set to level 2.	Enter the following command from the console screen on the file server to set the IPX checksum to either level 0 or level 1. set Enable IPX Checksum=x (x = 0 or 1)
The level settings for the NCP packet signature do not match.	Use the set command from the console screen on the file server to confirm whether the NCP packet signature is set to level 3.	Enter the following command from the console screen on the file server to set the NCP packet signature to either level 0, 1, or 2, and restart the file server. set NCP Packet Signature Option=x (x = 0, 1, or 2)
The default device name is incorrect.	Print the Configuration Report to confirm the last 6 digits (3 bytes) of the Ethernet address.	Set the device name using the correct Ethernet address. Set a device name differing from the default name.
The directory tree name is not configured.	Print Configuration Report to confirm whether the tree name is specified.	Set the tree name.

Cause	Check point	Remedy
The context is not set.	Print Configuration Report to confirm whether the context is specified.	Set the context.
Connected to a different printer object.	Use NWADMIN from a computer to confirm, on the layout information of the print server, whether the correct object is assigned.*	Use the Driver CD Kit from a computer to correctly set the file server name/tree name/context/active mode.
		Use Dell Printer Configuration Web Tool from a computer to correctly set the file server name/tree name/context/active mode.
The NetWare port on the machine is not activated.	Print Configuration Report to confirm whether the NetWare port is activated.	Select the [Enabled] check box of [NetWare] to activate the port.
The file server is down.	Search for the file server on [Network Neighborhood].	Start the file server.
There is another device on the network with an identical device name.	Turn off the machine and use NWADMIN from a computer to confirm whether the status of the relevant printer object is "Standby".	Use the Driver CD Kit from a computer to set a different device name.
The NetWare port is not activated.	Print Configuration Report to confirm whether the network number is "0000000" (NetWare server is down), if using IPX/SPX. If using TCP/IP, confirm whether the IP address is "0.0.0.0" (static address unspecified, or the DHCP server is down).	In the case of IPX/SPX, start the NetWare server. In the case of TCP/IP, either set a static IP address or start the DHCP server.

* :For more information on configuration and operations, refer to NetWare Online Documentation.

When "Switch the machine off" is displayed

Cause	Check point	Remedy
A NetWare problem occurred.	-	Restart the machine. Wait until the screen completely goes out to switch on the machine power.

When print result is not what was expected

Cause	Check point	Remedy
The printer language of the print data and the printer language configured on the machine are different.	Confirm the printer language on the machine.	Match the printer language of the print data and the printer language configured on the machine.

When no notification is received

The possible causes, check points, and remedies when a computer that instructed a print job does not receive notification are as follows:

When the printing problems are not notified

Cause	Check point	Remedy
The user is not listed on the print server notification recipient list.	Use PCONSOLE on the computer to confirm whether the job user or user's group is registered under [Print Server Information] > [Printer] > [Printer xxx Environment Settings] > [Notify].	Add the name of the job user or the name of the user's group to [Notify].

When the completion of the job is not notified

Cause	Check point	Remedy
The [Notify] option was not specified when the computer transmitted the print data.	Confirm whether the [Notify] option is specified when transmitting the print data.	Specify the [Notify] option when transmitting the print data.
Netware command [CASTOFF] has been executed on the computer.	-	Execute the NetWare command [CASTON] on the computer.

When using TCP/IP

The possible causes, check points, and remedies when using TCP/IP (LPD) are as follows.

Windows XP, Windows Vista, Windows 7, Windows 8, Windows 8.1, Windows Server 2003, Windows Server 2008, Windows Server 2008 R2, or Windows Server 2012

When you cannot print

Cause	Check point	Remedy
The IP address is incorrect.	Request your network administrator to check the machine's IP address.	Set a correct IP address on the machine.
The volume of the print data sent in an instruction from a computer exceeded the maximum receivable volume when the LPD spool is set to memory spool.	Confirm the memory amount for the LPD spool and the volume of the print data transmitted by an instruction.	If the one file of print data exceeds the memory amount, divide the file not to exceed the amount.
		If the print data is divided into multiple files and exceeds the memory amount, decrease the number of files not to exceed the amount.
An unrecoverable error occurred during the printing process.	Confirm whether any error messages are displayed on the control panel.	Restart the machine. Wait until the screen completely goes out to switch on the machine power.
The machine is not set to the transport protocol corresponding to the computer.	Confirm the transport protocol selected on the machine.	Select the transport protocol corresponding to the computer.
The machine is trying to process a data format that does not match the data format of the print data transmitted from a computer.	-	Set not to output Ctrl-D.

When print result is not what was expected

Cause	Check point	Remedy
Selected printer language on the machine does not match the printer language of the print data.	Confirm the selected printer language on the machine and the printer language of the print data.	Select the printer language on the machine to match the print data.
The computer is not using the print driver supplied with the machine (is using another company's print driver).	Confirm whether the print driver on the computer is the one supplied with the machine.	On the computer, select the print driver supplied with the machine. If the print driver is not listed for selection, install the print driver and then select it. Operation is not guaranteed if another company's print driver is used.

Mac OS X 10.5/10.6/10.7/10.8**When you cannot print**

Cause	Check point	Remedy
The LPD port is not activated.	Confirm whether the LPD port is activated.	When printing with a printer detected by using Bonjour, select the [Enabled] check box of [LPD] to activate the port.

When using EtherTalk

The possible symptoms, causes, and remedies for problems when using EtherTalk are as follows:

Cause	Check point	Remedy
Documents are printed by another machine.	If a machine assigned the same printer name already existed on the network, the printer names is automatically changed when starting the machine. Therefore, depending on the timing of starting the printer, the machine may be started with a different name, and documents are printed by another machine.	A machine that is assigned the same printer name may exist on the network. Confirm the printer name, and change the name if it is duplicated.
The printer cannot be browsed from clients.	If the machine is turned on before it is connected to a network, clients may not be able to identify the printer name and therefore cannot browse the printer.	Turn the machine on after connecting to the network. If the machine is turned on while disconnected from the network, turn the machine off, connect it to the network, and then turn the machine on again.

Dell Printer Configuration Web Tool Problems

The possible symptoms and remedies for problems when using Dell Printer Configuration Web Tool are as follows:

Symptom	Remedy
Cannot connect to Dell Printer Configuration Web Tool.	Is the machine working properly? Check whether the machine is turned on.
	Is Internet Services (HTTP) port activated? Print Configuration Report to confirm.
	Is the Internet address correctly entered? Confirm the Internet address again. If the problem persists, enter an IP address to connect to Dell Printer Configuration Web Tool.
	Is a proxy server being used? Depending on the proxy server, connections may not be possible.
The [Please wait] message is continuously displayed.	Wait for a while as instructed. If the status does not change, click the [Refresh] button. If this does not impart any effect, confirm whether the machine is operating correctly.
The [Refresh] button is not functioning.	Are you using a specified browser? Refer to "Installation of Dell Printer Configuration Web Tool" (P.462) to confirm whether your browser is supported.
Selecting the menu on the left frame does not update the right frame contents.	
The screen display is distorted.	Change the window size for the browser.
The latest information is not displayed.	Click the [Refresh] button.
Characters are not correctly displayed.	Use Western European language command.
Pressing [Apply] does not apply the new settings.	Are the entered values correct? If a value outside of the permitted range is entered, the update will automatically be made within the range.
	This may occur when the control panel is being operated or the operation has just been completed. When the automatic reset function is set, any setting configure with Dell Printer Configuration Web Tool is not applied until setting the time set for automatic reset. Wait until then.
When you click [Apply], a message such as "The server has returned ineffective or unrecognizable response" or "No data" is displayed on the browser.	Is the password correct? The entries for Password and Confirm Password do not match. Enter the correct password.
	Restart the machine.
Cannot delete jobs.	Wait for a while, and click [Refresh].

E-mail Features Problems

The possible symptoms and remedies for problems when using E-mail Notification Service, the Print E-mail feature, the E-mail service, and Internet Fax service as follows:

Symptom	Remedy
Cannot receive e-mail (Print E-mail, and Internet Fax).	Is the e-mail address for the machine configured?
	Is [Receive E-mail] set to [Enabled]?
	Are settings such as the IP addresses for the SMTP server and POP3 server (if POP3 is selected as the incoming mail protocol) configured correctly?
	Are the POP3 user name and password entered correctly?
	Is [Domain Filtering] set? Confirm whether your own domain is set to [Allow Domains], on Dell Printer Configuration Web Tool.
	Are the SMTP server and/or POP server operating properly? Consult your network administrator.
Cannot transmit e-mail (E-mail Notification Service, Internet Fax, and E-mail).	Is the E-mail address for the machine configured?
	Is [E-mail Notification Service] set to [Enabled]? (For E-mail Notification Service).
	Is [Send E-mail] set to [Enabled]?
	Is the IP address for the SMTP server configured correctly?
	Are the settings for notification of transmission configured correctly? (for E-mail Notification Service) Confirm the settings on the [Properties] tab of Dell Printer Configuration Web Tool.
	Is the destination address entered correctly?
	Is the SMTP server operating properly? Consult your network administrator.

Internet/Intranet Connection Problems

The possible causes and remedies for problems when connecting to the Internet or intranet are as follows:

When connection to the Internet/Intranet fails

Cause	Remedy
The Authentication feature used on the remote server is not supported by the machine.	Only Basic Authentication is supported by the machine. The machine does not support NTLM/digest. For security purposes, change to the Authentication feature using SSL.
The remote linkage services used does not support the model or accessories of the machine.	Purchase products/models/accessories supported by the remote linkage services.
The IP address is incorrect.	Confirm the IP address. If the IP address is incorrect, either set a static IP address or resolve the IP address using DHCP or Autonet.
The IP gateway address is incorrect.	Set the correct IP gateway address when connecting to the proxy server, or to a Web server via the IP gateway.
The subnet mask is incorrect.	Set the correct subnet mask corresponding to your environment.
The DNS server address is incorrect.	Confirm the DNS server address.
The DNS server selected cannot resolve the address.	Select a DNS server that can resolve the address. <ul style="list-style-type: none"> • When connecting via the proxy server Set the IP address of a DNS server that can resolve the address of the proxy server. • When not connecting via the proxy server Set the IP address of a DNS server that can resolve the destination address.
The address that does not use a proxy server is incorrect.	Confirm whether only addresses that do not use a proxy server are set. Even if addresses not through a proxy server are specified using the FQDN, if a server is directly accessed using its IP address, the registered server is not excluded. Set the address not to use a proxy server. Likewise, even if you directly specify an address that does not use a proxy server, if a server is accessed with the FQDN, the registered server is not excluded. Set an IP address with the FQDN not to use a proxy server.
The desired server, or the proxy server is down.	Confirm whether the desired server or the proxy server is operating correctly.
The network cable is not connected, or broken.	Confirm whether the network cable is correctly connected. We recommend using a spanning-tree configuration, with which network disconnection rarely occurs.
Cannot communicate because of overloading of the server application.	Wait for a while and try accessing again.
An error that is not displayed on the control panel occurs.	Even though an error occurs during background processing, no message appears on the control panel. Display the [Job Status] screen or print the Job History Report to confirm the result.

Cause	Remedy
Cannot access the proxy server, firewall, or Web server as a result of access control.	<p>The following types of access control are used. Confirm the configured access control.</p> <ul style="list-style-type: none"> • Address (port) restriction • SSL restriction • User access restriction (including access right levels) • Content block • Scheme restriction (cannot use HTTP etc.) • Transfer data size restriction • Method restriction (cannot use POST etc.) • HTTP header restriction (only accepting specified browsers etc.) • Time restriction (only available during a specific period of time etc.)

When connection to a desired Web server fails

Cause	Remedy
The setting to use the proxy server is not configured.	In the environment using the proxy server, you must configure the machine to use the proxy server to connect to a desired Web server. Make sure that you configure the settings to use the proxy server.
The setting to use a proxy server is configured even though the environment does not use a proxy server.	In an environment that does not use a proxy server, such as when connecting to an intranet, do not make the settings to use the proxy server.
The proxy server address is incorrect.	When the settings to use a proxy server are configured, you cannot connect to a desired Web server if the IP address of the proxy server is wrong. Set the correct IP address of the proxy server.
When the proxy server access requires authentication, you cannot connect to the server because the user name or password is incorrect.	Set the user name and password on the machine that allow connection to the proxy server.

IPv4 and IPv6 Connection Problems

The possible causes and remedies for problems when using an IPv4 or IPv6 address are as follows:

Unable to connect using an IPv4 address

Symptom	Remedy
When 0 (zero) is prepended to the head of a value for the IPv4 address (for example: 192.0.2.010), connection fails.	Do not prepend 0 (zero) to each value of an IPv4 address.

Unable to connect using an IPv6 address

Symptom	Remedy
You cannot connect to the machine with the link-local address.	When you specify the machine's link-local address, a scope ID must be appended to the address. For example, when you use Internet Explorer 7 on Windows Vista to access the address "fe80::203:baff:fe48:9010", you must append the Ethernet adapter local area connection number (for example, 8) for Windows Vista to the address as follows: fe80::203:baff:fe48:9010%8
The machine cannot connect to a computer running Windows OS that supports IPv6.	Assign a static IPv6 address to the computer running Windows OS that supports IPv6. Then, register the IPv6 address on the machine as host address to allow communication.
A device outside the router cannot be searched.	When searching for a device outside the router via SMB, directly specify the address. Multicasting is supported only within a local link (FF02::1).
When SSL is enabled on Dell Printer Configuration Web Tool, even if you specify "http://[IPv6 address]", you are not redirected to "https://[IPv6 address]".	When SSL is enabled, directly specify "https://[IPv6 address]".

Unable to print using an IPv6 address

Symptom	Remedy
On an IPv6 network without a DNS server, a computer running Windows OS that supports IPv6 cannot be connected to a Windows shared printer.	Register the computer name of the machine on the "hosts" file stored on the computer running Windows OS that supports IPv6. For example, register in the following file: C:\Windows\system32\driver\etc\hosts
IPv6 communication cannot be established with NetWare.	NetWare does not support IPv6 communication. Use IPv4 for NetWare.

Unable to scan using an IPv6 address

Symptom	Remedy
When the machine is configured with only a link-local address, file transfer fails.	Assign a global address to the machine.
When you specify the computer name on a storage destination server of the Scan to PC (SMB) service in an IPv6 environment without a DNS server, scan data cannot be transferred.	Scan data cannot be transferred with SMB if a destination server is specified using the computer name. Use the IPv6 format to specify the server.
The machine does not operate correctly if the Internet Fax direct destination is specified in IPv6 address literal format. Example: csw@[ipv6:2001:db8::1]	In an IPv6 environment, use a DNS server and specify a destination using a fully qualified domain name (FQDN).
The machine does not operate correctly if the mail address for the E-mail service is specified in IPv6 address literal format. Example: csw@[ipv6:2001:db8::1]	In an IPv6 environment, use a DNS server and specify an e-mail address using the FQDN.

Other problems on IPv6 addresses

Symptom	Remedy
Unable to search devices with IPv6 addresses in UPnP.	In an IPv6 environment, use Function Discovery of Web Services on Devices (WSD).
In an IPv6 network with no DNS server installed, authentication fails if an SMB authentication server is specified using the computer name.	Directly specify the IPv6 address to specify the computer name of an authentication server.
When the Web Applications service is used, you cannot correctly specify the destination URL using the IPv6 address. Example: http://[ipv6:2001:db8::1]	In an IPv6 environment, use a DNS server and specify a remote service's destination URL using the FQDN.
IPv6 addresses are not correctly recorded on output job logs.	Use an IPv4 network for correct logging.

Media Print - Text Trouble

The possible symptoms, causes, and remedies for problems when using Media Print - Text are as follows.

Symptom	Cause	Remedy
[Media Print - Text] is not displayed on the [Home] screen.	[Media Print] in Dell Printer Configuration Web Tool is not checked.	Check [Media Print] in Dell Printer Configuration Web Tool to enable the service.

Media Print - Photos Trouble

The possible symptoms, causes, and remedies for problems when using Media Print - Photos are as follows:

Symptom	Cause	Remedy
A blank sheet of paper is output.	Files that cannot be printed (image files in other than DCF1.0 format) are included among the files specified for printing.	Files that cannot be printed (image files in other than DCF1.0 format) are not printed with index printing. Specify printing again, excluding the images not displayed for index printing. Note <ul style="list-style-type: none">• Note that editing or saving DCF1.0-format image files on a computer makes those files' format other than DCF1.0.

Status Code

This section describes status codes.

An error message and status code (**-**) are displayed if printing terminated abnormally because of an error, or a malfunction occurred in the machine.

For faxing, a status code is also displayed on an Activity Report and a Transmission Report - Job Undelivered.

Refer to the status codes in the following table to resolve problems.

Note • If a status code is displayed, any print data remaining in the machine and information stored in the machine's memory is not secured.

If a status code is displayed that is not listed in the following table, or if you cannot resolve an error despite following the instructions described in the table, contact Customer Support at dell.com/contactdell.

Status Code	Cause and Remedy
002-500	<p>[Cause] An error occurred during the scan job.</p> <p>[Remedy] Execute the operation again. Also, check whether or not the account limit for the Scan service is set when the accounting type is ColorTrack. If the error still is not resolved, contact Customer Support at dell.com/contactdell.</p>

Status Code	Cause and Remedy
003-311 003-318 003-319 003-320 003-321 003-322 003-323 003-324 003-325 003-326 003-327 003-328 003-329 003-330 003-331 003-332 003-333 003-334 003-335 003-336 003-337 003-338 003-339 003-340 003-341 003-342 003-343 003-344 003-345 003-346	<p>[Cause] An error occurred.</p> <p>[Remedy] Switch off the machine power, make sure that the touch screen is blank, and then switch on the machine power. If the same message is displayed again, contact Customer Support at dell.com/contactdell.</p>
003-700	<p>[Cause] Too many documents are set in the document feeder after clearing the paper jam.</p> <p>[Remedy] Check the output, and then replace the documents that have not been copied yet.</p>
003-702	<p>[Cause] You tried to copy sides 1 and 2 of a document simultaneously specifying different Reduce/Enlarge ratio for each side.</p> <p>[Remedy] Specify the same Reduce/Enlarge ratio for both sides.</p>
003-703	<p>[Cause] The Calibration Chart is not detected correctly.</p> <p>[Remedy] Place the Calibration Chart properly.</p>
003-704	<p>[Cause] An error is found in the calibration pattern read, and the machine may be out of order.</p> <p>[Remedy] Execute the calibration again. If the error is not still resolved, contact Customer Support at dell.com/contactdell.</p>
003-705	<p>[Cause] Copying is started before the machine exits the Power Saver mode and detects the change for the tray size, when the paper size set in the tray that has been changed during the Power Saver mode.</p> <p>[Remedy] Cancel copying, and perform the operation for copying again.</p>
003-750	<p>[Cause] Unable to store any documents using the 2 Sided Book Copying feature.</p> <p>[Remedy] Check the 2 Sided Book Copying settings. Refer to "Layout Adjustment" (P.94).</p>

Status Code	Cause and Remedy
003-751	<p>[Cause] Unable to process the document because the specified scan area is too small.</p> <p>[Remedy] Increase the resolution or scan area.</p>
003-752	<p>[Cause] A mix sized document was to be scanned at 600 dpi in Color/2 sided.</p> <p>[Remedy] Set [Resolution] to [400 dpi] or lower, and try scanning again.</p>
003-753	<p>[Cause] A mix sized document was to be scanned at high resolution, 2 sided.</p> <p>[Remedy] Set [Resolution] to [200 dpi], and scan the document again.</p>
003-754 003-755	<p>[Cause] An error occurred in the document feeder.</p> <p>[Remedy] Execute the job again.</p>
003-756	<p>[Cause] The faxed document is completely blank.</p> <p>[Remedy] Check whether the document is blank or whether the side of the document to be faxed is loaded correctly.</p>
003-757	<p>[Cause] A mix sized document was to be scanned at high resolution, 2 sided.</p> <p>[Remedy] Set [Resolution] to [300 dpi] or lower, and scan the document again.</p>
003-760	<p>[Cause] An incompatible combination of feature is specified for document scan conditions.</p> <p>[Remedy] Confirm the selected options.</p>
003-761	<p>[Cause] The paper size of the tray selected for auto tray differs from the paper size of the tray selected for Auto Paper selection.</p> <p>[Remedy] Change the paper size for the tray, or change the [Paper Type Priority] settings.</p>
003-763	<p>[Cause] An error occurred when reading the Calibration Chart.</p> <p>[Remedy] Place the Calibration Chart correctly on the document glass. Refer to "Executing Calibration" (P.265).</p>
003-780	<p>[Cause] Failed to compress the scanned document.</p> <p>[Remedy] Reduce the resolution or the ratio for [Reduce / Enlarge] to decrease the data size, or split the data to send it separately.</p>
003-795	<p>[Cause] When enlarging/reducing a scanned document to the paper size specified, the reduction/enlargement ratio exceeds the allowed range.</p> <p>[Remedy] Take one of the following measures:</p> <ul style="list-style-type: none"> • Manually enter a reduction/enlargement ratio. • Change the paper size.
005-275 005-280	<p>[Cause] An error occurred in the document feeder.</p> <p>[Remedy] Switch off the machine power, make sure that the touch screen is blank, and then switch on the machine power. If the error still is not resolved, contact Customer Support at dell.com/contactdell.</p>
010-330	<p>[Cause] An error occurred in the machine.</p> <p>[Remedy] Switch off the machine power, make sure that the touch screen is blank, and then switch on the machine power. If the error still is not resolved, contact Customer Support at dell.com/contactdell.</p>

Status Code	Cause and Remedy
010-371 010-372 010-373 010-374 010-375 010-376 010-377 010-378 010-379 010-380 010-381 010-382 010-398	<p>[Cause] An error occurred in the machine.</p> <p>[Remedy] Switch off the machine power, make sure that the touch screen is blank, and then switch on the machine power. If the same message is displayed again, contact Customer Support at dell.com/contactdell.</p>
012-210 012-211 012-212 012-213 012-221 012-223 012-224 012-225 012-226 012-227 012-228 012-229 012-230 012-231 012-232 012-233 012-234 012-241 012-243	<p>[Cause] Finisher malfunction</p> <p>[Remedy] Switch off the machine power, make sure that the touch screen is blank, and then switch on the machine power. If the error still is not resolved, contact Customer Support at dell.com/contactdell.</p>
012-246	<p>[Cause] The Booklet Maker is not fully inserted completely into the Finisher.</p> <p>[Remedy] Completely insert the Booklet Maker into the Finisher, and turn the machine off and then on.</p>
012-247 012-249	<p>[Cause] Finisher malfunction</p> <p>[Remedy] Switch off the machine power, make sure that the touch screen is blank, and then switch on the machine power. If the error still is not resolved, contact Customer Support at dell.com/contactdell.</p>
012-255	<p>[Cause] Finisher Tray malfunction</p> <p>[Remedy] Switch off the machine power, make sure that the touch screen is blank, and then switch on the machine power. If the error still is not resolved, contact Customer Support at dell.com/contactdell.</p>

Status Code	Cause and Remedy
012-259 012-260 012-261 012-263 012-264 012-265 012-266 012-268 012-269 012-280 012-282 012-283 012-284 012-286 012-287 012-291 012-295 012-296	<p>[Cause] Finisher malfunction</p> <p>[Remedy] Switch off the machine power, make sure that the touch screen is blank, and then switch on the machine power. If the error still is not resolved, contact Customer Support at dell.com/contactdell.</p>
012-334	<p>[Cause] An error occurred.</p> <p>[Remedy] Switch off the machine power, make sure that the touch screen is blank, and then switch on the machine power. If the same message is displayed again, contact Customer Support at dell.com/contactdell.</p>
012-402	<p>[Cause] The hole punch waste container of the finisher is not installed.</p> <p>[Remedy] Install the hole punch waste container. When the same message is displayed even after you install the hole punch waste container, remove the container, and then install it again.</p>
012-500	<p>[Cause] An error occurred in the finisher.</p> <p>[Remedy] Switch off the machine power, make sure that the touch screen is blank, and then switch on the machine power. If the same message is displayed again, contact Customer Support at dell.com/contactdell.</p>
013-210 013-211 013-212 013-213 013-220	<p>[Cause] An error occurred in the Booklet Unit.</p> <p>[Remedy] Switch off the machine power, make sure that the touch screen is blank, and then switch on the machine power. If the error still is not resolved, contact Customer Support at dell.com/contactdell.</p>
016-210 016-211 016-212 016-213 016-214 016-215 016-216 016-217 016-218 016-219	<p>[Cause] An error occurred in the software.</p> <p>[Remedy] Switch off the machine power, make sure that the touch screen is blank, and then switch on the machine power. If the error still is not resolved, contact Customer Support at dell.com/contactdell.</p>

Status Code	Cause and Remedy
016-220 016-221 016-222 016-223 016-224 016-225 016-226 016-227 016-228	<p>[Cause] An error occurred in the document feeder.</p> <p>[Remedy] Switch off the machine power, make sure that the touch screen is blank, and then switch on the machine power. If the error still is not resolved, contact Customer Support at dell.com/contactdell.</p>
016-229 016-230	<p>[Cause] An error occurred in the software</p> <p>[Remedy] Switch off the machine power, make sure that the touch screen is blank, and then switch on the machine power. If the error still is not resolved, contact Customer Support at dell.com/contactdell.</p>
016-232	<p>[Cause] An error occurred during initialization of the high compression board.</p> <p>[Remedy] Switch off the machine power, make sure that the touch screen is blank, and then switch on the machine power. If the error still is not resolved, contact Customer Support at dell.com/contactdell.</p>
016-233	<p>[Cause] An error occurred in the software.</p> <p>[Remedy] Switch off the machine power, make sure that the touch screen is blank, and then switch on the machine power. If the error still is not resolved, contact Customer Support at dell.com/contactdell.</p>
016-234 016-235 016-236 016-237 016-238 016-239	<p>[Cause] An error occurred in the Authentication feature of the machine.</p> <p>[Remedy] Switch off the machine power, make sure that the touch screen is blank, and then switch on the machine power. If the error still is not resolved, contact Customer Support at dell.com/contactdell.</p>
016-240	<p>[Cause] An error occurred in the document feeder.</p> <p>[Remedy] Switch off the machine power, make sure that the touch screen is blank, and then switch on the machine power. If the error still is not resolved, contact Customer Support at dell.com/contactdell.</p>
016-242	<p>[Cause] An error occurred in the machine.</p> <p>[Remedy] Switch off the machine power, make sure that the touch screen is blank, and then switch on the machine power. If the error still is not resolved, contact Customer Support at dell.com/contactdell.</p>

Status Code	Cause and Remedy
016-310 016-311 016-312 016-313 016-314 016-315 016-316 016-317 016-318 016-319 016-320 016-321 016-322 016-323 016-324 016-325 016-326 016-327	[Cause] An error occurred. [Remedy] Switch off the machine power, make sure that the touch screen is blank, and then switch on the machine power. If the same message is displayed again, contact Customer Support at dell.com/contactdell .
016-330 016-331 016-332	[Cause] An error occurred in the machine. [Remedy] Switch off the machine power, make sure that the touch screen is blank, and then switch on the machine power. If the same message is displayed again, contact Customer Support at dell.com/contactdell .
016-335 016-336 016-337 016-338 016-339 016-340 016-341 016-342	[Cause] An error occurred. [Remedy] Switch off the machine power, make sure that the touch screen is blank, and then switch on the machine power. If the same message is displayed again, contact Customer Support at dell.com/contactdell .
016-345 016-347 016-348 016-350 016-351 016-360 016-362 016-363 016-364 016-365 016-366 016-367 016-368 016-369 016-370 016-371	[Cause] An error occurred. [Remedy] Switch off the machine power, make sure that the touch screen is blank, and then switch on the machine power. If the same message is displayed again, contact Customer Support at dell.com/contactdell .

Status Code	Cause and Remedy
016-372 016-373 016-374 016-375 016-376 016-377 016-378 016-379 016-380 016-381 016-382	<p>[Cause] An error occurred.</p> <p>[Remedy] Switch off the machine power, make sure that the touch screen is blank, and then switch on the machine power. If the same message is displayed again, contact Customer Support at dell.com/contactdell.</p>
016-400	<p>[Cause] The user name or password for 802.1x authentication does not match.</p> <p>[Remedy] Confirm and correctly enter the user name or password. If the error still is not resolved, check whether the network environment is set correctly.</p>
016-401	<p>[Cause] The 802.1x authentication method cannot be processed.</p> <p>[Remedy] Set the authentication method of the machine to the same method as set for the authentication server.</p>
016-402	<p>[Cause] The authentication connection timed out.</p> <p>[Remedy] Confirm the network connection and switch setting of the authentication device physically connected to the machine via a network, and check whether it is connected to the machine correctly.</p>
016-403	<p>[Cause] The root certificate did not match.</p> <p>[Remedy] Confirm the authentication server and store the root certificate of the server certificate of the authentication server into the machine. If you cannot acquire the root certificate of the server certificate, set [Server Certificate Verification] of [IEEE 802.1x Settings] to [Disabled] on the touch screen.</p>
016-404	<p>[Cause] An internal error occurred.</p> <p>[Remedy] Execute the operation again. If the error still is not resolved, contact Customer Support at dell.com/contactdell.</p>
016-405	<p>[Cause] An error occurred in the certificate stored in the machine.</p> <p>[Remedy] Initialize the certificate. For more information on initializing certificates, refer to "Delete All Certificates/Initialize Settings" (P.330).</p>
016-406	<p>[Cause] An error occurred in the SSL client certificate.</p> <p>[Remedy] Take one of the following measures: 1)Store an SSL client certificate in the machine, and set it as the SSL client certificate. 2)If an SSL client certificate cannot be set on the machine, select an option other than [EAP-TLS] in [Authentication Method].</p>
016-407 016-408 016-409 016-410 016-411 016-412	<p>[Cause] After automatically obtained the IP address, the machine failed to retrieve proxy server settings from the DHCP server.</p> <p>[Remedy] Modify the customized program and install it again.</p>

Status Code	Cause and Remedy
016-450	<p>[Cause] The SMB host name already exists.</p> <p>[Remedy] Change the host name. Refer to "Host Name" (P.366).</p>
016-453	<p>[Cause] Updating of the IPv6 address and host name for the DNS server failed.</p> <p>[Remedy] Check whether the IP address of the DNS server is set correctly.</p>
016-454	<p>[Cause] Unable to retrieve the IP address from DNS.</p> <p>[Remedy] Confirm the DNS configuration and IP address retrieve setting. Refer to "Protocol Settings" (P.363).</p>
016-455	<p>[Cause] Connection to the SNTP server timed out.</p> <p>[Remedy] Confirm the network cable connection and the IP address of the SNTP server are correct. Refer to "Machine Clock/Timers" (P.314).</p>
016-456	<p>[Cause] Received a message from the SNTP server stating that the server is not synchronized with the standard time source.</p> <p>[Remedy] Confirm the SNTP server settings. Refer to "Machine Clock/Timers" (P.314).</p>
016-500 016-501 016-502	<p>[Cause] An error occurred.</p> <p>[Remedy] Switch off the machine power, make sure that the touch screen is blank, and then switch on the machine power. If the same message is displayed again, contact Customer Support at dell.com/contactdell.</p>
016-503	<p>[Cause] Unable to resolve the SMTP server name when sending e-mail.</p> <p>[Remedy] Check on Dell Printer Configuration Web Tool whether the SMTP server settings are correct. Also, confirm whether the DNS server settings are correct.</p>
016-504	<p>[Cause] Unable to resolve the POP3 server name when sending e-mail.</p> <p>[Remedy] Check on Dell Printer Configuration Web Tool whether the POP3 server settings are correct. Also, confirm whether the DNS server settings are correct.</p>
016-505	<p>[Cause] Unable to log into the POP3 server when sending e-mail.</p> <p>[Remedy] Check on Dell Printer Configuration Web Tool whether the user name and password used on the POP3 server are correct.</p>
016-513	<p>[Cause] An error occurred in connecting to the SMTP server. Probable causes are as follows: 1)The SMTP server or network may be overloaded. 2)The source port number for SMTP is incorrect.</p> <p>[Remedy] For 1), wait for a while, and then execute the operation again. For 2), confirm whether the source port number for SMTP is correct.</p>
016-514	<p>[Cause] An error occurred during processing of an XPS document.</p> <p>[Remedy] If an error occurred while printing from a driver which supports XPS, print from the application using another print driver (PCL, etc.). If an error occurred while direct printing an XPS document (such as E-mail and Media Print - Text), print using the print driver (PCL, etc.) from XPS Document Viewer.</p> <p>Note • XPS stands for XML Paper Specification.</p>

Status Code	Cause and Remedy
016-515	<p>[Cause] There was insufficient memory during processing of an XPS document.</p> <p>[Remedy] Take one of the following measures:</p> <ul style="list-style-type: none"> • Set [Image Quality] to [Standard] • Print using the print driver (PCL, etc.) from XPS Document Viewer. <p>Note •XPS stands for XML Paper Specification.</p> <p>For more information on [Image Options], refer to the help of the print driver.</p>
016-516	<p>[Cause] The Print Ticket included in the XPS document includes an invalid description or a print setting not supported by the machine.</p> <p>[Remedy] Check whether there is a problem with the method of using the application that sent the print job, or with the content of the print instruction. If your application usage and print instruction are correct, check with the application manufacturer that sent the print job for operations of the application, not with Dell. If the error still is not resolved, contact Customer Support at dell.com/contactdell.</p> <p>Note •XPS stands for XML Paper Specification.</p>
016-517	<p>[Cause] There is an error in the content described in the PostScript file.</p> <p>[Remedy] Print with the PostScript driver. Furthermore, modify ProcessColorModel described in the PostScript file so that the color mode does not change.</p>
016-518	<p>[Cause] With the PostScript driver, booklet and Watermark/UUID were specified at the same time.</p> <p>[Remedy] With the PostScript driver, specifying a combination of booklet and Watermark/UUID is not possible. Cancel one of them.</p>
016-519	<p>[Cause] The number of pages reached the maximum number of pages specified, and the print job is terminated.</p> <p>[Remedy] Have your system administrator change the maximum limit of printable pages.</p>
016-520	<p>[Cause] An error occurred in the high compression hardware.</p> <p>[Remedy] Execute the operation again. Also change the output file format and color mode. If the problem is not resolved, switch off the machine power, make sure that the touch screen is blank, and then switch on the machine power. And then perform the above operation again. If the error still is not resolved, contact Customer Support at dell.com/contactdell.</p>
016-521	<p>[Cause] The smart card reader is disconnected from the machine while scanning the data with digital signature.</p> <p>[Remedy] Switch off the machine power and connect the smart card reader, and then switch on the machine power.</p>
016-522	<p>[Cause] LDAP server SSL authentication error. Unable to acquire an SSL client certificate.</p> <p>[Remedy] The LDAP server is requesting an SSL client certificate. Set an SSL client certificate on the machine.</p>
016-523	<p>[Cause] LDAP server SSL authentication error. The server certificate data is incorrect.</p> <p>[Remedy] The machine cannot trust the SSL certificate of the LDAP server. Register the root certificate for the LDAP server's SSL certificate to the machine.</p>
016-524	<p>[Cause] LDAP server SSL authentication error. The server certificate will expire soon.</p> <p>[Remedy] Change the SSL certificate of the LDAP server to a valid one. You can clear this error by selecting [Disabled] for [LDAP - SSL / TLS Communication] under [SSL / TLS Settings] on the machine; however, note that selecting this option does not ensure the validity of the LDAP server.</p>

Status Code	Cause and Remedy
016-525	<p>[Cause] LDAP server SSL authentication error. The server certificate has expired.</p> <p>[Remedy] Change the SSL certificate of the LDAP server to a valid one. You can clear this error by selecting [Disabled] for [LDAP - SSL / TLS Communication] under [SSL / TLS Settings] on the machine; however, note that selecting this option does not ensure the validity of the LDAP server.</p>
016-526	<p>[Cause] LDAP server SSL authentication error. The server name does not match the certificate.</p> <p>[Remedy] Set the same LDAP server address to the machine and to the SSL certificate of the LDAP server. You can clear this error by selecting [Disabled] for [LDAP - SSL / TLS Communication] under [SSL / TLS Settings] on the machine; however, note that selecting this option does not ensure the validity of the LDAP server.</p>
016-527	<p>[Cause] LDAP server SSL authentication error. This is an SSL authentication internal error.</p> <p>[Remedy] An error occurred in the software. Contact Customer Support at dell.com/contactdell.</p>
016-528	<p>[Cause] You are logged out of the smart card authentication mode while scanning the data with a digital signature.</p> <p>[Remedy] Log in to the machine with the smart card, and then execute the operation again.</p>
016-529	<p>[Cause] An error occurred when connecting to the Remote Download server. There was no response from the server within the specified time (45 seconds).</p> <p>[Remedy] Confirm the network connection. Check whether the Remote Download server is correctly set on the network.</p>
016-533	<p>[Cause] Kerberos server authentication protocol error</p> <p>[Remedy] The time difference between the machine and the Kerberos server exceeded the clock skew limit value set on the Kerberos server. Check whether the clocks on the machine and Kerberos server are correctly set. Also check whether the summer time and the time zone are correctly set on the machine and Kerberos server.</p>
016-534	<p>[Cause] Kerberos server authentication protocol error</p> <p>[Remedy] The domain set on the machine does not exist on the Kerberos server, or the Kerberos server address set on the machine is invalid for connection. Check whether the domain name and the server address have been correctly set on the machine. For connection to Windows 2003 Server, specify the domain name in uppercase.</p>
016-535	<p>[Cause] The specified file does not exist on the Remote Download server.</p> <p>[Remedy] Confirm the file.</p>
016-536	<p>[Cause] An error occurred when accessing the DNS prior to connecting to the Remote Download server.</p> <p>[Remedy] Confirm the connection with the DNS. Also check whether the Remote Download server name is registered to the DNS.</p>
016-537	<p>[Cause] Could not connect to the Remote Download server. The port of the destination Remote Download server is not open.</p> <p>[Remedy] Confirm the port in the network settings.</p>
016-538	<p>[Cause] An error occurred when writing the remote download file to the hard disk. The file obtained from the Remote Download server could not be written to the hard disk.</p> <p>[Remedy] Confirm the amount of available space, and delete files that are no longer required. Alternatively, replace the hard disk.</p>
016-539	<p>[Cause] Kerberos server authentication protocol error</p> <p>[Remedy] An error occurred in the software. Contact Customer Support at dell.com/contactdell.</p>
016-546	<p>[Cause] A Local User tried to obtain the information of another user.</p> <p>[Remedy] Contact Customer Support at dell.com/contactdell.</p>

Status Code	Cause and Remedy
016-559	<p>[Cause] A remote download parameter error occurred. An invalid value is set for essential system data.</p> <p>[Remedy] Confirm the settings for essential system data.</p>
016-562	<p>[Cause] Multiple entries containing the same smart card information were found in the guest database of Active Directory.</p> <p>[Remedy] Correct the guest database entries of Active Directory so that they do not contain the same smart card information.</p>
016-564	<p>[Cause] Failed to authenticate the Remote Download server.</p> <p>[Remedy] Confirm the login name and password to access the Remote Download server. If the error still is not resolved, contact Customer Support at dell.com/contactdell.</p>
016-569	<p>[Cause] Authentication Agent error</p> <p>[Remedy] Contact Customer Support at dell.com/contactdell.</p>
016-574	<p>[Cause] The machine failed to transfer data using FTP of the Scan to PC service because the host or server name of the FTP server could not be resolved when accessing the DNS server.</p> <p>[Remedy] Confirm the connection to the DNS server. Check whether the FTP server name is registered correctly on the DNS server.</p>
016-575	<p>[Cause] The machine failed to transfer data using FTP of the Scan to PC service because the DNS server address was not registered on the machine.</p> <p>[Remedy] Specify the correct DNS server address. Or, specify the destination FTP server by using its IP address.</p>
016-576	<p>[Cause] The machine failed to transfer data using FTP of the Scan to PC service because it could not connect to the FTP server.</p> <p>[Remedy] Ensure that both the destination FTP server and the machine are available for network communications, by checking the following conditions:</p> <ul style="list-style-type: none"> • The IP address of the server is set correctly. • The network cables are plugged in securely.
016-577	<p>[Cause] Unable to connect to the FTP service of the destination server.</p> <p>[Remedy] Take one of the following measures:</p> <ul style="list-style-type: none"> • Check whether the FTP service of the server is activated. • Check whether the FTP port number of the server is correctly registered on the machine.
016-578	<p>[Cause] The machine failed to transfer data using FTP of the Scan to PC service because of unsuccessful login to the FTP server.</p> <p>[Remedy] Check whether the login name (user name) and password are correct.</p>
016-579	<p>[Cause] The machine failed to transfer data using FTP of the Scan to PC service because the scanned image could not be saved in the FTP server after connection.</p> <p>[Remedy] Check whether the FTP server's save location is correct.</p>
016-580	<p>[Cause] The machine failed to transfer data using FTP of the Scan to PC service because the file or folder name on the FTP server could not be retrieved after connection.</p> <p>[Remedy] Confirm the access privilege for the FTP server.</p>
016-581	<p>[Cause] The machine failed to transfer data using FTP of the Scan to PC service because the suffix of the name of the file or folder exceeded the limit value when the machine was connected to the server and the name of a file or folder on the server was determined.</p> <p>[Remedy] Change the file name or forwarding destination folder of the scan server. Also try moving or deleting the files within the forwarding destination folder.</p>

Status Code	Cause and Remedy
016-582	<p>[Cause] The machine failed to transfer data using FTP of the Scan to PC service because files could not be created on the FTP server after connection.</p> <p>[Remedy] Take one of the following measures:</p> <ul style="list-style-type: none"> • Check whether the specified file name can be used in the save location. • Check whether enough space is available in the save location.
016-583	<p>[Cause] Failed to create the lock directory in the FTP server while transferring data using FTP of the Scan to PC service.</p> <p>[Remedy] Take one of the following measures:</p> <ul style="list-style-type: none"> • If the lock directory (*.LCK) exists in the destination, delete it manually, and then execute the operation again. • Check whether the specified name is available in the save location. • Confirm that the specified name is not duplicated in the save location. • Check whether enough space is available in the save location.
016-584	<p>[Cause] The machine failed to transfer data using FTP of the Scan to PC service because folders could not be created on the FTP server after connection.</p> <p>[Remedy] Take one of the following measures:</p> <ul style="list-style-type: none"> • Check whether the specified folder name can be used in the save location. • Check whether the same folder name exists in the save location. • Check whether enough space is available in the save location.
016-585	<p>[Cause] The machine failed to transfer data using FTP of the Scan to PC service because files could not be deleted on the FTP server after connection.</p> <p>[Remedy] Confirm the access privilege for the FTP server.</p>
016-586	<p>[Cause] The machine failed to delete the lock directory while transferring data using FTP of the Scan to PC service.</p> <p>[Remedy] Take one of the following measures:</p> <ul style="list-style-type: none"> • Confirm the access privilege for the server. • If the lock directory (*.LCK) exists in the destination, delete it manually, and then execute the operation again.
016-587	<p>[Cause] The machine failed to transfer data using FTP of the Scan to PC service because folders could not be deleted on the FTP server after connection.</p> <p>[Remedy] Confirm the access privilege for the FTP server.</p>
016-588	<p>[Cause] The machine failed to transfer data using FTP of the Scan to PC service because the data could not be written on the FTP server after connection.</p> <p>[Remedy] Check whether enough space is available in the save location.</p>
016-589	<p>[Cause] The machine failed to transfer data using FTP of the Scan to PC service because the data could not be read from the FTP server after connection.</p> <p>[Remedy] Confirm the access privilege for the FTP server.</p>
016-590	<p>[Cause] The machine failed to transfer data using FTP of the Scan to PC service because there are duplicate file names.</p> <p>[Remedy] Set [Do Not Save] for the action for file name conflict.</p>
016-591	<p>[Cause] The machine failed to perform the additional processing for the file name conflict using FTP of the Scan to PC service.</p> <p>[Remedy] If [Add to Existing Folder] is set for the additional processing for file name conflict, confirm that the file format is not multi-page.</p>

Status Code	Cause and Remedy
016-592	<p>[Cause] The machine failed to access the NEXTNAME.DAT file using FTP of the Scan to PC service.</p> <p>[Remedy] When [Add to Existing Folder] is set as the process to be executed in case of a file name duplication, check the NEXTNAME.DAT file is correct.</p>
016-593	<p>[Cause] The machine failed to transfer data using FTP of the Scan to PC service because an internal error occurred after connection to the FTP server.</p> <p>[Remedy] Execute the operation again. If the error still is not resolved, contact Customer Support at dell.com/contactdell.</p>
016-594 016-595	<p>[Cause] The machine failed to transfer data using FTP of the Scan to PC service because a network error occurred.</p> <p>[Remedy] Execute the operation again. If the error still is not resolved, contact Customer Support at dell.com/contactdell.</p>
016-596	<p>[Cause] The machine failed to transfer data using FTP of the Scan to PC service because a network error occurred.</p> <p>[Remedy] Execute the operation again. If the error still is not resolved, contact Customer Support at dell.com/contactdell.</p>
016-597	<p>[Cause] The machine failed to transfer data using FTP of the Scan to PC service because a network error occurred.</p> <p>[Remedy] Stop all accesses from the other devices, and then execute the operation again. If the error still is not resolved, contact Customer Support at dell.com/contactdell.</p>
016-598 016-599	<p>[Cause] The size of an e-mail page exceeds the maximum message size because of page splitting.</p> <p>[Remedy] Take one of the following measures:</p> <ul style="list-style-type: none"> • Reduce the file size for [Quality / File Size]. • Increase the value for [Maximum Split Count]. <p>For more information on [Maximum Split Count], refer to "Maximum Split Count" (P.407).</p>
016-700	<p>[Cause] The job was suspended because the number of the digits for the Secure Print or Charge Print passcode set on the print driver was less than the value specified in [Minimum Passcode Length for Stored Jobs] on the machine.</p> <p>[Remedy] On the print driver, set the passcode string equal to or longer than the value specified in [Minimum Passcode Length for Stored Jobs].</p>
016-702	<p>[Cause] Unable to process print data because of insufficient print page buffer.</p> <p>[Remedy] Take one of the following measures:</p> <ul style="list-style-type: none"> • Set [Image Quality] to [Standard]. • Increase the print page buffer size. <p>For more information on the [Image Quality], refer to the help of the print driver. For more information about memory, refer to "Allocate Memory" (P.380).</p>
016-703	<p>[Cause] The machine received an e-mail specified with an invalid folder number.</p> <p>[Remedy] For errors occurring during fax or Internet fax transmission: Contact Customer Support at dell.com/contactdell.</p> <p>For errors occurring during e-mail/fax/Internet fax reception: Take one of the following measures:</p> <ul style="list-style-type: none"> • Register the specified folder number, and request the sender to send the e-mail/fax/Internet fax again. • Request the sender to send to an available folder. <p>If the error still is not resolved, contact Customer Support at dell.com/contactdell.</p>

Status Code	Cause and Remedy
016-704	<p>[Cause] The folder is full, and hard disk capacity is insufficient.</p> <p>[Remedy] Delete unnecessary files from the folder, and save the file.</p>
016-705	<p>[Cause] You have not used the print driver for the machine.</p> <p>[Remedy] Use the print driver appropriate for the machine.</p> <p>If the error still is not resolved, contact Customer Support at dell.com/contactdell.</p>
016-706	<p>[Cause] The hard disk space is insufficient because the number of Secure Print users exceeded the maximum limit.</p> <p>[Remedy] Delete unnecessary files from the machine, and delete unnecessary Secure Print users. For more information on deleting users for Secure Print files, refer to "Printing and Deleting Stored Jobs" (P.208).</p>
016-708	<p>[Cause] Unable to annotate because of insufficient hard disk space.</p> <p>[Remedy] Delete unnecessary data from the hard disk to free up disk space.</p>
016-709	<p>[Cause] An error occurred during print processing.</p> <p>[Remedy] Contact Customer Support at dell.com/contactdell.</p>
016-711	<p>[Cause] The upper limit for the e-mail size has been exceeded.</p> <p>[Remedy] Take one of the following measures, and then try sending the mail again.</p> <ul style="list-style-type: none"> • Reduce the number of pages of the document. • Lower the resolution with [Resolution]. • Reduce the magnification with [Reduce / Enlarge]. • Ask your system administrator to increase the value set for [Maximum Total Data Size]. • For color scanning, set [MRC High Compression] to [On] under [File Format].
016-712	<p>[Cause] Unable to process the document because the specified scan area is too small.</p> <p>[Remedy] Increase the resolution or scan area.</p>
016-713	<p>[Cause] The passcode entered does not match the passcode set on the folder.</p> <p>[Remedy] Enter the correct passcode.</p>
016-714	<p>[Cause] The specified folder does not exist.</p> <p>[Remedy] Create a new folder or specify an existing folder.</p>
016-715	<p>[Cause] The machine failed to access the ESCP form because the password of the ESCP form does not match.</p> <p>[Remedy] Enter the correct password of the ESCP form.</p>
016-716	<p>[Cause] Unable to spool TIFF file because of insufficient hard disk space.</p> <p>[Remedy] Delete unnecessary files and users from the hard disk.</p> <p>Refer to "Printing and Deleting Stored Jobs" (P.208).</p>
016-717	<p>[Cause] Unable to create a Transmission Report - Job Undelivered or a Transmission Report because the transmission result information required for creating the report is not stored in the machine's memory.</p> <p>[Remedy] Take one of the following measures:</p> <ul style="list-style-type: none"> • Execute the jobs for large size Internet fax documents (about 2GB) by splitting each document to minimize memory or HDD usage. • If many scan or Internet fax documents are being processed, wait until the jobs are completed to execute a new job. • After completing the job that you want to confirm in a report, do not execute 200 or more jobs before printing the report.

Status Code	Cause and Remedy
016-718	<p>[Cause] Unable to process the PCL print data because of insufficient memory.</p> <p>[Remedy] Reduce the resolution, or cancel 2 sided printing or N up feature, and then print again.</p>
016-719	<p>[Cause] Unable to process the PCL print data because of insufficient print page buffer.</p> <p>[Remedy] Increase the size of the print page buffer.</p>
016-720	<p>[Cause] An invalid command is included in PCL print data.</p> <p>[Remedy] Confirm the print data and try printing again.</p>
016-721	<p>[Cause] An error occurred during print processing. Probable causes are as follows: 1)Printing was instructed by the Auto Paper selection when [Paper Type Priority] is set to [Auto Paper Off] for all paper in the [Common Service Settings]. 2)ESC/P-K command error occurred.</p> <p>[Remedy] For 1), when printing by the Auto Paper selection, set one of the paper types to other than [Auto Paper Off] in [Paper Type Priority]. For 2), confirm the print data. Refer to "Paper Type Priority" (P.323).</p>
016-722	<p>[Cause] The specified staple position is not supported by the machine, or the paper size specified is not supported by the finisher.</p> <p>[Remedy] Confirm the staple position and the paper size, and try printing again.</p>
016-723	<p>[Cause] The specified punch position is not supported by the machine, or the paper size specified is not supported by the finisher.</p> <p>[Remedy] Confirm the punch position and the paper size, and try printing again.</p>
016-724	<p>[Cause] The specified staple and punch position combination is unsupported.</p> <p>[Remedy] Specify the staple and punch positions on the same side, and try printing again.</p>
016-725	<p>[Cause] A scanned document stored in a folder was to be sent by fax using the Job Flow feature, but the file in the folder could not be converted to fax data.</p> <p>[Remedy] Do not use the Job Flow feature. Simply scan the document from the machine's [Fax] screen to send it by fax.</p>
016-727	<p>[Cause] A print job was cancelled without storing a file into a folder because the file was determined as not containing any pages.</p> <p>[Remedy] The file could not be stored into the folder because the machine determined the print file as not containing any pages. Disable [Skip Blank Pages] on the [Advanced] tab on the print driver, or add text to the file if the file is blank.</p>
016-728	<p>[Cause] An unsupported tag is included in the TIFF file.</p> <p>[Remedy] Confirm the print data.</p>
016-729	<p>[Cause] Unable to print because the number of colors or the resolution of the TIFF file exceeds the allowed range.</p> <p>[Remedy] Change the number of colors or resolution for the TIFF file, and execute the operation again.</p>
016-731	<p>[Cause] Unable to print TIFF data because it was interrupted.</p> <p>[Remedy] Retry printing.</p>
016-732	<p>[Cause] The form specified by emulation has not been registered at the host side.</p> <p>[Remedy] Resend the form data.</p>

Status Code	Cause and Remedy
016-733	<p>[Cause] Probable causes are as follows:</p> <ol style="list-style-type: none"> 1) Unable to obtain the IP address (the string after "@" in the destination e-mail address) when e-mail is sent. 2) DNS server was unable to resolve the Internet address (the string after "@") by the DNS server when e-mail is sent. <p>[Remedy] For 1), confirm the e-mail address. For 2), confirm the DNS server address.</p>
016-738	<p>[Cause] Unsupported paper size was specified when specifying booklet creation with PostScript.</p> <p>[Remedy] Specify a paper size supported for booklet creation, and try printing again.</p>
016-739	<p>[Cause] Used an unsupported combination of document size and paper size when specifying booklet creation with PostScript.</p> <p>[Remedy] Specify a combination of document size and paper size supported for booklet creation, and try printing again.</p>
016-740	<p>[Cause] Used an unsupported paper tray when specifying booklet creation with PostScript.</p> <p>[Remedy] Specify a paper tray supported for booklet creation, and try printing again.</p>
016-741 016-742 016-743 016-744 016-745	<p>[Cause] An error occurred during the update process of the machine.</p> <p>[Remedy] Switch off the machine power, make sure that the touch screen is blank, and then switch on the machine power. If the error still is not resolved, contact Customer Support at dell.com/contactdell.</p>
016-746	<p>[Cause] An unsupported feature is included in the received PDF.</p> <p>[Remedy] Print using a print driver.</p>
016-747	<p>[Cause] The memory became insufficient when using the Repeat Image feature and the Annotations features simultaneously.</p> <p>[Remedy] Take one of the following measures:</p> <ul style="list-style-type: none"> • Increase the annotation image size. • Reduce the usage of Repeat Image.
016-748	<p>[Cause] Unable to print because of insufficient hard disk space.</p> <p>[Remedy] Reduce the number of print pages by dividing the print data or by printing one copy at a time when printing multiple copies.</p>
016-749	<p>[Cause] Probable causes are as follows:</p> <p>For a print job:</p> <ol style="list-style-type: none"> 1) The printer language received from the print driver is unsupported by this machine. <p>For printing of a document received by Internet Fax:</p> <ol style="list-style-type: none"> 2) The printer language of the document received from the remote machine is unsupported by this machine. <p>[Remedy] For 1), use the machine's print driver for printing. If the error still is not resolved, contact Customer Support at dell.com/contactdell.</p> <p>For 2), request the sender to send Internet fax documents using a printer language supported by the machine.</p> <p>Note • An optional component must be installed for some printer languages such as PostScript. For more information, contact Customer Support at dell.com/contactdell.</p>

Status Code	Cause and Remedy
016-750	<p>[Cause] The machine received a printing job ticket with a PDF or XPS from an application that allows direct transmissions of files, but the printing job ticket data had a grammar or print instruction unsupported by the machine.</p> <p>[Remedy] Check whether you are correctly using the application and whether the print instruction was correct. If your application usage and print instruction are correct, check with the application manufacturer that sent the print job for operations of the application. If the error still is not resolved, have the Configuration Report, the Job History Report, and the print data with the printing job ticket ready, and contact Customer Support at dell.com/contactdell.</p> <p>Note • XPS stands for XML Paper Specification.</p>
016-751	<p>[Cause] Probable causes are as follows:</p> <ol style="list-style-type: none"> 1) During the PDF Bridge processing, a syntax or parameter error occurred, an undefined command was used, and a PDF file was damaged. 2) When [Print Processing Mode([408])] for the PDF Direct Print feature has been set to [PS([1])], memory is insufficient. 3) When [Print Processing Mode([408])] for the PDF Direct Print feature has been set to [PS([1])], a PDF file including OpenType fonts is processed. <p>[Remedy] For 1), use the print driver to print the document. For 2), take one of the following measures:</p> <ul style="list-style-type: none"> • Use the print driver to print the document. • Increase PostScript memory. <p>For 3), create a PDF file in which OpenType fonts are not included. For more information on the memory, refer to "Allocate Memory" (P.380).</p>
016-752	<p>[Cause] Unable to process for PDF Bridge because of insufficient memory space.</p> <p>[Remedy] Change the [Image Quality] setting from [High Resolution] to [High Quality], or from [High Quality] to [Standard].</p>
016-755	<p>[Cause] Attempted to process a print-protected PDF file.</p> <p>[Remedy] Cancel the print protection using Adobe Reader, and try printing again.</p>
016-756	<p>[Cause] Do not have permission to use the service.</p> <p>[Remedy] Consult your system administrator.</p>
016-757	<p>[Cause] The passcode is incorrect.</p> <p>[Remedy] Enter the correct passcode.</p>
016-758	<p>[Cause] The division does not have permission to use the service.</p> <p>[Remedy] Consult your system administrator.</p>
016-759	<p>[Cause] The number of pages reached the maximum number of pages for this service.</p> <p>[Remedy] Consult your system administrator.</p>
016-760	<p>[Cause] An error occurred during PostScript processing.</p> <p>[Remedy] Take one of the following measures:</p> <ul style="list-style-type: none"> • Set [Image Quality] to [High Speed]. • Increase PostScript memory. <p>For more information on [Image Quality], refer to the help of the print driver. For more information on memory, refer to "Allocate Memory" (P.380).</p>
016-761	<p>[Cause] An error occurred during image processing.</p> <p>[Remedy] Set [Image Quality] to [Standard] and execute the operation again. If the error still is not resolved, set [Print Page Mode] to [On].</p>

Status Code	Cause and Remedy
016-762	<p>[Cause] The specified printer language is not installed on the machine.</p> <p>[Remedy] For [USB] in [Print Mode] under [Port Settings], specify correct printer language.</p>
016-763	<p>[Cause] Unable to connect to the POP server.</p> <p>[Remedy] Confirm the POP server IP address set on the machine.</p>
016-764	<p>[Cause] Unable to connect to the SMTP server.</p> <p>[Remedy] Consult the SMTP server administrator.</p>
016-765	<p>[Cause] Unable to send the e-mail because the hard disk on the SMTP server is full.</p> <p>[Remedy] Consult the SMTP server administrator.</p>
016-766	<p>[Cause] An error occurred on the SMTP server.</p> <p>[Remedy] Consult the SMTP server administrator.</p>
016-767	<p>[Cause] Unable to send the e-mail because the address is not correct.</p> <p>[Remedy] Confirm the address, and try sending again.</p>
016-768	<p>[Cause] Unable to connect to the SMTP server because the machine's mail address is incorrect.</p> <p>[Remedy] Confirm the machine's mail address.</p>
016-769	<p>[Cause] The SMTP server does not support delivery receipts (DSN).</p> <p>[Remedy] Send e-mail without setting delivery receipts (DSN).</p>
016-770	<p>[Cause] Direct Fax is restricted.</p> <p>[Remedy] Consult your system administrator whether Direct Fax is available. If it is available, contact Customer Support at dell.com/contactdell.</p>
016-772	<p>[Cause] The DNS server address is not set.</p> <p>[Remedy] Set the DNS server address.</p>
016-774	<p>[Cause] Unable to process compression conversion because of insufficient hard disk space.</p> <p>[Remedy] Delete unnecessary data from the hard disk to free up disk space.</p>
016-775	<p>[Cause] Unable to process image conversion because of insufficient hard disk space.</p> <p>[Remedy] Delete unnecessary data from the hard disk to free up disk space.</p>
016-776	<p>[Cause] An error occurred during image conversion processing.</p> <p>[Remedy] For errors occurring when forwarding with Store to Folder or Internet Fax: The image conversion processing for the part of the data may be completed. Retrieve each converted page from the folder using Dell Printer Configuration Web Tool.</p> <p>For more information, refer to "Configuring Machine Settings Using Dell Printer Configuration Web Tool" (P.465).</p> <p>For errors occurring after instructing encryption or signature using a certificate: Take one of the following measures:</p> <ul style="list-style-type: none"> • Check whether the certificate is valid. • Set the correct date and time on the machine.
016-777	<p>[Cause] A hard disk error occurred during image processing.</p> <p>[Remedy] The hard disk may be defective. To replace the hard disk, contact Customer Support at dell.com/contactdell.</p>
016-778	<p>[Cause] The conversion processing of the scanned image was interrupted because of insufficient disk space.</p> <p>[Remedy] Delete unnecessary data from the hard disk to free up disk space.</p>

Status Code	Cause and Remedy
016-779	<p>[Cause] An error occurred during scanned image conversion processing.</p> <p>[Remedy] Retry scanning. If using large-size paper such as A3 with [Resolution] set to [600 dpi], specify [Resolution] to [400 dpi] or lower in [Layout Adjustment]. If the error still is not resolved, contact Customer Support at dell.com/contactdell.</p>
016-780	<p>[Cause] A hard disk error occurred during scanned image conversion processing.</p> <p>[Remedy] The hard disk may be defective. To replace the hard disk, contact Customer Support at dell.com/contactdell.</p>
016-781	<p>[Cause] Probable causes are as follows:</p> <ol style="list-style-type: none"> 1)The mail server cannot be found during e-mail sending (TCP/IP session establishment failed). 2)The machine received an SMTP server error from the mail server during e-mail sending. <p>[Remedy] 1)Take one of the following measures:</p> <ul style="list-style-type: none"> - Check whether the network cables are plugged in securely. - Check whether the IP address of the SMTP server is correct when an IP address is used for server specification. <p>2)Enter the host name of the machine using ASCII characters.</p> <p>Available ASCII characters are follows:</p> <ul style="list-style-type: none"> - alphabets - numerals <p>Check whether or not ASCII characters are used in [Tools] > [System Settings] > [Connectivity & Network Setup] > [Machine's E-mail Address / Host Name].</p>
016-786	<p>[Cause] When using the Scan feature, the machine could not write the file to the hard disk.</p> <p>[Remedy] Take one of the following measures:</p> <ul style="list-style-type: none"> • Switch off the machine power, make sure that the touch screen is blank, and then switch on the machine power. • Load paper on the paper tray as necessary. • If the error occurs when sending an e-mail, take one of the following measures: <ul style="list-style-type: none"> - Lower the resolution. - Reduce the size. - Reduce the number of pages, and divide the job into several e-mails to send. - Send the job by setting [Color Scanning] to [Black & White].
016-788	<p>[Cause] Failed to retrieve a file from the Web browser.</p> <p>[Remedy] Take one of the following measures, and then execute the operation again:</p> <ul style="list-style-type: none"> • Reload the browser page. • Restart the browser. • Switch off the machine power, make sure that the touch screen is blank, and then switch on the machine power.
016-790	<p>[Cause] Unable to send an e-mail with Split Send because of exceeding the maximum number of splits allowed.</p> <p>[Remedy] Take one of the following measures:</p> <ul style="list-style-type: none"> • Reduce the file size for [Quality / File Size]. • Increase the value for [Maximum Split Count]. <p>For more information on [Maximum Split Count], refer to "Maximum Split Count" (P.407).</p>
016-792	<p>[Cause] Failed to acquire the specified job history when printing a Job Report.</p> <p>[Remedy] The specified job history does not exist.</p>

Status Code	Cause and Remedy
016-794	<p>[Cause] Media is not inserted correctly.</p> <p>[Remedy] Check whether the media is inserted correctly.</p>
016-795 016-796 016-797	<p>[Cause] An error occurred when reading the data on the media.</p> <p>[Remedy] On a computer, confirm the content recorded on the media.</p>
016-799	<p>[Cause] An invalid print parameter is included in the print data of the application, or the print data and the Print Setup settings may not match.</p> <p>[Remedy] Check the print data of the application and the Print Setup settings, and try printing again.</p>
017-700	<p>[Cause] ThinPrint.Engine connection timed out.</p> <p>[Remedy] Confirm the connection to the ThinPrint.Engine.</p>
017-701	<p>[Cause] An error occurred while connecting to ThinPrint.Engine.</p> <p>[Remedy] Confirm the connection to the ThinPrint.Engine.</p>
017-702	<p>[Cause] The data sent to ThinPrint.Engine is invalid.</p> <p>[Remedy] Confirm the connection to the ThinPrint.Engine.</p>
017-703	<p>[Cause] The print data sent from ThinPrint.Engine exceeded the maximum size of the machine.</p> <p>[Remedy] Split the job, and try printing again.</p>
017-704	<p>[Cause] An internal error occurred.</p> <p>[Remedy] Switch off the machine power, make sure that the touch screen is blank, and then switch on the machine power. Send the job again.</p>
017-705 017-706 017-707 017-708	<p>[Cause] ThinPrint.Engine SSL authentication error.</p> <p>[Remedy] Check the server certificate information (expiry date and address) that is registered to ThinPrint.Engine.</p>
017-709	<p>[Cause] An SSL communication error occurred between ThinPrint.Engine and the machine.</p> <p>[Remedy] Check the settings of the machine.</p>
017-713	<p>[Cause] The SMTP server does not support STARTTLS.</p> <p>[Remedy] Change SSL/TLS communication setting to other than [STARTTLS].</p>
017-714	<p>[Cause] SSL connection to the SMTP server failed.</p> <p>[Remedy] Confirm whether the SMTP server supports SSL connection. If the server supports it, check the port number of the SMTP server. If the error still is not resolved, contact Customer Support at dell.com/contactdell.</p>
017-715	<p>[Cause] SMTP server SSL authentication error. The server certificate is invalid.</p> <p>[Remedy] Use the valid SSL server certificate of the SMTP server. You can avoid this error by setting [SMTP - SSL / TLS Communication] in [SSL / TLS Settings] to [Disabled], however the validity of the server cannot be warranted.</p>
017-716	<p>[Cause] SMTP server SSL authentication error. It is before the valid period of the server certificate.</p> <p>[Remedy] Use the valid SSL server certificate of the SMTP server. You can avoid this error by setting [SMTP - SSL / TLS Communication] in [SSL / TLS Settings] to [Disabled], however the validity of the server cannot be warranted.</p>

Status Code	Cause and Remedy
017-717	<p>[Cause] SMTP server SSL authentication error. The server certificate expired.</p> <p>[Remedy] Use the valid SSL server certificate of the SMTP server. You can avoid this error by setting [SMTP - SSL / TLS Communication] under [SSL / TLS Settings] to [Disabled], however the validity of the server cannot be warranted.</p>
017-718	<p>[Cause] SMTP server SSL authentication error. The server name and certificate do not match.</p> <p>[Remedy] Use the valid SSL server certificate of the SMTP server. You can avoid this error by setting [SMTP - SSL / TLS Communication] in [SSL / TLS Settings] to [Disabled], however the validity of the server cannot be warranted.</p>
017-719	<p>[Cause] SMTP server SSL authentication error. SSL authentication internal error.</p> <p>[Remedy] Execute the operation again. If the error still is not resolved, contact Customer Support at dell.com/contactdell.</p>
017-725	<p>[Cause] An error occurred while receiving a print job when the Force Annotation is enabled.</p> <p>[Remedy] Incorrect name is set for the template of the Force Annotation. Confirm the name of the template registered in the machine.</p>
017-729	<p>[Cause] When the machine is used as a print job storage device, print job sending was stopped temporarily because the number of jobs in the machine exceeded the maximum receivable volume or the space for spool data was insufficient.</p> <p>[Remedy] Take one of the following measures:</p> <ul style="list-style-type: none"> • Set to spool data to the hard disk from the setting of the storage destination machine. • Set [IPP] under [Properties] > [General Setup] > [Memory Settings] to [Spool to Hard Disk] by Dell Printer Configuration Web Tool. • Wait for a while and send the job again.
017-730	<p>[Cause] When the machine is used as a print job storage device, the computer failed to send a job to the machine because a network error occurred.</p> <p>[Remedy] Confirm the followings:</p> <ul style="list-style-type: none"> • The network cable is connected properly. • The storage destination machine is powered on. • The IPP port of the storage destination machine is enabled. <p>If the error still is not resolved, contact Customer Support at dell.com/contactdell.</p>
017-731	<p>[Cause] Unable to connect to the POP server.</p> <p>[Remedy] Confirm the followings:</p> <ul style="list-style-type: none"> • The IP address of the POP server is set on the machine. • The network cable is connected properly.
017-732	<p>[Cause] When the machine is used as a print job storage device, the computer failed to send a job because the machine is off-line.</p> <p>[Remedy] Press the <Machine Status> button of the storage destination machine, and set [Print Mode] to [On-line] on the [Machine Information] screen. If the error still is not resolved, contact Customer Support at dell.com/contactdell.</p>
017-733	<p>[Cause] When the machine is used as a print job storage device, an internal error in the software is occurred while the job sending to the machine.</p> <p>[Remedy] Execute the operation again. If the error still is not resolved, contact Customer Support at dell.com/contactdell.</p>
017-734	<p>[Cause] An internal error occurred.</p> <p>[Remedy] Execute the print job again using a print driver other than AirPrint or a software. If the error still is not resolved, contact Customer Support at dell.com/contactdell.</p>

Status Code	Cause and Remedy
018-400	<p>[Cause] Although IPsec is enabled, the IPsec settings are inconsistent.</p> <ul style="list-style-type: none"> • Although [Authenticate by Preshared Key] is set in [IKE Authentication Method], a passcode is not set. • Although [Authenticate by Digital Signature] is set in [IKE Authentication Method], an IPsec certificate is not set. <p>[Remedy] Remove the inconsistency of the IPsec settings, and enable IPsec again.</p> <ul style="list-style-type: none"> • When [Authenticate by Preshared Key] is set in [IKE Authentication Method], set the passcode. • When [Authenticate by Digital Signature] is set in [IKE Authentication Method], set an IPsec certificate.
018-405	<p>[Cause] An error occurred during LDAP authentication.</p> <p>[Remedy] The account is disabled in the active directory of the authentication server, or the access is set to disabled. Consult your network administrator.</p>
018-500	<p>[Cause] The certificate does not exist in the authentication server.</p> <p>[Remedy] Configure the server certificate. Or, cancel authentication.</p>
018-501	<p>[Cause] Communications with the CA server set in the machine failed.</p> <p>[Remedy] Check the network connection and the address of the CA server.</p>
018-502	<p>[Cause] The machine failed to transfer data using SMB of the Scan to PC service because computers allowed to login are restricted.</p> <p>[Remedy] Confirm the property information for the specified user, and check whether the computers allowed to login to the server are restricted.</p>
018-503 018-504	<p>[Cause] Communications with the CA server set in the machine failed.</p> <p>[Remedy] Execute the authentication operation again.</p>
018-505	<p>[Cause] Failed to log into the destination computer while transferring data using SMB of the Scan to PC service.</p> <p>[Remedy] Check whether the user name and password of the SMTP server registered in the machine is correct.</p> <p>Note</p> <ul style="list-style-type: none"> • The password cannot be confirmed. If you have forgotten the password, reset the password. Consult your system administrator for the password reset procedure. • When using Windows Server 2003, be sure to match the time set on the SMB server and the machine. • When the destination computer is Macintosh, you need to change the account settings of the shared folder so that file sharing with Windows users becomes available. For information about necessary accounting settings, consult your system administrator. The following is an example of a procedure for Mac OS X 10.6. It is recommended that users create a dedicated account for data transfer. You can create and set the account on the dialog box that appears by choosing Apple menu > [System Preferences] and then clicking [Accounts] icon. <ol style="list-style-type: none"> 1. From Apple menu, choose [System Preferences], and then click [Sharing]. 2. Make sure that [File Sharing] check box is selected, and then click [Options]. 3. Select [Share files and folders using SMB]. 4. Select the user accounts to enable for file sharing. Enter the user's password, then click [OK]. 5. Click [Done]. <p>For information on how to change the account settings on other version of Mac OS, consult your system administrator or the official website of Apple Inc.</p>
018-506	<p>[Cause] Communications with the CA server set in the machine failed.</p> <p>[Remedy] Execute the authentication operation again.</p>

Status Code	Cause and Remedy
018-507	<p>[Cause] The authentication failed because the user name or password entered is not correct.</p> <p>[Remedy] Enter the correct user name or password.</p>
018-508	<p>[Cause] A server error occurred during authentication.</p> <p>[Remedy] Check the status of the authentication server.</p>
018-543	<p>[Cause] Probable causes are as follows:</p> <ol style="list-style-type: none"> 1)The machine failed to transfer data using SMB of the Scan to PC service because the specified shared name does not exist. 2)The machine failed to transfer data using SMB of the Scan to PC service because Invalid characters are used in the specified shared name. 3)The machine failed to transfer data using SMB of the Scan to PC service because access privilege does not set on the specified shared name when the server is Macintosh. <p>[Remedy] 1)Confirm that the specified shared name exists in the destination PC.</p> <p>2)Take one of the following measures:</p> <ul style="list-style-type: none"> - Check whether the following invalid characters are included in the shared name set in the machine: " / : < > ; , * ? \ [] + = - Check whether a space character is included at the top or end of the shared name set in the machine. - Check whether the shared name set in the machine is specified only by a period. <p>3)When the destination computer is Macintosh, you need to change the access privileges for the user for shared folder. For information about necessary accounting settings, consult your system administrator.</p> <p>The following is an example of a procedure for Mac OS X 10.6.</p> <p>Note</p> <ul style="list-style-type: none"> • It is recommended to create a dedicated account for data transfer. You can create and set the account on the dialog box that appears by choosing Apple menu > [System Preferences] and then clicking [Accounts] icon. <ol style="list-style-type: none"> 1. From Apple menu, choose [System Preferences], and then click [Sharing]. 2. Make sure that [File Sharing] check box is selected. 3. Select the folder being shared from folders listed in the [Shared Folders] field. 4. Choose [Read & Write] as privilege option for the user listed in the [Users] field. <p>For information on how to change the access privilege settings on other version of Mac OS, consult your system administrator or the official website of Apple Inc.</p>
018-547	<p>[Cause] The machine failed to transfer data using SMB of the Scan to PC service because the number of users logging into the SMB server exceeded the limit when logging in to the SMB server.</p> <p>[Remedy] Take one of the following measures:</p> <ul style="list-style-type: none"> • Confirm how many users can access the shared folder. • Check whether the number of login users have exceeded the limit.
018-556	<p>[Cause] Received an error detection code from the HTTP server.</p> <p>[Remedy] 1)Check whether the specified drive and directory is available on the destination HTTP server for the scanned document.</p> <p>2)Perform the same operation again. If the problem persists, contact Customer Support at dell.com/contactdell.</p>
018-557	<p>[Cause] The specified file name contains invalid characters.</p> <p>[Remedy] Modify the file name. Make sure that invalid characters are not contained in the destination file name for the scanned document.</p>

Status Code	Cause and Remedy
018-558	<p>[Cause] Received an error code from HTTP server.</p> <p>[Remedy] 1)Check whether the specified directory exists on the destination HTTP server for the scanned document. 2)Check whether the specified file exists on the HTTP server.</p>
018-559	<p>[Cause] The same file name already exists. [Do Not Save] is selected when duplicate file name exists.</p> <p>[Remedy] Select any option other than [Do Not Save] in [File Name Conflict].</p>
018-560	<p>[Cause] A user authentication error occurred. (Received HTTP Status 401).</p> <p>[Remedy] Check the followings:</p> <ul style="list-style-type: none"> • The destination HTTP server for the scanned document is accessible by PC. • Login name • Login password • The HTTP server name • The HTTP server path name
018-561	<p>[Cause] The hostname or the script storage location is not correct. (Received HTTP Status 404).</p> <p>[Remedy] Check the followings:</p> <ul style="list-style-type: none"> • The destination HTTP server for the scanned document is accessible by PC. • The HTTP server name • The HTTP server path name
018-562	<p>[Cause] A client-side error occurred. (Received HTTP Status 4xx other than 401 and 404).</p> <p>[Remedy] Check the followings:</p> <ul style="list-style-type: none"> • The destination HTTP server for the scanned document is accessible by PC. • The server settings
018-563	<p>[Cause] A server-side error occurred. (Received HTTP Status 5xx).</p> <p>[Remedy] Check the followings:</p> <ul style="list-style-type: none"> • The destination HTTP server for the scanned document is accessible by PC. • The server settings
018-564	<p>[Cause] DNS resolution for the specified hostname failed.</p> <p>[Remedy] Check the followings:</p> <ul style="list-style-type: none"> • The destination HTTP server for the scanned document is registered on the DNS server. • The machine is connected to the DNS server. • The address of the DNS server is set on the machine.
018-565	<p>[Cause] DNS resolution for the proxy server name set on the machine failed.</p> <p>[Remedy] Check the followings:</p> <ul style="list-style-type: none"> • The proxy server name set on the machine is registered on the DNS server. • The machine is connected to the DNS server. • The address of the DNS server is set on the machine.
018-566	<p>[Cause] Unable to connect to the HTTP server.</p> <p>[Remedy] Check the followings:</p> <ul style="list-style-type: none"> • The network cable connection on the machine • The destination HTTP server for the scanned document is accessible by PC.

Status Code	Cause and Remedy
018-567	<p>[Cause] The followings may be the cause:</p> <ul style="list-style-type: none"> • The communication is disconnected while reading or writing due to some reason. • Close process of the file failed due to some reason <p>[Remedy] Check whether the destination HTTP server for the scanned document is accessible by PC.</p>
018-568	<p>[Cause] An SSL/TLS connection error occurred.</p> <p>[Remedy] Check the followings:</p> <ul style="list-style-type: none"> • The destination HTTP server for the scanned document is accessible by PC. • SSL settings for the HTTP server is correct. • The HTTP server name • The HTTP server path name
018-569	<p>[Cause] The SSL server certificate may have a problem.</p> <p>[Remedy] 1)Check whether the destination HTTP server for the scanned document is accessible by PC. 2)Check whether the SSL server certificate is registered on the HTTP server. 3)Check whether the SSL server certificate is valid. Check the followings: - the certificate is unexpired - the time set on the machine is correct - the certificate is not on the discard list 4)Check the certificate path to the SSL server certificate, and import the required CA certificate. 5)If the SSL server certificated is not registered on the HTTP server, disable the [Verify Remote Server Certificate] setting.</p>
018-570	<p>[Cause] A client certificate authentication error occurred on the HTTP server.</p> <p>[Remedy] Check the followings:</p> <ul style="list-style-type: none"> • The destination HTTP server for the scanned document is accessible by PC. • The SSL client certificate is registered on the machine. • The device certificate is correctly registered on the HTTP server.
018-571	<p>[Cause] An internal error occurred.</p> <p>[Remedy] Perform the same operation again. If the problem persists, contact Customer Support at dell.com/contactdell.</p>
018-572	<p>[Cause] The specified context name contains invalid characters.</p> <p>[Remedy] Check whether the specified context name is correct.</p>
018-573	<p>[Cause] The specified connection name contains invalid characters.</p> <p>[Remedy] Check whether the specified connection name is correct.</p>
018-574	<p>[Cause] The specified volume name contains invalid characters.</p> <p>[Remedy] Check whether the specified volume name is correct.</p>
018-575	<p>[Cause] The specified user name or password contains invalid characters.</p> <p>[Remedy] Check whether the specified user name or password is correct.</p>
018-576	<p>[Cause] The specified path name contains invalid characters.</p> <p>[Remedy] Check whether the specified path name is correct.</p>
018-577	<p>[Cause] The specified file name contains invalid characters.</p> <p>[Remedy] Check whether the specified file name is correct.</p>

Status Code	Cause and Remedy
018-578	<p>[Cause] The specified server or tree name does not exist.</p> <p>[Remedy] Check the followings:</p> <ul style="list-style-type: none"> • The network cable connection on the machine • The NetWare server is accessible by PC • The NetWare server or tree name <p>Run DSREPAIR at the server console on the NetWare server.</p>
018-579	<p>[Cause] The hard disk on the NetWare server may be full.</p> <p>[Remedy] Check the followings:</p> <ul style="list-style-type: none"> • The NetWare server is accessible by PC • The free space of the server to store data <p>Run DSREPAIR at the server console on the NetWare server.</p>
018-580	<p>[Cause] The specified volume name does not exist on the NetWare server.</p> <p>[Remedy] Check the followings:</p> <ul style="list-style-type: none"> • The NetWare server is accessible by PC • The volume name <p>Run DSREPAIR at the server console on the NetWare server.</p>
018-581	<p>[Cause] The specified directory path does not exist on the NetWare server.</p> <p>[Remedy] Check the followings:</p> <ul style="list-style-type: none"> • The NetWare server is accessible by PC • The directory path name <p>Run DSREPAIR at the server console on the NetWare server.</p>
018-582	<p>[Cause] The followings may be the cause:</p> <ul style="list-style-type: none"> • The login user does not have Open rights to the file. • The login user does not have Create rights to create a file. • The login user does not have Access rights to the directory. • The login user does not have Read rights to the file. • The login user does not have Write rights to the file. • The login user does not have Delete rights of the directory or file. • Made a delete request to the directories or files but all of them are read-only. • Made a delete request to the directories or files but some of them are read-only. <p>[Remedy] 1) Check whether the NetWare server is accessible by PC. 2) Check the user has the following rights.</p> <ul style="list-style-type: none"> - Open rights to the file - Create rights to a file - Access rights to the directory - Read rights to the file - Write rights to the file - Delete rights to the directory or file <p>3) Run DSREPAIR at the server console on the NetWare server.</p>
018-583	<p>[Cause] A hard disk error occurred on the NetWare server.</p> <p>[Remedy] 1) Check the status of the HDD on the NetWare server. 2) Check whether the NetWare server is accessible by PC. 3) Run DSREPAIR at the server console on the NetWare server.</p>

Status Code	Cause and Remedy
018-584	<p>[Cause] The followings may be the cause:</p> <ul style="list-style-type: none"> • The communication is disconnected while reading or writing due to some reason • Close process of the file failed due to some reason <p>[Remedy] 1) Check whether the NetWare server is accessible by PC. 2) Run DSREPAIR at the server console on the NetWare server.</p>
018-585	<p>[Cause] The followings may be the cause:</p> <ul style="list-style-type: none"> • The specified folder or file is in use by another user • Made a delete request to the directories or files though some of them are in use by another user • Made a delete request to the directories or files though all of them are in use by another user <p>[Remedy] 1) Check whether the NetWare server is accessible by PC. 2) Check the status of use of the other users. 3) Run DSREPAIR at the server console on the NetWare server.</p>
018-586	<p>[Cause] Login to the NetWare server was denied.</p> <p>[Remedy] Check the followings:</p> <ul style="list-style-type: none"> • The NetWare server is accessible by PC • Login user name • Login password • Volume name • Server or tree name • Context name <p>Run DSREPAIR at the server console on the NetWare server.</p>
018-587	<p>[Cause] There are duplicate file names. [Do Not Save] is set as a handling method when names are duplicated for scanned files.</p> <p>[Remedy] Set the process to be executed in case of a file name duplication to other than [Do Not Save].</p>
018-588	<p>[Cause] Detected an incorrect filing policy (when add was selected) after connecting to the server.</p> <p>[Remedy] When [Rename New File] is set as the process to be executed in case of a file name duplication, confirm that the file format is not multi-page.</p>
018-589	<p>[Cause] Failed to access the NEXTNAME.DAT file.</p> <p>[Remedy] When [Rename New File] is set as the process to be executed in case of a file name duplication, check the NEXTNAME.DAT file is correct.</p>
018-590	<p>[Cause] A file or folder of the same name was detected on the server.</p> <p>[Remedy] Take one of the following measures:</p> <ol style="list-style-type: none"> 1) Execute the operation again by not accessing the same folder or the same server from multiple machines. 2) If the error still is not resolved, contact Customer Support at dell.com/contactdell.
018-591	<p>[Cause] When the machine was connected to the server and the name of a file or folder on the server was determined, the suffix of the name of the file or folder exceeded the limit value.</p> <p>[Remedy] Change the file name or forwarding destination folder of the scan server. Also try moving or deleting the files within the forwarding destination folder.</p>

Status Code	Cause and Remedy
018-592	<p>[Cause] Failed to delete a scan lock folder.</p> <p>[Remedy] Take one of the following measures: 1) If an existing lock directory (*.LCK) remains in the forwarding destination, delete it manually, and then execute the job again. 2) Confirm that there is a folder with the name specified.</p>
018-593	<p>[Cause] Failed to create the scan lock folder.</p> <p>[Remedy] If an existing lock directory (*.LCK) remains in the forwarding destination, delete it manually, and then execute the job again.</p>
018-595	<p>[Cause] Multiple entries containing the same smart card information were detected in the database of the LDAP server.</p> <p>[Remedy] Correct the temporary user entries of the LDAP server so that they do not contain the same smart card information.</p>
018-596	<p>[Cause] An error occurred during LDAP server authentication.</p> <p>[Remedy] Execute the operation again. If the error still is not resolved, contact Customer Support at dell.com/contactdell.</p>
018-700	<p>[Cause] The network for Web Applications is being initialized.</p> <p>[Remedy] Wait for a while, and then execute the operation again.</p>
018-701	<p>[Cause] An LDAP server protocol error occurred as a result of the Address Book operation. The server returned RFC2251 Result Message No "1" (operations error) for Address Book query.</p> <p>[Remedy] Check whether [LDAP Server / Directory Service Settings] under [Remote Authentication / Directory Service] has been set correctly. Or, the server may have a problem. Consult your network administrator.</p>
018-702	<p>[Cause] An LDAP server protocol error occurred as a result of the Address Book operation. The server returned RFC2251 Result Message No "2" (protocol error) for Address Book query.</p> <p>[Remedy] Have your network administrator confirm the LDAP server settings, and execute the operation again.</p>
018-703	<p>[Cause] An LDAP server protocol error occurred as a result of the Address Book operation. The server returned RFC2251 Result Message No "3" (time limit exceeded) for Address Book query.</p> <p>[Remedy] Change the search conditions/start position to narrow the search range, and execute the operation again. If the error still is not resolved, consult your network administrator.</p>
018-704	<p>[Cause] An LDAP server protocol error occurred as a result of the Address Book operation. The server returned RFC2251 Result Message No "4" (size limit exceeded) for Address Book query.</p> <p>[Remedy] Change the search conditions/start position to narrow the search range, and execute the operation again. If the error still is not resolved, consult your network administrator.</p>
018-705	<p>[Cause] An LDAP server protocol error occurred as a result of the Address Book operation. The server returned RFC2251 Result Message No "5" (compare false) for Address Book query.</p> <p>[Remedy] The result may differ from the specified content. Have your network administrator confirm the LDAP server status.</p>
018-706	<p>[Cause] An LDAP server protocol error occurred as a result of the Address Book operation. The server returned RFC2251 Result Message No "6" (compare true) for Address Book query.</p> <p>[Remedy] The desired result has been achieved. No problem occurred.</p>

Status Code	Cause and Remedy
018-707	<p>[Cause] An LDAP server protocol error occurred as a result of the Address Book operation. The server returned RFC2251 Result Message No "7" (specified authentication method not supported) for Address Book query.</p> <p>[Remedy] The LDAP server does not support the specified authentication method. Change the authentication method. Consult your system administrator for another method.</p>
018-708	<p>[Cause] An LDAP server protocol error occurred as a result of the Address Book operation. The server returned RFC2251 Result Message No "8" (strong authentication required) for Address Book query.</p> <p>[Remedy] Check whether the authentication settings are correct. Consult your system administrator about the authentication, and execute the operation again.</p>
018-709	<p>[Cause] An error occurred for external access (Web Applications).</p> <p>[Remedy] Take one of the following measures depending on the setting:</p> <p>For IPv4 environment</p> <ul style="list-style-type: none"> • Check the IPv4 address of the machine. • Confirm whether the network cable is connected correctly. • Check the address of the DHCP server. <p>For IPv6 environment</p> <ul style="list-style-type: none"> • Confirm whether the global address distributed from an IPv6 router is assigned to the IPv6 address of the machine. • Confirm whether the network cable is connected correctly. • Confirm whether the IPv6 router is set correctly.
018-710	<p>[Cause] An LDAP server protocol error occurred as a result of the Address Book operation. The server returned RFC2251 Result Message No "10" (referral) for Address Book query.</p> <p>[Remedy] No registered items were found in the specified retrieval range. Have your network administrator confirm the authentication settings.</p>
018-711	<p>[Cause] An LDAP server protocol error occurred as a result of the Address Book operation. The server returned RFC2251 Result Message No "11" (admin limit exceeded) for Address Book query.</p> <p>[Remedy] Have your network administrator confirm the operational status of the server.</p>
018-712	<p>[Cause] An LDAP server protocol error occurred as a result of the Address Book operation. The server returned RFC2251 Result Message No "12" (unavailable extension) for Address Book query.</p> <p>[Remedy] Have your network administrator confirm the operational status of the server.</p>
018-713	<p>[Cause] An LDAP server protocol error occurred as a result of the Address Book operation. The server returned RFC2251 Result Message No "13" (confidentiality required) for Address Book query.</p> <p>[Remedy] Have your network administrator confirm the operational status of the server.</p>
018-714	<p>[Cause] An LDAP server protocol error occurred as a result of the Address Book operation. The server returned RFC2251 Result Message No "14" (SASL bind in progress) for Address Book query.</p> <p>[Remedy] Retry after waiting for a while. If the error still is not resolved, consult your network administrator.</p>

Status Code	Cause and Remedy
018-715	<p>[Cause] Kerberos server authentication protocol error. There is no authentication method which supports both the machine authentication and Kerberos server authentication.</p> <p>[Remedy] Take one of the following measures:</p> <ul style="list-style-type: none"> • Set the appropriate authentication method in the Kerberos server. • Disable the FIPS140 validation mode of the machine. <p>If the error still is not resolved, contact Customer Support at dell.com/contactdell.</p>
018-716	<p>[Cause] An LDAP server protocol error occurred as a result of the Address Book operation. The server returned RFC2251 Result Message No "16" (no such attribute) for Address Book query.</p> <p>[Remedy] The LDAP server has an attribute problem. Have your network administrator confirm the LDAP server status.</p>
018-717	<p>[Cause] An LDAP server protocol error occurred as a result of the Address Book operation. The server returned RFC2251 Result Message No "17" (undefined type) for Address Book query.</p> <p>[Remedy] The LDAP server has an attribute problem. Have your network administrator confirm the LDAP server status.</p>
018-718	<p>[Cause] An LDAP server protocol error occurred as a result of the Address Book operation. The server returned RFC2251 Result Message No "18" (inappropriate matching) for Address Book query.</p> <p>[Remedy] The LDAP server has an attribute problem. Have your network administrator confirm the LDAP server status.</p>
018-719	<p>[Cause] An LDAP server protocol error occurred as a result of the Address Book operation. The server returned RFC2251 Result Message No "19" (constraint violation) for Address Book query.</p> <p>[Remedy] The LDAP server has an attribute problem. Have your network administrator confirm the LDAP server status.</p>
018-720	<p>[Cause] An LDAP server protocol error occurred as a result of the Address Book operation. The server returned RFC2251 Result Message No "20" (attribute exists) for Address Book query.</p> <p>[Remedy] The LDAP server has an attribute problem. Have your network administrator confirm the LDAP server status.</p>
018-721	<p>[Cause] An LDAP server protocol error occurred as a result of the Address Book operation. The server returned RFC2251 Result Message No "21" (invalid syntax) for Address Book query.</p> <p>[Remedy] The LDAP server has an attribute problem. Have your network administrator confirm the LDAP server status.</p>
018-725	<p>[Cause] The user password set in the Kerberos server expired.</p> <p>[Remedy] Extend the expiration date of the password.</p>
018-726	<p>[Cause] The root (or intermediate) CA certificate on the smart card is not registered on the machine.</p> <p>[Remedy] Register the root (or intermediate) CA certificate on the smart card on the machine.</p>

Status Code	Cause and Remedy
018-728	<p>[Cause] Authentication by the Kerberos server failed.</p> <p>[Remedy] Take one of the following measures:</p> <ul style="list-style-type: none"> • When the root CA certificate of the KDC certificate is not registered, register the root CA certificate. • When the KDC certificate is revoked, update the KDC certificate of the server. • Confirm that the address of the Kerberos server set in the machine and the address on the KDC certificate of the server match.
018-732	<p>[Cause] An LDAP server protocol error occurred as a result of the Address Book operation. The server returned RFC2251 Result Message No "32" (no such object) for Address Book query.</p> <p>[Remedy] The specified e-mail address does not exist. Confirm the e-mail address you entered or the e-mail address registered on the LDAP server.</p>
018-733	<p>[Cause] An LDAP server protocol error occurred as a result of the Address Book operation. The server returned RFC2251 Result Message No "33" (incorrect alias) for Address Book query.</p> <p>[Remedy] The LDAP server has a name problem. Have your network administrator confirm the LDAP server status.</p>
018-734	<p>[Cause] An LDAP server protocol error occurred as a result of the Address Book operation. The server returned RFC2251 Result Message No "34" (invalid DN syntax) for Address Book query.</p> <p>[Remedy] The LDAP server has a name problem. Confirm the user name and password to cancel an incorrect password. If the error still is not resolved, have your network administrator confirm the authentication settings and status of the LDAP server.</p>
018-735	<p>[Cause] An LDAP server protocol error occurred as a result of the Address Book operation. The server returned RFC2251 Result Message No "35" (object is leaf) for Address Book query.</p> <p>[Remedy] The LDAP server has a name problem. Have your network administrator confirm the LDAP server status.</p>
018-736	<p>[Cause] An LDAP server protocol error occurred as a result of the Address Book operation. The server returned RFC2251 Result Message No "36" (alias differencing problem) for Address Book query.</p> <p>[Remedy] The LDAP server has a name problem. Have your network administrator confirm the LDAP server status.</p>
018-748	<p>[Cause] An LDAP server protocol error occurred as a result of the Address Book operation. The server returned RFC2251 Result Message No "48" (inappropriate authentication) for Address Book query.</p> <p>[Remedy] The LDAP server has a security problem. Have your network administrator confirm the authentication settings on the LDAP server.</p>
018-749	<p>[Cause] An LDAP server protocol error occurred as a result of the Address Book operation. The server returned RFC2251 Result Message No "49" (invalid credentials) for Address Book query. The address search was performed with an incorrect authentication user name and password.</p> <p>[Remedy] The LDAP server has a security problem. Confirm your authentication user name and password to cancel an incorrect login name. If the error still is not resolved, have your network administrator confirm the authentication settings on the LDAP server.</p>
018-750	<p>[Cause] An LDAP server protocol error occurred as a result of the Address Book operation. The server returned RFC2251 Result Message No "50" (insufficient access) for Address Book query.</p> <p>[Remedy] The LDAP server has a security problem. Have your network administrator confirm the access rights for the LDAP server.</p>

Status Code	Cause and Remedy
018-751	<p>[Cause] An LDAP server protocol error occurred as a result of the Address Book operation. The server returned RFC2251 Result Message No "51" (busy) for Address Book query.</p> <p>[Remedy] The service has a problem. Retry after waiting for a while. If the error still is not resolved, consult your network administrator.</p>
018-752	<p>[Cause] An LDAP server protocol error occurred as a result of the Address Book operation. The server returned RFC2251 Result Message No "52" (unavailable) for Address Book query.</p> <p>[Remedy] The LDAP server has a service problem. Retry after waiting for a while. If the error still is not resolved, consult your network administrator.</p>
018-753	<p>[Cause] An LDAP server protocol error occurred as a result of the Address Book operation. The server returned RFC2251 Result Message No "53" (unwilling to perform) for Address Book query.</p> <p>[Remedy] The LDAP server has a service problem. Retry after waiting for a while. If the error still is not resolved, consult your network administrator.</p>
018-754	<p>[Cause] An LDAP server protocol error occurred as a result of the Address Book operation. The server returned RFC2251 Result Message No "54" (loop detected) for Address Book query.</p> <p>[Remedy] The LDAP server has a service problem. Have your network administrator confirm the operational status of the service on the LDAP server.</p>
018-764	<p>[Cause] An LDAP server protocol error occurred as a result of the Address Book operation. The server returned RFC2251 Result Message No "64" (naming violation) for Address Book query.</p> <p>[Remedy] The LDAP server has an update problem. Have your network administrator confirm the LDAP server status.</p>
018-765	<p>[Cause] An LDAP server protocol error occurred as a result of the Address Book operation. The server returned RFC2251 Result Message No "65" (object class violation) for Address Book query.</p> <p>[Remedy] The LDAP server has an update problem. Have your network administrator confirm the LDAP server status.</p>
018-766	<p>[Cause] An LDAP server protocol error occurred as a result of the Address Book operation. The server returned RFC2251 Result Message No "66" (not allowed on nonleaf) for Address Book query.</p> <p>[Remedy] The LDAP server has an update problem. Have your network administrator confirm the LDAP server status.</p>
018-767	<p>[Cause] An LDAP server protocol error occurred as a result of the Address Book operation. The server returned RFC2251 Result Message No "67" (not allowed on RDN) for Address Book query.</p> <p>[Remedy] The LDAP server has an update problem. Have your network administrator confirm the LDAP server status.</p>
018-768	<p>[Cause] An LDAP server protocol error occurred as a result of the Address Book operation. The server returned RFC2251 Result Message No "68" (already exists) for Address Book query.</p> <p>[Remedy] The LDAP server has an update problem. Have your network administrator confirm the LDAP server status.</p>
018-769	<p>[Cause] An LDAP server protocol error occurred as a result of the Address Book operation. The server returned RFC2251 Result Message No "69" (no object class modifications) for Address Book query.</p> <p>[Remedy] The LDAP server has an update problem. Have your network administrator confirm the LDAP server status.</p>

Status Code	Cause and Remedy
018-770	<p>[Cause] An LDAP server protocol error occurred as a result of the Address Book operation. The server returned RFC2251 Result Message No "70" (results too large) for Address Book query.</p> <p>[Remedy] Change the search conditions/start position to narrow the search range, and execute the operation again. If the error still is not resolved, consult your network administrator.</p>
018-771	<p>[Cause] An LDAP server protocol error occurred as a result of the Address Book operation. The server returned RFC2251 Result Message No "71" (affecting multiple DSAs) for Address Book query.</p> <p>[Remedy] Have your network administrator confirm the LDAP server status.</p>
018-780	<p>[Cause] An LDAP server protocol error occurred as a result of the Address Book operation. The server returned RFC2251 Result Message No "80" (unknown error) for Address Book query.</p> <p>[Remedy] Have your network administrator confirm the LDAP server status.</p>
018-781	<p>[Cause] An LDAP server protocol error occurred as a result of the Address Book operation. Connection to the server cannot be established for the Address Book query.</p> <p>[Remedy] Take one of the following measures:</p> <ul style="list-style-type: none"> • Confirm the network cable connection. • If the network cable connection has no problem, confirm the active status of the target server. • Check whether the server name has been correctly set for [LDAP Server / Directory Service Settings] under [Remote Authentication / Directory Service].
018-782	<p>[Cause] An LDAP server protocol error occurred as a result of the Address Book operation. The server returned RFC2251 Result Message No "82" (program error or SASL authentication error) for Address Book query.</p> <p>[Remedy] Have your network administrator confirm the LDAP server status.</p>
018-783	<p>[Cause] An LDAP server protocol error occurred as a result of the Address Book operation. The server returned RFC2251 Result Message No "83" (encoding error) for Address Book query.</p> <p>[Remedy] Have your network administrator confirm the LDAP server status.</p>
018-784	<p>[Cause] An LDAP server protocol error occurred as a result of the Address Book operation. The server returned RFC2251 Result Message No "84" (decoding error) for Address Book query.</p> <p>[Remedy] Have your network administrator confirm the LDAP server status.</p>
018-785	<p>[Cause] An LDAP server protocol error occurred as a result of the Address Book operation. The server returned RFC2251 Result Message No "85" (timeout) for Address Book query.</p> <p>[Remedy] Change the search conditions/start position to narrow the search range, and execute the operation again. If the error still is not resolved, consult your network administrator.</p>
018-786	<p>[Cause] An LDAP server protocol error occurred as a result of the Address Book operation. The server returned RFC2251 Result Message No "86" (unknown authentication method) for Address Book query.</p> <p>[Remedy] Have your network administrator confirm the LDAP server status.</p>
018-787	<p>[Cause] An LDAP server protocol error occurred as a result of the Address Book operation. The server returned RFC2251 Result Message No "87" (search filter error) for Address Book query.</p> <p>[Remedy] Confirm the search conditions set on Address Book. If the error still is not resolved, consult your network administrator.</p>

Status Code	Cause and Remedy
018-788	<p>[Cause] An LDAP server protocol error occurred as a result of the Address Book operation. The server returned RFC2251 Result Message No "88" (user cancelled operation) for Address Book query.</p> <p>[Remedy] Have your network administrator confirm the LDAP server status.</p>
018-789	<p>[Cause] An LDAP server protocol error occurred as a result of the Address Book operation. The server returned RFC2251 Result Message No "89" (incorrect parameter) for Address Book query.</p> <p>[Remedy] Have your network administrator confirm the LDAP server status.</p>
018-790	<p>[Cause] An LDAP server protocol error occurred as a result of the Address Book operation. The server returned RFC2251 Result Message No "90" (no memory) for Address Book query.</p> <p>[Remedy] Have your network administrator confirm the LDAP server status.</p>
018-791	<p>[Cause] An LDAP server protocol error occurred as a result of the Address Book operation. The server returned RFC2251 Result Message No "91" (server connection error) for Address Book query.</p> <p>[Remedy] Have your network administrator confirm the LDAP server status.</p>
018-792	<p>[Cause] An LDAP server protocol error occurred as a result of the Address Book operation. The server returned RFC2251 Result Message No "92" (unsupported feature) for Address Book query.</p> <p>[Remedy] Have your network administrator confirm the LDAP server status.</p>
018-793	<p>[Cause] An LDAP server protocol error occurred as a result of the Address Book operation. The server returned RFC2251 Result Message No "93" (no results returned) for Address Book query.</p> <p>[Remedy] Have your network administrator confirm the LDAP server status.</p>
018-794	<p>[Cause] An LDAP server protocol error occurred as a result of the Address Book operation. The server returned RFC2251 Result Message No "94" (no more results) for Address Book query.</p> <p>[Remedy] Have your network administrator confirm the LDAP server status.</p>
018-795	<p>[Cause] An LDAP server protocol error occurred as a result of the Address Book operation. The server returned RFC2251 Result Message No "95" (results remaining) for Address Book query.</p> <p>[Remedy] Have your network administrator confirm the LDAP server status.</p>
018-796	<p>[Cause] An LDAP server protocol error occurred as a result of the Address Book operation. The server returned RFC2251 Result Message No "96" (client loop detected) for Address Book query.</p> <p>[Remedy] Have your network administrator confirm the LDAP server status.</p>
018-797	<p>[Cause] An LDAP server protocol error occurred as a result of the Address Book operation. The server returned RFC2251 Result Message No "97" (referral limit exceeded) for Address Book query.</p> <p>[Remedy] Have your network administrator confirm the LDAP server status.</p>
021-210 021-211 021-212	<p>[Cause] An error occurred in the smart card reader.</p> <p>[Remedy] Check the connection between the smart card reader and the machine. Switch off the machine power, make sure that the touch screen is blank, and then switch on the machine power. If the error still is not resolved, the smart card reader may be defective. Connect an unbroken smart card reader and execute the operation again.</p>

Status Code	Cause and Remedy
021-214	<p>[Cause] An error occurred during encrypted communication between the machine and the USB memory device.</p> <p>[Remedy] Switch off the machine power, make sure that the touch screen is blank, and then switch on the machine power. Execute the operation again. If the error still is not resolved, contact Customer Support at dell.com/contactdell.</p>
021-215	<p>[Cause] The accounting/billing device connected does not match the device set on the machine.</p> <p>[Remedy] Change the setting on the machine or connect the correct accounting/billing device, and switch off the machine power, make sure that the touch screen is blank, and then switch on the machine power.</p>
021-360 021-361	<p>[Cause] An error occurred.</p> <p>[Remedy] Switch off the machine power, make sure that the touch screen is blank, and then switch on the machine power. If the same message is displayed again, contact Customer Support at dell.com/contactdell.</p>
021-401	<p>[Cause] The number of authentication devices such as a smart card reader connected exceeds the setting value.</p> <p>[Remedy] Disconnect the authentication device connected.</p>
021-500	<p>[Cause] The following operation is performed when the Accounting mode for the Fax service is enabled.</p> <ul style="list-style-type: none"> • While a Send Fax job is processing, another job that the Accounting mode is enabled starts. • While another job that the Accounting mode is enabled is processing, a Send Fax job starts. <p>[Remedy] Wait for the active job finishes, and start the next job.</p>
021-731	<p>[Cause] While the EP system is available, you attempted to make color copies when the use of color is restricted.</p> <p>[Remedy] Contact Customer Support at dell.com/contactdell.</p>
021-732	<p>[Cause] The EP system is not available.</p> <p>[Remedy] Contact Customer Support at dell.com/contactdell.</p>
021-733	<p>[Cause] The EP system is not available because the use of color is restricted or the number of color pages reached the maximum.</p> <p>[Remedy] Contact Customer Support at dell.com/contactdell.</p>

Status Code	Cause and Remedy
024-340 024-341 024-342 024-343 024-345 024-346 024-347 024-348 024-349 024-350 024-351 024-352 024-353 024-354 024-355 024-356 024-357 024-358 024-359 024-360 024-361 024-362 024-363 024-364 024-365 024-366 024-367 024-368 024-370 024-371 024-372 024-373 024-375 024-376	<p>[Cause] An error occurred in the machine.</p> <p>[Remedy] Switch off the machine power, make sure that the touch screen is blank, and then switch on the machine power. If the same message is displayed again, contact Customer Support at dell.com/contactdell.</p>
024-701	<p>[Cause] The specified paper type is not compatible with the Face Up/Down Output setting selected.</p> <p>[Remedy] Specify a paper type that is compatible with the Face Up/Down setting.</p>
024-702	<p>[Cause] Paper jam occurred while [When Paper Jam Occurs] is set to [Delete Job] in [Print Service Settings].</p> <p>[Remedy] Remove the jammed paper, and then try printing again.</p>
024-703	<p>[Cause] Unable to print because the number of booklet pages exceeds the maximum number allowed.</p> <p>[Remedy] Use paper of less weight. Or, cancel the booklet creation.</p>
024-705	<p>[Cause] The template of the specified force annotation was not found in the machine.</p> <p>[Remedy] Delete the document in the folder of the machine, and then select [Store to Folder] again from the print driver to store the document.</p>

Status Code	Cause and Remedy
024-742	<p>[Cause] Booklet printing was specified for printer properties, but the number of print pages for the job exceeded the maximum number allowed for booklet creation.</p> <p>[Remedy] Change the printer properties setting to split the pages appropriately to create separate volumes, or to cancel the booklet creation setting.</p>
024-746	<p>[Cause] The specified paper type is not compatible with the specified paper size, paper tray, output tray, or 2 sided printing.</p> <p>[Remedy] Confirm the print data.</p>
024-747	<p>[Cause] Incompatible print parameters are used. The combination of the specified features such as Document Size, Paper Size, Paper Tray, 2 sided printing, and Output Tray is incompatible.</p> <p>[Remedy] Confirm the print data, and try printing again.</p>
024-748	<p>[Cause] The number of digits specified in [Bates Stamp - Number of Digits] screen does not match the value specified in [Starting Number].</p> <p>[Remedy] Set [Bates Stamp - Number of Digits] to the value specified in [Starting Number] or to [Auto Assign].</p>
024-775	<p>[Cause] Booklet printing was specified for printer properties, but the number of print pages for the job exceeded the maximum number allowed for booklet creation.</p> <p>[Remedy] Change the printer properties setting to split the pages appropriately to create separate volumes, or to cancel the booklet creation setting.</p>
025-596 025-597	<p>[Cause] An error occurred with the hard disk.</p> <p>[Remedy] Replace the hard disk.</p>
026-400	<p>[Cause] More than two devices are connected to the USB host port.</p> <p>[Remedy] Disconnect the third or more devices so that the number of connected devices becomes two. If the error still is not resolved, switch off the machine power, make sure that the touch screen is blank, and then switch on the machine power.</p>
026-700	<p>[Cause] By Address Book operation, the machine received an unsupported protocol from the LDAP server.</p> <p>[Remedy] Execute the operation again. If the error still is not resolved, contact Customer Support at dell.com/contactdell.</p>
026-701	<p>[Cause] The number of queries submitted to the Address Book exceeded the machine's processing capability.</p> <p>[Remedy] Wait for a while and execute the operation again. If the only one query is being submitted to the Address Book, the machine's software may be defective. Contact Customer Support at dell.com/contactdell.</p>
026-702	<p>[Cause] The number of accesses from the LDAP server to the machine by Address Book operation exceeded the machine's processing capability.</p> <p>[Remedy] Wait for a while and execute the operation again. If the error still is not resolved, contact Customer Support at dell.com/contactdell.</p>
026-703	<p>[Cause] Authentication is canceled when adding documents during faxing or scanning.</p> <p>[Remedy] Authenticate when adding documents.</p>

Status Code	Cause and Remedy
026-708	<p>[Cause] Exceeded the maximum limit for the scan data size that can be stored for one job with Store & Send Link.</p> <p>[Remedy] Take one of the following measures:</p> <ol style="list-style-type: none"> 1) Reduce the resolution (scan quality) of the scan parameters and execute the operation again. 2) Reduce the image with magnification of the scan parameters (such as A3 > A4) and then execute the operation again. 3) If [Store & Send Link - Maximum File Size] is set to a small value, increase the value.
026-709	<p>[Cause] The capacity of the hard disk that can be used to store scan data with Store & Send Link is insufficient.</p> <p>[Remedy] Wait around one day, and when capacity becomes available as a result of the automatic deletion of files, execute the operation again.</p>
026-710	<p>[Cause] The machine has received an e-mail encrypted by S/MIME, but does not support the encryption method.</p> <p>[Remedy] Take one of the following measures:</p> <ul style="list-style-type: none"> • Ask the sender to send the e-mail encrypted by 3DES. • Disable the FIPS140 validation mode of the machine.
026-711	<p>[Cause] Exceeded the maximum size allowed for a multi-page file when scanning.</p> <p>[Remedy] Take one of the following measures:</p> <ol style="list-style-type: none"> 1) Reduce the resolution (scan quality) of the scan parameters and execute the operation again. 2) Reduce the number of document pages and then execute the operation again. <p>The maximum size is 2 GB for TIFF, XPS, and PDF.</p> <p>Note • XPS stands for XML Paper Specification.</p>
026-712	<p>[Cause] An error occurred while operating from Dell Printer Configuration Web Tool.</p> <p>[Remedy] Retry after waiting for a while.</p>
026-718	<p>[Cause] Incompatible print parameters are used. The combination of the specified features such as Document Size, Paper Size, Paper Tray, 2 sided printing, and Output Tray is incompatible.</p> <p>[Remedy] Confirm the print data, and try printing again.</p>
026-719	<p>[Cause] An error occurred while operating the Store to USB service.</p> <p>[Remedy] Wait for a while and execute the operation again. If the error still is not resolved, contact Customer Support at dell.com/contactdell.</p>
026-720	<p>[Cause] The capacity of the USB memory device of the recipient is insufficient while performing the Store to USB service.</p> <p>[Remedy] Confirm the amount of available space.</p>
026-721	<p>[Cause] An error occurred while operating the Store to USB service.</p> <p>[Remedy] Check the following conditions:</p> <ul style="list-style-type: none"> • The USB memory device is inserted into the USB memory slot. • The USB memory device is accessible from your computer. • The unencrypted USB memory device is used.

Status Code	Cause and Remedy
026-722	<p>[Cause] The USB memory device is not initialized.</p> <p>[Remedy] Initialize the USB memory device on a computer with the following file format, and then execute the operation again.</p> <ul style="list-style-type: none"> • Supported file formats: FAT12, FAT16 (FAT), FAT32 <p>Note</p> <ul style="list-style-type: none"> • NTFS is not supported. • A software-encrypted USB memory device is not supported. <p>If the error still is not resolved, contact Customer Support at dell.com/contactdell.</p>
026-723	<p>[Cause] The machine failed to access to the medium.</p> <p>[Remedy] 1)Check that the medium is not inserted or removed, or the other medium is not inserted, while the machine is referencing the medium. 2)Check that the file in the medium can be accessed via a computer.</p>
026-726	<p>[Cause] The machine configuration information at a print job specification does not match the actual machine configuration.</p> <p>[Remedy] Modify the machine configuration information in the print driver screen to match the actual machine configuration.</p>
026-727	<p>[Cause] Probable causes are as follows:</p> <ol style="list-style-type: none"> 1)Unusable characters are included in the path name of the file location. 2)The length of the path name of the file location (including extension) exceeds the number of characters available. <p>[Remedy] Take one of the following measures:</p> <ol style="list-style-type: none"> 1)Change the path name of the file location. 2)Set the path in the range of 1 to 255 bytes.
026-730	<p>[Cause] The size of paper loaded in the specified tray is unknown.</p> <p>[Remedy] Check whether the paper guides are correctly positioned in the tray, and then try again.</p>
026-736	<p>[Cause] An internal error occurred while sending the scanned document to the HTTP server.</p> <p>[Remedy] Execute the operation again. If the error still is not resolved, contact Customer Support at dell.com/contactdell.</p>
026-737	<p>[Cause] Unable to send the scanned document to the HTTP server because a network error occurred.</p> <p>[Remedy] Consult your network administrator whether the network or the server have any problem.</p>
026-738	<p>[Cause] The machine failed to send scanned document data to the HTTP server because Web application is closed during it.</p> <p>[Remedy] Execute the operation again.</p>
027-400	<p>[Cause] Communications with the machine failed.</p> <p>[Remedy] If other messages are displayed, confirm their content. If the control panel is being operated, terminate the operation. If remote access is being executed, wait until it completes. If the error still is not resolved, switch off the machine power, make sure that the touch screen is blank, and then switch on the machine power. If the problem persists, contact Customer Support at dell.com/contactdell.</p>
027-442	<p>[Cause] The IP address of IPv6 already exists.</p> <p>[Remedy] Change the [Auto Stateless Address 1] for IPv6 on the machine, or the IP address of IPv6 on the network device, to remove the duplication of addresses.</p>
027-443	<p>[Cause] The IP address of IPv6 already exists.</p> <p>[Remedy] Change the [Auto Stateless Address 2] for IPv6 on the machine, or the IP address of IPv6 on the network device, to remove the duplication of addresses.</p>

Status Code	Cause and Remedy
027-444	<p>[Cause] The IP address of IPv6 already exists.</p> <p>[Remedy] Change the [Auto Stateless Address 3] for IPv6 on the machine, or the IP address of IPv6 on the network device, to remove the duplication of addresses.</p>
027-445	<p>[Cause] IP address for IPv6 set manually is incorrect.</p> <p>[Remedy] Set the IP address correctly.</p>
027-446	<p>[Cause] The IP address of IPv6 set manually already exists.</p> <p>[Remedy] Change the [Manually Configured IPv6 Address] on the machine, or the IP address of IPv6 on the network device, to remove the duplication of addresses.</p>
027-447	<p>[Cause] The IP address of IPv6 already exists.</p> <p>[Remedy] Change the [Link-local Address] for IPv6 on the machine, or the IP address of IPv6 on the network device, to remove the duplication of addresses.</p>
027-452	<p>[Cause] IP address of IPv4 already exists.</p> <p>[Remedy] Change the IP address of IPv4 set on the machine or the IP address of IPv4 on the network device.</p>
027-500	<p>[Cause] Unable to connect to the SMTP server.</p> <p>[Remedy] Specify the SMTP server name correctly or specify the server by using its IP address.</p>
027-501	<p>[Cause] A POP server error occurred.</p> <p>[Remedy] Execute the operation again. If the error still is not resolved, contact Customer Support at dell.com/contactdell.</p>
027-502	<p>[Cause] Failed to log into the POP3 server when using the POP3 protocol.</p> <p>[Remedy] Confirm whether the user name and password used in the POP3 server are correct on Dell Printer Configuration Web Tool.</p>
027-503	<p>[Cause] A POP server error occurred.</p> <p>[Remedy] Execute the operation again. If the error still is not resolved, contact Customer Support at dell.com/contactdell.</p>
027-504	<p>[Cause] An SMTP server error occurred.</p> <p>[Remedy] Execute the operation again. If the error still is not resolved, contact Customer Support at dell.com/contactdell.</p>
027-513	<p>[Cause] The machine failed to transfer data using SMB of the Scan to PC service because access to the SMB server was not permitted.</p> <p>When the server is Macintosh, a folder with the same name as the specified file name may exist on the server.</p> <p>[Remedy] Consult your system administrator for settings.</p>
027-514	<p>[Cause] The machine failed to transfer data using SMB of the Scan to PC service because an error has been occurred between the SMB server and the DNS server.</p> <p>[Remedy] Check the following conditions:</p> <ul style="list-style-type: none"> • The SMB server is connected to the DNS server. • The SMB server name is registered on the DNS server.
027-515	<p>[Cause] The machine failed to transfer data using SMB of the Scan to PC service because an error has been occurred.</p> <p>[Remedy] Take the following measures:</p> <ul style="list-style-type: none"> • Set the DNS server address. • Set the target SMB server address using IP address.

Status Code	Cause and Remedy
027-516	<p>[Cause] Probable causes are as follows:</p> <ol style="list-style-type: none"> 1)The SMB server of the destination computer cannot be found while transferring data using SMB of the Scan to PC service (TCP/IP session establishment failed). 2)The SMB server specified as the destination does not respond to the machine while transferring data using SMB of the Scan to PC service. 3)Failed to name resolution of the SMB server specified as destination to transfer data using SMB of the Scan to PC service. <p>[Remedy] Take one of the following measures:</p> <ol style="list-style-type: none"> 1)Confirm the connection of the network cable. <ul style="list-style-type: none"> - For communications over subnet, confirm the WINS server settings, and check whether the server address can be resolved correctly. - File Sharing service (communicating via port 137 (UDP), port 138 (UDP), and port 139 (TCP)) is authorized for the Firewall settings of the destination SMB server. 2)Check whether the file sharing service is enabled on the destination SMB server. <ul style="list-style-type: none"> - File Sharing service for Microsoft Network is activated. <p>If the error still is not resolved, check the following setting.</p> <ul style="list-style-type: none"> - NetBIOS over TCP/IP for TCP/IP is activated. 3)Take one of the following measures: <ul style="list-style-type: none"> - When the destination SMB server name is specified using the FQDN (example: mypc01.abc0.co.jp), confirm that the DNS server address is set correctly in the Connectivity & Network Setup of the machine. - If the connection with the DNS server has any problem, check whether the destination server name set in the machine is registered on the DNS server.
027-518	<p>[Cause] The machine failed to transfer data using SMB of the Scan to PC service because the specified password was incorrect.</p> <p>When the server is Macintosh, the specified user may not have been registered as a user who is permitted to use Windows Sharing.</p> <p>[Remedy] Confirm the password for the shared folder.</p> <p>When the server is Macintosh, specify a user who is permitted to use Windows Sharing.</p>
027-519	<p>[Cause] The machine failed to transfer data using SMB of the Scan to PC service because the save location or file name specified for the scanned image had a problem.</p> <ul style="list-style-type: none"> • The save location or the file name has a problem. • The specified save location does not exist on the server. • Invalid characters are used in the save location or the file name. • Because the specified save location has the Distributed File System (DFS) settings, it is linked to another shared folder. <p>[Remedy] Take one of the following measures:</p> <ul style="list-style-type: none"> • Check whether the save location is correct • Check whether the specified file name can be used on the SMB server. • Confirm the Distributed File System (DFS) settings with your system administrator. To confirm the settings, execute the following procedures: <ol style="list-style-type: none"> 1)Select [Start] > [Programs] > [Administrative Tools] > [Distributed File System] on the SMB server. 2)Select the specified save location from the left side frame of the [Distributed File System] window, and then confirm the target information displayed on the right side frame of the window. 3)Specify the SMB server, shared name, and save location based on the information you confirmed in step 2.

Status Code	Cause and Remedy
027-520	<p>[Cause] The machine failed to transfer data using SMB of the Scan to PC service because the file name or folder name could not be retrieved.</p> <p>[Remedy] Confirm the access privilege to the SMB server.</p>
027-521	<p>[Cause] The machine failed to transfer data using SMB of the Scan to PC service because the suffix of the name of the file or folder exceeded the limit value.</p> <p>[Remedy] Change the file name or forwarding destination folder of the scan server. Or, try moving or deleting the files within the forwarding destination folder.</p>
027-522	<p>[Cause] During forwarding using SMB of the Scan to PC service, the scanned image file could not be created on the SMB server because of one of the following reasons:</p> <ul style="list-style-type: none"> • The specified file name already exists. • The specified file name has already been used. • The specified file name exists as a directory. • Invalid characters are used in the file name. <p>[Remedy] Take one of the following measures:</p> <ul style="list-style-type: none"> • Check whether the specified file name can be used in the save location. • Check whether the specified file name has been used by another user. • Check whether the specified file name has been used for another file or folder.
027-523	<p>[Cause] The machine failed to transfer data using SMB of the Scan to PC service because a folder could not be created on the SMB server. The specified folder already exists.</p> <p>[Remedy] Check whether the specified name is being used for another file or folder on the SMB server.</p>
027-524	<p>[Cause] The machine failed to transfer data using SMB of the Scan to PC service because a folder could not be created on the SMB server. The specified folder already exists.</p> <p>[Remedy] Check whether the specified name is being used for another file or folder on the SMB server.</p>
027-525	<p>[Cause] During forwarding using SMB of the Scan to PC service, a file could not be deleted from the SMB server because of one of the following reasons:</p> <ul style="list-style-type: none"> • The file does not exist. • The file is opened. • The specified file name is being used as a directory. <p>[Remedy] Check whether the file is not being used by another user at the specified save location.</p>
027-526	<p>[Cause] The machine failed to delete the lock directory on the SMB server while transferring data using SMB of the Scan to PC service.</p> <p>[Remedy] If the lock directory (*.LCK) exists in the destination, delete it manually, and then execute the operation again.</p>
027-527	<p>[Cause] During forwarding using SMB of the Scan to PC service, a folder could not be deleted from the SMB server because of one of the following reasons:</p> <ul style="list-style-type: none"> • The file does not exist. • The directory is not empty. • The specified directory name does not exist. <p>[Remedy] Check whether the file is not being used by another user at the specified save location.</p>
027-528	<p>[Cause] The machine failed to transfer data using SMB of the Scan to PC service because no space is available at the save location on the SMB server.</p> <p>[Remedy] Check whether the save location has free space.</p>

Status Code	Cause and Remedy
027-529	<p>[Cause] The machine failed to transfer data using SMB of the Scan to PC service because an unexpected error has been received from the SMB server, or an unexpected internal error has occurred on the machine.</p> <p>[Remedy] Log into the server from another computer using the same user name, to confirm whether a file can be written into the same save location on the server. If the error still is not resolved, it may be an internal error. Contact Customer Support at dell.com/contactdell.</p>
027-530	<p>[Cause] There are duplicate file names. [Do Not Save] is set as a handling method when names are duplicated for scanned files.</p> <p>[Remedy] Set the process to be executed in case of a file name duplication to other than [Do Not Save].</p>
027-531	<p>[Cause] Detected an incorrect filing policy (when add was selected) after connecting to the server.</p> <p>[Remedy] When [Rename New File] is set as the process to be executed in case of a file name duplication, confirm that the file format is not multi-page.</p>
027-532	<p>[Cause] Failed to access the NEXTNAME.DAT file.</p> <p>[Remedy] When [Rename New File] is set as the process to be executed in case of a file name duplication, check the NEXTNAME.DAT file is correct.</p>
027-533	<p>[Cause] An internal error occurred.</p> <p>[Remedy] Execute the operation again. If the error still is not resolved, contact Customer Support at dell.com/contactdell.</p>
027-543	<p>[Cause] The SMB server (NetBIOS) name is invalid.</p> <p>[Remedy] Check whether the server name of the SMB server is correct.</p>
027-547	<p>[Cause] SMB protocol error. An invalid character was detected in the specified domain name.</p> <p>[Remedy] If the error occurred during SMB authentication:</p> <p>Consult your network administrator for the domain name, and then set it correctly.</p> <p>Also, check whether the domain name set on the machine is correct.</p> <p>To confirm the settings, execute the following procedures:</p> <ol style="list-style-type: none"> 1) Enter the System Administration mode, and select [Tools] > [System Settings] > [Connectivity & Network Setup] > [Remote Authentication / Directory Service] > [SMB Server Settings]. 2) Select the SMB server to confirm the domain name. <p>If the error occurred during transferring using SMB of the Scan to PC service:</p> <p>Consult your network administrator whether the domain name specified when entering login name is correct.</p> <p>To confirm the domain name on the server, execute the following procedures:</p> <ol style="list-style-type: none"> 1) Select [Start] > [Programs] > [Administrative Tools] > [Active Directory Domains and Trusts] on the Active Directory domain controller. 2) From the left side frame of the [Active Directory Domains and Trusts] window, select [Active Directory Domains and Trusts] > [Domains]. Right-click [Domains] to select [Properties]. 3) Select [General] tab in the domain properties window, and confirm the domain name (prior to Windows 2000).

Status Code	Cause and Remedy
027-548	<p>[Cause] SMB protocol error. An invalid character has been detected in the specified user name.</p> <p>[Remedy] Ask your network administrator to set the user name with valid characters.</p> <p>To confirm the user name on the server, execute the following procedures:</p> <ol style="list-style-type: none"> 1) Select [Start] > [Programs] > [Administrative Tools] > [Active Directory Users and Computers] on the Active Directory domain controller where the user information is set. 2) Select [Active Directory Users and Computers] > [Server] > [Domains] > [Users] from the left side frame of the [Active Directory Users and Computers] window, to display the user information. 3) Right-click the target user from the right side frame of the [Active Directory Domains and Trusts] window to select [Properties]. 4) Select the [Account] tab in the [User Properties] window, and confirm the user name of [User Log On Name (Prior to Windows 2000)].
027-549	<p>[Cause] SMB protocol error</p> <p>[Remedy] Execute the operation again. If the error still is not resolved, contact Customer Support at dell.com/contactdell.</p>
027-564	<p>[Cause] SMB protocol error. The SMB server was not found.</p> <p>[Remedy] Check whether the connection between the authentication server and the machine has been established via a network.</p> <p>For example, confirm the following conditions:</p> <ul style="list-style-type: none"> • Network cable connection • TCP/IP settings • Connection via Port 137 (UDP), Port 138 (UDP), and Port 139 (TCP)
027-565	<p>[Cause] SMB protocol error</p> <p>[Remedy] Execute the operation again. If the error still is not resolved, contact Customer Support at dell.com/contactdell.</p>
027-566	<p>[Cause] SMB protocol error. SMB (TCP/IP) is not active.</p> <p>[Remedy] Confirm that SMB (TCP/IP) is active on the [Port Settings] screen of the [Properties] tab on Dell Printer Configuration Web Tool.</p>
027-569	<p>[Cause] The SMB (TCP/IP) port is not activated.</p> <p>[Remedy] Confirm that SMB (TCP/IP) is active on the [Port Settings] screen of the [Properties] tab on Dell Printer Configuration Web Tool.</p>
027-572 027-573 027-574 027-576 027-578	<p>[Cause] SMB protocol error</p> <p>[Remedy] Execute the operation again. If the error still is not resolved, contact Customer Support at dell.com/contactdell.</p>
027-584	<p>[Cause] SMB protocol error. The SMB server is in shared security mode.</p> <p>[Remedy] The SMB server may be set on Windows 95, Windows 98, or Windows Me OS. Set the SMB server on an OS other than Windows 95, Windows 98, or Windows Me OS.</p>
027-585	<p>[Cause] SMB protocol error. Login is disabled at this time.</p> <p>[Remedy] Confirm the period login permitted with your system administrator.</p>
027-586	<p>[Cause] SMB protocol error. The password has expired.</p> <p>[Remedy] Obtain a valid password from your system administrator.</p>

Status Code	Cause and Remedy
027-587	<p>[Cause] SMB protocol error. The password must be changed.</p> <p>[Remedy] Log into Windows, and change the password. Ask your system administrator to change the setting so that you do not need to change the login password next time.</p>
027-588	<p>[Cause] SMB protocol error. The user is invalid.</p> <p>[Remedy] Ask your system administrator to validate the user.</p>
027-589	<p>[Cause] SMB protocol error. The user was locked out.</p> <p>[Remedy] Ask your system administrator to cancel the lockout status.</p>
027-590	<p>[Cause] SMB protocol error. The user account has expired.</p> <p>[Remedy] Obtain a valid user account from your system administrator. Or, ask your system administrator to extend the account expiration date.</p>
027-591	<p>[Cause] SMB protocol error. Users are restricted. A blank password is invalid.</p> <p>[Remedy] Set the password for the user.</p>
027-700	<p>[Cause] The domain section of the recipient's e-mail address is a prohibited domain.</p> <p>[Remedy] Specify a domain that is not prohibited for the domain section of the recipient's e-mail address.</p>
027-701	<p>[Cause] The network cable is disconnected from the machine.</p> <p>[Remedy] Connect the network cable securely if the cable is disconnected.</p>
027-702	<p>[Cause] The specified recipient's certificate does not exist.</p> <p>[Remedy] Register the certificate for the recipient on the machine.</p>
027-703	<p>[Cause] The specified recipient's certificate has expired.</p> <p>[Remedy] Register a valid certificate for the recipient on the machine.</p>
027-704	<p>[Cause] The CA certificate of the specified recipient's certificate does not exist.</p> <p>[Remedy] Confirm the path to the recipient's certificate, and register the required CA certificate on the machine.</p>
027-705	<p>[Cause] The specified recipient's certificate has been revoked.</p> <p>[Remedy] Specify a valid certificate for the recipient.</p>
027-706	<p>[Cause] Unable to find the S/MIME certificate associated with the machine's e-mail address when sending e-mail.</p> <p>[Remedy] Import the S/MIME certificate corresponding to the mail address to the machine.</p>
027-707	<p>[Cause] The S/MIME certificate associated with the machine's e-mail address has expired when sending e-mail.</p> <p>[Remedy] Ask the sender to issue a new S/MIME certificate, and then import the certificate to the machine.</p>
027-708	<p>[Cause] The S/MIME certificate associated with the machine's e-mail address is not reliable when sending e-mail.</p> <p>[Remedy] Import a reliable S/MIME certificate to the machine.</p>
027-709	<p>[Cause] The S/MIME certificate associated with the machine's e-mail address has been discarded when sending e-mail.</p> <p>[Remedy] Import a new S/MIME certificate to the machine.</p>
027-710	<p>[Cause] No S/MIME certificate is attached to the received e-mail.</p> <p>[Remedy] Ask the sender to send the e-mail with an S/MIME certificate attached.</p>

Status Code	Cause and Remedy
027-711	<p>[Cause] No S/MIME certificate can be obtained from the received e-mail.</p> <p>[Remedy] Import the sender's S/MIME certificate to the machine, or ask the sender to send S/MIME signature mail with an S/MIME certificate attached.</p>
027-712	<p>[Cause] The received S/MIME certificate has expired, or is an unreliable certificate.</p> <p>[Remedy] Ask the sender to send the e-mail with a valid S/MIME certificate attached.</p>
027-713	<p>[Cause] The received e-mail has been discarded because it may have been altered on its transmission route.</p> <p>[Remedy] Inform this error to the sender, and ask the sender to send the e-mail again.</p>
027-714	<p>[Cause] The received e-mail has been discarded because the address in its From field is different from the mail address in the S/MIME signature mail.</p> <p>[Remedy] Inform the sender that the mail addresses differ, and ask the sender to send the e-mail again.</p>
027-715	<p>[Cause] The received S/MIME certificate has not been registered on the machine, or has not been set for use on the machine.</p> <p>[Remedy] Import the sender's S/MIME certificate to the machine, or change settings to use the S/MIME certificate on the machine if the S/MIME certificate has already been registered.</p>
027-716	<p>[Cause] The received S/MIME certificate has been discarded because the certificate was unreliable.</p> <p>[Remedy] Ask the sender to send the e-mail with a reliable S/MIME certificate attached.</p>
027-717	<p>[Cause] Unable to obtain SMTP server address for e-mail transmissions from the DNS server.</p> <p>[Remedy] Check whether the DNS server is set correctly.</p>
027-722	<p>[Cause] The jobs timed out during connection with an application interface destination.</p> <p>[Remedy] Try processing the job flow again.</p>
027-727	<p>[Cause] A parameter is illegal during an application interface.</p> <p>[Remedy] Try processing the job flow again.</p>
027-728	<p>[Cause] The number of files that are to be sent to external services exceeded the maximum number.</p> <p>[Remedy] Reduce the number of files, and send them again.</p>
027-730	<p>[Cause] The number of the document pages attached to the SMTP mail exceeds the maximum number of pages allowed for the Split Send feature.</p> <p>[Remedy] Increase the number of pages allowed for the Split Send feature, or reduce the number of the document pages.</p>
027-735	<p>[Cause] The data transfer using SSL is specified, but the SSL setting of the machine is disabled.</p> <p>[Remedy] Enable the SSL setting, or specify HTTP for the transfer protocol.</p>
027-736	<p>[Cause] The server certificate verification feature of the machine is disabled when the server certificate verification is required.</p> <p>[Remedy] Enable the server certificate validation. Or, disable the server certificate validation for data transfer.</p>
027-750	<p>[Cause] Attempted to execute a fax, a print, or an Internet fax transmission to the scanned document.</p> <p>[Remedy] The Fax, Print, or Internet Fax features are unavailable for scanned documents. Set the job flow correctly.</p>
027-751	<p>[Cause] An error occurred during job flow processing.</p> <p>[Remedy] Confirm the settings of the job flow.</p>

Status Code	Cause and Remedy
027-752	<p>[Cause] A mandatory entry field is blank in the job flow.</p> <p>[Remedy] Take one of the following measures:</p> <ul style="list-style-type: none"> • Do not link folders to job flows that have mandatory entry fields. • Set the default values to the mandatory fields of the job flow.
027-753	<p>[Cause] 1) Attempted to execute the service while the port necessary for the job flow is either deactivated or disabled. 2) Attempted to execute a job flow to send e-mail using the Encryption or Digital Signature feature while S/MIME communication is disabled.</p> <p>[Remedy] For 1), have your system administrator confirm the port status. For 2), enable S/MIME communication, or modify the job flow so that e-mail is sent by not using the Encryption or Digital Signature feature.</p>
027-754	<p>[Cause] [PDF Signature] is set inconsistency in the job flow.</p> <p>[Remedy] Check the PDF signatures for both the system data settings (machine's current settings) and the executed job flow settings. If these settings differ, coordinate them.</p>
027-761	<p>[Cause] An on-demand print job was sent to the machine using the Web Applications feature, but the time interval from receiving the print job until starting the print processing exceeded the time limit specified on the machine.</p> <p>[Remedy] When multiple documents are to be printed, reduce the number of documents, and then execute the operation again. If the error still is not resolved, enter the System Administration mode, and then select [System Settings] > [Common Service Settings] > [Machine Clock/Timers] > [Print-On-Demand Duration], and specify a larger value or "0".</p> <p>When on-demand printing is executed using the Web Application feature, the print processing time is limited. Consequently if many documents are to be printed or if print processing takes time, a timeout may occur before all the data are received. To resolve this problem, change the time limit value according to the document volume and type. If the error still is not resolved, contact Customer Support at dell.com/contactdell.</p>
027-762	<p>[Cause] An on-demand print job is sent to the machine using the Web Applications feature, however, the specified job ticket is invalid because of one of the following causes:</p> <ul style="list-style-type: none"> • Abnormal change to the job ticket because of the machine software failure • Abnormal change to the job ticket because of a bug on the sender's remote server • Abnormal change to the job ticket because of network trouble • Intentional alteration to the job ticket <p>[Remedy] Execute the print job again. If the error still is not resolved, contact Customer Support at dell.com/contactdell.</p>
027-763	<p>[Cause] The machine failed to verify the user information against the remote accounting server.</p> <p>[Remedy] Take one of the following measures:</p> <ul style="list-style-type: none"> • Check whether the remote accounting server is operating properly. • Check whether there is no network failure. • Connect the network cable securely. • Confirm the settings on the machine.
027-770	<p>[Cause] The print job has a problem.</p> <p>[Remedy] Submit the print job again.</p>
027-771	<p>[Cause] The hard disk of the server connected to the machine is full.</p> <p>[Remedy] Delete unnecessary data from the server.</p>

Status Code	Cause and Remedy
027-772	<p>[Cause] An error occurred during communication with the SMTP server.</p> <p>[Remedy] Use ASCII characters to modify the host name that has been specified under [Tools] > [System Settings] > [Connectivity & Network Setup] > [Machine's E-mail Address / Host Name]. If the error still is not resolved, confirm with your network administrator whether the SMTP server supports the HELO command.</p>
027-773	<p>[Cause] An error occurred during communication with the SMTP server.</p> <p>[Remedy] Wait for a while, and then execute the operation again.</p>
027-774	<p>[Cause] The specified e-mail address contains unsupported characters.</p> <p>[Remedy] Specify the e-mail address using only ASCII characters.</p>
027-775	<p>[Cause] Too many destination addresses have been specified.</p> <p>[Remedy] Reduce the number of destination addresses. If the error still is not resolved, confirm with your network administrator whether the SMTP server supports the EHLO command.</p>
027-776	<p>[Cause] An error occurred during communication with the SMTP server.</p> <p>[Remedy] Use ASCII characters to modify the host name that has been specified under [Tools] > [System Settings] > [Connectivity & Network Setup] > [Machine's E-mail Address / Host Name]. If the error still is not resolved, confirm with your network administrator whether the SMTP server supports the EHLO command.</p>
027-777	<p>[Cause] The destination SMTP server does not support SMTP-AUTH.</p> <p>[Remedy] Set [E-mail Send Authentication] to [Off] under [Tools] > [System Settings] > [Connectivity & Network Setup] > [Outgoing / Incoming E-mail Settings] > [SMTP Server Settings].</p>
027-778	<p>[Cause] The destination SMTP server does not support the SMTP-AUTH system set on the machine.</p> <p>[Remedy] Confirm the authentication type supported by the SMTP server with your network administrator. The machine supports the following authentication types: AUTH GSSAPI (only for Kerberos), AUTH NTLMv2, AUTH NTLMv1, AUTH PLAIN, AUTH LOGIN, AUTH CRAM-MD5.</p>
027-779	<p>[Cause] Failed to authenticate the SMTP server.</p> <p>[Remedy] Confirm the login name and password set to SMTP-AUTH.</p>
027-796	<p>[Cause] The received e-mail was discarded because no documents were attached to it. (The machine is set to print attached documents only.)</p> <p>[Remedy] To print the mail body or header information also, change settings in the [Properties] screen of Dell Printer Configuration Web Tool.</p>
027-797	<p>[Cause] The output destination of the received e-mail is invalid.</p> <p>[Remedy] Specify a correct output destination, and send the e-mail again.</p>

Status Code	Cause and Remedy
033-310 033-311 033-312 033-313 033-314 033-315 033-316 033-317 033-318 033-319 033-320 033-321 033-322 033-323 033-324 033-325 033-326 033-327 033-328 033-329 033-330 033-331 033-332 033-333 033-334 033-335 033-336 033-338 033-339	<p>[Cause] An error occurred.</p> <p>[Remedy] Switch off the machine power, make sure that the touch screen is blank, and then switch on the machine power. If the same message is displayed again, contact Customer Support at dell.com/contactdell.</p>
033-500 033-501	<p>[Cause] An error occurred during fax transmission.</p> <p>[Remedy] Confirm the recipient, and then execute the operation again. If receiving, ask the sender to send again.</p>
033-502	<p>[Cause] A response is not received for the fax.</p> <p>[Remedy] Confirm the recipient, and then execute the operation again. Also, confirm the recipient's machine (memory is full, machine is being maintained, or other conditions), and execute the operation again.</p>
033-505	<p>[Cause] An error occurred during fax transmission.</p> <p>[Remedy] Confirm the recipient, and then execute the operation again. If receiving, ask the sender to send again.</p>
033-506	<p>[Cause] Communication was terminated at the recipient's machine.</p> <p>[Remedy] The job may have been canceled at the recipient. If the job was not canceled, check whether the other machine has a problem, and execute the operation again.</p>
033-507	<p>[Cause] The recipient's machine cannot receive.</p> <p>[Remedy] Confirm the recipient's machine (memory is full, machine is being maintained, or other conditions), and execute the operation again.</p>
033-508	<p>[Cause] No spooling documents exist at the other machine.</p> <p>[Remedy] Ask the other party to prepare polling documents, and execute the operation again.</p>

Status Code	Cause and Remedy
033-509	<p>[Cause] An error occurred during fax transmission.</p> <p>[Remedy] Execute the operation again. If the error still is not resolved, confirm the condition of the other machine.</p>
033-510	<p>[Cause] An error occurred during fax transmission.</p> <p>[Remedy] Confirm the condition of the line and the other machine, and execute the operation again.</p>
033-511	<p>[Cause] An error occurred during fax transmission.</p> <p>[Remedy] Confirm the following conditions:</p> <ul style="list-style-type: none"> • Whether a polling document exists at the other machine • Whether a document is jammed at the other machine • Whether the passwords match
033-512	<p>[Cause] The other party cannot execute Relay Broadcast.</p> <p>[Remedy] Confirm whether the other party can execute Relay Broadcast.</p>
033-513	<p>[Cause] The other machine does not have the Folder feature.</p> <p>[Remedy] Confirm whether the other machine has the Folder feature.</p>
033-514	<p>[Cause] An error occurred during fax transmission.</p> <p>[Remedy] Ask the sender to send again.</p>
033-516	<p>[Cause] An error occurred during fax transmission.</p> <p>[Remedy] Confirm the recipient, and then execute the operation again. If receiving, ask the sender to send again.</p>
033-517	<p>[Cause] An error occurred during fax transmission.</p> <p>[Remedy] Execute the operation again. If the error still is not resolved, confirm the condition of the other machine.</p>
033-518	<p>[Cause] The other machine cannot correspond to reception of SUB.</p> <p>[Remedy] Check whether the other machine can correspond to reception of SUB, and execute the operation again.</p>
033-519	<p>[Cause] The other machine cannot correspond to reception of SEP.</p> <p>[Remedy] Check whether the other machine can correspond to reception of SEP, and execute the operation again.</p>
033-520	<p>[Cause] The other machine cannot correspond to reception of PWD/SID.</p> <p>[Remedy] Check whether the other machine can correspond to reception of PWD/SID, and execute the operation again.</p>
033-521	<p>[Cause] An error occurred during fax transmission.</p> <p>[Remedy] Confirm the condition of the machine (memory is full, paper has run out, or other conditions), and execute the operation again.</p>
033-522	<p>[Cause] An error occurred during fax transmission.</p> <p>[Remedy] Ask the sender to execute the operation again.</p>
033-526	<p>[Cause] An error occurred during fax transmission.</p> <p>[Remedy] Confirm the model of the sender's machine, and then execute the operation again. If receiving, ask the sender to send again.</p>
033-527	<p>[Cause] An error occurred during fax transmission.</p> <p>[Remedy] Confirm the other machine has a problem, and then execute the operation again.</p>

Status Code	Cause and Remedy
033-528	[Cause] An error occurred during fax transmission. [Remedy] Ask the sender to send again.
033-529	[Cause] An error occurred during fax transmission. [Remedy] Confirm the other machine has a problem, and then execute the operation again.
033-530	[Cause] Received a procedure disabled signal. [Remedy] Execute the operation again. If the error still is not resolved, contact Customer Support at dell.com/contactdell .
033-531	[Cause] Received a command rejection signal. [Remedy] Confirm the condition of the other machine (memory is full, paper has run out, or other conditions), and execute the operation again.
033-532 033-533	[Cause] An error occurred during fax transmission. [Remedy] Execute the operation again. If receiving, ask the sender to send again.
033-534	[Cause] The other machine does not offer a feature to print the number of document sets sent. [Remedy] Do not specify multiple sets.
033-535	[Cause] An error occurred during fax transmission. [Remedy] Confirm information such as the recipient and folder information, and execute the operation again.
033-536 033-537	[Cause] An error occurred during fax transmission. [Remedy] Execute the operation again.
033-538 033-539 033-540	[Cause] An error occurred during fax transmission. [Remedy] Execute the operation again. If the error still is not resolved, contact Customer Support at dell.com/contactdell .
033-541	[Cause] The recipient is not specified. [Remedy] Specify the recipient correctly.
033-543	[Cause] The recipient (fax number) is incorrect. [Remedy] Enter a correct fax number, and execute the operation again.
033-544	[Cause] The recipient's line is busy. [Remedy] Wait for a while, and then execute the operation again.
033-546	[Cause] A dial tone was not detected. [Remedy] Check whether the line is connected correctly.
033-547	[Cause] Communication was terminated by a cause such as pressing the <Stop> button. [Remedy] No measure is required.
033-548	[Cause] Cannot transmit manually because a line is unavailable. [Remedy] Establish communication such as by telephone, and execute the operation again.
033-549	[Cause] Cannot use the Fax service because of causes such as memory is insufficient. [Remedy] Wait for a while, and execute the operation again.
033-550	[Cause] Cannot execute another job because fax communication is in progress. [Remedy] Wait until the job being communicated completes, and then execute the operation again.

Status Code	Cause and Remedy
033-551	<p>[Cause] You attempted to change a job immediately before fax or telephone communication completed.</p> <p>[Remedy] Wait for a while, and execute the operation again.</p>
033-552	<p>[Cause] The total quantity of error lines detected with G3 exceeded the set value.</p> <p>[Remedy] Confirm the model of the other machine, and execute the operation again. If receiving, ask the sender to send again.</p>
033-553	<p>[Cause] This machine does not have confidential or relay function. The F-code sent from the other machine contains an instruction for a function not supported by the machine.</p> <p>[Remedy] If necessary, check whether the sender entered an invalid F-code.</p>
033-554	<p>[Cause] The password was omitted or did not match in fax communication.</p> <p>[Remedy] No measure is required.</p>
033-555	<p>[Cause] The password received from the other machine did not match the password for receiving faxes on the machine.</p> <p>[Remedy] Check whether the sender specified an incorrect machine password.</p>
033-556	<p>[Cause] The password sent to the other machine did not match the password for receiving faxes on the other machine.</p> <p>[Remedy] If necessary, check whether the correct machine password has been instructed to the other machine.</p>
033-557	<p>[Cause] The number of services or of recipients exceeds the maximum limit.</p> <p>[Remedy] Wait until the number of jobs awaiting transmission decreases, or reduce the number of recipients, and then send again.</p>
033-558	<p>[Cause] The machine is set to reject faxes without a remote ID, and a remote ID was not sent from the other machine.</p> <p>[Remedy] Ask the sender to set a remote ID. If necessary, set the machine to receive even when a remote ID is not sent.</p>
033-563	<p>[Cause] Paper that can print faxed documents is not loaded in a tray.</p> <p>[Remedy] Take one of the following measures:</p> <ul style="list-style-type: none"> • Specify the paper size. • Confirm whether the paper tray is set correctly.
033-564	<p>[Cause] The machine was turned off during communication.</p> <p>[Remedy] Wait for a while, confirm the fax service settings and the fax number, and then send again if sending. If the error still is not resolved, contact Customer Support at dell.com/contactdell.</p>
033-565	<p>[Cause] Cannot send because too many recipients are specified.</p> <p>[Remedy] Wait until the number of jobs awaiting transmission decreases, or reduce the number of recipients, and then send again.</p>
033-566	<p>[Cause] Cannot send because the recipient (fax number) is not specified.</p> <p>[Remedy] Correctly specify the recipient's fax number.</p>
033-567	<p>[Cause] The recipient (fax number) is incorrect.</p> <p>[Remedy] Correctly enter the recipient's fax number, and execute the operation again.</p>
033-568	<p>[Cause] An error occurred during fax transmission.</p> <p>[Remedy] Execute the operation again. If receiving, ask the sender to send again. If the error still is not resolved, contact Customer Support at dell.com/contactdell.</p>

Status Code	Cause and Remedy
033-569	<p>[Cause] Paper in the tray is not loaded in the direction that the received fax data can be printed.</p> <p>[Remedy] Load paper in Tray 5 according to the direction displayed on the screen.</p>
033-570	<p>[Cause] The machine was turned off during communication.</p> <p>[Remedy] Wait for a while, confirm the Fax service settings and the fax number, and then send again if sending. If the error still is not resolved, contact Customer Support at dell.com/contactdell.</p>
033-571	<p>[Cause] The Fax service is not available from a reason such as insufficient memory.</p> <p>[Remedy] Cancel the fax data in the queue, or wait for a while, and execute the operation again.</p>
033-572	<p>[Cause] The data received is not printed.</p> <p>[Remedy] No measure is required. The data will be printed after a while.</p>
033-574	<p>[Cause] An unavailable line is specified.</p> <p>[Remedy] Specify an available line.</p>
033-575	<p>[Cause] An error occurred during fax transmission.</p> <p>[Remedy] Execute the operation again.</p>
033-576	<p>[Cause] The recipient (fax number) is incorrect.</p> <p>[Remedy] Enter a correct fax number, and execute the operation again.</p>
033-577	<p>[Cause] An error occurred during fax transmission.</p> <p>[Remedy] Execute the operation again.</p>
033-578	<p>[Cause] An error occurred during fax receiving.</p> <p>[Remedy] Confirm the status of the line and the recipient machine, and then ask the sender to send again.</p>
033-710	<p>[Cause] The document to be sent by polling was deleted.</p> <p>[Remedy] Store the document again.</p>
033-712	<p>[Cause] Unable to process because of insufficient memory.</p> <p>[Remedy] Delete unnecessary data.</p>
033-713	<p>[Cause] An error occurred during fax transmission.</p> <p>[Remedy] Contact Customer Support at dell.com/contactdell.</p>
033-716	<p>[Cause] The folder specified from the sender's machine does not exist.</p> <p>[Remedy] Register the folder. Refer to "Create Folder" (P.421).</p>
033-717	<p>[Cause] The folder passcode specified from the sender's machine is incorrect. Or, the machine passcode for reception is incorrect.</p> <p>[Remedy] Inform the correct information to the sender's machine.</p>
033-718	<p>[Cause] Fax or polling documents do not exist in the folder specified from the sender's machine.</p> <p>[Remedy] Store fax or polling documents into the folder as necessary.</p>
033-719	<p>[Cause] The document may be deleted by turning the machine off and then on.</p> <p>[Remedy] Retry sending.</p>
033-721	<p>[Cause] An error occurred during fax transmission.</p> <p>[Remedy] Switch off the machine power, make sure that the touch screen is blank, and then switch on the machine power. If the error still is not resolved, contact Customer Support at dell.com/contactdell.</p>

Status Code	Cause and Remedy
033-725	<p>[Cause] The hard disk is full.</p> <p>[Remedy] Delete unnecessary data from the hard disk to free up disk space.</p>
033-726	<p>[Cause] The received document was printed with 1 sided printing, because 2 sided printing is not available for mixed sized documents.</p> <p>[Remedy] No measure is required.</p>
033-727	<p>[Cause] The received page was printed without being rotated, because its data volume was too large to change the orientation automatically.</p> <p>[Remedy] No measure is required.</p>
033-728	<p>[Cause] The auto print formatting of the received fax document was interrupted by a manual print operation.</p> <p>[Remedy] No measure is required. The machine will automatically start the auto print job after manual printing completes.</p>
033-731	<p>[Cause] The printing of the received fax document was interrupted.</p> <p>[Remedy] The auto print processing of the received fax document was interrupted by a manual print operation. No measure is required.</p>
033-733	<p>[Cause] An error occurred during fax transmission.</p> <p>[Remedy] Switch off the machine power, make sure that the touch screen is blank, and then switch on the machine power. If the error still is not resolved, contact Customer Support at dell.com/contactdell.</p>
033-734	<p>[Cause] Because a report job was instructed while preparing to print a received fax, the printing of the received fax is temporarily suspended.</p> <p>[Remedy] No measure is required.</p>
033-735	<p>[Cause] An error occurred during fax transmission.</p> <p>[Remedy] Switch off the machine power, make sure that the touch screen is blank, and then switch on the machine power. If the error still is not resolved, contact Customer Support at dell.com/contactdell.</p>
033-736	<p>[Cause] The forwarding job was interrupted because the data volume exceeded the upper limit.</p> <p>[Remedy] No measure is required.</p>
033-737	<p>[Cause] An error occurred during fax transmission.</p> <p>[Remedy] Execute the operation again. If the error still is not resolved, contact Customer Support at dell.com/contactdell.</p>
033-738	<p>[Cause] Received abnormal JBIG data.</p> <p>[Remedy] No measure is required.</p>
033-740	<p>[Cause] The printing of the received fax document was interrupted.</p> <p>[Remedy] No measure is required.</p>
033-741	<p>[Cause] An error occurred during fax transmission.</p> <p>[Remedy] Execute the operation again. If the error still is not resolved, contact Customer Support at dell.com/contactdell.</p>
033-742	<p>[Cause] An error occurred during fax transmission. This error may occur if the remaining capacity of the machine's memory is 10% or less and Manual Send is used.</p> <p>[Remedy] If this error was caused when using Manual Send, connect the line after storing the document, and then send. If the error still is not resolved, delete unnecessary data from the hard disk to free up disk space, and execute the operation again. If the error persists, contact Customer Support at dell.com/contactdell.</p>

Status Code	Cause and Remedy
033-743 033-744 033-745 033-746	[Cause] An error occurred during fax transmission. [Remedy] Switch off the machine power, make sure that the touch screen is blank, and then switch on the machine power. Try again. If the error still is not resolved, contact Customer Support at dell.com/contactdell .
033-747	[Cause] The job is temporarily suspended. [Remedy] No measure is required.
033-749	[Cause] The machine will automatically recover and print the document. [Remedy] No measure is required.
033-750	[Cause] An error occurred during fax transmission. [Remedy] Switch off the machine power, make sure that the touch screen is blank, and then switch on the machine power. Try again. If the error still is not resolved, contact Customer Support at dell.com/contactdell .
033-751	[Cause] An activity report output occurred during the printer lockout duration. Outputting the activity report was suspended because the machine was in the Sleep mode. [Remedy] No measure is required because the machine will output the report after exiting the Sleep mode.
041-310	[Cause] An error occurred. [Remedy] Switch off the machine power, make sure that the touch screen is blank, and then switch on the machine power. If the same message is displayed again, contact Customer Support at dell.com/contactdell .
041-316 041-317	[Cause] An error occurred. [Remedy] Switch off the machine power, make sure that the touch screen is blank, and then switch on the machine power. If the same message is displayed again, contact Customer Support at dell.com/contactdell .
041-340 041-341 041-351	[Cause] An error occurred. [Remedy] Switch off the machine power, make sure that the touch screen is blank, and then switch on the machine power. If the same message is displayed again, contact Customer Support at dell.com/contactdell .
041-368 041-369	[Cause] An error occurred. [Remedy] Switch off the machine power, make sure that the touch screen is blank, and then switch on the machine power. If the same message is displayed again, contact Customer Support at dell.com/contactdell .
041-388	[Cause] An error occurred in the machine. [Remedy] Switch off the machine power, make sure that the touch screen is blank, and then switch on the machine power. If the same message is displayed again, contact Customer Support at dell.com/contactdell .
041-393 041-394 041-395 041-396 041-397 041-398 041-399	[Cause] An error occurred in the machine. [Remedy] Switch off the machine power, make sure that the touch screen is blank, and then switch on the machine power. If the same message is displayed again, contact Customer Support at dell.com/contactdell .

Status Code	Cause and Remedy
042-316 042-320 042-323 042-324 042-325 042-330 042-332 042-334 042-335 042-336 042-337 042-338 042-340 042-341 042-342 042-343 042-344	<p>[Cause] An error occurred in the machine.</p> <p>[Remedy] Switch off the machine power, make sure that the touch screen is blank, and then switch on the machine power. If the same message is displayed again, contact Customer Support at dell.com/contactdell.</p>
045-310 045-311 045-312	<p>[Cause] An error occurred.</p> <p>[Remedy] Switch off the machine power, make sure that the touch screen is blank, and then switch on the machine power. If the same message is displayed again, contact Customer Support at dell.com/contactdell.</p>
045-319 045-320 045-343	<p>[Cause] An error occurred in the machine.</p> <p>[Remedy] Switch off the machine power, make sure that the touch screen is blank, and then switch on the machine power. If the same message is displayed again, contact Customer Support at dell.com/contactdell.</p>
045-370 045-371 045-372 045-373 045-374 045-375 045-376	<p>[Cause] An error occurred.</p> <p>[Remedy] Switch off the machine power, make sure that the touch screen is blank, and then switch on the machine power. If the same message is displayed again, contact Customer Support at dell.com/contactdell.</p>
047-211 047-212	<p>[Cause] An error occurred in the Offset Stacking Unit.</p> <p>[Remedy] Switch off the machine power, make sure that the touch screen is blank, and then switch on the machine power. If the same message is displayed again, contact Customer Support at dell.com/contactdell.</p>
047-213	<p>[Cause] Detected the installation of a finisher of a different type than expected.</p> <p>[Remedy] Switch off the machine power, make sure that the touch screen is blank, and then switch on the machine power. If the same message is displayed again, contact Customer Support at dell.com/contactdell.</p>
047-216	<p>[Cause] An error occurred while detecting the finisher.</p> <p>[Remedy] Switch off the machine power, make sure that the touch screen is blank, and then switch on the machine power. If the same message is displayed again, contact Customer Support at dell.com/contactdell.</p>
047-217	<p>[Cause] An error occurred while detecting Tray 6 (HCF B1).</p> <p>[Remedy] Switch off the machine power, make sure that the touch screen is blank, and then switch on the machine power. If the same message is displayed again, contact Customer Support at dell.com/contactdell.</p>

Status Code	Cause and Remedy
047-320	<p>[Cause] An error occurred.</p> <p>[Remedy] Switch off the machine power, make sure that the touch screen is blank, and then switch on the machine power. If the same message is displayed again, contact Customer Support at dell.com/contactdell.</p>
061-350 061-351 061-352 061-353 061-354 061-355 061-356 061-357 061-358 061-359 061-360 061-361 061-362 061-363 061-364 061-365 061-366 061-367 061-368 061-369 061-370 061-371 061-372 061-373 061-374 061-375 061-376 061-377 061-378 061-379	<p>[Cause] An error occurred.</p> <p>[Remedy] Switch off the machine power, make sure that the touch screen is blank, and then switch on the machine power. If the same message is displayed again, contact Customer Support at dell.com/contactdell.</p>

Status Code	Cause and Remedy
061-384 061-385 061-386 061-387 061-388 061-389 061-390 061-391 061-392 061-393 061-394 061-395 061-396 061-397 061-398 061-399	[Cause] An error occurred. [Remedy] Switch off the machine power, make sure that the touch screen is blank, and then switch on the machine power. If the same message is displayed again, contact Customer Support at dell.com/contactdell .
062-277	[Cause] A communication error occurred between the document scanning unit and the document feeder. [Remedy] Contact Customer Support at dell.com/contactdell .
062-311	[Cause] An error occurred. [Remedy] Switch off the machine power, make sure that the touch screen is blank, and then switch on the machine power. If the same message is displayed again, contact Customer Support at dell.com/contactdell .
062-328 062-329	[Cause] An error occurred. [Remedy] Switch off the machine power, make sure that the touch screen is blank, and then switch on the machine power. If the same message is displayed again, contact Customer Support at dell.com/contactdell .
062-330 062-345 062-360 062-362 062-371 062-380 062-386 062-389 062-393 062-395 062-396 062-397 062-398	[Cause] An error occurred. [Remedy] Switch off the machine power, make sure that the touch screen is blank, and then switch on the machine power. If the same message is displayed again, contact Customer Support at dell.com/contactdell .
062-399	[Cause] An error occurred in the document feeder. [Remedy] Switch off the machine power, make sure that the touch screen is blank, and then switch on the machine power. If the same message is displayed again, contact Customer Support at dell.com/contactdell .
062-790	[Cause] Copying of the scanned document is prohibited. [Remedy] Refer to "Legal Notice" (P.31).

Status Code	Cause and Remedy
063-210	<p>[Cause] An error occurred in the document feeder.</p> <p>[Remedy] Contact Customer Support at dell.com/contactdell.</p>
065-210 065-221 065-222 065-223 065-224 065-225	<p>[Cause] An error occurred in the machine.</p> <p>[Remedy] Contact Customer Support at dell.com/contactdell.</p>
071-210	<p>[Cause] Tray 1 malfunction</p> <p>[Remedy] Confirm the paper loading condition for the Tray, and then switch off the machine power, make sure that the touch screen is blank, and then switch on the machine power. If the error still is not resolved, contact Customer Support at dell.com/contactdell. You can use a tray other than Tray 1.</p>
071-212	<p>[Cause] Tray 1 malfunction</p> <p>[Remedy] Execute the operation again.</p>
072-210	<p>[Cause] Tray 2 malfunction</p> <p>[Remedy] Confirm the paper loading condition for the Tray 2, and then switch off the machine power, make sure that the touch screen is blank, and then switch on the machine power. If the error still is not resolved, contact Customer Support at dell.com/contactdell. You can use a tray other than Tray 2.</p>
072-212	<p>[Cause] Tray 2 malfunctioned</p> <p>[Remedy] Contact Customer Support at dell.com/contactdell. You can use a tray other than Tray 2.</p>
073-210	<p>[Cause] Tray 3 malfunction</p> <p>[Remedy] Confirm the paper loading condition for the Tray, and then switch off the machine power, make sure that the touch screen is blank, and then switch on the machine power. If the error still is not resolved, contact Customer Support at dell.com/contactdell. You can use a tray other than Tray 3.</p>
073-212	<p>[Cause] Tray 3 malfunction</p> <p>[Remedy] Contact Customer Support at dell.com/contactdell. You can use a tray other than Tray 3.</p>
074-210	<p>[Cause] Tray 4 malfunction</p> <p>[Remedy] Confirm the paper loading condition for the Tray, and then switch off the machine power, make sure that the touch screen is blank, and then switch on the machine power. If the error still is not resolved, contact Customer Support at dell.com/contactdell. You can use a tray other than Tray 4.</p>
074-212	<p>[Cause] Tray 4 malfunction</p> <p>[Remedy] Contact Customer Support at dell.com/contactdell. You can use a tray other than Tray 4.</p>
075-212	<p>[Cause] Tray 5 malfunction</p> <p>[Remedy] Contact Customer Support at dell.com/contactdell. You can use a tray other than Tray 5.</p>
077-211 077-212	<p>[Cause] Detected the installation of a tray of a different type than expected.</p> <p>[Remedy] Contact Customer Support at dell.com/contactdell.</p>

Status Code	Cause and Remedy
077-214 077-215	[Cause] Detected the installation of a tray of a different type than expected. [Remedy] Contact Customer Support at dell.com/contactdell .
077-314 077-320	[Cause] An error occurred. [Remedy] Switch off the machine power, make sure that the touch screen is blank, and then switch on the machine power. If the same message is displayed again, contact Customer Support at dell.com/contactdell .
078-210 078-211	[Cause] Tray 6 (HCF B1) malfunction [Remedy] Contact Customer Support at dell.com/contactdell .
078-216 078-219 078-250	[Cause] An error occurred in Tray 6 (HCF B1). [Remedy] Switch off the machine power, make sure that the touch screen is blank, and then switch on the machine power. If the error still is not resolved, contact Customer Support at dell.com/contactdell .
078-500	[Cause] An error occurred. [Remedy] Switch off the machine power, make sure that the touch screen is blank, and then switch on the machine power. If the same message is displayed again, contact Customer Support at dell.com/contactdell .
091-313	[Cause] An error occurred. [Remedy] Switch off the machine power, make sure that the touch screen is blank, and then switch on the machine power. If the same message is displayed again, contact Customer Support at dell.com/contactdell .
091-407	[Cause] An error occurred in the drum cartridge [R1]. [Remedy] Pull out the drum cartridge [R1], and then insert the cartridge again.
091-417	[Cause] An error occurred in the drum cartridge [R4]. [Remedy] Pull out the drum cartridge [R4], and then insert the cartridge again.
091-427	[Cause] An error occurred in the drum cartridge [R3]. [Remedy] Pull out the drum cartridge [R3], and then insert the cartridge again.
091-437	[Cause] An error occurred in the drum cartridge [R2]. [Remedy] Pull out the drum cartridge [R2], and then insert the cartridge again.
092-312 092-313 092-314 092-315	[Cause] An error occurred. [Remedy] Switch off the machine power, make sure that the touch screen is blank, and then switch on the machine power. If the same message is displayed again, contact Customer Support at dell.com/contactdell .
093-314 093-315 093-316 093-317	[Cause] An error occurred. [Remedy] Switch off the machine power, make sure that the touch screen is blank, and then switch on the machine power. If the same message is displayed again, contact Customer Support at dell.com/contactdell .
093-401	[Cause] The toner cartridge [Y] (yellow) is not installed. [Remedy] Install the toner cartridge [Y] (yellow).
093-403	[Cause] The toner cartridge [M] (magenta) is not installed. [Remedy] Install the toner cartridge [M] (magenta).
093-404	[Cause] The toner cartridge [C] (cyan) is not installed. [Remedy] Install the toner cartridge [C] (cyan).

Status Code	Cause and Remedy
093-426	<p>[Cause] An error occurred in the toner cartridge [K] (black).</p> <p>[Remedy] Pull out the toner cartridge [K] (black), and then insert the cartridge again.</p>
093-427	<p>[Cause] An error occurred in the toner cartridge [Y] (yellow).</p> <p>[Remedy] Pull out the toner cartridge [Y] (yellow), and then insert the cartridge again.</p>
093-428	<p>[Cause] An error occurred in the toner cartridge [M] (magenta).</p> <p>[Remedy] Pull out the toner cartridge [M] (magenta), and then insert the cartridge again.</p>
093-429	<p>[Cause] An error occurred in the toner cartridge [C] (cyan).</p> <p>[Remedy] Pull out the toner cartridge [C] (cyan), and then insert the cartridge again.</p>
093-430	<p>[Cause] The toner cartridge [K] (black) is not installed.</p> <p>[Remedy] Install the toner cartridge [K] (black).</p>
094-320	<p>[Cause] An error occurred.</p> <p>[Remedy] Switch off the machine power, make sure that the touch screen is blank, and then switch on the machine power. If the same message is displayed again, contact Customer Support at dell.com/contactdell.</p>
102-356	<p>[Cause] An error occurred.</p> <p>[Remedy] Switch off the machine power, make sure that the touch screen is blank, and then switch on the machine power. If the same message is displayed again, contact Customer Support at dell.com/contactdell.</p>
103-310 103-311 103-312 103-313	<p>[Cause] An error occurred.</p> <p>[Remedy] Switch off the machine power, make sure that the touch screen is blank, and then switch on the machine power. If the same message is displayed again, contact Customer Support at dell.com/contactdell.</p>
116-210 116-211 116-212	<p>[Cause] An error occurred in the USB memory device.</p> <p>[Remedy] Switch off the machine power, make sure that the touch screen is blank, and then switch on the machine power. If the error still is not resolved, contact Customer Support at dell.com/contactdell.</p>
116-220	<p>[Cause] Failed to enter the Download mode.</p> <p>[Remedy] Contact Customer Support at dell.com/contactdell.</p>

Status Code	Cause and Remedy
116-310 116-311 116-312 116-313 116-314 116-315 116-316 116-317 116-318 116-319 116-321 116-322 116-323 116-324 116-325 116-328 116-329 116-330 116-331 116-332 116-333 116-334 116-336 116-337 116-338 116-340 116-341	<p>[Cause] An error occurred.</p> <p>[Remedy] Switch off the machine power, make sure that the touch screen is blank, and then switch on the machine power. If the same message is displayed again, contact Customer Support at dell.com/contactdell.</p>
116-324	<p>[Cause] An error occurred in the machine.</p> <p>[Remedy] If an error occurred while printing, turn off the machine once, then turn the machine on holding down both the <Start> and <Stop> buttons simultaneously for six seconds. This deletes the print data that caused the error. If the error was caused by another reason, switch off the machine power, make sure that the touch screen is blank, and then switch on the machine power. If the error still is not resolved, contact Customer Support at dell.com/contactdell.</p>
116-342	<p>[Cause] An error occurred.</p> <p>[Remedy] Contact Customer Support at dell.com/contactdell.</p>

Status Code	Cause and Remedy
116-343 116-345 116-346 116-347 116-348 116-349 116-350 116-351 116-352 116-353 116-354 116-355 116-356 116-357 116-358 116-359 116-360 116-361 116-362 116-363 116-364 116-365 116-366 116-367 116-368 116-370 116-371 116-372 116-373 116-374 116-375 116-376 116-377 116-378 116-379 116-380 116-381 116-382 116-383 116-384 116-385	<p>[Cause] An error occurred.</p> <p>[Remedy] Switch off the machine power, make sure that the touch screen is blank, and then switch on the machine power. If the same message is displayed again, contact Customer Support at dell.com/contactdell.</p>
116-386	<p>[Cause] The fax cable is not connected correctly.</p> <p>[Remedy] Connect the cable securely, and then switch off the machine power, make sure that the touch screen is blank, and then switch on the machine power. If the error still is not resolved, contact Customer Support at dell.com/contactdell.</p>
116-387	<p>[Cause] An error occurred in the machine.</p> <p>[Remedy] Switch off the machine power, make sure that the touch screen is blank, and then switch on the machine power. If the same message is displayed again, contact Customer Support at dell.com/contactdell.</p>

Status Code	Cause and Remedy
116-390	<p>[Cause] An error occurred in the machine.</p> <p>[Remedy] Follow the message displayed on the touch screen and initialize the memory of the machine.</p>
116-391 116-392 116-393 116-394 116-395 116-396 116-397 116-399	<p>[Cause] An error occurred in the machine.</p> <p>[Remedy] Switch off the machine power, make sure that the touch screen is blank, and then switch on the machine power. If the same message is displayed again, contact Customer Support at dell.com/contactdell.</p>
116-702	<p>[Cause] A print job was processed using a substitute font.</p> <p>[Remedy] Check the print data.</p>
116-703	<p>[Cause] Probable causes are as follows: 1)An error occurred during PostScript processing. 2)An error occurred because of insufficient memory for PostScript processing.</p> <p>[Remedy] For 1), check the print data. For 2), increase the value for [PostScript Memory].</p>
116-704	<p>[Cause] An error occurred when reading data on the media.</p> <p>[Remedy] Check whether the media is inserted correctly.</p>
116-705 116-706 116-707 116-708 116-709	<p>[Cause] An error occurred when reading data on the media.</p> <p>[Remedy] Use a computer to confirm the content recorded on the media.</p>
116-710	<p>[Cause] The correct document size could not be judged because the receive data exceeded the HP-GL/2 spool size.</p> <p>[Remedy] Increase the size assigned to HP-GL/2 auto layout memory.</p>
116-713	<p>[Cause] The data has been divided into a number of jobs because of insufficient disk space.</p> <p>[Remedy] Delete unnecessary data from the hard disk to free up disk space.</p>
116-714	<p>[Cause] An HP-GL/2 command error occurred.</p> <p>[Remedy] Check the print data.</p>
116-716 116-717	<p>[Cause] An error occurred when reading the data on the media.</p> <p>[Remedy] On a computer, confirm the content recorded on the media.</p>
116-720	<p>[Cause] An error occurred during print processing because of insufficient memory.</p> <p>[Remedy] Stop unnecessary ports or delete unnecessary data to free up disk space.</p>
116-738	<p>[Cause] The size and orientation of the form specified are not matched with the paper to be printed.</p> <p>[Remedy] Match the size and orientation of the paper with the form specified, and print again.</p>
116-739	<p>[Cause] The form or logo data cannot be registered because memory for the form and logo data or memory capacity for the hard disk is insufficient.</p> <p>[Remedy] Delete unnecessary data, or free up the space for the form memory.</p>

Status Code	Cause and Remedy
116-740	<p>[Cause] A numerical value operation error occurred because a value exceeding the value limit of the machine was used in the print data.</p> <p>[Remedy] Check the print data.</p>
116-741	<p>[Cause] The form cannot be registered because the number of the form registration exceeds the maximum number allowed.</p> <p>[Remedy] Delete unnecessary form. The maximum number allowed is 2048.</p>
116-742	<p>[Cause] The logo data cannot be registered because the number of the logo data registration exceeds the maximum number allowed.</p> <p>[Remedy] Delete unnecessary logo data.</p>
116-743	<p>[Cause] The logo data or form cannot be registered because the memory for the form and logo data is insufficient.</p> <p>[Remedy] Increase memory.</p>
116-746	<p>[Cause] The form specified is not registered.</p> <p>[Remedy] Use the form registered, or register the form.</p>
116-747	<p>[Cause] The paper margin value is too large for the HP-GL/2 active coordinates area.</p> <p>[Remedy] Decrease the paper margin value, and then execute the operation again.</p>
116-748	<p>[Cause] There is no plot data in the HP-GL/2 print data.</p> <p>[Remedy] Check the print data.</p>
116-749	<p>[Cause] The job was cancelled because the specified font does not exist.</p> <p>[Remedy] Install the font, or set the print driver to replace the font.</p>
116-750	<p>[Cause] Banner sheet tray malfunction</p> <p>[Remedy] Restore the tray to normal condition or change the Banner sheet tray.</p>
116-751	<p>[Cause] The process has been canceled because the hard disk is full.</p> <p>[Remedy] Delete stored data in the hard disk. If the error still is not resolved, split the file and send the job again.</p>
116-752	<p>[Cause] The descriptions of the PDF or XPS printing job ticket have a problem.</p> <p>[Remedy] Execute the operation again. If the error still is not resolved, contact Customer Support at dell.com/contactdell.</p> <p>Note • XPS stands for XML Paper Specification.</p>
116-771 116-772 116-773 116-774 116-775 116-776 116-777 116-778	<p>[Cause] The data was automatically modified because it included an invalid parameter.</p> <p>[Remedy] The printed image may be incomplete. Confirm with the sender whether the image has a problem, or ask the sender to send the data again. When using the Internet Fax Forwarding feature, confirm its condition with the e-mail recipient.</p>
116-780	<p>[Cause] There is a problem with the document attached to the received e-mail.</p> <p>[Remedy] Check the attached document.</p>

Status Code	Cause and Remedy
116-790	<p>[Cause] Probable causes are as follows:</p> <p>1)If the operator cancelled printing a document that was received using the Store Fax - Local Folder or Store Internet Fax - Local Folder feature: The first set of the document is not stapled.</p> <p>2)For causes other than 1) No set of the document is stapled.</p> <p>[Remedy] For 1), manually staple the first set of the document. Or, do not cancel printing of a document that is received using the Store Fax - Local Folder or Store Internet Fax - Local Folder feature.</p> <p>For 2), check whether the staple position has been correctly specified, and try printing again.</p>
117-312	<p>[Cause] An error occurred in the machine.</p> <p>[Remedy] Contact Customer Support at dell.com/contactdell.</p>
117-326	<p>[Cause] An error occurred in the machine.</p> <p>[Remedy] Switch off the machine power, make sure that the touch screen is blank, and then switch on the machine power. If the same message is displayed again, contact Customer Support at dell.com/contactdell.</p>
117-331 117-332 117-333	<p>[Cause] An error occurred in the machine.</p> <p>[Remedy] Switch off the machine power, make sure that the touch screen is blank, and then switch on the machine power. If the same message is displayed again, contact Customer Support at dell.com/contactdell.</p>
118-310	<p>[Cause] An error occurred in the machine.</p> <p>[Remedy] Switch off the machine power, make sure that the touch screen is blank, and then switch on the machine power. If the same message is displayed again, contact Customer Support at dell.com/contactdell.</p>
118-311	<p>[Cause] An error occurred during software processing.</p> <p>[Remedy] Switch off the machine power, make sure that the touch screen is blank, and then switch on the machine power. If the same message is displayed again, contact Customer Support at dell.com/contactdell.</p>
121-311	<p>[Cause] An error occurred between the machine and the device connected.</p> <p>[Remedy] Once a smart card reader is connected to the machine, the machine automatically changes the [Passcode Entry for Smart Card Login] setting to [On] under [Tools] > [Authentication / Security Settings] > [Authentication] > [Passcode Policy]. Change the setting as required.</p>
121-314 121-316 121-318 121-319 121-320 121-321 121-322 121-323 121-324	<p>[Cause] An error occurred between the machine and the device connected.</p> <p>[Remedy] Switch off the machine power, make sure that the touch screen is blank, and then switch on the machine power. If the same message is displayed again, contact Customer Support at dell.com/contactdell.</p>
121-333	<p>[Cause] An error occurred between the machine and the device connected.</p> <p>[Remedy] Confirm that the device is switched on, and then switch off the machine power, make sure that the touch screen is blank, and switch on the machine power. If the error still is not resolved, contact Customer Support at dell.com/contactdell.</p>

Status Code	Cause and Remedy
121-334 121-335 121-336 121-337 121-338	<p>[Cause] An error occurred between the machine and the device connected.</p> <p>[Remedy] Switch off the machine power, make sure that the touch screen is blank, and then switch on the machine power. If the same message is displayed again, contact Customer Support at dell.com/contactdell.</p>
121-340 121-350 121-370	<p>[Cause] An error occurred between the machine and the device connected.</p> <p>[Remedy] Switch off the machine power, make sure that the touch screen is blank, and then switch on the machine power. If the same message is displayed again, contact Customer Support at dell.com/contactdell.</p>
123-310 123-311 123-312 123-325 123-326 123-333 123-343 123-344 123-350 123-352 123-353 123-354 123-355 123-356 123-357 123-358 123-362 123-368 123-369 123-371 123-374 123-377 123-379 123-380 123-381 123-382 123-383 123-384 123-389 123-390 123-392 123-393 123-395 123-396 123-397 123-398 123-399	<p>[Cause] An error occurred in the machine.</p> <p>[Remedy] Switch off the machine power, make sure that the touch screen is blank, and then switch on the machine power. If the same message is displayed again, contact Customer Support at dell.com/contactdell.</p>

Status Code	Cause and Remedy
124-310	[Cause] An error occurred in the machine.
124-311	[Remedy] Switch off the machine power, make sure that the touch screen is blank, and then switch on the machine power. If the same message is displayed again, contact Customer Support at dell.com/contactdell .
124-312	
124-313	
124-314	
124-315	
124-316	
124-317	
124-318	
124-319	
124-320	
124-321	
124-322	
124-323	
124-324	
124-325	
124-326	
124-327	
124-328	
124-331	
124-332	
124-333	
124-334	
124-335	
124-336	
124-337	
124-338	
124-339	
124-340	
124-341	
124-342	
124-343	
124-344	
124-345	
124-346	
124-347	
124-348	
124-349	
124-350	
124-351	
124-352	
124-353	
124-360	
124-361	
124-362	
124-363	
124-372	
124-373	
124-374	
124-380	

Status Code	Cause and Remedy
124-381 124-382 124-383 124-390 124-391 124-392 124-393	<p>[Cause] An error occurred in the machine.</p> <p>[Remedy] Switch off the machine power, make sure that the touch screen is blank, and then switch on the machine power. If the same message is displayed again, contact Customer Support at dell.com/contactdell.</p>
124-701	<p>[Cause] The output destination was changed because of the malfunction of the specified output tray (Side Tray).</p> <p>[Remedy] Contact Customer Support at dell.com/contactdell. You can use any output trays other than the defective output tray.</p>
124-702	<p>[Cause] The output destination was changed because of the malfunction of the specified output tray (Finisher Tray).</p> <p>[Remedy] Contact Customer Support at dell.com/contactdell. You can use any output trays other than the defective output tray.</p>
124-705	<p>[Cause] The punch setting was cancelled.</p> <p>[Remedy] Confirm the punch position, and then execute the operation again.</p>
124-706	<p>[Cause] The folding setting was cancelled.</p> <p>[Remedy] Confirm the folding setting, and then execute the operation again.</p>
124-708	<p>[Cause] The output destination has been changed to the Center Tray or the Finisher Tray. The probable causes are as follows:</p> <ol style="list-style-type: none"> 1) Paper of a different size from the specified is loaded for 2 sided copying. 2) The Punching feature of the Finisher has malfunctioned. <p>[Remedy] For 1), check whether the specified size paper is loaded in the tray.</p> <p>For 2), confirm whether the status code 012-231, 012-232, 012-233, or 012-234 is displayed on the touch screen, and contact Customer Support at dell.com/contactdell.</p>
124-709	<p>[Cause] The document exceeded the maximum number of pages that can be stapled.</p> <p>[Remedy] Reduce the number of pages, or cancel the stapling setting, then try printing again.</p>
124-710	<p>[Cause] The machine cannot output to the output destination specified. A paper size or a paper type that cannot be output is specified or something is wrong with the output destination.</p> <p>[Remedy] The machine automatically selects the available output destination. If the paper is not still output from the specified output destination even after the correct paper size and type is selected, contact Customer Support at dell.com/contactdell.</p>
125-311	<p>[Cause] An error occurred in the machine.</p> <p>[Remedy] Switch off the machine power, make sure that the touch screen is blank, and then switch on the machine power. If the same message is displayed again, contact Customer Support at dell.com/contactdell.</p>
127-210 127-211 127-212	<p>[Cause] A communication error occurred between the machine and the Print Server.</p> <p>[Remedy] Disconnect the print server cable, and then securely insert the cable into the connector. Switch off the machine power, make sure that the touch screen is blank, and then switch on the machine power.</p>
127-213	<p>[Cause] A communication error occurred between the machine and the Print Server.</p> <p>[Remedy] Update the machine and the Print Server software to the latest versions.</p>

Status Code	Cause and Remedy
127-220 127-221	<p>[Cause] A communication error occurred between the machine and the Print Server.</p> <p>[Remedy] Disconnect the print server cable, and then securely insert the cable into the connector. Switch off the machine power, make sure that the touch screen is blank, and then switch on the machine power.</p>
127-310 127-311 127-312 127-313 127-314 127-315 127-320 127-337 127-342 127-353 127-354 127-396 127-398 127-399	<p>[Cause] An error occurred in the machine.</p> <p>[Remedy] Switch off the machine power, make sure that the touch screen is blank, and then switch on the machine power. If the same message is displayed again, contact Customer Support at dell.com/contactdell.</p>
133-210 133-211 133-212 133-213 133-214 133-215 133-216 133-217 133-218 133-219 133-220 133-221 133-222 133-223 133-224	<p>[Cause] An error occurred during fax transmission.</p> <p>[Remedy] Switch off the machine power, make sure that the touch screen is blank, and then switch on the machine power. If the error still is not resolved, contact Customer Support at dell.com/contactdell.</p>
133-226	<p>[Cause] A country/region code not supported by the machine was specified.</p> <p>[Remedy] Contact Customer Support at dell.com/contactdell.</p>
133-280 133-281 133-282 133-283	<p>[Cause] An error occurred during fax transmission.</p> <p>[Remedy] Switch off the machine power, make sure that the touch screen is blank, and then switch on the machine power. If the error still is not resolved, contact Customer Support at dell.com/contactdell.</p>
133-700	<p>[Cause] The staple/hole punch setting was cancelled.</p> <p>[Remedy] Check whether the staple/hole punch position is correct, and then execute the operation again.</p>

Status Code	Cause and Remedy
133-710	<p>[Cause] When printing the received fax document, the paper loaded on the bypass tray was used for printing because the specified tray could not be used.</p> <p>[Remedy] Take one of the following measures:</p> <ul style="list-style-type: none"> • Load paper available for printing the received fax document: A3 SEF☐, A4 LEF☐, B4 SEF☐, B5 LEF☐, A4 SEF☐, A5 SEF☐, B5 SEF☐, 8.5 x 11" SEF☐, 8.5 x 13" SEF☐, 8.5 x 14" SEF☐, 11 x 17" SEF☐, 8.5 x 11" LEF☐, 5.5 x 8.5" SEF☐. • Use a paper type available for printing the received fax document: plain paper, bond paper, recycled paper, side 2 paper, user-defined custom paper. • Confirm the settings by selecting [Tools] > [System Settings] > [Fax Service Settings] > [Fax Control] > [Receiving Paper Size]. <p>1) Select [Receiving Paper Size] > [Tray Mode] to add a tray to be used for printing the received fax documents.</p> <p>2) Set up paper so that the tray specified for [Tray Mode] can be used for printing the received fax documents.</p> <p>If the error still is not resolved, contact Customer Support at dell.com/contactdell.</p>
149-310	<p>[Cause] The machine was turned off during the downloading.</p> <p>[Remedy] Switch off the machine power, make sure that the touch screen is blank, and then switch on the machine power. If the same message is displayed again, contact Customer Support at dell.com/contactdell.</p>
149-700	<p>[Cause] The output destination was changed to the Finisher Output Tray although you selected the High Capacity Stacker.</p> <p>[Remedy] Check whether the specified paper is supported by the machine.</p>

Note • If you cannot resolve an error despite following the instructions described in the table, contact Customer Support at dell.com/contactdell.

Other Errors

This section describes the remedies when the following messages are displayed.

Error Message	Cause and Remedy
A fault has occurred. Switch off the machine. (xxx-yyy)	<p>[Cause] An error occurred.</p> <p>[Remedy] Switch off the machine power, make sure that the touch screen is blank, and then switch the machine power on again. If the message persists, record the content displayed for [(xxx-yyy)]. Then immediately switch the main power and power off, make sure that the touch screen is blank, and then contact Customer Support at dell.com/contactdell.</p>
Completed with an error. (xxx-yyy)	<p>[Cause] An error occurred, and the operation terminated abnormally.</p> <p>[Remedy] Execute the operation again.</p>
A fault has occurred. The machine has rebooted. Select [Close]. If the problem persists, call for service. (xxx-yyy)	<p>[Cause] An auto-recoverable internal error occurred, and the machine restarted automatically.</p> <p>[Remedy] Select [Close] to use the machine normally. If the error still is not resolved, contact Customer Support at dell.com/contactdell.</p>

Paper Jams

When a paper jam occurred, the machine stops and an alarm beeps. A message is also displayed on the touch screen. Follow the instructions displayed to remove the jammed paper.

Gently remove the paper to avoid it to be torn. If the paper is torn, remove all the torn pieces, making sure that none remain inside the machine.

If a paper jam message appears again after you have cleared the paper jam, another paper jam may be occurred in some other parts of the machine. Clear this by following the message.

When the paper jam is cleared, printing is automatically resumed from the point when the paper jam occurred.

If you were during copying, press the <Start> button to resume the copying from the point when the paper jam occurred.

This section describes how to clear a paper jam occurring in the following locations.

The following shows the reference section for the procedures to clear a paper jam in each location.

Paper Jams in Upper Left Cover A	683
Paper Jams in Bottom Left Cover C.....	685
Paper Jams in Top Left Cover D	685
Paper Jams in Trays 1 to 4.....	686
Paper Jams in Tray 5 (Bypass Tray)	687
Paper Jams in Tray 6 (HCF B1).....	687
Paper Jams in Duplex Module B.....	689
Paper Jams in Finisher-B1	690

- Note**
- When a paper jam occurred, if you pull out a paper tray without checking the paper jam location, the jammed paper may be torn and the pieces may remain inside the machine. This may cause machine malfunctions; therefore, always check where the paper jam occurred first.
 - If any piece of jammed paper remains inside the machine, the paper jam message will not disappear from the touch screen.
 - Clear the paper jams while the machine is powered on. If you turn off the machine, all data stored on the memory of the machine will be erased.
 - Do not touch components inside the machine. This may cause print defects.

Paper Jams in Upper Left Cover A

The following describes how to clear paper jams occurring in the upper left cover.

- Note**
- Do not touch the black film like Transfer Belt inside the upper left cover when you remove the jammed paper because images might be shifted on the Transfer Belt. If you touch the belt, the image quality might be deteriorated or the belt may be damaged and need replacement.

- 1 Remove paper from the Side Tray.

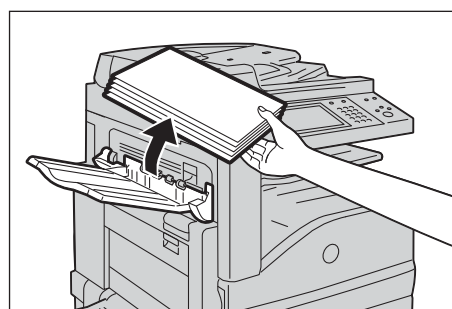

- 2 Open Tray 5 (1), and then while lifting up the release lever (2) gently open the upper left cover (3).

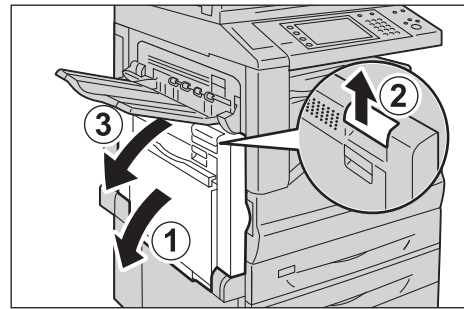

- 3 If you can see the edge of the jammed paper on the output tray, pull the paper straight from the exit area.

Note • Toner may adhere on the transfer roller, but the image quality will not be affected.

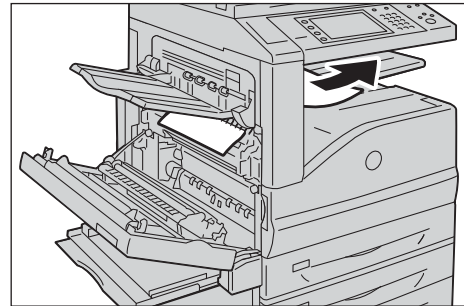

- 4 Remove the jammed paper.

Note • If the paper is torn, make sure no piece of paper remains inside the machine.

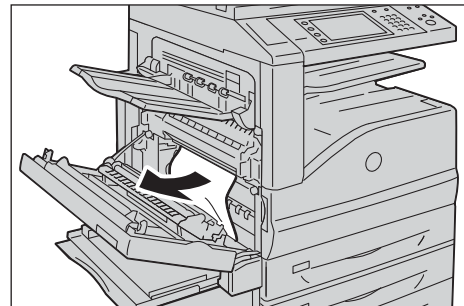

- 5 If paper is jammed in the Fusing Unit, gently remove the paper to avoid it to be torn.

Note • The Fusing Unit is extremely hot. Do not touch the Fusing Unit as it may result in burn injury.

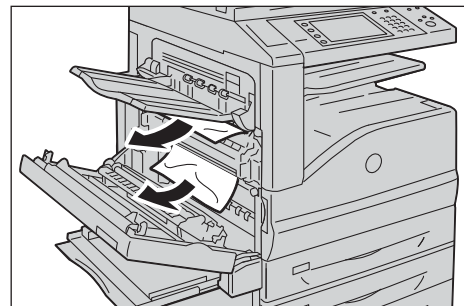

- 6 Push the center of the upper left cover and close the cover gently, and then close Tray 5.

Paper Jams in Bottom Left Cover C

The following describes how to clear paper jams occurring in the bottom left cover.

- 1 Gently open the bottom left cover while pulling the release lever.

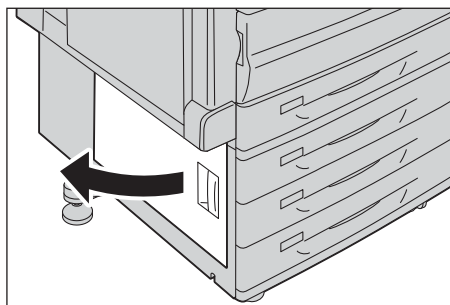

- 2 Remove the jammed paper.

- Note**
- Paper may be jammed in the hidden area on the upper position. Check inside thoroughly.
 - If the paper is torn, make sure no piece of paper remains inside the machine.

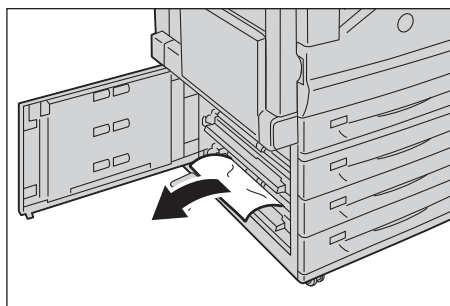

- 3 Close the bottom left cover gently.

Paper Jams in Top Left Cover D

The following describes how to clear paper jams occurring in the top left cover.

- Note**
- Do not touch the black film like Transfer Belt inside the top left cover when you remove the jammed paper because images might be shifted on the Transfer Belt. If you touch the belt, the image quality might be deteriorated or the belt may be damaged and need replacement.

- 1 Remove paper from the Side Tray.

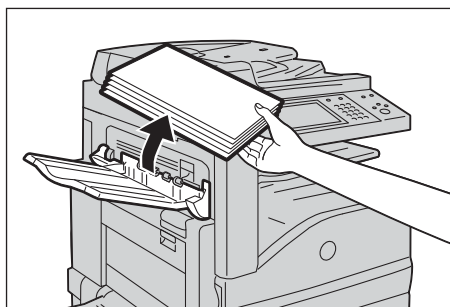

- 2 Open Tray 5 (1), and then while lifting up the release lever (2) gently open the upper left cover (3).

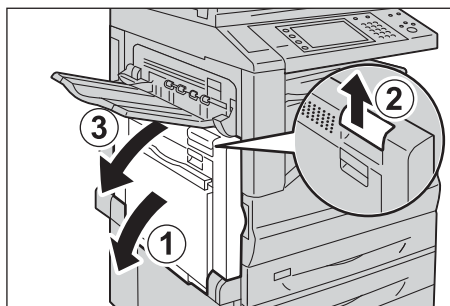

- 3 Lift up the lever to open the top left cover.

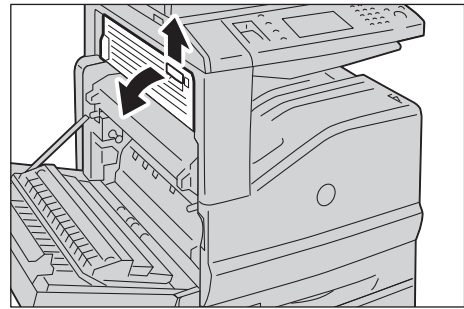

- 4 Remove the jammed paper.

Note • If the paper is torn, make sure no piece of paper remains inside the machine.

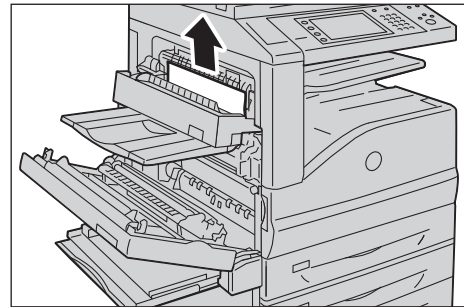

- 5 Close the top left cover gently.

- 6 Push the center of the upper left cover and close the cover gently, and then close Tray 5.

Paper Jams in Trays 1 to 4

The following describes how to clear paper jams occurring in Trays 1 to 4.

- 1 Pull out the tray where the paper jam occurred.

Note • If you pull out a paper tray without checking the paper jam location, the jammed paper may be torn and the pieces may remain inside the machine. This may cause machine malfunctions; therefore, always check where the paper jam occurred first.

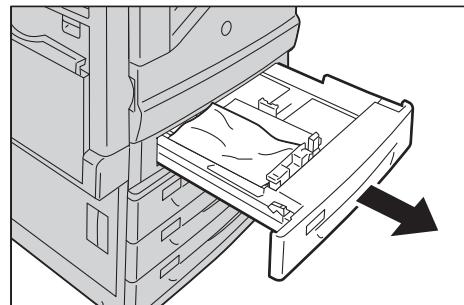

- 2 Remove the jammed paper.

Note • If the paper is torn, make sure no piece of paper remains inside the machine.

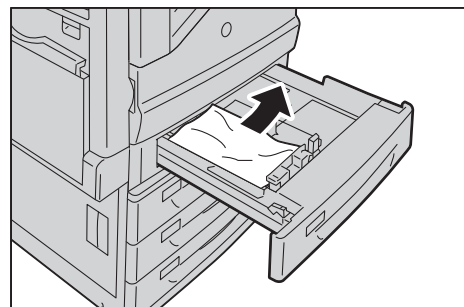

- 3 Push the tray in gently until it stops.

Paper Jams in Tray 5 (Bypass Tray)

The following describes how to clear paper jams occurring in Tray 5.

- 1 Check the back of Tray 5 (around the paper feed entrance) and remove the jammed paper.

- Note**
- When two or more sheets of paper are loaded, remove all of the sheets from the tray.
 - If the paper is torn, make sure no piece of paper remains inside the machine.

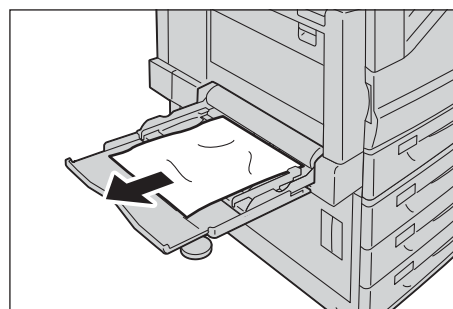

- 2 When two or more sheets of paper were loaded, jog the paper you removed making sure that all four corners are neatly aligned.

- 3 Insert the paper into the tray with the printing side facing down until its edge lightly touches against the paper feed entrance.

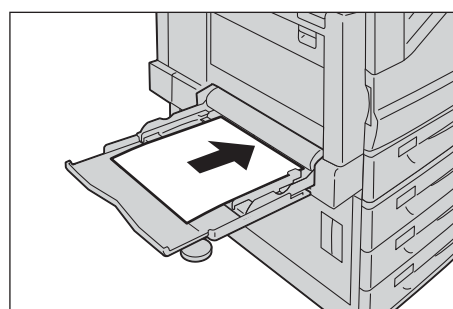

Paper Jams in Tray 6 (HCF B1)

This section describes how to clear paper jams occurring in Tray 6 (HCF B1).

- Note**
- Remedy differs depending on where the paper jam occurs. Follow the instructions displayed and remove the jammed paper.

Paper Jams in Tray 6 Exit

- 1 Gently move Tray 6 to the left until it stops by gripping the handle on the top left side of Tray 6.

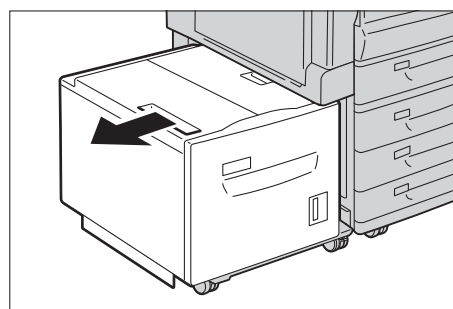

- 2 Remove the jammed paper.

- Note**
- If the paper is torn, make sure no pieces of paper remain inside Tray 6.

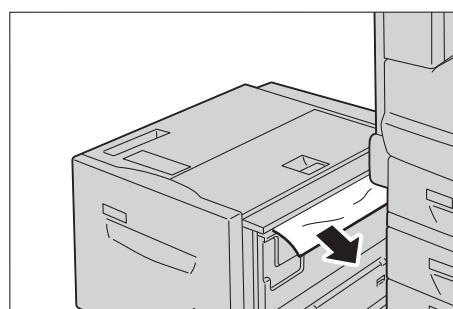

- 3 Gently put Tray 6 back into position.

Paper Jams in Tray 6 Top Cover

- 1 Gently move Tray 6 to the left until it stops by gripping the handle on the top left side of Tray 6.

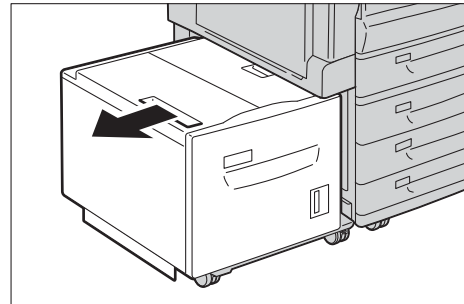

- 2 Open the Tray 6 top cover.

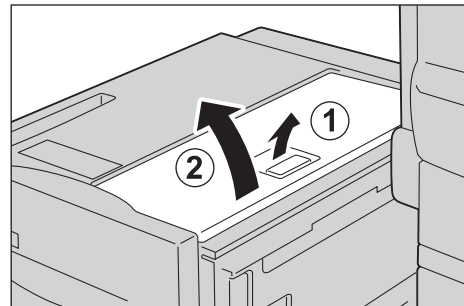

- 3 Remove the jammed paper.

Note • If the paper is torn, make sure no pieces of paper remain inside Tray 6.

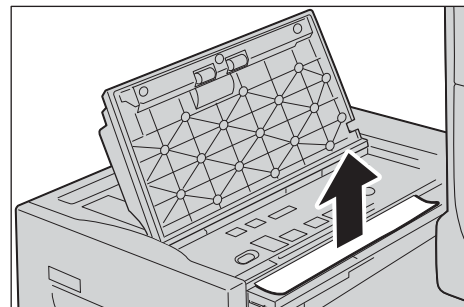

- 4 Close the top cover.
- 5 Gently put Tray 6 back into position.

Paper Jams in Tray 6

- 1 Pull out Tray 6 until it stops.

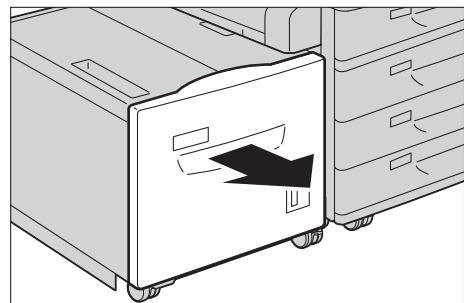

- 2 Remove the jammed paper.

Note • If the paper is torn, make sure no pieces of paper remain inside Tray 6.

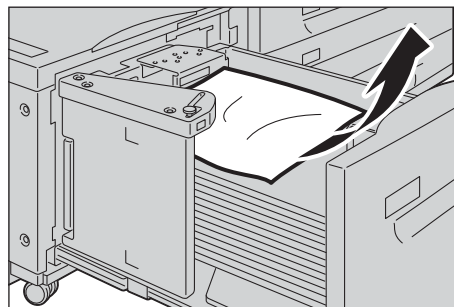

- 3 Push Tray 6 in gently until it stops.

Paper Jams in Duplex Module B

The following describes how to clear paper jams occurring in the Duplex Module B if the machine supports the 2 Sided Printing feature.

- 1 Open Tray 5 (1), lift up the release lever (2), and then gently open the cover of the Duplex Module B (3).

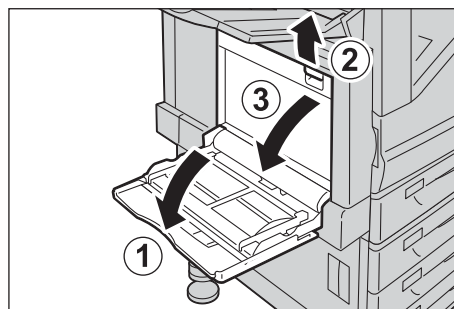

- 2 Remove the jammed paper.

Note • If the paper is torn, make sure no piece of paper remains inside the machine.

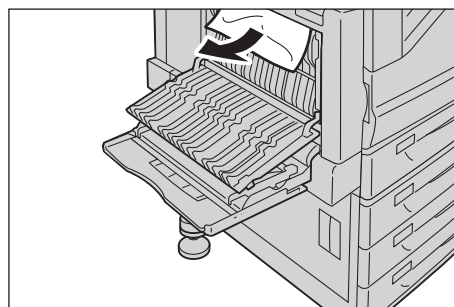

- 3 Close the cover (1), and then close Tray 5 (2).

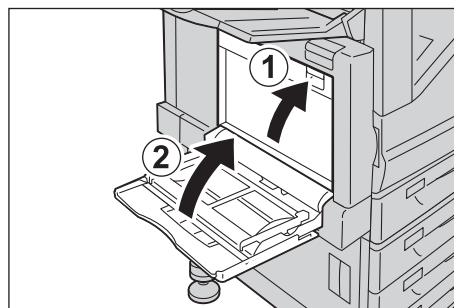

Paper Jams in Finisher-B1

The following describes how to clear paper jams occurring in the Finisher-B1 (optional).

Paper Jams under the Finisher Top Cover

- 1 Push up the lever on the finisher top cover.

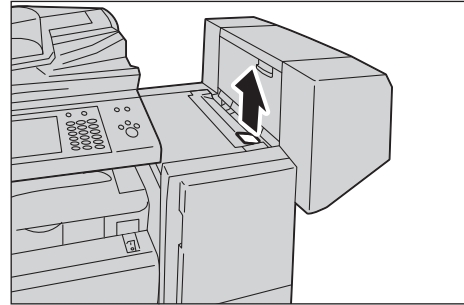

- 2 The finisher top cover opens.

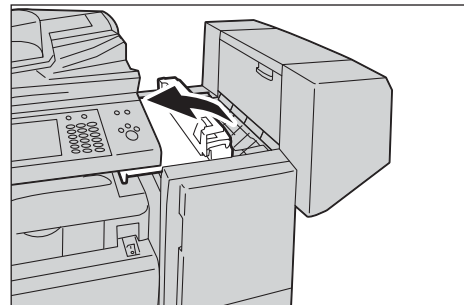

- 3 Remove the jammed paper.

Note • If the paper is torn, make sure no piece of paper remains inside the machine.

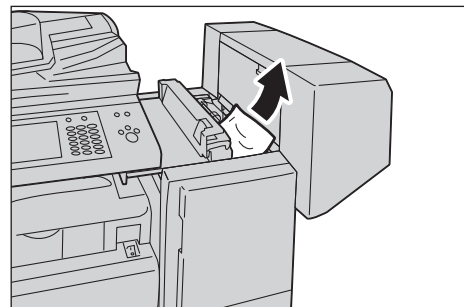

- 4 Close the finisher top cover.

Paper Jams in the Center Unit

- 1 Lift the top cover and open.

Note • The top cover cannot be detached from the machine.

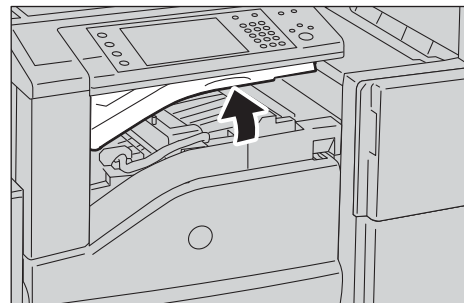

2 Remove the jammed paper.

- Note**
- If the paper is torn, make sure no piece of paper remains inside the machine.

3 Close the cover.



Document Jams

When a document jam occurred in the document feeder, the machine stops and a message is displayed on the touch screen. Follow the instructions displayed to clear the document jam and then load the document in the document feeder again.

Duplex Automatic Document Feeder B1-C

- 1 Pull up the handle of the top cover of the document feeder, and then open the top cover until it stops.

Note • When you fully open the cover, it enters a fixed position. Open the cover gently.

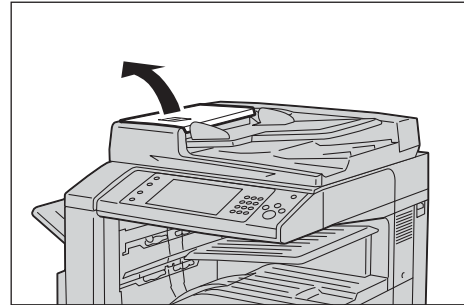

- 2 If the document is not caught in the entry of the document feeder, pull out the document.

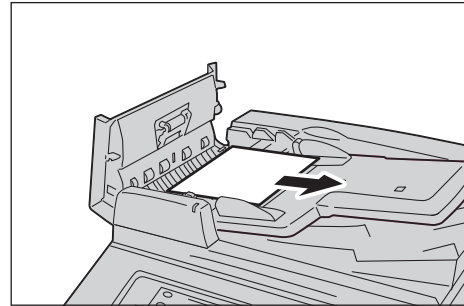

- 3 If the message on the screen instructs you to turn the knob, turn the knob to eject the document upward.

Note • If the document is caught, do not pull it out forcibly. The document could be damaged.

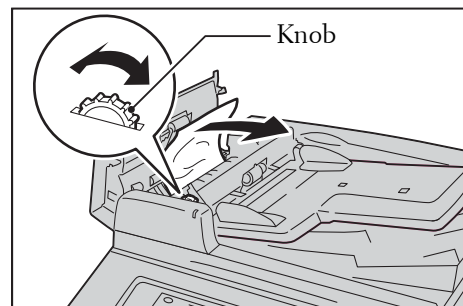

- 4 If the message on the display instructs you to open the inner cover, lift up the handle, and open the inner cover.

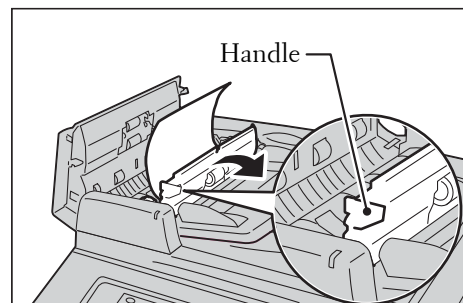

- 5 Turn the knob to eject the document upward to remove.

Note • If the document is caught, do not pull it out forcibly. The document could be damaged.

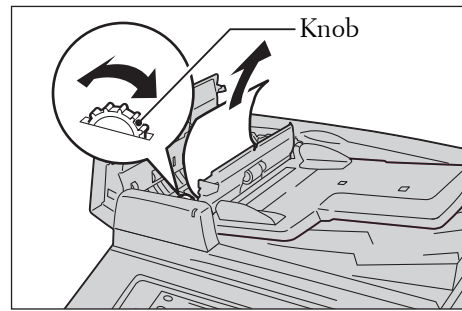

- 6 Close the inner cover of the document feeder.
- 7 Close the left cover of the document feeder until it clicks into place, and confirm that there is no space between the near or far side of the cover and the document feeder.
- 8 If you cannot find the document, lift the document feeder gently, and remove the document if it is there, and then close the document feeder.
- 9 If you still cannot find the document in step 8, lift the document feeder tray and remove the document.

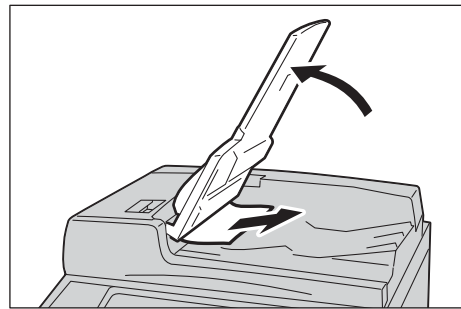

- 10 Return the document feeder tray gently.
- 11 Make sure that the document is not torn, wrinkled or folded, and then load the document again following the instructions displayed on the touch screen.
- Note**
- After removing the jammed document, reload the entire document including the pages already scanned. The machine will automatically skip the scanned pages and start scanning unscanned pages.
 - Torn, wrinkled or folded documents may cause document jams and damage. To scan such documents, directly place the document on the document glass to make copies.

Stapler Faults

This section describes how to clear stapler troubles when the optional finisher is installed. Perform the procedures on the following pages when copies are not stapled or staples are bent. Contact Customer Support at dell.com/contactdell if the problem persists after you have tried the following solutions.

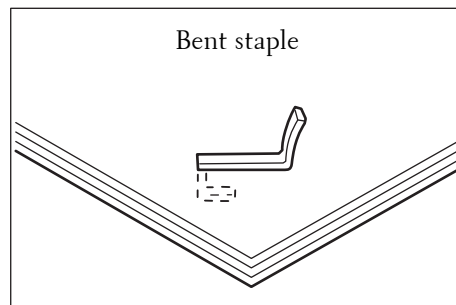
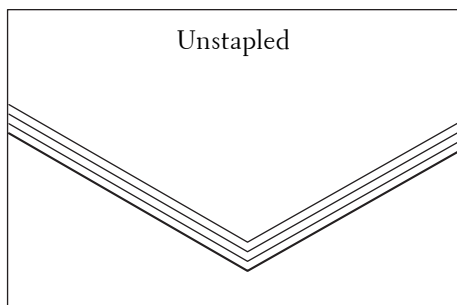

If copies are stapled as shown in the figures below, contact Customer Support at dell.com/contactdell.

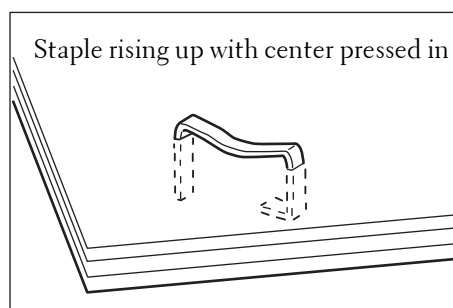
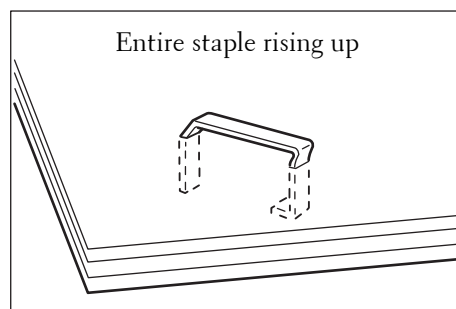
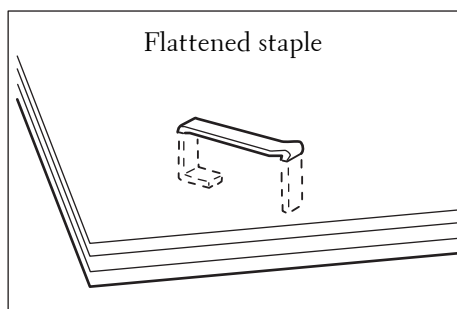
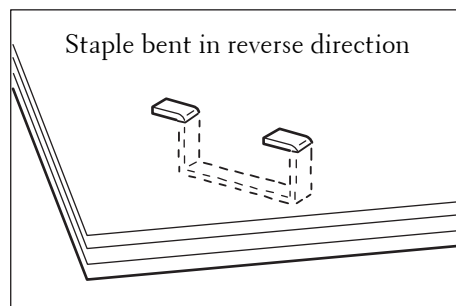
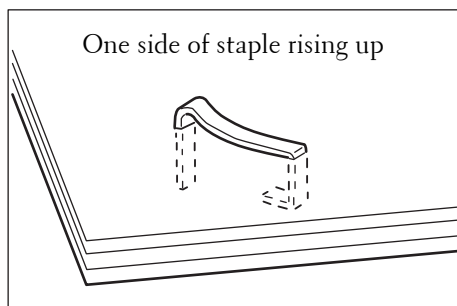

Staple Jams in Staple Cartridge (for Finisher-B1)

This section describes how to clear staple jam occurred in the staple cartridge of the Finisher-B1 (optional).

- 1 Make sure that the machine is not operating, and open the finisher front cover.



- 2 Grasp the handle as shown in the illustration to pull out the staple cartridge to the right, towards you.

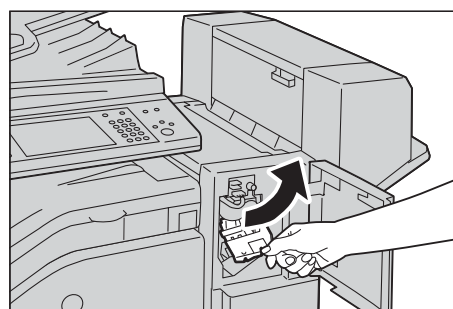

- 3 Move up the staple cartridge, and then take it out of the machine.

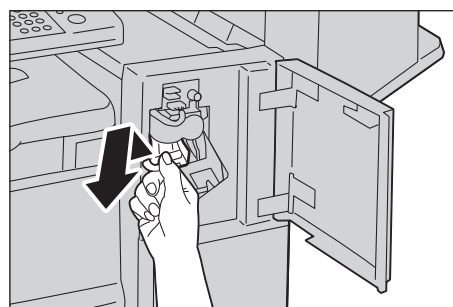

- 4 After you take out the staple cartridge, check inside of the finisher for any remaining staples.



- 5 Pull up the metal part of the staple cartridge as shown in the illustration.

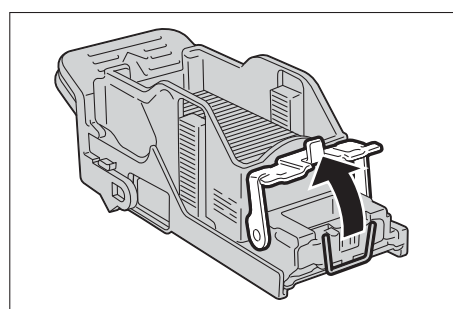

- 6 Remove the jammed staples (1), and then return the metal part pulled up in step 5 to the original position (2).

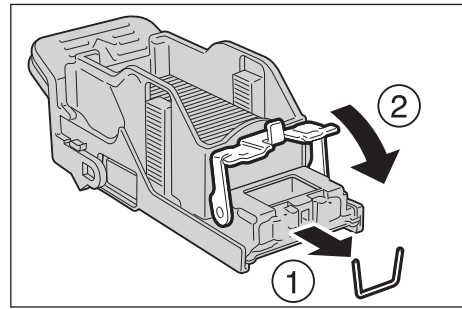

- 7 Push the staple cartridge into the machine until it clicks into place.

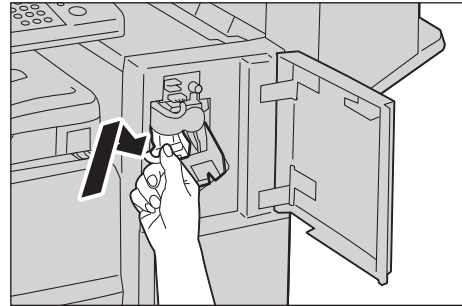

- 8 Close the finisher front cover.

Note • If the finisher front cover is not completely closed, a message will appear and the machine remains paused.

24 Install Operation for Eco copy/My Forms/Shortcut Menu

This chapter describes how to install Eco copy, My Forms, and Shortcut Menu to the machine.

- **Before Installation.....698**
- **Installation Procedures.....702**
- **About License.....705**

Before Installation

This section describes the procedures required before installation of Eco copy, My Forms, and Shortcut Menu.

Environment Settings	698
SSL / TLS Settings in Dell Printer Configuration Web Tool	700

Environment Settings

On your machine, settings listed below are required before you enable the features.

Items	Required Settings	Refer to
SOAP Port	<ul style="list-style-type: none"> Port Status: Enabled Port Number: 80 	"SOAP Port" (P.699)
Protocol Settings	<ul style="list-style-type: none"> IP address, subnet mask, and gateway address: settings for the use in TCP/IP network environment 	"Protocol Settings" (P.699)
Web Browser Setup	<ul style="list-style-type: none"> Web Applications Version: V4 (New Version) 	"Web Browser Setup" (P.699)
Login Type	<ul style="list-style-type: none"> Login Type: [Login to Local Accounts] or [Login to Remote Accounts] User registration 	"Login Type" (P.699)
Access Control	<ul style="list-style-type: none"> Device Access: Locked 	"Access Control" (P.700)

Make the settings from your machine in the [Tools] screen. Follow the steps below to display the [Tools] screen.

- 1 Press the <Log In/Out> button on the control panel.
- 2 Enter the system administrator's user ID with the numeric keypad or the keyboard displayed on the screen, and select [Enter].

Note

- The default user ID is "admin".
- The default passcode is "1111".

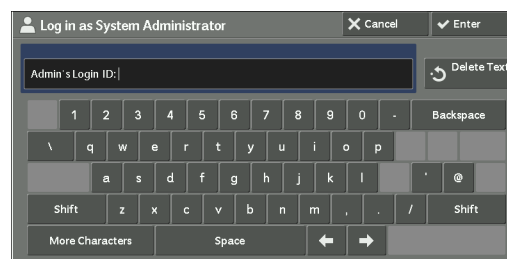

- 3 Select [Tools] on the [Home] screen.

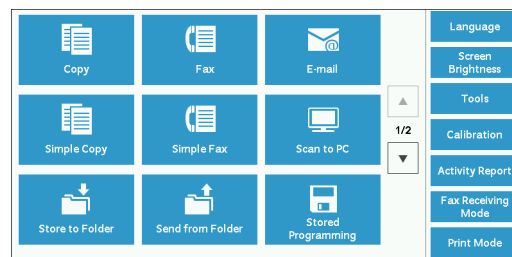

- 4 Select any options.

Note • Rebooting may be required to reflect the settings. In this case, follow the onscreen instructions.

SOAP Port

- 1 Select [SOAP] in [Port Settings] under [System Settings] > [Connectivity & Network Setup], and then select [Change Settings].
- 2 Select below value for each item.
 - [Port Status]: [Enabled]
 - [Port Number]: [80]
- 3 Select [Close] repeatedly until the [Tools] screen is displayed.
- 4 To exit [Tools], select [Close].

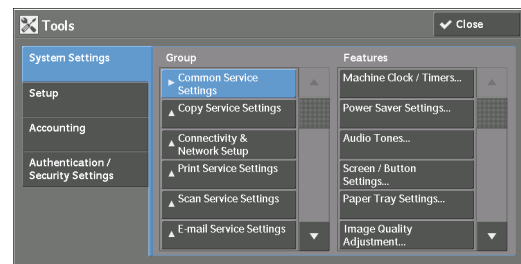

Protocol Settings

- 1 Select [Protocol Settings] in [Connectivity & Network Setup] under [System Settings], and then set an IP address, subnet mask, and gateway address (settings for the use in TCP/IP network environment).
- 2 Select [Close].
- 3 To exit [Tools], select [Close].

Web Browser Setup

- 1 Select [Web Applications Version] in [Web Browser Setup] under [System Settings], and then select [Change Settings].
- 2 Select [V4 (New Version)], and then select [Save].
- 3 Select [Close].
- 4 To exit [Tools], select [Close].

Login Type

- 1 Select [Login Type] in [Authentication] under [Authentication / Security Settings].
- 2 Select [Login to Local Accounts] or [Login to Remote Accounts], and then select [Save].
- 3 For [Login to Local Accounts], each user's information must be registered. Select [Create / View User Accounts] in [Authentication] under [Authentication / Security Settings].

Note • For [Login to Remote Accounts], skip to Step 9.
- 4 Select a user displayed as [<Available>], and then select [Create / Delete].
- 5 Enter a User ID and select [Save].
- 6 Select [User Name], enter the name and select [Save].
- 7 Make settings for other items if necessary, and then select [Close].
- 8 Select [Close].

- 9 To exit [Tools], select [Close].

Access Control

- 1 Select [Device Access] in [Access Control] under [Authentication / Security Settings] > [Authentication].
- 2 Select [Locked], and then select [Save].
- 3 Select [Close].
- 4 Select [Close].

Note • Rebooting is required for some settings. In these cases, follow the onscreen instructions.

SSL / TLS Settings in Dell Printer Configuration Web Tool

Installation and uninstallation of Eco copy, My Forms, and Shortcut Menu require HTTP - SSL / TLS communication between a network-connected computer and the machine. Follow the below steps to enable HTTP - SSL / TLS communication.

- 1 Start a web browser.
- 2 Enter the machine's IP address into the address box on the browser, and then press the <Enter> key. Connection to Dell Printer Configuration Web Tool is established.

Note • During connection/operation, a pop-up screen for user ID/passcode entry may appear. In this case, enter the system administrator's user ID/passcode and click [OK].

- 3 Select the [Properties] tab to click [Security] > [Machine Digital Certificate Management], and then click the [Create New Certificate] button.

Note • If [Create New Self Signed Certificate] is displayed, click it and go to step 5.

- 4 Select [Self-Signed Certificate] and click [Continue].
- 5 Click [Apply].

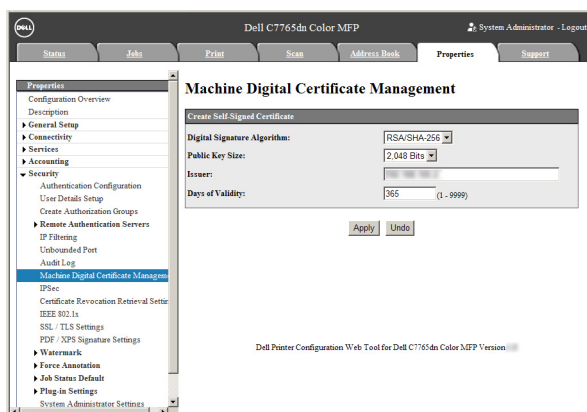

- 6 When the settings are updated and the following screen is displayed, refresh the web browser.

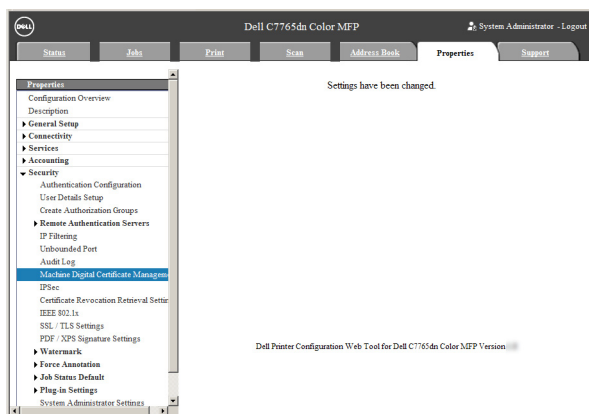

- 7 Select the [Properties] tab to click [Security] > [SSL / TLS Settings], and then select the [Enabled] check box for [HTTP - SSL / TLS Communication].

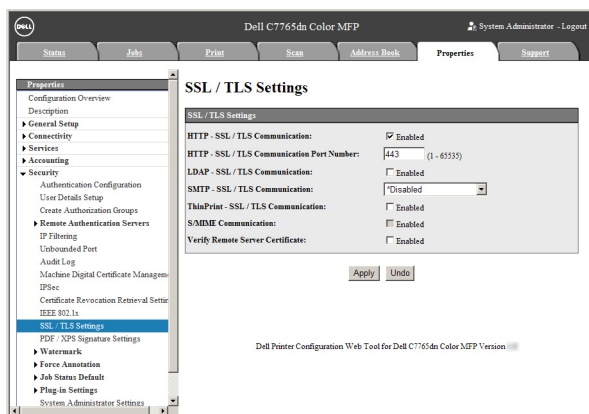

- 8 Click [Apply].

- 9 When the web browser shows the machine reboot message, click [Reboot Machine].

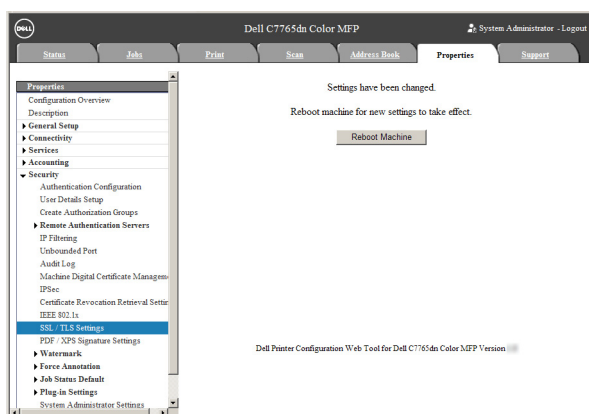

- 10 Click [OK] on the confirmation pop-up.
The machine reboots and the settings are enabled.

Installation Procedures

This section describes how to install Eco copy/My Forms/Shortcut Menu. The installation tools support the following operating systems:

Windows OS

- Microsoft® Windows® XP Professional Service Pack 3
- Microsoft® Windows® XP Professional x64 Service Pack 2
- Microsoft® Windows® Vista Business Service Pack 2
- Microsoft® Windows® Vista Business x64 Service Pack 2
- Microsoft® Windows® 7 Professional Service Pack 1
- Microsoft® Windows® 7 Professional x64 Service Pack 1
- Microsoft® Windows® 7 Enterprise Service Pack 1
- Microsoft® Windows® 7 Enterprise x64 Service Pack 1
- Microsoft® Windows® 8 Pro
- Microsoft® Windows® 8 Pro x64
- Microsoft® Windows® 8 Enterprise
- Microsoft® Windows® 8 Enterprise x64

Installation

Install Eco copy/My Forms/Shortcut Menu to your machine.

- Note**
- During machine operation or jobs in progress, installation process cannot be started. In this case, wait for a while and then start installation.
 - During installation process, machine operation is out of service.

Follow the installation procedures below.

1 Save the installation tool to your computer.

- Note**
- To obtain the installation tool, contact Customer Support at dell.com/contactdell.

2 Decompress the file (.zip) and double-click the exe file in the installation tool.

- Note**
- The [Open file - Security warning] pop-up screen may appear. In this case, click [Run] to continue.

3 Click [Next].

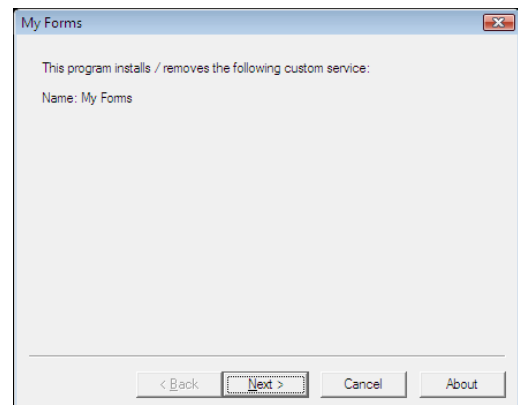

- 4 Enter the IP address or hostname of your machine, and then click [Next].
Example: 192.0.2.1

- 5 Enter the system administrator's user ID and password, and then click [Next].

- 6 Click [Next].

- 7 Click [Finish].

- Note**
- Several minutes may take before the installation process completes.
 - To install the feature to another machine in succession, select the check box on the screen, and then click [Finish]. You can start from step 3.

Uninstallation/Version Upgrade

Uninstall Eco copy/My Forms/Shortcut Menu from your machine or upgrade the software version.

- Note**
- Uninstallation deletes all Shortcut Menu settings for all users.

Follow the uninstallation/version upgrade procedures below.

- 1 On your computer, double-click the exe file in the installation tool.
- 2 Click [Next].

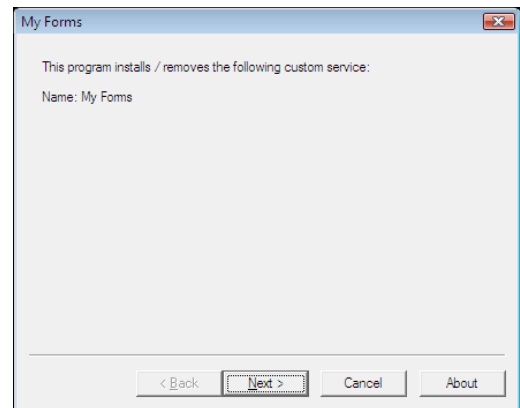

- 3 Enter the IP address or hostname of your machine, and then click [Next].
Example: 192.0.2.1

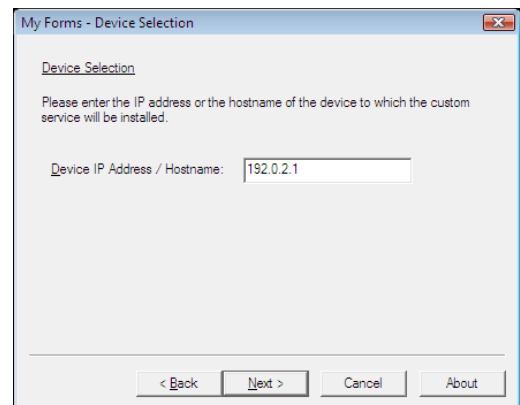

- 4 Enter the system administrator's user ID and password, and then click [Next].

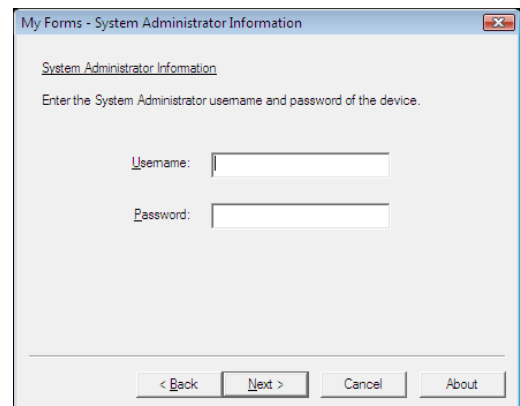

- 5 Select [Reinstall (Retain settings)] or [Reinstall] for version upgrade, or [Remove (Remove settings)] or [Remove] for uninstallation, and then click [Next].

Note

- When you select [Reinstall (Retain settings)], Shortcut Menu settings of each user are not deleted. The settings are taken over the new version. Settings you made for using the My Forms service will not be reset by reinstalling or uninstalling the service.

- 6 After the confirmation screen appears, click [Next].
- 7 Click [Finish].

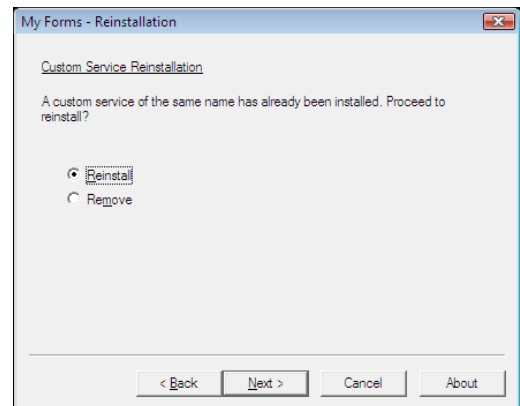

About License

This section describes OSS (Open Source Software) license used for the installer. Be sure to confirm.

About OSS

This product includes software developed by The Apache Software Foundation (<http://www.apache.org/>)

Apache Xerces

Copyright (c) 1999-2001 The Apache Software Foundation. All rights reserved.

The Apache Software License, Version 1.1

Copyright (c) 1999-2001 The Apache Software Foundation. All rights reserved.

Redistribution and use in source and binary forms, with or without modification, are permitted provided that the following conditions are met:

1. Redistributions of source code must retain the above copyright notice, this list of conditions and the following disclaimer.
2. Redistributions in binary form must reproduce the above copyright notice, this list of conditions and the following disclaimer in the documentation and/or other materials provided with the distribution.
3. The end-user documentation included with the redistribution, if any, must include the following acknowledgment:
"This product includes software developed by the Apache Software Foundation (<http://www.apache.org/>)."
Alternately, this acknowledgment may appear in the software itself, if and wherever such third-party acknowledgments normally appear.
4. The names "Xerces" and "Apache Software Foundation" must not be used to endorse or promote products derived from this software without prior written permission. For written permission, please contact apache@apache.org.
5. Products derived from this software may not be called "Apache", nor may "Apache" appear in their name, without prior written permission of the Apache Software Foundation.

THIS SOFTWARE IS PROVIDED ``AS IS'' AND ANY EXPRESSED OR IMPLIED WARRANTIES, INCLUDING, BUT NOT LIMITED TO, THE IMPLIED WARRANTIES OF MERCHANTABILITY AND FITNESS FOR A PARTICULAR PURPOSE ARE DISCLAIMED. IN NO EVENT SHALL THE APACHE SOFTWARE FOUNDATION OR ITS CONTRIBUTORS BE LIABLE FOR ANY DIRECT, INDIRECT, INCIDENTAL, SPECIAL, EXEMPLARY, OR CONSEQUENTIAL DAMAGES (INCLUDING, BUT NOT LIMITED TO, PROCUREMENT OF SUBSTITUTE GOODS OR SERVICES; LOSS OF USE, DATA, OR PROFITS; OR BUSINESS INTERRUPTION) HOWEVER CAUSED

AND ON ANY THEORY OF LIABILITY, WHETHER IN CONTRACT, STRICT LIABILITY, OR TORT (INCLUDING NEGLIGENCE OR OTHERWISE) ARISING IN ANY WAY OUT OF THE USE OF THIS SOFTWARE, EVEN IF ADVISED OF THE POSSIBILITY OF SUCH DAMAGE.

=====
=====

This software consists of voluntary contributions made by many individuals on behalf of the Apache Software Foundation and was originally based on software copyright (c) 1999, International Business Machines, Inc., <http://www.ibm.com>. For more information on the Apache Software Foundation, please see [<http://www.apache.org/>](http://www.apache.org/).

Apache Axis
Copyright Apache Software Foundation
Copyright 2011 Fuji Xerox Co., Ltd

Licensed under the Apache License, Version 2.0 (the "License"); you may not use this file except in compliance with the License. You may obtain a copy of the License at <http://www.apache.org/licenses/LICENSE-2.0>

Unless required by applicable law or agreed to in writing, software distributed under the License is distributed on an "AS IS" BASIS, WITHOUT WARRANTIES OR CONDITIONS OF ANY KIND, either express or implied. See the License for the specific language governing permissions and limitations under the License.

Apache License
Version 2.0, January 2004
<http://www.apache.org/licenses/>

TERMS AND CONDITIONS FOR USE, REPRODUCTION, AND DISTRIBUTION

1. Definitions.

"License" shall mean the terms and conditions for use, reproduction, and distribution as defined by Sections 1 through 9 of this document.

"Licensor" shall mean the copyright owner or entity authorized by the copyright owner that is granting the License.

"Legal Entity" shall mean the union of the acting entity and all other entities that control, are controlled by, or are under common control with that entity. For the purposes of this definition, "control" means (i) the power, direct or indirect, to cause the direction or management of such entity, whether by contract or otherwise, or (ii) ownership of fifty percent (50%) or more of the outstanding shares, or (iii) beneficial ownership of such entity.

"You" (or "Your") shall mean an individual or Legal Entity exercising permissions granted by this License.

"Source" form shall mean the preferred form for making modifications, including but not limited to software source code, documentation source, and configuration files.

"Object" form shall mean any form resulting from mechanical transformation or translation of a Source form, including but not limited to compiled object code, generated documentation, and conversions to other media types.

"Work" shall mean the work of authorship, whether in Source or Object form, made available under the License, as indicated by a copyright notice that is included in or attached to the work (an example is provided in the Appendix below).

"Derivative Works" shall mean any work, whether in Source or Object form, that is based on (or derived from) the Work and for which the editorial revisions, annotations, elaborations, or other modifications represent, as a whole, an original work of authorship. For the purposes of this License, Derivative Works shall not include works that remain separable from, or merely link (or bind by name) to the interfaces of, the Work and Derivative Works thereof.

"Contribution" shall mean any work of authorship, including the original version of the Work and any modifications or additions to that Work or Derivative Works thereof, that is intentionally submitted to Licensor for inclusion in the Work by the copyright owner or by an individual or Legal Entity authorized to submit on behalf of the copyright owner. For the purposes of this definition, "submitted" means any form of electronic, verbal, or written communication sent to the Licensor or its representatives, including but not limited to communication on electronic mailing lists, source code control systems, and issue tracking systems that are managed by, or on behalf of, the Licensor for the purpose of discussing and improving the Work, but excluding communication that is conspicuously marked or otherwise designated in writing by the copyright owner as "Not a Contribution."

"Contributor" shall mean Licensor and any individual or Legal Entity on behalf of whom a Contribution has been received by Licensor and subsequently incorporated within the Work.

2. Grant of Copyright License. Subject to the terms and conditions of this License, each Contributor hereby grants to You a perpetual, worldwide, non-exclusive, no-charge, royalty-free, irrevocable copyright license to reproduce, prepare Derivative Works of, publicly display, publicly perform, sublicense, and distribute the Work and such Derivative Works in Source or Object form.

3. Grant of Patent License. Subject to the terms and conditions of this License, each Contributor hereby grants to You a perpetual, worldwide, non-exclusive, no-charge, royalty-free, irrevocable (except as stated in this section) patent license to make, have made, use, offer to sell, sell, import, and otherwise transfer the Work, where such license applies only to those patent claims licensable by such Contributor that are necessarily infringed by their Contribution(s) alone or by combination of their Contribution(s) with the Work to which such Contribution(s) was submitted. If You institute patent litigation against any entity (including a cross-claim or counterclaim in a lawsuit) alleging that the Work or a Contribution incorporated within the Work constitutes direct or contributory patent infringement, then any patent licenses granted to You under this License for that Work shall terminate as of the date such litigation is filed.

4. Redistribution. You may reproduce and distribute copies of the Work or Derivative Works thereof in any medium, with or without modifications, and in Source or Object form, provided that You meet the following conditions:

(a) You must give any other recipients of the Work or Derivative Works a copy of this License; and

(b) You must cause any modified files to carry prominent notices stating that You changed the files; and

(c) You must retain, in the Source form of any Derivative Works that You distribute, all copyright, patent, trademark, and attribution notices from the Source form of the Work, excluding those notices that do not pertain to any part of the Derivative Works; and

(d) If the Work includes a "NOTICE" text file as part of its distribution, then any Derivative Works that You distribute must include a readable copy of the attribution notices contained within such NOTICE file, excluding those notices that do not pertain to any part of the Derivative Works, in at least one of the following places: within a NOTICE text file distributed as part of the Derivative Works; within the Source form or documentation, if provided along with the Derivative Works; or, within a display generated by the Derivative Works, if and wherever such third-party notices normally appear. The contents of the NOTICE file are for informational purposes only and do not modify the License. You may add Your own attribution notices within Derivative Works that You distribute, alongside or as an addendum to the NOTICE text from the Work, provided that such additional attribution notices cannot be construed as modifying the License.

You may add Your own copyright statement to Your modifications and may provide additional or different license terms and conditions for use, reproduction, or distribution of Your modifications, or for any such Derivative Works as a whole, provided Your use, reproduction, and distribution of the Work otherwise complies with the conditions stated in this License.

5. Submission of Contributions. Unless You explicitly state otherwise, any Contribution intentionally submitted for inclusion in the Work by You to the Licensor shall be under the terms and conditions of this License, without any additional terms or conditions. Notwithstanding the above, nothing herein shall supersede or modify the terms of any separate license agreement you may have executed with Licensor regarding such Contributions.

6. Trademarks. This License does not grant permission to use the trade names, trademarks, service marks, or product names of the Licensor, except as required for reasonable and customary use in describing the origin of the Work and reproducing the content of the NOTICE file.

7. Disclaimer of Warranty. Unless required by applicable law or agreed to in writing, Licensor provides the Work (and each Contributor provides its Contributions) on an "AS IS" BASIS, WITHOUT WARRANTIES OR CONDITIONS OF ANY KIND, either express or implied, including, without limitation, any warranties or conditions of TITLE, NON-INFRINGEMENT, MERCHANTABILITY, or FITNESS FOR A PARTICULAR PURPOSE. You are solely responsible for determining the appropriateness of using or redistributing the Work and assume any risks associated with Your exercise of permissions under this License.

8. Limitation of Liability. In no event and under no legal theory, whether in tort (including negligence), contract, or otherwise, unless required by applicable law (such as deliberate and grossly negligent acts) or agreed to in writing, shall any Contributor be liable to You for damages, including any direct, indirect, special, incidental, or consequential damages of any character arising as a result of this License or out of the use or inability to use the Work (including but not limited to damages for loss of goodwill, work stoppage, computer failure or malfunction, or any and all other commercial damages or losses), even if such Contributor has been advised of the possibility of such damages.

9. Accepting Warranty or Additional Liability. While redistributing the Work or Derivative Works thereof, You may choose to offer, and charge a fee for, acceptance of support, warranty, indemnity, or other liability obligations and/or rights consistent with this License. However, in accepting such obligations, You may act only on Your own behalf and on Your sole responsibility, not on behalf of any other Contributor, and only if You agree to indemnify, defend, and hold each Contributor harmless for any liability incurred by, or claims asserted against, such Contributor by reason of your accepting any such warranty or additional liability.

END OF TERMS AND CONDITIONS

APPENDIX: How to apply the Apache License to your work.

To apply the Apache License to your work, attach the following boilerplate notice, with the fields enclosed by brackets "[]" replaced with your own identifying information. (Don't include the brackets!) The text should be enclosed in the appropriate comment syntax for the file format. We also recommend that a file or class name and description of purpose be included on the same "printed page" as the copyright notice for easier identification within third-party archives.

Copyright [yyyy] [name of copyright owner]

Licensed under the Apache License, Version 2.0 (the "License"); you may not use this file except in compliance with the License.

You may obtain a copy of the License at

<http://www.apache.org/licenses/LICENSE-2.0>

Unless required by applicable law or agreed to in writing, software distributed under the License is distributed on an "AS IS" BASIS, WITHOUT WARRANTIES OR CONDITIONS OF ANY KIND, either express or implied.

See the License for the specific language governing permissions and limitations under the License.

 This product includes software developed by the OpenSSL Project for use in the OpenSSL Toolkit. (<http://www.openssl.org/>)
 This product includes cryptographic software written by Eric Young (eay@cryptsoft.com)

OpenSSL License

=====
 =====

Copyright (c) 1998-2011 The OpenSSL Project. All rights reserved.

Redistribution and use in source and binary forms, with or without modification, are permitted provided that the following conditions are met:

1. Redistributions of source code must retain the above copyright notice, this list of conditions and the following disclaimer.
2. Redistributions in binary form must reproduce the above copyright notice, this list of conditions and the following disclaimer in the documentation and/or other materials provided with the distribution.
3. All advertising materials mentioning features or use of this software must display the following acknowledgment:
"This product includes software developed by the OpenSSL Project for use in the OpenSSL Toolkit. (<http://www.openssl.org/>)"
4. The names "OpenSSL Toolkit" and "OpenSSL Project" must not be used to endorse or promote products derived from this software without prior written permission. For written permission, please contact openssl-core@openssl.org.
5. Products derived from this software may not be called "OpenSSL" nor may "OpenSSL" appear in their names without prior written permission of the OpenSSL Project.
6. Redistributions of any form whatsoever must retain the following acknowledgment:
"This product includes software developed by the OpenSSL Project for use in the OpenSSL Toolkit (<http://www.openssl.org/>)"

THIS SOFTWARE IS PROVIDED BY THE OpenSSL PROJECT ``AS IS" AND ANY EXPRESSED OR IMPLIED WARRANTIES, INCLUDING, BUT NOT LIMITED TO, THE IMPLIED WARRANTIES OF MERCHANTABILITY AND FITNESS FOR A PARTICULAR PURPOSE ARE DISCLAIMED. IN NO EVENT SHALL THE OpenSSL PROJECT OR ITS CONTRIBUTORS BE LIABLE FOR ANY DIRECT, INDIRECT, INCIDENTAL, SPECIAL, EXEMPLARY, OR CONSEQUENTIAL DAMAGES (INCLUDING, BUT NOT LIMITED TO, PROCUREMENT OF SUBSTITUTE GOODS OR SERVICES; LOSS OF USE, DATA, OR PROFITS; OR BUSINESS INTERRUPTION) HOWEVER CAUSED AND ON ANY THEORY OF LIABILITY, WHETHER IN CONTRACT, STRICT LIABILITY, OR TORT (INCLUDING NEGLIGENCE OR OTHERWISE) ARISING IN ANY WAY OUT OF THE USE OF THIS SOFTWARE, EVEN IF ADVISED OF THE POSSIBILITY OF SUCH DAMAGE.

=====
=====

This product includes cryptographic software written by Eric Young (ey@cryptsoft.com).
This product includes software written by Tim Hudson (tjh@cryptsoft.com).

Original SSLeay License

Copyright (C) 1995-1998 Eric Young (ey@cryptsoft.com)
All rights reserved.

This package is an SSL implementation written by Eric Young (eay@cryptsoft.com).
The implementation was written so as to conform with Netscapes SSL.

This library is free for commercial and non-commercial use as long as the following conditions are aheared to. The following conditions apply to all code found in this distribution, be it the RC4, RSA, lhash, DES, etc., code; not just the SSL code. The SSL documentation included with this distribution is covered by the same copyright terms except that the holder is Tim Hudson (tjh@cryptsoft.com).

Copyright remains Eric Young's, and as such any Copyright notices in the code are not to be removed.

If this package is used in a product, Eric Young should be given attribution as the author of the parts of the library used.

This can be in the form of a textual message at program startup or in documentation (online or textual) provided with the package.

Redistribution and use in source and binary forms, with or without modification, are permitted provided that the following conditions are met:

1. Redistributions of source code must retain the copyright notice, this list of conditions and the following disclaimer.

2. Redistributions in binary form must reproduce the above copyright notice, this list of conditions and the following disclaimer in the documentation and/or other materials provided with the distribution.

3. All advertising materials mentioning features or use of this software must display the following acknowledgement:

"This product includes cryptographic software written by Eric Young (eay@cryptsoft.com)"
The word 'cryptographic' can be left out if the rouines from the library being used are not cryptographic related :-).

4. If you include any Windows specific code (or a derivative thereof) from the apps directory (application code) you must include an acknowledgement:

"This product includes software written by Tim Hudson (tjh@cryptsoft.com)"

THIS SOFTWARE IS PROVIDED BY ERIC YOUNG ``AS IS'' AND ANY EXPRESS OR IMPLIED WARRANTIES, INCLUDING, BUT NOT LIMITED TO, THE IMPLIED WARRANTIES OF MERCHANTABILITY AND FITNESS FOR A PARTICULAR PURPOSE ARE DISCLAIMED. IN NO EVENT SHALL THE AUTHOR OR CONTRIBUTORS BE LIABLE FOR ANY DIRECT, INDIRECT, INCIDENTAL, SPECIAL, EXEMPLARY, OR CONSEQUENTIAL DAMAGES (INCLUDING, BUT NOT LIMITED TO, PROCUREMENT OF SUBSTITUTE GOODS OR SERVICES; LOSS OF USE, DATA, OR PROFITS; OR BUSINESS INTERRUPTION) HOWEVER CAUSED AND ON ANY THEORY OF LIABILITY, WHETHER IN CONTRACT, STRICT LIABILITY, OR TORT (INCLUDING NEGLIGENCE OR OTHERWISE) ARISING IN ANY WAY OUT OF THE USE OF THIS SOFTWARE, EVEN IF ADVISED OF THE POSSIBILITY OF SUCH DAMAGE.

The licence and distribution terms for any publically available version or derivative of this code cannot be changed. i.e. this code cannot simply be copied and put under another distribution licence [including the GNU Public Licence.]

-----Info-ZIP

This is version 1999-Oct-05 of the Info-ZIP copyright and license.

The definitive version of this document should be available at <ftp://ftp.cdrom.com/pub/infozip/license.html> indefinitely.

Copyright (c) 1990-1999 Info-ZIP. All rights reserved.

For the purposes of this copyright and license, "Info-ZIP" is defined as the following set of individuals:

Mark Adler, John Bush, Karl Davis, Harald Denker, Jean-Michel Dubois, Jean-loup Gailly, Hunter Goatley, Ian Gorman, Chris Herborth, Dirk Haase, Greg Hartwig, Robert Heath, Jonathan Hudson, Paul Kienitz, David Kirschbaum, Johnny Lee, Onno van der Linden, Igor Mandrichenko, Steve P. Miller, Sergio Monesi, Keith Owens, George Petrov, Greg Roelofs, Kai Uwe Rommel, Steve Salisbury, Dave Smith, Christian Spieler, Antoine Verheijen, Paul von Behren, Rich Wales, Mike White

This software is provided "as is," without warranty of any kind, express or implied. In no event shall Info-ZIP or its contributors be held liable for any direct, indirect, incidental, special or consequential damages arising out of the use of or inability to use this software.

Permission is granted to anyone to use this software for any purpose, including commercial applications, and to alter it and redistribute it freely, subject to the following restrictions:

1. Redistributions of source code must retain the above copyright notice, definition, disclaimer, and this list of conditions.
2. Redistributions in binary form must reproduce the above copyright notice, definition, disclaimer, and this list of conditions in documentation and/or other materials provided with the distribution.
3. Altered versions--including, but not limited to, ports to new operating systems, existing ports with new graphical interfaces, and dynamic, shared, or static library versions--must be plainly marked as such and must not be misrepresented as being the original source. Such altered versions also must not be misrepresented as being Info-ZIP releases--including, but not limited to, labeling of the altered versions with the names "Info-ZIP" (or any variation thereof, including, but not limited to, different capitalizations), "Pocket UnZip," "WiZ" or "MacZip" without the explicit permission of Info-ZIP. Such altered versions are further prohibited from misrepresentative use of the Zip-Bugs or Info-ZIP e-mail addresses or of the Info-ZIP URL(s).
4. Info-ZIP retains the right to use the names "Info-ZIP," "Zip," "UnZip," "WiZ," "Pocket UnZip," "Pocket Zip," and "MacZip" for its own source and binary releases.

-----zlib
THIS FILE is almost entirely based upon code by Jean-loup Gailly and Mark Adler. It has been modified by Lucian Wischik.

The modifications were: incorporate the bugfixes of 1.1.4, allow unzipping to/from handles/pipes/files/memory, encryption, unicode, a windowsish api, and putting everything into a single .cpp file.

The original code may be found at <http://www.gzip.org/zlib/>

The original copyright text follows.

zlib.h -- interface of the 'zlib' general purpose compression library version 1.1.3, July 9th, 1998

Copyright (C) 1995-1998 Jean-loup Gailly and Mark Adler

This software is provided 'as-is', without any express or implied warranty. In no event will the authors be held liable for any damages arising from the use of this software.

Permission is granted to anyone to use this software for any purpose, including commercial applications, and to alter it and redistribute it freely, subject to the following restrictions:

1. The origin of this software must not be misrepresented; you must not claim that you wrote the original software. If you use this software in a product, an acknowledgment in the product documentation would be appreciated but is not required.
2. Altered source versions must be plainly marked as such, and must not be misrepresented as being the original software.
3. This notice may not be removed or altered from any source distribution.

Jean-loup Gailly Mark Adler
jloup@gzip.org madler@alumni.caltech.edu

The data format used by the zlib library is described by RFCs (Request for Comments) 1950 to 1952 in the files <ftp://ds.internic.net/rfc/rfc1950.txt> (zlib format), [rfc1951.txt](ftp://ds.internic.net/rfc/rfc1951.txt) (deflate format) and [rfc1952.txt](ftp://ds.internic.net/rfc/rfc1952.txt) (gzip format).

The 'zlib' compression library provides in-memory compression and decompression functions, including integrity checks of the uncompressed data. This version of the library supports only one compression method (deflation) but other algorithms will be added later and will have the same stream interface.

Compression can be done in a single step if the buffers are large enough (for example if an input file is mmap'ed), or can be done by repeated calls of the compression function. In the latter case, the application must provide more input and/or consume the output (providing more output space) before each call.

The library also supports reading and writing files in gzip (.gz) format with an interface similar to that of stdio.

The library does not install any signal handler. The decoder checks the consistency of the compressed data, so the library should never crash even in case of corrupted input.

for more info about .ZIP format, see <ftp://ftp.cdrom.com/pub/infozip/doc/appnote-970311-iz.zip>

PkWare has also a specification at <ftp://ftp.pkware.com/probdesc.zip>

csvpp

Apache License

Version 2.0, January 2004

<http://www.apache.org/licenses/>

TERMS AND CONDITIONS FOR USE, REPRODUCTION, AND DISTRIBUTION

1. Definitions.

"License" shall mean the terms and conditions for use, reproduction, and distribution as defined by Sections 1 through 9 of this document.

"Licensor" shall mean the copyright owner or entity authorized by the copyright owner that is granting the License.

"Legal Entity" shall mean the union of the acting entity and all other entities that control, are controlled by, or are under common control with that entity. For the purposes of this definition, "control" means (i) the power, direct or indirect, to cause the direction or management of such entity, whether by contract or otherwise, or (ii) ownership of fifty percent (50%) or more of the outstanding shares, or (iii) beneficial ownership of such entity.

"You" (or "Your") shall mean an individual or Legal Entity exercising permissions granted by this License.

"Source" form shall mean the preferred form for making modifications, including but not limited to software source code, documentation source, and configuration files.

"Object" form shall mean any form resulting from mechanical transformation or translation of a Source form, including but not limited to compiled object code, generated documentation, and conversions to other media types.

"Work" shall mean the work of authorship, whether in Source or Object form, made available under the License, as indicated by a copyright notice that is included in or attached to the work (an example is provided in the Appendix below).

"Derivative Works" shall mean any work, whether in Source or Object form, that is based on (or derived from) the Work and for which the editorial revisions, annotations, elaborations, or other modifications represent, as a whole, an original work of authorship. For the purposes of this License, Derivative Works shall not include works that remain separable from, or merely link (or bind by name) to the interfaces of, the Work and Derivative Works thereof.

"Contribution" shall mean any work of authorship, including the original version of the Work and any modifications or additions to that Work or Derivative Works thereof, that is intentionally submitted to Licensor for inclusion in the Work by the copyright owner or by an individual or Legal Entity authorized to submit on behalf of the copyright owner. For the purposes of this definition, "submitted" means any form of electronic, verbal, or written communication sent to the Licensor or its representatives, including but not limited to communication on electronic mailing lists, source code control systems, and issue tracking systems that are managed by, or on behalf of, the Licensor for the purpose of discussing and

improving the Work, but excluding communication that is conspicuously marked or otherwise designated in writing by the copyright owner as "Not a Contribution."

"Contributor" shall mean Licensor and any individual or Legal Entity on behalf of whom a Contribution has been received by Licensor and subsequently incorporated within the Work.

2. Grant of Copyright License. Subject to the terms and conditions of this License, each Contributor hereby grants to You a perpetual, worldwide, non-exclusive, no-charge, royalty-free, irrevocable copyright license to reproduce, prepare Derivative Works of, publicly display, publicly perform, sublicense, and distribute the Work and such Derivative Works in Source or Object form.

3. Grant of Patent License. Subject to the terms and conditions of this License, each Contributor hereby grants to You a perpetual, worldwide, non-exclusive, no-charge, royalty-free, irrevocable (except as stated in this section) patent license to make, have made, use, offer to sell, sell, import, and otherwise transfer the Work, where such license applies only to those patent claims licensable by such Contributor that are necessarily infringed by their Contribution(s) alone or by combination of their Contribution(s) with the Work to which such Contribution(s) was submitted. If You institute patent litigation against any entity (including a cross-claim or counterclaim in a lawsuit) alleging that the Work or a Contribution incorporated within the Work constitutes direct or contributory patent infringement, then any patent licenses granted to You under this License for that Work shall terminate as of the date such litigation is filed.

4. Redistribution. You may reproduce and distribute copies of the Work or Derivative Works thereof in any medium, with or without modifications, and in Source or Object form, provided that You meet the following conditions:

(a) You must give any other recipients of the Work or Derivative Works a copy of this License; and

(b) You must cause any modified files to carry prominent notices stating that You changed the files; and

(c) You must retain, in the Source form of any Derivative Works that You distribute, all copyright, patent, trademark, and attribution notices from the Source form of the Work, excluding those notices that do not pertain to any part of the Derivative Works; and

(d) If the Work includes a "NOTICE" text file as part of its distribution, then any Derivative Works that You distribute must include a readable copy of the attribution notices contained within such NOTICE file, excluding those notices that do not pertain to any part of the Derivative Works, in at least one of the following places: within a NOTICE text file distributed as part of the Derivative Works; within the Source form or documentation, if provided along with the Derivative Works; or, within a display generated by the Derivative Works, if and wherever such third-party notices normally appear. The contents of the NOTICE file are for informational purposes only and do not modify the License.

You may add Your own attribution notices within Derivative Works that You distribute, alongside or as an addendum to the NOTICE text from the Work, provided that such additional attribution notices cannot be construed as modifying the License. You may add Your own copyright statement to Your modifications and may provide additional or different license terms and conditions for use, reproduction, or distribution of Your modifications, or

for any such Derivative Works as a whole, provided Your use, reproduction, and distribution of the Work otherwise complies with the conditions stated in this License.

5. Submission of Contributions. Unless You explicitly state otherwise, any Contribution intentionally submitted for inclusion in the Work by You to the Licensor shall be under the terms and conditions of this License, without any additional terms or conditions. Notwithstanding the above, nothing herein shall supersede or modify the terms of any separate license agreement you may have executed with Licensor regarding such Contributions.

6. Trademarks. This License does not grant permission to use the trade names, trademarks, service marks, or product names of the Licensor, except as required for reasonable and customary use in describing the origin of the Work and reproducing the content of the NOTICE file.

7. Disclaimer of Warranty. Unless required by applicable law or agreed to in writing, Licensor provides the Work (and each Contributor provides its Contributions) on an "AS IS" BASIS, WITHOUT WARRANTIES OR CONDITIONS OF ANY KIND, either express or implied, including, without limitation, any warranties or conditions of TITLE, NON-INFRINGEMENT, MERCHANTABILITY, or FITNESS FOR A PARTICULAR PURPOSE. You are solely responsible for determining the appropriateness of using or redistributing the Work and assume any risks associated with Your exercise of permissions under this License.

8. Limitation of Liability. In no event and under no legal theory, whether in tort (including negligence), contract, or otherwise, unless required by applicable law (such as deliberate and grossly negligent acts) or agreed to in writing, shall any Contributor be liable to You for damages, including any direct, indirect, special, incidental, or consequential damages of any character arising as a result of this License or out of the use or inability to use the Work (including but not limited to damages for loss of goodwill, work stoppage, computer failure or malfunction, or any and all other commercial damages or losses), even if such Contributor has been advised of the possibility of such damages.

9. Accepting Warranty or Additional Liability. While redistributing the Work or Derivative Works thereof, You may choose to offer, and charge a fee for, acceptance of support, warranty, indemnity, or other liability obligations and/or rights consistent with this License. However, in accepting such obligations, You may act only on Your own behalf and on Your sole responsibility, not on behalf of any other Contributor, and only if You agree to indemnify, defend, and hold each Contributor harmless for any liability incurred by, or claims asserted against, such Contributor by reason of your accepting any such warranty or additional liability.

END OF TERMS AND CONDITIONS

APPENDIX: How to apply the Apache License to your work.

To apply the Apache License to your work, attach the following boilerplate notice, with the fields enclosed by brackets "[]" replaced with your own identifying information. (Don't include the brackets!) The text should be enclosed in the appropriate comment syntax for the file format. We also recommend that a file or class name and description of purpose be included on the same "printed page" as the copyright notice for easier identification within third-party archives.

Copyright [yyyy] [name of copyright owner]

Licensed under the Apache License, Version 2.0 (the "License"); you may not use this file except in compliance with the License. You may obtain a copy of the License at

<http://www.apache.org/licenses/LICENSE-2.0>

Unless required by applicable law or agreed to in writing, software distributed under the License is distributed on an "AS IS" BASIS, WITHOUT WARRANTIES OR CONDITIONS OF ANY KIND, either express or implied.

See the License for the specific language governing permissions and limitations under the License.

25 Install Operation for Access Google Drive™

This chapter describes how to install Access Google Drive to the machine.

- **Before Installation.....720**
- **Installation Procedures.....725**
- **About License.....728**

Before Installation

This section describes the procedures required before installation of Access Google Drive.

Environment Settings.....	720
SSL / TLS Settings in Dell Printer Configuration Web Tool	722

Environment Settings

On your machine, settings listed below are required before you enable the feature.

Items	Required Settings	Refer to
SOAP Port	<ul style="list-style-type: none"> Port Status: Enabled Port Number: 80 	"SOAP Port" (P.721)
Port 9100	<ul style="list-style-type: none"> Port Status: Enabled 	"Port 9100" (P.721)
Protocol Settings	<ul style="list-style-type: none"> IP address, subnet mask, and gateway address: settings for the use in TCP/IP network environment DNS Server Setup: DNS server address setting IP Filter: Disabled 	"Protocol Settings" (P.721)
Proxy Server Settings*	<ul style="list-style-type: none"> Settings to use the machine in HTTP/HTTPS environment, such as server name, port number, login name, and passcode. Address to bypass the proxy server: localhost 	"Proxy Server Settings" (P.722)
Web Browser Setup	<ul style="list-style-type: none"> Web Applications Version: V4 (New Version) 	"Web Browser Setup" (P.722)

* :Make this setting when using a service that requires proxy settings.

Make the settings from your machine in the [Tools] screen. Follow the steps below to display the [Tools] screen.

- 1 Press the <Log In/Out> button on the control panel.
- 2 Enter the system administrator's user ID with the numeric keypad or the keyboard displayed on the screen, and select [Enter].

Note

- The default user ID is "admin".
- The default passcode is "1111".

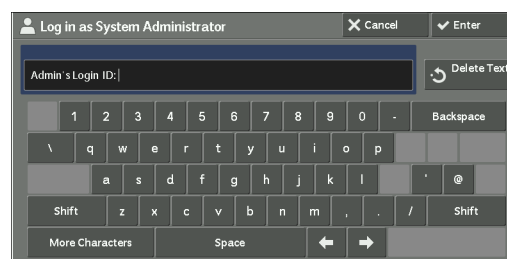

- 3 Select [Tools] on the [Home] screen.

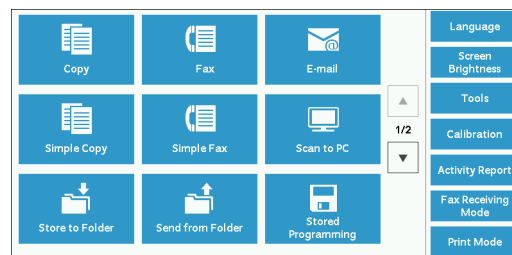

4 Select any options.

- Note**
- Rebooting may be required to reflect the settings. In this case, follow the onscreen instructions.

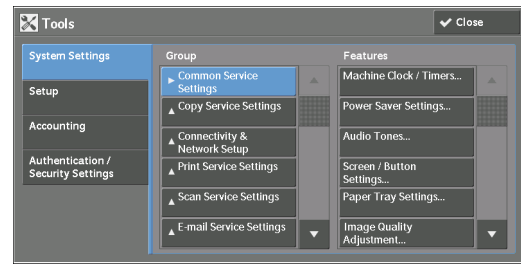

SOAP Port

- 1 Select [SOAP] in [Port Settings] under [System Settings] > [Connectivity & Network Setup], and then select [Change Settings].
- 2 Select below value for each item.
 - [Port Status]: [Enabled]
 - [Port Number]: [80]
- 3 Select [Close] repeatedly until the [Tools] screen is displayed.
- 4 To exit [Tools], select [Close].

Port 9100

- 1 Select [Port Status] under [System Settings] > [Connectivity & Network Setup] > [Port Settings] > [Port 9100], and then select [Change Settings].
- 2 Select [Enabled], and then select [Save].
- 3 Select [Close] repeatedly until the [Tools] screen is displayed.
- 4 To exit [Tools], select [Close].

Protocol Settings

- 1 Select [Protocol Settings] in [Connectivity & Network Setup] under [System Settings], and then set an IP address, subnet mask, and gateway address (settings for the use in TCP/IP network environment).
- 2 In the same [System Settings] > [Connectivity & Network Setup] > [Protocol Settings], select [IPv4 - DNS Server Setup] or [IPv6 - DNS Server Setup], and then select [Change Settings].
- 3 Make the following settings:
 - [Get IP Address from DHCP]: [Disabled]
 - [DNS Server IP Address]: Your DNS server address
- 4 In [System Settings] > [Connectivity & Network Setup] > [Protocol Settings], select [IPv4 - IP Filter] or [IPv6 - IP Filter], and select [Change Settings].
- 5 Select [Disabled], and select [Save].
- 6 Select [Close].
- 7 To exit [Tools], select [Close].

Proxy Server Settings

Note • Make this setting when using a service that requires proxy settings.

- 1 In [System Settings] > [Connectivity & Network Setup] > [Proxy Server Settings], make the settings needed to use the machine in HTTP/HTTPS environment, such as a server name, port number, login name, and passcode.
- 2 In [System Settings] > [Connectivity & Network Setup] > [Proxy Server Settings], select [Addresses to Bypass Proxy Server], and select [Change Settings].
- 3 Enter "localhost", and select [Save].

Note • While using this feature, do not delete this "localhost".

- 4 Select [Close].
- 5 To exit [Tools], select [Close].

Web Browser Setup

- 1 Select [Web Applications Version] in [Web Browser Setup] under [System Settings], and then select [Change Settings].
- 2 Select [V4 (New Version)], and then select [Save].
- 3 Select [Close].
- 4 To exit [Tools], select [Close].

SSL / TLS Settings in Dell Printer Configuration Web Tool

Installation and uninstallation of Access Google Drive require HTTP - SSL / TLS communication between a network-connected computer and the machine. Follow the below steps to enable HTTP - SSL / TLS communication.

- 1 Start a web browser from a network-connected computer.
- 2 Enter the machine's IP address into the address box on the browser, and then press the <Enter> key. Connection to Dell Printer Configuration Web Tool is established.

Note • During connection/operation, a pop-up screen for user ID/passcode entry may appear. In this case, enter the system administrator's user ID/passcode and click [OK].

- 3 Select the [Properties] tab to click [Security] > [Machine Digital Certificate Management], and then click the [Create New Certificate] button.

Note • If [Create New Self Signed Certificate] is displayed, click it and go to step 5.

- 4 Select [Self-Signed Certificate] and click [Continue].

5 Click [Apply].

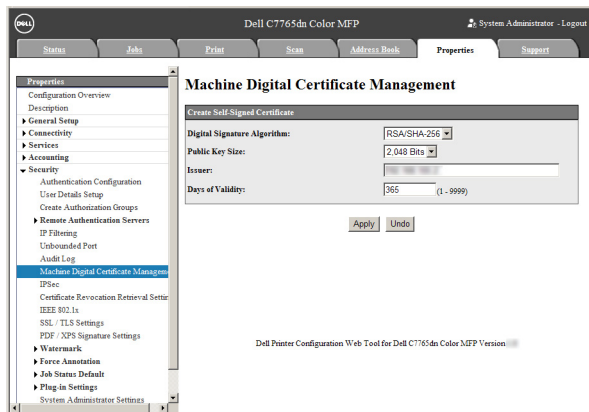

6 When the settings are updated and the following screen is displayed, refresh the web browser.

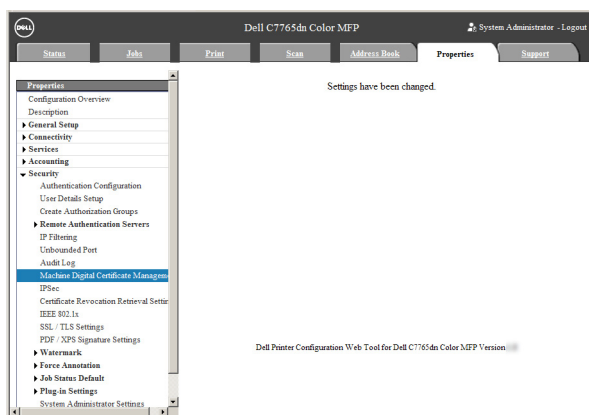

7 Select the [Properties] tab to click [Security] > [SSL / TLS Settings], and then select the [Enabled] check box for [HTTP - SSL / TLS Communication].

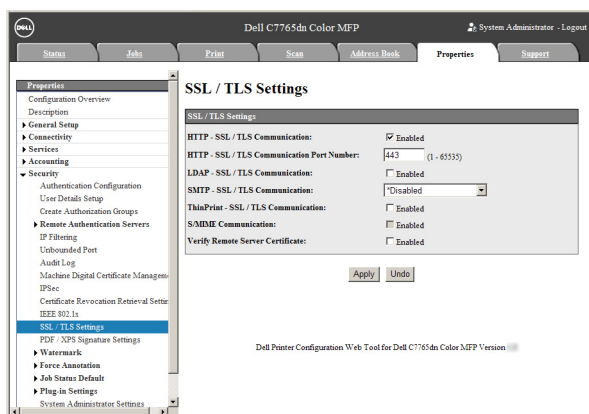

8 Click [Apply].

9 When the web browser shows the machine reboot message, click [Reboot Machine].

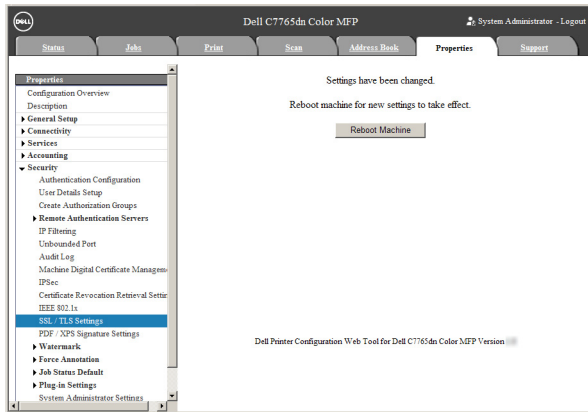

10 Click [OK] on the confirmation pop-up.

The machine reboots and the settings are enabled.

Installation Procedures

This section describes how to install Access Google Drive. The installation tools support the following operating systems:

Windows OS

- Microsoft® Windows® XP Professional Service Pack 3
- Microsoft® Windows® XP Professional x64 Service Pack 2
- Microsoft® Windows® Vista Business Service Pack 2
- Microsoft® Windows® Vista Business x64 Service Pack 2
- Microsoft® Windows® 7 Professional Service Pack 1
- Microsoft® Windows® 7 Professional x64 Service Pack 1
- Microsoft® Windows® 7 Enterprise Service Pack 1
- Microsoft® Windows® 7 Enterprise x64 Service Pack 1
- Microsoft® Windows® 8 Pro
- Microsoft® Windows® 8 Pro x64
- Microsoft® Windows® 8 Enterprise
- Microsoft® Windows® 8 Enterprise x64

Installation

Install Access Google Drive to your machine.

- Note**
- During machine operation or jobs in progress, installation process cannot be started. In this case, wait for a while and then start installation.
 - During installation process, machine operation is out of service.

Follow the installation procedures below.

1 Save the installation tool to your computer.

- Note**
- To obtain the installation tool, contact Customer Support at dell.com/contactdell.

2 Decompress the file (.zip) and double-click the exe file in the installation tool.

- Note**
- The [Open file - Security warning] pop-up screen may appear. In this case, click [Run] to continue.

3 Click [Next].

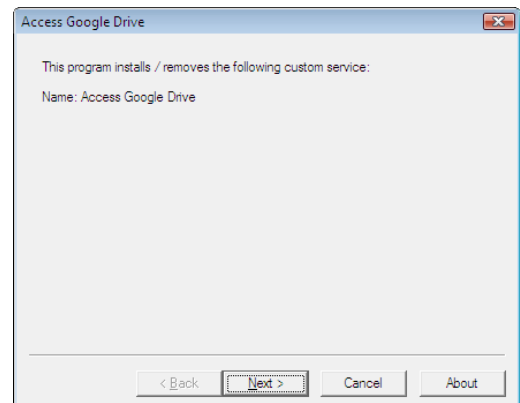

- 4 Enter the IP address or hostname of your machine, and then click [Next].
Example: 192.0.2.1

- 5 Enter the system administrator's user ID and password, and then click [Next].

- 6 Click [Next].

- Note**
- If an error message telling to delete other plug-ins appears, delete the other plug-ins from Dell Printer Configuration Web Tool [Properties] > [Security] > [Plug-in Settings] > [List of Embedded Plug-ins].

- 7 Click [Finish].

- Note**
- Several minutes may take before the installation process completes.
 - If the [Reboot device] check box is selected, the machine must be rebooted. Click [Finish] to reboot the machine.
 - To install this feature to another machine in succession, select the [Install on another device] check box, and then click [Finish]. You can start from step 3.

Uninstallation/Version Upgrade

Uninstall Access Google Drive from your machine or upgrade the software version.
Follow the uninstallation/version upgrade procedures below.

- 1 On your computer, double-click the exe file in the installation tool.
- 2 Click [Next].

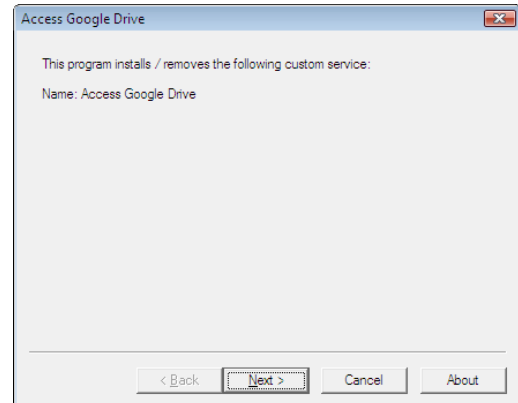

- 3 Enter the IP address or hostname of your machine, and then click [Next].
Example: 192.0.2.1

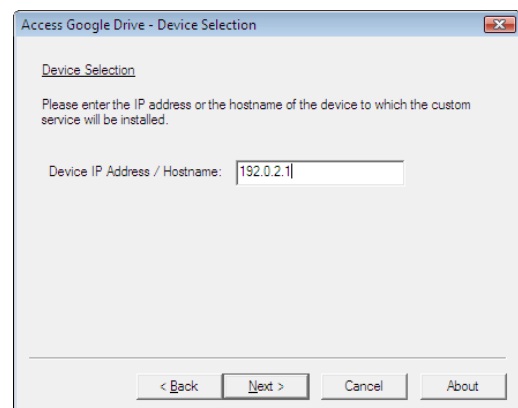

- 4 Enter the system administrator's user ID and password, and then click [Next].

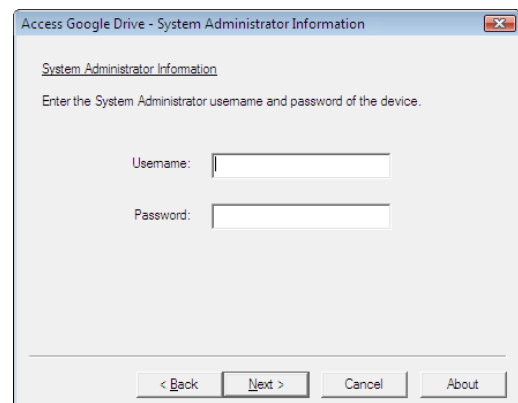

- 5 Select [Reinstall (Retain settings)] for version upgrade, or [Remove (Remove settings)] for uninstallation, and then click [Next].

- 6 Click [Next].

- 7 Click [Finish].

- Note**
- Several minutes may take before the installation process completes.
 - If the [Reboot device] check box is selected, the machine must be rebooted. Click [Finish] to reboot the machine.
 - To uninstall or upgrade this feature from another machine in succession, check [Install on another device] and click [Finish]. You can start from step 2.

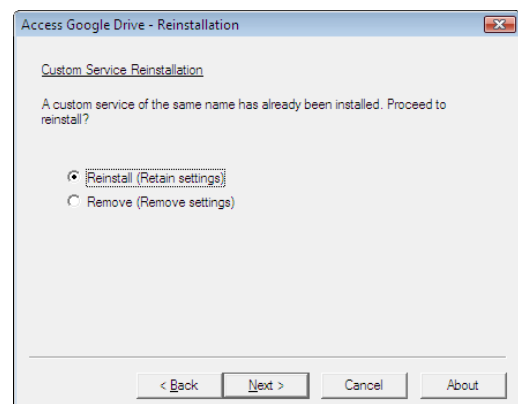

About License

This section describes OSS (Open Source Software) license used for the installer. Be sure to confirm.

About OSS

This product includes software developed by The Apache Software Foundation (<http://www.apache.org/>)

Apache Xerces

Copyright (c) 1999-2001 The Apache Software Foundation. All rights reserved.

The Apache Software License, Version 1.1

Copyright (c) 1999-2001 The Apache Software Foundation. All rights reserved.

Redistribution and use in source and binary forms, with or without modification, are permitted provided that the following conditions are met:

1. Redistributions of source code must retain the above copyright notice, this list of conditions and the following disclaimer.
2. Redistributions in binary form must reproduce the above copyright notice, this list of conditions and the following disclaimer in the documentation and/or other materials provided with the distribution.
3. The end-user documentation included with the redistribution, if any, must include the following acknowledgment:
"This product includes software developed by the Apache Software Foundation (<http://www.apache.org/>)."
Alternately, this acknowledgment may appear in the software itself, if and wherever such third-party acknowledgments normally appear.
4. The names "Xerces" and "Apache Software Foundation" must not be used to endorse or promote products derived from this software without prior written permission. For written permission, please contact apache@apache.org.
5. Products derived from this software may not be called "Apache", nor may "Apache" appear in their name, without prior written permission of the Apache Software Foundation.

THIS SOFTWARE IS PROVIDED ``AS IS" AND ANY EXPRESSED OR IMPLIED WARRANTIES, INCLUDING, BUT NOT LIMITED TO, THE IMPLIED WARRANTIES OF MERCHANTABILITY AND FITNESS FOR A PARTICULAR PURPOSE ARE DISCLAIMED. IN NO EVENT SHALL THE APACHE SOFTWARE FOUNDATION OR ITS CONTRIBUTORS BE LIABLE FOR ANY DIRECT, INDIRECT, INCIDENTAL, SPECIAL, EXEMPLARY, OR CONSEQUENTIAL DAMAGES (INCLUDING, BUT NOT LIMITED TO, PROCUREMENT OF SUBSTITUTE GOODS OR SERVICES; LOSS OF USE, DATA, OR PROFITS; OR BUSINESS INTERRUPTION) HOWEVER CAUSED

AND ON ANY THEORY OF LIABILITY, WHETHER IN CONTRACT, STRICT LIABILITY, OR TORT (INCLUDING NEGLIGENCE OR OTHERWISE) ARISING IN ANY WAY OUT OF THE USE OF THIS SOFTWARE, EVEN IF ADVISED OF THE POSSIBILITY OF SUCH DAMAGE.

=====
=====

This software consists of voluntary contributions made by many individuals on behalf of the Apache Software Foundation and was originally based on software copyright (c) 1999, International Business Machines, Inc., <http://www.ibm.com>. For more information on the Apache Software Foundation, please see [<http://www.apache.org/>](http://www.apache.org/).

Apache Axis
Copyright Apache Software Foundation
Copyright 2011 Fuji Xerox Co., Ltd

Licensed under the Apache License, Version 2.0 (the "License"); you may not use this file except in compliance with the License. You may obtain a copy of the License at <http://www.apache.org/licenses/LICENSE-2.0>

Unless required by applicable law or agreed to in writing, software distributed under the License is distributed on an "AS IS" BASIS, WITHOUT WARRANTIES OR CONDITIONS OF ANY KIND, either express or implied. See the License for the specific language governing permissions and limitations under the License.

Apache License
Version 2.0, January 2004
<http://www.apache.org/licenses/>

TERMS AND CONDITIONS FOR USE, REPRODUCTION, AND DISTRIBUTION

1. Definitions.

"License" shall mean the terms and conditions for use, reproduction, and distribution as defined by Sections 1 through 9 of this document.

"Licensor" shall mean the copyright owner or entity authorized by the copyright owner that is granting the License.

"Legal Entity" shall mean the union of the acting entity and all other entities that control, are controlled by, or are under common control with that entity. For the purposes of this definition, "control" means (i) the power, direct or indirect, to cause the direction or management of such entity, whether by contract or otherwise, or (ii) ownership of fifty percent (50%) or more of the outstanding shares, or (iii) beneficial ownership of such entity.

"You" (or "Your") shall mean an individual or Legal Entity exercising permissions granted by this License.

"Source" form shall mean the preferred form for making modifications, including but not limited to software source code, documentation source, and configuration files.

"Object" form shall mean any form resulting from mechanical transformation or translation of a Source form, including but not limited to compiled object code, generated documentation, and conversions to other media types.

"Work" shall mean the work of authorship, whether in Source or Object form, made available under the License, as indicated by a copyright notice that is included in or attached to the work (an example is provided in the Appendix below).

"Derivative Works" shall mean any work, whether in Source or Object form, that is based on (or derived from) the Work and for which the editorial revisions, annotations, elaborations, or other modifications represent, as a whole, an original work of authorship. For the purposes of this License, Derivative Works shall not include works that remain separable from, or merely link (or bind by name) to the interfaces of, the Work and Derivative Works thereof.

"Contribution" shall mean any work of authorship, including the original version of the Work and any modifications or additions to that Work or Derivative Works thereof, that is intentionally submitted to Licensor for inclusion in the Work by the copyright owner or by an individual or Legal Entity authorized to submit on behalf of the copyright owner. For the purposes of this definition, "submitted" means any form of electronic, verbal, or written communication sent to the Licensor or its representatives, including but not limited to communication on electronic mailing lists, source code control systems, and issue tracking systems that are managed by, or on behalf of, the Licensor for the purpose of discussing and improving the Work, but excluding communication that is conspicuously marked or otherwise designated in writing by the copyright owner as "Not a Contribution."

"Contributor" shall mean Licensor and any individual or Legal Entity on behalf of whom a Contribution has been received by Licensor and subsequently incorporated within the Work.

2. Grant of Copyright License. Subject to the terms and conditions of this License, each Contributor hereby grants to You a perpetual, worldwide, non-exclusive, no-charge, royalty-free, irrevocable copyright license to reproduce, prepare Derivative Works of, publicly display, publicly perform, sublicense, and distribute the Work and such Derivative Works in Source or Object form.

3. Grant of Patent License. Subject to the terms and conditions of this License, each Contributor hereby grants to You a perpetual, worldwide, non-exclusive, no-charge, royalty-free, irrevocable (except as stated in this section) patent license to make, have made, use, offer to sell, sell, import, and otherwise transfer the Work, where such license applies only to those patent claims licensable by such Contributor that are necessarily infringed by their Contribution(s) alone or by combination of their Contribution(s) with the Work to which such Contribution(s) was submitted. If You institute patent litigation against any entity (including a cross-claim or counterclaim in a lawsuit) alleging that the Work or a Contribution incorporated within the Work constitutes direct or contributory patent infringement, then any patent licenses granted to You under this License for that Work shall terminate as of the date such litigation is filed.

4. Redistribution. You may reproduce and distribute copies of the Work or Derivative Works thereof in any medium, with or without modifications, and in Source or Object form, provided that You meet the following conditions:

(a) You must give any other recipients of the Work or Derivative Works a copy of this License; and

(b) You must cause any modified files to carry prominent notices stating that You changed the files; and

(c) You must retain, in the Source form of any Derivative Works that You distribute, all copyright, patent, trademark, and attribution notices from the Source form of the Work, excluding those notices that do not pertain to any part of the Derivative Works; and

(d) If the Work includes a "NOTICE" text file as part of its distribution, then any Derivative Works that You distribute must include a readable copy of the attribution notices contained within such NOTICE file, excluding those notices that do not pertain to any part of the Derivative Works, in at least one of the following places: within a NOTICE text file distributed as part of the Derivative Works; within the Source form or documentation, if provided along with the Derivative Works; or, within a display generated by the Derivative Works, if and wherever such third-party notices normally appear. The contents of the NOTICE file are for informational purposes only and do not modify the License. You may add Your own attribution notices within Derivative Works that You distribute, alongside or as an addendum to the NOTICE text from the Work, provided that such additional attribution notices cannot be construed as modifying the License.

You may add Your own copyright statement to Your modifications and may provide additional or different license terms and conditions for use, reproduction, or distribution of Your modifications, or for any such Derivative Works as a whole, provided Your use, reproduction, and distribution of the Work otherwise complies with the conditions stated in this License.

5. Submission of Contributions. Unless You explicitly state otherwise, any Contribution intentionally submitted for inclusion in the Work by You to the Licensor shall be under the terms and conditions of this License, without any additional terms or conditions. Notwithstanding the above, nothing herein shall supersede or modify the terms of any separate license agreement you may have executed with Licensor regarding such Contributions.

6. Trademarks. This License does not grant permission to use the trade names, trademarks, service marks, or product names of the Licensor, except as required for reasonable and customary use in describing the origin of the Work and reproducing the content of the NOTICE file.

7. Disclaimer of Warranty. Unless required by applicable law or agreed to in writing, Licensor provides the Work (and each Contributor provides its Contributions) on an "AS IS" BASIS, WITHOUT WARRANTIES OR CONDITIONS OF ANY KIND, either express or implied, including, without limitation, any warranties or conditions of TITLE, NON-INFRINGEMENT, MERCHANTABILITY, or FITNESS FOR A PARTICULAR PURPOSE. You are solely responsible for determining the appropriateness of using or redistributing the Work and assume any risks associated with Your exercise of permissions under this License.

8. Limitation of Liability. In no event and under no legal theory, whether in tort (including negligence), contract, or otherwise, unless required by applicable law (such as deliberate and grossly negligent acts) or agreed to in writing, shall any Contributor be liable to You for damages, including any direct, indirect, special, incidental, or consequential damages of any character arising as a result of this License or out of the use or inability to use the Work (including but not limited to damages for loss of goodwill, work stoppage, computer failure or malfunction, or any and all other commercial damages or losses), even if such Contributor has been advised of the possibility of such damages.

9. Accepting Warranty or Additional Liability. While redistributing the Work or Derivative Works thereof, You may choose to offer, and charge a fee for, acceptance of support, warranty, indemnity, or other liability obligations and/or rights consistent with this License. However, in accepting such obligations, You may act only on Your own behalf and on Your sole responsibility, not on behalf of any other Contributor, and only if You agree to indemnify, defend, and hold each Contributor harmless for any liability incurred by, or claims asserted against, such Contributor by reason of your accepting any such warranty or additional liability.

END OF TERMS AND CONDITIONS

APPENDIX: How to apply the Apache License to your work.

To apply the Apache License to your work, attach the following boilerplate notice, with the fields enclosed by brackets "[]" replaced with your own identifying information. (Don't include the brackets!) The text should be enclosed in the appropriate comment syntax for the file format. We also recommend that a file or class name and description of purpose be included on the same "printed page" as the copyright notice for easier identification within third-party archives.

Copyright [yyyy] [name of copyright owner]

Licensed under the Apache License, Version 2.0 (the "License"); you may not use this file except in compliance with the License.

You may obtain a copy of the License at

<http://www.apache.org/licenses/LICENSE-2.0>

Unless required by applicable law or agreed to in writing, software distributed under the License is distributed on an "AS IS" BASIS, WITHOUT WARRANTIES OR CONDITIONS OF ANY KIND, either express or implied.

See the License for the specific language governing permissions and limitations under the License.

This product includes software developed by the OpenSSL Project for use in the OpenSSL Toolkit. (<http://www.openssl.org/>) This product includes cryptographic software written by Eric Young (eay@cryptsoft.com)

OpenSSL License

=====
=====

Copyright (c) 1998-2011 The OpenSSL Project. All rights reserved.

Redistribution and use in source and binary forms, with or without modification, are permitted provided that the following conditions are met:

1. Redistributions of source code must retain the above copyright notice, this list of conditions and the following disclaimer.
2. Redistributions in binary form must reproduce the above copyright notice, this list of conditions and the following disclaimer in the documentation and/or other materials provided with the distribution.
3. All advertising materials mentioning features or use of this software must display the following acknowledgment:
"This product includes software developed by the OpenSSL Project for use in the OpenSSL Toolkit. (<http://www.openssl.org/>)"
4. The names "OpenSSL Toolkit" and "OpenSSL Project" must not be used to endorse or promote products derived from this software without prior written permission. For written permission, please contact openssl-core@openssl.org.
5. Products derived from this software may not be called "OpenSSL" nor may "OpenSSL" appear in their names without prior written permission of the OpenSSL Project.
6. Redistributions of any form whatsoever must retain the following acknowledgment:
"This product includes software developed by the OpenSSL Project for use in the OpenSSL Toolkit (<http://www.openssl.org/>)"

THIS SOFTWARE IS PROVIDED BY THE OpenSSL PROJECT ``AS IS" AND ANY EXPRESSED OR IMPLIED WARRANTIES, INCLUDING, BUT NOT LIMITED TO, THE IMPLIED WARRANTIES OF MERCHANTABILITY AND FITNESS FOR A PARTICULAR PURPOSE ARE DISCLAIMED. IN NO EVENT SHALL THE OpenSSL PROJECT OR ITS CONTRIBUTORS BE LIABLE FOR ANY DIRECT, INDIRECT, INCIDENTAL, SPECIAL, EXEMPLARY, OR CONSEQUENTIAL DAMAGES (INCLUDING, BUT NOT LIMITED TO, PROCUREMENT OF SUBSTITUTE GOODS OR SERVICES; LOSS OF USE, DATA, OR PROFITS; OR BUSINESS INTERRUPTION) HOWEVER CAUSED AND ON ANY THEORY OF LIABILITY, WHETHER IN CONTRACT, STRICT LIABILITY, OR TORT (INCLUDING NEGLIGENCE OR OTHERWISE) ARISING IN ANY WAY OUT OF THE USE OF THIS SOFTWARE, EVEN IF ADVISED OF THE POSSIBILITY OF SUCH DAMAGE.

=====
=====

This product includes cryptographic software written by Eric Young (ey@cryptsoft.com).
This product includes software written by Tim Hudson (tjh@cryptsoft.com).

Original SSLeay License

Copyright (C) 1995-1998 Eric Young (ey@cryptsoft.com)
All rights reserved.

This package is an SSL implementation written by Eric Young (eay@cryptsoft.com).
The implementation was written so as to conform with Netscapes SSL.

This library is free for commercial and non-commercial use as long as the following conditions are adhered to. The following conditions apply to all code found in this distribution, be it the RC4, RSA, lhash, DES, etc., code; not just the SSL code. The SSL documentation included with this distribution is covered by the same copyright terms except that the holder is Tim Hudson (tjh@cryptsoft.com).

Copyright remains Eric Young's, and as such any Copyright notices in the code are not to be removed.

If this package is used in a product, Eric Young should be given attribution as the author of the parts of the library used.

This can be in the form of a textual message at program startup or in documentation (online or textual) provided with the package.

Redistribution and use in source and binary forms, with or without modification, are permitted provided that the following conditions are met:

1. Redistributions of source code must retain the copyright notice, this list of conditions and the following disclaimer.
2. Redistributions in binary form must reproduce the above copyright notice, this list of conditions and the following disclaimer in the documentation and/or other materials provided with the distribution.
3. All advertising materials mentioning features or use of this software must display the following acknowledgement:
"This product includes cryptographic software written by Eric Young (eay@cryptsoft.com)"
The word 'cryptographic' can be left out if the routines from the library being used are not cryptographic related :-).
4. If you include any Windows specific code (or a derivative thereof) from the apps directory (application code) you must include an acknowledgement:
"This product includes software written by Tim Hudson (tjh@cryptsoft.com)"

THIS SOFTWARE IS PROVIDED BY ERIC YOUNG ``AS IS'' AND ANY EXPRESS OR IMPLIED WARRANTIES, INCLUDING, BUT NOT LIMITED TO, THE IMPLIED WARRANTIES OF MERCHANTABILITY AND FITNESS FOR A PARTICULAR PURPOSE ARE DISCLAIMED. IN NO EVENT SHALL THE AUTHOR OR CONTRIBUTORS BE LIABLE FOR ANY DIRECT, INDIRECT, INCIDENTAL, SPECIAL, EXEMPLARY, OR CONSEQUENTIAL DAMAGES (INCLUDING, BUT NOT LIMITED TO, PROCUREMENT OF SUBSTITUTE GOODS OR SERVICES; LOSS OF USE, DATA, OR PROFITS; OR BUSINESS INTERRUPTION) HOWEVER CAUSED AND ON ANY THEORY OF LIABILITY, WHETHER IN CONTRACT, STRICT LIABILITY, OR TORT (INCLUDING NEGLIGENCE OR OTHERWISE) ARISING IN ANY WAY OUT OF THE USE OF THIS SOFTWARE, EVEN IF ADVISED OF THE POSSIBILITY OF SUCH DAMAGE.

The licence and distribution terms for any publically available version or derivative of this code cannot be changed. i.e. this code cannot simply be copied and put under another distribution licence [including the GNU Public Licence.]

-----Info-ZIP

This is version 1999-Oct-05 of the Info-ZIP copyright and license.

The definitive version of this document should be available at
<ftp://ftp.cdrom.com/pub/infozip/license.html> indefinitely.

Copyright (c) 1990-1999 Info-ZIP. All rights reserved.

For the purposes of this copyright and license, "Info-ZIP" is defined as the following set of individuals:

Mark Adler, John Bush, Karl Davis, Harald Denker, Jean-Michel Dubois, Jean-loup Gailly, Hunter Goatley, Ian Gorman, Chris Herborth, Dirk Haase, Greg Hartwig, Robert Heath, Jonathan Hudson, Paul Kienitz, David Kirschbaum, Johnny Lee, Onno van der Linden, Igor Mandrichenko, Steve P. Miller, Sergio Monesi, Keith Owens, George Petrov, Greg Roelofs, Kai Uwe Rommel, Steve Salisbury, Dave Smith, Christian Spieler, Antoine Verheijen, Paul von Behren, Rich Wales, Mike White

This software is provided "as is," without warranty of any kind, express or implied. In no event shall Info-ZIP or its contributors be held liable for any direct, indirect, incidental, special or consequential damages arising out of the use of or inability to use this software.

Permission is granted to anyone to use this software for any purpose, including commercial applications, and to alter it and redistribute it freely, subject to the following restrictions:

1. Redistributions of source code must retain the above copyright notice, definition, disclaimer, and this list of conditions.
2. Redistributions in binary form must reproduce the above copyright notice, definition, disclaimer, and this list of conditions in documentation and/or other materials provided with the distribution.
3. Altered versions--including, but not limited to, ports to new operating systems, existing ports with new graphical interfaces, and dynamic, shared, or static library versions--must be plainly marked as such and must not be misrepresented as being the original source. Such altered versions also must not be misrepresented as being Info-ZIP releases--including, but not limited to, labeling of the altered versions with the names "Info-ZIP" (or any variation thereof, including, but not limited to, different capitalizations), "Pocket UnZip," "WiZ" or "MacZip" without the explicit permission of Info-ZIP. Such altered versions are further prohibited from misrepresentative use of the Zip-Bugs or Info-ZIP e-mail addresses or of the Info-ZIP URL(s).
4. Info-ZIP retains the right to use the names "Info-ZIP," "Zip," "UnZip," "WiZ," "Pocket UnZip," "Pocket Zip," and "MacZip" for its own source and binary releases.

-----zlib
THIS FILE is almost entirely based upon code by Jean-loup Gailly and Mark Adler. It has been modified by Lucian Wischik.

The modifications were: incorporate the bugfixes of 1.1.4, allow unzipping to/from handles/pipes/files/memory, encryption, unicode, a windowsish api, and putting everything into a single .cpp file.

The original code may be found at <http://www.gzip.org/zlib/>

The original copyright text follows.

zlib.h -- interface of the 'zlib' general purpose compression library version 1.1.3, July 9th, 1998

Copyright (C) 1995-1998 Jean-loup Gailly and Mark Adler

This software is provided 'as-is', without any express or implied warranty. In no event will the authors be held liable for any damages arising from the use of this software.

Permission is granted to anyone to use this software for any purpose, including commercial applications, and to alter it and redistribute it freely, subject to the following restrictions:

1. The origin of this software must not be misrepresented; you must not claim that you wrote the original software. If you use this software in a product, an acknowledgment in the product documentation would be appreciated but is not required.
2. Altered source versions must be plainly marked as such, and must not be misrepresented as being the original software.
3. This notice may not be removed or altered from any source distribution.

Jean-loup Gailly Mark Adler
jloup@gzip.org madler@alumni.caltech.edu

The data format used by the zlib library is described by RFCs (Request for Comments) 1950 to 1952 in the files <ftp://ds.internic.net/rfc/rfc1950.txt> (zlib format), [rfc1951.txt](ftp://ds.internic.net/rfc/rfc1951.txt) (deflate format) and [rfc1952.txt](ftp://ds.internic.net/rfc/rfc1952.txt) (gzip format).

The 'zlib' compression library provides in-memory compression and decompression functions, including integrity checks of the uncompressed data. This version of the library supports only one compression method (deflation) but other algorithms will be added later and will have the same stream interface.

Compression can be done in a single step if the buffers are large enough (for example if an input file is mmap'ed), or can be done by repeated calls of the compression function. In the latter case, the application must provide more input and/or consume the output (providing more output space) before each call.

The library also supports reading and writing files in gzip (.gz) format with an interface similar to that of stdio.

The library does not install any signal handler. The decoder checks the consistency of the compressed data, so the library should never crash even in case of corrupted input.

for more info about .ZIP format, see <ftp://ftp.cdrom.com/pub/infozip/doc/appnote-970311-iz.zip>

PkWare has also a specification at <ftp://ftp.pkware.com/probdesc.zip>

csvpp

Apache License

Version 2.0, January 2004

<http://www.apache.org/licenses/>

TERMS AND CONDITIONS FOR USE, REPRODUCTION, AND DISTRIBUTION

I. Definitions.

"License" shall mean the terms and conditions for use, reproduction, and distribution as defined by Sections 1 through 9 of this document.

"Licensor" shall mean the copyright owner or entity authorized by the copyright owner that is granting the License.

"Legal Entity" shall mean the union of the acting entity and all other entities that control, are controlled by, or are under common control with that entity. For the purposes of this definition, "control" means (i) the power, direct or indirect, to cause the direction or management of such entity, whether by contract or otherwise, or (ii) ownership of fifty percent (50%) or more of the outstanding shares, or (iii) beneficial ownership of such entity.

"You" (or "Your") shall mean an individual or Legal Entity exercising permissions granted by this License.

"Source" form shall mean the preferred form for making modifications, including but not limited to software source code, documentation source, and configuration files.

"Object" form shall mean any form resulting from mechanical transformation or translation of a Source form, including but not limited to compiled object code, generated documentation, and conversions to other media types.

"Work" shall mean the work of authorship, whether in Source or Object form, made available under the License, as indicated by a copyright notice that is included in or attached to the work (an example is provided in the Appendix below).

"Derivative Works" shall mean any work, whether in Source or Object form, that is based on (or derived from) the Work and for which the editorial revisions, annotations, elaborations, or other modifications represent, as a whole, an original work of authorship. For the purposes of this License, Derivative Works shall not include works that remain separable from, or merely link (or bind by name) to the interfaces of, the Work and Derivative Works thereof.

"Contribution" shall mean any work of authorship, including the original version of the Work and any modifications or additions to that Work or Derivative Works thereof, that is intentionally submitted to Licensor for inclusion in the Work by the copyright owner or by an individual or Legal Entity authorized to submit on behalf of the copyright owner. For the purposes of this definition, "submitted" means any form of electronic, verbal, or written communication sent to the Licensor or its representatives, including but not limited to communication on electronic mailing lists, source code control systems, and issue tracking systems that are managed by, or on behalf of, the Licensor for the purpose of discussing and

improving the Work, but excluding communication that is conspicuously marked or otherwise designated in writing by the copyright owner as "Not a Contribution."

"Contributor" shall mean Licensor and any individual or Legal Entity on behalf of whom a Contribution has been received by Licensor and subsequently incorporated within the Work.

2. Grant of Copyright License. Subject to the terms and conditions of this License, each Contributor hereby grants to You a perpetual, worldwide, non-exclusive, no-charge, royalty-free, irrevocable copyright license to reproduce, prepare Derivative Works of, publicly display, publicly perform, sublicense, and distribute the Work and such Derivative Works in Source or Object form.

3. Grant of Patent License. Subject to the terms and conditions of this License, each Contributor hereby grants to You a perpetual, worldwide, non-exclusive, no-charge, royalty-free, irrevocable (except as stated in this section) patent license to make, have made, use, offer to sell, sell, import, and otherwise transfer the Work, where such license applies only to those patent claims licensable by such Contributor that are necessarily infringed by their Contribution(s) alone or by combination of their Contribution(s) with the Work to which such Contribution(s) was submitted. If You institute patent litigation against any entity (including a cross-claim or counterclaim in a lawsuit) alleging that the Work or a Contribution incorporated within the Work constitutes direct or contributory patent infringement, then any patent licenses granted to You under this License for that Work shall terminate as of the date such litigation is filed.

4. Redistribution. You may reproduce and distribute copies of the Work or Derivative Works thereof in any medium, with or without modifications, and in Source or Object form, provided that You meet the following conditions:

(a) You must give any other recipients of the Work or Derivative Works a copy of this License; and

(b) You must cause any modified files to carry prominent notices stating that You changed the files; and

(c) You must retain, in the Source form of any Derivative Works that You distribute, all copyright, patent, trademark, and attribution notices from the Source form of the Work, excluding those notices that do not pertain to any part of the Derivative Works; and

(d) If the Work includes a "NOTICE" text file as part of its distribution, then any Derivative Works that You distribute must include a readable copy of the attribution notices contained within such NOTICE file, excluding those notices that do not pertain to any part of the Derivative Works, in at least one of the following places: within a NOTICE text file distributed as part of the Derivative Works; within the Source form or documentation, if provided along with the Derivative Works; or, within a display generated by the Derivative Works, if and wherever such third-party notices normally appear. The contents of the NOTICE file are for informational purposes only and do not modify the License.

You may add Your own attribution notices within Derivative Works that You distribute, alongside or as an addendum to the NOTICE text from the Work, provided that such additional attribution notices cannot be construed as modifying the License. You may add Your own copyright statement to Your modifications and may provide additional or different license terms and conditions for use, reproduction, or distribution of Your modifications, or

for any such Derivative Works as a whole, provided Your use, reproduction, and distribution of the Work otherwise complies with the conditions stated in this License.

5. **Submission of Contributions.** Unless You explicitly state otherwise, any Contribution intentionally submitted for inclusion in the Work by You to the Licensor shall be under the terms and conditions of this License, without any additional terms or conditions. Notwithstanding the above, nothing herein shall supersede or modify the terms of any separate license agreement you may have executed with Licensor regarding such Contributions.

6. **Trademarks.** This License does not grant permission to use the trade names, trademarks, service marks, or product names of the Licensor, except as required for reasonable and customary use in describing the origin of the Work and reproducing the content of the NOTICE file.

7. **Disclaimer of Warranty.** Unless required by applicable law or agreed to in writing, Licensor provides the Work (and each Contributor provides its Contributions) on an "AS IS" BASIS, WITHOUT WARRANTIES OR CONDITIONS OF ANY KIND, either express or implied, including, without limitation, any warranties or conditions of TITLE, NON-INFRINGEMENT, MERCHANTABILITY, or FITNESS FOR A PARTICULAR PURPOSE. You are solely responsible for determining the appropriateness of using or redistributing the Work and assume any risks associated with Your exercise of permissions under this License.

8. **Limitation of Liability.** In no event and under no legal theory, whether in tort (including negligence), contract, or otherwise, unless required by applicable law (such as deliberate and grossly negligent acts) or agreed to in writing, shall any Contributor be liable to You for damages, including any direct, indirect, special, incidental, or consequential damages of any character arising as a result of this License or out of the use or inability to use the Work (including but not limited to damages for loss of goodwill, work stoppage, computer failure or malfunction, or any and all other commercial damages or losses), even if such Contributor has been advised of the possibility of such damages.

9. **Accepting Warranty or Additional Liability.** While redistributing the Work or Derivative Works thereof, You may choose to offer, and charge a fee for, acceptance of support, warranty, indemnity, or other liability obligations and/or rights consistent with this License. However, in accepting such obligations, You may act only on Your own behalf and on Your sole responsibility, not on behalf of any other Contributor, and only if You agree to indemnify, defend, and hold each Contributor harmless for any liability incurred by, or claims asserted against, such Contributor by reason of your accepting any such warranty or additional liability.

END OF TERMS AND CONDITIONS

APPENDIX: How to apply the Apache License to your work.

To apply the Apache License to your work, attach the following boilerplate notice, with the fields enclosed by brackets "[]" replaced with your own identifying information. (Don't include the brackets!) The text should be enclosed in the appropriate comment syntax for the file format. We also recommend that a file or class name and description of purpose be included on the same "printed page" as the copyright notice for easier identification within third-party archives.

Copyright [yyyy] [name of copyright owner]

Licensed under the Apache License, Version 2.0 (the "License"); you may not use this file except in compliance with the License. You may obtain a copy of the License at

<http://www.apache.org/licenses/LICENSE-2.0>

Unless required by applicable law or agreed to in writing, software distributed under the License is distributed on an "AS IS" BASIS, WITHOUT WARRANTIES OR CONDITIONS OF ANY KIND, either express or implied.

See the License for the specific language governing permissions and limitations under the License.

26 Using Eco copy

This chapter describes the basic operations and features for the Eco copy service.

- **About Eco copy742**
- **Eco copy Procedure743**
- **Problem Solving.....745**
- **Notes and Restrictions746**

About Eco copy

Eco copy is a copy service intended to be eco-friendly and user-friendly. The number of sheets of paper can be easily reduced by printing 2 or 4 copies per page, and printing on the reverse side of the sheet.

- Eco copy gives you the option of choosing 1, 2, or 4 copies per sheet. By selecting 2 or 4 copies per sheet, you can save up to 75% of the paper normally required.
- Eco copy also allows you to copy to the reverse side of the paper. This will reduce the number of sheets of paper required by half.
- By selecting both 4 copies per sheet, and printing on both sides of the paper, it will allow you to save up to 7 of 8 pieces of paper normally required.

At the end of each copy job, Eco copy will generate a report of the estimated number of pages you have saved.

Eco copy will lead you through the selections, and take care of the printing orientation in which the original images will appear on the copy paper, thus making it easy to reduce the number of paper used.

Eco copy Procedure

This section describes the Eco copy procedure.

1 Select [Eco copy].

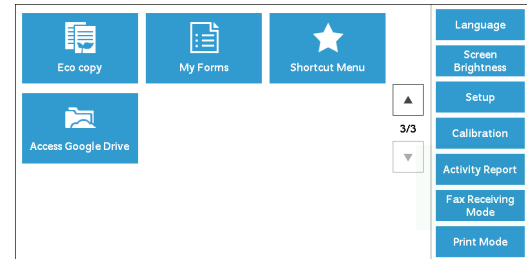

2 Select the orientation of the original (portrait or landscape).

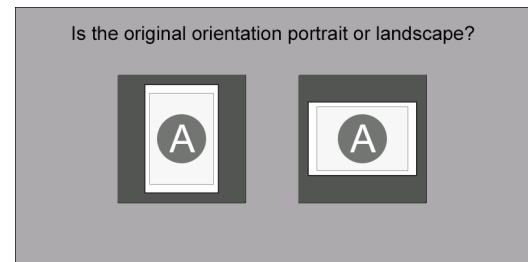

3 Place the original as illustrated and select [OK].

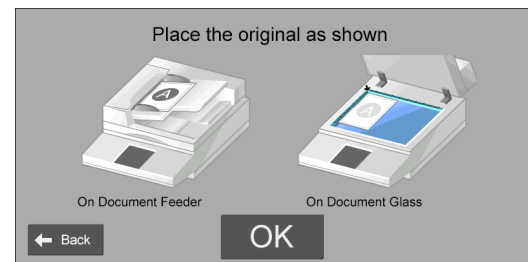

4 Select the number of pages per sheet or select [Next].

Note

- Choosing 2 pages per sheet saves up to half the number of the pages used. Choosing 4 pages per sheet can further save up to 75% of the paper normally required. The more pages you put on a sheet, the more paper you can save.

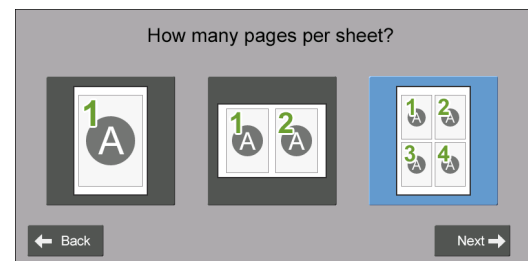

5 Select [Start Copy].

To change other settings, select [Edit].

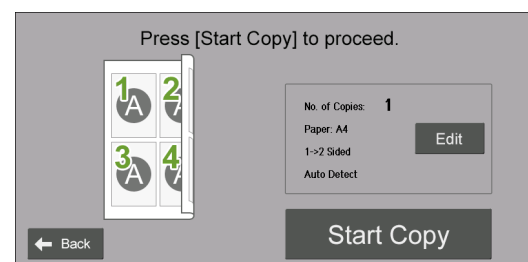

When [Edit] is selected

Change other settings and select [Save].

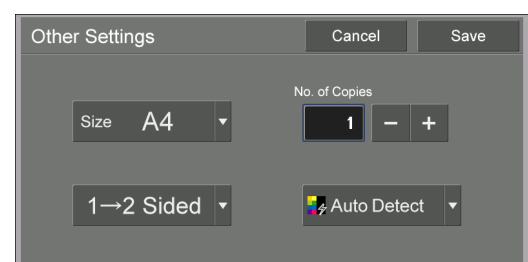

6 Select [Close].

Note

- When paper is saved from printing, the number of sheets of paper saved will be displayed.

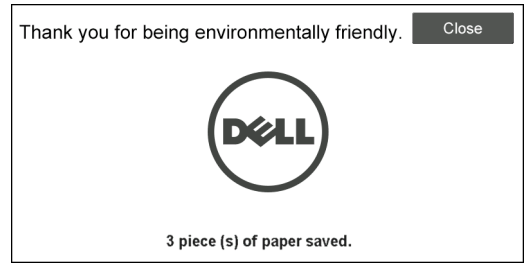

Problem Solving

This section describes troubles that may occur with the machine and its solutions. Follow the troubleshooting described below.

Troubleshooting

Symptom	Cause and Remedy
Text is too small to be readable.	Select a larger paper size or print fewer pages per sheet.
The original is printed on both sides but only the front side of the original is copied.	Select [Edit] to display the [Other Settings] screen and select [2→2 Sided]. Load the original in the document feeder.

View Detailed Information

Detailed information for the Eco copy feature may be required upon contacting us. Follow the procedures below to view the detailed information.

- 1 Select [Eco copy] on the [Home] screen.
- 2 Press the <Dial Pause> button on the control panel for over five seconds.
- 3 View the information on the screen.
- 4 Note the information.
- 5 Select [Close].

Notes and Restrictions

This section describes the notes and restrictions to observe when using this feature.

Print Options

Some print options (such as stapling, punching, and stacking) are not supported in conjunction with Eco copy even when the finisher is installed.

Priority on Scratch Paper

When you specify 1 sided print and scratch paper is loaded on a tray, scratch paper will be used for printing.

Paper Size

The paper size is restricted to 8.5 x 11" (letter), A-series (such as A4 and A3), and B-series (such as B4).

Paper Size Default

The default paper size is based on the contents of Tray 1. If the HCF-B1 is attached on the machine, Tray 6 is used to determine the default paper size.

27 Using My Forms

This chapter describes the basic operations and features for the My Forms service.

- **About My Forms**748
- **Setup**749
- **Using My Forms**750
- **Problem Solving**.....751
- **Notes and Restrictions**752

About My Forms

My Forms enables you to conveniently retrieve and print forms stored on the machine from the control panel directly.

Forms may be stored easily at the device using the scanner, or remotely using the print driver.

Forms can be organized into eight folders (No. 191 to 198) for easy access. Storing forms in the machine simplifies location and retrieval without the trouble of looking them up on a drive, personal, or shared computer each time you need to print.

If a file server is unavailable due to a network failure, you can still print forms stored on the machine.

In addition, the machine allows you to temporarily store prints in folders and retrieve them later from the machine.

Setup

You can setup My Forms using the following procedures.

- 1 Create folders for My Forms as an administrator.
- 2 Store forms in the folders.

Creating Folders on the Machine

To store forms in the machine, you need to create eight folders on the machine. Eight folders will be allocated from the folders numbered 191 to 198. For more information on how to create folders, refer to "15 Tools" > "Setup" > "Create Folder" in the User's Guide.

- Note**
- My Forms uses the folders 191 to 198 only. Other folders do not appear on the [Home] screen of My Forms.
 - Select [Off] for [Check Folder Passcode]. If you select default [On], others cannot access the forms stored in the folder.
 - Select [No] for [Delete Files After Retrieval] to retain the form after printing. Select [Yes] to automatically delete forms after printing.

Storing Files in a Folder on the Machine

You can store files in a folder on the machine in the following ways:

Storing to a folder using a print driver

You can store files using the print driver.

- 1 Click the [Properties] button on the print driver.
- 2 Click the [Paper/Output] tab.
- 3 Select [Store in Remote Folder] from [Job Type].
- 4 Click the [Setup] button.
- 5 Enter a value from 191 to 198 in [Folder Number].

Note • Do not enter any value in [Folder Passcode].

- 6 Select [Use Existing Name] or [Enter File Name] from [File Name].

When you select [Enter File Name], enter a new file name in [New File Name].

- 7 Click the [OK] button.
- 8 Print the file.

For more information, refer to the help of the print driver.

Storing to a folder using the scanner

You can store files using the scanner.

- 1 Select [Store to Folder] on the [Home] screen of the machine.
- 2 Select a folder from the folders 191 to 198 on the [Store to Folder] tab, and press the <Start> button to start scanning the document.

To specify the file name, select [File Name] on the [Filing Options] tab.

Using My Forms

This section describes how to print forms in a folder on the machine.

Printing Forms from the Folders on the Machine

This section describes how to print a form from a folder on the machine.

1 Select [My Forms].

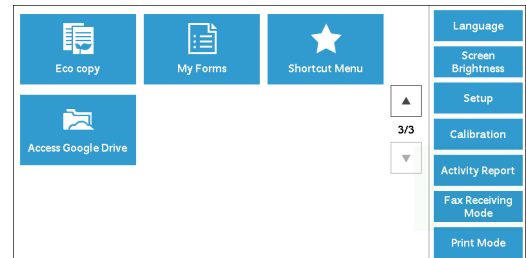

2 Select a folder on the [Home] screen of My Forms.

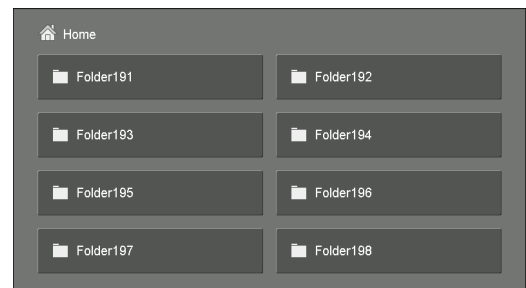

3 Select a file and select [Print].

- Note**
- To check the details of the file, select [File Details].
 - To go back to the [Home] screen of My Forms, select [Home].

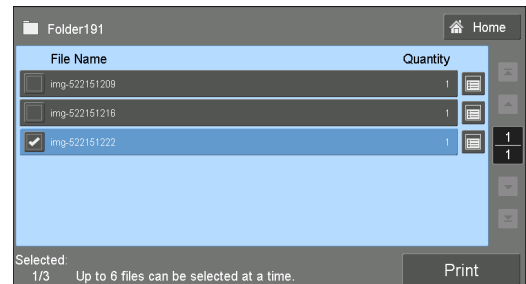

When [File Details] is selected

Check the details of the file, and change the quantity if necessary. Then, select [Confirm].

- Note**
- To delete the file, select [Delete This File].
 - To return to the previous screen, select [Cancel].

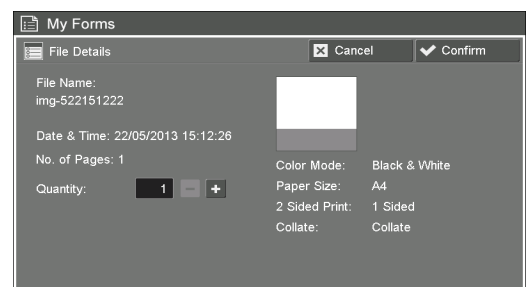

Problem Solving

This section describes problems that may occur with the machine and their solutions.

Troubleshooting

Symptom	Remedy
An authentication popup is shown when a folder is selected.	<p>Check the following administrator level settings:</p> <ul style="list-style-type: none"> • If [Check Folder Passcode] is [On]: Select [Tools] > [Setup] > [Create Folder] and make sure that [Check Folder Passcode] are all set to [Off] under Folder 191 to 198. • If [Retrieve Files from Folder] is [Locked]: Select [Tools] > [Authentication / Security Settings] > [Authentication] > [Access Control] > [Feature Access] and make sure that [Retrieve Files from Folder] is set to [Unlocked].
The created folder does not appear on the [Home] screen of My Forms.	Create folders between No. 191 and 198.

View Detailed Information

Detailed information for the My Forms feature may be required upon contacting us. Follow the procedures below to view the detailed information.

- 1 Select [My Forms] on the [Home] screen.
- 2 Press the <Dial Pause> button on the control panel for over five seconds.
- 3 View the information on the screen.
- 4 Note the information.
- 5 Select [Close].

Notes and Restrictions

This section describes the notes and restrictions to observe when using this feature.

Print Options

Some print options (such as stapling, punching, stacking, and 2 sided printing) are not supported in conjunction with My Forms even when the finisher is installed.

When [Delete Files After Retrieval] is Set to [Yes]

When [Delete Files After Retrieval] is set to [Yes] for a particular folder, and a file is printed from that folder, and the user selects [Close] on the [Completion] screen, then the file is still listed on the [File List] screen.

The file will only be deleted after the print job is completed. If the file size is big, it will take longer for the file to be deleted. During this period, if the user tries to print the file again, there will be a warning message displayed. When the file is deleted and the user selects the [File Details] of that file, a warning message will also be displayed. The file will not be shown on the list after this warning message is closed.

To confirm that the file is deleted, select [Home] and then select that folder. The file will not be shown on the list.

Date and Time Format

The format of [Date & Time] on the [File Details] screen is DD/MM/YYYY HH:MM:SS.

Storing a File Using Print Driver

When [Receive Control] of [Charge / Private Print Settings] is set to [Save as Private Charge Print Job] or [Save as Charge Print Job], the files printed may not be stored in folders on the machine. In this case, temporarily set [According to Print Accounting] for [Receive Control] and print the files. After you finish storing the files, you can restore the setting if necessary.

28 Using Shortcut Menu

This chapter describes the basic operations and features for the Shortcut Menu service.

- **About Shortcut Menu754**
- **Checking Your Environment756**
- **Shortcut Menu Settings757**
- **Problem Solving764**
- **Notes and Restrictions765**

About Shortcut Menu

Shortcut Menu enables you to show the customized menu screen in place of the [Home] screen. Different functions or screen layout can be arranged according to each user's preference.

Note • User preference settings by local users can be restricted by System Administrator settings. For more information, refer to "System Administrator Settings" (P.762).

Shortcut Menu Feature

You can customize the items described below.

Function Buttons to Show

You can select up to eight buttons to show on the Shortcut Menu screen.

For more information, refer to "Adding/Deleting Function Buttons" (P.757).

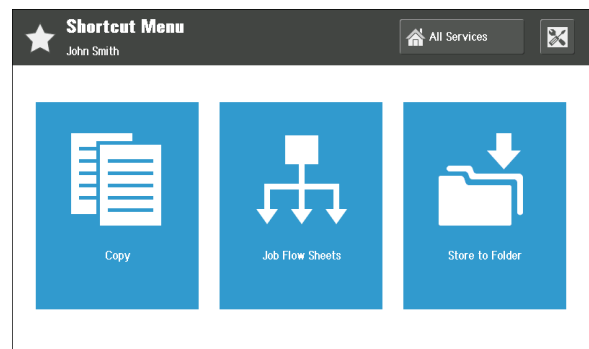

Changing Function Button Name

You can rename each function button.

For more information, refer to "Changing Function Button Name" (P.760).

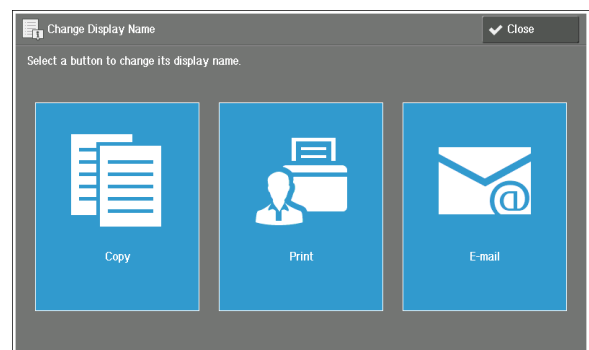

Default Screen with Private Charge Print Job

While using the Private Charge Print function, any Private Charge Print job you may have can be listed as the default screen. You can print the listed jobs directly after authentication.

For more information, refer to "Default Screen after Authentication" (P.761).

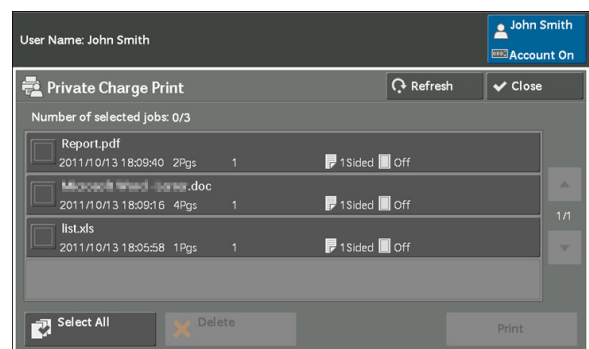

Shortcut Menu Operation

- 1 Enter the User ID with the numeric keypad or the keyboard displayed on the screen, and select [Enter] to login.

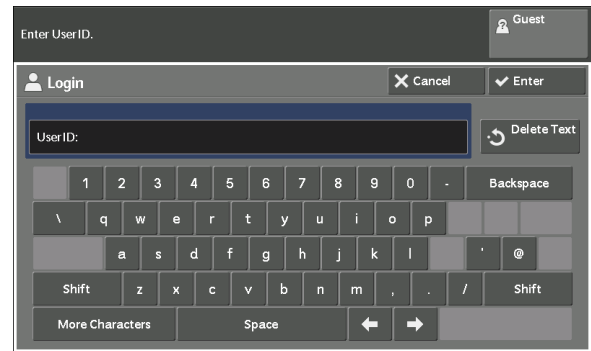

When the Shortcut Menu Screen Appears

Select any function button.

- Note**
- [All Services] or [⊗] (Shortcut Menu Settings) may not be displayed depending on the setting in the system administrator mode.

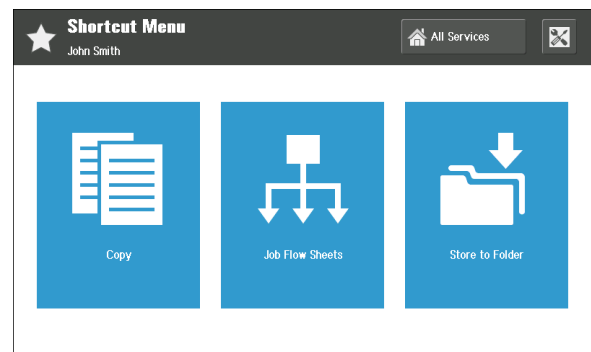

[All Services] button

Displays the [Home] screen.

- Note**
- You can use the <Home> button to show default menu screen depending on the setting in the system administrator mode. For information on setting procedures, refer to "System Administrator Settings" (P.762).

⊗ (Shortcut Menu Settings)

Displays the Shortcut Menu Settings screen.

For information on available items, refer to "Shortcut Menu Settings" (P.757).

When the Private Charge Print Screen Appears

Select the job to print and select [Print].

- Note**
- Select [Close] to show the Shortcut Menu screen.

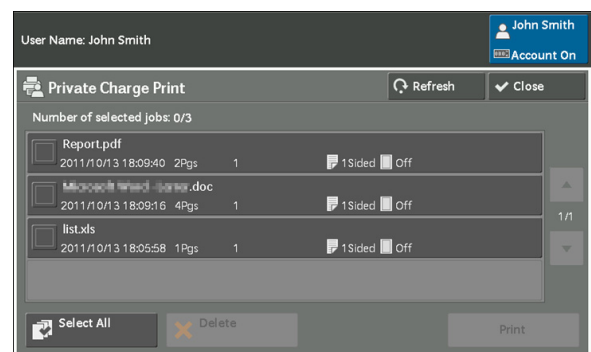

Checking Your Environment

This section describes several settings that must be set by system administrator to use Shortcut Menu feature. Check the proper settings below before you enable Shortcut Menu feature.

Port Settings

- [Port Status] is set to [Enabled] in [SOAP] under [System Settings] > [Connectivity & Network Setup] > [Port Settings].
- [Port Number] is set to [80] in [SOAP] under [System Settings] > [Connectivity & Network Setup] > [Port Settings].

Protocol Settings

- IP address, subnet mask, and gateway address (i.e. settings for the use in TCP/IP network environment) are set in [Protocol Settings] under [System Settings] > [Connectivity & Network Setup].

Web Browser Setup

- [V4 (New Version)] is set in [Web Applications Version] under [System Settings] > [Web Browser Setup].

Authentication Settings

- [Login to Local Accounts] or [Login to Remote Accounts] is set in [Login Type] under [Authentication / Security Settings] > [Authentication].
- Shortcut Menu users are registered on the machine.

Access Control

- [Device Access] is set to [Locked] in [Access Control] under [Authentication / Security Settings] > [Authentication].

Screen Default

- To show the Shortcut Menu screen after authentication: [Shortcut Menu] is set in [Screen Default] under [System Settings] > [Common Service Settings] > [Screen / Button Settings].
- To show the [Home] screen after authentication: [Home] is set in [Screen Default] under [System Settings] > [Common Service Settings] > [Screen / Button Settings].

Shortcut Menu Settings

This section describes available functions for the Shortcut Menu feature and how to configure them.

Note • Shortcut Menu settings made by system administrator work for all users without Shortcut Menu settings.

Adding/Deleting Function Buttons	757
Changing Function Button Name.....	760
Default Screen after Authentication.....	761
System Administrator Settings	762

Adding/Deleting Function Buttons

You can add/delete function buttons on your Shortcut Menu screen.

Below are the available functions to show on the Shortcut Menu screen.

Note • Functions not supported by the machine will not be displayed on the screen.

- Copy
- Fax
- E-mail
- Store to Folder
- Scan to PC
- Store to USB
- Send from Folder
- Job Flow Sheets
- Stored Programming
- Web Applications
- Store & Send Link
- Simple Copy
- Simple Fax
- Store to WSD

Note • WSD stands for Web Services on Devices.

- Media Print - Text
- Media Print - Photos
- Charge Print
- Sample Set
- Delayed Print
- Private Charge Print
- Web Application Server
- Custom Services

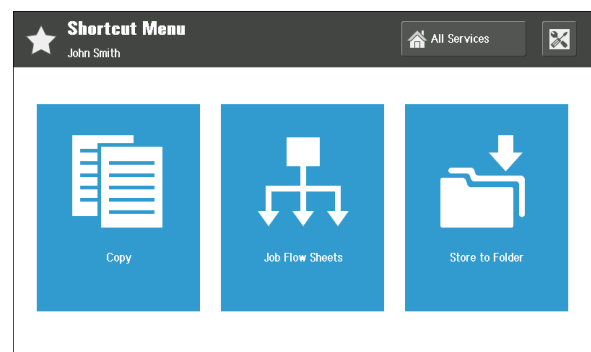

- Fax Receiving Mode
- Activity Report
- Language
- Setup
- Print Mode

Adding Function Buttons

1 Select [] (Shortcut Menu Settings) on your Shortcut Menu screen.

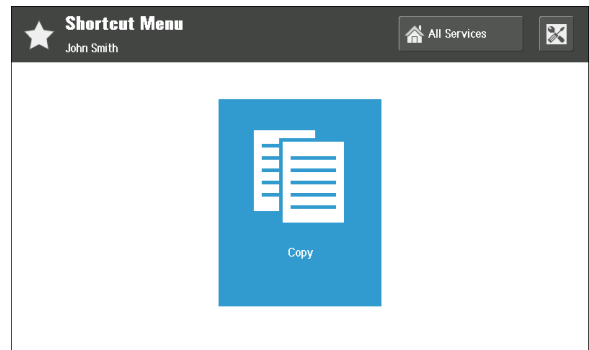

2 Select [Add / Delete / Change Service Position].

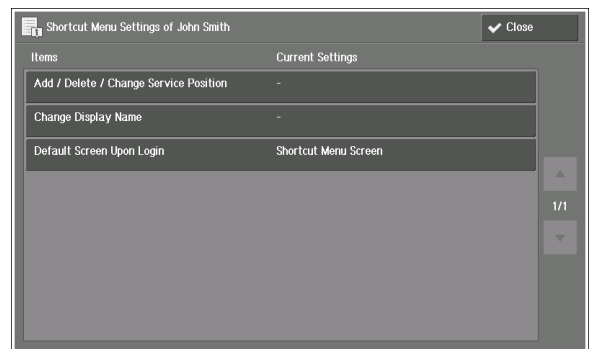

3 Select [Add].

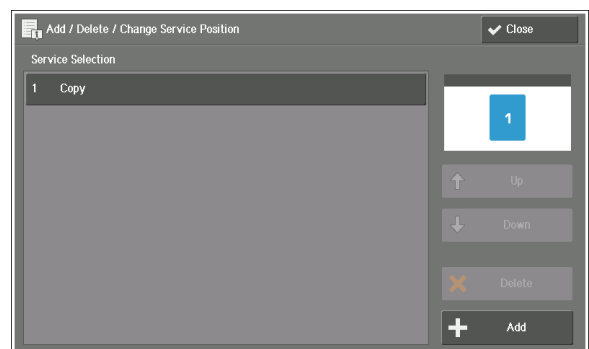

4 Choose the function to add and select [Save].

- Note**
- Use [] to show latter items of the list, such as [Fax Receiving Mode], [Activity Report], [Language], [Setup], and [Print Mode].

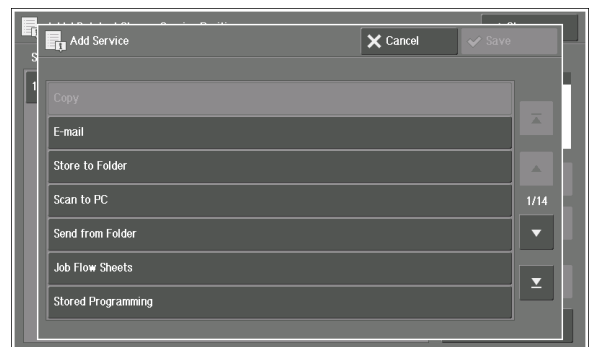

5 For newly added function, organize the screen layout.

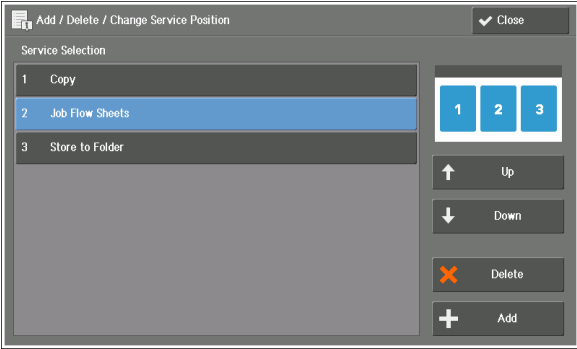

Service Selection

Functions to show on the Shortcut Menu screen are listed.

The numbers before function names are shown in the preview image on the upper right of the screen. You can check the image when allocating functions to buttons.

Up

Moves up in the list.

Down

Moves down in the list.

6 Select [Close].

7 Select [Close].

Deleting Function Buttons

1 Select [Close] (Shortcut Menu Settings) on your Shortcut Menu screen.

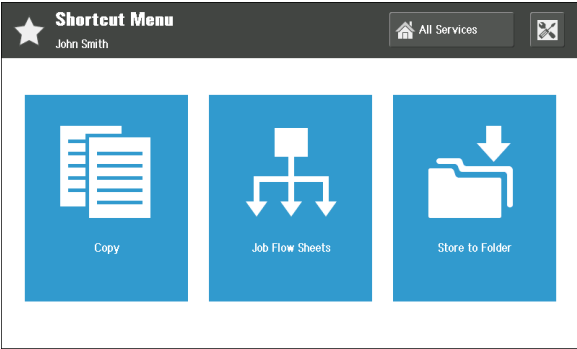

2 Select [Add / Delete / Change Service Position].

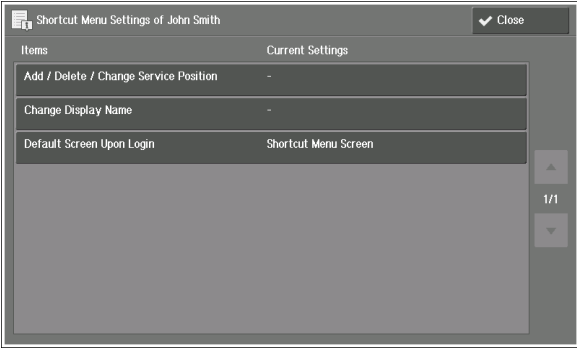

- 3 Choose the function to delete and select [Delete].

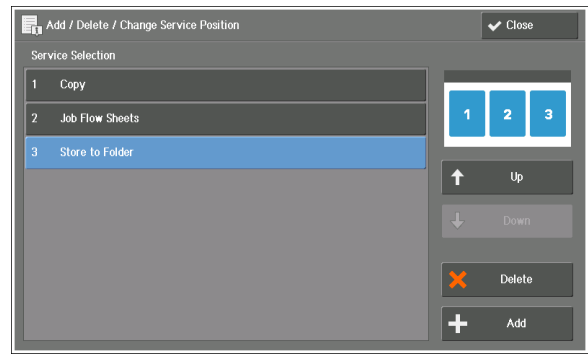

- 4 Select [Yes].



- 5 Select [Close].
- 6 Select [Close].

Changing Function Button Name

You can rename each function button on your Shortcut Menu screen.

Note • Changed name may not be displayed properly in another language.

- 1 Select [⊗] (Shortcut Menu Settings) on your Shortcut Menu screen.

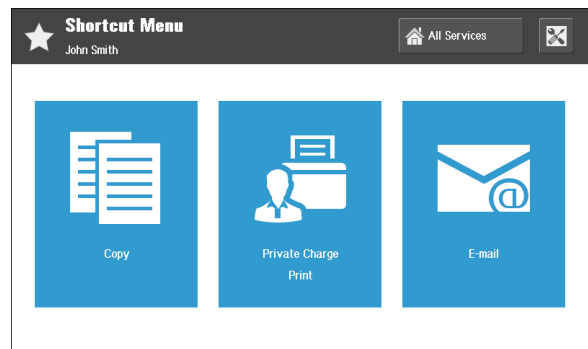

- 2 Select [Change Display Name].

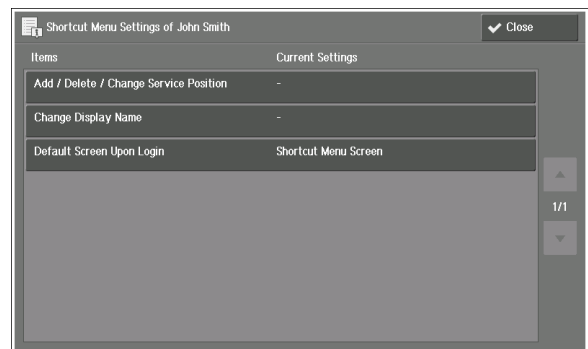

3 Choose the button to change its name.

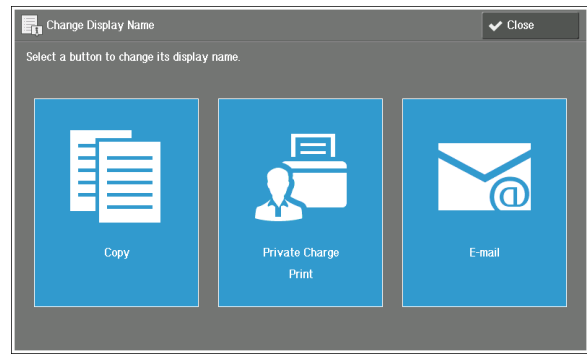

4 Enter a name with the keyboard displayed on the screen and select [Save].

Note • You can enter a name with up to two lines (17 single-byte characters per line) per button.

Line 1:

Enter characters for the first line of the button name.

Line 2:

Enter characters for the second line of the button name.

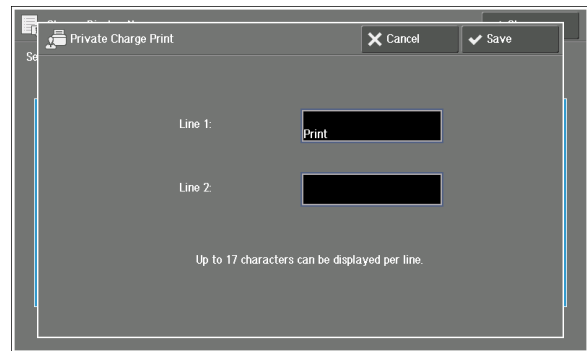

5 Check the entered name and select [Close].

6 Select [Close].

Default Screen after Authentication

While using the Private Charge Print function, any Private Charge Print job you may have can be listed as the default screen after authentication.

Note

- If there is no Private Charge Print job, the Shortcut Menu screen is displayed.
- Even when the Private Charge Print screen is set as the default screen after authentication, the Shortcut Menu screen may appear as the default screen after successive authentications by the same user. In this case, to display the Private Charge Print screen, select the Private Charge Print button on the Shortcut Menu screen.

1 Select [✕] (Shortcut Menu Settings) on your Shortcut Menu screen.

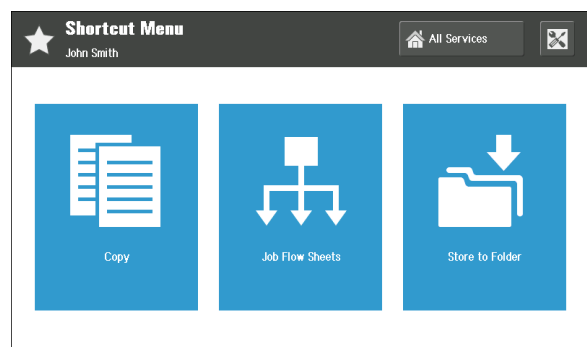

2 Select [Default Screen Upon Login].



3 Choose a screen type to show as default screen after authentication.

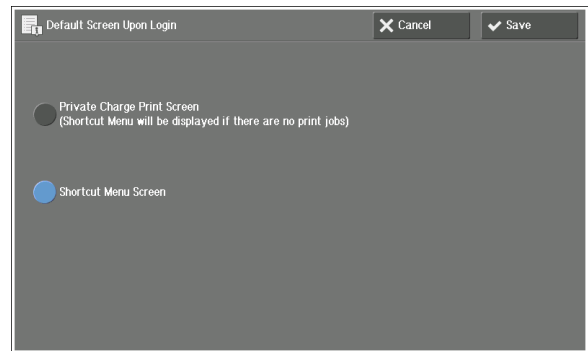

Private Charge Print Screen (Shortcut Menu will be displayed if there are no print jobs)

With any Private Charge Print job, shows the [Private Charge Print] screen.

Note

- Choosing this option automatically adds the [Private Charge Print] button on your Shortcut Menu screen. You can delete this button, but we recommend that you show it on your Shortcut Menu screen for Private Charge Print function use. Deleting this button is available from your Shortcut Menu screen by [Add / Delete / Change Service Position] under your Shortcut Menu Settings.

Shortcut Menu Screen

With or without any ongoing job, shows the Shortcut Menu screen.

4 Select [Save].

5 Select [Close].

System Administrator Settings

System administrator can configure the buttons, [All Services] and [] (Shortcut Menu Settings), to appear on the Shortcut Menu screen for local users.

Note

- For system administrator, both buttons always appear after authentication.

1 Login as system administrator.

2 Select [] (System Administrator Settings).

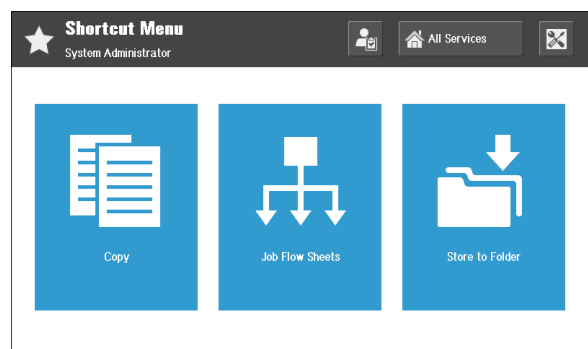

- 3 Configure below items on the [System Settings] screen.

All Services Button

For local users, system administrator can choose the [All Services] button to appear or not to appear on their Shortcut Menu screens.

Shortcut Menu Settings Button

For local users, system administrator can choose the [] (Shortcut Menu Settings) button to appear or not to appear on their Shortcut Menu screens.

When Home Is Pressed

For local users, system administrator can choose [Display Shortcut Menu Screen] or [Display Common Menu Screen] for the screen which appears after pressing the <Home> button on the control panel.

- Note**
- Setting [Do Not Show] in [All Services Button] option and [Display Shortcut Menu Screen] in [When Home Is Pressed] option at the same time prevents local users from showing the [Home] screen. To show the [Home] screen by local users, set [Display Common Menu Screen] in [When Home Is Pressed] option.

- 4 Select [Close].

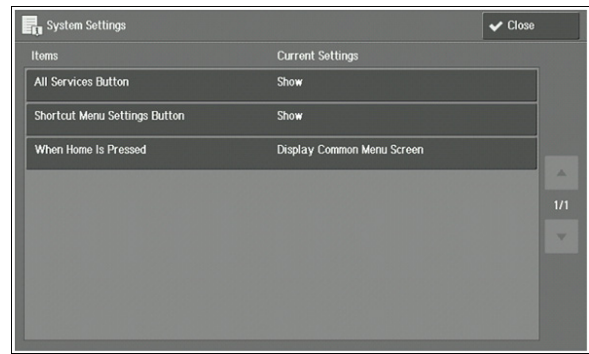

Problem Solving

This section describes troubles that may occur with your machine and their solutions.

Warning/Error Notification

Warning/error notification screen appears when an error occurs during the use of the Shortcut Menu feature.

Warning Notification

When a fault/error is detected, the warning screen appears.

Follow the onscreen instructions and reboot the machine.

If the error persists, contact Customer Support at dell.com/contactdell.

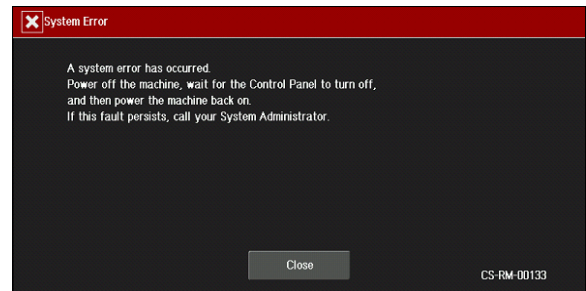

Error Notification

When a function on the Shortcut Menu screen is out of service, the error notification screen appears.

On this screen, select [Close] and then switch off the machine power, make sure that the touch screen is blank, and then switch on the machine power.

If the error persists, contact Customer Support at dell.com/contactdell.

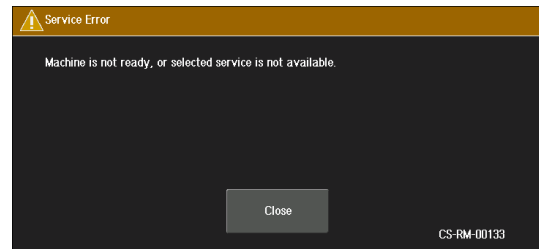

Checking Detail Information

Detail information for the Shortcut Menu feature may be required upon contacting us. Follow the procedures below to check the information.

- 1 Press the <Dial Pause> button on the control panel for over five seconds.
- 2 Check the information on the screen.

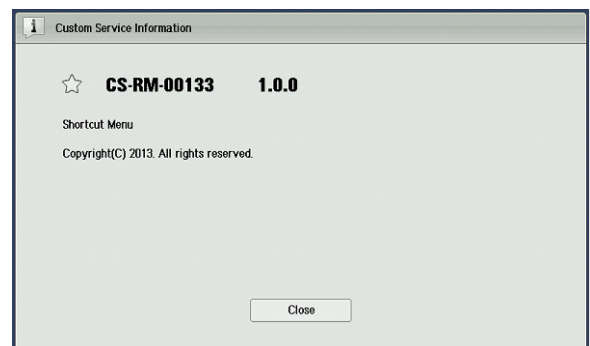

- 3 Select [Close].

Notes and Restrictions

This section describes the notes and restrictions to observe when using Shortcut Menu.

- Up to 1,000 user settings can be saved. When exceeding the limit, the user setting with the oldest record for the date of last use will be deleted automatically.
- When smart card login and login via keyboard entry are used in combination, the Shortcut Menu displayed may be different when you log in using a smart card and when you log in via keyboard entry even though it is the same user. However, the Private Charge Print files for the same user will be the same regardless of the login method.
- Changes made for Shortcut Menu settings cannot be restored to the default (in this case, system administrator's Shortcut Menu settings).

If you do not need those Shortcut Menu settings, uninstall Shortcut Menu from your machine. In this case, all the Shortcut Menu settings on your machine will be deleted.

29 Using Access Google Drive™

This chapter describes the basic operations and features for the Access Google Drive service.

- **About Access Google Drive.....768**
- **Using Google Drive from the Machine.....769**
- **Settings by a System Administrator.....785**
- **Entering Text791**
- **Problem Solving.....793**
- **Notes and Restrictions799**
- **About License.....800**

About Access Google Drive

Google Drive online storage service is a cloud service provided by Google Inc. Access Google Drive enables you to access Google Drive through the Internet with any compliant machines. Some examples of what you can do are: printing the documents saved in Google Drive, or saving the documents scanned by the machine to Google Drive. By creating a job flow sheet, the machine can automatically save scanned documents or received fax data to Google Drive.

By accessing Google Drive with an Internet-connected computer, the saved documents can be easily downloaded.

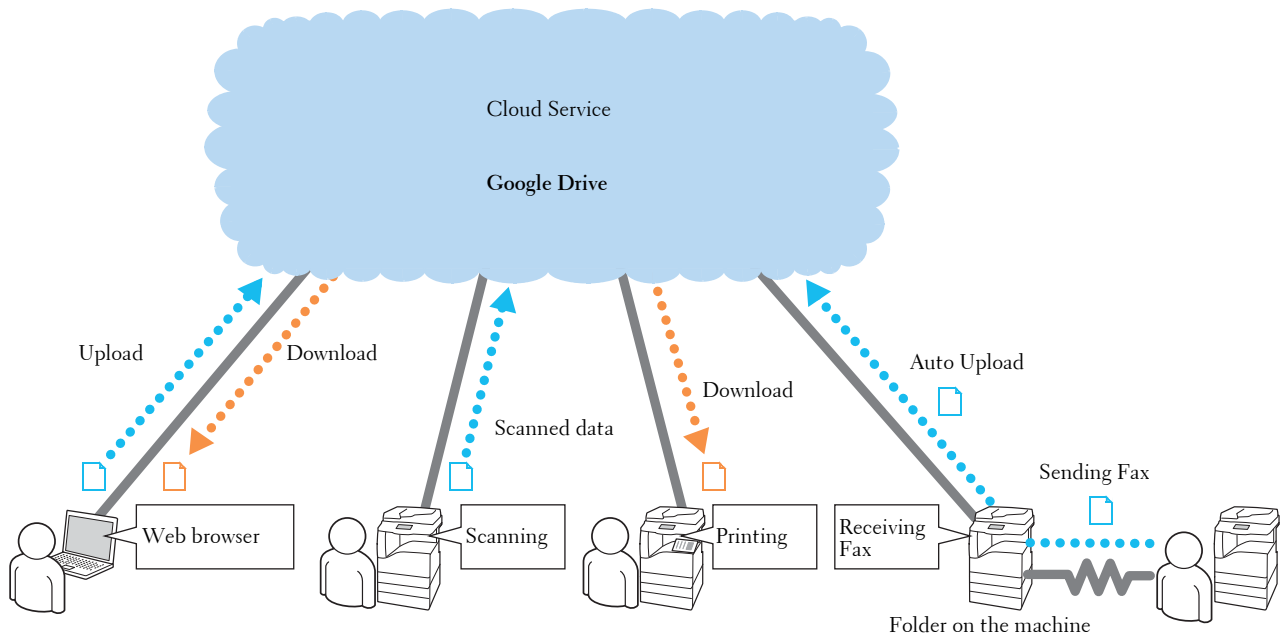

Using Google Drive from the Machine

This section describes how to use the Google Drive from the machine.

Log In / Log Out	769
About the Screens	771
Searching Files.....	774
Creating a New Collection.....	775
Printing Files.....	775
Uploading Data	777
Uploading Data Automatically from Folders.....	780

Log In / Log Out

Log In

Note • Create a Google Drive account before using this feature to log in to Google Drive. You cannot create an account from the machine.
For information on creating an account, refer to the Google Drive website.

1 Press the <Log In/Out> button on the control panel.

Note • If the machine does not use the authentication feature, skip this step and go to step 3.

2 Enter your user ID with the numeric keypad or the keyboard displayed on the screen, and select [Enter] to log in to the machine.

3 Select the [Access Google Drive] button on the [Home] screen.

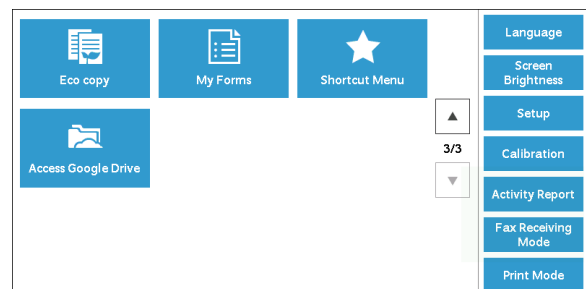

4 Enter the e-mail address and password with the keyboard displayed on the screen. Up to 256 characters are allowed for each box.
Then select [Log In].

When the Machine Uses the Authentication Feature

The following screen appears.

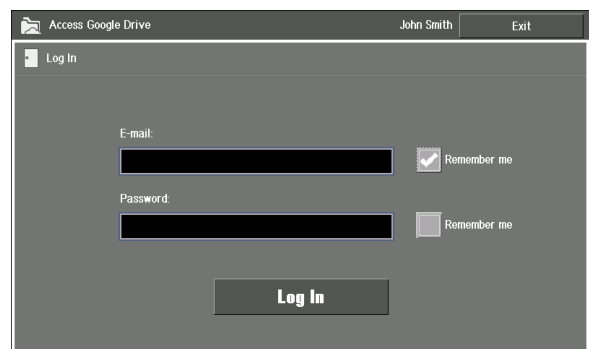

- Note**
- If [Store Authentication Details] in the administration menu is set to [On], the [Remember me] check box appears in the login screen. Select the check box to store the login information in the machine, linking with the machine user's information. Stored login information will be automatically filled in from the next time.
If [Store Authentication Details] is set to [Off], the [Remember me] check box does not appear.
For more information, refer to "Storing Authentication Information" (P.785).
 - When you set both the e-mail address and the password to be remembered, the login screen will not appear, since the machine automatically logs in to Google Drive.
 - After selecting [Log In], you may be asked to "Type the characters you see in the picture." Type the characters and select [Log In] again.

When the Machine Does Not Use the Authentication Feature

The following screen appears.

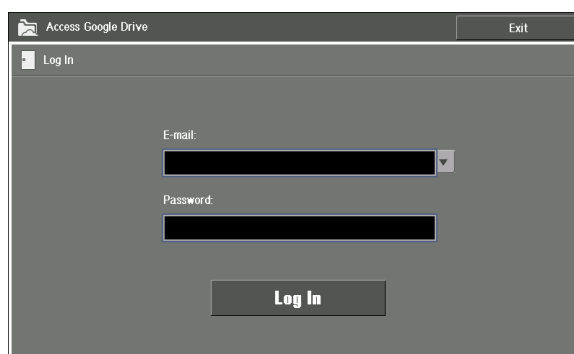

- Note**
- If [Store User History] in the administration menu is set to [On], you can select the [▼] button to select an e-mail address from the list of e-mail addresses used before.
If [Store User History] is set to [Off], the [▼] button does not appear.
For information on storing user history, refer to "Activating User History" (P.787).
 - After selecting [Log In], you may be asked to "Type the characters you see in the picture." Type the characters and select [Log In] again.

5 The Google Drive home screen appears.

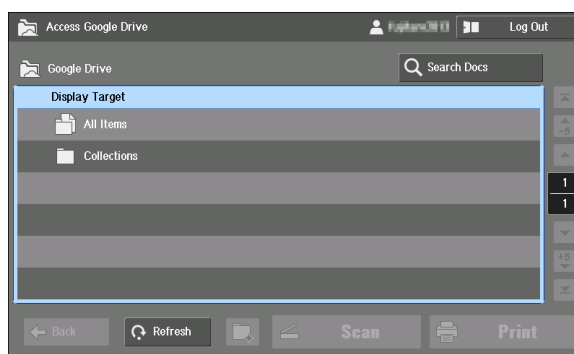

For information on the home screen items, refer to "About the Screens" (P.771).

Log Out

1 Select [Log Out] in the upper right corner of the touch screen.

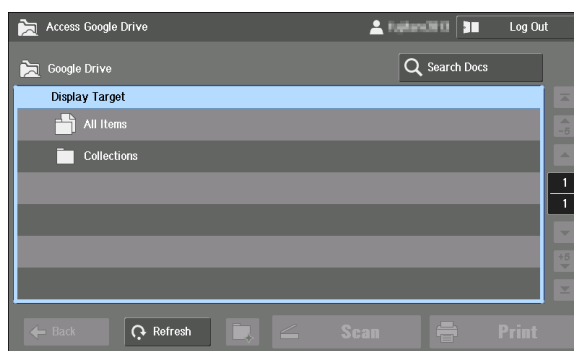

- 2 Select the [Yes] button on the confirmation screen.
- 3 Select the [Exit] button.

About the Screens

The following describes the screens displayed in this feature.

Home Screen

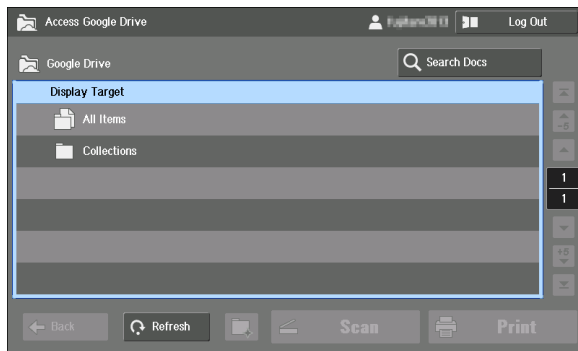

This screen appears first when you log in to Google Drive.

Select [All Items] to show all the saved items.

Select [Collections] to show the list of collections.

Note • To show the file that is not assigned to any collections, select [All Items].

[All Items] Screen

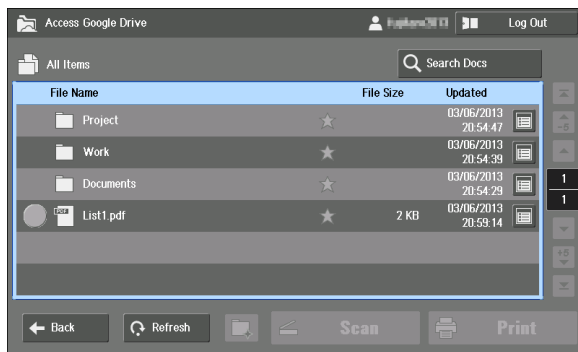

This screen shows all the saved items, in order of collections to files, updated date from new to old.

Select a collection to show the items assigned to that collection.

Note

- Up to 1024 items (in 171 pages) can be displayed. Some items cannot be displayed if the number of items exceeds the limit.
- On the list, select [▲-5]/[+5▼] to move five pages at a time, or [◀]/[▶] to show the first/last page. Use these buttons when you have many items.

[Collections] Screen

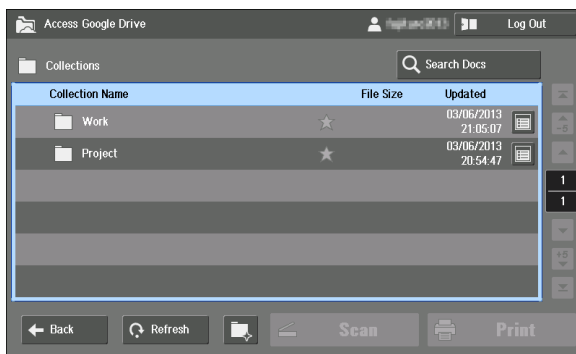

This screen shows the list of collections, in order of updated date from new to old.

Select a collection to show the items assigned to that collection.

- Note**
- Up to 1024 items (in 171 pages) can be displayed. Some items cannot be displayed if the number of items exceeds the limit.
 - On the list, select [] / [] to move five pages at a time, or [] / [] to show the first/last page. Use these buttons when you have many items.

Files Screen

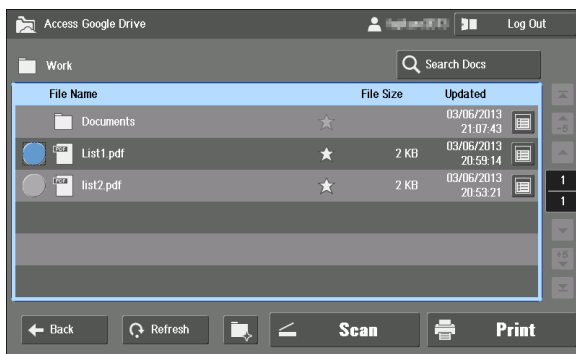

This screen shows the list of items, in order of collections to files, updated date from new to old.

- Note**
- Up to 1024 items (in 171 pages) can be displayed. Some items cannot be displayed if the number of items exceeds the limit.
 - On the list, select [] / [] to move five pages at a time, or [] / [] to show the first/last page. Use these buttons when you have many items.
 - To show the file that is not assigned to any collections, select [All Items].

The following describes the buttons displayed in this feature.

[] (Details) Button

Displays the [Details] screen of the selected collection/file. The [Details] screen shows the collection/file name, author, update date, and thumbnail of the file.

- [Open]
Displays the items assigned to the selected collection.
- [Print]
Displays the print setting screen for the selected file.
- [Close]
Closes the displayed setting screen.

For information on printing, refer to "Printing Files" (P.775).

[☆] Icon

Shows you if the item is starred or not. When a star is added, you can easily find the item by setting [Starred] as the search target in file search.

Note • For existing items, you cannot add or delete a star from your machine.

For information on file search, refer to "Searching Files" (P.774).

Back

Allows to move to the previous screen.

Refresh

Displays the latest status of the displayed items.

[📁] Button

Creates a new collection.

Note • You cannot select this button on the home screen or the [All Items] screen.

For information on creating a new collection, refer to "Creating a New Collection" (P.775).

Scan

Adds a scanned data as a new file to the displayed collection.

Note • You cannot select this button on the home screen, the [All Items] screen, or the [Collections] screen.

For information on scanning, refer to "Uploading the Scanned Data" (P.777).

Print

Displays the print setting screen of the selected item.

For information on printing, refer to "Printing Files" (P.775).

Search Docs

Searches from all files for the ones that have the specified attributes.

For information on searching files, refer to "Searching Files" (P.774).

Log Out

Log out from Google Drive and return to the login screen.

Network Connecting Screen

In this feature, the following screen appears when the machine is connecting to Google Drive.



Note • To disconnect from the network, select [Cancel].
Network connection will be canceled, and the last shown screen will be displayed.

Searching Files

This section describes how to search a file from all files by specifying a criteria.

1 Select [Search Docs].

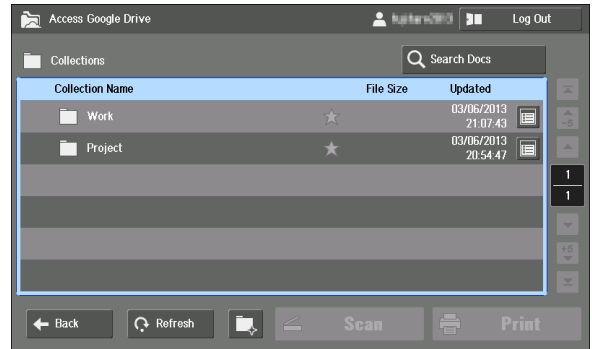

2 Select [▼] to select a search target. Then select the text box on the right.

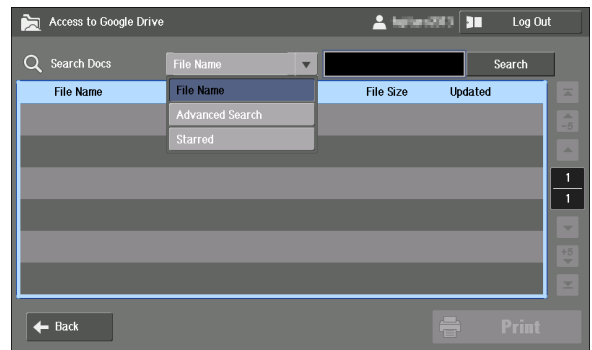

Note

- [Advanced Search] works the same way as in the cloud service.
- If you select [Starred], go to step 4 instead of selecting the text box.

3 Enter a search criteria with the keyboard displayed on the screen, and select [Enter].

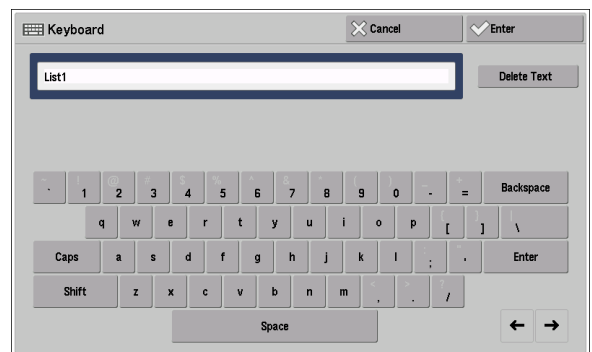

Note

- Upper and lower cases will not be distinguished on this search.

4 Select [Search].

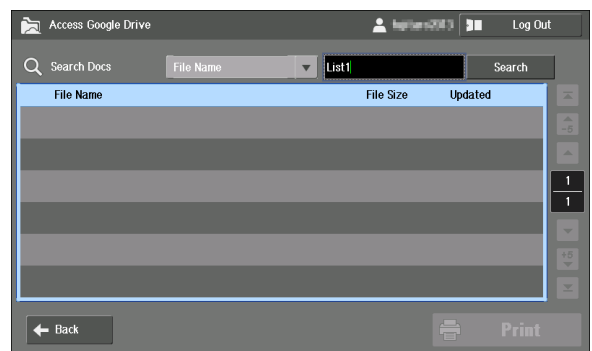

The search result will be displayed.

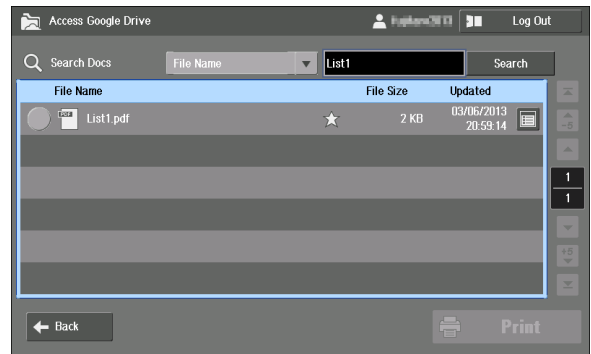

Creating a New Collection

In Google Drive, you can sort the files by linking them to collections. Files assigned to a collection will be shown in the file list for that collection.

This section describes how to create a new collection.

- 1 On the [Collections] screen or files screen, select .

Note • You cannot create a new collection from the home screen or [All Items] screen.

- 2 Select the [Collection Name] text box.

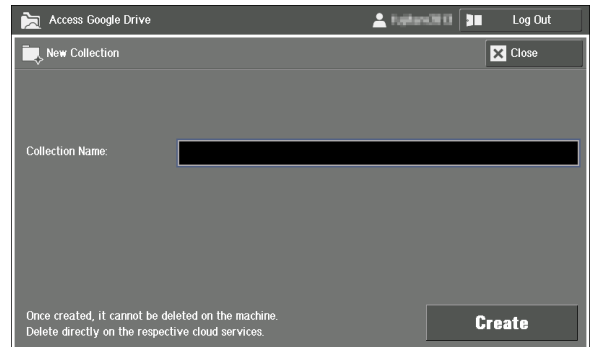

- 3 Enter the collection name with the keyboard displayed on the screen, and select [Enter].

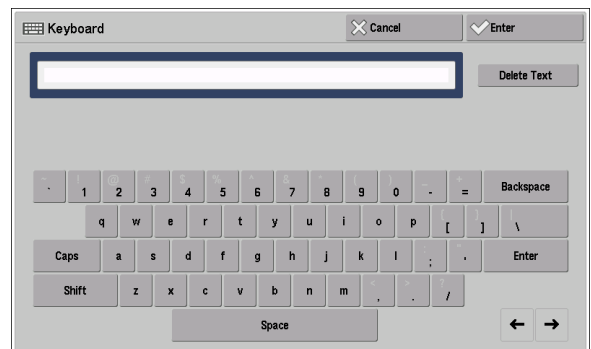

- 4 Select [Create].

Note • Collections cannot be deleted from the machine.

Printing Files

This section describes how to print the files in Google Drive with the machine.

Supported File Formats

The printable file formats with this feature are as follows:

- PDF
- JPEG

- Google Document (Document, Spreadsheet, Presentation, Form, Drawing)

File Printing

- 1 Select the file you want to print. Then select [Print].

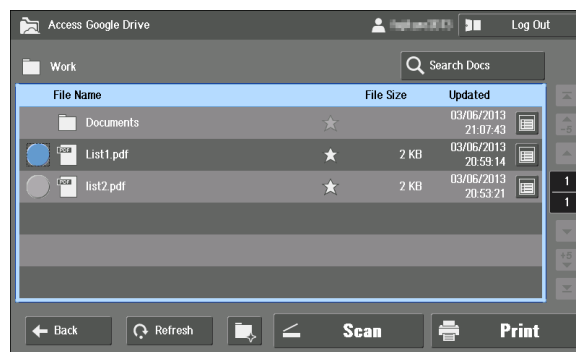

Note • You can also select [Print] from the [Details] screen of the file.

- 2 Confirm the setting, and select [Print].

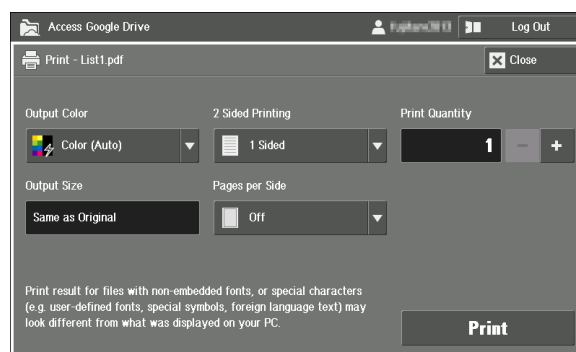

Output Color

Sets the color mode for printing. Select from [Color (Auto)] and [Black & White].

2 Sided Printing

Allows to copy 1-sided and 2-sided documents on one side or both sides of paper. Select from [1 Sided], [Flip on Long Edge], and [Flip on Short Edge].

Note • When printing JPEG files, [Flip on Long Edge] and [Flip on Short Edge] are not available.

Print Quantity

Sets the number of copy sets. Up to 999 copies are available.

Output Size

Displays the paper size. The machine sets the paper size automatically, depending on [Pages per Side] setting.

- Note**
- When you select [Off] for [Pages per Side], [Output Size] is automatically selected to [Same as Original].
 - When you select [2 Pages] or [4 Pages] for [Pages per Side], the machine will set the paper size defined by the system administrator in [System Settings] > [Common Service Settings] > [Other Settings] > [Default Print Paper Size].

Pages per Side

Allows to copy two, or four document pages onto one side of a single sheet of paper. Select from [Off], [2 Pages], and [4 Pages].

Note • When printing JPEG files, [2 Pages] and [4 Pages] are not available.

Print

Starts printing.

Close

Closes the displayed screen.

Canceling Printing

This section describes how to cancel printing after the machine has downloaded the print data and started printing.

Note • If the machine is still downloading the print data, select the [Cancel] button during the network connection to cancel printing. For more information, refer to "Network Connecting Screen" (P.773).

- 1 Press the <Job Status> button.
- 2 Select the job you want to cancel from the job list on the [Active Jobs] screen.

Note • If the job is not displayed on the screen, select the [▲]/[▼] button to show the previous/next page.
- 3 Select the [Delete] button.
- 4 Select the [Delete] button.
- 5 Select the [Close] button to return to the files screen.

Uploading Data

You can upload the scanned data directly from the machine to Google Drive, without saving it to a computer.

This section describes how to upload data.

Uploading the Scanned Data

- 1 Load a document.
- 2 Select [Scan] on the files screen.

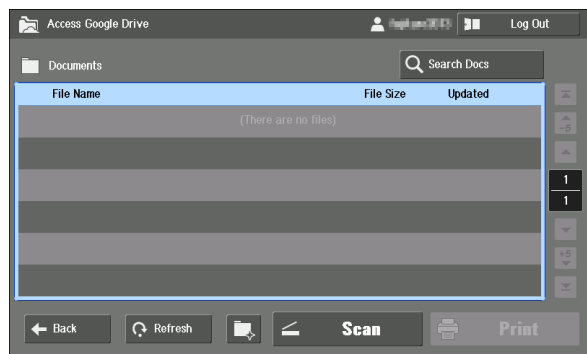

Note • [Scan] is not available on the home screen, the [All Items] screen, or the [Collections] screen.
• Scanned data will be assigned to the displayed collection.

- 3 Select how to name the file, from [Auto Name] and [Enter Name].

The following describes the example of selecting [Enter Name] and naming the file as "scan_test_DD_MM_YYYY" ("DD_MM_YYYY" being the scanning date).

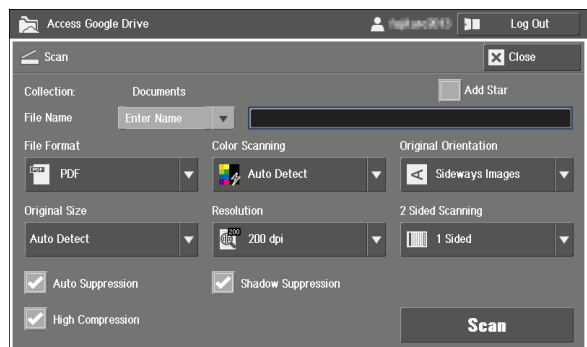

- 4 Select the [File Name] text box.

- 5 On the displayed input screen, select the text box below [Keyboard Input].

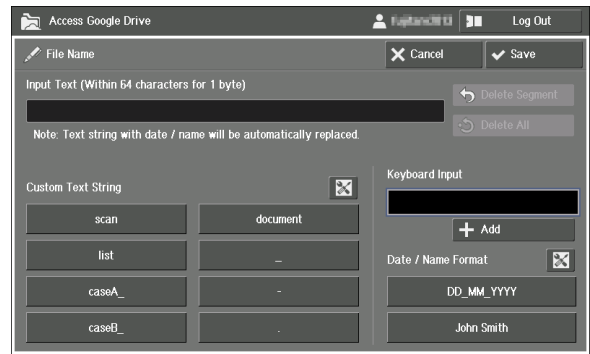

For information on the input screen, refer to "Entering Text" (P.791).

- 6 Input "scan_test" with the keyboard displayed on the screen, and select [Enter].

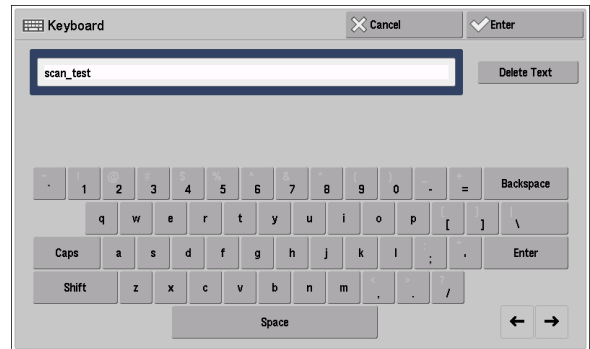

- 7 Confirm that "scan_test" is displayed in the text box below [Keyboard Input]. Then select [Add].

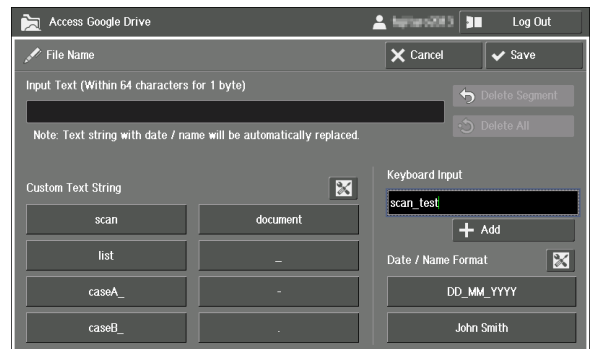

- 8 Select [_] in [Custom Text String].

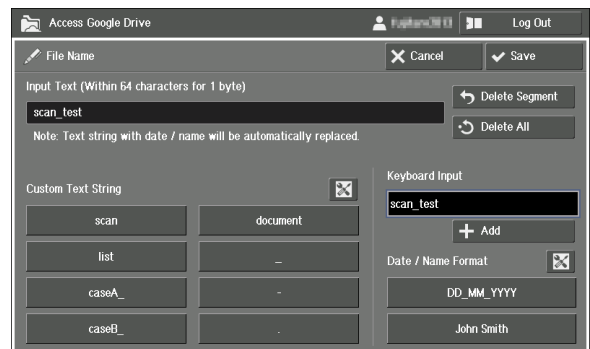

Note • You can set original strings to [Custom Text String]. For information on the setting, refer to "Setting Custom Text Strings" (P.792).

- 9 Select [DD_MM_YYYY] below [Date / Name Format].

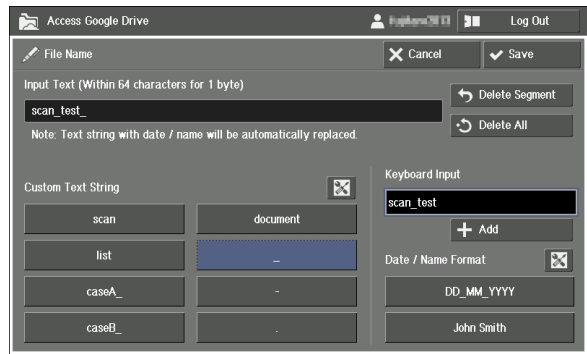

- Note**
- Text string "DD_MM_YYYY" is automatically replaced to the date when scan is run.
 - You can set a default value for the date/name. For information on the setting, refer to "Default Settings for Date / Name" (P.788).

- 10 Select [Save].

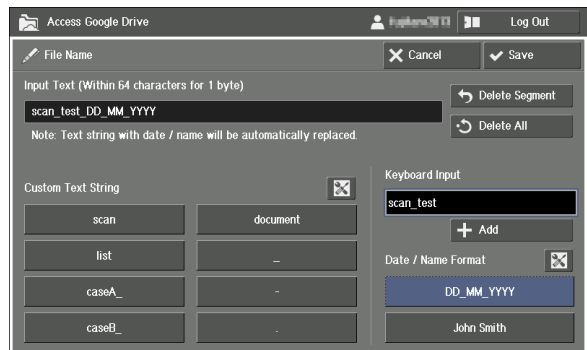

- 11 Confirm the setting, and select [Scan].

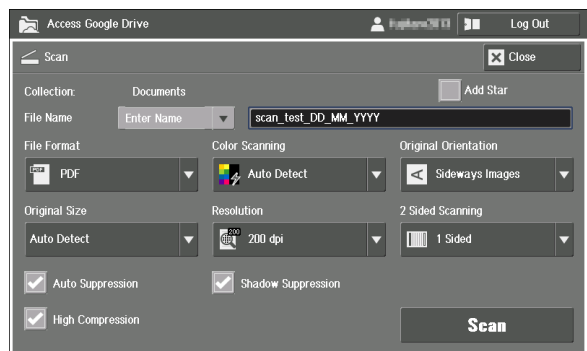

Collection

Displays the collection name which the scanned data will be assigned to.

Add Star

Allows to add a star to the scanned data. When a star is added, you can easily find the file by setting [Starred] as the search target in file search.

- Note**
- For information on searching files, refer to "Searching Files" (P.774).

File Name

Sets the file name for the scanned data.

If [Auto Name] is selected, the file will be named as "YYYYMMDDhhmmss".

If [Enter Name] is selected, you can select the text box to enter a file name from the input screen displayed. Up to 64 characters are allowed.

- Note**
- The file created cannot be deleted from the machine.
 - Text string "YYYYMMDDhhmmss" is automatically replaced to the date and time when scan is run.

For information on the input screen, refer to "Entering Text" (P.791).

File Format

The file format of the scanned data is fixed to [PDF].

Color Scanning

Sets the color mode for scanning. Select from [Auto Detect], [Color], [Grayscale], and [Black & White].

Original Orientation

Allows to specify the orientation of the document so that the machine can identify the top of the document. Select from [Sideways Images] and [Upright Images].

Original Size

Specifies the scan size for the document. Select from [Auto Detect], [Mixed Size Originals], [A3 Landscape], [A4 Landscape], [A4 Portrait], [B4 Landscape], [B5 Landscape], and [B5 Portrait].

Resolution

Sets the resolution for scanning. Select from [200 dpi] and [300 dpi].

2 Sided Scanning

Allows to copy 1-sided or 2-sided documents on one side or both sides of paper. Select from [1 Sided], [Head to Head], and [Head to Toe].

Auto Suppression

Allows to lighten the background color of documents. Select the check box to suppress the background color of documents such as newspaper and colored paper.

Note • Depending on the document type or color mode, this setting may be ignored.

Shadow Suppression

Suppresses the colors on the reverse side of the original document from being reproduced in the copy.

High Compression

Allows to set MRC high compression. Select the check box to compress and lighten the data. Lighter data will reduce burden to the network on data transfer.

Note • Depending on the document type or color mode, this setting may be ignored.

Scan

Starts scanning.

Close

Closes the displayed setting screen.

Uploading Data Automatically from Folders

The machine can automatically upload the data stored in folders to Google Drive by creating a job flow sheet with this feature and linked to folders.

- Note**
- You can save paper by using this feature, since it will enable you to check the received fax data stored in folders on a computer.
 - When the automatic uploading is unsuccessful, the job flow sheet will be sent again twice with intervals of 120 seconds. If it is still unsuccessful, the automatic uploading procedure will be finished, leaving an error.

Creating a Job Flow Sheet

- 1 Select the [📁] button for the collection you want to upload the data to.

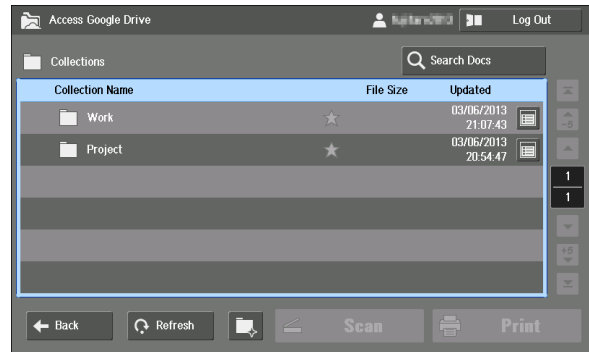

Note • You cannot create job flow sheets for [All Items], [Collections], or collections with 11 or deeper layer of directories.

- 2 Select [Create Job Flow Link to This Folder].

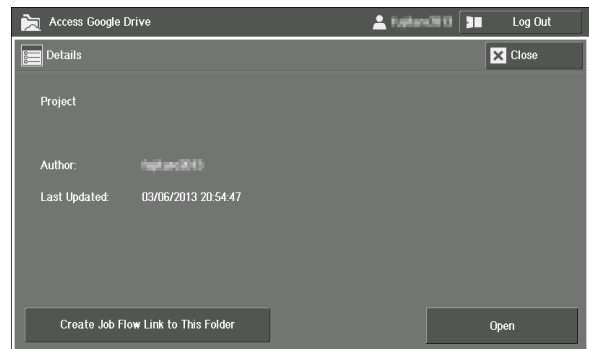

- 3 Enter [Job Flow Sheet Name]. Up to 64 characters are allowed.

Note • Do not use characters from a language other than English and the default language (the language used in the display when you turn on the machine).

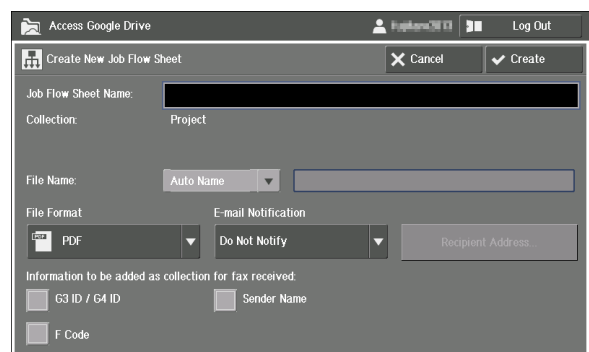

Note • You can only check the job flow sheet name and not the content, when you link the job flow sheet to a folder. We recommend you to name the job flow sheet with which shows what the job flow sheet is about.

• [Collection] shows the name of the collection to which the uploaded file will be added.

- 4 Set the [File Name] for the uploaded data.

If [Auto Name] is selected, the file will be named as "YYYYMMDDhhmmss".

If [Enter Name] is selected, you can select the text box to enter a file name from the input screen displayed. Up to 64 characters are allowed.

Note • The file created cannot be deleted from the machine.
• Text string "YYYYMMDDhhmmss" is automatically replaced to the date and time when the data is uploaded.

For information on the input screen, refer to "Entering Text" (P.791).

- 5 Set the other items if necessary, and select [Create].

File Format

Sets the file format of the uploaded data. Select from [PDF].

E-mail Notification

Sets to notify or not by e-mail when the job flow is finished. Select from [Do Not Notify], [Always Notify], and [Notify When Error].

Note • When you select [Always Notify], create a job flow sheet, and then confirm that an e-mail is correctly sent to the specified e-mail address by executing the following operations.

1. Make a link between the job flow sheet and the folder.
2. Scan a document and store it to the folder by using the Store to Folder service, and then confirm that an e-mail is correctly sent to the specified e-mail address.

For information on making a link between a job flow sheet and a folder, refer to "Making a Link between the Job Flow Sheet and the Folder" (P.783).

Recipient Address

Select the [Recipient Address] button to show the [Recipient Address Settings] screen. Set the following items.

- [E-mail Address 1] to [E-mail Address 3]

Set e-mail addresses to notify the result of the job flow when the job flow is finished. Up to 128 characters are allowed. You must set one or more addresses when you select to receive e-mail notifications.

Note • When the machine uses the authentication feature, the default value is the login user's e-mail address registered in the user information.

- [E-mail Message]

Sets a message to be written in the notification e-mail. Up to 64 characters are allowed.

Note • Do not use characters from a language other than English and the default language (the language used in the display when you turn on the machine). Otherwise, the e-mails may not be sent.

Information to be added as collection for fax received

Sets the information to be added on uploading to the received fax data.

- G3 ID / G4 ID
- Sender Name
- F Code

Note • The sender name may not be added depending on the machine used by the sender. The sender name is also not added when the sender has not made a setting to send the sender name.

- Each information will be shown as a collection, right beneath the collection which the data is uploaded. The file will be added to each of the collections.
- Depending on the sender or the fax type, some information may be unavailable. The information will not be added in that case.

6 Select [Close].

Note • You cannot view or edit the created job flow sheets, and you can delete them only from [Tools] > [Setup] > [Create Job Flow Sheet] > [Edit / Delete].

Making a Link between the Job Flow Sheet and the Folder

Make a link by selecting a job flow sheet created for the Google Drive collection from the [Link Job Flow Sheet to Folder] screen.

- 1 Select [Setup] on the [Home] screen.
- 2 Select [Create Folder].
- 3 Select the folder to link the job flow sheet.

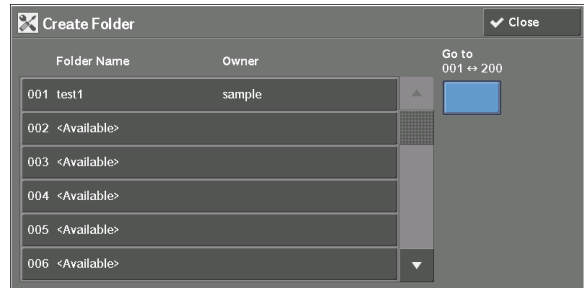

- 4 Select [Link Job Flow Sheet to Folder].

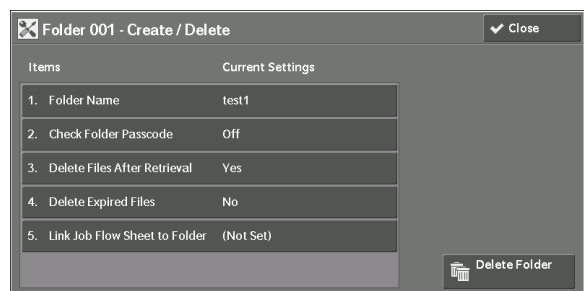

- 5 Select [Create / Change Link].

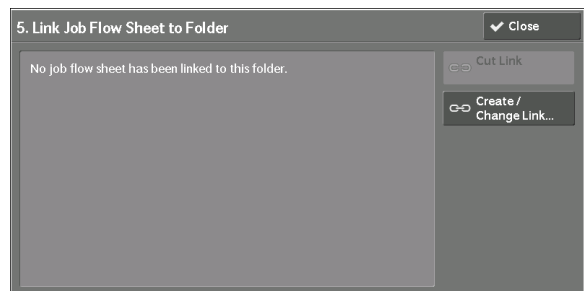

- 6 Select the job flow sheet created in "Creating a Job Flow Sheet" (P.781), and select [Save].

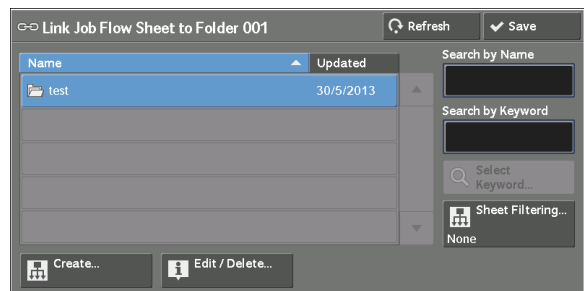

Note • You cannot check the content of job flow sheets created with [Access Google Drive] feature. "Access Google Drive" is displayed when the [Edit / Delete] button is selected.

- 7 Select the [Auto Start] check box, and then select [Close].

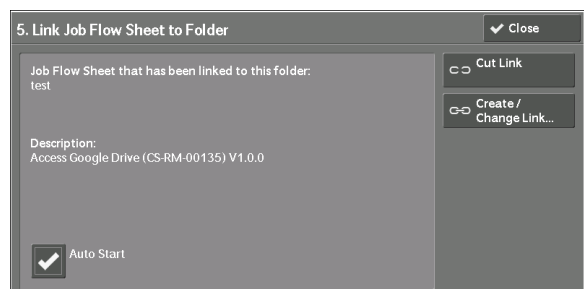

- Note**
- You can make a link between the job flow sheet and the folder in [Tools] > [Setup] > [Create Folder] > [Link Job Flow Sheet to Folder].

- 8 Select [Close] repeatedly until the [Setup] screen is displayed.
- 9 To exit [Setup], select [Close].

Settings by a System Administrator

Make the settings from the [Administration Menu] screen.

This section describes how to open the [Administration Menu] screen.

Note • When another user is logging in to the feature, return to the [Home] screen to log out, and then follow the steps below.

- 1 Log in to your machine as a system administrator.
- 2 Select [Access Google Drive] on the [Home] screen.
- 3 Select [Administration Menu].

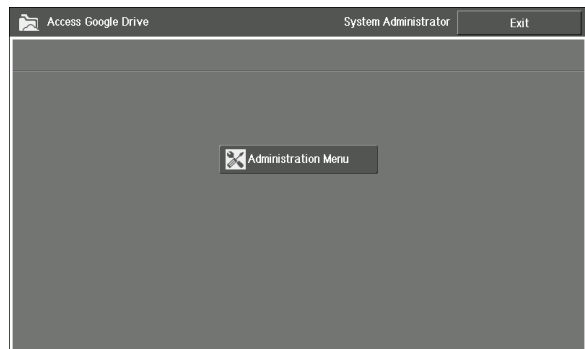

Note • If a user with a system administrator authority selects [Access Google Drive], [Administration Menu] will be displayed in the following position.



- 4 Select any options.

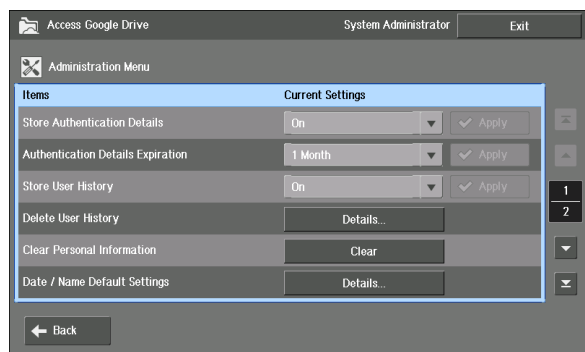

Note • Select [Back] to display the login screen for this feature.

- 5 When the settings are finished, select [Exit].

Storing Authentication Information

This section describes how to set the machine to remember the user information and the login information used to log in.

Note • This function is available only when the authentication feature is enabled.

Allowing to Store Authentication Details

- 1 Select [On] for [Store Authentication Details], and select [Apply].

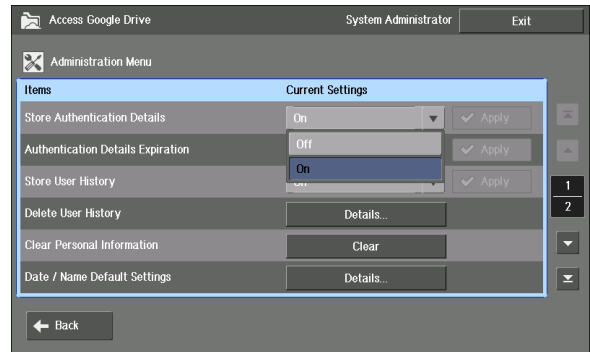

- Note**
- The [Apply] button is available only when you change the setting.
 - When this item is changed from [On] to [Off], a message is displayed to ask if all the authentication details currently stored should be deleted. If you do not delete the data, it will be stored in the machine, and could be used when this item is changed to [On] again.

- 2 From [Authentication Details Expiration], select a time period for the machine to store the authentication information, and select [Apply].

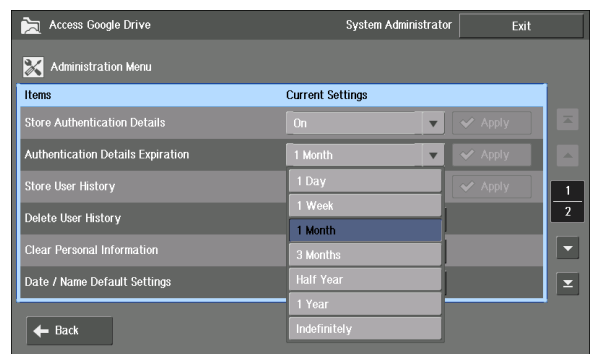

- Note**
- The [Apply] button is available only when you change the setting.
 - When the set time passes since the last login of a user, authentication information of that user is deleted.
 - Depending on the change, a confirmation screen may pop up. Confirm the setting, and select [Yes].

Deleting the Stored Authentication Information

This section describes how to delete all of the stored authentication information.

- 1 Select [Clear] for [Clear Personal Information].

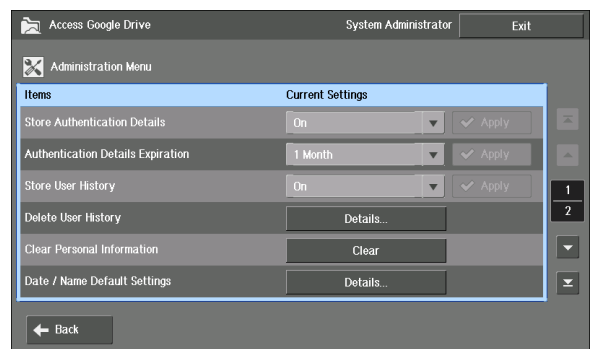

2 Select [Yes].

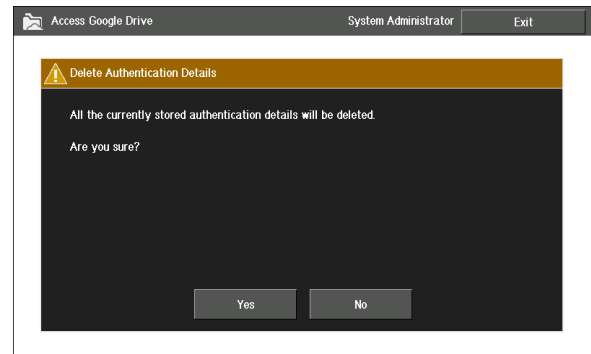

Activating User History

This section describes how to store e-mail addresses, used previously to log in, as a user history.

Note • This function is available only when the authentication feature is disabled.

Allowing to Store User History

1 Select [On] for [Store User History], and select [Apply].

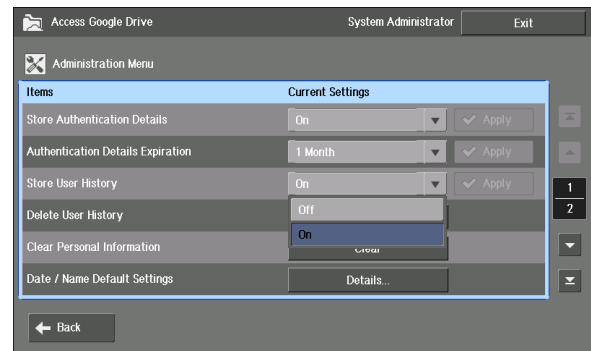

Note • The [Apply] button is available only when you change the setting.
• The user history will not be deleted even if you set [Off] for [Store User History]. The history will be available again when you change the setting to [On].

Deleting the Stored User History

This section describes how to delete a specific user history.

1 Select [Details] for [Delete User History].

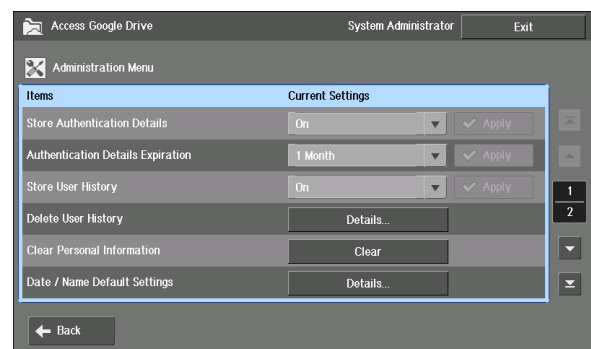

- 2 Select the user you want to delete the history, and select [Delete].

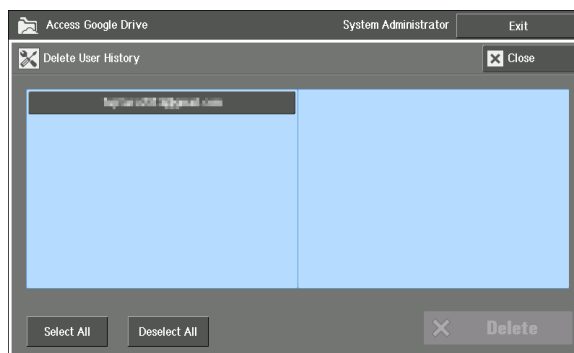

- Note**
- Select the user again to deselect.
 - The ending of a user name with more than 32 characters are omitted. When you select an user, however, up to 72 characters will be displayed at the top of the screen.

- 3 Select [Yes].

Setting the Default Value

This section describes how to set a default value for this feature -printing, scanning, and the file name input screen.

Default Settings for Date / Name

This section describes the default value for [Date / Name Default Settings] used in the file name input screen.

For details on the input screen, refer to "Entering Text" (P.791).

- 1 Select [Details] for [Date / Name Default Settings].

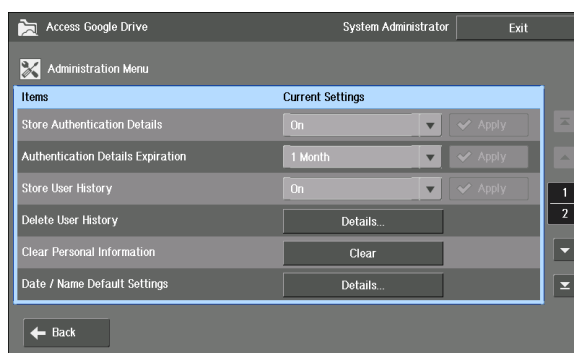

- 2 Set the default value for [Date Format], [Separator], and [Name Format]. Then select [Save].

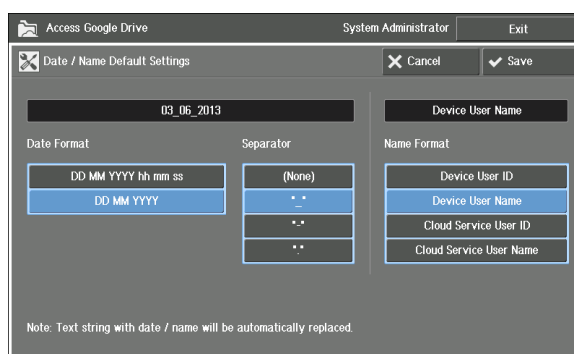

Date Format

Select whether or not to include the Hour, Minute, and Second in the default date on the input screen.

- Note**
- Text string for date and time is automatically replaced when scan is run. You can change the order of Year/Month/Day from [System Settings] > [Common Service Settings] > [Machine Clock / Timers] > [Date] > [Date Format].

Separator

Select the default separator to be used in the date. When you select [(None)], the date will be in a sequence of numbers.

Name Format

Set the default string to be used as the name on the input screen.

For using the machine user's information, select [Device User ID] or [Device User Name]. For using the authentic information of Google Drive, select [Cloud Service User ID] or [Cloud Service User Name].

Note • If you select [Device User ID] or [Device User Name] while the machine does not use the authentication feature, the string will not be shown on the file name input screen.

Default Settings for Scanning

This section describes how to set a default value for scanning.

- 1 Select [Details] for [Scan Defaults].

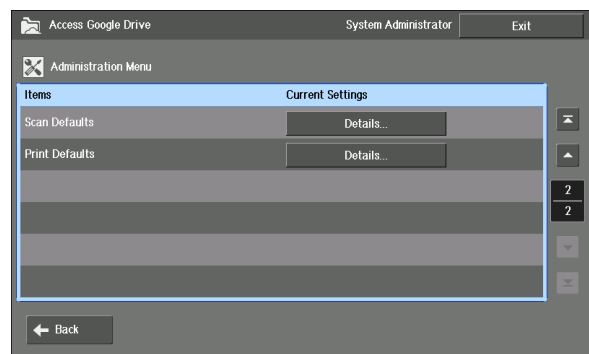

Note • [Scan Defaults] is in the second page of the administration menu. Select [] button to display.

- 2 Set the default value for scanning, and select [Save].

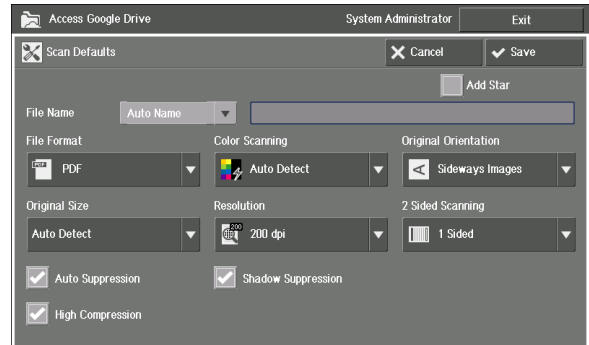

Note • Select [Enter Name] for [File Name] and enter a string to set a default name for scanned files. For the available setting items on scanning, refer to "Uploading the Scanned Data" (P.777).

Default Settings for Printing

This section describes how to set a default value for printing.

- 1 Select [Details] for [Print Defaults].

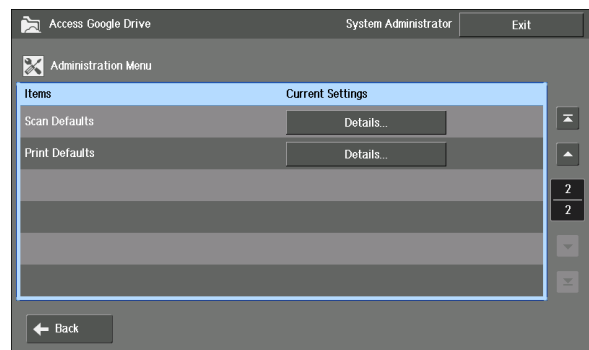

- Note** • [Print Defaults] is in the second page of the administration menu. Select the [▼] button to display.
- 2 Set the default value for printing, and select [Save].

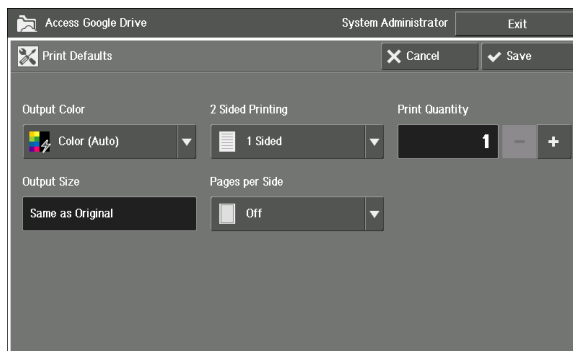

For the available setting items on printing, refer to "File Printing" (P.776).

Entering Text

For Access Google Drive, you can set some text input units in advance, such as date, user name, and word strings. With input units set, you can name items by simply pressing the button on the screen.

About the Input Screen

This section describes the input screen.

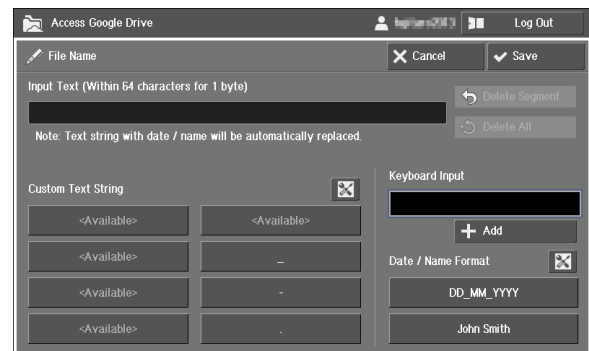

Input Text

Displays the file name to be set. Select [Save] to apply the displayed text to the file name. Up to 64 characters are allowed.

Custom Text String

Displays the text string set by the users. Select a string to add the text to [Input Text] as one segment.

For information on setting the custom text string, refer to "Setting Custom Text Strings" (P.792).

Keyboard Input

Allows to input any texts you want to add to the file name, such as some texts not set in [Custom Text String].

Select the text box, and enter a string to add with the keyboard displayed on the screen. Select [Add] to add the text to [Input Text] as one segment.

Date / Name Format

The date, and the user name or user ID are displayed. Select a string to add the text to [Input Text] as one segment.

Select the [X] button and select a string to change the text temporarily.

For information on the default date/name settings, refer to "Default Settings for Date / Name" (P.788).

Delete Segment

Delete the file name displayed in [Input Text] by segment.

Delete All

Delete every segment of the file name displayed in [Input Text].

Setting Custom Text Strings

This section describes how to set text strings for [Custom Text String] on the input screen.

Note • Custom text strings are common to all the users of the machine. Added/changed strings will be changed in other users' setting as well.

- 1 On the input screen, select the [] button next to [Custom Text String].

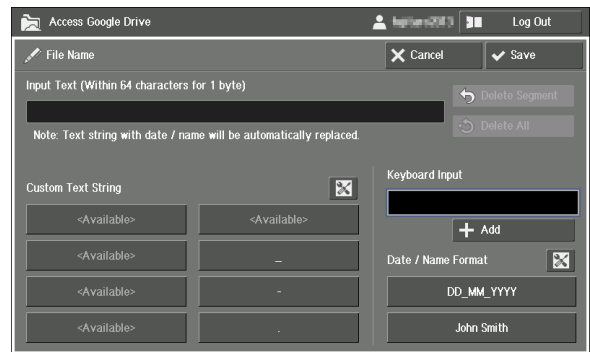

- 2 Select [<Available>] or the string you want to change. Then select the text box at the bottom.

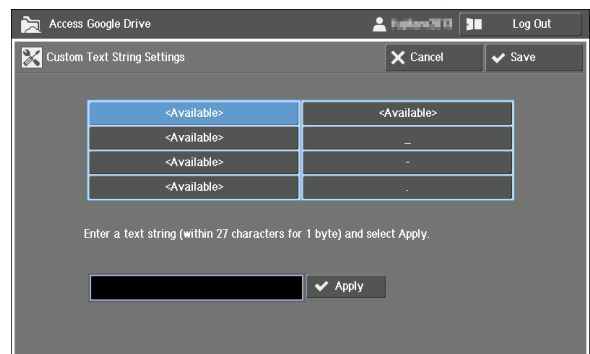

- 3 Enter text with the keyboard displayed on the screen, and select [Enter].
- 4 Select [Apply].
- 5 Make sure the text is copied from the text box to the string, and select [Save].

The registered texts are added to [Custom Text String].

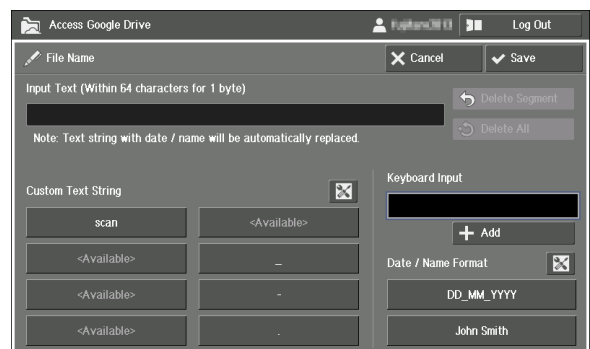

Problem Solving

This section describes troubles that may occur with the machine and their solutions. Follow the troubleshooting described below to solve the problems.

Troubleshooting

Unable to start Access Google Drive

Symptom	Cause and Remedy
The screen turns white and does not appear after selecting [Access Google Drive].	<p>[Cause] The web browser setting is incorrect.</p> <p>[Remedy] Set [V4 (New Version)] in [System Settings] > [Web Browser Setup] > [Web Applications Version].</p>

Unable to login to this feature/to connect to the network

Symptom	Cause and Remedy
"Communication Error" is displayed on the screen.	<p>[Cause] Probable causes are as follows:</p> <ol style="list-style-type: none"> 1) Proxy connection error occurred. 2) [Advanced Search] was selected for item searching, and [is:starred], [is:hidden], or [is:archived] was input as the criteria. 3) Network error occurred. <p>[Remedy] For 1, check that proxy settings in the machine are correct.</p> <p>For 2, set another search criteria. [is:starred], [is:hidden], and [is:archived] search are not available in this feature.</p> <p>For 3, check that the network cable connection and the usage environment settings are correct.</p>
"Authentication Error" is displayed on the screen.	<p>[Cause] Login has expired.</p> <p>[Remedy] Select [Close], and then login to this feature again.</p>
"Timeout" is displayed on the screen.	<p>[Cause] Network connection timed out because of an overload.</p> <p>[Remedy] Wait for a while, and then repeat the same steps.</p>

Unable to view items

Symptom	Cause and Remedy
The collection/file is not shown in the list.	<p>[Cause] Probable causes are as follows:</p> <ol style="list-style-type: none"> 1) Failed to connect with HTTP server. 2) The number of collections/files exceeded the display limit. <p>[Remedy] For 1, check the HTTP settings.</p> <p>For 2, lessen the collections/files to 1024 or less, or change the latest update date of the item to bring it to the top of the list.</p>
The search result differs from the specified criteria.	<p>[Cause] The time zone of the machine and the cloud service does not match.</p> <p>[Remedy] Match the time zone of the machine and the cloud service.</p> <p>You can set the time zone for the machine in [Tools] > [Common Service Settings] > [Machine Clock / Timers] > [Time Zone].</p>

Unable to print

Symptom	Cause and Remedy
Unable to print by selecting [Print].	<p>[Cause] The user is not allowed to print.</p> <p>[Remedy] Confirm with the system administrator if you are allowed to print.</p>

Unable to upload data

Symptom	Cause and Remedy
The scan data is not added to the cloud service, although the machine has finished scanning or stored a document in a folder with a job flow sheet linked to.	<p>[Cause] An error occurred in data transferring to the cloud service.</p> <p>[Remedy] Check [Status] from the [Job Status] screen. If "Completed -Error" is displayed, printout a job history report and check the status code to remedy.</p>

Unable to create job flow sheet

Symptom	Cause and Remedy
"Failed to create Job Flow Sheet." is displayed on the screen when trying to create a new job flow sheet.	<p>[Cause] Probable causes are as follows:</p> <ol style="list-style-type: none"> 1) The created job flow sheet reached the maximum allowable number. 2) The job flow sheet name includes characters from a language other than English and the default language. <p>[Remedy] For 1, delete unneeded job flow sheets.</p> <p>You can delete a job flow sheet in [Tools] > [Setup] > [Create Job Flow Sheet] > [Edit / Delete].</p> <p>For 2, select [Close] and rename the [Job Flow Sheet Name].</p>

Status Code

A status code is displayed on the touch screen or job history report if any error occurs while using this feature.

Refer to the status codes in the following table to resolve problems.

Note • If a status code is displayed, any print data remaining in the machine and information stored in the machine's memory is not secured.

If the displayed status code is not listed in the following table, refer to "23 Problem Solving" > "Status Code" in the User's Guide.

Status Code	Cause and Remedy
01-001	<p>[Cause] Hard disk error occurred during transmissions.</p> <p>[Remedy] Switch off the machine power, make sure that the touch screen is blank, and then switch on the machine power. If the same message is displayed again, contact Customer Support at dell.com/contactdell.</p>
01-002	<p>[Cause] Data in the hard disk may have been damaged.</p> <p>[Remedy] Switch off the machine power, make sure that the touch screen is blank, and then switch on the machine power. If the same message is displayed again, contact Customer Support at dell.com/contactdell.</p>
01-10x (x: 1-9)	<p>[Cause] A problem occurred with this feature.</p> <p>[Remedy] Check for a newer version of this feature. If you were already using the latest version, contact Customer Support at dell.com/contactdell.</p> <p>For checking the version of this feature, refer to "Checking the Content Status" (P.798).</p>
01-30x (x: 1-9)	<p>[Cause] An error occurred in communication between the machine and the cloud service.</p> <p>[Remedy] Try the same operation again. If the problem still remains, check for a newer version of this feature. If you were already using the latest version, contact Customer Support at dell.com/contactdell.</p> <p>For checking the version of this feature, refer to "Checking the Content Status" (P.798).</p>

Status Code	Cause and Remedy
02-101	<p>[Cause] The required plugin is disabled.</p> <p>[Remedy] Check the following settings from Dell Printer Configuration Web Tool:</p> <ol style="list-style-type: none"> 1) Make sure that [Enabled] is checked in [Properties] > [Security] > [Plug-in Settings] > [Plug-in Settings]. 2) Make sure that [Activated] is displayed for [Status] in both [Properties] > [Security] > [Plug-in Settings] > [List of Embedded Plug-ins] > [GoogleDriveLib] and [GoogleDrive]. <p>Note • If the machine power is turned off at an unexpected timing, plug-in may automatically be invalid.</p>
02-201	<p>[Cause] Since Port 9100 is disabled, this feature could not be started.</p> <p>[Remedy] Enable Port 9100. Also enable SOAP port, and check that SOAP port number is set to 80.</p>
02-202	<p>[Cause] Since SOAP port is disabled, this feature could not be started.</p> <p>[Remedy] Enable SOAP port. Also check that the SOAP port number is set to 80, and that Port 9100 is enabled.</p>
02-203	<p>[Cause] Since the SOAP port number is incorrect, this feature could not be started.</p> <p>[Remedy] Check that the SOAP port number is set to 80, and that Port 9100 is enabled.</p>
02-301	<p>[Cause] Since the proxy setting or DNS setting is incorrect, proxy server or DNS name resolution for the cloud service failed.</p> <p>[Remedy] Check that the proxy setting and DNS setting are correct.</p>
02-302	<p>[Cause] An error occurred during proxy server authentication.</p> <p>[Remedy] Check that the user name and password for proxy server authentication are correct.</p>
02-303	<p>[Cause] A communication error occurred between the proxy server and the cloud service.</p> <p>[Remedy] From a computer on the same network, access to the cloud service to check that no filter setting is enabled.</p>
03-301	<p>[Cause] The network is terminated. Probable causes are as follows:</p> <ol style="list-style-type: none"> 1) A network cable has been pulled out. 2) Proxy setting is required, but has not been set. 3) The cloud server has a trouble. <p>[Remedy] For 1, confirm that the network cables are connected.</p> <p>For 2, check the proxy setting for the machine.</p> <p>For 3, wait for a while, and then execute the operation again.</p>
04-301	<p>[Cause] Cannot log in to the cloud service.</p> <p>[Remedy] Delete the job flow sheet for automatic uploading, and create a job flow sheet again.</p>
04-303	<p>[Cause] The cloud service account does not exist.</p> <p>[Remedy] From a computer or other platforms, access the cloud service and create an account.</p>
04-304	<p>[Cause] The user does not have the right to access the selected folder.</p> <p>[Remedy] From a computer or other platforms, log in as a user authorized to change the access setting for the folder. Then enable the user access.</p>

Status Code	Cause and Remedy
04-307	<p>In case the status code is displayed on the touch panel: [Cause] The data amount in the cloud service exceeded the limit. [Remedy] From a computer or other platforms, access the cloud service and delete some data.</p> <p>In case the status code is displayed in the report: [Cause] 1) The data amount in the cloud service exceeded the limit. 2) The scan data size exceeded the limit of one-time upload. [Remedy] For 1, access the cloud service from a computer or other platforms, and delete some data. For 2, reduce the data size, by reducing the document pages or [Resolution]. Then scan again.</p>
04-309	<p>[Cause] The selected item has no content. [Remedy] Check the content of the item.</p>
04-310	<p>[Cause] Cannot log in to the cloud service upon carrying out a job flow sheet. [Remedy] Log in to the cloud server from the machine by using [Access Google Drive] feature.</p>
04-401	<p>[Cause] The selected collection/file does not exist. [Remedy] Close the error screen, and select [Refresh] to refresh the display. If you are using an automatic uploading feature, delete and create the job flow sheet again.</p> <p>Note • If you are using an automatic uploading feature, you cannot solve this problem by creating a collection with the same name as the one specified in the job flow sheet. However, if the specified collection is grouped as a collection scheduled for removal, the problem may be solved by placing the collection back to its original group.</p>
04-501	<p>[Cause] An error occurred during scanning. Probable causes are as follows: 1) A language other than English and the default language is included in the name of the collection which the scan data is to be linked to. 2) A language other than English and the default language is included in the name of the scan data file. 3) An internal error occurred.</p> <p>[Remedy] For 1, select a collection named with only English and the default language. For 2, change the file name. For 3, contact Customer Support at dell.com/contactdell.</p>
11-xxx (xxx: 001-999)	<p>[Cause] A problem occurred with this feature. [Remedy] Check for a newer version of this feature. If you were already using the latest version, contact Customer Support at dell.com/contactdell. For checking the version of this feature, refer to "Checking the Content Status" (P.798).</p>

Checking the Content Status

Confirm the software version for this feature. Contents status for this feature may be needed when contacting the customer support. Follow the procedure below to check the contents status.

- 1 While using this feature, hold the <Dial Pause> button on the control panel for more than five seconds.
- 2 Check the content status.

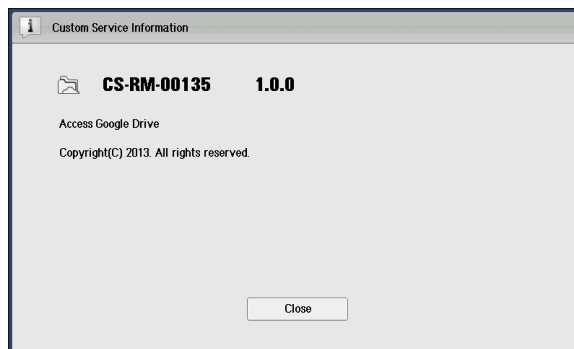

- 3 Select [Close].

Notes and Restrictions

This section describes the notes and restrictions to observe when using this feature.

Notes and Restrictions on the Use of the Machine

- When [Store Authentication Details] in the administration menu is set to [On], newest 100 authentication information is stored in the machine. If the number exceeds, information of the user with the oldest usage date is deleted.
- When storing user history is set to on, newest 16 e-mail addresses are stored in the machine. If the number exceeds, data of the user with the oldest usage date is deleted.
- It is recommended to set a short time span for [Authentication Details Expiration]. If it is not, even if the information on user register is changed in the machine, the old authentication information such as e-mail address and password may be displayed.

When changing the authentication mode for the machine, be sure to delete all of the stored authentication information from [Clear Personal Information].

- This feature is unavailable when [Login Type] is set to [No Login Required], and [Accounting Type] is set to [Network Accounting] for the machine. If printing is executed, it will cause an error (016-757).
- When the Google Drive time zone setting and the setting in [System Settings] > [Common Service Settings] > [Machine Clock / Timers] > [Time Zone] do not match, date related searching may not work properly.
- When [Auto Clear] is set to [On], the machine may be cleared without notice if the set time passes while communicating with the cloud service. Set a longer time for the [Auto Clear] when transferring a large sized data.

You can set the timer in [Tools] > [Common Service Settings] > [Machine Clock / Timers] > [Auto Clear].

Notes and Restrictions on the Use of the Print Feature

- Due to Google Drive specification, the printout may not match with the print instructed document.
- Spreadsheet is always printed in Letter (8.5 x 11") size, regardless of the machine settings. If you do not use a letter sized paper, change settings to [Use Closest Size] from [System Settings] > [Print Service Settings] > [Other Settings] > [Substitute Tray].
- This feature always print on a plain paper. The paper type cannot be specified.
- Some print options (such as stapling, punching, and stacking) are not supported in conjunction with Access Google Drive even when the finisher is installed.

Notes and Restrictions on the Use of the Scan Feature

- For collection with more than 10 layers of directories, the 11th or deeper layer cannot be selected, although they are shown on the screen.

About License

This software uses the following library provided by Google Inc.

- Google APIs Client Library for Java
- Google HTTP Client Library for Java

Copyright (c) 2011 Google Inc.

Licensed under the Apache License, Version 2.0 (the "License"); you may not use this file except in compliance with the License. You may obtain a copy of the License at

<http://www.apache.org/licenses/LICENSE-2.0>

Unless required by applicable law or agreed to in writing, software distributed under the License is distributed on an "AS IS" BASIS, WITHOUT WARRANTIES OR CONDITIONS OF ANY KIND, either express or implied.

See the License for the specific language governing permissions and limitations under the License.

Apache License

Version 2.0, January 2004

<http://www.apache.org/licenses/>

TERMS AND CONDITIONS FOR USE, REPRODUCTION, AND DISTRIBUTION

1. Definitions.

"License" shall mean the terms and conditions for use, reproduction, and distribution as defined by Sections 1 through 9 of this document.

"Licensor" shall mean the copyright owner or entity authorized by the copyright owner that is granting the License.

"Legal Entity" shall mean the union of the acting entity and all other entities that control, are controlled by, or are under common control with that entity. For the purposes of this definition, "control" means (i) the power, direct or indirect, to cause the direction or management of such entity, whether by contract or otherwise, or (ii) ownership of fifty percent (50%) or more of the outstanding shares, or (iii) beneficial ownership of such entity.

"You" (or "Your") shall mean an individual or Legal Entity exercising permissions granted by this License.

"Source" form shall mean the preferred form for making modifications, including but not limited to software source code, documentation source, and configuration files.

"Object" form shall mean any form resulting from mechanical transformation or translation of a Source form, including but not limited to compiled object code, generated documentation, and conversions to other media types.

"Work" shall mean the work of authorship, whether in Source or Object form, made available under the License, as indicated by a copyright notice that is included in or attached to the work (an example is provided in the Appendix below).

"Derivative Works" shall mean any work, whether in Source or Object form, that is based on (or derived from) the Work and for which the editorial revisions, annotations, elaborations, or other modifications represent, as a whole, an original work of authorship. For the purposes of this License, Derivative Works shall not include works that remain separable from, or merely link (or bind by name) to the interfaces of, the Work and Derivative Works thereof.

"Contribution" shall mean any work of authorship, including the original version of the Work and any modifications or additions to that Work or Derivative Works thereof, that is intentionally submitted to Licensor for inclusion in the Work by the copyright owner or by an individual or Legal Entity authorized to submit on behalf of the copyright owner. For the purposes of this definition, "submitted" means any form of electronic, verbal, or written communication sent to the Licensor or its representatives, including but not limited to communication on electronic mailing lists, source code control systems, and issue tracking systems that are managed by, or on behalf of, the Licensor for the purpose of discussing and improving the Work, but excluding communication that is conspicuously marked or otherwise designated in writing by the copyright owner as "Not a Contribution."

"Contributor" shall mean Licensor and any individual or Legal Entity on behalf of whom a Contribution has been received by Licensor and subsequently incorporated within the Work.

2. Grant of Copyright License. Subject to the terms and conditions of this License, each Contributor hereby grants to You a perpetual, worldwide, non-exclusive, no-charge, royalty-free, irrevocable copyright license to reproduce, prepare Derivative Works of, publicly display, publicly perform, sublicense, and distribute the Work and such Derivative Works in Source or Object form.

3. **Grant of Patent License.** Subject to the terms and conditions of this License, each Contributor hereby grants to You a perpetual, worldwide, non-exclusive, no-charge, royalty-free, irrevocable (except as stated in this section) patent license to make, have made, use, offer to sell, sell, import, and otherwise transfer the Work, where such license applies only to those patent claims licensable by such Contributor that are necessarily infringed by their Contribution(s) alone or by combination of their Contribution(s) with the Work to which such Contribution(s) was submitted. If You institute patent litigation against any entity (including a cross-claim or counterclaim in a lawsuit) alleging that the Work or a Contribution incorporated within the Work constitutes direct or contributory patent infringement, then any patent licenses granted to You under this License for that Work shall terminate as of the date such litigation is filed.
4. **Redistribution.** You may reproduce and distribute copies of the Work or Derivative Works thereof in any medium, with or without modifications, and in Source or Object form, provided that You meet the following conditions:
 - (a) You must give any other recipients of the Work or Derivative Works a copy of this License; and
 - (b) You must cause any modified files to carry prominent notices stating that You changed the files; and
 - (c) You must retain, in the Source form of any Derivative Works that You distribute, all copyright, patent, trademark, and attribution notices from the Source form of the Work, excluding those notices that do not pertain to any part of the Derivative Works; and
 - (d) If the Work includes a "NOTICE" text file as part of its distribution, then any Derivative Works that You distribute must include a readable copy of the attribution notices contained within such NOTICE file, excluding those notices that do not pertain to any part of the Derivative Works, in at least one of the following places: within a NOTICE text file distributed as part of the Derivative Works; within the Source form or documentation, if provided along with the Derivative Works; or, within a display generated by the Derivative Works, if and wherever such third-party notices normally appear. The contents of the NOTICE file are for informational purposes only and do not modify the License. You may add Your own attribution notices within Derivative Works that You distribute, alongside or as an addendum to the NOTICE text from the Work, provided that such additional attribution notices cannot be construed as modifying the License.

You may add Your own copyright statement to Your modifications and may provide additional or different license terms and conditions for use, reproduction, or distribution of Your modifications, or for any such Derivative Works as a whole, provided Your use, reproduction, and distribution of the Work otherwise complies with the conditions stated in this License.

5. **Submission of Contributions.** Unless You explicitly state otherwise, any Contribution intentionally submitted for inclusion in the Work by You to the Licensor shall be under the terms and conditions of this License, without any additional terms or conditions. Notwithstanding the above, nothing herein shall supersede or modify the terms of any separate license agreement you may have executed with Licensor regarding such Contributions.
6. **Trademarks.** This License does not grant permission to use the trade names, trademarks, service marks, or product names of the Licensor, except as required for reasonable and customary use in describing the origin of the Work and reproducing the content of the NOTICE file.

7. **Disclaimer of Warranty.** Unless required by applicable law or agreed to in writing, Licensor provides the Work (and each Contributor provides its Contributions) on an "AS IS" BASIS, WITHOUT WARRANTIES OR CONDITIONS OF ANY KIND, either express or implied, including, without limitation, any warranties or conditions of TITLE, NON-INFRINGEMENT, MERCHANTABILITY, or FITNESS FOR A PARTICULAR PURPOSE. You are solely responsible for determining the appropriateness of using or redistributing the Work and assume any risks associated with Your exercise of permissions under this License.
8. **Limitation of Liability.** In no event and under no legal theory, whether in tort (including negligence), contract, or otherwise, unless required by applicable law (such as deliberate and grossly negligent acts) or agreed to in writing, shall any Contributor be liable to You for damages, including any direct, indirect, special, incidental, or consequential damages of any character arising as a result of this License or out of the use or inability to use the Work (including but not limited to damages for loss of goodwill, work stoppage, computer failure or malfunction, or any and all other commercial damages or losses), even if such Contributor has been advised of the possibility of such damages.
9. **Accepting Warranty or Additional Liability.** While redistributing the Work or Derivative Works thereof, You may choose to offer, and charge a fee for, acceptance of support, warranty, indemnity, or other liability obligations and/or rights consistent with this License. However, in accepting such obligations, You may act only on Your own behalf and on Your sole responsibility, not on behalf of any other Contributor, and only if You agree to indemnify, defend, and hold each Contributor harmless for any liability incurred by, or claims asserted against, such Contributor by reason of your accepting any such warranty or additional liability.

END OF TERMS AND CONDITIONS

30 Google Cloud Print™

This chapter describes the basic operations and features for the Google Cloud Print service.

- **About Google Cloud Print.....806**
- **Environment Settings.....807**
- **Printing812**
- **Problem Solving.....813**
- **Notes and Restrictions817**

About Google Cloud Print

Overview of Google Cloud Print for Dell C7765dn

Google Cloud Print is a cloud printing service provided by Google Inc. Google Cloud Print enables you to print documents from Gmail™ webmail service and Google Docs™ program via iOS or Android™ platforms, without installing print drivers or other special softwares.

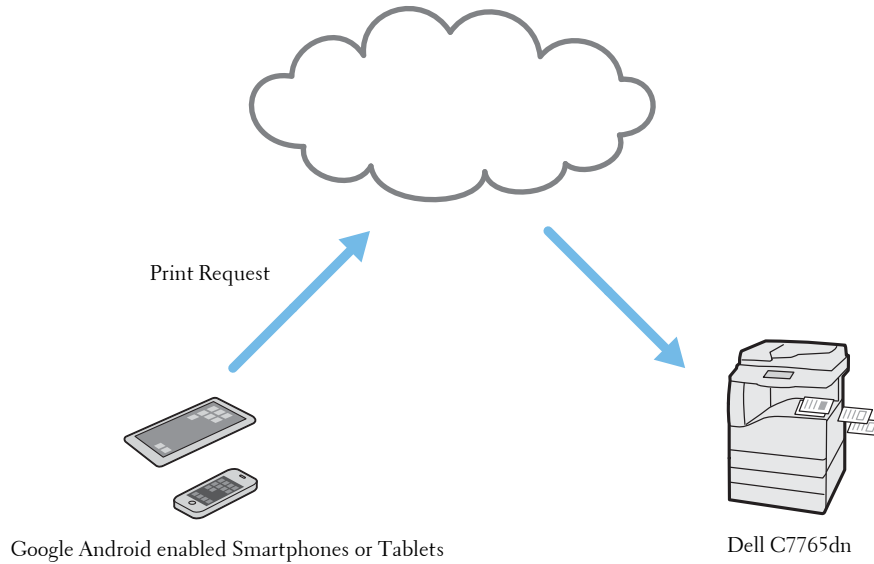

Operating Environment

This feature operates in the following environment:

Supported Clients

For the clients (operating system, web browser, and application) supported by this feature, refer to the Google Cloud Print help.

Environment Settings

This section explains how to set the environment for using Google Cloud Print.

Configuring the Machine

To print with Google Cloud Print, your machine needs to be connected to an IPv4 network and be online. Confirm in advance that the machine is set as below:

Items	Required Settings	Reference
Protocol Settings	<ul style="list-style-type: none"> Settings for using the machine in a TCP/IP environment, such as an IP address, a subnet mask, and a gateway address. Settings for DNS*. 	"Protocol Settings" (P.808)
Proxy Server Settings*	<ul style="list-style-type: none"> Settings for connecting to the Internet, such as a server name, a port number, a login name, and a passcode. 	"Proxy Server Settings" (P.808)

* :Set this item if it is required in your environment.

You can configure each setting on the [Tools] screen.

The following describes how to display the [Tools] screen.

Note • Some of the items in the screen shots used in this guide may not be displayed or not be available depending on your machine configuration.

1 Press the <Log In/Out> button on the control panel.

2 Enter the system administrator's user ID with the numeric keypad or the keyboard displayed on the screen, and select [Enter].

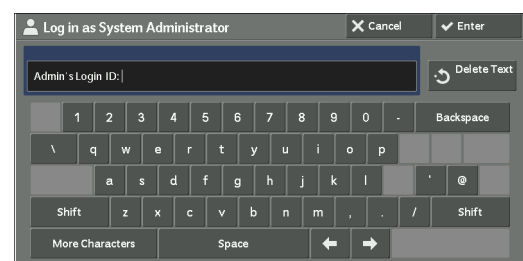

3 Select [Tools] on the services home screen.

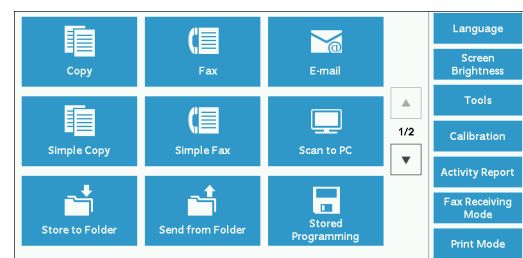

4 Set any option.

Note • The machine may ask you to reboot after making changes.

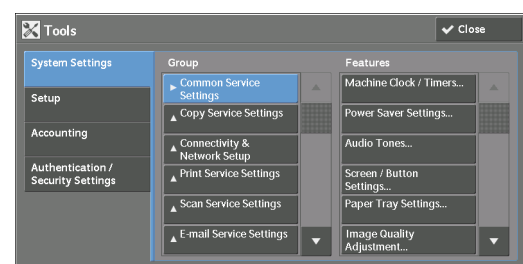

Protocol Settings

- 1 Select [System Settings] > [Connectivity & Network Setup] > [Protocol Settings] and make settings to use the machine in TCP/IP (IPv4) environment, such as an IP address, a subnet mask, and a gateway address.
Note • Google Cloud Print will not function in an IPv6 environment.
- 2 If a manual DNS server setting is required, select [IPv4 - DNS Server Setup] in [System Settings] > [Connectivity & Network Setup] > [Protocol Settings] and make settings for DNS server.
- 3 Select [Close] several times to return to the [Tools] screen.
- 4 If not setting other items, select [Close].

Proxy Server Settings

Note • These settings may not be necessary depending on your environment.

- 1 Select [System Settings] > [Connectivity & Network Setup] > [Proxy Server Settings] and make settings for connecting to the Internet, such as a server name, a port number, a login name, and a passcode.
- 2 Select [Close] several times to return to the [Tools] screen.
- 3 If not setting other items, select [Close].

Registering Devices to Google Cloud Print

This section explains how to register your machine with Google Cloud Print, using the Dell Printer Configuration Web Tool.

You need an existing Google account (e-mail address) prior to registering your machine with. If you do not already have an account, please create one before proceeding.

For more information on creating an account, refer to the Google Inc. web site.

Preparing to Print the Google Registration Form

The machine will print out a registration form during the procedure. This form will contain a barcode that you can use to connect a smartphone to the machine. Make the following print settings before starting the registration process.

Note • When the registration is finished, restore the original settings.

- 1 Log in to your machine as a system administrator.
- 2 Select [Tools] on the services home screen.
- 3 Select [System Settings] > [Print Service Settings] > [Other Settings] > [Substitute Tray]. Then select [Change Settings].
- 4 Select [Use Closest Size], and select [Save].
- 5 Select [Close].
- 6 Select [Close].

Enabling [Google Cloud Print] Port

- 1 Start a web browser from a network connected computer.
- 2 Enter the machine's IP address into the address box on the browser, and then press the <Enter> key. Connection to the Dell Printer Configuration Web Tool is established.
 - Note**
 - During connection/operation, pop-up screen for user ID/passcode entry may appear. In this case, enter a system administrator's user ID/passcode and click [OK].
- 3 Click [Properties] tab > [Connectivity] > [Port Settings]. Then check [Enabled] in [Google Cloud Print], and click [Apply].

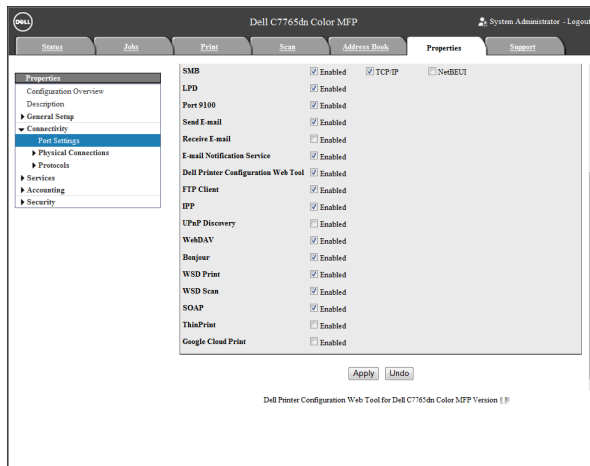

Note • WSD stands for Web Services on Devices.

- 4 Rebooting request screen is displayed on the web browser. Click [Reboot Machine].

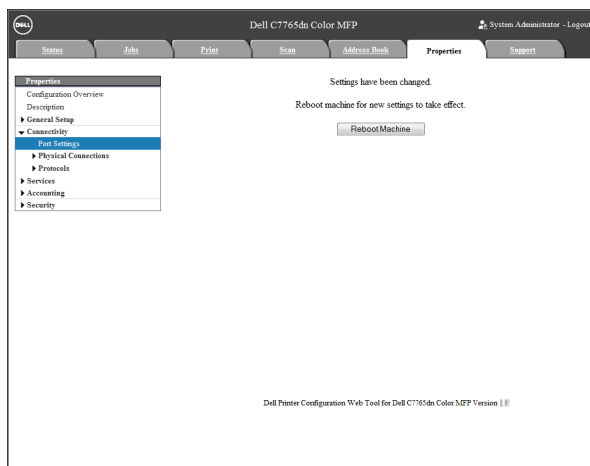

- 5 Click [OK] in the confirmation screen. The machine will reboot, and the settings will be reflected.

Registering the Device to Google Cloud Print

- 1 After the machine reboots, reload the web browser.
- 2 Click [Properties] tab > [Connectivity] > [Protocols] > [Google Cloud Print], and click [Register This Device to Google Cloud Print].

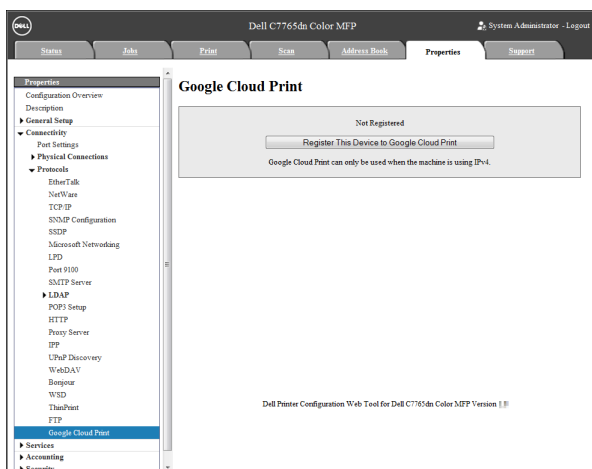

Note • WSD stands for Web Services on Devices.

- 3 Confirm that the message changes from [Not Registered] to [Registering], and a registration form is printed from your machine. This message may remain on the screen for some time.

You will need the printed registration form for the following steps.

Note • Message [Registering] will change to [Registered] when the registration is finished in step 6.

- You have 14 minutes to finish step 6. Once the web page no longer says [Registering], you will no longer be able to proceed with registration.

- 4 Enter the web address on the registration form to the address box of the browser, and press the <Enter> key, or scan the barcode with your smartphone.
- 5 Enter the Google account and passcode of the user using this feature, and log in.

Note • This account will be set as the machine owner on registration.

- 6 Follow the message on the screen to finish the registration.
- 7 Registering to Google Cloud Print is finished.

Click [Manage your printers].

- 8 Confirm that your machine is in the list.

When the registration is done, you can print from your machine by logging in to the owner's account.

- Note**
- If the registration failed, go back to step 2 and click [Register This Device to Google Cloud Print] again to re-print the registration form.
 - Sharing settings are needed to use the machine with non-owner accounts. For more information on sharing settings, refer to "Sharing a Device between Multiple Users" (P.811).

Checking the Device Registration Status

You can check if your machine is registered to Google Cloud Print, with the Dell Printer Configuration Web Tool.

- 1 Start a web browser from a network connected computer.
- 2 Enter the machine's IP address into the address box on the browser, and then press the <Enter> key. Connection to the Dell Printer Configuration Web Tool is established.

Note • During connection/operation, pop-up screen for user ID/passcode entry may appear. In this case, enter a system administrator's user ID/passcode and click [OK].

- 3 Click [Properties] tab > [Connectivity] > [Protocols] > [Google Cloud Print].

Depending on the registration status, [Registered] or [Not Registered] is displayed.

Note • It may take time for Google program to complete the registration, depending on the environment or busyness of the network.
• If [Google Cloud Print] does not show in [Protocols], Google Cloud Print port may not be enabled. For information on Google Cloud Print port, refer to "Enabling [Google Cloud Print] Port" (P.809).

Sharing a Device between Multiple Users

You can share the machine between multiple users by registering Google accounts of non-owner users. Then the users can use Google Cloud Print to print out from the machine.

For more information on registering, refer to Google Cloud Print help.

- 1 Start a web browser, and log in to Google Cloud Print with the owner account.
- 2 Google Cloud Print management page will appear. Click [Printers].
- 3 Select the machine to share, and click [Share].
- 4 On the displayed screen, enter the Google account (E-mail address) for the user who will be sharing the machine. Then click [Share].

Note • When the user registered to share the machine logs in to Google Cloud Print, a message tells that the owner made the sharing settings. The user needs to agree to sharing to use the machine.

Cancelling the Registration of the Device from Google Cloud Print

This section explains how to cancel the Google Cloud Print registration.

Note • Unregistration from Google Cloud Print printer managing screen will not be reflected to the machine. Be sure to make settings with the Dell Printer Configuration Web Tool as follows:

- 1 Start a web browser from a network connected computer.
 - 2 Enter the machine's IP address into the address box on the browser, and then press the <Enter> key. Connection to the Dell Printer Configuration Web Tool is established.
- Note** • During connection/operation, pop-up screen for user ID/passcode entry may appear. In this case, enter a system administrator's user ID/passcode and click [OK].
- 3 Click [Properties] tab > [Connectivity] > [Protocols] > [Google Cloud Print], and click [Cancel Registration].

- 4 Confirm that the message changes from [Registered] to [Not Registered].

Note • It may take time for Google program to complete the unregistration, depending on the environment or busyness of the network.

Printing

Using Android platforms or iPad/iPhone, you can print e-mails and attached files (PDF/JPEG) from Gmail webmail service, or documents from Google Docs program.

This section describes how to print from an Android platform, taking e-mail from Gmail webmail service for example.

- 1 Open the e-mail you want to print.
- 2 For printing the e-mail, tap [Print] from the top right menu.
 - Note**
 - When the attached files are printable, [Print] is shown after their file names. Tap [Print] to print the attached files.
 - To print Google Docs program spread sheets, tap [Print] shown after their file names.
- 3 Printer selecting screen will appear. Select your machine.
- 4 Make the print settings. Then tap [Print] in the top right menu.
 - Note**
 - Setting items are fixed regardless of your machine specifications. Therefore, the print result may differ from the settings, depending on the machine used.

Problem Solving

This section describes troubles that may occur with the machine and their solutions.

If the problem does not solve even after performing the remedy, contact Customer Support at dell.com/contactdell.

Problems on Registering

Symptom	Cause and Remedy
The message does not change to [Registered] even after clicking [Properties] tab > [Connectivity] > [Protocols] > [Google Cloud Print] > [Register This Device to Google Cloud Print] in the Dell Printer Configuration Web Tool.	[Cause] The machine could not connect to the Internet. [Remedy] Check the network settings. For more information on network settings, refer to "Configuring the Machine" (P.807).
	[Cause] Proxy server is used in the network environment. [Remedy] Make proxy server settings from [System Settings] > [Connectivity & Network Setup]. For more information on network settings, refer to "Configuring the Machine" (P.807).
	[Cause] The proxy server in the network environment uses authentication. [Remedy] This feature cannot be used with proxy authorization. Change your network setting not to use the proxy authorization.
	[Cause] DNS is not correctly set. [Remedy] Check the DNS settings from [System Settings] > [Connectivity & Network Setup] > [Protocol Settings] > [IPv4 - DNS Server Setup].
	[Cause] The certificate verification feature of the machine is validated. [Remedy] Disable the certificate validation. Or, import the adequate root certificate.
	[Cause] Connection has timed out because of the busy network. [Remedy] Wait for a while, and then execute the procedure again.
	[Cause] A firewall is installed in the network environment. [Remedy] The communication with "*.google.com" needs to be allowed. Check the firewall settings.

Symptom	Cause and Remedy
<p>The message does not change to [Registered] even after clicking [Properties] tab > [Connectivity] > [Protocols] > [Google Cloud Print] > [Register This Device to Google Cloud Print] in the Dell Printer Configuration Web Tool.</p>	<p>[Cause] An error occurred in the machine.</p> <p>[Remedy] Check the status code from [Error History] in the Dell Printer Configuration Web Tool.</p> <p>1) Start a web browser from a computer.</p> <p>2) Enter the IP or Internet address of your machine to the address box of the browser, and press the <Enter> key.</p> <p>3) From [Jobs] tab > [Error History], check [Date & Time] and [Error Code].</p> <p>4) Refer to "Status Code" (P.611) for information on the cause and remedy.</p>
<p>Registration form for Google Cloud Print is not printed out.</p>	<p>[Cause] The machine is set to Charge Print or Private Charge Print.</p> <p>[Remedy] This feature cannot be used with Charge Print or Private Charge Print. Change the machine setting.</p> <p>[Cause] The [Register This Device to Google Cloud Print] button was clicked immediately after the [Cancel Registration] button was clicked.</p> <p>[Remedy] Google program may not have completed the unregistration of the machine.</p> <p>Open the Google Cloud Print printer managing screen. Confirm that your machine is not in the list, and then execute the registration again.</p>
<p>Two sheets of registration form for Google Cloud Print were printed out.</p>	<p>[Cause] The machine power was switched off while registering operation.</p> <p>[Remedy] When the machine power is switched off during printing, two sheets of registration form may be printed out due to the recovery feature.</p>

Problems on Printing

Symptom	Cause and Remedy
<p>The print result differs from the settings made by the logical printer.</p>	<p>[Cause] Settings made by a logical printer cannot be reflected, due to Google Cloud Print specification. The print out will be done in Google Cloud Print print settings.</p> <p>[Remedy] Make printing settings from Google Cloud Print.</p>
<p>Characters or images are distorted.</p>	<p>[Cause] Print out may differ from the print instructed document, due to the Google Cloud Print specification.</p> <p>[Remedy] Select [Save to Google Docs] in the screen for selecting a printer, and check how the print out would be in the PDF document.</p>

Status Code

When a problem arises while using this feature, a status code is displayed in the screen of your machine.

Follow the troubleshooting below to solve the problems.

Note • When a status code is displayed, print data in the machine or the data stored in the machine memory is not assured.

For status codes not listed in the following table, refer to "Status Code" (P.611).

Status Code	Cause and Remedy
018-722	[Cause] The machine cannot connect to Google Cloud Print, because of a network error. [Remedy] Check that the network cable is connected properly. Also check that the environmental settings are adequate.
018-723	[Cause] The machine cannot connect to Google Cloud Print, because of a certificate error. [Remedy] Check that the root CA certificate registered to the machine and the certificate verification settings are correct.
018-724	[Cause] The machine cannot connect to Google Cloud Print, because of an SSL communication error. [Remedy] Check the SSL settings.
018-729	[Cause] The machine cannot connect to Google Cloud Print, because of a time out error. [Remedy] Wait for a while, and then execute the procedure again. If the problem still exists even after the remedy, check that the network cable is connected properly. Also check that the environmental settings are adequate.
018-730	[Cause] The machine cannot connect to Google Cloud Print, because of a network error. [Remedy] Check that the network cable is connected properly. Also check that the environmental settings are adequate. If the problem still remains even when there is nothing wrong, contact Customer Support at dell.com/contactdell .
018-731	[Cause] The printing job was canceled due to insufficient memory capacity for the hard disk. [Remedy] Check the hard disk capacity, and delete unnecessary data. Complete all the active jobs, and then execute the operation again.
018-737	[Cause] An internal error occurred. [Remedy] Execute the operation again. If the problem still exists even after the remedy, contact Customer Support at dell.com/contactdell .
018-738	[Cause] The machine cannot connect to Google Cloud Print, because of a network error. [Remedy] Check that the network cable is connected properly. Also check that the environmental settings are adequate.
018-739	[Cause] An internal error occurred. [Remedy] Execute the operation again. If the problem still exists even after the remedy, contact Customer Support at dell.com/contactdell .
018-740	[Cause] The machine cannot connect to Google Cloud Print, because of a certificate error. [Remedy] Check that the root CA certificate registered to the machine and the certificate verification settings are correct.
018-741	[Cause] An internal error occurred. [Remedy] Execute the operation again. If the problem still exists even after the remedy, contact Customer Support at dell.com/contactdell .

Status Code	Cause and Remedy
018-743	[Cause] The machine cannot connect to Google Cloud Print, because of a proxy connection error. [Remedy] Check that the proxy server settings are adequate.
018-744	[Cause] The machine cannot connect to Google Cloud Print, because DNS failed to resolve the name. [Remedy] Check that the DNS settings are adequate.
018-745	[Cause] The machine cannot connect to Google Cloud Print, because of a proxy connection error. [Remedy] Check that the proxy server settings are adequate.
018-746	[Cause] The machine cannot connect to Google Cloud Print, because DNS failed to resolve the name. [Remedy] Check that the DNS settings are adequate.
118-311	[Cause] An error occurred during software processing. [Remedy] Switch off the machine power, make sure that the touch screen is blank, and then switch on the machine power. If the problem exists even after the remedy, contact Customer Support at dell.com/contactdell .

Notes and Restrictions

This section describes the notes and restrictions to observe when using the machine.

Notes and Restrictions on Using the Machine

- Charge Print or Private Charge Print cannot be used with Google Cloud Print.
- When using this feature, HTTP/HTTPS proxy server which requires authentication validation is disabled.
- When a firewall is installed in the usage environment, the communication with "*.google.com" needs to be allowed.

Notes and Restrictions on Printing

- Available printer setting items vary by the application used. However, displayed items are fixed regardless of your machine specifications. Therefore, the print result may differ from the settings, depending on the machine used.
- In this printing feature, documents with only Japanese and/or English are assured.
- Text documents may be regarded as color images on print out, due to the Google Cloud Print specifications. Note that the default setting for Google Cloud Print is "Color", and you need to change settings to print the files as monochrome documents.

In order to print them in monochrome, make the color mode setting in Google Cloud Print to "Black & White".

- When using this feature, the order of printouts may differ from that of the print instructions. The order may be especially different when many print instructions are requested while the machine was turned off for a long time.
- When using this feature, the user name of the job requester shown in Job History Report will be "Google Cloud Print".
- When using this feature, the printed document name shown in Job History Report will be "Google Cloud Print Job". Job information in the Job History Report will be "PDF".

Index

Symbols

[Home] Screen.....	53
<C (Clear)> button	50
<Clear All> button.....	49
<Data> indicator.....	50
<Dial Pause> button.....	50
<Error> indicator	50
<Home> button	49
<Interrupt> button	49
<Job Status> button	49
<Log In/Out> button.....	49
<Machine Status> button	49
<Main Power> indicator	50
<Power Saver> button	49
<Speed Dial> button	50
<Start> button	50
<Stop> button.....	50

Numerics

1 Staple (Simple Copy)	73
1000BASE-T.....	471
100BASE-TX.....	471
10BASE-T.....	471
10BASE-T/100BASE-TX/1000BASE-T connector.....	36
2 Pages per Side (Simple Copy)	73
2 Pages Up On Receipt	399
2 Sided Book Copying	98
2 Sided Copying (default value)	351
2 Sided Copying (Simple Copy)	71
2 Sided Printing	399, 776
2 Sided Report.....	328
2 Sided Scanning.....	780

A

Access Control	451
Access Lamp.....	35
According to Print Accounting.....	457
Account Administration	562
Account Details.....	444
Account Limit	443

Accounting.....	441
Accounting Login Screen Settings.....	446
Accounting Reports	283
Accounting Type	445
Accounting/Billing Device.....	448
Accounting/Billing Device Settings	448
Activating User History	787
Activity Report	56, 277, 328
Add Address Book Entry.....	431
Add Domain Name to User Name	379
Add Fax Comment.....	440
Add Me to "CC" Field.....	408
Add Me to "To" Field	408
adding a comment/a date/page numbers to copies... 118	
adding originals.....	140
Additional Feature Buttons	55
Address Book.....	280, 281, 409
Address Type.....	433
Adjust Image Transfer.....	329
Adjust Paper Registration.....	330
adjusting color balance.....	92
adjusting contrast	90
adjusting copy density/sharpness/saturation	89
Adjusting foot	36
adjusting the color tone.....	93
adjusting the copy density.....	86
adjusting the image position.....	103
Administration Menu.....	785
Administrator Shared Folder	547
Administrator Shared Job Flow Sheet.....	546
Alert Tone	318
All Items screen	771
Allocate Memory.....	380
Allow Casual Users to Edit From Field.....	408
Allow Guest Users to Edit From Field	408
Allow to edit From if Search Failed.....	408
Allow to edit From if Search Found.....	408
Allow User to Disable Active Settings.....	458
Alternative Name for Account ID.....	447
Alternative Name for User ID.....	446, 454
Annotations.....	118, 353
Annotations - Comment Density	356
Annotations - Create Comments	357

ART IV, ESC/P, 201H Form Memory	380
attaching covers to copies.....	113
Audio Tones	317
authenticated user	536
Authentication	296, 451, 557
Authentication Details Expiration.....	786
Authentication System Setup	369
Authentication/Security Settings	450
Authorization Groups	537
Auto Clear	315
Auto Clear Alert Tone	318
Auto Display of Login Screen.....	319
Auto Job Promotion.....	335
Auto Job Release	315
Auto Paper Off.....	354
Auto Paper Select.....	322
Auto Print	315
Auto Receive	288
Auto Reduce On Receipt.....	398
Auto Select	237
Auto Suppression	780
Auto Tray Switching.....	324
Auto Validation of Speed Dial Entry	347
Automatically Configured IPv6 Address.....	366
automatically printed reports/lists.....	284

B

Back.....	773
Background Pattern (Watermark)	330
Background Suppression.....	326, 355
Background Suppression (default value)	351, 389
Background Suppression Level.....	392
Banner Sheet	384
Banner Sheet Offset.....	385
Banner Sheet Tray.....	385
Base Tone	318
Batch Send	398
Bates Stamp.....	353
Billing.....	438
Billing Data List	281
Billing Information.....	291
Black & White/Color (Simple Copy)	72
Block Inbound Faxes.....	400
Block Unknown Fax Numbers.....	401
Bonjour	360, 472

Book Copying.....	96
Booklet.....	110
Booklet Creation.....	110
Booklet Maker Unit for Finisher-B1	258
Booklet staple cartridge	39
Booklet unit.....	39
Booklet unit side cover	39
Border Limit.....	398
Bottom left cover	35, 685
Broadcast Checkbox on 1st Tab	397
Broadcast Report.....	284
Broadcast Starting Rate	404
Broadcast/Multi-Poll Report	328
Build Job.....	135
Bypass Proxy Server	367
bypass tray	687

C

Calibration	56, 327
calling a stored program	183
calling a stored program for Build Job	184
Center Erase/Binding Edge Erase	352
Center tray	40
Center Unit.....	690
Certificate Revocation Retrieval Settings	378
Chain Dial.....	397
Change Quantity	206
changing a job flow sheet	172
changing a stored program name.....	181
changing the orientation of images	107
changing the paper size	241
changing the paper type	244
Chapter Start	137
Charge Print.....	213
Charge Print Jobs.....	449
Charge Rate Per Unit	448
Charge/Private Print Settings.....	456
Check Folder Passcode.....	422
Check Smart Card Details	329
checking completed jobs	207
Checking the Content Status	798
checking the finished output of the copy.....	139
Circuit Breaker.....	44
cleaning the machine.....	260
Collection Name.....	775

-
- Collections screen 772
 - Color Balance 92, 351
 - Color Effects 91
 - Color Scanning..... 388
 - Color Shift..... 93, 351
 - Color Space 389, 392
 - ColorTrack 446
 - Combine Original Sets 140
 - Comment Position..... 356
 - Common Service Settings..... 314
 - Company Logo..... 402
 - Configuration Report 278, 279, 280
 - configuring the SNMP port..... 505
 - Confirmation indicator..... 37
 - Confirmation Options 395
 - confirming the fax job in Job Status 152
 - Connect with Accounting/Billing Device 448
 - Connection Interval..... 315
 - Connectivity & Network Setup..... 358
 - Constant Velocity Transport Glass 263
 - consumables 248, 344
 - consumables status notice (by e-mail) 488
 - Contrast..... 351, 388
 - Control panel 34, 49
 - Control Panel Alert Tone 318
 - Control Panel Select Tone 318
 - Convert Custom Size to Standard Size 410
 - Copies 96
 - Copy 348
 - Copy Control 354
 - Copy Defaults 349
 - Copy Output 129, 352
 - Copy Reports..... 277
 - Copy Service Settings 348
 - copying a job flow sheet..... 431
 - copying both sides of an ID card..... 133
 - copying facing pages onto separate sheets..... 96
 - copying multiple pages onto one sheet..... 85, 114
 - Cover Page..... 436
 - Cover Tray 354
 - Covers 113, 354
 - Creaser unit..... 39
 - Create Authorization Groups..... 453
 - Create Folder 421
 - Create Job Flow Sheet..... 423
 - Create Job Flow Sheet Keyword..... 431
 - create new collection 775
 - Create Text String..... 333
 - Create/View User Accounts..... 441
 - creating a booklet..... 110
 - creating a new job flow 425
 - Creating Fax Group Recipients 439
 - Custom Button 50, 319
 - Custom Colors..... 357
 - Custom Watermark (Watermark) 331
 - Customize User Prompts 446
- D**
- Data Encryption 344
 - Data Indicator..... 347
 - Date / Name Format 791
 - Date Stamp 353
 - Daylight Savings 316
 - Deactivate With wakeup motion sensor 317
 - Default Language 320
 - Default Print Paper Size..... 335
 - Default Programming..... 287
 - Default Settings for Date / Name 788
 - Default Settings for Printing..... 789
 - Default Settings for Scanning..... 789
 - Default Watermark (Watermark) 330
 - Delay Start 437
 - Delay Start - Specific Time 395
 - Delayed Print 212
 - Delete All 791
 - Delete All Certificates/Initialize Settings..... 330
 - Delete All Data 329
 - Delete Expired Files 422
 - Delete Files After Retrieval..... 422
 - Delete Folder 423
 - Delete Form 382
 - Delete Outside/Delete Inside 142
 - Delete Remote Accounts 455
 - Delete Segment 791
 - deleting a job flow sheet..... 431
 - deleting Charge Print jobs 215
 - deleting Delayed Print jobs 213
 - deleting outside or inside of the selected area 142
 - deleting Private Charge Print jobs 217
 - deleting Sample Set jobs 211
 - deleting Secure Print jobs 209
-

deleting stored jobs	208
deleting stored programs	180
Deleting the stored authentication information	786
Deleting the stored user history	787
Delivery Confirmation Method	404
Delivery Receipts/Read Receipts	395
Dell Printer Configuration Web Tool	462, 474, 494, 808
details button	772
Device Access	452
Digital Signature	518, 526
Direct Fax	400
disconnect from the network	773
DNS	489
document cover	34, 262
document feeder	60, 692
Document Feeder Rollers	263
Document feeder tray	37
document glass	34, 61, 147, 159, 262
Document guides	37
document jams	692
Document output tray	37
Document stopper	37
Domain Filter List	280, 281
Domain Filtering	379
Domain Name	367
Drum Cartridge Conservation Mode	347
Drum cartridge cover	36
Drum cartridge release lever	36
Dual Color - Non-target Area Color	350
Dual Color - Source Color	350
Dual Color - Target Area Color	350
Duplex Automatic Document Feeder	37
duplex module	689

E

Edge Erase	102, 351
Edge Erase - Left & Right Edges	399
Edge Erase - Top & Bottom Edges	399
Edge Erase (default value)	389
Edit E-mail Recipients	408
editing a job flow sheet	431
E-mail	488, 496
E-mail Address	433, 442
E-mail Control	406

E-mail Encryption	526
E-mail notification	488
E-mail Notification Service	361
E-mail Printing	488
E-mail Sending When Search Failed	408
E-mail Subject	389
E-mail/Internet Fax Service Settings	406
Encryption	518, 519
Encryption Key for Confidential Data	346
enlarged copies	74
entering a stored program name	181
entering text	57
Environment Settings	807
erasing edges and margin shadows of the document	101
erasing the background color of documents	90
Error History Report	277, 289
error terminations	222
ESC/P Logical Printers List	279
ESC/P Settings List	279
Ethernet II	471
Ethernet Rated Speed	363
EtherTalk	360, 485
Exit 2 Tray	34
Expiration Date for Files in Folder	413
Express Code	275
extension tray	238

F

F Code	437
Failed Access Log	454
Fault Tone	318
Fax Billing Data	447
Fax Comments List	281
Fax Control	396
Fax Data in Folder Priority	400
Fax Defaults	395
Fax Number	436
Fax Received Options	401
Fax Receiving Mode	56, 288, 398
Fax Reports	280
Fax Screen Default	394
Fax Service Settings	394
Fax Transfer from Address Book	405
Fax Transfer Maximum Data Size	405

Feature Access..... 442
 File Format..... 388
 Files Retrieved By Client 410
 files screen 772
 Fine-tune 100%..... 355
 Finisher Adjustment 329
 Finisher Top Cover..... 690
 Finisher tray 39
 Finisher-B1 39, 256, 259, 690, 695
 First Tab - Scan..... 387
 Folder List 282
 Folder Name..... 422
 Folder Report 328
 Folder Selector List..... 281
 Folder Selector Setup 399, 401
 Folder Service Settings 410
 Folding..... 126
 Font Color (Watermark)..... 330
 Font List 279
 Font Size (Watermark) 330
 Force Annotation..... 332
 Force Watermark - Client Print..... 331
 Force Watermark - Copy..... 331
 Force Watermark - Media Print..... 331
 Force Watermark - Print Stored File..... 331
 Front cover 34, 39
 Front transport cover 39
 FTP 360, 500
 FTP client port..... 501
 Fusing unit 36

G

G3 402
 G3 Line 1 - Dial Type..... 403
 G3 Line 1 - Fax ID..... 403
 G3 Line 1 - Line Type 403
 General Shared Folder..... 547
 Generation of URL Link..... 393
 Given Name 434
 Google account 808
 Google Cloud Print..... 806
 Google Cloud Print port..... 809
 Google Drive 768
 Guest User..... 455

H

handling paper 236
 Handout Tray..... 129
 HCF..... 687
 High Compression..... 780
 Hole Punch Kit 40
 hole punch waste container..... 39, 259
 home screen 771
 Host Name 366
 HP-GL/2 Auto Layout Memory 380
 HP-GL/2 Logical Printers List 279
 HP-GL/2 Palette List 279
 HP-GL/2 Settings List 279
 HTTP 463
 HTTP Proxy Server..... 367
 HTTPS 521
 HTTPS Proxy Server 367

I

ID Card Copy 133, 355
 IEEE 802.1x Settings..... 377
 IEEE802.3 471
 Image Enhancement 90, 327
 Image Options 89
 image quality..... 324
 image quality trouble..... 573
 Image Rotation 107, 352
 Image Shift..... 103, 352
 Image Transfer Screen..... 392
 Incoming E-mail Print Options 406
 Incoming Internet Fax Print Options 404
 Independent X - Y% 76
 Index..... 436
 Index Print 202
 Initialize Hard Disk 329
 Inner cover 37
 input screen..... 791
 input text 791
 inserting blank sheets between transparencies..... 128
 Internet Fax Control 403
 Internet Fax Output Destination 405
 Internet Fax Path..... 403
 Internet Fax Profile 395, 438
 Internet Fax Subject..... 396

Internet Fax to E-mail	410
Internet Fax to Internet Fax	410
Internet Printing Protocol	483
Internet Services	362, 504
Interrupt Mode	449
Invert Image	106
IP Address	275
IPP	360, 483
IPSec Settings	376
IPv4 - DNS Server Setup	365
IPv4 - IP Address Resolution	364
IPv4 Address	364
IPv4 Gateway Address	364
IPv4 IP Filter	365
IPv4 Subnet Mask	364
IPv6 Address Manual Configuration	365
IPv6 IP Filter	366

J

Job Complete Tone	318
Job Completion Notice	488
Job Counter Report	282
Job Flow Error Report	285, 328
Job Flow Scanning	496
Job Flow Service Settings	411
job flow sheet shared by local users	546
job flow sheet types	546
Job Flow Sheets	170, 504
Job History Report	277, 328
Job Status	204
Job Status Default	459
Job Status/Activity Report	277
Job Ticket Memory	380
Job with Insufficient Credit	449
jobs manageable by Account Administration	554

K

Kerberos Server Settings	369
Keyboard Input	791
Keyboard Input Restriction	344

L

Language	55, 320
----------------	---------

Language of the Original	390
Last Original	205
Layout Adjustment	94
layout template	332
LDAP Server/Directory Service	370
LED printhead	260
Left cover	37
lever	37
license	25
Lighten/Darken	86, 89, 350, 395
Lighten/Darken (default value)	388
Lighten/Darken (Simple Copy)	72
limited paper	231
LINE 1	38
Line 1 - Company Logo	402
Line Monitor Volume	319
Link Job Flow Sheet to Folder	423
linking job flow sheets to folders	548
loading documents	158
loading paper	237
Local Accounting	445, 539
Local machine authentication	557
Local Name	402
Local Terminal Information	402
local user	536
Lock Out Printer	56
Lock Out Printer/Release Printer	56
Locking casters	34
Log In	769
Log Out	770
logical printer	814
login	296
Login Credential to Access Destination	390
Login Information Field	53
Login to Local Accounts	538
Login to Remote Accounts	538
Login Type	451
Logout Confirmation Screen	454
Low Power Mode	46
Low Toner Alert Tone	318
Lower Center Tray	34
LPD	359, 475, 479
LPD Print Queue	386

M

Machine Clock/Timers	314
machine components.....	34
machine configuration.....	276, 465
machine information	275
Machine Name.....	366
Machine Password.....	402
Machine Ready Tone.....	318
Machine Status	274
machine trouble.....	569
machine's E-mail address	366, 492, 515
Main power switch.....	36
making 2 sided copies	95
making 2-sided copies of facing pages	98
making enlarged/reduced copies	74
making multiple copies on a single sheet	127
making multiple copies on one sheet.....	117
making reversed copies of images	105
Manual Receive.....	288
Manual Redial List - Dial Mode.....	397
Manual Redial List - Saved Entries.....	397
Manual Send	398
Manual Send/Receive Default.....	398
Manually Configured IPv6 Address	365
Manually Configured IPv6 Address Prefix	365
Manually Configured IPv6 Gateway	365
Mask Account ID (***)	447
Mask User ID (***)	447, 454
Maximum Address Entries.....	406
Maximum Data Size per E-mail	407
maximum fill line.....	238, 240, 243
Maximum Image Size.....	436
Maximum Login Attempts.....	456
Maximum Number of Sets.....	356
Maximum Passcode Length for Stored Jobs	414
Maximum Split Count	407
Maximum Stored Pages.....	354, 392, 400
Maximum Total Data Size.....	407
Media Print	190
Media Print - Photos.....	200
Media Print - Text	201
Media Print Service Settings	412
media print trouble.....	609, 610
Memory Full Procedure.....	354, 392, 400
Message Field.....	53

messages.....	611
Microsoft Network.....	481
Minimum Passcode Length	456
Mirror Image	106
Mixed Size Originals	100, 351, 389, 395
Mixed Size Originals - 2 Sided Copy.....	354
Mixed Size Originals Scan Mode.....	400
Multi-poll Report.....	285

N

naming files.....	777
Negative Image	106
NetWare.....	359, 478
network.....	470
Network Accounting.....	445, 539
Next Original	205
non-standard size document.....	99
Non-target Area Color	84
NTP Time Synchronization	315
Numeric keypad	50

O

Odd Page 2 Sided	335
Offset Stacking	334
one touch button	51, 319
One touch panels.....	51
Operating Environment	806
Operation of Up/Down Buttons	344
Optimize PDF For Quick Web View	388
Original Orientation	780
Original Orientation	96, 101, 103, 104, 106, 115, 352, 389
Original Size.....	99, 780
Original Size Defaults	356, 391, 402
Original Type	87, 350, 388, 395
Original Type - Auto (Black & White).....	350
Original Type - Auto (Non-Black & White)	350
Original Type - See-Through Paper.....	355
Originals	95
Out of Paper Warning Tone	318
outgoing/incoming E-mail settings.....	368
Output Color	81, 350, 776
Output Color (Simple Copy)	350
Output Destination.....	352

Output Destination for E-mail	379	Port Number	435
Output Format.....	109	Port Settings.....	358
Output Size	776	Poster.....	115
Output Size Defaults.....	391	PostScript Default Color.....	385
Output tray.....	34	PostScript Font Absence	385
Output/Offset	131	PostScript Font List.....	279
outputting bi-folded	126	PostScript Font Substitution	385
Overwrite Hard Disk	285, 459	PostScript Logical Printers List.....	279
Owner	810	PostScript Memory	380
		PostScript Paper Supply	385
		Power on Self Test	329
		Power Saver Mode	46, 317
		Power Saver Timers	317
		Power switch	34, 41
		Preset Repeat Image	127
		Print	776
		Print & Delete Confirmation Screen.....	410
		Print Area	382
		Print Delivery Confirmation Mail	407
		Print Error Notification E-mail	406
		Print Job Confirmation Screen	414
		Print Login Name on PDF Files	393
		Print Mode	56, 285
		Print Order for All Selected Files.....	414
		Print Quantity.....	776
		Print Reports	276, 327
		Print Service Settings	380
		Print this Sample List (Watermark).....	331
		Print User ID.....	384
		Printer Lockout	316
		Printer Reports.....	278
		Printing.....	812
		printing a report/list.....	269
		printing Charge Print jobs.....	215
		printing control numbers	124
		printing Delayed Print jobs	213
		printing pending jobs preferentially.....	221
		printing Private Charge Print jobs.....	217
		printing Sample Set jobs	212
		printing Secure Print jobs.....	210
		printing stored jobs.....	208
		Print-On-Demand Duration	316
		Private Charge Print	216, 270
		problem solving.....	567
		Problems on printing.....	814
		Problems on registering	813

P

Pages per Side.....	114, 352, 776
Paper clip tray.....	51
paper color	322
paper guides.....	239
paper jams	683
paper size	241, 322
Paper Size Settings.....	335
Paper Supply.....	77, 322, 349
Paper Supply (Simple Copy)	69
Paper Tray Attributes.....	322
Paper Tray Priority	323
Paper Tray Status	276
paper type	322
Paper Type Mismatch.....	383
Paper Type Priority	323
paper types.....	226
Passcode.....	296
Passcode Entry for Control Panel	456
Passcode Policy.....	456
Password	435
PCL Font List	279
PCL Macro List.....	278
PCL Settings List.....	278
PDF Settings List.....	278
PDF signature	530
PDF/XPS Signature Settings	376
Personal Folder.....	547
Personal Job Flow Sheet	546
Photo & Text/Printed Original.....	355
Photos - Paper Supply.....	412
Polled Files - Auto Delete.....	397
POP3	492, 515
POP3 Server Settings.....	368
Port 9100	360, 475

Profile for Broadcast Job	404
Promote Job.....	205
Proportional %.....	75
Protocol Settings	363
Protocol settings.....	808
Protocol to Receive E-mail.....	379
proxy server.....	367
Proxy server settings.....	808
Pseudo-Photo Gradation Mode	399
Public Folder	218
Punching	130

Q

Quality/File Size.....	389
Quality/File Size for Retrieval	410
Quantity Display	356

R

Read Receipts.....	407
Rear right cover	36
Receive Control.....	457
Receive E-mail	361, 514
Receiving Buffer - EtherTalk.....	382
Receiving Buffer - IPP.....	382
Receiving Buffer - LPD.....	381
Receiving Buffer - NetWare.....	381
Receiving Buffer - Port 9100.....	382
Receiving Buffer - SMB	381
Receiving Buffer - USB.....	381
Receiving Paper Size	398
receiving protocol.....	492, 515
Reconfirm E-mail Recipient.....	320
Reconfirm Fax/Internet Fax Recipient.....	320
Reduce 8.5 x 11" Original to A4	399
Reduce/Enlarge	74, 349
Reduce/Enlarge (Simple Copy).....	70
Reduce/Enlarge Presets.....	357, 391, 401
reduced copies.....	74
Re-enter Broadcast Recipients	396
Re-enter Group Recipients.....	396
Re-enter Recipients.....	396
Re-enter Speed Dial Recipients	396
Refresh.....	773
registering a server to setup	417

Registering Devices	808
registering stored programs	178
Registration paper.....	814
Relay Broadcast	437
Release Printer	56
remote accounting.....	539
remote authentication.....	557
Remote Folder	437
Repeat Image	117
Reset Account.....	444
RESET button	36
Reset Total Impressions	444
Reset User Accounts.....	444
Resolution	389, 395, 436, 780
Response to Read Receipts	406
Restore Tool.....	271
Restrict Recipient Selection Method	347
Restrict User to Edit Address Book	347
Resume Job After Print Error.....	384
Retrieve Programming.....	286
Ringing Volume	319
Rotate 90 degrees.....	397
RSA BSAFE.....	2, 25

S

S/MIME.....	493, 516
S/MIME certificate	434
S/MIME Settings	375
Sample Job	139, 353
Sample Set	210
Saturation.....	89, 351, 392
Save as Charge Print.....	458
Save as Private Charge Print	457
Save Deleted Faxes.....	397
Save Undelivered Faxes.....	397
Saved Faxes - Auto Delete	398
saving the scanned data.....	164
Scan	780
Scan Ahead for Copy Job	449
Scan Defaults.....	388
Scan File Transfer Report	328
Scan Reports	279
Scan Service Settings.....	387
Scan to PC	496, 500
scanning different size documents simultaneously ..	100

Screen After Auto Clear.....	319	Simple Copy.....	69
Screen Brightness.....	55, 320	Single Color.....	350
Screen Default.....	319	Skip Blank Pages.....	395, 400
Screen Type.....	327	Sleep Mode.....	46
Screen/Button Settings.....	319	smart card.....	454, 456
Screens.....	771	Smart Card Certificate Verification.....	455
Search Docs.....	774	Smart Card Link Mode.....	455
search target.....	774	SMB.....	359, 481, 500
Searchable - Page Orientation.....	393	SMB port.....	501
Searchable Text.....	390	SMB Server Settings.....	374
Searchable Text Compression.....	390	SMTP.....	492, 515
Secure Print.....	208	SMTP Server Settings.....	368
Security Settings.....	374	SNMP.....	360
Segment Separators.....	138	SNMP port.....	504
selecting a job flow sheet.....	172	SOAP.....	362
selecting an image quality.....	91	SOAP port.....	504
selecting the color for copying.....	81	Software Download.....	347
selecting the document type.....	87	Software Options.....	329
selecting the paper for copying.....	77	Software Version.....	276
selecting the printing options.....	200	Source Color.....	83
semi standard paper.....	227	special media.....	230
Send E-mail.....	361, 514	specifying destinations.....	149
Separator & Handout.....	129	specifying finishing options.....	129
Separator Tray.....	129, 352	specifying the orientation of the loaded documents.....	106
Separators.....	354	specifying the scan size for the document.....	99
Serial Number.....	275	Split Send Method.....	407
Server Certificate Verification Settings.....	415	SSL/TLS Communication.....	374
Server Name/IP address.....	435	SSL/TLS Settings.....	374
Service Access.....	452	standard paper.....	226
Service Buttons.....	53	Standard Size Threshold Value.....	410
Service Rep. Restricted Operation.....	346	Staple cartridge.....	39, 256, 258, 695
Service Tag.....	275	staple faults.....	694
setting custom text strings.....	792	star icon.....	773
setting via BOOTP.....	364	Starting Rate.....	395, 436
setting via DHCP.....	364	STATIC.....	364
setting via DHCP/Autonet.....	364	status code.....	611, 795, 815
setting via RARP.....	364	stopping a copy job.....	66
Setup.....	56, 421	stopping a fax job.....	153
Shadow Suppression.....	389, 780	stopping a scan job.....	165
Shadow Suppression Level.....	392	Store & Send Link.....	496, 506
Shared Name (SMB Only).....	435	Store & Send Link - Subject.....	390
Sharing a device.....	811	Store to Folder.....	496
Sharpness.....	89, 351	Store to USB.....	194, 496, 503
Sharpness (default value).....	388	Store to WSD.....	508
Sheet Filtering.....	425	Store User Details.....	447
Side Tray.....	35		

Stored File List.....	277	Transfer Protocol	390, 435
Stored File Manager 3	164	Transmission Header Text	395
Stored File Settings	413	Transmission Header Text - Fax Transfer	405
Stored Job Expiration Date	413	Transmission Header Text - Polling	397
Stored Programming Tone	319	Transmission Interval.....	398
Storing the Authentication Information	785	Transmission Report	284
Stylus pen.....	35	Transmission Report - Job Deleted	328
Stylus pen holder	35	Transmission Report - Job Undelivered	284, 328
Subnet mask.....	489	Transmission Screen.....	394
Substitute Tray	383	Transparency Options	128
Supplies	290	Transparency Tray	128
Supported clients	806	Tray 1 to 4.....	34
supported frame types	471	Tray 5 (Bypass)	34
supported interfaces.....	471	Tray 6 (HCF B1).....	34
supported operating systems	472	Tray 6 top cover	34
System Administration mode.....	296, 299	Tray attachment	39, 58
System Administrator Login ID.....	450	trouble during copying	579
System Administrator Meter (Copy Jobs)	445	trouble during printing.....	583
System Administrator Passcode	450	trouble during scanning.....	590
System Administrator Settings	450	troubleshooting.....	568
		types of authentication.....	538
T			
Target Area Color	84	U	
TCP/IP.....	475	unable to connect to the network.....	793
TCP/IP - IP Mode	363	unable to copy.....	579
TEL.....	38	unable to create job flow sheet	795
Telephone line connectors	38	unable to login to this feature.....	793
Text - Paper Supply	412	unable to print	583, 794
ThinPrint	363	unable to receive a fax	588
Thumbnail - Outgoing E-mail	388	unable to send a fax	586
Thumbnail - Scan to PC.....	388	unable to start Access Google Drive	793
TIFF / JPEG Logical Printers List.....	278	unable to upload scan data.....	794
TIFF / JPEG Settings List	278	unable to view the items	794
TIFF Format	392	unauthenticated user.....	536
Time Server Address	315	Uncollated with Separators	352
Time Zone.....	316	Undelivered Faxes	219
toner cartridge.....	36, 248	unit (millimeters/inches).....	344
Tools menu	300	UNITED STATES GOVERNMENT RESTRICTED RIGHTS	2
Top cover.....	39	Universal Unique ID	333
Top cover of the finisher transport	40	Unregistered Forms	383
Top left cover	35, 685	Unregistering the Device.....	811
touch screen	49, 262	unusable paper.....	236
Track Print Jobs.....	448	Uploading Data.....	777
Track Scan/Fax Jobs.....	449	Uploading Data Automatically from Folders.....	780
Track with Cumulative Device	449		

UPnP Discovery	361
Upper left cover.....	35, 683
URL File Expiration	393
usable paper.....	227
USB.....	193, 358, 473
USB 2.0 interface connector.....	35, 36
USB memory device.....	321
USB memory slot	50
Use of Smart Card	455
User Account Billing Information.....	292
User Authentication.....	564
User Details Setup	454
User ID	296
User ID for Login.....	454
User Name.....	435, 442
User Name for FTP Scan.....	390
User Role	443

V

Verify User Details	446
verifying server certificates	415
version information.....	798

W

Wakeup motion sensor.....	35, 47
Waste toner container	36
Watermark	124
Watermark/Background Contrast (Watermark).....	331
web Applications	186
Web Applications - Enable File Printing.....	420
Web Applications Service Setup.....	415
Web Applications Version.....	419
Web Browser Setup	419
WebDAV	362
WSD.....	160, 361, 472

X

XPS Print Ticket Processing.....	385
----------------------------------	-----

www.dell.com | dell.com/support

KB3206EN0-6