

imageCLASS LBP312dn

SERVICE MANUAL



Canon

January 27, 2017
Rev. 2

Introduction

Important Notices

Application

This manual has been issued by Canon Inc. for qualified persons to learn technical theory, installation, maintenance, and repair of products.

This manual covers all localities where the products are sold. For this reason, there may be information in this manual that does not apply to your locality.

Corrections

This manual may contain technical inaccuracies or typographical errors due to improvements or changes in products. When changes occur in applicable products or in the contents of this manual, Canon will release technical information as the need arises. In the event of major changes in the contents of this manual over a long or short period, Canon will issue a new edition of this manual.

The following paragraph does not apply to any countries where such provisions are inconsistent with local law.

Trademarks

The product names and company names used in this manual are the registered trademarks of the individual companies.

Copyright

The copyright of this document belongs to Canon Inc. This document may not be copied, reproduced or translated into another language, in whole or in part, without the prior consent of Canon Inc.







Copyright CANON INC. 2017















Caution

Use of this manual should be strictly supervised to avoid disclosure of confidential information.



Explanation of Symbols

The following symbols are used throughout this Service Manual.

Symbols	Explanation	Symbols	Explanation
	Check.		Remove the claw.
	Check visually.		Insert the claw.
	Check a sound.		Push the part.

Symbols	Explanation	Symbols	Explanation
	Disconnect the connector.		Connect the power cable.
	Connect the connector.		Disconnect the power cable.
	Remove the cable/wire from the cable guide or wire saddle.		Turn on the power.
	Install the cable/wire to the cable guide or wire saddle.		Turn off the power.
	Remove the screw.		Loosen the screw.
	Install the screw.		Tighten the screw.
	Cleaning is needed.		Measurement is needed.

The following rules apply throughout this Service Manual:

- Each chapter contains sections explaining the purpose of specific functions and the relationship between electrical and mechanical systems with reference to the timing of operation.
In the diagrams,  represents the path of mechanical drive; where a signal name accompanies the symbol, the arrow  indicates the direction of the electric signal.
The expression "turn on the power" means flipping on the power switch, closing the front door, and closing the delivery unit door, which results in supplying the machine with power.
- In the digital circuits, '1' is used to indicate that the voltage level of a given signal is "High", while '0' is used to indicate "Low". (The voltage value, however, differs from circuit to circuit.) In addition, the asterisk (*) as in "DRMD*" indicates that the DRMD signal goes on when '0'.
In practically all cases, the internal mechanisms of a microprocessor cannot be checked in the field. Therefore, the operations of the microprocessors used in the machines are not discussed: they are explained in terms of from sensors to the input of the DC controller PCB and from the output of the DC controller PCB to the loads.

The descriptions in this Service Manual are subject to change without notice for product improvement or other purposes, and major changes will be communicated in the form of Service Information bulletins.

All service persons are expected to have a good understanding of the contents of this Service Manual and all relevant Service Information bulletins and be able to identify and isolate faults in the machine.

Contents

Safety Precautions	1
Laser Safety.....	2
How to Handle the Laser Scanner Unit.....	2
Toner Safety.....	2
About Toner.....	2
Handling Adhered Toner.....	3
Notes When Handling a Lithium Battery.....	3
Notes on Assembly/Disassembly.....	3
1. Product Overview	4
Product Lineups.....	5
Host machine.....	5
Options.....	5
Features.....	6
Specification.....	7
Product Specifications.....	7
Print Speed.....	8
Paper type.....	9
Paper Size.....	9
Parts Name.....	11
External View.....	11
Cross Section View.....	12
Control Panel.....	13
2. Technical Explanation (Device)	14
Laser Exposure System.....	15
Overview.....	15
Laser Scanner Motor Control.....	15
Image Formation System.....	17
Image Formation Process.....	17
Cartridge.....	20
Pickup Feeding System.....	23
Overview.....	23
Lifter control.....	25
Cassette Detection.....	26
Cassette Pickup Control.....	27
Cassette Double Feed Prevention Mechanism.....	27
Multi-purpose Tray Pickup Control.....	27
Skew Correction.....	28
Paper Width Detection.....	29
Paper Length Detection.....	30
Feed Speed Control.....	30
Jam Detection.....	31
Fixing System.....	33

Overview/Configuration.....	33
Fixing Temperature Control.....	33
Protective Functions.....	34
Controller System.....	36
Main Controller.....	36
DC Controller.....	37
Motor/Fan Control.....	38
Failure Detection.....	38
Power supply.....	39
Protection function.....	40
Quick Startup.....	41
Energy Saving Function.....	42
3. Technical Explanation (System).....	43
Version Upgrade.....	44
Overview.....	44
Version Upgrade Using UST.....	45
Update Using Updater.....	45
Backup/Restoration.....	74
Backup/Restoration Using the DCM Function.....	74
Backup/Restoration Using a Function Other Than the DCM Function.....	82
Monitoring Function (e-Maintenance/imageWARE Remote).....	89
Overview of System.....	89
Cautions when Using E-RDS.....	90
Setting Procedure.....	90
Maintenance.....	92
MEAP Application Management.....	93
About MEAP.....	93
About SMS.....	93
Setting Procedure.....	98
Maintenance.....	106
4. Periodical Service.....	109
Periodically Replaced Parts.....	110
Consumable Parts.....	111
Periodical Service.....	112
5. Disassembly/Assembly.....	113
Parts List.....	114
Major Units.....	114
Electrical Components List.....	114
Removing from the connection equipment.....	117
Disengaging the Paper Feeder.....	117
External Cover System.....	119
Removing the Rear Cover Unit.....	119
Removing the Cartridge.....	119
Removing the Right Cover Unit.....	121
Removing the Left Cover.....	125
Removing the Upper Cover Unit.....	128

Removing the Cartridge Cover.....	129
Controller System.....	132
Removing the Controller Cover.....	132
Removing the Main Controller PCB.....	132
Removing the Controller Box.....	136
Removing the DC Controller PCB.....	138
Removing the Fixing Power Supply PCB.....	138
Removing the Low Voltage Power Supply Unit.....	141
Removing the High Voltage Power Supply PCB.....	141
Removing the Control Panel Unit.....	142
Removing the Control Panel Unit Key PCB.....	143
Removing the Main Fan.....	144
Removing the Sub Fan.....	145
Laser Exposure System.....	147
Removing the Laser Scanner Unit.....	147
Image Formation System.....	149
Removing the Transfer Roller Unit.....	149
Pickup Feed Delivery System.....	151
Removing the Registration Unit.....	151
Removing the Main Drive Unit.....	154
Removing the Cassette Pickup Unit.....	157
Removing the Cassette Separation Roller Unit.....	159
Removing the Multi-purpose Tray Pickup Roller.....	160
Removing the Multi-purpose Tray Separation Pad.....	161
Fixing System.....	164
Removing the Fixing Assembly.....	164
Removing the Fixing Motor.....	165

6. Adjustment..... 169

Actions after Replacement.....	170
Before Replacing the Main Controller PCB.....	170
After Replacing the Main Controller PCB.....	170

7. Troubleshooting..... 171

Test Print.....	172
Overview.....	172
Device Log List.....	176
Cartridge Log Print.....	177
Troubleshooting.....	179
Remedy for Image Failure.....	179
Repetitive Image Defects Ruler.....	179
Checking the Amount of Fixing Nip.....	179
Obtaining Debug Log.....	181
Function Overview.....	181
Sublog.....	181
Conditions for collecting logs.....	181
Sublog Collection Procedure.....	182

8. Error/Jam/Alarm.....	185
Overview.....	186
Error Code Details.....	187
Jam Code.....	192
Alarm Code.....	194
9. Service Mode.....	195
Overview.....	196
Entering Service Mode.....	196
Remote UI Service Mode.....	196
Service Report.....	197
Service Mode.....	200
ADJUST GR.....	200
OPTION GR.....	200
CRGMNG GR.....	201
FUNCTION GR.....	201
LOG GR.....	203
PANEL LOCK GR.....	204
FW UPDATE GR.....	204
NETWORK GR.....	204
SP.ADMIN.MODE.....	206
APPENDICES.....	207
Service Tools.....	208
Solvents and Oil List.....	208
General Circuit Diagram.....	209
General Circuit Diagram (1/2).....	209
General Circuit Diagram (2/2).....	210
List of Items Which Can Be Imported.....	211
Service Mode Items Which Can Be Imported.....	211
Backup Data List.....	213
Backup Data.....	213
Soft counter specifications	214
Soft counter specifications.....	214

Safety Precautions

Laser Safety.....	2
How to Handle the Laser Scanner Unit	2
Toner Safety.....	2
Notes When Handling a Lithium Battery.....	3
Notes on Assembly/Disassembly.....	3

Laser Safety

Since radiation emitted inside this machine is completely confined with protective housings and external covers, the laser beam cannot escape from the machine during any phase of normal use by users.

Therefore, this machine is classified as a Class 1 laser product under the international standard IEC60825-1 that is regarded as safe during normal use.

How to Handle the Laser Scanner Unit

This machine is classified as a Class 1 laser product.

However, the laser scanner unit contains source of Class 3B laser beam and exposure to the beam may cause eye injuries.

Therefore, be sure not to disassemble the laser scanner unit. No adjustment can be made to the laser scanner unit in the machine in the field.

The label shown in the following figure is affixed on the laser scanner unit.

Dieses Gerät ist der Klasse 1 der Laserprodukte zugeordnet.

Allerdings enthält die Laserscannereinheit eine Laserstrahlquelle der Klasse 3B, die Augenschäden verursachen kann, wenn man in diesen Strahl blickt.

Deshalb darf die Laserscannereinheit nicht zerlegt werden. An der Laserscannereinheit kann keine Justage vor Ort vorgenommen werden.

Der in folgendem Bild dargestellte Aufkleber ist auf der Laserscannereinheit angebracht.

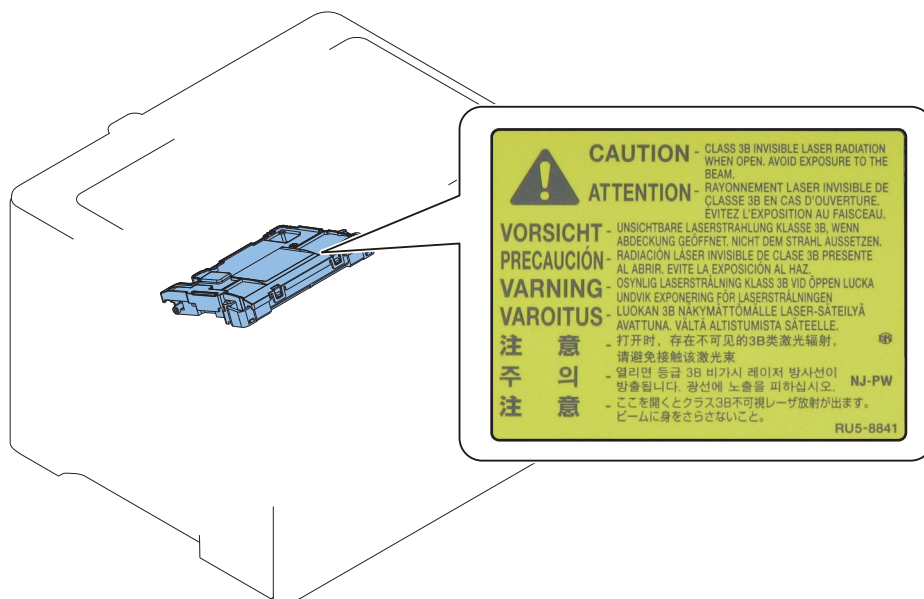

Toner Safety

About Toner

Toner is a nontoxic matter composed of plastic, iron and a trace of pigments.

CAUTION:

Never throw toner in flames to avoid explosion.

Handling Adhered Toner

- Use dry tissue paper to wipe off toner adhered to skin or clothes and wash in water.
- Never use warm water for cleaning up toner to prevent toner particles from being gelated to soak into fibers permanently.
- Toner particles are reactive with vinyl polymers. Avoid contacting these materials.

Notes When Handling a Lithium Battery

Dispose of used batteries according to the instructions.

CAUTION:

Risk of explosion if battery is replaced by an incorrect type.

The following warnings are given to comply with Safety Principles (EN60950-1).

CAUTION:

Wenn mit dem falschen Typ ausgewechselt, besteht Explosionsgefahr.
Gebrauchte Batterien gemäß der Anleitung beseitigen.

警告

如果更換不正確之電池型式會有爆炸的風險
請依製造商說明書處理用過之電池

Notes on Assembly/Disassembly

Follow the items below to assemble/disassemble the device.

1. Disconnect the power plug to avoid any potential dangers during assembling/disassembling works.
2. If not specially instructed, reverse the order of disassembly to reinstall.
3. Ensure to use the right screw type (length, diameter, etc.) at the right position when assembling.
4. To keep electric conduction, binding screws with washers are used to attach the grounding wire and the varistor. Ensure to use the right screw type when assembling.
5. Unless it is specially needed, do not operate the device with some parts removed.
6. Never remove the paint-locked screws when disassembling.



Product Overview

Product Lineups.....	5
Features.....	6
Specification.....	7
Parts Name.....	11

Product Lineups

Host machine

Function	LBP312x / LBP312dn	LBP311x	LBP310x
External			
Copy	No	No	No
Print	Yes	Yes	Yes
Fax	No	No	No
Remote UI	Yes	Yes	Yes
2-sided printing	Yes	Yes	Yes
MEAP	Yes	Yes	Yes
Network	Yes	Yes	Yes
Wireless LAN	No	No	No
PCL	Yes	Yes	No
PS	Yes	No	No

Options

Name	Detail
Paper Feeder PF-C1	A Paper Feeder with up to 3 decks can be installed.

Features

This product is a compact A4/LTR B&W SFP supporting multi decks, high capacity pickup, and large capacity cartridge.

1. High-speed printer
This machine is a printer in the high-speed range that realizes a print speed of 43 ppm (A4)/45 ppm (LTR) in 1-sided printing.
2. High capacity pickup
In addition to the Multi-purpose Tray and Standard Drawer, up to 3 Paper Feeders can be installed as options, and it is suitable for large volume printing.
Up to 2,300 sheets (in the case of 80 g/m²) / 2,660 sheets (in the case of 64g/m²) can be continuously and automatically picked up.
3. Large capacity cartridge
Two types of cartridge are available: standard capacity cartridge (estimated life: 10,000 pages) and large capacity cartridge (estimated life: 20,000 pages).
4. Compact design
Size of this machine is more compact compared with that of the current model (LBP6700 series).

Specification

Product Specifications

Item	Specification/Function
Machine installation method	Desktop page printer
Photosensitive medium	OPC Drum (24 mm dia.)
Exposure method	Laser beam
Charging method	Roller charging
Developing method	Toner projection
Transfer method	Roller transfer
Separation method	Curvature separation
Pickup method	Cassette: Roller separation method Multi-purpose Tray: Roller separation method
Fixing method	On-demand fixing method
Delivery method	Face down
Drum cleaning method	Cleaning Blade
Toner type	One-component magnetic toner
Toner supplying method	By replacing the cartridge
Toner level detection function	Yes
Toner save mode	Yes
Print method	Semiconductor laser + Dry-type electrophotographic method
Print resolution	600 dpi x 600 dpi
Print speed*1 (Plain paper (52 to 89 g/m ²), At continuous print)	43 sheets/min (A4), 45 sheets/min (LTR)
Warm-up time*2 (Duration from power-on to standby of the machine)	At normal startup: 30 sec. or less At quick startup: 3 sec. or less
Recovery time*3 (Time for recovery from sleep to standby)	3 sec. or less
First print time*3 (At 1-sided A4/LTR print)	Approx. 6.2 sec.
Paper type	Cassette: Plain paper (52 to 89 g/m ²), Recycled paper (52 to 89 g/m ²), Heavy paper (90 to 120 g/m ²), Bond paper (60 to 120 g/m ²) Multi-purpose Tray: Plain paper (52 to 89 g/m ²), Recycled paper (52 to 89 g/m ²), Heavy paper (90 to 199 g/m ²), Bond paper (60 to 120 g/m ²), Label paper, Envelope
Paper size	Cassette: A4, B5, A5, A6, LGL, LTR, STMT, EXEC, FLSC, 16K, Indian Legal, Custom paper*6 Multi-purpose Tray: A4, B5, A5, A6, LGL, LTR, STMT, EXEC, FLSC, 16K, Indian Legal, Index Card(3" x 5"), Envelope(Nagagata 3, Yougatanaga 3, No.10(COM10), Monarch, C5, DL), Custom paper*7
Maximum stacking capacity	Cassette: 550 sheets (80 g/m ²), 640 Sheets (64 g/m ²) Multi-purpose Tray: 100 sheets (80 g/m ²), 100 sheets (64 g/m ²)
Delivery stacking capacity *4	Approx. 250 sheets (64 g/m ²)

Item	Specification/Function
2-sided printing	A4, LGL,LTR,FLSC,Indian Legal, Custom paper (Width: 210.0 to 215.9 mm, Length: 279.4 to 355.6 mm)
Host Interface	USB Interface: Hi-Speed USB x 4 (1 on the front, 3 on the rear) Network Interface: Common to 10BASE-T, 100BASE-TX, and 1000BASE-T (RJ-45), Full/Half Duplex
Memory capacity	1,024 MB
Usage environment temperature range	10 to 30 deg C
Environment humidity range	20 to 80 % RH (Relative humidity; without dew condensation)
Operating noise (Measured based on ISO7779, Declared noise emission value based on ISO9296)	LwAd (declared A-weighted sound power level (1 B = 10 dB)): At standby: Inaudible At printing: 6.9 B or less (1-sided) At printing: 6.8 B or less (2-sided) LpAm (mean A-weighted emission sound-pressure level (bystander position)): At standby: Inaudible At printing: 54 dB (1-sided) At printing: 53 dB (2-sided)
Rated power supply	AC 120 to 127V, 60 Hz AC 220 to 240V, 50/60 Hz
Power consumption (At 20 deg C)	Maximum (Full Optional model): 1,290 W or less (120V), 1,310 W or less (230V) At operation: Approx. 700 W (120V), Approx. 670 W (230V) At standby: Approx. 9.6 W or less (120V), Approx. 9.5 W or less (230V) During sleep mode: Wired LAN connection: Approx. 0.9 W USB connection: Approx. 1.2 W At power OFF: • At shutdown: 0.3 W or less (120V), 0.3 W or less (230V) • In quick off mode: 0.72 W or less (120V), 0.76 W or less (230V)
Dimensions (W x D x H)	409 x 376 x 275 mm
Weight *5	Approx. 11.5 kg

*1: The print speed may become lower depending on the settings such as output resolution, paper size, type, orientation, and number of sheets printed.

*2: This may vary depending on the usage conditions of this machine (presence/absence of installed options, installation environment, etc.).

*3: This may vary depending on the print environment.

*4: This may vary depending on the site environment and the type of paper used.

*5: Excluding the Toner Cartridge

*6:

Portrait (Only when using the UFR II printer driver): Width 105.0 to 215.9 mm, Length 148.0 to 355.6 mm

Landscape: Width 148.0 to 215.9 mm, Length 148.0 to 215.9 mm

*7:

Portrait (Only when using the UFR II printer driver): Width 76.2 to 215.9 mm, Length 127.0 to 355.6 mm

Landscape: Width 127.0 to 215.9 mm, Length 127.0 to 215.9 mm

Print Speed

(Unit: sheets/min.)

Paper size	At 1-sided printing	At 2-sided printing
A4	43	34.4

Paper size	At 1-sided printing	At 2-sided printing
LTR	45	36.4

* The print speed may become lower depending on the settings such as output resolution, paper size, type, orientation, and number of sheets printed. In the case of 2-sided printing, 1 page on the front side and 1 page on the back side are output as 1 sheet.

Paper type

(Yes: Pickup possible)

Type of paper		Paper settings in this machine	Cassette	Multi-purpose Tray	Cassette (Option)
Plain paper, recycled paper	52 to 59 g/m ²	Plain L3	Yes*1	Yes*1	Yes*1
	60 g/m ²	Plain L2	Yes	Yes	Yes
	60 to 74 g/m ²	Plain L	Yes	Yes	Yes
	75 to 89 g/m ²	Plain	Yes	Yes	Yes
Heavy paper	90 to 105 g/m ²	Heavy 1	Yes	Yes	Yes
	106 to 120 g/m ²	Heavy 2	Yes	Yes	Yes
	121 to 149 g/m ²	Heavy 3	-	Yes*1	-
	150 to 199 g/m ²	Heavy 4	-	Yes*1	-
Bond paper	60 to 74 g/m ²	Bond 1	Yes	Yes	Yes
	75 to 104 g/m ²	Bond 2	Yes	Yes	Yes
	105 to 120 g/m ²	Bond 3	Yes	Yes	Yes
Label paper		Labels	-	Yes*1	-
Envelope (COM10 / Monarch / DL)		Envelope	-	Yes*1	-
Envelope (C5), Envelope (fixing priority)		Envelope H	-	Yes*1	-

*1: 1-sided printing only

Paper Size

(Yes: Pickup possible)

Paper size		Cassette	Multi-purpose Tray
A4	210.0 mm x 297.0 mm	Yes	Yes
B5	182.0 mm x 257.0 mm	Yes	Yes
A5	148.0 mm x 210.0 mm	Yes	Yes
A6	105.0 mm x 148.0 mm	-	Yes
LGL	215.9 mm x 355.6 mm	Yes	Yes
LTR	215.9 mm x 279.4 mm	Yes	Yes
STMT	139.7 mm x 215.9 mm	-	Yes
EXEC	184.2 mm x 266.7 mm	Yes	Yes
FLSC	215.9 mm x 330.2 mm	Yes	Yes
16K	195.0 mm x 270.0 mm	Yes	Yes
Index Card (3" x 5")	76.2 mm x 127.0 mm	-	Yes
Envelope No.10 (COM10)	104.7 mm x 241.3 mm	-	Yes
Envelope Monarch	98.4 mm x 190.5 mm	-	Yes
Envelope C5	162.0 mm x 229.0 mm	-	Yes
Envelope DL	110.0 mm x 220.0 mm	-	Yes
OFFICIO*1	215.9 mm x 317.5 mm	Yes	Yes
B-OFFICIO*1	216 mm x 355 mm	Yes	Yes
M-OFFICIO*1	216 mm x 341 mm	Yes	Yes
G-LTR*1	203.2 mm x 266.7 mm	Yes	Yes

Paper size		Cassette	Multi-purpose Tray
G-LGL*1	203.2 mm x 330.2 mm	Yes	Yes
AFLS*1	206 mm x 338 mm	Yes	Yes
Custom paper	-	Yes*2	Yes*3

*1:

Only when the user-defined size is configured on the driver

*2:

When paper is set in portrait orientation (Only when using the UFR II printer driver): Width 105.0 to 215.9 mm, Length 148.0 to 355.6 mm

Landscape: Width 148.0 to 215.9 mm, Length 148.0 to 215.9 mm

*3:

When paper is set in portrait orientation (Only when using the UFR II printer driver): Width 76.2 to 215.9 mm, Length 127.0 to 355.6 mm

Landscape: Width 127.0 to 215.9 mm, Length 127.0 to 215.9 mm

Parts Name

External View

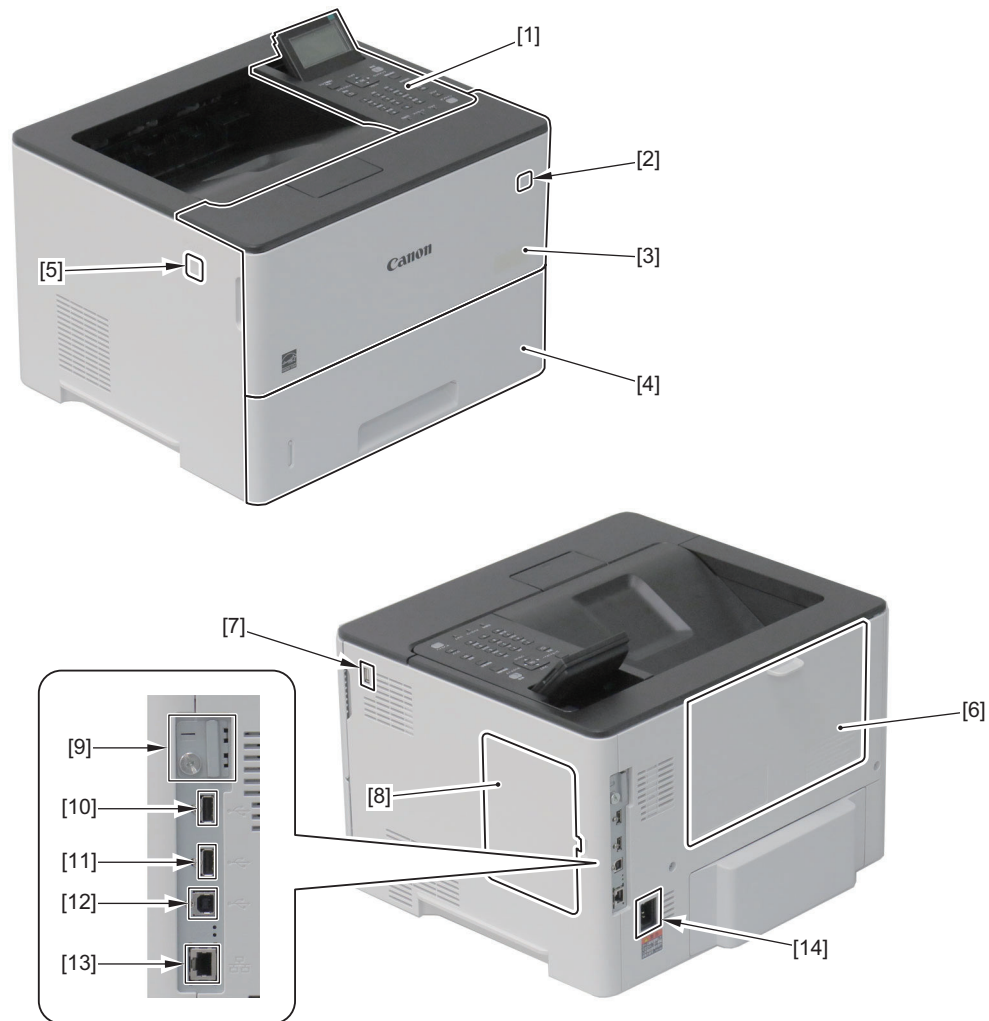

No.	Name	No.	Name
1	Control Panel	8	ROM Outer Cover
2	Power Switch	9	SD Card Slot Cover
3	Front cover unit	10	USB port (for USB flash drive)
4	Cassette	11	USB port (for USB flash drive)
5	Front Cover Unit Lock Release Button	12	USB port (for PC connection)
6	Rear cover	13	LAN port
7	USB port (for USB flash drive)	14	Power Socket

Cross Section View

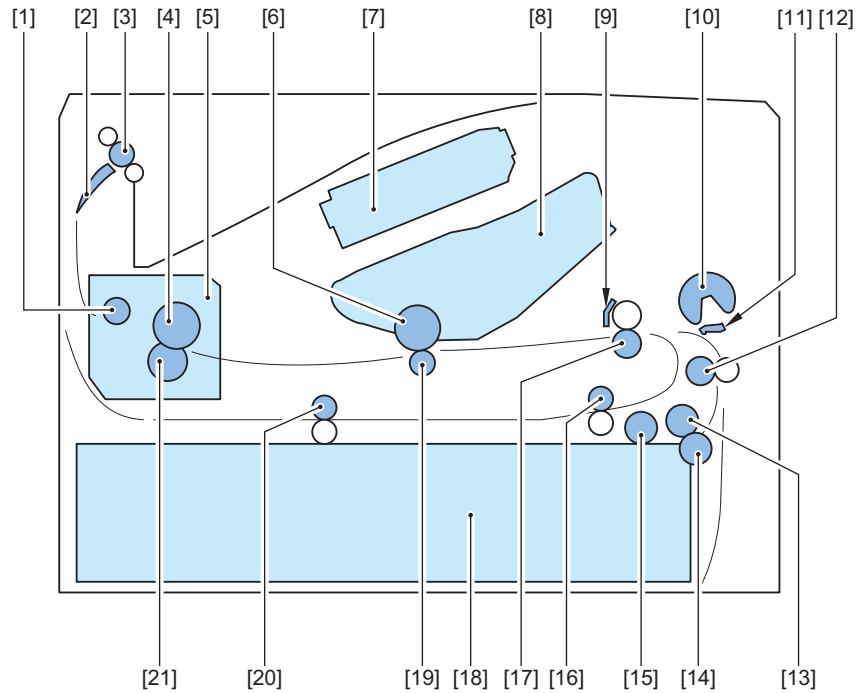

No.	Name	No.	Name
[1]	Fixing Delivery Roller	[12]	Vertical Path Roller
[2]	Duplex Flapper	[13]	Cassette Feed Roller
[3]	Delivery Roller	[14]	Cassette Separation Roller
[4]	Fixing Film	[15]	Cassette Pickup Roller
[5]	Fixing Assembly	[16]	Duplex Re-pickup Roller
[6]	Photosensitive Drum	[17]	Registration Roller
[7]	Laser Scanner Assembly	[18]	Cassette
[8]	Cartridge	[19]	Transfer Roller
[9]	Registration Shutter	[20]	Duplex Feed Roller
[10]	Multi-purpose Tray Pickup Roller	[21]	Pressure Roller
[11]	Multi-purpose Tray Separation Pad		

Control Panel

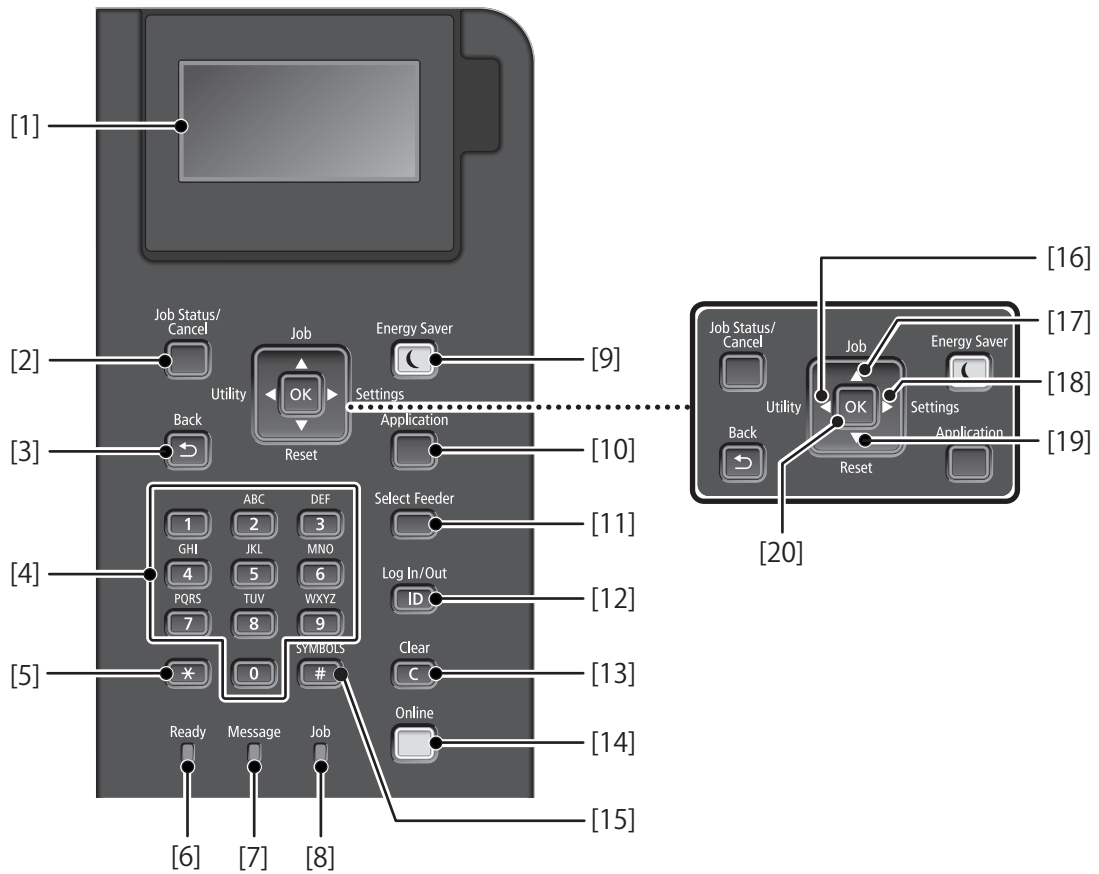

No.	Name	No.	Name
1	Display	11	[Select Feeder] key
2	[Job Status/Cancel] key	12	[Authentication] key
3	[Back] key	13	[Clear] key
4	Numeric keys ([0] to [9])	14	[Online] key
5	[Alphanumeric] key	15	[Symbol] key
6	[Print ready] lamp	16	[Utility] key / [<] key
7	[Message] lamp	17	[Job] key / [^] key
8	[Job] lamp	18	[Setup] key / [>] key
9	[Energy Saver] key	19	[Reset] key / [V] key
10	[Select Function] key	20	[OK] key



Technical Explanation (Device)

Laser Exposure System.....	15
Image Formation System.....	17
Pickup Feeding System.....	23
Fixing System.....	33
Controller System.....	36

Laser Exposure System

Overview

The Laser Scanner system forms a latent image on the Photosensitive Drum according to the video signal sent from the Main Controller.

The Laser Scanner Unit consists of the Laser Unit and the Scanner Motor Unit, and is controlled by the signal input from the DC Controller.

The following shows an outline drawing of the Laser Scanner Unit.

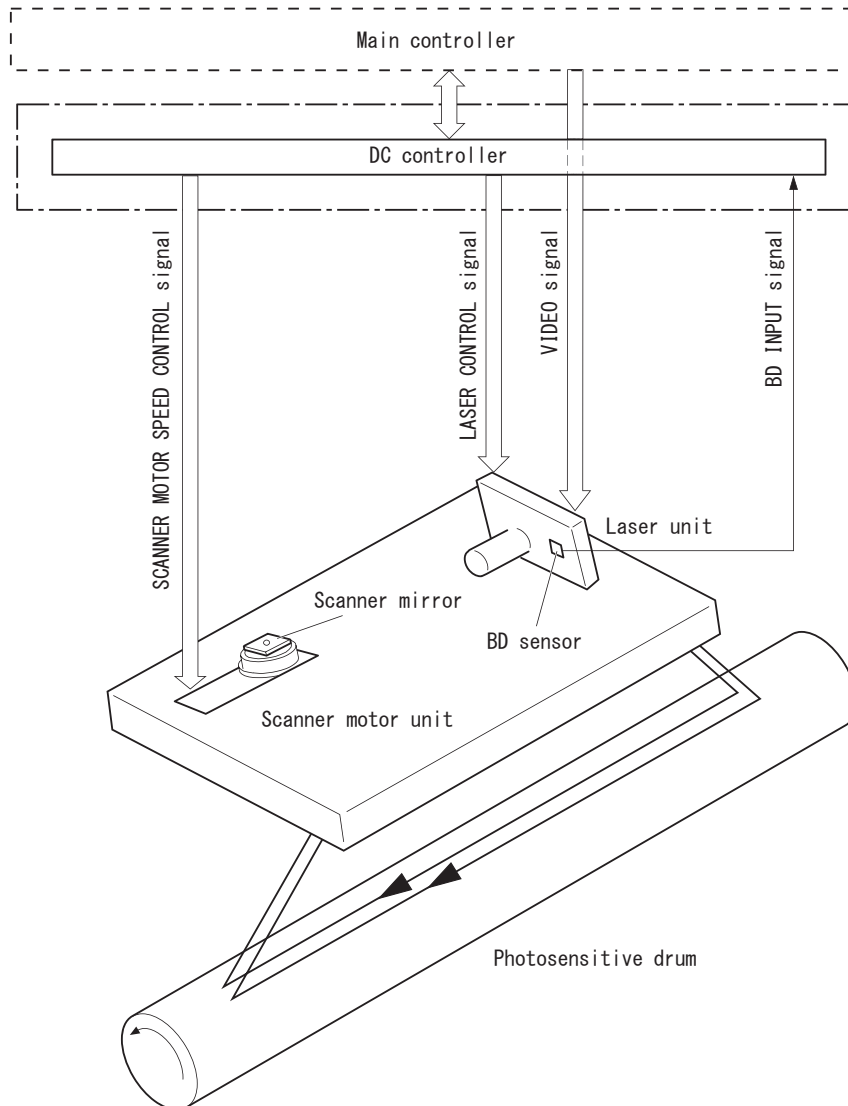

Laser Scanner Motor Control

Rotates the Polygon Mirror at a specified speed.

<Execution Timing>

At startup of the Laser Scanner Motor

<Control Description>

1. The DC Controller PCB controls rotation of the Laser Scanner Motor.
2. Sends acceleration signals (ACC) and deceleration signals (DEC) to the Laser Scanner Motor to control the speed to the specified speed.

<Related Error Code>

E110-0000: Failure of the Laser Scanner Unit

E110-0001: Error in the initial operation of the Scanner Motor

Image Formation System

Image Formation Process

■ Outline

The image formation process consists of the following seven steps divided among five functional blocks:

Latent image formation block

- Step 1: Primary charging
- Step 2: Laser-beam exposure

Developing block

- Step 3: Developing

Transfer block

- Step 4: Transfer
- Step 5: Separation

Fixing block

- Step 6: Fixing

Drum cleaning block

- Step 7: Drum cleaning

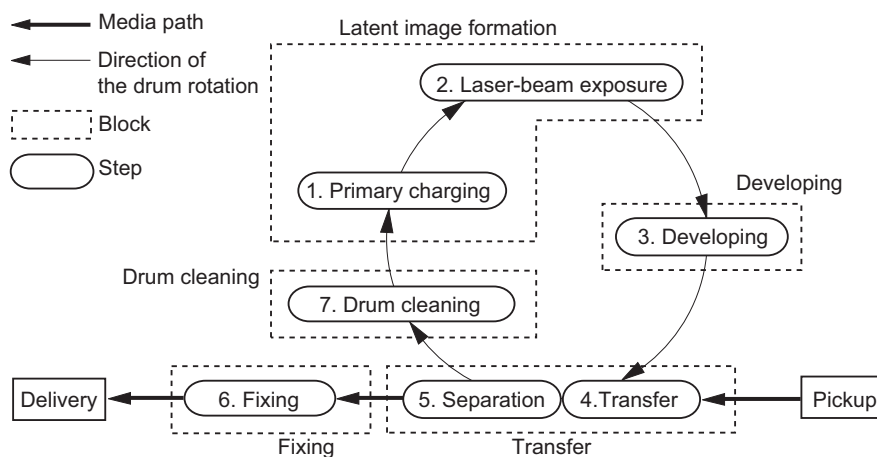

■ Latent image formation block

During the two steps that comprise this block, an invisible latent image is formed on the photosensitivedrum.

Step 1: Primary charging

To prepare for latent image formation, the surface of the photosensitive drum is charged with a uniform negative potential. The primary charging bias is applied to the primary charging roller and the roller charges the drum directly.

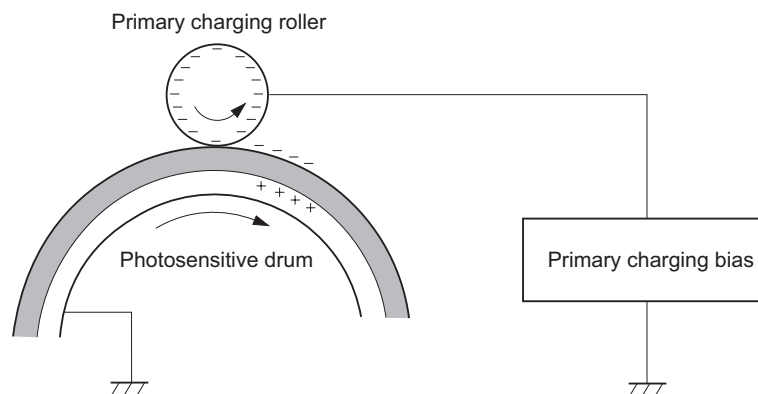

Step 2: Laser-beam exposure

The laser beam scans the photosensitive drum to neutralize the negative charge on portions of the drum surface. An electrostatic latent image forms where the negative charge was neutralized.

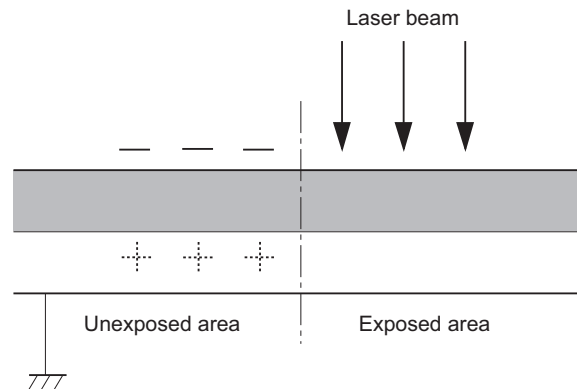

• Drum discharge

The drum discharge is a feature to remove residual charge on the Photosensitive Drum surface for preventing the uneven image density.

The Laser Beam strikes the surface of the Photosensitive Drum to remove the residual charge.

The drum discharge is performed during LSTR period.

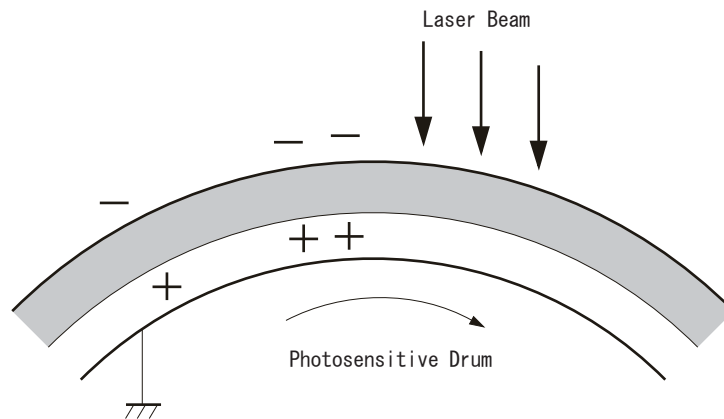

■ Developing block

Toner adheres to the electrostatic latent image on the photosensitive drum, which becomes visible.

Step 3: Developing

Toner acquires a negative charge from the friction that occurs when the developing roller rotates against the developing blade. The negatively charged toner is attracted to the latent image on the photosensitive drum surface because the drum surface has a higher potential. The developing bias is applied to the developing roller.

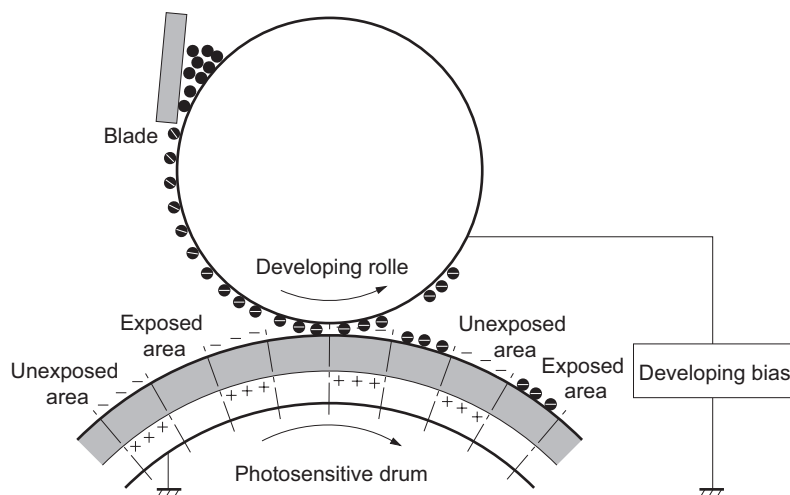

■ Transfer block

During the two steps that comprise this block, a toner image on the photosensitive drum is transferred to the print media.

Step 4: Transfer

The transfer bias is applied to the transfer roller to charge the print media positive. The positively charged media attracts the negatively charged toner from the photosensitive drum surface.

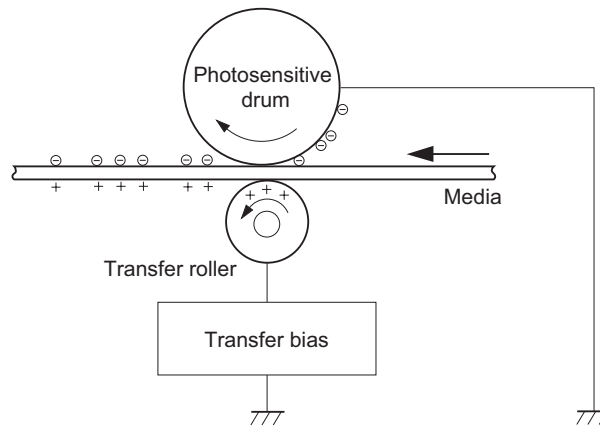

Step 5: Separation

The elasticity of the print media and the curvature of the photosensitive drum cause the media to separate from the drum surface. The static charge eliminator reduces back side static discharge of the media for stable media feed and image quality.

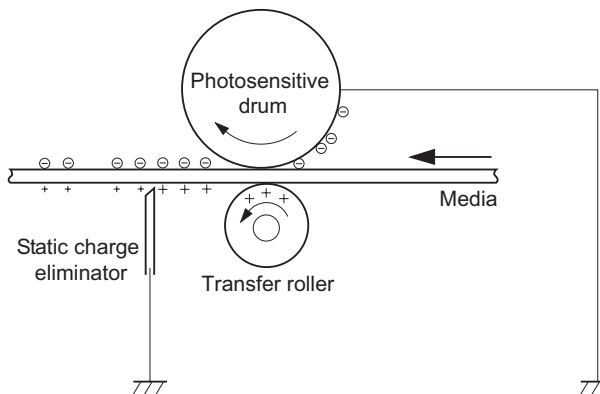

■ Fixing block

The toner image is fixed onto the print media.

Step 6: Fixing

The printer uses an on-demand fixing method. The toner image is permanently affixed to the print media by heat and pressure. Configuration of the Fixing Film is self-bias film (keep the surface of the Fixing Film charged with negative potential by contact with diode) to improve image quality.

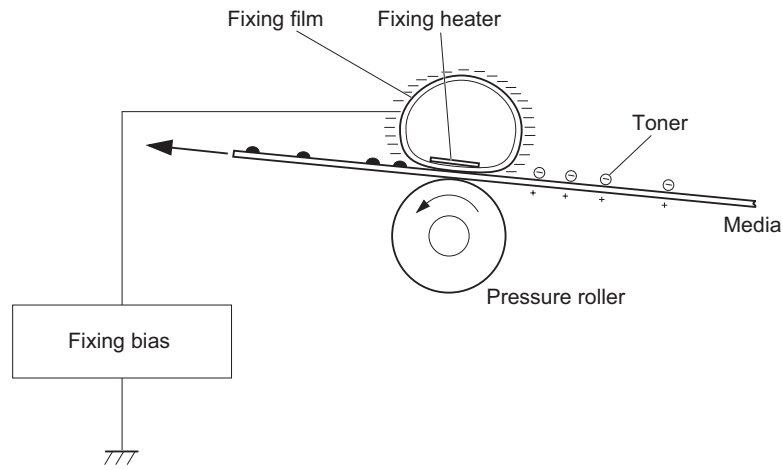

■ Drum cleaning block

The residual toner is cleared from the photosensitive drum surface.

Step 7: Drum cleaning

The cleaning blade scrapes the residual toner off the surface of the photosensitive drum. The residual toner is deposited in the toner collection box.

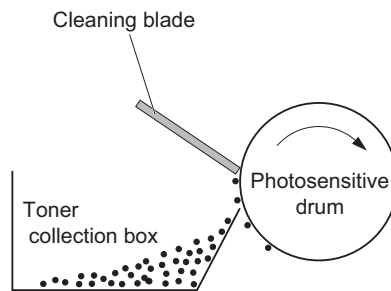

● Cartridge

■ Overview

The cartridge of this machine has the function to form a visible image on the Photosensitive Drum with toner. The following shows an outline drawing of the cartridge of this machine.

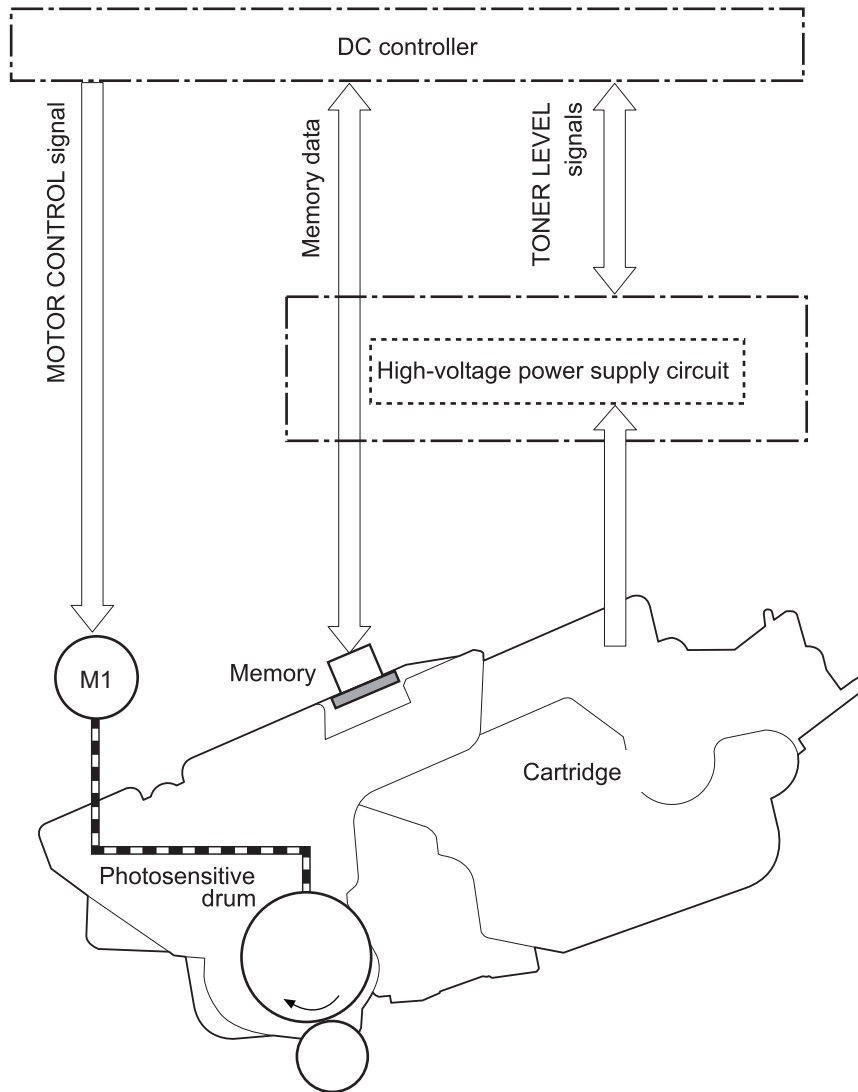

The cartridge of this machine consists of the Photosensitive Drum, Primary Charging Roller, Developing Sleeve, Stirring Plate, etc.

The parts other than the Primary Charging Roller are rotated by the drive of the Main Motor, and the Primary Charging Roller rotates by engaging with the Photosensitive Drum.

The DC Controller detects the toner level by monitoring the toner level detection signal.

■ Memory

This machine can detect and store the cartridge usage conditions and other information when the DC Controller PCB reads and writes the data stored in the memory.

If the memory cannot be detected, "Error. Non-Canon cart. not covered by warranty" is displayed.

■ Cartridge Detection

The DC Controller detects whether a cartridge is installed according to the presence/absence of memory and the detected toner level. The DC Controller notifies the Main Controller of the absence of a cartridge if it judges there is no cartridge.

Detection timing:

- At power-on
- When closing the Front Cover Unit

Display on the Control Panel:

- Insert toner cartridge.

■ Cartridge Life Detection

The DC Controller notifies the Main Controller when cartridge consumption reaches the specified value.

Upon reception of the notification the Main Controller displays a warning or a message that the cartridge has reached the end of its life.

	Warning display	End of life display
Toner level*1	Differs depending on the setting *2	0%
Detected to (location)	Memory	Memory
Message (machine operation)	16 Tnr cart. will soon reach end of lifetime.*3	1G Change toner cartridge recommended. *4, *5

*1: Can be checked in [Utility Menu > Consumables > Remaining Toner > Remaining Toner].

*2: Value set in [Setup > User Maintenance > Toner Check Timing/Specify Check Timing].

*3: "Continue Printing" or "Stop Printing" can be set in [Control Menu > Warning Step > Toner Cart. Warning].

*4: The operation to perform when the cartridge has reached the end of life can be set in [SERVICE MODE > OPTION GR. > CRG LIFE STEP].

*5: The cartridge life value can be changed in [SERVICE MODE > OPTION GR. > CRG LIFE STOP].

Pickup Feeding System

Overview

The Pickup Feed System performs pickup, feed, and delivery of print paper, and consists of various rollers.

Print paper flow

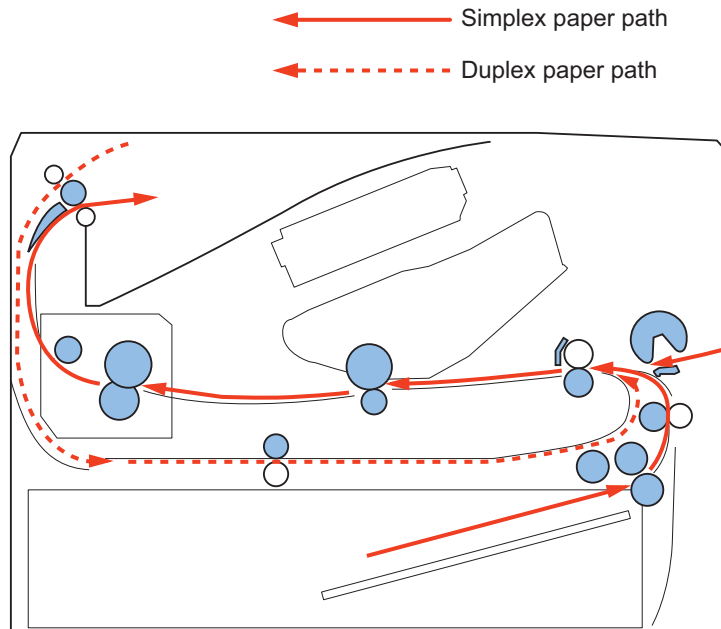

Load drives of electrical components

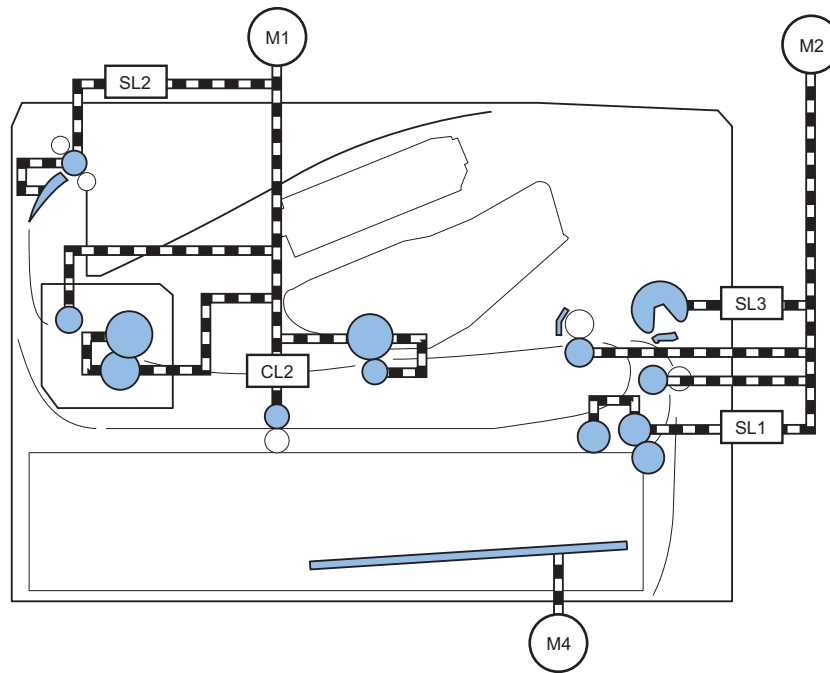

Symbol	Name
M1	Fixing Motor
M2	Pickup Motor
M4	Lifter Motor
CL2	Duplex Re-pickup Clutch
SL1	Cassette Pickup Solenoid
SL2	Duplex Reverse Solenoid
SL3	Multi-purpose Tray Pickup Solenoid

Outline drawing of sensors and rollers

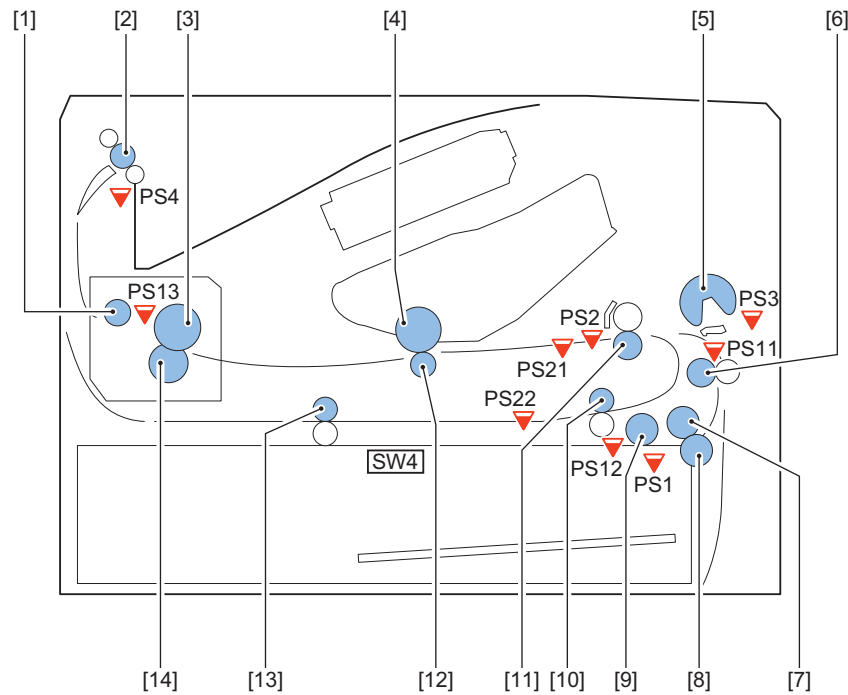

Symbol	Name
PS1	Cassette Media Presence Sensor
PS2	TOP Sensor
PS3	Multi-purpose Tray Media Presence Sensor
PS4	Delivery Tray Full Level Sensor
PS11	Pre-Registration Sensor
PS12	Media Stack Surface Sensor
PS13	Fixing Delivery Sensor
PS21	Paper Width Sensor
PS22	Duplex Feed Sensor
[1]	Fixing Delivery Roller
[2]	Delivery Roller
[3]	Fixing Film
[4]	Photosensitive Drum
[5]	MP tray Pickup roller
[6]	Feed Roller
[7]	Cassette Feed Roller
[8]	Cassette Separation Roller
[9]	Cassette Pickup Roller
[10]	Duplex Re-pickup Roller
[11]	Registration Roller
[12]	Transfer Roller
[13]	Duplex Feed Roller
[14]	Pressure Roller
SW4	Cassette Detection Switch

Lifter control

Paper inside a cassette is lifted up by the Lifting Plate.

The Lifting Plate is lifted up by rotating the Cassette Lifter Motor (M4).

The paper surface is detected by the Media Stack Surface Sensor (PS12).

When the Lifting Plate is rising, the Lifter Motor (M4) is controlled to keep the paper surface steady so that pickup can be performed stably.

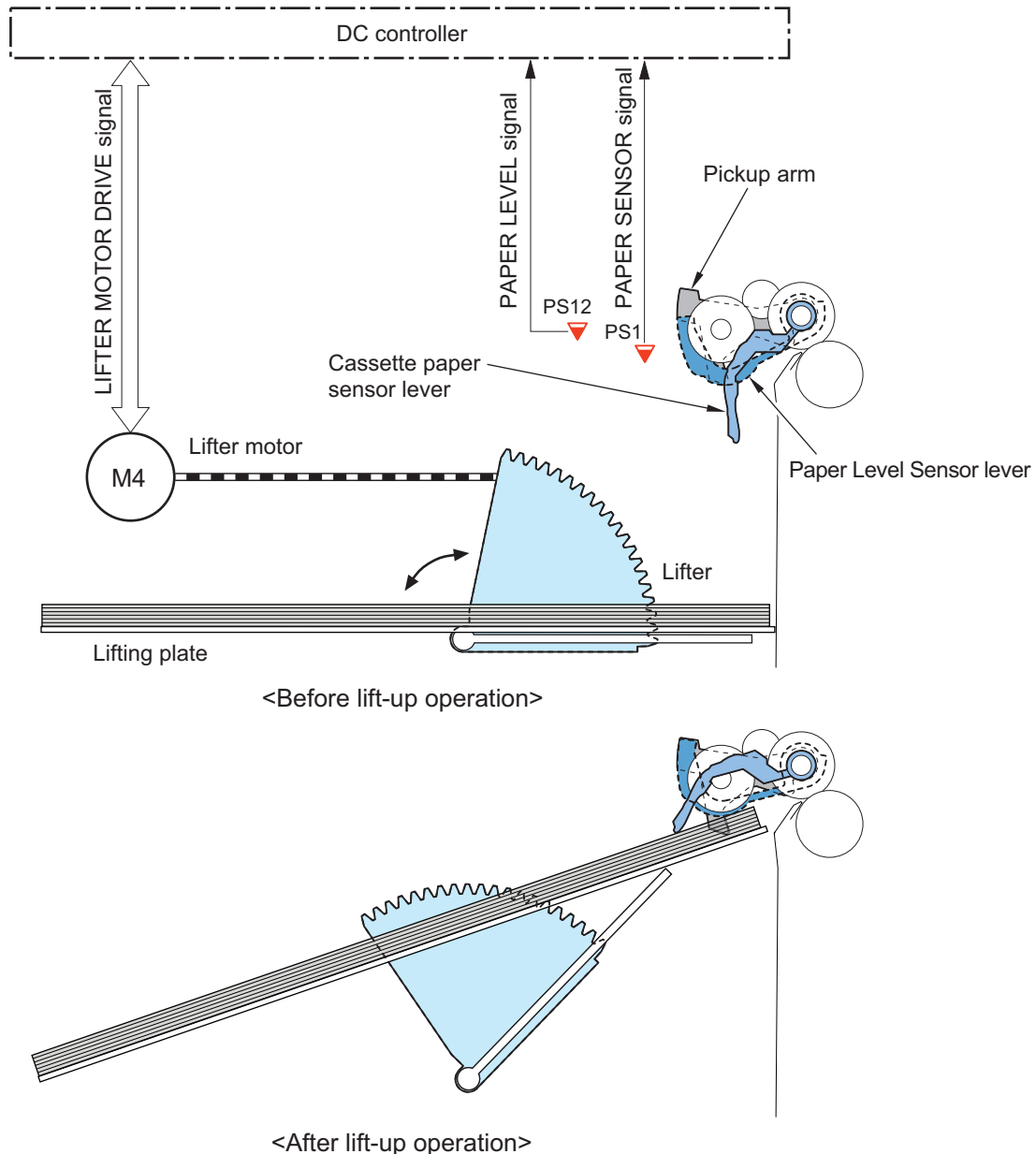

This operation is divided into two operations: the initial lift-up operation and the lift-up operation during printing.

1. Initial lift-up operation

When the power is turned ON or a cassette is inserted, the Lifter Motor (M4) is driven to lift up the Lifting Plate to the position for detection if the Media Stack Surface Sensor (PS12) do not detect the paper surface.

2. Lift-up operation during printing

This operation is performed if the paper surface is lowered a certain amount by the pickup operation.

If the Media Stack Surface Sensor (PS12) detect that there is no paper during printing, the Lifter Motor (M4) is driven to lift up the Lifting Plate to the pickup position.

< Related error codes >

- E015-0001: Cassette 1 lift-up error
- E015-0002: Cassette 2 lift-up error
- E015-0003: Cassette 3 lift-up error
- E015-0004: Cassette 4 lift-up error

Cassette Detection

Presence of the cassette is detected using the Cassette Detection Switch (SW4).

The cassette detection flag of the cassette is detected by the Cassette Detection Switch in the host machine.

Cassette Pickup Control

The DC Controller rotates the Pickup Roller by rotating the Pickup Motor (M2).

The Pickup Arm is lifted and lowered to feed the paper by rotating the Pickup Cam with the Pickup Solenoid (SL1).

Cassette Double Feed Prevention Mechanism

This machine employs the Separation Roller method for the cassette pickup double feed prevention mechanism.

The Separation Roller method of this machine is a method that prevents paper double feeds by using the Cassette Separation Rollers without drive. The Cassette Separation Rollers are driven and rotated by the Cassette Feed Roller.

■ At Normal Time

The Cassette Separation Roller is driven by the Cassette Feed Roller drive via paper. This causes the Cassette Separation Rollers to rotate in the feed direction.

■ During Double Feed

Since the friction force between sheets of paper becomes weaker when there are multiple sheets of paper, the Cassette Feed Roller drive force transmitted to the Cassette Separation Roller becomes extremely weak. Since force suppressing rotation is applied to the Cassette Separation Rollers of this machine, this mechanism does not allow rotation by the weak drive force transmitted from the Cassette Feed Roller during double feed. The Separation Rollers therefore do not rotate and do not pickup double feed paper.

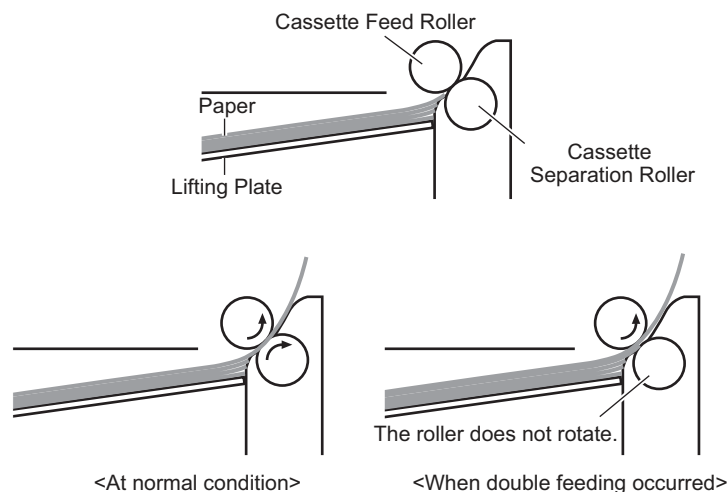

Multi-purpose Tray Pickup Control

The Multi-purpose Tray pickup feeds paper from the Multi-purpose Tray one sheet at a time into the machine.

The following describes the operation of the Multi-purpose Tray pickup.

1. When a print command is input from the Main Controller, the DC Controller rotates the Pickup Motor (M2).
2. When the DC Controller turns the Multi-purpose Tray Pickup Solenoid (SL3) on, the Multi-purpose Tray Pickup Roller rotates and paper is picked up.

3. After double feed paper is removed by the Multi-purpose Tray Separation Pad, paper is fed into the machine. Note that the presence of paper on the Multi-purpose Tray is detected by the Multi-purpose Tray Media Presence Sensor (PS3), and printing is not performed if there is no paper.

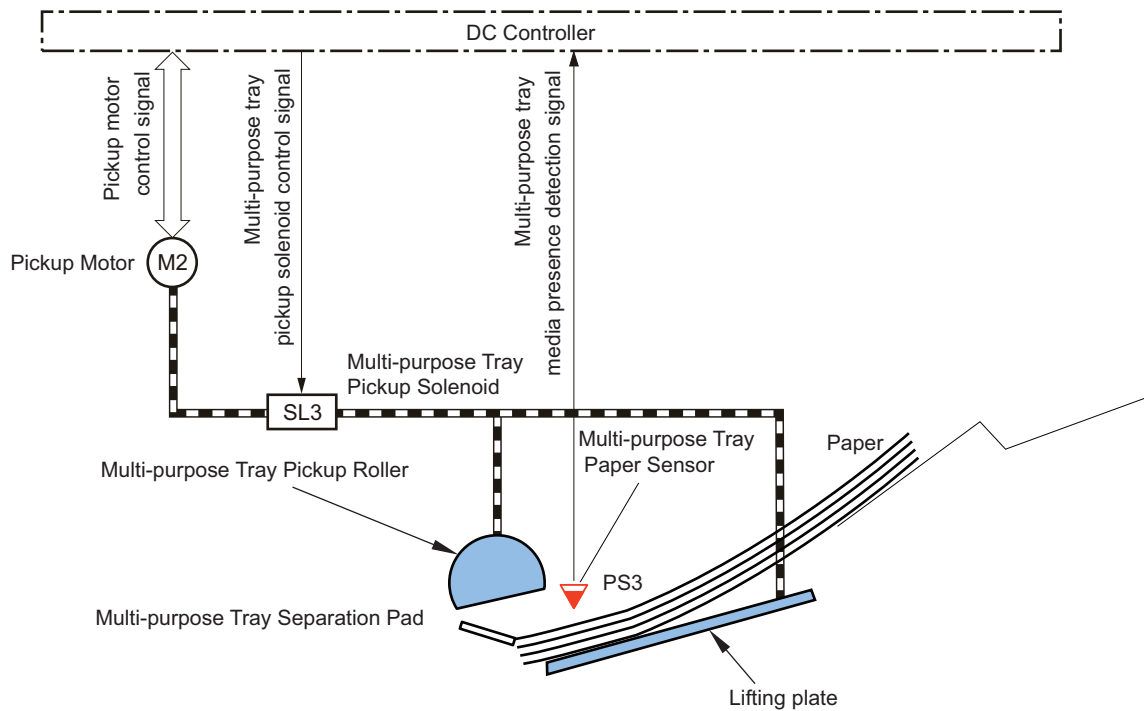

Skew Correction

This machine can correct paper skew without lowering throughput.

Skew is corrected as follows.

1. The paper leading edge pushes against the Registration Shutter to align the leading edge of the paper.
2. The trailing edge of the paper is fed and slack is generated at the leading edge of the paper.
3. When the trailing edge is fed even further, the paper leading edge for which slack was generated pushes up the Registration Shutter and then the paper is fed to the Registration Roller while the paper leading edge is aligned.

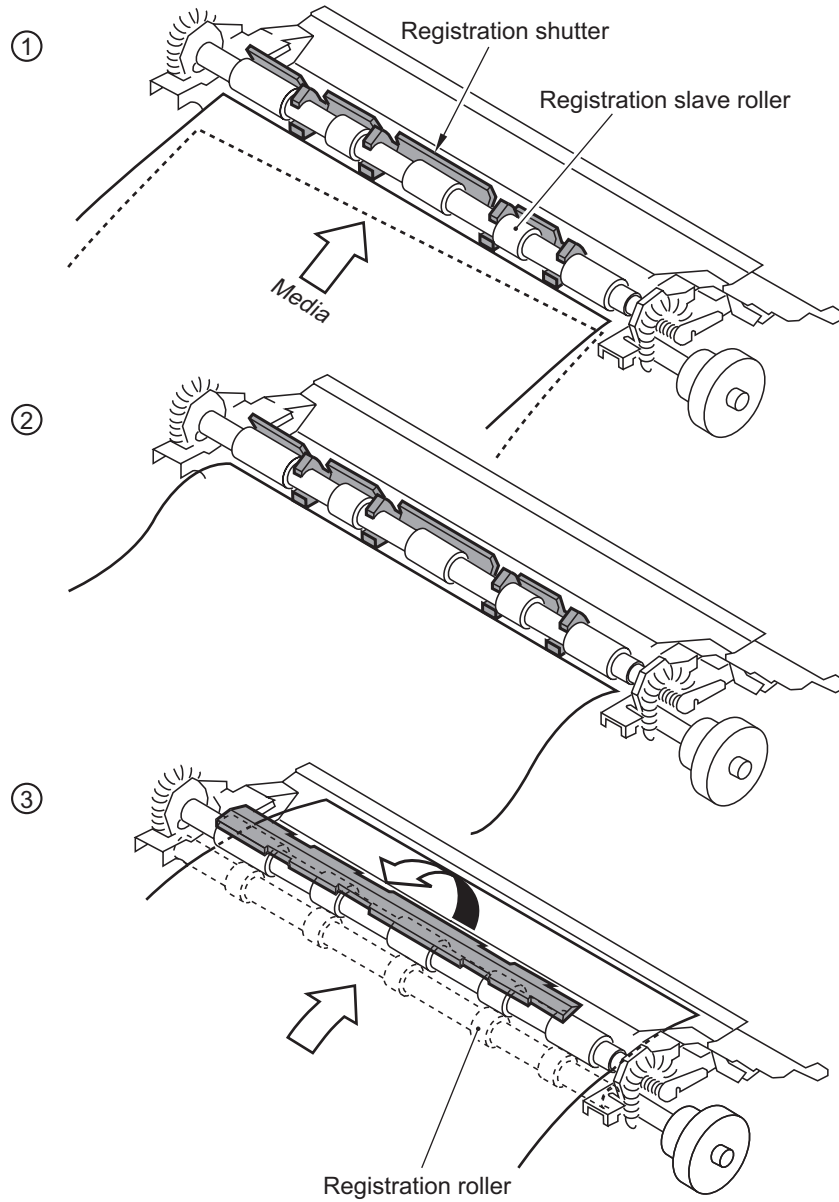

Paper Width Detection

Detection of paper width is performed to prevent temperature increase at the edge of the Fixing Heater. Width of paper being fed is detected by the Paper Width Sensor (PS21). When either of the Paper Width Sensor Flags on the right and left is turned ON, it is detected that the paper width is 210 mm or wider. If the paper width detected by the Paper Width Sensor Front did not match the paper size set in the paper size of the Select Feeder menu, "Check paper size." is displayed on the Control Panel.

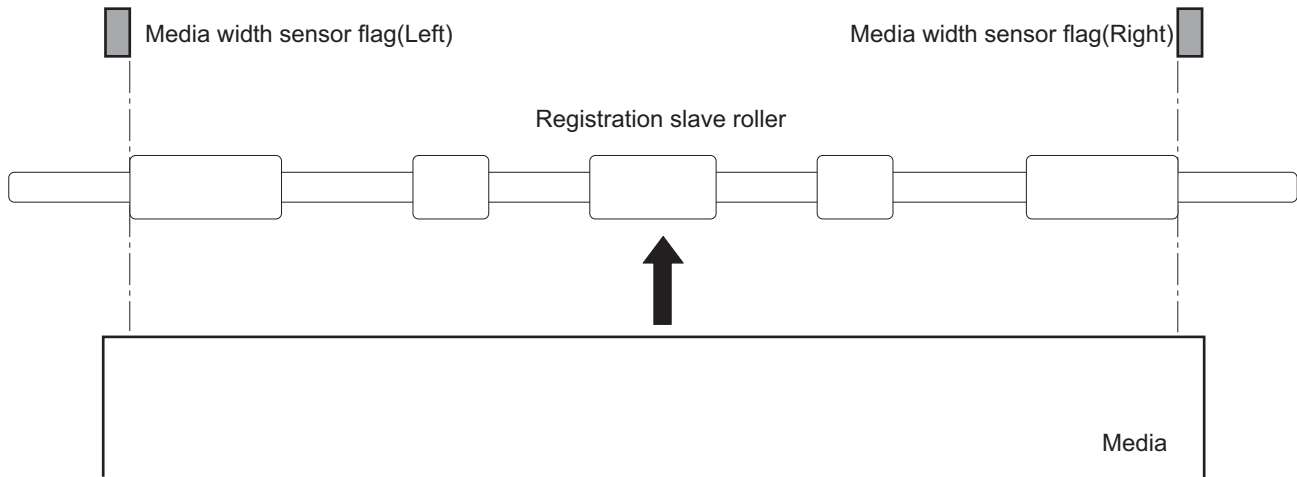

Paper Width Sensor (PS21)	Detection result	Paper size
ON	Paper width: 210 mm or wider	A4, LTR, LGL, Indian LGL
OFF	Paper width: shorter than 210 mm	EXEC, B5, A6, A5

Paper Length Detection

The TOP Sensor (PS2) measures the paper length to prevent soiling of the Transfer Roller.

There is no way to detect the size in the Multi-purpose Tray.

The DC Controller detects the actual length of the paper by measuring the time when paper is fed using the TOP Sensor (PS2). If the detected paper is detected to be shorter than the specified size, image masking is performed from that point in time to prevent toner soiling of the Transfer Roller.

Feed Speed Control

The printer changes the feed speed for each paper setting (print mode) to prevent fixing failures.

The DC Controller changes the paper feed speed (1/1 speed or 1/2 speed) for each paper setting to prevent the temperature rise at the edge of the Fixing Assembly.

Paper size	Pickup from Multi-Purpose Tray/Cassette	
	1/1 speed	1/2 speed
Plain L3	Yes	Yes
Plain L2	Yes	Yes
Plain L	Yes	Yes
Plain	Yes	Yes
Heavy 1	No	Yes
Heavy 2	No	Yes
Heavy 3	No	Yes*1
Heavy 4	No	Yes*1
Bond 1	No	Yes
Bond 2	No	Yes
Bond 3	No	Yes
Labels	No	Yes*1
Envelope	No	Yes*1
Envelope H	No	Yes*1

*1: Supported only at paper pickup from the Multi-purpose Tray.

Jam Detection

The sensors are provided at the locations shown below to detect the presence of print paper and whether the print paper is being fed correctly.

- PS2: TOP Sensor
- PS11: Pre-registration Sensor
- PS13: Fixing Delivery Sensor
- PS21: Paper Width Sensor
- PS22: Duplex Feed Sensor
- PS432: PF Media Path Sensor

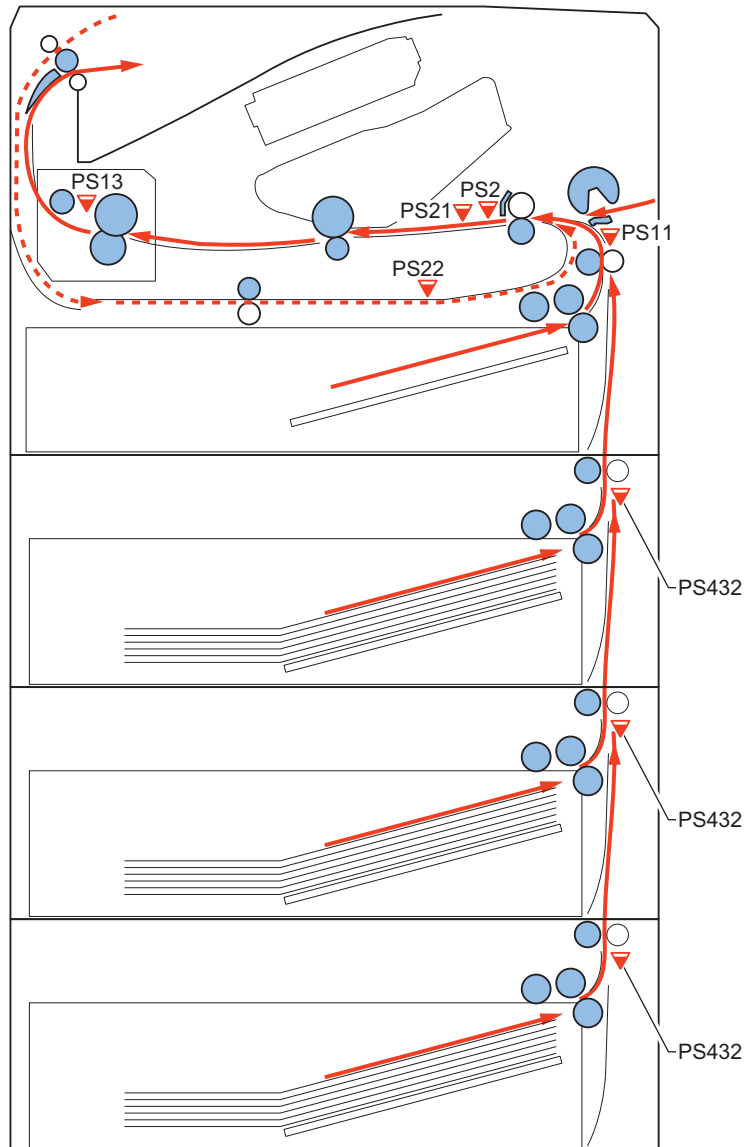

Occurrence of a jam is judged by whether paper is in the sensor area at the timings stored in the DC Controller. When the DC Controller judges that a jam has occurred, the printing operation is stopped and the jam is notified to the Main Controller at the same time. The following shows the jams that are detected.

Jam name	Details
Pickup Delay Jam 1	The TOP Sensor (PS2) does not detect the trailing edge although a specified period of time has passed after detection of the leading edge.
Pickup Delay Jam 2	Paper was picked up from the first, second, or third cassette of the Paper Feeder, but the PF Media Path Sensor (PS432) of its pickup slot failed to detect the paper leading edge.
Pickup Delay Jam 3	Paper was picked up from the second or third cassette of the Paper Feeder, but the PF Media Path Sensor (PS432) of the cassette just above its pickup slot failed to detect the paper leading edge.

Jam name	Details
Pickup Stationary Jam 1	The TOP Sensor (PS2) does not detect the trailing edge although a specified period of time has passed after detection of the leading edge.
Fixing Delivery Delay Jam 1	The Fixing Delivery Sensor (PF13) does not detect the leading edge although a specified period of time has passed after the TOP Sensor (PF2) detects the leading edge.
Fixing Delivery Stationary Jam 1	The Fixing Delivery Sensor (PS13) does not detect the trailing edge although a specified period of time has passed after the TOP Sensor (PS2) detects the trailing edge.
Internal Stationary Jam 1	During warm-up rotation, residual paper was detected by a sensor.
Internal Stationary Jam 2	The sensors detected paper when the print operation was completed. The stop command was received after the pickup operation started.
Door Open Jam 1	The door open was detected during printing and feeding paper.
Paper Wrapping Jam 1	The time from when the Fixing Delivery Sensor (PS13) detected the paper leading edge until the OFF status of the sensor was detected was shorter than the predetermined time.
Duplex Re-pickup Assembly Jam 1	At 2-sided print, the paper was reversed, but the TOP Sensor (PS2) failed to detect the paper leading edge within the specified period of time.

Fixing System

Overview/Configuration

Overview

Fixing Delivery Assembly consists of the Fixing Assembly for fixing toner on the print paper and the Delivery Assembly for delivering print paper on which toner is fixed to the Delivery Outlet (Face-down Tray).

Main Parts in the Fixing Assembly

This circuit is for controlling the temperature of the Fixing Assembly.

The Fixing Assembly of this machine uses an on-demand fixing method, and consists of the following parts:

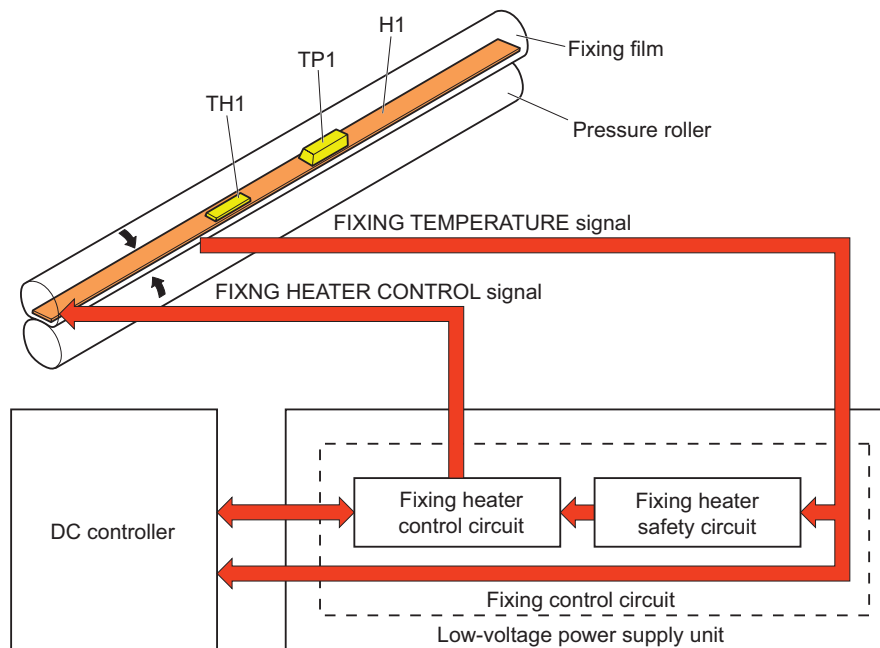

- Fixing Heater (H1): Ceramic Heater for heating the Fixing Film
- Thermistor (TH1): Thermistor for detecting the fixing temperature. (Contact type)
- Thermoswitch (TP1): Thermoswitch for preventing the abnormal temperature rise of the Fixing Heater. (Contact type)

Temperature control of the Fixing Assembly which consists of these parts is performed by the Fixing Heater control circuit and Fixing Heater safety circuit according to the command of the DC Controller.

Fixing Temperature Control

Heater Temperature Control

This control detects the surface temperature of the Fixing Heater and controls the drive signal of the Fixing Heater so that the temperature of the Fixing Heater becomes the target temperature.

The temperature is detected by the Thermistor, and the DC Controller controls the temperature to become the target temperature using the Fixing Heater drive (FSRD).

The following shows this control circuit:

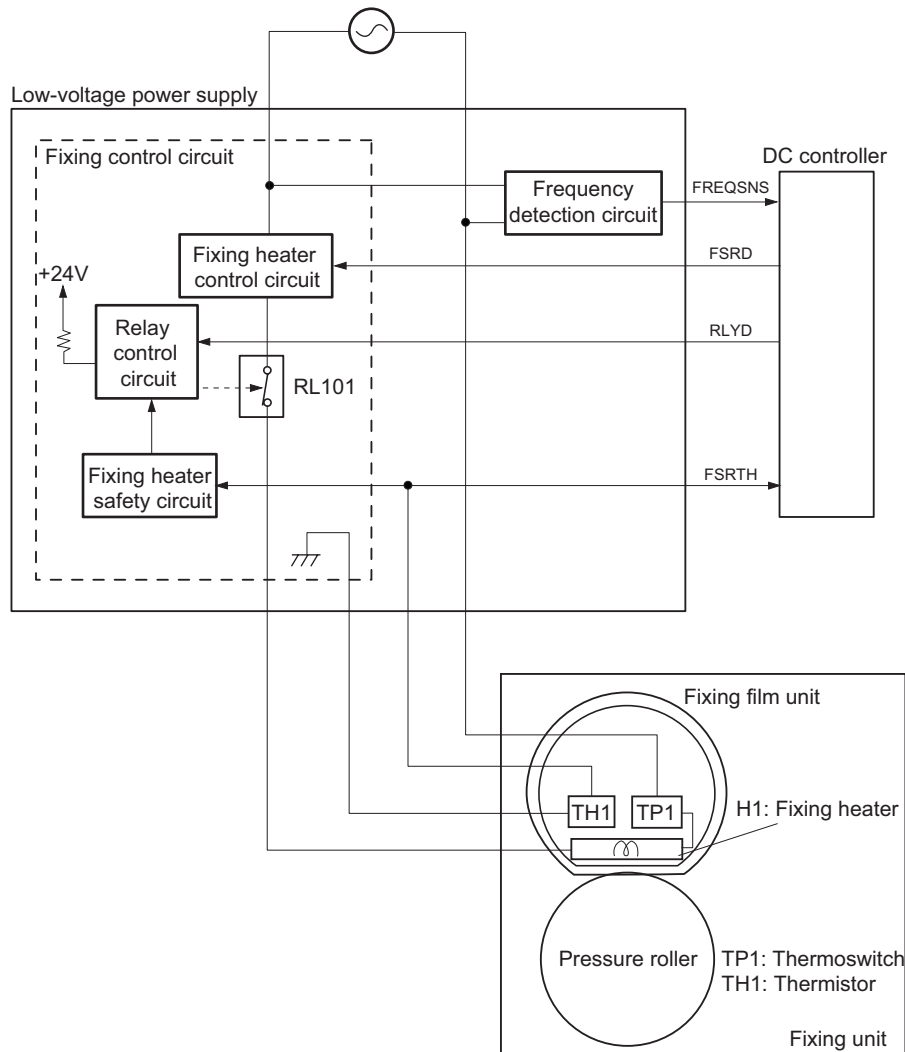

Protective Functions

Protection Function

The Protection Circuit shuts down the power supply to the Fixing Heater if the Fixing Assembly detects abnormal temperature rising.

The following three methods are used to perform detection to prevent abnormal temperature rising.

- DC Controller
- Fixing Heater safety circuit
- Thermoswitch

The following explains each of the functions.

1. DC Controller

The DC Controller monitors the detected temperatures of the Main Thermistor (TH1).

The DC Controller stops the fixing drive and shuts down the power supply when a thermistor exceeds a certain temperature.

2. Fixing Heater safety circuit

The Fixing Heater safety circuit detects the temperature of the Main Thermistor (TH1).

When the Fixing Heater safety circuit detects a temperature above a certain temperature, it shuts down the power supply to the Fixing Assembly.

3. Thermoswitch

When the temperature of the Fixing Heater rises abnormally and the Thermoswitch (TP1) exceeds a certain temperature, the contact of the Thermoswitch is disconnected to shut down the power supply to the Fixing Assembly.

Fixing Assembly failure detection

When the machine is under the following conditions, the DC Controller shuts down the power supply to the Fixing Assembly and notifies an error.

1. Fixing temperature rising error
Temperature of the thermistor does not rise although a specified period of time has passed since the heater was turned ON.
<Related error codes>
 - E000-0000: Temperature of the Thermistor did not become a certain temperature although the specified time had passed.
2. Abnormally high fixing temperature detection
When a Thermistor reaches a certain temperature or higher, it is judged as abnormal high temperature for the thermistor.
<Related error codes>
 - E001-0000: The Thermistor detected a temperature higher than a certain temperature.
3. Fixing drive circuit error
When the DC Controller cannot detect a specific frequency, a fixing drive circuit failure is judged to have occurred.
<Related error codes>
 - E004-0000: Error in either the Fixing Heater or the Fixing Motor
4. Power supply type detection
This machine does not perform detection of the fixing type based on power supply differences.

Controller System

Main Controller

The Main Controller receives print information from the external equipment (host computer, etc.) via the interface cable. This print information includes commands to exchange the status or unique information of a printer and the PDL data of the image data.

The PDL data is converted to a bitmap and then sent to the DC Controller.

The external equipment can view the printer status using a two-way interface.

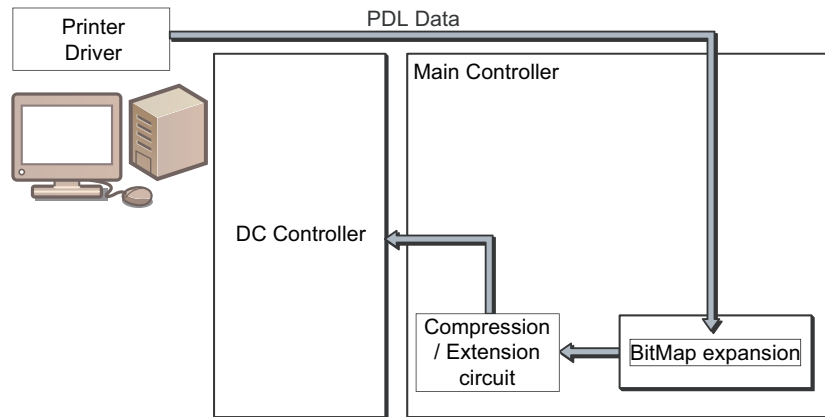

J No.	Connection destination		
	Electric code	Name	J No.
J1120	-	Control Panel PCB	J1
J1016	-	SOFT-ID PCB	J817
J1128	-	Memory PCB	J5
J1004	-	USB (Front)	J2
J807	SW1	Power Switch	J780
J808	-	DC Controller PCB	J131
J201	-	DC Controller PCB	J163
J2802	-	Low Voltage Power Supply PCB	J243 to J248
J1400	-	Expansion ROM PCB (option)/Sublog PCB	-

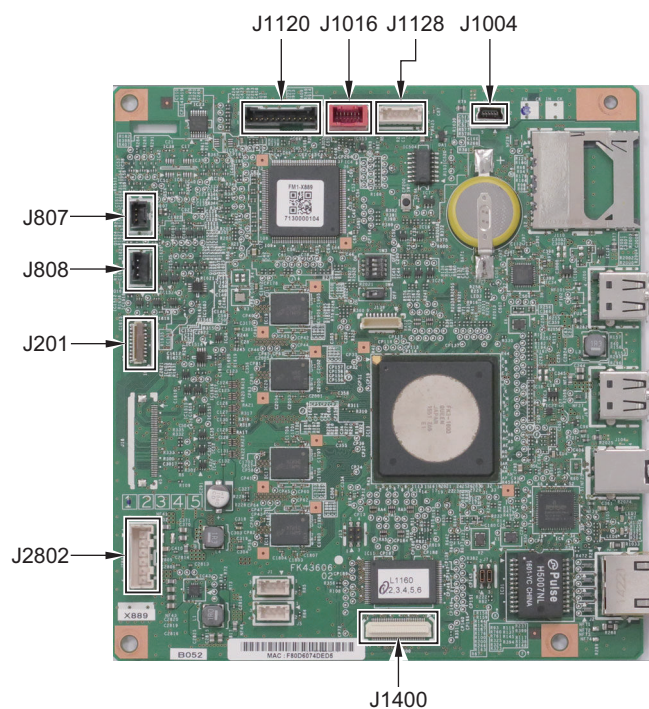

DC Controller

The DC Controller is a circuit to control the operation sequences of this machine, and controlled by the CPU in the DC Controller. The following explains the operation of the DC controller.

1. When the Power Switch of this machine is turned ON, DC power is supplied from the Power Supply PCB to the DC Controller.
2. The CPU in the DC Controller starts printer operation control.
3. When this machine enters the standby state, the CPU outputs signals to drive various loads such as laser diodes, motors, and solenoids based on the print instruction command and image data input from the Main Controller.

The following shows a block diagram of this circuit.

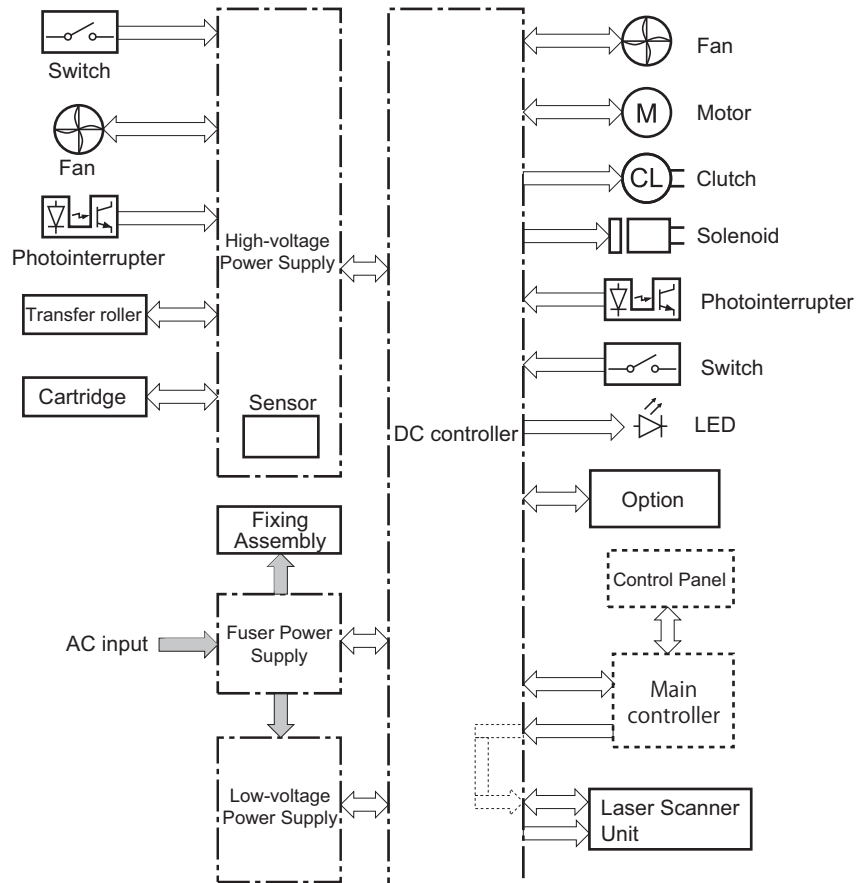

J No.	Connection destination		
	Electric code	Name	J No.
J111	-	Not used	-
J131	-	Low Voltage Power Supply PCB, Main Controller PCB	J241, J808
J132	-	Fixing Power Supply PCB	J216
J133	-	High Voltage Power Supply PCB	J341
J135	-	Low Voltage Power Supply PCB	J251 to J254
J141	SL2	Duplex Switchback Solenoid	-
J143	SL3	Multi-purpose Tray Pickup Solenoid	-
J144	SL1, M4	Cassette Pickup Solenoid, Lifter Motor	-
J146	M1	Fixing Motor	J712
J147	FM2	Sub Fan	-
J151	PS2, PS21, PS22	TOP Sensor, Paper Width Sensor, Duplex Feed Sensor	-
J152	PS4, PS13	Delivery Tray Full Level Sensor, Fixing Delivery Sensor	J405
J153	-	Paper Feeder (Option)	J602
J154	CL2	Duplex Re-pickup Clutch	J663

J No.	Connection destination		
	Electric code	Name	J No.
J156	PS12	Media Stack Surface Sensor	-
J157	PS11	Pre-registration Sensor	-
J158	SW4	Cassette Detection Switch	-
J159	SW5	Rear Cover Detection Switch	J860
J161	-	BD PCB	
J162	M3	Laser Scanner Motor	J802
J163	-	Main Controller PCB	J201
J171	M2	Pickup Motor	J711

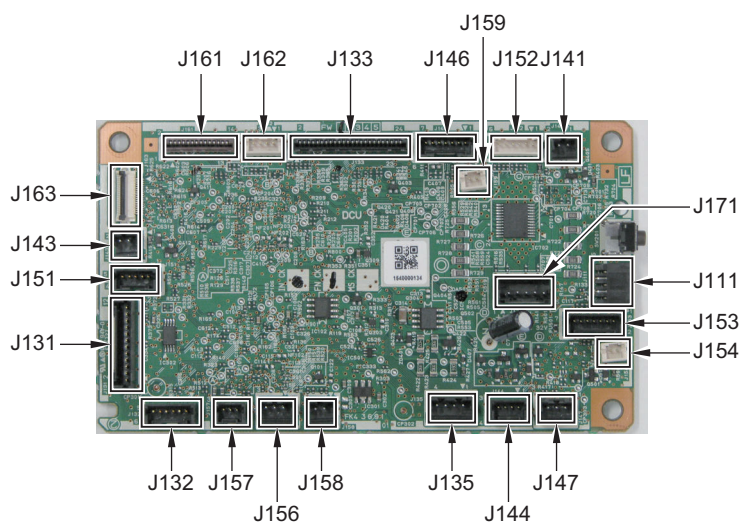

Motor/Fan Control

This machine uses 4 motors for paper feed and image formation. Furthermore, the machine has 2 Fan Motors for preventing overheating inside the machine.

Specifications of Each Fan

Name		Cooling area	Type	Speed
Main Fan	FM1	Cartridge, Laser Scanner	Suction	Full speed
Sub Fan	FM2	Area around the Low Voltage Power Supply, area around the controller	Suction	Full speed / Half speed

Specifications of Each Motor

Name		Drive parts
Fixing Motor	M1	Photosensitive Drum, Primary Charging Roller, Transfer Roller, Pressure Roller, Fixing Delivery Roller, Delivery Roller, Duplex Feed Roller, Rollers in the Paper Feeder
Pickup Motor	M2	Multi-purpose Tray Pickup Roller, Cassette Pickup Roller, Cassette Feed Roller, Registration Roller, Feed Roller
Scanner Motor	M3	Scanner Mirror
Lifter Motor	M4	Lifter in the cassette

Failure Detection

Motor Failure Detection

When the following state occurs, the DC Controller judges a motor failure and notifies the Main Controller.

- Error in startup of the Motor
 - If the motor speed does not reach the specified speed after the specified period of time has passed after starting the motor.

- Motor rotation error

If the speed of each motor fails to meet the specified speed continuously for more than the specified period of time after the speed once reached the specified speed.

<Related error codes>

- E014-0000: Error in startup of the Fixing Motor
- E014-0001: Error in rotation of the Fixing Motor
- E015-0001: Lifter Motor error (the cassette of the host machine)
- E015-0002: Lifter Motor error (the option cassette 1)
- E015-0003: Lifter Motor error (the option cassette 2)
- E015-0004: Lifter Motor error (the option cassette 3)
- E110-0000: Error in startup of the Scanner Motor
- E110-0001: Error in rotation of the Scanner Motor

Fan Failure Detection

If each of the fans is locked continuously for the specified period of time from startup, the DC Controller judges a fan failure and notifies the Main Controller.

<Related error codes>

- E805-0001: Main Fan failure
- E805-0002: Sub Fan failure

Power supply

This circuit is for converting the AC power supply input from the power supply receptacle to DC power supply and then supplying the DC power supply to each load.

The supplied AC power supply is converted to the +24 V, +5 V, and +3.3 V DC power supply required by the printer.

The following explains the main supply destinations for +24 V, +5 V, and +3 V.

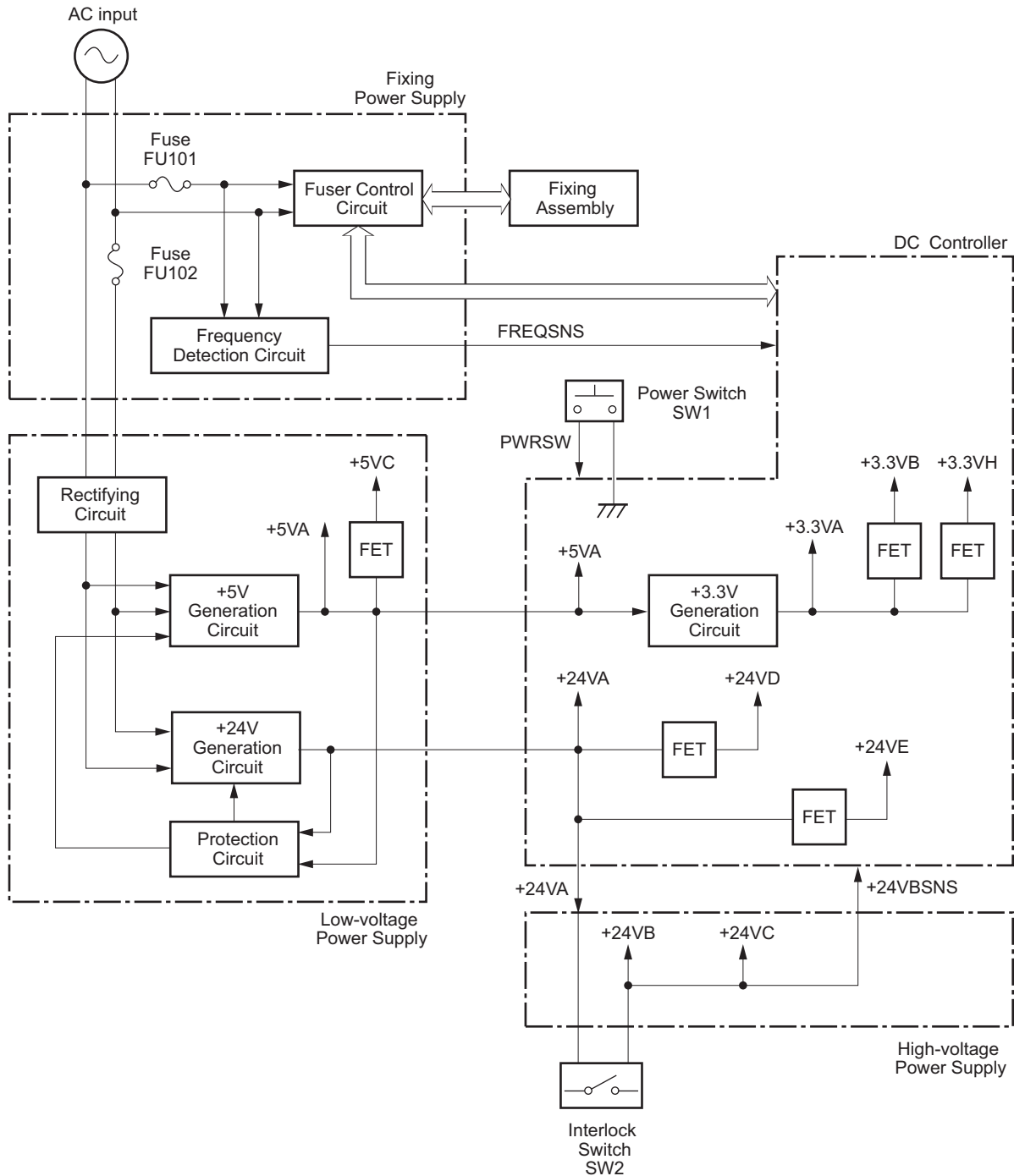

- The low voltage power supply converts the supplied AC power supply to the +24 V, +5 V, and +3.3 V DC power supply required by the printer.
- The +24V supply consists of +24VA which is always supplied from the low voltage power supply and the +24VB and +24VC which stop supplying power when the Front Cover is opened.

Protection function

The Low Voltage Power Supply has functions to protect against overcurrent and overvoltage to prevent damage to the Power Supply PCBs by automatically cutting off output voltage if overcurrent or abnormal voltage occurs due to a trouble. When no DC voltage is output from the Low Voltage Power Supply Assembly, the protection function is possibly activated. Therefore, turn OFF the Power Switch, disconnect the Power Supply Cord from the Inlet, and then fix the trouble before connecting the Power Supply Cord and turning ON the Power Switch again.

The machine has a power supply fuse immediately after the inlet as additional protection functions. If overcurrent occurs in the AC line, the power supply fuse blows and cuts off the power supply.

Quick Startup

Setting quick startup reduces the time from when the Power Switch is pressed until screen operation becomes possible. When the quick startup is set, pressing the Power Switch to turn off the power enables quick startup the next time the power is turned on (quick off).

NOTE:

The quick startup function can be set from the following menu.

- Setup > Control Menu > Main Pwr Quick Start
 - [ON]: Quick startup is executed.
 - [Off]: Quick startup is not executed (default).

The power supply to the PCBs depends on whether the quick startup function is ON or OFF as follows:

PCB name	Power supply status	
	Quick startup setting ON (quick off)	Quick startup setting OFF
Low Voltage Power Supply PCB	Power is supplied	Power is supplied
Main Controller PCB	Power is supplied	OFF

CAUTION:

Prohibited items when quick off

- Disconnecting the power plug from the outlet
- Inserting and removing an SD card
- Installing and removing the Duplex Unit
- Installing and removing pickup options

Never do any of the above in quick-off mode as doing so will cause an engine failure, controller PCB failure, MEAP data damage, etc.

In quick-off mode, be sure to perform a shutdown as described below and then disconnect the power plug from the outlet and perform the work.

- Reset > Shut Down > Yes

A shutdown can be performed by pressing the Main Power Switch for at least 5 seconds, but this is not recommended because the power may be turned OFF before the MEAP shutdown process completes.

Note that under the following conditions (settings), the machine always starts up normally (even if quick startup is ON).

- At first startup after the power plug is connected to the outlet
- When the network-related settings are configured as follows:
 - Setup > Network > TCP/IP Settings > IPv6 Settings > On
 - Setup > Network > TCP/IP Settings > IPv4 Settings > Protocol > Use BOOTP > ON
 - Setup > Network > TCP/IP Settings > IPv4 Settings > Protocol > Use RARP > ON
 - When IPSec is set
- MEAP-related Information
 - During execution of an MEAP application which prohibits quick startup
 - When a login application is switched by SMS
- When a job is being executed (including internal jobs in progress such as calibration or cleaning)
- During import of setting values using service mode or RUI
- When the menu setting values are changed using remote UI or the Operation Panel
- Others
 - When the Main Power Switch is pressed for at least 5 seconds
 - When an error code or a jam occurs
 - When a cover is open
 - When the accumulated time during which the machine is powered ON as well as powered OFF (with quick startup turned ON) is 110 hours or more.
 - When a system option license is registered

Energy Saving Function

This machine is equipped with a power-saving function.

The following shows energy saving status and condition of transition.

Status	Description	Condition of Transition
Panel sleep	Panel Off	When [Energy Saver] key is pressed
Engine sleep	The panel and engine are turned OFF.	When the time to transition to these modes has elapsed (Default setting: 5 minutes) * When USB is connected, the mode remains unchanged.
Deep sleep	The panel, engine and controller are turned OFF. (Only Power LED lights up.)	

■ Conditions for Not Entering Deep Sleep

The machine does not enter deep sleep when any of the following conditions are met.

- When a job is in progress (including internal jobs in progress such as calibration and cleaning)
- While the Front Cover is open
- While an error code is displayed/during a jam
- During a firmware update
- When the cartridge is not installed
- When information cannot be read from the cartridge memory (including a failure of the memory and a state in which the memory is not yet installed)
- When the life warning of the cartridge is displayed



Technical Explanation (System)

Version Upgrade.....	44
Backup/Restoration.....	74
Monitoring Function (e-Maintenance/ imageWARE Remote).....	89
MEAP Application Management.....	93

Version Upgrade

Overview

The following methods exist for version upgrade the system of the device.

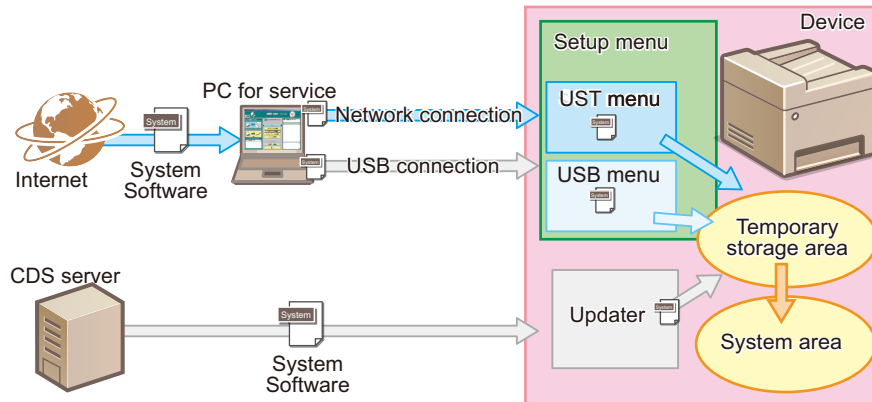

Version Upgrade Using UST (User Support Tool)

UST is a firmware update tool for general users that is included with the firmware for this machine.

Connect this machine to a PC with a USB cable or network cable, and execute UST on a PC to upgrade the firmware.

When connecting the host machine and the PC using a USB cable, version upgrades can be performed in an environment where a network is not available.

Version Upgrade Using Updater (CDS)

Send a command using service mode or the [Settings/Registration] menu of the Remote UI to download the firmware data from the CDS server to perform an upgrade.

When upgrading using the Updater, you can also link with the UGW server to automatically download the firmware.

CAUTION:

A message appears when an attempt is made to upgrade a host machine to which specified firmware has been applied. This is a precaution not to use wrong firmware to upgrade a host machine to which specified firmware has been applied. See the following regarding the combination of whether the message will be displayed:

Type of firmware applied to the host machine	Firmware to upgrade	
	General firmware	Specified firmware
General firmware	No message	No message
Specified firmware	Message displayed	Message displayed

Version Upgrade Using UST

UST is included in the firmware for the machine that can be downloaded from the website of CINC. Firmware is downloaded as a zip file and a folder containing UST is extracted by decompressing the file.

When executing UST on the PC connected to the machine with a USB Cable, the firmware can be upgraded by downloading it from the PC to the machine. For the detailed procedure, refer to the User Support Tool Operation Guide stored in the decompressed folder. The User Support Tool Operation Guide is also available from the website of CINC.

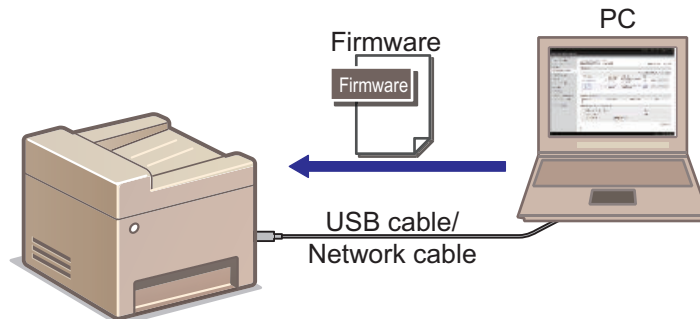

Update Using Updater

Updater provides functions that enable network communication with Content Delivery System (hereinafter CDS) to install firmware, MEAP applications and system options.

Firmware Installation

Updater function enables users to distribute firmware through CDS via Internet. Particularly on e-Maintenance/UGW enabled devices, firmware can be updated remotely, which effectively slashes costs incurred in field services.

MEAP Application

By linking devices to CDS and License Management System (providing the function to manage licenses; hereinafter LMS), applications can be installed in devices via Updater.

Upgrading Method

Although there are three ways to upgrade the firmware of this machine using the Updater, the following two ways are performed by the service technicians.

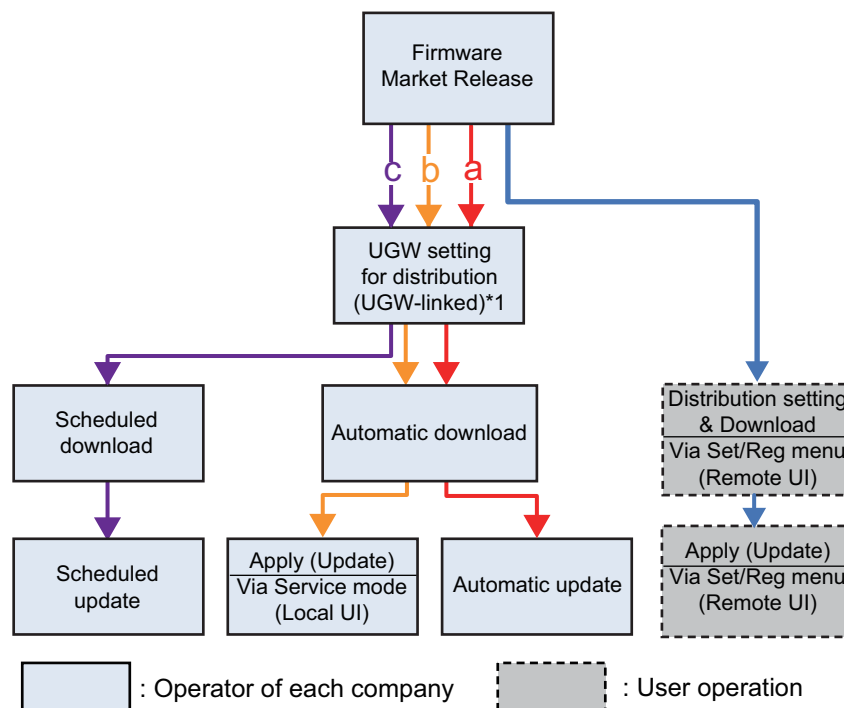

*1: When UGW is linked, schedule information is saved to CDS.

Distribution Method	Download instruction from	Update timing	Versions which can be distributed		
			Older than the current	Same as the current	Newer than the current
a. CDS Remote Update (download and update in conjunction with UGW)	UGW	Do not execute automatic distribution of updated module only.	No	Yes* ¹	Yes* ²
b. CDS Remote Download (download in conjunction with UGW)	UGW		Yes	Yes* ¹	Yes
c. CDS Scheduled Update (scheduled download and update in conjunction with UGW)	UGW/ Remote UI	Scheduled/Date and Time	No	No	Yes* ²

a. CDS Remote Update (download and update in conjunction with UGW)

Firmware update using complete remote operation has been realized by registering the distribution schedule and the update settings in the device using UGW from UGW in advance. The device downloads the firmware from CDS and then updates to the obtained firmware. The timing to start operation will be announced from the management department.

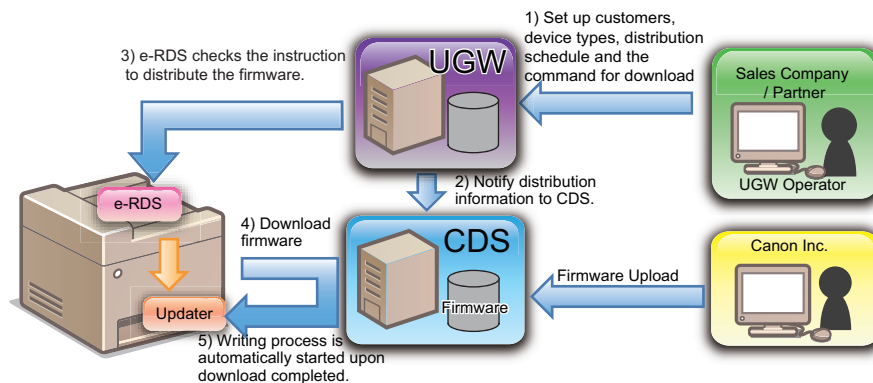

b. CDS Remote Download (download in conjunction with UGW)

Firmware distribution can be performed before a service technician visits the customer by registering the distribution schedule in the device using UGW from UGW in advance. The service technician who visits the customer can update the firmware manually after checking the device status.

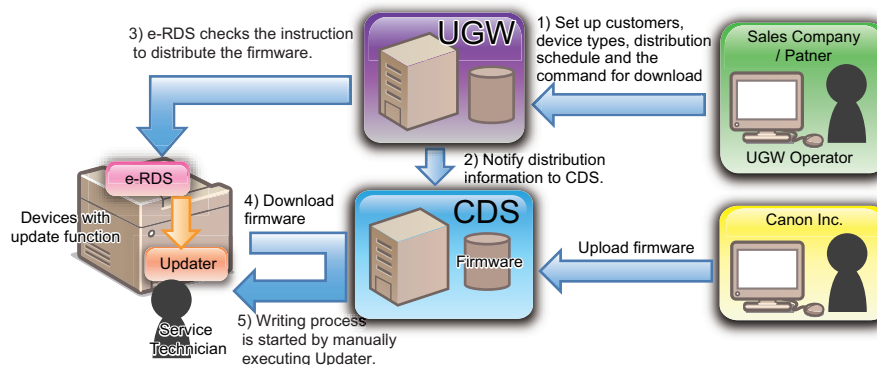

c. CDS Scheduled Update (scheduled download and update in conjunction with UGW)

In the case of device with the update function using UGW installed, scheduled update settings can be made from UGW. If scheduled update settings are registered on UGW in advance, Updater of the device will periodically and automatically update firmware.

*1. Do not execute [Updated Module Only].

*2. Only versions where manual remote update is allowed can be selected.

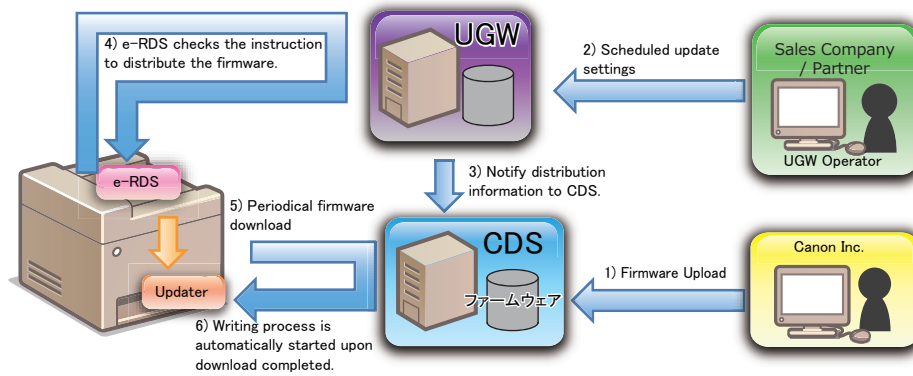

■ List of Functions

The matrix below shows the list of functions provided by Updater.

Category	Function	Remote UI	UGWlinked
Firmware	Checking firmware compatibility	—	—
	Checking special firmware	—	—
	Checking latest firmware version	Yes	—
	Registering/deleting firmware distribution schedule	Yes	—
	Confirming and downloading firmware	—	Yes
	Updating downloaded firmware	Yes	—
	Cancelling downloaded firmware	Yes	—
	Acquiring firmware distribution information registered from UGW	Yes	Yes
	Notifying firmware version information	—	Yes
MEAP application / system option	Installing MEAP application	Yes	—
	Installing system option	Yes	—
System Management	Settings	Yes	—
	Testing communications	Yes	—
	Displaying update logs	Yes	—
	Displaying system logs	Yes	—
Internal system error notification	Notifying internal system error occurrence to distribution server	Yes	Yes

■ Limitations and Cautions

● Limitations

Changing Date/Time on Device

When a user changes the date/time setting on the device (including change of the setting according to daylight saving time), the firmware distribution may not be performed as scheduled.

But there is not the problem if it is time adjustment of several minutes with NTP servers.

Change of Setting from Service mode

Any settings from Service mode will be enabled after restarting the device.

Confirming license agreement condition

When devices update the firmware by scheduled update, license agreement condition is not displayed and can't confirm its description.

● Cautions

Concurrent use of Updater functions

Multiple users cannot use Updater functions on a device concurrently by using it together with Remote UI.

Coexistence of Remote UI and other tools

Users logged in SMS (Service Management Service) are unable to use Update functions from Remote UI.

Using Updater function from Remote UI

Upon the following operations done, Updater functions are suspended from Remote UI for certain duration.

- When a user exits Web browser without clicking [Portal] or [Log Out] button in the setting of Remote Login Service via SMS
- When a user exits Web browser without clicking [Portal] button in the setting of not to use Remote Login Service via SMS.
- When a user exits Web browser without clicking [Log out from SMS] or [To Remote UI] button.

Wait for EOJ (end of job) Function

Firmware update will be triggered only after the following jobs are completed.

This is the Updater-specific specification.

Job/Function type	Receiving	Printing	Queued print jobs
PRINT	Wait for EOJ (end of job)	Wait for EOJ	Wait for EOJ
I-FAX Receipt	Cancel processing to trigger update *	Wait for EOJ	Wait for EOJ
Report Print	-	Wait for EOJ	Wait for EOJ

*The data are guaranteed even if cut off in the middle of a job. It becomes the recovery object after the device reboot and carry out send / reception again.

Even during transfer, Pull SCAN job processing is cancelled soon after scanning is completed.

Firmware update is cancelled if the jobs are not completed within 10 minutes. If this occurs, the error code, 8x001106, will be returned (different numbers will be shown for x depending on the execution modes).

Firmware update is executed if the jobs stated above are not in the queue.

Follow the shutdown sequence to reboot the device after the firmware is updated.

■ Preparation

● Setting Sales Company's Support Department

When using devices input in the markets listed below, the default setting of the sales company's Support Department should be changed before obtaining firmware distributed from CDS. Unless the setting is changed properly, the desired firmware may not be able to be selected.

Market	Default Setting of the sales company's Support Department.	Setting of the sales company's Support Department. after Change
Canada	US	CA
Latin America	US	LA

Go to the following screen to change the setting of the sales company's Support Department.

- SERVICE MODE > FUNCTION GR. > MEAP > CDS-CTL

NOTE:

The list below shows the setting of the sales company's Support Department for CDS-CTS by market. Check and adhere to the appropriate setting for your market.

Japan : JP	China : CN	Canada : CA	Singapore : SG	Latin America : LA
USA : US	Hong Kong : HK	Korea : KR	Europe : NL	Australia : AU

● Network Settings

Connecting to the external network

The method to connect to the external network (TCP/IP or proxy settings) is the same as that of normal network connection. For details, refer to the e-Manual of this machine.

NOTE:

- In order to use linkage with UGW or functions of [Settings/Registration], the preparation for it shown below needs to be performed.
 - Enabling linkage with UGW
 - Enabling the display of [Delivered Installation] in [Install Applications/Options] in [Settings/Registration] menu
 - Enabling the display of [Update Firmware] in [Settings/Registration] menu
 - Enabling the display of [Scheduled Update] in [Settings/Registration] menu
- The external network is the network connecting this machine and CDS via Internet.

Confirming URL Setting of Distribution Server

Confirm the URL setting of the distribution server (UGW server) set in the machine.

1. Access the following URL from the browser on a PC connected to the same network as this machine, and log in to the management screen.

URL : `https://<machine's IP address>:8443/svm/`

Password : *28*

Confirm the password to the Support Dept. of the sales company.

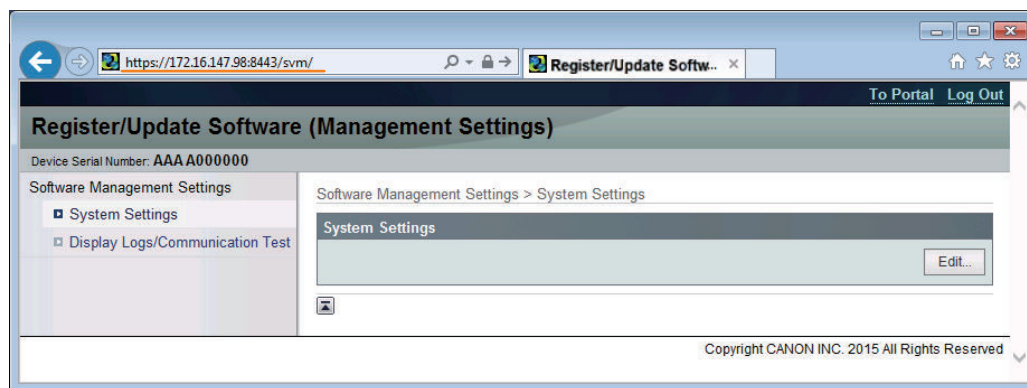
**CAUTION:**

In the case of the following, you cannot log in even if you input a right password.

- The other user is using "Register/Update Software (Management Settings)" .
- The other user is using "Register/Update Software" in normal Remote UI.
- Because you have closed a browser without logging out definitely, you are still logging in it. Waiting for time-out.

2. Select [System Settings] > [Edit].

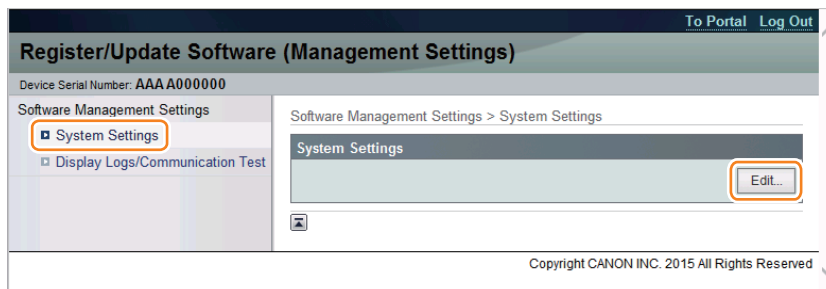

3. Confirm that the following information is set, and click [Cancel] if the settings are correct. If incorrect information is set, correct it and click [Configure].

- [Delivery Server URL] : https://device.c-cdsknn.net/cds_soap/updaterif
- [Log Level] : 1 to 4

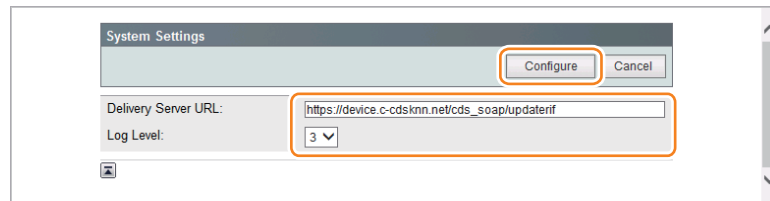

CAUTION:

The larger the value of the log level is, the more detailed the output log is (see the table below). Since changing the log level setting affects the performance, do not set a higher level than required. (Unless asked to do so by the Support Dept. of the sales company or the Canon R&D.)

Especially when the level 4 is set, the performance will be significantly lower and it will take time to collect logs.

Log Level and Leg Output Type

Log Output Type	Log Level					Description
	0	1	2	3	4	
Trace	-	-	-	-	Yes	Detailed logs for debug
Information	-	-	-	Yes	Yes	Logs related to operations done on the system
Important Message	-	-	Yes	Yes	Yes	Update logs output by firmware type Installation logs by MEAP application Logs related to enabled functions by system option
Ordinary Error	-	Yes	Yes	Yes	Yes	Logs for ordinary errors
System Error	Yes	Yes	Yes	Yes	Yes	Logs for internal system errors

4. Click [Yes] when a dialog box confirming whether you want to update the settings is displayed.

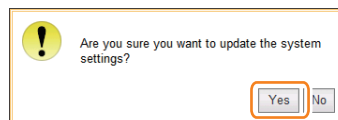

This completes the procedure for confirming the URL setting of the distribution server.

Communication Test with the Distribution Server

This section describes how to check if the communication is normally done to the distribution server and/or the file server.

NOTE:

Since the server accessed by the CDS function and the server accessed by the RDS function differ, make sure to perform a communication test for the CDS function even if the communication test for the RDS function is successful.

1. Access the following URL from the browser on a PC connected to the same network as this machine, and log in to the management screen.

URL : <https://<machine's IP address>:8443/svm/>

Password : *28*

2. Select [Display Log/Communication Test], and click [Communications Test].

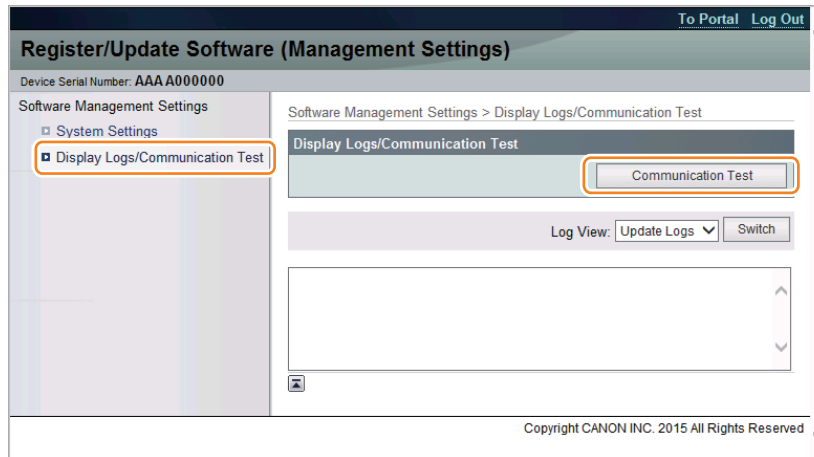

3. Click [Yes] when a dialog box confirming whether you want to execute the test is displayed

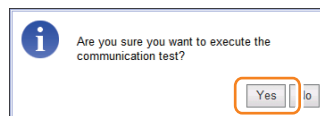

The Communication Test is carried out.



4. Upon the communication test completed, the communication test result screen is shown. Press [Back] button to exit this operation.

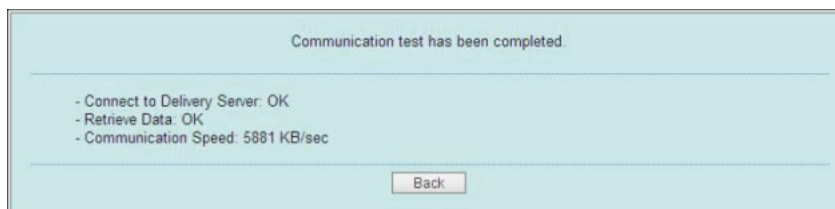

If "NG" is displayed as the result of the test, check the network settings and server URL settings.

• Enabling UGW Link

When installing the firmware in the method of "UGW-linked Download and Update" or "UGW-linked Download", the following should be set before actually using UGW link.

1. Set "On" for the following service mode:
 - SERVICE MODE > FUNCTION GR. >MEAP > CDS-UGW
2. Access the [Customer Information] screen of the UGW WebPortal, and specify [Yes] for the following setting:
 - Firmware Distribution

CAUTION:

- See "imageWARE Remote Operator's Manual / e-Maintenance Business Operation Manual" for how to operate UGW WebPortal.
- [Distribute Firmware] should be set on [Customer Management] screen for staff in charge of setting for [Enter customer information] or [Command for firmware distribution] in order to allow them to select the desired device on [Firmware Distribution Information] screen.
- If [Distribute Firmware] is not shown on [Customer Management] screen of UGW WebPortal, appropriate authorities may not be set to each account in Firmware Distribution Information. Contact the sales company's Support Department concerned for confirmation.

• Remote UI Display Settings

To display (hide) the menu for upgrading the version of firmware using Updater on the following Remote UI screen: [Settings/Registration] > [Management Settings] > [License/Others] > [Register/Update Software] (hereinafter referred to as [Register/Update Software] screen).

Display of [Delivered Installation] in [Install Applications/Options] in [Settings/Registration] menu

Set to display [Delivered Installation] in [Install Applications/Options] menu on [Register/Update Software] screen.

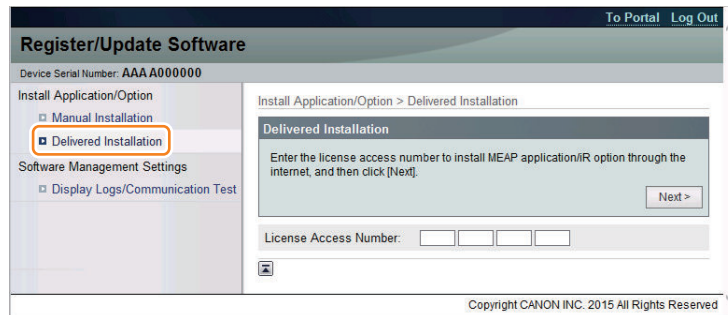

Specify this setting to allow users to install MEAP applications using the Updater function. This operation is not necessary if you do not want to allow users to do so.

1. Enter service mode.

2. Set "On" for the following service mode:

- SERVICE MODE > FUNCTION GR. > MEAP > CDS-MEAP

When this setting is enabled, [Delivered Installation] is displayed on [Register/Update Software] screen in [Settings/Registration] menu.

Displaying [Update Firmware] Menu on the [Register/ Update Software] Screen

Set to display the [Update Firmware] menu on the [Register/Update Software] menu of the Remote UI.

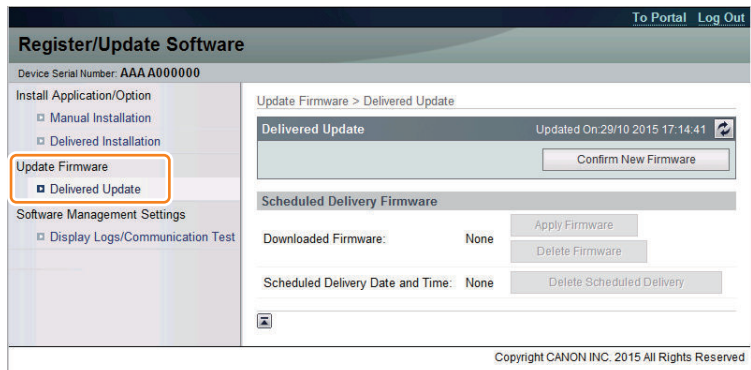

Specify this setting to allow users to upgrade the firmware using the Updater function. This operation is not necessary if you do not want to allow users to do so.

1. Enter service mode.

2. Set "On" for the following service mode:

- SERVICE MODE > FUNCTION GR. > MEAP > CDS-FIRM

When this setting is enabled, the [Update Firmware] menu is displayed on the [Register/Update Software] screen of the [Settings/Registration] menu.

Display of [Scheduled Update] on [Settings/Registration] menu

Set to display [Scheduled Update Settings] menu on [Register/Update Software] screen of Remote UI.

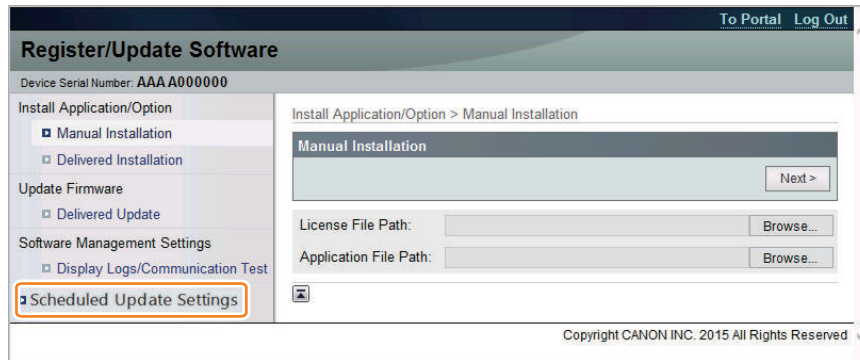

Specify this setting to allow users for the scheduled firmware update using the Updater function. This operation is not necessary if you do not want to allow users to do so.

1. Enter service mode.

2. Set "On" for the following service mode:

- SERVICE MODE > FUNCTION GR. > MEAP > CDS-LVUP

When this setting is enabled, [Scheduled Update] menu is displayed on [Register/Update Software] screen in [Settings/Registration] menu.

■ Firmware Update Procedure

● UGW-linked Download and Update (Full-remote Update)

The procedure for updating the firmware using "UGW-linked Download and Update" is described below.

1. The firmware distribution schedule to the certain device should be set on UGW.

NOTE:

See "UGW-linked Download and Update" in Operation Manual of Content Delivery System for Firmware Distribution for details.

The device checks the schedule concerned every 12 hours on UGW. This allows the device to register the firmware distribution setting, enabling automatic firmware download and update.

CAUTION:

[Device without the function to wait for job completion]

- Explain to the user in advance that a job cannot be accepted during firmware update. Also, it is recommended to execute the operation during the period of time when no print job is accepted.

[Device with the function to wait for job completion]

- When the following jobs exist at the time of firmware update, firmware update processing is not executed until job completion. (When the firmware update processing is not executed more than 10 minutes, it will be timeout error.)
 - Printing
 - I-FAX

NOTE:

To contacts registered for E-mail notification on UGW, the E-mail is sent from UGW upon completing firmware update.

● UGW-linked Download (Remote Distribution Update)

The procedure for updating the firmware using "UGW-linked download" is described below.

1. The firmware distribution schedule to the certain device should be set on UGW.

NOTE:

See "UGW-linked Download" in Operation Manual of Content Delivery System (for Firmware Distribution) for details.

2. When using the Control Panel, execute the following service mode to update the firmware downloaded to the device using the Updater function.

- SERVICE MODE > F/W UPDATE GR. > CDS

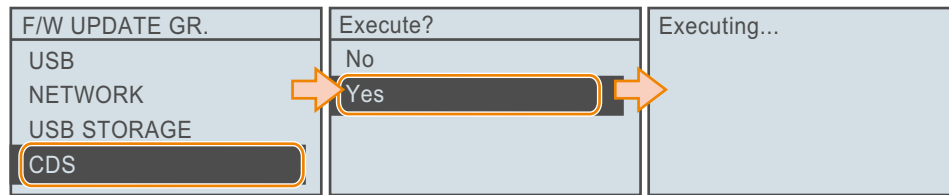

CAUTION:

When using the [Register/Update Software] screen of the Remote UI, click [Apply Firmware] in [Delivered Update].

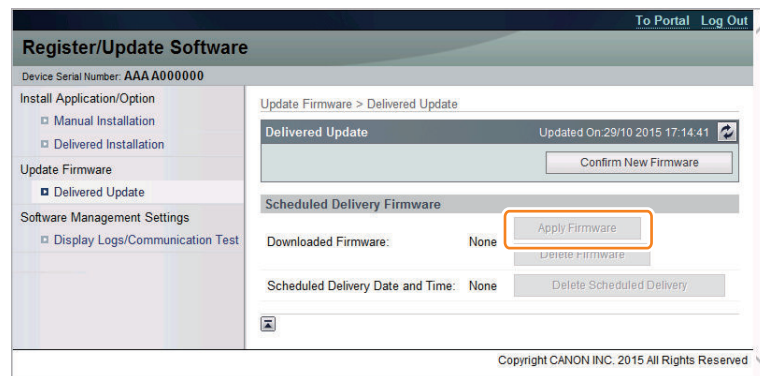

Example of Using the Remote UI

This machine is automatically restarted when the update processing is complete.

• CDS Scheduled Update (Scheduled Download and Upload in Conjunction with UGW)

There are two types of procedure for updating firmware using "CDS scheduled update": a procedure performed by service technician of sales company and a procedure performed by the user. Configure the setting by performing either one of the procedures.

1. Configure the schedule settings of firmware distribution to the device.

- When the sales company configures the settings, access UGW and configure the schedule settings of firmware distribution to the target device.

NOTE:

- For the operation procedure, refer to "CDS Scheduled Update" in the CDS Operation Manual (Firmware Distribution).
- When the e-mail notification setting is enabled on UGW, it will be notified at the following timing.
 - E-mail address specified in [Notification E-mail Settings]
The settings configured on the scheduled update setting screen are applied to the device, and an e-mail is sent when notification is sent from the device to CDS distribution server.
 - E-mail address specified in the schedule setting column
After firmware distribution from CDS distribution server to the device is completed and the notification is sent from the device to CDS distribution server, an e-mail is sent.

- When the user configures the settings, access Remote UI of the target device and configure the schedule settings of firmware distribution.

NOTE:

- For details of the procedure for configuring the settings from Remote UI, refer to the e-Manual of the target device.
- When the user configures the scheduled update settings, it is required to perform "Display of [Scheduled Update] on [Settings/Registration] menu" on page 52 in advance.

■ Updater Function Maintenance

● Checking Logs

If an error occurs when upgrading the firmware using the Updater, a log can be checked on the [Register/Update Software] screen of the Remote UI.

There are two types of logs; update logs and system logs.

Update log

A log regarding installation of system options/MEAP applications and firmware updates.

System log

The system log of this machine. Records all operations.

The procedure for checking a log is described below.

1. Access the following URL from the browser on a PC connected to the same network as this machine, and log in to the management screen.

- <https://<device address>:8443/svm/>

Confirm the password to the Support Dept. of the sales company.

2. Select [Display Logs/Communication Test], select [Update Logs] or [System Logs] in the Log View, and click [Switch].

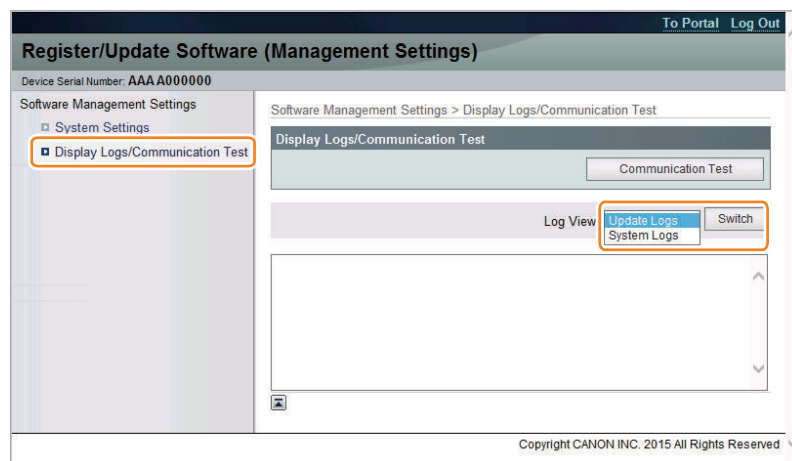

3. Check the log displayed in the log display area.

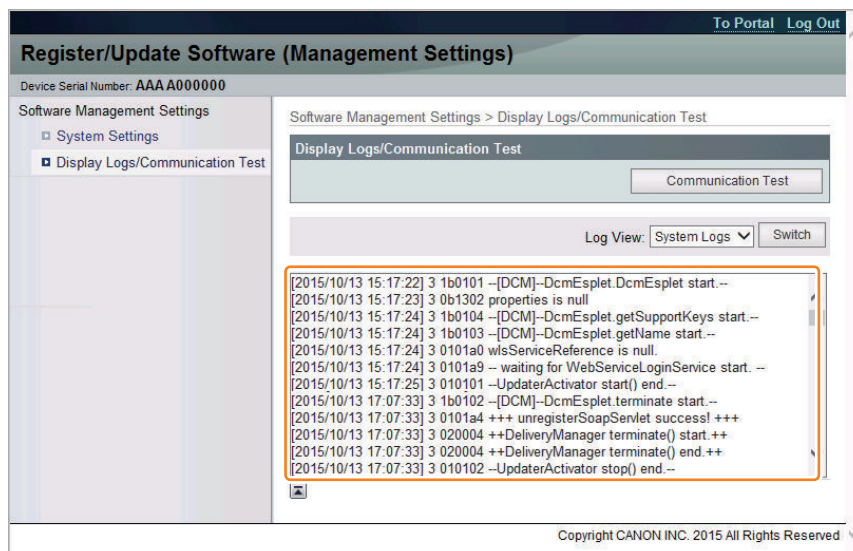

CAUTION:

To escalate the content of the log, copy the full text of the log and paste it in a text editor such as Notepad, then save it.

● Management of [Register/Update Software]

The [Register/Update Software] menu enables you to apply and delete firmware downloaded to this machine. When distribution is scheduled by linking with UGW, those schedules can also be deleted.

Applying Downloaded Firmware

This section describes the procedure for applying firmware downloaded to this machine.

When there is downloaded firmware in this machine, the [Update Firmware] button in the [Delivered Update] menu is activated.

1. Access [Register/Update Software] in the Remote UI, and select [Delivered Update].
2. Press the [Apply Firmware] button.
3. Check the downloaded firmware, and press the [Yes] button.

The processing for applying the firmware starts, and the device is automatically restarted when the processing is complete.

4. Output [Status Print] to check whether the firmware was upgraded correctly.

1. Press the [Utility Menu] key on the Control Panel.
2. Select [Status Print].
3. Select [Yes] when the message confirming whether you want to execute the operation is displayed.

Applying Downloaded Firmware

This section describes the procedure for deleting firmware downloaded to this machine.

When there is downloaded firmware in this machine, the [Delete Firmware] button in the [Delivered Update] menu is activated.

1. Access [Register/Update Software] in the Remote UI, and select [Delivered Update].
2. Press the [Delete Firmware] button.
3. Check the downloaded firmware, and press the [Yes] button.

The processing for deleting the firmware starts.

4. Confirm that the [Delete Firmware] button is grayed out and deactivated.

Deleting a Scheduled Distribution Date/Time

This section describes the procedure for deleting a scheduled distribution date/time set in this machine.

The [Scheduled Delivery Date and Time:] button in the [Delivered Update] menu is activated when a scheduled firmware distribution date/time is set in this machine by linking with a UGW server.

1. Access [Register/Update Software] in the Remote UI, and select [Delivered Update].
2. Press the [Delete Scheduled Delivery] button.
3. Check the scheduled distribution date/time, and press the [Yes] button.

The processing for deleting the scheduled distribution date/time starts.

4. Confirm that the [Delete Scheduled Delivery] button is grayed out and deactivated.

● Other Maintenance

Migrating Setting Information

In the following cases, the settings of the Updater function must be configured again because they cannot be migrated. For the detailed procedure, refer to “Preparation” on page 48.

- When replacing the Main Controller PCB including the SRAM
- When replacing this machine due to failure or when a lease is up

Upgrading the Updater

The Updater function is a part of the machine firmware. Therefore, the Updater function is also upgraded when the firmware of the machine is upgraded. When the machine firmware is upgraded, the setting information and logs (update logs and system logs) of the Updater function are migrated.

■ Error Messages of Updater Function

This section describes the error codes and error messages output by the Updater function.

• Updater Error Messages

Error messages displayed in Remote UI are shown below. As to error codes, see the next list.

No.	Messages	Timing of display	Cause	Remedy
1	An error occurred with the delivery server. Contact your sales representative. Error Code: [xxx]	In communicating with the delivery server.	System error occurred in server.	Obtain the log etc. (Refer to "System Management Operations" under "Version Upgrade" of "Updater" in "Troubleshooting" of this manual.) and contact Support Div. of the sales company.
2	Delivery server is stopped. Wait a while and then try to perform the operation again. Check the following URL for details. <Stopped Delivery Server URL>	In communicating with the delivery server.	Delivery server stopped.	Check the delivery server stop information. After the delivery server starts, perform the operation from this application. When the delivery server stop information is not available, contact the sales company's Support Department.
3	Failed to connect to delivery server. Check the delivery server and network.	In communicating with the delivery server.	Communication error due to incorrect settings of CDS URL.	Set correct CDS URL in the Updater settings.
			Excluding delivery server stop, communication error to the delivery server occurred.	Check if the network environment is correct to solve the cause of the error occurrence. If the network environment of the device is correct, obtain the log etc. (Refer to "System Management Operations" under "Version Upgrade" of "Updater" in "Troubleshooting" of this manual.) and contact Support Div. of the sales company.
4	Download was stopped because an error occurred with the file server. Check the network.	At the time of file download	Communication error to the delivery server occurred.	Check if the network environment is correct to solve the cause of the error occurrence. If the network environment of the device is correct, obtain the log etc. (Refer to "System Management Operations" under "Version Upgrade" of "Updater" in "Troubleshooting" of this manual.) and contact Support Div. of the sales company.
5	Downloaded files are invalid. Check the network.	At the time of file download	The received file is broken.	After checking the network environment of the device, re-execute the job. If it recurs, obtain the log etc. (Refer to "System Management Operations" under "Version Upgrade" of "Updater" in "Troubleshooting" of this manual.) and contact Support Div. of the sales company.
6	Failed to retrieve information of special firmware. Check the retrieval ID and password.	Acquisition of applicable firmware information	No information exists about firmware for special firmware retrieval ID or Password is invalid.	Enter the correct firmware ID or Password applicable to the firmware information. If it recurs, obtain the log etc. (Refer to "System Management Operations" under "Version Upgrade" of "Updater" in "Troubleshooting" of this manual.) and contact Support Div. of the sales company.
7	Scheduled delivery information of firmware does not exist. Check it because it may already have been deleted.	Acquisition of applicable firmware information	Delivery information with specified delivery ID does not exist.	Register the delivery schedule again. If this occurs at the time of canceling file download, deleting downloaded firmware or deleting scheduled delivery, no remedy is required.
8	Failed to apply firmware.	Firmware application error	Error due to the application (NLM)	Obtain the log etc. (Refer to "System Management Operations" under "Version Upgrade" of "Updater" in "Troubleshooting" of this manual.) and contact Support Div. of the sales company.

No.	Messages	Timing of display	Cause	Remedy
9	Delivery Server : Connect Failed File Server : Retrieve Failed Error Code: [xxxx]	Communication test, etc. (communication test result dialogue)	<p>In the communication test, failed to connect to the delivery server.</p> <p>In SOAP communication, failed to success after 1 min retry.</p> <p>ID and Password required for proxy to connect to the internet are not configured in device.</p> <p>The access to the network is limited.</p> <p>Delivery server stopped.</p>	<p>Check the network environment of the device, and re-execute the job.</p> <p>If it recurs, obtain the log etc. (Refer to "System Management Operations" under "Version Upgrade" of "Updater" in "Troubleshooting" of this manual.) and contact Support Div. of the sales company.</p> <p>Set proxy and restart the communication test.</p> <p>If it recurs, obtain the log etc. (Refer to "System Management Operations" under "Version Upgrade" of "Updater" in "Troubleshooting" of this manual.) and contact Support Div. of the sales company.</p> <p>Set the user environment to make the access to the following domain available.</p> <p>https://device.cdsknn.net/ http://cdsknn.net.edgesuite.net/</p> <p>If it recurs, obtain the log etc. (Refer to "System Management Operations" under "Version Upgrade" of "Updater" in "Troubleshooting" of this manual.) and contact Support Div. of the sales company.</p> <p>Contact Field Support Group in the sale company.</p> <p>After confirmation that the delivery server has been restored, restart the communication test.</p> <p>If it recurs, obtain the log etc. (Refer to "System Management Operations" under "Version Upgrade" of "Updater" in "Troubleshooting" of this manual.) and contact Support Div. of the sales company again.</p>
10	Delivery Server : Connect OK File Server : Retrieve Failed Error Code: [xxxx]	Delivery Server : Connect OK File Server : Retrieve Failed Error Code: [XXXX]	<p>Due to no return of data for the communication test, time-out (in HTTP communication, no response for 1min) occurred. After that, retried but failed to connect to server.</p> <p>The network cable was disconnected during data download in the communication test.</p> <p>The file server stopped during data download in the communication test.</p> <p>Hash value in the communication test file is incorrect.</p>	<p>Check the network environment of the device and re-execute the job.</p> <p>If it recurs, obtain the log etc. (Refer to "System Management Operations" under "Version Upgrade" of "Updater" in "Troubleshooting" of this manual.) and contact Support Div. of the sales company.</p> <p>Reconnect the network cable and then restart the communication test.</p> <p>If it recurs, obtain the log etc. (Refer to "System Management Operations" under "Version Upgrade" of "Updater" in "Troubleshooting" of this manual.) and contact Support Div. of the sales company.</p> <p>Contact the sales company's Support Department.</p> <p>After confirmation that the delivery server has been restored, restart the communication test.</p> <p>If it recurs, obtain the log etc. (Refer to "System Management Operations" under "Version Upgrade" of "Updater" in "Troubleshooting" of this manual.) and contact Support Div. of the sales company again.</p> <p>Check the network environment and re-execute the job.</p> <p>If it recurs, obtain the log etc. (Refer to "System Management Operations" under "Version Upgrade" of "Updater" in "Troubleshooting" of this manual.) and contact Support Div. of the sales company.</p>
11	An error occurred. Error Code: [xxx]	communication test, etc. (main screen)	The max value (space/file) was exceeded and new log was not accepted. Normally an old log file is deleted before the max value (space/file) is exceeded, but error may occur due to other element (e.g. I/O error).	<p>Check if the log file exceeded the max value.</p> <p><Update log> Max space: 128KB/file Max file number: 4</p> <p><System log> Max space: 512KB/file Max file number: 4</p> <p>If it recurs, obtain the log etc. (Refer to "System Management Operations" under "Version Upgrade" of "Updater" in "Troubleshooting" of this manual.) and contact Support Div. of the sales company.</p>

No.	Messages	Timing of display	Cause	Remedy
11	An error occurred. Error Code: [xxx]	Notice of version information (main screen)	Failed to acquire version information of device due to no CDS registration of firmware version of device.	Re-execute the job. If it recurs, obtain the log etc. (Refer to "System Management Operations" under "Version Upgrade" of "Updater" in "Troubleshooting" of this manual.) and contact Support Div. of the sales company.
			At the time of notifying version information, failed to connect to the delivery server.	Check if the network environment is correct to solve the cause of the error occurrence. If the network environment of the device is correct, obtain the log etc. (Refer to "System Management Operations" under "Version Upgrade" of "Updater" in "Troubleshooting" of this manual.) and contact Support Div. of the sales company.
			No return of notifying version information	Re-execute the job. If it recurs, obtain the log etc. (Refer to "System Management Operations" under "Version Upgrade" of "Updater" in "Troubleshooting" of this manual.) and contact Support Div. of the sales company.
			Network cable was disconnected during notice of version information.	Re-connect the network cable and re-execute the job. If it recurs, obtain the log etc. (Refer to "System Management Operations" under "Version Upgrade" of "Updater" in "Troubleshooting" of this manual.) and contact Support Div. of the sales company.
			Failed to send notice of version information since the main power was turned OFF and then ON during the sending.	Re-execute the job. If it recurs, obtain the log etc. (Refer to "System Management Operations" under "Version Upgrade" of "Updater" in "Troubleshooting" of this manual.) and contact Support Div. of the sales company.
			Server stopped at the time of sending notice of version information.	Check the network environment of the device and re-execute the job. If it recurs, obtain the log etc. (Refer to "System Management Operations" under "Version Upgrade" of "Updater" in "Troubleshooting" of this manual.) and contact Support Div. of the sales company.
			An internal error occurred at the time of sending notice of version information.	Obtain the log etc. (Refer to "System Management Operations" under "Version Upgrade" of "Updater" in "Troubleshooting" of this manual.) and contact Support Div. of the sales company.
11	An error occurred. Error Code: [xxx]	UGW linkage (main screen)	UGW linkage was turned ON when eRDS was OFF.	For a device using eRDS, turn ON the eRDS. For a device not using eRDS, turn OFF the UGW linkage. If it recurs, obtain the log etc. (Refer to "System Management Operations" under "Version Upgrade" of "Updater" in "Troubleshooting" of this manual.) and contact Support Div. of the sales company.
			An internal error occurred at the time of acquiring delivery information.	Re-execute the job. If it recurs, obtain the log etc. (Refer to "System Management Operations" under "Version Upgrade" of "Updater" in "Troubleshooting" of this manual.) and contact Support Div. of the sales company.
		On-site (error dialogue)	An internal error occurred at the time of acquiring applicable firmware information.	Re-execute the job. If it recurs, obtain the log etc. (Refer to "System Management Operations" under "Version Upgrade" of "Updater" in "Troubleshooting" of this manual.) and contact Support Div. of the sales company.
			An internal error occurred at the time of sending approval information.	Re-execute the job. If it recurs, obtain the log etc. (Refer to "System Management Operations" under "Version Upgrade" of "Updater" in "Troubleshooting" of this manual.) and contact Support Div. of the sales company.
			An internal error occurred at the time of delivery order	Re-execute the job. If it recurs, obtain the log etc. (Refer to "System Management Operations" under "Version Upgrade" of "Updater" in "Troubleshooting" of this manual.) and contact Support Div. of the sales company.
		Immediate download (error dialogue)	An internal error occurred at the time of requesting firmware delivery information.	Re-execute the job. If it recurs, obtain the log etc. (Refer to "System Management Operations" under "Version Upgrade" of "Updater" in "Troubleshooting" of this manual.) and contact Support Div. of the sales company.

No.	Messages	Timing of display	Cause	Remedy
11	An error occurred. Error Code: [xxx]	Immediate download (error dialogue)	During the download, all space in the storage disk was occupied. (DiskFull)	After adding vacant space of the storage disk, re-execute the job. If it recurs, obtain the log etc. (Refer to "System Management Operations" under "Version Upgrade" of "Updater" in "Troubleshooting" of this manual.) and contact Support Div. of the sales company.
			At the end of receipt, an internal error occurred.	Re-execute the job. If it recurs, obtain the log etc. (Refer to "System Management Operations" under "Version Upgrade" of "Updater" in "Troubleshooting" of this manual.) and contact Support Div. of the sales company.
		Manual update (error dialogue)	At the update start, an internal error occurred.	Re-execute the job. If it recurs, obtain the log etc. (Refer to "System Management Operations" under "Version Upgrade" of "Updater" in "Troubleshooting" of this manual.) and contact Support Div. of the sales company
		Automatic update (error dialogue)	At the update start, an internal error occurred.	Re-execute the job. If it recurs, obtain the log etc. (Refer to "System Management Operations" under "Version Upgrade" of "Updater" in "Troubleshooting" of this manual.) and contact Support Div. of the sales company.
		Deletion of downloaded firmware	At the time of notifying cancellation, an internal error occurred.	Re-execute the job. If it recurs, obtain the log etc. (Refer to "System Management Operations" under "Version Upgrade" of "Updater" in "Troubleshooting" of this manual.) and contact Support Div. of the sales company.
12	An error occurred. Check the Update Firmware screen.	UGW linkage (main screen)	eRDS sent an order but Updater failed to connect to server.	Conduct a communication test to analyze the cause of the error. After solving the cause, resend the order from the eRDS. If it recurs, obtain the log etc. (Refer to "System Management Operations" under "Version Upgrade" of "Updater" in "Troubleshooting" of this manual.) and contact Support Div. of the sales company.
			Delivery server stopped.	Contact the sales company's Support Department. After confirming restoration of the delivery server, re-execute the job. If it recurs, obtain the log etc. (Refer to "System Management Operations" under "Version Upgrade" of "Updater" in "Troubleshooting" of this manual.) and contact Support Div. of the sales company.
			Scheduled date and time acquired from the delivery server was before current time (15 or more min had passed.)	Do the delivery setting from UGW again. If it recurs, obtain the log etc. (Refer to "System Management Operations" under "Version Upgrade" of "Updater" in "Troubleshooting" of this manual.) and contact Support Div. of the sales company.
			Scheduled data and time acquired from the delivery server did not exist.	Do the delivery setting from UGW again. If it recurs, obtain the log etc. (Refer to "System Management Operations" under "Version Upgrade" of "Updater" in "Troubleshooting" of this manual.) and contact Support Div. of the sales company.
		Immediate download (main screen)	At the time of immediate download, turned OFF and then ON the power of device main body.	Re-execute the job. If it recurs, obtain the log etc. (Refer to "System Management Operations" under "Version Upgrade" of "Updater" in "Troubleshooting" of this manual.) and contact Support Div. of the sales company.
		Manual update (main screen) Automatic update (main screen)	Updated version was different from the ordered version.	Re-execute the job. If it recurs, obtain the log etc. (Refer to "System Management Operations" under "Version Upgrade" of "Updater" in "Troubleshooting" of this manual.) and contact Support Div. of the sales company

No.	Messages	Timing of display	Cause	Remedy
12	An error occurred. Check the Update Firmware screen.	Manual update (main screen) Automatic update (main screen)	After the update, failed to connect to the delivery server.	Check the network environment and re-execute the job. If it recurs, obtain the log etc. (Refer to "System Management Operations" under "Version Upgrade" of "Updater" in "Troubleshooting" of this manual.) and contact Support Div. of the sales company.
			After the update, delivery server stopped.	Contact the sales company's Support Department. After confirming restoration of the delivery server, re-execute the job. If it recurs, obtain the log etc. (Refer to "System Management Operations" under "Version Upgrade" of "Updater" in "Troubleshooting" of this manual.) and contact Support Div. of the sales company.
			After the update, the network cable was disconnected.	Re-connect the network cable and re-execute the job. If it recurs, obtain the log etc. (Refer to "System Management Operations" under "Version Upgrade" of "Updater" in "Troubleshooting" of this manual.) and contact Support Div. of the sales company.
			After the update, server returned an error.	Obtain the log etc. (Refer to "System Management Operations" under "Version Upgrade" of "Updater" in "Troubleshooting" of this manual.) and contact Support Div. of the sales company.
			After the update, an internal error occurred.	If it recurs, obtain the log etc. (Refer to "System Management Operations" under "Version Upgrade" of "Updater" in "Troubleshooting" of this manual.) and contact Support Div. of the sales company.
13	Delivery Error Error Code: [xxx]	UGW linkage (Update Firmware screen)	eRDS sent an order but Updater failed to connect to the server.	Conduct a communication test to analyze the cause of the error. After solving the cause, resend the order from the eRDS. If it recurs, obtain the log etc. (Refer to "System Management Operations" under "Version Upgrade" of "Updater" in "Troubleshooting" of this manual.) and contact Support Div. of the sales company.
			The delivery server stopped.	Contact the sales company's Support Department. After confirming restoration of the delivery server, re-execute the job. If it recurs, obtain the log etc. (Refer to "System Management Operations" under "Version Upgrade" of "Updater" in "Troubleshooting" of this manual.) and contact Support Div. of the sales company.
			The scheduled data and time acquired from delivery server does not exist.	Do the delivery setting from UGW again. If it recurs, obtain the log etc. (Refer to "System Management Operations" under "Version Upgrade" of "Updater" in "Troubleshooting" of this manual.) and contact Support Div. of the sales company.
14	Delivery Error Delivery Time Delivery Firmware Label Delivery Firmware version Error Code: [xxx]	UGW linkage (Update Firmware screen)	The scheduled date and time acquired from delivery server was before current time (15 or more min had passed).	Do the delivery setting from UGW again. If it recurs, obtain the log etc. (Refer to "System Management Operations" under "Version Upgrade" of "Updater" in "Troubleshooting" of this manual.) and contact Support Div. of the sales company.
		Immediate download (Update Firmware screen)	At the time of immediate download, turned OFF and then ON the power of device main body.	Re-execute the job. If it recurs, obtain the log etc. (Refer to "System Management Operations" under "Version Upgrade" of "Updater" in "Troubleshooting" of this manual.) and contact Support Div. of the sales company.
15	Applicable firmware is not registered.	On-site (error dialogue)	At the user site, no latest firmware exists.	This means the current firmware is the latest, so this error has no impact. But when the latest firmware to be retrieved must exist e.g. released new firmware information has been notified, contact Field Support Group in the sales company.
			No applicable firmware exists on CDS, so the service person can't select any applicable firmware.	Contact the sales company's Support Department.

No.	Messages	Timing of display	Cause	Remedy
16	Restart failed. Turn the main power OFF and ON.	Manual update (error dialogue)	An error occurred at the time of the device restart.	After turning OFF and then ON the main power of the device, re-execute the job. If it recurs, obtain the log etc. (Refer to "System Management Operations" under "Version Upgrade" of "Updater" in "Troubleshooting" of this manual.) and contact Support Div. of the sales company.
		Automatic update (error dialogue)	An error occurred at the time of the device restart.	After turning OFF and then ON the main power of the device, re-execute the job. If it recurs, obtain the log etc. (Refer to "System Management Operations" under "Version Upgrade" of "Updater" in "Troubleshooting" of this manual.) and contact Support Div. of the sales company.
17	Specify [E-Mail Address] with up to 64 characters.	At the time of periodical update setting	The specified E-mail address exceeded 64 characters.	Specify E-mail address within 64 characters.
18	The following characters cannot be used for the [E-Mail Address]: , ; " () [] < > \	At the time of periodical update setting	The E-mail address was including the characters which could not be used.	Do not specify E-mail address with characters which cannot be used.
19	Specify [Comments] with up to 128 characters.	At the time of periodical update setting	Comments exceeded 128 characters.	Specify comments within 128 characters.
20	The [Delivery Server URL] is incorrect.	In setting with the deliver server URL.	The specified deliver server URL is wrong.	Enter the right URL(https://device.c-cdsknn.net/cds_soap/updaterif)

• Explanation on Error Codes and Their Remedies

The following shows the error codes displayed on CDS error dialogs and the Control Panel of the device (local UI) and explanation of those error codes.

How to read an error code

An error code consists of a number of eight digits (hexadecimal number) displayed on the UI.

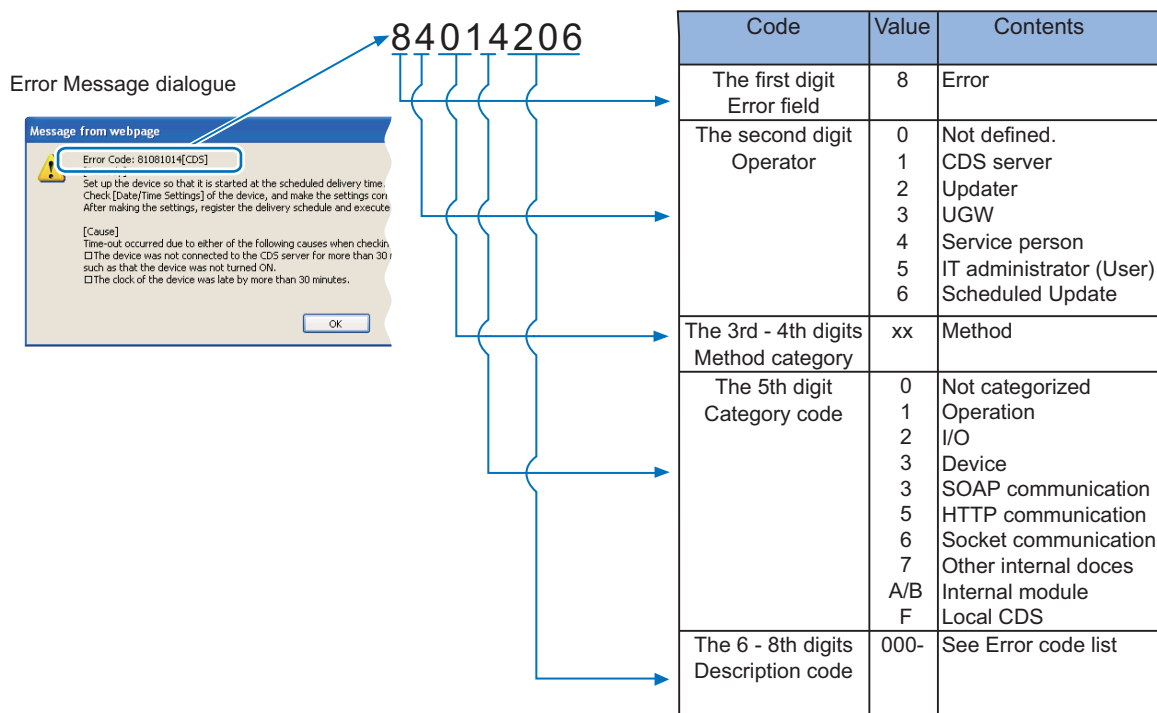

Remedy by Error Code

Remedy to Be Taken When an Error Code Starting with [81-----] Is Displayed

The remedy for an error code whose first two digits are "81" is shown below.

1. Refer to [“List of Error Codes Starting with 81” on page 63](#) / [“List of Error Codes Related to Local CDS” on page 72](#), and try the remedy.
2. If the symptom is not resolved by performing the remedy shown in the error code list, report it to the support department of the sales company with the following information.
 - Time of occurrence
 - Serial number of the device

Remedy to Be Taken When an Error Code Starting with a Number Other than [81-----] Is Displayed

The remedy for an error code whose first two digits are not "81" is shown below.

1. Check the last four digits of the code, and try the remedy shown in [“List of Error Codes Starting with a Number Other than 81” on page 67](#)/[“Error Codes When Using the UGW-linked Function” on page 72](#).
2. In the case of an error message with a check mark on the "Network" column of "Cause of error" in the error code list, try the remedy shown below.
 - Execute the operation again.
 - Perform a communication test on the Touch Panel of the device.
 - Check the status of the network equipment (disconnection of the LAN cable, etc.).
 - Check the network settings of the device.
 - Check that there is no restriction on the network environment of the site (e.g. restriction on communication at night).
 - Check the proxy server of the customer. If it does not work properly, perform the remedy. If the problem still persists, clear the cache of the proxy server.
3. If the symptom is not resolved by performing the foregoing remedy, report it to the support department of the sales company with the following information.
 - The generated error code
 - The Sublog of the device
 - The update log of the device (Set the log level to 4, and then collect the log.)

When an Error Code Not Included in the List of Error Codes Is Displayed

When an error code not included in the list of error codes is displayed, see [“Error Codes Not Included in the Error Code List and Remedy for Them” on page 73](#).

• Error Code List

List of Error Codes Starting with 81

The list of error codes starting with 81 is shown below. This error is related to the CDS server.

Report the error to the support department of the sales company with the time of occurrence and the serial number of the device.

Error Code	Description	Remedy	Cause of error	
			CDS server	UP DATER
81xx0001	No value is set in a mandatory data entry item	Contact the support department of the sales company. (Attach information on the time of occurrence and the serial number of the device.)	✓	✓
81xx0002	In the case of [81xx0002] except follows. In a string type of a data entry item, digit number and/or character type is/are set against the regulations is displayed in the following cases:		✓	✓
81040002	<ul style="list-style-type: none"> • The number of digits of the registration ID or password is not 8. • The registration ID or password includes characters other than single-byte numeric characters. 	Enter the correct ID and password for Special Firmware. (User)	✓	✓

Error Code	Description	Remedy	Cause of error	
			CDS server	UP DATER
81060002	<ul style="list-style-type: none"> The number of digits or type of characters used for Firm Type, Firmware Version, Firmware Group Version, or Firmware Label does not meet the specified number of digits or type of characters. The character string of Firmware Group Version (firmGroupVersion) includes characters other than numeric values. The number of digits of E-mail Address (mailAddress) is larger than 128. Characters other than single-byte alphanumeric characters and symbols are used for E-mail Address (mailAddress). An invalid e-mail address was input (The domain name is missing, . (dot) was input instead of , (comma), etc.) 	Register the correct e-mail address. If it occurs again, contact the support department of the sales company. (Attach information on the time of occurrence and the serial number of the device.) (Canon Inc. Only) In the case of an error in Firm Type, Firmware Version, or Firmware Group Version, register the correct firmware again.	✓	✓
81xx0003	In an data entry item, the value is set against the regulations (E.g. the set value is other than "Operator: 4. Service person, 5. User")	Contact the support department of the sales company. (Attach information on the time of occurrence and the serial number of the device.)	✓	✓
81xx0004	No applicable delivery information exists		✓	-
81xx0005	Error in the system settings		✓	-
Operation				
81xx1001	In the case of [81xx0001] except follows. Inconsistency between the current firmware component in the data entry item and delivery information (E.g. the conditions for automatic update are not met. The settings of a mandatory additional set are invalid)	If distribution of the firmware is necessary, search the applicable firmware again, and perform distribution of the firmware.	✓	✓
81071001	A cancellation notification was sent to CDS when the distribution status was not correct. (CDS has not received the status change due to a network failure, etc.)		✓	✓
81091001	<ul style="list-style-type: none"> The firmware information of the device at the time of execution of distribution differs from the firmware information of the device at the time of registration of the distribution schedule. The firmware was upgraded without using CDS when distribution schedule for the device that supports the UGW-linked function had been registered. As a result, the firmware information of the CDS server at the time of execution of distribution differs from the firmware information of the CDS server at the time of registration of the distribution schedule. When the remote update setting for the firmware to be updated was disabled after distribution schedule was registered using auto update. 		✓	✓
81xx1002	In a notice of delivery-allowed information, an install-set was release to the market, but the market release was stopped during the delivery	Contact the support department of the sales company. (Attach information on the time of occurrence and the serial number of the device.)	✓	-
81xx1003	No mail template file exists		✓	-
81xx1004	The device serial number in the data entry item differs from that in delivery information		✓	-
81xx1005	User is selected as Operator in the data entry items and the retrieval type is other than the latest		✓	-
81xx1006	The retrieval type in the data entry item is special and registration ID and individual Password are not set (* Operator did not enter registration ID and individual Password)		✓	-
81xx1007	The retrieval type in the data entry item is special and Operator is not Service person		✓	-

Error Code	Description	Remedy	Cause of error	
			CDS server	UP DATER
81xx1008	As to the device serial number in the data entry items, there is no applicable device code product	Contact the support department of the sales Company. (Attach information on the time of occurrence and the serial number of the device.) (Canon Inc. Only) Check registration of LMS.	✓	-
81xx1009	The retrieval type in the data entry items is special and there are no basic-set applicable to the registration ID and Password (* When wrong registration ID or Password was entered by an operator)	Enter correct ID and the password.	✓	-
81xx100A	The delivery status is Applying After the firmware was updated and when an update completion notification has not been sent to CDS, distribution of the firmware was attempted again before update time-out is processed in CDS.	After 2 hours and 30 minutes have passed since the failed attempt to distribute the firmware, search the applicable firmware again, and perform distribution of the firmware.	✓	-
81xx100B	No approval information exists about EULA or the export criteria when the delivery is determined	Contact the support department of the sales company. (Attach information on the time of occurrence and the serial number of the device.)	✓	-
81xx100C	The delivery status is Distributing/Distributed/Applying/Finished/Failed When the distribution status was not correct, distribution information was obtained from CDS. (CDS has not been notified of the status change due to a network failure, etc.)	Search the applicable firmware again, and perform distribution of the firmware.	✓	-
81xx100D	The delivery status is Distributing/Distributed/Applying/Finished/Failed		✓	-
8108100D	When the distribution status was not correct, schedule information was checked with CDS. (CDS has not been notified of the status change due to a network		✓	-
81xx100E	The delivery status is New/Waiting to Distribute/Distributed/Applying/Finished/Failed	Contact the support department of the sales company. (Attach information on the time of occurrence and the serial number of the device.)	✓	-
81xx100F	The delivery code is other than Distributing. (Firmware distribution)		✓	-
81xx1010	The delivery status is New/Waiting to Distribute/Distributing/Applying/Finished/Failed	Search the applicable firmware again, and perform distribution of the firmware.	✓	-
810B1010	An update start notification was sent to CDS with an invalid status. (The CDS server failed to receive the status change due to a network error, etc.)			
81xx1011	The delivery status is Distributing/Distributed/Applying/Finished/Failed	Contact the support department of the sales company. (Attach information on the time of occurrence and the serial number of the device.)	✓	-
81xx1012	Device is "Not applicable to CDS" (Firmware distribution) * It occurs only when a device that can access CDS is managed.	Register the device as a CDS device.	✓	-
81xx1013	When the specified distribution time was within the time frame of CDS distribution stop. (Firmware distribution)	Contact the support department of the sales company. (Attach information on the time of occurrence and the serial number of the device.)	✓	-
81xx1014	When confirmation of the firmware distribution settings ended in time-out. CDS was not accessed within 30 minutes after the distribution time. The device has been turned OFF, the network has been disconnected, etc.	Search the applicable firmware again, and perform distribution of the firmware.	✓	-

Error Code	Description	Remedy	Cause of error	
			CDS server	UP DATER
81xx1015	When firmware distribution time-out occurs. A reception completion notification was not sent to CDS within 24 hours after the start of the distribution. The device has been turned OFF, the network has been disconnected, etc.	Search the applicable firmware again, and perform distribution of the firmware.	✓	-
81xx1016	Firmware update time-out occurred. An update completion notification had not been sent to CDS even after 2 hours since the start of the update.	Check the device to see if the update has been completed. When the update has ended in failure, execute the operation again if there is no problem with the device.	✓	-
81xx1017	When the firmware distribution information notification showed an error in processing the distribution information.	Contact the support department of the sales company. (Attach information on the time of occurrence and the serial number of the device.)	✓	-
81xx1018	When the firmware distribution information notification showed an error in processing the scheduled update information.		✓	-
81xx1019	When the status of the scheduled update information is "Set", "Finished", or "Failed".		✓	-
81xx1020	When the status of the scheduled update information is "Waiting to Transmit" or "New".	Contact the support department of the sales company. (Attach information on the time of occurrence and the serial number of the device.)	✓	-
81xx1021	When the status of the scheduled update information is "Set".		✓	-
81xx1022	The scheduled update setting information differs between the input information and the distribution information.		✓	-
81xx1023	When the distribution status is "Cancel".		✓	-
81xx1024	A forced automatic update was scheduled for distribution, but it could not be performed because the firmware to be distributed or the status of the device was changed.	Check the firmware to be distributed or the status of the device. If necessary, schedule distribution again.	✓	-
81xx1025	A time-out occurred when starting to apply the firmware.	Contact the support department of the sales company. (Attach information on the time of occurrence and the serial number of the device.)	✓	-
81xx1026	[Auto] is specified for the update method even though an application time is specified.	Change the update method to [Date & Time].	✓	-
81xx1027	The application time has been set to a time earlier than the time from which the distributed firmware can be applied (when a specific period of time has passed since the distribution time).	Set the application time to a time which is later than the time when the specific period of time has passed since the distribution time.	✓	-
81xx1028	The acquisition type of the input information is set to [Special], and an error where the basic set was not found has occurred more than the specified number of times (the maximum number of times of authentication failure).	Contact the support department of the sales company. (Attach information on the time of occurrence and the serial number of the device.)	✓	-
I/O				
81xx2014	Device information corresponding to the target device serial number does not exist. (There is no relevant information on the device firmware group.)	Contact the support department of the sales company. (Attach information on the time of occurrence and the serial number of the device.)	✓	-
81xx2015	The error "The specified license access number does not exist in LMS" occurred more than the specified number of times (the maximum number of times of authentication failure).	Contact the support department of the sales company. (Attach information on the time of occurrence and the serial number of the device.)	✓	-

List of Error Codes Starting with a Number Other than 81

The list of error codes starting with a number other than 81 is shown below. If such an error has occurred, search the remedy using the last four digits of the error code.

Report the error to the support department of the sales company with the Sublog and update log of the device.

The "CDS server" in the "Cause of error" column includes CDS distribution servers and CDS file servers.

Error Code		Description	Remedy	Cause of error		
				CDS server	UP DATER	Network
8xxx	1001	Processing exclusively	Start the operation again after terminating other Updater operations being executed simultaneously	-	✓	-
	1002	Stopped	Restart the device, and start the operation again.	-	✓	-
	1101	Failed to process preparation for use	Contact the support department of the sales company. (Attach the Sublog and update log of the device.)	-	✓	-
	1102	Failed to process use end		-	✓	-
	1103	Time out during restart of readiness preparation		-	✓	-
	1104	Session time-out excluding after application inquiry (after issuing delivery ID)	Start the operation again from the beginning	-	✓	-
	1105	CDS URL is not set	Set CDS URL	-	✓	-
	1106	Another job existed immediately before the firmware update processing.	Start the operation again after terminating the job of the device	-	✓	-
	1202	Specifying of scheduled update for a model that does not support scheduled update	Contact the support department of the sales company. (Attach the Sublog and update log of the device.)	✓	-	-
	1203	Firmware processing for a model that does not support firmware processing		✓	-	-
	1301	Security Token verification error		-	-	✓
	1302	Privilege check error	Perform the authentication as a correct user.	-	-	✓
	1303	Parameter error	Contact the support department of the sales company. (Attach the Sublog and update log of the device.)	-	-	✓
	1304	There is no distribution information from the server.		-	-	-
	1305	Version notification is not required.		-	-	-
	1306	Connection server information mismatch error	Check the connection server settings.	-	-	✓
I/O						
21xx	An internal error about file operation	Contact the support department of the sales company. (Attach the Sublog and update log of the device.)	-	✓	-	
22xx	An internal error about XML file operation		-	✓	-	
2301	Failed to output the license file		-	✓	-	
2401	Failure in creation of an auto shutdown stop file		-	✓	-	
2402	Failure in deletion of the auto shutdown stop file		-	✓	-	
Device						
31xx	An internal error in CPCA	Contact the support department of the sales company. (Attach the Sublog and update log of the device.)	-	✓	-	
32xx	An internal error in IMI		-	✓	-	
33xx	An internal error in SMS		-	✓	-	
34xx	An internal error in NLM		-	✓	-	
35xx	Configuration Service property setting error		-	✓	-	

Error Code		Description	Remedy	Cause of error		
				CDS server	UP DATER	Network
8xxx	36xx	An internal error related to APL_CDS partition	Contact the support department of the sales company. (Attach the Sublog and update log of the device.)	-	✓	-
	37xx	DCM-related service error		-	✓	-
	38xx	An error related to storage service, partition information, or path information acquisition	Contact the support department of the sales company. (Attach information on the time of occurrence and the serial number of the device.)	-	✓	-
SOAP communication						
	4101	The processing thread stopped	Contact the support department of the sales company. (Attach the Sublog and update log of the device.)	-	✓	-
	4102	Processing SOAP communication now		-	✓	-
	4103	The function type is not matched		-	✓	-
	4104	An invalid SOAP response error	Check the network environment. When this problem recurs, contact the support department of the sales company.	✓	-	-
	4105	No network cable connection (device side)	Check the network environment. If it occurs again, contact the support department of the sales company. (Attach the Sublog and update log of the device.)	✓	-	-
	4106	A character other than numeric characters has been specified for the HTTP status code.	Specify the HTTP status code using numeric characters.	✓	-	-
	4201	An internal error about application information	Contact the support department of the sales company. (Attach the Sublog and update log of the device.)	-	✓	-
	4202	Config.xml is not found		-	✓	-
	4203	Type.xml is not found		-	✓	-
	4204	An error in binding type.xml	Contact the support department of the sales company. (Attach the Sublog and update log of the device.)	-	✓	-
	4205	An error in creating a service tab		-	✓	-
	4206	A runtime error in performing the web method		-	✓	✓
	4207	An unknown host error in performing the web method	<ul style="list-style-type: none"> • Check the network environment of the device and start the operation again • Check if the URL settings of the CDS server are correct, and start the operation again after resetting 	✓	✓	✓
	4301	The delivery server is stopped	Contact the support department of the sales company. (Attach the Sublog and update log of the device.)	✓	-	-

Error Code		Description	Remedy	Cause of error		
				CDS server	UP DATER	Network
8xxx	4302	<p><In the case of scheduled update> In response to a download start notification sent from the device, the distribution server returned an error and stopped the operation of the device within a certain period of time before the distribution server maintenance time.</p> <p><In the case of distribution executed by specifying the date and time> The firmware version of the device at the time when the distribution settings were specified and the version at the time immediately before update are different.</p>	<p><In the case of scheduled update> Specify the distribution settings again, making sure that the distribution server maintenance time and the scheduled update time do not overlap.</p> <p><In the case of distribution executed by specifying the date and time> Specify the distribution settings again, making sure that the firmware version of device at the time when the distribution settings are specified and the version at the time immediately before update are the same.</p>	✓	✓	-
HTTP communication						
	5101	Specified Hash Algorithm is unknown	Contact the support department of the sales company. (Attach the Sublog and update log of the device.)	-	✓	-
	5102	Download file URL is invalid	Check the URL setting of CDS server, reset the setting, and then start the operation again.	-	✓	-
	5103	No network cable connection (device side)	Check the network environment of the device, and start the operation again.	-	✓	-
	5201	Invalid HTTP request	Contact the support department of the sales company. (Attach the Sublog and update log of the device.)	✓	✓	✓
	5202	Failed to connect to the server	Check the network environment of the device (such as the examples shown below) and start the operation again. <ul style="list-style-type: none"> • Check if the network cable is disconnected. • Check if connection with the proxy server has failed. • Check if there is any problem with the DNS server. 	✓	✓	✓
	5203	Failed to find the server	Check the network environment of the device (the proxy settings, etc.), and start the operation again.	✓	✓	✓
	5204	An input/output error occurred during the connecting process to the server	Check that no problem is found in the two items displayed during the communication test. If any problem was found, check the network environment.	✓	✓	✓
	5205	Failed to read a HTTP response. An error or time-out has occurred because the line speed is low.	Check that no problem is found in the two items displayed during the communication test. If any problem was found, check the network environment. If it occurs again, contact the support department of the sales company. (Together with information regarding the network environment of the user and the system log/sublog of the device)	✓	✓	✓

Error Code	Description	Remedy	Cause of error		
			CDS server	UP DATER	Network
8xxx 5206	An HTTP status code other than 206 or 200 was returned from HTTP.	Check the network environment of the device (such as the examples shown below). <ul style="list-style-type: none"> Check if the user authentication of the proxy is wrong. Check if an invalid response or time-out has been returned from the gateway, proxy server, or DNS server. If it occurs again, contact the support department of the sales company. (Together with the system log/sublog of the device, the distribution log of the Updater, the SOAP message notifying of the error, and the log of the proxy server)	✓	✓	✓
5207	Generation of secure socket failed.	Contact the support department of the sales company. (Attach the Sublog and update log of the device.)	✓	✓	✓
5208	Certificate check error		✓	✓	✓
5209	Connection time-out		-	✓	✓
520A	The port number is invalid.	Check the network environment of the device and start the operation again.	-	✓	✓
520B	The port number is invalid (when using a proxy server).	If it occurs again, contact the support department of the sales company. (Together with information regarding the network environment of the user and the system log/sublog of the device)	-	✓	✓
520C	The remote host cannot be accessed.		-	✓	✓
520D	The remote host cannot be accessed (when using a proxy server).		-	✓	✓
520E	The host name cannot be resolved.		-	✓	✓
520F	The host name cannot be resolved (when using a proxy server).		-	✓	✓
5301	Failed to retrieve the data stream	Contact the support department of the sales company. (Attach the Sublog and update log of the device.)	-	✓	✓
5302	Failed to create the file object for receipt		-	✓	✓
5303	Failed to create the data stream of the file for receipt		-	✓	✓
5304	Failed to receive the data	Check the network environment of the device, and start the operation again.	✓	✓	✓
5305	An error about reserving the file data for receipt	Check that no problem is found in the HDD. When this error occurs again, contact Support Group of sales companies.	-	✓	-
5306	Failed to close the data stream	Contact the support department of the sales company. (Attach the Sublog and update log of the device.)	-	✓	-
5307	Failed to close the file data for receipt		-	✓	-
5308	Invalid hash code of the download file	Check the network environment of the device, and start the operation again.	✓	✓	✓
5309	The proxy authentication method is not supported, or access to the CDS file server is not permitted.	Check the proxy authentication method being used, change the setting to use a supported proxy authentication, and then start the operation again. Check that access to the following URL is permitted. <ul style="list-style-type: none"> device.c-cdsknn.net (protocol: https) cdsknn.net.edgesuite.net (protocol: http)* * The following URL in the product of after iR-ADV C2200 series. a02.c-cdsknn.net (protocol: https) But, it excludes iR-ADV C5200/9200/7200 series.	-	✓	✓

Error Code	Description	Remedy	Cause of error			
			CDS server	UP DATER	Network	
8xxx	530A	A privilege error during creation of a file	Check the network environment of the device and start the operation again.	✓	✓	✓
	530B	A privilege error during output of a file		✓	✓	✓
	530C	The data of an HTTP response from an invalid input stream was read.		✓	✓	✓
	530D	An error in reading the data of an HTTP response		✓	✓	✓
	530E	An error in reading the data of an HTTP response		✓	✓	✓
	530F	An error in reading the data of an HTTP response		✓	✓	✓
	5310	An error in reading the data of an HTTP response		✓	✓	✓
	5311	The hash code length of the file to download is invalid.		✓	✓	✓
	5312	The hash code of the file to download is invalid.		✓	✓	✓
Socket communication						
6101	Failed to connect the eRDS	Contact the support department of the sales company. (Attach the Sublog and update log of the device.)	-	✓	✓	
6102	No response from eRDS		-	✓	✓	
6103	No notice of start from the eRDS		-	✓	✓	
6104	Error of socket reading		-	✓	✓	
6105	Socket communication time-out		-	✓	✓	
Other internal codes						
71xx	An error by using invalid API	Contact the support department of the sales company. (Attach the Sublog and update log of the device.)	-	✓	-	
72xx	An internal error in SMS		-	✓	-	
7301	No existence of delivery ID		-	✓	-	
7302	Invalid delivery ID		-	✓	-	
7303	The updated firmware information is not identical with the firmware information after activation of the Updater		-	✓	-	
7304	The process of firmware download is incomplete It occurs when the power of the device is turned OFF during download.		-	✓	-	
7305	The update process is incomplete The power was turned OFF after completion of download and before start of update processing.		-	✓	-	
7401	Failed to retrieve delivery information		-	✓	-	
7501	Failed to execute the delivery process		-	✓	-	
7502	The scheduled distribution had not been executed even after a certain period of time due to the power of the device being OFF at the scheduled time or other reasons.		Scheduled deliveries not executed within the defined period of time are abandoned, so register a scheduled delivery again. When setting the date and time of the scheduled delivery, be sure to designate a time when the device is ON	-	✓	-
7503	The download results could not be obtained.	Contact the support department of the sales company.	-	✓	-	

Error Code		Description	Remedy	Cause of error		
				CDS server	UP DATER	Network
8xxx	7504	There is no download list information.	(Attach the Sublog and update log of the device.)	-	✓	-
	Internal module					
	Axxx	Communication error in the internal module	Contact the support department of the sales company. (Attach the Sublog and update log of the device.)	-	✓	-
Bxxx	-			✓	-	

List of Error Codes Related to Local CDS

A list of error codes related to Local CDS is shown below.

Error Code	Description	Remedy
81xxF003	Firmware information not registered. Firmware information corresponding to the target device serial number does not exist.	Contact the support department of the sales company.
81xxF007	Invalid firmware version. The firmware version at the time of registration of the distribution schedule differs from the current firmware version.	
81xxF008	Invalid firmware information. Firmware information to be distributed does not exist.	
81xxF009	Forcible termination. Distribution information is forcibly terminated from the server UI.	
81xxF00F	Invalid distribution status. Distribution status of the server is in a condition where a requested method from the client cannot be accepted.	
81xxF010	Invalid parameter. Requested parameter from the client is not correct.	
81xxF011	Version information not registered. Version information corresponding to the specified serial number has not been registered.	
81xxF012	Distribution time-out. Distribution has not been completed even after a certain period of time from the start of the distribution.	
81xxF013	Unable to judge the necessity of distribution Version information from a device has not been registered in the local CDS. Since the local CDS does not know the version information of the device, it cannot respond to the distribution request from updater. As a result of that, an error occurred when the request has been made.	
81xxFFFE	DB error. General error to access DB.	
81xxFFFF	DB error. Internal error other than error to access DB (file I/O, etc.).	
8xxx1204	L-CDS update process for a model that does not support L-CDS	

Error Codes When Using the UGW-linked Function

Codes displayed as eRDS errors when the UGW-linked function is used

Error Code	Description	Remedy
8xxx0000	An unexpected error occurred in the device.	Restart the device, and perform the operation again. When this problem recurs, the firmware of the device needs to be reinstalled (upgraded).
8xxx0002	A time-out error occurred due to no response from Updater within the specified time (3 seconds).	Obtain the sublog, and contact the support department of the sales company.
8xxx0101	Processing in the device (event processing) failed. Restart the device, and perform the operation again.	Restart the device, and perform the operation again. When this problem recurs, the firmware of the device needs to be reinstalled (upgraded).
8xxx0303	Queue could not be sent due to failure of processing in the device (event processing).	Restart the device, and perform the operation again. When this problem recurs, the firmware of the device needs to be reinstalled (upgraded).
8xxx0304	An error occurred in control of synchronization or interruption processing between processes being handled in parallel.	Wait for a while, and perform a communication test again.
8xxx0706	Communication with Updater failed.	Restart the device, and perform the operation again after checking that Updater has been started.
8xxx0707		When this problem recurs, obtain the sublog, and contact the support department of the sales company.
8xxx0708		

Error Code	Description	Remedy
8xxx0709	At the time of firmware update, the Tracking ID ordered by UGW and the one to which the Updater responded did not match.	Obtain the sublog, and contact the support department of the sales company.

Error Codes Not Included in the Error Code List and Remedy for Them

Scenes Where an Error Occurs

When an error code not included in the error code list is displayed, one of the errors shown in the following scenes may have occurred.

Scenes Where an Error Occurs

Scenes Where an Error Occurs	Content
Communication test, etc. (main screen)	Log could not be written due to maximum value (capacity/the number of files) being exceeded.
Version information notification (main screen)	Retrieval of device version information ended in failure because the firmware version of the device was not registered in CDS.
	Connection to the delivery server failed at the time of notification of version information.
	The network cable was disconnected during notification of version information.
	Notification of version information ended in failure because the device was restarted during notification of version information.
UGW linkage (main screen)	UGW linkage was turned ON while eRDS was OFF.
On-site (error dialog)	An internal error occurred when obtaining the applicable firmware information.
Immediate download (error dialog)	An internal error occurred at the time of request of firmware delivery information.
	Free space in the storage destination disk ran out during download. (DiskFull)
Manual/auto update (error dialog)	An internal error occurred at start of update.
Deletion of downloaded firmware	An internal error occurred at the time of cancellation notification.

Remedy

Check that the log files shown below do not exceed the maximum values.

When this problem recurs, obtain the log, and contact the support department of the sales company.

Logs and maximum capacity / number

Log name	Maximum capacity	Maximum number of files
Update log	128KB/ file	4
System log	512KB/ file	4

Backup/Restoration

Depending on the works to be done such as replacing parts, this data needs to be backed up and restored.

There are some ways to back up and restore data, and the appropriate one should be used depending on the purpose and storage destination.

This section describes the procedure for backing up and restoring service mode setting values.

For the procedure for backing up and restoring other information, refer to “[Backup Data List](#)” on page 213 in the Appendix.

Backup/Restoration Using the DCM Function

Use the DCM (Device Configuration Manager) function equipped in the machine to back up/restore the various data.

This operation can be performed from the [Settings/Registration] menu or from service mode.

The backup file can be saved in a USB flash drive or the local disk of a PC accessed via the Remote UI.

Backup/Restoration Using PCB

An Expansion ROM for servicing and the Sublog Board can be used to back up setting data from a PCB that has failed, to migrate the setting information to an unused Main Controller.

Backup/Restoration Using the DCM Function

Function Overview

This machine has a setting information export/import function (hereinafter referred to as DCM (Device Configuration Management function) which exports/imports the machine's setting value information as a file. The file exported/imported using the DCM function is called a DCM file, and the target setting information is as follows:

- Setting information of [Settings/ Registration]
- Setting information of service mode

The DCM file is exported to a USB flash drive or PC local disk from the Control Panel or remote UI.

The exported DCM file can be returned to the original device or imported to a different device.

When the file is returned to the original device, this can be used as a setting backup function, and when the file is imported to a different device, this can be used as a setting information migration function.

Data can also be imported to or exported from an iR-ADV machine by using iW EMC/MC DCM Plug-in.

In the case of the setting value backup function before DCM, an exported file could be imported to the same device, but the DCM function enables import of an exported file to a different device.

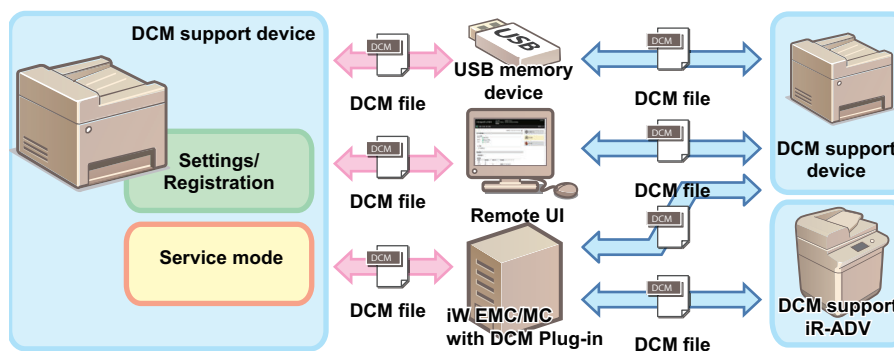

Image

NOTE:

In order to export or import setting information using DCM, it is necessary that the device supports DCM.

Backup/Restoration for Service Technicians

Backup and Restoration from the [Settings/Registration] Menu

Setting information can be backed up and restored from the Control Panel of the device or from the [Settings/Registration] menu of remote UI.

Although the [Settings/Registration] menu is for users, the service mode settings information can be backed up and restored from the Import/Export function by changing the service mode setting.

In order to back up and restore the service mode setting information from the [Settings/Registration] menu, it is necessary to access from remote UI.

Backup/Restoration Using Service Mode

Some of the functions in service mode can be used to backup and restore data.

The setting value information and service counter values of each controller can be backed up and restored.

• Combination of Information Exported/Imported by DCM, Means, and Storage Locations

A DCM file is exported and imported using the Control Panel, remote UI, or the iW EMC server, depending on the situation of the site.

The information exported/imported differs depending on the means.

Combinations of them are shown in the following table.

Menu used	Menu used Operation	Information exported		Save destination
		Setting values of menu options	Service mode setting values	
[Settings/Registration] menu	Control panel	Yes (fixed)**1	No	USB flash drive
	Remote UI	Yes	With conditions**2	PC local disk
Service mode	Control panel	No	Yes	USB flash drive
	Remote UI	No	Yes	PC local disk

• Compatibility of Data

The following table shows compatibility of data in the case where the device from which the data is exported and the device to which the data is imported differ in model and/or serial number.

For items that are imported in Cases A, B, and C, refer to List of "Service Mode Items Which Can Be Imported".

Compatibility of Data List

Model	Serial number	Import process
Same	Same	Items corresponding to Case A are imported. *1
Same	Different	Items corresponding to Case B are imported. *1
Different	Different	Items corresponding to Case C are imported. *2
Different	Same	The file is judged to be invalid, and the process ends with an error.

*1 If the firmware version at the time of import differs from that at the time of export, predetermined corrective processing may be performed.

*2 Predetermined corrective processing may be performed.

• Limitations

Disk Size Constraints

There is no problem when exporting/importing setting information between devices of the same model, but when exchanging information between devices of a different model, it is possible for the disk capacity to be insufficient. In particular, the disk capacity may be insufficient when importing the export file from an advanced model with many setting values registered to a model with fewer functions, because the data size that can be handled by the device is exceeded. The following behavior occurs in this case:

- If the disk capacity is insufficient when receiving a file to import, an error occurs before starting the import processing, and the information is not imported.
- The import processing performed until the disk capacity became insufficient remains reflected and a rollback does not occur.
- If the file to import remains in the temporary area of the controller, it is deleted.
- If the file to export remains in the temporary area of the controller, it is deleted.

*1. When the [Settings/Registration] menu is used from the Control Panel, both the setting menu information and the address book are imported/exported. It is not possible to export/import only either of them. Information which is not included in the data to be imported is not imported.

*2. Service mode is added to the data to be exported only when service mode level 1 > COPIER > OPTION > USER > SMD-EXPT is set. For information on items that are imported, refer to "List of Items Which Can Be Imported".

■ Import/Export Procedure from [Settings/Registration] of Remote UI

This section describes the procedure for backing up and restoring service mode setting information by using the [Import/Export] function in the [Settings/Registration] menu of Remote UI.

CAUTION:

- The service mode setting information can be backed up and restored only from the [Settings/Registration] menu on Remote UI, and the operation cannot be performed from the [Settings/Registration] menu on the Control Panel.
- In the case of backing up and restoring only the setting information of the [Settings/Registration] menu or the address book, refer to the procedure described in the e-Manual (In the e-Manual, [Top] > [Printer Management] > [Import/Export Settings]).

● Limitations

The following limitations exist when backing up and restoring the service mode settings information from the [Settings/Registrations] menu of remote UI.

A job must not be accepted during an import/export processing.

Except for the calibration requested by the engine, a job is not allowed to be accepted during a processing. In addition, import/export must not be performed during execution of a job.

Firmware must not be updated during an import/export processing.

Fax cannot be received while firmware is updated during a processing. In addition, import/export must not be performed also during firmware update.

Power must not be turned off during an import/export processing.

If power discontinuity occurs during an import processing, a rollback processing is not performed, therefore the settings imported up to that point are reflected while the rest of the settings remain as-is.

When power discontinuity occurs during an export processing, export is not executed.

● Procedure for Export Using Remote UI ([System Management Settings] Menu)

Service mode setting information can be exported from the [System Management Settings] menu by setting the following service mode setting value to "1".

1. Enter service mode, and set the following item to "1".

- SERVICE MODE > FUNCTION GR. > SMD-EXPT

The screenshot shows the 'SERVICE MODE' configuration window. On the left, a tree view lists various groups: COUNTER GR., ADJUST GR., OPTION GR., FUNCTION GR. (selected), LOG GR., PANEL LOCK GR., F/W UPDATE GR., NETWORK GR., SP ADMIN MODE, and SUBLCG LIST. Under 'FUNCTION GR.', 'SMD-EXPT' is selected. The main panel displays the 'FUNCTION GR. EDIT' dialog for 'SMD-EXPT', which is checked. Other options include 'USB-H' (unchecked), 'MEAP' (with a value of 8000), and 'MEAP-PN' (with a value of 1-65535). A 'REBOOT' button is located in the top right corner. A copyright notice for CANON INC. 2015 is visible at the bottom right.

NOTE:

[SMD-EXPT] setting can be specified either from the Control Panel or from the remote UI.

2. Exit service mode, start remote UI, log in as a system administrator, and then select the following item:

- [Settings/Registration] > [Import/Export] > [Import]

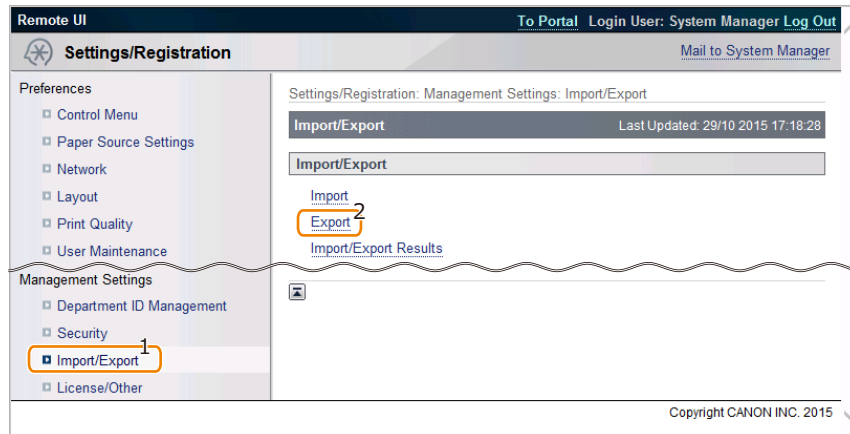

3. After confirming that [Service Mode] is displayed/selected in [Select Item to Export], enter the password and click [Start Exporting].

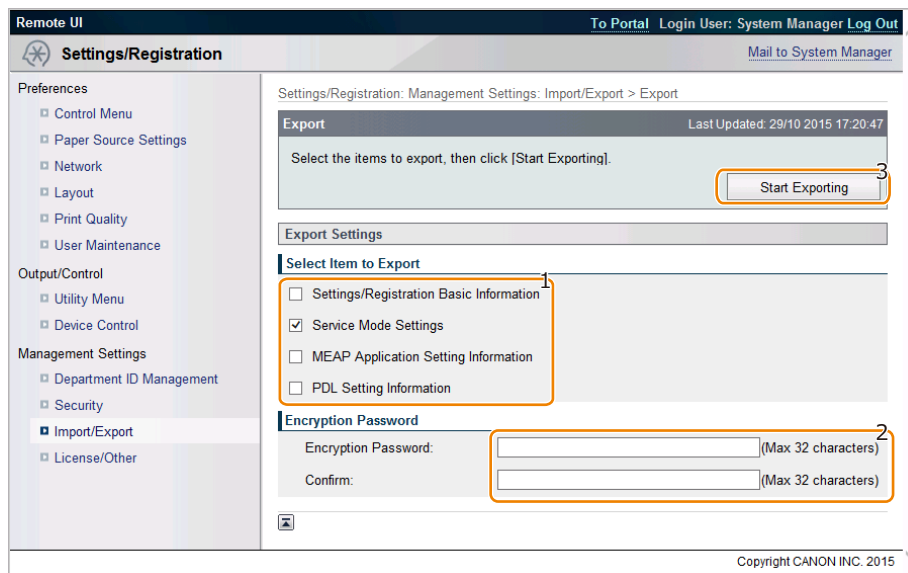

Settings/Registration Basic Information

Select this check box to export basic setting data of menu options.

Service Mode Settings

Select this check box to export various setting data of service mode.

MEAP Application Setting Information

Select this check box to export the setting information of MEAP applications.

PDL Setting Information

Select this check box to export the setting information of page description languages.

Encryption Password

Enter 32 or less numeric characters set when the file was exported.

4. The File Download dialog box will appear. Save the file to any location.

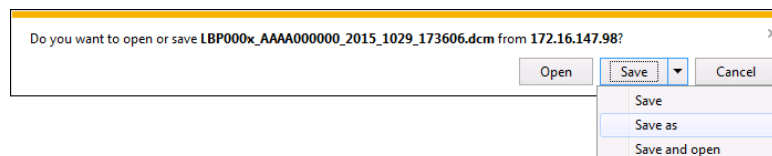

5. Enter service mode, and set the following item to "0".

- SERVICE MODE > FUNCTION GR. > SMD-EXPT

CAUTION:

Since the screen of export function can also be accessed by the user, be sure to disable the [SMD-EXPT] setting (setting value: 0).

• Procedure for Import Using Remote UI ([System Management Settings] Menu)

Import the service mode setting information file that was exported in the previous procedure.

1. Enter service mode, and set the following item to "1".

- SERVICE MODE > FUNCTION GR. > SMD-EXPT

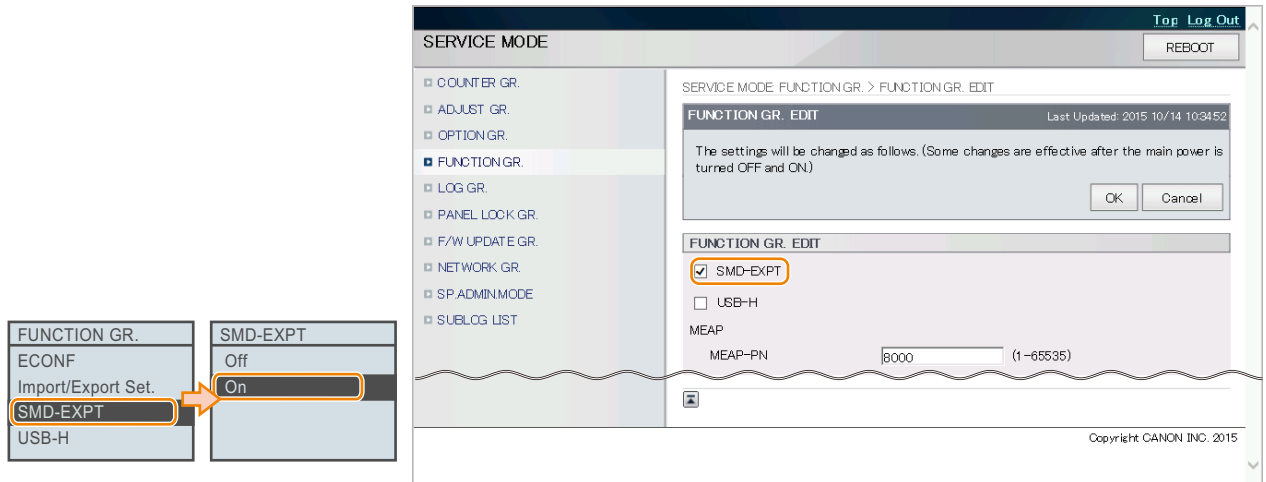

NOTE:

The [SMD-EXPT] setting can be specified either from the Control Panel or from the remote UI.

2. Exit service mode, start remote UI, log in as a system administrator, and then select the following item:

- [Settings/Registration] > [Import/Export] > [Import]

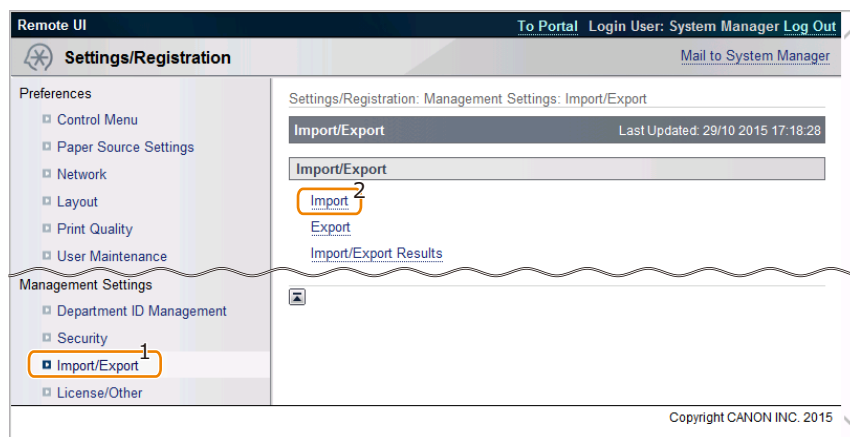

3. Configure the import setting, and click [Start Importing].

Entering the encryption password and clicking [Start Importing] imports the menu option data.

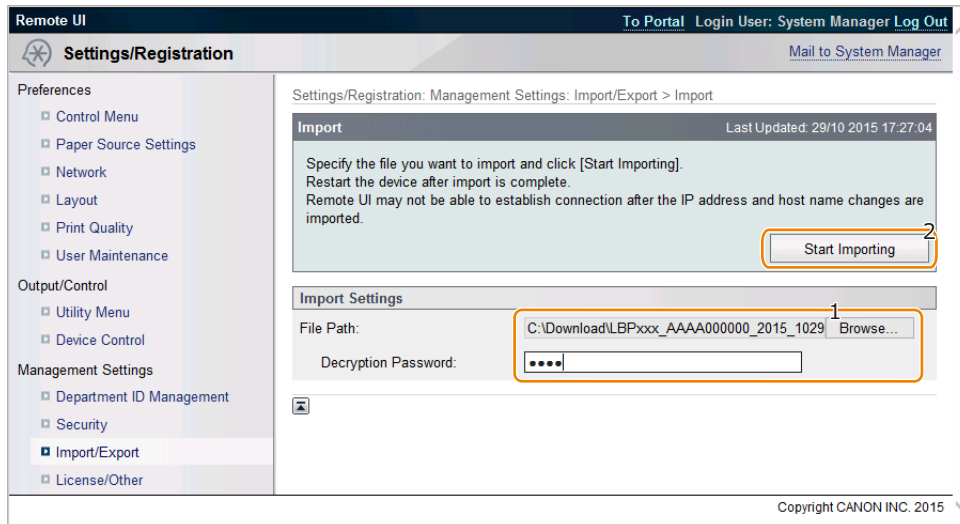

[Browse..]button

Click to select the file to import.

Decryption Password

Enter up to 32 alphanumeric characters for the password that was set when the file was exported.

4. A dialog box asking whether the user wants to execute import will appear. Click [OK].

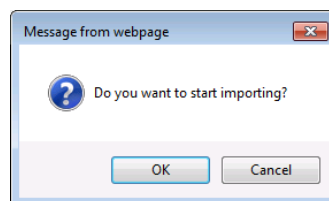

5. A message will appear to indicate that the process has been completed. Click the [OK] button.

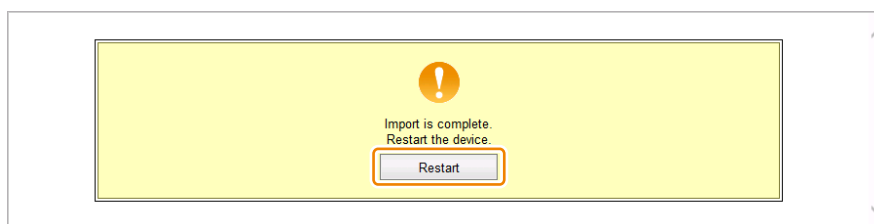

6. Restart the host machine, enter service mode, and then check that the setting information is reflected. This completes the procedure for importing a setting information file.

7. Enter service mode, and set the following item to "0".

- SERVICE MODE > FUNCTION GR. > SMD-EXPT

CAUTION:

The [SMD-EXPT] setting can be specified either from the Control Panel or from the remote UI.

■ Backup/Restoration Procedure Using Service Mode

Service mode setting information can be backed up and restored by using the [Import/Export] function in service mode.

● Procedure for Exporting to a USB Flash Drive

Use the service mode function to save the service mode setting information to a USB flash drive.

With this model, service mode can be used from the Remote UI.

The following USB flash drives can be used for export/import.

- USB flash drive in FAT 16 format (storage capacity: 2 GB)
- USB flash drive in FAT 32 format (storage capacity: 32 GB)

Note that the descriptions in parenthesis in the procedure are the descriptions in the case of remote UI.

1. Connect a USB memory device to the USB memory port.

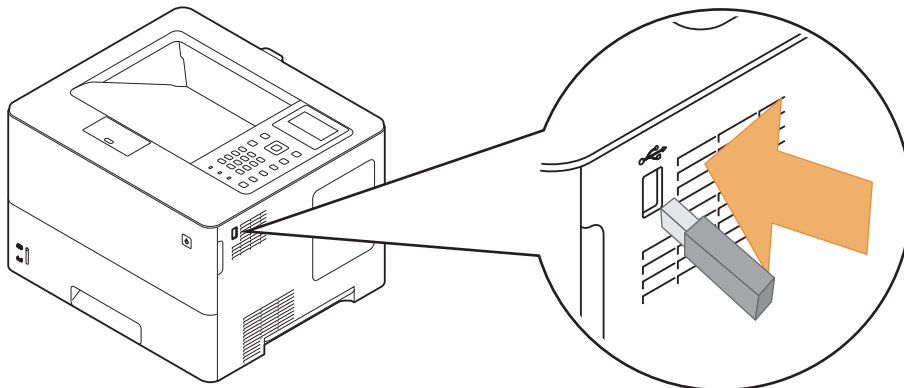

2. Enter service mode, select the following service mode, and enter the password.

- SERVICE MODE > FUNCTION GR. > Import/Export Set. > EXPORT > Password

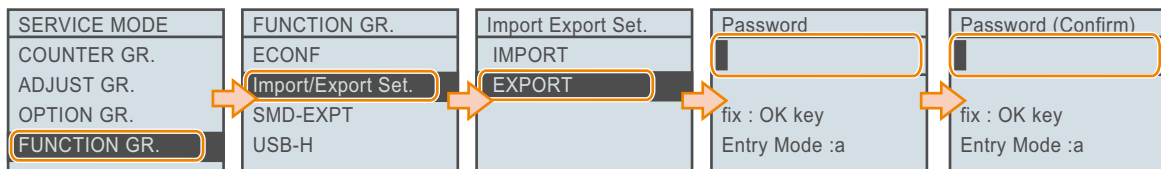

3. When the [Import Export Set.] screen is displayed after the processing is complete, press the [Application] button on the Control Panel, select [<Remove USB Memory>], and remove the USB flash drive.

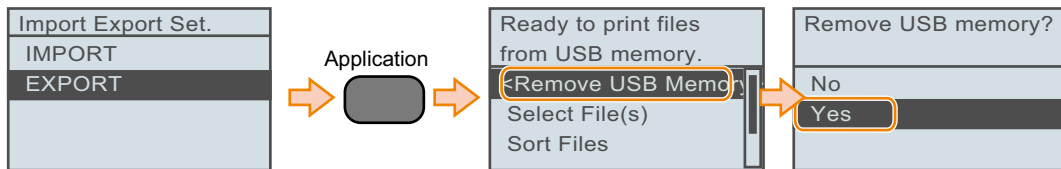

4. Check that a setting information file (".dcm" file) exists in the directory directly under the root of the USB flash drive.
This completes the procedure for exporting a setting information file.

• Procedure for Import from USB Flash Drive

Use the service mode function to import the service mode setting information.

1. Prepare a USB flash drive containing the setting information file (".dcm" file) to import.
2. Connect a USB memory device to the USB memory port.

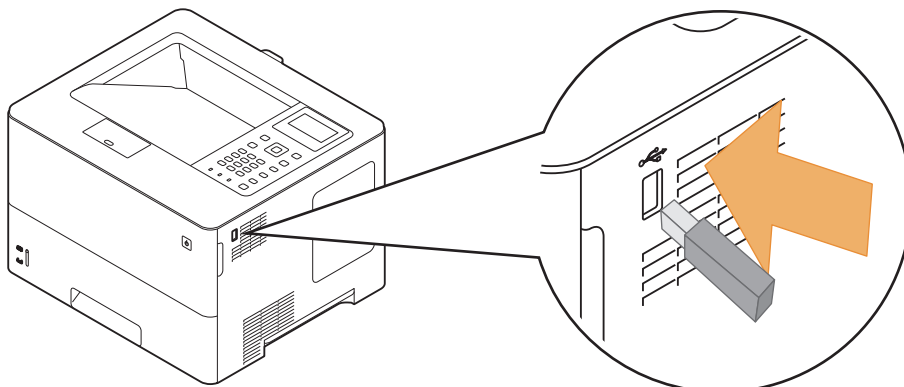

3. Access the following service mode from the Control Panel, specify the file to import, enter the encryption password, and press the [OK] key.

- SERVICE MODE > FUNCTION GR. > Import/Export Set. >IMPORT

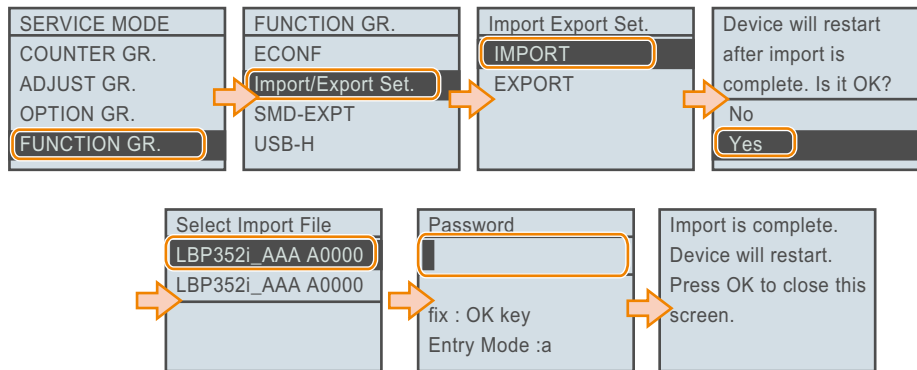

The message "Import is complete. Device will restart. Press OK to close this screen." is displayed when the processing is complete. Press the [OK] key.

4. When the machine has restarted, press the [Application] key on the Control Panel, select [<Remove USB Memory>], and remove the USB flash drive.

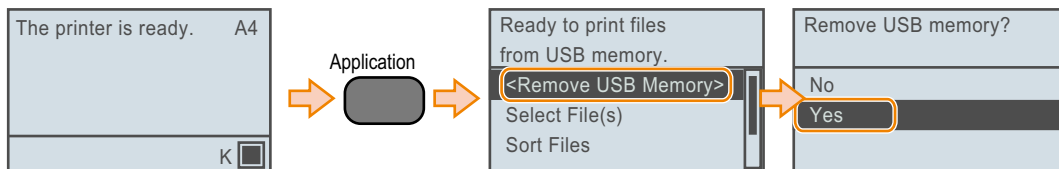

5. Restart this machine, enter service mode, and confirm that the setting information is reflected.

This completes the procedure for importing a setting information file.

• Exporting to a PC

You can export the service mode setting information by accessing from the Remote UI to use the service mode function.

1. Select the following service mode from the Remote UI service mode, enter the password, and click [Start Exporting].

- SERVICE MODE > FUNCTION GR. > Import/Export Set. > EXPORT

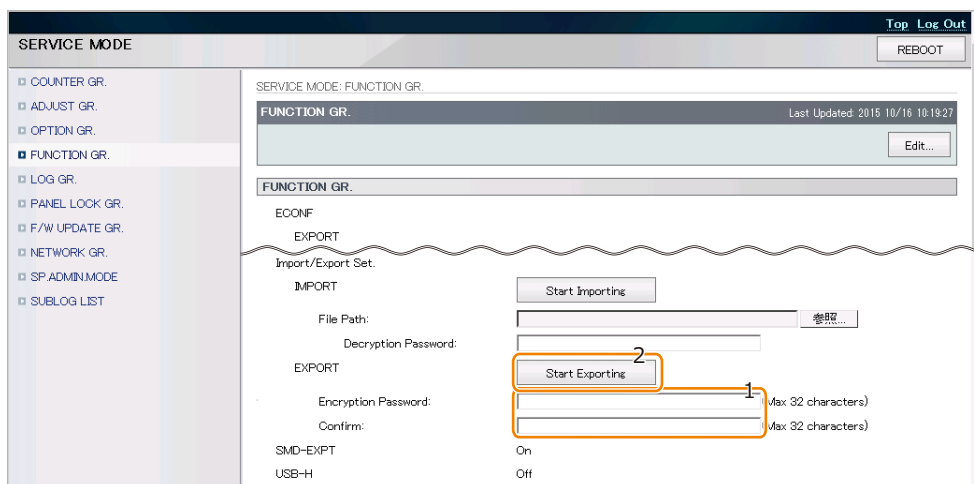

2. A dialog box for saving the file is displayed after the completion of the export processing. Select the location to save the file.

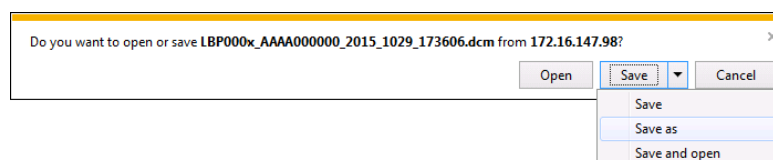

This completes the procedure for importing a setting information file.

● Procedure for Importing from a PC

1. Prepare the setting information file (".dcm" file) to import.
2. Access the following service mode in the Remote UI from a PC browser, specify the file to import, enter the encryption password, and click [Start Importing].
 - SERVICE MODE > FUNCTION GR. > Import/Export Set. > IMPORT

3. When the following message is displayed after the processing is complete, click [Restart].

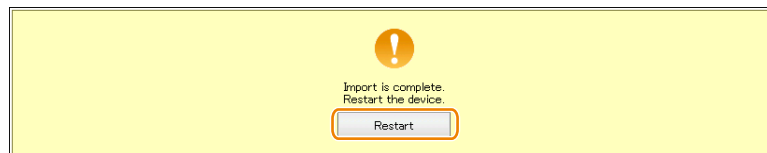

4. Restart this machine, enter service mode, and confirm that the setting information is reflected.
This completes the procedure for importing a setting information file.

● Backup/Restoration Using a Function Other Than the DCM Function

This machine is equipped with functions other than the DCM function for migrating data to an unused Main Controller PCB when the Main Controller PCB has failed.

Backup Method

This machine is equipped with the following backup methods other than the DCM function.

Backup Method	Items which can be backed up
USB	Setting Value(USER MODE, SERVICE MODE, etc)
Expansion ROM for servicing/Sublog Board	Setting Value(USER MODE, SERVICE MODE, etc) Management Data (Page Counter, Main Controller service counter, Serial No.)

■ Backup to/Restoration from a USB Flash Drive Using Service Mode

You can use service mode to back up settings information to a USB flash drive and restore data backed up to a USB flash drive, without using the DCM function.

Target Data for Backup

- [Settings/Registration] menu setting values
- Service mode setting values

● Backing Up to a USB Flash Drive

This section describes the procedure for backing up to a USB flash drive.

1. Connect the USB flash drive to the USB Memory Port of this machine.

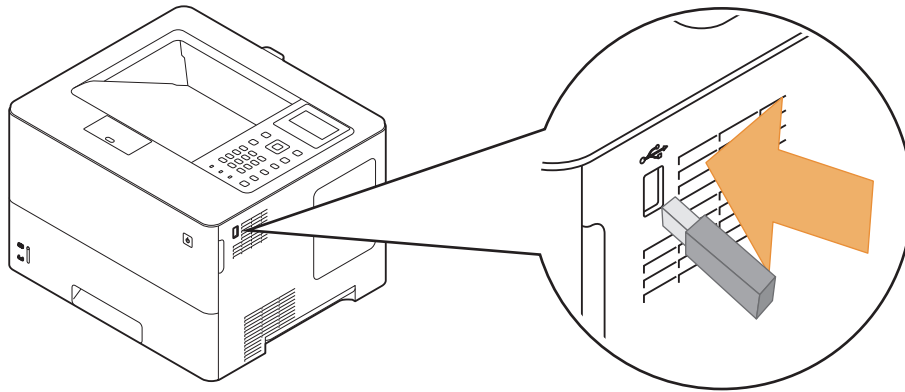

2. Execute the following service mode to export the setting values in the machine to the USB flash drive.

- SERVICE MODE > FUNCTION GR. > ECONF > EXPORT > ALL > Yes



3. Remove the USB flash drive when the previous screen is displayed again after the export processing is complete.

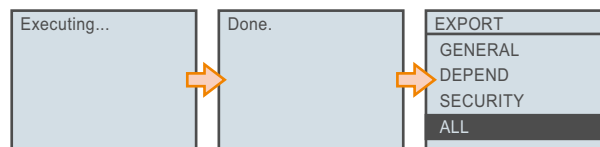

4. Check the content of the USB flash drive to confirm that the setting information file has been saved (backed up).

- <Root directory>\SETTING\CGJLALL.BIN

• Restoration from a USB Flash Drive

You can import (restore) a setting information file exported (backed up) to a USB flash drive to the host machine.

1. Connect the USB flash drive to the Memory Port.

2. Execute the following service mode to import the setting values saved in the USB flash drive to the host machine.

- SERVICE MODE > FUNCTION GR. > ECONF > IMPORT > Yes

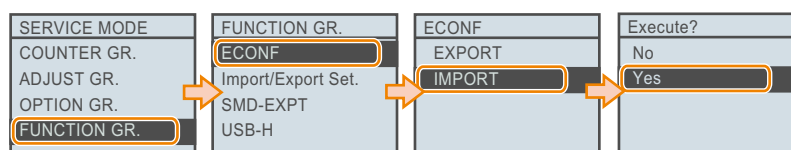

3. Remove the USB flash drive when the previous screen is displayed again after the export processing is complete.

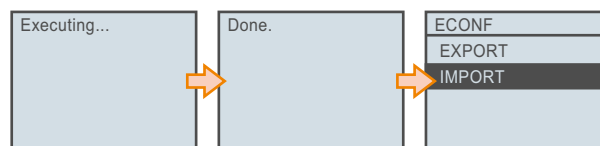

4. Access service mode and confirm that the settings are reflected.

5. Remove the USB flash drive.

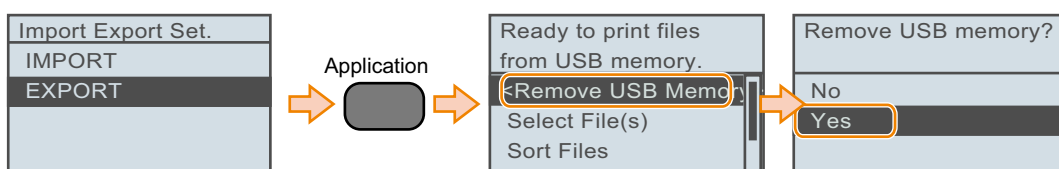

■ Backup/restoration using the Expansion ROM for servicing and the Sublog Board

Use the Expansion ROM for servicing and the Sublog Board to migrate the setting information in a failed Main Controller PCB to an unused Main Controller.

Target data for backup

Target data for backup is as follows: (For details, see [Appendix] > [Backup Data List] in this manual.)

- User mode setting values
- Service mode setting values

● Backup and Restoration (Export and Import) Procedure

Flow Chart

The flow of backup/restoration using the Expansion ROM for servicing and the Sublog Board is described below.

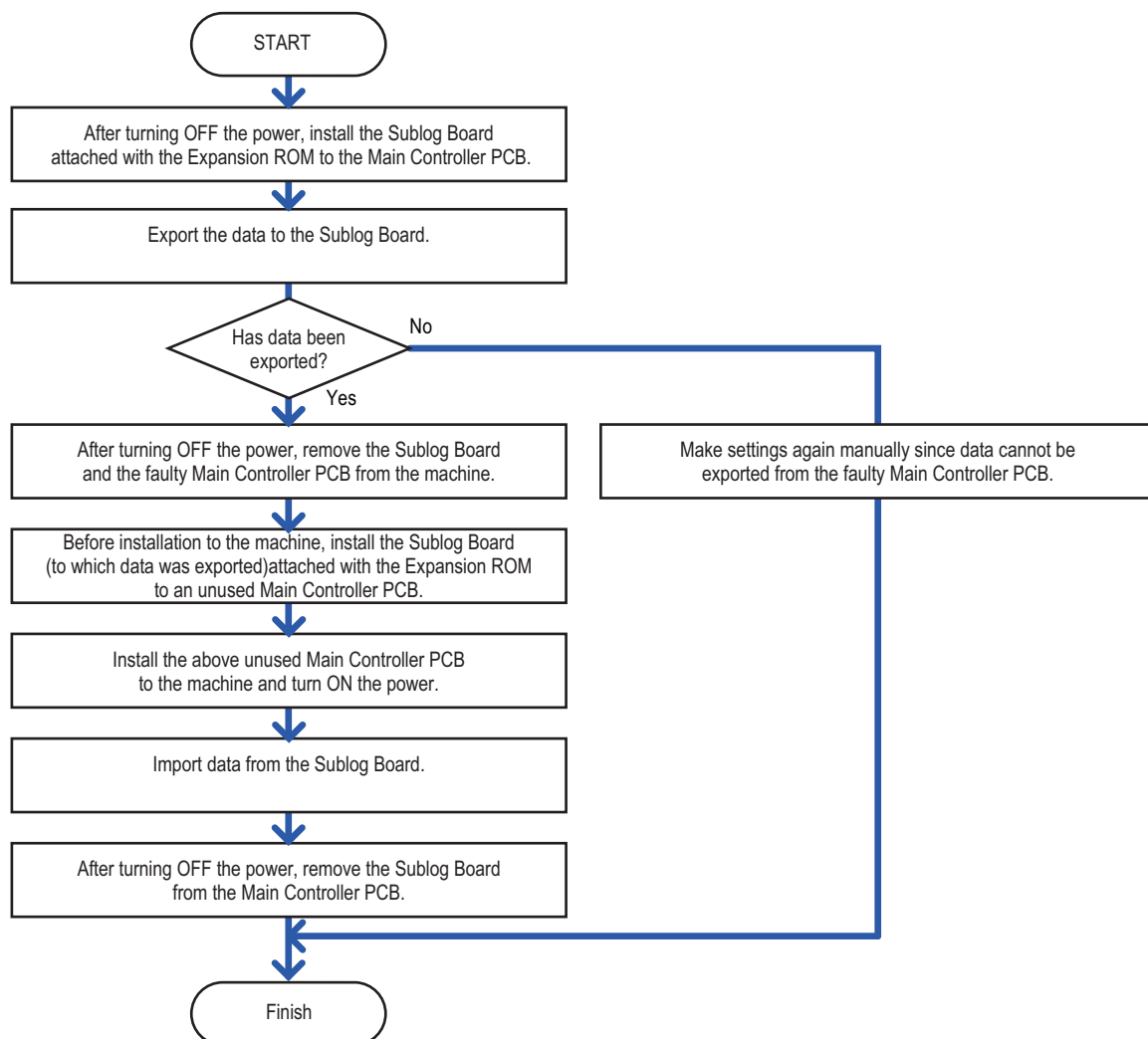

Changing the Height of the Sublog Board

NOTE:

When installing the Sublog Board, it needs to be installed parallel to the Main Controller PCB in order to prevent connection error of the connector connecting the Main Controller PCB and the Sublog Board.

This machine utilizes the height of the spacer (short), and how to replace the spacers with each other is shown below.

1. Disassemble the Sublog Board [1], and replace the spacer (short) [1] and the spacer (long) [3] with each other.

- 1 screw [4]

CAUTION:

Because the screw [4] is a molded part, do not tighten it too much. Otherwise, it may be damaged.

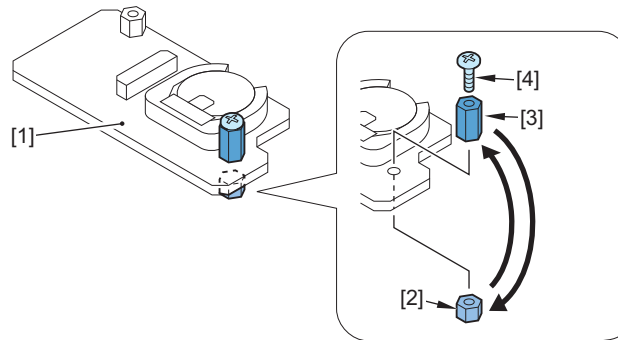

Installing the Expansion ROM for servicing and Sublog Board

1. Push SW1 on the board and confirm that LED1 turns on.

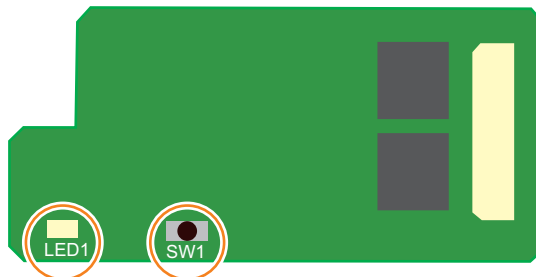

If LED1 does not turn on, You need change the battery on Sublog Board is located at BATS1 (CR2032).

CAUTION:

There is danger of explosion if the battery is replaced with an incorrect type. Replace it only with the same type of battery. Dispose of used batteries according to the manufacturer's instructions.

2. Install the Expansion ROM for servicing to the Sublog Board.

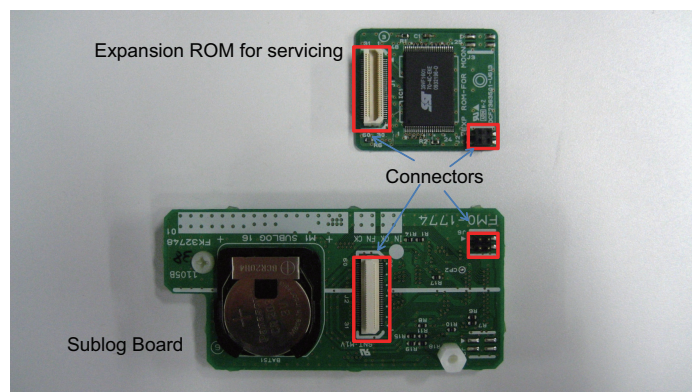

3. Install the above Sublog Board to the machine.

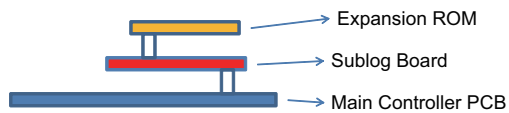
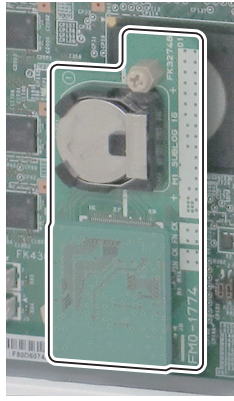

CAUTION:

Connect a PCB (Expansion ROM for servicing and Sublog Board) which has the setting information backed up, to an unused Main Controller PCB.

Be sure to connect a PCB in which the setting information is backed up (Expansion ROM for servicing and Sublog Board) when connecting to an unused Main Controller PCB.

Backup data cannot be imported to a once-used PCB. Therefore, if a PCB from which the setting information is not exported (backed up) is connected to an unused Main Controller PCB, backup data cannot be imported.

Backup Procedure (Export)

1. The menu is displayed when turning ON the power while the Sublog Board attached with the Expansion ROM for servicing is installed.



2. Press the down arrow key on the Control Panel.

This operation causes the information stored in the machine to be exported to the Sublog Board.

3. The following message is displayed when backup is completed successfully.

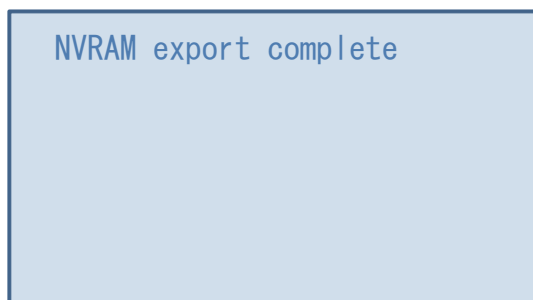

- Turn OFF the power, and remove the faulty Main Controller PCB and the Sublog Board to which data was exported.

CAUTION:

Since data cannot be migrated to a Main Controller PCB that has been used before, connect an unused Main Controller PCB to the Sublog Board and Expansion ROM PCB where the data has been backed up (exported to) before installing it to the machine.

A Main Controller PCB that has been connected to a machine and powered ON even once becomes a used PCB.

Restoration Procedure (Import)

- Connect the Sublog Board with the Expansion ROM for servicing which has data exported, to an unused Main Controller PCB.
- Install the unused Main Controller PCB to the machine, and turn ON the power.
- Perform the following operation to write the information saved in the Sublog Board back to the machine.

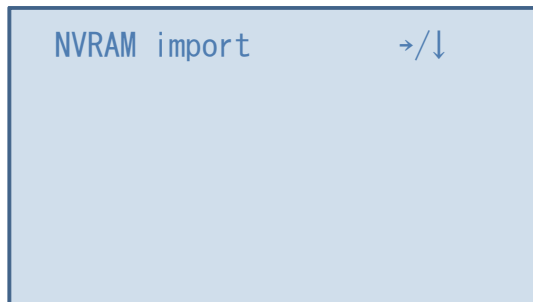

- Press the right arrow key on the Control Panel.
- Select [NVRAM import].
- Press the down arrow key.

- If the import processing completes without a problem, the data saved on the Sublog Board is deleted and the following message is displayed.

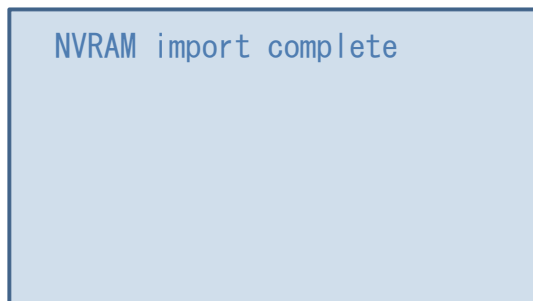
**CAUTION:**

If the Main Controller PCB has not been replaced with an unused Main Controller PCB, the following message is displayed and the operation stops. In this case, turn OFF the power, and replace the Main Controller PCB with an unused Main Controller PCB.

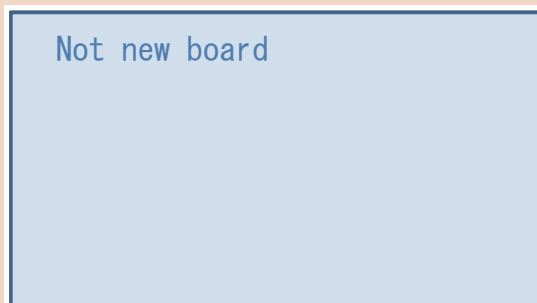

- Turn OFF the power and remove the Sublog Board.

Deletion (Erase)

When the data is not imported although it was exported, it needs to be deleted to prevent leakage of information.

1. Install the Sublog Board (containing data to be deleted) attached with the Expansion ROM to the Main Controller PCB.
2. Turn ON the power and select [NVRAM erase], and then delete the information stored in the Sublog Board.

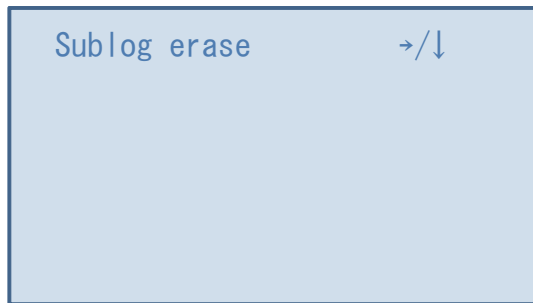

3. The following message is displayed in the case of successful completion.

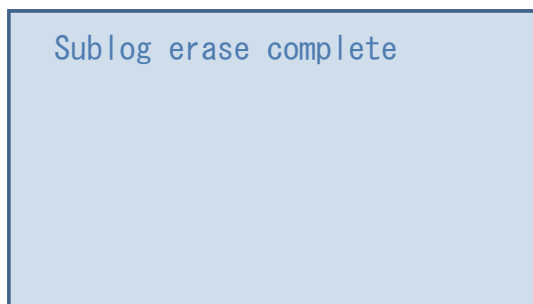

4. Turn OFF the power and remove the Sublog Board.

List of Error Messages

The following messages are displayed when certain failures occur during operation.

List of Messages	Detail
Sublog board not found	Sublog Board is not installed.
NVRAM read error	Export cannot be executed because the faulty Main Controller PCB is too damaged to retrieve information.
Sublog R/W error	When the same data cannot be read 3 consecutive times due to Sublog Board error, the error message is displayed and the operation is stopped.
NVRAM write error	When information cannot be written to an unused Main Controller PCB for some reasons, the error message is displayed and the operation is stopped.
Sublog data not found	When the export data is not stored in the Sublog Board (including checksum check error), import process or erase process cannot be executed.
Not new board	Import cannot be executed since the Main Controller PCB is not unused or the one to which no serial number has been written.
Different product	Data is attempted to be imported to a model different from the one from which data was exported.

Monitoring Function (e-Maintenance/imageWARE Remote)

Overview of System

Function Overview

Embedded RDS (hereinafter referred to as E-RDS) is a monitoring program that runs on the host machine. When the monitoring option is enabled by making the setting on this machine, information such as the status change of the machine, counter information, and failure information are collected. The collected device information is sent to a remote maintenance server called UGW (Universal Gateway Server) via Internet, thus allowing for e-Maintenance/ imageWARE Remote (Remote Diagnosis System).

The following device information/ status can be monitored.

- Billing counts
- Parts counter
- Firmware info
- Service call error log
- Jam log
- Alarm log
- Status changes (Toner low/ out, etc.)

Since high confidentiality is required for the information shown above, it performs communication between this machine and the UGW using HTTPS/ SOAP protocol.

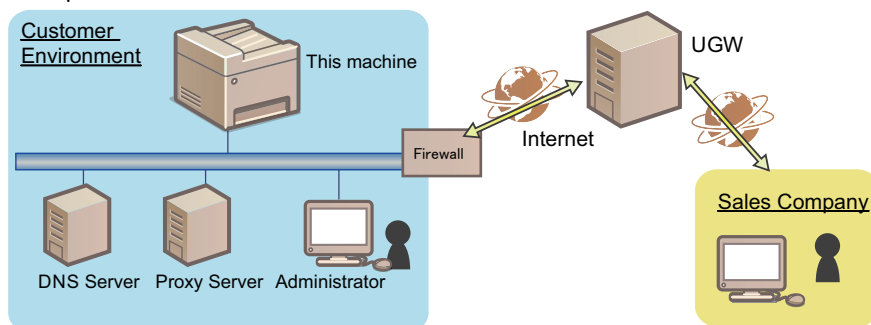

The e-Maintenance/ imageWARE Remote system configuration

Features

E-RDS is embedded in the network module of the device, and the front-end module of the e-Maintenance/ imageWARE Remote system is realized without requiring hardware besides the device.

Main Functions

Functional category	Sub category	Description
Communication test	COM-TEST	Execute service mode to communicate with the server, retrieve schedule information, and establish communication.
Transmission of counters	Billing / all resources / parts / mode-by-mode counters	Periodically send billing/all resources/parts/mode-by-mode counters to the server.
Transmission of event logs	Alerts	Each time the status of the device is changed, the status information is sent to the server.
	Service call/alarm/jam log *1	Each time a service call, alarm, or jam log occurs, the error log is sent to the server.
Data transmission:	ROM version	Periodically send firmware information of the device.
	Schedule	Periodically send schedule information of the device.
	Debug log	Send debug information of E-RDS which exceeds a specific size to the server.
	Environment log*1	Periodically send environment information (such as the temperature inside the machine).
	Service call button	Send error information (image failure, jams, etc.) with a user command.

*1. Only some models

Functional category	Sub category	Description
Data transmission:	Sublog	Send data such as device Sublogs and DCON logs to the server.
Operation instruction	Operation check	Contact the server to check if there is processing to be executed, and receive the following instructions if any. <ul style="list-style-type: none"> • Change the schedule • Change the alarm level • Change the alert filter

Cautions when Using E-RDS

- The following settings in service mode must not be change unless there are specific instructions to do so. Changing these values will cause error in communication with UGW.
 - Port number of UGW
SERVICE MODE > NETWORK GR. > E-RDS > RGW-PORT
Default :
- If the e-Maintenance/ imageWARE Remote contract of the device is invalid, be sure to turn OFF the E-RDS setting (E-RDS : 0).
- The following restrictions apply when enabling IPv6 in the network settings.
 - If the router advertisement expires while the machine is in the sleep mode when only a stateless address is enabled, transmission will fail immediately after the machine returns from the sleep mode.
 - When only a manual address is enabled, it is necessary to set a default router address.
 - When only DHCPv6 is enabled, transmission fails because the router address is unknown.

Setting Procedure

■ Preparation

Since this function communicates with the UGW server, it is necessary to connect to the external network. Check the following items, and make the settings if not yet set.

- IP address settings
- DNS server settings
- Proxy server settings^{*1}
- Installation of CA certificate (arbitrary ^{*2})

CAUTION:

- Obtain the information on the network environment from the system administrator of the user.
- When having changed the network settings, turn OF and then ON the main power of the machine.

^{*1}. If authentication is necessary, make the settings of the authentication information as well.

^{*2}. When using a certificate other than those pre-installed in the device

■ Setting Items

Configure E-RDS in service mode. The setting items are described below.

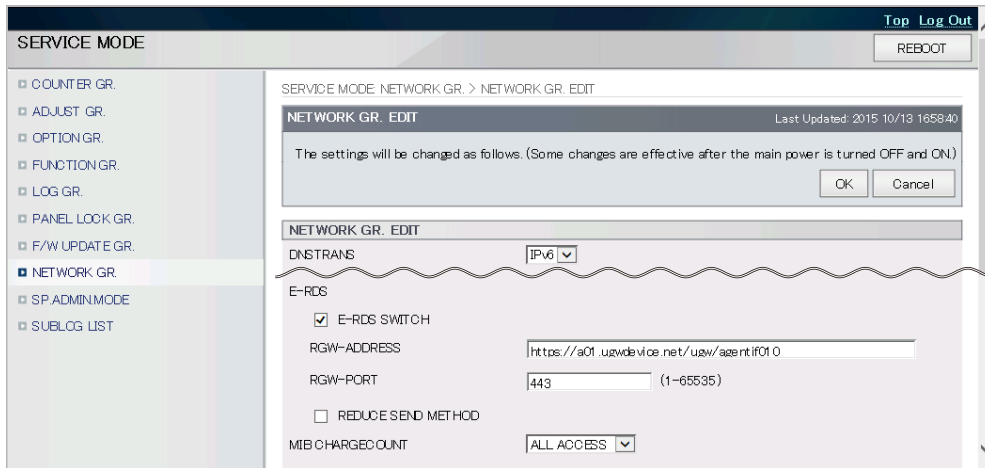

Example of the Remote UI Screen

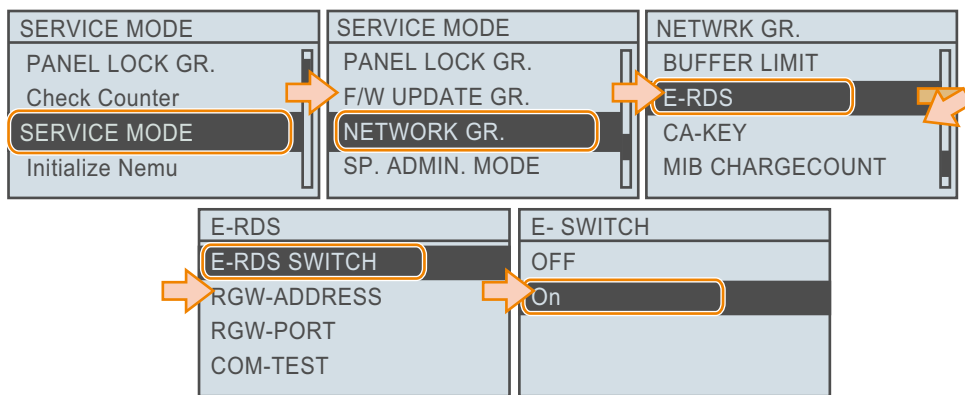

Example of the Control Panel Screen

Service mode	Description	Setting value
E-RDS SWITCH	The switch for enabling Embedded-RDS. Enables this function.	ON: Use Embedded-RDS OFF: Do not use Embedded-RDS (default value)
RGW-ADDRESS	The destination URL for the UGW server. Use the "up, down, left and right keys, Job Status/Cancel key and Feeder selection key" to enter URL, and "OK key" to determine it. "↓" is displayed at the end of the character string. The number of characters which can be entered is 128. The default value is the server URL. Characters which can be set are as follows. 0123456789ABCDEFGHIJKLMNPNOPQRSTUVWXYZabcdefghijklmnopqrstuvwxyz!#\$%&'()*+,-./:;<=>@[¥]_`{ }~ If "ugwdevice.net/" is not included in the character string when entering the URL, it is judged as an authentication error and an error message is displayed.	https://a01.ugwdevice.net/ugw/agentif010
RGW-PORT	The port number used when communicating with the UGW server.	443
COM-TEST	Executes a communication test with the UGW server and displays the result.	-
COM-LOG	Displays details of the communication test result. Attempts to communicate with the UGW server, and the time, error codes and error information of errors up to the present date are displayed. Maximum of 5 logs are saved, and the latest log is displayed. Error information is 130 byte maximum.	-
CLEAR	Initializes the setting values related to E-RDS. Clears the schedule information, alarm errors, and filtering information.	-

■ Procedure for Setting E-RDS

Refer to the above service mode setting items to specify the initial settings of E-RDS.

1. Open the following service mode, and confirm that the URL for accessing UGW is set correctly. If the correct URL is not set, set it.

- SERVICE MODE > NETWORK GR.> E-RDS > RGW-ADDRESS

E-RDS	RGW-ADDRESS
E-RDS SWITCH	https://a01.ugwdevice.net/u
RGW-ADDRESS	
RGW-PORT	fix : OK key
COM-TEST	Entry Mode: a

2. Open the following service mode, and confirm the port number used when communicating with the UGW server. If the correct number is not set, set it.

- SERVICE MODE > NETWORK GR.> E-RDS > RGW-PORT

E-RDS	RGW-PORT
E-RDS SWITCH	
RGW-ADDRESS	
RGW-PORT	443
COM-TEST	(1~65535)

3. Open the following service mode, and set whether to reduce transmission costs for E-RDS data when the power is turned ON.

- SERVICE MODE > NETWORK GR.> E-RDS > REDUCE SEND METHOD

4. Execute the following service mode to perform a communication test with the UGW server.

- SERVICE MODE > NETWORK GR.> E-RDS > COM-TEST

E-RDS	Execute?
E-RDS SWITCH	No
RGW-ADDRESS	Yes
EGW-PORT	
COM-TEST	

Maintenance

■ Initializing E-RDS settings

It is possible to clear the FLASH data of E-RDS and change the E-RDS setting back to the default value.

● Initialization procedure

1. Press [OK] to execute the following service mode to initialize the E-RDS settings.

- NETWORK GR. > E-RDS > CLEAR

E-RDS	Execute?
RGW-PORT	No
COM-TEST	Yes
COM-LOG	
CLEAR	

● Setting values and data to be initialized

The following E-RDS settings, internal data, and Alarm filtering information are initialized.

- SERVICE MODE > NETWORK GR. > E-RDS > E-RDS SWITCH
- SERVICE MODE > NETWORK GR. > E-RDS > RGW-PORT
- SERVICE MODE > NETWORK GR. > E-RDS > RGW-ADR
- SERVICE MODE > NETWORK GR. > E-RDS > COM-LOG

MEAP Application Management

About MEAP

MEAP (Multifunctional Embedded Application Platform) is an application platform (execution platform) that allows the user to execute an application written in the Java language on a Java virtual machine installed on the device.

In this chapter, a device with MEAP is called a device supporting MEAP, and an application which runs on MEAP is called a MEAP application.

MEAP applications are installed on a MEAP device to provide various functions to the device.

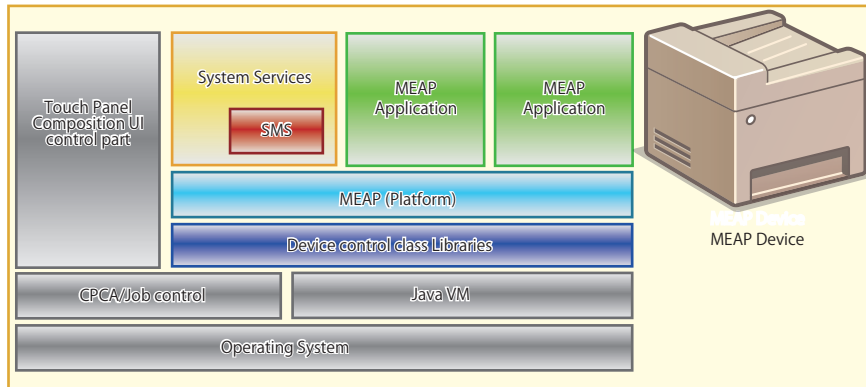

NOTE:

For basic information on MEAP, see "Function Guide for MEAP Application Management".

About SMS

MEAP has SMS (Service Management Service) as a service for managing login services and MEAP applications. SMS is a servlet-type service which is used via a PC's browser.

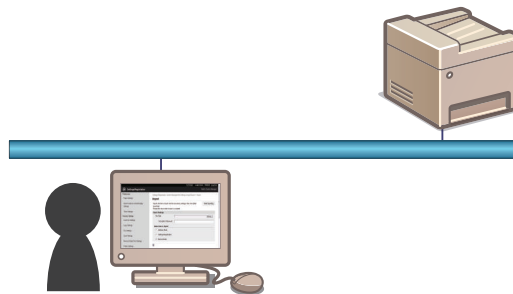

Example of the SMS screen

■ Preparation of PC for Accessing SMS

● Checking of operation environment

The PC and browser used to access SMS require the following system environment.

Combination of the Browser and the OS

OS	Supported browser
Windows XP Professional SP3	Internet Explorer 7 Internet Explorer 8
Windows Vista SP2	Internet Explorer 7 Internet Explorer 8 Internet Explorer 9
Windows 7 SP1	Internet Explorer 8 Internet Explorer 9
Windows 8	Internet Explorer 10
Mac OS X v10.5	Safari 4.0.5 Safari 5.0.5
Mac OS X v10.6	Safari 4.0.5 Safari 5.0.5 Safari 5.1
Mac OS X Lion	Safari 5.1
Mac OS X Mountain Lion	Safari 6.0

● PC and browser settings

The PC and browser used to access SMS must meet the following conditions.

- The supported browser language should be the same with the language of the OS.
- Session cookie should be enabled.
- The supported screen size should be 800 x 600 or larger (recommended size: 1024 x 768).
- Java Script should be enabled.

■ Initial Display Languages of SMS

SMS supports English and Japanese. Display language can be changed with selecting by the drop down list on a login page. The initial display language at the time of accessing SMS depends on the setting.

1. The language priority set in the browser (the settings in the Accept-Language header sent by the browser)
2. The order of the display language settings in the [Settings/Registration] menu
3. English is used if a language other than English or Japanese is set

■ Device compatibility with the MEAP application

To find out whether the device is compatible with the MEAP application, check the devices supported by the MEAP application. Depending on the application, the device's firmware may require version upgrade.

■ Resources availability (remaining amount)

The necessary resources (free storage space and free memory available) must be secured for an MEAP application to run; otherwise, you cannot install the MEAP application.

To check the resource information, see [Resource Information] .

The screenshot displays the 'Service Management Service' interface. On the left is a navigation menu with options like 'MEAP Application Management', 'System Management', and 'MEAP Application Information'. The main content area is titled 'MEAP Application Management' and includes a table of installed applications:

Application Name	Version	Installed on	Status	Start	Uninstall	License
Sample Application A	4.4.0	09/26/2012	Installed	Start	Uninstall	Installed
Sample Application B	4.4.0	09/25/2012	Installed	Start	Uninstall	Installed
Sample Application C	4.4.0	09/25/2012	Installed	Start	Uninstall	Installed

Below the application table is a 'Resource Information' section with a table showing system resources:

Resource Name	Amount Used	Remaining	Percent Used
Storage	2877 KB	160963 KB	2%
Memory	200 KB	32568 KB	1%
Threads	4	144	3%
Sockets	0	128	0%
File Descriptors	1	127	1%

The 'Resource Information' table is highlighted with an orange border in the screenshot. The interface also shows a 'meap' logo and 'Copyright CANON INC. 2012 All Rights Reserved' at the bottom.

■ What is MEAP Specifications (MEAP Spec Version)?

MEAP Specifications is one of the information required to judge whether MEAP applications can be operated or not. With MEAP Specifications, you can prevent an application that uses a specific function of device from being installed onto the device that does not have the function.

About Name

The displayed name for Meap Specifications differs depending on the screen or the location where the name is displayed. In this document, it is referred to as "Meap Specifications".

The location where the name is displayed/shown	Displayed name
Platform Information : SMS > [System Management] > [System Information] > [Platform Information]	MEAP Specifications
System Information Print : Local UI [Settings/Registration] > [Management Settings] > [License/Other] > [MEAP Settings] > [System Information Print]	
Manifest file of the MEAP application	MeapSpecVersion
SDK documents	

Mechanism

MEAP platform judges whether MEAP applications can be operated on it using on the 2 information below:

- DeviceSpecificationID
- MEAP Specifications

Device Specification ID shows information such as the original functions of MFP (including print, scan, and copy), and one that differs by model such as maximum copy number, thus each model has a different ID. (It is easy to determine the IDs for this reason.) MEAP application declares 1 or more Device Specification ID required for its execution. Declaration of multiple Device Specification IDs means that the application is operable in all the models declared. Upon installation of MEAP application in (using) SMS or MEAP Enterprise Service Manager, matching of Device Specification ID is executed on the side of MEAP platform machine. The machine which doesn't support the ID declared by the application rejects installation of such an application. Meanwhile, MEAP Specifications shows other information than defined by Device Specification ID above, including network and security. Thus each model does not always have the same version.

MEAP application declares 1 or more MEAP Specifications required for its execution.

Declaration of multiple Device Specification IDs means that the application is operable in all the environments declared. Upon installation of MEAP application in SMS or MEAP Enterprise Service Manager, matching of MEAP Specifications is executed on

the side of MEAP platform machine. The machine which doesn't support the version declared by the application rejects installation of such an application.

■ Managing the License File

● Outline

The license file management functions allow you to perform the following operations related to the license file necessary for the MEAP application to run.

- Update the license which has already expired.
- Disable or delete the license file in order to uninstall the MEAP application.

These license management functions can be performed from the [MEAP Application Management] screen.

The main license management functions are as follows:

Adding a license

When the license has expired, you can add a license file.

Disabling a License File

Before uninstalling the MEAP application, the license needs to be deleted. In that case, you must first disable the license file because a license file which has not been disabled cannot be downloaded or deleted.

Downloading / Removing an Invalidated License File

Before uninstalling the MEAP application, you need to delete its license file which has already been disabled.

By downloading the license file to your PC before it is deleted, you can use it when installing the application again to the same device.

CAUTION:

After deleting the license file which has been disabled, you can no longer download the license file.

● Reusable license

When reinstalling, Disable License file should be downloaded or a license for reinstallation should be obtained from LMS, before reinstallation.

This specification aims to prevent misuse of applications.

To increase convenience of users, only application with unlimited validity date and application counter (e.g. Portal Service, SDL, SSO) has been made to be able to install as many times as needed by the same license file. This kind of license is called 'Reusable license'.

Reinstallation of MEAP applications is necessary after replacing the Main PCB. In this case, it is necessary to perform installation using a reusable license.

For other MEAP applications that do not have a reusable license, use a special license for reinstallation, as when the storage drive fails.

For information on obtaining a special license for reinstallation, see "[Special license for reinstallation](#)" on page 106.

● License for forwarding

If the machine needs to be replaced due to a device failure, you can transfer the license information used in the MEAP application to the new machine and continue its usage. Service engineers are responsible for license transfer as this task requires the SMS hidden page (not open to users).

■ System Information

The device platform information and MEAP application system information are called the "System Information" of MEAP. The System Information can be checked on the SMS screen or by printing it out.

Application System Information

Application Name: C-Cabinet Gateway for MEAP Application ID/System Application Name: 03a46668-63e4-4636-9cbb-492b6cef05d5 Application Version: 1.0.0 Status: Resolved Installed: Tue Oct 21 14:00:11 GMT+09:00 2003 Vendor : Canon Inc. License Status : Installed Maximum Memory Usage : 1024 Registered Service :

Content of MEAP system information

Item	content
Application Name	It is the name (bundle-name) declared in a statement within the application program. It may not necessarily be identical to the name of the program.
Application ID/System Application Name	Application ID (application-id) items which are declared on the declaration statement in the application program are printed.
Application Version	It is the version of the application (bundle-version) declared in a statement within the application program.
Status	It indicates the status of the application in question; specifically, <ul style="list-style-type: none"> • Installed: the application has been installed. • Active: the application is being in use. • Resolved: the application is at rest.
Installed	It indicates the date on which the application was installed.
Vender	It is the name of the vendor that developed the application, and is the name (bundle-vendor) declared in a statement within the application program.
License Status	It indicates the status of the license; specifically, <ul style="list-style-type: none"> • None: no license is needed. • Not Installed: no license has been installed. • Installed: the appropriate license has been installed. • Invalid: the license has been invalidated. • Overlimt: the license has been used beyond its permitted limit.
License Expires After	It indicates the date after which the license expires. If the status of the license is "none", this item will not be printed.
License Upper Limit	It indicates the limit imposed on individual counter readings. If the status of the license is "none", this item will not be printed.
Counter Value	It is the current counter reading of a specific counter. If the status of the license is "none", this item will not be printed.
Maximum Memory Usage	It indicates the maximum amount of memory that the application uses. It is the amount (maximum memory usage) declared in a statement within the application program, and is expressed in kilobytes.
Registered Service	It is a list of services that have been registered by the application with the MEAP framework. Some services may not have printable data.

MEAP Application Setting Information Management and Log Management

The MEAP Application Setting Information Management page and the MEAP Application Log Management page provide menu related to "MEAP Application Configuration Service" for managing MEAP application setting information and menu related to "MEAP Application Log Service" for managing log information respectively

The screenshot displays the 'Service Management Service' interface for MEAP Application Management. The device serial number is AAA A000000. The interface includes a navigation menu on the left with options like 'MEAP Application Management', 'System Management', and 'MEAP Application Setting Information Management'. The main content area shows 'MEAP Application Management' with a table of application details and a 'Resource Information' table.

Application Name	Installed on	Status	License
[Add Application]			

Resource Name	Amount Used	Remaining	Percent Used
Storage	3865 KB	415975 KB	1%
Memory	200 KB	32568 KB	1%
Threads	4	144	3%
Sockets	0	128	0%
File Descriptors	1	127	1%

MEAP Application Configuration Service

This service is used to manage the MEAP application setting information. It has functions such as saving setting information to the MEAP area. Ver 57 of MEAP Specifications supports this service.

MEAP Application Log Service

This service is used to collect MEAP application logs (debug logs and authentication logs).

Ver 58 of MEAP Specifications supports this service.

The collected logs can be downloaded or deleted in user mode.

The settings such as the log level to be saved cannot be made from SMS.

These settings depend on the MEAP application. For detailed information, refer to the manual for the application.

• Advantages Obtained When Using the Services

By using MEAP Application Setting Information Management and MEAP Application Log Service, as long as the MEAP application supports these services, you can collectively perform data management tasks.

Devices and MEAP applications which do not support new functions

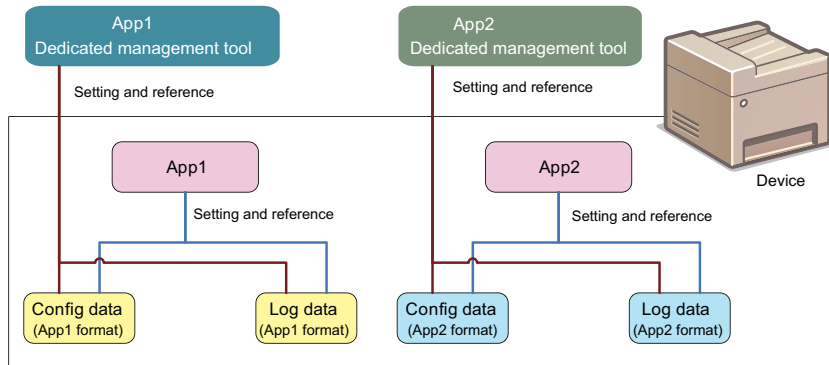

As for devices and MEAP applications that do not support the service, the setting information and log data are managed on an application-by-application basis.

Devices and MEAP applications which support new functions

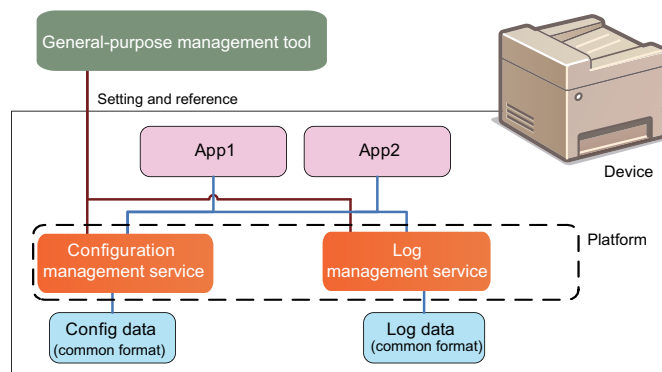

As for devices and MEAP applications that support the service, information can be collectively managed.

● Setign Procedure

■ Preparation

The following settings are required on the machine to provide a MEAP device with support via a network such as SMS.

Network Settings (HTTP)

Select [Setup] > [Network] > [TCP/IP Settings] > [HTTP] from the setup menu to activate the network. ([ON] is specified at the time of shipment.) For details on the work procedure, refer to e-Manual [Top page] > [Setting Menu List] > [Setup Menu] > [Network].

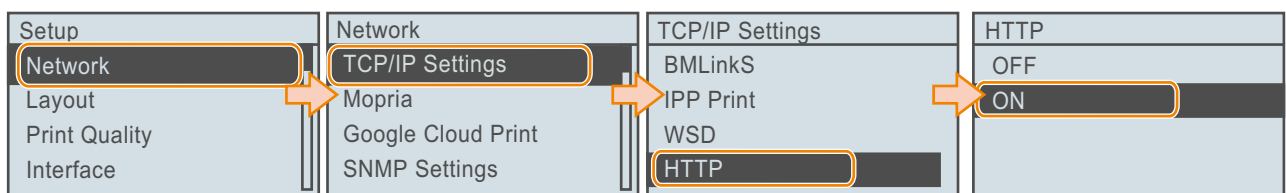

Network Settings (Remote UI)

Select [Setup] > [Network] > [Remote UI Settings] from the setup menu to activate the Remote UI function. ([ON] is specified at the time of shipment.) For details on the work procedure, refer to e-Manual [Top page] > [Setting Menu List] > [Setup Menu] > [Network].

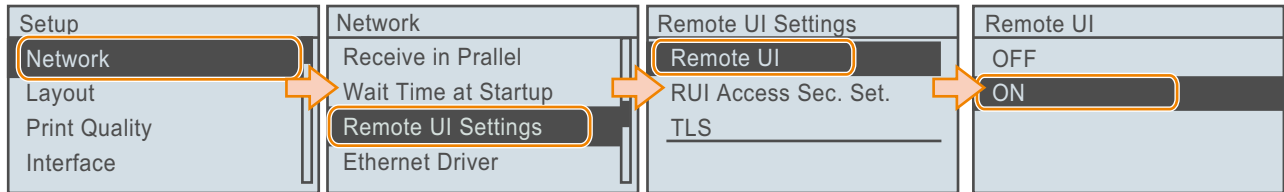

Setting the Key Pair and Server Certificate Used When Communicating with TLS Encryption

To use SMS via TLS connection, it is required to specify a key pair and server certificate as the key to be used.

Since a key (default key) that can be used for encrypted TLS communication is installed as standard on this device, advance setting of the key pair and server certificate is not required.

To use an encryption key other than the default key, refer to the e-Manual [Top page] > [Security] > [Implementing Robust Security Features] > [Using TLS for Encrypted Communications] to set the key pair and server certificate required to perform encrypted TLS communication.

NOTE:

As for SMS, by setting a Default Key, encrypted SSL communication is always executed regardless of the following setting: [Setup] > [Network] > [Remote UI Settings] > [TLS]: ON/OFF.

Setting the Network Port

The default port of the HTTP server used for MEAP and MEAP applications to provide the servlet function is 8000, and the HTTPS server's default port is 8443. In the case that these ports have already used by the customer who is to introduce this application, the MEAP application cannot use the HTTP (or HTTPS) server(s).

By changing the following ports to use, however, the MEAP application can be used as well as the existing system.

For details on the work procedure, refer to .

NOTE:

A port number can be any integer from 0 to 65535. To avoid port numbers that are frequently used, do not use any integer from 0 to 1023.

Server	Setting value	Default value / Value after RAM clear
HTTP Server	1024 to 65535	8000
HTTPS Server	1024 to 65535	8443

NOTE:

- If Print Server is connected, do not specify port 8080. If port 8080 is specified, it is not possible to access the remote UI of the device where the MEAP authentication application is running. (Port 8080 is reserved to allow the PS Print Server Unit to redirect to the device.)
- As for port on HTTPS server, it only applies to the device that supports SSL function.

■ MEAP Application Managemet

Log in to SMS to manage MEAP applications.

Installing MEAP Applications

Install the MEAP application on this machine.

Specify an application file (.jar) and license file (.lic) on the [Install MEAP Application] page of SMS. For details on the procedure, see [Top Page] > [MEAP Application Settings] > [Installing MEAP Applications] in "Function Guide for MEAP Application Management".

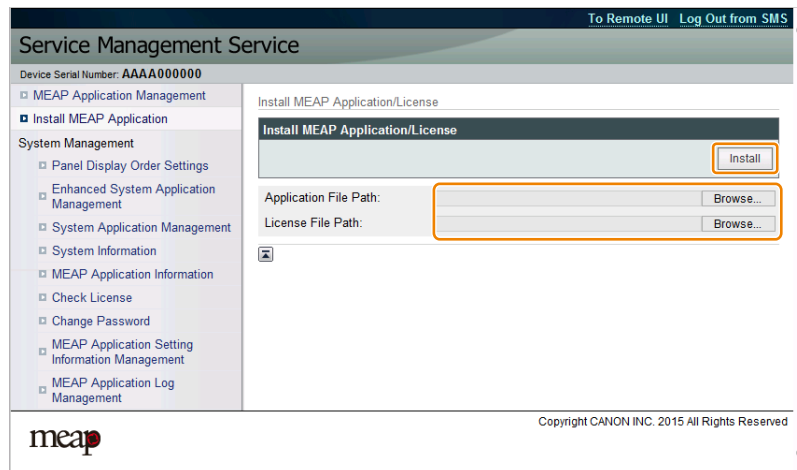

Uninstalling MEAP Applications

Uninstall MEAP applications by clicking [Uninstall] for the target application on the [MEAP Application Management] page (the SMS top page).

It is necessary to disable/delete the license to uninstall a MEAP application. For details on the procedure, see [Top Page] > [MEAP Application Settings] > [Uninstalling MEAP Applications] in "Function Guide for MEAP Application Management".

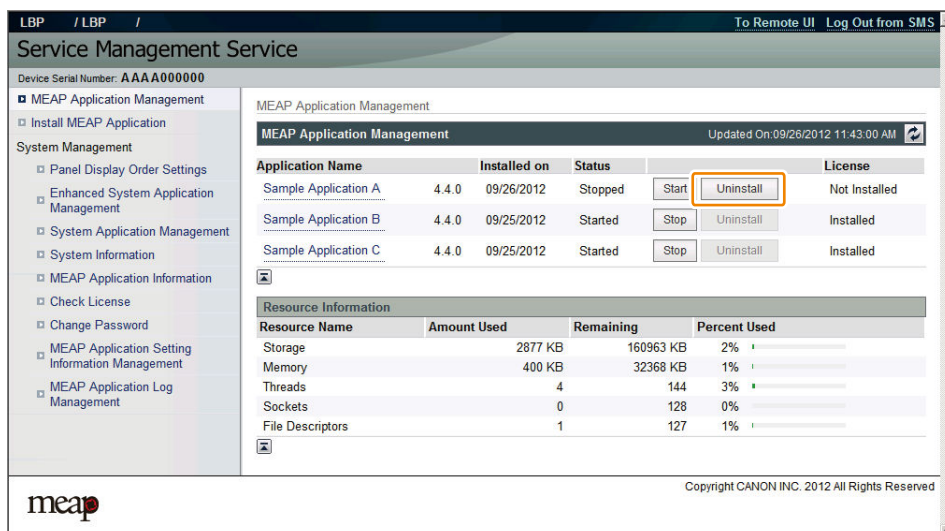

Starting/Stopping MEAP Applications

Start and stop MEAP applications by clicking [Start] and [Stop] for the target application from the [MEAP Application Management] page (the SMS top page).

For details on the procedure, see [Top Page] > [MEAP Application Settings] > [Starting/Stopping MEAP Applications] in "Function Guide for MEAP Application Management".

The screenshot displays the 'Service Management Service' interface. The top navigation bar shows 'LBP / LBP /' and 'To Remote UI Log Out from SMS'. The main content area is titled 'MEAP Application Management' and shows a table of installed applications. The 'Start' buttons for 'Sample Application A', 'Sample Application B', and 'Sample Application C' are highlighted with a red box. Below the table is a 'Resource Information' section with a table showing resource usage.

Application Name	Installed on	Status	License
Sample Application A	4.4.0 09/26/2012	Installed	Installed
Sample Application B	4.4.0 09/25/2012	Installed	Installed
Sample Application C	4.4.0 09/25/2012	Installed	Installed

Resource Name	Amount Used	Remaining	Percent Used
Storage	2877 KB	160963 KB	2%
Memory	200 KB	32568 KB	1%
Threads	4	144	3%
Sockets	0	128	0%
File Descriptors	1	127	1%

MEAP Application Authentication Information Settings

When executing jobs from an application that does not require a printer operation, it is necessary to set authentication information in advance. For details on the procedure, see [Top Page] > [MEAP Application Settings] > [Setting Authentication Information for MEAP Applications] in "Function Guide for MEAP Application Management".

License Management

The following cases exist for the license management of MEAP applications. Since license management is generally performed by the user, see "Function Guide for MEAP Application Management" for the basic operations.

Adding License Files

Add a license when you want to continue using an application after a license has expired. For details on the procedure, see [MEAP Application License Settings] in "Function Guide for MEAP Application Management".

Disabling/Deleting License Files

It is necessary to disable and delete the license to uninstall a MEAP application. For details on the procedure, see [MEAP Application License Settings] in "Function Guide for MEAP Application Management".

Downloading License Files

When uninstalling and reinstalling a MEAP application in cases such as initializing the storage, download the license before deleting the disabled license. The downloaded license can be used as the license for reinstalling to the same device. For details on the procedure, see [MEAP Application License Settings] in "Function Guide for MEAP Application Management".

Downloading a License for Forwarding

The license downloaded in "Downloading License Files" can be used when reinstalling to the same device (a machine with the same serial number), but cannot be installed to a different machine. When migrating a MEAP application to another machine, it is necessary to download a "License for Forwarding". For details on the procedure, see the following.

● Procedure for Downloading a License for Forwarding

1. Log in to SMS, stop the application to be forwarded.

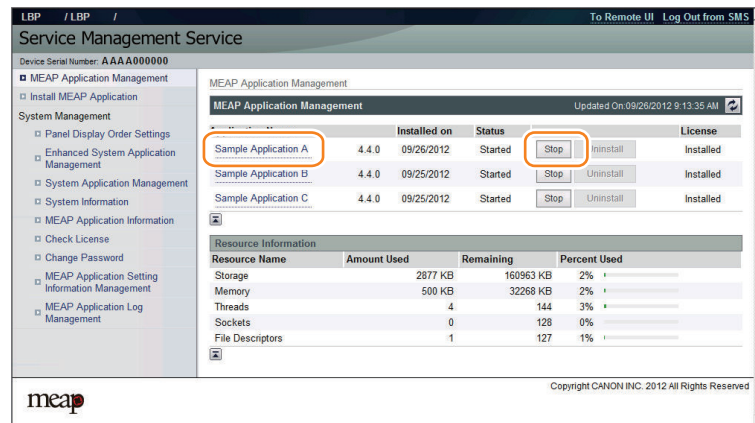

2. Move to the download page of license forwarded for the device as sender ([https:// <IP address of device>:8443/sms/ForwardLicense](https://<IP address of device>:8443/sms/ForwardLicense)).

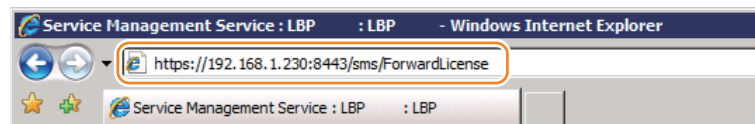

3. Specify the application to be forwarded.

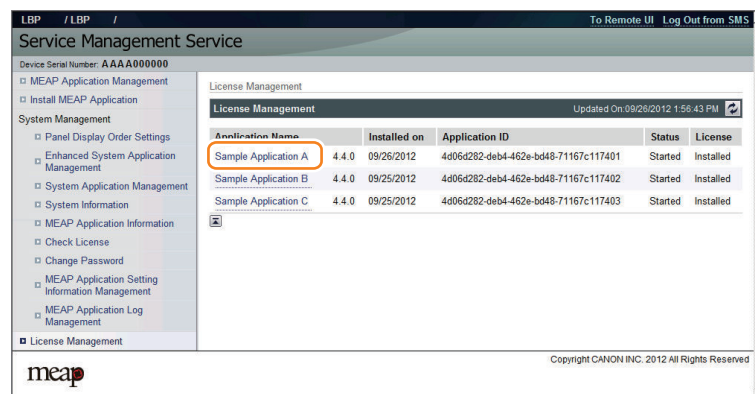

4. Click [Disable] on the [Disable License File].

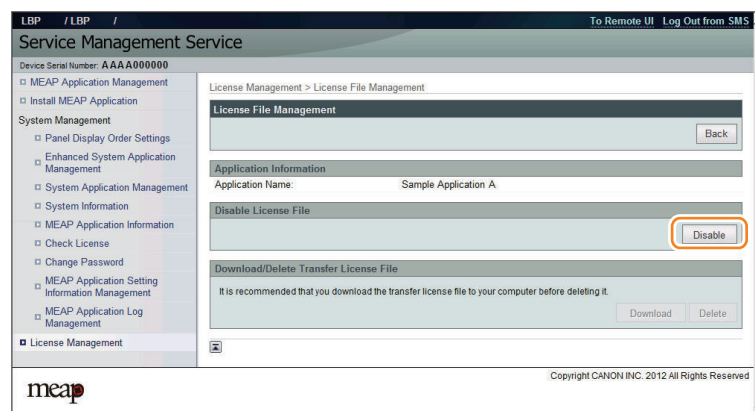

5. The window to confirm whether to create a transfer licence will be displayed. Click [Yes].

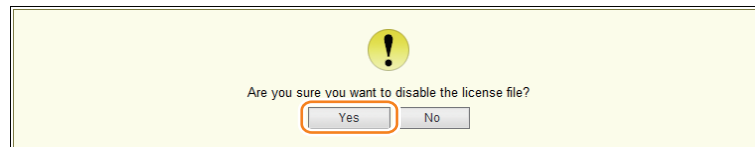

6. When [Download] on the [Download / Delete Transfer License File] becomes effective, click [Download].

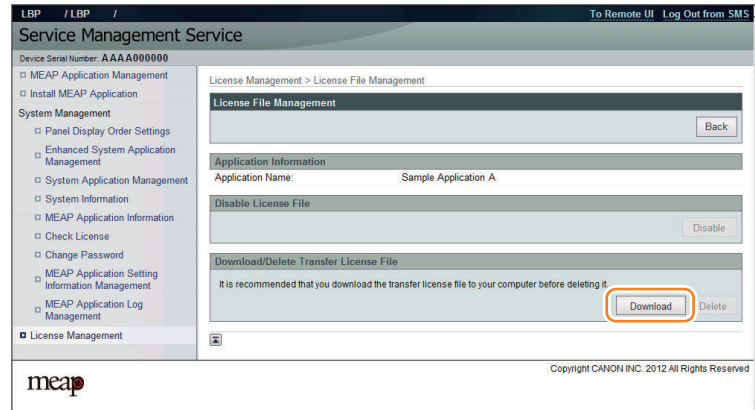

7. Specify the preservation place of the file according to the instruction of the screen.
8. After downloading the license file for forwarding, click [Delete] to display the confirmation screen and click [Yes] to delete the file (in consideration of breakage of license for forwarding, deleting disabled license can be executed after all steps have been completed).

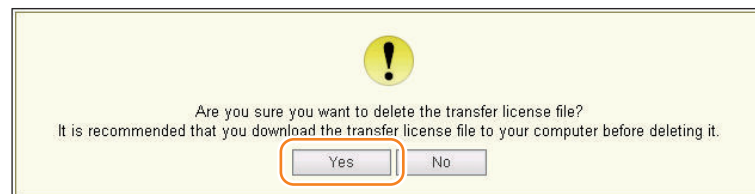

9. Log out of SMS.
10. Since this downloaded transfer license is the file only to prove the license invalidation, it cannot be used for installation to the other device as it is. Send the transfer license to the service support contact of your nearest sales company to request issuance of the new license for installation in the new device.

NOTE:

When requesting issuance of license for forwarding, inform the sales company of the name of product name and serial No. of the device as sender, and of the name of product name and serial No. of the forwarding destination.

11. Install application using the license for forwarding issued by the sales company.

■ Authentication Settings Management (Enhanced System Application Management)

The authentication function (login application) used when logging in to the machine is configured on the [Enhanced System Application Management] screen of SMS.

Change Login Application Procedure

If multiple login applications are installed*¹, you can activate the login application that you wish to use by accessing the [Enhanced System Application Management] screen of SMS, clicking the [SWITCH] button of the login application, and restarting this machine. For details on the procedure, see [Top Page] > [System Settings] > [Setting Enhanced System Applications] > [Starting/Stopping Enhanced System Applications] in "Function Guide for MEAP Application Management".

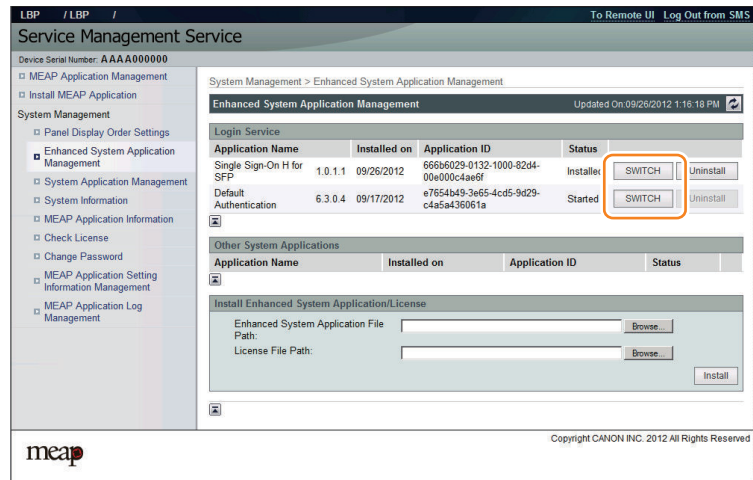

Login Service Installation Procedure

To install a login application to this machine, access the [Enhanced System Application Management] screen of SMS, specify the program file (.jar) and license file (.lic) of the login application that you wish to use, and click the [Install] button. For details on the procedure, see [Top Page] > [System Settings] > [Setting Enhanced System Applications] > [Installing Enhanced System Applications] in "Function Guide for MEAP Application Management".

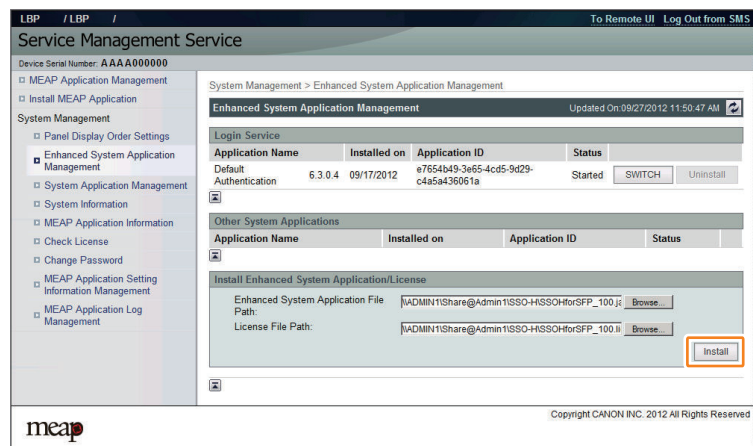

*1. When a 3rd party login application is installed, etc.

Login Service Uninstallation Procedure

To uninstall a login application, access the [Enhanced System Application Management] screen of SMS, stop the corresponding login application (change its status to "Installed"), and click the [Uninstall] button. For details on the procedure, see [Top Page] > [System Settings] > [Setting Enhanced System Applications] > [Uninstalling Enhanced System Applications] in "Function Guide for MEAP Application Management".

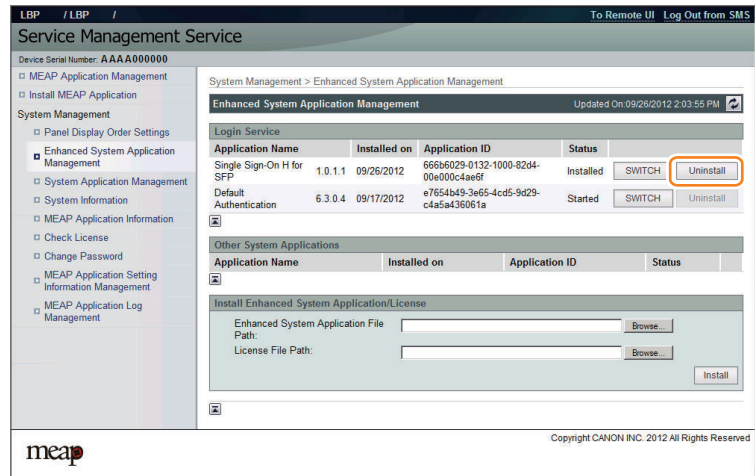

■ Changing the SMS Password

The password used to log in to SMS can be changed by accessing the [Change Password] screen and entering the old password and new password. It is recommended that the SMS password is changed to prevent security threats. For details on the procedure, see [Top Page] > [System Settings] > [Changing the SMS Password] in "Function Guide for MEAP Application Management".

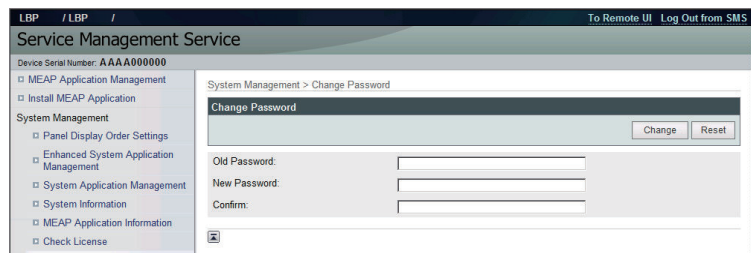

■ Checking Various Information

SMS has a screen for checking the information of this machine.

System Information

You can access the [System Information] screen of SMS to check the system information relating to the MEAP of this machine. The following information can be checked on this screen.

- Platform Information
- System Application Information

CAUTION:

The detailed information for system applications can be checked by clicking the [Display Details] button.

MEAP Application Information

You can access the [MEAP Application Information] screen of SMS to check the information relating to the MEAP applications installed in this machine.

License File

You can access the [Check License] screen of SMS, specify a license, and click [Check] to check information such as the expiration date of the license.

Maintenance

■ When Replacing the PCB

● Special license for reinstallation

When replacing the PCB, a special license file is required to reinstall the application with the expiration date of the current counter value migrated as it is. This special license file is handled as a service tool and cannot be obtained by end users.

In order to obtain a special license file, the service technician needs to contact the person in charge of support at the sales company.

The service technician needs to give the device serial number and the names of the MEAP applications that had been installed. Since the support department of the sales company manages all the issued application license files by device serial number, it is basically possible for them to successively issue license files once the device serial number is confirmed.

NOTE:

The application that is installed with a reusable license can be reinstalled by using the same license.

● Procedure for reinstalling MEAP applications after replacing the PCB

The following shows the procedure when replacing the PCB.

1. Preparation before replacement

The following work needs to be done before replacing the PCB.

- Some MEAP applications have a function to back up or export the data to be used. If such a MEAP application is installed, back up or export the data in advance.
- In order to reinstall the applications, copy the licenses (special licenses, reusable licenses, etc.) of all the MEAP applications to the laptop PC.

2. Replacing the drive

Prepare the necessary service parts, and replace the drive.

3. Reinstalling the MEAP application

When the device has started normally, obtain the jar files of the MEAP applications from the user, and install them using the license files for reinstallation.

Installation method is the same as normal installation.

4. Importing user information

As necessary, make login service selections and import user information.

NOTE:

When you replace the PCB without uninstalling MEAP applications, make sure to reinstall the previously installed applications. Unless reinstalling them, MEAP counter will not be released and the message "The number of applications that can be installed has exceeded the limit. Try to install this application after uninstalling other applications." is displayed so that the installation of new applications may not be accepted. If you want to install new applications in this case, once reinstall the applications in-stalled before formatting and uninstall unnecessary applications.

CAUTION:

Do not install a Main PCB of another device and conduct operation check in order to check whether an error has occurred in the Main PCB. If the PCB is replaced and the system is started, the data on the installed PCB will be initialized.

■ Actions to be taken when E616 is displayed

When E602 is displayed and then the device is restarted as a remedy, E616 may be displayed in some cases.

This is a symptom that occurs when the power is cut off without shutdown (such as disconnecting the plug of the device). The error code is displayed when the file system of the MEAP storage area is in an abnormal status.

When the device is started, it checks the file system. If the device detects an error, it displays the error code E602, disables the MEAP function, and then starts.

When the device is restarted according to the remedy for E602, the file system is recovered automatically in the system. If the recovery procedure succeeds, the device starts normally with the MEAP function enabled.

However, if the file system could not be recovered by auto recovery, E616 is displayed.

Since the system is automatically formatted when E616 is displayed, the installed MEAP applications will disappear and the device's MEAP function itself will also be disabled.

For this reason, it is necessary to enable the MEAP function and then reinstall the MEAP applications.

• Work procedure

Perform the following procedure when E616 is displayed.

1. **Start the device in service mode.**
2. **Select [Setup] > [SERVICE MODE] > [FUNCTION GR.] > [MEAP FUNCTION] > On to enable the MEAP function.**
3. **Restart the device to start the MEAP function.**
4. **Access SMS, and then use a reusable license or special license for reinstallation to install the MEAP application.**

NOTE:

As for MEAP applications that were installed using reusable licenses, the reusable licenses can be used to reinstall the applications. For other MEAP applications without reusable licenses, use special license files to reinstall them, in the same as way as handling a storage drive failure.

For information on how to obtain a special license for reinstallation, see [“Special license for reinstallation” on page 106](#) in this chapter. Then contact the support department of the sales company to have the license issued before starting the work.

5. **Start the MEAP application.**

■ MEAP Safe Mode

Use safe mode if you need to start up the system without worrying about extra applications. It will start up only those system software files (including SMS) that normally start up as default files while preventing MEAP applications and the like from starting up.

When you have made changes and restart the device, the control panel will indicate 'MPSF' in its lower right corner. The MEAP applications that may have been active before you shut down the equipment will not start up on their own. Make use of safe mode when restoring the system software as when MEAP applications or services cause a fault as the result of a conflict or wrong sequence of registration/use. You can access to SMS in this condition so that you can take necessary measures, for example, you can stop application that may cause the trouble.

If default authentication has been selected, the mode of authentication remains valid; otherwise, the message "The login service must be set again with SMS" appears. Change the login service as necessary.

• Starting in Safe Mode

To start the device in the MEAP SAFE mode, turn ON the power with the [Application] key and the [ID] key pressed.

• How to cancel MEAP SAFE mode

If you want to cancel MEAP SAFE mode, just restart the device as usual. It will start in normal mode.

NOTE:

If accessed to SMS in MEAP SAFE mode, the device started mode is shown on the title bar of the browser

When normally started:

Service Management Service : <Device Name>: <Product Name>

When starting in MEAP SAFE mode:

Service Management Service : <Device Name>:<Product Name>: Safe Mode

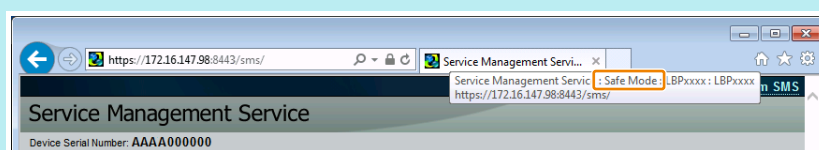

CAUTION:

If the device has been started in the MEAP SAFE mode, all MEAP applications stop and the status becomes "Installed". This status remains unchanged even if the MEAP SAFE mode is cancelled and the device is started again in normal mode. It is therefore necessary to access SMS after normal startup, and start the MEAP application.

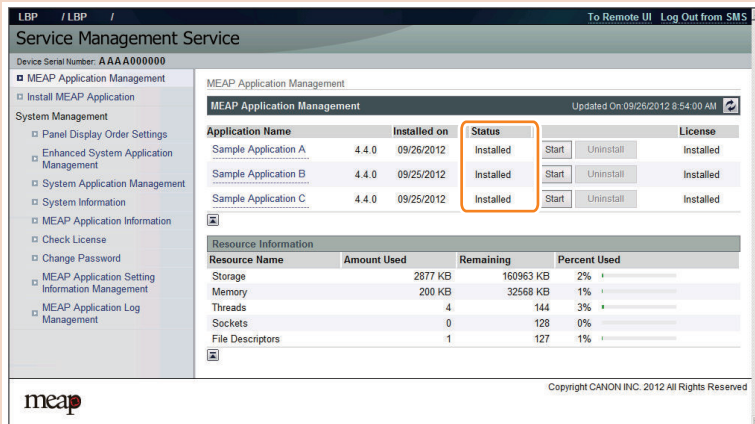

■ Using USB Devices

● Two types of USB drivers

While the USB driver that can be used in iR series is only the USB driver designed exclusively for MEAP application (hereinafter referred to as "MEAP driver"), not only MEAP driver but also USB system driver (hereinafter referred to as "system driver") can be used in this device.

System driver and MEAP driver cannot be used together. When either of them is used, the other driver cannot be used.

In this model, the USB system driver supports only Mass Storage; HID is not supported. In other words, storage devices such as USB Flash memory can be used via system driver, but interface devices such as USB keyboard cannot be used via system driver.

● USB driver setting

System driver is active by default in this device.

The driver can be changed in setup menu.

Usually, It is not necessary to change the setting because it is specified in the MEAP application side.

Only in the case of a special MEAP application, it is necessary to change the USB driver setting.

For details, refer to specifications of MEAP application side.

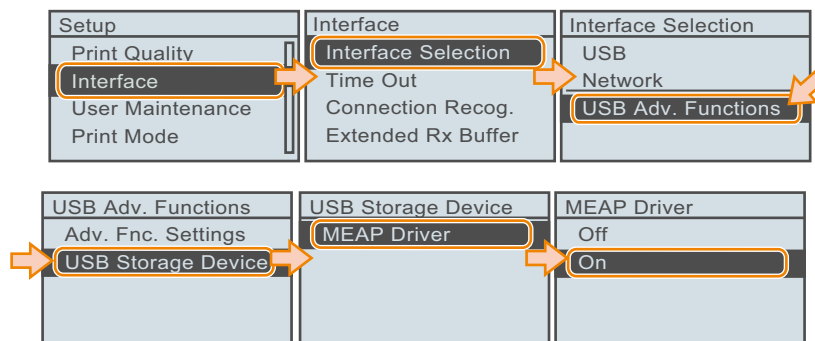

USB Storage Device : [MEAP Driver]	Application that supports mass storage device	MEAP application that supports system driver
ON MEAP driver (compatibility mode)	Can use USB mass storage device. Can work only on the applications that support the MEAP application driver.	Cannot use USB mass storage device.
OFF (default) Native driver	Cannot use USB mass storage device. (Device cannot be detected.)	Can use USB mass storage device.

NOTE:

When any settings changes are made, the device must be restarted.



Periodical Service

Periodically Replaced Parts.....	110
Consumable Parts.....	111
Periodical Service.....	112

Periodically Replaced Parts

Periodically Replaced Parts

- Periodic replacement parts are not required in this machine.

Consumable Parts

Durables Replaced by the Service Person

- Consumable parts are not required in this machine.

Periodical Service

Periodical Service

- No periodic services are required to this machine.



Disassembly/ Assembly

Parts List.....	114
Removing from the connection equipment.....	117
External Cover System.....	119
Controller System.....	132
Laser Exposure System.....	147
Image Formation System.....	149
Pickup Feed Delivery System.....	151
Fixing System.....	164

Parts List

Major Units

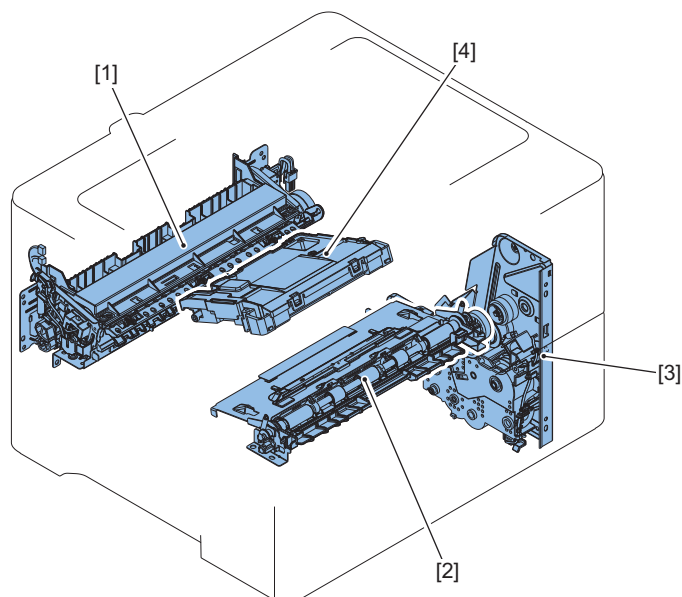

No.	Name
[1]	Fixing Assembly
[2]	Registration Unit
[3]	Main Drive Unit
[4]	Laser Scanner Unit

Electrical Components List

Motor/Fan

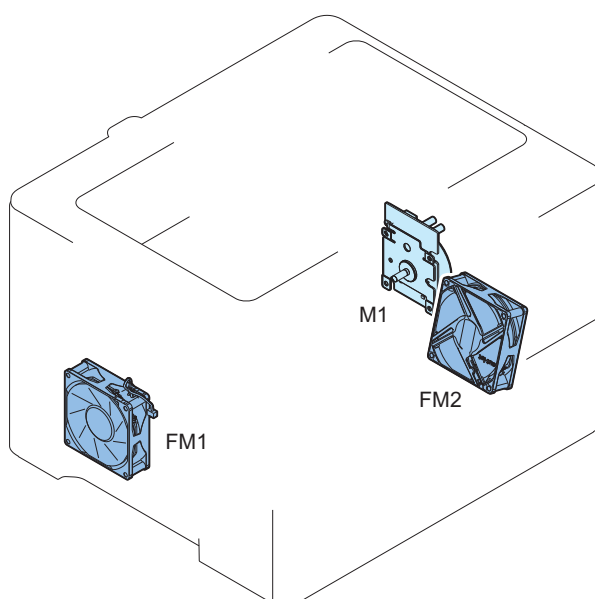

Electric code	Name
M1	Fixing Motor
FM1	Main Fan

Electric code	Name
FM2	Sub Fan

■ Heater

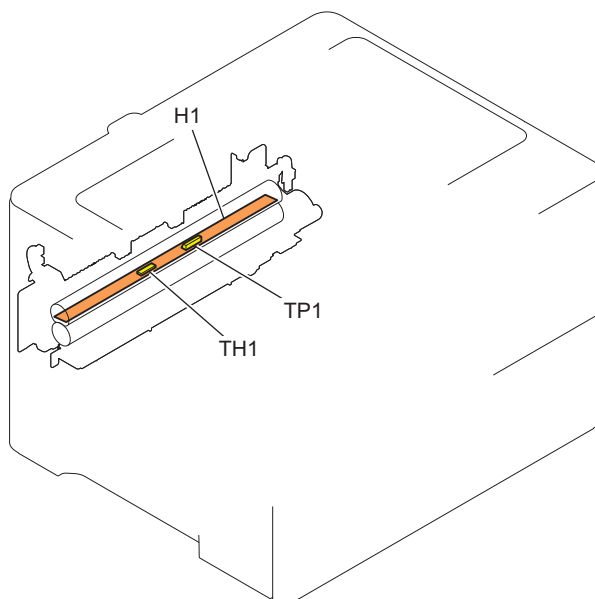

Electric code	Name
H1	Fixing Heater
TH1	Thermistor
TP1	Thermoswitch

■ Switch

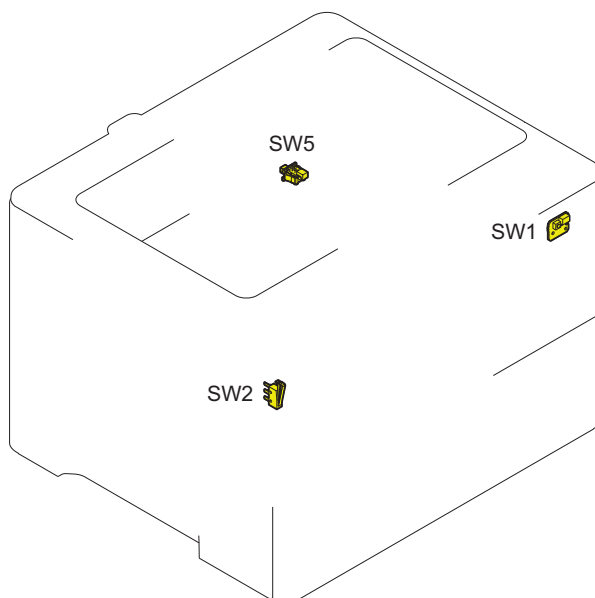

Electric code	Name
SW1	Power Switch
SW2	24V Interlock Switch
SW5	Rear Door Detection Switch

■ PCB

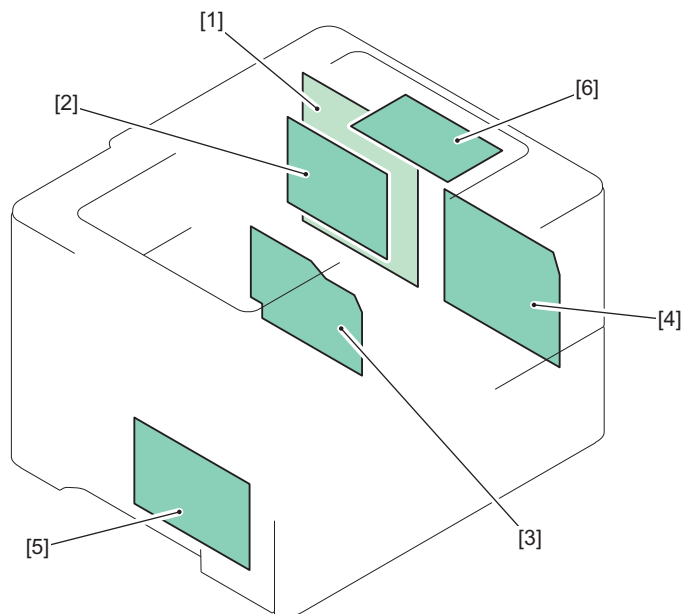

No.	Name
[1]	Main Controller PCB
[2]	DC Controller PCB
[3]	Fixing Power Supply PCB
[4]	Low Voltage Power Supply PCB
[5]	High Voltage Power Supply PCB
[6]	Control Panel Key Switch PCB

Removing from the connection equipment

Disengaging the Paper Feeder

■ Preparation

1. Remove the cassette.

■ Procedure

NOTE:

Disengage the Paper Feeder from the host machine as needed when disassembling/assembling this equipment.

1. Release the 2 locks engaging the host machine and the Paper Feeder.

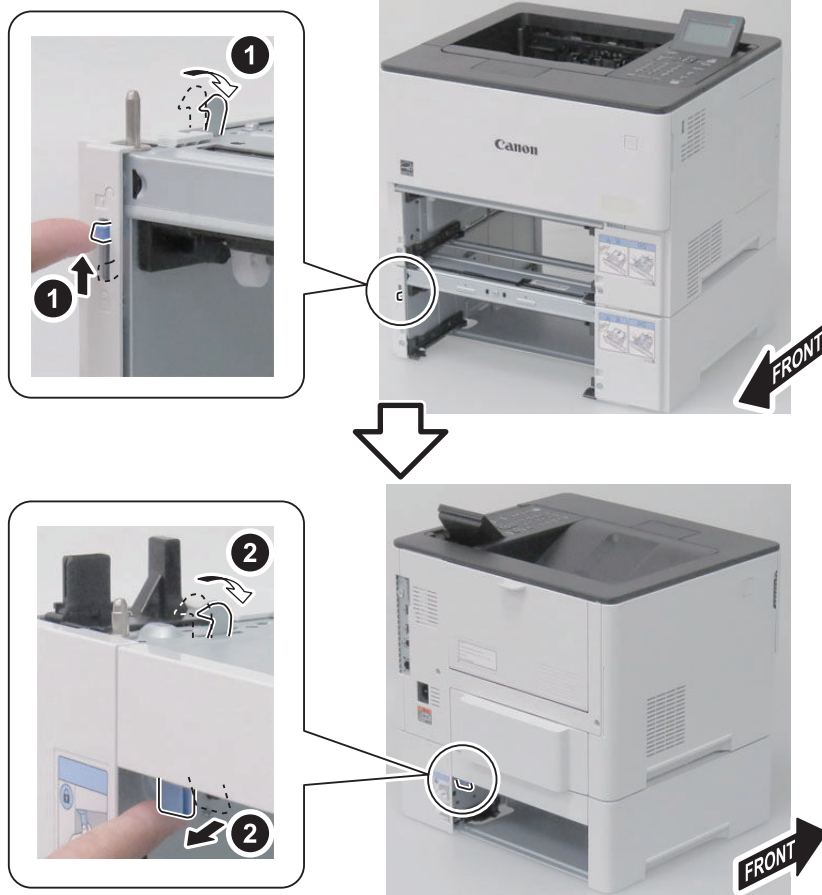

2. Insert your hands into the 2 handles, lift the host machine, and move it to the destination.



External Cover System

● Removing the Rear Cover Unit

■ Procedure

1. Remove the Rear Cover Unit.

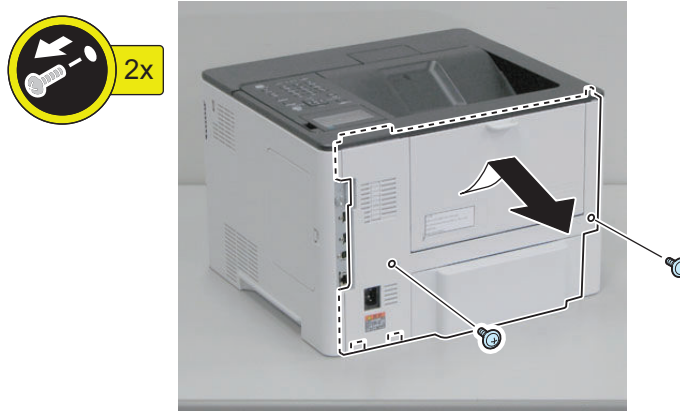

NOTE:

Procedure for Installing the Rear Cover Unit

1. Put the 2 hooks of the Rear Cover inside the Upper Cover.



2. Install the 2 screws that were removed.

● Removing the Cartridge

■ Procedure

CAUTION:

When handling the cartridge, be sure to follow the CAUTION shown below.

1. When removing the cartridge, be sure to block light to the Photosensitive Drum. Cover the removed drum with 5 or more sheets of paper to block light.
2. Do not place the cartridge in a location where it is exposed to direct rays of the sun (e.g. near the window).

1. Place paper on the work space.

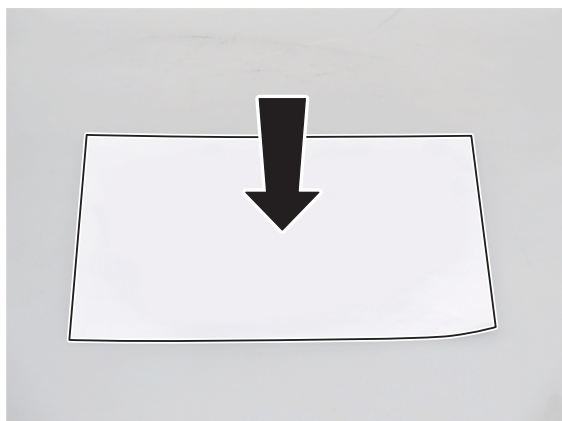

2. Open the Front Cover Unit.

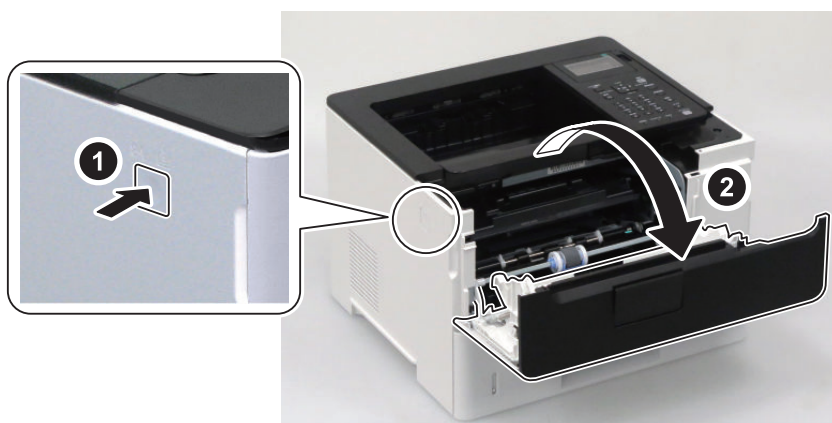

3. Remove the cartridge.



4. Put the cartridge on the sheet of paper placed on the work space.

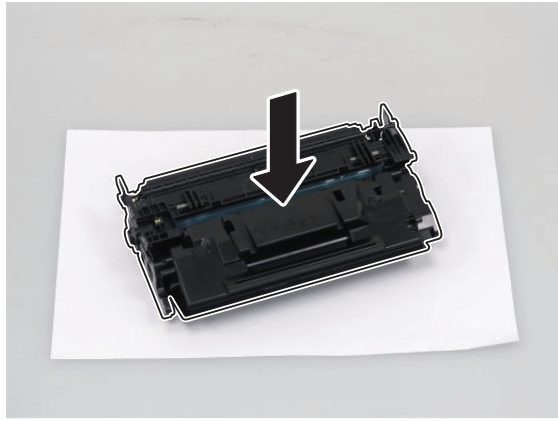

5. Cover the Photosensitive Drum of the cartridge with 5 or more sheets of paper.

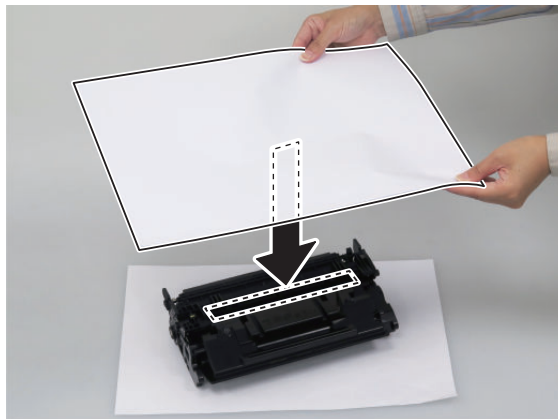

● Removing the Right Cover Unit

■ Preparation

1. "Removing the Rear Cover Unit" on page 119
2. Remove the cassette.
3. "Removing the Cartridge" on page 119

■ Procedure

1. Remove the ROM Outer Cover.

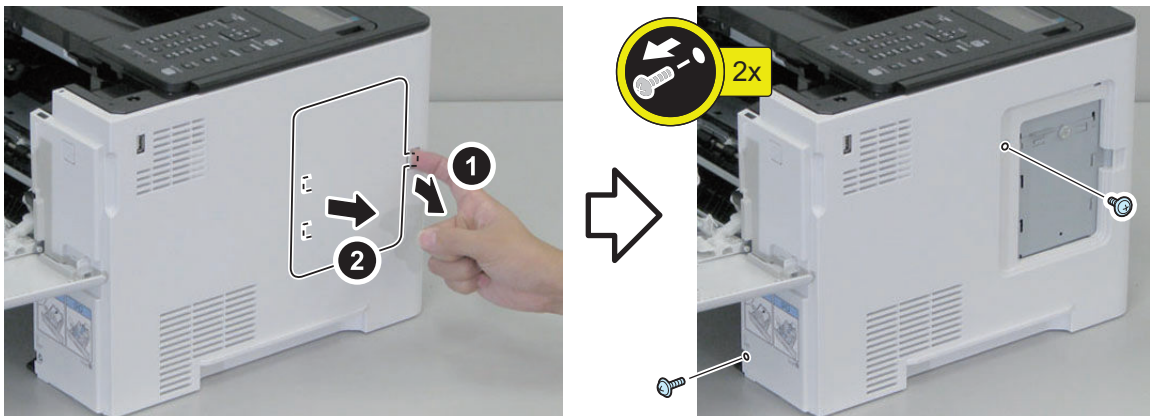

2. Remove the Cartridge Cover Fixation Member.

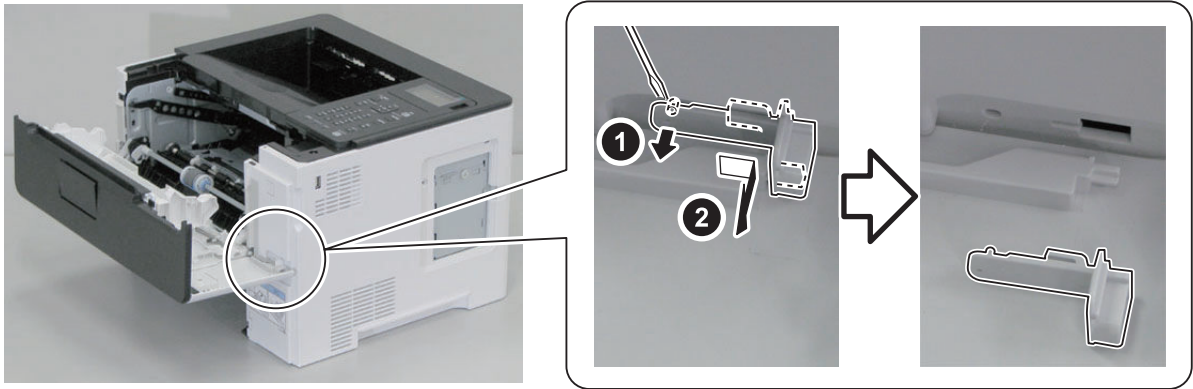

3. Place the host machine so that its right edge [A] is parallel with the edge [B] of the table, and then shift the host machine so that it protrudes off the edge [B] of the table by 9 cm.

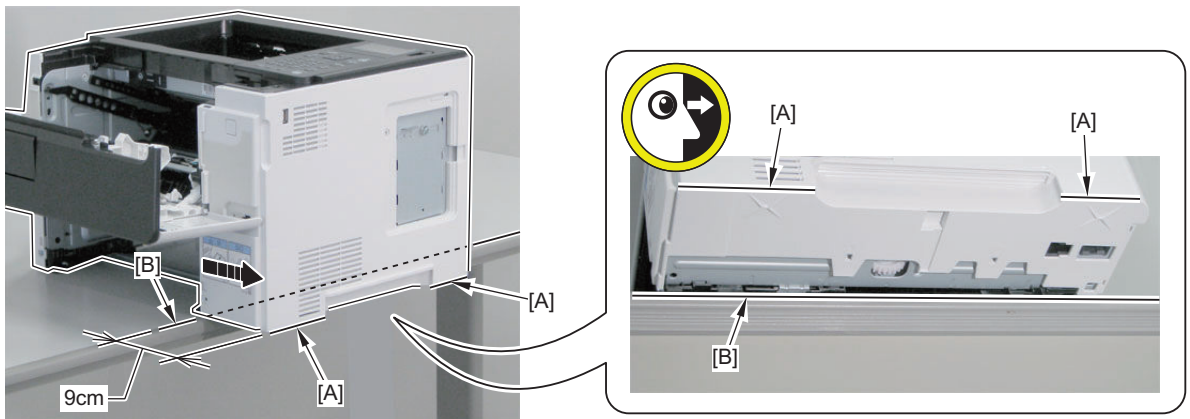

4. Release the 3 hooks of the Right Cover.

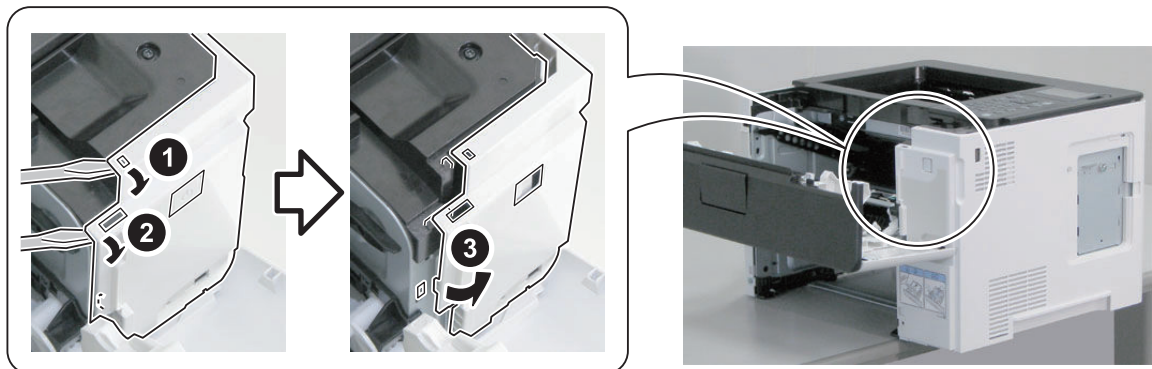

5. Remove the Right Cover.

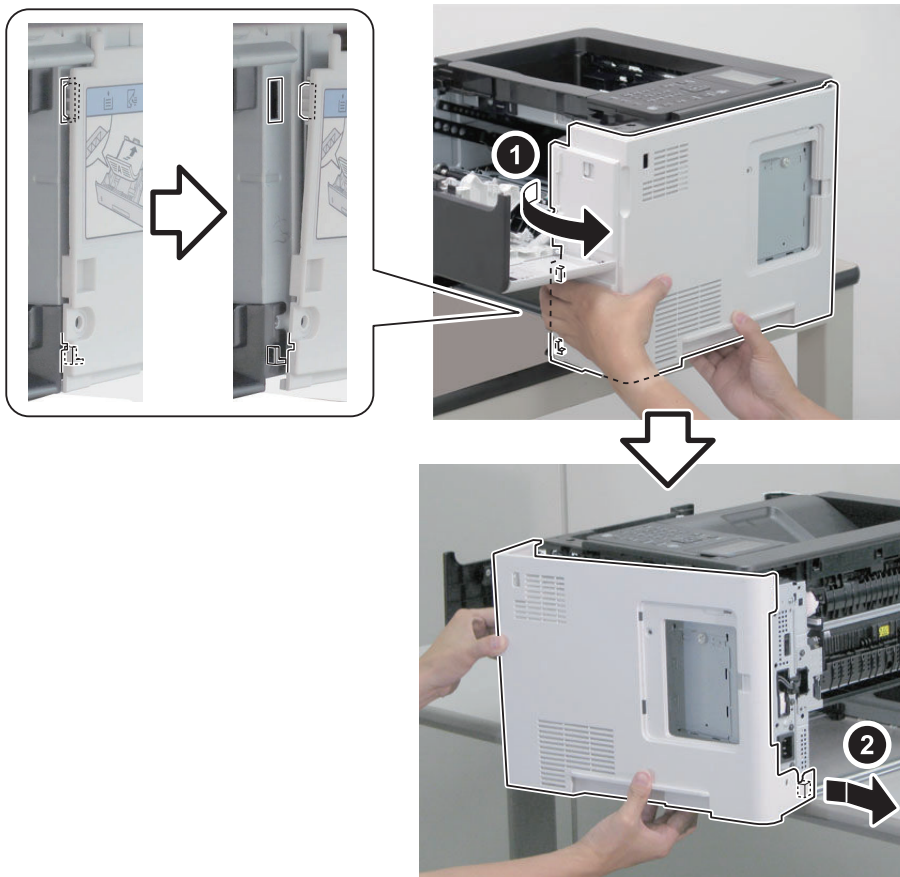

<To Remove with the Host Machine Placed on Its Side>

CAUTION:

Points to Note when Placing the Host Machine on Its Side

When placing the host machine on its side, check that the Left Cover is installed.

1. Place the host machine on its side.

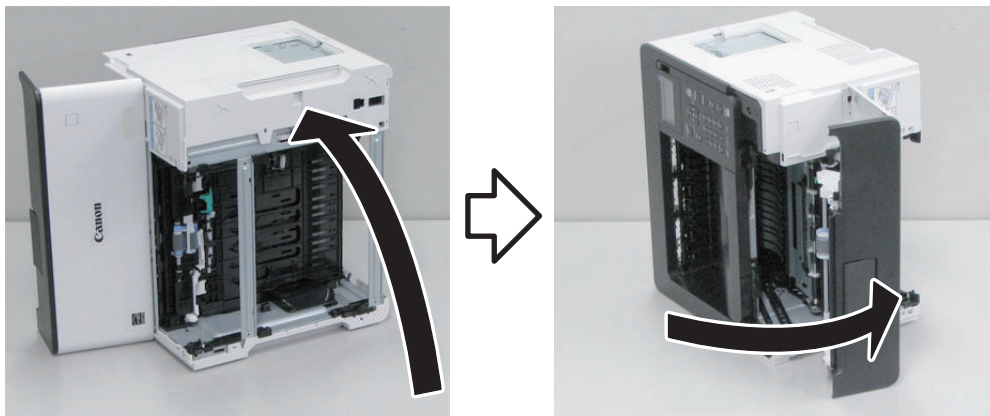

2. Release the 3 hooks of the Right Cover.

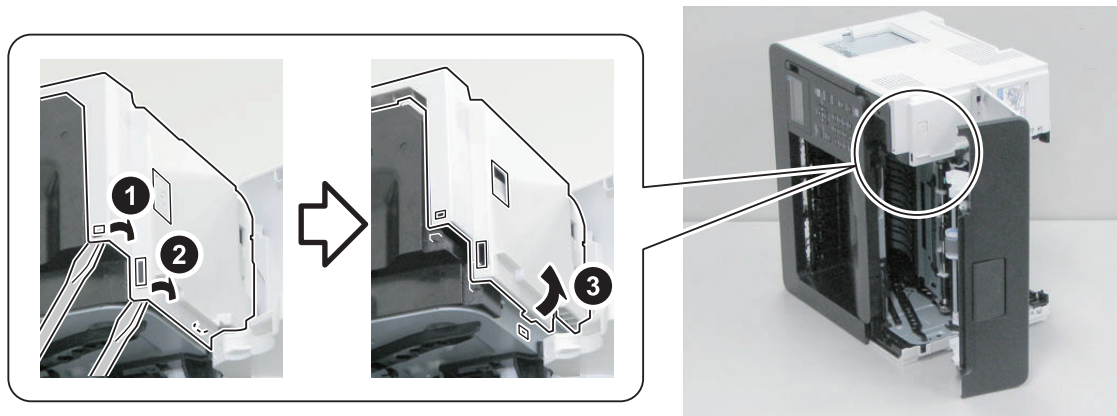

3. Remove the Right Cover.

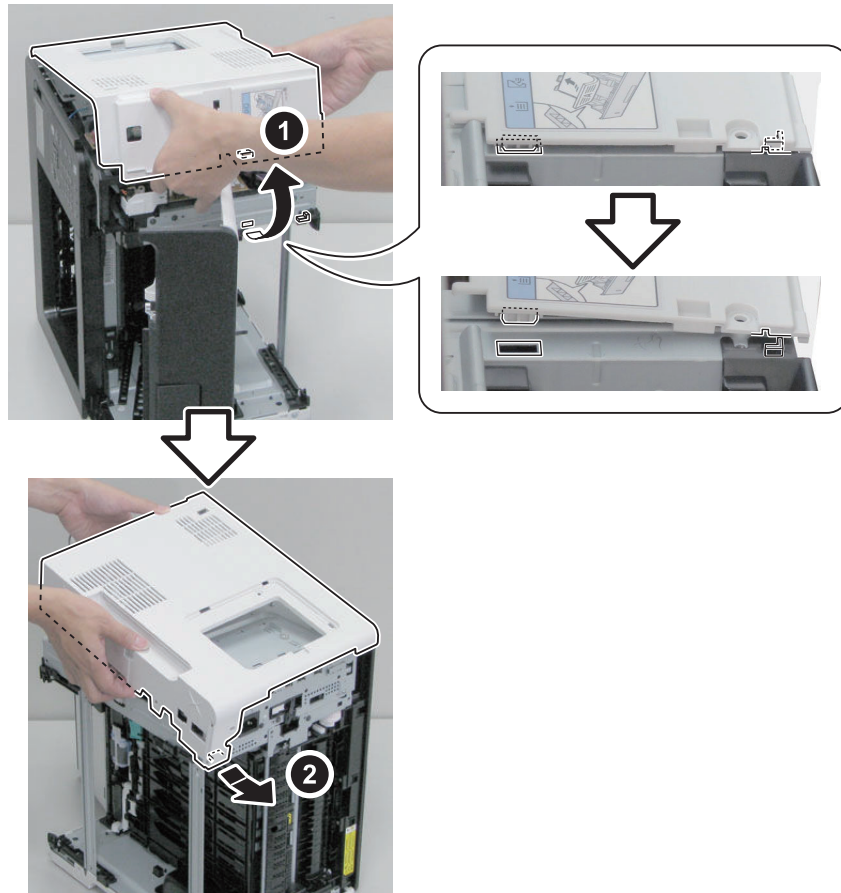

● Removing the Left Cover

■ Preparation

1. "Removing the Rear Cover Unit" on page 119
2. Remove the cassette.
3. "Removing the Cartridge" on page 119

■ Procedure

1. Remove the screw.

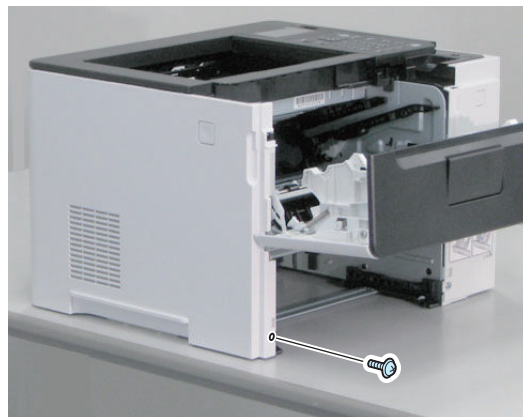

2. Place the host machine so that its left edge [A] is parallel with the edge [B] of the table, and then shift the host machine so that it protrudes off the edge [B] of the table by 3 cm.

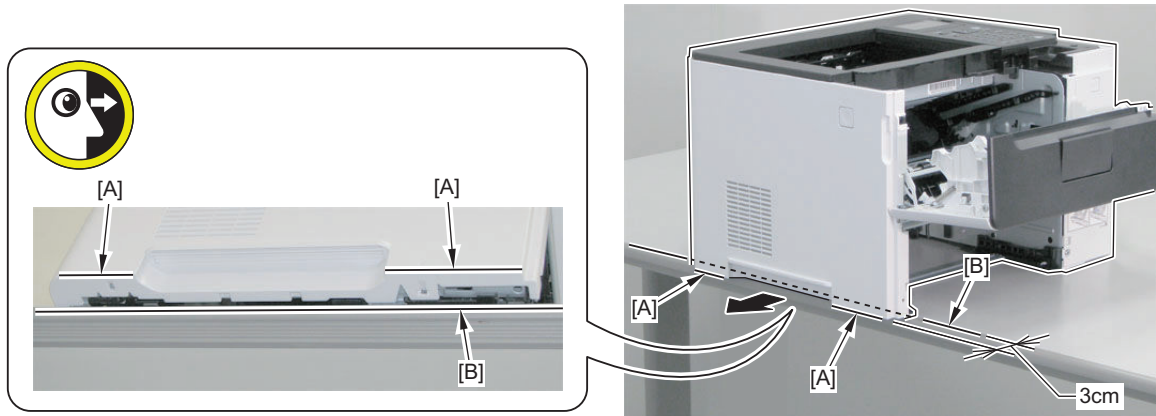

3. Release the 2 hooks of the Left Cover.

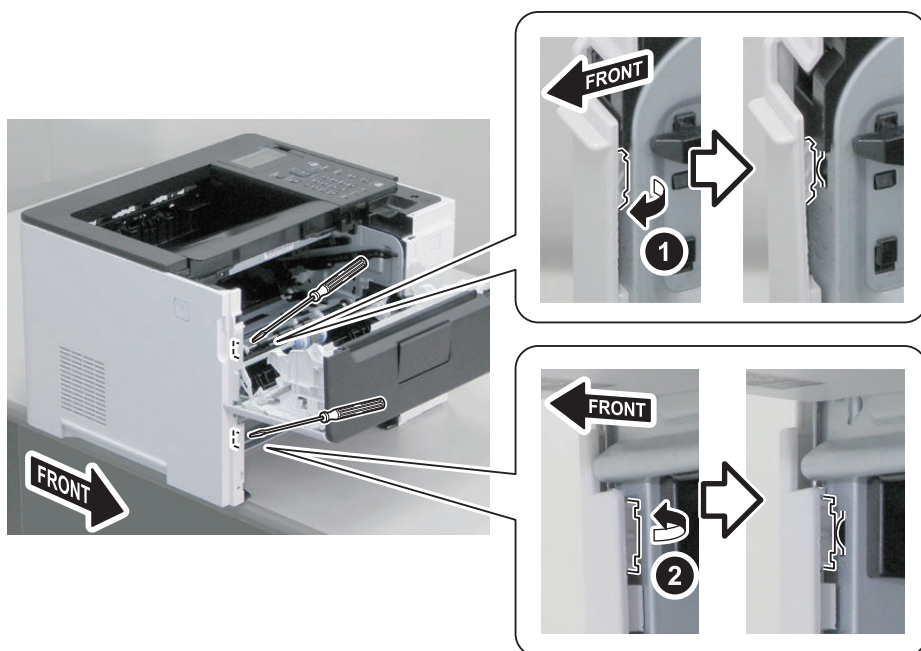

4. Free the 3 hooks from the frame.

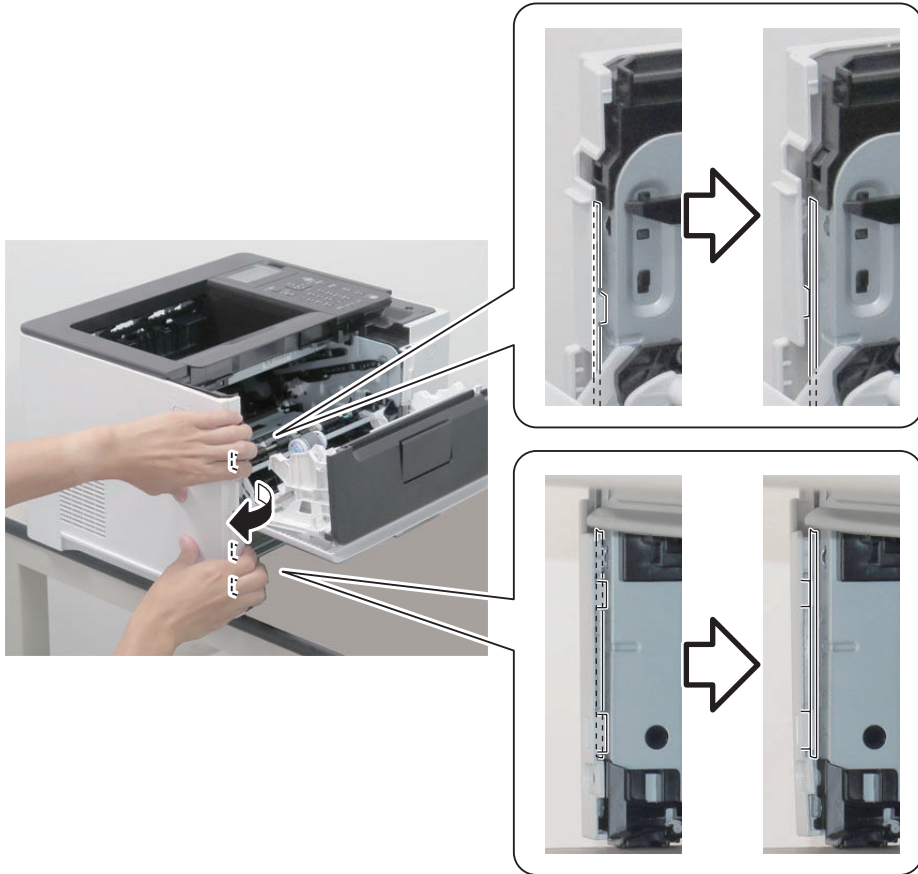

5. Release the claw on the lower side.



6. Remove the Left Cover.

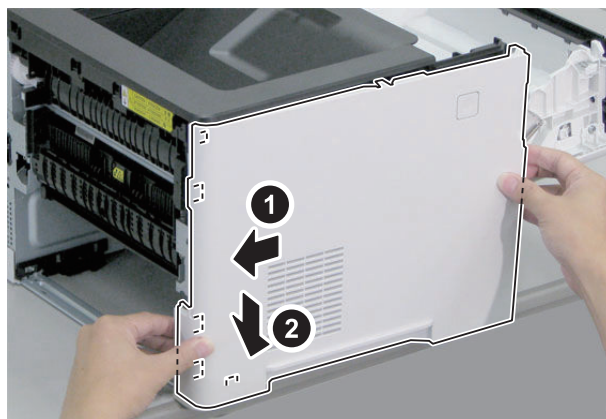

NOTE:

Procedure for Installing the Left Cover

1. Insert the 5 hooks of the Left Cover into the 5 slots on the host machine side.

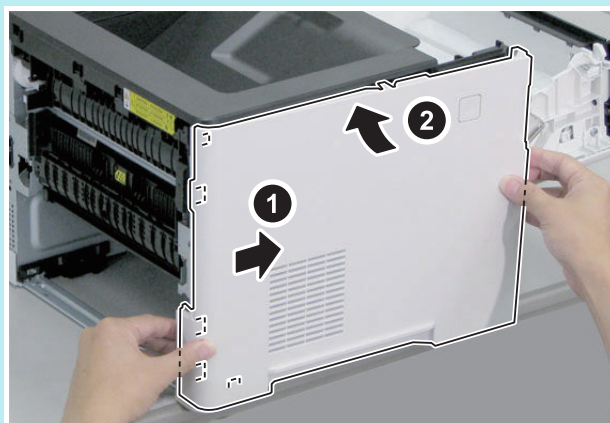

2. Attach the Left Cover by pushing the 2 points on the right edge shown in the figure with your thumb.

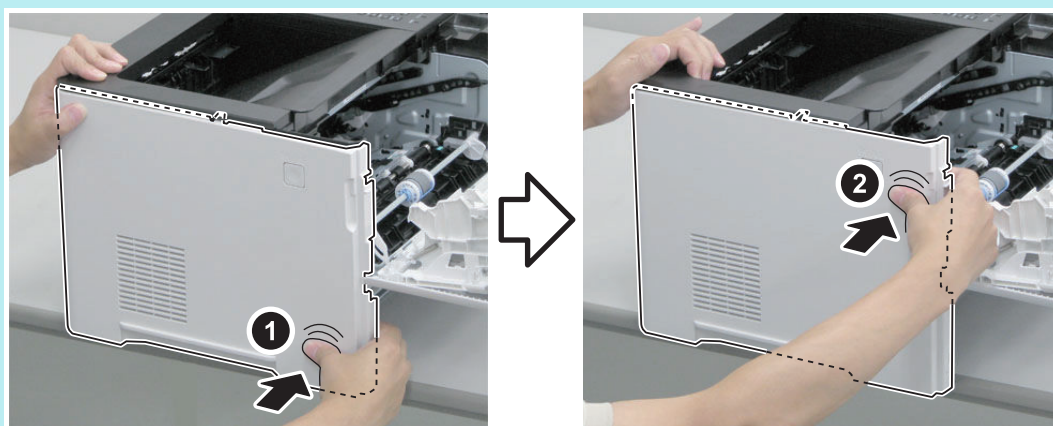

3. Install the screw that was removed.

● Removing the Upper Cover Unit

■ Preparation

1. [“Removing the Rear Cover Unit” on page 119](#)
2. Remove the cassette.
3. [“Removing the Cartridge” on page 119](#)
4. [“Removing the Right Cover Unit” on page 121](#)
5. [“Removing the Left Cover” on page 125](#)
6. [“Removing the Controller Cover” on page 132](#)
7. [“Removing the Control Panel Unit” on page 142](#)

■ Procedure

1. Remove the Upper Cover Unit.

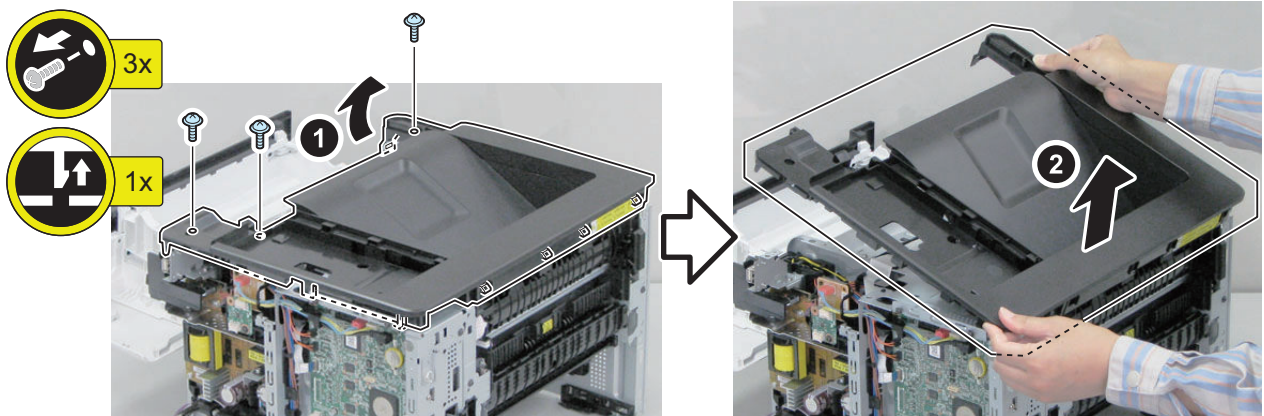

NOTE:

Points to Note at Installation/Removal

Be sure not to let it come in contact with the Full Detection Flag.

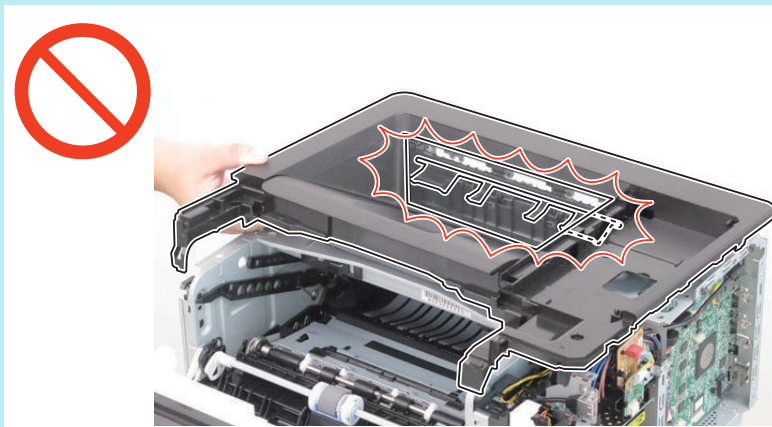

● Removing the Cartridge Cover

■ Preparation

1. Remove the cassette.
2. "Removing the Cartridge" on page 119

■ Procedure

1. Remove the guide.

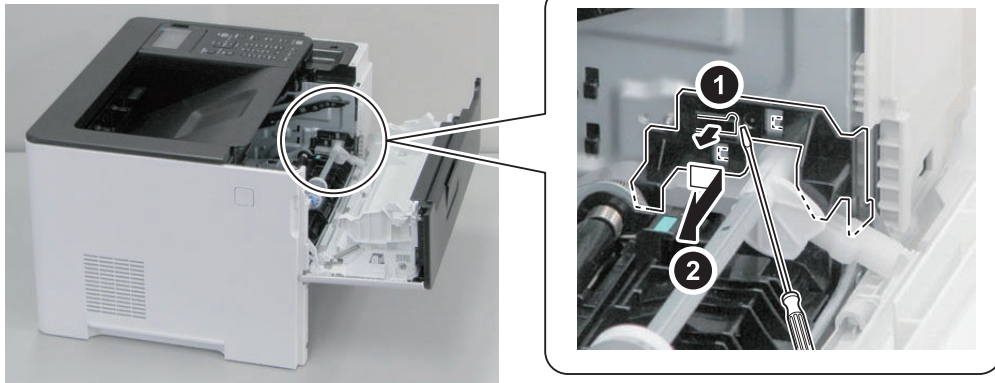

2. Free the Link Arm.

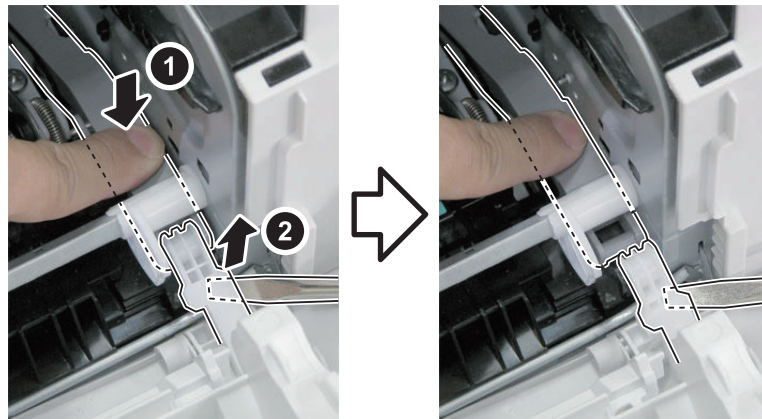

3. Remove the shaft.

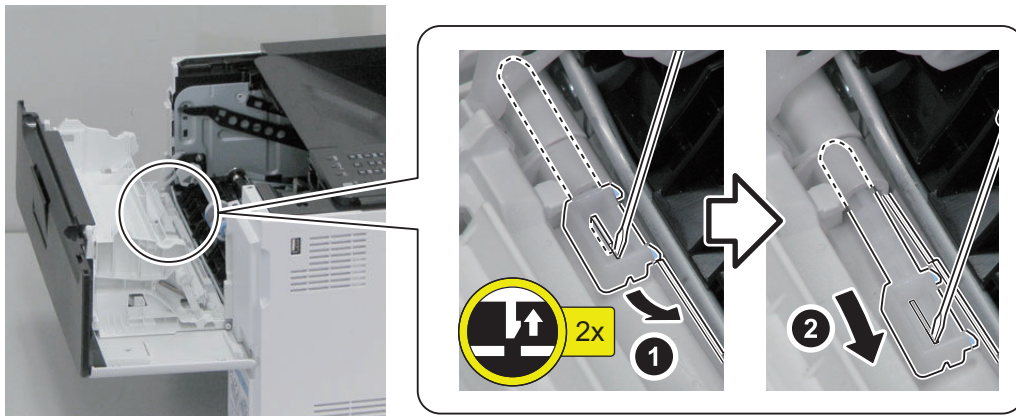

4. Open the Front Cover, adjust the direction of the cut-off of the boss hole, and release the hinge.

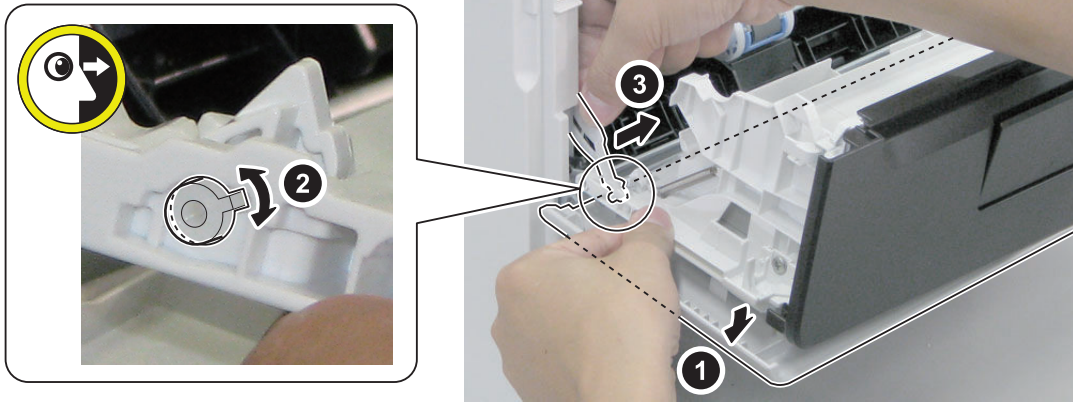

5. Remove the Cartridge Cover.



Controller System

Removing the Controller Cover

Preparation

1. “Removing the Rear Cover Unit” on page 119
2. Remove the cassette.
3. “Removing the Cartridge” on page 119
4. “Removing the Right Cover Unit” on page 121

Procedure

1. Remove the Controller Cover.

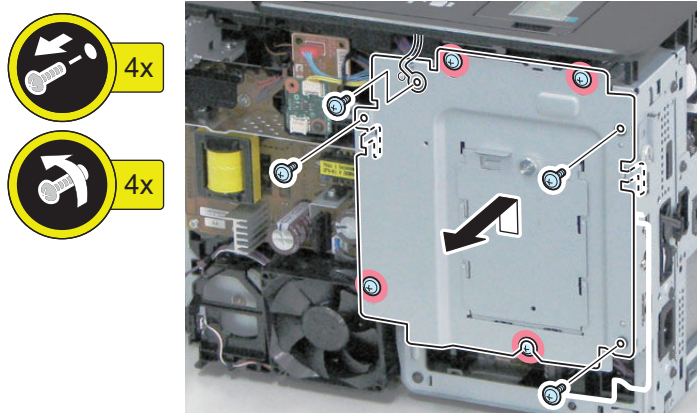

Removing the Main Controller PCB

Preparation

CAUTION:

“Before Replacing the Main Controller PCB” on page 170

1. “Removing the Rear Cover Unit” on page 119
2. Remove the cassette.
3. “Removing the Cartridge” on page 119
4. “Removing the Right Cover Unit” on page 121
5. “Removing the Controller Cover” on page 132

■ Procedure

1. Remove the SD Card Slot Cover.

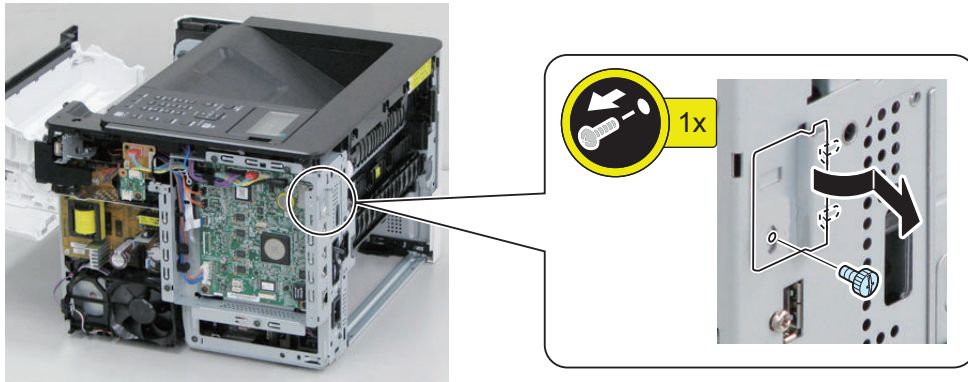

2. Remove the SD Card. (If the SD Card had been used)

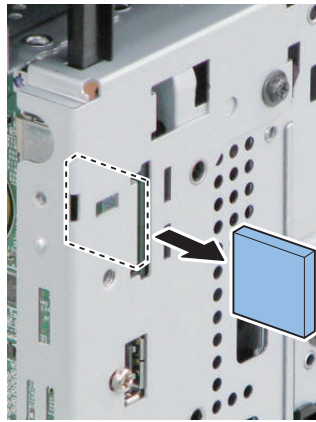

3. Remove the cables of the Main Controller PCB.

CAUTION:

Be careful not to let the terminal of the USB Cable come in contact with the elements on the Main Controller PCB. It may trigger a BT Clock error after the power is turned ON. If the error is triggered, the date and time will be cleared. Specify the date and time setting (Setup > Control Menu > Date/Time Settings) again, and turn OFF and then ON the main power.

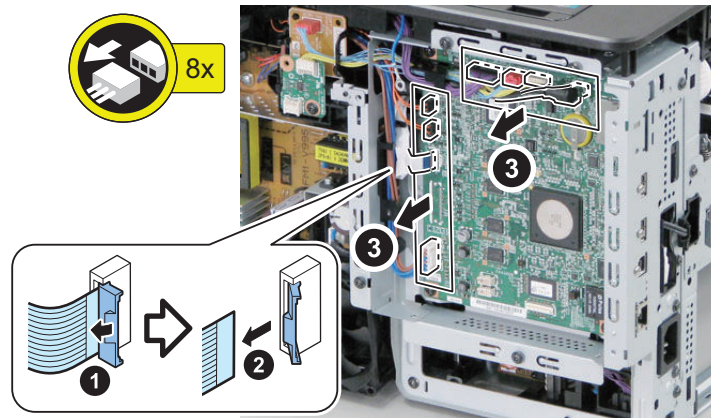
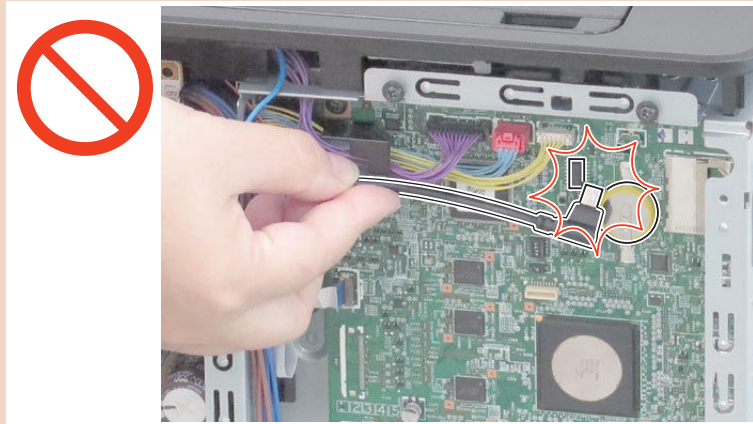

4. Free the cables from the guides [A] and [B].

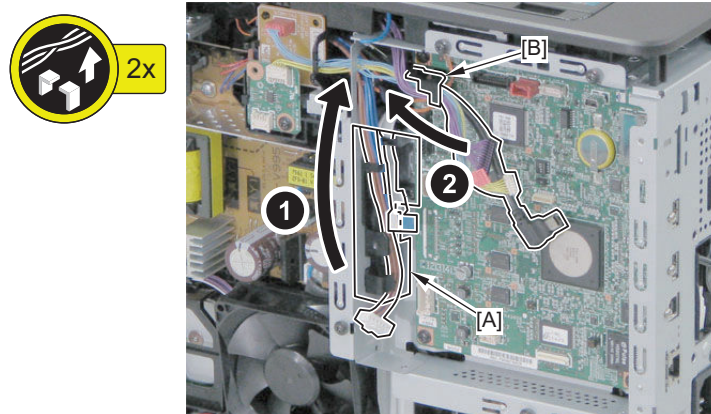

5. Remove the Harness Guide.

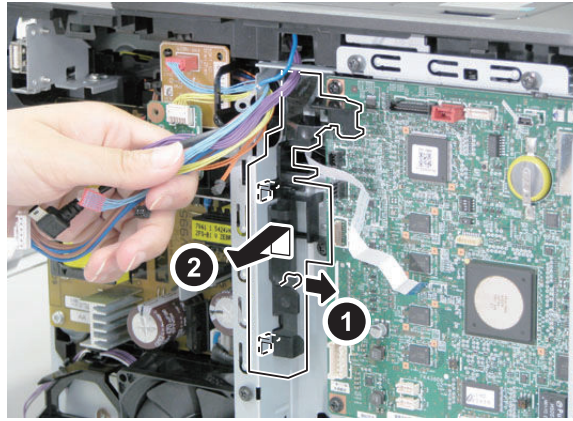

6. Remove the Main Controller PCB.

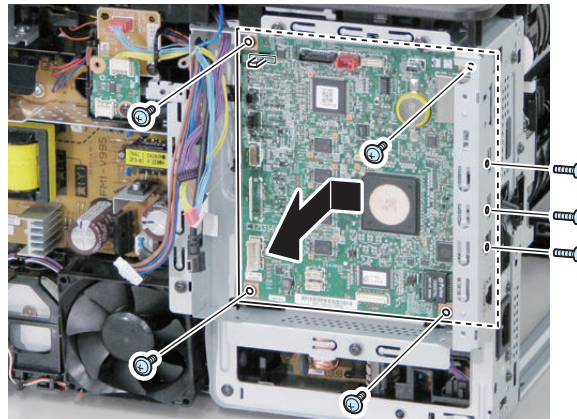
**NOTE:**

The completed assembly of the Main Controller PCB is shown below.

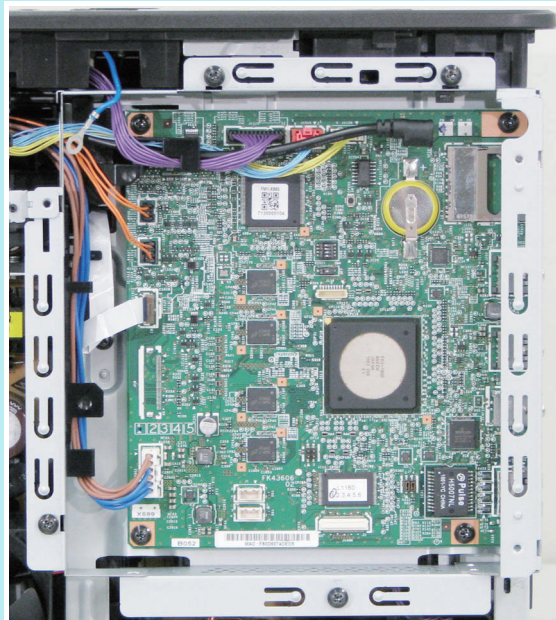
**CAUTION:**

"After Replacing the Main Controller PCB" on page 170

● Removing the Controller Box

■ Preparation

1. “Removing the Rear Cover Unit” on page 119
2. Remove the cassette.
3. “Removing the Cartridge” on page 119
4. “Removing the Right Cover Unit” on page 121
5. “Removing the Left Cover” on page 125
6. “Removing the Controller Cover” on page 132
7. “Removing the Control Panel Unit” on page 142
8. “Removing the Upper Cover Unit” on page 128

■ Procedure

1. Disconnect the 4 connectors of the Controller Box, and remove the USB Cable and the Flat Cable.

CAUTION:

Be careful not to let the terminal of the USB Cable come in contact with the elements on the Main Controller PCB. It may trigger a BT Clock error after the power is turned ON. If the error is triggered, the date and time will be cleared. Specify the date and time setting (Setup > Control Menu > Date/Time Settings) again, and turn OFF and then ON the main power.

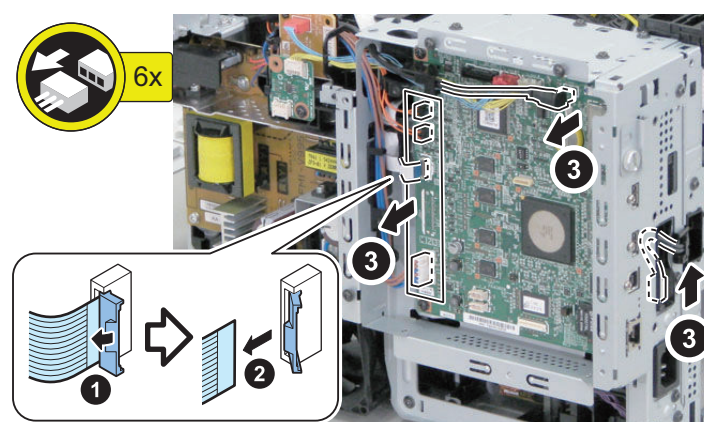
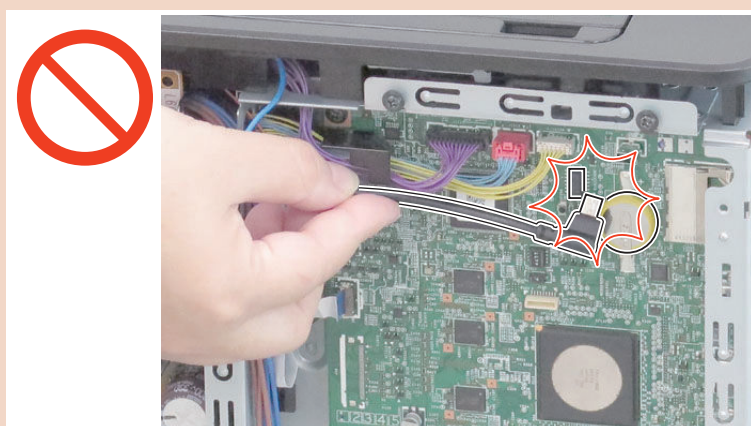

2. Free the cable from the guides [A] and [B].

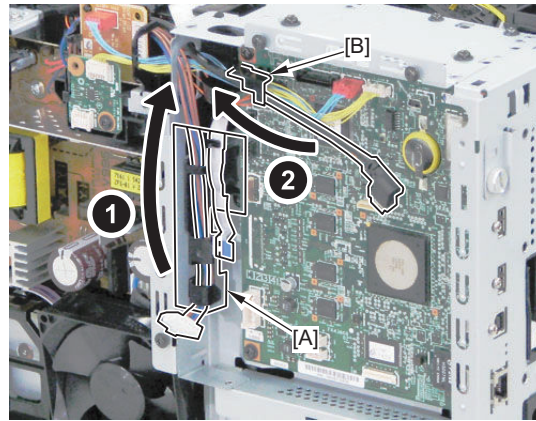

3. Free the cables from the hole [A] on the Controller Box and the guide [B].

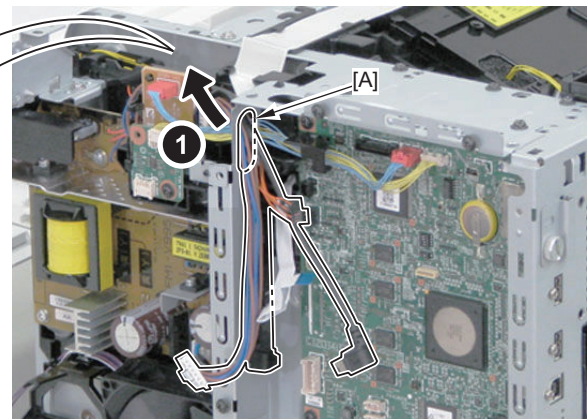
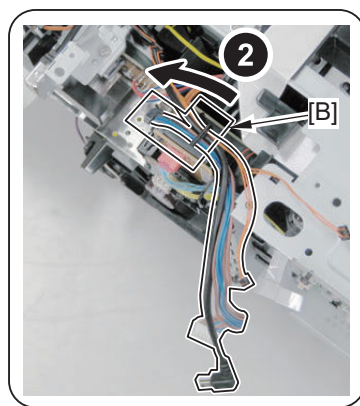

4. Remove the Controller Box.

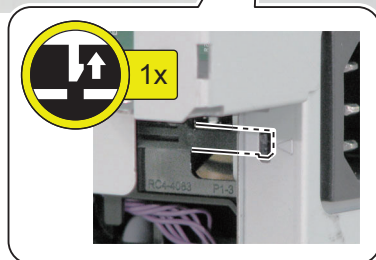
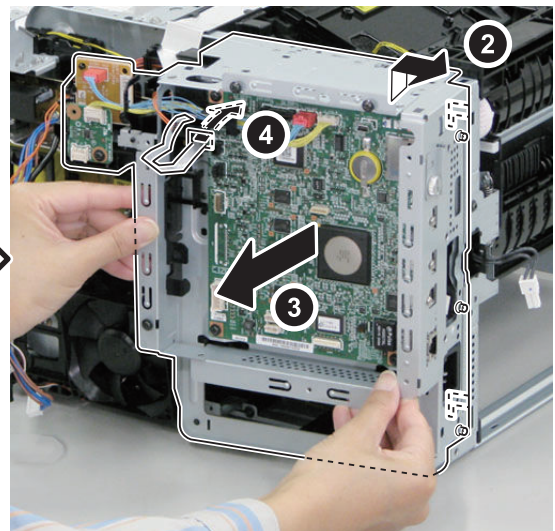
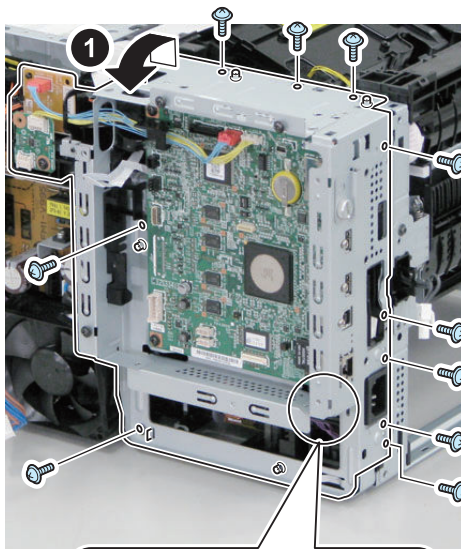

● Removing the DC Controller PCB

■ Preparation

1. “Removing the Rear Cover Unit” on page 119
2. Remove the cassette.
3. “Removing the Cartridge” on page 119
4. “Removing the Right Cover Unit” on page 121
5. “Removing the Left Cover” on page 125
6. “Removing the Controller Cover” on page 132
7. “Removing the Control Panel Unit” on page 142
8. “Removing the Upper Cover Unit” on page 128
9. “Removing the Controller Box” on page 136

■ Procedure

1. Remove the DC Controller PCB.

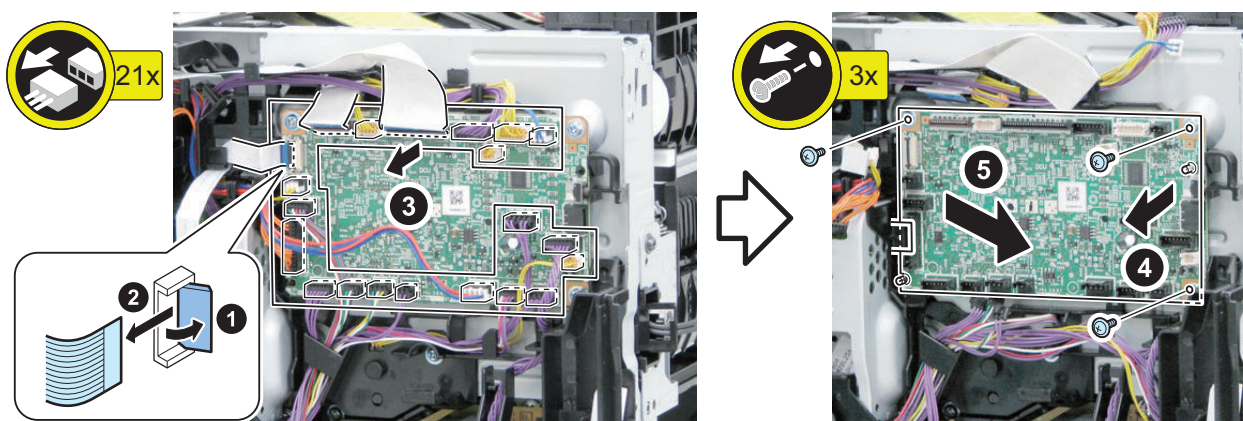

NOTE:

The completed assembly of the DC Controller PCB is shown below.

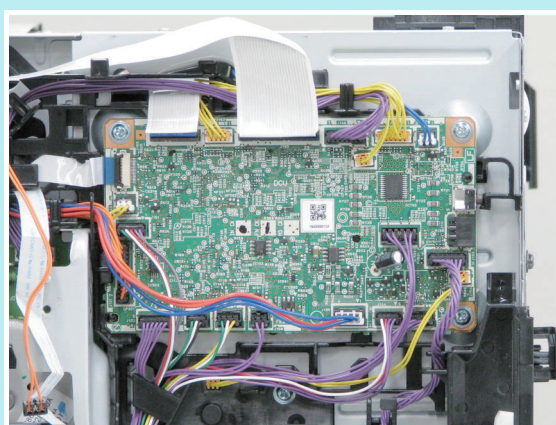

● Removing the Fixing Power Supply PCB

■ Preparation

1. “Removing the Rear Cover Unit” on page 119

2. Remove the cassette.
3. "Removing the Cartridge" on page 119
4. "Removing the Right Cover Unit" on page 121
5. "Removing the Left Cover" on page 125
6. "Removing the Controller Cover" on page 132
7. "Removing the Control Panel Unit" on page 142
8. "Removing the Upper Cover Unit" on page 128
9. "Removing the Controller Box" on page 136

■ Procedure

1. Disconnect the 3 connectors, remove the screw, and free the harness.

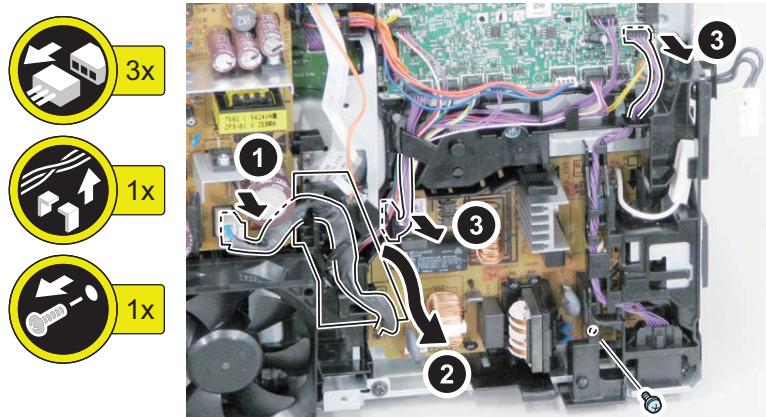

2. Remove the Fixing Power Supply Unit Holder.

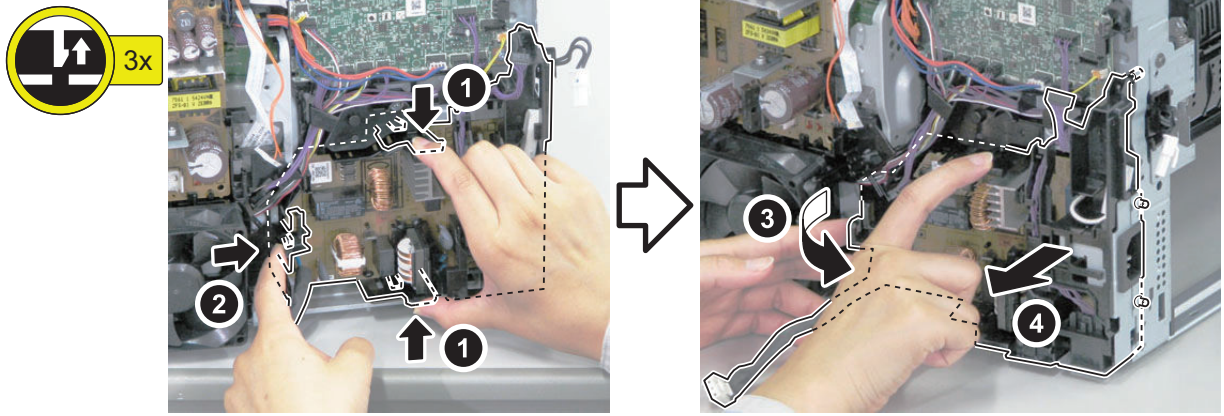

CAUTION:

Points to Note at Installation

Be sure to check that the hook on the side and the hook shown in the figure are fitted properly.

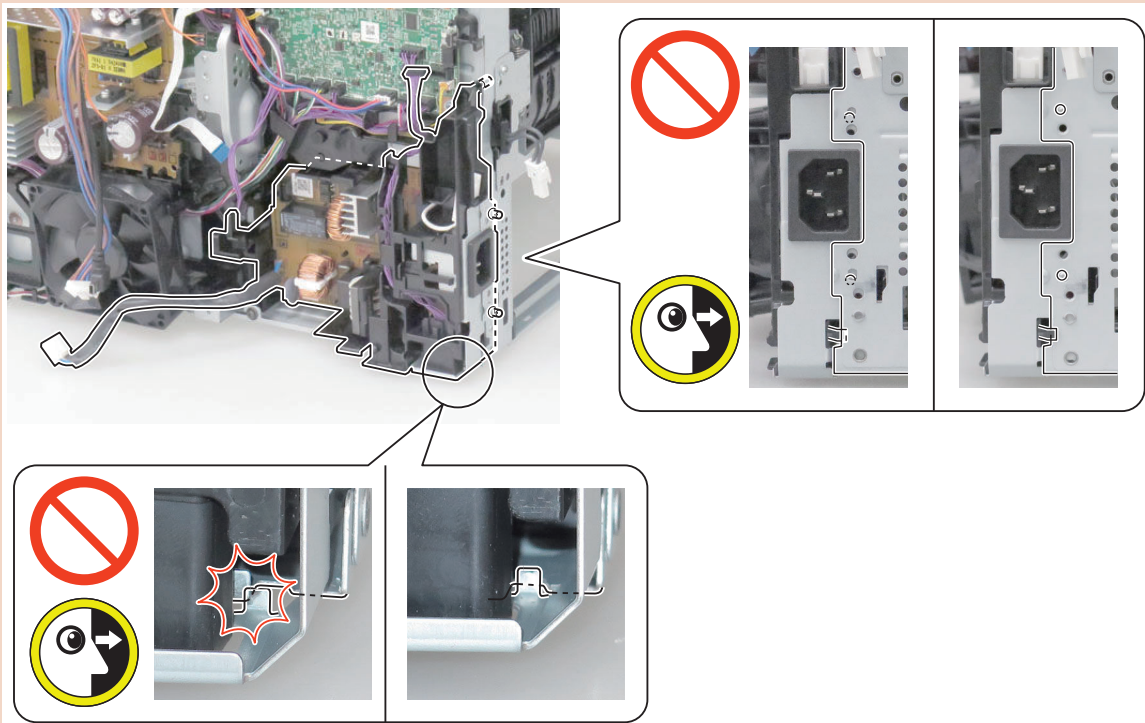

3. Remove the Fixing Power Supply PCB from the Fixing Power Supply Unit Holder.

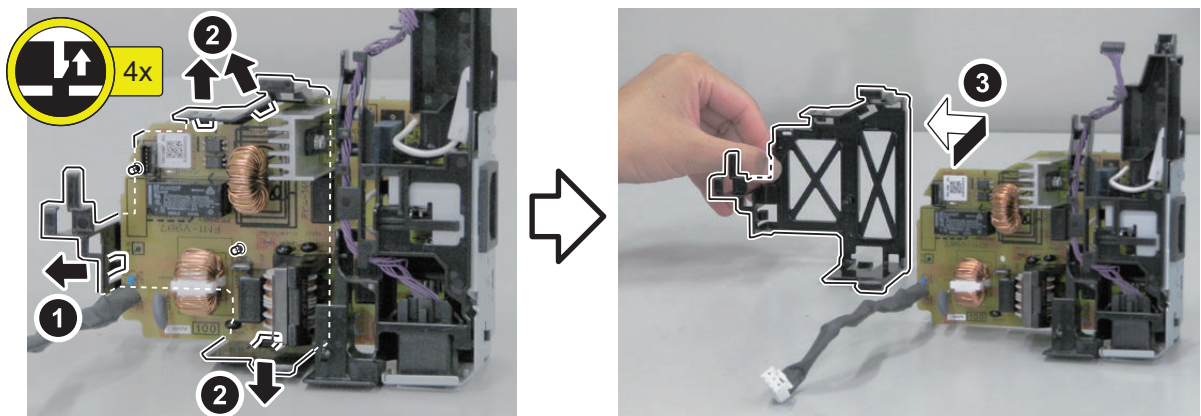

Removing the Low Voltage Power Supply Unit

Preparation

1. "Removing the Rear Cover Unit" on page 119
2. Remove the cassette.
3. "Removing the Cartridge" on page 119
4. "Removing the Right Cover Unit" on page 121
5. "Removing the Left Cover" on page 125
6. "Removing the Controller Cover" on page 132
7. "Removing the Control Panel Unit" on page 142
8. "Removing the Upper Cover Unit" on page 128
9. "Removing the Controller Box" on page 136

Procedure

1. Free the harness from the guide, and remove the Power Supply Holder.

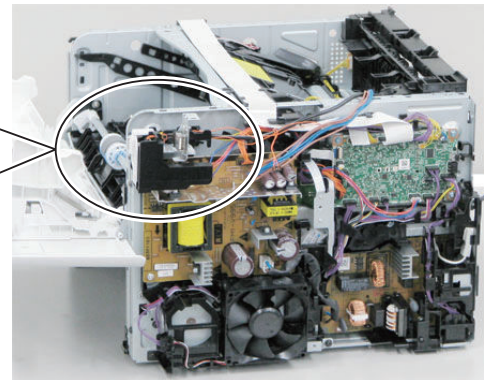
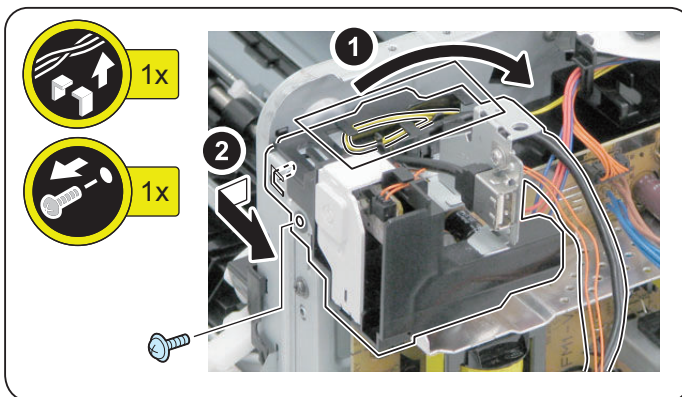

2. Remove the Low Voltage Power Supply Unit.

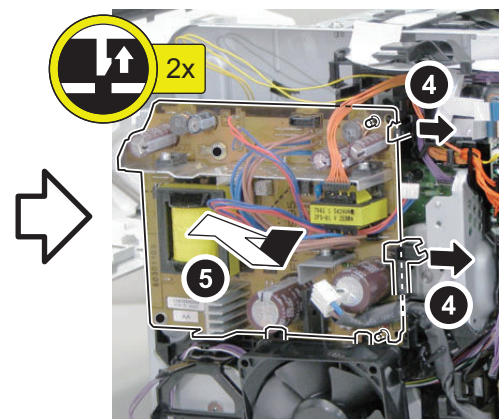
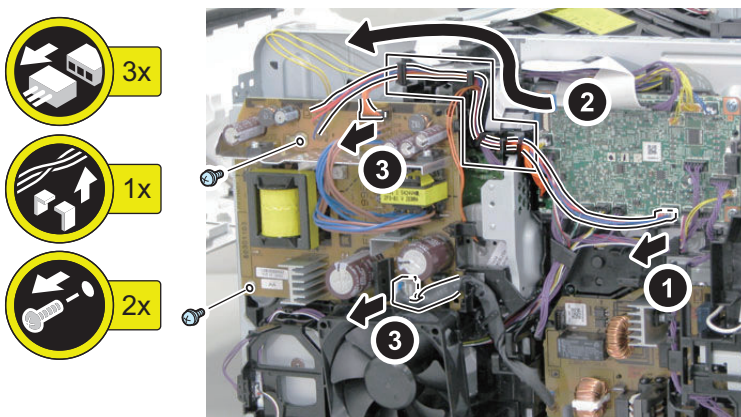

Removing the High Voltage Power Supply PCB

Preparation

1. "Removing the Rear Cover Unit" on page 119
2. "Removing the Cartridge" on page 119
3. "Removing the Left Cover" on page 125

■ Procedure

1. Disconnect the Flat Cable, 4 connectors, and 2 terminals.

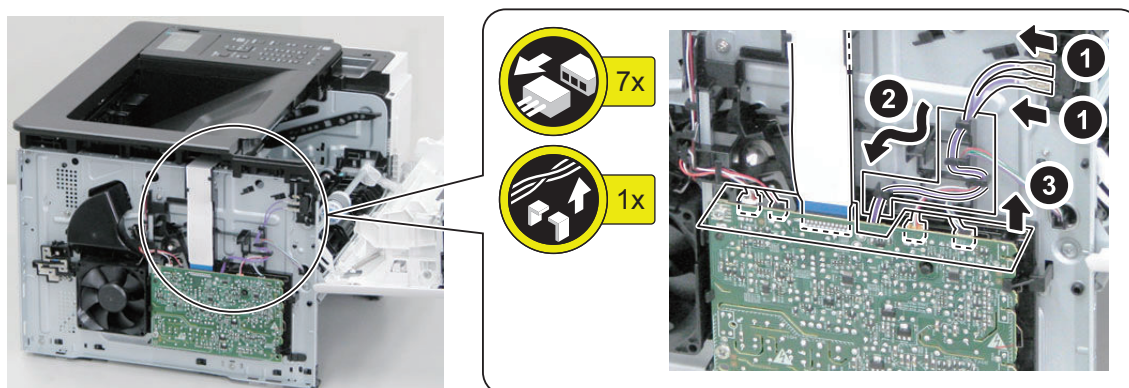

2. Remove the High Voltage Power Supply PCB.

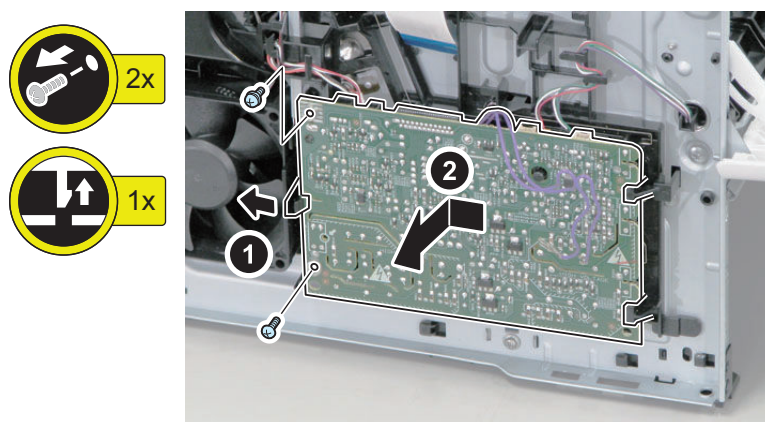

CAUTION:

When installing the PCB, check that the Contact Springs are fitted in the 3 grooves [A] of the High Voltage Power Supply PCB and the Contact Spring is visible through the hole [B].

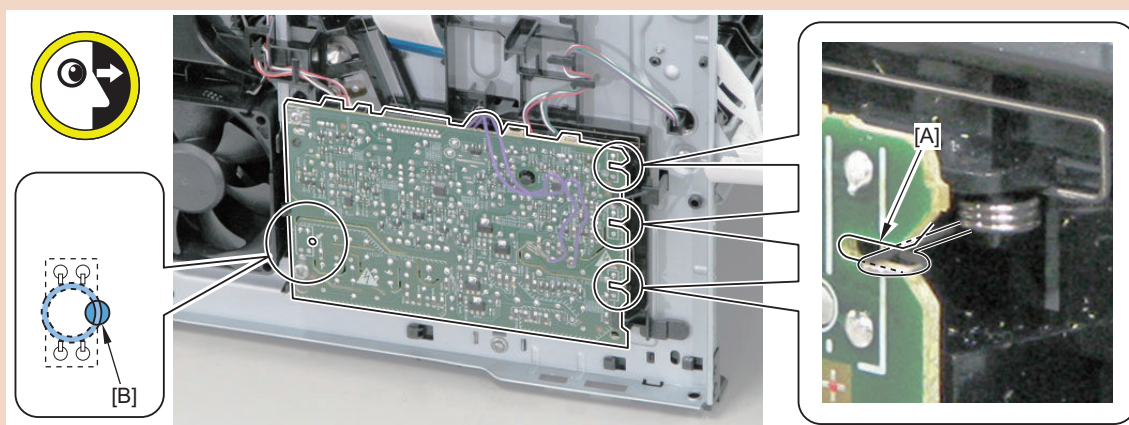

● Removing the Control Panel Unit

■ Preparation

1. "Removing the Rear Cover Unit" on page 119
2. Remove the cassette.
3. "Removing the Cartridge" on page 119

4. "Removing the Right Cover Unit" on page 121

5. "Removing the Controller Cover" on page 132

■ Procedure

1. Free the harness.

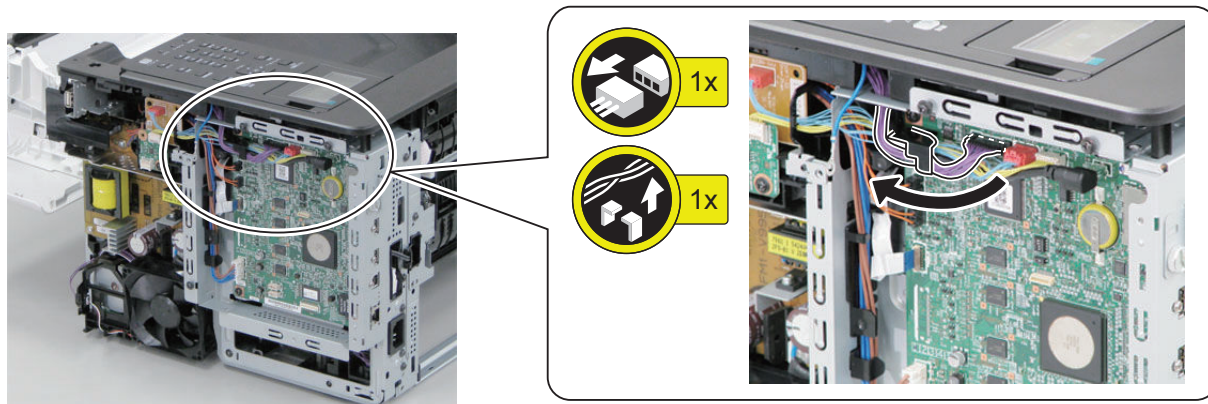

2. Remove the Operation Panel Unit.

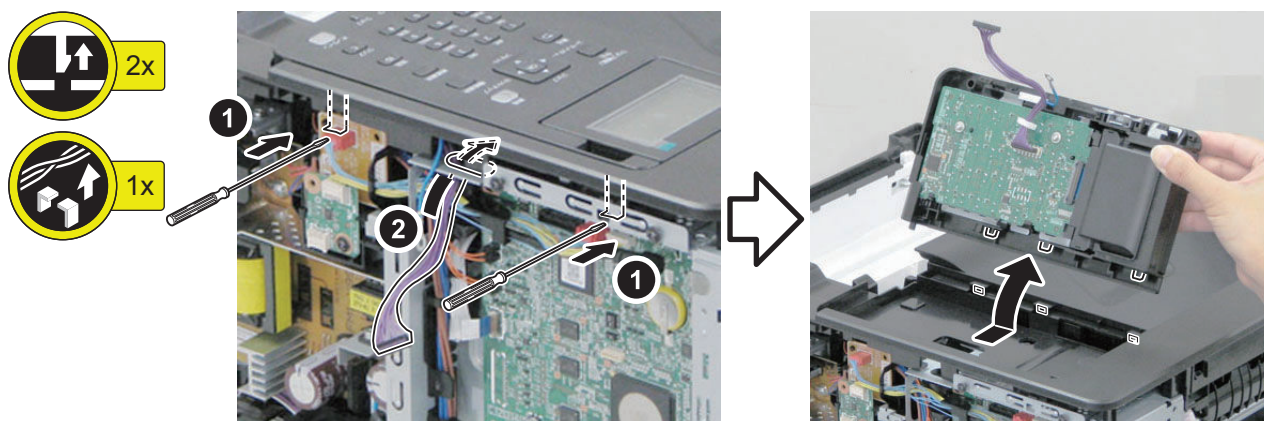

● Removing the Control Panel Unit Key PCB

■ Preparation

1. "Removing the Rear Cover Unit" on page 119

2. Remove the cassette.

3. "Removing the Cartridge" on page 119

4. "Removing the Right Cover Unit" on page 121

5. "Removing the Controller Cover" on page 132

6. "Removing the Control Panel Unit" on page 142

■ Procedure

1. Place the Control Panel Unit on a base of approx. 5 cm in height, and tilt the indicator.

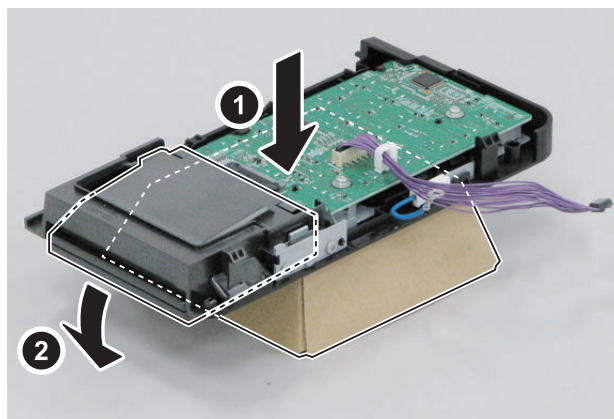

2. Remove the Control Panel Unit Key PCB.

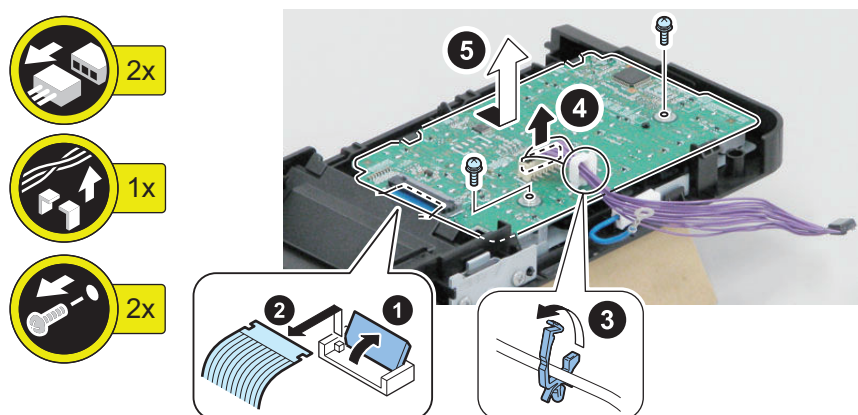

3. Remove the Wire Saddle from the Control Panel Unit Key PCB.

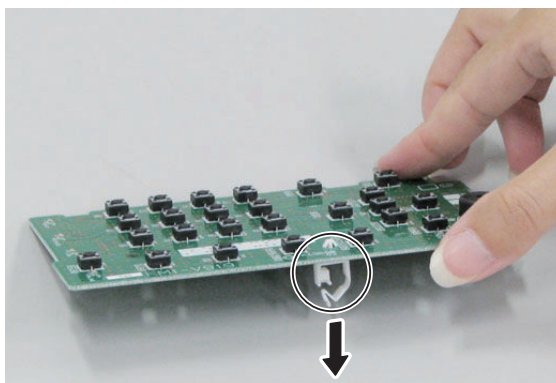

● Removing the Main Fan

■ Preparation

1. "Removing the Rear Cover Unit" on page 119
2. Remove the cassette.
3. "Removing the Cartridge" on page 119
4. "Removing the Right Cover Unit" on page 121
5. "Removing the Left Cover" on page 125

6. "Removing the Controller Cover" on page 132
7. "Removing the Control Panel Unit" on page 142
8. "Removing the Upper Cover Unit" on page 128
9. "Removing the Controller Box" on page 136

■ Procedure

1. Remove the Main Fan Unit.

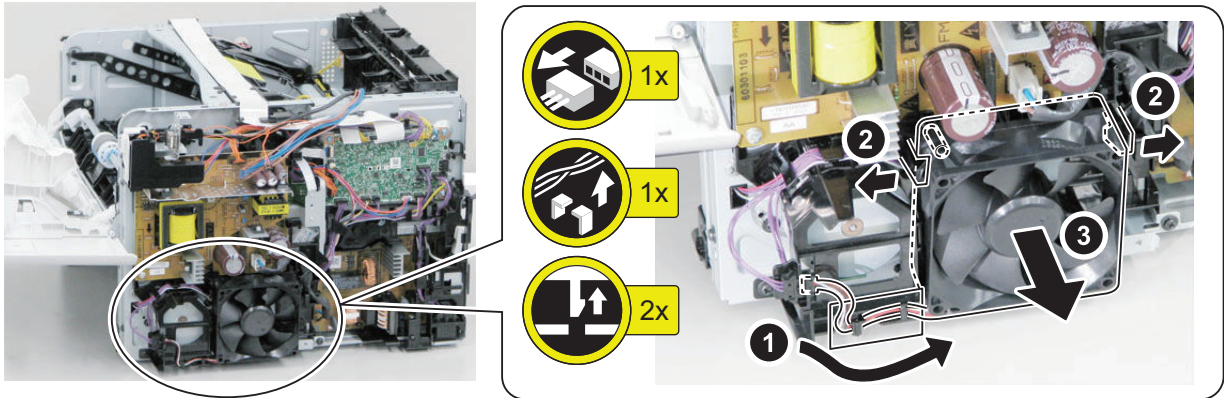

● Removing the Sub Fan

■ Preparation

1. "Removing the Rear Cover Unit" on page 119
2. Remove the cassette.
3. "Removing the Cartridge" on page 119
4. "Removing the Left Cover" on page 125

■ Procedure

1. Remove the Bias Unit.

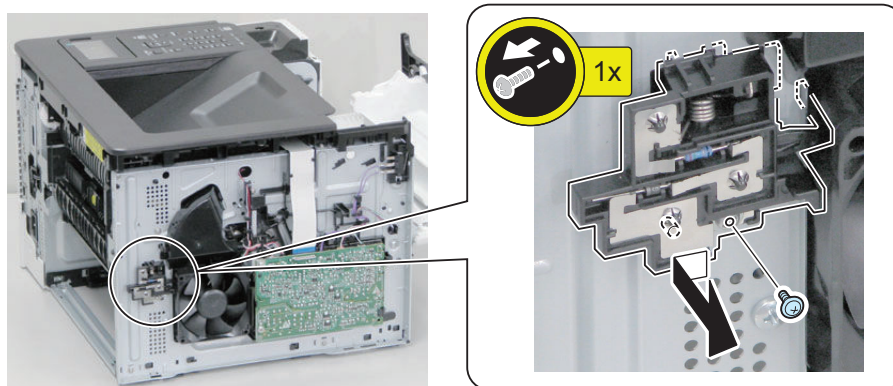

NOTE:

When installing the Bias Unit, be sure to insert the 3 hooks and install the screw while pressing the boss.

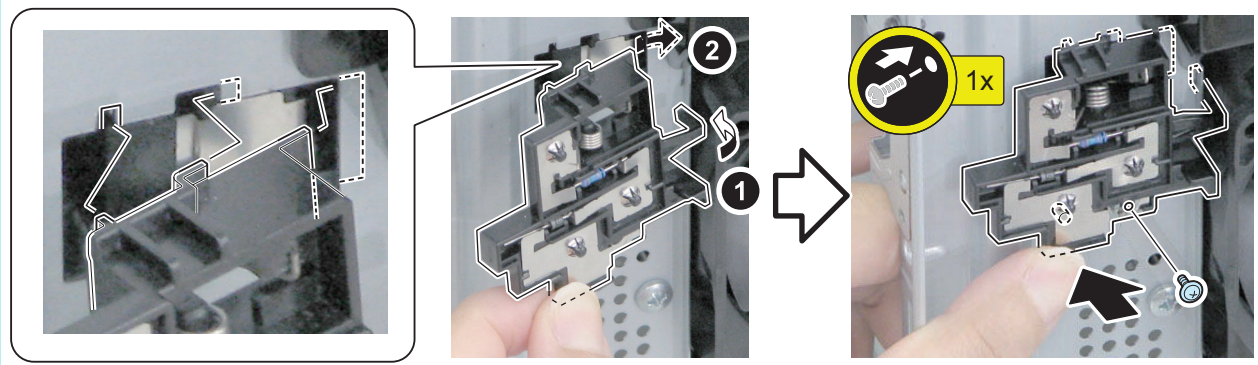
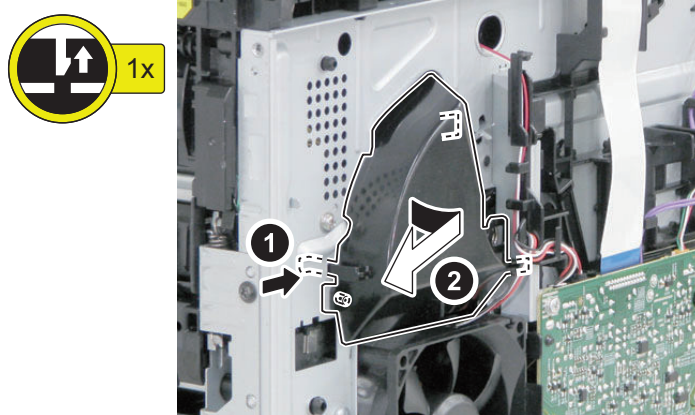
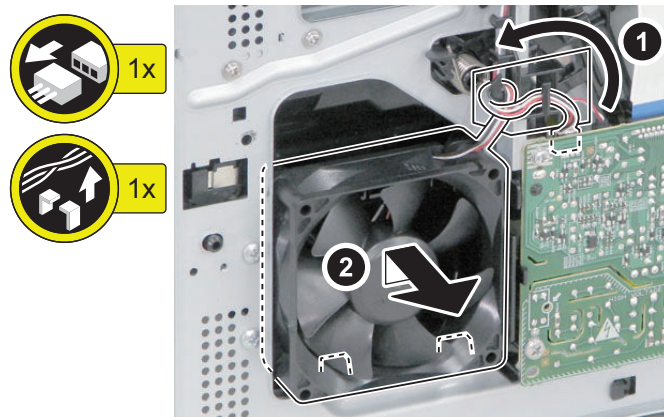
**2. Remove the Duct.****3. Remove the Sub Fan.**

Laser Exposure System

Removing the Laser Scanner Unit

Preparation

1. "Removing the Rear Cover Unit" on page 119
2. Remove the cassette.
3. "Removing the Cartridge" on page 119
4. "Removing the Right Cover Unit" on page 121
5. "Removing the Left Cover" on page 125
6. "Removing the Controller Cover" on page 132
7. "Removing the Control Panel Unit" on page 142
8. "Removing the Upper Cover Unit" on page 128
9. "Removing the Controller Box" on page 136

Procedure

1. Disconnect the Flat Cable.

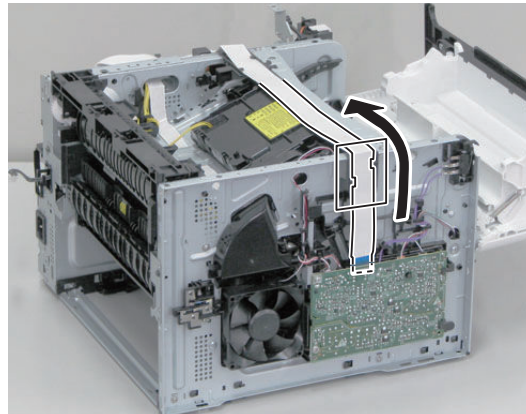

2. Remove the Duct.

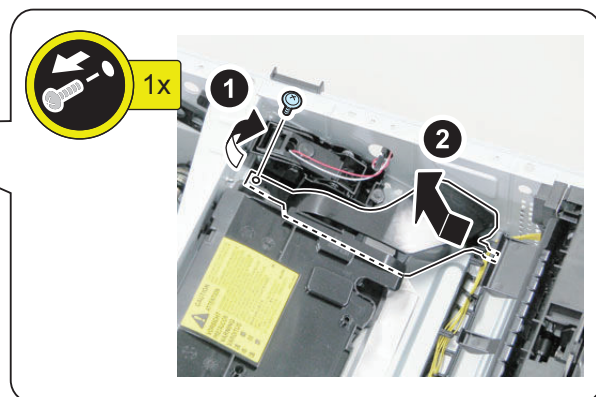
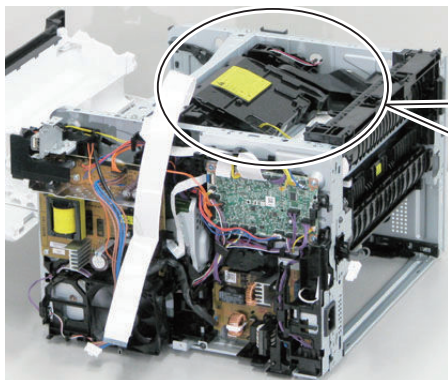

3. Free the harness.

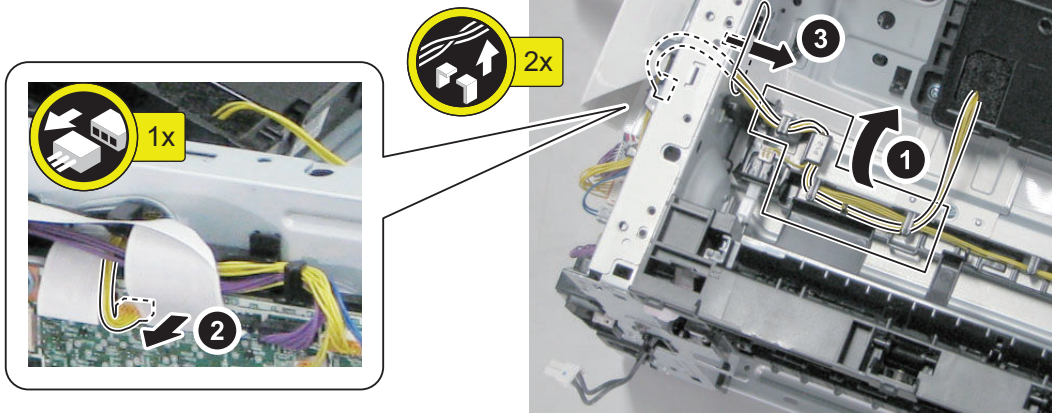

4. Remove the Laser Scanner Unit.

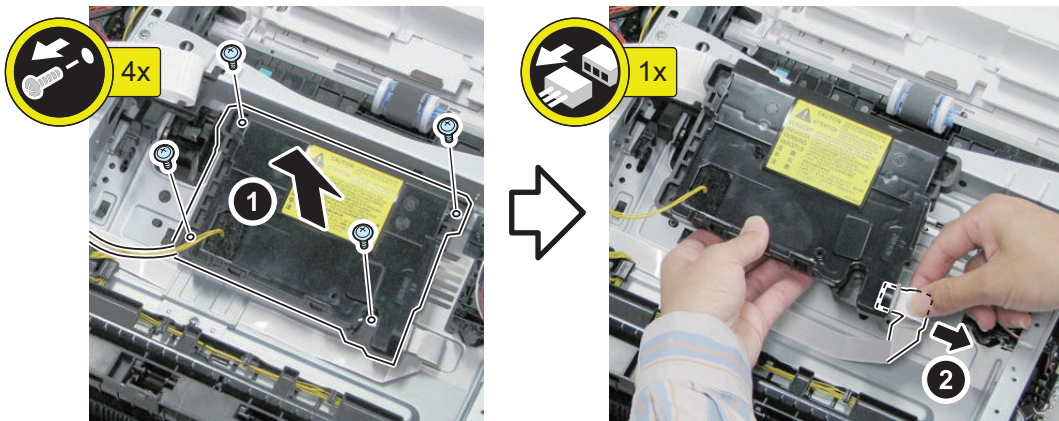

Image Formation System

● Removing the Transfer Roller Unit

■ Preparation

1. "Removing the Cartridge" on page 119

■ Procedure

1. Pull the bushing of the Transfer Roller upward.

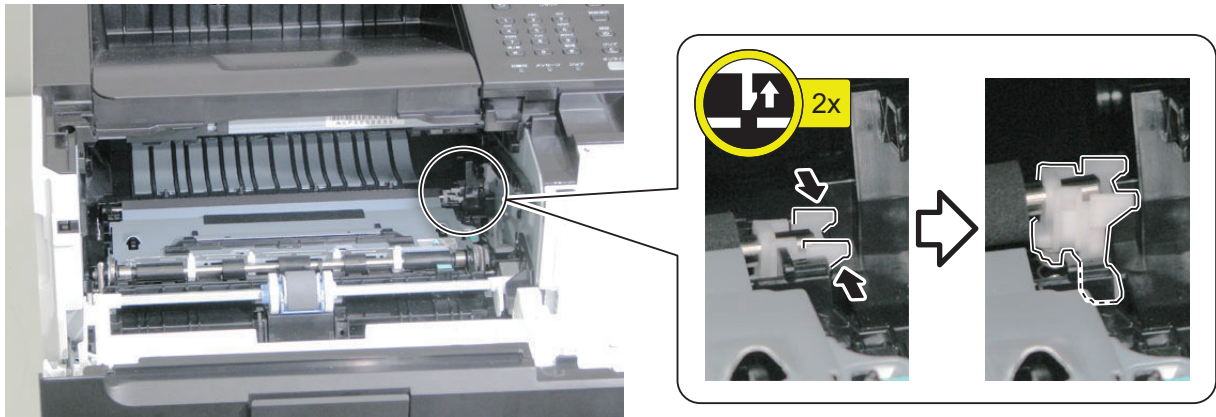

2. Holding the bushing on the right side and the shaft, remove the shaft from the bushing on the left side, and remove the Transfer Roller.

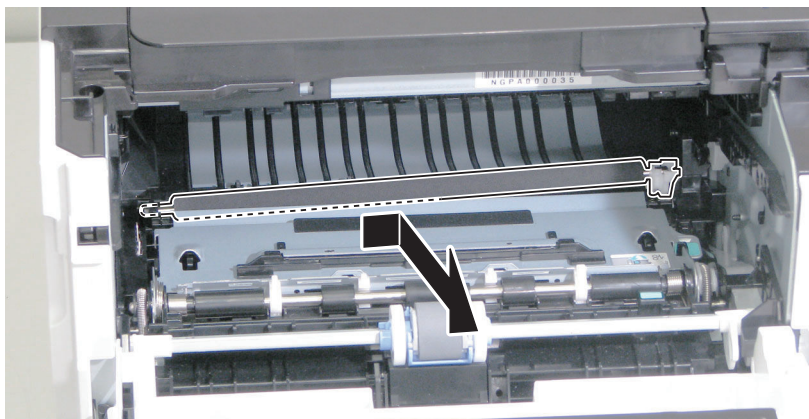
**NOTE:**

Procedure for Installing the Transfer Roller
Be sure to fit the boss of the bushing to the spring.

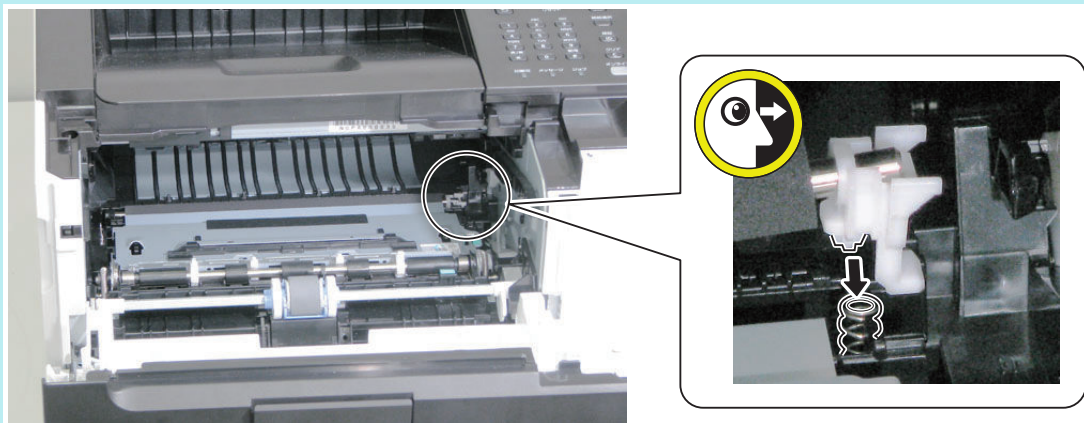

Pickup Feed Delivery System

● Removing the Registration Unit

■ Preparation

1. "Removing the Rear Cover Unit" on page 119
2. Remove the cassette.
3. "Removing the Cartridge" on page 119
4. "Removing the Upper Cover Unit" on page 128

■ Procedure

CAUTION:

Do not touch the Gear Unit of the Registration Unit.

Grease is applied on the Gear Unit. If you have accidentally touched grease, wipe with lint-free paper so as not to smear other parts with your greasy hand.

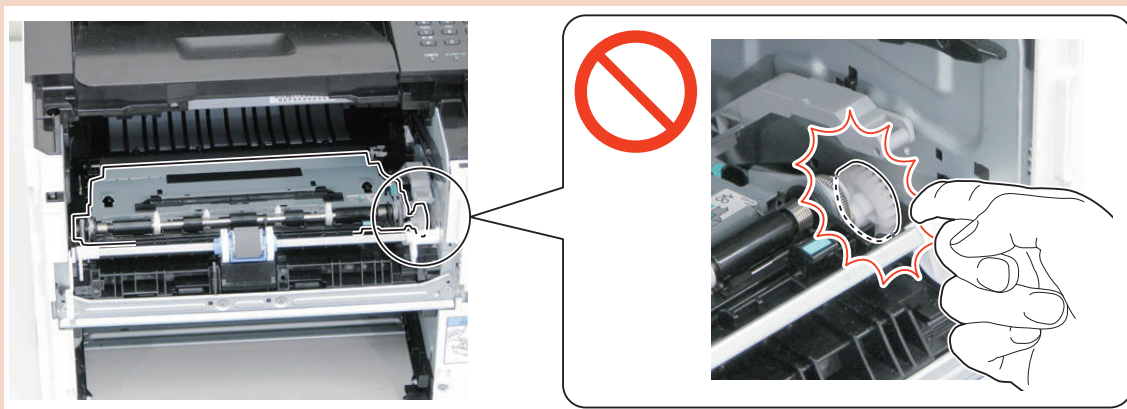

1. Place the host machine with the Right Cover side down.

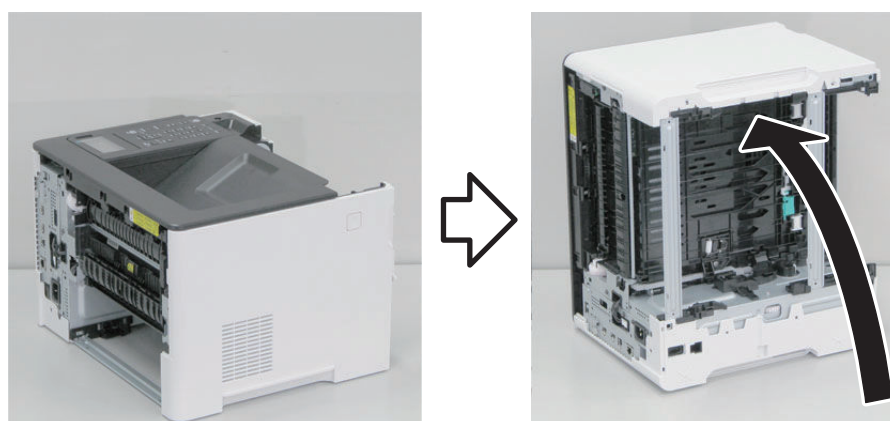

2. Remove the Cross-feed Roller Guide.

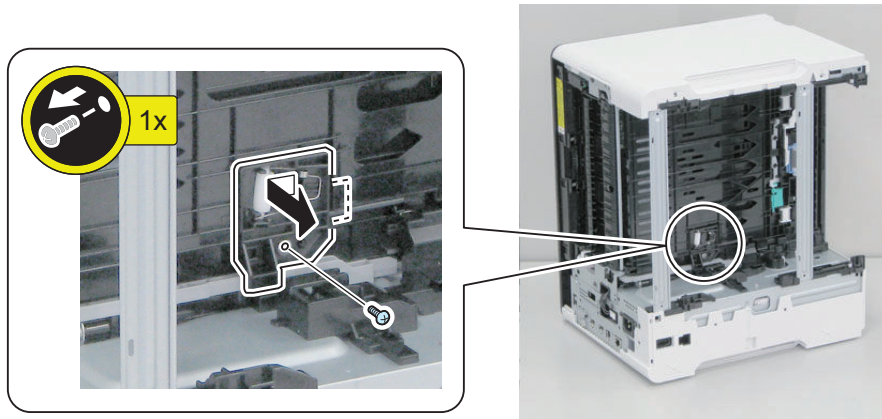

CAUTION:

After removing the Cross-feed Roller Guide, caution is required because the Link Arm becomes free and the link with the Fixing Assembly tends to come off easily.

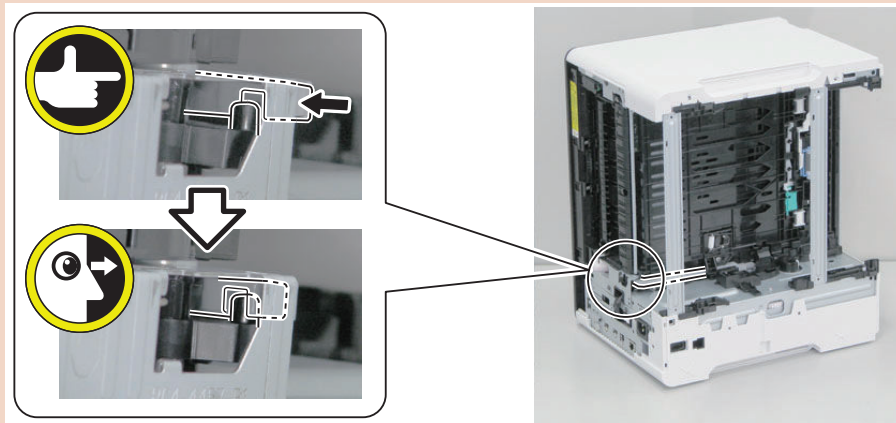

3. Turn the host machine back to the original direction.

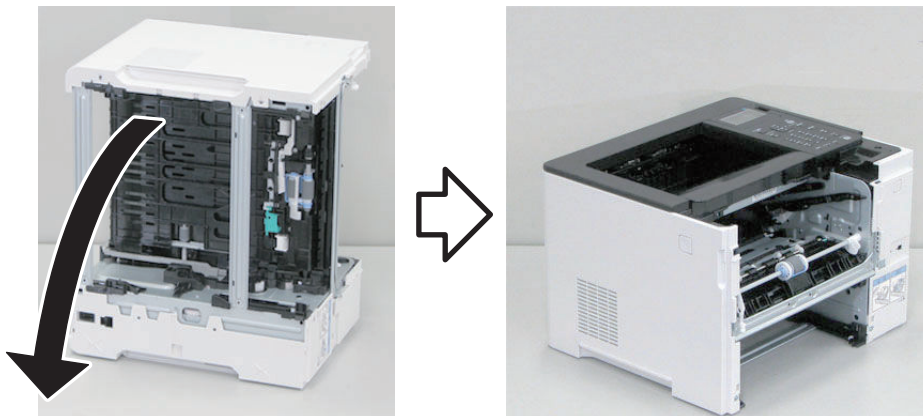

4. Lift the Link Arm.

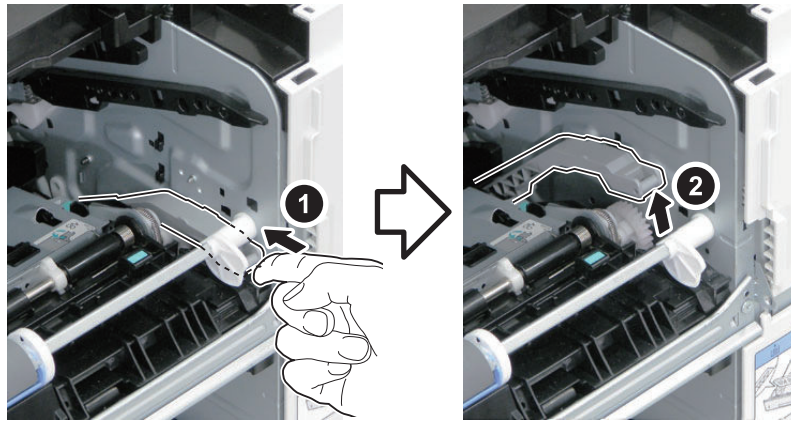

5. Remove the 2 screws.

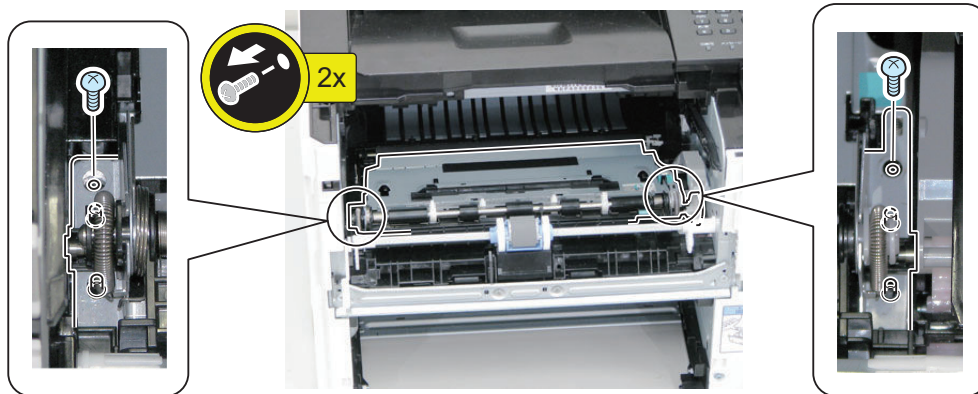

6. Free the bosses on the right and left, and raise the Registration Unit.

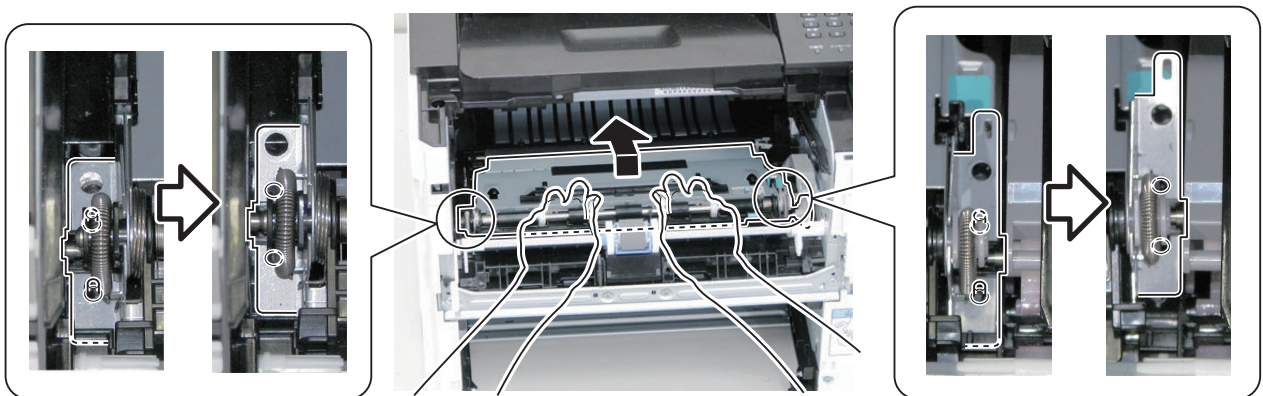

7. Remove the Registration Unit.

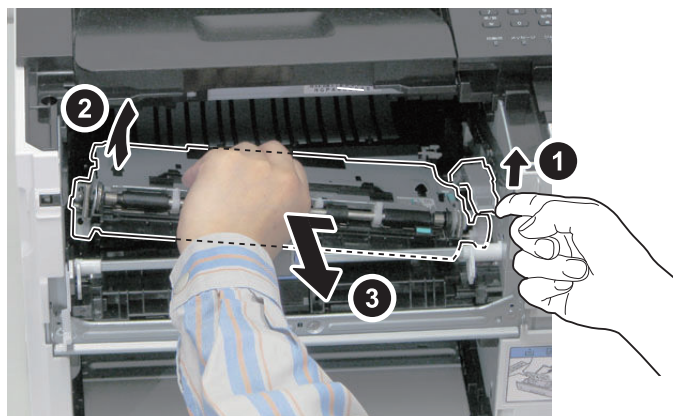

CAUTION:

Points to Note when Installing the Link Arm

Be sure to check that the Link Arm is installed properly, otherwise the Cartridge Cover cannot be closed.

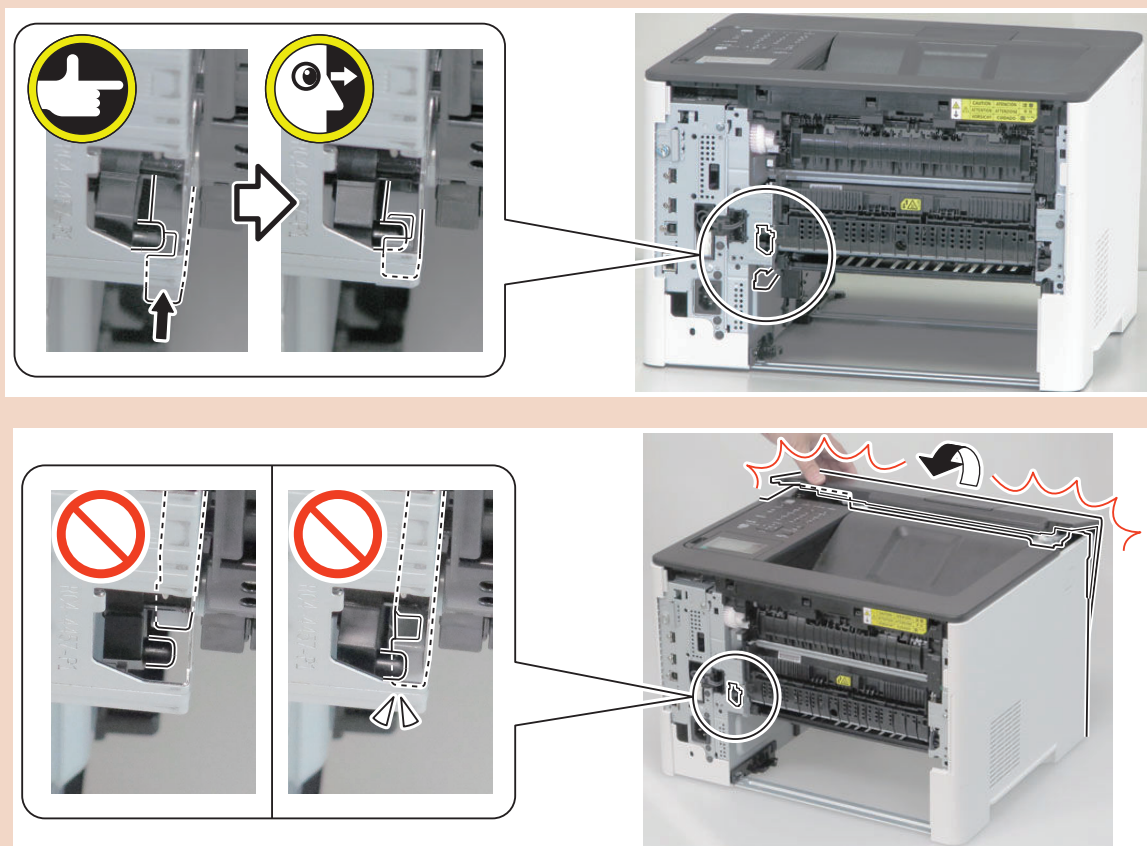

● Removing the Main Drive Unit

■ Preparation

1. "Removing the Rear Cover Unit" on page 119
2. Remove the cassette.
3. "Removing the Cartridge" on page 119
4. "Removing the Right Cover Unit" on page 121
5. "Removing the Left Cover" on page 125
6. "Removing the Left Cover" on page 125
7. "Removing the Control Panel Unit" on page 142
8. "Removing the Upper Cover Unit" on page 128
9. "Removing the Controller Box" on page 136
10. "Removing the Cartridge Cover" on page 129
11. "Removing the DC Controller PCB" on page 138
12. "Removing the Fixing Power Supply PCB" on page 138
13. "Removing the Low Voltage Power Supply Unit" on page 141
14. "Removing the Main Fan" on page 144

■ Procedure

1. Free the harness from the guides [A] and [B], and remove the guide [B].

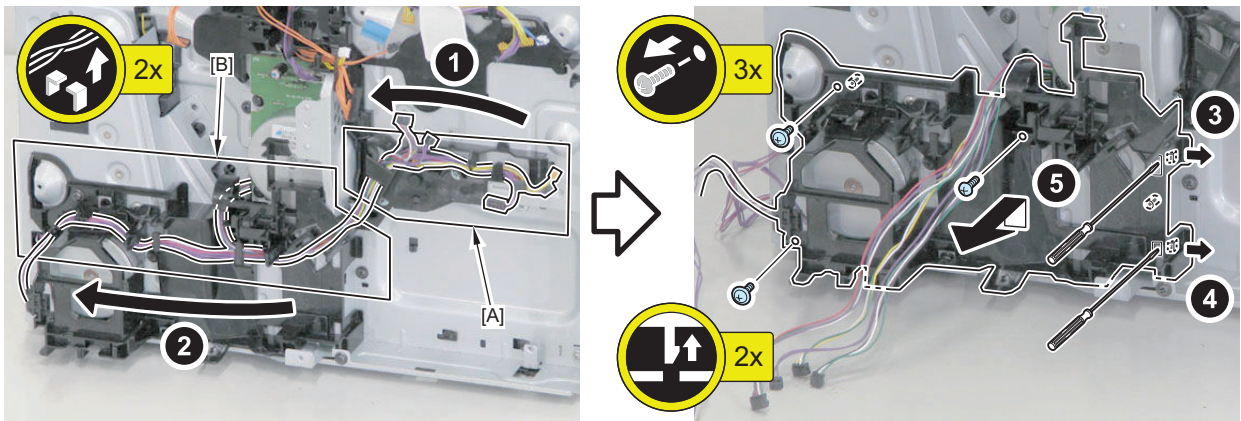

NOTE:

When inserting the 2 claws, be sure to press the boss until you hear a click sound.

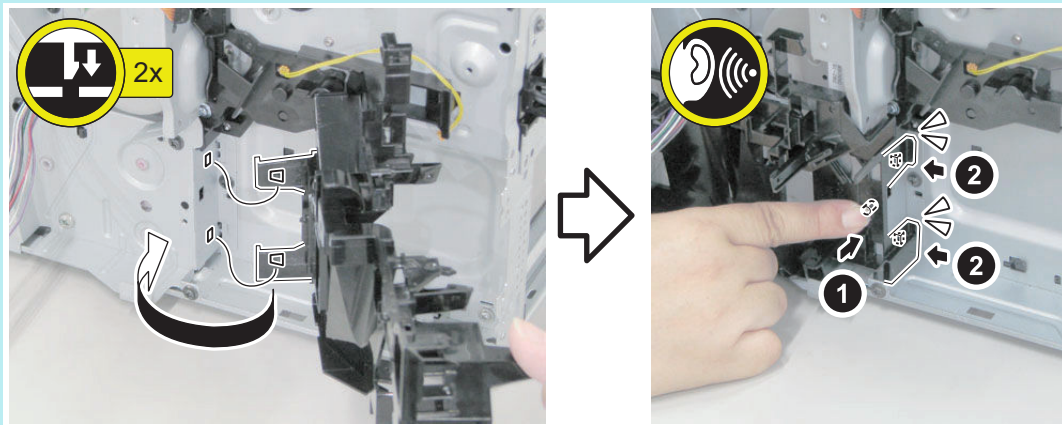

2. Slide the guide to the left, and lift it.

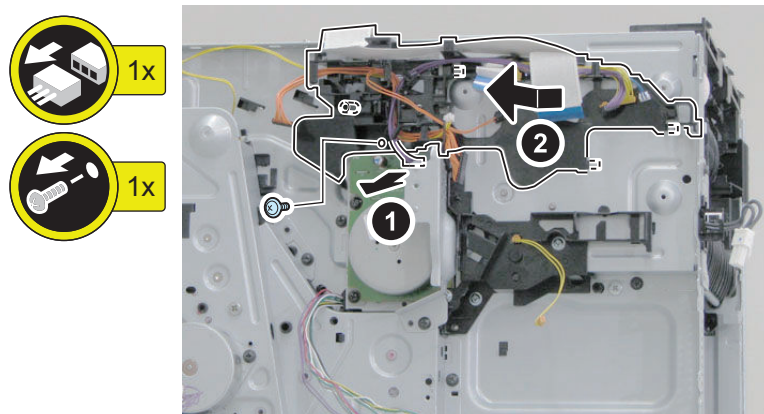

3. Remove the plate.

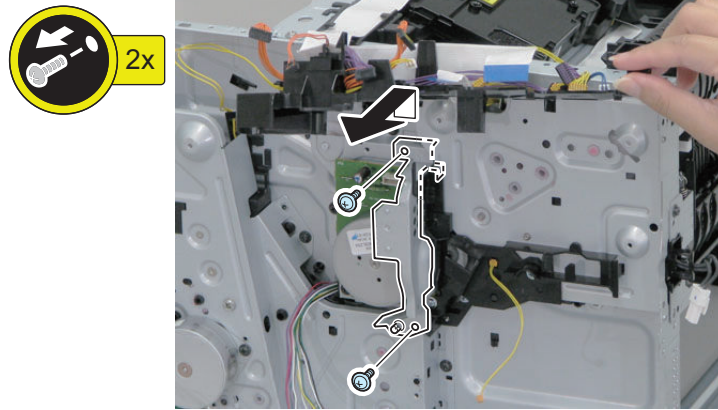

4. Remove the harness from the hole on the guide, and remove the guide.

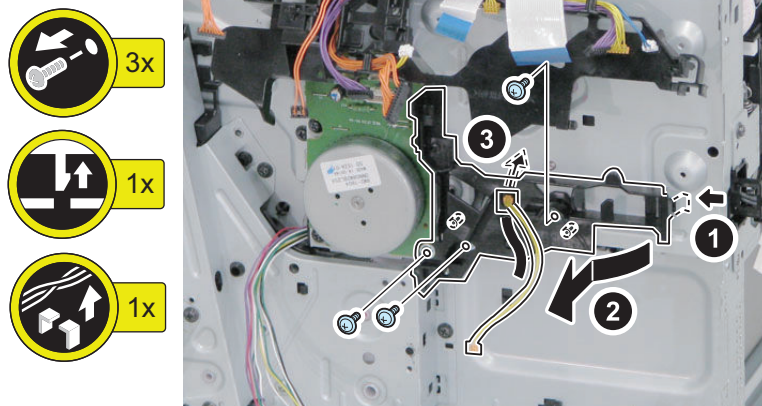

CAUTION:

Caution is required because the 3 gears tend to drop easily.

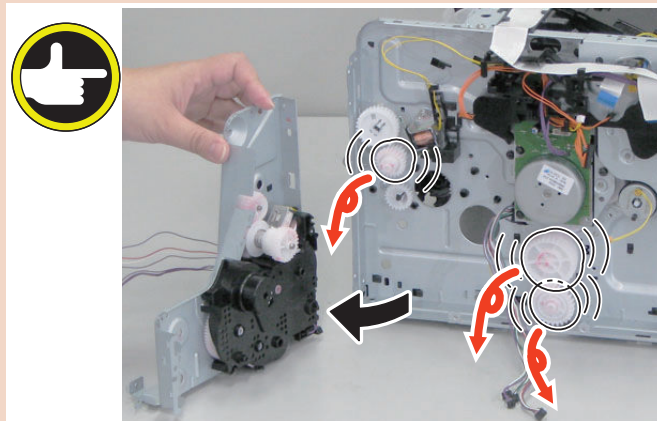

5. Remove the Main Drive Unit.

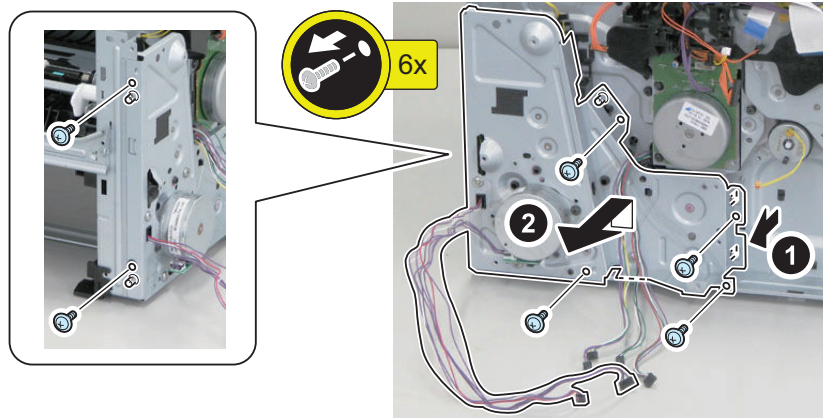

CAUTION:

Points to Note at Assembly

When installing the Main Drive Unit, be sure that the shafts of the 3 gears are fitted in the holes [A] on the Main Drive Unit.

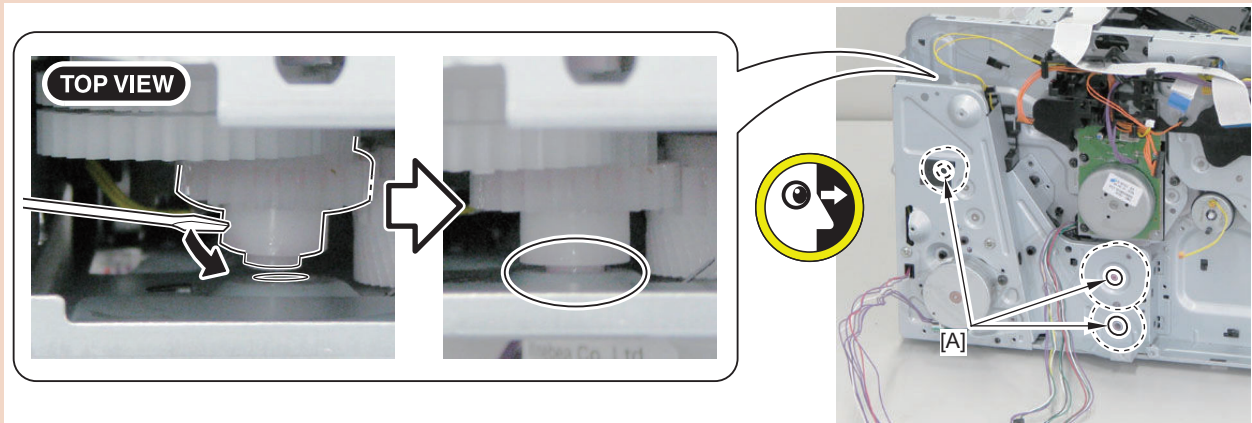

● Removing the Cassette Pickup Unit

■ Preparation

1. Remove the cassette.

■ Procedure

CAUTION:

Do not touch the surface of the 2 rollers of the Cassette Pickup Unit.

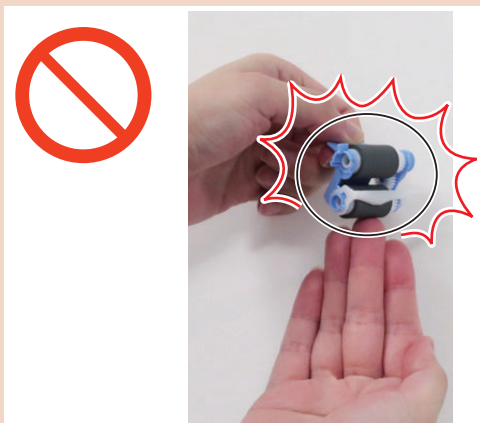

1. While pressing the lever, push the Cassette Pickup Unit to the left until it stops, and remove the Cassette Pickup Unit from the shaft on the left side.

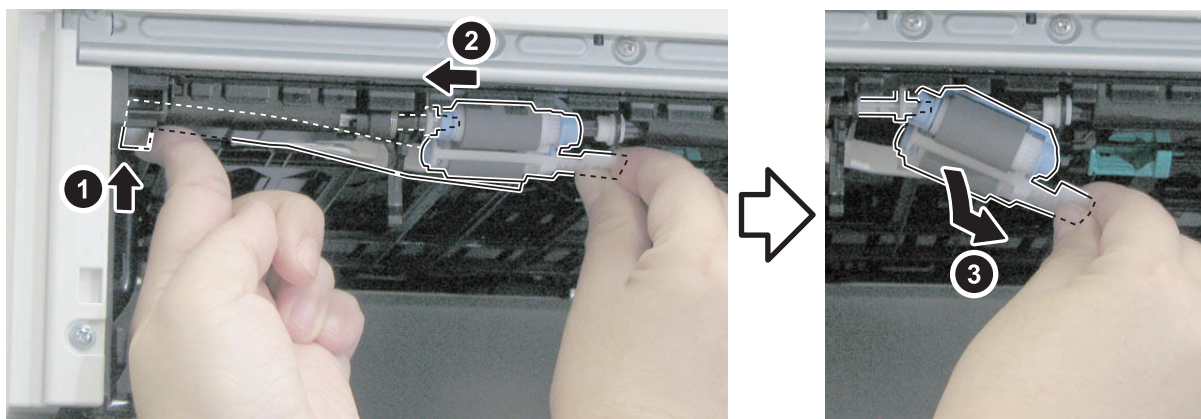

NOTE:

Procedure for Installing the Cassette Pickup Unit

1. While pressing the lever, fit the boss into the groove on the lever.

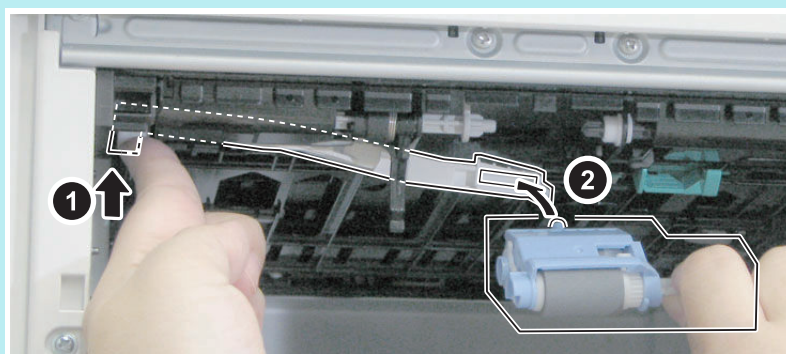

2. Fit the hole of the Cassette Pickup Unit onto the shaft on the left side, and push it until it stops.

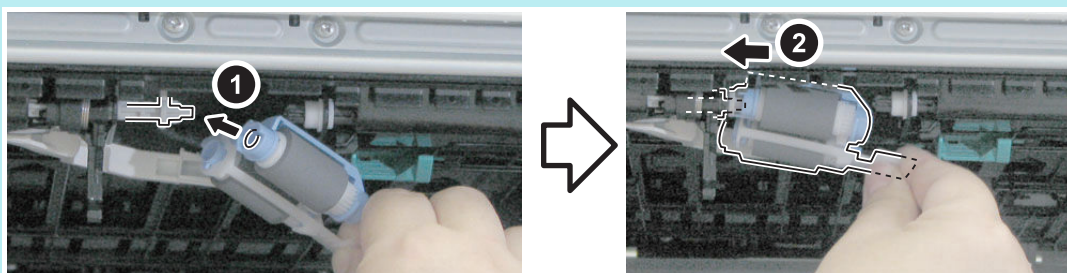

3. Fit the hole of the Cassette Pickup Unit onto the shaft on the right side to install the Cassette Pickup Roller Unit.

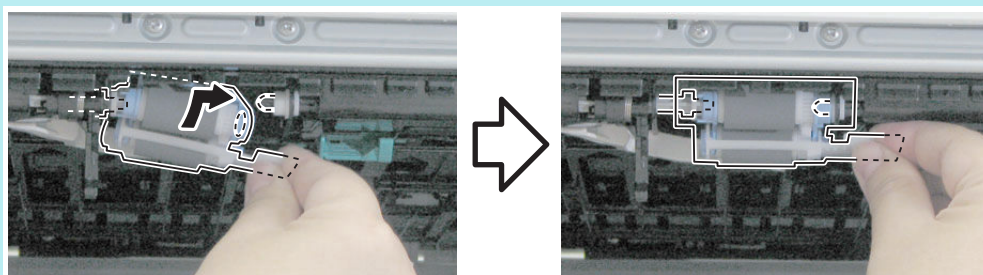
**CAUTION:**

After installation, push the lever to check that it is interlocked with the Cassette Pickup Unit. If not, remove and install the Cassette Pickup Unit again.

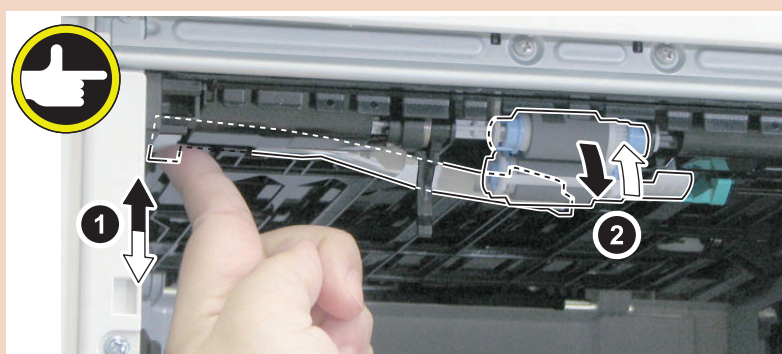

● Removing the Cassette Separation Roller Unit

■ Preparation

1. Remove the cassette.

■ Procedure

CAUTION:

Do not touch the surface of the Cassette Separation Roller.

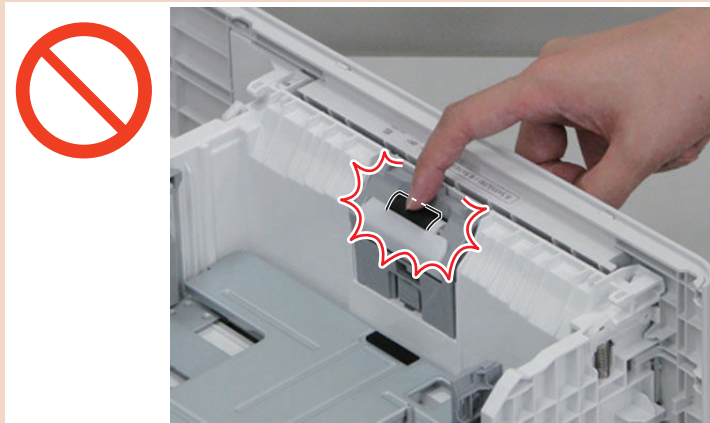

1. Remove the Cassette Separation Roller Unit.

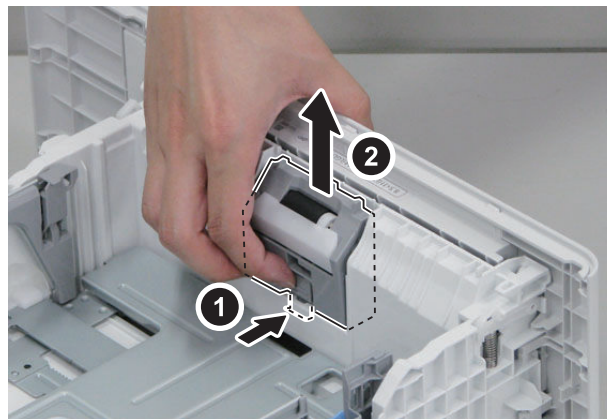

● Removing the Multi-purpose Tray Pickup Roller

■ Preparation

1. "Removing the Cartridge" on page 119

■ Procedure

CAUTION:

Be sure not to touch the surface of the Multi-purpose Tray Pickup Roller.

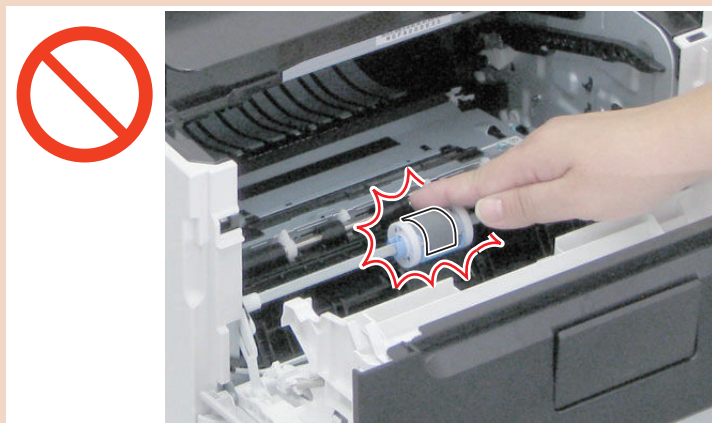

1. Remove the Multi-purpose Tray Pickup Roller.

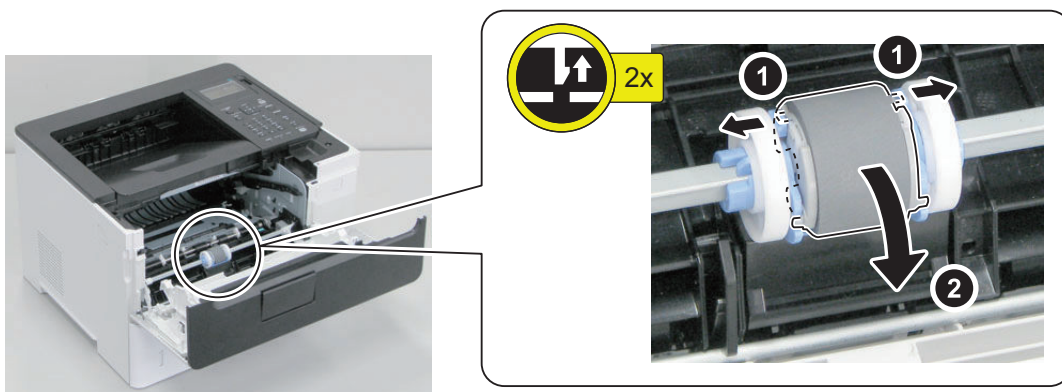

● Removing the Multi-purpose Tray Separation Pad

■ Preparation

1. "Removing the Cartridge" on page 119
2. "Removing the Multi-purpose Tray Pickup Roller" on page 160

■ Procedure

CAUTION:

Be sure not to touch the surface of the Multi-purpose Tray Separation Pad.

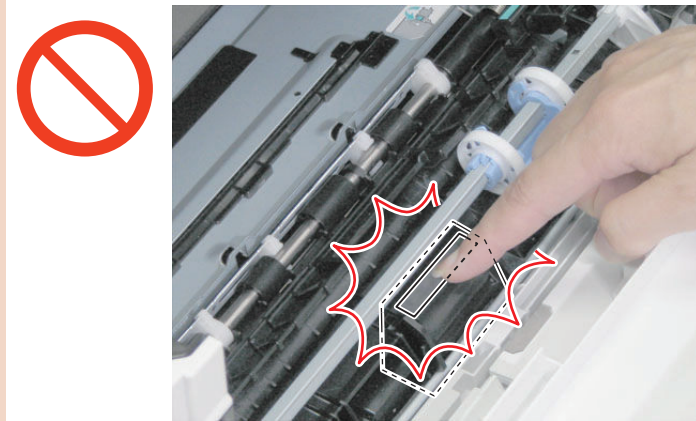

1. Lift up the Jam Removal Lever.

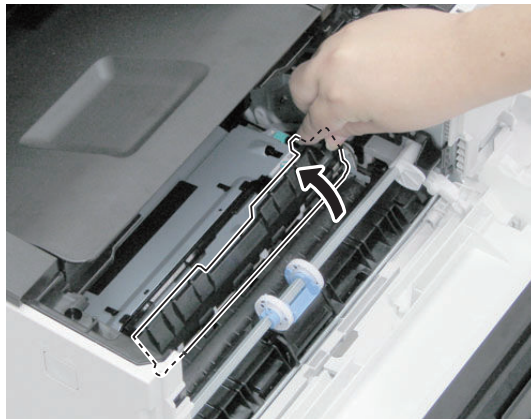

2. While holding the Separation Pad, slide the Multi-purpose Tray Roller Holder to the right.

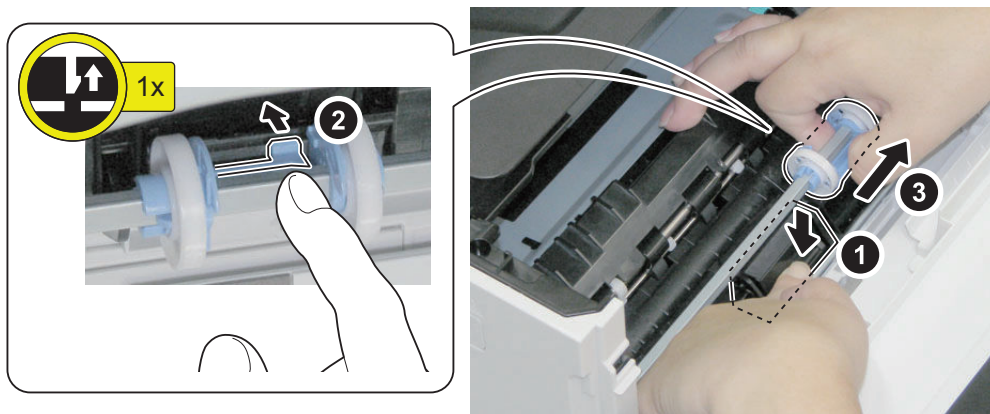

3. Remove the Multi-purpose Tray Separation Pad.

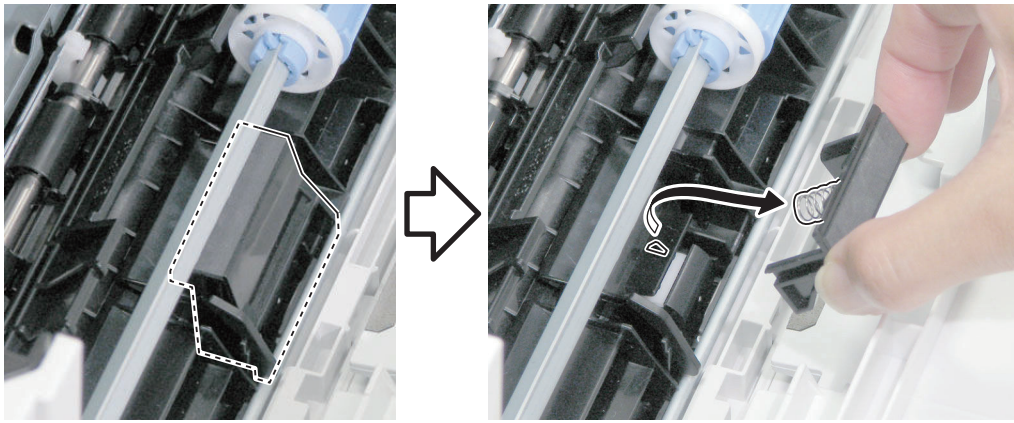

CAUTION:

Points to Note at Installation

- When installing it, be sure that the grooves on the left and right and the spring are fitted correctly.



- Be sure to slide the Multi-purpose Tray Roller Holder until it clicks.

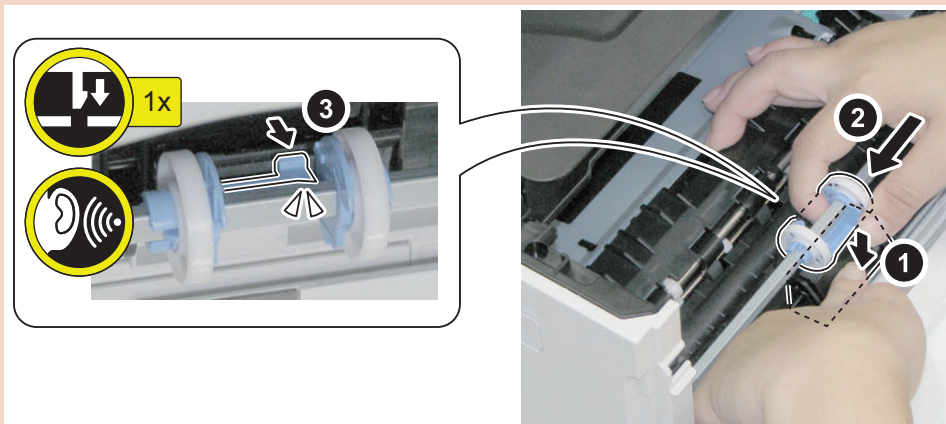

Fixing System

● Removing the Fixing Assembly

■ Preparation

1. “Removing the Rear Cover Unit” on page 119
2. Remove the cassette.
3. “Removing the Cartridge” on page 119

■ Procedure

CAUTION:

- Since the Fixing Assembly is hot immediately after the power is turned OFF, give it time to cool down before removing it.
- After removing the cartridge, be sure to close the Cartridge Cover.

1. Remove the Connector Cover, and disconnect the 2 connectors and the connector.

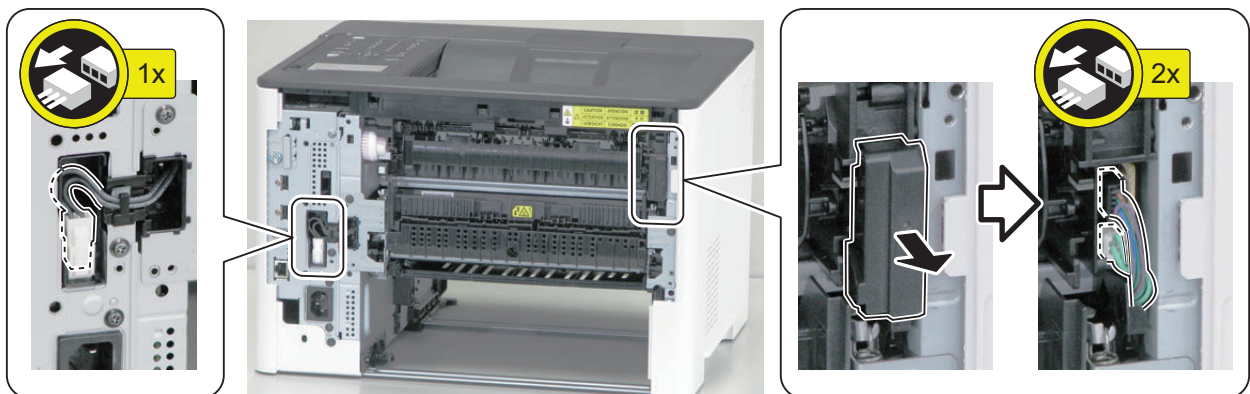

2. Free the Link Arm from the boss of the Fixing Assembly, and remove the Fixing Assembly.

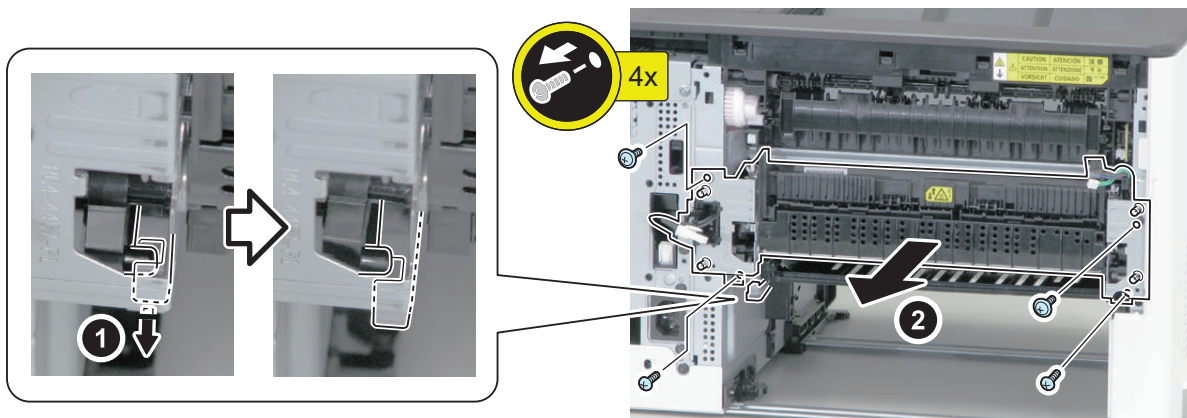

CAUTION:

Points to Note when Installing the Link Arm

Be sure to check that the Link Arm is installed properly, otherwise the Cartridge Cover cannot be closed.

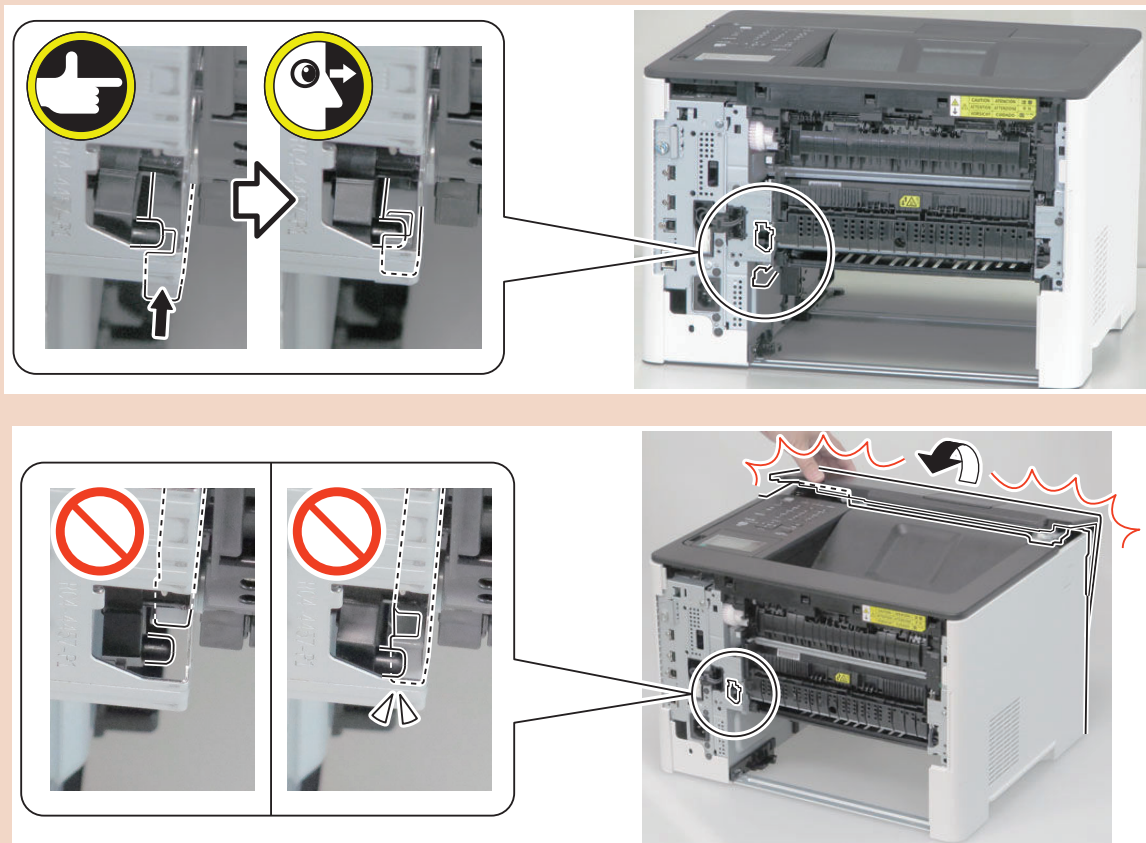

● Removing the Fixing Motor

■ Preparation

1. "Removing the Rear Cover Unit" on page 119
2. Remove the cassette.
3. "Removing the Cartridge" on page 119
4. "Removing the Right Cover Unit" on page 121
5. "Removing the Left Cover" on page 125

6. "Removing the Left Cover" on page 125
7. "Removing the Control Panel Unit" on page 142
8. "Removing the Upper Cover Unit" on page 128
9. "Removing the Controller Box" on page 136
10. "Removing the Cartridge Cover" on page 129
11. "Removing the DC Controller PCB" on page 138
12. "Removing the Fixing Power Supply PCB" on page 138
13. "Removing the Low Voltage Power Supply Unit" on page 141
14. "Removing the Main Fan" on page 144

■ Procedure

1. Free the harness from the guides [A] and [B], and remove the guide [B].

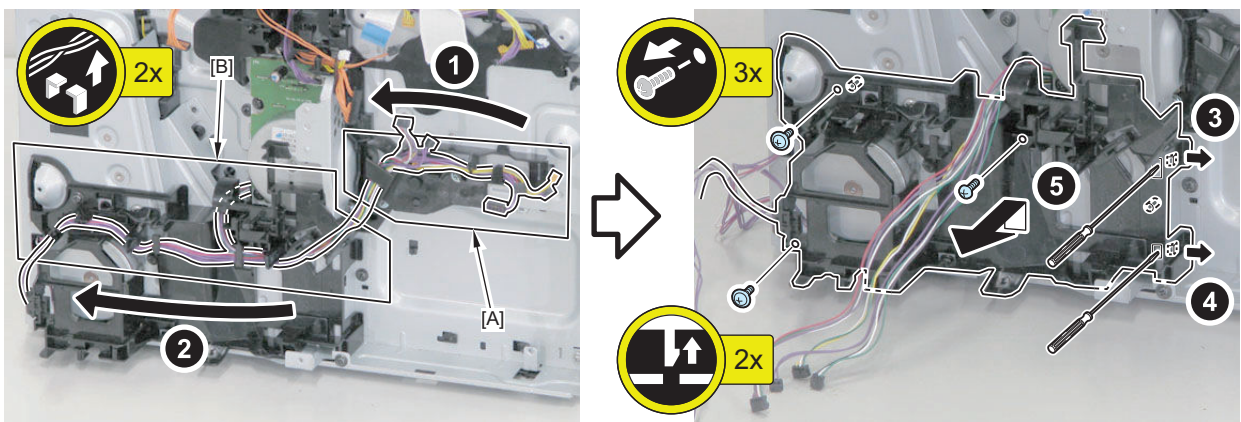

NOTE:

When inserting the 2 claws, be sure to press the boss until you hear a click sound.

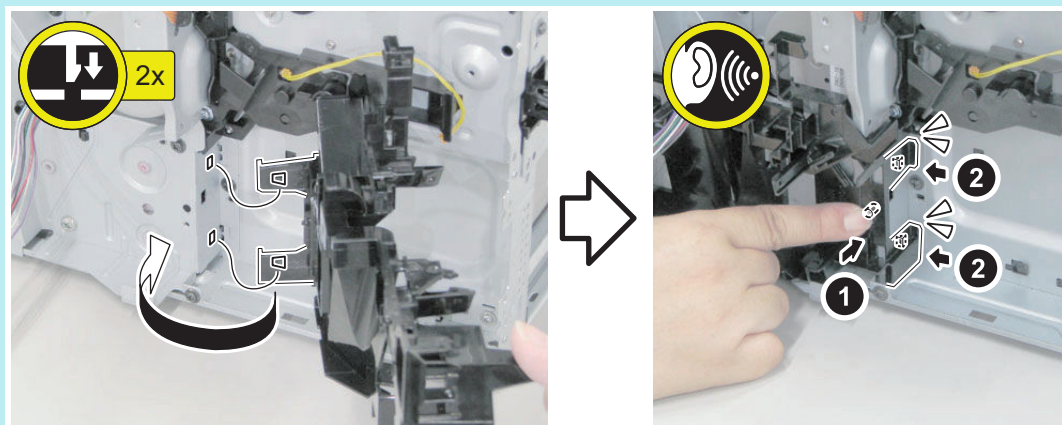

2. Slide the guide to the left, and lift it.

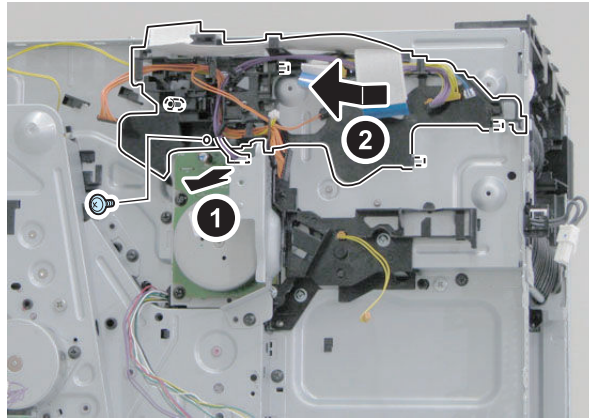

3. Remove the plate.

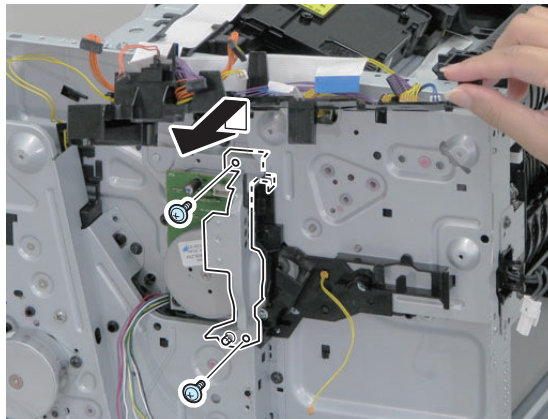

4. Remove the harness from the hole on the guide, and remove the guide.

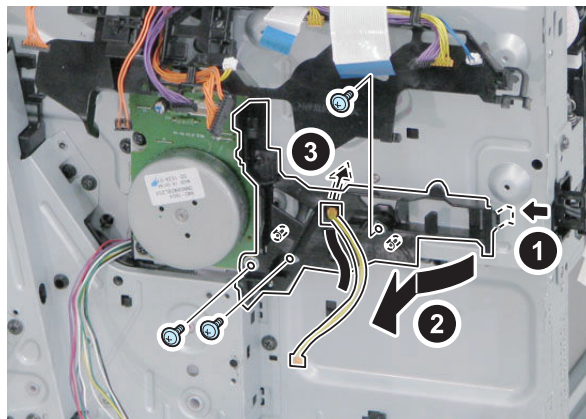
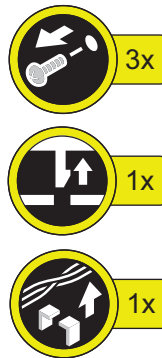

5. Remove the Fixing Motor.

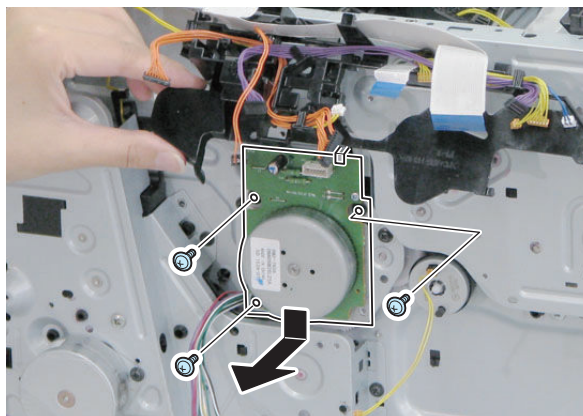

CAUTION:

Points to Note at Installation

When installing the Fixing Motor, be sure to tighten the screws in the order shown below.

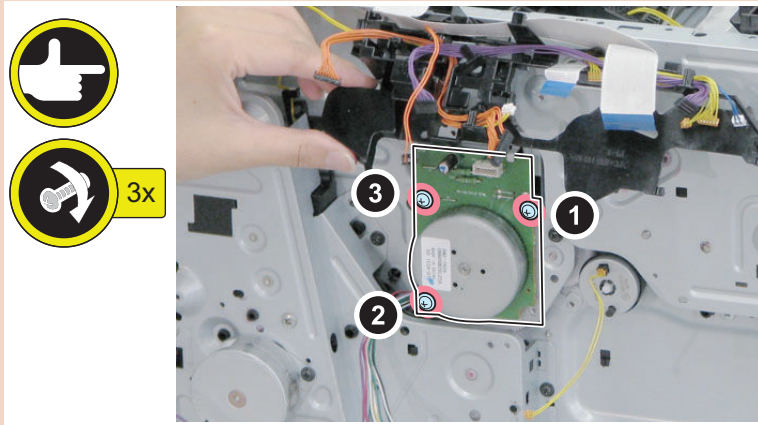



Adjustment

Actions after Replacement..... 170

Actions after Replacement

Before Replacing the Main Controller PCB

The following setting values are recorded in the Main Controller PCB. When the Main Controller PCB is replaced, these setting values are all returned to the default unless they are restored.

- User mode setting values
- Service mode setting values

These setting values can be restored by performing backup by either of the following methods:

Refer to the Backup List for the details of items that are backed up. [“Backup Data” on page 213](#)

- Backup/restoration using the Expansion ROM for servicing and the Sublog Board (Recommended) [“Backup/restoration using the Expansion ROM for servicing and the Sublog Board” on page 84](#)
- SERVICE MODE > FUNCTION GR. > ECONF > EXPORT
- SERVICE MODE > FUNCTION GR. > Import/Export Set. > EXPORT
- Setup > User Maintenance > Import/Export Set. > EXPORT
- RUI > Settings/Registration > Management Settings > Import/Export > Export

CAUTION:

Perform backup immediately before replacing the Main Controller PCB.

After Replacing the Main Controller PCB

Restore the data in the same way as that of backup.

Refer to the Backup List for the details of items that are restored. [“Backup Data” on page 213](#)

- Backup/restoration using the Expansion ROM for servicing and the Sublog Board (Recommended) [“Backup/restoration using the Expansion ROM for servicing and the Sublog Board” on page 84](#)
- SERVICE MODE > FUNCTION GR. > ECONF > IMPORT
- SERVICE MODE > FUNCTION GR. > Import/Export Set. > IMPORT
- Setup > User Maintenance > Import/Export Set. > IMPORT
- RUI > Settings/Registration > Management Settings > Import/Export > Import

Update firmware as necessary.

CAUTION:

Be sure to restore the data after replacing the Main Controller PCB.



Troubleshooting

Test Print.....	172
Troubleshooting.....	179
Obtaining Debug Log.....	181

Test Print

Overview

Printing test pages helps determine if the printer is functioning.

CAUTION:

There are two types of test pages: engine-test page and Main Controller-test page. Print a test page to make sure the printer engine and the Main Controller are functioning.

■ Engine Test Print

Press the button inside the Rear Cover to print the test pattern on one side of a sheet of paper. Hold down the button to start continuous test print, and release the button to end it.

The image of the engine test print (Test Print C) is recorded in the DC Controller. Because of this, it can be output even if the Main Controller is faulty.

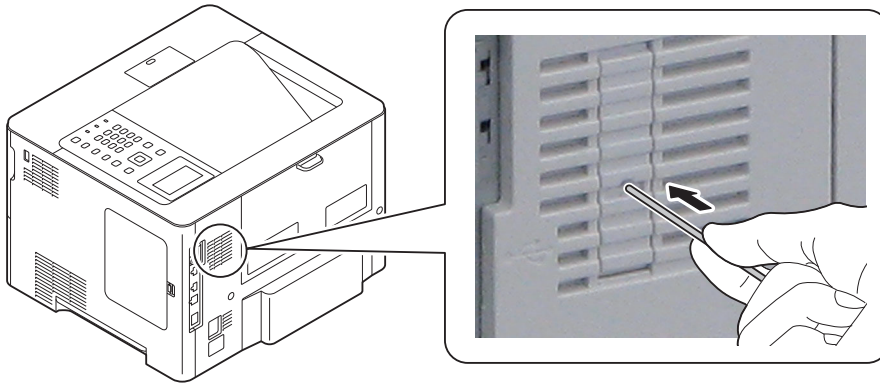

Test Print C Pattern

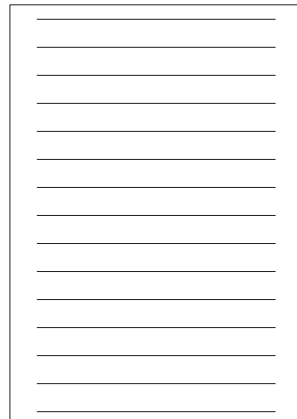



■ Controller Test Print

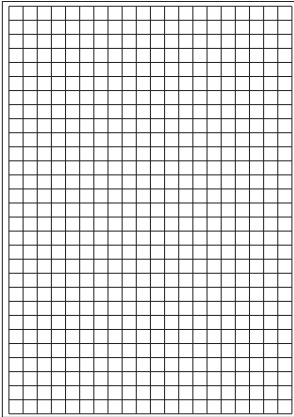
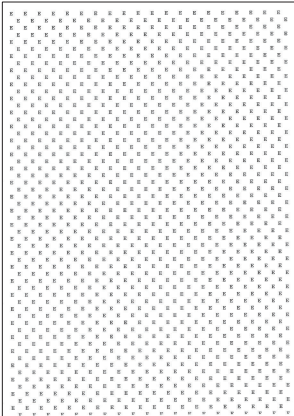
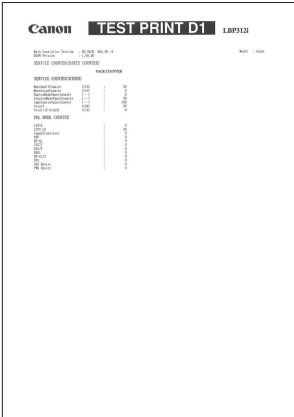
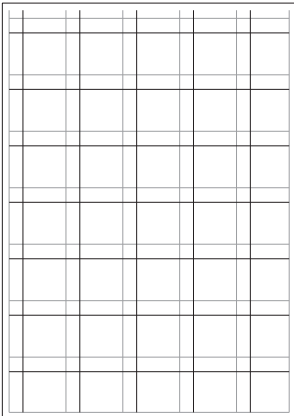

Data of the controller test print is created inside the Main Controller. When no image failure is found in the test print in normal output mode, it is assumed that the failure is caused by the PDL input.

NOTE:

Method to display the test print: It appears in the menu by pressing [Job Status/Cancel] key and [Utility] key simultaneously.

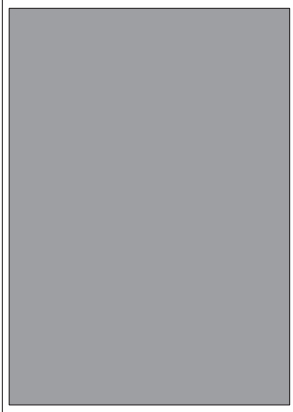
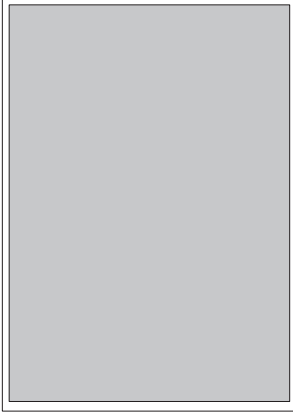
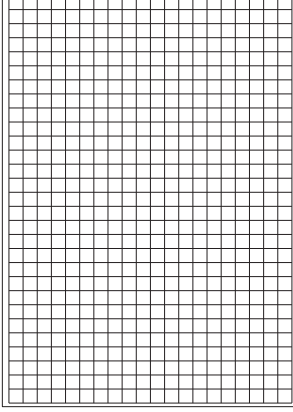
Test Print	Pattern	Purpose of use	Image
B	Grid*1	To check the right angle accuracy and straight line accuracy.	
D	Print letters "E" all over the page*1	To check for any distorted letters	
D1	--	To check the counter values and information on devices for service. <ul style="list-style-type: none"> • Firmware version • Service counter • PDL mode counter 	
E	Grid (Half-tone)*1	To check the right angle accuracy and straight line accuracy.	

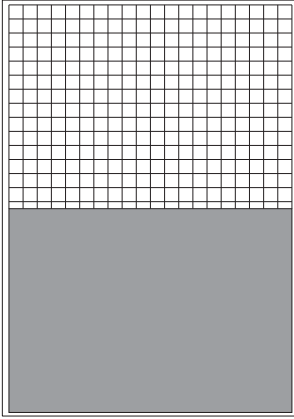
Test Print	Pattern	Purpose of use	Image
I	Solid black	To check transfer failure, white line, scratches and margin.	
J	Halftone (dark)	To check the symptom of various image failures such as transfer failure, lines, uneven density, scratches and margin.	
K	Halftone (light)	To check the symptom of various image failures such as transfer failure, lines, uneven density, scratches and margin.	
L	Grid	To check the right angle accuracy and straight line accuracy.	

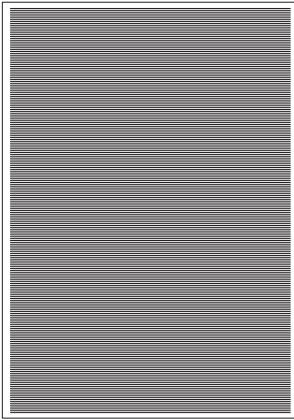
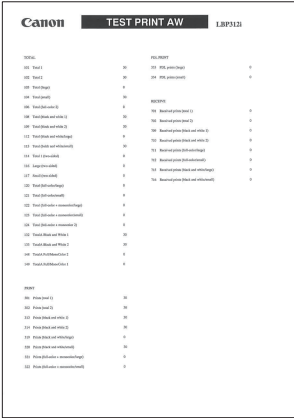
Test Print	Pattern	Purpose of use	Image
X	Halftone / Grid	To check the transfer failure, lines, right angle accuracy and straight line accuracy.	
Z	Blank (not-printed)	To check fogging	
AS	Image failure diagnosis chart	For checking smeared image	
AW	Software counter list	For checking the supported software counter	

Test Print	Pattern	Purpose of use	Image
BH	Device configuration	For checking the device configuration	

*1: Since this is a continuous test print with no designated number of pages, the following operation needs to be done to stop the printing.

1. Press keys in the order of [Online] > [Job Status/Cancel].

[1: --- ReportPri] appears on the display.

2. Press the [OK] key.

The screen to choose whether to stop appears.

3. Select "Yes", and press the [OK] key.

Device Log List

Print jam, error and alarm logs.

NOTE:

Method to display the test print

It appears in the menu by pressing [Job Status/Cancel] + [Utility] simultaneously.

Log	Purpose of use
Log1	Jam log list Print 50 logs at a maximum.
Log2	Jam log list stored in the controller Print 50 logs at a maximum.
Log3	Error log list Print 50 logs at a maximum.
Log4	Alarm log list Print 50 logs at a maximum.

Canon		Device Log List		LBP312i			
List 1							
Index	Serial	Type	Date	Time	Printed Page		
01	000 0000	C0	00	00	000000		
02	000 0000	C0	00	00	000000		
03	000 0000	C0	00	00	000000		
04	000 0000	C0	00	00	000000		
05	000 0000	C0	00	00	000000		
List 2							
Index	Serial	Type	Date	Time	Printed Page	Level	Time
List 3							
Index	Serial	Type	Date	Time	Printed Page		
01	000 0000	C0	00	00	000000		
02	000 0000	C0	00	00	000000		
List 4							
Index	Serial	Type	Date	Time	Printed Page		

Cartridge Log Print

NOTE:

How to output a cartridge log print

- For users (simplified): Service mode > CRGMNG GR. > PRINT (USER)
- For service technicians (detailed): Service mode > CRGMNG GR. > PRINT (SERVICE)

Do not provide users with the cartridge log print for service technicians because it contains detailed information that are not disclosed to end users.

- Replacement logs

The record of replacement and usage of cartridges will be printed. Just after the cartridge has been replaced with a genuine cartridge or when a non-genuine cartridge is used, accurate information cannot be obtained and a random or approximate value may be printed. The remaining lives of some of the parts are not supported depending on the model.

Item	Description
(1) CRG S/N	Serial number of the cartridge
(2) Type	Cartridge type (C0: unknown, C1: genuine, C2 to C8: non-genuine)
(3) Capacity	Cartridge capacity (display according to the amount of toner filled)
(4) Date and time first used	Date and time first used
(S1) Page count *1	Cartridge page count at first usage
(5) Level	Cartridge remaining life at first usage (new: 100 %)
(S2) Toner *1	Toner level at first usage (new: 100 %)
(S3) Drum *1	Drum remaining life at first usage (new: 100 %)
(S4) Developing *1	Developing Assembly remaining life at first usage (new: 100 %)
(6) Date and time last used	Date and time last used
(S5) Page count *1	Cartridge page count at last usage
(7) Level	Cartridge remaining life at last usage (new: 100 %)
(S6) Toner *1	Toner level at last usage (new: 100 %)
(S7) Drum *1	Drum remaining life at last usage (new: 100 %)
(S8) Developing *1	Developing Assembly remaining life at last usage (new: 100 %)

*1: S1 to S8 are printed only on prints for service technicians.

- Number of detections of non-genuine cartridge / Page count of non-genuine cartridge

Troubleshooting

Remedy for Image Failure

When an image failure occurs, perform the remedy by referring to the following material.

- User's Guide > Top > Troubleshooting > When You Cannot Print Properly

NOTE:

URL of User's Guide -> <http://canon.com/oip-manual>

Repetitive Image Defects Ruler

Cause of failure		Intervals (mm)	Symptom			
			Soiling	White spots	Soiled back	Fixing failure
Cassette Pickup Roller		Approx. 50	Yes	-	-	-
Cassette Separation Roller		Approx. 44	-	-	Yes	-
Cassette Feed Roller		Approx. 50	Yes	-	-	-
Registration Roller		Approx. 43	-	-	Yes	-
Cartridge	Primary Charging Roller	Approx. 28	-	Yes	-	-
	Photosensitive Drum	Approx. 75	Yes	Yes	-	-
	Developing Cylinder	Approx. 31	-	Yes	-	-
Transfer Roller		Approx. 39	-	Yes	Yes	-
Fixing Assembly	Fixing Film	Approx. 75	Yes	Yes	-	Yes
	Pressure Roller	Approx. 63	Yes	-	Yes	Yes

Checking the Amount of Fixing Nip

Although the nip width of the Fixing Assembly cannot be adjusted with this machine, it can be checked.

By checking the nip width when fixing failure occurs, it is possible to judge whether there is a problem with the Fixing Assembly.

Check the nip width of the Fixing Assembly by the following procedure.

NOTE:

Method to display the test print: It appears in the menu by pressing [Job Status/Cancel] key and [Utility] key simultaneously.

1. Output Test Print I (solid black).
2. Load the solid black printed paper with its printing side facing up in a cassette of the machine.
3. Output Test Print Z to feed paper in the cassette.
4. When the leading edge of the paper comes out to the Delivery Outlet, open the Front Cover unit to cause a jam.
5. About 10 seconds afterwards, remove the jammed paper.
6. Measure the widths of the glossy part of the toner shown in the figure below on the printed paper, and check the following.

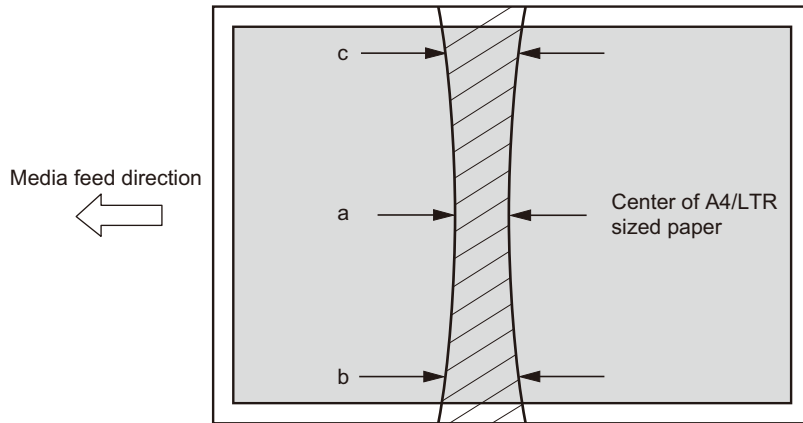

1. Check if the fixing nip width satisfies the reference values shown below.
Fixing nip width (reference value): Center (a) = 6.7 ± 1.0 mm, Edges (b and c) = 6.2 ± 1.0 mm
 2. Check if the values "a - b", "b - c", and "a - c" are 1.5 mm (reference value) or less.
- If either of the above conditions are not satisfied, fixing failure may occur.

Obtaining Debug Log

Function Overview

Debug logs (hereinafter "Sublogs") are logs that record the internal operations of the Main Controller, and are used to analyze program operations and used by developers to identify problems.

When a problem that is difficult to reproduce occurs, collecting a Sublog immediately after the problem has occurred on site can increase the efficiency of analyzing the problem and reduce the time it takes to deal with the problem.

Be sure to collect the debug log when the Support Dept. of sales company so instructs.

Note that there is no need for service technicians to check the content of collected debug log.

Sublog

It is available only when the Sublog Board is installed on the Main Controller PCB.

When the Sublog Board is not installed, log is not saved anywhere.

It is stored in the Sublog Board and its content is stored even when the power is turned OFF to be displayable when the power is turned ON again.

The Sublog Board has a limited capacity and when the log exceeding this storage number is attempted to be stored, the log is deleted in the order of length of time stored.

How the log is written

The RAM of the Sublog Board is directly overwritten by a processing of the Main Controller. The logs are not erased when the power of this machine is turned OFF, because a button battery is included.

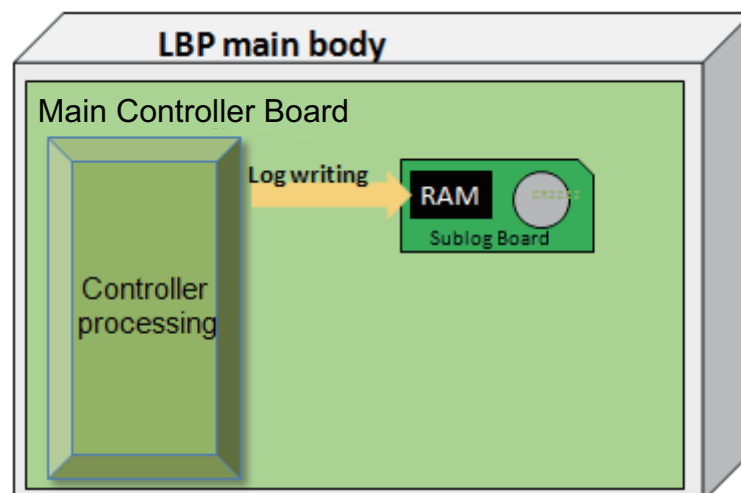

Conditions for collecting logs

Conditions where log collection is valid

Collection of debug log is effective in the following cases:

- Neither the Support Dept. of sales company nor CINC can reproduce the trouble that occurred at the customer site.
- When the error frequency is low
- When a failure of firmware, etc. is suspected, rather than a mechanical failure or electrical failure

CAUTION:

If the procedure for reproducing the failure is clear and the Support Dept. of sales company and CINC can reproduce it, collection of debug log is not necessary.

Conditions where logs cannot be collected

Logs cannot be collected under the following conditions:

- Service mode screen cannot be accessed
- The machine cannot recognize a USB flash drive.
- The machine does not have a USB port.

Sublog Collection Procedure

1. Push SW1 on the board and confirm that LED1 turns on.

If LED1 does not turn on, You need change the battery on Sublog board is located at BATS1 (CR2032) .

CAUTION:

There is danger of explosion if the battery is replaced with an incorrect type.

Replace it only with the same type of battery.

Dispose of used batteries according to the manufacturer's instructions.

2. Check that the power supply of the host machine is OFF. Remove the ROM Outer Cover on the right side of the host machine.
3. Remove the screw of the ROM Inner Cover, and then remove the cover.



4. Install the Sublog Expansion Board into the slot over the Controller.



5. Turn ON the power of the machine, and reproduce the problem that is occurring.
The log is automatically written to the ROM of the Sublog Board.
6. Turn OFF the power of the host machine.

7. Insert the USB flash drive into the host machine.

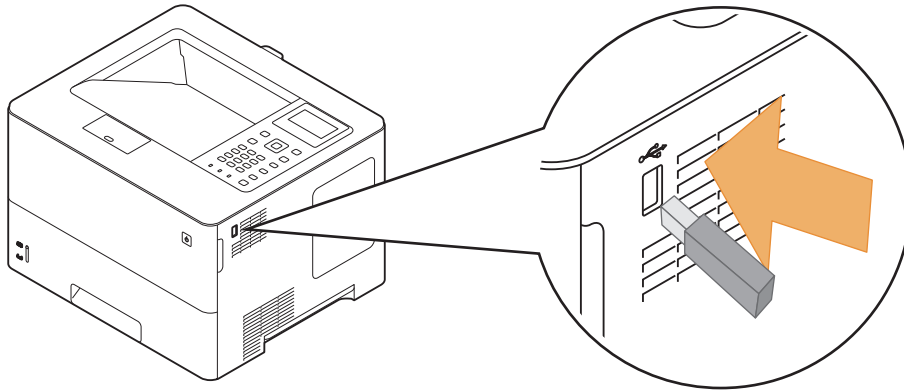

8. Turn ON the power while pressing down the "<-", "OK" and "Online" simultaneously.



9. Press the left arrow key or the right arrow key on the Control Panel until the "LOG TO USBMEM" menu is displayed.

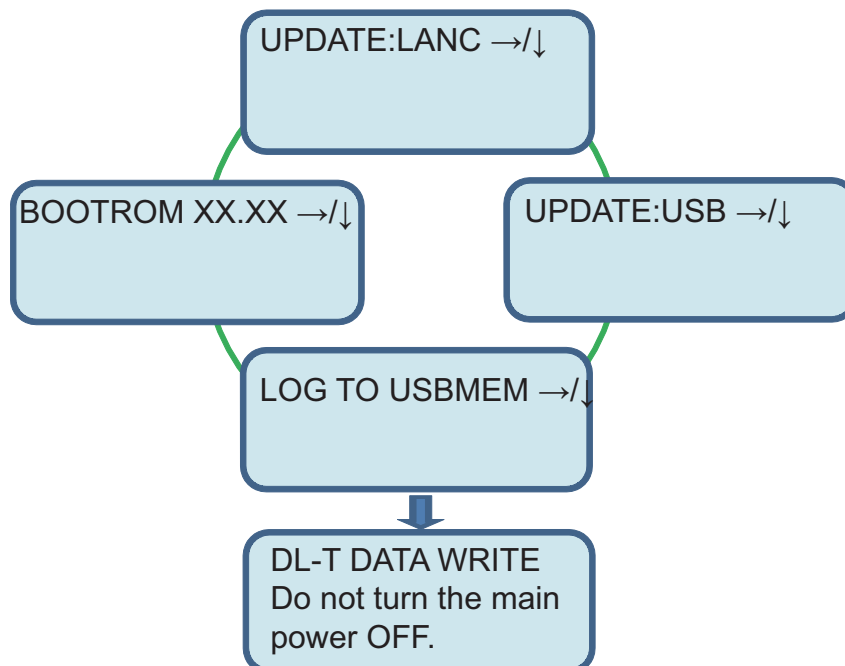

10. Press the down arrow key on the Control Panel, and check that "DL-T DATA WRITE Do not turn the main power OFF." is displayed.

CAUTION:

The log is written when the machine is restarted the next time after the Sublog Board is attached. Therefore, make sure to quickly turn OFF the power after the problem has occurred and write to the USB flash drive to collect the log for the problem. If you do not perform this operation quickly, the target operation log may be overwritten by the logs that are written periodically, etc.

The message "UPDATE:LANC→/↓" is displayed when the log has been written.

11. Turn OFF the power of the machine, and remove the USB flash drive.
12. Connect the USB flash drive to the PC, and check that the Sublog has been saved to the following path:
 - /LOG_TMP/SUBLOG.bin

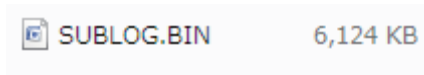

13. Send the file saved to the USB flash drive to the Support Dept. of the sales company.



Error/Jam/Alarm

Overview.....	186
Error Code Details.....	187
Jam Code.....	192
Alarm Code.....	194

Overview

This section describes the error codes that are displayed when failure has occurred. The codes are divided into three categories. The codes can be checked by printing the device log list.

Code types	Description
Error codes	This code is displayed when a failure which impacts printing has occurred.
Jam code	This code is displayed when a jam occurs inside the machine.
Alarm code	This code is displayed when some functions are disabled.

NOTE:

Device Log List Print Method
 "Job Status/Stop Key" + "Utility Menu" > [Device Log List]

If a code which is not mentioned in the Service Manual occurs, obtain the following information as much as possible.

- Logs (jam/error log report, etc.)
- Version information, machine configuration
- Debug log
- Occurrence status

Obtaining the foregoing information allows for smooth response when the case is escalated to the department in charge of quality management.

Error Code Details

Error Code	Title	Detection description	Remedy
A4-nn-Error	System error	System error	<ul style="list-style-type: none"> • Turn OFF and then ON the main power. If the error persists, obtain the following information and contact the department in charge of quality management. • Output STATUS PRINT/ P-PRINT. • Collect Sublog • Collect information on conditions to reproduce the error • Obtain user's print data (binary data)
A5-nn-Error	System error	System error	<ul style="list-style-type: none"> • Turn OFF and then ON the main power. If the error persists, obtain the following information and contact the department in charge of quality management. • Output STATUS PRINT/ P-PRINT. • Collect Sublog • Collect information on conditions to reproduce the error • Obtain user's print data (binary data)
A7-nn-Error	System error	System error	<ul style="list-style-type: none"> • Turn OFF and then ON the main power. If the error persists, obtain the following information and contact the department in charge of quality management. • Output STATUS PRINT/ P-PRINT. • Collect Sublog • Collect information on conditions to reproduce the error • Obtain user's print data (binary data)
D0-nn-Error	System error	System error	<ul style="list-style-type: none"> • Turn OFF and then ON the main power. If the error persists, obtain the following information and contact the department in charge of quality management. • Output STATUS PRINT/ P-PRINT. • Collect Sublog • Collect information on conditions to reproduce the error • Obtain user's print data (binary data)
D7-nn-Error	System error	System error	<ul style="list-style-type: none"> • Turn OFF and then ON the main power. If the error persists, obtain the following information and contact the department in charge of quality management. • Output STATUS PRINT/ P-PRINT. • Collect Sublog • Collect information on conditions to reproduce the error • Obtain user's print data (binary data)
D8-nn-Error	System error	System error	<ul style="list-style-type: none"> • Turn OFF and then ON the main power. If the error persists, obtain the following information and contact the department in charge of quality management. • Output STATUS PRINT/ P-PRINT. • Collect Sublog • Collect information on conditions to reproduce the error • Obtain user's print data (binary data)
D9-nn-Error	System error	System error	<ul style="list-style-type: none"> • Turn OFF and then ON the main power. If the error persists, obtain the following information and contact the department in charge of quality management. • Output STATUS PRINT/ P-PRINT. • Collect Sublog • Collect information on conditions to reproduce the error • Obtain user's print data (binary data)
F9-nn-Error	System error	Communication error between the Main Controller and the Control Panel	<ul style="list-style-type: none"> • Check for any poor contact/open circuit of the connector between the Main Controller and the Control Panel. If there is no problem with the connector but the error persists, obtain the following information and contact the department in charge of quality management. • Output STATUS PRINT/PPRINT. • Collect Sublog • Collect information on conditions to reproduce the error
E000 - 0000	Fixing temperature rising error	Temperature of the Main Thermistor did not become the specified temperature although the specified time had passed.	<ol style="list-style-type: none"> 1. Check the connector between the Fixing Assembly and the Fixing Power Supply Unit. 2. Replace the Fixing Assembly. 3. Replace the Fixing Power Supply Unit.

Error Code	Title	Detection description	Remedy
E001 - 0000	Abnormally high fixing temperature 1	The Main Thermistor detected a temperature higher than the specified temperature.	<ol style="list-style-type: none"> 1. Check the connector between the Fixing Assembly and the Fixing Power Supply Unit. 2. Replace the Fixing Assembly. 3. Replace the Fixing Power Supply Unit.
E004 - 0000	Fixing Drive Assembly circuit error	Error in either the Fixing Heater or the Fixing Motor	<ol style="list-style-type: none"> 1. Check the connector between the Fixing Assembly and the Fixing Power Supply Unit. 2. Check the connection of the Fixing Motor. 3. Replace the Fixing Assembly. 4. Replace the Fixing Motor. 5. Replace the Fixing Power Supply Unit.
E004 - 0005	Fixing Area Error	Fixing Relay Error	<ol style="list-style-type: none"> 1. Check the connector between the DC Controller PCB and the Fixing Power Supply PCB. 2. Replace the Fixing Power Supply PCB. 3. Replace the DC Controller PCB.
E014 - 0000	Fixing Motor error	Error in startup of the Fixing Motor	<ol style="list-style-type: none"> 1. Check the connection of the Fixing Motor. 2. Replace the Fixing Motor. 3. Replace the DC Controller PCB.
E014 - 0001	Fixing Motor error	Error in rotation of the Fixing Motor	<ol style="list-style-type: none"> 1. Check the connection of the Fixing Motor. 2. Replace the Fixing Motor. 3. Replace the DC Controller PCB.
E015 - 0001	Cassette 1 lift-up error	Cassette 1 Lifter Motor error	<ol style="list-style-type: none"> 1. Check the Cassette 1 Lifter Motor (dropout, gear tooth jump, etc.). 2. Check the connector between the Cassette 1 Lifter Motor and the DC Controller PCB. 3. Replace the Cassette 1 Lifter Motor. 4. Replace the DC Controller PCB.
E015 - 0002	Cassette 2 lift-up error	Cassette 2 Lifter Motor error	<ol style="list-style-type: none"> 1. Check the Cassette 2 Lifter Motor (dropout, gear tooth jump, etc.). 2. Check the connector between the Cassette 2 Lifter Motor and the Cassette 2 Driver PCB. 3. Replace the Cassette 2 Lifter Motor. 4. Replace the Cassette 2 Driver PCB.
E015 - 0003	Cassette 3 lift-up error	Cassette 3 Lifter Motor error	<ol style="list-style-type: none"> 1. Check the Cassette 3 Lifter Motor (dropout, gear tooth jump, etc.). 2. Check the connector between the Cassette 3 Lifter Motor and the Cassette 3 Driver PCB. 3. Replace the Cassette 3 Lifter Motor. 4. Replace the Cassette 3 Driver PCB.
E015 - 0004	Cassette 4 lift-up error	Cassette 4 Lifter Motor error	<ol style="list-style-type: none"> 1. Check the Cassette 4 Lifter Motor (dropout, gear tooth jump, etc.). 2. Check the connector between the Cassette 4 Lifter Motor and the Cassette 4 Driver PCB. 3. Replace the Cassette 4 Lifter Motor. 4. Replace the Cassette 4 Driver PCB.
E066 - 0000	Environment Sensor error	Failure of the Environment Sensor was detected.	<ol style="list-style-type: none"> 1. Check the connection of the Environment Sensor. 2. Replace the Environment Sensor. 3. Replace the DC Controller PCB.
E110 - 0000	Scanner Motor error	Error in the initial operation of the Scanner Motor	<ol style="list-style-type: none"> 1. Check the connector of the Laser Scanner Unit. 2. Replace the Laser Scanner Unit. 3. Replace the DC Controller PCB.
E110 - 0001	Scanner Motor error	Error in rotation of the Scanner Motor	<ol style="list-style-type: none"> 1. Check the connector between the Laser Scanner Unit and the DC Controller PCB. 2. Replace the Laser Scanner Unit. 3. Replace the DC Controller PCB.
E196 - 0000	Firmware error (The host machine or the option cassette)	Engine firmware error	<ol style="list-style-type: none"> 1. Turn OFF and then ON the power. 2. Update firmware. 3. Replace the DC Controller PCB
E196 - 0002	DC Controller internal error	The memory area in the DC Controller cannot be accessed.	<ol style="list-style-type: none"> 1. Turn OFF and then ON the power. 2. Update firmware. 3. Replace the DC Controller PCB
E245 - 1011	System error	System error	Contact the sales company.
E245 - 1012	System error	System error	Contact the sales company.

Error Code	Title	Detection description	Remedy
E245 - 1013	System error	System error	Contact the sales company.
E245 - 1021	System error	System error	Contact the sales company.
E245 - 1022	System error	System error	Contact the sales company.
E245 - 1023	System error	System error	Contact the sales company.
E245 - 2012	System error	System error	Contact the sales company.
E245 - 2022	System error	System error	Contact the sales company.
E246 - 0001	System error	System error	Contact the sales company.
E246 - 0002	System error	System error	Contact the sales company.
E246 - 0003	System error	System error	Contact the sales company.
E246 - 0004	System error	System error	Contact the sales company.
E246 - 0005	System error	System error	Contact the sales company.
E247 - 0001	System error	System error	Contact the sales company.
E247 - 0002	System error	System error	Contact the sales company.
E247 - 0003	System error	System error	Contact the sales company.
E247 - 0004	System error	System error	Contact the sales company.
E350 - 1001	System error	System error	Contact the sales company.
E350 - 1002	System error	System error	Contact the sales company.
E350 - 1003	System error	System error	Contact the sales company.
E350 - 3000	System error	System error	Contact the sales company.
E354 - 0001	System error	System error	Contact the sales company.
E354 - 0002	System error	System error	Contact the sales company.
E355 - 0001	System error	System error	Contact the sales company.
E355 - 0003	System error	System error	Contact the sales company.
E602 - 0001	Insufficient SD Card capacity	Capacity of the installed SD Card is smaller than the size of the area used for the system.	<ol style="list-style-type: none"> 1. Check the capacity of the SD Card. 2. Replace the SD Card with another one with 2 GB or more capacity.
E602 - 0002	Firmware error	Loading of Bootable ends in failure.	<ol style="list-style-type: none"> 1. Reinstall the firmware. 2. Replace the Main Controller PCB.
E602 - 0003	SD Card access error	Error caused by hardware (such as damage on the sector, etc.) occurred when accessing to the SD Card during execution of Boot ROM	<ol style="list-style-type: none"> 1. Turn OFF and then ON the power. 2. Back up data, and format the SD Card. 3. Replace the SD Card. 4. Replace the Main Controller PCB.
E602 - 0006	Firmware error	Loading of Subbootable ends in failure.	<ol style="list-style-type: none"> 1. Reinstall the firmware. 2. Replace the Main Controller PCB.
E602 - 0007	Firmware error	Damage on the internal file	<ol style="list-style-type: none"> 1. Reinstall the firmware. 2. Replace the Main Controller PCB.
E602 - 0008	The memory area in the Main Controller is depleted	Remaining memory area in the Main Controller is small.	<p>* Turning OFF and then ON the main power stops the error code to be displayed, but the continuous use causes the memory area in the Main Controller PCB to be completely used up or causes symptoms such as machine freeze.</p> <ol style="list-style-type: none"> 1. Replace the Main Controller PCB.
E602 - 0009	MEAP cannot be started.	MEAP cannot be started due to an error caused by invalid power down.	<ol style="list-style-type: none"> 1. Select Function.gr > MEAP > MEAP FUNCTION = ON, and turn OFF and then ON the main power. <p>* Since the installed MEAP application and its management information are all cleared after reboot, MEAP needs to be reinstalled.</p>
E602 - 1102	File system could not be initialized normally. (MEAP-related)	File system could not be initialized normally.	<ol style="list-style-type: none"> 1. Turning OFF and then ON the main power executes auto recovery. Since E616-0001 may be displayed in some cases, execute the remedy for E616-0001. <p>* When this error occurs, the firmware downloaded by the CDS Updater will be lost.</p>
E602 - 1112	Device access error (MEAP-related)	Device access error	<ol style="list-style-type: none"> 1. Turning OFF and then ON the main power executes auto recovery. Since E616-0001 may be displayed in some cases, execute the remedy for E616-0001. <p>* When this error occurs, the firmware downloaded by the CDS Updater will be lost.</p>

Error Code	Title	Detection description	Remedy
E602 - 1113	Device access error (MEAP-related)	Device access error	1. Turning OFF and then ON the main power executes auto recovery. Since E616-0001 may be displayed in some cases, execute the remedy for E616-0001. * When this error occurs, the firmware downloaded by the CDS Updater will be lost.
E602 - 1302	File system could not be initialized normally.	File system could not be initialized normally.	1. Turning OFF and then ON the main power executes auto recovery. * When this error occurs, the firmware downloaded by the CDS Updater will be lost.
E602 - 1312	Device access error	Device access error	1. Turning OFF and then ON the main power executes auto recovery. * When this error occurs, the firmware downloaded by the CDS Updater will be lost.
E602 - 1313	Device access error	Device access error	1. Turning OFF and then ON the main power executes auto recovery. * When this error occurs, the firmware downloaded by the CDS Updater will be lost.
E602 - 1602	File system could not be initialized normally. (CDS-related)	File system could not be initialized normally	1. Turning OFF and then ON the main power executes auto recovery. * When this error occurs, the firmware downloaded by the CDS Updater will be lost.
E602 - 1612	Device access error (CDS-related)	Device access error	1. Turning OFF and then ON the main power executes auto recovery. * When this error occurs, the firmware downloaded by the CDS Updater will be lost.
E602 - 1613	Device access error (CDS-related)	Device access error	1. Turning OFF and then ON the main power executes auto recovery. * When this error occurs, the firmware downloaded by the CDS Updater will be lost.
E604 - 0000	Insufficient memory capacity	Insufficient memory capacity	1. Check the memory capacity of ROM mounted on the Main Controller. 2. Replace the Main Controller PCB.
E604 - 0001	Memory error	Memory required to start PDL cannot be allocated.	1. Check the installed memory. 2. Remove and then install the memory. 3. Replace the memory.
E616 - 0001	MEAP application is lost.	MEAP application is lost.	1. Select Function.gr > MEAP > MEAP FUNCTION = ON, and turn OFF and then ON the main power. * The setting is switched to the following after reboot. <ul style="list-style-type: none"> • Initial screen setting: Native • MEAP authentication: Off • USB-Host setting: Native • CDS-related: Off
E616 - 0002	System error	System error	1. Execute Setup > Initialize Menu to initialize NVRAM.
E730 - 100A	System error	System error	1. Turn OFF and then ON the power. 2. Replace the Main Controller PCB.
E730 - C000	An error, such as failure in memory retrieval at initialization, occurred.	An error, such as failure in memory retrieval at initialization, occurred.	1. Turning OFF and then ON the main power executes auto recovery.
E730 - C001	An error occurred when accessing the controller.	An error occurred when accessing the controller.	1. Turning OFF and then ON the main power executes auto recovery.
E730 - D000	An error, such as failure in memory retrieval at initialization, occurred.	An error, such as failure in memory retrieval at initialization, occurred.	1. Turn OFF and then ON the power. 2. Replace the Main Controller PCB.
E730 - D001	System error	System error	1. Turn OFF and then ON the power. 2. Replace the Main Controller PCB.
E733 - 0001	Printer communication error	Communication error occurred after normal startup.	1. Turn OFF and then ON the power. 2. Replace the Main Controller PCB.
E733 - 0004	Printer communication error	Command error	1. Turn OFF and then ON the power. 2. Replace the Main Controller PCB.

Error Code	Title	Detection description	Remedy
E733 - 0006	Printer communication error	Unknown communication error	1. Turn OFF and then ON the power. 2. Replace the Main Controller PCB.
E740 - 0002	An invalid MAC address has been detected.	An invalid MAC address has been detected.	1. Check the Mac address. 2. Replace the Main Controller PCB.
E740 - 0004	Network Chip error detection	Controller Chip access error	1. Turn OFF and then ON the power. 2. Replace the Main Controller PCB.
E744 - 0800	System error	System error	Contact the sales company.
E744 - 0900	Detection of invalid Bootable	Bootable of another model was detected.	1. Turn OFF and then ON the power. 2. Reinstall the firmware. 3. Replace the Main Controller PCB.
E744 - 1000	Firmware error	Mismatch of the model for which the firmware was downloaded is detected.	1. Install the firmware according to the model.
E744 - 1100	System error	System error	1. Turn OFF and then ON the power. 2. Replace the Main Controller PCB.
E748 - 2012	System error	System error	Contact the sales company.
E748 - 4000	System error	System error	1. Replace the Main Controller PCB. 2. Contact the sales company.
E748 - 4020	System error	System error	Contact the sales company.
E760 - 0000	Firmware error	An error in connection occurred due to controller software.	Due to firmware error, the possibility of solving the error by replacing the Main Controller PCB is low. 1. Check the downloaded firmware again.
E805 - 0001	Fan 1 failure	Fan 1 failure	1. Check the connection of the Fan 1 2. Replace the Fan 1. 3. Replace the DC Controller PCB.
E805 - 0002	Fan 2 failure	Fan 2 failure	1. Check the connection of the Fan 2 2. Replace the Fan 2. 3. Replace the DC Controller PCB.
E808 - 0001	Low-voltage power supply failure	Low-voltage power supply failure was detected.	1. Check the connection of the Power Supply PCB or the connector. 2. Replace the Power Supply PCB.
E840 - 0000	Fixing disengagement error	Fixing pressure release mechanism error	1. Check the connector between the Fixing Assembly and the Power Supply PCB. 2. Replace the Fixing Assembly. 3. Replace the Power Supply PCB.

* XX-nn-Error:nn: 2-digit alphanumeric

Jam Code

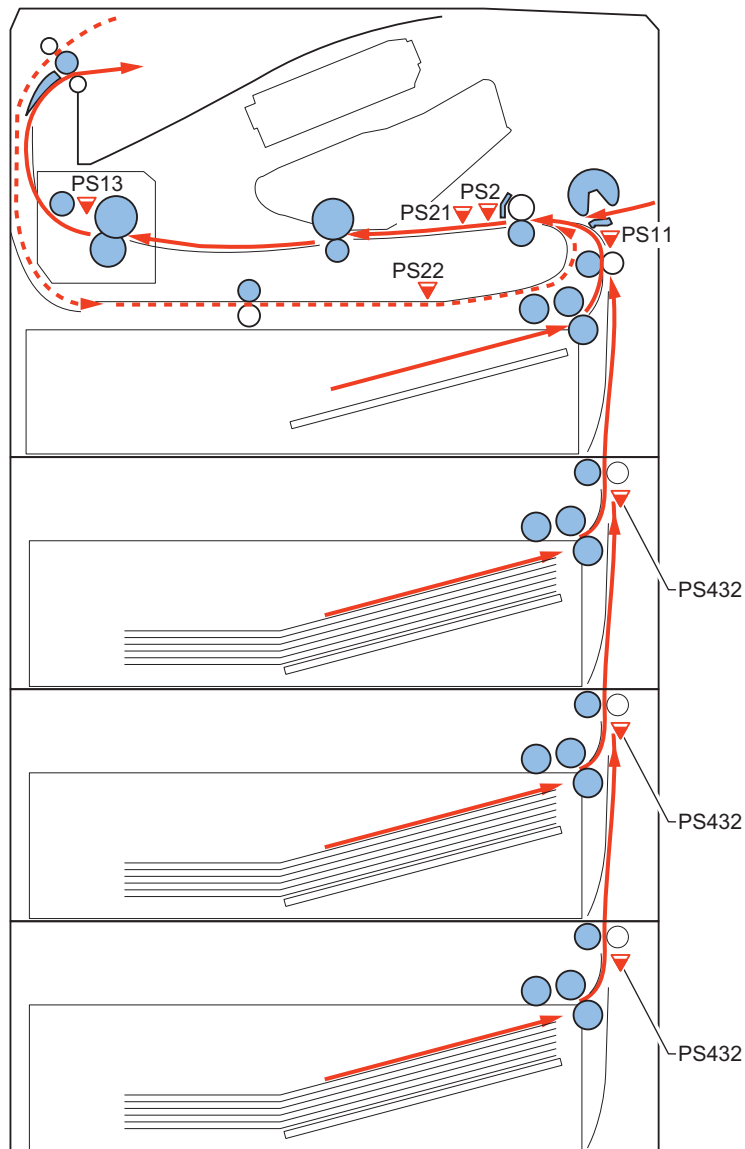

High Order	Low Order	Sensor ID	Sensor Name	Type	Area
84	01	PS2	TOP Sensor	Pickup Delay Jam 1	Multi-purpose Tray
84	02	PS2	TOP Sensor	Pickup Delay Jam 1	Cassette 1
84	03	PS2	TOP Sensor	Pickup Delay Jam 1	Cassette 2
84	04	PS2	TOP Sensor	Pickup Delay Jam 1	Cassette 3
84	05	PS2	TOP Sensor	Pickup Delay Jam 1	Cassette 4
85	03	PS432	PF Media Path Sensor	Pickup Delay Jam 2	Cassette 2
85	04	PS432	PF Media Path Sensor	Pickup Delay Jam 2	Cassette 3
85	05	PS432	PF Media Path Sensor	Pickup Delay Jam 2	Cassette 4
86	03	PS432	PF Media Path Sensor	Pickup Delay Jam 3	Cassette 2
86	04	PS432	PF Media Path Sensor	Pickup Delay Jam 3	Cassette 3
86	05	PS432	PF Media Path Sensor	Pickup Delay Jam 3	Cassette 4
88	07	PS2	TOP Sensor	Pickup Stationary Jam 1	Registration Area to Cartridge
88	08	PS21	Paper Width Sensor	Pickup Stationary Jam 1	Cartridge to Fixing Roller Area
8C	07	PS2	TOP Sensor	Fixing Delivery Delay Jam 1	Registration Area to Cartridge
8C	09	PS13	Fixing Delivery Sensor	Fixing Delivery Delay Jam 1	Fixing Roller to Delivery Area

High Order	Low Order	Sensor ID	Sensor Name	Type	Area
90	07	PS2	TOP Sensor	Fixing Delivery Stationary Jam 1	Registration Area to Cartridge
90	09	PS13	Fixing Delivery Sensor	Fixing Delivery Stationary Jam 1	Fixing Roller to Delivery Area
94	02	PS11	Pre-Registration Sensor	Power ON Jam 1 (*2)	Cassette 1
94	03	PS11	Pre-Registration Sensor	Power ON Jam 1 (*2)	Cassette 2
94	04	PS11	Pre-Registration Sensor	Power ON Jam 1 (*2)	Cassette 3
94	05	PS11	Pre-Registration Sensor	Power ON Jam 1 (*2)	Cassette 4
94	07	PS2	TOP Sensor	Power ON Jam 1 (*2)	Registration Area to Cartridge
94	08	PS21	Paper Width Sensor	Power ON Jam 1 (*2)	Cartridge to Fixing Roller Area
94	09	PS13	Fixing Delivery Sensor	Power ON Jam 1 (*2)	Fixing Roller to Delivery Area
94	0D	PS22	Duplex Feed Sensor	Power ON Jam 1 (*2)	Duplex Feed Area
95	02	PS11	Pre-Registration Sensor	Power ON Jam 2 (*2)	Cassette 1
95	03	PS11	Pre-Registration Sensor	Power ON Jam 2 (*2)	Cassette 2
95	04	PS11	Pre-Registration Sensor	Power ON Jam 2 (*2)	Cassette 3
95	05	PS11	Pre-Registration Sensor	Power ON Jam 2 (*2)	Cassette 4
95	07	PS2	TOP Sensor	Power ON Jam 2 (*2)	Registration Area to Cartridge
95	08	PS21	Paper Width Sensor	Power ON Jam 2 (*2)	Cartridge to Fixing Roller Area
95	09	PS13	Fixing Delivery Sensor	Power ON Jam 2 (*2)	Fixing Roller to Delivery Area
95	0D	PS22	Duplex Feed Sensor	Power ON Jam 2 (*2)	Duplex Feed Area
98	02	PS432	PF Media Path Sensor	Door Open Jam (*1)	Cassette 2
98	03	PS432	PF Media Path Sensor	Door Open Jam (*1)	Cassette 3
98	04	PS432	PF Media Path Sensor	Door Open Jam (*1)	Cassette 4
98	07	PS2	TOP Sensor	Door Open Jam (*1)	Registration Area to Cartridge
98	08	PS21	Paper Width Sensor	Door Open Jam (*1)	Cartridge to Fixing Roller Area
98	09	PS13	Fixing Delivery Sensor	Door Open Jam (*1)	Fixing Roller to Delivery Area
9C	09	PS13	Fixing Delivery Sensor	Wrap Jam 1	Fixing Roller to Delivery Area
A4	0D	PS22	Duplex Feed Sensor	Duplex Re-pickup Assembly Jam 1	Duplex Feed Area

*1 : It is a jam that appears when door open is detected during printing.

When the power is turned OFF and then ON while the door open jam is detected, it is displayed as an internal stationary jam instead of a door open jam.

*2 : It is a jam that appears when residual paper is detected in the machine at power-on.

When the power is turned OFF and then ON while the door open jam is detected, it is displayed as an internal stationary jam instead of a door open jam.

Alarm Code

Alarm Code	Area	Details	Cause	Remarks
10 - 0404	Developing Assembly, Host machine	Toner out (K) Alarm	Toner out (K)	



Service Mode

Overview.....	196
Service Mode.....	200

Overview

Entering Service Mode

For information on how to enter service mode, contact the Support Dept. of the sales company.

Remote UI Service Mode

Function Overview

It is possible to display, configure, and execute various service mode modes as well as restart the host machine by using remote UI.

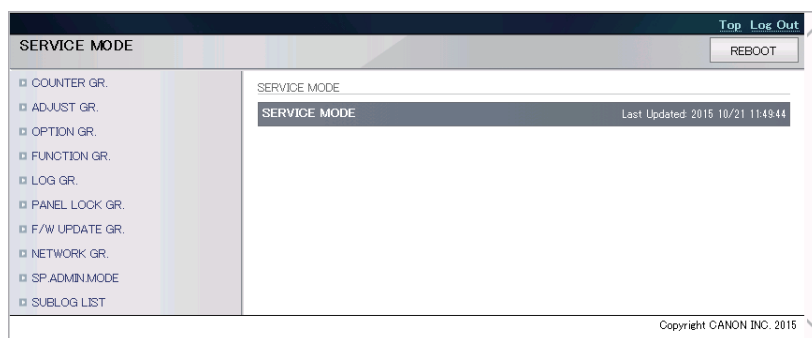

Operating conditions

In order to operate service mode using Remote UI, the following conditions must be met.

- The RMT-SW (Remote UI service mode function) setting is enabled (setting value: ON) in service mode
Set RMT-SW by performing one of the following operations. Both operations have the same effect.
 - SERVICE MODE > OPTION GR. > RMT-SW
 - [Setup] > [Control Menu] > RMT-SW

How to Use

1. **Activate the Web browser, and access the following URL:**
<http://<Host machine's IP address or host name>/servicemode.html>

2. Enter the password, and click [LOGIN].

Password required for authentication differs depending on the following service mode setting:

SERVICE MODE > OPTION GR. > PSWD-SW

Combinations of service mode settings and required passwords

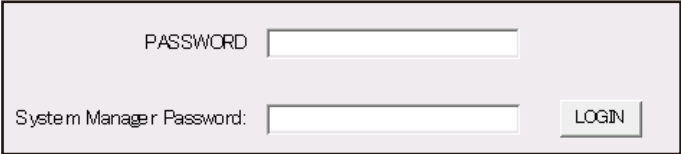
PSWD-SW setting value	Password required for authentication	Authentication screen
0	<ul style="list-style-type: none"> Password of remote UI service mode 	
1	<ul style="list-style-type: none"> Password of remote UI service mode Password of system administrator 	

NOTE:

- If you do not know the password of remote UI service mode, contact the Support Dept. of the sales company.
- Password of service mode cannot be changed.

3. When finishing the operation, click [REBOOT] or [Log Out].**NOTE:**

If the user logged in and then closed the browser without logging out, connection status remains as "LOGIN". If the user attempts to log in to service mode under "LOGIN" status, exclusive control is executed so that the user cannot access service mode. In that case, wait for a fixed time (3 minutes) from the last access to let the user be automatically logged out, or turn OFF/ON the power of the machine to be forcibly logged out.

Service Report

■ Output of Service Report Data

This machine has a function for outputting service reports such as P-PRINT.

Service Print and Data File Name Supported for File Output

Report	Description
P-PRINT	Output of service mode setting values

CAUTION:

When P-PRINT is printed and output, items set to a value other than the default value are marked.

Canon		Configuration Page		LBPxxx					
Main Controller Version : RxxxxPH Bxxxx			RAM Size : xxxMB						
DCON Version : xxxxx			Model : xxxxx						
Option Drawer Version : OPTxxxx									
Font Version : 00000000									
<hr/>									
<table border="0"> <tr> <td style="vertical-align: top;"> <ul style="list-style-type: none"> Toner Cart. Warning Auto Skip Error Language Alarm Show Warnings Toner Cart. Warning Mtl. Kit Warning Drawer Empty E-Mail Trans. Error Date/Time Settings Date Time (24 hour) Main Pwr Quick Start USB-Connected PC OS PDL Selection (PnP) Mng. Settings Settings Key Lock RMT-SW Adjust Screen Contrast Backlight Brightness Animated Instruction </td> <td style="vertical-align: top;"> <ul style="list-style-type: none"> Continue Printing Off English Off On On On On 2015 10/29 14:32:30 Off Windows LIPSLX Off Off 0 Level 3 On </td> <td style="vertical-align: top;"> <ul style="list-style-type: none"> Interface Interface Selection USB Network USB Adv. Functions Adv. Func. Settings USB Storage Device MBAP Driver Timeout Timeout Timeout Time Connection Recog. Extended RX Buffer User Maintenance Adj. Print Position 0 fset Y (MP Tray) 0 fset X (MP Tray) 0 fset Y (Drawer 1) 0 fset X (Drawer 1) 0 fset Y (Drawer 2) 0 fset X (Drawer 2) </td> <td style="vertical-align: top;"> <ul style="list-style-type: none"> On On Meap Priority Off On 15 sec On On 0.0 mm 0.0 mm 0.0 mm 0.0 mm 0.0 mm </td> </tr> </table>						<ul style="list-style-type: none"> Toner Cart. Warning Auto Skip Error Language Alarm Show Warnings Toner Cart. Warning Mtl. Kit Warning Drawer Empty E-Mail Trans. Error Date/Time Settings Date Time (24 hour) Main Pwr Quick Start USB-Connected PC OS PDL Selection (PnP) Mng. Settings Settings Key Lock RMT-SW Adjust Screen Contrast Backlight Brightness Animated Instruction 	<ul style="list-style-type: none"> Continue Printing Off English Off On On On On 2015 10/29 14:32:30 Off Windows LIPSLX Off Off 0 Level 3 On 	<ul style="list-style-type: none"> Interface Interface Selection USB Network USB Adv. Functions Adv. Func. Settings USB Storage Device MBAP Driver Timeout Timeout Timeout Time Connection Recog. Extended RX Buffer User Maintenance Adj. Print Position 0 fset Y (MP Tray) 0 fset X (MP Tray) 0 fset Y (Drawer 1) 0 fset X (Drawer 1) 0 fset Y (Drawer 2) 0 fset X (Drawer 2) 	<ul style="list-style-type: none"> On On Meap Priority Off On 15 sec On On 0.0 mm 0.0 mm 0.0 mm 0.0 mm 0.0 mm
<ul style="list-style-type: none"> Toner Cart. Warning Auto Skip Error Language Alarm Show Warnings Toner Cart. Warning Mtl. Kit Warning Drawer Empty E-Mail Trans. Error Date/Time Settings Date Time (24 hour) Main Pwr Quick Start USB-Connected PC OS PDL Selection (PnP) Mng. Settings Settings Key Lock RMT-SW Adjust Screen Contrast Backlight Brightness Animated Instruction 	<ul style="list-style-type: none"> Continue Printing Off English Off On On On On 2015 10/29 14:32:30 Off Windows LIPSLX Off Off 0 Level 3 On 	<ul style="list-style-type: none"> Interface Interface Selection USB Network USB Adv. Functions Adv. Func. Settings USB Storage Device MBAP Driver Timeout Timeout Timeout Time Connection Recog. Extended RX Buffer User Maintenance Adj. Print Position 0 fset Y (MP Tray) 0 fset X (MP Tray) 0 fset Y (Drawer 1) 0 fset X (Drawer 1) 0 fset Y (Drawer 2) 0 fset X (Drawer 2) 	<ul style="list-style-type: none"> On On Meap Priority Off On 15 sec On On 0.0 mm 0.0 mm 0.0 mm 0.0 mm 0.0 mm 						

• Output Procedure (from the Control Panel to a USB Flash Drive)

1. Connect the USB flash drive to the USB Memory Port of this machine.

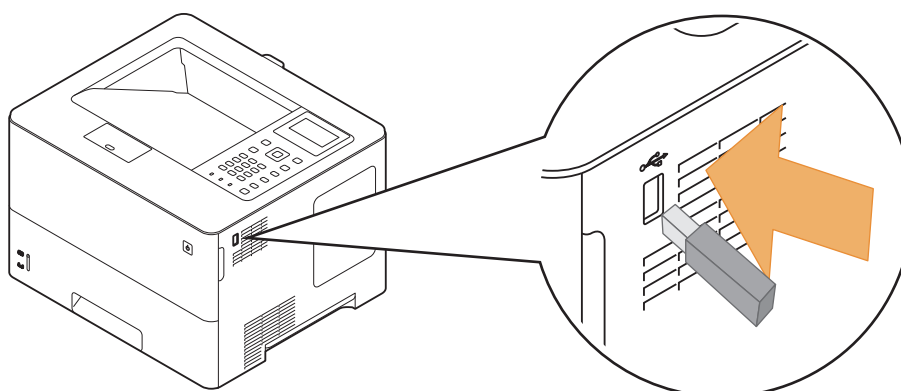

2. Enter service mode, and execute the following service mode.

- SERVICE MODE > FUNCTION GR. > MISC-P > RPT2USB > Yes

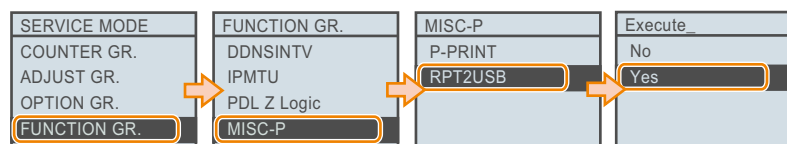

The service report (P-PRINT) is saved to the USB flash drive as a text file.

• Output Procedure (from the Remote UI Service Mode to a PC)

1. Select the following service mode from the Remote UI service mode, enter the password, and click [Start Exporting].

- SERVICE MODE > FUNCTION GR. > MISC-P > RPT2USB

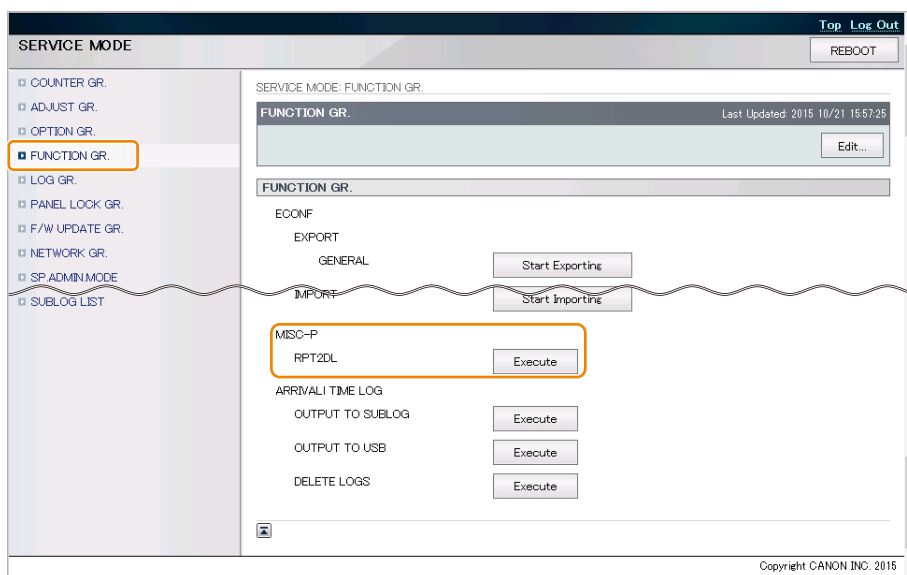

2. When a dialog box for saving the file is displayed, select the location to save the file.

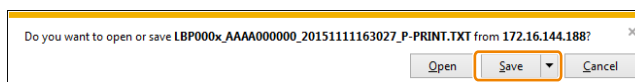

This completes the procedure for exporting a setting information file.

Service Mode

ADJUST GR.

* : Default Value

Item	Description
CHARGE BIAS K	Change the primary charging bias value for black. • -5 to 5 (0*)
DEV BIAS K	Change the developing bias value for black. • -5 to 5 (0*)
FRT FUSE TEMP	Change the fixing temperature on the front side. • -4 to 4 (0*)
T2 ATVC BIAS F	Change the secondary transfer ATVC value on the front side. • -5 to 5 (0*)
SUBTLE DENSITY CORR.	Correction of fine density To adjust fine density at 1200dpi. • -1, 0*, 1
Special Grad.Process	Special gradation processing To set whether to make the gradation processing the same as that of the current products. • OFF */ON
LASER BRIGHT K	To change the light emission value of the black Laser Scanner. • -4 to 4 (0*)

OPTION GR.

* : Default Value

*1 : Supporting the North America models with the charge counter only

Item	Description
B4-L-CNT	Not use
COUNTER-SW *1	Set the counter switch. • MODEL1 *: Setting value 1 • MODEL2 : Setting value 2
CRG LIFE STEP	To set the operation performed when a cartridge reaches the end of life. It is a menu to set 3 kinds of operation (printing is not stopped temporarily stopped/completely stopped) when a cartridge has reached the end of life. • CONT. PRINTING *: Printing is not stopped. • TEMP. STOP PRINT: Printing is temporarily stopped. • STOP PRINTING: Printing is completely stopped.
CRG LIFE STOP	To be able to change the end of cartridge life. Change the setting value when using a cartridge for a period longer than its life. Note that an image failure may occur. • 100 to 200 % (100*)
CHANGE CRG WARN LV	To switch display/hide of the menu for setting the toner check timing (Setup > User Maintenance > Toner Check Timing). • OFF, ON *
PSWD-SW	Setting of the password type used to log in to remote UI service mode • 0: Password for service technician * • 1: Password for service technician + system administrator
SLEEP SETTINGS	To change the display items of the sleep mode setting menu (Setup > Control Menu > Sleep Mode). • Mode 1 (* except for EUR) • Mode 2 (*EUR only)
RMT-SW	ON/OFF of remote UI service mode function • OFF *, ON
MPT 2-Sd (1st Side)	Setting of the print side at manual 2-sided print (Multi-purpose Tray) To specify the print side for manual 2-sided printing from the Multi-purpose Tray. • 1st Side: Front side. (Print with the transfer bias of printing on the first side) • 2nd Side*: Back side. (Print with the transfer bias of printing on the second side)

Item	Description
Quiet Mode	Specifying silent mode When silent mode is enabled, the print speed becomes 1/2 speed. <ul style="list-style-type: none"> • ON: Enable silent mode • OFF: Disable silent mode*
Img Calibration Mode	Specifying scanner calibration mode When enabled, calibration of the image scanner is performed. Use this only for 1-sheet jobs because the image cannot be guaranteed in the case of continuous printing. <ul style="list-style-type: none"> • ON: Performed • OFF: Not performed*

CRGMNG GR.

* : Default Value

Item	Description
CRGLOG MENU	Setting for outputting Cartridge Log Print (simplified) from user mode (VISIBLE*/ INVISIBLE) Whether to display or hide "Cartridge Log Print" in the report output items of Utility in user mode is set.
PRINT (USER)	Output of Cartridge Log Print (simplified) Simplified Cartridge Log Print for users is output.
PRINT (SERVICE)	Output of Cartridge Log Print (detailed) Data of simplified Cartridge Log Print and information for service technicians are output.
CRGLOG COUNTER RE-SET	The number of detections of non-genuine cartridge and the page count of non-genuine cartridge that are printed on Cartridge Log Print are all reset to 0. The replacement log itself is not deleted.

FUNCTION GR.

* : Default Value

Item	Description
ECONF	
EXPORT	To export the binary file of setting data. To export the setting data to a USB flash drive. <ul style="list-style-type: none"> • GENERAL Whether to set items whose device settings do not depend on the PCB, but can be performed commonly within the same device as the target. • DEPEND Whether to set items whose device settings change depending on the PCB as the target. • SECURITY Whether to set items related to security as the target. • ALL Whether to set all items exported in GENERAL/DEPEND/SECURITY as the target.
IMPORT	To import the setting data to a USB flash drive.
Import/Export Set.	
IMPORT	To import service mode setting values. This function supports the following import methods. <ul style="list-style-type: none"> • USB flash drive • PC (using remote UI service mode)
EXPORT	To export service mode setting values. This function supports the following export methods. <ul style="list-style-type: none"> • USB flash drive • PC (using remote UI service mode)
SMD-EXPT	To set whether to export "service mode data" from remote UI. When 1 is set, "service mode data" is displayed as the target data of export on remote UI. When installing more than 1 machine at the same time, the same service mode data can be registered. Remote UI > Settings/Registration: Management Settings: Import/Export > Export

Item	Description
USB-H	<p>To set to enable/disable the USB host function. By turning ON the host function, USB flash drive can be used.</p> <div style="background-color: #fce4d6; padding: 10px; border-radius: 5px;"> <p>CAUTION: Points to note when pulling out the USB flash drive</p> <ul style="list-style-type: none"> • Be sure to pull out the USB flash drive after turning USB-H to OFF because the USB flash drive is in the connected state when USB-H is ON • Pulling out the USB flash drive while it is being accessed causes an error. <p>ON: Use the USB host function. OFF: Do not use the USB host function. (* default)</p> </div>
SUBLOG TO USB	<p>To output sublog to the USB flash drive. It can be used regardless of the USB-H setting.</p> <div style="background-color: #fce4d6; padding: 10px; border-radius: 5px;"> <p>CAUTION: It cannot be executed more than 2 times consecutively. Since automatic recording of sublog can no longer be performed when executed once, be sure to turn OFF and then ON the main power after execution.</p> </div>
MEAP	
MEAP-PN	<p>To specify the port number of MEAP HTTP.</p> <ul style="list-style-type: none"> • 1 to 65535 (8000 *default)
MEAP-SSL	<p>To specify the port number of MEAP HTTPS.</p> <ul style="list-style-type: none"> • 1 to 65535 (8443 *default)
CDS-MEAP	<p>To set whether to permit the user administrator to install MEAP application.</p> <ul style="list-style-type: none"> • On*/Off
CDS-FIRM	<p>To set whether to permit the user administrator to update firmware.</p> <ul style="list-style-type: none"> • On/Off*
CDS-UGW	<p>To set whether to permit firmware update from UGW.</p> <ul style="list-style-type: none"> • On/Off*
CDS-LVUP	<p>To set whether to permit service technician or user administrator to use the periodical update function of CDS.</p> <ul style="list-style-type: none"> • On/Off*
CDS-CTL	<p>It is a menu to switch countries for obtaining firmware via CDS. Use this item to switch countries when obtaining firmware from another country due to the distance to the location server.</p>
MEAP FUNCTION	<p>Use this item when "E602-0009" occurs. It is a menu to clear the error code and recover MEAP.</p> <ul style="list-style-type: none"> • ON: Recover MEAP. (*default) • OFF: Do not recover MEAP.
LCDSFLG	<p>To set whether to allow the user administrator to use the CDS in local environment (L-CDS).</p> <ul style="list-style-type: none"> • On/Off*
Check File System	Not use
Restore File System	Not use
CLEAR MEAP	<p>To delete the following data retained by MEAP application at the next startup.</p> <ul style="list-style-type: none"> • MEAP application • Data retained by MEAP application • Data retained by the service-purposed area in the MEAP platform
CLEAR CDS	To delete the CDS-related settings at the next startup.
DDNSINTY	<p>To change DDNS periodical update interval</p> <ul style="list-style-type: none"> • 0: Do not perform periodical update. • 1 to 48: 1 to 48 hours (default value: 24)
	<div style="background-color: #e0f2f1; padding: 10px; border-radius: 5px;"> <p>NOTE: [Description of terminology] DDNS (Dynamic Domain Name System): A system to dynamically register and manage the IP addresses which are dynamically allocated and their host names.</p> </div>

Item	Description
IPMTU	<p>To change MTU size of network packet.</p> <p>Use this item when performing communications between locations (such as SEND) connected with Ethernet in a field environment where MTU black hole problem occurs (NTT/FLET'S).</p> <ul style="list-style-type: none"> • 1 to 10 <p>NOTE: [Description of terminology]</p> <ul style="list-style-type: none"> • MTU: A unit of transmission showing the maximum value of data which can be sent per 1 transfer (1 frame) in a network. • MTU black hole: A problem which occurs when ICMP packet is being filtered by fire-wall, etc. (Since the message does not reach the sender, the sender is not aware of the packet being lost, which then results in time-out.)
PDL Z Logic	Not use
FILE BOX FUNC.	<p>To switch to enable/disable the stored job print function.</p> <p>* Displayed only when Set up > Control Menu > SD Card > ON is set.</p> <p>The SD card needs to be formatted in advance.</p>
MISC-P	
P-PRINT	<p>To print P-PRINT.</p> <p>* This cannot be used in remote UI service mode.</p>
RPT2USB	<p>To output P-PRINT to the connected USB flash drive in .TXT format.</p> <p>* This cannot be used in remote UI service mode.</p>
RPT2DL	<p>To output P-PRINT to the PC in .TXT format using remote UI service mode.</p> <p>* This can be used only in remote UI service mode.</p>
ARRIVAL TIME LOG	
OUTPUT TO SUBLOG	For R&D
OUTPUT TO USB	For R&D
DELETE LOGS	For R&D



* : Default Value

Item	Description
SYSTEM LOG	<p>To set whether to use the system log function.</p> <ul style="list-style-type: none"> • ON: Use the system log function. (* default) • OFF: Do not use the system log function.
SUBLOG FTP GET	<p>To obtain sublog without using the serial console.</p> <p>For details on how to obtain sublog, refer to Chapter 7 "Debug Log".</p> <p>* This item can only be executed when no job is in progress.</p>
Logging Utility	<p>To set whether to use the "Logging Utility" function in the utility menu.</p> <ul style="list-style-type: none"> • ON: Use the logging utility function. • OFF: Do not use the logging utility function. (* default)
DEBUGLOG-SW	<p>To set whether to perform sublog auto output when error code/exception/service call occurs.</p> <ul style="list-style-type: none"> • ON: Output automatically. • OFF: Do not output automatically. (* default) <p>- Basic procedure:</p> <p>[A] In the case of manual setting by service technicians (LUI)</p> <ol style="list-style-type: none"> 1. Insert the USB flash drive. 2. Set the service switch [USB-H] to ON. 3. Set the service switch [DEBUGLOG-SW] to ON. 4. After an error occurs, record the debug log from the menu (LUI) to the USB flash drive. 5. Perform shutdown operation and turn OFF and then ON the power of the device. <p>[B] In the case of remote setting from RDS</p> <ol style="list-style-type: none"> 1. Insert the USB flash drive. 2. Set the service switch [DEBUGLOG-SW] to ON from RDS. 3. After an error occurs, record the debug log to the USB flash drive. 4. Turn OFF and then ON the power.

Item	Description
DEBUGLOG-MODE	<ul style="list-style-type: none"> Mode 1 The file name of the debug log is fixed. When the number of debug logs exceeds the maximum number of logs that can be saved at saving of debug logs, the latest debug log file is deleted to save the new file. Mode 2 (* default) The file name of the debug log is one with a device serial number and time stamp. When the number of debug logs exceeds the maximum number of logs that can be saved at saving of debug logs, the oldest debug log file is deleted to save the new file.

PANEL LOCK GR

* : Default Value

Item	Description
PANEL LOCK	<p>To perform access restriction for each key on the Control Panel.</p> <ul style="list-style-type: none"> ON: Enable the panel lock function. OFF: Disable the panel lock function. (* default)

F/W UPDATE GR

* : Default Value

Item	Description
USB	Not use
NETWORK	Not use
USB STRAGE	Not use
CDS	<p>Firmware auto/manual update function by MEAP application (updater).</p> <ul style="list-style-type: none"> Yes: Update automatically/manually. No: Do not update automatically/manually. <p>Update procedure is as follows.</p> <ol style="list-style-type: none"> Start MEAP (Updater). The Updater downloads the firmware via network. The Updater calls the program, and interrupts job input or user operation. The Updater decompress the firmware. The Updater calls the program and instructs to reboot. The machine reboots, and the new firmware starts operation. <p>Before executing this menu, service technicians should perform up to step 2.</p>

NETWORK GR.

* : Default Value

Item	Description
DNSTRANS	<p>To determine priority order of the protocol (IPv4/IPv6) to be used for DNS query.</p> <ul style="list-style-type: none"> IPV4 IPV 6*
ARP/PING	<p>To set the ARP/PING function.</p> <ul style="list-style-type: none"> ON: Use the function. OFF: Do not use. the function. (*default)
FTP SYSLOG	<p>To set the function to obtain various system log files.</p> <ul style="list-style-type: none"> ON: Obtain the function. (*default) OFF: Do not obtain the function.
JOB SERIALIZE	<p>To set connection serialize function.</p> <ul style="list-style-type: none"> ON: Use the function. OFF: Do not use. the function. (*default)
BUFFER LIMIT	<p>To clear the buffer acquisition limit of PSS.</p> <ul style="list-style-type: none"> ON: Clear the buffer acquisition limit. OFF: Limit the buffer acquisition. (*default)

Item	Description
E-RDS	
E-RDS SWITCH	<p>Set use/no use of Embedded-RDS function</p> <ul style="list-style-type: none"> • ON: Use Embedded-RDS. • OFF: Do not use Embedded-RDS. <p>Default Value :</p> <ul style="list-style-type: none"> • Except China model : On*/Off • China model : On/Off*
RGW-AD-DRESS	<p>To check and set the server URL. Use the "up, down, left and right keys, Job Status/Cancel key and Feeder selection key" to enter URL, and "OK key" to determine it.</p> <p>"↓" is displayed at the end of the character string. The number of characters which can be entered is 128. The default value is the server URL. Characters which can be set are as follows.</p> <p>01233456789ABCDEFGHIJKLMN0PQRSTUVWXYZabcdefghijklmnopqrstuvwxyz!#\$%&'()*+,-./:;<=>?@[\]^_`{ }~</p> <div style="background-color: #fce4d6; padding: 10px; border: 1px solid #ccc;"> <p>CAUTION: If "ugwdevice.net/" is not included in the character string when entering an URL, it is judged as an authentication error and an error message is displayed.</p> </div>
RGW-PORT	<p>To set the port number of the server.</p> <ul style="list-style-type: none"> • 443*
COM-TEST	To execute a communication test, and display the result.
COM-LOG	<p>To display the detail of the communication test result.</p> <p>Communication with the server is attempted, and the time, error codes and error information at error occurrence up to the present date are displayed. Maximum of 5 logs are saved, and the latest log is displayed. Error information is 130 byte maximum.</p>
CLEAR	To clear the schedule information, alarm error and filtering information besides the eRDS setting value in service mode by executing this item.
REDUCE SEND METHOD	<p>Setting for reducing transmission of methods</p> <p>Setting for reducing the load on the heavily used network bandwidth due to simultaneous transmission from thousands of devices.</p> <p>When enabled, if there are periodical methods that were scheduled to be sent before the time when the power was turned ON, those methods are not sent.</p> <ul style="list-style-type: none"> • ON • OFF*
CA-KEY	
CLEAR	To change CA certificate to the default by executing this item and turning ON and then OFF the power.
MIB CHARGECOUNT	<p>To set the range of counter information that can be obtained as MIB (Management Information Base).</p> <ul style="list-style-type: none"> • ALL ACCESS: All charge counters are obtained (*default) • DISP ACCESS: Only displayed counter is obtained • NON ACCESS: All charge counters are not obtained
WOLtrans	<p>To set recovery from sleep mode.</p> <ul style="list-style-type: none"> • 1: Recover from sleep by WSD, and do not recover from sleep by the old utility using the broadcast packet. (*default) • 2: Recover from sleep by WSD, and do not have the function to recover from sleep by the old utility using the SNMP search broadcast packet. • 3: Enable recovery from sleep by the old utility, and do not recover from sleep by WSD. <div style="background-color: #fce4d6; padding: 10px; border: 1px solid #ccc;"> <p>CAUTION: [Description of terminology] WSD (Web services on devices): A protocol to easily set up connection and use of various devices connected to the network.</p> </div>
SLEEP ADVERTISE	
SWITCH	<p>To set whether to use the sleep notification.</p> <ul style="list-style-type: none"> • ON: Notify sleep. (*default) • OFF: Do not notify sleep.
PORT	<p>To set the port number as the destination of sleep notification.</p> <ul style="list-style-type: none"> • Setting value: 1 to 65535 (*Default value: 11427)
TTL	<p>To set the number of routers which can send sleep notification messages.</p> <ul style="list-style-type: none"> • Setting value: 0 to 254 (*Default value: 3)

Item	Description
INTERVAL	To set the notification interval (seconds) of sleep notification. <ul style="list-style-type: none"> Setting value: 60 to 65535 (*Default value: 600)
PROXYRES	To set whether the proxy server (instead of internal network) returns proxy response to the external network. <ul style="list-style-type: none"> ON: Perform proxy response. (*Default) OFF: Do not perform a proxy response.
IPSEC SETTING	
IKERETRY	To set the IKE retry times. <ul style="list-style-type: none"> 0 to 3 (* Default value: 1)
IKEINTVL	To set the IKE retry interval (seconds). <ul style="list-style-type: none"> 1 to 30 (* Default value: 5)
SPDALDEL	To set whether to initialize the device at next startup. Be sure to return this value to "0" after initialization is completed. <ul style="list-style-type: none"> 0: Do not initialize the device. (*default) 1: Initialize the device.
IPSDEBLY	Since IPsec operates by a different process from the main program, log information is not kept in the Sublog Board. Therefore, change the value when obtaining the IPsec log. The setting is enabled after restart, and this value becomes "0" internally after restart. When this log is enabled, a file named "/APL_LOG/ipsec/ipseclog.txt" is generated, in which the log information is stored. However, this file is cleared when turning ON and then OFF the power. <ul style="list-style-type: none"> 0: Do not keep logs. (*default) 1 to 3: Log level 1 to 3, fatal error information 4 to 6: Log level 4 to 6, warning information 7: Log level 7, important log information 8 to 10: Log level 8, all logs
PFW SETTING	
IPTBROAD	Transmission to IPv4 multicast address, broadcast address and subnet broadcast address is allowed even if the default policy is set to "Reject" in the IPv4 transmission setting. In addition, IPv6 multicast address transmission is allowed even if the default policy is set to "Reject" in the IPv6 transmission setting. When setting to reject multicast transmission also, the setting can be changed by switching the service mode value. <ul style="list-style-type: none"> 0: Allow multicast transmission. (*default) 1: Reject multicast address transmission when the transmission default policy is set to "Reject". 2 to 10: Not used
EAPOL_WT	Time to wait for a response (or the next request) to EAPOL packet sent by the device. <ul style="list-style-type: none"> 10 to 120 (* Default value: 30)
GCP-URLC	To enable changing of the connection destination URL for cloud print from remote UI. Remote UI> Settings/Registration: Preferences: Network > Google Cloud Print Settings > Edit Basic Settings > Connection Destination <ul style="list-style-type: none"> ON: Can be changed (display) OFF: Cannot be changed (hide)* default
DHCP NACK SW	Setting of the behavior upon receiving DHCP NACK <ul style="list-style-type: none"> ON: Retry (Try again from "Discover") OFF: Not retry (Use the value of SCM)*

SP.ADMIN.MODE

Item	Description
MAINTENANCE C.	Not used

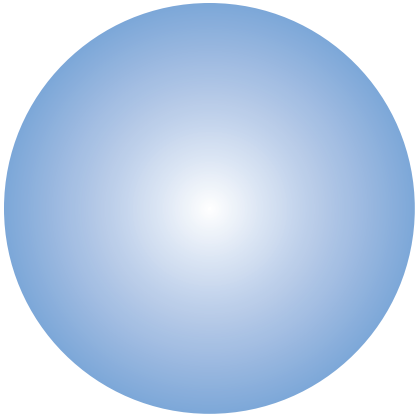

APPENDICES

Service Tools.....	208
General Circuit Diagram.....	209
List of Items Which Can Be Imported	211
Backup Data List.....	213
Soft counter specifications	214

Service Tools

Solvents and Oil List

No.	Type	Purpose	Remark
1	Ethyl alcohol	<ul style="list-style-type: none">• Cleaning: metal part, oil stains, toner stains	<ul style="list-style-type: none">• Purchase locally• Keep away from flame

General Circuit Diagram

General Circuit Diagram (1/2)

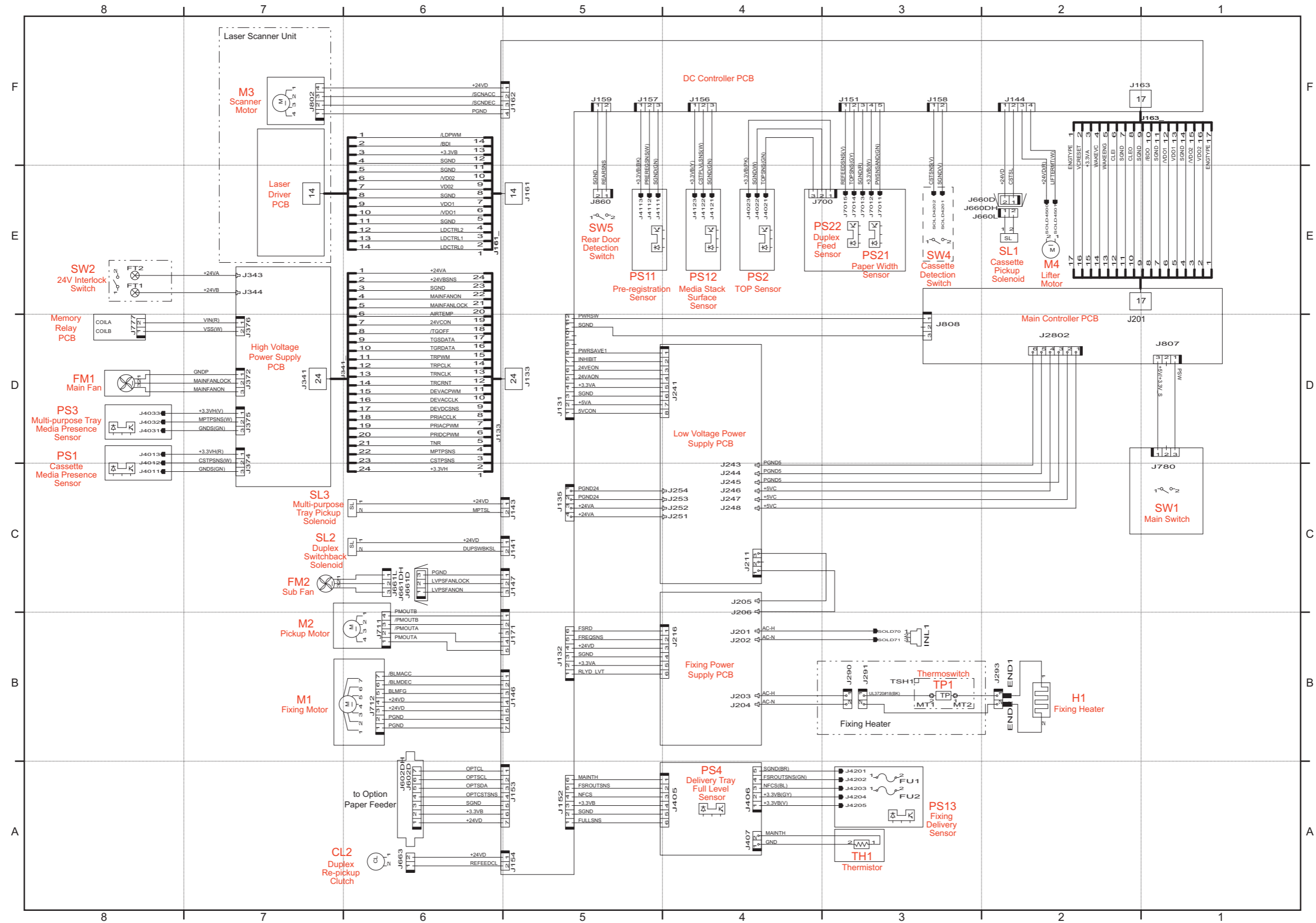

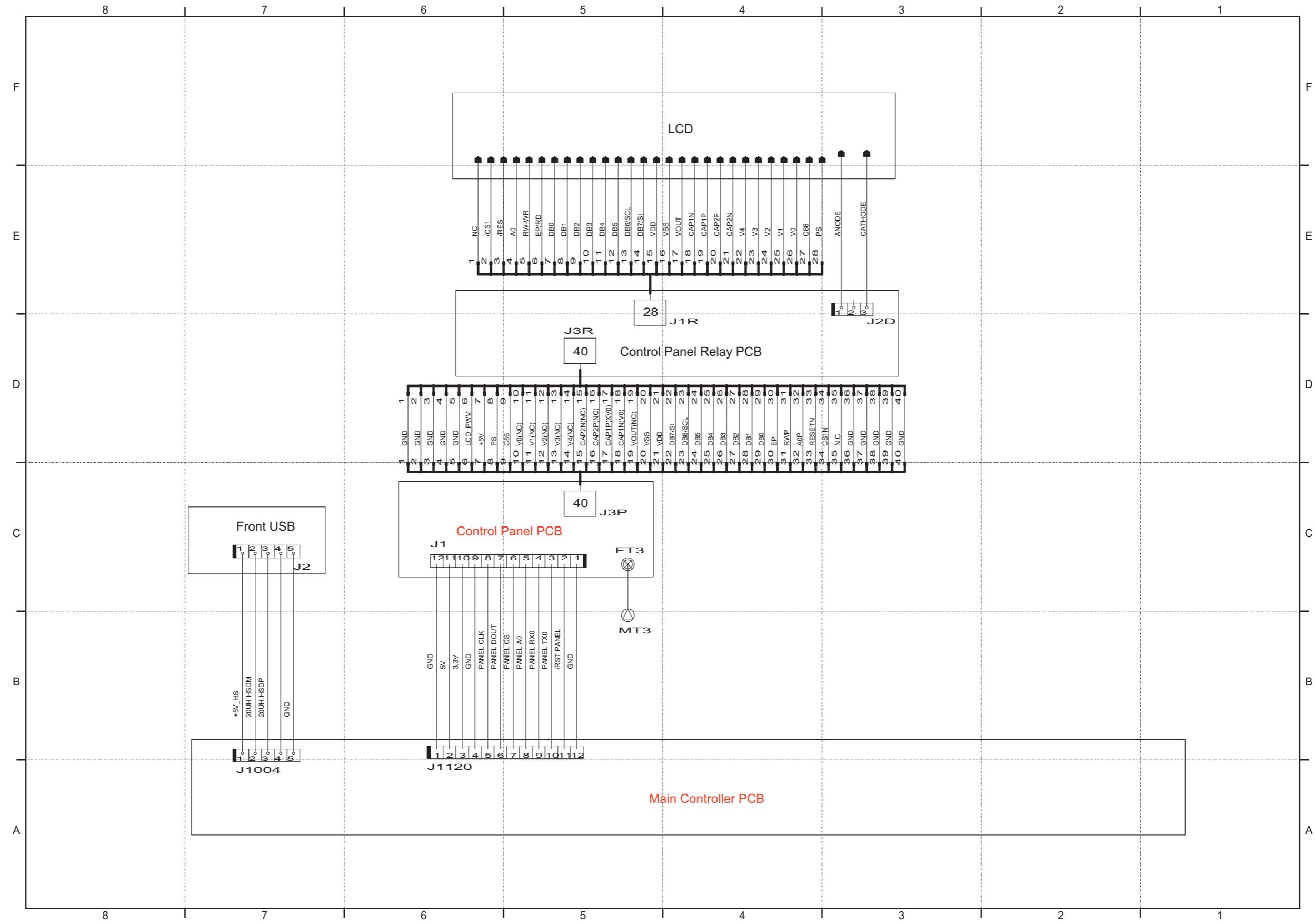

List of Items Which Can Be Imported

The following shows the items to be imported for this model.

Note that the setting values are not imported in cases such as below:

- Items which are originally not included in a DCM file (e.g.: "Settings/Registration Basic Information" of a DCM file exported using service mode)
- Not included in the import coverage (Cases A to C)
- There are no options and functions related to setting values

The import coverage shown in the table below is as shown below. Those that are not described here cannot be imported.

Import coverage	Description
Case A: The same machine	Import to the same machine (for backup and restoration, etc.)
Case B: The same model	Import to a different machine of the same model (the same series)
Case C: Different model	Import to a different machine of a different model (a different series)

Service Mode Items Which Can Be Imported

The service mode items that can be imported using the DCM function are described below.

Initial screen	Large	Small	Case A	Case B	Case C
ADJUST GR.					
	CHARGE BIAS K		Yes	-	-
	DEV BIAS K		Yes	-	-
	FRT FUSE TEMP		Yes	-	-
	SUBTLE DENSITY CORR.		Yes	-	-
	Special Grad.Process		Yes	Yes	-
	LASER BRIGHT K		Yes	-	-
OPTION GR.					
	B4-L-CNT		Yes	Yes	-
	COUNTER-SW		Yes	Yes	-
	CRG LIFE STEP		Yes	Yes	-
	CRG LIFE STOP		Yes	Yes	-
	CHANGE CRG WARN LV		Yes	Yes	-
	SLEEP SETTINGS		Yes	Yes	-
	RMT-SW		Yes	Yes	-
	MPT 2-Sd (1st Side)		Yes	Yes	-
	Img Calibration Mode		Yes	Yes	-
FUNCTION GR.					
	USB-H		Yes	Yes	-
	MEAP				
		MEAP FUNCTION	Yes	Yes	-
	DDNSINTY		Yes	Yes	Yes
	IPMTU		Yes	Yes	Yes
	PDL Z Logic		Yes	Yes	-
	FILE BOX FUNC.		Yes	Yes	-
LOG GR.					
	SYSTEM LOG		Yes	Yes	-
	LOGGING UTILITY		Yes	Yes	-
	DEBUGLOG-SW		Yes	Yes	-
	DEBUGLOG-MODE		Yes	Yes	-
PANEL LOCK GR.					
	PANEL LOCK		Yes	Yes	-
NETWORK GR.					
	DNSTRANS		Yes	Yes	Yes
	JOB SERIALIZE		Yes	Yes	Yes

Initial screen	Large	Small	Case A	Case B	Case C
	BUFFER LIMIT		Yes	Yes	-
	E-RDS				
		E-RDS SWITCH	Yes	Yes	Yes
		RGW-ADDRESS	Yes	Yes	Yes
		RGW-PORT	Yes	Yes	Yes
	WOLtrans		Yes	Yes	Yes
	PROXYRES		Yes	Yes	Yes
	IPSEC SETTING				
		IKERETRY	Yes	Yes	Yes
		IKEINTVL	Yes	Yes	Yes
		SPDALDEL	Yes	Yes	Yes
		IPSDEBLY	Yes	Yes	Yes
	PFW SETTING				
		IPTBROAD	Yes	Yes	Yes
	EAPOL_WT		Yes	Yes	Yes
	GCP-URLC		Yes	Yes	Yes

Backup Data List

Backup Data

Data	Location	Replacement		Delete Method				Backup by User			Backup by Service		
				Setup			Service Function	Yes/No	Method	Location	Yes/No	Method	Location
		DC Control- ler PCB	Main Control- ler PCB	Initialize Menu	Network > Init. Network Set.	User Mainte- nance > Initialize Counter	Service Mode						
Panel Settings (excluding Network Settings)	Main Controller PCB	-	Clear	Clear	-	-	-	Yes	LUI *5, RUI *6	PC, USB flash drive	Yes	Service Mode *7, *8 RUI Service Mode *7 Expansion ROM for servicing + Sublog Board *10	PC, USB flash drive, Sublog Board
Panel Settings (Network Settings)		-	Clear	-	Clear	-	-						
MEAP (Application/Setting Data)		-	Clear	-	-	-	Clear *1						
eRDS Settings		-	Clear	-	-	-	Clear *2	No	-	-			
Key and Certificate		-	Clear	-	-	-	Clear *3	No	-	-	No	-	-
Logs		-	Clear	-	-	-	-	No	-	-	No	-	-
Parts Counter		-	Clear	-	-	Clear *4	-	Yes *9	LUI *5, RUI *6	PC, USB flash drive	Yes	Service Mode *7, *8 RUI Service Mode *7 Expansion ROM for servicing + Sublog Board *10	PC, USB flash drive, Sublog Board
Service Mode Setting Values		-	Clear	Clear	-	-	-						

*1: Execute SERVICE MODE > FUNCTION GR. > MEAP > CLEAR MEAP to initialize data/settings.

*2: Execute SERVICE MODE > NETWORK GR. > E-RDS > CLEAR to initialize settings.

*3: Execute SERVICE MODE > NETWORK GR. > CA-KEY to initialize data.

*4: Items in SERVICE MODE > COUNTER GR. are the target.

*5: Perform backup in Setup > User Maintenance > Import/Export Set. > Export.

*6: Perform backup in RUI > Settings/Registration > Management Settings > Import/Export > Export.

*7: Perform backup in SERVICE MODE > FUNCTION GR. > Import/Export Set. > EXPORT.

*8: Perform backup in SERVICE MODE > FUNCTION GR. > ECONF > EXPORT.

*9: It is enabled only in the case of SERVICE MODE > FUNCTION GR. > SMD-EXPT = 1.

*10: Refer to [Backup/Restoration by Expansion ROM for servicing and Sublog Board].

Soft counter specifications

Soft counter specifications

The numbers entered for software counters are classified as follows:

No.	Counter Details
100 to 119	Total
300 to 399	Print
700 to 799	Reception print

Counter No.	Counter Description		
	Job	Counter Type	
101	Total	Total 1	
102		Total 2	
104		Total (small)	
108		Total (black and white 1)	
109		Total (black and white 2)	
113		Total (black and white/small)	
114		Total 1(double sided)	
117		Small (double sided)	
132		Total A black and white 1	
133		Total A black and white 2	
301		Print	Print (Total 1)
302			Print (Total 2)
313			Print (black and white1)
314	Print (black and white2)		
320	Print (black and white/small)		
334	PDL Print	PDL Print (small)	
701	Reception print	Reception print (Total 1)	
702		Reception print (Total 2)	
709		Reception print (black and white1)	
710		Reception print (black and white2)	
716		Reception print (black and white/small)	